

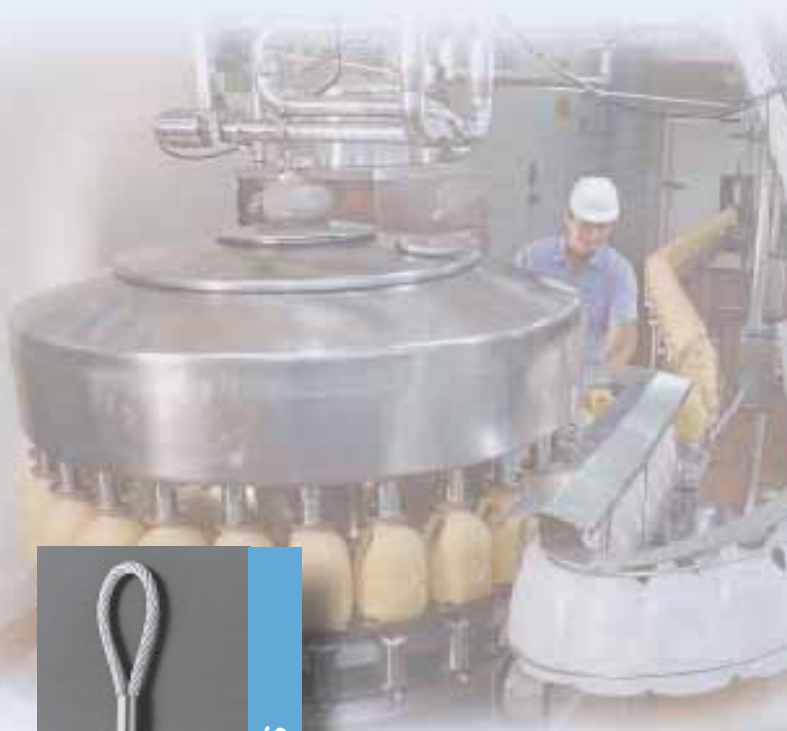

# Wire Mesh Safety Grips

Products For Safe Management  
of Cable, Flexible Metal Conduit,  
Cord and Hose Installations





**PULLING GRIPS**

**TABLE OF CONTENTS**

Introduction	1-2
Selecting Proper Sized Pulling and Support Grips	3-5
Pulling Grips	6-14
Strain-Relief Grips	15-19
Support Grips	20-28
Technical Reference	29
Leviton Cross Reference	30-33

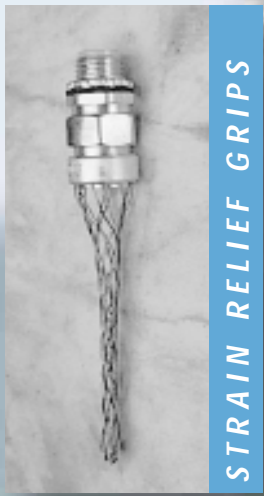

**STRAIN RELIEF GRIPS**

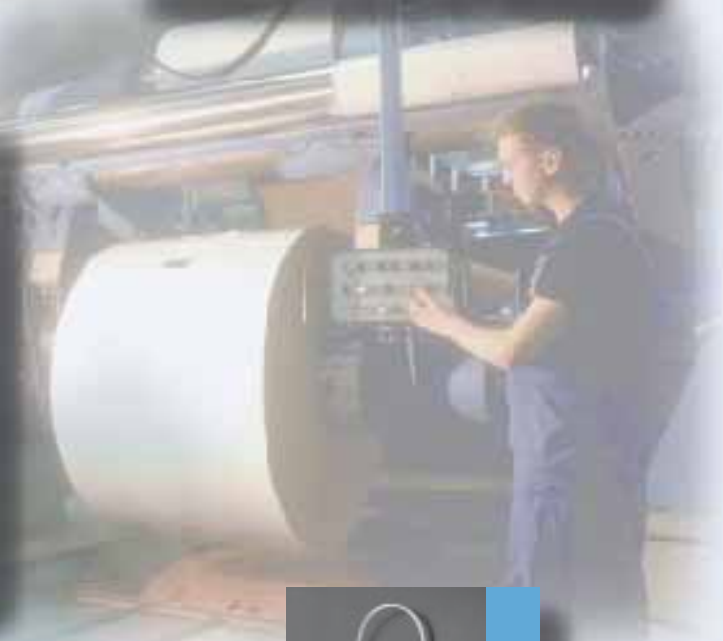

**SUPPORT GRIPS**





### AN EXTENSIVE LINE OF PRODUCTS FOR TODAY'S INDUSTRIAL APPLICATIONS



Leviton Wire Mesh Safety Grips are built tough to provide the strength, reliability and gripping force required for today's demanding wire management applications. They are designed to distribute stress over a large area so they can securely hold, pull or support the wire, rope, tubing or fiber optic cable to which they are applied.

Leviton pulling grips are reusable tools with both flexible eye and rotating eye attachments. They are designed to pull cable, rope, fiber optic lines and service lines in utility work, new construction and rugged-duty industrial applications.

Leviton strain relief grips prevent cable or conduit pullout by securing cable and flexible conduit with electrical assemblies in industrial applications. They are designed to prevent stress from being placed on the inner conductors at the point of termination. This helps avert the risk of costly downtime on the job.

Leviton support grips hold cable, tubing or hose in vertical or sloping-run applications and are ideal for both indoor and outdoor use. By firmly supporting dead weight, they reduce the risk of damage due to breakage or stress. They are woven with tinned bronze wire and are available in stainless steel wire for applications where greater corrosion-resistance is required.

Leviton Wire Mesh Safety Grip products offer a wide selection of style, weave, attachment and wire options -- all designed to meet the highest standards for strength, flexibility, durability and longevity. With Leviton Wire Mesh Safety Grips you're ensured top performance in all your cable management operations.



## WIRE MESH SAFETY GRIPS

### INTRODUCTION

#### What are Wire Mesh Safety Grips?

Leviton Wire Mesh Safety Grips are flexible holding devices used to pull cable, rope, or tubing into place; to support it after it has been installed, to prevent cable pullout; or to provide strain-relief that reduces the arc of bend at points of wire connections or terminations.

#### 1. Pulling Grips

Pulling Grips are *reusable tools* for pulling insulated conductors or bare wires, cable, nylon and wire rope, fiber optic cable etc. Both flexible eye and rotating eye attachments are available.

#### 2. Strain-Relief Grips

Strain-Relief Grips are used to connect cable or flexible conduit to electrical enclosures and equipment. This prevents pullout and bending due to tension at the inner conductors at the point of termination.

#### 3. Nylon Cord Sealing Grips with Mesh

Cord Sealing grips are nylon devices designed with mesh used to connect electrical cables to boxes, cabinets, push-buttons, enclosures, etc. These devices prevent cord/cable pullout at the point of termination. They are liquid-tight devices that are highly resistant to impact and corrosion. They are available in both straight and 90° models.

#### 4. Support Grips

Support Grips distribute the weight of the vertical or sloping runs of electrical and fiber optic cable, metal rods, tubing or hose over the entire length of the grip so that the cable is not subject to damage. A variety of hangers and bales are available. These grips are also available in stainless steel for additional corrosion-resistance.

#### Agency Approvals

UL Listings and CSA Certifications are indicated on the appropriate product catalog pages. For File Numbers, See Technical Reference, page 29.

#### Standards

Leviton Wire Mesh Safety Grips meet the following standards:

- NEC 300-19** Supporting cables in vertical raceways.
- NEC 351-2** Liquid-tight flexible metal conduit installations.
- NEC 400-7** Flexible cord installations.
- NEC 400-10** Strain-relief at joints and terminals.
- JIC H 13.11** Prevention of flexible hose failure.

### THE PRODUCT SELECTION CODE AND HOW IT WORKS

The Product Selection Code indicates the type of grip and type of mesh, the minimum cable diameter the grip will support and the attachment method.

- The **alpha prefix** denotes the type of grip and mesh.
- For support and pulling grips, the three digits following the prefix indicate the minimum cable diameter the grip will accommodate.
- The **alpha suffix** indicates the type of support attachment and type of mesh.

Examples:		
Leviton Numbers		Product Selection Numbers
L9501	=	SC050-U
L8677	=	SCK250-1

**Alpha prefixes and suffixes for each type of grip are listed at the beginning of each section.**





SELECTING PROPER SIZED PULLING AND SUPPORT GRIPS

HOW TO SELECT PROPER GRIP SIZE

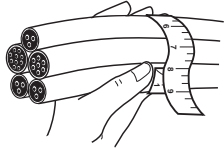

Select grip size based on the outside diameter or circumference of the cable(s). See the Reference Tables (on this and the following page) for convenience in determining cable diameters.

Use the Grip Selection Tables (on this page and the following page) to determine the "Size" portion of the Product Selection No. Size Code for the cable diameter required. In the ordering tables (see following pages), this "Size" code is incorporated into the Product Selection Number under the various grip type classifications. **Be sure to order by the Leviton Catalog Number, not the Product Selection Number.**

**Example:** For five cables bundled together with a diameter of 0.42":

- 1) Locate "5 Cables" column.
- 2) Read down column to range (0.38"-0.48").
- 3) Read across line to Grip Diameter Range (1.00-1.25).

**Grip Selection for One or More Cables of Equal Diameter**

1. Read across top line for number of cables in one grip.
2. Read down for diameter of each cable.
3. Use Leviton Number Size Code to select Leviton Number of the required size grip.

Decimal and Fractional Inch Cable Diameters—for one or more cables of equal diameter							Product Selection No. Size Code	Grip Diameter Range	
1 Cable	2 Cables		3 Cables		4 Cables				
0.25-0.37	1/4-3/8	0.16-0.25	1/64-1/4	0.15-0.22	5/32-7/32	0.12-0.20	1/8-13/64	025	.250-.375
0.37-0.50	3/8-1/2	0.25-0.36	1/4-23/64	0.22-0.33	7/32-21/64	0.20-0.28	13/64-9/32	037	.375-0.50
0.50-0.62	1/2-5/8	0.27-0.36	17/64-23/64	0.26-0.33	17/64-21/64	0.24-0.28	15/64-9/32	050	0.50-0.75
0.62-0.75	5/8-3/4	0.36-0.45	23/64-29/64	0.33-0.36	21/64-23/64	0.28-0.31	9/32-5/16	062	0.62-0.75
0.75-1.00	3/4-1	0.45-0.60	29/64-39/64	0.36-0.49	23/64-31/64	0.31-0.42	5/16-27/64	075	0.75-1.00
1.00-1.25	1-1-1/4	0.60-0.76	39/64-49/64	0.49-0.63	31/64-5/8	0.42-0.54	27/64-35/64	100	1.00-1.25
1.25-1.50	1-1/4-1-1/2	0.76-0.91	49/64-29/32	0.63-0.76	5/8-49/64	0.54-0.65	35/64-21/32	125	1.25-1.50
1.50-1.75	1-1/2-1-3/4	0.91-1.08	29/32-1-5/64	0.76-0.89	49/64-57/64	0.65-0.77	21/32-49/64	150	1.50-1.75
1.75-2.00	1-3/4-2	1.08-1.23	1-5/64-1-15/64	0.89-1.02	57/64-1-1/64	0.77-0.88	49/64-7/8	175	1.75-2.00
2.00-2.50	2-2-1/2	1.23-1.54	1-15/64-1-35/64	1.02-1.28	1-1/64-1-9/32	0.88-1.00	7/8-1	200	2.00-2.50
2.50-3.00	2-1/2-3	1.54-1.84	1-35/64-1-27/32	1.28-1.53	1-9/32-1-17/32	1.10-1.32	1-3/32-1-21/64	250	2.50-3.00
3.00-3.50	3-3-1/2	1.84-2.15	1-27/32-2-5/32	1.53-1.79	1-17/32-1-51/64	1.32-1.54	1-21/64-1-35/64	300	3.00-3.50
3.50-4.00	3-1/2-4	2.15-2.45	2-5/32-2-29/64	1.79-2.05	1-51/64-2-3/64	1.54-1.76	1-35/64-1-49/64	350	3.50-4.00

Decimal and Fractional Inch Cable Diameters—for one or more cables of equal diameter							Product Selection No. Size Code	Grip Diameter Range	
5 Cables	6&7 Cables		8 Cables		9 Cables				
0.11-0.14	7/64-9/64	0.10-0.11	3/32-7/64	0.09-0.10	3/32-7/64	0.06-0.09	1/16-3/32	025	.250-.375
0.14-0.25	9/64-1/4	0.11-0.25	7/64-1/4	0.10-0.20	7/64-13/64	0.09-0.19	3/32-3/16	037	.375-0.50
0.21-0.25	7/32-1/4	0.19-0.22	3/16-7/32	0.17-0.20	11/64-13/64	0.15-0.19	5/32-3/16	050	0.50-0.75
0.25-0.29	1/4-19/64	0.22-0.26	7/32-17/64	0.20-0.23	13/64-15/64	0.19-0.22	3/16-7/32	062	0.62-0.75
0.29-0.38	19/64-3/8	0.26-0.34	17/64-11/32	0.23-0.31	15/64-5/16	0.22-0.31	7/32-5/16	075	0.75-1.00
0.38-0.48	3/8-31/64	0.34-0.43	11/32-7/16	0.31-0.39	5/16-25/64	0.29-0.36	19/64-23/64	100	1.00-1.25
0.48-0.58	31/64-37/64	0.43-0.52	7/16-33/64	0.39-0.46	25/64-15/32	0.36-0.43	23/64-7/16	125	1.25-1.50
0.58-0.67	37/64-43/64	0.52-0.60	33/64-39/64	0.46-0.54	15/32-35/64	0.43-0.49	7/16-31/64	150	1.50-1.75
0.67-0.77	43/64-49/64	0.60-0.69	39/64-11/16	0.54-0.62	35/64-5/8	0.49-0.57	31/64-37/64	175	1.75-2.00
0.77-0.96	49/64-31/32	0.69-0.86	11/16-55/64	0.62-0.77	5/8-49/64	0.57-0.72	37/64-23/32	200	2.00-2.50
0.96-1.16	31/32-1-5/32	0.86-1.03	55/64-1-1/32	0.77-0.93	49/64-15/16	0.72-0.86	23/32-55/64	250	2.50-3.00
1.16-1.35	1-5/32-1-23/64	1.03-1.20	1-1/32-1-13/64	0.93-1.08	15/16-1-5/64	0.86-1.00	55/64-1	300	3.00-3.50
1.35-1.54	1-23/64-1-35/64	1.20-1.37	1-13/64-1-3/8	1.08-1.24	1-5/64-1-15/64	1.00-1.14	1-1-9/64	350	3.50-4.00



SELECTING PROPER SIZED PULLING AND SUPPORT GRIPS

HOW TO SELECT PROPER GRIP SIZE

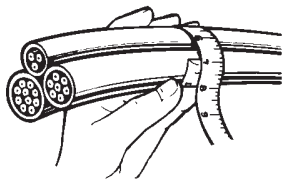

**Example:**  
For three cables together with circumference of 6.35",  
(1) Read down Inches (Decimal) column for 6.35" (6.29-7.86 in.).  
(2) Read across for Size Code "200".

**Selection Table for Cables of Different Diameters**

Grip Circumference Range refers to the circumference of all cables held together.

1. Determine Grip Circumference Range by measuring circumference of bundle of cables to be held (as shown in illustration).
2. Read down to locate correct range.
3. Read across for Product Selection Number Size Code.

Grip Circumference Range—for cables of different diameters			
Inches (Fractional)	Inches (Decimal)	Product Selection No. Size Code	Grip Dia. Range
25/32-1 11/64	0.78-1.17	025	.250-.375
1 11/64-1 37/64	1.17-1.57	037	.375-.50
1 37/64-1 15/16	1.57-1.94	050	.50-.625
1 15/16-2 3/8	1.94-2.37	062	.625-.75
2 3/8-3 5/32	2.37-3.15	075	.75-1.00
3 5/32-3 15/16	3.15-3.94	100	1.00-1.25
3 15/16-4 23/32	3.94-4.72	125	1.25-1.50
4 23/32-5 33/64	4.72-5.51	150	1.50-1.75
5 33/64-6 19/64	5.51-6.29	175	1.75-2.00
6 19/64-7 55/64	6.29-7.86	200	2.00-2.50
7 55/64-9 7/16	7.86-9.43	250	2.50-3.00
9 7/16-11 1/64	9.43-11.01	300	3.00-3.50
11 1/64-12 37/64	11.01-12.58	350	3.50-4.00

REFERENCE TABLE CORD DIAMETERS

For your convenience, the following are nominal overall diameters (in inches) for flexible cord.

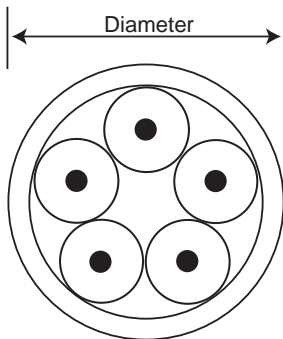

AWG Wire Size and Type	Conductors			
	2	3	4	5
18 SO, STO	.36	.38	.41	.49
18 SJO, SJTO	.30	.32	.35	--
16 SO, STO	.39	.41	.44	.52
16 SJO, SJTO	.32	.34	.37	--
14 SO, STO	.52	.55	.59	.67
12 SO, STO	.60	.62	.68	.74
10 SO, STO	.65	.69	.74	.80
8 SO, STO	.83	.88	.99	1.08
6 SO, STO	.99	1.04	1.12	1.25

REFERENCE TABLE DIAMETERS AWG OR MCM

This table is to be used as a guide only. Sizes may vary by manufacturer.

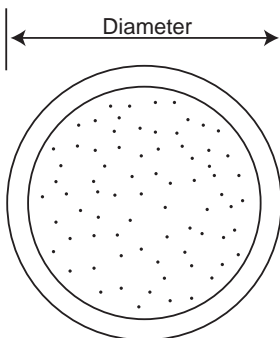

AWG or MCM	Approx. Diameter (Inches)		AWG or MCM	Approx. Diameter (Inches)	
	THHN	THW		THHN	THW
14	.105	.162	3/0	.588	.647
12	.122	.179	4/0	.646	.705
10	.153	.199	250	.716	.788
8	.201	.259	300	.771	.843
6	.257	.323	350	.822	.895
4	.328	.372	400	.869	.942
3	.356	.401	500	.955	1.03
2	.388	.433	600	1.06	1.14
1	.450	.508	700	1.13	1.21
1/0	.491	.549	750	1.16	1.25
2/0	.537	.595	1000	1.32	1.40

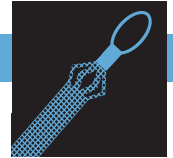

SELECTING PROPER SIZED PULLING AND SUPPORT GRIPS

STRENGTH INFORMATION

The approximate breaking strength of any Leviton Wire Mesh Safety Grip is based on working load information established by our engineering laboratories. In making these determinations, it is not possible to cover all applications and operating conditions. Variables such as diameter, gripping surface, number of items gripped, tension, movement, attachments, abrasion, corrosion, prior use and abuse must be assessed by the user. Greater safety factors should be utilized when the conditions of application are vague or unknown.

For specific applications where strength and holding power are important, consult Leviton’s Technical Services Department. To determine the recommended working load safety factor for listed cable grips, divide the approximate breaking strength by 5 for pulling grips and by 10 for support grips. Leviton maintains a 6 sigma safety factor for this recommended working load (using average break strengths obtained on new grips under lab test conditions).

**Example:** For pulling grips –  $33,000 \div 5 = 6,600$  lbs. which is the workload factor.

**Example:** For support grips –  $10,080 \div 10 = 1,008$  lbs. which is the workload factor.

All warranties concerning product quality or performance are based on wire mesh safety grips that are properly stored and handled by the user, and grips that are maintained and inspected at a proper frequency in keeping with their use and condition.

GRIP CABLE RANGE  
CONVERSION

Inches (Fractional)	Inches (Decimal)	Metric (mm)
1/4–23/64	0.25–0.36	6.35–9.13
3/8–31/64	0.37–0.49	9.52–12.30
1/2–39/64	0.50–0.61	12.70–15.48
5/8–47/64	0.62–0.74	15.88–18.65
3/4–63/64	0.75–0.99	19.05–25.00
1–1 15/64	1.00–1.24	25.40–31.35
1 1/4–1 31/64	1.25–1.49	31.75–37.70
1 1/2–1 63/64	1.50–1.99	38.10–50.40
2–2 31/64	2.00–2.49	50.80–63.10
2-1/2–2 63/64	2.50–2.99	63.50–75.80
3–3 31/64	3.00–3.49	76.20–88.50
3 1/2–3 63/64	3.50–3.99	88.90–101.20



## PULLING GRIPS

SPLIT-LACE/SPLIT-ROD ATTACHMENTS (FOR USE WHERE END OF CABLE IS NOT ACCESSIBLE—APPLIES TO SLACK GRIPS ONLY)

Beginning at the end of the grip closest to the bale fitting, thread the lacing through the first two loops of the split, pulling the lace through until the ends are centered evenly. Cross the laces and thread them through the next two loops, and so on down the grip, being careful not to pull the lacing too tight.

Spacing of the laced closure should be approximately the same as the mesh weave. When the end of grip is reached, twist the lacing strands tightly together, wrapping the ends of the lace around the grip, and twisting again to secure. Excess length may be cut off.

Split grips with rod closing are economical, since they are quickly installed, and are reusable. Simply wrap the grip around the cable and thread the rod through the loops, using a corkscrew motion. To remove, pull the rod out, and the grip is ready for re-use.

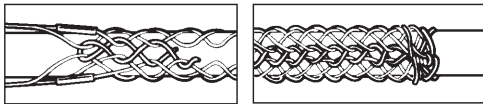

SPLIT-LACE

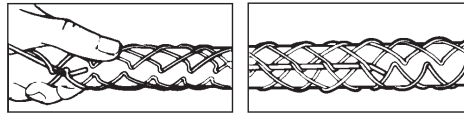

SPLIT-ROD





PULLING GRIPS

Leviton Pulling Grips are reusable tools for pulling bare conductors, insulated wires, synthetic rope, wire rope, and fiber optic cable. These grips do not damage the cable, as the tension remains uniform throughout the length of the grip. The mesh responds to fit either a single cable or a bundle of cables.

Leviton Pulling Grips may be used for pulling cable on overhead or underground applications, for stringing service or communication lines into factories, for pulling wire through conduit, and for underground electrical pulls.

Leviton Pulling Grips are woven in tinned bronze or galvanized steel for greater strength and longer life.

PULLING GRIP  
EYE OPTIONS



BALE EYE

**Attachments and prefix information:**

**Bale Eye**  
Attachment flexes to follow line of pull.

Alpha prefix	Description
PM	Bale Eye—Medium Duty, Double Weave
P	Bale Eye—Heavy Duty, Double Weave



FLEXIBLE ROPE EYE

**Flexible Rope Eye**  
For Medium and Heavy Duty pulling jobs. Multi Weave and Double Weave construction.

Alpha prefix	Description
PJ	Flexible Eye—Junior Duty, Single Weave
PL	Flexible Eye—Light Duty, Single Weave
PF	Flexible Eye—Heavy Duty, Multi-Weave
PHS	Flexible Eye—High Strength



OFFSET FLEXIBLE EYE

**Offset Flexible Eye**  
For use on slack pulling grips.

Alpha prefix	Description
SCK	Slack Grips, Closed Mesh
SSK	Slack Grips, Split Lace
SRK	Slack Grips, Split Lace, with rod



ROTATING EYE

**Rotating Eye**  
For use in changing wire rope in large cranes and derricks.

Alpha prefix	Description
PS	Rotating Eye—Heavy Duty, Double Weave
PR	Rotating Eye—Heavy Duty, Multi-Weave

NOTE: To determine workload safety factor, divide approximate break strength by 5.

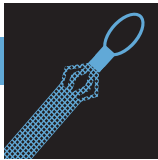

## WIRE MESH SAFETY GRIPS

### PULLING GRIPS

#### PJ SERIES



*PJ Junior Duty Series Grips* are indispensable tools for electricians with small job requirements. They are used to connect insulated wire bundles to pulling tape or to pull wire rope through conduit.



#### Single Weave, Flexible Eye, Junior Duty

Cable Dia. Range (Inches)	Leviton Catalog Numbers	Product Selection Numbers	Approximate Break Strength*	Mesh Length (Inches)
0.25–0.36	L8500	PJ25	1,700	5
0.37–0.49	L8501	PJ37	1,700	7
0.50–0.61	L8502	PJ50	1,700	8
0.62–0.74	L8503	PJ62	2,800	10
0.75–0.99	L8504	PJ75	4,100	10
1.00–1.24	L8505	PJ100	4,100	12

L8510 Kit includes 1 each of:	Leviton Numbers	Product Selection Numbers
	L8500	PJ25
	L8501	PJ37
	L8502	PJ50
	L8503	PJ62
	L8504	PJ75
	L8505	PJ100

#### PL SERIES



*PL Light Duty Grips* are the most economical pulling grips for many applications, such as industrial plant wiring, rewiring, and underground electrical pulls.

#### Single Weave, Flexible Rope Eye, Light Duty, Short

Cable Dia. Range (Inches)	Leviton Catalog Numbers	Product Selection Numbers	Approximate Break Strength*	Mesh Length (Inches)
0.50–0.61	L8511	PL050-1	3,400	11
0.62–0.74	L8512	PL062-1	4,100	11
0.75–0.99	L8513	PL075-1	4,100	13
1.00–1.24	L8514	PL100-1	5,800	14
1.25–1.49	L8515	PL125-1	5,800	15
1.50–1.74	L8516	PL150-1	7,500	16
1.75–1.99	L8517	PL175-1	10,000	18
2.00–2.49	L8518	PL200-1	10,000	19
2.50–2.99	L8519	PL250-1	13,000	19

#### Single Weave, Flexible Rope Eye, Light Duty, Medium

0.50–0.61	L8523	PL050-2	3,400	16
0.62–0.74	L8524	PL062-2	4,100	16
0.75–0.99	L8525	PL075-2	4,100	20
1.00–1.24	L8526	PL100-2	7,500	20
1.25–1.49	L8527	PL125-2	7,500	22
1.50–1.99	L8528	PL150-2	7,500	25
2.00–2.49	L8529	PL200-2	10,000	26
2.50–2.99	L8530	PL250-2	13,000	28
3.00–3.49	L8531	PL300-2	16,200	30
3.50–3.99	L8532	PL350-2	19,400	32

L8540 Kit includes 1 each of:	Leviton Catalog Numbers	Product Selection Numbers
	L8525	PL075-2
	L8526	PL100-2
	L8528	PL150-2
	L8529	PL200-2

\* To determine workload safety factor, divide approximate break strength by 5. See page 5 for strength information.



PULLING GRIPS

PM SERIES



Single/Double Weave Pulling Grips are available with a rope eye.



Single/Double Weave, Bale Eye, Medium Duty				
Cable Dia. Range (Inches)	Leviton Catalog Numbers	Product Selection Numbers	Approximate Break Strength*	Mesh Length (Inches)
0.37-0.49	L8541	PM037	2,600	12
0.50-0.74	L8542	PM050	3,400	14
0.75-0.99	L8543	PM075	5,500	18
1.00-1.24	L8544	PM100	8,100	22
1.25-1.49	L8545	PM125	8,100	24
1.50-1.99	L8546	PM150	8,100	26

L8550	Leviton Catalog Numbers	Product Selection Numbers
Includes 1 each of:	L8541	PM037
	L8542	PM050
	L8543	PM075
	L8544	PM100
	L8545	PM125
	L8546	PM150

\*To determine workload safety factor, divide approximate break strength by 5. See page 5 for strength information.

FIBER OPTIC PF SERIES



Fiber Optic Pulling Grips are used for installation of fiber optic communication lines. They easily install on cables and are re-usable. Applications include underground, overhead, through-conduit and/or enclosure type pulls.

Leviton fiber optic pulling grips are two-in-one reusable grips: the same tool features both a flexible eye and a swivel eye. The rounded, flexible eye attaches easily to pulling lines, and allows smoother passage through tight spaces than needle-eye designs .

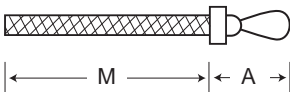

Flexible/Swivel Eye Fiber Optic Grips						
Cable Dia. Range (Inches)	Leviton Catalog Numbers	Product Selection Numbers	Approximate Break Strength	Length (Inches)		
				Bale (Dim. A)	Mesh (Dim. M)	Nose Dia.
.10-.20	L8801	PF010	1,000	4.75	9	.8
.21-.35	L8802	PF021	1,500	4.75	14	.8
.35-.48	L8803	PF032	2,200	5.00	18	.9
.42-.61	L8804	PF042	2,800	5.00	21	.9
.53-.74	L8805	PF053	3,300	5.00	24	1.2
.64-.87	L8806	PF064	4,700	5.00	27	1.2



## WIRE MESH SAFETY GRIPS

### PULLING GRIPS

P SERIES



Leviton's *P Series* is recommended for heavy or rugged applications, and is ideally suited for overhead and underground installations. Grips are woven in galvanized steel.

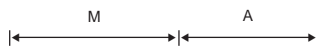
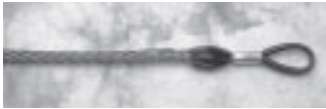

Single/Double Weave, Bale Eye, Medium Duty, Short							
Cable Dia. Range (Inches)	Leviton Catalog Numbers	Product Selection Numbers	Nominal Grip Size	Approximate Break Strength*	Length (Inches)		Flexible Eye Size (Inches)
					Bale (Dim. A)	Mesh (Dim. M)	
0.50-0.61	L8551	P050-21	0.55	4,500	8	21	7/32
0.62-0.74	L8552	P062-21	0.68	5,600	8	24	1/4
0.75-0.99	L8553	P075-24	0.87	6,800	8	24	1/4
1.00-1.49	L8554	P100-24	1.25	9,600	9	24	5/16
1.50-1.99	L8555	P150-24	1.75	16,400	11	24	7/16
2.00-2.49	L8556	P200-24	2.25	18,500	12	24	7/16
2.50-2.99	L8557	P250-24	2.75	24,500	12	24	1/2
3.00-3.49	L8558	P300-24	3.25	24,500	14	24	1/2
3.50-3.99	L8559	P350-26	3.75	31,000	14	26	5/8

Single/Double Weave, Bale Eye, Medium Duty, Standard							
Cable Dia. Range (Inches)	Leviton Catalog Numbers	Product Selection Numbers	Nominal Grip Size	Approximate Break Strength*	Bale (Dim. A)	Mesh (Dim. M)	Flexible Eye Size (Inches)
0.75-0.99	L8563	P075-36	0.87	6,800	9	36	1/4
1.00-1.49	L8564	P100-36	1.25	9,600	9	36	5/16
1.50-1.99	L8565	P150-36	1.75	16,400	11	36	7/16
2.00-2.49	L8566	P200-36	2.25	18,500	12	36	7/16
2.50-2.99	L8567	P250-36	2.75	24,500	12	36	1/2
3.00-3.49	L8568	P300-36	3.25	24,500	14	36	1/2
3.50-3.99	L8569	P350-40	3.75	31,000	14	40	5/8

L8560	
Kit includes 1 each of:	
Leviton Numbers	Product Selection Numbers
L8563	P075-36
L8564	P100-36
L8565	P150-36
L8566	P200-36

Single/Double Weave, Bale Eye, Heavy Duty, Long					
Cable Dia. Range (Inches)	Leviton Catalog Numbers	Product Selection Numbers	Nominal Grip Size	Approximate Break Strength*	Mesh Length Dim. M (Inches)
0.75-0.99	L8572	P075-48	0.87	8,100	48
1.00-1.49	L8573	P100-48	1.25	11,600	48
1.50-1.99	L8574	P150-48	1.75	19,400	48
2.00-2.49	L8575	P200-48	2.25	19,400	48
2.50-2.99	L8576	P250-48	2.75	25,900	48
3.00-3.49	L8577	P300-48	3.25	25,900	48
3.50-3.99	L8578	P350-48	3.75	32,400	48

NOTE: See installation instructions supplied with grip for recommended swivels, links and clamps or accessories listing.  
 \*To determine workload safety factor, divide approximate break strength by 5. See page 5 for strength information.

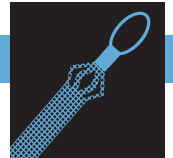

PULLING GRIPS

PS SERIES



PS Series grips feature a double weave of galvanized steel strands for greater strength and added mesh contact with the cable. Leviton Double Weave Pulling Grips are designed to handle longer or heavier pulling jobs such as installation of underground cables, communication lines, and service lines.



Double Weave Pulling Grips are available with a forged steel compact rotating eye which can be attached to a swivel.

Double Weave, Rotating Eye, Heavy Duty, Short							
Cable Dia. Range	Leviton Catalog Numbers	Product Selection Numbers	Nominal Grip Size	Approximate Break Strength*	Length (Inches)		Flexible Eye Size (Inches)
					Bale (Dim. A)	Mesh (Dim. M)	
0.50-0.61	L8581	PS050-1	0.55	5,600	5	11	7/8
0.62-0.74	L8582	PS062-1	0.68	6,800	5	11	7/8
0.75-0.99	L8583	PS075-2	0.87	9,600	6	20	1
1.00-1.24	L8584	PS100-2	1.12	16,400	7	20	1-3/8
1.25-1.49	L8585	PS125-2	1.37	16,400	7	21	1-3/8
1.50-1.99	L8586	PS150-2	1.74	27,200	7	25	1-5/8
2.00-2.49	L8587	PS200-2	2.24	33,000	8	26	1-7/8
2.50-2.99	L8588	PS250-2	2.74	41,000	10	28	1-7/8
3.00-3.49	L8589	PS300-2	3.24	48,000	10	30	1-7/8
3.50-3.99	L8591	PS350-2	3.74	48,000	10	32	1-7/8
4.00-4.49	L8592	PS400-2	4.24	48,000	10	33	1-7/8

Double Weave, Rotating Eye, Heavy Duty, Standard							
Cable Dia. Range	Leviton Catalog Numbers	Product Selection Numbers	Nominal Grip Size	Approximate Break Strength*	Length (Inches)		Flexible Eye Size (Inches)
					Bale (Dim. A)	Mesh (Dim. M)	
0.50-0.61	L8601	PS050-2	0.55	5,600	5	16	7/8
0.62-0.74	L8602	PS062-2	0.68	6,800	5	16	7/8
0.75-0.99	L8603	PS075-3	0.87	9,600	6	32	1
1.00-1.49	L8604	PS100-3	1.12	16,400	7	33	1-3/8
1.50-1.99	L8605	PS150-3	1.74	16,400	7	34	1-3/8
2.00-2.49	L8606	PS200-3	2.24	27,200	9	36	1-5/8
2.50-2.99	L8607	PS250-3	2.74	33,000	10	38	1-7/8
3.00-3.49	L8608	PS300-3	3.24	41,000	10	39	1-7/8
3.50-3.99	L8609	PS350-3	3.74	48,000	10	41	1-7/8
4.00-4.49	L8611	PS400-3	4.24	48,000	10	42	1-7/8
4.50-4.99	L8612	PS450-4	4.74	48,000	10	58	1-7/8
5.00-5.99	L8613	PS500-4	5.49	48,000	10	60	1-7/8
6.00-6.99	L8614	PS600-4	6.49	48,000	10	66	1-7/8

L8600 Kit includes 1 each of:	Leviton Catalog Numbers	Product Selection Numbers
	L8603	PS075-3
	L8604	PS100-3
	L8605	PS150-3
	L8606	PS200-3

NOTE: See installation instructions supplied with grip for recommended swivels, links and clamps or accessories listing.  
 \*To determine workload safety factor, divide approximate break strength by 5. See page 5 for strength information.

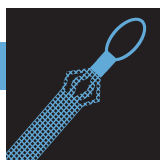

## WIRE MESH SAFETY GRIPS

### PULLING GRIPS

#### MULTI-WEAVE GRIPS



Leviton *Multi-Weave Pulling Grips* are constructed of high strength galvanized steel strands and are designed for pulling aluminum or copper bare conductor, wire rope and insulated cables. These grips are used in applications such as distribution line stringing and overhead transmission.

Multi-Weave Pulling Grips are available with a flexible and rotating eye which can be attached to a swivel. The forged steel rotating eye will thread through sheaves and blocks without binding, but is not a swivel and will not turn under tension. The rotating eye can turn to relieve pulling torque when tension is relaxed.



Multi-Weave, Rotating Eye								
Cable Dia. Range (Inches)	Leviton Catalog Numbers	Product Selection Numbers	Nominal Grip Size	Approximate Break Strength*	Length Bale (Dim. A)	Length (Inches) Mesh (Dim. M) Color		Flexible Eye Size (Inches)
0.25-0.49	<b>L8621</b>	PR025-26MS	3/8	6,800	5	26	Dk. Green	7/8
0.50-0.74	<b>L8622</b>	PR050-32MS	5/8	10,000	6	32	Brown	1
0.75-0.99	<b>L8623</b>	PR075-41MS	7/8	14,400	6	41	Lt. Blue	1
1.00-1.24	<b>L8624</b>	PR100-52MS	1-1/8	24,600	8	52	Gold	1-3/8
1.25-1.49	<b>L8625</b>	PR125-56MS	1-3/8	30,600	8	56	Black	1-5/8
1.50-1.74	<b>L8626</b>	PR150-60MS	1-5/8	30,600	9	60	Red	1-7/8
1.75-1.99	<b>L8627</b>	PR175-70MS	2	48,000	10	70	Dk. Blue	1-7/8
2.00-2.49	<b>L8628</b>	PR200-50MS	2-1/4	48,000	10	50	Yellow	1-7/8
2.50-2.99	<b>L8629</b>	PR250-52MS	2-3/4	48,000	10	52	Orange	1-7/8
3.00-3.49	<b>L8631</b>	PR300-54MS	3-1/4	48,000	10	54	Alum.	1-7/8
3.50-3.99	<b>L8632</b>	PR350-56MS	3-3/4	48,000	10	56	Lt. Green	1-7/8



Multi-Weave, Flexible Eye								
Cable Dia. Range (Inches)	Leviton Catalog Numbers	Product Selection Numbers	Nominal Grip Size	Approximate Break Strength*	Length Bale (Dim. A)	Length (Inches) Mesh (Dim. M) Color		Flexible Eye Size (Inches)
0.25-0.49	<b>L8641</b>	PF025-26MS	3/8	6,800	9	26	Dk. Green	1/4
0.50-0.74	<b>L8642</b>	PF050-32MS	5/8	10,000	9	32	Brown	5/16
0.75-0.99	<b>L8643</b>	PF075-41MS	7/8	14,400	11	41	Lt. Blue	3/8
1.00-1.24	<b>L8644</b>	PF100-52MS	1-1/8	24,600	12	52	Gold	1/2
1.25-1.49	<b>L8645</b>	PF125-56MS	1-3/8	30,600	12	56	Black	1/2
1.50-1.74	<b>L8646</b>	PF150-60MS	1-5/8	30,600	12	60	Red	1/2
1.75-1.99	<b>L8647</b>	PF175-70MS	2	48,000	15	70	Dk. Blue	5/8
2.00-2.49	<b>L8648</b>	PF200-50MS	2-1/4	48,000	18	50	Yellow	5/8
2.50-2.99	<b>L8649</b>	PF250-52MS	2-3/4	48,000	18	52	Orange	5/8
3.00-3.49	<b>L8651</b>	PF300-54MS	3-1/4	48,000	18	54	Alum.	5/8
3.50-3.99	<b>L8652</b>	PF350-56MS	3-3/4	48,000	18	56	Lt. Green	5/8

NOTE: It is recommended that a swivel be used for release of torque during a pull. Use a connecting link when a swivel is not needed. Do not run grips or swivels over bullwheels while under tension. Do not use Multi-Weave for pulling rope. When higher loads are required, use Leviton's high strength-style pulling grips. See installation instructions supplied with grip for recommended swivels, links and clamps or accessories listing.

\*To determine workload safety factor, divide approximate break strength by 5. See page 5 for strength information.





PULLING GRIPS

HIGH STRENGTH GRIPS



*High Strength Pulling Grips* are designed for situations where load and safety considerations require an extra high strength grip. They are most commonly used for attaching pulling lines to conductors, conductors to running boards, and conductor-to-conductor connections. These grips can be used for pulling bare or insulated conductor, wire rope or synthetic rope.

A feed tube is used when assembling synthetic rope<sup>1</sup> into the High Strength Pulling Grip and is required on the two largest grip sizes.



Grip Range O.D. (Inches)		Leviton Catalog Numbers	Product Selection Numbers	Approximate Break Strength*	Length (Inches)		Color Code	Flexible Eye Size (Inches)
Rope <sup>1</sup>	Conductor				Bale (Dim. A)	Mesh (Dim. M)		
0.25–0.65	0.19–0.37	<b>L8660</b>	PHS025	6,500	10	24	Black	.218
0.50–0.90	0.38–0.62	<b>L8661</b>	PHS050	14,000	13	26	Dk. Green	.375
0.75–1.10	0.63–0.87	<b>L8662</b>	PHS075	20,000	14	48	Red	.437
1.00–1.50	0.88–1.12	<b>L8663</b>	PHS100	30,600	15	60	Dk. Blue	.500
1.25–1.70	1.13–1.37	<b>L8664</b>	PHS125	46,800	18	76	Yellow	.625
1.50–2.10	1.38–1.90	<b>L8665</b>	PHS150	66,500	24	89	Alum.	.750

<sup>1</sup>For rope, select smallest size grip which meets required workload.

\*To determine workload safety factor, divide approximate break strength by 5. See page 5 for strength information.

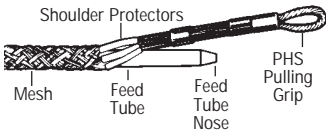

**Recommended Rope Assembly Using High Strength Feed Tube**

1. Insert feed tube into High Strength Pulling Grip.
2. Insert rope end fully into feed tube.
3. Hold rope in feed tube by pinning rope to the ground with end of tube. Pull mesh down onto feed so feed tube nose is protruding through shoulder protectors as shown.
4. Push mesh to end of feed tube and pull feed tube through mesh. When tube is pulled, the mesh gripping action will hold rope in place.
5. Position rope so that its end is inside the shoulder protectors. Remove slack from mesh by smoothing mesh tight to rope.
6. Apply clamps to mesh end.



## WIRE MESH SAFETY GRIPS

### PULLING GRIPS

#### SLACK GRIPS



*Slack Grips* are reusable grips used for pulling slack in underground cable preparatory to final placement. They may also be used for cable removal. Slack Grips feature an offset eye for easy attachment to the pulling line.

#### Closed Mesh, Double Weave, Offset Eye, Heavy Duty, Medium

Cable Dia. Range (Inches)	Leviton Catalog Numbers	Product Selection Numbers	Approximate Break Strength*	Mesh Length (Inches)
0.75-0.99	L8671	SCK075-1	3,000	13
1.00-1.24	L8672	SCK100-1	4,200	16
1.25-1.49	L8673	SCK125-1	5,500	17
1.50-1.74	L8674	SCK150-1	7,400	18
1.75-1.99	L8675	SCK175-1	11,000	19
2.00-2.49	L8676	SCK200-1	11,000	20
2.50-2.99	L8677	SCK250-1	11,000	21
3.00-3.49	L8678	SCK300-1	16,000	22
3.50-3.99	L8679	SCK350-1	16,000	23

#### Closed Mesh, Double Weave, Offset Eye, Heavy Duty, Long

0.75-0.99	L8681	SCK075-2	3,000	21
1.00-1.24	L8682	SCK100-2	5,500	21
1.25-1.49	L8683	SCK125-2	5,500	24
1.50-1.99	L8684	SCK150-2	7,400	26
2.00-2.49	L8685	SCK200-2	11,000	27
2.50-2.99	L8686	SCK250-2	11,000	30
3.00-3.49	L8687	SCK300-2	16,000	33
3.50-3.99	L8688	SCK350-2	16,000	36

#### Split Lace, Double Weave, Offset Eye, Heavy Duty, Medium

0.75-0.99	L8691	SSK075-1	3,000	13
1.00-1.24	L8692	SSK100-1	4,100	16
1.25-1.49	L8693	SSK125-1	4,100	17
1.50-1.74	L8694	SSK150-1	5,500	18
1.75-1.99	L8695	SSK175-1	7,300	19
2.00-2.49	L8696	SSK200-1	7,300	20
2.50-2.99	L8697	SSK250-1	7,300	21
3.00-3.49	L8698	SSK300-1	9,200	22
3.50-3.99	L8699	SSK350-1	11,000	23

#### Split Lace, Double Weave, Offset Eye, Heavy Duty, Long

0.75-0.99	L8701	SSK075-2	3,000	21
1.00-1.24	L8702	SSK100-2	4,100	21
1.25-1.49	L8703	SSK125-2	4,100	24
1.50-1.74	L8704	SSK150-2	5,500	25
2.00-2.49	L8705	SSK200-2	7,300	27
2.50-2.99	L8706	SSK250-2	7,300	30
3.00-3.49	L8707	SSK300-2	9,200	33
3.50-3.99	L8708	SSK350-2	11,000	36

#### Split Rod, Single Weave, Offset Eye, Heavy Duty, Medium

0.50-0.61	L8711	SRK050-1	1,800	7
0.62-0.74	L8712	SRK062-1	1,900	9
0.75-0.99	L8713	SRK075-1	3,000	11
1.00-1.24	L8714	SRK100-1	4,100	12
1.25-1.49	L8715	SRK125-1	5,700	14
1.50-1.74	L8716	SRK150-1	5,800	16
1.75-1.99	L8717	SRK175-1	7,700	17
2.00-2.49	L8718	SRK200-1	9,300	20
2.50-2.99	L8719	SRK250-1	11,300	21
3.00-3.49	L8721	SRK300-1	15,100	22
3.50-3.99	L8722	SRK350-1	15,100	25

\*To determine workload safety factor, divide approximate break strength by 5. See page 5 for strength information.



STRAIN-RELIEF GRIPS

*Strain-Relief Grips* are used to connect cord or cable to electrical enclosures and equipment. These grips prevent pullout due to tension and limit the arc of bend at the point of entry; strain is distributed over the length of mesh rather than concentrated at one point or transferred to the internal termination.

HOW TO SELECT STRAIN-RELIEF GRIPS

Prefix information:

Alpha Prefix	Description
WRP	Wide range, insulated for flexible cord (dust-tight)
PG	Deluxe fitting for flexible cord (rain-tight)
ST	Liquid-Tight fitting, insulated throat, female only for metallic conduit
STB	Liquid-Tight fitting, insulated throat, male for metallic conduit
STNM	Liquid-Tight fitting, insulated throat, male for metallic conduit
Nylon Cord Sealing Grips with Mesh	Non-metallic cord grip bodies with mesh assemblies

WIDE-RANGE GRIPS



*Wide-Range Grips* are recommended for use in wiring of enclosures, power boxes, machine tools, and power centers. They include an insulated bushing.

Cable Dia. Range (Inches)	NPT Size (Inches)	Leviton Numbers	Product Selection Numbers	Mesh Length @ Nom. Dia. (Inches)	Min. Btwn. Grips (Inches)
0.22-0.32	1/2	L7501	WRP-022	3-1/4	1-1/4
0.30-0.43	1/2	L7502	WRP-030	3-3/4	1-1/4
0.40-0.54	1/2	L7503	WRP-040	4-3/4	1-1/4
0.52-0.73	3/4	L7504	WRP-052	5-3/4	1-1/2
0.70-0.97	1	L7505	WRP-070	7	1-7/8
0.94-1.25	1-1/4	L7506	WRP-094	9	2-3/8
1.20-1.50	1-1/2	L7507	WRP-120	11-3/4	2-5/8
1.40-1.75	2	L7508	WRP-140	13-1/4	3-1/4
1.62-2.00	2-1/2	L7509	WRP-162	13-1/2	3-5/8
2.00-2.45	2-1/2	L7511	WRP-200	13-3/4	3-5/8

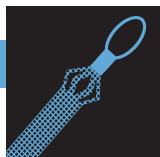

## WIRE MESH SAFETY GRIPS

### STRAIN-RELIEF GRIPS

#### NYLON CORD SEALING GRIPS WITH MESH – STRAIGHT AND 90°



*Cord Sealing Grips with Mesh* are nylon devices used to connect electrical cables to boxes, cabinets, pushbuttons, enclosures, etc. They are liquid-tight devices that are highly resistant to impact and corrosion. Non-metallic cord sealing grips will not support combustion. The ratings are: Wire Mesh Grip-94 HB and Fitting-94V-2. Cord Sealing Grip products are suitable for use in wet locations so long as the listed sealing ring is used between the box and the fitting.



STRAIGHT



90°



STRAIGHT



90°

Cable Dia. Range (Inches)	NPT (Form Size)	Leviton Catalog Numbers			
		Stainless Steel Mesh <sup>2</sup>		Non-Metallic Mesh	
		Straight	90°	Straight	90°
.187 – .250		L7521	L7523	L7522	L7524
.250 – .312		L7525	L7527	L7526	L7528
.312 – .375	1/2"	L7529	L7532	L7531	L7533
.375 – .437	(F2)	L7534	L7536	L7535	L7537
.437 – .500		L7538	L7541	L7539	L7542
.500 – .562		L7543 <sup>1</sup>	L7544 <sup>1</sup>		
.562 – .625		L7545 <sup>1</sup>	L7546 <sup>1</sup>		
.187 – .250		L7601	L7603	L7602	L7604
.250 – .375		L7605	L7607	L7606	L7608
.375 – .437		L7609	L7612	L7611	L7613
.437 – .562	3/4"	L7547	L7549	L7548	L7551
.500 – .625	(F3)	L7552	L7554	L7553	L7555
.562 – .687		L7556	L7558	L7557	L7559
.625 – .750		L7561	L7563	L7562	L7564
.687 – .812		L7565 <sup>1</sup>	L7566 <sup>1</sup>		
.437 – .562		L7567		L7568	L7569
.500 – .625		L7571	L7573	L7572	L7574
.562 – .687		L7575	L7577	L7576	L7578
.625 – .750	1"	L7579	L7582	L7581	L7583
.687 – .812	(F4)	L7584	L7586	L7585	L7587
.750 – .875		L7588	L7591	L7589	L7592
.812 – .937		L7593	L7595	L7594	L7596
.875 – 1.000		L7597	L7599	L7598	L7590
1.000 – 1.100					

<sup>1</sup>Cable jacket may have to be stripped for clearance.  
NOTE: F2, F3 and F4 are fitting form sizes.

\* Cord Sealing Grips with non-metallic mesh are UL Listed and CSA Certified. Cord Sealing Grips with stainless steel mesh are CSA Certified only.



STRAIN-RELIEF GRIPS

DIMENSIONS FOR  
NYLON CORD-SEALING  
FITTINGS  
STRAIGHT BODY

Form	NPT	A	B	C	D	E	F	G	H (Ref.)
0	1/4"	.500	.778	.370	.187	.921	.778	.687	1.25
1	3/8"	1.000	1.150	.500	.250	1.250	1.115	1.000	1.85
2	1/2"	1.000	1.300	.500	.300	1.450	1.250	1.100	2.00
3	3/4"	1.000	1.500	.550	.375	1.700	1.578	1.375	2.00
4	1"	1.000	1.850	.687	.375	1.800	1.900	1.650	2.12
5	1 1/4"	1.000	2.050	.687	.375	1.800	2.100	1.850	2.12

FORM 0

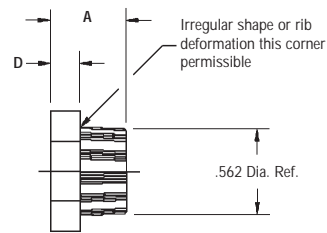

FORMS 1-5

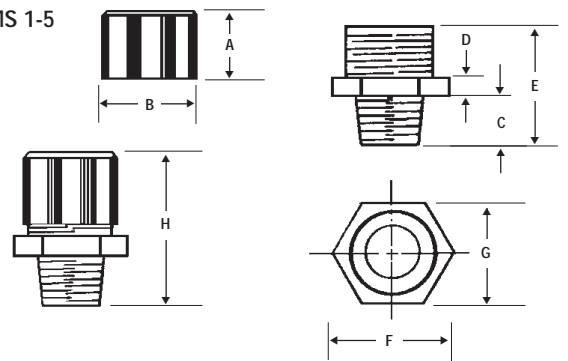

DIMENSIONS FOR  
NYLON CORD-SEALING  
FITTINGS  
90° BODY

Form	NPT	A	B	C	D	E	F	G	H (Ref.)
1	3/8"	1.000	1.150	1.100	.187	1.812	.450	1.687	2.35
2	1/2"	1.000	1.300	1.165	.187	1.900	.578	1.820	2.40
3	3/4"	1.000	1.500	1.600	.187	2.421	.593	2.218	2.75
4	1"	1.000	1.850	1.850	.187	2.656	.800	2.700	3.00
5	1 1/4"	1.000	2.050	1.965	.187	2.859	.750	2.812	3.25

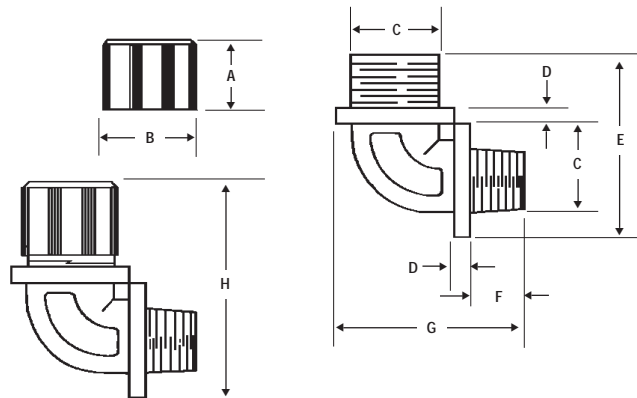



STRAIN-RELIEF GRIPS

DELUXE CORD GRIPS

*Deluxe Cord Grips* are woven of stainless steel mesh with an anodized aluminum body for corrosion resistance. They are offered in Single/Double Weave construction to help absorb direct pull, resist flexing and binding, and eliminate strain. Aluminum fittings are offered in a variety of NPT thread sizes. They are recommended for indoor or outdoor use where moisture may be present in the wiring of pendant stations, processing equipment, hand tools, and extension cord sets. They are U.L. Listed and CSA Certified. Deluxe Cord Grips are suitable for use in hazardous locations per Class I, Div. 2; Class II, Div. 1 and 2; and Class III, Div. 1 and 2. They are also suitable for use in wet locations as long as the listed sealing ring is used between the box and the fitting.



STRAIGHT-MALE



90°-MALE



45°-MALE



STRAIGHT-FEMALE

Single/Double Weave		Leviton Catalog Numbers			
Cable Dia. Range (Inches)	NPT Size	Straight Male	90° Male	45° Male	Straight Female
.187-.250		L7701			
.250-.312		L7702			L7821
.312-.375	3/8"	L7703			L7822
.375-.437		L7704			L7823
.187-.250		L7705	L7761	L7801	L7824
.250-.375		L7706	L7762	L7802	L7825
.375-.500	1/2"	L7707	L7763	L7803	L7826
.500-.625		L7708	L7764	L7804	L7827
.625-.750		L7709			
.250-.375		L7711	L7765	L7805	L7828
.375-.500		L7712	L7766	L7806	L7829
.500-.625	3/4"	L7700	L7767	L7807	L7831
.625-.750		L7713	L7768	L7808	L7832
.750-.875		L7714			
.437-.562		L7715	L7769		
.562-.687		L7716	L7771	L7809	L7833
.625-.750	1"	L7717	L7772	L7811	L7834
.750-.875		L7718	L7773	L7812	L7835
.875-1.000		L7719	L7774	L7813	L7836
1.000-1.125		L7721			
1.125-1.250		L7722			
.750-.875		L7723	L7775		
.875-1.000		L7724	L7776		
1.000-1.125	1-1/4"	L7725	L7777	L7810	
1.125-1.250		L7726	L7778		
1.250-1.375		L7727	L7779	L7820	
.750-.875		L7728	L7781		
.875-1.000		L7729	L7782		
1.000-1.125	1-1/2"	L7731	L7783		
1.125-1.250		L7732	L7784		
1.250-1.375		L7733	L7785		
1.312-1.437		L8011			
1.437-1.562		L7770			
1.562-1.687		L7750			
1.687-1.812		L7760			
1.250-1.375		L7734	L7786		
1.375-1.500		L7735	L7787		
1.500-1.625	2"	L7736	L7788		
1.625-1.750		L7737	L7789		
1.750-1.875		L7738	L7791		
1.812-1.937		L8012			
1.937-2.062		L8013			
2.062-2.187		L7720			
2.187-2.312		L7730			
1.688-1.812		L7739			
1.812-1.937		L7741			
1.937-2.062	2-1/2"	L7742			
2.062-2.187		L7743			
2.187-2.312		L7744			
2.312-2.437		L7740			
1.750-1.875		L7745			
1.875-2.000		L7746			
2.000-2.125		L7747			
2.125-2.250		L7748			
2.187-2.312	3"	L7749			
2.312-2.437		L7751			
2.437-2.625		L7752			
2.625-2.812		L7753			
2.812-3.000		L7754			
3.000-3.250		L7755			





STRAIN-RELIEF GRIPS

LIQUID-TIGHT GRIPS



*Liquid-Tight Grips* are woven stainless steel mesh with an anodized aluminum body for corrosion-resistance. They are used to connect liquid-tight flexible metal conduit to electrical enclosures to prevent conduit pullout. Each fitting is supplied with an insulated throat to ensure conductor insulation and protect against damage caused by flexing, heat expansion or contraction.

Liquid-Tight Grips are recommended in the wiring of motors and any electrical enclosure where liquid-tight conduit is subject to motion or strain. U.L. Listed. CSA Certified.



STRAIGHT-MALE



90°-MALE



45°-MALE

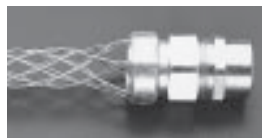

STRAIGHT-FEMALE

Liquid-Tight Grips					
Fitting Size (Inches)	Leviton Catalog Numbers				
	Straight Male	90° Male	45° Male	Straight Female	Mesh Length (Inches)
3/8	L7901	L7915	L7931	L7951	2-5/8
1/2	L7902	L7916	L7932	L7952	3-7/8
3/4	L7903	L7917	L7933	L7953	4-3/8
1	L7904	L7918	L7934	L7954	5-1/4
1-1/4	L7905	L7919	L7935		5-5/8
1-1/2	L7906	L7921	L7936		5-3/4
2	L7907	L7922	L7937		7-1/2
2-1/2	L7908	L7923	L7938		9-5/8
3	L7911	L7924	L7939		10-5/8
4	L7912	L7925	L7941		12

LIQUID-TIGHT GRIPS FOR NON-METALLIC TYPE "A" FLEXIBLE CONDUIT

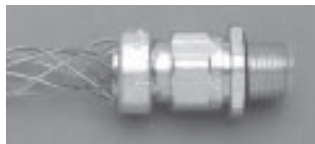

STRAIGHT-MALE



90°-MALE

Liquid-Tight Grips for Non-Metallic Type "A" Flexible Conduit			
Fitting Size (Inches)	Leviton Catalog Numbers		Mesh Length (Inches)
	Straight Male	90° Male	
3/8	L7961	L7999	9
1/2	L7962	L7990	10
3/4	L7963	L7967	10-1/2
1	L7964	L7968	12
1-1/4	L7965	L7969	17
1-1/2	L7966	L7971	21-1/2
2	L7970	L7972	24

CONNECTION WIRE MESH GRIPS



*Connection Wire Mesh Grips* provide additional strain-relief for plugs and connectors used on portable equipment in commercial and institutional applications, and industrial plant and construction site areas which incur abnormally high abuse.

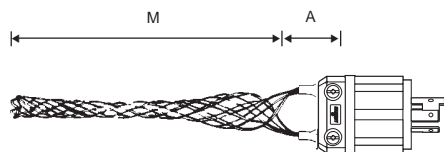

Cable Dia. Range (Inches)	Leviton Catalog Numbers	Eye Dimension (A) (Inches)	Mesh Length (M) (Inches)
.30-.43	L8001	1-11/16	4-3/4
.40-.56	L8002	1-11/16	6
.52-.73	L8003	1-11/16	7
.70-.85	L8004	1-15/16	8-1/2
.82-1.00	L8005	1-15/16	8-1/2
.94-1.25	L8006	1-15/16	10-1/2



SUPPORT GRIPS

*Support Grips* are designed to hold the weight of vertical or sloping runs. They may be used indoors or outdoors to support electrical and fiber optic cable, metal rods and tubing.

Leviton Support Grips are woven with tinned bronze wire. For applications requiring a greater degree of corrosion resistance, stainless steel wire is available on special order. For information regarding selection of the proper sized support grip, see pages 3 and 4.

PREFIX INFORMATION

The alpha prefix of the Product Selection Number for Support Grips indicates the type of fitting supplied.

Alpha Prefix	Description
SC	Closed mesh
SS	Split mesh with lace
SR	Split mesh with rod
SCHL	Closed mesh, heavy duty, long
SSHL	Split lace, heavy duty, long

SUFFIX INFORMATION

**Single "U" Eye**

For use when cable is vertical and for applications where cable bends or where a single attachment is more advantageous for positioning.



SINGLE "U" EYE

Alpha Suffix	Description
U	Single eye
UD	Single eye, double weave mesh (open and closed)

**Double "U" Eye**

For use when cable is vertical and extends through the grip without bending. Eyes may be fastened to open hooks, but should not be more than 15° from the axis of vertical cable. When eyes are supported equally, this attachment offers a fully balanced load.



DOUBLE "U" EYE

Alpha Suffix	Description
UUD	Double eye, double weave mesh
UD	Single eye, double weave mesh (open and closed)
UU	Double eye

**Offset Eye**

Similar to single eye applications, but for use when offset positioning is required.



OFFSET EYE

Alpha Suffix	Description
OF	Offset eye

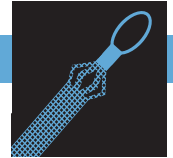

SUPPORT GRIPS

SUFFIX INFORMATION

**Locking (Universal) Bale**

Adjustable and self-locking, this attachment fits around a beam, pipe or other continuous structural object. The bale wraps around the object and is securely anchored in the bar.



LOCKING BALE

Alpha Suffix	Description
LB	Locking bale

SPLIT LACE/SPLIT ROD



SPLIT LACE

**Split Lace**

Beginning at the lead end of the grip, thread the lacing through the first two loops of the split, pulling the lace through until the ends are centered evenly. Cross laces and thread through the next two loops, and so on down the grip, being careful not to pull the lacing too tight. The spacing of the lace closure should be approximately the same as that of the mesh weave. When the end of grip is reached, twist the lacing strands tightly together; wrap the ends of the lace around the grip and twist again to secure. Excess length may be cut off.

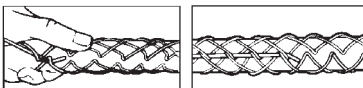

SPLIT ROD

**Split Rod**

Split grips with rod closing install quickly and they are economical and reusable. Simply wrap the grip around the cable and thread the rod through the loops, using a corkscrew motion. To remove, pull the rod out; and the grip is ready for re-use.

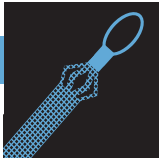

SUPPORT GRIPS

STANDARD CLOSED MESH SUPPORT GRIPS



Standard Closed Mesh Support Grips are designed for loads up to 500 lbs. and vertical runs of no more than 100 feet. Heavy-duty closed mesh support grips are designed for loads in excess of 500 lbs. They are available in a variety of eye styles and cable ranges for supporting electrical cable, metal rods and tubing. Closed mesh support grips are used when the end of the cable is accessible.



SINGLE EYE

Single Eye, Closed Mesh, Single Weave					
Cable Dia. Range (Inches)	Leviton Catalog Numbers	Product Selection Numbers	Approximate Break Strength*	Length (Inches)	
				Bale (Dim. A)	Mesh (Dim.M)
0.50-0.61	L9501	SC050-U	770	7	11
0.62-0.74	L9502	SC062-U	960	8	11
0.75-0.99	L9503	SC075-U	1,300	8	14
1.00-1.24	L9504	SC100-U	1,680	9	15
1.25-1.49	L9505	SC125-U	1,680	10	16
1.50-1.74	L9506	SC150-U	1,680	12	18
1.75-1.99	L9507	SC175-U	2,640	14	20
2.00-2.49	L9508	SC200-U	3,760	16	22
2.50-2.99	L9509	SC250-U	3,760	18	24
3.00-3.49	L9511	SC300-U	5,040	21	26
3.50-3.99	L9512	SC350-U	5,040	24	28



DOUBLE EYE

Double Eye, Closed Mesh, Single Weave					
0.50-0.61	L9515	SC050-UU	770	4	11
0.62-0.74	L9516	SC062-UU	1,150	4	11
0.75-0.99	L9517	SC075-UU	1,320	4	14
1.00-1.24	L9518	SC100-UU	1,920	5	15
1.25-1.49	L9519	SC125-UU	1,920	5	16
1.50-1.74	L9521	SC150-UU	1,920	6	18
1.75-1.99	L9523	SC175-UU	3,150	6	20
2.00-2.49	L9524	SC200-UU	3,360	6	22
2.50-2.99	L9525	SC250-UU	3,360	6	24
3.00-3.49	L9526	SC300-UU	5,280	8	26
3.50-3.99	L9527	SC350-UU	5,280	8	28



OFFSET EYE

Offset Eye, Closed Mesh, Single Weave					
0.50-0.61	L9531	SC050-OF	770	4	11
0.62-0.74	L9532	SC062-OF	960	4	11
0.75-0.99	L9533	SC075-OF	960	4	14
1.00-1.24	L9534	SC100-OF	1,680	5	15
1.25-1.49	L9535	SC125-OF	1,680	5	16
1.50-1.74	L9536	SC150-OF	1,680	5	18
1.75-1.99	L9537	SC175-OF	2,640	6	20
2.00-2.49	L9538	SC200-OF	3,760	6	21
2.50-2.99	L9539	SC250-OF	3,760	8	24
3.00-3.49	L9541	SC300-OF	5,040	9	26
3.50-3.99	L9542	SC350-OF	5,040	9	28

\*To determine workload safety factor, divide approximate break strength by 10. See page 5 for strength information.  
NOTE: Support grips are also available in stainless steel – contact your Leviton Representative.



SUPPORT GRIPS

STANDARD CLOSED MESH  
SUPPORT GRIPS



LOCKING BALE

Locking Bale, Closed Mesh, Single Weave

Cable Dia. Range (Inches)	Leviton Catalog Numbers	Product Selection Numbers	Approximate Break Strength*	Length(Inches)	
				Bale (Dim. A)	Mesh (Dim. M)
0.50-0.61	L9551	SC050-LB	770	18	11
0.62-0.74	L9552	SC062-LB	1,150	18	11
0.75-0.99	L9553	SC075-LB	1,320	18	14
1.00-1.24	L9554	SC100-LB	1,920	18	15
1.25-1.49	L9555	SC125-LB	1,920	18	16
1.50-1.74	L9556	SC150-LB	1,920	18	18
1.75-1.99	L9557	SC175-LB	3,150	18	20
2.00-2.49	L9558	SC200-LB	3,360	18	21
2.50-2.99	L9559	SC250-LB	3,360	18	24
3.00-3.49	L9561	SC300-LB	5,280	18	26
3.50-3.99	L9562	SC350-LB	5,280	18	28

\*To determine workload safety factor, divide approximate break strength by 10. See page 5 for strength information.

HEAVY DUTY  
SUPPORT GRIPS



SINGLE EYE

Heavy Duty Support Grips handle continuous loads of over 500 lbs. in vertical runs greater than 100 ft. for cable diameters from 3/4" to 4 1/2".

Single Eye, Double Weave, Heavy Long, Closed Mesh

Cable Dia. Range (Inches)	Leviton Catalog Numbers	Product Selection Numbers	Approximate Break Strength*	Length (Inches)	
				Bale (Dim. A)	Mesh (Dim. M)
0.75-0.99	L9701	SCHL075-UD	2,700	10	26
1.00-1.24	L9702	SCHL100-UD	4,720	10	29
1.25-1.49	L9703	SCHL125-UD	4,720	10	31
1.50-1.99	L9704	SCHL150-UD	4,720	10	35

Double Eye, Double Weave, Heavy Long, Closed Mesh

0.75-0.99	L9711	SCHL075-UUD	2,700	10	26
1.00-1.25	L9712	SCHL100-UUD	4,720	10	29
1.25-1.49	L9713	SCHL125-UUD	4,720	10	31
1.50-1.99	L9714	SCHL150-UUD	4,720	10	35
2.00-2.49	L9715	SCHL200-UUD	10,080	10	37
2.50-2.99	L9716	SCHL250-UUD	10,080	10	39
3.00-3.49	L9717	SCHL300-UUD	10,080	10	41
3.50-3.99	L9718	SCHL350-UUD	13,120	10	45
4.00-4.49	L9719	SCHL400-UUD	13,120	10	47

\*To determine workload safety factor, divide approximate break strength by 10. See page 5 for strength information.



SUPPORT GRIPS

STANDARD SPLIT-LACE SUPPORT GRIPS



*Split Lace Support Grips* are designed for loads up to 500 lbs. and vertical runs of no more than 100 feet. Heavy-duty split lace support grips are designed for loads in excess of 500 lbs. They are available in a variety of eye styles and cable ranges for supporting electrical cable, metal rods and tubing. Split lace grips are utilized when the end of the cable cannot be feasibly accessed and the support grip is intended for permanent installation.



SINGLE EYE

Single Eye, Split Lace, Single Weave

Cable Dia. Range (Inches)	Leviton Catalog Numbers	Product Selection Numbers	Approximate Break Strength*	Length (Inches)	
				Bale (Dim. A)	Mesh (Dim. M)
0.50-0.61	L9571	SS050-U	770	7	11
0.62-0.74	L9572	SS062-U	960	8	11
0.75-0.99	L9573	SS075-U	1,320	8	14
1.00-1.24	L9574	SS100-U	1,680	9	15
1.25-1.49	L9575	SS125-U	1,680	10	16
1.50-1.74	L9576	SS150-U	1,680	12	18
1.75-1.99	L9577	SS175-U	2,640	14	20
2.00-2.49	L9578	SS200-U	3,760	16	22
2.50-2.99	L9579	SS250-U	3,760	18	24
3.00-3.49	L9581	SS300-U	5,040	21	26
3.50-3.99	L9582	SS350-U	5,040	24	28



DOUBLE EYE

Double Eye, Split Lace, Single Weave

0.50-0.61	L9585	SS050-UU	770	4	11
0.62-0.74	L9586	SS062-UU	1,150	4	11
0.75-0.99	L9587	SS075-UU	1,320	4	14
1.00-1.24	L9588	SS100-UU	1,920	5	15
1.25-1.49	L9589	SS125-UU	1,920	5	16
1.50-1.74	L9591	SS150-UU	1,920	5	18
1.75-1.99	L9592	SS175-UU	3,150	6	20
2.00-2.49	L9593	SS200-UU	3,360	6	22
2.50-2.99	L9594	SS250-UU	3,360	6	24
3.00-3.49	L9595	SS300-UU	5,280	8	26
3.50-3.99	L9596	SS350-UU	5,280	8	28



OFFSET EYE

Offset Eye, Split Lace, Single Weave

0.50-0.61	L9601	SS050-OF	770	4	11
0.62-0.74	L9602	SS062-OF	960	4	11
0.75-0.99	L9603	SS075-OF	960	4	14
1.00-1.24	L9604	SS100-OF	1,680	5	15
1.25-1.49	L9605	SS125-OF	1,680	5	16
1.50-1.74	L9606	SS150-OF	1,680	5	18
1.75-1.99	L9607	SS175-OF	2,640	8	20
2.00-2.49	L9608	SS200-OF	3,760	8	22
2.50-2.99	L9609	SS250-OF	3,760	8	24
3.00-3.49	L9611	SS300-OF	5,040	9	26
3.50-3.99	L9612	SS350-OF	5,040	9	28

\*To determine workload safety factor, divide approximate break strength by 10. See page 5 for strength information. NOTE: Support grips are also available in stainless steel – contact your Leviton Representative.





SUPPORT GRIPS

STANDARD SPLIT LACE SUPPORT GRIPS



LOCKING BALE

Locking Bale, Split Lace, Single Weave					
Cable Dia. Range (Inches)	Leviton Catalog Numbers	Product Selection Numbers	Approximate Break Strength*	Length (Inches)	
				Bale (Dim. A)	Mesh (Dim. M)
0.50-0.61	L9621	SS050-LB	770	18	11
0.62-0.74	L9622	SS062-LB	1,150	18	11
0.75-0.99	L9623	SS075-LB	1,320	18	14
1.00-1.24	L9624	SS100-LB	1,920	18	15
1.25-1.49	L9625	SS125-LB	1,920	18	16
1.50-1.74	L9626	SS150-LB	1,920	18	18
1.75-1.99	L9627	SS175-LB	3,150	18	20
2.00-2.49	L9628	SS200-LB	3,360	18	22
2.50-2.99	L9629	SS250-LB	3,360	18	24

\*To determine workload safety factor, divide approximate break strength by 10. See page 5 for strength information.

HEAVY DUTY SPLIT LACE SUPPORT GRIPS



DOUBLE EYE

Heavy Duty Support Grips handle continuous loads of over 500 lbs. in vertical runs greater than 100 ft. for cable diameters from 3/4" to 4 1/2".

Single Eye, Double Weave, Heavy Long, Split Lace					
Cable Dia. Range (Inches)	Leviton Catalog Numbers	Product Selection Numbers	Approximate Break Strength*	Length (Inches)	
				Bale (Dim. A)	Mesh (Dim. M)
0.75-0.99	L9722	SSHL075-UD	2,700	10	26
1.00-1.24	L9723	SSHL100-UD	4,720	10	29
1.25-1.49	L9724	SSHL125-UD	4,720	10	31
1.50-1.99	L9725	SSHL150-UD	4,720	10	35

Double Eye, Double Weave, Heavy Long, Split Lace					
Cable Dia. Range (Inches)	Leviton Catalog Numbers	Product Selection Numbers	Approximate Break Strength*	Length (Inches)	
				Bale (Dim. A)	Mesh (Dim. M)
0.75-0.99	L9731	SSHL075-UUD	2,700	10	26
1.00-1.24	L9732	SSHL100-UUD	4,720	10	29
1.25-1.49	L9733	SSHL125-UUD	4,720	10	31
1.50-1.99	L9734	SSHL150-UUD	4,720	10	35
2.00-2.49	L9735	SSHL200-UUD	10,080	10	37
2.50-2.99	L9736	SSHL250-UUD	10,080	10	39
3.00-3.49	L9737	SSHL300-UUD	10,080	10	41
3.50-3.99	L9738	SSHL350-UUD	13,120	10	45
4.00-4.49	L9739	SSHL400-UUD	13,120	10	47

\*To determine workload safety factor, divide approximate break strength by 10. See page 5 for strength information.

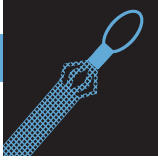

SUPPORT GRIPS

STANDARD SPLIT ROD SUPPORT GRIPS



*Split Rod Support Grips* are designed for loads up to 500 lbs. and vertical runs of no more than 100 feet. Heavy-duty split rod support grips are designed for loads in excess of 500 lbs. They are available in a variety of eye styles and cable ranges for supporting electrical cable, metal rods and tubing. Split rod support grips are utilized when the end of the cable cannot be feasibly accessed and the installation is temporary.



SINGLE EYE

Single "U" Eye, Split Rod, Single Weave					
Cable Dia. Range (Inches)	Leviton Catalog Numbers	Product Selection Numbers	Approximate Break Strength*	Length (Inches)	
				Bale (Dim. A)	Mesh (Dim. M)
0.50-0.61	L9631	SR050-U	770	7	9
0.62-0.74	L9632	SR062-U	960	8	9
0.75-0.99	L9633	SR075-U	1,320	8	11
1.00-1.24	L9634	SR100-U	1,680	9	13
1.25-1.49	L9635	SR125-U	1,680	10	15
1.50-1.74	L9636	SR150-U	1,680	12	16
1.75-1.99	L9637	SR175-U	2,640	14	17
2.00-2.49	L9638	SR200-U	3,760	16	20
2.50-2.99	L9639	SR250-U	3,760	18	22
3.00-3.49	L9641	SR300-U	6,560	21	24
3.50-3.99	L9642	SR350-U	6,560	24	26



DOUBLE EYE

Double "U" Eye, Split Rod, Single Weave					
Cable Dia. Range (Inches)	Leviton Catalog Numbers	Product Selection Numbers	Approximate Break Strength*	Length (Inches)	
				Bale (Dim. A)	Mesh (Dim. M)
0.50-0.61	L9651	SR050-UU	770	4	9
0.62-0.74	L9652	SR062-UU	1,150	4	9
0.75-0.99	L9653	SR075-UU	1,320	4	11
1.00-1.24	L9654	SR100-UU	1,920	5	13
1.25-1.49	L9655	SR125-UU	1,920	5	15
1.50-1.74	L9656	SR150-UU	1,920	5	16
1.75-1.99	L9657	SR175-UU	3,150	6	17
2.00-2.49	L9658	SR200-UU	3,360	6	20
2.50-2.99	L9659	SR250-UU	3,360	6	22
3.00-3.49	L9661	SR300-UU	7,520	8	24
3.50-3.99	L9662	SR350-UU	7,520	8	26



OFFSET EYE

Offset Eye, Split Rod, Single Weave					
Cable Dia. Range (Inches)	Leviton Catalog Numbers	Product Selection Numbers	Approximate Break Strength*	Length (Inches)	
				Bale (Dim. A)	Mesh (Dim. M)
0.50-0.61	L9671	SR050-OF	770	4	9
0.62-0.74	L9672	SR062-OF	960	4	9
0.75-0.99	L9673	SR075-OF	960	4	11
1.00-1.24	L9674	SR100-OF	1,680	5	13
1.25-1.49	L9675	SR125-OF	1,680	5	15
1.50-1.74	L9676	SR150-OF	1,680	5	16
1.75-1.99	L9677	SR175-OF	2,640	6	17
2.00-2.49	L9678	SR200-OF	3,760	6	20
2.50-2.99	L9679	SR250-OF	3,760	6	22
3.00-3.49	L9681	SR300-OF	5,040	8	24
3.50-3.99	L9682	SR350-OF	5,040	8	26

\*To determine workload safety factor, divide approximate break strength by 10. See page 5 for strength information.

# WIRE MESH SAFETY GRIPS



## SUPPORT GRIPS

### STANDARD SPLIT ROD SUPPORT GRIPS

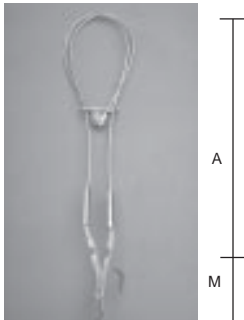

LOCKING BALE

#### Locking Bale, Split Rod, Single Weave

Cable Dia. Range Inches	Leviton Catalog Numbers	Product Selection Numbers	Approximate Break Strength*	Length (Inches)	
				Bale (Dim. A)	Mesh (Dim. M)
0.50-0.61	L9688	SR050-LB	770	10	9
0.62-0.74	L9689	SR062-LB	1,150	10	9
0.75-0.99	L9691	SR075-LB	1,320	10	11
1.00-1.24	L9692	SR100-LB	1,920	14	13
1.25-1.49	L9693	SR125-LB	1,920	14	15
1.50-1.74	L9694	SR150-LB	1,920	14	16
1.75-1.99	L9695	SR175-LB	3,150	14	17
2.00-2.49	L9696	SR200-LB	3,360	18	20
2.50-2.99	L9697	SR250-LB	3,360	18	22
3.00-3.49	L9698	SR300-LB	7,520	18	24
3.50-3.99	L9699	SR350-LB	7,520	18	26

\* To determine workload safety factor, divide approximate break strength by 10. See page 5 for strength information.

### BUS-DROP GRIPS



*Bus-Drop Grips* are used as cable support. They relieve any direct tension from the critical connection and absorb vibration and flexing. Bus-Drop Grips are woven of galvanized steel wire. They are offered with either single eye or locking bale attachments.

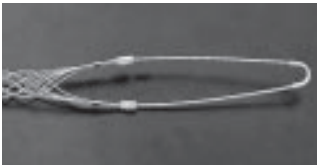

SINGLE "U" EYE



LOCKING BALE

Cable Dia. Range (Inches)	Leviton Catalog Numbers		Approximate Break Strength
	Locking Bale	Single "U" Eye	
.220-.320	L7988	L7981	1,100
.300-.430	L7991	L7982	1,100
.410-.560	L7992	L7983	1,100
.530-.730	L7993	L7984	1,800
.700-.850	L7994	L7985	1,900
.820-1.00	L7995	L7986	1,900
.960-1.25	L7996	L7987	1,900

### BUS-DROP GRIP ACCESSORIES

Safety Springs are used with Bus-Drop Grips to relieve sudden strains on the cable system. To use with single eye-type grips, disassemble drawbar from coil, place through the eye and replace the drawbar.



SAFETY SPRING

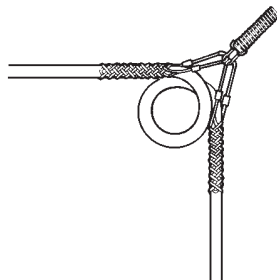

Safety Springs		
Leviton Catalog Numbers	Length (Inches)	Description
L7997	7.50	Zinc-plated max. load 40 lbs.
L7998	8.50	Zinc-plated max. load 80 lbs.



SUPPORT HOOK

Support Hook	
Leviton Catalog Number	Description
L7980	3/8" right hand thread wood screw Zinc-plated 4-1/2" long



SUPPORT GRIPS

All Leviton fiber optic support grips are designed to wrap securely around fiberoptic cable without damaging it. They are designed to reduce stress on cable in vertical, sloping, or horizontal positions. Single-eye or locking-bale style grips afford lasting support for a wide variety of applications where fiberoptic cable is used.

FIBER OPTIC GRIPS

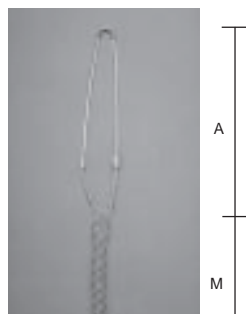

SINGLE EYE

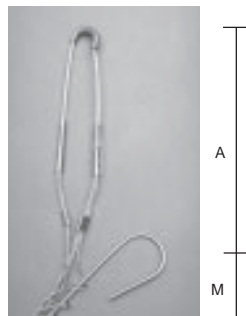

SINGLE EYE

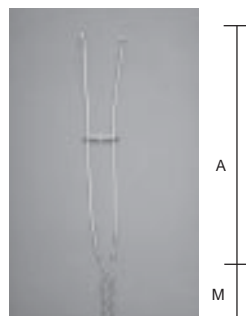

LOCKING BALE

Single Eye, Closed Mesh, Single Weave Fiber Optic Grips				
Cable Dia. Range (Inches)	Leviton Catalog Numbers	Approximate Break Strength	Length (Inches)	
			Eye (Dim. A)	Mesh (Dim. M)
.18-.25	L8807	300	3	1.7
.23-.32	L8808	300	3	2.5
.30-.39	L8809	300	4	2.5
.37-.48	L8811	300	5	4
.46-.58	L8812	400	6	4
.56-.71	L8813	600	7	5.5
.69-.88	L8814	800	8	6

Single Eye, Split Rod, Single Weave Fiber Optic Grips				
Cable Dia. Range (Inches)	Leviton Catalog Numbers	Approximate Break Strength	Length (Inches)	
			Eye (Dim. A)	Mesh (Dim. M)
.18-.25	L8815	300	3	2.5
.23-.32	L8816	300	3	2.5
.30-.39	L8817	300	4	2.5
.37-.48	L8818	300	5	4
.46-.58	L8819	400	6	5
.56-.71	L8821	600	7	5
.69-.88	L8822	800	8	6

Locking Bale, Closed Mesh, Single Weave Fiber Optic Grips				
Cable Dia. Range (Inches)	Leviton Catalog Numbers	Approximate Break Strength	Length (Inches)	
			Eye (Dim. A)	Mesh (Dim. M)
.18-.25	L8823	300	9	2.5
.23-.36	L8824	300	9	2
.30-.39	L8825	300	9	2.5
.37-.48	L8826	300	10	4
.46-.58	L8827	400	10	4
.56-.71	L8828	600	10	5.5
.69-.88	L8829	800	10	6



TECHNICAL REFERENCE

**Approvals:** U.L. Listings and CSA Certifications are indicated on the appropriate product catalog pages. File numbers are listed below.

Agency	Control Number	File Number
Underwriters Laboratories, Inc.	965U	E173944
	16G5	E176347
Canadian Standards Association	----	LR702185

**Hazardous Locations:** The product categories listed to the right are suitable for use in hazardous locations per Class I, Div. 2; Class II, Div. 1 & 2; and Class III, Div. 1 & 2 requirements.

Product Category	Type
Deluxe cord grips	Aluminum fitting Nylon fitting Non-metallic
Sealtite conduit grips	—

**Flammability:** Non-metallic Deluxe Cord Grips will not support combustion. The ratings are listed to the right.

Component	Rating
Wire mesh grip	94HB <sup>1</sup>
Fitting	94V-2 <sup>2</sup>

<sup>1</sup>A test method used by U.L. to determine a rate of burning and/or extent and time of burning of self-supporting plastics in a horizontal position (ASTM D 635-88, IEC 707-1981, ISO/DIS 1210.2).

<sup>2</sup>A test method used by U.L. for measuring the comparative extinguishing characteristics of solid plastics in a vertical position (IEC 707-1981, ISO/DIS 1210.2).

**Wet Locations:** The products listed to the right are suitable for use in wet locations so long as the listed sealing ring is used between the box and the fitting.

Product Category	Type
Deluxe cord grip	Aluminum fitting Nylon fitting Non-metallic
Sealtite conduit grips	
Non-metallic conduit grips	
Cord connectors	

Product Group	Description	Material	
Pulling grips	PJ junior duty	Galvanized steel wire	
	PL light duty	Galvanized steel wire	
	PM medium duty	Galvanized steel wire	
	P heavy duty	Galvanized steel wire	
	PS heavy duty swivel	Galvanized steel wire	
	PR-MS multi-weave, rotating eye	Galvanized steel wire	
	PF-MS multi-weave, flexible eye	Galvanized steel wire	
	PHS high strength	Galvanized steel wire	
	SCK slack, offset eye	Galvanized steel wire	
	SSK slack, offset eye	Galvanized steel wire	
	SRK slack, offset eye	Galvanized steel wire	
	Strain-relief grips	Wide range (with gasket)	Galvanized steel wire
		Deluxe cord grips	Stainless steel wire
Liquid-tight (metallic cond.)		Stainless steel wire	
Liquid-tight (non-metallic cond.)		Stainless steel wire	
Nylon cord sealing grips with mesh		Nylon	
Deluxe cord grips (non-metallic)		Non-conductive	
Bus drop grips		Galvanized steel wire	
Support grips	Safety springs	Spring steel	
	SC-support closed	Tinned bronze or stainless steel <sup>1</sup>	
	SS-support split with lace	Tinned bronze or stainless steel <sup>1</sup>	
	SR-support split with rod	Tinned bronze or stainless steel <sup>1</sup>	
	SCHL-support closed, heavy duty, long	Tinned bronze or stainless steel <sup>1</sup>	
	SSHL-support split lace, heavy duty, long	Tinned bronze or stainless steel <sup>1</sup>	

<sup>1</sup>Stainless steel available on request. Contact your Leviton Representative.



LEVITON CROSS REFERENCE

Hubbell/Kellems* Cat#	Woodhead* Cat#	Leviton Cat#	Catalog Page#
20303001	36241	L7980	27
74011254		L7770	18
74093548	37405	L7922	19
02201001	35001	L9515	22
02201002	35002	L9516	22
02201003	35003	L9517	22
02201005	35004	L9518	22
02201006	35005	L9519	22
02201007	35006	L9521	22
02201008	35007	L9523	22
02201009	35008	L9524	22
02201010	35009	L9525	22
02201011	35010	L9526	22
02201012	35011	L9527	22
02201013	35030	L9501	22
02201014	35031	L9502	22
02201015	35032	L9503	22
02201017	35033	L9504	22
02201018	35034	L9505	22
02201019	35035	L9506	22
02201020	35036	L9507	22
02201021	35037	L9508	22
02201022	35038	L9509	22
02201023	35039	L9511	22
02201024	35040	L9512	22
02201037	35060	L9531	22
02201038	35061	L9532	22
02201039	35062	L9533	22
02201041	35063	L9534	22
02201042	35064	L9535	22
02201043	35065	L9536	22
02201044	35066	L9537	22
02201045	35067	L9538	22
02201046	35068	L9539	22
02201047	35069	L9541	22
02201048	35070	L9542	22
02201050	35093	L9554	23
02201051	35090	L9551	23
02201052	35091	L9552	23
02201053	35092	L9553	23
02201054	35094	L9555	23
02201055	35095	L9556	23
02201056	35096	L9557	23
02201057	35097	L9558	23
02201058	35098	L9559	23
02201059	35099	L9561	23
02201060	35100	L9562	23
02202001	35135	L9585	24
02202002	35136	L9586	24
02202003	35137	L9587	24
02202005	35138	L9588	24
02202006	35139	L9589	24
02202007	35140	L9591	24
02202008	35141	L9592	24
02202009	35142	L9593	24
02202010	35143	L9594	24
02202011	35144	L9595	24
02202012	35145	L9596	24
02202013	35165	L9571	24
02202014	35166	L9572	24
02202015	35167	L9573	24
02202017	35168	L9574	24
02202018	35169	L9575	24
02202019	35170	L9576	24
02202020	35171	L9577	24
02202021	35172	L9578	24
02202022	35173	L9579	24
02202023	35174	L9581	24
02202024	35175	L9582	24
02202037	35195	L9601	24
02202038	35196	L9602	24
02202039	35197	L9603	24
02202041	35198	L9604	24
02202042	35199	L9605	24
02202043	35200	L9606	24
02202044	35201	L9607	24
02202045	35202	L9608	24
02202046	35203	L9609	24

Hubbell/Kellems* Cat#	Woodhead* Cat#	Leviton Cat#	Catalog Page#
02202047	35204	L9611	24
02202048	35205	L9612	24
02202050	35225	L9621	25
02202051	35226	L9622	25
02202052	35227	L9623	25
02202054	35228	L9624	25
02202055	35229	L9625	25
02202056	35230	L9626	25
02202057	35231	L9627	25
02202058	35232	L9628	25
02202059	35233	L9629	25
02203001	35270	L9651	26
02203002	35271	L9652	26
02203003	35272	L9653	26
02203005	35273	L9654	26
02203006	35274	L9655	26
02203007	35275	L9656	26
02203008	35276	L9657	26
02203009	35277	L9658	26
02203010	35278	L9659	26
02203011	35279	L9661	26
02203012	35280	L9662	26
02203013	35285	L9631	26
02203014	35286	L9632	26
02203015	35287	L9633	26
02203017	35288	L9634	26
02203018	35289	L9635	26
02203019	35290	L9636	26
02203020	35291	L9637	26
02203021	35292	L9638	26
02203022	35293	L9639	26
02203023	35294	L9641	26
02203024	35295	L9642	26
02203037	35300	L9671	26
02203038	35301	L9672	26
02203039	35302	L9673	26
02203041	35303	L9674	26
02203042	35304	L9675	26
02203043	35305	L9676	26
02203044	35306	L9677	26
02203045	35307	L9678	26
02203046	35308	L9679	26
02203047	35309	L9681	26
02203048	35310	L9682	26
02203064	35330	L9688	27
02203065	35331	L9689	27
02203066	35332	L9691	27
02203068	35333	L9692	27
02203069	35334	L9693	27
02203070	35335	L9694	27
02203071	35336	L9695	27
02203072	35337	L9696	27
02203073	35338	L9697	27
02203074	35339	L9698	27
02203075	35340	L9699	27
02206001	35425	L9711	23
02206002	35426	L9712	23
02206003	35427	L9713	23
02206004	35428	L9714	23
02206005	35429	L9715	23
02206006	35430	L9716	23
02206007	35431	L9717	23
02206008	35432	L9718	23
02206009	35433	L9719	23
02206010	35435	L9701	23
02206011	35436	L9702	23
02206012	35437	L9703	23
02206013	35438	L9704	23
02207001	35440	L9731	25
02207002	35441	L9732	25
02207003	35442	L9733	25
02207004	35443	L9734	25
02207005	35444	L9735	25
02207006	35445	L9736	25
02207007	35446	L9737	25
02207008	35447	L9738	25
02207009	35448	L9739	25
02207010	35450	L9722	25

\* Similar in application and function.





LEVITON CROSS REFERENCE

Hubbell/Kellems* Cat#	Woodhead* Cat#	Leviton Cat#	Catalog Page#	Hubbell/Kellems* Cat#	Woodhead* Cat#	Leviton Cat#	Catalog Page#
02207011	35451	L9723	25	03303009	35909	L8519	8
02207012	35452	L9724	25	03303010	35910	L8523	8
02207013	35453	L9725	25	03303011	35911	L8524	8
022291000	36670	L8807	28	03303012	35912	L8525	8
022291001	36671	L8808	28	03303013	35913	L8526	8
022291002	36672	L8809	28	03303015	35914	L8527	8
022291003	36673	L8811	28	03303016	35915	L8528	8
022291004	36674	L8812	28	03303017	35916	L8529	8
022291005	36675	L8813	28	03303018	35917	L8530	8
022291006	36676	L8814	28	03303019	35918	L8531	8
022291008	36690	L8823	28	03303029	35919	L8532	8
022291009	36691	L8824	28	033041082	35940	L8551	10
022291010	36692	L8825	28	033041083	35941	L8552	10
022291011	36693	L8826	28	033041084	35942	L8553	10
022291012	36694	L8827	28	033041085	35943	L8554	10
022291013	36695	L8828	28	033041086	35944	L8555	10
022291014	36696	L8829	28	033041087	35945	L8556	10
022291016	36680	L8815	28	033041088	35946	L8557	10
022291017	36681	L8816	28	033041089	35947	L8558	10
022291018	36682	L8817	28	033041090	35948	L8559	10
022291019	36683	L8818	28	033041091	35950	L8563	10
022291020	36684	L8819	28	033041092	35951	L8564	10
022291021	36685	L8821	28	033041093	35952	L8565	10
022291022	36686	L8822	28	033041094	35953	L8566	10
03301001	35850	L8581	11	033041095	35954	L8567	10
03301002	35851	L8582	11	033041096	35955	L8568	10
03301011	35865	L8601	11	033041097	35956	L8569	10
03301012	35866	L8602	11	03305001	35970	L8500	8
03301013	35867	L8583	8	03305002	35971	L8501	8
03301014	35868	L8584	11	03305003	35972	L8502	8
03301016	35869	L8585	11	03305004	35973	L8503	8
03301017	35870	L8586	11	03305005	35974	L8504	8
03301018	35871	L8587	11	03305006	35975	L8505	8
03301019	35872	L8588	11	033051114	35976	L8510	8
03301020	35873	L8589	11	03308003	36101	L8671	14
03301021	35874	L8591	11	03308004	36102	L8672	14
03301024	35880	L8603	11	03308005	36103	L8673	14
03301025	35881	L8604	11	03308006	36104	L8674	14
03301026	35882	L8605	11	03308007	36105	L8675	14
03301027	35883	L8606	11	03308008	36106	L8676	14
03301028	35884	L8607	11	03308009	36107	L8677	14
03301029	35885	L8608	11	03308010	36108	L8678	14
03301030	35886	L8609	11	03308011	36109	L8679	14
03301031	35887	L8611	11	03308012	36111	L8681	14
03301039	35897	L8612	11	03308013	36112	L8682	14
03301045	35899	L8614	11	03308014	36113	L8683	14
03301047	35898	L8613	11	03308015	36114	L8684	14
033011017	35875	L8592	11	03308016	36115	L8685	14
03302016	36620	L8621	12	03308017	36116	L8686	14
03302018	36621	L8622	12	03308018	36117	L8687	14
03302020	36622	L8623	12	03308019	36118	L8688	14
03302022	36623	L8624	12	03309003	36120	L8691	14
03302024	36624	L8625	12	03309004	36121	L8692	14
03302026	36625	L8626	12	03309005	36122	L8693	14
03302028	36626	L8627	12	03309006	36123	L8694	14
03302044	36640	L8641	12	03309007	36124	L8695	14
03302046	36641	L8642	12	03309008	36125	L8696	14
03302048	36642	L8643	12	03309009	36126	L8697	14
03302050	36643	L8644	12	03309010	36127	L8698	14
03302052	36644	L8645	12	03309011	36128	L8699	14
03302054	36645	L8646	12	03309012	36130	L8701	14
03302056	36646	L8647	12	03309013	36131	L8702	14
03302066	36627	L8628	12	03309014	36132	L8703	14
03302097	36628	L8629	12	03309015	36133	L8704	14
033021030	36629	L8631	12	03309016	36134	L8705	14
033021031	36630	L8632	12	03309017	36135	L8706	14
033021078	36647	L8648	12	03309018	36136	L8707	14
033021079	36648	L8649	12	03309019	36137	L8708	14
033021080	36649	L8651	12	03310001	36140	L8711	14
033021081	36650	L8652	12	03310002	36141	L8712	14
03303001	35901	L8511	8	03310003	36142	L8713	14
03303002	35902	L8512	8	03310004	36143	L8714	14
03303003	35903	L8513	8	03310005	36144	L8715	14
03303004	35904	L8514	8	03310006	36145	L8716	14
03303005	35905	L8515	8	03310007	36146	L8717	14
03303006	35906	L8516	8	03310008	36147	L8718	14
03303007	35907	L8517	8	03310009	36148	L8719	14
03303008	35908	L8518	8	03310010	36149	L8721	14

\* Similar in application and function.



## WIRE MESH SAFETY GRIPS

### LEVITON CROSS REFERENCE

Hubbell/Kellems* Cat#	Woodhead* Cat#	Leviton Cat#	Catalog Page#
03310011	36150	L8722	14
033271037	36610	L8660	12
033271038	36611	L8661	13
033271039	36612	L8662	13
033271040	36613	L8663	13
033271041	36614	L8664	13
033271042	36615	L8665	13
033291000	36660	L8801	9
033291001	36661	L8802	9
033291002	36662	L8803	9
033291003	36663	L8804	9
033291004	36664	L8805	9
033291005	36665	L8806	9
073031206	36501	L7501	15
073031207	36503	L7502	15
073031208	36505	L7503	15
073031209	36508	L7504	15
073031210	36512	L7505	15
073031211	36515	L7506	15
073031212	36516	L7507	15
073031213	36517	L7508	15
073031214	36518	L7509	15
073031215	36519	L7511	15
073041276	36560	L7981	27
073041277	36562	L7982	27
073041278	36564	L7983	27
073041279	36567	L7984	27
073041280	36569	L7985	27
073041281	36571	L7986	27
073041282	36574	L7987	27
073041283	36580	L7988	27
073041284	36582	L7991	27
073041285	36584	L7992	27
073041286	36587	L7993	27
073041287	36589	L7994	27
073041288	36591	L7995	27
073041289	36594	L7996	27
07310001	36550	L8001	9
07310002	36551	L8002	9
07310003	36552	L8003	9
07310004	36553	L8004	9
07310005	36554	L8005	9
07310006	36555	L8006	9
07401001	36430	L7702	18
07401002	36431	L7703	18
07401003	36432	L7704	18
07401004	36250	L7705	18
07401006	36251	L7706	18
07401008	36254	L7707	18
07401010	36256	L7708	18
07401013	36257	L7711	18
07401015	36259	L7712	18
07401017	36261	L7700	18
07401018	36263	L7713	18
07401019	36275	L7716	18
07401021	36265	L7717	18
07401023	36267	L7718	18
07401025	36269	L7719	18
07401026	36271	L7724	18
07401027	36272	L7725	18
07401028	36273	L7726	18
07401029	36475	L7729	18
07401030	36476	L7731	18
07401031	36477	L7732	18
07401032	36478	L7733	18
07401033	36486	L7736	18
07401035	36487	L7737	18
07401036	36433	L7821	18
07401037	36434	L7822	18
07401038	36435	L7823	18
07401039	36280	L7824	18
07401041	36282	L7825	18
07401043	36284	L7826	18
07401045	36286	L7827	18
07401048	36290	L7828	18
07401050	36292	L7829	18
07401052	36294	L7831	18
07401053	36296	L7832	18

Hubbell/Kellems* Cat#	Woodhead* Cat#	Leviton Cat#	Catalog Page#
07401056	36298	L7834	18
07401058	36300	L7835	18
07401060	36302	L7836	18
07401074	36340	L7761	18
07401076	36342	L7762	18
07401078	36344	L7763	18
07401080	36346	L7764	18
07401081	36349	L7766	18
07401083	36351	L7767	18
07401084	36353	L7768	18
07401087	36355	L7772	18
07401089	36357	L7773	18
07401091	36359	L7774	18
074011021	36314	L7803	18
074011028	36276	L7722	18
074011030	36800	L7739	18
074011032	36801	L7741	18
074011033	36802	L7742	18
074011034	36803	L7743	18
074011036	36807	L7746	18
074011037	36808	L7747	18
074011038	36810	L7749	18
074011038	36809	L7748	18
074011039	36811	L7751	18
074011042	36363	L7778	18
074011044	36470	L7782	18
074011045	36471	L7783	18
074011046	36472	L7784	18
074011047	36473	L7785	18
074011049	36321	L7807	18
074011051	36323	L7808	18
074011055	36326	L7811	18
074011057	36328	L7812	18
074011059	36333	L7810	18
074011061	36335	L7820	18
07401108	36362	L7777	18
074011178	36274	L7727	18
074011186	36812	L7752	18
074011187	36813	L7753	18
074011188	36814	L7754	18
074011189	36815	L7755	18
074011195	36249	L7715	18
074011199	36330	L7813	18
074011232	36834	L7786	18
074011234	36500	L7791	18
074011236	36312	L7802	18
074011237	36316	L7804	18
074011238	36319	L7806	18
074011244	36497	L7787	18
074011245	36498	L7788	18
074011246	36499	L7789	18
074011247	36245	L7709	18
074011249	36248	L7714	18
074011250	36270	L7721	18
074011251	36277	L7723	18
074011252	36278	L7728	18
074011255	36481	L7750	18
074011256	36488	L7738	18
074011258	36484	L7734	18
074011259	36485	L7735	18
074011263	36287	L7720	18
074011264	36288	L7730	18
074011266	36805	L7740	18
074011266	36804	L7744	18
074011331	5522M	L7521	16
074011332	5526M	L7529	16
074011333	5530M	L7538	16
074011334	5532M	L7543	16
074011334	5534M	L7545	16
074011335	5536M	L7547	16
074011336	5538M	L7552	16
074011337	5542M	L7561	16
074011338	5544M	L7565	16
074011339	5546M	L7567	16
074011340	5548M	L7571	16
074011341	5552M	L7579	16
074011342	5556M	L7588	16
074011343	5560M	L7597	16

\* Similar in application and function.



LEVITON CROSS REFERENCE

Hubbell/Kellems* Cat#	Woodhead* Cat#	Leviton Cat#	Catalog Page#
074011345	5523M	L7523	16
074011346	5527M	L7532	16
074011347	5531M	L7541	16
074011348	5533M	L7544	16
074011348	5535M	L7546	16
074011349	5537M	L7549	16
074011350	5539M	L7554	16
074011351	5543M	L7563	16
074011352	5545M	L7566	16
074011354	5549M	L7573	16
074011355	5553M	L7582	16
074011356	5557M	L7591	16
074011357	5561M	L7599	16
07401137	36361	L7776	18
07409022	36380	L7952	19
07409023	36381	L7953	19
07409024	36382	L7954	19
074090522	37031	L7911	19
074093511	36440	L7901	19
074093512	36370	L7902	19
074093513	36371	L7903	19
074093514	36372	L7904	19
074093515	36373	L7905	19
074093516	36374	L7906	19
074093518	36375	L7907	19
074093520	37030	L7908	19
074093526	37032	L7912	19
074093541	36443	L7915	19
074093542	36400	L7916	19
074093543	36401	L7917	19
074093544	36402	L7918	19
074093545	36403	L7919	19
074093546	36404	L7921	19
074093550	37033	L7923	19
074093552	37034	L7924	19
074093556	37035	L7925	19
074093561	36442	L7931	19
074093562	36390	L7932	19
074093563	36391	L7933	19
074093564	36392	L7934	19
074093565	36393	L7935	19
074093566	36394	L7936	19
074093568	36395	L7937	19
20302001	36237	L7997	27
20302002	36238	L7998	27
CG40490NM	5523NM	L7524	16
CG404NM	5522NM	L7522	16
CG40690NM	5527NM	L7533	16
CG406NM	5526NM	L7531	16
CG40890NM	5531NM	L7542	16
CG408NM	5530NM	L7539	16
CG60890NM	5537NM	L7551	16
CG608NM	5536NM	L7548	16
CG61090NM	5539NM	L7555	16
CG610NM	5538NM	L7553	16
CG61290NM	5543NM	L7564	16
CG612NM	5542NM	L7562	16
CG81090NM	5549NM	L7574	16
CG810NM	5548NM	L7572	16
CG81290NM	5553NM	L7583	16
CG812NM	5552NM	L7581	16
CG81490NM	5557NM	L7592	16
CG814NM	5556NM	L7589	16
CG81690NM	5561NM	L7590	16
CG816NM	5560NM	L7598	16
H0389CNK	37100-90	L7999	16
H038CNK	37100	L7961	16
H0509CNK	37101-90	L7990	19
H050CNK	37101	L7962	19
H0759CNK	37102-90	L7967	19
H075CNK	37102	L7963	19
H1009CNK	37103-90	L7968	19
H100CNK	37103	L7964	19
H1259CNK	37104-90	L7969	19
H125CNK	37104	L7965	19
H1509CNK	37105-90	L7971	19
H150CNK	37105	L7966	19
H2009CNK	37106-90	L7972	19

Hubbell/Kellems* Cat#	Woodhead* Cat#	Leviton Cat#	Catalog Page#
H200CNK	37106	L7970	19
N/A	5524M	L7525	16
N/A	5524NM	L7526	16
N/A	5525M	L7527	16
N/A	5525NM	L7528	16
N/A	5528M	L7534	16
N/A	5528NM	L7535	16
N/A	5529M	L7536	16
N/A	5529NM	L7537	16
N/A	5540M	L7556	16
N/A	5540NM	L7557	16
N/A	5541M	L7558	16
N/A	5541NM	L7559	16
N/A	5546NM	L7568	16
N/A	5547NM	L7569	16
N/A	5550M	L7575	16
N/A	5550NM	L7576	16
N/A	5551M	L7577	16
N/A	5551NM	L7578	16
N/A	5554M	L7584	16
N/A	5554NM	L7585	16
N/A	5555M	L7586	16
N/A	5555NM	L7587	16
N/A	5558M	L7593	16
N/A	5558NM	L7594	16
N/A	5559M	L7595	16
N/A	5559NM	L7596	16
N/A	5620M	L7601	16
N/A	5620NM	L7602	16
N/A	5621M	L7603	16
N/A	5621NM	L7604	16
N/A	5622M	L7605	16
N/A	5622NM	L7606	16
N/A	5623M	L7607	16
N/A	5623NM	L7608	16
N/A	5624M	L7609	16
N/A	5624NM	L7611	16
N/A	5625M	L7612	16
N/A	5625NM	L7613	16
N/A	36490	L7701	18
N/A	36806	L7745	18
N/A	36482	L7760	18
N/A	36347	L7765	18
N/A	36829	L7769	18
N/A	36830	L7771	18
N/A	36831	L7775	18
N/A	36364	L7779	18
N/A	36469	L7781	18
N/A	36310	L7801	18
N/A	36317	L7805	18
N/A	36827	L7809	18
N/A	36819	L7833	18
N/A	37036	L7938	19
N/A	37037	L7939	19
N/A	37038	L7941	19
N/A	36441	L7951	19
N/A	35990	L8540	8
N/A	35930	L8541	9
N/A	35931	L8542	9
N/A	35932	L8543	9
N/A	35933	L8544	9
N/A	35934	L8545	9
N/A	35935	L8546	9
N/A	35936	L8550	9
N/A	35980	L8560	10
N/A	35960	L8572	10
N/A	35961	L8573	10
N/A	35962	L8574	10
N/A	35963	L8575	10
N/A	35964	L8576	10
N/A	35965	L8577	10
N/A	35966	L8578	10
N/A	36010	L8600	11

\* Similar in application and function.

## Discover the Leviton Family of Industrial Products



Leviton Industrial Specification Grade products offer unmatched quality, performance and durability for demanding real-world usage. They are built of the finest materials to meet your most stringent specifications. You can depend on Leviton products to stand up to chemicals, heat, cold, rough use and other punishing conditions. For more information, contact your local Leviton representative today.

*Distributed by:*

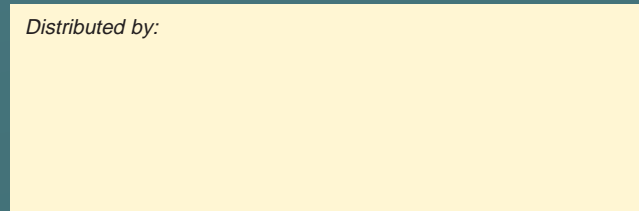

**Leviton Manufacturing Company, Inc.**  
59-25 Little Neck Parkway, Little Neck, NY 11362-2591  
Phone: 1-800-323-8920 Tech Line: 1-800-824-3005 FAX: 1-800-832-9538

**Leviton Mfg. of Canada, Ltd.**  
165 Hymus Blvd., Pointe Claire, Quebec H9R 1E9  
Phone: 1-800-469-7890 FAX: 1-800-563-1853

Visit us at <http://www.leviton.com>

© 1998 Leviton Manufacturing Company. All rights reserved.