



**Southwire™**

TOOLS & EQUIPMENT

# 2017 JOBSITE SOLUTIONS CATALOG



BUILT FOR DURABILITY.  
BUILT FOR RELIABILITY.  
BUILT FOR WORK.™

[SOUTHWIRETOOLS.COM](http://SOUTHWIRETOOLS.COM)

# OUR STORY

For over 60 years, Southwire has provided high quality electrical wire and cable to the commercial and industrial construction industries. Now, the name you trust provides durable, cutting-edge, professional grade tools, designed with safety and productivity in mind. Look to Southwire for solutions to all your electrical needs, from electrician's hand tools, meters, contractor equipment, temporary power and extension cords.

## SOUTHWIRE, THE COMPANY

Southwire Company, LLC is North America's leading manufacturer of wire and cable used in the distribution and transmission of electricity. Throughout its history, our company has sought to help provide power through our products, our service and by helping empower our customers, employees and communities.

## SOUTHWIRE, THE PEOPLE

With more than 6,800 people at customer service centers, manufacturing facilities and sales offices throughout North America, we are dedicated to developing the highest-quality products and legendary service.

## THE DRIVE FOR EXCELLENCE

Driving for excellence starts with being responsive to our customers and the markets we serve. By creating business units, Southwire Company enables each to foster an entrepreneurial spirit, innovative solutions and responsiveness required in today's business. At the same time each division can leverage the resources and rich history of Southwire Company as a whole.

## THE PRODUCTS

To be successful requires products that give you solutions no matter what stage of the project cycle you are in. Our product teams and dedicated resources work together to listen to and work with our customers, creating solutions that deliver unparalleled value through product innovation, safety and efficiency.

## THE SERVICE

Service is more than a word or a phone number, it's a tangible support system that assists you through the entire project cycle. Starting with our own knowledgeable customer service team, to our National Field Sales team, and our District Merchandising Specialists. In the office or in the field, we're there to lend a hand, just when you need it most. Feel free to reach us at 1-855-SWTOOLS (855-798-6657)



# TABLE OF CONTENTS

## HAND TOOLS

Pliers .....	5
Stripping & Cutting .....	10
Drivers .....	17
Measuring & Levels.....	30
Fishing .....	33
Benders.....	39
Bending Accessories .....	40
Kits & Accessories .....	42
Roto-Split .....	50
Roto-Flex .....	54
Roto-Blades .....	55
Strip-All .....	59
Hole Making .....	63

## TEST & MEASUREMENT

Multimeters .....	78
Clamp Meters .....	90
Voltage Detectors & Testers .....	98
IR Thermometers.....	109
Imaging .....	113
Circuit Testers .....	114

## VOICE • DATA • VIDEO

Cutting Tools.....	117
Prep & Strip.....	120
Terminate .....	123
Test .....	128

## EQUIPMENT

Pullers .....	137
Feeders.....	140
Pulling Grips.....	142
Rope.....	143
Accessories.....	144
Termination.....	148
Conduit Bending.....	158
PVC Benders.....	161
Knockouts .....	165
Accessories.....	170
Material Handling .....	173
Reel Jacks .....	174
Screw Jax .....	177
Wire Carts .....	180
Wire Wagon Carts.....	182
Cabinets .....	185
Piano Boxes.....	186
Compact Chests.....	188

## SUMNER\* PRODUCTS

Lifts, Gantries, Stands, Dollies.....	191
---------------------------------------	-----

## PROLINE PRODUCTS

Cords.....	204
Portable Power.....	212
GFCI.....	214
Work Lights.....	217
Replacements.....	223
Automotive .....	224

# HAND TOOLS

Your hands are your most important tools, the ones you need for every job. Equip them with high-quality, durable hand tools from Southwire™. With a strong yet comfortable design and limited lifetime warranty\*, you can rely on these tools to make your life easier and last through years of hard work.

- Pliers
- Stripping & Cutting
- Drivers
- Measuring & Levels
- Fishing & Benders
- Kits & Accessories
- Tool Bags
- Hole Making



\*Limited warranty available on most tools

## HIGH LEVERAGE DIAGONAL CUTTING PLIERS

### DCP8



The high leverage design of these diagonal cutting pliers provides greater cutting power while the hot riveted joint ensures smooth action with no handle wobble.

- Induction hardened cutting blades ensure efficient and lasting cutting surfaces

### DCPA8



- Drop forged CRV steel for durability
- High leverage design provides maximum cutting power
- Hot riveted pivot joint provides smooth action and no wobble
- Effectively cuts most hardened wire, ACSR, bolts, screws, and nails
- Available in dual molded comfort grips and plastic dipped handles

### DCP8D



## SPECIFICATIONS

### COMFORT GRIP

MODEL #	STOCK #	DESCRIPTION		
DCP8	589933	8" High Leverage Diagonal Cutting Pliers		
DCPA8	589932	8" High Leverage Diagonal Cutting Pliers w/ Angled Head		
	HEIGHT	WIDTH	DEPTH	WEIGHT
DCP8	8.25"	2.25"	0.75"	11.6 oz
DCPA8	8.25"	2.25"	0.75"	11.6 oz

### DCPA8D



### DIPPED GRIP

MODEL #	STOCK #	DESCRIPTION		
DCP8D	582894	8" High Leverage Diagonal Cutting Pliers w/ Dipped Handle		
DCPA8D	582895	8" High Leverage Diagonal Cutting Pliers w/ Angled Head and Dipped Handle		
DCP6D	58739601	6" High Leverage Diagonal Cut Pliers Dip Handle		
	HEIGHT	WIDTH	DEPTH	WEIGHT
DCP8D	8"	2"	0.63"	9.8 oz
DCPA8D	8"	2"	0.63"	9.8 oz
DCP6D	6"	2"	0.63"	10 oz

### DCP6D

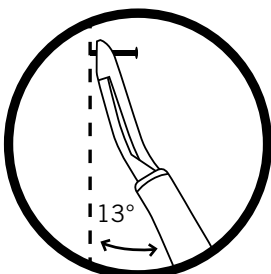

\*DCPA8 and DCPA8D



# PLIERS

## HIGH LEVERAGE SIDE CUTTING PLIERS

SCP9TPC



SCP9C



SCP9



SCP9CD



SCP9D



Our high leverage side cutting pliers offer streamlined design with sure-gripping, cross-hatched knurled jaws.

- Induction hardened cutting blades ensure efficient and lasting cutting surfaces for hard and soft wire
- Drop forged CRV steel for durability
- File teeth on jaws help remove burrs in conduit
- Curved ergonomic handle for comfortable use

### SPECIFICATIONS

#### COMFORT GRIP

MODEL #	STOCK #	DESCRIPTION		
SCP9TPC	589931	High Leverage Side Cutting Pliers w/ Fish Tape Puller & Crimper		
SCP9C	589930	High Leverage Side Cutting Pliers w/ Crimper		
SCP9	589929	High Leverage Side Cutting Pliers		
	HEIGHT	WIDTH	DEPTH	WEIGHT
SCP9TPC	9.5"	2.5"	0.88"	19 oz
SCP9C	9.5"	2.5"	0.88"	19 oz
SCP9	9.5"	2.5"	0.88"	19 oz

#### DIPPED GRIP

MODEL #	STOCK #	DESCRIPTION		
SCP9D	582898	High Leverage Diagonal Cutting Pliers w/ Dipped Handle		
SCP9CD	587491	High Leverage Diagonal Cutting Pliers W/Crimper Dipped Handles		
	HEIGHT	WIDTH	DEPTH	WEIGHT
SCP9D	9.5"	2.13"	0.75"	19 oz
SCP9CD	9.5"	2.13"	0.75"	19 oz



## LONG NOSE PLIERS

**LNP8S**



Southwire long nose pliers provide a better grip without sacrificing tool strength or durability.

- Knurled jaws for sure gripping
- High leverage, hot rivet design for smooth action and no handle wobble
- Drop forged CRV steel for durability
- Long nose design for forming and looping wire and handling small parts
- Precision induction hardened cutting knives
- 12 AWG solid wire stripping feature on LNP8S and LNP8SD models

**LNP7**



**LNP6**



**LNP8SD**



**LNP7D**



**LNP6D**



## SPECIFICATIONS

### COMFORT GRIP

MODEL #	STOCK #	DESCRIPTION		
LNP8S	589928	8" Heavy Duty Long Nose Pliers w/ Side Cutting Stripper		
LNP7	589927	7" Long Nose Pliers w/ Side Cutter		
LNP6	589926	6" Long Nose Pliers w/ Side Cutter		
	HEIGHT	WIDTH	DEPTH	WEIGHT
LNP8S	8.5"	2.13"	0.88"	10.3 oz
LNP7	7.13"	2.25"	0.75"	5.7 oz
LNP6	7"	2.25"	0.75"	5.5 oz

### DIPPED GRIP

MODEL #	STOCK #	DESCRIPTION		
LNP8SD	582897	8" Hvy. Dty. Long Nose Pliers Side Cutting Stripper Dipped Handle		
LNP7D	587490	7" Long Nose Pliers w/ Side Cut Dipped Handle		
LNP6D	582896	6" Long Nose Pliers w/ Side Cut Dipped Handle		
	HEIGHT	WIDTH	DEPTH	WEIGHT
LNP8SD	8.38"	2.13"	0.63"	10.3 oz
LNP7D	7.38"	2.13"	0.63"	6 oz.
LNP6D	6.88"	2.13"	0.63"	5 oz



# PLIERS

## PUMP PLIERS



Our tongue and groove design provides a firm and secure grip in a wide range of versatile jaw positions.

- V-jaw design allows for greater holding force and better surface contact
- Undercut tongue and groove design resists slipping
- Smoothly adjusts between seven machined tongue and groove jaw positions
- Right angle, laser heat-treated teeth grip better and last longer
- High-carbon, CRV polished steel
- Molded comfort grip for comfortable use

## SPECIFICATIONS

MODEL #	STOCK #	DESCRIPTION	HEIGHT	WIDTH	DEPTH	WEIGHT
PP16	58739501	16" Pump Pliers	16.25"	3.5"	0.63"	2.35 oz
PP12	58739301	12" Pump Pliers	12.63"	3"	0.63"	1.35 oz
PP10	589937	10" Pump Pliers	10.5"	2.5"	0.44"	15.5 oz
PP6	589938	6 1/2" Pump Pliers	7"	2"	0.5"	7.6 oz

## CRIMPING/CUTTING PLIERS - INSULATED AND NON-INSULATED CONNECTORS



These high leverage crimping pliers have two die positions that permit the tool to crimp insulated and non-insulated terminals and ferrules.

- Tapered nose for working in confined spaces
- Crimps 10-22 AWG solderless terminals and connectors
- Specially hardened wire cutter in nose
- Curved handle and ergonomic molded grip for comfortable use
- Crimps insulated and non-insulated terminals and connectors

## SPECIFICATIONS

MODEL #	STOCK #	DESCRIPTION	HEIGHT	WIDTH	DEPTH	WEIGHT
TCC9D	582899	Terminal Crimper Cutter w/ Dipped Handle	9.75"	2.38"	0.63"	12.7 oz
TCC9	589936	Terminal Crimper Cutter	9.38"	1.88"	0.75"	13.7 oz



## 5-IN-1 MULTI TOOL PLIERS



This versatile pair of spring action pliers performs multiple functions.

- Multi-functional pliers: grips, strips, crimps, reams, and cuts
- Narrow knurled jaw allows access to tight spaces
- Cuts small gauge copper wire and communication cables
- Crimps common size wire ferrules
- Reams and smooths thin-wall conduit ends
- Easily strips 10-14 AWG solid wire
- Durable forged construction for lasting performance
- Comfortable grips minimize hand wear and fatigue



### SPECIFICATIONS

MODEL #	STOCK #	DESCRIPTION		
S5N1	589939	5-IN-1 Multi Tool Pliers w/ Comfort Grip		
	HEIGHT	WIDTH	DEPTH	WEIGHT
S5N1	8.25"	2.5"	0.63"	5.6 oz

## MULTI-PURPOSE SIDE CUTTING PLIER



Multi-Purpose Side Cutting Plier cuts ACSR, screws, nails, and most hardened wire.

- Drop forged construction
- High-leverage pivot joint
- Strips 8-14 AWG solid wire and 10-16 stranded wire
- 6-32 and 8-32 screw shearing

### SPECIFICATIONS

MODEL #	STOCK #	DESCRIPTION		
MPSCP	59724401	Multi Purpose Side Cutting Plier		
	HEIGHT	WIDTH	DEPTH	WEIGHT
MPSCP	11.38"	3.75"	1.50"	0.6 lb.

# STRIPPING & CUTTING

## WIRE STRIPPERS & CUTTERS

### S1018SOL



Made of stainless steel, these wire strippers have precision ground stripping holes and are fitted with comfortable double-dipped plastic grips.

- Stainless steel construction is durable and rust-proof
- Serrated nose grasps the cable for easy twisting and pulling
- Specially designed cutting blades provide fast and clean wire stripping and cutting
- Spring loaded for self-opening action
- Double dipped grip provides comfortable feel

### S1018STR



### S612STR



### S1626STR



## SPECIFICATIONS

MODEL #	STOCK #	DESCRIPTION		
S1018SOL	582780	Wire Stripper Cutter 10-18SOL;12-20 Stranded Ergonomic Handle		
S1018STR	582781	Compact Stripper Cutter 10-18 AWG Soild		
S612STR	582779	Wire Stripper Cutter 6-12 AWG Stranded Ergonomic Handle		
S1626STR	582782	Compact Stripper Cutter 16-26 AWG Stranded		
	HEIGHT	WIDTH	DEPTH	WEIGHT
S1018SOL	7.63"	8.38"	0.69"	5.3 oz
S1018STR	6.25"	2.38"	0.69"	4.6 oz
S612STR	7.38"	2.5"	0.63"	5.3 oz
S1626STR	6.25"	2"	0.69"	4.5 oz

# STRIPPING & CUTTING

## WIRE STRIPPERS & CUTTERS

### SNM1012



Made of stainless steel, these wire strippers have precision ground stripping holes and are fitted with comfortable double-dipped plastic grips.

- Stainless steel\* construction is durable and rust-proof
- Serrated nose grasps the cable for easy twisting and pulling
- Specially designed cutting blades provide fast and clean wire stripping and cutting
- Spring loaded for self-opening action (on models SNM1012, SNM1214)
- Double dipped grip provides comfortable fit

### SNM1214



### MP61



### MPLN



### SVN



## SPECIFICATIONS

MODEL #	STOCK #	DESCRIPTION	HEIGHT	WIDTH	DEPTH	WEIGHT
SNM1012	582784	NM Cable Stripper Cutter 10-12 AWG Ergonomic Handle	8.13"	2.19"	0.69"	6 oz
SNM1214	582785	NM Cable Stripper Cutter 12-14 AWG Ergonomic Handle	7.88"	2.19"	0.69"	5.8 oz
MP61	582789	6-IN-1 Multipurpose Stripper	9"	2.38"	0.69"	6.8 oz
MPLN	582788	Long Nose Multipurpose Tool	8.5"	2.38"	0.75"	5.8 oz
SVN	582787	Wire Stripper V-Notch	5.25"	2.31"	0.44"	2.3 oz

\* Not available on SVN

# STRIPPING & CUTTING

## CABLE CUTTING PLIERS

CCP9



Shear type hook jaws grab and hold cable while shear cutting action makes clean cuts.

- Heat treated, precision ground blades ensure clean cuts
- Comfortable cushion grips reduce hand fatigue
- Forged steel with black-oxide finish for long life
- High leverage pivot joint ensures smooth action and no handle wobble

CCP6



### SPECIFICATIONS

#### COMFORT GRIP

MODEL #	STOCK #	DESCRIPTION		
CCP9	589935	9" High Leverage Cable Cutters		
CCP6	589934	6 1/2" Cable Cutting Shears		
CCP350	591585	16" Utility Cable Cutters 350 Cu		
	HEIGHT	WIDTH	DEPTH	WEIGHT
CCP9	9.38"	2.13"	0.63"	15 oz
CCP6	6.75"	2"	0.75"	8.6 oz
CCP350	17"	5"	0.75"	2.8 oz

CCP350



#### DIPPED GRIP

MODEL #	STOCK #	DESCRIPTION		
CCP9D	582932	9" High Leverage Cable Cutters w/ Dipped Handle		
CCP6D	587480	6 1/2" Cable Cutting Shears w/Dipped Handle		
	HEIGHT	WIDTH	DEPTH	WEIGHT
CCP9D	9.38"	2.25"	0.63"	15.4 oz
CCP6D	6.75"	2"	0.75"	8.2 oz

CCP9D



CCP6D



## CABLE CUTTERS



The blades on these heavy duty cutters ensure consistent cuts and long-term durability, while the rounded blade design minimizes cable distortion during cutting.

- Replaceable, hardened steel blades provide long lasting cutting of copper and aluminum cables
- Two-step ratcheting mechanism for fewer strokes per cut

### SPECIFICATIONS

MODEL #	STOCK #	DESCRIPTION		
CCPR400	582777	Ratcheting Cable Cutter		
	HEIGHT	WIDTH	DEPTH	WEIGHT
CCPR400	10.25"	5.5"	1.25"	31 oz
*MAXIMUM CUTTING POWER (COPPER)		*MAXIMUM CUTTING POWER (ALUMINUM)		
750 kcmil(MCM)		1000 kcmil(MCM)		

\*Note: Maximum cutting capacity is for single conductor wires

## CABLE RIPPING TOOL



This NM-B cable ripper makes cable jacket removal quick and easy. It slits the cable jacket with one easy stroke.

- Makes end or mid-run slits to expose insulated wires
- Easily slits the outer jacket on NM-B cable
- Accurate wire measuring gauge holes - 6 to 14 AWG solid wire

### SPECIFICATIONS

MODEL #	STOCK #	DESCRIPTION
CRT	582933	Cable Ripper Tool

## BOOT KNIFE



Our tough boot knife cuts electronic wire, telephone cables and skins cable jackets.

- Tough forged steel blade
- Use to cut electronic wire, telephone cables, & skin cable jackets
- Comes with protective storage cap

### SPECIFICATIONS

MODEL #	STOCK #	DESCRIPTION		
BN01	582884	Boot Knife		
	HEIGHT	WIDTH	DEPTH	WEIGHT
BN01	6.38"	1"	0.5"	2 oz

# STRIPPING & CUTTING

## ELECTRICIAN'S SCISSORS



Unlike regular scissors or shears, the serrated blades keep wire from slipping out of the jaws, so that cutting through hardware cloth, cable, wire netting, and other difficult-to-cut materials becomes an easy task.

- Durable nickel-plated steel for resistance from rust and corrosion
- Strips 19 AWG & 23 AWG
- Scraper and file on outside of both blades
- Cuts up to 16 AWG solid and 12 AWG stranded wire

### SPECIFICATIONS

MODEL #	STOCK #	DESCRIPTION		
ES001	582835	Electricians Scissors		
	HEIGHT	WIDTH	DEPTH	WEIGHT
ES001	5.38"	2.19"	0.38"	3 oz

## ELECTRICIAN'S MULTI TOOL



Meets the needs of electricians and maintenance professionals with features that come in handy on any job.

- Specially designed for electricians
- Stainless steel construction
- Strips 10-20 AWG, cuts, pulls, screws, saws, tightens and files

### SPECIFICATIONS

MODEL #	STOCK #	DESCRIPTION		
MT001	582834	Electrician's Multi Tool		
	HEIGHT	WIDTH	DEPTH	WEIGHT
MT001	4"	1.75"	1"	10.8 oz

## 6-IN-1 UTILITY KNIFE



A multi-purpose tool that helps with most of those "around-the-job" needs. A must-have pocket tool for every electrician.

- Six tools in one:
  - Quick change utility blade
  - #2 phillips screwdriver
  - Sanding rasp to trim excess or rough edges
  - Keyhole saw
  - Nail and tack puller and holder
  - Hammer butt end

### SPECIFICATIONS

MODEL #	STOCK #	DESCRIPTION		
UTIL61	582885	6-IN-1 Utility Knife		
	HEIGHT	WIDTH	DEPTH	WEIGHT
UTIL61	5"	1.25"	0.88"	10.9 oz

## AUTOMATIC WIRE STRIPPER



With this wire stripper, insert a wire, squeeze the handles, and you're finished.

- Strips 8-22 AWG wire quickly and easily
- Removes up to 1" of jacket layer with single step
- Spring design returns wire to ready position after stripping

### SPECIFICATIONS

MODEL #	STOCK #	DESCRIPTION	HEIGHT	WIDTH	DEPTH	WEIGHT
SA822	582786	Wire Stripper Automatic 8-22 AWG				
SA822			7"	3.38"	1.13"	13 oz

## ELECTRICIAN'S HACKSAW



An essential tool for plumbers, electricians and HVAC professionals.

- Cushioned, ergonomic grip for performance and comfort
- Extra blade storage in frame
- Blades can be adjusted to 55 degree angle for flush cutting
- Forward handle can be removed and used as jab saw

### SPECIFICATIONS

MODEL #	STOCK #	DESCRIPTION	HEIGHT	WIDTH	DEPTH	WEIGHT
HSAW	582827	Electrician's Hacksaw				
HSAW			17"	6"	1"	2.1 oz

## DRYWALL JAB SAW



Our Drywall Jab Saw is designed with a triple cut blade for a fast and efficient cut. The sharp tip excels at plunge cutting, and its aggressive tooth design cuts fast.

- Hardened and tempered steel blade for long lasting durability and strength
- Sharp cross-ground teeth cut through drywall, wood, or plastic
- Overmolded cushion handle for comfort and firm grip
- 7" blade with cross-grained teeth cuts drywall in both directions

### SPECIFICATIONS

MODEL #	STOCK #	DESCRIPTION	HEIGHT	WIDTH	DEPTH	WEIGHT
DESAW	582824	Drywall Jab Saw				
DESAW			12"	1.63"	1.13"	4.7 oz

# STRIPPING & CUTTING

## TRIFOLD DRYWALL SAW



Ideal for flush cutting applications or when a hacksaw is not available.

- Ergonomic handle for greater comfort
- Blade locks in three positions for safer operation
- Includes three blades 5"x18 TPI, 5"x6 TPI, 5"x9 TPI; accepts standard reciprocating

## CONDUIT SCORER AND CUTTER



Cut copper, aluminum and brass tubing and galvanized thin wall conduit in a few revolutions.

- Scores and cuts EMT conduit
- Cutting wheel can be changed quickly and easily

## PLASTIC PIPE CUTTER



Our plastic pipe and tubing cutter has non-slip grips and a strong stainless steel blade that makes cutting plastic tubing easy.

- Easily performs flush cuts on ridged plastic tubing
- Durable design for rugged use
- Locking latch allows easy one-handed operation
- Cuts up to 3/4" PVC and 1-5/8" flexible tubing

## ROTARY CABLE CUTTER



Easily handles all common MC, BX, and flex cables. Securely holds cable in place and releases quickly.

- Quickly splits the armored jacket on 14-2 to 10-4 armored cables and 3/8" flexible conduit with a few turns of the handle
- Adjustable cutting depth for standard and reduced diameter BX/MC cables
- Stores up to 6 extra blades in handle knob
- Durable die cast epoxy enameled construction

## SPECIFICATIONS

MODEL #	STOCK #	DESCRIPTION	HEIGHT	WIDTH	DEPTH	WEIGHT
FDWSAW	582826	Trifold Drywall Saw	7"	1.5"	1.13"	11 oz
CONCUT	582820	Conduit Cutter Scorer	5.25"	2"	1.5"	15.4 oz
PLACUT	582821	Plastic Pipe Cutter	8.75"	1.83"	1.17"	5.6 oz
MCCUT	582822	BX MC Rotary Cutter w/Lever	7.5"	1.75"	3.5"	19 oz
MCBLADE	582823	BX MC Replacement Blade (1 blade/pack)	1"	1"	0.06"	0.1 oz



## PHILLIPS TIP SCREWDRIVERS

**SD2P6HD**



**SD2P4HD**



**SD1P3**



**SD2P1-1/2**



**SDI2P4**



Southwire's screwdrivers are designed for the professional with durability, quality and comfort in mind.

- Comfortable cushion grip handle offers slip resistance and greater torque
- Integral flanges provide a solid, twist-resistant blade anchor
- Handle end is marked for easy identification of tip type and size
- Chrome-plated, steel shaft for maximum torque with less shaft twisting
- Precision-machined, black phosphate coated tip reduces slipping

## SPECIFICATIONS

MODEL #	STOCK #	DESCRIPTION			
SD2P6HD	582851	#2 Phillips w/ 6" Heavy duty round shank			
SD2P4HD	582847	#2 Phillips Screwdriver w/ 4" Heavy duty round shank			
SD1P3	582849	#1 Phillips Screwdriver w/ 3" round shank			
SD2P1-1/2	582861	#2 Stubby Screwdriver w/ 1-1/2" shank			
SDI2P4	582843	#2 Phillips Screwdriver w/ 4" Insulated			
	HEIGHT	WIDTH	DEPTH	WEIGHT	
SD2P6HD	10.25"	1.25"	1.25"	7 oz	
SD2P4HD	6.5"	1.25"	1.25"	4.2 oz	
SD1P3	6.5"	1.13"	1.13"	2.4 oz	
SD2P1-1/2	3.75"	1.25"	1.25"	1.8 oz	
SDI2P4	8.5"	1"	1"	3.9 oz	
	SHANK TYPE		SHANK LENGTH		
SD2P6HD	ROUND W/BOLSTER		6"		
SD2P4HD	ROUND W/BOLSTER		4"		
SD1P3	ROUND		3"		
SD2P1-1/2	ROUND		1 1/2"		
SDI2P4	INSULATED		4"		

# DRIVERS

## KEYSTONE TIP SCREWDRIVERS

**SD5/16K6HD**



**SD1/4K4HD**



**SD1/4K1-1/2**



Southwire's screwdrivers are designed for the professional with durability, quality and comfort in mind.

- Integral flanges provide a solid, twist-resistant blade anchor
- Comfortable cushion grip handle offers slip resistance and greater torque
- Heavy duty models include bolster on shaft to provide additional torque
- Handle end is marked for easy identification of tip type and size
- Chrome-plated, steel shaft for application of maximum torque with less shaft twisting

## SPECIFICATIONS

MODEL #	STOCK #	DESCRIPTION		
SD5/16K6HD	582846	5/16" Keystone tip screwdriver w/ 6" Heavy Duty Square Shank		
SD1/4K4HD	582854	1/4" Keystone tip screwdriver w/ 4" Heavy Duty Shank		
SD1/4K1-1/2	582860	1/4" Keystone tip Stubby screwdriver		
	HEIGHT	WIDTH	DEPTH	WEIGHT
SD5/16K6HD	11"	1.25"	1.25"	6.5 oz
SD1/4K4HD	8.38"	1.25"	1.25"	3.2 oz
SD1/4K1-1/2	3.73"	1.25"	1.25"	2.4 oz
	HEAD CLASS	SHANK TYPE	SHANK LENGTH	
SD5/16K6HD	KEYSTONE	HD SQUARE	6"	
SD1/4K4HD	KEYSTONE	HD SQUARE	4"	
SD1/4K1-1/2	KEYSTONE	ROUND	1 1/2"	

## CABINET TIP SCREWDRIVERS

**SD1/4C6**



Southwire's screwdrivers are designed for the professional with durability, quality, and comfort in mind.

- Integral flanges provide a solid, twist-resistant blade anchor
- Comfortable cushion grip handle offers slip resistance and greater torque
- Heavy duty models include bolster on shaft to provide additional torque
- Handle end is marked for easy identification of tip type and size
- Chrome-plated, steel shaft for application of maximum torque with less shaft twisting

**SD1/4C4**



## SPECIFICATIONS

**SD3/16C6**



**SD3/16C4**



**SDI1/4K4**



MODEL #	STOCK #	DESCRIPTION			
SD1/4C6	582853	1/4" Cabinet Tip Screwdriver w/ 6" Round Shank			
SD1/4C4	582937	1/4" Cabinet Tip Screwdriver w/ 4" Round Shank			
SD3/16C6	582850	3/16" Cabinet-Tip Screwdriver w/ 6" Round Shank			
SD3/16C4	582852	3/16" Cabinet Tip Screwdriver w/ 4" Round Shank			
SDI1/4K4	582844	1/4" Flat Tip Screwdriver w/ 4" Insulated Shank			
		HEIGHT	WIDTH	DEPTH	WEIGHT
SD1/4C6		10.25"	1.25"	1.25"	3.9 oz
SD1/4C4		8.38"	1.25"	1.25"	3.9 oz
SD3/16C6		9.6 3"	1.13"	1.13"	7 oz
SD3/16C4		6.5"	1.13"	1.13"	3.2 oz
SDI1/4K4		8.38"	1.25"	1.25"	3.9 oz
		HEAD CLASS	SHANK TYPE	SHANK LENGTH	
SD1/4C6		CABINET	ROUND	6"	
SD1/4C4		CABINET	ROUND	4"	
SD3/16C6		CABINET	ROUND	6"	
SD3/16C4		CABINET	ROUND	4"	
SDI1/4K4		FLAT	ROUND/INSULATED	4"	

# DRIVERS

## SQUARE TIP SCREWDRIVERS

SDQ2P1-1/2



SDQ2P4

Southwire's screwdrivers are designed for the professional with durability, quality and comfort in mind.

- Chrome-plated, steel shaft for maximum torque with less shaft twisting
- Precision-machined, black phosphate coated tip reduces slipping
- Comfortable cushion grip handle offers slip resistance and greater torque
- Integral flanges provide a solid, twist-resistant blade anchor
- Handle end is marked for easy identification of tip type and size

### SPECIFICATIONS

MODEL #	STOCK #	DESCRIPTION		
SDQ2P1-1/2	582842	#2 Square Recessed Tip Screwdriver w/ 1.5" Shank		
SDQ2P4	582862	#2 Square Recessed Tip Screwdriver w/ 4" Shank		
	HEIGHT	WIDTH	DEPTH	WEIGHT
SDQ2P1-1/2	3.75"	1.25"	1.25"	1.8 oz
SDQ2P4	8.5"	1.25"	1.25"	3.8 oz
	HEAD CLASS	SHANK TYPE	SHANK LENGTH	
SDQ2P1-1/2	SQUARE	ROUND	1 1/2"	
SDQ2P4	SQUARE	ROUND	4"	

## CUSHION-GRIP SCRATCH AWL



Our heavy-duty, hard-pointed awl is perfect for scribing metal, starting screw holes and a variety of other piercing and punching jobs.

- Heavy duty chrome plated steel shaft
- Comfortable cushion grip handle offers slip resistance and greater torque

### SPECIFICATIONS

MODEL #	STOCK #	DESCRIPTION		
AWL001	582836	Scratch Awl		
	HEIGHT	WIDTH	DEPTH	WEIGHT
AWL001	6.75"	1.13"	1.13"	3 oz

## 5-IN-1 MULTI-BIT LIGHTED SCREWDRIVER



Convenient multi-bit screwdriver, 5 tools in one.

- Comfortable cushion grip handle offers slip resistance and greater torque
- Three LEDs illuminate work surface for better visibility
- Requires 3 AAA batteries (not included)
- Two double-sided quick change bits: #1 phillips, #2 phillips, 3/16" slotted and 1/4" slotted

## 9-IN-1 MULTI TOOL SCREWDRIVER



Convenient multi-tool screwdriver, 9 tools in one.

- Three double sided quick change bits and three hex head nut drivers:  
Includes 3/16", and 1/4" slotted, #1 & #2 phillips, #1 & #2 square tips, 1/4", 5/16", 3/8" hex drivers
- Comfortable cushion grip handle offers slip resistance and greater torque

## SCREWDRIVER WITH INTEGRATED WIRE STRIPPER



Driver with integrated wire stripper provides 2 applications in 1 tool.

- Integrated 10-20 AWG wire stripper in handle
- Two double sided bits: #1 & #2 phillips, 3/16" & 1/4" slotted
- Comfortable cushion grip handle offers slip resistance and greater torque
- Constructed of durable, heavy duty materials

## SPECIFICATIONS

MODEL #	STOCK #	DESCRIPTION	HEIGHT	WIDTH	DEPTH	WEIGHT	INCLUDES
SD5N1LITE	582939	5-IN-1 Multi Bit Lighted Screwdriver	8"	1.38"	1.238"	4 oz	Slotted Tips: 3/16", 1/4" Phillips Tips: #1, #2
SD9N1	582856	9-IN-1 Multi Tool Screwdriver	8.25"	1.25"	1.25"	9 oz	Slotted Tips: 3/16", 1/4" Phillips Tips: #1, #2 Hex Tips: 1/4", 5/16", 3/8" Square Tips: #1, #2
SDWS	582864	Screwdriver with Wire Stripper	8.5"	1.5"	1.5"	4.91 oz	10-20 AWG Solid Wire Stripper Slotted Tips: 3/16", 1/4" Phillips Tips: #1, #2

# DRIVERS

## 12-N-1 MULTI-BIT SCREWDRIVER

### SD12N1



**12-N-1 Multi-Bit Screwdriver with precision machined quick change bits.**

- Precision-machined quick change bits for driving hex, phillips, slotted, and square head screws
- Handles 3/16", 1/4", 5/16" Slotted; #1, #2, #3 Phillips; #1, #2, Square Recessed; and 1/4", 5/16", 3/8", 1/2" Hex Drive
- Cushion grip handle provides extra comfort and maximum torque
- Premium chrome-plated shaft is durable and rust- and corrosion-resistant
- Meets ANSI/ASME specifications

### SPECIFICATIONS

MODEL #	STOCK #	DESCRIPTION		
SD12N1	59723901	12-N-1 Multi-Bit Screwdriver		
	HEIGHT	WIDTH	DEPTH	WEIGHT
SD12N1	11.75"	3.25"	1.38"	0.85 lb.

## 9-N-1 RATCHETING SCREWDRIVER

### SDR9N1



**9-N-1 Ratcheting Multi-Tool Screwdriver allows for quick driving of screws and nuts.**

- Precision-machined quick change bits for driving hex, phillips, slotted and square head screws
- Handles 1/4-in, 3/8-in, 5/16-in Hex, #1 - #2 phillips, 1/4-in and 3/16-in slotted, #1 and #2 square
- Cushion grip handle provides extra comfort and maximum torque
- Premium chrome-plated shaft is durable and rust- and corrosion-resistant
- Meets ANSI/ASME specifications

### SPECIFICATIONS

MODEL #	STOCK #	DESCRIPTION		
SDR9N1	59724001	9-N-1 Ratcheting Screwdriver		
	HEIGHT	WIDTH	DEPTH	WEIGHT
SDR9N1	11.38"	3.75"	1.50"	0.6 lb.

## 6-IN-1 STUBBY MULTIBIT SCREWDRIVER

### SDS6N1



6-N-1 Multi-Bit Screwdriver features precision machined quick change bits.

- Includes 2 double sided screw driver bits and 1 double sided nut driver
- Sizes include 5/16" & 1/2" Hex, #1 & #2 Phillips, & 3/16" & 1/4" Slotted tips
- Cushion grip handles for added comfort and improved torque
- Durable chrome-plated shaft is rust and corrosion resistant

### SPECIFICATIONS

MODEL #	STOCK #	DESCRIPTION		
SDS6N1	58739701	6-IN-1 Stubby Multi-Bit Screwdriver		
	HEIGHT	WIDTH	DEPTH	WEIGHT
SDS6N1	3.50"	1.25"	1.25"	.20 lb.

## SDREV-1 REVERSIBLE-SHANK SCREWDRIVER, PHILLIPS



This reversible screwdriver has the two screwdriver sizes needed to work on wall plates and outlets.

- Phillips #1, Cabinet Tip #2
- Shank is easily reversed



### SPECIFICATIONS

MODEL #	STOCK #	DESCRIPTION
SDREV-1	587460	Reversible-Shank Screwdriver

# DRIVERS

## ROTARY SCREWDRIVERS



Rotary action screwdrivers facilitate fast and easy screw installation and removal.

- Chrome-plated, steel shaft spins to permit faster one-handed screwing than conventional screwdrivers
- Precision-machined tips reduce slipping
- Comfortable cushion grip handle offers slip resistance and greater torque
- Handle end is marked for easy identification of tip type and size

### SPECIFICATIONS

MODEL #	STOCK #	DESCRIPTION		
SD3/16CRD	582855	3/16" Cabinet Tip Crank Screwdriver		
SDC2P	582848	#2 Phillips Screwdriver CrankK		
	HEIGHT	WIDTH	DEPTH	WEIGHT
SD3/16CRD	10.5"	2"	1"	4.2 oz
SDC2P	10.5"	2"	1"	4.2 oz

## SCREW HOLDING SCREWDRIVERS



Protective sheath holds screws in place to allow one-handed operation

- Precision-machined, black phosphate coated tip reduces slipping
- Comfortable cushion grip handle offers slip resistance and greater torque
- Integral flanges provide a solid, twist-resistant blade anchor
- Handle end is marked for easy identification of tip type and size

### SPECIFICATIONS

MODEL #	STOCK #	DESCRIPTION			
SDSH1/4	582842	1/4" Slotted Screwholding Screwdriver			
SDSH2P6	582862	#2 Phillips Screwholding Screwdriver			
	HEIGHT	WIDTH	DEPTH	WEIGHT	HEAD SIZE
SDSH1/4	11.25"	1.25"	1.25"	4.9 oz	1/4"
SDSH2P6	11.25"	1.25"	1.25"	4.9 oz	#2
	HEAD CLASS	SHANK TYPE	SHANK LENGTH		
SDSH1/4	SLOTTED	SCREWHOLDING	6"		
SDSH2P6	PHILLIPS	SCREWHOLDING	6"		



## 4-PIECE MINI SCREWDRIVER SET



Versatile mini drivers for precise applications.

- Comfortable cushion grip handle offers slip resistance and greater torque
- Precision tips for an exact fit
- Includes 1/16", 3/32", and 1/8" slotted and #0 phillips tipped screwdrivers
- Handles marked for easy identification

## 8-PIECE CUSHION GRIP SCREWDRIVER SET



All-purpose assortment of frequently used screwdrivers.

- Comfortable cushion grip handle offers slip resistance and greater torque
- Precision tips for an exact fit
- Handles marked for easy identification
- Includes 8 pieces: 3/16"x4", 3/16"x6" and 1/4"x4" slotted tip, 1/4"x4" and 5/16"x6" keystone tip, and #1x3", #2x4", phillips tip & #2x4" square tipped screwdrivers

## 2-PIECE STUBBY SCREWDRIVER SET



Drivers for accurate fits in tight spaces.

- Comfortable cushion grip handle offers slip resistance and greater torque
- Precision tips for an exact fit
- Handles marked for easy identification
- #2 phillips and 1/4" keystone
- 1-1/2" shank

## SPECIFICATIONS

MODEL #	STOCK #	DESCRIPTION	HEIGHT	WIDTH	DEPTH	WEIGHT	INCLUDES
SDSET4MINI	582857	4 Piece Mini Screwdrivers	5.5"	0.75"	0.75"	3.5 oz	Slotted: 1/16 X 2-1/2", 3/32 X 3", 1/8 X 3" Phillips: #0 X 3"
SDSET8	582845	8 Piece Cushion Grip Screwdriver Set	11"	1.25"	1.25"	2.3 oz	SD3/16C4, SD3/16C6, SD1/4K4HD, SD1/4C4, SD5/16K6HD, SD1P3, SD2P4HD, SDQ2P4
SDSET2-3	582859	2 Piece Stubby Screwdriver Set	3.75"	1.25"	1.25"	3.6 oz	SD1/4K41-1/2, SD2P1-1/2

# DRIVERS

## NUT DRIVERS

ND1/2-3



Get to those hard to reach nuts/bolts with our hex head nut driver. The hollow shaft fits over long bolts and studs for most applications.

- Comfortable cushion grip handle offers slip resistance and greater torque
- Internal flanges provide solid, twist-resistant shaft anchor
- Chrome plated shanks are corrosion resistant
- Hollow 3" shafts for additional screw clearance

ND7/16-3



## SPECIFICATIONS

MODEL #	STOCK #	DESCRIPTION
ND1/2-3	582870	1/2" Nut driver with 3" Shank
ND7/16-3	582868	7/16" Nut driver with 3" Shank
ND3/8-3	582871	3/8" Nut driver with 3" Shank
ND5/16-3	582869	5/16" Nut driver with 3" Shank
ND1/4-3	582872	1/4" Nut driver with 3" Shank

	HEIGHT	WIDTH	DEPTH	WEIGHT	SHANK LENGTH
ND1/2-3	7.5"	1.25"	1.25"	4.2 oz	3"
ND7/16-3	7.5"	1.28"	1.25"	4.2 oz	3"
ND3/8-3	6.75"	0.38"	0.13"	4.2 oz	3"
ND5/16-3	6.75"	0.38"	0.13"	2.8 oz	3"
ND1/4-3	6.75"	0.38"	0.13"	2.8 oz	3"

ND3/8-3



ND5/16-3



ND1/4-3



## 7-PIECE NUT DRIVER SET



The 7-piece nut driver set has a compact design and is ideal for use in tight spaces and hard-to-reach fasteners.

- Hollow shafts for screw clearance
- Comfortable cushion grip handle offers slip resistance and greater torque
- Seven nutdriver sizes for all applications
- Internal flanges provide solid, twist-resistant shaft anchor

### SPECIFICATIONS

MODEL #	STOCK #	DESCRIPTION			
NDSET7	582873	7-Piece Nut Driver Set			
	HEIGHT	WIDTH	DEPTH	WEIGHT	SET INCLUDES
NDSET7	7.5"	1.25"	1.25"	32 oz	3/16", 1/4", 5/16", 11/32", 3/8", 7/16" and 1/2" Nut Drivers w/ 3" Shanks

## 2-PIECE NUT DRIVER SET



Includes 1/4" and 5/16" nut-drivers with 6" shanks.

- Comfortable cushion grip handle offers slip resistance and greater torque
- Precision tips for an exact fit
- Handles marked for easy identification
- Hollow shaft for screw clearance

### SPECIFICATIONS

MODEL #	STOCK #	DESCRIPTION			
NDSET2-6	582867	2-Piece 6" Nut Driver Set			
	HEIGHT	WIDTH	DEPTH	WEIGHT	SET INCLUDES
NDSET2-6	10"	1.25"	1.25"	9 oz	1/4" AND 5/16" Nut Driver with 6" Shank

# DRIVERS

## 2-PIECE MAGNETIC NUT DRIVER SET

### NDSET2-6M



2-Piece Magnetic Nut Driver Set with 6" shanks for screw clearance.

- Hollow 6-in shaft for screw clearance
- Includes 1/4-in and 5/16-in magnetic nut drivers
- Handles marked for easy identification
- Cushion grip handles for added comfort and improved torque

### SPECIFICATIONS

MODEL #	STOCK #	DESCRIPTION			
NDSET2-6M	59723801	2-piece Magnetic Nut Driver Set			
		HEIGHT	WIDTH	DEPTH	WEIGHT
NDSET2-6M		4.33"	12.60"	1.18"	0.56 lb.

## 2-PIECE STUBBY NUT DRIVER SET



The 2-piece stubby nut driver set is made for 1/4" and 5/16" hex nut and hex screw sizes. Their compact designs are ideal for use in tight spaces and hard-to-reach fasteners.

- Hollow 1-1/2" shaft for screw clearance
- Handles marked for easy identification
- Comfortable cushion grip handle offers slip resistance and greater torque

### SPECIFICATIONS

MODEL #	STOCK #	DESCRIPTION				
NDSET2-1-1/2	582865	2-Piece Stubby Nut Driver Set				
		HEIGHT	WIDTH	DEPTH	WEIGHT	SET LENGTH
NDSET2-1-1/2		3.75"	1.25"	1.25"	3.6 oz	1/4" AND 5/16" Nut Driver with 1-1/2" Shanks

## T-HANDLE HEX KEYS



Designed to efficiently tighten and loosen hex screws.

- T-handle design permits application of more torque
- Hex key blade - long and short for flexible use
- Forged heavy duty steel blade for durable usage
- Overmolded grip for comfortable feel

### SPECIFICATIONS

MODEL #	STOCK #	DESCRIPTION			
THEX6-1/2	582878	1/2" Hex T-Handle 8" Shank			
THEX6-3/8	582877	3/8" Hex T-Handle 6" Shank			
	HEIGHT	WIDTH	DEPTH	WEIGHT	SET LENGTH
THEX6-1/2	9.75"	4.75"	1"	14.5 oz	8"
THEX6-3/8	7.25"	4.75"	1"	8.2 oz	6"

## FOLDING HEX KEY SETS



Convenient and reliable, these folding hex key sets will help you get the job done quickly and easily.

- Precision made hex keys reduce slipping and stripping
- Set easily stores in metal case to reduce lost keys and damage
- Strong durable body doubles as a handle

### SPECIFICATIONS

MODEL #	STOCK #	DESCRIPTION			
HEX-5	582875	5-Piece Folding Hex Key Set			
HEX-8	582876	8-Piece Folding Hex Key Set			
	HEIGHT	WIDTH	DEPTH	WEIGHT	KEY SIZES
HEX-5	5.25"	1.5"	0.75"	14.3 oz	3/16", 7/32", 1/4", 5/16", & 3/8"
HEX-8	5.25"	1.5"	0.75"	10.8 oz	3/32", 7/64", 1/8", 9/64", 5/32", 3/16", 7/32", & 1/4"

# MEASURING & LEVELS

## CONDUIT BENDING LEVEL



High visibility vials are easy to read and set for measurements at 0°, 30°, 45° and 90°.

- Set screw secures level to conduit
- Four powerful magnets for hands free operation
- Easy to read high impact acrylic bubble vials
- V-grooved edge helps hold the level in place on pipe or conduit
- Lightweight and durable aluminum construction

### SPECIFICATIONS

MODEL #	STOCK #	DESCRIPTION			
MCBLEVEL	582816	6" Conduit Bending Level			
	HEIGHT	WIDTH	DEPTH	WEIGHT	INCLUDES
MCBLEVEL	6.31"	1.88"	0.63"	4.9 oz	Magnets, thumb screw for attaching to conduit

## TORPEDO LEVEL



Professional grade hands-free level - perfect for pipe and conduit work.

- Integrated light illuminates vials for better visibility
- Three leveling vials set at 0°, 45°, and 90°
- Lightweight and durable aluminum construction
- Easy to read high impact acrylic bubble vials
- V-grooved edge helps hold the level in place on pipe or conduit
- Four powerful magnets for hands free operation
- Requires 2 AAA batteries (not included)

### SPECIFICATIONS

MODEL #	STOCK #	DESCRIPTION			
LVLTOR9	582818	9" Torpedo Level			
	HEIGHT	WIDTH	DEPTH	WEIGHT	INCLUDES
LVLTOR9	9"	1.5"	0.75"	8.7 oz	Magnets and lighted vials

## 25' TAPE MEASURE WITH CONDUIT HOOK



Great for measuring pipe, conduit, sheet metal, siding, drywall and much more.

- Tough, impact resistant case
- Printed scale on the front and back sides of the blade for easier measurements
- Double-sided end hook allows for easier measuring
- Extra-wide, high-visibility blade with oversized scale printed on the front and back
- Nylon coating on blade provides improved durability and corrosion resistance
- Exclusive V-notched bottom allows tape measure to balance on curved surfaces
- Heat-treated spring provides for long life and smooth blade recoil
- Impact-resistant, rubberized case protects end hook and button

### SPECIFICATIONS

MODEL #	STOCK #	DESCRIPTION			
ETAPE	582883	25' Tape Measure with Conduit Hook			
	HEIGHT	WIDTH	DEPTH	WEIGHT	LENGTH
ETAPE	3.13"	3.38"	1.63"	14.7 oz	25'

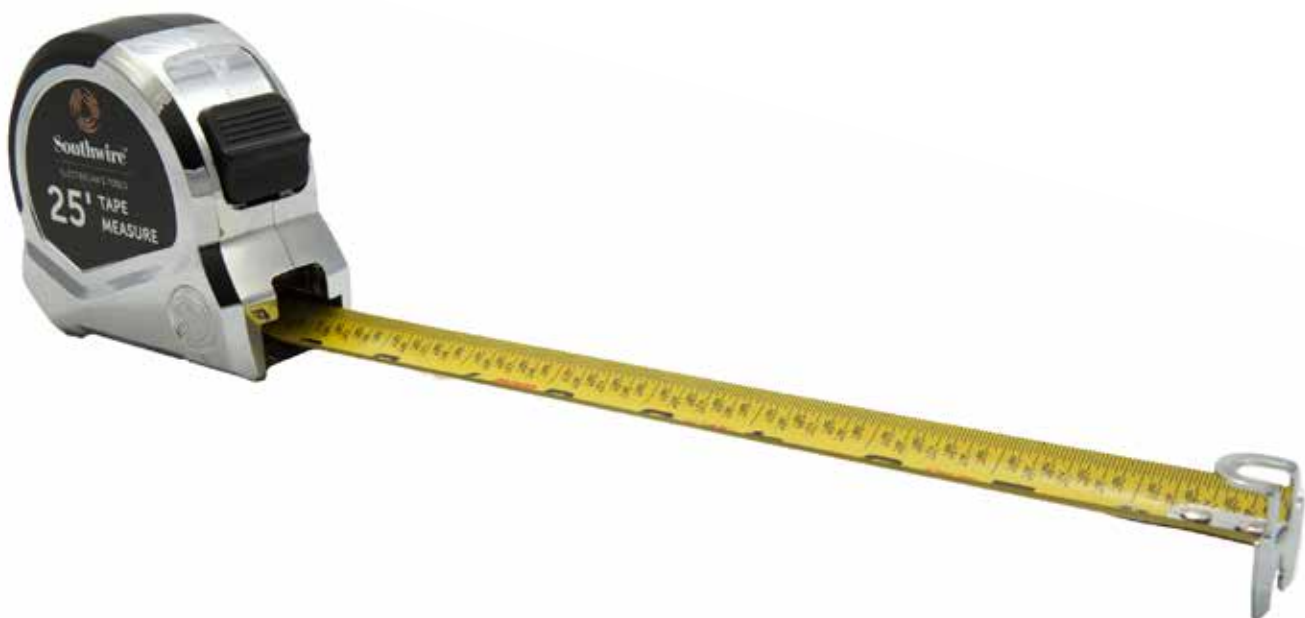

# MEASURING

## MARKSMAN® CONDUIT LAYOUT TOOL



A conduit layout tool that will pinpoint a center knockout in seconds. The Marksman Layout Tool also features a panel schedule showing the branch circuit number and its corresponding phase.

- Easy to use
- No math
- For KO sizes 1/2" to 4"
- Underground and overhead
- The Southwire® Marksman® conduit layout tool is constructed of tough durable anodized aluminum
- Markings are etched for maximum durability

### SPECIFICATIONS

MODEL #	STOCK #	DESCRIPTION			
MM01	582819	Marksman Conduit Layout Tool			
	HEIGHT	WIDTH	DEPTH	WEIGHT	KNOCKOUT SIZES
MM01	6.5"	2"	0.25"	2.5 oz	1/2" - 4"



## SIMPULL GRIPIT™ CIRCUIT SIZED PULLING HEAD

The SIMpull Gript™ Circuit sized pulling head can help make every branch circuit and home run pull safer, easier and more productive.



- Easily connects to fish tape, string or rope
- 14 AWG - 10 AWG solid or stranded conductors
- Reusable pulling head for circuit wire
- Easily attach up to 7 wires per SIMpull pulling head
- No cutting, stripping or weaving of wire to make pulling head
- No need to strip or tape the wire

### SPECIFICATIONS

MODEL #	STOCK #	DESCRIPTION		
CSPH1	582811	SIMpull Gript™ w/ Hook		
	WIDTH	DEPTH	WEIGHT	WEIGHT
CSPH1	1.5"	0.06"	1.3 oz	Up to 7 wires of 10-14 AWG Solid or Stranded

# SIMpull™

## FISH TAPES

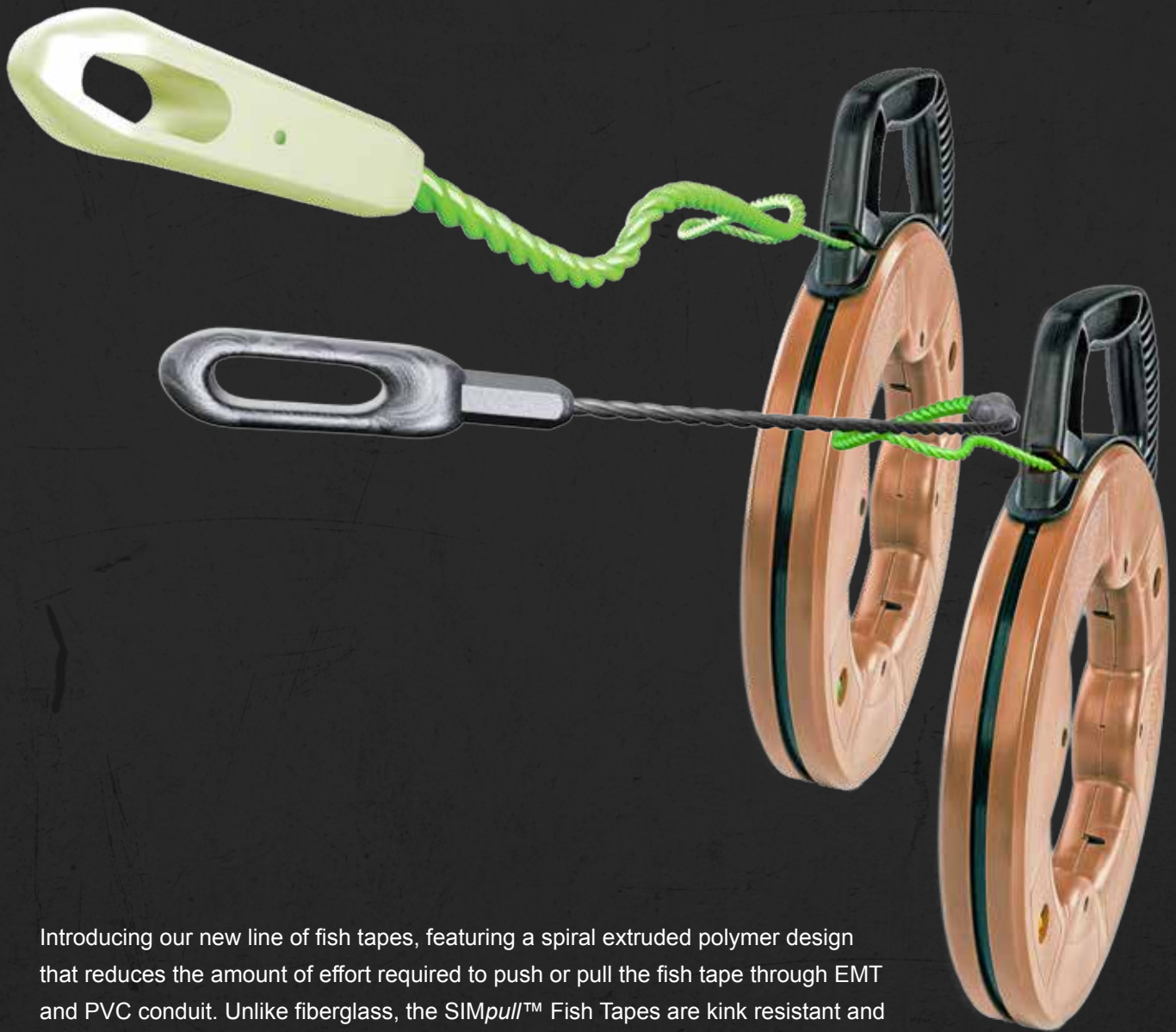

Introducing our new line of fish tapes, featuring a spiral extruded polymer design that reduces the amount of effort required to push or pull the fish tape through EMT and PVC conduit. Unlike fiberglass, the SIMpull™ Fish Tapes are kink resistant and virtually unbreakable, ensuring maximum efficiency\*. SIMpull™ fish tapes are available in 9 different variations of length, diameter, & leader type.

\*As compared to Southwire™ steel and fiberglass fish tapes.

## SIMPULL™ NON CONDUCTIVE FISH TAPE



Spiral extruded polymer design reduces the amount of effort required to push or pull the fish tape through EMT or PVC conduit

- 75', 100', 125', 240' non-conductive tip fish tape
- High impact, durable case for lasting durability and use
- Non-Conductive leader
- Glows in the dark
- Spiral extruded polymer allows for faster install time
- Spiral extruded polymer does not rust and will not break when folded
- Weighs less than steel



Does not break when folded



Weighs less than steel



Does not rust



Faster install time



Glows in the dark



Non-conductive leader

### SPECIFICATIONS

MODEL #	STOCK #	DESCRIPTION	LENGTH	WIDTH	DEPTH	WEIGHT
FTSP45-75NCT	63029801	SIMPull™ Fish tape 4.5mm 75'/22.8M, Large Case	75'/22.8M	13"	1.75"	3.10 lbs.
FTSP45-125NCT	63163701	SIMPull™ Fish tape 4.5mm 125'/38.1M, Large Case	125'/38.1M	13"	1.75"	2.50 lbs.
FTSP3-100NCT	63029901	SIMPull™ Fish tape 3mm 100'/30.4M, Medium Case	100'/30.4M	8.75"	1.25"	1.20 lbs.
FTSP3-240NCT	63029701	SIMPull™ Fish tape 3mm 240'/73.1M, Large Case	240'/73.1M	13"	1.75"	3.00 lbs.
FTSP45-240FMLT	63164701	SIMPull™ Fish Tape 4.5mm 240' Flexible Metal Leader/Non Conductive, Tube				

## SIMPULL™ FLEXIBLE METAL LEADER FISH TAPE



Spiral extruded polymer design reduces the amount of effort required to push or pull the fish tape through EMT or PVC conduit

- 75', 100', 125', 240' flexible metal leader tip fish tape
- High impact, durable case for lasting durability and use
- Swiveling Leader
- Spiral extruded polymer allows for faster install time
- Spiral extruded polymer does not rust and will not break when folded
- Weighs less than steel



Does not break when folded



Weighs less than steel



Does not rust



Faster install time



Swiveling Leader

### SPECIFICATIONS

MODEL #	STOCK #	DESCRIPTION	LENGTH	WIDTH	DEPTH	WEIGHT
FTSP45-75FML	59897001	SIMPull™ Fish tape 4.5mm 75'/22.8M, Large Case	75'/22.8M	13"	1.75"	2.50 lbs.
FTSP45-125FML	59896901	SIMPull™ Fish tape 4.5mm 125'/38.1M, Large Case	125'/38.1M	13"	1.75"	11.00 lbs.
FTSP3-100FML	59897101	SIMPull™ Fish tape 3mm 100'/30.4M, Medium Case	100'/30.4M	8.75"	1.25"	1.20 lbs.
FTSP3-240FML	63164701	SIMPull™ Fish tape 3mm 240'/73.1M, Large Case	240'/73.1M	13"	1.75"	3.00 lbs.
FTSP45-240FMLT	63164701	SIMPull™ Fish Tape 4.5mm 240' Flexible Metal Leader/Non Conductive, Tube				

## FIBERGLASS FISH TAPE



**Non-conductive fiberglass tape with low-friction coating for faster and easier fishing.**

- 50' and 100' non-conductive, fiberglass fish tape for safer use in occupied conduit
- 3/16" wide fish tape unwinds and rewinds easily
- High impact, durable case for lasting durability and use

### SPECIFICATIONS

MODEL #	STOCK #	DESCRIPTION			
FTFG3/16-100	582803	3/16" Fish Tape 100' Fiberglass			
FTFG3/16-50	582804	3/16" Fish Tape 50' Fiberglass			
	LENGTH	WIDTH	DEPTH	WEIGHT	TAPE LENGTH
FTFG3/16-100	16.5"	12.75"	1.63"	2.9 oz	100'
FTFG3/16-50	17"	13"	1.75"	2.3 oz	100'

## STEEL FISH TAPE



**Southwire's steel fish tape reaches easily above ceilings, under carpets, and through walls to install wire. The fish tape is available in multiple lengths.**

- Available in the following lengths: 25', 50', 65', 125' and 240'
- Laser etched footage markings to help identify length of pull
- High impact, durable case for long lasting performance and use
- Specially treated steel fish tape for longer life and easier pulling

### SPECIFICATIONS

MODEL #	STOCK #	DESCRIPTION		
FTS1/8-240	582798	1/8" Fish Tape Steel 240'		
FTS1/8-125	582799	1/8" Fish Tape Steel 125'		
FTS1/8-65	582800	1/8" Fish Tape Steel 65'		
FTS1/8-50	582801	1/8" Fish Tape Steel 50'		
FTS1/8-25	582802	1/8" Fish Tape Steel 25'		
FTS1/4-25	582797	1/4" Flat Fish Tape 25'		
	LENGTH	WIDTH	DEPTH	WEIGHT
FTS1/8-240	8.5"	7"	1.13"	4.3 oz
FTS1/8-125	16.5"	121.75"	1.63"	4.3 oz
FTS1/8-65	11.5"	8.75"	1.13"	4.3 oz
FTS1/8-50	11.5"	8.75"	1.13"	4.3 oz
FTS1/8-25	11.5"	8.75"	1.13"	4.3 oz
FTS1/4-25	8.5"	7"	1.63"	4.3 oz

## FISH TAPE LEADER



Flexible leader guides steel tapes through conduit and helps reduce the challenge of pulling and pushing.

- Flexible 13" leader easily attaches to 1/8" steel fish tapes
- Assists in guiding steel fish tapes through conduit turns and bends

### SPECIFICATIONS

MODEL #	STOCK #	DESCRIPTION				
FTFL13	582807	Fish Tape Leader 13"				
	HEIGHT	WIDTH	DEPTH	WEIGHT	DIA.	EYELET CAPACITY
FTFL13	14.25"	0.38"	0.25"	2 oz	3/16"	5 X 12 AWG Unstripped, 7 X 10 AWG Bare

## GLOW-IN-THE-DARK FISH STICK



Make fishing through walls or over ceilings easier with our Glow-in-the-Dark Fish Sticks.

- Luminescent fiberglass rods glow in the dark and recharges in most available light sources
- 3/16" flexible rods resist splintering and cracking
- Includes bullet nose with eyelet and hook attachments
- Individual sections easily screw together to form single rod

### SPECIFICATIONS

MODEL #	STOCK #	DESCRIPTION			
FS15	582793	Fish Stick Glow in Dark 15'			
FS12	582794	Fish Stick Glow in Dark 12'			
FS8	582795	Fish Stick Glow in Dark 8'			
	ASSEMBLED LENGTH	WIDTH	DEPTH	WEIGHT	TAPE LENGTH
FS15	180"	0.19"	0.19"	13.3 oz	3x5' Pieces
FS12	144"	0.19"	0.19"	13.9 oz	3x4' Pieces
FS8	96"	0.19"	0.19"	8 oz	4x2' Pieces

# FISHING

## PULLING GRIPS



Flexible leader guides steel tapes through conduit and helps reduce the challenge of pulling and pushing.

- Used to pull wire and cable through walls and conduit
- Swivel design minimizes cable twisting
- Mesh design holds wire or cable securely during pull
- Capacity: 100 lb. pulling force
- Two separate grips available to meet your pulling requirements for 1/2" and 3/4" diameter wire and cable

## SPECIFICATIONS

MODEL #	STOCK #	DESCRIPTION				
WPG3/4	582808	3/4" Pulling Grip				
WPG1/2	582810	1/2" Pulling Grip				
	HEIGHT	WIDTH	DEPTH	WEIGHT	SIZE	PULLING FORCE
WPG3/4	14.25"	.5"	.5"	2 oz.	3/4"	100 lb.
WPG1/2	14.25"	.5"	.5"	2 oz.	1/2"	100 lb.

## HIGH TENSILE STRENGTH POLY LINE



Tangle resistant poly line for light duty cable or rope pulling applications.

- Ready to use storage containers quickly dispenses a tangle free line
- Line is resistant to rot and mildew
- Use to pull electrical and communication wire
- 210 lb tensile strength
- Made in the USA

## SPECIFICATIONS

MODEL #	STOCK #	DESCRIPTION			
PL6500	582805	POLY LINE 6500' 210 Tensile Strength			
PL500	582806	POLY LINE 500' 210 Tensile Strength			
	LENGTH	WIDTH	DEPTH	WEIGHT	LINE LENGTH
PL6500	13"	11"	11"	11 oz	6500'
PL500	8"	3"	3"	9 oz	500'

## CONDUIT BENDERS



Reliably and repeatedly perform common bends, such as stub-ups, offsets, back-to-back and saddle bends. Available in 1", 3/4" and 1/2" sizes.

- Durable cast metal heads
- Swaged steel handle permits insertion of conduit to correct overbends
- Raised and highly visible bender markings are cast on both sides of the bender head
- Large serrated step provides greater control and helps prevent slippage when applying force

## SPECIFICATIONS

MODEL #	STOCK #	DESCRIPTION		
MCB1	582814	1" Steel Conduit Bender with Handle		
MCB3/4	582812	3/4" AL Conduit Bender with Handle		
MCB1/2	582813	1/2" AL Conduit Bender with Handle		
	HEIGHT	WIDTH	DEPTH	WEIGHT
MCB1	1.75"	12"	45"	13 lbs
MCB3/4	1.25"	9"	39"	9 lbs
MCB1/2	1.25"	8"	39"	7 lbs

# BENDING ACCESSORIES

## CONDUIT FITTING REAMING SCREWDRIVER



Removable conduit reaming screwdriver deburs thin wall conduit with speed and ease.

- Reams and smooths 1/2", 3/4" and 1" thin-wall conduit ends to protect wire and permit correct installation of fittings
- Reams inside and outside of conduit simultaneously
- Cushion grip handles for comfort and use
- Detachable head can also be used in a drill"

### SPECIFICATIONS

MODEL #	STOCK #	DESCRIPTION		
SDCFR	582837	Conduit Fitting Reaming Screwdriver		
	HEIGHT	WIDTH	DEPTH	WEIGHT
SDCFR	7.5"	1.25"	1.25"	9.5 lbs



## SPEEDSET™ CONDUIT LEVEL



Four-in-one conduit tool: conduit spacer, torpedo level, dog-leg preventer and a bending tool

- Equipped with strong magnets for easy leveling
- Create perfect bends every time
- Will easily attach to any 3/4", 1", and 1-1/4" bender head
- Multiple conduit bends exactly the same, every time without comparing them to each other

### SPECIFICATIONS

MODEL #	STOCK #	DESCRIPTION			
SS01	582815	SPEEDSET™ Conduit Level			
		HEIGHT	WIDTH	DEPTH	WEIGHT
SS01	0.5"	2.38"	2"	3.2 oz	



# KITS & ACCESSORIES

## 4-PIECE ELECTRICIAN'S TOOL KIT



Complete with 10-18 AWG wire stripper, 9-in-1 multi-bit screwdriver, high leverage side cutting pliers and nylon carrying pouch.

### 10-18 AWG Wire Stripper - Model # S1018STR

- Strips and cuts 10-18 AWG solid and 12-20 AWG stranded wire
- Stainless steel construction is durable and corrosion resistant
- Double dipped grip provides comfortable fit
- Specially designed stainless steel cutting blades provide fast and clean wire stripping
- Serrated nose grasps the cable for easy twisting and pulling
- Spring loaded for self-opening action
- Not intended for cutting bolts or steel cable

### High Leverage Side Cutting Pliers - Model # SCP9

- Induction hardened cutting blades ensure efficient and lasting cutting surfaces for hard and soft wire
- File teeth on jaws help remove burrs in conduit
- Cuts ACSR, screws, nails, and most hardened wire
- Curved handle and ergonomic molded grip for comfortable use
- Drop forged CRV steel for durability

### 9-in-1 Multi-Bit Screwdriver - Model # SD9N1

- Includes 6 bits and 3 nut drivers for multi-purpose use
- Cushion grip handle for comfortable use and application of maximum torque

## SPECIFICATIONS

MODEL #	STOCK #	DESCRIPTION			
EKIT-4	591587	Electrician's Tool Kit			
	HEIGHT	WIDTH	DEPTH	WEIGHT	
EKIT-4	4.25"	9.75"	2.25"	2.5 oz	S1018STR, SCP9, and SD9N1

## CANVAS ZIPPER BAG



Our canvas zipper bag is a very convenient storage place for pliers, wrenches and other tools that you use daily.

- Durable, heavy-duty cotton canvas bag
- Sturdy plastic resin zipper

### SPECIFICATIONS

MODEL #	STOCK #	DESCRIPTION			
BAG12	582828	12" Canvas Zipper Bag			
	HEIGHT	WIDTH	DEPTH	WEIGHT	
BAG12	12"	7"	0.25"	2 oz	

## FLEXIBLE LED FLASHLIGHT



A flexible, compact light, designed to illuminate hard-to-reach places.

- 9" flexible cable will bend and hold desired position
- Heavy-duty LED light
- On/Off button on cap
- Strong aluminum housing
- Requires 2 AA batteries (not included)

### SPECIFICATIONS

MODEL #	STOCK #	DESCRIPTION			
FLITE1	582829	Flexible LED Light			
	HEIGHT	WIDTH	DEPTH	WEIGHT	
FLITE	14.5"	3.25"	3.25"	3.9 oz	*Batteries not included

# CABLE TIES

## HEAVY-DUTY CABLE TIES



Easily mount to any standard surface with a screw or nail without splitting the tie itself, using the evenly spaced pre-molded holes.

- Offered in 8", 11" and 14" lengths
- 50 & 90 pound tensile strength
- UV Resistant; UL 62275 Plenum Rated
- 2-4" Max Bundle
- Molded from 6/6 Nylon
- Resists temperatures ranging from -40°F (40°C) to 185°F (85°C).

## SPECIFICATIONS

### CABLE TIES

MODEL #	STOCK #	DESCRIPTION	PACK	COLOR	LENGTH
58298201	CT0850100	UVB cable tie 50 lb.	100PK	Black	8"
58298301	CT1150100	UVB cable tie 50 lb.	100PK	Black	11"
58298401	CT1450100	UVB cable tie 50 lb.	100PK	Black	14"
58298501	CT0890100	UVB cable tie 90 lb.	100PK	Black	8"
58298601	CT1190100	UVB cable tie 90 lb.	100PK	Black	11"
58298701	CT1490100	UVB cable tie 90 lb.	100PK	Black	14"
58298801	CT0850015	UVB cable tie 50 lb.	15PK	Black	8"
58298901	CT1150015	UVB cable tie 50 lb.	15PK	Black	11"
58299001	CT1450015	UVB cable tie 50 lb.	15PK	Black	14"
58299101	CT8111412	Sample Pack - Asst.	12PK	Black	8" - 11" - 14"

## CLAMP TIES



Organize, carry and store cords, ropes, hoses, wire and more with the Southwire Clamp Tie featuring a 360° rotating handle and easy release trigger.

- 360° rotating handle built for heavy duty work
- Easy release trigger and flexible tie design

## SPECIFICATIONS

MODEL #	STOCK #	DESCRIPTION	PACK QTY	COLOR	PALLET QTY
CLPT02	58299201	2" Clamp Tie	25	Brown	5,450
CLPT03	58299301	3" Clamp Tie	25	Brown	3,525
CLPT04	58299401	4" Clamp Tie	20	Brown	2,820
CLPT02GR	58973201	2" Clamp Tie	25	Green	5,450
CLPT03GR	58973301	3" Clamp Tie	25	Green	3,525
CLPT04GR	58973401	4" Clamp Tie	20	Green	2,820

## TOOL BAG BACKPACK



Our tool bag backpack allows you to comfortably carry your tools on your back or by hand. Easy opening zippers allows access to the numerous tool storage compartments. Enclosed pouches are located on both external and internal surfaces to provide additional tool storage security.

- Constructed from 2400d ballistic weave for durability
- 58 storage pockets, zippered pouches, and tool loops
- Non-tipping rubber base is wear and water resistant

### SPECIFICATIONS

MODEL #	STOCK #	DESCRIPTION		
BAGBP	587384	Tool BackPack		
	HEIGHT	WIDTH	DEPTH	INTERNAL CAPACITY
BAGBP	18"	15"	6"	1404 cubic inches

## ELECTRICIAN'S SHOULDER POUCH



Convenient shoulder bag provides a lightweight, durable tool carrier that can be hand-carried, slung over your shoulder or attached to a belt. Features 16 storage pockets and the patent pending Flip Lid™ Spill Guard.

- Multiple carrying options: shoulder strap, padded handle, belt loop tunnel
- Constructed from 2400d ballistic weave for durability
- 16 tool storage pockets

### SPECIFICATIONS

MODEL #	STOCK #	DESCRIPTION		
BAGESP	587387	Electrician's Shoulder Pouch		
	HEIGHT	WIDTH	DEPTH	INTERNAL CAPACITY
BAGESP	12"	8.5"	6.5"	247 cubic inches

# TOOL BAGS

## TOOL BAG MESSENGER STYLE



The Messenger Tool Bag is a convenient carrying solution with ample storage capacity. It features easy to access internal storage loops and several internal and external mounted zippered pockets.

- Constructed from 2400d ballistic weave for durability
- Grommets on the outer flap for hanging bag
- Padded mesh shoulder straps and breathable EVA padded back offers protection and carrying comfort

### SPECIFICATIONS

MODEL #	STOCK #	DESCRIPTION		
BAGMSGR	587388	Messenger Style Tool Bag		
	HEIGHT	WIDTH	DEPTH	INTERNAL CAPACITY
BAGMSGR	13"	7"	0.25"	708 cubic inches

## ELECTRICIAN'S TOTE



This tote is a perfect daily use tool bag. Large enough to carry the tools you will need for almost any job, yet compact enough to comfortably carry around the job site as necessary.

- 15 pockets, 1 zippered pocket and 10 tool loops for tool storage
- Constructed from 2400d ballistic weave for durability
- 2 exterior tape measure clips

### SPECIFICATIONS

MODEL #	STOCK #	DESCRIPTION		
BAGTOTE8	587385	8" Electrician's Tote		
	HEIGHT	WIDTH	DEPTH	INTERNAL CAPACITY
BAGTOTE8	15.5"	11"	8.75"	1713 cubic inches

## TOOL BAG OPEN TOP



15" Open Top Tool Bag has a weather protected rubberized bottom and comes with removable dividers so that you may customize the interior compartment to fit your needs. Numerous storage pockets and tool loops allow for ample vertical storage locations. Also features a rotatable handle that can be rotated to the side to allow better access to bag contents.

- Constructed from 1680d ballistic weave for durability
- 3 removable interior organization dividers with 6 pockets and 4 tool loops
- Convenient rotatable handle

### SPECIFICATIONS

MODEL #	STOCK #	DESCRIPTION		
BAGOT15	587384	15" Open Top Tool Bag		
	HEIGHT	WIDTH	DEPTH	INTERNAL CAPACITY
BAGOT15	14.75"	15"	9"	1194 cubic inches

## 5-POCKET LEATHER TOOL POUCH



The 5-Pocket Leather Tool Pouch with electrical tape chain and designed for easy storage and tool access

- Saddle leather resistant to fade and stain
- Washer rivets for extra strength
- Fits belts up to 3" wide

### SPECIFICATIONS

MODEL #	STOCK #	DESCRIPTION		
POUCH4	582831	Tool Pouch 5 Pocket		
	HEIGHT	WIDTH	DEPTH	MATERIAL
POUCH4	9.25"	7"	3"	Leather

# TOOL BAGS

## POLYESTER ZIPPERED BAG 4-PACK



Durable heavy duty polyester bags. Perfect for storing pliers, screwdrivers, staples or electrical connectors.

- 4-Pack, durable, heavy duty polyester bags
- Sturdy composite zipper

### SPECIFICATIONS

MODEL #	STOCK #	DESCRIPTION		
BAG4P	59724101	Polyester Zippered Bag 4-Pack		
	HEIGHT	WIDTH	DEPTH	WEIGHT
BAG4P	13.25"	7.88"	1"	.35 lb.

## CABLE SPLICERS KIT



Cable Splicers Kit is ideal for prepping installation of category cable.

- Lock holds blades closed for storage
- Serrated lower blades grip wire for non-slip cutting action
- Includes marking pen
- Includes leather carrying pouch
- Includes Boot Knife for sheathing and removing cable jackets

### SPECIFICATIONS

MODEL #	STOCK #	DESCRIPTION		
CSK5	59724201	Cable Splicers Kit		
	HEIGHT	WIDTH	DEPTH	WEIGHT
CSK5	8.25"	8.63"	12.25"	4.40 lb.





## ELECTRICIAN'S WORK GLOVES

High dexterity electrician's gloves with anti-slip fingertips.

- Anti-slip finger tips for secure holding of wire and tools
- Padded palm for protection and secure grip
- Wrapped index finger for durability
- Breathable spandex back for comfortable fit and feel
- Touchscreen compatible index finger and thumb

### SPECIFICATIONS

MODEL #	STOCK #	DESCRIPTION
GLOVE1L	587390	Electrician's Work Gloves - Large
PRIMARY MATERIAL		SECONDARY MATERIAL
GLOVE1L	Breathable Spandex	Synthetic Leather



# ROTO-SPLIT™

## ROTO-SPLIT™, ORIGINAL RS-101



Cuts or strips any armored cable from AWG 14-2 to 10-4, including AC, MC, BX & HCF

- Cuts or strips any armored cable from AWG 14-2 to 10-4, including AC, MC, BX & HCF
- Cuts 3/8" trade size flex (Greenfield)
- Includes ergonomic handle without blade storage



### SPECIFICATIONS

MODEL #	STOCK #	DESCRIPTION		
RS-101	59816540	Roto-split™, Original RS-101		
WEIGHT	MIN OPENING	MAX OPENING	FLEX (TRADE SIZE)	AWG (SOLID) OR MC RANGE
1.2lbs	0.375	0.75	3/8"	14/2 to 8/4

## ROTO-SPLIT™, SUPER RS-101A



Quick clamping RS-101A cuts or strips any armored cable from AWG 14-2 to 10-4, including AC, MC, BX & HCF.

- Quick clamping RS-101A cuts or strips any armored cable from AWG 14-2 to 10-4, including AC, MC, BX & HCF.
- Cuts 3/8" trade size Flex.
- Includes ergonomic handle & blade storage knob.



### SPECIFICATIONS

MODEL #	STOCK #	DESCRIPTION		
RS-101A	59816640	Roto-split™, Super RS-101A		
WEIGHT	MIN OPENING	MAX OPENING	FLEX (TRADE SIZE)	AWG (SOLID) OR MC RANGE
1.2lbs	0.375	0.75	3/8"	14/2 to 8/4

## ROTO-SPLIT™, SUPER W/ B-107, RS-101AL

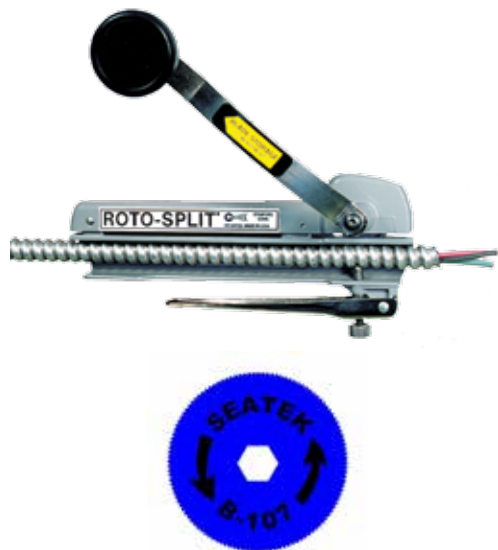

Roto-Split™ cutter equipped with B-107 blade to cut or strip aluminum armored cable from AWG 14-2 to 10-4, including AC, MC, BX & HCF

- Roto-Split™ cutter equipped with B-107 blade to cut or strip aluminum armored cable from AWG 14-2 to 10-4, including AC, MC, BX & HCF
- Cuts 3/8" trade size Flex
- Gives faster, cleaner and safer cuts



### SPECIFICATIONS

MODEL #	STOCK #	DESCRIPTION	WEIGHT	MIN OPENING	MAX OPENING	FLEX (TRADE SIZE)	AWG (SOLID) OR MC RANGE
RS-101AL	59816801	Roto-split™ Super w/ B-107, RS-101AL	1.2lbs	0.375	0.75	3/8"	14/2 to 8/4

## ROTO-SPLIT™, AUTO-CLAMPING, RS-101B



Roto-Split™ cutter equipped with B-107 blade to cut or strip aluminum armored cable from AWG 14-2 to 10-4, including AC, MC, BX & HCF

- Roto-Split™ cutter with auto-clamping feature. Does not require adjustment to clamp 14-2 TO AWG 10-4 BX, MC or 3/8" Flex
- Does not require adjustment to clamp 14-2 TO AWG 10-4 BX, MC or 3/8" Flex
- The Patent Pending RS-101AC automatically adjusts the clamping pin to the correct diameter
- Includes ergonomic handle, knob with blade storage, and B-102 blade



### SPECIFICATIONS

MODEL #	STOCK #	DESCRIPTION	WEIGHT	MIN OPENING	MAX OPENING	FLEX (TRADE SIZE)	AWG (SOLID) OR MC RANGE
RS-101B	59817040	Roto-split™, Auto-Clamping, RS-101B	1.25lbs	0.375	0.75	3/8"	14/2 to 8/4

# ROTO-SPLIT™

## ROTO-SPLIT™, AUTOMATIC RS-101AC



Roto-Split™ cutter with auto-clamping feature. Does not require adjustment to clamp 14-2 TO AWG 10-4 BX, MC or 3/8" Flex

- The Patent Pending RS-101AC automatically adjusts the clamping pin to the correct diameter
- Depth of cut adjustment lever switches between standard MC & new brands of reduced diameter MC cable
- Includes ergonomic handle, knob with blade storage, and B-102 blade



### SPECIFICATIONS

MODEL #	STOCK #	DESCRIPTION		
RS-101AC	59816740	Roto-split™, Automatic RS-101AC		
WEIGHT	MIN OPENING	MAX OPENING FLEX (TRADE SIZE)	AWG (SOLID) OR MC RANGE	
1.2lbs	0.375	0.75	3/8"	14/2 to 8/4

## ROTO-SPLIT™, MOTORIZED SUPER, RS-101AP



Cuts or strips any armored cable from 14-2 to 10-4 AWG including AC, MC, BX & HCF

- Also cuts 3/8" trade size Flex (Greenfield)
- Equipped with quick action clamping lever and b-108 blade
- Driven by a standard magnetic 1/4" hex bit holder and a cordless drill (bit holder & drill are not included)



### SPECIFICATIONS

MODEL #	STOCK #	DESCRIPTION		
RS-101AP	59816901	Roto-split™, Motorized Super RS-101A		
WEIGHT	MIN OPENING	MAX OPENING FLEX (TRADE SIZE)	AWG (SOLID) OR MC RANGE	
1.2lbs	0.375	0.75	3/8"	14/2 to 8/4

## ROTO-FLEX™, GREENFIELD, 1/2-3/4, RF-120A



Roto-Flex™ cutter cuts large flexible conduit from 1/2" to 3/4"

- Strips large AC, BX, MC cables ranging from AWG 2-3, 3-4, & 4-3.
- Equipped with B-102 blade, quick clamping, ergonomic handle and blade storage



### SPECIFICATIONS

MODEL #	STOCK #	DESCRIPTION		
RF-120A	59816240	Roto-Flex™, Greenfield, 1/2 - 3/4, RF-120A		
WEIGHT	MIN OPENING	MAX OPENING FLEX (TRADE SIZE)	AWG (SOLID) OR MC RANGE	
1.25lbs	0.75	1.13	1/2" - 3/4"	4/4 to 2/4

## ROTO-FLEX™, GREENFIELD, 3/8-3/4, RF-120B



Roto-Flex™ cutter with extended range

- Strips armored cables from 14-2 to 4-3, flex from 3/8" to 3/4"
- Hinged adapter swings in or out to accommodate small or large cables
- Automatically reduces blade penetration for smaller cables



### SPECIFICATIONS

MODEL #	STOCK #	DESCRIPTION		
RF-120B	59816340	Roto-Flex™, Greenfield, 3/8 - 3/4, RF-120B		
WEIGHT	MIN OPENING	MAX OPENING FLEX (TRADE SIZE)	AWG (SOLID) OR MC RANGE	
1.2lbs	0.38	1.13	3/8", 1/2", 3/4"	14/2 to 4/3

## ROTO-FLEX™, GIANT 1/2 - 1-1/2, RF-170



Giant size Roto-Flex™ cutter that cuts .84" to 1.82" OD

- Also cuts 1/2" to 1-1/2" flex
- Equipped with B-107 blade for aluminum
- Adjustable clamping bracket automatically sets blade penetration
- Includes ergonomic handle with blade storage
- B-102 blade can be used with steel casing



### SPECIFICATIONS

MODEL #	STOCK #	DESCRIPTION		
RF-170	59816440	Roto-Flex™, Giant 1/2-1 1/2, RF-170		
WEIGHT	MIN OPENING	MAX OPENING FLEX (TRADE SIZE)	AWG (SOLID) OR MC RANGE	
1.2lbs	0.82	1.13	1/2" - 1-1/2"	-

# KITS

## HARDWARE KIT

101-106



Spare parts kit for the Roto-Split™ & Roto-Flex™ cutters

- Contains 1 shaft, 1 nut, 1 #4-40 knurled screw, and 1 thumbscrew for RS-101



## POWER KIT

101-107



Power conversion kit. Motorize any Roto-Split™ and Roto-Flex™ cutters

- Consists of a B-108 blade, shaft, screw, washers, hex nut & hex wrench



## RS HANDLE

101-110



Handle assembly for all models of the Roto-Split™ & Roto-Flex™ with blade storage cartridge in the knob

- Note: blades not included



## LUBRICANT STICK

LS-105



Lubricant stick for blades all models of the Roto-Split™, Roto-Flex™ & all Rotomatic models

- Not for use when cutting aluminum



## SPECIFICATIONS

MODEL #	STOCK #	DESCRIPTION
101-106	59818001	Kit, Hardware Retrofit
101-107	59817901	Kit, Power Conversion
101-110	59818101	Kit, Handle
LS-105	59816101	Stick, Lubricant, LS-105
INCLUDES		
101-106	One Shaft, One Hex Nut, One 4-40 Knurled Screw, One RS-101 Thumbscrew	
101-107	Contains: B-108 Blade, Shaft, Screw, Washers, Hex Nut & Wrench	
101-110	Full handle assembly	
LS-105	Lubricant Stick	

## SEATEK™ BLADE, RS/RF STANDARD, B-102



Blue Sapphire blade for the Roto-Split™ & Roto-Flex™ cutters

- Sold in packs of 2



### SPECIFICATIONS

MODEL #	STOCK #	DESCRIPTION		
B-102	59814440	Blade, RS/RF Standard, B-102		
UPC	WEIGHT	HEIGHT	WIDTH	DEPTH
72387580102	0.025 lb.	1.22"	1.22"	.02"

## SEATEK™ BLADE, RS/RF STANDARD BULK, B-102-BULK



Bulk pack of 100 B-102 blades

- No clamshell or packaging



### SPECIFICATIONS

MODEL #	STOCK #	DESCRIPTION		
B-102Bulk	59814540	Blade, RS/RF Standard bulk, B-102-Bulk		
UPC	WEIGHT	HEIGHT	WIDTH	DEPTH
	0.025 lb.	1.22"	1.22"	.02"

# BLADE

## SEATEK™ BLADE, OFFSET TEETH, B-107



Blade to cut steel or aluminium armor on 1/2" and larger trade size flex

- For all Roto-Flex™ models
- Note: Not for use with the RS-101AC



### SPECIFICATIONS

MODEL #	STOCK #	DESCRIPTION		
B-107	59814901	Blade, Offset Teeth, B-107		
UPC	WEIGHT	HEIGHT	WIDTH	DEPTH
72387580107	0.025 lbs.	1.25"	1.25"	.02"

## SEATEK™ BLADE, MOTORIZED TOOL, B-108



Blade for all power tools & machines

- Works with all Rotomatics, RS-101AP & PC-205A



### SPECIFICATIONS

MODEL #	STOCK #	DESCRIPTION		
B-108	59815101	Blade, Motorized Tool, B-108		
UPC	WEIGHT	HEIGHT	WIDTH	DEPTH
72387580108	0.025 lbs.	1.25"	1.25"	.02"



## SEATEK™ BLADE, RS/RF LARGE DIM, B-122



Large blade for all models of the Roto-Flex™ cutter

- Used to cut through rubber jacketed Flex



### SPECIFICATIONS

MODEL #	STOCK #	DESCRIPTION		
B-122	59815301	Blade, RS/RF Large DIM, B-122		
UPC	WEIGHT	HEIGHT	WIDTH	DEPTH
72387580122	0.25 lbs.	1.50"	1.50"	.02"

## SEATEK™ BLADE, SA-200, B-202

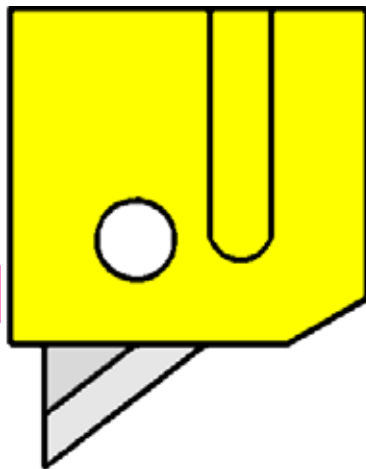

Blade for all models of the SA-200 Strip-All



### SPECIFICATIONS

MODEL #	STOCK #	DESCRIPTION		
B-202	59815401	Blade, SA-200, B-202		
UPC	WEIGHT	HEIGHT	WIDTH	DEPTH
72387580202	0.025 lbs.	.75"	.19"	1.50"

# BLADE

## SEATEK™ BLADE, JR-128, B-228



Blade for JR-128 Jacket Ripper



### SPECIFICATIONS

MODEL #	STOCK #	DESCRIPTION		
B-228	59815601	Blade, JR-128, B-228		
UPC	WEIGHT	HEIGHT	WIDTH	DEPTH
72387580228	0.05 lbs.	.88"	.25"	.50"

## SEATEK™ BLADE, VT-270, B-272



Blade for VT-270 Vee-Twin cable stripper



### SPECIFICATIONS

MODEL #	STOCK #	DESCRIPTION		
B-272	59815801	Blade, VT-270, B-272		
UPC	WEIGHT	HEIGHT	WIDTH	DEPTH
72387580272	0.025 lbs	.75"	.25"	.06"

## STRIP-ALL™ STRIPPER WITH KNIFE, SA-200SK



Strips plenum, communication, Romex® cable, and category cables.

- Precision depth of cut adjustment
- Straight & ring cut from 1/8" to 5/8" diameter
- Includes wire stripper, folding utility knife, A-201 adapter & replacement blade cartridge



### SPECIFICATIONS

MODEL #	STOCK #	DESCRIPTION	WEIGHT	MIN OPENING	MAX OPENING	OVERALL LENGTH	AWG (SOLID) OR MC RANGE
SA-200SK	59817340	Strip-All™ Stripper with Knife, SA-200SK	0.25 lbs	1/4	5/8	5-1/4"	2 to 4/0

## STRIP-ALL™ STRIPPER WITHOUT KNIFE, SA-200S



Strips plenum, communication, Romex® cable, and category cables.

- Precision depth of cut adjustment
- Straight & ring cut from 1/8" to 5/8" diameter
- Equipped with wire stripper, A-201 adapter, replacement blade cartridge



### SPECIFICATIONS

MODEL #	STOCK #	DESCRIPTION	WEIGHT	MIN OPENING	MAX OPENING	OVERALL LENGTH	AWG (SOLID) OR MC RANGE
SA-200S	59817240	Strip-All™ Stripper without Knife, SA-200S	0.25 lbs	1/4	5/8	5-1/4"	2 to 4/0

# STRIP-ALL™

## STRIP-ALL™ STRIPPER, LARGE UP TO 7/8 DIM, SA-200L



By popular demand an increased capacity Strip-All™! from 3/8" to 7/8" diameter

- Make straight or ring cuts and set depth of cut with micrometer dial
- Ships with replacement blade cartridge stored in top housing
- Does not include wire stripper or utility knife, A-201 Adapter not compatible



### SPECIFICATIONS

MODEL #	STOCK #	DESCRIPTION		
SA-200L	59817140	Strip-All™ Stripper, Large up to 7/8 DIM, SA-200L		
WEIGHT	MIN OPENING	MAX OPENING FLEX (TRADE SIZE)	AWG (SOLID) OR MC RANGE	
0.25 lbs	3/8	7/8	5-1/4"	14/2 to 6/3

## STRIP-ALL™ STRIPPER, UP CRIMPER, SA-200UR



Strip-All™ with crimper for UR & UY connectors

- Set depth of cut with micrometer dial
- Cut wire from 20 to 24 AWG with built in wire cutter
- Includes A-201 Adapter to strip & ring cut wires as small as 1/8". Perfect for data, phone and communications work



### SPECIFICATIONS

MODEL #	STOCK #	DESCRIPTION		
SA-200UR	59817540	Strip-All™ Stripper, UP Crimper, SA-200UR		
WEIGHT	MIN OPENING	MAX OPENING	OVERALL LENGTH	AWG (SOLID) OR MC RANGE
0.25 lbs	1/4	5/8	5-1/4"	2 to 4/0

## ADAPTER, SA-200-A-201



Cable adapter to strip & ring cut smaller cables from 1/8" to 5/16" diameter

- Not compatible with Strip-All SA-200L



### SPECIFICATIONS

MODEL #	STOCK #	DESCRIPTION		
A-201	59814201	Adapter, SA-200-A-201		
UPC	MIN. OPENING	MAX. OPENING	OVERALL LENGTH	WEIGHT
72387590201	5	.50"	.13"	0.02 lbs

## RIPPER, JACKET, JR-128



Great way to remove jackets of medium and large multi-conductor cables

- Use on entrance, plenum, multi-pair & tray, Liquid-Tight, Flex or MC
- Safer than razor blades or knives! Ergonomic rubberized handle



### SPECIFICATIONS

MODEL #	STOCK #	DESCRIPTION		
JR-128	59816001	Ripper, Jacket, JR-128		
UPC	WEIGHT	HEIGHT	WIDTH	DEPTH
72387500128	0.02 lbs	5.75"	2.25"	.25"

## STRIPPER, VEE-TWIN™, VT-270



Use the VT-270 to easily & precisely strip the jacket on plastic jacketed cables

- Works great on cables from 5/16" to 2-1/8" O.D.
- Easy to adjust, safe to use, and can fit into difficult to reach locations with maximum depth of cut 1/4"



### SPECIFICATIONS

MODEL #	STOCK #	DESCRIPTION			
VT-270	59817701	Stripper, Vee-Twin™, VT-270			
WEIGHT	MIN OPENING	MAX OPENING	MAX CUT DEPTH	AWG (SOLID) OR MC RANGE	
0.7 lbs	5/16"	2-1/8"	1/4"	14/2 to 4/0-4	

## ADAPTER, VISE MOUNT ADAPTER, A-271

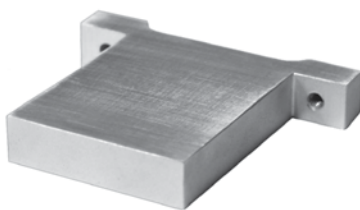

Adapter A-271 for the Vee-Twin™, recovers scrap material quickly & easily

- Adapter A-271 for the Vee-Twin™, recovers scrap material quickly & easily
- Attach the A-271 to the Vee-Twin™ & clamp in a vise
- Pull the cable through the Vee-Twin™ to remove long lengths of cable jackets



### SPECIFICATIONS

MODEL #	STOCK #	DESCRIPTION			
A-271	59814301	Adapter, Vise Mount Adapter, A-271			
UPC	WEIGHT	HEIGHT	WIDTH	DEPTH	
72387590271	0.02 lbs	-	-	-	

## BI-METAL HOLESAWS

ABS1/2



BMHS6-3/8



Bi-metal holesaws for heavy-duty, fast cutting of steel, aluminum, brass, wood, plastic and drywall.

- Unique teeth configuration for fast removal of cutting materials
- Split tip double helix grooves for faster starts
- Hardened mandrel for long thread life

### SPECIFICATIONS

MODEL #	STOCK #	DESCRIPTION
BHMSKIT9	58297601	Bi-Metal Holesaw Kit, 9-piece
BMHS6-3/8	58297501	Bi-Metal Holesaw, 6-3/8" for recessed lights
ABS1/2	58295301	(1) 1/2" Arbor bit shank
MODEL #	STOCK #	INCLUDES
BHMSKIT9	58297601	(6) Bi-metal hole saws: 7/8", 1-3/8", 2", 1-1/8", 1-3/4", 2-1/2", (1) 3/8" hex shank mandrel, (1) 3/8" qck. chg. mandrel, (2) pilot
BMHS6-3/8	58297501	(1) 6-3/8" Hole Saw
ABS1/2	58295301	(1) 1/2" Arbor bit shank

## DRILL / TAP BITS

Combination drill/tap bit seven piece set features a one-piece drill/tap design that saves time.

- Made of high-speed steel for durability
- Tapered design prevents thread damage
- For use with steel, copper, brass, aluminum and plastic



### SPECIFICATIONS

MODEL #	STOCK #	DESCRIPTION
CDTBKIT	58296301	Combination Drill and Tap Set
MODEL #	STOCK #	INCLUDES
CDTBKIT	58296301	(6) Drill/Tap Sets: 6-32 NC, 8-32 NC, 10-24 NC, 10-32 Nf, 12-24 NC, 1/4-20 NC, (1) Quick Change Adapter

# HOLE MAKING

## FLEX AUGER BITS



Flex auger bits with screw point tips, easily drill clean holes through wood inside walls.

- Pilot feed-screw draws bit into wood
- Spring steel shaft resists deformation
- Hole in tip for use with wire and cable pulling grips

### SPECIFICATIONS

MODEL #	STOCK #	DESCRIPTION
FABK9/16X54	58297701	9/16" Flex Bit Kit
FAB9/16X54	58296901	9/16" Flex Bit
FAB3/8X54	58296801	3/8" Flex Bit
FAB1x54	58297001	1" Flex Bit
FAB3/4X54	58296701	3/4" Flex Bit
MODEL #	STOCK #	INCLUDES
FABK9/16X54	58297701	(1) 9/16" X 54" Flex Bit, (1) Cable Pulling Grip, (1) Folding Placement Tool
FAB9/16X54	58296901	(1) 9/16" Flex Bit
FAB3/8X54	58296801	(1) 3/8" Flex Bit
FAB1x54	58297001	(1) 1" Flex Bit
FAB3/4X54	58296701	(1) 3/4" Flex Bit

## STEP DRILL BITS

### SB1/4-1-3/8



Step drill bits for clean hole drilling in metals.

- Laser etched sizes for easy identification
- Tri-lobe shank reduced slippage and firm grip in the chuck
- Double Flute design for a true round hole every time

### SB3/16-7/8



### SPECIFICATIONS

MODEL #	STOCK #	DESCRIPTION
SB3/16-7/8	58297401	3/16"-7/8" Step Drill Bit
SB1/4-1-3/8	58297201	1/4"- 1-3/8" Step Drill Bit
MODEL #	STOCK #	INCLUDES
SB3/16-7/8	58297401	(1) Step Drill Bit
SB1/4-1-3/8	58297201	(1) Step Drill Bit



## ADJUSTABLE CAN LIGHT HOLE SAW

ACLHS



Adjustable hole saw featuring black oxide blades, cleanly and efficiently cuts precise holes in drywall and ceiling tiles.

- 10 blade adjustment positions ranging from 2-1/2" to 7"
- Black oxide blades cut cleanly through drywall and ceiling tiles
- Hex key adjustment allows for easy movement of blade

### SPECIFICATIONS

MODEL #	STOCK #	DESCRIPTION			
ACLHS	59705401	Adjustable Can Light Hole Saw			
		HEIGHT	WIDTH	DEPTH	WEIGHT
ACLHS		2.17"	8.27"	44"	2.08 lb.

## FLEX AUGER BIT EXTENSION

FAE3/16X54



For use with bits to extend length to easily drill clean holes through wood inside walls.

- Extends auger bit lengths
- Spring steel shaft resists deformation
- Overall length 54 in.
- Tapered back for easy bit retrieval

### SPECIFICATIONS

MODEL #	STOCK #	DESCRIPTION			
FAE3/16X54	59705301	Flex Auger Bit Extension			
		HEIGHT	WIDTH	DEPTH	WEIGHT
ACLHS		54"	0.91"	0.91"	.11 lb.

# HOLE MAKING

## FLEXIBLE QUICK CONNECT EXTENSION KIT

### FQCKIT



Perfect for installing wire in existing walls and ceilings.

- Kit includes everything needed to drill and pull light to medium wire
- Multiple extensions can be joined for increased versatility
- Convenient 1/4" quick connect receivers
- Auger bit with self-feeding screw tip draws bit through wood
- Quick connect accepts bits up to 3/4" in diameter

### SPECIFICATIONS

MODEL #	STOCK #	DESCRIPTION		
FQCKIT	59705001	Flexible Quick Connect Extension Kit		
	HEIGHT	WIDTH	DEPTH	WEIGHT
FQCKIT	59.5" Assembled"	3/4" (max bit width)"	1"	0.66 lb.

## FLEXIBLE QUICK CONNECT EXTENSION

### FQCE36



36" flexible quick change extension is perfect for installing wire in existing walls and ceilings.

- Flexible shaft allows easy access to difficult and confined areas
- Quick connect accepts bits up to 3/4" in diameter
- Multiple extensions can be joined for increased versatility
- Convenient 1/4" quick connect receivers

### SPECIFICATIONS

MODEL #	STOCK #	DESCRIPTION		
FQCE36	59704901	Flexible Quick Connect Extension		
	HEIGHT	WIDTH	DEPTH	WEIGHT
FQCE36	36"	1/4" (shank)"	0.86"	0.33 lb.

## CARBIDE TIPPED HOLE CUTTERS

### CHC7/8



Carbide tipped hole cutters with durable cutting design specifically for stainless steel and sheet metal.

- Precision ground teeth for fast cutting of clean, round holes
- Fast starts split tip, double helix grooves for faster starts
- Grooved edge design to prevent extended penetration

### SPECIFICATIONS

MODEL #	STOCK #	DESCRIPTION
CHC1-1/8	58294901	1-1/8" Carbide Tipped Hole Cutter
CHC7/8	58295001	7/8" Carbide Tipped Hole Cutter
CHCKIT4	58295101	Carbide Tipped Hole Cutter Kit
MODEL #	STOCK #	INCLUDES
CHC1-1/8	58294901	(1) 1-1/8" Carbide tipped hole cutter, For use with 3/4" Fittings
CHC7/8	58295001	(1) 7/8" Carbide tipped hole For use with 1/2" fittings
CHCKIT4	58295101	(3) Carbide Tipped Hole Cutters: 7/8", 1-1/8", 1-3/8"; (4) Pilot drill bits; (1) Allen wrench

## MANUAL KNOCKOUTS

### KODRAW3/4



Manual knockout sets with unique 3-point cup cutting surface provides a clean, quick and easy cut, saving time.

- Optimized design reduces wrench effort
- Unique 3-point cup cutting surface provides a clean, quick and easy cut
- Cup design creates crimping effect on slug for easy removal

### SPECIFICATIONS

MODEL #	STOCK #	DESCRIPTION
KOKIT6	58297801	Manual Knockout Kit
KODRAW1/2	58297901	Knockout Set
KODRAW3/4	58298001	Knockout Set
MODEL #	STOCK #	INCLUDES
KOKIT6	58297801	(4) Maxis® Max Punch® Cups & Cutters 1/2" to 1-1/4", (1) 7/16" Draw Stud, (1) 3/4" Draw Stud
KODRAW1/2	58297901	(1) 1/2" Knockout Draw Stud
KODRAW3/4	58298001	(1) 3/4" Knockout Draw Stud

# HOLE MAKING

## SHIP AUGER BITS

### SAB3/4X18



Heavy-duty Ship Auger Bit, featuring a self-feeding screw tip, drills clean holes through nails, wood, vinyl, plastic, and heavy timber.

- Screw tip draws bit through wood
- Polished and coated flutes increase removal of cutting material
- 18" Length allows deep drilling without an extension

### SAB7/8X18



## SPECIFICATIONS

MODEL #	STOCK #	DESCRIPTION
SAB3/4x18	58295501	3/4" Ship Auger Bit
SAB7/8X18	58295601	7/8" Ship Auger Bit
SAB1X18	58295401	1" Ship Auger Bit
MODEL #	STOCK #	INCLUDES
SAB3/4x18	58295501	(1) Ship Auger Bit
SAB7/8X18	58295601	(1) Ship Auger Bit
SAB1X18	58295401	(1) Ship Auger Bit

### SAB1X18



## WOOD BORING BITS

### WAB3/4x4-1/2



Heavy-duty, self-feeding Wood Boring Bits cut clean holes in wood.

- Screw tip draws bit through wood
- Polished and coated flutes increase removal of cutting material
- 4.5" Length for drilling in tight spaces

### WAB7/8X4-1/2



## SPECIFICATIONS

MODEL #	STOCK #	DESCRIPTION
WAB3/4X4-1/2	58296001	3/4" Wood Auger Bit
WAB7/8X4-1/2	58296101	7/8" Wood Auger Bit
WAB1X4-1/2	58296901	1" Wood Auger Bit
MODEL #	STOCK #	INCLUDES
WAB3/4X4-1/2	58296001	(1) Wood Auger Bit
WAB7/8X4-1/2	58296101	(1) Wood Auger Bit
WAB1X4-1/2	58296901	(1) Wood Auger Bit

### WAB1X4-1/2



## MAX PUNCH® RATCHET SET WITH 1/2"-2" CUTTING DIES



Flex head ratchet wrench allows for easy maneuverability around obstacles.

- Unique 3-point cup cutting surface provides a clean, quick and easy cut for 1" through 2" dies
- Cuts through 10 gauge mild steel as well as aluminum, fiberglass, and plastics
- Cup design creates crimping effect on slug for easy removal for 1" thru 2" dies
- Ball bearing draw stud for reduced friction
- Includes Southwire® Marksman® (Model # MM01) conduit layout tool

### SPECIFICATIONS

MODEL #	STOCK #	DESCRIPTION		
MPR-01SD	582892	MAX PUNCH Ratchet Set with 1/2"-2" Dies		
	HEIGHT	WIDTH	LENGTH	WEIGHT
MPR-01SD	14.17"	10.43"	2.76"	11.57 lbs

# WARRANTIES

## **WARRANTY ON SOUTHWIRE ELECTRICIAN'S NON-ELECTRONIC HAND TOOLS**

Southwire Company, LLC warrants this product to be free from defects in materials and workmanship for the life of the product. This warranty does not cover normal wear and tear resulting from product use, nor does it cover damage arising out of misuse, abuse, modification, and/or improper maintenance of the product. If the product breaches this warranty, Southwire will replace the product free of charge. If Southwire no longer manufactures the product, then it will, at its option, replace the nonconforming product with a substantially similar Southwire product or refund the purchase price. SOUTHWIRE MAKES NO WARRANTY THAT THE PRODUCT WILL BE MERCHANTABILITY OR FIT FOR ANY PARTICULAR PURPOSE. SOUTHWIRE MAKES NO OTHER WARRANTY, EXPRESSED OR IMPLIED, OTHER THAN THE WARRANTY SPECIFICALLY SET FORTH HEREIN. SOUTHWIRE WILL NOT BE LIABLE FOR ANY INCIDENTAL, CONSEQUENTIAL, INDIRECT, SPECIAL, OR PUNITIVE DAMAGES FOR ANY BREACH OF THIS WARRANTY.

This warranty is void if this product is used for rental purposes. No product reseller is authorized to extend any other warranty on Southwire's behalf relating to this product, and no such reseller warranty will be binding on Southwire. If the product needs to be serviced, please contact the Customer Service Department at 855-SWTOOLS (855-798-6657) to obtain a return authorization from Southwire. The sender is responsible for all shipping, freight, insurance, and packaging costs associated with sending a product to Southwire. Southwire will not be responsible for lost or damaged products returned for service or returned under this warranty. All products returned to Southwire under this warranty should be mailed to:

Southwire Tools & Assembled Products Division  
840 Old Bremen Road  
Carrollton, GA 30117  
Phone Number: 1.855.SW.TOOLS

# HANDTOOL NOTES

---

---

---

---

---

---

---

---

---

---

---

---

---

---

---

---

---

---

---

---

---

---

---

---

---

---

---

---

---

---

Hole Making | **HAND TOOLS**

# TEST/MEASUREMENT

When there's no room for error, depend on our reliable test and measurement tools to get the job done. Backed by a two-year warranty, these tools withstand the elements and provide accurate, versatile, and professional results that every electrician can count on.

- Multimeters
- Clamp Meters
- Voltage Detectors & Testers
- Circuit Testers
- IR Thermometers
- Imaging
- Kits & Accessories



**METERS  
WITH  
CONNECTIONS**





# MAPP™ MOBILE APP

## MAPP™ MOBILE APP



Mobile App for connecting to Southwire Bluetooth® enabled meters.

- View readings from a safe distance right from your mobile phone
- Set up recording sessions
- Add photos and notes to create a detailed report
- Pull-up menu to modify meter settings remotely
- Communicate critical equipment issues by email



» **VIEW READINGS AND SET UP RECORDING SESSIONS FROM MOBILE**



» **JOB VALIDATION: ADD PHOTOS, NOTES AND GPS LOCATION**



» **POP UP MENU MODIFIES METER SETTINGS REMOTELY**



» **E-MAIL REPORTS TO MAINTENANCE TEAM ON CRITICAL EQUIPMENT ISSUES**

MAPP™ | TEST & MEASUREMENT

# MULTIMETER COMPARISON

	15190T	14090T	14070T	14060S	13090T	13070T
BLUETOOTH®	●	●			●	
TRUERMS	●	●	●		●	●
AC/DC VOLTAGE	1000V	1000V	1000V	1000V	600V	600V
LOWZ VOLTAGE		●	●		●	●
AC + DC VOLTAGE	●	●				
AC/DC CURRENT	10A	10A	10A	10A	10A	10A
RESISTANCE	50MΩ	60MΩ	60MΩ	60MΩ	40MΩ	40MΩ
CONTINUITY	●	●	●	●	●	●
DIODE TEST	●	●	●	●	●	●
CAPACITANCE	5000μF	6000μF	6000μF	4000μF	4000μF	4000μF
FREQUENCY	10MHZ	10KHZ	10KHZ	10KHZ	10MHZ	10MHZ
DUTY CYCLE	●	●	●	●	●	●
TEMPERATURE	2462° (1350°C)	1400°F (760°C)	1400°F (760°C)	1400°F (760°C)	1400°F (760°C)	1400°F (760°C)
DISPLAY COUNT	50,000	6000	6000	6000	4000	4000
BACKLIT DISPLAY	COLOR	●	●	●	●	●
BARGRAPH	●	●	●	●	●	●
NCV (NON-CONTACT AC VOLTAGE)						
WORKLIGHT		●	●	●	●	●
MAX/MIN	●(AVG)	●(AVG)	●(AVG)	●	●	●
PEAK HOLD	●	●	●			
AUTO HOLD						
AUTO POWER OFF	●	●	●	●	●	●
MAGNETIC HANGER	●	●	●	●		
IP67 (WATER/DUST PROOF)		●	●	●	●	●
SAFETY RATING	CAT IV 600V CAT III 1000V	CAT IV 600V CAT III 1000V	CAT IV 600V CAT III 1000V	CAT IV 600V CAT III 1000V	CAT III 600V	CAT III 600V

# MULTIMETER COMPARISON

	13050S	16040T	16020N	16030A	10040N	10030S
BLUETOOTH®		●				
TRUERMS		●		●		
AC/DC VOLTAGE	600V	600V	600V	600V	600V	600V
LOWZ VOLTAGE						
AC + DC VOLTAGE						
AC/DC CURRENT	10A	10A	200MA		10A	10A (DC)
RESISTANCE	40MΩ	40MΩ	40MΩ	400KΩ	40MΩ	2000KΩ
CONTINUITY	●	●	●	●	●	●
DIODE TEST	●	●	●		●	●
CAPACITANCE	4000μF	4000μF	100μF		100μF	
FREQUENCY	10MHZ	10KHZ	10KHZ		10MHZ	
DUTY CYCLE	●	●	●		●	
TEMPERATURE	1400°F (760°C)				1400°F (760°C)	
DISPLAY COUNT	4000	4000	4000	4000	4000	2000
BACKLIT DISPLAY	●	●	●	●	●	●
BARGRAPH	●					
NCV (NON-CONTACT AC VOLTAGE)			●	●	●	
WORKLIGHT	●	●	●	●		
MAX/MIN	●	●				
PEAK HOLD						
AUTO HOLD				●		
AUTO POWER OFF	●	●	●	●	●	
MAGNETIC HANGER						
IP67 (WATER/DUST PROOF)	●			●		
SAFETY RATING	CAT III 600V	CAT III 600V	CAT IV 600V	CAT IV 600V	CAT III 600V	CAT III 300V CAT III 600V

# CLAMP METER COMPARISON

TEST & MEASUREMENT | Clamp Meter Table

	23090T	23070T	23030T	22070T	21050T	21030T	21010N
BLUETOOTH®	●						
TRUERMS	●	●	●	●	●	●	
AC CURRENT	1000A	1000A	1000A	1000A	400A	400A	400A
DC CURRENT	1000A	1000A		1000A	400A		
AC + DC VOLTAGE	1000V	1000V	1000V	600V	600V	600V	600V
RESISTANCE	50MΩ	60MΩ	60MΩ	60MΩ	40MΩ	40MΩ	40MΩ
CONTINUITY	●	●	●	●	●	●	●
DIODE TEST	●	●	●	●	●	●	●
CAPACITANCE	5mF	6000μF	6000μF	4000μF	100μF	100μF	100μF
FREQUENCY	10MHZ	10MHZ	10MHZ	10KHZ	10KHZ	10KHZ	10KHZ
DUTY CYCLE	●	●	●	●	●	●	●
TEMPERATURE	1832°F (1000°C)	1400°F (760°C)	1400°F (760°C)	1400°F (760°C)	1400°F (760°C)	1400°F (760°C)	1400°F (760°C)
DISPLAY COUNT	50,000	6000	6000	6000	4000	4000	4000
BACKLIT DISPLAY	●	●	●	●	●	●	
BARGRAPH	●	●	●	●			
NCV (NON-CONTACT AC VOLTAGE)	●	●	●	●	●	●	●
WORKLIGHT	●	●	●				
INRUSH	●						
MAX/MIN	●	●	●	●			
PEAK HOLD	●						
AUTO POWER OFF	●	●	●	●	●	●	●
SAFETY RATING	CAT IV 600V CAT III 1000V	CAT IV 600V CAT III 1000V	CAT IV 600V CAT III 1000V	CAT III 600V	CAT III 600V	CAT III 600V	CAT III 600V

# NON-CONTACT VOLTAGE COMPARISON

40150N

40136N

40126N

40116N

AC DETECTION RANGE

12 TO 1000V 100 TO 1000V	50 to 600V	24 TO 600V 100 TO 600V	100 TO 600V
CAT IV 1000V	CAT IV 600V	CAT IV 600V	CAT IV 600V

SAFETY RATINGS

---

---

---

---

---

---

---

---

---

---

---

---

---

---

---

---

---

---

---

---

---

---

---

---

---

---

NCV Table | TEST & MEASUREMENT

# MULTIMETERS

## 15190T MAINTENANCEPRO™ DATA LOGGING CAT IV MULTIMETER



Southwire's new Bluetooth® enabled 15190T MaintenancePRO™ multimeter and MApp™ mobile app are taking test and measurement to a whole new level. When used together, this system provides one of the safest and most convenient ways for electrical professionals to get the job done.

- Bluetooth® interface for downloading, viewing, recording and sharing using Southwire's Mapp™ mobile app
- Onboard memory allows datalogging even when Bluetooth™ wireless is not connected
- Hi-Res color display with graphing feature
- On board memory for saving and viewing measurements and recordings
- Intuitive Menu navigated by function keys
- Use as stand-alone unit or pair to cell phone via Bluetooth™ and MApp™ mobile app
- Rugged meter with CAT IV 600V/CAT III 1000V safety rating, UL listed
- Includes
  - Test leads
  - Type K temperature probe with banana plug adapter
  - Magnetic hanging strap
  - Canvas bag
  - Rechargeable Li-ion battery and battery charger

### SPECIFICATIONS

MODEL #	STOCK #	UPC#	DESCRIPTION
15190T	596865	32886957666	MaintenancePRO™ Data Logging CAT IV Multimeter
FUNCTION	RANGE	MAX. RESOLUTION	MAX. ACCURACY (% OF READING)
AC Voltage	1000V	0.01mV	±0.5%
DC Voltage	1000V	0.01mV	±0.1%
AC + DC Voltage	1000V	0.1mV	±1.2%
AC Current	10A	0.01µA	±0.8%
DC Current	10A	0.01µA	±0.2%
Resistance	50MΩ	0.01Ω	±0.2%
Capacitance	5000µF	1pF	±1.5%
Frequency	10MHz	0.001Hz	±0.01%
Duty Cycle	0.1 to 99.9%	0.01%	±1.2%
Temperature	-328°F to 2462°F	0.1°	±1.0%
	-200°C to 1350°C	0.1°	±1.0%
Continuity	Audible threshold approx. 30Ω		
Diode Test	Yes		
Dimensions	6.6 x 3.1 x 2 in.		
Weight	0.90 lb.		

## 14090T TECHNICIANPRO™ BLUETOOTH® CAT IV MULTIMETER



This Bluetooth® enabled multimeter in combination with Southwire's Mapp™ mobile app allows you to view, record, and share readings on your smartphone. Designed for demanding environments. Features include a CAT IV safety rating, a rugged IP67 waterproof and dust tight housing, True RMS and Low Z readings, backlit controls, and powerful built-in work light.

- Bluetooth® interface for viewing, recording and sharing using Southwire's Mapp™ mobile app
- Lighted controls and backlit display allow use in dimly lit areas
- TrueRMS readings provide higher accuracy on AC circuits
- Low Z function eliminates false readings from "Ghost" voltage
- Includes magnetic hanging strap for hands free operation
- Powerful LED work light for added convenience
- CAT IV 600V/CAT III 1000V safety rating and IP67 waterproof and dust tight housing
- Includes
  - Test leads
  - Type K temperature probe with banana plug adapter
  - Magnetic hanging strap
  - Carrying case
  - Four AAA batteries

### SPECIFICATIONS

MODEL #	STOCK #	UPC#	DESCRIPTION
14090T	630184	032886963360	TechnicianPRO™ Bluetooth® CAT IV Multimeter
FUNCTION	RANGE	MAX. RESOLUTION	MAX. ACCURACY (% OF READING)
AC Voltage	1000V	1mV	±1.0%
Low Z (AC Voltage)	600V	1mV	±3.0%
DC Voltage	1000V	0.1mV	±0.9%
Low Z (DC Voltage)	600V	0.1mV	±3.0%
AC + DC Voltage	1000V	1mV	±2.0%
AC Current	10A	0.1µA	±1.0%
DC Current	10A	0.1µA	±1.0%
Resistance	60MΩ	0.1Ω	±1.5%
Capacitance	6000µF	10pF	±3.0%
Frequency	10kHz	0.001Hz	±1.0%
Duty Cycle	20 to 80%	0.1%	±1.2%
Temperature	-4°F to 1400°F	0.1°	±1.5%
	-20°C to 780°C	0.1°	±1.5%
Continuity	Audible threshold approx. 50Ω		
Diode Test	Yes		
Dimensions	6.7 x 3.0 x 1.9 in.		
Weight	0.85 lb.		

# MULTIMETERS

## 14070T TECHNICIANPRO™ TRUERMS CAT IV MULTIMETER



This built-tough multimeter offers a CAT IV safety rating and an IP67 waterproof and dust tight housing. With TrueRMS readings, a Low Z measurement function, backlit controls, and a powerful built-in work light, it has the features needed for the professional electrician.

- Lighted controls and backlit display allow use in dimly lit areas
- Low Z function eliminates false readings from "Ghost" voltage
- TrueRMS readings provide higher accuracy on AC circuits
- Includes magnetic hanging strap for hands free operation
- Powerful LED work light for added convenience
- CAT IV 600V/CAT III 1000V safety rating and IP67 waterproof and dust tight housing
- Includes
  - Test leads
  - Type K temperature probe with banana plug adapter
  - Magnetic hanging strap
  - Carrying case
  - Four AAA batteries

### SPECIFICATIONS

MODEL #	STOCK #	UPC#	DESCRIPTION
14070T	630182	032886963346	TechnicianPRO™ TrueRMS CAT IV Multimeter
FUNCTION	RANGE	MAX. RESOLUTION	MAX. ACCURACY (% OF READING)
AC Voltage	1000V	1mV	±1.0%
Low Z (AC Voltage)	600V	1mV	±3.0%
DC Voltage	1000V	0.1mV	±1.0%
Low Z (DC Voltage)	600V	0.1mV	±3.0%
AC Current	10A	0.1µA	±1.5%
DC Current	10A	0.1µA	±1.0%
Resistance	60MΩ	0.1Ω	±1.5%
Capacitance	6000µF	10pF	±3.0%
Frequency	10kHz	0.001Hz	±1.0%
Duty Cycle	20 to 80%	0.1%	±1.2%
Temperature	-4°F to 1400°F	0.1°	±2.0%
	-20°C to 780°C	0.1°	±2.0%
Continuity	Audible threshold approx. 50Ω		
Diode Test	Yes		
Dimensions	6.7 x 3.0 x 1.9 in.		
Weight	0.85 lb.		



## 14060S TECHNICIANPRO™ AUTO RANGING CAT IV MULTIMETER



This built-tough multimeter offers a CAT IV safety rating and an IP67 waterproof and dust tight housing. With 11 measuring functions, backlit controls, and a powerful built-in work light, it's fully equipped for a wide range of applications.

- 11 measuring functions plus MAX/MIN
- Lighted controls and backlit display allow use in dimly lit areas
- Powerful LED work light for added convenience
- Includes magnetic hanging strap for hands free operation
- Rugged IP67 waterproof and dust tight housing
- CAT IV 600V/CAT III 1000V safety rating, UL listed
- Includes
  - Test leads
  - Type K temperature probe with banana plug adapter
  - Magnetic hanging strap
  - Carrying case
  - Four AAA batteries

### SPECIFICATIONS

MODEL #	STOCK #	UPC#	DESCRIPTION
14060S	630287	032886963322	TechnicianPRO™ Auto-ranging CAT IV Multimeter
FUNCTION	RANGE	MAX. RESOLUTION	MAX. ACCURACY (% OF READING)
AC Voltage	1000V	1mV	±1.0%
DC Voltage	1000V	0.1mV	±1.0%
AC Current	10A	0.1µA	±1.5%
DC Current	10A	0.1µA	±1.0%
Resistance	60MΩ	0.1Ω	±1.5%
Capacitance	4000µF	10pF	±3.0%
Frequency	10kHz	0.001Hz	±1.0%
Duty Cycle	1 to 99.9%	0.1%	±1.2%
Temperature	-4°F to 1400°F	0.1°	±3.0%
	-20°C to 780°C	0.1°	±3.0%
Continuity	Audible threshold approx. 30Ω		
Diode Test	Yes		
Dimensions	6.7 x 3.0 x 1.9 in.		
Weight	0.85 lb.		

# MULTIMETERS

## 13090T RESIDENTIALPRO™ BLUETOOTH® CAT III MULTIMETER



This Bluetooth® enabled multimeter in combination with Southwire's MApp™ mobile app allows you to view, record, and share readings on your smartphone. With TrueRMS and Low Z readings, a rugged waterproof and dust proof housing, and built-in flashlight, this compact multimeter can be used in a wide range of applications.

- Bluetooth® interface for viewing, recording and sharing using Southwire's MApp™ mobile app
- TrueRMS readings provide higher accuracy on AC circuits
- Low Z function eliminates false readings from "Ghost" voltage
- Powerful LED work light for added convenience
- Rugged IP67 waterproof and dust tight housing
- CAT III 600V safety rating, UL listed
- Includes
  - Test leads
  - Type K temperature probe with banana plug adapter
  - Three AAA batteries

### SPECIFICATIONS

MODEL #	STOCK #	UPC#	DESCRIPTION
13090T	630160	032886963308	ResidentialPRO™ Bluetooth® CAT III Multimeter
FUNCTION	RANGE	MAX. RESOLUTION	MAX. ACCURACY (% OF READING)
AC Voltage	600V	1mV	±1.0%
Low Z (AC Voltage)	300V	1mV	±1.5%
DC Voltage	600V	0.1mV	±1.0%
Low Z (DC Voltage)	300V	0.1mV	±1.5%
AC Current	10A	1mA	±2.5%
DC Current	10A	1mA	±2.0%
Resistance	40MΩ	0.1Ω	±1.5%
Capacitance	4000μF	10pF	±3.0%
Frequency	10kHz	0.001Hz	±1.0%
Duty Cycle	1.0 to 99.9%	0.1%	±1.2%
Temperature	0°F to 1400°F	0.1°	±2.0%
	-18°C to 760°C	0.1°	±2.0%
Continuity	Audible threshold: approx. 50Ω		
Diode Test	Yes		
Dimensions	5.8 x 2.7 x 2.0 in.		
Weight	0.70 lb.		

## 13070T RESIDENTIALPRO™ TRUERMS CAT III MULTIMETER



With 11 measurement functions, TrueRMS readings, a Low Z measurement function, and a rugged waterproof and dust proof housing, this compact multimeter has the features needed to get the job done. A built-in flashlight provides added convenience.

- TrueRMS readings provide higher accuracy on AC circuits
- Low Z function eliminates false readings from "Ghost" voltage
- 11 measuring functions plus MAX/MIN
- Powerful LED work light for added convenience
- Rugged IP67 waterproof and dust tight housing
- CAT III 600V safety rating, UL listed
- Includes
  - Test leads
  - Type K temperature probe with banana plug adapter
  - Three AAA batteries

### SPECIFICATIONS

MODEL #	STOCK #	UPC#	DESCRIPTION
13070T	630150	032886963285	ResidentialPRO™ TrueRMS CAT III Multimeter
FUNCTION	RANGE	MAX. RESOLUTION	MAX. ACCURACY (% OF READING)
AC Voltage	600V	1mV	±1.5%
Low Z (AC Voltage)	300V	1mV	±1.5%
DC Voltage	600V	0.1mV	±0.8%
Low Z (DC Voltage)	300V	0.1mV	±0.8%
AC Current	10A	1mA	±3.0%
DC Current	10A	1mA	±2.5%
Resistance	40MΩ	0.1Ω	±1.2%
Capacitance	4000μF	10pF	±3.0%
Frequency	10kHz	0.001Hz	±1.2%
Duty Cycle	0.1 to 99.9%	0.1%	±1.2%
Temperature	-4°F to 1400°F	0.1°	±3.0%
	-20°C to 760°C	0.1°	±3.0%
Continuity	Audible threshold approx. 40Ω		
Diode Test	Yes		
Dimensions	5.8 x 2.7 x 2.0 in.		
Weight	0.70 lb.		

# MULTIMETERS

## 13050S RESIDENTIALPRO™ AUTO RANGING CAT III MULTIMETER



With 11 measuring functions, an easy to read backlit display, and a rugged IP67 waterproof and dust proof housing, this compact multimeter is perfect for general use. A built-in flashlight provides added convenience.

- 11 Measuring functions plus MAX/MIN
- Backlit 4000-count display with bar graph
- Powerful LED work light for added convenience
- Rugged IP67 waterproof and dust tight housing
- CAT III 600V safety rating UL listed
- Includes
  - Test leads
  - Type K temperature probe with banana plug adapter
  - Three AAA batteries

### SPECIFICATIONS

MODEL #	STOCK #	UPC#	DESCRIPTION
13050S	630145	032886963261	ResidentialPRO™ Autoranging CAT III Multimeter
FUNCTION	RANGE	MAX. RESOLUTION	MAX. ACCURACY (% OF READING)
AC Voltage	600V	1mV	±1.5%
DC Voltage	600V	0.1mV	±0.8%
AC Current	10A	1mA	±3.0%
DC Current	10A	1mA	±3.0%
Resistance	40MΩ	0.1Ω	±1.2%
Capacitance	4000μF	10pF	±3.0%
Frequency	10kHz	0.001Hz	±1.2%
Duty Cycle	0.1 to 99.9%	0.1%	±1.2%
Temperature	-4°F to 1400°F	0.1°	±3.0%
	-20°C to 760°C	0.1°	±3.0%
Continuity	Audible threshold approx. 50Ω		
Diode Test	Yes		
Dimensions	5.8 x 2.7 x 2.0 in.		
Weight	0.70 lb.		

## 16040T COMPACT BLUETOOTH® CAT III MULTIMETER



This compact Bluetooth® enabled multimeter in combination with Southwire's MApp™ mobile app allows you to view, record, and share readings on your smartphone. With TrueRMS readings and 10 measuring functions, it can be used in a wide range of applications.

- Bluetooth® interface for viewing, recording and sharing readings using Southwire's Mapp™ mobile app
- TrueRMS readings provide higher accuracy on AC circuits
- 10 measuring functions plus MAX/MIN
- Powerful LED work light for added convenience
- Rugged double molded housing
- CAT III 600V safety rating, UL Listed
- Includes
  - Test leads
  - Two AAA batteries

### SPECIFICATIONS

MODEL #	STOCK #	UPC#	DESCRIPTION
16040T	630194	032886963421	Compact Bluetooth® CAT III Multimeter
FUNCTION	RANGE	MAX. RESOLUTION	MAX. ACCURACY (% OF READING)
AC Voltage	600V	1mV	±1.0%
DC Voltage	600V	0.1mV	±1.0%
AC Current	10A	0.1µA	±2.0%
DC Current	10A	0.1µA	±1.0%
Resistance	40MΩ	0.1Ω	±1.0%
Capacitance	4000µF	10pF	±3.0%
Frequency	10kHz	0.001Hz	±1.0%
Duty Cycle	20 to 80%	0.1%	±1.2%
Continuity	Audible threshold approx. 50Ω		
Diode Test	Yes		
Dimensions	4.8 x 2.6 x 1.4 in.		
Weight	0.32 lb.		

# MULTIMETERS

## 16030A AUTOSELECTING CAT IV MULTIMETER



Easy to use TrueRMS CAT IV multimeter automatically selects AC or DC voltage when connected to live circuits. Added features include a rugged IP67 waterproof and dust tight housing, a built-in flashlight and non-contact AC voltage detector, and Auto Hold for fast touch and hold readings.

- Automatically selects AC or DC voltage
- Auto Hold function for quick touch and hold readings
- TrueRMS readings provide higher accuracy on AC circuits
- Easy to read 4000 count backlit display
- Built-in non-contact AC voltage detector and powerful work light
- Rugged IP67 Waterproof/Dust Tight housing
- CAT IV 600V safety rating, UL listed
- Includes
  - Test leads
  - Two AAA batteries

### SPECIFICATIONS

MODEL #	STOCK #	UPC#	DESCRIPTION
16030A	630191	032886963407	Autoselecting CAT IV Multimeter
<b>DIMENSIONS</b>		5.5 x 3.0 x 1.6 in.	<b>WEIGHT</b>
			0.50 lb.
FUNCTION	RANGE	MAX. RESOLUTION	MAX. ACCURACY (% OF READING)
AC Voltage:	600V	0.1V	±1.0%
DC Voltage:	600V	0.1V	±1.0%
Non-Contact AC Voltage	100 to 600V AC	—	—
Resistance:	400kΩ	0.1Ω	±2.0%
Continuity:	Audible threshold approx. 50Ω		

## 16020N COMPACT 3-IN-1 CAT IV MULTIMETER



Designed for the electrician on the go. This compact CAT IV 3-in-1 combination multimeter with built-in flashlight and non-contact AC voltage detector is a great fit for a crowded tool bag.

- 3-in-1 Combination: Multimeter, Work Light and Non-Contact AC Voltage Detector
- Compact size with integrated test leads is perfect for crowded tool bag
- 10 measuring functions
- Fuse automatically resets itself
- Rugged double molded housing
- CAT IV 600V safety rating, UL Listed
- Includes:
  - Multimeter with integrated test leads
  - Two AAA batteries

### SPECIFICATIONS

MODEL #	STOCK #	UPC#	DESCRIPTION
16020N	630186	032886963384	Compact 3-IN-1 CAT IV Multimeter
<b>DIMENSIONS</b>	4.6 x 2.3 x 1.4 in.	<b>WEIGHT</b>	0.32 lb.
FUNCTION	RANGE	MAX. RESOLUTION	MAX. ACCURACY (% OF READING)
AC Voltage:	600V	0.1mA	± 1.0%
DC Voltage:	600V	0.1mA	± 0.5%
Non-Contact AC Voltage	100 to 600V AC	—	—
AC Current:	200mA	0.1µA	±2.5%
DC Current:	200mA	0.1µA	±2.0%
Resistance:	40MΩ	0.1Ω	±0.8%
Capacitance:	100µF	10pF	±3.0%
Frequency:	10kHz	0.001Hz	±2.0%
Duty Cycle:	0.5 to 99%	0.1%	±2.0%
Continuity:	Audible threshold approx. 100Ω		
Diode Test	Yes		

# MULTIMETERS

## 10040N AUTORANGING MULTIMETER



This compact multimeter is the perfect fit for the crowded tool bag. Features include a CAT III safety rating, built-in non-contact AC voltage (NCV) detector, and Capacitance and Temperature functions.

- 12 Functions including: Capacitance, Frequency, Duty Cycle, and Temperature
- Built-in non-contact AC voltage detector
- Easy to read backlit 4,000 count digital display
- Impact resistant double molded housing also provides comfortable grip
- CAT III 600V safety rating, UL listed
- Includes:
  - Test leads
  - Type K temperature probe with banana plug adapter
  - 9 volt battery

### SPECIFICATIONS

MODEL #	STOCK #	DESCRIPTION	
10040N	582910	Auto-ranging Multimeter	
	RANGE	MAX. RESOLUTION	MAX. ACCURACY (% OF READING)
AC Voltage:	600V	1.0mV	±1.2%
DC Voltage:	600V	0.1mV	±0.5%
NCV: (non-contact AC Voltage)	100 to 600V	-	-
AC Current:	10A	0.1µA	±1.5%
DC Current:	10A	0.1µA	±1.0%
Resistance:	40MΩ	0.1Ω	±1.0%
Capacitance:	100µF	10pF	±3.0%
Frequency:	10MHz	0.001Hz	±1.2%
Duty Cycle:	99.9%	0.1%	±1.2%
Temperature:	-4 to 1400°F -20 to 760°C	0.1°F 0.1°C	±3.0% ±3.0%
Continuity:	Audible threshold: Approximately 30Ω		
Diode Test:	Yes		
Dimensions:	5.4 x 2.7 x 1.5 in.		
Weight:	0.46 lb.		





## 10030S MANUAL RANGING MULTIMETER



This general purpose multimeter features a CAT III safety rating, rugged double molded housing, and a backlit display.

- 7 functions with 20 ranges. Functions are: AC Voltage, DC Voltage, DC Current, Resistance, Battery Test, Continuity and Diode Test
- Tests AAA, AA, C, D, and 9 volt batteries
- Impact resistant double molded housing also provides comfortable grip
- Easy to read backlit digital display
- CAT III 300V/CAT II 600V safety rating, UL listed
- Includes:
  - Test leads
  - 9 volt battery

### SPECIFICATIONS

MODEL #	STOCK #	DESCRIPTION	
10030S	582908	Manual Ranging Multimeter	
	RANGE	MAX. RESOLUTION	MAX. ACCURACY (% OF READING)
AC Voltage:	600V	0.1V	±1.2%
DC Voltage:	600V	0.1mV	±0.5%
DC Current:	10A	1µA	±1.0%
Resistance:	2000kΩ	0.1Ω	±0.8%
Battery Test:	1.5V and 9V	10mV	±1.0%
Continuity:	Audible threshold: Approximately 30Ω		
Diode Test:	Yes		
Dimensions:	5.9 x 2.8 x 1.9 in.		
Weight:	0.56 lb.		

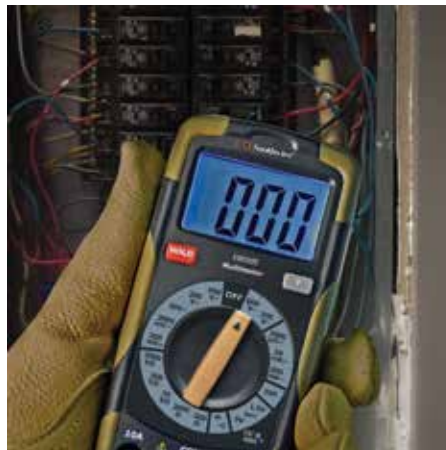

Test in low-light areas



# CLAMP METERS

## 23090T MAINTENANCEPRO™ SMART 1000A CLAMP METER



Southwire's new MaintenancePRO™ 23090T adds Bluetooth® connectivity to a rugged high end clamp meter. Used with our MApp™ mobile app, the 23090T lets electricians safely get the measurements they need even in hostile environments. The app can be used to view readings, set up recording sessions, and assemble complete reports right from your mobile phone. This and other features like the 50,000 count display and the inrush feature make the 23090T the optimal choice for the serious electrician.

- Bluetooth® interface for viewing, saving and sharing using Southwire's MApp™ mobile app
- Inrush function captures motor start-up current
- 11 measuring functions, plus MAX/MIN
- Precision TrueRMS meter
- Hi-Res 50,000 count backlit display with bargraph
- Built in non-contact AC voltage detector and powerful LED work light
- Rugged meter with CAT IV 600V / CAT III 1000V safety rating, UL listed
- Includes:
  - Test leads
  - Type K temperature probe with banana plug adapter
  - Carrying case
  - 9 volt battery

### SPECIFICATIONS

MODEL #	STOCK #	UPC#	DESCRIPTION
23090T	596868	32886957697	MaintenancePRO™ Bluetooth® 1000A Clamp Meter
FUNCTION	RANGE	MAX. RESOLUTION	MAX. ACCURACY (% OF READING)
AC Current	1000A	10mA	±2.5%
DC Current	1000A	10mA	±2.5%
Jaw Opening	1.9" (48mm)	—	—
AC Voltage	1000V	0.01mV	±1.0%
DC Voltage	1000V	0.01mV	±1.0%
Non-Contact AC Voltage	110 to 1000V AC	—	—
Resistance	50MΩ	0.01Ω	±1.0%
Capacitance	5mF	10pF	±3.5%
Frequency	10MHz	0.001Hz	±0.3%
Duty Cycle	5 to 95%	0.01%	±1.0%
Temperature	-148°F to 1832°F	0.1°	±1.0%
	-100°C to 1000°C	0.1°	±1.0%
Continuity	Audible threshold approx. 50Ω		
Diode Test	Yes		
Dimensions	9.0 x 3.0 x 1.6 in.		
Weight	0.69 lb.		

## 23070T MAINTENANCEPRO™ 1000A AC/DC CLAMP METER



The MaintenancePRO™ 23070T clamp meter is a rugged high end AC/DC clamp meter for the serious electrician who needs both AC and DC current measurements. With a UL listed safety rating of CAT IV 600V / CAT III 1000V, this clamp meter is built to get the tough jobs done.

- 11 measuring functions plus MAX/MIN
- TrueRMS readings provide higher accuracy on AC circuits
- Measures both AC and DC current
- Built in non-contact AC voltage detector and powerful LED work light
- 6,000 count backlit display with bar graph
- Rugged meter with CAT IV 600V / CAT III 1000V safety rating, UL listed
- Includes:
  - Test leads
  - Type K temperature probe with banana plug adapter
  - Carrying case
  - 9 volt battery

### SPECIFICATIONS

MODEL #	STOCK #	UPC#	DESCRIPTION
23070T	596867	32886957680	MaintenancePRO™ 1000A AC/DC Clamp Meter
FUNCTION	RANGE	MAX. RESOLUTION	MAX. ACCURACY (% OF READING)
AC Current	1000A	10mA	±2.5%
DC Current	1000A	10mA	±2.5%
Jaw Opening	1.9" (48mm)	—	—
AC Voltage	1000V	1mV	±1.5%
DC Voltage	1000V	0.1mV	±1.0%
Non-Contact AC Voltage	100 to 1000V AC	—	—
Resistance	60MΩ	0.1Ω	±1.0%
Capacitance	6000μF	10pF	±3.0%
Frequency	10MHz	0.001Hz	±1.0%
Duty Cycle	0.5 to 99.9%	0.01%	±1.2%
Temperature	-4°F to 1400°F	0.1°	±3.0%
	-20°C to 760°C	0.1°	±3.0%
Continuity	Audible threshold approx. 50Ω		
Diode Test	Yes		
Dimensions	9.0 x 3.0 x 1.6 in.		
Weight	0.69 lb.		

# CLAMP METERS

## 23030T MAINTENANCEPRO™ 1000A AC CLAMP METER



The MaintenancePRO™ 23030T clamp meter is a rugged high end AC clamp meter. With a UL listed safety rating of CAT IV 600V / CAT III 1000V, this clamp meter is built to get the tough jobs done. Plus, added features like an easy to read 6,000 count backlit display and a built in non-contact AC voltage detector makes the 23030T the new standard in residential, commercial and maintenance clamp meters.

- 10 measuring functions plus MAX/MIN
- TrueRMS readings provide higher accuracy on AC circuits
- Powerful LED work light for added convenience
- Built in non-contact AC voltage detector
- 6,000 count backlit display with bar graph
- Rugged meter with CAT IV 600V / CAT III 1000V safety rating, UL listed
- Includes:
  - Test leads
  - Type K temperature probe with banana plug adapter
  - Carrying case
  - 9 volt battery

### SPECIFICATIONS

MODEL #	STOCK #	UPC#	DESCRIPTION
23030T	596866	32886957673	MaintenancePRO™ 1000A AC Clamp Meter
FUNCTION	RANGE	MAX. RESOLUTION	MAX. ACCURACY (% OF READING)
AC Current	1000A	10mA	±2.5%
Jaw Opening	1.9" (48mm)	—	—
AC Voltage	1000V	1mV	±1.5%
DC Voltage	1000V	0.1mV	±1.0%
Non-Contact AC Voltage	100 to 1000V AC	—	—
Resistance	60MΩ	0.1Ω	±1.0%
Capacitance	6000μF	10pF	±3.0%
Frequency	10MHz	0.001Hz	±1.0%
Duty Cycle	0.5 to 99.9%	0.01%	±1.2%
Temperature	-4°F to 1400°F	0.1°	±3.0%
	-20°C to 760°C	0.1°	±3.0%
Continuity	Audible threshold approx. 50Ω		
Diode Test	Yes		
Dimensions	9.0 x 3.0 x 1.6 in.		
Weight	0.69 lb.		

# CLAMP METERS

## 22070T 1000A AC/DC TRUERMS CLAMP METER



1000A AC/DC clamp meter combines the features needed for the professional electrician including TrueRMS readings, a built-in non-contact AC voltage detector, Multimeter, Capacitance and Temperature functions.

- 11 measuring functions plus Max/Min
- TrueRMS for accurate AC voltage and current readings
- Measures both AC and DC current
- Built-in non-contact AC voltage detector
- Easy to read backlit 6,000-count digital display with bar graph
- Impact resistant double molded housing provides comfortable grip
- CAT III 600V safety rating, UL listed
- Includes:
  - Test leads
  - Type K temperature probe with banana plug adapter
  - Carrying case
  - 9 volt battery

### SPECIFICATIONS

MODEL #	STOCK #	UPC#	DESCRIPTION
22070T	582903	032886909801	1000A TrueRMS AC/DC Clamp Meter
FUNCTION	RANGE	MAX. RESOLUTION	MAX. ACCURACY (% OF READING)
AC Current	1000A	0.1A	±2.8%
DC Current	1000A	0.1A	±2.8%
Jaw Opening	1.5" (40mm)	—	
AC Voltage	600V	1mV	±1.8%
DC Voltage	600V	0.1mV	±0.8%
Non-Contact AC Voltage	100 to 600V AC	—	
Resistance	60MΩ	0.1Ω	±1.0%
Capacitance	4000μF	10pF	±3.0%
Frequency	10kHz	0.001Hz	±1.5%
Duty Cycle	0.5 to 99%	0.1%	±1.2%
Temperature	-4°F to 1400°F	0.1°	±3.0%
	-20°C to 760°C	0.1°	±3.0%
Continuity	Beeper on <30Ω, Beeper off >150Ω		
Diode Test	Yes		
Dimensions	9.1 x 3.0 x 1.5 in.		
Weight	0.60 lb.		



Clamp Meters | TEST & MEASUREMENT

# CLAMP METERS

## 21050T 400A AC/DC TRUERMS CLAMP METER



The 21050T is a feature-packed TrueRMS AC/DC compact clamp meter. TrueRMS is especially valuable for current measurements on circuits with harmonic distortion. The addition of DC current testing makes this even more versatile than the 21030T.

- 11 measuring functions including Capacitance, Frequency, Duty Cycle, and Temperature
- TrueRMS for accurate AC voltage and current readings
- Measures both AC and DC current
- Built-in non-contact AC voltage detector
- Easy to read backlit, 4,000-count digital display
- Impact resistant double molded housing provides comfortable grip
- CAT III 600V safety rating, UL listed
- Includes:
  - Test leads
  - Type K temperature probe with banana plug adapter
  - Carrying case
  - Two AAA batteries

### SPECIFICATIONS

MODEL #	STOCK #	UPC#	DESCRIPTION
21050T	582902	032886909795	400A TrueRMS AC/DC Clamp Meter
FUNCTION	RANGE	MAX. RESOLUTION	MAX. ACCURACY (% OF READING)
AC Current	400A	10mA	±2.8%
DC Current	400A	10mA	±2.5%
Jaw Opening	1.2" (30mm)	—	—
AC Voltage	600V	1mV	±1.5%
DC Voltage	600V	0.1mV	±0.8%
Non-Contact AC Voltage	100 to 600V AC	—	—
Resistance	40MΩ	0.1Ω	±1.0%
Capacitance	100μF	10pF	±3.0%
Frequency	10kHz	0.001Hz	±1.5%
Duty Cycle	0.5 to 99%	0.1%	±1.2%
Temperature	-4°F to 1400°F	0.1°	±3.0%
	-20°C to 760°C	0.1°	±3.0%
Continuity	Beeper on <30Ω, Beeper off >150Ω		
Diode Test	Yes		
Dimensions	7.9 x 2.6 x 1.5 in.		
Weight	0.45 lb.		



# CLAMP METERS

## 21030T 400A AC TRUE RMS CLAMP METER



The 21030T has all the features of the 21010N, plus TrueRMS for accuracy and a backlit LCD screen for better visibility in dark work environments.

- 10 measuring functions including Capacitance, Frequency, Duty Cycle, and Temperature
- TrueRMS for accurate AC voltage and current readings
- Built-in non-contact AC NCV detector
- Easy to read backlit, 4,000-count digital display
- Impact resistant double molded housing also provides comfortable grip
- CAT III 600V safety rating, UL listed
- Includes:
  - Test leads
  - Type K temperature probe with banana plug adapter
  - Carrying case
  - Two AAA batteries

### SPECIFICATIONS

MODEL #	STOCK #	UPC#	DESCRIPTION
21030T	582901	032886909788	400A TrueRMS AC Clamp Meter
FUNCTION	RANGE	MAX. RESOLUTION	MAX. ACCURACY (% OF READING)
AC Current	400A	10mA	±2.8%
Jaw Opening	1.2" (30mm)	—	—
AC Voltage	600V	1mV	±1.8%
DC Voltage	600V	0.1mV	±0.8%
Non-Contact AC Voltage	100 to 600V AC	—	—
Resistance	40MΩ	0.1Ω	±1.0%
Capacitance	100μF	10pF	±3.0%
Frequency	10kHz	0.001Hz	±1.5%
Duty Cycle	0.5 to 99%	0.1%	±1.2%
Temperature	-4°F to 1400°F	0.1°	±3.0%
	-20°C to 760°C	0.1°	±3.0%
Continuity	Beeper on <30Ω, Beeper off >150Ω		
Diode Test	Yes		
Dimensions	7.9 x 2.6 x 1.5 in.		
Weight	0.45 lb.		



Clamp Meters | TEST & MEASUREMENT

# CLAMP METERS

## 21010N 400A AC CLAMP METER



Our entry-level clamp meter, the 21010N is a 400A AC clamp with a very useful mix of functions including a built-in non-contact AC voltage detector, temperature and multimeter functions including capacitance.

- 10 measuring functions including Capacitance, Frequency, Duty Cycle, and Temperature
- Built-in non-contact AC NCV detector
- Easy to read backlit, 4,000-count digital display
- Impact resistant double molded housing also provides comfortable grip
- CAT III 600V safety rating, UL listed
- Includes:
  - Test leads
  - Type K temperature probe with banana plug adapter
  - Carrying case
  - Two AAA batteries

### SPECIFICATIONS

MODEL #	STOCK #	UPC#		DESCRIPTION
21010N	582900	032886909771		400A AC Clamp Meter
FUNCTION	RANGE	MAX. RESOLUTION		MAX. ACCURACY (% OF READING)
AC Current	400A	10mA		±2.8%
Jaw Opening	1.2" (30mm)	—		—
AC Voltage	600V	1mV		±1.8%
DC Voltage	600V	0.1mV		±0.8%
Non-Contact AC Voltage	100 to 600V AC	—		—
Resistance	40MΩ	0.1Ω		±1.0%
Capacitance	100μF	10pF		±3.0%
Frequency	10kHz	0.001Hz		±1.5%
Duty Cycle	0.5 to 99%	0.1%		±1.2%
Temperature	-4°F to 1400°F	0.1°		±3.0%
	-20°C to 760°C	0.1°		±3.0%
Continuity	Beeper on <30Ω, Beeper off >150Ω			
Diode Test	Yes			
Dimensions	7.9 x 2.6 x 1.5 in.			
Weight	0.45 lb.			





## 10036K ELECTRICAL TEST KIT



Combines the 3 most commonly used electrical testers in one convenient kit. Ideal for household repairs and electrical troubleshooting.

- Manual ranging multimeter features a CAT III 300V / CAT II 600V safety rating, easy to read backlit display, and battery test function
- Non-contact AC voltage detector checks for live voltage from 100 to 600V AC and features a built-in flashlight
- Receptacle tester quickly checks for miswired outlets

Kit Includes:

- 10030S Manual Ranging Multimeter with test leads
- 40116N Non-Contact AC Voltage Detector
- 40010S-A Receptacle Tester
- One 9 volt and two AAA batteries

## SPECIFICATIONS

MODEL #	STOCK #	UPC#	DESCRIPTION
10030S	582908	032886909856	Manual Ranging CAT III Multimeter
FUNCTION	RANGE	MAX. RESOLUTION	MAX. ACCURACY (% OF READING)
AC Current	600V	0.1V	±1.2%
DC Current	600V	0.1mV	±0.5%
DC Voltage	10A	1µA	±1.0%
Resistance	2000kΩ	0.1Ω	±0.8%
Battery Test	1.5V, 9V	10mV	±1.0%
Continuity	Audible threshold approx. 50Ω		
Diode Test	Yes		
Dimensions	5.9 x 2.8 x 1.9 in.		
Weight	0.56 lb.		

MODEL #	STOCK #	UPC#	DESCRIPTION
40116N	599920	032886963025	NCV Detector 100-600V AC
FUNCTION	RANGE	RESOLUTION	ACCURACY (% OF READING)
AC Detection Range	100-600V AC	—	—
Safety Rating	CAT IV 600V		
Frequency Range	50/60Hz		
Dimensions	6.2 x 0.8 x 1 in.		

MODEL #	STOCK #	UPC#	DESCRIPTION
40010S-A	582925	032886910029	Receptacle Tester
Identifies	Open Ground, Open Neutral, Open Hot, Reversed Hot Ground, Reversed red Hot Neutral, Correct Wiring		
Dimensions	3.4 x 1.7 x 1 in.		

# VOLTAGE DETECTORS & TESTERS

## 41170S VOLTAGE/CONTINUITY/PHASE ROTATION TESTER



This versatile tester features a built-in flashlight, single probe AC voltage check, phase rotation on three phase circuits, and automatic indication of continuity and AC and DC voltage up to 600 volts in 8 steps.

- LED indication of AC voltage from 24 to 600V and DC voltage from 6 to 400V in 8 steps
- One-probe live voltage check
- Indicates phase rotation on three phase circuits
- Audible and visual continuity test
- Built-in LED flashlight
- Includes 41170S Tester with integrated test leads & two AAA batteries
- CAT III 600V safety rating, UL listed

### SPECIFICATIONS

MODEL #	STOCK #	DESCRIPTION
41170S	582935	Voltage/Continuity/Phase Rotation Tester
AC Voltage Indication:	24, 48, 120, 208, 240, 277, 480, 600V AC	
DC Voltage Indication:	6, 12, 24, 36, 48, 110, 220, 400V DC	
Tolerances:	-30% to 0% of reading	
Single Pole Voltage Test:	100 to 480V AC	
Rotary Field Indication:	100 to 400V AC	
AC Operating Frequency:	50/60Hz	
Continuity Test:	Beeper will sound if the resistance is under 300kΩ	
Overload Protection:	600V AC/DC	
Dimensions:	9.46 x 2.07 x 1.45 in.	
Weight:	0.50 lb.	



# VOLTAGE DETECTORS & TESTERS

## 41160S VOLTAGE/CONTINUITY TESTER



Simple to use tester automatically indicates polarity and live AC and DC voltage up to 600 volts in 7 steps.

- Checks continuity of wires, light bulbs and fuses
- Automatic selection: AC, DC, or continuity
- Indicates polarity and seven levels of AC/DC voltage
- Automatically turns on and off
- UL listed, CAT III 600V
- Includes 41160S Tester with integrated test leads and two AA batteries

### SPECIFICATIONS

MODEL #	STOCK #	DESCRIPTION
41160S	582916	Voltage/Continuity Tester
AC Voltage Indication:	24, 120, 208, 240, 277, 480, 600V	
DC Voltage Indication:	6, 12, 24, 36, 48, 110, 220V	
Tolerances:	-30% to 0% of reading	
AC Operating Frequency:	50/60Hz	
Continuity Test:	Beeper will sound if the resistance is under 85kΩ	
Maximum Input:	600V AC/DC	
Dimensions:	7.25 x 3.00 x 1.55 in.	
Weight:	0.65 lb.	



# VOLTAGE DETECTORS & TESTERS

## 41150S AC/DC VOLTAGE TESTER



Simple to use tester automatically indicates live AC and DC voltage up to 240 volts in 7 steps.

- Indicates polarity and voltage up to 240 V in 7 steps
- No batteries required, simple automatic operation
- GFCI - verifies operation of GFCI protected outlets
- CAT II 300V and UL listed
- Includes 41150S Tester with integrated test leads
- No batteries required

### SPECIFICATIONS

MODEL #	STOCK #	DESCRIPTION
41150S	582917	AC/DC Voltage Tester
AC/DC Voltage Indication:	6, 12, 24, 48, 120, 208, 240V	
Tolerances:	-30% to 0% of reading	
AC Operating Frequency:	50/60Hz	
Overload Protection:	250V AC/DC <5s	
Dimensions:	9.46 x 1.25 x 0.95 in.	
Weight:	0.20 lb.	



# VOLTAGE DETECTORS & TESTERS

## 40150N ADVANCED DUAL RANGE NCV 12-1000V AC



### Advanced Dual Range NCV 12-1000V & 100-1000V AC

- High power rear flashlight and forward facing flashlight
- Thinner probe tip for working with wall outlets
- Power switch (standard)
- Green LED means Power on, flashing red LED with beeper means voltage detected
- Low Battery self test
- Two modes- Green- means high voltage mode, Yellow-means low voltage mode
- Silent Mode
- IP67 Waterproof

### SPECIFICATIONS

MODEL #	STOCK #	DESCRIPTION
40150N	630207	40150N Advanced Dual Range NCV 12-1000V AC
AC Detection Range	12-1000V & 100-1000V AC	
GENERAL SPECIFICATIONS		
Safety Rating	CAT IV 1000V	
Frequency Range	50/60Hz	
Batteries	Two AAA	
Operating Temperature	32°F to 104°F (0°C to 40°C)	
Storage Temperature	14°F to 140°F (-10°C to 60°C)	
Dimensions	6.23 x 0.83 x 0.99 in (158 x 21 x 25 mm)	
Humidity	80% max	



Voltage Detectors & Testers | TEST & MEASUREMENT

# VOLTAGE DETECTORS & TESTERS

## 40136N NCV DETECTOR 50-600V AC PRO



### NCV Detector 50-600V AC Pro

- Flashlight now 2X brighter
- Thinner probe tip for working with wall outlets
- Power switch (standard)
- Green LED means Power on, Flashing red LED with beeper means voltage detected
- Low battery self test
- Silent Mode
- Flash and Beep rate increase as the detector gets closer to the voltage source helping the user pinpoint live circuits

### SPECIFICATIONS

MODEL #	STOCK #	DESCRIPTION
40136N	599924	40136N NCV Detector 48-600V AC Pro
AC Detection Range	50-600V AC	
GENERAL SPECIFICATIONS		
Safety Rating	CAT IV 600V	
Frequency Range	50/60Hz	
Batteries	Two AAA	
Operating Temperature	32°F to 104°F (0°C to 40°C)	
Storage Temperature	14°F to 140°F (-10°C to 60°C)	
Dimensions	6.23 x 0.83 x 0.99 in (158 x 21 x 25 mm)	
Humidity	80% max	



# VOLTAGE DETECTORS & TESTERS

## 40126N NCV DUAL RANGE 24-600V AC



### NCV Dual Range 24-600V & 100-600V AC

- Flashlight now 2X brighter
- Thinner probe tip for working with wall outlets
- Power switch (standard)
- Green LED means Power on, Flashing red LED with beeper means voltage detected
- Low battery self test
- Two modes- Green- means high voltage mode, Yellow-means low voltage mode

### SPECIFICATIONS

MODEL #	STOCK #	DESCRIPTION
40126N	599922	40126N NCV Dual Range 24-600V AC
AC Detection Range	24-600V & 100-600V AC	
GENERAL SPECIFICATIONS		
Safety Rating	CAT IV 600V	
Frequency Range	50/60Hz	
Batteries	Two AAA	
Operating Temperature	32°F to 104°F (0°C to 40°C)	
Storage Temperature	14°F to 140°F (-10°C to 60°C)	
Dimensions	6.23 x 0.83 x 0.99 in (158 x 21 x 25 mm)	
Humidity	80% max	



# VOLTAGE DETECTORS & TESTERS

## 40116N NCV DETECTOR 100-600V AC



### NCV Detector 100-600V AC

- Flashlight now 2X brighter
- Thinner probe tip for working with wall outlets
- Power switch (standard)
- Green LED means power on, Flashing red LED with beeper means voltage detected
- Low battery self test

### SPECIFICATIONS

MODEL #	STOCK #	DESCRIPTION
40116N	599920	40116N NCV Detector 100-600V AC
AC Detection Range	100-600V AC	
GENERAL SPECIFICATIONS		
Safety Rating	CAT IV 600V	
Frequency Range	50/60Hz	
Batteries	Two AAA	
Operating Temperature	32°F to 104°F (0°C to 40°C)	
Storage Temperature	14°F to 140°F (-10°C to 60°C)	
Dimensions	6.23 x 0.83 x 0.99 in (158 x 21 x 25 mm)	
Humidity	80% max	





# VOLTAGE DETECTORS & TESTERS

## 40020S-A GFCI RECEPTACLE TESTER



The 40020S-A quickly identifies the most common wiring faults in standard 3-wire outlets and verifies operation of GFCI protected outlets.

- LED indicators and wiring legend identify fault
- For use on 120V AC outlets
- GFCI Test verifies operation of GFCI protected outlets
- UL listed

### SPECIFICATIONS

MODEL #	STOCK #	DESCRIPTION																								
40020S-A	582926	40020S-A GFCI Receptacle Tester																								
<table border="1"> <thead> <tr> <th>Receptacle is wired correctly</th> <th>Fault</th> <th>Reason for Wiring Fault</th> </tr> </thead> <tbody> <tr> <td>○●○</td> <td>Open Ground</td> <td>Ground terminal is not connected</td> </tr> <tr> <td>○○●</td> <td>Open Neutral</td> <td>Neutral terminal is not connected</td> </tr> <tr> <td>○○○</td> <td>Open Hot</td> <td>Hot terminal is not connected</td> </tr> <tr> <td>●○●</td> <td>Reversed Hot Ground</td> <td>Hot and ground connections are interchanged</td> </tr> <tr> <td>●●○</td> <td>Reversed Hot Neutral</td> <td>Hot and neutral connections are interchanged</td> </tr> <tr> <td>○●●</td> <td>Correct</td> <td>Receptacle is wired correctly</td> </tr> <tr> <td>Dimensions</td> <td colspan="2">3.43x1.73x0.95inch (87 x 44 x 24mm)</td> </tr> </tbody> </table>			Receptacle is wired correctly	Fault	Reason for Wiring Fault	○●○	Open Ground	Ground terminal is not connected	○○●	Open Neutral	Neutral terminal is not connected	○○○	Open Hot	Hot terminal is not connected	●○●	Reversed Hot Ground	Hot and ground connections are interchanged	●●○	Reversed Hot Neutral	Hot and neutral connections are interchanged	○●●	Correct	Receptacle is wired correctly	Dimensions	3.43x1.73x0.95inch (87 x 44 x 24mm)	
Receptacle is wired correctly	Fault	Reason for Wiring Fault																								
○●○	Open Ground	Ground terminal is not connected																								
○○●	Open Neutral	Neutral terminal is not connected																								
○○○	Open Hot	Hot terminal is not connected																								
●○●	Reversed Hot Ground	Hot and ground connections are interchanged																								
●●○	Reversed Hot Neutral	Hot and neutral connections are interchanged																								
○●●	Correct	Receptacle is wired correctly																								
Dimensions	3.43x1.73x0.95inch (87 x 44 x 24mm)																									



# VOLTAGE DETECTORS & TESTERS

## 40010S-A RECEPTACLE TESTER



The 40010S-A quickly identifies the most common wiring faults in standard 3-wire outlets.

- LED indicators and wiring legend identify fault
- For use on 120V AC outlets
- UL listed

### SPECIFICATIONS

MODEL #	STOCK #	DESCRIPTION
40010S-A	582925	40010S-A Receptacle Tester
Receptacle is wired correctly	Fault	Reason for Wiring Fault
○●○	Open Ground	Ground terminal is not connected
○○●	Open Neutral	Neutral terminal is not connected
○○○	Open Hot	Hot terminal is not connected
●○●	Reversed Hot Ground	Hot and ground connections are interchanged
●●○	Reversed Hot Neutral	Hot and neutral connections are interchanged
○●●	Correct	Receptacle is wired correctly
Dimensions	3.43x1.73x0.95inch (87 x 44 x 24mm)	

# VOLTAGE DETECTORS & TESTERS

## 40040S PRO CONTINUITY TESTER WITH REMOTE



The Southwire 40040S provides a simple way of checking continuity on wire and cables. The bright LEDs and loud pulsating beeper provide a positive indication of continuity and polarity. A detachable remote indicator is included for tracing multiple cable runs.

- Bi-color LEDs determine polarity
- Color coded alligator clips for easy connection
- Wiring legend on tester provides simple operation
- Rugged double molded housing

### SPECIFICATIONS

MODEL #	STOCK #	DESCRIPTION
40040S	597248	Pro Continuity Tester with Remote
Hight - 4.0"		
Width - 2.1"		
Depth - 1.3"		
Weight - 0.42lb (191g)		



# VOLTAGE DETECTORS & TESTERS

## 40140S 4-WAY VOLTAGE TESTER



Handy pocket size tester checks live AC voltage from 120 to 480 volts in four steps.

- Indicates live voltage from 120 to 480V AC and 160 to 600V DC
- Works on AC or DC voltage
- Compact design
- Probes spaced to fit standard AC outlets
- CAT III 600V and UL listed
- Compact size with pocket clip and durable double molded enclosure
- Includes:
  - 40140S Voltage tester
  - Built-in test leads



### SPECIFICATIONS

MODEL #	STOCK #	DESCRIPTION
40140S	582927	4-Way Voltage Tester
AC Voltage Indication:	120V, 240V, 277V, 480V	
AC Operating Frequency:	60Hz	
DC Voltage Indication:	160V, 330V, 380V, 600V	
Dimensions:	5.79 x 1.30 x 1.02 in.	
Weight:	0.23 lb.	



Test leads in storage position

# IR THERMOMETERS

## 31040S 1500 DEGREE FAHRENHEIT 20:1 THERMOMETER WITH COLOR ALERT



The 31040S features 20:1 distance-to-spot ratio and a broad temperature range; this device truly stands out because of its fast response, high/low alarms and dual laser pointer. It is used by maintenance professionals to quickly locate worn machinery, hot spots in electrical panels and defective HVAC equipment.

- Dual lasers pinpoint target area
- 20:1 distance to spot size ratio allows measurements at greater distance
- High/Low temperature alarms and color alert
- Fast 150 milli-second response time
- Backlit display
- Adjustable emissivity for use on reflective surfaces
- Max hold captures highest reading
- Lock-on feature for continuous measurement

### SPECIFICATIONS

MODEL #	STOCK #	DESCRIPTION
31040S	582915	1500°F 20:1 Infrared Thermometer with Dual Lasers and Color Alert
Range:	-58° to 1500°F (-50° to 815°C)	
Resolution:	0.1°F/°C <1000°    1°F/°C >1000°	
Max. Accuracy:	±1% ±1.8°F (1°C)	
Response Time:	150ms	
Emissivity:	Adjustable from 0.10 to 1.0	
Distance to Spot Ratio:	20:1 (at 20" distance measures 1" spot)	
Dimensions:	5.75 x 4.10 x 1.69 in.	
Weight:	0.58 lb.	



# IR THERMOMETERS

## 31030S 1000 DEGREE FAHRENHEIT 12:1 THERMOMETER



Includes features, such as fast response, high and low alarms and a dual laser pointer that can help the maintenance professional quickly locate problems in electrical panels, motors, bearings, machinery and HVAC equipment.

- Dual lasers pinpoint target area
- 12:1 distance to spot size ratio allows measurements at greater distance
- High/Low temperature alarms
- Backlit display
- Adjustable emissivity for use on reflective surfaces
- Max hold captures highest reading
- Fast 150 milli-second response time
- Lock-on feature for continuous measurement

### SPECIFICATIONS

MODEL #	STOCK #	DESCRIPTION
31030S	582934	1000°F 20:1 Infrared Thermometer with Dual Lasers
Range:	-58° to 1000°F (-50° to 537°C)	
Resolution:	0.1°F/°C <1000°	
Max. Accuracy:	±1% ±1.8°F (1°C)	
Response Time:	150ms	
Emissivity:	Adjustable from 0.10 to 1.0	
Distance to Spot Ratio:	12:1 (at 12" distance measures 1" spot)	
Dimensions:	5.75 x 4.10 x 1.69 in.	
Weight:	0.58 lb.	



# IR THERMOMETERS

## 30020S 900 DEGREE FAHRENHEIT 10:1 THERMOMETER



With 10:1 distance to spot, back-lit display and a temperature range of -58 to 900°F, the 30020S is a versatile addition to any toolbox.

- Laser pointer quickly identifies target
- 10:1 distance to spot size ratio allows measurements at greater distance
- Easy to read backlit display
- Max/Min captures highest and lowest readings

### SPECIFICATIONS

MODEL #	STOCK #	DESCRIPTION
30020S	582914	900°F 10:1 Infrared Thermometer
Range:	-58° to 900°F (-50° to 482°C)	
Resolution:	0.1°F/°C	
Max. Accuracy:	±2% of reading or ±4°F/±2°C, whichever is greater	
Response Time:	< 1 sec	
Emissivity:	Fixed at 0.95	
Distance to Spot Ratio:	10:1 (at 10" distance measures 1" spot)	
Dimensions:	5.75 x 4.10 x 1.69 in.	
Weight:	0.44 lb.	



# IR THERMOMETERS

## 30010S 700 DEGREE FAHRENHEIT 8:1 INFRARED THERMOMETER



Provides quick surface temperature measurements without contact. The ideal service tool for HVAC, mechanical and electrical maintenance.

- 8 to 1 distance to spot ratio
- Max/Min captures highest and lowest readings
- Laser pointer identifies target
- Backlit display
- Simple operation

### SPECIFICATIONS

MODEL #	STOCK #	DESCRIPTION
30010S	582913	700°F Fahrenheit Infrared Thermometer
Range:	-22°F to 700°F (-30° to 371°C)	
Resolution:	0.1°F/°C	
Max. Accuracy:	± 2% of reading or ±4°F/± 2°C, whichever is greater	
Response Time:	Less than 1 second	
Emissivity:	Fixed at 0.95	
Distance to Spot Ratio:	8:1 (at 8" distance measures 1" spot)	
Dimensions:	5.16 x 3.78 x 1.38 in.	
Weight:	0.44 lb.	





## 51010S BORESCOPE INSPECTION CAMERA



Borescope inspection camera with 1 meter-long flexible gooseneck allows the user to probe behind walls, inside ventilation ducts and difficult to reach areas that are not otherwise accessible.

- Great tool for maintenance and repair
- High resolution color display
- Four powerful and adjustable LED lights illuminate dark spaces
- Flexible gooseneck can be configured for best viewing
- Up to 2X digital zoom
- Auto Power-Off
- Image Rotation
- Includes (3) accessories that clip on to camera head
  - mirror
  - hook
  - magnet

### SPECIFICATIONS

MODEL #	STOCK #	DESCRIPTION
5101S	582923	Borescope Inspection Camera
<b>Camera</b>		
Maximum Resolution:	640 x 480	
Maximum Frame Rate:	30 frames per second	
Depth of Field:	0.4" (10mm) to infinity	
Gooseneck Length:	39" (1m)	
Camera Diameter:	0.66" (17mm)	
<b>TFT-LCD Display:</b>		
LCD Size:	2.4" (61mm)	
Display Resolution:	480 (W) x 234 (H)	
Power Supply:	(4) "AA" Batteries (Included)	
Dimensions:	9.46 x 6.30 x 3.94 in.	



# CIRCUIT TESTERS

## 41210S CIRCUIT BREAKER FINDER WITH GFCI



The circuit breaker finder pinpoints the specific breaker powering the circuit being worked on. Eliminates guessing and unwanted power outages caused by tripping the wrong breaker.

- Advanced design quickly and reliably pinpoints single breaker without service interruption
- Tests GFCI outlets
- For use on energized circuits
- Includes:
  - 41210S Transmitter and Receiver
  - 3-prong to 2-prong adapter
  - 9 volt battery
- Available accessory: 60030S Adapter Kit

### SPECIFICATIONS

MODEL #	STOCK #	DESCRIPTION
41210S	582921	Circuit Breaker Finder
Height:	7.56 in.	
Width:	2.52 in.	
Depth:	1.65 in.	



## 60020S PIPE CLAMP TEMPERATURE PROBE



The 60020S pipe clamp temperature probe allows quick maintenance checks on heating and air-conditioning systems. It's the perfect accessory for clamp meters and multimeters with a temperature function.

- For multimeters, clamp meters and thermometers that accept a type K temperature probe
- Spring-loaded jaw clamps around heating/cooling pipes up to 1.5" in diameter
- Temperature range: -4° to 200°F (-20° to 93°C)

MODEL #	STOCK #	DESCRIPTION
60020S	582931	Type K Temperature Clamp

## 60010S REPLACEMENT TEST LEADS



Southwire's 60010S Replacement Test Leads are universal replacement leads for all Southwire meters except the 10010S Analog Multimeter. UL-listed CAT IV 600V, CAT III 1000V. Also includes alligator clip attachments (CAT III 600V).

MODEL #	STOCK #	DESCRIPTION
60010S	582929	Test Lead Kit

## 60030S ADAPTER KIT FOR CIRCUIT BREAKER FINDER



This adapter kit includes a light socket adapter allowing for rapid location of circuit breakers connected to lighting fixtures. Also includes alligator clips allowing transmitter to be connected to unterminated branch circuit wiring.

- For use with 41210S Circuit Breaker Finder

MODEL #	STOCK #	DESCRIPTION
60010S	582922	Adapter Kit for Circuit Breaker Finder

# VOICE • DATA • VIDEO

Southwire offers a full line of VDV tools including cable cutters, strippers, crimpers and punchdown tools, as well as cable tracers and testers. Our goal is to provide professional tools that exceed customers' expectations for quality, performance and features – tools that make a difference on the real-world jobsite.

- VDV Tools
- VDV Test Equipment



## ESP-1 PROFESSIONAL DATACOMM SNIPS



Patented design with unique spring-loaded action, these snips provide very precise control. These snips provide very precise control and offer a patented design with unique spring-loaded action.

- Ergonomic, spring-loaded design for precise control
- Lock holds snips closed for storage
- Double-dipped, textured grip
- Strips 19 AWG and 23 AWG
- Serrated blade grips wire as it cuts

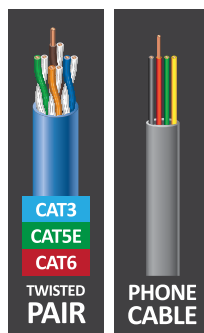

MODEL #	STOCK #	DESCRIPTION
ESP-1	587437	ESP-1 Electrician Scissors - Pro

## ESS-1 ELECTRICIAN'S SCISSORS



Unlike regular scissors or shears, the serrated blades of this powerful scissor keeps wire from slipping out of the jaws. Cutting through hardware cloth, cable, wire netting, and other difficult-to-cut materials becomes as easy task.

- Strips 19 AWG & 23 AWG
- Strong, tempered steel
- Nickel-plated finish resists corrosion
- Scraper and file on outside of both blades

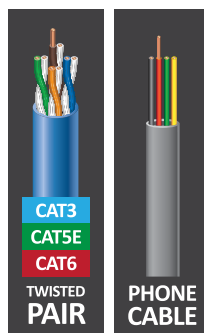

MODEL #	STOCK #	DESCRIPTION
ESS-1	587438	ESS-1 Electrician/DataComm Scissors

# CUTTERS

## ESPKIT (CSK5) ELECTRICIAN'S SPLICING KIT

This 5 piece kit includes ESP scissors, a boot knife, a marker, and an LED pen-light in a rugged leather pouch.

- Spring-loaded scissors for precise cuts
- Serrated blade grips wires as it cuts
- Stripping notches for 19 and 22 AWG wire
- Double dipped texture grip
- LED pen-light illuminates work space



MODEL #	STOCK #	DESCRIPTION		
ESP-KIT	597242	Electrician's Splicing Kit		
	HEIGHT	WIDTH	DEPTH	WEIGHT
	8.25"	8.63"	12.25"	4.40 lb.



## CCSX-C1 COAX CCS CUTTER



Many coax cables today have a copper clad steel (CCS) center conductor. This specially designed cutter is made to reliably cut CCS coax that might damage standard cable cutters.

- Reliably cuts copper-clad steel coax without blade damage
- V-notch blade doesn't deform cable
- Forged steel
- Double dipped textured grip

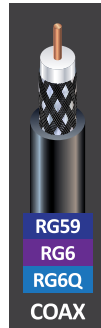

MODEL #	STOCK #	DESCRIPTION
CCSX-C1	587433	CCSX-C1 Coax CCS Cutter

## X-C1 ROUND CABLE CUTTER



The stainless steel X-C1 has two cable cutting profiles; a long nose for cutting in confined spaces and a cable tie cutting tip. This is perfect for coax and twisted pair cabling.

- Curved blade profile for clean cuts
- Elongated nose to reach and cut in tight places
- Stainless steel for corrosion resistance
- Double dipped textured grip
- Cutting areas for small and large round cable

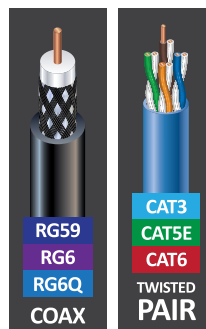

MODEL #	STOCK #	DESCRIPTION
X-C1	587467	X-C1 Round Cable Cutter

# PREP AND STRIP

## XSR-T1 RADIAL CUTTER/STRIPPER FOR TWISTED PAIR



Cut and strip twisted pair cabling quickly and easily with one tool.

- Rotate knob to adjust depth of the cut
- Strips outer jacket without nicking wires



MODEL #	STOCK #	DESCRIPTION
XSR-T1	587470	Radial Cutter/Stripper for Twisted Pair

## SK-T1 KEY STRIP TOOL FOR TWISTED PAIR



The Key Strip Tool for Twisted Pair quickly strips outer cable jackets from CAT 3, 5, 5e and 6 data cable.

- Quickly removes outer cable jacket
- Three positions for different size cables
- Cost effective

MODEL #	STOCK #	DESCRIPTION
SK-T1	587461	SK-T1 Key Strip Tool for Twisted Pair

## ST-C1 COAX TRIGGER STRIP TOOL

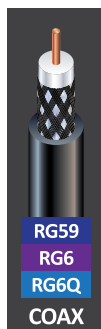

The rotary-style coax stripper performs a fast and precise two-level strip in one easy step.

- Standard two-level strip exposes ¼" of center conductor and ¼" of shield braid
- Innovative "trigger" design improves control and fits comfortably in hand
- Use with RG59, RG6 and RG6 quad shield coax



MODEL #	STOCK #	DESCRIPTION
ST-C1	587462	Coax Trigger Strip Tool



## SA-C1 AUTOMATIC WIRE STRIPPER FOR COAX



The SA-C1 Automatic Wire Stripper for Coax allows for quick, two-step stripping of RG6 and RG6Q cable.

- Traditional automatic design preferred by many installers
- 2-level strip: Center conductor and outer jacket



MODEL #	STOCK #	DESCRIPTION
SA-C1	587459	Automatic Wire Stripper for Coax

## XS-C1 COAX CUTTER/STRIPPER



The XS-C1 Coax Cutter/Stripper cuts and strips coax cable and features a cable tie cutting tip.

- Cuts and strips RG59, RG6 and RG6 quad shield coax
- Stainless steel for corrosion resistance
- Textured double dip handles for better grip and comfort
- Tip is designed to cleanly cut cable ties



MODEL #	STOCK #	DESCRIPTION
XS-C1	587468	Coax Cutter/Stripper

# PREP AND STRIP

## CPT-CF1 COAX PREP TOOL

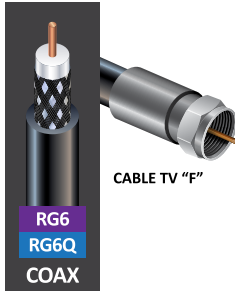

The time-saving Coax Prep Tool is a 3-in-1 tool for loosening/tightening cable TV "F" connectors from jacks. It also flares the cable jacket and holds the connector during assembly.

- Easily loosens stubborn connectors
- Flares coax jacket for easy connector insertion
- Holds cable TV "F" connector during cable insertion
- Double-molded grip for long-lasting comfort



MODEL #	STOCK #	DESCRIPTION
CPT-CF1	587434	Coax Prep Tool

## PDTP-K1 PROFESSIONAL IMPACT PUNCHDOWN TOOL

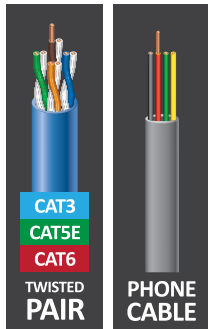

### BLADES AVAILABLE SEPARATELY :

- B1 Reversible 66 Punch/110 Cut-Only Punchdown Blade
- B2 Reversible 110 Cut/Punch Punchdown Blade
- B3 Reversible 66 Cut/Punch Punchdown Blade

The Professional Impact Punchdown Tool includes 110 & 66 twist-to-lock blades and features unique pull out accessory tools in a comfortable, durable tool body.

- Terminates twisted pair category cable into wall jacks and patch panels for phone and data communications
- Includes both 110 and 66-style, long life, metal injection molded blades
- Comfortable Double-molded tool body
- Wire hook and spudger accessory tools pull out one-handed with easy-to-use thumb studs
- Covered blade storage



Includes both 110 and 66 style blades



Easy to pull out wire hook and spudger tools

MODEL #	STOCK #	DESCRIPTION
PDTP-K1	587455	Contractor Impact Punchdown Tool

## PDTC-1 COMFORT GRIP PUNCHDOWN TOOL, 110-STYLE



The Comfort Grip 110-style Punchdown Tool easily terminates 110-style blocks on patch panels and wall jacks.

- Punch down 110-Style jacks or patch panels
- Soft rubber comfort grip
- 110-style blade terminates cable and trims excess wire



MODEL #	STOCK #	DESCRIPTION
PDTC-1	587454	Comfort Grip Punchdown Tool, 110-style

# TERMINATE

## RJCR-T1 RATCHETING PHONE & DATA CRIMP TOOL

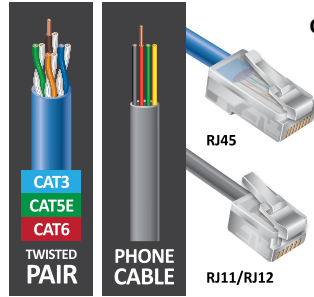

The RJCR-T1 is a professional ratcheting phone & data crimp Tool that cuts and strips voice and data cable. It also crimps RJ45 data connectors as well as RJ11/RJ12 phone modular plugs.

- Ratcheting tool cuts, strips, and crimps phone and data cable
- Comfortable double-molded grips help to orient the tool
- Compatible with standard RJ45, RJ11/RJ12, and RJ22 modular plugs
- Locks closed for easy storage



MODEL #	STOCK #	DESCRIPTION
RJCR-T1	587458	3-in-1 Phone & Data Crimp Tool

## RJCC-T1 COMPACT VOICE & DATA CRIMP TOOL

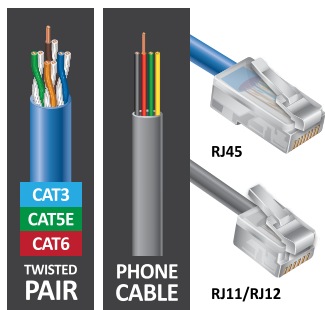

This all-in-one tool cuts and strips both phone and data cable. crimps RJ45 (data) as well as RJ11/RJ12 and RJ22 (phone) mod plugs.

- Cuts, strips, and crimps data and voice cable
- Compact and versatile design
- Compatible with RJ45, RJ11/RJ12 and RJ22 plugs
- Convenient handle lock for easy storage
- For network and phone applications



MODEL #	STOCK #	DESCRIPTION
RJCC-T1	587457	Compact Phone & Data Crimp Tool

## KIT-TP1 NETWORK TOOL KIT



This 13-piece Network Tool Kit includes the tools you need to cut, strip, terminate and install data cabling.

- Complete 13 piece kit for terminating data cable
- Make custom length patch cables
- Includes tools to cut, strip, and terminate data cabling
- Kit Includes:
  - Compact 3-In-1 Cut/Strip/Crimp Tool
  - Comfort Grip Punchdown Tool
  - Reversible Screwdriver
  - 10 RJ45 Connectors
  - Rugged Tool Case

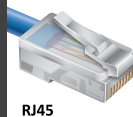

MODEL #	STOCK #	DESCRIPTION
KIT-TP1	587441	Network Tool Kit

## LNP6DC-1 CRIMPING LONG NOSE PLIERS- UR/UY/UG



Long Nose Pliers for crimping IDC (insulation displacement) UR, UY, and UG type connectors.

- Crimps UR/UY/UG connectors
- Strips 22-24 AWG wire
- Induction hardened cutting blade
- Hot-rivet joint for smooth action and long life
- 6 in. length

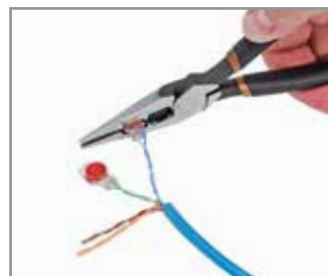

MODEL #	STOCK #	DESCRIPTION
LNP6DC-1	587442	Crimping Long Nose Pliers - UR/UY/UG

# TERMINATE

## CCM-C1 MULTI-CONNECTOR COMPRESSION COAX CRIMP TOOL

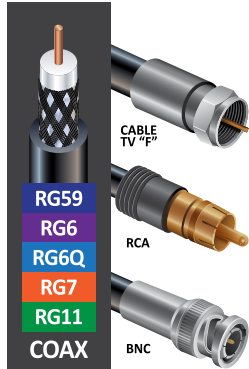

When you need versatility, Southwire's Multi-Connector Compression Crimp Tool is 3-way adjustable to work with F, BNC, and RCA compression connectors as well as RG59/6/6Q and RG7/11 coax cable.

- 3-way chuck can be positioned for cable TV "F", RCA, and BNC connectors
- Rotatable connector cradle accommodates RG59, RG6, RG6 quad as well as larger RG7 and RG11 cable
- Thumb-wheel for fine-tuning crimping length
- For cable tv, satellite, security, and home theater applications
- Comfortable double-molded grips are indexed to help orient the tool



MODEL #	STOCK #	DESCRIPTION
CCM-C1	587432	Compression Coax Crimp Tool - Multi-Connector

## CCF-C1 COMPACT COMPRESSION COAX CRIMP TOOL FOR "F" CONNECTORS



The CCF-C1 Compact Compression Coax Crimp Tool for "F" connectors.

- Compatible with RG59, RG6, and RG6Q coaxial cable
- Simple, compact and powerful
- Double-molded handles for durability and grip



MODEL #	STOCK #	DESCRIPTION
CCF-C1	587431	Compact Compression Coax Crimp Tool - CATV "F"

## KIT-C1 CABLE TV TOOL KIT



This 13-piece Cable TV Tool Kit includes all the tools you need to cut, strip, crimp and install "F" connectors onto coax cable.

- Complete 13-piece kit for terminating coax
- Make custom length coax patch cables
- All 3 tools included to cut, strip, and crimp coax
- Kit Includes:
  - Round Cable Cutter
  - Radial "Trigger" Stripper
  - Compression Crimper for "F" Connectors
  - 10 "F" Connectors for RG6 Coax
  - Rugged Tool Case

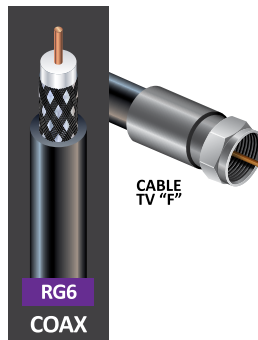

MODEL #	STOCK #	DESCRIPTION
KIT-C1	587440	Cable TV Tool Kit

## HCT-C1 COAX 3-IN-1 CRIMP TOOL



The stainless steel Southwire 3-in-1 Crimp Tool cuts and strips coax as well as crimps Cable TV "F" hex-style connectors.

- One tool cuts, strips, and crimps coax cable
- Crimps "F" connectors
- Stainless steel for corrosion resistance
- Double dipped textured grip

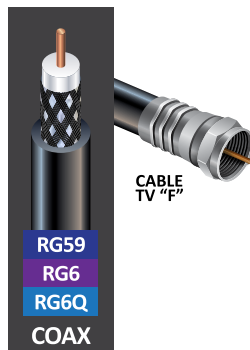

MODEL #	STOCK #	DESCRIPTION
HCT-C1	587439	Coax 3-in-1 Crimp Tool

## M300P PROFESSIONAL VDV CABLE MAPPER

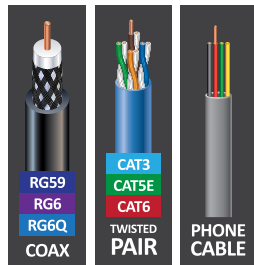

Quickly tests voice, data and video cabling for common wiring faults including split pairs. Rugged, double-molded body includes silicone port covers to protect the ports and an easy-to-read backlit LCD screen.

- Quickly checks for faults on voice, data and video cables
- Identifies correct wiring, opens, shorts, reversals, miswires, split pairs, and shielded cables
- Test patch cables or installed cables
- Built for durability: Double injection-molded housing provides a soft, impact absorbing rubber over a strong ABS frame
- Maps multiple cable runs with included RJ45 & Coax "F" ID remotes (5 of each are included)
- Remote ID kits available separately:
  - M310 Replacement Kit of ID Remotes (5 RJ45 and 5 Coax "F", Remote Numbers 1 - 5)
  - M310-F Expansion Kit of 11 "F" Coax ID Remotes (Remote Numbers 6-16)
  - M310-RJ Expansion Kit of 11 RJ45 ID Remotes (Remote Numbers 6-16)
- Built in tone generator for cable tracing (separate amplifier probe required)

### SPECIFICATIONS

Cable Types:	Shielded or Unshielded: Cat 7, Cat 7a, Cat 6a, Cat 6, Cat 5e, Cat 5, Cat 3, Coax
Minimum Cable Length for Split Pair Detection:	1.6 feet (0.5m)
Maximum Coax Cable Length:	1000 feet (305m)
Maximum Coax Cable Resistance:	100 ohms maximum DC
Dimensions:	7.13" x 2.86" x 1.61" (18.1cm x 7.3cm x 4.1 cm)
Weight:	0.78lb (353g)

MODEL #	STOCK #	DESCRIPTION
M300P	587443	Contractor Cable Mapper VDV



Built in tone generator for cable tracing (separate amplifier probe required)



Port covers protect RJ45 and RJ11 ports from dust and debris



Remote stores securely in tester body



Easy-to-read backlit display



## M400TP PROFESSIONAL MAPPER FOR DATA CABLE



Quickly tests twisted pair data cable for common wiring faults including split pairs. It even sends a tone and features a backlit LCD screen, double-molded housing and silicone port cover.

- Easy-to-read LCD display with backlight
- Port cover protects RJ45 port from dust and debris
- Rugged double-molded housing with snap-in remote
- Identifies correct wiring, opens, shorts, reversals, miswires, split pairs, and shielded cables
- Built-in tone generator for tracing cables (separate amplifier probe required)

### SPECIFICATIONS

Cable Types:	Shielded or Unshielded: Cat 7, Cat 7a, Cat 6a, Cat 6, Cat 5e, Cat 5, Cat 3
Minimum Cable Length for Split Pair Detection:	1.6 feet (0.5m)
Batteries	Two "AAA" 1.5V
Dimensions:	4.80" X 2.05" X 1.30" (12.2cm X 5.2cm X 3.3 cm)
Weight:	4.5oz (129.4g)

MODEL #	STOCK #	DESCRIPTION
M400TP	587448	Contractor Mapper for Data Cable



Built in tone generator for cable tracing (separate amplifier probe required)



Port covers protect RJ45 ports from dust and debris



Remote stores securely in tester body



Easy-to-read backlit display

## M550 DATAVIDEO CABLE TESTER

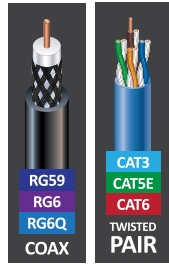

The M550 gives instant continuity status for both twisted pair and coaxial cables. Features rugged, double-molded tester body with on-board remote storage and an easy-to-interpret LED display.

- Quickly detects wiring faults in network and coax cables
- Test patch cables or installed cables
- Identifies correct wiring, opens, shorts, reversals, miswires, split pairs and shielded cables
- Auto power off
- Tests shielded, unshielded twisted pair, and coax
- Includes adapter cables

### SPECIFICATIONS

Cable Types:	Shielded or Unshielded: Cat 7, Cat 7a, Cat 6a, Cat 6, Cat 5e, Cat 5, Cat 3, Coax
Minimum Cable Length for Split Pair Detection:	1.6 feet (0.5m)
Maximum Coax Cable Length:	1000 feet (305m)
Batteries	Two "AAA" 1.5V
Dimensions:	5.11" x 2.05" x 1.30" (13.0cm x 5.2cm x 3.3cm)
Weight:	4.5oz (129.4g)

MODEL #	STOCK #	DESCRIPTION
M550	587450	Continuity Tester for Phone, Data, Coax Cable



Includes adapter cables



Quickly detects wiring faults in network and coax cables



Remote stores securely in tester body



Easy-to-interpret LED display

## M555TP CONTINUITY TESTER FOR DATA CABLE



Provides a quick check for common wiring faults on data cables and includes a handy color wiring guide right on the tester.

- LEDs illuminate in sequence identifying correct wiring and misconnections
- Intuitive color wiring reference chart included
- Checks data cables for simple miswires (tests patch cables and installed cables)
- Double-molded housing for durability and grip
- Remote stores securely in tester body
- Includes adapter cables

### SPECIFICATIONS

Cable Types:	Shielded or Unshielded: Cat 7, Cat 7a, Cat 6a, Cat 6, Cat 5e, Cat 5, Cat 3
Batteries	Two "AAA" 1.5V
Dimensions:	4.72" x 2.05" x 1.30" (12.0 cm x 5.2cm x 3.3cm)
Weight:	4.81oz (136.5g)

MODEL #	STOCK #	DESCRIPTION
M555TP	587452	Continuity Tester for Phone and Data Cable



Includes adapter cables



Quickly detects wiring faults in data cables



Tests patch cables and installed cables



Illuminated LEDs and color wiring reference chart

## M500CX4 COAX CONTINUITY TESTER/MAPPER



The M500CX4 speeds troubleshooting and installation by testing and identifying up to four Cable TV remote wall outlets at a time. It includes four color-coded remotes.

- Easy-to-Understand LED display
- Test patch cables or installed cables
- Identify up to four coax cable remote locations - includes 4 color-coded ID remotes
- Double-molded housing for durability and grip
- Auto power off

### SPECIFICATIONS

Max. Testing Length:	10,000 feet (3km) maximum
Batteries	Four LR44 Batteries
Case Dimensions:	5.4" x 1.26" x 0.98" (13.7cm x 3.2cm x 2.5cm)
Weight:	3.14oz (89g)

MODEL #	STOCK #	DESCRIPTION
M500CX4	587449	Continuity Tester for Cable TV Coax



includes 4 color-coded ID remotes



Double-molded housing for durability and grip



Test patch cables or installed cables



Easy-to-Understand LED display

## P700 PHONE OUTLET TESTER



The P700 checks phone outlets - Lines 1 and 2 - for correct wiring, line reversed, AC ring voltage and dead line conditions.

- Quickly checks phone outlets for correct wiring
- Identifies correct wiring, line reversed, AC ring voltage, and dead line conditions
- Tri-color LED display.
- Color legend printed on tester makes interpreting results simple
- Tests both Line 1 and Line 2
- Double-molded housing for durability and grip

MODEL #	STOCK #	DESCRIPTION
P700	587453	Phone Outlet Tester

## B600 PROFESSIONAL TELEPHONE TEST SET



Rugged and cost-effective, the B600 Professional Telephone Test Set features Hi-Z monitoring, Pulse and Tone (DTMF), 10 number speed dial and polarity indication in a rugged, double-molded housing.

- Hi-Z monitoring will not disrupt network traffic
- High and low volume settings, polarity LED, tone & pulse modes
- ABN (angled bed of nails) clips with rugged RJ45 and RJ11 plugs
- Last number redial and memory to store up to 10 phone numbers
- Double-molded housing for comfort and durability

### SPECIFICATIONS

ELECTRICAL	
Humidity	10% to 90% non-condensing
Loop Limit	2.4KΩ maximum at 48VDC (nominal 15 mA minimum loop current)
DC Resistance (Talk Mode)	150Ω typical at 80mA current
AC Impedance (Monitor Mode)	HI Z: 100kΩ@ 1KHz RING: 600Ω @ 1KHz
ROTARY DIAL OUTPUT	
Pulsing Rate	20pps +/-0.5pps
Percent Break	60% +/-2%
Interdigit Interval	500 ms typical
Leakage During Break	>50KΩ
DTMF OUTPUT	
Tone Frequency Error	+/-1% maximum
Level per Tone Pair	+2dBm maximum, -8dBm minimum
High versus Low Tone Difference	4dBm maximum
PHYSICAL	
Dimensions	10.12" x 2.43" x 2.49" (25.7cm x 6.17cm x 6.33 cm)
Weight	11.0oz (312.8g)
Battery	CR2032 (included)

MODEL #	STOCK #	DESCRIPTION
B600	587429	Contractor Analog Telephone Test Set



## T100PK PROFESSIONAL TONE & PROBE KIT



The T100PK Professional Tone & Probe Kit quickly traces non-energized cabling. It is powerful enough to trace cables behind walls but sensitive enough to identify individual conductors.

- Quickly trace non-energized cables - even behind walls
- Positive cable detection: tone changes when wires are shorted
- Toner features on-board test lead storage
- Probe features replaceable tip, LED flashlight, LED signal strength indicator, rear facing speaker and stereo headphone jack

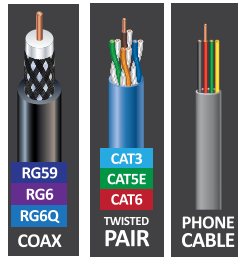

### SPECIFICATIONS

T100PK includes T110TG and T120AP

T110TG Tone Generator Specifications	
Continuous Tone Frequency	1.06kHz nominal
Over Voltage Protection	60VDC in Toner/Polarity Mode
Output Power in Tone Mode	+9.65 dbm into 600 ohms
Auto-Off	30 minutes
Open Circuit Voltage in Continuity Mode	8.2VDC with fresh battery
Battery	One 9V battery
Case Dimensions	4.02" x 2.58" x 2.36" (10.2cm x 6.5cm x 6cm)
Weight	8 oz (230g)
T120P Analog Probe Specifications	
Battery	One 9V battery
Case Dimensions	9.33" x 1.70" x 1.51" (23.7cm x 4.3cm x 3.8cm)
Weight	5 oz (143g)

MODEL #	STOCK #	DESCRIPTION
T100PK	587463	Contractor Tone & Probe Kit



Speaker faces up and back for clear sound. Stereo headphone jack is compatible with standard headphones



Test leads wrap around racetrack in toner and snap securely in place



Lock-in Test leads with cable management



Built-in LED flashlight for dark wiring closets

## T200K MULTIPURPOSE WIRE TRACING KIT



The T200K is a self-contained kit for tracing a variety of cable types. It includes a belt-mount case with five adapter cables, separate toner and probe. The probe features an LED flashlight for cable tracing in low-light areas.

- Belt-mount, rugged carrying case
- Double-molded housings for durability and grip
- Provides audible and visual indication
- Five adapter cables can be stored in the case and plugged into RJ11 jack on transmitter
- Traces non-energized low-voltage cables

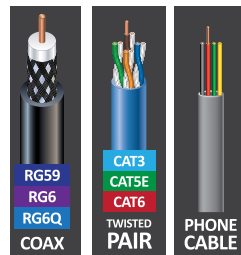

Five adapter cables store in case:

- Coax adapter with F connector
- Data adapter with RJ45 connector
- Phone adapter with RJ11 connector
- Automotive fuse adapter
- Alligator clip adapter

### SPECIFICATIONS

Tone Signal Frequency	2.72kHz nominal
Tone Output Power	+24dbm into 600 ohms
Tone Auto-Off	30 minutes
Battery (Transmitter and Receiver)	Two "AAA" 1.5V Batteries in each unit
Case Dimensions	7.06" x 3.19" x 2.04" (17.9cm x 8.1cm x 5.2cm)
Tone Dimensions	5.17" x 0.94" x 1.32" (13.2cm x 2.4cm x 3.4cm)
Probe Dimensions	6.18" x 0.94" x 1.32" (15.7cm x 2.4cm x 3.4cm)
Weight	0.7lb (322g)

MODEL #	STOCK #	DESCRIPTION
T200K	587466	Multipurpose Tone & Probe Kit



Double-molded tester housing for durability and grip



Traces non-energized low-voltage cables/speaker wires



Traces a variety of cable types



Built-in LED flashlight for dark wiring closets

# CABLE PULLING

---

Southwire cable pulling equipment sets the industry standard. We've revolutionized these tools to make them faster, safer, and smarter than ever before. With Southwire cable pulling equipment on your jobsite, you can see an increase in safety, efficiency, and profitability.

- Pullers
- Feeders
- Pulling Grips
- Rope
- Accessories





## MAXIS® XD10 EXTREME DUTY CABLE PULLER



The MAXIS® XD10 EXTREME Duty Cable Puller is designed to get the job done, thriving in the most extreme pulling conditions. The XD10 allows you to pull faster and safer up to 10,000 lb.

- Smooth Elevation Control: Operates with handle or 18V cordless drill helping to eliminate any lifting
- Pulls out 10 ft. of extra wire without extending the boom
- Gear reducer design allows for increased efficiency, durability and power while maintaining low operating temperature
- 10,000 lb. peak pulling force with a continuous pulling rate of 7,000 lb.
- Conduit adapter sizes 2" - 4" included, 5" & 6" adapters sold separately
- Self Contained: ready to pull with no need for additional parts or equipment to use for set up
- Single person set up and operation: Quickly adapts from underground to overhead pulls
- Collapsible down to 40"H x 26"W x 70"L to fit through standard doorways and ease of transport



### SPECIFICATIONS

MODEL #	STOCK #	DESCRIPTION		
XD10	59190402	MAXIS® XD10 EXTREME Duty Cable Puller		
HEIGHT	LENGTH	WIDTH	WEIGHT	WARRANTY
40"	70"	26"	598 lb.	1 year
CAPACITY				
Pulling Speed Low:		Pulling Speed High:		
at 2,000 lb.	11fpm	at 2,000 lb.	21fpm	
at 4,000 lb.	10fpm	at 4,000 lb.	18fpms	
at 6,000 lb.	9fpm	-	-	
at 8,000 lb.	8fpm	-	-	
at 10,000 lb.	7fpm	-	-	

## XD10 BOLT DOWN ADAPTER



### Floor mount adapter for XD10

- Easily attaches to the XD10
- Does not require disassembly of cable puller
- Simple bolt down adapter for when overhead pulling is required



### SPECIFICATIONS

MODEL #	STOCK #	DESCRIPTION		
XD10BD	59727001	XD10-BD Maxis® XD10 Bolt Down Kit		
HEIGHT	WIDTH	DEPTH	WEIGHT	
XD10BD	18"	14"	16"	35 lb.

# PULLERS

## MAXIS® 6K CABLE PULLER



A 6,000 pound cable puller that sets up in less than 2 minutes.

- One person, 2 minute setup
- 2 pulling speeds: 12 fpm on low (at no load) and 44 fpm on high (at no load)
- Quickly adapts from underground to overhead pulls
- No need to bolt to the ground on most pulls
- 6,000 lb. peak pulling force with continuous rating of 3,500 lb. on low
- Can adapt to virtually any wire pull
- Can be anchored to most trucks' standard 2" receiver hitch
- Able to pull up to 9 ft. of wire out of the conduit
- Includes 5 conduit adapters 2" through 4", 5" and 6" sold separately
- Includes puller cart with tool bag

### SPECIFICATIONS

MODEL #	STOCK #	DESCRIPTION		
M6K-M	57648501	MAXIS® 6K (with motor) - includes conduit adapters 2" - 4" and PC100		
M6K	57142901	MAXIS® 6K (no motor) - includes conduit adapters 2" - 4" and PC100		
PC100	56829601	Puller cart for M3K and M6K pullers		
	LENGTH	WIDTH	DEPTH	WEIGHT
M6K-M	45"	21"	20"	194.5 lb.
PC100	50" (height)	21"	17.5"	40 lb.



## MAXIS® 3K CABLE PULLER



A high speed, lightweight 3,000 pound cable puller.

- One person, 2 minute set up
- 2 pulling speeds: 25 fpm on low (at no load) and 100 fpm on high (at no load)
- Quickly adapts from underground to overhead pulls
- No need to bolt to the ground on most pulls
- Able to pull up to 8 ft. of wire out of the conduit
- 3,000 lb. peak pulling force with continuous rate of 1,500 lb. on low
- Can adapt to virtually any wire pull
- Can be anchored to most trucks' standard 2" receiver hitch
- Includes 8 conduit adapters: 2" - 4"
- Puller cart with tool bag

### SPECIFICATIONS

MODEL #	STOCK #	DESCRIPTION
M3K-M	57648401	MAXIS® 3K (with motor) - includes conduit adapters 1" - 4" and PC100
M3K	57143101	MAXIS® 3K (no motor) - includes conduit adapters 1" - 4" and PC100
PC100	56829601	Puller cart for M3K and M6K pullers

	LENGTH	WIDTH	DEPTH	WEIGHT
M3K-M	45"	20"	20"	148.5 lb.
PC100	50" (height)	21"	17.5"	40 lb.



Pullers | EQUIPMENT

# FEEDERS

## MAXIS® FEEDER



**A revolutionary new way to feed wire quickly and efficiently.**

- Designed and built specifically to accommodate Southwire® SIMPULL™ wire
- Quick 1 person, 2 minute set-up and operate
- Forward and reverse, variable speed, and feeds up to 30 fpm
- May be used with Triggers® Safety system for simultaneous feeder/puller control
- Easily adjust wire tension, even during operation
- Feeds wire sizes from 3/0-3 1/2" cable
- Solid rubber tires and swivel casters that will never go flat for easy job site maneuverability
- Digital footage meter allows easy monitoring of approximate conductor length being fed
- Uses grooved roller design with increased surface area for greater traction force (no pneumatic tires)
- Dual anchoring mechanism
- Maximum traction force: single conductor 800 lb., 4 SIMPULL™ THHN® 500 MCM conductors 1,600 lb. capacity
- Cable capacity: 8 x 250 MCM, 6 x 500 MCM, 5 x 750 MCM

### SPECIFICATIONS

MODEL #	STOCK #	DESCRIPTION		
MCF01	58133301	MAXIS® Feeder		
			LENGTH	WIDTH
MCF01			35"	26"
			DEPTH	WEIGHT
			44"	366 lb.



# PULLING ACCESSORIES

## TRIGGERS® WIRELESS SAFETY SWITCH SYSTEM



Safety system designed to control the input power of any piece of jobsite equipment.

- Works with all brands of electrically driven equipment
- Saves time by avoiding unnecessary stops and restarts
- High visibility LED status lights
- Monitors amperage draw indicating when to switch puller to low speed
- Triggers® Wireless Safety Switch System is UL and FCC Certified and carries an IP55 rating
- Foot controls contain dual redundant activation switches
- Military grade 3.4 amps per hour lithium ion battery packs
- Handheld remotes can control pull from any location
- High range: communicates up to 1500' between walls and 1.5 miles line of sight



### SPECIFICATIONS

MODEL #	STOCK #	DESCRIPTION		
TSS01	59713201	Triggers® Wireless Safety Switch System		
	LENGTH	WIDTH	DEPTH	WEIGHT
TSS01	12.54" (height)	21.5"	16.42"	30 lb.

## SLIDE-IT



Slide-It is made for pulling applications to protect cable and rope as it enters the conduit.

- Embedded magnets for quick set up on panels
- Made from durable material
- Tapered end for fast set up in conduit
- Protects rope and cable from sharp panel edges and openings

### SPECIFICATIONS

MODEL #	STOCK #	DESCRIPTION		
SFB01	59158901	Slide-it		
	LENGTH	WIDTH	DEPTH	WEIGHT
SFB01	1/8" (height)	12"	40.5"	1.25 lb.

# PULLING GRIPS

## MAXIS® GRIPS PULLING HEADS



The MAXIS® GRIPS PULLING HEADS are a dual lock pulling system that uses both a cam lock head and a double braided wire to quickly secure cable to rope without the fear of losing a conductor. These pulling heads provide increased efficiency with 2 minute head preparation.

- Rated at 4,000 lb.
- Holds securely to NO-LUBE® wire
- Disconnect wire from pulling heads in 2 minutes without cutting the wire
- No cutting, stripping or weaving of wire to make pulling head
- Easily moves through conduit and around 90° bends
- Staggered lengths for easier movement
- Keeps pulling head tight for easier movement through conduit

## SPECIFICATIONS

MODEL #	STOCK #	MAXIS GRIPS	GRIPS	WIRE	PULLING JACKET		ROPE SWIVEL		CARRYING	DOUBLE LOCKING HEAD
					MED.	LRG.	LRG.	SML.	BAG	
GP110	56822701	Complete Set	Complete Set	1/0 - 750MCM	X	X	X	X	X	
GP00AA	56822801	Group AA	4 Grips	1/0 - 4/0						
GP101A	56822901	Group A	4 Grips	3/0 - 4/0				X	X	X
GP102b	56823001	Group B	4 Grips	250 - 350MCM	X			X	X	X
GP103C	56823101	Group C	4 Grips	400 - 500MCM		X	X		X	X
GP104D	56823201	Group D	3.75"	600 - 750MCM		X	X		X	X



## QWIKROPE®



**An innovative, new high performance pulling rope that is UV resistant, lightweight, and ultra low stretch for all of your feeder and circuit wire needs.**

- High performance pulling rope made from ultra high molecular weight polyethylene fibers
- 12 Strand single braided 9/16" pulling rope with a breaking strength of 32,000 lb., pound for pound stronger than steel
- 2 Sizes for all your circuit wire pulls: 1/8" pulling rope with 1,100 lb. of breaking strength, and 1/4" pulling rope with 7,500 lb. of breaking strength
- 24% reduction in the coefficient of friction, as compared to traditional pulling ropes
- Dual factory installed pulling eyes
- Does not absorb water, no rope rot
- Need only one size rope (9/16") for feeder conductor that pulls up to 10,000 pounds
- 1/8" QWIKrope® can easily be vacuumed into any conduit run up to 290 ft.
- 9/16" QWIKrope® recommended for use with all MAXIS® cable pullers

### SPECIFICATIONS

MODEL #	STOCK #	DIAMETER	LENGTH	AVG. BREAKING STRENGTH	TOTAL WEIGHT
SPR183	58387401	1/8"	300 ft.	1,100 lb.	2.5 lb.
SPR143	58387501	1/4"	300 ft.	7,500 lb.	6.5 lb.
SPR146	58526301	1/4"	600 ft.	7,500 lb.	11 lb.
SPR963	58305601	9/16"	300 ft.	32,000 lb.	26 lb.
SPR966	58305701	9/16"	600 ft.	32,000 lb.	52 lb.
SPR969	58305801	9/16"	900 ft.	32,000 lb.	77 lb.
SPR9612	58305901	9/16"	1,200 ft.	32,000 lb.	103 lb.

## DOUBLE BRAIDED PULLING ROPE



**An innovative, new high performance pulling rope that is UV resistant, lightweight, and ultra low stretch for all of your feeder and circuit wire needs.**

- Polyester double braid
- high strength low stretch

### SPECIFICATIONS

MODEL #	STOCK #	DIAMETER	LENGTH	AVG. BREAKING STRENGTH	TOTAL WEIGHT
P-963	56823501	9/16"	300 ft.	14,000 lb.	50
P-966	56823601	9/16"	600 ft.	14,000 lb.	75
P-583	56823701	5/8"	300 ft.	18,000 lb.	63
P-586	56823901	5/8"	600 ft.	18,000 lb.	85
P-786	56824001	7/8"	600 ft.	31,000 lb.	240
P-789	57791301	7/8"	900ft.	31,000lb.	269
P-7812	56824101	7/8"	1200 ft.	31,000 lb.	298

# PULLING ACCESSORIES

## SWIVEL AND CLEVIS



Connects pulling head and pulling rope to eliminate winding and tangling of rope and wire during cable pulls.

### 6,000 lb. Swivel

- Swivel diameter: 1 1/4"
- Maximum rope size: 5/8"
- Designed to pass over sheaves, pulleys and rollers
- Pin roller design added for larger diameter rope and for increased strength by evenly spreading load pressure

### 10,000 lb. Swivel

- Swivel diameter: 1 5/8"
- Maximum rope size: 1"
- Designed to pass over sheaves, pulleys and rollers
- Pin roller design added for larger diameter rope and for increased strength by evenly spreading load pressure



### 6,000 lb. Clevis

- Clevis diameter: 1 1/4"
- Maximum rope size: 5/8"
- Connects to cable grip and pulling rope
- Designed to pass over sheaves, pulleys and rollers

### 10,000 lb. Clevis

- Clevis diameter: 1 5/8"
- Maximum rope size: 1"
- Connects to cable grip and pulling rope
- Designed to pass over sheaves, pulleys and rollers

## SPECIFICATIONS

MODEL #	STOCK #	DESCRIPTION
RC114	56830601	6,000 lb. Rope Clevis
RC1584	56830701	10,000 lb Rope Clevis
MS114	57178101	6,000 LB. Pulling Swivel
MS158	57178001	10,000 LB. Pulling Swivel





# PULLING ACCESSORIES

## SIMPULL™ CABLE GUIDE SYSTEM



Integrated guidance system allowing wire and cable to be routed from a reel into a conduit or cable tray without human intervention.

- Designed to eliminate the manual handling of service and feeder conductors during wire pulls
- Completely customizable for any wire and cable installation
- Minimizes labor effort during installation
- Reduces the risk of jobsite injuries
- Specialized storage cart for ease of transportation
- Roller guides direct and protect wire and cable along any desired path
- Universal clamps attach the system to the reel jacks, switchgear or panel box

### SPECIFICATIONS

MODEL #	STOCK #	DESCRIPTION		
CGS01	59893101	SIMPull™ Cable Guide System		
LENGTH	WIDTH	DEPTH	WEIGHT	
CGS01	43" (height)	25"	67"	300 lb.



Pulling Accessories | EQUIPMENT

# PULLING ACCESSORIES

## TRIPODS



M3K and M6K Tripods attach to MAXIS® cable pullers to make underground wire pulls simple and easy.

- Easily attach to the M3K or M6K cable puller
- Helps when pulling from transformer pads, vaults and meter bases
- Setup in two minutes
- Helps to pull out extra wire



## SPECIFICATIONS

MODEL #	STOCK #	DESCRIPTION
P3T01	56822201	P3T01 Tripod for MAXIS® 3K
SIZE		WEIGHT
Adjustable height: 3ft - 6ft	Adjustable leg width: 13in - 50in	43 lb.

MODEL #	STOCK #	DESCRIPTION
P6T02	56829401	P6T02 TRIPOD FOR MAXIS® 6K
SIZE		WEIGHT
Adjustable height: 3ft - 6ft	Adjustable leg width: 13in - 50in	45 lb.



# PULLING ACCESSORIES

## GUIDEIT™ CIRCUIT ROUTER



A wire router for circuit panel and junction boxes.

- Universal adapter for hands free circuit wire feeding
- Routes circuit wire in enclosures up to 32 inches
- Helps to prevent any damage to wire during installation
- Reduces the need to route circuit wire into a raceway or conduit

### SPECIFICATIONS

MODEL #	STOCK #	DESCRIPTION		
WG01	58387301	Circuit Router		
	HEIGHT	WIDTH	DEPTH	WEIGHT
WG01	2.5"	7.5"	23"	2 lb.

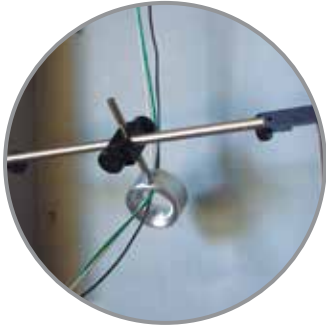

# TERMINATION

---

Southwire™ Termination Line of tools sets a new industry Standard. We've revolutionized these tools to make them faster, safer, and smarter than ever before. With Southwire™ cable stripping, cutting and crimping tools on your job site you can see an increase in safety, efficiency, and profitability.

- Wire Strippers
- Wire Stripper Accessories
- Utility Crimper
- Utility Crimper Accessories
- Commercial Crimper
- Commercial Crimper Accessories
- Cutters



## XT CABLE STRIPPER



The XTS-01 Cable Stripper is made for end and mid-span terminations of 600 volt 1/0 to 1000 KCMIL or outside diameters from .33"-1.284". Works on THHN, XHHW, RHH, RHW, and USE jackets.

- Cutting depth is adjustable to precisely match insulation thickness for fast stripping while eliminating cable scoring
- Adjustable 4" depth gauge provides consistent repeatable cuts
- Replaceable, precision razor sharp blade that is safely enclosed within the tool, eliminates stripping cables with a knife
- Capacity : wire 1/0 (.33" in diameter) in size to 1000kCMil (approx. 1.284" diameter)



### SPECIFICATIONS

MODEL #	STOCK #	DESCRIPTION			
XTS-01	64984901	XT Cable Stripper			
XTS01RB	59368901	XTS-01 Cable Stripper Replacement Blade Kit			
	HEIGHT	WIDTH	DEPTH	WEIGHT	
XTS-01	8.5"	2.5"	2.25"	1.30 lb.	
XTS01RB	1"	3/8"	3/8"		



# WIRE STRIPPERS

## XT MINI STRIPPER



### XT Mini Stripper for Sizes #6 through 1/0

- For end termination on THHN/XHHW 600V insulation types
- Cutting depth is self setting to eliminate cable scoring
- Replaceable blade that is safely enclosed within the housing
- Capacity: Wire sizes #6 through 1/0



### SPECIFICATIONS

MODEL #	STOCK #	DESCRIPTION		
XTS02	59894601	XT Mini Stripper		
XTS02RB	59973501	XT Mini Stripper Replacement Blade Kit		
	LENGTH	WIDTH	HEIGHT	WEIGHT
XTS02	1.2"	1.38"	5"	.38 lb.
XTS02RB	1/2"	1/4"	5/16"	2.34gm

## XT CABLE STRIPPER COMBO KIT



### XTC100 Strippers with Blade Replacement Kit.



### SPECIFICATIONS

MODEL #	STOCK #	DESCRIPTION		
XTC100	59894501	XT Cable Stripper Combo Kit		
	LENGTH	WIDTH	HEIGHT	WEIGHT
XTC100	10"	10"	3"	2.9 lb.

## STRIPPER, VEE-TWIN™, VT-270



Use the VT-270 to easily & precisely strip the jacket on plastic jacketed cables

- Works great on cables from 5/16" to 2-1/8" O.D.
- Easy to adjust, safe to use, and can fit into difficult to reach locations with maximum depth of cut 1/4"



### SPECIFICATIONS

MODEL #	STOCK #	DESCRIPTION			
VT-270	59817701	Stripper, Vee-Twin™, VT-270			
WEIGHT	MIN OPENING	MAX OPENING	MAX CUT DEPTH	AWG (SOLID) OR MC RANGE	
0.7 lbs	5/16"	2-1/8"	1/4"	14/2 to 4/0-4	

# UTILITY CRIMPERS

## MAXTERM™ 6-TON UTILITY CRIMPER



SCR6-BG  
SCR6-O  
SCR6-SN  
SCR6-K

Autorelease once Complete crimp is accomplished

- Brushless Motor
- Milwaukee M18 REDLITHIUM™2.0AH battery deliver 250+ Crimps on 500 MCM per charge
- Southwire Crimper + Southwire Dies produce UL classified connections across most major connector manufacturers
- 350 degree rotation
- Autorelease once complete crimp is accomplished
- Hydraulic system is optimized for consistent performance from 0°F to 122°F
- LED Lights illuminates work area
- Hydraulic pressure relief button for manual return
- Single trigger operation, crimps in the most confined spaces
- Interchangeable Jaws for different crimping applications
- Fully balanced design for improved control and ergonomics
- Weather protected electronics keep dirt, dust, and moisture out
- Each kit includes 1 platform, 1 crimper jaw, 1 battery charger, 2 batteries

### SPECIFICATIONS

MODEL #	STOCK #	DESCRIPTION		
SCR6-BG	59517101	MAXTERM™ 6-Ton Utility Crimper w/ BG Jaw		
		LENGTH	WIDTH	HEIGHT
SCR6-BG		16.5"	23"	5.5"
		WEIGHT		
		18 lb.		

MODEL #	STOCK #	DESCRIPTION		
SCR6-O	59517201	MAXTERM™ 6-Ton Utility Crimper w/ O Jaw		
		LENGTH	WIDTH	HEIGHT
SCR6-O		16.5"	23"	5.5"
		WEIGHT		
		18 lb.		

MODEL #	STOCK #	DESCRIPTION		
SCR6-SN	59517301	MAXTERM™ 6-Ton Utility Crimper w/ Snub Nose Jaw		
		LENGTH	WIDTH	HEIGHT
SCR6-SN		16.5"	23"	5.5"
		WEIGHT		
		18 lb.		

MODEL #	STOCK #	DESCRIPTION		
SCR6-K	59517401	MAXTERM™ 6-Ton Utility Crimper w/ Kerney Jaw		
		LENGTH	WIDTH	HEIGHT
SCR6-K		16.5"	23"	5.5"
		WEIGHT		
		18 lb.		



# UTILITY CRIMPER ACCESSORIES

## "W" STYLE DIES

### SDW-TREE



### Individual "W" Dies

- Clearly marked for easy identification
- Stainless steel resists rust
- Compatible with all crimping tools that accept "W" Dies
- Easily storable on "W" Die Tree

## SPECIFICATIONS

### INDIVIDUAL "W" DIES

PART#	STOCK#	DESCRIPTION
SDW-TREE	59517901	W Die Tree
SDW-BG	59518001	W Style Die: W-BG
SDW-O	59518101	W Style Die: W-O
SDW-C	59518201	W Style Die: W-C
SDW-K840	59518301	W Style Die: W-K840
SDW-161	59518401	W Style Die: W-161
SDW-162	59518501	W Style Die: W-162
SDW-163	59518601	W Style Die: W-163
SDW-164	59518701	W Style Die:W-164
SDW-165	59518801	W Style Die W-165
SDW-166	59518901	W Style Die: W-166
SDW-237	59519001	W Style Die: W-237
SDW-239	59519101	W Style Die: W-239
SDW-243	59519201	W Style Die: W-243
SDW-247	59519301	W Style Die: W-247
SDW-249	59519401	W Style Die: W-249

## UTILITY CRIMPER JAWS



**STJ6-BG**  
(1) STJ6-BG Seated BG Jaw



**STJ6-SN**  
(1) STJ6-SN Snub-Nosed Jaw



**STJ6-O**  
(1) STJ6-O Seated O Jaw



**STJ6-K**  
(1) STJ6-K Kearney Jaw

MODEL #	STOCK #	DESCRIPTION
STJ6-BG	59517501	Seated BG Jaw
STJ6-O	58517601	Seated O Jaw
STJ6-SN	59517701	Snub-Nosed Jaw
STJ6-K	59517801	Kearney Jaw

# COMMERCIAL CRIMPER

## MAXTERM™ 6-TON COMMERCIAL CRIMPER W/ U JAW



### Powerful 6-Ton Hydraulic Crimping Platform

- Brushless Motor
- Milwaukee M18 REDLITHIUM™2.0AH battery deliver's 250+ crimps on 500 MCM per charge
- Southwire Crimper + Southwire Dies produce UL classified connections across most major connector manufacturers
- 350 degree rotation
- Autorelease once complete crimp is accomplished
- Hydraulic system is optimized for consistant performance from 0°F to 122°F
- LED lights illuminate work area
- Hydraulic pressure relief button for manual return
- Single trigger operation, crimps in the most confined spaces
- Interchangeable jaws for different crimping applications
- Fully balanced designed for improved control and ergonomics
- Weather protected electronics keep dirt, dust, and moisture out
- Each kit includes 1 platform, 1 crimper jaw, 1 battery charger, 2 batteries

### SPECIFICATIONS

MODEL #	STOCK #	DESCRIPTION		
SCR6-C	59519501	MAXTERM™ 6-Ton Commercial Crimper w/ U Jaw		
	LENGTH	WIDTH	HEIGHT	WEIGHT
SCR6-C	16.5"	23"	5.5"	18 lb.

## 6-TON COMMERCIAL U JAW



### STJ6-CU Commercial U Jaw

MODEL #	STOCK #	DESCRIPTION		
STJ6-CU	59519601	6-Ton Commercial Crimper U Jaw		
	LENGTH	WIDTH	HEIGHT	WEIGHT
STJ6-CU	6.18"	6.93"	3.23"	2.76 lb.

# COMMERCIAL CRIMPER ACCESSORIES

## ALUMINUM & COPPER "U" DIES

### SDU-KITA



#### Individual Aluminum & Copper Kits & "U" Dies

- Clearly marked for easy identification
- Stainless steel resists rust
- Compatible with all crimping tools that accept "U" Dies
- Comes in storable case that fits in product container
- Imprints size die used on termination lug

### SPECIFICATIONS

#### ALUMINUM "U" DIE KIT & DIES

PART#	STOCK#	DESCRIPTION
SDU-KITA	59519701	#8 AWG-350 MCM Aluminum U Die Kit
SDU-A8	59520201	#8 Aluminum U Die
SDU-A6	59520301	#6 Aluminum U Die
SDU-A4	59520101	#4 Aluminum U Die
SDU-A2	59520001	#2 Aluminum U Die
SDU-A1	59519901	#1 Aluminum U Die
SDU-OA1	59520401	1/0 Aluminum U Die
SDU-OA2	59520501	2/0 Aluminum U Die
SDU-OA3	59520601	3/0 Aluminum U Die
SDU-OA4	59520701	4/0 Aluminum U Die
SDU-A250	59520801	250 Aluminum U Die
SDU-A300	59520901	300 Aluminum U Die
SDU-A350	59521001	350 Aluminum U Die

### SDU-KITC



#### COPPER "U" DIE KIT & DIES

PART#	STOCK#	DESCRIPTION
SDU-KITC	59519801	#8 AWG-350 MCM Copper U Die Kit
SDU-C8	59521501	#8 Copper U Die
SDU-C6	59521401	#6 Copper U Die
SDU-C4	59521301	#4 Copper U Die
SDU-C2	59521201	#2 Copper U Die
SDU-C1	59521101	#1 Copper U Die
SDU-OC1	59521601	1/0 Copper U Die
SDU-OC2	59521701	2/0 Copper U Die
SDU-OC3	59521801	3/0 Copper U Die
SDU-OC4	59521901	4/0 Copper U Die
SDU-C250	59522001	250 Copper U Die
SDU-C300	59522101	300 Copper U Die
SDU-C350	59522201	350 Copper U Die
SDU-C400	59522301	400 Copper U Die
SDU-C500	59522401	500 Copper U Die
SDU-C600	59522501	600 Copper U Die

# CUTTERS

## MAXTERM™ 6-TON CUTTER & BLADES

### SCU6-S



### SCU-AL



### STJB-CUAL



### STJB-ACSR



### Powerful 6-Ton Hydraulic Cutting Platform

- Brushless motor
- Milwaukee M18 REDLITHIUM™2.0AH battery delivers 250+ crimps on 500 MCM per charge
- Cuts ACSR up to 477 hen, cuts copper up to 750 MCM and up to 1000 MCM in aluminum
- Multiple cutting kits available
- Fully balanced to reduce user fatigue
- Hydraulic system is optimized for constant performance from 0°F to 122°F
- LED lights illuminates work area
- Hydraulic pressure relief button for manual return
- Single trigger operation, crimps in the most confined spaces
- Interchangeable jaws for different crimping applications
- Fully balanced design for improved control and ergonomics
- Weather protected electronics keep dirt, dust, and moisture out
- Each kit includes 1 platform, 1 cutter jaw, 1 battery charger, 1 battery, 1 cutting blade

### SPECIFICATIONS

MODEL #	STOCK #	DESCRIPTION		
SCU6-S	59522701	MAXTERM™ 6-Ton Cutter w/ ACSR Blades		
		LENGTH      WIDTH      HEIGHT      WEIGHT		
SCU6-S	16.5"	23"	5.5"	18 lb.

MODEL #	STOCK #	DESCRIPTION		
SCU-AL	59522601	MAXTERM™ 6-Ton Cutter w/ CU/AL Blades		
		LENGTH      WIDTH      HEIGHT      WEIGHT		
SCU-AL	16.5"	23"	5.5"	18 lb.

MODEL #	STOCK #	DESCRIPTION		
STJB-CUAL	59522801	6-Ton CU/AL Jaw		
STJB-CUAL	59523001	Replacement Blades CU/AL		
		LENGTH      WIDTH      HEIGHT      WEIGHT		
STJB-CUAL	6.18"	6.93"	3.23"	3.13 lb.
STJB-CUAL	1"	6"	8"	1 lb.

MODEL #	STOCK #	DESCRIPTION		
STJB-ACSR	59522901	6-Ton ACSR Jaw		
STJB-ACSR	59523101	Replacement Blades ACSR		
		LENGTH      WIDTH      HEIGHT      WEIGHT		
STJB-ACSR	6.18"	6.93"	3.23"	2.76 lb.
STJB-ACSR	1"	6"	8"	1 lb.





# CONDUIT BENDING

---

We don't just help you bend conduit—we change the way you do it. In addition to offering traditional conduit bending tools, Southwire has designed bending platforms that allow you to bend 1/2" to 2" EMT, IMC, and GRC conduit more efficiently, helping you do more work faster and stay fresh longer.

## BENDMAX™ POWER BENDER

### PB2000



#### Power Bender 3/4" - 2" EMT, IMC, Rigid Conduit

- Easily adjustable to ergonomic working height
- 3/4" - 2" EMT, IMC, and Rigid conduit bender
- 2 degree leveling adjustment
- Industrial grade DC drive, and electrical components
- Push cart mounted platform
- Includes free standing conduit roller support
- Total lock casters
- Programmable springback incorporated into digital readout
- Large analog protractor for accurate bends
- Backlit digital display
- Manual operation in the event of electronics failure
- Billet aluminum hand pendant
- Easily replaceable control cable



#### SPECIFICATIONS

MODEL #	STOCK #	DESCRIPTION			
PB2000	59840601	Powered Bender 3/4"- 2" EMT, IMC, Rigid Conduit			
		DEPTH	WIDTH	HEIGHT	WEIGHT
PB2000		38"	30"	50"	600 lbs

## BENDSTATION™ RIGID WORK STATION

### RB1000



#### RIGID RB1000 3/4"-1"

- More accurate measurements, bends, and cuts
- Built-in protractor for quick and accurate bends
- Measure, bend, clamp and cut at a comfortable 36" work table height for reduced labor fatigue
- Store up to 700 feet of conduit or strut
- Extra shelf for storage of tools and materials
- Heavy duty casters for easy transportation and mobility
- Dual bending shoe designed for both 3/4" and 1" Rigid and IMC
- Requires up to 40% less effort than other mechanical benders
- Multi-position chain vise for quick and safe cutting and threading
- Built-in 60" ruler for quick and accurate measuring
- Built-in protractor for quick and accurate bends



#### SPECIFICATIONS

MODEL #	STOCK #	DESCRIPTION			
RB1000	59840701	BENDSTATION™ RIGID for 3/4" and 1" rigid and IMC			
		LENGTH	WIDTH	HEIGHT	WEIGHT
RB1000		69"	29"	38.5"	170 lb.

# BENDERS

## BENDSTATION™ PRO WORKSTATION

### MB1000



A comprehensive conduit bending workstation for 3/4" & 1" EMT.

- Speeds up the entire bending process up to 30%
- More accurate measurements, bends, and cuts
- Built-in protractor for quick and accurate bends
- Comfortable work table height at 36"
- The ability to store up to 900 feet of conduit
- Extra shelf for storage of tools and materials
- Heavy duty casters for easy transportation and mobility
- Eliminates the need to bend over to get a closer look at hand bends
- Less labor fatigue: work standing up and not constantly bending over
- Unique dual bending shoe, designed for both 3/4" & 1" EMT
- Ratchet system designed to make bending 1" EMT safer, easier, and more accurate
- A 60" ruler is incorporated on the working surface for quick and accurate marking
- Unique speed vice designed specifically to hold conduit and unistrut, helps make cutting quicker and safer



## SPECIFICATIONS

MODEL #	STOCK #	DESCRIPTION		
MB1000	64306901	BENDSTATION™ PRO for 3/4" and 1" EMT		
	LENGTH	WIDTH	HEIGHT	WEIGHT
MB1000	69"	29"	38.5"	150 lb.



## PVCB-06M



### 1/2" to 6" PVC Motorized Bender

- Durable black powder coating for increased corrosion resistance
- Solid 6" wheels for easy maneuverability
- Chrome plated reflectors for maximum reflection of infrared energy for a faster bend
- Label includes nec bending tables
- Bright red indicator light to advise when unit is turned "ON"



### SPECIFICATIONS

MODEL #	STOCK #	DESCRIPTION			
PVCB-06M	64301301	1/2" to 6" PVC Motorized Bender			
		DEPTH	WIDTH	HEIGHT	WEIGHT
PVCB-06M		11.75"	73"	16.5"	81 lb.

## PVCB-06



### 1/2" to 6" PVC Bender

- Durable black powder coating for increased corrosion resistance
- Solid 6" wheels for easy maneuverability
- Chrome plated reflectors for maximum reflection of infrared energy for a faster bend
- Label includes nec bending tables
- Bright red indicator light to advise when unit is turned "on"



### SPECIFICATIONS

MODEL #	STOCK #	DESCRIPTION			
PVCB-06	64301201	1/2" to 6" PVC Bender			
		DEPTH	WIDTH	HEIGHT	WEIGHT
PVCB-06		11.75"	73"	16.5"	80 lb.

# PVC BENDERS

## PVCB-04



### 1/2" to 4" PVC Bender

- Durable black powder coating for increased corrosion resistance
- Solid 6" wheels for easy maneuverability
- Chrome plated reflectors for maximum reflection of infrared energy for a faster bend
- Label includes NEC bending tables
- Bright red indicator light to advise when unit is turned "on"



### SPECIFICATIONS

MODEL #	STOCK #	DESCRIPTION			
PVCB-04	64301101	1/2" to 4" PVC Bender			
		DEPTH	WIDTH	HEIGHT	WEIGHT
PVCB-04		8.5"	56"	13"	50 lb.

## PLUG KIT PVCP



### PVCP-01 PVCP-02

- Rugged carrying case to store and transport plugs
- Durable long lasting neoprene gaskets
- Twist lock design for easy installation and removal
- Provides air tight seal
- Prevents conduit from collapsing when heated



### SPECIFICATIONS

MODEL #	STOCK #	DESCRIPTION
PVCP-01	64301401	2" to 4" Bending Plug Kit
PVCP-02	64301601	2" to 6" Bending Plug Kit



# HOLE MAKING

Southwire™ has developed industry leading tools for electrical contractors, including a comprehensive line of hole making solutions. With tools ranging from cutting dies to the original drill-powered knockout punch, you can make quick, accurate holes every time without the muscle or mess.

- Knockouts
- Stud punches
- Accessories



## MAX PUNCH® XD



**Heavy duty knockout punch driver for stainless and mild steel.**

- No hydraulics, no ratcheting, no mess
- Thread-in/thread-out removable drawstuds (universal to fit most common KO dies)
- Rated to cut 10 gauge mild and stainless steel up to 4"
- Minimum drill recommendations: 18v cordless, equivalent of 550 in. lbs. torque rated

### MPXD-SD

Includes:

- MAX PUNCH® XD drive unit
- 1/2" – 2" MAX PUNCH® Pro cutting dies (rated for stainless steel)
- 2 drawstuds sizes 3/4" & 7/16"
- MAXIS® Marksman™ conduit layout tool
- Step drill bit (3/16" – 7/8", 2 nut drivers) (3/8")
- Heavy duty carrying case



### MP-03PRO

Includes:

- 2 1/2" - 4" MAX PUNCH® Pro cutting dies
- 1 1/8" drawstud
- Heavy duty carrying case



## SPECIFICATIONS

MODEL #	STOCK #	DESCRIPTION	WEIGHT	WIDTH	DEPTH	HEIGHT
MPXD	63159701	MAX PUNCH® XD: drive unit only (no case)	5.5"	11.5"	4.25"	5.5"

MODEL #	STOCK #	DESCRIPTION	WEIGHT	WIDTH	DEPTH	HEIGHT
MPXD-SD	63159901	MAX PUNCH® XD w/ stainless steel rated dies - 1/2" - 2" set (1 case)	14.5"	8.5"	13"	16.5"

MODEL #	STOCK #	DESCRIPTION	WEIGHT	WIDTH	DEPTH	LENGTH
MP-03PRO	57177201	MAX PUNCH® PRO STAINLESS STEEL 2 1/2" - 4" SET	22.5lb.	13"	5"	16.5"

# KNOCKOUTS

## MAX PUNCH™ 360 HYDRAULIC KNOCKOUT TOOL



Heavy Duty 12 ton hydraulic knockout with 360 degree articulation.

- Full 360 degree articulating head for tight spaces
- Lightweight aluminum head
- Compact pump with padded handle

### SPECIFICATIONS

MODEL#	STOCK #	DETAILS		
MP360HP	59159001	MAX PUNCH™ 360 DRIVE UNIT ONLY		
MP360SDPRO	58973801	MAX PUNCH™ 360 STAINLESS STEEL 1/2" - 2" SET		
MP-03PRO	57177201	MAX PUNCH™ MILD STEEL SET 2 1/2" - 4" SET		
MODEL#	LENGTH	WIDTH	DEPTH	WEIGHT
MP360HP	4.5"	5.25"	3.75"	5.5 lb.
MP360SDPRO	21"	12"	4"	15 lb.
MP-03PRO	16.5"	13"	8.5"	23 lb.



# STUD PUNCHES

## MAX PUNCH™ HSP HYDRAULIC STUD PUNCH



4 tools in 1 and is adjustable for 3 5/8" and 6" studs, punches 7/8" or 1 11/32" holes.

- Punches holes in 16 gauge structural steel studs
- Compact design fits in tight spaces
- Padded handles provide gripping comfort and greater control
- Heavy duty carrying case

### SPECIFICATIONS

MODEL #	STOCK #	DESCRIPTION	
MPHSP	58946501	MAX PUNCH™ Hydraulic Stud Punch	
MODEL #	LENGTH	WIDTH	WEIGHT
MPHSP	17.5"	10.5"	11 lb.



Stud Punches | EQUIPMENT

# STUD PUNCHES

## MAX PUNCH™ MANUAL STUD PUNCH



### 2 tools in 1

- Sizes include - 7/8" (22.5mm) & 1-11/32" (34.1mm)
- MAX PUNCH™ Manual Stud Punch is intended to punch round holes in 20 gauge steel studs
- Lock to keep handle in place when not in use
- Lightweight punch makes accurate location of holes easier
- Cushioned handle gives more leverage and makes it easier to punch in tight spaces, meaning less operator fatigue and more comfortable handling

### SPECIFICATIONS

MODEL #	STOCK #	DESCRIPTION		
MSP01	57576201	MAX PUNCH™ MANUAL STUD PUNCH		
MODEL #	HEIGHT	WIDTH	LENGTH	WEIGHT
MSP01	2.25"	8.55"	18.5"	7.5 lb.





## MAX PUNCH® STAINLESS STEEL CUPS & CUTTERS

Cleaner, quicker stainless steel punch dies.



- Unique 3 point cutting surface provides a cleaner, quicker and easier cut for 1" through 4" dies
- Rated for 10 gauge stainless steel (3.5mm) as well as mild steel, aluminum, fiberglass and plastics
- Will not bow panel or leave jagged edges
- Crimping effect on slug for easy removal

### SPECIFICATIONS

MODEL #	STOCK #		CONDUIT & PIPE SIZE	HOLE SIZE ACTUAL "	MM	CAPACITY S.S. GA
MPK050PRO	57174601	MAX PUNCH® Cutter for Stainless Steel 1/2"	1/2"	.89	23	10
MPC50PRO	57176101	MAX PUNCH® Cup for Stainless Steel 1/2"	1/2"	.89	23	10
MPK075PRO	57174701	MAX PUNCH® Cutter for Stainless Steel 3/4"	3/4"	1.12	28	10
MPC75PRO	57176201	MAX PUNCH® Cup for Stainless Steel 3/4"	3/4"	.12	28	10
MPK0100PRO	57174801	MAX PUNCH® Cutter for Stainless Steel 1"	1"	1.36	35	10
MPC100PRO	57176301	MAX PUNCH® Cup for Stainless Steel 1"	1"	1.36	35	10
MPK0125PRO	57174901	MAX PUNCH® Cutter for Stainless Steel 1 1/4"	1 1/4"	1.70	43	10
MPC125PRO	57176401	MAX PUNCH® Cup for Stainless Steel 1 1/4"	1 1/4"	1.70	43	10
MPK0150PRO	57175001	MAX PUNCH® Cutter for Stainless Steel 1 1/2"	1 1/2"	1.95	50	10
MPC150PRO	57176501	MAX PUNCH® Cup for Stainless Steel 1 1/2"	1 1/2"	1.95	50	10
MPK0200PRO	57175101	MAX PUNCH® Cutter for Stainless Steel 2"	2"	2.42	62	10
MPC200PRO	57176601	MAX PUNCH® Cup for Stainless Steel 2"	2"	2.42	62	10
MPK0250PRO	57175301	MAX PUNCH® Cutter for Stainless Steel 2 1/2"	2 1/2"	2.92	74	10
MPC250PRO	57176701	MAX PUNCH® Cup for Stainless Steel 2 1/2"	2 1/2"	2.92	74	10
MPK0300PRO	57175401	MAX PUNCH® Cutter for Stainless Steel 3"	3"	3.55	90	10
MPC300PRO	57176801	MAX PUNCH® Cup for Stainless Steel 3"	3"	3.55	90	10
MPK0350PRO	57175501	MAX PUNCH® Cutter for Stainless Steel 3 1/2"	3 1/2"	4.04	103	10
MPC350PRO	57176901	MAX PUNCH® Cup for Stainless Steel 3 1/2"	3 1/2"	4.04	103	10
MPK0400PRO	57175601	MAX PUNCH® Cutter for Stainless Steel 4"	4"	4.54	115	10
MPC400PRO	57177001	MAX PUNCH® Cup for Stainless Steel 4"	4"	4.54	115	10
MPO2PRO*	57177101	Small Die Set 1/2"-2" in case (drive unit not included)	1/2" - 2"	.89-2.42	23-62	10
MPO3PRO*	57177201	MAX PUNCH® PRO STAINLESS STEEL SET 2 1/2" - 4"	2 1/2" - 4"	2.92-4.54	74-115	10

\*(drive unit not included)

# ACCESSORIES

## OILTIGHT PUNCHES WITH NOTCHES

### Special application punches

- Model #MPOP78, Stock #58142201, 7/8" (22.5mm) oiltight punch with notches
- Model #MPOP1732, Stock #58142301, 1 7/32" (30.5mm) oiltight punch with notches
- Punch, die, draw stud and nut

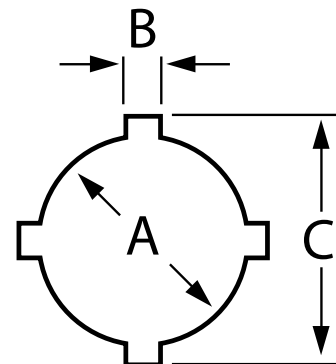

### SPECIFICATIONS

MODEL #	STOCK #	DETAILS		
MPOP78	58142201	7/8" OILTIGHT PUNCH		
MPOP1732	58142301	1 7/32" OILTIGHT PUNCH		
HOLE SIZE	INCH	A	B	C
MPOP78		.875	.125	1.000
MPOP1732		1.210	.190	1.380
HOLE SIZE	MM	A	B	C
MPOP78		22.5	3.2	25.4
MPOP1732		30.5	4.8	36.0
MAXIMUM CAPACITY MILD STEEL			GA	MM
MPOP78			14	2.0
MPOP1732			10	3.5

## DRAW STUDS FOR MAX PUNCH® DRIVE UNITS



### MAX PUNCH® PRO DRAW STUDS

- 3/4" - Main Draw Stud - Stock #57717701  
Model #PRDS34
- 7/16" - Medium Draw Stud - Stock #57717901  
Model #PRDS716
- 1 1/8" - Large Draw Stud (for 2 1/2" – 4" MAX PUNCH® and MAX PUNCH® PRO Dies) Stock #58306101  
Model #PRDS118 (BLK/SI)



### MAX PUNCH® DRAW STUDS

- 3/4" - Main Draw Stud - Stock #56825901  
Model #MPDS12

## SPECIFICATIONS

MODEL#	STOCK #	DETAILS	LENGTH	WEIGHT	DIAMETER
PRDS34	57717701	3/4" MAIN DRAW STUD MAX PUNCH® PRO	5"	8.7 oz	3/4"
PRDS716	57717901	7/16" MEDIUM DRAW STUD - MAX PUNCH® PRO	4.25"	4.6 oz	7/16" - 3/4"
PRDS118	58306101	LARGE DRAW STUD - 1 1/8" (FOR MILD STEEL OR STAINLESS STEEL LARGE DIES)	4.4371"	15.6 oz	1 1/8"
MPDS12	56825901	1/2" MAIN DRAW STUD - MAX PUNCH®	11.5"	4.4 oz	15/16"



# MATERIAL HANDLING

As one of the most innovative tool lines in the industry, Southwire Tools and Equipment has provided material handling solutions that move material quickly, easily, and safely. With a product line that includes reel jacks, SIMpull™ CoilPAK™ carts, and Wire Wagon® carts, you can complete the job better than ever before while saving time and energy.

- Reel Jacks
- SIMpull™ CoilPAK™ Carts
- Wire Wagon® Carts
- Storage Boxes



# REEL JACKS

## PRO-JAX™ REEL STANDS



A 6,000 lb. capacity portable reel stand.

- One person can easily transport through most jobsite environments
- Minimum drill recommendations: 18V cordless, equivalent of 550 in. lb. torque rated, for reels 3,000 - 6,000 lb.
- Easy adjustment for uneven surfaces on jobsite
- Axle rests on steel rollers for easy wire pay off
- Axle safety guard ensures that reel will not fall off of jack stands
- Uses an 18V cordless drill to lift wire reels
- PRO-JAX™ stands can lift up to 6,000 lb.
- Can be used with 1 1/4" - 3" axle



### SPECIFICATIONS

MODEL #	STOCK #	DESCRIPTION		
MPJ01	58133201	PRO-JAX™ (Single)		
MPJ02	58526401	PRO-JAX™ (Pair)		
	LENGTH	WIDTH	HEIGHT	WEIGHT
MPJ01 (single)	41"	17"	43"	118 lb.



## QWIKJAX™ REEL STAND



### QWIKJAX™ 3,000lb colapsable reel stand (single)

- 6,000lb capacity per pair
- One person can easily transport through most jobsite environments
- 6,000 lb axle safety catch hook ensures that reel will not fall off of jack stands
- Axle rests on steel rollers for easy wire pay off
- Maximum reel height: up to 72" reel
- Quick folding feature for compact storage
- Sliding cradle for quick adjustments on large reels
- Easy-to-use, one person setup and operation
- Easy adjustment for uneven surfaces on jobsites



### SPECIFICATIONS

MODEL#	STOCK #	DETAILS	WEIGHT	WIDTH	HEIGHT	DEPTH
QJ-01	64237801	QWIKJAX™ portable reel stand (single)	35 lb.	17"	29"-42"	29"



# REEL JACKS

## MAXISJAX<sup>®</sup> REEL STANDS



A unique reel stand that will quickly set up and lift wire reels safely and efficiently without the hassle of conventional stands.

- Easy to store and transport
- Breaks down into a compact storable tool
- Jaw clamps onto axle so that wire reels won't come off or fall over
- Multiple steel rollers make it easy for one person to roll off heavy wire
- Max lever allows one person to lift wire reels off the ground with minimal effort
- Uses either a 1-1/2" to 2" rigid pipe for an axle
- Works on reels up to 48" tall

## SPECIFICATIONS

MODEL #	STOCK #	DESCRIPTION		
MJ707	56824501	MAXISJAX <sup>®</sup> - 3,000 lb. REEL STANDS (pair)		
	HEIGHT	WIDTH	LENGTH	WEIGHT
MJ707	37"	7"	9.5"	54 lb.





## SCREW JAX



### Screw-Type Reel Jax 22"-54"

- Roller bearing incorporated into Jax rollers
- Powder-coat finish for superior durability and corrosion resistance
- Rollers fit inside axel grooves to prevent axle running
- Wide welded steel base for added strength and stability
- Telescoping mid section for adjustability
- Strut lock pin for added strength and stability



### SPECIFICATIONS

MODEL #	STOCK #	DESCRIPTION		
CJ01	59892901	Screw Jax		
	LENGTH	WIDTH	HEIGHT	WEIGHT
CJ01	15"	15"	28" Max Height	22 lb.

## SCREW JAX



### Screw-Type Reel Jax 13"-27"

- Roller bearing incorporated into Jax rollers
- Powder-coat finish for superior durability and corrosion resistance
- Rollers fit inside axel grooves to prevent axle running
- Wide welded steel base for added strength and stability
- Telescoping mid section for adjustability
- Strut lock pin for added strength and stability



### SPECIFICATIONS

MODEL #	STOCK #	DESCRIPTION		
CJ02	59893001	Screw Jax		
	LENGTH	WIDTH	HEIGHT	WEIGHT
CJ02	21"	24"	54" Max Height	42 lb.

# ACCESSORIES

## AXLES

### PJA-01



#### Axle

- Heavy duty 6,000 lb. capacity
- Low deflection high strength steel
- Available in 60" and 72" lengths

### PJA-02



## SPECIFICATIONS

MODEL #	STOCK #	DESCRIPTION
PJA-01	58948701	6,000 lb. capacity 72" reel axle
PJA-02	59161901	6,000 lb. capacity 60" reel axle

## RISERS



#### Risers

- Enables PRO-JAX™ to be used with 96" reels



## SPECIFICATIONS

MODEL #	STOCK #	DESCRIPTION
PJS-01	58955301	12" riser attachment for PRO-JAX™ pair

## SIMPULL™ COILPAK™ CART



The best material handling solution for SIMPULL™ COILPAK™ Payoffs.

- Rugged transport system for (8) SIMPULL™ COILPAK™ Payoffs with an integrated pay off system
- Allows SIMPULL™ COILPAK™ Wire Payoffs to be added or changed easily without impacting other SIMPULL™ COILPAK™ Wire Payoffs
- Innovative staging springs allow you to secure and organize up to 8 wires
- Best for scenarios where conductors are frequently changing, adding or dropping
- Cart includes 8 inch total lock casters
- Easy to use in hallways and fits through standard doors
- Individual wire feeds similar to a wire cart



### SPECIFICATIONS

MODEL #	STOCK #	DESCRIPTION		
CK01	58386901	SIMPULL™ CoilPAK™ CART		
	LENGTH	WIDTH	HEIGHT	WEIGHT
CK01	52"	24"	90"	60.5 lb.

## SIMPULL™ COILPAK™ UTILITY CART



Multipurpose cart designed for rugged use on nearly any construction.

- Can hold and transport a variety of materials, tools, supplies, and SIMPULL™ COILPAK™ Payoffs
- Ability to hold up to 8 SIMPULL™ COILPAK™ Payoffs
- Incorporated low payoff height for easy circuit wire pulling at any angle
- Compact cart design for easy storage and transport
- Cart includes 8 inch total lock casters



### SPECIFICATIONS

MODEL #	STOCK #	DESCRIPTION		
UC100	58617201	HEAVY DUTY 2 SHELF UTILITY CART		
	LENGTH	WIDTH	HEIGHT	WEIGHT
UC100	46"	24"	45"	107 lb.

# WIRE CARTS

## SIMPULL™ BARREL™ HAND TRUCK



The SIMPULL™ BARREL™ Hand Truck makes it easy to handle and transport your SIMPULL BARREL™ Drum.

- The SIMPULL™ BARREL™ Hand Truck, when used with the SIMPULL™ BARREL™ package, replaces the old wire cart and reels and the issues associated with them
- The hand truck includes a wire payoff feature, and is designed to transport the SIMPULL™ BARREL™ package anywhere on the jobsite - through narrow electrical room doors, over cords on the floor or construction gravel
- Solid rubber tires for no-flat jobsite peace of mind
- Rugged steel frame with unique design



### SPECIFICATIONS

MODEL #	STOCK #	DESCRIPTION			
SBT01	58133001	SIMPULL™ BARREL™ HAND TRUCK			
		LENGTH	WIDTH	HEIGHT	WEIGHT
SBT01		27"	24.5"	61"	145 lb.

## SIMPULL™ BARREL™ TRIPOD



The SIMPULL™ BARREL™ Tripod is a circuit wire payoff accessory used in connection with your new SIMPULL™ BARREL™ Drum.

- The SIMPULL™ BARREL™ Tripod is a circuit wire guide that mounts easily on the rim of the SIMPULL™ BARREL™
- This wire guide system provides unique means for guiding the paralleled conductors out of the barrel when it is not on the SIMPULL™ BARREL™ Hand Truck.



### SPECIFICATIONS

MODEL #	STOCK #	DESCRIPTION				
SBT02	58133101	SIMPULL™ BARREL™ TRIPOD				
		LENGTH	WIDTH	HEIGHT	WEIGHT	TAP OUTSIDE DIAMETER
SBT02		36.5"	6.25"	6.25"	5.5 lb.	4.98"

## WIRE WAGON® 510



### XL Conduit and Wire Cart

- Holds up to 14 - 2500' spools or a combination of 2500' and 500' spools
- Holds several hundred feet of conduit as well as all the additional materials and tools needed for your entire work day
- Designed with a full 24"x60" metal top shelf for storage and assembly
- Cart includes 8 inch total lock casters
- 2,000 lb. capacity



### SPECIFICATIONS

MODEL #	STOCK #	DESCRIPTION	LENGTH	WIDTH	HEIGHT	WEIGHT
WW510	56824801	Wire Wagon® 510				
WW510			60.5"	29.5"	46.25"	191 lb.

## WIRE WAGON® 520



### MC Cable and Conduit Cart

- Holds 4 spools of 1000' MC cable
- Allows for different sizes and colors on one rack
- Comes standard with two sets of axles for wider than normal spools
- Eliminate spool jacks and the unnecessary set up and tear down time between pulls
- Cart includes 8 inch total lock casters
- Holds up to 1,000 ft. of conduit or strut
- 2,000 lb. capacity



### SPECIFICATIONS

MODEL #	STOCK #	DESCRIPTION	LENGTH	WIDTH	HEIGHT	WEIGHT
WW520	56825001	Wire Wagon® 520				
WW520			60"	52"	13"	125 lb.

# WIRE WAGON<sup>®</sup> CARTS

## WIRE WAGON<sup>®</sup> 530



### Large Spool Cart

- Holds 8 spools up to 16 inches in diameter
- Storage for extra tools, spools and materials
- Easy to load and unload
- Cart includes 8 inch total lock casters
- 1,000 lb. capacity



### SPECIFICATIONS

MODEL #	STOCK #	DESCRIPTION		
WW530	56825101	Wire Wagon <sup>®</sup> 530		
	LENGTH	WIDTH	HEIGHT	WEIGHT
WW530	50"	29.5"	42"	155 lb.

## WIRE WAGON<sup>®</sup> 535



### Large Capacity Wire Cart

- Holds up to 20 – 500' spools of 12 AWG and 14 AWG or 6 -2500' spools of 12 AWG and 14 AWG
- Will hold up to 9 boxes of data cable or 6 - 1,000 ft. spools
- Extra storage shelf for tools, spools and materials
- Easy to load and unload, there are no axles or pins to remove
- Cart includes 8 inch total lock casters
- 1,000 lb. capacity



### SPECIFICATIONS

MODEL #	STOCK #	DESCRIPTION		
WW535	56825201	Wire Wagon <sup>®</sup> 535		
	LENGTH	WIDTH	HEIGHT	WEIGHT
WW535	50"	29.5"	42"	142 lb.

## WIRE WAGON® 538



### Service Cart

- Holds up to 12 – 500' spools of 12 AWG and 14 AWG
- Constructed with 5/8" solid steel bar to support almost any combination of wire spools
- Easy movement around the jobsite
- Folds flat in seconds for minimal storage
- Great for service trucks or vans



### SPECIFICATIONS

MODEL #	STOCK #	DESCRIPTION		
WW538	56825401	Wire Wagon® 538		
	LENGTH	WIDTH	HEIGHT	WEIGHT
WW538	32.5"	26.5"	36.5"	25.5 lb.

## WIRE WAGON® 550



### Mobile Print Table and Work Station

- No wasting time looking around the jobsite for something to use as a print table
- No wasting time back and forth to a stationary print table
- Move your plans and materials right to the work area
- 1,000 lb. capacity
- Cart includes 8 inch total lock casters
- Multiple uses:
  - Mobile print table
  - Material shelf
  - Conduit rack
  - Portable work bench



### SPECIFICATIONS

MODEL #	STOCK #	DESCRIPTION		
WW550	56825501	Wire Wagon® 550		
	LENGTH	WIDTH	HEIGHT	WEIGHT
WW550	54"	32"	42"	180 lb.



# WIRE WAGON® CARTS

## WIRE WAGON® 560



### Wire Wagon® 560 Conduit Rack.

- Cart includes 8 inch total lock casters
- Fast and simple collapsible design for storage and transportation
- Multipurpose conduit, pipe, and strut rack
- 1,000 lb. capacity



### SPECIFICATIONS

MODEL #	STOCK #	DESCRIPTION		
WW-560	58986801	Wire Wagon® 560		
	LENGTH	WIDTH	HEIGHT	WEIGHT
WW-560	58.5"	34"	19"	140 lb.

EQUIPMENT | Wire Wagon® Carts



## CB603065 BI-FOLD CABINET



**Bi-Fold Cabinet gives you unrestricted access to your tools. With heavy duty shelves and a single locking point.**

- Recessed lock housing for protection against theft with one-time lock installation
- Powder-coat finish for superior durability and corrosion resistance
- Heavy duty 16 gauge box construction
- Welded shelves
- Heavy duty hinges to resist break in
- Casters included



### SPECIFICATIONS

MODEL #	STOCK #	DESCRIPTION		
CB603065	59822701	CB603065 Bi-Fold Cabinet		
	LENGTH	WIDTH	HEIGHT	WEIGHT
CB603065	14"	120"	65"	470 lb.

## CB602460 TWO DOOR CABINET



**Two Door Cabinet gives you two ways to store your tools. With heavy duty shelves and a large vertical storage area, you can easily organize and secure your tools.**

- Recessed lock housing for protection against theft with one-time lock installation
- Four-way skids allow access from any side, making it easier and faster to transport
- Powder-coat finish for superior durability and corrosion resistance
- Caster-ready 7 gauge steel skids
- Heavy duty 16 gauge box construction
- Welded shelves
- Heavy-duty hinges to resist break in
- Casters not included



### SPECIFICATIONS

MODEL #	STOCK #	DESCRIPTION		
CB602460	59822801	CB602460 Two Door Cabinet		
	LENGTH	WIDTH	HEIGHT	WEIGHT
CB602460	24"	60"	60"	385 lb.

# PIANO BOXES

## PB603049 PIANO BOX



Piano boxes offer, at a glance, storage for both small and large tools, making it possible to organize and secure your livelihood, save time, and reduce costs on the jobsite.

- Recessed lock housing for protection against theft with one-time lock installation
- Four-way skids allow access from any side, making it easier and faster to transport
- Powder-coat finish for superior durability and corrosion resistance
- Caster-ready 7 gauge steel skids
- Heavy-duty 16 gauge box construction
- Welded shelves
- Heavy-duty hinges to resist break in
- Casters not included



### SPECIFICATIONS

MODEL #	STOCK #	DESCRIPTION		
PB603049	59822401	PB603049 Piano Box		
		LENGTH	WIDTH	HEIGHT
PB603049		30"	60"	48.5"
				WEIGHT
				337 lb.

## PB483048 PIANO BOX



Piano boxes offer, at a glance, storage for both small and large tools, making it possible to organize and secure your livelihood, save time, and reduce costs on the jobsite.

- Recessed lock housing for protection against theft with one-time lock installation
- Four-way skids allow access from any side, making it easier and faster to transport
- Powder-coat finish for superior durability and corrosion resistance
- Caster-ready 7 gauge steel skids
- Heavy-duty 16 gauge box construction
- Welded shelves
- Heavy-duty hinges to resist break in
- Casters not included



### SPECIFICATIONS

MODEL #	STOCK #	DESCRIPTION		
PB483048	59822301	PB483048 Piano Box		
		LENGTH	WIDTH	HEIGHT
PB483048		20"	48"	48"
				WEIGHT
				287 lb.

# PIANO BOX AND FIELD OFFICE

## PB603034 PIANO BOX



Piano boxes offer, at a glance, storage for both small and large tools, making it possible to organize and secure your livelihood, save time, and reduce costs on the jobsite.

- Recessed lock housing for protection against theft with one-time lock installation
- Four-way skids allow access from any side, making it easier and faster to transport
- Powder-coat finish for superior durability and corrosion resistance
- Caster-ready 7 gauge steel skids
- Heavy-duty 16 gauge box construction
- Welded shelves
- Heavy-duty hinges to resist break in
- Casters not included



### SPECIFICATIONS

MODEL #	STOCK #	DESCRIPTION		
PB603034	59822201	PB603034 Piano Box		
	LENGTH	WIDTH	HEIGHT	WEIGHT
PB603034	30"	60"	34"	282 lb.

## FO604482 FIELD OFFICE



Field Office offers a large workstation with shelved storage and a single locking point, allowing you to control and secure any jobsite.

- Recessed lock housing for protection against theft with one-time lock installation
- Four-way skids allow access from any side, making it easier and faster to transport
- Powder-coat finish for superior durability and corrosion resistance
- Caster-ready 7 gauge steel skids
- Heavy-duty 16 gauge box construction
- Welded shelves
- Heavy-duty hinges to resist break in
- Casters not included



### SPECIFICATIONS

MODEL #	STOCK #	DESCRIPTION		
FO604482	59822501	FO604482 Field Office		
	LENGTH	WIDTH	HEIGHT	WEIGHT
FO604482	44"	60"	82"	678 lb.

# COMPACT CHEST

## CC482423 COMPACT CHEST



Compact chest is a highly mobile storage vault. With the perfect profile for a truck bed and steel fork lift skids, this box will become your workhorse.

- Recessed lock housing for protection against theft with one-time lock installation
- Four-way skids allow access from any side, making it easier and faster to transport
- Powder-coat finish for superior durability and corrosion resistance
- Caster-ready 7 gauge steel skids
- Heavy-duty 16 gauge box construction
- Welded shelves
- Heavy-duty hinges to resist break in
- Casters not included



### SPECIFICATIONS

MODEL #	STOCK #	DESCRIPTION			
CC482423	59822601	CC482423 Compact Chest			
		LENGTH	WIDTH	HEIGHT	WEIGHT
CC482423	24"	48"	22.5"	145 lb.	

## CC191932 MINI COMPACT CHEST



- Recessed lock housing for protection against theft with one-time lock installation
- Four-way skids allow access from any side, making it easier and faster to transport
- Powder-coat finish for superior durability and corrosion resistance
- Caster-ready 7 gauge steel skids
- Heavy-duty 16 gauge box construction
- Welded shelves
- Heavy-duty hinges to resist break in
- Casters not included



### SPECIFICATIONS

MODEL #	STOCK #	DESCRIPTION			
CC191932	63036001	CC191932 Mini Compact Chest			
		LENGTH	WIDTH	HEIGHT	WEIGHT
CC191932	32"	19"	19"	73 lb.	

# MATERIAL HANDLING

---

---

---

---

---

---

---

---

---

---

---

---

---

---

---

---

---

---

---

---

---

---

---

---

---

Piano Box and Field Office | **EQUIPMENT**

# WARRANTIES

## What Does This Warranty Cover?

### Five-Year Limited Warranty on Contractor Equipment

Under Southwire's Contractor Equipment 5-Year Limited Warranty, Southwire Company, LLC warrants that all Southwire Contractor Equipment will be free from manufacturer defects for a period of five (5) years from the date of the original end user's purchase. However, electrical components and consumable parts such as ropes, blades, dies, draw studs, grips, are excluded from this 5-Year Limited Warranty and are subject to the One -Year warranty terms. Under this 5-Year Limited Warranty, the following are also excluded and Southwire Company, LLC will have no liability for any of the following: normal wear and tear resulting from product use and damage arising out of misuse, abuse, modification, and improper product maintenance. This warranty also does not cover Southwire Contractor Equipment products that have been modified by any party other than Southwire Company, LLC or its authorized third party designee. This 5-Year Limited Warranty is not transferrable to or enforceable by any person other than the product's original end user.

### Three-Year Limited Warranty on Material Boxes

Under Southwire's Material Boxes 3 -Year Limited Warranty, Southwire Company, LLC warrants that all Southwire Material Boxes will be free from manufacturer defects for a period of three (3) years from the date of the original end user's purchase. Under this Three-Year Limited Warranty for Material Boxes, the following are excluded and Southwire Company, LLC will have no liability for any of the following: normal wear and tear resulting from product use and damage arising out of misuse, abuse, modification, and improper product maintenance. This warranty also does not cover Material Boxes that have been modified by any party other than Southwire Company, LLC or its authorized third party designee. This 3-Year Limited Warranty is not transferrable to or enforceable by any person other than the product's original end user.

### One-Year Limited Warranty on Electrical Components and Consumable Parts (with 5-Year warranty)

Under Southwire's 1-Year Limited Warranty, Southwire Company, LLC warrants that all electrical components and consumable parts such as ropes, blades, dies, draw studs, grips will be free from manufacturer defects for a period of one-year from the date of the original end user's purchase. Under this 1-Year Limited Warranty, Southwire Company, LLC will have no liability for any of the following: normal wear and tear resulting from product use and damage arising out of misuse, abuse, modification, and improper product maintenance. This warranty also does not cover Southwire electrical components and consumable parts that have been modified by any party other than Southwire Company, LLC or its authorized third party designee. This 1-Year Limited Warranty is not transferrable to or enforceable by any person other than the product's original end user.

### One-Year Limited Warranty (stand alone)

Under Southwire's 1-Year Limited Warranty, Southwire Company, LLC warrants that this product will be free from manufacturer defects for a period of one-year from the date of the original end user's purchase. Under this 1-Year Limited Warranty, Southwire Company, LLC will have no liability for any of the following: normal wear and tear resulting from product use and damage arising out of misuse, abuse, modification, and improper product maintenance. This warranty also does not cover Southwire products that have been modified by any party other than Southwire Company, LLC or its authorized third party designee. This 1-Year Limited Warranty is not transferrable to or enforceable by any person other than the product's original end user.

### Exclusion of Incidental, Consequential, Indirect, Special and Punitive Damages

SOUTHWIRE MAKES NO WARRANTY THAT SOUTHWIRE CONTRACTOR EQUIPMENT PRODUCTS WILL BE MERCHANTABILITY OR FIT FOR ANY PARTICULAR PURPOSE. SOUTHWIRE MAKES NO OTHER WARRANTY, EXPRESSED OR IMPLIED, OTHER THAN THE RELEVANT WARRANTY SPECIFICALLY SET FORTH IN THIS WARRANTY SECTION. SOUTHWIRE WILL NOT BE LIABLE FOR ANY INCIDENTAL, CONSEQUENTIAL, INDIRECT, SPECIAL, OR PUNITIVE DAMAGES FOR ANY BREACH OF THIS LIMITED LIFETIME WARRANTY.

Some states do not allow the exclusion or limitation of incidental or consequential damages, so the above limitation or exclusion may not apply to you. Warranty Claim Information/How Do You Get Service?

For all warranty, customer service, and product return authorizations and inquiries, please contact Southwire's Tools & Assembled Products at:  
Southwire Tools & Assembled Products

840 Old Bremen Road

Carrollton, GA, 30117

Phone Number: 1.855.SW.Tools

1. All warranty claims must be approved by Southwire's Tools & Assembled Products Warranty Department prior to return of product. If Southwire determines that a product is defective, Southwire will, at its option, repair or replace defective products or defective product components, free of charge.
2. Upon approval, Southwire will issue a Product Return Authorization Form which will include instructions on how and where to return the product. The product serial number and the original date of delivery must be set forth on the Product Return Authorization Form.
3. Southwire will cover standard freight charges (Courier Ground rate) incurred in connection with products that Southwire ultimately determines to be defective.
4. All defective components and defective products that Southwire replaces under these Warranties will become Southwire's property and will be retained by Southwire.

### Fixing Your Product When it is Out of Warranty

Southwire is happy to provide information about where a purchaser can send a product for repair at consumers' own expense, please contact 1.855.SW.tools or visit [www.southwiretools.com/tools/home.do](http://www.southwiretools.com/tools/home.do) for more information about servicing for Southwire Products.

# SUMNER\*

 A Southwire Company

Sumner, A Southwire Company, is a recognized leading manufacturer of material lifts, jack stands, welding tools, material carts and other tools and equipment for the construction market. We are a key supplier to the welding and mechanical contracting industries and have a market presence in more than 50 countries around the world. Sumner maintains manufacturing and sales operations in Houston, Canada, China, the UK and the Netherlands.



For a full range of material lifts see the Sumner Material Lift Catalog or visit [sumner.com](http://sumner.com).

*\*Trademark of Sumner Manufacturing, LLC.*

# SPECIALTY LIFTS

## EL-405 Stacker Lift



784650

## Roust-A-Bout™



780300

## Fab-Mate™



783900

SUMNER\* | Specialty Lifts



# MATERIAL LIFTS

Series 1900 Material Lift (8' - 10' / 2.4 - 3 m), 350 - 400 lb (160 - 180 kg) Capacity

Series 2000 Material Lift (10' - 25' / 2.9 - 7.7 m), 650 - 1,000 lb (300- 455 kg) Capacity

Series 2100 Contractor Lift (12' - 24' / 3.9 - 7.2 m), 650 (300 kg) Capacity

Series 2200 Lil' Hoister™ Lift (9' - 11' / 2.7 - 3.4 m), 300 lb (135 kg) Capacity

Series 2300 Drywall/HVAC Lift (11' - 15' / 3.4 m - 4.5 m), 150 lb (70 kg) Capacity

Series 2400 Contractor Lift (13' - 17' / 4.0 - 5.2 m), 450 lb (200 kg) Capacity

Series 2500 Counter Weight Lift (10 - 25' / 3.0 - 7.7 m), 650 - 1,000 lb (300-455 kg) Capacity

Series 2600 "Axel" The Big Lift™ (10 - 15' / 3.0 - 4.6 m), 1,100 lb (500 kg) Capacity



Assembled  
IN AMERICA

## Series 2400 Contractor Lift

The ideal lift for:

- HVAC contractors
- Electrical contractors
- Industrial maintenance
- Steel erectors
- Facility management

784750

## Series 2100 Contractor Lift

Model 2118 pictured here.



Assembled  
IN AMERICA



783651

For a full range of material lifts see the Sumner Material Lift Catalog or visit [sumner.com](http://sumner.com).

# ALL ALUMINUM GANTRIES

**GH3/4 Gantry**

**GH2T Gantry**

**GH5T Gantry**



*Chain hoist  
not included*

**5 Ton  
5 Metric Ton  
11,000 lbs  
785805**

**2 Ton  
2 Metric Ton  
4,400 lbs  
785100**

**3/4 Ton  
3/4 Metric Ton  
1,650 lbs  
785301**



For a full range of material lifts see the Sumner Material Lift Catalog or visit [sumner.com](http://sumner.com).

*\*Trademark of Sumner Manufacturing, LLC.*

**SUMNER\* | Gantries**

# EVENTER™ STAGE LIFT

## Standard Features:

- Blackened anodized mast
- Fits through standard doorways in stowed position
- No winch cable in operator's face
- Forks reverse for added height
- Large, rubber-padded leveling jacks
- Built-in safety brakes



All EVENTER stage lifts are designed for compact storage.

## Ideal for small to medium venues:

- Hotel Ballrooms
- Churches
- Schools
- Clubs

**EVENTER 16**  
pictured here.



*The EVENTER 16  
is easily transportable*

**784760**



For a full range of material lifts see the Sumner Material Lift Catalog or visit [sumner.com](http://sumner.com).

*\*Trademark of Sumner Manufacturing, LLC.*

# PIPE STANDS

## Standard Features on all Sumner Jacks:

- 1-1/2" (38 mm) Acme fine adjustment thread — the largest in the industry
- Large, convenient adjustment handle
- Quick-action lock washer
- Fall Guard™ support
- Set screw can the lock jack head to the stand — no loose pieces
- Backed by over forty years of jack stand manufacturing experience

## Sumner Jacks:

Heavy Duty Jack

Heavy Duty Jack Plus

"Pro Jack"™

Fold-A-Jack™

FAB SAF™ Jack

Fat Jack™

Hi Boy™ Jack

Midi Fat™ Jack  
w/Vee Head  
785251

FAB SAF™ Jack  
w/Vee Head  
780395

Hi Fold-A-Jack™  
781300



For a full range of material lifts see the Sumner Material Lift Catalog or visit [sumner.com](http://sumner.com).

*\*Trademark of Sumner Manufacturing, LLC.*

# PRO ROLLS™ & ADJUST-A-ROLL™

Hi Adust-A-Roll™

Lo Adust-A-Roll™

Table Adjust-A-Roll™

Mini-Roll™

Pro Roll™

Hi Adjust-A-Roll  
with roller wheels  
780565



Pro Roll with roller wheels  
780441

Mini-Roll with roller wheels  
785283

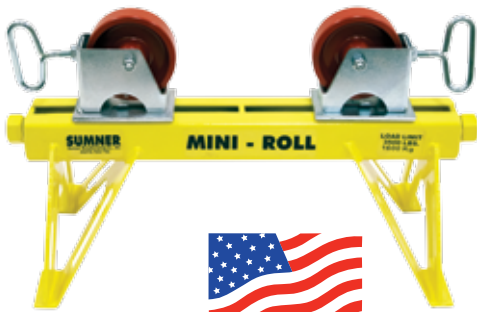

For a full range of material lifts see the Sumner Material Lift Catalog or visit [sumner.com](http://sumner.com).

*\*Trademark of Sumner Manufacturing, LLC.*

Adjust-A-Roll™ | SUMNER\*

# MAX-JAX I & II AND BEAM JAX

## Max-Jax\* (Kit #1 shown)

The versatile Max-Jax stand is the ideal fabricator stand. The large 12" (30 cm) vee head and heavy duty five-leg design offers the welder a larger margin of safety on pipe up to 36" (90 cm).



## Max-Jax\* 2 (Kit #2 with Rocking Rollers shown)

The Max-Jax 2 stand has the unique capability of being either a low or high moveable jack stand for 4 - 36" (100 - 915 mm) pipe. By removing the jack head and casters from the base, it can be rotated from a Lo to a Hi stand.

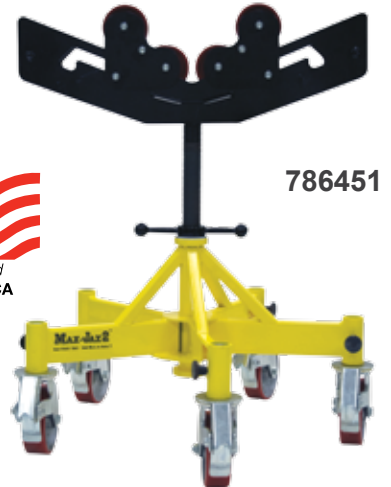

## Beam-Jax™ (Basic Beam-Jax shown)

Used as a stand, the basic Beam-Jax base safely supports 24" range (61 cm) and beams up to 2,500 lb (1,135 kg).



For a full range of material lifts see the Sumner Material Lift Catalog or visit [sumner.com](http://sumner.com).

*\*Trademark of Sumner Manufacturing, LLC.*

## PFAST™

### PIPE FITTING ALIGNMENT SYSTEM TECHNIQUE

## A Professional Fit-Up System For The Fabricator



785450



- ✓ Fit-up 1" to 8" flanges, fittings, reducers, caps and pup joints
- ✓ Capable of 300 lb pressure-rated flanges
- ✓ Handles 600 lbs / 270 kg loads
- ✓ Exceptionally accurate
- ✓ Fit and tack 75 to 90 joints during an 8 hour shift
- ✓ Now in stainless steel

With the purchase of each PFAST system, Sumner provides optional in-house set up and training to ensure that your team is comfortable in operating and maintaining your PFAST system. Each unit comes complete with all accessories to perform most fit up applications and a mounted electronic tablet that provides a step-by-step pictorial instruction on how each assembly is set up.

Built for years of use, the Sumner PFAST system will quickly help fabricators be a production leader in their industry.

## Other Fit-Up Tools

Adjust-A-Fit™	Fit Kits	Mul-T-Square*	Ultra Qwik Clamp™
Adjust-A-Flange™	Flange Leveler	Purge Star*	Ultra Fit™
Center Punch	Flange Pins	Qwik Pins*	Ultra Qwik Fit™
Clamp Champ™	Flange Spreaders	Ring Purge	Universal Center Punch
DX Clamp	Internal Fit-Up Clamp	Rotary Ground Clamp	Welder's Stool
Expansion Plugs	Levels	Standard Square	Welding Gage
Fab Mate™	Magnetic Holder	Ultra Clamp*	

For a full range of material lifts see the Sumner Material Lift Catalog or visit [sumner.com](http://sumner.com).

\*Trademark of Sumner Manufacturing, LLC.

# PIPE DOLLYS

## CRICKET\* Pipe Buggy

*Uses leverage  
to lift pipe!*



782699

## GRASSHOPPER™ Texas Pipe Dolly

*Enables  
one man to lift up to  
2,000 lbs. (900 kg)  
unassisted!*



780351

For a full range of material lifts see the Sumner Material Lift Catalog or visit [sumner.com](http://sumner.com).

*\*Trademark of Sumner Manufacturing, LLC.*



# MATERIAL HANDLING

Bundle Mac™

Handi-Bench™

Hanger Mac™

Mac Rack I & II™

Pipe Mac™

Stor Mac™

Tainer Mac™

Weldbox™

Stor Mac 48™  
785921



Hanger Mac™  
785651



Mac Rack I™  
783317



Tainer Mac 60™  
784990



For a full range of material lifts see the Sumner Material Lift Catalog or visit [sumner.com](http://sumner.com).

*\*Trademark of Sumner Manufacturing, LLC.*

Material Handling | SUMNER\*

# WELDING CYLINDER CARTS

Small Single

Heavy Duty Single

Small-Medium High Rail

Medium Range High Rail

Full Range High Rail



**Medium Range, High Rail  
Cylinder Cart w/Chain  
Model #209  
209-14S**

**Small-Med High Rail  
Cylinder Carts  
(Model #207)  
2017-10S**



**Full Range, High Rail  
Cylinder Cart w/ Lifting Eye  
& Firewall  
(Model #213)  
213-16FB-LF**



For a full range of material lifts see the Sumner Material Lift Catalog or visit [sumner.com](http://sumner.com).

*\*Trademark of Sumner Manufacturing, LLC.*

# PROLINE PRODUCTS

Southwire's Proline Products have what you need to get the job done right. Our products have been trusted by contractors and electricians for more than 40 years and have raised the standards for quality and innovation. Our product categories include: the broadest assortment of indoor and outdoor cords sets, a full line up of cord storage devices, portable lighting, time switches, surge protectors, power strips, and automotive products. Count on these products to create your complete project solutions for today's toughest applications.

- Cords
- Portable Power
- GFCI
- Work Lights
- Automotive



\*Limited warranty available on most tools

# CORDS

## PREMIUM OUTDOOR EXTENSION CORDS

1428



Premium TPE Polar/Solar® cords, made with Southwire's exclusive T\*Prene® insulation, stay flexible under the most extreme temperatures. They are highly abrasion resistant and provide outstanding oil and chemical resistance.

### SPECIFICATIONS

#### POLAR/SOLAR® STANDARD EXTENSION CORDS



PART#	WIRE GA/COND	WIRE TYPE	COLOR	125V RATING	LENGTH
1287SW0002	16/3	SJE00W	Yellow	13A	25 ft.
1288SW0002	16/3	SJE00W	Yellow	13A	50 ft.
1289SW0002	16/3	SJE00W	Yellow	10A	100 ft.
1427SW0008	14/3	SJE00W	Black	15A	25ft.
1428SW0008	14/3	SJE00W	Black	15A	50 ft.
1429SW0008	14/3	SJE00W	Black	13A	100ft.
1487SW0002	14/3	SJE00W	Yellow	15A	25 ft.
1488SW0002	14/3	SJE00W	Yellow	15A	50 ft.
1489SW0002	14/3	SJE00W	Yellow	13A	100 ft.
1628SW0008	12/3	SJE00W	Black	15A	50 ft.
1629SW0008	12/3	SJE00W	Black	15A	100 ft.
1687SW0002	12/3	SJE00W	Yellow	15A	25 ft.
1688SW0002	12/3	SJE00W	Yellow	15A	50 ft.
1689SW0002	12/3	SJE00W	Yellow	15A	100 ft.
1787SW0002	10/3	SJE00W	Yellow	15A	25 ft.
1788SW0002	10/3	SJE00W	Yellow	15A	50 ft.
1789SW0002	10/3	SJE00W	Yellow	15A	100 ft.
1769SW0002	12/3	SE00W†	Yellow	15A	100 ft.

Extreme cold performance, the Polar/Solar® Supreme Extension Cord is made with our exclusive T\*Prene insulation jacket. T\*Prene is formulated to offer superior jobsite performance in extremely cold weather. Polar/Solar® Supreme cord is abrasion, chemical and oil resistant for survival in the toughest of environments.

### SPECIFICATIONS

#### POLAR/SOLAR® SUPREME EXTENSION CORDS



PART#	WIRE GA/COND	WIRE TYPE	COLOR	125V RATING	LENGTH
1437SW0061	14/3	SJE0W	Blue/White	15A	25 ft.
1438SW0061	14/3	SJE0W	Blue/White	15A	50 ft.
1439SW0061	14/3	SJE0W	Blue/White	13A	100 ft.
1637SW0061	12/3	SJE0W	Blue/White	15A	25 ft.
1638SW0061	12/3	SJE0W	Blue/White	15A	50 ft.
1639SW0061	12/3	SJE0W	Blue/White	15A	100 ft.

1439



ASSEMBLED PRODUCTS | Cords

## PREMIUM OUTDOOR EXTENSION CORDS



Premium TPE Polar/Solar® cords, made with Southwire's exclusive T\*Prene® insulation, stay flexible under the most extreme temperatures. They are highly abrasion resistant and provide outstanding oil and chemical resistance.

### SPECIFICATIONS

#### POLAR/SOLAR® SEOWW EXTENSION CORDS



PART#	WIRE GA/COND	WIRE TYPE	COLOR	125V RATING	LENGTH
1567SW0002	14/3	SEOWW	Yellow	15A	25 ft.
1568SW0002	14/3	SEOWW	Yellow	15A	50 ft.
1569SW0002	14/3	SEOWW	Yellow	13A	100 ft.
1767SW0002	12/3	SEOWW	Yellow	15A	25 ft.
1768SW0002	12/3	SEOWW	Yellow	15A	50 ft.
1769SW0002	12/3	SEOWW	Yellow	15A	100 ft.

#### POLAR/SOLAR® THREE-WAY POWER BLOCKS

PART#	WIRE GA/COND	WIRE TYPE	COLOR	125V RATING	LENGTH
3482SW0002*	12/3	SEOWW†	Yellow	15A	2 ft.
3487SW0002	12/3	SJEOWW	Yellow	15A	25 ft.
3488SW0002	12/3	SJEOWW	Yellow	15A	50 ft.
3489SW0002	12/3	SJEOWW	Black	15A	100 ft.
3588SW0002	10/3	SJEOWW	Yellow	15A	50 ft.
3589SW0002	10/3	SJEOWW	Yellow	15A	100 ft.

\*Import †600V

## ROYAL® PREMIUM OUTDOOR EXTENSION CORDS



Thermostat rubber jacketed cords have superior resistance to high temperature environments without losing the chemical and abrasion resistance. Harsh applications may include heavy industrial work, welding and metal fabrication.

- Flexible in a wide range of temperatures
- Royal® SJ00W jacket

### SPECIFICATIONS

#### ROYAL® SJ00W EXTENSION CORDS



PART#	WIRE GA/COND	WIRE TYPE	COLOR	125V RATING	LENGTH
3677SW0008	12/3	SJ00W	Black	15A	25 ft.
3678SW0008	12/3	SJ00W	Black	15A	50 ft.
3679SW0008	12/3	SJ00W	Black	15A	100 ft.
3687SW0002	12/3	SJ00W	Yellow	15A	25 ft.
3688SW0002	12/3	SJ00W	Yellow	15A	50 ft.
3689SW0002	12/3	SJ00W	Yellow	15A	100 ft.



# CORDS

## OUTDOOR EXTENSION CORDS

2407



Vinyl jacket resists moisture, abrasion, and prolonged exposure to sunlight.

- Power indicator light in female receptacle to show that power is on
- Power block provides additional outlets for power distribution

### SPECIFICATIONS

#### THREE CONDUCTOR



PART#	WIRE GA/COND	WIRE TYPE	COLOR	125V RATING	LENGTH
2211SW8808	16/3	SJOW	Black	13A	10ft.
2304SW8803	16/3	SJTW	Orange	13A	10 ft.
2305SW8803	16/3	SJTW	Orange	13A	15ft.
2306SW8808	16/3	SJTW	Black	13A	15ft.
2307SW8803	16/3	SJTW	Orange	13A	25 ft.
2308SW8803	16/3	SJTW	Orange	13A	50 ft.
2309SW8803	16/3	SJTW	Orange	10A	100 ft.
2407SW8804	14/3	SJTW	Red	15A	25 ft.
2408SW8804	14/3	SJTW	Red	15A	50 ft.
2409SW8804	14/3	SJTW	Red	13A	100 ft.
2618SW8802*	10/3	SJTOW	Yellow	20A	50 ft.

\*T-SLOT cord

2687



#### THREE CONDUCTOR - LIGHTED ENDS



PART#	WIRE GA/COND	WIRE TYPE	COLOR	125V RATING	LENGTH
2367SW8806	16/3	SJTW	Light Blue	13A	25ft.
2368SW8806	16/3	SJTW	Light Blue	13A	50ft.
2487SW8804	14/3	SJTW	Red	15A	25 ft.
2488SW8804	14/3	SJTW	Red	15A	50 ft.
2489SW8804	14/3	SJTW	Red	13A	100 ft.
2587SW8802	12/3	SJTW	Yellow	15A	25 ft.
2588SW0002	12/3	SJTW	Yellow	15A	50 ft.
2589SW0002	12/3	SJTW	Yellow	15A	100 ft.
2687SW8802	10/3	SJTW	Yellow	15A	25 ft.
2688SW8802	10/3	SJTW	Yellow	15A	50 ft.
2689SW8802	10/3	SJTW	Yellow	15A	100 ft.
2457SW0003	14/3	STW	Orange	15A	25 ft.
2458SW0003	14/3	STW	Orange	15A	50 ft.
2459SW0003	14/3	STW	Orange	13A	100 ft.
2557SW0003	12/3	STW	Orange	15A	25 ft.
2558SW0003	12/3	STW	Orange	15A	50 ft.
2559SW0003	12/3	STW	Orange	15A	100 ft.

## OUTDOOR EXTENSION CORDS

Vinyl jacket resists moisture, abrasion, and prolonged exposure to sunlight.

- Power indicator light in female receptacle to show that power is on
- Power block provides additional outlets for power distribution



### SPECIFICATIONS

#### THREE-WAY POWER BLOCK



PART#	WIRE GA/COND	WIRE TYPE	COLOR	125V RATING	LENGTH
4004SW8803	14/3	SJTW	Orange	15A	6ft.
4217SW8804	14/3	SJTW	Red	15A	25 ft.
4218SW8804	14/3	SJTW	Red	15A	50 ft.
4219SW8804	14/3	SJTW	Red	13A	100 ft.



#### THREE-WAY POWER BLOCK WITH LIGHTED ENDS



PART#	WIRE GA/COND	WIRE TYPE	125V RATING	LENGTH
4112SW8802*	12/3	STW(600V)	15A	2 ft.
4187SW8802	12/3	SJTW	15A	25 ft.
4188SW8802	12/3	SJTW	15A	50 ft.
4189SW8802	12/3	SJTW	15A	100 ft.
4388SW8802	10/3	SJTW	15A	50ft.
4389SW8802	10/3	SJTW	15A	100ft.

\*not lighted



#### TWIST-TO-LOCK (NEMA L5-20P TO NEMA L5-20R)

PART#	WIRE GA/COND	WIRE TYPE	COLOR	125V RATING	LENGTH
9208SW8802	12/3	SJTW	Yellow	20A	50 ft.
9209SW8802	12/3	SJTW	Yellow	15A	100 ft.



#### TWIST-TO-LOCK (NEMA L5-20P TO NEMA L5-20R)

PART#	WIRE GA/COND	WIRE TYPE	COLOR	125V RATING	LENGTH
9208SW8802	12/3	STW(600V)	Yellow	20A	50 ft.
9209SW8802	12/3	STW(600V)	Yellow	15A	100 ft.



# CORDS

## STRIPES & COOL COLORS® EXTENSION CORDS

2548USA1



Display America's colors on the jobsite with the rugged, striped, contractor grade extension cords dedicated to hard working contractors. They are highly visible red, with patriotic stripe colors. Contractor grade extension cords all have molded water resistant connectors with reinforced blades that make them suitable for all weather use. Increase safety awareness and help to prevent jobsite loss or theft with STRIPES and Cool Colors outdoor extension cords. Each extension cord features a dominate high-visibility color. Other cords feature a stripe that runs the length of the jacket. All Stripes and Cool Color cords feature a power indicator light in the receptacle to show power is on.

- Variety of colors for added safety and theft deterrence on the jobsite
- Power indicator light in the female receptacle to show that power is on

2579



### SPECIFICATIONS

#### STRIPES OUTDOOR EXTENSION CORDS



PART#	WIRE GA/ COND	WIRE TYPE	COLOR	125V RATING	LENGTH
2548SWUSA1	12/3	SJTW	Red,Wht,Blue	15A	50 ft.
2549SWUSA1	12/3	SJTW	Red,Wht,Blue	15A	100 ft.
2548SW00XX	12/3	SJTW	See Color Options Below*	15A	50 ft.
2549SW00XX	12/3	SJTW		15A	100 ft.
2648SW00XX	10/3	SJTW		15A	50 ft.

\* 12/3: Color (XX): 54=Lime Green/Red, 22=Yellow/Purple, 52=Dark Green/Yellow, 64=Blue/Red, 41=Red/White, 77=Pink/Lime Green, 3V=Orange/Blue  
10/3: 54=Lime Green/Red, 64=Blue/Red

2548



#### COOL COLORS OUTDOOR EXTENSION CORDS



PART#	WIRE GA/COND	WIRE TYPE	COLOR	125V RATING	LENGTH
2577SW00XX	12/3	SJTW	See Color Options Below*	15A	25 ft.
2578SW00XX	12/3	SJTW		15A	50 ft.
2579SW00XX	12/3	SJTW		15A	100 ft.

\* Color (XX): OA=Pink, OH=Blue, OX=Green



## HIGH VISIBILITY - LOW TEMP CORDS

2467

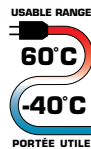

Bright blue cord is easily identified on the job site. High Vis/Low Temp vinyl cords provide super flexibility at temperatures down to -40°F.

- Jacket resists deterioration from moisture, abrasion and extended exposure to sunlight
- Power indicator light in the female receptacle to show that power is on

### SPECIFICATIONS

#### THREE CONDUCTOR WITH LIGHTED ENDS

PART#	WIRE GA/COND	WIRE TYPE	COLOR	125V RATING	LENGTH
2367SW8806	16/3	SJTW Premium	Blue	13A	25 ft.
2368SW8806	16/3	SJTW Premium	Blue	13A	50 ft.
2467SW8806	14/3	SJTW Premium	Blue	15A	25 ft.
2468SW8806	14/3	SJTW Premium	Blue	15A	50 ft.
2469SW8806	14/3	SJTW Premium	Blue	13A	100 ft.
2568SW0006	12/3	SJTW Premium	Blue	15A	50 ft.
2569SW0006	12/3	SJTW Premium	Blue	15A	100 ft.

## CORD + RV ADAPTERS

9906



9020



### SPECIFICATIONS

#### 15 AMP "W", 3 & 5 WAY, RV, AND OTHER ADAPTERS

PART#	WIRE GA/COND	WIRE TYPE	COLOR	125V RATING	LENGTH
9020SW8802*	12/3	STW(600V)	Yellow	-	9 in.
9021SW8802†	12/3	STW(600V)	Yellow	-	9 in.
15AMP "W" ADAPTER					
9019SW8802	12/3	STW(600V)	Yellow	15A	2 ft.
5 WAY ADAPTER					
997362	-	-	Yellow	15A	-
3 WAY ADAPTER					
9906SW8803	T-S		Orange	15A	-
9906SW8808	T-S		Black	15A	-
RV ADAPTERS 125/250 VOLT					
9552SW9008	10/3	STW(600V)	Black	30A to 50A	-
POWER SUPPLY CORDS					
9527SW0008	6/3-8/1	STW(600V)	Black	50A	25 ft.
9561SW0008	6/3-8/1	SEW(600V)	Black	50A	36 ft.
9536SW0008	6/3-8/1	STW(600V)	Black	50A	36 ft.

\*15A S/B PLUG 20A T/L Conn †20A T/L Plug 15A S/B Conn \*20A RV Plug 50A RV Conn

Cords | ASSEMBLED PRODUCTS

# CORDS

## RANGE & DRYER CORDS

9044



Thick vinyl insulation with right angle male plug. Strain relief clamp helps prevent cord damage. Hardware included.

- Reinforced blades help prevent accidental bending or breaking
- Heavy duty strain relief protects electrical connections

### SPECIFICATIONS

#### RANGE AND DRYER CORDS

PART#	WIRE GA/COND	WIRE TYPE	COLOR	125V RAT.	LENGTH
9014SW8809	6/2-8/1	SRDT Flat	Gray	50A	4 ft.
9016SW8809	6/2-8/1	SRDT Flat	Gray	50A	6 ft.
9044SW8808	6/2-8/2	SRDT Round	Black	50A	4 ft.
9046SW8808	6/2-8/2	SRDT Round	Black	50A	6 ft.
9124SW8809	10/3	SRDT Flat	Gray	30A	4 ft.
9126SW8809	10/3	SRDT Flat	Gray	30A	6 ft.
9154SW8808	10/4	SRDT Round	Black	30A	4 ft.
9156SW8808	10/4	SRDT Round	Black	30A	6 ft.

## POWER SUPPLY CORDS

9854



Professional grade replacement power cords designed for use in rough or dirty indoor environments, shops, garages, etc.

- Heavy duty strain relief protects electrical connections
- Reinforced blades help prevent accidental bending or breaking
- SJEOW rating is water and oil resistant

### SPECIFICATIONS

#### WATER & OIL RESISTANT CORDS

PART#	WIRE GA/COND	WIRE TYPE	COLOR	125V RAT.	LENGTH
9011SW0008*	12/3	SE00W/600V	Black	20A	25"
9012SW0008†	12/3	SE00W/600V	Black	15A	25"
9846SW0008	16/3	SE00W/600V	Black	13A	13.24 ft.
9853SW0008	16/2	SJE00W	Black	13A	6ft.
9854SW0008	16/2	SJE00W 5-15P	Black	13A	9 ft
9855SW0008	16/3	SJE00W 5-15P	Black	13A	6 ft.
9856SW0008	16/3	SJE00W 5-15P	Black	13A	9 ft.
6503SW0008	16/3	SJE00W 5-15P	Black	13A	20 ft.
9857SW0008	14/3	SJE00W 5-15P	Black	15A	6 ft.
9858SW0008	14/3	SJE00W 5-15P	Black	15A	9 ft.

\*Twist to Lock

†Straight Blade

## POWER SUPPLY CORDS

9709



Replacement cords are designed for easy use on appliances, power tools, air conditioners, refrigerators, etc.

- Heavy duty strain relief protects electrical connections

### SPECIFICATIONS

#### VINYL CONSTRUCTION

PART#	WIRE GA/COND	WIRE TYPE	COLOR	125V RAT.	LENGTH
3953	14/3	SJEW	Black	15A	10 ft.
9702SW8808	16/2	SJTW	Black	13A	6ft.
9703SW8808	16/3	SJTW	Black	13A	3 ft.
9706SW8808	16/3	SJTW	Black	13A	6 ft.
9709SW8808	16/3	SJTW	Black	13A	9 ft.
9716SW8808	14/3	SJTW	Black	15A	6 ft.
9719SW8808	14/3	SJTW	Black	15A	9 ft.

9736



#### FLAT SPT-3 CONSTRUCTION

PART#	WIRE GA/COND	WIRE TYPE	COLOR	125V RAT.	LENGTH
9723SW8809	16/3	SPT-3	Grey	13A	3ft.
9724SW8809	16/3	SPT-3 -R/Angle	Grey	13A	4 ft.
9726SW8809	16/3	SPT-3 -R/Angle	Grey	13A	6 ft.
9733SW8809	16/3	SPT-3 -Straight	Grey	13A	3 ft.
9734SW8809	16/3	SPT-3 -Straight	Grey	13A	4 ft.
9736SW8809	16/3	SPT-3 -Straight	Grey	13A	6 ft.
9743SW8823	14/3	SPT-3 -Straight	Beige	15A	3 ft.
9746SW8823	14/3	SPT-3 -Straight	Beige	15A	6 ft.

#### MAJOR APPLIANCE CORD

PART#	WIRE GA/COND	WIRE TYPE	COLOR	125V RAT.	LENGTH
3531SW3323	14/3	SPT-3	Beige	15A	3ft.
3532SW3323	14/3	SPT-3	Beige	15A	6 ft.
3533SW3323	14/3	SPT-3	Beige	15A	9 ft.
3535SW3323	14/3	SPT-3	Beige	15A	12ft.
3536SW3323	14/3	SPT-3	Beige	15A	15ft.
3537SW8809*	12/3	SPT-3	Grey	20A	9ft.

\*6-20 P/R

# PORTABLE POWER

## X-TREME BOX™

### 1970SW3R02



The X-Treme Box™ is a portable, rugged modular power distribution system for all jobsite conditions. Connect the MINI X-Treme Box for smaller jobs.

- X-Treme Box features NEMA 3R rating and spring-loaded covers on all inlets and outlets
- Powder-coated, heavy gauge carbon-steel enclosure and reinforced sled base for superior durability
- Each 20 AMP outlet provided with a dedicated GFCI module with open neutral protection
- MINI X-Treme Box offers 2 circuits, each with 2 duplex 5-20 t-slot receptacles, GFCI module and 20A premium circuit breaker

### 1980SW0102



## SPECIFICATIONS

### X-TREME BOX™

PART#	MODEL TYPE	POWER INLET	30A OUTLETS	20A OUTLETS
1960SW3R02	Standard	50 AMP 125/250V California-Style Twist Lock	30 AMP 250V NEMA L6-30 Twist Lock	NEMA L5-20
1962SW3R02	Roll Cage			NEMA 5-20
1970SW3R02	Standard			
1972SW3R02	Roll Cage			
1971SW3R02	Standard			
MINI X-TREME BOX™		20A OUTLETS		
1980SW0102	NEMA Type 1	30A NEMA L14-30 Inlet	4 x NEMA 5-20 T-Slot Duplex	

## POWER DISTRIBUTION EXTENSION CORDS

### 1920SW0008



Temporary power cords designed for use with X-Treme Box™ family of products.

- Heavy duty SEOW or STW cord
- Generator cords or splitter for MINI X-Treme Box or other appliances

### DISTRIBUTION CORDS

PART#	WIRE GA/COND	PLUG CONNECTOR	COLOR	LENGTH
CALIFORNIA-STYLE TWIST LOCK ENDS				
1937SW0008	6/3 - 8/1 SEOW	50 AMP 125/250V California-Style Twist Lock	Black	25 ft.
1918SW0008			Black	50 ft.
1918SW0008			Black	100 ft.
1920SW0008	6/4 SE00W		Black	3 ft.
PREMIUM HUBBELL CALIFORNIA TWIST LOCK ENDS				
1938SW0008	6/3 - 8/1 SEOW	50 AMP 125/250V California-Style Twist Lock	Black	50 ft.
1938SW0008			Black	100 ft.
GENERATOR CORDS				
1493	10-3 STW	L14-30 P/R	Yellow	25 ft.
1934SW8802	10/4 - 10/3 STW	NEMA L14 30P 2X NEMA 5-20R	Black	3 ft.

## RETRACTABLE ELECTRICAL POWER CORD REELS

R112318845



Southwire's heavy-duty, industrial-grade, spring retractable electrical and power cord reels are ideal for putting light and power where needed with quick retraction and convenient storage. They are suitable for many industrial and commercial applications where portable electrical power and handheld lighting is required. These versatile cord reels help make cord handling safer and more efficient while extending the life of the cord and improving the work place.

- All steel construction is rugged and durable, providing structural strength
- Long-life drive spring is enclosed for protection against the environment
- A baked-on powder coated finish on steel components provides maximum corrosion resistance
- Adjustable guide arm allows reel to mount on ceiling, wall, bench or floor
- Latching system allows cord length to be maintained outside of reel
- Supplied with premium electrical cord and pre-installed accessories
- Frame is stamped with stiffening ribs and forms then robotically welded
- Stamped steel cable spool has angled edges to protect cord
- Highest quality spring steel drive spring has several free coils in the center; forming a smooth radius that engages the spring arbor for maximum performance and life
- Premium quality, highly flexible, long-life electrical cord is ideally suited for use on a reel

48208802SW



### SPECIFICATIONS

#### RETRACTABLE CORD REELS

PART#	WIRE GA/COND	WIRE TYPE	HOUSING	AMP	CORD SIZE
<b>HEAVY DUTY</b>					
R112318845	12/3	SJEOW	Metal	20A	45 ft.
R112718845	12/3	SJEOW	Metal	20A	45 ft.
<b>MEDIUM DUTY</b>					
48006SW	14/3	SJTW	Metal	13A	30 ft.
48208802SW	12/3	SJEOW	Plastic	13A	50 ft.
<b>SELF-WINDING CORD REELS</b>					
E235	14/3	SJTW	Plastic	15A	50 ft.
E238	12/3	SJTW	Plastic	15A	50 ft.

48006SW



E235



# GFCI

## GFCI BOXES

2816SW8802



High impact resin with a slant-roof design to prevent water entry. Receptacles can accommodate large plugs.

- Economical, safe, jobsite power distribution
- Contact factory for available plug outlet and cord connections

## SPECIFICATIONS

### OUTLET BOXES

PART#	STOCK#	WIRE GA/COND	WIRE TYPE	DESCRIPTION	AMP	LENGTH
DUPLEX BOX						
2822SW8802	58844601	12/3	SJTW	with test reset button	15A	6 ft.
QUAD BOX						
2816SW8802	-	12/3	SJTW	with test reset button and handle	15A	6 ft.
RIGHT ANGLE QUAD BOX						
14880003-3	-	12/3	SJTW	right angle GFCI with circuit breakers	15A	6 ft.

14880003-3



2822SW8802



## RIGHT ANGLE GFCI CORD SETS

14650013-6



Right angle models offer a variety of receptacles and cord lengths that are perfect where space is a premium. All models are manual reset GFCIs and feature 15 Amp capacity relays.

- For use on construction sites and with industrial appliances
- Rainproof rated, UL listed for outdoor use
- Custom cable gauges, lengths and terminations available by special order, contact factory for details

### SPECIFICATIONS

#### USER ATTACHABLES AND ADAPTERS

PART#	GAUGE	DESCRIPTION	AMP
COMMERCIAL-DUTY JACKET			
14880002-6	18-12	Right Angle Manual Reset	15A
14650013-6	-	GFCI Outlet Adapter	15A

#### RIGHT ANGLE CORD SETS

PART#	GAUGE	WIRE TYPE	DESCRIPTION	AMP	LENGTH
COMMERCIAL-DUTY JACKET					
14880023-6	12/3	SJTW	Tri-Source NEMA 5-15	15A	2 ft.
14880226-6*	12/3	SJTW	Tri-Source NEMA 5-15	15A	2 ft.
14880118-2	12/3	SJTW	Tri-Source NEMA 5-15	15A	25 ft.
14880119-1	12/3	SJTW	Tri-Source NEMA 5-15	15A	50 ft.
14880120-1	12/3	SJTW	Tri-Source NEMA 5-15	15A	100 ft.
HEAVY-DUTY OIL RESISTANT JACKET					
14880228-6	12/3	SJEOW	Tri-Source NEMA 5-15	15A	25 ft.
14880229-6	12/3	SJEOW	Tri-Source NEMA 5-15	15A	50 ft.
14880230-4	12/3	SJEOW	Tri-Source NEMA 5-15	15A	100 ft.

\*Lighted End

14880002-6



14880023-6



## INLINE GFCI CORD SETS

26020008-6



26020148-1



Excellent for industrial plant maintenance, equipment service and construction site applications. Provides compliance with the National Electrical Code (NEC 2014) Article 590.6 for “Temporary Installations.” All inline models constructed with 20 AMP relays.

- For use on construction Sites and with industrial appliances
- Rainproof rated GFCI, UL listed for outdoor use.
- Custom cable gauges, lengths and terminations available by special order.
- Manual reset to prevent un-monitored equipment startup.
- Reset is required after GFCI trip or a power outage
- Add user-attachables to any cordset or tool to drive safety and code-compliance

### SPECIFICATIONS

#### INLINE GFCI CORD SETS

PART#	GAUGE	WIRE TYPE	DESCRIPTION	AMP	LENGTH
26020002-6	14/3	SJTW	NEMA 5-15 P&R	15A	2 ft.
26020050-1	14/3	SJTW	NEMA 5-15 P&R	15A	50 ft.
26020124-2	14/3	SJTW	NEMA 5-15 P&R	15A	25 ft.
25080025-2	12/3	SJTW	NEMA 5-20 P&R	20A	25 ft.
26020011-6	12/3	SJTW	NEMA 5-15 P&R	15A	2 ft.
26020150-1	12/3	SJTW	NEMA 5-15 P&R	15A	50 ft.
26000011-6	12/3	SJTW	NEMA 6-20 P&R	20A/240V	2 ft.
44720013-2	10/3	SJTW	NEMA L6-30 P&R	240V/30A	6 ft.
44720065-4	10/3	SJTW	NEMA L6-30 P&R	240V/30A	15 ft.
TRI-SOURCE					
26020008-6	12/3	SJTW	NEMA 5-15P	15A	2 ft.
26020148-1	12/3	SJTW	NEMA 5-15P	15A	50 ft.
30040008-6	12/3	SEOW	NEMA 5-15P	15A	2.5 ft.

#### USER ATTACHABLES

PART#	GAUGE	DESCRIPTION	RELAY CAP.
25000016-6	18-12	120/240V	20A
30040006-6	16-12	High Capacity	20A

30040008-6





## ECOZONE® LED WORK LIGHTS

### L1320SW



LED Work Lights use cutting edge LED technology and offer high quality. These functional, portable designs furnish residential and commercial customers with cool running safety, energy efficiency, long lasting LED's, and years of maintenance free use.

- 120 Volt corded or rechargeable models available
- Cool to the touch safety
- Durable polymeric or die cast housing with steel H-frame bases
- Comfort grip heavy duty handle
- Non-skid feet on H-frame base
- Weather proof on/off switch

### SPECIFICATIONS

#### LED WORK LIGHTS

PART#	STOCK#	LUMENS	DESCRIPTION	CORD LGTH.
L1320SW	58841501	779	24 High-Intensity LED(SMD) Rechargeable	Battery
L1323SW	-	779	24 High-Intensity LED(SMD) Portable	5 ft.
L1324SW	59185201	1244	40 High-Intensity LED (SMD) Portable	5 ft.
L1322SW	59180501	2 x 779	48 High-Intensity LED (SMD) Twin Head*	5 ft.
L1681SW	-	1940	23 Watt LED (Array) AC Portable	5 ft.
L1682SW	-	2 x 1940	46 Watt LED (Array) AC Twin Head*	5 ft.
L1325SW	-	4800	46 Watt LED (Array) AC Portable	5 ft.
L1326SW	-	2 x 4800	92 Watt LED (Array) AC Twin Head*	5 ft.

\*Comes with Tripod

### L1681SW



### L1325SW



# WORK LIGHTS

## HALOGEN WORK LIGHTS

### L14SLEDSW



These work lights offer robust designs constructed in heavy duty die casting. The extra large housings run cooler for longer bulb life. These lights include the bulbs, have shadow fighter grills and grounded power cords. Suitable for residential construction, commercial construction or maintenance projects.

- All metal construction
- Tempered glass for safety with UV protection
- Shadow Fighter™ grill frames
- Easy grip adjustment nuts
- Comfort grip heavy duty handles
- UL and CUL listed

### SPECIFICATIONS

#### HALOGEN WORK LIGHTS

PART#	STOCK#	BULBS	DESCRIPTION	CORD LENGTH
L20SW	58991501	1 - 500W	Economy with S-base	5 ft.
L33SW	58990901	1 - 500W	Contractor Grade with Switch	5 ft.
L845SW	59189601	1 - 250W	Clamp Lamp	5 ft.
L10SLEDSW	-	1 - 500W	Single Head - Detachable Sled with Tripod	5 ft.
L13SW	59180301	2 - 500W	Twin Head - No Detachable Sled with Tripod	5 ft.
L113SW	-	1 - 500W	Contractor Grade - Spring Supported Head*	10 ft.
L14SLEDSW	58844901	5 - 500W	Contractor Grade Twin Head - Detachables†	5 ft.
L41HDSW	59181401	1 - 500W	Dock Swing Arm - 40" Extension from Wall	10 ft.

\*Comes with Roll Cage  
†Comes with Bulb Storage Tube and Tripod

### L20SW



### L113SW

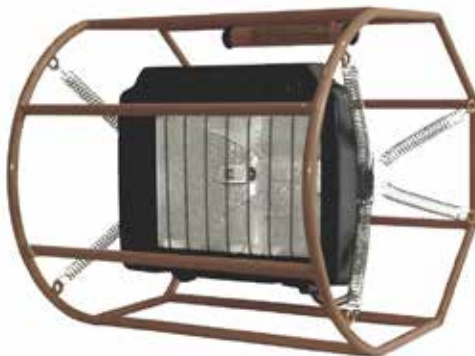

### L33SW



## LED TASK LIGHTS

L1407SW



Handheld task lighting provides tough, convenient lights for smaller work spaces. These LED lights provide long life, convenient portability and outstanding features.

- LEDs offer years of maintenance free operation
- Shock resistant durable construction
- Non-slip grip
- Batteries included
- Many with magnets for hands-free use
- On/Off push button switches
- Polycarbonate lens

## SPECIFICATIONS

### BATTERY POWERED LED TASK LIGHTS

PART#	STOCK#	LUMENS	DESCRIPTION	BULB
L1925SW	58842001	180	72 LED Rechargeable Task Light (charger included)	LED
L1407SW	58843501	32	24 LED (16 LED Area + 8 LED Spot) with laser pointer and magnet + base*	LED
L1240SW	58991101	42	21 LED Head Light with Adjst. Lycra Head Band*	LED
1437SW	-	97	37 LED (36 LED Task + 1 LED Spot) with Back Magnet*	LED

\*Batteries Included

L1925SW



1437SW



L1240SW



# WORK LIGHTS

## INCANDESCENT TROUBLE LIGHTS

691SW



Trouble lights feature durability and practicality. Constructed from tough PVC with power switch, metal guard and grounded outlets. The choices in SJEOW cord are oil and chemical resistant and stay flexible under temperature extremes to -67°F.

- Metal reflective shield with protective grill
- Tough PVC construction makes handling effortless
- Dual hook permits hanging by either the guard or handle
- Standard with power switches and bulb cages
- 75 watt bulb maximum
- UL Listed

### SPECIFICATIONS

053378802SW



## INCANDESCENT TROUBLE LIGHTS

PART#	STOCK#	GAUGE	WIRE TYPE	DESCRIPTION	LENGTH
OIL AND WATER RESISTANT - LOW TEMP					
053378802SW	-	18/3	SJEOW	Metal Guard with Outlet	25 ft.
058578802SW	-	16/3	SJEOW	Metal Guard with Outlet	25 ft.
058588802SW	-	16/3	SJEOW	Metal Guard with Outlet	50 ft.
056578802SW	58986101	14/3	SJEOW	Metal Guard with Outlet	25 ft.
056588802SW	-	14/3	SJEOW	Metal Guard with Outlet	50 ft.
WOODS BRANDED					
0691SW	-	16/3	SJTW	Metal Guard with Outlet	25 ft.
0692SW	-	16/3	SJTW	Metal Guard with Outlet	50 ft.

## CLAMP LIGHTS

151SW



These lights are designed to meet the needs of contractors, farmers and painters. These economical products provide convenient temporary light.

- Aluminum shades
- Non-Slip vinyl grip clamp
- Heat resistant sockets rated 150 watt or 300 watt for brooders

### SPECIFICATIONS

## CLAMP LIGHTS

PART#	STOCK#	GAUGE	WIRE TYPE	DESCRIPTION	LENGTH
151SW	-	18/2	SPT-2	8.5" Reflector	6 ft.
160SW	-	18/2	SPT-2	5.5" Reflector	6 ft.
BROODER LAMPS					
166SW	-	18/2	SJTW	Brooder 10.5" Shade	6 ft.
324SW	-	18/2	SJTW	Porcelain Socket with Grill Protector	6 ft.

## SECURITY LIGHTING

L1701SW



These lights have different designs for use in residential, commercial and industrial applications. We offer all the standard technologies, LED and motion activated products and accessories. These lights are the most effective investment to prevent theft and vandalism.

- Acrylic reflectors
- Dusk to dawn button photocells
- Complete with bulbs

## SPECIFICATIONS

### SECURITY LIGHTS

PART#	STOCK#	WATTS	DESCRIPTION	BULB
L1637BZSW	-	200	Twin Flood - Bronze Finish	Halogen
L1706SW	58843101	100	Weather Tight Light	Incandescent
L1795BZSW	-	42	Security Wall Light - bulb incl.	Fluorescent
L1701SW	58991301	100	Security Light	Metal Halide
L1762MHSW	-	100	Security Wall Pack - Lamp incl.	High Press. Sodium

L1795BZSW



# WORK LIGHTS

## STRING LIGHTS AND GUARDS

7538SW



String lights are durable indoor/outdoor temporary lighting systems available in 50 and 100 ft lengths, 12 and 14 gauge. Each is provided with either a wire-form coated metal guard or easy-to-open, snap-on plastic guards to meet OSHA regulations. Molded lamp sockets spaced 10 feet apart. Lamps not included.

- NEC, OSHA Compliant, UL Listed
- Sturdy molded-on lamp holder sockets and electrical connectors

### SPECIFICATIONS

#### LIGHTS

PART#	STOCK#	GAUGE	WIRE TYPE	DESCRIPTION	LENGTH
7538SW	-	12/3	SJTW	Coated Metal - 5-15 P&R	50 ft.
7539SW	-	12/3	SJTW	Coated Metal - 5-15 P&R	100 ft.
7548SW	-	12/3	SJTW	Plastic - 5-15 P&R	50 ft.
7549SW	-	12/3	SJTW	Plastic - 5-15 P&R	100 ft.
7145SW	-	14/2	SJTW	Plastic - 1-15P	100ft.
7155SW	-	14/2	SJTW	Plastic - 5-15 P&R	100 ft.

7145SW



## METAL HALIDE TEMPORARY LIGHT - PULSE START

7605SW



NEC compliant pulse start lamp with up to 36,000 initial lumens, 20,000 hours of bulb life and 50% faster warm-up. Fast plug-in installation and spring-loaded hook. Knock-outs for hard wire and local codes. EISA 2007 compliant

- Includes fixture, bulb, hook, guard and bottom cover
- UL Listed, exclusionary ex-39 (pink) socket, Type O Lamp

### SPECIFICATIONS

#### SECURITY LIGHTING

PART#	STOCK#	WATT	WIRE TYPE	DESCRIPTION	LENGTH
7605SW	-	400	18/3 SJTW	10" Wire Guard, Type "o" incl.	3 ft.

## REPLACEMENT BULBS

### 78805000SW



A variety of replacement bulbs including halogen, rough service incandescent, CFL and metal halide are available, and they are designed for maximum light output for a variety of lighting designs. The Patented Bulb Buddy™ cases are included for halogen bulbs.

- Rough service incandescent bulbs offer extra durability
- Mogul base metal halide bulbs are Type O pulse start

### L23SW



## SPECIFICATIONS

### BULBS

PART#	STOCK#	WATTS	DESCRIPTION	BULB
L766SW	59189801	65	Fluorescent Flat	CFL
76158800SW	-	105	Self Ballasted Bulb	CFL
76258800SW	-	400	Pulse Start Type "O"	Metal Halide
78805000SW	-	500	T3	Quartz Halogen
L15SW	-	500	6 Bulbs - T3 - Bulk Buddy Case	Quartz Halogen
L23SW	59181201	500	6 Bulbs - T3 - Rough Service Case	Quartz Halogen

## REPLACEMENT PLUGS & CONNECTORS

### 059740000



### 059750000



All jobsites require rugged, safe replacement wiring devices when the need arises. Safety issues lead to a more durable design able to withstand harsh jobsite conditions. Construction-grade devices have tough, vinyl or nylon housing with many built-in features for speed, safety and assembly convenience. 15A and 50A models address a wide range of customer needs, including locking jobsite power distribution applications.

### 59590000



### 59580000



- California-Style 50 Amp devices for jobsite power distribution cord repair and replacement
- Standard replacement cord ends for extension cord and tool repair

### 59840000



### 59850000



## SPECIFICATIONS

PART#	STOCK#	DESCRIPTION	INFO
59580000	-	Premium Locking Male Plug	50A/125/250V
59590000	-	Premium Locking Female Connector	50A/125/250V
59740000	-	Locking Male Plug	50A/125/250V
59750000	-	Locking Female Connector	50A/125/250V
59840000	-	NEMA 5-15 Attachable Plug Yellow	15A/125V
59850000	-	NEMA 5-15 Attachable Connector Yellow	15A/125V-

## BATTERY BOOSTER CABLES

08860



Southwire has manufactured booster cables for several decades leading the marketplace with product innovations that include: No-Tangle™ cable twin extrusion, TPE insulation, no-shock clamp, UL listings, and copper-clad aluminum cable.

Some models feature Southwire's patented Polar-Glo™ clamp with triple-polarity identification: color-coding, indent stamping, and glow-in-the-dark labels. This clamp attaches firmly to both top post and side terminal batteries. All energized clamp surfaces are shielded to avoid short circuits and conductive clamp surfaces are recessed to prevent accidental contact.

- Jacket material exhibits rubber-like flexibility, high abrasion resistance, a -40° to 60° C temperature range, lighter in weight than other PVC, high resistance to almost all environmental exposures

## SPECIFICATIONS

### BOOSTER CABLES

PART#	STOCK#	GAUGE	DESCRIPTION	LENGTH
084678802	-	8	Booster Cable CCA	12 ft.
086660104	-	4	Booster Cable CCA Polar Glow Clamp	16 ft.
087600108	-	4	Booster Cable CCA Parrot Clamp	20 ft.
086600104	-	4	Booster Cable CCA Polar Glow Clamp	20 ft.
088600108	-	2	Booster Cable CCA Parrot Clamp	20 ft.
088620108	-	2	Booster Cable CCA Parrot Clamp	25 ft.





# NOTES

---

---

---

---

---

---

---

---

---

---

---

---

---

---

---

---

---

---

---

---

---

---

---





**Southwire™**

TOOLS & EQUIPMENT

# 2017 JOBSITE SOLUTIONS CATALOG

## GET SOCIAL WITH US:



**/SOUTHWIRETOOLS**  
**/SOUTHWIRETOOLSLATINO**



**@SOUTHWIRETOOLS**



**@SOUTHWIRETOOLS**



**SOUTHWIRETOOLS**

**SOUTHWIRETOOLS.COM | 1-855-SWTOOLS**

Delrin® is a registered trademark of E. I. du Pont de Nemours and Company of its affiliates for its brand of acetal resin.  
Milwaukee, Super Hawg, Hole Hawg are trademarks, service marks, or trade names of Milwaukee Electric Tool Corporation ("Milwaukee Electric Tool Corporation's Intellectual Property").  
All other Trademarks or Registered Trademarks (TM/®) are owned or licensed by Southwire Company.  
Any other ™/®- Trademark or Registered Trademark of Southwire Company.

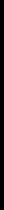

RESOURCES FOR OBSERVING THE SOLUTIONS OF THE 2017 JOBSITE SURVEY  
FOR THE 2017 JOBSITE SURVEY

855-510-8551