















WALL PLATES

Toggle Switch Openings Standard Size Plastic & Metal

DESCRIPTION	COLOR	NYLON	THERMOSET	METAL	
		TRADEMASTER® PLATES	SMOOTH	MATERIAL	SMOOTH
TOGGLE SWITCH OPENINGS					
One Gang 	Ivory	TP1I	SP1I	Aluminum	SA1
	White	TP1W	SP1W	Brass	SB1
	Brown	TP1	SP1	Polished Brass	SB1PB
	Gray	TP1GRY	SP1GRY	430S/S	SL1
	Black	TP1BK		302/304 S/S	SS1
	Red	TP1RED		Brushed Bronze	SB1BZ
	Light Almond	TP1LA	SP1LA	Chrome	SB1CH
Two Gang 	Ivory	TP2I	SP2I	Aluminum	SA2
	White	TP2W	SP2W	Brass	SB2
	Brown	TP2	SP2	Polished Brass	SB2PB
	Gray	TP2GRY	SP2GRY	430S/S	SL2
	Black	TP2BK		302/304 S/S	SS2
	Red	TP2RED		Brushed Bronze	SB2BZ
	Light Almond	TP2LA	SP2LA	Chrome	SB2CH
Three Gang 	Ivory	TP3I	SP3I	Aluminum	SA3
	White	TP3W	SP3W	Brass	SB3
	Brown	TP3	SP3	Polished Brass	SB3PB
	Gray	TP3GRY	SP3GRY	430S/S	SL3
	Black	TP3BK		302/304 S/S	SS3
	Red	TP3RED		Brushed Bronze	SB3BZ
	Light Almond	TP3LA	SP3LA	Chrome	SB3CH
Four Gang 	Ivory	TP4I	SP4I	Aluminum	SA4
	White	TP4W	SP4W	Brass	SB4
	Brown	TP4	SP4	Polished Brass	SB4PB
	Gray	TP4GRY	SP4GRY	430S/S	SL4
	Black	TP4BK		302/304 S/S	SS4
	Red	TP4RED			
	Light Almond	TP4LA	SP4LA		
Five Gang 	Ivory	TP5I	SP5I	Brass	SB5
	White	TP5W	SP5W		Polished Brass
	Brown	TP5	SP5	302/304 S/S	SS5
	Gray	TP5GRY	SP5GRY		
	Black	TP5BK			
Light Almond	TP5LA	SP5LA			
Six Gang 	Ivory	TP6I	SP6I	Polished Brass	SB6PB
	White	TP6W	SP6W		
	Brown	TP6		302/304 S/S	SS6
	Gray	TP6GRY	SP6GRY		
	Black	TP6BK			
Light Almond	TP6LA	SP6LA			
Seven Gang 				302/304 S/S	SS601
				302/304 S/S Painted Ivory	SS601I
				302/304 S/S Painted White	SS601W
Eight Gang 				302/304 S/S	SS602
				302/304 S/S Painted Ivory	SS602I
				302/304 S/S Painted White	SS602W

WALL PLATES







Duplex Receptacle & Decorator Openings Standard Size Plastic & Metal

DESCRIPTION	COLOR	NYLON	THERMOSET	METAL	
		TRADEMASTER® PLATES	SMOOTH	MATERIAL	SMOOTH
DUPLEX RECEPTACLE OPENINGS					
One Gang 	Ivory	TP8I	SP8I	Aluminum	SA8
	White	TP8W	SP8W		Brass
	Brown	TP8	SP8	Polished Brass	SB8PB
	Gray	TP8GRY	SP8GRY	430S/S	SL8
	Black	TP8BK	SP8LA	302/304 S/S	SS8
	Red	TP8RED		Brushed Bronze	SB8BZ
	Light Almond	TP8LA		Chrome	SB8CH
	Blue	TP8BL			
	Orange	TP8OR			
Two Gang 	Ivory	TP82I	SP82I	Aluminum	SA82
	White	TP82W	SP82W		Brass
	Brown	TP82	SP82	Polished Brass	SB82PB
	Gray	TP82GRY	SP82GRY	430S/S	SL82
	Black	TP82BK	SP82LA	302/304 S/S	SS82
	Red	TP82RED		Brushed Bronze	SB82BZ
	Light Almond	TP82LA		Chrome	SB82CH
	Blue	TP82BL			
	Orange	TP82OR			
Three Gang 	Ivory		SP83I	Brass	SB83
	White		SP83W		
	Brown		SP83	302/304 S/S	SS83
	Gray		SP83GRY		
	Light Almond		SP83LA		
Four Gang 	Ivory		SP84I	Polished Brass	SB84PB
	White		SP84W		
	Brown		SP84		
	Gray		SP84GRY		
Five Gang 				302/304 S/S	SS85
Six Gang 				302/304 S/S	SS86
DECORATOR OPENINGS					
One Gang 	Ivory	TP26I	SP26I	Aluminum	SA26
	White	TP26W	SP26W		Brass
	Brown	TP26	SP26	Polished Brass	SB26PB
	Gray	TP26GRY	SP26GRY	430S/S	SL26
	Black	TP26BK	SP26BK	302/304 S/S	SS26
	Red	TP26RED	SP26LA	Brushed Bronze	SB26BZ
	Light Almond	TP26LA		Chrome	SB26CH
	Blue	TP26BL			
	Orange	TP26OR			

WALL PLATES





WALL PLATES

Decorator Openings Standard Size Plastic & Metal

DESCRIPTION	COLOR	NYLON	THERMOSET	METAL	
		TRADEMASTER® PLATES	SMOOTH	MATERIAL	SMOOTH
DECORATOR OPENINGS					
Two Gang 	Ivory	TP262I	SP262I	Aluminum Brass Polished Brass 430S/S 302/304 S/S	SA262 SB262 SB262PB SL262 SS262
	White	TP262W	SP262W		
	Brown	TP262	SP262		
	Gray	TP262GRY	SP262GRY		
	Black	TP262BK	SP262BK		
	Red	TP262RED			
	Light Almond	TP262LA	SP262LA		
	Blue	TP262BL			
	Orange	TP262OR			
Three Gang 	Ivory	TP263I	SP263I	Brass Polished Brass 302/304 S/S	SB263 SB263PB SS263
	White	TP263W	SP263W		
	Brown	TP263			
	Gray	TP263GRY	SP263GRY		
	Black	TP263BK	SP263BK		
	Red	TP263RED			
	Light Almond	TP263LA	SP263LA		
Four Gang 	Ivory	TP264I	SP264I	Brass Polished Brass 302/304 S/S	SB264 SB264PB SS264
	White	TP264W	SP264W		
	Brown	TP264	SP264		
	Gray	TP264GRY	SP264GRY		
	Black	TP264BK	SP264BK		
	Red	TP264RED			
	Light Almond	TP264LA	SP264LA		
Five Gang 	Ivory	TP265I	SP265I	302/304 S/S	SS265
	White	TP265W	SP265W		
	Brown	TP265			
	Gray	TP265GRY	SP265GRY		
	Black	TP265BK	SP265BK		
	Red		SP265RED		
	Light Almond	TP265LA	SP265LA		
Six Gang 	Ivory	TP266I	SP266I	302/304 S/S	SS266
	White	TP266W	SP266W		
	Brown	TP266	SP266		
	Gray	TP266GRY	SP266GRY		
	Black	TP266BK	SP266BK		
	Light Almond	TP266LA	SP266LA		
Seven Gang 				302/304 S/S 302/304 S/S Painted Ivory 302/304 S/S Painted White	SS267 SS267I SS267W
Eight Gang 				302/304 S/S 302/304 S/S Painted Ivory 302/304 S/S Painted White	SS268 SS268I SS268W

WALL PLATES



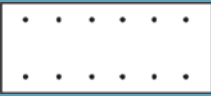
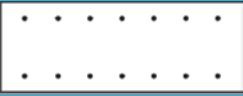
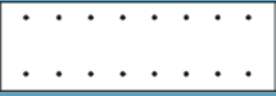

Blank Plates – Box Mounted Standard Size Plastic & Metal

DESCRIPTION	COLOR	NYLON	THERMOSET	METAL	
		TRADEMASTER® PLATES	SMOOTH	MATERIAL	SMOOTH
BLANK PLATES – BOX MOUNTED					
One Gang Blank – Box Mtd. 	Ivory	TP13I	SP13I	Aluminum	SA13
	White	TP13W	SP13W	Brass	SB13
	Brown	TP13	SP13	Polished Brass	SB13PB
	Gray	TP13GRY	SP13GRY	430S/S	SL13
	Black	TP13BK		302/304 S/S	SS13
	Red	TP13RED		302/304 S/S (1/2" Screws)	SS13.5
	Light Almond	TP13LA	SP13LA	Brushed Bronze	SB13BZ
			Chrome	SB13CH	
Two Gang Blank – Box Mtd. 	Ivory	TP23I	SP23I	Aluminum	SA23
	White	TP23W	SP23W	Brass	SB23
	Brown	TP23	SP23	Polished Brass	SB23PB
	Gray	TP23GRY	SP23GRY	430S/S	SL23
	Black	TP23BK		302/304 S/S	SS23
	Light Almond	TP23LA	SP23LA	302/304 S/S (1/2" Screws)	SS23.5
				Brushed Bronze	SB23BZ
			Chrome	SB23CH	
Three Gang Blank – Box Mtd. 	Ivory		SP33I	Polished Brass	SB33PB
	White		SP33W		
	Brown		SP33	302/304 S/S	SS33
	Gray		SP33GRY	302/304 S/S (1/2" Screws)	SS33.5
	Light Almond		SP33LA		
Four Gang Blank – Box Mtd. 	Ivory		SP43I		
	White		SP43W		
	Brown		SP43	302/304 S/S	SS43
	Gray		SP43GRY		
Five Gang Blank – Box Mtd. 				302/304 S/S	SS53
Six Gang Blank – Box Mtd. 				302/304 S/S	SS63
Seven Gang Blank – Box Mtd. 				302/304 S/S	SS6013
Eight Gang Blank – Box Mtd. 				302/304 S/S	SS6023

WALL PLATES









WALL PLATES

Blank Plates – Strap Mounted Standard Size Plastic & Metal

DESCRIPTION	COLOR	NYLON	THERMOSET	METAL		
		TRADEMASTER® PLATES	SMOOTH	MATERIAL	SMOOTH	
BLANK PLATES – STRAP MOUNTED WITH ADJUSTMENT YOKE						
One Gang Blank – Strap Mtd. 	Ivory	TP14I	SP14I	Aluminum	SA14	
	White	TP14W	SP14W		Brass	SB14
	Brown	TP14	SP14	430S/S	SL14	
	Gray	TP14GRY	SP14GRY		302/304 S/S	SS14
	Black	TP14BK	SP14BK		302/304 S/S (1/2" Screws)	SS14.5
	Red		SP14RED			
	Light Almond	TP14LA	SP14LA			
Two Gang Blank – Strap Mtd. 	Ivory	TP24I	SP24I	Aluminum	SA24	
	White	TP24W	SP24W		Brass	SB24
	Brown	TP24	SP24	430S/S	SL24	
	Gray	TP24GRY	SP24GRY		302/304 S/S	SS24
	Black	TP24BK	SP24BK		302/304 S/S (1/2" Screws)	SS24.5
	Red		SP24RED			
	Light Almond	TP24LA	SP24LA			
Three Gang Blank – Strap Mtd. 	Ivory		SP34I	302/304 S/S	SS34	
	White		SP34W			
	Brown		SS34			
	Gray		SP34GRY			
Four Gang Blank – Strap Mtd. 	Ivory		SP44I	302/304 S/S	SS44	
	White		SP44W			
	Brown		SP44			
	Gray		SP44GRY			







WALL PLATES

Single Receptacle & Power Outlet Openings Standard Size Plastic & Metal

DESCRIPTION	COLOR	NYLON	THERMOSET	METAL	
		TRADEMASTER® PLATES	SMOOTH	MATERIAL	SMOOTH
SINGLE RECEPTACLE OPENINGS					
One Gang 	Ivory	TP7I	SP7I	Aluminum Brass Polished Brass 430S/S 302/304 S/S	SA7
	White	TP7W	SP7W		SB7
	Brown	TP7	SP7		SB7PB
	Gray	TP7GRY	SP7GRY		SL7
	Black	TP7BK			SS7
	Red	TP7RED			
Two Gang 	Ivory		SP72I	302/304 S/S	SS72
	White		SP72W		
	Brown		SP72		
Three Gang 				302/304 S/S	SS73
				302/304 S/S Painted Ivory	SS73I
				302/304 S/S Painted White	SS73W
				302/304 S/S Painted Gray	SS73GRY
POWER OUTLET RECEPTACLE OPENINGS – ONE GANG					
 1.5938" hole for 1.5625" dia. device – 2 mtg. holes	Ivory	TP720I	SP720I	302/304 S/S	SS720
	White	TP720W	SP720W		
	Brown	TP720	SP720		
	Gray	TP720GRY	SP720GRY		
	Light Almond	TP720LA	SP720LA		
 1.625" hole for 1.5938" dia. device – 2 mtg. holes				302/304 S/S	SS721
 1.75" hole for 1.7186" dia. device – 2 mtg. holes				302/304 S/S	SS725
 2.125" hole for 2.094" dia. device – 2 mtg. holes				302/304 S/S	SS723
 2.156" hole for 2.125" dia. device – 2 mtg. holes	Ivory	TP724I	384I	Chrome 302/304 S/S	S384C SS724
	White	TP724W	384		
	Brown	TP724			
	Gray	TP724GRY			
	Black	TP724BK			
	Light Almond	TP724LA			









WALL PLATES

Power Outlet Receptacle Openings Standard Size Plastic & Metal

DESCRIPTION	NYLON		THERMOSET	METAL	
	COLOR	TRADEMASTER® PLATES	SMOOTH	MATERIAL	SMOOTH
POWER OUTLET RECEPTACLE OPENINGS – TWO GANG					
 <p>2.4688" hole for 2.375" dia. device – 4 mtg. holes</p>				Chrome 302/304 S/S	S3863C SS701
 <p>2.1563" hole for 2.125" dia. device – 2 mtg. holes</p>				302/304 S/S	SS702
 <p>2.1563" hole for 2.125" dia. device – 4 mtg. holes</p>	Ivory Ivory White Brown Brown Gray Black Light Almond	TP703I TP703W TP703 TP703GRY TP703BK TP703LA	SP703I 3862I SP703 3862	Chrome 302/304 S/S	S3862C SS703
 <p>2.2813" hole for 2.125" dia. device – 4 mtg. holes</p>				Aluminum 302/304 S/S 302/304 S/S	SA716 SS716 SS705
 <p>2.1563" hole for 2.125" dia. device – 4 mtg. holes</p>					
 <p>1.5938" hole for 1.5625" dia. device – 2 mtg. holes</p>				302/304 S/S	SS710





WALL PLATES

Combination Openings Standard Size Plastic & Metal

DESCRIPTION	COLOR	NYLON	THERMOSET	METAL	
		TRADEMASTER® PLATES	SMOOTH	MATERIAL	SMOOTH
TOGGLE SWITCH & DUPLEX RECEPTACLE OPENINGS					
Two Gang 1 Toggle, 1 Duplex 	Ivory	TP18I	SP18I	Brass	SB18
	White	TP18W	SP18W		
	Brown	TP18	SP18	Polished Brass	SB18PB
	Gray	TP18GRY	SP18GRY	302/304 S/S	SS18
	Black	TP18BK			
	Red	TP18RED			
Light Almond	TP18LA	SP18LA			
Three Gang 2 Toggles, 1 Duplex 	Ivory	TP28I	SP28I	Brass	SB28
	White	TP28W	SP28W		
	Brown	TP28	SP28	Polished Brass	SB28PB
	Gray	TP28GRY	SP28GRY	302/304 S/S	SS28
	Black	TP28BK			
	Red	TP28RED			
Light Almond	TP28LA	SP28LA			
Four Gang 3 Toggles, 1 Duplex 	Ivory		SP38I	Polished Brass	SB33PB
	White		SP38W	302/304 S/S	SS33
	Brown		SP38		
	Gray		SP38GRY		
	Light Almond		SP38LA		SS33.5
Five Gang 4 Toggles, 1 Duplex 				302/304 S/S	SS48
				302/304 S/S Painted Ivory	SS48I
				302/304 S/S Painted White	SS48W
TOGGLE SWITCH & DECORATOR OPENINGS					
Two Gang 1 Toggle, 1 Decorator 	Ivory	TP126I	SP126I	Aluminum	SA126
	White	TP126W	SP126W		
	Brown	TP126	SP126	Brass	SB126
	Gray	TP126GRY	SP126GRY	Polished Brass	SB126PB
	Light Almond	TP126LA	SP126LA	302/304 S/S	SS126
Three Gang 2 Toggles, 1 Decorator 	Ivory	TP226I	SP226I	302/304 S/S	SS226
	White	TP226W	SP226W		
	Brown	TP226	SP226		
	Gray	TP226GRY	SP226GRY		
	Light Almond	TP226LA	SP226LA		
Black	TP226BK				
Three Gang 1 Toggle, 2 Decorator 	Ivory		SP1262I	302/304 S/S	SS1262
	White		SP1262W		
	Brown		SP1262		
	Gray		SP1262GRY		
	Black		SP1262BK		
	Light Almond		SP1262LA		
Four Gang 3 Toggles, 1 Decorator 	Ivory		SP326I	302/304 S/S	SS326
	White		SP326W		
	Brown		SP326		
	Gray		SP326GRY		
	Light Almond		SP326LA		









WALL PLATES

Combination Openings Standard Size Plastic & Metal

DESCRIPTION	COLOR	NYLON	THERMOSET	METAL	
		TRADEMASTER® PLATES	SMOOTH	MATERIAL	SMOOTH
TOGGLE SWITCH & DECORATOR OPENINGS (CONT.)					
Four Gang 2 Toggles, 2 Decorator 	Ivory White Brown Light Almond		SP2262I SP2262W SP2262 SP2262LA		
TOGGLE SWITCH & BLANK STRAP MOUNTED OPENINGS					
Two Gang 1 Toggle, 1 Blank 				302/304 S/S	SS114
Three Gang 2 Toggles, 1 Blank 				302/304 S/S	SS214
Four Gang 3 Toggles, 1 Blank 				302/304 S/S	SS314









WALL PLATES

Combination Openings Standard Size Plastic & Metal

DESCRIPTION	COLOR	NYLON	THERMOSET	METAL	
		TRADEMASTER® PLATES	SMOOTH	MATERIAL	SMOOTH
TWO GANG COMBINATION OPENINGS					
Two Gang 1 Toggle, 1 Single 	Ivory White Brown Gray		SP17I SP17W SP17 SP17GRY	302/304 S/S	SS17
Two Gang Single/Duplex 	Ivory White Brown Gray		SP78I SP78W SP78 SP78GRY	Aluminum 302/304 S/S	SA78 SS78
Two Gang Duplex/Decorator 	Ivory White Brown Gray Black Red Light Almond	TP826I TP826W TP826 TP826GRY TP826BK TP826RED TP826LA	SP826I SP826W SP826 SP826GRY SP826LA	Polished Brass 302/304 S/S	SB826PB SS826
Two Gang Telephone/Toggle 	Ivory White Brown		SP112I SP112W SP112		
Two Gang Telephone/Duplex 	Ivory White Brown Gray		SP128I SP128W SP128 SP128GRY	302/304 S/S	SS128
Two Gang Telephone/Blank (Strap Mtd) 	Ivory White Brown Gray Light Almond Black	TP226I TP226W TP226 TP226GRY TP226LA TP226BK	SP226I SP226W SP226 SP226GRY SP226LA	302/304 S/S	SS226
Three Gang Telephone/Decorator 	White Brown		SP1226W SP1226	302/304 S/S	SS1226
Four Gang Blank (Box Mtd)/Duplex 	Ivory White Brown Gray Black Red Light Almond	TP138I TP138W TP138 TP138GRY TP138BK TP138RED TP138LA	SP138I SP138W SP138 SP138GRY	302/304 S/S	SS138
Four Gang Toggle/Blank (Box Mtd) 	Ivory White Brown Gray Black Light Almond	TP113I TP113W TP113 TP113GRY TP113BK TP113LA		302/304 S/S	SS113

WALL PLATES

Combination Openings Standard Size Plastic & Metal









DESCRIPTION	COLOR	NYLON	THERMOSET	METAL	
		TRADEMASTER® PLATES	SMOOTH	MATERIAL	SMOOTH
TWO GANG COMBINATION OPENINGS (CONT.)					
Two Gang Blank (Strap Mtd) Duplex 	Ivory White Brown Gray		SP148I SP148W SP148 SP148GRY	302/304 S/S	SS148
Two Gang Blank (Strap Mtd)/Single 	Ivory White		SP147I SP147W	302/304 S/S	SS147
Two Gang Blank (Strap Mtd)/Decorator 	Ivory White Brown Gray Light Almond		SP1426I SP1426W SP1426 SP1426GRY SP1426LA	302/304 S/S	SS1426
THREE & FOUR GANG COMBINATION OPENINGS					
Three Gang Toggle/Duplex/Duplex 	Ivory White Brown Gray Light Almond		SP182I SP182W SP182 SP182GRY SP182LA	Polished Brass 302/304 S/S	SB182PB SS182
Three Gang Blank (Strap Mtd)/Toggle/ Blank (Strap Mtd) 				302/304 S/S	SS8148
Two Gang Blank (Strap Mtd)/Toggle/ Blank (Strap Mtd) 				302/304 S/S	SS14114
Three Gang Telephone/Decorator 				302/304 S/S	SS14814
Four Gang Blank (Box Mtd)/Duplex 				302/304 S/S	SS282

These products listed to UL514, Cover Plates for Flush-Mounted Wiring Devices, CSA Certified.

WALL PLATES

Despard® Openings







Standard Size Plastic & Metal Despard Interchangeable Plate Supplied with Mounting Straps

DESCRIPTION	COLOR	NYLON	THERMOSET	METAL	
		TRADEMASTER® PLATES	SMOOTH	MATERIAL	SMOOTH
ONE HORIZONTAL OPENING PER GANG					
One Gang 	Ivory White Brown		K11 K1W K1	302/304 S/S	SSK1
Two Gang 				302/304 S/S	SSK12
Three Gang 				302/304 S/S	SSK13
TWO HORIZONTAL OPENINGS PER GANG					
One Gang 	Ivory White Brown		K21 K2W K2	302/304 S/S	SSK2
Two Gang 				302/304 S/S	SSK22
THREE HORIZONTAL OPENINGS PER GANG					
One Gang 	Ivory White Brown		K31 K3W K3	302/304 S/S	SSK3
Two Gang 				302/304 S/S	SSK32
Three Gang 				302/304 S/S	SSK33
ONE VERTICAL OPENING PER GANG					
One Gang 	Ivory White Brown		K41 K4W K4		

WALL PLATES





WALL PLATES

Two Gang with Center Opening Standard Size Metal

DESCRIPTION	COLOR	NYLON	THERMOSET	METAL	
		TRADEMASTER® PLATES	SMOOTH	MATERIAL	SMOOTH
ONE HORIZONTAL OPENING PER GANG					
Toggle Switch 				302/304 S/S	SS740
Blank-Box Mount 				302/304 S/S	SS743
Decorator 				302/304 S/S	SS746
Single Receptacle 				302/304 S/S	SS747
Duplex Receptacle 				302/304 S/S	SS748
KL SERIES LOCKING SWITCH PLATES					
One Gang  <p>.906 diameter Reference Page A-5 for device</p>				302/304 S/S	SS717
Two Gang  <p>.906 diameter Reference Page A-5 for device</p>				302/304 S/S	SS727









WALL PLATES

Louver & Biplex/Triplex Openings Standard Size Metal

DESCRIPTION	COLOR	NYLON	THERMOSET	METAL	
		TRADEMASTER® PLATES	SMOOTH	MATERIAL	SMOOTH
LOUVER PLATES					
One Gang Horizontal 				Brass 302/304 S/S 302/304 S/S Painted Ivory 302/304 S/S Painted White 302/304 S/S Painted Light Almond	SB760 SS760 SS760I SS760W SS760LA
One Gang Vertical 				Brass 302/304 S/S 302/304 S/S Painted Ivory 302/304 S/S Painted White 302/304 S/S Painted Brown 302/304 S/S Painted Gray 302/304 S/S Painted Light Almond	SB771 SS771 SS771I SS771W SS771X SS771GRY SS771LA
Two Gang Vertical 				302/304 S/S	SS772
BIPLEX/TRIPLEX RECEPTACLE					
One Gang 1 Biplex/Triplex 				302/304 S/S	SS9

WALL PLATES

Toggle Switch, Duplex & Single Receptacle Openings Junior-Jumbo & Jumbo Plastic & Metal

DESCRIPTION	COLOR	NYLON		THERMOSET		METAL		
		TRADEMASTER®		JUNIOR-JUMBO	JUMBO	MATERIAL	JUNIOR-JUMBO	JUMBO
		JUMBO	SMOOTH	SMOOTH	SMOOTH		SMOOTH	
TOGGLE SWITCH OPENINGS								
One Gang 	Ivory	TPJ1I	SPJ1I	SP01I	Brass 302/304 S/S	SBJ1 SSJ1	SB01 SS01	
	White	TPJ1W	SPJ1W	SP01W				
	Brown	TPJ1	SPJ1	SP01				
	Gray	TPJ1GRY	SPJ1LA					
	Light Almond	TPJ1LA						
Two Gang 	Ivory	TPJ2I	SPJ2I	SP02I	Brass 302/304 S/S	SBJ2 SSJ2	SB02 SS02	
	White	TPJ2W	SPJ2W	SP02W				
	Brown	TPJ2	SPJ2	SP02				
	Gray	TPJ2GRY	SPJ2LA					
	Light Almond	TPJ2LA						
Three Gang 	Ivory	TPJ3I	SPJ3I	302/304 S/S	SSJ3	SB03 SS03		
	White	TPJ3W	SPJ3W					
	Brown	TPJ3	SPJ3					
	Gray	TPJ3GRY	SPJ3LA					
	Light Almond	TPJ3LA						
Four Gang 	Ivory	TPJ4I	SPJ4I	302/304 S/S		SB04 SS04		
	White	TPJ4W	SPJ4W					
	Brown	TPJ4	SPJ4					
	Gray	TPJ4GRY	SPJ4LA					
	Light Almond	TPJ4LA						
DUPLEX RECEPTACLE OPENINGS								
One Gang 	Ivory	TPJ8I	SPJ8I	SP08I	Brass 302/304 S/S	SBJ8 SSJ8	SB08 SS08	
	White	TPJ8W	SPJ8W	SP08W				
	Brown	TPJ8	SPJ8	SP08				
	Gray	TPJ8GRY	SPJ8LA	SP08LA				
	Light Almond	TPJ8LA						
Two Gang 	Ivory	TPJ82I	SPJ82I	SP082I	302/304 S/S	SBJ82 SSJ82	SB082 SS082	
	White	TPJ82W	SPJ82W	SP082W				
	Brown	TPJ82	SPJ82	SP082				
	Gray	TPJ82GRY	SPJ82GRY	SPJ82LA				
	Light Almond	TPJ82LA						
Three Gang 					302/304 S/S		SB083 SS083	
SINGLE RECEPTACLE OPENINGS								
One Gang 	Ivory	TPJ7I	SPJ7I	302/304 S/S	SSJ7	SB07 SS07		
	White	TPJ7W	SPJ7W					
	Brown	TPJ7	SPJ7					
	Gray	TPJ7GRY	SPJ7LA					
	Light Almond	TPJ7LA						

WALL PLATES

Decorator Openings & Blank Plates Junior-Jumbo & Jumbo Plastic & Metal

DESCRIPTION	COLOR	NYLON	THERMOSET		METAL		
		TRADEMASTER®	JUNIOR-JUMBO	JUMBO	MATERIAL	JUNIOR-JUMBO	JUMBO
		JUMBO	SMOOTH	SMOOTH		SMOOTH	SMOOTH
DECORATOR OPENINGS							
One Gang 	Ivory	TPJ26I	SPJ26I	SP026I	Brass 302/304 S/S	SBJ26 SSJ26	SB026 SS026
	White	TPJ26W	SPJ26W	SP026W			
	Brown	TPJ26	SPJ26	SP026			
	Gray	TPJ26GRY					
	Red	TPJ26RED					
	Light Almond	TPJ26LA	SPJ26LA	SP026LA			
Two Gang 	Ivory	TPJ262I	SPJ262I	SP0262I	302/304 S/S	SSJ262	SS0262
	White	TPJ262W	SPJ262W	SP0262W			
	Brown	TPJ262	SPJ262	SP0262			
	Gray	TPJ262GRY					
	Light Almond	TPJ262LA	SPJ262LA				
Three Gang 	Ivory	TPJ263I	SPJ263	302/304 S/S	SSJ263		
	White	TPJ263W	SPJ263W				
	Brown	TPJ263	SPJ263				
	Gray	TPJ263GRY					
	Light Almond	TPJ263LA	SPJ263LA				
Four Gang 	Ivory	TPJ264I	SPJ264I				
	White	TPJ264W	SPJ264W				
	Brown	TPJ264	SPJ264				
	Gray	TPJ264GRY					
	Light Almond	TPJ264LA	SPJ264LA				
BLANK PLATES - BOX & STRAP MOUNTED							
One Gang Blank Box Mtd. 	Ivory	TPJ13I	SPJ13I	SP013I	302/304 S/S	SSJ13	SS013
	White	TPJ13W	SPJ13W	SP013W			
	Brown	TPJ13	SPJ13	SP013			
	Gray	TPJ13GRY					
	Light Almond	TPJ13LA	SPJ13LA				
Two Gang Blank Box Mtd. 	Ivory			SP023I	302/304 S/S		SS023
	White			SP023W			
	Brown			SP023			
Three Gang Blank Box Mtd. 					302/304 S/S		SS033
One Gang Strap Mtd. 					302/304 S/S		SS014
Two Gang Blank Strap Mtd. 					302/304 S/S		SS024
Three Gang Blank Strap Mtd. 					302/304 S/S		SS034

WALL PLATES

Combination Openings Junior-Jumbo & Jumbo Plastic & Metal





DESCRIPTION	COLOR	NYLON		THERMOSET		METAL		
		TRADEMASTER®		JUNIOR-JUMBO	JUMBO	MATERIAL	JUNIOR-JUMBO	JUMBO
		JUMBO		SMOOTH	SMOOTH		SMOOTH	SMOOTH
TWO GANG COMBINATION OPENINGS								
Two Gang Toggle/Duplex 	Ivory White Brown Gray Light Almond	TPJ18I TPJ18W TPJ18 TPJ18GRY TPJ18LA	SPJ18I SPJ18W SPJ18 SPJ18LA	SP018I SP018W SP018	302/304 S/S	SSJ18	SS018	
Two Gang Toggle/Decorator 	Ivory White Brown Gray Light Almond	TPJ126I TPJ126W TPJ126 TPJ126GRY TPJ126LA	SPJ126I SPJ126W SPJ126 SPJ126LA		302/304 S/S	SSJ126	SS0126	
Two Gang Toggle/Blank (Strap Mtd) Supplied with 340 Yoke 					302/304 S/S		SS0114	
Two Gang Toggle/Blank (Box Mtd.) 	Ivory White Brown Gray Light Almond	TPJ113I TPJ113W TPJ113 TPJ113GRY TPJ113LA	SPJ113I SPJ113W SPJ113	SP0113I SP0113				
Two Gang Blank (Box Mtd)/Duplex 	Ivory White Brown		SPJ138I SPJ138W SPJ138	SP0138I SP0138	302/304 S/S		SS0138	
Two Gang Duplex/Decorator 	Ivory White Brown Gray Light Almond	TPJ826I TPJ826W TPJ826 TPJ826GRY TPJ826LA	SPJ826I SPJ826W SPJ826LA					
Two Gang Blank/Decorator 	Ivory White Brown		SPJ1426I** SPJ1426W** SPJ1426**	SP01326I* SP01326W* SP01326*				
Three Gang 2 Toggles/Duplex 					302/304 S/S		SS028	

*Box mounted
**Strap mounted

WALL PLATES

Sectional

Thermoplastic

DESCRIPTION	SEMI-JUMBO	
	COLOR	SMOOTH NYLON
SECTIONAL WALL PLATES – END SECTIONS		
Toggle Switch 	Ivory White Light Almond	PJSE1I PJSE1W PJSE1LA
Duplex Receptacle 	Ivory White Light Almond	PJSE8I PJSE8W PJSE8LA
Single Receptacle 	Ivory White Light Almond	PJSE7I PJSE7W PJSE7LA
Blank, Strap Mounted  supplied with #340 Yoke	Ivory White Light Almond	PJSE14I PJSE14W PJSE14LA
Decorator 	Ivory White Light Almond	PJSE26I PJSE26W PJSE26LA

Thermoplastic

DESCRIPTION	SEMI-JUMBO	
	COLOR	SMOOTH NYLON
SECTIONAL WALL PLATES – CENTER SECTIONS		
Toggle Switch 	Ivory White Light Almond	PJSC1I PJSC1W PJSC1LA
Duplex Receptacle 	Ivory White Light Almond	PJSC8I PJSC8W PJSC8LA
Single Receptacle 	Ivory White Light Almond	PJSC7I PJSC7W PJSC7LA
Blank, Strap Mounted  supplied with #340 Yoke	Ivory White Light Almond	PJSC14I PJSC14W PJSC14LA
Decorator 	Ivory White Light Almond	PJSC26I PJSC26W PJSC26LA

WALL PLATES

Tandem & Handy Box Plates

Features

- Tandem wall plates are ideal for curtain wall and movable partitions or wherever limited wiring exists.
- Note: Write factory for availability of other tandem sizes, materials, and openings.

DESCRIPTION	MATERIAL	CATALOG NUMBER
TANDEM WALL PLATES		
1-3/4" W x 6-1/8" H 2 Vertical Devices Supplied with #342 Strap	302/304 S/S	SSTK424

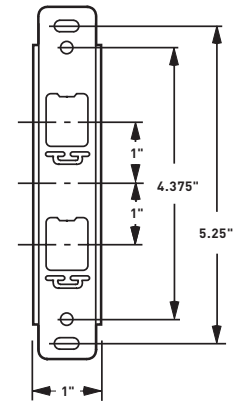

342 Strap

Features

- Handy Box Plates give a finished appearance and style to surface mounted boxes.
- Available in the five most-used openings, they have a bright corrosion-resistant zinc-plated finish.
- Plate conceals rough edge of box.

	MATERIAL	CATALOG NUMBER
GALVANIZED STEEL HANDY BOX PLATES		
One Gang Toggle Switch 	Plated	SH1
One Gang Single Receptacle 	Plated	SH7
One Gang Duplex Receptacle 	Plated	SH8
One Gang Blank (Box Mounted) 	Plated	SH13
One Gang Decorator/GFCI 	Plated	SH26

WALL PLATES

Narrow Metal Made to Order – Consult factory for price and availability

MADE TO ORDER WALL PLATES								
			1-3/8"	1-1/2"	1-11/16"	1-3/4"	2"	2-1/2"
DECORATOR OPENINGS		MATERIAL	CATALOG NUMBERS					
	Toggle Switch	Aluminum 302/304 S/S	SAN11 SSN11			SAN14 SSN14	SSN15	
	Telephone Outlet 13/32" Hole – Box Mounted	302/304 S/S						SSN117
	Telephone Outlet 13/32" Hole – Strap Mounted	302/304 S/S	SSN121					
	Blank Strap Mounted, 1 #340 Yoke	Aluminum 302/304 S/S		SSN142		SAN144 SSN144		
	Duplex Receptacle	Aluminum 302/304 S/S					SAN85 SSN85	
	1 Despard® Interchangeable Horizontal Opening Supplied With #348 Mounting Strap	Aluminum 302/304 S/S				SANK14 SSNK14		
	2 Despard Interchangeable Horizontal Openings Supplied With #348 Mounting Strap	Aluminum 302/304 S/S				SANK24 SSNK24		
	3 Despard Interchangeable Horizontal Openings Supplied With #348 Mounting Strap	302/304 S/S				SSNK34		
	1 Despard Interchangeable Vertical Opening Supplied With #347 Mounting Strap	Aluminum 302/304 S/S	SANK41 SSNK41		SANK43 SSNK43	SANK44 SSNK44		
	1 Despard Interchangeable Vertical Opening Device Mounted Use with #347 Strap	Aluminum 302/304 S/S	SANK51 SSNK51		SANK53 SSNK53	SANK54 SSNK54		

Note: All narrow plates are 4-1/2" high.

WALL PLATES

Dustproof Stainless Steel Covers Specification Grade

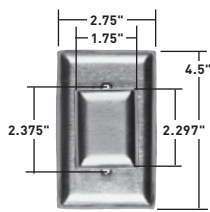

WP1, WP7

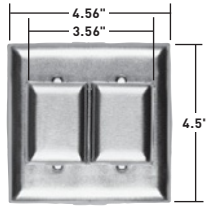

WP2

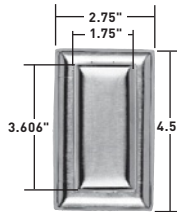

WP8, WP26

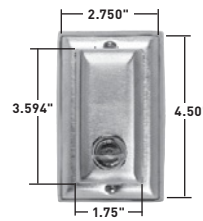

WP26L

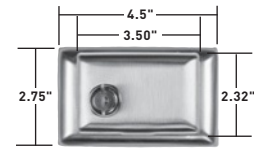

WPH1L, WPH7L

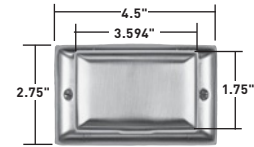

WPH8, WPH26

Stainless Steel Covers are dustproof only and do not meet NEC 406.8(A) or (B).

Features

- Exclusive – Spec-grade stainless steel dust covers.
- Ideal for hard-use and corrosive applications.
- Aesthetically pleasing.

CATALOG NUMBER	DESCRIPTION	3rd PARTY COMPLIANCE	
		UL	SR
DUSTPROOF STAINLESS STEEL COVERS			
WP1	1 Toggle Switch, 1 Small Cover, Vertical 1 Gang Plate. Available for Four Screw Mount – add suffix -FS	•	•
WP2	2 Toggle Switches 2 Small Covers, Vertical 2 Gang Plate	•	•
WP7	1 Single Receptacle 1 Small Cover, Vertical 1 Gang Plate Available for Four Screw Mount – add suffix -FS	•	•
WP8	1 Duplex Receptacle 1 Long Cover, Vertical 1 Gang Plate	•	•
WPH8	1 Duplex Receptacle 1 Long Cover, Horizontal 1 Gang Plate	•	•
WPD8	1 Duplex Receptacle 2 Small Covers, Horizontal 1 Gang Plate	•	•
WP26	1 Decorator/GFCI 1 Long Cover, Vertical 1 Gang Plate	•	•
WPH26	1 Decorator/GFCI 1 Long Cover, Horizontal 1 Gang Plate	•	•
DUSTPROOF LOCKING STAINLESS STEEL COVERS*			
WPH1L	Toggle Opening, Horizontal	•	•
WPH7L	Single Receptacle Opening, Horizontal	•	•
WPH8L	Duplex Receptacle Opening, Horizontal	•	•
WP26L	Decorator/GFCI, Vertical	•	•

*Catalog Number WP255K – replacement key for all Dustproof Locking Covers. (Two keys furnished with each unit.)

Note: All locks keyed the same.

These products listed to UL514, Cover Plates for Flush-Mounted Wiring Devices, CSA Certified.

WALL PLATES

Communication Devices Telephone Wiring Devices

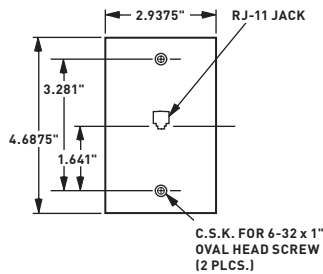

TPTE1

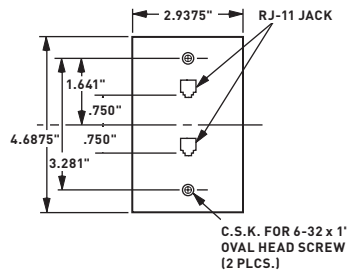

TPTE2

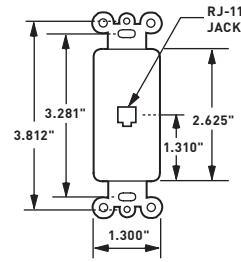

26TE14
26TE16

Features

- RJ11 modular jack.
- Mar-resistant wall plate.
- Wall plate dimension is Standard size.
- Fits standard size single gang electrical box.
- Meets FCC Part 68 requirements.

CATALOG NUMBER	DESCRIPTION	CONFIGURATION	3rd PARTY COMPLIANCE UL UL1863
SINGLE GANG OPENING MODULAR TELEPHONE JACK WITH WALL PLATE			
TPTE11	Ivory	4 Conductor	
TPTE1W	White	4 Conductor	
TPTE1	Brown	4 Conductor	
TPTE1GRY	Gray	4 Conductor	
TPTE1BK	Black	4 Conductor	
TPTE1LA	Light Almond	4 Conductor	
SINGLE GANG, TWO MODULAR RJ11 TELEPHONE JACKS WITH WALL PLATE			
TPTE21	Ivory	4 Conductor	
TPTE2W	White	4 Conductor	
TPTE2	Brown	4 Conductor	
TPTE2BK	Black	4 Conductor	
TPTE2LA	Light Almond	4 Conductor	

Features

- Decorator-style rectangular design.
- RJ11 modular jack.
- Fits standard single gang electrical box.
- May be used in multigang applications.
- Face constructed of high-impact thermoplastic.
- Brass terminals with nickel-plated steel screws and washers.
- Meets FCC Part 68 requirements.

CATALOG NUMBER	DESCRIPTION	CONFIGURATION	3rd PARTY COMPLIANCE UL UL1863
DECORATOR MODULAR JACK SINGLE GANG, 1 OPENING MODULAR JACK			
26TE14I	Ivory	4 Conductor	•
26TE14W	White	4 Conductor	•
26TE14LA	Light Almond	4 Conductor	•
26TE16I	Ivory	6 Conductor	•
26TE16W	White	6 Conductor	•

WALL PLATES

Communication Devices Telephone Wiring Devices

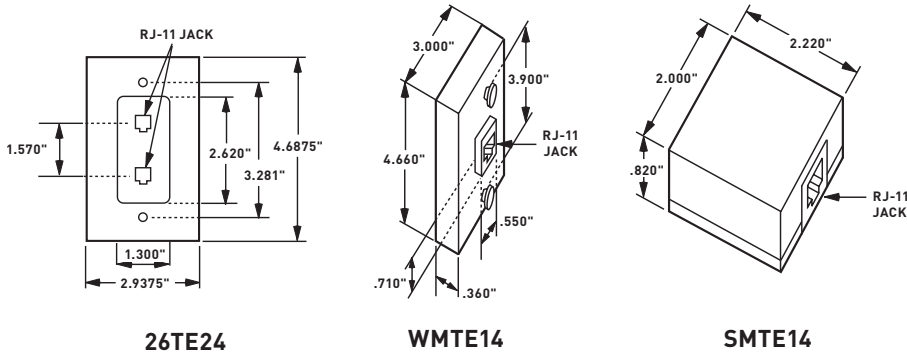

Features

- One piece molded plate Decorator outline.
- Two RJ11 modular jacks.
- Fits standard single gang electrical box.
- Face constructed of high-impact thermoplastic.
- Brass terminals with nickel-plated steel screws and washers.
- Wall plate dimension is standard size.
- Meets FCC Part 68 requirements.

CATALOG NUMBER	COLOR	CONFIGURATION	3rd PARTY COMPLIANCE UL UL1863
DECORATOR DUPLEX MODULAR JACK WITH SMOOTH PLATE SINGLE GANG, 2 OPENINGS			
26TE24I	Ivory	4 Conductor	•
26TE24W	White	4 Conductor	•
26TE24LA	Light Almond	4 Conductor	•
26TE26I	Ivory	6 Conductor	•
26TE26W	White	6 Conductor	•

Features

- RJ-11 modular jack.
- High-impact thermoplastic face plate and back body.
- Nickel-plated steel screw terminals.
- Zinc-plated mounting lugs.

CATALOG NUMBER	COLOR	CONFIGURATION	3rd PARTY COMPLIANCE UL UL1863
MODULAR WALL MOUNT TELEPHONE JACK FOR HANGING PHONES			
WMTE14I	Ivory	4 Conductor	•
WMTE14W	White	4 Conductor	•
WMTE14LA	Light Almond	4 Conductor	•

Features

- Nickel-plated steel screws and washers.
- Brass terminals.
- Comes with mounting screws and adhesive pad.
- Snap-on cover and base constructed of high-impact thermoplastic.

CATALOG NUMBER	COLOR	CONFIGURATION	3rd PARTY COMPLIANCE UL UL1863
SURFACE MOUNT MODULAR RJ-11 TELEPHONE JACK			
SMTE14I	Ivory	4 Conductor	•

WALL PLATES

Communication Devices Telephone & CATV Wiring Devices

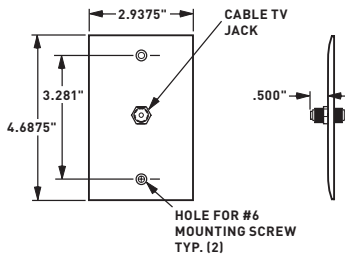

TPCATV

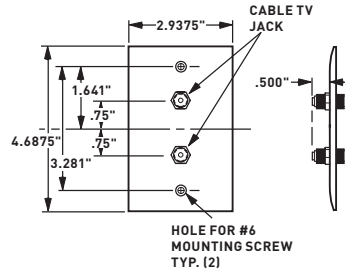

TPCATV2

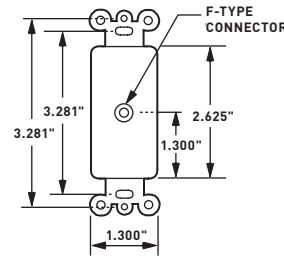

26CATV

Features

- Mar-resistant wall plate.
- Fits standard size single gang electrical box.
- Wall plate dimension is Standard size.
- Nickel-plated steel.
- Connector is threaded at each end.

CATALOG NUMBER	COLOR	CONFIGURATION	3rd PARTY COMPLIANCE UL1863
"F" TYPE WITH ONE COAXIAL CONNECTOR & WALL PLATE, SINGLE GANG			
TPCATVI	Ivory	F-type COAX Connector	•
TPCATVW	White	F-type COAX Connector	•
TPCATV	Brown	F-type COAX Connector	•
TPCATVBK	Black	F-type COAX Connector	•
TPCATVLA	Light Almond	F-type COAX Connector	•
"F" TYPE WITH TWO COAXIAL CONNECTORS & WALL PLATE, SINGLE GANG			
TPCATV2I	Ivory	2 F-type COAX Connectors	•
TPCATV2W	White	2 F-type COAX Connectors	•
TPCATV2	Brown	2 F-type COAX Connectors	•
TPCATV2BK	Black	2 F-type COAX Connectors	•
TPCATV2LA	Light Almond	2 F-type COAX Connectors	•

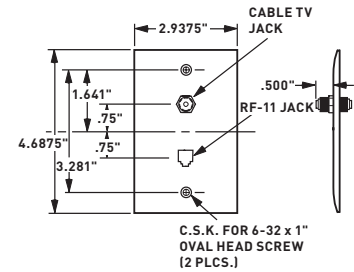

TPELTV

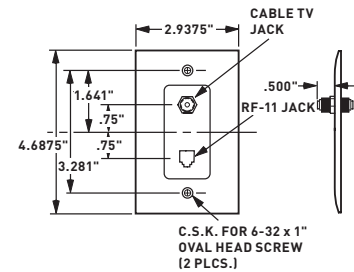

26TELTVC10

Features

- Decorator outline.
- Face constructed of high-impact thermoplastic.
- Zinc-plated steel strap.
- Nickel-plated "F" type connector.
- Threaded on each end.

CATALOG NUMBER	COLOR	CONFIGURATION	3rd PARTY COMPLIANCE UL1863
DECORATOR "F" TYPE COAXIAL CONNECTOR SINGLE GANG WITH 1 COAX CONNECTOR			
26CATVI	Ivory	F-type COAX Connector	•
26CATVW	White	F-type COAX Connector	•
26CATVLA	Light Almond	F-type COAX Connector	•

Features









- Decorator outline.
- RJ11 modular jack.
- Face constructed of high-impact thermoplastic.
- Zinc-plated steel strap.
- Nickel-plated "F" type connector.
- Threaded on each end.

CATALOG NUMBER	COLOR	CONFIGURATION	3rd PARTY COMPLIANCE UL1863
COMBINATION COAXIAL CONNECTOR & TELEPHONE JACK			
TPELTVI	Ivory		•
TPELTVW	White	F-type COAX Connector with	•
TPELTV	Brown	4 Conductor RJ-11 jack	•
TPELTVBK	Black		•
TPELTVLA	Light Almond		•
26TELTVIC10	Ivory	Same as TPELTV with	•
26TELTVC10	White	one-piece molded plate	•
26TELTVLACC10	Light Almond	Decorator outline.	•

These products listed to UL514, Cover Plates for Flush-Mounted Wiring Devices, CSA Certified.

WALL PLATES

Communication Plates Standard Size Plastic & Metal

DESCRIPTION	COLOR	NYLON	THERMOSET	METAL	
		TRADEMASTER® PLATES	SMOOTH	MATERIAL	SMOOTH
TELEPHONE OR CABLE OUTLET 13/32" HOLE, BOX MOUNTED					
 One Gang 1 Outlet (Metal plates have removable 13/32" I.D. grommet in 17/32" hole.)	Ivory	TP11I	SP11I	Brass	SB11
	White	TP11W	SP11W	302/304 S/S	SS11
	Brown	TP11	SP11		
	Gray	TP11GRY			
	Black	TP11BK			
	Red	TP11RED			
	Light Almond	TP11LA			
 Two Gang 2 Outlets	Ivory		SP21I		
	White		SP21W		
	Gray		SP21GRY	302/304 S/S	SS21
TELEPHONE OR CABLE OUTLET 13/32" HOLE, STRAP MOUNTED, WITH ADJUSTMENT YOKE					
 One Gang 1 Outlet, 1 #340 Yoke (Metal plates have removable 13/32" I.D. grommet in 17/32" hole.)	Ivory	TP12I	SP12I	Brass	SB12
	White	TP12W	SP12W		
	Brown	TP12	SP12	430S/S	SL12
	Gray	TP12GRY		302/304 S/S	SS12
	Black	TP12BK		SP12BK	
	Red	TP12RED		SP12RED	
	Light Almond	TP12LA	SP12LA		
 Two Gang 2 Outlets				302/304 S/S	SS22
				302/304 S/S Painted Ivory	SS22I
				302/304 S/S Painted White	SS22W
				302/304 S/S Painted Gray	SS22GRY
TELEPHONE OR CABLE OUTLET 5/8" HOLE, STRAP MOUNTED					
 One Gang 1 Outlet 1 #340 Yoke (Metal plates have removable 13/32" I.D. grommet in 17/32" hole.)				302/304 S/S	SS730
TELEPHONE OR CABLE OUTLET 13/32" HOLE WITH KNOCKOUT, STRAP MOUNTED					
 One Gang 1 Outlet 1 #340 Yoke	Ivory		SP732I		
	Brown		SP732		
	Gray		SP732GRY		
TELEPHONE OR CABLE OUTLET 5/8" ID, BOX MOUNTED					
 One Gang 1 Outlet	Ivory	TP60I	SP60I		
	White	TP60W	SP60W		
	Light Almond	TP60LA	SP60LA		
TELEPHONE OR CABLE OUTLET 11/4" HOLE, STRAP MOUNTED					
 One Gang 1 Outlet Supplied With #340 Yoke				302/304 S/S	SS736