

CATALOG



Wiremold®
WIRE & CABLE MANAGEMENT

2013

designed to be better.™

 **legrand®**

TABLE OF CONTENTS



REFERENCE

Using The Wiremold Catalog
After Table of Contents

Sustainability
After Table of Contents

New Products
After Table of Contents

Index
p.693

Warranty Information
Inside Back Cover

Trademarks
Inside Back Cover



AUDIO/VIDEO COMPATIBILITY

1

Legrand AVIP Device Plates
p.2

Wiremold® A/V
Quick Selection Guide
p.6



COMMUNICATIONS CONNECTIVITY

15

Ortronics® Connectivity
p.16

Wiremold Open System
Connectivity
p.16

CM Series™
Communication Modules
p.17



STEEL SURFACE RACEWAY SYSTEMS

21

Quick Selection Guide
p.23

One-Piece Raceways
500® & 700® Series Raceway
p.24

Two-Piece Small Single- & Dual-Channel Raceways
2000® Series Raceway
p.34

2400 Series™ Raceway
p.38
2400D Series™ Raceway
p.44

3000® Series Raceway
p.50

4000® Designer Series Raceway
DS4000® Raceway
p.56

Two-Piece Large Multiple Channel Raceways
4000® Series Raceway
p.61

4047 Series™ Device Plates
p.67
S4000® Series Raceway
p.72
6000® Series Raceway
p.79

Multi-Compartment Surface Metal Raceway
AnySize™ Raceway
p.84

TABLE OF CONTENTS

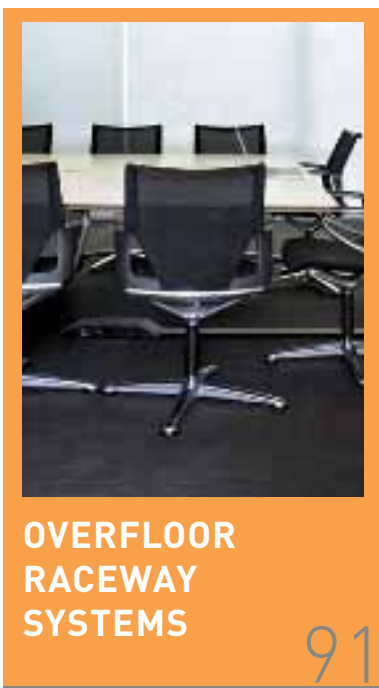

OVERFLOOR RACEWAY SYSTEMS

91

Quick Selection Guide
p.93

Multiple-Channel Overfloor Raceway
OFR Series™ Overfloor Raceway
p.94

Overfloor Raceway
1500 Series™ Raceway
p.98
2600 Series™ Raceway
p.102

Nonmetallic Pancake Overfloor Raceway
1200/1400/1600 Series™ Raceway
p.105



NONMETALLIC SURFACE RACEWAY SYSTEMS

107

Quick Selection Guide
p.109

Low Voltage Single-Channel Raceways
Uniduct® 2700, 2800, & 2900 Series Raceways
p.111

Power-Rated Single- & Dual-Channel Raceways
Eclipse™ PN03, PN05, & PN05 Series Raceways
p.119
400, 800, 2300/2300D Series™ Raceways
p.124

Large Capacity Multiple-Channel Raceways
Access® 5000 Raceway
p.133
CableSmart® 40N Series Raceway
p.139
5400 Series™ Raceway
p.142
5500 Series™ Raceway
p.149
5507 Series™ Faceplates
p.154

Hide Cord Raceway
300 Series™ Duct
p.157

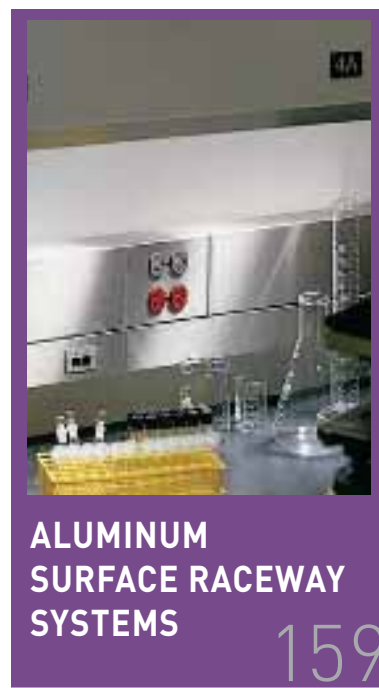

ALUMINUM SURFACE RACEWAY SYSTEMS

159

Quick Selection Guide
p.160

Small Single- & Dual-Channel Raceways
AL2000 Series™ Raceway
p.162
AL2400 Series™ Raceway
p.166
AL3300 Series™ Raceway
p.169

4000® Designer Series Raceway
ALDS4000™ Raceway
p.173

Large Single- & Dual-Channel Raceways
ALA3800 Series™ Raceway
p.177
ALA4800 Series™ Raceway
p.181
AL5200 Series™ Raceway
p.185

TABLE OF CONTENTS



PREWIRED RACEWAY SYSTEMS 191

Why Prewired
p.194

Single Channel, Single Cover Aluminum Raceway Systems
AL3000 Series™ Raceway p.202
ALA3800 Series™ Raceway p.203

Single/Dual Channel, Single Cover Aluminum Raceway Systems
AL3300 Series™ Raceway p.205
AL4000 Series™ Raceway p.207
AL4400 Series™ Raceway p.209
AL4750 Series™ Raceway p.211

Dual Channel, Dual Cover Aluminum Raceway Systems
AL4320 Series™ Raceway p.213
AL4520 Series™ Raceway p.215
ALA4800 Series™ Raceway p.217
ALDS4000 Series™ Raceway p.219

Three Channel, Dual Cover Aluminum Raceway Systems

AL7320 Series™ Raceway p.221
AL7450 Series™ Raceway p.223

Prewired Steel Raceway Systems
3000® Series™, 4000® Series, DS4000® & 6000® Series Raceways p.225

Prewired Nonmetallic Raceway Systems
CableSmart™ 40N2 Series, 5400 Series™ & 5500 Series™ Raceways p.227

Prewired Select Series™ Raceways
p.229



SPECIALTY RACEWAYS & ACCESSORIES 231

Quick Selection Guide
p.232

SpecMate Wireway & Enclosures
p.233

WallSource™ Multiple Service Box
p.250



PLUGMOLD® MULTIOUTLET SYSTEMS 253

Plugmold® Steel Multioutlet Systems
2000 Series™ Multioutlet System p.256
2400 Series™ Multioutlet System p.262

Plugmold® Plus Nonmetallic Multioutlet Systems
NM2000 Series™ Multioutlet System p.267

Plugmold® Aluminum Multioutlet Systems
AL2000 Series™ Multioutlet System p.272

Plugmold® Tamper-Resistant Multioutlet Systems
2000TR Series™ Multioutlet System p.276

adorne™ Under-Cabinet Lighting System
p.279

TABLE OF CONTENTS



POKE-THRU DEVICES

285

Quick Selection Guide
p.287

**Recessed Style
Poke-Thru Devices**
Evolution™ 6AT Series
Poke-Thru Devices
p.291
Evolution™ 8AT Series
Poke-Thru Devices
p.299

**Surface Style
Poke-Thru Devices**
RC7 Series™
Poke-Thru Devices
p.306
RC9 Series™
Poke-Thru Devices
p.308
RC9AMD Series™
Poke-Thru Devices
p.310
AMD8 Series™
Poke-Thru Devices
p.312
AV3 Series™
Poke-Thru Devices
p.314
RC4 Series™
Poke-Thru Devices
p.316
RC3 Series™
Poke-Thru Devices
p.318

Furniture Feed Style Poke-Thru Devices

4FFATC Series™
Poke-Thru Devices
p.320
RC7AFFTC Series™
Poke-Thru Devices
p.322
RC9AFFTC Series™
Poke-Thru Devices
p.324
RC9AM2TC Series™
Poke-Thru Devices
p.326

Pedestal Style Poke-Thru Devices

Fit Series™
Poke-Thru Devices
p.328
RC91GHBTC & RC92GHBTC
Series™ Poke-Thru Devices
p.331



FLOOR BOX SYSTEMS

335

Quick Selection Guide
p.338

Evolution™ Series
Floor Boxes
p.344
Fire Classified Floor Boxes
p.360

FloorPort™ Series Cover
Assemblies
p.371, 397
Ratchet-Pro™ Series Round
Floor Boxes
p.380
Modulink™ 880MP Series
Floor Boxes
p.387
Resource RFB® Series
Floor Boxes
p.394
Omnibox™ Series
Floor Boxes
p.420
880 Series™ Floor Boxes
p.432
800 Series™ Floor Boxes
p.436
800W Series™ Floor Boxes
p.438
861 Series™ Floor Boxes
p.446
862 Series™ Floor Boxes
p.449
863 Series™ Floor Boxes
p.451
WMFB Series™ Floor Boxes
p.453

FloorSource™ Raised Floor Boxes

AF Series™ Raised
Floor Boxes
p.456
AC Series™ Raised
Floor Boxes
p.463
CRFB Series™ Raised
Floor Boxes
p.468
CCFB Series™
Convention Center
Series™ Products
p.473
CCBB Series Ballroom
Floor Boxes
p.477

TABLE OF CONTENTS



SERVICE FITTINGS & ACTIVATION ACCESSORIES **483**

Quick Selection Guide **p.485**

525 Series™ Service Fittings **p.486**

1200 Series™ Service Fittings

p.489

Multiplex™ Service Fittings **p.490**

525 & Multiplex Series™ Activation Accessories **p.492**

Source 1® Series Service Fittings **p.494**

FloorPort™ Series Cover Assemblies **p.498**

Walkerduct® Flush Poke-Thru Style Service Fittings

PSRC9 Series™ Service Fittings **p.501**

Walkerduct® Pro Series Service Fittings **p.503**



INFLOOR DUCT SYSTEMS **511**

Quick Selection Guide **p.513**

Walkerduct® Underfloor Duct Systems **p.516**

Walkerduct® Carpet/Tile Holders **p.528**

Flushduct Infloor Duct Systems **p.531**

Wallduct Raceway Systems **p.536**

Trenchduct Feeder Systems **p.543**

Walkercell® Cellular Raceway Systems **p.547**



MODULAR WIRING SOLUTIONS **557**

Walkerflex® Modular Wiring System **p.558**



VERTICAL SOLUTIONS **575**

Quick Selection Guide **p.577**

Vista™ Architectural Columns **p.579**

Vista CP™ Consolidation Point **p.586**

TABLE OF CONTENTS

Vista Point5™
Architectural Columns
p.593
Tele-Power® Poles
p.599
Vertical Drop Poles
p.607
Custom Tele-Power® Poles
p.610



Quick Selection Guide
p.607

Power Distribution Units for Data Centers

Power Commander®
IQ Units
p.616
Power Commander®
Plus Units
p.619
Power Commander® Series
High Amperage Units
p.622
Meter Reader™ Series
Current Monitoring Devices
p.624
Cabinet Power Solutions
CabinetMATE® Series
Surge Protected
p.625

CabinetMATE® Series
Power Only
p.627
Rack Mounted Power Solutions
Surge Protected Products
p.628
Power Only Products 15
Amp, 20 Amp
p.629

Workstation Power Solutions

Surge Protected Plug-In
Outlet Center® Units
p.631
Power Only Plug-In Outlet
Center® Units
p.633

Hard Wired Surge Protection

ZoneMaster®/ZoneSentinel®
Series
p.638
ZoneDefender Pro Series
p.640
PA/PB™ Series
p.641

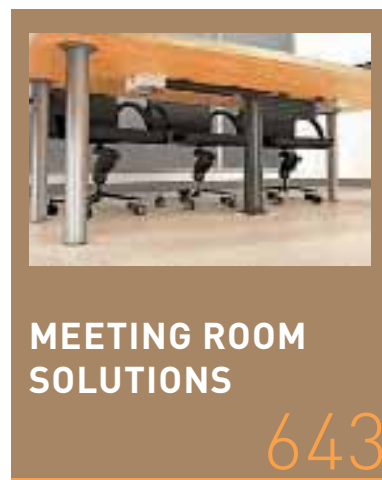

Quick Selection Guide

p.645
Under Table
Cable Management
p.646
Meeting Room
Transition Channel
p.647
Work Surface
Modular Power
p.648
Evolution™ Series
Work Surface Portals
p.652
deQuorum™ Recessed
Work Surface Portals
p.655
deQuorum™ Flip-Up
Work Surface Portals
p.658
TableSource™ Work Surface
Portals
p.660
Lab Bench Work Surface
Portals
p.663
Desktop Power Center
Work Surface Portals
p.666
Desk Module
Work Surface Portal
p.667

TABLE OF CONTENTS



FIRE STOP SOLUTIONS

669

FlameStopper™ Series
Thru-Wall & Thru-Floor
Fittings
p.671



WIRELESS & ZONE CABLING SOLUTIONS

673

Wireless Enclosures
VLWAP Vista™ Wireless
Access Point Enclosure
p.675
WAPE Series Wireless
Access Point Ceiling
Enclosures
p.676
WAPENCL Series Wireless
Access Point Ceiling
Enclosures
p.678
NME1250AP Wall-Mounted
Nonmetallic Wireless
Access Point Enclosure
p.679
WAPBRKT Wireless Access
Point Mounting Bracket for
Overhead Applications
p.680

Zone Cabling Enclosures
CZE Series Zone Cabling
Enclosures
p.681
RFE Series Zone Cabling
Enclosures
p.682



TECHNICAL SELECTION

683

Raceway Cross-Sectional
Areas/Wire & Cable
Cross-Sectional Areas
p.684
Raceway Wire & Cable
Dimensions
p.685
Device Box Cubic Inch
Capacities
p.686
Calculating Wire & Cable
Capacities
p.687
Master Format 2004
Design Checklist
p.688
Conductor Derating
(Lighting & Power Circuits)
National Electrical Code
Articles
p.689
Mounting Methods for
Wiremold Raceways
p.690
Electrical Symbols in
Accordance with ANSI
Y32.9-1972
p.691
Steel Raceway
Color Specifications
p.692

WELCOME

Using the Wiremold Catalog

Color Coding:

Color coding has been used throughout the Catalog including in the Table of Contents and on the outside edge of the pages of each section to help you quickly access the products or information you need. A color key to the sections can also be found on the right side of this page.

Organization:

Sections of this catalog have been reorganized to give you faster access to key information about our products. System layouts, wire fill capacity charts and UL Code Reference information is located on the beginning pages of each product section.

New Products:

The newest Wiremold product innovations are featured in the New Products section. You'll find color photos and information on where these products are located in the Catalog.

Product Guide Available Online:

The Wiremold Catalog is also available online. With all the same information as the print version, the online Catalog is fully searchable and easy to use. You can access the online catalog at: www.legrand.us/wiremold and then click on the link for the Online Catalog.

Code Reference Information:

UL Code Reference information for each product line is indicated at the beginning of the product section (see example on right).

CODE REFERENCE

cTUVus Listed:
File 30783215.002 EN60950-1

Color Information:

Color swatches (see sample below) for each product line are shown at the beginning of the product section. Each part number listing also shows all the available color versions for that part. Information on how the color values were developed can be found in the Technical Section.

COLOR OPTIONS



500 and 700 Series Raceway Part Numbers with a "V" prefix have an ivory finish. Part Numbers with a "-WH" suffix have a white finish.

Product Sections are identified throughout the Catalog with the following color coding:

	AUDIO/VIDEO COMPATIBILITY
	COMMUNICATIONS CONNECTIVITY
	STEEL SURFACE RACEWAY SYSTEMS
	OVERFLOOR RACEWAY SYSTEMS
	NONMETALLIC SURFACE RACEWAY SYSTEMS
	ALUMINUM SURFACE RACEWAY SYSTEMS
	PREWIRED RACEWAY SYSTEMS
	SPECIALTY RACEWAYS & ACCESSORIES
	PLUGMOLD® MULTIOUTLET SYSTEMS
	POKE-THRU DEVICES
	FLOOR BOX SYSTEMS
	SERVICE FITTINGS & ACTIVATION ACCESSORIES
	INFLOOR DUCT SYSTEMS
	MODULAR WIRING SOLUTIONS
	VERTICAL SOLUTIONS
	POWER DISTRIBUTION & SURGE PROTECTIVE DEVICES
	WORK SURFACE SOLUTIONS
	FIRE STOP SOLUTIONS
	WIRELESS & ZONE CABLING SOLUTIONS
	TECHNICAL INFORMATION

LEGRAND SUSTAINABILITY

Legrand has made a commitment to the path of sustainability. As such we are making an ongoing effort to understand and responsibly address the intersection of social, environmental and economic issues in the course of conducting our business. Sustainability serves as a new lens through which we are assessing the impact of our operations, the expectations of our customers, employees and other key stakeholders, and the role of our products and solutions. Like many companies we see sustainability as a journey of discovery and innovation. We are sharing our learning and experience as we progress on this path. Visit www.legrand.us/sustainability to access useful tools to fulfill your own sustainability journey.

A Global Sustainable Development Framework

Legrand North America is part of the Legrand Group, a global organization that operates in over 170 countries. The Legrand Group has developed an overall framework to sustainability that is organized into three key areas - social responsibility, environment and governance, which are defined below. The approach to sustainability in North America is aligned with this global framework – and adapted as appropriate and relevant to the context of the local culture and economy.

These three “pillars” serve as the organizing principle for our actions. They express our intention toward continuous improvement in our approach to sustainability. We have initiatives underway in each area and are actively exploring others. We are working to ensure that our sustainability commitment translates into greater benefits and tangible value for our customers, business partners, employees and the broader communities in which we operate.



Social

Promote the welfare and development of our employees and communities in which we operate and serve, and apply our technology and products to meet social needs.

Environment

Advance environmental stewardship at every stage of business from product design, manufacturing, distribution, marketing and delivery of products that promote clean and efficient energy.

Governance

Ensure Legrand employees all over the world adhere to our stated principles, values and standards; seek out and work with suppliers who operate in a manner consistent with these commitments.



The FSC certified paper used to print this catalog is Consoweb® Gloss, which is made from 10% post-consumer recycled paper. Over 246,000 pounds of paper were used to produce this catalog, and by substituting Consoweb Gloss for standard gloss paper, the following savings were realized:

- Wood Use – Post consumer content means a savings of more than 72 tons of wood.
- Greenhouse Gases – Eliminated more than 850 pounds of greenhouse gases vs. conventional paper production.
- Water – Saved more than 200,000 gallons of wastewater vs. water used to produce conventional paper.
- Solid Waste – 3000 pounds less solid waste was generated during papermaking that won't need to be landfilled.*

Achieving these savings was a team effort:

Lindenmeyr Munroe – a leading paper broker.

NewPage Corporation – Manufacturer of Consoweb Gloss and other quality printing papers with certified and recycled options.

Quad/Graphics – Catalog printer, reduced the environmental impact by using a 27.3% renewable content (soy) ink.

The result is a catalog that significantly reduces environmental impacts without compromising quality. It's the way Legrand approaches sustainability across the entire company and its many products.

*Source: Environmental Paper Network Online Paper Calculator. FSC® is not responsible for the savings calculations by using this paper.

NEW PRODUCTS

Wire & Cable Management



Wiremold® New Products are the results of years of engineering, design, innovation, listening to our customers, and our constant focus on improving or developing the best wire and cable management solutions available. These products provide users and installers with enhanced ease of use, respond to the constantly changing needs of the marketplace...both today and tomorrow, reduce installation times while providing more features, functionality, and capacity, with the reliability and durability you've come to expect from Wiremold products.



NEW PRODUCTS

Wire & Cable Management

adorne™ Under-Cabinet Lighting System

Page 279

adorne™ Under-Cabinet Lighting System is a fully customizable and modular solution for eliminating kitchen clutter. It is compatible with any kitchen layout, such as a galley, L-shaped, or U-shaped, as well as with any home wiring.

The adorne Under-Cabinet Lighting System brings an array of modular components that swap out so easily, you'll want to reconfigure whenever the mood strikes. From speakers and smart phone docks to lighting and outlets, there's a world of possibilities to choose from with these high-tech, highly convenient building blocks.

Visit www.adornemyhome.com to use the Under-Cabinet System Planning and Configuration Tool



LED Puck Lighting



Power Control Boxes



LED Linear Lighting



Digital Music Kit with Bluetooth® connectivity



Modular Track – in multiple lengths



Interchangeable Modules

Meeting Room Transition Channel

Page 647

Wiremold® Meeting Room Transition Channel (MRTC) is an integral component in a "last meter" solution for bringing power and technology closer to the user's work area.

- **Easy to order.** Kit consists of aluminum center spine with steel mounting plate and four (4) screws, black aluminum side channels, black nonmetallic bottom boot and two (2) black nonmetallic transition covers.
- **Easy to install.** Telescoping design accommodates installations between 26" and 30" in height to fit most standard table configurations.
- **Flexible feed options.** Boot allows for easy access to floor connections from floor boxes, poke-thru devices, overfloor raceway or other wiring sources.
- **Transition covers allow for seamless integration** with Wiremold Under Table Cable Management solution.
- **Multiple channels.** Allow separate channels to feed power, communication or A/V services to the work surface.



NEW PRODUCTS

Wire & Cable Management

Under Table Cable Management

Page 646

Wiremold® Under Table Cable management (UTCM) organizes and retains cables, while allowing ready access to these services without the cords and cables getting in the way.

- **Easy to order.** Offered in convenient kits with everything you need to complete your install. UTCM kits include: 5' of base, 5' of mounting hinge rail and four (4) latching clips.
- **Easy to install.** Adapts to underside of table and requires no special tools.
- **Easy to maintain.** Future technology upgrades or room reconfigurations are completed with the least disruptions using tray that opens with the push of a clip and manages cables with designed-in cable retaining dividers.
- **Adds to overall room aesthetics.** Keeps meeting rooms free from tangled cords and cables.
- **Field modifiable.** Tray is simple to cut to length to accommodate table length.

Use with the Meeting Room Transition Channel for an integrated cable management solution.



Work Surface Modular Power

Page 648

Wiremold® Work Surface Modular Power Kits make rearranging meeting rooms fast, easy, and safe.

- **Ease of Installation.** Standard kits for both 5' and 6' long tables contain everything needed for installation.
- **Flexible design.** Rearranging a room layout is as easy as unplugging tables, re-positioning and then plugging tables back together.
- **Power Capacity.** Two circuit wiring means that a total of 10 enhanced portals can be fed from each feed source (5 per circuit), or 20 standard portals (10 per circuit).
- **Multi-service integrated solution.** In addition to power, work surface portals have openings for RJ45 network connections.
- **Ultimate flexibility.** Non-sequential system allows moving tables around without the need to conform to a color code or numbering sequence.
- **Adapts to a variety of popular cable management systems.** Quick disconnect inserts allow system feed from OFR Series Overfloor Raceway, 2400 Series Raceway, WallSource Multiple Service Boxes, 8" Evolution Series Poke-Thru Devices, Floor Boxes or existing wall outlets.
- **UL Listed.** System is listed to CSA and UL183, Manufactured Wiring Systems.



NEW PRODUCTS

Wire & Cable Management

Desk Module

Page 667

Wiremold® Desk Module upgrades workstations to well connected spaces so users can focus on the business at hand.

- **Easy to install.** Designed to fit into existing 2 3/8" – 3 1/8" core hole in desktop with clip system that secures unit to the work surface.
- **Multiple connection options.** Two models provide desktop access to power, USB connectivity and charging, and RJ45 connectivity.
- **Convenient cable management.** RJ45 and USB retractor options provide cable management under the work surface for connecting cables.



Medical Grade Plug-In Outlet Center Units

Page 637

Wiremold® ULM Series Medical Grade Plug-in Outlet Centers (PIOCs) offer medical professionals quick and flexible power delivery solutions for demanding patient care environments.

- **Safety Certified by TUV Rheinland as Medical Electrical Devices.** For use in patient care areas in compliance with Article 517 of the National Electrical Code (NEC)¹. Allows maximum flexibility when powering patient care equipment.
- **Redundant bonding.** Assures an ultra reliable grounding path is provided. Proper grounding of medical equipment is essential for patient wellbeing.
- **Rugged aluminum housing.** Durable housing withstands the rigors of the healthcare environment assuring long service life.
- **Pass & Seymour® Hospital Grade Receptacles.** Superior quality Pass & Seymour receptacles ensure reliable connections and long life.
- **Available in both 15A & 20A configurations.** 20A configuration meets the ever increasing power demands of medical equipment. Expand your capabilities without having to expand your infrastructure.



¹ As with all Medical Electrical Devices, Wiremold ULM Series of PIOCs should only be used under the direction and supervision of your local Health & Safety Officer.

NEW PRODUCTS

Wire & Cable Management

Ratchet-Pro™ Series Floor Boxes

Page 380

Wiremold® Ratchet-Pro™ Series Floor Boxes now are available in nonmetallic and steel versions that provide single- and dual-service capability in a variety of easy-to-install round floor boxes. These designs allow the flexibility for providing power, A/V or communication services to open-space areas in an aesthetic solution. Ratchet-Pro™ Series Floor Boxes are cULus Listed for use in both on grade and above grade concrete construction.

- **Slab-on-grade versions.** Boxes offered in PVC and steel with a special fusion bonded epoxy corrosion resistant paint, enables the boxes to be installed in on-grade applications without the need for additional vapor barriers.
- **Ratchet adjusting ring.** Allows for quick and easy installation without gluing, as well as removal of cover to activate at a future date for dual service. 10° of flexible adjustment allows cover to conform to the surface of the concrete pour, which significantly reduces labor costs.
- **Multiple size conduit feeds.** Conduit feed ranging from 2" to 3/4" trade size openings allow for more flexibility and capacity.
- **Individual conduit reducers & plugs.** Reduction in labor savings by providing a direct reduction to support smaller conduit feeds.

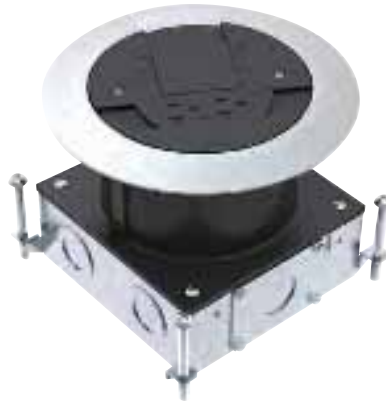

Evolution™ Series Floor Boxes

Page 344

Wiremold® Evolution™ Series Floor Boxes. The most innovative and versatile floor boxes in the industry, has just been upgraded giving more flexibility and configurable options.

- **2" conduit knockout on the bottom of the EFB6S-0G box** – for increased capacity and flexibility.
- **EFB6S-2HUB** – 2" conduit hub that can be used to deliver services to the 6-gang floor box, while maintaining a 4" deep concrete pour.
- **Molded mounting bracket** – mounting brackets are now manufactured out of a durable nonmetallic material that will allow for a more consistent and reliable assembly.
- **Installation and informational videos** – We have developed a series of videos that explain the various features of these boxes and the installation process. These videos can be found on the Legrand website and also on Youtube.

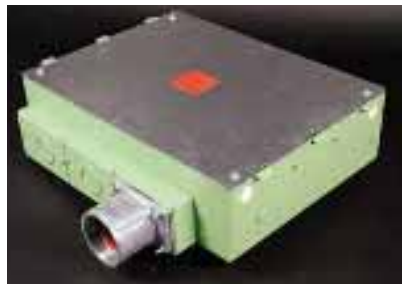

NEW PRODUCTS

Wire & Cable Management

OFR Series Overfloor Raceway

Page 94

Wiremold® OFR Series Overfloor Raceway System

provides four-channels of capacity and access to a wide range of power, communications, and A/V connectivity options in the smallest, lowest, narrowest, ADA compliant profile available in overfloor raceway systems.

- **Lowest profile overfloor raceway available.** Smaller, narrower, lower raceway profile reduces potential trip hazards while also being installer friendly to speed installations.
- **Multiple channel base.** Four-channel raceway provides space for multiple combinations of power, communication and A/V to be provided through a single raceway installation.
- **Multiple options for communication and A/V connectivity.** OFR Series Raceway accepts Wiremold Open System device plates that provide connectivity to a wide range of devices from leading communication and A/V providers.
- **Meets ADA Accessibility Guidelines.** Low profile, unobtrusive design meets the ADA Accessibility Guidelines that pertain to ADA Standard 4.5 which addresses changes in floor and ground surface levels.
- **cETLus Listed.**



NEW COMPONENTS:



OFR6



OFR10W



OFR15



OFR17



OFR89-VFL

880MP2 Nonmetallic Floor Boxes Page

387

Wiremold® Modulink™ 880 Series Nonmetallic Floor Boxes

provide power and communication services directly to the workstation or to any open space location. The Modulink Floor Box is a gangable box that allow a one-gang floor box to easily be turned into a two- or three-gang box simply by ganging together individual boxes.

- **Multiple service capability.** Eliminates the cost of a separate floor box and cover to accommodate communication service.
- **2" [51mm] conduit openings.** Provides the largest conduit feed in the industry. Meets customer requirements for greater communication cable capacity.
- **Ratchet adjusting ring.** Allows connection of cover flange without glue or mechanical fasteners. Reduces installation time and cost by providing 10° of post-pour adjustment of the cover flange.
- **Conduit reducers and plugs provided.** Allows direct reduction from 2" to 1/2" [51mm to 12.7mm] conduit and all sizes in between. Reduces installation time by providing direct reduction and separate plugs by eliminating the need to cut out plugs to form reducers.
- **cULus Listed.** Listed by Underwriters Laboratories Inc. to their standard UL514A, 514C, 514D, and Canadian standard C22.2.



AUDIO/VIDEO COMPATIBILITY



For years, A/V installation has been an afterthought in the remodeling and construction of buildings, leaving integrators with the challenge of creating work-around solutions. Today, through **Wiremold**® Pathways, we are changing the way integrators work, by incorporating A/V compatibility into our broad product line from the start. Wiremold gives you

- Over 100 years of experience in pathway solutions.
- The market leader in cable management.
- The broadest product line in the industry.
- Cross-trade experience assures proper integration of power, communication, and A/V into our products.



Table of Contents

AVIP Series Device Plates

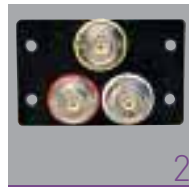

2

Wiremold® A/V Quick Selection Guide



6

Featured Products



AVIP Series Device Plates – Video

3



AVIP Series Device Plates – A/V

5

AUDIO/VIDEO COMPATIBILITY

Legrand AVIP Connectivity



Legrand audio/video interface plates (AVIP) allow for A/V connectivity in all of Wiremold's A/V compatible pathways. AVIP Series Device Plates are metal, screwed-down connectors which ensure a secure connection that will resist being pulled out or broken while in use.

From data to audio to video, Legrand AVIP device plates help you stay connected in your meetings and training rooms, collaboration spaces or work areas. Wherever your connectivity needs are, we have the device plates and pathways to get you there.



CODE REFERENCE

Please visit the individual product sections located throughout this Product Guide for specific product Code Reference information.

AVIP Series Device Plates – Computer

AV1000BK



One 15 Pin HD Female to Female, single plate. Dimensions: 2.2" x 0.7" x 0.7" [53.89mm x 17.78mm x 17.78mm].



AV4000BK



One 9 Pin HD Female to Female, single plate. Dimensions: 2.2" x 0.7" x 0.7" [53.89mm x 17.78mm x 17.78mm].



AV1002BK



One 15 Pin HD Female to Five BNC on 4" Pigtails, single plate. Dimensions: 2.2" x 0.7" x 7.25" [53.89mm x 17.78mm x 184.15mm].



AV4005BK



One USB A Female to USB A Female Adapter, single plate. Dimensions: 2.2" x 0.7" x 10" [53.89mm x 17.78mm x 254mm].



AUDIO/VIDEO COMPATIBILITY

AVIP Connectivity Ordering Information

AVIP Series Device Plates – Video

AV2002BK



One RCA Female to BNC Female Adapter, single plate. Dimensions: 2.2" x 0.7" x 1.3" [53.89mm x 17.78mm x 33.02mm].



AV2003BK



Two RCA Female to BNC Female Adapters, single plate. Dimensions: 2.2" x 0.7" x 1.3" [53.89mm x 17.78mm x 33.02mm].

AV5002BK



Three BNC Female to BNC Female Barrels, double plates. Dimensions: 2.2" x 1.4" x 1.3" [53.89mm x 35.56mm x 33.02mm].



AV3000BK



One HDMI Female to One HDMI Female on 10" pigtail, single plate. Dimensions: 2.2" x 0.7" x 10" [53.89mm x 17.78mm x 254mm].



AV5004BK



One Display Port Female to One Display Port Female on 10" Pigtail, single plate. Dimensions: 2.2" x 0.7" x 10" [53.89mm x 17.78mm x 254mm].



AV5000BK



One BNC Female to Female Barrel, single plate. Dimensions: 2.2" x 0.7" x 1.3" [53.89mm x 17.78mm x 33.02mm].



AV5001BK



Two BNC Female to Female Barrels, single plate. Dimensions: 2.2" x 0.7" x 1.3" [53.89mm x 17.78mm x 33.02mm].



AV9010BK



One F-Connector Female to Female Barrel, single plate. Dimensions: 2.2" x 0.7" x 0.7" [53.89mm x 17.78mm x 17.78mm].



AUDIO/VIDEO COMPATIBILITY

Legrand AVIP Connectivity Ordering Information

AVIP Series Device Plates – Audio

AV6001BK



Two RCA Female to Solder Cups, single plate. Dimensions: 2.2" x 0.7" x 0.9" [53.89mm x 17.78mm x 33.86mm].



AV8008BK



One XLR 3-pin Male to Solder Cups, double plates. Dimensions: 2.2" x 1.4" x 1.1" [53.89mm x 35.56mm x 27.94mm].



AV7000BK



One 1/4" Stereo Phone Female to Solder Tabs, single plate. Dimensions: 2.2" x 0.7" x 1.4" [53.89mm x 17.78mm x 35.56mm].



AV8009BK



One XLR 3-pin Female to Solder Cups, double plates. Dimensions: 2.2" x 1.4" x 1.6" [53.89mm x 35.56mm x 40.64mm].



AV7004BK



One 3.5mm Stereo Mini Jack to Solder Tabs, single plate. Dimensions: 2.2" x 0.7" x 0.75" [53.89mm x 17.78mm x 19.04mm].



AV8010BK



One Mini XLR 3-pin Male to Solder Cups, single plate. Dimensions: 2.2" x 0.7" x 0.7" [53.89mm x 17.78mm x 17.78mm].



AV7005BK



One 3.5mm Stereo Mini Jack to Captive Screw Term, single plate. Dimensions: 2.2" x 0.7" x 1.2" [53.89mm x 35.56mm x 30.48mm].



AV9016BK



One XLR Pane Mount Plate (accepts D-Size Connectors), double plates. Dimensions: 2.2" x 1.4" [53.89mm x 35.56mm].

AUDIO/VIDEO COMPATIBILITY

Legrand AVIP Connectivity Ordering Information

AVIP Series Device Plates – Audio/Video

AV2004BK



One RCA Female to BNC Female Adapter, one 3.5mm Stereo Mini Jack to Solder Tabs, single plate. Dimensions: 2.2" x 0.7" x 1.3" [53.89mm x 17.78mm x 33.02mm].



AV5005BK



One DVI Female to one DVI Female on 10" [254mm] pigtail, with 3.5mm Stereo to Solder Tabs, triple plates. Dimensions: 2.2" x 2.1" x 10" [53.89mm x 53.34mm x 254mm].



AVIP Series Device Plates – Data

AV9008BK



One Keystone Jack Plate, single plate. Dimensions: 2.2" x 0.7" [53.89mm x 17.78mm].

AV9015BK



One Keystone CAT6 Jack Plate, single plate. Dimensions: 2.2" x 1.7" x 1.2" [53.89mm x 17.78mm x 30.48mm].



AVIP Series Device Plates – Accessories

AV9003BK



Blank Plate-Single, single plate. Dimensions: 2.2" x 0.7" [53.89mm x 17.78mm].

AV9004BK



Blank Plate-Double, double plates. Dimensions: 2.2" x 1.4" [53.89mm x 35.56mm].

AV9012BK



Cable Kit, 4 Openings (2 small & 2 large), triple plates. Dimensions: 2.2" x 2.1" [53.89mm x 53.34mm].

AV9014BK



Cable Kit, 8 Openings (4 small & 4 large), quintuple plates. Dimensions: 2.2" x 3.5" [53.89mm x 88.90mm].

AUDIO/VIDEO COMPATIBILITY

Quick Selection Guide

FLOOR BOXES

Product Line	Compatible A/V Device Plates
--------------	------------------------------

Evolution™ Series

EFB6S Series



EFB-AAP
Device Plate with Extron® Electronics AAP opening.

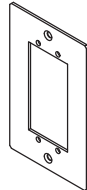

EFB-MAAP
Device Plate with GFCI or decorator style opening for open A/V devices such as Legrand AVIP or Extron® Electronics, Crestron® and Atinex® Intera.

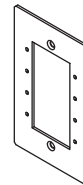

EFB8S Series



EFB-AAP
Device Plate with Extron® Electronics AAP opening.

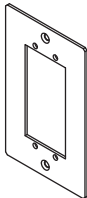

EFB-MAAP
Device Plate with GFCI or decorator style opening for open A/V devices such as Legrand AVIP or Extron® Electronics, Crestron® and Atinex® Intera.

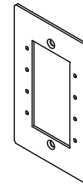

EFB10S Series



EFB10-DEC
For use with decorator style GFCI and A/V devices.

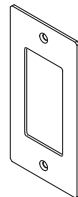

EFB10-AAP
Device Plate holds 2 Extron® Electronics AAP devices.

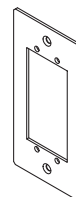

EFB10-MAAP
Device Plate holds 4 Legrand AVIP or Extron® Electronics MAAP devices.

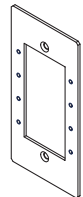

Resource RFB® Series

RFB2 Series

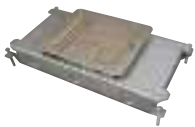

RFB2-AAP
Device Plate with Extron® Electronics AAP opening.

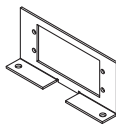

RFB2EXT
Device Plate with Legrand AVIP or Extron® Electronics MAAP opening.

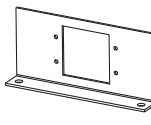

RFB2GFI
Device Plate with GFCI or decorator style opening for open A/V devices such as Extron® Electronics, Crestron® and Atinex® Intera.

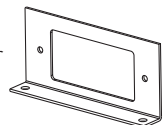

RFB2RT
Device Plate with bracket that accepts Ortronics® Series II Devices.

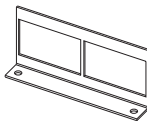

RFB4 Series

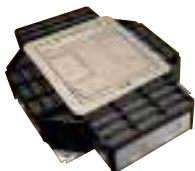

RFB4-SS-MAAP
Shallow Device Plate with Legrand AVIP or Extron® Electronics MAAP opening.

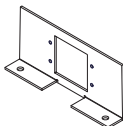

RFB4-GFI-4DB
Device Plate with GFCI or decorator style opening for open A/V devices such as Extron® Electronics, Crestron® and Atinex® Intera.

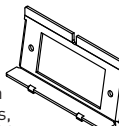

WTB-AAP
Device Plate with Extron® Electronics AAP opening.

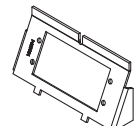

RFB4-SS-AAP
Shallow Device Plate with Extron® Electronics AAP opening.

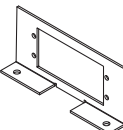

WTB-MAAP
Device Plate with Legrand AVIP or Extron® Electronics MAAP opening.

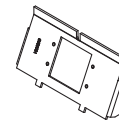

RFB-GFI-SS
Shallow Device Plate with GFCI or decorator style opening for open A/V devices such as Extron® Electronics, Crestron® and Atinex® Intera.

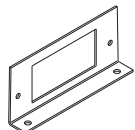

NOTE: Wiremold manufactures many additional pathway solutions. Those represented here have been designed/modified to provide the depth behind the plate required for most A/V devices. For additional design and installation considerations, please contact the factory.

AUDIO/VIDEO COMPATIBILITY

Quick Selection Guide



FLOOR BOXES

Product Line	Compatible A/V Device Plates
--------------	------------------------------

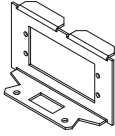
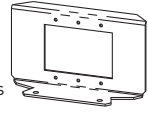
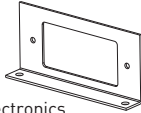
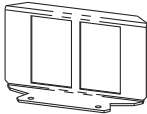
Resource RFB® Series

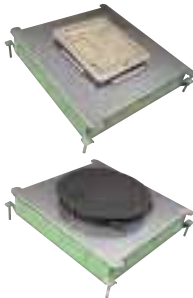
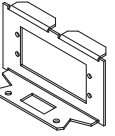
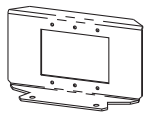
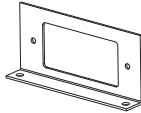
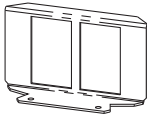
<p>RFB4E Series</p> 	<p>RFB6-AAP Device Plate with Extron® Electronics AAP opening.</p> 	<p>RFB6EXT Device Plate accepts three (3) Legrand AVIP or Extron® Electronics MAAP Devices.</p> 	<p>RFB6GFI Device Plate with GFCI or decorator style opening for open A/V devices such as Extron® Electronics, Crestron® and Atinex® Intera.</p> 
	<p>RFB6RT Device Plate with adapter to accept two (2) Ortronics® Series II Devices.</p> 		

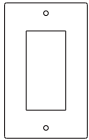
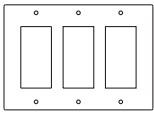
<p>RFB6, RFB6E Series</p> 	<p>RFB6-AAP Device Plate with Extron® Electronics AAP opening.</p> 	<p>RFB6EXT Device Plate accepts three (3) Legrand AVIP or Extron® Electronics MAAP Devices.</p> 	<p>RFB6GFI Device Plate with GFCI or decorator style opening for open A/V devices such as Extron® Electronics, Crestron® and Atinex® Intera.</p> 
	<p>RFB6RT Device Plate with adapter to accept two (2) Ortronics® Series II Devices.</p> 		

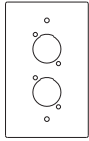
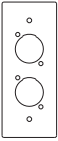
<p>RFB9 & RFB11 Series</p> 	<p>RFB119-GFI Device Plate with GFCI or decorator style opening for open A/V devices such as Extron® Electronics, Crestron® and Atinex® Intera.</p> 	<p>RFB119-3GFI Device Plate with three (3) GFCI or decorator style openings for open A/V devices such as Extron® Electronics, Crestron® and Atinex® Intera.</p> 	<p>RFB119-SGFI Device Plate with GFCI or decorator style opening for open A/V devices such as Extron® Electronics, Crestron® and Atinex® Intera.</p> 
	<p>RFB119-XLR Device Plate with two (2) openings to accept microphone devices.</p> 	<p>RFB119-SXLR Device Plate with two (2) openings to accept microphone devices.</p> 	

OmniBox™ Series

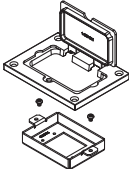
<p>828-MAAP</p> 	<p>Device Plate for mounting Legrand AVIP or Extron® Electronics MAAP Devices using 828GFI Covers. For use with 828GFITC or 828GFITCAL Cover Plates (sold separately).</p> 
--	--

880W Series™

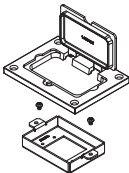
<p>828-MAAP</p> 	<p>Device Plate for mounting Legrand AVIP or Extron® Electronics MAAP Devices using 828GFI Covers. For use with 828GFITC or 828GFITCAL Cover Plates (sold separately).</p> 
--	--

NOTE: Wiremold manufactures many additional pathway solutions. Those represented here have been designed/modified to provide the depth behind the plate required for most A/V devices. For additional design and installation considerations, please contact the factory.

AUDIO/VIDEO COMPATIBILITY

Quick Selection Guide

FLOOR BOXES

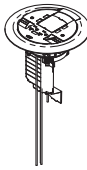
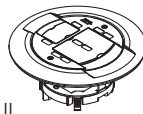
Product Line	Compatible A/V Device Plates
Ratchet-Pro™ Series	
	<p>881AV3CTCGY 881AV3CTCBK 881AV3CTCAL 881AV3CTCBS</p> <p>Floor Box Cover Kit with Legrand AVIP or Extron® Electronics MAAP and Ortronics® Series II Adapters.</p> 
	<p>881AMD8CTCGY 881AMD8CTCBK 881AMD8CTCAL 881AMD8CTCBS</p> <p>Floor Box Cover Kit with Ortronics® Series II Adapters.</p> 

RAISED FLOOR BOXES

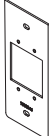
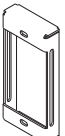
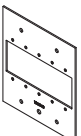
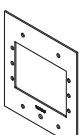
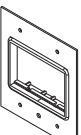
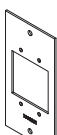
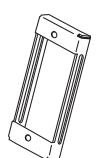
Product Line	Compatible A/V Device Plates		
FloorSource AF Series™			
	<p>SGT-MAAP Device Plate with Legrand AVIP or Extron® Electronics MAAP opening.</p> 	<p>SGT-3S2 Device Plate accepts three (3) Ortronics® Series II Devices.</p> 	<p>DGT-MAAP Device Plate with Legrand AVIP or Extron® Electronics MAAP opening.</p> 
	<p>DGT-AAP Device Plate with Extron® Electronics AAP opening.</p> 	<p>DGT-RT Device Plate includes one (1) Ortronics® Series II Adapter.</p> 	<p>SGB-MAAP Device Plate with Legrand AVIP or Extron® Electronics MAAP opening.</p> 
	<p>SGB-3S2 Device Plate accepts three (3) Ortronics® Series II Devices.</p> 		

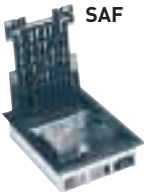
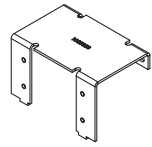
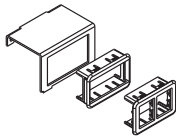
Product Line	Compatible A/V Device Plates	
FloorSource AF Series™		
	<p>SGC2-MAAP Device Plate accepts two (2) Legrand AVIP or Extron® Electronics MAAP Devices.</p> 	<p>SGC2-RT Device Plate with Adapter that accepts one (1) Ortronics® Series II Device.</p> 

AUDIO/VIDEO COMPATIBILITY

NOTE: Wiremold manufactures many additional pathway solutions. Those represented here have been designed/modified to provide the depth behind the plate required for most A/V devices. For additional design and installation considerations, please contact the factory.

AUDIO/VIDEO COMPATIBILITY

Quick Selection Guide

RAISED FLOOR BOXES

Product Line	Compatible A/V Device Plates
--------------	------------------------------

FloorSource AC Series™

	<p>C8005P-MAAP-6A Device Plate with Legrand AVIP or Extron® Electronics MAAP opening.</p>	<p>C8005P-AAP-6A Device Plate with Extron® Electronics AAP opening.</p>	<p>C8005P-RT C8005P-2RT C8005P-3RT Device Plate with Adapters for one (1), two (2), or three (3) Ortronics® Series II Devices.</p>	
	<p>C8004P-2RT Device Plate with Adapters for two (2) Ortronics® Series II Devices.</p>	<p>C10105P-MAAP-6A Device Plate with Extron® Electronics MAAP opening.</p>	<p>C10105P-AAP-6A Device Plate with Extron® Electronics AAP opening.</p>	
	<p>C10105P-3RT Device Plate with Adapters for three (3) Ortronics® Series II Devices.</p>			

FloorSource CFRB Series™

	<p>CRFB-MAAP-4 Device Plate with Legrand AVIP or Extron® Electronics MAAP opening.</p>	<p>CRFB-GFI-1 Device Plate with standard GFCI or decorator style opening for open A/V devices such as Extron® Electronics, Crestron® and Atinex® Intera.</p>	<p>CRFB-GFI-2 Device Plate with standard GFCI or decorator style opening for open A/V devices such as Extron® Electronics, Crestron® and Atinex® Intera.</p>
	<p>CRFB-GFI-3 Device Plate with standard GFCI or decorator style opening for open A/V devices such as Extron® Electronics, Crestron® and Atinex® Intera.</p>	<p>CRFB-BEZ-6A-4 Device Plate with Adapter for one (1) Ortronics® Series II Device.</p>	<p>CRFB-CGFI-4 Device Plate with standard GFCI or decorator style opening for open A/V devices such as Extron® Electronics, Crestron® and Atinex® Intera.</p>

POKE-THRU DEVICES

Product Line	Compatible A/V Device Plates
--------------	------------------------------

Evolution™ Series Poke-Thru Devices

<p>6AT Series</p>	<p>6AAP Device Plate accepts two (2) Extron® Electronics AAP Devices.</p>	<p>6MAAP Device Plate accepts six (6) Legrand AVIP or Extron® Electronics MAAP Devices.</p>	<p>6MAAP-2A Device Plate accepts three (3) Legrand AVIP or Extron® Electronics MAAP Devices and up to two (2) ports for communication devices.</p>
	<p>6DEC Device Plate accepts standard GFCI or decorator style opening for open A/V devices such as Extron® Electronics, Crestron® and Atinex® Intera.</p>	<p>6SER Device Plate accepts up to four (4) Ortronics® Series II modular inserts.</p>	<p>68MAAP Device Plate accepts up to two (2) Legrand AVIP or Extron® Electronics MAAP Devices.</p>

NOTE: Wiremold manufactures many additional pathway solutions. Those represented here have been designed/modified to provide the depth behind the plate required for most A/V devices. For additional design and installation considerations, please contact the factory.

AUDIO/VIDEO COMPATIBILITY

Quick Selection Guide

POKE-THRU DEVICES

Product Line	Compatible A/V Device Plates
--------------	------------------------------

Evolution™ Series Poke-Thru Devices

8AT Series



8CREST

Device Plate accepts Crestron® & Extron® Electronics double gang decorator style devices.

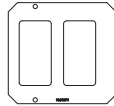

8CREST3G

3 gang device plate accepts Crestron® & Extron® Electronics triple gang decorator style devices.

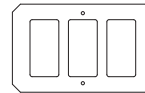

8AAP

Device Plate accepts four (4) Extron® Electronics AAP Devices.

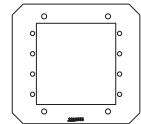

8MAAP

Device Plate accepts four (4) Legrand AVIP or Extron® Electronics MAAP Devices.

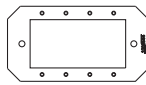

8DEC

Device Plate with standard GFCI or decorator style opening for open A/V devices such as Extron® Electronics, Crestron® and Atinex® Intera.



8SER

Device Plate accepts up to three (3) Ortronics® Series II modular inserts.

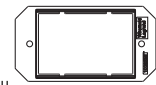

68MAAP

Device Plate accepts up to two (2) Legrand AVIP or Extron® Electronics MAAP Devices.

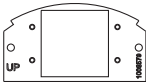

AV3 Series™ Poke-Thru Devices



AV3ATCGY

Assembled Poke-Thru Device that includes bezels to accept one Legrand AVIP or Extron® Electronics MAAP device or one Ortronics® Series II insert.



AV3CTCGY

Assembled Poke-Thru Device that includes bezels to accept one Legrand AVIP or Extron® Electronics MAAP device or one Ortronics® Series II insert.



AV3ATCBK

AV3ATCAL

AV3ATCAA

AV3ATCBS

AV3ATCAB

AV3ATCVY

AV3CTCBK

AV3CTCAL

AV3CTCAA

AV3CTCBS

AV3CTCAB

AV3CTCVY

AMD8™ Series Poke-Thru Devices



AMD8ATCGY

Assembled Poke-Thru Device that includes bezels to accept four (4) Ortronics® Series II inserts.

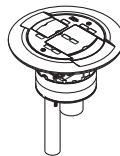

AMD8ATCBK

AMD8ATCAL

AMD8ATCAA

AMD8ATCBS

AMD8ATCAB

AMD8ATCVY

RC9AMD Series™ Poke-Thru Devices



RC9AMDTCGY

Assembled Poke-Thru Device that includes bezels to accept two (2) Ortronics® Series II inserts.

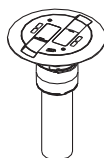

RC9AMDTCBK

RC9AMDTCAL

RC9AMDTCBS

RC9AMDTCAB

RC9AMDTCVY

RC9AMDTCAA

NOTE: Wiremold manufactures many additional pathway solutions. Those represented here have been designed/modified to provide the depth behind the plate required for most A/V devices. For additional design and installation considerations, please contact the factory.

AUDIO/VIDEO COMPATIBILITY

Quick Selection Guide

WORK SURFACE SOLUTIONS

Product Line	Compatible A/V Device Plates
--------------	------------------------------

dequorum™ Work Surface Portals



KA305-AAP
Device Plate with Legrand AVIP or Extron® Electronics AAP Opening.

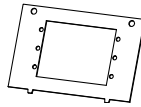

KA305
Device Plate with Legrand AVIP or Extron® Electronics MAAP Opening.

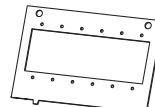

KA302
Device Plate holds cables captive for easy access when active jacks are not needed.



Evolution™ Series Work Surface Portals

WSF6 Series



Field-Wired

WSF6FNK, WSF6FBS, WSF6FGY, WSF6FBK, WSF6FBZ, WSF6SNK, WSF6SBS, WSF6SGY, WSF6SBK, WSF6SBZ

Cord-Ended

WS6FNK, WS6FBS, WS6FGY, WS6FBK, WS6FBZ, WS6SNK, WS6SBS, WS6SGY, WS6SBK, WS6SBZ

Field-Wired

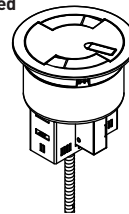

6" [152mm] Field-Wired or Cord-Ended Work Surface Portals that can accept up to five (5) Legrand AVIP or Extron® Electronics MAAP device plates.

WSF8 Series



Field-Wired

WSF8FNK, WSF8FBS, WSF8FGY, WSF8FBK, WSF8FBZ, WSF8SNK, WSF8SBS, WSF8SGY, WSF8SBK, WSF8SBZ

Cord-Ended

WS8FNK, WS8FBS, WS8FGY, WS8FBK, WS8FBZ, WS8SNK, WS8SBS, WS8SGY, WS8SBK, WS8SBZ

Cord-Ended

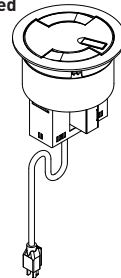

8" [203mm] Field-Wired or Cord-Ended Work Surface Portals that can accept up to ten (10) Legrand AVIP or Extron® Electronics MAAP device plates.

STEEL RACEWAY SYSTEMS

Product Line	Compatible A/V Device Plates
--------------	------------------------------

2400 Series™ Raceway



**V24DWNU
G3046U**
Downward-Facing Device Plate with Legrand AVIP or Extron® Electronics MAAP opening.

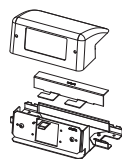

**V24DWNS
G3046S**
Downward-Facing Device Plate with Ortronics® Series II opening.

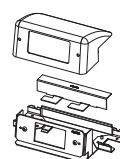

3000 Series™ Raceway



**V3046U
G3046U**
Bump-Up Device Plate with Legrand AVIP or Extron® Electronics MAAP opening.

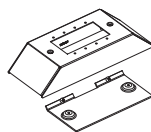

**V3046V
G3046V**
Bump-Up Device Plate with Extron® Electronics AAP opening.

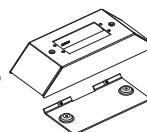

**V3046S
G3046S**
Bump-Up Device Plate with Ortronics® Series II opening.

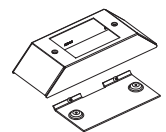

NOTE: Wiremold manufactures many additional pathway solutions. Those represented here have been designed/modified to provide the depth behind the plate required for most A/V devices. For additional design and installation considerations, please contact the factory.

AUDIO/VIDEO COMPATIBILITY

Quick Selection Guide

STEEL RACEWAY SYSTEMS

Product Line	Compatible A/V Device Plates
--------------	------------------------------

4000 Series™ Raceway



**V4047UX
G4047UX**
Bump-Up Device Plate with Extron® Electronics MAAP opening.

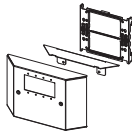

**V4047VX
G4046VX**
Bump-Up Device Plate with Extron® Electronics AAP opening.

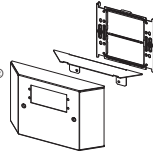

**5507MAAP
5507MAAP-G**
5507 Series Device Plate with Extron® Electronics MAAP opening.

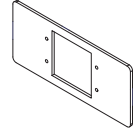

**5507AAP
5507AAP-G**
5507 Series Device Plate with Extron® Electronics AAP opening.

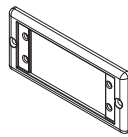

**5507R
5507R-G**
5507 Series Device Plate with decorator style opening for open A/V devices such as Extron® Electronics, Crestron® and Atinex® Intera.

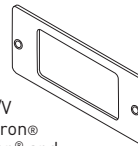

DS4000® Series Raceway



**DSDWNR-BK
DSDWNR-BZ
DSDWNR-DG
DSDWNR-DV**
Downward-Facing Device Plate with decorator style opening for open A/V devices such as Extron® Electronics, Crestron® and Atinex® Intera.

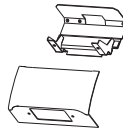

**DSDWNS-BK
DSDWNS-BZ
DSDWNS-DG
DSDWNS-DV**
Downward-Facing Device Plate with Ortronics® Series II opening.

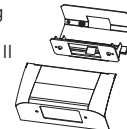

**DSDWNU-BK
DSDWNU-BZ
DSDWNU-DG
DSDWNU-DV**
Downward-Facing Device Plate with Extron® Electronics MAAP opening.

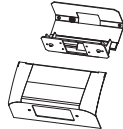

6000® Series Raceway



**5507MAAP
5507MAAP-G**
5507 Series Device Plate with Legrand AVIP or Extron® Electronics MAAP opening.

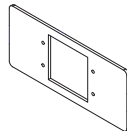

**5507AAP
5507AAP-G**
5507 Series Device Plate with Extron® Electronics AAP opening.

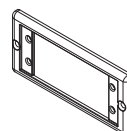

**5507R,
5507R-G**
5507 Series Device Plate with decorator style opening for open A/V devices such as Extron® Electronics, Crestron® and Atinex® Intera.

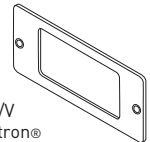

**V4047UX
G4047UX**
Bump-Up Device Plate with Legrand AVIP or Extron® Electronics MAAP opening.

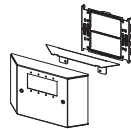

**V4047VX
G4047VX**
Bump-Up Device Plate with Extron® Electronics AAP opening.

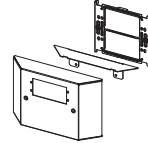

OFR Series™ Overflow Raceway

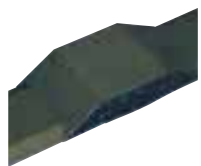

OFR47-U
Accepts up to four (4) Legrand AVIP or Extron® Electronics MAAP style plates.

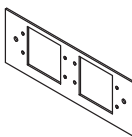

OFR47-V
Accepts two (2) Extron® Electronics AAP single space modules.

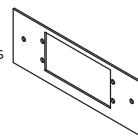

OFR47-U2A
Accepts up to two (2) Legrand AVIP or Extron® Electronics MAAP style plates.

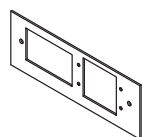

OFR47-R
For covering rectangular decorator style devices.

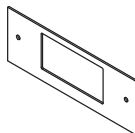



NOTE: Wiremold manufactures many additional pathway solutions. Those represented here have been designed/modified to provide the depth behind the plate required for most A/V devices. For additional design and installation considerations, please contact the factory.

AUDIO/VIDEO COMPATIBILITY

Quick Selection Guide

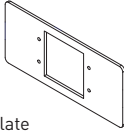
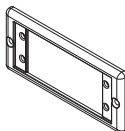
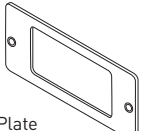
STEEL RACEWAY SYSTEMS

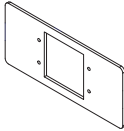
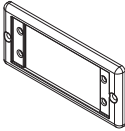
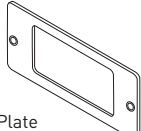
Product Line	Compatible A/V Device Plates		
5400 Series™ Raceway	 <p>5507MAAP 5507MAAP-FW 5507MAAP-WH 5507MAAP-BK 5507MAAP-G 5507MAAP-GY</p> <p>5507 Series Device Plate with Legrand AVIP or Extron® Electronics MAAP opening.</p> 	<p>5507AAP 5507AAP-FW 5507AAP-WH 5507AAP-BK 5507AAP-G 5507AAP-GY</p> <p>5507 Series Device Plate with Extron® Electronics AAP opening.</p> 	<p>5507R 5507R-FW 5507R-WH 5507R-BK 5507R-G 5507R-GY</p> <p>5507 Series Device Plate with decorator style opening for open A/V devices such as Extron® Electronics, Crestron® and Atinex® Intera.</p> 
5500 Series™ Raceway	 <p>5507MAAP 5507MAAP-FW 5507MAAP-WH 5507MAAP-BK 5507MAAP-G 5507MAAP-GY</p> <p>5507 Series Device Plate with Legrand AVIP or Extron® Electronics MAAP opening.</p> 	<p>5507AAP 5507AAP-FW 5507AAP-WH 5507AAP-BK 5507AAP-G 5507AAP-GY</p> <p>5507 Series Device Plate with Extron® Electronics AAP opening.</p> 	<p>5507R 5507R-FW 5507R-WH 5507R-BK 5507R-G 5507R-GY</p> <p>5507 Series Device Plate with decorator style opening for open A/V devices such as Extron® Electronics, Crestron® and Atinex® Intera.</p> 

IN WALL SYSTEMS

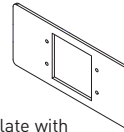
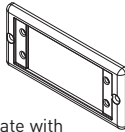
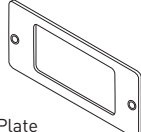
Product Line	Compatible A/V Device Plates		
WallSource™ Multiple Service Boxes Raceway	 <p>5507MAAP 5507MAAP-FW 5507MAAP-WH 5507MAAP-BK 5507MAAP-G 5507MAAP-GY</p> <p>5507 Series Device Plate with Legrand AVIP or Extron® Electronics MAAP opening.</p> 	<p>5507AAP 5507AAP-FW 5507AAP-WH 5507AAP-BK 5507AAP-G 5507AAP-GY</p> <p>5507 Series Device Plate with Extron® Electronics AAP opening.</p> 	<p>5507R 5507R-FW 5507R-WH 5507R-BK 5507R-G 5507R-GY</p> <p>5507 Series Device Plate with decorator style opening for open A/V devices such as Extron® Electronics, Crestron® and Atinex® Intera.</p> 

VERTICAL SOLUTIONS

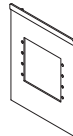
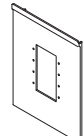
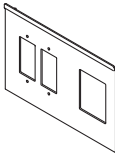
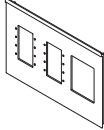
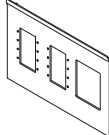
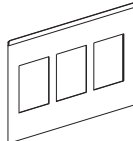
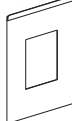
Product Line	Compatible A/V Device Plates		
Vista™ Architectural Columns	<p>VSCR Crestron® & Extron® Electronics Double-Gang Decorator Style Device Plate for Small Vista Columns.</p> 	<p>VSEA Device Plate with Extron® Electronics AAP opening for Small Vista Columns.</p> 	<p>VSEM Device Plate with Legrand AVIP or Extron® Electronics MAAP opening for Small Vista Columns.</p> 
	<p>VLCR Crestron® & Extron® Electronics Double-Gang Decorator Style Device Plate for Large Vista Columns.</p> 	<p>VLEA Device Plate with Extron® Electronics AAP opening for Large Vista Columns.</p> 	<p>VLEM Device Plate with Legrand AVIP or Extron® Electronics MAAP opening for Large Vista Columns.</p> 
		<p>VLRT Device Plate with opening for three (3) Ortronics® Series II devices for Large Vista Columns.</p> 	<p>VSRT Device Plate with opening for one (1) Ortronics® Series II device for Small Vista Columns.</p> 

NOTE: Wiremold manufactures many additional pathway solutions. Those represented here have been designed/modified to provide the depth behind the plate required for most A/V devices. For additional design and installation considerations, please contact the factory.

AUDIO/VIDEO COMPATIBILITY

AUDIO/VIDEO COMPATIBILITY

Quick Selection Guide

VERTICAL SOLUTIONS

Product Line	Compatible A/V Device Plates
--------------	------------------------------

Vista™ Point5 Architectural Columns



VSCR
Crestron® & Extron® Electronics Double-Gang Decorator Style Device Plate for Small Vista Columns.



VSEA
Device Plate with Extron® Electronics AAP opening for Small Vista Columns.

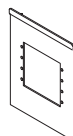

VSEM
Device Plate with Legrand AVIP or Extron® Electronics MAAP opening for Small Vista Columns.

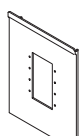

VSEAP5
Device Plate with two (2) duplex receptacles and Extron® Electronics AAP openings for small Point 5 Vista.



VSEMP5
Device Plate with two (2) duplex receptacles and Legrand AVIP or Extron® Electronics MAAP openings for small Point 5 Vista.

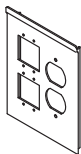

VL2A
Device plate for Wiremold CM Series Open System for Ortronics Series II and TracJack devices for large Point 5 Vista.

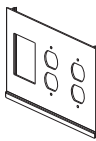

VL2CR
Crestron® & Extron® Electronics Double-Gang Decorator Style Device Plate for Large Vista Columns.



VLEA
Device Plate with Extron® Electronics AAP opening for Large Vista Columns.

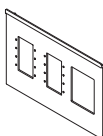

VLEM
Device Plate with Extron® Electronics MAAP opening for Large Vista Columns.

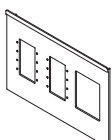

VLEAP5
Device Plate with two (2) duplex receptacles and Extron® Electronics AAP openings for large Point 5 Vista.

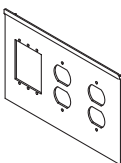

VLEMP5
Device Plate with two (2) duplex receptacles and Legrand AVIP or Extron® Electronics MAAP openings for large Point 5 Vista.

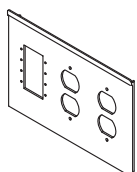

Tele-Power® Poles



30TP-MAAP
Device Plate with Legrand AVIP or Extron® Electronics MAAP opening.

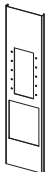

30TP-L
Device Plate with Extron® Electronics AAP opening.

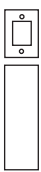

30TP-AAP
Device Plate with GFCI or decorator style opening for open A/V devices such as Extron® Electronics, Crestron® and Atinex® Intera.



INFLOOR SYSTEMS

Product Line	Compatible A/V Device Plates
--------------	------------------------------

525 Series™ Service Fittings – For use with Walkerdut® Underfloor Duct Systems



500-MAAP
525 Series Device Plate with Legrand AVIP or Extron® Electronics MAAP opening.

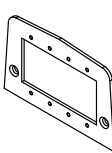

500RT
525 Series Device Plate with opening for one (1) Ortronics® Series II Device.



Multiplex™ Series Service Fittings

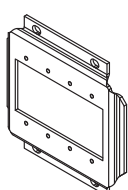
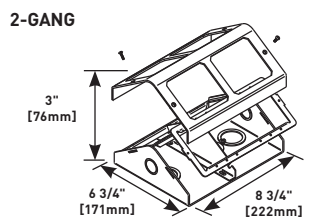
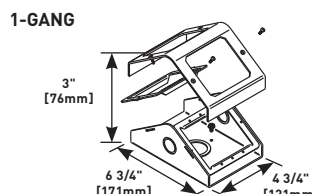

LTF48-MAAP
Multiplex Series Device Plate with Legrand AVIP or Extron® Electronics MAAP opening.

NOTE: Wiremold manufactures many additional pathway solutions. Those represented here have been designed/modified to provide the depth behind the plate required for most A/V devices. For additional design and installation considerations, please contact the factory.

COMMUNICATIONS CONNECTIVITY



Wiremold® pathways and cable management systems offer a wide range of options for providing datacom connectivity.

Table of Contents

Ortronics® Connectivity



16

Wiremold® Open System Connectivity



16

Wiremold® CM Series™ Communication Modules



17

Featured Products



**CM Series™
Communication
Modules**

17

COMMUNICATIONS CONNECTIVITY

Ortronics® Connectivity



TracJack Individual Jack System

- Front-loading, snap-in design supports future moves adds and changes
- Inserts for voice, data, audio, and video
- Available Category 3, 5e, 6, USOC 6-position, and other media
- Flat or angled 45° exit configurations
- Choice of 13 colors and color matched to Wiremold systems
- Universal T568A/B wiring format

Series II Front-Loading, Module System

- Module design features easy snap-in front-loading design
- Linear 110 punch down format for easy termination
- Inserts for voice, data, audio, and video
- Available Category 3, 5e, 6, USOC 6-position, and other media
- Available in flat or angled 45° exit configurations
- Color matched to Wiremold Systems

For detailed product selection refer to the Ortronics Catalog or visit www.ortronics.com.

Wiremold® Open Connectivity Solutions



Wiremold Open System Communications Modules

- Accommodate a wide range of manufacturers' communications outlets including keystone jacks, as well as proprietary solutions from Systimax (Avaya) and NORDX
- Modules fit into a wide range of Wiremold Systems
- Pre-punched faceplates accept common communication devices

For more information on integrating connectivity into Wiremold Cable Management Systems, contact the Wiremold Applications Engineering Team or your local Wiremold Sales Representative.

Typical Installation for Cable Management Applications

CM-EPLA

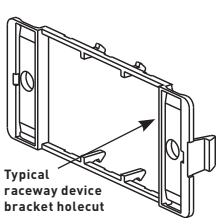

1. Bring all station cables through the opening in the device mounting bracket.
2. Mount communication devices in unloaded inserts and terminate or attach cable per manufacturers instructions.
3. Reverse the module and snap into the device bracket. Entire faceplate must be filled with inserts or blanks.

Typical Mounting Brackets (4050, 5450, 5550, 40N2, 2344SD-2A, 2444D-2A and WSA07A Device Mounting Plates)

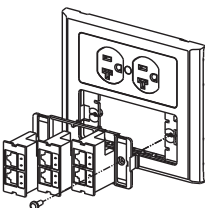

1. Insert CM-EPLA end plate into the bracket opening.
2. Slide end plate to engage hooks into locking slots. (Be sure end plate edge is seated against edge of trim plate opening.) Two end plates are required as shown.
3. After end plates are in place, install modules by aligning over space between end plates and pushing inward until snaps engage. 6A configuring options apply to opening.

CM SERIES™ COMMUNICATION MODULES



Wiremold® CM Series™ Communication Modules provide a variety of unloaded modules to accept devices from other manufacturers. These open system modules provide a flexible and aesthetically pleasing way to connect communication cabling at the point-of-use.

CODE REFERENCE

cULus Listed Communication Circuit Accessories:
File E145222 Guide DUXR.
Meets Article 800 of NEC.
Meets Article 60-308 of CEC.

CM Series Communication Modules Ordering Information

CM2-U1KEYA 2A Single Flushmount Unloaded Keystone Module

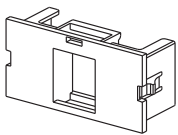

Accepts keystone jacks with a latching area of 0.58" x 0.76" [14.7mm x 19.3 mm]. Also available in white (CM2-U1KEYA-WH), light grey (CM2-U1KEYA-GY), black (CM2-U1KEYA-BK) and grey (CM2-U1KEYA-G).

CM2-U1ATT 2A Single Systimax (Avaya) Unloaded Module

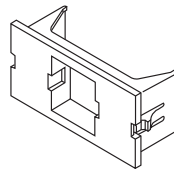

Accepts both M-series jacks and LC fiber adapters. Also available in white (CM2-U1ATT-WH), light grey (CM2-U1ATT-GY), black (CM2-U1ATT-BK) and grey (CM2-U1ATT-G).

CM2-U2KEYA 2A Dual Flushmount Unloaded Keystone Module

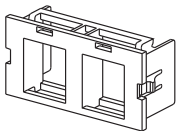

Accepts keystone jacks with a latching area of 0.58" x 0.76" [14.7mm x 19.3 mm]. Also available in white (CM2-U2KEYA-WH), light grey (CM2-U2KEYA-GY), black (CM2-U2KEYA-BK) and grey (CM2-U2KEYA-G).

CM2-U2ATT 2A Single Systimax (Avaya) Unloaded Module

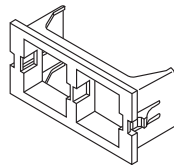

Accepts both M-series jacks and LC fiber adapters. Also available in white (CM2-U2ATT-WH), light grey (CM2-U2ATT-GY), black (CM2-U2ATT-BK) and grey (CM2-U2ATT-G).

COLOR OPTIONS



CM Series™ Communication Modules standard color is ivory. For other colors, add one of the following suffixes: "-WH" for white, "-GY" for light gray (matches aluminum and nonmetallic products), "-BK" for black, or "-G" for gray (matches Wiremold gray steel products).

CM SERIES™ COMMUNICATION MODULES

Ordering Information

CM Series Communication Modules Ordering Information (cont.)

CM2-U1NOR 2A Single Flushmount NordX/CDT Unloaded Module

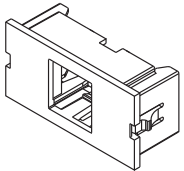

Accepts MDVOflex jacks and fiber modules. Also available in white (CM2-U1NOR-WH), light grey (CM2-U1NOR-GY), black (CM2-U1NOR-BK) and grey (CM2-U1NOR-G).

CM2-U2NOR 2A Dual Flushmount NordX/CDT Unloaded Module

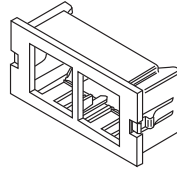

Accepts MDVOflex jacks and fiber modules. Also available in white (CM2-U2NOR-WH), light grey (CM2-U2NOR-GY), black (CM2-U2NOR-BK) and grey (CM2-U2NOR-G).

CM2-U2ST 2A Dual Unloaded ST Adapter Module

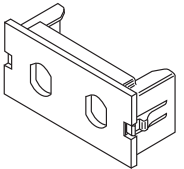

Accepts 2 ST adapters. Also available in white (CM2-U2ST-WH), light grey (CM2-U2ST-GY), black (CM2-U2ST-BK) and grey (CM2-U2ST-G).

CM2-U2AMP 2A Unloaded Single AMP Netconnect Module

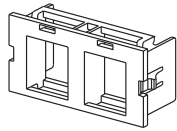

For mounting two AMP Netconnect SL Series devices. Also available in white (CM2-U2AMP-WH), light grey (CM2-U2AMP-GY), black (CM2-U2AMP-BK) and grey (CM2-U2AMP-G).

CM2-U2SC 2A Unloaded Duplex SC Adapter Module

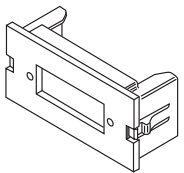

Accepts one SC adapter. Also available in white (CM2-U2SC-WH), light grey (CM2-U2SC-GY), black (CM2-U2SC-BK) and grey (CM2-U2SC-G).

CM2-BL 2A Blank Module

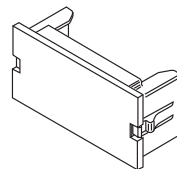

Required to fill unused openings. Also available in white (CM2-BL-WH), light grey (CM2-BL-GY), black (CM2-BL-BK) and grey (CM2-BL-G).

CM2-U2TJ 2A Dual Flushmount Unloaded Ortronics® TracJack Module

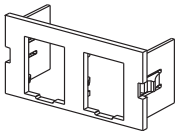

For mounting two Ortronics® TracJack devices. Also available in white (CM2-U2TJ-WH), light grey (CM2-U2TJ-GY), black (CM2-U2TJ-BK) and grey (CM2-U2TJ-G).

CM2-U2SVGA 2A SVGA Module

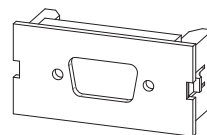

Accepts one SVGA connector. Also available in white (CM2-U2SVGA-WH), light grey (CM2-U2SVGA-GY), black (CM2-U2SVGA-BK) and grey (CM2-U2SVGA-G).

CM SERIES™ COMMUNICATION MODULES

Ordering Information

CM Series Communication Modules Specialty Mounting Adapters Ordering Information

CM-EPLA End Plate

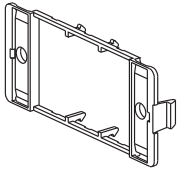

End plates with two outlet ID labels with clear covers and two matching screw covers. Required when mounting modules into 4050, 5450, 5550, and WSA07-4A device mounting brackets, and the V2444D-2A and 2344SD-2A 2-gang divided raceway box. Also available in white (CM-EPLA-WH), fog white (CM-EPLA-FW), and grey (CM-EPLA-G).

AB2TJ Ortronics® TracJack 2A Mini Mounting Adapter

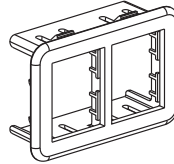

Accepts two Ortronics® TracJack Inserts. Also available in white (AB2TJ-WH), light grey (AB2TJ-GY), black (AB2TJ-BK) and grey (AB2TJ-G).

CM-2AB CM2/Activate 2A Mini Mounting Adapter

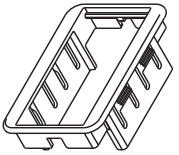

Accepts one CM2 Series communication module or one Pass & Seymour 2A Activate Series insert. Also available in white (CM-2AB-WH), light grey (CM-2AB-GY), black (CM-2AB-BK) and grey (CM-2AB-G).

ABS2 Ortronics® Series II 2A Mini Mounting Adapter

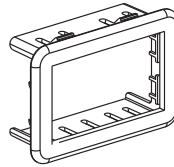

Accepts one Ortronics® Series II 1-unit insert. Also available in white (ABS2-WH), light grey (ABS2-GY), black (ABS2-BK) and grey (ABS2-G).

CM-MAB 6A Mini Mounting Adapter

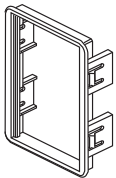

6A opening. Must be purchased separately for mounting communication modules in service fittings where it is indicated they are not included. Also available in light grey (CM-MAB-GY), black (CM-MAB-BK) and fog white (CM-MAB-FW).

MAB3S2 Ortronics® Series II 6A Mounting Adapter

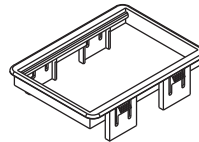

Accepts three Ortronics® Series II 1-unit inserts. Also available in light grey (MAB3S2-GY), black (MAB3S2-BK) and grey (MAB3S2-G).

MAB6TJ Ortronics® TracJack 6A Mounting Adapter

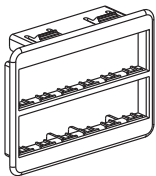

Accepts six Ortronics® TracJack inserts. Also available in white (MAB6TJ-WH), light grey (MAB6TJ-GY), black (MAB6TJ-BK) and grey (MAB6TJ-G).

CM-ARA Angled Raceway Adapter

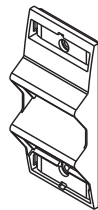

For use with multi-channel raceway device brackets and WallSource device mounting brackets. Angled exit provides additional mounting depth required for audio/visual connections as well as ensuring the required bend radius for UTP and fiber optic cabling. Holds two CM2 Series modules or two 2A inserts. Fits 5507 Series Faceplate opening. Also available in white (CM-ARA-WH), light grey (CM-ARA-GY), black (CM-ARA-BK) and grey (CM-ARA-G).

CM SERIES™ COMMUNICATION MODULES

Ordering Information

CM Series Communication Modules Specialty Mounting Adapters Ordering Information (cont.)

CM-SAP Single-Gang Angled Faceplate

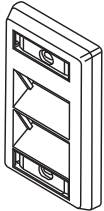

For mounting two CM2 Series modules or Pass & Seymour Activate Series device modules. Also available in white (CM-SAP-WH), light grey (CM-SAP-GY), black (CM-SAP-BK) and grey (CM-SAP-G).

CM-DFP Double-Gang Faceplate

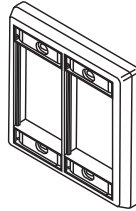

For mounting six CM2 Series modules or Pass & Seymour Activate Series device modules. Also available in white (CM-DFP-WH), light grey (CM-DFP-GY), black (CCM-DFP-BK) and grey (CM-DFP-G).

ARA-S2 Angled Raceway Adapter

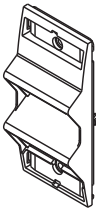

For use with multi-channel raceway device brackets and WallSource device mounting brackets. Angled exit provides additional mounting depth required for A/V connections as well as ensuring the required bend radius for UTP and fiber optic cabling. Holds two Ortronics® Series II modules. Fits 5507 Series Faceplate opening. Also available in white (ARA-S2-WH), light grey (ARA-S2-GY), black (ARA-S2-BK) and grey (ARA-S2-G).

CM-SFP Single-Gang Faceplate

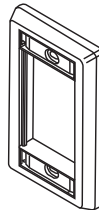

For mounting three CM2 Series modules or Pass & Seymour Activate Series device modules. Also available in white (CM-SFP-WH), light grey (CM-SFP-GY), black (CM-SFP-BK) and grey (CM-SFP-G).

CM-DAP Double-Gang Angled Faceplate

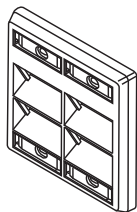

For mounting four CM2 Series modules or Pass & Seymour Activate Series device modules. Also available in white (CM-DAP-WH), light grey (CM-DAP-GY), black (CM-DAP-BK) and grey (CM-DAP-G).

STEEL SURFACE RACEWAY SYSTEMS



Wiremold® Steel Surface Raceway Systems are the industry leaders in quality, ease of installation, and for providing pathway solutions for all types of installations. For over 50 years, Wiremold Steel Surface Raceway Systems have provided the highest quality, most dependable solutions for installers, building owners, and designers.

With the introduction of DS4000® Series Raceway, we're again pushing the envelope by expanding the capacity, capabilities, and aesthetics of surface raceway systems.

Featured Products



**DS4000® Designer
Series Raceway**

56



**500® & 700® Series
Raceway**

24

STEEL SURFACE RACEWAY SYSTEMS

Table of Contents

One-Piece Steel Raceway Systems



24
500[®] Series Raceway

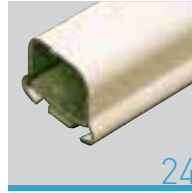

24
700[®] Series Raceway

Two-Piece Steel Small Single- & Dual-Channel Raceway Systems



34
2000[®] Series Raceway



38
2400[™] Series Raceway

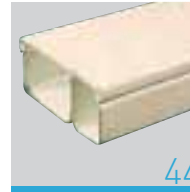

44
2400D[™] Series Raceway

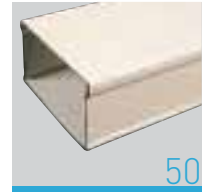

50
3000[®] Series Raceway

4000 Designer Series Raceway

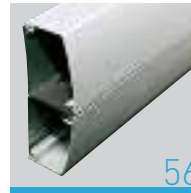

56
DS4000[®] Series Raceway

Two-Piece Steel Large Multiple-Channel Raceway Systems



61
4000[®] Series Raceway

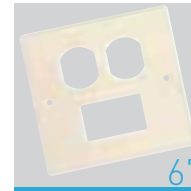

67
4047[™] Series Device Plates



72
S4000[®] Series Stainless Steel Raceway



79
6000[®] Series Raceway

Multi-Compartment Surface Metal Raceway Systems



84
AnySize[™] Series Raceway

STEEL SURFACE RACEWAY SYSTEMS

Quick Selection Guide

500® Series Raceway

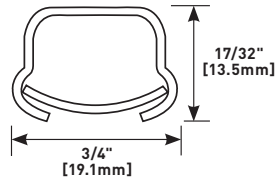

Type: One-Piece, Single-Channel
Colors: Ivory
Capacity: 0.19 in² [123mm²]

700® Series Raceway

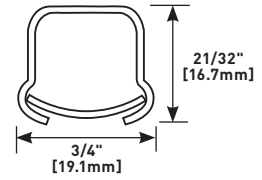

Type: Two-Piece, Single-Channel
Colors: Ivory, White
Capacity: 0.26 in² [168mm²]

2000® Series Raceway

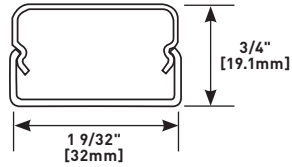

Type: Two-Piece, Single-Channel
Colors: Ivory, Gray
Capacity: 0.80 in² [516mm²]

2400™ Series Raceway

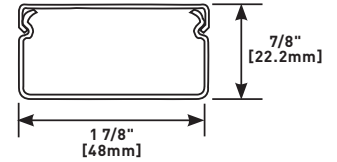

Type: Two-Piece, Single-Channel
Colors: Ivory, Fog White
Capacity: 1.39 in² [897mm²]

2400D Series™ Raceway

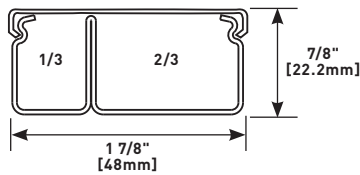

Type: Two-Piece, Dual-Channel
Capacity: 1/3 Comp.: 0.374 in² [241mm²]; 2/3 Comp.: 0.865 in² [558mm²]
Colors: Ivory, Fog White

3000® Series Raceway

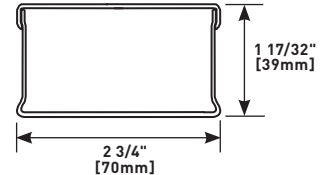

Type: Two-Piece, Single-Channel
Capacity: 3.70 in² [2340mm²]
Colors: Ivory, Gray

DS4000® Series Raceway

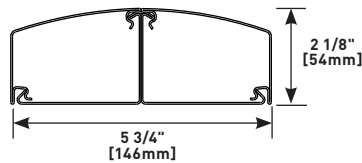

Type: Three-Piece, Dual-Channel
Capacity: Each Compartment: 5.01 in² [3235mm²]
Colors: Designer Ivory, Designer Gray, Matte Black

4000® Series Raceway

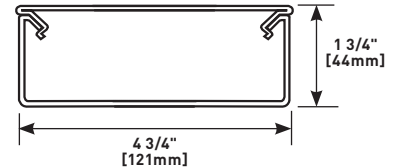

Type: Two-Piece, Single- or Dual-Channel
Capacity: Divided: 3.10 in² [2000mm²], Undivided: 7.20 in² [4645mm²]
Colors: Ivory, Gray, Stainless

6000® Series Raceway

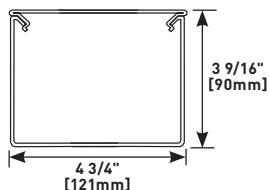

Type: Two-Piece, Single- or Dual-Channel
Capacity: Divided: 7.20 in² [4645mm²], Undivided: 16.00 in² [10320mm²]
Colors: Ivory, Gray

AnySize™ Series Raceway

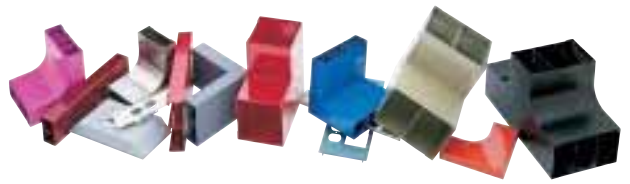

500® & 700® SERIES RACEWAY



One-piece, single-channel raceway. Easy-to-install and ideal for basic power or communication/low voltage installations. Provides low profile appearance that blends with any decor.

CODE REFERENCE

cULus Listed Raceway:
File E4376 Guide RJBT.

Fittings:
File E41751 Guide RJPR.
Meets Article 386 of NEC.
Meets Section 12-1600 of CEC.

System Layout

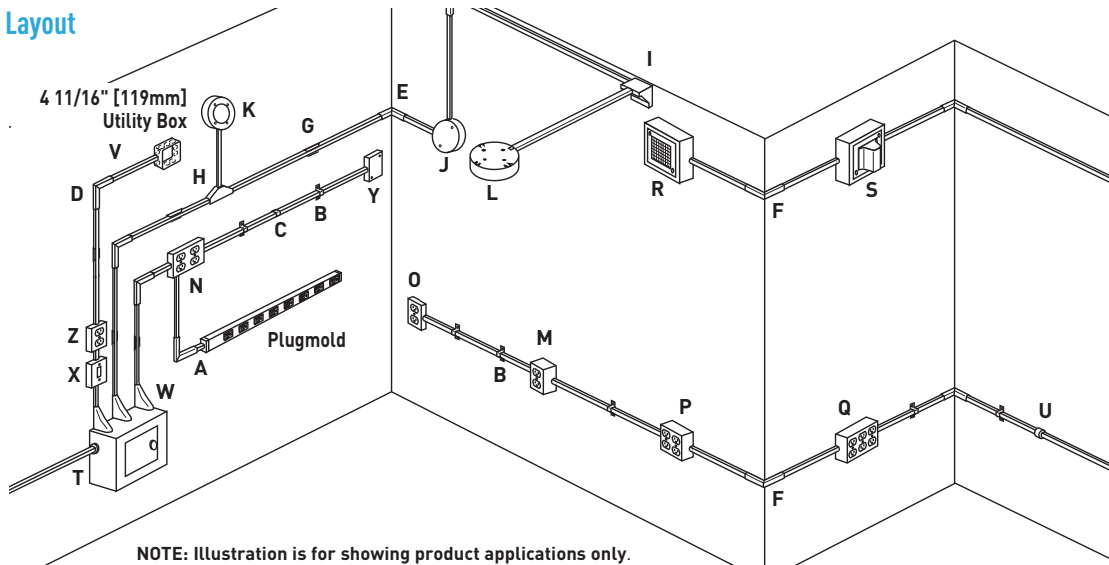

NOTE: Illustration is for showing product applications only.

KEY

- | | | | |
|---------------------------|---------------------------------------|---|--------------------------------------|
| A. 2089E Reducing Fitting | I. 5719 Corner Box | P. 5748-2 Two-Gang Device Box | V. 5785 Combination Connector |
| B. 504 Mounting Strap | J. 5734A Utility Box | Q. 5748-3 Three-Gang Device Box | W. V5786 Adjustable Offset Connector |
| C. 506 Cover Clip | K. 5738 Fixture Box Solid Base | R. 5752 Alarm Device Box | X. 57240 Single Pole Switch and Box |
| D. 511 Flat Elbow | L. V5739 Fixture Box Solid Base | S. 5753 Extra Deep Alarm Device Box | Y. 57242 Utility Box |
| E. 517 Internal Elbow | M. 5744 Extra Deep Device Box | T. 5781 Box Connector | Z. 57243G Duplex Receptacle and Box |
| F. 518 External Elbow | N. 5747-2 Two-Gang Shallow Device Box | U. 5782 1/2" Trade Size Conduit Connector | |
| G. 5703 Supporting Clip | O. 5748S Shallow Device Box | | |
| H. 5715 Tee | | | |

COLOR OPTIONS



500® and 700® Series Raceway Part Numbers with a "V" prefix have an ivory finish. Part Numbers with a "WH" suffix have a white finish. Some Device Boxes used in safety applications are also available with a red painted finish.

Custom color options are also available. Consult the factory for more information.

500[®] & 700[®] SERIES RACEWAY

500 Series Wire Fill Capacities For Communications

	CABLE/WIRE SIZE	O.D. (APPROX. DIA.)		40% FILL
		Inches	[mm]	
UNSHIELDED TWISTED PAIR	4-pair, 24 AWG, Cat 3	0.190	[4.8]	2
	4-pair, 24 AWG, Cat 5e	0.210	[5.3]	2
	4-pair, 24 AWG, Cat 6	0.250	[6.3]	1
	4-pair, 24 AWG, Cat 6a*	0.354	[9.0]	0
	25-pair, 24 AWG	0.410	[10.4]	0
COAXIAL	RG6/U	0.270	[6.9]	1
FIBER	ZipCord	0.118 x 0.236	[3 x 6]	2
	Round 4 Strand Fiber	0.187	[4.8]	2
	Round 6 Strand Fiber	0.256	[6.5]	1

500 Series Raceway Ordering Information

V500 One-Piece Raceway

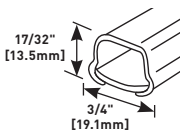

.040" [1.0mm] steel. Ivory finish. Available in 10' [3m] lengths, 100' [31m] per carton. One (1) 5701 Coupling furnished with each length.

V500-5 One-Piece Raceway

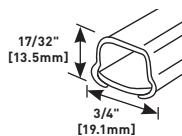

Same as V500 Raceway except in 5' [1.5m] lengths, 50' [15m] per carton. One (1) 5701 Coupling furnished with each 5' [1.5m] length.

605 500 Series Raceway Cutter

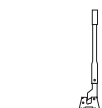

Single action portable cutter. Fast and easy square cuts.

605K Replacement Blades

Case hard steel replacement blades for 605 Raceway Cutter.

502 Bushing

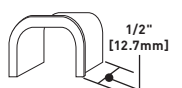

Protects wires from abrasion. Slips into open end of 500 Series Raceway.

V504 Mounting Strap

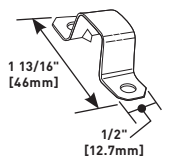

(One- or Two-Hole) – Converts to one-hole by breaking off at score. Lanced tab holds strap in place while fastening to surface.

NOTE: Use #8 flathead screws with all fittings requiring screws except V504. With V504, use #8 panhead screws.

500 Series Wire Fill Capacities for Power

WIRE SIZE	O.D.		NO. OF CONDUCTORS 40% FILL
	Inches	[mm]	
THHN/THWN			
14 AWG	0.111	[2.8]	7
12 AWG	0.130	[3.3]	5
10 AWG	0.164	[4.2]	3

NOTE: For additional information, refer to the Technical Section.
* Category 6 augmented (6a) cable for 10 gigabit ethernet – max allowed cable diameter per addenda No. 11 ANSI TIA/EIA 568-B.2.

V506 Connection Cover

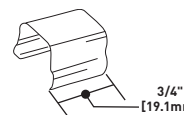

Covers seam where two lengths of 500 Series Raceway come together.

V511 Flat Elbow

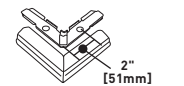

Right angle turns on the same surface.

V512 45° Flat Elbow

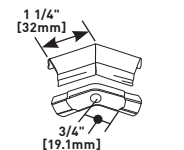

Diagonal 45° turns on same surface.

V517 Internal Elbow

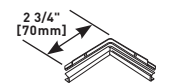

Inside right angle turns.

V518 Outside Elbow

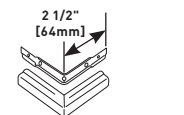

Outside right angle turns.

5700LL Laser Level



For 500/700 Series Raceway. Attaches to outlet box base and raceway fittings for perfect alignment of runs of raceway.

5700CG Cutting Guide

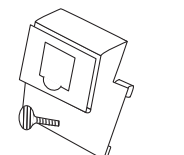

For 500/700 Series Raceway. Attaches to step ladder and holds raceway channel securely for accurate cuts.

500® & 700® SERIES RACEWAY

700 Series Wire Fill Capacities For Communications

	CABLE/WIRE SIZE	O.D. (APPROX. DIA.)		40% FILL
		Inches	[mm]	
UNSHIELDED TWISTED PAIR	4-pair, 24 AWG, Cat 3	0.190	[4.8]	3
	4-pair, 24 AWG, Cat 5e	0.210	[5.3]	3
	4-pair, 24 AWG, Cat 6	0.250	[6.3]	2
	4-pair, 24 AWG, Cat 6a*	0.354	[9.0]	1
	25-pair, 24 AWG	0.410	[10.4]	0
COAXIAL	RG6/U	0.270	[6.9]	1
FIBER	ZipCord	0.118 x 0.236	[3 x 6]	3
	Round 4 Strand Fiber	0.187	[4.8]	3
	Round 6 Strand Fiber	0.256	[6.5]	2

700 Series Wire Fill Capacities for Power

WIRE SIZE	O.D.		NO. OF CONDUCTORS
	Inches	[mm]	
THHN/THWN	40% FILL		
14 AWG	0.111	[2.8]	10
12 AWG	0.130	[3.3]	7
10 AWG	0.164	[4.2]	4

NOTE: For additional information, refer to the Technical Section.
 * Category 6 augmented (6a) cable for 10 gigabit ethernet – max allowed cable diameter per addenda No. 11 ANSI TIA/EIA 568-B.2.

700 Series Raceways Ordering Information

V700, 700WH One-Piece Raceway

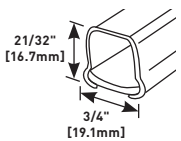

.040" [1.0mm] steel. Ivory finish. Available in 10' [3m] lengths, 100' [31m] per carton. One (1) 5701 Coupling furnished with each length.

702 Bushing

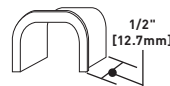

Protects wires from abrasion. Slips into open end of 700 Series Raceway.

607 700 Series Raceway Cutter

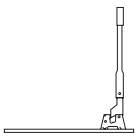

Single action portable cutter. Fast and easy square cuts.

V704, 704WH Mounting Strap

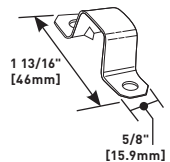

(One- or Two-Hole) Converts to one-hole by breaking off at score. Lanced tab holds strap in place while fastening to surface.

607K Replacement Blades

Case hard steel replacement blades for 607 Raceway Cutter.

V706, 706WH Connection Cover

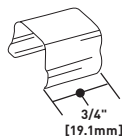

Covers seam where two lengths of 700 Series Raceway come together.

NOTE: Use #8 flathead screws with all fittings requiring screws except V704. With V704, use #8 panhead screws.

500[®] & 700[®] SERIES RACEWAY

500 & 700 Series Raceway Fittings Ordering Information

V711, 711WH Flat Elbow

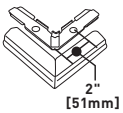

Right angle turns on the same surface.

V712, 712WH 45° Flat Elbow

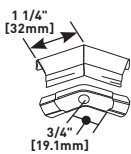

Diagonal 45° turns on same surface.

V717, 717WH Internal Elbow

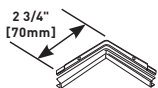

Inside right angle turns.

V718, 718WH Outside Elbow

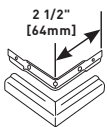

Outside right angle turns.

V5700F Flexible Section



For installing raceway around offsets, side bends, twisted turns, and curved surfaces. Wire fill capacity is the same as 500 & 700 Series Raceways. Consult factory for custom lengths. Maximum painted length 3' [915mm].

5701 Coupling

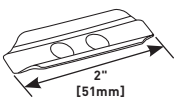

Joins and supports lengths of 500 or 700 Series Raceway. One coupling included with each length of raceway.

V5703, 5703WH Supporting Clip

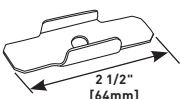

Supports lengths of 500 and 700 Series Raceway.

5709 Ground Clamp

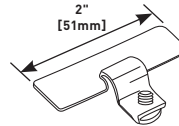

Provides additional grounding for 500 or 700 Series Raceway or to ground remotely located devices. Insert clamp into raceway before installing. Attach ground wire to screw as required by National Electrical Code.

5709GC Grounding Connector

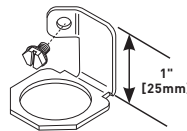

Provides grounding means for 1/2" trade size conduit using lock nut.

5711LHA, 5711RHA Internal Twist Elbows

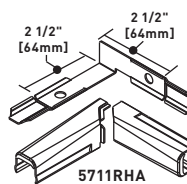

90° twist with a 90° turn. For double turn at right angles from one surface to another. For transitions from a sidewall to ceiling or edge of door or window trim. Twistout in cover adapts for use with 700 Series Raceway. Available in ivory (5711LHA, 5711RHA) and white (5711LHAWH, 5711RHAWH).

V5715, 5715WH Tee

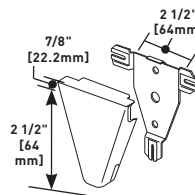

Connects branches of 700 Series Raceway at right angles. When used with 700 Series Raceway, break out crescent twistout in cover.

V5719, 5719WH Corner Box

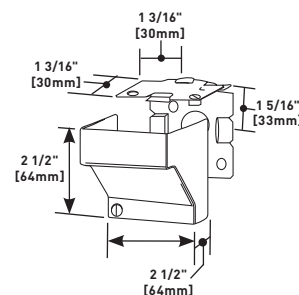

For feeding raceway from ceiling or floor. Allows for ample splice room. Base has 1/2" trade size KO.

500[®] & 700[®] SERIES RACEWAY

500 & 700 Series Raceways Interconnectivity Fittings

CONNECTION REQUIRED		USE CATALOG NUMBER
FROM	TO	
500 Series, 700 Series Raceway	1500 Series Raceway	1517B
500 Series Raceway	Side of 2000 Series Raceway	V2089
500 Series Raceway	End of 2000 Series Raceway	V2089E
Existing Outlet	500 or 700 Series Raceway	V5751
Panel Box	500 or 700 Series Raceway	V5786
1/2" trade size Conduit or Armored Cable	500 or 700 Series Raceway	5782, V5784
3/4" trade size Conduit or Armored Cable	500 or 700 Series Raceway	5782A
Boxes with 1/2" trade size KOs	500 or 700 Series Raceway	5781, V5785
Boxes with 3/4" trade size KOs	500 or 700 Series Raceway	5781A
3" [76mm] or 4" [102mm] Ceiling Boxes	500 or 700 Series Raceway	V5737, V5737A, V5739
Single-Gang Outlet Box	Two-Gang Surface Box	V5735, V5744-2, V5744S-2, V5747-2, V5748-2
14/2, 14/3, 12/2, 12/3 Armored Cable	500 or 700 Series Raceway	5790B
1/2" trade size EMT	5700 Series Boxes	5791

500 & 700 Series Raceway Fittings Ordering Information (continued)

V5760 Blank Extension Box

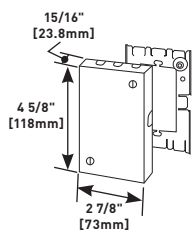

Extension for existing flush switch and receptacle boxes to blank original outlet. Closed base version available as a special order.

5782, 5782A Conduit Connector (Galvanized)

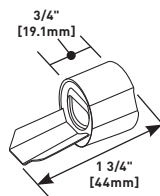

Interior threaded female connector for connecting raceway to conduit. When used with 700 Series Raceway, break out crescent twistout in connector. **5782** has 1/2" trade size conduit opening and **5782A** has 3/4" trade size conduit opening.

5780 Special Nipple (Galvanized)



For hanging either 3/8" [9.5mm] or 1/2" [12.7mm] fixtures to Wiremold fittings with 1/2" trade size KOs. Has female 3/8" [9.5mm] pipe thread inside and male 1/2" [12.7mm] pipe thread outside.

V5783 Elbow Box Connector

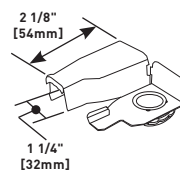

Connects raceway at right angles to conduit boxes or panel boxes that have 1/2" trade size conduit KOs. When used with 700 Series Raceway, break out crescent twistout in cover.

5781, 5781A Box Connector (Galvanized)

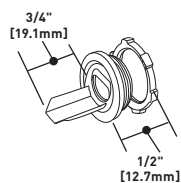

Male connector for connecting raceway to conduit boxes or panel boxes that have KOs for conduit. Can also be used with conduit type fittings. When used with 700 Series Raceway, break out crescent twistout in connector. 5781 has 1/2" trade size conduit opening and 5781A has 3/4" trade size conduit opening.

V5784 Elbow Box Connector

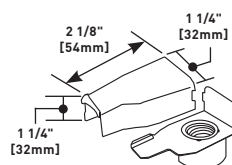

Connects raceway at right angles to 1/2" trade size conduit or armored cable connectors. When used with 700 Series Raceway, break out crescent twistout in cover.

500[®] & 700[®] SERIES RACEWAY

500 & 700 Series Raceway Fittings Ordering Information (continued)

V5785, 5785WH Combination Connector

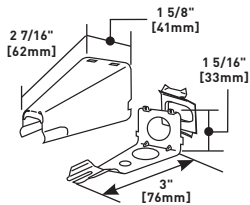

Connects raceway, without offsetting, to any surface-mounted 3 1/4" or 4" [83mm or 102mm] outlet box with 1/2" trade size conduit KOs. Base has two 1/2" trade size KOs, one on end and one on bottom. Included spring steel bushing eliminates need

for conduit nipple and locknut for end connection to box. When used with 700 Series Raceway, break off cover extension.

V5786, 5786WH Adjustable Offset Connector

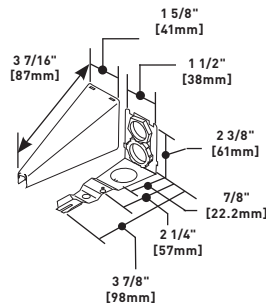

Eliminates need to offset raceway when connecting to surface type panel boxes. Adjustment from surface to center of bushings is 5/8" [15.9mm] minimum to 1 3/8" [35mm] maximum. When used as adjustable offset connector, break out metal between the two holes. When used with 700 Series Raceway, break out crescent twistout in cover. 1/2" trade size chase nipple and locknut furnished.

5790B Armored Cable Connector (Galvanized)

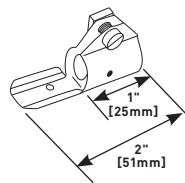

Connects 14/2, 14/3, 12/2, and 12/3 "MC" and armored cable to Wiremold fittings. A short piece of 500 or 700 Series Raceway (1 5/8" [41mm] min.) must be used between connector and Wiremold fittings. Not for use with 1/2" [12.7mm] flex conduit.

5791 EMT Connector

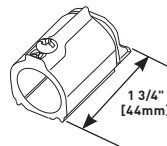

Connects 1/2" trade size EMT to 5700 Series rectangular and round device boxes (except 5733). Derates the fill capacity of the EMT.

500 & 700 Series Raceways Device Boxes Ordering Information

V5731 Blank Cover

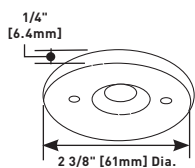

Use with 5733 Outlet Box to convert box into pull or junction box. Has 1/2" trade size KO in center.

V5735 Distribution Box

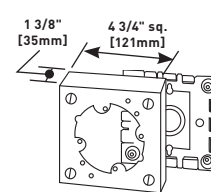

Twistouts permit use of three parallel raceway runs on each side. Base has 1/2" and 1" concentric trade size KOs and a 1 13/16" [46mm] x 2 7/8" [73mm] rectangular KO to mount on a one-gang in-wall outlet box. Cover accepts devices with mounting screw centers of 2 3/4", 3 1/2" or 4 1/16" [70mm, 89mm or 103mm], and canopy fixtures no larger than 4 5/8" [117mm] in diameter. With 5736 Blank Cover, this fitting can be used as junction box, pull box, etc.

V5733 Outlet Box

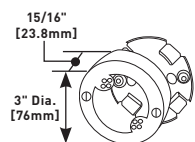

For devices with mounting screw centers of 1 15/32", 1 5/8", 1 11/16", or 1 27/32" [37mm, 41mm, 44mm, or 46mm]. Will accept any device that mounts on "G" or "H" type conduit fittings.

V5736, 5736WH Blank Cover

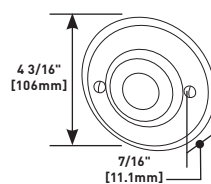

1/2" trade size KO in center. For use with 5735, 5737, 5737A, 5738, 5738AF, 5739, 5739A or 2135 Device Boxes. Converts these boxes into pull or junction boxes or for hanging lightweight pendant fixtures with 1/2" trade size pipe stems.

NOTE: 500 & 700 Series Raceway Systems Device Boxes that are identified with this symbol are Certified to Canadian Safety Standards for sale in Canada. When ordering these products (this page and the next page), change the "V" color prefix to "VC" or the "WH" color suffix to "WHC" to deNOTE the Canadian versions.

500® & 700® SERIES RACEWAY

500 & 700 Series Raceways Device Boxes Ordering Information (continued)

5737, 5739 Open Base Extension Box

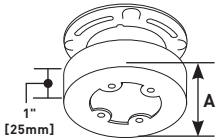

Mounts on 3 1/4" or 4" [83mm or 102mm] conduit boxes or other recessed outlets. Cover accepts devices with mounting screw centers of 2 3/4", 3 1/2" or 4 1/16" [70mm, 89mm, or 103mm]. Can be used with 5736 Blank Cover as a pull or junction box.

CAT. NO.	DIA. A.
V5737, 5737WH	4 3/4" [121mm]
V5737A, 5737AWH	5 1/2" [140mm]
V5739A	6 3/8" [162mm]

5738, 5738A, 5739 Solid Base Fixture Box

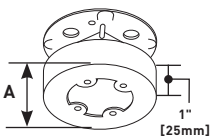

Used to hang fixtures. Cover accepts devices with mounting screw centers of 2 3/4", 3 1/2", and 4 1/16" [70mm, 89mm, and 103mm]. Base has four holes for fixture studs, four 1/2" trade size KOs, and raised section for no-bolt fixture-stud. Use as a junction or pull box with 5736 Blank Cover.

CAT. NO.	DIA. A.
V5738, 5738WH	4 3/4" [121mm]
5738A, 5738AWH	5 1/2" [140mm]
5739, 5739WH	6 3/8" [162mm]

V5738AF, 5738AFWH Solid Base Fan Box

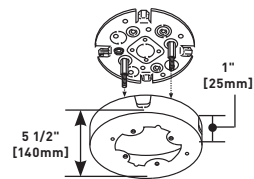

Cover accepts fan bracket with mounting centers of 3 3/16" [81mm]. Base has six mounting holes and 4 1/2" trade size KOs. #10 mounting studs provided. Rated for fans and fixtures up to 50 lbs.

V57240 15A, 125V Single Pole Switch & Box

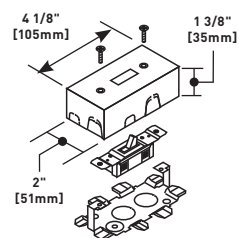

Single pole switch included. Accepts standard single-gang switches including three-way. Cover has twistouts for 500 or 700 Series Raceway on each end and sides. Twistouts on ends of box permit running raceway close to interior trim. Base has 1/2" trade size KOs.

NOTE: One-gang device boxes accept NEMA single-gang standard faceplates. Two-gang device boxes accept NEMA double-gang standard faceplates.

V57242 Utility Box

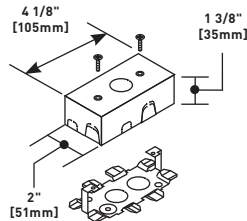

Can be used as tee, cross, pull box, junction box, or blank box. Cover has 1/2" trade size KO and twistouts for 500, and 700 Series Raceway on each end and sides. Twistouts on ends of box permit running raceway close to interior trim. Base has 1/2" trade size KOs.

V57243G 15A, 125V Duplex Grounding Receptacle (NEMA 5-15R) & Box

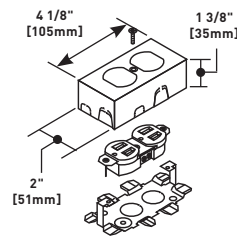

Accommodates 15A (NEMA 5-15R) or 20A (NEMA 5-20R) duplex devices in place of duplex grounding receptacle included. Cover has twistouts for 500 and 700 Series Raceway on each end and sides. Twistouts on ends of box permit running raceway close to interior trim. Base has 1/2" trade size KOs.

V5741, 5741WH Switch & Receptacle Box

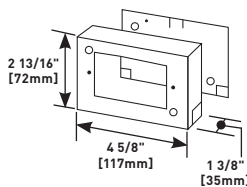

For shallow type switches (three-way, single, and double pole) and receptacles, including three-wire locking receptacles and single-gang combination devices. Base has 1/2" trade size KO. Position of twistouts on ends permits running raceways close to interior trim.

5744, 5744-2, 5744-3 Extra Deep Switch & Receptacle Box

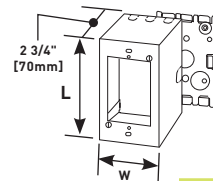

For deep devices such as momentary contact, remote control switches, and hospital signaling system devices. Base has 1/2" trade size KOs. Larger gang boxes available by special order.

CAT. NO.	L	W	GANGS
V5744, 5744-WH	4 5/8" [117mm]	2 7/8" [73mm]	1
V5744-2, 5744-2WH	4 3/4" [121mm]	4 3/4" [121mm]	2
V5744-3	4 5/8" [117mm]	6 1/2" [165mm]	3

NOTE: 500 & 700 Series Raceway Systems Device Boxes that are identified with this symbol are Certified to Canadian Safety Standards for sale in Canada. When ordering these products (this page and the next page), change the "V" color prefix to "VC" or the "WH" color suffix to "WHC" to deNOTE the Canadian versions.

500[®] & 700[®] SERIES RACEWAY

500 & 700 Series Raceways Device Boxes Ordering Information (continued)

5744S, 5744S-2, 5744S-3 Deep Switch & Receptacle Box

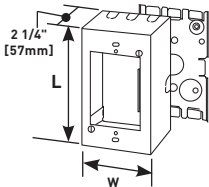

Designed especially for use in the installation of signal system and alarm wiring. Base has 1/2" trade size KOs. Larger gang boxes are available by special order.

CAT. NO.	L	W	GANGS
V5744S, 5744SWH	4 5/8" [117mm]	2 7/8" [73mm]	1
V5744S-2, 5744S-2WH	4 3/4" [121mm]	4 3/4" [121mm]	2
V5744S-3	4 5/8" [117mm]	6 1/2" [165mm]	3

5748, 5748-2, 5748-3, 5748-4, 5748-5, 5748-6 Switch & Receptacle Box

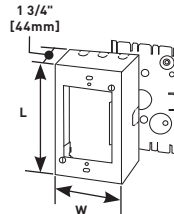

For deep switches and receptacles. Base has two 1/2" trade size KOs. Larger gang boxes available by special order.

CAT. NO.	L	W	GANGS
V5748, V5748WH	4 5/8" [117mm]	2 7/8" [73mm]	1
V5748-2, V5748-2WH	4 3/4" [121mm]	4 3/4" [121mm]	2
V5748-3, V5748-3WH	4 5/8" [117mm]	6 1/2" [165mm]	3
V5748-4	4 5/8" [117mm]	8 11/32" [212mm]	4
V5748-5	4 5/8" [117mm]	10 5/32" [258mm]	5
V5748-6	4 5/8" [117mm]	11 31/32" [304mm]	6

V5745, 5745WH Combination Switch & Receptacle Box

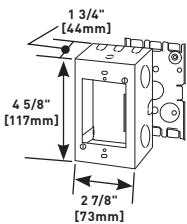

Connects to surface runs of 1/2" trade size conduit. Cover has 1/2" trade size KO and two raceway twistouts on one end and three raceway twistouts on opposite end, two 1/2" KOs and a raceway twistout on each side. Base has two 1/2" trade size KOs. Larger gang boxes are available by special order.

V5748S, 5748SWH Shallow Switch & Receptacle Box

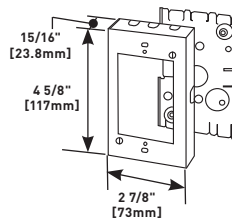

For shallow type switch and duplex receptacles. Base has 1/2" trade size KOs.

5747, 5747-2, 5747-3 Shallow Switch & Receptacle Box

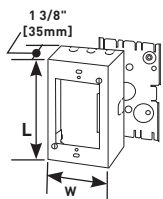

For standard shallow switches and receptacles including single-gang combination devices. Base has two 1/2" trade size KOs. Larger gang boxes available by special order.

CAT. NO.	L	W	GANGS
V5747, 5747WH	4 5/8" [117mm]	2 7/8" [73mm]	1
V5747-2, 5747-2WH	4 3/4" [121mm]	4 3/4" [121mm]	2
V5747-3	4 5/8" [117mm]	6 1/2" [165mm]	3

5751, 5751-2, 5751-3 Flush Type Extension Adapter

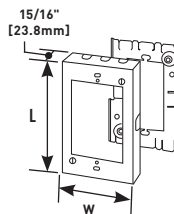

For extensions from existing flush switch and receptacle boxes. Larger gang boxes available by special order.

CAT. NO.	L	W	GANGS
V5751, 5751WH	4 5/8" [117mm]	2 7/8" [73mm]	1
V5751-2, 5751-2WH	4 3/4" [121mm]	4 3/4" [121mm]	2
V5751-3	4 5/8" [117mm]	6 1/2" [165mm]	3

NOTE: 500 & 700 Series Raceway Systems Device Boxes that are identified with this symbol are Certified to Canadian Safety Standards for sale in Canada. When ordering these products (this page and the next page), change the "V" color prefix to "VC" or the "WH" color suffix to "WHC" to denote the Canadian versions.

500[®] & 700[®] SERIES RACEWAY

500 & 700 Series Raceways Device Boxes Ordering Information (continued)

V5751A, 5751AWH Deep Flush Type Extension Adapter

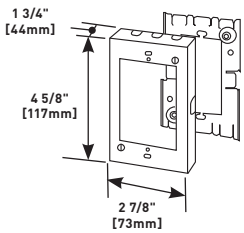

For deep extensions from existing wall boxes.

V5752, R5752 Two-Gang Alarm Device Box

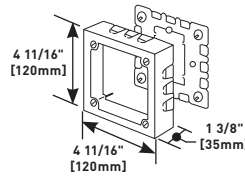

For surface mounting of alarm devices and safety signals designed to fit into 4" [102mm] square back boxes. Cover has three raceway twistouts on each side. Base has 1/2" and 1" concentric and single-gang box KOs. R5752 has red finish.

CM-MMB-571 One Insert Multimedia Box

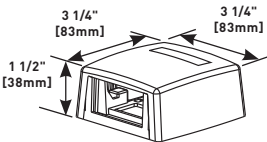

Accepts one CM2 Wiremold Open System Communications Module or one Pass & Seymour[®] Activate Series Insert. Compatible with 500 and 700 Series Raceway. ivory finish.

V5753, R5753 Two-Gang Extra Deep Alarm Device Box

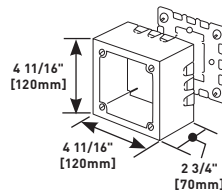

For surface mounting of alarm devices and safety signals designed to fit into 4" [102mm] square back boxes. R5753 has red finish. Cover is 2 3/4" [70mm] deep and has three twistouts for raceways on each side. Base has 1/2" and 1" concentric and single-gang box KOs.

NOTE: One-gang device boxes accept NEMA single-gang standard faceplates. Two-gang device boxes accept NEMA double-gang standard faceplates.

500 & 700 Series Raceways Tools

600B Wiremold Bender



For making smooth, accurate bends, saddles and offsets in Wiremold 500 and 700 Series Raceways. Two-piece handle fits in tool box.

IWE-S Spray Paint



Used for touching up large areas. Contains 12 oz. of paint.

NOTE: Can only be shipped via ground transportation.

615 Wire Pulley

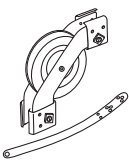

For fishing wires around inside corners of 500 or 700 Series Raceway. When conductors are through the run, detach pulley and snap on appropriate internal elbow cover.

One 616 Fish Tape Leader included.

IWE-P Touch-Up Paint Pen



Used for touching up small areas. Contains 0.3 oz. of paint.

NOTE: Can only be shipped via ground transportation.



616 Fish Tape Leader



For pulling conductors through 500 or 700 Series Raceways. Holes provided for up to eight conductors.

500[®] & 700[®] SERIES RACEWAY

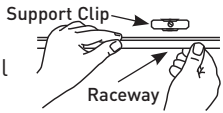
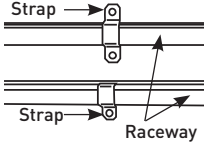
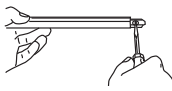
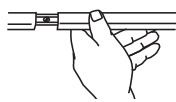
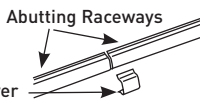
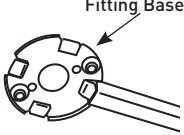
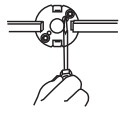
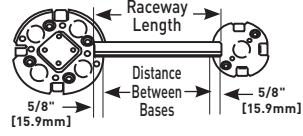
500 & 700 Series Raceways Installation Details

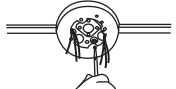
- Each length of Wiremold raceway is furnished with a coupling. Push coupling out to expose clearance hole (5701). 
 - Fasten support clips (V5703) to surface at approximately 32" [816mm] intervals. See the Technical Information Section for surface mounting methods. After support clips are installed, snap raceway into clips. 
 - As an alternate method of mounting (especially if the surface is uneven), 504 or 704 straps can be used. Hold raceway in position and fasten strap to surface. Straps should be spaced no greater than 32" [816mm] O.C. 
 - For added support or to secure raceway prior to installing straps, fasten coupling to surface through clearance holes (5701). 
 - Slide adjoining section of raceway onto coupling (5701). 
- NOTE: If raceway has been field cut, it must be deburred prior to coupling.**
- If ends of adjoining raceways are not square, use 506 or 706 Cover Connection to fill gap. 
 - Couple raceway to fitting base by slipping tongue of fitting under the base of raceway. (Use 502 or 702 Bushing to protect wires from abrasion.) Do not mount more than one fitting base at a time. Sequence should be base, raceway, base, raceway, etc. 
 - Fasten base of fitting to surface using proper flat head fastener: #8 with V500 and V700 Series. See Technical Information Section for surface mounting methods. 
 - Determine desired location of next fitting. Measure and cut raceway as shown. Install fitting base and raceway as in steps 1 and 2. 
 - Pull wiring in. (Use 502 or 702 Bushing to protect wires from abrasion.) 
 - Remove proper twistouts in fitting cover(s) with pliers. Twist inward as shown. 
 - Install fitting cover(s) over raceway(s) and fasten to fitting base with screws provided. 

2000 SERIES® RACEWAY



Two-piece, single-channel raceway. Easy-to-install and ideal for basic power or communication/low voltage installations

CODE REFERENCE

cULus Listed Raceway:
File E4376 Guide RJBT.

Fittings:
File E41751 Guide RJPR.
Meets Article 386 of NEC.
Meets Section 12-1600 of CEC.

System Layout

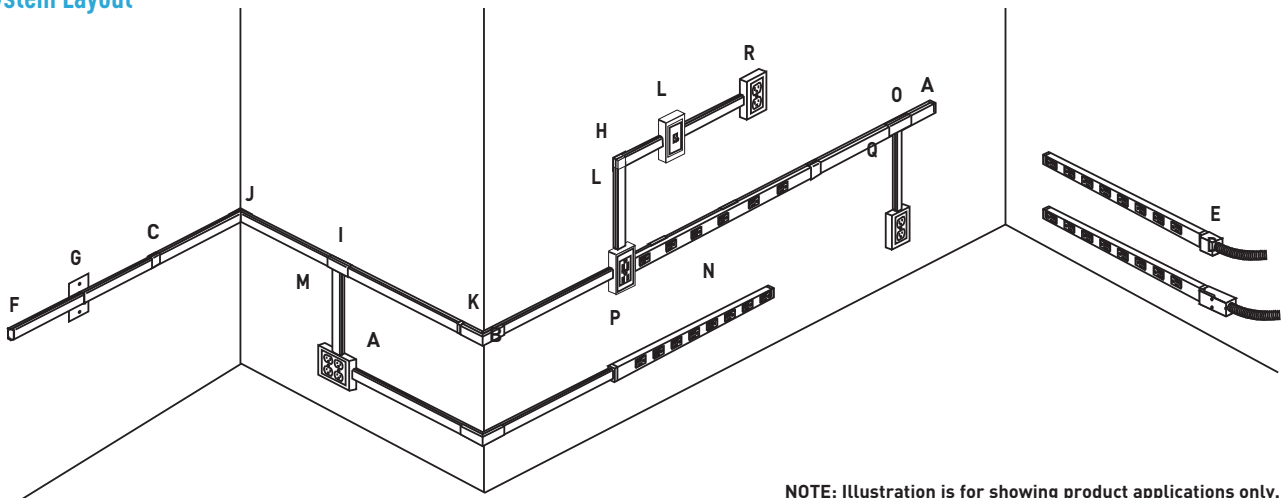

KEY

- | | | |
|--------------------------------|------------------------------------|---------------------------------|
| A. 500 Series Raceway | G. 2051H Flush Plate Adapter | M. 2048-2 Two-Gang Device Box |
| B. 518 External Elbow Fitting | H. 2011 90° Flat Elbow Fitting | N. 20GB506 Plugmold Strip |
| C. 2006 Cover Clip | I. 2015 Tee Fitting | O. 2089A Flush Plate Adapter |
| D. 2010A3 Entrance End Fitting | J. 2017TC Internal Corner Coupling | P. 2089E End-Reducing Connector |
| E. 2010A2 Entrance End Fitting | K. 2018C External Elbow Cover | Q. 5748 Single-Gang Device Box |
| F. 2010B Blank End Fitting | L. 2048 Single-Gang Device Box | |

COLOR OPTIONS



2000® Series Raceway Part Numbers with a "V" prefix have an ivory finish. Part Numbers with a "G" prefix have a gray finish. Part Numbers without a prefix or suffix have a protective zinc finish.

Custom color options are also available. Consult the factory for more information.

2000 SERIES® RACEWAY

2000 Series Raceway Wire Fill Capacities For Communications

	CABLE/WIRE SIZE	O.D. (APPROX. DIA.)		40% FILL
		Inches	[mm]	
UNSHIELDED TWISTED PAIR	4-pair, 24 AWG, Cat 3	0.190	[4.8]	11
	4-pair, 24 AWG, Cat 5e	0.210	[5.3]	9
	4-pair, 24 AWG, Cat 6	0.250	[6.3]	6
	4-pair, 24 AWG, Cat 6a*	0.354	[9.0]	3
	25-pair, 24 AWG	0.410	[10.4]	2
COAXIAL	RG6/U	0.270	[6.9]	5
FIBER	ZipCord	0.118 x 0.236	[3 x 6]	11
	Round 4 Strand Fiber	0.187	[4.8]	11
	Round 6 Strand Fiber	0.256	[6.5]	6

2000 Series Raceway Wire Fill Capacities For Power

WIRE SIZE	O.D.		NO. OF CONDUCTORS	
	Inches	[mm]	WITHOUT DEVICES	WITH PLUGMOLD RECEPTACLE
THHN/THWN				
14 AWG	0.111	[2.8]	7	5
12 AWG	0.130	[3.3]	7	5

NOTE: For additional information, refer to the Technical Section.
 * Category 6 augmented (6a) cable for 10 gigabit ethernet – max allowed cable diameter per addenda No. 11 ANSI TIA/EIA 568-B.2.

2000 Series Raceway Ordering Information

V2000BC, G2000BC Raceway Base & Cover

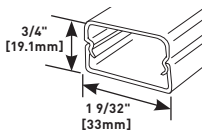

Packed ten (10) 5' [1.5m] lengths per carton.

V2000B-5, G2000B-5, V2000B-10, G2000B-10 Raceway Base

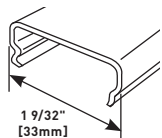

.040" [1.0mm] steel. Packed twenty (20) 5' [1.5m] lengths per carton. 10' [3m] lengths (V2000B-10, G2000B-10) are also available. Packed 100' [30.5m] per carton.

V2000BC, G2000BC Raceway Base & Cover

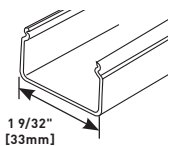

.025" [.8mm] steel. Packed twenty 5' [1.5m] lengths per carton. Shipped without receptacle hole cuts.

620 2000 Series Raceway Base & Cover Cutter

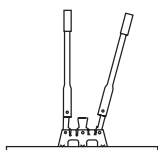

Portable cutter for both 2000 Series Raceway Base and Cover. Provides clean and easy square cuts every time.

620BCK Replacement Blade Kit

Case hard steel replacement blades and die set for 620 Cutter.

W30/W30G Pressure-Type Wire Connectors

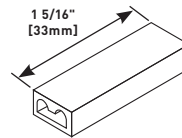

W30 – Common connection of two, three, or four No. 12 or No.14 solid copper conductors.
W30G – Connection of equipment grounding of 2, 3, or 4 solid conductors No. 14 or No. 12 AWG. 300V maximum; 20A 105° C maximum.

NOTE: Not for use with aluminum conductors.

2000WC Wire Clip (Galvanized)

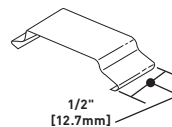

Additional support for conductors.

2001 Coupling (Galvanized)

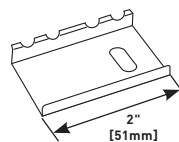

Connects lengths of 2000B Raceway Base.

V2003, 2003 Supporting Clip

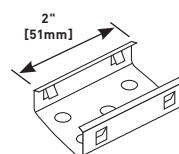

Supports lengths of 2000 Series Raceway at any point desired. Mounts to surface with No. 6 flathead screw. 2003 support clip has plated finish. V2003 has ivory finish.

2000 SERIES® RACEWAY

2000 Series Raceway Interconnectivity Fittings

CONNECTION REQUIRED		USE CATALOG NUMBER
FROM	TO	
500 Series Raceway	Side of 2000 Series Raceway	V2089, V2048, V2048-2
500 Series Raceway	End of 2000 Series Raceway	V2089E, V2048, V2048-2
Existing Outlet	2000 Series Raceway	V2051H
1/2" trade size Conduit or Armored Cable	2000 Series Raceway	V2010A2, V2010A3

V2010B, G2010B Blank End Fitting

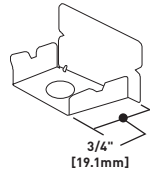

Closes off the open end of 2000 Series Raceway.

2000 Series Raceway Ordering Information (continued)

V2006, G2006 Cover Clip

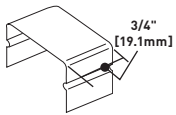

Covers seam where two lengths of 2000 Series Raceway come together.

V2011, G2011 Flat Elbow Fitting

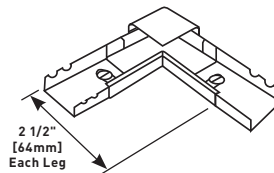

For right angle turns on same surface. Cover stop permits neat butting of 2000C Cover. Two couplings included.

2009 Ground Clamp

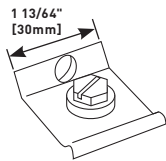

Connects equipment grounding conductor. Provides an additional ground for raceway.

How 2009 is used.

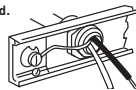

V2015, G2015 Tee Fitting

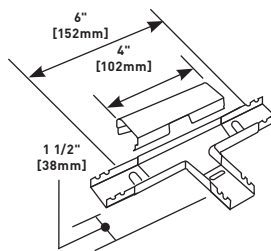

For branching raceway at right angles. Three couplings included.

V2010A2, G2010A2 Entrance End Fitting

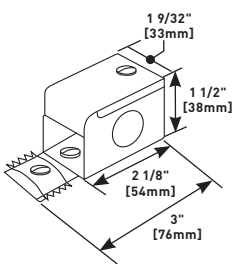

Connects 2000 Series Raceway to 1/2" trade size conduit or armored cable connectors. 1/2" trade size KO's located on end, sides, and bottom of fitting. Includes ground screw. If more capacity is required, use 2010A3.

2017TC Internal Corner Coupling

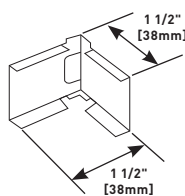

Can be used as inside corner coupling or as coupling and straight thru fitting. Furnished with one fiber bushing.

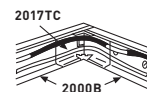

2017TC used as a corner coupling.

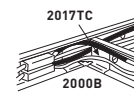

2017TC used as a corner coupling and a straight-through fitting.

V2010A3, G2010A3 Entrance End Fitting

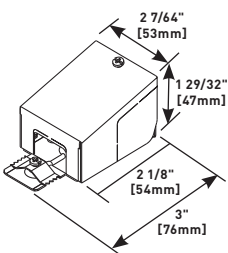

1/2" trade size KO's located on end, sides, and bottom of fitting. 3/4" KO's on bottom and rear. Includes ground screw.

V2018C, G2018C External Elbow Cover

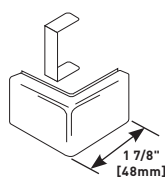

Covers gap when external corner is made by notching and bending 2000B Base. Continues raceway runs around outside corners.



Corner gap filler snapped into place in 2018C

2000 SERIES® RACEWAY

2000 Series Raceway Ordering Information (continued)

IWE-S, GWE-S Spray Paint

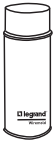

Used for touching up large areas. Contains 12 oz. of paint.
NOTE: Can only be shipped via ground transportation.

IWE-P, GWE-S Touch-Up Paint Pen



Used for touching up small areas. Contains 0.3 oz. of paint.

V2048, G2048 Single-Gang Device Box

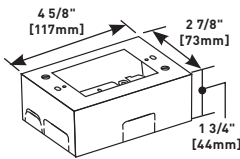

Cover has twistouts for 2000, 500, and 700 Series Raceways. Base has 1/2" trade size KO and rectangular KO for extension to wall box. Base has #10 threaded hole for ground connection.

V2048-2, G2048-2 Two-Gang Device Box

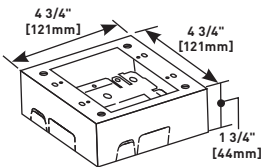

Cover has twistouts for 2000, 500, and 700 Series Raceways. Base has 1/2" trade size KO and rectangular KO for extension to wall box. Base has #10 threaded hole for ground connection.

V2051H, G2051H Flush Plate Adapter

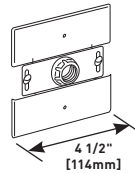

Feeds 2000 Series Raceway from an existing wall outlet. Equipped with 1/2" trade size threaded stud, toothed lock washer for grounding, and conduit bushing.

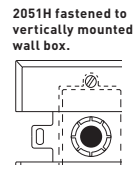
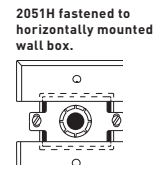
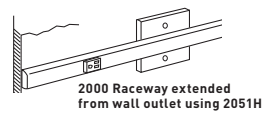

V2089 Side Reducing Connector

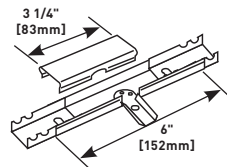

Connects 2000 Series Raceway with 500 Series Raceway through the side of 2000 Series Raceway.

V2089E End Reducing Connector

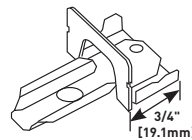

Connects 2000 Series Raceway with 500 Series Raceway through the end of 2000 Series Raceway.

NOTE: Parts identified with this symbol  are Certified to Canadian Safety Standards for sale in Canada. When ordering these products, change the "V" color prefix to "CV" or the "G" color prefix to "CG" to denote the Canadian versions.

2400 SERIES™ RACEWAY



Single Channel Raceway . Easy-to-install and ideal for basic power or communication/low voltage installations in classrooms, hotels, and anywhere a low profile raceway solution is needed.

CODE REFERENCE

cULus Listed Raceway:
File E4376 Guide RJBT.

Fittings:
File E41751 Guide RJPR.
Meets Article 386 of NEC.
Meets Section 12-1600 of CEC.

2400 Series Raceway System Layout for Power

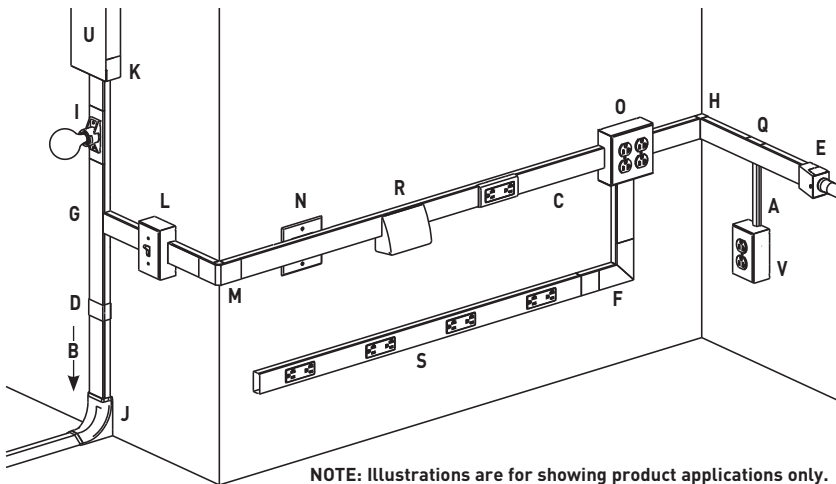

KEY

- A. 500 Series Raceway
- B. 1500/2600 Raceway Feed
- C. 2400 Series Raceway
- D. 2406 Cover Clip
- E. 2410C Entrance End Fitting
- F. 2411M Flat Elbow Fitting
- G. 2415M Tee Fitting
- H. 2417M Internal Elbow Fitting
- I. 2426 Lamp Holder
- J. 2686FO Transition Fitting
- K. 4089 Reducing Connector
- L. 2448 One-Gang Device Box
- M. 2418M External Elbow Fitting
- N. 2451H Back Feed Fitting
- O. 2448-2 Two-Gang Device Box
- P. 2475D Bridge Fitting
- Q. 2489 Reducing Adapter
- R. 24DWND Downward Duplex Device Bracket
- 24DWNR Downward Decorator Device Bracket
- S. 24S7218GBX99IV 2400 Series Plugmold Strip
- U. U4000 Series Raceway
- V. 5747 Shallow Switch Box
- W. 2400BC 2400 Series Raceway
- X. 2411FO Radiused Flat Elbow
- Y. 2415H Back Feed Fitting
- Z. 2415FO Radiused Tee Fitting
- AA. 2417FO Radiused Internal Elbow
- BB. 2418FO Radiused External Elbow
- CC. 2686FO Transition Feed Fitting
- DD. 5744 Extra Deep Device Box

2400 Series Raceway System Layout for Communications

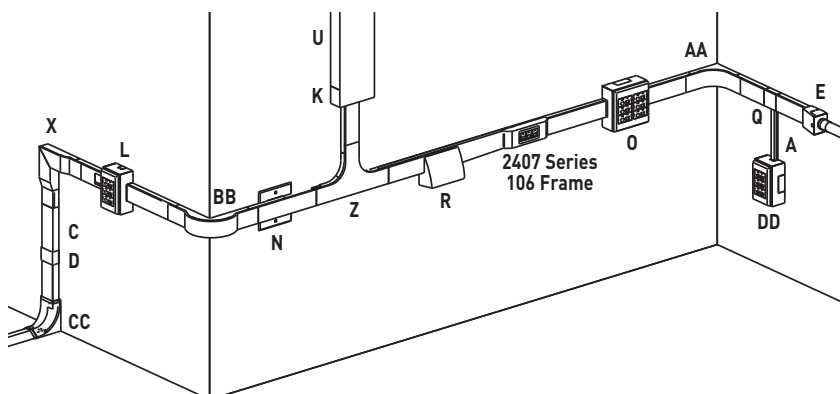

COLOR OPTIONS



2400 Series™ Raceway Part Numbers with a "V" prefix have an ivory finish. Part Numbers with a "-FW" suffix have a fog white finish.

Custom color options are also available. Consult the factory for more information.

2400 SERIES™ RACEWAY

2400 Series Raceway Wire Fill Capacities for Communications

	CABLE/WIRE SIZE	O.D. (APPROX. DIA.)		40% FILL
		Inches	[mm]	
UNSHIELDED TWISTED PAIR	4-pair, 24 AWG, Cat 3	0.190	[4.8]	19
	4-pair, 24 AWG, Cat 5e	0.210	[5.3]	16
	4-pair, 24 AWG, Cat 6	0.250	[6.3]	11
	4-pair, 24 AWG, Cat 6a*	0.354	[9.0]	5
	25-pair, 24 AWG	0.410	[10.4]	4
COAXIAL	RG6/U	0.270	[6.9]	9
FIBER	ZipCord	0.118 x 0.236	[3 x 6]	20
	Round 4 Strand Fiber	0.187	[4.8]	20
	Round 6 Strand Fiber	0.256	[6.5]	10

2000 Series Raceway Wire Fill Capacities For Power

WIRE SIZE	O.D.		NO. OF CONDUCTORS (40%)	
	Inches	[mm]	WITHOUT DEVICES	WITH 2427 RECEPTACLE
THHN/THWN 14 AWG	0.111	[2.8]	57	12
12 AWG	0.130	[3.3]	41	9
10 AWG	0.164	[4.2]	26	0

NOTE: For additional information, refer to the Technical Section.
 * Category 6 augmented (6a) cable for 10 gigabit ethernetmax allowed cable diameter per addenda No. 11 ANSI TIA/EIA 568-B.2.

2400 Series Raceways Ordering Information

V2400B, V2400B-10, 2400B-FW, 2400B-10FW Raceway Base

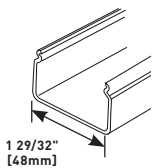

.040" [1.0mm] steel, 5' [1.5m] lengths. Packed twenty 5' [1.5m] lengths per carton (V2400B, 2400B-FW) or ten 10' [3m] lengths per carton (V2400B-10, 2400B-10FW).

V2400BC, 2400BC-FW Raceway Base & Cover

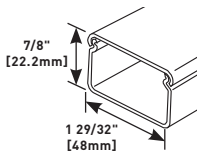

.040" [1.0mm] steel. Packed ten 5' [1.5m] lengths of base and cover per carton.

V2400C, 2400C-FW Raceway Cover

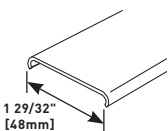

.040" [1.0mm] steel; packed twenty 5' [1.5m] lengths per carton.

624 2400 Series Raceway Base & Cover Cutter

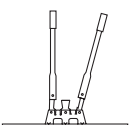

Portable cutter for 2400 & 2400D Series Raceway Base and Cover. Provides a clean and easy square cut every time.

624BCK Replacement Blade Kit

Case hard steel replacement blades and die set for 624 Cutter.

2400 Series Raceway Fittings Ordering Information

2400WC Wire Clip

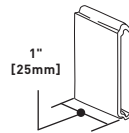

Additional support for conductors. (Nonmetallic)

2401 Coupling

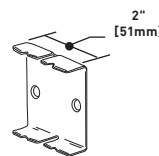

Joins lengths of 2400B Base together.

V2406, 2406-FW Cover Clip

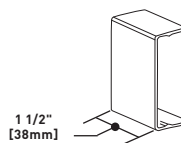

Covers seams where two lengths of 2400 Series Raceway come together (nonmetallic).

2409 Ground Clamp

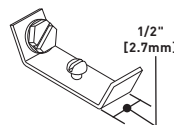

Connects equipment grounding conductor to provide ground to 2400 Series Raceway. No. 10 ground screw provided.

V2410A, 2410A-FW Entrance End Fitting

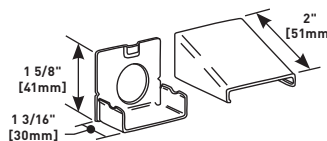

Connects 2400 Series Raceway with 1/2" trade size conduit or armored cable.

2400 SERIES™ RACEWAY

2400 Series Raceway Fittings Ordering Information (continued)

V2410B, 2410B-FW Blank End Fitting

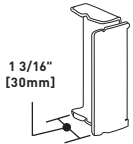

Closes off open end of 2400 Series Raceway.

V2411M, 2411M-FW Flat Elbow

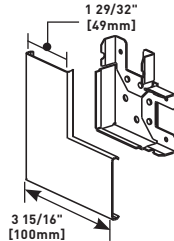

Right angle turns on same surface.

V2410C, 2410C-FW Entrance End Fitting

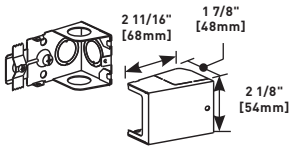

Feeds 2400 Series Raceway. Includes 1/2" and 3/4" trade size KOs on end and bottom. Additional 1/2" trade size KOs on each side.

V2415FO, 2415FO-FW Radiused Tee

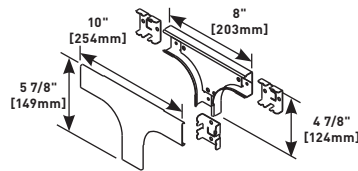

For branches at right angles. Provides 2" [51mm] cable bend radius control for fiber optic and UTP/STP cable installations. Couplings included.

V2410DFO, 2410DFO-FW Divided Entrance End Fitting

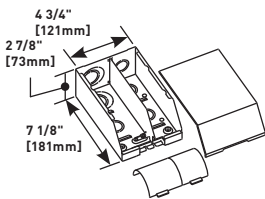

Feeds 2400 & 2400D Series Raceway. Has 1/2", 3/4", and 1" trade size KOs on back and end. Removable divider and radiused insert included.

V2415M, 2415M-FW Tee

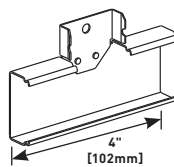

For branching raceway at right angles. Two couplings included.

V2410FC, 2410FC-FW Full Capacity Entrance End Fitting

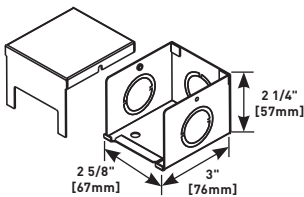

Feeds 2400 Series Raceway. Has 3/4" and 1" concentric trade size KOs located on each side.

V2417FO, 2417FO-FW Radiused Internal Elbow

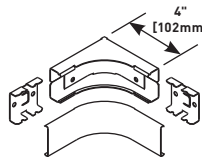

90° internal corner elbow provides 2" [51mm] cable bend radius control for fiber optic and UTP/STP cable installations. Two couplings included.

V2411FO, 2411FO-FW Radiused Flat Elbow

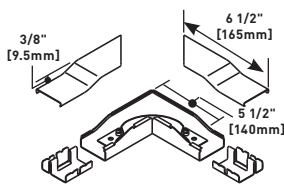

90° flat corner elbow provides 2" [51mm] cable bend radius control for fiber optic and UTP/STP cable installations. Ideal for lay-in or pull-through installations. Couplings included.

V2417M, 2417M-FW Internal Elbow

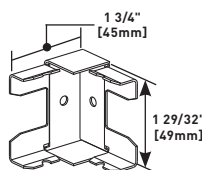

Inside 90° angle turns.

2400 SERIES™ RACEWAY

2400 Series Raceway Fittings Ordering Information (continued)

V2418FO, 2418FO-FW Radiused External Elbow

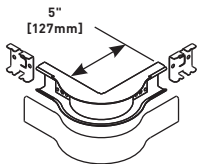

90° external elbow provides 2" [51mm] cable bend radius control for fiber optic and UTP/STP cable installations. Two couplings included.

V2418M, 2418M-FW External Elbow

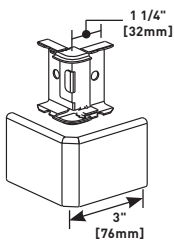

90° external corners.

V2426, 2426-FW Lamp Holder

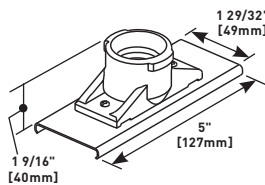

Medium base lamp holder 660W, 250V. Black general purpose phenolic.

V24DWND, 24DWND-FW Downward Duplex Device Bracket

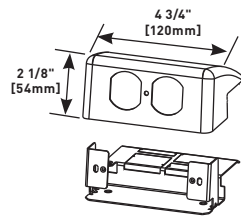

Labor saving, over-the-raceway device bracket. Accepts 15A or 20A duplex receptacles or 106 style data frame.

V24DWNR, 24DWNR-FW Downward Decorator Device Bracket

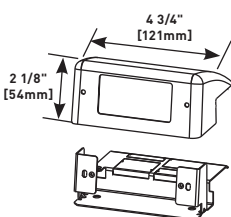

Labor saving, over-the-raceway device bracket. Accepts 15A or 20A decorator receptacles, GFCI receptacle, or 106 style data frame.

V24DWNU, 24DWNU-FW Downward Extron® MAAP Device Plate

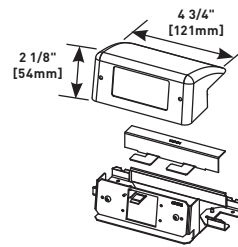

Accepts two Extron® Electronics MAAP single space modules.

V24DWNS, 24DWNS-FW Downward Ortronics® Series II Device Plate

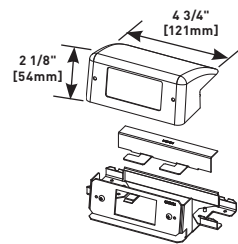

Accepts one Ortronics® Series II module.

V2444, 2444-FW Extra Deep Device Box

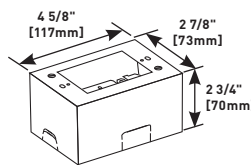

One-gang device box with extra depth to allow installation of cabling that requires greater bend radius and storage. Cover has one twistout for 2400 Series Raceway on each side and one twistout for 500 and 700 Series Raceway on the

top and bottom. Accepts industry standard faceplates for electrical and communication devices.

V2444D, 2444D-FW Device Box

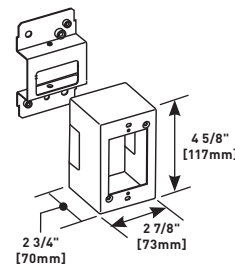

One-gang labor saving, over-the-raceway device box. Cover has twistout on each side for 2400 Series Raceway. Accepts industry standard faceplates for electrical and communication devices.

NOTE: One-gang device boxes accept NEMA single-gang standard faceplates. Two-gang device boxes accept NEMA double-gang standard faceplates.

NOTE: Parts identified with this symbol are Certified to Canadian Safety Standards for sale in Canada. When ordering these products, add "C" to the color prefix to denote the Canadian versions, i.e. "CV2444".

2400 SERIES™ RACEWAY

2400 Series Raceway Fittings Ordering Information (continued)

V2444-2, 2444-2FW Extra Deep Device Box

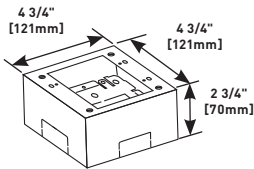

Two-gang device box with extra depth to allow installation of cabling that requires greater bend radius and storage. Cover has twistout on all four sides for 2400 Series Raceway. Base has knockout to enable extension from

existing single-gang flush wall box and 1/2" and 1" concentric trade size KOs. Accepts industry standard faceplates for electrical and communication devices.

V2444-2LS, 2444-2LSFW Device Box

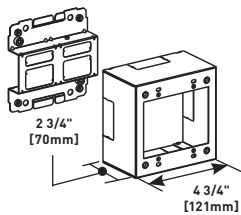

Two-gang labor saving, over-the-raceway device box. Cover has twistout on all four side for 2400 Series Raceway. Accepts industry standard faceplates for electrical and communication devices.

V2448, 2448-FW Device Box

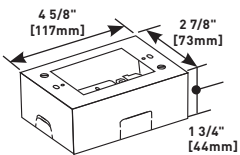

One-gang device box. Cover has twistout for 2400 Series Raceway on each side and one twistout for 500 and 700 Series Raceway on the top and bottom. Base has knockout to enable extension from

existing single-gang, flush wall box and 1/2" trade size KOs. Accepts industry standard faceplates for electrical and communication devices.

V2448-2, 2448-2FW Device Box

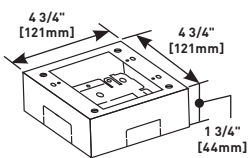

Two-gang device box. Cover has twistouts on all four sides for 2400 Series Raceway. Base has knockout to enable extension from existing single-gang, flush wall box and 1/2" trade size KOs. Accepts industry standard faceplates for electrical and communication devices.

V2451H, 2451H-FW Back Feed Fitting

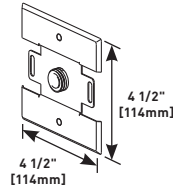

Feeds 2400 Series Raceway from an existing outlet box. Includes 1/2" trade size male bushing and lock nut washer for grounding.

V2475D, 2475D-FW Bridge Fitting

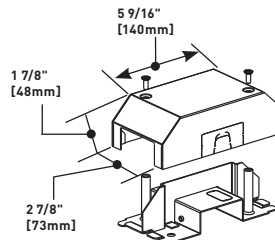

Allows 2400 Series Raceway runs to bridge over existing installations of 2400, 500, and 700 Series Raceways.

V2489 Side Reducing Connector

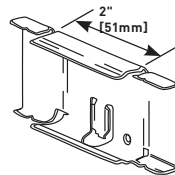

Connects 2400 Series Raceway with 500 Series Raceway.

V2489TB Transition Box

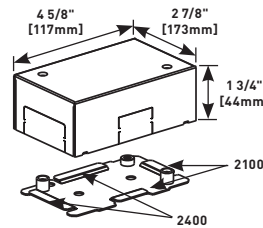

Connects existing installations of 2100 Series Raceway to 2400 Series Raceway.

2686FO Transition Feed Fitting

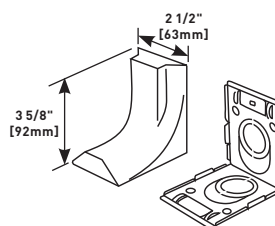

Eliminates need to offset 2400 Series Raceway when connecting with surface panel boxes. Has 3/4" and 1" concentric trade size KOs with 1" trade size KO elongated so adjustment from surface to center of bushing is 1" [25mm] minimum to 1 5/8" [41mm] maximum. Has twistouts

for transition to 1500 and 2600 Series Pancake Raceways.

NOTE: Parts identified with this symbol are Certified to Canadian Safety Standards for sale in Canada. When ordering these products, add "C" to the color prefix to denote the Canadian versions, i.e. "CV2444".

2400 SERIES™ RACEWAY

2400 Series Raceway Fittings Ordering Information (continued)

V4089 Reducing Connector

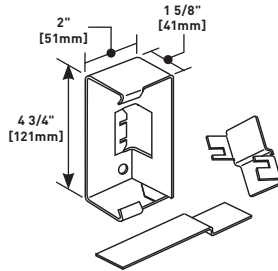

Connects 4000 Series Raceway to 2400 Series Raceway.

V2427GT 20A Duplex Receptacle

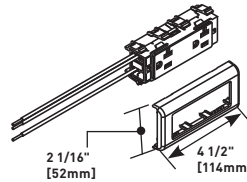

3-Wire 125V NEMA 5-20R receptacle. Includes 10-1/2" [267mm] pigtails and inline splice connectors. Also available in fog white (V2427GT-FW).

V2407-2CM, 2407-2CMFW 106 Device Bracket & Frame

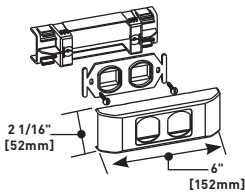

For installing two network wiring keystone device modules in 2400 Series Raceway. Does not accept Quad 106 Frame.

V2427GA 15A Duplex Receptacle

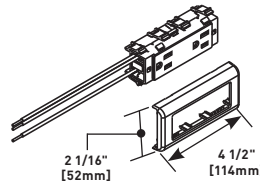

3-Wire 125V NEMA 5-15R receptacle. Includes 10-1/2" [267mm] pigtails and inline splice connectors. Also available in fog white (V2427GA-FW).

V2407-2TJ, 2407-2TJFW 106 Device Bracket & Frame

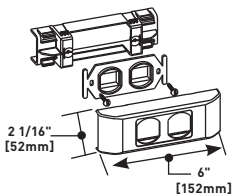

For installing two Ortronics® TracJack device modules in 2400 Series Raceway. Does not accept Quad 106 Frame.

IG2427GT 20A Isolated Ground Duplex Receptacle

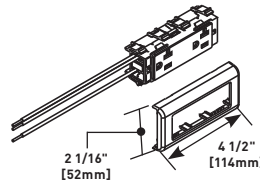

3-Wire 125V NEMA 5-20R orange receptacle. Includes 10-1/2" [267mm] pigtails and inline splice connectors. Also available in fog white (IG2427GT-FW).

V2407-3TJ, 2407-3TJFW 106 Device Bracket & Frame

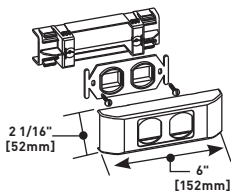

For installing three Ortronics® TracJack device modules in 2400 Series Raceway. Does not accept Quad 106 Frame.

IG2427GA 15A Isolated Ground Duplex Receptacle

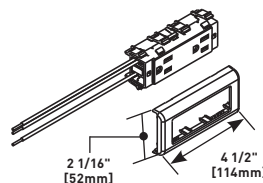

3-Wire 125V NEMA 5-15R orange receptacle. Includes 10-1/2" [267mm] pigtails and inline splice connectors. Also available in fog white (IG2427GA-FW).

IWE-S, DVWE-S Spray Paint



Used for touching up large areas. Contains 12 oz. of paint. Available in ivory (IWE-S) and fog white (DVWE-S).

NOTE: Can only be shipped via ground transportation

IWE-P, DVWE-P Touch-Up Paint Pen



Used for touching up small areas. Contains 0.3 oz. of paint. Available in ivory (IWE-P) and fog white (DVWE-P).

2400D[®] SERIES RACEWAY



Dual channel version of 2400 Series Raceway. Easy-to-install and ideal for basic power and communication/low voltage installations in classrooms, hotels, and anywhere a low profile raceway solution is needed.

CODE REFERENCE

cULus Listed Raceway:
File E4376 Guide RJBT.

Fittings:
File E41751 Guide RJPR.
Meets Article 386 of NEC.
Meets Section 12-1600 of CEC.

2400D Series Raceway System Layout for Power & Data

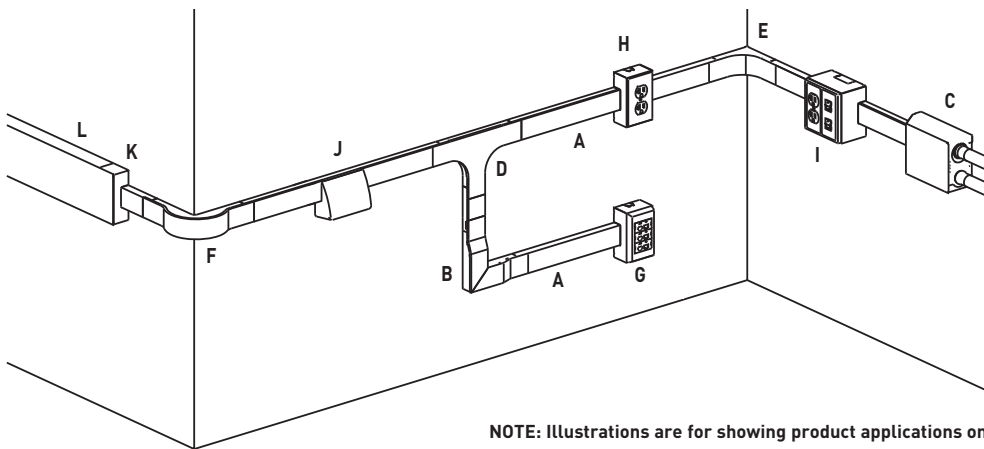

NOTE: Illustrations are for showing product applications only.

KEY

- | | |
|--|--|
| A. 2400D 2400 Series Divided Raceway | H. 2444D One-Gang Device Box |
| B. 2411DFO Radiused Divided Flat Elbow | I. 2444D-2A Two-Gang Divided Device Box |
| C. 2410DFO Divided Entrance End Fitting | J. 24DWND Downward Duplex Device Bracket |
| D. 2415DFO Radiused Divided Tee | 24DWNR Downward Decorator Device Bracket |
| E. 2417DFO Radiused Divided Internal Elbow | K. 4089 Reducing Connector |
| F. 2418DFO Divided External Elbow | L. U4000 Series Raceway |
| G. 2444 One-Gang Extra Deep Device Box | |

COLOR OPTIONS



2400 Series™ Raceway Part Numbers with a "V" prefix have an ivory finish. Part Numbers with a "-FW" suffix have a fog white finish.

Custom color options are also available. Consult the factory for more information.

2400D SERIES™ RACEWAY

2400D Series Raceway Wire Fill Capacities for Communications

	CABLE/ WIRE SIZE	O.D. (APPROX. DIA.)		1/3 COMP 40% FILL	2/3 COMP 40% FILL
		Inches	[mm]		
UNSHIELDED TWISTED PAIR	4-pair, 24 AWG, Cat 3	0.190	[4.8]	5	12
	4-pair, 24 AWG, Cat 5e	0.210	[5.3]	4	9
	4-pair, 24 AWG, Cat 6	0.250	[6.3]	3	7
	4-pair, 24 AWG, Cat 6a*	0.354	[9.0]	1	3
	25-pair, 24 AWG	0.410	[10.4]	1	2
COAXIAL	RG6/U	0.270	[6.9]	2	6
Fiber	ZipCord	0.118 x 0.236	[3 x 6]	5	12
	Round 4 Strand Fiber	0.187	[4.8]	5	12
	Round 6 Strand Fiber	0.256	[6.5]	2	6

2400D Series Raceway Wire Fill Capacities for Power

WIRE SIZE	O.D.		NUMBER OF CONDUCTORS (40%)	
	Inches	[mm]	1/3 COMP	2/3 COMP
THHN/THWN				
14 AWG	0.111	[2.8]	11	26
12 AWG	0.130	[3.3]	9	19
10 AWG	0.164	[4.2]	6	11

NOTE: For additional information, refer to the Technical Section.
* Category 6 augmented (6a) cable for 10 gigabit ethernet – max allowed cable diameter per addenda No. 11 ANSI TIA/EIA 568-B.2.

2400D Series Raceway Ordering Information

V2400BD, 2400BD-FW Divided Raceway Base

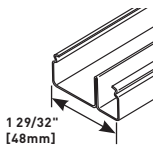

.040" [1.0mm] steel. Divided into two compartments (1/3 and 2/3 capacity). Packed ten 10' [3.0m] lengths per carton.

624BCK Replacement Blade Kit

Case hard steel replacement blades and die set for 624 Cutter.

V2400C, 2400C-FW Raceway Cover

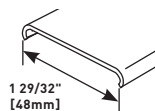

.040" [1.0mm] steel. Packed twenty 5' [1.5m] lengths per carton.

IWE-S, DVWE-S Spray Paint



Used for touching up large areas. Contains 12 oz. of paint. Available in ivory (IWE-S) and fog white (DVWE-S).

NOTE: Can only be shipped via ground transportation

624 2400 Series Raceway Base & Cover Cutter

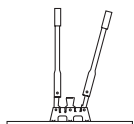

Portable cutter for 2400 & 2400D Series Raceway Base and Cover. Provides a clean and easy, square cut every time.

IWE-P, DVWE-P Touch-Up Paint Pen



Used for touching up small areas. Contains 0.3 oz. of paint. Available in ivory (IWE-P) and fog white (DVWE-P).

2400D Series Raceway Fittings Ordering Information

2400WC Wire Clip

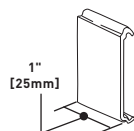

Additional support for conductors (nonmetallic).

2401D Divided Coupling

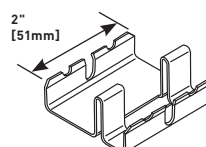

Joins lengths of 2400BD Divided Base.

2400D SERIES™ RACEWAY

2400D Series Raceway Fittings Ordering Information (continued)

V2406, 2406-FW Cover Clip

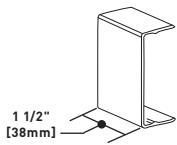

Covers seam where two lengths of 2400D Series Raceway come together (nonmetallic).

V2410BD, 2410BD-FW Divided Blank End Fitting

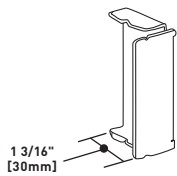

Closes off open end of 2400D Series Raceway.

V2410D, 2410D-FW Divided Entrance End Fitting

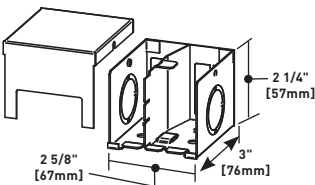

Feeds 2400D Series Raceway. Back has two 1/2" trade size KOs and two rectangular KOs for communication cabling. Additional 1" and 3/4" concentric trade size KO on each side.

V2410DFO, 2410DFO-FW Divided Entrance End Fitting

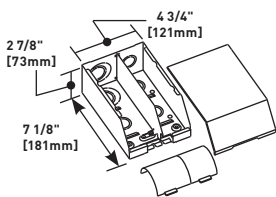

Feeds 2400 & 2400D Series Raceway. Includes 1/2", 3/4", and 1" trade size KOs on back and end. Removable/ adjustable divider and radiused insert included

V2411D, 2411D-FW Divided Flat Elbow

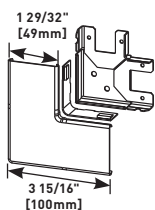

Right angle turns on the same surface.

V2411DFO, 2411DFO-FW Radiused Divided Flat Elbow

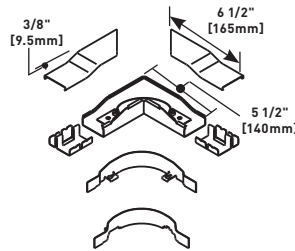

90° flat elbow with integral dividers. Provides 2" [51mm] full capacity cable bend radius control for fiber optic and UTP/STP cable installations. Ideal for lay-in or pull-through installations. Two couplings included.

V2415DFO, 2415DFO-FW Radiused Divided Tee

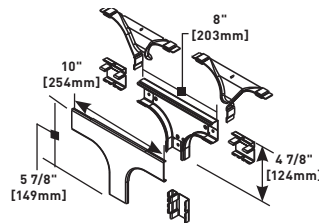

For branching raceway at right angles. Provides 2" [51mm] cable bend radius control for fiber optic and UTP/STP cable installations. Couplings included.

V2417D, 2417D-FW Divided Internal Elbow

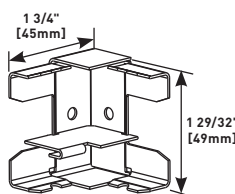

Internal 90° corners.

V2417DFO, 2417DFO-FW Radiused Divided Internal Elbow

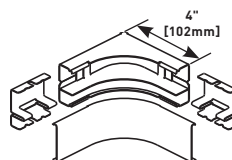

90° internal corner provides 2" [51mm] cable bend radius control for fiber optic and UTP/STP cable installations. Two couplings included.

V2418DFO, 2418DFO-FW Radiused Divided External Elbow

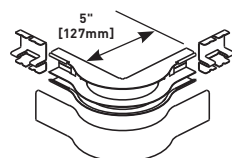

90° external elbow provides 2" [51mm] cable bend radius control for fiber optic and UTP/STP cable installations. Two couplings included.

2400D SERIES™ RACEWAY

2400D Series Raceway Fittings Ordering Information (continued)

V24DWND, 24DWND-FW Downward Duplex Device Bracket

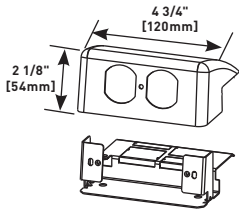

Labor saving, over-the-raceway device bracket. Accepts 15A or 20A duplex receptacles or 106 style data frame.

V2444D, 2444D-FW Device Box

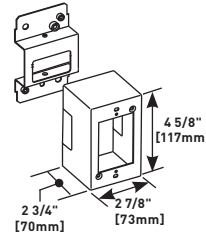

One-gang labor saving, over-the-raceway box. Cover has two twistouts for 2400 Series Raceway. Accepts industry standard faceplates for electrical and communication devices

V24DWNR, 24DWNR-FW Downward Decorator Device Bracket

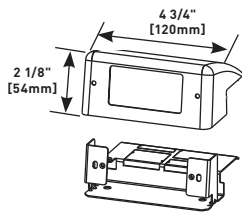

Labor saving, over-the-raceway device bracket. Accepts 15A or 20A decorator receptacles, GFCI receptacle, or 106 style data frame.

V2444D-2A, 2444D-2AFW Divided Device Box

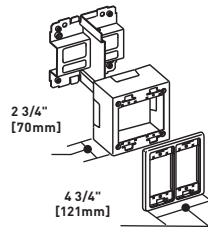

Divided, two-gang, labor saving over-the-raceway device box. Allows both power and low voltage at a single point-of-use. Accepts 5507 Series Faceplates, Ortronics® TracJack & Series II Modules (requires S2-EPL Plate), Pass & Seymour® Activate Series Inserts (requires CM-EPLA Plate), and Wiremold Open System Communication Modules (requires CM-EPLA Plate).

V24DWNU, 24DWNU-FW Downward Device Plate

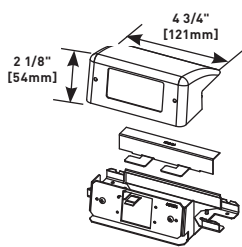

Accepts two Extron® Electronics MAAP single space modules.

V2444D-2N, 2444D-2NFW Divided Device Box

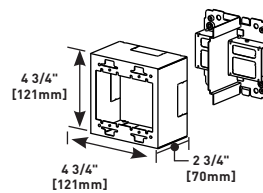

Labor saving, over-the-raceway device box. Divided, two-gang box allows both power and low voltage at a single point-of-use. For use with commercially available faceplates.

V24DWNS, 24DWNS-FW Downward Ortronics® Series II Device Plate

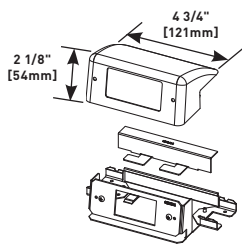

Accepts one Ortronics® Series II module.

V2450, 2450-FW Device Bracket

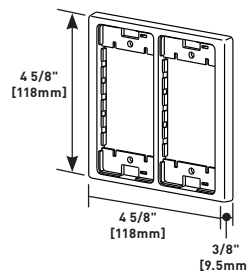

For use with 2444D-2N. Allows both power and low voltage at a single point-of-use. Accepts 5507 Series Faceplates, Ortronics® TracJack & Series II Modules (requires S2-EPL Plate), Pass & Seymour® Activate Series Inserts (requires CM-EPLA Plate), and Wiremold Open System Communication Modules (requires CM-EPLA Plate).

NOTE: Parts identified with this symbol are Certified to Canadian Safety Standards for sale in Canada. When ordering these products, add "C" to the color prefix to denote the Canadian versions, i.e. "CV2444" or "C2444-FW".

2400D SERIES™ RACEWAY

2400D Series Raceway Fittings Ordering Information (continued)

V2475D, 2475D-FW Bridge Fitting

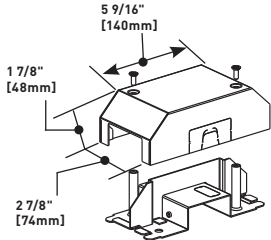

Allows 2400D Series Raceway runs to bridge over existing installations of 2400, 2400D, 500, and 700 Series Raceways.

IWE-S, DVWE-S Spray Paint



Used for touching up large areas. Contains 12 oz. of paint. Available in ivory (IWE-S) and fog white (DVWE-S).

NOTE: Can only be shipped via ground transportation

V4089 Reducing Connector

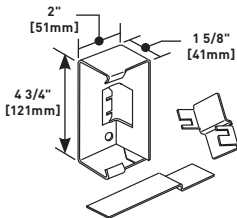

Connects 4000 Series Raceway to 2400D Series Raceway.

IWE-P, DVWE-P Touch-Up Paint Pen



Used for touching up small areas. Contains 0.3 oz. of paint. Available in ivory (IWE-P) and fog white (DVWE-P).

5507 Series Faceplates Ordering Information

5507AD, 5507AD-FW Modular Furniture Adapter

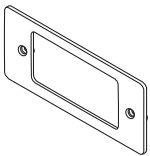

Covers Activate modular furniture adapter and other modular furniture adapters. Not for use with decorator (rectangular) style devices.

5507R, 5507R-FW Rectangular Faceplate

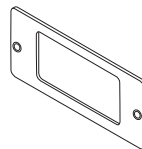

Covers rectangular decorator style devices.

5507B, 5507B-FW Blank Faceplate

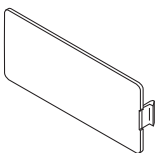

Covers unused compartments in the device bracket.

5507SW, 5507SW-FW Switch Faceplate

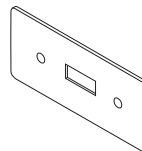

Covers standard toggle switches.

5507D, 5507D-FW Duplex Faceplate

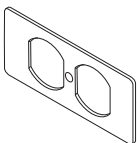

Covers duplex style devices including 106 Frame.

5507T1, 5507T1-FW Single Receptacle Faceplate

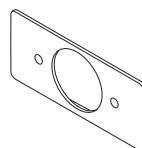

Covers single receptacles 1.59" [40.4mm] diameter.

2400D SERIES™ RACEWAY

5507 Series Faceplates Ordering Information (continued)

5507T2, 5507T2-FW Single Receptacle Faceplate

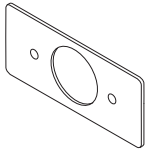

Covers single receptacles 1.41" [35.8mm] diameter.

5507RJ, 5507RJ-FW Dual RJ11/RJ45 Connector Faceplate

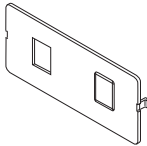

Accepts one or two keystone device modules. Has one keystone opening and a KO for the other.

5507FRJ, 5507FRJ-FW Flush Dual RJ11/RJ45 Connector Faceplate

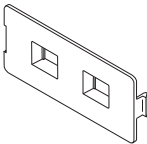

Accepts one or two keystone device modules, recessed to provide a flush installation. Has one keystone opening and a KO for the other.

5507-4TJ, 5507-4TJFW Ortronics® Faceplate

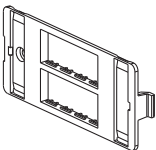

Accepts four Ortronics® TracJack Devices.

5507-6TJ, 5507-6TJFW Ortronics® Faceplate

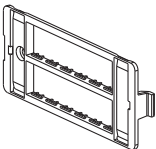

Accepts six Ortronics® TracJack Devices.

5507AAP Extron® AAP Faceplate

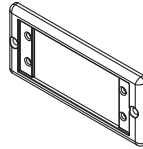

Metal faceplate for use with two Extron® Electronics AAP single space modules. Also available in white (WH), gray (G), black (BK) and fog white (FW).

5507MAAP Extron® MAAP Faceplate

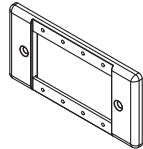

Metal faceplate for use with four Extron® Electronics MAAP single space modules. Also available in white (WH), gray (G), black (BK) and fog white (FW).

CM-EPLA, CM-EPLA-FW End Plates

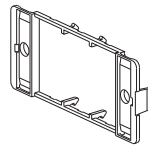

Mounts Pass & Seymour® Activate and Wiremold Open System communication modules into 5507 opening. Includes two outlet identification labels with clear covers and two matching screw covers.

S2-EPL, S2-EPL-FW End Plates

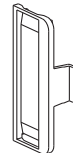

Mounts Ortronics® Series II modules into 5507 opening. Includes two outlet identification labels with clear covers and two matching screw covers.

5507AVIP Legrand AAVIP Faceplate

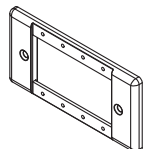

Metal faceplate for use with four Legrand AVIP Interface Plates. Also available in white (WH), gray (G), black (BK) and fog white (FW).

NOTE: All 5507 Series Faceplates have standard dimensions of 4 1/4" x 1 7/8" [108mm x 34mm].

3000® SERIES RACEWAY



Single-Channel Raceway. Easy-to-install and ideal for basic power or communication/low voltage installations. Well-suited for labs, hospitals, or anywhere that requires the capacity of a medium size raceway.

CODE REFERENCE

cULus Listed Raceway:
File E4376 Guide RJBT.

Fittings:
File E41751 Guide RJPR.
Meets Article 386 of NEC.
Meets Section 12-1600 of CEC.

System Layout

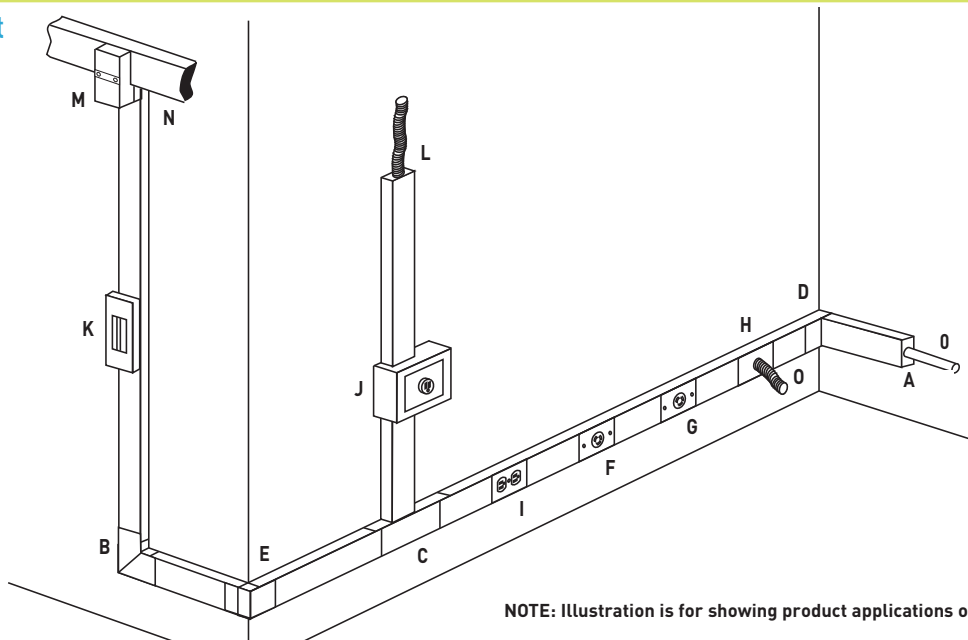

KEY

- | | | | |
|-------------------------------------|---|--|---|
| A. 3010B Blank End Fitting | F. 3027AE Single Receptacle Cover | J. 3044-2 Extra Deep Switch & Receptacle Box | M. 4074A Take Off Connector – 4000 to 3000 Series Raceway |
| B. 3011E 90° Flat Elbow | G. 3033JE Single Receptacle Cover | K. 3046KD Circuit Breaker Housing | N. 4000 Series Raceway |
| C. 3015E Tee Fitting | H. 3036HE Blank Cover | L. 3082 Conduit Connector | O. CONDUIT 1/2" [12.7mm] Flexible Metal Conduit |
| D. 3017TCE Internal Corner Coupling | I. 3043GE Duplex Grounding Receptacle & Cover | | |
| E. 3018AE External Corner Coupling | | | |

COLOR OPTIONS



3000® Series Raceway Part Numbers with a "V" prefix have an ivory finish. Part Numbers with a "G" prefix have a gray finish. Custom color options are also available. Consult the factory for more information.

3000 SERIES® RACEWAY

3000 Series Raceway Wire Fill Capacities for Communications

	CABLE/WIRE SIZE	O.D. (APPROX. DIA.)		40% FILL
		Inches	[mm]	
UNSHIELDED TWISTED PAIR	4-pair, 24 AWG, Cat 3	0.190	[4.8]	52
	4-pair, 24 AWG, Cat 5e	0.210	[5.3]	42
	4-pair, 24 AWG, Cat 6	0.250	[6.3]	30
	4-pair, 24 AWG, Cat 6a*	0.354	[9.0]	15
	25-pair, 24 AWG	0.410	[10.4]	11
COAXIAL	RG6/U	0.270	[6.9]	25
Fiber	ZipCord	0.118 x 0.236	[3 x 6]	53
	Round 4 Strand Fiber	0.187	[4.8]	53
	Round 6 Strand Fiber	0.256	[6.5]	28

3000 Series Raceway Wire Fill Capacities for Power

WIRE SIZE THHN/THWN	O.D.		NUMBER OF CONDUCTORS (40% FILL)			
	Inches	[mm]	WITHOUT DEVICES	WITH DUPLEX RECT. DEVICES 1.59in. ² [1025mm ²]	WITH SURGE/GFCI DEVICES 2.30in. ² [1485mm ²]	LARGE SINGLE RECEPTACLES 3.00in. ² [1935mm ²]
14 AWG	0.111	[2.8]	152	70	40	28
12 AWG	0.130	[3.3]	111	51	29	21
10 AWG	0.164	[4.2]	70	32	18	13
8 AWG	0.216	[5.5]	40	18	10	7
6 AWG	0.254	[6.5]	29	13	7	5

NOTE: For additional information, refer to the Technical Section.

* Category 6 augmented (6a) cable for 10 gigabit ethernet – max allowed cable diameter per addenda No. 11 ANSI TIA/EIA 568-B.2.

3000 Series Raceway Ordering Information

V3000B, G3000B Raceway Base

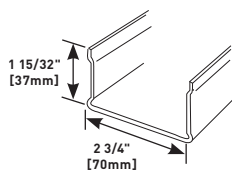

.040" [1.0mm] steel, Packed in ten 10' [3m] lengths, 100' [31m] per carton. Base sections have predrilled 1/2" and 3/4" trade size entrance KOs and 9/32" [7.1mm] diameter mounting screw KOs on approx. 9 3/8" [238mm] centers.

V3000C195, G3000C195 19.5" [495mm] Precut Raceway Cover

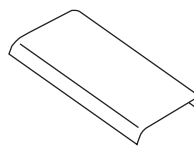

For mounting devices 24" [610mm] on center using 3027AE, 3033JE, 3036HE, 3040CE, 3043, 3046, 3048R, and 3051LE Series Device Plates.

V3000CE, G3000CE Raceway Cover

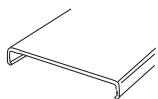

.040" [1.0mm] steel. Packed in twenty 5' [1.5m] lengths, 100' [31m] per carton.

630B Raceway Base Cutter

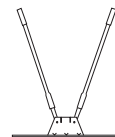

Portable cutter for 3000 Series Raceway Base. Provides clean and easy square cuts.

V3000C075, G3000C075 7.5" [191mm] Precut Raceway Cover

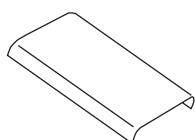

For mounting devices 12" [305mm] on center using 3027AE, 3033JE, 3036HE, 3040CE, 3043, 3046, 3048R, and 3051LE Series Device Plates.

630BDK Replacement Blade Kit

Case hard steel replacement blades and die set for 630B Cutter.

3000 SERIES® RACEWAY

3000 Series Raceway Ordering Information (continued)

630C Raceway Cover Cutter

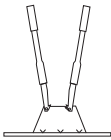

Portable cutter for 3000 Series Raceway Cover. Provides clean and easy square cuts.

630CDK Replacement Blade Kit

Case hard steel replacement blades and die set for 630C Cutter.

G3000WC Wire Clip (Galvanized)

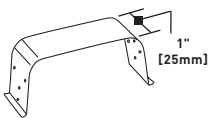

Holds conductors in place.

G3001 Coupling (Galvanized)

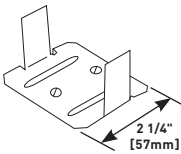

Joins lengths of 3000 Series Raceway.

G3001A Rigid Inside Coupling (Galvanized)

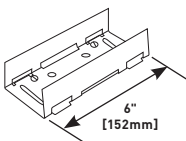

Joins lengths of 3000 Series Raceway in installations where added rigidity is required, such as when raceway is suspended overhead.

V3003, G3003 Supporting Clip

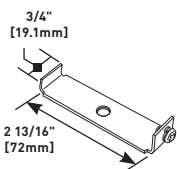

Supports lengths of 3000 Series Raceway at any point along length. Mounts with #8 flat head fasteners. Includes set screw for locking to raceway.

V3006E, G3006E Cover Clip

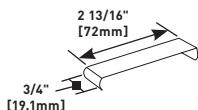

Covers seam where two pieces of 3000 Series Raceway Cover come together.

G3007C Device Bracket

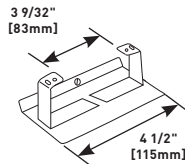

Mounts standard after-market devices into 3000 Series Raceway. Accepts single-gang devices with 3.281" [95mm] mounting centers. Use with commercially available flush plates (not included).

G3008C C-Hanger

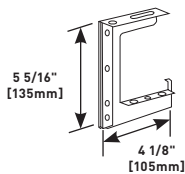

Suspends 3000 Series Raceway from structural ceilings. Designed for use with 3/8" [9.5mm] threaded rod. Hangers should be installed no more than 5' [1.5m] apart along raceway run.

G3008C C-Hanger can be mounted back-to-back for double run of 3000 Series Raceway.

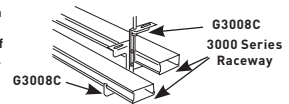

V3010AE, G3010AE Entrance End Fitting

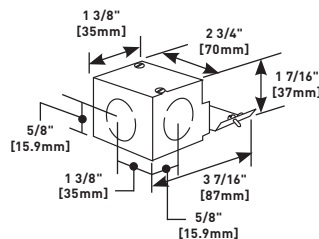

Connects 3000 Series Raceway to 1/2" trade size conduit and armored cable connectors. 1/2" trade size KOs on end and each side of fitting. Can be connected to conduit boxes by using 1/2" chase nipple.

V3010B, G3010B Blank End Fitting

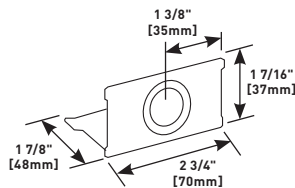

Closes off open end of 3000 Series Raceway. Has concentric 1/2" and 3/4" trade size KOs.

V3010C, G3010C Entrance End Fitting

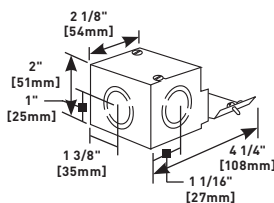

Connects 3000 Series Raceway to rigid or flexible conduit. Concentric 1/2", 3/4" and 1" trade size KOs on end and each side.

3000 SERIES® RACEWAY

3000 Series Raceway Ordering Information (continued)

V3011E, G3011E Flat Elbow Fitting

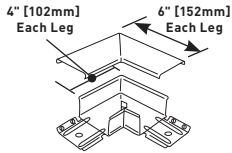

Right angle turns on the same surface.

IWE-P, GWE-P Touch-Up Paint Pen



Used for touching up small areas. Contains 0.3 oz. of paint. Available in ivory (IWE-P) and gray (GWE-P).

V3014C, G3014C Wall Box Connector

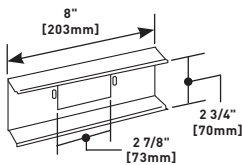

Connects 3000 Series Raceway from flushed-in wall box.

V3018AE, G3018AE External Corner Coupling

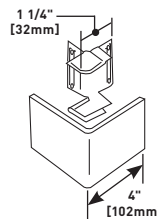

Right angle turns around external corners.

Use with G3017TCE to offset around columns etc. (minimum 4" [102mm] offset).

V3015E, G3015E Tee Fitting

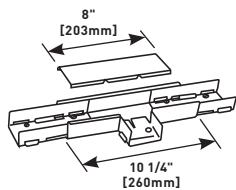

For branching raceway at right angles. Three couplings included.

V3027AE, G3027AE Single Receptacle Cover

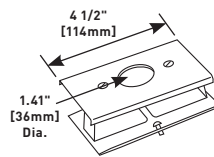

Installs commercially available straight blade and locking single receptacles with face diameters of 1.38"-1.40" [35mm-36mm] into 3000 Series Raceway. G3007C Device Bracket included.

V3017TCE, G3017TCE Internal Corner Coupling



For surfaces at right angles, or for use as a straight-through fitting. Solid leg of base has concentric 1/2" and 3/4" trade size KOs.

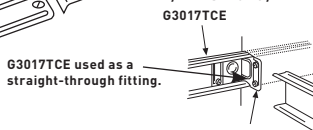

V3028, G3028 Utility Box

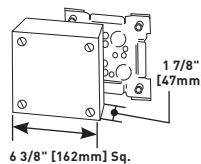

Used as a tee, cross, junction box, or for branch circuit extensions in 3000 Series Raceway. Cover has raceway twistouts on all sides. Base has five 1/2" trade size KOs and four fixture mounting holes.

	#6 AWG	#8 AWG	#10 AWG	#12 AWG	#14 AWG
THHN, THWN	13	18	24	55	75

IWE-S, GWE-S Spray Paint



Used for touching up large areas. Contains 12 oz. of paint. Available in ivory (IWE-S) and gray (GWE-S).

NOTE: Can only be shipped via ground transportation

V3033JE, G3033JE Single Receptacle Cover

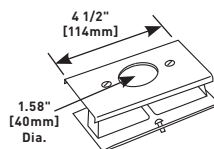

Installs commercially available straight blade and locking single receptacles with face diameters of 1.56"-1.57" (approximately [40mm]) into 3000 Series Raceway. G3007C Device Bracket included.

NOTE: Parts identified with this symbol are Certified to Canadian Safety Standards for sale in Canada. When ordering these products, change the "V" color prefix to "CV" or the "G" color prefix to "CG" to denote the Canadian versions.

V3036HE, G3036HE Blank Cover

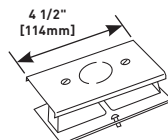

Use as a blank cover or tap off KO in center of plate for 1/2" trade size conduit. G3007C Device Bracket included.

3000 SERIES® RACEWAY

3000 Series Raceway Ordering Information (continued)

V3040CE, G3040CE Switch Cover

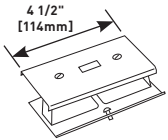

Installs commercially available single-pole, two-pole, three-way or four-way switches into 3000 Series Raceway. G3007C Device Bracket included.

V3043BE, G3043BE Duplex Receptacle Cover

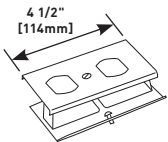

Installs commercially available 15A and 20A duplex receptacles or 106 style data frame into 3000 Series Raceway. G3007C Device Bracket included.

V3043GE, G3043GE Duplex Grounding Receptacle Cover

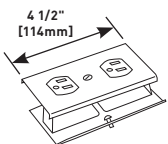

Installs commercially available 15A-125V (NEMA-15R) grounding receptacles into 3000 Series Raceway. Grounding receptacle included.

V3044-2, G3044-2 Extra Deep Switch & Receptacle Box

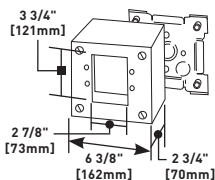

Two-gang. For standard 30A, 50A, and 60A receptacles. Four sides of cover have one set of combination twistouts for 3000 Series Raceway. Hole cut in cover: 3 3/4" x 2 7/8" [95mm x 73mm]. Base has five 1/2" trade size KOs.

V3046BE, G3046BE Duplex Receptacle Cover

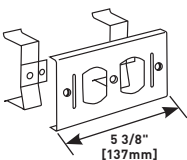

Installs commercially available 15A and 20A duplex receptacles or 106 style data frame into 3000 Series Raceway.

V3046H-2, G3046H-2 Tap-Off Fitting

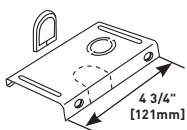

For feeding out of the bottom of raceway. Has concentric 1/2" and 3/4" trade size KOs and twistout for communication cables. Grommet furnished for telephone KO.

NOTE: Parts identified with this symbol are Certified to Canadian Safety Standards for sale in Canada. When ordering these products, change the "V" color prefix to "CV" or the "G" color prefix to "CG" to denote the Canadian versions.

V3046KD, G3046KD Circuit Breaker Housing

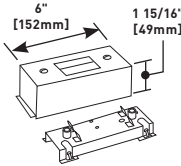

Cover used as is with single-pole breaker. KO is removed for two-pole. For two-pole circuit breakers where the toggle is center located, web is snipped or cut out.



For use with the following breakers rated 50A maximum. General Electric: THQC, THHQ Westinghouse: Quicklag C, QCH.

Two-pole circuit breaker being mounted on base of G3046KD.

Single-pole circuit breaker being mounted on base of G3046KD.

V3046KTSQ, G3046KTSQ Circuit Breaker Housing

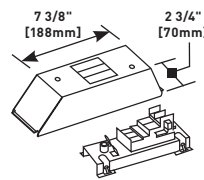

Mounts Square D™ Quik-Gard QOB bolt-on circuit breakers into 3000 Series Raceway. Rated up to 50A maximum capacity. Includes Square D QON3B Compact Base for single- to three-pole circuit breakers. For GFI breakers, use Square D QOB-GFI Series.

V3046QOU, G3046QOU Circuit Breaker Housing

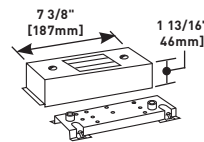

Mounts Square D Type QOU one-, two-, or three-pole breakers, rated up to 50A maximum capacity, into 3000 Series Raceway.

Wire capacity of 3000 Series Raceway with G3046KD, KTSQO, QOU circuit breaker housings.

	#6 AWG	#8 AWG	#10 AWG	#12 AWG	#14 AWG
THHN, THWN	6	8	10	18	26

V3048R, G3048R Rectangular Decorator Receptacle Cover

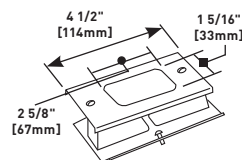

Installs commercially available 15A and 20A rectangular receptacles into 3000 Series Raceway. G3007C Device Bracket included.

V3051LE, G3051LE Extension Cover

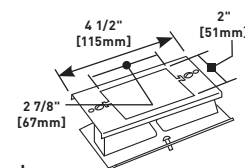

Accepts shallow-type 30A and 50A devices and flush plates. Also Fustat devices SRU, SSU, SRW, SOU and SOW, or equivalent. Deeper devices can be accommodated with a combination of G3051LE and any of the V5700 Series single-gang, open base boxes. G3007C Device Bracket included.

3000 SERIES® RACEWAY

3000 Series Raceway Ordering Information (continued)

V3046U, G3046U Bump-Up Extron® MAAP Plate

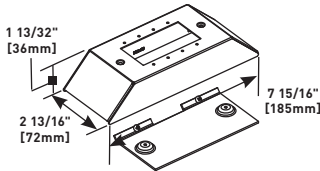

Device plate for use with four Extron® Electronics MAAP single space modules.

G3082 Conduit Connector

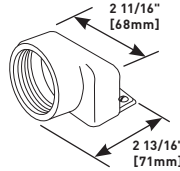

Connects end of 3000 Series Raceway to 1 1/2" trade size conduit or armored cable.

V3046V, G3046V Bump-Up Extron® AAP Plate

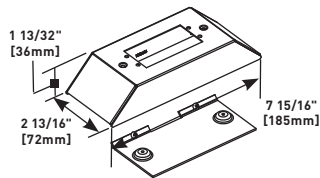

Device plate for use with two Extron® Electronics AAP single space modules.

DRP20A-V Colormatch Ivory Duplex Receptacle & Plate

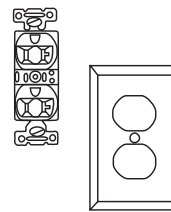

Specification grade rated 20A 125V NEMA 5-20R receptacle with color matched nylon faceplate. Receptacle has nylon face and thermoplastic base. One-piece brass triple-wipe line contacts and double-wipe ground contacts. Locked in wrap-around steel yoke. Break off tab for two circuit wiring. 2.7" W x 4.5" H [69mm x 114mm]. Verified under Fed. Spec. #WC596F.

V3046S, G3046S Bump-Up Ortronics® Series II Plate

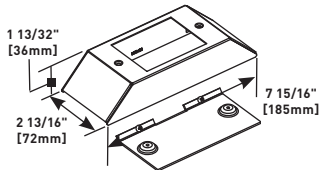

Device plate for use with three Ortronics® Series II modules. 6 TracJacks, or Wiremold CM Series inserts.

DR20A-V, DR20A-G Colormatch Gray or Ivory Receptacle



Specification grade rated 20A 125V NEMA 5-20R receptacle. Receptacle has nylon face and thermoplastic base. One-piece brass triple-wipe line contacts and double-wipe ground contacts. Locked in wrap-around steel yoke. Break off tab for two circuit wiring. 2.7" W x 4.5" H [69mm x 114mm]. Verified under Fed. Spec. #WC596F.

3000 Series Raceway Installation Details

1. Determine the method of feeding raceway using an entrance end fitting or through 1/2" or 3/4" trade size KO in raceway base (shown).

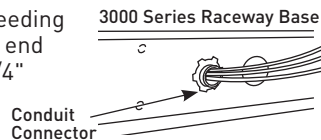

2. **To mount 3000 Base on surface:** Remove mounting screw KOs (approx. 9 3/8" [238mm] O.C. along base) as required. Mount base with No. 8 flathead fasteners.

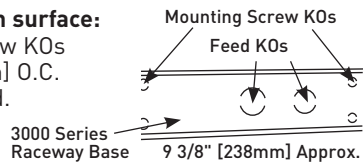

3. For coupling lengths of 3000B, insert either the G3001 or G3001A (shown) into one base section centered on joint. Slide other length of base onto coupling. Tighten locking screws.

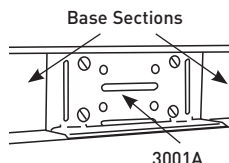

4. **To install devices:** Install device bracket in 3000 Base. Wire device and assemble on bracket. Install cover over 3000 Base and device (if device has plaster ears, break off before mounting on device bracket).

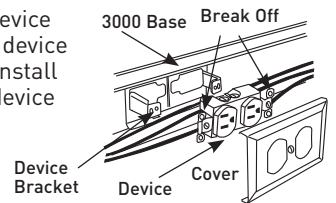

5. Cut sections of 3000 Cover to fit between device plates. Snap cover sections in place along entire run as shown.

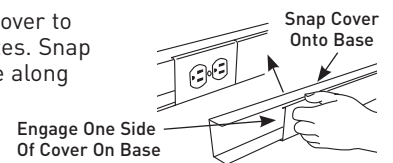

DS4000® SERIES RACEWAY



Dual-channel raceway with increased capacity due to its unique profile, integral divider and downward facing activations. Ideal for any application that requires a high capacity metal raceway.



CODE REFERENCE

cULus Listed Raceway:
File E4376 Guide RJBT.

Fittings:
File E41751 Guide RJPR.
Meets Article 386 of NEC.
Meets Section 12-1600 of CEC.

System Layout

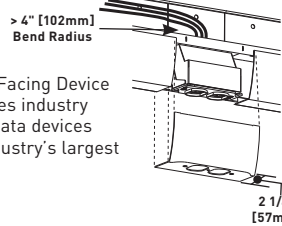
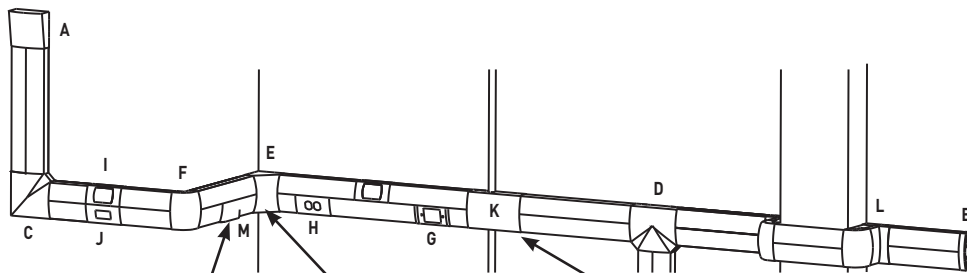

Universal Downward Facing Device Bracket accommodates industry standard power and data devices while allowing the industry's largest termination radius.

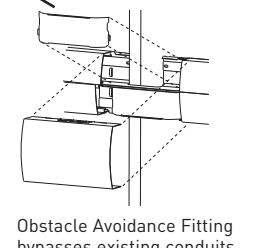
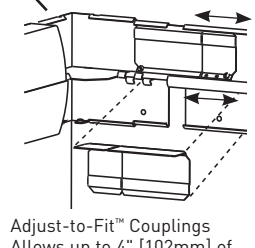

KEY

- | | | | |
|----------------------------------|---|--|--|
| A. DS4010A Entrance End Fitting | G. DS4047C Single-Channel NEMA Device Plate | J. DS4047R Single-Channel Decorator Device Plate | M. DSDWND Downward Duplex Device Plate |
| B. DS4010B Blank End Fitting | H. DS4047D Single-Channel Duplex Device Plate | K. DS4075 Small Obstacle Transition Fitting | DSDWNR Downward Decorator Device Plate |
| C. DS4011 90° Flat Elbow Fitting | I. DS4047MAB Single-Channel MAB Device Plate | L. DS4075A Offset Fitting | |
| D. DS4015 Divided Tee Fitting | | | |
| E. DS4017 Internal Elbow Fitting | | | |
| F. DS4018 External Elbow Fitting | | | |

COLOR OPTIONS

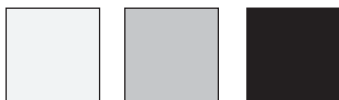

DS4000® Raceway Part Numbers with a "DV" suffix have a fog white finish. Part Numbers with a "DG" suffix have a gray finish. Part Numbers with a "BK" suffix have an black finish.

Custom color options are also available. Consult the factory for more information.

DS4000® SERIES RACEWAY

DS4000 Series Raceway Wire Fill Capacities for Power

WIRE SIZE THHN/THWN	O.D.		NUMBER OF CONDUCTORS (40%) PER COMPARTMENT				
	Inches	[mm]	WITHOUT DEVICES	WITH DUPLEX RECT. DEVICES 1.59in. ² [1025mm ²]	WITH SURGE/ GFCI DEVICES 2.30in. ² [1485mm ²]	WITH LARGE SINGLE RECEPTACLES 3.00in. ² [1935mm ²]	40% FILL WITH DOWNWARD ACTIVATION/CROSSOVER
14 AWG	0.111	[2.8]	206	141	111	83	46
12 AWG	0.130	[3.3]	150	103	81	60	33
10 AWG	0.164	[4.2]	95	64	51	38	21
8 AWG	0.216	[5.5]	54	37	29	22	12
6 AWG	0.254	[6.5]	39	27	21	15	8

DS4000 Series Raceway Wire Fill Capacities for Communications

	CABLE/WIRE SIZE	O.D. [Approx. Dia.]		40% FILL EACH COMPARTMENT	40% FILL WITH DOWNWARD ACTIVATION/ CROSSOVER
		Inches	[mm]		
UNSHIELDED TWISTED PAIR	4-pair, 24 AWG, Cat 3	0.190	[4.8]	70	28
	4-pair, 24 AWG, Cat 5e	0.210	[5.3]	57	23
	4-pair, 24 AWG, Cat 6	0.250	[6.3]	40	16
	4-pair, 24 AWG, Cat 6a*	0.354	[9.0]	20	8
	25-pair, 24 AWG	0.410	[10.4]	15	6
COAXIAL	RG6/U	0.270	[6.9]	35	14
FIBER	ZipCord	0.118 x 0.236	[3 x 6]	72	29
	Round 4 Strand Fiber	0.187	[4.8]	73	29
	Round 6 Strand Fiber	0.256	[6.5]	38	15

NOTE : For additional information, refer to the Technical Section.

* Category 6 augmented [6a] cable for 10 gigabit ethernet – max allowed cable diameter per addenda No. 11 ANSI TIA/EIA 568-B.2.

Prewired DS4000 Raceway Cover Wire Fill Capacities with Downward Facing Power & Communication Devices

WIRE SIZE THHN/THWN	O.D. (Approx. Dia.)		40% FILL
	Inches	[mm]	
14 AWG	0.111	[2.8]	31
12 AWG	0.130	[3.3]	23
10 AWG	0.164	[4.2]	14
8 AWG	0.216	[5.5]	8
6 AWG	0.254	[6.5]	6

NOTE: Prewired downward facing covers are punched in line for a sleek flush look. Power conductors are provided in the lower channel. Additional wires can be added and should not exceed totals above. Communications are to be installed in the top channel refer to standard cable fill chart for capacities.

DS4000 Series Raceway Fittings Wire Fill Capacities

WIRE SIZE/THHN	O.D. (APPROX. DIA.)		DS4010A*		DS4011		DS4015		DS4017**		DS4018**		DS4075		DS4075A**		
	Inches	[mm]	40%	60%	40%	60%	40%	60%	40%	60%	40%	60%	40%	60%	40%	60%	
THHN	14	0.111	[2.8]	125	187	171	256	62	93	160	238	142	213	106	160	142	213
	12	0.130	[3.3]	91	137	125	187	45	68	116	175	104	156	78	116	104	156
	10	0.164	[4.2]	57	86	78	118	28	43	73	110	65	98	49	73	65	98
	8	0.216	[5.5]	33	50	45	68	16	25	42	63	38	57	28	42	38	57
	6	0.254	[6.5]	24	36	33	49	12	18	31	46	27	41	20	31	27	41
UTP	4-pair, 24 AWG	0.150	[4.8]	68	103	94	140	49	74	87	131	78	117	58	87	78	117
	4-pair, 24 AWG, Cat 3	0.190	[4.8]	43	64	58	87	31	46	55	82	49	73	36	55	49	73
	4-pair, 24 AWG, Cat 5e	0.210	[5.3]	35	52	48	72	25	38	45	67	40	60	30	45	40	60
	4-pair, 24 AWG, Cat 6	0.250	[6.3]	25	37	34	51	18	27	32	47	28	42	21	32	28	42
	4-pair, 24 AWG, Cat 6a*	0.354	[9.0]	12	18	17	25	9	13	16	24	14	21	10	16	14	21
25-pair, 24 AWG	0.410	[10.4]	12	18	16	24	9	13	15	23	14	20	10	15	14	20	
COAXIAL	RG6/U	0.270	[6.9]	21	32	29	43	15	23	27	41	24	36	18	27	24	36
FIBER	ZipCord	0.118 x 0.236	[3 x 6]	44	65	59	89	31	47	56	83	50	74	37	56	50	74
	Round 4 Strand Fiber	0.187	[4.8]	44	66	60	90	32	48	56	85	50	75	38	56	50	75
	Round 6 Strand Fiber	0.256	[6.5]	24	35	32	48	17	26	30	45	27	40	20	30	27	40

* Entrance end fitting fill rate is calculated using backfeed capability and radius inserts. Inserts are removable and fitting can obtain maximum raceway fill from utilizing end fitting knockouts and removing radius control inserts.

** Calculated using radius control inserts. Inserts are factory installed and may be removed in order to obtain full raceway capacity if radius control is not required.

DS4000[®] SERIES RACEWAY

DS4000 Series Raceway Ordering Information (continued)

DS4000B Raceway Base

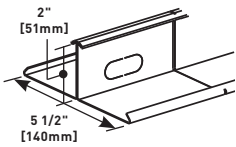

.040" [1.0mm] galvanized steel. Each base section has mounting holes, two 9/32" [7.1mm] diameter, located every 4" [102mm] and pass through KOs located every 8" [203mm] along the entire length. Packed four 10' [3.05m] sections of base per carton. Two DS4001 Couplings included with each 10' section.

DS4000C Raceway Cover

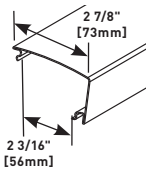

.040" [1.0mm] galvanized steel. Packed eight 5' [1.5m] lengths per carton. Four 5' [1.5m] cover sections required for each 10' [3.05m] section of base. Available in fog white (DS4000C-DV), black (DS4000C-BK) and gray (DS4000C-DG).

DS4000WC Wire Clip

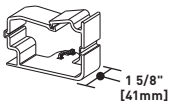

Holds conductors in place.

DS4001 Adjust-to-Fit™ Coupling

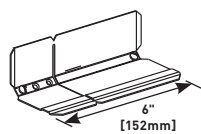

Joins lengths of DS4000B together. Sold in pairs.

DS4006 Seam Clip

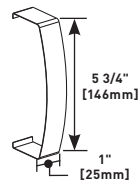

Covers seam where two sections of DS4000C come together. Available in fog white (DS4006-DV), black (DS4006-BK) and gray (DS4006-DG).

DS4006B Half Seam Clip/Blank Faceplate

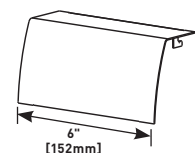

Covers seams where two sections of DS4000C Cover come together. Can also be used as a blank faceplate. Available in fog white (DS4006B-DV), black (DS4006B-BK) and gray (DS4006B-DG).

DS4010A Entrance End Fitting

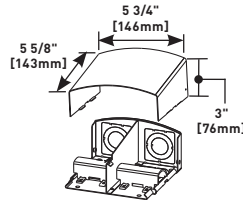

Full-capacity end fitting. Includes four 3/4" and 1 1/4" concentric trade size KOs and four 2 1/8" large capacity KOs. Available in fog white (DS4010A-DV), black (DS4010A-BK) and gray (DS4010A-DG).

DS4010B Blank End Fitting

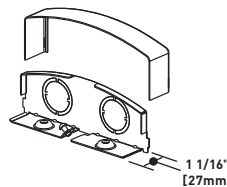

Closes off open end of DS4000B Raceway Base Has two 3/4" and 1" trade size KOs. Available in fog white (DS4010B-DV), black (DS4010B-BK) and gray (DS4010B-DG).

DS4011 Flat Elbow

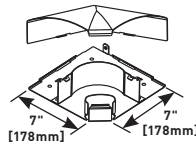

90° flat corner for new lay-in or pull-through installations. One pair of DS4001 Couplings included. Available in fog white (DS4011-DV), black (DS4011-BK) and gray (DS4011-DG).

DS4014A Backfeed Coupling

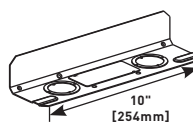

Extra long coupling allows attachment to a wall box or to back feed DS4000 Series Raceway from 1" or 1 1/4" trade size conduit.

DS4015 Divided Tee

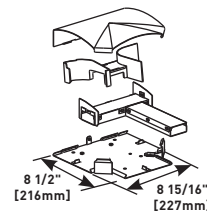

For new lay-in or pull-through installations. Two pair of DS4001 Couplings included. Two pair of DS4001 Couplings included. Available in fog white (DS4015-DV), black (DS4015-BK) and gray (DS4015-DG).

DS4000® SERIES RACEWAY

DS4000 Series Raceway Ordering Information (continued)

DS4017 Internal Elbow

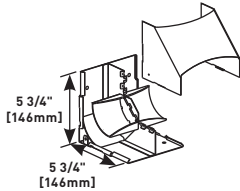

90° Full capacity divided internal elbow that provides a 2" [51mm] cable bend radius for fiber optic/UTP/STP installations. One pair of DS4001 Couplings included. Available in fog white (DS4017-DV), black (DS4017-BK) and gray (DS4017-DG).

DS4018 External Elbow

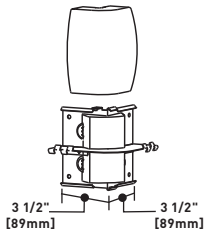

90° full capacity divided external elbow provides a 2" [51mm] cable bend radius for fiber optic/UTP/STP installations. One pair of DS4001 Couplings included. Available in fog white (DS4018-DV), black (DS4018-BK) and gray (DS4018-DG).

DS4047D Single-Channel Duplex Device Plate

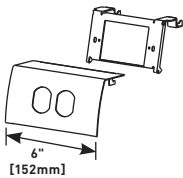

Installs 15A or 20A duplex receptacles or 106 style data frames into DS4000 Series Raceway. Available in fog white (DS4047-DV), black (DS4047-BK) and gray (DS4047-DG).

DS4047DQ Single-Channel Duplex Device Plate with One Duplex Installed

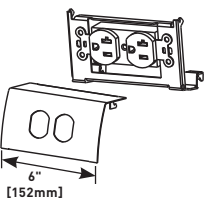

Pass & Seymour® 20A duplex receptacle with 6" [152mm] lead wires pre-installed on a bracket into DS4000 Series Raceway. Also available in fog white (DS4047DQ-DV), black (DS4047DQ-BK) and gray (DS4047DQ-DG).

DS4047R Single-Channel Decorator Device Plate

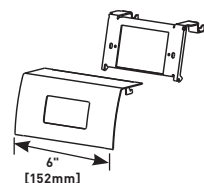

Installs 15A or 20A decorator style receptacles, GFCI and surge devices into DS4000 Series Raceway. Available in fog white (DS4047R-DV), black (DS4047R-BK) and gray (DS4047R-DG).

DS4047MAB Single-Channel MAB Device Plate

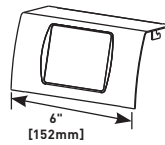

Installs communication devices into DS4000 Series Raceway. Includes CM-MAB Adapter for Wiremold Open System connectivity modules and Pass & Seymour® Activate inserts. Also includes MAB2S2 Adapter for Ortronics® Series II inserts and MAB6TJ Adapter for Ortronics® TracJack connectors. Also available in fog white (DS4047MAB-DV), black (DS4047MAB-BK) and gray (DS4047MAB-DG).

DS4047C Single-Channel NEMA Device Plate

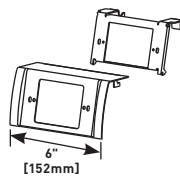

For Turnlok® and most straight blade devices up to 50 Amps. Use with commercially available flush plates. Available in fog white (DS4047C-DV), black (DS4047C-BK) and gray (DS4047C-DG).

DSDWND Downward Duplex Device Plate

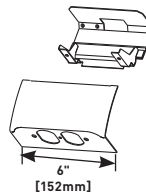

Installs 15A and 20A duplex receptacles or 106 style data frames into DS4000 Series Raceway in a downward facing, protected position. Also available in fog white (DSDWND-DV), black (DSDWND-BK) and gray (DSDWND-DG).

DSDWNDQ Downward Duplex Device Plate with One Duplex installed

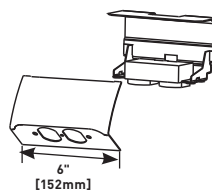

Pass & Seymour® 20A duplex receptacle with 6" [152mm] lead wires pre-installed on a bracket into DS4000 Series Raceway in a downward facing, protected position. Also available in fog white (DSDWNDQ-DV), black (DSDWNDQ-BK) and gray (DSDWNDQ-DG).

DSDWNR Downward Decorator Device Plate

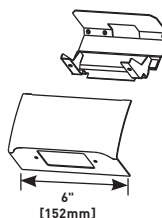

Installs 15A and 20A decorator style receptacles, GFCI and Surge devices into DS4000 Series Raceway in a downward facing, protected position. Available in fog white (DSDWNR-DV), black (DSDWNR-BK) and gray (DSDWNR-DG).

DS4000® SERIES RACEWAY

Ordering Information

DS4000 Series Raceway Ordering Information (continued)

DSDWNX Crossover Kit



Provides shielding when using downward-facing activations. Includes enclosures for power or data crossover.

DS4075 Small Obstacle/Transition Fitting

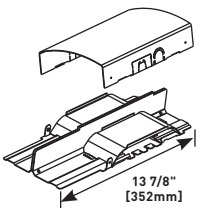

Passes DS4000 Series Raceway over previously installed conduit or raceways as large as 2400 Series Raceway. Also creates transition to 500, 700 or 2400D Series Raceway from DS4000 Series Raceway. Available in fog white (DS4075-DV), black (DS4075-BK) and gray (DS4075-DG).

DSDWNS Downward Ortronics® Series II Device Plate

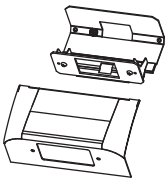

Accepts one Ortronics® Series II module, 2 TracJacks or 1 CM Series insert. Also available in fog white (DSDWNS-DV), black (DSDWNS-BK) and gray (DSDWNS-DG).

DSDWNU Downward Device Plate

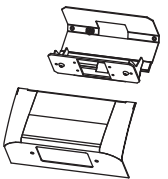

Accepts two Extron® Electronics MAAP single space modules. Available in fog white (DSDWNU-DV), black (DSDWNU-BK) and gray (DSDWNU-DG).

DS4075A Offset Fitting

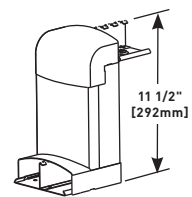

Mounts DS4000 Series Raceway around wall offsets and columns with maximum offset depth of 9" [229mm]. Minimum Offset: 3" [76mm]. Maximum Offset: 9 3/4" [235mm]. Available in fog white (DS4075A-DV), black (DS4075A-BK) and gray (DS4075A-DG).

DS4089 Adapter to 4000 Series Raceway

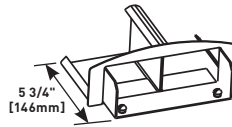

In-line transition from DS4000 Series Raceway to 4000 Series Raceway. Available in fog white (DS4089-DV), black (DS4089-BK) and gray (DS4089-DG).

DSTRK Tamper-Resistant Kit

Kit includes 25 screws and special bit to secure covers for fittings and raceway to DS4000B Raceway Base.

640DS DS4000 Series Raceway Cutter

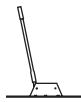

Portable cutter provides clean square cuts for DS4000C Raceway Cover.

640DSBDK Replacement Blade Kit

Case hard steel replacement blades and die set for 640DS Cutter.

650RT Fitting Cover Removal Tool



Easy removal of installed DS4000 Series raceway and fittings' covers without scratching or damaging their finish.

DVWE-S, DGWE-S, BKWE-S Spray Paint



Used for touching up large areas. Contains 12 oz. of paint. Available in ivory (DVIWE-S), gray (DGWE-S) or black (BKWE-S).

NOTE: Can only be shipped via ground transportation.

DVWE-P, BKWE-P Touch-Up Paint Pen



Used for touching up small areas. Contains 0.3 oz. of paint. Available in ivory (DIWE-P), gray (DGWE-P) or black (BKWE-P).

4000[®] SERIES RACEWAY



Single- and Dual-Channel, Steel Raceway. Easy-to-install and ideal for basic power or communication/low voltage installations.

CODE REFERENCE

cULus Listed Raceway:
File E4376 Guide RJBT.

Fittings:
File E41751 Guide RJPR.
Meets Article 386 of NEC.
Meets Section 12-1600 of CEC.

System Layout

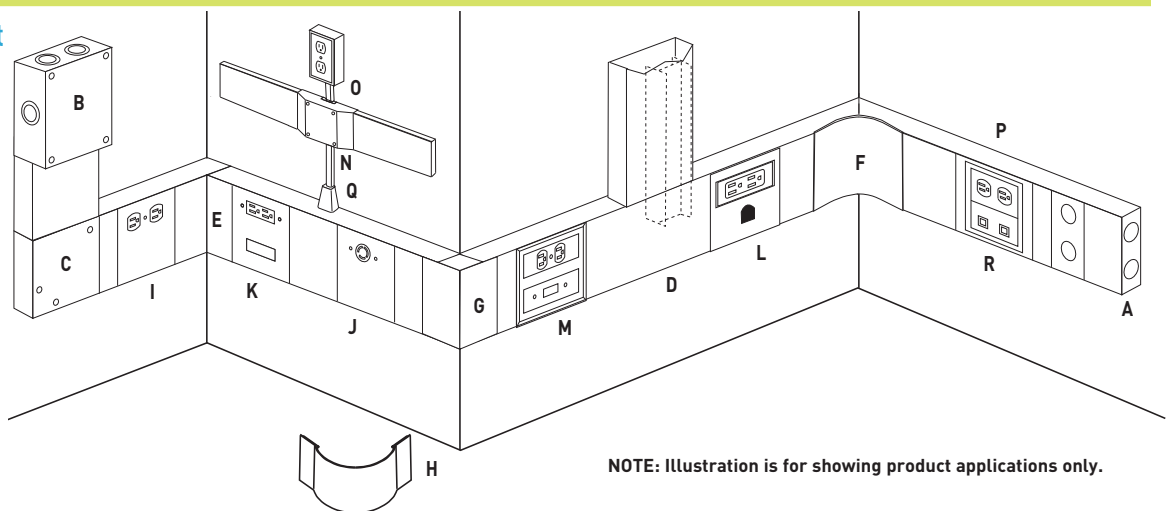

NOTE: Illustration is for showing product applications only.

KEY

- | | | | |
|---|---|--|--|
| A. 4010B Blank End Fitting | G. 4018 External Elbow | K. 4047RF Rectangular Receptacles and Modular Furniture Device Plate | N. 4075DA Bridge Fitting |
| B. 4010DF0 Entrance End Fitting | H. 4018FO Radiused Full Capacity External Elbow | L. 4047RH Device Plate for Rectangular Receptacle and Mousehole | O. 500 Series Raceway |
| C. 4011 Flat Elbow | I. 4047BX Duplex Receptacle Device Plate | M. 4050 Device Mounting Plate with 5507 Series Faceplates | P. 5507D Duplex Faceplate |
| D. 4015D Divided Tee | J. 4047JX Single Receptacle & Device Plate | | Q. 5785 Combination Connector |
| E. 4017 Internal Elbow | | | R. 5507RJ Device Plate with two RJ ports |
| F. 4017FO Radiused Full Capacity Internal Elbow | | | |

COLOR OPTIONS



4000[®] Series Raceway Part Numbers with a "V" prefix have an ivory finish. Part Numbers with a "G" prefix have a gray finish.

Custom color options are also available. Consult the factory for more information.

4000[®] SERIES RACEWAY

4000 Series Raceway Wire Fill Capacities for Communications

	CABLE/WIRE SIZE	O.D. (APPROX. DIA.)		DIVIDED 40% FILL	UNDIVIDED 40% FILL
		Inches	[mm]		
UNSHIELDED TWISTED PAIR	4-pair, 24 AWG, Cat 3	0.190	[4.8]	49	101
	4-pair, 24 AWG, Cat 5e	0.210	[5.3]	40	83
	4-pair, 24 AWG, Cat 6	0.250	[6.3]	28	58
	4-pair, 24 AWG, Cat 6a*	0.354	[9.0]	14	29
	25-pair, 24 AWG	0.410	[10.4]	10	21
COAXIAL	RG6/U	0.270	[6.9]	24	50
FIBER	ZipCord	0.118 x 0.236	[3 x 6]	50	103
	Round 4 Strand Fiber	0.187	[4.8]	51	104
	Round 6 Strand Fiber	0.256	[6.5]	27	55

4000 Series Raceway Wire Fill Capacities for Power

WIRE SIZE THHN/THWN	O.D.		NUMBER OF CONDUCTORS (40% FILL)							
			WITHOUT DEVICES		WITH DUPLEX RECT. DEVICES 1.59in. ² [1025mm ²]		WITH SURGE/ GFCI DEVICES 2.30in. ² [1485mm ²]		LARGE SINGLE RECEPTACLES 3.00in. ² [1935mm ²]	
	Inches	[mm]	Undiv.	Divided	Undiv.	Divided	Undiv.	Divided	Undiv.	Divided
14 AWG	0.111	[2.8]	296	127	165	78	107	49	49	20
12 AWG	0.130	[3.3]	216	93	120	57	78	36	36	15
10 AWG	0.164	[4.2]	136	58	76	36	49	22	22	9
8 AWG	0.216	[5.5]	78	33	43	20	28	13	13	5
6 AWG	0.254	[6.5]	56	24	31	15	20	9	9	3
4 AWG	0.324	[8.2]	34	15	0	0	0	0	0	0
3 AWG	0.352	[8.9]	29	12	0	0	0	0	0	0
2 AWG	0.384	[9.8]	24	10	0	0	0	0	0	0

4000 Series Raceway Fittings Wire Fill Capacities When using 4000 Radius Inserts

	CABLE/WIRE SIZE	O.D.		4011 FLAT ELBOW 40% FILL		4017 & 4018 ELBOWS 40% FILL		4015D & 4015 TEE FITTING 40% FILL	
		Inches	[mm]	4011DRI DIV.	4011/15RI UNDIV.	4017/18RI DIV.	4017/18RI UNDIV.	4015DRI DIV.	4011/15RI UNDIV.
POWER WIRING THHN/THWN	2	0.384	[9.8]	11	21	6	11	6	16
	4	0.324	[8.2]	15	30	8	15	9	23
	6	0.254	[6.5]	24	48	13	25	14	37
	8	0.216	[5.5]	34	67	18	35	20	51
	10	0.164	[4.2]	68	136	36	71	40	104
	12	0.130	[3.3]	107	214	56	112	63	163
	14	0.111	[2.8]	145	288	75	151	85	220
UNSHIELDED TWISTED PAIR	Cat. 3 UTP	0.190	[4.8]	44	88	23	46	26	67
	Cat 5e UTP	0.210	[5.3]	36	72	19	38	21	55
	Cat 6 UTP	0.250	[6.3]	23	47	12	24	13	36
	Cat 6a UTP	0.354	[9.0]	16	31	9	15	10	24
	25-pair	0.410	[10.4]	9	19	5	10	6	14
COAXIAL	RG6/U	0.270	[6.9]	22	44	22	23	13	33
FIBER	ZipCord	0.118 x 0.236	[3 x 6]	132	263	69	137	78	201
	Round 4 Strand Fiber	0.187	[4.8]	44	88	23	46	26	67
	Round 6 Strand Fiber	0.256	[6.5]	36	72	19	38	21	55

NOTE: For additional information, refer to the Technical Section.

* Category 6 augmented (6a) cable for 10 gigabit ethernetmax allowed cable diameter per addenda No. 11 ANSI TIA/EIA 568-B.2.

4000[®] SERIES RACEWAY

4000 Series Raceway Ordering Information

V4000B-10, G4000B-10 Raceway Base

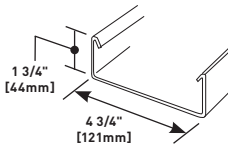

.054" [13.7mm] galvanized steel. Packed five 10' [3m] lengths per carton. Base has two 9/32" [7.1mm] diameter KOs every 18" [457mm] throughout length. No KOs 1 1/4" [32mm] from each end.

G4000D Divider

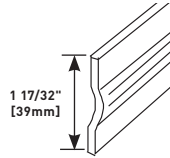

.040" [1.0mm] galvanized steel. Painted on one side only to provide compartment identification. Packed ten 5' [1.5m] lengths (50' [15.2m]) per carton.

NOTE: Not for use with stainless steel S4000 Series Raceway.

V4000C, G4000C Raceway Cover

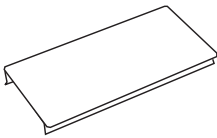

.040" [1.0mm] galvanized steel. Packed ten 5' [1.5m] lengths per carton. 4000C Cover is also compatible with 6000B, 6000 Series Raceway Base.

640B Base Cutter

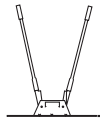

Portable cutter for 4000 Series Raceway Base. Provides clean and square end cuts.

NOTE: Not for use with stainless steel S4000 Series Raceway.

V4000C075, G4000C075 7.5" [191mm] Precut Raceway Cover

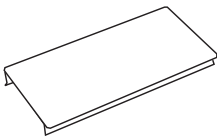

Mounts devices spaced 12" [305mm] on center using 4047 Series device plates.

640BDK Replacement Blade Kit

Case hard steel replacement blade and die set for 640B Cutter

V4000C135, G4000C135 13.5" [343 mm] Precut Raceway Cover

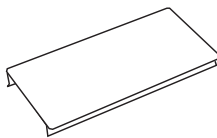

Mounts devices spaced 18" [457mm] on center using 4047 Series device plates.

640C Cover Cutter

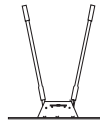

Portable cutter for 4000 and 6000 Series Raceway Cover. Provides clean and square end cuts.

NOTE: Not for use with stainless steel S4000 Series Raceway.

V4000C195, G4000C195 19.5" [495 mm] Precut Raceway Cover

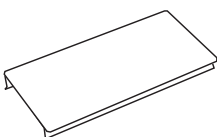

Mounts devices spaced 24" [610mm] on center using 4047 Series device plates.

640CDK Replacement Blade Kit

Case hard steel replacement blade and die set for 640C Cutter.

V4000C315, G4000C315 31.5" [800 mm] Precut Raceway Cover

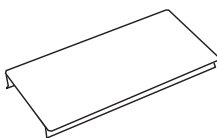

Mounts devices spaced 36" [915mm] on center using 4047 Series device plates.

G4000WC Wire Clip (Galvanized)



Holds conductors in place.

4001A Coupling (Galvanized)

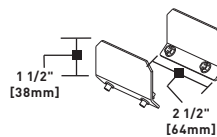

Joins lengths of 4000B Raceway Base. Sold in pairs.

4000[®] SERIES RACEWAY

4000 Series Raceway Ordering Information (continued)

4001DA Divider Clip (Galvanized)

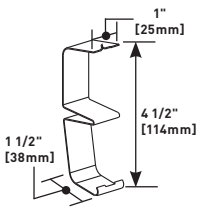

Required for holding G4000D Divider in place. Use one every 2 1/2' [.762m].

V4011FO, G4011FO Radiused Full Capacity Flat Elbow

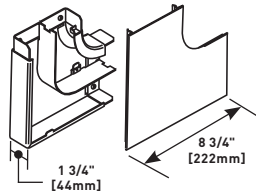

Full capacity 90° flat corner used in divided or undivided applications. 2" [51mm] bend radius control for UTP, STP and fiber optic installations. Ideal for new installations when the cable is lay-in or pull-through.

V4006, G4006 Seam Clip

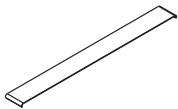

Covers seams where two sections of 4000 Series Raceway covers come together.

V4012TX, G4012TX Internal or External 45° Elbow

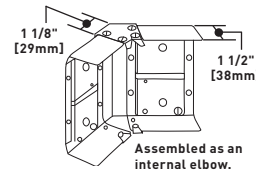

Internal or external 45° turns in a run of 4000 Series Raceway. Can also be assembled as an inverted 45° elbow.



V4010B, G4010B Blank End Fitting

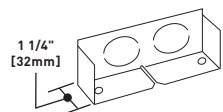

Closes off open end of 4000 Series Raceway. Has two 1/2" trade size KOs to facilitate end feeding.

V4014A, G4014A Wall Box Connector

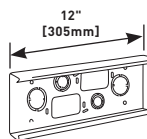

Base has two concentric 1", 3/4", and 1/2" trade size KOs, two concentric 1 1/4", and 1" KOs (undivided only), and two rectangular 2 9/16" x 1 11/16" KOs.

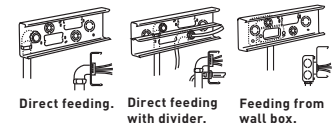

V4010DFO, G4010DFO Entrance End Fitting

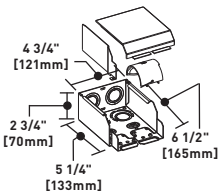

Full capacity entrance end fitting. Has concentric 3/4", 1", and 1 1/4" trade size KOs on end and bottom for feeding 4000 Series Raceway. Includes removable divider and 1 1/4" [32mm] bend radius control insert for UTP/STP and fiber optic cable installations.

V4015, G4015 Tee

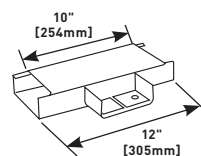

For branching raceway at right angles. Use with undivided raceway only. Join to raceway run with two pair of 4001A Couplings (not included).

V4011, G4011 Flat Elbow

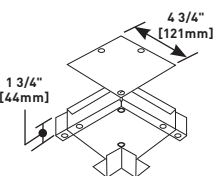

Right angle turns on the same surface.

V4015D, G4015D Divided Tee

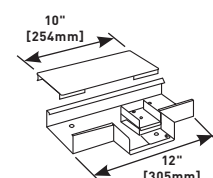

For branching raceway at right angles. Use with divided raceway only. Join to raceway run with two pair of 4001A Couplings (not included).

4000[®] SERIES RACEWAY

4000 Series Raceway Ordering Information (continued)

V4015FO, G4015FO Radiused Full Capacity Tee

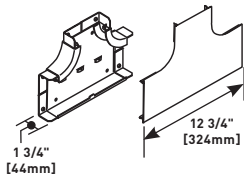

Full capacity, undivided tee fitting. Provides 2" [51mm] cable bend radius control for UTP, STP and fiber optic installations. Ideal for new installations whether the cable is lay-in or pull-through.

V4015DFO, G4015DFO Radiused Full Capacity Divided Tee

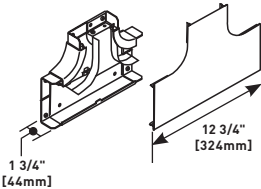

Full capacity, divided tee fitting. Provides 2" [51mm] cable bend radius control for UTP, STP and fiber optic installations. Ideal for new installations whether the cable is lay-in or pull-through.

V4017, G4017 Internal Elbow

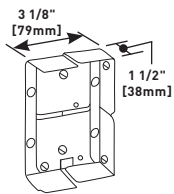

90° internal corners. Fiber bushing included.

V4017FO, G4017FO Internal Full Capacity Elbow

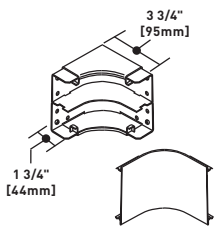

Full capacity, divided internal elbow. Provides 2" [51mm] cable bend radius control for UTP, STP and fiber optic installations. Ideal for new installations whether the cable is lay-in or pull-through.

V4017N, G4017N Inverted Internal Elbow

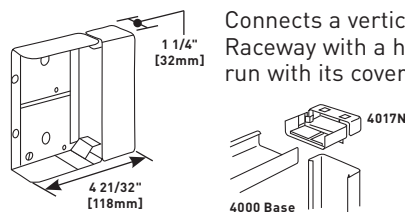

Connects a vertical run of 4000 Series Raceway with a horizontal overhead run with its cover facing up.

G4017TCA Internal Corner Coupling (Plated)

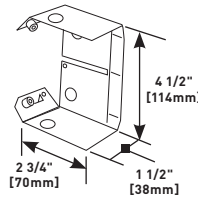

Makes an internal corner while continuing original run in a straight line. May be used with or without divider. Fiber bushing included.

V4018, G4018 External Elbow

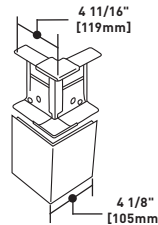

90° external corners.

V4018FO, G4018FO Radiused Full Capacity External Elbow

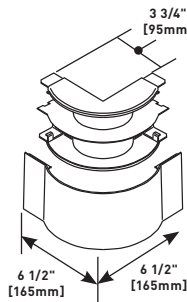

Full capacity 90° external corner. Used in both divided and undivided applications. Provides 2" [51mm] cable bend radius control for UTP, STP and fiber optic installations. Ideal for new installations whether the cable is lay-in or pull-through.

4011/15RI Radiused Corner Insert



Radiused insert for 4011 Flat Elbow and for 4015 Undivided Tee. Provides 2" [51mm] cable bend radius control for UTP, STP and fiber optic cable installations. Ideal for new and retrofit applications whether the cable installation is lay-in or pull-through.

4000[®] SERIES RACEWAY

4000 Series Raceway Ordering Information (continued)

4017/18RI Radiused Insert for Internal/External Elbow

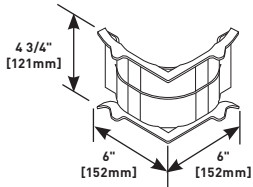

Radiused insert for 4017 Internal Elbow and 4018 External Elbow in divided or undivided applications. Provides 2" [51mm] cable bend radius control for UTP, STP and fiber optic cable installations. Ideal for new and retrofit applications whether the cable installation is lay-in or pull-through.

4011DRI Radiused Insert for Divided Flat Elbow



Bend radius control insert for 4011 Divided Flat Elbow. Provides 2" [51mm] cable bend radius control for UTP, STP and fiber optic cable installations. Ideal for new or retrofit applications where cable installation is lay-in or pull-through.

4015DRI Radiused Insert for Divided Tee

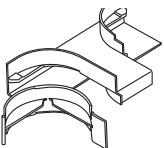

Radiused insert for 4015D Divided Tee. Provides 2" [51mm] cable bend radius control for UTP/STP or fiber optic installations. Ideal for new and retrofit applications whether the cable installation is lay-in or pull-through.

V4075D, G4075D Bridge Fitting

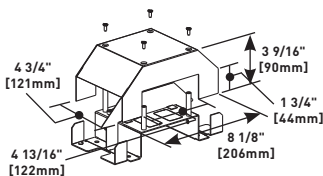

Allows 4000 Series Raceway to cross over existing installations of 4000 Series Raceway.

V4075DA, G4075DA Bridge Fitting

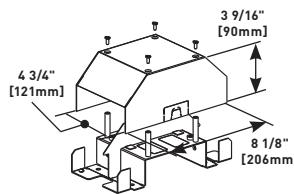

Allows 4000 Series Raceway to cross over existing installations of 2400, 700, or 500 Series Raceway.

V4074A, G4074A Take-Off Connector (4000 to 3000 Series Raceway)

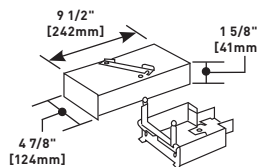

90° tee connection at any point along a run of 4000 Series Raceway.

V4086A, G4086A Panel Connector

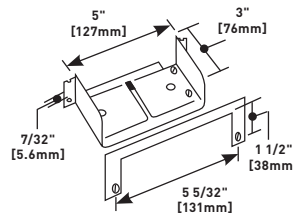

Connects 4000 Series Raceway to surface type panel boxes. Maintains maximum wire capacity of 4000 Series Raceway. Separate C-shaped flange fits around raceway to hide irregularities made during cutting into box.

V4089 Reducing Connector

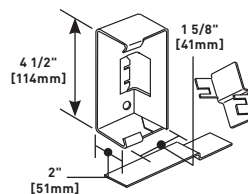

Reduces 4000 Series Raceway to either 2400 or 2400BD Series Raceway.

NOTE: CM-EPLA End Plates are required when using Wiremold CM2 communication modules and Pass & Seymour® Activate inserts. S2-EPL End Plates are required when using Ortronics® Series II inserts. To mount TracJack modules, use 55074TJ or 55076TJ Faceplates.

4000[®] SERIES RACEWAY

4000 Series Raceway Ordering Information (continued)

V4050, G4050 Device Mounting Bracket

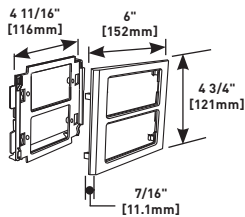

High impact plastic mounting bracket and trim plate. Overlaps raceway cover for a seamless transition with cover fittings. Accepts 5507 Faceplates, as well as, Wiremold Open System communication modules, Ortronics[®] TracJack and Series II inserts, and Pass & Seymour[®] Activate Series inserts.

For faceplate options, see 5507 Series[™] Faceplates.

IWE-P, GWE-P Touch-Up Paint Pen



Used for touching up small areas. Contains 0.3 oz. of paint. Available in ivory (IWE-P) and gray (GWE-P).

IWE-S, GWE-S Spray Paint



Used for touching up large areas. Contains 12 oz. of paint. Available in ivory (IWE-S) and gray (GWE-S).

NOTE: Can only be shipped via ground transportation.

4047 Series Faceplates Ordering Information

V4046H-2, G4046H-2 Tap-Off Fitting

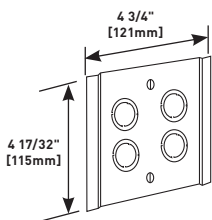

Four concentric 1/2" and 3/4" trade size KO's.

V4047BX, G4047BX Two-Gang Cover One Duplex Receptacle

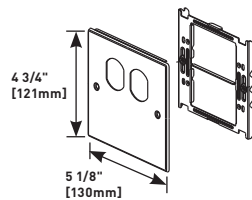

Accepts 15A or 20A duplex receptacles and 106 style frames when used for communications outlets.

V4047AX, G4047AX Two-Gang Cover Single Round Opening

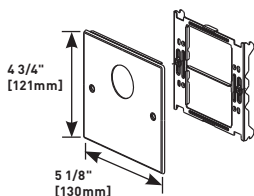

Accepts straight blade and locking single receptacles with face diameters of 1.38" to 1.39" [35mm to 36mm].

V4047BB, G4047BB Two-Gang Cover Two Duplex Receptacles

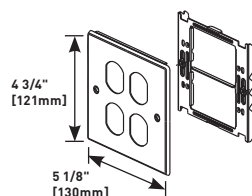

Accepts 15A or 20A duplex receptacles and 106 style frames.

NOTE: Parts identified with this symbol are Certified to Canadian Safety Standards for sale in Canada. When ordering these products, change the "V" color prefix to "CV" or the "G" color prefix to "CG" to denote the Canadian versions.

NOTE: All 4047 Series Faceplates provide 1/4" [6.4mm] of overlap on each side of plate.

4000[®] SERIES RACEWAY

4047 Series Faceplates Ordering Information (continued)

V4047BF, G4047BF Two-Gang Cover Duplex & Modular Furniture

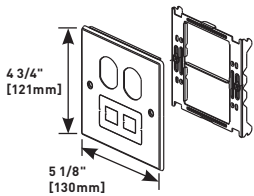

Accepts 15A or 20A duplex receptacles. Includes combination twistout that can accept either one Modular Furniture adapter, 106 style frame, or two Keystone RJ45s.

V4047C-1, G4047C-1 One-Gang Device Plate

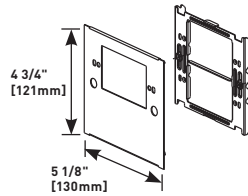

Accepts commercially available flush plates (not included).

V4047BM, G4047BM Two-Gang Cover & Pass & Seymour[®] Activate 2A Mini Adapter

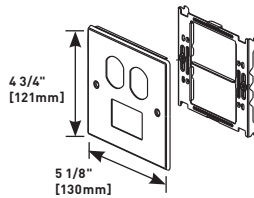

Accepts 15A or 20A duplex receptacles and 106 style frames. Includes Mini adapter that will accept Activate Series inserts and Wiremold Open System communication modules.

V4047C-2, G4047C-2 Two-Gang Device Plate

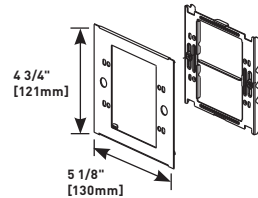

Accepts commercially available flush plates (not included).

V4047BS, G4047BS Two-Gang Cover & Ortronics[®] Series II Mini Adapter

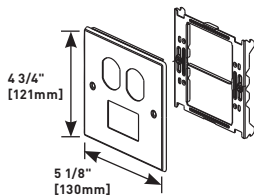

Accepts 15A or 20A duplex receptacles and 106 style frames. Includes Mini adapter that will accept one Ortronics[®] Series II insert.

V4047JX, G4047JX Two-Gang Cover Single Round Opening

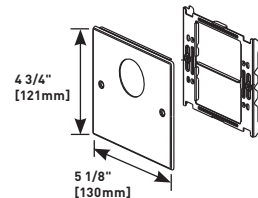

Accepts straight blade and single locking receptacles with face diameters of 1.56" - 1.58" [39mm - 40mm].

V4047BT, G4047BT Two-Gang Cover & Ortronics[®] TracJack Mini Adapter

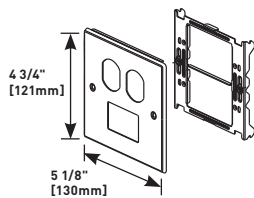

Accepts 15A or 20A duplex receptacles and 106 style frames. Includes Mini adapter that will accept two Ortronics[®] TracJack inserts.

V4047RX, G4047RX Two-Gang Cover with One Rectangular Opening

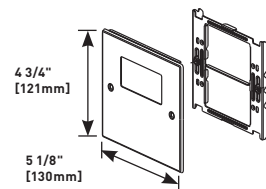

Accepts rectangular GFCI, Surge and Decorator Style devices. Does not accept 5507 Series Faceplates.

4000[®] SERIES RACEWAY

4047 Series Faceplates Ordering Information (continued)

V4047RF, G4047RF

Two-Gang Cover Rectangular Opening & Modular Furniture

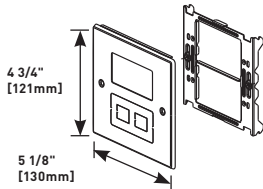

Accepts rectangular GFCI, Surge and Decorator Style devices, modular furniture adapters and RJ45s. Does not accept 5507 Series Faceplates.

V4047WS, G4047WS

Two-Gang Cover One Duplex Receptacle Installed & Series II Mini Adapter

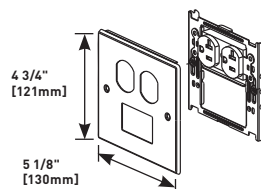

Includes one Pass & Seymour[®] 20A Duplex Receptacle with 12" wire leads installed on bracket. Includes Mini adapter that will accept one Ortronics[®] Series II insert.

V4047WX, G4047WX

Two-Gang Cover One Duplex Receptacle Installed

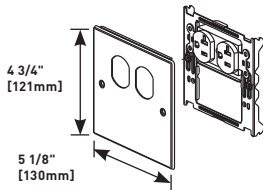

Includes one Pass & Seymour[®] Duplex Receptacle with 12" wire leads installed on bracket.

V4047WT, G4047WT

Two-Gang Cover One Duplex Receptacle Installed & TracJack Mini Adapter

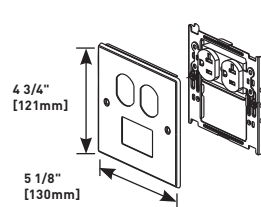

Includes one Pass & Seymour[®] 20A Duplex Receptacle with 12" wire leads installed on bracket. Includes Mini adapter that accepts two Ortronics[®] TracJack inserts.

V4047WF, G4047WF

Two-Gang Cover One Duplex Receptacle Installed & One Modular Furniture Opening

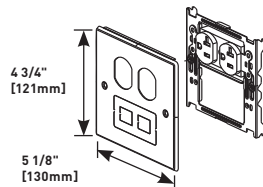

Includes one Pass & Seymour[®] 20A Duplex Receptacle with 12" wire leads installed on bracket. Has combination twistout that can accept either one Modular Furniture adapter or two Keystone RJ45s.

V4047-2BBBB, G4047-2BBBB

Four-Gang Cover Four Duplex Openings

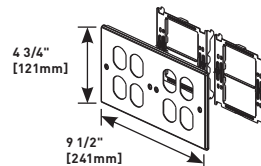

Accepts 15A or 20A duplex receptacles and 106 style frames.

V4047WM, G4047WM

Two-Gang Cover One Duplex Receptacle Installed & Activate Mini Adapter

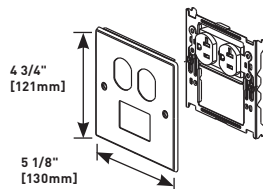

Includes one Pass & Seymour[®] 20A Duplex Receptacle with 12" wire leads installed on bracket. Includes Mini adapter that accepts Pass & Seymour[®] Activate inserts and Wiremold Open System communication modules.

NOTE: Parts identified with this symbol are Certified to Canadian Safety Standards for sale in Canada. When ordering these products, change the "V" color prefix to "CV" or the "G" color prefix to "CG" to deNOTE the Canadian versions.

NOTE: All 4047 Series Faceplates provide 1/4" [6.4mm] of overlap on each side of plate.

4000[®] SERIES RACEWAY

4047 Series Faceplates Ordering Information (continued)

V4047-2BBFF, G4047-2BBFF

Four-Gang Cover Two Duplex & Two Modular Furniture Openings

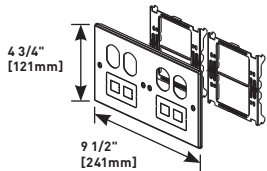

Accepts 15A or 20A duplex receptacles and 106 style frame. Includes combination twistouts for either modular furniture adapter or two keystone RJ45s.

V4047-2BBXX, G4047-2BBXX

Four-Gang Cover with Two Duplex Openings

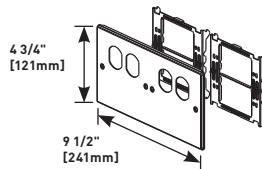

Accepts 15A or 20A duplex receptacles and 106 style frames.

V4047-2BBMM, G4047-2BBMM

Four-Gang Cover Two Duplex & Two Mini Adapters

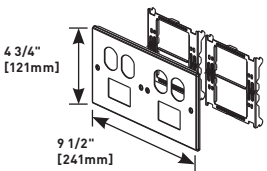

Accepts 15A or 20A duplex receptacles and 106 style frame. Includes Mini adapter that accepts Pass & Seymour[®] Activate inserts, or Wiremold Open System communication modules.

V4047-2RRXX, G4047-2RRXX

Four-Gang Cover with Two Rectangular Openings

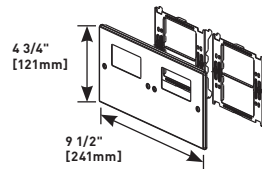

Accepts rectangular, GFCI, Surge, and decorator style devices. Does not accept 5507 Series Faceplates.

V4047-2BBSS, G4047-2BBSS

Four-Gang Cover Two Duplex & Two Series II Mini Adapters

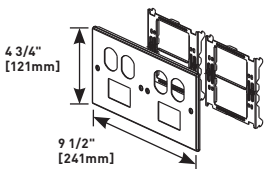

Accepts 15A or 20A duplex receptacles and 106 style frame. Includes Mini adapter that accepts one Ortronics[®] Series II insert.

V4047-2WWFF, G4047-2WWFF

Four-Gang Cover with Two Duplex & Two Modular Furniture Openings

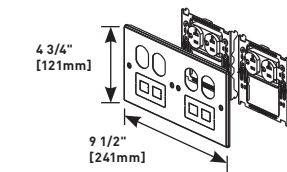

Includes two Pass & Seymour[®] 20A Duplex Receptacles with 12" wire leads installed on bracket. Two combination twistouts accept either modular furniture adapters or Keystone RJ45s.

V4047-2BBTT, G4047-2BBTT

Four-Gang Cover Two Duplex & Two TracJack Mini Adapters

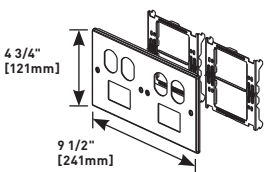

Accepts 15A or 20A duplex receptacles and 106 style frame. Includes Mini adapter that accepts two Ortronics[®] TracJack inserts.

V4047-2WWMM, G4047-2WWMM

Four-Gang Cover with Two Activate Mini Adapters

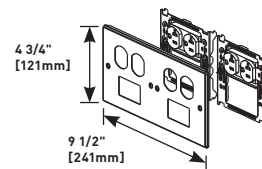

Includes two Pass & Seymour[®] 20A Duplex Receptacles with 12" wire leads installed on bracket. Includes Mini adapter that accepts Pass & Seymour[®] Activate inserts & Wiremold Open System communication modules.

V4047-2WWSS, G4047-2WWSS

Four-Gang Cover with Two Series II Mini Adapters

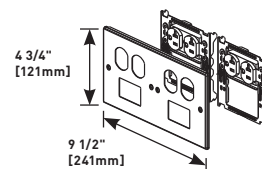

Includes two Pass & Seymour[®] 20A Duplex Receptacles with 12" wire leads installed on bracket. Includes Mini adapter that accepts one Ortronics[®] Series II insert.

NOTE: Parts identified with this symbol are Certified to Canadian Safety Standards for sale in Canada. When ordering these products, change the "V" color prefix to "CV" or the "G" color prefix to "CG" to denote the Canadian versions.

NOTE: All 4047 Series Faceplates provide 1/4" [6.4mm] of overlap on each side of plate.

4000[®] SERIES RACEWAY

4047 Series Faceplates Ordering Information (continued)

V4047-2WWTT, G4047-2WWTT

Four-Gang Cover with Two TracJack Mini Adapters

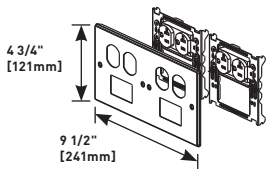

Includes two Pass & Seymour[®] 20A Duplex Receptacles with 12" wire leads installed on bracket. Includes Mini adapter that accepts two Ortronics[®] TracJack inserts.

V4047UX, G4047UX Bump-Up Device Plate

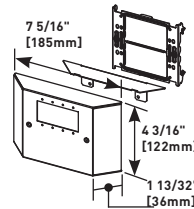

Accepts four Extron[®] Electronics MAAP single space modules.

V4047-2WWXX, G4047-2WWXX

Four-Gang Cover with Two Duplex Receptacles Installed

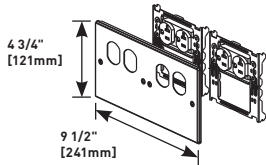

Includes two Pass & Seymour[®] 20A Duplex Receptacles with 12" wire leads installed on bracket.

V4047VX, G4047VX

Bump-Up Extron[®] AAP Device Plate

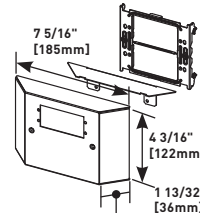

Accepts two Extron[®] Electronics AAP single space modules.

4000 Series Raceway Interconnectivity Fittings

CONNECTION REQUIRED		USE CATALOG NUMBER
FROM	TO	
4000 Series Raceway	DS4000 Series Raceway	DS4089
4000 Series Raceway	3000 (Tee Connection)	G4074A
4000 Series Raceway	4000 (Tee Connection)	4015/4015FO
4000 Series Raceway w/Divider	4000 w/Divider (Tee Connection)	4015D
4000 Series Raceway	500 Series Raceway	V5785
6000 Series Raceway	4000 (Tee Connection)	6074A
1/2" or 3/4" trade size Conduit or Armored Cable	Cover of 4000 Series Raceway	4064H-2
1/2" trade size Conduit or Armored Cable	End of 4000 Series Raceway	4010B
3/4", 1", or 1 1/4" trade size Conduit or Armored Cable	Back, Side or End of 4000 Series Raceway	4010DFO
1" or 1 1/4" trade size Conduit or Armored Cable	Back or End of 4000 Series Raceway	4010DFC
1/2", 3/4", 1", or 1 1/4" trade size Conduit or Armored Cable	Back of 4000 Series Raceway	4014A
Flush Mounted Wall Box	Back of 4000 Series Raceway	4014A

4047 Configurable Cover Plates Number Logic

1. For "X", Choose one of the following options:

- V Ivory & UL Listed CV Ivory & cULus Listed (Canada only)
- G Gray & UL Listed CG Gray & cULus Listed (Canada only)

2. Choose a Plate Configuration:

Two-Gang Plate: **X 4047 Y Y** **Four-Gang Plate: X 4047-2 Y Y Y Y**

3. For "Y", Choose any combination of configurations from the options listed below:

- A. 1.41" [35.8mm] Diameter, Single Round Receptacle
- B. Duplex Receptacle Opening
- F. Combination Modular Furniture & 2 Keystone Twist Out
- H. Mouse Hole Twist Out & Grommet
- T. Ortronics TracJack 2A Mini Adapter Opening with Adapter
- X. Blank
- J. 1.59" [40mm] Diameter, Single Round Receptacle
- M. Pass & Seymour Activate 2A Mini Adapter Opening with Adapter
- R. Rectangular Receptacle
- S. Ortronics[®] Series II 2A Mini Adapter Opening with Adapter
- W. P&S Light Almond 20 Amp Receptacle pre-pigtailed with 12" wire leads installed on Bracket
- Z. 3 Keystone Twist Out

4. Finished Part Number:

 4047 4047-2

NOTE: JJ combination not available.
For additional colors or configurations, call 1-800-621-0049, option 2.

NOTE: Parts identified with this symbol are Certified to Canadian Safety Standards for sale in Canada. When ordering these products, change the "V" color prefix to "CV" or the "G" color prefix to "CG" to denote the Canadian versions.

NOTE: All 4047 Series Faceplates provide 1/4" [6.4mm] of overlap on each side of plate.

S4000[®] SERIES RACEWAY



Easy-to-install and ideal for specialized power or communication/low voltage installations.

CODE REFERENCE

cULus Listed Raceway:
File E4376 Guide RJBT.

Fittings:
File E41751 Guide RJPR.
Meets Article 386 of NEC.
Meets Section 12-1600 of CEC.

System Layout

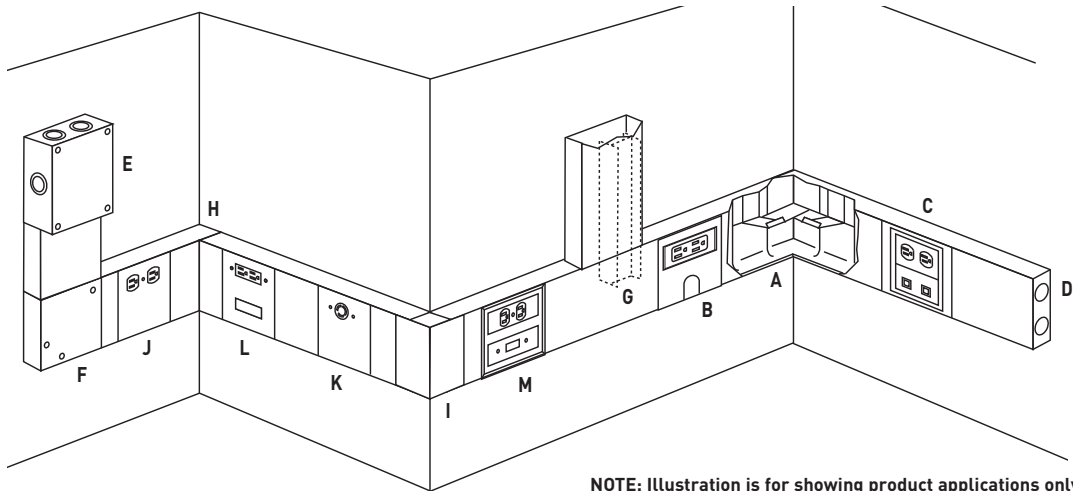

NOTE: Illustration is for showing product applications only.

KEY

- | | |
|---|--|
| A. G4017TC Internal Corner Coupling (Plated) | H. S4017 Internal Elbow Fitting |
| B. S4007C-1R Single Device Fitting | I. S4018 External Elbow Fitting |
| C. S4007C-2 Two-Gang Device Plate with Wallplates | J. S4048B Duplex Receptacle Device Plate |
| D. S4010B2 Blank End Fitting | K. S4048J Single Twistlock Receptacle Cover |
| E. S4010D Entrance End Fitting | L. S4048RF Rectangular Receptacles & AMP Flexmode or ACO |
| F. S4011 Flat Elbow Fitting | M. V4050 Device Mounting Plate (Inserts included) |
| G. S4015D Divided Tee Fitting | |

COLOR OPTIONS

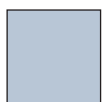
-  S4000[®] Series Raceway Part Numbers are available with a brushed stainless steel finish unless otherwise indicated in the part number description.
- Custom color options are also available. Consult the factory for more information.**

S4000® SERIES RACEWAY

S4000 Series Raceway Wire Fill Capacities for Communications

	CABLE/WIRE SIZE	O.D. (APPROX. DIA.)		DIVIDED 40% FILL	UNDIVIDED 40% FILL
		Inches	[mm]		
UNSHIELDED TWISTED PAIR	4-pair, 24 AWG, Cat 3	0.190	[4.8]	49	101
	4-pair, 24 AWG, Cat 5e	0.210	[5.3]	40	83
	4-pair, 24 AWG, Cat 6	0.250	[6.3]	28	58
	4-pair, 24 AWG, Cat 6a*	0.354	[9.0]	14	29
	25-pair, 24 AWG	0.410	[10.4]	10	21
COAXIAL	RG6/U	0.270	[6.9]	24	50
FIBER	ZipCord	0.118 x 0.236	[3 x 6]	50	103
	Round 4 Strand Fiber	0.187	[4.8]	51	104
	Round 6 Strand Fiber	0.256	[6.5]	27	55

S4000 Series Raceway Wire Fill Capacities for Power

WIRE SIZE THHN/THWN	O.D.		NUMBER OF CONDUCTORS (40% FILL)							
			WITHOUT DEVICES		WITH DUPLEX RECT. DEVICES 1.59in. ² [1025mm ²]		WITH SURGE/ GFCI DEVICES 2.30in. ² [1485mm ²]		LARGE SINGLE RECEPTACLES 3.00in. ² [1935mm ²]	
	Inches	[mm]	Undiv.	Divided	Undiv.	Divided	Undiv.	Divided	Undiv.	Divided
14 AWG	0.111	[2.8]	296	127	165	78	107	49	49	20
12 AWG	0.130	[3.3]	216	93	120	57	78	36	36	15
10 AWG	0.164	[4.2]	136	58	76	36	49	22	22	9
8 AWG	0.216	[5.5]	78	33	43	20	28	13	13	5
6 AWG	0.254	[6.5]	56	24	31	15	20	9	9	3
4 AWG	0.324	[8.2]	34	15	0	0	0	0	0	0
3 AWG	0.352	[8.9]	29	12	0	0	0	0	0	0
2 AWG	0.384	[9.8]	24	10	0	0	0	0	0	0

NOTE: For additional information, refer to the Technical Section.

* Category 6 augmented (6a) cable for 10 gigabit ethernet – max allowed cable diameter per addenda No. 11 ANSI TIA/EIA 568-B.2.

S4000 Series Raceway Wire Fill Capacities for Communications

S4000B Raceway Base

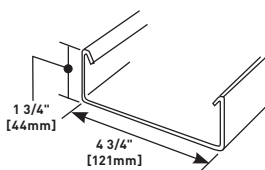

.050" [1.3mm] stainless steel. Base has two 9/32" [7.1mm] diameter KOs 1 1/4" [32mm] from each end and every 18" [457mm] on center throughout. S4000B is available in 10' [3m] lengths. Also available in lengths precut to customer specifications.

S4000C-5 Raceway Cover

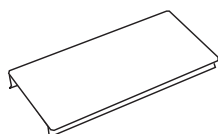

.040" [1.0mm] stainless steel. S4000C-5 is available in 5' [1.5m] lengths, packed ten 5' [1.5m] lengths per carton. Also available in lengths precut to customer specifications. Max. 5' [1.5m] length.

S4000C075 7.5" [191mm] Precut Raceway Cover

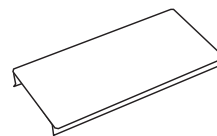

.040" [1.0mm] stainless steel. Snap-on cover for mounting 4 1/2" [114mm] device plates on 12" [305mm] centers.

S4000C090 9" [229mm] Precut Raceway Cover

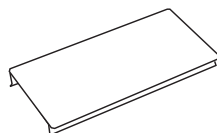

.040" [1.0mm] stainless steel. Snap-on cover for mounting 9" [229mm] device plates on 18" [457mm] centers.

S4000C135 13.5" [343mm] Precut Raceway Cover

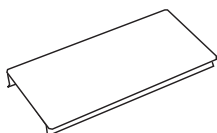

.040" [1.0mm] stainless steel. Snap-on cover for mounting 4 1/2" [114mm] device plates on 18" [457mm] centers.

S4000® SERIES RACEWAY

S4000 Series Raceway Wire Fill Capacities for Communications (continued)

S4000C150 15" [381mm] Precut Raceway Cover

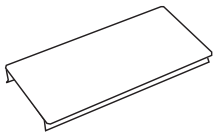

.040" [1.0mm] stainless steel. Snap-on cover for mounting 9" [229mm] device plates on 24" [610mm] centers.

S4000C195 19.5" [495mm] Precut Raceway Cover

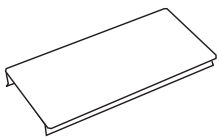

.040" [1.0mm] stainless steel. Snap-on cover for mounting 4 1/2" [114mm] device plates on 24" [610mm] centers.

S4000C270 27" [686mm] Precut Raceway Cover

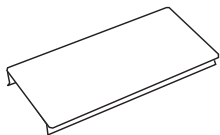

.040" [1.0mm] stainless steel. Snap-on cover for mounting 9" [229mm] device plates on 36" [915mm] centers.

S4000C315 31.5" [800mm] Precut Raceway Cover

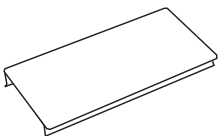

.040" [1.0mm] stainless steel. Snap-on cover for mounting 4 1/2" [114mm] device plates on 36" [915mm] centers.

S4000C390 39" [990mm] Precut Raceway Cover

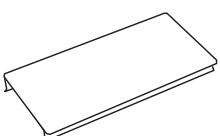

.040" [1.0mm] stainless steel. Snap-on cover for mounting 9" [229mm] device plates on 48" [1220mm] centers.

S4000C435 43.5" [1105mm] Precut Raceway Cover

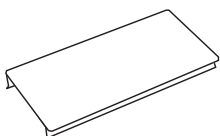

.040" [1.0mm] stainless steel. Snap-on cover for mounting 4 1/2" [114mm] device plates on 48" [1220mm] centers.

G4000D Divider

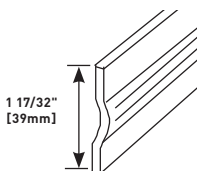

.040" [1.0mm] galvanized steel. Packed ten 5' [1.5m] lengths (50' [15.20m]) per carton. Painted buff on one side to provide compartment identification. 4001DA Divider Clips (not included) are required to hold divider in place.

4001DA Divider Clip (Galvanized)

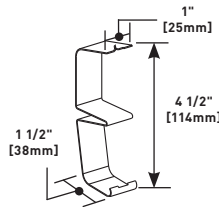

Required for holding G4000D Divider in place. Use one every 2 1/2' [.762m].

S6008A C-Hanger

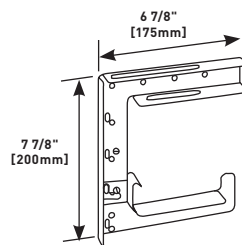

Suspends S4000, 4000 or 6000 Series Raceway from a structural ceiling. Designed for use with 3/8" [9.5mm] rod. Hangers should be installed no more than 5' [1.5m] apart along raceway run. Can be bolted back-to-back for dual runs of 3000, 4000 or 6000 Series Raceway.

S4010B0 Blank End Fitting

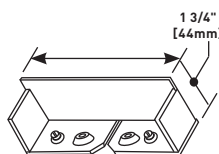

Closes off open end of S4000 Base. Use when no end feeding is required. Includes two No. 10-32 ground terminals.

S4010B1 Blank End Fitting

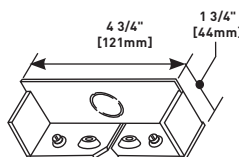

Closes off open end of S4000 Base. Use when one end feed is required in an undivided installation. Includes one 1/2" - 3/4" trade size KO and two No. 10-32 ground terminals.

S4010B2 Blank End Fitting

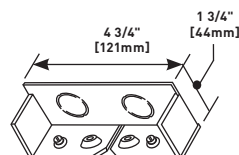

Closes off open end of S4000 Base. Use when end feeds are required for an installation. Includes two 1/2" - 3/4" trade size KOs and two No. 10-32 ground terminals.

S4000® SERIES RACEWAY

S4000 Series Raceway Wire Fill Capacities for Communications (continued)

S4010D Entrance End Fitting

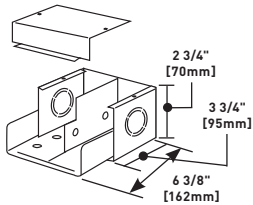

Has concentric 1/2" and 3/4" trade size KOs on end, sides, and bottom for feeding S4000 Series Raceway. Use punch kit to increase KO size up to 1 1/4". Removable divider and two No. 10-32 ground terminals included.

S4017 Internal Elbow

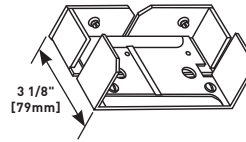

90° internal corners. No couplings required.

S4011 Flat Elbow

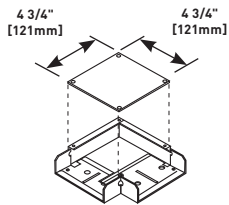

Right angle turns on the same surface. No couplings required.

G4017TCA Internal Corner Coupling

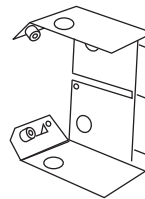

Creates internal corner while continuing original run in a straight line. Galvanized finish. Use with or without divider. Fiber bushing included. 4010B Blank End Fitting required for installation (not included).

S4014A Wall Box Connector

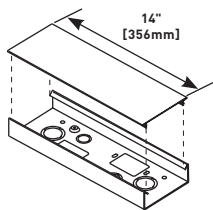

Base has two concentric 3/4", and 1/2" trade size KOs, two concentric 1 1/4" and 1" trade size KOs (undivided only), and two rectangular 2 9/16" x 1 11/16" [65mm x 43mm] KOs. Includes cover and two No. 10-32 ground terminals.



S4018 External Elbow

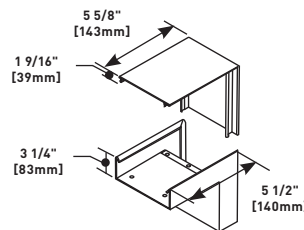

90° external corners. Connect to raceway with G4001 Couplings (not included).

S4015 Tee

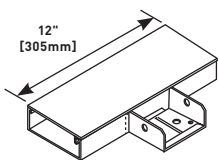

Divides S4000 Series Raceway at right angles. Only for use with undivided raceway. Use two pair of G4001 Couplings to attach to raceway (not included).

S6008A C-Hanger (Galvanized)

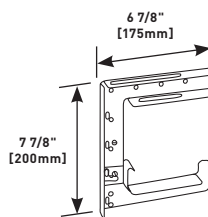

Suspends S4000, 4000 or 6000 Series Raceway from a structural ceiling. Designed for use with 3/8" [9.5mm] rod. Hangers should be installed no more than 5' [1.5m] apart along raceway run. Can be bolted back-to-back for dual runs of 3000, 4000 or 6000 Series Raceway.

S4015D Divided Tee

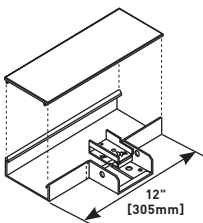

Divides S4000 Series Raceway at right angles. Only for use with divided raceway. Use two pair of G4001 Couplings to attach to raceway (not included).

S4007C-1 One-Gang Device Plate

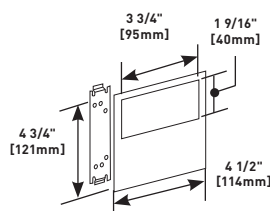

For horizontal mounting of standard single-gang devices. Accepts industry standard single-gang faceplates for electrical and communication devices.

S4000[®] SERIES RACEWAY

S4000 Series Raceway Wire Fill Capacities for Communications (continued)

S4007C-1R Single Device Plate

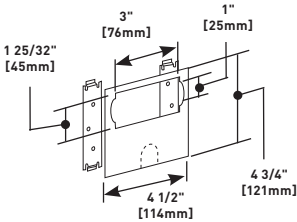

For horizontal mounting of surge suppression receptacles in S4000 Divided or Undivided Raceway. Also accepts most manufacturers' GFCI, large twistlock, and rectangular faced single-gang wiring devices and two-port ACO. Use with commercially available flush plate (not furnished).

S4046DRJ-2 Double In-Line Device Cover

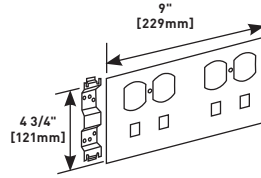

For installation of two duplex style receptacles and four RJ11/45 type modular connectors. Complete with necessary bridges.

S4007C-2 Two-Gang Device Plate

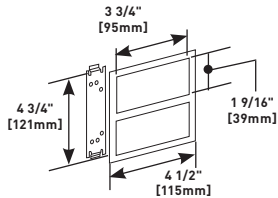

For horizontal mounting of two devices. Accepts industry standard double-gang faceplates for electrical and communication devices.

S4046ARJ Combination Device Cover

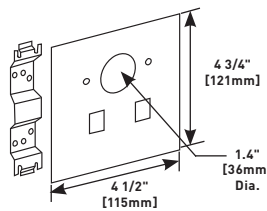

For installation of straight blade and single locking receptacles and two RJ11/45 type modular connectors. Complete with necessary bridges.

S4046DRJ Combination Device Cover

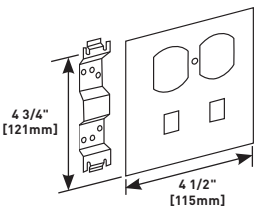

For installation of one duplex receptacle and two RJ11/45 type modular connectors. Complete with necessary bridges.

S4046JRJ Combination Device Cover

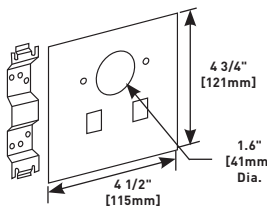

For installation of one twistlock receptacle and two RJ11/45 type telephone connectors. Complete with necessary bridges.

S4048B Duplex Receptacle Device Cover

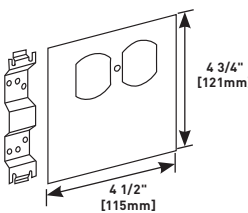

For installation of one duplex receptacle cover. Complete with necessary bridges.

S4046RRJ Combination Device Cover

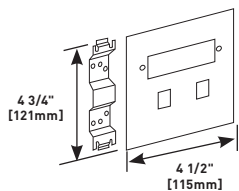

For installation of one rectangular style device and two RJ11/45 type modular connectors. Complete with necessary bridges.

S4048J TwistLock Receptacle Device Cover

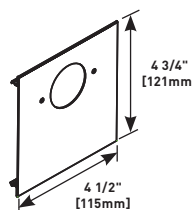

For installation of one twistlock receptacle.

S4046B-2 Double Duplex Device Cover

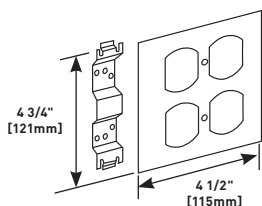

For installation of two duplex style receptacles. Complete with necessary bridges.

S4000[®] SERIES RACEWAY

S4000 Series Raceway Wire Fill Capacities for Communications (continued)

S4048R Rectangular Receptacle Device Cover

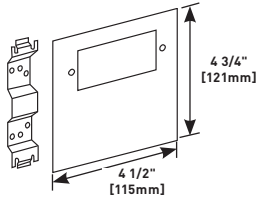

For installation of one rectangular receptacle. Complete with necessary bridges.

S4048RF Rectangular Receptacle Cover with Modular Furniture Opening

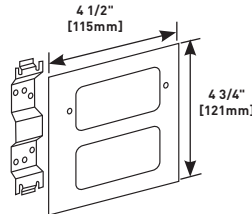

For installing a rectangular style device and a modular furniture adapter for communications.

S4048BF Duplex Receptacle Cover with Modular Furniture Opening

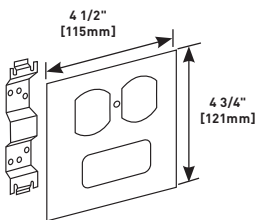

For installing a duplex style device and one modular furniture adapter for communications.

S4086A Panel Connector

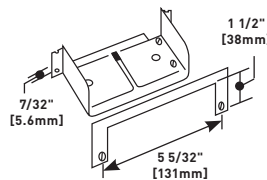

To connect S4000 Series Raceway with surface panel boxes. Accommodates maximum wire capacity of S4000 Series Raceway. Separate C-shaped flange fits around raceway, covering any irregularities from cutting into box. Cut 4 3/4" x 1 3/4" [121mm x 44mm] hole in panel box.

S4000 Series Raceway Made-to-Order Stainless Steel Device Plates

To keep pace with changing power and communication technology, Wiremold offers a variety of openings available on a made-to-order basis. Choose from the assortment of openings shown below to design your own device plates. Consult the factory if a special opening is desired.

To make ordering easier, a catalog number suffix has been included beside the description. Please send a sketch with your order indicating the letter of the desired opening.

Cat. No.

Suffix	Description of Device Opening	Diagram
D	Standard Duplex Receptacle	
R	Decorator Style Duplex Receptacle	
RJ	Two RJ11/45 Modular Connectors	
A	Single Receptacle [1.4" [35.6mm] Dia.]	
J	Single Receptacle [1.6" [40.6mm] Dia.]	
K	One 1/2-3/4" [12.7-19.1mm] KO with 1/2" [12.7mm] I.D. Grommet	
M	One IBM style connector	
MFB	One Modular Furniture Adapter	
2A	One 2A Mini Adapter	

Example: S4046RRJ 4 1/2" [115mm] Device Plates

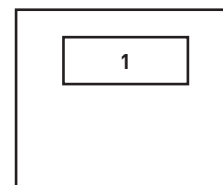
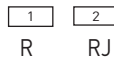
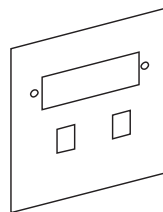

Qty.	1
___	S4048
___	S4048
___	S4048
___	S4048

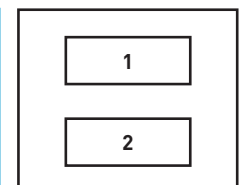

Qty.	1	2
___	S4046	___
___	S4046	___
___	S4046	___
___	S4046	___

9" [229mm] Device Plates

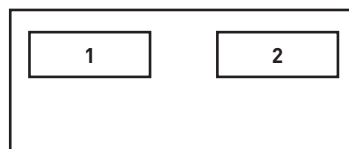

Qty.	1	2
___	S4048	___
___	S4048	___
___	S4048	___
___	S4048	___

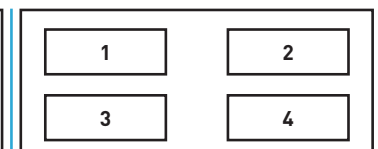

Qty.	1	2
___	S4046	___
___	S4046	___
___	S4046	___
___	S4046	___

NOTE: Necessary device brackets are supplied with all device plates.

S4000® SERIES RACEWAY

S4000 Series Raceway Installation Details

Determine method of feeding raceway: S4014A for back feed, S4010D, S4010BO, S4010B1 or S4010B2 for end feed.

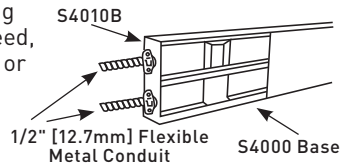

For divided installations, place S4000B Sections divider into the strut on the 4001DA and snap into raceway. Clips must be used every 30" [762mm].

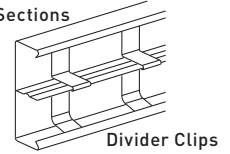

To mount S4000B Base to surface, remove mounting screw KOs (approx. 18" [457mm] centers along base) as required. Mount base with No. 8 flat head fasteners.

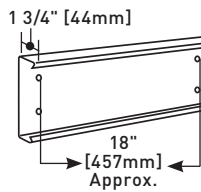

To install device covers, snap device straps into base as shown. Wire device and assemble to straps. Snap device plate over base and device.

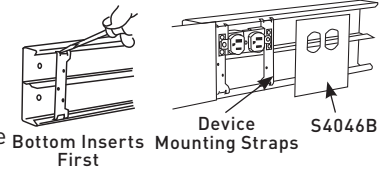

To join lengths of S4000B, insert the pair of 4001A Couplings into one side of each base. Slide bases together and tighten locking screws.

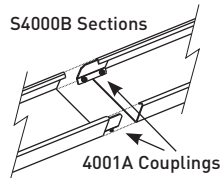

Cut S4000C Cover to fit between device plates. Snap in place as shown. Continue along entire run.

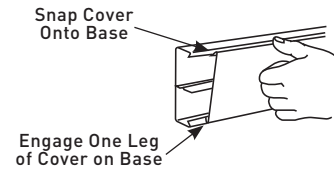

6000[®] SERIES RACEWAY



6000 Series Raceway is ideal for all applications requiring high cable capacity.

CODE REFERENCE

cULus Listed Raceway:
File E4376 Guide RJBT.

Fittings:
File E41751 Guide RJPR.
Meets Article 386 of NEC.
Meets Section 12-1600 of CEC.

System Layout

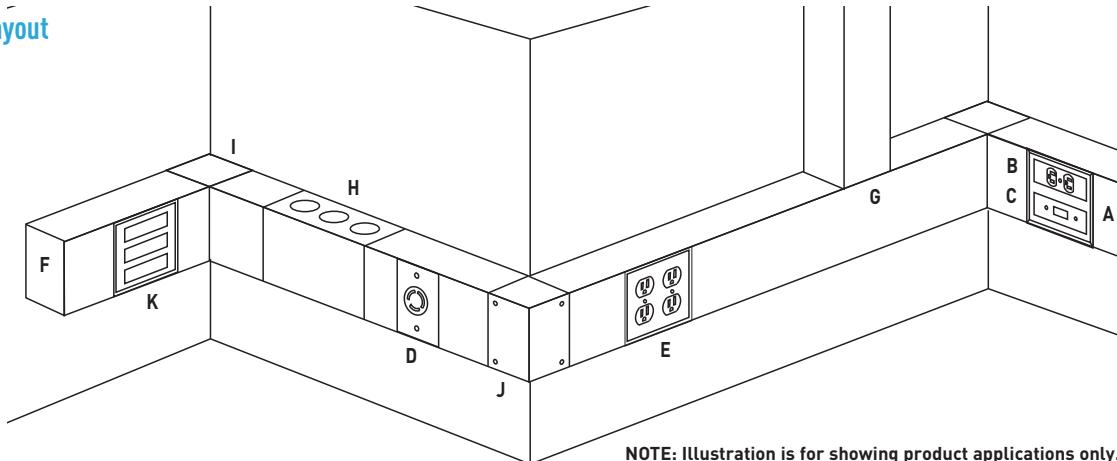

KEY

- | | |
|---|--|
| A. 4050 Device Mounting Plate
Inserts included | G. 6011TX Combination Flat Elbow |
| B. 5507D Duplex Receptacle Faceplate | H. 6014A Connector Fitting |
| C. 5507SW Switch Faceplate | I. 6017TX Combination Internal External
Elbow |
| D. 6007C-1 Single-Gang Device Plate | J. 6017TX Inverted to External Elbow |
| E. 6007C-2 Two-Gang Device Plate | K. 6046KD Circuit Breaker Housing |
| F. 6010B Blank End Fitting | |

COLOR OPTIONS



6000[®] Series Raceway Part Numbers with a "V" prefix have an ivory finish. Part Numbers with a "G" prefix have an gray finish.

Custom color options are also available. Consult the factory for more information.

6000[®] SERIES RACEWAY

6000 Series Raceway Wire Fill Capacities for Communications

	CABLE/WIRE SIZE	O.D. (APPROX. DIA.)		DIVIDED 40% FILL	UNDIVIDED 40% FILL
		Inches	[mm]		
UNSHIELDED TWISTED PAIR	4-pair, 24 AWG, Cat 3	0.190	[4.8]	101	225
	4-pair, 24 AWG, Cat 5e	0.210	[5.3]	83	184
	4-pair, 24 AWG, Cat 6	0.250	[6.3]	58	130
	4-pair, 24 AWG, Cat 6a*	0.354	[9.0]	29	65
	25-pair, 24 AWG	0.410	[10.4]	21	48
COAXIAL	RG6/U	0.270	[6.9]	50	111
FIBER	ZipCord	0.118 x 0.236	[3 x 6]	103	230
	Round 4 Strand Fiber	0.187	[4.8]	104	233
	Round 6 Strand Fiber	0.256	[6.5]	55	124

6000 Series Raceway Wire Fill Capacities for Power

WIRE SIZE THHN/THWN	O.D.		NUMBER OF CONDUCTORS (40% FILL)							
			WITHOUT DEVICES		WITH DUPLEX RECT. DEVICES 1.59in. ² [1025mm ²]		WITH SURGE/ GFCI DEVICES 2.30in. ² [1485mm ²]		LARGE SINGLE RECEPTACLES 3.00in. ² [1935mm ²]	
	Inches	[mm]	Undiv.	Divided	Undiv.	Divided	Undiv.	Divided	Undiv.	Divided
14 AWG	0.111	[2.8]	659	296	528	231	470	202	412	173
12 AWG	0.130	[3.3]	481	216	395	168	342	147	300	126
10 AWG	0.164	[4.2]	303	136	243	106	216	92	189	79
8 AWG	0.216	[5.5]	174	78	140	61	124	53	109	45
6 AWG	0.254	[6.5]	126	56	101	44	89	38	78	33
4 AWG	0.324	[8.2]	77	34	0	0	0	0	0	0
3 AWG	0.352	[8.9]	65	29	0	0	0	0	0	0
2 AWG	0.384	[9.8]	55	24	0	0	0	0	0	0
1AWG	0.446	[11.3]	40	18	0	0	0	0	0	0
1/0 AWG	0.496	[12.3]	34	15	0	0	0	0	0	0
2/0 AWG	0.532	[13.5]	28	12	0	0	0	0	0	0

NOTE: For additional information, refer to the Technical Section.

* Category 6 augmented (6a) cable for 10 gigabit ethernet – max allowed cable diameter per addenda No. 11 ANSI TIA/EIA 568-B.2.

6000 Series Raceway Ordering Information

V6000B-10, G6000B-10 Raceway Base

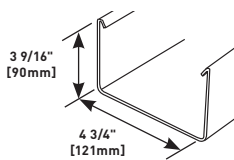

.054" [1.4mm] galvanized steel. Base has two 9/32" dia. trade size KOs, 1 1/4" [32mm] from each end and on centers of approximately 18" [457mm] throughout. Packed 20' [6.1m] per carton. 6000B-10 packed two 10' [3m] lengths.

G6000DA Raceway Divider

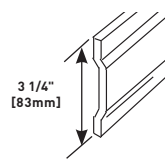

.040" [1.0mm] galvanized steel. One side painted buff primer to provide identification of compartments. Packed four 5' [1.5m] lengths per carton.

V6000C, G6000C Raceway Cover

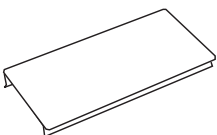

.040" [1.0mm] galvanized steel. Packed four 5' [1.5m] lengths per carton. 4000 Series Raceway Cover is also compatible with 6000 Series Raceway Base.

660B Raceway Base Cutter

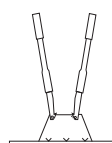

Portable cutter for 6000 Series Raceway Base. Provides clean and easy square cuts.

6000[®] SERIES RACEWAY

6000 Series Raceway Ordering Information (continued)

660BDK Replacement Blade Kit

Replacement blades and die set for 660B Cutter.

640C Raceway Cover Cutter

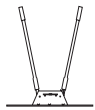

Portable cutter for 4000 and 6000 Series Raceway Cover. Provides clean and easy square cuts.

640CDK Replacement Blade Kit

Replacement blades and die set for 640C Cutter.

G6000WC Wire Clip (Galvanized)



For holding conductors in place.

6001A Coupling (Galvanized)

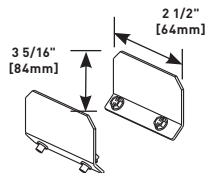

For joining lengths of 6000B.

G6001DA Divider Clip

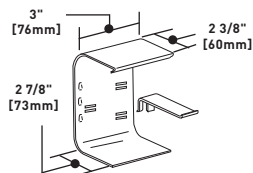

Use for holding G6000DA Divider in place to divide raceway into 1/3, 1/2, or 2/3 compartments.

NOTE: 6000 Series Raceway divided into 1/3 compartments will not accept devices.

G6001TX Converter Coupling

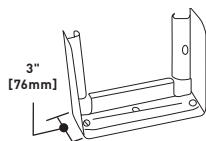

Use this coupling to convert G6011TX or G6017TX into a tee or cross. For tee, one required; for cross, two required.

V6006, G6006 Connection Cover

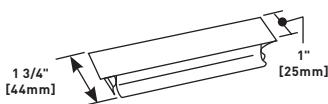

Use where two sections of 4000C or 6000C Cover, not squarely cut, come together.

V6007C-1, G6007C-1 Single-Gang Device Plate

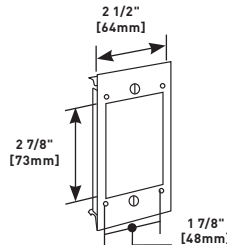

For vertical mounting of single-gang devices. Use with industry standard faceplates for electrical and communication devices. Can also be used with 4000B Base.

V6007C-2, G6007C-2 Two-Gang Device Plate

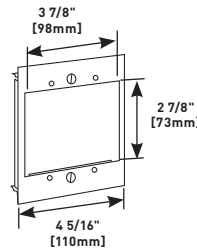

For installation of two-gang devices or two vertically mounted single-gang devices on undivided raceway. Use with industry standard double-gang faceplates for electrical and communication devices. Can also be used with 4000B Base.

G6008A C-Hanger (Galvanized)

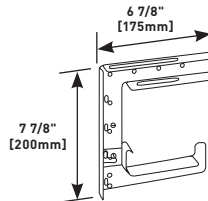

For suspending 6000 or 4000 Series Raceway from structural ceiling. Designed for use with 3/8" [9.5mm] rod. Hangers should be installed no more than 5' [1.5m] apart along raceway run. Can be bolted back-to-back for dual runs of 4000, 6000 or 3008C or for combined runs with 3000 Series Raceway.

V6010B, G6010B Blank End Fitting

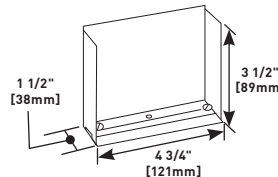

For closing open end of 6000 Series Raceway.

V6011TX, G6011TX Combination Flat Elbow

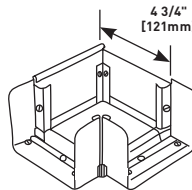

For use as a flat elbow. Can also be used as a tee or cross (one G6001TX required for tee; two for cross; not included).



Shown 6011TX with 6001TX to make tee.

NOTE: Parts identified with this symbol are Certified to Canadian Safety Standards for sale in Canada. When ordering these products, change the "V" color prefix to "CV" or the "G" color prefix to "CG" to deNOTE the Canadian versions.

6000[®] SERIES RACEWAY

6000 Series Raceway Ordering Information (continued)

V6012TX, G6012TX Internal or External Elbow

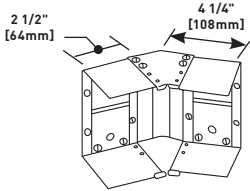

For making internal or external 45° turns in a run of 6000 Series Raceway. Can also be assembled as an inverted 45° elbow.

V6014A, G6014A Connector Fitting

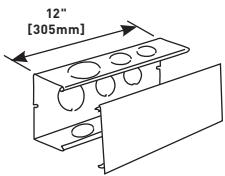

Has 1 1/4", 1 1/2" and 2" trade size KOs in back and on each side.

V6017TX, G6017TX Combination Internal/External Elbow

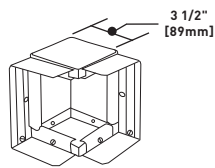

For use as internal or external elbow, straight-through fitting, tee, or cross (one G6001TX required for tee or straight through fitting; two for cross; not included).

V6046KD, G6046KD Circuit Breaker Housing

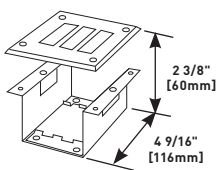

KOs in cover can be removed for installation of three single-pole breakers. For use with the following breakers rated 100A maximum.

MANUFACTURER	SERIES
General Electric	THQC, THHQ
Westinghouse	Quicklag, C, QCH

V4047UX, G4047UX Bump-Up Device Plate

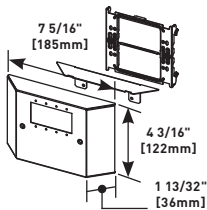

Accepts four Extron[®] Electronics MAAP single space modules.

NOTE: Parts identified with this symbol are Certified to Canadian Safety Standards for sale in Canada. When ordering these products, change the "V" color prefix to "CV" or the "G" color prefix to "CG" to denote the Canadian versions.

V4047VX, G4047VX Bump-Up Extron[®] AAP Device Plate

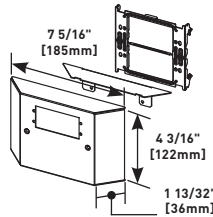

Accepts two Extron[®] Electronics AAP single space modules.

IWE-S, GWE-S Spray Paint



Used for touching up large areas. Contains 12 oz. of paint. Available in ivory (IWE-S) and gray (GWE-S).

NOTE: Can only be shipped via ground transportation.

IWE-P, GWE-P Touch-Up Paint Pen



Used for touching up small areas. Contains 0.3 oz. of paint. Available in ivory (IWE-P) and gray (GWE-P).

V4050, G4050 Device Mounting Bracket

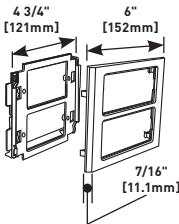

High impact plastic mounting bracket and trim plate. Trim plate overlaps raceway cover providing a seamless transition between cover fittings. Utilizes 5507 Faceplates, as well as Wiremold Open System communication modules, Ortronics[®] TracJack and Series II inserts, and Pass & Seymour[®] Activate Series inserts. For faceplate options, see 5507 Series Faceplates.

NOTE: When ordering to use with 6000 Series Raceway in Canada specify CV6050 (ivory) or CG6050 (gray) as the grounding bracket provided is larger than the one provided when using with 4000 Series Raceway. CM-EPLA End Plates are required when using Wiremold CM2 communication modules and Pass & Seymour[®] Activate inserts. S2-EPL End Plates are required when using Ortronics[®] Series II inserts. To mount TracJack modules, use 55074TJ or 55076TJ Faceplates.

V6074, G6074 Take-Off Connector (6000-6000)

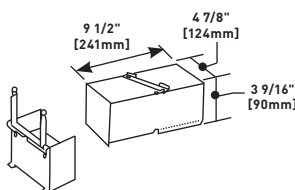

For 90° tee connection at any point along a run of 6000 Series Raceway.

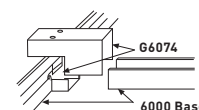

6000[®] SERIES RACEWAY

6000 Series Raceway Ordering Information (continued)

V6074A, G6074A Take-Off Connector (6000-4000)

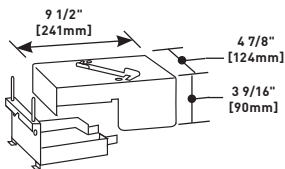

For 90° tee connection at any point along a run of 6000 Series Raceway.

V6086, G6086 Panel Connector Fitting

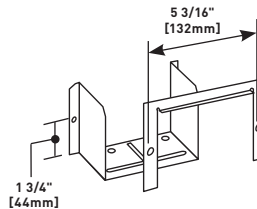

For connecting 6000 Series Raceway with surface type panel boxes. Accommodates maximum wire capacity of 6000 system. Separate C-flange fits around raceway, covering any irregularities made when cutting into box. Cut 4 3/4" x 3 9/16" [121mm x 90mm] hole in panel box.

6000 Series Interconnectivity Fittings

CONNECTION REQUIRED		USE CATALOG NUMBER
FROM	TO	
6000 Series Raceway	4000 (Tee Connection)	G6074A
6000 Series Raceway	6000 (Tee Connection)	G6074
1/2", 3/4", 1" or 1 1/4" trade size Conduit or Armored Cable	Cover of 6000	G4046H-2
1 1/4", 1 1/2", or 2" trade size Conduit or Armored Cable	Back and/or Side of 6000	G6014A

6000 Series Raceway Installation Details

- Determine method of feeding raceway:** 6014A for backfeed, 6086 (shown) for panel feed.

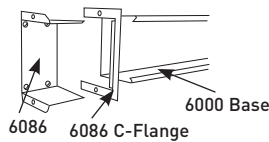

- For divided installations:** Install G6001DA Divider Clips at 30" [762mm] intervals. Snap G6000DA Divider into place.

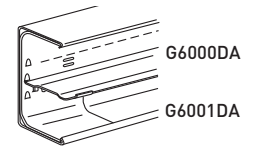

- To mount 6000 Base to surface:** Remove mounting screw KOs (approx. 18" [457mm] O.C. along base) as required. Mount base with No. 8 flathead fasteners.

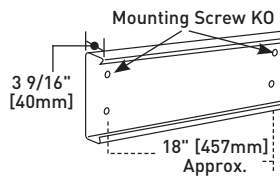

- To install G6007C-1 or G6007C-2 Device Plates:** Snap into base and tighten clamps as shown. Wire device and assemble to bracket. Install flush plate (not furnished).

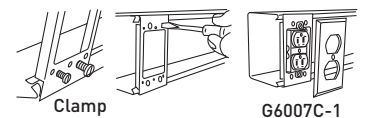

- To join lengths of 6000B, insert the pair of 6001A Couplings into one side of each base. Slide bases together and tighten locking screws.

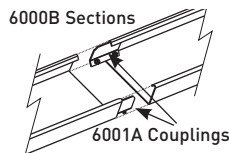

- Cut 6000C Cover to fit between device brackets. Snap in place as shown. Continue along entire run.

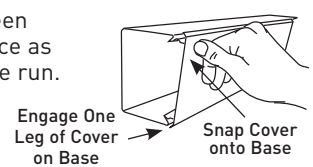

ANYSIZE™ SERIES RACEWAY



AnySize™ Raceway is the ideal solution for applications that require a specific size raceway. Available in a variety of compartment sizes and finishes.



CODE REFERENCE

cULus Listed Raceway:
File E4376 Guide RJBT.

Fittings:
File E41751 Guide RJPR.
Meets Article 386 of NEC.
Meets Section 12-1600 of CEC.

AnySize Series Raceway Base Specifier

Where special lengths are required, provide a detailed bill of material, indicating the various quantities, lengths and type of covers. Raceway must have a width greater than its depth.

AnySize Base

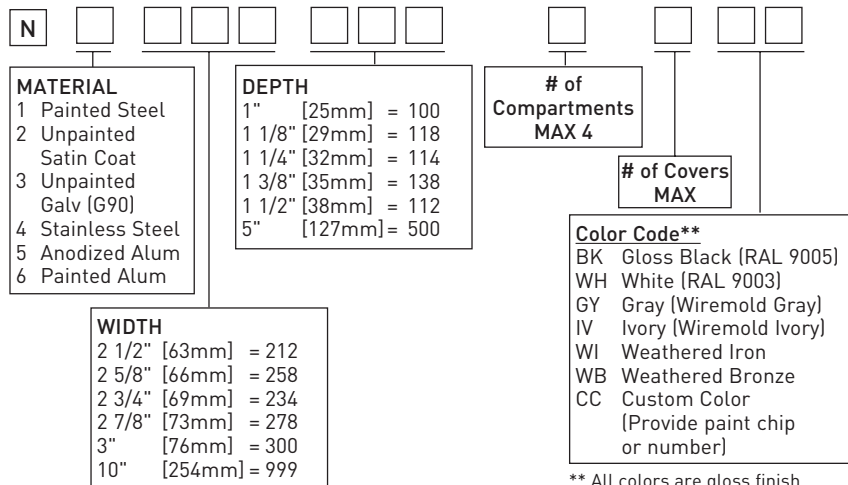

EXAMPLE 1: N1 834 212 3 2 WI

This is a 8 3/4" [222mm] wide by 2 1/2" [63mm] deep raceway, with three compartments and two covers, painted "Weathered Iron."



EXAMPLE 2: N1 612 300 2 2 IV

This is a 6 1/2" [165mm] wide by 3" [76mm] deep raceway, with two compartments and two covers, painted ivory.



** All colors are gloss finish unless otherwise specified.

COVER

- NE1C** = Standard Cover
- NE1CW** = Cover for use when wire clips are used. Wire clips are spaced 30" [762mm] on center only.
- NE1CT*** = Tamper-Resistant Cover
- NE1CTW*** = Tamper-Resistant Cover for use when wire clips are used. Wire clips are spaced 30" [76mm] on center only.

*Supplied with one tamper-resistant bracket.

COLOR OPTIONS

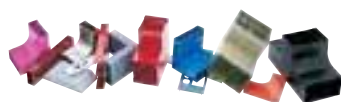

AnySize Raceway and components are available in a wide range of sizes, colors and options.

ANYSIZE™ SERIES RACEWAY

AnySize Series Raceway Wire Fill Capacities for Communications

	CABLE/WIRE SIZE	O.D. (APPROX. DIA.)		40% FILL
		Inches	[mm]	
UNSHIELDED TWISTED PAIR	4-pair, 24 AWG, Cat 3	0.190	[4.8]	14.11
	4-pair, 24 AWG, Cat 5e	0.210	[5.3]	11.55
	4-pair, 24 AWG, Cat 6	0.250	[6.3]	8.15
	4-pair, 24 AWG, Cat 6a*	0.354	[9.0]	4.06
	25-pair, 24 AWG	0.410	[10.4]	3.03
COAXIAL	RG6/U	0.270	[6.9]	6.98
FIBER	ZipCord	0.118 x 0.236	[3 x 6]	14.38
	Round 4 Strand Fiber	0.187	[4.8]	14.57
	Round 6 Strand Fiber	0.256	[6.5]	7.77

Wire Fill Calculation: "Depth" and "Width" refer to the measurements of the compartment with the cover on and are measured from the outside of the material. All measurements are in inches. Due to loading issues, use maximum wire fill of 4" [102mm] deep raceway for all raceways greater than 4" [102mm] deep.

- Determine useable area of compartment.
Useable area in square inches with no devices = [Width x (Depth - 0.2)] - 0.6
Useable area in square inches with standard 15A/20A devices = [Width x (Depth - 0.7)] - 0.3
- Determine wire fill for compartment.
Multiply the compartment area (from Step 1) by the number of wires per square inch, from the chart above Wire Fill = Area (sq. in.) x No. Wires per sq. in. (Chart above)
- Reduce fill by 20% if 2" [51mm] radiused fittings are not being used. Wire Fill for standard fittings = .8 x wire fill from Step 2
- Calculate fill for multi-compartment tees.
 - Standard Tee Wire Fill = (Wire fill from Step 2 or 3) / 2
Standard Full Capacity Tee Wire Fill = (Wire fill from Step 2 or 3) x 0.75
 - Radiused 2" Tee Wire Fill = (Wire fill from Step 2 or 3) / (No. of compartments)
Radiused 2" Full Capacity Tee Wire Fill = 1.5 x (Wire fill from Step 2 or 3) / (No. of compartments)

Sample Wire Fill Calculation: Determine the number of Cat. 6 cables that will fit in a 2" [51mm] deep by 2.75" [70mm] wide compartment for 40% fill. Fittings in the system have a 2" [51mm] radius.

- Useful area = 2.75 x (2.0 - 0.2) - 0.6 = 4.35 in²
- Wire Fill = 4.35 in² x 8.15 cables / in² (from chart) = 35 Cat. 6 cables

All Wiremold electrical products, unless specifically NOTEd, are listed by Underwriters Laboratories Inc. and conform to U.S. Federal Specification W-C-582. They comply with the National Electrical Code. Products designed primarily for use in telephone or communications wiring and tools normally do not require UL or cUL Listing. Most products are cUL Listed in compliance with the Canadian Electrical Code. All products must be installed in a manner consistent with applicable electrical codes. Wiremold Surface Raceway is UL and cUL Listed by Underwriters Laboratories Inc. (File #E4376 [Raceway] & #E41751 [Fittings]). This product is in compliance with the National Electrical Code and the Canadian Electrical Code.

AnySize Series Raceway Wire Fill Capacities for Power

WIRE SIZE	O.D.		40% FILL
	Inches	[mm]	
THHN/THWN			
14 AWG	0.111	[2.8]	41.24
12 AWG	0.130	[3.3]	30.08
10 AWG	0.164	[4.2]	18.96
8 AWG	0.216	[5.5]	10.93
6 AWG	0.254	[6.5]	7.89

NOTE: Values are per square inch of inside area. See above to determine useful area of compartment. Capacity range is calculated at 20% to 40% of raceway area as stated in a proposed revision to the Commercial Building Standard for Telecommunications Pathways & Spaces, TIA/EIA-569.

AnySize Series Raceway Ordering Information

NE1000TB Tamper-Resistant Retaining Bracket

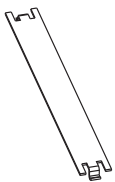

For retaining cover in enhanced tamper-resistant systems. Order additional brackets if field cutting cover for enhanced tamper-resistant system.

NE1000GC Ground Clamp

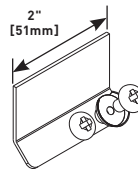

For connection of equipment grounding conductor to provide additional ground to raceway.

NE1000WC Wire Clip

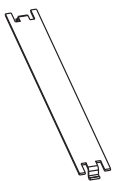

For holding conductors in place.

NE1001 Coupling

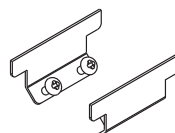

For joining lengths of AnySize Raceway. (Unpainted galvanized steel).

ANYSIZE™ SERIES RACEWAY

AnySize Series Raceway Ordering Information (continued)

NE1008A C-Hanger

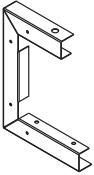

For supporting raceway from structural ceiling. Designed for use with 3/8" [9.5mm] threaded rod. Hangers should be installed no more than 5' [1.5m] apart along raceway run.

NE1008AW Wall Bracket Hanger

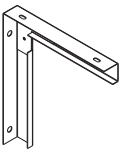

For supporting raceway from structural wall. Use hardware capable of supporting loaded raceway. Hangers should be installed no more than 5' [1.5m] apart along raceway run.

NE1010B, NE1010BK Blank End Fitting

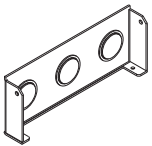

For closing open end of AnySize Base. NE1010BK has knockouts available for connection to adjacent wiring systems. Size and quantity of knockouts to be specified by end user.

NE1010DFO, NE1010DFOT Radiused Large Capacity Entrance End Fitting

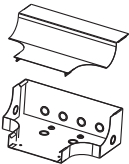

Has concentric conduit trade size KOs on sides, end and bottom for feeding raceway. Useful where large conduits feed the raceway. Size of knockouts to be specified by end user.

NE1010D, NE1010DT Entrance End Fitting

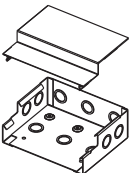

Has concentric conduit trade size KOs on sides, ends and bottom for feeding raceway. Size of knockouts to be specified by end user.

NE1011FO, NE1011FOT Radiused Full Capacity Flat Elbow

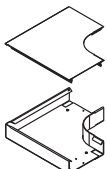

Used in divided and undivided applications to provide a 2" [51mm] cable bend radius for new lay-in or pull-through installations.

NE1011RFO, NE1011RFOT Radiused Full Capacity Flat Elbow

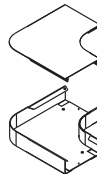

Same as NE1011FO but outside corner is curved to a 2" [51mm] radius.

NE1011, NE1011T Flat Elbow

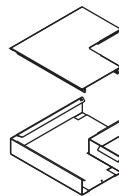

For right angle turns on the same surface.

NE1014, NE1014T Wall Box Connector

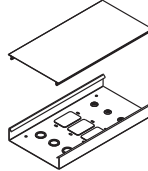

Base is provided with ground terminal for 10-32 screw and user specified conduit knockouts and/or wall box rectangular knockouts [2 9/16" x 1 11/16" [65mm x 43mm]].

NE1015FO, NE1015FOT Radiused Full Capacity Tee

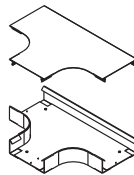

Provides a 2" [51mm] cable bend radius for new lay-in or pull-through installations. Dual cover version not available. Single cover can be used in all applications. Capacity is reduced in multi-compartment applications.

NE1015, NE1015T Tee

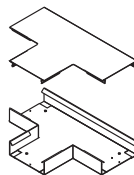

For branches at right angles. Dual cover version not available. Single cover can be used in all applications. Capacity is reduced in multi-compartment applications.

NOTE: "T" at the end of part number indicates it is for use in an enhanced tamper-resistant system.

ANYSIZE™ SERIES RACEWAY

AnySize Series Raceway Ordering Information (continued)

NE1015LFO, NE1015LFOT Radiused Large Capacity Tee

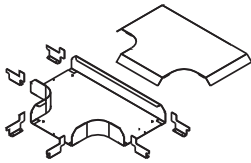

Provides a 2" [51mm] cable bend radius new lay-in or pull-through installations. Deeper fitting provides 50% more fill than the standard tee fitting. Useful for multi-compartment installations. Supplied with special couplings. Dual cover version not available. Single cover can be used in all applications.

NE1015L, NE1015LT Large Capacity Tee

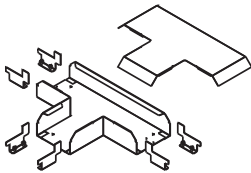

For branches at right angles. Deeper fitting provides 50% more fill than the standard tee fitting. Useful for multi-compartment installations. Supplied with special couplings. Dual cover version not available. Single cover can be used in all applications.

NE1017FO, NE1017FOT Radiused Full Capacity Internal Elbow

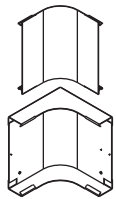

Provides a 2" [51mm] cable bend radius for new lay-in or pull-through installations.

NE1017, NE1017T Internal Elbow

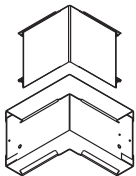

For 90° internal corners.

NE1017P, NE1017PT Compact Internal Elbow

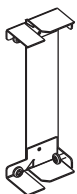

For 90° internal corners. Compact size is useful when going around columns.

NOTE: "T" at the end of part number indicates it is for use in an enhanced tamper-resistant system.

NE1018FO, NE1018FOT Radiused Full Capacity External Elbow

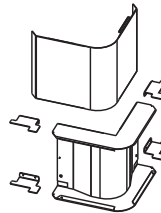

A full capacity 90° external elbow to provide a 2" [51mm] cable bend radius for new lay-in or pull-through installations. Supplied with special couplings.

NE1018, NE1018T External Elbow

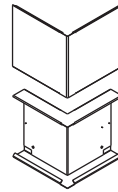

For 90° external corners.

NE1047, NE1047WC, NE1047T, NE1047WCT Device Cover

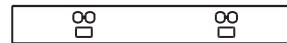

Variable length from 6" to 60" [152mm to 1.5m] long. Specify cutout type and location.

Eliminates frequent seams when devices are located close together along the raceway. Supplied with appropriate brackets.

NE1407, NE1407T Deep Device Plate

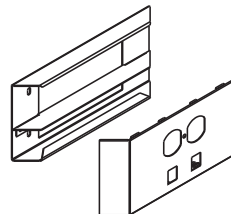

Used to minimize or eliminate fill reduction at activations. Mounts on top of raceway and helps maintain recommended bend radii at activation. Specify depth required between 5/8" [15.9mm] and 3" [76mm]. Supplied with appropriate brackets.

NE1046H, NE1046HT Custom Tap-Off Fitting

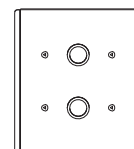

Provided with user-specified trade size KOs. Supplied with appropriate brackets.

ANYSIZE™ SERIES RACEWAY

AnySize Series Raceway Ordering Information (continued)

NE1046AP Tamper-Resistant Access Plate

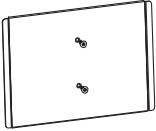

Required on an entrance point to allow cover removal on tamper-resistant systems. One plate is required on every run between opposing walls. Provides 1/4" [6.4mm] overlap flange for improved aesthetics at cover edge. Supplied with appropriate brackets.

NE1046APN Tamper-Resistant Access Plate

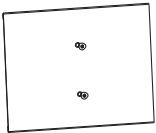

Required on an entrance point to allow cover removal on tamper-resistant systems. One plate is required on every run between opposing walls. NE1046APN does not have a flange to overlap adjacent covers. Use for access at end of run.

V4050, G4050 Device Mounting Bracket

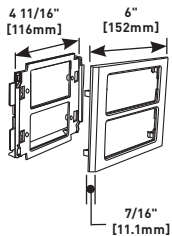

High impact plastic mounting bracket and trim plate which overlap raceway cover providing a seamless transition between cover fittings. For use with: 5507 Series™ Faceplates, Ortronics® TracJack and Series II modules, Pass & Seymour® Activate Series inserts, and Wiremold Open System communication modules.

NOTE: For use only with 4 3/4" [121mm] wide raceway.

NE1086A Panel Connector

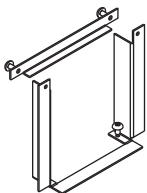

To connect AnySize Raceway with surface type panel boxes. Accommodates maximum wire capacity of AnySize system used. Separate C-shaped flange fits around raceway, covering any irregularities made when cutting into box.

NOTE: Parts identified with this symbol are Certified to Canadian Safety Standards for sale in Canada. When ordering these products, change the "V" color prefix to "CV" or the "G" color prefix to "CG" to denote the Canadian versions.

NE610 Tamper-Resistant Notch Tool

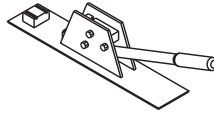

Required to create tamper-resistant notches in raceway covers that are field cut during installation.

NE610C Raceway Cover Cutter

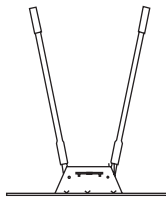

Portable Cutter for AnySize Raceway Covers for clean and easy square cuts every time.

NE1046, NE1046T 6" [152mm] Device Plate

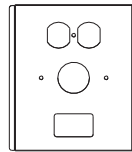

Provides 1/4" [6mm] overlap flange for improved aesthetics at cover edge. Supplied with appropriate brackets.

NOTE: For use only with 4 3/4" [121mm] wide raceway.

Three Compartment Plate Shown.

NE1046-2, NE1046-2T 12" [305mm] Device Plate

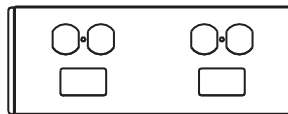

Allows high density activations. Provides 1/4" [6.4mm] overlap flange for improved aesthetics at cover edge. Supplied with appropriate brackets.











NOTE: For use only with 4 3/4" [121mm] wide raceway.

Two Compartment Plate Shown.

ANYSIZE™ SERIES RACEWAY

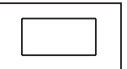
AnySize Series Raceway Device Plate Configurator

The following represent various cutouts available for AnySize Raceway. The corresponding letter designations used to create the device plate part number are also shown.

 Standard Duplex (D)	 Decorator Duplex (R)	 1.4" [35.5mm] Dia. Single (A)	 1.6" [40.6mm] Dia. Single (J)	 4007C-1 Cutout * (C1)	 4007C-1R Cutout * (C1R)
 2 RJ11/45 (RJ)	 AMP Flex/single ACO (F)	 Accommodates: Wiremold Open System communications, Ortronics TracJack & Series II (LV6)	 Accommodates: Wiremold Open System communications (MFB)	 1/2" - 3/4" [12.7mm - 19.1mm] KO & Grommet (K)	 Accommodates: Wiremold Open System communications, Ortronics TracJack & Series II (LV2)

* These openings also require the use of commercially available faceplates.

Device Plate Design and Part Numbers

- 1** To specify type of device plate, and cutout locations:
- 2** 1) Specify device plate type above.
- 3** 2) Add the suffix(es) (in parentheses above) that corresponds to the cutout type required, beginning from the top compartment. For 12" [305mm] device plates, indicate if the second column of cutouts is the same as the first. If it is not, please send sketch. For NE1047 Covers sketch to indicate quantity and spacing of devices.
- 4** For other special cutouts, contact factory.

Sample Plate: NE1046DJLV2

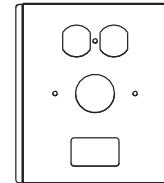

Sample Part Number:

Prefix	<input type="text" value="1"/>	<input type="text" value="2"/>	<input type="text" value="3"/>	<input type="text" value="4"/>	2nd. col. (yes/no or N/A)
<u>NE1046</u>	<u>D</u>	<u>J</u>	<u>LV2</u>	<u> </u>	<u>N/A</u>

ANYSIZE™ SERIES RACEWAY

AnySize Raceway Installation Details

See the typical basic system (illustrated below) for installation details. In general, the following procedure for installing AnySize Raceway is recommended.

- Starting at feed connection, install base sections over entire run. Butt ends of sections and install couplings as shown below. Cut base sections to length as required for connection of bases of fittings. Determine the method of feeding raceway: raceway base or wall box connector for back feed, end blanks (shown), entrance end fittings, or panel connector for end feed.

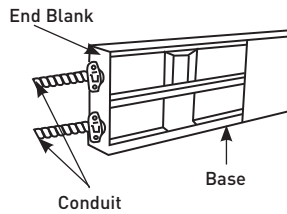

- To mount base to surface: Remove mounting knockouts as required. Mount base with No. 8 flathead fasteners.

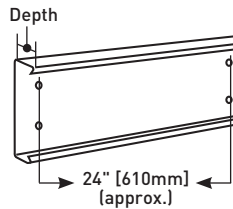

- Install wiring in base and wire devices. To couple lengths of base or fittings, butt the adjacent base sections together and insert one coupling centered over the splice. Tighten the set screws. Repeat the process on the other side of the base.

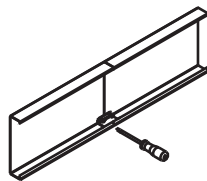

- Assemble devices and device covers in base. To install device plates, snap device straps in base as shown. Wire device and assemble to straps. Snap device plate over base and device. For deep device plates or offset device plates fasten to raceway base by screwing into device brackets in raceway base.

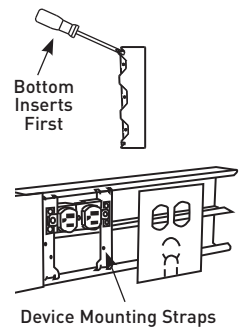

- Cut cover sections to length as necessary and snap onto base. It is recommended that covers overlap base joint. Use pre-cut cover, or cut cover to fit between device plates. Snap in place as shown. Continue along entire run.

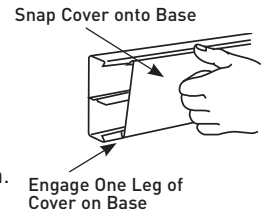

AnySize Raceway – Typical Tamper-Resistant Installation

- Complete instructions 1 to 3.
- Add covers progressively from access point to other end, utilizing instructions 4 and 5 as needed. See Illustrations below.
- Repeat (ii) and (iii) as required.
- Any cut covers will require replacement of the tamper-resistant notch using NE610 tool.
- Tighten all screws securely.

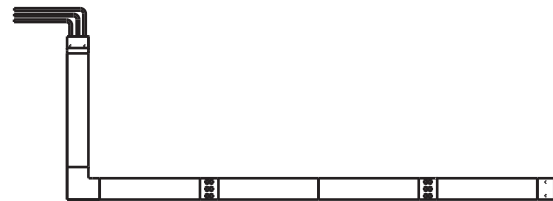
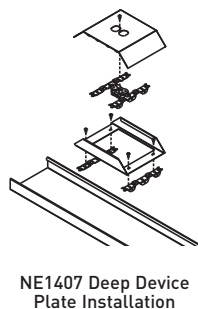
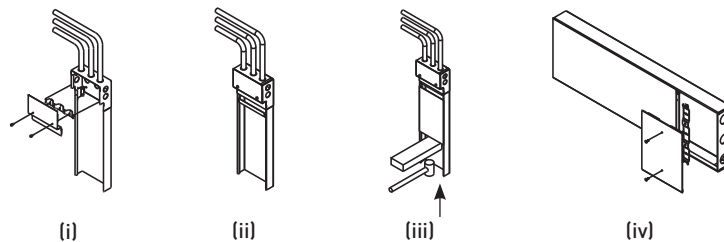

OVERFLOOR RACEWAY SYSTEMS



Wiremold® Overfloor Raceway Systems provide unique solutions to solve specific installation issues when access to floors and ceilings is not an option for installers, building owners, and designers.



Featured Products



**OFR Series
Overfloor Raceway**

94



**1200/1400/1600
Series Raceway**

105

OVERFLOOR RACEWAY SYSTEMS

Table of Contents

Multiple-Channel Overfloor Raceway Systems



94

OFR Series
Overfloor Raceway
System

Steel Pancake Overfloor Raceway Systems

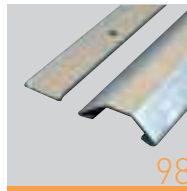

98

1500 Series™
Raceway

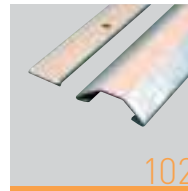

102

2600 Series™
Raceway

Nonmetallic Pancake Overfloor Raceway Systems





105

1200/1400/1600
Series™ Raceways

OVERFLOOR RACEWAY SYSTEMS

Quick Selection Guide

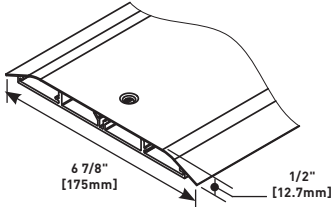

Multiple-Channel Overfloor Raceway Systems

OFR Series Overfloor Raceway	Device Boxes	Transition Fittings
<p>OFRB-8 & OFRC-8</p>  	<p>OFR48-4</p> 	<p>OFR89-DS4000</p> 

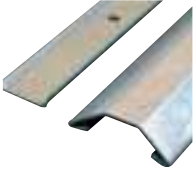
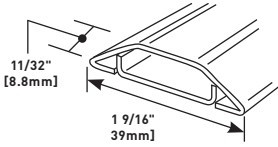
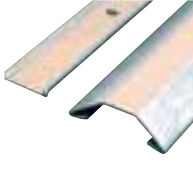
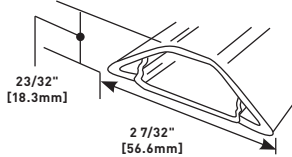
Two-Piece Steel Single-Channel Overfloor Raceway Systems

1500 Series™ Raceway	2600 Series™ Raceway
 	 

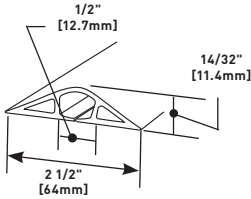
One-Piece Nonmetallic Single-Channel Overfloor Raceway Systems

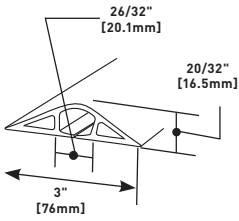
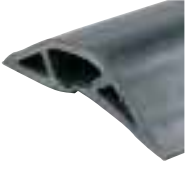
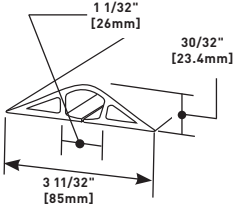
1200 Series™ Raceway	1400 Series™ Raceway	
 	 	
<th>1600 Series™ Raceway</th> <td></td>	1600 Series™ Raceway	
 		

OFR SERIES OVERFLOOR RACEWAY



Wiremold® OFR Series Overfloor Raceway System provides four-channels of capacity and access to a wide range of data and A/V connectivity options in the smallest, lowest, narrowest, ADA compliant profile available in over floor raceway systems.

CODE REFERENCE

OFR Series Overfloor Raceway System is cETLus Listed.

OFR Series Overfloor Raceway System Layout

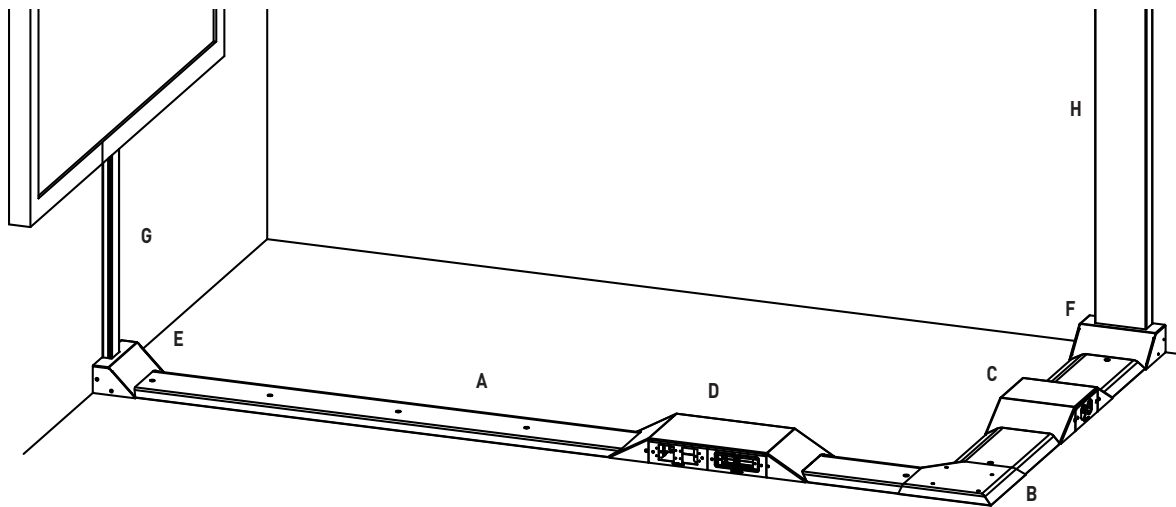

NOTE: Illustration is for showing product applications only.

KEY

- | | |
|---|---|
| A. OFRBC-8 Overfloor Raceway Base & Cover | E. OFR89-2400 Series Raceway Transition Fitting |
| B. OFR11 90° Flat Elbow | F. OFR89-4000 Series Raceway Transition Fitting |
| C. OFR48-2 Two-Gang Device Box | G. 2400D Series Divided Raceway |
| D. OFR48-4 Four-Gang Device Box | H. 4000 Series Raceway |

COLOR OPTIONS



OFR Series Overfloor Raceway System is available with a black powder coat finish that is also paintable.

OFR SERIES OVERFLOOR RACEWAY

Ordering Information

OFR Series Raceway Wire Fill Capacities for Power

WIRE SIZE THHN/THWN	O.D.		WIRE CROSS-SECTIONAL AREA	# OF WIRES PER OUTER CHANNEL (40% FILL)	# OF WIRES PER OUTER CHANNEL w/OFR1 (40% FILL)	# OF WIRES PER OUTER CHANNEL w/OFR9 (40% FILL)	# OF WIRES PER INNER CHANNEL (40% FILL)
	Inches	[mm]					
14 AWG	0.111	[2.8]	0.010	18	13	10	19
12 AWG	0.130	[3.3]	0.013	13	10	7	14
10 AWG	0.164	[4.2]	0.021	8	3	2	9
8 AWG	0.216	[5.5]	0.037	4	4	3	5

OFR Series Raceway Wire Fill Capacities for Communications

	CABLE/WIRE SIZE	O.D. (APPROX. DIA.)		WIRE CROSS- SECTIONAL AREA	# OF WIRES PER OUTER CHANNEL (40% FILL)	# OF WIRES PER OUTER CHANNEL with OFR1 (40% FILL)	# OF WIRES PER OUTER CHANNEL with OFR9 (40% FILL)	# OF WIRES PER INNER CHANNEL (40% FILL)
		Inches	[mm]					
UNSHIELDED TWISTED PAIR	4-pair, 24 AWG, Cat 3	0.190	[4.8]	0.028	6	4	3	6
	4-pair, 24 AWG, Cat 5e	0.210	[5.3]	0.035	5	3	2	5
	4-pair, 24 AWG, Cat 6	0.250	[6.3]	0.049	3	2	2	3
	4-pair, 24 AWG, Cat 6a*	0.354	[9.0]	0.098	1	1	1	2
COAXIAL	RG6/U	0.270	[6.9]	0.057	3	2	1	3
FIBER	ZipCord	0.118 x 0.236	[3 x 6]	0.025	7	5	3	7
	Round 4 Strand Fiber	0.187	[4.8]	0.027	6	4	3	6
	Round 6 Strand Fiber	0.256	[6.5]	0.051	3	2	1	3

NOTE: For additional information, refer to the Technical Section.

* Category 6 augmented (6a) cable for 10 gigabit ethernet – max allowed cable diameter per addenda No. 11 ANSI TIA/EIA 568-B.2.

OFRB-8 Overfloor Raceway Base

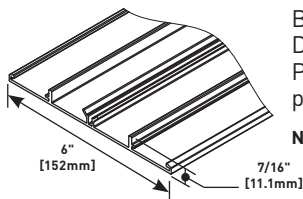

Base: 0.080" [2.0mm] aluminum. Divided into four channels. Packed four (4) 8' [2.4m] lengths per carton.

NOTE: Not recommended for use in high traffic areas.

OFRBC-8 Overfloor Raceway Base & Cover

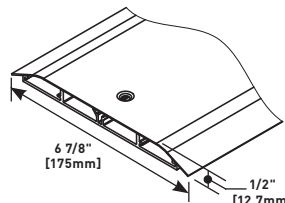

Cover: 0.040" [1.0mm] steel. Base: 0.080" [2.0mm] aluminum. Durable black powder coat finish. Divided into four channels. Packed one (1) 8' [2.4m] length of base and cover per carton.

NOTE: Not recommended for use in high traffic areas.

OFRC-8 Overfloor Raceway Cover

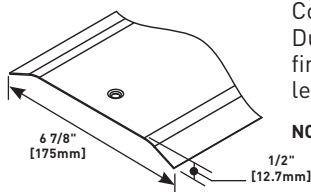

Cover: 0.040" [1.0mm] steel. Durable black powder coat finish. Packed four (4) 8' [2.4m] lengths of cover per carton.

NOTE: Not recommended for use in high traffic areas.

OFR6 Overfloor Raceway Seam Clip

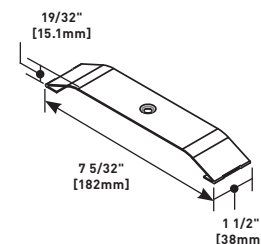

Covers seam where two sections of OFR Series Overfloor Raceway cover come together.

OFR SERIES OVERFLOOR RACEWAY

Ordering Information

OFR10A Overfloor Raceway Entrance End Fitting

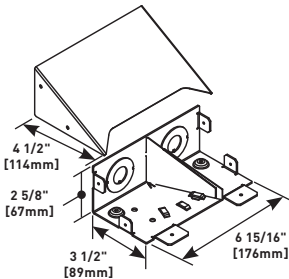

Feeds OFR Series Raceway, Has two (2) concentric 1/2" and 1 1/4" trade size KOs on end. Includes removable divider that can be positioned to feed any raceway channel. Can be used to feed raceway from wall or into furniture.

OFR10IW OFR In-Wall Entrance End Fitting

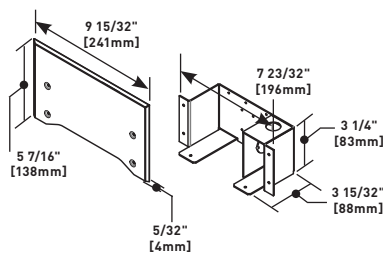

Feeds OFR Series Overfloor Raceway from behind wall. Configurable to provide one or two channels of power. Has 1/2" trade size KO for single channel and 3/4" trade KO for two channel.

OFR48-2 Overfloor Raceway 2-Gang Box

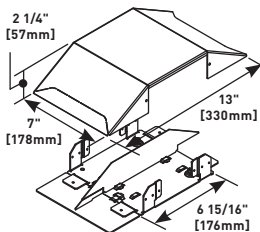

Divided two-gang device box. Allows multiple services (power, data, A/V) at a single point-of-use. Side facing device mounting provides low profile, with space for large cable bend radius. Accepts OFR Series device plates. Removable divider can be aligned with any of the raceway channels.

OFR48-4 Overfloor Raceway 4-Gang Box

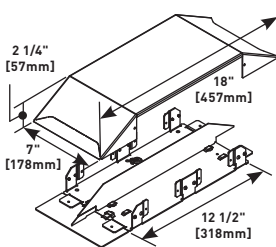

Divided four-gang device box. Allows multiple services (power, data, A/V) at a single point-of-use. Side facing device mounting provides low profile, with space for large cable bend radius. Accepts OFR Series device plates. Removable divider can be aligned with any of the raceway channels.

OFR48-4GX OFR Crossover Kit

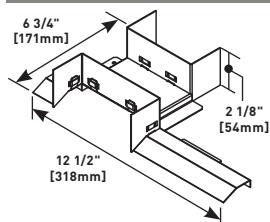

Allows access to power and data on both sides of OFR48-4 4-Gang Device Box.

OFRWC Overfloor Raceway Wire Clips

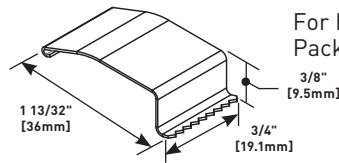

For holding conductors in place. Packed twelve (12) per pack.

OFR89-2400 OFR 2400 Raceway Transition

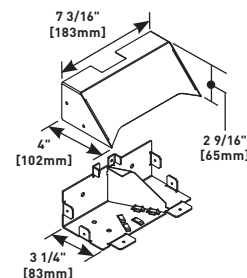

For connecting vertical runs of 2400 & 2400D Series Raceway with OFR Series Raceway. Includes removable divider that can be positioned to feed any raceway channel.

OFR89-4000 OFR 4000 Raceway Transition

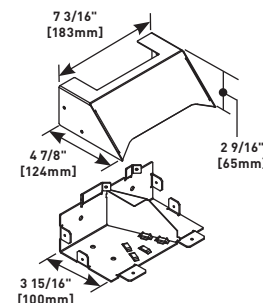

For connecting vertical runs of 4000 Series Raceway with OFR Series Raceway. Includes removable divider that can be positioned to feed any raceway channel.

OFR89-DS4000 OFR DS4000 Raceway Transition

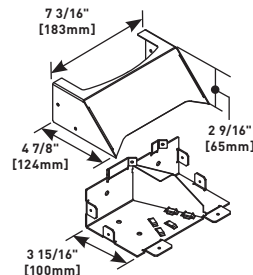

For connecting vertical runs of DS4000 Series Raceway with OFR Series Raceway. Includes removable divider that can be positioned to feed any raceway channel.

OFR89-VIS Overfloor Vista Point5 Transition

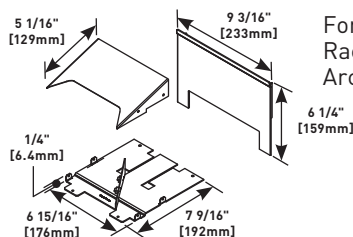

For connecting OFR Series Raceway to Vista Point5 Architectural Columns.

OFR SERIES OVERFLOOR RACEWAY

Ordering Information

OFR89-VFL Overfloor Large Vista Transition

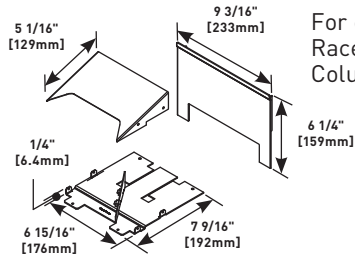

For connecting OFR Series Raceway to Vista Architectural Columns.

OFR47-D OFR Duplex Device Plate

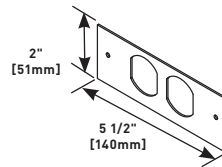

For covering duplex style devices in OFR48-2 and OFR48-4 Device Boxes. Accepts 106 Frame.

OFR11 OFR Flat Elbow

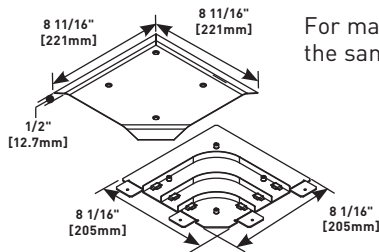

For making right angle turns on the same surface.

OFR47-R OFR Decorator Device Plate

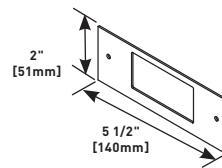

For covering rectangular decorator style devices in OFR48-2 and OFR48-4 Device Boxes.

OFR47-U OFR Extron® MAAP-2A Device Plate

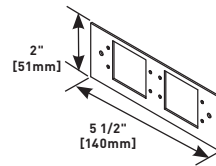

Device plate that will accept up to four (4) Extron® Electronics MAAP style plates in OFR48-2 and OFR48-4 Device Boxes.

OFR1 OFR Coupling

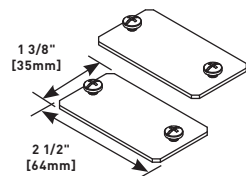

Joins lengths of OFRB-8 OFR Series Raceway Base together. Sold in pairs.

OFR47-V OFR Extron® AAP Device Plate

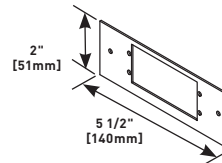

Device plate that will accept two (2) Extron® Electronics AAP single space modules.

OFR9 OFR Grounding Clip

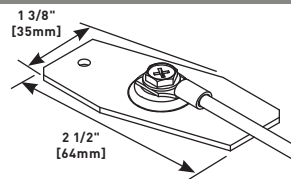

Connects equipment grounding conductor to provide ground to OFR Series Raceway. No. 10 ground screw provided.

OFR47-2A OFR Communications Device Plate

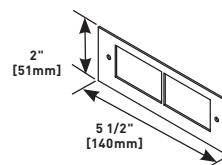

Device plate that will accept up to four (4) ports of communications devices. Includes adapters for Ortronics® TracJack, Series II, Pass & Seymour® Activate inserts and Wiremold Open System communication modules.

OFR47-B OFR Duplex Device Plate

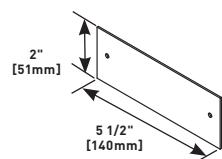

For covering unused compartments in OFR48-2 and OFR48-4 Device Boxes.

OFR47-U2A OFR Extron® MAAP-2A Combo Device Plate

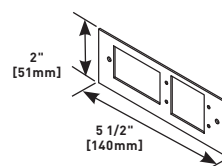

Combination device plate that will accept up to two (2) Extron® Electronics MAAP style plates and up to two (2) ports of communications devices. Includes adapters for Ortronics® TracJack, Series II, Pass & Seymour® Activate inserts and Wiremold Open System communication modules.

1500 SERIES™ OVERFLOOR RACEWAY



Wiremold® 1500 Series™ Steel Pancake Raceway provides permanent protection for overfloor cabling in high traffic areas.

CODE REFERENCE

cULus Listed Underfloor Raceways:
File E4376 Guide RJBT.

Fittings: File E41751 Guide RJPR.
Meets Article 386 of NEC.
Meets Section 12-1600 of CEC.

1500 Series Raceway System Layout

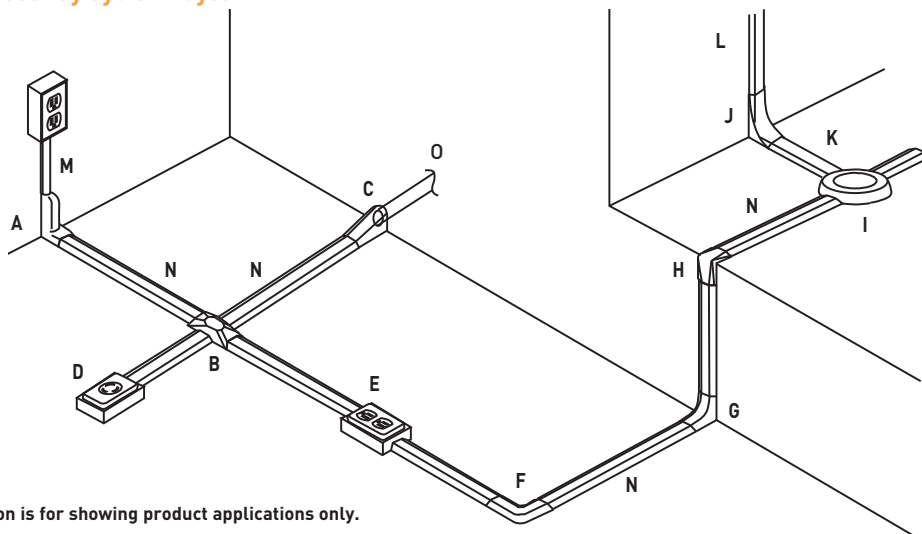

NOTE: Illustration is for showing product applications only.

KEY

- | | | |
|---------------------------------------|---|---|
| A. V1517B Adapter Fitting | G. 1517 Internal Elbow | L. 2400 Series Raceway |
| B. 1528 Utility Box | H. 1518 External Elbow | M. V500 500/700 Series Raceway |
| C. 1585 Combination Connector | I. 2642D Junction Box | N. 1500 Raceway Base & Cover |
| D. 1546A Single Receptacle Box | J. 2686FO Transition Feed Fitting | O. 1/2" Conduit or Armored Cable |
| E. 1546B Duplex Receptacle Box | K. 2600 Series Pancake Overfloor Steel Raceway | |
| F. 1511 90° Flat Elbow | | |

COLOR OPTIONS

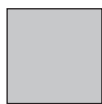
 1500 Series™ Raceway components are available in galvanized steel unless otherwise indicated in the part number description.

1500 SERIES™ OVERFLOOR RACEWAY

Ordering Information

1500 Series Raceway Wire Fill Capacities for Communications

	CABLE/WIRE SIZE	O.D. (Approx. dia.)		40% FILL
		Inches	[mm]	
UNSHIELDED TWISTED PAIR	4-pair, 24 AWG, Cat 3	0.190	[4.8]	3
	4-pair, 24 AWG, Cat 5e	0.210	[5.3]	2
	4-pair, 24 AWG, Cat 6	0.250	[6.3]	1
	4-pair, 24 AWG, Cat 6a*	0.354	[9.0]	0
	25-pair, 24 AWG	0.410	[10.4]	0
COAXIAL	RG6/U	0.270	[6.9]	1
FIBER	ZipCord	0.118 x 0.236	[3 x 6]	3
	Round 4 Strand Fiber	0.187	[4.8]	3
	Round 6 Strand Fiber	0.256	[6.5]	1

1500 Series Raceway Wire Fill Capacities for Power

WIRE SIZE THHN/THWN	O.D. (Approx. dia.)		NO. OF CONDUCTORS 40% FILL
	Inches	[mm]	
14 AWG	0.111	[2.8]	9
12 AWG	0.130	[3.3]	6
10 AWG	0.164	[4.2]	4

NOTE: For additional information, refer to the Technical Section.
 * Category 6 augmented (6a) cable for 10 gigabit ethernet – max allowed cable diameter per addenda No. 11 ANSI TIA/EIA 568-B.2.

1500-10 Raceway Base & Cover

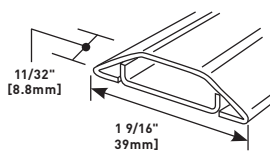

.040" [1.0mm] galvanized steel. Packed ten 10' [3m] lengths per carton. Base has 9/32" [7.1mm] diameter mounting holes on centers of approximately 8" [203mm].

1511 90° Flat Elbow

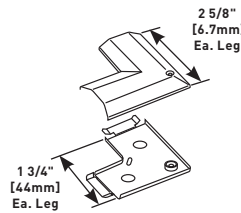

For right angle turns on the same surface.

656 Cover Removal Tool

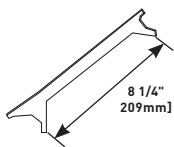

For removing cover of 1500 and 2600 Series Overfloor Raceways.

1517 Internal Elbow

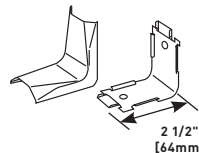

For internal 90° corners.

1500WC Wire Clip

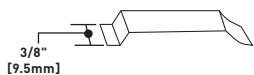

For holding conductors in place. Not UL Listed.

V1517B Adapter Fitting

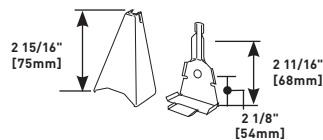

To feed to or from 500 or 700 Series Raceway on wall to 1500 Series Raceway on floor. Ivory finish.

1502 Fiber Bushing

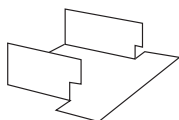

Protects wires from abrasion. Slips into open end of 1500 Series Raceway where it enters a fitting.

1518 External Elbow

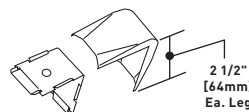

For external 90° corners.

1504 Strap



Two-hole strap. Use to fasten 1500 Series Raceway to surfaces at any point desired.

1500 SERIES™ OVERFLOOR RACEWAY

Ordering Information

1528 Utility Box

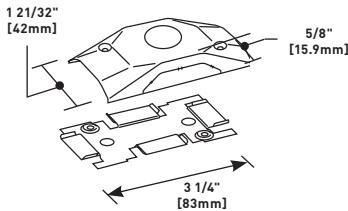

Base and cover each have 1/2" trade size KO. May be used as a cross, tee, straight through or to terminate run. Two 1500WC Wire Clips included.

1546B Duplex Receptacle Box

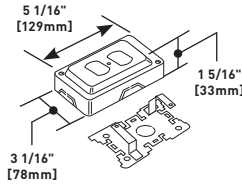

Will accommodate commercially available 15A or 20A duplex receptacles. Base has 1/2" and 3/4" concentric trade size KOs. Nonmetallic cover has 1500 and 2600 Series Raceway twistouts on all four sides. Two 1500WC Wire Clips included. Side wiring recommended. Gray finish.

NOTE: Box covers are manufactured of UL Listed Noryl plastic, gray textured finish.

1542D Junction Box

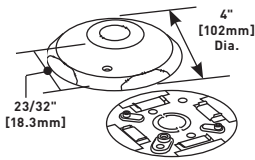

May be used as a cross, tee or elbow. Cover has 1/2" trade size KO. Base has 1/2" and 3/4" concentric trade size KOs to enable connection to floor outlet boxes or underfloor duct systems (use Chase nipple - not included). Two 1500WC Wire Clips included.

1546T Telephone Outlet Box

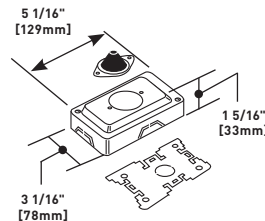

Furnished with 1/2" [12.7mm] rubber stem. Designed to accept modular connecting blocks within the fitting. Nonmetallic cover has 1500 and 2600 Series Raceway twistouts on both ends and both sides. Two 1500WC Wire Clips included. Not UL Listed. Gray finish.

1543GL Grounding Duplex Receptacle 15A-125V NEMA 5-15R & Cover

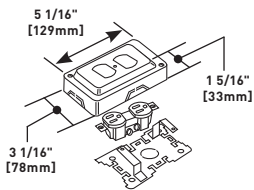

Cover has twistouts for 1500 and 2600 Series Raceway on all four sides. Base has 1/2" and 3/4" trade size concentric KOs. Two 1500WC Wire Clips included. Gray finish.

1585 Combination Connector

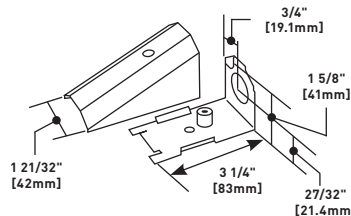

For connecting 1/2" trade size conduit or armored cable to 1500 Series Raceway.

1546A Single Receptacle Box

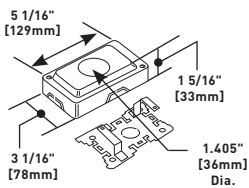

Will accommodate commercially available straight blade and locking single receptacles with face diameters of 1.38-1.40" [35-36mm]. Base has 1/2" and 3/4" trade size concentric KOs. Nonmetallic cover has 1500 and 2600 Series Raceway twistouts on all four sides. Two 1500WC Wire Clips included. Gray finish.

NOTE: Parts identified with this symbol are Certified to Canadian Safety Standards for sale in Canada. When ordering these products, add "C" prefix to part number to denote the Canadian version, i.e. "C1546A".

1500 SERIES™ OVERFLOOR RACEWAY

Ordering Information

500 & 700 Series Raceways Installation Details

1. Determine method of feeding raceway with 1517B, 1585 (shown), 2186 or through a junction box or receptacle box (i.e., 1542, 1546B).

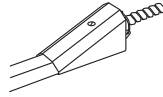

2. Determine length of raceway base to first fitting location. Cut base to desired length.

3. Mount raceway base to surface using No. 8 flathead fasteners through all mounting holes provided.

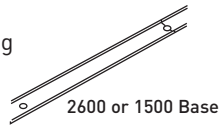

4. Slip fitting tongue over raceway base and fasten fitting base to surface. Repeat steps 2-4 until fitting and raceway bases are installed along entire run.

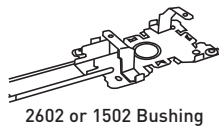

5. Lay conductors in raceway base using 1500WC or 2600WC Wire Clips to hold conductors in place. Wire and install devices along run.

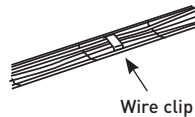

6. Cut lengths of cover to fit between fittings. (Cover must be shorter than mating base: 3/8" [9.5mm] shorter for 1500, 9/16" [14.3mm] shorter for 2600.) Snap covers onto base, latching one side under the base bead and striking cover with a rubber mallet.

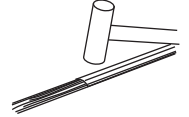

7. When raceway bases are butted, cover must be installed so that it overlaps joint.

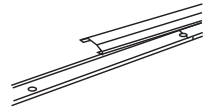

8. Remove proper twistouts in fitting cover making sure that mounting holes line up with fitting base. Install cover with screws furnished.

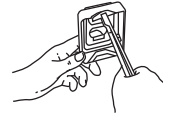

2600 SERIES™ OVERFLOOR RACEWAY

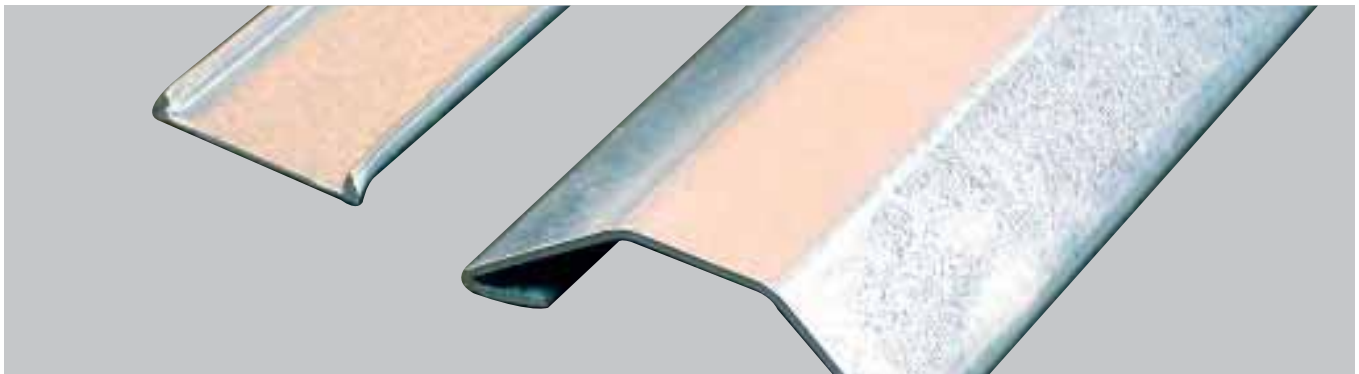

2600 Series™ Raceway UL Code Reference, Color Options, System Layout, Wire Fill Capacity Charts, Ordering Information, Installation Details and Interconnectivity Options.

CODE REFERENCE

cULus Listed Underfloor Raceways:
File E4376 Guide RJBT.
Fittings: File E41751 Guide RJPR.
Meets Article 386 of NEC.
Meets Section 12-1600 of CEC.

2600 Series Raceway System Layout

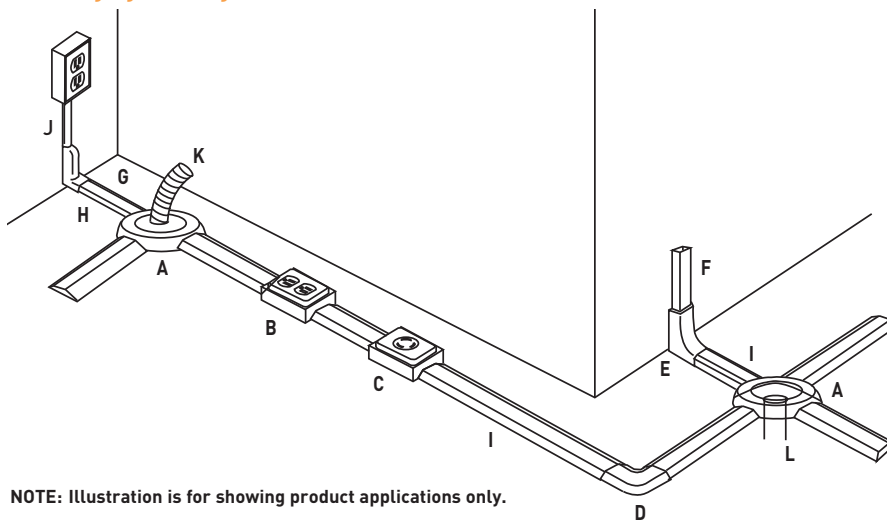

NOTE: Illustration is for showing product applications only.

KEY

- A. 2642D Junction Box
- B. 1543GL Grounding Duplex Receptacle & Cover
- C. 1546A Single Receptacle Box
- D. 2611 90° Flat Elbow
- E. 2686FO Transition Feed Fitting
- F. 2400 Wiremold 2400 Series Raceway
- G. 1500 Wiremold 1500 Series Raceway
- H. V1517B Adapter Fitting
- I. 2600 Wiremold 2600 Series Overfloor Steel Raceway
- J. 500 Wiremold 200, 500 or 700 Series Raceway
- K. Conduit 1/2" [12.7mm] Flexible Conduit
- L. Conduit 1/2" or 3/4" Conduit to Underfloor Duct System

COLOR OPTIONS

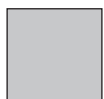

2600 Series™ Raceway components are available in galvanized steel unless otherwise indicated in the part number description.

2600 SERIES™ OVERFLOOR RACEWAY

Ordering Information

2600 Series Raceway Wire Fill Capacities for Communications

	CABLE/WIRE SIZE	O.D. (Approx. dia.)		40% FILL
		Inches	[mm]	
UNSHIELDED TWISTED PAIR	4-pair, 24 AWG, Cat 3	0.190	[4.8]	10
	4-pair, 24 AWG, Cat 5e	0.210	[5.3]	8
	4-pair, 24 AWG, Cat 6	0.250	[6.3]	5
	4-pair, 24 AWG, Cat 6a*	0.354	[9.0]	2
	25-pair, 24 AWG	0.410	[10.4]	2
COAXIAL	RG6/U	0.270	[6.9]	5
FIBER	ZipCord	0.118 x 0.236	[3 x 6]	10
	Round 4 Strand Fiber	0.187	[4.8]	10
	Round 6 Strand Fiber	0.256	[6.5]	5

2600 Series Raceway Wire Fill Capacities for Power

WIRE SIZE THHN/THWN	O.D. (Approx. dia.)		NO. OF CONDUCTORS 40% FILL
	Inches	[mm]	
14 AWG	0.111	[2.8]	29
12 AWG	0.130	[3.3]	21
10 AWG	0.164	[4.2]	13

NOTE: For additional information, refer to the Technical Section.
 * Category 6 augmented (6a) cable for 10 gigabit ethernet – max allowed cable diameter per addenda No. 11 ANSI TIA/EIA 568-B.2.

2600-10 Raceway Base & Cover

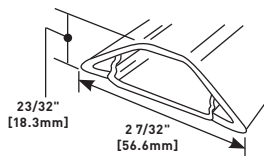

Cover: .050" galvanized steel.
 Base: .040" [1.0mm] galvanized steel. Packed five 10' [3m] lengths per carton. Base has 9/32" [7.1mm] diameter mounting holes on centers of approximately 8" [203mm].

2611 90° Flat Elbow

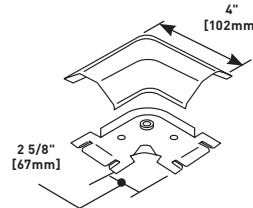

For right angle turns on the same surface.

656 Cover Removal Tool

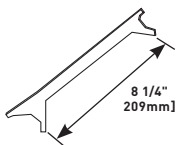

For removing cover of 1500 and 2600 Series Overfloor Raceways.

2642D Junction Box

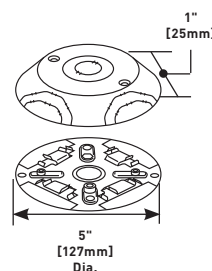

May be used with 1500 and/or 2600 Series Raceway as a cross, tee, or elbow. Cover has 1/2" trade size KO. Base has 1/2" and 3/4" concentric KO to enable connection to floor, outlet boxes or under floor duct systems (use Chase nipple – not included). Two 2600WC Wire Clips included.

NOTE: Box covers are manufactured of UL Listed Noryl plastic, gray textured finish.

2600WC Wire Clip

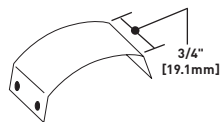

For holding conductors in place.

2602 Fiber Bushing

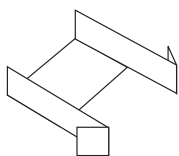

Protects wires from abrasion. Slips into open end of 2600 Series Raceway where it enters a fitting.

2686FO Transition Feed Fitting

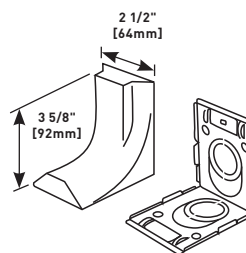

Eliminates offsetting 2400 Series Raceway in connecting with surface panel boxes. Has 3/4" and 1" concentric trade size KOs with 1" trade size KO elongated so adjustment from surface to center of bushing is 1" [25mm] to 1 5/8" [41mm] maximum. Has twistouts for transition to 1500 and 2600 Series Raceway.

NOTE: Box covers are manufactured of UL Listed Noryl plastic, gray textured finish.

NOTE: Parts identified with this symbol are Certified to Canadian Safety Standards for sale in Canada. When ordering these products, add "C" prefix to part number to denote the Canadian version, i.e. "C1546A".

2600 SERIES™ OVERFLOOR RACEWAY

Ordering Information

2600 Series Raceway Interconnectivity Fittings

CONNECTION REQUIRED		USE CATALOG NUMBER
FROM	TO	
2600 Series Raceway	1500 Series Raceway	2642D, 1543GL, 1546A, 1546B, 1546T
2600 Series Raceway	2400 Series Raceway	2686FO
1/2" trade size Conduit or Armored Cable	End of 1500 Series Raceway	1585
1/2" trade size Conduit or Armored Cable	Bottom of 1500 Series Raceway	1528
1/2" or 3/4" trade size Conduit or Armored Cable	Bottom of 1500 or 2600 Series Raceway	2642D
1/2" or 3/4" trade size Conduit or Armored Cable	Bottom of 1500 Series Raceway	1542D

1543GL Grounding Duplex Receptacle 15A-125V NEMA 5-15R & Cover

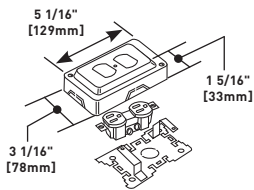

Cover has twistouts for 1500 and 2600 Series Raceway on all four sides. Base has 1/2" and 3/4" trade size concentric KOs. Two 1500WC Wire Clips included. Gray finish.

1546B Duplex Receptacle Box

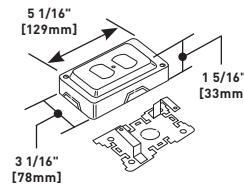

Will accommodate commercially available 15A or 20A duplex receptacles. Base has 1/2" and 3/4" concentric trade size KOs. Nonmetallic cover has 1500 and 2600 Series Raceway twistouts on all four sides. Two 1500WC Wire Clips included. Side wiring recommended. Gray finish.

1546A Single Receptacle Box

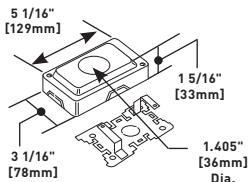

Will accommodate commercially available straight blade and locking single receptacles with face diameters of 1.38-1.40" [35-36mm]. Base has 1/2" and 3/4" trade size concentric KOs. Nonmetallic cover has 1500 and 2600 Series Raceway twistouts on all four sides. Two 1500WC Wire Clips included. Gray finish.

1546T Telephone Outlet Box

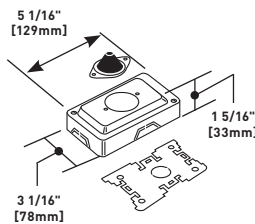

Furnished with 1/2" [12.7mm] rubber stem. Designed to accept modular connecting blocks within the fitting. Nonmetallic cover has 1500 and 2600 Series Raceway twistouts on both ends and both sides. Two 1500WC Wire Clips included. Not UL Listed. Gray finish.

NOTE: Parts identified with this symbol are Certified to Canadian Safety Standards for sale in Canada. When ordering these products, add "C" prefix to part number to denote the Canadian version, i.e. "C1546A".



1200/1400/1600 SERIES™ OVERFLOOR RACEWAYS



Wiremold® 1200/1400/1600 Series Overfloor Raceway Systems provide permanent or temporary protection for overfloor cabling in high traffic areas.

CODE REFERENCE
1200, 1400, and 1600 Series Raceway is not UL Listed and is designed for use in protecting wiring and cabling.

1200 Series — Channel Capacity Up to 5/16" [7.9mm] Cable Diameter

CATALOG NUMBER	COLOR	LENGTH
BE1200-5	Beige	5' [1.5m]
BE1200-5R	Beige	5' [1.5m]
BE1200-10	Beige	10' [3.0m]
BE1200-50	Beige	50' [15.2m]
BK1200-5	Black	5' [1.5m]
BK1200-10	Black	10' [3.0m]
BK1200-50	Black	50' [15.2m]
BR1200-5R	Brown	5' [1.5m]
BR1200-5	Brown	5' [1.5m]
BR1200-10	Brown	10' [3.0m]
BR1200-50	Brown	50' [15.2m]
GR1200-5	Gray	5' [1.5m]
GR1200-5R	Gray	5' [1.5m]
GR1200-10	Gray	10' [3.0m]
GR1200-50	Gray	50' [15.2m]
YL1200-50	High Visibility Yellow	50' [15.2m]

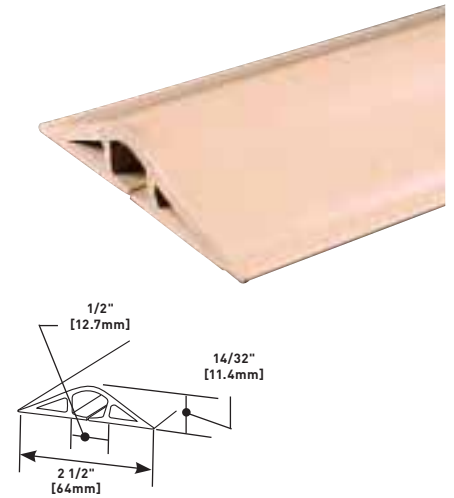

COLOR OPTIONS



1200/1400/1600 Series Raceways are available in gray, black, beige, brown and high visibility yellow.

Custom color options are also available. Consult the factory for more information.

1200/1400/1600 SERIES™ OVERFLOOR RACEWAYS

Ordering Information

1400 Series — Channel Capacity Up To 1/2" [12.7mm] Cable Diameter

CATALOG NUMBER	COLOR	LENGTH
BE1400-5	Beige	5' [1.5m]
BE1400-10	Beige	10' [3.0m]
BE1400-50	Beige	50' [15.2m]
BK1400-5	Black	5' [1.5m]
BK1400-10	Black	10' [3.0m]
BK1400-50	Black	50' [15.2m]
BR1400-5	Brown	5' [1.5m]
BR1400-10	Brown	10' [3.0m]
BR1400-50	Brown	50' [15.2m]
GR1400-5	Gray	5' [1.5m]
GR1400-10	Gray	10' [3.0m]
GR1400-50	Gray	50' [15.2m]
YL1400-50	High Visibility Yellow	50' [15.2m]

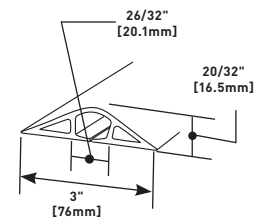

1600 Series — Channel Capacity Up To 3/4" [19.1mm] Cable Diameter

CATALOG NUMBER	COLOR	LENGTH
BE1600-5	Beige	5' [1.5m]
BE1600-10	Beige	10' [3.0m]
BE1600-25	Beige	25' [7.6m]
BK1600-5	Black	5' [1.5m]
BK1600-10	Black	10' [3.0m]
BK1600-25	Black	25' [7.6m]
BR1600-5	Brown	5' [1.5m]
BR1600-10	Brown	10' [3.0m]
BR1600-25	Brown	25' [7.6m]
GR1600-5	Gray	5' [1.5m]
GR1600-10	Gray	10' [3.0m]
GR1600-25	Gray	25' [7.6m]
YL1600-25	High Visibility Yellow	25' [7.6m]

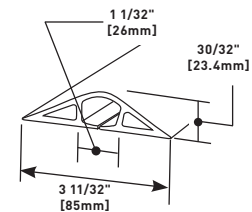
DST2

DOUBLE-SIDED TAPE

 For long term installation.
 2" wide x 17 yds.

NONMETALLIC SURFACE RACEWAY SYSTEMS



Wiremold® Nonmetallic Surface Raceway Systems are the industry leaders in quality, ease of installation, and for providing pathway solutions for all types of installations. For over 50 years, Wiremold Nonmetallic Surface Raceway Systems have provided the highest quality, most dependable solutions for installers, building owners, and designers.



Featured Products



**CableSmart™ 40N2
Series Raceway**

139



**Eclipse™ Series
Raceway**

119

NONMETALLIC SURFACE RACEWAY SYSTEMS

Table of Contents

Low Voltage Single-Channel Raceways



111
Uniduct® 2700,
2800, 2900 Series
Raceway

Power-Rated Single- and Dual-Channel Raceways



119
Eclipse™ PN03,
PN05, PN10
Series Raceway



124
400, 800,
2300/2300D
Series™ Raceway

Large Capacity Multiple-Channel Raceways

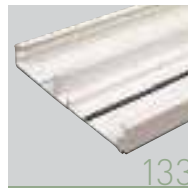

133
Access® 5000
Series Raceway

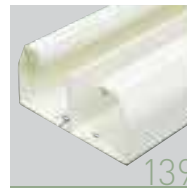

139
CableSmart™ 40N2
Series Raceway



142
5400 Series™
Raceway



149
5500 Series™
Raceway



154
5507 Series™
Faceplates

Hide Cord Raceway



157
300 Series™ Duct

NONMETALLIC SURFACE RACEWAY SYSTEMS

Quick Selection Guide

Low Voltage Single-Channel Raceway Profiles

Uniduct® Raceway



Uniduct 2700 Raceway

2700 Series
Capacity: 0.163 in.² [105mm²]

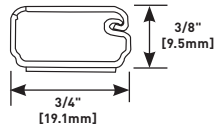

2800 Series
Capacity: 0.337 in.² [217mm²]

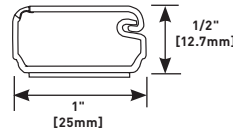

2900 Series
Capacity: 0.869 in.² [530mm²]

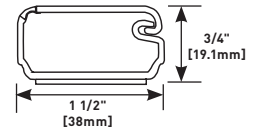

Power-Rated Single- & Dual-Channel Raceway Profiles

Eclipse™ Series Raceway*



PN05L08 Raceway

Eclipse PN03*
Capacity: 0.285 in.² [184mm²]

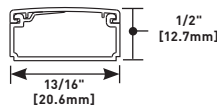

Eclipse PN05*
Capacity: 0.538 in.² [347mm²]

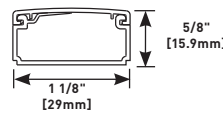

Eclipse PN10*
Capacity: 0.99 in.² [638.7mm²]

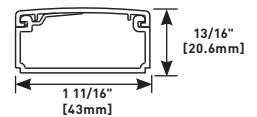

400 Series™ Raceway*



400BAC Raceway
Capacity: 0.130 in.² [83.9mm²]

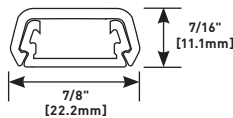

800 Series™ Raceway*



800BAC Raceway
Capacity: 0.272 in.² [175mm²]

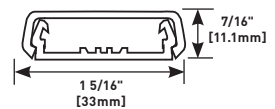

2300 Series™ Raceway*



2300BAC Raceway
Capacity: 0.852 in.² [550mm²]

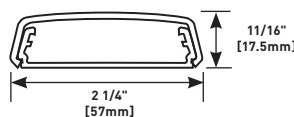

2300D Series™ Raceway*



2300BACD Raceway
Capacity: 0.426 in.² [275mm²]
Each Compartment

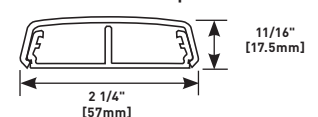

* UL Listed for up to 600V.

NONMETALLIC SURFACE RACEWAY SYSTEMS

Quick Selection Guide

High Capacity Multiple Channel Raceway Profiles

Access® 5000 Series Raceway



5000B Raceway Base
Capacity: Compartment A: 1.39 in.² [849mm²]
Compartment B: 1.94 in.² [1250mm²]

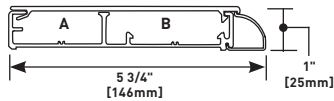

5400 Series™ Raceway



5400TB Raceway
Capacity: Each Compartment:
3.72 in.² [2400mm²]

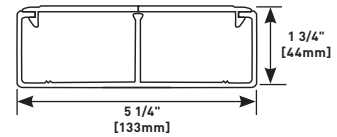

CableSmart® 40N2 Series Raceway



40N2B08 Raceway Base
Capacity: Each Compartment:
3.22 in.² [2080mm²]

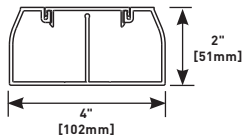

5500 Series™ Raceway



5500BD3 Raceway
Capacity: Each Compartment:
2.64 in.² [67mm²]

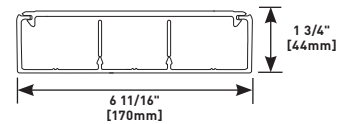

Hide Cord Raceway Profiles

300 Series™ Duct



300 Duct
Capacity: .900 in.² [581mm²]

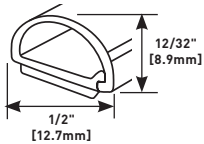

UNIDUCT® SERIES RACEWAYS

Single-Channel



One-piece, latching single-channel raceway available in three profiles. Easy-to-install and ideal for basic communication installations.

CODE REFERENCE

Uniduct Series Raceway is not UL Listed and is only designed for use in protecting electrical cords, low voltage wiring and cabling.

Uniduct 2700, 2800, 2900 Series Raceways System Layout

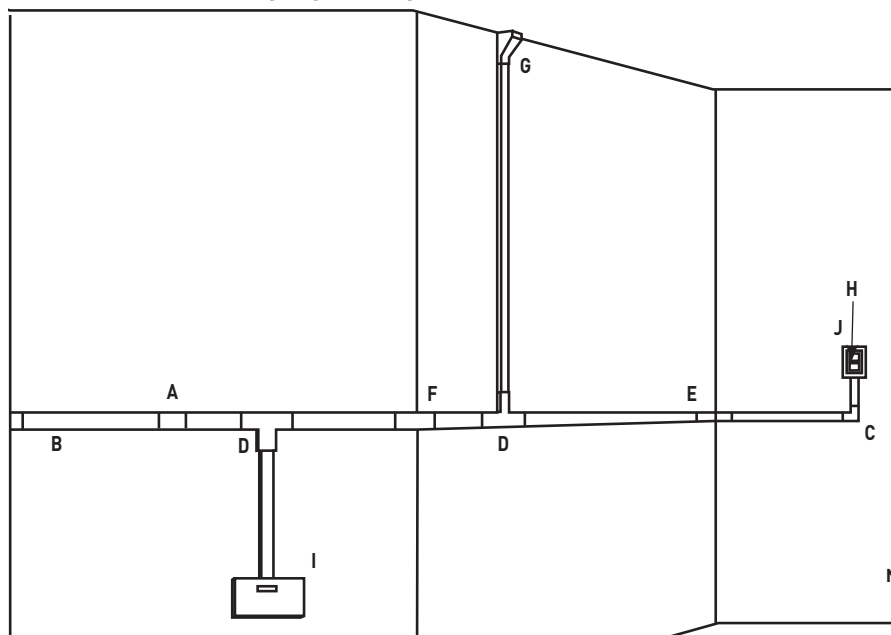

NOTE: Illustration is for showing product applications only.

KEY

- | | | |
|--|--|---|
| A. 2706, 2806, 2906 Cover Clip | E. 2717, 2817, 2917 Internal Elbow | H. CM2, Series II, TracJack Communication Devices |
| B. 2710B, 2810B, 2910B Blank End Fitting | F. 2718, 2818, 2918 External Elbow | I. CM-MMB-293 Multimedia Box |
| C. 2711, 2811, 2911 Flat Elbow | G. 2786, 2886, 2986 Drop Ceiling Connector | J. NM2048 Device Box |
| D. 2715, 2815, 2915 Tee Fitting | | |

COLOR OPTIONS

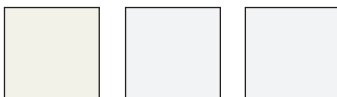

Uniduct® Series Raceway Part Numbers with a "-WH" suffix have a white finish. Part Numbers with a "-FW" suffix have a fog white finish. Part Numbers without a suffix have an ivory finish. Uniduct Raceway can also be painted using latex paint.

UNIDUCT® 2700 SERIES RACEWAYS

Ordering Information

Uniduct® 2700 Series Raceway Wire Fill Capacities for Communications

	CABLE/WIRE SIZE	O.D. (Approx. Dia.)		40% FILL
		Inches	[mm]	
UNSHIELDED TWISTED PAIR	4-pair, 24 AWG, Cat 3	0.190	[4.8]	2
	4-pair, 24 AWG, Cat 5e	0.210	[5.3]	1
	4-pair, 24 AWG, Cat 6	0.250	[6.3]	1
	4-pair, 24 AWG, Cat 6a*	0.354	[9.0]	0
	25-pair, 24 AWG	0.410	[10.4]	0
COAXIAL	RG6/U	0.270	[6.9]	1
FIBER	ZipCord	0.118 x 0.236	[3 x 6]	2
	Round 4 Strand Fiber	0.187	[4.8]	2
	Round 6 Strand Fiber	0.256	[6.5]	1

NOTE: For additional information, refer to the Technical Section.

* Category 6 augmented (6a) cable for 10 gigabit ethernet – max allowed cable diameter per addenda No. 11 ANSI TIA/EIA 568-B.2.

2700, 2700L8 One-Piece Latching Raceway Cover

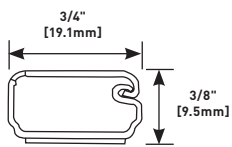

Co-extruded design, smooth plastic 2700L8 finish with adhesive backing. Available in [1.8m] length, packed 120' [36.6m] per carton. 2700L8 available in 8' [2.44m] length, packed 160' [48.8m] per carton. Also available in white (2700-WH, 2700L8-WH).

2700, 2700L8 One-Piece Latching Raceway Cover

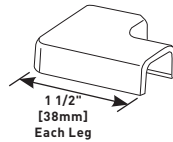

Makes right angle turns in 2700 Series Raceway on same surface. Also available in white (2711-WH).

2715 Tee

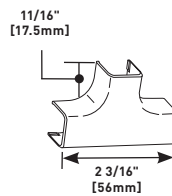

For branching of raceway running at right angles. Also available in white (2715-WH).

2717 Internal Elbow

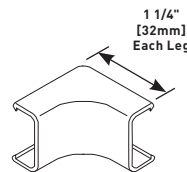

Makes right angle turns around internal corners. Also available in white (2717-WH).

PVC-1 PVC Raceway Cutter

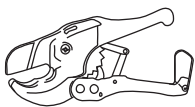

Regular duty cutter. Ideal for use with small nonmetallic raceways.

2718 External Elbow

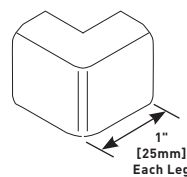

Makes right angle turns around external corners. Also available in white (2718-WH).

2706 Cover Clip

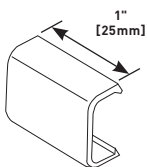

Covers seam where two pieces of 2700 Series Raceway Cover come together. Also available in white (2706-WH).

2786 Drop Ceiling Connector

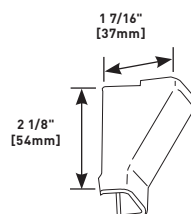

Conceals cables dropped from ceiling into the 2700 Series Raceway. Also available in white (2786-WH).

2710B Blank End Fitting

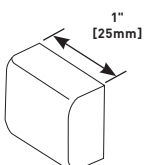

Closes off open end of 2700 Series Raceway. Also available in white (2710B-WH).

NOTE: Device Boxes for Uniduct 2700 Series Raceway can be found on pages located at the end of this product section.

UNIDUCT® 2800 SERIES RACEWAYS

Ordering Information

Uniduct® 2800 Series Raceway Wire Fill Capacities for Communications

	CABLE/WIRE SIZE	O.D. (Approx. Dia.)		40% FILL
		Inches	[]	
UNSHIELDED TWISTED PAIR	4-pair, 24 AWG, Cat 3	0.190	[4.8]	4
	4-pair, 24 AWG, Cat 5e	0.210	[5.3]	3
	4-pair, 24 AWG, Cat 6	0.250	[6.3]	2
	4-pair, 24 AWG, Cat 6a*	0.354	[9.0]	1
	25-pair, 24 AWG	0.410	[10.4]	1
COAXIAL	RG6/U	0.270	[6.9]	2
FIBER	ZipCord	0.118 x 0.236	[3 x 6]	4
	Round 4 Strand Fiber	0.187	[4.8]	4
	Round 6 Strand Fiber	0.256	[6.5]	2

NOTE: For additional information, refer to the Technical Section.
 * Category 6 augmented (6a) cable for 10 gigabit ethernet – max allowed cable diameter per addenda No. 11 ANSI TIA/EIA 568-B.2.

2800, 2800L8 One-Piece Latching Raceway

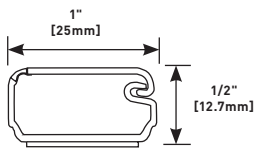

Co-extruded design, smooth ivory plastic finish with adhesive backing. 2800 available in 6' [1.8m] lengths, packed 120' [36.6m] per carton. 2800L8 available in 8' [2.44m] length, packed 160' [48.8m] per carton. Also available in white (2800-WH, 2800L8-WH).

PVC-1 PVC Raceway Cutter

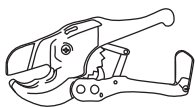

Regular duty cutter. Ideal for use with small nonmetallic raceways.

2806 Cover Clip

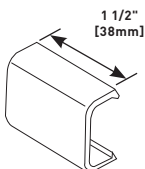

Covers seam where two pieces of 2800 Series Raceway Cover come together. Also available in white (2806-WH).

2810B Blank End Fitting

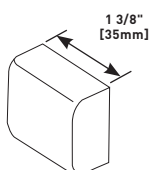

Closes off end of 2800 Series Raceway. Also available in white (2810B-WH).

NOTE: Device Boxes for Uniduct 2700 Series Raceway can be found on pages located at the end of this product section.

2811 Flat Elbow

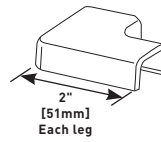

Makes right angle turns in 2800 Series Raceway on same surface. Also available in white (2811-WH).

2811FO Radiused Flat Elbow

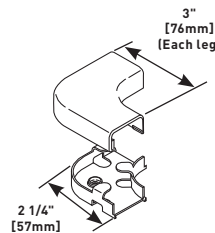

Makes right angle turns in 2800 Series Raceway on same surface. Maintains 1 1/4" [32mm] bend radius when installing UTP and fiber optic cable. Also available in white (2811FO-WH).

2815 Tee

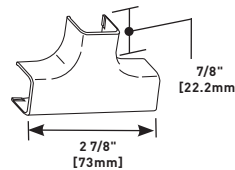

For branching of 2800 Series Raceway running at right angles. Also available in white (2815-WH).

2815FO Radiused Tee

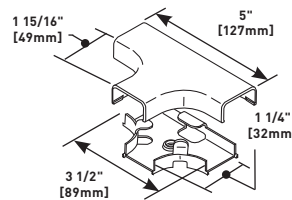

For branching of 2800 Series Raceway running at right angles. Maintains 1 1/4" [32mm] cable bend radius when installing UTP and fiber optic cable. Also available in white (2815FO-WH).

2817 Internal Elbow

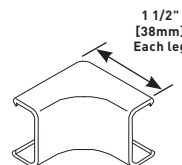

For right angle turns around internal corners. Also available in white (2817-WH).

2817FO Radiused Internal Elbow

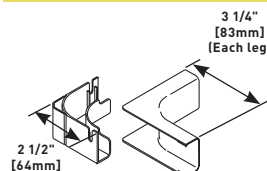

Makes right angle turns around internal corners of 2800 Series Raceway. Maintains 1 1/4" [32mm] bend radius when installing UTP and fiber optic cable. Also available in white (2817FO-WH).

UNIDUCT® 2800 & 2900 SERIES RACEWAYS

Ordering Information

2818 External Elbow

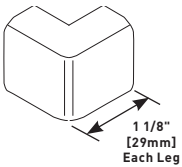

Makes right angle turns around external corners. Also available in white (2818-WH).

2886 Drop Ceiling Connector

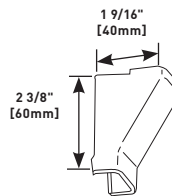

Conceals dropped cables from ceiling into 2800 Series Raceway. Also available in white (2886-WH).

2818FO Radiused External Elbow

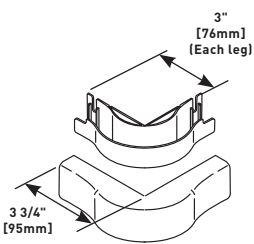

Makes right angle turns around external corners of 2800 Series Raceway. Maintains 1 1/4" [32mm] cable bend radius when installing UTP and fiber optic cable. Also available in white (2818FO-WH).

2889 Reducing Connector (2800 - 2700)

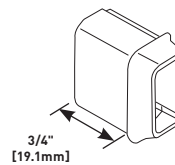

For transitioning from 2800 Series Raceway to 2700 Series Raceway. Also available in white (2889-WH).

NOTE: Device Boxes for Uniduct 2700 Series Raceway can be found on pages located at the end of this product section.

Uniduct® 2900 Series Raceway Ordering Information

2900, 2900L8 One-Piece Latching Raceway

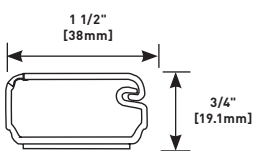

Co-extruded design, smooth plastic finish with adhesive backing. Available in 6' [1.8m] length, packed 120' [36.6m] per carton. 2900L8 available in 8' [2.44m] length, packed 160' [48.8m] per carton. Also available in white (2900-WH, 2900L8-WH).

PVC-1 PVC Raceway Cutter

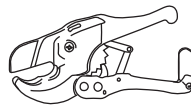

Regular duty cutter. Ideal for use with small nonmetallic raceways.

2906 Cover Clip

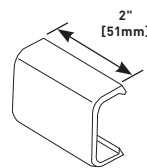

For covering joint where two pieces of 2900 Series Raceway Cover come together. Also available in white (2906-WH).

Uniduct® 2900 Series Raceway Wire Fill Capacities for Communications

	CABLE/WIRE SIZE	O.D. (Approx. Dia.)		40% FILL
		Inches	[]	
UNSHIELDED TWISTED PAIR	4-pair, 24 AWG, Cat 3	0.190	[4.8]	12
	4-pair, 24 AWG, Cat 5e	0.210	[5.3]	10
	4-pair, 24 AWG, Cat 6	0.250	[6.3]	7
	4-pair, 24 AWG, Cat 6a*	0.354	[8.9]	3
	25-pair, 24 AWG	0.410	[10.4]	2
COAXIAL	RG6/U	0.270	[6.9]	6
FIBER	ZipCord	0.118 x 0.236	[3 x 6]	12
	Round 4 Strand Fiber	0.187	[4.8]	12
	Round 6 Strand Fiber	0.256	[6.5]	6

NOTE: For additional information, refer to the Technical Section.

* Category 6 augmented (6a) cable for 10 gigabit ethernet – max allowed cable diameter per addenda No. 11 ANSI TIA/EIA 568-B.2.

2910B Blank End Fitting

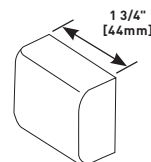

For closing open end of 2900 Series Raceway. Also available in white (2910B-WH).

2911 Flat Elbow

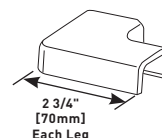

For right angle turns on same surface. Also available in white (2911-WH).

UNIDUCT® 2900 SERIES RACEWAYS

Ordering Information

2911FO Radiused Flat Elbow

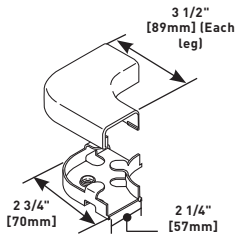

For right angle turns on same surface. Maintains 1 1/4" [32mm] bend radius when installing UTP and fiber optic cable. Also available in white (2911FO-WH).

2918 External Elbow

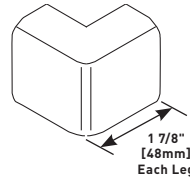

For right angle turns around external corners. Also available in white (2918-WH).

2915 Tee

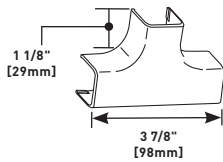

For branching of 2900 Series Raceway running at right angles. Also available in white (2915-WH).

2918FO Radiused External Elbow

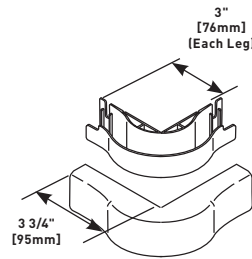

For right angle turns around external corners. Maintains 1 1/4" [32mm] bend radius when installing UTP and fiber optic cable. Also available in white (2918FO-WH).

2915FO Radiused Tee

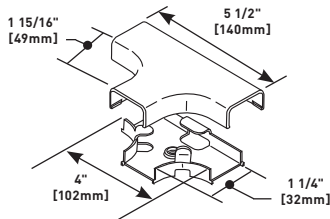

For branching of raceway running at right angles. Maintains 1 1/4" [32mm] bend radius when installing UTP and fiber optic cable. Also available in white (2915FO-WH).

2986 Drop Ceiling Connector

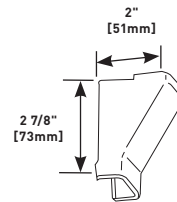

For dropping cables from ceiling into the raceway. Also available in white (2986-WH).

2917 Internal Elbow

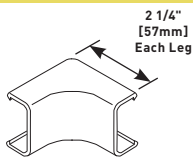

For right angle turns around internal corners. Also available in white (2917-WH).

2989 Reducing Connector

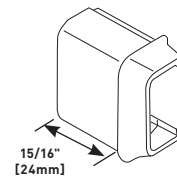

For transitioning from 2900 Series Raceway to 2800 Series Raceway. Also available in white (2989-WH).

2917FO Radiused Internal Elbow

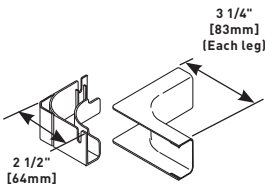

For right angle turns around internal corners. Maintains 1 1/4" [32mm] bend radius when installing UTP and fiber optic cable. Also available in white (2917FO-WH).

2989A Reducing Connector

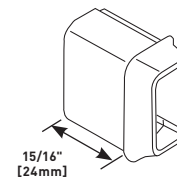

For transitioning from 2900 Series Raceway to 2700 Series Raceway. Also available in white (2989A-WH).

UNIDUCT® SERIES RACEWAY

Device Box Ordering Information

Uniduct 2700, 2800, 2900 Series Raceways Interconnectivity Fittings

CONNECTION REQUIRED		USE CATALOG NUMBER
FROM	TO	
Uniduct 2800 Series Raceway	Uniduct 2700 Series Raceway	2889
Uniduct 2900 Series Raceway	Uniduct 2700 Series Raceway	2989A
Uniduct 2900 Series Raceway	Uniduct 2800 Series Raceway	2989
Drop Ceiling	Uniduct 2800 Series Raceway	2786
Drop Ceiling	Uniduct 2800 Series Raceway	2886
Drop Ceiling	Uniduct 2900 Series Raceway	2986
NM2000	Uniduct 2700, 2800, or 2900 Series Raceway	NM2044, NM2044-2, NM2048, NM2048-2

NM2044 Extra Deep Device Box

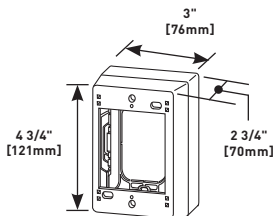

For mounting voice/data devices when additional depth is required. Has combination twistouts for Uniduct 2700, 2800, 2900 and NM2000 Series Raceways. Accepts industry standard NEMA faceplates. Also available in white (NM2044-WH).

NM2048-2 Two-Gang Deep Device Box

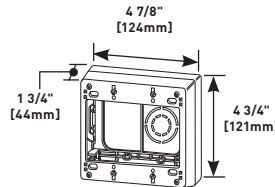

For mounting multiple voice data devices. Has combination twistouts for Uniduct 2700, 2800, 2900, and NM2000 Series Raceways. Accepts industry standard NEMA faceplates. Also available in white (NM2048-2WH).

NM2044-2 Two-Gang Extra Deep Device Box

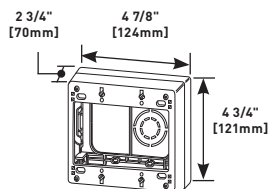

For mounting multiple voice/data devices when additional depth is required. Has combination twistouts for Uniduct 2700, 2800, 2900 and NM2000 Series Raceways. Accepts industry standard NEMA faceplates. Also available in white (NM2044-2WH).

CM-MMB-291 One Insert Multimedia Box

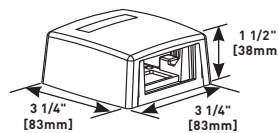

Accepts one 2A size Wiremold Open System Communication Module or Pass & Seymour® Activate Series Insert. Compatible with Uniduct 2700 and 2800 Series Raceways. Also available in white (CM-MMB-291-WH).

NM2048 Deep Device Box

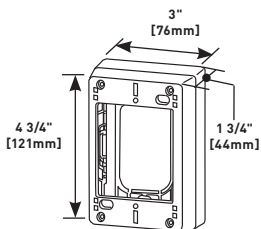

For mounting deep voice/data devices. Has combination twistouts for Uniduct 2700, 2800, 2900, and NM2000 Series Raceways. Accepts industry standard NEMA faceplates. Also available in white (NM2048-WH).

CM-MMB-292 Two Insert Multimedia Box

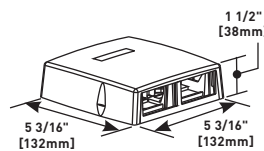

Fiber storage loop. Accepts two 2A size Wiremold® Open System Communication Modules or Pass & Seymour® Activate Series Inserts. Compatible with Uniduct 2700, 2800, and 2900 Series Raceways. Also available in white (CM-MMB-292-WH).

CM-MMB-293 Three Insert Multimedia Box

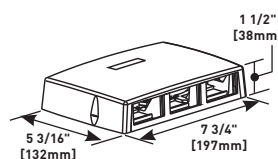

Fiber storage loop. Accepts three 2A size Wiremold® Open System Communication Modules or Pass & Seymour® Activate Series Inserts. Compatible with Uniduct 2700, 2800, and 2900 Series Raceways. Also available in white (CM-MMB-293-WH).

UNIDUCT® 2700, 2800, 2900 SERIES RACEWAYS

Installation Details

2700, 2800, 2900 Series Raceways Installation Details

1. Cover Clip: 2706/2806/2906

To join two pieces of Uniduct Raceway in line. Install the Uniduct Raceway butted as shown. Snap the cover clip (2706/2806/2906) onto the Uniduct Raceway, leaving no gap.

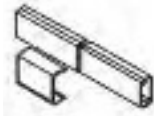

2. Blank End Fitting: 2710B/2810B/2910B

To cover the open end of Uniduct Raceway. Snap the blank end fitting (2710B/2810B/2910B) onto the open end of 2700, 2800, or 2900 Series Uniduct Raceway.

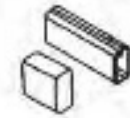

3. 90° Flat Elbow: 2711/2811/2911

To make right angle turn on same surface. Install the Uniduct Raceway butted as shown. Snap 90° flat elbow (2711/2811/2911) onto the Uniduct Raceway, leaving no gap.

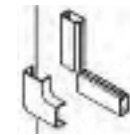

4. Bend Radius 90° Flat Elbow: 2811FO/2911FO

To make right angle turn on same surface and maintain 1 1/4" [32mm] bend radius. Mount the fitting base to the wall by using screws or the adhesive strip supplied. Butt the Uniduct Raceway as shown and snap the fitting cover over the base after the cabling has been completed.

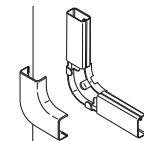

5. Tee: 2715/2815/2915

For branching at right angles. Install the Uniduct Raceway butted as shown. Snap tee (2715/2815/2915) onto the Uniduct Raceway, leaving no gap.

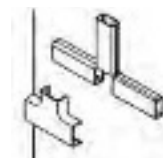

6. Bend Radius Tee: 2815FO/2915FO

To branch at right angles and maintain a 1 1/4" [32mm] bend radius. Mount the fitting base to the wall by using screws or the adhesive strip supplied. Butt the Uniduct Raceway as shown and snap the fitting cover over the base after the cabling has been completed.

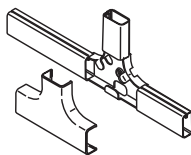

7. Internal Elbow: 2717/2817/2917

To go around internal corner. Install Uniduct 2700, 2800, or 2900 Series Raceway butted as shown. Snap internal elbow (2717/2817/2917) onto the Uniduct Raceway, leaving no gap.

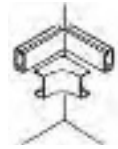

8. Bend Radius Internal Elbow: 2817FO/2917FO

To make internal corner connection and maintain 1 1/4" [32mm] bend radius. Mount the fitting base to the wall by using screws or the adhesive strip supplied. Butt the Uniduct Raceway as shown and snap the fitting cover over the base after the cabling has been completed.

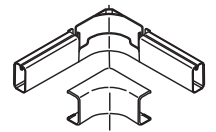

9. External Elbow: 2718/2818/2918

To go around external corner. Install Uniduct 2700, 2800, or 2900 Series Raceway butted as shown. Snap external elbow (2718/2818/2918) onto the Uniduct Raceway, leaving no gap.

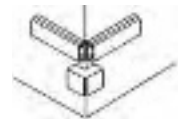

10. Bend Radius External Elbow: 2818FO/2918FO

To make external corner connection and maintain 1 1/4" [32mm] bend radius. Mount the fitting base to the wall by using screws or the adhesive strip supplied. Butt the Uniduct Raceway as shown and snap the fitting cover over the base after the cabling has been completed.

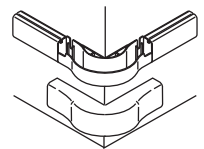

10. Drop Ceiling Connector: 2786/2886/2986

For bringing cables from ceiling to raceway. Cut a hole in the ceiling tile right next to metal grid. Drop the cables from the ceiling into the Uniduct Raceway. Push the drop ceiling connector (2786/2886/2986) through the hole so that the notch in the large end of the connector butts with the metal grid. Snap the drop ceiling connector onto the Uniduct Raceway.



UNIDUCT® 2700, 2800, 2900 SERIES RACEWAYS

Installation Details

2700, 2800, 2900 Series Raceways Device Box Installation Details

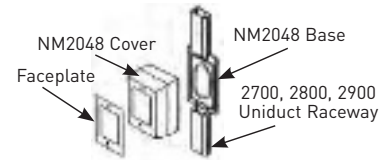
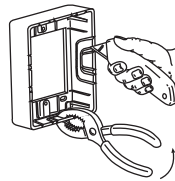
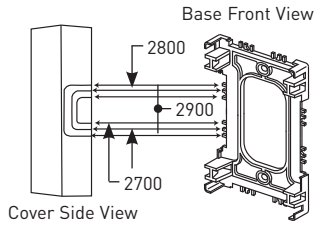

1. Remove proper tongue on the device box (NM2048) base.
2. Notch proper knockout in cover using knife. Use pliers to remove knockout inward for cleaner edge. (Trimming may be necessary.)
3. Fasten device box base to wall using screws (not provided).
4. Mount raceway to box. Install cables.
5. Snap device box cover onto base.
6. Mount device and faceplate.

ECLIPSE™ SERIES RACEWAYS

Single Channel



One-piece, latching, single-channel raceway available in three profiles. Easy-to-install and ideal for demanding communication designs. Accommodates communication or power wiring.

CODE REFERENCE

cULus Listed Raceway:
File E90378 Guide RJTX.
Complies with flammability requirements of UL-5A.

Fittings:
File E90377 Guide RJYT.
Meets Article 388 of NEC.
UL Listed for up to 600V.
Meets Section 12-1600 of CEC.

Eclipse Series PN03, PN05, PN10 Raceways System Layout

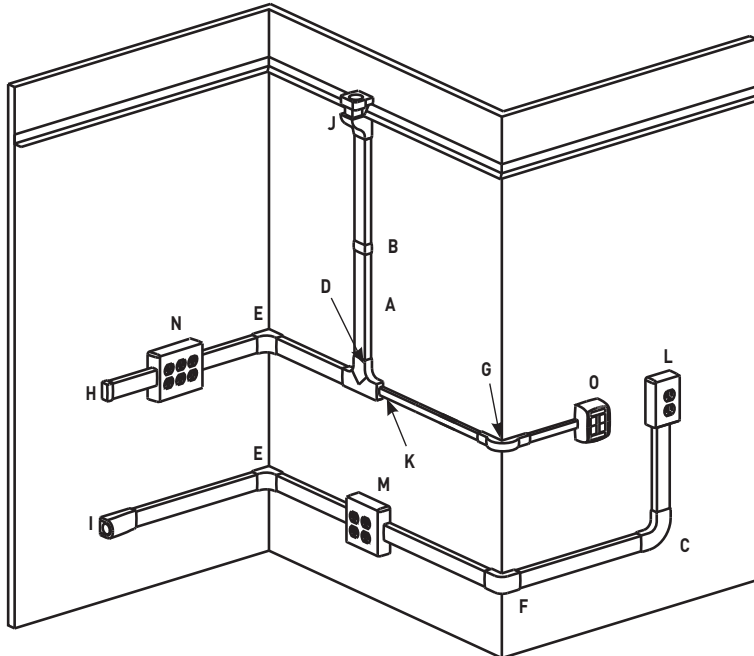

NOTE: Illustration is for showing product applications only.

KEY

- A. PN03L08, PN03L10, PN05L08, PN05L10, PN10L08, PN10L10 Latching Raceway
- B. PN03F06, PN05F06, PN10F06 Cover Clip
- C. PN03F11, PN05F11, PN10F11 90° Flat Elbow Fitting
- D. PN03F15, PN05F15, PN10F15 Tee Fitting
- E. PN03F17, PN05F17, PN10F17 Internal Elbow Fitting
- F. PN03F18, PN05F18, PN10F18 External Elbow Fitting
- G. PN03F19, PN05F19, PN10F19 Bend Radius External Elbow Fitting
- H. PN03F20, PN05F20, PN10F20 Blank End Fitting
- I. PN10F21 Entrance End Fitting
- J. PN05F86, PN10F86 Drop Ceiling Connector
- K. PN153R Reducer Adapter
- L. PSB1 One-Gang Device Box
- M. PSB2 Two-Gang Device Box
- N. PSB3 Three-Gang Device Box
- O. PBB2S2, PBB4TJ, PDB1CM, PDB1S2, PDB2CM, PDB2S2, PDB4TJ Communication Box

COLOR OPTIONS



Eclipse™ Series Raceway Part Numbers with a "-WH" suffix have a white finish. Part Numbers with a "-FW" suffix have a fog white finish. Part Numbers with a "-V" suffix have an ivory finish. Eclipse Series Raceways are paintable using latex paint.

ECLIPSE™ SERIES RACEWAYS

Ordering Information

Eclipse Series Raceway Wire Fill Capacities for Communications

	CABLE/WIRE SIZE	O.D. (APPROX. DIA.)		40% FILL		
		Inches	[mm]	PN03	PN05	PN10
UNSHIELDED TWISTED PAIR	4-pair, 24 AWG, Cat 3	0.190	[4.8]	3	5	13
	4-pair, 24 AWG, Cat 5e	0.210	[5.3]	2	5	11
	4-pair, 24 AWG, Cat 6	0.250	[6.3]	1	3	8
	4-pair, 24 AWG, Cat 6a*	0.354	[9.0]	0	1	4
	25-pair, 24 AWG	0.410	[10.4]	0	1	3
COAXIAL	RG6/U	0.270	[6.9]	1	3	6
FIBER	ZipCord	0.118 x 0.236	[3 x 6]	3	6	14
	Round 4 Strand Fiber	0.187	[4.8]	3	6	14
	Round 6 Strand Fiber	0.256	[6.5]	1	3	7

Eclipse Series Raceway Wire Fill Capacities for Power

WIRE SIZE THHN/THWN	O.D.		NO. OF CONDUCTORS		
	Inches	[mm]	PN03	PN05	PN10
14 AWG	0.111	[2.8]	8	16	15
12 AWG	0.130	[3.3]	7	14	20
10 AWG	0.164	[4.2]	0	0	19

NOTE: For additional information, refer to the Technical Section.
 * Category 6 augmented (6a) cable for 10 gigabit ethernet – max allowed cable diameter per addenda No. 11 ANSI TIA/EIA 568-B.2.

PN03L08, PN03L10, PN05L08, PN05L10, PN10L08, PN10L10 Latching Raceway

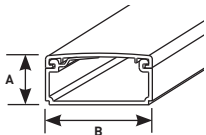

One-piece latching raceway with co-extruded hinge and adhesive backing. Available in 8' [2.44m] and 10' [3.0m] lengths.

CAT. NO.	A	B
PN03L08-FW, -V, -WH	1/2" [12.7mm]	13/16" [20.6mm]
PN03L10-FW, -V, -WH	1/2" [12.7mm]	13/16" [20.6mm]
PN05L08-FW, -V, -WH	5/8" [15.9mm]	1 1/8" [29mm]
PN05L10-FW, -V, -WH	5/8" [15.9mm]	1 1/8" [29mm]
PN10L08-FW, -V, -WH	3/16" [20.6mm]	1 11/16" [43mm]
PN10L10-FW, -V, -WH	3/16" [20.6mm]	1 11/16" [43mm]

PN03F06, PN05F06, PN10F06 Cover Clip

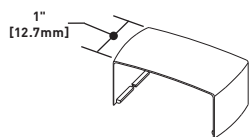

For covering joint where two pieces of Eclipse PN03, PN05, or PN10 Series Raceway Cover come together. Available in fog white (PN03F06-FW, PN05F06-FW, PN10F06-FW), white (PN03F06-WH, PN05F06-WH, PN10F06-WH), and ivory (PN03F06-V, PN05F06-V, PN10F06-V).

PN03F11, PN05F11, PN10F11 Flat Elbow

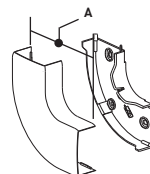

For right angle turns on the same surface. 1" [25mm] bend radius.

CAT. NO.	A
PN03F11FW, -V, -WH	2 11/16" [68mm]
PN05F11FW, -V, -WH	2 15/16" [75mm]
PN10F11FW, -V, -WH	3 11/16" [94mm]

ECLIPSE™ SERIES RACEWAYS

Ordering Information

PN03F15, PN05F15, PN10F15 Tee

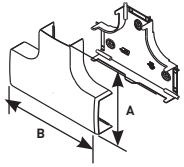

For branches of raceway running at right angles. 1" [25mm] bend radius.

CAT. NO.	A	B
PN03F15-FW, -WH, -V	2 11/16" [68mm]	4 5/16" [110mm]
PN05F15-FW, -WH, -V	2 15/16" [75mm]	4 3/4" [121mm]
PN10F15-FW, -WH, -V	3 11/16" [94mm]	5 5/16" [135mm]

PN03F17, PN05F17, PN10F17 Internal Elbow

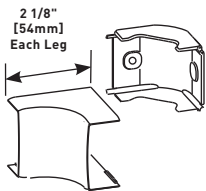

For right angle turns around internal corners. 1" [25mm] bend radius. Available in fog white (PN03F17-FW, PN05F17-FW, PN10F17-FW), white (PN03F17-WH, PN05F17-WH, PN10F17-WH), and ivory (PN03F17-V, PN05F17-V, PN10F17-V).

PN03F18, PN05F18, PN10F18 External Elbow

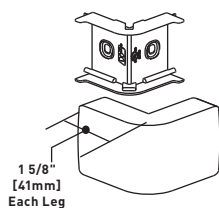

For right angle turns around external corners. Available in fog white (PN03F18-FW, PN05F18-FW, PN10F18-FW), white (PN03F18-WH, PN05F18-WH, PN10F18-WH), and ivory (PN03F18-V, PN05F18-V, PN10F18-V).

PN03F19, PN05F19, PN10F19 Radiused Extruded Elbow

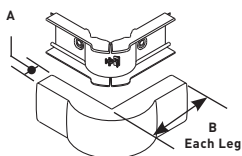

For right angle turns around external corners. 1" [25mm] bend radius.

CAT. NO.	A	B
PN03F19-FW, -WH, -V	1 5/16" [23.8mm]	3 1/8" [79mm]
PN05F19-FW, -WH, -V	1 3/16" [30mm]	3 1/8" [79mm]
PN10F19-FW, -WH, -V	1 3/16" [30mm]	3 3/8" [116mm]

PN03F20, PN05F20, PN10F20 Blank End Fitting

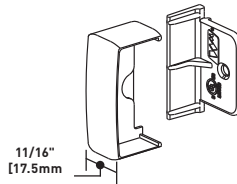

For closing open end of Eclipse PN03, PN05, or PN10 Series Raceway. Available in fog white (PN03F20-FW, PN05F20-FW, PN10F20-FW), white (PN03F20-WH, PN05F20-WH, PN10F20-WH), and ivory (PN03F20-V, PN05F20-V, PN10F20-V).

PN153R Reducer Adapter Fitting

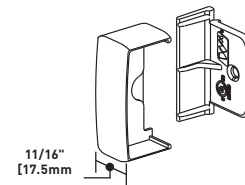

For adapting PN03 or PN05 Series Raceway to a PN10 Series Raceway trunking through the PN10F15 Tee Fitting. Available in fog white (PN153R-FW), white (PN153R-WH), and ivory (PN153R-V).

PN05F86, PN10F86 Drop Ceiling Connector

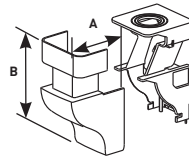

For dropping cables from ceiling into the raceway. Has 1/2" and 3/4" concentric trade size KO's. Includes PN153R Reducer Adapter for use with PN03 Series Raceway.

CAT. NO.	A	B
PN05F86-FW, -WH, -V	1 5/16" [33mm]	4 3/8" [111mm]
PN10F86-FW, -WH, -V	2 1/2" [64mm]	4 3/8" [111mm]

PN10F21 Entrance End Fitting

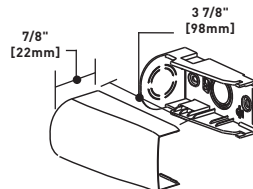

For feeding raceway with 1/2" and 3/4" trade size conduit or armored cable. Has 1/2 and 3/4" concentric trade size KO's. Includes PN153R Reducer Adapter for use with PN03 and PN05 Series Raceway. Available in fog white (PN10F21-FW), white (PN10F21-WH), and ivory (PN10F21-V).

ECLIPSE™ SERIES RACEWAYS

Ordering Information

PSB1 One-Gang Device Box

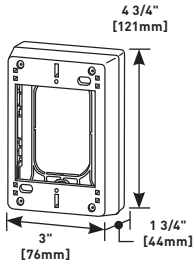

Accepts all standard single-gang NEMA faceplates and keystone jacks. Twistouts on all four sides for PN03, PN05, and PN10 Series Raceways. Designed for use with Ortronics® WiJack™ Wireless Access Point. Available in fog white (PSB1-FW), white (PSB1-WH), and ivory (PSB1-V).

PDB1CM CM Data Box

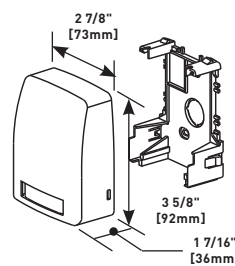

Surface mount box for use with Eclipse Raceway or standalone application. Has one 1/2" trade size KO. Accepts one front-loaded downward facing Pass & Seymour® Activate or Wiremold® Open System communication module. Available in fog white (PDB1CM-FW), white (PDB1CM-WH), and ivory (PDB1CM-V).

PSB2 Two-Gang Device Box

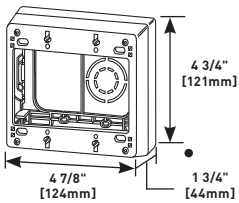

Accepts all standard two-gang NEMA faceplates and keystone jacks. Twistouts on all four sides for PN03, PN05, and PN10 Series Raceways. Has 1/2" and 3/4" concentric trade size KOs, as well as rectangular KO for wall box mounting. Designed for use with Ortronics® WiJack™ Wireless Access Point. Available in fog white (PSB2-FW), white (PSB2-WH), and ivory (PSB2-V).

PDB2S2 Series II Data Box

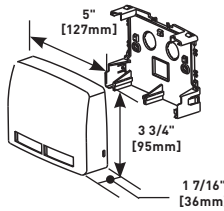

Surface mount box for use with Eclipse Raceway or standalone application. Has two 1/2" trade size KOs. Accepts two front-loaded downward facing Ortronics® Series II inserts. Available in fog white (PDB2S2-FW), white (PDB2S2-WH), and ivory (PDB2S2-V).

PSB3 Three-Gang Device Box

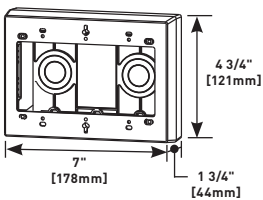

Accepts all standard three-gang NEMA faceplates and keystone jacks. Twistouts on all four sides for PN03, PN05, and PN10 Series Raceways. Has 1/2" and 3/4" concentric trade size KOs. Designed for use with Ortronics® WiJack™ Wireless Access Point. Available in fog white (PSB3-FW), white (PSB3-WH), and ivory (PSB3-V).

PDB2CM CM Data Box

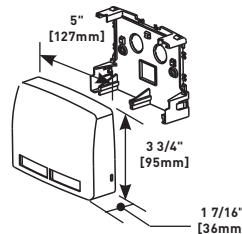

Surface mount box for use with Eclipse Raceway or standalone application. Has two 1/2" trade size KOs. Accepts two front-loaded downward-facing Pass & Seymour® Activate or Wiremold® Open System communication modules. Available in fog white (PDB2CM-FW), white (PDB2CM-WH), and ivory (PDB2CM-V).

PDB1S2 Series II Data Box

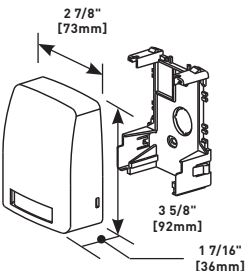

Surface mount box for use with Eclipse Raceway or standalone application. Accepts one front-loaded downward facing Ortronics® Series II insert. Available in fog white (PDB1S2-FW), white (PDB1S2-WH), and ivory (PDB1S2-V).

PDB2TJ TracJack Data Box

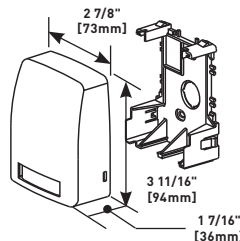

Surface mount box for use with Eclipse Raceway or standalone application. Has one 1/2" trade size KO. Accepts two front-loaded downward facing Ortronics® TracJack inserts. Available in fog white (PDB2TJ-FW), white (PDB2TJ-WH), and ivory (PDB2TJ-V).

ECLIPSE™ SERIES RACEWAYS

Ordering Information

PDB4TJ TracJack Data Box

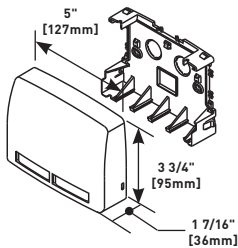

Surface mount box for use with Eclipse Raceway or standalone application. Has two 1/2" trade size KOs. Accepts four front-loaded downward facing Ortronics® TracJack inserts. Available in fog white (PDB4TJ-FW), white (PDB4TJ-WH), and ivory (PDB4TJ-V).

PBB4TJ Bezel Box

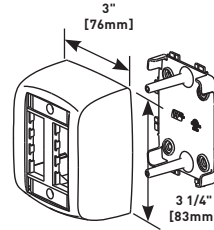

Surface mount box for use with Eclipse Raceway or standalone application. Accepts four front-loaded outward facing Ortronics® TracJack inserts. Available in fog white (PBB4TJ-FW), white (PBB4TJ-WH), and ivory (PBB4TJ-V).

PBB2S2 Bezel Box

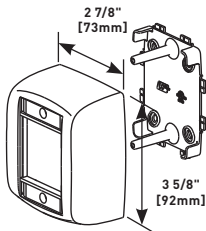

Surface mount box for use with Eclipse Raceway or standalone application. Accepts two front-loaded outward facing Ortronics® Series II inserts. Available in fog white (PBB2S2-FW), white (PBB2S2-WH), and ivory (PBB2S2-V).

400, 800, 2300 & 2300D SERIES™ RACEWAYS

Two-Piece, Single- and Dual-Channel, Low Profile



Two-piece, single- and dual-channel, low profile raceway. Easy-to-install and ideal for power or communication installations.

CODE REFERENCE

cULus Listed Raceway:
File E90378 Guide RJTX.
Complies with flammability requirements of UL-5A.

Fittings:
File E90377 Guide RJYT.
Meets Article 388 of NEC.
UL Listed for up to 600V.
Meets Section 12-1600 of CEC.

400, 800, 2300 & 2300D Series Raceways System Layout

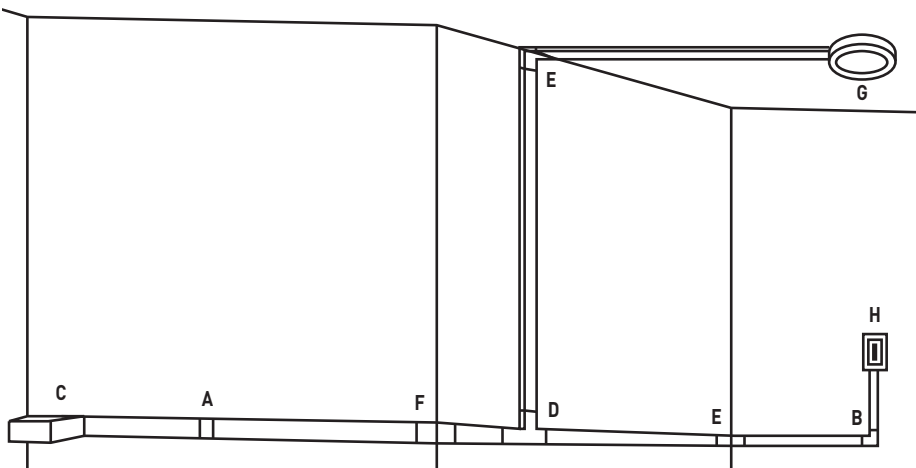

NOTE: Illustration is for showing product applications only.

KEY

- | | |
|---|--|
| A. 406, 806, 2306 Cover Clip | E. 417, 817, 2317, 2317DFO Internal Elbow |
| B. 411, 811, 2311, 2311DFO Flat Elbow Fitting | F. 418, 818, 2318, 2318DFO External Elbow |
| C. 810A2, 2310A, 2310DFO Entrance End Fitting | G. 2337A, 2338A Round Device Boxes |
| D. 415, 815, 2315 Tee | H. 2344, 2347, 2348 Sure-Snap Device Boxes |

COLOR OPTIONS



400, 800, 2300 Series Raceway Part Numbers with a "-WH" suffix have a white finish. Part Numbers without a suffix have an ivory finish. 400, 800, 2300 Series Raceways are paintable using latex paint.

Custom color options are also available. Consult the factory for more information.

400, 800, 2300 & 2300D SERIES™ RACEWAYS

Ordering Information

400 Series Raceway Wire Fill Capacities for Communications

	CABLE/WIRE SIZE	O.D. (Approx. Dia.)		40% FILL
		Inches	[mm]	
UNSHIELDED TWISTED PAIR	4-pair, 24 AWG, Cat 3	0.190	[4.8]	1
	4-pair, 24 AWG, Cat 5e	0.210	[5.3]	1
	4-pair, 24 AWG, Cat 6	0.250	[6.3]	1
	4-pair, 24 AWG, Cat 6a*	0.354	[9.0]	0
	25-pair, 24 AWG	0.410	[10.4]	0
COAXIAL	RG6/U	0.270	[6.9]	0
FIBER	ZipCord	0.118 x 0.236	[3 x 6]	1
	Round 4 Strand Fiber	0.187	[4.8]	1
	Round 6 Strand Fiber	0.256	[6.5]	1

400 Series Raceway Wire Fill Capacities for Power

WIRE SIZE THHN/THWN	O.D.		NO. OF CONDUCTORS
	Inches	[mm]	
14 AWG	0.111	[2.8]	5
12 AWG	0.130	[3.3]	3
10 AWG	0.164	[4.2]	0

NOTE: For additional information, refer to the Technical Section.

* Category 6 augmented (6a) cable for 10 gigabit ethernet – max allowed cable diameter per addenda No. 11 ANSI TIA/EIA 568-B.2.

400BAC Raceway Base and Cover

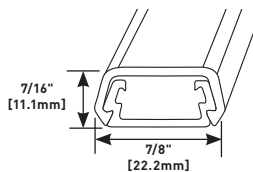

Low-profile, two-piece raceway with durable, textured PVC ivory or white finishes. Available in 5' [1.52m] lengths. Packed 100' [30.5m] per carton. Supplied with wide adhesive tape along its entire length. Also available in white (400BAC-WH).

410B Blank End Fitting

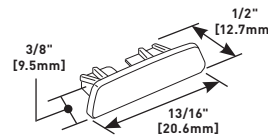

For closing open end of 400BAC Series Raceway. Also available in white (410B-WH).

PVC-1 PVC Raceway Cutter

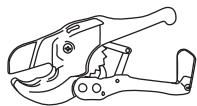

Regular duty cutter. Ideal for use with small nonmetallic raceways.

411 Flat Elbow

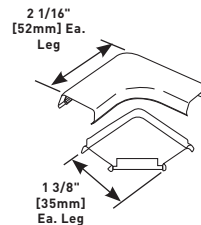

For right angle turns on same surface. Also available in white (411-WH).

400WC Wire Clip

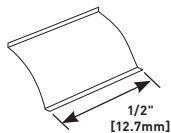

For holding conductors in place.

415 Tee

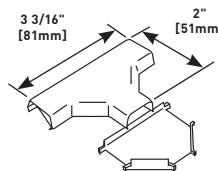

For branching of raceway running at right angles. Also available in white (415-WH).

406 Cover Clip

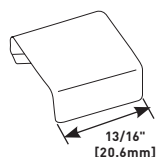

For covering joint where two pieces of 400BAC Series Raceway Cover come together. Also available in white (406-WH).

417 Internal Elbow

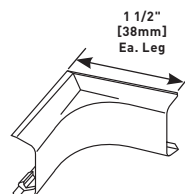

For right angle turns around internal corners. Also available in white (417-WH).

400, 800, 2300 & 2300D SERIES™ RACEWAYS

Ordering Information (continued)

418 External Elbow

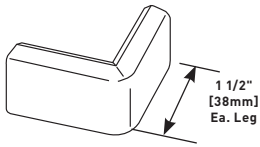

For right angle turns around external corners. Also available in white (418-WH)

810A2 Entrance End Fitting

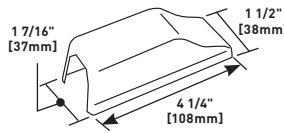

For connecting 400 or 800 Series Raceway with 1/2" trade size conduit or armored cable. 1/2" trade size KO on end and bottom. Also available in white (810A2-WH).

NOTE: Device Boxes for 400 Series Raceway can be found on pages located at the end of this product section.

800 Series Raceway Wire Fill Capacities for Communications

	CABLE/WIRE SIZE	O.D. (Approx. Dia.)		40% FILL
		Inches	[mm]	
UNSHIELDED TWISTED PAIR	4-pair, 24 AWG, Cat 3	0.190	[4.8]	3
	4-pair, 24 AWG, Cat 5e	0.210	[5.3]	3
	4-pair, 24 AWG, Cat 6	0.250	[6.3]	2
	4-pair, 24 AWG, Cat 6a*	0.354	[9.0]	1
	25-pair, 24 AWG	0.410	[10.4]	0
COAXIAL	RG6/U	0.270	[6.9]	1
FIBER	ZipCord	0.118 x 0.236	[3 x 6]	3
	Round 4 Strand Fiber	0.187	[4.8]	3
	Round 6 Strand Fiber	0.256	[6.5]	2

800 Series Raceway Wire Fill Capacities for Power

WIRE SIZE THHN/THWN	O.D.		NO. OF CONDUCTORS
	Inches	[mm]	
14 AWG	0.111	[2.8]	6
12 AWG	0.130	[3.3]	5
10 AWG	0.164	[4.2]	4

NOTE: For additional information, refer to the Technical Section.

* Category 6 augmented (6a) cable for 10 gigabit ethernet – max allowed cable diameter per addenda No. 11 ANSI TIA/EIA 568-B.2.

800BAC Raceway Base & Cover

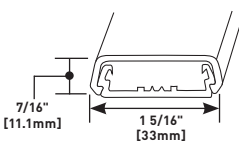

Low-profile, two-piece raceway with durable, textured PVC ivory or white finishes. Available in 5' [1.52m] lengths. Packed 100' [3.05m] per carton. Supplied with wide adhesive tape along its entire length. Also available in white (800BAC-WH).

806 Cover Clip

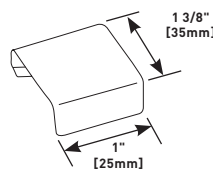

For covering joint where two pieces of 800BAC Series Raceway Cover come together. Also available in white (806-WH).

PVC-1 PVC Raceway Cutter

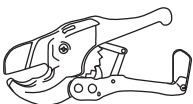

Regular duty cutter. Ideal for use with small nonmetallic raceways.

810A2 Entrance End Fitting

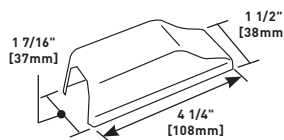

For connecting 400 or 800 Series Raceway with 1/2" trade size conduit or armored cable. 1/2" trade size KO on end and bottom. Also available in white (810A2-WH).

800WC Wire Clip

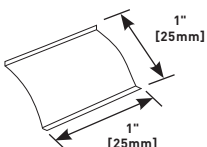

For holding conductors in place.

810B Blank End Fitting

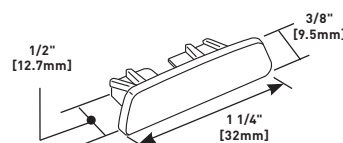

For closing open end of 800BAC Series Raceway. Also available in white (810B-WH).

NOTE: Device Boxes for 800 Series Raceway can be found on pages located at the end of this product section.

400, 800, 2300 & 2300D SERIES™ RACEWAYS

Ordering Information

811 Flat Elbow

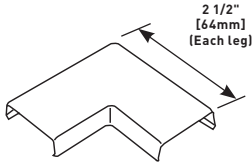

For right angle turns on same surface. Also available in white (811-WH).

818 External Elbow

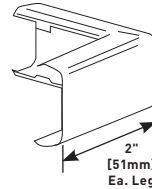

For right angle turns around external corners. Also available in white (818-WH).

815 Tee

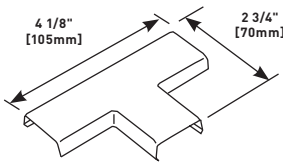

For branching of raceway running at right angles. Also available in white (815-WH).

889A Reducing Connector

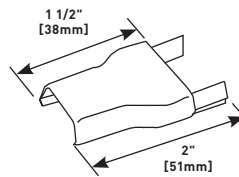

For transitioning from 800 Series Raceway to 400 Series Raceway. Also available in white (889A-WH).

817 Internal Elbow

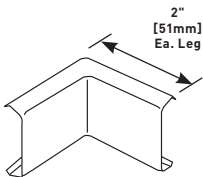

For right angle turns around internal corners. Also available in white (817-WH).

NOTE: Device Boxes for 800 Series Raceway can be found on pages located at the end of this product section.

2300 Series Raceway Wire Fill Capacities for Communications

	CABLE/WIRE SIZE	O.D. (Approx. Dia.)		40% FILL
		Inches	[mm]	
UNSHIELDED TWISTED PAIR	4-pair, 24 AWG, Cat 3	0.190	[4.8]	11
	4-pair, 24 AWG, Cat 5e	0.210	[5.3]	9
	4-pair, 24 AWG, Cat 6	0.250	[6.3]	6
	4-pair, 24 AWG, Cat 6a*	0.354	[9.0]	3
	25-pair, 24 AWG	0.410	[10.4]	2
COAXIAL	RG6/U	0.270	[6.9]	5
FIBER	ZipCord	0.118 x 0.236	[3 x 6]	12
	Round 4 Strand Fiber	0.187	[4.8]	12
	Round 6 Strand Fiber	0.256	[6.5]	6

2300 Series Raceway Wire Fill Capacities for Power

WIRE SIZE THHN/THWN	O.D.		NO. OF CONDUCTORS
	Inches	[mm]	
14 AWG	0.111	[2.8]	15
12 AWG	0.130	[3.3]	12
10 AWG	0.164	[4.2]	12

2300D Series Raceway Wire Fill Capacities for Communications

	CABLE/WIRE SIZE	O.D. (Approx. Dia.)		40% FILL (Ea. Comp.)
		Inches	[mm]	
UNSHIELDED TWISTED PAIR	4-pair, 24 AWG, Cat 3	0.190	[4.8]	5
	4-pair, 24 AWG, Cat 5e	0.210	[5.3]	4
	4-pair, 24 AWG, Cat 6	0.250	[6.3]	3
	4-pair, 24 AWG, Cat 6a*	0.354	[9.0]	1
	25-pair, 24 AWG	0.410	[10.4]	1
COAXIAL	RG6/U	0.270	[6.9]	2
FIBER	ZipCord	0.118 x 0.236	[3 x 6]	6
	Round 4 Strand Fiber	0.187	[4.8]	6
	Round 6 Strand Fiber	0.256	[6.5]	3

2300D Series Raceway Wire Fill Capacities for Power

WIRE SIZE THHN/THWN	O.D.		NO. OF CONDUCTORS (Each Compartment)
	Inches	[mm]	
14 AWG	0.111	[2.8]	12
12 AWG	0.130	[3.3]	8
10 AWG	0.164	[4.2]	5

NOTE: For additional information, refer to the Technical Section.

* Category 6 augmented (6a) cable for 10 gigabit ethernet – max allowed cable diameter per addenda No. 11 ANSI TIA/EIA 568-B.2.

400, 800, 2300 & 2300D SERIES™ RACEWAYS

Ordering Information

2300/2300D Series Raceway Ordering Information

2300BAC Raceway Base and Cover

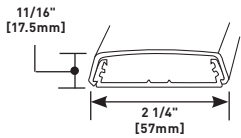

Low-profile, two-piece raceway with durable, textured PVC ivory or white finishes. Available in 5' [1.52m] lengths. Packed 50' [15.2m] per carton. Supplied with wide adhesive tape along its entire length. Also available in white (2300BAC-WH).

2310B Blank End Fitting

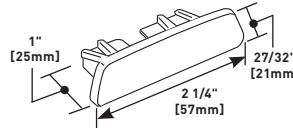

For closing open end of 2300BAC and 2300BACD Series Raceways. Also available in white (2310B-WH).

2300BACD Divided Raceway Base and Cover

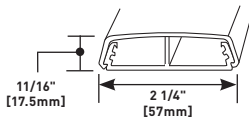

Low-profile, two-piece raceway with durable, textured PVC ivory or white finishes. Available in 5' [1.52m] lengths. Supplied with wide adhesive tape along its entire length. Also available in white (2300BACD-WH).

2311 Flat Elbow

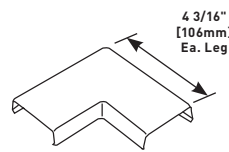

For right angle turns on same surface. Also available in white (2311-WH).

PVC-1 PVC Raceway Cutter

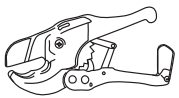

Regular duty cutter. Ideal for use with small nonmetallic raceways.

2315 Tee

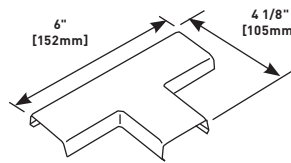

For branching of raceway running at right angles. Also available in white (2315-WH).

2300WC Wire Clip

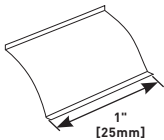

For holding conductors in place.

2317 Internal Elbow

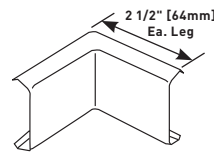

For right angle turns around internal corners. Also available in white (2317-WH).

2306 Cover Clip

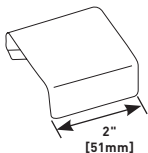

For covering joint where two pieces of 2300BAC and 2300BACD Series Raceway Cover come together. Also available in white (2306-WH).

2318 External Elbow

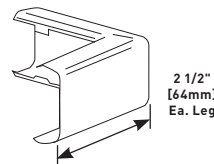

For right angle turns around external corners. Also available in white (2318-WH).

2310A Entrance End Fitting

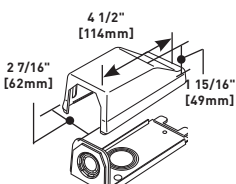

For connecting 2300 Series Raceway with 1/2", 3/4", or 1" trade size conduit or armored cable. 1/2" and 3/4" trade size KO on end, 1/2", 3/4", and 1" trade size KOs on bottom. Also available in white (23120A-WH).

2389 Reducing Connector

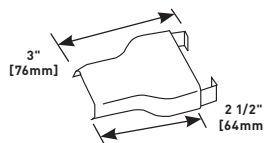

For transitioning from 2300 Series Raceway to 800 Series Raceway. Also available in white (2389-WH).

NOTE: Device Boxes for 2300 and 2300D Series Raceway can be found on the next page of this product section.

400, 800, 2300 & 2300D SERIES™ RACEWAYS

Ordering Information

2389A Reducing Connector

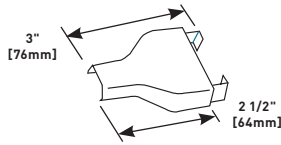

For transitioning from 2300 Series Raceway to 400 Series Raceway. Also available in white (2389A-WH).

2317DFO Radiused Divided Internal Elbow

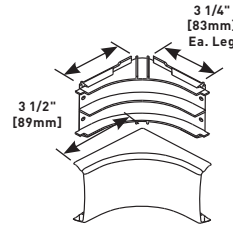

A 90° internal corner with integral dividers provide 2" [51mm] cable bend radius for UTP and fiber optic installations. Also available in white (2317DFO-WH).

2310DFO Radiused Divided Entrance End Fitting

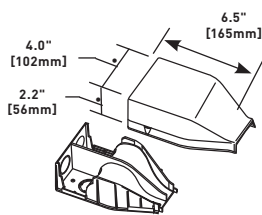

Divided fitting to feed 2300 and 2300 Divided Series Raceway. Includes 1/2", 3/4", and 1" trade size KOs on back and top. Also available in white (2310DFO-WH).

2318DFO Radiused Divided External Elbow

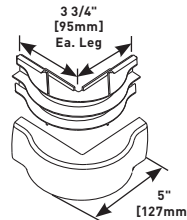

A 90° external corner with integral dividers provide 2" [51mm] cable bend radius for UTP and fiber optic installations. Also available in white (2318DFO-WH).

2311DFO Radiused Divided Flat Elbow

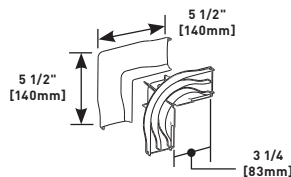

A 90° flat corner with integral dividers provide 2" [51mm] cable bend radius for UTP and fiber optic installations. Also available in white (2311DFO-WH).

400/800/2300/2300D Series Raceway Device Box Ordering Information

2336 Blank Cover

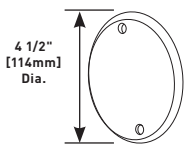

Use with any nonmetallic round device box to convert into a junction box. Also available in white (2336-WH).

2338A Fixture Box

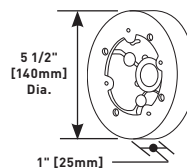

For hanging fixtures, smoke/fire alarms and other security devices with 3 1/2" [89mm] or 4 1/16" [103mm] mounting centers. Has 1/2" trade size KO. Not for use with fans. Also available in white (2338A-WH).

2337A Round Box Extension

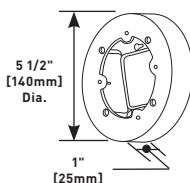

For hanging fixtures, smoke/fire alarms and other security devices with 3 1/2" [89mm] or 4 1/16" [103mm] mounting centers. 5 1/2" [140mm] diameter with open base. Not for use with fans. Also available in white (2337A-WH).

2344, 2344-2 Extra Deep Device Box

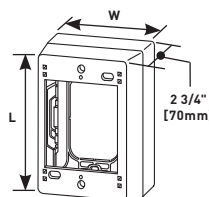

2344 one-gang, 2344-2 two-gang. Two-gang base has rectangular KO to enable extension from existing single-gang flush wallbox and 1/2" and 1" trade size concentric KOs. Accepts industry standard faceplates for switch and communication devices.

CAT. NO.	L	W	GANG
2344	4 3/4" [121mm]	3" [76mm]	1
2344-WH	4 3/4" [121mm]	3" [76mm]	1
2344-2	4 3/4" [121mm]	4 7/8" [124mm]	2
2344-2-WH	4 3/4" [121mm]	4 7/8" [124mm]	2

400, 800, 2300 & 2300D SERIES™ RACEWAYS

Ordering Information

400/800/2300/2300D Series Raceway Device Box Ordering Information

2347, 2347-2 Device Box

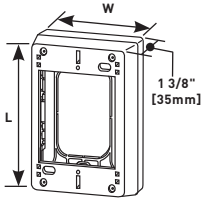

2347 one-gang, 2347-2 two-gang. For standard switches and devices. 2347 Base has rectangular KO. 2347-2 Base has rectangular KO to enable extension from existing flush wall box and 1/2" and 1" concentric KOs. Accepts industry standard faceplates for switch and communication devices.

CAT. NO.	L	W	GANG
2347	4 3/4" [121mm]	3" [76mm]	1
2347-WH	4 3/4" [121mm]	3" [76mm]	1
2347-2	4 3/4" [121mm]	4 7/8" [124mm]	2
2347-2-WH	4 3/4" [121mm]	4 7/8" [124mm]	2

2348, 2348-2, 2348-3 Deep Device Box

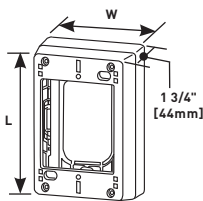

2348 one-gang, 2348-2 two-gang, 2348-3 three-gang. For deeper switches and devices. 2348 Base has rectangular KO. 2348-2 and 2348-3 Bases have rectangular KO to enable extension from existing flush wall box and 1/2" and 1" concentric KOs. Accepts industry standard faceplates for switch and communication devices.

CAT. NO.	L	W	GANG
2348	4 3/4" [121mm]	3" [76mm]	1
2348-WH	4 3/4" [121mm]	3" [76mm]	1
2348-2	4 3/4" [121mm]	4 7/8" [124mm]	2
2348-2-WH	4 3/4" [121mm]	4 7/8" [124mm]	2
2348-3	4 3/4" [121mm]	7" [178mm]	3
2348-3-WH	4 3/4" [121mm]	7" [178mm]	3

2348S/51 Shallow Device Box/Extension Box

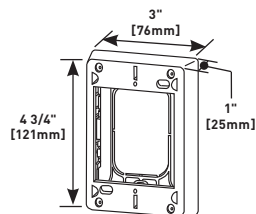

For shallow switches and receptacles. Base has rectangular KO. Also available in white [2348S/51-WH].

2348AMP Magnetic Deep Device Box (with Grommet)

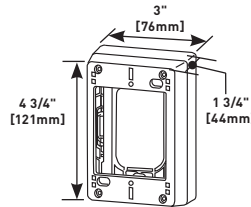

For deeper switches and devices, and has magnetic backing. Base has rectangular KO. Also available in white [2348AMP-WH].

2348D Device Box

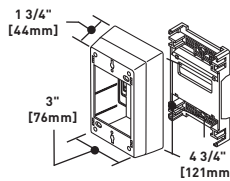

For use with 2300D Series Divided Raceway. For mounting standard switches, receptacles, and industry standard faceplates for communication devices. Also available in white [2348D-WH].

2344D Extra Deep Device Box

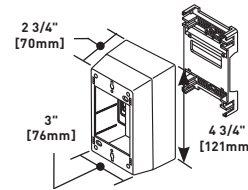

For use with 2300D Series Divided Raceway when additional depth is required. For mounting standard switches, receptacles and industry standard faceplates for communication devices. Also available in white [2344D-WH].

2344SD-2A Two-Gang Deep Divided Device Box

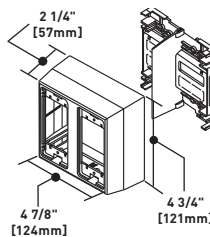

Divided two-gang box for use with 2300D Series Divided Raceway. Provides the ability to have both power and low voltage at a single point of use. Utilizes 5507 Series™ faceplates, as well as Wiremold Open System communication modules, Ortronics® TracJack, Series II, and Pass & Seymour® Activate Series inserts. For faceplate options, see 5507 Series™ Faceplates. Also available in white [2344SD-2A-WH].

NOTE: CM-EPLA End Plates are required when using Wiremold CM2 communication modules and Pass & Seymour® Activate inserts. S2-EPL End Plates are required when using Ortronics® Series II inserts. To mount TracJack modules, use 55074TJ or 55076TJ Faceplates.

400, 800, 2300 & 2300D SERIES™ RACEWAYS

Ordering Information

400/800/2300 Series Raceway Device Box Ordering Information

CM-MMB-231 One Insert Multimedia Box

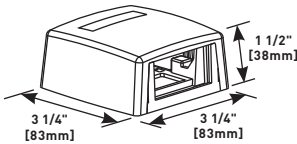

Accepts one CM2 size Wiremold Open System communication module or Pass & Seymour® Activate Series insert. Compatible with Wiremold 400 and 800 Series Raceways. Also available in white (CM-MMB-231-WH).

CM-MMB-233 Three Insert Multimedia Box

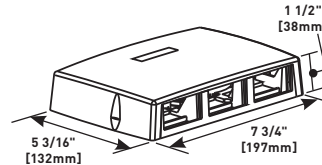

Fiber storage loop. Accepts three CM2 size Wiremold Open System communication modules or Pass & Seymour® Activate Series inserts. Compatible with Wiremold 400, 800, and 2300 Series Raceways. Also available in white (CM-MMB-233-WH)

CM-MMB-232 Two Insert Multimedia Box

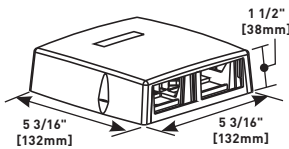

Fiber storage loop. Accepts two CM2 size Wiremold Open System communication modules or Pass & Seymour® Activate Series inserts. Compatible with Wiremold 400, 800, and 2300 Series Raceways. Also available in white (CM-MMB-232-WH)

400/800/2300 Series Raceway Interconnectivity Fittings

CONNECTION REQUIRED		USE CATALOG NUMBER
FROM	TO	
800 Series Raceway	400 Series Raceway	889A
2300 Series Raceway	400 Series Raceway	2389A
2300 Series Raceway	800 Series Raceway	2389
Existing Outlet	400, 800, 2300 Series Raceways	2348S/51
1/2" Trade Size Conduit	400, 800 Series Raceways	810A2
1/2" or 3/4" Trade Size Conduit	2300 Series Raceway	2310A
3" [76mm] or 4" [102mm] Ceiling Boxes	400, 800, 2300 Series Raceways	2337A

400, 800, 2300 & 2300D SERIES™ RACEWAYS

Installation Details

400, 800, 2300 Series Raceways Installation Details

- Bring in and connect feed wires using approved connection method. Assemble raceway cover to butt against the fitting base. Snap fitting cover onto base.

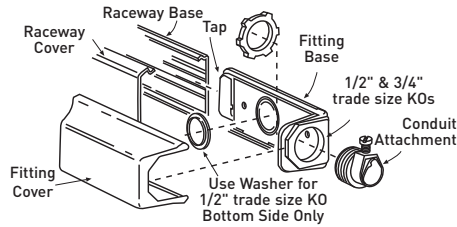

Install Base: 400BAC, 800BAC, 2300BAC

The adhesive on the 400BAC, 800BAC, 2300BAC and 2300BACD is intended to be used as an installation aid for positioning the product. Applications with power wire, screw fasteners must be used in addition to the adhesive. Applications with communication cable only, screw fasteners are recommended in addition to the adhesive.

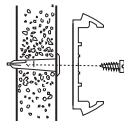

For low-voltage applications – 400BAC can be mounted with adhesive only (screw fasteners may be required depending on the cable quantity and size); 800BAC and 2300BAC require screw fasteners at 18" [457mm] intervals in addition to the adhesive.

Peel release paper from adhesive strip and mount immediately to surface. Adhesive-backed raceway should be mounted to a clean, dry, grease-free, smooth surface. Apply pressure along entire raceway base to insure proper adhesion.

2. To install runs of raceway cover:

Measure distance from fitting to fitting. Cut required length of cover. When two raceway sections butt together, cover sections should span base joints for maximum rigidity. When two raceway cover sections butt together, use cover clip as shown (406/806/2306).

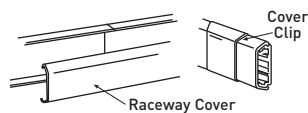

3. Notching for Tee:

- Make two cuts on side of base to be notched. Notch to equal width of base. Break clean with pliers.
- Butt 400BAC Raceway Base to base of 415 Tee. Screw tee fitting base to wall. Cut 400BAC Raceway Cover 3/8" [9.5mm] shorter than base. Snap on 415 Tee.

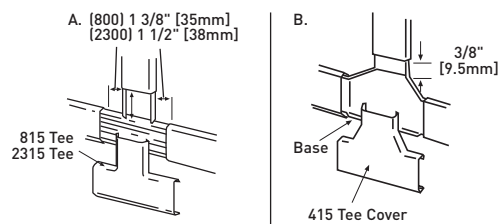

4. Notching for External Elbow:

- Cut side of base to be notched.
- Break clean with pliers.

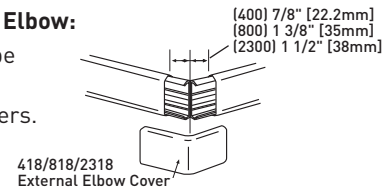

5. Notching for Flat Elbow:

- Cut side of base to be notched. Notch to equal width of base. Break clean with pliers.

- Butt 400BAC Raceway Base to base of 411 Flat Elbow. Screw flat elbow base to wall. Cut 400BAC Raceway Cover 3/8" [9.5mm] shorter than base. Snap on 411 Flat Elbow Cover.

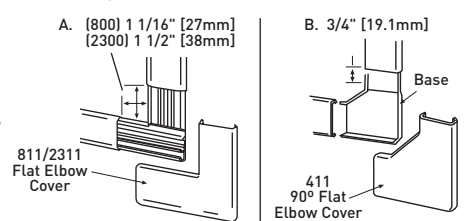

6. Notching for Internal Elbow:

- Cut side of base to be notched.
- Break clean with pliers.

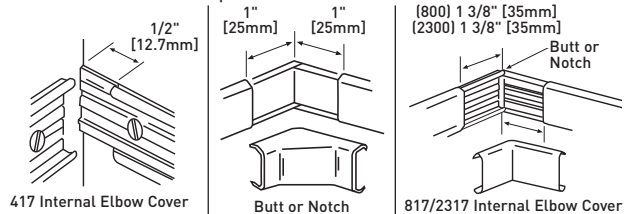

7. All Sure-Snap® device boxes are packaged unassembled for easy installation.

During shipment the base and cover pieces may snap together. To unsnap the cover from base, place the blade of a screwdriver into the locking tab (Figure 1). Push downward and gently pry the cover from the base. Repeat at each corner if necessary.

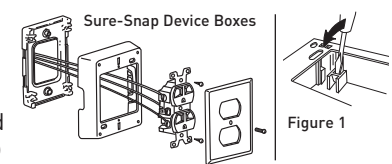

- Mount the cover to the base by aligning key on the inside of the cover with one of the grooves on the base. Assemble with four screws. (Tap screws to seat.)

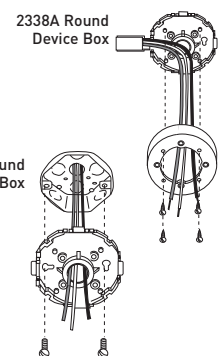

- Pull wiring through the center knockout and attach the base directly to in-ceiling box.

ACCESS[®] 5000 RACEWAY

Baseboard Molding



Attractive baseboard molding that organizes and conceals electrical wiring and communications cabling.

CODE REFERENCE

cULus Listed Raceway:
File E90378 Guide RJTX.
Complies with flammability requirements of UL-5A.

Fittings: File E90377 Guide RJYT.
Meets Article 388 of NEC.
UL Listed for up to 600V.
Meets Section 12-1600 of CEC.

Access 5000 Series Raceway System Layout

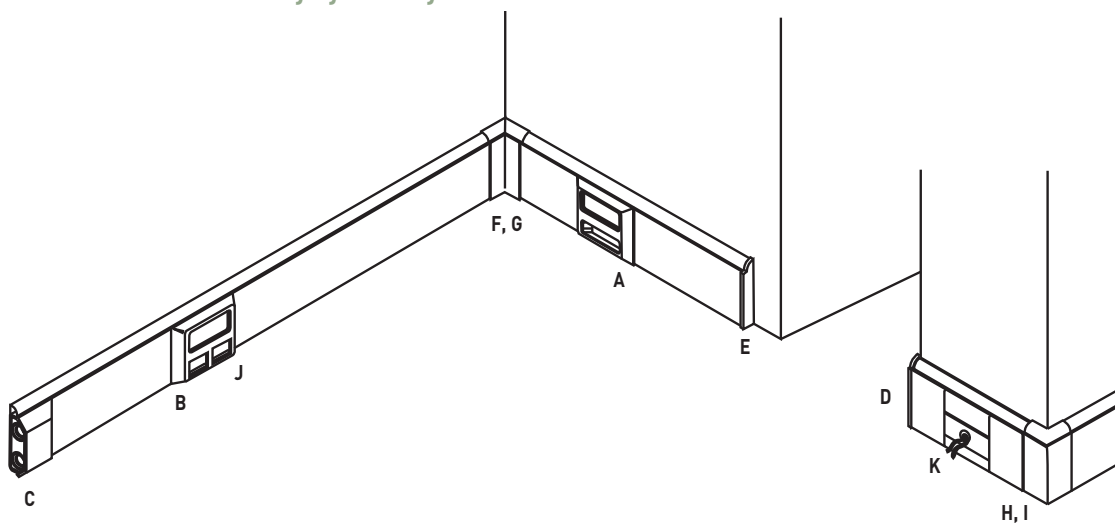

NOTE: Illustration is for showing product applications only.

KEY

- | | | |
|---|-------------------------------|--|
| A. 5007C-1A Device Bracket | E. 5010R Right End Cap | I. 5018C External Cover Elbow |
| B. 5007C-2AB/5007C-2RT
Deep Device Bracket | F. 5017B Internal Base Elbow | J. CM2, Series II, TracJack
Communication Devices |
| C. 5010A Entrance End Feed | G. 5017C Internal Cover Elbow | K. Back Feed Position |
| D. 5010L Left End Cap | H. 5018B External Base Elbow | |

COLOR OPTIONS



Access[®] 5000 Series Raceway Part Numbers with a "WH" suffix are available with a white PVC finish. Part Numbers with a "BK" suffix are available with a black PVC finish. Part Numbers with a "GY" suffix are available with a gray PVC finish. Part Numbers with a "W" suffix are available in a real maple veneer finish. Part Numbers with a "OA" suffix are available with a real oak veneer finish.

Custom color options are also available. Consult the factory for more information.

ACCESS® 5000 RACEWAY

Ordering Information

Access 5000 Series Raceway Wire Fill Capacities for Communications

	CABLE/WIRE SIZE	O.D. (Approx. Dia.)		TOP COMP. 40% FILL	BOTTOM COMP. 40% FILL
		Inches	[mm]		
UNSHIELDED TWISTED PAIR	4-pair, 24 AWG, Cat 3	0.190	[4.8]	27	19
	4-pair, 24 AWG, Cat 5e	0.210	[5.3]	22	16
	4-pair, 24 AWG, Cat 6	0.250	[6.3]	15	11
	4-pair, 24 AWG, Cat 6a*	0.354	[9.0]	7	5
	25-pair, 24 AWG	0.410	[10.4]	5	4
COAXIAL	RG6/U	0.270	[6.9]	13	9
FIBER	ZipCord	0.118 x 0.236	[3 x 6]	27	20
	Round 4 Strand Fiber	0.187	[4.8]	28	20
	Round 6 Strand Fiber	0.256	[6.5]	15	10

Access 5000 Series Raceway Wire Fill Capacities for Power

WIRE SIZE THHN/THWN	O.D.		NO. OF CONDUCTORS TOP COMPARTMENT
	Inches	[mm]	
14 AWG	0.111	[2.8]	24
12 AWG	0.130	[3.3]	20
10 AWG	0.164	[4.2]	12

NOTE: For additional information, refer to the Technical Section.

* Category 6 augmented (6a) cable for 10 gigabit ethernet – max allowed cable diameter per addenda No. 11 ANSI TIA/EIA 568-B.2.

5000B Raceway Base

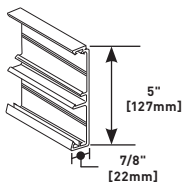

5000B Base has an integral divider forming two channels for power and low-voltage separation. Base supplied in 8' [2.44m] lengths, packed 80' [24.4m] per carton. (Base is not visible in a typical finished installation.)

5006 Cover Clip

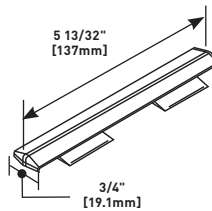

For covering joint where two pieces of Access 5000 Series Raceway Cover come together. Available in white (5006WH), black (5006BK), or gray (5006GY) PVC finishes.

5000C Raceway Cover

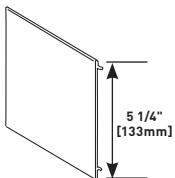

5000C Cover is available standard in white (5000CWH), black (5000CBK), or gray (5000CGY) PVC or maple (5000CW) and oak (5000COA) veneer finishes. Covers supplied in 8' [2.44m] lengths.

5006A Internal Wire Guard

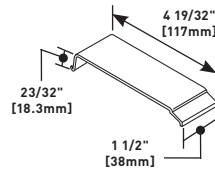

Use inside the base. Protects inside wires and cables from gaps behind butted cover sections. Installed when the 5006 Cover Clips are not used.

5000T Quarter-Round Trim

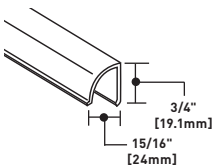

Trim Cover available in white (5000TWH), black (5000TBK), or gray (5000TGY) PVC or maple (5000TW) and oak (5000TOA) veneer finishes. Trim covers supplied in 8' [2.44m] lengths.

5010A Entrance End Fitting

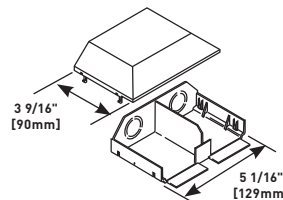

Used to connect Access 5000 to 1/2" or 3/4" trade size conduit. Has one 1/2" or 3/4" concentric KO for both channels in end only. Available in white (5010AWH), black (5010ABK), or gray (5010AGY) PVC finishes.

Overall Assembled Depth is 1 15/16" [49mm].

5001 Base Coupling

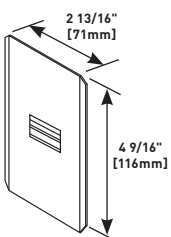

Use for aligning base sections.

5010R Right End Cap

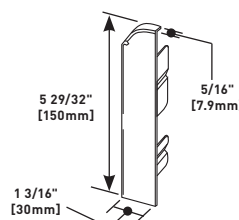

For closing right end of Access 5000 Series Raceway Base. Available in white (5010RWH), black (5010RBK), or gray (5010RGY) PVC finishes.

ACCESS® 5000 RACEWAY

Ordering Information

5010L Left End Cap

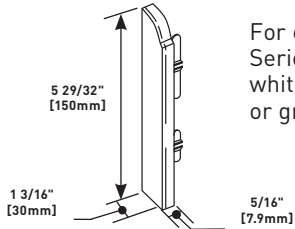

For closing left end of Access 5000 Series Raceway Base. Available in white (5010LWH), black (5010LBK), or gray (5010LGY) PVC finishes.

5018C External Cover Elbow

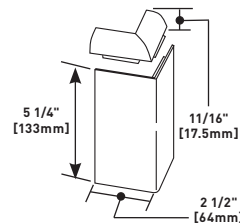

For mounting cover and trim cover at 90° external corners. Available in white (5018CWH), black (5018CBK), or gray (5018CGY) PVC finishes.

5017B Internal Elbow Base

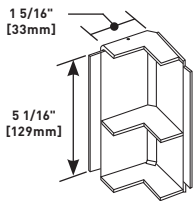

For mounting base at 90° internal corners.

5018WG External Elbow Wire Guard

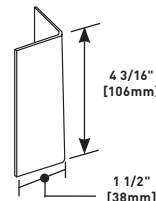

Installs at a mitered external elbow joint behind the covers to protect sharp objects from being inserted. Not needed when the external cover elbow is used.

5017C Internal Elbow Cover

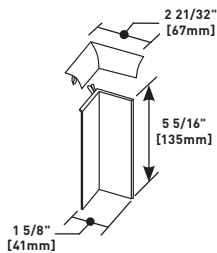

For mounting cover and trim cover at 90° internal corners. Available in white (5017CWH), black (5017CBK), or gray (5017CGY) PVC finishes.

5007C-1A Device Plate

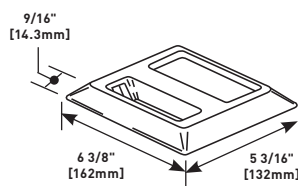

External device cover; for mounting one standard device and up to two communication connections. Available in white (5007C-1AWH), black (5007C-1ABK), or gray (5007C-1AGY) PVC finishes.

For faceplate options, see 5507 Series™ Faceplates. (For power side only.)

5017WG Internal Elbow Wire Guard

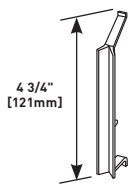

Protects wiring at mitered internal cover; snaps into 5017B Base Elbow. Not needed when 5017C Internal Cover Elbow is used.

5007C-2AB Deep Device Plate

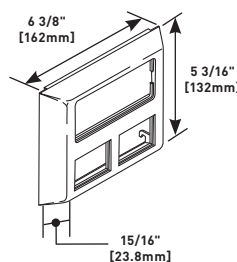

For mounting deeper devices such as TVSS receptacles, GFCI devices, and Pass & Seymour® Activate inserts. Accepts 5507 Series™ Faceplates, 2A size Activate inserts, and Open System communication modules. Bezels included. Available in white (5007C-2ABWH), black (5007C-2ABBK), or gray (5007C-2ABGY) PVC finishes.

For faceplate options, see 5507 Series™ Faceplates.

5018B External Base Elbow

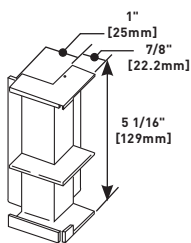

For mounting base at 90° external corners.

ACCESS[®] 5000 RACEWAY

Ordering Information

5007C-2RT Deep Device Plate

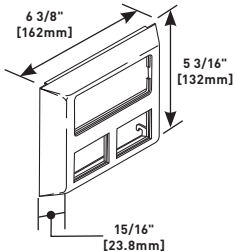

For mounting deeper devices such as TVSS receptacles, GFCI devices, and Pass & Seymour[®] Activate inserts. Accepts 5507 Series[™] Faceplates, Ortronics[®] TracJack, and Series II Inserts. Bezels included. Available in white (5007C-2RTWH), black (5007C-2RTBK), or gray (5007C-2RTGY) PVC finishes.

For faceplate options, see 5507 Series[™] Faceplates.

5004 Blank/Coax Adapter

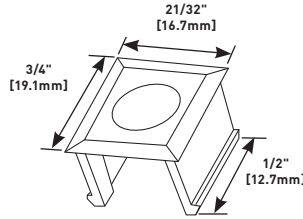

For use as a blank; has KO to accept an "F" type coax connector. Snaps into low-voltage slots on device plates. For use with 5007C-1AXX only. Available in white (5004WH), black (5004BK) and gray (5004GY) PVC or maple (5004W) or oak (5004OA) veneer finishes.

5007C Electrical Device Bracket

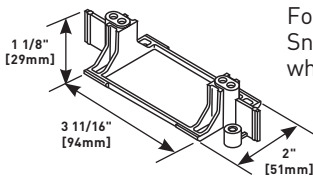

For mounting standard devices. Snaps into top section of base wherever an outlet is needed.

2700WC, 2800WC, 2900WC Wire Clip

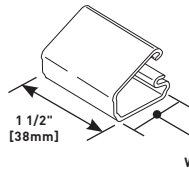

Holds and secures wiring and cabling inside raceway. Mounts with adhesive backing. 2700WC is used for small bundles. 2800WC is used for bigger bundles. 2900WC is used for larger bundles in the top section only.

CAT. NO.	WIDTH	
	Inches	mm
2700WC	3/4"	[19.1]
2800WC	1"	[25]
2900WC	1 1/2"	[38]

5005 Low-Voltage Blank Plate

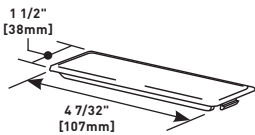

Blanks entire low-voltage recess in device plate. For use with 5007C-1AXX only. Available in white (5005WH), black (5005BK), or gray (5005GY) PVC finishes.

ACCESS® 5000 RACEWAY

Installation Details

Access 5000 Series Raceways Installation Details

1. For Corners Using Molded Fittings:

Corners must be 90 degrees to ensure proper installation. The 5018B External Base Elbow and 5018C External Cover Elbow are installed as shown. Butt the 5000B Base against the 5018B Fitting Shoulder before mounting. The 5000C is snapped in place, aligning both with the 5018B fitting shoulder. The 5018C External Cover Elbow is installed by engaging the right-hand side of the cover with the 5018B Base and sliding until the left side top and bottom snap in. The 5018C External Cover Elbow is then snapped in place overlapping the 5000T Trim Covers and interlocking under the 5018C External Cover.

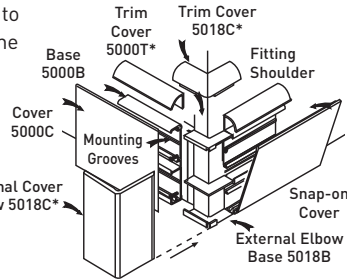

2. For Mitered Corners:

The 5018WG External Elbow Wire Guard is installed as shown inside the 5018B External Base Elbow when the covers are mitered instead of using the 5018C External Cover Elbow. It is recommended that the covers be mitered first and fitted before cutting to proper length to minimize waste. For ease of installation, the covers should be installed starting at the mitered corners. As with the corner fittings, install the 5000T Trim Cover first, then snap the 5000C Covers in place.

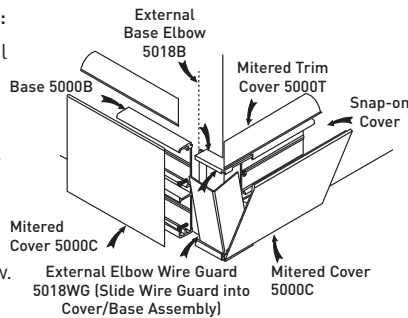

3. This illustration shows an example of a back feed using a nonmetallic sheathed cable. Punch or drill up to 3/4" trade size hole in the top compartment for feeding power or communication wiring. Make sure to allow space between the bottom of the 5000B Base if on a subfloor to allow for the finished floor or carpeting.

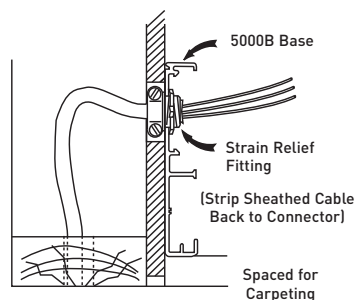

NOTE: If baseboard 5000 is to be used without trim covers (5000T), cover (5000C) should be mitered.

4. The 5006 Cover Clip is installed between two covers to hide an uneven joint. Snap one cover onto the Base, slide the 5006 Cover Clip over the end of the other cover, butt up against the installed cover and snap into place.

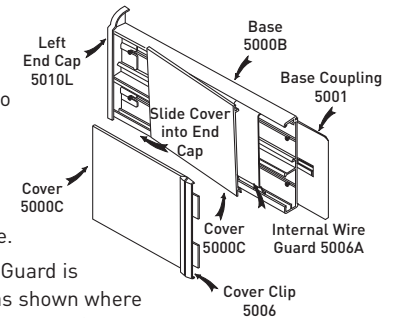

The 5006A Internal Wire Guard is used behind the covers as shown where two pieces of cover butt together instead of using the 5006 Cover Clip. This option is primarily used when a wood veneer finish is used and the look of an exposed cover clip is not wanted.

A 5010L or 5010R Left or Right End Cap is installed as shown at the end of a base run before mounting. The 5000T Trim Cover and the 5000C Cover are installed by partially snapping them in place onto the 5000B Base, installing the 5000T first, and sliding them to the end of the end caps. The rest of the cover is then snapped progressively onto the base.

An optional 5001 Base Coupling can be installed as shown to assist alignment when butting two 5000B Bases together.

5. For Corners Using Molded Fittings:

Corners must be 90° to ensure proper installation. The 5017B Internal Base Elbow is installed as shown, using a spacing shim to allow for the finished floor. The 5000B Base butts up to the 5017B Base Elbow at shoulder before mounting. The 5000T Trim Cover is installed first, then the 5000C Cover is snapped in place aligning both with the 5017B Base Elbow. The 5017C Internal Elbow Cover Trim is snapped in place, overlapping the 5000T Trim Cover pieces. The 5017C Internal Elbow Cover is then snapped onto the 5017B Base Elbow, overlapping the 5000C Cover pieces. The locking tab on the 5017C Cover Elbow will snap into slots in the back of the 5017B Base Elbow.

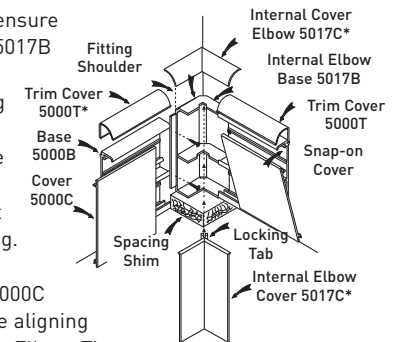

ACCESS® 5000 RACEWAY

Installation Details

Access 5000 Series Raceways Installation Details (continued)

6. For Mitered Corners:

The 5017WG Internal Elbow Wire Guard is snapped into the 5017B Base Elbow when the covers are mitered instead of using the 5017C Cover Elbow.

It is recommended that the covers be mitered and fitted first before cutting to proper length to minimize waste. For ease of installation the covers should be installed starting at the mitered corners. As with the corner fittings, install the 5000T Trim Covers first and then snap the 5000C Covers in place.

NOTE: If baseboard 5000 is to be used without trim covers (5000T), cover (5000C) should be mitered and assembled as shown.

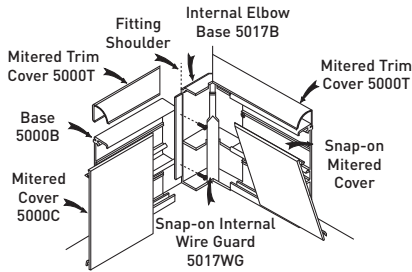

9. The 5007C-1A Device Plate assembles by engaging the hooks on back side of device plate to the bottom lip on the 5000B Base and rotating toward wall. Secure to base using 5507D or 5507R Faceplate. This illustration shows the procedure for installing the 5000T Trim Cover. For deep devices such as GFCI and surge receptacles, or the use of Wiremold Open System communication modules and Pass & Seymour® Activate Series inserts, the 5007C-2A should be used. For Ortronics® Series II or Ortronics® TracJack inserts, the 5507C-2R7 should be used.

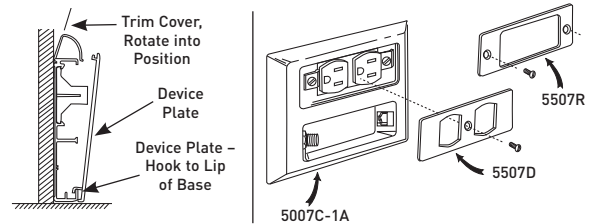

7. The illustration shows a typical installation of a duplex outlet in the top compartment and a telephone and coax connection in the lower compartment.

To install an outlet in the top compartment, a 5007C Device Bracket must be installed. The raceway will accommodate a device up to 1 1/16" [27mm] in depth. A 5507R Rectangular Faceplate can be used instead of the 5507D Faceplate to accommodate decorative type devices.

The 2900WC, 2800WC, and 2700WC Wire Clips are used to hold wires and cables within the raceway. Remove the adhesive and mount to the 5000B Base. Suggested spacing between wire clips is 48" [14.6m].

The 5000C Cover is to butt up against the tabs on the 5007C Device Brackets as shown.

The 5007C-1A Device Plate accommodates up to two RJ11 or RJ45 voice or data connectors in the lower compartment. The 5004 Blank/Coax Adapter is used as a blank when only one opening is needed or to adapt an "F" type coax connector. This is done by knocking out the center of the adapter which accepts the "F" connector. The wires are then connected to the 5007C-1A assembly. If no low-voltage connections are needed, the 5005 Blank Plate is used to cover the openings. The 5007C-1A assembly is then mounted to the 5000B Base.

8. The 5007C Device Bracket is installed as shown. Insert the bracket in the top compartment, place the blade of a screwdriver on the left bottom tab of the bracket and strike with a hammer. Repeat on the right side. 5007C Device Brackets are mounted anywhere a device is needed, in upper compartment only.

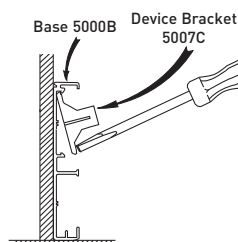

10. Use 5007C-2AB/5007C-2RT for deep devices such as Ground Fault Circuit Interrupters, Surge Protection Outlets and/or communication devices, and may be utilized in the Wiremold Access 5000 Raceway System using this 5007C-2AB/5007C-2RT Deep Device Plate.

Twist off the two spacers attached to the 5007C Device Bracket. Snap the 5007C Device Bracket into the base channel provided. Assemble the device to the device bracket, utilizing the spacers. Assemble the deep device plate to the raceway base. Engage the hooks, located next to the double window opening, to the lower (large) lip of the raceway base. Rotate the device plate toward the wall snapping it into place. Assemble the desired 5507 Faceplate with Wiremold Open System communication modules, Ortronics® TracJack and Series II inserts, or Pass & Seymour® Activate Series inserts.

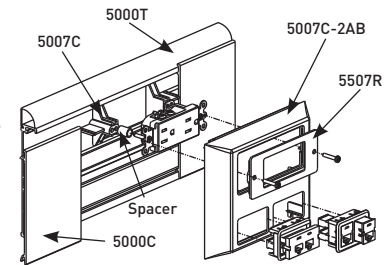

11. The 5010A Entrance End Feed provides an end feed to Access 5000 Raceway with 1/2" or 3/4" trade size conduit. Install with side walls of the fitting base and raceway base aligned.

Access 5000 Raceway installed at baseboard level should be spaced a minimum of 1/8" [3.2mm] above the floor level. This will facilitate the assembly/disassembly of the end fitting cover.

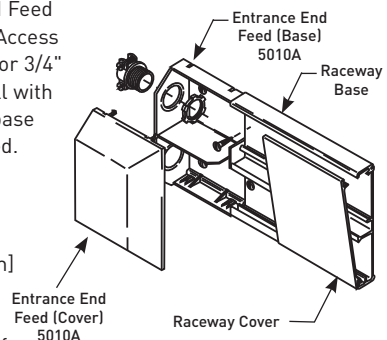

CABLESMART® 40N2 SERIES RACEWAY

Two-Piece, Dual-Channel, Large



Two-piece, dual-channel, large raceway. Lightweight and easy-to-install. Ideal for both power and communication installations.

CODE REFERENCE

cULus Listed Raceway:
File E90378 Guide RJTX.
Complies with flammability requirements of UL-5A.

Fittings: File E90377 Guide RJYT.
Meets Article 388 of NEC.
UL Listed for up to 600V.
Meets Section 12-1600 of CEC.

CableSmart 40N2 Series Raceway System Layout

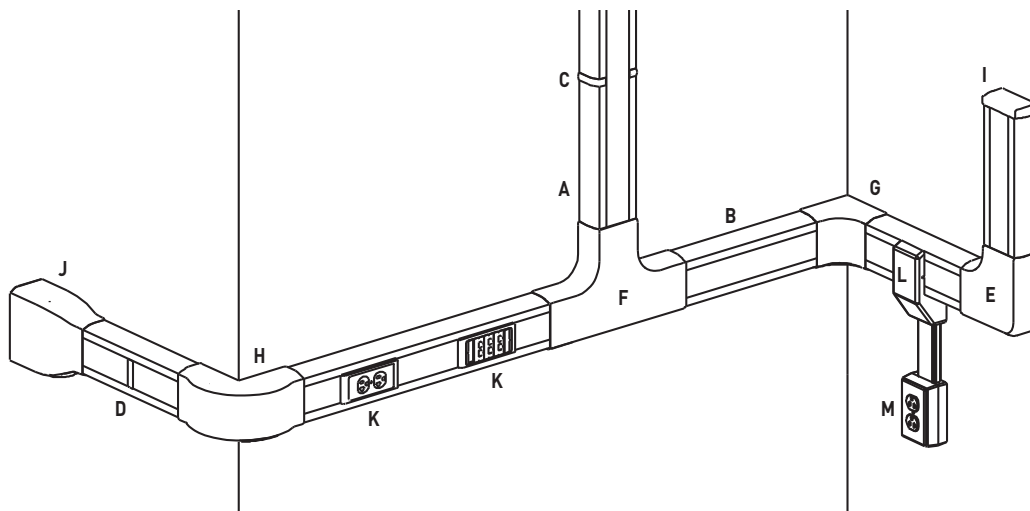

NOTE: Illustration is for showing product applications only.

KEY

- | | | |
|-----------------------------------|---------------------------------------|---|
| A. 40N2B08 Raceway Base | F. 40N2F15 Bend Radius Tee | J. 40N2F21 Divided Entrance End Fitting |
| B. 40N2C08 Raceway Cover | G. 40N2F17 Bend Radius Internal Elbow | K. 40N2F31 Twin Cover Device Bracket |
| C. 40N2F05 Base Clip | H. 40N2F19 Bend Radius External Elbow | L. 40N2F74 Divided Transition Fitting |
| D. 40N2F06 Cover Clip | I. 40N2F20 Blank End Fitting | M. PSB1 One-Gang Device Box |
| E. 40N2F11 Bend Radius Flat Elbow | | |

COLOR OPTIONS



Cablesmart® 40N2 Series Raceway Part Numbers with a "V" suffix are available in an ivory finish. Part Numbers with a "WH" suffix have a white finish. 40N2 Series Raceway is paintable using latex paint or stain.

Custom color options are also available. Consult the factory for more information.

CABLESMART® 40N2 SERIES RACEWAY

Ordering Information

40N2 Series Raceway Wire Fill Capacities for Communications

	CABLE/WIRE SIZE	O.D. (Approx. Dia.)		SECTION C 40% FILL	SECTION D 40% FILL
		Inches	[mm]		
UNSHIELDED TWISTED PAIR	4-pair, 24 AWG, Cat 3	0.190	[4.8]	45	24
	4-pair, 24 AWG, Cat 5e	0.210	[5.3]	37	19
	4-pair, 24 AWG, Cat 6	0.250	[6.3]	26	13
	4-pair, 24 AWG, Cat 6a**	0.354	[9.0]	13	6
	25-pair, 24 AWG	0.410	[10.4]	9	5
COAXIAL	RG6/U	0.270	[6.9]	22	11
FIBER	ZipCord	0.118 x 0.236	[3 x 6]	103	55
	Round 4 Strand Fiber	0.187	[4.8]	46	24
	Round 6 Strand Fiber	0.256	[6.5]	25	13

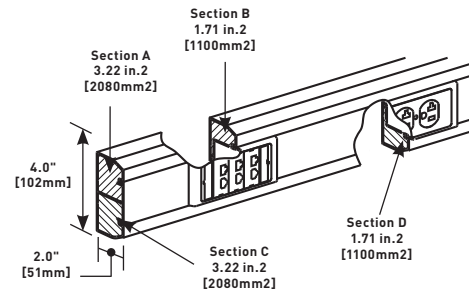

NOTE: For additional information, refer to the Technical Section.

* 40% fill is the maximum designed cable fill based on TIA/EIA 569-A.

** Category 6 augmented (6a) cable for 10 gigabit ethernet – max allowed cable diameter per addenda No. 11 ANSI TIA/EIA 568-B.2.

40N2 Series Raceway Wire Fill Capacities for Power

WIRE SIZE THHN/THWN	O.D. (Approx. Dia.)		NUMBER OF COMPARTMENTS		MAX NUMBER OF CONDUCTORS BOTH COMPARTMENTS
	Inches	[]	COMP. A	COMP. B	
14 AWG	0.111	[2.8]	20	20	28
12 AWG	0.130	[3.3]	18	18	36
10 AWG	0.164	[4.2]	17	17	24
8 AWG	0.216	[5.5]	5	15	20
6 AWG	0.254	[6.5]	5	5	10

40N2B08 Two-Compartment Raceway Base

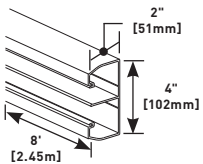

Two equal compartments. Use with 40N2 Cover only. Available in 8' [2.4m] lengths with pre-punched mounting holes, packed 48' [14.6m] per carton. Available in ivory (40N2B08V) or white (40N2B08WH).

40N2C08 Full Width Raceway Cover

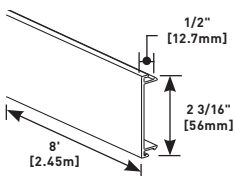

Use with 40N2B08 Base. Available in 8' [2.4m] lengths, packed 48' [14.6m] per carton. Available in ivory (40N2C08V) or white (40N2C08WH).

40N2FWC Wire Clip

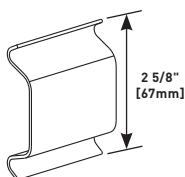

Used to retain cables in raceway during installation.

40N2F05 Base Clip

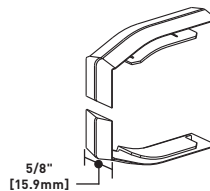

Covers seams between sections of 40N2B08 Raceway Base. Available in ivory (40N2F05V) or white (40N2F05WH).

40N2F06 Cover Clip

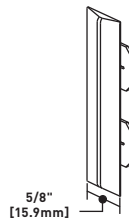

Covers seams between sections of 40N2C08 Raceway Cover. Available in ivory (40N2F06V) or white (40N2F06WH).

CABLESMART® 40N2 SERIES RACEWAY

Ordering Information

Cablesmart 40N2 Series Raceway Interconnectivity Fittings

CONNECTION REQUIRED FROM	TO	USE CATALOG NUMBER
1/2" or 3/4" trade size Conduit	40N2 Series Raceway	40N2F20
3/4", 1", 1 1/4" & 1 1/2" trade size conduit or armored cable	40N2 Series Raceway	40N2F21
40N2 Series Raceway	PN03, PN05, PN10 Series Raceways	40N2F74

40N2F11 Radiused Full Capacity Flat Elbow

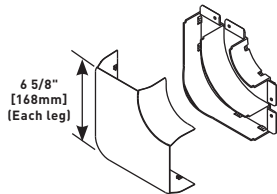

A 90° flat corner with integral dividers to provide 2" [51mm] cable bend radius for UTP and fiber optic installations. Ideal for lay-in or pull-through installations. Available in ivory (40N2F11V) or white (40N2F11WH).

40N2F20 Blank End Fitting

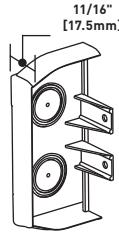

Closes off raceway end runs. Can be used to feed raceway using 1/2" or 3/4" trade size conduit. Holes for conduit must be drilled. Use a step drill or other means. Available in ivory (40N2F20V) or white (40N2F20WH).

40N2F21 Divided Entrance End Fitting

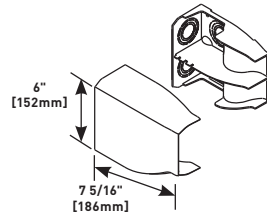

FiberReady divided fitting to feed 40N2 Series Raceway. Includes 3/4", 1", 1 1/4", and 1 1/2" trade size KOs on back and top. Available in ivory (40N2F21V) or white (40N2F21WH).

40N2F15 Radiused Full Capacity Tee

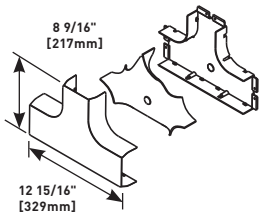

For branches at right angles. A full capacity tee fitting that provides separation of services and 2" [51mm] cable bend radius for UTP and fiber optic installations. Available in ivory (40N2F15V) or white (40N2F15WH).

40N2F31 Twin Cover Device Bracket

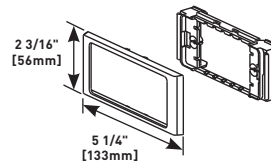

Used for power or communications devices in a single compartment. Accepts 5507 Series™ Faceplates. For use with Ortronics® TracJack Individual Jack System, Ortronics® Series II Front-Loading, Module System

Wiremold Open System Communication Modules. Available in ivory (40N2F31V) or white (40N2F31WH).

NOTE: CM-EPLA End Plates are required when using Wiremold communication modules and Pass & Seymour® inserts. S2-EPL End Plates are required when using Ortronics® Series II inserts. To mount TracJack inserts, use 5507-4TJ or 5507-6TJ Faceplates.

40N2F17 Radiused Full Capacity Internal Elbow

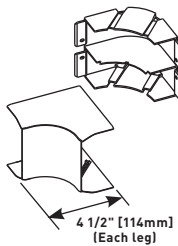

A 90° internal corner with integral dividers to provide 2" [51mm] cable bend radius for UTP and fiber optic installations. Ideal for lay-in or pull-through installations. Available in ivory (40N2F17V) or white (40N2F17WH).

40N2F55 High Capacity Device Box

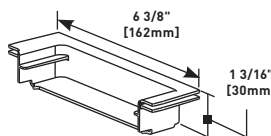

Required for mounting power or datacom devices into a divided raceway application. One used per device location.

40N2F19 Radiused Full Capacity External Elbow

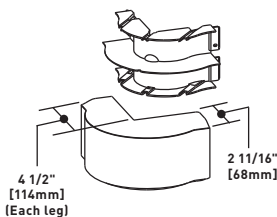

A 90° external corner with integral dividers to provide 2" [51mm] cable bend radius for UTP and fiber optic installations. Ideal for lay-in or pull-through installations. Available in ivory (40N2F19V) or white (40N2F19WH).

40N2F74 Divided Transition Fitting

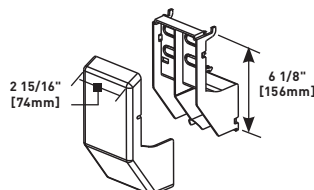

Makes transition from 40N2 Series Raceway to PN03, PN05, and PN10 Series Raceways. Available in ivory (40N2F74V) or white (40N2F74WH).

5400 SERIES™ RACEWAY

Large Capacity, Multiple Channel



Large capacity, multiple channel raceway. Lightweight and easy-to-cut. Ideal for power or communication installations that require multiple services.

CODE REFERENCE

Listed Raceway:
File E90378 Guide RJTX.
Complies with flammability requirements of UL-5A.

Fittings: File E90377 Guide RJYT.
Meets Article 388 of NEC.
UL Listed for up to 600V.
Meets Section 12-1600 of CEC.

5400 Series Raceway System Layout

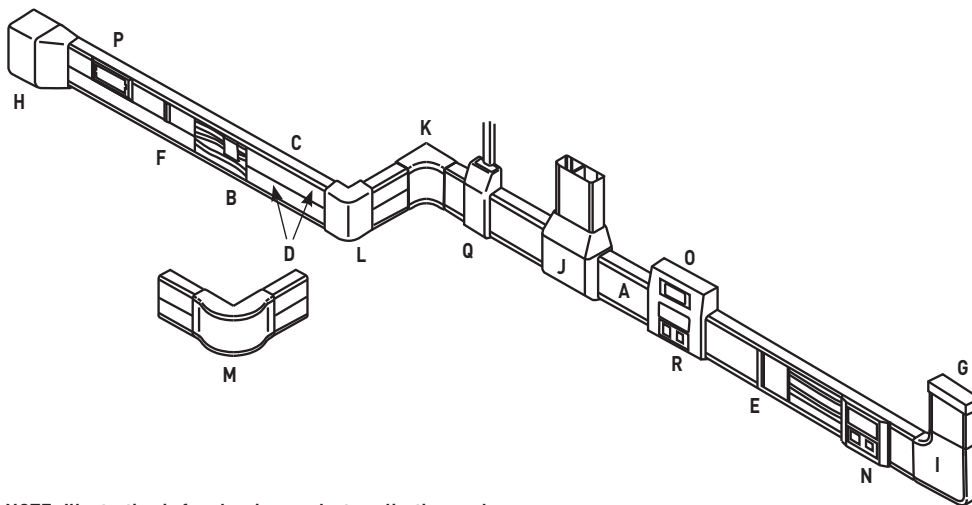

NOTE: Illustration is for showing product applications only.

KEY

- | | | |
|---------------------------------|-----------------------------------|-----------------------------------|
| A. 5400C Raceway Cover | G. 5410 Entrance End Fitting | M. 5418FO Radiused External Elbow |
| B. 5400TWC Twin Cover Wire Clip | H. 5410DFO Entrance End Feed | N. 5450 In-Line Device Bracket |
| C. 5400TB Two Compartment Base | I. 5411FO Flat Elbow | O. 5450A3 Multiple Device Bracket |
| D. 5400TC Twin Snap Cover | J. 5415 Tee | P. 5450T Twin Snap Device Bracket |
| E. 5406A Cover Clip | K. 5417FO Radiused Internal Elbow | Q. 5474 Transition Fitting |
| F. 5406T Twin Cover Seam Clip | L. 5418 Standard External Elbow | R. Communication Device |

COLOR OPTIONS



5400 Series™ Raceway Part Numbers with a "-WH" suffix have a white finish. Part Numbers without a suffix are only available in an ivory finish. 5400 Series Raceway is paintable using latex paint or stain.

Custom color options are also available. Consult the factory for more information.

5400 SERIES™ RACEWAY

Ordering Information

5400 Series Raceway Wire Fill Capacities for Communications

	CABLE/WIRE SIZE	O.D. (Approx. Dia.)		SECTION EACH COMPARTMENT 40% FILL*
		Inches	[]	
UNSHIELDED TWISTED PAIR	4-pair, 24 AWG, Cat 3	0.190	[4.8]	52
	4-pair, 24 AWG, Cat 5e	0.210	[5.3]	42
	4-pair, 24 AWG, Cat 6	0.250	[6.3]	30
	4-pair, 24 AWG, Cat 6a*	0.354	[9.0]	15
	25-pair, 24 AWG	0.410	[10.4]	11
COAXIAL	RG6/U	0.270	[6.9]	26
FIBER	ZipCord	0.118 x 0.236	[3 x 6]	53
	Round 4 Strand Fiber	0.187	[4.8]	54
	Round 6 Strand Fiber	0.256	[6.5]	28

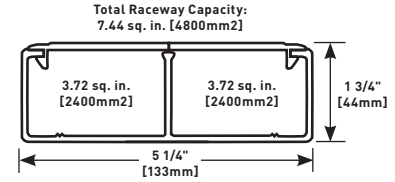

NOTE: For additional information, refer to the Technical Section.

* Wire capacity is reduced to allow for proper conductor bend radius and maximum permissible heat rise.

** Category 6 augmented (6a) cable for 10 gigabit ethernet – max allowed cable diameter per addenda No. 11 ANSI TIA/EIA 568-B.2.

5400 Series Raceway Wire Fill Capacities for Power

	WIRE SIZE THHN/THWN	O.D. (Approx. Dia.)		NUMBER OF CONDUCTORS EACH COMPARTMENT
		Inches	[]	
POWER WIRING WITHOUT DEVICES	14 AWG	0.111	[2.8]	50
	12 AWG	0.130	[3.3]	34
	10 AWG	0.164	[4.2]	60
	8 AWG	0.216	[5.5]	21
	6 AWG	0.254	[6.5]	19
POWER WIRING WITH DEVICES	14 AWG	0.111	[2.8]	50
	12 AWG	0.130	[3.3]	34
	10 AWG	0.164	[4.2]	60
	8 AWG	0.216	[5.5]	21
	6 AWG	0.254	[6.5]	19

* Total raceway capacity not to exceed capacity specified in Compartment.

5400TC Twin Snap Raceway Cover

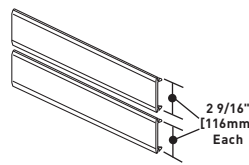

Use with 5400 Series Raceway in Twin Snap applications. Order cover for each compartment. Available in 8' [2.4m] lengths. Available in standard ivory (5400TC) and white (5400TC-WH).

5400TWC Twin Snap Cover Wire Clip

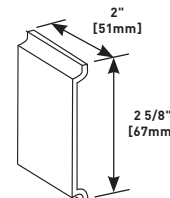

Retains wires in raceway.

5400TB Two-Compartment Raceway Base

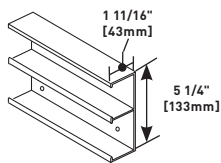

Two equal compartments – Base accepts single or Twin Snap Cover. 5400 Series raceway is available in 8' [2.4m] lengths with pre-punched mounting holes, packed 48' [14.6m] per carton. Available in standard ivory (5400TB) and white (5400TB-WH).

5406A Cover Clip

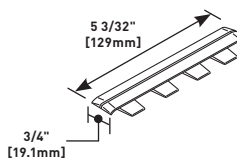

For covering joint where two pieces of 5400C Raceway Cover come together. Available in standard ivory (5406A) and white (5406A-WH).

5400C Full-Width Raceway Cover

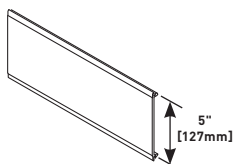

Use with 5400 Series Raceway. Available in 8' [2.4m] lengths, packed 48' [14.6m] per carton. Available in standard ivory (5400C) and white (5400C-WH).

5406T Twin Cover Clip

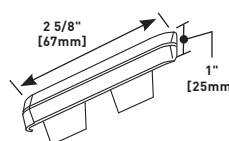

For covering joint where two pieces of 5400TC Cover come together. Available in standard ivory (5406T) and white (5406T-WH).

5400 SERIES™ RACEWAY

Ordering Information

5406TB Base Seam Clip

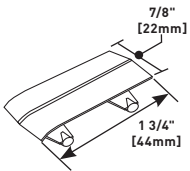

For covering joint where two pieces of 5400TB Base come together. One clip per package. Available in standard ivory (5406TB) and white (5406TB-WH).

5411FO Radiused Full Capacity Flat Elbow

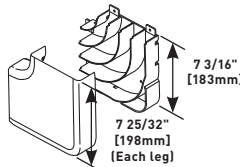

For right angle turns on the same surface. Integral dividers provide 2" [51mm] cable bend radius for UTP and fiber optic installations. Ideal for lay-in or pull-through installations. Available in standard ivory (5411FO) and white (5411FO-WH).

5408L Transition Fitting

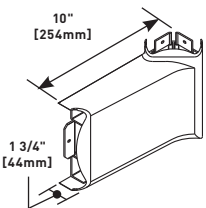

For transitioning from MXN2A08 Corner Drop to a horizontal run of 5400TB Series Raceway to the left. Available in standard ivory (5408L) and white (5408L-WH).

5415 Tee

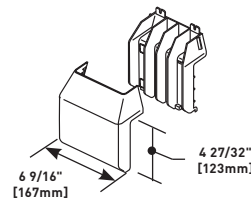

For branching raceway at right angles. Available in standard ivory (5415) and white (5415-WH).

5408R Transition Fitting

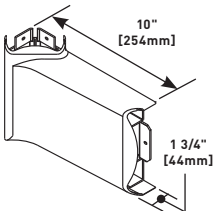

For transitioning from MXN2A08 Corner Drop to a horizontal run of 5400TB Series Raceway to the right. Available in standard ivory (5408R) and white (5408R-WH).

5415FO Radiused Full Capacity Tee

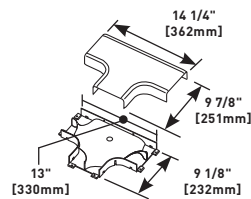

A full capacity tee fitting for branching raceway at right angles. Provides separation of services and 2" [51mm] cable bend radius for UTP and fiber optic installations. Available in standard ivory (5415FO) and white (5415FO-WH).

5410 Blank End Fitting

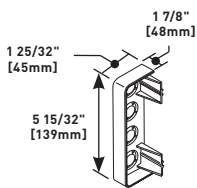

For closing open end of 5400 Series Raceway. Has four 1/2" trade size KOs for end feed. Available in standard ivory (5410) and white (5410-WH).

5417FO Radiused Full Capacity Internal Elbow

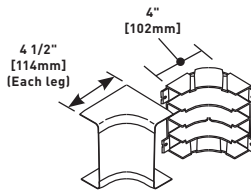

For right angle turns around internal corners. Integral dividers provide 2" [51mm] cable bend radius for UTP and fiber optic installations. Ideal for lay-in or pull-through installations. Available in standard ivory (5417FO) and white (5417FO-WH).

5410DFO Radiused Divided Entrance End Cap

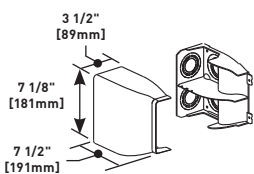

FiberReady divided fitting to feed 5400 Series Raceway. Includes 1", 1 1/4", 1 1/2", and 2" trade size KOs on back and top. Available in standard ivory (5410DFO) and white (5410DFO-WH).

5418 External Elbow

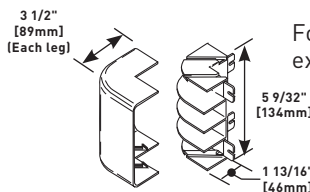

For right angle turns around external corners.

5400 SERIES™ RACEWAY

Ordering Information

5418FO Radiused Full Capacity External Elbow

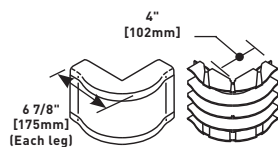

For right angle turns around external corners. Integral dividers provide 2" [51mm] cable bend radius for UTP and fiber optic installations. Use the 5418FO for an alternative to 5418. Available in standard ivory (5418FO) and white (5418FO-WH).

5450A3 Three Device Mounting Bracket

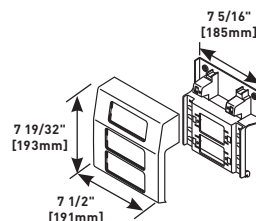

For mounting up to three power or communication devices at one location in-line and offset from 5400 Series Raceway. For use with 5507 Series™ Faceplates, Ortronics® TracJack & Series II Modules, Pass & Seymour® Activate Series Inserts, and Wiremold Open System Communication Modules. Available in standard ivory (5450A3) and white (5450A3-WH).

5450 Device Bracket

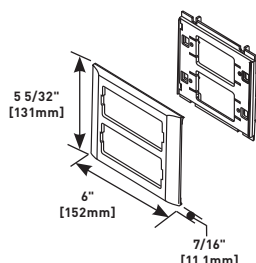

For mounting power and communication devices in-line with 5400 Series Raceway. Utilizes 5507 Series™ Faceplates, as well as Wiremold Open System communication modules, Ortronics® TracJack & Series II inserts, and Pass & Seymour® Activate Series inserts. For faceplate options, see 5507 Series™ Faceplates. Available in standard ivory (5450) and white (5450-WH).

NOTE: CM-EPLA End Plates are required when using Wiremold communication modules. S2-EPL End Plates are required when using Ortronics® Series II inserts. To mount TracJack inserts, use 5507-4TJ or 5507-6TJ Faceplates.

5450-ORAP Wireless Bracket

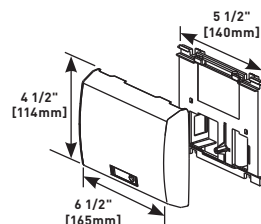

Used to mount Ortronics® Wi-Jack™ Wireless Access Points to 5400 Series Raceway.

5450T Twin Snap Device Bracket

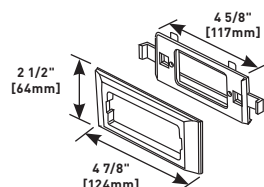

For power or communication devices in a single compartment. For use with 5507 Series™ Faceplates, Ortronics® TracJack & Series II Modules, Pass & Seymour® Activate Series Inserts, and Wiremold Open System Communication Modules. Available in standard ivory (5450T) and white (5450T-WH).

NOTE: CM-EPLA End Plates are required when using Wiremold communication modules and Pass & Seymour® Activate inserts. S2-EPL End Plates are required when using Ortronics® Series II inserts. To mount TracJack inserts, use 5507-4TJ or 5507-6TJ Faceplates.

5474 Transition Fitting

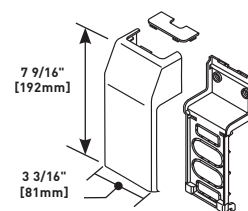

Makes transition from 5400 Series Raceway to the 400/800/2300, or PN03, PN05, and PN10 Series Latching Raceways. Available in standard ivory (5474) and white (5474-WH).

5400 SERIES™ RACEWAY

Ordering Information

MXN Series RACEWAY Wire Fill Capacities for Communications

	CABLE/WIRE SIZE	O.D. (Approx. Dia.)		SECTION EACH COMPARTMENT 40% FILL*
		Inches	[]	
UNSHIELDED TWISTED PAIR	4-pair, 24 AWG, Cat 3	0.190	[4.8]	19
	4-pair, 24 AWG, Cat 5e	0.210	[5.3]	16
	4-pair, 24 AWG, Cat 6	0.250	[6.3]	11
	4-pair, 24 AWG, Cat 6a*	0.354	[9.0]	5
	25-pair, 24 AWG	0.410	[10.4]	4
COAXIAL	RG6/U	0.270	[6.9]	9
FIBER	ZipCord	0.118 x 0.236	[3 x 6]	20
	Round 4 Strand Fiber	0.187	[4.8]	20
	Round 6 Strand Fiber	0.256	[6.5]	10

NOTE: For additional information, refer to the Technical Section.
 * Category 6 augmented (6a) cable for 10 gigabit ethernet – max allowed cable diameter per addenda No. 11 ANSI TIA/EIA 568-B.2.

MXN Series Raceway Wire Fill Capacities for Power

WIRE SIZE THHN/THWN	O.D. (Approx. Dia.) Inches []	NO. OF CONDUCTORS EACH COMPARTMENT
14 AWG	0.111 [2.8]	50
12 AWG	0.130 [3.3]	34
10 AWG	0.164 [4.2]	60
8 AWG	0.216 [5.5]	21

MXN2F21 Entrance End Fitting

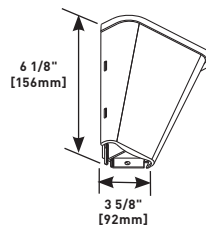

For feeding corner drop raceway from large conduits. Has concentric 3/4", 1", and 1 1/2" trade size KOs. Available in standard ivory (MXN2F21) and white (MXN2F21-WH).

MXN2A08 Corner Drop Raceway Base and Cover

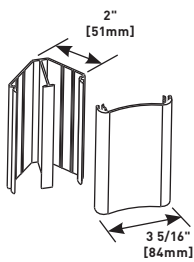

Used as a vertical corner feed drop to horizontal runs of 5400 Series Raceway. Two compartments. Packaged with base and cover. MXN2A08 available in 8' [2.44m] lengths. Available in standard ivory (MXN2A08) and white (MXN2A08-WH). Use 5408L or 5408R to transition to 5400 Series Raceway.

MXN2FWC Wire Clip



Retains wires in MXN2A08 Corner Drop Raceway.

5400 SERIES™ RACEWAY

Installation Details

Access 5400 Series Raceways Installation Details

1. Mount raceway base to wall by using appropriate screws. Use two screws every 18" [457mm] using the ribs on the outermost compartments of the raceway as guides.

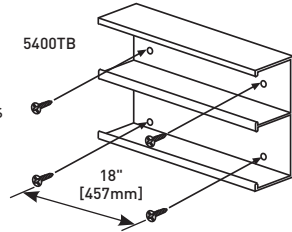

2. Place the 5400TWC Wire Clips in base as shown to contain the wires in place while installing.

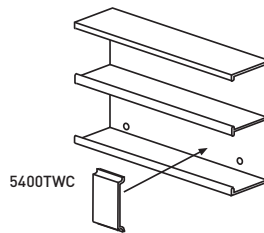

3. Slide the 5406A and 5406T Seam Covers on the uninstalled section of raceway cover as shown; snap cover to the base overlapping the seam cover over the installed section. 5406TB Base Seam Clip used for base seams.

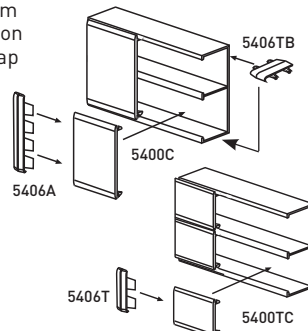

4. Sequence for installing devices:
 1. Snap bracket in raceway base.
 2. Fasten devices to bracket. Communication devices snap onto bracket.
 3. Snap raceway covers to base, butting against bracket.
 4. Assemble trim ring.
 5. Insert CM-EPLA or S2-EPL, if required.

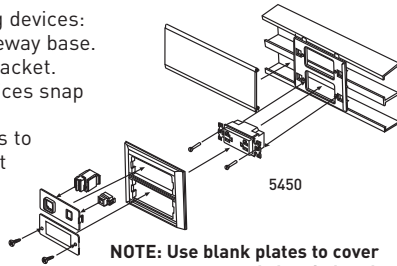

NOTE: Use blank plates to cover any unused slots in bracket.

6. Install Wiremold Open System communication modules, Ortronics® TracJack or Series II inserts, or Pass & Seymour® Activate Series inserts required.
7. Or install 5507 Faceplates, if required.

5. Install bracket to raceway base first, mount to the wall with screws, and mount device. After installing raceway cover, snap box cover to bracket and assemble faceplates. Install Wiremold Open System Communication Modules, Ortronics® TracJack or Series II inserts, or Pass & Seymour® Activate Series Inserts, or 5507 Faceplates. Use 5407A3 with 5400TB to install three devices at one location.

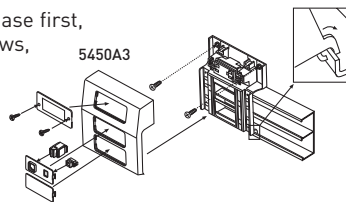

6. Snap 5450T Bracket to raceway base, engage sidewall first then divider side. Install Wiremold Open System communication modules, Ortronics® TracJack or Series II inserts, or Pass & Seymour® Activate Series inserts, or 5507 Faceplates. Snap raceway cover to base and finish with 5450T Trim Plate (engaging raceway sidewall first then divider side).

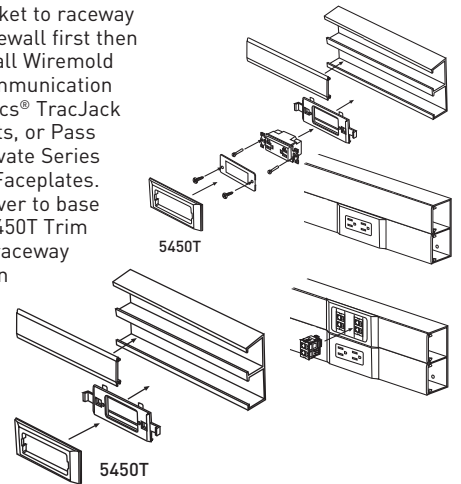

7. End cap may be used as a blank to cap off the raceway at the end-of-run, or to feed wires from a 1/2" trade size pipe; punch out the proper KO. Mount endcap to raceway base using appropriate screws.

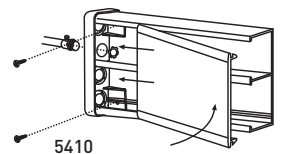

8. **Feeding raceway from conduit.**

1. Line up base of the fitting with the raceway base using the tongues as guides.
2. Fasten the base of the fitting to the wall using screws.
3. Remove the proper KO.
4. Attach conduit using proper fitting.
5. Feed the necessary cables.
6. Slide the dividers (two provided) into the mounting guides if needed.
7. Snap the raceway cover on the base.
8. Snap fitting cover onto the base using guiding keyslots in base.

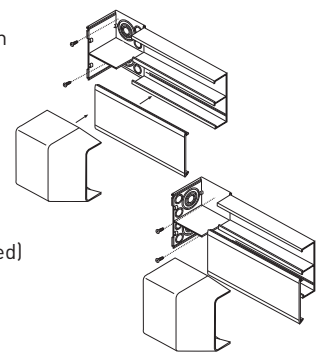

NOTE: The 5400TB Base can be rotated 90° to allow feed from back instead of side.

9. Mount flat elbow as shown; assemble raceway covers first, then elbow cover.

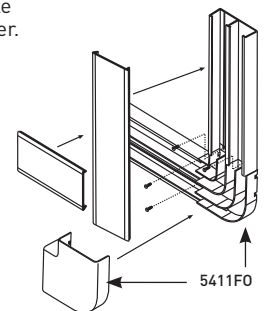

5400 SERIES™ RACEWAY

Installation Details

5400 Series Raceways Installation Details

10. Punch out appropriate hole in the tee fitting base and snap to raceway base; screw down to wall. Assemble raceway covers to base and then snap tee cover, overlapping raceway covers.

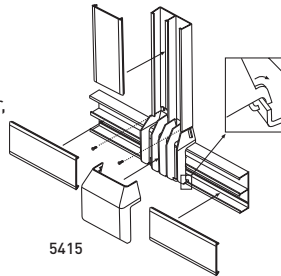

12. Punch out appropriate hole in fitting base and snap to the raceway base; screw down to the wall. Remove proper twistout from the insert by first scoring with a knife. Slide the insert onto fitting cover. Assemble raceway covers to base and then snap fitting cover, overlapping raceway covers.

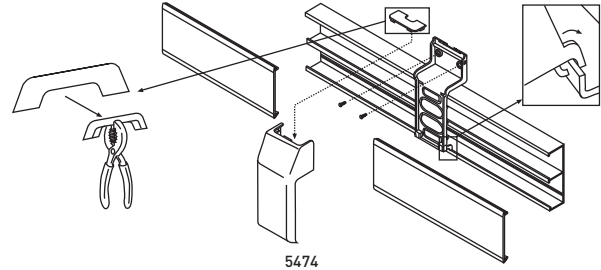

11. Install one corner base first, then measure to other corner (measure from edges of fittings). Mount raceway base and cover; assemble fitting cover last.

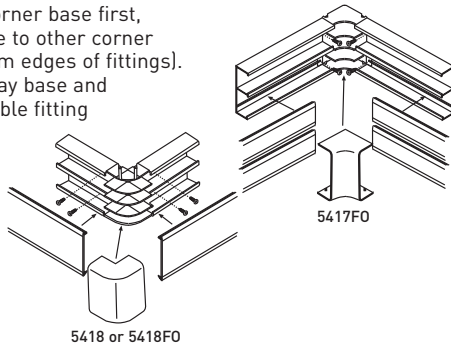

5400 Series Raceway Interconnectivity Fittings

FROM	CONNECTION REQUIRED	TO	USE CATALOG NUMBER
5400 Series Raceway		400, 800, 2300 Series Raceways	5474
5400 Series Raceway		PN03, PN05, PN10 Series Raceways	5474
5400 Series Raceway		MXN2A08	5408L/5408R
1/2" Trade size Conduit or Armored Cable		Side of 5400 Series Raceway	5410 or 5410DFO
3/4", 1", 1 1/2" & 2" Trade size Conduit or Armored Cable		Back or Side of 5400TB	5410DFO

5500 SERIES™ RACEWAY

Large Capacity, Multiple Channel



Large capacity, multiple channel raceway. Lightweight and easy to cut. Ideal for power or communication installations where flexibility for future moves and changes is important.

CODE REFERENCE

Listed Raceway:

File E90378 Guide RJTX.
Complies with flammability requirements of UL-5A.

Fittings: File E90377 Guide RJYT.

Meets Article 388 of NEC.
UL Listed for up to 600V.
Meets Section 12-1600 of CEC.

5500 Series Raceway System Layout

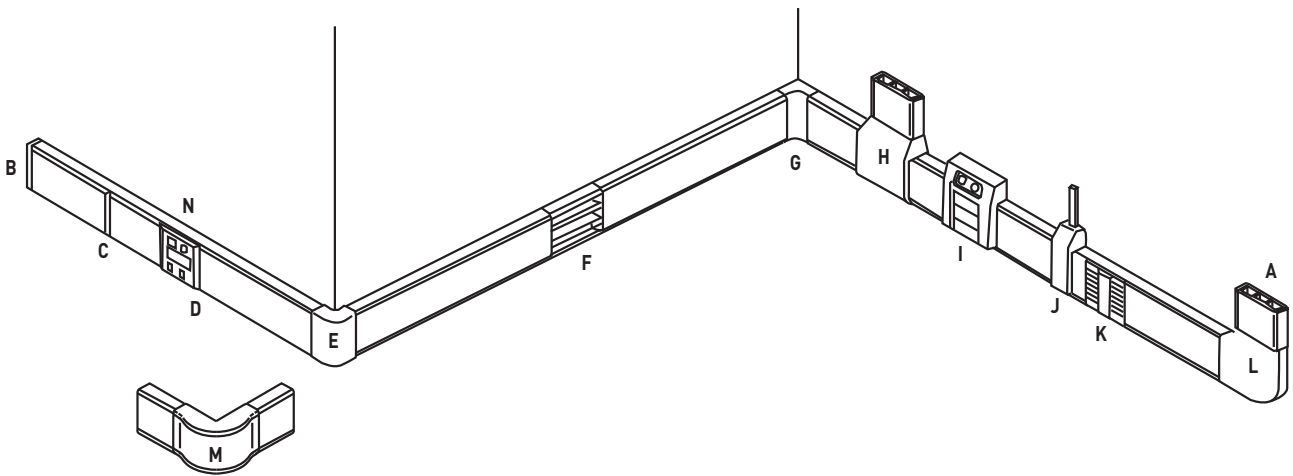

NOTE: Illustration is for showing product applications only.

KEY

- | | | |
|--------------------------------------|---|---|
| A. 5510 End Cap/Entrance End Fitting | G. 5517F0 Radiused Full Capacity Internal Elbow | L. 5511F0 Radiused Full Capacity Flat Elbow |
| B. 5510D Entrance End Fitting | H. 5515 Tee Fitting/Take-Off Connector | M. 5518F0 Radiused Full Capacity External Elbow |
| C. 5506 Cover Clip | I. 5550A4 Multiple Device Bracket | N. Communication Devices |
| D. 5550 In-Line Device Bracket | J. 5574 or 5574A Inline Transition Fitting | |
| E. 5518 External Elbow | K. 5500WCA Wire Clip | |
| F. 5514A Back Connector Feed | | |

COLOR OPTIONS

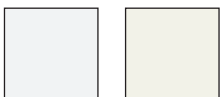

5500 Series™ Raceway Part Numbers with a "-WH" suffix have a white finish. Part Numbers without a suffix are only available in an ivory finish. 5500 Series Raceway is paintable using latex paint.

Custom color options are also available. Consult the factory for more information.

5500 SERIES™ RACEWAY

Ordering Information

5500 Series Raceway Wire Fill Capacities for Communications

	CABLE/WIRE SIZE	O.D. (Approx. Dia.)		SECTION 40% FILL*		
		Inches	[]	A	B	C
UNSHIELDED TWISTED PAIR	4-pair, 24 AWG, Cat 3	0.190	[4.8]	114	37	71
	4-pair, 24 AWG, Cat 5e	0.210	[5.3]	94	30	58
	4-pair, 24 AWG, Cat 6	0.250	[6.3]	66	21	41
	4-pair, 24 AWG, Cat 6a**	0.354	[8.9]	33	10	20
	25-pair, 24 AWG	0.410	[10.4]	24	8	15
COAXIAL	RG6/U	0.270	[6.9]	56	18	35
FIBER	ZipCord	0.118 x 0.236	[3 x 6]	117	37	72
	Round 4 Strand Fiber	0.187	[4.8]	118	38	73
	Round 6 Strand Fiber	0.256	[6.5]	63	20	39

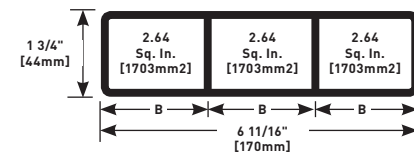
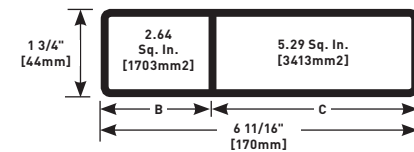
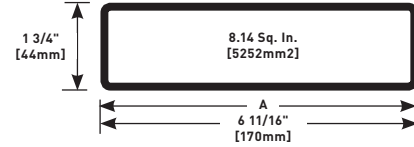

NOTE: For additional information, refer to the Technical Section.

* Wire capacity is reduced to allow for proper conductor bend radius and maximum permissible heat rise.

** Category 6 augmented (6a) cable for 10 gigabit ethernet – max allowed cable diameter per addenda No. 11 ANSI TIA/EIA 568-B.2.

5500 Series Raceway Wire Fill Capacities for Power

	WIRE SIZE THHN/THWN	O.D. (Approx. Dia.)		NUMBER OF CONDUCTORS		
		Inches	[]	COMP A	COMP B	COMP C
POWER WIRING WITHOUT DEVICES	14 AWG	0.111	[2.8]	64	41	50
	12 AWG	0.130	[3.3]	60	25	44
	10 AWG	0.164	[4.2]	90	46	70
	8 AWG	0.216	[5.5]	65	18	40
	6 AWG	0.254	[6.5]	45	15	34
POWER WIRING WITH DEVICES	14 AWG	0.111	[2.8]	64	35	50
	12 AWG	0.130	[3.3]	60	25	44
	10 AWG	0.164	[4.2]	90	16	70
	8 AWG	0.216	[5.5]	65	8	36
	6 AWG	0.254	[6.5]	45	5	25

5500 Series Raceway Ordering Information

5500BD3 Divided Raceway Base

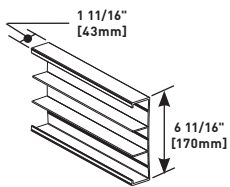

Three equal compartments – use for separate services in one raceway. Breakaway dividers enable compartment configurations. Available in 8' [2.4m] lengths. Packed 48' [14.6m] per carton. Available in ivory (5500BD3) and white (5500BD3-WH).

5500WCA Wire Clip

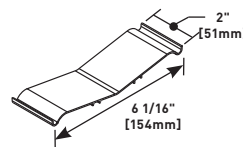

Retains wires in raceway.

5500C Raceway Cover

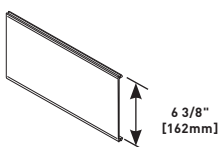

Use with 5500BD3. Available in 8' [2.4m] lengths. Packed 48' [14.6m] per carton. Available in ivory (5500C) and white (5500C-WH).

5506 Cover Clip

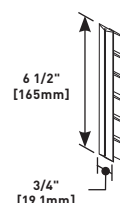

For covering seam where two pieces of 5500C Cover come together. Available in ivory (5506) and white (5506-WH).

5500 SERIES™ RACEWAY

Ordering Information

5506B Base Seam Clip

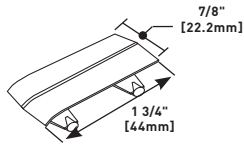

For covering seam where two pieces of 5500BD3 Base come together. Available in ivory (5506B) and white (5506B-WH)

5510 Blank End Fitting

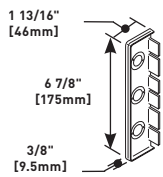

For closing open end of 5500BD3 Raceway. Three 1/2" trade size KOs for end feed. Available in ivory (5510) and white (5510-WH).

5510D Entrance End Fitting

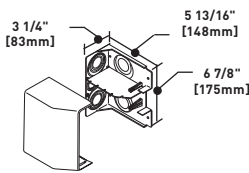

For feeding raceway from larger conduits. Has concentric 3/4", 1", 1 1/2", and 2" trade size KOs on end and back. Two removable dividers are included. Available in ivory (5510D) and white (5510D-WH).

5511FO Radiused Full Capacity Flat Elbow

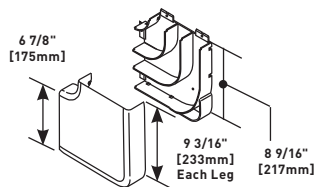

90° flat corner with integral dividers that provides a 2" [51mm] cable bend radius for UTP and fiber optic installations. Ideal for lay-in or pull-through installations. Available in ivory (5511FO) and white (5511FO-WH).

5514A Backfeed Connector

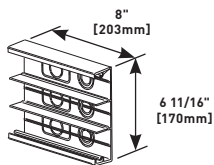

Use when a backfeed is needed. Has three rectangular KOs for use with existing wall box and three 1/2", 3/4", and 1" trade size KOs. Available in ivory (5514A) and white (5514A-WH).

5515 Tee/Take-Off Connector



For branching raceway at right angles. Available in ivory (5515) and white (5515-WH).

5517FO Bend Radius Full Capacity Internal Elbow

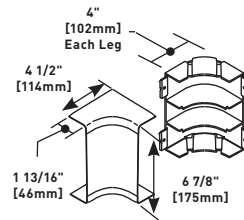

90° internal corner with integral dividers that provides a 2" [51mm] cable bend radius for UTP and fiber optic installations. Ideal for lay-in or pull-through installations. Available in ivory (5517FO) and white (5517FO-WH).

5518 External Elbow

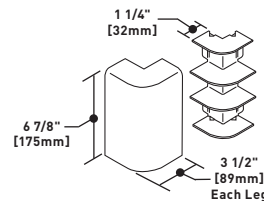

For right angle turns around external corners. Available in ivory (5518) and white (5518-WH).

5518FO Bend Radius Full Capacity External Elbow

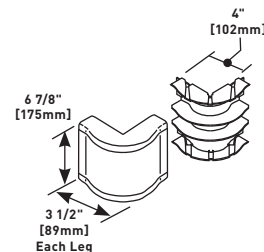

90° external corner with integral dividers that provide a 2" [51mm] cable bend radius for UTP and fiber optic installations. Use the 5518FO for a alternative to the 5518. Available in ivory (5518FO) and white (5518FO-WH).

5574 Transition Fitting

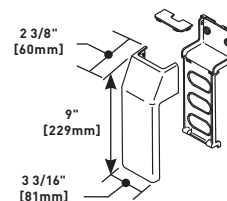

Makes transition from 5500 Series Raceway to the 400, 800, 2300, PN03, PN05 and PN10 Latching Series Raceways. Available in ivory (5574) and white (5574-WH).

5500 SERIES™ RACEWAY

Ordering Information

5550 Device Inline Bracket

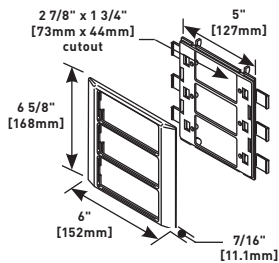

For mounting up to three power and communication devices with the 5500 Series Raceway. Utilizes 5507 Series™ Faceplates, Wiremold Open System communication modules, Ortronics® TracJack and Series II inserts, and Pass & Seymour® Activate Series inserts. For faceplate options, see 5507 Series™ Faceplates. Available in ivory (5550) and white (5550-WH).

NOTE: CM-EPLA End Plates are required when using Wiremold communication modules and Pass & Seymour® Activate inserts. S2-EPL End Plates are required when using Ortronics® Series II inserts. To mount TracJack inserts, use 5507-4TJ or 5507-6TJ Faceplates.

5550A4 Offset Mounting Device Bracket

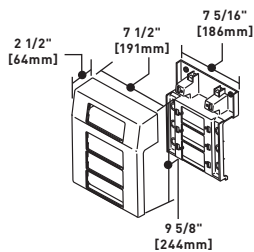

For mounting up to four power and communication devices at one location. Utilizes 5507 Series™ Faceplates, Wiremold Open System communication modules, Ortronics® TracJack and Series II inserts, and Pass & Seymour® Activate Series inserts. For faceplate options, see 5507 Series™ Faceplates. Available in ivory (5550A4) and white (5550A4-WH).

NOTE: CM-EPLA End Plates are required when using Wiremold communication modules and Pass & Seymour® Activate inserts. S2-EPL End Plates are required when using Ortronics® Series II inserts. To mount TracJack inserts, use 5507-4TJ or 5507-6TJ Faceplates.

5574A Transition Fitting

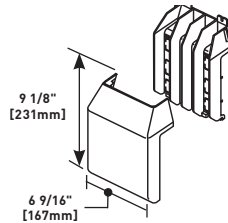

Makes transition from 5500 Series Raceway to 5400 Series Raceway. Available in ivory (5574A) and white (5574A-WH).

ARA-S2 Angled Raceway Adapter

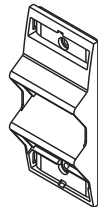

Provides angled exit in multi-channel raceway systems. Snaps into standard 4050, 5450, 5450T, 5550, 40N2F31 and WallSource Device Brackets. Angled exit provides additional mounting depth required for A/V connections as well as ensuring the required bend radius for UTP and fiber optic cabling. Holds two Ortronics® Series II modules. Fits 5507 Series Faceplate opening.

CM-ARA Angled Raceway Adapter

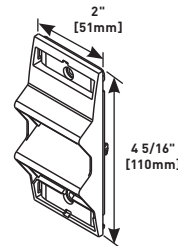

Provides angled exit in multi-channel raceway systems. Snaps into standard 4050, 5450, 5450T, 5550, 40N2F31 and WallSource Device Brackets. No CM-EPLA End Plates required. Accepts two CM2 Series Wiremold Open System communication modules or Pass & Seymour® Activate Series inserts.

5500 Series Raceway Interconnectivity Fittings

FROM	CONNECTION REQUIRED TO	USE CATALOG NUMBER
5500BD3 Series Raceway	400BAC, 800BAC, 2300BAC	5574
5500BD3 Series Raceway	PN03, PN05, PN10 Series Raceway	5574
5500BD3 Series Raceway	5400TB Series Raceway	5574A
Existing Outlet	5500BD3 Series Raceway	5514A
1/2", 3/4", & 1" Trade Size Conduit or Armored Cable	Back of 5500BD3 Series Raceway	5514A or 5510D
1/2" Trade Size Conduit or Armored Cable	Side of 5500BD3 Series Raceway	5510 or 5510D
3/4", 1", 1 1/2" & 2" Trade Size Conduit or Armored Cable	Back or Side of 5500BD3 Series Raceway	5510D

5500 SERIES™ RACEWAY

Installation Details

5500 Series Raceway Installation Details

- Integral dividers of the 5500BD3 may be removed by tearing off at the score mark. Mount raceway base to wall by using appropriate screws. Use two screws every 18" [457mm], using the ribs on the outermost compartments of the raceway as guides.

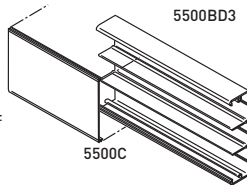

- Place the 5500WCA Wire Clips in base as shown to contain the wires in place while installing.

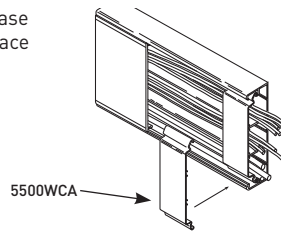

- Slide the 5506 Cover Clip on the uninstalled section of raceway cover as shown; snap cover to the base overlapping the seam cover over the installed section.

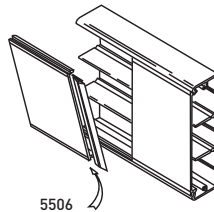

4. Sequence for installing devices:

- Snap bracket in raceway base.
- Fasten devices to bracket. Communication devices snap onto bracket (see Communication Connectivity Section).
- Snap raceway covers to base, butting against bracket.
- Assemble trim ring.
- Insert CM-EPLA or S2-EPL, if required.
- Install Wiremold Open System communication modules, Ortronics® TracJack or Series II inserts, or Pass & Seymour® Activate Series inserts required.
- Or install 5507 faceplates, if required.

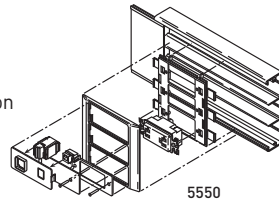

Note: Use blank plates to cover any unused slots in bracket.

- Install bracket to raceway base first, mount to the wall with screws, and mount device. After installing raceway cover, snap box cover to bracket and assemble device plate.

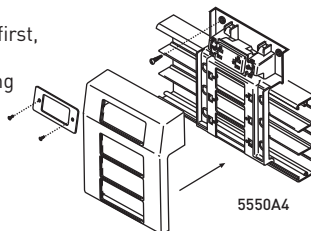

- End cap may be used as a blank to cap off the raceway at the end-of-run, or to feed wires from a 1/2" trade size pipe (punch out the proper KO). Mount endcap to raceway base using appropriate screws. Slide raceway cover under the upper lip of the end cap as shown, before snapping to base.

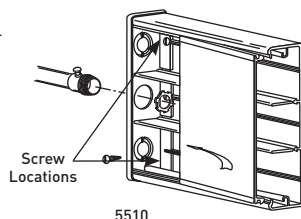

7. Feed raceway from larger conduit.

- Line up base of the fitting with the raceway base using the tongues as guides.
- Fasten the base of the fitting to the wall using screws.
- Remove the proper KO.
- Attach conduit using proper fitting.
- Feed the necessary cables.
- Slide the dividers (two provided) into the mounting guides if needed.
- Snap the raceway cover on the base.
- Snap fitting cover onto the base using guiding keyslots in base.

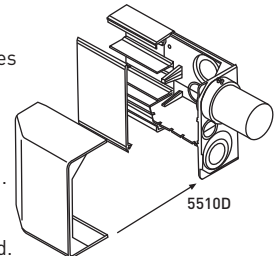

- Mount flat elbow as shown; assemble raceway covers first, then elbow cover.

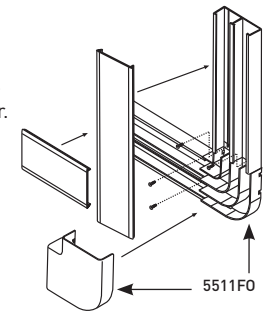

- Use this fitting to back feed from existing wall box, or to feed from 1/2", 3/4" and 1" trade size conduit: score KO with knife, then punch out.

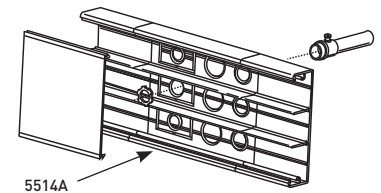

- Punch out appropriate hole in the tee fitting base, and snap to raceway base; screw down to wall. Assemble raceway covers to base and then snap to tee cover overlapping raceway covers.

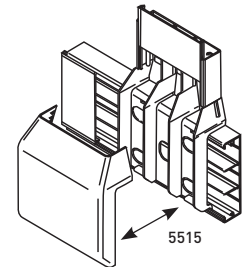

- Install one corner base first, then measure to other corner (measure from edges of fittings). Mount raceway base, and cover; assemble fitting cover last.

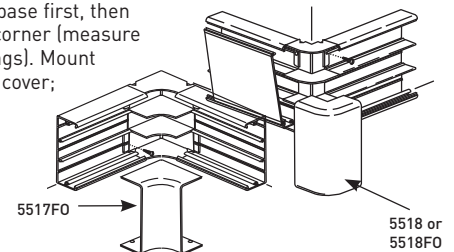

- Punch out appropriate hole in fitting base and snap to the raceway base; screw down to the wall. Remove proper twistout from the insert by first scoring with a knife and then twisting. Slide the insert onto fitting cover. Assemble raceway covers to base and then snap fitting cover, overlapping raceway covers.

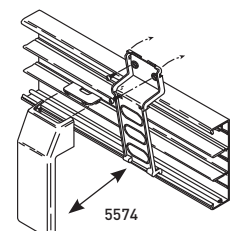

5507 SERIES™ FACEPLATES

Ordering Information



5507 Series™ Faceplates accept a wide assortment of power, A/V and datacom devices from leading manufacturers. Faceplates can be used in nonmetallic device brackets for 2300BACD, 400BAC, 5000, 5400TB, 5500BD3, 40N2 Series Raceways, 4050 Device Bracket for Steel Raceways, and WallSource™ Boxes.

NOTE: All 5507 Series™ Faceplates have a standard measurement of 4 1/4" x 1 7/8" [108mm x 34mm].

CODE REFERENCE

Listed Raceway:

File E90378 Guide RJTX.
Complies with flammability requirements of UL-5A.

Fittings: File E90377 Guide RJYT.

Meets Article 388 of NEC.
UL Listed for up to 600V.
Meets Section 12-1600 of CEC.

COLOR OPTIONS



5507 Series™ faceplate Part Numbers without a suffix are available in an ivory finish. Part Numbers with a "-WH" suffix have a white finish. Part Numbers with a "-G" suffix have a gray finish. Part Numbers with a "-BK" suffix have a black finish. Part Numbers with a "-FW" suffix have a fog white finish. Part numbers with a "-GY" suffix have a light gray finish.

5507 Series Faceplates Ordering Information

5507AD Modular Furniture Adapter

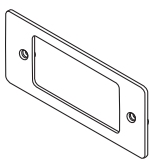

For mounting Activate and other modular furniture bezels and other modular furniture adapters. Not for use with rectangular (decorator) style devices. Available in ivory (5507AD), white (5507AD-WH), gray (5507AD-G) and fog white (5507AD-FW).

5507D Duplex Receptacle Faceplate

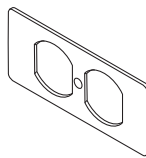

For covering duplex style devices. Accepts 106 Frame. Available in ivory (5507D), white (5507D-WH), gray (5507D-G), black (5507D-BK), light gray (5507D-GY) and fog white (5507D-FW).

5507B Blank Faceplate

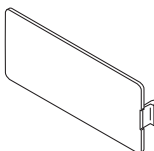

For covering unused compartments in the device bracket. Available in ivory (5507B), white (5507B-WH), gray (5507B-G), light gray (5507B-GY) and fog white (5507B-FW).

5507FRJ Flush Dual RJ Connector Faceplate

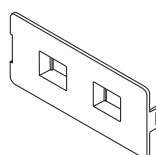

For mounting one or two keystone device modules, recessed to provide a flush installation. Has one opening and one KO. Available in ivory (5507FRJ), white (5507FRJ-WH), gray (5507FRJ-G), light gray (5507FRJ-GY) and fog white (5507FRJ-FW).

5507 SERIES™ FACEPLATES

Ordering Information

5507R Rectangular Receptacle Faceplate

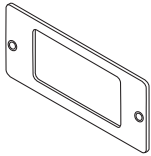

For covering rectangular decorator style devices. Available in ivory (5507R), white (5507R-WH), gray (5507R-G) and fog white (5507R-FW).

5507-4TJ Ortronics® Faceplate

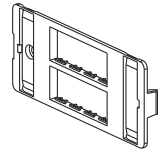

For mounting Ortronics® datacom inserts. Accepts four TracJack devices. Available in ivory (5507-4TJ), white (5507-4TJ-WH), gray (5507-4TJ-G) and fog white (5507-4TJ-FW).

5507RJ Dual RJ11/RJ45 Connector Faceplate

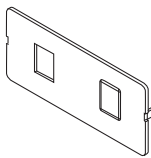

For mounting one or two keystone device modules. Has one opening and one KO. Available in ivory (5507RJ), white (5507RJ-WH), gray (5507RJ-G), light gray (5507RJ-GY) and fog white (5507RJ-FW).

5507-6TJ Ortronics® Faceplate

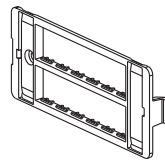

For mounting Ortronics® datacom inserts. Accepts six TracJack devices. Available in ivory (5507-6TJ), white (5507-6TJ-WH), gray (5507-6TJ-G) and fog white (5507-6TJ-FW).

5507S Rectangular Spacer

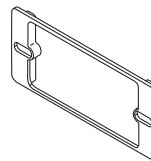

For mounting commercial device plates. Installs between the device bracket and a device. Available in ivory (5507S), white (5507S-WH), black (5507S-BK), fog white (5507S-FW), light gray (5507S-GY) and gray (5507S-G).

5507MAAP Extron® MAAP Faceplate

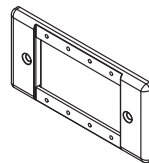

Accepts four AVIP and Extron® Electronics MAAP single space modules. Available in ivory (5507MAAP), white (5507MAAP-WH), gray (5507MAAP-G), black (5507MAAP-BK), light gray (5507MAAP-GY) and fog white (5507MAAP-FW).

5507SW Switch Faceplate

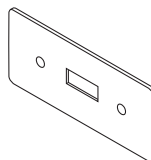

For covering standard toggle switches. Available in ivory (5507SW), white (5507SW-WH), gray (5507SW-G) and fog white (5507SW-FW).

5507AAP Extron® AAP Faceplate

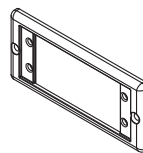

Accepts two Extron® Electronics AAP single space modules. Available in ivory (5507AAP), white (5507AAP-WH), gray (5507AAP-G), black (5507AAP-BK), light gray (5507AAP-GY) and fog white (5507AAP-FW).

5507T1 Single Receptacle Faceplate

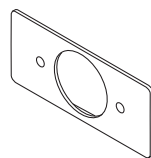

For covering single receptacles 1.59" [40mm] diameter. Available in ivory (5507T1), white (5507T1-WH), gray (5507T1-G) and fog white (5507T1-FW).

ARA-S2 Angled Raceway Adapter

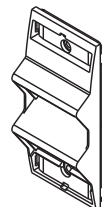

Provides angled exit in multi-channel raceway systems. Snaps into standard 4050, 5450, 5450T, 5550, 40N2F31 and WallSource Device Brackets. Angled exit provides additional mounting depth required for A/V connections as well as ensuring the required bend radius for UTP and fiber optic cabling. Holds two Ortronics® Series II modules. Fits 5507 Series Faceplate opening. Available in ivory (ARA-S2-IV), fog white (ARA-S2-FW), black (ARA-S2-BK), gray (ARA-S2-G), light gray (ARA-S2-GY) and white (ARA-S2-WH).

5507T2 Single Receptacle Faceplate

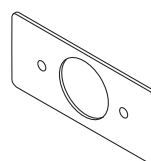

For covering single receptacles 1.41" [36mm] diameter. Available in ivory (5507T2), white (5507T2-WH), gray (5507T2-G) and fog white (5507T2-FW).

5507 SERIES™ FACEPLATES

Ordering Information

CM-EPLA End Plate

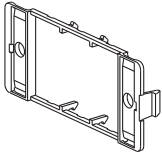

For mounting Pass & Seymour® Activate and Wiremold Open System communication modules into 5507 openings. Includes two outlet identification labels with clear covers and two matching screw covers. Available in ivory (CM-EPLA), white (CM-EPLA-WH), gray (CM-EPLA-G) and fog white (CM-EPLA-FW).

S2-EPL End Plate

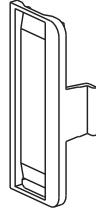

For mounting Ortronics® Series II modules into 5507 opening. Includes two outlet identification labels with clear covers and two matching screw covers. Available in ivory (S2-EPL), white (S2-EPL-WH), gray (S2-EPL-G) and fog white (S2-EPL-FW).

CM-ARA Angled Raceway Adapter

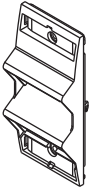

Provides angled exit in multi-channel raceway systems. Snaps into standard 4050, 5450, 5450T, 5550, 40N2F31 and WallSource Device Brackets. No CM-EPLA End Plates required. Accepts two CM2 Series Wiremold Open System communication modules or Pass & Seymour® Activate Series inserts. Available in ivory (CM-ARA), white (CM-ARA-WH), gray (CM-ARA-G), light gray (CM-ARA-GY) and fog white (CM-ARA-FW).

300 SERIES™ DUCT



300 Series™ Duct conceals electrical cords and low voltage wiring. With a full complement of fittings and adhesive backing, 300 Series Duct is easy-to-install and paintable so that it blends with any decor.

CODE REFERENCE

300 Series Duct is not UL Listed and is designed only for use in protecting electrical cords, low voltage wiring and cabling.

COLOR OPTIONS



300 Series™ Duct is available in an ivory finish and is paintable using latex paint.

300 Series Faceplates Ordering Information

300 Duct

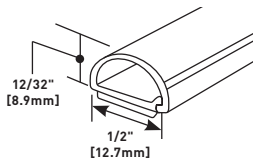

One-piece latching duct. 5' [1.5m] strip extruded from rigid natural PVC. Adhesive back. Smooth texture ivory.

317 Internal Elbow

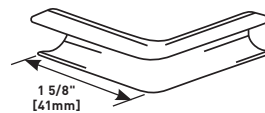

For right angle turns around internal corners.

306 Coupling

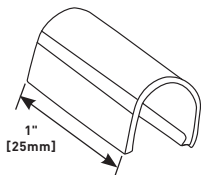

For joining strips of 300 Series duct.

318 External Elbow

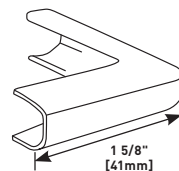

For right angle turns around external corners.

311 Flat Elbow

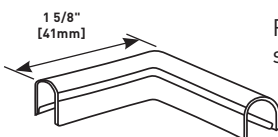

For right angle turns on the same surface.

PVC-1 Raceway Cutter

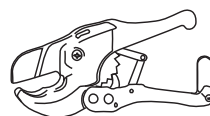

Regular duty cutter. Ideal for use with small nonmetallic raceways.

This table area contains a series of horizontal lines spaced evenly down the page, intended for technical drawing or specifications. The lines are thin and grey, extending across the width of the page.

ALUMINUM SURFACE RACEWAY SYSTEMS



Wiremold® Aluminum Surface Raceway Systems are the industry leaders in quality, ease of installation, and for providing pathway solutions for all types of installations. For over 50 years, Wiremold Surface Raceway Systems have provided the highest quality, most dependable solutions for installers, building owners, and designers.

With the introduction of ALDS4000 Series Raceway System, we're again pushing the envelope and expanding the capacity, capabilities, and aesthetics of surface raceway systems.

Featured Products



ALDS4000 Series Raceway

173

Table of Contents

Small Single- & Dual-Channel Raceways



AL2000 Series



AL2400 Series

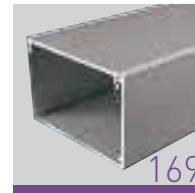

AL3300 Series

ALDS400 Series Raceway



173

Large Single- & Dual-Channel Raceways



ALA3800 Series



ALA4800 Series



AL5200 Series

ALUMINUM SURFACE RACEWAY SYSTEMS

Quick Selection Guide

Two-Piece Small Single- & Dual-Channel Raceway Profiles

AL2000 Series™ Raceway

AL2000B & AL2000C

CAPACITY: 1.1 in.² [710mm²]

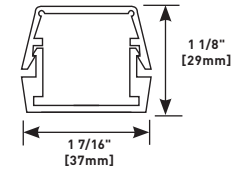

AL2400 Series™ Raceway

AL2400B & AL2400C

CAPACITY: 1.7 in.² [1097mm²]

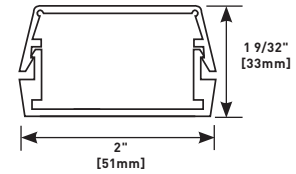

AL3300 Series™ Raceway

AL3300B & AL3300C

CAPACITY: 4.40 in.² [2389mm²]

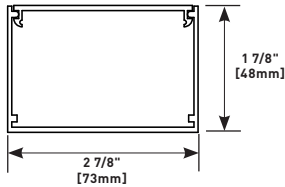

- Capacity with Offset Divider – 1.35 sq. in. [871mm²]
- Capacity with 1/2 Divider – 2.2 sq. in. [1419mm²]
- Capacity Undivided – 4.4 sq. in. [2839mm²]

AL3300 w/Half Divider

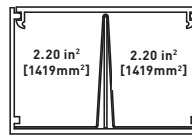

AL3300 w/Offset Divider

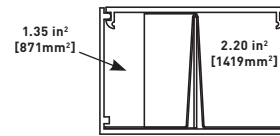

AL3300 with Offset Divider

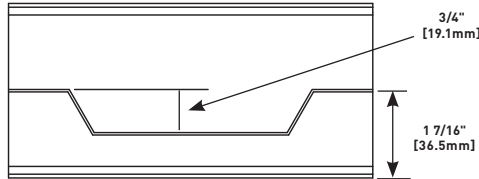

Two-Piece Large Single- & Dual-Channel Raceway Profiles

ALA3800 Series™ Raceway

ALA3800B & ALA3800C

CAPACITY: 5.96 in.² [3842mm²]

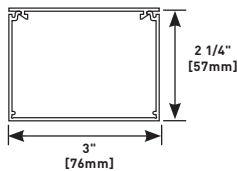
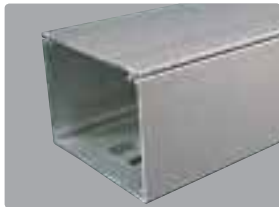

ALA4800 Series™ Raceway

ALA4800B & ALA4800C

CAPACITY:
Each Compartment
5.93 in.² [3826mm²]

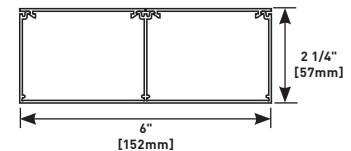
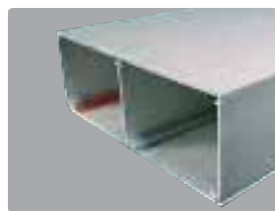

- Capacity as Shown – 3.90 sq. in./4.5 sq. in. [2526mm²/2903mm²]
- Capacity Three Compartments – 2.85 sq. in./2.40 sq. in./2.85 sq. in. [1839mm²/1548mm²/1839mm²]
- Capacity Undivided – 8.5 sq. in. [5484mm²]

NOTE: See the AL5200 Series Raceway section for additional raceway compartment configurations.

ALUMINUM SURFACE RACEWAY SYSTEMS

Quick Selection Guide

Two-Piece Large Single- & Dual-Channel Raceway Profiles (continued)

AL5200 Series™ Raceway

AL5200B & AL5200C

CAPACITY:
Each Compartment: 8.5 in.² [5484mm²]

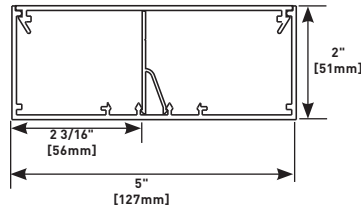

Large Dual-Channel Raceway Profile

ALDS4000® Series Raceway

ALDS4000B & ALDS4000C

CAPACITY:
Each Compartment - 4.85 in.² [3192 mm²]

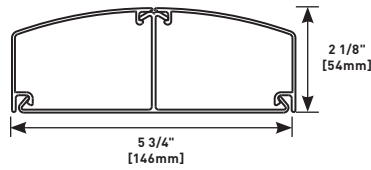

AL2000™ SERIES RACEWAY



Two-piece, single-channel raceway. Satin anodized finish complements decor in commercial offices, laboratories, and health care facilities.

CODE REFERENCE

cULus Listed Raceway:
File E4376 Guide RJPR.

Fittings:
File E41751 Guide RJPR.

Raceway & Fittings:
Meet Article 386 of NEC.

Multioutlet Assemblies:
Meet Article 380 of NEC.

AL2000 Series Raceway System Layout

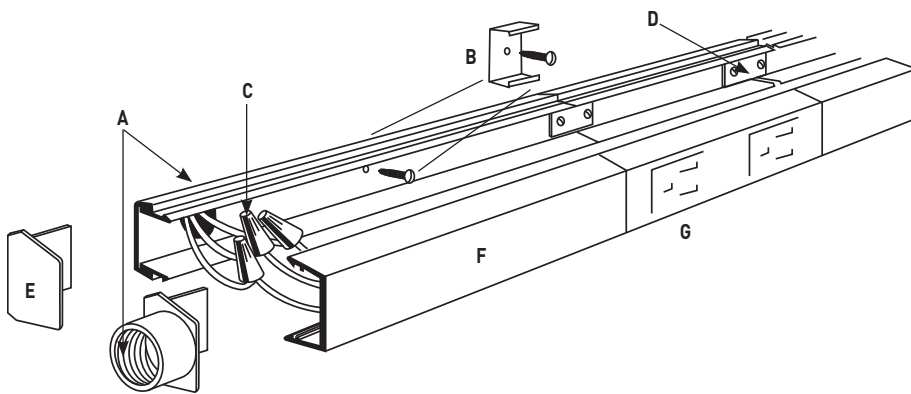

NOTE: Illustration is for showing product applications only.

KEY

- A. Supply conductors may be fed from 1/2" trade size KO in base, or through AL2010A Feed End Fitting. This system is designed with capacity for additional feed or circuitry conductors.
- B. Attach base section to mounting surface with AL2003 Spring Mounting Clips, or by drilling 9/32" [7.1mm] holes in the base and use #8 flathead screws.
- C. Connect circuit wires with connectors.
- D. Additional multiple outlet sections or AL2000 Raceway sections may be attached at ends with AL2001 Coupling.
- E. Close ends with blank end fitting (AL2010B), or with feed end fittings (AL2010A).
- F. Snap in cover section.
- G. In-line receptacle AL2043.

COLOR OPTIONS

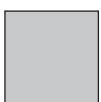

AL2000 Series™ Raceway is available with a satin anodized finish.

AL2000™ SERIES RACEWAY

AL2000 Series Raceway Wire Fill Capacities for Communications

	CABLE/WIRE SIZE	O.D. (Approx Dia.)		40% FILL
		Inches	[mm]	
UNSHIELDED TWISTED PAIR	4-pair, 24 AWG, Cat 3	0.190	[4.8]	3
	4-pair, 24 AWG, Cat 5e	0.210	[5.3]	3
	4-pair, 24 AWG, Cat 6	0.250	[6.3]	2
	4-pair, 24 AWG, Cat 6a*	0.354	[9.0]	1
	25-pair, 24 AWG	0.410	[10.4]	0
COAXIAL	RG6/U	0.270	[6.9]	17
FIBER	ZipCord	0.118 x 0.236	[3 x 6]	3
	Round 4 Strand Fiber	0.187	[4.8]	2
	Round 6 Strand Fiber	0.256	[6.5]	2

AL2000 Series Raceway Wire Fill Capacities for Power

WIRE SIZE THHN/THWN	O.D.		NUMBER OF CONDUCTORS	
	Inches	[mm]	WITHOUT DEVICES	WITH PLUGMOLD RECEPTACLES
14 AWG	0.111	[2.8]	51	8
12 AWG	0.130	[3.3]	38	6
10 AWG	0.164	[4.2]	24	3
8 AWG	0.216	[5.5]	12	
6 AWG	0.254	[6.5]	8	

NOTE: For additional information, refer to the Technical Section.

*Category 6 augmented (6a) cable for 10 gigabit ethernet – max allowed cable diameter per addenda No. 11 ANSI TIA/EIA 568-B.2.

AL2000 Series Raceway Ordering Information

AL2000B-5, AL2000B-10 Raceway Base

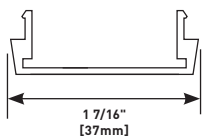

6063-T5 extruded aluminum, satin anodized finish, .060" [1.5mm] nominal thickness. Packed (12) 5' [1.5m] lengths (AL2000B-5) or six 10' [3m] lengths (AL2000B10) per carton.

AL2000WC Wire Retainer (Plastic)

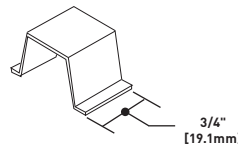

Holds conductors in place in raceway base.

AL2000C-5 Raceway Cover

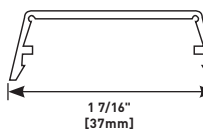

6063-T5 extruded aluminum, satin anodized finish, .060" [1.5mm] nominal thickness. Packed (12) 5' [1.5m] lengths per carton.

AL2001 Coupling (Galvanized Steel)

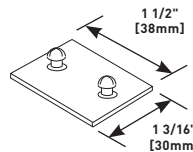

Joins lengths of AL2000B Base.

W30/W30G Pressure-Type Wire Connectors

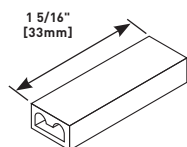

W30 – For common connection of two, three, or four No. 12 or No.14 solid copper conductors. Packed 24 pieces per carton (16 W30 and 8 W30G). W30G – For connection of equipment grounding of 2, 3, or 4 solid conductors No. 14 or No. 12 AWG. 300V maximum; 20A 105° C maximum.

NOTE: Not for use with aluminum conductors.

AL2003 Mounting Clip (Spring Steel)

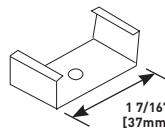

Supports lengths of AL2000 Raceway at any point desired. Mount to surface with No. 8 flathead screw.

AL2006 Cover Clip (Spring Steel)

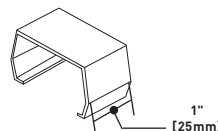

Covers seam where lengths of cover or base come together.

AL2000™ SERIES RACEWAY

AL2000 Series Raceway Ordering Information (continued)

AL2009 Ground Clamp (Galvanized Steel)

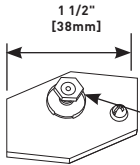

Connects equipment grounding conductor to provide an additional ground to raceway.

#10 Ground Stud with Cup Washer.

AL2018 External Elbow

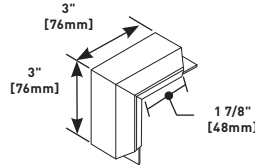

Makes 90° external corners. Two AL2001 Couplings included

AL2010A Feed Fitting

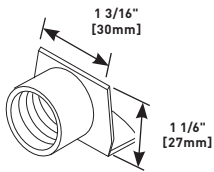

End fitting with 1/2" [12.7mm] hub adapter.

AL2038 Round Fixture Box (Solid Base)

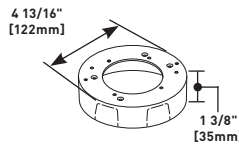

Designed for use in hanging fixtures. Cover takes any device with mounting screw centers of 2 3/4", 3 1/2" and 4 1/16" [70mm, 89mm, 103mm]. Base has concentric 1/2" and 3/4" trade size KOs.

AL2010B Blank End Fitting

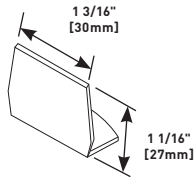

Closes off end of raceway.

AL2040A In-Line Single Pole Switch

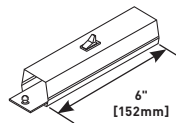

Single-pole 120V switch. Two couplings furnished.

AL2011 Flat Elbow

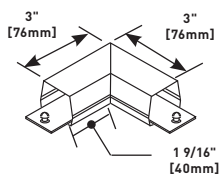

Right angle turn on same surface. Two AL2001 Couplings included.

AL2043 In-Line Receptacle

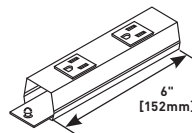

Two 15A, 120V U-ground factory wired receptacles. Two couplings furnished.

AL2015 Tee

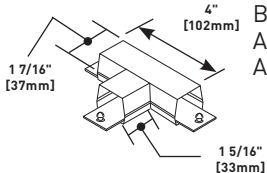

Branch connection of two runs of AL2000 Series Raceway. Three AL2001 Couplings included

AL2043IG In-Line Isolated Ground Receptacle

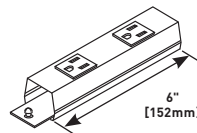

Two 15A, 120V factory wired, isolated ground, orange receptacles. Two couplings furnished.

AL2017 Internal Elbow

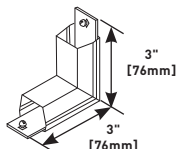

Makes 90° internal corners. Two AL2001 Couplings included

AL2000™ SERIES RACEWAY

AL2000 Series Raceway Ordering Information (continued)

AL2044, AL2044-2 Deep Device Box

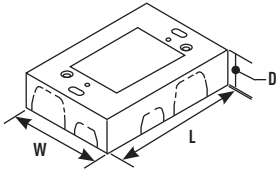

For larger receptacles and deep devices such as those of signal and alarm systems. Base has open back plate for mounting to existing wall box and solid back plate insert with 1/2" and 3/4" trade size KOs to close opening. Accepts industry standard faceplates for communication devices.

CAT NO.	L	W	D	GANG
AL2044	4 5/8" [117mm]	3 1/16" [78mm]	2 1/4" [57mm]	1
AL2044-2	4 5/8" [117mm]	4 27/32" [123mm]	2 1/2" [64mm]	2

AL2051H Box Adapter

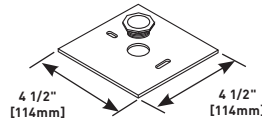

Used to feed raceway from existing wall outlet box.

AL2047, AL2047-2 Shallow Switch & Receptacle Box

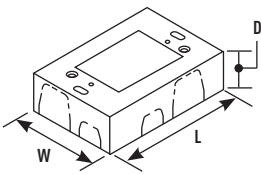

Designed for standard shallow switches and receptacles. Base has open back plate for mounting to existing wall box and solid back plate insert with 1/2" and 3/4" trade size KOs to close opening.

CAT NO.	L	W	D	GANG
AL2047	4 5/8" [117mm]	3 1/16" [78mm]	1 3/8" [35mm]	1
AL2047-2	4 5/8" [117mm]	4 27/32" [123mm]	1 3/8" [35mm]	2

AL2400™ SERIES RACEWAY



Two-piece, single-channel raceway. Satin anodized finish complements decor in commercial offices, laboratories, and health care facilities.

CODE REFERENCE

cULus Listed Raceway:
File E4376 Guide RJPR.

Fittings:
File E41751 Guide RJPR.

Raceway & Fittings:
Meet Article 386 of NEC.

Multioutlet Assemblies:
Meet Article 380 of NEC.

AL2400 Series Raceway Wire Fill Capacities for Communications

	CABLE/WIRE SIZE	O.D. (Approx. Dia.)		40% FILL
		Inches	[mm]	
UNSHIELDED TWISTED PAIR	4-pair, 24 AWG, Cat 3	0.190	[4.8]	23
	4-pair, 24 AWG, Cat 5e	0.210	[5.3]	19
	4-pair, 24 AWG, Cat 6	0.250	[6.3]	13
	4-pair, 24 AWG, Cat 6a*	0.354	[9.0]	6
	25-pair, 24 AWG	0.410	[10.4]	5
COAXIAL	RG6/U	0.270	[6.9]	11
FIBER	ZipCord	0.118 x 0.236	[3 x 6]	24
	Round 4 Strand Fiber	0.187	[4.8]	24
	Round 6 Strand Fiber	0.256	[6.5]	13

NOTE: For additional information, refer to the Technical Section.

*Category 6 augmented (6a) cable for 10 gigabit ethernet – max allowed cable diameter per addenda No. 11 ANSI TIA/EIA 568-B.2.

AL2400 Series Raceway Wire Fill Capacities for Power

WIRE SIZE THHN/THWN	O.D.		NUMBER OF CONDUCTORS	
	Inches	[mm]	WITHOUT DEVICES	WITH PLUGMOLD RECEPTACLES
14 AWG	0.111	[2.8]	78	16
12 AWG	0.130	[3.3]	58	12
10 AWG	0.164	[4.2]	37	8
8 AWG	0.216	[5.5]	18	4
6 AWG	0.254	[6.5]	13	3

COLOR OPTIONS



AL2400 Series™ Raceway is available with a satin anodized finish.

AL2400 SERIES™ RACEWAY

AL2000 Series Raceway Ordering Information

AL2400B-5, AL2400B-10 Raceway Base

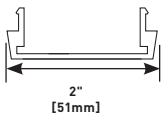

6063-T5 extruded aluminum, satin anodized finish, .060" [1.5mm] nominal thickness. Packed (12) 5' [1.5m] lengths (AL2400B-5) or six 10' [3m] lengths (AL2400B10) per carton.

AL2410B Blank End Fitting

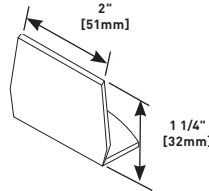

Closes off open end of raceway.

AL2400C Raceway Cover

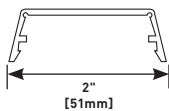

6063-T5 extruded aluminum, satin anodized finish, .060" [1.5mm] nominal thickness. Packed (12) 5' [1.5m] lengths per carton.

AL2410B2 Feed Fitting

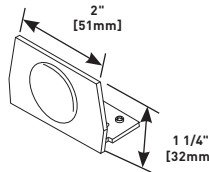

End fitting with plastic 1/2" trade size KO.

AL2400WC Wire Retainer (Plastic)

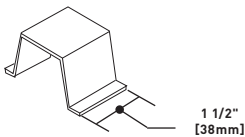

Holds conductors in place in raceway base.

AL2411 Flat Elbow

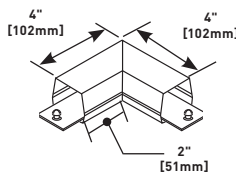

Right angle turn on same surface. Two AL2401 Couplings included.

AL2401 Coupling (Galvanized Steel)

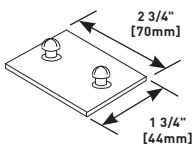

Joins lengths of AL2400B Base.

AL2415 Tee

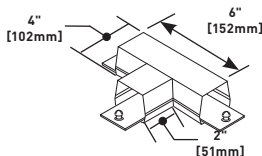

Branch connection of two runs of AL2400 Series Raceway. Three AL2401 Couplings included.

AL2406 Cover Clip (Spring Steel)

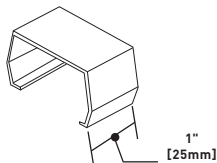

Covers seam where lengths of cover or base come together.

AL2416 Cross Fitting

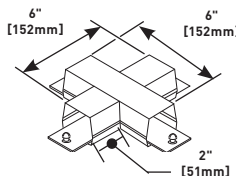

Cross connection of two runs of AL2400 Series Raceway. Four AL2401 Couplings included.

AL2409 Ground Clamp (Galvanized Steel)

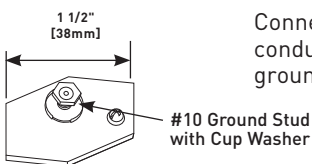

Connects of equipment grounding conductor to provide an additional ground to raceway.

AL2417 Internal Elbow

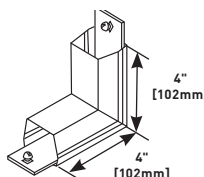

Makes 90° internal corners. Two AL2401 Couplings included.

AL2400™ SERIES RACEWAY

AL2400 Series Raceway Ordering Information (continued)

AL2418 External Elbow

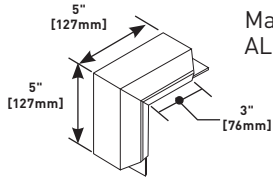

Makes 90° external corners. Two AL2401 Couplings included.

AL2451H Box Adapter

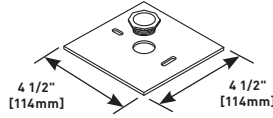

Feeds raceway from existing wall outlet box.

AL2446P-D Duplex Receptacle Cover Plate

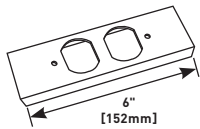

For in-line mounting of commercially available duplex receptacle.

AL3300™ SERIES RACEWAY



Two-piece, single-channel raceway. Satin anodized finish complements decor in commercial offices, laboratories, and health care facilities.

CODE REFERENCE

cULus Listed Raceway:
File E4376 Guide RJPR.

Fittings:
File E41751 Guide RJPR.

Raceway & Fittings:
Meet Article 386 of NEC.

Multioutlet Assemblies:
Meet Article 380 of NEC.

AL3300 Series Raceway Wire Fill Capacities for Communications

WIRE SIZE THHN/THWN	O.D.		CAPACITY OF CROSS SECTIONAL AREA					
			WITH DUPLEX DEVICE			WITHOUT DEVICE		
	Inches	[mm]	WITH OFFSET DIVIDER 1.35 in ² [871mm ²]	WITHOUT DIVIDER 4.40 in ² [2839mm ²]	WITH HALF DIVIDER 2.20 in ² [1419mm ²]	WITH OFFSET DIVIDER 1.35 in ² [871mm ²]	WITHOUT DIVIDER 4.40 in ² [2839mm ²]	WITH HALF DIVIDER 2.20 in ² [1419mm ²]
14 AWG	0.111	[2.8]	59	136	39	59	193	96
12 AWG	0.130	[3.3]	40	93	27	40	132	66
10 AWG	0.164	[4.2]	25	58	17	25	83	41
8 AWG	0.216	[5.5]	14	33	9	14	48	24
6 AWG	0.254	[6.5]	10	24	7	10	34	17

COLOR OPTIONS



AL3300 Series™ Raceway is available with a satin anodized finish.

AL3300™ SERIES RACEWAY

AL3300 Series Raceway Wire Fill Capacities for Power

CABLE TYPE	CABLE/WIRE SIZE	O.D.		WITHOUT DIVIDER		WITH OFFSET DIVIDER		WITH HALF DIVIDER	
		(Approx. Dia.) Inches	[mm]	1.35in ² [871mm ²] 20% FILL	40% FILL	4.40 in ² [2839mm ²] 20% FILL	40% FILL	2.20 in ² [1419mm ²] 20% FILL	40% FILL
UNSHIELDED TWISTED PAIR	4-pair, 24 AWG, Cat 3	0.190	[4.8]	30	61	9	19	15	30
	4-pair, 24 AWG, Cat 5e	0.210	[5.3]	25	50	7	15	12	35
	4-pair, 24 AWG, Cat 6	0.250	[6.3]	17	35	5	10	8	17
	4-pair, 24 AWG, Cat 6a*	0.354	[9.0]	8	17	2	5	4	8
	25-pair, 24 AWG	0.410	[10.4]	6	13	2	4	3	6
COAXIAL	RG6/U 20 Gage	0.270	[6.9]	15	30	4	9	7	15
FIBER	2 Stranded ZipCord	0.118 x 0.236	[3 x 6]	31	63	9	19	15	31
	Round 4 Strand Fiber	0.187	[4.8]	32	64	9	19	16	32
	Round 6 Strand Fiber	0.256	[6.5]	17	34	5	10	8	17

NOTE: For additional information, refer to the Technical Section.

* Category 6 augmented (6a) cable for 10 gigabit ethernet – max allowed cable diameter per addenda No. 11 ANSI TIA/EIA 568-B.2.

AL3300 Series Raceway Ordering Information

AL3300B10 Raceway Base

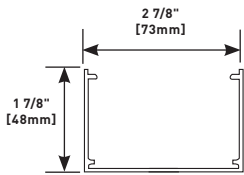

6063-T5 extruded aluminum, satin anodized finish. Nominal wall thickness .060" [1.5mm]. Packed four 10' [3m] lengths per carton.

AL3300WC Wire Clip (Spring Steel)

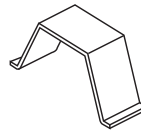

Holds wires and cables in raceway base. Use with undivided raceway, snaps into grooves in base.

AL3300C5 Raceway Cover

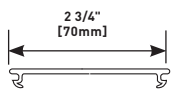

6063-T5 extruded aluminum, satin anodized finish. Nominal wall thickness .060" [1.5mm]. Packed eight 5' [1.5m] lengths per carton.

AL3301 Base Coupling (Galvanized Steel)

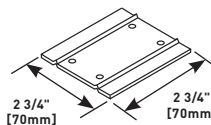

Set screw coupling used for attaching in-line raceway sections.

AL3300D5 Divider

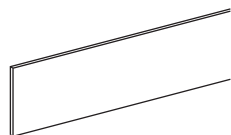

Divider is 0.040" [1.0mm] galvanized steel. Packed eight 5' [1.5m] lengths per carton. AL3301D Divider Clip sold separately.

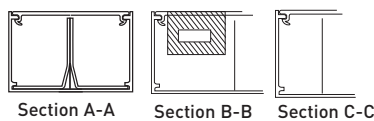

AL3301D Divider Clip (Galvanized Steel)

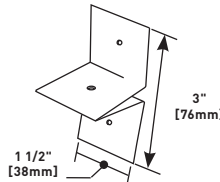

Required for holding AL3300D5 Divider in place. Use one every 30" [762mm].

AL3309 Ground Clamp (Galvanized Steel)

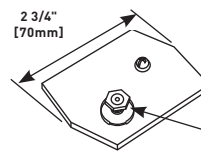

Connects equipment grounding conductor to raceway.

#10 Ground Stud with Cup Washer

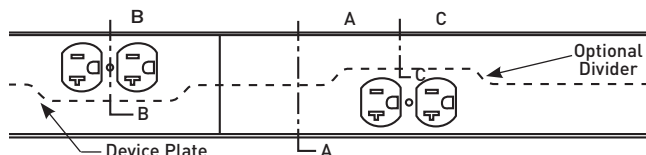

AL3300™ SERIES RACEWAY

AL3300 Series Raceway Ordering Information (continued)

AL3310B Blank End Fitting

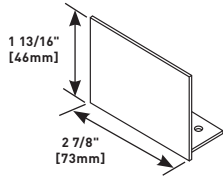

Closes off open end of AL3300 Series Raceway.

AL3318 External Elbow

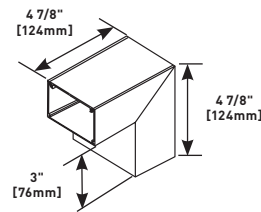

For making external corners. Two AL3301 Couplings included.

AL3310B1 End Fitting

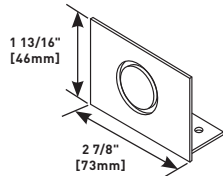

End feeds raceway with 1/2" or 3/4" trade size conduit or armored cable.

AL3346D Duplex Receptacle Cover

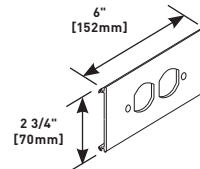

Mounts standard duplex devices to cover. Can also be used with 106 communication frames.

AL3311 90° Flat Elbow

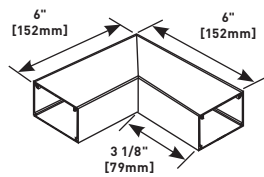

Right angle turns on same surface. Two AL3301 Couplings included.

AL3346DO Offset Duplex Receptacle Cover Plate (For Divided Raceway)

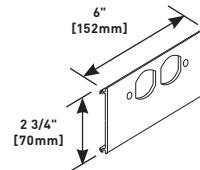

Installs duplex devices in divided aluminum raceway. 6" [152mm] offset divider included. Can also be used with 106 communication frames. Provided with offset divider.

AL3315 Tee

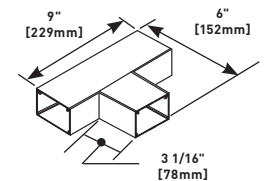

90° tee connection of two runs of AL3300 Series Raceway. Three AL3301 Couplings included.

AL3346E Single Receptacle Cover Plate (1.40" diameter)

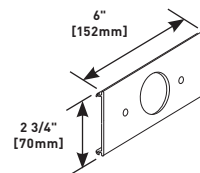

Installs straight blade and locking single receptacles with face diameters of 1.38"-1.39" [35mm-36mm].

AL3316 Cross Fitting

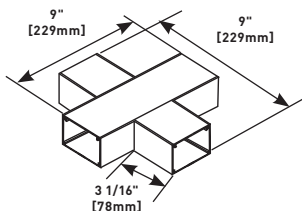

90° cross-through connection of two runs of raceway. Four AL3301 Couplings included.

AL3346G Rectangular Device Cover Plate

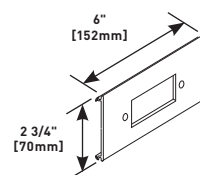

Installs rectangular devices including surge receptacles, GFCI, and other rectangular faced single-gang wiring devices. Can also be used with 106 communication frames.

AL3317 Internal Elbow

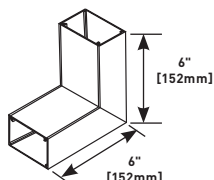

For making 90° internal corners. Two AL3301 Couplings included.

AL3300™ SERIES RACEWAY

AL3300 Series Raceway Ordering Information (continued)

AL3346GO Offset GFCI Receptacle Cover Plate (For Divided Raceway)

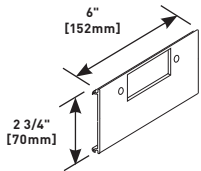

Installs rectangular devices including surge receptacles, GFCI and other rectangular faced single-gang wiring devices in divided aluminum raceway. 6" [152mm] offset divider included. Can also be used with 106 communication frames. Provided with offset divider.

AL3356ABRT Ortronics® Cover Plate

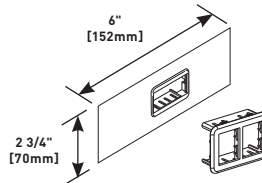

Accepts only Ortronics® datacom inserts. Supplied with both adapters to accommodate two TracJack™ devices or one Series II device.

AL3356-ACTLPB Low Profile Adapter Cover Plate

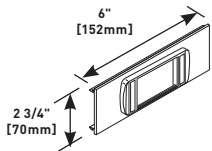

Installs communication connectivity devices. Includes cover and low profile adapter cover [6A opening].

AL3356Z Grommeted Cover Plate

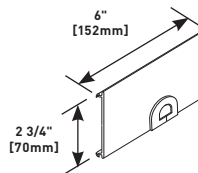

For exiting of communication cable. Grommet furnished.

AL3356-LPB3S2 Ortronics® Low Profile Adapter Cover Plate

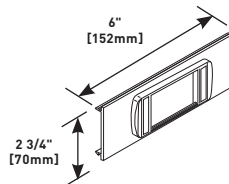

Accepts only Ortronics® datacom inserts, three Series II devices. Low profile adapter included.

AL3356R Cover Plate (with 2" x 2 7/8" [51mm x 73mm] Hole cut)

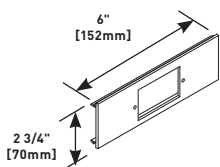

Installs communication connectivity devices utilizing the industry standard single-gang faceplates. Hole cut is 2" x 2 7/8" [51mm x 73mm]. Faceplates must be ordered separately.

AL33562A* 2A Mini Adapter Cover Plate

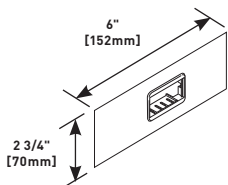

Installs a single 2A size communication connectivity device (2A opening). Includes cover and 2A mini adapter.

* Refer to the Communications Connectivity section of this Product Guide for information on CM2 Series modules.

ALDS4000® SERIES RACEWAY



Dual-channel raceway. Provides 1/3 more capacity in sleek, innovative design. Meets or exceeds industry standards.

NOTE: Downward activations only available prewired.

CODE REFERENCE

cULus Listed Raceway:
File E4376 Guide RJPR.

Fittings:
File E41751 Guide RJPR.

Raceway & Fittings:
Meet Article 386 of NEC.

Multioutlet Assemblies:
Meet Article 380 of NEC.

ALDS4000 Raceway System Layout

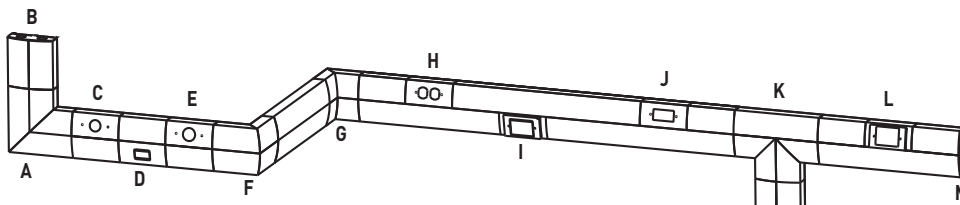

NOTE: Illustration is for showing product applications only.

KEY

- | | |
|--|-------------------------------------|
| A. ALDS4011 Flat Elbow | H. ALDS4047D Duplex Device Plate |
| B. ALDS4010A Entrance End Fitting | I. ALDS4047MAB MAB Device Plate |
| C. ALDS4047E 1.41 Dia. Device Plate | J. ALDS4047R Decorator Device Plate |
| D. ALDS4047-2A Mini adapter Device Plate | K. ALDS4015 Tee |
| E. ALDS4047F 1.59 Dia. Device Plate | L. ALDS4047C One-Gang Device Plate |
| F. ALDS4018 External Elbow | M. ALDS4010B Blank End Fitting |
| G. ALDS4017 Internal Elbow | |

COLOR OPTIONS



ALDS4000® Series Raceway is available with a satin anodized finish.

ALDS4000® SERIES RACEWAY

ALDS4000 Series Raceway Wire Fill Capacities for Communications

	CABLE/WIRE SIZE	O.D. (Approx Dia.)		40% FILL
		Inches	[mm]	1/2 COMPARTMENT
UNSHIELDED TWISTED PAIR	4-pair, 24 AWG, Cat 3	0.190	[4.8]	68
	4-pair, 24 AWG, Cat 5e	0.210	[5.3]	56
	4-pair, 24 AWG, Cat 6	0.250	[6.3]	40
	4-pair, 24 AWG, Cat 6a*	0.354	[9.0]	22
	25-pair, 24 AWG	0.410	[10.4]	19
COAXIAL	RG6/U	0.270	[6.9]	34
FIBER	ZipCord	0.118 x 0.236	[3 x 6]	70
	Round 4 Strand Fiber	0.187	[4.8]	71
	Round 6 Strand Fiber	0.256	[6.5]	38

NOTE: For additional information, refer to the Technical Section.

*Category 6 augmented (6a) cable for 10 gigabit ethernet – max allowed cable diameter per addenda No. 11 ANSI TIA/EIA 568-B.2.

ALDS4000 Series Raceway Wire Fill Capacities for Power

WIRE SIZE THHN/THWN	Inches O.D. [mm]	NO. OF CONDUCTORS 40%	W/DUPLEX RECT. DEVICES	W/SURGE GFCI DEVICES	LARGE SINGLE RECEPTACLE
14 AWG	0.111 [2.8]	200	134	105	76
12 AWG	0.130 [3.3]	146	98	77	56
10 AWG	0.164 [4.2]	92	62	48	35
8 AWG	0.216 [5.5]	53	36	28	20
6 AWG	0.254 [6.5]	38	26	20	158

ALDS4000 Designer Series Raceway Fittings Wire Fill Capacities

	WIRE SIZE/THWN	O.D. (Approx. Dia.)		ALDS4011		ALDS4015		ALDS4017		ALDS4018	
		Inches	[mm]	40%	60%	40%	60%	40%	60%	40%	60%
THHN	14 AWG	0.111	[2.8]	122	182	49	73	75	112	133	199
	12 AWG	0.130	[3.3]	89	133	35	53	54	82	97	145
	10 AWG	0.164	[4.2]	56	84	22	34	34	51	61	92
	8 AWG	0.216	[5.5]	32	48	13	19	20	30	35	53
	6 AWG	0.254	[6.5]	23	35	9	14	14	21	25	38
UTP	4-pair, 24 AWG	0.150	[4.8]	67	100	27	40	41	61	73	109
	4-pair, 24 AWG, Cat 3	0.190	[4.8]	42	62	17	25	25	38	45	68
	4-pair, 24 AWG, Cat 5e	0.210	[5.3]	34	51	14	20	21	31	37	56
	4-pair, 24 AWG, Cat 6	0.250	[6.3]	24	36	10	14	15	22	26	39
	4-pair, 24 AWG, Cat 6a*	0.354	[9.0]	13	20	6	8	8	12	15	22
	25-pair, 24 AWG	0.410	[10.4]	12	17	6	7	7	11	13	19
COAXIAL	RG6/U	0.270	[6.9]	21	31	8	12	13	19	22	34
FIBER	ZipCord	0.118 x 0.236	[3 x 6]	42	64	17	25	26	39	46	69
	Round 4 Strand Fiber	0.187	[4.8]	43	64	17	26	26	40	47	70
	Round 6 Strand Fiber	0.256	[6.5]	23	34	9	14	14	21	25	38

NOTE: 40% and 60% Wire fill capacities are calculated using radius control inserts. Inserts are factory installed and may be removed if not required to obtain full raceway capacity.

* Entrance end fitting fill rate is calculated using backfeed capability and radius inserts. Inserts are removable and fitting can obtain maximum raceway fill from utilizing end fitting knockouts and removing radius control inserts.

ALDS4000[®] SERIES RACEWAY

ALDS4000 Series Raceway Ordering Information

ALDS4000B Raceway Base

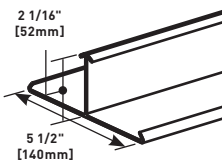

.060" [1.52mm] satin anodized finish. Packed four 10' [3.05m] lengths per carton.

ALDS4010B Blank End Fitting

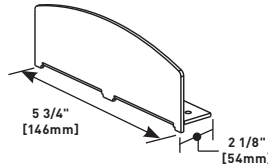

Closes off open end of ALDS4000B Base.

ALDS4000C Raceway Cover

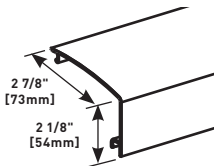

.060 [1.52mm] satin anodized finish. Packed eight 5' [1.5m] lengths per carton. Two covers per base.

ALDS4011 Flat Elbow

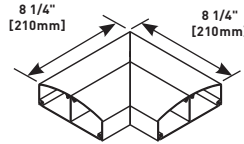

Flat corner for new lay-in or pull-through applications. Includes one pair of DS4001 Couplings.

DS4000WC Wire Clip

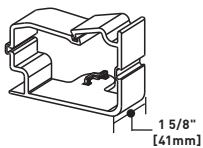

Holds conductors in place.

DS4014A Backfeed Coupling

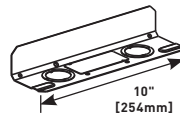

Extra long coupling allows attachment to wall box or back fed to 1" or 1 1/4" trade size conduit.

DS4001 Adjust-to-Fit[™] Coupling

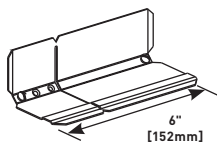

Joins lengths of ALDS4000B together. Sold in pairs.

ALDS4015 Divided Tee

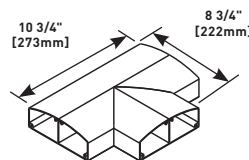

Divided Tee fitting. For new lay-in or pull-through installations. Includes two pairs of DS4001 Couplings.

ALDS4006 Seam Clip

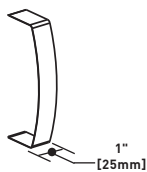

Covers seam where two sections of ALDS4000C come together.

ALDS4017 Internal Elbow

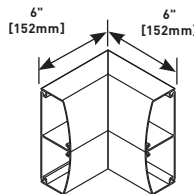

Internal corner for new lay-in or pull-through installations. Includes one pair of DS4001 Couplings.

ALDS4010A Entrance End Fitting

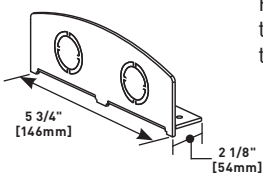

Full capacity End Fitting. Has two 1/2" & 3/4" concentric trade size KOs.

ALDS4018 External Elbow

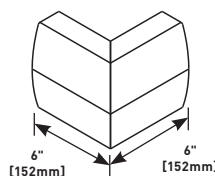

External corner for new lay-in or pull-through installations. Includes one pair of DS4001 Couplings.

ALDS4000[®] SERIES RACEWAY

ALDS4000 Series Raceway Ordering Information (continued)

ALDS4047C

Single-Channel One-Gang Device Plate

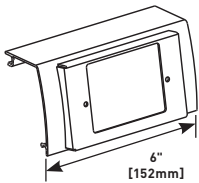

Use with commercially-available single-gang flush plate.

ALDS4047R

Single-Channel Decorator Device Plate

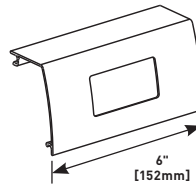

For 15A and 20A decorator receptacles.

ALDS4047D

Single-Channel Duplex Device Plate

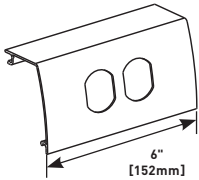

For 15A and 20A duplex receptacles, or 106 style data frames.

ALDS4047-2A*

Single-Channel 2A Mini Adapter Device Plate

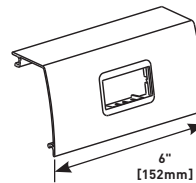

2A opening. Includes adapters for Ortronics TracJack, Series II, Wiremold CM2 Series inserts, Pass & Seymour Activate and other manufacturers.

ALDS4047E

Single-Channel 1.41" Diameter Device Plate

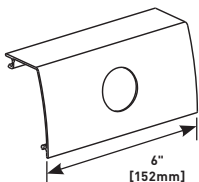

For straight blade and locking receptacles.

ALDS4047MAB*

Single-Channel MAB Device Plate

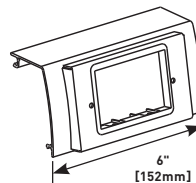

For installing Wiremold CM2 Series inserts and Activate connectivity inserts. Provides flush installation. Includes 6A CM-MAB adapter and Ortronics[®] MAB3S2 and MAB6TJ adapters.

ALDS4047F

Single-Channel 1.59" Diameter Device Plate

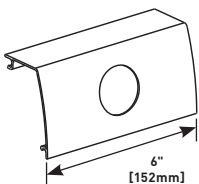

For straight blade and locking receptacles.

* Refer to the Communications Connectivity section of this Product Guide for information on CM2 Series modules.

ALA3800 SERIES™ RACEWAY



Single-channel raceway. Satin anodized finish complements decor in commercial offices, laboratories, and health care facilities.

CODE REFERENCE

- cULus Listed Raceway:**
File E4376 Guide RJPR.
- Fittings:**
File E41751 Guide RJPR.
- Raceway & Fittings:**
Meet Article 386 of NEC.
- Multioutlet Assemblies:**
Meet Article 380 of NEC.

AL3800 Series Raceway Wire Fill Capacities for Communications

	CABLE/WIRE SIZE	O.D. (Approx Dia.)		40% FILL
		Inches	[mm]	
UNSHIELDED TWISTED PAIR	4-pair, 24 AWG, Cat 3	0.190	[4.8]	86
	4 -pair, 24 AWG, Cat 5e	0.210	[5.3]	70
	4-pair, 24 AWG, Cat 6	0.250	[6.3]	50
	4-pair, 24 AWG, Cat 6a*	0.354	[9.0]	25
	25-pair, 24 AWG	0.410	[10.4]	24
COAXIAL	RG6/U	0.270	[6.9]	43
FIBER	ZipCord	0.118 x 0.236	[3 x 6]	88
	Round 4 Strand Fiber	0.187	[4.8]	89
	Round 6 Strand Fiber	0.256	[6.5]	47

NOTE: For additional information, refer to the Technical Section.
 *Category 6 augmented (6a) cable for 10 gigabit ethernet – max allowed cable diameter per addenda No. 11 ANSI TIA/EIA 568-B.2.

AL3800 Series Raceway Wire Fill Capacities for Power

	WIRE SIZE THHN/THWN	O.D.		40% FILL
		Inches	[mm]	
POWER WIRING WITHOUT DEVICES	14 AWG	0.111	[2.8]	214
	12 AWG	0.130	[3.3]	156
	10 AWG	0.164	[4.2]	98
	8 AWG	0.216	[5.5]	56
	6 AWG	0.254	[6.5]	41
POWER WIRING WITH DEVICES 2.04 Sq. In. [51.82mm]	14 AWG	0.111	[2.8]	159
	12 AWG	0.130	[3.3]	116
	10 AWG	0.164	[4.2]	73
	8 AWG	0.216	[5.5]	42
	6 AWG	0.254	[6.5]	30

COLOR OPTIONS



AL3800 Series™ Raceway is available with a satin anodized finish.

ALA3800 SERIES™ RACEWAY

ALA3800 Series Raceway Ordering Information

ALA3800B-10

Single Compartment Raceway Base

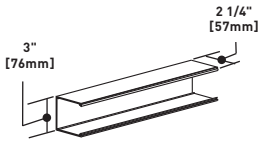

Satin Anodized finish. Nominal wall thickness of .078" [1.99mm]. Packed four 10' [3m] lengths per carton.

ALA3806 Cover Clip

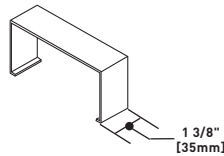

Covers seam where lengths of raceway come together.

ALAC-5 Raceway Cover

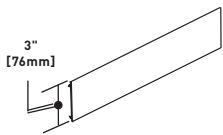

Satin Anodized finish. Nominal wall thickness of .078" [1.99mm]. Packed eight 5' [1.50m] lengths per carton. ALAC-5 is compatible with ALA3800 and ALA4800 Series Raceways.

ALA3811 Flat Elbow

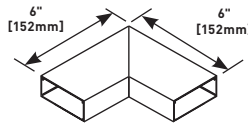

For making a 90° flat turn in a raceway run. Includes two ALA01 Couplings.

ALAWC Wire Clip

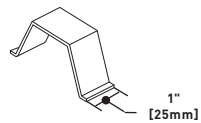

Holds conductors in place in long raceway runs. Snaps into grooves on base.

ALA3815 Tee

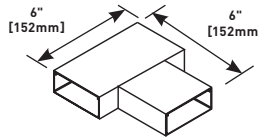

For branch connections of two runs of ALA3800 Series Raceway. Includes three ALA01 Couplings.

ALA01 Couplings

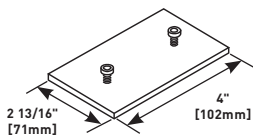

Joins lengths of inline ALA3800B-10 Raceway Base together.

ALA3817 Internal Elbow

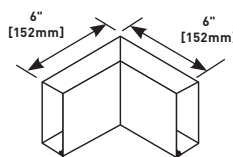

For making a 90° internal turn in a raceway run. Includes two ALA01 Couplings.

ALA3810B Blank End Fitting

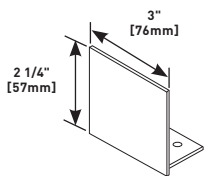

Closes off open end of raceway.

ALA3817N Inverted Internal Elbow

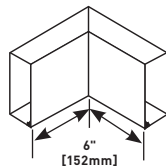

For connecting a vertical run of ALA3800 Series Raceway with a horizontal run with its cover facing up. Includes two ALA01 Couplings.

ALA3810B1 Entrance End Fitting

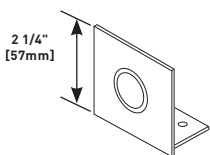

For feeding raceway, has concentric 1/2" and 3/4" trade size knockouts.

ALA3818 External Elbow

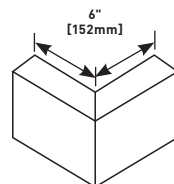

For making a 90° external turn in a raceway run. Includes two ALA01 Couplings.

ALA3800 SERIES™ RACEWAY

ALA3800 Series Raceway Ordering Information (continued)

ALA-DR Duplex Receptacle Cover Plate

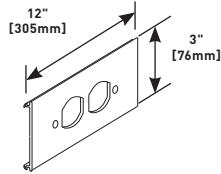

Mounts standard duplex device to the cover.

ALA-N Toggle Switch Cover Plate

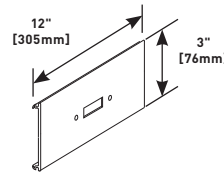

Mounts toggle switch in line.

ALA-E Single Receptacle Cover Plate (1.40" [35.40mm])

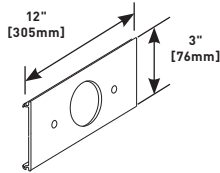

Installs commercially available straight blade and locking single receptacle with face diameters of 1.38"-1.39" [36mm-37mm].

ALA-LPB* Low Profile Adapter Cover Plate

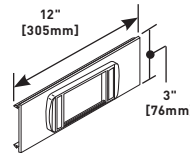

Accepts three (3) Wiremold CM2 Series communication connectivity inserts. Includes cover and low profile adapter, (6A-opening).

ALA-F Single Receptacle Cover Plate (1.59" [38.90mm])

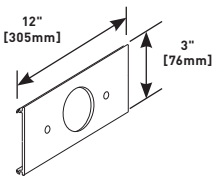

Installs commercially available straight blade and locking single receptacle with face diameters of 1.56"-1.58" [38mm-39mm].

ALA-LPB3S2 Ortronics® Low Profile Adapter Cover Plate

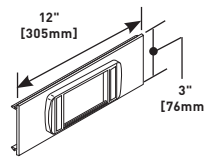

Accepts three Ortronics® Series II datacom inserts. Low profile adapter included.

ALA-G GFCI/Surge/Decorator Cover Plate

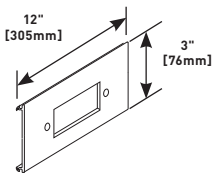

Mounts commercially available GFCI or surge suppression receptacles.

ALA-MAB* 6A Mini Adapter Cover Plate

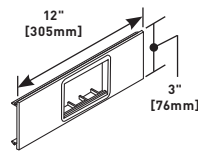

Accepts three (3) Wiremold CM2 Series communication connectivity inserts. Provides a flush installation. Includes cover and 6A mini adapter, (6A-opening).

ALA-J Single Receptacle Cover Plate

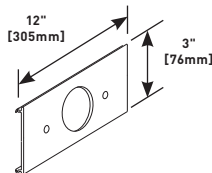

Mounts commercially available straight blade or locking single receptacles with face diameters of 2.13" [52mm].

ALA-MABRT Ortronics® Cover Plate

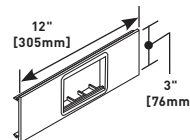

Accepts six Ortronics® TracJack or three Series II datacom inserts. Both adapters included.

NOTE: All device plates are 3" x 12" [76mm x 305mm]. These parts are compatible with both ALA4800 and ALA3800 Series Raceways.

* Refer to the Communications Connectivity section of this Product Guide for information on CM2 Series modules.

ALA3800 SERIES™ RACEWAY

ALA3800 Series Raceway Ordering Information (continued)

ALA-SG Cover Plate with 1 3/4" x 2 15/16" Opening

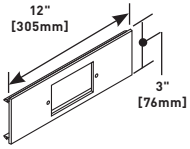

Installs communication connectivity devices utilizing industry standard single-gang faceplates. Hole cut is 1 3/4" x 2 15/16" [44mm x 75mm]. Faceplates must be ordered separately.

ALA-Z 3/4" [19.1mm] Grommet/Mouse Hole Device Cover Plate

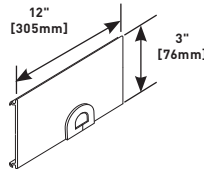

Facilitates the exit of communication cabling. Grommet included.

ALA-2A* 2A Mini Adapter Cover Plate

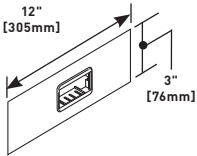

Accepts one (1) Wiremold CM2 Series communication connectivity device. Includes cover and 2A mini adapter, (2A-opening).

NOTE: All device plates are 3" x 12" [76mm x 305mm]. These parts are compatible with both ALA4800 and ALA3800 Series Raceways.

* Refer to the Communications Connectivity section of this Product Guide for information on CM2 Series modules.

ALA4800 SERIES™ RACEWAY



Dual-channel raceway. Satin anodized finish complements decor in commercial offices, laboratories, and health care facilities.

CODE REFERENCE

cULus Listed Raceway:
File E4376 Guide RJPR.

Fittings:
File E41751 Guide RJPR.

Raceway & Fittings:
Meet Article 386 of NEC.

Multioutlet Assemblies:
Meet Article 380 of NEC.

ALA4800 Series Raceway Wire Fill Capacities for Communications

	CABLE/WIRE SIZE	O.D. (Approx Dia.)		40% FILL
		Inches	[mm]	
UNSHIELDED TWISTED PAIR	4-pair, 24 AWG, Cat 3	0.190	[4.8]	86
	4-pair, 24 AWG, Cat 5e	0.210	[5.3]	70
	4-pair, 24 AWG, Cat 6	0.250	[6.3]	50
	4-pair, 24 AWG, Cat 6a*	0.354	[9.0]	25
	25-pair, 24 AWG	0.410	[10.4]	24
COAXIAL	RG6/U	0.270	[6.9]	43
FIBER (Each Compartment)	ZipCord	0.118 x 0.236 [3 x 6]		88
	Round 4 Strand Fiber	0.187	[4.8]	89
	Round 6 Strand Fiber	0.256	[6.5]	47

NOTE: For additional information, refer to the Technical Section.
*Category 6 augmented (6a) cable for 10 gigabit ethernet – max allowed cable diameter per addenda No. 11 ANSI TIA/EIA 568-B.2.

ALA4800 Series Raceway Wire Fill Capacities for Power

	WIRE SIZE THHN/THWN	O.D.		40% FILL
		Inches	[mm]	
POWER WIRING WITHOUT DEVICES	14 AWG	0.111	[2.8]	214
	12 AWG	0.130	[3.3]	156
	10 AWG	0.164	[4.2]	98
	8 AWG	0.216	[5.5]	56
	6 AWG	0.254	[6.5]	41
	POWER WIRING WITH DEVICES [2.04 Sq. In. [51.82mm]] (Each Compartment)	14 AWG	0.111	[2.8]
12 AWG		0.130	[3.3]	116
10 AWG		0.164	[4.2]	73
8 AWG		0.216	[5.5]	42
6 AWG		0.254	[6.5]	30

COLOR OPTIONS



ALA4800 Series™ Raceway is available with a satin anodized finish.

ALA4800 SERIES™ RACEWAY

ALA4800 Series Raceway Ordering Information

ALA4800B-10 Dual Compartment Raceway Base

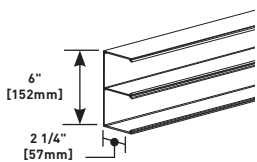

6063-T5 extruded aluminum, satin anodized finish, .078" [1.98mm] wall thickness. Base has integral divider for separation of service. Packed 40' [12m] per carton.

ALA4810B Blank End Fitting

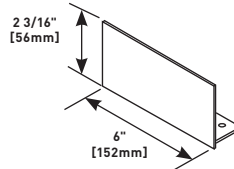

For covering ends of raceway.

ALAC-5 Raceway Cover

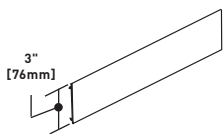

6063-T5 extruded aluminum, satin anodized finish, .078" [1.98mm] wall thickness. Two covers per base. Allows only one compartment to be accessed at a time. Packed 40' [12m] per carton. ALAC-5 is compatible with ALA4800 Series and ALA3800 Series Raceways.

ALA4810B2 Entrance End Fitting

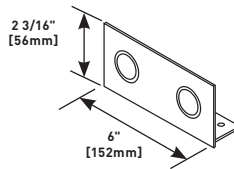

For feeding raceway, has two concentric 1/2" and 3/4" trade size KOs.

ALAWC Wire Clip

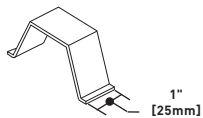

For holding conductors in place in long raceway runs. Snaps into grooves in base.

ALA4811 Flat Elbow

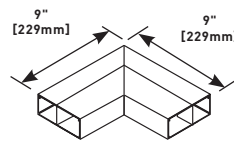

Makes 90° flat turn in a raceway run. Includes four ALA01 Couplings.

ALA01 Couplings

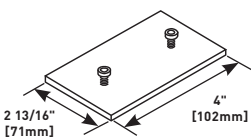

Joins lengths of inline ALA4800B-10 Raceway Base together. Two required per section of base.

ALA4815 Tee

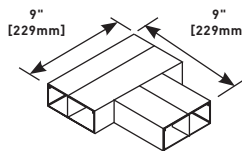

For branch connections of two runs of ALA4800 Series Raceway. Includes six ALA01 Couplings.

ALA4806 Cover Clip

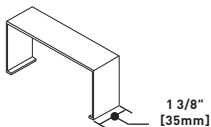

Stainless steel clip to cover joint where lengths of cover or base come together.

ALA4817 Internal Elbow

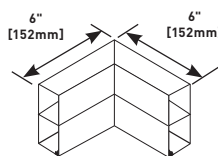

To make an internal turn in a raceway run. Includes four ALA01 Couplings.

ALA09 Grounding Adapter



For connection of equipment grounding conductor to provide additional ground to raceway.

ALA17A Internal Corner Coupling

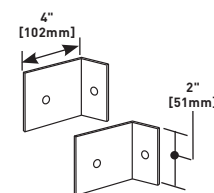

For butting two raceway sections to form an internal 90° turn in a raceway run.

NOTE: These parts are compatible with both ALA4800 and ALA3800 Series Raceways.

ALA4800 SERIES™ RACEWAY

ALA4800 Series Raceway Ordering Information (continued)

ALA4817N Inverted Internal Elbow

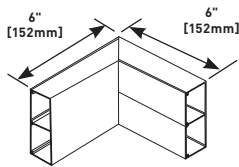

For connecting a vertical run of ALA4800 Series Raceway with a horizontal run with its cover facing up. Includes four ALA01 Couplings.

ALA4818 External Elbow

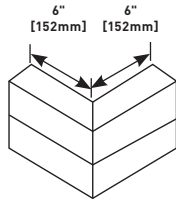

For making a 90° external turn in a raceway run. Includes four ALA01 Couplings.

ALA-ABRT Ortronics® Cover Plate

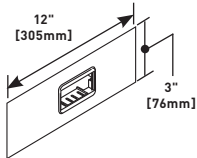

For two Ortronics® TracJack or one Series II datacom insert. Both adapters included.

ALA-BL Blank Cover Plate

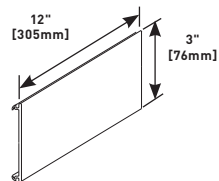

To cover a 12" [305mm] section of raceway.

ALA-DR Duplex Receptacle Cover Plate

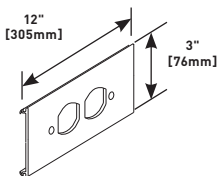

Mounts standard duplex device to the cover.

ALA-E Single Receptacle Cover Plate (1.40" [35.40mm])

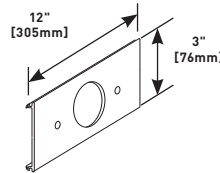

Installs commercially available straight blade and locking single receptacle with face diameters of 1.38" - 1.39" [36mm-37mm].

ALA-F Single Receptacle Cover Plate (1.59" [38.90mm])

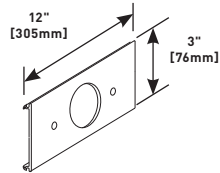

Installs commercially available straight blade and locking single receptacle with face diameters of 1.56" - 1.58" [38mm-39mm].

ALA-G GFCI/ Surge/ Decorator Cover Plate

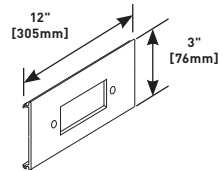

Mounts commercially available GFCI or surge suppression receptacles.

ALA-J Single Receptacle Cover Plate

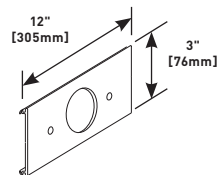

Mounts commercially available straight blade or locking single receptacles with face diameters of 2.13" [52mm].

ALA-N Toggle Switch Cover Plate

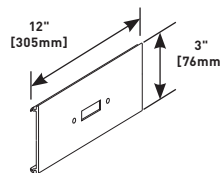

Mounts toggle switch in line.

NOTE: All device plates are 3" x 12" [76mm x 305mm]. These parts are compatible with both ALA4800 and ALA3800 Series Raceways.

*Refer to the Communications Connectivity section of this Product Guide for information on CM2 Series modules.

ALA4800 SERIES™ RACEWAY

ALA4800 Series Raceway Ordering Information (continued)

ALA-LPB* Low Profile Adapter Cover Plate

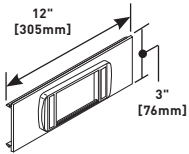

Accepts three (3) Wiremold CM2 Series communication connectivity inserts. Includes cover and low profile adapter, (6A-opening).

ALA-2A* 2A Mini Adapter Cover Plate

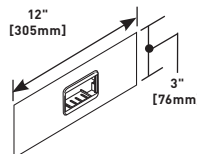

Accepts three (3) Wiremold CM2 Series communication connectivity devices. Includes cover and 2A mini adapter, (2A-opening).

ALA-LPB3S2 Ortronics® Low Profile Adapter Cover Plate

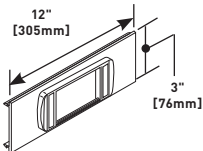

Accepts three Ortronics® datacom inserts for three Series II devices. Low profile adapter included.

ALA-Z 3/4" [19.1mm] Grommet/Mouse Hole Device Cover Plate

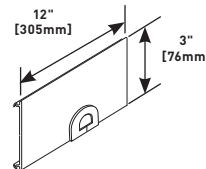

Facilitates the exit of communication cabling. Grommet included.

ALA-MAB* 6A Mini adapter Cover Plate

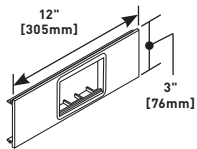

Accepts three (3) Wiremold CM2 Series communication connectivity inserts. Provides a flush installation. Includes cover and 6A mini adapter, (6A-opening).

ALA11RI Radiused Insert

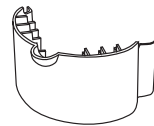

A radiused insert for the ALA3811 and ALA4811 flat elbow to provide a bend radius of 2" [51mm] for Fiber Optic/ Category 5e installations. The insert is ideal for new and retrofit applications whether the cable installation is lay-in or pull-through.

ALA-MABRT Ortronics® Cover Plate

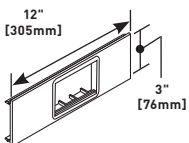

Accepts six Ortronics® TracJack or three Series II datacom inserts. Both adapters included.

ALA17/18RI Radiused Insert

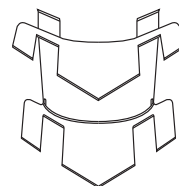

A radiused insert for ALA3817, ALA4817, ALA3817N, ALA4817N, ALA3818, and ALA4818 fittings to provide a bend radius of 2" [51mm] for Fiber Optic/ Category 5e installations. The insert is ideal for new and retrofit applications whether the cable installation is lay-in or pull-through.

ALA-SG Cover Plate with 1 3/4" x 2 15/16" Opening

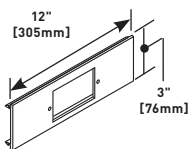

Installs communication connectivity devices utilizing industry standard single-gang faceplates. Hole cut is 1 3/4" x 2 15/16" [44mm x 75mm]. Faceplates must be ordered separately.

NOTE: All device plates are 3" x 12" [76mm x 305mm]. These parts are compatible with both ALA4800 and ALA3800 Series Raceways.

*Refer to the Communications Connectivity section of this Product Guide for information on CM2 Series modules.

AL5200 SERIES™ RACEWAY



Two-piece raceway. Field-installed divider provides for numerous raceway channel configurations. Satin anodized finish complements decor in commercial offices, laboratories, and health care facilities.

CODE REFERENCE

cULus Listed Raceway:
File E4376 Guide RJPR.

Fittings:
File E41751 Guide RJPR.

Raceway & Fittings:
Meet Article 386 of NEC.

Multioutlet Assemblies:
Meet Article 380 of NEC.

AL5200 Raceway System Layout

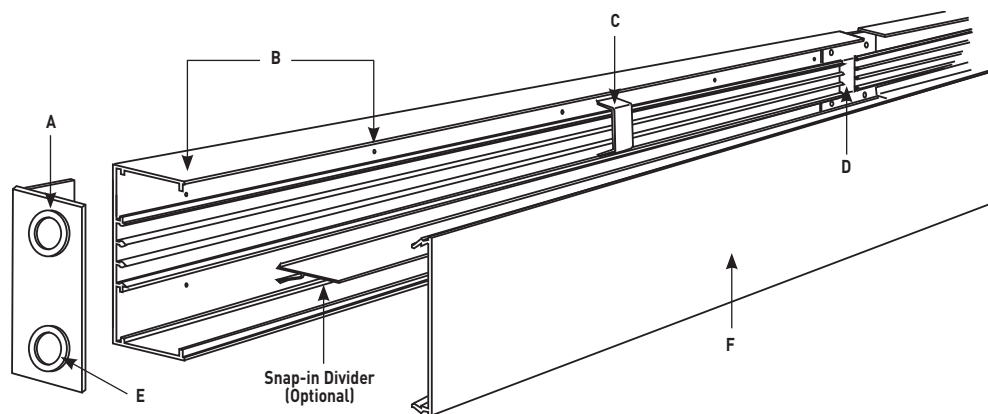

KEY

- A Provide electrical feed through 1/2" or 3/4" [12.7mm or 19.1mm] KO's in AL5210B2 End Cap.
- B Attach base section to mounting surface by drilling 9/32" [7.1mm] holes in the base, and using #8 flathead screws.
- C Secure conductors in place with AL5200WC Wire Clip.
- D Join additional raceway sections with two AL5201 Couplings.
- E Close ends with AL5210B2 Blank End Fittings.
- F Snap cover into base to complete installation.

NOTE: Illustration is for showing product applications only.

COLOR OPTIONS

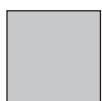

AL5200 Series™ Raceway is available with a satin anodized finish.

AL5200 SERIES™ RACEWAY

AL5200 Series Raceway Wire Fill Capacities for Power

WIRE SIZE THHN/THWN	O.D. Inches [mm]		NUMBER OF CONDUCTORS (40% FILL) WITHOUT DEVICES							
			2.40in. ² [1550mm ²]	2.85in. ² [1840mm ²]	3.50 in. ² [2260mm ²]	3.90 in. ² [2520mm ²]	4.50 in. ² [2900mm ²]	4.80 in. ² [3100mm ²]	5.50 in. ² [3550mm ²]	8.50 in. ² [5480mm ²]
14 AWG	0.111	[2.8]	98	117	144	160	185	197	226	350
12 AWG	0.130	[3.3]	72	85	105	117	135	144	165	255
10 AWG	0.164	[4.2]	45	54	66	73	85	90	104	161
8 AWG	0.216	[5.5]	26	31	38	42	49	52	60	92
6 AWG	0.254	[6.5]	18	22	27	30	35	37	43	67

WIRE SIZE THHN/THWN	O.D. Inches [mm]		WITH DUPLEX RECTANGULAR DEVICES 1.59IN. ² [1025MM ²]							
			2.85in. ² [1840mm ²]	3.50 in. ² [2260mm ²]	3.90 in. ² [2520mm ²]	4.50 in. ² [2900mm ²]	4.80 in. ² [3100mm ²]	5.50 in. ² [3550mm ²]	8.50 in. ² [5480mm ²]	
14 AWG	0.111	[2.8]	54	78	95	120	132	161	284	
12 AWG	0.130	[3.3]	39	57	69	87	96	117	207	
10 AWG	0.164	[4.2]	24	36	43	55	60	74	130	
8 AWG	0.216	[5.5]	14	20	25	31	35	42	75	
6 AWG	0.254	[6.5]	10	15	18	22	25	30	54	

AL5200 Series Raceway Wire Fill Capacities for Communications

	CABLE/WIRE SIZE	O.D. Inches [mm]		40% FILL CAPACITY CROSS SECTIONAL AREA							
				2.40in. ² [1550mm ²]	2.85in. ² [1840mm ²]	3.50 in. ² [2260mm ²]	3.90 in. ² [2520mm ²]	4.50 in. ² [2900mm ²]	4.80 in. ² [3100mm ²]	5.50 in. ² [3550mm ²]	8.50 in. ² [5480mm ²]
UNSHIELDED TWISTED PAIR	4-pair, 24 AWG, Cat 3	0.190	[4.8]	33	40	49	55	63	67	77	119
	4-pair, 24 AWG, Cat 5e	0.210	[5.3]	27	32	40	45	51	55	63	98
	4-pair, 24 AWG, Cat 6	0.250	[6.3]	19	23	28	31	36	39	44	69
	4-pair, 24 AWG, Cat 6a*	0.354	[9.0]	9	11	14	15	18	19	22	34
	25-pair, 24 AWG	0.410	[10.4]	7	8	10	11	13	14	16	25
COAXIAL	RG6/U	0.270	[6.9]	16	19	24	27	31	33	38	59
FIBER	ZipCord	0.118 x 0.236	[3 x 6]	34	41	50	56	64	69	79	122
	Round 4 Strand Fiber	0.187	[4.8]	34	41	51	56	65	69	80	123
	Round 6 Strand Fiber	0.256	[6.5]	18	22	27	30	34	37	42	66

NOTE: For additional information, refer to the Technical Section.

*Category 6 augmented (6a) cable for 10 gigabit ethernet – max allowed cable diameter per addenda No. 11 ANSI TIA/EIA 568-B.2.

AL5200 SERIES™ RACEWAY

AL5200 Series Raceway Ordering Information

AL5200B-5, AL5200B-10 Raceway Base

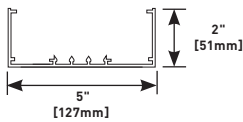

6063-T5 extruded aluminum, satin anodized finish, .080" [2.03mm] wall thickness. Base has four ribs for snap-in divider. AL5200B-5 is packed eight 5' [1.5m] lengths and AL5200B-10 is packed four 10' [3m] lengths per carton.

Raceway may be configured in single or multiple channels in several versatile ways to accommodate power or communications wiring.

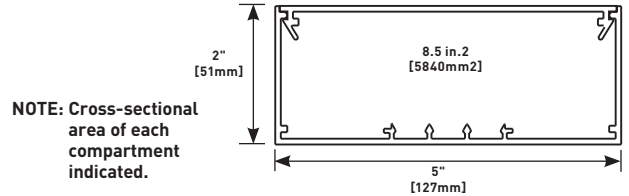

AL5200C-5, AL5200C-10 Raceway Cover

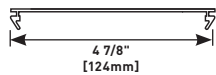

6063-T5 extruded aluminum, satin anodized finish, .075" [1.9mm] wall thickness. AL5200C-5 is packed eight 5' [1.5m] lengths and AL5200C-10 is packed four 10' [3m] lengths per carton.

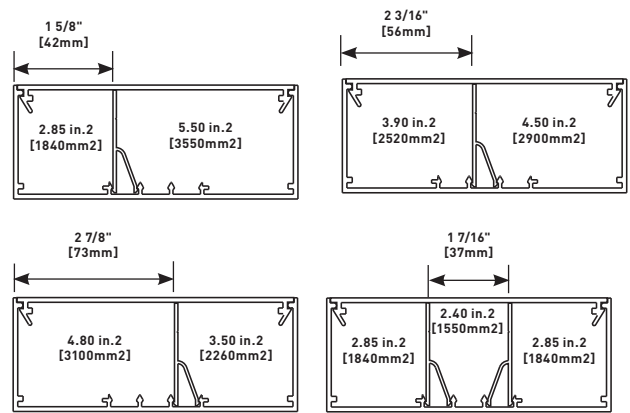

AL5200D-5, AL5200D-10 Divider

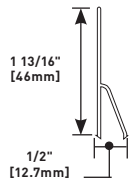

Extruded .050" [1.8mm] thick aluminum. AL5200D-5 is packed eight 5' [1.5m] lengths and AL5200D-10 is packed four 10' [3m] lengths per carton.

AL5206 Cover Clip (Spring Steel)

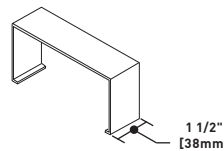

Covers seam where lengths of cover or base come together.

AL5200WC, AL5200WC2, AL5200WC3 Wire Clip

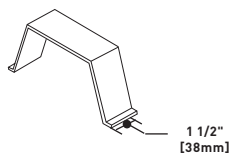

For holding conductors in place in long raceway runs. Snaps into grooves in raceway. AL5200WC Full, AL5200WC2 3/4, and AL5200WC3 1/2.

AL5209 Grounding Adapter

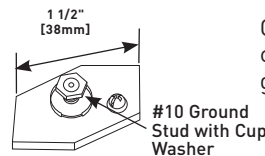

Connects equipment grounding conductor to provide an additional ground to raceway.

AL5201 Coupling

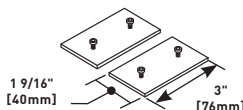

Set screw couplings. Use two for attaching in-line raceway sections.

AL5210B Blank End Fitting

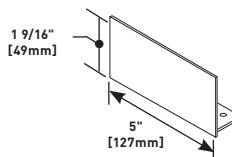

Closes off open ends of raceway.

AL5200 SERIES™ RACEWAY

AL5200 Series Raceway Ordering Information (continued)

AL5210B1, AL5210B2, AL5210B3 Entrance End Fitting

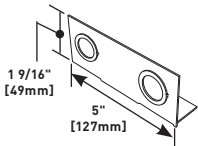

With single or multiple concentric 1/2" and 3/4" trade size KOs for conduit connections. (AL5210B1 and AL5210B3, not shown, have one and three double KOs respectively.)

AL5211 Flat Elbow

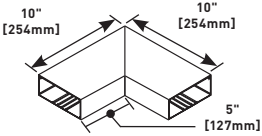

Makes a 90° flat turn in a raceway run. Includes two pairs of AL5201 Couplings.

AL5214 Wall Box Connector

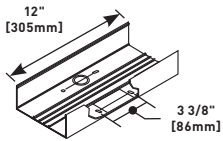

Feeds raceway from a wall-mounted outlet box. Rectangular hole cut or concentric 1/2" and 3/4" trade size KOs. Couplings included.

AL5215 Tee

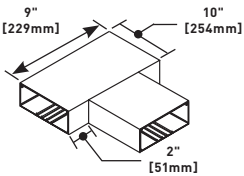

Branch connection of two runs of AL5200 Series Raceway. Includes three pairs of AL5201 Couplings.

AL5216 Cross Fitting

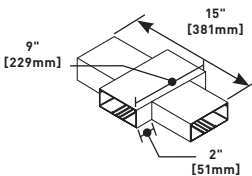

Cross through connection in a raceway run. Includes four pairs of AL5201 Couplings.

AL5217 Internal Elbow

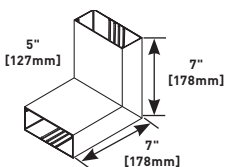

Makes 90° internal corner in a raceway run. Includes two pairs of AL5201 Couplings.

AL5217A Internal Corner Coupling

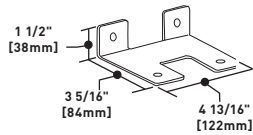

Connects two raceway sections to form an internal 90° turn in a raceway run.

AL5217N Inverted Internal Elbow

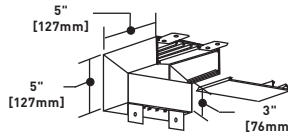

Connects a vertical run of AL5200 Series Raceway with a horizontal overhead run with its cover facing up.

AL5218 External Elbow

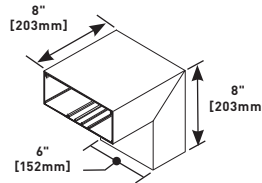

Makes a 90° external turn in a raceway run. Includes two pair of AL5201 Couplings.

AL5246-B Blank Cover

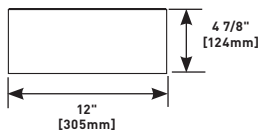

Covers a 12" [305mm] section of raceway.

AL5246-D Duplex Receptacle Cover Plate

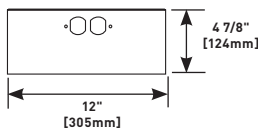

Mounts standard duplex devices to cover.

AL5246-DD Double Duplex Cover Plate

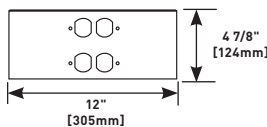

Installs 15A and 20A duplex receptacles or duplex style communication devices.

AL5200 SERIES™ RACEWAY

AL5200 Series Raceway Ordering Information (continued)

AL5246-F Single Receptacle Device Cover Plate

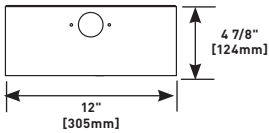

Installs commercially available straight blade and locking single receptacles with face diameters of 1.56" - 1.58" [39.2mm-39.3mm].

AL5246-G GFCI Device Cover Plate

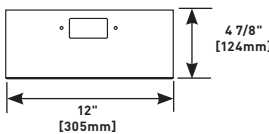

Mounts commercially available GFCI or surge suppression receptacles.

AL5256-ACTLPB* Low Profile Adapter Cover Plate

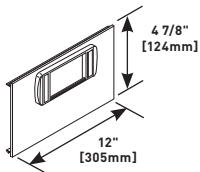

Accepts three (3) Wiremold CM2 Series communication connectivity devices. Includes cover and low profile adapter (6A-opening).

AL5256-ACT2LP* Device Cover Plate with Two Low Profile Adapters

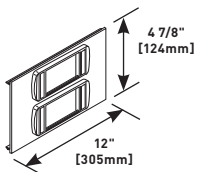

Accepts three (3) Wiremold CM2 Series communication connectivity devices. Includes cover and two low profile adapters (6A-openings).

AL5256-ACTMAB Device Cover Plate with 6A Mini Adapter

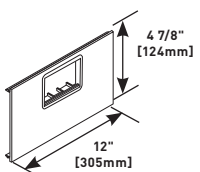

Installs communication connectivity devices. Includes cover and 6A mini adapter (6A-opening).

AL5256-DACT* Duplex & 6A Mini Adapter Cover Plate

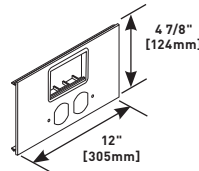

For installation requiring a 15A or 20A duplex receptacle and accepts three (3) Wiremold CM2 Series communication connectivity devices. Cover includes 6A mini adapter (6A-opening).

AL5256-GACT* GFCI & 6A Mini Adapter Cover Plate

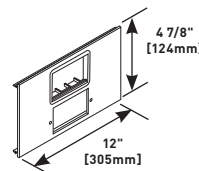

For installation requiring a GFCI or surge suppression receptacle and accepts three (3) Wiremold CM2 Series communication connectivity devices. Cover includes 6A mini adapter (6A-opening).

AL5256-D2A* Duplex Receptacle & 2A Mini Adapter Cover Plate

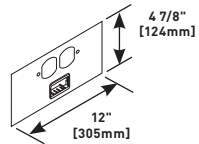

Duplex receptacle cover accepts one (1) Wiremold CM2 Series and 2A mini adapter (2A opening).

AL5256-DZ Duplex Receptacle & Mouse Hole Device Cover Plate

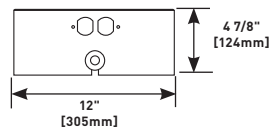

Grommeted cable access at duplex receptacle location (2A opening).

AL5256-ABRT Ortronics® Cover Plate

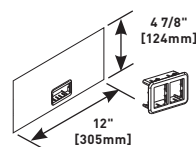

Accepts only Ortronics® datacom inserts. Supplied with both adapters to accommodate two TracJack devices or one Series II device.

* Refer to the Communications Connectivity section of this Product Guide for information on CM2 Series modules.

AL5200 SERIES™ RACEWAY

AL5200 Series Raceway Ordering Information (continued)

AL5256-DABRT Duplex & Ortronics® Cover Plate

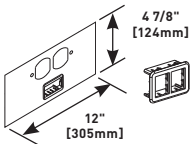

Accepts only Ortronics® datacom inserts. Supplied with both adapters to accommodate two TracJack devices or one Series II device.

AL5256-GMABRT GFCI & Ortronics® Cover Plate

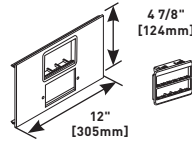

Accepts Ortronics® datacom inserts. Supplied with both adapters to accommodate six TracJack devices or three Series II devices.

AL5256-GABRT GFCI & Ortronics® Cover Plate

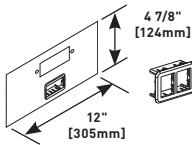

Accepts only Ortronics® datacom inserts. Supplied with both adapters to accommodate two TracJack devices or one Series II device.

AL5256-2A* 2A Mini adapter Cover Plate

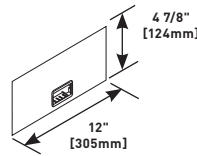

Accepts one (1) Wiremold CM2 Series 2A communication connectivity device. Includes cover and 2A mini adapter (2A opening).

AL5256-G2A* GFCI & 2A Mini Adapter Cover Plate

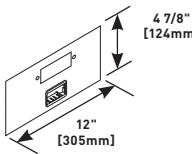

GFCI sized hole cut accepts one (1) Wiremold CM2 Series and 2A mini adapter (2A opening).

AL5256-LPB3S2 Ortronics® Low Profile Adapter Cover Plate

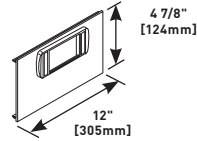

Accepts Ortronics® datacom inserts. Accepts three Series II devices. Low profile adapter included.

AL5256-GZ GFCI & Mouse Hole Device Cover Plate

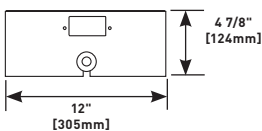

Grommeted cable opening at GFCI receptacle location.

AL5256-2LPB3S2 Ortronics® Low Profile Adapter Cover Plate

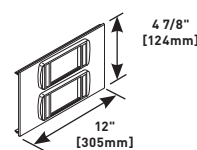

Accepts Ortronics® datacom inserts. Accepts six Series II devices. Two low profile adapters included.

AL5256-MABRT Ortronics® Cover Plate

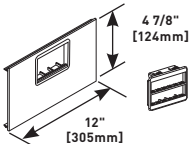

Accepts Ortronics® datacom inserts. Supplied with both adapters to accommodate six TracJack devices or three Series II devices.

AL5256-Z Mouse Hole Device Cover Plate

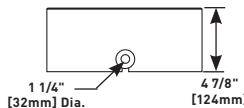

Facilitates exit of voice or data communication cabling. Grommet furnished.

AL5256-DMABRT Duplex & Ortronics® Cover Plate

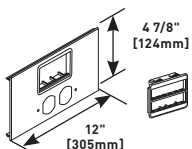

Accepts Ortronics® datacom inserts. Supplied with both adapters to accommodate six TracJack devices or three Series II devices.

AL5260 Offset Divider

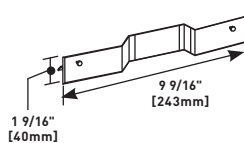

Used to allow device offsets and to extend over ribs in the raceway base. Snap fits into base.

* Refer to the Communications Connectivity section of this Product Guide for information on CM2 Series modules.

PREWIRED RACEWAY SYSTEMS



When time is an issue, **Wiremold**® Prewired Raceway gives you the option of letting our experts do the work for you. Wiring is labeled, wrapped and ready for termination at the job site. All you need to do is mount the raceway on the wall and connect the feed wires. Use our new Prewired Connectors, and you'll get off the job even faster. Save installation time, labor and money with raceway that's ready for work before it even gets on the job.

Featured Products



AL4000 Series™
Raceway

207



ALDS4000 Series
Raceway

219



Prewired Select
Series™
Raceways

229

PREWIRED RACEWAY SYSTEMS

Table of Contents

Why Prewired?



Single Channel, Single Cover Aluminum Raceway Systems



AL3000 Series Raceway

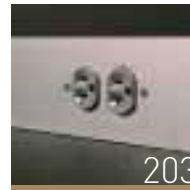

ALA3800 Series Raceway

Single/Dual Channel, Single Cover Aluminum Raceway Systems

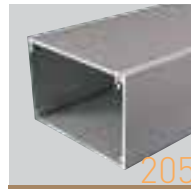

AL3300 Series Raceway

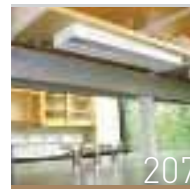

AL4000 Series Raceway



AL4400 Series Raceway

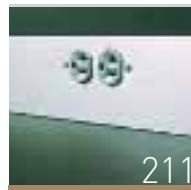

AL4750 Series Raceway

Dual Channel, Dual Cover Aluminum Raceway Systems

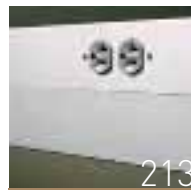

AL4320 Series Raceway

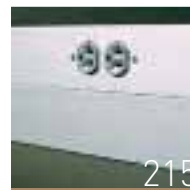

AL4520 Series Raceway

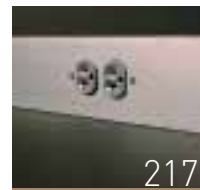

ALA4800 Series Raceway



ALDS4000 Series Raceway

PREWIRED RACEWAY SYSTEMS

Table of Contents

Three Channel, Dual Cover Aluminum Raceway Systems

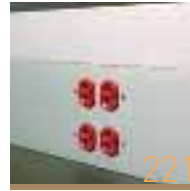

AL7320 Series Raceway

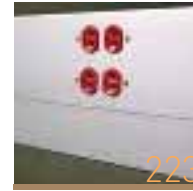

AL7450 Series Raceway

Prewired Steel Raceway Systems



3000[®] Series,
4000[®] Series,
DS4000[®] & 6000[®]
Series Raceways

Prewired Nonmetallic Raceway Systems

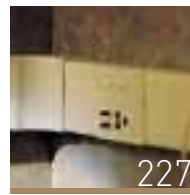

5400 Series™,
5500 Series™
& CableSmart™
40N2 Series Raceways

Prewired Select Series™ Teacher Drops



Prewired Select Series™ Raceways

PREWIRED RACEWAY SYSTEMS

At Wiremold®, our goal for Prewired Raceway is to enhance the value to the end user and installer by providing value-added services to their projects, i.e. specific wiring configurations, labeling and special services.

Wiremold® has been setting the standard in the engineering and manufacturing of Prewired Raceway solutions over the last 20 years. Wiremold has the knowledgeable sales, project management and engineering resources to provide you with assistance in:

- Defining bills of material and project quotes.
- Interpreting project specifications, electrical drawings and elevation plans to produce detailed submittal and installation drawings.
- Coordinating production, packaging and shipping schedules to meet your job site requirements.

As a leader in the electrical industry Wiremold continues to look for new and innovative ways to simplify the installation of our Prewired Raceway systems. Over the last 5 years Wiremold has:

- Redesigned our submittal and installation documentation to more clearly depict design intent and ease installation.

- Introduced Wiremold “Prewired Connectors”. The only UL and cUL listed modular connector for Prewired Raceway systems available on the market. “Prewired Connectors” have been shown to decrease installation time and eliminate miswiring in the field that can lead to costly callbacks.
- Introduced UL and cUL listed Commercial Outlet Centers (Cord-Ended) that are optimal for mounting to semi-permanent structures such as shelving and rack displays found in many Lab applications.

When deadlines are looming and skilled labor is in short supply Wiremold has the expertise and quality solutions to help you complete your project on time. Wiremold Prewired Raceway solutions will:

- Save up to 67% of the installation time needed for field install of component raceway parts.
- Provide maximum flexibility for adding or relocating power and communication requirements during renovations or equipment changes.
- Provide you with an established project team who has the knowledge and experience from successfully completing work on thousands of projects for the educational, pharmaceutical, hospital, retail and military markets.

Ordering Process for Prewired Applications

Detailed Submittal

The detailed submittal shows exactly how each raceway run will be built (lengths, number and type of receptacles, wiring schematics, circuiting information, etc.). The contractor and/or distributor must review and correct any information not clearly indicated on the drawings or specs, approve and return before production can be scheduled.

Submittal Free

The Prewired Express Building Plan Checklist is filled out by the contractor or distributor and sent along with plans, casework, and specs. No submittal is required and the project is scheduled for production upon receipt of all information.

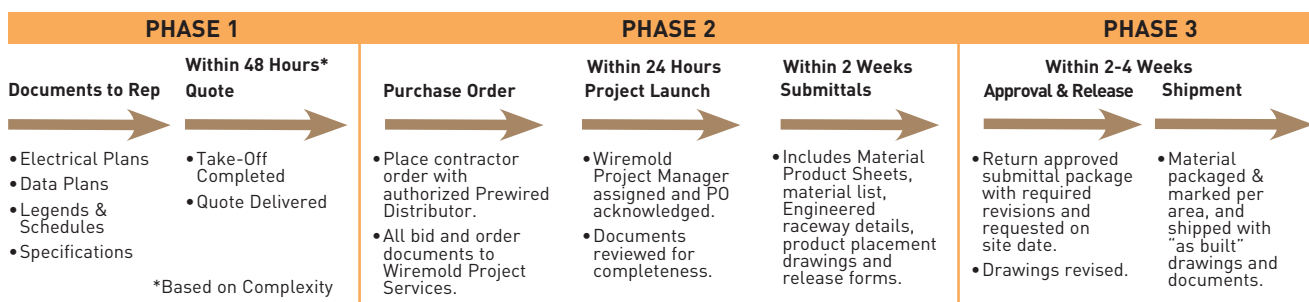

Prewired Raceway gets installers off the job in 1/3 less time than conventional raceway installations.



Wiremold Prewired Raceway is available in a wide range of capacity and configuration options.



Prewired Connectors provide contractors with peace-of-mind. Connectors are factory wired and tested so errors, backtracking and troubleshooting are virtually eliminated.



Commercial Outlet Centers (Cord-Ended) that are optimal for mounting to semi-permanent structures such as shelving and rack displays found in many Lab applications.

PREWIRED RACEWAY SYSTEMS

The Process

1. Raceway is wired and assembled per customer specifications.
2. Finished raceway is quality tested to insure performance and accuracy of wiring
3. Raceway is labelled and packed per job and job site requirements.
4. Detailed project drawings are included with every project.
5. Raceway is shipped to arrive at job site per production schedule and project specifications.



Prewired Connectors

Introducing Faster, More Reliable Connections for Prewired Raceway Systems

New Wiremold Prewired Connectors offer the fastest, most reliable connectivity solution available for prewired raceway system installations. Independent testing has shown that when using new Prewired Connectors in prewired raceway installations, installers can get off the job up to eighteen times faster than when using conventional installation methods... while virtually eliminating any callbacks for wiring errors.

Supports following NEMA configurations:

5-15R	L5-15R	6-15R	L6-15R
5-20R	L5-20R	6-20R	L6-20R
5-30R	L5-30R	6-30R	L6-30R

NOTE: Consult factory for other configurations.

Specification Guidelines:

- Maximum of one (1) device per foot of raceway.
- Harnesses from multiple feeds may not cross in duct when feeding from different directions.
- Maximum base segment length of ten (10) feet.
- No downstream protection on GFCI or Surge devices.

Prewired Connector Applications:

Current Rating:	30A maximum
Voltage Rating:	250V maximum
Wire Gauge:	10AWG maximum
Wire Type:	Stranded Copper



Prewired Connectors provide fast and reliable connectivity and are available in 3-, 6- and 8-wire configurations.



Prewired Testimonials



For the Contractor:
Getting a complete package of detailed drawings helps my guys know where every carton and piece of raceway go.



For the Lab:
Cord-ended Prewired gives me the flexibility I need to reconfigure my lab.



For the Contractor:
Prewired Connectors increase my productivity. Installs are ultra fast and there are no miswiring or troubleshooting issues.

PREWIRED RACEWAY SYSTEMS

Aluminum



Isoduct® Aluminum Prewired Raceway Systems are manufactured to specific job lengths, completely assembled and shipped to the jobsite ready to install.



CODE REFERENCE

cULus Listed Multioutlet Assemblies:
File E15191 Guide PVGT.

Surface Metal Raceway:
File E4376 Guide RJBT.

Fittings: File E41751 Guide RJPR.
Meet Article 380 of NEC.

Prewired Aluminum Raceway Features

FEATURES	STANDARD	OPTIONS
Communication Devices	Ortronics & Activate Connectivity System Devices	Other manufacturers
Electrical Devices	Pass & Seymour	Other manufacturers
Cover Length	12" [305mm] or 18" [457mm]	24" [610mm], 36" [914mm], custom or continuous
Body Length	Longest = 10' [3.05m], shortest = 1' [305mm]	
Installation	Surface mounted	Flush mounted (recessed)
Finish	Architectural Class II Clear Anodized	Custom colors available, consult factory.*
Fittings	Mitered	Butt joints or custom
Wire Type	THHN Stranded	Options per specification
Wiring Splices	Insulation displacement connectors	Continuous wiring or twist-on wire connector
Grounding Conductors	Wire gauge per National Electrical	Oversized and/or separate grounding wires Code (NEC) and shared grounding wires
Device Identification	Gray self-adhesive polyester label with black letters	Engraved covers, self-adhesive engraved nameplate, screw mounted engraved nameplate
Neutrals	Shared neutral	Oversized and/or separate neutral wires
Pigtails	12" [305mm] feeds and receptacle leads	Per specification
Conduit Feeds	Raceway drilled at job site with hole saw	Entrance end cap
Device Mounting	Mounted to cover with 2 counter-sunk #6-32 screws	Device mounting brackets
Record Drawings	3 sets and 2 copies of marked-up blueprints	Per job requirements
Submittal Services	Detailed Submittal	Express Submittal or Submittal Free

* Paint chip required for custom colors.

COLOR OPTIONS

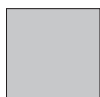

Aluminum Prewired Raceway Systems are available with an anodized aluminum finish.

Custom color options are also available. Consult the factory for more information.

PREWIRED RACEWAY SYSTEMS

Quick Selection Guide

Single Channel - Single Cover Raceway Profiles

ALA3000 Series Raceway

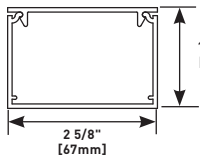

Capacity: 1.1 in² [710mm²]
Cover Options: AL3000C

ALA3800 Series Raceway

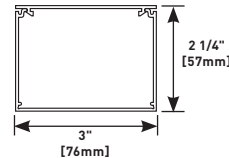

Capacity: 6.10 in² [3963mm²]
Cover Options: ALA-C

Single/Dual Channel - Single Cover Raceway Systems

NOTE: These profiles are available as either a single channel raceway or as a divided dual channel raceway.

AL3300 Series Raceway

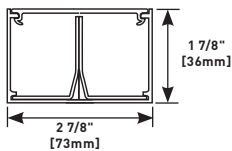

Capacity:
1/2 Divided: 2.20 in² [1419mm²]
Offset Divided: 1.35 in² [871mm²]
Undivided: 4.40 in² [2389mm²]

Cover Options: AL3300C

AL4000 Series Raceway

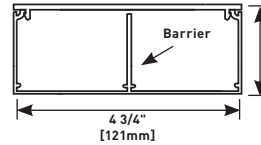

Capacity:
Divided: 3.10 in² [2000mm²]
Undivided: 7.20 in² [4645mm²]

Cover Options: AL4000C

Available with Barrier removed.

AL4400 Series Raceway

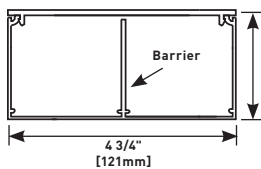

Capacity:
Per Compartment:
 4.72 in² [3045mm²]

Cover Options: AL4000C

Available with Barrier removed.

AL4750 Series Raceway

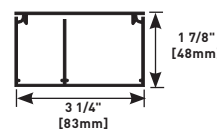

Capacity:
Small: 2.22 in² [1536mm²]
Large: 3.75 in² [2950mm²]

Cover Options: AL4750C

Dual Channel - Dual Cover Raceway Systems

AL3320 Series Raceway

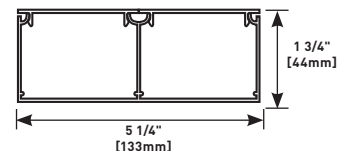

Capacity:
Per Compartment:
 4.45 in² [2970mm²]

Cover Options: AL3000C

AL4520 Series Raceway

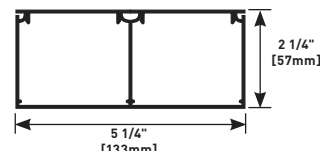

Capacity:
Per Compartment:
 5.90 in² [3818mm²]

Cover Options: AL3000C

ALA4800 Series Raceway

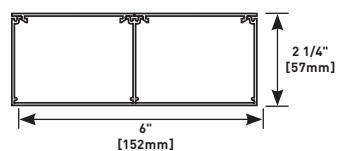

Capacity:
Per Compartment:
 5.93 in² [3026mm²]

Cover Options: ALA-C

ALDS4000 Series Raceway

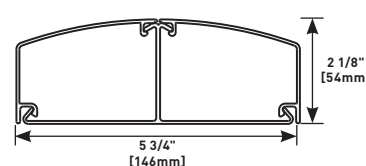

Capacity:
Per Compartment:
 4.85 in² [3129mm²]

Cover Options: ALDS4000C

PREWIRED RACEWAY SYSTEMS

Quick Selection Guide

Three Channel - Dual Cover Raceway Systems

AL7320 Series Raceway

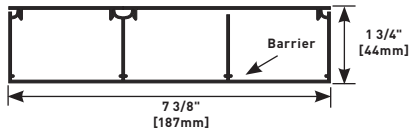

Capacity:
Per Compartment:
4.31 in² [2797mm²]

Cover Options:
AL3000C, AL4000C

Available with Barrier removed.

AL7450 Series Raceway

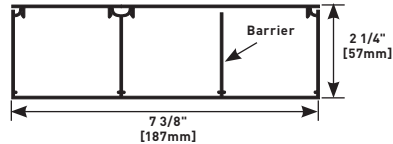

Capacity:
Single: 5.02 in² [3239mm²]
Dual: 4.72 in² [3045mm²]

Cover Options:
AL3000C, AL4000C

Available with Barrier removed.

Aluminum Prewired Raceway Systems Wire Fill Capacities for Data/Communications

CABLE/WIRE TYPE	O.D.	Inches	[mm]	AL3000	AL4000	AL4320**	AL7320		ALDS4000
				40%	40%	40%	No Barrier 40%	Single 40%	40%
UNSHIELDED TWISTED PAIR	4-pair, 24 AWG Cat 3	0.190	[4.8]	53	48	53	81	43	68
	4-pair, 24 AWG Cat 5e	0.210	[5.3]	43	39	43	66	35	56
	4-pair, 24 AWG Cat 6	0.250	[6.4]	31	28	31	47	25	40
	4-pair, 24 AWG Cat 6a*	0.354	[9.0]	15	14	15	23	12	20
	25-pair, 24 AWG	0.360	[9.1]	15	13	15	23	12	19
COAXIAL	RG6/U	0.270	[6.9]	26	24	26	40	21	34
FIBER OPTIC	ZipCord	0.118 x 0.236	[3 x 6]	54	48	54	83	44	70
	Round 4 Strand Fiber	0.187	[4.7]	55	49	55	84	44	71
	Round 6 Strand Fiber	0.256	[6.5]	29	26	29	45	24	38

Aluminum Prewired Raceway Systems Wire Fill Capacities for Data/Communications (continued)

CABLE/WIRE TYPE	O.D.	Inches	[mm]	AL4400	AL4520**	ALA4750	ALA3800	ALA4800**	AL7450	
				40%	40%	40%	40%	40%	Top 40%	Bottom 40%
UNSHIELDED TWISTED PAIR	4-pair, 24 AWG Cat 3	0.190	[4.8]	66	84	69	86	86	71	66
	4-pair, 24 AWG Cat 5e	0.210	[5.3]	55	69	57	70	70	58	55
	4-pair, 24 AWG Cat 6	0.250	[6.4]	38	48	40	50	50	41	38
	4-pair, 24 AWG Cat 6a*	0.354	[9.0]	19	24	20	25	25	20	19
	25-pair, 24 AWG	0.360	[9.1]	19	23	19	24	24	20	19
COAXIAL	RG6/U	0.270	[6.9]	33	41	34	43	43	35	33
FIBER OPTIC	ZipCord	0.118 x 0.236	[3 x 6]	68	85	70	88	88	72	68
	Round 4 Strand Fiber	0.187	[4.7]	69	87	71	89	89	73	69
	Round 6 Strand Fiber	0.256	[6.5]	37	46	38	47	47	39	37

NOTE: For additional information, refer to the Technical Section.

* Category 6 augmented (6a) cable for 10 gigabit ethernet – max allowed cable diameter per addenda No. 11 ANSI TIA/EIA 568-B.2.

** Each compartment.

PREWIRED RACEWAY SYSTEMS

Quick Selection Guide

Aluminum Prewired Raceway Systems Wire Fill Capacities for Power (40% fill factor)

THHN/THWN (STRANDED)		AL3000	AL4000*	AL4320*	AL7320		ALDS4000*
					Single	Dual*	
POWER WIRING WITHOUT DEVICES	6 AWG	30	27	30	31	56	–
	8 AWG	41	37	42	42	78	53
	10 AWG	72	64	73	74	135	92
	12 AWG	114	102	115	117	214	146
	14 AWG	156	140	158	161	294	200
POWER WIRING WITH GFCI DEVICES (2.04 SQ.IN.)	6 AWG	14	10	14	14	40	–
	8 AWG	19	15	19	20	55	27
	10 AWG	33	25	34	35	96	47
	12 AWG	53	41	54	56	153	75
	14 AWG	72	56	74	77	210	102



Aluminum Prewired Raceway Systems Wire Fill Capacities for Power (40% fill factor) (continued)

THHN/THWN (STRANDED)		ALA3800*	AL4400*	AL4520*	AL4750*	AL7450		ALA4800
						Single	Dual*	
POWER WIRING WITHOUT DEVICES	8 AWG	41	50	54	35	53	49	41
	10 AWG	56	87	110	61	108	101	56
	12 AWG	98	139	172	97	170	159	98
	14 AWG	156	190	232	133	229	215	156
POWER WIRING WITH GFCI DEVICES (2.04 SQ.IN.)	8 AWG	30	28	32	13	31	27	30
	10 AWG	42	49	65	22	64	57	42
	12 AWG	73	77	102	35	100	89	73
	14 AWG	116	106	137	49	135	121	116

PREWIRED RACEWAY SYSTEMS

Quick Selection Guide

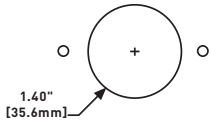
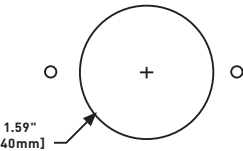
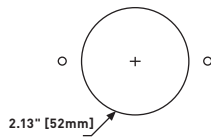
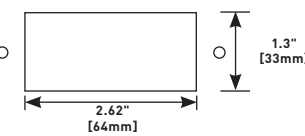
Prewired Aluminum Raceway Systems Device Opening

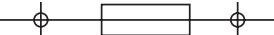
Opening	Device Compatibility	Raceway Profile Compatibility		
Single Receptacle 	15A and 20A Straight Blade and Locking 5-15R 15-20R 5-20R 18-20R 6-15R L5-15R 6-20R L6-15R 10-20R L7-15R 14-20R	AL3000 AL3300 ALA3800 AL4000	AL4400 AL4750 AL4320 AL4520	ALA4800 ALDS4000 AL7320 AL7450
Single Receptacle 	NEMA Locking Devices. Accommodates all NEMA Locking Devices except L5-15R, L6-15R and L7-15R.	AL3000 AL3300* ALA3800 AL4000	AL4400 AL4750* AL4320 AL4520	ALA4800 ALDS4000 AL7320 AL7450
Single Receptacle 	30A and 50A Straight Blade 5-30R 7-30R 5-50R 7-50R 6-30R 10-30R 6-50R 10-50R	AL3000* AL3300** ALA3800 AL4000*	AL4400* AL4750** AL4320* AL4520*	ALA4800 ALDS4000* AL7320* AL7450*
Rectangular Openings 	Decorator Style, Rectangular GFCIs, and Rectangular Surge Protection Receptacles	AL3000 AL3300 ALA3800 AL4000	AL4400 AL4750* AL4320 AL4520	ALA4800 ALDS4000 AL7320 AL7450
Duplex 	5-15R L5-15R 5-20R L6-15R 6-15R L7-15R 6-20R	AL3000 AL3300 ALA3800 AL4000	AL4400 AL4750 AL4320 AL4520	ALA4800 ALDS4000 AL7320 AL7450
Single-Gang Switch 	NOTE: Custom openings are also available – consult factory for more information.	AL3000 AL3300 ALA3800 AL4000	AL4400 AL4750 AL4320 AL4520	ALA4800 ALDS4000 AL7320 AL7450

* Raceway profile will accommodate opening and device when undivided.

* Raceway profile requires installation of an adapter box to accommodate device.

** Raceway profile requires removal of barrier and installation of an adapter box to accommodate device.

* Raceway profile will accommodate opening and device when undivided.

PREWIRED RACEWAY SYSTEMS

Quick Selection Guide

Prewired Aluminum Raceway Systems Data/Communications Opening

Opening	Device Compatibility	Opening	Device Compatibility
---------	----------------------	---------	----------------------

Wallplate Openings

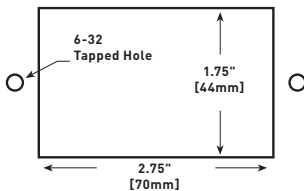

Accommodates a wide range of standard size commercially available wall plates.

Duplex for Data



Accommodates Standard Duplex 106 Style Frames.

Opening	Device Compatibility	Opening	Device Compatibility
---------	----------------------	---------	----------------------

Rectangular Openings

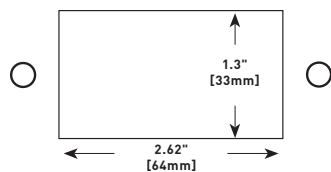

Accommodates Standard Decorator Style Frames.

Grommet Openings

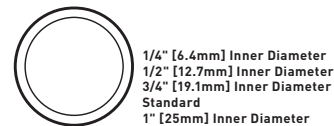

Accommodates commercially available Grommets

Opening	Device Compatibility
---------	----------------------

AB Adapter Openings

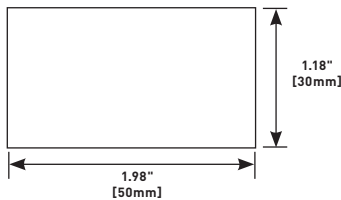

Accommodates 2A size Activate and Ortronics® Bezels.

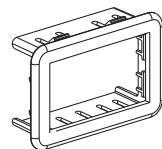

CM-2AB – Accepts One Series II Module

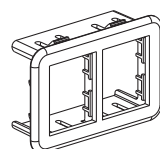

ABS2 – Accepts Two TracJack Modules

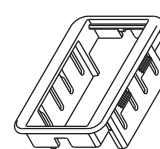

AB2TJ – Accepts One Activate 2A Module

Low or High Profile Adapter Openings

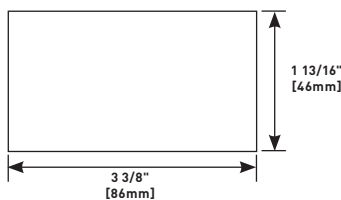

Accommodates Activate and Ortronics® Low Profile Adapters.

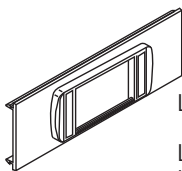

Low Profile Adapter (LPB)

LPB – Accepts 3 Pass & Seymour Activate Inserts
LPB3S2 – Accepts 3 Ortronics Series II Inserts

Modular Adapter Opening

Accommodates MAB Activate and Ortronics® Adapters.

NOTE: Custom openings are also available – consult factory for more information.

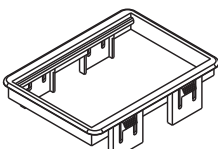

MAB

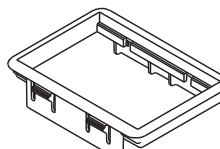

MAB3S2

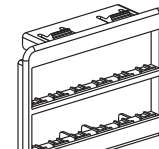

MAB6TJ

AL3000 SERIES RACEWAY

Ordering Information

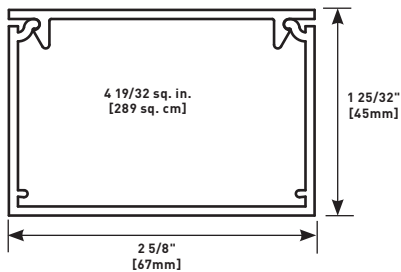

AL3000 Series Raceway is a single-channel, single-cover raceway that is a cost effective, highly aesthetic solution to provide access to communication cabling or electrical wiring systems. The raceway is designed to meet most installation requirements for UTP, fiber optic and electrical wiring.

Material: 6063 T6 Aluminum Alloy
Wall Thickness: 0.078" [1.99mm]
Anodized Finish Thickness: 0.004" [0.004mm]

AL3010B
Blank End Cap

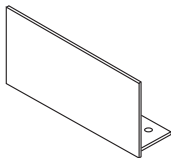

AL3017
Internal Elbow with Coupling

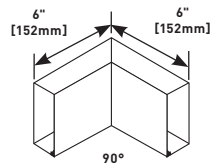

AL3011
90° Flat Elbow

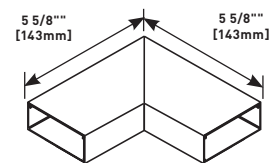

AL3010B1
Entrance End Cap

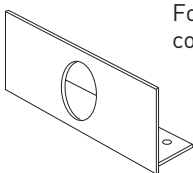

For 3/4" [19.1mm] conduit connector

AL3018
External Elbow with Coupling

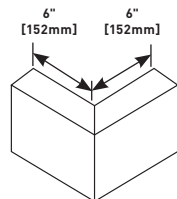

AL3012B
45° External Elbow with Coupling

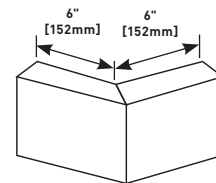

AL3001
Slide Coupling

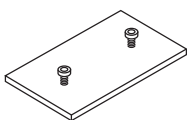

AL3015
Flat Tee

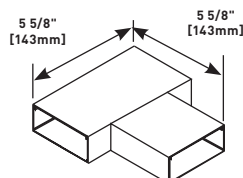

AL3012A
45° Internal Elbow with Coupling

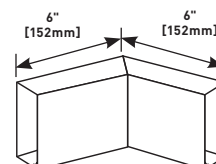

ALA3800 SERIES RACEWAY

Ordering Information

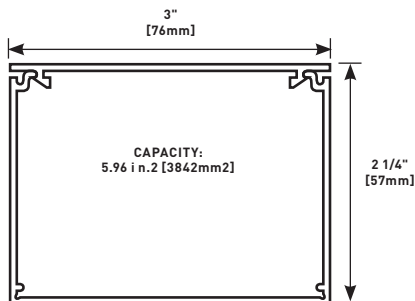

ALA3800 Series Aluminum Raceway System meets the demands of commercial spaces, directing power or communications services where required. The low-profile surface mounted raceway is easy to install and because of its two-piece design, wiring is always accessible.

Material: 6063 T6 Aluminum Alloy
Wall Thickness: 0.078" [1.99mm]
Anodized Finish Thickness: 0.004" [0.004mm]

ALAWC Wire Clip

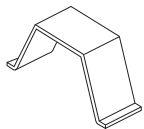

Holds conductors in place in long runs of ALA3800 Series Raceway. Snaps into grooves on base.

ALA17A Internal Corner Coupling

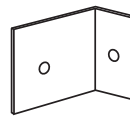

Forms an internal 90° turn in a run of ALA3800 Series Raceway.

ALA01 Slide Coupling

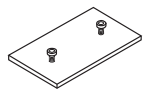

Connects adjoining sections of ALA3800 Series Raceway base.

ALA3806 Cover Clip

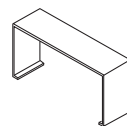

Covers seams where sections of ALAC-5 Cover come together.

ALA09 Grounding Adapter

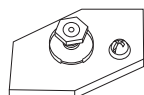

Connects equipment grounding conductor to ALA3800 Series Raceway.

ALA3810B Entrance End Cap

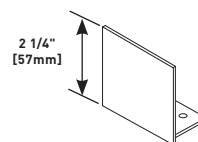

Closes off open ends of ALA3800 Series Raceway

ALA3800 SERIES RACEWAY

Ordering Information

ALA3810B1 Entrance End Cap

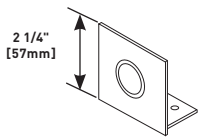

For feeding raceway, has concentric 1/2" and 3/4" knockouts.

ALA3818 External Mitered Elbow with Coupling

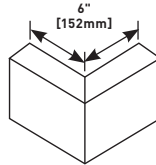

Makes 90° external turns in runs of ALA3800 Series Raceway. Includes two (2) ALA01 Couplings.

ALA3811 90° Flat Mitered Elbow with Coupling

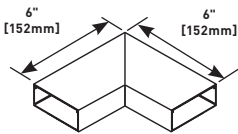

Makes 90° turns in runs of ALA3800 Series Raceway. Includes two (2) ALA01 Couplings.

ALA11R1 2" [51mm] Bend Radius Control Insert for Flat Elbow

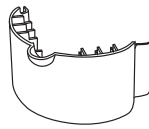

Installs in ALA3811 Flat Elbow. For new and retrofit applications whether the cable installation is lay-in or pull-through.

ALA3815 Flat Tee with Coupling

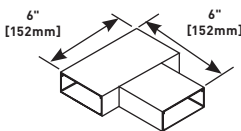

Makes branch connections of two runs of ALA3800 Series Raceway. Includes three (3) ALA01 Couplings.

ALA17/18R1 2" [51mm] Bend Radius Control Insert for Internal and External Elbows

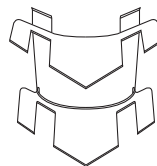

Inserts into ALA3817, ALA3817N, and ALA3818 fittings. For new and retrofit applications whether the cable installation is lay-in or pull-through.

ALA3817 Internal Mitered Elbow with Coupling

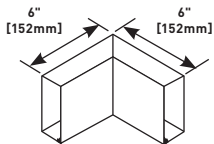

Makes 90° internal turns in runs of ALA3800 Series Raceway. Includes two (2) ALA01 Couplings.

ALA3817N Inverted Internal Elbow

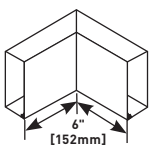

Connects vertical runs with horizontal runs of ALA3800 Series Raceway with its cover facing up. Includes two ALA01 Couplings.

AL3300 SERIES RACEWAY

Ordering Information

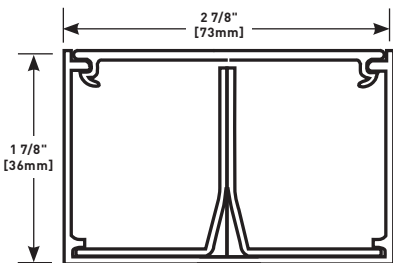

AL3300 Series Raceway's low profile, divided aluminum raceway meets the demands of today's laboratories, healthcare facilities and upscale office locations, providing a compact and effective method of consolidating power and communication cabling.

Material: 6063 T6 Aluminum Alloy
Wall Thickness: 0.078" [1.99mm]
Anodized Finish Thickness: 0.004" [0.004mm]

AL3300WC Wire Clip

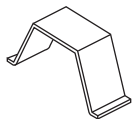

For holding wires and cables in raceway base. Use with undivided raceway, snap into grooves of base.

AL3309 Ground Clamp

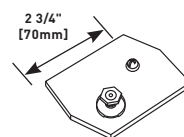

For connection of equipment grounding conductor to provide additional ground to raceway.

AL3301 Coupling

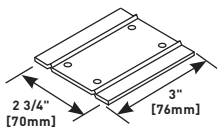

Set screw coupling used for attaching in-line raceway sections.

AL3310B Blank End

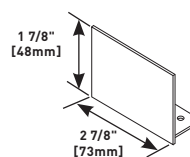

For closing open end of AL3300 Series Raceway.

AL3301D Divider Clip

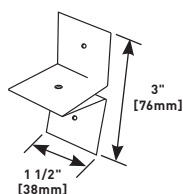

Required for holding AL3300D5 divider in place. Use one every 30" [76.2m].

AL3310B1 End

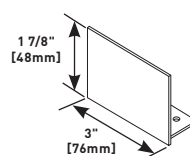

For end feeding raceway with 1/2" [12.7mm] or 3/4" [19.1mm] trade size conduit or armored cable.

AL3300 SERIES RACEWAY

Ordering Information

AL3311 90° Flat Elbow

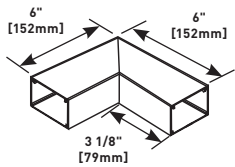

For right angle turns on same surface. Two (2) couplings included.

AL3317 Internal Elbow

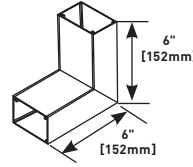

For making 90° internal corners. Couplings included.

AL3315 Tee

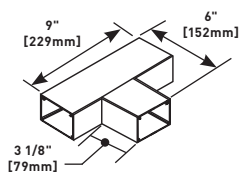

For 90° tee connection of two runs of AL3300 Series Raceway. Three (3) couplings included.

AL3318 External Elbow

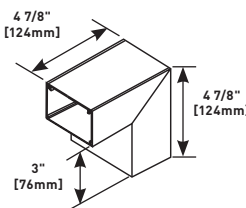

For making external corners. Couplings included.

AL3316 Cross

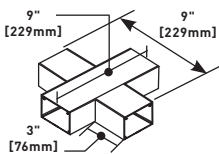

For 90° cross-through connection of two runs of raceway. Couplings included.

AL4000 SERIES™ RACEWAY

Ordering Information

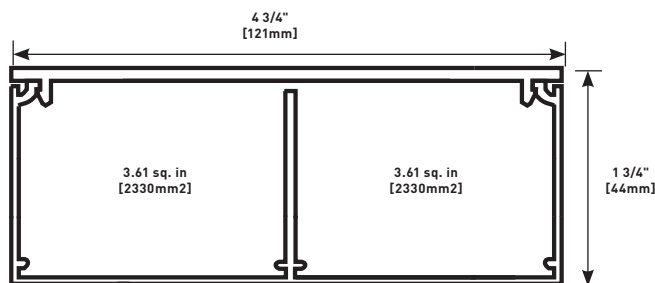

AL4000 Series Raceway is a two-channel, single-cover, highly aesthetic, raceway solution designed to provide access to communication cabling and electrical wiring systems.

Material: 6063 T6 Aluminum Alloy
Wall Thickness: 0.078" [1.99mm]
Anodized Finish Thickness: 0.004" [0.004mm]

AL4010B Blank End Cap

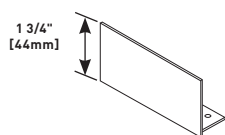

Closes off open end of raceway.

AL4011

90° Flat Mitered Elbow with Coupling

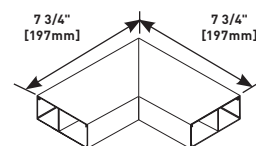

Makes 90° turns in runs of AL4000 Series Raceway. Includes two (2) sets of two (2) AL4001 Couplings.

AL4010B2

Entrance End Cap with two 1 1/16" Provisions

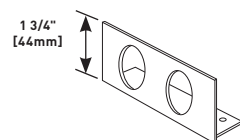

End Cap with two connections for 3/4" conduit.

AL4012A

45° Internal Mitered Elbow with Coupling

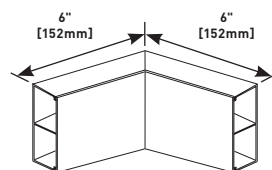

Makes 45° internal turns in runs of AL4000 Series Raceway. Includes two (2) sets of two (2) AL4001 Couplings.

AL4001 Slide Coupling

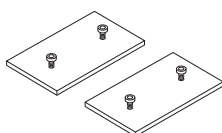

Connects adjoining sections of AL4000 Series Raceway base. Includes two (2) couplings

AL4012B

45° External Mitered Elbow with Coupling

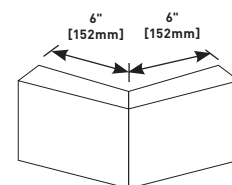

Makes 45° external turns in runs of AL4000 Series Raceway. Includes two (2) sets of two (2) AL4001 Couplings.

AL4000 SERIES RACEWAY

Ordering Information

AL4015 Flat Tee with Coupling

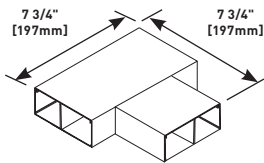

Makes branch connections of two runs of AL4000 Series Raceway. Includes three (3) sets of two (2) AL4001 Couplings.

AL4017 Internal Mitered Elbow with Coupling

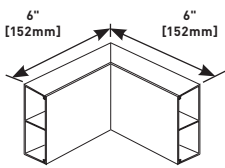

Makes 90° internal turns in runs of AL4000 Series Raceway. Includes two (2) sets of two (2) AL4001 Couplings.

AL4018 External Mitered Elbow with Coupling

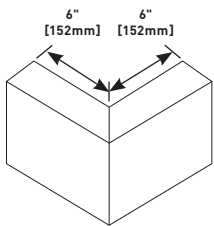

Makes 90° external turns in runs of AL4000 Series Raceway. Includes two (2) sets of two (2) AL4001 Couplings.

AL4400 SERIES RACEWAY

Ordering Information

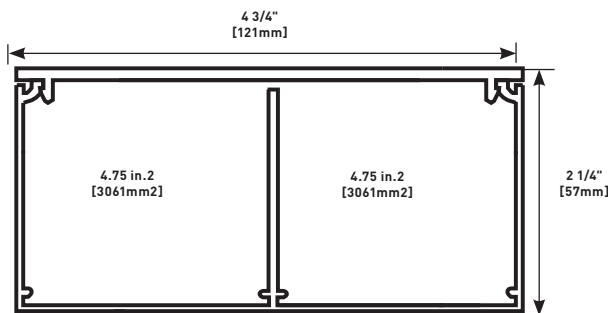

AL4400 Series Raceway is a two-channel, single-cover, cost effective solution for providing access to communication cabling and electrical wiring systems.

Material: 6063 T6 Aluminum Alloy
Wall Thickness: 0.078" [1.99mm]
Anodized Finish Thickness: 0.004" [0.004mm]

AL4410B Blank End Cap

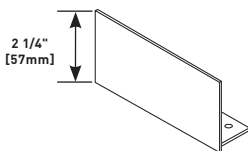

Closes off open end of raceway.

AL4411 90° Flat Mitered Elbow with Coupling

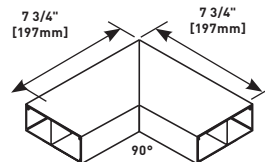

Makes 90° turns in runs of AL4400 Series Raceway. Includes two (2) sets of two (2) AL4401 Couplings.

AL4410B2 Entrance End Cap with Two 1 1/16" Provisions

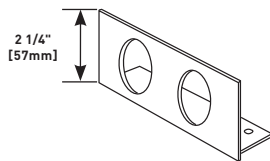

End Cap with two connections for 3/4" conduit.

AL4012A 45° Internal Mitered Elbow with Coupling

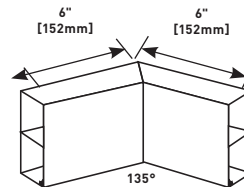

Makes 45° internal turns in runs of AL4400 Series Raceway. Includes two (2) sets of two (2) AL4401 Couplings.

AL4401 Slide Coupling

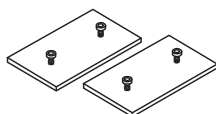

Connects adjoining sections of AL4400 Series Raceway base. Includes two (2) couplings.

AL4400 SERIES RACEWAY

Ordering Information

AL4412B

45° External Mitered Elbow with Coupling

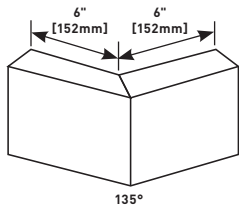

Makes 45° external turns in runs of AL4400 Series Raceway. Includes two (2) sets of two (2) AL4401 Couplings.

AL4417 Internal Mitered Elbow with Coupling

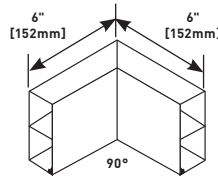

Makes 90° internal turns in runs of AL4400 Series Raceway. Includes two (2) sets of two (2) AL4401 Couplings.

AL4415 Flat Tee with Coupling

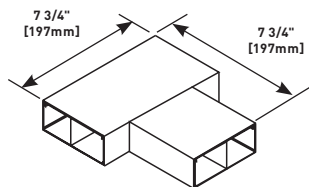

Makes branch connections of two runs of AL4400 Series Raceway. Includes three (3) sets of two (2) AL4401 Couplings.

AL4418 External Mitered Elbow with Coupling

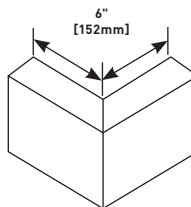

Makes 90° external turns in runs of AL4400 Series Raceway. Includes two (2) sets of two (2) AL4401 Couplings.

AL4750 SERIES RACEWAY

Ordering Information

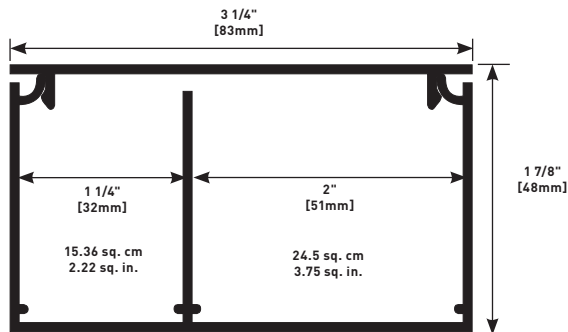

AL4750 Series Raceway is a cost effective, highly aesthetic two-channel, single cover raceway solution to provide access for communication cabling and electrical wiring systems.

Material: 6063 T6 Aluminum Alloy

Wall Thickness: 0.078" [1.99mm]

Anodized Finish Thickness: 0.004" [0.004mm]

AL4710B Blank End Cap

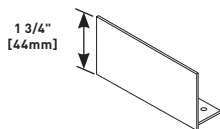

Closes off open end of raceway.

AL4711 90° Flat Mitered Elbow with Coupling

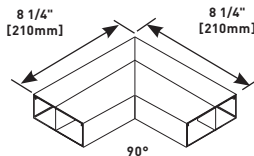

Makes 90° turns in runs of AL4750 Series Raceway. Includes two (2) sets of two (2) AL4701 Couplings.

AL4710B2 Entrance End Cap

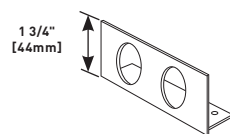

End Cap with two connections for 1/2" conduit.

AL4712A 45° Internal Mitered Elbow with Coupling

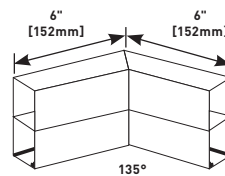

Makes 45° internal turns in runs of AL4750 Series Raceway. Includes two (2) sets of two (2) AL4701 Couplings.

AL4701 Slide Coupling

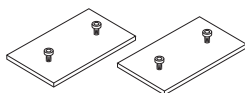

Connects adjoining sections of AL4750 Series Raceway base. Includes two (2) Couplings.

AL4750 SERIES RACEWAY

Ordering Information

AL4712B

45° External Mitered Elbow with Coupling

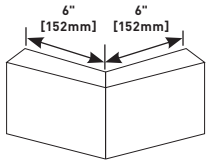

Makes 45° external turns in runs of AL4750 Series Raceway. Includes two (2) sets of two (2) AL4701 Couplings.

AL4717 Internal Mitered Elbow with Coupling

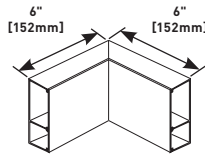

Makes 90° internal turns in runs of AL4750 Series Raceway. Includes two (2) sets of two (2) AL4701 Couplings.

AL4715 Flat Tee with Coupling

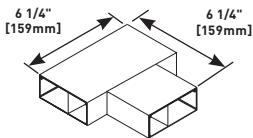

Makes branch connections of two runs of AL4750 Series Raceway. Includes three (3) sets of two (2) AL4701 Couplings.

AL4718 External Mitered Elbow with Coupling

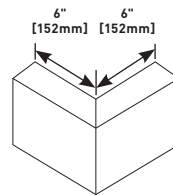

Makes 90° external turns in runs of AL4750 Series Raceway. Includes two (2) sets of two (2) AL4701 Couplings.

AL4320 SERIES RACEWAY

Ordering Information

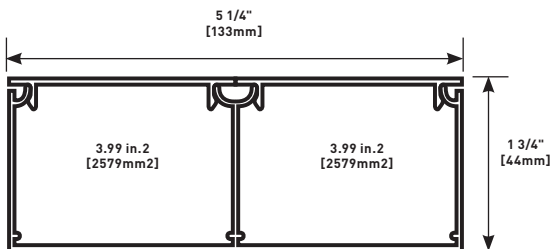

AL4320 Series Raceway is a two-channel, dual-cover, highly aesthetic, raceway solution designed to provide access to communication cabling and electrical wiring systems.

Material: 6063 T6 Aluminum Alloy
Wall Thickness: 0.078" [1.99mm]
Anodized Finish Thickness: 0.004" [0.004mm]

AL4310B Blank End Cap

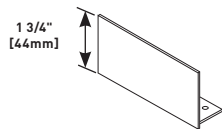

Closes off open end of AL4320 Series Raceway.

AL4311 90° Flat Mitered Elbow with Coupling

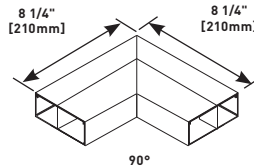

Makes 90° turns in runs of AL4320 Series Raceway. Includes two (2) sets of two (2) AL4301 Couplings.

AL4310B2 Entrance End Cap with Two 1 1/16" Provisions

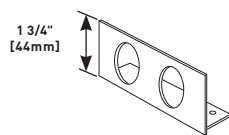

End Cap with two connections for 3/4" conduit.

AL4312A 45° Internal Mitered Elbow with Coupling

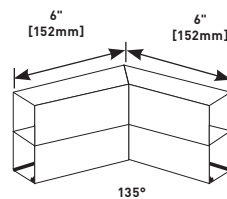

Makes 45° internal turns in runs of AL4320 Series Raceway. Includes two (2) sets of two (2) AL4301 Couplings.

AL4301 Slide Coupling

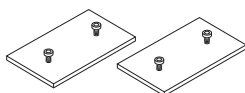

Connects adjoining sections of AL4320 Series Raceway base. Includes two (2) couplings.

AL4320 SERIES RACEWAY

Ordering Information

AL4312B

45° External Mitered Elbow with Coupling

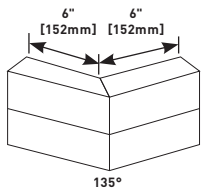

Makes 45° external turns in runs of AL4320 Series Raceway. Includes two (2) sets of two (2) AL4301 Couplings.

AL4317 Internal Mitered Elbow with Coupling

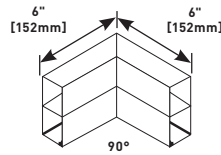

Makes 90° internal turns in runs of AL4320 Series Raceway. Includes two (2) sets of two (2) AL4301 Couplings.

AL4315 Flat Tee with Coupling

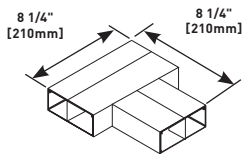

Makes branch connections of two runs of AL4320 Series Raceway. Includes three (3) sets of two (2) AL4301 Couplings.

AL4318 External Mitered Elbow with Coupling

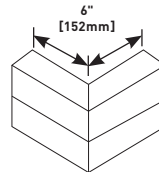

Makes 90° external turns in runs of AL4320 Series Raceway. Includes two (2) sets of two (2) AL4301 Couplings.

AL4520 SERIES RACEWAY

Ordering Information

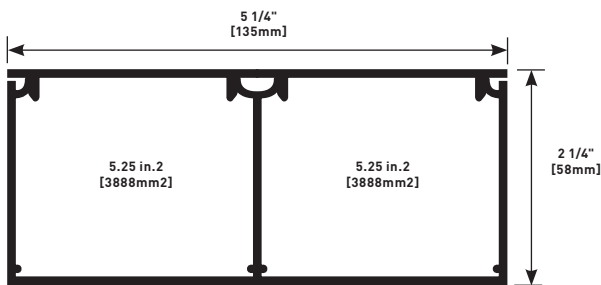

AL4520 Series Raceway is a two-channel, dual-cover, highly aesthetic, raceway solution designed to provide access to communication cabling and electrical wiring systems.

Material: 6063 T6 Aluminum Alloy
Wall Thickness: 0.078" [1.99mm]
Anodized Finish Thickness: 0.004" [0.004mm]

AL4510B Blank End Cap

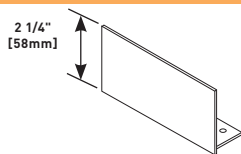

Closes off open end of AL4520 Series Raceway.

AL4511 90° Flat Mitered Elbow with Coupling

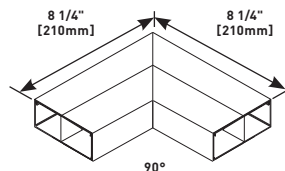

Makes 90° turns in runs of AL4520 Series Raceway. Includes two (2) sets of two (2) AL4501 Couplings.

AL4510B2

Entrance End Cap with Two 1 1/16" Provisions

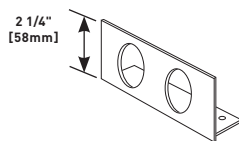

End Cap with two connections for 3/4" conduit.

AL4512A 45° Internal Mitered Elbow with Coupling

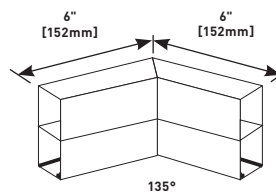

Makes 45° internal turns in runs of AL4520 Series Raceway. Includes two (2) sets of two (2) AL4501 Couplings

AL4501 Slide Coupling

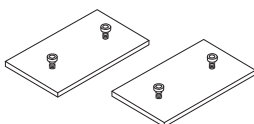

Connects adjoining sections of AL4320 Series Raceway base. Includes two (2) couplings

AL4520 SERIES RACEWAY

Ordering Information

AL4512B 45° External Mitered Elbow with Coupling

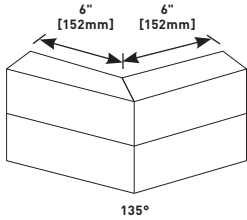

Makes 45° external turns in runs of AL4520 Series Raceway. Includes two (2) sets of two (2) AL4501 Couplings.

AL4517 Internal Mitered Elbow with Coupling

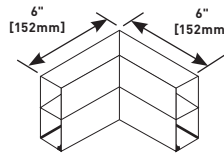

Makes 90° internal turns in runs of AL4520 Series Raceway. Includes two (2) sets of two (2) AL4501 Couplings.

AL4515 Flat Tee with Coupling

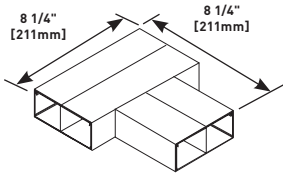

Makes branch connections of two runs of AL4520 Series Raceway. Includes three (3) sets of two (2) AL4501 Couplings.

AL4518 External Mitered Elbow with Coupling

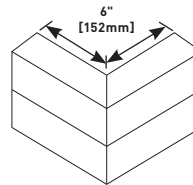

Makes 90° external turns in runs of AL4520 Series Raceway. Includes two (2) sets of two (2) AL4501 Couplings.

Why Wiremold...

It took planning and coordination to fit out new lab space with flexible power and data for the University Health Network in Toronto. What's more, everyone was under a tight timetable. That's why the team specified Wiremold Prewired Aluminum Raceway. Prewired raceway is manufactured to exact job specifications with all circuits and devices exactly as shown on the drawings. Numerous projects have shown that prewired raceway installs significantly faster and saves cost.



ALA4800 SERIES RACEWAY

Ordering Information

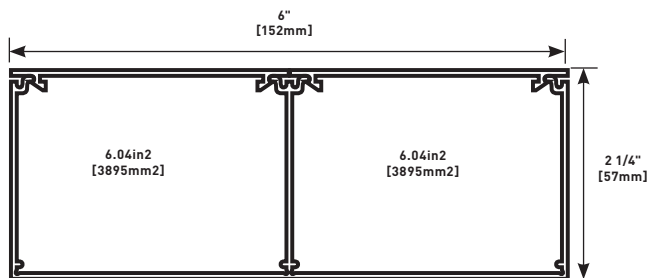

ALA4800 Series Aluminum Raceway's two-channel, dual-cover aluminum raceway meets the demands of laboratories, healthcare facilities and upscale office locations by providing an effective method of consolidating power and communications cabling.

Material: 6063 T6 Aluminum Alloy
Wall Thickness: 0.078" [1.99mm]
Anodized Finish Thickness: 0.004" [0.004mm]

ALAWC Wire Clip

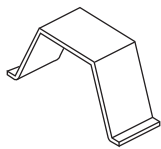

Holds conductors in place along raceway. Snaps into grooves on base.

ALA17A Internal Corner Coupling

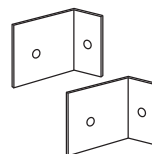

Makes internal 90° turn in a raceway run.

ALA01 Slide Coupling

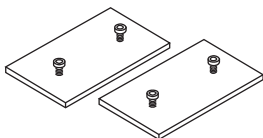

Connects adjoining sections of ALA4800 Series Raceway base. Includes two (2) couplings.

ALA4806 Cover Clip

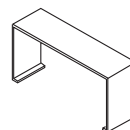

Covers seam where two sections of ALAC-5 Cover come together.

ALA09 Grounding Adapter

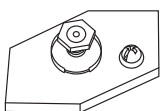

Connects to equipment grounding conductor.

ALA4810B Blank End Cap

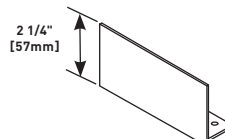

Closes off open end of ALA4800 Series Raceway.

ALA4800 SERIES RACEWAY

Ordering Information

ALA4810B2 Entrance End Cap

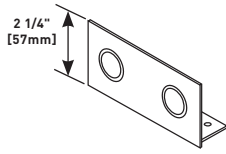

For feeding raceway. Has two concentric 1/2" and 3/4" knockouts.

ALA4817 Internal Mitered Elbow with Coupling

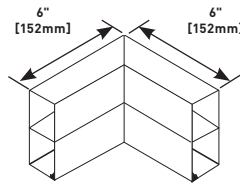

Makes 90° internal turns in runs of ALA4800 Series Raceway. Includes two (2) sets of two (2) ALA01 Couplings.

ALA4811 90° Flat Mitered Elbow with Coupling

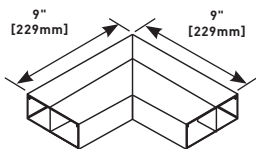

Makes 90° turns in runs of ALA4800 Series Raceway. Includes two (2) sets of two (2) ALA01 Couplings.

ALA4817N Inverted Internal Mitered Elbow with Coupling

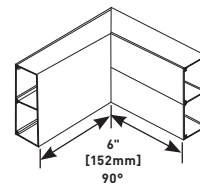

For connecting a vertical run of ALA4800 Series Raceway with a horizontal run of ALA4800 Series Raceway with its cover facing up. Includes four (4) ALA01 Couplings.

ALA4812A 45° Internal Mitered Elbow with Coupling

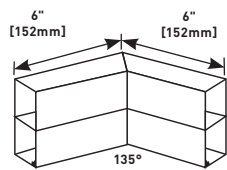

Makes 45° internal turns in runs of ALA4800 Series Raceway. Includes two (2) sets of two (2) ALA01 Couplings.

ALA4818 External Mitered Elbow with Coupling

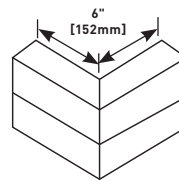

Makes 90° external turns in runs of ALA4800 Series Raceway. Includes four (4) ALA01 Couplings.

ALA4812B 45° External Mitered Elbow with Coupling

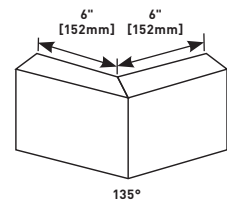

Makes 45° external turns in runs of ALA4800 Series Raceway. Includes two (2) sets of two (2) ALA01 Couplings.

ALA11R 12" [51mm] Bend Radius Control Insert for Flat Elbow

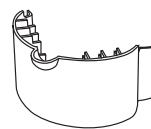

Installs in ALA3811 Flat Elbow. For new and retrofit applications whether the cable installation is lay-in or pull-through.

ALA4815 Flat Tee with Coupling

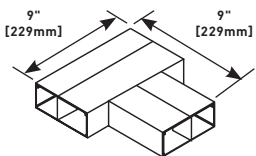

Makes branch connections of two runs of ALA4800 Series Raceway. Includes three (3) sets of two (2) ALA01 Couplings.

ALA17/18R 12" [51mm] Bend Radius Control Insert for Internal & External Elbows

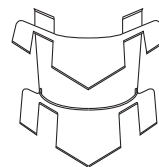

Inserts into ALA3817, ALA3817N, and ALA3818 fittings. For new and retrofit applications whether the cable installation is lay-in or pull-through.

ALDS4000 SERIES RACEWAY

Ordering Information

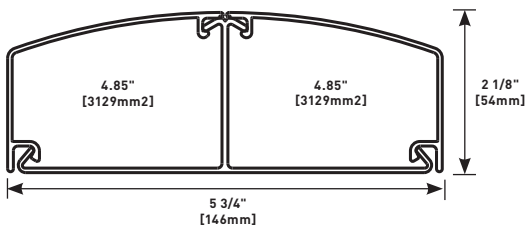

ALDS4000 Series Raceway offers a variety of innovative features and fittings that save installation time, cost less to specify, and provide 1/3 more wiring capacity than conventional box-style raceway profiles.

Material: 6063 T6 Aluminum Alloy

Wall Thickness: 0.078" [1.99mm]

Anodized Finish Thickness: 0.004" [0.004mm]

DS4000WC Wire Clip

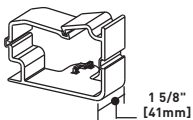

For holding conductors in place.

1 5/8"
[41mm]

DS4001 Adjust-to-fit™ Coupling

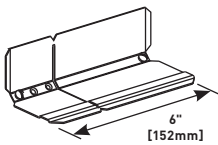

For joining lengths of ALDS4000B together. Sold in pairs.

6"
[152mm]

ALDS4006 Seam Clip

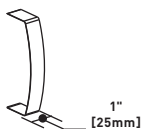

For covering seams where two sections of ALDS4000C come together.

1"
[25mm]

ALDS4010A Entrance End Fitting

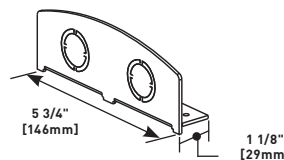

Full-capacity end fitting. Includes two 1/2" and 3/4" trade size KOs.

5 3/4"
[146mm]

1 1/8"
[29mm]

ALDS4010B Blank End Fitting

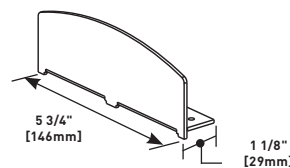

For closing open end of ALDS4000B Raceway Base.

5 3/4"
[146mm]

1 1/8"
[29mm]

ALDS4011 Flat Elbow

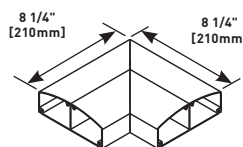

90° flat corner for new lay-in or pull-through installations.

8 1/4"
[210mm]

8 1/4"
[210mm]

ALDS4000 SERIES RACEWAY

Ordering Information

DS4014A Backfeed Fitting

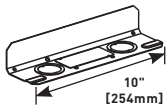

Extra long coupling allows attachment to wall box or back fed 1" or 1 1/4" trade size conduit.

ALDS4017 90° Internal Elbow

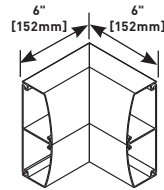

Internal corner for new lay-in or pull-through installations.

ALDS4015 Divided Tee Fitting

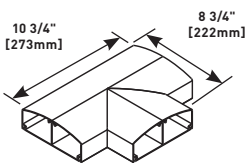

For new lay-in or pull-through installations.

ALDS4018 90° External Elbow

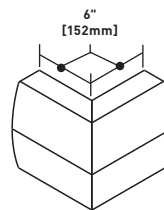

External corner for new lay-in or pull-through installations.

AL7320 SERIES RACEWAY

Ordering Information

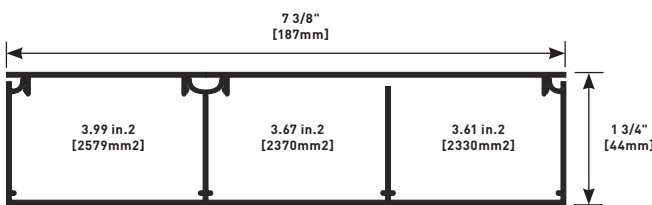

AL7320 Series Raceway's three-channel, dual-cover profile is a cost-effective, highly aesthetic solution to provide access to your communication cabling and electrical wiring systems.

Material: 6063 T6 Aluminum Alloy

Wall Thickness: 0.078" [1.99mm]

Anodized Finish Thickness: 0.004" [0.004mm]

AL7301 Slide Coupling

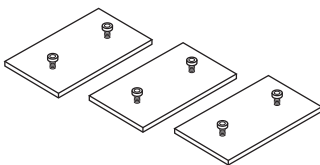

Connects adjoining sections of AL7320 Series Raceway base. Includes three (3) couplings.

AL7311 90° Flat Mitered Elbow with Coupling

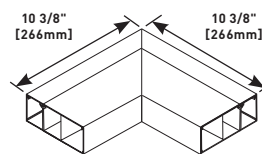

Makes 90° turns in runs of AL7320 Series Raceway. Includes six (6) AL7301 Couplings.

AL7310B Blank End Cap

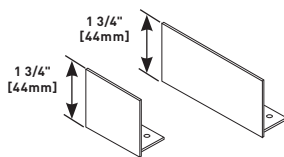

Closes off open end of AL7320 Series Raceway.

AL7312A 45° Internal Mitered Elbow with Coupling

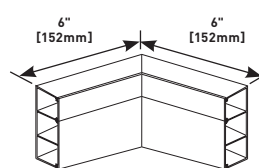

45° internal turns in runs of AL7320 Series Raceway. Includes six (6) AL7301 Couplings.

AL7310B3

Entrance End Cap with Two 1 1/16" Provisions

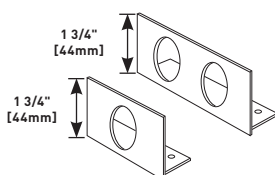

End Cap with three connections for 3/4" conduit.

AL7320 SERIES RACEWAY

Ordering Information

AL7312B

45° External Mitered Elbow with Coupling

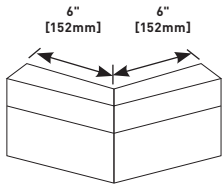

Makes 45° external turns in runs of AL7320 Series Raceway. Includes six (6) AL7301 Couplings.

AL7317 Internal Mitered Elbow with Coupling

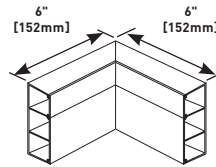

Makes 90° internal turns in runs of AL7320 Series Raceway. Includes six (6) AL7301 Couplings.

AL7315 Flat Tee with Coupling

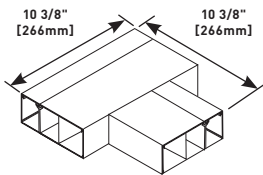

Makes branch connections of two runs of AL7320 Series Raceway. Includes nine (9) AL7301 Couplings.

AL7318 External Mitered Elbow with Coupling

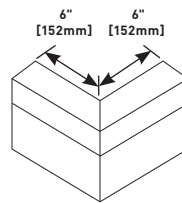

Makes 90° external turns in runs of AL7320 Series Raceway. Includes six (6) AL7301 Couplings.

AL7450 SERIES RACEWAY

Ordering Information

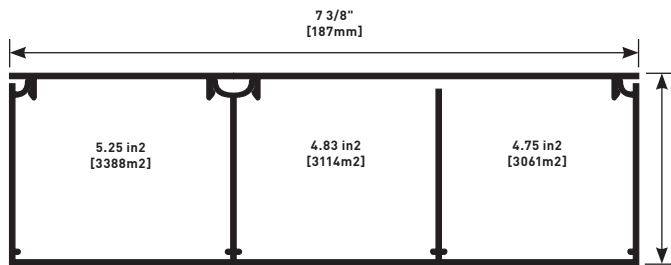

AL7450 Series Raceway's three-channel, dual-cover profile is a cost-effective, highly aesthetic solution for providing access to communication cabling and electrical wiring systems.

Material: 6063 T6 Aluminum Alloy

Wall Thickness: 0.078" [1.99mm]

Anodized Finish Thickness: 0.004" [0.004mm]

AL7401 Slide Coupling

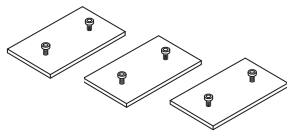

Connects adjoining sections of AL7450 Series Raceway base. Includes three (3) couplings.

AL7411 90° Flat Mitered Elbow with Coupling

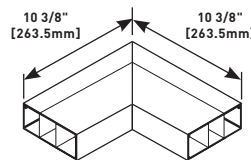

Makes 90° turns in runs of AL7450 Series Raceway. Includes six (6) AL7401 Couplings.

AL7410B Blank End Cap

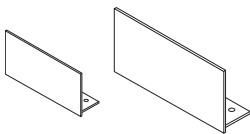

Closes off open end of AL7450 Series Raceway.

AL7412A 45° Internal Mitered Elbow with Coupling

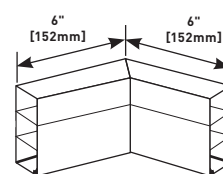

Makes 45° internal turns in runs of AL7450 Series Raceway. Includes six (6) AL7401 Couplings.

AL7410B3 Entrance End Cap with Two 1 1/16" Provisions

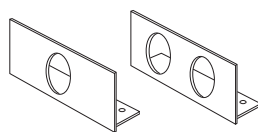

End Cap with three connections for 3/4" conduit.

AL7450 SERIES RACEWAY

Ordering Information

AL7412B

45° External Mitered Elbow with Coupling

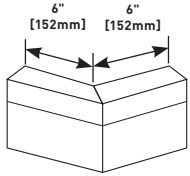

Makes 45° external turns in runs of AL7450 Series Raceway. Includes six (6) AL7401 Couplings.

AL7417 Internal Mitered Elbow with Coupling

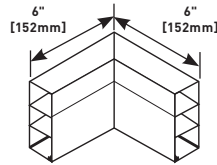

Makes 90° internal turns in runs of AL7450 Series Raceway. Includes six (6) AL7401 Couplings.

AL7415 Flat Tee with Coupling

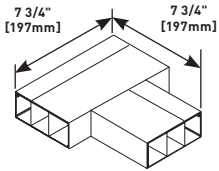

Makes branch connections of two runs of AL7450 Series Raceway. Includes nine (9) AL7401 Couplings.

AL7418 External Mitered Elbow with Coupling

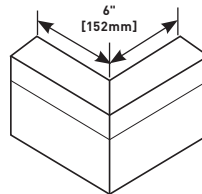

Makes 90° external turns in runs of AL7450 Series Raceway. Includes six (6) AL7401 Couplings.

PREWIRED RACEWAY SYSTEMS

Steel



Steel Prewired Raceway Systems offer the lowest installed cost for communications cabling or electrical wiring. Raceways come completely assembled and ready to install, significantly reducing on-site labor costs.

CODE REFERENCE

cULus Listed Multioutlet Assemblies:
File E15191 Guide PVGT.

Surface Metal Raceway:
File E4376 Guide RJBT.

Fittings: File E41751 Guide RJPR.
Meet Article 380 of NEC.

Steel Prewired Raceway Features and Benefits

- Prewired raceway offers the lowest installed cost.** Manufactured to specified job site lengths, electrically prewired and assembled – ready to install. Reduces on-site installation time and costs. For lowest installed cost, specify factory mounted and labeled communication connectivity devices.
- Accommodates high-density communication cabling for networks and phone systems.** Features communication connectivity devices. Raceway is compatible with other manufacturers' activation devices. Blank openings also available.
- Accommodates most electrical wiring devices or communication faceplates including single outlets, duplex outlets, NEMA-locking outlets, GFCI outlets, and surge protected outlets.** (Refer to the raceway device compatibility chart in the 3000, 4000, and 4000 Designer Series Raceway sections of this catalog.)
- Broad range of standard fittings available**
Accommodates every possible site situation, from internal and external elbows to flat tees. All fittings are made from galvanized steel to ensure continuity.
- Removable cover.** Provides maximum flexibility for adding or relocating circuits, data openings or electrical devices.
- Ivory ScuffCoat™ finish and gray baked enamel finish.** Assures durability. Can be overpainted to complement decor.
- Communication and electrical device identification with self-adhesive polyester or self-adhesive phenolic labels are available as options.** No guesswork or time-consuming tracing of circuits. Speeds circuit additions and renovations.
- Jobs can be packaged by room, area, floor or building, and shipped per your job site requirements.**
- Datacom Connectivity Options.** Accepts industry standard and proprietary devices from a wide range of manufacturers to provide a seamless and aesthetically pleasing interface for voice, data, audio, and video applications at the point of use.
- UL Listed commercial outlet centers.** File E317375 Multioutlet assemblies rated to 20A maximum can be provided with listed cord and plug assemblies. These assemblies are optimal for mounting to semi-permanent structures such as shelving and rack displays found in many lab applications.

COLOR OPTIONS



Steel Prewired Raceways are available with an ivory ScuffCoat™ finish or a gray enamel finish. DS4000® Series Raceway available in Designer Ivory, Designer Gray, Designer Black, and Designer Bronze.

Custom color options are also available. Consult the factory for more information.

STEEL PREWIRED RACEWAY SYSTEMS

Ordering Information

Steel Prewired Raceway Profiles

3000 Series Raceway

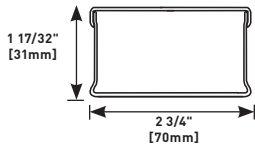

3.51 sq. in.
[89.15mm²]

4000 Series Raceway

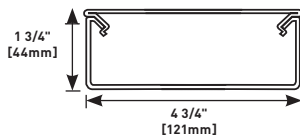

Divided:
3.7 sq. in. [93.98mm²]
Undivided:
7.5 sq. in. [190.5mm²]

DS4000® Series Raceway

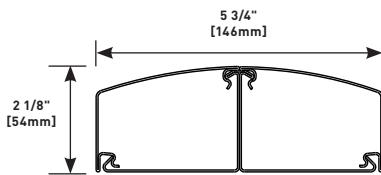

Each Compartment –
5.01 in.² [3235mm²]

6000® Series Raceway

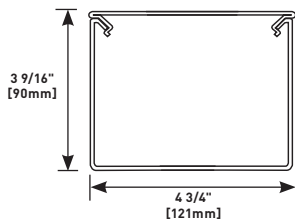

Divided:
7.20 in.² [4645mm²]
Undivided:
16.00 in.² [10320mm²]

Consult your local Wiremold representative for price, quotation and delivery information.

PREWIRED RACEWAY SYSTEMS

Nonmetallic



Nonmetallic Prewired Raceway Systems offer the lowest installed cost for communications cabling or electrical wiring. Raceways come completely assembled and ready to install, significantly reducing on-site labor costs.

CODE REFERENCE

cULus Listed Multioutlet Assemblies:
File E15191 Guide PVGT.

Surface Metal Raceway:
File E4376 Guide RJBT.

Fittings: File E41751 Guide RJPR.
Meet Article 380 of NEC.

Nonmetallic Prewired Raceway Features and Benefits

- **Prewired raceway offers the lowest installed cost.** Manufactured to specified job site lengths, electrically prewired and assembled – ready to install. Reduces on-site installation time and costs. For lowest installed cost, specify factory mounted and labeled communication connectivity devices.
- **Accommodates high-density communication cabling for networks and phone systems.** Features communication connectivity devices. Raceway is compatible with other manufacturers' activation devices. Blank openings also available.
- **Accommodates most electrical wiring devices or communication faceplates including single outlets, duplex outlets, NEMA-locking outlets, GFCI outlets, and surge protected outlets.** (Refer to the raceway device compatibility chart in the 5400 and 5500 Series Raceway sections of this catalog.)
- **Broad range of standard fittings available.** Accommodates every possible site situation, from internal and external elbows to flat tees. All fittings are made from galvanized steel to ensure continuity.
- **Removable cover.** Provides maximum flexibility for adding or relocating circuits, data openings or electrical devices.
- **Communication and electrical device identification with self-adhesive polyester or self-adhesive phenolic labels are available as options.** No guesswork or time-consuming tracing of circuits. Speeds circuit additions and renovations.
- **Jobs can be packaged by room, area, floor or building, and shipped per your job site requirements.**
- **Datacom Connectivity Options.** Accepts industry standard and proprietary devices from a wide range of manufacturers to provide a seamless and aesthetically pleasing interface for voice, data, audio, and video applications at the point of use.

COLOR OPTIONS



Nonmetallic Prewired Raceways are available with an ivory finish.

Custom color options are also available. Consult the factory for more information.

NONMETALLIC PREWIRED RACEWAY SYSTEMS

Ordering Information

Nonmetallic Prewired Raceway Profiles

CableSmart 40N2 Series Raceway

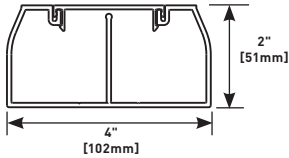

Each Compartment:
3.22 in.² [2080mm²]

5400 Series Raceway

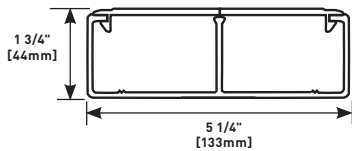

Each Compartment:
3.72 sq. in. [2400mm²]
Full:
7.31 sq. in. [4716mm²]

5500 Series Raceway

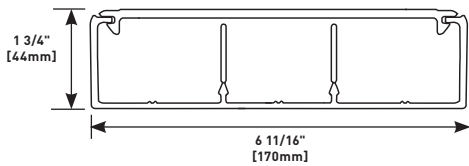

Each
Compartment:
2.64 sq. in.
[1703mm²]

Consult your local Wiremold representative for price, quotation and delivery information.

PREWIRED SELECT SERIES™ RACEWAYS

Ordering Information



Prewired Select™ Raceway Systems are designed to be installed in classrooms to facilitate power and low voltage needs for teacher workstations.

CODE REFERENCE

cULus Listed Multioutlet Assemblies:
File E15191 Guide PVGT.

Surface Metal Raceway:
File E4376 Guide RJBT.

Fittings: File E41751 Guide RJPR.
Meet Article 380 of NEC.

ALA48TD8RT ALA4800 Teacher Drop

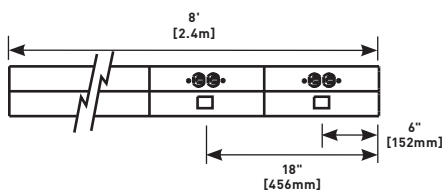

Prewired ALA4800 Raceway. Two-circuit power wiring with separate neutral and 24" [610mm] leads. Supplied with bezels to accommodate Ortronics® TracJack and Series II devices. **For information on fittings, see the latest version of ED799 Product Specification.**

ALA48TD8CM ALA4800 Teacher Drop

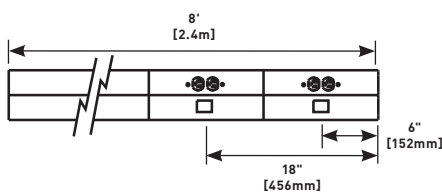

Prewired ALA4800 Raceway. Two-circuit power wiring with separate neutral and 24" [610mm] leads. Supplied with bezels to accommodate Pass & Seymour® Activate Inserts and Wiremold® Open System Communication Modules. **For information on fittings, see the latest version of ED799 Product Specification.**

V4000TD8 V4000 Teacher Drop

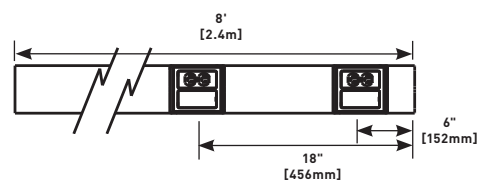

Prewired 4000 Series Raceway. Two-circuit power wiring with separate neutral and 24" [610mm] leads. Ready to accommodate Ortronics® TracJack and Series II Devices, Pass & Seymour® Activate Inserts, and Wiremold® Open System Communication Modules. **For information on fittings, see the latest version of ED531 Product Specification.**

COLOR OPTIONS



Prewired Select™ Series Raceways are available in steel with an ivory enamel finish, in aluminum with a satin anodized finish, and in nonmetallic with an ivory-colored finish.

Custom color options are also available. Consult the factory for more information.

PREWIRED SELECT SERIES™ RACEWAYS

Ordering Information

5400TD8 V5400 Teacher Drop

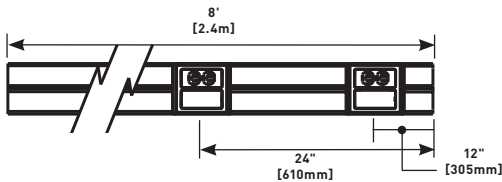

Prewired 5400 Raceway. Two-circuit power wiring with separate neutral and 24" [610mm] leads. Ready to accommodate Ortronics® TracJack and Series II Devices, Pass & Seymour® Activate Inserts, and Wiremold® Open System Communication Modules. **For information on fittings, see the latest version of ED467 Product Specification.**

ALA48HR1024RT ALA4800 Horizontal Run

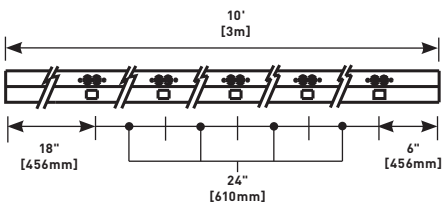

Prewired ALA4800 Raceway. Receptacles mounted 24" [610mm] O.C. Two-circuit power wiring with separate neutral and 24" [610mm] leads on both ends. Supplied with bezels to accommodate Ortronics® TracJack and Series II devices. **For information on 4800 fittings, see the Aluminum Raceway section of this catalog.**

ALA48HR1024CM ALA4800 Horizontal Run

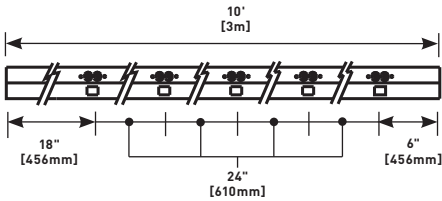

Prewired ALA4800 Raceway. Receptacles mounted 24" [610mm] O.C. Two-circuit power wiring with separate neutral and 24" [610mm] leads on both ends. Supplied with bezels to accommodate Pass & Seymour® Activate Inserts and Wiremold® Open System Communication Modules. **For information on 4800 fittings, see the Aluminum Raceway section of this catalog.**

V4000HR1024 V4000 Horizontal Run

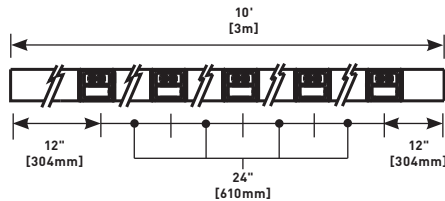

Prewired V4000 Raceway. Receptacles mounted 24" [610mm] O.C. Two-circuit power wiring with separate neutral and 24" [610mm] leads on both ends. Ready to accommodate Ortronics® TracJack and Series II Devices, Pass & Seymour® Activate Inserts and Wiremold® Open System Communication Modules. **For information on 4000 fittings, see the Steel Raceway section of this catalog.**

5400HR824 5400 Horizontal Run

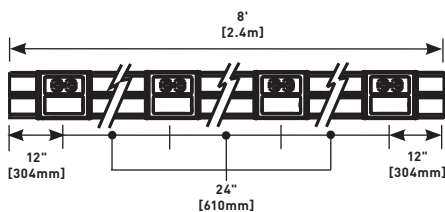

Prewired 5400 Raceway. Receptacles mounted 24" [610mm] O.C. Two-circuit power wiring with separate neutral and 24" [610mm] leads on both ends. Ready to accommodate Ortronics® TracJack and Series II Devices, Pass & Seymour® Activate Inserts and Wiremold® Open System Communication Modules. **For information on fittings, see the Nonmetallic Raceway section of this catalog.**

SPECIALTY RACEWAYS & ACCESSORIES



Wiremold® Specialty Raceway Systems provide unique solutions to solve specific installation issues or provide special capabilities for installers, building owners, and designers.

Featured Products	 SpecMate™ Wireway 233	 WallSource™ Multiple Service Boxes 250
--------------------------	--	--

SpecMate™ Wireway & Enclosures



WallSource Multiple Service Box

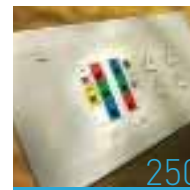

SPECIALTY RACEWAYS & ACCESSORIES

Quick Selection Guide

SpecMate™ Type 1 Wireway & Enclosures

Type 1 Wireway

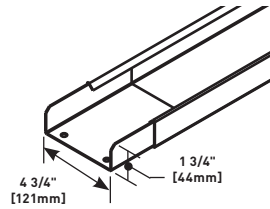

Wallsource™ Multiple Service Box

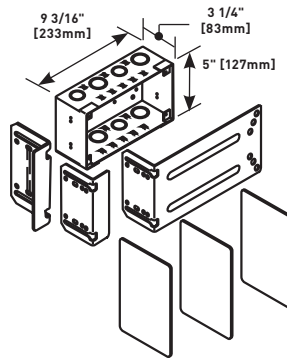
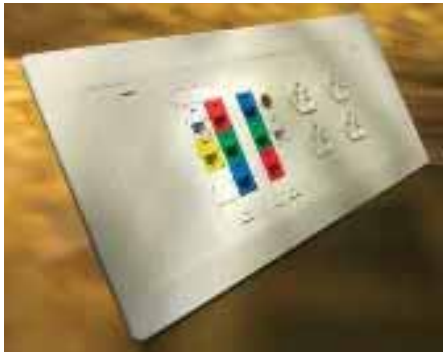

SPECMATE™ WIREWAY & ENCLOSURES



Wiremold® Specmate™ Type 1 Wireway and Enclosures are available in a broad range of enclosure and trough sizes to accommodate specific wire fill and bend radii requirements.

CODE REFERENCE

UL Listed Wireway, Auxiliary Gutters & Associated Fittings:
 File E137690 Guide ZDYX.
 Meets Article 376 of NEC.
 CSA File: 59760.
 Meets Section 12-2200 of CEC.

Specmate Type 1 Wireway System Layout

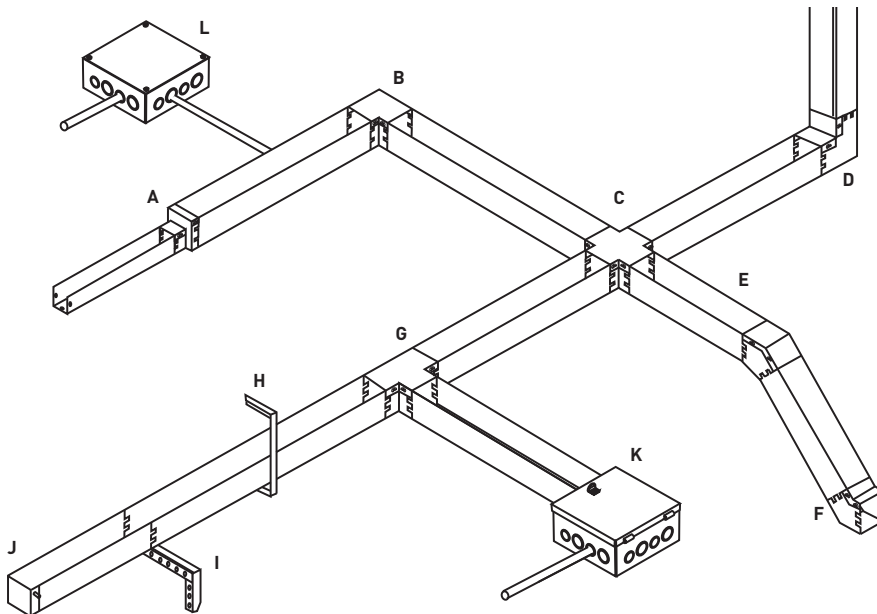

Key

- A. C14R25 Reducer
- B. C14E 90° Flat Elbow
- C. C14X Cross
- D. C14EVI 90° Inside Elbow
- E. C14E45VO 45° Outside Elbow
- F. C14E45VI 45° Inside Elbow
- G. C14T Tee
- H. C14H Hanger
- I. C14BH Bracket Hanger
- J. C14EB End Blank
- K. SPMJP-8-8-6 Hinged Cover Junction Box
- L. SPMJ-8-8-6 Screw Cover Junction Box

NOTE: Illustration is for showing product applications only.

COLOR OPTIONS



SpecMate™ Wireway is available with a gray baked enamel finish. Custom color options are also available. Consult the factory for more information.

SPECMATE™ WIREWAY & ENCLOSURES

Technical Data

Specmate Wireway Wire Fill Capacities for Power & Communications

CABLE/WIRE TYPE	CATEGORY/WIRE SIZE	O.D		20% FILL (per sq. inch of area)	40% FILL (per sq. inch of area)
		Inches	[mm]		
POWER WIRING (THHN/THWN)	6 AWG	0.257	[6.5]	3.35	-
	6 AWG	0.218	[5.5]	5.36	-
	6 AWG	0.153	[3.9]	10.88	-
	6 AWG	0.122	[3.1]	17.11	-
	6 AWG	0.105	[2.7]	23.09	-
UNSHIELDED TWISTED PAIR	4-pair, 24 AWG Cat. 5 UTP	0.220	[5.6]	5.26	10.52
	4-pair, 24 AWG Cat. 3 UTP	0.190	[4.8]	7.05	14.11
TELEPHONE	2-pair, 24 AWG	0.140	[3.5]	12.99	25.98
	3-pair, 24 AWG	0.150	[3.8]	11.32	22.64
	4-pair, 24 AWG	0.190	[4.8]	7.05	14.1
	25-pair, 24 AWG	0.410	[10.3]	1.51	3.03
COAXIAL CABLES	RG58/U	0.195	[4.7]	6.70	13.39
	RG59/U	0.242	[6.1]	4.35	8.70
	RG62/U	0.242	[6.1]	4.35	8.70
	RG6/U	0.270	[6.8]	3.49	6.99
TWINAXIAL	100 Ohm	0.330	[8.4]	2.34	4.68
SHIELDED TWISTED PAIR	TYPE 1	0.390	[9.6]	1.67	3.35
	TYPE 2	0.465	[11.8]	1.18	2.36
	TYPE 3	0.275	[6.9]	4.24	8.48
FIBER OPTIC	Two Strand [Duplex] Multimode 62.5/125µm	0.190	[4.8]	7.05	14.11

Wire Fill Calculation:

1. Determine useable area of compartment. Useable area in square inches = [Width x Depth].
2. Determine wire fill for compartment. Multiply the compartment area (from Step 1) by the number of wires per square inch, from the chart above. Wire Fill = Area (sq. in.) x No. Wires per sq. in. (Chart above).
3. Calculate fill for multi-compartment tees or crosses. Wire Fill = (Wire Fill from Step 2) / No. of compartments.)

Sample Wire Fill Calculation:

- Determine the number of 12 gauge wires that will fit in a 4" [102mm] deep by 4" [102mm] wide compartment.
- 1) Useful area = 4" x 4" = 16 in²
 - 2) Wire Fill = 16" x 17.11" wires/in² (from chart) = 273 #12 THHN wires

Specmate Wireway Wire Fill Capacities for Power & Communications

Wireway Capacity

The following charts show the wireway size and number of conductors allowed.

To apply these numbers correctly to your application, observe the rules outlined below, which are taken from the applicable Electrical Code or UL/CSA standard.

National Electrical Code (NEC):

Article 376-22 of the NEC (2002) states that "The sum of cross-sectional areas of all contained conductors at any cross section of the wireway shall not exceed 20 percent of the interior cross-sectional area of the wireway".

Further to this "The derating factors in 310.15(B)(2)(a) shall be applied only when the number of current carrying conductors, including neutral conductors classified as current-carrying under the provisions of 310.15(B)(4), exceeds 30."

Where the conductors enter the wireway through the bottom or the sides, the maximum conductor size is limited due to the need to control the bend radius of the conductor. Please see Article 376 of the NEC (2002) for more details.

Canadian Electrical Code (CEC):

The rules in CEC 12-2104 regarding conductors in wireways are as follows:

- (1) Conductors used in wireways shall be the insulated types indicated in Table 19 (CEC) as being suitable for use in raceways.
- (2) Except as permitted in Subrule (4) wireways shall contain not more than 200 conductors and the aggregate cross-sectional area of the conductors and their insulation shall not exceed 20% of the interior cross-sectional area of the wireway.
- (3) No conductor larger than 500 kcmil (MCM) copper or 750 kcmil (MCM) aluminum shall be installed in any wireway.
- (4) Wireways containing only signal and control conductors may contain any number of conductors but the aggregate cross-sectional area of the conductors and their insulation shall not exceed 40% of the interior cross-sectional area of the wireway.
- (5) The cross-sectional area for conductors in Subrules (2) and (4) shall be determined in accordance with Rule 12-1014(4).

NOTE: See Section 12-2100 of the CEC for more details if required. For divided wireway (two equal compartments), add suffix "D" (i.e. C1800D). Consult factory to order unequal compartments.

SPECMATE™ WIREWAY & ENCLOSURES

Technical Data

Area of Conductor (Sq. In.)

CONDUCTOR SIZE		A RFH-2, RH, RHH, RHW*, SF-2*		B TF, TH, THW, TW**		C TFN, THHN, T90, THWN		D XHHW, ZW†	
AWG-MCM	[mm ²]	sq. inch	[mm ²]	sq. inch	[mm ²]	sq. inch	[mm ²]	sq. inch	[mm ²]
18	[0.8]	.0167	[11]	.0088	[6]	.0062	[4]	-	-
16	[1.3]	.0196	[13]	.0109	[7]	.0079	[5]	-	-
14	[2.1]	.0230	[15]	.0135	[9]	.0087	[6]	-	-
14	[2.1]	.0327*	-	-	-	-	-	-	-
14	[2.1]	-	-	.0206†	[13]	-	-	.0131	[8]
12	[3.3]	.0278	[18]	.0172	[11]	.0117	[8]	-	-
12	[3.3]	.0384*	-	-	-	-	-	-	-
12	[3.3]	-	-	.0252†	[16]	-	-	.0167	[11]
10	[5.3]	.0460	[30]	.0222	[14]	.0184	[12]	-	-
10	[5.3]	-	-	.0311	[20]	-	-	.0216	[14]
8	[8.4]	.0845	[55]	.0471	[30]	.0373	[24]	-	-
8	[8.4]	-	-	.0598†	[39]	-	-	.0456	[29]
6	[13.3]	.1238	[80]	.0819	[53]	.0519	[33]	.0625	[40]
4	[21.2]	.1605	[104]	.1087	[70]	.0845	[55]	.0845	[55]
3	[26.7]	.1817	[117]	.1263	[81]	.0995	[64]	.0995	[64]
2	[33.6]	.2067	[133]	.1473	[95]	.1182	[76]	.1182	[76]
1	[42.4]	.2715	[175]	.2027	[131]	.1590	[103]	.1590	[103]
1/0	[53.5]	.3107	[200]	.2367	[153]	.1893	[122]	.1893	[122]
2/0	[67.4]	.3578	[231]	.2781	[179]	.2265	[146]	.2265	[146]
3/0	[85.1]	.4151	[268]	.3288	[212]	.2715	[175]	.2715	[175]
4/0	[107.2]	.4840	[312]	.3904	[252]	.3278	[211]	.3278	[211]
250	[127.0]	.5917	[382]	.4877	[315]	.4026	[260]	.4026	[260]
300	[152.0]	.6837	[441]	.5581	[360]	.4669	[301]	.4669	[301]
350	[177.0]	.7620	[492]	.6291	[406]	.5307	[342]	.5307	[342]
400	[203.0]	.8365	[540]	.6969	[450]	.5931	[383]	.5931	[383]
500	[253.0]	.9834	[634]	.8316	[537]	.7163	[462]	.7163	[462]
600	[304.0]	1.1940	[770]	1.0261	[662]	.8791	[567]	.9043	[583]
700	[355.0]	1.3355	[862]	1.1575	[747]	1.0011	[646]	1.0297	[664]
750	[380.0]	1.4082	[909]	1.2252	[790]	1.0623	[685]	1.0936	[706]
800	[405.0]	1.4784	[954]	1.2908	[833]	1.1234	[725]	1.1499	[742]
900	[456.0]	1.6173	[1043]	1.4208	[917]	1.2449	[803]	1.2668	[817]
1000	[507.0]	1.7530	[1131]	1.5482	[999]	1.3623	[879]	1.3893	[896]
1250	[633.0]	2.2062	[1423]	1.9532	[1260]	-	-	1.7671	[1140]
1500	[760.0]	2.5475	[1644]	2.2751	[1468]	-	-	2.0612	[1330]
1750	[887.0]	2.8832	[1860]	2.5930	[1673]	-	-	2.3779	[1534]
2000	[1013.0]	3.2079	[2070]	2.9013	[1872]	-	-	2.6590	[1715]

* Dimensions of RHH and RHW without outer covering are the same as THW No. 18 through No. 10, solid, as well as No. 8 and larger, stranded.

** Dimensions of THW in sizes No. 14 through No. 8. No. 6 THW and larger are the same dimensions as TW.

† No. 14 through No. 2.

SPECMATE™ WIREWAY & ENCLOSURES

Technical Data (continued)

SpecMate Wireway Capacity Chart

SpecMate Wireway size and maximum number of conductors allowed. (Areas shown are 20% of the wireway’s full interior cross sectional area.) This data is valid where conductors enter the wireway only at the end of the run; when this is not the case, use the “Conductor Size Based on Bending Space” chart.

CONDUCTOR SIZE		2.5" x 2.5" [64mm x 64mm] [1.25 sq. inch [808mm ²]]				4" x 4" [102mm x 102mm] [3.20 sq. inch [2068mm ²]]				6" x 6" [152mm x 152mm] [7.20 sq. inch [4652mm ²]]				8" x 8" [203mm x 203mm] [12.80 sq. inch [8271mm ²]]			
AWG-MCM	[mm ²]	A	B	C	D	A	B	C	D	A	B	C	D	A	B	C	D
18	[0.8]	74	142	201	-	191	363	516	-	431	818	1161	-	766	1454	2064	-
16	[1.3]	63	114	158	-	163	293	405	-	367	660	911	-	653	1174	1620	-
14	[2.1]	54	92	143	-	139	237	367	-	313	533	827	-	556	948	1471	-
14	[2.1]	38	-	-	-	97	-	-	-	220	-	-	-	391	-	-	-
14	[2.1]	-	60	-	95	-	155	-	244	-	349	-	549	-	621	-	977
12	[3.3]	44	72	106	-	115	186	273	-	258	418	615	-	460	744	1094	-
12	[3.3]	32	-	-	-	83	-	-	-	187	-	-	-	333	-	-	-
12	[3.3]	-	49	-	74	-	126	-	191	-	285	-	431	-	507	-	766
10	[5.3]	27	56	67	-	69	144	173	-	156	324	391	-	278	576	695	-
10	[5.3]	-	40	-	57	-	102	-	148	-	231	-	333	-	411	-	592
8	[8.4]	14	26	33	-	37	67	85	-	85	152	193	-	151	271	343	-
8	[8.4]	-	20	-	27	-	53	-	70	-	120	-	157	-	214	-	280
6	[13.3]	10	15	24	20	25	39	61	51	58	87	138	115	103	156	246	204
4	[21.2]	7	11	14	14	19	29	37	37	44	66	85	85	79	117	151	151
3	[26.7]	6	9	12	12	17	25	32	32	39	57	72	72	70	101	128	128
2	[33.6]	6	8	10	10	15	21	27	27	34	48	60	60	61	86	108	108
1	[42.4]	4	6	7	7	11	15	20	20	26	35	45	45	47	63	80	80
1/0	[53.5]	4	5	6	6	10	13	16	16	23	30	38	38	41	54	67	67
2/0	[67.4]	3	4	5	5	8	11	14	14	20	25	31	31	35	46	56	56
3/0	[85.1]	3	3	4	4	7	9	11	11	17	21	26	26	30	38	47	47
4/0	[107.2]	2	3	3	3	6	8	9	9	14	18	21	21	26	32	39	39
250	[127.0]	2	2	3	3	5	6	7	7	12	14	17	17	21	26	31	31
300	[152.0]	1	2	2	2	4	5	6	6	10	12	15	15	18	22	27	27
350	[177.0]	1	1	2	2	4	5	6	6	9	11	13	13	16	20	24	24
400	[203.0]	1	1	2	2	3	4	5	5	8	10	12	12	15	18	21	21
500	[253.0]	1	1	1	1	3	3	4	4	7	8	10	10	13	15	17	17
600	[304.0]	1	1	1	1	2	3	3	3	6	7	8	7	10	12	14	14
700	[355.0]	-	1	1	1	2	2	3	3	5	6	7	6	9	11	12	12
750	[380.0]	-	1	1	1	2	2	3	2	5	5	6	6	9	10	12	11
800	[405.0]	-	-	1	1	2	2	2	2	4	5	6	6	8	9	11	11
900	[456.0]	-	-	1	-	1	2	2	2	4	5	5	5	7	9	10	10
1000	[507.0]	-	-	-	-	1	2	2	2	4	4	5	5	7	8	9	9
1250	[633.0]	-	-	-	-	1	1	-	1	3	3	-	4	5	6	-	7
1500	[760.0]	-	-	-	-	1	1	-	1	2	3	-	3	5	5	-	6
1750	[887.0]	-	-	-	-	1	1	-	1	2	2	-	3	4	4	-	5
2000	[1013.0]	-	-	-	-	-	1	-	1	2	2	-	2	3	4	-	4

NOTE: Letters “A,” “B,” “C”, and “D” refer to conductor insulation types specified in the Area of Conductor Chart found earlier in this section.

SPECMATE™ WIREWAY & ENCLOSURES

Technical Data (continued)

SpecMate Wireway Capacity Chart (continued)

CONDUCTOR SIZE		12" x 12" [305mm x 305mm] [28.80 sq. inch [18609mm ²]]				10" x 4" [254mm x 102mm] [8.00 sq. inch [5169mm ²]]			
AWG-MCM	[mm ²]	A	B	C	D	A	B	C	D
18	[0.8]	1724	3272	4645	-	479	909	1290	-
16	[1.3]	1469	2642	3645	-	408	773	1012	-
14	[2.1]	1252	2133	3310	-	347	592	919	-
14	[2.1]	880	-	-	-	244	-	-	-
14	[2.1]	-	1398	-	2198	-	388	-	610
12	[3.3]	1035	1674	2461	-	287	465	683	-
12	[3.3]	750	-	-	-	208	-	-	-
12	[3.3]	-	1142	-	1724	-	317	-	479
10	[5.3]	626	1297	1565	-	173	360	434	-
10	[5.3]	-	926	-	1333	-	257	-	370
8	[8.4]	340	611	772	-	94	169	214	-
8	[8.4]	-	481	-	631	-	133	-	175
6	[13.3]	232	351	554	460	64	97	154	128
4	[21.2]	179	264	340	340	49	73	94	94
3	[26.7]	158	228	289	289	44	63	80	80
2	[33.6]	139	195	243	243	38	54	67	67
1	[42.4]	106	142	181	181	29	39	50	50
1/0	[53.5]	92	121	152	152	25	33	42	42
2/0	[67.4]	80	103	127	127	22	28	35	35
3/0	[85.1]	69	87	106	106	19	24	29	29
4/0	[107.2]	59	73	87	87	16	20	24	24
250	[127.0]	48	59	71	71	13	16	19	19
300	[152.0]	42	51	61	61	11	14	17	17
350	[177.0]	37	45	54	54	10	12	15	15
400	[203.0]	34	41	48	48	9	11	13	13
500	[253.0]	29	34	40	40	8	9	11	11
600	[304.0]	24	28	32	31	6	7	9	8
700	[355.0]	21	24	28	27	5	6	7	7
750	[380.0]	20	23	27	26	5	6	7	7
800	[405.0]	19	22	25	25	5	6	7	6
900	[456.0]	17	20	23	22	4	5	6	6
1000	[507.0]	16	18	21	20	4	5	5	5
1250	[633.0]	13	14	-	16	3	4	-	4
1500	[760.0]	11	12	-	13	3	3	-	3
1750	[887.0]	9	11	-	12	2	3	-	3
2000	[1013.0]	8	9	-	10	2	2	-	3

NOTE: Letters "A," "B," "C," and "D" refer to conductor insulation types specified in the Area of Conductor Chart found earlier in this section.



SpecMate Type 1 Wireway offers custom and configurable options to meet wide range of installation requirements.

SPECMATE™ WIREWAY & ENCLOSURES

Technical Data (continued)

SpecMate Wireway Capacity Chart (continued)

Wireway size and maximum number of conductors allowed. (Areas shown are 20% of the wireway's full interior cross sectional area.) This data is valid where conductors enter the wireway only at the end of the run; when this is not the case, use the "Conductor Size Based on Bending Space" chart.

CONDUCTOR SIZE		12" x 6" [305mm x 152mm] [14.4 sq. inch [9305mm ²]]				18" x 6" [457mm x 152mm] [21.6 sq. inch [13957mm ²]]				24" x 6" [610mm x 152mm] [28.8 sq. inch [18609mm ²]]				SMALLER INSIDE DIMENSION OF WIREWAY		MAXIMUM CONDUCTOR SIZE	
AWG-MCM	[mm ²]	A	B	C	D	A	B	C	D	A	B	C	D	In.	[mm ²]	AWG-MCM	[mm ²]
18	[0.8]	862	1636	2322	-	1293	2454	3483	-	1724	3272	4645	-	1 1/4	[32]	6 AWG	[13]
16	[1.3]	734	1321	1822	-	1102	1981	2734	-	1469	2642	3645	-	2	[51]	3 AWG	[27]
14	[2.1]	626	1066	1655	-	939	1600	2482	-	1252	2133	3310	-	2 1/2	[64]	2 AWG	[34]
14	[2.1]	440	-	-	-	660	-	-	-	880	-	-	-	3	[75]	1 AWG	[42]
14	[2.1]	-	699	-	1099	-	1048	-	1648	-	1398	-	2198	3 1/2	[89]	2/0 AWG	[67]
12	[3.3]	517	837	1230	-	776	1255	1846	-	1035	1674	2461	-	4	[102]	4/0 AWG	[107]
12	[3.3]	375	-	-	-	562	-	-	-	750	-	-	-	4 1/2	[114]	250 MCM	[127]
12	[3.3]	-	571	-	862	-	857	-	1293	-	1142	-	1724	5	[127]	350 MCM	[177]
10	[5.3]	313	648	782	-	469	972	1173	-	626	1297	1565	-	6	[152]	500 MCM	[253]
10	[5.3]	-	463	-	666	-	694	-	1000	-	926	-	1330	8	[203]	900 MCM	[456]
8	[8.4]	170	305	386	-	255	458	579	-	340	611	772	-	10	[254]	1250 MCM	[633]
8	[8.4]	-	240	-	315	-	361	-	473	-	481	-	631	12	[305]	2000 MCM	[1013]
6	[13.3]	116	175	277	230	174	263	416	345	232	351	554	460				
4	[21.2]	89	132	170	170	134	198	255	255	179	264	340	340				
3	[26.7]	79	114	144	144	118	171	217	217	158	228	289	289				
2	[33.6]	69	97	121	121	104	146	182	182	139	195	243	243				
1	[42.4]	53	71	90	90	79	106	135	135	106	142	181	181				
1/0	[53.5]	46	60	76	76	69	91	114	114	92	121	152	152				
2/0	[67.4]	40	51	63	63	60	77	95	95	80	103	127	127				
3/0	[85.1]	34	43	53	53	52	65	79	79	69	87	106	106				
4/0	[107.2]	29	36	43	43	44	55	65	65	59	73	87	87				
250	[127.0]	24	29	35	35	36	44	53	53	48	59	71	71				
300	[152.0]	21	25	30	30	31	38	46	46	42	51	61	61				
350	[177.0]	18	22	27	27	28	34	40	40	37	45	54	54				
400	[203.0]	17	20	24	24	25	30	36	36	34	41	48	48				
500	[253.0]	14	17	20	20	21	25	30	30	29	34	40	40				
600	[304.0]	12	14	16	15	18	21	24	23	24	28	32	31				
700	[355.0]	10	12	14	13	16	18	21	20	21	24	28	27				
750	[380.0]	10	11	13	13	15	17	20	19	20	23	27	26				
800	[405.0]	9	11	12	12	14	16	19	18	19	22	25	25				
900	[456.0]	8	10	11	11	13	15	17	17	17	20	23	22				
1000	[507.0]	8	9	10	10	12	13	15	15	16	18	21	20				
1250	[633.0]	6	7	-	8	9	11	-	12	13	14	-	16				
1500	[760.0]	5	6	-	6	8	9	-	10	11	12	-	13				
1750	[887.0]	4	5	-	6	7	8	-	9	9	11	-	12				
2000	[1013.0]	4	4	-	5	6	7	-	8	8	9	-	10				

NOTE: The above chart limits the maximum conductor size when conductors are entering through the side.



SpecMate Type 1 Wireway is also available in a wide range of color and finish options. Consult the factory for more information.

NOTE: Letters "A," "B," "C," and "D" refer to conductor insulation types specified in the Area of Conductor Chart found earlier in this section.

SPECMATE™ WIREWAY & ENCLOSURES

Technical Data (continued)

SpecMate Wireway Dimension Reference Chart

SIZE:	2 1/2 x 2 1/2		4 x 4		6 x 6		8 x 8		12 x 12	
DIMENSION:	Inches	[mm]	Inches	[mm]	Inches	[mm]	Inches	[mm]	Inches	[mm]
A x B	2 1/2 x 2 1/2	[64 x 64]	4 x 4	[102 x 102]	6 x 6	[152 x 152]	8 x 8	[203 x 203]	12 x 12	[305 x 305]
C	2	[51]	2	[51]	2	[51]	2	[51]	2	[51]
D1	2 7/16	[62]	3 15/16	[100]	5 15/16	[150]	7 15/16	[201]	11 15/16	[303]
D2	2 7/16	[62]	3 15/16	[100]	5 15/16	[150]	7 15/16	[201]	11 15/16	[303]
E	4 5/8	[118]	6 1/8	[156]	8 1/8	[206]	10 1/8	[257]	14 1/8	[359]
F	4 5/8	[118]	6 1/8	[156]	8 1/8	[206]	10 1/8	[257]	14 1/8	[359]
H1	3 1/16	[78]	3 3/4	[95]	4 9/16	[116]	5 3/8	[137]	7	[178]
H2	3 1/16	[78]	3 3/4	[95]	4 9/16	[116]	5 3/8	[137]	7	[178]
J	2 1/2	[64]	2 7/8	[73]	3 5/16	[84]	3 11/16	[94]	4 1/2	[114]
K	3 5/16	[84]	4 1/16	[103]	5 1/16	[128]	6 1/16	[154]	8 1/16	[205]
L	3 1/4	[83]	4	[102]	5	[127]	6	[153]	8	[204]
M	3 1/8	[79]	4 5/8	[118]	6 5/8	[168]	8 5/8	[219]	12 5/8	[321]
N	7	[177]	10	[254]	14	[356]	18	[457]	26	[660]
P	2 5/16	[59]	3 13/16	[97]	5 3/4	[146]	7 3/4	[197]	11 3/4	[298]
R	1 5/8	[41]	3 1/2	[89]	4 1/2	[114]	6 5/8	[168]	10 5/8	[270]
S	3 5/16	[84]	4 1/16	[103]	5 1/16	[129]	6 1/16	[154]	8 1/16	[205]
T	4 1/8	[105]	5 5/8	[143]	7 5/8	[194]	9 5/8	[245]	13 5/8	[346]
U	3 1/8	[79]	4 5/8	[118]	6 5/8	[168]	8 5/8	[219]	12 5/8	[321]
V	8 1/2	[216]	10	[254]	12	[305]	14	[356]	18	[457]
W	1 5/8	[41]	3 1/2	[89]	4 1/2	[114]	6 1/2	[165]	9 1/2	[241]

SIZE:	10 x 4		12 x 6		18 x 6		24 x 6	
DIMENSION:	Inches	[mm]	Inches	[mm]	Inches	[mm]	Inches	[mm]
A x B	10 x 4	[254 x 102]	12 x 6	[305 x 152]	18 x 6	[457 x 152]	24 x 6	[610 x 152]
C	2	[51]	2	[51]	2	[51]	2	[51]
D1	9 15/16	[252]	11 15/16	[303]	17 15/16	[455]	23 15/16	[608]
D2	3 15/16	[100]	5 15/16	[150]	5 15/16	[150]	5 15/16	[150]
E	12 1/8	[308]	14 1/8	[359]	20 1/8	[511]	26 1/8	[664]
F	6 1/8	[156]	8 1/8	[206]	8 1/8	[206]	8 1/8	[206]
H1	6 3/16	[157]	7	[178]	9 1/2	[241]	12	[305]
H2	3 3/4	[95]	4 9/16	[116]	4 9/16	[116]	4 9/16	[116]
J	4 3/32	[104]	4 1/2	[114]	5 3/4	[146]	7	[178]
K	7 1/16	[179]	8 1/16	[205]	11 1/16	[281]	14 1/16	[357]
L	7	[178]	8	[204]	11	[280]	14	[356]
M	10 5/8	[270]	12 5/8	[321]	N/A	N/A	N/A	N/A
N	16	[406]	20	[506]	N/A	N/A	N/A	N/A
P	9 3/4	[248]	11 3/4	[298]	17 3/4	[451]	23 3/4	[603]
R	3 1/2	[89]	4 1/2	[114]	4 1/2	[114]	4 1/2	[114]
S	7 1/16	[179]	8 1/16	[205]	11 1/16	[281]	14 1/16	[357]
T	11 5/8	[295]	13 5/8	[346]	19 5/8	[498]	25 5/8	[651]
U	10 5/8	[270]	12 5/8	[321]	18 5/8	[473]	24 5/8	[626]
V	16	[406]	18	[457]	24	[610]	30	[762]
W	3 1/2	[89]	4 1/2	[114]	4 1/2	[114]	4 1/2	[114]

SPECMATE™ WIREWAY & ENCLOSURES

Specmate Type 1 Wireway Ordering Information

Specmate Wireway Type 1



For divided wireway (two equal compartments), add suffix “-D”, i.e.: C1250-D. Wireway can also be provided with divider(s) in specified locations. Consult factory to order.

Steel finished in ANSI61 gray powder coat paint.

One coupling required with each length of duct.

1/2" [12.7mm] and 3/4" [19.1mm] concentric trade size KOs 24" [610mm] on centers.

UL Listed and CSA Certified for support on 5' [1.5m] centers. (2 1/2", 4", and 6" [64mm, 102mm, 152mm] square profiles also UL Listed on 10' [3m] centers). Special sizes, lengths, and colors available.

Ordering Data

STANDARD SIZES		GAUGE	10' LENGTH [3m]	5' LENGTH [1.5m]	2' LENGTH [.61m]	1' LENGTH [.30m]
Inches	[mm]					
2 1/2" x 2 1/2"	[64 x 64]	16	C1250	C1255	C1252	C1251
4" x 4"	[102 x 102]	16	C1400	C1405	C1402	C1401
6" x 6"	[152 x 152]	16	C1600	C1605	C1602	C1601
8" x 8"	[203 x 203]	16	C1800	C1805	C1802	C1801
12" x 12"	[305 x 305]	16	C11200	C11205	C11202	C11201
10" x 4"	[254 x 102]	16	C110-40	C110-45	C110-42	C110-41
12" x 6"	[305 x 152]	16	C112-60	C112-65	C112-62	C112-61
18" x 6"	[457 x 152]	14	-	C118-65	C118-62	C118-61
24" x 6"	[610 x 152]	12	-	C124-65	C124-62	C124-61

Specmate Type 1 Wireway Ordering Information

90° Flat Elbow

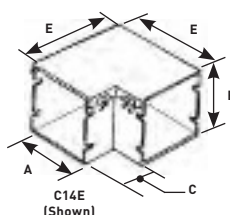

C125E	2 1/2" x 2 1/2"	[64mm x 64mm]
C14E	4" x 4"	[102mm x 102mm]
C16E	6" x 6"	[152mm x 152mm]
C18E	8" x 8"	[203mm x 203mm]
C112E	12" x 12"	[305mm x 305mm]
C110-4E	10" x 4"	[254mm x 102mm]
C112-6E	12" x 6"	[305mm x 152mm]
C118-6E	18" x 6"	[457mm x 152mm]
C124-6E	24" x 6"	[610mm x 152mm]

One coupling required with each fitting.

45° Flat Elbow

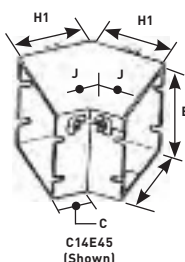

C125E45	2 1/2" x 2 1/2"	[64mm x 64mm]
C14E45	4" x 4"	[102mm x 102mm]
C16E45	6" x 6"	[152mm x 152mm]
C18E45	8" x 8"	[203mm x 203mm]
C112E45	12" x 12"	[305mm x 305mm]
C110-4E45	10" x 4"	[254mm x 102mm]
C112-6E45	12" x 6"	[305mm x 152mm]
C118-6E45	18" x 6"	[457mm x 152mm]
C124-6E45	24" x 6"	[610mm x 152mm]

One coupling required with each fitting.

SPECMATE™ WIREWAY & ENCLOSURES

Specmate Type 1 Wireway Ordering Information (continued)

90° Vertical Inside Elbow

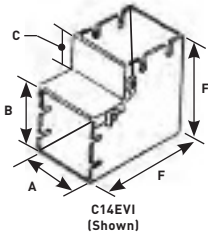

C125EVI	2 1/2" x 2 1/2"	[64mm x 64mm]
C14EVI	4" x 4"	[102mm x 102mm]
C16EVI	6" x 6"	[152mm x 152mm]
C18EVI	8" x 8"	[203mm x 203mm]
C112EVI	12" x 12"	[305mm x 305mm]
C110-4EVI	10" x 4"	[254mm x 102mm]
C112-6EVI	12" x 6"	[305mm x 152mm]
C118-6EVI	18" x 6"	[457mm x 152mm]
C124-6EVI	24" x 6"	[610mm x 152mm]

One coupling required with each fitting.

45° Vertical Inside Elbow

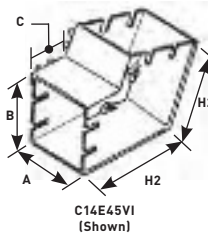

C125E45VI	2 1/2" x 2 1/2"	[64mm x 64mm]
C14E45VI	4" x 4"	[102mm x 102mm]
C16E45VI	6" x 6"	[152mm x 152mm]
C18E45VI	8" x 8"	[203mm x 203mm]
C112E45VI	12" x 12"	[305mm x 305mm]
C110-4E45VI	10" x 4"	[254mm x 102mm]
C112-6E45VI	12" x 6"	[305mm x 152mm]
C118-6E45VI	18" x 6"	[457mm x 152mm]
C124-6E45VI	24" x 6"	[610mm x 152mm]

One coupling required with each fitting.

90° Vertical Outside Elbow

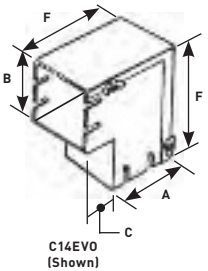

C125EVO	2 1/2" x 2 1/2"	[64mm x 64mm]
C14EVO	4" x 4"	[102mm x 102mm]
C16EVO	6" x 6"	[152mm x 152mm]
C18EVO	8" x 8"	[203mm x 203mm]
C112EVO	12" x 12"	[305mm x 305mm]
C110-4EVO	10" x 4"	[254mm x 102mm]
C112-6EVO	12" x 6"	[305mm x 152mm]
C118-6EVO	18" x 6"	[457mm x 152mm]
C124-6EVO	24" x 6"	[610mm x 152mm]

One coupling required with each fitting.

45° Vertical Outside Elbow

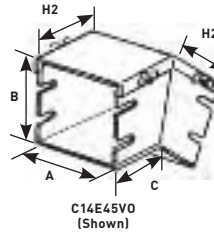

C125E45VO	2 1/2" x 2 1/2"	[64mm x 64mm]
C14E45VO	4" x 4"	[102mm x 102mm]
C16E45VO	6" x 6"	[152mm x 152mm]
C18E45VO	8" x 8"	[203mm x 203mm]
C112E45VO	12" x 12"	[305mm x 305mm]
C110-4E45VO	10" x 4"	[254mm x 102mm]
C112-6E45VO	12" x 6"	[305mm x 152mm]
C118-6E45VO	18" x 6"	[457mm x 152mm]
C124-6E45VO	24" x 6"	[610mm x 152mm]

One coupling required with each fitting.

End Blank

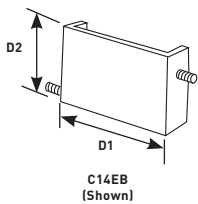

C125EB	2 1/2" x 2 1/2"	[64mm x 64mm]
C14EB	4" x 4"	[102mm x 102mm]
C16EB	6" x 6"	[152mm x 152mm]
C18EB	8" x 8"	[203mm x 203mm]
C112EB	12" x 12"	[305mm x 305mm]
C110-4EB	10" x 4"	[254mm x 102mm]
C112-6EB	12" x 6"	[305mm x 152mm]
C118-6EB	18" x 6"	[457mm x 152mm]
C124-6EB	24" x 6"	[610mm x 152mm]

Coupling

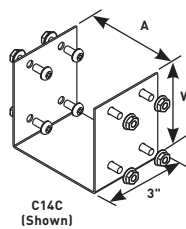

C125C	2 1/2" x 2 1/2"	[64mm x 64mm]
C14C	4" x 4"	[102mm x 102mm]
C16C	6" x 6"	[152mm x 152mm]
C18C	8" x 8"	[203mm x 203mm]
C112C	12" x 12"	[305mm x 305mm]
C110-4C	10" x 4"	[254mm x 102mm]
C112-6C	12" x 6"	[305mm x 152mm]
C118-6C	18" x 6"	[457mm x 152mm]
C124-6C	24" x 6"	[610mm x 152mm]

NOTE: Refer to "Dimension Reference Chart" shown previously in this section. For divided fittings (two equal compartments), add suffix "D" (i.e. C14ED). Consult factory to order unequal compartments.

SPECMATE™ WIREWAY & ENCLOSURES

Specmate Type 1 Wireway Ordering Information (continued)

Tee

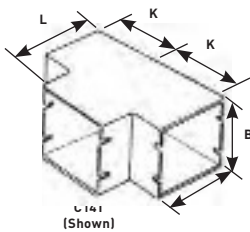

C125T	2 1/2" x 2 1/2"	[64mm x 64mm]
C14T	4" x 4"	[102mm x 102mm]
C16T	6" x 6"	[152mm x 152mm]
C18T	8" x 8"	[203mm x 203mm]
C112T	12" x 12"	[305mm x 305mm]
C110-4T	10" x 4"	[254mm x 102mm]
C112-6T	12" x 6"	[305mm x 152mm]
C118-6T	18" x 6"	[457mm x 152mm]
C124-6T	24" x 6"	[610mm x 152mm]

Two coupling required with each Tee.

Trapeze Hanger

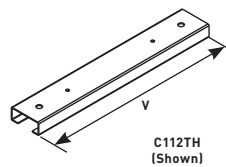

C125TH	2 1/2" x 2 1/2"	[64mm x 64mm]
C14TH	4" x 4"	[102mm x 102mm]
C16TH	6" x 6"	[152mm x 152mm]
C18TH	8" x 8"	[203mm x 203mm]
C112TH	12" x 12"	[305mm x 305mm]
C110-4TH	10" x 4"	[254mm x 102mm]
C112-6TH	12" x 6"	[305mm x 152mm]
C118-6TH	18" x 6"	[457mm x 152mm]
C124-6TH	24" x 6"	[610mm x 152mm]

NOTE: Hanger recommended for use with wireways more than 12 inches [305mm] wide. Also available for smaller wireways.

Cross

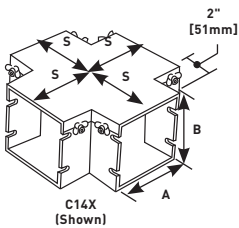

C125X	2 1/2" x 2 1/2"	[64mm x 64mm]
C14X	4" x 4"	[102mm x 102mm]
C16X	6" x 6"	[152mm x 152mm]
C18X	8" x 8"	[203mm x 203mm]
C112X	12" x 12"	[305mm x 305mm]
C110-4X	10" x 4"	[254mm x 102mm]
C112-6X	12" x 6"	[305mm x 152mm]
C118-6X	18" x 6"	[457mm x 152mm]
C124-6X	24" x 6"	[610mm x 152mm]

Two coupling required with each Cross.

Bracket Hanger

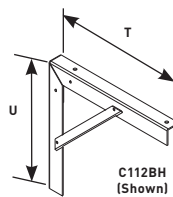

C125BH	2 1/2" x 2 1/2"	[64mm x 64mm]
C14BH	4" x 4"	[102mm x 102mm]
C16BH	6" x 6"	[152mm x 152mm]
C18BH	8" x 8"	[203mm x 203mm]
C112BH	12" x 12"	[305mm x 305mm]
C110-4BH	10" x 4"	[254mm x 102mm]
C112-6BH	12" x 6"	[305mm x 152mm]
C118-6BH	18" x 6"	[457mm x 152mm]
C124-6BH	24" x 6"	[610mm x 152mm]

NOTE: Gusset appears only on hangers for 12" [305mm] wide or larger wireway.

Reducer

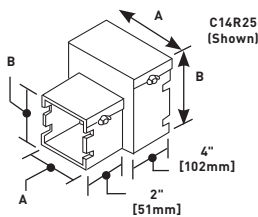

C14R25	4" x 4" - 2 1/2" x 2 1/2"	[102mm x 102mm - 64mm x 64mm]
C16R4	6" x 6" - 4" x 4"	[152mm x 152mm - 102mm x 102mm]
C18R6	8" x 8" - 6" x 6"	[203mm x 203mm - 152mm x 152mm]
C112R8	12" x 12" - 8" x 8"	[305mm x 305mm - 203mm x 203mm]
C112-6R6	12" x 6" - 6" x 6"	[305mm x 152mm - 152mm x 152mm]
C118-6R12-6	18" x 6" - 12" x 6"	[457mm x 152mm - 305mm x 152mm]
C124-6R18-6	24" x 6" - 18" x 6"	[610mm x 152mm - 457mm x 152mm]
C118-6EB	18" x 6"	[457mm x 152mm]
C124-6EB	24" x 6"	[610mm x 152mm]

One coupling required with each fitting.

Panel Flange

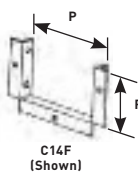

C125F	2 1/2" x 2 1/2"	[64mm x 64mm]
C14F	4" x 4"	[102mm x 102mm]
C16F	6" x 6"	[152mm x 152mm]
C18F	8" x 8"	[203mm x 203mm]
C112F	12" x 12"	[305mm x 305mm]
C110-4F	10" x 4"	[254mm x 102mm]
C112-6F	12" x 6"	[305mm x 152mm]
C118-6F	18" x 6"	[457mm x 152mm]
C124-6F	24" x 6"	[610mm x 152mm]

SPECMATE™ WIREWAY & ENCLOSURES

Specmate Type 1 Wireway Ordering Information (continued)

Changer

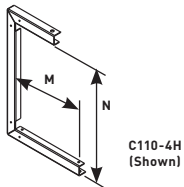

C125H	2 1/2" x 2 1/2"	[64mm x 64mm]
C14H	4" x 4"	[102mm x 102mm]
C16H	6" x 6"	[152mm x 152mm]
C18H	8" x 8"	[203mm x 203mm]
C112H	12" x 12"	[305mm x 305mm]
C110-4H	10" x 4"	[254mm x 102mm]
C112-6H	12" x 6"	[305mm x 152mm]
C118-6T	18" x 6"	[457mm x 152mm]
C124-6T	24" x 6"	[610mm x 152mm]

Barrier – Field Installed

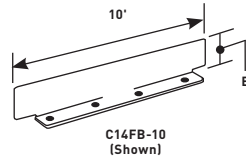

C125FB	2 1/2" x 120"	[64mm x 3m]
C14FB	4" x 120"	[102mm x 3m]
C16FB	6" x 120"	[152mm x 3m]
C18FB	8" x 120"	[203mm x 3m]
C112FB	12" x 120"	[305mm x 3m]
C110-4TH	10" x 4"	[254mm x 102mm]
C112-6TH	12" x 6"	[305mm x 152mm]
C118-6TH	18" x 6"	[457mm x 152mm]
C124-6TH	24" x 6"	[610mm x 152mm]

NOTE: Refer to "Dimension Reference Chart" shown previously in this section. For divided fittings (two equal compartments), add suffix "D" (i.e. C14ED). Consult factory to order unequal compartments.

Specmate Type 1 Wireway Installation Details

Typical Installation: The wireway should be installed as a complete system incorporating all fittings necessary to provide for directional changes. All connections should be fastened securely with the fasteners provided by the manufacturer in order to ensure compliance with UL and CSA bonding requirements. Conductors of appropriate types as outlined by the applicable Electrical Code may be used in wireway following installation. Specific installation instructions are given below.

Hanging Method

Three styles of hangers may be purchased with wireway.

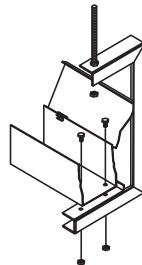

C-Hanger: For widths up to 12" [305mm].*

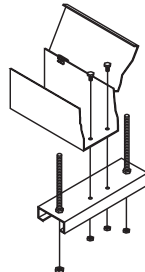

Trapeze Hanger: For any size of wireway.*

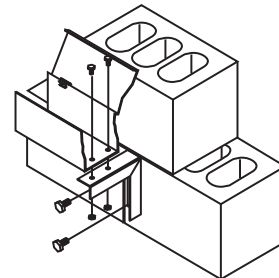

Wall Bracket: For installations along walls. For any size of wireway.

Installation:

For C-Hangers and Trapeze hangers, threaded rod should be cut to the appropriate length, and fastened to a structural member. The hanger should then be bolted to the threaded rod through the holes provided, level and in line with the other hangers. Wall mounted hangers should be fastened to structural members in the wall in a manner ensuring sufficient support strength. Once the wireway is in place, it must be fastened to the hanger by any structurally sound method. Most installations use 1/4" [6.4mm] nuts and bolts fastened through holes drilled in the wireway base. No sharp edges should be allowed in the wireway as a result of fastening. Fastening hardware for hangers is not provided. UL Listed wireway with square cross sections of 2.5", 4", and 6" [64mm, 102mm, and 152mm] may be supported on maximum spans of 10' [3m]. All other wireway shall be supported on spans of 5' [1.5m] or less.

Installation of Couplings:

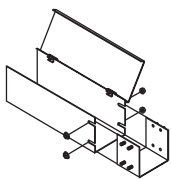

Couplings are provided with necessary hardware. Slide the coupling into the end of the wireway and tighten the fasteners with a wrench, ensuring they are secure. Slide the end of the next length of wireway over the other half of the coupling and attach the fasteners. Repeat until complete. Couplings are best located at one-quarter of the distance between supports (hangers).

Installation of End Blanks

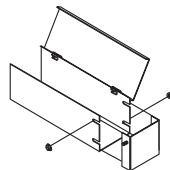

End Blanks provided with necessary hardware. Slide the end blank into the end of the wireway and tighten the fasteners with a wrench, ensuring they are secure.

SPECMATE™ WIREWAY & ENCLOSURES

Specmate Type 1 Wireway Installation Details (continued)

Installation of Tele-Power Pole Adapter:

1. Locate the Pole Adapter on the wireway. Drill holes in the appropriate locations to match the holes in the Pole Adapter. Cut and grommet hole to match pole adapter entrance feed.
2. Bolt the Pole Adapter to the underside of the wireway. No sharp edges should remain in the wireway. (Bolts not furnished.)
3. Insert the Wiremold NP600 Series Tele-Power Pole into the underside of the Pole Adapter. Tighten the two set screws (furnished) onto the pole.

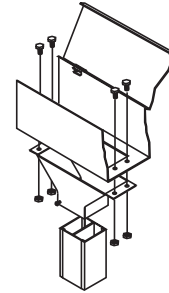
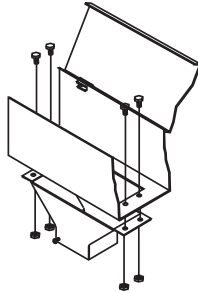
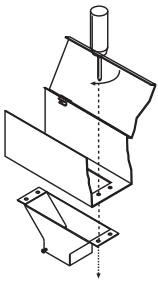

Specmate Type 1 Wireway Enclosures Technical Data

“Type 1 Enclosures are intended for indoor use primarily to provide a degree of protection against contact with the enclosed equipment and wiring.” – NEMA Standard / No. 250-1991

Standard Knockout Configuration

The knockout configuration shown below is referred to for each standard catalog number.

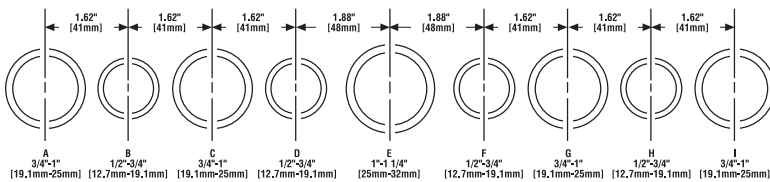

The following chart indicates the standard knockout pattern that can be accommodated according to the dimension specified when custom sizes are ordered.

Standard Knockout Configuration for Custom Sizes

Length of Side (L)	Standard KO Configuration	Metric Conversion	
		In.	[mm]
4" [102mm] to less than 6" [152mm]	B-C	4	[102]
6" [152mm] to less than 8" [203mm]	B-C-D	6	[152]
8" [203mm] to less than 10" [254mm]	F-G-H-I	8	[203]
10" [254mm] to less than 15" [381mm]	C-D-E-F-G	10	[254]
15" [381mm] to less than 18" [457mm]	B-C-D-E-F-G-H	12	[305]
18" [457mm] and up	A-B-C-D-E-F-G-H-I	15	[381]
		18	[457]
		20	[508]
		24	[610]
		30	[762]
		36	[914]
		48	[1220]

SPECMATE™ WIREWAY & ENCLOSURES

Specmate Type 1 Wireway Ordering Information

Hinged Cover Junction Box with Padlock Hasp

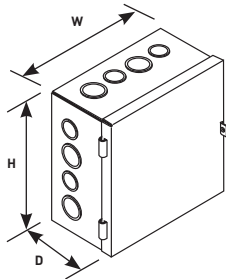

Hinged cover junction boxes for surface mounting. Formed steel hinges, friction catch and a padlock hasp provide easy opening and secure closing.

Internal mounting holes and a ground terminal with ground screw provided.

Standard boxes are provided with concentric knockouts. Custom configurations and boxes without knockouts are available on request. ANSI / ASA 61 gray finish inside and out.

Hinged Cover Junction Box with Padlock Hasp - Painted Steel

CATALOG NUMBER	BOX DIMENSIONS						KNOCKOUT CONFIGURATION*		INTERNAL CU. IN. (APPROX.)	STANDARD HINGE TYPE
	HEIGHT		WIDTH		DEPTH		FACE HEIGHT	FACE WIDTH		
	In.	[mm]	In.	[mm]	In.	[mm]				
SPMJL-12-12-6	12	[305]	12	[305]	6	[152]	C-D-E-F-G	C-D-E-F-G	828	Formed
SPMJL-18-12-6	18	[457]	12	[305]	6	[152]	A-B-C-D-E-F-G-H-I	C-D-E-F-G	1247	Formed
SPMJL-18-18-6	18	[457]	18	[459]	6	[152]	A-B-C-D-E-F-G-H-I	A-B-C-D-E-F-G-H-I	1877	Formed
SPMJL-24-12-6	24	[610]	12	[305]	6	[152]	A-B-C-D-E-F-G-H-I	C-D-E-F-G	1666	Butt
SPMJL-24-18-6	24	[610]	18	[457]	6	[152]	A-B-C-D-E-F-G-H-I	A-B-C-D-E-F-G-H-I	2507	Butt
SPMJL-24-24-6	24	[610]	24	[610]	6	[152]	A-B-C-D-E-F-G-H-I	A-B-C-D-E-F-G-H-I	3349	Butt
SPMJL-20-20-10	20	[508]	20	[508]	10	[254]	A-B-C-D-E-F-G-H-I	A-B-C-D-E-F-G-H-I	3901	Butt
SPMJL-30-30-10	30	[762]	30	[762]	10	[254]	A-B-C-D-E-F-G-H-I	A-B-C-D-E-F-G-H-I	8814	Butt
SPMJL-36-24-10	36	[914]	24	[610]	10	[254]	A-B-C-D-E-F-G-H-I	A-B-C-D-E-F-G-H-I	8458	Continuous

NOTE: Add "C" prefix to denote Canadian version -- Agency approved for sale in Canada.

*See standard knockout configuration diagram shown previously in this section.

SPECMATE™ WIREWAY & ENCLOSURES

Specmate Type 1 Wireway Ordering Information (continued)

Hinged Cover Junction Box with Pull Ring

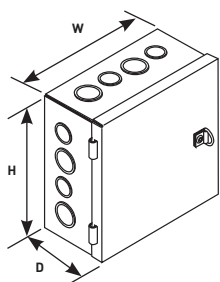

Hinged cover junction boxes for surface mounting. Formed steel hinges, friction catch and a “D” ring style handle provide easy opening and secure closing. Internal mounting holes and a ground terminal with ground screw provided. Standard boxes are provided with concentric knockouts. Custom configurations and boxes without knockouts are available on request. ANSI/ASA 61 gray finish inside and out.

Hinged Cover Junction Box with Pull Ring – Painted Steel

CATALOG NUMBER	BOX DIMENSIONS						KNOCKOUT CONFIGURATION*		INTERNAL CU. IN. (APPROX.)	STANDARD HINGE TYPE
	HEIGHT		WIDTH		DEPTH		FACE HEIGHT	FACE WIDTH		
	In.	[mm]	In.	[mm]	In.	[mm]				
SPMJ-6-4-4	6	[152]	4	[102]	4	[102]	B-C-D	B-C	88	Formed
SPMJ-6-6-4	6	[152]	6	[152]	4	[102]	B-C-D	B-C-D	134	Formed
SPMJ-8-6-4	8	[203]	6	[152]	4	[102]	F-G-H-I	B-C-D	179	Formed
SPMJ-8-8-4	8	[203]	8	[203]	4	[102]	F-G-H-I	F-G-H-I	240	Formed
SPMJ-10-10-4	10	[254]	10	[254]	4	[102]	C-D-E-F-G	C-D-E-F-G	378	Formed
SPMJ-12-12-4	12	[305]	12	[305]	4	[102]	C-D-E-F-G	C-D-E-F-G	546	Formed
SPMJ-18-12-4	18	[457]	12	[305]	4	[102]	A-B-C-D-E-F-G-H-I	C-D-E-F-G	823	Formed
SPMJ-8-6-6	8	[203]	6	[152]	6	[152]	F-G-H-I	B-C-D	272	Formed
SPMJ-8-8-6	8	[203]	8	[203]	6	[152]	F-G-H-I	F-G-H-I	364	Formed
SPMJ-10-10-6	10	[254]	10	[254]	6	[152]	C-D-E-F-G	C-D-E-F-G	573	Formed
SPMJ-12-12-6	12	[305]	12	[305]	6	[152]	C-D-E-F-G	C-D-E-F-G	828	Formed
SPMJ-18-12-6	18	[457]	12	[305]	6	[152]	A-B-C-D-E-F-G-H-I	C-D-E-F-G	1247	Formed
SPMJ-18-18-6	18	[457]	18	[457]	6	[152]	A-B-C-D-E-F-G-H-I	A-B-C-D-E-F-G-H-I	1877	Formed
SPMJ-24-18-6	24	[610]	18	[457]	6	[152]	A-B-C-D-E-F-G-H-I	A-B-C-D-E-F-G-H-I	2507	Butt
SPMJ-24-24-6	24	[610]	24	[610]	6	[152]	A-B-C-D-E-F-G-H-I	A-B-C-D-E-F-G-H-I	3349	Butt
SPMJ-30-24-6	30	[762]	24	[610]	6	[152]	A-B-C-D-E-F-G-H-I	A-B-C-D-E-F-G-H-I	4190	Butt
SPMJ-18-12-8	18	[457]	12	[305]	8	[203]	A-B-C-D-E-F-G-H-I	C-D-E-F-G	1672	Formed
SPMJ-18-18-8	18	[457]	18	[457]	8	[203]	A-B-C-D-E-F-G-H-I	A-B-C-D-E-F-G-H-I	2516	Formed
SPMJ-24-18-8	24	[610]	18	[457]	8	[203]	A-B-C-D-E-F-G-H-I	A-B-C-D-E-F-G-H-I	3361	Butt
SPMJ-30-24-8	30	[762]	24	[610]	8	[203]	A-B-C-D-E-F-G-H-I	A-B-C-D-E-F-G-H-I	5617	Butt
SPMJ-36-24-8	36	[914]	24	[610]	8	[203]	A-B-C-D-E-F-G-H-I	A-B-C-D-E-F-G-H-I	6745	Continuous
SPMJ-36-24-12	36	[914]	24	[610]	12	[305]	A-B-C-D-E-F-G-H-I	A-B-C-D-E-F-G-H-I	10171	Continuous

SPECMATE™ WIREWAY & ENCLOSURES

Specmate Type 1 Wireway Ordering Information (continued)

Wiring Troughs

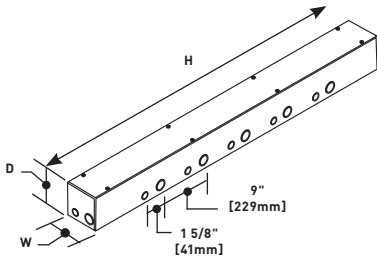

Screw-on cover wiring troughs are used as junction boxes or pull boxes for surface mounting. Internal mounting holes and a ground terminal with ground screw provided. Custom configurations of troughs up to 120" [3m] in length are available with or without knockouts. ANSI/ASA 61 gray finish inside and out.

Clusters of 1/2" [12.7mm] – 3/4" [19.1mm] and 3/4" [19.1mm] – 1" [25mm] trade size knockouts are spaced on 9" [229mm] centers along the trough. Other knockout sizes and spacings are available on request.

Wiring Throughs - Painted Steel

CATALOG NUMBER	BOX DIMENSIONS						INTERNAL CU. IN. (APPROX.)
	HEIGHT		WIDTH		DEPTH		
	In.	[mm]	In.	[mm]	In.	[mm]	
SPMJW-12-4-4	12	[305]	4	[102]	4	[102]	178
SPMJW-24-4-4	24	[610]	4	[102]	4	[102]	358
SPMJW-36-4-4	36	[914]	4	[102]	4	[102]	539
SPMJW-48-4-4	48	[1220]	4	[102]	4	[102]	719
SPMJW-60-4-4	60	[1525]	4	[102]	4	[102]	899
SPMJW-72-4-4	72	[1830]	4	[102]	4	[102]	1079
SPMJW-12-6-6	12	[305]	6	[152]	6	[152]	410
SPMJW-24-6-6	24	[610]	6	[152]	6	[152]	824
SPMJW-36-6-6	36	[914]	6	[152]	6	[152]	1238
SPMJW-48-6-6	48	[1220]	6	[152]	6	[152]	1652
SPMJW-60-6-6	60	[1525]	6	[152]	6	[152]	2067
SPMJW-72-6-6	72	[1830]	6	[152]	6	[152]	2481
SPMJW-18-8-8	12	[305]	8	[203]	8	[203]	736
SPMJW-24-8-8	24	[610]	8	[203]	8	[203]	1481
SPMJW-36-8-8	36	[914]	8	[203]	8	[203]	2225
SPMJW-48-8-8	48	[1220]	8	[203]	8	[203]	2969
SPMJW-60-8-8	60	[1525]	8	[203]	8	[203]	3713
SPMJW-72-8-8	72	[1830]	8	[203]	8	[203]	4457

NOTE: Add "C" prefix to denote Canadian version -- Agency approved for sale in Canada.

*See standard knockout configuration diagram shown previously in this section.

SPECMATE™ WIREWAY & ENCLOSURES

Specmate Type 1 Wireway Ordering Information (continued)

Surface Mount & Flush Mount Screw Cover Junction Boxes

Surface Mount

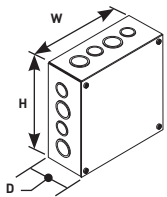

Flush Mount

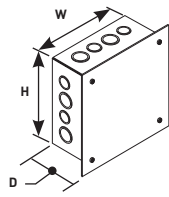

Screw-on cover junction boxes for surface or flush mounting. Internal mounting holes and a ground terminal with ground screw provided. Standard boxes are provided with concentric knockouts. Custom configurations and boxes without knockouts are available on request. ANSI / ASA 61 Gray finish inside and out.

Screw Cover Junction Boxes – Surface Mount – Painted Steel

CATALOG NUMBER	BOX DIMENSIONS						KNOCKOUT CONFIGURATION		INTERNAL CU. IN. (APPROX.)
	HEIGHT		WIDTH		DEPTH		HEIGHT	FACE WIDTH	
	In.	[mm]	In.	[mm]	In.	[mm]			
SPMJ-6-4-4	6	[152]	4	[102]	4	[102]	B-C-D	B-C-	88
SPMJ-6-6-4	6	[152]	6	[152]	4	[102]	B-C-D	B-C-D	134
SPMJ-8-6-4	8	[203]	6	[152]	4	[102]	F-G-H-I	B-C-D	179
SPMJ-8-8-4	8	[203]	8	[203]	4	[102]	F-G-H-I	F-G-H-I	240
SPMJ-10-10-4	10	[254]	10	[254]	4	[102]	C-D-E-F-G	C-D-E-F-G	378
SPMJ-12-12-4	12	[305]	12	[305]	4	[102]	C-D-E-F-G	C-D-E-F-G	546
SPMJ-18-12-4	18	[457]	12	[305]	4	[102]	A-B-C-D-E-F-G-H-I	C-D-E-F-G	823
SPMJ-18-18-4	18	[457]	18	[457]	4	[102]	A-B-C-D-E-F-G-H-I	A-B-C-D-E-F-G-H-I	1250
SPMJ-8-6-6	8	[203]	6	[152]	6	[152]	F-G-H-I	B-C-D	272
SPMJ-8-8-6	8	[203]	8	[203]	6	[152]	F-G-H-I	F-G-H-I	364
SPMJ-10-10-6	10	[254]	10	[254]	6	[152]	C-D-E-F-G	C-D-E-F-G	573
SPMJ-12-12-6	12	[305]	12	[305]	6	[152]	C-D-E-F-G	C-D-E-F-G	828
SPMJ-18-12-6	18	[457]	12	[305]	6	[152]	A-B-C-D-E-F-G-H-I	C-D-E-F-G	1247
SPMJ-18-18-6	18	[457]	18	[457]	6	[152]	A-B-C-D-E-F-G-H-I	A-B-C-D-E-F-G-H-I	1877
SPMJ-24-18-6	24	[610]	18	[457]	6	[152]	A-B-C-D-E-F-G-H-I	A-B-C-D-E-F-G-H-I	2507
SPMJ-24-24-6	24	[610]	24	[610]	6	[152]	A-B-C-D-E-F-G-H-I	A-B-C-D-E-F-G-H-I	3349
SPMJ-30-24-6	30	[762]	24	[610]	6	[152]	A-B-C-D-E-F-G-H-I	A-B-C-D-E-F-G-H-I	4190
SPMJ-18-12-8	18	[457]	12	[305]	8	[203]	A-B-C-D-E-F-G-H-I	C-D-E-F-G	1672
SPMJ-18-18-8	18	[457]	18	[457]	8	[203]	A-B-C-D-E-F-G-H-I	A-B-C-D-E-F-G-H-I	2516
SPMJ-24-18-8	24	[610]	18	[457]	8	[203]	A-B-C-D-E-F-G-H-I	A-B-C-D-E-F-G-H-I	3361
SPMJ-30-24-8	30	[762]	24	[610]	8	[203]	A-B-C-D-E-F-G-H-I	A-B-C-D-E-F-G-H-I	5617
SPMJ-36-24-8	36	[914]	24	[610]	8	[203]	A-B-C-D-E-F-G-H-I	A-B-C-D-E-F-G-H-I	6745
SPMJ-36-24-12	36	[914]	24	[610]	12	[305]	A-B-C-D-E-F-G-H-I	A-B-C-D-E-F-G-H-I	10171

SPECMATE™ WIREWAY & ENCLOSURES

Screw Cover Junction Boxes - Flush Mount - Painted Steel

CATALOG NUMBER	BOX DIMENSIONS						KNOCKOUT CONFIGURATION*		INTERNAL CU. IN. (APPROX.)	COVER DIMENSION	
	HEIGHT		WIDTH		DEPTH					HEIGHT	WIDTH
	In.	[mm]	In.	[mm]	In.	[mm]	FACE HEIGHT	FACE WIDTH		In. [mm]	In. [mm]
SPMJF-6-6-4	6	[152]	6	[152]	4	[102]	B-C-D	B-C-D	134	7.5 [191]	7.5 [191]
SPMJF-8-6-4	8	[203]	6	[152]	4	[102]	F-G-H-I	B-C-D	179	9.5 [242]	7.5 [191]
SPMJF-8-8-4	8	[203]	8	[203]	4	[102]	F-G-H-I	F-G-H-I	240	9.5 [242]	9.5 [242]
SPMJF-10-10-4	10	[254]	10	[254]	4	[102]	C-D-E-F-G	C-D-E-F-G	378	11.5 [292]	11.5 [292]
SPMJF-12-12-4	12	[305]	12	[305]	4	[102]	C-D-E-F-G	C-D-E-F-G	546	13.5 [343]	13.5 [343]
SPMJF-18-12-4	18	[457]	12	[305]	4	[102]	A-B-C-D-E-F-G-H-I	C-D-E-F-G	823	19.5 [534]	13.5 [343]
SPMJF-18-18-4	18	[457]	18	[457]	4	[102]	A-B-C-D-E-F-G-H-I	A-B-C-D-E-F-G-H-I	1250	19.5 [534]	19.5 [534]
SPMJF-8-6-6	8	[203]	6	[152]	6	[152]	F-G-H-I	B-C-D	272	9.5 [242]	7.5 [191]
SPMJF-8-8-6	8	[203]	8	[203]	6	[152]	F-G-H-I	F-G-H-I	364	9.5 [242]	9.5 [242]
SPMJF-10-10-6	10	[254]	10	[254]	6	[152]	C-D-E-F-G	C-D-E-F-G	573	11.5 [292]	11.5 [252]
SPMJF-12-12-6	12	[305]	12	[305]	6	[152]	C-D-E-F-G	C-D-E-F-G	828	13.5 [343]	13.5 [343]
SPMJF-18-12-6	18	[457]	12	[305]	6	[152]	A-B-C-D-E-F-G-H-I	C-D-E-F-G	1247	19.5 [534]	13.5 [343]
SPMJF-18-18-6	18	[457]	18	[457]	6	[152]	A-B-C-D-E-F-G-H-I	A-B-C-D-E-F-G-H-I	1877	19.5 [534]	19.5 [534]
SPMJF-24-18-6	24	[610]	18	[457]	6	[152]	A-B-C-D-E-F-G-H-I	A-B-C-D-E-F-G-H-I	2507	25.5 [649]	19.5 [534]
SPMJF-24-24-6	24	[610]	24	[610]	6	[152]	A-B-C-D-E-F-G-H-I	A-B-C-D-E-F-G-H-I	3349	25.5 [649]	25.5 [648]
SPMJF-30-24-6	30	[762]	24	[610]	6	[152]	A-B-C-D-E-F-G-H-I	A-B-C-D-E-F-G-H-I	4190	31.5 [775]	25.5 [648]

NOTE: Add "C" prefix to denote Canadian version — Agency approved for sale in Canada.
 *See standard knockout configuration diagram shown previously in this section.

WALLSOURCE™ SERVICE BOXES



Wiremold® WallSource™ Multiple Service Boxes are six-gang boxes that can accommodate multiple services including power and communications eliminating multiple drops and uneven wall faceplates.

CODE REFERENCE

UL Listed Wireway, Auxiliary Gutters & Associated Fittings:
File E2961 Guide QCIT.
Meets Article 314 of NEC.

WallSource Box Installation Details

WSA42-4 Box Installation Shown

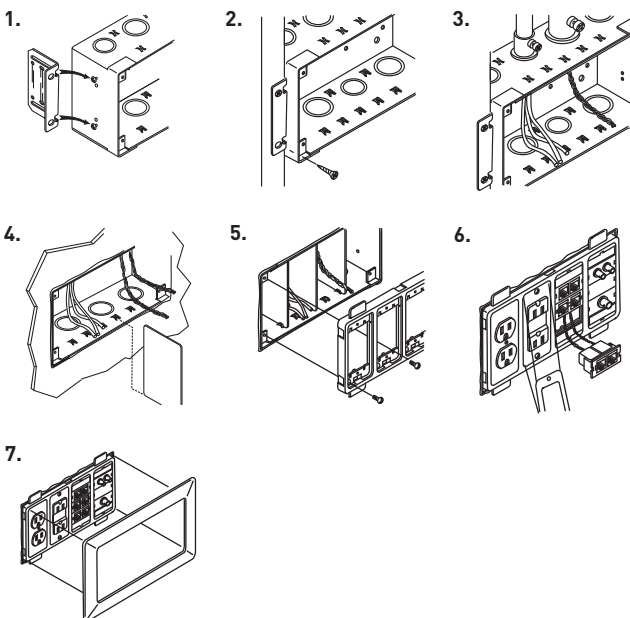

Installing WSA00-4 on WSA42-4

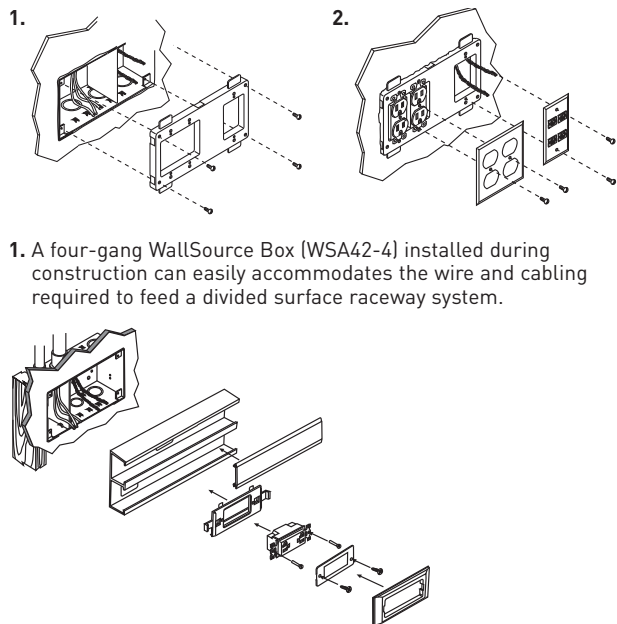

1. A four-gang WallSource Box (WSA42-4) installed during construction can easily accommodate the wire and cabling required to feed a divided surface raceway system.

COLOR OPTIONS



Wallsource Multiple Service Boxes and components are available in ivory, black, gray, light gray or white as indicated in the part number descriptions.

Custom color options are also available. Consult the factory for more information.

WALLSOURCE™ SERVICE BOXES

WallSource Service Boxes Ordering Information

WSB42-2

WallSource Box, Divider & Mounting Bracket

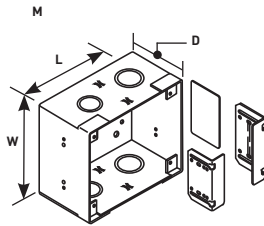

Slide-in dividers separate the box for power and communication services. Adjustable mounting brackets offer flexibility to flush mount box in 1/2", 5/8", 1", and 1/4" [12.7mm, 15.9mm, 25mm, and 32mm] wall thicknesses.

ORDERING DATA						
CAT. NO.	L	W	D	Gang	Trade Size KOs	
WSB42-2	4 3/4"	[121mm]	5"	[127mm]	3 1/4"	[83mm] 2 1/2", 3/4", 1"

WSA07-4A Device Mounting Bracket & Trim Ring

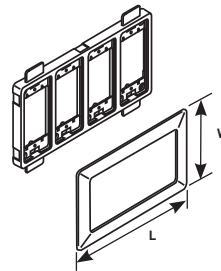

Self-leveling bracket accommodates a wide variety of electrical and communications devices. The trim ring hides the holecut to give the box a finished look. For use with: 5507 Series Faceplates, Ortronics® TracJack & Series II Modules, Pass & Seymour Activate Series Inserts and Wiremold Open System Communication Modules. Available

in white (WSA07-4AWH), black (WSA07-4ABK), gray (WSA07-4AG), and gray (WSA07-4AGY).

ORDERING DATA				
CAT. NO.	L		W	Gang
WSA07-4A	11 1/4"	[286mm]	7"	[177mm] 4

WSA42-4

Wallsource Box, Divider & Mounting Brackets

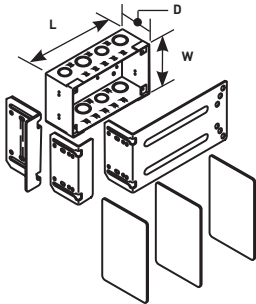

Slide-in dividers separate the box for power and communication services. Adjustable mounting brackets offer flexibility to flush mount box in 1/2", 5/8", 1", and 1 1/4" [12.7mm, 15.9mm, 25mm, and 32mm] wall thicknesses.

ORDERING DATA						
CAT. NO.	L	W	D	Gang	Trade Size KOs	
WSA42-4	9 3/16"	[233mm]	5"	[127mm]	3 1/4"	[83mm] 4 1/2", 3/4", 1", 1 1/2"

WSC07-6A Device Mounting Bracket & Trim Ring

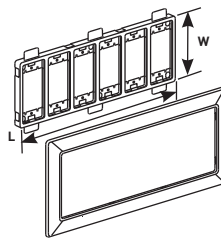

Self-leveling bracket accommodates a wide variety of electrical and communications devices. The trim ring hides the holecut to give the box a finished look. For use with: 5507 Series Faceplates, Ortronics® TracJack & Series II Modules, Pass & Seymour Activate Series Inserts and Wiremold Open System Communication Modules. Available in white (WSC07-6AWH), black (WSC07-6ABK), gray (WSC07-6AG), and gray (WSC07-6AGY).

ORDERING DATA				
CAT. NO.	L		W	Gang
WSC07-6A	15 13/16"	[402mm]	7"	[177mm] 6

Parts identified with this symbol are Certified to Canadian Safety Standards for sale in Canada. When ordering these products, add "C" suffix to part number to denote the Canadian version, i.e. "WSB42-2C".

WALLSOURCE™ SERVICE BOXES

WallSource Service Boxes Ordering Information

WSC42-6

Wallsource Box, Divider & Mounting Brackets

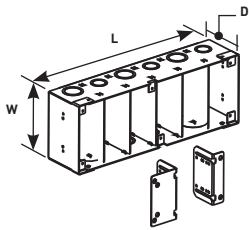

Slide-in dividers separate the box for power and communication services. Adjustable mounting brackets offer flexibility to flush mount box in 1/2", 5/8", 1", and 1 1/4" [12.7mm, 15.9mm, 25mm, and 32mm] wall thicknesses.

ORDERING DATA							
CAT. NO.	L	W	D	Gang	Trade Size KOs		
WSA42-6	13 3/4"	[350mm]	5"	[127mm]	3 1/4"	[83mm]	6 1/2", 3/4", 1", 1 1/2"

WSA00-4

Open Architecture Device Mounting Bracket & Trim Ring

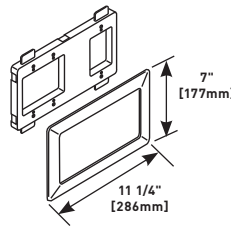

Self-leveling bracket accommodates a wide variety of electrical and communications devices. This bracket accommodates a standard single- and dual-gang faceplate. The trim ring hides the holecut to give the box a finished look. Standard color is Ivory, for other colors

add one of the following: white (WSA00-4WH), black (WSA00-4BK) and gray (WSA00-4GY).

FSS-18 Fiber Storage Loop

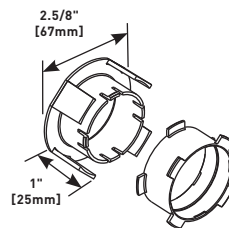

Use this loop to store 18" [457mm] of cable with a controlled 1" [25mm] bend radius.

WSB07-2A Device Mounting Bracket & Trim Ring

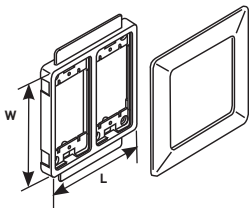

Self-leveling bracket accommodates a wide variety of electrical and communications devices. The trim ring hides the holecut to give the box a finished look. For use with: 5507 Series Faceplates, Ortronics® TracJack & Series II Modules, Pass & Seymour Activate Series Inserts

and Wiremold Open System Communication Modules. Available in white (WSB07-2AWH), black (WSB07-2ABK), gray (WSB07-2AG), and gray (WSB07-2AGY).

ORDERING DATA					
CAT. NO.	L	W	GANG		
WSB07-2A	6 13/16"	[173mm]	7"	[177mm]	2

CM-EPLA End Plates

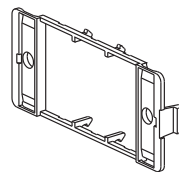

Includes two outlet identification labels with clear covers and two matching screw covers. Required for mounting Pass & Seymour Activate™ and Wiremold Open System communication modules into the WSX07-X Series device brackets.

WSA86 Backfeed Kit

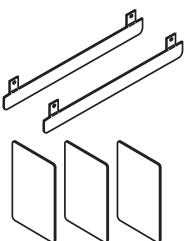

For backfeeding 4000, 6000, 5400, 5500 and ALA4800 Series Raceways. Use included templates to easily cut entrances into raceway. Use the dividers for UL Listed separation. Use the backfeed plate with 4000 and 6000 Series Raceway to completely cover wall hole cut. Includes ivory and gray pieces.

S2-EPL End Plates

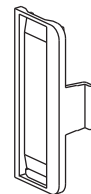

Includes two outlet identification labels with clear covers and two matching screw covers. Required for mounting Ortronics® Series II modules into the WSX07-X Series device brackets.

Parts identified with this symbol are Certified to Canadian Safety Standards for sale in Canada. When ordering these products, add "C" suffix to part number to denote the Canadian version, i.e. "WSC42-2C".

PLUGMOLD® MULTIOUTLET SYSTEMS



Wiremold® Plugmold® Multioutlet Systems are an excellent choice for applications where space is minimal but multiple outlets for power are required.



Featured Products



adorne™ Under-Cabinet
Lighting System
279



Tamper-Resistant
Plugmold®
276

PLUGMOLD® MULTIOUTLET SYSTEMS

Table of Contents

Plugmold® Steel Multioutlet Systems



Plugmold® Plus Nonmetallic Multioutlet Systems



Plugmold® Aluminum Multioutlet Systems



Plugmold® Tamper-Resistant Multioutlet Systems



adorne Under-Cabinet Lighting System



PLUGMOLD® MULTIOUTLET SYSTEMS

Quick Selection Guide

Plugmold® Multioutlet Systems – Steel Profiles

Plugmold® 2000 Series™



CAPACITY: 0.80 in.² [516mm²]

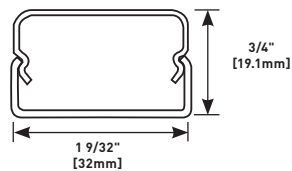

Plugmold® 2400, 24S, 24R™ Series



CAPACITY: 1.39 in.² [897mm²]

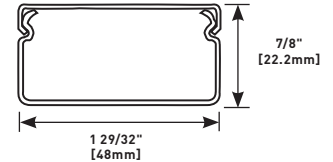

Plugmold® Multioutlet Systems – Nonmetallic Profiles

Plugmold® Plus NM2000 Series™



CAPACITY: 0.114 in.² [735mm²]

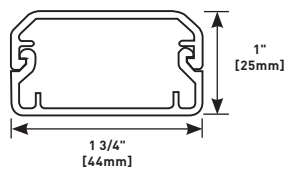

Plugmold® Multioutlet Systems – Aluminum Profiles

Plugmold® AL2000 Series™



CAPACITY: 1.10 in.² [710mm²]

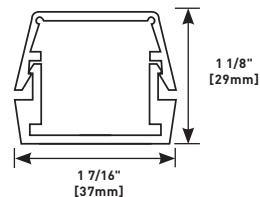

Plugmold Multioutlet Systems and Raceways

SERIES	MATERIAL	AMPERAGE	PROFILE DIMENSIONS		RECEPTACLE TYPE
			Inches	[mm]	
2000	Steel	15 Amp	3/4" x 1 9/32"	[19.1mm x 33mm]	Simplex
2000TR	Steel	15 Amp	3/4" x 1 9/32"	[19.1mm x 33mm]	Simplex
V2400	Steel	20 Amp	7/8" x 1 29/32"	[22.2mm x 48mm]	Simplex
24R	Steel	15 Amp	7/8" x 1 29/32"	[22.2mm x 48mm]	TR Duplex
24S	Steel	20 Amp	7/8" x 1 29/32"	[22.2mm x 48mm]	Duplex
NM2000	Nonmetallic	15 Amp	1" x 1 3/4"	[25mm x 44mm]	Duplex
AL2000	Aluminum	15 Amp	1 1/8" x 1 7/16"	[29mm x 37mm]	Simplex
AL2000TR	Aluminum	15 Amp	1 1/8" x 1 7/16"	[29mm x 37mm]	Simplex

NOTE: All systems can be custom configured to suit specific job requirements.

PLUGMOLD® 2000 SERIES™



Two-piece, low profile multiple outlet raceway. Low profile requires minimal space.

CODE REFERENCE

cULus Listed Base & Blank Cover:
File E4376 Guide RJBT.

Multioutlet Assemblies:
File E15191 Guide PVGT.

Fittings:
File E41751 Guide RJPR.

Base & Blank Cover & Plugmold Series with Snapicoil Harness:
Meets Article 386 of NEC.
Meets Section 12-3032 of CEC.

Plugmold Wired Sections:
Meets Article 380 of NEC.
Meets Section 12-3032 of CEC.

Plugmold 2000 Series System Layout

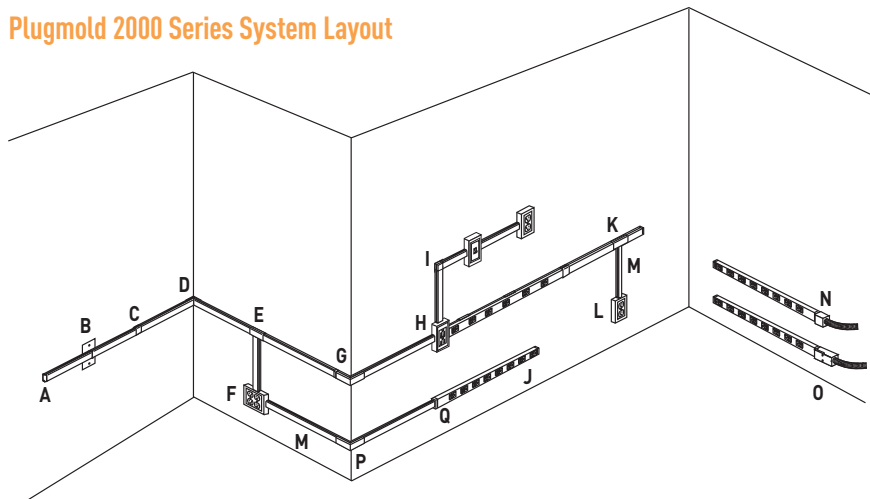

KEY

- A. V2010B Blank End Fitting
- B. V2051H Flush Plate Adapter
- C. V2006 Cover Clip
- D. 2017TC Internal Corner Coupling
- E. V2015 Tee Fitting
- F. V2048-2 Two-Gang Device Box
- G. V2018C Extern Elbow Cover
- H. V2048 Single-Gang Device Box
- I. V2011 90° Flat Elbow
- J. V20GB506 Plugmold Strip
- K. V2089 Side-Reducing Fitting
- L. V5748 Single-Gang Device Box
- M. V500 500 Series Raceway
- N. V2010A2 Entrance End Fitting
- O. V2010A3 Entrance End Fitting
- P. V518 External Elbow
- Q. V2089E End-Reducing Connector

NOTE: Illustration is for showing product applications only.

COLOR OPTIONS



Plugmold® 2000 Series™ Part Numbers with a "V" prefix have an ivory finish. Part Numbers with a "G" prefix have a gray finish. Part Numbers with a "S" prefix have a stainless finish. Part Numbers with a "WH" prefix have a white finish. Part Numbers with a "BK" prefix have a black finish. Part Numbers without a prefix have a galvanized steel finish unless otherwise specified.

Custom color options are also available. Consult the factory for more information.

PLUGMOLD® 2000 SERIES™

Plugmold 2000 Series Wire Fill Capacities for Power

WIRE SIZE THHN/THWN	O.D.		NUMBER OF CONDUCTORS	
	Inches	[mm]	WITHOUT DEVICES	WITH PLUGMOLD RECEPTACLES
12 AWG	0.111	[2.8]	7	5
14 AWG	0.130	[3.3]	7	5

Plugmold 2000 Series Product Configuration Matrix

CAT. NO	FINISH	LENGTH		WIRING CONFIG.	OUTLETS (15A 125V NEMA 5-15R) CENTER DISTANCE		OUTLET QTY.
		Feet	[mm]		Inches	[mm]	
20GB206	S	2	[610mm]	GB	6	[152mm]	4 Single
20GB306	V, G, BK, WH, S	3	[915mm]	GB	6	[152mm]	6 Single
20IG306	V, G	3	[915mm]	IG	6	[152mm]	6 Single
20GB506	V, G, BK, WH, S	5	[1.5m]	GB	6	[152mm]	10 Single
20GB512	V, G, BK, WH, S	5	[1.5m]	GB	12	[305mm]	5 Single
20GBA512	V, G	5	[1.5m]	GBA	12	[305mm]	5 Single
20IG512	V, G	5	[1.5m]	IG	12	[305mm]	5 Single
20GB606	V, G, BK, WH, S	6	[1.8m]	GB	6	[152mm]	12 Single
20GB609	V, G	6	[1.8m]	GB	9	[229mm]	8 Single
20GB612	V, G, BK, WH, S	6	[1.8m]	GB	12	[305mm]	6 Single
20GB618	V, G	6	[1.8m]	GB	18	[457mm]	4 Single
20GBA609	V, G	6	[1.8m]	GBA	9	[229mm]	8 Single
20GBA612	V, G	6	[1.8m]	GBA	12	[305mm]	6 Single
20GBA618	V, G	6	[1.8m]	GBA	18	[457mm]	4 Single
20IG606	V, G	6	[1.8m]	IG	6	[152mm]	12 Single

NOTE: Ivory, gray, white, and black Plugmold Series in GB and GBA wiring have matching color receptacles. Stainless steel Plugmold Series has black receptacles and Plugmold Series with IG wiring has orange receptacles.

Plugmold 2000 Series 48' and 50' [14.6m & 15.2m] Lengths – Ivory, Gray Finish

CAT. NO	LENGTH		WIRING CONFIG.	OUTLETS (15A 125V NEMA 5-15R) CENTER DISTANCE			2000B AND 2000C HOLE CUT COVER LENGTH		
	Feet	[mm]		Inches	[mm]	QTY.	QTY.	Feet	[mm]
20GB12	48	[14.6]	GB	12	[305]	48 Single	8	6	[1.830]
20GB18	48	[14.6]	GB	18	[457]	32 Single	8	6	[1.830]
20GB30	50	[15.2]	GB	30	[760]	20 Single	10	5	[1.525]
20GBA12	48	[14.6]	GBA	12	[305]	48 Single	8	6	[1.830]

Plugmold 2000 Series Wiring Configuration



GB SERIES:
3-wire #12 THHN solid (1 hot, 1 neutral, and 1 ground), 1-circuit; has insulated grounding conductor.



GBA SERIES:
4-wire #12 THHN solid (2 hot, 1 neutral, and 1 ground), 2-circuits; outlets wired alternately; has insulated grounding conductor.



IG SERIES:
3-wire #12 THHN solid (1 hot, 1 neutral, and 1 ground), 1 circuit; has insulated-isolated grounding conductor, orange receptacle.

WITH SNAPICOIL HARNESS



GB SERIES:
3-wire #12 THHN solid (1 hot, 1 neutral, and 1 ground), 1-circuit; has insulated grounding conductor.



GBA SERIES:
4-wire #12 THHN solid (2 hot, 1 neutral, and 1 ground), 2-circuits; outlets wired alternately; has insulated grounding conductor.



V20GB612

V20GB306

V20GB12

NOTE: Snapicoil Reels on custom order. Snapicoil Harness is available on reels if lengths greater than 50' are needed, or if multiple lengths are required for production-type jobs. The maximum length per reel is 240' for Snapicoil Harness with outlets 12" and 18" on centers; 500' with outlets 30" on center. Packaging includes the necessary number of lengths of base, holecut cover, wire clips, and couplings for complete installation. Price and delivery information should be obtained prior to specifying or ordering. To specify or order, add R to the Snapicoil Harness number. Ex: V20GB12R. Other outlet spacings available on custom order.
Receptacles are made from high impact thermoplastic. Plugmold 2000 Series is supplied with two (2) 2010B Blank End Fittings and (1) 2001 Base Coupling.

PLUGMOLD® 2000 SERIES™

Plugmold 2000 Series Ordering Information

2000BC Base and Cover

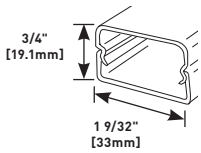

2000B Base: .040" [1.0mm] steel; 2000C Cover: .025" [.6mm] steel. Packed ten 5' [1.5m] lengths of each per carton. Available in ivory (V2000BC), gray (G2000BC), black (BK2000BC), white (WH2000BC) and stainless steel (S2000BC).

2000B-5 Raceway Base

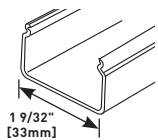

.040" [1.0mm] steel. Packed twenty 5' [1.5m] lengths per carton. Available in ivory (V2000B-5), gray (G2000B-5), black (BK2000B-5), white (WH2000B-5) and stainless steel (S2000B-5).

2000B-10 Raceway Base

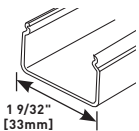

.040" [1.0mm] steel. Packed ten 10' [3.05m] lengths per carton. Available in ivory (V2000B-10), gray (G2000B-10), black (BK2000B-10), white (WH2000B-10) and stainless steel (S2000B-10).

2000C Raceway Base

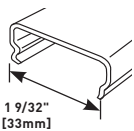

.025" [.6mm] steel. Packed twenty 5' [1.5m] lengths per carton. Has no receptacle hole cuts. Available in ivory (V2000C), gray (G2000C), black (BK2000C), white (WH2000C) and stainless steel (S2000C).

620 Raceway Base and Cover Cutter

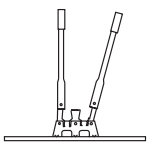

Portable cutter for both 2000 Base and Cover.

620BCK Replacement Blade Kit

Replacement blades and die set for 620 Cutter.

W30/W30G Pressure-Type Wire Connectors

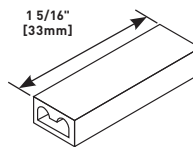

NOTE: Not for use with aluminum conductors.

W30 – For common connection of two, three, or four No. 12 or No.14 solid copper conductors.

W30G – For connection of equipment grounding of 2, 3, or 4 solid conductors No. 14 or No. 12 AWG. 300V maximum; 20A 105° C maximum.

2000WC Wire Clip (Plated)

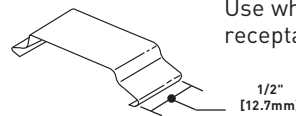

Use when conductors bypass receptacles. Not UL Listed.

2001 Coupling (Galvanized Steel)

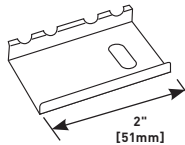

Joins lengths of 2000 Series Raceway Base.

2003 Supporting Clip

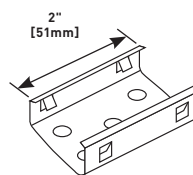

Temporary support, while positioning lengths of raceway base. Use with 2000 Series Raceway. V2003 has ivory finish; 2003 has plated finish.

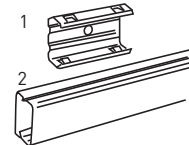

- 2003 mounted on surface with No. 6 flathead screw.
- Plugmold 2000 or 2100 snaps into 2003 Supporting Clip.

2006 Cover Clip

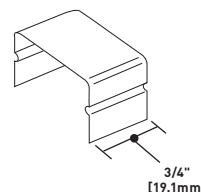

Covers seam where lengths of cover or base meet. Available in ivory (V2006), gray (G2006), black (BK2006), white (WH2006) and stainless steel (S2006).

PLUGMOLD® 2000 SERIES™

Plugmold 2000 Series Ordering Information (continued)

2009 Ground Clamp (Galvanized)

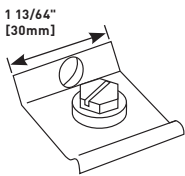

Connects equipment grounding conductor to provide an additional ground to raceway.

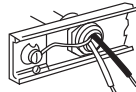

How 2009 is used.

2010A3 Entrance End Fitting

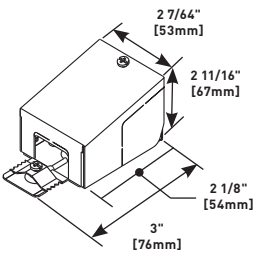

Offers larger capacity than V2010A2. 1/2" trade size KOs on end, each side and bottom. 3/4" trade size KOs on bottom and rear. Includes ground screw. Available in ivory (V2010A3), gray (G2010A3), black (BK2010A3) and white (WH2010A3).

2010A2 Entrance End Fitting

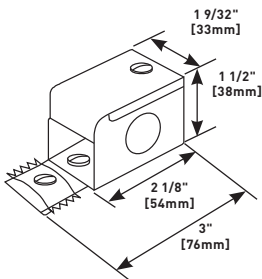

Connects 2000 Series Raceway with 1/2" trade size conduit and armored cable connectors. 1/2" trade size KOs on end, each side and bottom. Includes ground screw. Available in ivory (V2010A2), gray (G2010A2), black (BK2010A2), white (WH2010A2) and stainless steel (S2010A2).

2010B Blank End

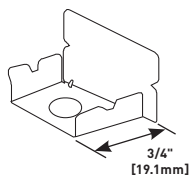

Closes off open end of 2000 Series Raceway. Available in ivory (V2010B), gray (G2010B), black (BK2010B), white (WH2010B) and stainless steel (S2010B).

2011 90° Flat Elbow

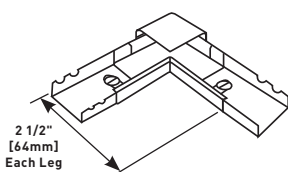

Right angle turns on same surface. Cover stop permits neat butting of 2000C Cover. Two couplings furnished. Available in ivory (V2011), gray (G2011), black (BK2011), white (WH2011) and stainless steel (S2011).

2015 Tee

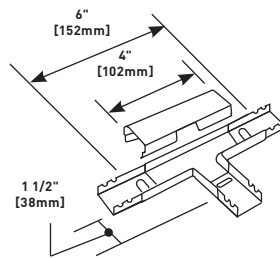

Branches raceway at right angles. Couplings furnished. Available in ivory (V2015), gray (G2015), black (BK2015) and white (WH2015).

2017TC Internal Corner Coupling

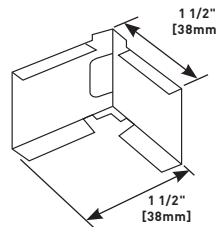

Furnished with one fiber bushing.

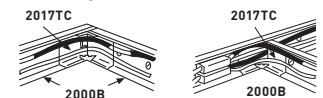

- 2017TC used as a corner coupling.
- 2017TC used as a corner coupling and a straight-through fitting.

2018C External Elbow Cover

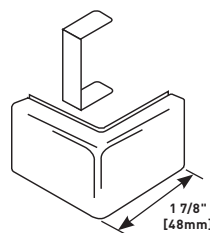

Continues raceway runs around outside corner. Fills the gap when external corner is made by notching and bending the 2000 Base. Available in ivory (V2018C), gray (G2018C), black (BK2018C), white (WH2018C) and stainless steel (S2018C).

Corner Gap Filler snapped into place in 2018C.

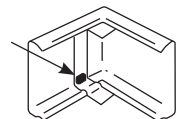

2048 Single-Gang Device Box

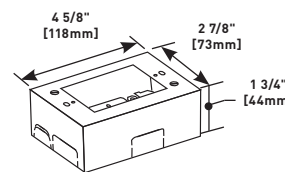

Cover has twistouts for 2000, 500 and 700 Series Raceways. Base has 1/2" trade size KO and rectangular KO for extension to wall box. Base has No. 10 threaded hole for ground connection. Available in ivory (V2048), gray (G2048), black (BK2048), white (WH2048) and stainless steel (S2048).

PLUGMOLD 2000® SERIES™

Plugmold 2000 Series Ordering Information (continued)

2048-2 Two-Gang Device Box

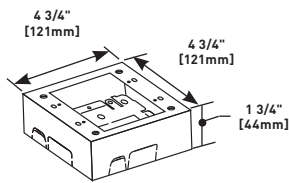

Cover has twistouts for 2000, 500 and 700 Series Raceways. Base has 1/2" trade size KO and rectangular KO for extension to wall box. Base has No.10 threaded hole for ground connection. Available in ivory (V2048-2), gray (G2048-2), black (BK2048-2), white (WH2048-2) and stainless steel (S2048-2). (S204822).

V2089E End Reducing Connector

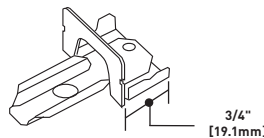

Connects 2000 Series Plugmold with 500 Series Raceway through the end of 2000 Series Plugmold.

2051H Flush Plate Adapter

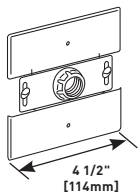

Feeds 2000 Series Plugmold from an existing wall outlet. Equipped with 1/2" [12.7mm] threaded stud, toothed lock washer for grounding, threaded hole for and conduit bushing. Available in ivory (V2051H), gray (G2051H), black (BK2051H), white (WH2051H) and stainless steel (S2051H).

PIP36 Plugin Plugmold

Available in 3' [915mm] with six single receptacles and two (2) mounting clips. Available in black (PIP36BK), white (PIP36WH) and ivory (PIP36V).

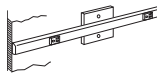

Plugmold 2000 extended from wall outlet using 2051H.



2051H fastened to horizontally mounted wall box.

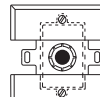

2051H fastened to vertically mounted wall box.

V2089 Side Reducing Connector

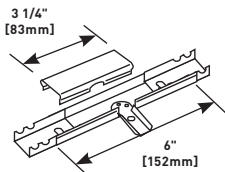

Connects 2000 Series Plugmold with 500 Series Raceway through the side of 2000 Series Plugmold.

2000 Series Interconnectivity Fittings

FROM	CONNECTION REQUIRED		USE CATALOG NUMBER
		TO	
500 Series Raceway	Side of Plugmold 2000 Series		V2089, V2048, V2048-2
500 Series Raceway	End of Plugmold 2000 Series		V2089E, V2048, V2048-2
Existing Outlet	Plugmold 2000 Series		V2051H
1/2" trade size Conduit or Armored Cable	End of Plugmold 2000 Series		V2010A2, V2010A3

PLUGMOLD® 2000 SERIES™

Plugmold Multioutlet Systems Installation Details

- Determine the method of feeding and bring feed conductors into base section.

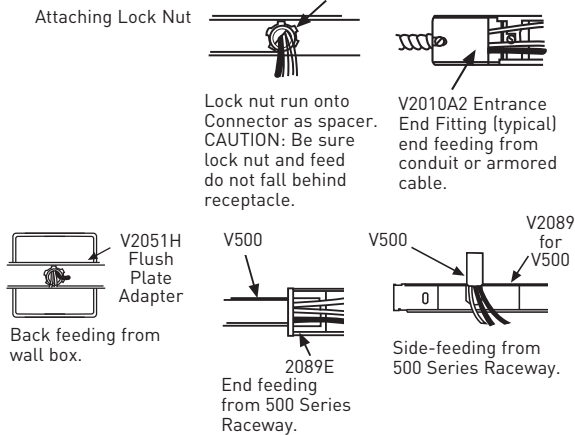

- Install 2000B Base on surface, starting with feed section. Mount base section with No. 8 flathead screws, through mounting screw knockouts and piercings, or mount with 2003 Support Clips. **Random piercing and knockout pattern does not start and end at same point on bases of Plugmold.**

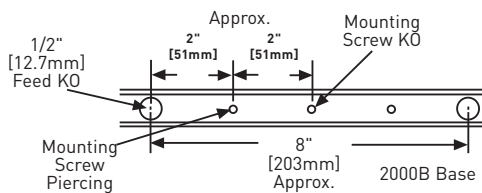

- Connect feed to prewired cover section. **Use approved connection method for ground conductor. Use only W30G (green) wire connectors on equipment grounding conductors, not W30.**

W30 and W30G CONNECTORS

W30 – Common connection of 2, 3 or 4 solid conductors No.14 or No.12 AWG.

W30G – For connection of equipment grounding of 2, 3, or 4 solid conductors No.14 or No.12 AWG.

Rating – 300 volts maximum, 20 AMP. 105° C maximum.

Note: W30 Connector has a white finish, W30G Connector has a green finish.

- Strip wire ends to width of product (1/2" [12.7mm]).
- Insert wire ends the full stripped distance.

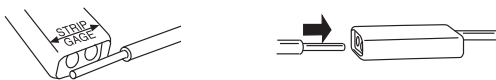

- Engage lower bead of cover in base. Starting at one end, snap in top bead. Be careful not to pinch wires.

To snap cover in, work from one end to the other, striking sharply with heel of hand.



Snapicoil Harness Installation Details

- Determine method of feeding. Bring feed conductors into base.

- Stub-in feed at beginning of run, half the distance or less from first receptacle. Cut off base so 1/2" [12.7mm] entrance KO aligns with feed (also provides for cover to overlap base joint). Save base section cut-off for opposite end of run.
- Remove appropriate entrance KO and install 1/2" [12.7mm] connector as shown.

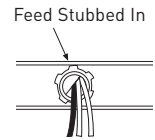

CAUTION: Be sure lock nut and feed do not fall behind receptacle.

- Install 2000B Raceway Base on surface, starting with feed section. Mount entire run with No. 8 flat head screws, through mounting screw knockouts and piercings. Cut base to length at corners and end of run. **Random piercing and knockout pattern does not start and end at same point on bases of Plugmold.**

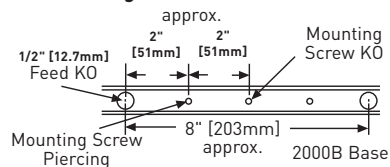

- Snap in 2001 Coupling where base sections abut.

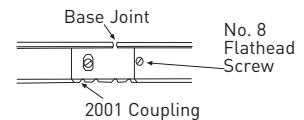

- Lay out Snapicoil Harness along entire run of base so that receptacles are not located over feed or in corners. Connect harness to feed. Use approved connection method for ground conductor.

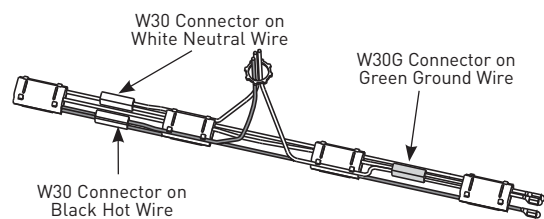

- Starting at feed, snap receptacles completely into first cover section.



- Engage lower bead of cover in base and starting at one end, snap in top bead. be careful not to pinch wires. Continue snapping receptacles into covers, and covers into base along entire run.

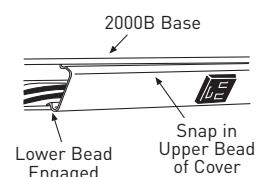

PLUGMOLD® 2400 SERIES™



Two-piece, single channel raceway. Easy-to-install and ideal for basic power or communication installations

CODE REFERENCE

cULus Listed Base and Blank Cover:
File E4376 Guide RJBT.

Multioutlet Assemblies:
File E15191 Guide PVGT.

Fittings:
File E41751 Guide RJPR.

Base and Blank Cover and Plugmold Series with Snapicoil Harness:
Meets Article 386 of NEC.
Meets Section 12-3032 of CEC.

Plugmold Wired Sections:
Meets Article 380 of NEC.
Meets Section 12-3032 of CEC.

Plugmold 2400 Series System Layout

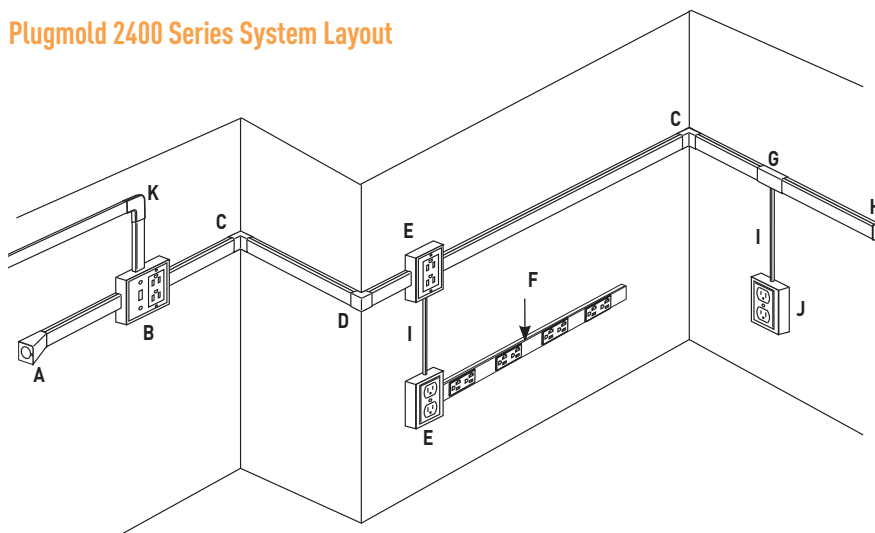

KEY

- A V2410A Entrance End Fitting
- B V2448-2 Two-Gang Device Box
- C V2417 Internal Elbow
- D V2418 External Elbow
- E V2448 Single-Gang Device Box
- F 24S7218GBX99IV Plugmold Multi-outlet System
- G V2489 Side Reducing Connector
- H V2410B Blank End Fitting
- I 500 500 Series Raceway
- J V5747 Single-Gang Device Box
- K V2411 Flat Elbow

NOTE: Illustration is for showing product applications only.

COLOR OPTIONS



Plugmold® 2400 Series™ Part Numbers with a "V" prefix have an ivory finish. Part Numbers without a prefix have a galvanized steel finish unless otherwise specified. Custom color options are also available. Consult the factory for more information.

PLUGMOLD® 2400 SERIES™

Plugmold 2400 Series Wire Fill Capacities for Power

WIRE SIZE THHN/THWN	O.D.		NUMBER OF CONDUCTORS	
	Inches	[mm]	WITHOUT DEVICES	WITH PLUGMOLD RECEPTACLES
14 AWG	0.111	[2.8]	57	12
12 AWG	0.130	[3.3]	41	9
10 AWG	0.164	[4.2]	26	0

Plugmold 2400 Series Product Configuration Matrix

CAT NO.	LENGTH		WIRING CONFIG.	OUTLETS (20A 125V NEMA 5-20R)		
	Feet	[mm]		CENTER Inches	DIS-TANCE [mm]	OUTLET QTY.
V24GB306	3	[915mm]	GB	6	[152]	6 Single
V24GB506	5	[1.5m]	GB	6	[152]	10 Single
V24GB512	5	[1.5m]	GB	12	[305]	5 Single
V24GBA512	5	[1.5m]	GBA	12	[305]	5 Single
V24GB606	6	[1.8m]	GB	6	[152]	12 Single
V24GB612	6	[1.8m]	GB	12	[305]	6 Single
V24GB618	6	[1.8m]	GB	18	[457]	4 Single
V24GBA612	6	[1.8m]	GBA	12	[305]	5 Single
V24GBA618	6	[1.8m]	GBA	18	[457]	4 Single
24S3612GBX99IV	3	[915mm]	GB	12	[305]	3 Duplex
24S3612GBA99IV	3	[915mm]	GBA	12	[305]	3 Duplex
24S6012GBX99IV	5	[1.5m]	GB	12	[305]	5 Duplex
24S6012IGX99IV	5	[1.5m]	IG	12	[305]	5 Duplex
24S6012GBA99IV	5	[1.5m]	GBA	12	[305]	5 Duplex
24S7212GBX99IV	6	[1.8m]	GB	12	[305]	6 Duplex
24S7224GBA99IV	6	[1.8m]	GBA	24	[608]	3 Duplex
24S7218GBX99IV	6	[1.8m]	GB	18	[457]	4 Duplex
24S7224GBX99IV	6	[1.8m]	GB	24	[608]	3 Duplex
24S7218IGX99IV	6	[1.8m]	IG	18	[457]	4 Duplex
24S7212IGX99IV	6	[1.8m]	IG	12	[305]	6 Duplex
24S7224IGX99IV	6	[1.8m]	IG	24	[608]	3 Duplex
24S7212GBA99IV	6	[1.8m]	GBA	12	[305]	6 Duplex
24S7218GBA99IV	6	[1.8m]	GBA	18	[457]	4 Duplex



NOTE: One Coupling and two End Clips included.

Wiring Configuration

GB SERIES:

3 wire, #12 THHN solid (1 hot, 1 neutral and 1 ground) 1 circuit; has grounding conductor.

GBA SERIES:

4-wire, #12 THHN solid (2 hot, 1 neutral, and 1 ground) 2 circuits; outlets wired alternately; has grounding conductor.

Cross Section

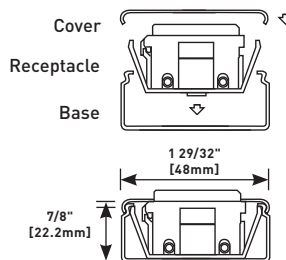

PLUGMOLD® 2400 SERIES™

Plugmold 2400 Series Ordering Information

V2400BC Base and Cover

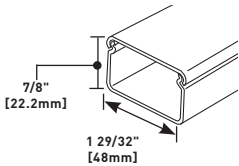

V2400B Base: .040" [1.0mm] steel;
V2400C Cover: .025" [.6mm] steel.
Packed ten 5' [1.5m] lengths of
each per carton.

V2406 Cover Clip

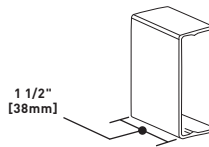

Covers seam where lengths
of cover or base meet. Use
with Plugmold® 2400 Series.
(Nonmetallic.)

V2400B Raceway Base

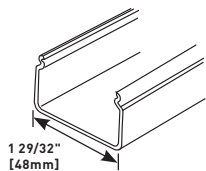

.040" [1.0mm] steel. Packed twenty
5' [1.5m] lengths per carton.

2409 Ground Clamp

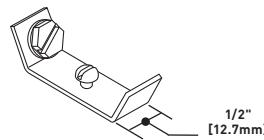

No. 10 ground screw provided.
Use with Plugmold® 2400
Series.

V2400C Raceway Cover

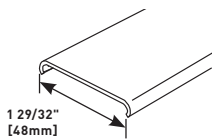

.040" [1.0mm] steel 5' [1.5m]
lengths. Packed (20) 5' [1.5m]
lengths per carton. V2400C Cover
has no receptacle hole cuts.

V2410A Entrance End Fitting

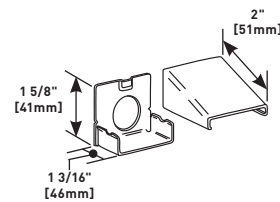

Connects Plugmold® 2400
Series with 1/2" trade size
conduit and armored cable.

PM48T Multiple Outlet Strip (Diamond Plate Finish)

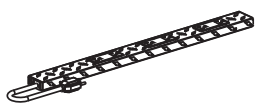

Diamond plate finish base
.040" [1.0mm] steel. Cover
.040" [1.0mm] steel. 48" [1.2m]
length. Provides five duplex 15A
receptacles. Packed three per carton. PM48T Merchandiser
available – 10 cartons of PM48T packed in a merchandising
display. Order as PM48T-DISP.

V2410B Blank End Fitting

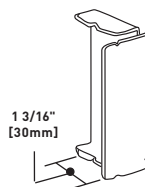

Closes off open end of
Plugmold® 2400 Series.

2400WC Wire Clip

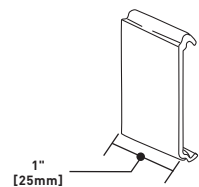

Holds conductors in place in
raceway.

V2410C Entrance End Fitting

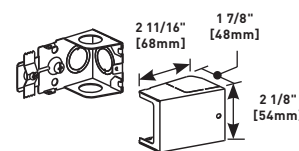

Has 1/2" and 3/4" trade size
KOs on end and bottom.
Additional 1/2" trade size KO
on sides.

2401 Coupling

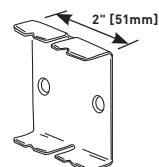

Joins lengths of raceway. Use with
Plugmold® 2400 Series.

PLUGMOLD® 2400 SERIES™

Plugmold 2400 Series Ordering Information (continued)

V2411M Flat Elbow

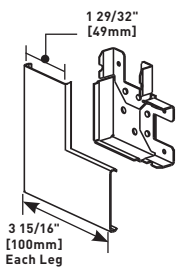

Right angle turns on the same surface.

V2417M Internal Elbow

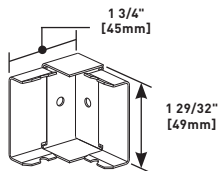

Makes internal 90° corners. All steel construction.

V2418M External Elbow

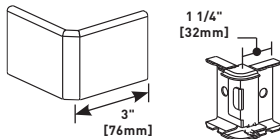

Covers outside corners. (Nonmetallic Cover.)

V2451H Back Feed Fitting

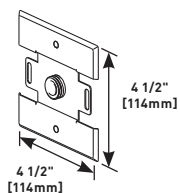

Feeds Plugmold 2400 Series Raceway from an existing outlet box. Equipped with 1/2" trade size male bushing and locknut washer for grounding.

V2444, V2444-2 Extra Deep Device Box

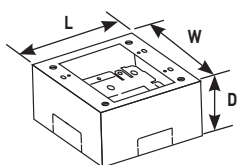

Base has rectangular knockout to enable extension from existing single-gang flush wall box and 1/2" and 1" concentric KOs. V2444 Cover has two twistouts for 500 and 700 Series Raceway, and two twistouts for 2400 Series Raceway. V2444-2 Cover has four 2400 Series Raceway Series twistouts.

CAT NO.	L	W	D	GANG
V2444	4 5/8" [117mm]	2 7/8" [73mm]	2 3/4" [44mm]	1
V2444-2	4 3/4" [121mm]	4 3/4" [121mm]	2 3/4" [44mm]	2

V2448, V2448-2 Device Box

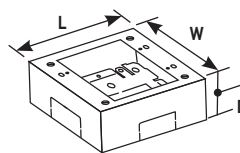

Base has 1/2" trade size KO and rectangular KO for extension to wall box. Has #10 threaded hole for ground connection. V2448 Cover has two twistouts for 500 and 700 Series Raceway, and two twistouts for 2400 Series Raceway. V2448-2 Cover has four 2400 Series Raceway twistouts.

CAT NO.	L	W	D	GANG
V2448	4 5/8" [117mm]	2 7/8" [73mm]	1 3/4" [44mm]	1
V2448-2	4 3/4" [121mm]	4 3/4" [121mm]	1 3/4" [44mm]	2

V2489 Side Reducing Connector

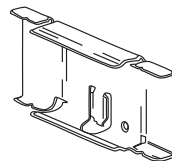

Connects Plugmold 2400 Series with 500 Series Raceway.

624 2400 and 2400D Raceway Base and Cover Cutter

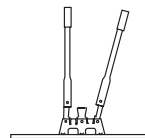

Portable cutter for 2400B and 2400BD Series Raceway.

624BCK Replacement Blade Kit

Replacement blades and die set for 624 Cutter.

V2427GA Duplex Receptacle

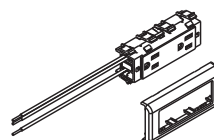

3-wire, 15A, 125V, NEMA 5-15R. Provided with 10 1/2" [267mm] pigtails and inline splice connectors. Ivory receptacle with ivory trim plate.

PLUGMOLD® 2400 SERIES™

Plugmold 2400 Series Ordering Information (continued)

V2427GT Duplex Receptacle

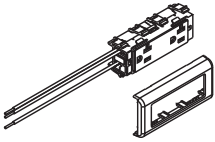

3-wire, 20A, 125V, NEMA 5-20R. Provided with 10 1/2" [267mm] pigtails and inline splice connectors. Ivory receptacle with ivory trim plate.

IG2427GT Isolated Ground Duplex Receptacle

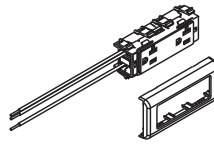

3-wire, 20A, 125V NEMA 5-20R. Provided with 10 1/2" [267mm] pigtails and inline splice connectors. Orange receptacle with ivory trim plate.

2686FO Transition Feed Fitting

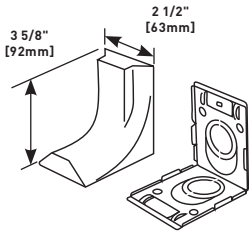

Eliminates offsetting V2400 in connecting with surface panel boxes. Has 3/4" and 1" concentric trade size KOs with 1" trade size KO elongated so adjustment from surface to center of bushing is 1" [25mm] minimum to 1 5/8" [41mm] maximum. Has twistouts for transition to Pancake 1500 and 2600 Series Raceway.

V2426 Lamp Holder

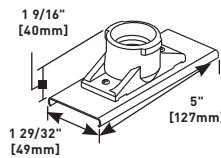

Medium base lamp holder 660W, 250V. Black, general purpose phenolic.

IG2427GA Isolated Ground Duplex Receptacle

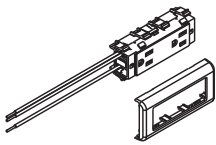

3-wire, 15A, 125V NEMA 5-15R. Provided with 10 1/2" [267mm] pigtails and inline splice connectors. Orange receptacle with ivory trim plate.

PLUGMOLD® NM2000 SERIES™



Two-piece, single channel raceway. Easy-to-install and ideal for basic power or communication installations.

CODE REFERENCE

cULus Listed Base & Blank Cover:
File E4376 Guide RJBT.

Multioutlet Assemblies:
File E15191 Guide PVGT.

Fittings:
File E41751 Guide RJPR.

Base and Blank Cover and Plugmold Series with Snapicoil Harness:
Meets Article 386 of NEC.
Meets Section 12-3032 of CEC.

Plugmold Wired Sections:
Meets Article 380 of NEC.
Meets Section 12-3032 of CEC.

Plugmold NM2000 Series System Layout

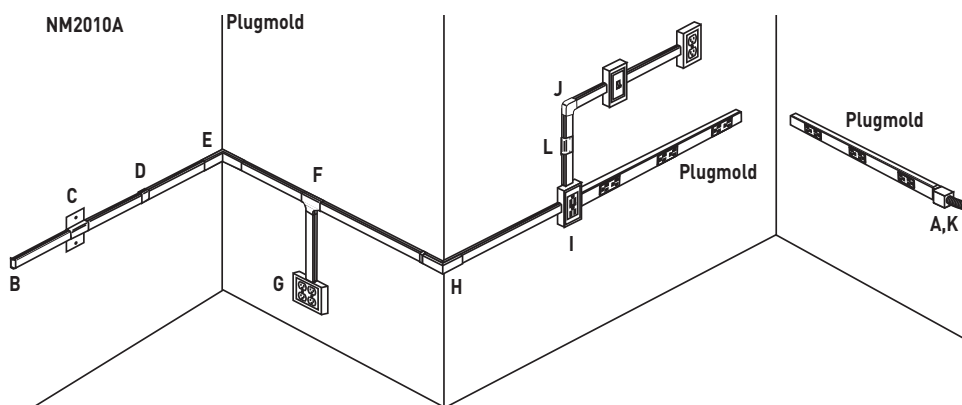

NOTE: Illustration is for showing product applications only.

KEY

- A. NM2010A Entrance End Fitting
- B. NM2010B Blank End Fitting
- C. NM2051H Horizontal Wall Box Adapter
- D. NM2006 Cover Clip
- E. NM2017 Internal Elbow
- F. NM2015 Tee Fitting
- G. NM2048-2 Two-Gang Device Box
- H. NM2018 External Elbow
- I. NM2048 Single-Gang Device Box
- J. NM2011 Flat Elbow
- K. NM2010A Entrance End Fitting
- L. NM2051V Vertical Wall Box Adapter Plugmold Plus Multioutlet System

COLOR OPTIONS



Plugmold® Plus NM2000 Series™ Part Numbers without a prefix have an ivory finish unless otherwise specified.
Custom color options are also available. Consult the factory for more information.

PLUGMOLD® NM2000 SERIES™

Plugmold NM2000 Series Wire Fill Capacities for Communications

	CABLE/WIRE SIZE	O.D. (Approx. Dia.)		40% FILL
		In	[mm]	
UNSHIELDED TWISTED PAIR	4-pair, 24 AWG, Cat 3	0.190	[4.8]	16
	4-pair, 24 AWG, Cat 5e	0.210	[5.3]	13
	4-pair, 24 AWG, Cat 6	0.250	[6.3]	9
	4-pair, 24 AWG, Cat 6a*	0.354	[9.0]	4
	25-pair, 24 AWG	0.410	[10.4]	3
COAXIAL	RG6/U	0.270	[6.9]	7
Fiber	ZipCord	0.118 x 0.236	[3 x 6]	16
	Round 4 Strand Fiber	0.187	[4.8]	16
	Round 6 Strand Fiber	0.256	[6.5]	8

NOTE: For additional information, refer to the Technical Section.

* Category 6 augmented (6a) cable for 10 gigabit ethernet – max allowed cable diameter per addenda No. 11 ANSI TIA/EIA 568-B.2.

Plugmold NM2000 Multioutlet Strips

CAT NO.	LENGTH Feet [mm]		WIRING CONFIG	Duplex Outlets (15A 120V NEMA 5-15R)		
				CENTER DISTANCE		QTY.
				Inches	[mm]	
NM20GB412	4	[1220]	GB	12	[305]	4
NM20GBA412			GBA	12	[305]	4
NM20IG412			IG	12	[305]	4
NM20GB512	5	[1525]	GB	12	[305]	5
NM20GB515			GB	15	[381]	4
NM20GB530			GB	30	[762]	2
NM20GBA512			GBA	12	[305]	5
NM20IG512			IG	12	[305]	5
NM20GB609	6	[1830]	GB	9	[229]	8
NM20GB612			GB	12	[305]	6
NM20GB618			GB	18	[457]	4
NM20GBA609			GBA	9	[229]	8
NM20GBA612			GBA	12	[305]	6
NM20IG612			IG	12	[305]	6

Plugmold NM2400 Multioutlet Strips

CAT NO.	LENGTH Feet [mm]		WIRING CONFIG	DUPLEX OUTLETS (20A 120V NEMA 5-20R)		
				CENTER DISTANCE		QTY.
				Inches	[mm]	
NM24GB412	4	[1220]	GB	12	[305]	4
NM24GBA412			GBA	12	[305]	4
NM24GB512	5	[1525]	GB	12	[305]	5
NM24GB530			GB	30	[762]	2
NM24GBA512			GBA	12	[305]	5
NM24GB612	6	[1830]	GB	12	[305]	6
NM24GB618			GB	18	[457]	4
NM24GBA612			GBA	12	[305]	6

NOTE: Fed. Spec. duplex receptacles are made from high impact nylon and colored to match the raceway

Plugmold NM2000 with Snapicoil Harness

CAT NO.	LENGTH Feet [mm]		WIRING CONFIG	DUPLEX OUTLETS (15A 120V NEMA 5-15R)			NM2000B & NM2000C		
				CENTER DISTANCE		QTY.	LENGTH		
				Inches	[mm]			QTY.	Feet
NM20GB12	48	[14.6]	GB	12	[305]	48	8	6	[1.830]
NM20GBA12	48	[14.6]	GBA	12	[305]	48	8	6	[1.830]

Plugmold NM2000 Series Wire Fill Capacities for Power

WIRE SIZE THHN/THWN	O.D.		NUMBER OF CONDUCTORS
	Inches	[mm]	
14 AWG	0.111	[2.8]	45
12 AWG	0.130	[3.3]	31
10 AWG	0.164	[4.2]	15

Plugmold NM2000 Wiring Configuration

GB SERIES:

3-wire #12 THHN solid (1 hot, 1 neutral, and 1 ground), 1-circuit; has insulated grounding conductor.



GBA SERIES:

4-wire #12 THHN solid (2 hot, 1 neutral, and 1 ground), 2-circuits; outlets wired alternately; has insulated grounding conductor.



IG SERIES:

3-wire #12 THHN solid (1 hot, 1 neutral, and 1 ground), 1 circuit; has insulated-isolated grounding conductor, orange receptacle.



REELS: Reels available as follows:

- Lengths greater than 50' [15.2m]
- Multiple lengths
- For outlet spacing of 12" and 18" [305mm and 457mm], the maximum length is 240' [73m] per reel.
- For outlet spacing of 30" [762mm], the maximum length is 500' [152m] per reel.

Packaging includes the necessary lengths of NM2000B Base, NM2000C Hole Cut Cover, NM2000WC Wire Clips, and 2001 Couplings for complete installation. Price and delivery information should be obtained prior to specifying or ordering. To specify or order, add R to the Snapicoil Harness number. Ex: NM20GB12. Other outlet spacings available on custom order, contact your field sales representative or Specialized Products at 1-800-621-0049.

PLUGMOLD® NM2000 SERIES™

Ordering Information

Plugmold NM2000 Series Ordering Information (continued)

NM2000BC Base and Cover

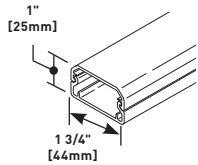

NM2000B and NM2000C packed ten 5' [1.5m] lengths of each per carton.

NM2003 Supporting Clip

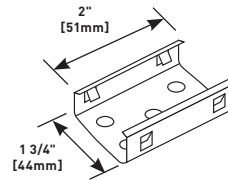

Supports lengths of raceway at any point desired. Mount to surface with No. 8 flathead screw.

NM2000B Raceway Base

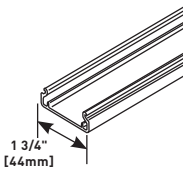

Single channel plastic base, ivory finish. Packed ten 8' [2.4m] lengths per carton.

NM2006 Cover Clip

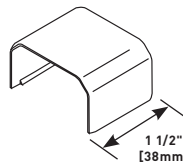

Covers seam where lengths of cover or base meet.

NM2000C Raceway Cover

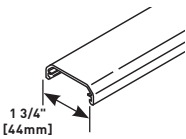

Tapered snap-on cover. Textured ivory finish. Packed ten 8' [2.4m] lengths per carton.

NM2010A Entrance End Fitting

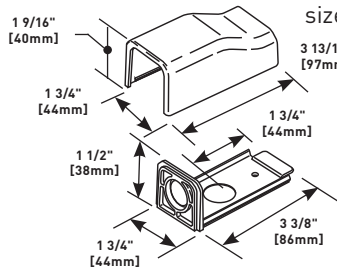

To end feed raceway or Plugmold strip. Has 1/2" trade size KO on end and bottom.

W30/W30G Pressure-Type Wire Connectors

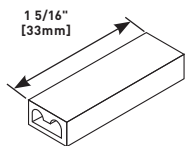

NOTE: Not for use with aluminum conductors.

W30 - For common connection of two, three, or four No. 12 or No. 14 solid copper conductors.

W30G - For connection of equipment grounding of 2, 3, or 4 solid conductors No. 14 or No. 12 AWG. 300V maximum; 20A 105° C maximum.

NM2010B Blank End Fitting

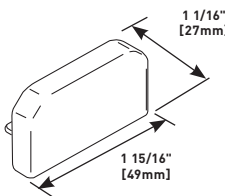

Closes off open end of NM2000 Series Raceway.

NM2000WC Wire Clip

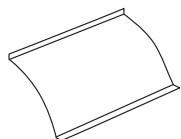

Holds wire or cable in place or for use when conductors bypass receptacles.

NM2011 Flat Elbow

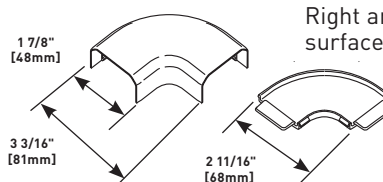

Right angle turns on same surface.

PLUGMOLD® NM2000 SERIES™

Plugmold NM2000 Series Ordering Information (continued)

NM2015 Tee

Branches NM2000 Series Raceway at right angles.

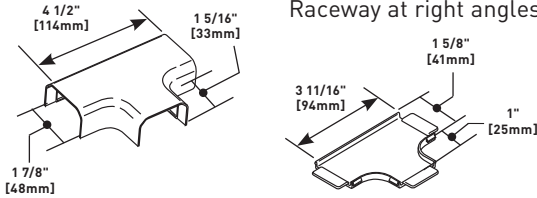

NM2048 and NM2048-2 Sure-Snap® Deep Device Box

Cover snaps onto base – no screws required. Cover has twistouts on all sides. Rectangular KO in base for extension to wall box.

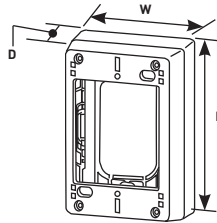

NM2017 Internal Elbow

Right angle turns at inside corners.

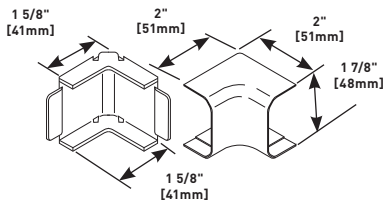

CAT NO.	L	W	D	GANG
NM2048	4 3/4" [121mm]	3" [76mm]	1 3/4" [44mm]	1
NM2048-2	4 3/4" [121mm]	4 7/8" [124mm]	1 3/4" [44mm]	2

NM2051H Horizontal Wall Box Adapter

Feeds NM2000 Series Raceway from an existing wall outlet for horizontal applications. Provides complete access to wall box for connections.

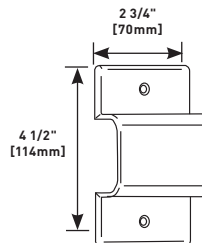

NM2018 External Elbow

Used for making 90° turns at outside corners.

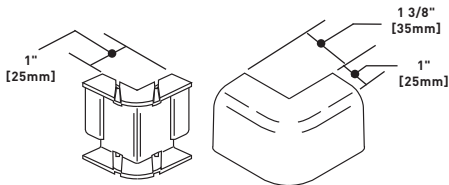

NM2051V Vertical Wall Box Adapter

Feeds NM2000 Series Raceway from an existing wall outlet for vertical applications. Provides complete access to wall box for connections.

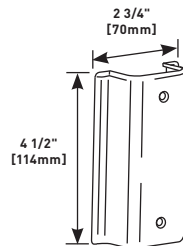

NM2044 , NM2044-2 Extra Deep Device Box

Mounts power/communications devices when additional depth is required. Has combination twistouts for 2700, 2800, 2900, and NM2000 Series Raceways.

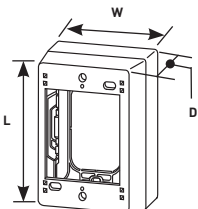

CAT NO.	L	W	D	GANG
NM2044	4 3/4" [121mm]	3" [76mm]	2 3/4" [70mm]	1
NM2044-2	4 3/4" [121mm]	4 7/8" [124mm]	2 3/4" [70mm]	2

NM2027-15, NM2027-20 Replacement Receptacle

15 and 20A replacement devices. 6" [152mm] wire leads each side.

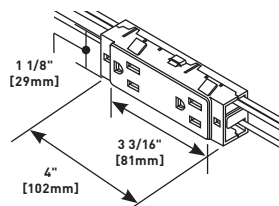

PLUGMOLD® NM2000 SERIES™

Installation Details

Plugmold NM2000 Series Installation Details

1. Lay out raceway path. Determine feed method and location from figures A, B, and C below.

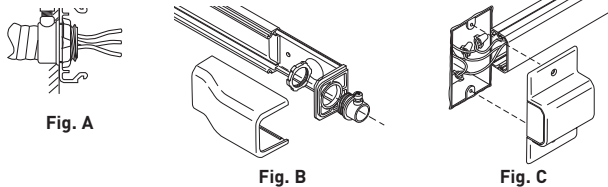

2. Measure and cut raceway base and cover. See common fitting dimensions below.

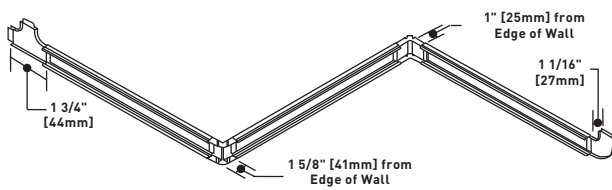

3. Install raceway and fitting bases using No. 8 flathead screws.

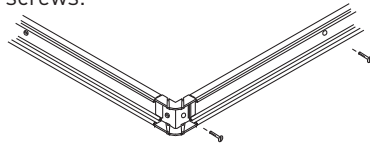

4. Wiring Method – Refer to Instructions A through E according to your application

A FIELD WIRED RACEWAY

A1 Install wire in raceway wire clips as needed.

A2 Snap on raceway and install fitting covers.

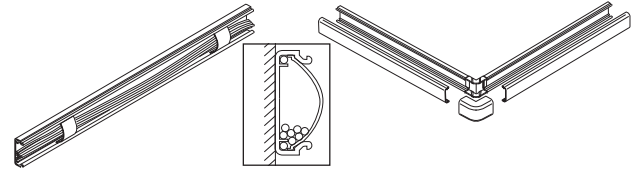

B WIRED COVER SECTIONS

B1 Connect receptacle harness to feed point, using approved methods.

B2 Snap cover/harness assembly onto base and snap on fitting covers.

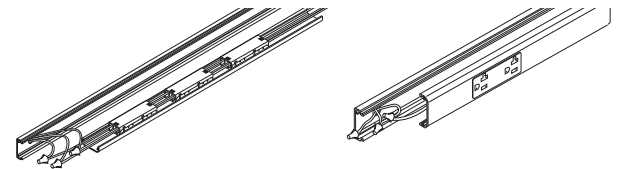

C SNAPICOIL HARNESS

C1 Lay out Snapicoil Harness so that receptacles are not located over feed point or at corners. Connect harness to feed point.

C2 Snap receptacles into NM2000 Cover.

C3 Snap wired cover section onto base.

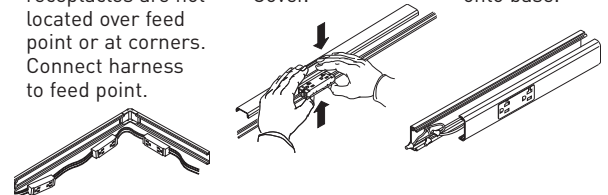

Plugmold NM2000/NM2400 Series Installation Details

NM2010A
Entrance
End Fitting

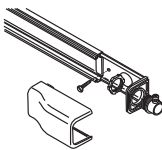

NM2051H
(Shown)
Wall Box
Adapter

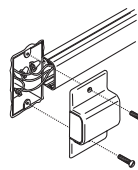

NM2010B
Blank End Fitting

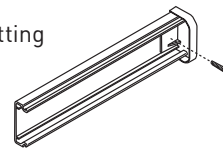

NM2017
Internal
Elbow

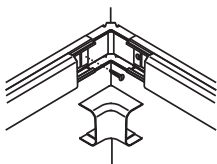

NM2018
External
Elbow

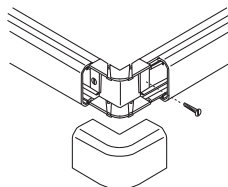

NM2011
Flat Elbow

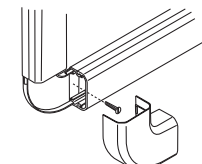

NM2015
Tee Fitting

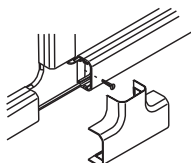

NM2006
Cover Clip

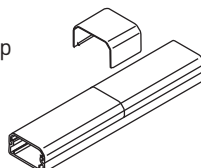

NM2048
Device Box

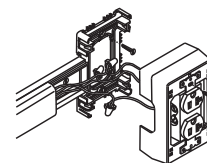

PLUGMOLD® AL2000 SERIES™



Low profile multiple outlet system with an aesthetic finish.

CODE REFERENCE

- cULus Listed Base & Blank Cover:**
File E4376 Guide RJBT.
- Multioutlet Assemblies:**
File E15191 Guide PVGT.
- Fittings:**
File E41751 Guide RJPR.
- Base & Blank Cover:**
Meets Article 386 of NEC.
- Plugmold Strips:**
Meets Article 380 of NEC.

Plugmold AL2000 Series System Layout

NOTE: Illustration is for showing product applications only.

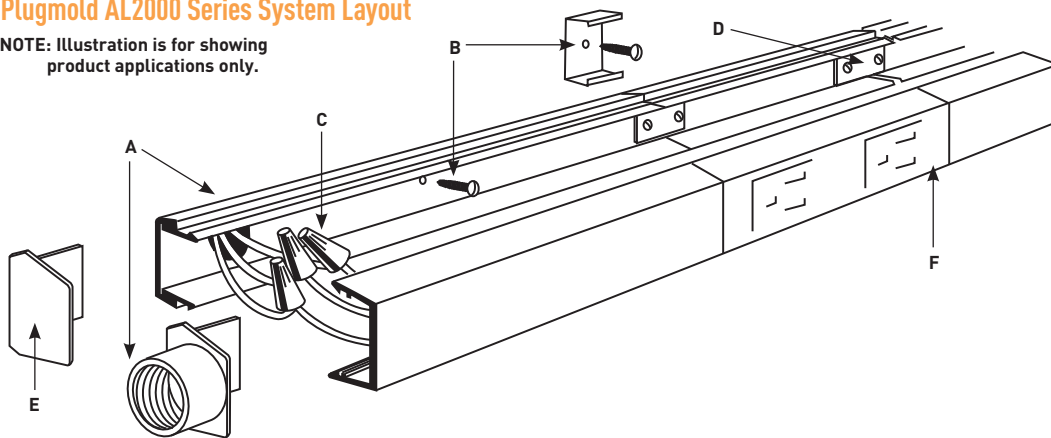

NOTE:
To remove cover, insert screwdriver into groove, push down and twist.

IMPORTANT:
All mounting methods must result in a flush interior surface. Special outlet assemblies manufactured to specifications. Consult factory.

KEY

- A** Supply conductors may be fed from 1/2" [12.7mm] KO in base, or through AL2010A Feed Fitting. This system is designed with capacity for additional feed or circuitry conductors.
- B** Attach base section to mounting surface with AL2003 Spring Mounting Clips or by drilling 9/32" [7.1mm] holes in the base and using #8 flathead screws.
- C** Connect circuit wires with connectors.
- D** Additional multiple outlet sections or AL2000 Raceway sections may be attached at ends with AL2001 Coupling.
- E** Close ends with blank end fitting (AL2010B), or with feed fittings (AL2010A).
- F** Snap in cover section.

COLOR OPTIONS

-  Plugmold® AL2000 Series™ Part Numbers without a prefix have an satin anodized finish unless otherwise specified.
- Custom color options are also available. Consult the factory for more information.

PLUGMOLD® AL2000 SERIES™

Plugmold AL2000 Series Wire Fill Capacities for Power

WIRE SIZE THHN/THWN	O.D.		NUMBER OF CONDUCTORS	
	Inches	[mm]	WITHOUT DEVICES	WITH PLUGMOLD RECEPTACLE
14 AWG	0.111	[2.8]	51	8
12 AWG	0.130	[3.3]	38	6
10 AWG	0.164	[4.2]	24	3
8 AWG	0.216	[5.5]	12	
6 AWG	0.254	[6.5]	8	

Plugmold AL2000 Series Multioutlet Strips

CAT. NO.*	Length		WIRING CONFIG.	SINGLE OUTLETS (15A 120V NEMA 5-15R)		
	Feet	[mm]		CENTER DISTANCE		QTY.
				Inches	[mm]	
AL20GB306	3	[915]	GB	6	[152]	6
AL20IG306			IG	6	[152]	6
AL20GB506	5	[1525]	GB	6	[152]	10
AL20GB512			GB	12	[305]	5
AL20IG506			IG	6	[457]	10
AL20GB606	6	[1830]	GB	6	[152]	12
AL20GB612			GB	12	[305]	6
AL20GB618			GB	18	[457]	4
AL20GBA606			GBA	6	[152]	12
AL20GBA612			GBA	12	[305]	6
AL20GBA618			GBA	18	[457]	4
AL20IG606	IG	6	[152]	12		

*AL2000 Series Plugmold has gray outlets. Each AL2000 Plugmold strip is supplied with two AL2010B Blank End Fittings and one AL2001 Coupling.

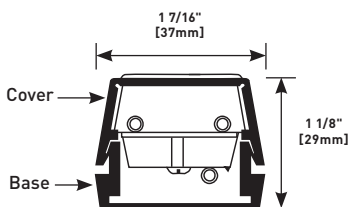
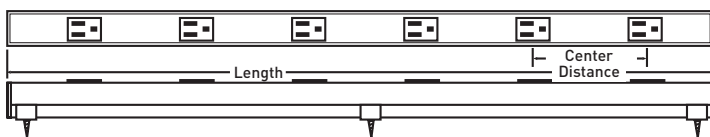

Plugmold AL2000 Series Wiring Configuration

GB SERIES:

3-wire #12 THHN solid, 1-circuit; has insulated grounding conductor. Gray receptacles.



GBA SERIES:

4-wire #12 THHN solid, 2-circuit; outlets wired alternately; has insulated grounding conductor. Gray receptacles.

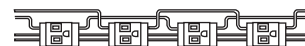

IG SERIES:

3-wire #12 THHN solid, 1 circuit; has insulated-isolated grounding conductor. Orange receptacles.



AL20GB306
AL20GB612
AL20GB618



PLUGMOLD® AL2000 SERIES™

Plugmold AL2000 Series Ordering Information

AL2000B-5, AL2000B-10 Raceway Base

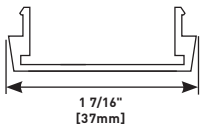

6063-T5 extruded aluminum, satin anodized finish, .060" [1.5mm] nominal thickness. Packed (12) 5' [1.5m] lengths (AL2000B-5) or six 10' [3m] lengths (AL2000B-10) per carton.

AL2003 Mounting Clip (Spring Steel)

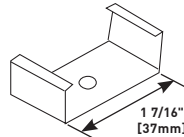

Supports lengths of AL2000 Series Raceway at any point desired. Mount to surface with No. 8 flathead screw.

AL2000C-5 Raceway Cover

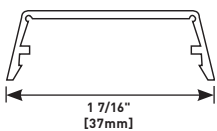

6063-T5 extruded aluminum, satin anodized finish, .060" [1.5mm] nominal thickness. Packed (12) 5' [1.5m] lengths per carton.

AL2006 Cover Clip (Spring Steel)

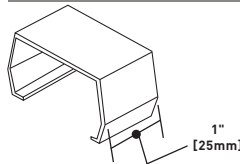

Covers seam where lengths of cover or base come together.

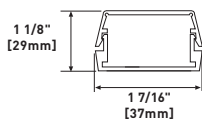

AL2000 Base and Cover shown assembled. Cross sectional area 1in.² [1037mm²].

AL2009 Ground Clamp (Galvanized Steel)

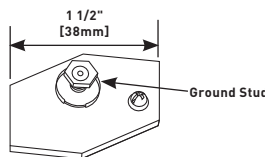

Connects equipment grounding conductor to provide additional ground to raceway.

W30, W30G Pressure-Type Wire Connectors

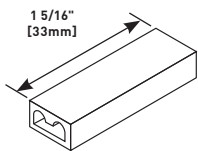

W30 – For common connection of two, three, or four No. 12 or No.14 solid copper conductors.

W30G – For connection of equipment grounding of 2, 3, or 4 solid conductors No. 14 or No. 12 AWG. 300V maximum; 20A 105° C maximum.

NOTE: Not for use with aluminum conductors.

AL2010A Feed Fitting

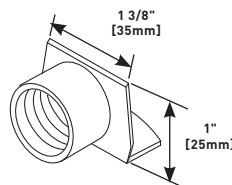

End fitting with 1/2" [12.7mm] hub adapter.

AL2000WC Wire Retainer (Nonmetallic)

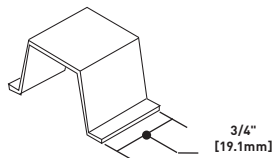

Holds conductors in place in raceway base.

AL2010B Blank End Fitting

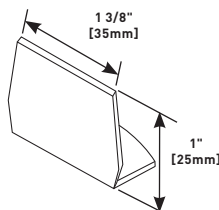

Closes off end of AL2000 Series Raceway.

AL2001 Slide Coupling

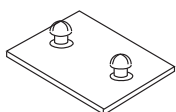

Connects adjoining sections of AL2000 Series Raceway base.

AL2011 Flat Elbow

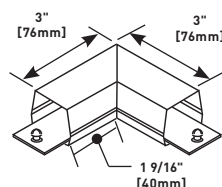

Right angle turn on same surface. Comes with two couplings.

PLUGMOLD® AL2000 SERIES™

Plugmold AL2000 Series Ordering Information (continued)

AL2015 Tee

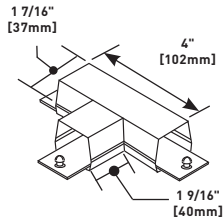

Branch connection of two runs of AL2000 Series Raceway. Comes with three couplings.

AL2043IG In-Line Isolated Ground Receptacle

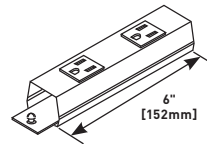

Two 15A, 120V factory wired isolated ground orange receptacles. Two couplings furnished.

AL2017 Internal Elbow

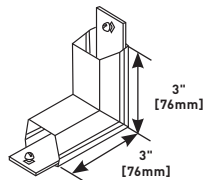

Makes 90° internal corners. Two couplings furnished.

AL2044, AL2044-2 Deep Device Box

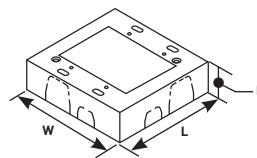

For larger receptacles and deep devices such as those of signal and alarm systems. Base has open back plate for mounting to existing wall box and solid back plate insert with 1/2" and 3/4" trade size KOs to close opening. Not for use on AL2400 Series Raceway.

AL2018 External Elbow

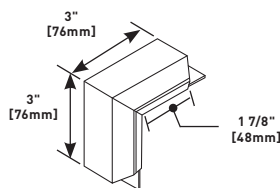

Makes 90° external corners. Two couplings furnished.

CAT NO.	L	W	D	GANG
AL2044	4 5/8" [117mm]	3 1/16" [78mm]	2 1/4" [57mm]	1
AL2044-2	4 5/8" [117mm]	4 27/32" [123mm]	2 1/2" [64mm]	2

AL2038 Round Fixture Box (Solid Base)

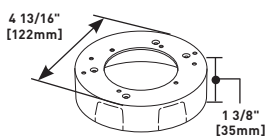

Designed for use in hanging fixtures. Cover takes any device with mounting screw centers of 2 3/4", 3 1/2" and 4 1/16" [70mm, 89mm and 103mm]. Base has concentric 1/2" and 3/4" trade size KOs. Not rated for fan use.

AL2047, AL2047-2 Shallow Switch Receptacle Box

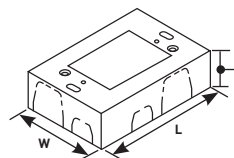

Designed for standard shallow switches and receptacles. Base has open back plate for mounting to existing wall box and solid back plate insert with 1/2" and 3/4" trade size KOs to close opening. Not for use on AL2400 Series Raceway.

CAT NO.	L	W	D	GANG
AL2047	4 5/8" [117mm]	3 1/16" [78mm]	1 3/8" [35mm]	1
AL2047-2	4 5/8" [117mm]	4 27/32" [123mm]	1 3/8" [35mm]	2

AL2040A In-Line Single Pole Switch

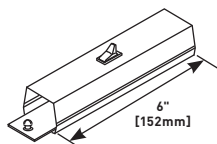

Single pole 120V Black switch. Two couplings furnished.

AL2051H Box Adapter

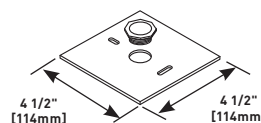

Used to feed raceway from existing wall outlet box. Accepts up to 5/8" trade size conduit.

AL2043 In-Line Receptacle

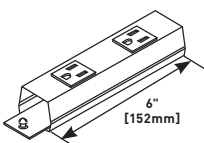

Two 15A, 120V U-ground factory wired receptacles. Two couplings furnished.

PLUGMOLD® 2000TR SERIES™



Plugmold® 2000TR Series™ Tamper-Resistant Multioutlet Systems meet the 2008 NEC requirement 406.11 for Tamper Resistant receptacles in dwelling units.

CODE REFERENCE

- cULus Listed Base & Blank Cover:**
File E4376 Guide RJBT.
- Multioutlet Assemblies:**
File E15191 Guide PVGT.
- Fittings:**
File E41751 Guide RJPR.
- Base & Blank Cover**
Meets Article 386 of NEC.
- Plugmold Strips:**
Meets Article 380 of NEC.

Steel Plugmold 2000TR Series Ordering Information

20GB306TR, 20GB506TR, 20GB606TR Tamper-Resistant Plugmold

Available in 3' [914mm] and 5' [1.5m] lengths with 6" [152mm] receptacle spacing. 15A tamper-resistant receptacles. 3-wire, #12 THHN (1 hot, 1 neutral, and insulated ground conductor). .040" [1.0mm] steel housing. Packed 2 per carton. Each unit supplied with one (1) Coupling and two (2) Blank End Fittings. Available in ivory (V20GB306TR, V20GB506TR), gray (G20GB306TR, G20GB506TR), black (BK20GB306TR, BK20GB506TR, BK20GB606TR), white (WH20GB306TR, WH20GB506TR, WH20GB606TR) and stainless steel (S20GB306TR, S20GB506TR and S20GB606TR).

Plugmold 2000TR Series Cross Section

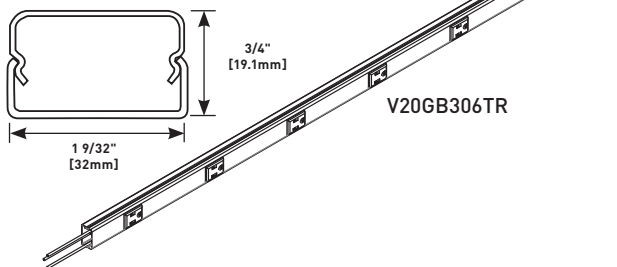

20GB306TRGFI Tamper-Resistant Plugmold with GFCI

Available in 3' [914mm] and 5' [1.5m] lengths with 6" [152mm] receptacle spacing. 15A tamper-resistant receptacles. 3-wire, #12 THHN (1 hot, 1 neutral, and insulated ground conductor). .040" [1.0mm] steel housing. Packed 2 per carton. Each unit supplied with one (1) Coupling and two (2) Blank End Fittings. Available in ivory (V20GB306TRGFI, V20GB506TRGFI), gray (G20GB306TRGFI, G20GB506TRGFI), black (BK20GB306TRGFI, BK20GB506TRGFI), white (WH20GB306TRGFI, WH20GB506TRGFI), stainless steel (S20GB306TRGFI, S20GB506TRGFI, S20GB606TRTRGFI) and aluminum (AL20GB306TRGFI, AL20GB506TRTRGFI).

Plugmold GFCI2000TR Series Cross Section

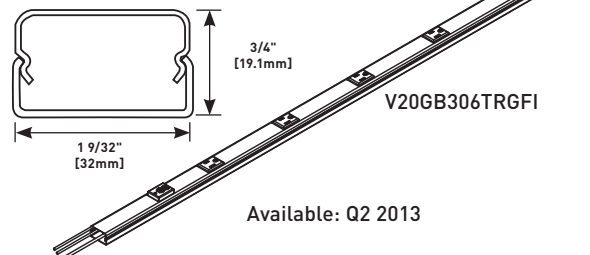

Available: Q2 2013

COLOR OPTIONS

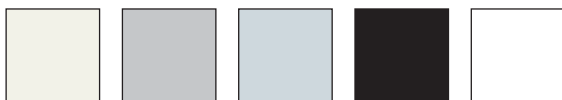

2000 Series Plugmold is available in an Ivory, Gray, Black, or White baked enamel finish or in durable stainless steel or satin anodized aluminum unless otherwise specified in the part number description.

Custom color options are also available. Consult the factory for more information.

PLUGMOLD® 2000TR SERIES™

Steel Plugmold 2000TR Series Ordering Information (continued)

2001 Coupling

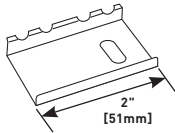

Joins lengths of Plugmold 2000TR Series together.

2009 Ground Clamp

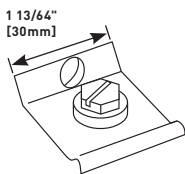

Connects equipment grounding conductor to Plugmold 2000TR Series.

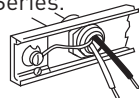

How 2009 is used.

2010B Blank End Fitting

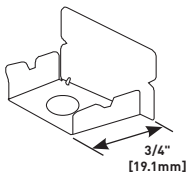

Closes off open end of sections of Plugmold 2000TR Series. Available in ivory (V2010B), gray (G2010B), black (BK2010B), white (WH2010B) and stainless steel (S2010B).

V2051H Back Feed Fitting

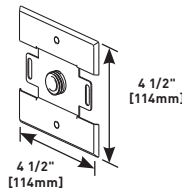

Feeds Plugmold 2000TR Series from an existing outlet box. Equipped with 1/2" trade size male bushing and lock nut washer for grounding.

2010A2 Entrance End Fitting

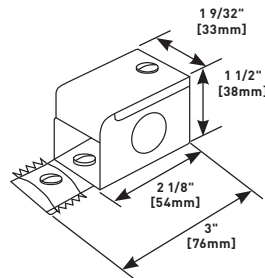

Connects Plugmold 2000TR Series with 1/2" trade size conduit and armored cable connectors. 1/2" trade size KOs on end, each side and bottom. Includes ground screw. Available in ivory (V2010A2), gray (G2010A2), black (BK2010A2), white (WH2010A2) and stainless steel (S2010A2).

2040B Entrance End Fitting

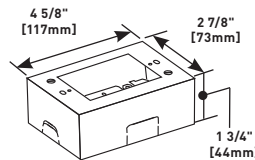

One-gang device box. Cover has one twistout for 2000 Series Plugmold on two sides and one twistout for 500® and 700® Series Raceway on the top and bottom. Base includes knockout to enable extension from existing single-gang flush wall box and 1/2" trade size KOs. Accepts industry standard faceplates for electrical and communication devices. Available in ivory (V2040B), gray (G2040B), black (BK2040B), white (WH2040B), and stainless steel (S2040B).

PLUGMOLD® 2000TR SERIES™

Aluminum Plugmold 2000TR Series Ordering Information

AL20GB306TR, AL0GB506TR Tamper-Resistant Plugmold

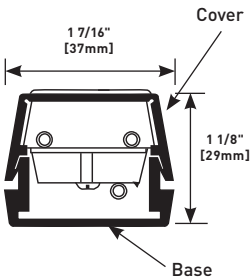

Available in 3' [914mm] and 5' [1.5m] lengths with 6" [152mm] receptacle spacing. 15A tamper-resistant receptacles. 3-wire, #12 THHN (1 hot, 1 neutral, and insulated ground conductor). .060" [1.5mm] 6063-T5 extruded aluminum housing with satin anodized finish. Packed 2 per carton. Each unit supplied with one (1) Coupling and two (2) Blank End Fittings.

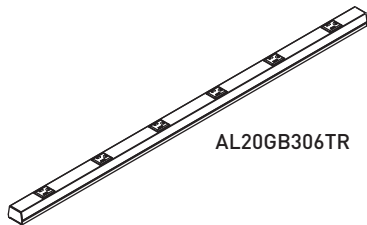

AL20GB306TR

AL2010A Feed Fitting

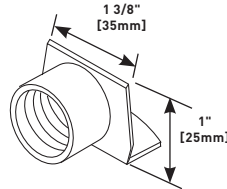

End fitting with 1/2" [12.7mm] hub adapter.

AL2010B Blank End Fitting

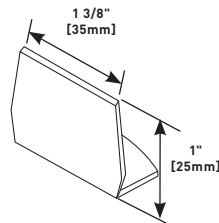

Closes off open end of sections of AL2000 Series Raceway.

AL2001 Coupling

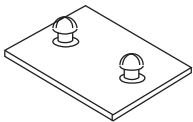

Connects adjoining sections of AL2000 Series Raceway base.

AL2047 Shallow Switch and Receptacle Box

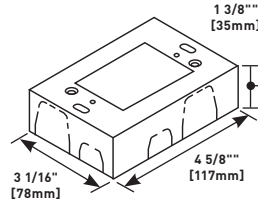

Designed for standard shallow switches and receptacles. Base has open back plate for mounting to existing wall box and solid back plate insert with 1/2" and 3/4" trade size KO's to close opening. Not for use with AL2400 Series Raceway.

AL2009 Ground Clamp

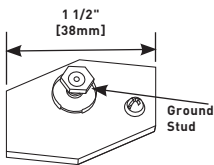

(Galvanized Steel) Connects equipment grounding conductor to provide additional ground to raceway.

AL2051H Box Adapter

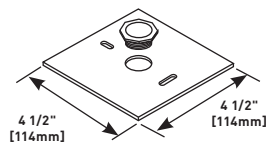

Used to feed raceway from existing wall outlet box. Accepts up to 5/8" trade size conduit.

ADORNE™ UNDER-CABINET LIGHTING SYSTEM



The adorne Under-Cabinet Lighting System is a fully customizable and modular solution for eliminating kitchen clutter. It is compatible with any kitchen layout, such as a galley, L-shaped, or U-shaped, as well as with any home wiring.

Visit www.adornemyhome.com to use the Under-Cabinet System Planning and Configuration Tool.

CODE REFERENCE

adorne Under-Cabinet Lighting System is cETLus Listed

ETL Listed System:
100477147

How to Specify the System

1. Planning Your System Layout

- First, determine where you want to install the system. Then measure your cabinets to determine the length of Modular Track required:
- Measure each cabinet length at back of cabinet.
- For installations with a corner, allow 3" on each side for Corner Connector.
- When totaling up the length of required Modular Track, be sure to include the length of the desired Control Box or Direct Wire Connector. For a 1-gang box, allow 5". For a 2-gang box, allow 5.25". For Direct Wire Connector, allow 6". For more detail on Control Box options, see page 58.
- If your selection of Modular Tracks does not match the exact length of your cabinets, you can use a Modular Track Extender to complete the track. This piece can be cut down to 6". Standard 12", 18", and 27" Modular Tracks cannot be shortened.



12" Modular Track



18" Modular Track



27" Modular Track



18" Modular Track Extender



Modular Track Corner Connector

ADORNE™ UNDER-CABINET LIGHTING SYSTEM

How to Specify the System

1. Planning Your System Layout (continued)

Sample Installation: Length of cabinets is equal to combined length of standard Modular Tracks

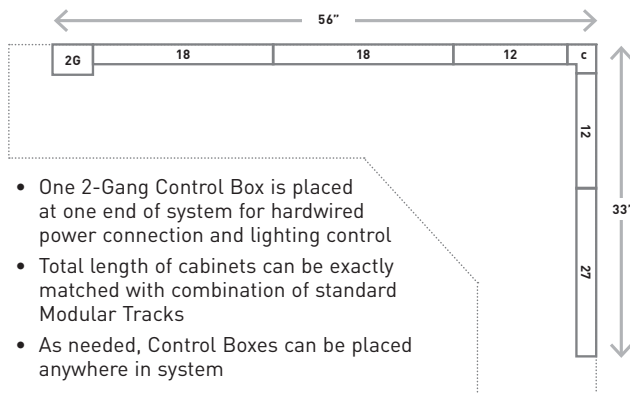

- One 2-Gang Control Box is placed at one end of system for hardwired power connection and lighting control
- Total length of cabinets can be exactly matched with combination of standard Modular Tracks
- As needed, Control Boxes can be placed anywhere in system

Sample Installation: Length of cabinets is greater than combined length of standard Modular Tracks

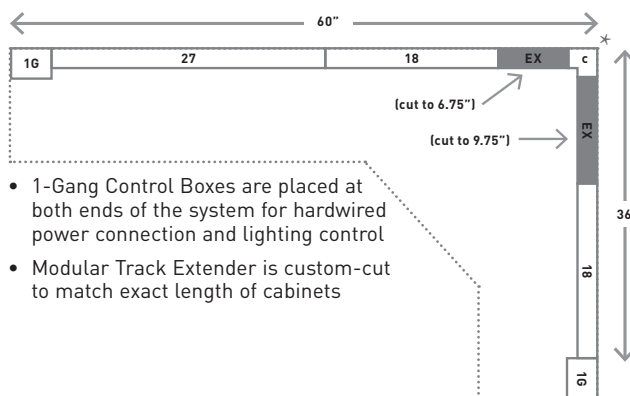

- 1-Gang Control Boxes are placed at both ends of the system for hardwired power connection and lighting control
- Modular Track Extender is custom-cut to match exact length of cabinets

Sample Installation: Direct wire with system controls in a remote location

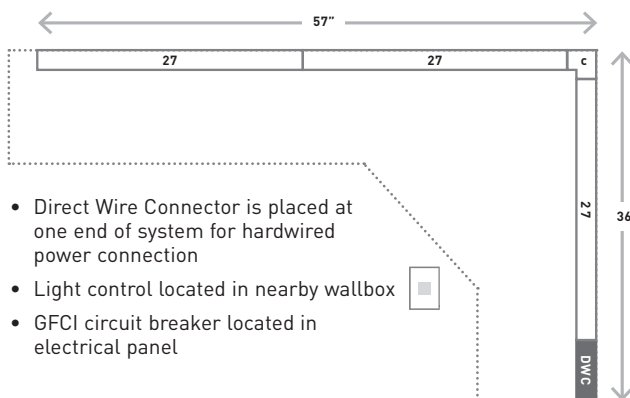

- Direct Wire Connector is placed at one end of system for hardwired power connection
- Light control located in nearby wallbox
- GFCI circuit breaker located in electrical panel

2. Selecting the Control Box and Power Options

Next, select the type of lighting and power connection you'd like to include. For a simple install, the Plug-In Control Box provides the easiest solution. For a hardwired installation, there are three options to choose from which enable expanded lighting control options such as dimming:

- Control Box with Paddle Dimmer
- Control Box with Paddle Dimmer and GFCI protection
- Direct Wire Connector

For hardwired installations, there must be three separate circuits from the electrical panel:

- Receptacle Circuit: 20 Amps; GFCI-protected; 280Use #12 wire
- Lighting Circuit: 15 Amps; Use #12 or #15 wire
- Accessory Circuit: 15 Amps; Use #12 or #14 wire

Hardwired Control Boxes



NOTE: Compatible with all adorne 2-module devices. The CFL/LED Paddle Dimmer (ADPD453LM2) is recommended for use with the adorne system.

ADORNE™ UNDER-CABINET LIGHTING SYSTEM

How to Specify the System

3. Selecting the LED Lights

The adorne Under-Cabinet Lighting System is only compatible with adorne LED lights. These are available in Puck and Linear versions. Recommended placement for lights is every 18" along Modular Track.

You can select any combination of Puck and Linear lights to complete your system. In addition, if you are mounting a light under the cabinet and wish to move it further to the front of the counter, you can use the LED Light Extender. This enables you to increase the length of any light from the Modular Track from a standard 11" to up to 22". This is especially useful in corner installations.



LED Puck Light



LED Linear Light



Light Extender

4. Choosing Accessories to Complete the System

The final step is to select the accessories to perfectly complement your system. adorne offers a range of options, including USB charging ports, mobile and tablet cradles, and a Digital Music Kit. Each of these accessories provides flexibility in that it can be added or removed at any time – simply swap it with an existing outlet or blank module to increase your system capabilities. For more detail on accessories, see page 60.

Modular Tracks











The adorne system is a flexible and modular solution designed to eliminate kitchen clutter. Fully customizable, you can select from several types of modules and modify your system in minutes. Simply pop out an existing module and replace it with a new module at any time.

The Modular Tracks listed below simply plug together to create a full system custom-designed for any kitchen.

They form the base of the system, housing all of the wiring that connects the modules.

Each system must include a Control Box or Direct Wire Connector that is hardwired to existing wiring or plugged into an outlet on the backsplash.

Visit www.adornemyhome.com for more information.

Name	Compliance	Specifications	Part Number
 12" Modular Track		Includes one Outlet Module and one Blank Module. Can support up to two LED lights. Provides 120V power via 15A outlet modules and 20A pass-through. Module openings are 6" on-center.	APMT12TM2
 18" Modular Track		Includes one Outlet Module and one Blank Module. Can support up to two LED lights. Provides 120V power via 15A outlet modules and 20A pass-through. Module openings are 9" on-center.	APMT18TM4
 27" Modular Track		Includes two Outlet Modules and one Blank Module. Can support up to three LED lights. Provides 120V power via 15A outlet modules and 20A pass-through. Module openings are 9" on-center.	APMT27TM2
 18" Modular Track Extender		Enables a perfect fit for any kitchen. Simply cut to length (minimum of 6") and attach to end of Modular Track. Does not include any module openings.	APME18TM2
 Modular Track Corner Connector		Use with installations that include a right-angle corner to connect two Modular Tracks. Allow 3" on each side for installations with Corner Connectors.	APCCTM4









ADORNE™ UNDER-CABINET LIGHTING SYSTEM

Control Boxes

Every Under-Cabinet Lighting System must include one of the below Control Boxes or Direct Wire Connector. These boxes connect to existing in-wall wiring or plug into an outlet on the backsplash to provide system power.

Control Boxes include system end caps, ensuring a clean finish on the left and right edges of the installed system.

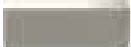

Name	Compliance	Specifications	Part Number
Control Box with Paddle Dimmer 	450W 	Connects to existing in-wall wiring. Fits onto end of Modular Track, adding 5" onto system length. Includes adorne 450W CFL/LED Paddle Dimmer (ADPD453LM2). GFCI protection must be provided at the electrical panel	APCB1TM4
Control Box with Paddle Dimmer and 15A GFCI 	450W 15A 	Connects to existing in-wall wiring. Fits onto end of Modular Track, adding 5.25" onto system length. Includes adorne 450W CFL/LED Paddle Dimmer (ADPD453LM2) and 15A Tamper-Resistant GFCI Outlet (AGFTR153M4).	APCB2TM2
Plug-In Control Box 		Snaps into any module opening on the track and plugs into an existing outlet to provide system power. Cord length of 11" can easily be shortened to match the distance from outlet to Modular Track.	APCB3TM4
Direct Wire Connector 		Enables direct wire feed of power from in-wall wiring, eliminating need for a Control Box. Connector is 6" in length.	APDWCTM1

ADORNE™ UNDER-CABINET LIGHTING SYSTEM









Lighting

adore Puck and Linear LED Lights are designed for use with the adore system only. They can be paired with the adore CFL/LED Paddle Dimmer (ADPD453L) to enable dimming.

Lights easily plug into a connection port on any system module. Optimal positioning is one light for every 18" of Modular Track. Lights can be added or removed as needed.

adore LED lights are Energy Star certified.



Name	Compliance	Specifications	Part Number
 LED Puck Light	 	<ul style="list-style-type: none"> • 8W • 240 lumens • correlated color temperature: 3000 kelvin color rendering index: 95 	ALPKLEDTM4
 LED Linear Light	 	<ul style="list-style-type: none"> • 8W • 280 lumens • correlated color temperature: 3000 kelvin color rendering index: 95 	ALLNLEDTM4
 Light Extender		Enables adore LED lights to be mounted up to 22" from backsplash by extending cord length beyond default 11". Ideal for corner cabinet installations.	ALEXTLEDTM4

The adore system is optimized to provide a premium under-cabinet lighting solution by utilizing the latest innovations in lighting research and LED technologies.

System specifications:

- OSRAM OSOLON® Color Champ LED
- Nominal 3000K Correlated Color Temperature (CCT) warm light output
- Color Rendering Index (CRI) of 95
- Excellent range of color differentiation and rendering of the important red color (think red meat and apples) and skin tones
- A bright lumen light output (Puck = 240 lumens/ Linear = 280 lumens) provides optimized lighting for the under-cabinet environment
- Efficient driver design integrated in each fixture results in:
 - Reliable and smooth dimming
 - ENERGY STAR certification
 - Rated for 40,000 hours of high performance
- LED quality control uses a "fine bin system" based on a three-step MacAdams ellipse to ensure color consistency

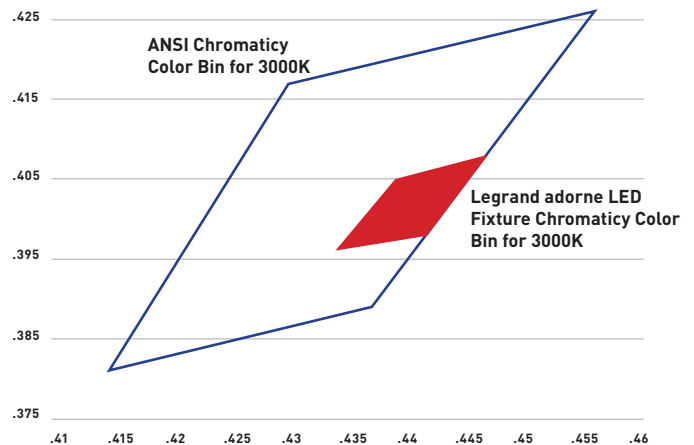

NOTE: adore individual LEDs are specifically selected to ensure fixture output CCT uniformity within a range of less than 100. This tight manufacturing assurance process ensures that variations inherent in the LED chip manufacturing process do not compromise reliable light quality.



ADORNE™ UNDER-CABINET LIGHTING SYSTEM

Digital Music Kit

The Digital Music Kit adds high performance sound to your adorne Under-Cabinet Lighting System. It includes two speakers and a detachable dock for smart phones or MP3 players. Simply fit the main speaker into one module opening and then place the second speaker in any other module location. Speakers can be easily removed and relocated at any time by simply pushing on the sides of the modules and popping them out of the track.

The system features BLUETOOTH® wireless technology to enable streaming of music from your devices. It also includes a 3.5mm cable to manually connect devices.



Name	Compliance	Specifications	Part Number
Digital Music Kit 	 	2" (50mm) full range drivers Digital signal processing for full, rich sound BLUETOOTH wireless technology is A2DP compatible Includes USB charging capability	AUDMTM1









NOTE: Bluetooth® is a registered trademark of Bluetooth SIG, Inc. The Bluetooth word mark and logos are owned by the Bluetooth SIG, Inc. and any use of such marks (licensee name) is under license. Other trademarks and trade names are those of their respective owners.

Modules and Accessories

adorne system modules are designed to fit in any module opening, and can be easily added or removed by using the included module tool. Simply fit the tool into either end of the module and pop it out of the track.

Cradles do not occupy a module opening. Instead, they save space by resting on the back edge of the track.



Name	Compliance	Specifications	Part Number
15A Outlet Module 	15A, 120V  	Provides two power outlets by snapping into any module opening. Tamper-resistant outlet is designed with a patented shutter system. Included with 12", 18", and 27" Modular Tracks.	APTR15TM4
USB Outlet Module 	2.1A, 5V  	Provides two USB charging ports for devices such as mobile phones and tablets by snapping into any module opening. Charging cable not included.	APUSB2TM4
Mobile Phone Cradle 		Attaches anywhere along track to hold a mobile phone. Perfect for use with USB Outlet Module while charging devices.	AAPCTM4
Tablet Cradle 		Attaches anywhere along track to hold a tablet. Perfect for use with USB Outlet Module while charging devices.	AATCTM4

POKE-THRU DEVICES

Wiremold® Poke-Thru Devices are TopGuard protected to meet and exceed the UL scrub water exclusion requirement.



With the introduction of our new Evolution™ Series of Poke-Thru Devices, **Wiremold®** is again pushing the envelope by expanding the capacity, capabilities, and aesthetics of Infloor power and communication delivery systems for open spaces.

Featured Products



Evolution Series™
Poke-Thru Devices

291



AV3 Series™
Poke-Thru Devices

314

POKE-THRU DEVICES

Table of Contents

Recessed Style Poke-Thru Devices



291
Evolution™ 6AT Series



299
Evolution™ 8AT Series

Surface Style Poke-Thru Devices



306
RC7 Series™



308
RC9 Series™



310
RC9AMD Series™



312
AMD8 Series™



314
AV3 Series™



316
RC4 Series™



318
RC3 Series™

Furniture Feed Style Poke-Thru Devices



320
4FFATC Series™

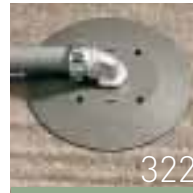

322
RC7AFFTC Series™



324
RC9AFFTC Series™



326
RC9AM2TC Series™

Pedestal Style Poke-Thru Devices



328
FIT Series™

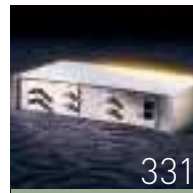

331
RC91GHBTC & RC92GHBTC Series™

POKE-THRU DEVICES

Quick Selection Guide

Recessed Poke-Thru Devices

6" & 8" DIAMETER HOLE									
POKE-THRU SERIES		EVOLUTION™ 6ATC SERIES		EVOLUTION™ 6AT SERIES		EVOLUTION™ 6ATCFF SERIES		EVOLUTION™ 8AT SERIES	
HOLE SIZE – COVER FLOORS		Minimum: 6" [152mm] Maximum: 6 1/8" [156mm]	Minimum: 6" [152mm] Maximum: 6 1/8" [156mm]	Minimum: 6" [152mm] Maximum: 6 1/8" [156mm]	Minimum: 6" [152mm] Maximum: 6 1/8" [156mm]	Minimum: 8" [203mm] Maximum: 8 1/8" [206mm]			
HOLE SIZE – BARE CONCRETE & TERRAZZO FLOORS		Minimum: 6 1/16" [154mm] Maximum: 6 1/8" [156mm]	Minimum: 6 1/16" [154mm] Maximum: 6 1/8" [156mm]	Minimum: 6 1/16" [154mm] Maximum: 6 1/8" [156mm]	Minimum: 6 1/16" [154mm] Maximum: 6 1/8" [156mm]	Minimum: 8 1/16" [205mm] Maximum: 8 1/8" [206mm]			
UL FIRE CLASSIFICATION		1-, 1 1/2- & 2-Hours		1-, 1 1/2- & 2-Hours		1-, 1 1/2- & 2-Hours		1-, 1 1/2- & 2-Hours	
UL SCRUBWATER PROTECTION		TopGuard™		TopGuard™		TopGuard™		TopGuard™	
CAPACITY		2 1/2 Gangs 3 Duplex Receptacles or 12 Communication Ports or 10 Extron® MAAP or 2 AAP Plates or any combination of the above		2 1/2 Gangs 3 Duplex Receptacles or 12 Communication Ports or 10 Extron® MAAP or 2 AAP Plates or any combination of the above		N/A		4 Gangs 5 Duplex Receptacles or 22 Communication Ports or 16 Extron® MAAP or 4 AAP Plates or any combination of the above	
MAXIMUM COPPER CROSS SECTION*	OUTER CHANNELS	.0154 sq. in. [9.9mm ²]		.0154 sq. in. [9.9mm ²]		.0187 in ² [12.1mm ²] Power: 0.0815 [52.6mm ²]		.0154 sq. in. [9.9mm ²]	
	CENTER CHANNEL(S)	.0387 sq. in. [24.97mm ²]		.0387 sq. in. [24.97mm ²]		.0686 in ² [44.3mm ²]		.0775 sq. in. [16.60mm ²]	
POWER	OUTER CHANNELS	Three (3) #12 AWG		Three (3) #12 AWG		Fifteen (15) #12 AWG		Three (3) #12 AWG	
	CENTER CHANNEL(S)	Seven (7) #12 AWG		Seven (7) #12 AWG		N/A		Fifteen (15) #12 AWG	
COMMUNICATIONS	OUTER CHANNELS	Four (4) Cat 6A		Four (4) Cat 6A		Six (6) Cat 6A		Four (4) Cat 6A	
	CENTER CHANNEL(S)	Twelve (12) Cat 6A		Twelve (12) Cat 6A		Twenty Two (22) Cat 6A		Twenty Four (24) Cat 6A	
CONDUIT FEEDS		3/4" Conduit for Outer Channel, Maximum 1 1/4" Conduit for Center Channel or 2" Conduit which takes up the Center Channel and one Outer Channel		3/4" Conduit for Outer Channel, Maximum 1 1/4" Conduit for Center Channel or 2" Conduit which takes up the Center Channel and one Outer Channel		3/4" Conduit for Outer Channel, Maximum 1 1/4" Conduit for Center Channel or 2" Conduit which takes up the Center Channel and one Outer Channel		3/4" Conduit for Outer Channel, Maximum 1 1/4" Conduit for Center Channel or 2" Conduit which takes up the Center Channel and one Outer Channel	
COVER SIZE		7 1/4" [184mm]		7 1/4" [184mm]		7 3/4" [197mm]		9 1/4" [235mm]	
COVER COLORS		Black, Gray, Nickel, Bronze, Brass		Black, Gray, Nickel, Bronze, Brass		Black, Gray, Nickel, Bronze, Brass		Black, Gray, Nickel, Bronze, Brass	
APPROVED CONCRETE FLOOR COVERINGS		Carpet, Tile, Concrete/Terrazzo & Wood		Carpet, Tile, Concrete/Terrazzo & Wood		Carpet, Tile, Concrete/Terrazzo & Wood		Carpet, Tile, Concrete/Terrazzo & Wood	
FLOOR COVERING THICKNESS		Minimum: 0" [0mm] Maximum: 1 1/4" [32mm]	Minimum: 0" [0mm] Maximum: 1 1/4" [32mm]	Minimum: 0" [0mm] Maximum: 1 1/4" [32mm]	Minimum: 0" [0mm] Maximum: 1 1/4" [32mm]	Minimum: 0" [0mm] Maximum: 1 1/4" [32mm]	Minimum: 0" [0mm] Maximum: 1 1/4" [32mm]	Minimum: 0" [0mm] Maximum: 1 1/4" [32mm]	Minimum: 0" [0mm] Maximum: 1 1/4" [32mm]

NOTE: For modular prewired Walkerflex® versions, see the Walkerflex® product section.
 *The above maximum copper fill values are the maximum amount of copper to maintain fire classification and are for each individual power and communication compartments. Do not add values together for any one compartment.
NOTE: Pre-Pour Sleeves for 6" (6PPS) and 8" (8PPS) Evolution Series Poke-Thru Devices speed installation and insure accurate location of devices.



POKE-THRU DEVICES

Quick Selection Guide

Surface Style Poke-Thru Devices

3" DIAMETER HOLE		RC7 SERIES		RC9 SERIES		RC9AMD SERIES	
POKE-THRU SERIES		RC7 SERIES		RC9 SERIES		RC9AMD SERIES	
HOLE SIZE		Minimum: 3 1/16" [78mm] Maximum: 3 1/8" [79mm]		Minimum: 3 1/16" [78mm] Maximum: 3 1/8" [79mm]		Minimum: 3" [76mm] Maximum: 3 1/8" [79mm]	
UL FIRE CLASSIFICATION		1-, 1 1/2- & 2-Hours		1-, 1 1/2- & 2-Hours		1-, 1 1/2- & 2-Hours	
UL SCRUBWATER PROTECTION		TopGuard™		TopGuard™		TopGuard™	
CAPACITY		2 Gangs (1) 20A Duplex Receptacle, (2) Ports of Communication Devices		2 Gangs (1) 15A Quad Receptacle, (2) Openings for Communication Pass-Through		1 Gang (4) Ports of Communication Devices	
MAXIMUM COPPER FILL	POWER*	(3) #12 AWG .01536 sq. in. [9.91 sq. mm]		(3) #12 AWG .01536 sq. in. [9.91 sq. mm]		N/A	
	COMMUNICATIONS*	(1) Cat 6/Channel .004 sq. in. [2.58 sq. mm]		(1) Cat 6/Channel .004 sq. in. [2.58 sq. mm]		(4) Cat 6/Channel .01600 sq. in. [10.324 sq. mm]	
FEED CHANNELS	POWER	3/4" Trade Size		3/4" Trade Size		N/A	
	COMMUNICATIONS	1/2" Trade Size/Channel (2) Channels per unit		1/2" Trade Size/Channel (2) Channels per unit		2" Trade Size	
COVER SIZE		7" [178mm]		7" [178mm]		7" [178mm]	
COVER COLORS		Black, Brass, Aluminum, Gray, Ivory		Black, Brass, Aluminum, Gray, Ivory		Black, Brass, Aluminum, Gray, Ivory	
APPROVED CONCRETE FLOOR COVERINGS		Carpet, Tile & Wood		Carpet, Tile & Wood		Carpet, Tile & Wood	
FLOOR COVERING THICKNESS		Minimum: 1/8" [3.2mm] Maximum: 3/4" [19.1mm]		Minimum: 1/8" [3.2mm] Maximum: 3/4" [19.1mm]		Minimum: 1/8" [3.2mm] Maximum: 3/4" [19.1mm]	



RC7 Series



RC9AMD Series



AV3 Series

4" DIAMETER HOLE		AV3 SERIES		AMD8 SERIES		RC4 SERIES		RC3 SERIES	
POKE-THRU SERIES		AV3 SERIES		AMD8 SERIES		RC4 SERIES		RC3 SERIES	
HOLE SIZE		Minimum: 4" [102mm] Maximum: 4 1/8" [105mm]		Minimum: 4" [102mm] Maximum: 4 1/8" [105mm]		Minimum: 4" [102mm] Maximum: 4 1/8" [105mm]		Minimum: 4" [102mm] Maximum: 4 1/8" [105mm]	
UL FIRE CLASSIFICATION		1-, 1 1/2- & 2-Hours		1-, 1 1/2- & 2-Hours		1-, 1 1/2- & 2-Hours		1-, 1 1/2- & 2-Hours	
UL SCRUBWATER PROTECTION		TopGuard™		TopGuard™		TopGuard™		TopGuard™	
CAPACITY		2 Gangs (1) 20A Duplex Receptacle, (3) Single Width Extron MAAP Devices or (4) Ports of Communications		1 Gang All Communications (8) Ports for Communication Devices		2 Gangs (2) 20A Duplex Receptacles (4) Ports for Communication Devices		2 Gangs (1) Duplex Receptacle (4) Ports for Communication Devices	
MAXIMUM COPPER FILL	POWER*	(3) #12 AWG .01536 sq. in. [9.91 sq. mm]		N/A		(6) #12 AWG .03072 sq. in. [19.82 sq. mm]		(3) #12 AWG .01536 sq. in. [9.91 sq. mm]	
	COMMUNICATIONS*	(4) Cat 6 .01938 sq. in. [12.503 sq. mm]		(8) Cat 6 .03474 sq. in. [22.412 sq. mm]		(4) Cat 6/Channel .016 sq. in. [10.3 sq. mm]		(4) Cat 6/Channel .016 sq. in. [10.3 sq. mm]	
FEED CHANNELS	POWER	3/4" Trade Size		3/4" Trade Size		3/4" Trade Size		3/4" Trade Size	
	COMMUNICATIONS	1 1/4" Trade Size/Channel		1 1/4" Trade Size/Channel		3/4" Trade Size [Equivalent] Oval Shaped Opening		3/4" Trade Size [Equivalent] Oval Shaped Opening	
COVER SIZE		8 1/4" [210mm]		8 1/4" [210mm]		8 1/4" [210mm]		7 1/2" [191mm]	
COVER COLORS		Black, Brass, Aluminum, Gray, Ivory		Black, Brass, Aluminum, Gray, Ivory		Black, Brass, Aluminum, Gray, Ivory		Black, Brass, Aluminum, Gray, Ivory	
APPROVED CONCRETE FLOOR COVERINGS		Carpet, Tile & Wood		Carpet, Tile & Wood		Carpet, Tile & Wood		Carpet, Tile & Wood	
FLOOR COVERING THICKNESS		Minimum: 1/8" [3.2mm] Maximum: 3/4" [19.1mm]		Minimum: 1/8" [3.2mm] Maximum: 3/4" [19.1mm]		Minimum: 1/8" [3.2mm] Maximum: 3/4" [19.1mm]		Minimum: 1/8" [3.2mm] Maximum: 3/4" [19.1mm]	

*The above maximum copper fill values are the maximum amount of copper to maintain fire classification and are for each individual power and communication compartments. Do not add values together for any one compartment.

POKE-THRU DEVICES

Quick Selection Guide

Furniture Feed Style Poke-Thru Devices

3" DIAMETER HOLE		RC7AFFTC SERIES	RC7AM2TC SERIES	RC9FFTC SERIES	RC9AM2TC SERIES
POKE-THRU SERIES		RC7AFFTC SERIES	RC7AM2TC SERIES	RC9FFTC SERIES	RC9AM2TC SERIES
HOLE SIZE		Minimum: 3 1/16" [78mm] Maximum: 3 1/8" [79mm]	Minimum: 3" [76mm] Maximum: 3 1/8" [79mm]	Minimum: 3" [76mm] Maximum: 3 1/8" [79mm]	Minimum: 3" [76mm] Maximum: 3 1/8" [79mm]
UL FIRE CLASSIFICATION		1-, 1 1/2- & 2-Hours	1-, 1 1/2- & 2-Hours	1-, 1 1/2- & 2-Hours	1-, 1 1/2- & 2-Hours
UL SCRUBWATER PROTECTION		TopGuard™	TopGuard™	TopGuard™	TopGuard™
CAPACITY		2 Gangs Two (2) 1/2" & one (1) 3/4" Trade Size Screw Plug Openings	1 Gang Two (2) 1/2" & one (1) 3/4" Trade Size Screw Plug Openings	2 Gangs Hexagonal Service Head with one (1) 3/4" Trade Size Conduit & five (5) Communication Openings	1 Gang One (1) 1 1/4"/2" Concentric Screw Plug
MAXIMUM COPPER FILL	POWER*	(10) #12 AWG .05214 sq. in. [33.64mm ²]	(20) #12 AWG .09216 sq. in. [59.46mm ²]	(3) #12 AWG .05726 sq. in. [36.94mm ²]	(20) #12 AWG .09216 sq. in. [59.46mm ²]
	COMMUNICATIONS*	(7) Cat 6/Channel .05000 sq. in. [32.26mm ²]	(7) Cat 6/Channel .09216 sq. in. [59.46mm ²]	(15) Cat 6/Channel .06425 sq. in. [41.45mm ²]	(32) Cat 6/Channel .09216 sq. in. [59.46mm ²]
COVER SIZE		7" [178mm]	7" [178mm]	7" [178mm]	7" [178mm]
COVER COLORS		Black, Brass, Aluminum, Gray	Black, Brass, Aluminum, Gray	Black, Brass, Aluminum, Gray	Black, Brass, Aluminum, Gray
COVER CONSTRUCTION		Die-Cast	Die-Cast	Die-Cast	Die-Cast
CONDUIT/STEM DIAMETER		One (1) 3/4" & two (2) 1/2" Trade Size Conduit	One (1) 2" Trade Size Conduit	One (1) 3/4" & one 1 1/4" Trade Size Conduit	One (1) 2" Trade Size Conduit
FLOOR COVERING THICKNESS		Minimum: 1/8" [3.2mm] Maximum: 3/4" [19.1mm]	Minimum: 1/8" [3.2mm] Maximum: 3/4" [19.1mm]	Minimum: 1/8" [3.2mm] Maximum: 3/4" [19.1mm]	Minimum: 1/8" [3.2mm] Maximum: 3/4" [19.1mm]

4" DIAMETER HOLE		4FFATC SERIES
POKE-THRU SERIES		4FFATC SERIES
HOLE SIZE		Minimum: 4" [76mm] Maximum: 4 1/8" [78mm]
UL FIRE CLASSIFICATION		1-, 1 1/2- & 2-Hours
UL SCRUBWATER PROTECTION		TopGuard™
CAPACITY		2 Gangs One (1) 3/4" & one (1) 1 1/4" Trade Size Screw Plug Openings
MAXIMUM COPPER FILL	POWER*	(16) #12 AWG or (10) #10 AWG .08192 sq. in. [52.851mm ²]
	COMMUNICATIONS*	(18) Cat 6/Channel .072 sq. in. [46.45mm ²]
COVER SIZE		7 1/2" [191mm]
COVER COLORS		Black, Brass, Aluminum, Gray
COVER CONSTRUCTION		Die-Cast
CONDUIT/STEM DIAMETER		One (1) 3/4" & one (1) 1 1/4" Trade Size Conduit
FLOOR COVERING THICKNESS		Minimum: 1/8" [3.2mm] Maximum: 3/4" [19.1mm]



RC9FF Series



RC9AM2 Series



RC7AFF Series



4FFATC Series

* The above maximum copper fill values are the maximum amount of copper to maintain fire classification and are for each individual power and communication compartments. Do not add values together for any one compartment.

POKE-THRU DEVICES

Quick Selection Guide

Pedestal Style Poke-Thru Devices

2" DIAMETER HOLE		
POKE-THRU SERIES	FIT SERIES	FIT SERIES
HOLE SIZE	Minimum: 2 1/32" [52mm] Maximum: 2 1/8" [54mm]	Minimum: 2 1/32" [52mm] Maximum: 2 1/8" [54mm]
CAPACITY	Single Width 200-H/BTC Service Head	Double Width 241-H/BTC Service Head
UL FIRE CLASSIFICATION	1-, 1 1/2-, 2-, 3- & 4-hrs	1-, 1 1/2-, 2-, 3- & 4-hrs
UL SCRUBWATER PROTECTION	TopGuard™	TopGuard™
MAXIMUM COPPER FILL	POWER*	(3) #12 AWG .01536 sq. in. [9.91 mm ²]
	COMMUNICATIONS*	(6) Cat 6/Channel .05020 sq. in. [32.39 mm ²]
FLANGE/COVER DIAMETER	4 5/8" x 4" x 2 5/8" [118mm x 102mm x 69mm]	4 5/8" x 9 1/4" x 2 5/8" [118mm x 235mm x 69mm]
CONDUIT/STEM DIAMETER	One 1" Trade Size Conduit	One 1" Trade Size Conduit
SERVICE HEAD CONSTRUCTION	Aluminum	Aluminum
COVER COLORS	Brushed Aluminum	Brushed Aluminum



FIT Series

3" DIAMETER HOLE		
POKE-THRU SERIES	RC91GHBTC SERIES	RC92GHBTC SERIES
HOLE SIZE	Minimum: 3 1/16" [78mm] Maximum: 3 1/8" [79mm]	Minimum: 3 1/16" [78mm] Maximum: 3 1/8" [79mm]
CAPACITY	Single Width Service Head	Double Width Service Head
UL FIRE CLASSIFICATION	1-, 1 1/2-, 2-hrs	1-, 1 1/2-, 2-hrs
UL SCRUBWATER PROTECTION	TopGuard™	TopGuard™
MAXIMUM COPPER FILL	POWER*	(3) #12 AWG .01536 sq. in. [9.91 mm ²]
	COMMUNICATIONS*	(15) Cat 6/Channel .05020 sq. in. [32.39 mm ²]
FLANGE/COVER DIAMETER	4 5/8" x 4" x 2 5/8" [118mm x 102mm x 69mm]	4 5/8" x 9 1/4" x 2 5/8" [118mm x 235mm x 69mm]
CONDUIT/STEM DIAMETER	One (1) 1/2" & one (1) 1 1/4" Trade Size Conduit	One (1) 1/2" & one (1) 1 1/4" Trade Size Conduit
SERVICE HEAD CONSTRUCTION	Aluminum	Aluminum
COVER COLORS	Brushed Aluminum	Brushed Aluminum



RC92GHBTC Series

NOTE: For modular prewired Walkerflex® versions, see the Walkerflex® product section.

EVOLUTION™ 6AT SERIES POKE-THRU DEVICES



Evolution™ 6AT Series Poke-Thru Devices allow all power and communication devices to be recessed 3 1/4" below floor level, and provide 2 1/2-gang capacity for power, communication, or A/V devices.



CODE REFERENCE

cULus Listed Metallic Outlet Boxes:
File E2961 Guide QCIT.

cULus Listed Nonmetallic Outlet Boxes & Fittings Classified for Fire Resistance:
File R8209 Guide CEYY.

Meets Article 300.21, 300.22(C) & 314 of NEC.



Cover Assemblies for the 6AT Series Poke-Thru Devices are available in a variety of service configurations for installation in carpet or tile floors.

Evolution Series Poke-Thru Devices feature loads of capacity and a flush to the floor surface cover and flange configuration.

HOLE DIAMETER	
Minimum:	6" [152mm]
Maximum:	6 1/8" [156mm]

COLOR OPTIONS



Evolution 6AT Series parts are available in the following powder coated finishes: "BK" black, "GY" gray, "NK" nickel, "BS" brass, and "BZ" bronze.

Custom color options are also available. Consult the factory for more information.

EVOLUTION™ 6AT SERIES POKE-THRU DEVICES

Evolution 6AT Series Poke-Thru Devices Ordering Information

6ATCP Recessed Prewired Assembly with Surface Style Cover

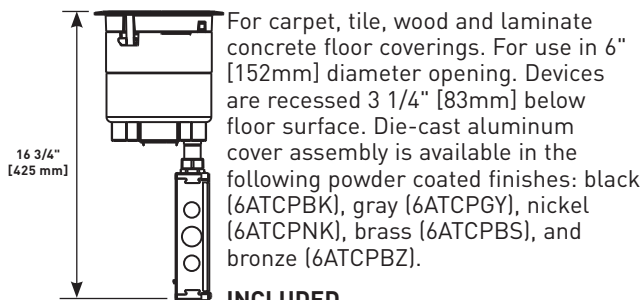

For carpet, tile, wood and laminate concrete floor coverings. For use in 6" [152mm] diameter opening. Devices are recessed 3 1/4" [83mm] below floor surface. Die-cast aluminum cover assembly is available in the following powder coated finishes: black (6ATCPBK), gray (6ATCPGY), nickel (6ATCPNK), brass (6ATCPBS), and bronze (6ATCPBZ).

NOTE: UL Fire Classified for up to 2 hour rated floors.

NOTE: Receptacles can be wired as a standard or isolated ground device.

INCLUDED

For Side Compartments:

- Two (2) proprietary 20AMP Duplex Receptacles installed

For Center Compartment:

- One (1) 6ACT8A Mounting Plate
- One (1) 6TRAC Mounting Plate
- One (1) 6SER Mounting Plate

For Bottom Feed Compartment:

- One (1) 5BLH 1/2-Gang Blank Housing*
- One (1) 1PTHA 1-Gang Pass-Through Housing Assembly
- One (1) 575CHA 1/2-Gang 3/4" Conduit Housing Assembly**

6ATC Recessed Assembly with Surface Style Cover

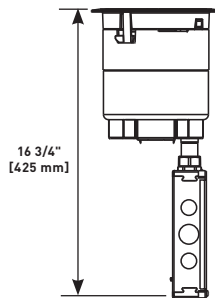

For carpet, tile, wood and laminate concrete floor coverings. For use in 6" [152mm] diameter opening. Devices are recessed 3 1/4" [83mm] below floor surface. Die-cast aluminum cover is available in the following powder coated finishes: black (6ATCBK), gray (6ATCGY), nickel (6ATCNK), brass (6ATCBS), and bronze (6ATCBZ).

NOTE: UL Fire Classified for up to 2 hour rated floors.

INCLUDED

For Side Compartments:

- No Device Plates are provided.

For Center Compartment:

- No Device Plates are provided.

For Bottom Feed Compartment:

- One (1) 5PTHA 1/2-Gang Pass-Through Housing Assembly
- One (1) 1PTHA 1-Gang Pass-Through Housing Assembly
- One (1) 575CHA 1/2-Gang 3/4" Conduit Housing Assembly**

6ATP Recessed Prewired Assembly with Flush Style Cover



For tile, wood and laminate concrete floor coverings. For use in 6" [152mm] diameter opening. Devices are recessed 3 1/4" [83mm] below floor surface. Die-cast aluminum cover assembly is available in the following powder coated finishes: black (6ATPBK), gray (6ATPGY), nickel (6ATPNK), brass (6ATPBS), and bronze (6ATPBZ).

NOTE: UL Fire Classified for up to 2 hour rated floors.

NOTE: Receptacles can be wired as a standard or isolated ground device.

NOTE: Includes one (1) 6TS Tile Shim.

INCLUDED

For Side Compartments:

- Two (2) proprietary 20AMP Duplex Receptacles installed

For Center Compartment:

- One (1) 6ACT8A Mounting Plate
- One (1) 6TRAC Mounting Plate
- One (1) 6SER Mounting Plate

For Bottom Feed Compartments:

- One (1) 5BLH 1/2-Gang Blank Housing*
- One (1) 1PTHA 1-Gang Pass-Through Housing Assembly
- One (1) 575CHA 1/2-Gang 3/4" Conduit Housing Assembly**

6AT Recessed Assembly With Flush Style Cover

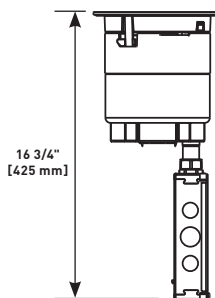

For tile, wood or laminate concrete floor coverings. For use in 6" [152mm] diameter opening. Devices are recessed 3 1/4" [83mm] below floor surface. Die-cast aluminum cover is available in the following powder coated finishes: black (6ATBK), gray (6ATGY), nickel (6ATNK), brass (6ATBS), and bronze (6ATBZ).

NOTE: UL Fire Classified for up to 2 hour rated floors.

NOTE: Includes one (1) 6TS Tile Shim.

INCLUDED

For Side Compartments:

- No Device Plates are provided.

For Center Compartment:

- No Device Plates are provided.

For Bottom Feed Compartment:

- One (1) 5PTHA 1/2-Gang Pass-Through Housing Assembly
- One (1) 1PTHA 1-Gang Pass-Through Housing Assembly
- One (1) 575CHA 1/2-Gang 3/4" Conduit Housing Assembly**

* Tunneling extends from the 5BLH to 575CHA so that power cables from the 20A duplex receptacle mounted on the left side of the poke-thru device are run into the junction box attached to the 575CHA.

** Also includes junction box attached to the 3/4" conduit.

NOTE: For more information on Device Plates and Bottom Feed Plates and on the additional options available, see the Device Plates and Bottom Feed Plates sections found later in this document.

EVOLUTION™ 6AT SERIES POKE-THRU DEVICES

Evolution 6AT Series Poke-Thru Devices Ordering Information (continued)

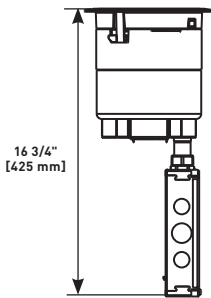
6ATCPAV Recessed Prewired Audio/Video Assembly with Surface Style Cover

For carpet, tile, wood and laminate concrete floor coverings. For use in 6" [152mm] diameter opening. Devices are recessed 3 1/4" [83mm] below floor surface. Die-cast aluminum cover assembly is available in the following powder coated finishes: black (6ATCPAVBK), gray (6ATCPAVGY), nickel (6ATCPAVNK), brass (6ATCPAVBS), and bronze (6ATCPAVBZ).

INCLUDED**For Side Compartments:**

- One (1) Proprietary 20AMP Duplex Power Receptacle installed
- One (1) 682A Device Plate
- One (1) 68MAAP Device Plate

For Center Device Compartment:

- One (1) 6DEC Mounting Plate
- One (1) 6AAP Mounting Plate
- One (1) 6MAAP Device Plate

For Bottom Feed Compartment:

- One (1) 5PTHA 1/2-Gang Pass-Through Housing Assembly
- One (1) 1PTHA 1-Gang Pass-Through Housing Assembly
- One (1) 575CHA 1/2-gang 3/4" Conduit Housing Assembly**

NOTE: UL Fire Classified for up to 2 hour rated floors.

NOTE: Receptacles can be wired as a standard or isolated ground device.

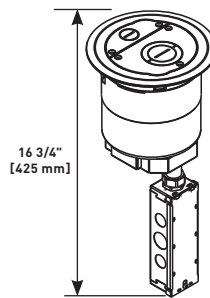
6ATCFF Recessed Furniture Feed Assembly with Surface Style Cover

For carpet, tile, wood and laminate concrete floor coverings. For use in 6" [152mm] diameter opening. Devices are recessed 3 1/4" [83mm] below floor surface. Die-cast aluminum cover assembly provides one (1) 3/4" trade size screw plug opening and one (1) concentric 2"-1 1/4" trade size screw plug opening and is available in the following powder coated finishes: black (6ATCBK), gray (6ATCGY), nickel (6ATCNK), brass (6ATCBS), and bronze (6ATCBZ).

NOTE: UL Fire Classified for up to 2 hour rated floors.

INCLUDED**For Side Compartments:**

- No Device Plates are provided.

For Center Compartment:

- No Device Plates are provided.

For Bottom Feed Compartment:

- One (1) 5PTHA 1/2-Gang Pass-Through Housing Assembly
- One (1) 15FFHA 1 1/2-Gang Pass-Through Housing Assembly
- One (1) 575CHA 1/2-Gang 3/4" Conduit Housing Assembly**

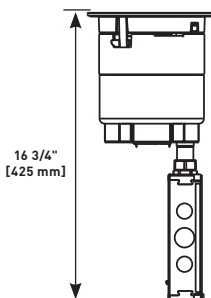
6ATPAV Recessed Prewired Audio/Video Assembly with Flush Style Cover

For tile, wood and laminate concrete floor coverings. For use in 6" [152mm] diameter opening. Devices are recessed 3 1/4" [83mm] below floor surface. Die-cast aluminum cover assembly is available in the following powder coated finishes: black (6ATPAVBK), gray (6ATPAVGY), nickel (6ATPAVNK), brass (6ATPAVBS), and bronze (6ATPAVBZ).

INCLUDED**For Side Compartments:**

- One (1) Proprietary 20AMP Duplex Power Receptacle installed
- One (1) 682A Device Plate
- One (1) 68MAAP Device Plate

For Center Device Compartment:

- One (1) 6DEC Mounting Plate
- One (1) 6AAP Mounting Plate
- One (1) 6MAAP Device Plate

For Bottom Feed Compartments:

- One (1) 5PTHA 1/2-Gang Pass-Through Housing Assembly
- One (1) 1PTHA 1-Gang Pass-Through Housing Assembly
- One (1) 575CHA 1/2-gang 3/4" Conduit Housing Assembly**

NOTE: UL Fire Classified for up to 2 hour rated floors.

NOTE: Receptacles can be wired as a standard or isolated ground device.

NOTE: Includes one (1) 6TS Tile Shim.

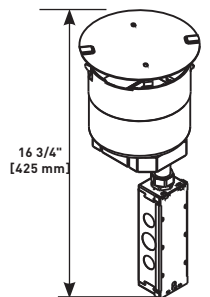
6STC Recessed Assembly with Disposable Plate

Includes 6" diameter poke-thru stem assembly with a disposable plate. Devices are recessed 3 1/4" [83mm] below floor surface. No cover assembly is included. For use with the following cover assemblies (purchased separately): 6CTC, 6CT Series, and 6CFFTC Series.

NOTE: UL Fire Classified for up to 2 hour rated floors.

INCLUDED**For Side Compartments:**

- No Device Plates are provided.

For Center Compartment:

- No Device Plates are provided.

For Bottom Feed Compartments:

- One (1) 5PTHA 1/2-Gang Pass-Through Housing Assembly
- One (1) 1PTHA 1-Gang Pass-Through Housing Assembly
- One (1) 575CHA 1/2-gang 3/4" Conduit Housing Assembly**

** Also includes junction box attached to the 3/4" conduit.

NOTE: For more information on Device Plates and Bottom Feed Plates and on the additional options available, see the Device Plates and Bottom Feed Plates sections found later in this document.

EVOLUTION™ 6AT SERIES POKE-THRU DEVICES

Evolution 6AT Series Poke-Thru Devices Ordering Information (continued)

6STCPAV Recessed Prewired Audio/Video Assembly with Disposable Plate

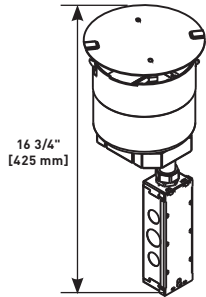

Includes 6" diameter poke-thru stem assembly with a disposable plate. Devices are recessed 3 1/4" [83mm] below floor surface. No cover assembly is included. For use with the following cover assemblies (purchased separately): 6CTC and 6CT Series.

INCLUDED

For Side Compartments:

- One (1) Proprietary 20AMP Duplex Power Receptacle installed
- One (1) 682A Device Plate
- One (1) 68MAAP Device Plate

For Center Compartment:

- One (1) 6DEC Mounting Plate
- One (1) 6AAP Mounting Plate
- One (1) 6MAAP Device Plate

For Bottom Feed Compartments:

- One (1) 5PTHA 1/2-Gang Pass-Through Housing Assembly
- One (1) 1PTHA 1-Gang Pass-Through Housing Assembly
- One (1) 575CHA 1/2-gang 3/4" Conduit Housing Assembly**

NOTE: UL Fire Classified for up to 2 hour rated floors.

NOTE: Receptacles can be wired as a standard or isolated ground device.

6STCP Recessed Prewired Assembly with Disposable Plate

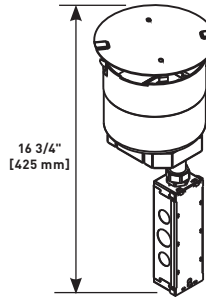

Includes 6" diameter poke-thru stem assembly with a disposable plate. Devices are recessed 3 1/4" [83mm] below floor surface. No cover assembly is included. For use with the following cover assemblies (purchased separately): 6CTC and 6CT Series.

INCLUDED

For Side Compartments:

- Two (2) Proprietary 20AMP Duplex Power Receptacles installed

For Center Compartment:

- One (1) 6ACT8A Mounting Plate
- One (1) 6TRAC Mounting Plate
- One (1) 6SER Mounting Plate

For Bottom Feed Compartment:

- One (1) 5BLH 1/2-Gang Blank Housing*
- One (1) 1PTHA 1-Gang Pass-Through Housing Assembly
- One (1) 575CHA 1/2-Gang 3/4" Conduit Housing Assembly**

NOTE: UL Fire Classified for up to 2 hour rated floors.

NOTE: Receptacles can be wired as a standard or isolated ground device.

* Tunneling extends from the 5BLH to 575CHA so that power cables from the 20A duplex receptacle mounted on the left side of the poke-thru device are run into the junction box attached to the 575CHA.

** Also includes junction box attached to the 3/4" conduit.

NOTE: For more information on Device Plates and Bottom Feed Plates and on the additional options available, see the Device Plates and Bottom Feed Plates sections found later in this document.

ABPLUG6 Abandonment Plug Assembly

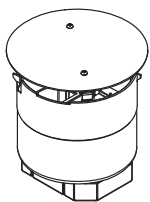

Complete abandonment plug assembly for 6" opening. Assembly includes intumescent fire stop material to maintain a 2 hour fire rating of the floor

6PPS 6" Pre-Pour Poke-Thru Sleeve

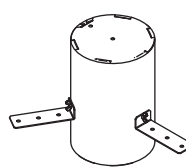

Nonmetallic sleeve attaches to structural decking and plywood decking designs while maintaining a 6"-6 1/8" diameter cast in hole. Unit includes three (3) attachment legs, two (2) end caps and three (3) thumb screws.

Evolution 6AT Series Cover Assemblies Ordering Information

6CTC* Surface Style Cover Assembly

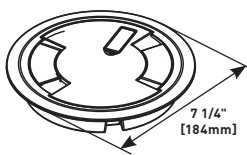

Die-cast aluminum cover assembly. Cover assembly is available in the following powder coated finishes: black (6CTCBK), gray (6CTCGY), nickel (6CTCNK), brass (6CTCBS), and bronze (6CTCBZ). 6CTC Series

cover assemblies designed for use with 6STCP, 6STC, and 6STCPAV Poke-Thru Stem Assemblies.

6CT* Flush Style Cover Assembly

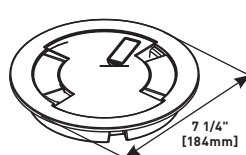

Die-cast aluminum cover assembly. Cover assembly is available in the following powder coated finishes: black (6CTBK), gray (6CTGY), nickel (6CTNK), brass (6CTBS), and bronze (6CTBZ). 6CT Series cover assemblies

designed for use with 6STCP, 6STC, and 6STCPAV Poke-Thru Stem Assemblies. Includes one (1) 6TS Tile Shim.

* Add suffix "TR" to the end of the part number to indicate tamper-resistant cover assembly. Tamper-resistant versions are secured with a single tamper-resistant screw.

EVOLUTION™ 6AT SERIES POKE-THRU DEVICES

Evolution 6AT Series Cover Assemblies Ordering Information (continued)

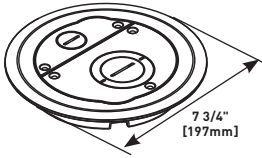
6CFFTC Furniture Feed Cover Assembly

Surface style, die-cast aluminum cover assembly, with one (1) 3/4" trade size screw plug opening, and one (1) concentric 2"-1 1/4" trade size screw plug opening. Cover assembly is available in the following powder coated finishes:

black (6CFFTCBK), gray (6CFFTCGY), nickel (6CFFTCNK), brass (6CFFTCBS), and bronze (6CFFTCBZ). 6CFFTC Series Cover Assemblies designed for use with 6STC Poke-Thru Stem Assembly. Includes one (1) 3/4" and one (1) 2" trade size conduit fittings and one (1) divider to separate devices

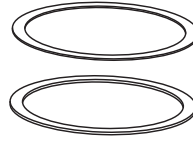
6TS Tile Shim

Used for floor coverings greater than 5/16" [7.9mm]. The 6TS will allow the top surface of the cover to be flush with the finished floor. Includes six (6) 1/16" [1.6mm] thick shims. Up to a total of 3/8" [9.5mm] of adjustment.

Evolution 6AT Series Center Mount Device Plates Ordering Information

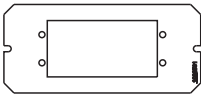
6AAP Device Plate

Device plate that will accept up to two (2) Extron® Electronics AAP style plates. For use in the center compartment only. Devices supplied by others.

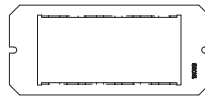
6MOS Mosaic Device Plate

Device plate will accept two (2) standard [45mm x 45mm] or one (1) standard [45mm x 90mm] Mosaic style device(s). Devices supplied by others.

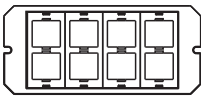
6ACT8A Device Plate

Device plate that will accept up to eight (8) ports of communication devices. For use in the center compartment only. Devices supplied by others.

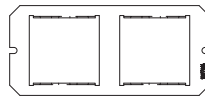
6MOSBS Mosaic British Standard Device Plate

Device plate will accept two (2) Mosaic British standard devices [45mm x 45mm]. Devices supplied by others.

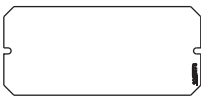
6B Device Plate

Device plate used to blank off center compartment, when no devices are used.

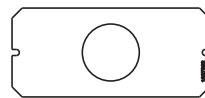
6S1 Device Plate

Receptacle opening 1 3/8" [35mm]. For 6" poke-thru units only.

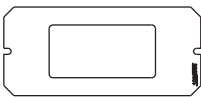
6DEC Device Plate

Device plates that will accept either decorator, GFCI, 106 style devices for power and audio/video applications.

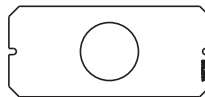
6S2 Device Plate

Receptacle opening 1 9/16" [40mm]. For 6" poke-thru units only.

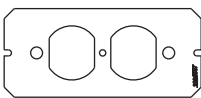
6DP Device Plate

Device plate that will accept standard 20A duplex receptacle or duplex Turnlok receptacle. For use in the center compartment only. Devices supplied by others.

6SER Device Plate

Device plate that will accept up to four (4) Ortronics® Series II dual modular inserts. For use in the center compartment only. Devices supplied by others.

EVOLUTION™ 6AT SERIES POKE-THRU DEVICES

Evolution 6AT Series Center Mount Device Plates Ordering Information (continued)

6MAAP Device Plate

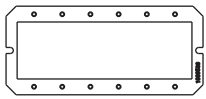

Device plate that will accept up to six (6) Legrand AVIP or Extron® Electronics MAAP style plates. For use in the center compartment only. Devices supplied by others.

6MAAP2A Device Plate

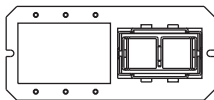

Combination device plate that will accept up to three (3) Legrand AVIP or Extron® Electronics MAAP style plates, and up to two (2) ports of communication devices. For use in the center compartment only. Devices supplied by others.

6TRAC Device Plate



Device plate that will accept up to eight (8) Ortronics® TracJack devices. For use in the center compartment only. Devices supplied by others.

6AT Center Mount Device Plate Mounting Location

Device Plates on this page can be installed in the shaded location indicated in this illustration.

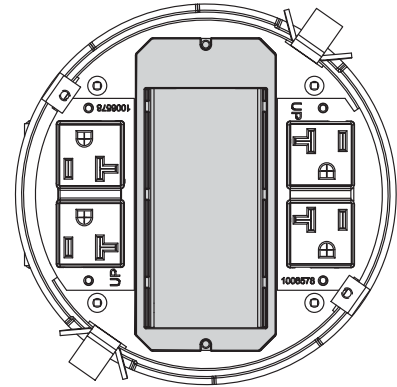

Evolution 6AT Series Side Mount Device Plates Ordering Information

68REC 20AMP Duplex Receptacles

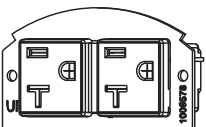

Two (2) proprietary 20AMP duplex power receptacles with mounting plates. Designed to fit in either of the two side compartments in both the 6ATC and the 8ATC Series Poke-Thru Devices. Receptacle can be wired as a standard or isolated ground device.

682A Device Plate

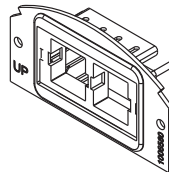

Device plate that will accept up to two (2) ports of communication devices. For use in either of the two side compartments only. Not for use in the center compartment. Communication devices supplied by others.

68B Device Plate



Blank plate. Used to blank off either of the side compartments when no devices or cabling are to be used.

682A-PT Device Plate

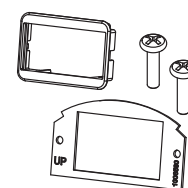

Device plate that allows for communication cabling to pass through. Includes one (1) rectangular adapter ring.

68MAAP Device Plate

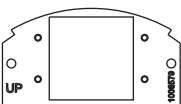

Device plate that will accept up to two (2) Legrand AVIP or Extron® Electronics MAAP device plates. For use in either of the two side compartments only. Not for use in the center compartment. Extron® Devices supplied by others.

68REC-25 20AMP Duplex Receptacles

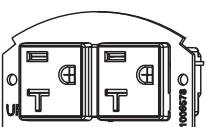

Two (2) proprietary 20AMP duplex power receptacles with mounting plates and 25' leads. Designed to fit in either of the two side compartments in both the 6ATC and the 8ATC Series Poke-Thru Devices. Receptacle can be wired as a standard or isolated ground device.

6AT Side Mount Device Plates Mounting Locations

Device Plates in this section can be installed in the shaded locations indicated in this illustration.

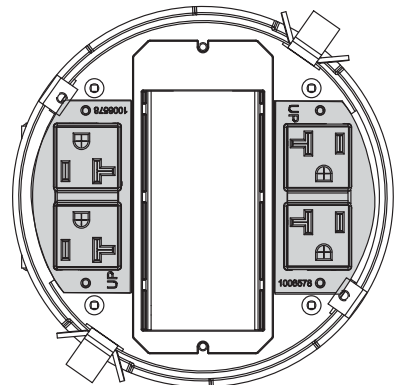

EVOLUTION™ 6AT SERIES POKE-THRU DEVICES

Evolution 6AT Series Bottom Feed Side Mount Device Plates Ordering Information

5PTHA Bottom Housing Assembly

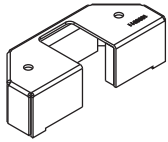

Half-gang pass through housing assembly. Designed to allow pass through of communication cables when no conduit is required. For use on side compartments only.

5BLH Bottom Housing Assembly

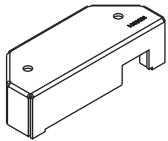

Half-gang blank housing assembly. Designed to blank off compartment when no devices are used. Includes tunnel for 6AT and 8AT Series Poke-Thru Devices. For use on side compartments only.

152CHA Bottom Housing Assembly

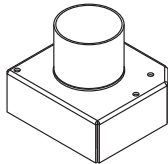

One and a half-gang 2" trade size conduit housing assembly. Recommended for use with furniture feed devices (6ATCFF). Covers the center compartment and one of the side compartments.

575CHA Bottom Housing Assembly

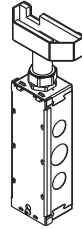

Half-gang 3/4" trade size conduit housing assembly. Includes junction box attached to 3/4" trade size conduit for electrical power connections. For use on side compartments only.

6AT Bottom Feed Side Mount Device Plate Mounting Locations

Device Plates in this section can be installed in the shaded locations indicated in this illustration.

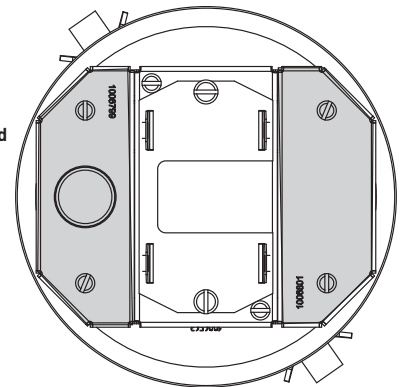

Evolution 6AT Series Bottom Feed Center Mount Device Plates Ordering Information

175CHA Bottom Housing Assembly

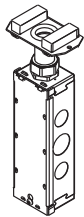

One-gang 3/4" trade size conduit housing assembly. Includes junction box attached to 3/4" trade size conduit for electrical power connections.

NOTE: When using on a 6ATCFF Furniture Feed unit, 1BHA (sold separately) is required.

1PTHA Bottom Housing Assembly

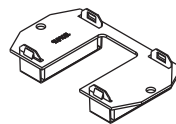

One-gang pass through housing assembly. Designed to allow pass through of communication cables when no conduit is required.

NOTE: When using on a 6ATCFF Furniture Feed unit, 1BHA (sold separately) is required.

175CHA-LJB Bottom Housing Assembly

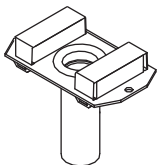

One-gang 3/4" trade size conduit housing assembly. Junction box not included.

NOTE: When using on a 6ATCFF Furniture Feed unit, 1BHA (sold separately) is required.

1BLH Bottom Housing Assembly

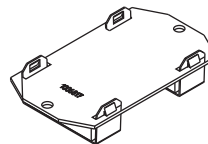

One-gang blank housing assembly. Designed to blank off compartment when no devices are used.

NOTE: When using on a 6ATCFF Furniture Feed unit, 1BHA (sold separately) is required.

1125CHA Bottom Housing Assembly

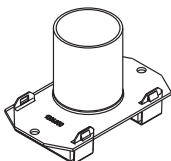

One-gang 1 1/4" conduit housing assembly.

NOTE: When using on a 6ATCFF Furniture Feed unit, 1BHA (sold separately) is required.

15FFHA Bottom Housing Assembly

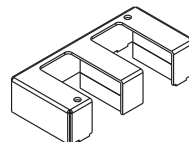

One and a half-gang pass through conduit housing assembly. Used for furniture feed applications on the center compartment only. Only for use with 6AT Series units.

EVOLUTION™ 6AT SERIES POKE-THRU DEVICES

Evolution 6AT Series Bottom Feed Center Mount Device Plates Ordering Information

1BHA Bottom Housing Assembly

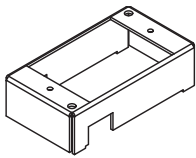

One-gang bottom housing assembly. Designed to accept 175CHA, 175CHA-LJB, 1125CHA, 1PTHA, and 1BLH plates.

6AT Bottom Feed Center Mount Device Plate Location

All Bottom Housing Assemblies on this page can be installed in the shaded locations indicated in this illustration.

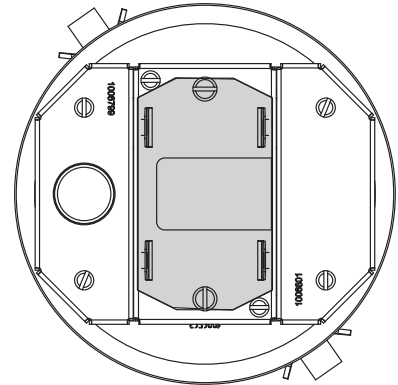

Copper Cross Sectional Area of Commonly Used Conductors

SIZE	SOLID
#24	0.00032 sq. in. [0.20645mm ²]
#22	0.00050 sq. in. [0.32258mm ²]
#14	0.00323 sq. in. [2.08386mm ²]
#12	0.00512 sq. in. [3.30321mm ²]
#10	0.00815 sq. in. [5.25805mm ²]
#8	0.01296 sq. in. [8.36127mm ²]

6AT Hole Sizes

FLOOR TYPE	HOLE SIZE (Min.)	HOLE SIZE (Max.)
Covered Floors (Carpet, Tile or Wood)	6" [152mm]	6 1/8" [156mm]
Bare Concrete or Terrazzo	6 1/16" [154mm]	6 1/8" [156mm]

NOTE: Use above values for solid or stranded conductors.

CAUTION: Receptacle supplied with this Poke-Thru is not suitable for direct field wiring. Contact manufacturer for replacement. Field modifications will void UL Listing and Classification. Replacement receptacle is limited to this manufacturers' Catalog No 68REC.

6AT Copper Cross-Section

	OUTER CHANNELS	CENTER CHANNEL
Max Copper X Section	0.0154 sq. in. [9.9mm ²]	0.0387 sq. in. [24.97mm ²]
Max # Conductors	(3) 12 AWG or (4) Cat 6A	(12) 14 AWG or (12) Cat 6A

6ATCFF Copper Cross-Section – Furniture Feed Poke-Thru Devices

	POWER CHANNEL	DATA CHANNEL (CENTER)	DATA CHANNEL (OUTSIDE)
Max Copper X Section	.0815 sq. in. [52.6mm ²]	0.0686 sq. in. [44.3mm ²]	0.0187 [12.1mm ²]
Max # Conductors	(10) 10 AWG	(22) Cat 6a	(6) Cat 6a

NOTE: When using conductor sizes other than listed above, the aggregate cross-sectional area of the copper conductors shall not exceed the cross-sectional areas listed.

EVOLUTION™ 8AT SERIES POKE-THRU DEVICES



Evolution™ 8AT Series Poke-Thru Devices allow all power and communication devices to be recessed below floor level, and provide 4-gang capacity for power, communication, and A/V devices.

CODE REFERENCE

cULus Listed Metallic Outlet Boxes:
File E2961 Guide QCIT.

cULus Listed Nonmetallic Outlet Boxes and Fittings Classified for Fire Resistance:
File R8209 Guide CEYY.

Meets Article 300.21, 300.22(C) & 314 of NEC.



Evolution Series 8CTC Cover Assembly Lids open a full 180° to reduce the risk of damage when plugging in devices.



Cover Assemblies for the 8AT Series Poke-Thru Devices are available in a variety of finishes and service configurations for carpet or tile floor installations.

HOLE DIAMETER	
Minimum:	8" [203mm]
Maximum:	8 1/8" [206mm]

COLOR OPTIONS



Evolution 8AT Series parts are available in the following powder coated finishes: "BK" black, "GY" gray, "NK" nickel, "BS" brass, and "BZ" bronze.

Custom color options are also available. Consult the factory for more information.

EVOLUTION™ 8AT SERIES POKE-THRU DEVICES

Evolution 8AT Series Poke-Thru Devices Ordering Information

8ATCP Recessed Prewired Assembly with Surface Style Cover

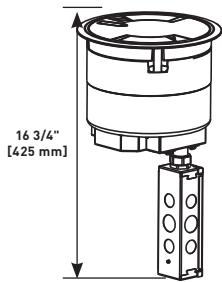

For carpet, tile, wood and laminate concrete floor coverings. For use in 8" [203mm] diameter opening. Devices are recessed 3 1/4" [83mm] below floor surface. Die-cast aluminum cover assembly is available in the following powder coated finishes: black (8ATCPBK), gray (8ATCPGY), nickel (8ATCPNK), brass (8ATCPBS), and bronze (8ATCPBZ).

NOTE: UL Fire Classified for up to 2 hour rated floors.

NOTE: Receptacles can be wired as a standard or isolated ground device.

INCLUDED

For Side Compartments:

- Two (2) proprietary 20AMP Duplex Receptacles installed

For Center Compartments:

- No Device Plates are provided

For Bottom Feed Compartments:

- One (1) 5BLH 1/2-Gang Blank Housing*
- Three (3) 1PTHA 1-Gang Pass-Through Housing Assembly
- One (1) 575CHA 1/2-Gang 3/4" Conduit Housing Assembly**
- One (1) 8DIV 8" Divider

8ATC Recessed Assembly with Surface Style Cover

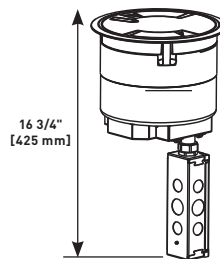

For carpet, tile, wood and laminate concrete floor coverings. For use in 8" [203mm] diameter opening. Devices are recessed 3 1/4" [83mm] below floor surface. Die-cast aluminum cover assembly is available in the following powder coated finishes: black (8ATCBK), gray (8ATCGY), nickel (8ATCNK), brass (8ATCBS), and bronze (8ATCBZ).

NOTE: UL Fire Classified for up to 2 hour rated floors.

INCLUDED

For Side Compartments:

- No Device Plates are provided

For Center Compartments:

- No Device Plates are provided

For Bottom Feed Compartments:

- One (1) 5PTHA 1/2-Gang Pass-Through Housing Assembly
- Three (3) 1PTHA 1-Gang Pass-Through Housing Assembly
- One (1) 575CHA 1/2-gang 3/4" Conduit Housing Assembly**
- One (1) 8DIV 8" Divider

8ATP Recessed Prewired Assembly with Flush Style Cover

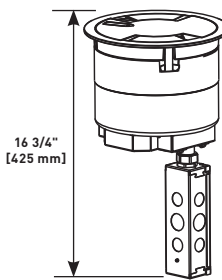

For tile, wood and laminate concrete floor coverings. For use in 8" [203mm] diameter opening. Devices are recessed 3 1/4" [83mm] below floor surface. Die-cast aluminum cover assembly is available in the following powder coated finishes: black (8ATPBK), gray (8ATPGY), nickel (8ATPNK), brass (8ATPBS), and bronze (8ATPBZ). Includes one (1) 8TS Tile Shim.

NOTE: UL Fire Classified for up to 2 hour rated floors.

NOTE: Receptacles can be wired as a standard or isolated ground device.

INCLUDED

For Side Compartments:

- Two (2) proprietary 20 Amp Duplex Receptacles installed

For Center Compartments:

- No Device Plates are provided

For Bottom Feed Compartments:

- One (1) 5BLH 1/2-Gang Blank Housing*
- Three (3) 1PTHA 1-Gang Pass-Through Housing Assembly
- One (1) 575CHA 1/2-Gang 3/4" Conduit Housing Assembly**
- One (1) 8DIV 8" Divider
- One (1) 8TS Tile Shim

8AT Recessed Assembly with Flush Style Cover

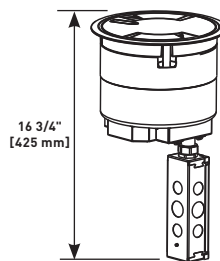

For tile, wood and laminate concrete floor coverings. For use in 8" [203mm] diameter opening. Devices are recessed 3 1/4" [83mm] below floor surface. Die-cast aluminum cover assembly is available in the following powder coated finishes: black (8ATBK), gray (8ATGY), nickel (8ATNK), brass (8ATBS), and bronze (8ATBZ). Includes one (1) 8TS Tile Shim.

NOTE: UL Fire Classified for up to 2 hour rated floors.

INCLUDED

For Side Compartments:

- No Device Plates are provided

For Center Compartments:

- No Device Plates are provided

For Bottom Feed Compartments:

- One (1) 5PTHA 1/2-Gang Pass-Through Housing Assembly*
- Three (3) 1PTHA 1-Gang Pass-Through Housing Assembly
- One (1) 575CHA 1/2-gang 3/4" Conduit Housing Assembly**
- One (1) 8DIV 8" Divider
- One (1) 8TS Tile Shim

* Tunneling extends from the 5BLH to 575CHA so that power cables from the 20A duplex receptacle mounted on the left side of the poke-thru device are run into the junction box attached to the 575CHA.

** Also includes junction box attached to the 3/4" conduit.

NOTE: For more information on Device Plates and Bottom Feed Plates and on the additional options available, see the Device Plates and Bottom Feed Plates sections found later in this document.

EVOLUTION™ 8AT SERIES POKE-THRU DEVICE

Evolution 8AT Series Poke-Thru Devices Ordering Information (continued)

8STC Recessed Assembly with Disposable Plate

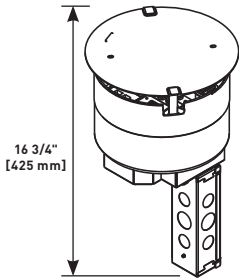

NOTE: UL Fire Classified for up to 2 hour rated floors.

Includes 8" diameter poke-thru stem assembly with a disposable plate. Devices are recessed 3 1/4" [83mm] below floor surface. No cover assembly is included. For use with the following cover assemblies (purchased separately): 8CTC and 8CT Series.

INCLUDED

For Side Compartments:

- No Device Plates are provided

For Center Compartments:

- No Device Plates are provided

For Bottom Feed Compartments:

- One (1) 5PTHA 1/2-Gang Pass-Through Housing Assembly
- Three (3) 1PTHA 1-Gang Pass-Through Housing Assembly
- One (1) 575CHA 1/2-gang 3/4" Conduit Housing Assembly**
- One (1) 8DIV 8" Divider

8STCP Recessed Prewired Assembly with Disposable Plate

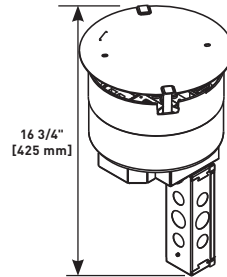

NOTE: UL Fire Classified for up to 2 hour rated floors.

NOTE: Receptacles can be wired as a standard or isolated ground device.

Includes 8" diameter poke-thru stem assembly with a disposable plate. Devices are recessed 3 1/4" [83mm] below floor surface. No cover assembly is included. For use with the following cover assemblies (purchased separately): 8CTC and 8CT Series.

INCLUDED

For Side Compartments:

- Two (2) proprietary 20 Amp Duplex Receptacles installed
- No Device Plates are provided

For Center Compartments:

- No Device Plates are provided

For Bottom Feed Compartments:

- One (1) 5BLH - 1/2-Gang Blank Housing*
- Three (3) 1PTHA - 1-Gang Pass-Through Housing Assembly
- One (1) 575CHA - 1/2-gang 3/4" Conduit Housing Assembly**
- One (1) 8DIV 8" Divider

NOTE: For more information on Device Plates and Bottom Feed Plates and on the additional options available, see the Device Plates and Bottom Feed Plates sections found later in this document.

* Tunneling extends from the 5BLH to 575CHA so that power cables from the 20A duplex receptacle mounted on the left side of the poke-thru device are run into the junction box attached to the 575CHA.

** Also includes junction box attached to the 3/4" conduit.

8PPS 8" Pre-Pour Poke-Thru Sleeve

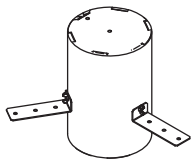

Nonmetallic sleeve attaches to structural decking and plywood decking designs while maintaining a 8"-8 1/8" diameter cast in hole. Unit includes three (3) attachment legs, two (2) end caps and three (3) thumb screws.



NOTE: Pre-Pour Sleeves for 6" (6PPS) and 8" (8PPS) Evolution Series Poke-Thru Devices speed installation and insure accurate location of devices.

ABPLUG8 Abandonment Plug

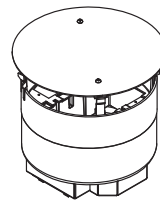

Complete abandonment plug assembly for 8" diameter hole. Assembly comes complete with intumescent material to maintain a 2-hour fire classification of the floor.

EVOLUTION™ 8AT SERIES POKE-THRU DEVICES

Evolution 8AT Series Poke-Thru Devices Cover Assemblies Ordering Information

8CTC* Surface Style Cover Assembly

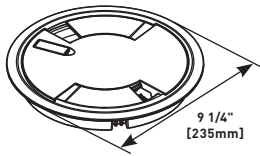

Die-cast aluminum cover assembly. Cover assembly is available in the following powder coated finishes: black (8CTCBK*), gray (8CTCGY*), nickel (8CTCNK*), brass (8CTCBS*), and bronze (8CTCBZ*). 8CTC Series Cover Assemblies designed for use with 8STC and 8STCP Poke-Thru Stem Assemblies.

8CT* Flush Style Cover Assembly

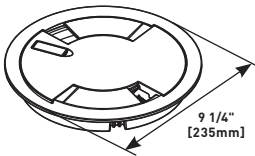

Die-cast aluminum cover assembly. Cover assembly is available in the following powder coated finishes: black (8CTBK*), gray (8CTGY*), nickel (8CTNK*), brass (8CTBS*), and bronze (8CTBZ*). 8CTC Series Cover Assemblies designed for use with 8STC and 8STCP Poke-Thru Stem Assemblies. Includes one (1) 8TS Tile Shim.

8TS Tile Shim

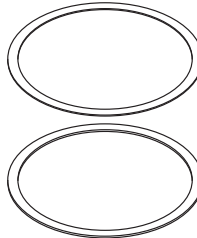

Used for floor coverings greater than 5/16" [7.9mm]. The 8TS will allow the top surface of the cover to be flush with the finished floor. Includes six (6) 1/16" [1.6mm] thick shims. Up to a total of 3/8" [9.5mm] of adjustment.

* Add suffix "TR" to the end of the part number to indicate tamper-resistant cover assembly. Tamper-resistant versions are secured with a single tamper-resistant screw.

Evolution 8AT Series Center Mount Device Plates Ordering Information

8B Device Plate



Single-gang device plate used to blank off any one (1) of the three (3) gangs in the center compartment, when no devices are used.

8MOS Mosaic Device Plate

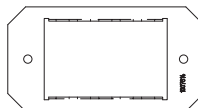

Device plate accepts three (3) standard Mosaic devices [45mm x 22.5mm]. Devices supplied by others.

8DP Device Plate



Single-gang device plate that accepts standard 20A duplex receptacle or duplex Turnlok receptacle. Fits in any one (1) of the three (3) gangs in the center compartment. Devices supplied by others.

8CREST Crestron Double Gang Plate

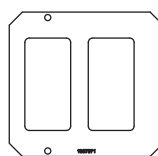

Device plate accepts Crestron double-gang decorator style devices.

8DEC Device Plate

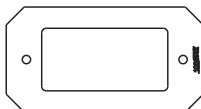

Device plates that will accept either decorator, GFCI, 106 style devices for power and audio/video applications.

8S1 Device Plate

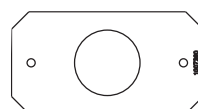

Receptacle opening 1 3/8" [35mm]. For 8" poke-thru units only.

8ACT6A Device Plate

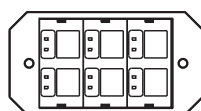

Single-gang device plate that will accept up to six (6) ports of communication devices. Fits in any one (1) of the three (3) gangs in the center compartment. Devices supplied by others.

8S2 Device Plate

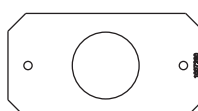

Receptacle opening 1 9/16" [40mm]. For 8" poke-thru units only.

EVOLUTION™ 8AT SERIES POKE-THRU DEVICES

Evolution 8AT Series Center Mount Device Plates Ordering Information (continued)

8TRAC Device Plate

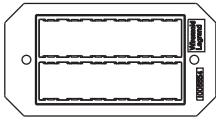

Single-gang device plate that will accept up to six (6) Ortronics® TracJack devices. Fits in any one (1) of the three (3) gangs in the center compartment. Devices supplied by others.

8SER Device Plate

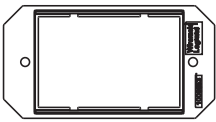

Single-gang device plate that will accept up to three (3) Ortronics® Series II dual modular inserts. Fits in any one (1) of the three (3) gangs in the center compartment. Devices supplied by others.

8MAAP Device Plate

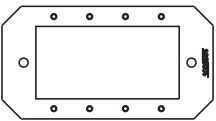

Single-gang device plate that will accept up to four (4) Legrand AVIP or Extron® Electronics MAAP style plates. Fits in any one (1) of the three (3) gangs in the center compartment. Devices supplied by others.

8AAP Device Plate

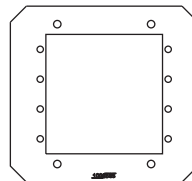

Two-gang device plate that will accept up to four (4) Extron® Electronics AAP style plates. 8AAP takes up 2 of the 3 gangs in the center compartment. Devices supplied by others.

8CREST3G Device Plate

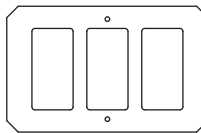

Three-gang device plate that will accept Crestron® or Extron® Electronics triple-gang decorator style devices. Takes up all 3 gangs in the center compartment. Devices supplied by others.

8AT Center Mount Device Plate Mounting Locations

Device Plates on this page can be installed in the shaded location indicated in this illustration.

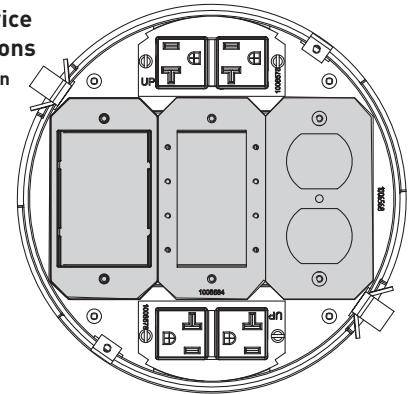

Evolution 8AT Series Side Mount Device Plates Ordering Information

68REC 20AMP Duplex Receptacles

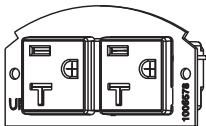

Two proprietary 20AMP duplex power receptacles with mounting plates. Designed to fit in either of the two side compartments in both the 6ATC and the 8ATC Series Poke-Thru Devices. Receptacle can be wired as a standard or isolated ground device.

68MAAP Device Plate

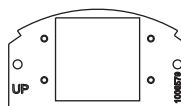

Device plate that will accept up to two (2) Legrand AVIP or Extron® Electronics MAAP device plates. For use in either of the two side compartments only. Not for use in the center compartment. Extron Devices supplied by others.

68B Device Plate



Blank plate. Used to blank off either of the side compartments when no devices or cabling are to be used.

68REC-25 20AMP Duplex Receptacles

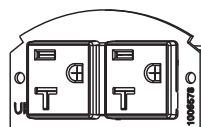

Two (2) proprietary 20AMP duplex power receptacles with mounting plates and 25' leads. Designed to fit in either of the two side compartments in both the 6ATC and the 8ATC Series Poke-Thru Devices. Receptacle can be wired as a standard or isolated ground device.

EVOLUTION™ 8AT SERIES POKE-THRU DEVICES

Evolution 8AT Series Side Mount Device Plates Ordering Information (continued)

682A Device Plate

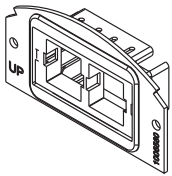

Device plate that will accept up to two (2) ports of communication devices. For use in either of the two side compartments only. Not for use in the center compartment. Communication devices supplied by others.

682A-PT Device Plate

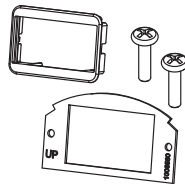

Device plate that allows for communication cabling to pass through. Includes one (1) rectangular adapter ring.

8AT Side Mount Device Plates Mounting Locations

Device Plates in this section can be installed in the shaded locations indicated in this illustration.

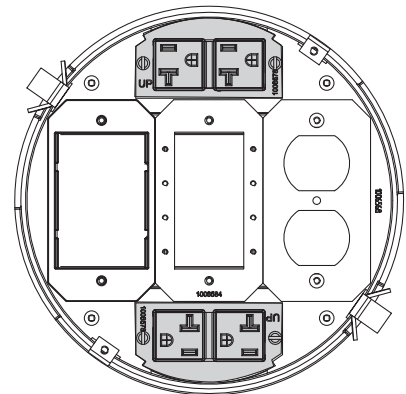

Evolution 8AT Series Bottom Feed Side Mount Device Plates Ordering Information

5PTHA Bottom Housing Assembly

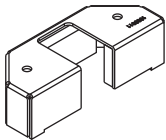

Half-gang pass through housing assembly. Designed to allow pass through of communication cables when no conduit is required. For use on side compartments only.

5BLH Bottom Housing Assembly

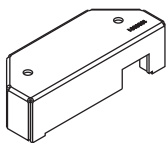

Half-gang blank housing assembly. Designed to blank off compartment when no devices are used. Includes tunnel for 6AT and 8AT Series Poke-Thru Devices. For use on side compartments only.

575CHA Bottom Housing Assembly

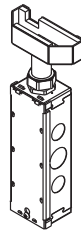

Half-gang 3/4" trade size conduit housing assembly. Includes junction box attached to 3/4" trade size conduit for electrical power connections. For use on side compartments only.

8AT Bottom Feed Side Mount Device Plate Mounting Locations

Device Plates in this section can be installed in the shaded locations indicated in this illustration.

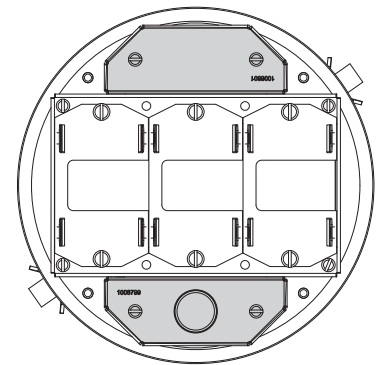

EVOLUTION™ 8AT SERIES POKE-THRU DEVICES

Evolution 8AT Series Bottom Feed Center Mount Device Plates Ordering Information

175CHA Bottom Housing Assembly

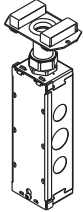

One-gang 3/4" trade size conduit housing assembly. Includes junction box attached to 3/4" trade size conduit for electrical power connections. For use on any one (1) of the three (3) gangs in the center compartment.

1BLHN Bottom Housing Assembly

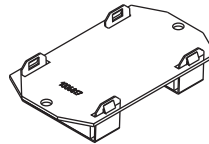

One-gang blank housing assembly. Designed to blank off compartment when no cable pass through is required. For use on any one (1) of the three (3) gangs in the center compartment.

1125CHA Bottom Housing Assembly

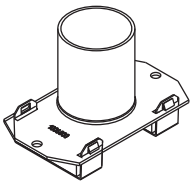

One-gang 1 1/4" trade size conduit housing assembly. For use on any one (1) of the three (3) gangs in the center compartment.

22CHA Bottom Housing Assembly

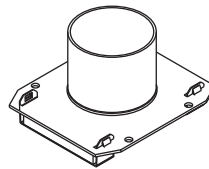

Two-gang 2" trade size conduit housing assembly. Used on 8AT Series devices. Covers two (2) of the three (3) gangs in the center compartment. Only for use with 8AT Series units.

175CHA-LJB Bottom Housing Assembly

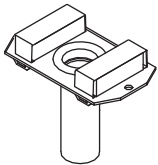

One-gang 3/4" trade size conduit housing assembly. Junction box not included.

8AT Bottom Feed Center Mount Device Plate Locations

All Bottom Housing Assemblies on this page can be installed in the shaded locations indicated in this illustration.

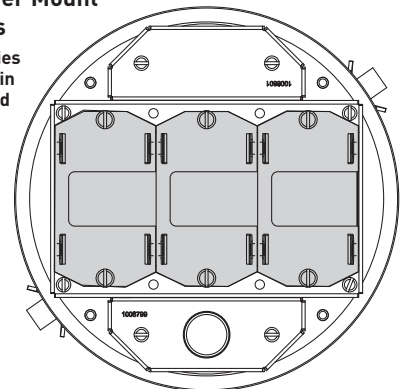

1PTHA Bottom Housing Assembly

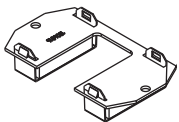

One-gang pass through housing assembly. Designed to allow pass through of communication cables when no conduit is required. For use on any one (1) of the three (3) gangs in the center.

8DIV 8" [203mm] Divider

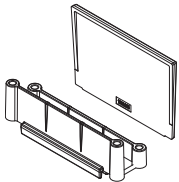

Divider allows for separation of services when required.

Copper Cross Sectional Area of Commonly Used Conductors

SIZE	SOLID	
#24	0.00032 sq. in.	[0.20645mm ²]
#22	0.00050 sq. in.	[0.32258mm ²]
#14	0.00323 sq. in.	[2.08386mm ²]
#12	0.00512 sq. in.	[3.30321mm ²]
#10	0.00815 sq. in.	[5.25805mm ²]
#8	0.01296 sq. in.	[8.36127mm ²]

NOTE: Use above values for solid or stranded conductors.

CAUTION: Receptacle supplied with this Poke-Thru is not suitable for direct field wiring. Contact manufacturer for replacement. Field modifications will void UL Listing and Classification. Replacement receptacle is limited to this manufacturers' Catalog No 68REC.

8AT Copper Cross-Section

	OUTER CHANNELS	CENTER CHANNEL
Max Copper X-Section	0.0154 sq. in. [9.9mm ²]	0.0775 sq. in. [16.60mm ²]
Max # Conductors	{3} 12 AWG or {4} Cat 6A	{24} 14 AWG or {24} Cat 6A

NOTE: When using conductor sizes other than listed above, the aggregate cross-sectional area of the copper conductors shall not exceed the cross-sectional areas listed.

8AT Hole Sizes

FLOOR TYPE	HOLE SIZE (MIN.)	HOLE SIZE (MAX.)
Covered Floors (Carpet, Tile or Wood)	8" [203mm]	8 1/8" [206mm]
Bare Concrete or Terrazzo	8 1/16" [205mm]	8 1/8" [266mm]

RC7 SERIES™ POKE-THRU DEVICES

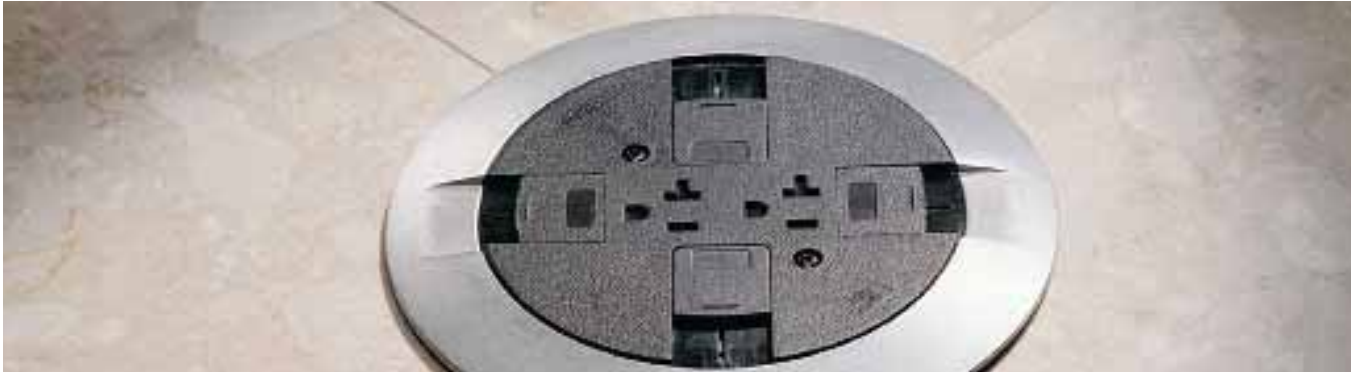

RC7 Series™ Surface Style Poke-Thru Devices provide one (1) 20A duplex power device and up to two (2) ports of communication.

CODE REFERENCE

cULus Listed Metallic Outlet Boxes:
File E2961 Guide QCIT.

cULus Listed Nonmetallic Outlet Boxes & Fittings Classified for Fire Resistance:
File R8209 Guide CEYY.

Meets Article 300.21, 300.22(C) & 314 of NEC.



RC7 Series Poke-Thru Device.

HOLE DIAMETER	
Minimum:	3 1/16" [78mm]
Maximum:	3 1/8" [79mm]

COLOR OPTIONS



RC7 Series parts are available in gray "GY", black "BK", brushed aluminum "AL", brass "BS", ivory "VY", and brass-colored finish "AB".

Custom color options are also available. Consult the factory for more information.

RC7 SERIES™ POKE-THRU DEVICES

RC7 Series Poke-Thru Devices Ordering Information

RC7STC Insert Assembly with Disposable Plate

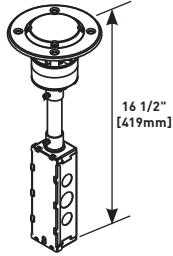

Used with RC7CTC Series Covers to complete installation.

RC7SHTC Slide Holder Assembly

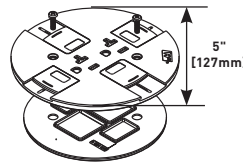

Nonmetallic slide holder assembly. Available in black (RC7SHTCBK), gray (RC7SHTCGY), ivory (RC7SHTCVY), nonmetallic brass (RC7SHTCBS), and nonmetallic aluminum (RC7SHTCAA). Assembled with scrub water gasket. For use on tile or carpet floors.

RC7CTC Assembled Poke-Thru Device

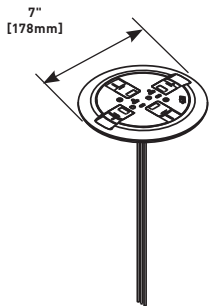

Prewired 20A duplex receptacle can be wired as standard duplex or isolated ground. Flanges available painted in gray (RC7CTCGY), black (RC7CTCBK), ivory (RC7CTCVY). Flanges also available in plated brushed brass (RC7CTCBS) and brushed aluminum (RC7CTCAL). Slide covers match the painted flange colors, gray, black, ivory. Aluminum and brass flanges shipped with black slide cover. Brass flange also available with nonmetallic brass colored slide holder (RC7CTCAB). Aluminum flange also available with nonmetallic aluminum color slide holder (RC7CTCAA). Includes Wiremold Open System unloaded inserts.

NOTE: Includes two Cat 6 TechChoice discrete keystone connectors, two Ortronics TracJack adapters, and two Wiremold Open System adapters.

RC7APTC Abandonment Plate

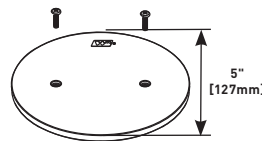

Abandonment available in black (RC7APTGBK) or gray (RC7APTGGY).

NOTE: To abandon the RC7 Series Poke-Thru Device, the internal gasket, duplex receptacle, and communication modules must not be removed in order to maintain UL Classification. Also the stem must remain in the hole.

RC37REC, RC37REC-25 Replacement Receptacle



Prewired snap-in 20A receptacle can be wired as standard duplex or isolated ground. Available only in black. See installation instructions with replacement receptacle for complete installation details. The RC37REC-25 is available with 25 foot leads and can be wired as standard duplex or isolated ground.

RC7ATC Assembled Poke-Thru Device

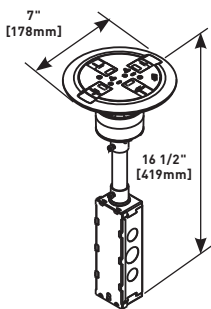

Prewired 20A duplex receptacle can be wired as standard duplex or isolated ground. Flanges available painted in gray (RC7ATCGY), black (RC7ATCBK), ivory (RC7ATCVY). Flanges also available in plated brushed brass (RC7ATCBS) and brushed aluminum (RC7ATCAL). Slide covers match the painted flange colors, gray, black, ivory. Aluminum and brass flanges shipped with black slide cover. Brass flange also available with nonmetallic brass colored slide holder (RC7ATCAB).

Aluminum flange also available with nonmetallic aluminum color slide holder (RC7ATCAA). Includes Wiremold Open System unloaded inserts.

NOTE: Assembled with scrub water gasket. For use on tile or carpet floors.

NOTE: RC7 Series Poke-Thru Devices require a 3 1/16" [78mm] diameter hole. Not designed to work with bare concrete or terrazzo. Floor covering thickness 1/8" minimum.

ABPLUG3 Abandonment Plug Assembly

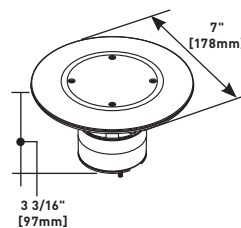

Complete plug assembly for abandoning an open 3" [76mm] diameter hole. Assembly includes intumescent fire-stop material to maintain the fire-classification of the floor, integral retainer ring to prevent the unit from pulling up through the floor, and a black die-cast aluminum cover.

COM50, COM75 Communication Adapter

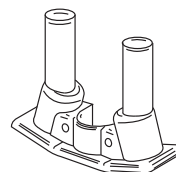

For two 1/2" trade size conduit connections (COM50). For two 3/4" trade size conduit connections (COM75). No additional capacity with COM75.

NOTE: RC7 Series Poke-Thru Devices require a 3 1/16" [78mm] diameter hole. Not designed to work with bare concrete or terrazzo. Floor covering thickness 1/8" minimum.

RC9 SERIES™ POKE-THRU DEVICES



RC9 Series™ Surface Style Poke-Thru Devices provide a 15 Amp quad power device and two (2) openings for communication pass-through.

CODE REFERENCE

cULus Listed Metallic Outlet Boxes:
File E2961 Guide QCIT.

cULus Listed Nonmetallic Outlet Boxes & Fittings Classified for Fire Resistance:
File R8209 Guide CEYY.

Meets Article 300.21, 300.22(C) & 314 of NEC.



RC9 Series Poke-Thru Device (RC9A15TCAL) installed in a tile floor.

HOLE DIAMETER

Minimum:	3 1/16" [78mm]
Maximum:	3 1/8" [79mm]

COLOR OPTIONS



RC9 Series parts are available in gray "GY", black "BK", brushed aluminum "AL", brass "BS", ivory "VY", and a brass-colored finish "AB".

Custom color options are also available. Consult the factory for more information.

RC9 SERIES™ POKE-THRU DEVICES

RC9 Series Poke-Thru Devices Ordering Information

RC9STC Insert Assembly with Disposable Plate

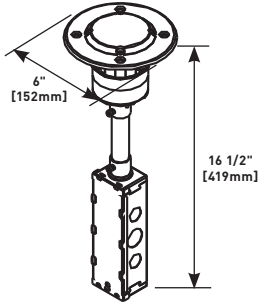

Includes prewired 15A quad receptacle. Use with RC9C Series Covers to complete installation.

RC9SHTC Nonmetallic Slide Holder Assembly

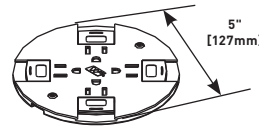

Available in gray (RC9SHTCGY), black (RC9SHTCBK), ivory (RC9SHTCVY), nonmetallic brass (RC9SHTCBS), and nonmetallic aluminum (RC9SHTCAA).

NOTE: Assembled with scrub water gasket. For use on tile or carpet floors.

RC9CTC Finish Flange & Slide Holder Assembly

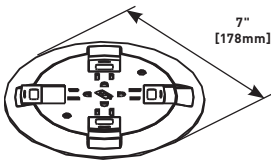

Flange available in painted gray (RC9CTCGY), black (RC9CTCBK), ivory (RC9CTCVY), and brushed metal finishes in aluminum (RC9CTCAL) and brass (RC9CTCBS). Aluminum and brass flanges shipped with black

cover. Brass flange also available with brass colored cover assembly (RC9CTCAB). Aluminum flange also available with aluminum colored cover assembly (RC9CTCAA). Cover assembly also includes two openings for pass-through capability for one 4-pair Category 5e or Category 6 cable per opening.

NOTE: Assembled with scrub water gasket. For use on tile or carpet floors.

RC9APTC Abandonment Plate

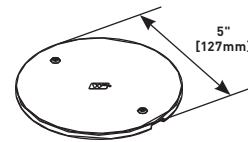

Abandonment available in black (RC9APTCBK).

NOTE: To abandon the RC9 Series Poke-Thru Device, the internal gasket and quad receptacle must not be removed in order to maintain UL Classification. Also, the stem must remain in the hole.

RC9A15TC Assembled Poke-Thru Device

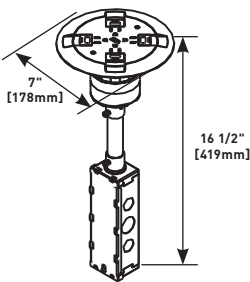

Prewired 15A quad receptacle can be wired as standard quad receptacle or isolated ground. Flange available in painted gray (RC9A15TCGY), black (RC9A15TCBK), ivory (RC9A15TCVY), and brushed metal finishes in aluminum (RC9A15TCAL) and brass (RC9A15TCBS). Aluminum and brass flanges shipped with black cover. Brass flange also available with brass colored cover assembly

(RC9A15TCAB). Aluminum flange also available with aluminum colored cover assembly (RC9A15TCAA). Unit also includes two openings for pass-through capability for one 4-pair Category 5e or Category 6 cable per opening.

NOTE: Assembled with scrub water gasket. For use on tile or carpet floors.

NOTE: RC9 Series Poke-Thru Devices require a 3 1/16" [78mm] diameter hole. Not designed to work with bare concrete or terrazzo. Floor covering thickness 1/8" minimum.

RC9REC, RC9REC-25 Replacement Receptacle

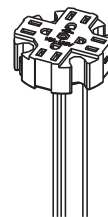

Prewired 15A quad receptacle can be wired as standard receptacle or isolated ground. Available only in black. See installation instructions with replacement receptacle for complete installation details. Receptacle also available with 25' leads (RC9REC-25).

ABPLUG3 Abandonment Plug Assembly

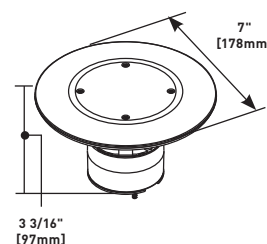

Complete plug assembly for abandoning an open 3" [76mm] diameter hole. Assembly includes intumescent fire-stop material to maintain the fire-classification of the floor, integral retainer ring to prevent the unit from pulling up through the floor, and a black die-cast aluminum cover.

RC9AMD SERIES™ POKE-THRU DEVICES



RC9AMD Series™ Surface Style Poke-Thru Devices provide up to four (4) ports of communication.

CODE REFERENCE

cULus Listed Metallic Outlet Boxes:
File E2961 Guide QCIT.

cULus Listed Nonmetallic Outlet Boxes & Fittings Classified for Fire Resistance:
File R8209 Guide CEYY.

Meets Article 300.21, 300.22(C) & 314 of NEC.



RC9AMD Series Poke-Thru Device (RC9AMDTCAL) installed in a carpeted floor.

HOLE DIAMETER

Minimum:	3" [76mm]
Maximum:	3 1/8" [79mm]

COLOR OPTIONS



RC9AMD Series parts are available in gray "GY", black "BK", brushed aluminum "AL", brass "BS", ivory "VY", and a brass-colored finish "AB".

Custom color options are also available. Consult the factory for more information.

RC9AMD SERIES™ POKE-THRU DEVICES

RC9AMD Series Poke-Thru Devices Ordering Information

RC9AM2STC

Insert Assembly with Disposable Plate

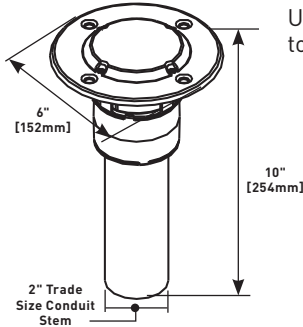

Use with RC9CMD Series Covers to complete installation.

RC9SHMDTC

Nonmetallic Slide Holder Assembly

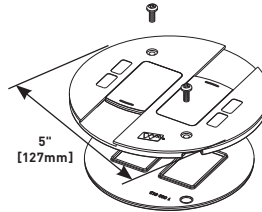

Available in black (RC9SHMDTCBK), gray (RC9SHMDTCGY), ivory (RC9SHMDTCVY), nonmetallic brass (RC9SHMDTCBS) and nonmetallic aluminum (RC9SHMDTCAA).

RC9CMDTC

Finish Flange & Slide Holder Assembly

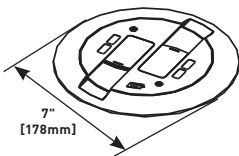

Flange available in painted gray (RC9CMDTCGY), black (RC9CMDTCBK), ivory (RC9CMDTCVY), and brushed metal finishes in aluminum (RC9CMDTCAL) and brass (RC9CMDTCBS). Aluminum and brass flanges shipped with black cover. Brass flange also available

RC9APTC

Abandonment Plate

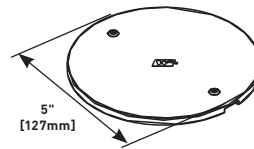

Available in black (RC9APTCKB).

with brass colored cover assembly (RC9CMDTCAB). Aluminum flange also available with aluminum-colored cover assembly (RC9CMDTCAA). Includes two (2) Ortronics TracJack adapters, two (2) Ortronics Series II adapters, and two (2) Wiremold Open System adapters. Modular jacks sold separately.

NOTE: Assembled with scrub water gasket. For use on tile or carpet floors.

RC9AMDTC

Assembled Poke-Thru Device

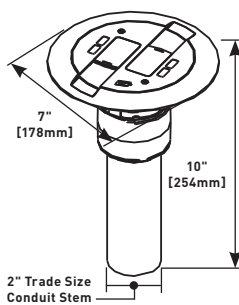

All communication device accepts up to four UTP connectors. Flange available in painted gray (RC9AMDTCGY), black (RC9AMDTCKB), ivory (RC9AMDTCVY), and brushed metal finishes in aluminum (RC9AMDTCAL) and brass (RC9AMDTCBS). Aluminum and brass flanges shipped with black cover. Brass flange also available with brass colored cover assembly

(RC9AMDTCAB). Aluminum flange also available with aluminum-colored cover assembly (RC9AMDTCAA). Unit includes two (2) Ortronics TracJack adapters, two (2) Ortronics Series II adapters, and two (2) Wiremold Open System inserts. Modular jacks sold separately.

NOTE: Assembled with scrub water gasket. For use on tile or carpet floors.

NOTE: RC9 Series Poke-Thru Devices require a 3" [76mm] diameter hole. Not designed to work with bare concrete or terrazzo. Floor covering thickness 1/8" minimum.

ABPLUG3

Abandonment Plug Assembly

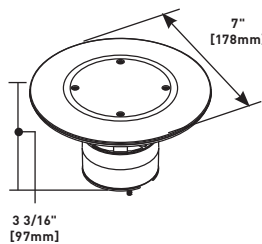

Complete plug assembly for abandoning an open 3" [76mm] diameter hole. Assembly includes intumescent fire-stop material to maintain the fire-classification of the floor, integral retainer ring to prevent the unit from pulling up through the floor, and a black die-cast aluminum cover.

AMD8 SERIES™ POKE-THRU DEVICES



AMD8 Series™ All Communication Surface Style Poke-Thru Devices provide up to eight (8) ports of communication.

CODE REFERENCE

cULus Listed Metallic Outlet Boxes:
File E2961 Guide QCIT.

cULus Listed Nonmetallic Outlet Boxes & Fittings Classified for Fire Resistance:
File R8209 Guide CEYY.

Meets Article 300.21, 300.22(C) & 314 of NEC.



AMD8 Series Poke-Thru Device installed in a carpeted floor.

HOLE DIAMETER

Minimum:	4" [102mm]
Maximum:	4 1/8" [105mm]

COLOR OPTIONS

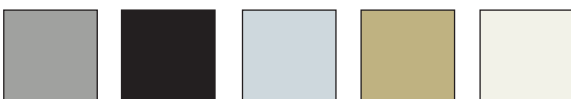

AMD8 Series parts are available in gray "GY", black "BK", brushed aluminum "AL", brass "BS", ivory "VY", brass-colored finish "AB", and an aluminum-colored finish "AA".

Custom color options are also available. Consult the factory for more information.

AMD8 SERIES™ POKE-THRU DEVICES

AMD8 Series Poke-Thru Devices Ordering Information

AMD8STC Insert Assembly with Disposable Plate

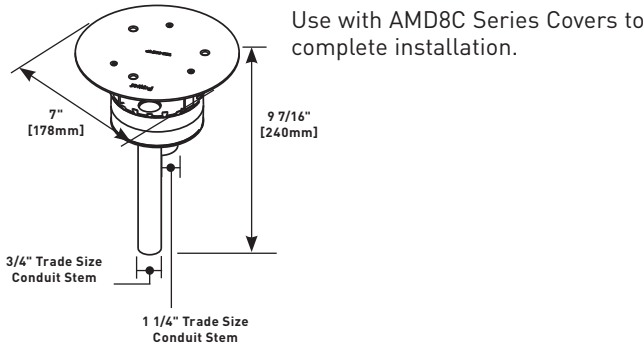

AMD8SHTC Slide Holder

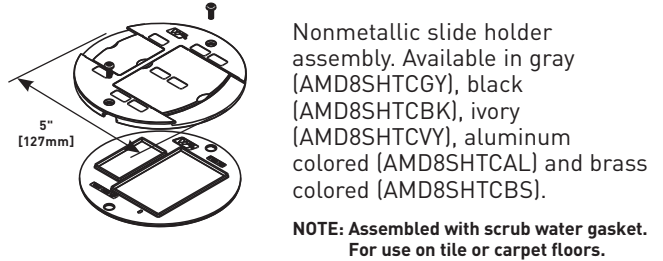

AMD8CTC Finish Flange & Slide Holder

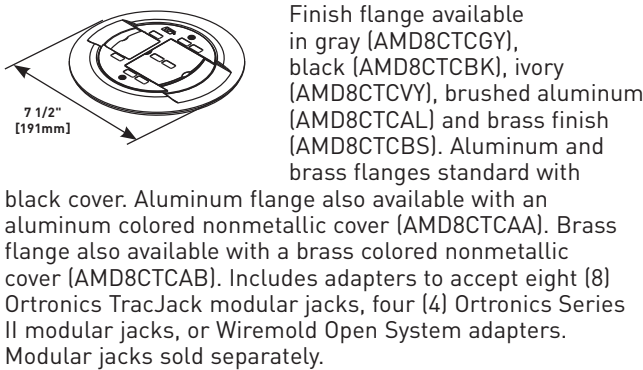

AMD8APTC Abandonment Plate



AMD8ATC Assembled Poke-Thru Device

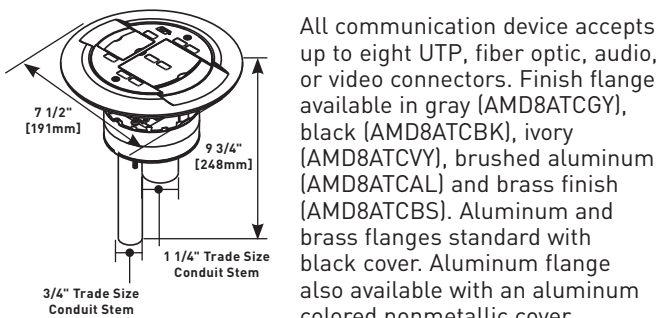

ABPLUG4 Abandonment Plug Assembly

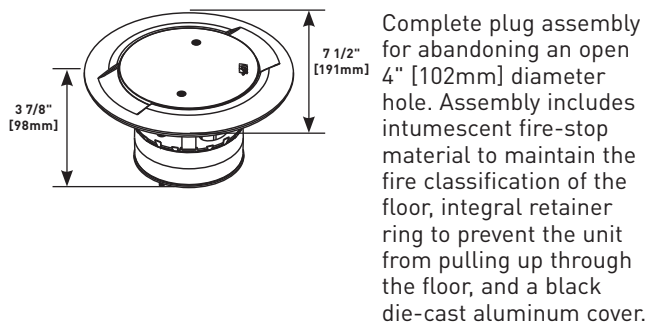

NOTE: Assembled with scrub water gasket. For use on tile or carpet floors.

NOTE: AMD8 Series Poke-Thru Devices require a 4" [102mm] diameter hole. Not designed to work with bare concrete or terrazzo. Floor covering thickness 1/8" minimum.

AV3 SERIES™ POKE-THRU DEVICES



AV3 Series™ Surface Style Poke-Thru Devices provide one (1) 20 Amp duplex power device and accepts up to three (3) Extron® Electronics MAAP Series device plates.

CODE REFERENCE

cULus Listed Metallic Outlet Boxes:
File E2961 Guide QCIT.

cULus Listed Nonmetallic Outlet Boxes & Fittings Classified for Fire Resistance:
File R8209 Guide CEYY.

Meets Article 300.21, 300.22(C) & 314 of NEC.



AV3 Series Poke-Thru Device installed in a carpeted floor.

HOLE DIAMETER

Minimum:	4" [102mm]
Maximum:	4 1/8" [105mm]

COLOR OPTIONS



AV3 Series parts are available in gray "GY", black "BK", brushed aluminum "AL", brass "BS", ivory "VY", brass-colored finish "AB", and an aluminum-colored finish "AA".

Custom color options are also available. Consult the factory for more information.

AV3 SERIES™ POKE-THRU DEVICES

AV3 Series Poke-Thru Devices Ordering Information

AV3STC Insert Assembly with Disposable Plate

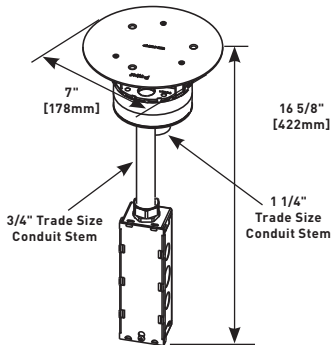

Use with AV3CTC Series Covers to complete installation.

AV3SHTC Slide Holder

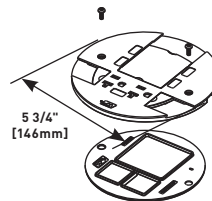

Nonmetallic slide holder assembly. Available in gray (AV3SHTCGY), black (AV3SHTCBK), ivory (AV3SHTCVY), aluminum colored (AV3SHTCAL) and brass colored (AV3SHTCBS).

NOTE: Assembled with scrub water gasket. For use on tile or carpet floors.

AV3CTC Finish Flange & Slide Holder

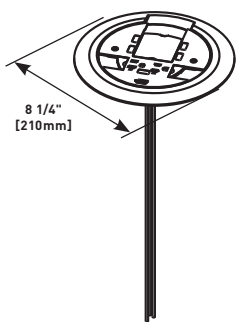

Includes one prewired 20A duplex receptacle which can be wired as a standard receptacle or isolated ground. Finish flange available in gray (AV3CTCGY), black (AV3CTCBK), ivory (AV3CTCVY), brushed aluminum (AV3CTCAL) and brass finish (AV3CTCBS). Aluminum and brass flanges standard with black cover. Aluminum flange also available with an aluminum colored nonmetallic cover (AV3CTCAA).

Brass flange also available with brass colored nonmetallic cover (AV3CTCAB). Includes one adapter to accept Legrand AVIP or Extron® Electronics MAAP mini architectural adapter plates, Wiremold Open System adapters, and Ortronics TracJack and Series II mounting adapters. Modular Jacks sold separately.

NOTE: Assembled with scrub water gasket. For use on tile or carpet floors.

AV3APTC Abandonment Plate

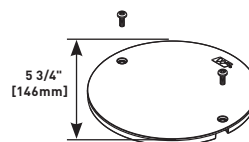

Available in black (AV3APTGBK) and gray (AV3APTGGY).

RC37REC, RC37REC-25 Replacement Receptacles

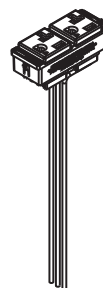

Prewired snap-in 20A receptacle can be wired as standard duplex or isolated ground. Available only in black. See installation instructions with replacement receptacle for complete installation details. The RC37REC-25 is available with 25 foot [7.62m] leads and can be wired as standard duplex or isolated ground.

AV3ATC Assembled Poke-Thru Device

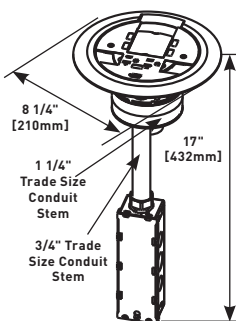

A/V device includes one prewired 20A duplex receptacle which can be wired as a standard receptacle or isolated ground. Finish flange available in gray (AV3ATCGY), black (AV3ATCBK), ivory (AV3ATCVY), brushed aluminum (AV3ATCAL) and brass finish (AV3ATCBS). Aluminum and brass flanges standard with black cover. Aluminum flange also available with an aluminum colored nonmetallic cover (AV3ATCAA).

Brass flange also available with brass colored nonmetallic cover (AV3ATCAB). Includes one adapter to accept Legrand AVIP or Extron® Electronics MAAP mini architectural adapter plates, Wiremold Open System adapters, and Ortronics TracJack and Series II mounting adapters. Modular Jacks sold separately.

NOTE: Assembled with scrub water gasket. For use on tile or carpet floors.

NOTE: AMD8 Series Poke-Thru Devices require a 4" [102mm] diameter hole. Not designed to work with bare concrete or terrazzo. Floor covering thickness 1/8" minimum.

ABPLUG4 Abandonment Plug Assembly

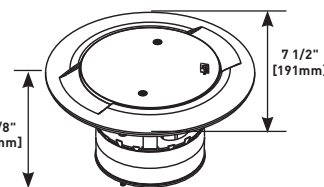

Complete plug assembly for abandoning an open 4" [102mm] diameter hole. Assembly includes intumescent fire-stop material to maintain the fire classification of the floor, integral retainer ring to prevent the unit from pulling up through the floor, and a black die-cast aluminum cover.

NOTE: AV3 Series Poke-Thru Devices require a 4" [102mm] diameter hole. Not designed to work with bare concrete or terrazzo. Floor covering thickness 1/8" minimum.

RC4 SERIES™ POKE-THRU DEVICES



RC4 Series™ Surface Style Poke-Thru Devices provide two (2) 20 Amp duplex power devices and four (4) ports of communication.

CODE REFERENCE

cULus Listed Metallic Outlet Boxes:
File E2961 Guide QCIT.

cULus Listed Nonmetallic Outlet Boxes & Fittings Classified for Fire Resistance:
File R8209 Guide CEYY.

Meets Article 300.21, 300.22(C) & 314 of NEC.

RC4 Series Poke-Thru Devices Ordering Information

RC4STC Insert Assembly with Disposable Plate

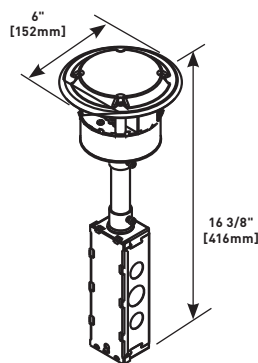

Comes complete with four prewired 20A receptacles. Use RC4STC with RC4C Series Covers.

NOTE: If wiring for Isolated Ground, attach orange IG label (supplied).



RC4 Series Poke-Thru Device (RC4CTCBS).

HOLE DIAMETER

Minimum: 4" [102mm]

Maximum: 4 1/8" [105mm]

RC4SHTC Slide Holder

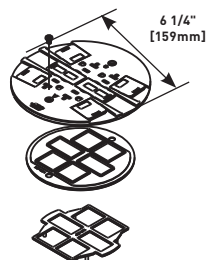

Nonmetallic slide holder assembly. Available in gray (RC4SHTCGY), black (RC4SHTCBK), ivory (RC4SHTCVY), nonmetallic brass (RC4SHTCBS), and nonmetallic aluminum (RC4SHTCAL).

NOTE: Assembled with scrub water gasket. For use on tile or carpet floors.

COLOR OPTIONS



RC4 Series parts are available in gray "GY", black "BK", brushed aluminum "AL", brass "BS", ivory "VY", brass-colored finish "AB", and an aluminum-colored finish "AA".

RC4 SERIES™ POKE-THRU DEVICES

RC4 Series Poke-Thru Devices Ordering Information

RC4CTC Finish Flange & Slide Holder Assembly

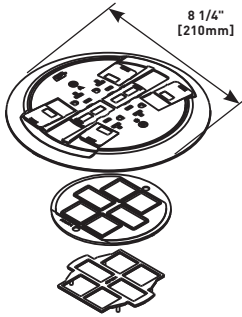

Flange available in painted gray (RC4CTCGY), black (RC4CTCBK), ivory (RC4CTCVY) or brushed metal finished in aluminum (RC4CTCAL), and brass (RC4CTCBS). Slide covers match the painted flange colors: gray, black, and ivory. Aluminum and brass flanges shipped with black slide cover. Brass flange also available with nonmetallic brass colored slide holder (RC4CTCAB). Aluminum flange also available with

nonmetallic aluminum color slide holder (RC4CTCAA). Includes Wiremold Open System unloaded adapters to accept four discrete keystone connectors from most manufacturers. Unit also includes Ortronics TracJack Mounting adapters and Ortronics Series II Communication Housing. Modular jacks sold separately.

NOTE: Assembled with scrub water gasket. For use on tile or carpet floors.

RC4ATC Assembled Poke-Thru Device

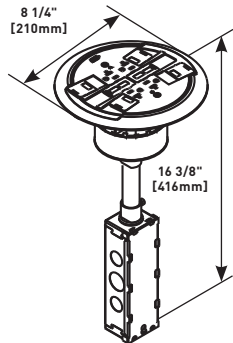

Unit includes four prewired 20A receptacles. Each duplex receptacle is wired as a separate circuit. The duplex can be wired as a standard receptacle or isolated ground. Finish flange available in gray (RC4ATCGY), black (RC4ATCBK), ivory (RC4ATCVY), or brushed metal finishes in aluminum (RC4ATCAL), and brass (RC4ATCBS). Aluminum and brass flanges shipped with black slide cover. Brass flange also available with nonmetallic brass colored slide holder (RC4ATCAB). Aluminum

flange also available with nonmetallic aluminum color slide holder (RC4ATCAA). Includes Wiremold Open System unloaded adapters to accept four discrete keystone connectors from most manufacturers. Unit also includes Ortronics TracJack Mounting adapters and Ortronics Series II Communication Housing. Modular jacks sold separately.

NOTE: Assembled with scrub water gasket. For use on tile or carpet floors.

NOTE: If wiring for Isolated Ground, attach orange IG label (supplied).

NOTE: AMD8 Series Poke-Thru Devices require a 4" [102mm] diameter hole. Not designed to work with bare concrete or terrazzo. Floor covering thickness 1/8" minimum.

RC4APTC Abandonment Plate

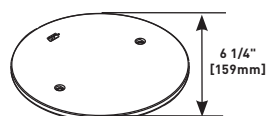

Available in black (RC4APTCBK), gray (RC4APTCGY), painted brass (RC4APTCBS), and ivory (RC4APTCVY).

NOTE: To abandon the RC4 Series Poke-Thru Device, the internal gasket, duplex receptacle, and communication modules must not be removed in order to maintain UL Classification. Also the stem must remain in the core-drilled hole.

COM75 Communication Adapter

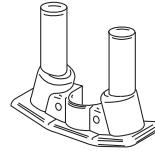

Provides two 3/4" trade size threaded openings to accommodate conduit connections.

RC4KTCG Retrofit Kit

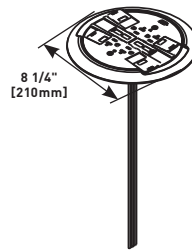

Used to upgrade existing installations of RC4 Poke-Thru Devices on carpet floors to meet scrub water requirements. Includes two 20A duplex receptacles that can be wired as a standard duplex or isolated ground. Also includes scrub water finish flange and slide holder assembly. Flange available in painted black (RC4KTCBK), gray (RC4KTCGY), ivory (RC4KTCVY), and brushed metal finishes in aluminum (RC4KTCAL), and brass

(RC4KTCBS). See installation instructions with retrofit kit for complete installation details.

NOTE: Existing installations of RC4 Poke-Thru Devices are not required to be upgraded to meet carpet scrub water requirements, if manufactured prior to June 2003.

NOTE: RC4 Series Poke-Thru Devices require a 4" [102mm] diameter hole. Not designed to work with bare concrete or terrazzo. Floor covering thickness 1/8" minimum.

RC4REC2, RC4REC2-25 Replacement Receptacles

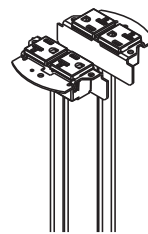

Two prewired 20A duplex receptacles can be wired as standard duplex or isolated ground. Available only in black. See installation instructions with replacement receptacle for complete installation details. RC4REC2-25 is available with 25 foot [7.62m] leads.

ABPLUG4 Abandonment Plug Assembly

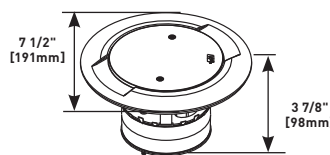

Complete plug assembly for abandoning an open 4" [102mm] diameter hole. Assembly includes intumescent fire-stop material to maintain the fire classification of the floor,

integral retainer ring to prevent the unit from pulling up through the floor, and a black die-cast aluminum cover.

RC3 SERIES™ POKE-THRU DEVICES



RC3 Series™ Surface Style Poke-Thru Devices provide one (1) 20 Amp power device and four (4) ports of communication.

CODE REFERENCE

cULus Listed Metallic Outlet Boxes:
File E2961 Guide QCIT.

cULus Listed Nonmetallic Outlet Boxes & Fittings Classified for Fire Resistance:
File R8209 Guide CEYY.

Meets Article 300.21, 300.22(C) & 314 of NEC.



RC3 Series Poke-Thru Device installed in a carpeted floor.

HOLE DIAMETER	
Minimum:	4" [102mm]
Maximum:	4 1/8" [105mm]

RC3 Series Poke-Thru Devices Ordering Information

RC3STC Insert Assembly with Disposable Plate

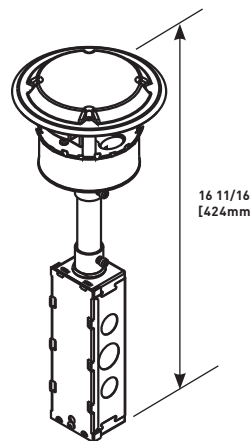

Use with RC3C Series Covers to complete installation.

RC3APTC Abandonment Plate

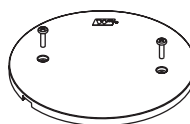

Available in black (RC3APTCKBK) and gray (RC3APTCKGY).

NOTE: To abandon the RC3 Series Poke-Thru Device, the duplex receptacle must be left installed in the unit in order to maintain scrub water compliance. Also the stem must remain in the hole.

COLOR OPTIONS



RC3 Series parts are available in gray "GY", black "BK", brushed aluminum "AL", brass "BS", ivory "VY", a brass-colored finish "AB" and an aluminum-colored finish "AA".

Custom color options are also available. Consult the factory for more information.

RC3 SERIES™ POKE-THRU DEVICES

RC3 Series Poke-Thru Devices Ordering Information

RC3CTC Finish Flange & Slide Holder

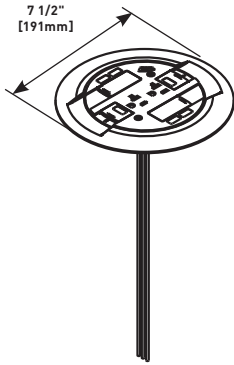

Finish flange and slide holder. Prewired 20A duplex receptacle can be wired as standard duplex or isolated ground. Flange available in painted gray (RC3CTCGY), black (RC3CTCBK), ivory (RC3CTCVY), or brushed metal finishes in aluminum (RC3CTCAL) and brass. Aluminum and brass flanges shipped with black slide cover. Brass flange also available with nonmetallic brass colored slide holder (RC3CTCAB). Aluminum flange also available with nonmetallic aluminum colored slider holder (RC3CTCAA). Includes Wiremold Open System unloaded

adapters to accept four (4) discrete keystone connectors from most manufacturers. Unit also includes two (2) Ortronics TracJack adapters and two (2) Ortronics Series II adapters. Modular Jacks sold separately.

NOTE: Assembled with scrub water gasket. For use on tile or carpet floors.

RC3ATC Assembled Poke-Thru Device

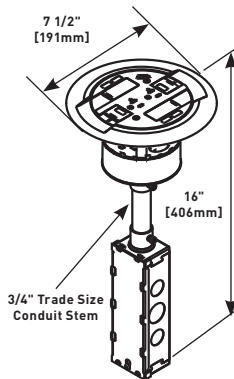

Assembled unit. Prewired 20A duplex receptacle can be wired as standard duplex or isolated ground. Flange available in painted gray (RC3ATCGY), black (RC3ATCBK), ivory (RC3ATCVY), or brushed metal finishes in aluminum (RC3ATCAL) and brass. Slide covers match the painted flange colors: gray, black, and ivory. Aluminum and brass flanges shipped with black slide cover. Brass flange also available with nonmetallic brass colored slider holder (RC3ATCAB). Aluminum flange also available with nonmetallic aluminum colored

slider holder (RC3ATCAA). Includes Wiremold Open System unloaded adapters to accept four (4) discrete keystone connectors from most manufacturers. Unit also includes two (2) Ortronics TracJack adapters and two (2) Ortronics Series II adapters. Modular Jacks sold separately.

NOTE: Assembled with scrub water gasket. For use on tile or carpet floors.

NOTE: RC3 Series Poke-Thru Devices require a 4" [102mm] diameter hole. Not designed to work with bare concrete or terrazzo. Floor covering thickness 1/8" minimum.

RC3SHTC Slide Holder

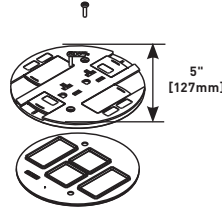

Nonmetallic slide holder assembly. Available in gray (RC3SHTCGY), black (RC3SHTCBK), ivory (RC3SHTCVY), nonmetallic brass (RC3SHTCBS), and nonmetallic aluminum (RC3SHTCAA).

NOTE: Assembled with scrub water gasket. For use on tile or carpet floors.

RC37REC, RC37REC-25 Replacement Receptacles



Prewired snap-in 20A receptacle can be wired as standard duplex or isolated ground. Available only in black. See installation instructions with replacement receptacle for complete installation details. The RC37REC-25 is available with 25 foot [7.62m] leads and can be wired as standard duplex or isolated ground.

NOTE: The 20A duplex receptacle supplied with the new scrub water version RC3 Poke-Thru Device is proprietary and can only be replaced with the RC37REC.

NOTE: RC3 Series Poke-Thru Devices require a 4" [102mm] diameter hole. Not designed to work with bare concrete or terrazzo. Floor covering thickness 1/8" minimum.

COM50, COM75 Communication Adapter

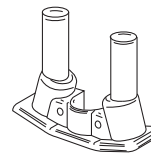

For two 1/2" trade size conduit connections (COM50). For two 3/4" trade size conduit connections (COM75). No additional capacity with COM75.

ABPLUG4 Abandonment Plug Assembly

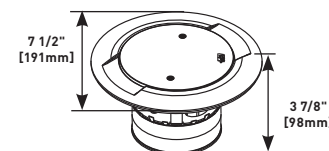

Complete plug assembly for abandoning an open 4" [102mm] diameter hole. Assembly includes intumescent fire-stop material to maintain the fire classification of the floor, integral retainer ring to prevent the unit from pulling up through the floor, and a black die-cast aluminum cover.

4FFATC SERIES™ POKE-THRU DEVICES



4FFATC Series™ Furniture Feed Style Poke-Thru Devices provide one (1) 3/4" trade size opening for power and one (1) 1 1/4" trade size opening for communication.

CODE REFERENCE

cULus Listed Metallic Outlet Boxes:
File E2961 Guide QCIT.

cULus Listed Nonmetallic Outlet Boxes & Fittings Classified for Fire Resistance:
File R8209 Guide CEYY.

Meets Article 300.21, 300.22(C) & 314 of NEC.



4FFATC Series Furniture Feed Style Poke-Thru Device (4FFATCBK).

HOLE DIAMETER

Minimum:	4" [102mm]
Maximum:	4 1/8" [105mm]

COLOR OPTIONS



4FFATC Series flanges are available in gray "GY", black "BK", brushed aluminum "AL", and plated brass "BS".

4FFATC SERIES™ POKE-THRU DEVICES

4FFATC Series Poke-Thru Devices Ordering Information

AV3STC Insert Stem with Disposable Plate

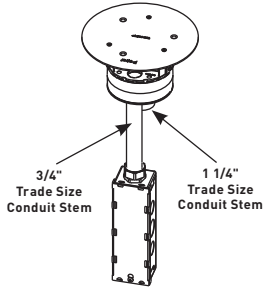

Use with 4FFCTC Series covers to form a complete poke-thru assembly.

4FFATC Furniture Feed Poke-Thru Assembly

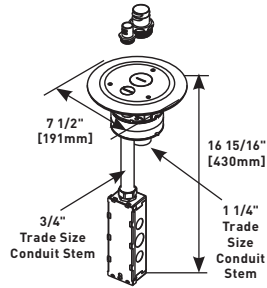

Complete with one-piece finish flange and conduit assembly. Conduit assembly consists of one 3/4" and one 1 1/4" trade size conduit. Finish cover flange provided with one 3/4" and one 1 1/4" trade size screw plug opening. Colors available in painted gray (4FFATCGY), painted black (4FFATCBK), brushed aluminum (4FFATCAL), and plated brass (4FFATCBS).

NOTE: Assembled with scrub water gasket. For use on tile or carpet covered concrete floors.

4FFCTC Finish Flange & Conduit Adapter Assembly

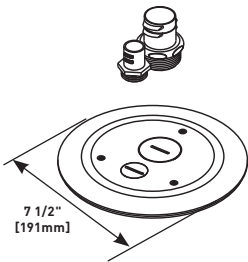

Complete with one 3/4" and one 1 1/4" trade size conduit adapters and closure plugs. Colors available in painted black (4FFCTCBK), gray (4FFCTCGY), forged brushed aluminum (4FFCTCAL), and plated brass (4FFCTCBS). Use with the AV3STC Insert to form a complete poke-thru assembly.

NOTE: Assembled with scrub water gasket. For use on tile or carpet floors.

ABPLUG4 Abandonment Plug Assembly

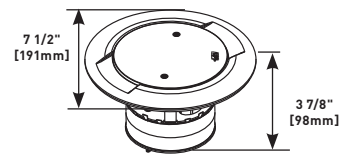

Complete plug assembly for abandoning an open 4" [102mm] diameter hole. Assembly includes intumescent fire-stop material to maintain the fire classification of the floor, integral retainer ring to prevent the unit from pulling up through the floor, and a black die-cast aluminum cover.

NOTE: 4FFATC Series Poke-Thru Devices require a 4" [102mm] diameter hole. Not designed to work with bare concrete or terrazzo. Floor covering thickness 1/8" minimum.

RC7AFFTC SERIES™ POKE-THRU DEVICES



RC7AFFTC Series™ Furniture Feed Style Poke-Thru Devices provide one (1) 3/4" trade size opening for power and two (2) 1/2" trade size openings for communication.

CODE REFERENCE

cULus Listed Metallic Outlet Boxes:
File E2961 Guide QCIT.

cULus Listed Nonmetallic Outlet Boxes & Fittings Classified for Fire Resistance:
File R8209 Guide CEYY.

Meets Article 300.21, 300.22(C) & 314 of NEC.



RC7AFFTC Series Furniture Feed Style Poke-Thru Device installed in a tiled floor.

HOLE DIAMETER

Minimum:	3 1/16" [78mm]
Maximum:	3 1/8" [79mm]

COLOR OPTIONS



RC7AFFTC Series flanges are available in gray "GY", black "BK", brushed aluminum "AL", and brass "BS".

RC7AFFTC SERIES™ POKE-THRU DEVICES

RC7AFFTC Series Poke-Thru Devices Ordering Information

RC7STC Insert Stem with Disposable Plate

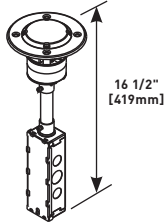

Use with RC7CFF Series covers to form a complete poke-thru assembly.

RC7AFFTC Flush Furniture Feed Poke-Thru Assembly

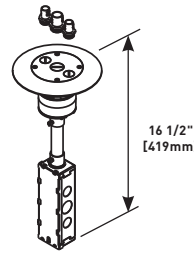

Complete with one-piece finish flange and conduit assembly with one 3/4" and two 1/2" trade size conduit adapters and closure plugs. Colors available in painted aluminum, black (RC7AFFTCBK), gray (RC7AFFTCGY), brushed aluminum (RC7AFFTCAL), and plated brass (RC7AFFTCBS).

NOTE: Assembled with scrub water gasket. For use on tile or carpet floors.

RC7CFFTC Finish Flange & Conduit Adapter Assembly

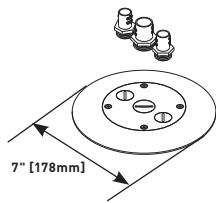

Complete with one 3/4" [19.1mm] conduit and two 1/2" trade size adapters and closure plugs. Colors available in painted black (RC7CFFTCBK), gray (RC7CFFTCGY), brush aluminum (RC7CFFTCAL), and plated brass (RC7CFFTCBS). Use with the RC7STC Insert to form a complete poke-thru assembly.

NOTE: Assembled with scrub water gasket. For use on tile or carpet floors.

COM50, COM75 Communication Adapter

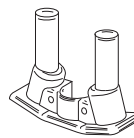

For two 1/2" trade size conduit connections (COM50). For two 3/4" trade size conduit connections (COM75). No additional capacity with COM75.

ABPLUG3 Abandonment Plug Assembly

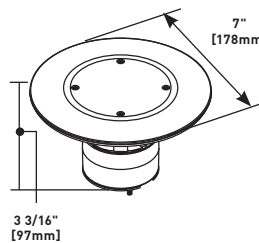

Complete plug assembly for abandoning an open 3" [76mm] diameter hole. Assembly includes intumescent fire-stop material to maintain the fire classification of the floor, integral retainer ring to prevent the unit from pulling up through the floor, and a black die-cast aluminum cover.

NOTE: RC7AFFTC Series Poke-Thru Devices require a 3 1/16" [78mm] diameter hole. Not designed to work with bare concrete or terrazzo. Floor covering thickness 1/8" minimum.

RC9AFFTC SERIES™ POKE-THRU DEVICES



RC9AFFTC Series™ Furniture Feed Style Poke-Thru Devices provide a hexagonal housing to allow for multi-directional feeds.

CODE REFERENCE

cULus Listed Metallic Outlet Boxes:
File E2961 Guide QCIT.

cULus Listed Nonmetallic Outlet Boxes & Fittings Classified for Fire Resistance:
File R8209 Guide CEYY.

Meets Article 300.21, 300.22(C) & 314 of NEC.



RC9AFFTC Series Furniture Feed Style Poke-Thru Device (RC9AFFTCBK).

HOLE DIAMETER

Minimum: 3 1/16" [78mm]

Maximum: 3 1/8" [79mm]

COLOR OPTIONS



RC9AFFTC Series flanges are available in gray "GY" or black "BK" finishes.

RC9AFFTC SERIES™ POKE-THRU DEVICES

RC9AFFTC Series Poke-Thru Devices Ordering Information

RC9FFS Insert Stem with Disposable Plate

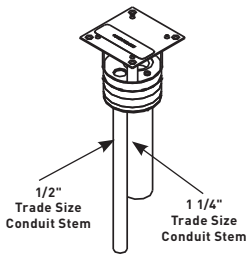

Furniture feed insert with one 1 1/4" and one 1/2" trade size conduit to feed power and communication services. Use with RC9CFFTC Series Covers to form a complete poke-thru assembly.

FFD-P Drop-In Hub

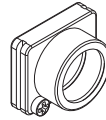

3/4" trade size threaded drop-in hub. Used to make conduit connections to the service head.

RC9AFFTC Assembled Furniture Feed Poke-Thru Device

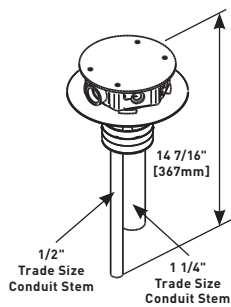

Complete with hexagonal service head. Service head has one 3/4" trade size threaded conduit hub and five rubber grommets. The service head includes scrub water gasket. Unit is supplied with one 1 1/4" and one 1/2" trade size conduit stem to feed power and communication services. Service head is not to be used as a junction box. All power connections must be made in a junction box below (not supplied). Available in gray (RC9AFFTCGY) and black (RC9AFFTCBK).

NOTE: Assembled with scrub water gasket. For use on tile or carpet floors.

TG-1 Communication Grommet



Drop-in rubber grommet for pass-through cabling. Set of two grommets (one grommet shown) black.

RCAPFFTC Abandonment Plate

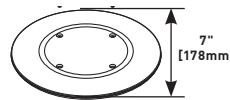

Used to abandon fitting by removing hexagonal housing and placing plate inside the flange. Insert stem must remain in the place. Available in black (RCAPFFTCBK).

RC9CFFTC Finish Flange & Service Head Assembly

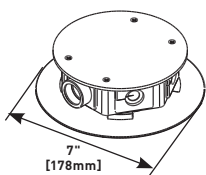

Complete with gray or black carpet flange, gray hexagonal housing, five black rubber grommets, and one 3/4" trade size threaded drop-in hub. The service head includes scrub water gasket. Use with RC9FFS Insert to form a complete poke-thru assembly. Available in gray (RC9CFFTCGY) or black (RC9CFFTCBK).

ABPLUG3 Abandonment Plug Assembly

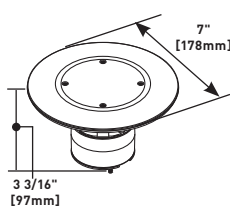

Complete plug assembly for abandoning an open 3" [76mm] diameter hole. Assembly includes intumescent fire-stop material to maintain the fire-classification of the floor, integral retainer ring to prevent the unit from pulling up through the floor, and a black die-cast aluminum cover.

NOTE: RC9AFFTC Series Poke-Thru Devices require a 3" [76mm] diameter hole. Not designed to work with bare concrete or terrazzo. Floor covering thickness 1/8" minimum.

RC9AM2TC SERIES™ POKE-THRU DEVICES



RC9AM2TC Series™ Furniture Feed Style Poke-Thru Devices provide one (1) 1 1/4" and 2" trade size concentric openings for single service pass-through.

CODE REFERENCE

cULus Listed Metallic Outlet Boxes:
File E2961 Guide QCIT.

cULus Listed Nonmetallic Outlet Boxes & Fittings Classified for Fire Resistance:
File R8209 Guide CEYY.

Meets Article 300.21, 300.22(C) & 314 of NEC.



RC9AM2TC Series Furniture Feed Style Poke-Thru Device (RC9AM2STC).

HOLE DIAMETER

Minimum:	3" [76mm]
Maximum:	3 1/8" [79mm]

COLOR OPTIONS



RC9AM2TC Series flanges are available in gray "GY", black "BK", brushed brass "BS", and brushed aluminum "AL" finishes.

Custom color options are also available. Consult the factory for more information.

RC9AM2TC SERIES™ POKE-THRU DEVICES

RC9AM2TC Series Poke-Thru Devices Ordering Information

RC9AM2STC Insert Stem with Disposable Plate

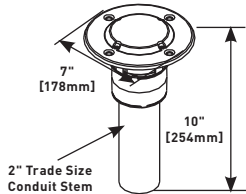

Use with RC9CM2TC Series cover to complete installation.

RC9CM2TC Furniture Feed Poke-Thru Device Cover Assembly

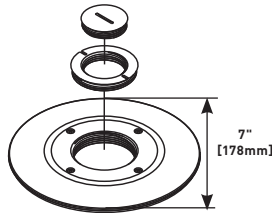

Complete with combination 1 1/4" and 2" trade size threaded conduit openings and closure plugs. Must be used with a conduit connector (not included) at the adapter assembly plate to maintain fire classification. Finish flange/cover assembly available in gray (RC9CM2TCGY), black (RC9CM2TCBK), and brushed aluminum (RC9CM2TCAL).

NOTE: Assembled with scrub water gasket. For use on tile or carpet floors.

RC7CFFTC Furniture Feed Poke-Thru Device Cover Assembly

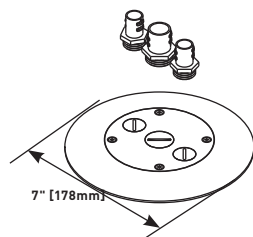

Complete with one 3/4" trade size conduit and two 1/2" trade size adapters and closure plugs. Colors available in painted gray (RC7CFFTCGY), black (RC7CFFTCBK), brushed plated brass (RC7CFFTCBS), and brushed aluminum (RC7CFFTCAL). Use with RC9AM2STC Insert Stem to form a complete poke-thru assembly.

NOTE: RC9AM2TC Series Poke-Thru Devices require a 3" [76mm] diameter hole. Not designed to work with bare concrete or terrazzo. Floor covering thickness 1/8" minimum.

RC9AM2TC Assembled Furniture Feed Poke-Thru Device

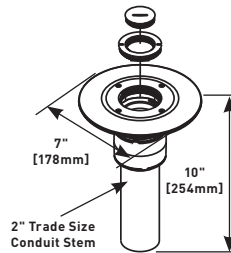

Complete with combination 1 1/4" and 2" trade size threaded conduit openings and closure plugs. Must be used with a conduit connector (not included) at the adapter assembly plate to maintain fire classification. Finish flange/cover assembly available in gray (RC9AM2TCGY), black (RC9AM2TCBK), and brushed aluminum (RC9AM2TCAL).

NOTE: Assembled with scrub water gasket. For use on tile or carpet floors.

RC7AM2TC Assembled Furniture Feed Poke-Thru Device

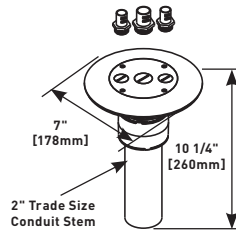

2" trade size conduit stem, complete with one 3/4" trade size conduit and two 1/2" trade size adapters and closure plugs. Finish flange/cover assembly available in painted gray (RC7AM2TCGY), black (RC7AM2TCBK), brushed plated brass (RC7AM2TCBS), and brushed aluminum (RC7AM2TCAL).

NOTE: Assembled with scrub water gasket. For use on tile or carpet floors.

RCAPFFTC Abandonment Plate

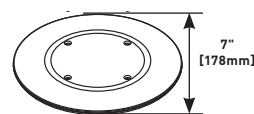

Used to abandon fitting by removing hexagonal housing and placing plate inside the flange. Insert stem must remain in the place. Available in black (RCAPFFTCBK).

ABPLUG3 Abandonment Plug Assembly

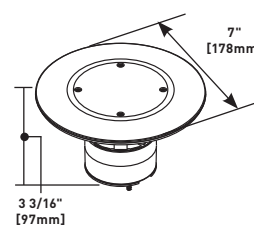

Complete plug assembly for abandoning an open 3" [76mm] diameter hole. Assembly includes intumescent fire-stop material to maintain the fire-classification of the floor, integral retainer ring to prevent the unit from pulling up through the floor, and a black die-cast aluminum cover.

FIT SERIES™ POKE-THRU DEVICES



FIT Series™ Pedestal Style Poke-Thru Devices provide dual service capability in either a single- or dual-width service head.

CODE REFERENCE

cULus Listed Metallic Outlet Boxes:
File E2961 Guide QCIT.

cULus Listed Nonmetallic Outlet Boxes & Fittings Classified for Fire Resistance:
File R8209 Guide CEYY.

Meets Article 300.21, 300.22(C) & 314 of NEC.



FIT Series Pedestal Style Poke-Thru Device with 241 Service Head.

CORE HOLE DIAMETER

Minimum: 2 1/32" [52mm]

Maximum: 2 1/8" [54mm]

FIT SERIES™ POKE-THRU DEVICES

FIT Series Poke-Thru Devices Ordering information

FIT 2" [51mm] Poke-Thru Insert with Junction Box Assembly

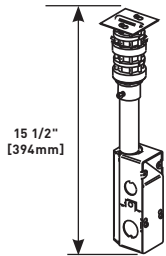

1" trade size barred conduit. Also includes BX/MC cable connector. Must be activated with 200 Series or 241 Series Service Head and FIFP or FP Series Faceplates (sold separately) to maintain UL Listing and/or Classification.

NOTE: FIT Series Poke-Thru Devices require a minimum 2 1/32" [52mm], 2 1/8" [54mm] maximum diameter hole.

200-H/BTC Housing & Base

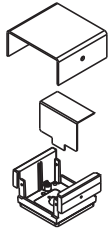

Single width. For 200 Series Service Head. Barrier included (may not be needed on single service applications). Base has a 3/4" trade size knockout for connection to FIT insert. Also includes scrub water gasket.

NOTE: Assembled with scrub water gasket. For use on tile or carpet floors.

FIFP-1.390 Faceplate

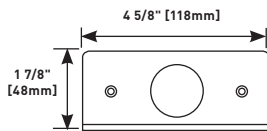

Single-gang with one 1.390" [35.3mm] receptacle opening.

FIFP-1.562 Faceplate

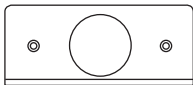

Single-gang with one 1.562" [39.7mm] receptacle opening.

FIFP-B Faceplate



Single-gang, blank.

FIFP-R Faceplate

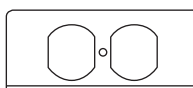

Single-gang with one duplex receptacle opening.

FIFP-SS Faceplate

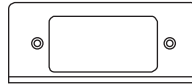

Single-gang with one surge suppression receptacle opening.

FIFP-T Faceplate

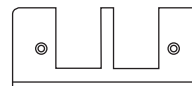

Single-gang faceplate with one telephone opening. Communication grommets included.

FIFP50 Faceplate

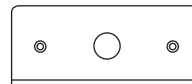

Single-gang with one 1/2" trade size knockout.

FIFP75 Faceplate

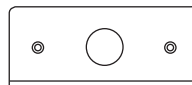

Single-gang with one 3/4" trade size knockout.

TG-1 Communications Grommet

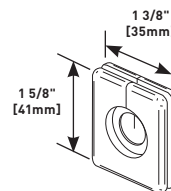

One set of two grommets.

241-H/BTC Assembly & Base

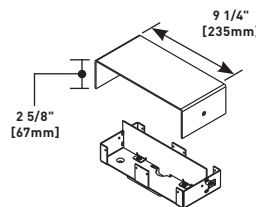

Double width housing for 241 Series Service Head. Barrier included (may not be needed for single service applications). Base has a 3/4" trade size KO for connection to FIT insert. See faceplates on this page. Order two plates to complete service head assembly.

NOTE: Assembled with scrub water gasket. For use on tile or carpet floors.

FP1.390-1.390 Faceplate

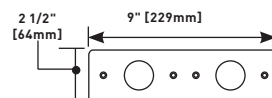

Two-gang with two 1.390" [35.3mm] receptacle openings.

FIT SERIES™ POKE-THRU DEVICES

FIT Series Poke-Thru Devices Ordering information (continued)

FP1.562-1.562 Faceplate



Two-gang with two 1.562" [39.7mm] receptacle openings.

FPB-B Faceplate



Two-gang faceplate – blank.

FP2R Faceplate



Two-gang faceplate with two duplex receptacle openings.

FP2T Faceplate

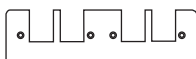

Two-gang faceplate with two communications openings.

FP50-50 Faceplate



Two-gang with two 1/2" trade size knockouts.

FP75-50 Faceplate



Two-gang with one 3/4" and one 1/2" trade size knockout.

FP75-75 Faceplate

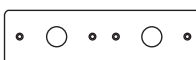

Two-gang with two 3/4" trade size knockouts.

FPSS-SS Faceplate

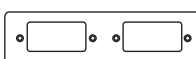

Two-gang with two surge suppression device openings.

FPACT-ACT Faceplate

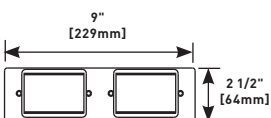

Two-gang faceplate with two 6A mini adapters openings. Two adapters included. Accepts Wiremold Open System communication modules.

FPB-ACT Faceplate

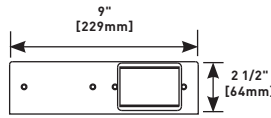

Two-gang faceplate with one 6A mini adapter opening. One adapter included. Accepts Wiremold Open System communication modules.

FPB-RT Faceplate

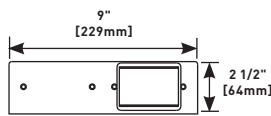

Two-gang plate with one Ortronics® TracJack adapter included and one Ortronics® Series II adapter included. Flat connector only.

FPB-2RT Faceplate

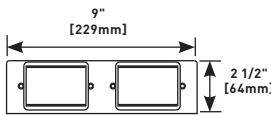

Two-gang plate with two Ortronics® TracJack adapters included and two Ortronics® Series II adapters included. Flat connector only.

AP-FITTC Poke-Thru Abandonment Plate

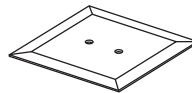

2" [51mm]. Stem must remain in cored hole.

FIT-EXT Assembled Extension



4 5/8" [118mm]. Includes 1" trade size barriercd conduit and coupling. For use with slabs greater than 8" [203mm].

221-21 Carpet Fire-Rated Plug

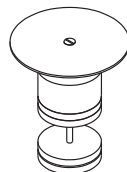

For carpet applications.

221-21 Tile Fire-Rated Plug

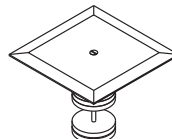

For tile applications.

NOTE: FIT Series Poke-Thru Devices require a 2" [51mm] diameter hole.

RC91GHBTC & RC92GHBTC SERIES™ POKE-THRU DEVICES



RC91GHBTC & RC92GHBTC Series™ Pedestal Style Poke-Thru Devices provide dual service capability in either a single- or dual-width service head.

CODE REFERENCE

cULus Listed Metallic Outlet Boxes:
File E2961 Guide QCIT.

cULus Listed Nonmetallic Outlet Boxes & Fittings Classified for Fire Resistance:
File R8209 Guide CEYY.

Meets Article 300.21, 300.22(C) & 314 of NEC.



RC92GHBTC Series Poke-Thru Device.

HOLE DIAMETER	
Minimum:	3 1/16" [78mm]
Maximum:	3 1/8" [79mm]

RC91GHBTC & RC92GHBTC SERIES™ POKE-THRU DEVICES

Ordering Information

RC91GHBTC Poke-thru Insert with Single Width Service Head

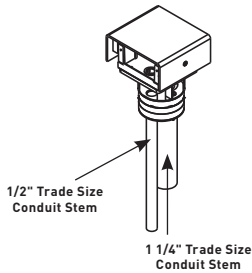

Includes insert stem with disposable plate and service head with housing, base, scrub water gasket, and barrier. Service head and insert install together to make a poke-thru assembly. Combine with faceplates (sold separately) to complete service head assembly. Shown assembled. Service head is shipped unassembled with the insert stem.

NOTE: Assembled with scrub water gasket. For use on tile or carpet floors.

291-H/BTC Single Width Service Head

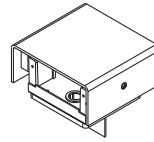

Includes housing, base, scrub water gasket, and barrier. Use with Insert Assembly RC9FFS.

292-H/BTC Double Width Service Head

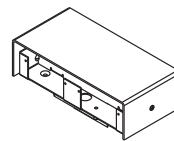

Includes housing, base, scrub water gasket, and barrier. Use with Insert Assembly RC9FFS.

RC92GHBTC Poke-thru Insert with Double Width Service Head

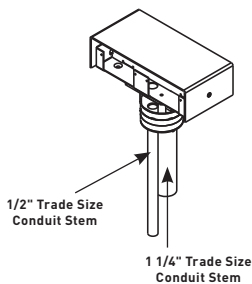

Includes insert stem with disposable plate and service head with housing, base, scrub water gasket, and barrier. Service head and insert install together to make a poke-thru assembly. Combine with faceplates (sold separately) to complete service head assembly. Shown assembled. Service head is shipped unassembled with the insert stem.

NOTE: Assembled with scrub water gasket. For use on tile or carpet floors.

RC9FFS Insert Stem With Disposable Plate

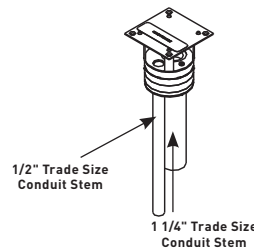

Furniture feed insert with one 1 1/4" and one 1/2" trade size conduit to feed power and communication services. Use with either 291-H/BTC or 292-H/BTC Service Head to form complete unit.

NOTE: RC91GHBTC and RC92GHBTC Series Poke-Thru Devices require a minimum 31/16" [78mm] diameter hole.

RC91GHBTC & RC92GHBTC SERIES™ POKE-THRU DEVICES

Ordering Information

FIFP-1.390 Faceplate

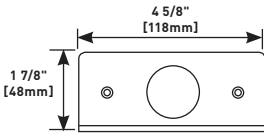

Single-gang with one 1.390" [35.3mm] receptacle opening.

FIFP-1.562 Faceplate

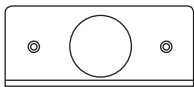

Single-gang with one 1.562" [39.7mm] receptacle opening.

FIFP-B Faceplate

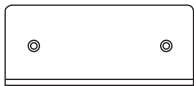

Single-gang, blank.

FIFP-R Faceplate

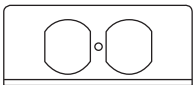

Single-gang with one duplex receptacle opening.

FIFP-SS Faceplate

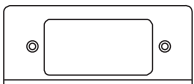

Single-gang with one surge suppression receptacle opening.

FIFP-T Faceplate

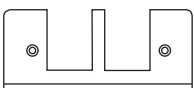

Single-gang faceplate with one telephone opening. Communication grommets included.

FIFP50 Faceplate

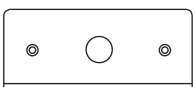

Single-gang with one 1/2" trade size knockout.

FIFP75 Faceplate

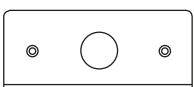

Single-gang with one 3/4" trade size knockout.

FPB-B Faceplate



Two-gang faceplate – blank.

FP2R Faceplate



Two-gang faceplate with two duplex receptacle openings.

FP2T Faceplate

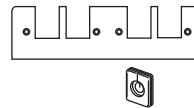

Two-gang faceplate with two communications openings.

FP50-50 Faceplate



Two-gang with two 1/2" trade size knockouts.

FP75-50 Faceplate



Two-gang with one 3/4" and one 1/2" trade size knockout.

FP75-75 Faceplate



Two-gang with two 3/4" trade size knockouts.

FPSS-SS Faceplate

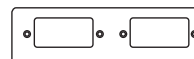

Two-gang with two surge suppression device openings.

FPACT-ACT Faceplate

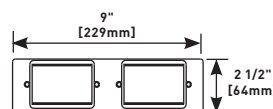

Two-gang faceplate with two 6A mini adapter openings. Two adapters included. Accepts Wiremold Open System communication modules.

RC91GHBTC & RC92GHBTC SERIES™ POKE-THRU DEVICES

Ordering Information

FPB-ACT Faceplate

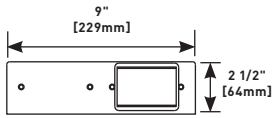

Two-gang faceplate with one 6A mini adapter opening. One adapter included. Accepts Wiremold Open System communication modules.

FPB-RT Faceplate

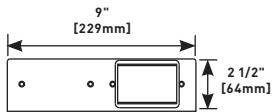

Two-gang plate with one Ortronics® TracJack adapter included and one Ortronics® Series II adapter included. Flat connector only.

FPB-2RT Faceplate

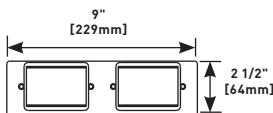

Two-gang plate with two Ortronics® TracJack adapters included and two Ortronics® Series II adapters included. Flat connector only.

ABPLUG3 Abandonment Plug Assembly

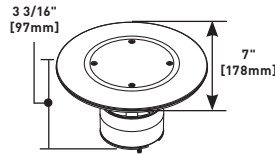

Complete plug assembly for abandoning an open 3" [76mm] diameter hole. Assembly includes intumescent fire-stop material to maintain the fire classification of the floor, integral retainer ring to prevent the unit from pulling up through the floor, and a black die-cast aluminum cover.

TG-1 Communication Grommet



One set of two grommets (one grommet shown) black.

RCAPFFTCBK Abandonment Plate

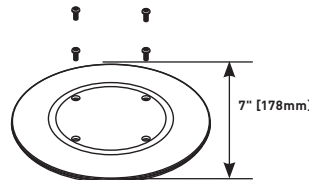

Used to abandon fitting by removing hexagonal housing and placing plate inside the flange. Insert stem must remain in the place. Available in black (BK).

FLOOR BOX SYSTEMS

Wiremold® Floor Boxes are TopGuard protected to meet and exceed the UL scrub water exclusion requirement.



Wiremold® offers one of the most complete lines of both commercial and residential floor box solutions in the industry. From small, single service boxes to large multi-utility convention center versions, there is a Wiremold floor box to meet any need.

Table of Contents

Evolution™ Series Floor Boxes



344

Fire Classified Floor Boxes



360

Ratchet-Pro™ Series Floor Boxes



380

Modulink™ 880MP Series Floor Boxes



387

Featured Products



RATCHET-PRO SERIES FLOOR BOX

380



RFB4E SERIES FLOOR BOX

407

FLOOR BOX SYSTEMS

Table of Contents

Wiremold® Floor Boxes are TopGuard protected to meet and exceed the UL scrub water exclusion requirement.



Resource RFB® Series Floor Boxes



OmniBox™ Series Floor Boxes



880 Series™ Floor Boxes



800 Series™ Floor Boxes



800W Series™ Floor Boxes



861 Series™ Floor Boxes



862 Series™ Floor Boxes



FLOOR BOX SYSTEMS

Table of Contents

Wiremold® Floor Boxes are TopGuard protected to meet and exceed the UL scrub water exclusion requirement.



863 Series™ Floor Boxes



451

WMFB Series™ Floor Boxes



453

FloorSource™ Raised Floor Boxes

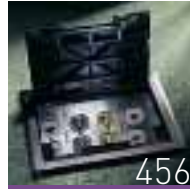

456

AF Series™ Raised Floor Boxes



463

AC Series™ Raised Floor Boxes

CRFB Series Raised Floor Boxes



468

CCFB Series Convention Center Products



473

CCBB Series Ballroom Floor Boxes



477

FLOOR BOX SYSTEMS

Quick Selection Guide

Wiremold® Floor Boxes are TopGuard protected to meet and exceed the UL scrub water exclusion requirement.



On-Grade Floor Boxes for Concrete Floors

PVC BOXES

Box Model	Box Type	Service Capability	Box Capacity	Box Construction	Depth Behind Device Plates	KO Sizes	Cover Model	Cover Construction	Cover & Flange Part Nos.	Notes
Ratchet-Pro 881	Round	Single	1 Gang	PVC	1 3/4" [44mm]	1" Trade Size	Metal, Polycarbonate	Tile, Carpet	895, 896	Flush Devices, On-Grade or Above-Grade
Ratchet-Pro RPNFB	Round	Dual	2 Gangs	PVC	3 1/2" [89mm]	3/4" – 2"	Die-Cast Aluminum	Tile, Carpet	RPAV3CTC, RP7CTC, RPAMD4CTC, RPAMD8CTC, RP4FFCTC, RP9AM2CTC	Surface Devices, On-Grade or Above-Grade
Modulink 880MP2	Rectangular	Single	1 Gang	PVC	1 3/4" [44mm]	1/2" – 2" Trade Size	Metal, Polycarbonate	Tile, Carpet	817, 818, 828, 829, 830 Series	Flush Devices, On-Grade or Above-Grade
Modulink 880MP2	Rectangular	Single	2 or 3 Gangs	PVC	1 3/4" [44mm]	1/2" – 2" Trade Size	Metal, Polycarbonate	Tile, Carpet	827, 828, 829, 830, 837, 838 Series	Flush Devices, On-Grade or Above-Grade

EPOXY PAINTED METAL & CAST IRON BOXES

Box Model	Box Type	Service Capability	Box Capacity	Box Construction	Depth Behind Device Plates	KO Sizes	Cover Model	Cover Construction	Cover & Flange Part Nos.	Notes
Ratchet-Pro RPSFB-OG	Round	Dual	2 Gangs	PVC	3 1/2" [89mm]	3/4" – 2"	Die-Cast Aluminum	Tile, Carpet	RPAV3CTC, RP7CTC, RPAMD4CTC, RPAMD8CTC, RP4FFCTC, RP9AM2CTC	Surface Devices, On-Grade or Above-Grade
RFB Series RFB2-OG	Rectangular	Triple	2 Gangs	Steel	3" [76mm]	3/4" – 1 1/4" Trade Size	FloorPort™ Die-Cast Aluminum	Tile, Carpet, Wood, Terrazzo	FPCT, FPBT, FPFPT Series	Recessed Devices, Fully Adjustable
RFB Series RFB4-C1-1	Rectangular	Dual	4 Gangs	Cast Iron	2" [51mm]	1" – 1 1/4" Trade Size	FloorPort™ Die-Cast Aluminum	Tile, Carpet	FPCT, FPBT, FPFPT Series	Recessed Devices, Fully Adjustable
RFB Series RFB4E-OG	Rectangular	Triple	4 Gangs	Steel	3 1/2" [89mm]	3/4" – 2" Trade Size	Evolution Round Poke-Thru Cover	Tile, Carpet, Wood, Terrazzo, Bare Concrete	6CT Series	Recessed Devices, Fully Adjustable
RFB Series RFB6-OG	Rectangular	Triple	6 Gangs	Steel	3 1/4" [83mm]	3/4" – 1 1/4" Trade Size	FloorPort™ Die-Cast Aluminum	Tile, Carpet, Wood, Terrazzo	FPCT, FPBT, FPFPT Series	Recessed Devices, Fully Adjustable
RFB Series RFB6E-OG	Rectangular	Triple	6 Gangs	Steel	3 1/4" [83mm]	3/4" – 1 1/4" Trade Size	Evolution™ Round Poke-Thru Cover	Tile, Carpet, Wood, Terrazzo, Bare Concrete	8CT Series	Recessed Devices, Fully Adjustable
RFB Series RFB9-OG	Rectangular	Triple	9 Gangs	Steel	2 1/2" [64mm]	3/4" – 1 1/4" Trade Size	Die-Cast Aluminum	Tile, Carpet, Wood, Terrazzo	RFB119CTC, RFB119BTC	Recessed Devices, Fully Adjustable
RFB Series RFB11-OG	Rectangular	Triple	11 Gangs	Steel	2 1/2" [64mm]	3/4" – 2" Trade Size	Die-Cast Aluminum	Tile, Carpet, Wood, Terrazzo	RFB119CTC, RFB119BTC	Recessed Devices, Fully Adjustable
Evolution Series EFB6S-OG	Rectangular	Triple	6 Gangs	Steel	3 7/8" [98mm]	3/4" – 2" Trade Size	Evolution Rectangular Die-Cast Aluminum	Tile, Carpet, Wood, Terrazzo, Polished Concrete	EFB610CTC, EFB610BTC, EFB610BT, EFB610CT	Removable Modules, Standard Size Device Plates

NOTE: Most Wiremold floor boxes and accessories are listed by Underwriters Laboratories Inc., and comply with Federal Specifications W-C-583b in one of the following types and classes: Type I-Fully adjustable, Type II-Semi-adjustable, Type III-Non-adjustable, Class 1-Watertight, Class 2-Concrete-tight.

FLOOR BOX SYSTEMS

Quick Selection Guide

Wiremold® Floor Boxes are TopGuard protected to meet and exceed the UL scrub water exclusion requirement.



On-Grade Floor Boxes for Concrete Floors (continued)

EPOXY PAINTED METAL & CAST IRON BOXES										
Box Model	Box Type	Service Capability	Box Capacity	Box Construction	Depth Behind Device Plates	KO Sizes	Cover Model	Cover Construction	Cover & Flange Part Nos.	Notes
Evolution Series EFB8S-OG	Rectangular	Triple	8 Gangs	Steel	3 1/2" [89mm]	3/4" – 2" Trade Size	Evolution Rectangular	Tile, Carpet, Wood, Terrazzo, Polished Concrete	EFB610CTC, EFB610BTC, EFB610BT, EFB610CT	Removable Modules, Standard size Device Plates
Evolution Series EFB10S-OG	Rectangular	Triple	10 Gangs	Steel	3 1/2" [89mm]	1" – 2" Trade Size	Evolution Rectangular	Tile, Carpet, Wood, Terrazzo, Polished Concrete	EFB610CTC, EFB610BTC, EFB610BT, EFB610CT	Removable Modules, Finished Interior
800 Series 800CILCK	Round	Single	1 Gang	Cast Iron	N/A	1/2" – 3/4" Trade Size	Brass	Tile, Carpet	825 Series	Flush Devices, Fully Adjustable
OmniBox 880CS1, 880CM1	Rectangular	Single	1 Gang	Cast Iron	880CS1: 2 3/4" [70mm] 880CM1: 1 3/4" [44mm]	1" Trade Size	Metal, Polycarbonate	Tile, Carpet	817, 818, 828, 829, 830 Series	Flush Devices, Fully Adjustable
OmniBox 880CS2, 880CM2	Rectangular	Dual	2 Gangs	Cast Iron	880CS2: 2 3/4" [70mm] 880CM2: 1 3/4" [44mm]	1" Trade Size	Metal, Polycarbonate	Tile, Carpet	827, 828, 829, 830 Series	Flush Devices, Fully Adjustable
OmniBox 880CS3, 880CM3	Rectangular	Triple	3 Gangs	Cast Iron	880CS3: 2 3/4" [70mm] 880CM3: 1 3/4" [44mm]	1" Trade Size	Metal, Polycarbonate	Tile, Carpet	828, 829, 830, 837, 838 Series	Flush Devices, Fully Adjustable
880 Series 887B/889B	Round	Single	1 Gang	Cast Iron	887: 2" [51mm] 889: 3" [76mm]	887B: 1/2" – 3/4" 889B: 1" – 1 1/4" Trade Size	Metal, Polycarbonate	Tile, Carpet	895, 896 Series	Flush Devices, Fully Adjustable
CCBB Series CCBBS-OG, CCBBL-OG	Rectangular	Triple	12 Gangs	Steel	CCBBS-OG: 3 3/4" [95mm] CCBBL-OG: Custom	CCBBS: 3/4" – 2" Trade Size CCBBL: Field Punched	Cast Aluminum	Carpet	CCBBSCTCAL, CCBBLCTCAL	Recessed Devices, Adjustable Pre-pour
CCFB Series	Rectangular	Multi	Customs	Steel	Custom	Field Punched	Cast Aluminum	Tile, Carpet, Bare Concrete	CCFBCTC	Power, A/V, Comm., Water, Air

Above-Grade Floor Boxes for Concrete Floors

PVC BOXES										
Box Model	Box Type	Service Capability	Box Capacity	Box Construction	Depth Behind Device Plates	KO Sizes	Cover Model	Cover Construction	Cover & Flange Part Nos.	Notes
Ratchet-Pro 881	Round	Single	(4) #12 AWG or (6) Cat 6A	PVC	1 3/4" [44mm]	1" Trade Size	Metal, Polycarbonate	Tile, Carpet	895, 896 Series	Flush Devices, On-Grade or Above-Grade
Ratchet-Pro RPNFB	Round	Dual	2 Gang	PVC	3 1/2" [89mm]	3/4" – 2" Trade Size	Metal, Polycarbonate	Tile, Carpet	RPAMD4CTC, RPAMD8CTC, RF4FFCTC, RPAV3CTC, RP9AM2CTC, RP7CTC	Flush Devices, On-Grade or Above-Grade
Modulink 880MPFC	Rectangular	Single	(4) #12 AWG or (6) Cat 6A	PVC	1 3/4" [44mm]	1" Trade Size	Metal, Polycarbonate	Tile, Carpet	817, 818, 828, 829, 830 Series	Flush Devices, On-Grade or Above-Grade
Modulink 880MP2	Rectangular	Single	(4) #12 AWG or (6) Cat 6A	PVC	1 3/4" [44mm]	1/2" – 2" Trade Size	Metal, Polycarbonate	Tile, Carpet	817, 818, 828, 829, 830 Series	Flush Devices, On-Grade or Above-Grade
Modulink 880MP2	Rectangular	Dual		PVC	1 3/4" [44mm]	1/2" – 2" Trade Size	Metal, Polycarbonate	Tile, Carpet	827, 828, 829, 830, 837, 838 Series	Flush Devices, On-Grade or Above-Grade

Fire Classified Floor Boxes – Add "FC" Suffix to part number for fire classified version. All fire classified boxes feed with 1 1/4" conduit feeds.

NOTE: Most Wiremold floor boxes and accessories are listed by Underwriters Laboratories Inc., and comply with Federal Specifications W-C-583b in one of the following types and classes: Type I-Fully adjustable, Type II-Semi-adjustable, Type III-Non-adjustable, Class 1-Watertight, Class 2-Concrete-tight.

FLOOR BOX SYSTEMS

Quick Selection Guide

Wiremold® Floor Boxes are TopGuard protected to meet and exceed the UL scrub water exclusion requirement.



Above-Grade Floor Boxes for Concrete Floors (continued)

STEEL BOXES										
Box Model	Box Type	Service Capability	Box Capacity	Box Construction	Depth Behind Device Plates	KO Sizes	Cover Model	Cover Construction	Cover & Flange Part Nos.	Notes
800 Series 800LCK	Round	Single	1 Gang	Steel	N/A	1/2" – 3/4" Trade Size	Brass	Tile, Carpet	825 Series	Flush Devices, Fully Adjustable
880 Series 885B/886B	Round	Single	1 Gang	Steel	885B: 2" [51mm] 886B: 2 1/4" [57mm]	885B: 1/2" – 3/4" 886B: 1/2" – 1" Trade Size	Metal, Polycarbonate	Tile, Carpet	895, 896 Series	Flush Devices, Fully Adjustable
OmniBox 880S1, 880M1	Rectangular	Single	1 Gang (4) #12 AWG/ Gang or (6) Cat 6A/Gang	Steel	880S1: 2 3/4" [70mm] 880M1: 1 3/4" [44mm]	880S1: 1/2" – 1" 880M1: 1/2" – 3/4" Trade Size	Metal, Polycarbonate	Tile, Carpet	817, 818, 827, 828, 829, 830 Series	Flush Devices, Fully Adjustable
OmniBox 880S2, 880M2	Rectangular	Dual	2 Gangs (4) #12 AWG/ Gang or (6) Cat 6A/Gang	Steel	880S2: 2 3/4" [70mm] 880M2: 1 3/4" [44mm]	880S2: 1/2" – 1" 880M2: 1/2" – 3/4" Trade Size	Metal, Polycarbonate	Tile, Carpet	827, 828, 829, 830 Series	Flush Devices, Fully Adjustable
OmniBox 880S3, 880M3	Rectangular	Triple	1 Gang (4) #12 AWG/ Gang or (6) Cat 6A/Gang	Steel	880S3: 2 3/4" [70mm] 880M3: 1 3/4" [44mm]	880S3: 1/2" – 1" 880M3: 1/2" – 3/4" Trade Size	Metal, Polycarbonate	Tile, Carpet	828, 829, 830, 837, 838 Series	Flush Devices, On-Grade or Above-Grade
RPSFB	Round	Dual	2 Gangs	PVC	3 1/2" [89mm]	3/4" – 2"	Die-Cast Aluminum	Tile, Carpet	RPAV3CTC, RP7CTC, RPAMD4CTC, RPAMD8CTC, RP4FFCTC, RPAM2CTC, RP9AM2CTC	Surface Devices, On-Grade or Above-Grade
RFB Series RFB2	Rectangular	Triple	1 Gang (4) #12 AWG/ Gang or (6) Cat 6A/Gang	Steel	3" [76mm]	3/4" – 1 1/4" Trade Size	FloorPort Die-Cast Aluminum	Tile, Carpet, Wood, Terrazzo	FPCT, FPBT, FPFFT Series	Recessed Devices, On-Grade or Above-Grade
RFB Series RFB4	Rectangular	Triple	1 Gang (4) #12 AWG/ Gang or (6) Cat 6A/Gang	Steel	2" [51mm]	3/4" – 1 1/4" Trade Size	FloorPort Die-Cast Aluminum	Tile, Carpet, Wood, Terrazzo	FPCT, FPBT, FPFFT Series	Recessed Devices, On-Grade or Above-Grade
RFB Series RFB4E	Rectangular	Triple	4 Gangs	Steel	3 1/2" [89mm]	3/4" – 2" Trade Size	Evolution Series Poke-Thru Covers	Tile, Carpet, Wood, Terrazzo, Bare Concrete	6CT & 6CTC Series	Recessed Devices, Fully Adjustable
RFB Series RFB6	Rectangular	Triple	6 Gangs	Steel	3 1/4" [83mm]	3/4" – 1 1/4" Trade Size	FloorPort Die-Cast Aluminum	Tile, Carpet, Wood, Terrazzo	FPCT, FPBT, FPFFT Series	Recessed Devices, On-Grade or Above-Grade
RFB Series RFB6E	Rectangular	Triple	6 Gangs	Steel	3 1/4" [83mm]	3/4" – 1 1/4" Trade Size	Evolution Series Poke-Thru Covers	Tile, Carpet, Wood, Terrazzo, Bare Concrete	8CT Series	Recessed Devices, Fully Adjustable
RFB Series RFB9	Rectangular	Triple	9 Gangs	Steel	2 1/2" [64mm]	3/4" – 1 1/4" Trade Size	Die-Cast Aluminum	Tile, Carpet, Wood, Terrazzo	RFB119TC	Recessed Devices, On-Grade or Above-Grade
RFB Series RFB11	Rectangular	Triple	11 Gangs	Steel	2 1/2" [64mm]	3/4" – 2" Trade Size	Die-Cast Aluminum	Tile, Carpet, Wood, Terrazzo	RFB119TC	Recessed Devices, On-Grade or Above-Grade

Fire Classified Floor Boxes – Add "FC" Suffix to part number for fire classified version. All fire classified boxes feed with 1 1/4" conduit feeds.

NOTE: Most Wiremold floor boxes and accessories are listed by Underwriters Laboratories Inc., and comply with Federal Specifications W-C-583b in one of the following types and classes: Type I-Fully adjustable, Type II-Semi-adjustable, Type III-Non-adjustable, Class 1-Watertight, Class 2-Concrete-tight.

FLOOR BOX SYSTEMS

Quick Selection Guide

Wiremold® Floor Boxes are TopGuard protected to meet and exceed the UL scrub water exclusion requirement.



Above-Grade Floor Boxes for Concrete Floors (continued)

STEEL BOXES (continued)

Box Model	Box Type	Service Capability	Box Capacity	Box Construction	Depth Behind Device Plates	KO Sizes	Cover Model	Cover Construction	Cover & Flange Part Nos.	Notes
Evolution Series EFB6S	Rectangular	Triple	6 Gangs	Steel	3 7/8" [98mm]	3/4" - 2" Trade Size	Die-Cast Aluminum	Tile, Carpet, Wood, Terrazzo, Polished Concrete	EFB610CTC, EFB610BTC, EFB610BT, EFB610CT	Removable Modules, Standard size Device Plates
Evolution Series EFB8S	Rectangular	Triple	8 Gangs	Steel	3 1/2" [89mm]	3/4" - 2" Trade Size	Die-Cast Aluminum	Tile, Carpet, Wood, Terrazzo, Polished Concrete	EFB610CTC, EFB610BTC, EFB610BT, EFB610CT	Removable Modules, Standard size Device Plates
Evolution Series EFB10S	Rectangular	Triple	10 Gangs	Steel	3 1/4" [83mm]	3/4" - 2" Trade Size	Die-Cast Aluminum	Tile, Carpet, Wood, Terrazzo, Polished Concrete	EFB610CTC, EFB610BTC, EFB610BT, EFB610CT	Removable Modules, Finished Interior
CCBB Series CCBS, CCBL	Rectangular	Triple	12 Gangs	Steel	CCBS: 3 3/4" [95mm] CCBL: Custom	CCBS: 3/4" - 2" Trade Size CCBL: Field Punched	Cast Aluminum	Carpet	CCBSCTCAL, CCBLCTCAL	Recessed Devices, Adjustable Pre-pour
CCFB Series	Rectangular	Multi	Custom	Steel	Custom	Field Punched	Cast Aluminum	Tile, Carpet, Bare Concrete	CCFBCTC	Power, A/V, Comm., Water, Air

Floor Boxes for Wood Floor

COMMERCIAL BOXES

Box Model	Box Type	Service Capability	Box Capacity	Box Construction	Depth Behind Device Plates	KO Sizes	Cover Construction	Cover Type	Cover & Flange Part Nos.
861 Series	Round	Single	1 Gang	Die-Cast Aluminum	N/A	1/2" Trade Size	Brass, Brushed Aluminum	Tile, Carpet	895 Series & Poke-Thru Covers
863 Series	Round	Dual	2 Gangs	PVC	N/A	1/2" Trade Size Romex strain relief pass-through opening for communications.	Brass, Brushed Aluminum	Carpet	Included with Kits
880W Series, 880W1	Rectangular	Single	1 Gang	Steel	2 3/4" [70mm]	1/2" & 3/4" Trade Size	Brass, Brushed Aluminum, Nonmetallic	Tile, Carpet	817, 818, 828, 829, 830 Series
880W Series, 880W2	Rectangular	Dual	2 Gangs	Steel	2 3/4" [70mm]	1/2" & 3/4" Trade Size	Brass, Brushed Aluminum, Nonmetallic	Tile, Carpet	827, 828, 829, 830 Series
880W Series, 880W3	Rectangular	Triple	3 Gangs	Steel	2 1/4" [57mm]	1/2" & 3/4" Trade Size	Brass, Brushed Aluminum, Nonmetallic	Tile, Carpet	828, 829, 830, 837, 838 Series
CRFB Series	Round	Triple	4 Gangs	Die-Cast Aluminum	2 1/4" [57mm]	1/2, 3/4", 1", 1 1/4" & 2" Trade Size	CRFB & Evolution Die-Cast Aluminum	Tile, Carpet	CRFBCTC, CRFBBTC, 8AT Series

NOTE: Most Wiremold floor boxes and accessories are listed by Underwriters Laboratories Inc., and comply with Federal Specifications W-C-583b in one of the following types and classes: Type I-Fully adjustable, Type II-Semi-adjustable, Type III-Non-adjustable, Class 1-Watertight, Class 2-Concrete-tight.

FLOOR BOX SYSTEMS

Quick Selection Guide

Wiremold® Floor Boxes are TopGuard protected to meet and exceed the UL scrub water exclusion requirement.



Floor Boxes for Wood Floor (continued)

RESIDENTIAL BOXES									
862 Series	Round	Single	1 Gang	PVC	N/A	3/4" Trade Size	Brass, Brushed Aluminum	Tile, Carpet	Included with Kit or 895, 896 Series
WMFB Series, WMFB1	Square	Single	1 Gang	PVC	N/A	1/2" & 3/4" Trade Size	Brass, Brushed Nickel	Tile, Carpet	Included with Kit
WMFB Series, WMFB2	Square	Dual	2 Gangs	PVC	N/A	1/2" & 3/4" Trade Size	Brass, Brushed Nickel	Tile, Carpet	Included with Kit
863 Series	Round	Dual	2 Gangs	PVC	N/A	1/2" Trade Size Romex strain relief pass-through opening for communications	Brass, Brushed Aluminum	Carpet	Included with Kit

Raised Floor Boxes

ACCESS FLOOR DEPTH: 2 1/2"									
Box Model	Box Type	Service Capability	Box Capacity	Box Construction	Depth Behind Device Plates	KO Sizes	Cover Construction	Cover Type	Cover & Flange Part Nos.
AF Series SAF 2 1/2	Square	Triple	3 Gangs	Steel	1 3/4" [44mm]	1/2" & 3/4" Trade Size	Polycarbonate	Tile, Carpet	Included with Box
CONCRETE FLOOR DEPTH: 4"									
AF Series SAF 2 1/2	Square	Triple	3 Gangs	Steel	1 3/4" [44mm]	1/2" & 3/4" Trade Size	Polycarbonate	Tile, Carpet	Included with Box
AC Series AC8840	Square	Single	2 Gangs	Steel	1 1/2" [38mm]	1/2" & 3/4" Trade Size	Die-Cast Zinc	Carpet	Included with Box
AC Series AC8104	Square	Dual	4 Gangs	Steel	1 5/8" [41mm]	1/2" & 3/4" Trade Size	Die-Cast Zinc	Carpet	Included with Box
ACCESS FLOOR DEPTH: 5"									
AF Series SAF 2 1/2	Square	Triple	3 Gangs	Steel	1 3/4" [44mm]	1/2" & 3/4" Trade Size	Polycarbonate	Tile, Carpet	Included with Box
AF Series AF1	Square	Triple	4 Gangs	Die-Cast Aluminum	2 3/4" [70mm]	1/2" & 3/4" Trade Size	Polycarbonate	Tile, Carpet	Included with Box
AF Series AF3	Square	Triple	8 Gangs	Die-Cast Aluminum	2 3/4" [70mm]	1/2" & 3/4" Trade Size	Polycarbonate	Tile, Carpet	Included with Box
AC Series AC8840	Square	Single	2 Gangs	Steel	1 1/2" [38mm]	1/2" & 3/4" Trade Size	Die-Cast Zinc	Carpet	Included with Box
AC Series AC8850	Square	Single	4 Gangs	Steel	2" [51mm]	1/2" & 3/4" Trade Size	Die-Cast Zinc	Carpet	Included with Box
AC Series AC8104	Square	Dual	4 Gangs	Steel	1 5/8" [41mm]	1/2" & 3/4" Trade Size	Die-Cast Zinc	Carpet	Included with Box
AC Series AC8105	Square	Triple	6 Gangs	Steel	2" [51mm]	1/2" & 3/4" Trade Size	Die-Cast Zinc	Carpet	Included with Box
AC Series AC10105	Square	Triple	8 Gangs	Steel	2" [51mm]	1/2" & 3/4" Trade Size	Die-Cast Zinc	Carpet	Included with Box

NOTE: Most Wiremold floor boxes and accessories are listed by Underwriters Laboratories Inc., and comply with Federal Specifications W-C-583b in one of the following types and classes: Type I-Fully adjustable, Type II-Semi-adjustable, Type III-Non-adjustable, Class 1-Watertight, Class 2-Concrete-tight.

FLOOR BOX SYSTEMS

Quick Selection Guide

Wiremold® Floor Boxes are TopGuard protected to meet and exceed the UL scrub water exclusion requirement.



Raised Floor Boxes (continued)

ACCESS FLOOR DEPTH: 6"										
Box Model	Box Type	Service Capability	Box Capacity	Box Construction	Depth Behind Device Plates	KO Sizes	Cover Construction	Cover Type	Cover & Flange Part Nos.	Notes
AF Series SAF 2 1/2	Square	Triple	3 Gangs	Steel	1 3/4" [44mm]	1/2" & 3/4" Trade Size	Polycarbonate	Tile, Carpet	Included with Box	
AF Series AF1	Square	Triple	4 Gangs	Die-Cast Aluminum	2 3/4" [70mm]	1/2" & 3/4" Trade Size	Polycarbonate	Tile, Carpet	Included with Box	
AF Series AF3	Square	Triple	8 Gangs	Die-Cast Aluminum	2 3/4" [70mm]	1/2" & 3/4" Trade Size	Polycarbonate	Tile, Carpet	Included with Box	
AC Series AC8840	Square	Single	2 Gangs	Steel	1 1/2" [38mm]	1/2" & 3/4" Trade Size	Die-Cast Zinc	Carpet	Included with Box	
AC Series AC8850	Square	Single	4 Gangs	Steel	2" [51mm]	1/2" & 3/4" Trade Size	Die-Cast Zinc	Carpet	Included with Box	
AC Series AC8104	Square	Dual	4 Gangs	Steel	1 5/8" [41mm]	1/2" & 3/4" Trade Size	Die-Cast Zinc	Carpet	Included with Box	
AC Series AC8105	Square	Triple	6 Gangs	Steel	2" [51mm]	1/2" & 3/4" Trade Size	Die-Cast Zinc	Carpet	Included with Box	
AC Series AC10105	Square	Triple	8 Gangs	Steel	2" [51mm]	1/2" & 3/4" Trade Size	Die-Cast Zinc	Carpet	Included with Box	
CRFB Series	Round	Triple	4 Gangs	Die-Cast Aluminum	2 1/4" [57mm]	1/2", 3/4", 1", 1-1/4" & 2" Trade Size	CRFB & Evolution Die-Cast Aluminum	Tile, Carpet	CRFBCTC, CRFBBTC, 8AT Series	
Evolution Series EFB6S	Rectangular	Triple	6 Gangs	Steel	3 7/8" [98mm]	3/4" - 2" Trade Size	Die-Cast Aluminum	Tile, Carpet, Wood, Terrazzo, Polished Concrete	EFB610CTC, EFB610BTC, EFB610BT, EFB610CT	Removable Modules, Standard Size Device Plates
Evolution Series EFB8S	Rectangular	Triple	8 Gangs	Steel	3 1/2" [89mm]	3/4" - 2" Trade Size	Die-Cast Aluminum	Tile, Carpet, Wood, Terrazzo, Polished Concrete	EFB610CTC, EFB610BTC, EFB610BT, EFB610CT	Removable Modules, Standard Size Device Plates
Evolution Series EFB10S	Rectangular	Triple	10 Gangs	Steel	3 1/4" [83mm]	3/4" - 2" Trade Size	Die-Cast Aluminum	Tile, Carpet, Wood, Terrazzo, Polished Concrete	EFB610CTC, EFB610BTC, EFB610BT, EFB610CT	Removable Modules, Finished Interior

NOTE: Most Wiremold floor boxes and accessories are listed by Underwriters Laboratories Inc., and comply with Federal Specifications W-C-583b in one of the following types and classes: Type I-Fully adjustable, Type II-Semi-adjustable, Type III-Non-adjustable, Class 1-Watertight, Class 2-Concrete-tight.

EVOLUTION™ SERIES FLOOR BOXES



Wiremold® Evolution™ Series Floor Boxes are the latest advancement in the most complete and innovative line of floor solutions in the industry.



CODE REFERENCE

cULus Listed
Metallic Outlet Boxes:
 File E2961 Guide QCIT.
 Meets Article 314.27(C) of NEC.

Evolution™ Series Floor Box Components

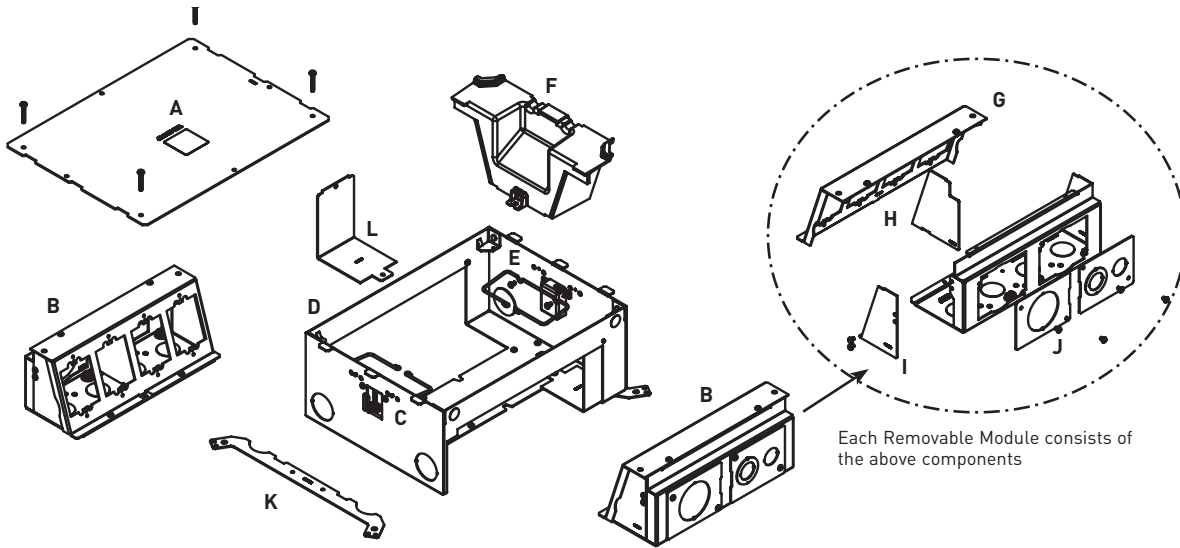

Each Removable Module consists of the above components

KEY

- | | |
|---|---------------------------------------|
| A. Mud Cap (temporary construction cover) | G. Mounting Bracket |
| B. Removable Module | H. Divider (removable repositionable) |
| C. Toggle Clamp | I. End Cap |
| D. Box | J. Back Knockout Plate |
| E. Cable Guide | K. Concrete Level Leg |
| F. Tunnel | L. "L" Bracket |

All items shown above are included with Evolution Series floor boxes.

COLOR OPTIONS



Evolution Series Floor Box Covers are available in the following powder coated finishes: "BK" black, "GY" gray, "NK" nickel, "BS" brass, and "BZ" bronze.

Custom color options are also available. Consult the factory for more information.

EVOLUTION™ SERIES FLOOR BOXES

Evolution™ Series Floor Box Model Selection Guide

EVOLUTION FLOOR BOX MODEL	EFB6S	EFB6S-OG	EFB6S-FC	EFB8S	EFB8S-OG	EFB8S-FC	EFB10S	EFB10S-OG	EFB10S-FC	EFBFF	EFBFF-OG
INSTALL FLOOR TYPE: Concrete Floor Raised Floor Wood Floor	YES YES YES	YES	YES	YES YES YES	YES	YES	YES YES YES	YES	YES	YES YES YES	YES
BOX TYPE:	Standard	On-Grade	Fire Classified	Standard	On-Grade	Fire Classified	Standard	On-Grade	Fire Classified	Furniture Feed	Furniture Feed
BOX CAPACITY:	6-Gangs	6-Gangs	6-Gangs	8-Gangs	8-Gangs	8-Gangs	10-Gangs	10-Gangs	10-Gangs	2-Gangs	2-Gangs
DEPTH BEHIND PLATES:	3 7/8" [98mm]	3 7/8" [98mm]	3 7/8" [98mm]	3 1/2" [89mm]	3 1/2" [89mm]	3 1/2" [89mm]	3 1/2" [89mm]	3 1/2" [89mm]	3 1/2" [89mm]	N/A	N/A
REMOVABLE MODULES:	YES	YES	YES	YES	YES	YES	YES	YES	YES		
DEVICE PLATE SIZE:	Uses Standard Size Device Plates: Single-Gang [2 3/4" x 4 1/2"] [70mm x 114mm]			Uses Standard Size Device Plates: Single-Gang [2 3/4" x 4 1/2"] Double-Gang [4 9/16" x 4 1/2"] Triple-Gang [6 3/8" x 4 1/2"]			Uses Non-Standard Size Device Plates [4.652" x 2.302"] [117mm x 58mm]				
COVERS: COLORS:	EFB610CTC Series, EFB610BTC Series, EFB610CT Series, EFB610BT Series Black, Gray, Brass, Nickel, Bronze									FPFFTC Series Black, Gray, Brass, Nickel, Bronze, Brushed Aluminum	
FLOOR SURFACE:	Carpet, Tile, Wood, Bare (Polished) Concrete & Terrazzo									Carpet, Tile & Wood	
KO SIZE RANGE: (TRADE SIZE)	3/4" to 2"	3/4" to 2"	1 1/4"	3/4" to 2"	3/4" to 2"	1 1/4"	3/4" to 2"	3/4" to 2"	1 1/4"	1/2" to 2"	1/2" to 2"
FIRE RATING: (HOURS)			Up to 2 Hours			Up to 2 Hours			Up to 2 Hours		

NOTE: Covers open full 180°, slide cable egress doors, painted interior.

Evolution Series Floor Box Compartment Volumes

MODEL	OUTER COMPARTMENTS (EACH)		CENTER COMPARTMENTS (EACH)	
EFB6 SERIES	32 in. ³	[524ml]	38.5 in. ³	[630ml]
EFB8 SERIES	27.5 in. ³	[450ml]	34 in. ³	[557ml]
EFB10 SERIES	23.5 in. ³	[385ml]	27.5 in. ³	[450ml]
EFBFF SERIES	64.5 in. ³	[1056ml]	64.5 in. ³	[1056ml]



Finished Interior

Fully finished interior removes the unfinished industrial look while increasing visibility, making it easier to see where to plug in devices.



Configurable with Removable Modules

In addition to having removable dividers and a tunnel feature that allows all compartments to be connected, the modules are removable through the top or back of the floor box. This allows for easier installations and facilitates moves, adds and changes without having to disconnect services, saving time and money.



Audio/Video Design

Evolution Series Floor Boxes have been developed specifically with the A/V industry in mind. With 3 1/2" – 3 7/8" [89mm x 98mm] of wiring capacity behind each device plate, these boxes will accept devices from leading A/V manufacturers including Extron® Electronics and Crestron®.



Durable 180° Articulating Hinge

Hinge design enables covers to open a full 180° and lie flat on the floor surface with the durability to support a large cover. Provides easy access to all interior modules and activations while reducing tripping hazards.

EVOLUTION™ SERIES FLOOR BOXES

Evolution™ Series 6-Gang Floor Boxes Ordering Information

EFB6S 6-Gang Floor Box

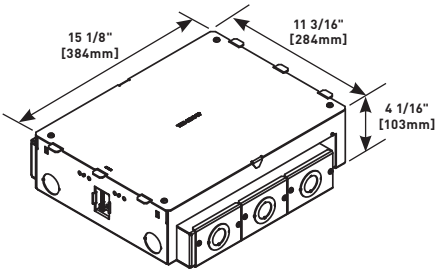

Designed to be installed in concrete floors, raised floors, and wood floor applications. Box has a fully finished interior to assist plugging and unplugging of devices. Designed to work with standard size wall plates. **Box comes complete with all components needed for initial installation. Included components are:** Protective/ Disposable cover, tunnel system for connecting the two modules of compartments, two (2) removable modules, two (2) toggle clamps to secure box to raised and wood floors, two (2) cable management guides, two (2) leveling support legs for concrete applications and trade size knockouts ranging in size from 3/4" to 2" trade size. **Items not included with the box and sold separately are:** receptacles, communication jacks, and A/V devices and device plates. Box is compatible with Wiremold® Walkerflex Modular Wiring System. Custom options are available upon request.

NOTE: For use on bare (polished) concrete or terrazzo floors EFB610-CTR must be used (sold separately).

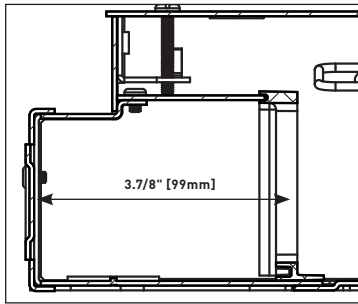

EFB6 Depth Behind Plates

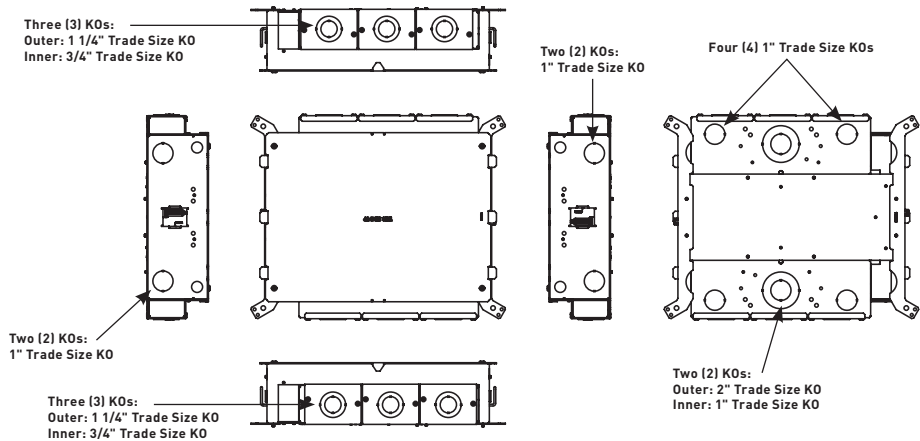

EFB6S-0G Six-Gang Floor Box

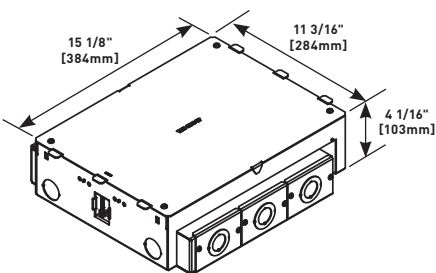

Designed to be installed in both on-grade and above grade concrete floor applications. Box has an epoxy coating that allows the box to be placed in on-grade applications without the need for additional vapor barriers. Designed to work with standard size wall plates. **Box comes complete with all components needed for initial installation. Included components are:** protective/disposable cover, tunnel system for connecting the two modules of compartments, two (2) removable modules, two (2) cable management guides, two (2) leveling support legs for concrete applications and trade size knockouts ranging in size from 3/4" to 1 1/4". **Items not included with the box and sold separately are:** receptacles, communication jacks, and A/V devices and device plates. Custom options are available upon request.

Note: For use on bare (polished) concrete or terrazzo floors EFB610-CTR must be used (sold separately).

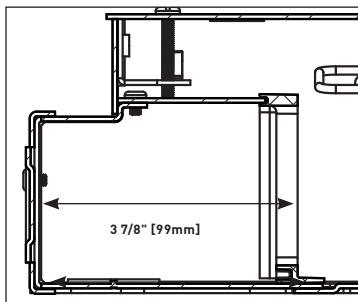

EFB6-0G Depth Behind Plates

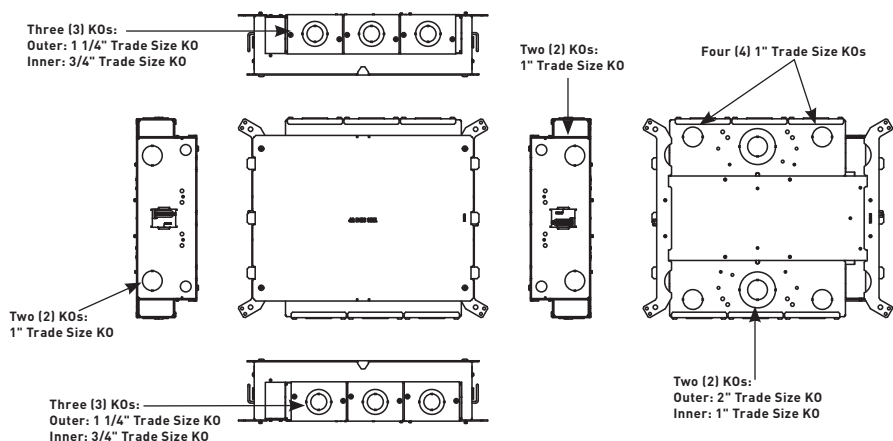

EVOLUTION™ SERIES FLOOR BOXES

Evolution™ Series 6-Gang Floor Boxes Ordering Information (continued)

EFB6S-FC Six-Gang Fire-Classified Floor Box

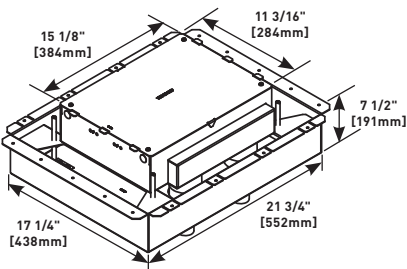

Designed to be installed in above grade concrete floors while maintaining the fire classification of the floor. This box is classified to be used in 2-hour fire rated floors. Designed to accept standard size wall plates. **Box comes complete with all components needed for initial installation. Included components are:** protective/disposable cover, tunnel system for connecting the two modules of compartments, fire classified pan, two (2) removable modules, four (4) 1 1/4 intumescent conduit feeds and two (2) cable management guides. **Items not included with the box and sold separately are:** receptacles, communication jacks, and A/V devices and device plates

NOTE: For use on bare (polished) concrete or terrazzo floors EFB610-CTR must be used. (Sold separately).

NOTE: Designed for new construction applications.

NOTE: Consult structural engineer before making cuts into decking. Add additional supports as instructed by the structural engineer.

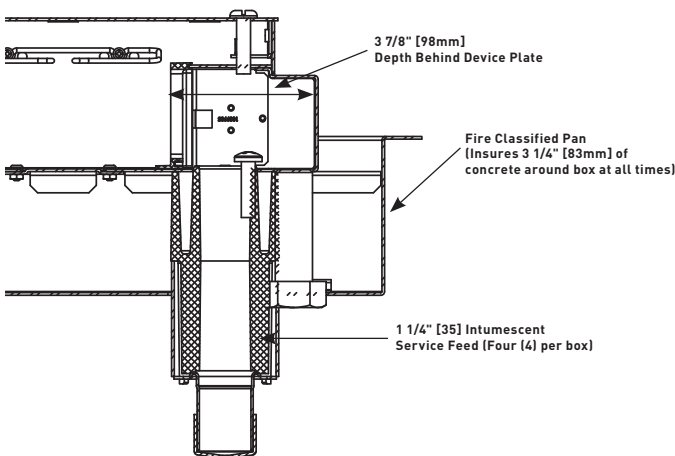

Outlet Boxes and Fittings Classified for Fire Resistance Legrand/Wiremold (R8209)

Type EFB6S-FC, EFB8S-FC and EFB10S-FC preset electrical insert for use in 2-hour fire rated D900 Series Floor-Ceiling designs constructed with nominal 2" or 3" deep fluted steel floor units having a nominal 5" wide valley and crests spaced 12" OC, with a minimum 3 1/4" [83mm] thickness of structural concrete topping. The assembly preset electrical insert with floor plate kit and service activations fitting will not reduce the 2-hour fire rating of the floor assembly when installed in accordance with the installation instructions accompanying the preset electrical insert and when the preset electrical insert are spaced 2' [0.61m] OC with not more than one unit per 4 square feet [0.37m²] of floor area in each span.

Evolution™ Series 6-Gang Floor Box Accessories Ordering Information

EFB6M Module

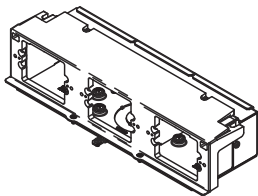

Bank of three (3) compartments that accept power, communications and audio/video devices. Accepts standard size [2 3/4" x 4 1/2" [70mm x 114mm]] device plates. Includes device bracket, back plate, three (3) knockout plates [3/4"/1 1/4" concentric], two (2) end caps and one (1) divider.

NOTE: Module will fit on either side of the floor box.

EFB6-MB Mounting Bracket

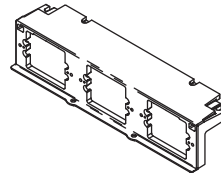

Holds up to three (3) devices of power, communications or audio/video devices. Bracket accepts standard size [2 3/4" x 4 1/2" [70mm x 114mm]] device plates sold separately by others.

EFB-AAP Device Plate

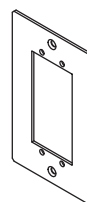

Holds two (2) Extron® Electronics AAP devices. Device plate dimensions: 2 3/4" x 4 1/2" [69mm x 114mm].

EVOLUTION™ SERIES FLOOR BOXES

Evolution™ Series 6-Gang Floor Box Accessories Ordering Information (continued)

EFB-MAAP Device Plate



Holds four (4) Extron® Electronics MAAP devices. Device plate dimensions: 2 3/4" x 4 1/2" [69mm x 114mm].

EFB6-DIV Relocatable Divider

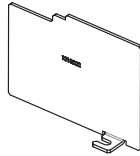

Provides separation of services. Includes one (1) divider plate.

EFB-MOS Device Plate

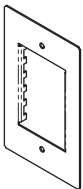

European device plate accepts up to [45mm x 67.5mm] Arteor device. Device plate dimensions: 2 3/4" x 4 1/2" [69mm x 114mm].

EFBCLL Concrete Leveling Legs

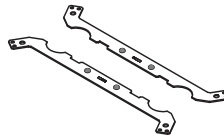

Provide floor box adjustment up or down to match the desired pour height of the concrete. Included two (2) leveling legs, threaded rod not supplied.

EFB-B Blank Device Plate



Device plate dimensions: 2 3/4" x 4 1/2" [69mm x 114mm].

EFBCMG Cable Management Guides

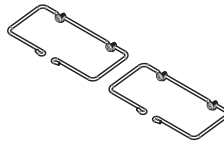

Guides help organize and maintain cable position when opening and closing the cover.

EFB6-3/4-11/4 Knockout Plate

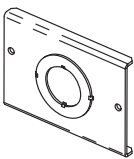

Has one (1) 1 1/4" concentric trade size knockout opening.

EFB6S-2HUB 2" Conduit Hub

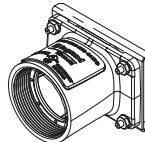

Hub allows 2" conduit to be fed into the back of EFB6S and EFB6S-OG Floor Boxes. Maximum of six (6) hubs per box.

EFB6-TUN Tunnel

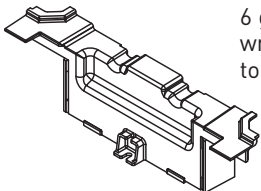

6 gang tunnel allows for cables to be wrapped around box from one module to the other.

EVOLUTION™ SERIES FLOOR BOXES

Evolution™ Series 8-Gang Floor Boxes Ordering Information

EFB8S 8-Gang Floor Box

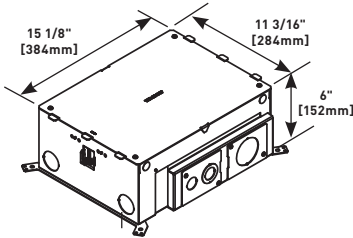

Designed to be installed in concrete floors, raised floors, and wood floor applications. Box has a fully finished interior to assist plugging and unplugging of devices. Designed to work with standard size wall plates. **Box comes complete with all components needed for initial installation. Included components are:** protective/disposable cover, tunnel system for connecting the two modules of compartments, two (2) removable modules, two (2) toggle clamps to secure box to raised and wood floors, two (2) cable management guides, two (2) leveling support legs for concrete applications and trade size knockouts ranging in size from 3/4" to 2". **Items not included with the box and sold separately are:** receptacles, communication jacks, and A/V devices and device plates. Box is compatible with Wiremold® Walkerflex Modular Wiring System. Custom options are available upon request.

NOTE: For use on bare (polished) concrete or terrazzo floors EFB610-CTR must be used (sold separately).

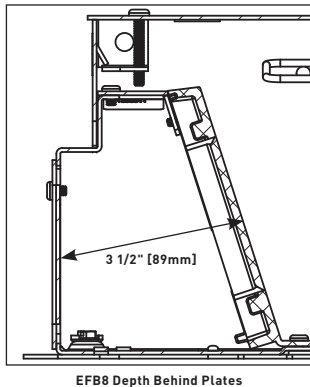

EFB8S Depth Behind Plates

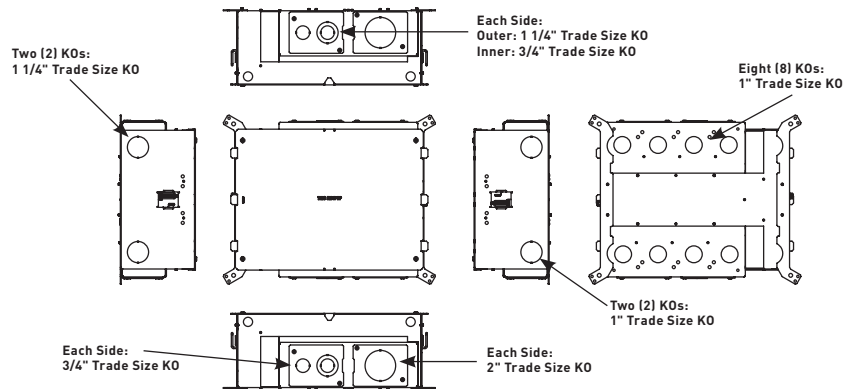

EFB8S-OG 8-Gang Floor Box

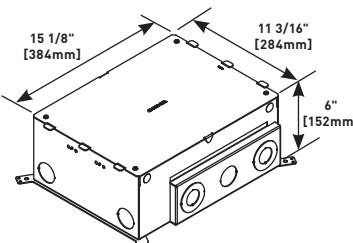

Designed to be installed in both on-grade and above grade concrete floor applications. Box has an epoxy coating that allows the box to be placed in on-grade applications without the need for additional vapor barriers. Designed to work with standard size wall plates. **Box comes complete with all components needed for initial installation. Included components are:** protective/disposable cover, tunnel system for connecting the two modules of compartments, two (2) removable modules, two (2) cable management guides, two (2) leveling support legs for concrete applications, trade size knockouts ranging in size from 3/4" to 2". **Items not included with the box and sold separately are:** receptacles, communication jacks, and A/V devices and device plates. Custom options are available upon request.

NOTE: For use on bare (polished) concrete or terrazzo floors EFB610-CTR must be used (sold separately).

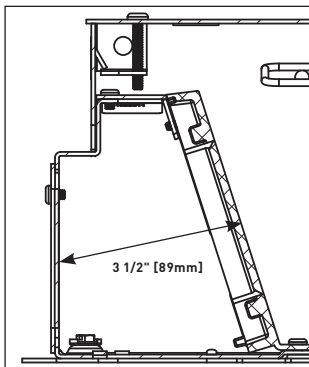

EFB8S-OG Depth Behind Plates

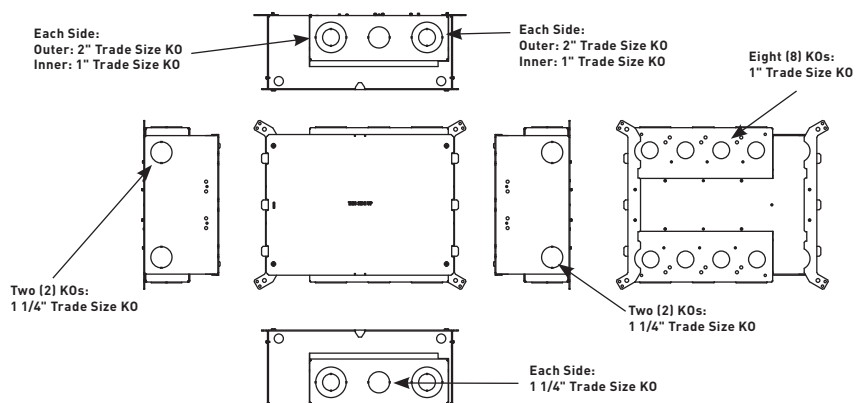

EVOLUTION™ SERIES FLOOR BOXES

Evolution™ Series 8-Gang Floor Boxes Ordering Information (continued)

EFB8S-FC 8-Gang Fire-Classified Floor Box

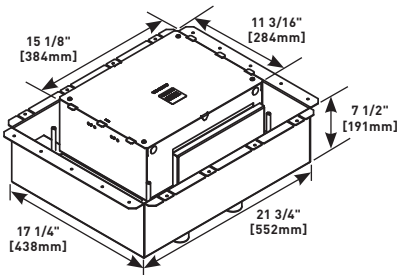

Designed to be installed in above grade concrete floors while maintaining the fire classification of the floor. This box is classified for use in 2-hour fire rated floors. Designed to work with standard size wall plates. **Box comes complete with all components needed for initial installation. Included components are:** protective/disposable cover, tunnel system for connecting the two modules of compartments, fire classified pan, two (2) removable modules, four (4) 1 1/4 intumescent conduit feeds and two (2) cable management guides. **Items not included with the box and sold separately are:** receptacles, communication jacks, and A/V devices and device plates.

NOTE: For use on bare (polished) concrete or terrazzo floors EFB610-CTR must be used (sold separately).

NOTE: Designed for new construction applications.

NOTE: Consult structural engineer before making cuts into decking. Add additional supports as instructed by the structural engineer.

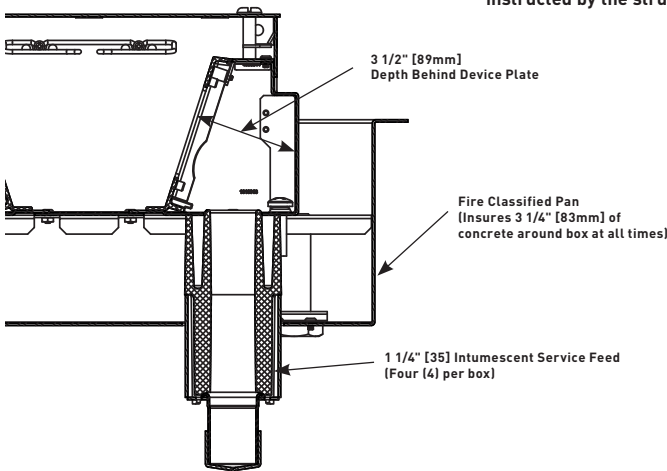

Outlet Boxes and Fittings Classified for Fire Resistance Legrand/Wiremold (R8209)

Type EFB6S-FC, EFB8S-FC and EFB10S-FC preset electrical insert for use in 2-hour fire rated D900 Series Floor-Ceiling designs constructed with nominal 2" or 3" deep fluted steel floor units having a nominal 5" wide valley and crests spaced 12" OC, with a minimum 3 1/4" [83mm] thickness of structural concrete topping. The assembly preset electrical insert with floor plate kit and service activations fitting will not reduce the 2-hour fire rating of the floor assembly when installed in accordance with the installation instructions accompanying the preset electrical insert and when the preset electrical insert are spaced 2' [0.61m] OC with not more than one unit per 4 square feet [0.37m²] of floor area in each span.

Evolution™ Series 8-Gang Floor Box Accessories Ordering Information

EFB8M Module

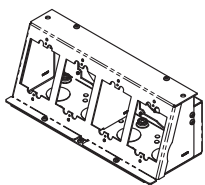

Bank of four (4) compartments that accept power, communications and audio/video devices. Accepts standard size (2 3/4" x 4 1/2") [70mm x 114mm] device plates. Includes one device bracket, one back plate, two (2) knockout plates, two (2) end caps and one divider.

NOTE: Module will fit on either side of the floor box.

EFB8S-22GMB Mounting Bracket

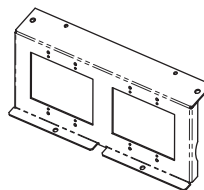

Equipped with two (2) 2-gang standard size device openings for a standard 2-gang (4 9/16" x 4 1/2" [116mm x 114mm]). Ideal for 2-gang A/V devices such as Crestron® 2-gang digital media devices. Device plates and devices supplied by others.

EFB8S-4GMB Mounting Bracket

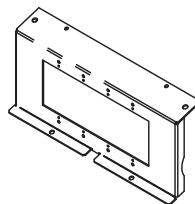

Holds a standard 4 gang device plate. Device plate dimensions: 8 1/8" x 4 1/4" [206mm x 116mm].

EFB8-MB Mounting Bracket

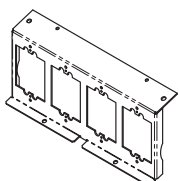

Holds up to four (4) devices for power, communications or audio/video. Bracket accepts standard size (2 3/4" x 4 1/2" [70mm x 114mm]) device plates sold separately by others.

EVOLUTION™ SERIES FLOOR BOXES

Evolution™ Series 8-Gang Floor Box Accessories Ordering Information (continued)

EFB-AAP Device Plate

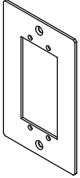

Holds two (2) Extron® Electronics AAP devices. Device plate dimensions: 2 3/4" x 4 1/2" [69mm x 114mm].

EFB810-2 Knockout Plate

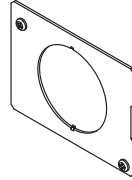

Has one 2" trade size knockout.

EFB-MAAP Device Plate

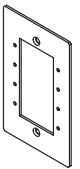

Holds four (4) Extron® Electronics MAAP devices. Device plate dimensions: 2 3/4" x 4 1/2" [69mm x 114mm].

EFB810-TUN Tunnel

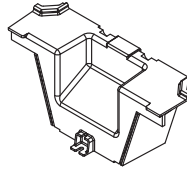

For EFB8 Series and EFB10 Series boxes. Tunnel allows cables to be wrapped around box from one module to the other.

EFB-MOS Device Plate

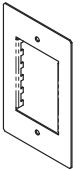

European device plate accepts up to [45mm x 67.5mm] Arteor device. Device plate dimensions: 2 3/4" x 4 1/2" [69mm x 114mm].

EFB810-DIV Relocatable Divider

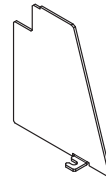

Provides separation of services. Includes one (1) divider plate.

EFB-B Blank Device Plate

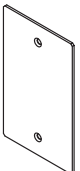

Device plate dimensions: 2 3/4" x 4 1/2" [69mm x 114mm].

EFB-CLL Concrete Leveling Legs

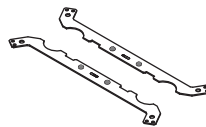

Concrete Leveling Legs – Legs allow floor box to be adjusted up or down to match the desired pour height of the concrete. Includes two (2) leveling legs. Threaded rod not supplied.

EFBCMG Cable Management Guides

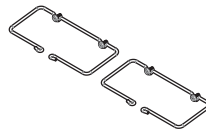

Guides help organize and maintain cable position when opening and closing the cover.

EFB810-3/4-3/4 Knockout Plate

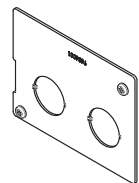

Has two (2) 3/4" trade size knockouts.

EFB-50A 50A Adapter

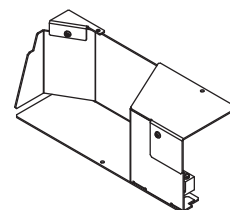

Allows for a 50A device to be installed on the 8-gang and 10-gang series boxes.

NOTE: Only fits on the side of the floor box where the device is facing the tunnel.

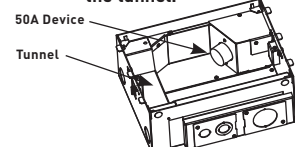

EFB810-3/4-11/4 Knockout Plate

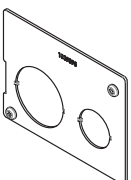

Has one 3/4" and one 3/4"/1 1/4" concentric trade size knockout.

EVOLUTION™ SERIES FLOOR BOXES

Evolution™ Series 10-Gang Floor Box Ordering Information

EFB10S 10-Gang Floor Box

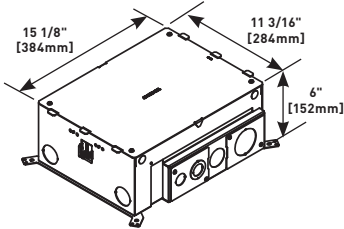

Designed to be installed in concrete floors, raised floors, and wood floor applications. Box has a fully finished interior to assist plugging and unplugging of devices. **Box comes complete with all components needed for initial installation. Included components are:** protective/disposable cover, tunnel system for connecting the two modules of compartments, two (2) removable modules, two (2) toggle clamps to secure box to raised and wood floors, two (2) cable management guides, two (2) leveling support legs for concrete applications, trade size knockouts ranging in size from 3/4" to 2". **Items not included with the box and sold separately are:** receptacles, communication jacks, and A/V devices and device plates. Box is compatible with Wiremold® Walkerflex Modular Wiring System. Custom options are available upon request.

NOTE: For use on bare (polished) concrete or terrazzo floors EFB610-CTR must be used (sold separately).

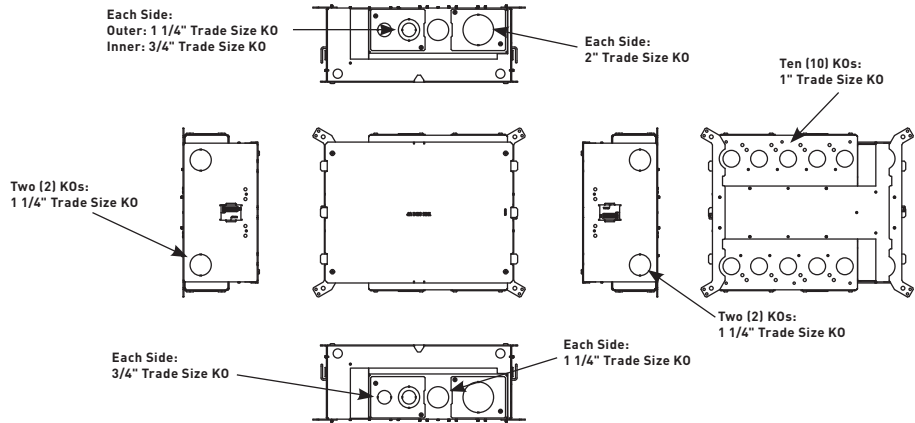
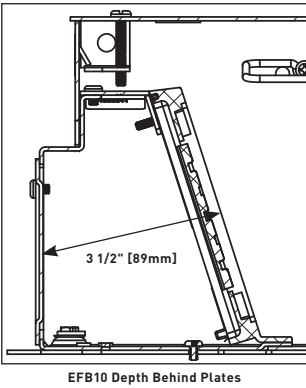

EFB10S-OG 10-Gang Floor Box

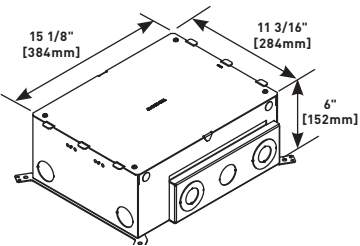

Designed to be installed in both on-grade and above grade concrete floor applications. Box has an epoxy coating that allows the box to be placed in on-grade applications without the need for additional vapor barriers. **Box comes complete with all components needed for initial installation. Included components are:** protective/disposable cover, tunnel system for connecting the two modules of compartments, two (2) removable modules, two (2) cable management guides, two (2) leveling support legs for concrete applications and trade size knockouts ranging in size from 3/4" to 1 1/4". **Items not included with the box and sold separately are:** receptacles, communication jacks, and A/V devices and device plates. Custom options are available upon request.

NOTE: For use on bare (polished) concrete or terrazzo floors EFB610-CTR must be used (sold separately).

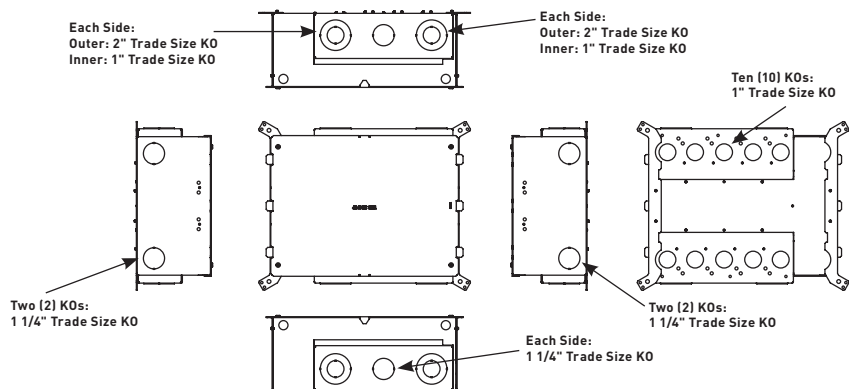
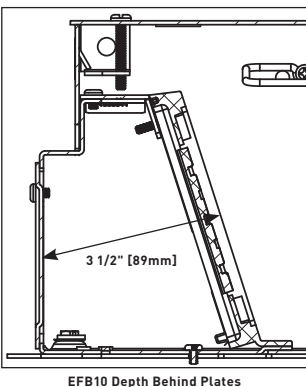

EVOLUTION™ SERIES FLOOR BOXES

Evolution™ Series 10-Gang Floor Box Ordering Information (continued)

EFB10S-FC 10 -Gang Fire-Classified Floor Box

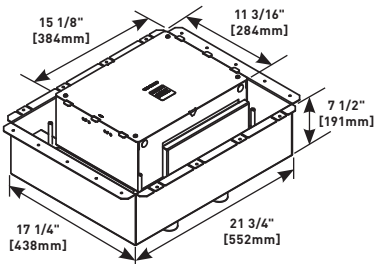

Designed to be installed in above grade concrete floors while maintaining the fire classification of the floor. This box is classified for use in 2-hour fire rated floors. **Box comes complete with all components needed for initial installation. Included components are:** protective/disposable cover, tunnel system for connecting the two modules of compartments, fire classified pan, two (2) removable modules, four (4) 1 1/4" trade size intumescent conduit feeds and two (2) cable management guides. **Items not included with the box and sold separately are:** receptacles, communication jacks, and A/V devices and device plates.

NOTE: For use on bare (polished) concrete or terrazzo floors EFB610-CTR must be used. (Sold separately).
NOTE: Designed for new construction applications.
NOTE: Consult structural engineer before making cuts into decking. Add additional supports as instructed by the structural engineer.

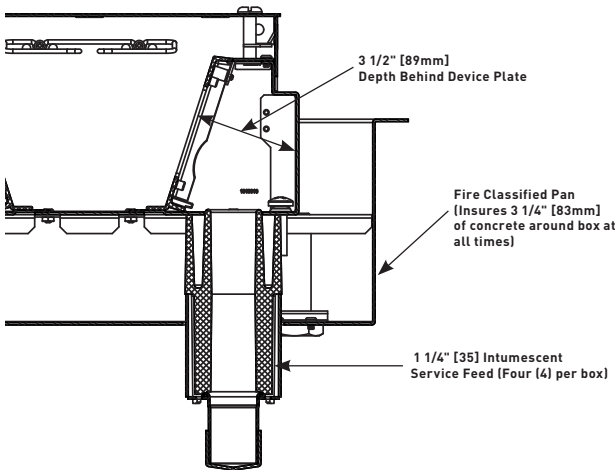

Outlet Boxes and Fittings Classified for Fire Resistance Legrand/Wiremold (R8209)
 Type EFB6S-FC, EFB8S-FC and EFB10S-FC preset electrical insert for use in 2-hour fire rated D900 Series Floor-Ceiling designs constructed with nominal 2" or 3" deep fluted steel floor units having a nominal 5" wide valley and crests spaced 12" OC, with a minimum 3 1/4" [83mm] thickness of structural concrete topping. The assembly preset electrical insert with floor plate kit and service activations fitting will not reduce the 2-hour fire rating of the floor assembly when installed in accordance with the installation instructions accompanying the preset electrical insert and when the preset electrical insert are spaced 2' [0.61m] OC with not more than one unit per 4 square feet [0.37m²] of floor area in each span.

Evolution™ Series 10-Gang Floor Box Accessories Ordering Information

EFB10M Module

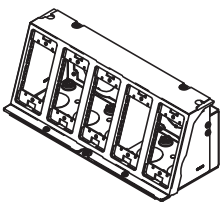

Bank of five (5) compartments that accept power, communications and audio/video devices. Accepts EFB10 Series device plates [2 1/32" x 4 5/8"] [58mm x 117mm]. Includes one mounting bracket, one back plate, one divider, two (2) end caps and two (2) knockout plates. Device plates sold separately.

NOTE: Module will fit on either side of the floor box.

EFB10S-23GMB Mounting Bracket

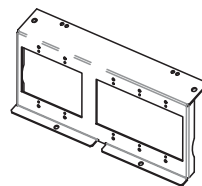

Equipped with one (1) 2-gang standard size device opening and one (1) 3-gang standard size device opening. Accepts a standard 2-gang [4 9/16" x 4 1/2" [116mm x 114mm]] and a 3-gang [6 3/8" x 4 1/2" [162mm x 114mm]] device plate. Ideal for 2-gang A/V devices such as Crestron® 2-gang and 3-gang digital media devices. Device plates and devices supplied by others.

EFB10-MB Mounting Bracket

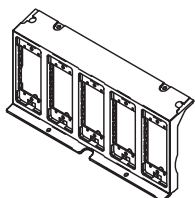

Holds up to five (5) devices for power, communications or audio/video. Bracket accepts EFB10 Series device plates [2 1/32" x 4 5/8"] [58mm x 117mm] device plates sold separately.

EFB10S-5GMB Mounting Bracket

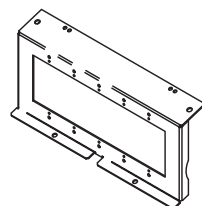

Holds a standard 5 gang device plate. Device plate dimensions: 10" x 4 1/2" [254mm x 116mm].

EVOLUTION™ SERIES FLOOR BOXES

Evolution™ Series 10-Gang Floor Box Accessories Ordering Information (continued)

EFB10-B Device Plate



Blank device plate. Device plate dimensions: 2.3" x 4.652" [58mm x 118mm].

EFB10-6AB Device Plate

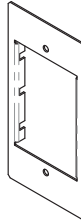

Accepts up to three (3) dual Wiremold Open System communication adapters. Adapters sold separately. Device plate dimensions: 2.3" x 4.652" [58mm x 118mm].

EFB10-DP Device Plate

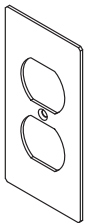

Duplex device plate. Device plate dimensions: 2.3" x 4.652" [58mm x 118mm]. Includes receptacle spacers.

EFB10-3S2 Device Plate

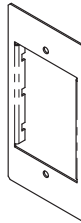

Accepts up to three (3) Ortronics® Series II devices. Ortronics® devices sold separately. Device plate dimensions: 2.3" x 4.652" [58mm x 118mm].

EFB10 -DEC Decorator Style Device Plate

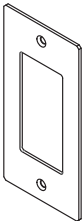

For use with decorator style receptacles, GFCI receptacle, and decorator style audio/ video devices. Device plate dimensions: 2.3" x 4.652" [58mm x 118mm]. Includes receptacle spacers.

EFB10-2C Device Plate

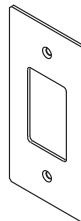

Accepts one dual Wiremold Open System adapter, or one Ortronics® Series II adapter, or one Ortronics® TracJack adapter. Adapters sold separately. Device plate dimensions: 2.3" x 4.652" [58mm x 118mm].

EFB10-S1 Knockout Plate

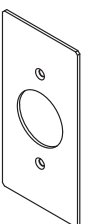

Single receptacle 1.39" [35mm]. diameter. Device plate dimensions: 2.3" x 4.652" [58mm x 118mm]. Includes receptacle spacers.

EFB10-AAP Device Plate

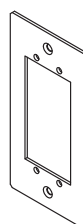

Holds two (2) Extron® Electronics AAP devices. Device plate dimensions: 2.3" x 4.652" [58mm x 118mm].

EFB10-S2 Knockout Plate

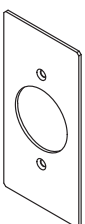

Single receptacle 1.59" [40mm] diameter. Device plate dimensions: 2.3" x 4.652" [58mm x 118mm]. Includes receptacle spacers.

EFB10-MAAP Device Plate

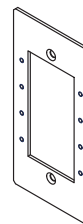

Holds four (4) Extron® Electronics MAAP devices. Device plate dimensions: 2.3" x 4.652" [58mm x 118mm].

EVOLUTION™ SERIES FLOOR BOXES

Evolution™ Series 10-Gang Floor Box Accessories Ordering Information (continued)

EFB10-MOS Device Plate

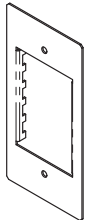

[45mm x 67.5mm] device plate. Device plate dimensions: 2.3" x 4.652" [58mm x 118mm].

5507T2-WH Single Receptacle Faceplate

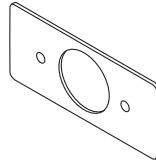

For covering single receptacles – 1.41" [36mm] in diameter.

5507B-WH Blank Faceplate

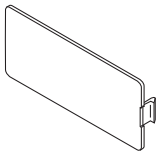

For covering unused compartments in the device bracket.

55074TJ-WH Ortronics® Faceplate

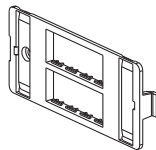

For mounting Ortronics® datacom inserts. Accepts four (4) TracJack devices.

5507D-WH Duplex Receptacle Faceplate

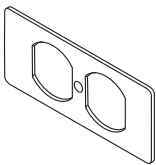

For covering duplex style devices. Accepts 106 frame.

55076TJ-WH Ortronics® Faceplate

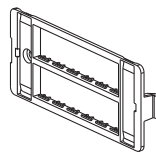

For mounting Ortronics® datacom inserts. Accepts six (6) TracJack devices.

5507R-WH Rectangular Receptacle Faceplate

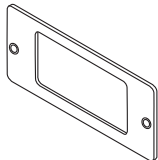

For covering rectangular decorator style devices.

EFB810-3/4-3/4 Knockout Plate

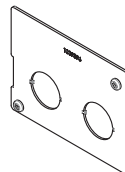

Has two 3/4" trade size knockout.

5507S-WH Rectangular Spacer

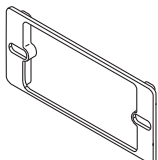

For mounting commercial device plates. Installs between the device bracket and a device.

EFB810-3/4-11/4 Knockout Plate

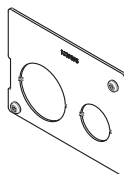

Has one 3/4" and one 3/4"/1 1/4" concentric trade size knockout.

5507T1-WH Single Receptacle Faceplate

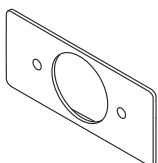

For covering single receptacles – 1.59" [40mm] in diameter.

EFB810-2 Knockout Plate

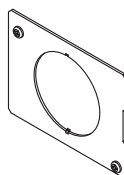

Has one 2" trade size knockout.

EVOLUTION™ SERIES FLOOR BOXES

Evolution™ Series 10-Gang Floor Box Accessories Ordering Information (continued)

EFB810-TUN Tunnel

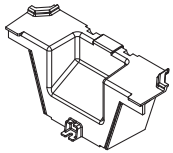

For EFB8 Series and EFB10 Series boxes. Tunnel allows cables to be wrapped around box from one module to the other.

EFBCMG Cable Management Guides

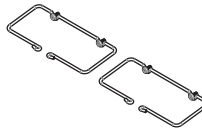

Guides help organize and maintain cable position when opening and closing the cover.

EFB810-DIV Relocatable Divider

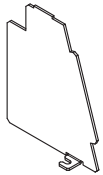

Provides separation of services. Includes one (1) divider plate.

EFB-50A 50A Adapter

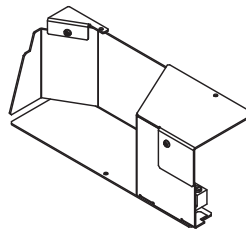

Allows for a 50A device to be installed on the 8-gang and 10-gang series boxes.

NOTE: Only fits on the side of the floor box where the device is facing the tunnel.

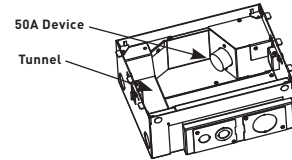

EFB-CLL Concrete Leveling Legs

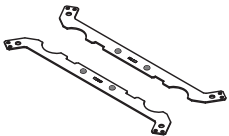

Legs allow floor box to be adjusted up or down to match the desired pour height of the concrete. Includes two (2) leveling legs. Threaded rod not supplied.

Evolution™ Series Floor Box Cover Plates & Accessories Ordering Information

EFB610CTC Surface Style Cover with Carpet Insert

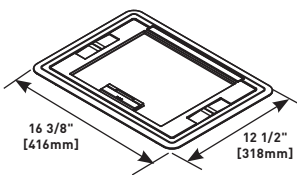

EFB610CTCBK, EFB610CTCGY, EFB610CTCBS, EFB610CTCNK, EFB610CTCBZ

Die cast aluminum cover assembly designed to be used on top of the floor covering. Available in the following powder coated finishes: black, gray brass, nickel and bronze. For use on Evolution™ Series 6-, 8- and 10-gang floor boxes (EFB6, EFB8 and EFB10).

NOTE: Depth of recess area in plate is 1/4" [6.35mm].

EFB610CT Flush Style Cover with Carpet Insert

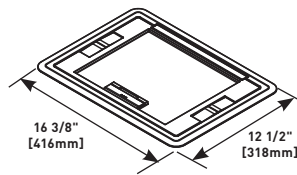

EFB610CTBK, EFB610CTGY, EFB610CTBS, EFB610CTNK, EFB610CTBZ

Die cast aluminum cover assembly designed to be used level (flush) with finish floor covering. Available in the following powder coated finishes: black, gray, brass, nickel and bronze. For use on Evolution™ Series 6-, 8- and 10-gang floor boxes (EFB6, EFB8 and EFB10).

NOTE: Depth of recess area in plate is 1/4" [6.35mm].

EVOLUTION™ SERIES FLOOR BOXES

Evolution™ Series Floor Box Cover Plates & Accessories Ordering Information (continued)

EFB610BTC Surface Style Cover with Solid Lid

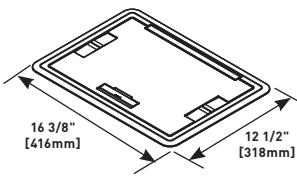

EFB610BTCBK, EFB610BTCGY, EFB610BTCBS, EFB610BTCNK, EFB610BTCBZ

Die cast aluminum cover assembly designed to be used on top of the floor covering. Available in the following powder coated finishes: black, gray, brass, nickel and bronze. For use on Evolution™ Series 6-, 8- and 10-gang floor boxes (EFB6, EFB8 and EFB10).

EFB610CTR Bare Concrete/Terrazzo Trim Ring

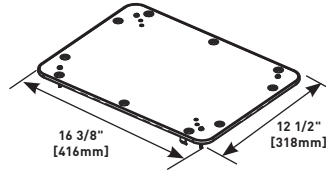

Nonmetallic ring for use with bare concrete and terrazzo floor applications.

NOTE: Ring must be attached to the floor box before pouring concrete or terrazzo.

EFB610BT Flush Style Cover with Solid Lid

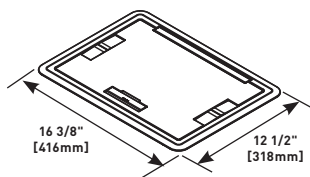

EFB610BTBK, EFB610BTGY, EFB610BTBS, EFB610BTNK, EFB610BTBZ

Die cast aluminum cover assembly designed to be used on top of floor covering. Available in the following powder coated finishes: black, gray, brass, nickel and bronze. For use on Evolution™ Series 6-, 8- and 10-gang floor boxes (EFB6, EFB8 and EFB10).

EFB610-TS Tile Shim

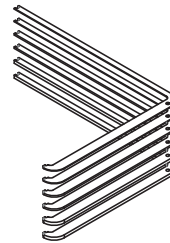

Used for floor coverings greater than 3/16" [4.7mm]. The EFB610-TS allows the finished cover assembly to be flush with the finished floor. Includes one (1) 1/16" [1.6mm], one (1) 1/8" [3.2mm] and one 1/4" [6.4mm] tile shims for 9/16" [14.3mm] of upward adjustment.

EFB-Template Floor Box Template

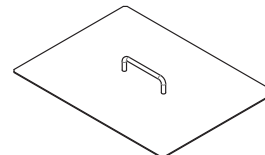

Designed to help mark out floor to insure a proper fit.

Load Capacities for Evolution™ Series Floor Box Cover Assemblies

CATALOG NUMBERS	MAXIMUM LOAD IN POUNDS
EFB610BTC Series	1800
EFB610CTC Series	1800
EFB610BT Series	1800
EFB610CT Series	1800

NOTE: Load applied through a 3" [76mm] mandrel in center of the cover. Loads above are static loads only and do not pertain to rolling loads.



Evolution Series Floor Box Covers are available in powder coated finishes of (L to R) gray, nickel, bronze, brass and black.

EVOLUTION™ SERIES FLOOR BOXES

Evolution™ Series EFBFF Furniture Floor Boxes Ordering Information

EFBFF 2-Gang Furniture Feed Floor Box Assembly

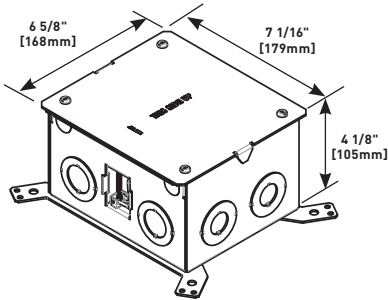

NOTE: For use with bare concrete or terrazzo floors. Use FP-CTR Trim Ring.

NOTE: Box is divided down center to allow for separation between power and communication or A/V services.

For carpet, tile and wood covered floors. For use in concrete, raised and wood floor applications. Box is provided with a protective, disposable cover that allows the box to be installed at any point in the construction process. Box is available in a standard version for use in above grade concrete, raised, and wood floor applications. Boxes are also compatible with Wiremold® Walkerflex Modular Wiring System. Custom options are available upon request.

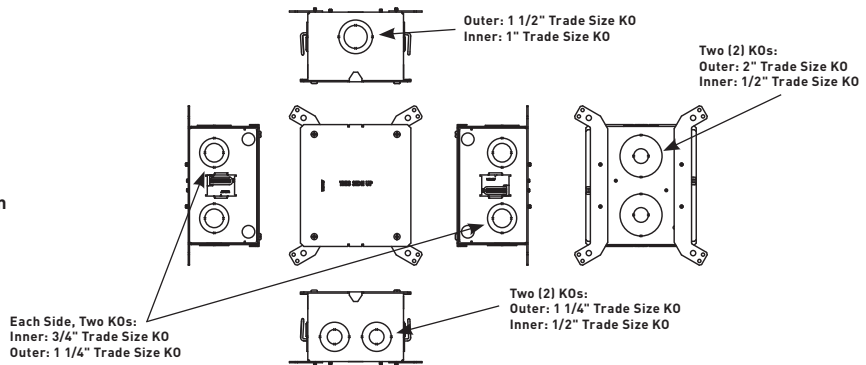

EFBFF-OG 2-Gang Furniture Feed Floor Box Assembly

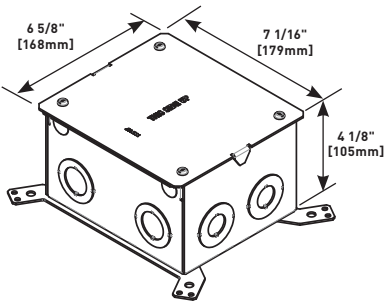

NOTE: For use with bare concrete or terrazzo floors. Use FP-CTR Trim Ring.

NOTE: Box is divided down center to allow for separation between power and communication or A/V services.

For carpet, tile and wood covered floors. For use in on-grade and above grade concrete floor applications. Box is provided with a protective, disposable cover that allows the box to be installed at any point in the construction process. Box is available with an epoxy coating for on-grade applications. Custom options are available upon request.

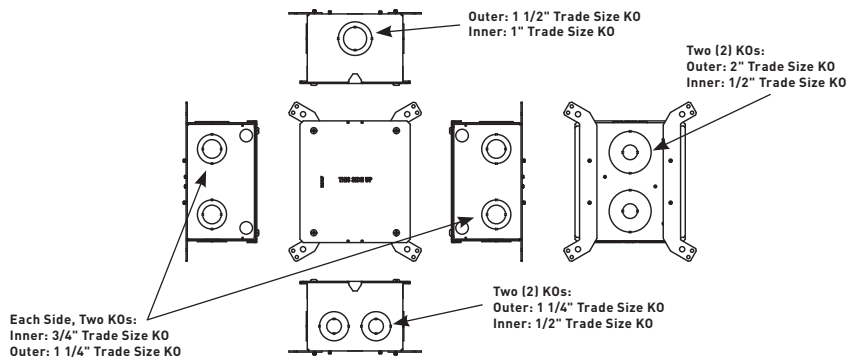

EVOLUTION™ SERIES FLOOR BOXES

Evolution™ Series EFBFF Furniture Floor Box Accessories Ordering Information

EFBFF-DIV Divider

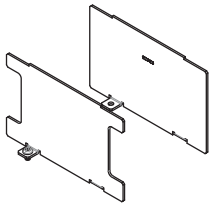

Provides separation of services.

FPFFTC Furniture Feed Cover Assembly

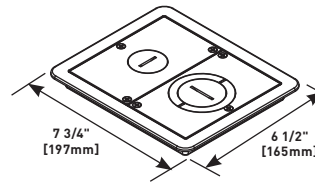

FPFFTCBK, FPFFTCBZ, FPFFTCBS, FPFFTCNK, FPFFTCGY, FPFFTCAL

Flanged cover for use in tile or carpet or wood floor installations. Die-cast aluminum assembly available in powder coat finishes of black, bronze, brass, nickel, gray or brushed aluminum. Provided with one (1) 1" trade size screw plug for power or communication type cabling and one (1) combination 1 1/4" and 2" trade size screw plug for communication and A/V type cabling. Allows for feeding both power and communication cabling.

NOTE: Flangeless FloorPort Series (FPFFT) covers are not designed to work with Evolution Series Furniture Feed Floor Boxes.

FP-CTR Bare Concrete & Terrazzo Ring

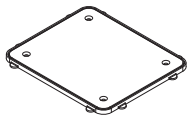

Nonmetallic ring for use on bare polished concrete and terrazzo floor applications.

NOTE: Ring must be attached to the floor box before pouring concrete or terrazzo.

EFBFF-CLL Concrete Leveling legs

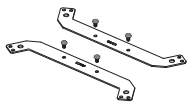

Legs allow floor box to be adjusted up or down to match the desired pour height of the concrete. Includes two (2) leveling legs. Threaded rod not supplied.

FIRE CLASSIFIED FLOOR BOXES



Wiremold® Fire Classified Floor Boxes meet or exceed the UL Fire Classification requirements for floor boxes eliminating the need for additional spraying or fireproofing.

CODE REFERENCE

cULus Listed
Metallic Outlet Boxes:
 File E2961 Guide QCIT.
 Meets Article 314.27(C) of NEC.

Shallow Depth Steel Floor Boxes Ordering Information

880S1FC

1-Gang Fire Classified Shallow Depth Steel Floor Box

Adjustment range over deck of 4 1/2" [114mm] minimum to 5" [127mm] maximum. Use in normal weight concrete 4 1/2" [114mm] minimum pour over deck. One 1 1/4" [32mm] conduit feed opening. Box Capacity – 53 cubic inches.

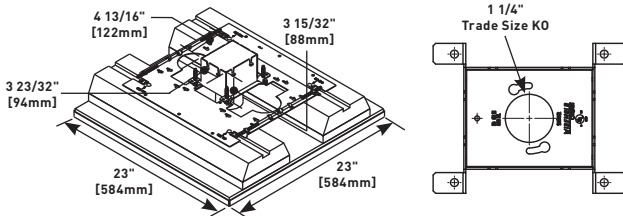

880S3FC

3-Gang Shallow Depth Steel Floor Box

Adjustment range over deck of 4 1/2" [114mm] minimum to 5" [127mm] maximum. Use in normal weight concrete 4 1/2" [114mm] minimum pour over deck. Three 1 1/4" [32mm] conduit feed openings. Inside Gang Capacity – 67.5 cubic inches. Outside Gang Capacity – 54 cubic inches each gang.

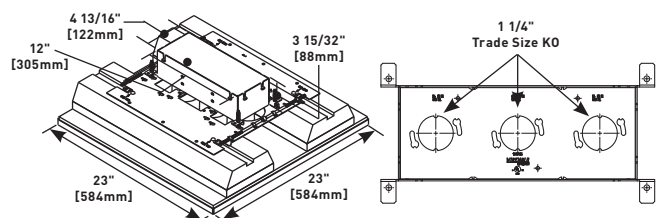

880S2FC

2-Gang Fire Classified Shallow Depth Steel Floor Box

Adjustment range over deck of 4 1/2" [114mm] minimum to 5" [127mm] maximum. Use in normal weight concrete 4 1/2" [114mm] minimum pour over deck. Two 1 1/4" [32mm] conduit feed openings. Box Capacity – 58.5 cubic inches per gang.

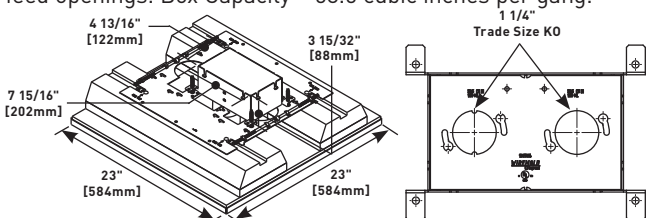

NOTE: Floor Box spacing 2' on center and one for every 4 square feet in a span. Four (4) #12 AWG Type THHN Power Conductors or 48 #23 AWG (6 Cat. 6) Tele Data Conductors per gang.

COLOR OPTIONS

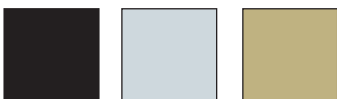

Cover Plates and Flanges for Fire Classified OmniBox Series™ Floor Boxes are available in the colors shown as indicated in the part number descriptions.

Custom color options are also available. Consult the factory for more information.

FIRE CLASSIFIED FLOOR BOXES

Omnibox Series Floor Boxes

Standard Depth Steel Floor Boxes Ordering Information

880M1FC

1-Gang Fire Classified Steel Floor Box

Adjustment range over deck of 3 1/4" [83mm] minimum to 4" [102mm] maximum. Use in light weight concrete 3 1/4" [83mm] minimum pour over deck. One 1 1/4" [32mm] conduit feed opening. Box Capacity – 37 cubic inches.

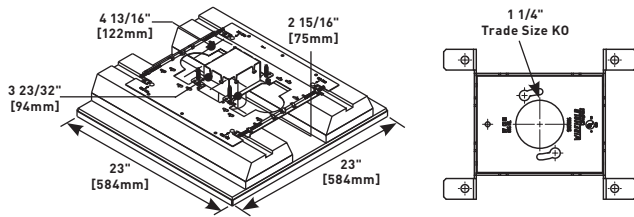

880M3FC

3-Gang Fire Classified Steel Floor Box

Adjustment range over deck of 3 1/4" [83mm] minimum to 4" [102mm] maximum. Use in light weight concrete 3 1/4" [83mm] minimum pour over deck. Three 1 1/4" [32mm] conduit feed openings. Inside Gang Capacity – 45 cubic inches. Outside Gang Capacity – 36 cubic inches each gang.

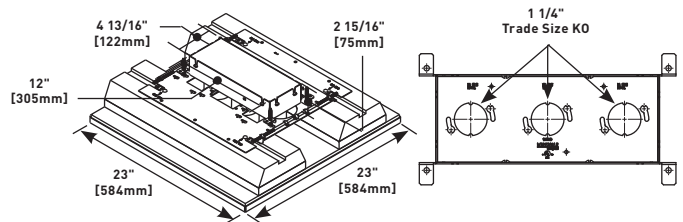

880M2FC

2-Gang Fire Classified Steel Floor Box

Adjustment range over deck of 3 1/4" [83mm] minimum to 4" [102mm] maximum. Use in light weight concrete 3 1/4" [83mm] minimum pour over deck. Two 1 1/4" [32mm] conduit feed openings. Box Capacity – 40 cubic inches each gang.

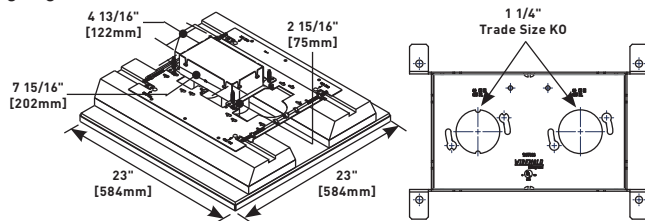

NOTE: Floor Box spacing 2' on center and one for every 4 square feet in a span. Four (4) #12 AWG Type THHN Power Conductors or 48 #23 AWG (6 Cat. 6) Tele Data Conductors per gang.

Omnibox Series Floor Boxes Solid Brass Cover Plate Flanges Ordering Information

817B 1-Gang Brass Combination Carpet & Tile Flange

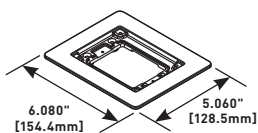

Accepts Ortronics® MAB6TJ TracJack and MAB3S2 Series II adapters and Wiremold CM Series inserts, sold separately.

837B 3-Gang Brass Combination Carpet & Tile Flange

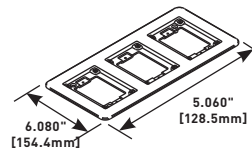

Accepts Ortronics® MAB6TJ TracJack and MAB3S2 Series II adapters and Wiremold CM Series inserts, sold separately.

827B 2-Gang Brass Combination Carpet & Tile Flange

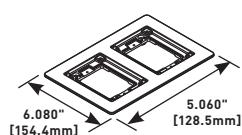

Accepts Ortronics® MAB6TJ TracJack and MAB3S2 Series II adapters and Wiremold CM Series inserts, sold separately.

817C 1-Gang Brass Carpet Flange

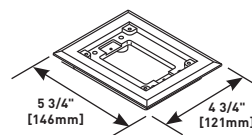

For use on 880S1, 880M1, 880CS1-1, and 880CM1-1 Floor Boxes.

FIRE CLASSIFIED FLOOR BOXES

Omnibox Series Floor Boxes

Omnibox Series Floor Boxes Solid Brass Cover Plate Flanges Ordering Information (continued)

827C 2-Gang Brass Carpet Flange

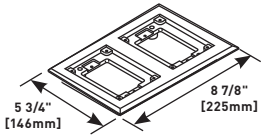

For use on 880S2, 880M2, 880CS2-1, and 880CM2-1 Floor Boxes.

837C 3-Gang Brass Carpet Flange

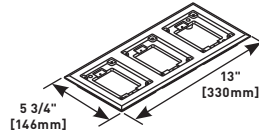

For use on 880S3, 880M3, 880CS32-1, and 880CM3-1 Floor Boxes.

Omnibox Series Floor Boxes Metal Cover Plates Ordering Information

828R Brass Duplex Cover Plate

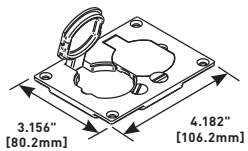

Flip lids. Can also be used with a 106 type communication adapter.

828DLR Brass Single Locking Receptacle Cover Plate

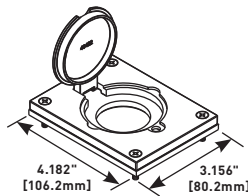

Single flip lid cover for 20A or 30A single locking receptacles. Device opening is 2 5/8" [67mm]. For use with maximum female locking device of 1.58" diameter, and maximum male plug face of 2.25" diameter.

828GFITC Brass GFI Cover Plate

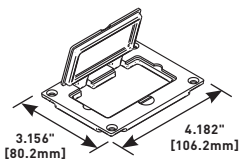

May be used with Activate and Ortronics® Connectivity Systems in conjunction with 817B, 827B, and 837B Flanges.

828SPTC Brass Duplex Cover Plate

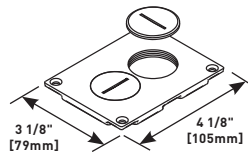

Screw plugs are 1 1/2" [38mm] in diameter.

828DPGFITC Brass Rectangular Cover Plate

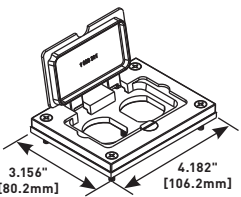

Allows for mounting of a duplex style receptacle with a rectangular style flip lid cover.

829STC Brass Communications Cover Plate

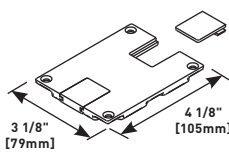

Brass communications cover plate, data slides. Feed through only, not for use with a mounting plate for flush mounted communication adapter.

828COMTC Brass Communication Cover Plate

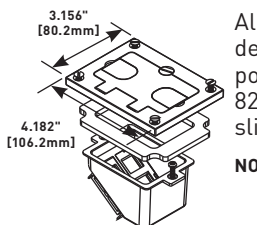

Allows for up to four communication devices to be mounted in a recessed position within the 880 Floor Box. The 828COMTC Cover Plate has removable slides for cable egress.

NOTE: For use with 880S and 880CS Series Boxes only.

829CK Brass Communications Cover Plate

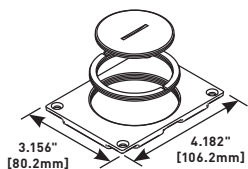

2 5/8" and 2 1/4" [67mm and 57mm] plugs. Not for use with threaded conduit.

NOTE: UL Listed for tile, terrazzo and carpet floors, brass covers and flanges are not interchangeable with aluminum or nonmetallic covers and flanges. Nonmetallic covers are interchangeable with aluminum flanges.

FIRE CLASSIFIED FLOOR BOXES

Omnibox Series Floor Boxes

Omnibox Series Floor Boxes Metal Cover Plates Ordering Information (continued)

829CK-1 Brass Communications Cover Plate

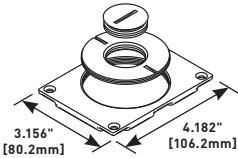

2 5/8" and 1" [67mm and 25mm] plugs. Not for use with threaded conduit.

829CK-1/2 Brass Communications Cover Plate

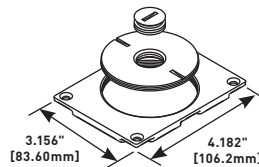

Brass communications cover plate, 2 5/8" and 1/2" [67mm and 12.7mm] plugs. For carpet or tile installations. Not for use with threaded conduit.

829CK-3/4 Brass Communications Cover Plate

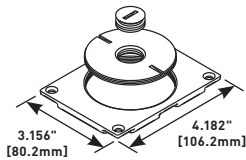

2 5/8" and 3/4" [67mm and 19.1mm] plugs. Not for use with threaded conduit.

828MAAP AV Adapter Plate

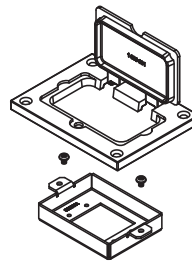

Sheet metal adapter plate that accepts two (2) Extron® Electronics MAAP style device plates (sold separately). For use with 828GFITC or 828GFITCAL cover plates (sold separately).

Omnibox Series Floor Boxes Brushed Aluminum Cover Plate Flanges Ordering Information

818TCAL 1-Gang Brushed Aluminum Combination Carpet & Tile Flange

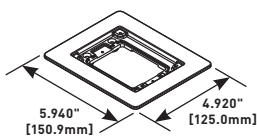

Accepts Ortronics® MAB6TJ TracJack and MAB3S2 Series II adapters and Wiremold CM Series inserts, sold separately.

838TCAL 3-Gang Brushed Aluminum Combination Carpet & Tile Flange

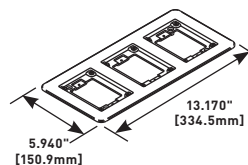

Accepts Ortronics® MAB6TJ TracJack and MAB3S2 Series II adapters and Wiremold CM Series inserts, sold separately.

828TCAL 2-Gang Brushed Aluminum Combination Carpet & Tile Flange

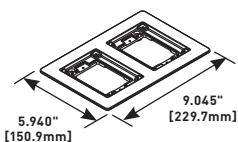

Accepts Ortronics® MAB6TJ TracJack and MAB3S2 Series II adapters and Wiremold CM Series inserts, sold separately.

NOTE: Brushed aluminum flanges come with beveled edges.

NOTE: UL Listed for tile, terrazzo, wood, and carpet floors. Brass covers and flanges are not interchangeable with aluminum or nonmetallic covers and flanges. Nonmetallic covers are interchangeable with aluminum flanges.

FIRE CLASSIFIED FLOOR BOXES

Omnibox Series Floor Boxes

Omnibox Series Floor Boxes Brushed Aluminum Cover Plates Ordering Information

828R-TCAL Brushed Aluminum Duplex Cover Plate

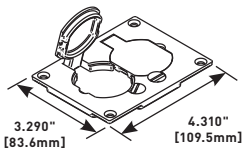

Flip lids. Can also be used with a 106 type communication adapter.

830CKTCAL Brushed Aluminum Cover Plate

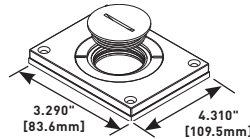

Power or communication plate with 2" [51mm] and 1 1/4" [32mm] plugs.

NOTE: Acceptable for use with threaded conduit when passing through power cables.

828GFITCAL Brushed Aluminum GFI Cover Plate

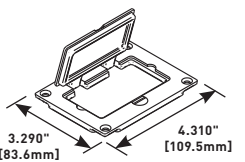

May be used with Activate and Ortronics® Connectivity Systems in conjunction with 817B, 827B, and 837B Flanges.

830CKTCAL-1 Brushed Aluminum Cover Plate

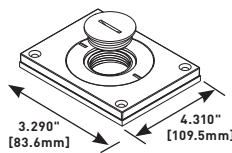

Power or communication plate with 2" [51mm] and 1" [25mm] plugs.

NOTE: Acceptable for use with threaded conduit when passing through power cables.

828DPGFITCAL Brushed Aluminum Rectangular Cover Plate

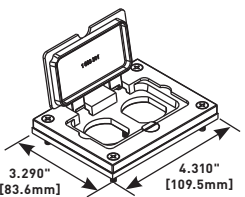

Allows for mounting of a duplex style receptacle with a rectangular style flip lid cover.

830CKTCAL-3/4 Brushed Aluminum Cover Plate

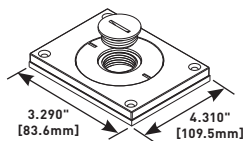

Power or communication plate with 2" [51mm] and 3/4" [19.1mm] plugs.

NOTE: Acceptable for use with threaded conduit when passing through power cables.

828COMTCAL Brushed Aluminum Communication Cover Plate

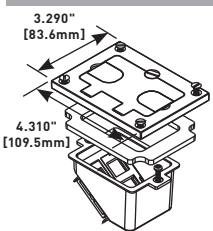

Allows for up to four communication devices to be mounted in a recessed position within the 880 Floor Box. The 828COMTCAL Cover Plate has removable slides for cable egress.

NOTE: For use with 880S and 880CS Series Boxes only.

830CKTCAL-1/2 Brushed Aluminum Cover Plate

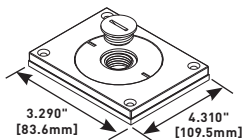

Power or communication plate with 2" [51mm] and 1/2" [12.7mm] plugs.

NOTE: Acceptable for use with threaded conduit when passing through power cables.

828DLRAL Brushed Aluminum Single Locking Receptacle Cover Plate

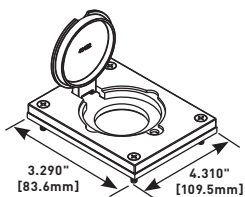

Single flip lid cover for 20A or 30A single locking receptacles. Device opening is 2 5/8" [67mm]. For use with maximum female locking device of 1.58" diameter, and maximum male plug face of 2.25" diameter.

828MAAP AV Adapter Plate

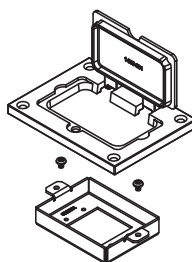

Sheet metal adapter plate that accepts two (2) Extron® Electronics MAAP style device plates (sold separately). For use with 828GFITC or 828GFITCAL cover plates (sold separately).

NOTE: UL Listed for tile, terrazzo, wood, and carpet floors. Brass covers and flanges are not interchangeable with aluminum or nonmetallic covers and flanges. Nonmetallic covers are interchangeable with aluminum flanges.

FIRE CLASSIFIED FLOOR BOXES

Omnibox Series Floor Boxes

Powder-Coated Aluminum Cover Plate & Flanges Ordering Information

817TCAL 1-Gang Powder-Coated Aluminum Combination Carpet and Tile Flange

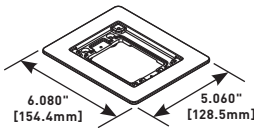

817TCAL-BK, 817TCAL-GY, 817TCAL-BS, 817TCAL-NK, 817TCAL-BZ

Accepts Ortronics® MAB6TJ TracJack and MAB3S2 Series II adapters and Wiremold CM Series inserts, sold separately. Flanges are available in five decorative colors: black, gray brass, nickel and bronze.

828GFITCAL Powder-Coated Aluminum Rectangular Cover Plate

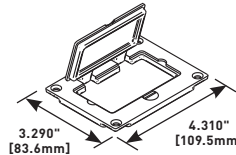

828GFITCAL-BK, 828GFITCAL-GY, 828GFITCAL-BS, 828GFITCAL-NK, 828GFITCAL-BZ

Allows for mounting of a duplex receptacle (Duplex or GFCI style) with a rectangular flip cover.

827TCAL 2-Gang Powder-Coated Aluminum Combination Carpet and Tile Flange

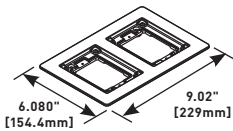

827TCAL-BK, 827TCAL-GY, 827TCAL-BS, 827TCAL-NK, 827TCAL-BZ

Accepts Ortronics® MAB6TJ TracJack and MAB3S2 Series II adapters and Wiremold CM Series inserts, sold separately. Flanges are available in five decorative colors: black, gray brass, nickel and bronze.

829CKAL-1 Powder-Coated Aluminum Cover Plate

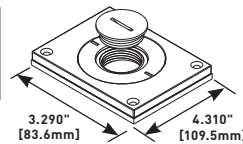

829CKAL-1BK, 829CKAL-1GY, 829CKAL-1BS, 829CKAL-1NK, 829CKAL-1BZ

Power or communication plate with 2" [51mm] and 1" [25mm] plugs. Covers are available in five decorative colors: black, gray, brass, nickel and bronze.

NOTE: Acceptable for use with threaded conduit when passing through power cables.

837TCAL 3-Gang Powder-Coated Aluminum Combination Carpet and Tile Flange

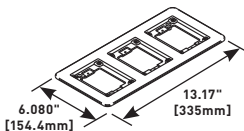

837TCAL-BK, 837TCAL-GY, 837TCAL-BS, 837TCAL-NK, 837TCAL-BZ

Accepts Ortronics® MAB6TJ TracJack and MAB3S2 Series II adapters and Wiremold CM Series inserts, sold separately. Flanges are available in five decorative colors: black, gray brass, nickel and bronze.

829CKAL-3/4 Powder-Coated Aluminum Cover Plate

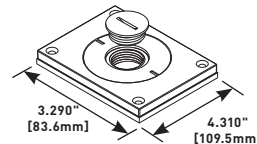

829CKAL-3/4BK, 829CKAL-3/4GY, 829CKAL-3/4BS, 829CKAL-3/4NK, 829CKAL-3/4BZ

Power or communication plate with 2" [51mm] and 3/4" [19.1mm] plugs. Covers are available in five decorative colors: black, gray, brass, nickel and bronze.

NOTE: Acceptable for use with threaded conduit when passing through power cables.

828R-TCAL Powder-Coated Aluminum Duplex Cover Plate

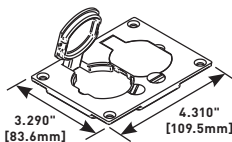

828R-TCAL-BK, 828R-TCAL-GY, 828R-TCAL-BS, 828R-TCAL-NK, 828R-TCAL-BZ

Flip lids. Can also be used with a 106 type communication adapter.

828MAAP AV Adapter Plate

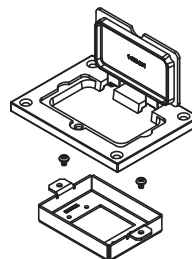

Sheet metal adapter plate that accepts two (2) Extron® Electronics MAAP style device plates (sold separately). For use with 828GFITCAL or 828GFITCAL cover plates (sold separately).

NOTE: UL Listed for tile, terrazzo, wood, and carpet floors. Brass covers and flanges are not interchangeable with aluminum or nonmetallic covers and flanges. Nonmetallic covers are interchangeable with aluminum flanges.

FIRE CLASSIFIED FLOOR BOXES

Omnibox Series Floor Boxes

Nonmetallic Cover Plate Flanges Ordering Information

817PCC 1-Gang Nonmetallic Carpet Flange

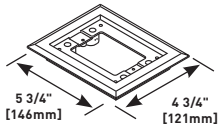

817PCC-BLK, 817PCC-BRN

Available in black or brown. For Ortronics® connectivity use with 829PFLRT Cover. For Activate connectivity use with 829PFL Cover. Accepts Ortronics® MAB6TJ TracJack and MAB3S2 Series II adapters and Wiremold CM Series inserts, sold separately.

837PCC 3-Gang Nonmetallic Carpet Flange

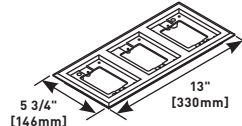

837PCC-BLK, 837PCC-BRN

Available in black or brown. For Ortronics® connectivity use with 829PFLRT Cover. For Activate connectivity use with 829PFL Cover. Accepts Ortronics® MAB6TJ TracJack and MAB3S2 Series II adapters and Wiremold CM Series inserts, sold separately.

827PCC 2-Gang Nonmetallic Carpet Flange

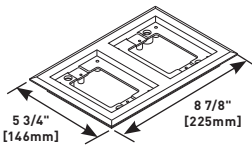

827PCC-BLK, 827PCC-BRN

Available in black or brown. For Ortronics® connectivity use with 829PFLRT Cover. For Activate connectivity use with 829PFL Cover. Accepts Ortronics® MAB6TJ TracJack and MAB3S2 Series II adapters and Wiremold CM Series inserts, sold separately.

Nonmetallic Cover Plates Ordering Information

828PR Nonmetallic Duplex Cover Plate

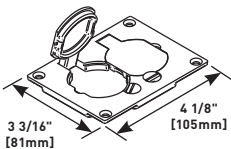

828PR-BLK, 828PR-BRN

Flip lids. Available in black or brown. Can also be used with a 106 type communication adapter.

829PFLRT Nonmetallic Communication Cover Plate

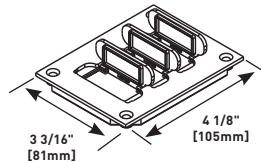

829PFLRT-BLK, 829PFLRT-BRN

Individual flip lids. Available in black or brown. Gasket included. Ortronics® MAB6TJ TracJack and MAB3S2 Series II adapters included.

828PRGFI Nonmetallic GFI Cover Plate

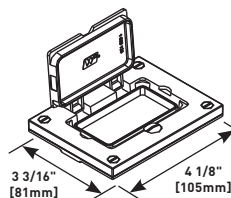

828PRGFI-BLK, 828PRGFI-BRN

Available in black or brown. May be used with Ortronics® Connectivity systems in conjunction with 817, 827 and 837PCC Series flanges.

829PCK Nonmetallic Communication Cover Plate

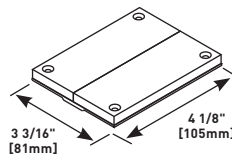

829PCK-BLK, 829PCK-BRN

Breakouts. Available in black or brown. Feed through only, not for use with a mounting plate for communication jacks.

829PFL Nonmetallic Communication Cover Plate

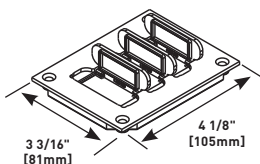

829PFL-BLK, 829PFL-BRN

Individual flip lids. Available in black or brown. Gasket included. Wiremold CM Series inserts included.

829PSTC Nonmetallic Communications Cover Plate

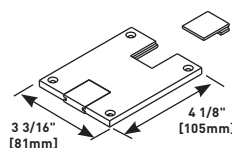

829PSTC-BLK, 829PSTC-BRN

Data slides. Available in black or brown. Feed through only, not for use with a mounting plate for communication jacks.

NOTE: UL Listed for tile, terrazzo, wood, and carpet floors. Brass covers and flanges are not interchangeable with aluminum or nonmetallic covers and flanges. Nonmetallic covers are interchangeable with aluminum flanges.

FIRE CLASSIFIED FLOOR BOXES

RFB Series Floor Boxes

Fire Classified RFB2 Series Multiservice Steel Recessed Floor Boxes Ordering Information

RFB2FC Fire Classified Two-Compartment Box

For use in either concrete or wood floors. Fully adjustable with tunnel compartment. Supplied with one (1) duplex receptacle mounting plate, and one (1) communication mounting plate (RFB22AB). Other device plates sold separately.

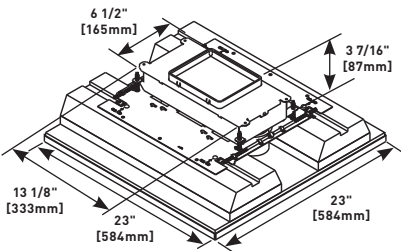

Note: For use in normal weight concrete floors with a minimum pour depth of 4 1/2" [114mm] over the crest of the deck.

RFB2-SSFC Fire Classified Two-Compartment Box

For use in either concrete or wood floors. Fully adjustable with tunnel compartment. Supplied with one (1) duplex receptacle mounting plate, and one (1) communication mounting plate (RFB22AB). Other device plates sold separately.

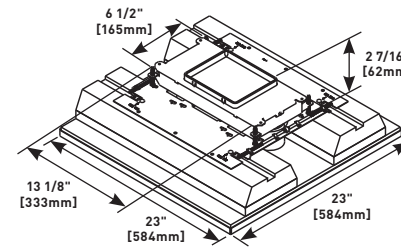

NOTE: For use in light weight concrete floors with a minimum pour depth of 3 1/4" [83mm] over the crest of the deck.

NOTE: Floor Box spacing 2' on center and one for every 4 square feet in a span.
Four (4) #12 AWG Type THHN Power Conductors or 48 #23 AWG (6 Cat. 6) Tele Data Conductors per gang.

Fire Classified RFB2 Series Floor Box Compartment Capacities, Knockout Locations & Sizes

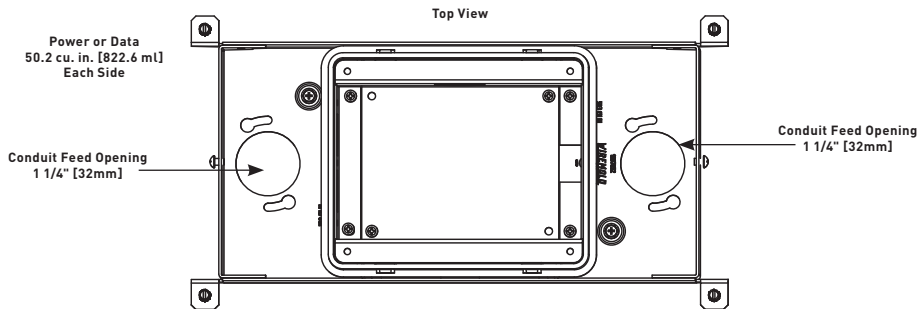

Fire Classified RFB2 Series Multiservice Steel Recessed Floor Box Accessories Ordering Information

RFB2DP Internal Duplex Receptacle Bracket

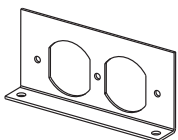

Accepts standard 15A and 20A duplex receptacles.

NOTE: For RFB2 Series Floor Boxes only.

RFB2-AAP Internal Audio Video Bracket

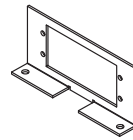

Accepts two (2) Extron® Electronics AAP Series Devices (sold separately).

NOTE: For RFB2 Series Floor Boxes only.

RFB2B Internal Blank Bracket



Plate used to close off unused gangs.

NOTE: For RFB2 Series Floor Boxes only.

RFB2GFI Internal GFI or Decorator Style Receptacle Opening

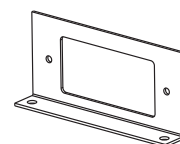

Accepts standard GFCI or Decorator style receptacles.

NOTE: For RFB2 Series Floor Boxes only.

FIRE CLASSIFIED FLOOR BOXES

RFB Series Floor Boxes

Fire Classified RFB2 Series Multiservice Steel Recessed Floor Box Accessories Ordering Information (continued)

RFB22AB Internal Communication Bracket

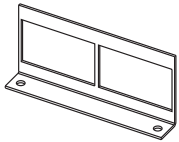

Includes two (2) adapters to accept Wiremold Open System communication inserts (Sold separately).

NOTE: For RFB2 Series Floor Boxes only.

RFB2EXT Internal Audio Video Bracket

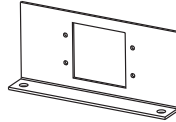

Accepts two (2) Legrand AVIP device plates or (2) Extron® Electronics MAAP Series devices (Sold separately).

NOTE: For RFB2 Series Floor Boxes only.

RFB2RT Internal Communication Bracket

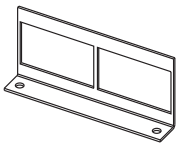

Includes two (2) adapter to accept Ortronics® TracJack devices, and two (2) adapters to accept Ortronics Series II devices (Sold separately).

NOTE: For RFB2 Series Floor Boxes only.

Fire Classified RFB4 Multiservice Steel Recessed Floor Boxes Ordering Information

RFB4-4DBFC Fire Classified Four-Compartment Floor Box

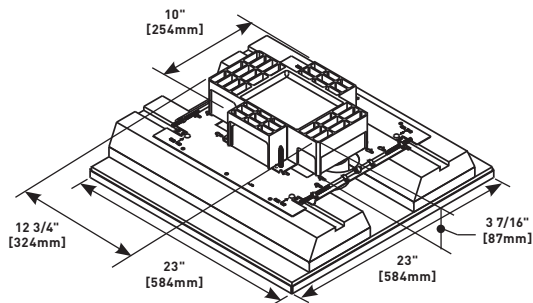

Includes four duplex receptacle brackets. 12 3/4" L x 10" W x 3 7/16" D [324mm x 254mm x 87mm]. Fully adjustable. **Tunneling from adjacent or opposite compartments only, (not cross compartments).** Tunneling can be set to feed all four compartments from one conduit in a single-service application.

NOTE: For use in normal weight concrete floors with a minimum pour depth of 4 1/2" [114mm] over the crest of the deck.

NOTE: Floor Box spacing 2' on center and one for every 4 square feet in a span. Four (4) #12 AWG Type THHN Power Conductors or 48 #23 AWG (6 Cat. 6) Tele Data Conductors per gang.

NOTE: All boxes and activations are sold separately.

Fire Classified RFB4 Series Floor Box Compartment Capacities, Knockout Locations & Sizes

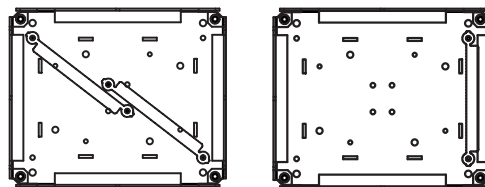
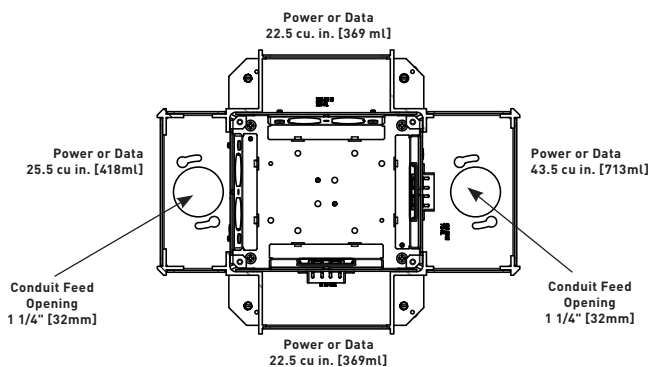

FIRE CLASSIFIED FLOOR BOXES

RFB Series Floor Boxes

Fire Classified RFB4 Series Multiservice Steel Recessed Floor Box Accessories Ordering Information

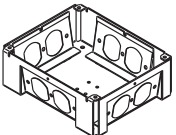
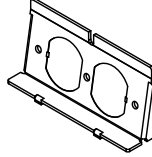
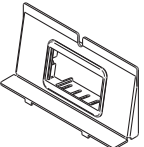
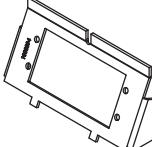
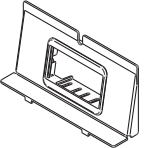
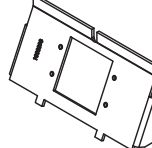
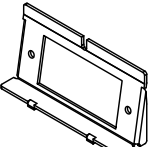
<p>RFB-WTB Conversion Kit</p>	<p>RFB-DR-4DB Internal Duplex Receptacle Bracket</p>
 <p>Converts RFB4 Box to an RFB4-4DB Box.</p>	 <p>Accepts 15 Amp and 20 Amp duplex receptacles. NOTE: For use with the RFB4-4DB.</p>
<p>WTB-2-AB Communication Bracket</p>	<p>WTB-AAP Internal Audio Video Bracket</p>
 <p>One 2A size Pass & Seymour® Activate adapter included. Wiremold Open System inserts sold separately. NOTE: For use with the RFB4-4DB.</p>	 <p>Accepts two (2) Extron® Electronics AAP Series devices (Sold separately). NOTE: For use with the RFB4-4DB.</p>
<p>WTB-2-RT Communication Bracket</p>	<p>WTB-MAAP Internal Audio Video Bracket</p>
 <p>Ortronics AB2TJ TracJack and ABS2 Series II adapters included. NOTE: For use with the RFB4-4DB.</p>	 <p>Accepts two (2) Legrand AVIP or Extron® Electronics MAAP Series devices (Sold separately). NOTE: For use with the RFB4-4DB.</p>
<p>RFB-GFI-4DB Internal GFCI or Decorator Style Receptacle Opening</p>	
 <p>Accepts standard GFCI or Decorator Style Receptacles, Communication or Audio/Video Devices. NOTE: For use with the RFB4-4DB.</p>	

Additional configurations available. Please consult your Wiremold Field Sales Representative for more information.

Fire Classified RFB4 Series Multiservice Shallow Steel Recessed Floor Boxes Ordering Information

RFB4-SSFC Fire Classified Four-Compartment Shallow Stamped Steel Floor Box

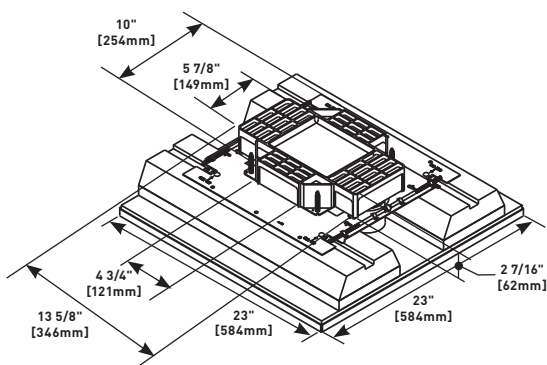

13 5/8" L x 10" W x 2 7/16" D [346mm x 254mm x 62mm]. Fully adjustable with tunnel compartment and two receptacle brackets. **Feed through tunneling to adjacent compartments only.** Tunneling can be set to feed all four compartments from one conduit in a single-service application. Communication brackets not included. See "Accessories".

- NOTE: All boxes and activations are sold separately.**
- NOTE: For use in light weight concrete floors with a minimum pour depth of 3 1/4" [83mm] over the crest of the deck.**
- NOTE: Floor Box spacing 2' on center and one for every 4 square feet in a span. Four (4) #12 AWG Type THHN Power Conductors or 48 #23 AWG (6 Cat. 6) Tele Data Conductors per gang.**

FLOOR BOX SYSTEMS

FIRE CLASSIFIED FLOOR BOXES

RFB Series Floor Boxes

Fire Classified RFB4 Series Multiservice Shallow Steel Floor Box Compartment Capacities, Knockout Locations & Sizes

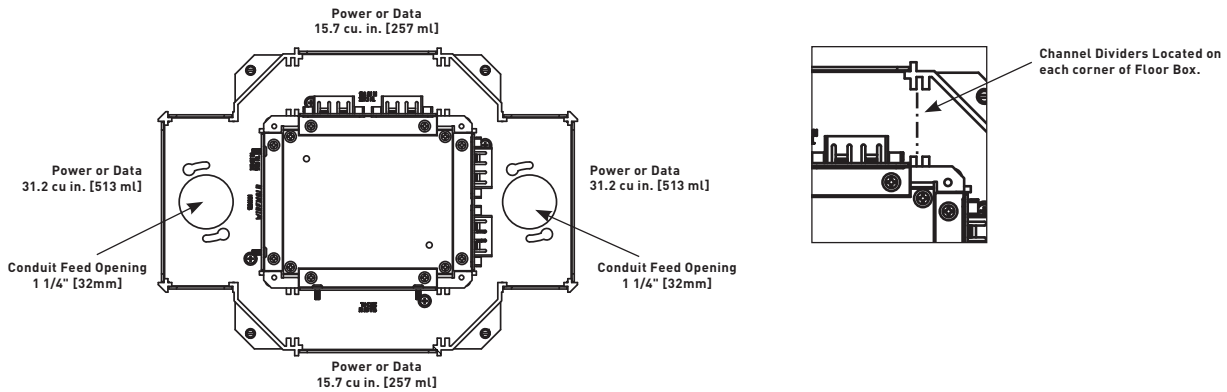

Fire Classified RFB4 Series Multiservice Shallow Steel Floor Box Accessories Ordering Information

RFB-B-SS Internal Blank Bracket

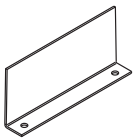

Used to close off unused gangs.

RFB-2-SSRT Communication Bracket

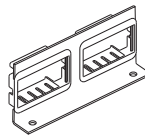

Ortronics® AB2TJ TracJack and ABS2 Series II adapters included.

RFB-RB-SS Internal Duplex Receptacle Bracket

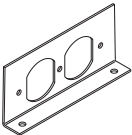

Accepts standard 15 Amp and 20 Amp duplex receptacles.

RFB-4TKO-SS Internal Bracket

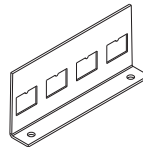

Four RJ Keystone opening knockouts. Use as blank plate or for up to four RJ openings.

NOTE: Opening dimension is 9/16" x 3/4" [14.3mm x 19.1mm].

RFB-GFI-SS Internal GFI Receptacle Bracket

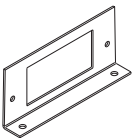

Accepts standard GFCI and Decorator style receptacles, communications or Audio/Video Devices.

RFB4-SS-AAP Internal Audio Video Bracket

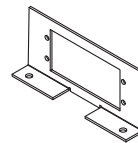

Accepts two (2) Extron® Electronics AAP Series devices (Sold separately).

RFB-2AB-SS Internal Bracket

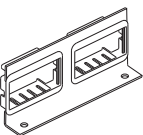

Two Pass & Seymour® Activate adapters included. Wiremold CM Series Open System adapters (sold separately).

RFB4-SS-MAAP Internal Audio Video Bracket

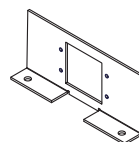

Accepts two (2) Legrand AVIP or Extron® Electronics MAAP Series devices (Sold separately).

Additional configurations available. Please consult your Wiremold Field Sales Representative for more information.

FIRE CLASSIFIED FLOOR BOXES

RFB Series Floor Boxes

FloorPort™ Series Flanged Cover Plates Ordering Information

Floorport Part Number Configurator



FloorPort Series:



Cover Style:



Top Style:



Cover Color:

Blank Top = B	Tile (flangeless) = T	Brushed Aluminum = AL
Cutout Top = C	Tile/Carpet (flanged) = TC	Black = BK
Furniture Feed = FF		Brass = BS
		Bronze = BZ
		Gray = GY
		Nickel = NK

FPCTC Cutout Cover Assembly

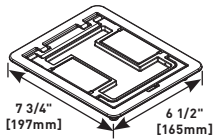

FPCTCBK, FPCTCBZ, FPCTCBS, FPCTCNK, FPCTCGY, FPCTCAL

Flanged cover for use in tile or carpet installation. Die-cast aluminum assembly available in black, bronze, brass, nickel, gray or brushed aluminum. Insert in lid allows for carpet or tile cutouts to match finished floor.

FPFFTC Furniture Feed Cover Assembly

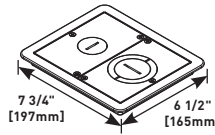

FPFFTCBK, FPFFTCBZ, FPFFTCBS, FPFFTCNK, FPFFTCGY, FPFFTCAL

Flanged cover for use in tile or carpet installation. Die-cast aluminum assembly available in black, bronze, brass, nickel, gray or brushed aluminum. Provided with one 1" trade size screw plug for power or communication type cabling and one combination 1 1/4" and 2" trade size screw plug for communication type cabling. Allows for feeding both power and communication cabling.

FPBTC Blank Cover Assembly

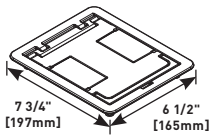

FPBTCBK, FPBTCBZ, FPBTCBS, FPBTCNK, FPBTCGY, FPBTCAL

Flanged cover for use in tile or carpet installation. Die-cast aluminum assembly available in black, bronze, brass, nickel, gray, or brushed aluminum. Lid area is flush with the finished floor, no cutouts provided.

Load Capacities for FloorPort Cover Assemblies

CATALOG NUMBERS	MAXIMUM LOAD IN POUNDS
FPCTC	1000
FPBTC	750
FPFFT	1000

NOTE: Load applied through a 2" [51mm] mandrel in center of service fitting. Loads above are static loads only and do not pertain to rolling loads.

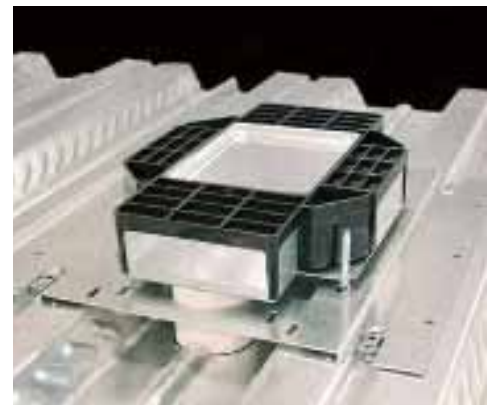

Fire Classified RFB Series Floor Boxes are available in four options.

FIRE CLASSIFIED FLOOR BOXES

RFB Series Floor Boxes

North American Made FloorPort™ Series Flanged Cover Plates Ordering Information

Floorport Part Number Configurator

FloorPort Series:	Cover Style:	Top Style:	Cover Color:	Origin:
	Blank Top = B Cutout Top = C Furniture Feed = FF	Tile (flangeless) = T Tile/Carpet (flanged) = TC	Nickel = NK Brass = BS Black = BK Bronze = BZ Gray = GY	North American Made NA

FPCTC-NA Cutout Cover Assembly

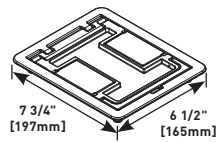

FPCTCBK-NA, FPCTCBZ-NA, FPCTCBS-NA, FPCTCNK-NA, FPCTCGY-NA

Flanged cover for use in tile or carpet installation. Die-cast aluminum assembly available in black, bronze, brass, nickel or gray. Insert in lid allows for carpet or tile cutouts to match finished floor.

FPFFTC Furniture Feed Cover Assembly

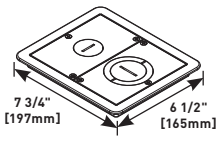

FPFFTCBK, FPFFTCBZ, FPFFTCBS, FPFFTCNK, FPFFTCGY, FPFFTCAL

Flanged cover for use in tile or carpet installation. Die-cast aluminum assembly available in black, bronze, brass, nickel or gray. Provided with one 1" trade size screw plug for power or communication type cabling and one combination 1 1/4" and 2" trade size screw plug for communication type cabling. Allows for feeding both power and communication cabling.

FPBTC-NA Blank Cover Assembly

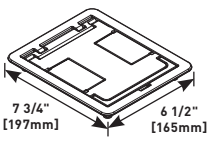

FPBTCBK-NA, FPBTCBZ-NA, FPBTCBS-NA, FPBTCNK-NA, FPBTCGY-NA

Flanged cover for use in tile or carpet installation. Die-cast aluminum assembly available in black, bronze, brass, nickel or gray. Lid area is flush with the finished floor, no cutouts provided.

Load Capacities for North American Made FloorPort Cover Assemblies

CATALOG NUMBERS	MAXIMUM LOAD IN POUNDS
FPCTC	1000
FPBTC	750
FPFFT	1000

NOTE: Load applied through a 2" [51mm] mandrel in center of service fitting.
Loads above are static loads only and do not pertain to rolling loads.

FIRE CLASSIFIED FLOOR BOXES

880MP Series Floor Boxes

Fire Classified 880MP Series Floor Boxes Ordering Information

880MPFC

Fire Classified Nonmetallic Rectangular Box

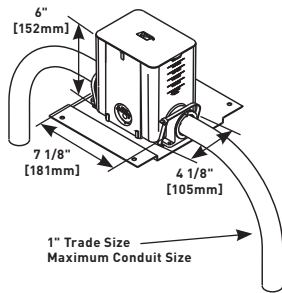

Box comes complete with reusable mudcap, insert spacer, conduit plugs and reducers. Reducers provided for reduction to 1", 3/4", and 1/2" [25mm, 19.1mm, and 12.7mm] conduit. Minimum concrete depth is 3 1/2" [89mm] and maximum concrete depth is 6" [152mm]. Minimum capacity is 50 cu. in. [819ml] and maximum capacity is 100 cu. in. [1639ml]. Box dimensions are 4 1/8" W x 5 1/2" L x 6" [105mm x 140mm x 152mm].

- NOTE: Insert spacer should not be removed until after concrete pour.
- NOTE: 880MPFC is a single gang offering. Can not gang boxes together and maintain Fire Classification.
- NOTE: Floor Box spacing 2' on center, no more than 1 per 65 s.f. span.
- NOTE: Maximum Copper Cross Section per Insert: Four (4) #12 AWG Type THHN Power Conductor or 48 #23 AWG (6 Cat. 6) Tele Data conductors.

880MPA Nonmetallic Floor Box Adjusting Ring

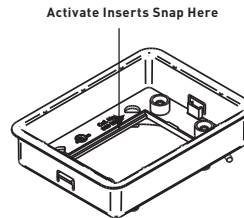

Comes with fiber storage loop. Also includes brass inserts for flange connection and green ground wire for ground connection. Activate modular inserts snap directly into the adjusting ring without the need for an adapter. Also includes mounting screws to attach flange to box body. Ortronics connectivity inserts do not snap directly into the adjusting ring. For Ortronics inserts use the 828GFITC or 829PFLRT.

NOTE: One 880MPA is needed for each 880MPFC used.

Fire Classified 880MP Series Floor Boxes Solid Brass Cover Plate Flanges Ordering Information

817B 1-Gang Brass Combination Carpet & Tile Flange

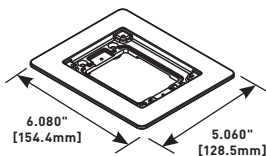

Accepts Ortronics® MAB6TJ TracJack and MAB3S2 Series II adapters and Wiremold CM Series inserts sold separately.

817C 1-Gang Brass Combination Carpet Flange

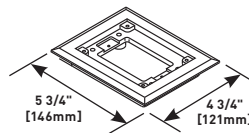

For use on 880S1, 880M1, 880CS1-1, and 880CM1-1 Floor Boxes.

Fire Classified 880MP Series Floor Boxes Metal Cover Plates Ordering Information

828R Brass Duplex Cover Plate

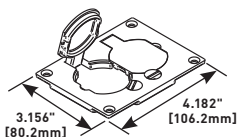

Flip lids. Can also be used with a 106 type communication adapter.

828GFITC Brass GFI Cover Plate

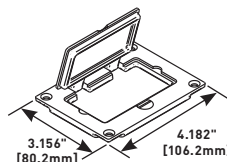

May be used with Activate and Ortronics® Connectivity Systems in conjunction with 817B, 827B, and 837B Flanges.

NOTE: UL Listed for tile, terrazzo, and carpet floors. Brass covers and flanges are not interchangeable with aluminum or nonmetallic covers and flanges. Nonmetallic covers are interchangeable with aluminum flanges.

FIRE CLASSIFIED FLOOR BOXES

880MP Series Floor Boxes

Fire Classified 880MP Series Floor Boxes Metal Cover Plates Ordering Information (continued)

828DPGFITC Brass Rectangular Cover Plate

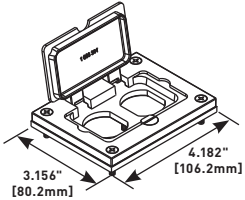

Allows for mounting of a duplex style receptacle with a rectangular style flip lid cover.

829CK-1 Brass Communications Cover Plate

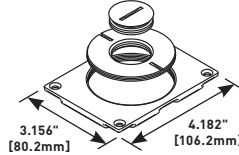

2 5/8" and 1" [67mm and 25mm] plugs.

828DLR Brass Single Locking Receptacle Cover Plate

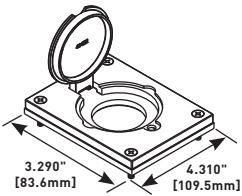

Single flip lid cover for 20A or 30A single locking receptacles. Device opening is 2 5/8" [67mm]. For use with maximum female locking device of 1.58" diameter, and maximum male plug face of 2.25" diameter.

829CK-3/4 Brass Communications Cover Plate

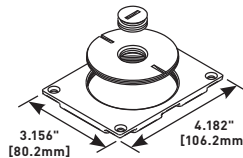

2 5/8" and 3/4" [67mm and 19.1mm] plugs.

828SPTC Brass Duplex Cover Plate

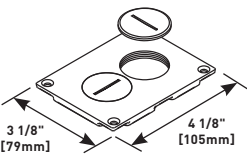

Screw plugs. Screw plugs are 1 1/2" [38mm] in diameter.

829CK-1/2 Brass Communications Cover Plate

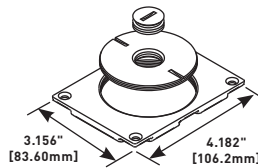

2 5/8" and 1/2" [67mm and 12.7mm] plugs.

829STC Brass Communication Cover Plate

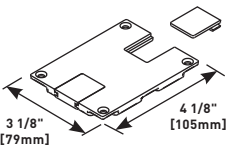

Data slides. Feed through only, not for use with a mounting plate for communication adapter.

828MAAP AV Adapter Plate

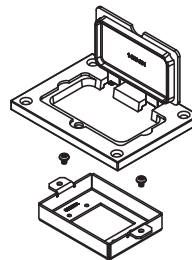

Sheet metal adapter plate that accepts two (2) Legrand AVIP or Extron® Electronics MAAP style device plates (sold separately). For use with 828GFITC or 828GFITCAL cover plates (sold separately).

829CK Brass Communication Cover Plate

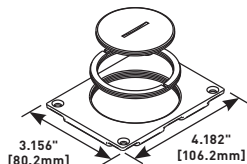

2 5/8" and 2 1/4" [67mm and 57mm] plugs.

818TCAL 1-Gang Brushed Aluminum Combination Carpet & Tile Flange

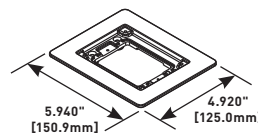

Accepts Ortronics® MAB6TJ TracJack and MAB3S2 Series II adapters and Wiremold CM Series inserts, sold separately.

NOTE: Brushed aluminum flanges come with beveled edges.

NOTE: UL Listed for tile, terrazzo, and carpet floors. Brass covers and flanges are not interchangeable with aluminum or nonmetallic covers and flanges. Nonmetallic covers are interchangeable with aluminum flanges.

FIRE CLASSIFIED FLOOR BOXES

880MP Series Floor Boxes

Fire Classified 880MP Series Floor Boxes Brushed Aluminum Cover Plates Ordering Information

828R-TCAL

Brushed Aluminum Duplex Cover Plate

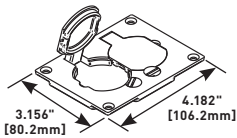

Flip lids. Can also be used with a 106 type communication adapter.

829CKTCAL-1

Brushed Aluminum Communications Cover Plate

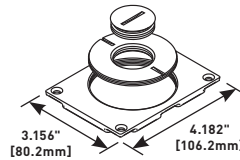

2 5/8" and 1" [67mm and 25mm] plugs.

NOTE: Acceptable for use with threaded conduit when passing through power cables.

828GFITCAL

Brushed Aluminum GFI Cover Plate

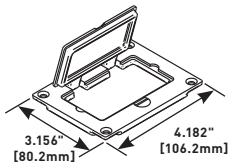

May be used with Activate and Ortronics® Connectivity Systems in conjunction with 817B, 827B, and 837B Flanges.

829CKTCAL-3/4

Brushed Aluminum Communications Cover Plate

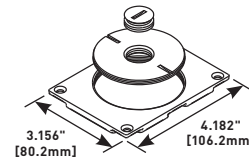

2 5/8" and 3/4" [67mm and 19.1mm] plugs.

NOTE: Acceptable for use with threaded conduit when passing through power cables.

828DPGFITCAL

Brushed Aluminum Rectangular Cover Plate

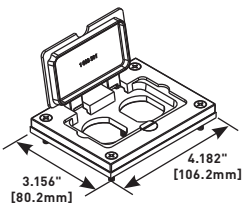

Allows for mounting of a duplex style receptacle with a rectangular style flip lid cover.

829CKTCAL-1/2

Brushed Aluminum Communications Cover Plate

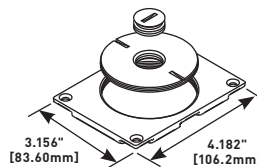

2 5/8" and 1/2" [67mm and 12.7mm] plugs.

NOTE: Acceptable for use with threaded conduit when passing through power cables.

828DLRAL

Brushed Aluminum Locking Receptacle Cover Plate

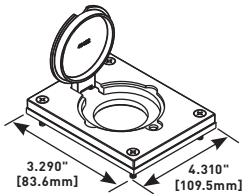

Single flip lid cover for 20A or 30A single locking receptacles. Device opening is 2 5/8" [67mm]. For use with maximum female locking device of 1.58" diameter, and maximum male plug face of 2.25" diameter.

828MAAP AV Adapter Plate

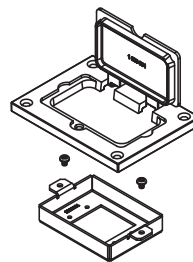

Sheet metal adapter plate that accepts two (2) Legrand AVIP or Extron® Electronics MAAP style device plates (sold separately). For use with 828GFITC or 828GFITCAL cover plates (sold separately).

829CKTCAL

Brushed Aluminum Communication Cover Plate

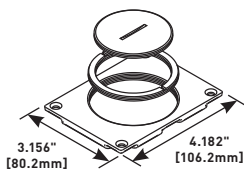

2 5/8" and 2 1/4" [67mm and 57mm] plugs.

NOTE: Acceptable for use with threaded conduit when passing through power cables.

NOTE: UL Listed for tile, terrazzo, and carpet floors. Brass covers and flanges are not interchangeable with aluminum or nonmetallic covers and flanges. Nonmetallic covers are interchangeable with aluminum flanges.

FIRE CLASSIFIED FLOOR BOXES

880MP Series Floor Boxes

Fire Classified 880MP Series Floor Boxes Powder-Coated Aluminum Cover Plates & Flanges Ordering Information

817TCAL 1-Gang Powder-Coated Aluminum Combination Carpet & Tile Flange

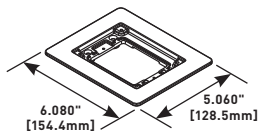

817TCAL-BK, 817TCAL-GY, 817TCAL-BS, 817TCAL-NK, 817TCAL-BZ

Accepts Ortronics® MAB6TJ TracJack and MAB3S2 Series II adapters and Wiremold CM Series inserts, sold separately. Flanges are available in five decorative color: black, gray, brass, nickel and bronze.

829CKAL-1 Powder-Coated Aluminum Cover Plate

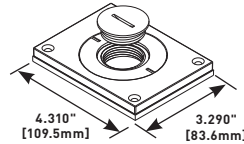

829CKAL-1BK, 829CKAL-1GY, 829CKAL-1BS, 829CKAL-1NK, 829CKAL-1BZ

Power or communication plate with 2" [51mm] and 1" [25mm] plugs. Covers are available in five decorative colors: black, gray, brass, nickel and bronze.

NOTE: Acceptable for use with threaded conduit when passing through power cables.

828R-TCAL Powder-Coated Aluminum Duplex Cover Plate

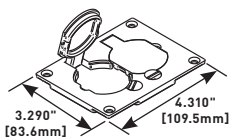

828R-TCAL-BK, 828R-TCAL-GY, 828R-TCAL-BS, 828R-TCAL-NK, 828R-TCAL-BZ

Flip lids. Can also be used with a 106 type communication adapter.

829CKAL-3/4 Powder-Coated Aluminum Cover Plate

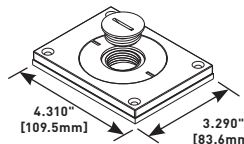

829CKAL-3/4BK, 829CKAL-3/4GY, 829CKAL-3/4BS, 829CKAL-3/4NK, 829CKAL-3/4BZ

Power or communication plate with 2" [51mm] and 3/4" [19.1mm] plugs. Covers are available in five decorative colors: black, gray, brass, nickel and bronze.

NOTE: Acceptable for use with threaded conduit when passing through power cables.

828GFITCAL Powder-Coated Aluminum GFI Cover Plate

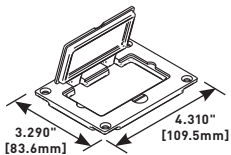

828GFITCAL-BK, 828GFITCAL-GY, 828GFITCAL-BS, 828GFITCAL-NK, 828GFITCAL-BZ

Allows for mounting a duplex receptacle (Decorator or GFCI style) with a rectangular flip cover.

828MAAP AV Adapter Plate

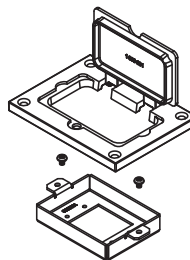

Sheet metal adapter plate that accepts two (2) Legrand AVIP or Extron® Electronics MAAP style device plates (sold separately). For use with 828GFITC or 828GFITCAL cover plates (sold separately).

Fire Classified 880MP Series Floor Boxes Nonmetallic Cover Plate Flanges Ordering Information

817PCC 1-Gang Nonmetallic Carpet Flange

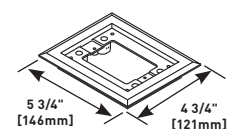

817PCC-BLK, 817PCC-BRN

Available in black or brown. For Ortronics® connectivity use with 829PFLRT Cover. For Activate connectivity use with 829PFL Cover. Accepts Ortronics® MAB6TJ TracJack and MAB3S2 Series II adapters and Wiremold CM Series inserts, sold separately.

NOTE: UL Listed for tile, terrazzo, and carpet floors. Brass covers and flanges are not interchangeable with aluminum or nonmetallic covers and flanges. Nonmetallic covers are interchangeable with aluminum flanges.

FIRE CLASSIFIED FLOOR BOXES

880MP Series Floor Boxes

Fire Classified 880MP Series Floor Boxes Nonmetallic Cover Plates Ordering Information

828PR Nonmetallic Duplex Cover Plate

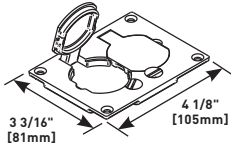

828PR-BLK, 828PR-BRN

Flip lids. Available in black or brown. Can also be used with a 106 type communication adapter.

829PFLRT Nonmetallic Communication Cover Plate

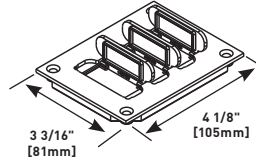

829PFLRT-BLK, 829PFLRT-BRN

Individual flip lids. Available in black or brown. Gasket included. Ortronics® MAB6TJ TracJack and MAB3S2 Series II adapters included.

828PRGFI Nonmetallic GFI Cover Plate

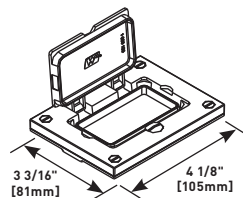

828PRGFI-BLK, 828PRGFI-BRN

Available in black or brown. May be used with Ortronics® Connectivity systems in conjunction with 817, 827 and 837PCC Series flanges.

829PCK Nonmetallic Communication Cover Plate

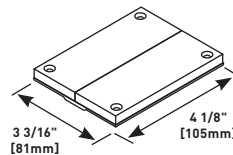

829PCK-BLK, 829PCK-BRN

Breakouts. Available in black or brown. Feed through only, not for use with a mounting plate for communication jacks.

829PFL Nonmetallic Communication Cover Plate

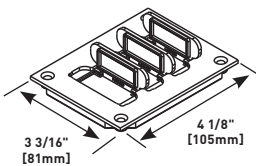

829PFL-BLK, 829PFL-BRN

Individual flip lids. Available in black or brown. Gasket included. Wiremold CM Series inserts included.

829PSTC Nonmetallic Communications Cover Plate

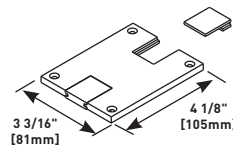

829PSTC-BLK, 829PSTC-BRN

Data slides. Available in black or brown. Feed through only, not for use with a mounting plate for communication jacks.

FIRE CLASSIFIED FLOOR BOXES

Ratchet-Pro Series Floor Boxes

Fire Classified Ratchet-Pro Series Floor Boxes Ordering Information

881FC

Fire Classified Nonmetallic Round PVC Floor Box

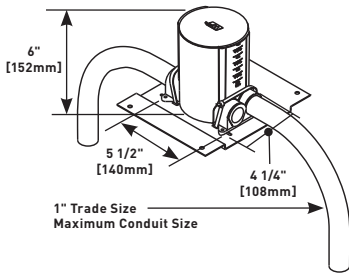

Supplied with reusable concrete cap, conduit reducers, and conduit hub plugs. Available for single service only. Graduated cubic inch markings inside the box indicate volume capacity at any depth. Box has parallel conduit hubs eliminating the need for 90° sweeps in installation. One-piece reduction from 1" to 1/2" [25mm to 12.7mm] conduit. Reducers and plugs located on a mounting bar for easier selection. For concrete pours of 2 1/4" to 6" [57mm to 152mm].

NOTE: Maximum Copper Cross Section per Insert: Four (4) #12 AWG Type THHN Power Conductor or 48 #23 AWG (6 Cat. 6) Tele Data conductors.

NOTE: Floor Box spacing 2' on center and one for every 4 square feet in a span.

881ADP PVC Floor Box Ratchet Adjusting Ring

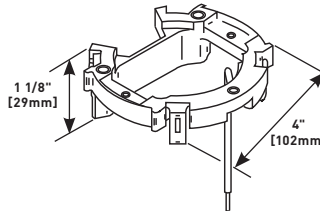

Used to attach wiring devices and cover plates to PVC Box. Locks into place without using glue or mechanical fasteners. Compensates for up to 10° of tilt if box is not level. Ground wire is factory attached to the adjusting ring.

NOTE: One ring required per box, single- or dual-service.

Volume Capacities for Ratchet-Pro PVC Floor Box

BOX HEIGHT In [mm]	Single Service 895 Activation WIRING VOLUME	
	Cu. In	[mL]
6 [152.0]	56.0	[917.0]
5 1/2 [140.0]	49.0	[803.0]
5 [127.0]	42.0	[688.0]
4 1/2 [114.0]	35.0	[574.0]
4 [102.0]	28.0	[459.0]
3 1/2 [89.0]	21.0	[344.0]
3 1/4 [83.0]	17.0	[278.0]

NOTE: To calculate total box volume, use the displacement of the largest uncut section remaining.

Fire Classified Ratchet-Pro Series Floor Boxes Cover Plates Ordering Information

895, 895TCAL

Brass/Brushed Aluminum Duplex Cover Plate

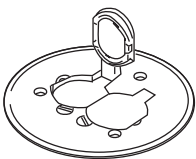

With flip lids. 5 1/2" [140mm] diameter for carpet.

895TCAL Aluminum Duplex Power Plate

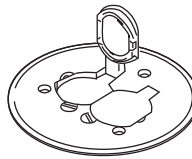

895TCAL-BK, 895TCAL-BS, 895TCAL-GY, 895TCAL-NK, 895TCAL-BZ

With flip lids, 5 1/2" [140mm] diameter for carpet. Available in black, brass, gray, nickel and bronze.

895GFI, 895GFICAL

Brass/Brushed Aluminum GFI Receptacle Cover Plate

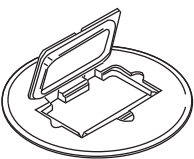

5 1/2" [140mm] diameter for carpet.

CAUTION

Installation must comply with NEC and local code conductor volume requirements. Not for use when concrete is the finished floor. Use only for tile, carpet, or wood covered floors.

NOTE: 1. All cover plates are furnished with gasket and three screws.
2. Polycarbonate cover plates cannot be used on the 881FC Fire Classified Floor Box.

FIRE CLASSIFIED FLOOR BOXES

Fire Classified Floor Boxes Installation Cross Sections

3" [76mm] Deck Installation

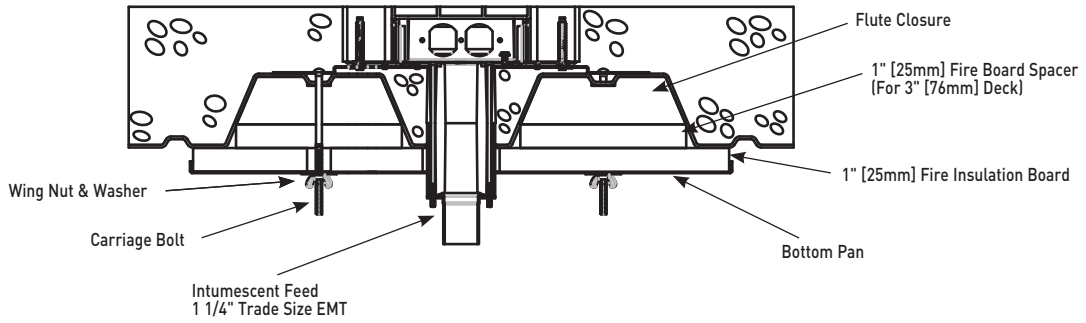

2" [51mm] Deck Installation

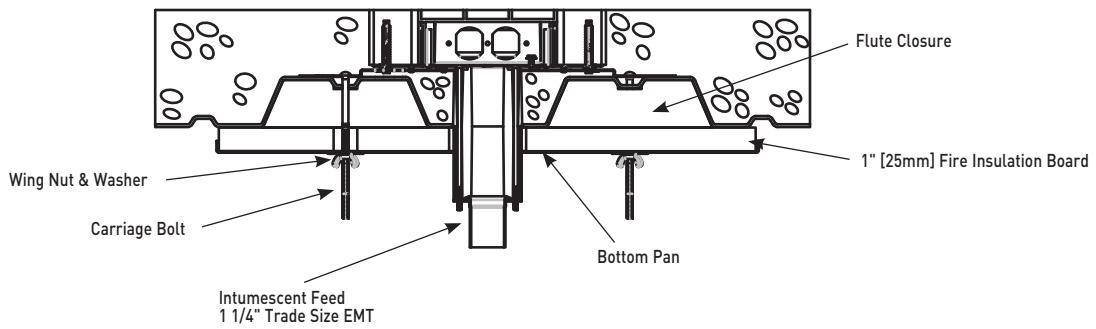

Nonmetallic Floor Box Deck Installation

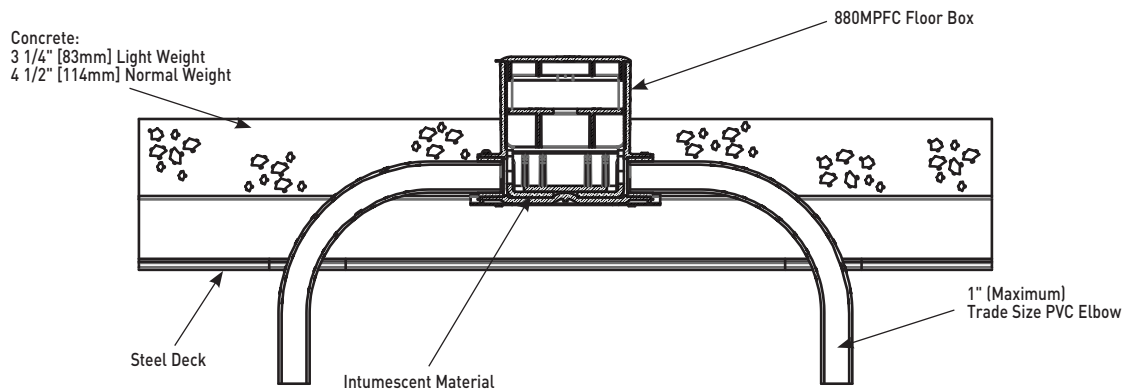

RATCHET-PRO™ SERIES FLOOR BOXES



Ratchet-Pro™ Series Floor Boxes provide dual-service capability in a single, easy-to-install round floor box.



CODE REFERENCE

cULus Listed
Nonmetallic Outlet Boxes:
 File E110748 Guide QCMZ.
 Meets Article 314.27(C) of NEC.

Ratchet-Pro 881 Series Floor Boxes Ordering Information

881 Round PVC Floor Box

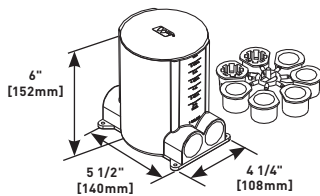

Supplied with reusable concrete cap, adjusting ring, conduit reducers and conduit hub plugs. Available for both single and dual service (895DCC required for dual service brass activation). Graduated cubic inch markings inside the box indicate volume capacity at any depth. Box has parallel conduit hubs eliminating need for 90° sweeps in installation. One-piece reduction from 1" to 1/2" [25mm to 12.7mm] conduit. Reducers and plugs located on a mounting bar for easier selection. For concrete pours of 2 1/4" to 6" [57mm to 152mm].

881-ADP PVC Floor Box Ratchet Adjusting Ring

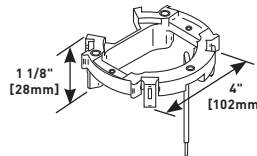

Used to attach wiring devices and cover plates to PVC box. Locks into place without using glue or mechanical fasteners. Compensates for up to 10° of tilt if box is not level.

NOTE: Ground wire is factory attached to the adjusting ring. One ring required per box, single- or dual-service, ordered separately.

881-DIV PVC Floor Box Divider Plate

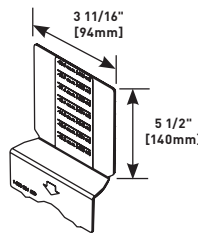

Used to isolate power and communication compartments. Graduated cubic inch markings are marked clearly on the divider and correspond directly to the cubic inch markings on the interior of the box. Cuts easily with a utility knife. Supplied with a receptacle plate that completes separation of power and communication services. One divider required for **dual-service** activation.

COLOR OPTIONS



895 and 896 Series Cover Plates are compatible with Ratchet-Pro 881 Series Floor Boxes and are available in all or some of the following colors as indicated in the part number descriptions. **Custom color options are also available. Consult the factory for more information.**

RATCHET-PRO™ SERIES FLOOR BOXES

Ratchet-Pro 881 Series Floor Boxes Cover Plates Ordering Information

895DCC

Dual Service Brass Duplex Cover Plate

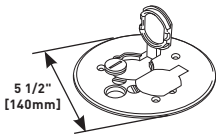

With flip lids. Supplied with 1/2" [12.7mm] screw plug for accessing communication cables. 5 1/2" [140mm] diameter **for carpet applications only**. Used in conjunction with the 881DIV to complete dual-service activation.

895, 895TCAL Duplex Cover Plate

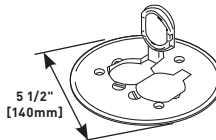

With flip lids. Brass (895) or brushed aluminum (895TCAL) duplex cover plate with flip lids, 5 1/2" [140mm] diameter for carpet.

895T, 895TAL Duplex Cover Plate with Flip Lids

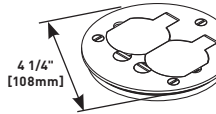

Brass (895T) or brushed aluminum (895TAL) duplex cover plate with flip lids, 4 1/4" [108mm] diameter for tile.

895SP, 895SPCAL Cover Plate

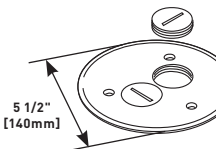

Brass (895SP) or brushed aluminum (895SPCAL) cover plate with two screw plug openings, 5 1/2" [140mm] diameter for carpet.

895TSP Cover Plate

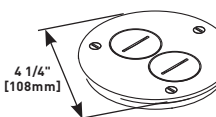

Brass cover plate with two screw plug openings, 4 1/4" [108mm] diameter for tile.

NOTE: Screw plug openings are 1 1/2" [38mm] tapped openings.

895GFI, 895GFICAL GFI Receptacle Cover Plate

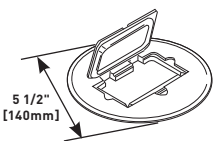

Brass (895GFI) or brushed aluminum (895GFICAL) GFI receptacle cover plate, 5 1/2" [140mm] diameter for carpet.

895TGFI, 895TGFIAL

GFI Receptacle Cover Plate

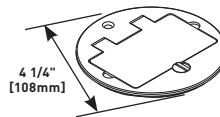

Brass (895TGFI) or brushed aluminum (895TGFIAL) GFI receptacle cover plate, 4 1/4" [108mm] diameter for tile.

896 Communication or Power Cover Plate

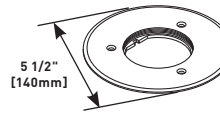

Brass communication or power cover plate with 2 5/8" [67mm] threaded opening, 5 1/2" [140mm] diameter for carpet.

NOTE: Sold without abandon plug.

896T Communication or Power Cover Plate

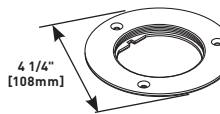

Brass communication or power cover plate with 2 5/8" [67mm] threaded opening, 4 1/4" [108mm] diameter for tile.

NOTE: Sold without abandon plug.

896CK Communication or Power Cover Plate

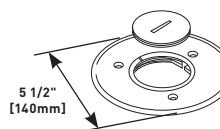

Brass communication or power cover plate with 2 1/4" [57mm] threaded opening, 5 1/2" [140mm] diameter for carpet.

896TCK Communication or Power Cover Plate

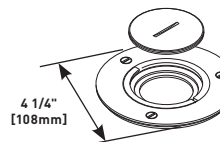

Brass communication or power cover plate with 2 1/4" [57mm] threaded opening, 5 1/2" [140mm] diameter for tile.

896CK-1/2, 896CKAL-1/2 Cover Plate

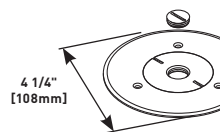

Brass (896CK-1/2) or brushed aluminum (896CKAL-1/2) cover plate with 1/2" [12.7mm] threaded opening, 5 1/2" [140mm] diameter for carpet.

NOTE: All cover plates are furnished with gasket and three screws. The 895P Polycarbonate Series Cover Plates must be field modified for dual service.

RATCHET-PRO™ SERIES FLOOR BOXES

Ratchet-Pro 881 Series Floor Boxes Cover Plates Ordering Information (continued)

896TCK-1/2, 896TCKAL-1/2 Cover Plate

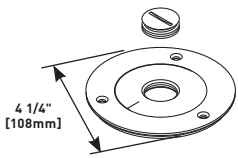

Brass (896TCK-1/2) or brushed aluminum (896TCKAL-1/2) cover plate with 1/2" [12.7mm] threaded opening, 5 1/2" [140mm] diameter for tile.

896CK-1 Cover Plate

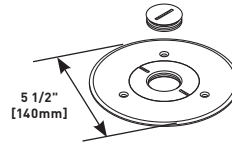

Brass cover plate with 1" [25mm] threaded opening, 5 1/2" [140mm] diameter for carpet.

896CK-3/4 Cover Plate

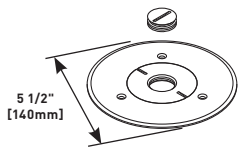

Brass cover plate with 3/4" [19.1mm] threaded opening, 5 1/2" [140mm] diameter for carpet.

896TCK-1 Cover Plate

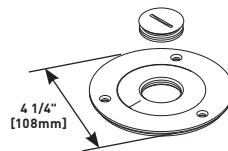

Brass cover plate with 1" [25mm] threaded opening, 5 1/2" [140mm] diameter for tile.

896TCK-3/4 Cover Plate

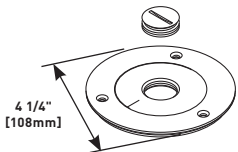

Brass cover plate with 3/4" [19.1mm] threaded opening, 5 1/2" [140mm] diameter for tile.

NOTE: All cover plates are furnished with gasket and three screws. The 895P Polycarbonate Series Cover Plates must be field modified for dual service.

North American Made Ratchet-Pro 881 Series Floor Boxes Cover Plates Ordering Information

895TCAL Aluminum Duplex Power Plate

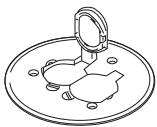

895TCAL-BK, 895TCAL-BS, 895TCAL-GY, 895TCAL-NK, 895TCAL-BZ

With flip lids, 5 1/2" [140mm] diameter for carpet. Available in black, brass, gray, nickel and bronze.

895PCK Polycarbonate Communication or Power Cover Plate

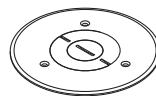

895PCK-BLK, 895PCK-BRN, 895PCK-BRZ, 895PCK-AL

5 1/2" [140mm] diameter. Available in black, brown, bronze and aluminum.

895P Polycarbonate Duplex Cover Plate

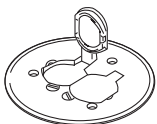

895P-BLK, 895P-BRN, 895P-BRZ, 895P-AL

With flip lids, 5 1/2" [140mm] diameter for carpet. Available in black, brown, bronze and aluminum.

RATCHET-PRO™ SERIES FLOOR BOXES

Ratchet-Pro RPSFB & RPSFB-OG Series Floor Boxes Ordering Information

RPSFB

Rectangular Dual Service Metal Concrete Floor Box

Rectangular dual service metal concrete floor box with a nonmetallic top that allows for concrete pours between 4" thick to 6" thick. Graduated markings on the inside and outside of the box indicating volume capacity, as well as the depth of concrete pour. Box accepts 2HUB to allow 2" conduit feeds (sold separately) while maintaining a 4" deep concrete pour.

Box includes (1) Reusable concrete cap, (2) Removable knockout plates to allow the 2HUB to be attached. 2HUB sold separately.

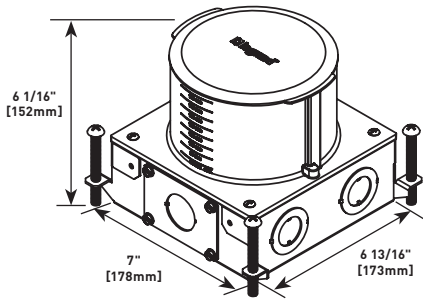

RPSFB-OG

On-Grade Rectangular Dual Service Metal Concrete Floor Box

Rectangular dual service metal concrete floor box with a nonmetallic top that allows for concrete pours between 4" thick to 6" thick. Graduated markings on the inside and outside of the box indicating volume capacity, as well as the depth of concrete pour. Box accepts 2HUB to allow 2" conduit feeds (sold separately) while maintaining a 4" deep concrete pour.

Box includes (1) Reusable concrete cap, (2) Removable knockout plates to allow the 2HUB to be attached. 2HUB sold separately.

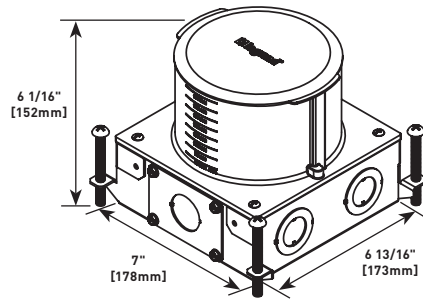

Ratchet-Pro RPSFB & RPSFB-OG Dimensions & Knockout Locations

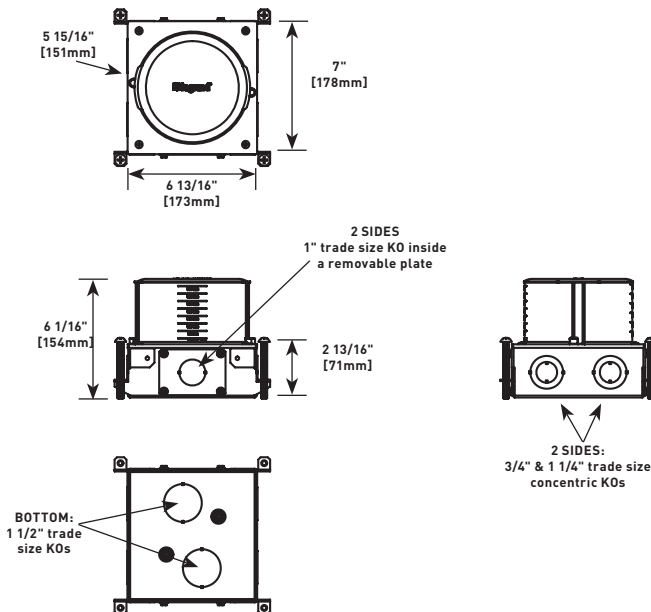

RATCHET-PRO™ SERIES FLOOR BOXES

Ratchet-Pro RPNFB Series Floor Boxes Ordering Information

RRPNFB

Round Dual Service Nonmetallic Concrete Floor Box

Round dual service nonmetallic concrete floor box. Floor box has two 1 1/4" trade size conduit hubs for power and two 2" trade size conduit hubs for communications and audio/video services.

Box Includes: (1) Reusable concrete cap, (1) Reducing ring for the 2" hubs that can be reduced down to 1 1/2 Trade size, and 1 1/4" trade size openings, (1) Reducing ring for the 1 1/4" hubs that allow to be reduced to 1" trade size opening or 3/4" trade size opening.

Ratchet-Pro RPNFB Dimensions & Knockout Locations

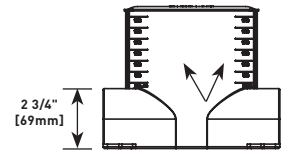
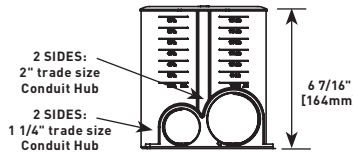
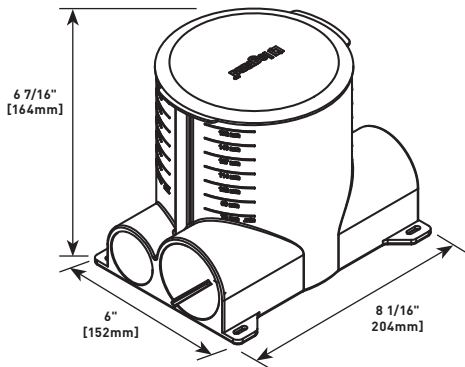
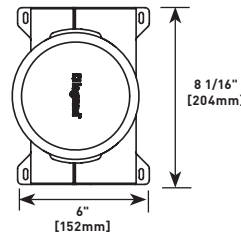

Ratchet-Pro RPNFB, RPSFB & RPSFB-OG Series Floor Box Kits Ordering Information

RP7CTC Multiple Service Floor Box Cover Kit

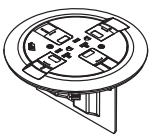

RP7CTCGY, RP7CTCBK, RP7CTCAL, RP7CTCBS, RP7CTCAA, RP7CTCAB

Kit comes complete with (1) prewired 20A duplex receptacle, (receptacle can be wired as a standard receptacle, or isolated ground), flange and slide holder, adapter ring to secure into the boxes, divider (RP-DIV), Wiremold CM series open system adapters (unloaded), Ortronics® Series II, and TracJack adapters. Modular jacks and A/V connectors sold separately.

Flange Color	Slide Holder Color
Gray	Gray
Black	Black
Aluminum	Black
Brass	Black
All Aluminum	Aluminum
All Brass	Brass

RPAV3CTC Multiple Service Floor Box Cover Kit

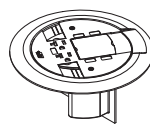

RPAV3CTCGY, RPAV3CTCBK, RPAV3CTCAL, RPAV3CTCBS, RPAV3CTCAA, RPAV3CTCAB

Kit comes complete with (1) prewired 20A duplex receptacle, (receptacle can be wired as standard receptacle, or isolated ground), flange and slide holder, adapter ring to secure into the boxes, divider (RP-DIV), Wiremold CM series open system adapters (unloaded), Ortronics® Series II, TracJack adapters and adapter to accept AVIP or Extron® Electronics MAAP devices. Modular jacks and A/V connectors sold separately.

Flange Color	Slide Holder Color
Gray	Gray
Black	Black
Aluminum	Black
Brass	Black
All Aluminum	Aluminum
All Brass	Brass

Caution: Floor box kits are not for use on concrete pours less than 4 1/2" [114mm] and are not for use when concrete is the finished floor. Use only for tile, carpet, or wood covered floors.

RATCHET-PRO™ SERIES FLOOR BOXES

Ratchet-Pro RPNFB, RPSFB & RPSFB-OG Series Floor Box Kits Ordering Information (continued)

RPAMD4CTC Single Service Floor Box Cover Kit

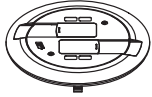

**RPAMD4CTCGY, RPAMD4CTCBK,
RPAMD4CTCAL, RPAMD4CTCBS,
RPAMD4CTCAA, RPAMD4CTCAB**

Kit comes complete with adapter ring to secure into the boxes, Wiremold CM series open system adapters (unloaded), Ortronics® Series II, and TracJack adapters. Modular jacks and A/V connectors sold separately.

Flange Color	Slide Holder Color
Gray	Gray
Black	Black
Aluminum	Black
Brass	Black
All Aluminum	Aluminum
All Brass	Brass

RP4FFCTC

Multiple Service Furniture Feed Floor Box Cover Kit

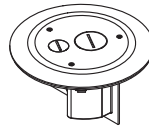

**RP4FFCTCGY, RP4FFCTCBK, RP4FFCTCAL,
RP4FFCTCBS, RP4FFCTCAA, RP4FFCTCAB**

Kit comes complete with adapter ring to secure into the boxes, (1) 3/4" trade size screw plug and conduit fitting for power, 1-1/4" trade size screw plug and conduit fitting for low voltage (communications or Audio/Video) services.

Flange Color
Gray
Black
Aluminum
Brass

RPAMD8CTC Single Service Floor Box Cover Kit



**RPAMD8CTCGY, RPAMD8CTCBK,
RPAMD8CTCAL, RPAMD8CTCBS,
RPAMD8CTCAA, RPAMD8CTCAB**

Kit comes complete with adapter ring to secure into the boxes, Wiremold CM series open system adapters (unloaded), Ortronics® Series II, and TracJack adapters. Modular jacks and A/V connectors sold separately.

Flange Color	Slide Holder Color
Gray	Gray
Black	Black
Aluminum	Black
Brass	Black
All Aluminum	Aluminum
All Brass	Brass

RP9AM2CTC

Single Service Furniture Feed Floor Box Cover Kit

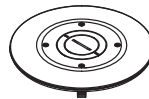

**RP9AM2CTCGY, RP9AM2CTCBK,
RP9AM2CTCAL, RP9AM2CTCBS,
RP9AM2CTCAA, RP9AM2CTCAB**

Kit comes complete with adapter ring to secure into the boxes, (1) 1 1/4" concentric screw plug closure plug. Conduit fittings sold separately by others.

Flange Color
Gray
Black
Aluminum
Brass

Caution: Floor box kits are not for use on concrete pours less than 4 1/2" [114mm] and are not for use when concrete is the finished floor. Use only for tile, carpet, or wood covered floors.

RATCHET-PRO™ SERIES FLOOR BOXES

Ratchet-Pro RPNFB, RPSFB & RPSFB-OG Series Floor Box Kits Ordering Information (continued)

2HUB 2" Conduit Transition Hub

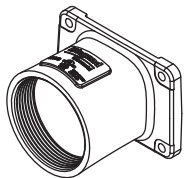

Trade size 2" die cast zinc conduit fitting allows for 2" conduit to transition into a shallow box design. Includes: die cast fitting gasket. Accepts standard 2" threaded conduit or trade size EMT and PVC conduit fittings.

NOTE: For use with RPSFB & RFSFB-OG Series floor boxes.

125CRR Conduit Reducing Ring

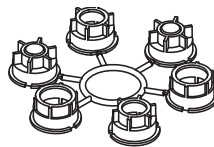

Conduit reducing ring allows for 1 1/4" conduit hub (for RPNFB only) to allow for smaller conduit feeds where needed. Ring includes: (2) blanking plug, (2) 3/4" trade size plugs, and (2) 1" trade size plugs.

RP-DIV Divider

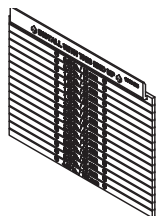

Used to isolate power and low voltage (communications and audio/video) compartments. Graduated markings indicating location to cut divider to, in order to match concrete pour.

2CRR Conduit Reducing Ring

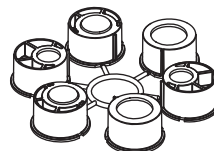

Conduit reducing ring allows for 2" conduit hub (for RPNFB only) to allow for smaller conduit feeds where needed. Ring includes: (2) blanking plug, (2) 1 1/2" trade size plugs, and (2) 1 1/4" trade size plugs, and (2) blank plugs.

MODULINK™ 880MP2 SERIES FLOOR BOXES



Modulk™ Nonmetallic Floor Boxes provide power and communication services directly to the workstation or to any open space location.

CODE REFERENCE

**cULus Listed
Nonmetallic Outlet Boxes:**
File E110748 Guide QCMZ.
Meets Article 314.27(C) of NEC.

Modulk 880MP2 Series Floor Boxes Ordering Information

880MP2 Nonmetallic Rectangular Floor Box

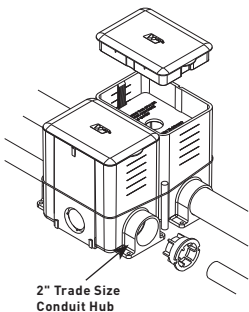

Box comes complete with reusable mudcap, insert spacer, conduit plugs and reducers. Reducers provided for reduction to 1 1/2", 1 1/4", 1", 3/4", and 1/2" [25mm, 19.1mm, and 12.7mm] conduit. Minimum concrete depth is 4" [102mm] and maximum concrete depth is 6" [152mm]. Minimum capacity is 50 cu. in. [819ml] and maximum capacity is 100 cu. in. [1693ml]. Box dimensions are 4 1/8" W x 5 1/2" L x 6" H [105mm W x 140mm L x 152mm H].

NOTE: Insert spacer should not be removed until after concrete pour.
Box can be connected together to create a two- or three-gang option.

880MPA Nonmetallic Rectangular Floor Box Adjusting Ring

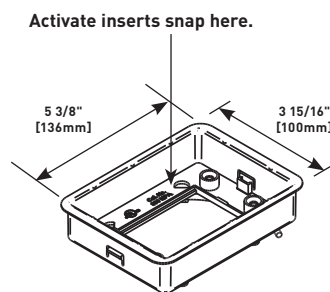

Comes with fiber storage loop. Also includes brass inserts for flange connection and green ground wire for ground connection. Wiremold CM Series Open System adapters that snap directly into the adjusting ring without the need for an adapter. Also includes mounting screws to attach flange to box body.

NOTE: One 880MPA is needed for each 880MP2 used. For example, a three-gang box will require three 880MPA Adjusting Rings, ordered separately.

COLOR OPTIONS



817, 828, 829, 830, 837 & 838 Series Cover Plates are designed for use with Modulk™ 880MP Series Floor Boxes and are available in the colors at left as indicated in the part number descriptions.

Custom color options are also available. Consult the factory for more information.

MODULINK™ 880MP2 SERIES FLOOR BOXES

Modulink 880MP2 Series Floor Boxes Solid Brass Cover Plate Flanges Ordering Information

817B 1-Gang Brass Combination Carpet & Tile Flange

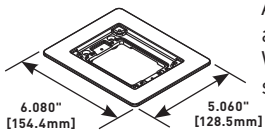

Accepts Ortronics® MAB6TJ TracJack and MAB3S2 Series II adapters and Wiremold CM Series inserts, sold separately.

837B 3-Gang Brass Combination Carpet & Tile Flange

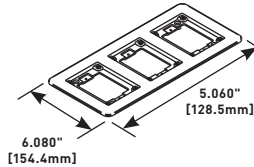

Accepts Ortronics® MAB6TJ TracJack and MAB3S2 Series II adapters and Wiremold CM Series inserts, sold separately.

827B 2-Gang Brass Combination Carpet & Tile Flange

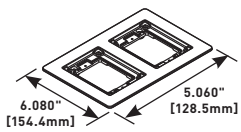

Accepts Ortronics® MAB6TJ TracJack and MAB3S2 Series II adapters and Wiremold CM Series inserts, sold separately.

Modulink 880MP2 Series Floor Boxes Metal Cover Plates Ordering Information

828R Brass Duplex Cover Plate

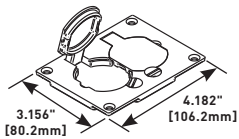

Flip lids. Can also be used with a 106 type communication adapter.

828DLR Brass Single Locking Receptacle Cover Plate

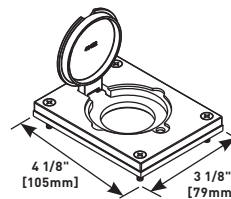

Single flip lid cover for 20A or 30A single locking receptacles. Device opening is 2 5/8" [67mm]. For use with maximum female locking device of 1.58" diameter, and maximum male plug face of 2.25" diameter.

828GFITC Brass GFI Cover Plate

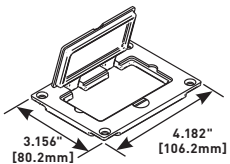

May be used with Activate and Ortronics® Connectivity Systems in conjunction with 817B, 827B, and 837B Flanges.

828SPTC Brass Duplex Cover Plate

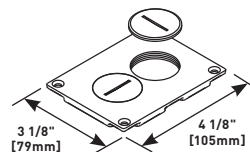

Screw plugs are 1 1/2" [38mm] in diameter.

828DPGFITC Brass Rectangular Cover Plate

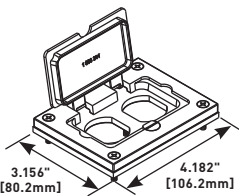

Allows for mounting of a duplex style receptacle with a rectangular style flip lid cover.

829STC Brass Communications Cover Plate

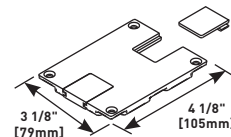

Brass communications cover plate, data slides. Feed through only, not for use with a mounting plate for flush mounted communication adapter.

NOTE: Brass covers and flanges are not interchangeable with aluminum or nonmetallic covers and flanges. Nonmetallic covers are interchangeable with aluminum flanges.

MODULINK™ 880MP2 SERIES FLOOR BOXES

Modulink 880MP2 Series Floor Boxes Metal Cover Plates Ordering Information (continued)

829CK Brass Communications Cover Plate

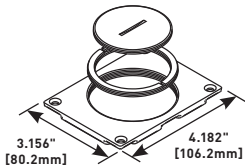

2 5/8" and 2 1/4" [67mm and 57mm] plugs. Not for use with threaded conduit.

829CK-1/2 Brass Communications Cover Plate

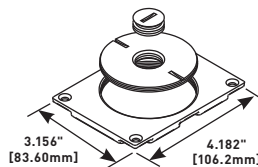

Brass communications cover plate, 2 5/8" and 1/2" [67mm and 12.7mm] plugs. For carpet or tile installations. Not for use with threaded conduit.

829CK-1 Brass Communications Cover Plate

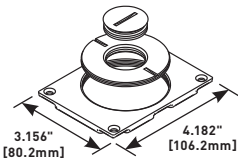

2 5/8" and 1" [67mm and 25mm] plugs. Not for use with threaded conduit.

828MAAP AV Adapter Plate

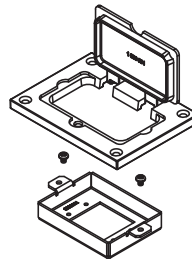

Sheet metal adapter plate that accepts two (2) Legrand AVIP or Extron® Electronics MAAP style device plates (sold separately). For use with 828GFITC or 828GFITCAL cover plates (sold separately).

829CK-3/4 Brass Communications Cover Plate

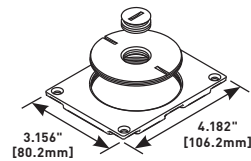

2 5/8" and 3/4" [67mm and 19.1mm] plugs. Not for use with threaded conduit.

NOTE: Brass covers and flanges are not interchangeable with aluminum or nonmetallic covers and flanges. Nonmetallic covers are interchangeable with aluminum flanges.

Modulink 880MP2 Series Floor Boxes Brushed Aluminum Cover Plate Flanges Ordering Information

818TCAL 1-Gang Brushed Aluminum Combination Carpet & Tile Flange

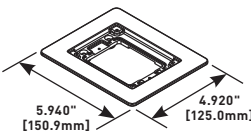

Accepts Ortronics® MAB6TJ TracJack and MAB3S2 Series II adapters and Wiremold CM Series inserts, sold separately.

838TCAL 3-Gang Brushed Aluminum Combination Carpet & Tile Flange

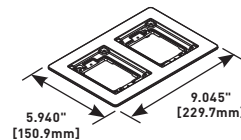

Accepts Ortronics® MAB6TJ TracJack and MAB3S2 Series II adapters and Wiremold CM Series inserts, sold separately.

828TCAL 2 -Gang Brushed Aluminum Combination Carpet & Tile Flange

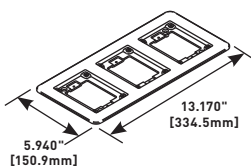

Accepts Ortronics® MAB6TJ TracJack and MAB3S2 Series II adapters and Wiremold CM Series inserts, sold separately.

NOTE: Brushed aluminum flanges come with beveled edges.

MODULINK™ 880MP2 SERIES FLOOR BOXES

Modulink 880MP2 Series Floor Boxes Brushed Aluminum Cover Plates Ordering Information

828R-TCAL Brushed Aluminum Duplex Cover Plate

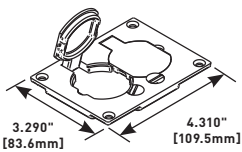

Flip lids. Can also be used with a 106 type communication adapter.

830CKTCAL-1 Brushed Aluminum Cover Plate

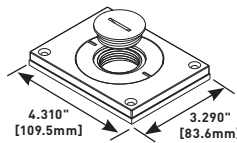

Power or communication plate with 2" [51mm] and 1" [25mm] plugs.

NOTE: Acceptable for use with threaded conduit when passing through power cables.

828GFITCAL Brushed Aluminum GFI Cover Plate

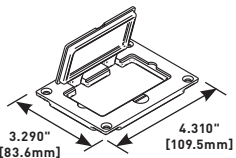

May be used with Activate and Ortronics® Connectivity Systems in conjunction with 817B, 827B, and 837B Flanges.

830CKTCAL-3/4 Brushed Aluminum Cover Plate

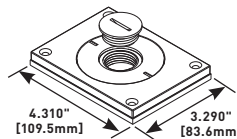

Power or communication plate with 2" [51mm] and 3/4" [19.1mm] plugs.

NOTE: Acceptable for use with threaded conduit when passing through power cables.

828DPGFITCAL Brushed Aluminum Rectangular Cover Plate

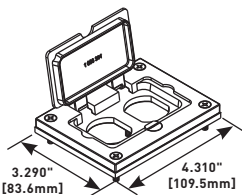

Allows for mounting of a duplex style receptacle with a rectangular style flip lid cover.

830CKTCAL-1/2 Brushed Aluminum Cover Plate

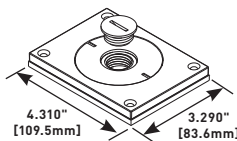

Power or communication plate with 2" [51mm] and 1/2" [12.7mm] plugs.

NOTE: Acceptable for use with threaded conduit when passing through power cables.

828DLRAL Brushed Aluminum Single Locking Receptacle Cover Plate

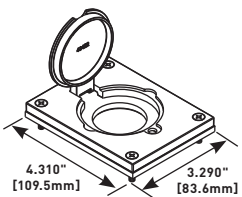

Single flip lid cover for 20A or 30A single locking receptacles. Device opening is 2 5/8" [67mm]. For use with maximum female locking device of 1.58" diameter, and maximum male plug face of 2.25" diameter.

828MAAP AV Adapter Plate

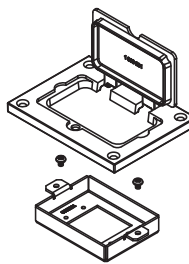

Sheet metal adapter plate that accepts two (2) Legrand AVIP or Extron® Electronics MAAP style device plates [sold separately]. For use with 828GFITC or 828GFITCAL cover plates [sold separately].

830CKTCAL Brushed Aluminum Cover Plate

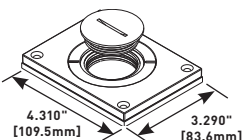

Power or communication plate with 2" [51mm] and 1 1/4" [32mm] plugs.

NOTE: Acceptable for use with threaded conduit when passing through power cables.

817TCAL 1-Gang Powder-Coated Aluminum Combination Carpet and Tile Flange

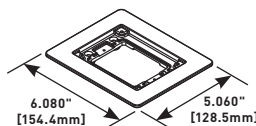

817TCAL-BK, 817TCAL-GY, 817TCAL-BS, 817TCAL-NK, 817TCAL-BZ

Accepts Ortronics® MAB6TJ TracJack and MAB3S2 Series II adapters and Wiremold CM Series inserts, sold separately. Flanges are available in five decorative colors: black, gray brass, nickel and bronze.

NOTE: Brass covers and flanges are not interchangeable with aluminum or nonmetallic covers and flanges. Nonmetallic covers are interchangeable with aluminum flanges.

MODULINK™ 880MP2 SERIES FLOOR BOXES

Modulink 880MP2 Series Floor Boxes Powder Coated Aluminum Cover Plate Flanges Ordering Information

827TCAL 2-Gang Powder-Coated Aluminum Combination Carpet and Tile Flange

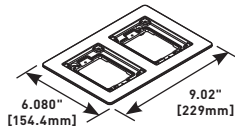

827TCAL-BK, 827TCAL-GY, 827TCAL-BS, 827TCAL-NK, 827TCAL-BZ

Accepts Ortronics® MAB6TJ TracJack and MAB3S2 Series II adapters and Wiremold CM Series inserts, sold separately. Flanges are available in five decorative colors: black, gray brass, nickel and bronze.

837TCAL 3-Gang Powder-Coated Aluminum Combination Carpet and Tile Flange

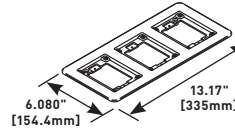

837TCAL-BK, 837TCAL-GY, 837TCAL-BS, 837TCAL-NK, 837TCAL-BZ

Accepts Ortronics® MAB6TJ TracJack and MAB3S2 Series II adapters and Wiremold CM Series inserts, sold separately. Flanges are available in five decorative colors: black, gray brass, nickel and bronze.

Modulink 880MP2 Series Floor Boxes Powder Coated Aluminum Cover Plates Ordering Information

828R-TCAL Powder-Coated Aluminum Duplex Cover Plate

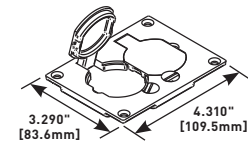

828R-TCAL-BK, 828R-TCAL-GY, 828R-TCAL-BS, 828R-TCAL-NK, 828R-TCAL-BZ

Flip lids. Can also be used with a 106 type communication adapter.

829CKAL-3/4 Powder-Coated Aluminum Cover Plate

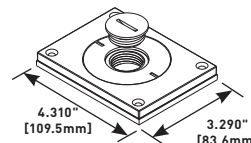

829CKAL-3/4BK, 829CKAL-3/4GY, 829CKAL-3/4BS, 829CKAL-3/4NK, 829CKAL-3/4BZ

Power or communication plate with 2" [51mm] and 3/4" [19.1mm] plugs. Covers are available in five decorative colors: black, gray, brass, nickel and bronze.

NOTE: Acceptable for use with threaded conduit when passing through power cables.

828GFITCAL Powder-Coated Aluminum Rectangular Cover Plate

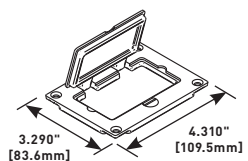

828GFITCAL-BK, 828GFITCAL-GY, 828GFITCAL-BS, 828GFITCAL-NK, 828GFITCAL-BZ

Allows for mounting of a duplex receptacle (Duplex or GFCI style) with a rectangular flip cover.

828MAAP AV Adapter Plate

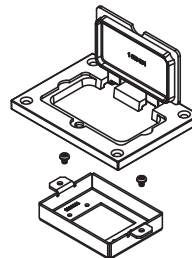

Sheet metal adapter plate that accepts two (2) Legrand AVIP or Extron® Electronics MAAP style device plates (sold separately). For use with 828GFITC or 828GFITCAL cover plates (sold separately).

829CKAL-1 Powder-Coated Aluminum Cover Plate

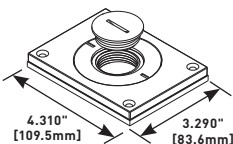

829CKAL-1BK, 829CKAL-1GY, 829CKAL-1BS, 829CKAL-1NK, 829CKAL-1BZ

Power or communication plate with 2" [51mm] and 1" [25mm] plugs. Covers are available in five decorative colors: black, gray, brass, nickel and bronze.

NOTE: Acceptable for use with threaded conduit when passing through power cables.

NOTE: Brass covers and flanges are not interchangeable with aluminum or nonmetallic covers and flanges. Nonmetallic covers are interchangeable with aluminum flanges.

MODULINK™ 880MP2 SERIES FLOOR BOXES

Modulink 880MP2 Series Floor Boxes Nonmetallic Cover Plates Flanges Ordering Information

817PCC 1-Gang Nonmetallic Carpet Flange

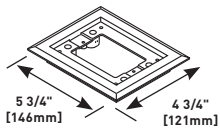

817PCC-BLK, 817PCC-BRN

Available in black or brown. For Ortronics® connectivity use with 829PFLRT Cover. For Activate connectivity use with 829PFL Cover. Accepts Ortronics® MAB6TJ TracJack and MAB3S2 Series II adapters and Wiremold CM Series inserts, sold separately.

837PCC 3-Gang Nonmetallic Carpet Flange

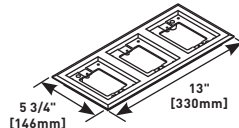

837PCC-BLK, 837PCC-BRN

Available in black or brown. For Ortronics® connectivity use with 829PFLRT Cover. For Activate connectivity use with 829PFL Cover. Accepts Ortronics® MAB6TJ TracJack and MAB3S2 Series II adapters and Wiremold CM Series inserts, sold separately.

827PCC 2-Gang Nonmetallic Carpet Flange

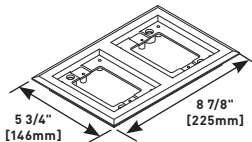

827PCC-BLK, 827PCC-BRN

Available in black or brown. For Ortronics® connectivity use with 829PFLRT Cover. For Activate connectivity use with 829PFL Cover. Accepts Ortronics® MAB6TJ TracJack and MAB3S2 Series II adapters and Wiremold CM Series inserts, sold separately.

NOTE: Brass covers and flanges are not interchangeable with aluminum or nonmetallic covers and flanges. Nonmetallic covers are interchangeable with aluminum flanges.

Modulink 880MP Series Floor Boxes Nonmetallic Cover Plates Ordering Information

828PR Nonmetallic Duplex Cover Plate

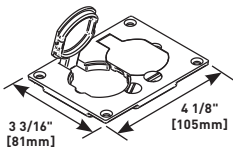

828PR-BLK, 828PR-BRN

Flip lids. Available in black or brown. Can also be used with a 106 type communication adapter.

829PFLRT* Nonmetallic Communication Cover Plate

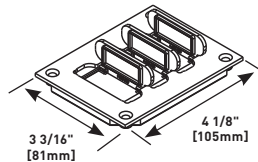

829PFLRT-BLK, 829PFLRT-BRN

Individual flip lids. Available in black or brown. Gasket included. Ortronics® MAB6TJ TracJack and MAB3S2 Series II adapters included.

828PRGFI Nonmetallic GFI Cover Plate

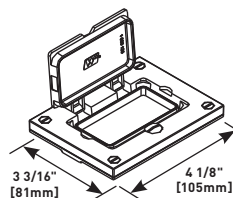

828PRGFI-BLK, 828PRGFI-BRN

Available in black or brown. May be used with Ortronics® Connectivity systems in conjunction with 817, 827 and 837PCC Series flanges.

829PCK Nonmetallic Communication Cover Plate

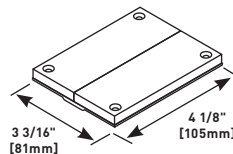

829PCK-BLK, 829PCK-BRN

Breakouts. Available in black or brown. Feed through only, not for use with a mounting plate for communication jacks.

829PFL* Nonmetallic Communication Cover Plate

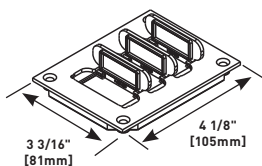

829PFL-BLK, 829PFL-BRN

Individual flip lids. Available in black or brown. Gasket included. Wiremold CM Series inserts included.

829PSTC Nonmetallic Communications Cover Plate

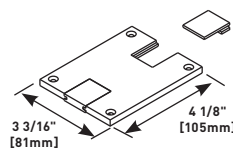

829PSTC-BLK, 829PSTC-BRN

Data slides. Available in black or brown. Feed through only, not for use with a mounting plate for communication jacks.

*Replacement flip lids can be ordered under Cat. No. PFL-BLK and PFL-BRN. Each Cat. No. comes with three flip lids. The above cover plates are listed for tile and carpet applications.

MODULINK™ 880MP2 SERIES FLOOR BOXES

Modulink 880MP2 Series Floor Boxes Mounting Options for Connectivity Insets

Flush installation with Activate installed using the Activate bezel, or Ortronics installed using the Ortronics bezels.

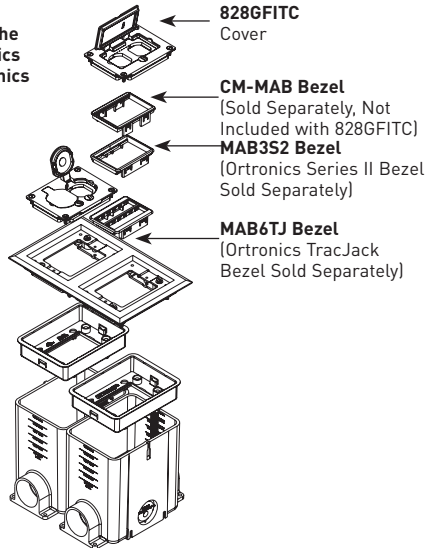

Recessed installation with Activate installed directly into the 880MPA Adjusting Ring. Ortronics inserts cannot be inserted directly into 880MPA, see below for Ortronics solution.

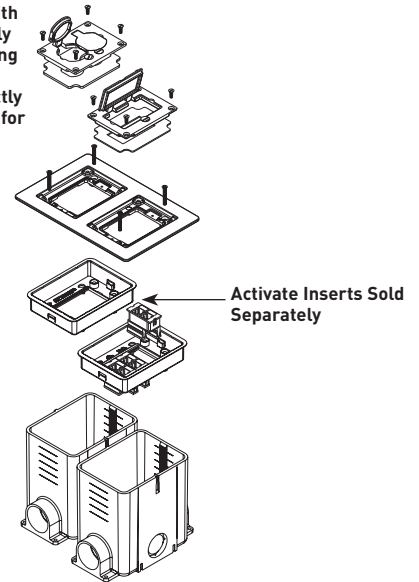

Flush installation with Ortronics installed using 829PFLRT Cover or Activate installed using 829PFL Cover.

NOTE: Part is approved for scrub water applications only with inserts in the flush position.

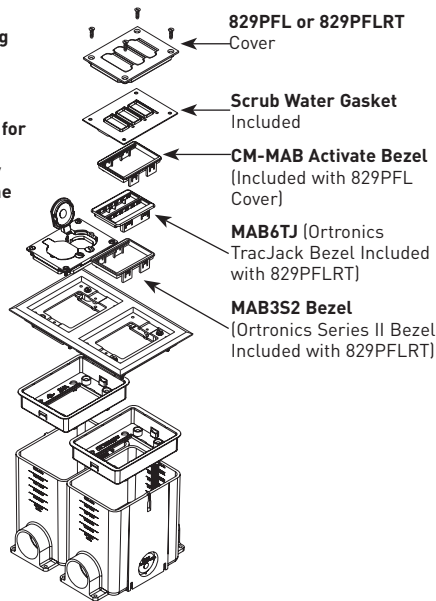

Fiber Optic Insert (sold separately)

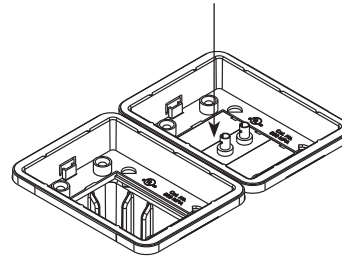

Fiber Storage Loop

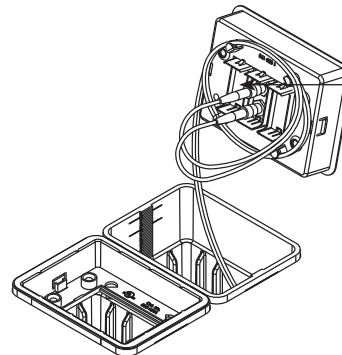

RESOURCE RFB® SERIES FLOOR BOXES

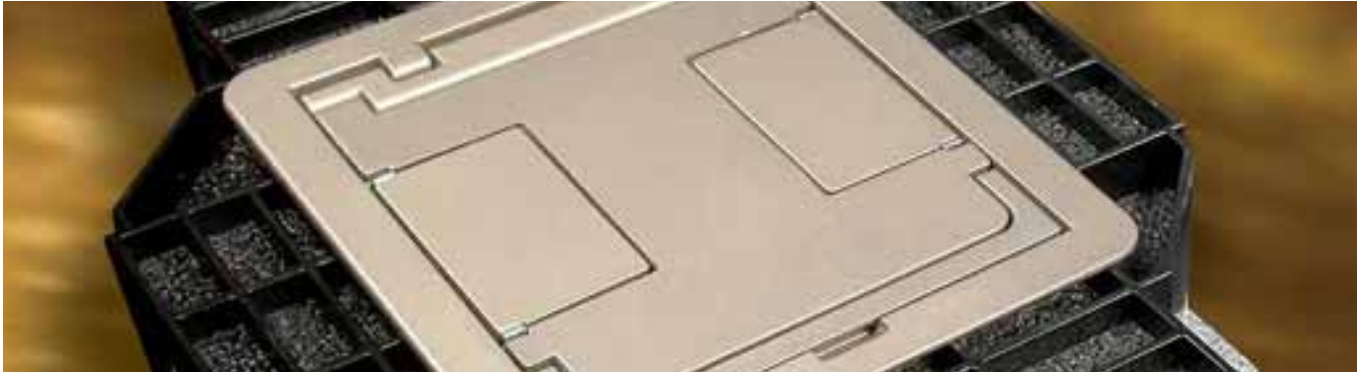

Resource RFB® Series Floor Boxes are a versatile solution that provides power and/or communication services to open space areas.

CODE REFERENCE

**cULus Listed
Metallic Outlet Boxes:**
File E2961 Guide QCIT.
Meets Article 314.27(C) of NEC.

RFB2 Series Multiservice Steel Recessed Floor Boxes Ordering Information

RFB2-SS Two-Compartment Shallow Stamped Steel Box

For use in either concrete or wood floors. Fully adjustable with tunnel compartment. Supplied with one (1) duplex receptacle mounting plate, and one (1) communication mounting plate (RFB22AB). Other device plates sold separately.

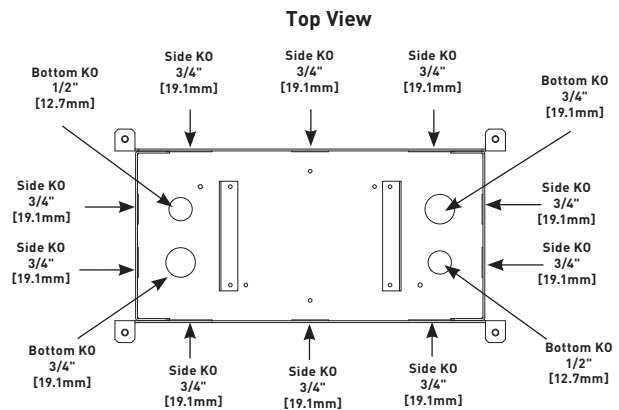
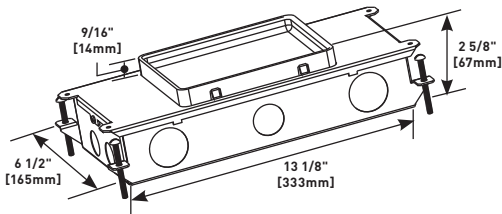

Power or Data
38.0 cu. in. [622.7 ml] Each Side

RESOURCE RFB® SERIES FLOOR BOXES

RFB2 Series

RFB2 Series Multiservice Steel Recessed Floor Boxes Ordering Information (continued)

RFB2 Two-Compartment Box

For use in either concrete or wood floors. Fully adjustable with tunnel compartment. Supplied with one (1) duplex receptacle mounting plate, and one (1) communication mounting plate (RFB22AB). Other device plates sold separately.

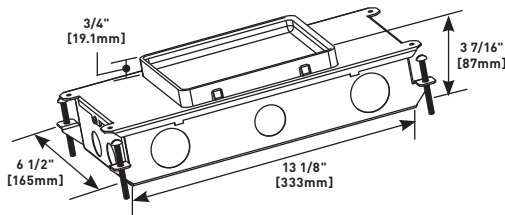

RFB2-OG Two-Compartment Box

For use On Grade. Fully adjustable with tunnel compartment. Supplied with one (1) duplex receptacle mounting plate, and one (1) communication mounting plate (RFB22AB). Other device plates sold separately.

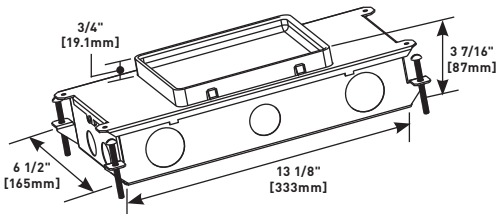

NOTE: RFB2-OG for on-grade applications is painted with a fusion-bonded epoxy designed for use on metal reinforcement bar and related accessories before encapsulating in concrete.

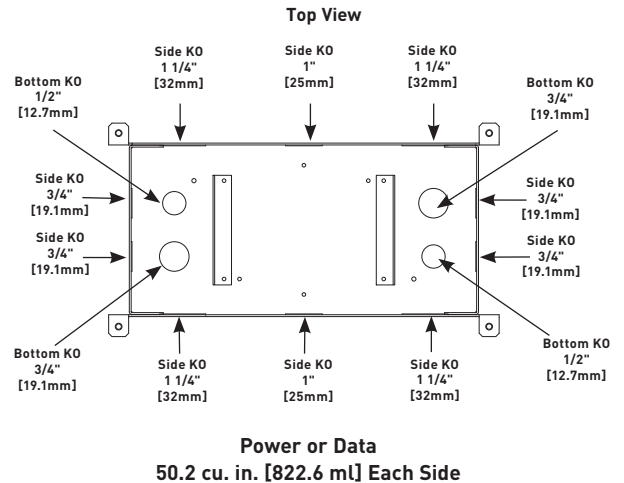

RESOURCE RFB[®] SERIES FLOOR BOXES

RFB2 Series

RFB2 Series Multiservice Steel Recessed Floor Box Accessories Ordering Information

RFB2DP Internal Duplex Receptacle Bracket

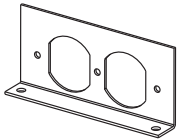

Accepts standard 15A and 20A duplex receptacles.

NOTE: For RFB2 Series Floor Boxes only..

RFB2EXT Internal A/V Bracket

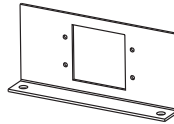

Accepts two (2) Legrand AVIP or Extron[®] Electronics MAAP Series devices (sold separately).

NOTE: For RFB2 Series Floor Boxes only.

RFB2B Internal Blank Bracket

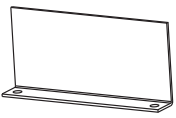
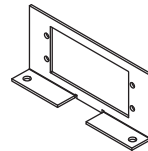

Plate used to close off unused gangs.

NOTE: For RFB2 Series Floor Boxes only.

RFB2-AAP Internal A/V Bracket



Accepts two (2) Extron[®] Electronics AAP Series devices (sold separately).

NOTE: For RFB2 Series Floor Boxes only.

RFB2GFI Internal GFI or Decorator Style Receptacle Bracket

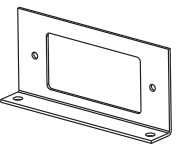

Accepts standard GFCI or Decorator Style Receptacles, Communication or A/V Devices.

NOTE: For RFB2 Series Floor Boxes only.

RFBKIT Barrier Kit

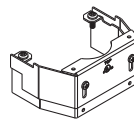

Barrier kit used to separate power and communication wires in partition feed covers. Supplied with base and three extensions to adjust to cover height. Kit should be used on RFB2, RFB2-OG, RFB2-SS, RFB4 and RFB4-SS Floor Boxes. Kits are sold separately.

RFB22AB Internal Communication Bracket

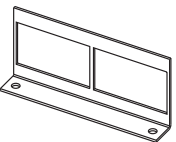

Includes two (2) adapters to accept Wiremold CM2 Series Open System communication inserts (sold separately).

NOTE: For RFB2 Series Floor Boxes only.

FP-CTR Bare Concrete & Terrazzo Ring

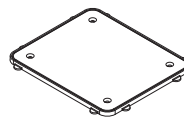

Nonmetallic ring for use on bare polished concrete and terrazzo floor applications.

RFB2RT Internal Communication Bracket

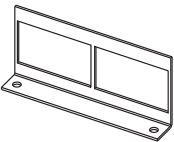

Includes two (2) adapters to accept Ortronics[®] TracJack devices, and two (2) adapters to accept Ortronics[®] Series II devices (sold separately).

NOTE: For RFB2 Series Floor Boxes only.

NOTE: All device plates and accessories shown on this page are made in the United States of America.

RESOURCE RFB[®] SERIES FLOOR BOXES

RFB2 Series

FloorPort™ Series Flanged Cover Plates Ordering Information

Floorport Part Number Configurator



FloorPort Series:



Cover Style:



Top Style:



Cover Color:

Blank Top = B	Tile (flangeless) = T	Brushed Aluminum = AL
Cutout Top = C	Tile/Carpet (flanged) = TC	Black = BK
Furniture Feed = FF		Brass = BS
		Bronze = BZ
		Gray = GY
		Nickel = NK

FPCTC Cutout Cover Assembly

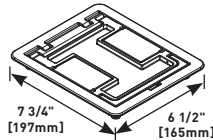

FPCTCBK, FPCTCBZ, FPCTCBS, FPCTCNK, FPCTCGY, FPCTCAL
Flanged cover for use in tile or carpet installation. Die-cast aluminum assembly available in black, bronze, brass, nickel, gray, or brushed aluminum. Insert in lid allows for carpet or tile cutouts to match finished floor.

FPFFTC Furniture Feed Cover Assembly

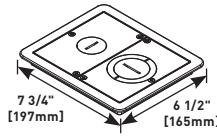

FPFFTCBK, FPFFTCBZ, FPFFTCBS, FPFFTCNK, FPFFTCGY, FPFFTCAL
Flanged cover for use in tile or carpet installation. Die-cast aluminum assembly available in black, bronze, brass, nickel, gray, or brushed aluminum. Provided with one 1" trade size screw plug for power or communication type cabling and one combination 1 1/4" and 2" trade size screw plug for communication type cabling. Allows for feeding both power and communication cabling.

FPBTC Blank Cover Assembly

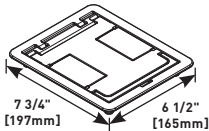

FPBTCBK, FPBTCBZ, FPBTCBS, FPBTCNK, FPBTCGY, FPBTCAL
Flanged cover for use in tile or carpet installation. Die-cast aluminum assembly available in black, bronze, brass, nickel, gray, or brushed aluminum. Lid area is flush with the finished floor, no cutouts provided.

FloorPort™ Series Flangeless Cover Assemblies Ordering Information

FPCT Cutout Cover Assembly

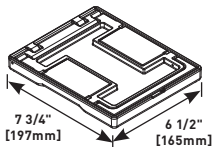

FPCTCBK, FPCTCBZ, FPCTCBS, FPCTCNK, FPCTCGY, FPCTCAL
Flangeless cover for use in tile or carpet installations. Die-cast aluminum assembly available in black, bronze, brass, nickel, gray, or brushed aluminum. Insert in lid allows for carpet or tile cutouts to match finished floor.

FPFFT Furniture Feed Cover Assembly

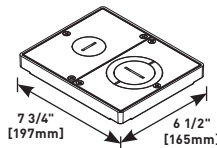

FPFFTCBK, FPFFTCBZ, FPFFTCBS, FPFFTCNK, FPFFTCGY, FPFFTCAL
Flangeless cover for use in tile or carpet installation. Die-cast aluminum assembly available in black, bronze, brass, nickel, gray, or brushed aluminum. Provided with one 1" trade size screw plug for power or communication type cabling and one combination 1 1/4" and 2" trade size screw plug for communication type cabling. Allows for feeding both power and communication cabling.

FPBT Blank Cover Assembly

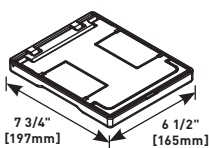

FPBTCBK, FPBTCBZ, FPBTCBS, FPBTCNK, FPBTCGY, FPBTCAL
Flangeless cover for use in tile or carpet installation. Die-cast aluminum assembly available in black, bronze, brass, nickel, gray, or brushed aluminum. Lid area is flush with the finished floor, no cutouts provided.

RESOURCE RFB® SERIES FLOOR BOXES

RFB2 Series

North American Made FloorPort™ Series Flanged Cover Plates Ordering Information

Floorport Part Number Configurator

FloorPort Series:	Cover Style:	Top Style:	Cover Color:	Origin:
	Blank Top = B Cutout Top = C Furniture Feed = FF	Tile (flangeless) = T Tile/Carpet (flanged) = TC	Nickel = NK Brass = BS Black = BK Bronze = BZ Gray = GY	North American Made NA

FPCTC-NA Cutout Cover Assembly

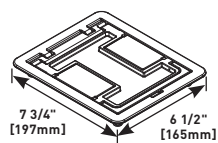

FPCTCBK-NA, FPCTCBZ-NA, FPCTCBS-NA, FPCTCNK-NA, FPCTCGY-NA

Flanged cover for use in tile or carpet installation. Die-cast aluminum assembly available in black, bronze, brass, nickel, gray, or brushed aluminum. Insert in lid allows for carpet or tile cutouts to match finished floor.

FPFFTC Furniture Feed Cover Assembly

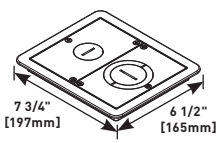

FPFFTCBK, FPFFTCBZ, FPFFTCBS, FPFFTCNK, FPFFTCGY, FPFFTCAL

Flanged cover for use in tile or carpet installation. Die-cast aluminum assembly available in black, bronze, brass, nickel, gray, or brushed aluminum. Provided with one 1" trade size screw plug for power or communication type cabling and one combination 1 1/4" and 2" trade size screw plug for communication type cabling. Allows for feeding both power and communication cabling.

FPBTC-NA Blank Cover Assembly

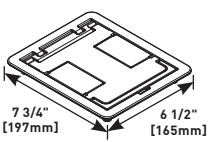

FPBTCBK-NA, FPBTCBZ-NA, FPBTCBS-NA, FPBTCNK-NA, FPBTCGY-NA

Flanged cover for use in tile or carpet installation. Die-cast aluminum assembly available in black, bronze, brass, nickel, gray, or brushed aluminum. Lid area is flush with the finished floor, no cutouts provided.

Load Capacities for FloorPort™ Cover Assemblies

CATALOG NUMBERS	MAXIMUM LOAD IN POUNDS
FPCTC	1000
FPBTC	750
FPFFT	1000
FPBT	750
FPCT	1000
FPFF	1000

NOTE: Load applied through a 2" [51mm] mandrel in center of service fitting. Loads above are static loads only and do not pertain to rolling loads.

RESOURCE RFB® SERIES FLOOR BOXES

RFB4 Series

RFB4 & RFB4-4DB Series Multiservice Steel Recessed Floor Boxes Ordering Information

RFB4 Four-Compartment Combination Box

12 3/4" x 10" x 3 7/16" [324mm x 254mm x 87mm]. Fully adjustable with tunnel compartment and two receptacle brackets. **Tunneling from end power compartment to end power compartment only.** Communication brackets not included. All boxes and covers are sold separately.

NOTE: Only for use in concrete floors.

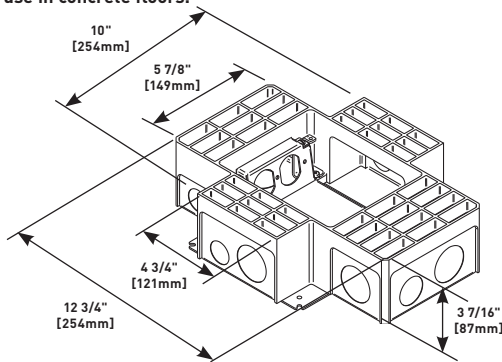

NOTE: All boxes and activations are sold separately.

RFB4-4DB Four-Compartment Box With Four Duplex Receptacle Brackets

Includes four duplex receptacle brackets. 12 3/4" x 10" x 3 7/16" [324mm x 254mm x 87mm]. Fully adjustable. **Tunneling from adjacent or opposite compartments only, (not cross compartments).** Tunneling can be set to feed all four compartments from one conduit in a single-service application. All boxes and covers are sold separately.

NOTE: Only for use in concrete floors.

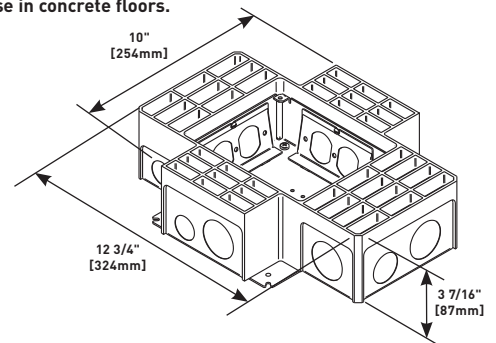

Resource RFB4 & RFB4-4DB Series Floor Boxes Compartment Capacities, Knockout Locations & Sizes

Compartment Capacities

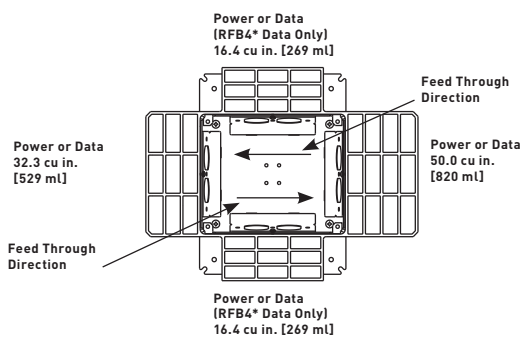

No feed through to opposite data compartment on RFB4.

Knockout Locations & Sizes

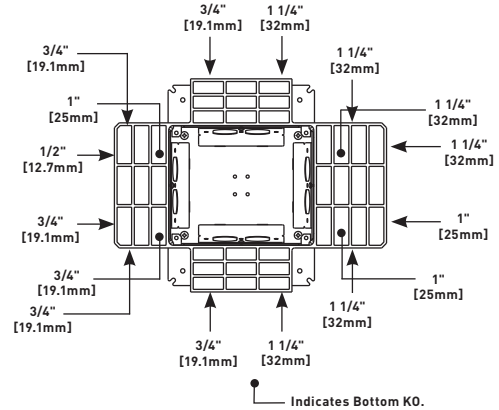

RESOURCE RFB® SERIES FLOOR BOXES

RFB4 Series

Resource RFB4 & RFB4-4DB Series Multiservice Steel Recessed Floor Box Accessories Ordering Information

RFB-B Internal Blank Bracket

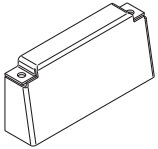

Power compartments only. Used to close off unused gangs.

NOTE: For RFB4 only.

RFB-DR Internal Duplex Bracket

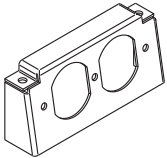

Accepts standard 15A and 20A duplex receptacles.

NOTE: For RFB4 only.

RFB-GFI Internal GFI Bracket

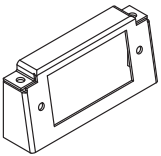

Accepts standard GFCI or Decorator Style receptacles, Communication or A/V Devices.

NOTE: For RFB4 only.

RFB4-LPB Communication Bracket

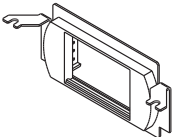

Activate™ low profile adapter included. Wiremold CM Series Open System inserts sold separately.

NOTE: For RFB4 only.

RFB4-LPBS2 Communication Bracket

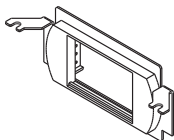

Ortronics® Series II low profile adapter included.

NOTE: For RFB4 only.

DTB-2-2AB Communication Bracket

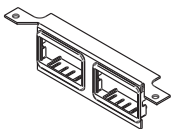

Two (2) 2A size adapters included. Wiremold CM2 Series Open System inserts, sold separately.

NOTE: For RFB4 only.

DTB-2-2RT Communication Bracket

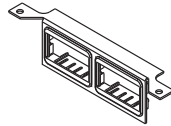

Ortronics® AB2TJ TracJack and ABS2 Series II adapters included.

NOTE: For RFB4 only.

DTB-2-DECORA Communication Bracket

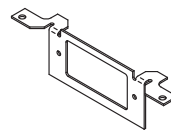

Decorator style opening for decorator style 106 adapter.

NOTE: For RFB4 only.

DTB-2-AAP Internal A/V Bracket

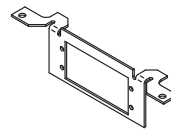

Accepts two (2) Extron® Electronics AAP devices (sold separately).

NOTE: For RFB4 only.

DTB-2-4TKO Communication Bracket

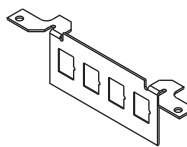

Four (4) RJ keystone opening knockouts. Use as blank plate or for up to four (4) RJ openings.

NOTE: For RFB4 only. Opening dimension is 9/16" x 3/4" [14.3mm x 19.1mm].

DTB-2-DT Communication Bracket

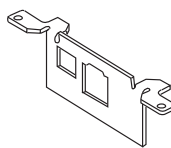

With one (1) IBM Type II opening and one (1) keystone opening (devices not included).

NOTE: For RFB4 only.

DTB-2-SD Communication Bracket

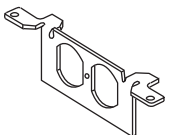

With duplex opening for use with 106 adapter (sold separately, devices not included).

NOTE: For RFB4 only.

DTB-2-EXT Internal A/V Bracket

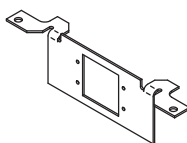

Accepts two (2) Legrand AVIP or Extron® Electronics MAAP devices (sold separately).

NOTE: For RFB4 only.

NOTE: Additional configurations available. Please consult your local Sales Representative for more information.

RESOURCE RFB® SERIES FLOOR BOXES

RFB4 Series

RFB4 & RFB4-4DB Series Multiservice Steel Recessed Floor Box Accessories Ordering Information

RFB-GFI-4DB Internal GFCI Bracket

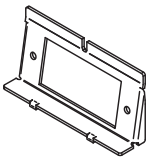

Accepts standard GFCI or Decorator style receptacles, communications or A/V devices.

NOTE: For RFB4-4DB only.

WTB-AAP Internal A/V Bracket

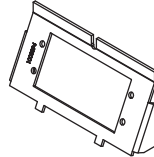

Accepts two (2) Extron® Electronics AAP Series devices (sold separately).

NOTE: For RFB4-4DB only.

RFB-WTB Conversion Kit

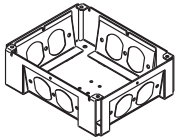

To convert RFB4 Box to an RFB4-4DB Box.

NOTE: For RFB4-4DB only.

WTB-MAAP Internal A/V Bracket

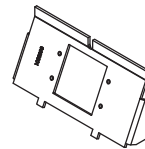

Accepts two (2) Legrand AVIP or Extron® Electronics MAAP Series devices (sold separately).

NOTE: For RFB4-4DB only.

WTB-2-AB Communication Bracket

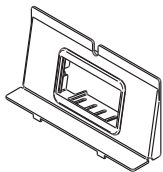

One (1) 2A adapter included. Wiremold CM2 Series Open System inserts sold separately.

NOTE: For RFB4-4DB only.

FP-CTR Bare Concrete & Terrazzo Ring

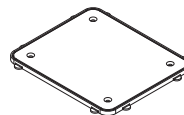

Nonmetallic ring for use on bare polished concrete and terrazzo floor applications.

WTB-2-RT Communication Bracket

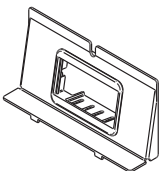

Ortronics® AB2TJ TracJack and ABS2 Series II adapters included.

NOTE: For RFB4-4DB only.

RFBKIT Barrier Kit

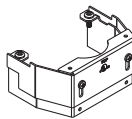

Barrier kit used to separate power and communication wires in partition feed covers. Supplied with base and three extensions to adjust to cover height. Kit should be used on RFB2, RFB2-OG, RFB2-SS, RFB4 and RFB4-SS Floor Boxes. Kits are sold separately.

NOTE: Additional configurations available. Please consult your local Sales Representative for more information.

RESOURCE RFB® SERIES FLOOR BOXES

RFB4 Series

RFB4-CI-1 Series Multiservice Cast Iron Recessed Floor Boxes Ordering Information

RFB4-CI-1 Four-Compartment Cast Iron Combination Box

14 1/2" L x 11 7/8" W x 3 7/16" D [368mm x 302mm x 87mm]. Fully adjustable with tunnel compartment and two receptacle brackets. **Feed through from adjacent or opposite compartments only, (not cross compartments).** Communication brackets not included. All boxes and activations are sold separately.

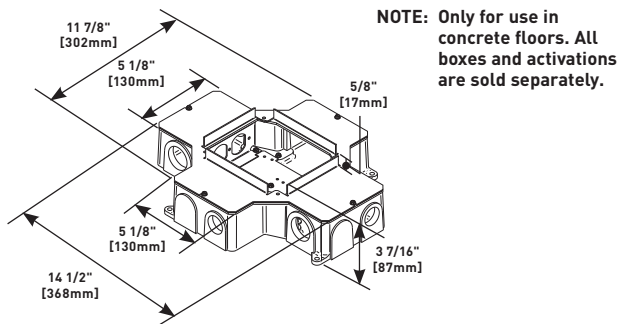

RFB4-CI-1 North American Made Four-Compartment Cast Iron Combination Box

14 1/2" L x 11 7/8" W x 3 7/16" D [368mm x 302mm x 87mm]. Fully adjustable with tunnel compartment and two receptacle brackets. **Feed through from adjacent or opposite compartments only, (not cross compartments).** Communication brackets not included. All boxes and activations are sold separately.

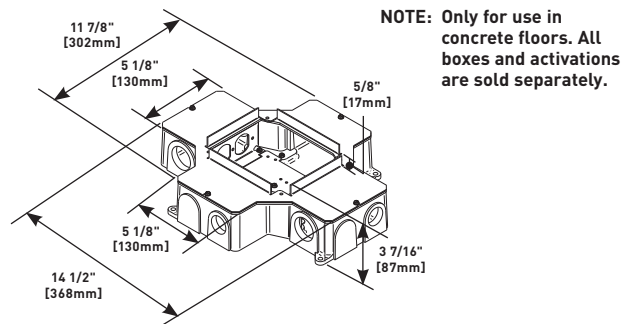

RFB4-CI-1 Series Multiservice Cast Iron Recessed Floor Boxes Compartment Capacities, Knockout Locations and Sizes

Compartment Capacities

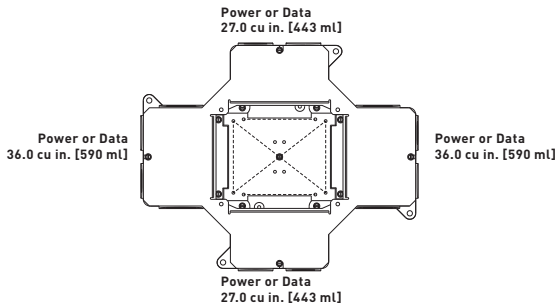

Knockout Locations & Sizes

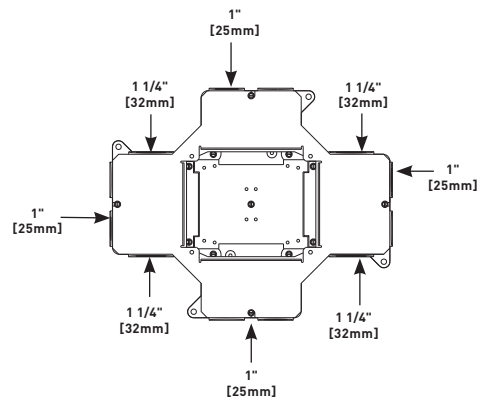

RFB4-CI-1 Series Multiservice Cast Iron Recessed Floor Box Accessories Ordering Information

CIHT-D Internal Duplex Receptacle Bracket

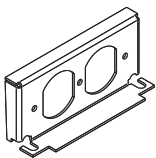

Accepts standard 15 Amp and 20 Amp Duplex Receptacles.

CIHT-GFI Internal GFI Bracket

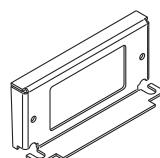

Accepts standard GFCI or Decorator Style Receptacles, Communication or A/V Devices.

CIH/LT-B Internal Blank Bracket

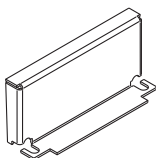

Used to close off unused gangs.

CILT-2AB Communication Bracket

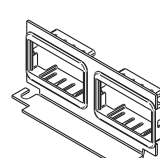

Communication bracket with two (2) 2A size Activate™ adapters included. Accepts Wiremold CM2 Series Open System communication modules (sold separately).

RESOURCE RFB® SERIES FLOOR BOXES

RFB4 Series

RFB4-C1-1 Series Multiservice Cast Iron Recessed Floor Box Accessories Ordering Information (continued)

CILT-2-RT Communication Bracket

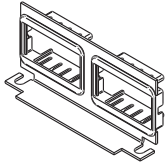

Communication bracket with Ortronics® AB2TJ TracJack and ABS2 Series II adapters included. Accepts Ortronics® workstation connectivity outlets and modular inserts.

RFBCKIT Barrier Kit

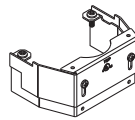

Barrier kit used with RFB4-CI floor boxes. Kits are sold separately.

CILT-4TKO Communication Bracket

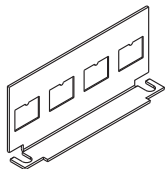

Communication bracket with four (4) RJ opening knockouts. Use as blank plate or for up to four RJ openings.

NOTE: Opening dimension is 9/16" x 3/4" [14.3mm x 19.1mm]

FP-CTR Bare Concrete & Terrazzo Ring

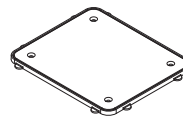

Nonmetallic ring for use on bare polished concrete and terrazzo floor applications.

NOTE: Additional configurations available. Please consult your local Sales Representative for more information.

RFB4-SS Multiservice Shallow Steel Recessed Floor Boxes Ordering Information

RFB4-SS Four-Compartment Shallow Stamped Steel Combination Box

13 5/8" L x 10" W x 2 7/16" D [346mm x 254mm x 62mm]. Fully adjustable with tunnel compartment and two (2) receptacle brackets. **Feed through tunneling to adjacent compartments only.** Tunneling can be set to feed all four compartments from one conduit in a single-service application. Communication brackets not included. All boxes and activations are sold separately.

NOTE: Only for use in concrete floors. All boxes and activations are sold separately.

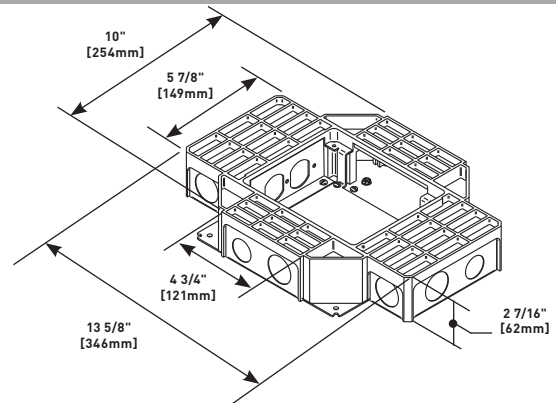

RFB4-SS Series Multiservice Shallow Steel Recessed Floor Boxes Compartment Capacities, Knockout Locations and Sizes

Compartment Capacities

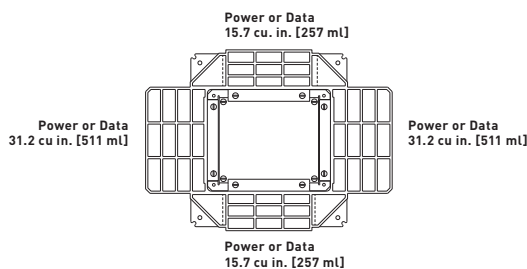

Knockout Locations & Sizes

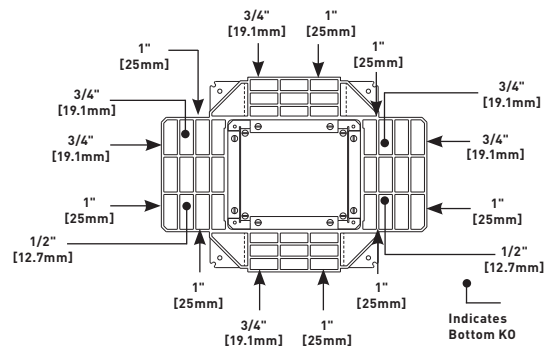

RESOURCE RFB® SERIES FLOOR BOXES

RFB4 Series

RFB4-SS Multiservice Shallow Steel Floor Box Accessories Ordering Information

RFB-B-SS Internal Blank Bracket

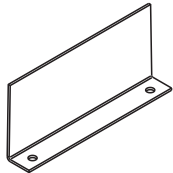

Used to close off unused gangs.

RFB-4TKO-SS Internal Bracket

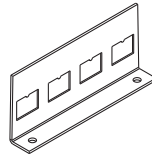

Four (4) RJ keystone opening knockouts. Use as blank plate or for up to four RJ openings.

NOTE: Opening dimension is 9/16" x 3/4" [14.3mm x 19.1mm]

RFB-RB-SS Internal Duplex Receptacle Bracket

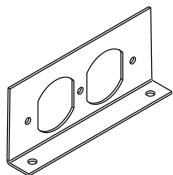

Accepts standard 15A and 20A duplex receptacles.

RFB4-SS-AAP Internal A/V Bracket

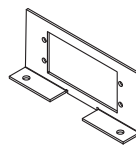

Accepts two (2) Extron® Electronics AAP Series devices (sold separately).

NOTE: For RFB4-SS Series Floor Boxes only.

RFB-GFI-SS Internal GFI Bracket

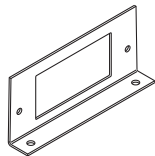

Accepts standard GFCI & Decorator style receptacles, Communication or A/V devices.

RFB4-SS-MAAP Internal A/V Bracket

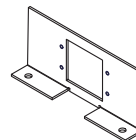

Accepts two (2) Legrand AVIP or Extron® Electronics MAAP Series devices (sold separately).

NOTE: For RFB4-SS Series Floor Boxes only.

RFB-2AB-SS Internal Bracket

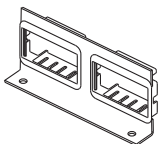

Two Pass & Seymour® Activate™ adapters included. Wiremold CM Series Open System inserts (sold separately).

RFBKIT Barrier Kit

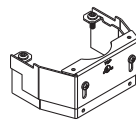

Barrier kit used to separate power and communication wires in partition feed covers. Supplied with base and three extensions to adjust to cover height. Kit should be used on RFB2, RFB2-OG, RFB2-SS, RFB4 and RFB4-SS Floor Boxes. Kits are sold separately.

RFB-2-SSRT Communication Bracket

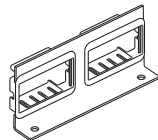

Ortronics® AB2TJ TracJack and ABS2 Series II adapters included.

FP-CTR Bare Concrete & Terrazzo Ring

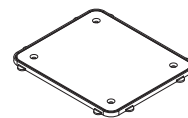

Nonmetallic ring for use on bare polished concrete and terrazzo floor applications.

NOTE: Additional configurations available. Please consult your local Sales Representative for more information.

RESOURCE RFB® SERIES FLOOR BOXES

RFB4 Series

FloorPort™ Series Flanged Cover Plates Ordering Information

Floorport Part Number Configurator

FloorPort Series:	Cover Style:	Top Style:	Cover Color:
F P	Blank Top = B	Tile (flangeless) = T	Brushed Aluminum = AL
	Cutout Top = C	Tile/Carpet = TC	Black = BK
	Furniture Feed = FF	(flanged)	Brass = BS
			Bronze = BZ
			Gray = GY
			Nickel = NK

FPCTC Cutout Cover Assembly

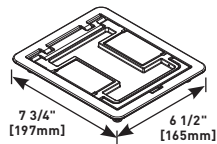

FPCTCBK, FPCTCBZ, FPCTCBS, FPCTCNK, FPCTCGY, FPCTCAL
 Flanged cover for use in tile or carpet installation. Die-cast aluminum assembly available in black, bronze, brass, nickel, gray, or brushed aluminum. Insert in lid allows for carpet or tile cutouts to match finished floor.

FPFFTC Furniture Feed Cover Assembly

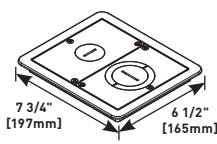

FPFFTCBK, FPFFTCBZ, FPFFTCBS, FPFFTCNK, FPFFTCGY, FPFFTCAL
 Flanged cover for use in tile or carpet installation. Die-cast aluminum assembly available in black, bronze, brass, nickel, gray, or brushed aluminum. Provided with one 1" trade size screw plug for power or communication type cabling and one combination 1 1/4" and 2" trade size screw plug for communication type cabling. Allows for feeding both power and communication cabling.

FPBTC Blank Cover Assembly

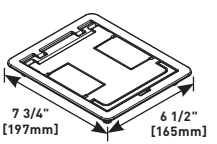

FPBTCBK, FPBTCBZ, FPBTCBS, FPBTCNK, FPBTCGY, FPBTCAL
 Flanged cover for use in tile or carpet installation. Die-cast aluminum assembly available in black, bronze, brass, nickel, gray, or brushed aluminum. Lid area is flush with the finished floor, no cutouts provided.

FloorPort™ Series Flangeless Cover Assemblies Ordering Information

FPCT Cutout Cover Assembly

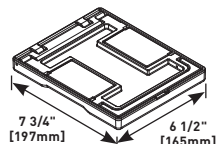

FPCTCBK, FPCTCBZ, FPCTCBS, FPCTCNK, FPCTCGY, FPCTCAL
 Flangeless cover for use in tile or carpet installations. Die-cast aluminum assembly available in black, bronze, brass, nickel, gray, or brushed aluminum. Insert in lid allows for carpet or tile cutouts to match finished floor.

FPFFT Furniture Feed Cover Assembly

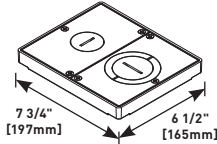

FPFFTCBK, FPFFTCBZ, FPFFTCBS, FPFFTCNK, FPFFTCGY, FPFFTCAL
 Flangeless cover for use in tile or carpet installation. Die-cast aluminum assembly available in black, bronze, brass, nickel, gray, or brushed aluminum. Provided with one 1" trade size screw plug for power or communication type cabling and one combination 1 1/4" and 2" trade size screw plug for communication type cabling. Allows for feeding both power and communication cabling.

FPBT Blank Cover Assembly

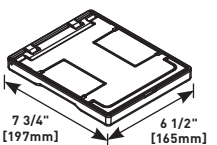

FPBTCBK, FPBTCBZ, FPBTCBS, FPBTCNK, FPBTCGY, FPBTCAL
 Flangeless cover for use in tile or carpet installation. Die-cast aluminum assembly available in black, bronze, brass, nickel, gray, or brushed aluminum. Lid area is flush with the finished floor, no cutouts provided.

RESOURCE RFB[®] SERIES FLOOR BOXES

RFB4 Series

North American Made FloorPort™ Series Flanged Cover Plates Ordering Information

Floorport Part Number Configurator

FloorPort Series:	Cover Style:	Top Style:	Cover Color:	Origin:
	Blank Top = B Cutout Top = C Furniture Feed = FF	Tile (flangeless) = T Tile/Carpet (flanged) = TC	Nickel = NK Brass = BS Black = BK Bronze = BZ Gray = GY	North American Made NA

FPCTC-NA Cutout Cover Assembly

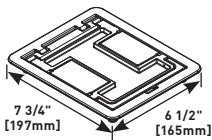

FPCTCBK-NA, FPCTCBZ-NA, FPCTCBS-NA, FPCTCNK-NA, FPCTCGY-NA

Flanged cover for use in tile or carpet installation. Die-cast aluminum assembly available in black, bronze, brass, nickel, gray, or brushed aluminum. Insert in lid allows for carpet or tile cutouts to match finished floor.

FPFFTC Furniture Feed Cover Assembly

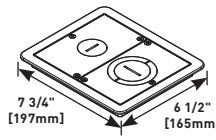

FPFFTCBK, FPFFTCBZ, FPFFTCBS, FPFFTCNK, FPFFTCGY, FPFFTCAL

Flanged cover for use in tile or carpet installation. Die-cast aluminum assembly available in black, bronze, brass, nickel, gray, or brushed aluminum. Provided with one 1" trade size screw plug for power or communication type cabling and one combination 1 1/4" and 2" trade size screw plug for communication type cabling. Allows for feeding both power and communication cabling.

FPBTC-NA Blank Cover Assembly

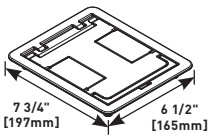

FPBTCBK-NA, FPBTCBZ-NA, FPBTCBS-NA, FPBTCNK-NA, FPBTCGY-NA

Flanged cover for use in tile or carpet installation. Die-cast aluminum assembly available in black, bronze, brass, nickel, gray, or brushed aluminum. Lid area is flush with the finished floor, no cutouts provided.

Load Capacities for FloorPort™ Cover Assemblies

CATALOG NUMBERS	MAXIMUM LOAD IN POUNDS
FPCTC	1000
FPBTC	750
FPFFTC	1000
FPBT	750
FPCT	1000
FPFF	1000

NOTE: Load applied through a 2" [51mm] mandrel in center of service fitting. Loads above are static loads only and do not pertain to rolling loads.

RESOURCE RFB® SERIES FLOOR BOXES

RFB4 Series



RFB4E Series Multiservice Steel Recessed Floor Boxes Ordering Information

RFB4E Four-Compartment Box

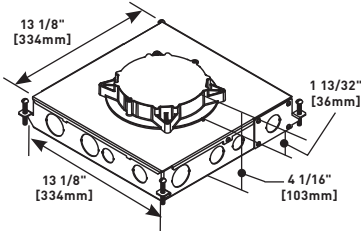

For use in concrete floors. For use with round Evolution Series™ covers. Fully adjustable with tunnel compartments. Device plates sold separately

RFB4E-OG Four-Compartment On-Grade Box

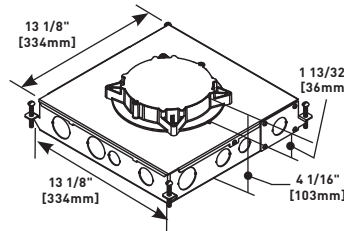

For use in concrete floors. For use in on-grade concrete floors. For use with round Evolution Series™ covers. Fully adjustable with tunnel compartments. Device plates sold separately.

RFB4E Series Multiservice Steel Recessed Floor Boxes Compartment Capacities, Knockout Locations & Sizes

Compartment Capacities

Four Compartments: (A, B, C, D)
Each Compartment Capacity:
75.0in³ [1230ml]

Knockout Locations & Sizes

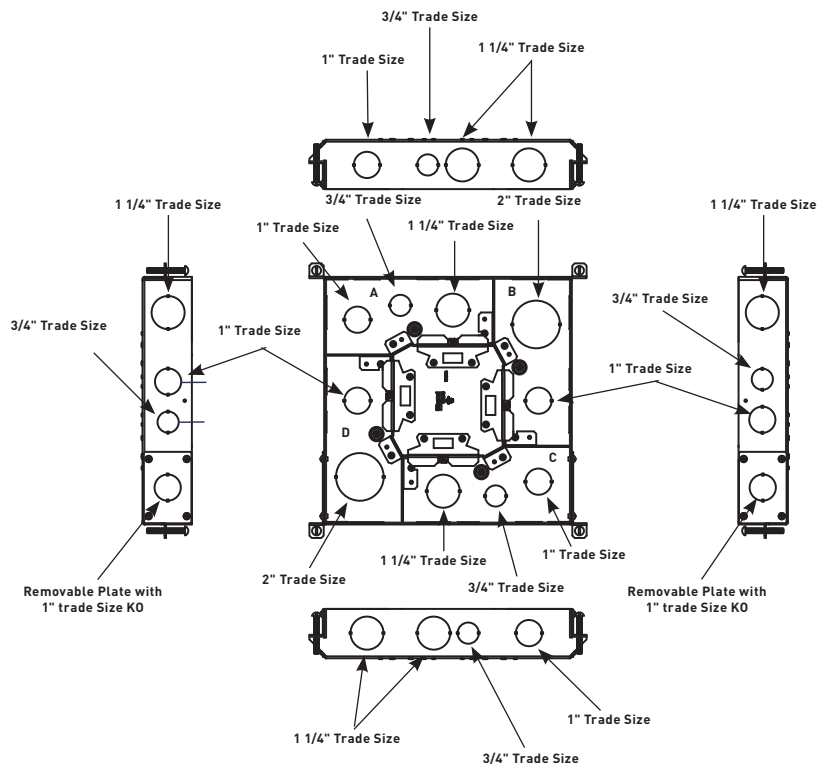

RESOURCE RFB® SERIES FLOOR BOXES

RFB4 Series

RFB4E & RB6 Series Multiservice Steel Recessed Floor Box Accessories Ordering Information

RFB4EKIT Barrier Kit

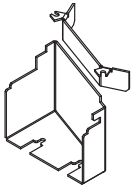

Used to separate power and communication services in combination with a 6CFFTC Furniture Feed Cover (sold separately)

RFB6RT Internal Communication Bracket

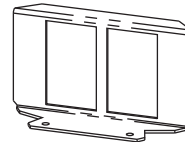

Includes one (1) adapter to accept Ortronics® TracJack devices, and one (1) adapter to accept Ortronics Series II devices (sold separately).

NOTE: For RFB4E, RFB6 & RFB6E Series Floor Boxes only.

RFB6DP Internal Duplex Receptacle Bracket

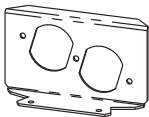

Accepts standard 15A and 20A duplex receptacles.

NOTE: For RFB4E, RFB6 & RFB6E Series Floor Boxes only.

RFB6EXT Internal A/V Bracket

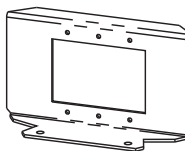

Accepts three (3) Legrand AVIP or Extron® Electronics MAAP Series devices (sold separately).

NOTE: For RFB4E, RFB6 & RFB6E Series Floor Boxes only.

RFB6B Internal Blank Bracket

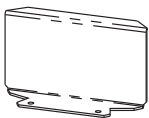

Closed off unused gangs.

NOTE: For RFB4E, RFB6 & RFB6E Series Floor Boxes only.

RFB62A Internal Communication Bracket

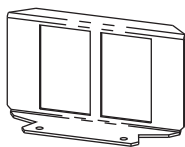

Included two (2) adapter to accept Wiremold CM2 Series Open System communication inserts (sold separately).

NOTE: For RFB4E, RFB6 & RFB6E Series Floor Boxes only.

RFB6GFI Internal GFI or Decorator Style Receptacle Bracket

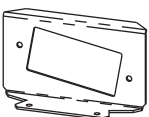

Accepts standard GFCI and Decorator Style receptacles, communication or A/V devices.

NOTE: For RFB4E, RFB6 & RFB6E Series Floor Boxes only.

RFB6-AAP Internal A/V Bracket

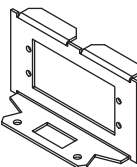

Accepts two (2) Extron® Electronics AAP Series devices (sold separately).

NOTE: For RFB4E, RFB6 & RFB6E Series Floor Boxes only.

RFB6S1 Internal Single Receptacle Bracket

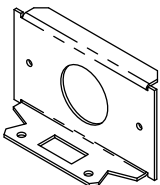

Receptacle opening 1 3/8" [35mm].

NOTE: For RFB4E, RFB6 & RFB6E Series Floor Boxes only.

RFB4E-CTR Bare Concrete & Terrazzo Ring

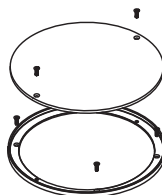

Nonmetallic ring for use with bare concrete and terrazzo floor applications.

NOTE: Only for use on RFB4E and RFB4E-OG Floor Boxes. Designed to work with 6CT Series Covers only.

RFB6S2 Internal Single Receptacle Bracket

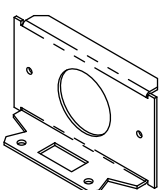

Receptacle opening 1 9/16" [40mm].

NOTE: For RFB4E, RFB6 & RFB6E Series Floor Boxes only.

2HUB 2" Conduit Transition Hub

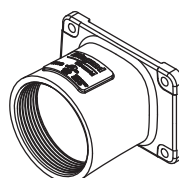

Trade size 2" die cast zinc conduit fitting allows for 2" conduit to transition into a shallow box design. Includes: die cast fitting, gasket, and mounting screws.

RESOURCE RFB® SERIES FLOOR BOXES

RFB4 Series

Evolution Series Cover Assemblies for RFB4E & RFB4E-0G Floor Boxes Ordering Information

6CTC* Surface Style Cover Assembly

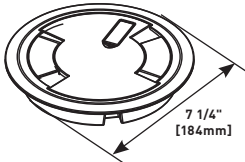

Die-cast aluminum cover assembly. Cover assembly is available in the following finishes: painted black (6CTCBK), painted gray (6CTCGY), nickel (6CTCNK), brass (6CTCBS), and bronze (6CTCBZ). 6CTC Series cover assemblies designed for use with 6STCP, 6STC, and 6STCPAV Poke-Thru Stem Assemblies.

6CT* Flush Style Cover Assembly

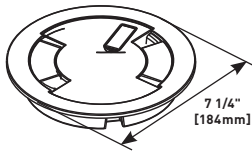

Die-cast aluminum cover assembly. Cover assembly is available in the following finishes: painted black (6CTBK), painted gray (6CTGY), nickel (6CTNK), brass (6CTBS), and bronze (6CTBZ). 6CT Series cover assemblies designed for use with 6STCP, 6STC, and 6STCPAV Poke-Thru Stem Assemblies. Includes one (1) 6TS Tile Shim.

* Add suffix "TR" to the end of the part number to indicate tamper-resistant cover assembly. Tamper-resistant versions are secured with a single tamper-resistant screw.

6CFFTC Furniture Feed Cover Assembly

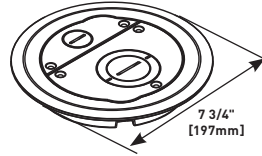

Surface style, die-cast aluminum cover assembly, with one (1) 3/4" trade size screw plug opening, and one (1) concentric 2"-1 1/4" trade size screw plug opening. Cover assembly is available in the following powder coated finishes: black (6CFFTCBK), gray (6CFFTCGY), nickel (6CFFTCNK), brass (6CFFTCBS), and bronze (6CFFTCBZ). 6CFFTC Series Cover Assemblies designed for use with 6STC Poke-Thru Stem Assembly. Includes one (1) 3/4" and one (1) 1" trade size conduit fittings and one (1) divider to separate devices.

6TS Tile Shim

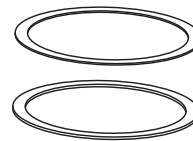

Used for floor coverings greater than 5/16" [7.9mm]. The 6TS will allow the top surface of the cover to be flush with the finished floor. Includes: six (6) 1/16" [1.6mm] thick shims. Up to a total of 3/8" [9.5mm] of adjustment.

RESOURCE RFB® SERIES FLOOR BOXES

RFB6 Series

RFB6 & RFB6E Multiservice Steel Recessed Floor Boxes Ordering Information

RFB6 Six-Compartment Box

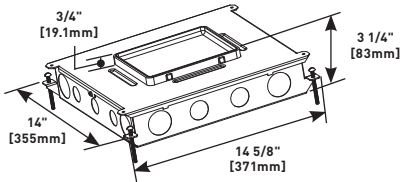

For use in either concrete or wood floors. Fully adjustable with tunnel compartment. Supplied with two (2) duplex mounting plates, two (2) communication mounting plates (RFB62A), and (2) blank mounting plates. Other plates sold separately.

RFB6E Six-Compartment Box

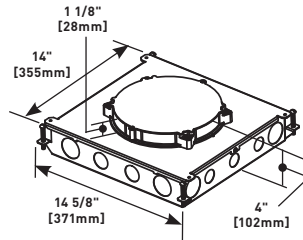

For use in concrete floors. For use with round Evolution™ Series covers. Fully adjustable with tunnel compartments. Supplied with two (2) duplex mounting plates. Other plates sold separately.

RFB6-OG Six-Compartment On-Grade Box

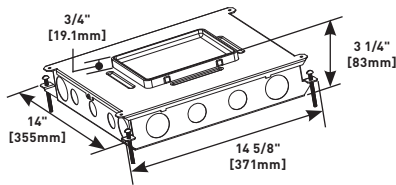

For use in either concrete or wood floors. Fully adjustable with tunnel compartment. Supplied with two (2) duplex mounting plates, two (2) communication mounting plates (RFB62A), and (2) blank mounting plates. Other plates sold separately.

RFB6E-OG Six-Compartment On-Grade Box

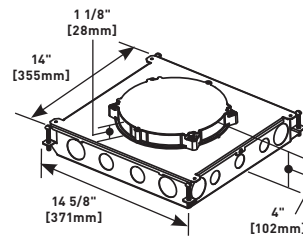

For use in concrete floors. For use with round Evolution™ Series covers. Fully adjustable with tunnel compartments. Supplied with two (2) duplex mounting plates. Other plates sold separately.

RFB6 & RFB6E Series Multiservice Steel Recessed Floor Boxes Compartment Capacities, Knockout Locations and Sizes

Side Knockout Locations

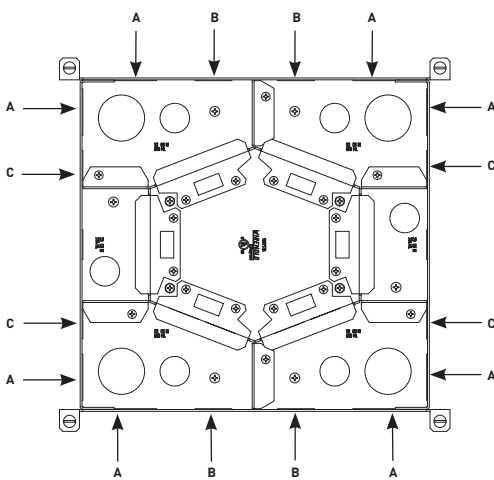

KNOCKOUTS

- A = Side KO 1 1/4" [32mm]
- B = Side KO 1" [25mm]
- C = Side KO 3/4" [19.1mm]

Bottom Knockout Locations

Compartment Wire and Communication Capacities

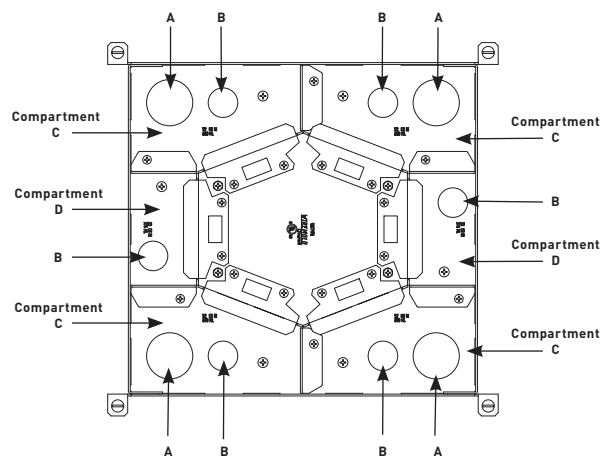

KNOCKOUTS

- A = Bottom KO 1 1/4" [32mm]
- B = Bottom KO 3/4" [19.1mm]

COMPARTMENT CAPACITIES

- C = Power or Data 52 in³ [852ml]
- D = Power or Data 23 in³ [376ml]

Feed through is accomplished through removable plugs.

RESOURCE RFB® SERIES FLOOR BOXES

RFB6 Series

RFB6 & RFB6E Series Steel Recessed Floor Boxes Ordering Information

RFB6DP Internal Duplex Receptacle Bracket

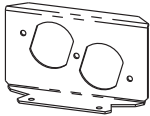

Accepts standard 15A and 20A duplex receptacles.

NOTE: For RFB4E, RFB6 and RFB6E Series Floor Boxes.

RFB6RT Internal Communication Bracket

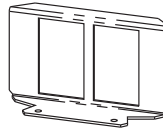

Includes one (1) adapter to accept Ortronics® TracJack devices, and one (1) adapter to accept Ortronics Series II devices (sold separately).

NOTE: For RFB4E, RFB6 and RFB6E Series Floor Boxes.

RFB6B Internal Blank Bracket

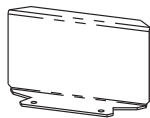

Closes off unused gangs.

NOTE: For RFB4E, RFB6 and RFB6E Series Floor Boxes.

RFB6EXT Internal A/V Bracket

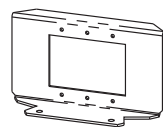

Accepts three (3) Legrand AVIP or Extron® Electronics MAAP Series devices (sold separately).

NOTE: For RFB4E, RFB6 and RFB6E Series Floor Boxes.

RFB6GFI Internal GFI or Decorator Style Receptacle Bracket

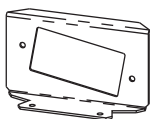

Accepts standard GFCI and Decorator Style receptacles, communication or A/V devices.

NOTE: For RFB4E, RFB6 and RFB6E Series Floor Boxes.

RFB62A Internal Communication Bracket

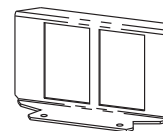

Includes two (2) adapters to accept Wiremold CM2 Series Open System communication inserts (sold separately).

NOTE: For RFB4E, RFB6 and RFB6E Series Floor Boxes.

RFB6S1 Internal Single Receptacle Bracket

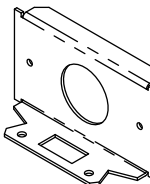

Receptacle opening 1 3/8" [35mm].

NOTE: For RFB4E, RFB6 and RFB6E Series Floor Boxes.

RFB6-AAP Internal A/V Bracket

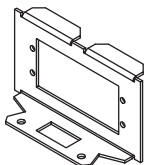

Accepts two (2) Extron® Electronics AAP Series devices (sold separately).

NOTE: For RFB4E, RFB6 and RFB6E Series Floor Boxes.

RFB6S2 Internal Single Receptacle Bracket

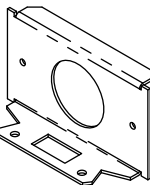

Receptacle opening 1 9/16" [40mm].

NOTE: For RFB4E, RFB6 and RFB6E Series Floor Boxes.

RFB6E-CTR Bare Concrete & Terrazzo Ring

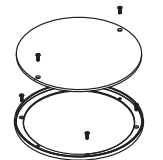

Nonmetallic ring for use with bare concrete and terrazzo floor applications.

NOTE: For RFB4E, RFB6 and RFB6E Series Floor Boxes. Designed to work with 8CTC and 8CT Series Covers only.

FP-CTR Bare Concrete & Terrazzo Ring

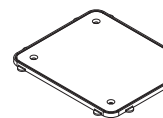

Nonmetallic ring for use on bare polished concrete and terrazzo floor applications.

NOTE: For RFB6 Series Floor Boxes.

RESOURCE RFB® SERIES FLOOR BOXES

RFB6 Series

Evolution Series Cover Assemblies for RFB6E & RFB6E-0G Floor Boxes Ordering Information

8CTC* Surface Style Cover Assembly

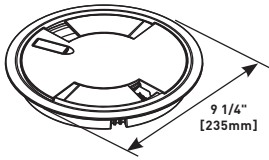

Die-cast aluminum cover assembly. Cover assembly is available in the following finishes: painted black (8CTCBK), painted gray (8CTCGY), nickel (8CTCNK), brass (8CTCBS), and bronze (8CTCBZ). 8CTC Series

Cover Assemblies designed for use with 8STC and 8STCP Poke-Thru Stem Assemblies.

8TS Tile Shim

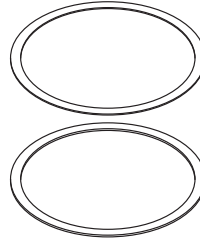

Used for floor coverings greater than 5/16" [7.9mm]. The 8TS will allow the top surface of the cover to be flush with the finished floor. Includes: two (2) 1/8" [3.2mm] thick shims and two (2) 1/16" [1.6mm] thick shims. Up to a total of 3/8" [9.5mm] of adjustment.

8CT* Flush Style Cover Assembly

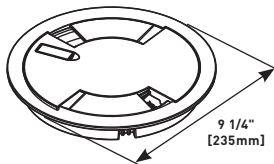

Die-cast aluminum cover assembly. Cover assembly is available in the following finishes: painted black (8CTBK), painted gray (8CTGY), nickel (8CTNK), brass (8CTBS), and bronze (8CTBZ). 8CTC Series

Cover Assemblies designed for use with 8STC and 8STCP Poke-Thru Stem Assemblies. Includes one (1) 8TS Tile Shim.

* Add suffix "TR" to the end of the part number to indicate tamper-resistant cover assembly. Tamper-resistant versions are secured with a single tamper-resistant screw.

Load Capacities for Evolution™ Series Cover Assemblies

Catalog Numbers	Maximum Load in Pounds
6CT	1000
6CTC	1000
6CFFTC	1000
8CT	1000
8CTC	1000

NOTE: Load applied through a 1" mandrel in the center of cover assembly.

NOTE: Loads above are static loads only and do not pertain to rolling loads.

RESOURCE RFB® SERIES FLOOR BOXES

RFB6 Series

FloorPort™ Series Flanged Cover Plates Ordering Information

Floorport Part Number Configurator

FloorPort Series:	Cover Style:	Top Style:	Cover Color:
	Blank Top = B	Tile (flangeless) = T	Brushed Aluminum = AL
	Cutout Top = C	Tile/Carpet (flanged) = TC	Black = BK
	Furniture Feed = FF		Brass = BS
			Bronze = BZ
			Gray = GY
			Nickel = NK

FPCTC Cutout Cover Assembly

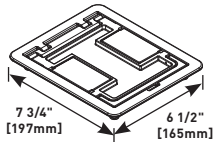

FPCTCBK, FPCTCBZ, FPCTCBS, FPCTCNK, FPCTCGY, FPCTCAL
 Flanged cover for use in tile or carpet installation. Die-cast aluminum assembly available in black, bronze, brass, nickel, gray, or brushed aluminum. Insert in lid allows for carpet or tile cutouts to match finished floor.

FPFFTC Furniture Feed Cover Assembly

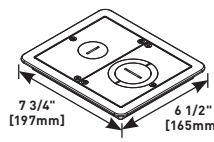

FPFFTCBK, FPFFTCBZ, FPFFTCBS, FPFFTCNK, FPFFTCGY, FPFFTCAL
 Flanged cover for use in tile or carpet installation. Die-cast aluminum assembly available in black, bronze, brass, nickel, gray, or brushed aluminum. Provided with one 1" trade size screw plug for power or communication type cabling and one combination 1 1/4" and 2" trade size screw plug for communication type cabling. Allows for feeding both power and communication cabling.

FPBTC Blank Cover Assembly

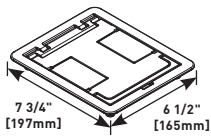

FPBTCBK, FPBTCBZ, FPBTCBS, FPBTCNK, FPBTCGY, FPBTCAL
 Flanged cover for use in tile or carpet installation. Die-cast aluminum assembly available in black, bronze, brass, nickel, gray, or brushed aluminum. Lid area is flush with the finished floor, no cutouts provided.

FloorPort™ Series Flangeless Cover Assemblies Ordering Information

FPCT Cutout Cover Assembly

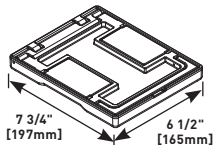

FPCTCBK, FPCTCBZ, FPCTCBS, FPCTCNK, FPCTCGY, FPCTCAL
 Flangeless cover for use in tile or carpet installations. Die-cast aluminum assembly available in black, bronze, brass, nickel, gray, or brushed aluminum. Insert in lid allows for carpet or tile cutouts to match finished floor.

FPFFT Furniture Feed Cover Assembly

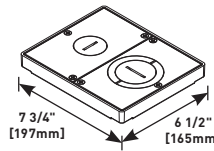

FPFFTCBK, FPFFTCBZ, FPFFTCBS, FPFFTCNK, FPFFTCGY, FPFFTCAL
 Flangeless cover for use in tile or carpet installation. Die-cast aluminum assembly available in black, bronze, brass, nickel, gray, or brushed aluminum. Provided with one 1" trade size screw plug for power or communication type cabling and one combination 1 1/4" and 2" trade size screw plug for communication type cabling. Allows for feeding both power and communication cabling.

FPBT Blank Cover Assembly

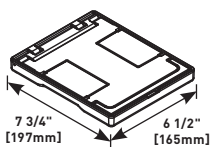

FPBTCBK, FPBTCBZ, FPBTCBS, FPBTCNK, FPBTCGY, FPBTCAL
 Flangeless cover for use in tile or carpet installation. Die-cast aluminum assembly available in black, bronze, brass, nickel, gray, or brushed aluminum. Lid area is flush with the finished floor, no cutouts provided.

RESOURCE RFB® SERIES FLOOR BOXES

RFB6 Series

North American Made FloorPort™ Series Flanged Cover Plates Ordering Information

Floorport Part Number Configurator

FloorPort Series:	Cover Style:	Top Style:	Cover Color:	Origin:
	Blank Top = B Cutout Top = C Furniture Feed = FF	Tile (flangeless) = T Tile/Carpet (flanged) = TC	Nickel = NK Brass = BS Black = BK Bronze = BZ Gray = GY	North American Made NA

FPCTC-NA Cutout Cover Assembly

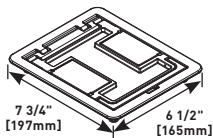

FPCTCBK-NA, FPCTCBZ-NA, FPCTCBS-NA, FPCTCNK-NA, FPCTCGY-NA

Flanged cover for use in tile or carpet installation. Die-cast aluminum assembly available in black, bronze, brass, nickel, gray, or brushed aluminum. Insert in lid allows for carpet or tile cutouts to match finished floor.

FPFFTC Furniture Feed Cover Assembly

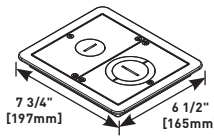

FPFFTCBK, FPFFTCBZ, FPFFTCBS, FPFFTCNK, FPFFTCGY, FPFFTCAL

Flanged cover for use in tile or carpet installation. Die-cast aluminum assembly available in black, bronze, brass, nickel, gray, or brushed aluminum. Provided with one 1" trade size screw plug for power or communication type cabling and one combination 1 1/4" and 2" trade size screw plug for communication type cabling. Allows for feeding both power and communication cabling.

FPBTC-NA Blank Cover Assembly

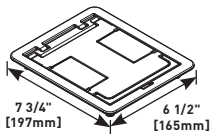

FPBTCBK-NA, FPBTCBZ-NA, FPBTCBS-NA, FPBTCNK-NA, FPBTCGY-NA

Flanged cover for use in tile or carpet installation. Die-cast aluminum assembly available in black, bronze, brass, nickel, gray, or brushed aluminum. Lid area is flush with the finished floor, no cutouts provided.

Load Capacities for FloorPort™ Cover Assemblies

CATALOG NUMBERS	MAXIMUM LOAD IN POUNDS
FPCTC	1000
FPBTC	750
FPFFT	1000
FPBT	750
FPCT	1000
FPFF	1000

NOTE: Load applied through a 2" [51mm] mandrel in center of service fitting. Loads above are static loads only and do not pertain to rolling loads.

RESOURCE RFB® SERIES FLOOR BOXES

RFB9/RFB11 Series

RFB9/RFB11 Series Floor Boxes Ordering Information

RFB11 Four-Compartment Eleven-Gang Floor Box

Adjustable before concrete pour. Provided with mudcap to prevent entry of concrete during pour. Cover assembly and device plates sold separately. For use on bare concrete, tile, terrazzo, carpe and wood covered floors.

NOTE: When used on bare concrete floor applications, RFB119-PAN must be installed before concrete pour. RFB119-PAN sold separately.

Caution: When used on terrazzo covered floors with a thickness of 1/4" [6.4mm] or greater, mudcap catalog number #RFB119-PAN must be used and ordered separately.

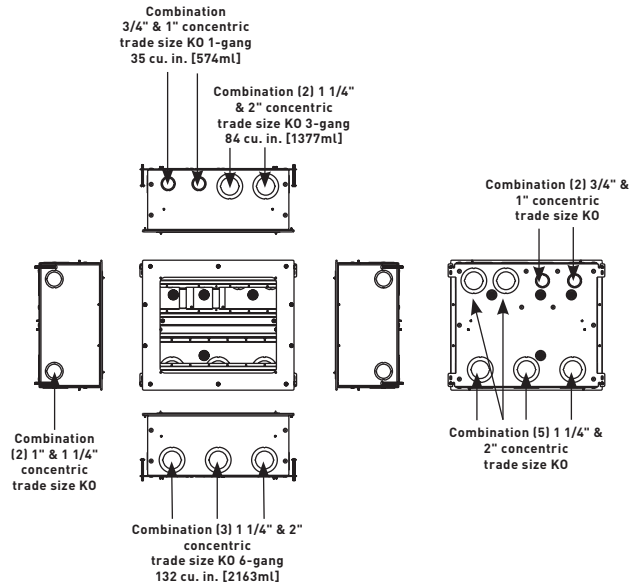
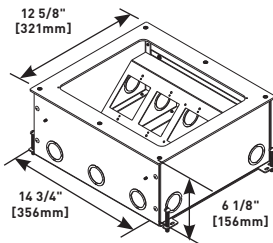

RFB11-OG Four-Compartment Eleven-Gang On-Grade Floor Box

Adjustable before concrete pour. Provided with mudcap to prevent entry of concrete during pour. Cover assembly and device plates sold separately. For use on bare concrete, tile, terrazzo, carpet and wood covered floors.

NOTE: When used on bare concrete floor applications, RFB119-PAN must be installed before concrete pour. RFB119-PAN sold separately.

NOTE: RFB11-OG for on-grade applications is painted with fusion-bonded epoxy designed for use on metal reinforcement bar and related accessories before encapsulating in concrete.

Caution: When used on terrazzo covered floors with a thickness of 1/4" [6.4mm] or greater, mudcap catalog number #RFB119-PAN must be used and ordered separately.

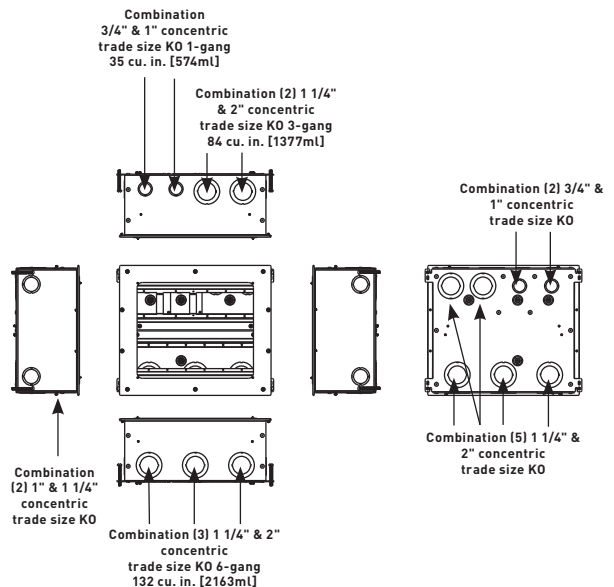
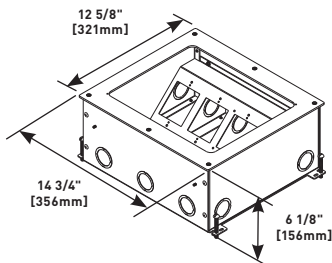

NOTE: RFB11 and RFB9 will also accept industry standard and standard sectional device plates from most manufacturers.

RESOURCE RFB® SERIES FLOOR BOXES

RFB9/RFB11 Series

RFB9/RFB11 Series Floor Boxes Ordering Information (continued)

RFB9 Four-Compartment Nine-Gang Floor Box

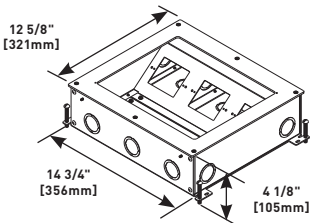

Adjustable before concrete pour. Provided with mudcap to prevent entry of concrete during pour. Cover assembly and device plates sold separately. For use on bare concrete, tile, terrazzo, carpet and wood covered floors.

NOTE: When used on bare concrete floor applications, RFB119-PAN must be installed before concrete pour. RFB119-PAN sold separately.

Caution: When used on terrazzo covered floors with a thickness of 1/4" [6.4mm] or greater, RFB119-PAN must be used and ordered separately.

RFB9-OG Four-Compartment Nine-Gang on-Grade Floor Box

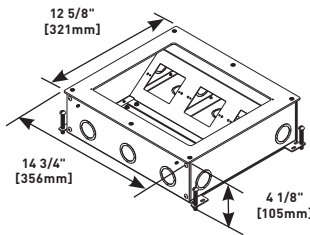

Four-compartment, 9-gang floor box. Adjustable before concrete pour. Provided with mudcap to prevent entry of concrete during pour. Cover assembly and device plates sold separately. For use on tile, terrazzo, carpet and wood covered floors.

NOTE: When used on bare concrete floor applications, RFB119-PAN must be installed before concrete pour. RFB119-PAN sold separately.

Knockouts:

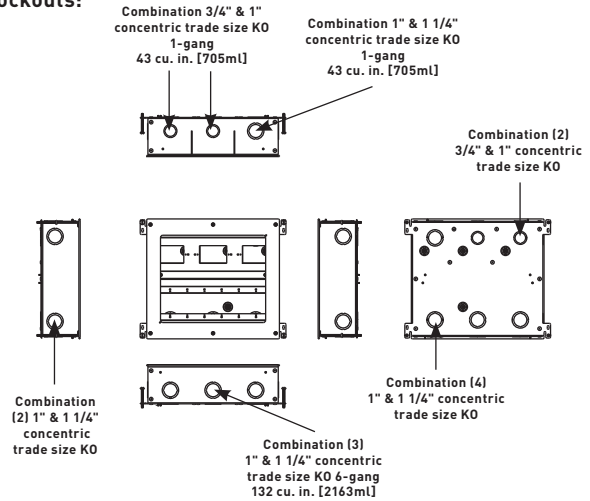

NOTE: RFB9-OG for on-grade applications is painted with fusion-bonded epoxy designed for use on metal reinforcement bar and related accessories before encapsulating in concrete.

NOTE: RFB11 and RFB9 will also accept industry standard and standard sectional device plates from most manufacturers.

Caution: When used on terrazzo covered floors with a thickness of 1/4" [6.4mm] or greater, mudcap catalog number #RFB119-PAN must be used and ordered separately.

RFB9/RFB11 Series Floor Box Accessories Ordering Information

RFB119CTC Carpet Cover Assembly

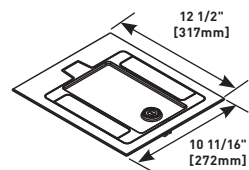

RFB119CTCAL, RFB119CTCBK, RFB119CTCGY

Cast aluminum cover assembly available in brushed aluminum, painted black, and gray. Provided with carpet cut-out area. Maximum load capacity 1,500 lbs. UL Listed to U.S. and Canadian safety standards to meet UL requirements under UL514A for scrub water exclusion.

RFB119BTC Flush Tile or Carpet Cover Assembly

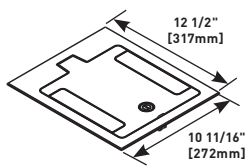

RFB119BTCAL, RFB119BTCBK, RFB119BTCGY

Flush with floor, cast aluminum cover assembly available in brushed aluminum, black, and gray. Maximum load capacity 3,000 lbs. UL Listed to U.S. and Canadian safety standards to meet UL requirements under UL514A for scrub water exclusion.

NOTE: For bare concrete or terrazzo applications. Cover must be used in conjunction with RB119-PAN. RFB119-PAN must be attached to the box prior to concrete or terrazzo pour.

RESOURCE RFB® SERIES FLOOR BOXES

RFB9/RFB11 Series

RFB9/RFB11 Series Floor Box Accessories Ordering Information (continued)

RFB119-PAN Mudcap for Terrazzo Floor Applications

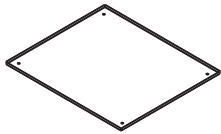

When used on bare concrete and terrazzo-covered floors with a thickness of 1/4" [6.35mm] or greater, this mudcap must be used. The RFB119-PAN must be ordered separately.

NOTE: Must be used with RFB119-TS (Tile Spacer, see below) for terrazzo heights greater than 1/4" [6.35mm]. Use one spacer for 3/8" [9.54mm] thick tile Use two spacers for 1/2" [12.70mm] thick tile.

RFB119-TS Tile Spacer

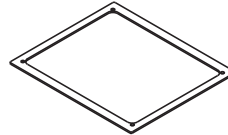

Used for floor coverings greater than 1/4" [6.35mm]. Use one spacer for 3/8" [9.53mm] thick tile. Use two spacers for 1/2" [12.70mm] thick tile. The RFB119-TS will allow the top surface of the cover assembly to be flush with 3/8" [9.53mm] to 1/2" [12.70mm] floor coverings.

RFB9/RFB11 Series Floor Boxes Installation Ordering Information

Multi-Gang Mounting Brackets Used with Sectional Device Plates

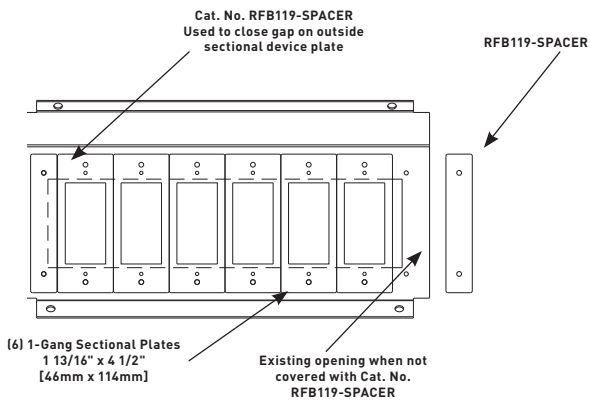

Multi-Gang Mounting Brackets Used with Standard Device Plates

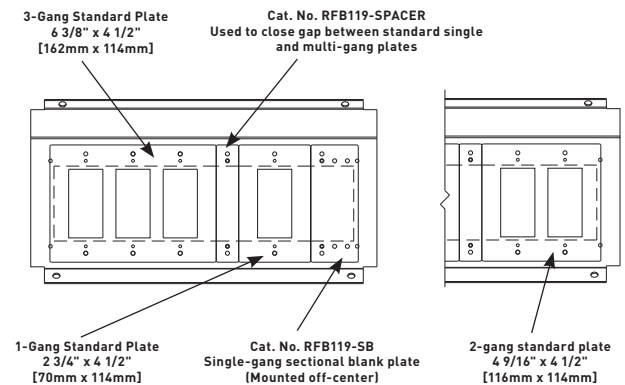

RFB9/RFB11 Series Floor Boxes Steel Sectional Device Plates Ordering Information

RFB119-SB, RFB119-2SB, RFB119-3SB Blank Device Plate

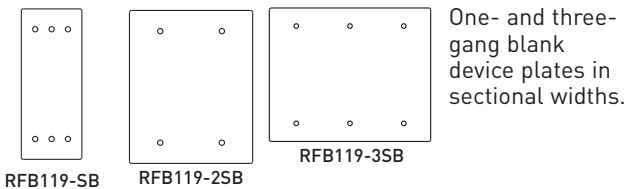

RFB119SD Duplex Receptacle Device Plate

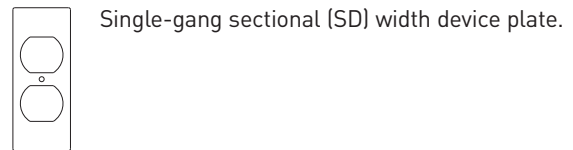

RFB119-SGFI GFI Receptacle Device Plate

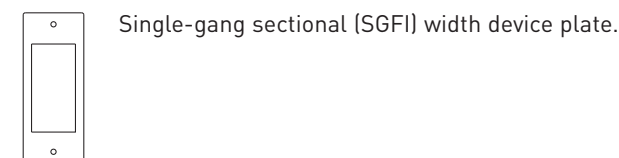

RFB119-SSR1, RFB119-SSR2 Single Receptacle Device Plate

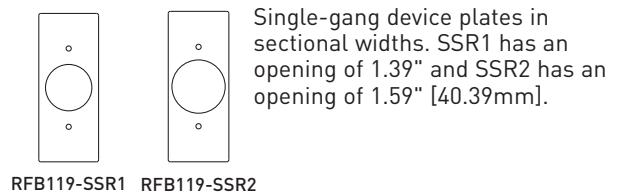

NOTE:Sectional device plates allow for custom configuration of a multi-gang plate that conforms to the standard NEMA 1.812" (1 13/16") [46.02mm] center-to-center spacing.

RFB11 and RFB9 will also accept industry standard and standard sectional device plates from most manufacturers.

RESOURCE RFB® SERIES FLOOR BOXES

RFB9/RFB11 Series

RFB9/RFB11 Series Floor Boxes Steel Sectional Device Plates Ordering Information (continued)

RFB119-AAP Device Plate

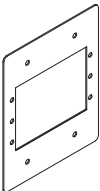

Two-gang sectional device plate. Holds three (3) Extron® Electronics AAP devices.

RFB119-2SAB Communication Device Plate

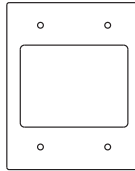

Available in two-gang sectional width. Provided with bezel to accept up to three (3) dual Wiremold CM Series Open System communication modules or Pass & Seymour® Activate Connectivity System inserts. Modular inserts sold separately.

RFB119-SKO Combination 1/2" & 3/4" Trade Size Knockout Device Plate

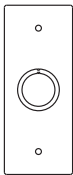

Available in sectional (SKO) width.

RFB119-2SRT Communication Device Plate

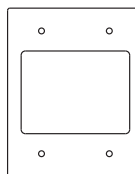

Available in two-gang sectional width. Provided with one opening to accept one Ortronics® TracJack bezel and one Ortronics® Series II bezel. Will accept up to six Ortronics® TracJack devices or up to three dual Ortronics® Series II modular inserts. Modules sold separately.

RFB9/RFB11 Series Floor Boxes Steel Standard Device Plates Ordering Information

RFB119-B, RFB119-3B, RFB119-SB Blank Device Plate

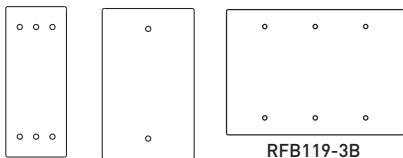

RFB119-SB RFB119-B

RFB119-3B

One-, two- and three-gang blank device plates in sectional (SB) widths.

RFB119-D, RFB119-3D Duplex Receptacle Device Plates

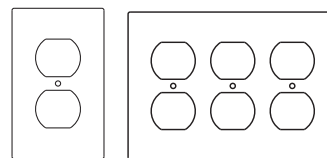

RFB119-D

RFB119-3D

One- and three-gang device plates in standard (D) widths.

RFB119-GFI, RFB119-3GFI GFI Receptacle Device Plates

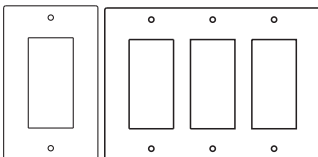

RFB119-GFI

RFB119-3GFI

One- and three-gang device plates in standard (GFI) widths.

RFB119-SR1, RFB119-SR2, RFB119-SR3 Single Receptacle Device Plates

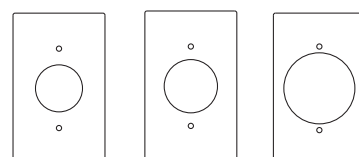

RFB119-SR1

RFB119-SR2

RFB119-SR3

One-device plates in standard (SR) widths. SR1 has an opening of 1.39" [35.31mm]. SR2 has an opening of 1.59" [40.39mm]. SR3 has a 2.14" [54.36mm] opening.

NOTE:Sectional device plates allow for custom configuration of a multi-gang plate that conforms to the standard NEMA 1.812" (1 13/16") [46.02mm] center-to-center spacing.

RFB11 and RFB9 will also accept industry standard and standard sectional device plates from most manufacturers.

RESOURCE RFB® SERIES FLOOR BOXES

RFB9/RFB11 Series

RFB9/RFB11 Series Floor Boxes Steel Standard Device Plates Ordering Information (continued)

RFB119-MAAP Device Plate

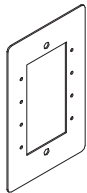

One-gang standard device plate. Holds four (4) Legrand AVIP or Extron® Electronics MAAP devices.

RFB119-RT Communication Device Plate

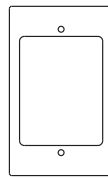

Available in standard width. Provided with one opening to accept one Ortronics® TracJack bezel and one Ortronics® Series II bezel. Will accept up to six Ortronics® TracJack devices or up to three dual Ortronics® Series II modular inserts. Modular inserts and devices sold separately.

RFB119-KO Combination 1/2" & 3/4" Trade Size Knockout Device Plates

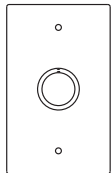

Available in standard (KO) widths.

RFB119-XLR Microphone Device Plate

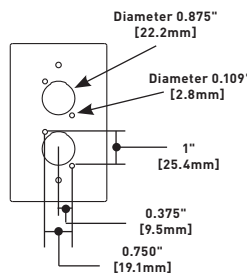

Available in standard widths. Provided with double opening to accept two microphone devices.

RFB119-AB Communication Device Plate

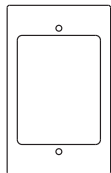

Available in standard width. Provided with bezel to accept up to three (3) dual Wiremold CM Series Open System communication modules or Pass & Seymour® Activate Connectivity System inserts. Modules and inserts sold separately.

RFB119-Spacer Spacer Plate



Used to close off openings when certain combinations of standard width device plates leave open spaces. Four (4) spacer plates are included with the RFB11 and two (2) with the RFB9.

NOTE:Sectional device plates allow for custom configuration of a multi-gang plate that conforms to the standard NEMA 1.812" (1 13/16") [46.02mm] center-to-center spacing.

RFB11 and RFB9 will also accept industry standard and standard sectional device plates from most manufacturers.

OMNIBOX™ SERIES FLOOR BOXES



OmniBox Series™ Floor Boxes provide an excellent activation solution when multiple services are required in open space areas to meet the workstation needs of today's applications.

CODE REFERENCE

cULus Listed
Metallic Outlet Boxes:
File E2961 Guide QCIT.
Meets Article 314.27(C) of NEC.

COLOR OPTIONS



OmniBox Series™ Flanges Cover Plates are available in the these colors as indicated in the part number descriptions.

Custom color options are also available. Consult the factory for more information.

OMNIBOX™ SERIES FLOOR BOXES

Omnibox Series Stamped Steel Floor Boxes Technical Specifications

CAT. NO.	CONDUIT OPENINGS	COMPARTMENT CAPACITY	ADJUSTMENT BEFORE POUR	ADJUSTMENT AFTER POUR
880S1	(3)-1/2" [12.7mm], (5)-3/4" [19.1mm], (2)-1" [25mm]	53 cu in. [869ml ³]	1 3/4" [44mm]	1/2" [12.7mm]
880S2	(4)-1/2" [12.7mm], (8)-3/4" [19.1mm], (4)-1" [25mm]	117 cu in. [1918ml ³] 58 cu in. [951ml ³] 59 cu in. [967ml ³]	1 3/4" [44mm]	1/2" [12.7mm]
880S3	(5)-1/2" [12.7mm], (11)-3/4" [19.1mm], (6)-1" [25mm]	180 cu in. [2950ml ³] 58 cu in. [951ml ³] 68 cu in. [1115ml ³] 56 cu in. [918ml ³]	1 3/4" [44mm]	1/2" [12.7mm]



Omnibox Series Stamped Steel Floor Boxes Ordering Information

880S1 1-Gang Stamped Steel Floor Box

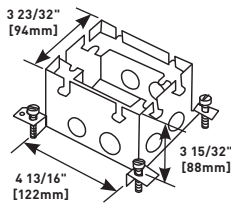

Fully adjustable.

Knockouts:

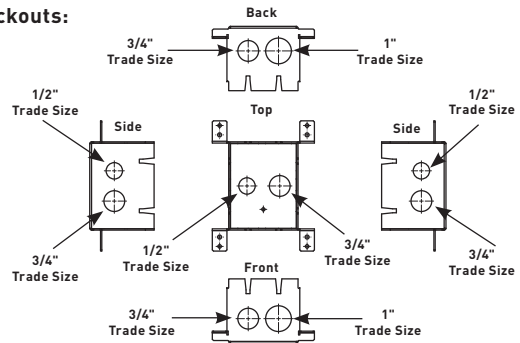

880S2 2-Gang Stamped Steel Floor Box

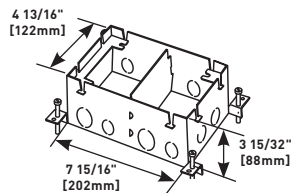

Fully adjustable.

Knockouts:

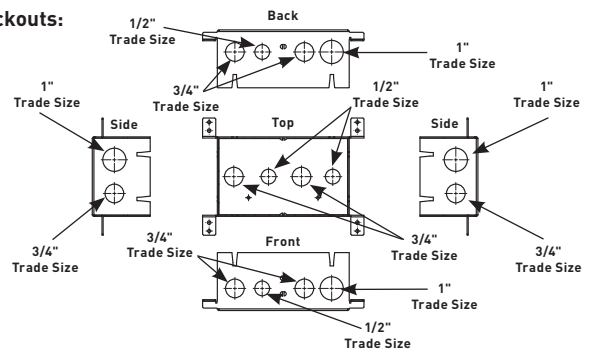

880S3 3-Gang Stamped Steel Floor Box

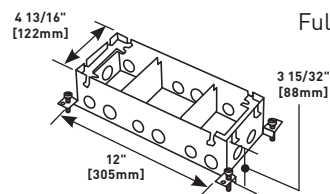

Fully adjustable.

Knockouts:

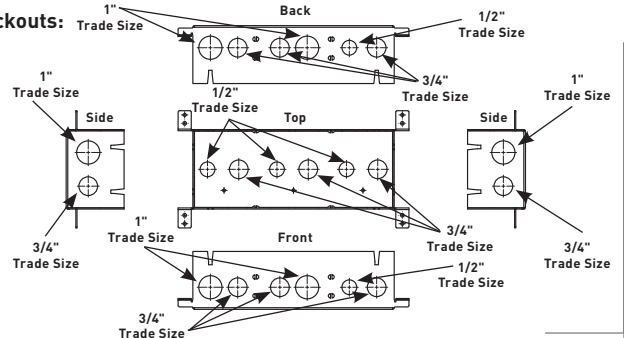

WWW.LEGRAND.US/WIREMOLD

OMNIBOX™ SERIES FLOOR BOXES

Omnibox Series Shallow Stamped Steel Floor Boxes Technical Specifications

CAT. NO.	CONDUIT OPENINGS	COMPARTMENT CAPACITY	ADJUSTMENT BEFORE POUR	ADJUSTMENT AFTER POUR
880M1	(5)-1/2" [12.7mm], (5)-3/4" [19.1mm]	37 cu in. [606m ³]	1 3/4" [44mm]	1/2" [12.7mm]
880M2	(8)-1/2" [12.7mm], (8)-3/4" [19.1mm]	80 cu in. [1311m ³] 40 cu in. [656m ³] 40 cu in. [656m ³]	1 3/4" [44mm]	1/2" [12.7mm]
880M3	(11)-1/2" [12.7mm], (11)-3/4" [19.1mm]	126 cu in. [2065m ³] 39 cu in. [639m ³] 48 cu in. [787m ³] 39 cu in. [639m ³]	1 3/4" [44mm]	1/2" [12.7mm]



Omnibox Series Shallow Stamped Steel Floor Boxes Ordering Information

880M1 1-Gang Shallow Stamped Steel Floor Box

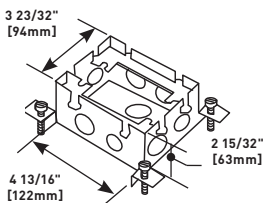

Fully adjustable.

Knockouts:

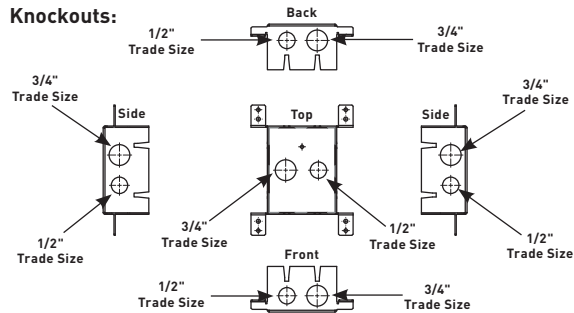

880M2 2-Gang Shallow Stamped Steel Floor Box

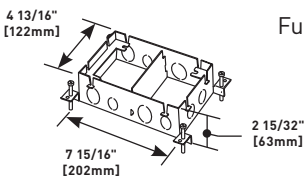

Fully adjustable.

Knockouts:

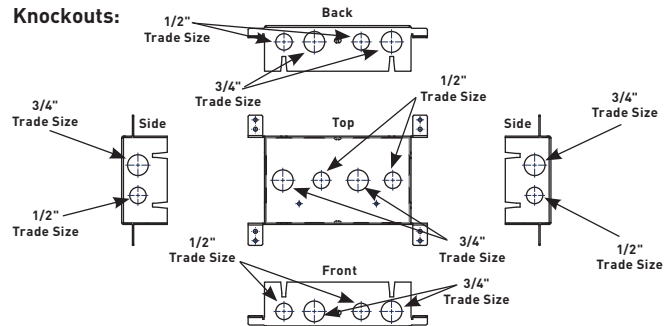

880M3 3-Gang Shallow Stamped Steel Floor Box

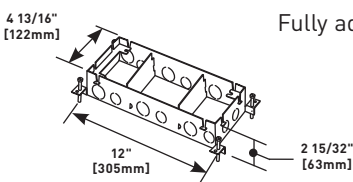

Fully adjustable.

Knockouts:

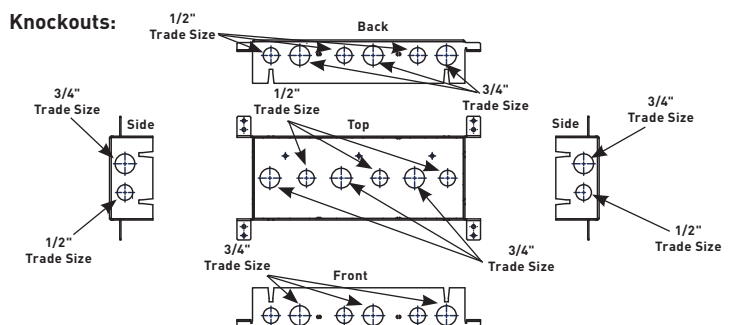

OMNIBOX™ SERIES FLOOR BOXES

Omnibox Series Cast Iron Floor Boxes Technical Specifications

CAT. NO.	CONDUIT OPENINGS	COMPARTMENT CAPACITY	ADJUSTMENT BEFORE POUR	ADJUSTMENT AFTER POUR
880CS1-1	(4)-1" [25mm]	48 cu in. [787ml ³]	1 3/4" [44mm]	1/2" [12.7mm]
880CS2-1	(6)-1" [25mm]	94 cu in. [1541ml ³] 45 cu in. [738ml ³] 49 cu in. [803ml ³]	1 3/4" [44mm]	1/2" [12.7mm]
880CS3-1	(8)-1" [25mm]	160 cu in. [2622ml ³] 53 cu in. [869ml ³] 54 cu in. [885ml ³] 53 cu in. [869ml ³]	1 3/4" [44mm]	1/2" [12.7mm]



Omnibox Series Cast Iron Floor Boxes Ordering Information

880CS1-1 1-Gang Cast-Iron Floor Box

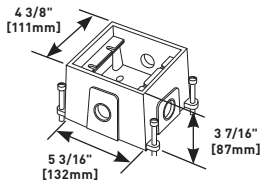

Fully adjustable.

Knockouts:

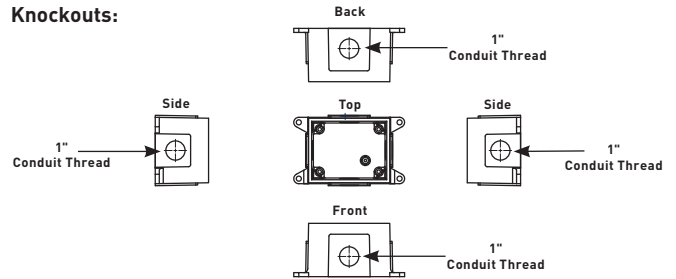

880CS2-1 2-Gang Cast-Iron Floor Box

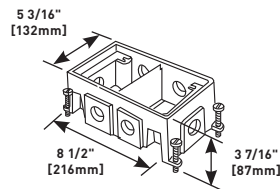

Fully adjustable.

Knockouts:

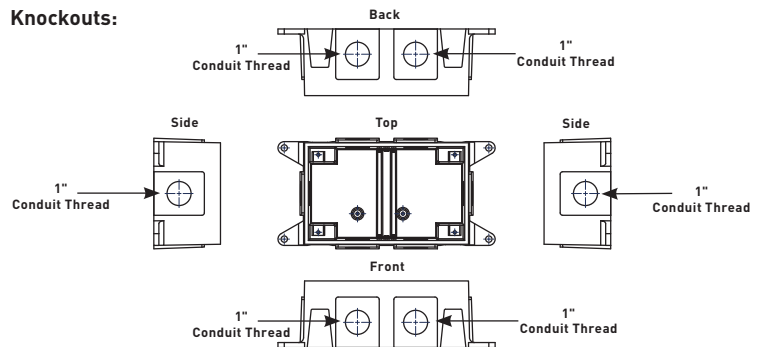

880CS3-1 3-Gang Cast-Iron Floor Box

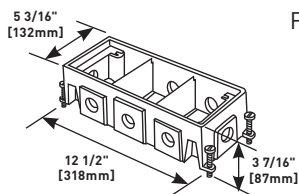

Fully adjustable.

Knockouts:

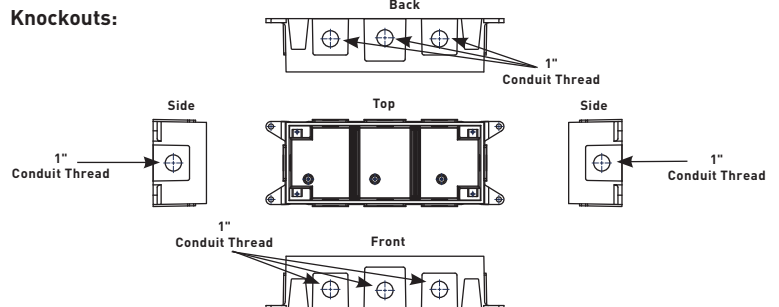

OMNIBOX™ SERIES FLOOR BOXES

Omnibox Series Shallow Cast Iron Floor Boxes Technical Specifications

CAT. NO.	CONDUIT OPENINGS	COMPARTMENT CAPACITY	ADJUSTMENT BEFORE POUR	ADJUSTMENT AFTER POUR
880CM1-1	(4)-1" [25mm]	34 cu in. [557ml ³]	1 3/4" [44mm]	1/2" [12.7mm]
880CM2-1	(6)-1" [25mm]	76 cu in. [1246ml ³] 36 cu in. [595ml ³] 40 cu in. [656ml ³]	1 3/4" [44mm]	1/2" [12.7mm]
880CM3-1	(8)-1" [25mm]	118 cu in. [1934ml ³] 39 cu in. [639ml ³] 40 cu in. [656ml ³] 39 cu in. [639ml ³]	1 3/4" [44mm]	1/2" [12.7mm]



Omnibox Series Shallow Cast Iron Floor Boxes Ordering Information

880CM1-1 1-Gang Shallow Cast Iron Floor Box

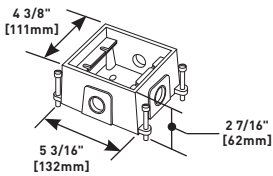

Fully adjustable.

Knockouts:

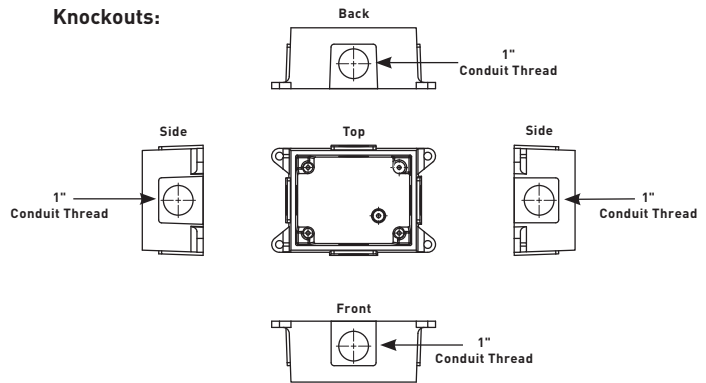

880CM2-1 2-Gang Shallow Cast Iron Floor Box

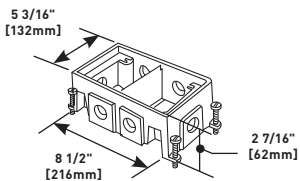

Fully adjustable.

Knockouts:

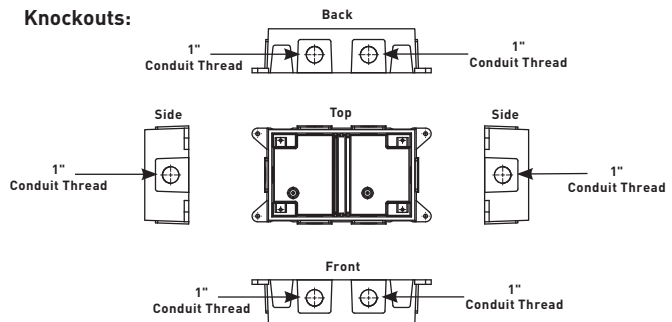

880CM3-1 3-Gang Shallow Cast Iron Floor Box

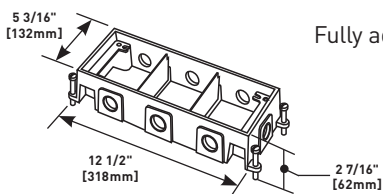

Fully adjustable.

Knockouts:

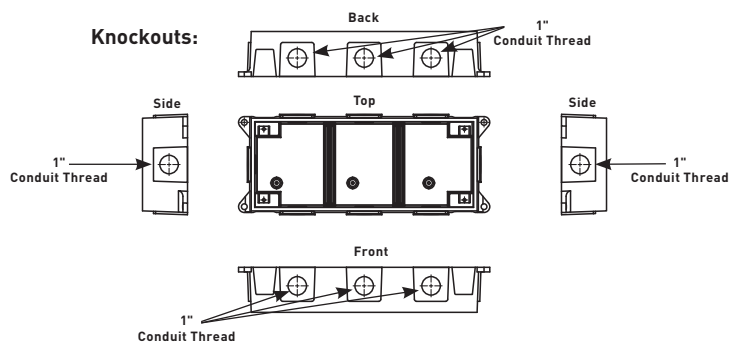

OMNIBOX™ SERIES FLOOR BOXES

Omnibox Series Solid Brass Floor Boxes Cover Plate Flanges Ordering Information

817B 1-Gang Brass Combination Carpet & Tile Flange

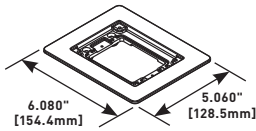

Accepts Ortronics® MAB6TJ TracJack and MAB3S2 Series II adapters and Wiremold CM Series inserts, sold separately.

837C 3-Gang Brass Carpet Flange

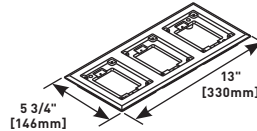

For use on 880S3, 880M3, 880CS32-1, and 880CM3-1 Floor Boxes.

827B 2-Gang Brass Combination Carpet & Tile Flange

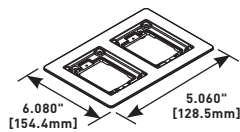

Accepts Ortronics® MAB6TJ TracJack and MAB3S2 Series II adapters and Wiremold CM Series inserts, sold separately.

817T 1-Gang Brass Tile Flange

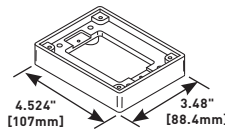

For use on 880S1, 880M1, 880CS1-1, and 880CM1-1 Floor Boxes.

837B 3-Gang Brass Combination Carpet & Tile Flange

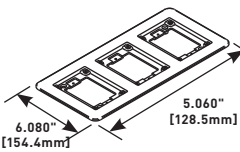

Accepts Ortronics® MAB6TJ TracJack and MAB3S2 Series II adapters and Wiremold CM Series inserts, sold separately.

827T 2-Gang Brass Tile Flange

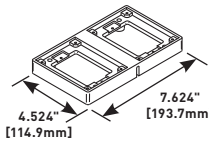

For use on 880S2, 880M2, 880CS2-1, and 880CM2-1 Floor Boxes.

817C 1-Gang Brass Carpet Flange

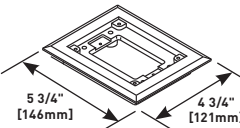

For use on 880S1, 880M1, 880CS1-1, and 880CM1-1 Floor Boxes.

837T 3-Gang Brass Tile Flange

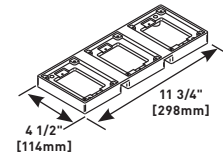

For use on 880S3, 880M3, 880CS3-1, and 880CM3-1 Floor Boxes.

827C 2-Gang Brass Carpet Flange

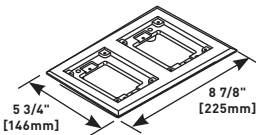

For use on 880S2, 880M2, 880CS2-1, and 880CM2-1 Floor Boxes.

Omnibox Series Metal Cover Plates Ordering Information

828R Brass Duplex Cover Plate

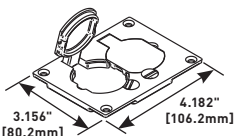

Flip lids. Can also be used with a 106 type communication adapter.

828GFITC Brass GFI Cover Plate

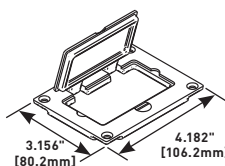

May be used with Activate and Ortronics® Connectivity Systems in conjunction with 817B, 827B, and 837B Flanges.

NOTE: UL Listed for tile, terrazzo, and carpet floors. Brass covers and flanges are not interchangeable with aluminum or nonmetallic covers and flanges. Nonmetallic covers are interchangeable with aluminum flanges.

OMNIBOX™ SERIES FLOOR BOXES

Omnibox Series Metal Cover Plates Ordering Information (continued)

828DPGFITC Brass Rectangular Cover Plate

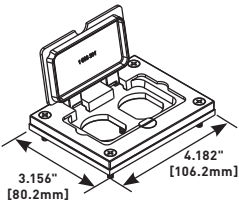

Allows for mounting of a duplex style receptacle with a rectangular style flip lid cover.

829CK Brass Communication Cover Plate

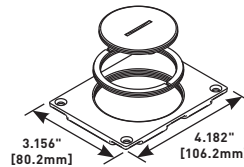

2 5/8" and 2 1/4" [67mm and 57mm] plugs.

828COMTC Brass Communications Cover Plate

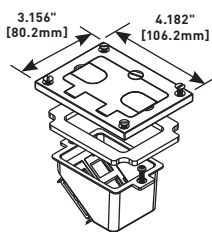

Allows for up to four communication devices to be mounted in a recessed position within the 880 Floor Box. The 828COM Cover Plates has removable slides for cable egress.

NOTE: For use with 880S and 880CS Series Boxes only.

829CK-1 Brass Communications Cover Plate

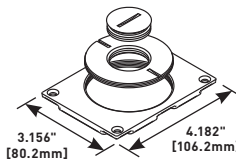

2 5/8" and 1" [67mm and 25mm] plugs.

828DLR Brass Single Locking Receptacle Cover Plate

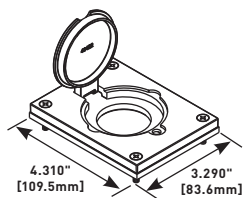

Single flip lid cover for 20A or 30A single locking receptacles. Device opening is 2 5/8" [67mm]. For use with maximum female locking device of 1.58" diameter, and maximum male plug face of 2.25" diameter.

829CK-3/4 Brass Communications Cover Plate

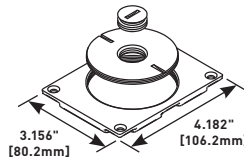

2 5/8" and 3/4" [67mm and 19.1mm] plugs.

829CK-1/2 Brass Communications Cover Plate

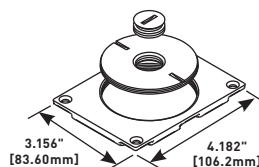

2 5/8" and 1/2" [67mm and 12.7mm] plugs.

828SPTC Brass Duplex Cover Plate

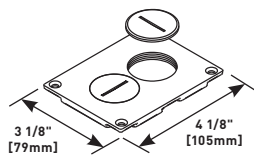

Screw plugs. Screw plugs are 1 1/2" [38mm] in diameter.

828MAAP AV Adapter Plate

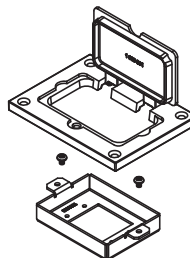

Sheet metal adapter plate that accepts two (2) Legrand AVIP or Extron® Electronics MAAP style device plates (sold separately). For use with 828GFITC or 828GFITCAL cover plates (sold separately).

829STC Brass Communication Cover Plate

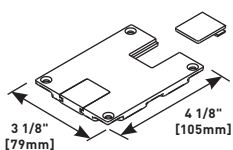

Data slides. Feed through only, not for use with a mounting plate for communication adapter.

NOTE: UL Listed for tile, terrazzo, and carpet floors. Brass covers and flanges are not interchangeable with aluminum or nonmetallic covers and flanges. Nonmetallic covers are interchangeable with aluminum flanges.

OMNIBOX™ SERIES FLOOR BOXES

Omnibox Series Brushed Aluminum Cover Plate Flanges Ordering Information

818TCAL 1-Gang Brushed Aluminum Combination Carpet & Tile Flange

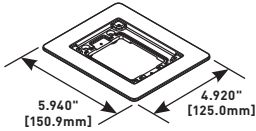

Accepts Ortronics® MAB6TJ TracJack and MAB3S2 Series II adapters and Wiremold CM Series inserts, sold separately.

NOTE: Brushed aluminum flanges come with beveled edges.

818TAL 1-Gang Brushed Aluminum Tile Flange

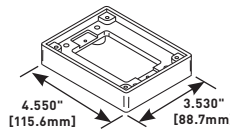

For use on 880S1, 880M1, 880CS1-1, and 880M1-1 Floor Boxes.

828TCAL 2-Gang Brushed Aluminum Combination Carpet & Tile Flange

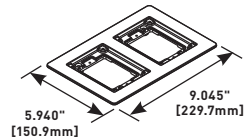

Accepts Ortronics® MAB6TJ TracJack and MAB3S2 Series II adapters and Wiremold CM Series inserts, sold separately.

NOTE: Brushed aluminum flanges come with beveled edges.

828TAL 2-Gang Brushed Aluminum Tile Flange

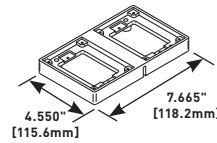

For use on 880S2, 880M2, 880CS2-1, and 880CM2-1 Floor Boxes.

838TCAL 3-Gang Brushed Aluminum Combination Carpet & Tile Flange

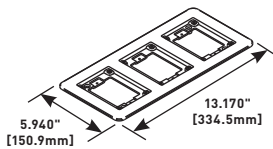

Accepts Ortronics® MAB6TJ TracJack and MAB3S2 Series II adapters and Wiremold CM Series inserts, sold separately.

NOTE: Brushed aluminum flanges come with beveled edges.

838TAL-880S3, 838TAL-880M3, 838TAL-880CS3, 838TAL-880CM3 Kit

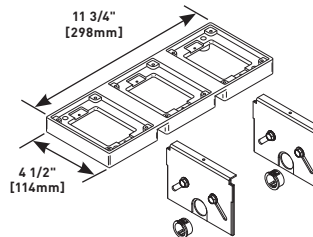

The 838TAL-880 Series flanges provide additional load support for 3-gang tile flanges. Kit includes 838TAL Flange and two support dividers.

NOTE: Order kit for specific box type: 880S3, 880M3, 880CS3, or 880CM3

NOTE: UL Listed for tile, terrazzo, and carpet floors. Brass covers and flanges are not interchangeable with aluminum or nonmetallic covers and flanges. Nonmetallic covers are interchangeable with aluminum flanges.

OMNIBOX™ SERIES FLOOR BOXES

Omnibox Series Brushed Aluminum Cover Plates Ordering Information

828R-TCAL Brushed Aluminum Duplex Cover Plate

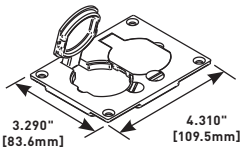

Flip lids. Can also be used with a 106 type communication adapter.

830CKTCAL Brushed Aluminum Cover Plate

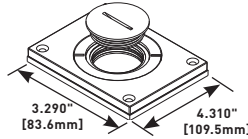

Power or communication plate with 2" [51mm] and 1 1/4" [32mm] plugs.

NOTE: Acceptable for use with threaded conduit when passing through power cables.

828GFITCAL Brushed Aluminum GFI Cover Plate

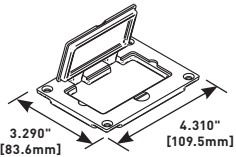

May be used with Activate and Ortronics® Connectivity Systems in conjunction with 817B, 827B, and 837B Flanges.

830CKTCAL-1 Brushed Aluminum Cover Plate

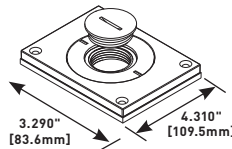

Power or communication plate with 2" [51mm] and 1" [25mm] plugs.

NOTE: Acceptable for use with threaded conduit when passing through power cables.

828DPGFITCAL Brushed Aluminum Rectangular Cover Plate

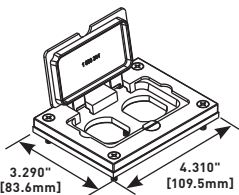

Allows for mounting of a duplex style receptacle with a rectangular style flip lid cover.

830CKTCAL-3/4 Brushed Aluminum Cover Plate

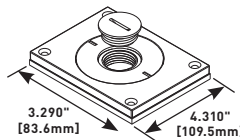

Power or communication plate with 2" [51mm] and 3/4" [19.1mm] plugs.

NOTE: Acceptable for use with threaded conduit when passing through power cables.

828COMTCAL Brushed Aluminum Communication Cover Plate

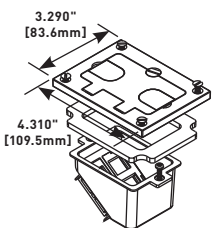

Allows for up to four communication devices to be mounted in a recessed position within the 880 Floor Box. The 828COMTCAL Cover Plate has removable slides for cable egress.

NOTE: For use with 880S & 880CS Series Boxes only.

830CKTCAL-1/2 Brushed Aluminum Cover Plate

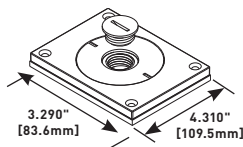

Power or communication plate with 2" [51mm] and 1/2" [12.7mm] plugs.

NOTE: Acceptable for use with threaded conduit when passing through power cables.

828MAAP AV Adapter Plate

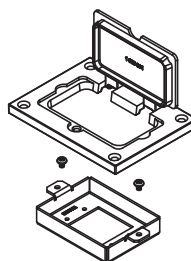

Sheet metal adapter plate that accepts two (2) Legrand AVIP or Extron® Electronics MAAP style device plates (sold separately). For use with 828GFITC or 828GFITCAL cover plates (sold separately).

828DLRAL Brushed Aluminum Single Locking Receptacle Cover Plate

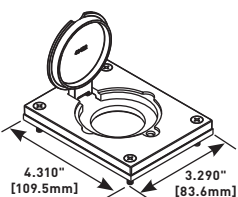

Single flip lid cover for 20A or 30A single locking receptacles. Device opening is 2 5/8" [67mm]. For use with maximum female locking device of 1.58" diameter, and maximum male plug face of 2.25" diameter.

NOTE: UL Listed for tile, terrazzo, and carpet floors. Brass covers and flanges are not interchangeable with aluminum or nonmetallic covers and flanges. Nonmetallic covers are interchangeable with aluminum flanges.

OMNIBOX™ SERIES FLOOR BOXES

Omnibox Series Powder-Coated Aluminum Cover Plate Flanges Ordering Information

817TCAL 1-Gang Powder-Coated Aluminum Combination Carpet and Tile Flange

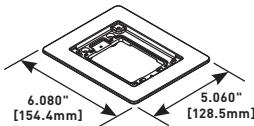

817TCAL-BK, 817TCAL-GY, 817TCAL-BS, 817TCAL-NK, 817TCAL-BZ

Accepts Ortronics® MAB6TJ TracJack and MAB3S2 Series II adapters and Wiremold CM Series inserts, sold separately. Flanges are available in five decorative colors: black, gray brass, nickel and bronze.

817TAL 1-Gang Powder Coated Aluminum Tile Flange

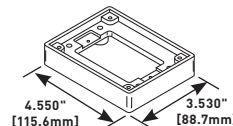

817TAL-BK, 817TAL-GY, 817TAL-BS, 817TAL-NK, 817TAL-BZ

For use on 880S1, 880M1, 880CS1-1, and 880M1-1 Floor Boxes. Flanges are available in five decorative colors: black, gray, brass, nickel and bronze.

827TCAL 2-Gang Powder-Coated Aluminum Combination Carpet and Tile Flange

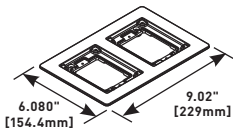

827TCAL-BK, 827TCAL-GY, 827TCAL-BS, 827TCAL-NK, 827TCAL-BZ

Accepts Ortronics® MAB6TJ TracJack and MAB3S2 Series II adapters and Wiremold CM Series inserts, sold separately. Flanges are available in five decorative colors: black, gray brass, nickel and bronze.

827TAL 2-Gang Powder Coated Aluminum Tile Flange

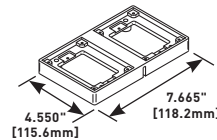

827TAL-BK, 827TAL-GY, 827TAL-BS, 827TAL-NK, 827TAL-BZ

For use on 880S2, 880M2, 880CS2-1, and 880M2-1 Floor Boxes. Flanges are available in five decorative colors: black, gray, brass, nickel and bronze.

837TCAL 3-Gang Powder-Coated Aluminum Combination Carpet and Tile Flange

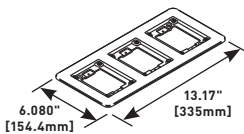

837TCAL-BK, 837TCAL-GY, 837TCAL-BS, 837TCAL-NK, 837TCAL-BZ

Accepts Ortronics® MAB6TJ TracJack and MAB3S2 Series II adapters and Wiremold CM Series inserts, sold separately. Flanges are available in five decorative colors: black, gray brass, nickel and bronze.

NOTE: UL Listed for tile, terrazzo, and carpet floors. Brass covers and flanges are not interchangeable with aluminum or nonmetallic covers and flanges. Nonmetallic covers are interchangeable with aluminum flanges.

OMNIBOX™ SERIES FLOOR BOXES

Omnibox Series Powder-Coated Aluminum Cover Plates Ordering Information

828R-TCAL

Powder-Coated Aluminum Duplex Cover Plate

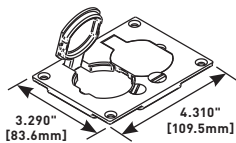

828R-TCAL-BK, 828R-TCAL-GY, 828R-TCAL-BS, 828R-TCAL-NK, 828R-TCAL-BZ

Flip lids. Can also be used with a 106 type communication adapter.

829CKAL-3/4

Powder-Coated Aluminum Cover Plate

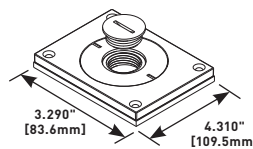

829CKAL-3/4BK, 829CKAL-3/4GY, 829CKAL-3/4BS, 829CKAL-3/4NK, 829CKAL-3/4BZ

Power or communication plate with 2" [51mm] and 3/4" [19.1mm] plugs. Covers are available in five decorative colors: black, gray, brass, nickel and bronze.

NOTE: Acceptable for use with threaded conduit when passing through power cables.

828GFITCAL

Powder-Coated Aluminum Rectangular Cover Plate

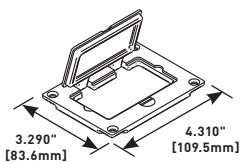

828GFITCAL-BK, 828GFITCAL-GY, 828GFITCAL-BS, 828GFITCAL-NK, 828GFITCAL-BZ

Allows for mounting of a duplex receptacle (Duplex or GFCI style) with a rectangular flip cover.

828MAAP AV Adapter Plate

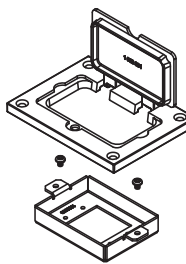

Sheet metal adapter plate that accepts two (2) Legrand AVIP or Extron® Electronics MAAP style device plates (sold separately). For use with 828GFITC or 828GFITCAL cover plates (sold separately).

829CKAL-1 Powder-Coated Aluminum Cover Plate

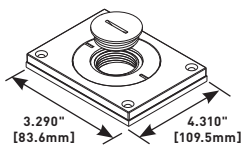

829CKAL-1BK, 829CKAL-1GY, 829CKAL-1BS, 829CKAL-1NK, 829CKAL-1BZ

Power or communication plate with 2" [51mm] and 1" [25mm] plugs. Covers are available in five decorative colors: black, gray, brass, nickel and bronze.

NOTE: Acceptable for use with threaded conduit when passing through power cables.

Omnibox Series Nonmetallic Cover Plate Flanges Ordering Information

817PCC 1-Gang Nonmetallic Carpet Flange

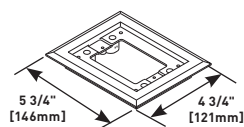

817PCC-BLK, 817PCC-BRN

For Ortronics® connectivity use with 829PFLRT Cover. For Activate™ connectivity use with 829PFL Cover. Accepts Ortronics® MAB6TJ TracJack and MAB3S2 Series II adapters and Wiremold CM Series inserts, sold separately.

827PCC 2-Gang Nonmetallic Carpet Flange

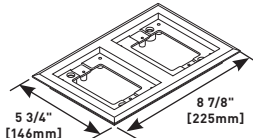

827PCC-BLK, 827PCC-BRN

For Ortronics® connectivity use with 829PFLRT Cover. For Activate™ connectivity use with 829PFL Cover. Accepts Ortronics® MAB6TJ TracJack and MAB3S2 Series II adapters and Wiremold CM Series inserts, sold separately.

NOTE: UL Listed for tile, terrazzo, and carpet floors. Brass covers and flanges are not interchangeable with aluminum or nonmetallic covers and flanges. Nonmetallic covers are interchangeable with aluminum flanges.

OMNIBOX™ SERIES FLOOR BOXES

Omnibox Series Nonmetallic Cover Plate Flanges Ordering Information (continued)

837PCC 3-Gang Nonmetallic Carpet Flange

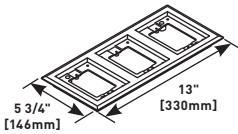

837PCC-BLK, 837PCC-BRN

For Ortronics® connectivity use with 829PFLRT Cover. For Activate™ connectivity use with 829PFL Cover. Accepts Ortronics® MAB6TJ TracJack and MAB3S2 Series II adapters and Wiremold CM Series inserts, sold separately.

Omnibox Series Nonmetallic Cover Plates Ordering Information

828PR Nonmetallic Duplex Cover Plate

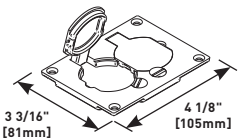

828PR-BLK, 828PR-BRN

Flip lids. Can also be used with a 106 type communication adapter.

829PFLRT Nonmetallic Communication Cover Plate

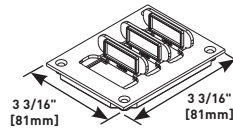

9829PFLRT-BLK, 829PFLRT-BRN

Individual flip lids. Gasket included. Ortronics® MAB6TJ TracJack and MAB3S2 Series II adapters included.

828PRGFI Nonmetallic GFI Cover Plate

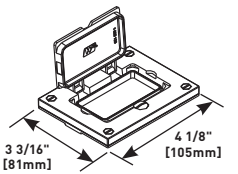

828PRGFI-BLK, 828PRGFI-BRN

May be used with Ortronics® Connectivity systems in conjunction with 817, 827 and 837PCC Series flanges.

829PCK Nonmetallic Communications Cover Plate

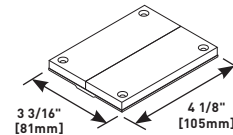

829PCK-BLK, 829PCK-BRN

Breakouts. Feed through only, not for use with a mounting plate for communication jacks.

829PFL Nonmetallic Communication Cover Plate

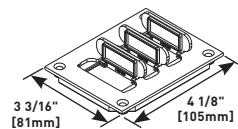

829PFL-BLK, 829PFL-BRN

Individual flip lids. Gasket included. Wiremold CM Series inserts included.

829PSTC Nonmetallic Communications Cover Plate

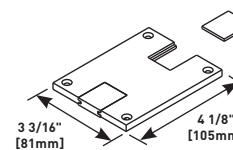

829PSTC-BLK, 829PSTC-BRN

Data slides. Feed through only, not for use with a mounting plate for communication jacks.

NOTE: UL Listed for tile, terrazzo, and carpet floors. Brass covers and flanges are not interchangeable with aluminum or nonmetallic covers and flanges. Nonmetallic covers are interchangeable with aluminum flanges.

880 SERIES™ FLOOR BOXES



880 Series™ Floor Boxes provide an excellent solution for low density power or communication requirements in open space areas.

CODE REFERENCE

cULus Listed
Metallic Outlet Boxes:
 File E2961 Guide QCIT.
 Meets Article 314.27(C) of NEC.

CLASS	CAT. NO.	DIMENSIONS		ADJUSTMENT		CAPACITY CUBIC IN. [CM ³]	KNOCKOUTS OR CONDUIT OPENINGS*
		A	B	BEFORE THE POUR	AFTER THE POUR		
CONCRETE-TIGHT (STEEL)	885B	4 13/16" [122mm]	2 7/16" [62mm]	1 3/4" [44mm]	1/2" [12.7mm]	29.5 in. ³ [483.5cm ³]	Four Sides – (1)-1/2", (1)-3/4" Bottom – (2)-1/2", (2)-3/4"
	886B	4 13/16" [122mm]	2 3/4" [70mm]	1 3/4" [44mm]	1/2" [12.7mm]	39 in. ³ [639.2cm ³]	Two Sides – (1)-1/2", (1)-3/4" Two Sides – (1)-3/4", (1)-1" Bottom – (2)-1/2", (2)-3/4"
WATERTIGHT (CAST-IRON)	887B	4 13/16" [122mm]	2 5/8" [67mm]	2" [51mm]	1/2" [12.7mm]	24.7 in. ³ [404.8cm ³]	Two Sides – (1)-1/2" Two Sides – (1)-3/4"
	889B	4 13/16" [122mm]	3 1/2" [89mm]	2" [51mm]	1/2" [12.7mm]	40 in. ³ [655.6cm ³]	Two Sides – (1)-1" Two Sides – (1)-1 1/4"

*1/2" = [12.7mm], 3/4" = [19.1mm], 1" = [25mm], 1 1/4" = [32mm].

- Can be used with all Wiremold 895/896 Series Cover Plates: brass or plastic, carpet, or tile application.
- All 880 Series Floor Boxes have 10° angular adjustment after the concrete pour.
- All 880 Series Floor Boxes can accommodate a duplex receptacle mounted flush with the floor.

COLOR OPTIONS



880 Series™ Flanges and Cover Plates are available in these colors as indicated in the part number descriptions.

Custom color options are also available. Consult the factory for more information.

880 SERIES™ FLOOR BOXES

880 Series Stamped Steel Floor Boxes Ordering Information

885B Stamped Steel Floor Box

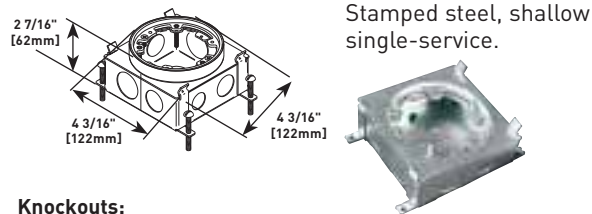

Knockouts:

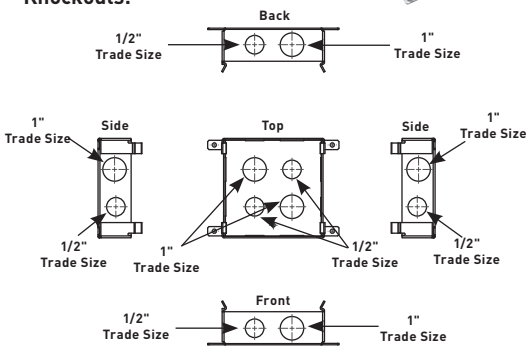

886B Stamped Steel Floor Box

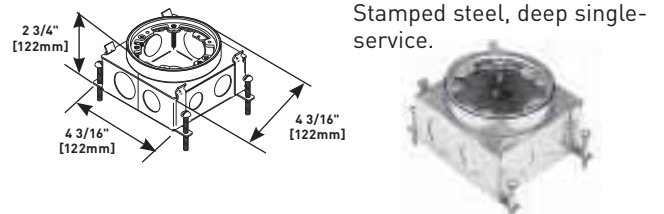

Knockouts:

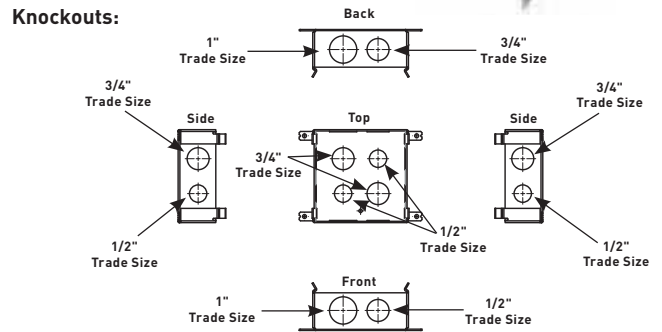

880 Series Cast-Iron Floor Boxes Ordering Information

887B Cast-Iron Floor Box

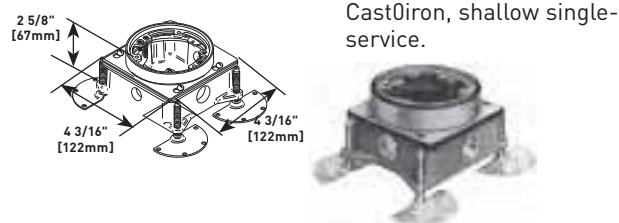

Knockouts:

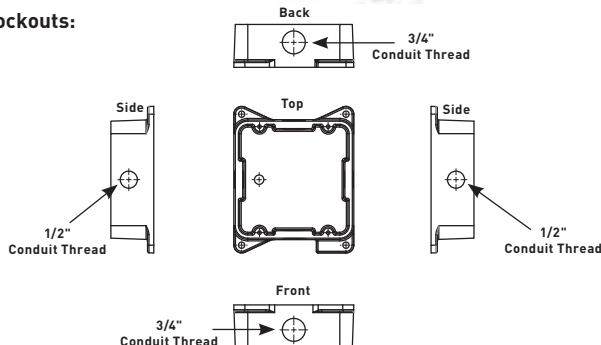

889B Cast-Iron Floor Box

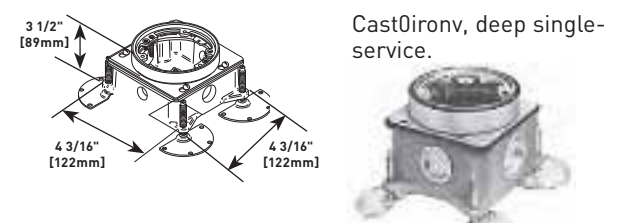

Knockouts:

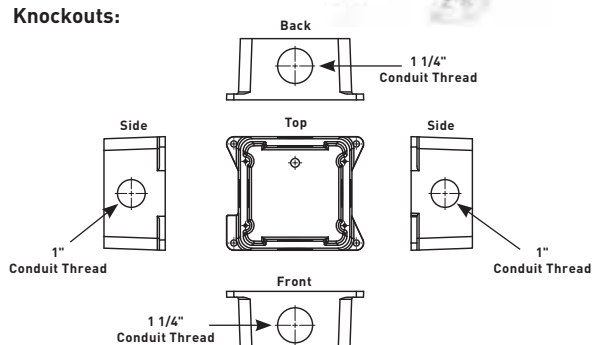

880 SERIES™ FLOOR BOXES

880 Series Floor Box Cover Plates Ordering Information

895, 895TCAL Duplex Cover Plate with Flip Lid

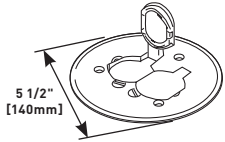

Brass (895) or brushed aluminum (895TCAL) duplex cover plate with flip lids, 5 1/2" [140mm] for carpet.

895TGFI, 895TGFIAL GFI Receptacle Cover Plate

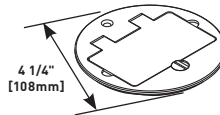

Brass (895TGFI) or brushed aluminum (895TGFIAL) GFI receptacle cover plate, 4 1/4" [108mm] for tile.

895TCAL Aluminum Duplex Power Plate

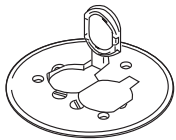

895TCAL-BK, 895TCAL-BS, 895TCAL-GY, 895TCAL-NK, 895TCAL-BZ

With flip lids, 5 1/2" [140mm] diameter for carpet,. Available in black, brass, gray, nickel and bronze.

895TCAL Aluminum Duplex Power Plate

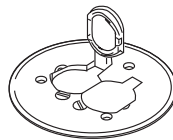

895TCAL-BK, 895TCAL-BS, 895TCAL-GY, 895TCAL-NK, 895TCAL-BZ

With flip lids, 5 1/2" [140mm] diameter for carpet,. Available in black, brass, gray, nickel and bronze.

895T, 895TAL Duplex Cover Plate with Flip Lids

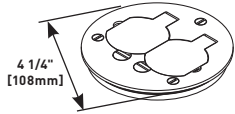

Brass (895T) or brushed aluminum (895TAL) duplex cover plate with flip lids, 4 1/4" [108mm] for tile.

895P Duplex Cover Plate

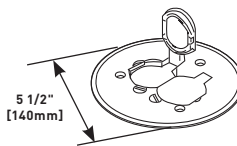

895P-BLK, 895P-BRN, 895P-BRZ, 895P-AL

Polycarbonate duplex cover plate with flip lids for carpet. Available in black, brown, bronze and aluminum.

895SP, 895SPCAL Cover Plate With Two Screw Plug Openings

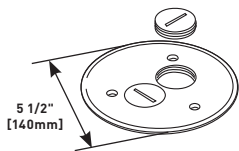

Brass (895SP) or brushed aluminum (895SPAL) cover plate with two 1 1/2" [38mm] screw plug openings, 5 1/2" [140mm] for carpet.

896 Communication or Power Cover Plate

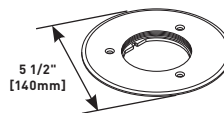

Brass communication or power cover plate with 2 5/8" [67mm] threaded opening for carpet. Sold without abandon plug.

895TSP Cover Plate With Two Screw Plug Openings

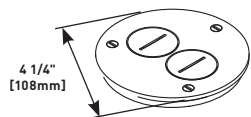

Brass cover plate with two 1 1/2" [38mm] screw plug openings, 4 1/4" [108mm] for tile.

896T Communications or Power Cover Plate

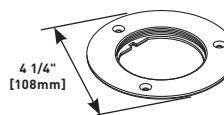

Brass communications or power cover plate with 2 5/8" [67mm] threaded opening for tile. Sold without abandon plug.

895GFI, 895GFICAL GFI Receptacle Cover Plate

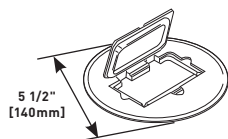

Brass (895GFI) or brushed aluminum (895GFICAL) GFI receptacle cover plate, 5 1/2" [140mm] for carpet.

896CK Communications or Power Cover Plate

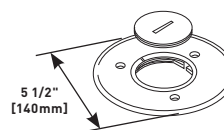

Brass communications or power cover plate with 2 1/4" [57mm] threaded opening for carpet.

880 SERIES™ FLOOR BOXES

880 Series Floor Box Cover Plates Ordering Information (continued)

896TCK Communications or Power Cover Plate

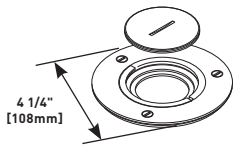

Brass communications or power cover plate with 2 1/4" [57mm] threaded opening for tile.

896CK-1 Communications or Power Cover Plate

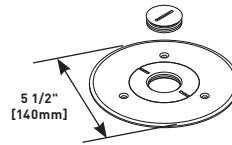

Brass cover plate with 1" [25mm] threaded opening for carpet.

896CK-1/2, 896CKAL-1/2 Communications or Power Cover Plate

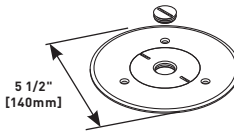

Brass (896CK-1/2) or brushed aluminum (896CKAL-1/2) cover plate with 1/2" [12.7mm] threaded opening 5 1/2" [140mm] for carpet.

896TCK-1 Communications or Power Cover Plate

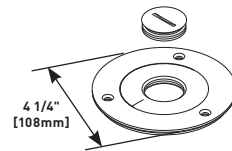

Brass cover plate with 1" [25mm] threaded opening for tile.

896TCK-1/2, 896TCKAL-1/2 Communications or Power Cover Plate

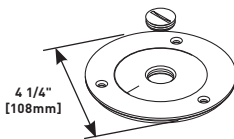

Brass (896TCK-1/2) or brushed aluminum (896TCKAL-1/2) cover plate with 1/2" [12.7mm] threaded opening, 4 1/4" [108mm] for tile.

896PCK Communications or Power Cover Plate

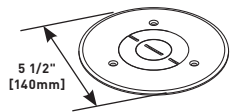

896PCK-BLK, 896PCK-BRN, 896PCK-BRZ, 896PCK-AL

Polycarbonate communications or power cover plate. Includes one plug with 3/4" [19mm] opening, one plug with 1" [25mm] opening, and one plug with 2 5/8" [67mm] opening. For pass-through only. Available in black, brown, bronze and aluminum .

896CK-3/4 Communications or Power Cover Plate

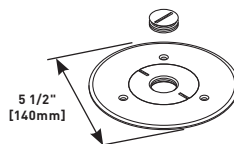

Brass cover plate with 3/4" [19.1mm] threaded opening for carpet.

896TCK-3/4 Communications or Power Cover Plate

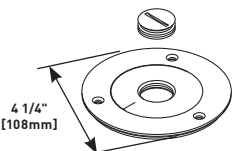

Brass cover plate with 3/4" [19.1mm] threaded opening for tile.

800 SERIES™ FLOOR BOXES



800 Series™ Semi-Adjustable Floor Boxes provide an economical solution for low density power or communication services in open space areas.

CODE REFERENCE

cULus Listed
Metallic Outlet Boxes:
 File E2961 Guide QCIT.
 Meets Article 314.27(C) of NEC.

800 Series Floor Boxes Technical Specifications

CAT. NO.	ADJUSTMENT		CAPACITY CUBIC IN. [CM ³]	KNOCKOUTS OR CONDUIT OPENINGS
	BEFORE THE POUR	AFTER THE POUR		
800LCK	2 3/4" vertical [70mm]	1/2" vertical [12.7mm]	23.6 cu. in. [357ml ³]	Sides - (2)-1/2" [12.7mm]; (2)-3/4" [19.1mm] Bottom - (2)-1/2" [12.7mm]; (2)-3/4" [19.1mm]
800CILCK	2 3/4" vertical [70mm]	1/2" vertical [12.7mm]	28.3 cu. in. [463ml ³]	Sides - (2)-1/2" [12.7mm] and (2)-3/4" [19.1mm] threaded

800 Series Semi-Adjustable Floor Boxes Ordering Information

800LCK Steel Floor Box

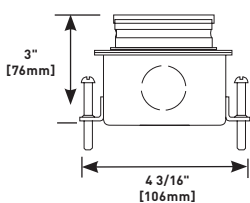

Adjustable before and after the concrete pour. Sold less conversion kit.

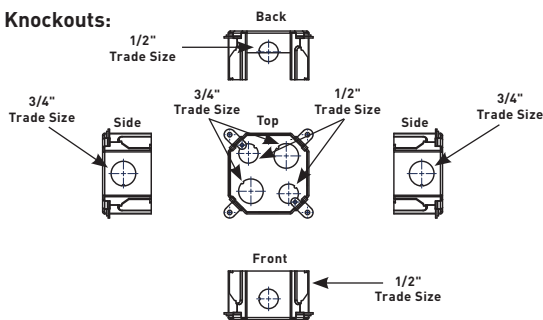

800CILCK Cast-Iron Floor Box

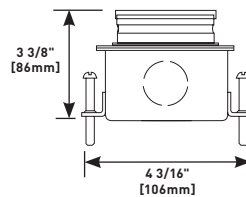

Adjustable before and after the concrete pour. Sold less conversion kit.

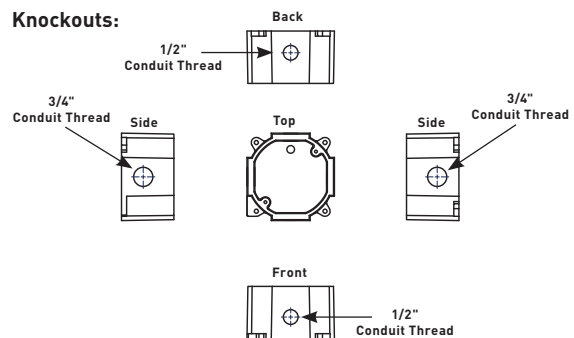

COLOR OPTIONS



800 Series™ Conversion Kits are available in these colors.

800 SERIES™ FLOOR BOXES

800 Series Floor Box Conversion Kits Ordering Information

825CK Conversion Kit

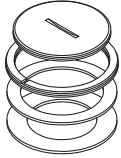

Brass conversion kit which includes one 825A – 2 1/4" [57mm] diameter plug, one 825C, one 825L, and one 825N. For carpet or tile installations.

825SFCK Conversion Kit

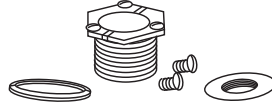

Conversion kit to fit 525 Series service fitting on 800 Series Boxes. Includes one 825C, one 825P-1, and one 1124L-1. For carpet or tile installations.

825CK-1 Conversion Kit

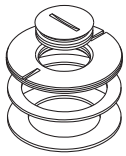

Brass conversion kit which includes one 825A-1 – 1" [25mm] diameter plug, one 825C-1, one 825L, and one 825N. For carpet or tile installations.

825A Abandon Plug

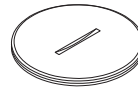

2 1/4" [57mm] diameter brass abandon plug. Thread size is pipe thread size.

825CK-3/4 Conversion Kit

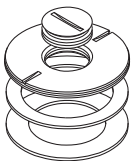

Brass conversion kit which includes one 825A-3/4 – 3/4" [19.1mm] diameter plug, one 825C-3/4, one 825L, and one 825N. For carpet or tile installations.

825A-1/2 Abandon Plug

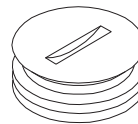

1/2" [12.7mm] diameter brass abandon plug. Thread size is pipe thread size.

825CK-1/2 Conversion Kit

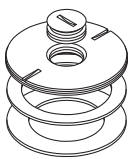

Brass conversion kit which includes one 825A-1/2 – 1/2" [12.7mm] diameter plug, one 825C-1/2, one 825L, and one 825N. For carpet or tile installations.

825A-3/4 Abandon Plug

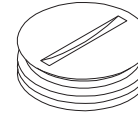

3/4" [19.1mm] diameter brass abandon plug. Thread size is pipe thread size.

825CP Brass Carpet Plate Assembly

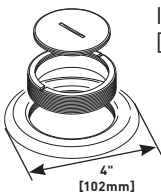

Includes the 825A. Total diameter is 2 5/8" [67mm].

825A-1 Abandon Plug

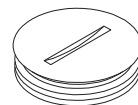

1" [25mm] diameter brass abandon plug. Thread size is pipe thread size.

880W SERIES™ FLOOR BOXES



880W Series™ Floor Boxes provide an excellent solution for wood floor applications when both power and communication services are required in open space areas.

CODE REFERENCE

cULus Listed
Metallic Outlet Boxes:
 File E2961 Guide QCIT.
 Meets Article 314.27(C) of NEC.

880W Series Floor Boxes Ordering Information

880W1 1-Gang Steel Floor Box for Wood Floors

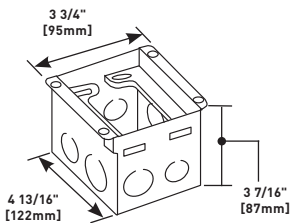

Knockouts for three (3) 1/2" [12.7mm], five (5) 3/4" [19.1mm], and two (2) 1" [25mm] conduits. 53 cu. in. [869ml] of capacity.

Knockouts:

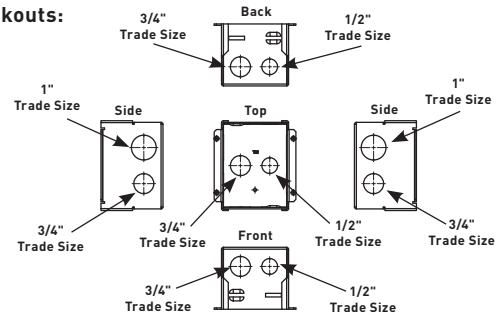

880W2 2-Gang Steel Floor Box for Wood Floors

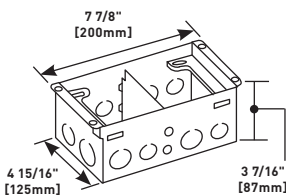

Knockouts for six (6) 1/2" [12.7mm], eight (8) 3/4" [19.1mm], and two (2) 1" [25mm] conduits. 58 cu. in. [951ml] of capacity in one compartment. 59 cu. in. [967ml] of capacity in second compartment. Barrier is removable for greater capacity if needed.

Knockouts:

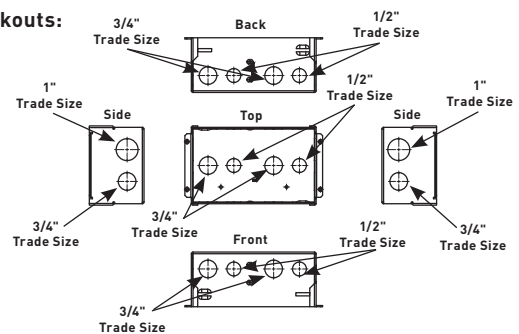

COLOR OPTIONS



880W Series™ Flanges and Cover Plates are available in these colors as indicated in the part number descriptions.

Custom color options are also available. Consult the factory for more information.

880W SERIES™ FLOOR BOXES

880W Series Floor Boxes Ordering Information (continued)

880W3 3-Gang Steel Floor Box for Wood Floors

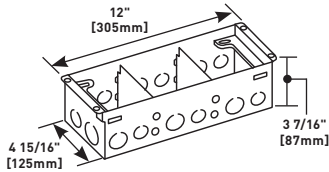

Knockouts for nine (9) 1/2" [12.7mm], eleven (11) 3/4" [19.1mm], and two (2) 1" [25mm] conduits. 56 cu. in. [918ml] of capacity in each of the outside compartments. 68 cu. in. [1115ml] of capacity in center compartment. Barrier is removable for greater capacity if needed.

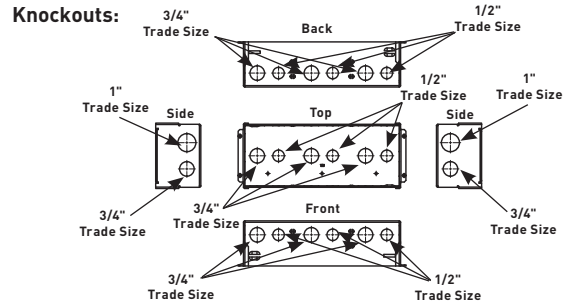

880W Series Floor Box Kits Ordering Information

880W1817B 1-Gang Steel Floor Box for Wood Floors

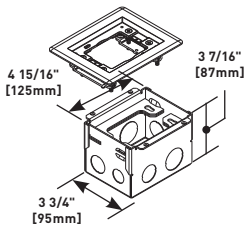

880W1 Floor Box with 817B brass flange included. Flange can be used for tile or carpet applications.

NOTE: Order cover separately.

880W2828TCAL 2-Gang Steel Floor Box for Wood Floors

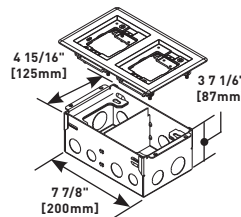

880W2 Floor Box with 828TCAL brushed aluminum flange included. Flange can be used for tile or carpet applications.

NOTE: Order cover separately.

880W1818TCAL 1-Gang Steel Floor Box for Wood Floors

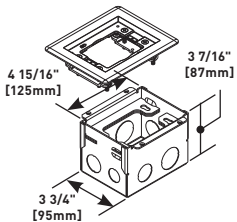

880W1 Floor Box with 818TCAL brushed aluminum flange included. Flange can be used for tile or carpet applications.

NOTE: Order cover separately.

880W3837B 3-Gang Steel Floor Box for Wood Floors

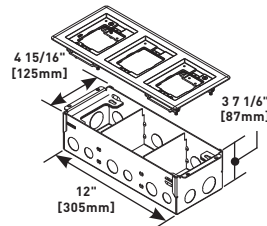

880W3 Floor Box with 837B brass flange included. Flange can be used for tile or carpet applications.

NOTE: Order cover separately.

880W2827B 2-Gang Steel Floor Box for Wood Floors

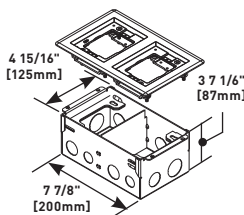

880W2 Floor Box with 827B brass flange included. Flange can be used for tile or carpet applications.

NOTE: Order cover separately.

880W3838TCAL 3-Gang Steel Floor Box for Wood Floors

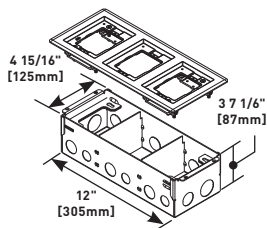

880W3 Floor Box with 838TCAL brushed aluminum flange included. Flange can be used for tile or carpet applications.

NOTE: Order cover separately.

880W SERIES™ FLOOR BOXES

880W Series Floor Boxes Solid Brass Cover Plate Flanges Ordering Information

817B 1-Gang Brass Combination Carpet & Tile Flange

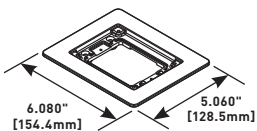

Accepts Ortronics® MAB6TJ TracJack and MAB3S2 Series II adapters and Wiremold CM Series inserts, sold separately.

837C 3-Gang Brass Carpet Flange

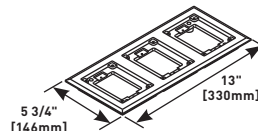

For use on 880S3, 880M3, 880CS32-1, and 880CM3-1 Floor Boxes.

827B 2-Gang Brass Combination Carpet & Tile Flange

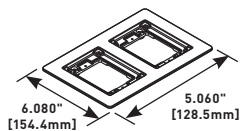

Accepts Ortronics® MAB6TJ TracJack and MAB3S2 Series II adapters and Wiremold CM Series inserts, sold separately.

817T 1-Gang Brass Tile Flange

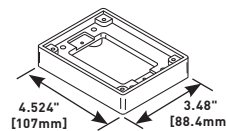

For use on 880S1, 880M1, 880CS1-1, and 880CM1-1 Floor Boxes.

837B 3-Gang Brass Combination Carpet & Tile Flange

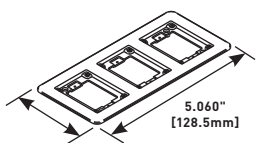

Accepts Ortronics® MAB6TJ TracJack and MAB3S2 Series II adapters and Wiremold CM Series inserts, sold separately.

827T 2-Gang Brass Tile Flange

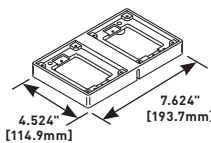

For use on 880S2, 880M2, 880CS2-1, and 880CM2-1 Floor Boxes.

817C 1-Gang Brass Carpet Flange

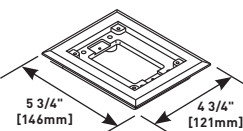

For use on 880S1, 880M1, 880CS1-1, and 880CM1-1 Floor Boxes.

837T 3-Gang Brass Tile Flange

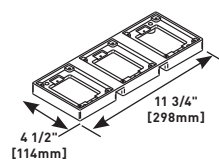

For use on 880S3, 880M3, 880CS3-1, and 880CM3-1 Floor Boxes.

827C 2-Gang Brass Carpet Flange

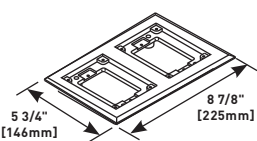

For use on 880S2, 880M2, 880CS2-1, and 880CM2-1 Floor Boxes.

880W Series Floor Boxes Metal Cover Plates Ordering Information

828R Brass Duplex Cover Plate

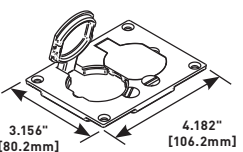

Flip lids. Can also be used with a 106 type communication adapter.

828GFITC Brass GFI Cover Plate

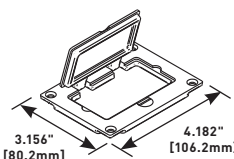

May be used with Activate and Ortronics® Connectivity Systems in conjunction with 817B, 827B, and 837B Flanges.

NOTE: UL Listed for tile, terrazzo, and carpet floors. Brass covers and flanges are not interchangeable with aluminum or nonmetallic covers and flanges. Nonmetallic covers are interchangeable with aluminum flanges.

880W SERIES™ FLOOR BOXES

880W Series Floor Boxes Metal Cover Plates Ordering Information (continued)

828DPGFITC Brass Rectangular Cover Plate

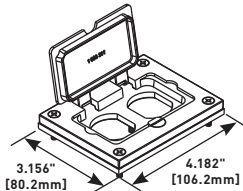

Allows for mounting of a duplex style receptacle with a rectangular style flip lid cover.

829CK-1/2 Brass Communication Cover Plate

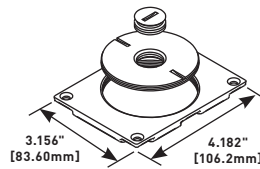

2 5/8" and 1/2" [67mm and 12.7mm] plugs. For carpet or tile installations.

828DLR Brass Single Locking Receptacle Cover Plate

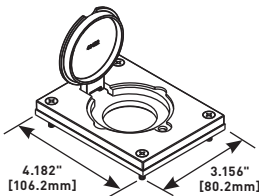

Single flip lid cover for 20A or 30A single locking receptacles. Device opening is 2 5/8" [67mm]. For use with maximum female locking device of 1.58" diameter, and maximum male plug face of 2.25" diameter.

829CK-3/4 Brass Communication Cover Plate

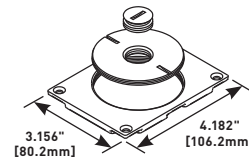

2 5/8" and 3/4" [67mm and 19.1mm] plugs.

828SPTC Brass Duplex Cover Plate

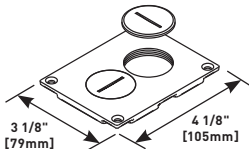

Screw plugs are 1 1/2" [38mm] in diameter.

829CK-1 Brass Communication Cover Plate

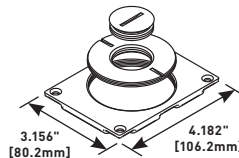

2 5/8" and 1" [67mm and 25mm] plugs.

829STC Brass Communication Cover Plate

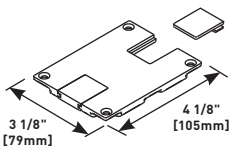

Data slides. Feed through only, not for use with a mounting plate for flush mounted communication adapter.

828MAAP AV Adapter Plate

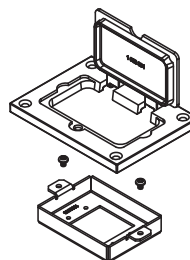

Sheet metal adapter plate that accepts two (2) Legrand AVIP or Extron® Electronics MAAP style device plates (sold separately). For use with 828GFITC or 828GFITCAL cover plates (sold separately).

829CK Brass Communication Cover Plate

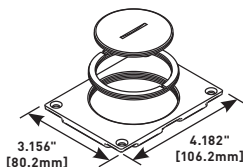

2 5/8" and 2 1/4" [67mm and 57mm] plugs.

NOTE: UL Listed for tile, terrazzo, and carpet floors. Brass covers and flanges are not interchangeable with aluminum or nonmetallic covers and flanges. Nonmetallic covers are interchangeable with aluminum flanges.

880W SERIES™ FLOOR BOXES

880W Series Floor Boxes Brushed Aluminum Cover Plate Flanges Ordering Information

818TCAL 1-Gang Brushed Aluminum Combination Carpet & Tile Flange

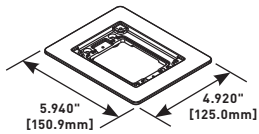

Accepts Ortronics® MAB6TJ TracJack and MAB3S2 Series II adapters and Wiremold CM Series inserts, sold separately.

NOTE: Brushed Aluminum flanges come with beveled edges.

818TAL 1-Gang Brushed Aluminum Tile Flange

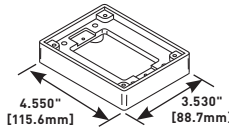

For use on 880S1, 880M1, 880CS1-1, and 880M1-1 Floor Boxes.

828TCAL 2-Gang Brushed Aluminum Combination Carpet & Tile Flange

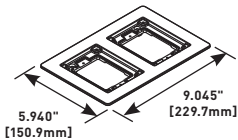

Accepts Ortronics® MAB6TJ TracJack and MAB3S2 Series II adapters and Wiremold CM Series inserts, sold separately.

NOTE: Brushed Aluminum flanges come with beveled edge

828TAL 2-Gang Brushed Aluminum Tile Flange

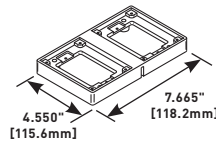

For use on 880S2, 880M2, 880CS2-1, and 880CM2-1 Floor Boxes.

838TCAL 3-Gang Brushed Aluminum Combination Carpet & Tile Flange

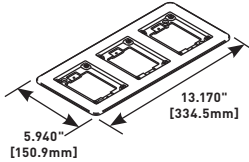

Accepts Ortronics® MAB6TJ TracJack and MAB3S2 Series II adapters and Wiremold CM Series inserts, sold separately.

NOTE: Brushed Aluminum flanges come with beveled edge

880W Series Floor Boxes Metal Cover Plates Ordering Information

828R-TCAL Brushed Aluminum Duplex Cover Plate

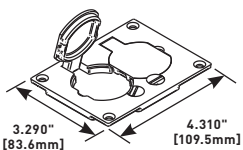

Flip lids. Can also be used with a 106 type communication adapter.

828DPGFITCAL Brushed Aluminum Rectangular Cover Plate

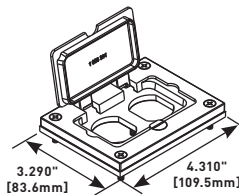

Allows for mounting of a duplex style receptacle with a rectangular style flip lid cover.

828GFITCAL Brushed Aluminum GFI Cover Plate

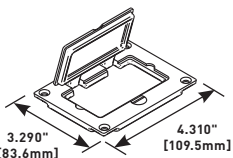

May be used with Activate and Ortronics® Connectivity Systems in conjunction with 817B, 827B, and 837B Flanges.

828DLRAL Brushed Aluminum Single Locking Receptacle Cover Plate

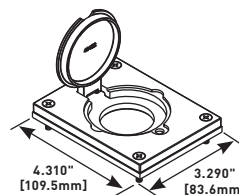

Single flip lid cover for 20A or 30A single locking receptacles. Device opening is 2 5/8" [67mm]. For use with maximum female locking device of 1.58" diameter, and maximum male plug face of 2.25" diameter.

NOTE: UL Listed for tile, terrazzo, and carpet floors. Brass covers and flanges are not interchangeable with aluminum or nonmetallic covers and flanges. Nonmetallic covers are interchangeable with aluminum flanges.

880W SERIES™ FLOOR BOXES

880W Series Floor Boxes Metal Cover Plates Ordering Information (continued)

830CKTCAL Brushed Aluminum Cover Plate

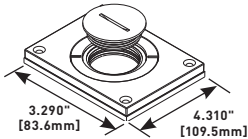

Power or communication plate with 2" [51mm] and 1 1/4" [32mm] plugs.

NOTE: Acceptable for use with threaded conduit when passing through power cables.

830CKTCAL-1/2 Brushed Aluminum Cover Plate

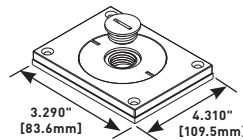

Power or communication plate with 2" [51mm] and 1/2" [12.7mm] plugs.

NOTE: Acceptable for use with threaded conduit when passing through power cables.

830CKTCAL-1 Brushed Aluminum Cover Plate

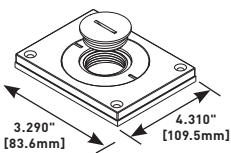

Power or communication plate with 2" [51mm] and 1" [25mm] plugs.

NOTE: Acceptable for use with threaded conduit when passing through power cables.

828MAAP AV Adapter Plate

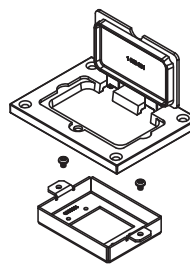

Sheet metal adapter plate that accepts two (2) Legrand AVIP or Extron® Electronics MAAP style device plates (sold separately). For use with 828GFITC or 828GFITCAL cover plates (sold separately).

830CKTCAL-3/4 Brushed Aluminum Cover Plate

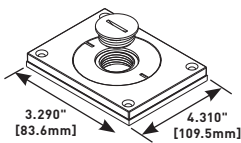

Power or communication plate with 2" [51mm] and 3/4" [19.1mm] plugs.

NOTE: Acceptable for use with threaded conduit when passing through power cables.

880W Series Floor Boxes Powder-Coated Aluminum Cover Plate Flanges Ordering Information

817TCAL 1-Gang Powder-Coated Aluminum Combination Carpet and Tile Flange

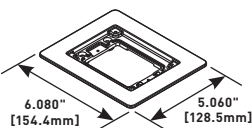

817TCAL-BK, 817TCAL-GY, 817TCAL-BS, 817TCAL-NK, 817TCAL-BZ

Accepts Ortronics® MAB6TJ TracJack and MAB3S2 Series II adapters and Wiremold CM Series inserts, sold separately. Flanges are available in five decorative colors: black, gray brass, nickel and bronze.

837TCAL 3-Gang Powder-Coated Aluminum Combination Carpet and Tile Flange

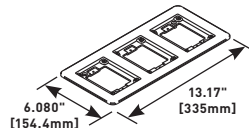

837TCAL-BK, 837TCAL-GY, 837TCAL-BS, 837TCAL-NK, 837TCAL-BZ

Accepts Ortronics® MAB6TJ TracJack and MAB3S2 Series II adapters and Wiremold CM Series inserts, sold separately. Flanges are available in five decorative colors: black, gray brass, nickel and bronze.

827TCAL 2-Gang Powder-Coated Aluminum Combination Carpet and Tile Flange

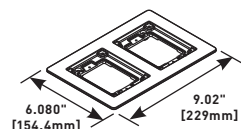

827TCAL-BK, 827TCAL-GY, 827TCAL-BS, 827TCAL-NK, 827TCAL-BZ

Accepts Ortronics® MAB6TJ TracJack and MAB3S2 Series II adapters and Wiremold CM Series inserts, sold separately. Flanges are available in five decorative colors: black, gray brass, nickel and bronze.

817TAL 1-Gang Powder Coated Aluminum Tile Flange

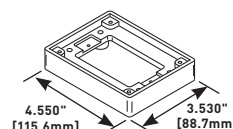

817TAL-BK, 817TAL-GY, 817TAL-BS, 817TAL-NK, 817TAL-BZ

For use on 880S1, 880M1, 880CS1-1, and 880M1-1 Floor Boxes. Flanges are available in five decorative colors: black, gray, brass, nickel and bronze.

NOTE: UL Listed for tile, terrazzo, and carpet floors. Brass covers and flanges are not interchangeable with aluminum or nonmetallic covers and flanges. Nonmetallic covers are interchangeable with aluminum flanges.

880W SERIES™ FLOOR BOXES

880W Series Floor Boxes Powder-Coated Aluminum Cover Plate Flanges Ordering Information (continued)

827TAL

2-Gang Powder Coated Aluminum Tile Flange

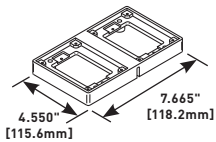

827TAL-BK, 827TAL-GY, 827TAL-BS, 827TAL-NK, 827TAL-BZ

For use on 880S2, 880M2, 880CS2-1, and 880M2-1 Floor Boxes. Flanges are available in five decorative colors: black, gray, brass, nickel and bronze.

880W Series Floor Boxes Powder-Coated Aluminum Cover Plates Ordering Information

828R-TCAL

Powder Coated Aluminum Duplex Cover Plate

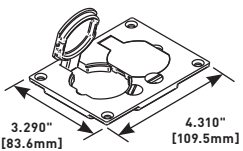

828R-TCAL-BK, 828R-TCAL-GY, 828R-TCAL-BS, 828R-TCAL-NK, 828R-TCAL-BZ

Flip lids. Can also be used with a 106 type communication adapter. Covers are available in five decorative colors: black, gray, brass, nickel and bronze.

829CKAL-3/4

Powder-Coated Aluminum Cover Plate

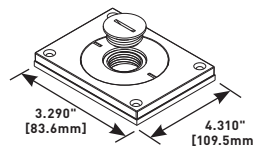

829CKAL-3/4BK, 829CKAL-3/4GY, 829CKAL-3/4BS, 829CKAL-3/4NK, 829CKAL-3/4BZ

Power or communication plate with 2" [51mm] and 3/4" [19.1mm] plugs. Covers are available in five decorative colors: black, gray, brass, nickel and bronze.

NOTE: Acceptable for use with threaded conduit when passing through power cables.

828GFITCAL

Powder Coated Aluminum GFI Cover Plate

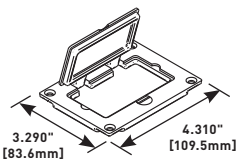

828GFITCAL-BK, 828GFITCAL-GY, 828GFITCAL-BS, 828GFITCAL-NK, 828GFITCAL-BZ

Allows for mounting a duplex receptacle (Decorator or GFCI style) with a rectangular flip cover. Covers are available in five decorative colors: black, gray, brass, nickel and bronze.

828MAAP AV Adapter Plate

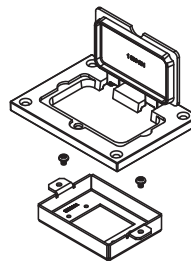

Sheet metal adapter plate that accepts two (2) Legrand AVIP or Extron® Electronics MAAP style device plates (sold separately). For use with 828GFITC or 828GFITCAL cover plates (sold separately).

829CKAL-1 Powder-Coated Aluminum Cover Plate

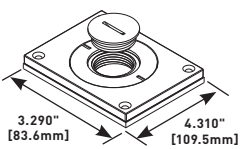

829CKAL-1BK, 829CKAL-1GY, 829CKAL-1BS, 829CKAL-1NK, 829CKAL-1BZ

Power or communication plate with 2" [51mm] and 1" [25mm] plugs. Covers are available in five decorative colors: black, gray, brass, nickel and bronze.

NOTE: Acceptable for use with threaded conduit when passing through power cables.

NOTE: UL Listed for tile, terrazzo, and carpet floors. Brass covers and flanges are not interchangeable with aluminum or nonmetallic covers and flanges. Nonmetallic covers are interchangeable with aluminum flanges.

880W SERIES™ FLOOR BOXES

880W Series Floor Boxes Nonmetallic Cover Plate Flanges Ordering Information

817PCC 1-Gang Nonmetallic Carpet Flange

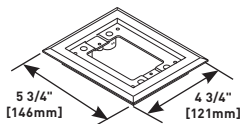

817PCC-BLK, 817PCC-BRN

For Ortronics® connectivity use with 829PFLRT Cover. For Activate™ connectivity use with 829PFL Cover. Accepts Ortronics® MAB6TJ TracJack and MAB3S2 Series II adapters and Wiremold CM Series inserts, sold separately.

837PCC 3-Gang Nonmetallic Carpet Flange

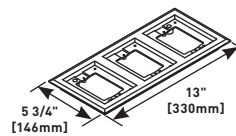

837PCC-BLK, 837PCC-BRN

For Ortronics® connectivity use with 829PFLRT Cover. For Activate™ connectivity use with 829PFL Cover. Accepts Ortronics® MAB6TJ TracJack and MAB3S2 Series II adapters and Wiremold CM Series inserts, sold separately.

827PCC 2-Gang Nonmetallic Carpet Flange

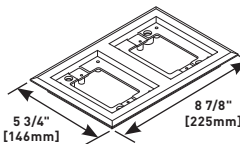

827PCC-BLK, 827PCC-BRN

For Ortronics® connectivity use with 829PFLRT Cover. For Activate™ connectivity use with 829PFL Cover. Accepts Ortronics® MAB6TJ TracJack and MAB3S2 Series II adapters and Wiremold CM Series inserts, sold separately.

880W Series Floor Boxes Nonmetallic Cover Plates Ordering Information

828PR Nonmetallic Duplex Cover Plate

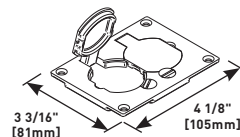

828PR-BLK, 828PR-BRN

Flip lids. Can also be used with a 106 type communication adapter.

829PFLRT Nonmetallic Communications Cover Plate

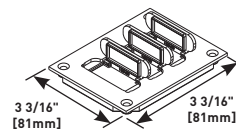

9829PFLRT-BLK, 829PFLRT-BRN

Individual flip lids. Gasket included. Ortronics® MAB6TJ TracJack and MAB3S2 Series II adapters included.

828PRGFI Nonmetallic GFI Cover Plate

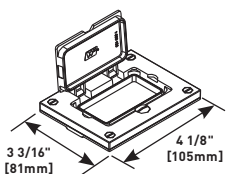

828PRGFI-BLK, 828PRGFI-BRN

May be used with Ortronics® Connectivity systems in conjunction with 817, 827 and 837PCC Series flanges.

829PCK Nonmetallic Communications Cover Plate

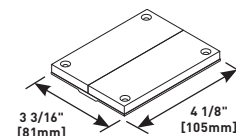

829PCK-BLK, 829PCK-BRN

Breakouts. Feed through only, not for use with a mounting plate for communication jacks.

829PFL Nonmetallic Communication Cover Plate

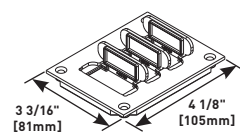

829PFL-BLK, 829PFL-BRN

Individual flip lids. Gasket included. Wiremold CM Series inserts included.

829PSTC Nonmetallic Communications Cover Plate

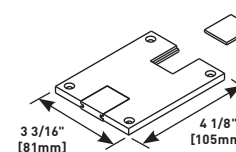

829PSTC-BLK, 829PSTC-BRN

Data slides. Feed through only, not for use with a mounting plate for communication jacks.

NOTE: UL Listed for tile, terrazzo, and carpet floors. Brass covers and flanges are not interchangeable with aluminum or nonmetallic covers and flanges. Nonmetallic covers are interchangeable with aluminum flanges.

861 SERIES™ FLOOR BOXES



861 Series™ Single Service Wood Floor Boxes bring power or communication service directly to the open space. Available with poke-thru style covers.

CODE REFERENCE

cULus Listed
Metallic Outlet Boxes:
 File E2961 Guide QCIT.
 Meets Article 314.27(C) of NEC.

861 Series Floor Boxes Ordering Information

Knockouts:

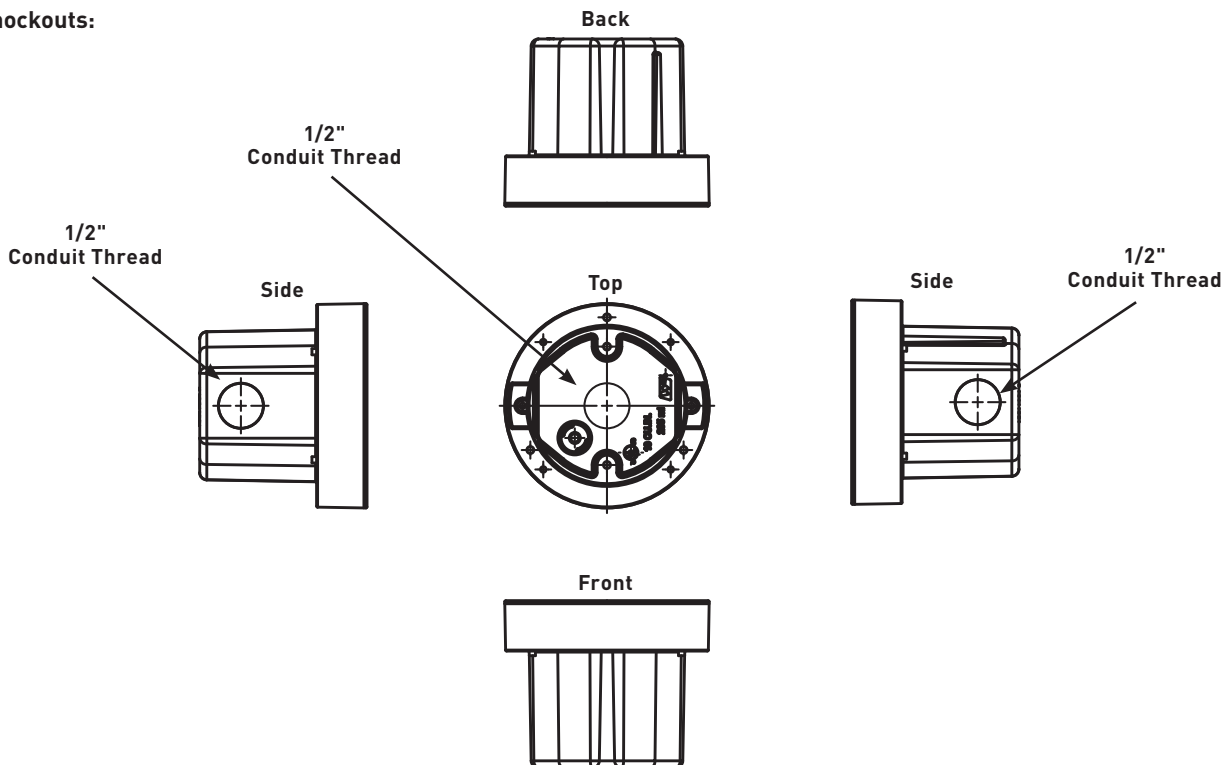

COLOR OPTIONS



861 Series™ Cover Plates are available in these colors as indicated in the part number descriptions.

Custom color options are also available. Consult the factory for more information.

861 SERIES™ FLOOR BOXES

861 Series Floor Boxes Ordering Information (continued)

861 Wood Floor Box

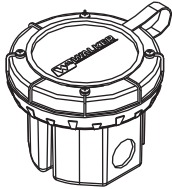

Die-cast aluminum construction with three 1/2" [12.7mm] knockouts; two on the sides and one on the bottom. 18 cu. in. [295ml³] of capacity. Requires a 4" [102mm] diameter hole. Comes complete with a disposable cover, receptacle and cover sold separately.

861DB Wood Floor Box Assembly

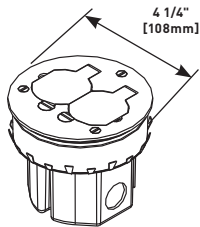

Complete with 20A duplex receptacle and brass cover plate. Die-cast aluminum construction with three 1/2" [12.7mm] knockouts; two on the sides and one on the bottom. 18 cu. in. [295ml³] of capacity. Requires a 4" [102mm] diameter hole.

861AMDTC Wood Floor Box Assembly

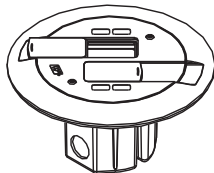

All communication floor boxes accept up to four UTP connectors. Flush poke-thru-style flanges available in painted gray (861AMDTCGY), black (861AMDTCBK), ivory (861AMDTCVY), or brushed metal finishes in aluminum (861AMDTCAL) and brass (861AMDTCBS). Slide covers match painted flange colors. Aluminum and brass flanges shipped with black slide cover. Brass flange also available with nonmetallic brass-color (AB) slide holder. Die-cast aluminum construction with three 1/2" trade size knockouts: two on the sides and one on the bottom. 18 cu. in. [295 cu.cm] capacity. Requires a 4" [102mm] diameter hole and overall floor depth of 1" [25mm]. Includes two (2) Ortronics TracJack inserts, two (2) Ortronics Series II adapters and two Wiremold Open System adapters. Assembled with scrub water gasket. For use on tile, wood, or carpet floors. Modular jacks sold separately.

861QTC Wood Floor Box Assembly

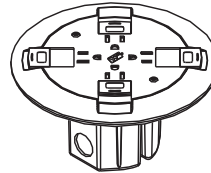

Complete with prewired 15A quad receptacle can be wired as standard or isolated ground. Flush poke-thru-style cover is available in painted gray (861QTCGY), black (861QTCBK), ivory (861QTCVY), or brushed metal finishes in aluminum (861QTCAL) and brass (861QTCBS). Slide covers match painted flange colors. Aluminum and brass covers shipped with black slide covers. Brass flange also available with nonmetallic brass-color (AB) slide holder. Die-cast aluminum construction with three 1/2" trade size knockouts: two on the sides and one on the bottom. 18 cu. in. [295 cu.cm] capacity. Requires a 4" [102mm] diameter hole and overall floor depth of 1" [25mm]. Assembled with scrub water gasket. For use on tile, wood, or carpet floors.

861FFTC Furniture Feed Raised Floor Box Assembly

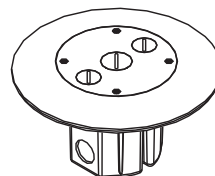

Cover has two 1/2" trade size conduits and one 3/4" trade size threaded conduit opening for feeding cables and wires through floor. Flush flanges available in painted gray (861FFTCGY), black (861FFTCBK), ivory (861FFTCVY), or brushed metal finishes in aluminum (861FFTCAL) and brass (861FFTCBS). Die-cast aluminum construction with three 1/2" trade size knockouts; two on the sides and one on the bottom, 18 cu. in. [295 cu. cm] capacity. Requires a 4" [102mm] diameter hole.

861 SERIES™ FLOOR BOXES

861 Series Floor Box Cover Plate Ordering Information

895, 895TCAL Duplex Cover Plate With Flip Lids

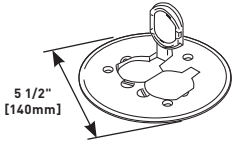

Brass (895) or brushed aluminum (895TCAL) duplex cover plate with flip lids, 5 1/2" [140mm] for carpet.

895GFI, 895GFICAL GFI Receptacle Cover Plate

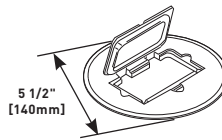

Brass (895GFI) or brushed aluminum (895GFICAL) GFI receptacle cover plate, 5 1/2" [140mm] for carpet.

895T, 895TAL Duplex Cover Plate With Flip Lids

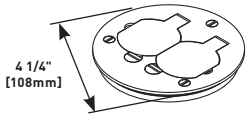

Brass (895T) or brushed aluminum (895TAL) duplex cover plate with flip lids, 4 1/4" [108mm] for tile.

895TGFI, 895TGFIAL GFI Receptacle Cover Plate

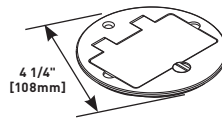

Brass (895TGFI) or brushed aluminum (895TGFIAL) GFI receptacle cover plate, 4 1/4" [108mm] for tile.

895SP, 895SPCAL Cover Plate With Two Screw Plug Openings

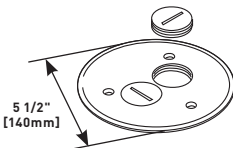

Brass (895SP) or brushed Aluminum (895SPAL) cover plate with two screw plug openings, 5 1/2" [140mm] for carpet.

895P Duplex Cover Plate

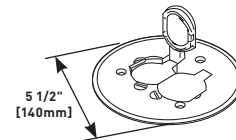

895P-BLK, 895P-BRN, 895P-BRZ, 895P-AL

Polycarbonate duplex cover plate with flip lids for carpet.

895TSP, 895TSPAL Cover Plate with Two Screw Plug Openings

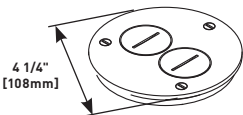

Brass (895TSP) or brushed aluminum (895TSPAL) cover plate with two screw plug openings, 4 1/4" [108mm] for tile.

895TCAL Aluminum Duplex Power Plate

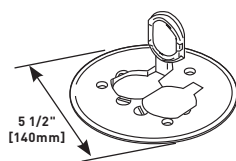

895TCAL-BK, 895TCAL-BS, 895TCAL-GY, 895TCAL-NK, 895TCAL-BZ

With flip lids, 5 1/2" [140mm] diameter for carpet,. Available in black, brass, gray, nickel and bronze.

NOTE: All 895 Style Cover Plates are furnished with gasket and three screws. All carpet cover plates are 5 1/2" [140mm] in diameter. All tile cover plates are 4 1/4" [108mm] in diameter.

862 SERIES™ FLOOR BOXES



862 Series™ Residential Floor Boxes provide an excellent solution for low density power or communication requirements for both concrete or wood floor applications.

CODE REFERENCE

cULus Listed
Nonmetallic Outlet Boxes:
 File E110748 Guide QCMZ.
 Meets Article 314.27(C) of NEC.

862 Series Floor Box Kits Ordering Information

Knockouts:

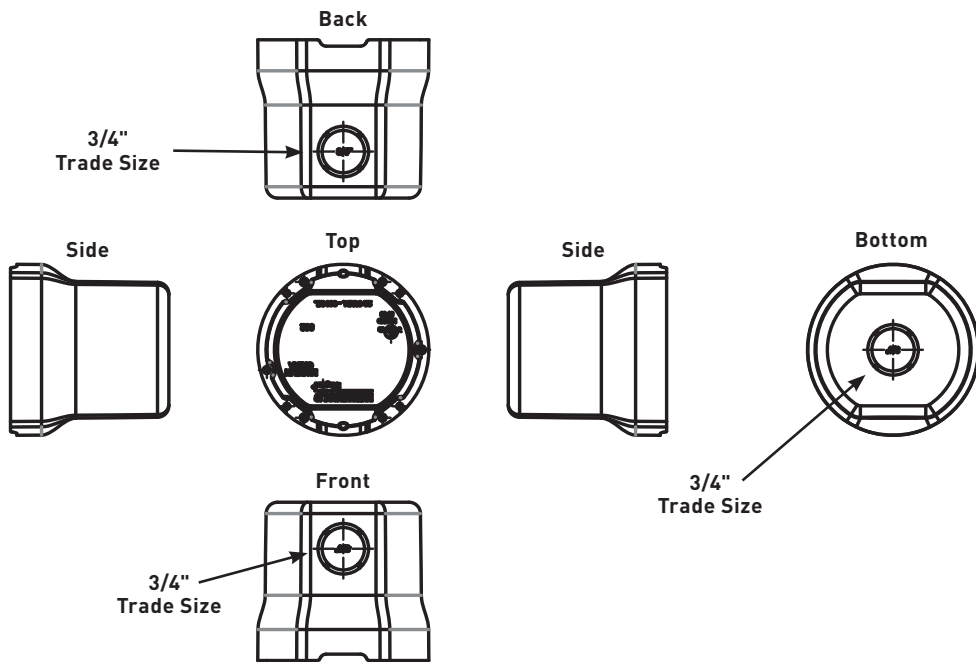

COLOR OPTIONS



862 Series™ Floor Box Kits are available in these colors as indicated in the part number descriptions.
Custom color options are also available. Consult the factory for more information.

862 SERIES™ FLOOR BOXES

862 Series Floor Box Kits Ordering Information (continued)

862 PVC Floor Box

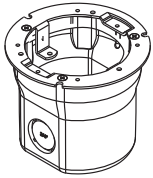

Box only, for wood or concrete floors. When using in concrete floor, order 862KIT with 862 Floor Box.

862KIT Concrete Floor Kit

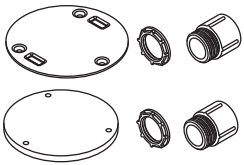

When using any of the 862 Series Floor Boxes in a concrete floor, the 862KIT will provide a mud cap for the concrete pour, two 3/4" trade size conduit hubs, and a scrub water gasket. Not needed for wood floor installations.

862DB PVC Floor Box Assembly For Wood or Concrete Floors

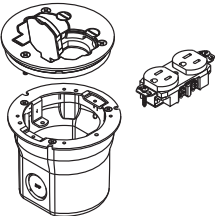

Includes 862 Series Floor Box, one 15A, 125V tamper-resistant brown duplex receptacle, and one 895T brass duplex receptacle cover for tile. Order 862KIT when using in concrete floor.

862C PVC Floor Box Assembly For Wood or Concrete Floors

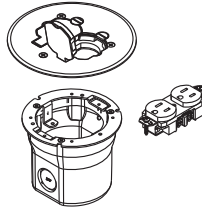

Includes 862 Series Floor Box, one 15A, 125V tamper-resistant brown duplex receptacle, and one 895 brass duplex receptacle cover for carpet. Order 862KIT when using in concrete floor.

862GFI PVC Floor Box Assembly For wood or Concrete floors

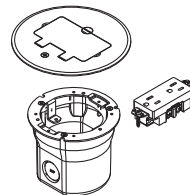

Includes 862 Series Floor Box, one Decorator style 15A, 125V tamper-resistant brown receptacle, and one 895GFI brass cover for carpet. Order 862KIT when using in concrete floor.

862TGFI PVC Floor Box Assembly For Wood or Concrete Floors

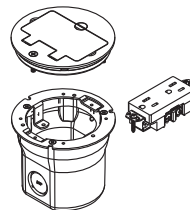

Includes 862 Series Floor Box, one Decorator style 15A, 125V tamper-resistant brown receptacle, and one 895TGFI brass cover for tile. Order 862KIT when using in concrete floor.

863 SERIES™ FLOOR BOXES



863 Series™ Multi-Service Round Floor Box Assembly Kits for Wood Floors for New and Retrofit Residential Applications.

CODE REFERENCE

cULus Listed
Nonmetallic Outlet Boxes:
 File E110748 Guide QCMZ.
 Meets Article 314.27(C) of NEC.

863 Series Floor Box Assembly Kits Ordering Information

Knockouts:

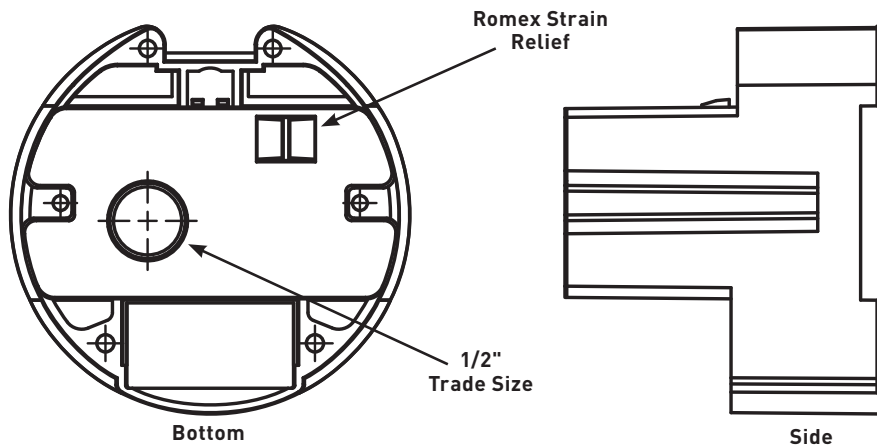

COLOR OPTIONS



863 Series™ Cover Plates are available in these colors as indicated in the part number descriptions.
Custom color options are also available. Consult the factory for more information.

863 SERIES™ FLOOR BOXES

863 Series Floor Boxes Ordering Information

863DPCOM Dual-Service Floor Box Kit

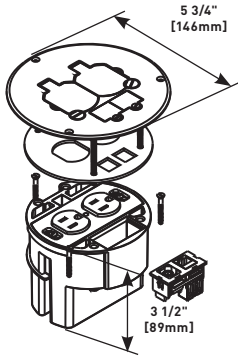

Includes round PVC floor box, one 15A, 125V tamper-resistant duplex receptacle, one coax F connector, one RJ45 Category 5e connector, and brass duplex opening cover plate with two flip lids.

863DRGFICOM Dual-Service Floor Box Kit

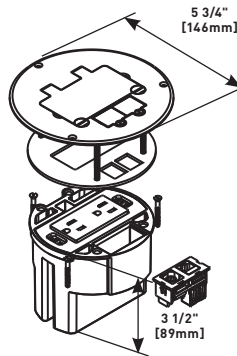

Includes round PVC floor box, one 15A, 125V tamper-resistant decorator style duplex receptacle, one coax F connector, one RJ45 Category 5e connector, and brass duplex opening cover plate with single flip lid.

863DPCOMAL Dual-Service Floor Box Kit

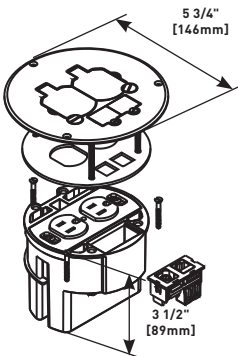

Includes round PVC floor box, one 15A, 125V tamper-resistant duplex receptacle, one coax F connector, one RJ45 Category 5e connector, and brushed aluminum duplex opening cover plate with two flip lids.

863DRGFICOMAL Dual-Service Floor Box Kit

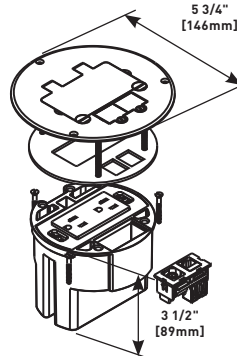

Includes round PVC floor box, one 15A, 125V tamper-resistant decorator style duplex receptacle, one coax F connector, one RJ45 Category 5e connector, and brushed aluminum duplex opening cover plate with single flip lid.

WMFB SERIES™ FLOOR BOXES



Multi-Service Floor Box Assembly Kits for Wood Floors for New and Retrofit Residential Applications.

CODE REFERENCE

cULus Listed
Nonmetallic Outlet Boxes:
 File E143222 Guide QCMZ.
 Meets Article 314.27(C) of NEC.

WMFB Series Floor Boxes Ordering Information

Knockouts:

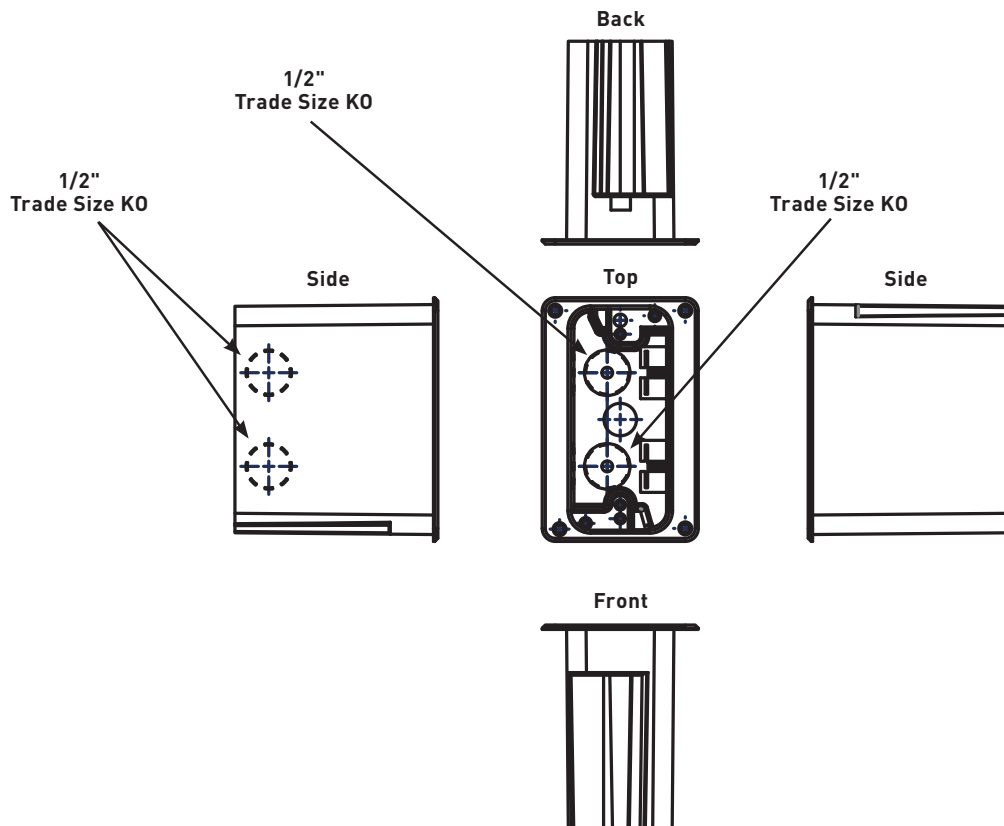

COLOR OPTIONS



WMFB Series™ Cover Plates are available in these colors as indicated in the part number descriptions.
Custom color options are also available. Consult the factory for more information.

WMFB SERIES™ FLOOR BOXES

WMFB Series Floor Boxes Ordering Information (continued)

WMFB1SRKS1B Single-Gang Floor Box Assembly

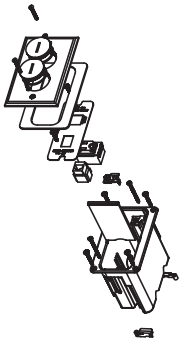

Includes single-gang box, divider, one 15A, 125V receptacle, one opening for communication device, and brass cover with two screw plugs. For hole cut dimensions, see installation instructions sheet.

Box Dimensions:
2 1/8" W x 3 3/4" L x 3 7/8" D
[54mm W x 95mm L x 98mm D]
Device Plate:
3 1/8" W x 4 15/16" L
[79mm W x 125mm L]

WMFB1SRB Single-Gang Floor Box Assembly

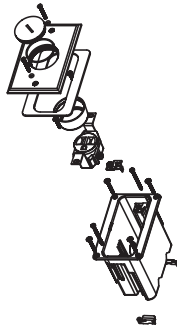

Includes single-gang box, one 15A tamper-resistant receptacle, and brass cover with one screw plug. For hole cut dimensions, see installation instructions sheet.

Box Dimensions:
2 1/8" W x 3 3/4" L x 3 7/8" D
[54mm W x 95mm L x 98mm D]
Device Plate:
3 1/8" W x 4 15/16" L
[79mm W x 125mm L]

WMFB1SRKS1N Single-Gang Floor Box Assembly

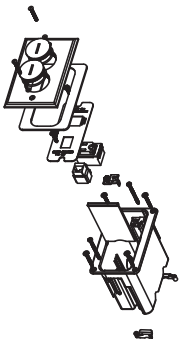

Includes single-gang box, divider, one 15A, 125V receptacle, one opening for communication device, and nickel cover with two screw plugs. For hole cut dimensions, see installation instructions sheet.

Box Dimensions:
2 1/8" W x 3 3/4" L x 3 7/8" D
[54mm W x 95mm L x 98mm D]
Device Plate:
3 1/8" W x 4 15/16" L
[79mm W x 125mm L]

WMFB1SRN Single-Gang Floor Box Assembly

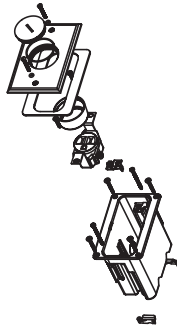

Includes single-gang box, one 15A tamper-resistant receptacle, and nickel cover with one screw plug. For hole cut dimensions, see installation instructions sheet.

Box Dimensions:
2 1/8" W x 3 3/4" L x 3 7/8" D
[54mm W x 95mm L x 98mm D]
Device Plate:
3 1/8" W x 4 15/16" L
[79mm W x 125mm L]

WMFB1DRB Single-Gang Floor Box Assembly

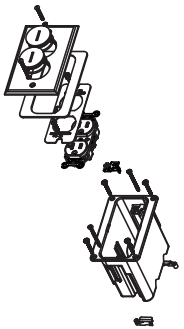

Includes single-gang box, one 15A, 125V tamper-resistant duplex receptacle, and brass cover with two screw plugs. For hole cut dimensions, see installation instructions sheet.

Box Dimensions:
2 1/8" W x 3 3/4" L x 3 7/8" D
[54mm W x 95mm L x 98mm D]
Device Plate:
3 1/8" W x 4 15/16" L
[79mm W x 125mm L]

WMFB2DR2B Dual-Gang Floor Box Assembly

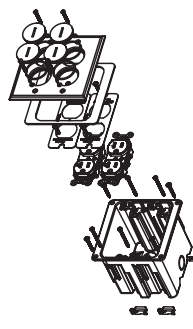

Includes dual-gang box, two 15A tamper-resistant duplex receptacles, and brass cover with four screw plugs. For hole cut dimensions, see installation instructions sheet.

Box Dimensions:
3 1/4" W x 3 3/4" L x 3 7/8" D
[83mm W x 95mm L x 98mm D]
Device Plate:
4 7/8" W x 5 1/16" L
[124mm W x 129mm L]

WMFB1DRN Single-Gang Floor Box Assembly

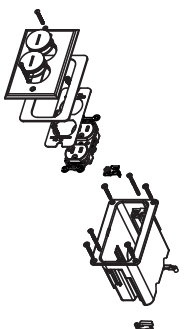

Includes single-gang box, one 15A, 125V tamper-resistant duplex receptacle, and nickel cover with two screw plugs. For hole cut dimensions, see installation instructions sheet.

Box Dimensions:
2 1/8" W x 3 3/4" L x 3 7/8" D
[54mm W x 95mm L x 98mm D]
Device Plate:
3 1/8" W x 4 15/16" L
[79mm W x 125mm L]

WMFB2DR2N Dual-Gang Floor Box Assembly

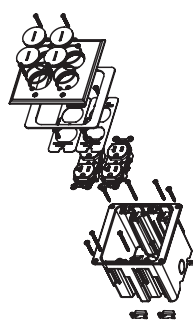

Includes dual-gang box, two 15A tamper-resistant duplex receptacles, and nickel cover with four screw plugs. For hole cut dimensions, see installation instructions sheet.

Box Dimensions:
3 1/4" W x 3 3/4" L x 3 7/8" D
[83mm W x 95mm L x 98mm D]
Device Plate:
4 7/8" W x 5 1/16" L
[124mm W x 129mm L]

WMFB SERIES™ FLOOR BOXES

WMFB Series Floor Boxes Ordering Information (continued)

WMFB1KS2B Single-Gang Floor Box Assembly

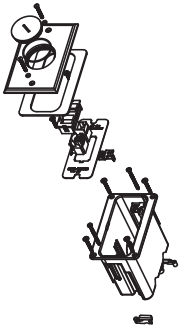

Includes single-gang box, device plate with two openings for communication devices, and brass cover with one screw plug. For hole cut dimensions, see installation instructions sheet.

Box Dimensions:
2 1/8" W x 3 3/4" L x 3 7/8" D
[54mm W x 95mm L x 98mm D]
Device Plate:
3 1/8" W x 4 15/16" L
[79mm W x 125mm L]

WMFB2DRKS4B Dual-Gang Floor Box Assembly

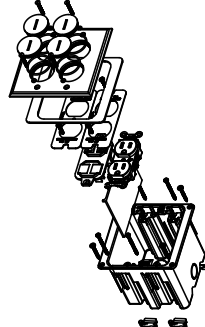

Includes dual-gang box, one 15A tamper-resistant duplex receptacle, 106 adapter with four openings for communication devices, and brass cover with four screw plugs. For hole cut dimensions, see installation instructions sheet.

Box Dimensions:
3 1/4" W x 3 3/4" L x 3 7/8" D
[83mm W x 95mm L x 98mm D]
Device Plate:
4 7/8" W x 5 1/16" L
[124mm W x 129mm L]

WMFB1KS2N Single-Gang Floor Box Assembly

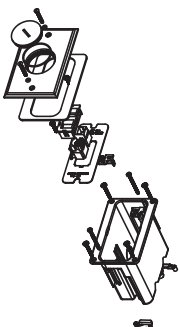

Includes single-gang box, device plate with two openings for communication devices, and nickel cover with one screw plug. For hole cut dimensions, see installation instructions sheet.

Box Dimensions:
2 1/8" W x 3 3/4" L x 3 7/8" D
[54mm W x 95mm L x 98mm D]
Device Plate:
3 1/8" W x 4 15/16" L
[79mm W x 125mm L]

WMFB2DRKS4N Dual-Gang Floor Box Assembly

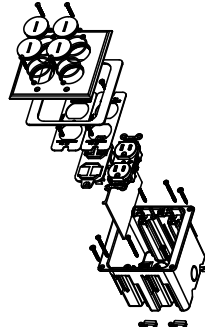

Includes dual-gang box, one 15A tamper-resistant duplex receptacle, 106 adapter with four openings for communication devices, and nickel cover with four screw plugs. For hole cut dimensions, see installation instructions sheet.

Box Dimensions:
3 1/4" W x 3 3/4" L x 3 7/8" D
[83mm W x 95mm L x 98mm D]
Device Plate:
4 7/8" W x 5 1/16" L
[124mm W x 129mm L]

WMFB1KS4B Single-Gang Floor Box Assembly

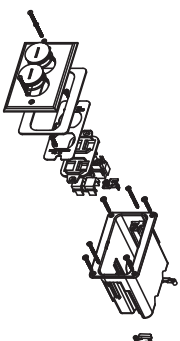

Includes single-gang box, 106 adapter with four openings for communication devices, and brass cover with two screw plugs. For hole cut dimensions, see installation instructions sheet.

Box Dimensions:
2 1/8" W x 3 3/4" L x 3 7/8" D
[54mm W x 95mm L x 98mm D]
Device Plate:
3 1/8" W x 4 15/16" L
[79mm W x 125mm L]

WMFB2KS8B Dual-Gang Floor Box Assembly

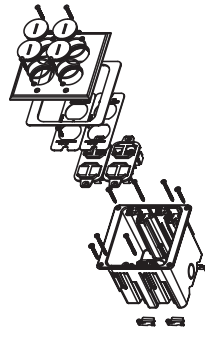

Includes dual-gang box, two 106 adapter with eight openings for communication devices, and brass cover with four screw plugs. For hole cut dimensions, see installation instructions sheet.

Box Dimensions:
3 1/4" W x 3 3/4" L x 3 7/8" D
[83mm W x 95mm L x 98mm D]
Device Plate:
4 7/8" W x 5 1/16" L
[124mm W x 129mm L]

WMFB1KS4N Single-Gang Floor Box Assembly

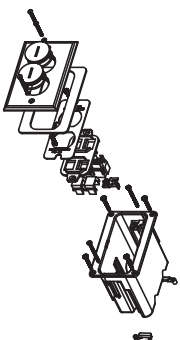

Includes single-gang box, 106 adapter with four openings for communication devices, and nickel cover with two screw plugs. For hole cut dimensions, see installation instructions sheet.

Box Dimensions:
2 1/8" W x 3 3/4" L x 3 7/8" D
[54mm W x 95mm L x 98mm D]
Device Plate:
3 1/8" W x 4 15/16" L
[79mm W x 125mm L]

WMFB2KS8N Dual-Gang Floor Box Assembly

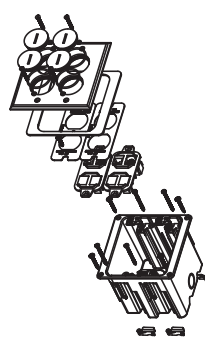

Includes dual-gang box, two 106 adapter with eight openings for communication devices, and nickel cover with four screw plugs. For hole cut dimensions, see installation instructions sheet.

Box Dimensions:
3 1/4" W x 3 3/4" L x 3 7/8" D
[83mm W x 95mm L x 98mm D]
Device Plate:
4 7/8" W x 5 1/16" L
[124mm W x 129mm L]

AF™ SERIES FLOOR BOXES



FloorSource AF Series™ Raised Floor Boxes provide point-of-use activations for multiple power and communications devices while offering greater flexibility relating to adds, moves and changes within a standard and shallow raised floor application.

CODE REFERENCE

UL Listed Classified Raised Floor Box:
File E2961, Guide QCIT.

UL Listed Classified Raised Floor Box (prewired):
File E51105, Guide QQVX.
Meets Article 314 of NEC.
Meets Article 12-2500 of CEC.

COLOR OPTIONS



AF Series™ Raised Floor Boxes are available in die-cast aluminum with black, brown or gray covers and trim flanges as indicated in the part number descriptions.

AF™ SERIES FLOOR BOXES

AF Series Raised Floor Boxes Ordering Information

AF-1 Raised Floor Box



The AF1 Raised Floor and Stage Floor Box provides three separate compartments that accommodate a combination of power, communication and audio/video devices. This combination is accomplished with the built-in service dividers. These dividers are arranged in a single-double, single-gang configuration. Die-cast aluminum housing provides added strength and reliability. Polycarbonate hinged lid and trim flange are available for carpet or tile applications, as well as color choice of black, brown, or gray.

Faceplate Locations



Knockouts:

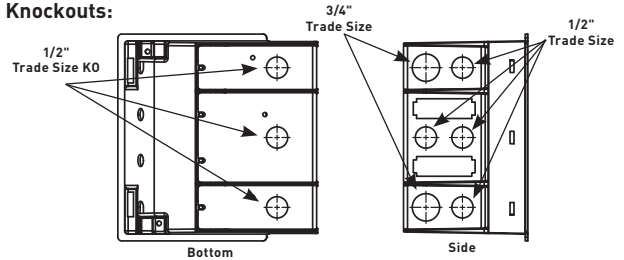

Specifications

DESCRIPTION	DIMENSIONS
OVERALL TRIM RING	8 3/4" x 6 3/4" [222mm x 171mm]
MODULE DEPTH OVERALL	5" [127mm]
PANEL OPENING	8" x 6" [203mm x 152mm]
COVER SIZE	7 1/2" x 5" [191mm x 127mm]
ACTIVATION CHAMBER VOLUME	130 cu in. [2130ml]
USER VOLUME	78.6 cu in. [1288ml]
TOTAL VOLUME	208.6 cu in. [3418ml]
KNOCKOUT SIZES	Seven (7) 1/2" & Two (2) 3/4" Trade Size KOs (Power Side only)
SERVICE	Triple
MAXIMUM FLOOR THICKNESS	1 1/2" [38mm] (Includes floor covering)

Ordering Data

CAT. NO.	DESCRIPTION	BOX DIMENSION
AF1-KC	AF1 with Black Carpet Cover and Trim	8" x 6" [203mm x 152mm]
AF1-KT	AF1 with Black Tile Cover and Trim	8" x 6" [203mm x 152mm]
AF1-NC	AF1 with Brown Carpet Cover and Trim	8" x 6" [203mm x 152mm]
AF1-NT	AF1 with Brown Tile Cover and Trim	8" x 6" [203mm x 152mm]
AF1-YC	AF1 with Gray Carpet Cover and Trim	8" x 6" [203mm x 152mm]
AF1-YT	AF1 with Gray Tile Cover and Trim	8" x 6" [203mm x 152mm]

NOTE: AF1 and AF3 Floor Boxes are available in a prewired (power only) version. Consult factory for ordering information. For information on prewired versions with Walkerflex, see the Walkerflex Section of this Product Guide.

NOTE: All boxes and plates are sold separately.

AF™ SERIES FLOOR BOXES

AF Series Raised Floor Boxes Ordering Information

AF-3 Raised Floor Box



The AF3 Raised Floor and Stage Floor Box provides four separate compartments that accommodate up to eight gangs of communication, power and/or audio/ video devices. The top panel has a unique built-in service divider that accommodates a combination power, communication and audio/video devices. These dividers are arranged in a single-double, single-gang configuration. The lower panel provides single-gang activation points in a single service configuration. Die-cast aluminum housing provides added strength and reliability. Polycarbonate hinged lid and trim flange are available for carpet or tile applications, as well as a color choice of black, brown, or gray.

Faceplate Locations

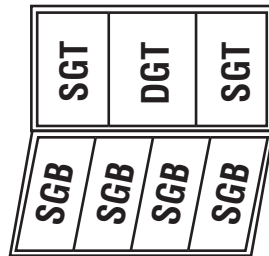

Knockouts:

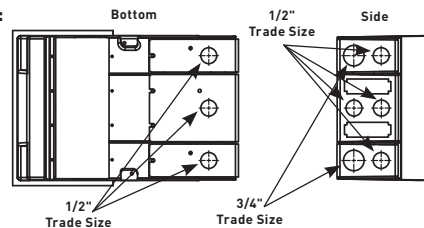

Specifications

DESCRIPTION	DIMENSIONS
OVERALL TRIM RING	9 1/8" x 11" [232mm x 279mm]
MODULE DEPTH OVERALL	5" [127mm]
PANEL OPENING	8" x 10" [203mm x 254mm]
COVER SIZE	7 1/2" x 9 1/2" [191mm x 242mm]
ACTIVATION CHAMBER VOLUME	220 cu in. [3604ml]
USER VOLUME	180 cu in. [2948ml]
TOTAL VOLUME	300 cu in. [4915ml]
KNOCKOUT SIZES	Seven (7) 1/2" & Two (2) 3/4" Trade Size KOs (Power Side only)
SERVICE	Triple
MAXIMUM FLOOR THICKNESS	1 1/2" [38mm] (Includes floor covering)

Ordering Data

CAT. NO.	DESCRIPTION	BOX DIMENSION
AF3-KC	AF3 with Black Carpet Cover and Trim	8" x 10" [203mm x 254mm]
AF3-KT	AF3 with Black Tile Cover and Trim	8" x 10" [203mm x 254mm]
AF3-NC	AF3 with Brown Carpet Cover and Trim	8" x 10" [203mm x 254mm]
AF3-NT	AF3 with Brown Tile Cover and Trim	8" x 10" [203mm x 254mm]
AF3-YC	AF3 with Gray Carpet Cover and Trim	8" x 10" [203mm x 254mm]
AF3-YT	AF3 with Gray Tile Cover and Trim	8" x 10" [203mm x 254mm]

NOTE: AF1 and AF3 Floor Boxes are available in a prewired (power only) version. Consult factory for ordering information. For information on prewired versions with Walkerflex, see the Walkerflex Section of this Product Guide.

NOTE: All boxes and plates are sold separately.

AF™ SERIES FLOOR BOXES

AF Series Upper (Top) Panel Device Plates for Raised Floor Boxes Ordering Information

SGT-B Single-Gang Plate

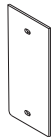

Blank plate for field punching.

DGT-B Double-Gang Plate



Blank plate. Use in center compartment only.

SGT-DP Single-Gang Plate

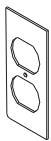

One duplex opening.

DGT-2DP Double-Gang Plate



Two duplex openings. Use in center compartment only.

SGT-H Single-Gang Plate



For Heyco bushing opening or single receptacle 1.046" [35.7mm] diameter. Use in outer, side compartments only.

DGT-DP/B Double-Gang Plate

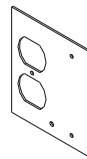

One duplex opening and blank. Use in center compartment only.

SGT-1K0 Single-Gang Plate



1" [25mm] knockout.

DGT-ACT Double-Gang Plate

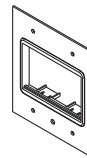

Includes one (1) Wiremold Open System adapter. Adapter accepts three (3) Wiremold CM Series inserts or three (3) Wiremold CM2 Series modules. Use in center compartment only.

SGT-ACT Single-Gang Plate

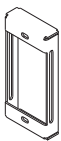

Accepts three (3) Wiremold Open System inserts or three (3) Wiremold CM Series Open System modules.

DGT-AAP Internal Audio/Video Plate

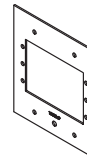

Accepts three (3) Extron® Electronics AAP Series Devices (sold separately).

SGT-3S2 Single-Gang Plate



Accepts three (3) Ortronics® Series II inserts.

DGT-MAAP Internal Audio/Video Plate



Accepts five (5) Legrand AVIP or Extron® Electronics MAAP Series Devices (sold separately).

SGT-MAAP Internal Audio/Video Plate

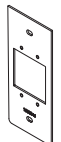

Accepts two (2) Legrand AVIP or Extron® Electronics MAAP Series Devices (sold separately).

AF™ SERIES FLOOR BOXES

AF Series Upper (Top) Panel Device Plates for Raised Floor Boxes Ordering Information

DGT-RT Double-Gang Plate

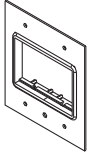

Includes one (1) Ortronics® Series II adapter and one (1) TracJack adapter. Use in center compartment only.

SGT-3TJ Single-Gang Plate



Accepts three (3) Ortronics® TracJack inserts.

Lower (Bottom) Panel Device Plates for AF3 Raised Floor Boxes Ordering Information

SGB-B Single-Gang Plate

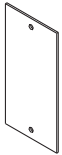

Blank plate for field punching.

SGB-ACT Single-Gang Plate

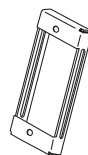

Accepts three (3) Wiremold Open System inserts or three (3) CM2 Series Open System modules.

SGB-DP Single-Gang Plate

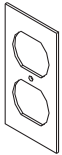

One duplex opening.

SGB-3S2 Single-Gang Plate

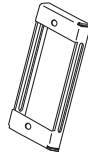

Accepts three (3) Ortronics® Series II inserts.

SGB-MAAP Internal Audio/Video Plate

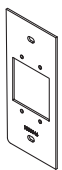

Accepts two (2) Legrand AVIP or Extron® Electronics MAAP Series Devices (sold separately).

SGB-3TJ Single-Gang Plate

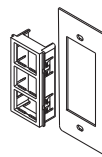

Accepts three (3) Ortronics® Tracjack inserts.

AF™ SERIES FLOOR BOXES

AF Series Raised Floor Boxes Ordering Information

SAF Raised Floor Box



The SAF Shallow Raised Floor Box has been designed to fit into 2 1/2" floor depths and provides two compartments that accommodate a combination of power, communication and audio/video devices. The SAF21/2 can accommodate two duplex receptacles on one side and up to six communication devices on the other side. The power and communication compartments can only be used for designated services. Four 1/2" trade size KOs are in the sides of the box to feed the power devices. The hinged polycarbonate lid and trim flange for carpet or tile are available in black, brown, or gray. Two duplex receptacle power plates are supplied with each box. Receptacles not included. Three blank communication plates are included with each box. Box includes a communication compartment cover plate for use in air handling spaces. SAF21/2 Box will accept up to two SG2 Power Plates, and up to three SGC2 Communication Plates. Consult factory for custom plates.

Knockouts:

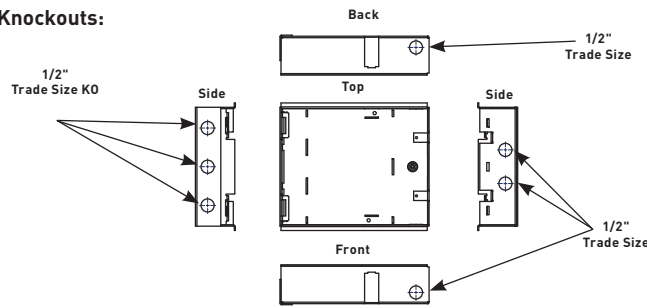

Specifications

DESCRIPTION	DIMENSIONS
OVERALL TRIM RING	9 1/8" x 11" [232mm x 279mm]
MODULE DEPTH OVERALL	2 1/2" [64mm]
PANEL OPENING	8" x 10" [203mm x 254mm]
COVER SIZE	7 1/2" x 9 1/2" [191mm x 242mm]
ACTIVATION VOLUME	18.5 cubic inches [303ml]
POWER VOLUME	29 cubic inches [475ml]
MAXIMUM FLOOR PANEL THICKNESS WITH FLOOR COVERING	1 3/16" [30mm]
KNOCKOUTS	Power – Four (4) 1/2" Trade Size Concentric KOs Communication – Three (3) 1/2" Trade Size Concentric KOs
SERVICE	Triple
MAXIMUM FLOOR THICKNESS	1 3/8" [35mm] (includes floor covering)

Ordering Data

CAT. NO.	DESCRIPTION	BOX DIMENSION
SAF21/2-KC	Black Carpet Cover and Trim	8" x 10" [203mm x 254mm]
SAF21/2-KT	Black Tile Cover and Trim	8" x 10" [203mm x 254mm]
SAF21/2-NC	Brown Carpet Cover and Trim	8" x 10" [203mm x 254mm]
SAF21/2-NT	Brown Tile Cover and Trim	8" x 10" [203mm x 254mm]
SAF21/2-YC	Gray Carpet Cover and Trim	8" x 10" [203mm x 254mm]
SAF21/2-YT	Gray Tile Cover and Trim	8" x 10" [203mm x 254mm]

AF™ SERIES FLOOR BOXES

SAF21/2 Raised Floor Box Device Plates Ordering Information

SG2-DP Power Plate

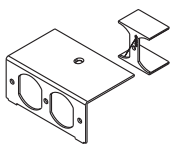

Single-gang duplex receptacle.

SGC2-B Communication Plate

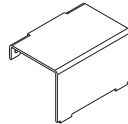

Single-gang blank.

SG2-B Power Plate

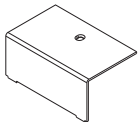

Single-gang blank plate.

SGC2-ACT Communication Plate

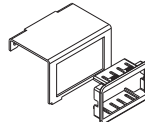

Single-gang adapter. Includes one (1) Wiremold Open System adapter.

SGC2-MAAP Communication Plate

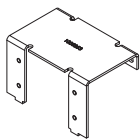

Accepts two (2) Legrand AVIP or Extron® Electronics MAAP Series Devices (sold separately).

SGC2-RT Communication Plate

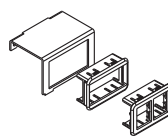

Includes one (1) Ortronics® Series II adapter and one (1) TracJack adapter.

AC™ SERIES FLOOR BOXES



FloorSource AC Series™ Raised Floor Boxes provide point-of-use activations for multiple power, communication and audio/video devices while offering greater flexibility relating to adds, moves and changes within the raised floor.

CODE REFERENCE

UL Listed Classified Raised Floor Box:
File E2961, Guide QCIT.

UL Listed Classified Raised Floor Box (prewired):
File E51105, Guide QQVX.
Meets Article 314 of NEC.
Meets Article 12-2500 of CEC.

AC Series Raised Floor Boxes Ordering Information

AC8850, AC8105 Raised Floor Box

The AC8850 and AC8105 are boxes with a 5" [127mm] depth design, with the AC8105 providing an extra 2" [51mm] of width for additional wiring capacity. These boxes can accommodate four duplex power receptacles on one side. Power plate with duplex knockouts included with box. The communication plate will accept at least three communication adapters for up to 18 ports of activation. Lids rotate 180° for easy orientation. Gray lids are die-cast zinc construction.

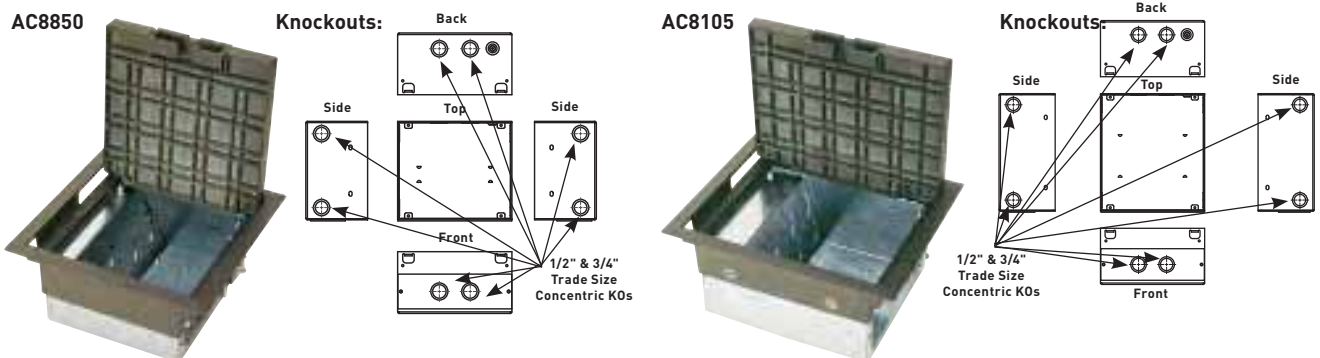

NOTE: Back plate is removable for greater depth capacity.

COLOR OPTIONS

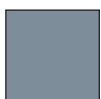

AC Series™ Raised Floor Boxes are available in die-cast zinc construction with gray covers as indicated in the part number descriptions.

AC™ SERIES FLOOR BOXES

AC Series Raised Floor Boxes Ordering Information

Specifications

DESCRIPTION	AC8850 DIMENSIONS	AC8105 DIMENSIONS
BOX DIMENSIONS	8" x 8" x 5" [203mm x 203mm x 127mm]	8" x 10" x 5" [203mm x 254mm x 127mm]
OVERALL TRIM RING	9 1/4" x 9 1/4" [235mm x 235mm]	9 1/4" x 11 1/4" [235mm x 286mm]
MODULE DEPTH OVERALL	5" [127mm]	5" [127mm]
PANEL OPENING	8" x 8" [203mm x 203mm]	8" x 10" [203mm x 254mm]
COVER SIZE	7 11/16" x 7 11/16" [195mm x 195mm]	7 11/16" x 9 11/16" [195mm x 246mm]
ACTIVATION CHAMBER VOLUME	97.22 cubic inches [1593ml]	111.08 cubic inches [1820ml]
USER VOLUME	102.22 cubic inches [1674ml]	151.97 cubic inches [2490ml]
TOTAL VOLUME	199.22 cubic inches [3264ml]	262.97 cubic inches [4309ml]
KNOCKOUTS	Power – Four (4) 1/2"-3/4" Trade Size Concentric KOs Communication – Four (4) 1/2"-3/4" Trade Size Concentric KOs	
SERVICE	Single	Triple
MAXIMUM FLOOR THICKNESS	2" [51mm] (includes floor covering)	2" [51mm] (includes floor covering)

NOTE: For custom options, consult factory. All boxes are sold with one power plate: 4" [102mm] deep boxes have plate with two power duplex receptacle KOs, 5" [127mm] deep boxes have plate with four power duplex receptacle KOs. All communication plates sold separately.

Power Plates for AC8850 & AC8105 Raised Floor Boxes Ordering Information

P8105-4DP Double-Gang Power Plate

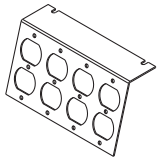

Four (4) duplex KOs. One plate supplied with AC8105 Box.

P8850-4DP Power Plate

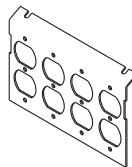

Four (4) duplex KOs. One plate supplied with AC8850 Box.

* AC8850 is a single-service box. Power plates cannot be used in conjunction with communication plates.

Communication Plates for AC8850 & AC8105 Raised Floor Boxes Ordering Information

C8005P-3DBP* Communication Plate

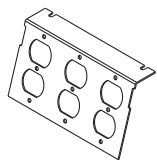

Three (3) duplex KOs for 106 communication style adapter. Fits both AC8850 and AC8105 Boxes.

C8850P-RT*, C8850P-2RT* Communication Plate

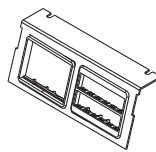

For AC8850 Box. Includes one (1) or two (2) Ortronics® Series II and one (1) or two (2) TracJack adapter(s).

C8850P-ACT*, C8850P-2ACT* Communication Plate

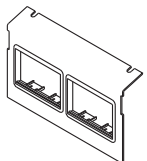

For AC8850 Box. Includes one (1) (C8850P-ACT) or two (2) (C8850P-2ACT) Wiremold CM Series Open System adapter(s).

C8005P-3RT* Communication Plate

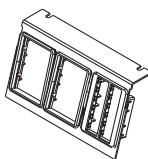

For AC8850 and AC8105 Boxes. Includes three (3) Ortronics® Series II and three (3) TracJack adapters.

AC™ SERIES FLOOR BOXES

Communication Plates for AC8850 & AC8105 Raised Floor Boxes Ordering Information

C8005P-3ACT* Communication Plate

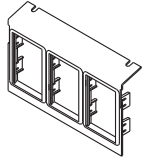

For AC8850 and AC8105 Boxes. Includes three (3) 6A Wiremold CM Series Open System adapters.

C8005P-AAP-6A* Internal Audio/Video Plate

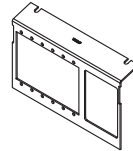

Accepts six (6) Extron® Electronics AAP Series Devices (Sold Separately) and one (1) CM communication adapter.

NOTE: For use in AC8105 style box.

C8005P-MAAP-6A* Internal Audio/Video Plate

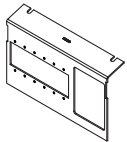

Accepts six (6) Legrand AVIP or Extron® Electronics MAAP Series Devices (Sold Separately) and one (1) CM communication adapter.

NOTE: For use in AC8105 style box.

* AC8850 is a single-service box. Power plates cannot be used in conjunction with communication plates.

Communication Plates for AC8850 & AC8105 Raised Floor Boxes Ordering Information

AC8840, AC8104 Raised Floor Boxes

The AC8840 and AC8104 are boxes with a 4" [102mm] depth design, with the AC8104 providing an extra 2" [51mm] of width for added wiring capacity. These boxes can accommodate two duplex power receptacles on one side. Power plate with duplex knockouts included with box. The communication plate will accept two communication adapters for up to 12 ports of activation. Lids can be rotated 180° for easy orientation. Gray lids are die-cast zinc construction.

AC8840

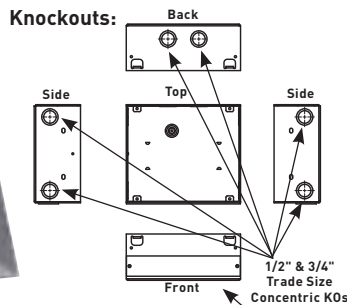

AC8104

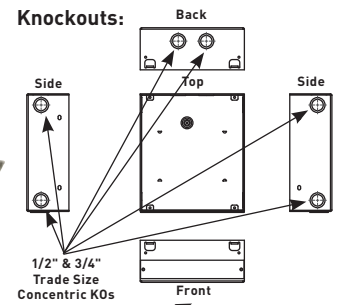

NOTE: Plate is removable for greater depth capacity.

Specifications

DESCRIPTION	AC8840 DIMENSIONS	AC8104 DIMENSIONS
BOX DIMENSIONS	8" x 8" x 4" [203mm x 203mm x 102mm]	8" x 10" x 4" [203mm x 254mm x 102mm]
OVERALL TRIM RING	9 1/4" x 9 1/4" [235mm x 235mm]	9 1/4" x 11 1/4" [235mm x 286mm]
MODULE DEPTH OVERALL	4" [102mm]	4" [102mm]
PANEL OPENING	8" x 8" [203mm x 203mm]	8" x 10" [203mm x 254mm]
COVER SIZE	7 11/16" x 7 11/16" [195mm x 195mm]	7 11/16" x 9 11/16" [195mm x 246mm]
ACTIVATION CHAMBER VOLUME	63.92 cubic inches [1047ml]	76.87 cubic inches [1260ml]
USER VOLUME	84.34 cubic inches [1382ml]	130.09 cubic inches [2131ml]
TOTAL VOLUME	152.34 cubic inches [2496ml]	201.09 cubic inches [3295ml]
KNOCKOUTS	Power – Four (4) 1/2"-3/4" Trade Size Concentric KOs Communication – Two (2) 1/2"-3/4" Trade Size Concentric KOs	
SERVICE	Single	Dual
MAXIMUM FLOOR THICKNESS	2" [51mm] (includes floor covering)	2" [51mm] (includes floor covering)

NOTE: For custom options, consult factory. All boxes are sold with one power plate: 4" [102mm] deep boxes have plate with two power duplex receptacle KOs, 5" [127mm] deep boxes have plate with four power duplex receptacle KOs. All communication plates sold separately.

AC™ SERIES FLOOR BOXES

Power Plates for AC8840 & AC8104 Raised Floor Boxes Ordering Information

P8840-2DP Power Plate

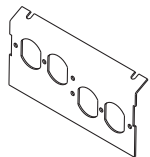

Two duplex KOs. One (1) plate supplied with AC8840 Box.

C8004P-2DBP Communication Plate

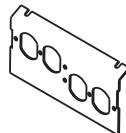

Two duplex KOs. For AC8840 and AC8104 Boxes.

NOTE: AC8840 is a single-service box. Power plates cannot be used in conjunction with communication plates.

P8104-2DP Power Plate

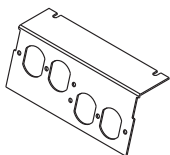

Two duplex KOs. One (1) plate supplied with AC8104 Box.

Communication Plates for AC8840 & AC8104 Raised Floor Boxes Ordering Information

C8004P-2ACT Communication Plate

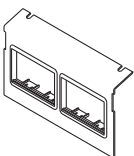

For AC8840 and AC8104 Boxes. Includes two (2) Wiremold CM Series Open System adapters.

C8004P-2RT Communication Plate

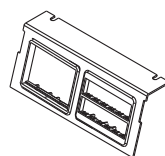

For AC8840 and AC8104 Boxes. Includes two (2) Ortronics® Series II adapters and two (2) TracJack adapters.

NOTE AC8840 is a single-service box. Power plates cannot be used in conjunction with communication plates.

AC™ SERIES FLOOR BOXES

AC Series Raised Floor Boxes Ordering Information

Specifications

DESCRIPTION	DIMENSIONS
BOX DIMENSIONS	10" x 10" x 5" [254mm x 254mm x 127mm]
OVERALL TRIM RING	11 1/2" x 11 1/2" [292mm x 292mm]
MODULE DEPTH OVERALL	5" [127mm]
PANEL OPENING	10" x 10" [254mm x 254mm]
COVER SIZE	9 5/8" x 9 5/8" [245mm x 245mm]
ACTIVATION CHAMBER VOLUME	115 cu in. [1884ml]
USER VOLUME	243 cu in. [3981ml]
TOTAL VOLUME	358 cu in. [5865ml]
KNOCKOUT SIZES	Power – Four (4) 1/2" Trade Size Concentric KOs Communication – Four (4) 1/2" Trade Size Concentric KOs
SERVICE	Triple
MAXIMUM FLOOR THICKNESS	2" [51mm] (includes floor covering)

AC10105-2 Raised Floor Box



The AC10105-2 box with a 5" [127mm] depth is a square profile box that provides eight-gangs of power and/or communication device capacity. Power plate with duplex knockouts included with box. The AC10105-2 also provides increased plug-in volume which is ideal for the additional space needed when plugging in transformer type plugs. Lids can be rotated 180° for easy orientation. Gray lids are die-cast zinc construction.

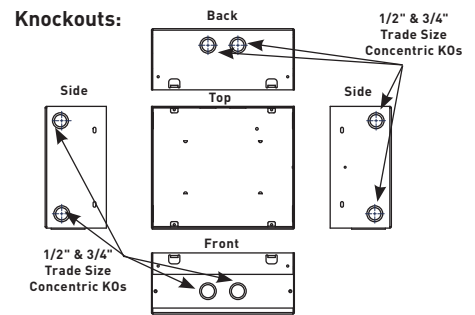

Power Plates for AC10105-2 Raised Floor Box Ordering Information

P10105-4DP Double-Gang Power Plate

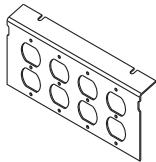

Four duplex KOs. One supplied with AC10105-2 Box.

P10105-5DP Double-Gang Power Plate

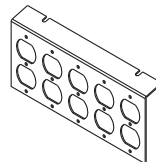

Five duplex KOs for AC10105-2 Box.

Communication Plates for AC10105-2 Raised Floor Box Ordering Information

C10105P-B Communication Plate

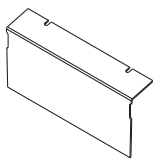

Blank. For AC10105 Box.

C10105P-3RT Communication Plate

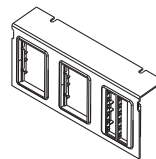

For AC10105 Box. Includes three (3) Ortronics® Series II adapters and three (3) TracJack adapters.

C10105P-3ACT Communication Plate

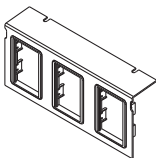

For AC10105 Box. Includes three (3) Wiremold CM Series Open System adapters.

C10105P-MAAP-6A Internal Audio/Video Plate

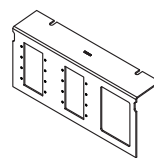

Accepts eight (8) Legrand AVIP or Extron® Electronics MAAP Series Devices (Sold separately) and one (1) CM Series communication adapter.

C10105P-AAP-6A Internal Audio/Video Plate

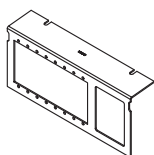

Accepts eight (8) Extron® Electronics AAP Series Devices (Sold separately) and one (1) CM Series communication adapter.

CRFB SERIES™ FLOOR BOXES



CRFB Series Floor Boxes are round recessed floor boxes designed to meet the functionality and flexibility requirements of the raised and wood floor markets.

CODE REFERENCE

UL Listed Classified Raised Floor Box:
File E2961, Guide QCIT.

UL Listed Classified Raised Floor Box (prewired):
File E51105, Guide QQVX.
Meets Article 314 of NEC.
Meets Article 12-2500 of CEC.



New egress design for CRFB Series Floor Box Covers offers larger wire/cable egress with locking feature.

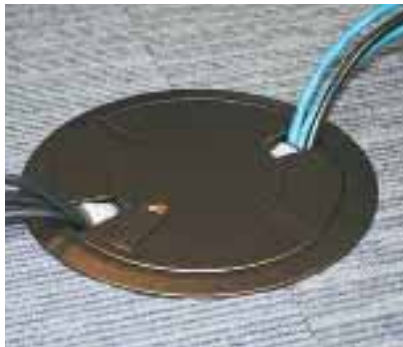

Cables egress from a CRFB Series Floor Box with Evolution Series Poke-Thru Cover.



CRFB Series four-compartment configurable box.

COLOR OPTIONS



CRFB Series Floor Boxes Cover and Evolution™ Series Poke-Thru Covers are available in black, brass, nickel, bronze, and gray finishes.

CRFB SERIES™ FLOOR BOXES

CRFB Series Floor Boxes Assembly Details

CRFB-Housing

The housing is die-cast aluminum construction with stamped steel bottom plate.

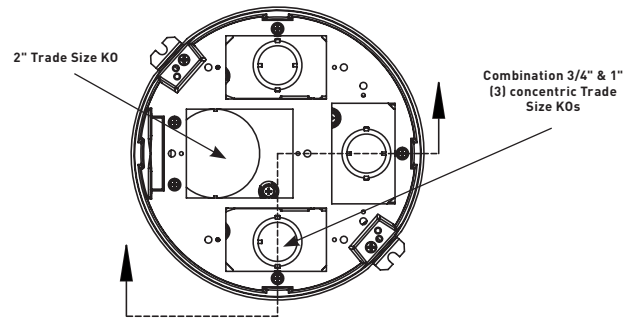
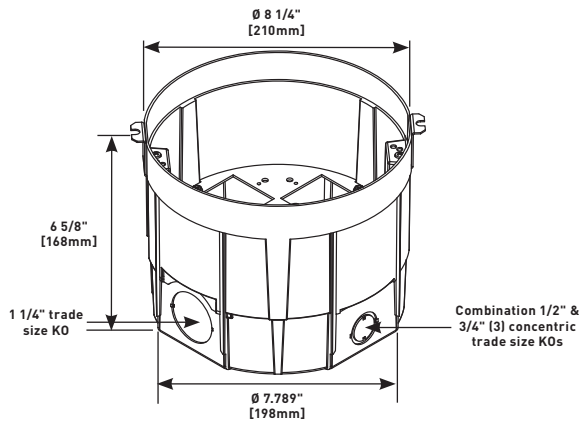

COMPARTMENT DEPTH

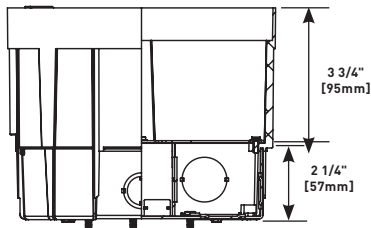

COMPARTMENT VOLUMES

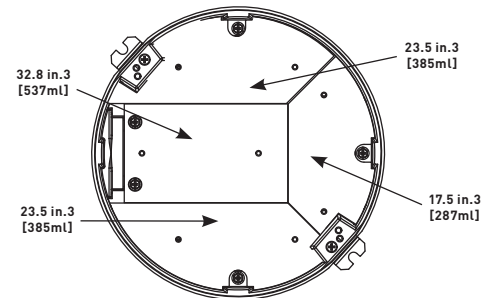

CRFB Series Round Raised Floor Boxes Ordering Information

CRFB4 CRFB Housing

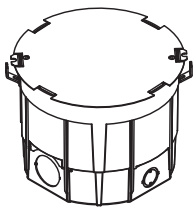

Die-cast aluminum construction with stamped steel bottom plate. Includes 3 duplex receptacle plates, 1 center communication plate and 3 cable pass through grommets for 1" trade size tunnel.

NOTE: Floor thickness range (including floor covering) 3/8" - 2" [9.5mm - 51mm].

CRFBBTC Surface Style Cover Assembly

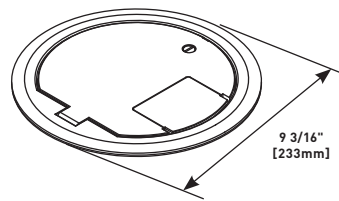

Available in die cast aluminum with a painted black (CRFBBTCBK), brass (CRFBBTCBS), nickel (CRFBBTCNK), bronze (CRFBTCBZ) or gray (CRFBTCGY) finish. No cutouts are provided for floor coverings.

CRFBCTC Surface Style Cover Assembly

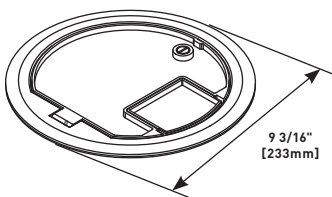

Available in die cast aluminum with a painted black (CRFBCTCBK), brass (CRFBCTCBS), nickel (CRFBCTCNK), bronze (CRFBCTCBZ) or gray (CRFBCTCGY) finish. Insert areas allow for tile or carpet cutouts to match finished floor.

CRFBCTC-TR Tamper Resistant Surface Style Cover Assembly

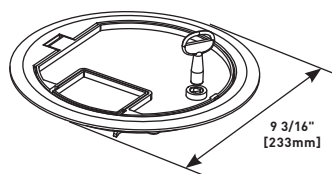

Lid has built-in key locking feature for tamper resistance. Insert areas allow for tile or carpet cutouts to match finished floor.

Available in die cast aluminum with a painted black (CRFBCTCBKTR), brass (CRFBCTCBSTR), nickel (CRFBCTCNKTR), bronze (CRFBCTCBZTR) or gray (CRFBCTCGYTR) finish.

CRFB SERIES™ FLOOR BOXES

CRFB Series Round Raised Floor Boxes Ordering Information

CRFB-TUN Tunnel

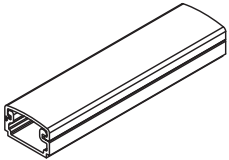

Tunnel allows the two outer compartments to be utilized for one service while the center two compartments are utilized for other services.

CRFBBTC-TR Tamper Resistant Surface Style Cover Assembly

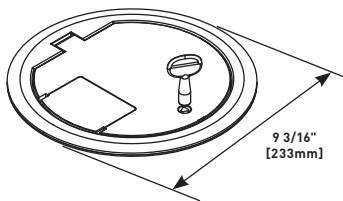

Available in die cast aluminum with a painted black (CRFBBTCBKTR), brass (CRFBBTCBSTR), nickel (CRFBBTCNKTR), bronze (CRFBBTCBZTR) or gray (CRFBBTCGYTR) finish. No cutouts are provided. Lid has built-in key locking feature for tamper resistance.

8CTC Surface Style Cover Assembly

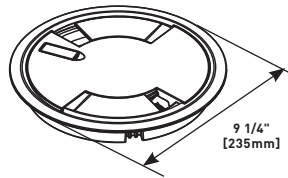

Die-cast aluminum cover assembly. Cover assembly is available in the following painted finishes: (8CTCBK) black, (8CTCGY) gray, (8CTCNK) nickel, (8CTCBS) brass, or (8CTCBZ) bronze.

NOTE: Add suffix "TR" to the end of the part number to indicate tamper-resistant cover assembly.

8CT Flush Style Cover Assembly

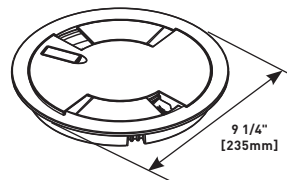

Die-cast aluminum cover assembly. Cover assembly is available in the following painted finishes: black (8CTBK), gray (8CTGY), nickel (8CTNK), brass (8CTBS), or bronze (8CTBZ).

NOTE: Add suffix "TR" to the end of the part number to indicate tamper-resistant cover assembly.

CRFB Series Device Plates for Location 1 Ordering Information

CRFB-B-1 Blank Device Plate #1



Used to close off unused gang.

CRFB-D-1 Duplex Device Plate

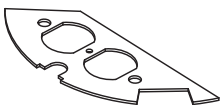

Accepts standard 15A and 20A duplex receptacles.

CRFB-GFI-1 GFCI/Decorator Plate

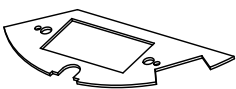

Accepts standard GFCI or Decorator style receptacles.

CRFB-SR1-1 1.39" [35mm] Device Plate



Accepts single device 1.39" [35mm]

CRFB-AB-1 Communication Device Plate

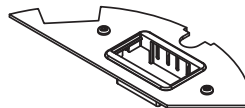

Accepts two (2) ports of communication devices. Includes one (1) Wiremold CM Series Open System adapter and inserts.

CRFB-RT-1 Communication Device Plate

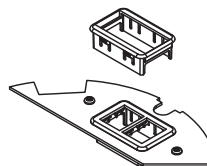

Accepts two (2) ports of communication devices. Includes one (1) Ortronics® Series II and one (1) Tracjack adapter.

Device Plate Location #1

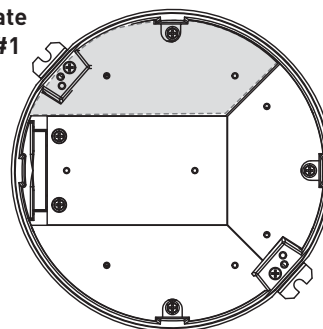

NOTE: Standard size for device plates for Plate Location 1 is 6 11/32" [161mm] x 2 3/4" [62mm].

CRFB SERIES™ FLOOR BOXES

CRFB Series Device Plates for Location 2 Ordering Information

CRFB-B-2 Blank Device Plate #2

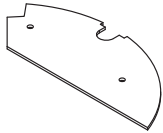

Used to close off unused gang.

CRFB-AB-2 Communication Device Plate

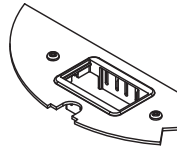

Accepts two (2) ports of communication devices. Includes one (1) Wiremold CM Series Open System adapter and inserts.

CRFB-D-2 Duplex Device Plate

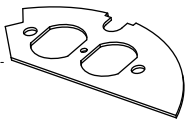

Accepts standard 15A and 20A duplex receptacles.

CRFB-RT-2 Communication Device Plate

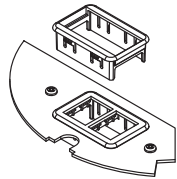

Accepts two (2) ports of communication devices. Includes one (1) Ortronics® Series II and one (1) Tracjack adapter.

CRFB-GFI-2 GFCI/Decorator Plate

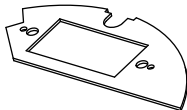

Accepts standard GFCI or Decorator style receptacles.

Device Plate Location #2

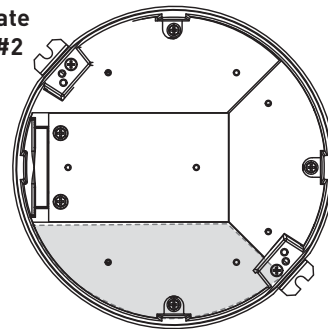

CRFB-SR1-2 1.39" [35mm] Device Plate

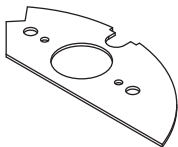

Accepts single device 1.39" [35mm]

NOTE: Standard size for device plates for Plate Location 2 is 5 7/32" [132mm] x 2 3/4" [62mm].

CRFB-SR2-2 1.60" [41mm] Device Plate

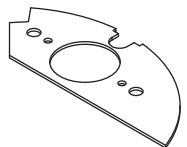

Accepts single device 1.60" [41mm]

CRFB Series Device Plates for Location 3 Ordering Information

CRFB-B-3 Blank Device Plate #3



Used to close off unused gang.

CRFB-GFI-3 GFCI/Decora Plate



Accepts standard GFCI or Decora style receptacles.

CRFB-D-3 Duplex Device Plate



Accepts standard 15A and 20A duplex receptacles.

CRFB-SR1-3 1.39" [35mm] Device Plate



Accepts single device 1.39" [35mm].

CRFB SERIES™ FLOOR BOXES

CRFB Series Device Plates for Location 3 Ordering Information (continued)

CRFB-AB-3 Communication Device Plate

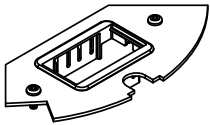

Accepts two (2) ports of communication devices. Includes one (1) Wiremold CM Series Open System adapter and inserts.

CRFB-RT-3 Communication Device Plate

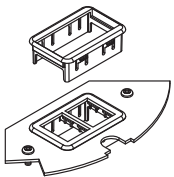

Accepts two (2) ports of communication devices. Includes one (1) Ortronics® Series II and one (1) Tracjack adapter.

Device Plate Location #3

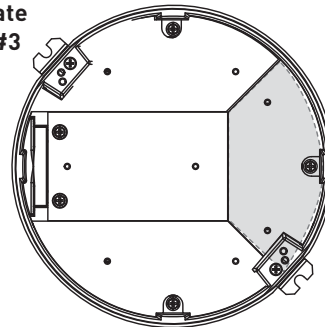

NOTE: Standard size for device plates for Plate Location 3 is 5 7/32" [132mm] x 2 3/4" [62mm].

CRFB Series Device Plates for Location 4 Ordering Information

CRFB-BEZ6A-4 Center 6A Comm Adapter

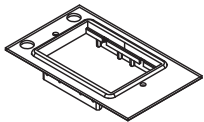

6A communications plate. Includes: (1) 6A Wiremold Open System Adapter, (1) Ortronics Series II Adapter, (1) Ortronics TracJack Adapter. Modular jacks sold separately.

CRFB-MAAP-4 Extron® MAAP Plate

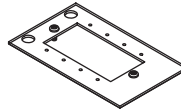

Holds four (4) Legrand AVIP or Extron® Electronics MAAP device plates.

CRFB-B-4 Center Blank Plate

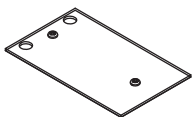

Used to close off unused gang.

CRFB-6COM-4 Center Communication Plate

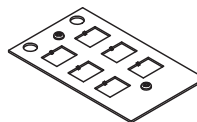

Communication plate with six (6) RJ knockouts. Modular jacks sold separately.

CRFB-D-4 Center Duplex Plate

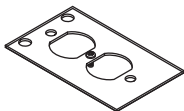

Accepts standard 15A and 20A Duplex Receptacles.

Device Plate Location #4

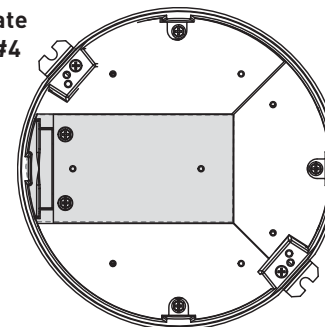

NOTE: Standard size for device plates for Plate Location 4 is 5 7/32" [132mm] x 2 3/4" [62mm].

CRFB-GFI-4 Center Decorator Style Plate

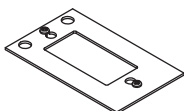

Accepts standard GFCI or Decorator Style Receptacles.

CRFB-SR1-4 Center 1.39" [35mm] Device Plate

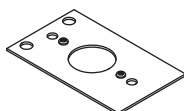

Accepts single device 1.39" [35mm].

CCFB SERIES™ CONVENTION CENTER SERIES PRODUCTS

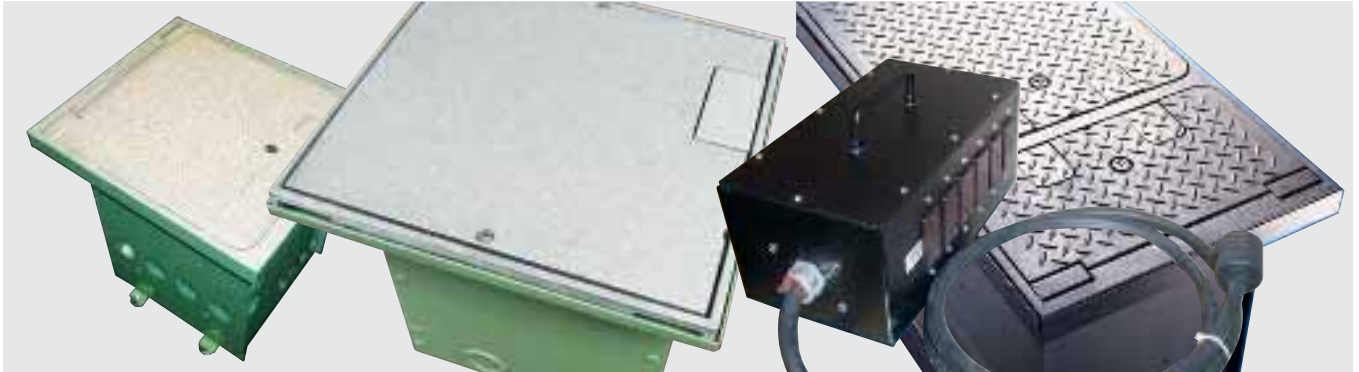

Convention Center Series™ Products are industry leading solutions for providing multiple utilities services directly to the show room.



Available Prewired Electrical Sub-Assembly

Water services (W) available. If water services are required, a main divider is automatically added to isolate the electrical/communications compartments from the water compartment. Compressed air services are also available.



Circuit Breakers
(Prewired to Receptacles)

100A Watertight Pin
and Sleeve Device



Drain Compartment

Water & Compressed
Air Utilities

CCFB SERIES™ CONVENTION CENTER SERIES PRODUCTS

CCFB Ballroom Floor Boxes Ordering Information

CCFB-XXXX Multi-Utility Recessed Floor Box

Designed to accept power, communication and audio/video devices, water and compressed air. CCFB boxes are available in four (4) different finishes: unpainted G90 galvanized steel (UGS), painted galvanized steel (PGS), stainless steel (USS) and painted stainless steel (PSS). Cast aluminum cover assembly has a peened textured finish. Provided with a carpet cut-out area and is designed to meet loads up to 64,000 lbs.

TYPE S BOX

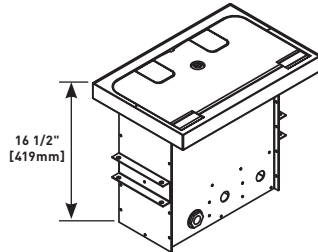
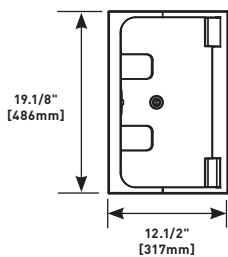

Cover Styles

CCFBC-NS-H-C1
CCFBC-NS-N-C1
CCFBC-CR-H-C1
CCFBC-CR-N-C1
CCFBC-BL-H-C1
CCFBC-BL-N-C1

CODE REFERENCE

cULus Listed Metallic Outlet Boxes:
File E317375 Guide AUUZ, AUU27.
Meets Article 314 & 408 of NEC.

Power Capabilities

- One (1) 100A 120/208V Pin and Sleeve Receptacle
- One (1) 100A 277/480V Pin and Sleeve Receptacle
- 20A Receptacles
- 20A Panel Mounted Circuit Breakers
- 350A 600V Terminal Blocks

TYPE SS BOX

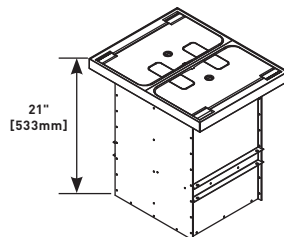
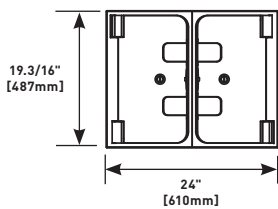

Cover Styles

CCFBC-NS-H-C3
CCFBC-NS-N-C3
CCFBC-CR-H-C3
CCFBC-CR-N-C3
CCFBC-BL-H-C3
CCFBC-BL-N-C3

Maximum Electric Ratings

- 140A, 480V 3 Phase
- 140A, 120/208V 3 Phase into Terminal Blocks
- 100A, 277/480V 3 Phase for individually wired Devices

TYPE L BOX

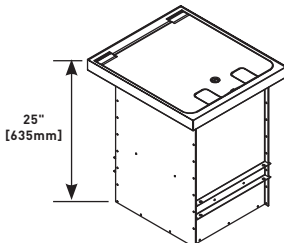
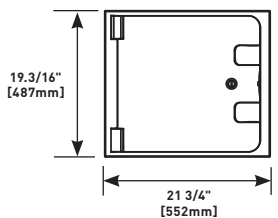

Cover Styles

CCFBC-NS-H-C2
CCFBC-NS-N-C2
CCFBC-CR-H-C2
CCFBC-CR-N-C2
CCFBC-BL-H-C2
CCFBC-BL-N-C2

Other Utilities

- Water
- Compressed Air

Note: Boxes and Device Plates are custom made to order. "-XXXX" in title denotes Project Number assigned by Wiremold Project Services Team.

Note: Boxes and Covers are shipped separately.

Note: Load was applied in the center of the cover over a 1" x 16" rectangular bar.

Note: Service feed openings are field installed.

TYPE LS BOX

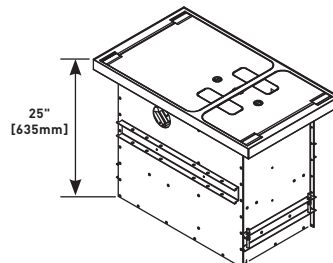
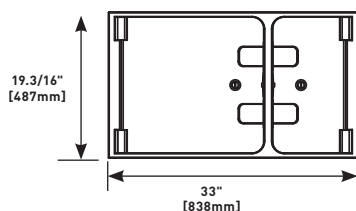

Cover Styles

CCFBC-NS-H-C4
CCFBC-NS-N-C4
CCFBC-CR-H-C4
CCFBC-CR-N-C4
CCFBC-BL-H-C4
CCFBC-BL-N-C4

TYPE LL BOX

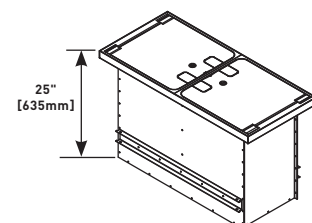
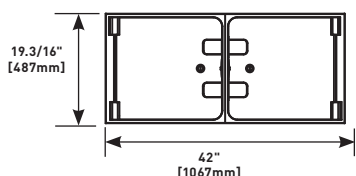

Cover Styles

CCFBC-NS-H-C5
CCFBC-NS-N-C5
CCFBC-CR-H-C5
CCFBC-CR-N-C5
CCFBC-BL-H-C5
CCFBC-BL-N-C5

CCFB SERIES™ CONVENTION CENTER SERIES PRODUCTS

CCFB Series Floor Boxes Replacement Parts Ordering Information

CCFB-EBCH Checked Egress Block

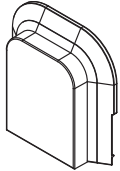

Replacement egress blocks with a diamond plate checkered pattern. Includes two egress blocks and hinges.

CCFB-PH Egress Hinge

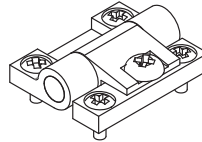

Replacement egress hinges. Includes two (2) hinges.

CCFB-EBCI Carpet Insert Egress Block

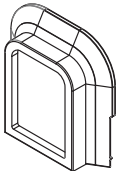

Replacement egress blocks with carpet. Includes two egress blocks and hinges.

CCFB-QT Quarter Turn Latch

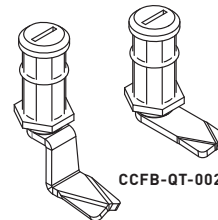

Quarter turn latch assembly allows cover to be secured down when cover is in closed position.

CCFB-HB Hinge Block Assembly

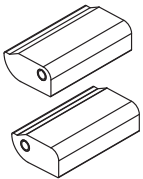

Replacement cover hinges. Includes a left and right hinge.

CCFB-QT-001

CCFB-QT-002

ITTBOX Series Floor Boxes Ordering Information

ITTBOX-XXXX 6-Gang Recessed Floor Box

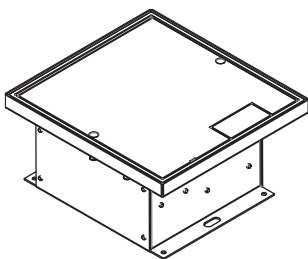

Accepts power, communications and audio/video devices. Available for above grade applications with G90 galvanized steel and epoxy coating for on-grade applications.

NOTE: Boxes and Device Plates are custom made to order. “-XXXX” in title denotes Project Number assigned by Wiremold Project Services Team.

NOTE: Boxes and Covers are shipped separately.

NOTE: Knockouts range from 1/2" to 2" trade size and are located per requirements.

CODE REFERENCE

cULus Listed Metallic Outlet Boxes:
File E2961 Guide QCIT.
Meets Article 314 NEC.

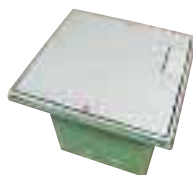

CCFB SERIES™ CONVENTION CENTER SERIES PRODUCTS

CCWB Series Wall Boxes Ordering Information

CCWB-XXXX Convention Center Wall Box

Available in recessed and wall mount versions. Available with key locks for increased security and are designed for power, communications and audio/video devices. Wall mount version available painted or in a paintable G60 material. Recessed wall box is available in a G90 steel material and the recessed wall box covers are available in a paintable G60 material.

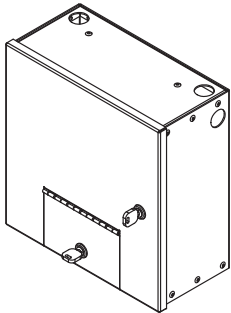

Surface Mounted Wall Box

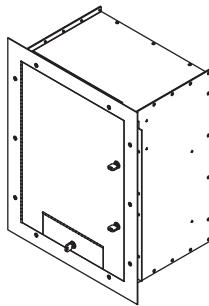

Recessed Wall Box

Power Capabilities

- One (1) 100A 120/208V Pin and Sleeve Receptacle
- One (1) 100A 277/480V Pin and Sleeve Receptacle
- 20A Receptacles
- 20A Panel Mounted Circuit Breakers
- 350A 600V Terminal Blocks

NOTE: Boxes and device plates are custom made to order. “-XXXX” in part number denotes project number assigned by Wiremold Project Services team.

Factory installed KOs per project requirements.

CODE REFERENCE

cULus Listed Metallic Outlet Boxes:
File E317375 Guide AUUZ, AUU27.
Meets Article 314 & 408 of NEC.

CCFB Series PDU Portable Power Distribution Units Ordering Information

PPDU-620 Power Distribution Unit

Designed to supply power to an exhibition hall. Available in a painted steel enclosure with six (6) GFCI (20A/120V) duplex receptacles, and six (6) single pole 20A, circuit breakers.

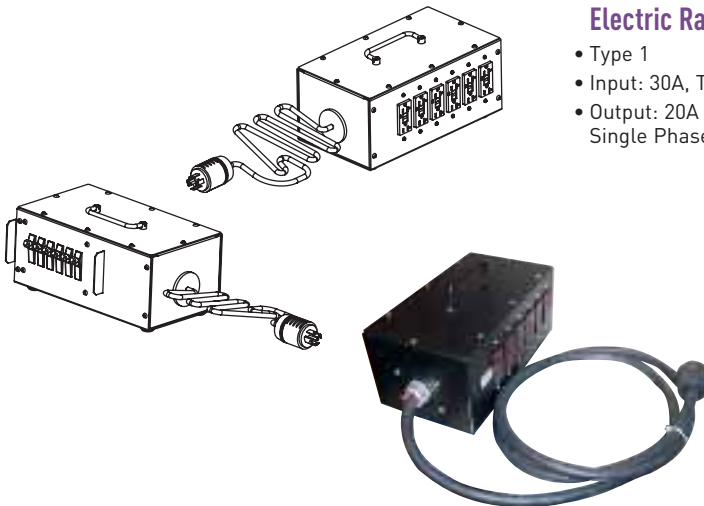

Electric Ratings

- Type 1
- Input: 30A, Three Phase 120/208V
- Output: 20A per Receptacle, Single Phase 120VAC

CODE REFERENCE

cULus Listed Portable Power Units & Devices:
File E302114 Guide QPSH.
Meets Article(s) 518, 520, 525, 530 & 590 of NEC.

CCBB SERIES™ BALLROOM FLOOR BOXES



CCBB Series™ Ballroom Floor Boxes are concrete floor boxes that have been designed for above-grade and on-grade applications.

CODE REFERENCE

UL Listed Commercial Appliance & Outlet Centers:
File E237584. Guide AUUZ, AUU27.
Meets Article 314 of NEC.

CCBB Series Ballroom Floor Boxes Ordering Information

CCBBS, CCBBS-OG 12-Gang Recessed Floor Box

Adjustable before concrete pour, provided with mudcap to prevent concrete entry during pour. Cover assembly and device plates sold separately. Available in a standard model for above grade applications (CCBBS) or with a painted epoxy coating for on grade applications (CCBBS-OG).

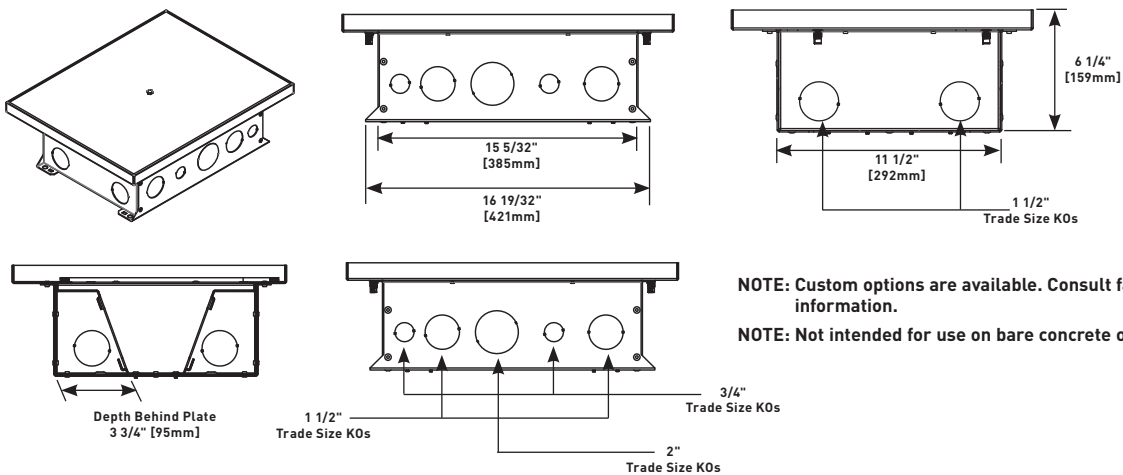

NOTE: Custom options are available. Consult factory for more information.
NOTE: Not intended for use on bare concrete or terrazzo floors.

COLOR OPTIONS



CCFB Series Floor Box covers are cast aluminum and available with a peened textured finish.

CCBB SERIES™ BALLROOM FLOOR BOXES

CCBB Series Ballroom Floor Boxes Ordering Information (continued)

CCBBSCTCAL Carpet Cover Assembly

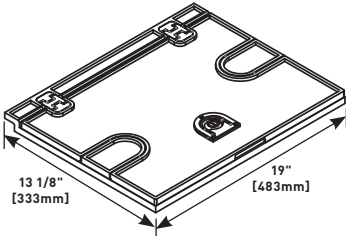

Cast aluminum cover assembly. Available in a peened textured finish. Provided with a carpet cut-out area. Load tested over 25,000 lbs.

NOTE: Load was applied in the center of the cover over a 1" x 14" rectangular bar. Covers are designed for use in floors with a floor covering of 1/4" [6.4mm] minimum. (Not intended for bare concrete or terrazzo applications.)

CCBBL-XXXX Recessed Floor Box

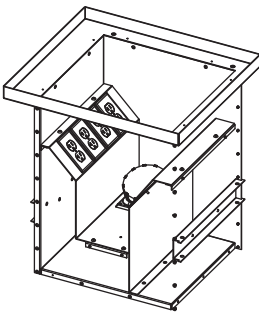

Box Depth:
25" [635mm]
Depth varies
based on
services included.

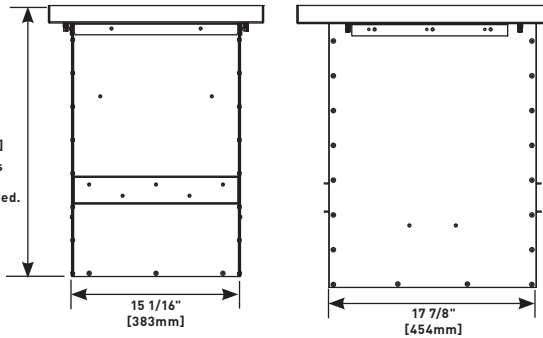

Designed to accept power, communication and A/V device.

Power Capabilities

- One (1) 100A 120/208V Pin and Sleeve Receptacle
- One (1) 100A 277/480V Pin and Sleeve Receptacle
- 20A Receptacles
- 20A Panel Mounted Circuit Breakers
- 350A 600V Terminal Blocks

Maximum Electric Ratings

- 140A, 480V 3 Phase
- 140A, 120/208V 3 Phase into Terminal Blocks
- 100A, 277/480V 3 Phase for individually wired Devices

NOTE: Boxes and Device Plates are custom made to order. "-XXXX" in title denotes Project Number assigned by Wiremold Project Services Team.

NOTE: Not intended for use on bare concrete or terrazzo floors.

NOTE: Service feed openings are field installed.

CCBBLCTCAL Carpet Cover Assembly

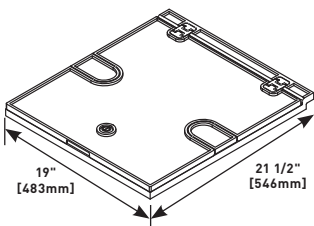

Cast aluminum cover assembly. Available in a peened textured finish. Provided with a carpet cut-out area. Load tested over 30,000 lbs.

NOTE: Load was applied in the center of the cover over a 1" x 14" rectangular bar. Covers are designed for use in floors with a floor covering of 1/4" [6.4mm] minimum. (Not intended for bare concrete or terrazzo applications.)

CCBB SERIES™ BALLROOM FLOOR BOXES

Ordering Information and Small Ballroom Floor Boxes Device Plate Installation information

CCBBS Small Ballroom Series Floor Boxes Device Plate Installation Information

Multi-Gang Mounting Brackets Used with Sectional Device Plates

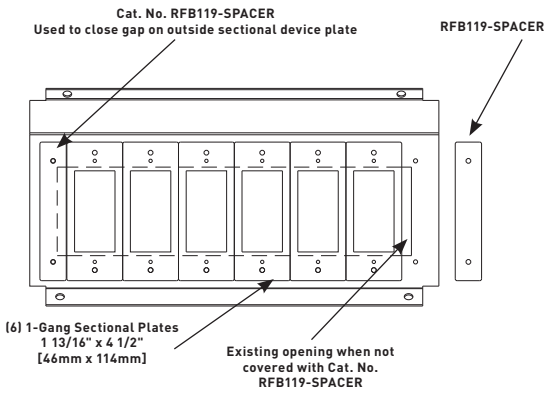

Multi-Gang Mounting Brackets Used with Standard Device Plates

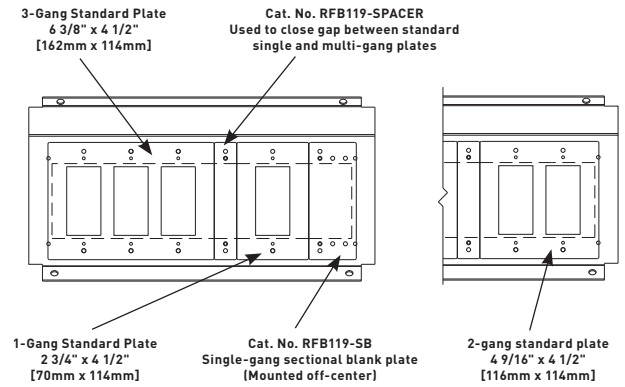

CCBB SERIES™ BALLROOM FLOOR BOXES

CCBBS Series Floor Boxes Steel Sectional Device Plates Ordering Information

RFB119-SB, RFB119-2SB, RFB119-3SB Blank Device Plate

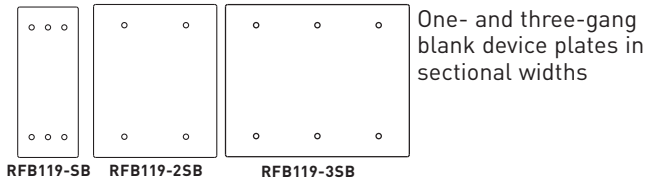

RFB119-SKO Combination 1/2" & 3/4" Trade Size Knockout Device Plate

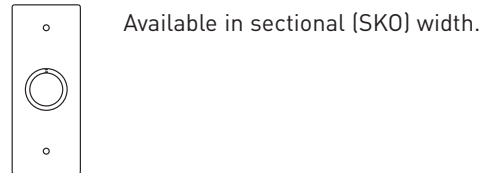

RFB119-SGFI GFI Receptacle Device Plate

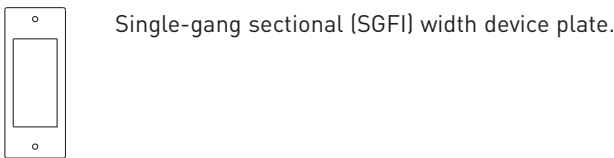

RFB119-2SAB Communication Device Plate

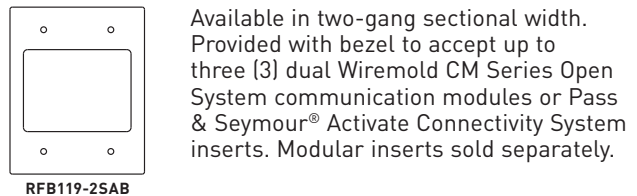

RFB119SD Duplex Receptacle Device Plate

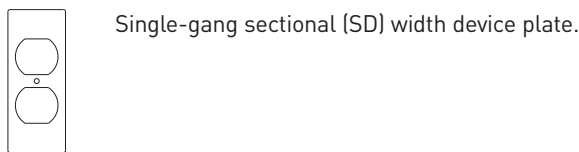

RFB119-2SRT Communication Device Plate

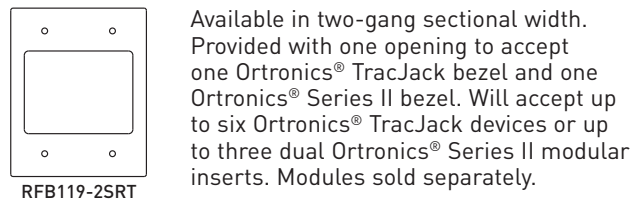

RFB119-SSR1, RFB119-SSR2 Single Receptacle Device Plate

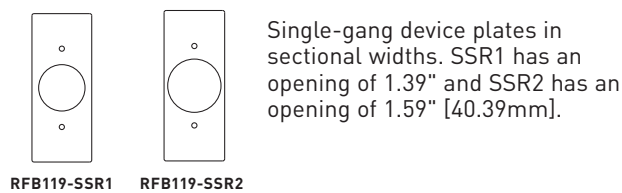

CCBBS-DIV Relocatable Divider

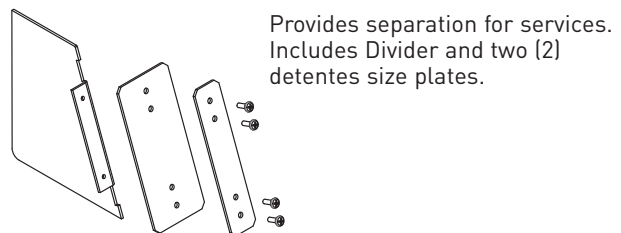

RFB119-AAP Device Plate

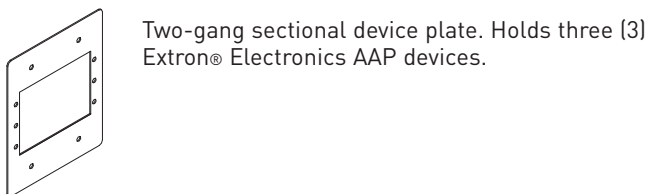

RFB119-XLR Microphone Device Plate

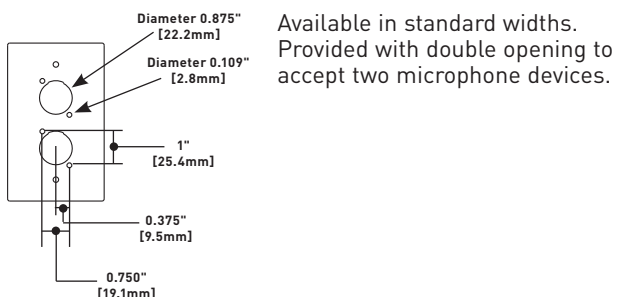

CCBB SERIES™ BALLROOM FLOOR BOXES

CCBBS Floor Boxes Steel Standard Device Plates Ordering Information (continued)

RFB119-Spacer Spacer Plate



Used to close off openings when certain combinations of standard width device plates leave open spaces. Four (4) spacer plates are included with the RFB11 and two (2) with the RFB9.

CCBBS-DIV Relocatable Divider

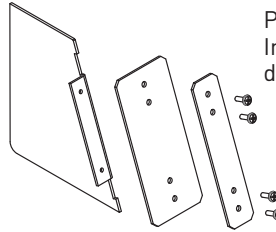

Provides separation for services. Includes Divider and two (2) different size plates.

RFB119-B, RFB119-3B, RFB119-SB Blank Device Plate

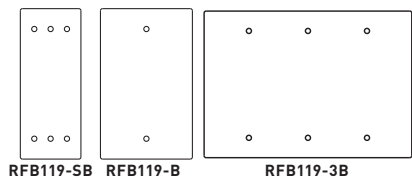

One-, two- and three-gang blank device plates in sectional (SB) widths

RFB119-MAAP Device Plate

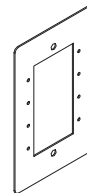

One-gang standard device plate. Holds four (4) Legrand AVIP or Extron® Electronics MAAP devices.

RFB119-GFI, RFB119-3GFI GFI Receptacle Device Plates

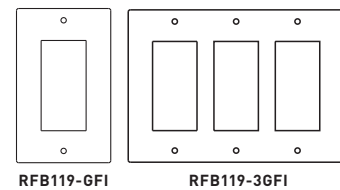

One- and three-gang device plates in standard (GFI) widths.

RFB119-KO Combination 1/2" & 3/4" Trade Size knockout Device Plates

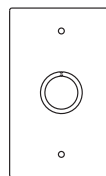

Available in standard (KO) widths.

RFB119-D, RFB119-3D Duplex Receptacle Device Plates

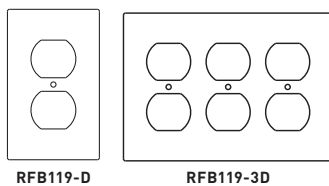

One- and three-gang device plates in standard (D) widths.

RFB119-AB Communication Device Plate

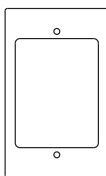

Available in standard width. Provided with bezel to accept up to three (3) dual Wiremold CM Series Open System communication modules or Pass & Seymour® Activate Connectivity System inserts. Modules and inserts sold separately.

RFB119-SR1, RFB119-SR2, RFB119-SR3 Single Receptacle Device Plates

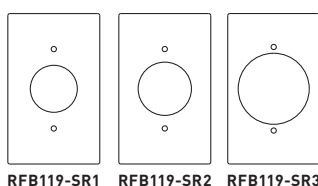

One-device plates in standard (SR) widths. SR1 has an opening of 1.39" [35.31mm]. SR2 has an opening of 1.59" [40.39mm]. SR3 has a 2.14" [54.36mm] opening.

RFB119-RT Communication Device Plate

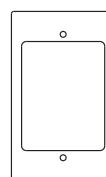

Available in standard width. Provided with one opening to accept one Ortronics® TracJack bezel and one Ortronics® Series II bezel. Will accept up to six Ortronics® TracJack devices or up to three dual Ortronics® Series II modular inserts. Modular inserts and devices sold separately.

NOTE: Sectional device plates allow for custom configuration of a multi-gang plate that conforms to the standard NEMA 1.812" (1 13/16") [46.02mm] center-to-center spacing. RFB11 and RFB9 will also accept industry standard and standard sectional device plates from most manufacturers.

CCBB SERIES™ BALLROOM FLOOR BOXES

CCBBS Floor Boxes Steel Standard Device Plates Ordering Information (continued)

RFB119-XLR Microphone Device Plate

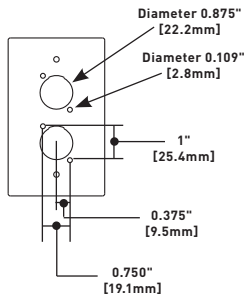

Available in standard widths. Provided with double opening to accept two microphone devices.

RFB119-Spacer Spacer Plate





Used to close off openings when certain combinations of standard width device plates leave open spaces. Four (4) spacer plates are included with the RFB11 and two (2) with the RFB9.

SERVICE FITTINGS & ACTIVATION ACCESSORIES



Wiremold® Service Fittings and Activation Accessories are designed to offer the highest level of flexibility relating to point of use for both power and communications while adapting to both new and retrofit construction.

Featured Products	 Floorport™ Series Cover Assemblies 498	 Pro Series Flanges 503
-------------------	---	--

525 Series™ Service Fittings



1200 Series™ Service Fittings



Multiplex™ Series Service Fittings



SERVICE FITTINGS & ACTIVATION ACCESSORIES

Table of Contents

525 & Multiplex™ Series Activation Accessories



Source I® Service Fittings



Floorport™ Series Cover Assemblies



PSRC9 Series™ Service Fittings



®Walkerduct Pro Service Service Fittings



SERVICE FITTINGS & ACTIVATION ACCESSORIES

Quick Selection Guide

PRODUCT FAMILY	CATALOG NUMBER	SYSTEM COMPATIBILITY				ACTIVATION LOCATION			SERVICE CAPACITY			SERVICE COMPATIBILITY			MATERIAL/COLORS						
		WALKERDUCT	WALKERCELL	FLUSHDUCT	TRENCHDUCT	Flush	Recessed	Pedestal	Single Service	Dual Service	Triple Service	Power	Communication	Audio/Visual	Polycarbonate	Aluminum	Brass	Gray	Black	Nickel	Bronze
FloorPort	FPCTC Series		•				•			•	•	•	•		•	•	•	•	•	•	•
	FPBTC Series		•				•			•	•	•	•		•	•	•	•	•	•	•
	FPPFTC Series		•				•			•	•	•	•		•	•	•	•	•	•	•
	FPCT Series		•				•			•	•	•	•		•	•	•	•	•	•	•
	FPBT Series		•				•			•	•	•	•		•	•	•	•	•	•	•
	FPPFT Series		•				•			•	•	•	•		•	•	•	•	•	•	•
Pro Series Flanges	817B	•				•			•		•	•				•					
	827B	•				•				•	•	•				•					
	837B	•				•				•	•	•				•					
	817PCC	•				•			•		•	•		•					•		
	827PCC	•				•				•	•	•		•					•		
	837PCC	•				•				•	•	•		•					•		
	818TCAL	•				•			•		•	•			•						
	828TCAL	•				•				•	•	•			•						
	838TCAL	•				•				•	•	•			•						
Source I	S165B	•				•			•		•					•					
	S165BLK/BRN	•				•			•				•						•		
	S166B	•				•			•		•					•					
	S166BLK/BRN	•				•			•		•			•					•		
	S175BLK/BRN	•				•			•		•			•					•		
PSRC9 Series	PSRC9TC	•				•			•		•				•	•	•	•			
	PSRC9AMDTC	•				•			•			•			•	•	•	•			
	PSRC9FFTC	•				•			•			•			•	•	•	•			
1200 Series	1204BF	•	•						•	•		•				•					
	1204AL	•	•						•	•		•			•						
	1223BF	•	•						•	•		•				•					
	1223AL	•	•						•	•		•			•						
Multiplex	MP4	•	•	•			•	•			•	•	•		•						
	MP8	•		•			•		•		•	•	•		•						
	MP8-1	•	•	•			•		•		•	•	•		•						
525 Series	525A	•	•	•			•	•			•	•			•						
	525B	•	•	•			•	•			•	•			•						
	525C	•	•	•			•	•			•	•			•						
	525D	•	•	•			•	•			•	•			•						
	525F	•	•	•			•	•			•				•						
	525G	•	•	•			•	•			•				•						
	525H	•	•	•			•	•			•				•						
	525I	•	•	•			•	•			•				•						
	525J	•	•	•			•	•			•	•	•		•						
	525RT	•	•	•			•	•			•				•						
525ACT	•	•	•			•	•			•				•						•	

525 SERIES™ SERVICE FITTINGS



525 Series Service Fittings deliver the flexibility of interchangeable faceplates and the durability to withstand multiple adds, moves and changes.

CODE REFERENCE

cULus Listed Underfloor Raceway Fittings:
File E11912, Guide RQXX
Meets Article 390 of NEC

525 Series Service Fittings Installation Details

1. Typical installation diagram to adapt 525 Series Service Fittings to underfloor duct or cellular raceway: 2" [51mm] IPS Preset or afterset inserts.

2. Typical installation diagram to adapt 525 Series Service Fittings to Flushduct (1 5/8" [41mm] opening).

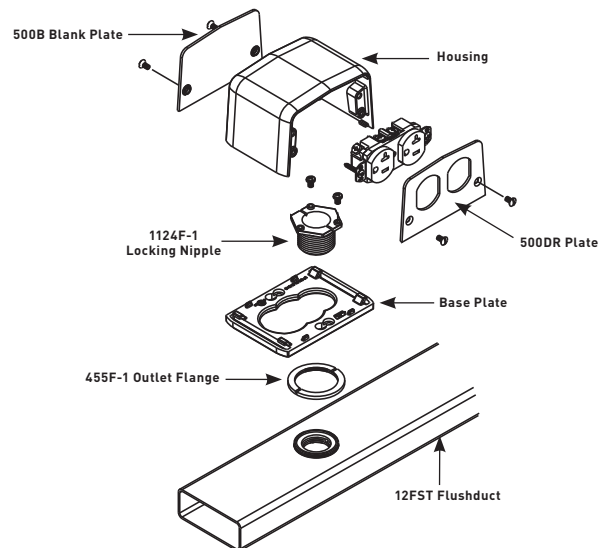
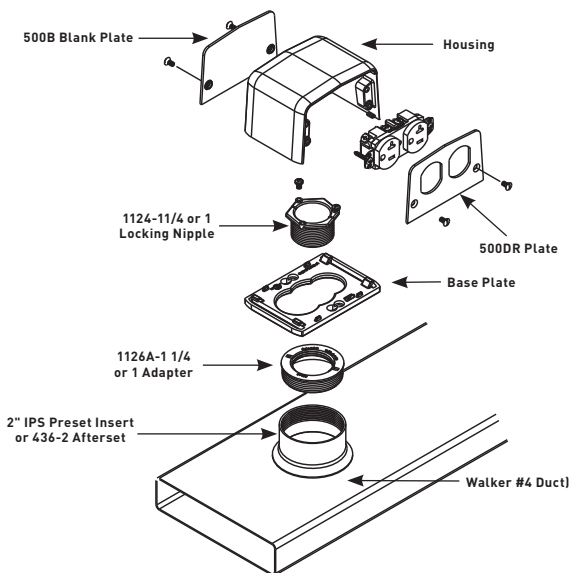

COLOR OPTIONS

All 525 Series Service Fittings are brushed aluminum finish unless otherwise specified in the part number description.
Custom color options are also available. Consult the factory for more information.

525 SERIES™ SERVICE FITTINGS

525 Series Service Fittings Ordering Information

525RT Four-Piece Communication Service Fitting

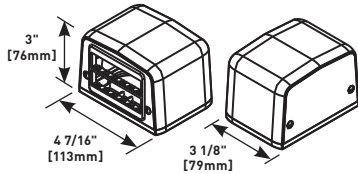

Includes faceplate with opening one side. Ortronics® Series II and TracJack adapters included.

525D Four-Piece Communication Service Fitting

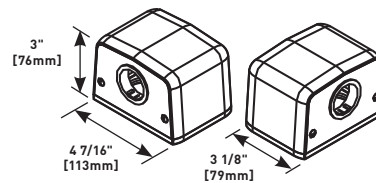

1 1/4" [32mm] I.D. grommeted hole on both sides.

525ACT Four-Piece Communication Service Fitting

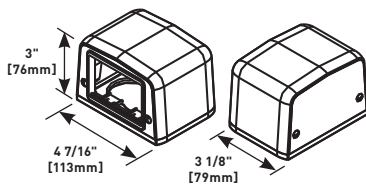

6A opening with communication adapter on one side. Accommodates Wiremold Open System communication modules.

525F Four-Piece Power Service Fitting

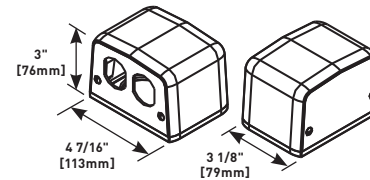

Duplex opening one side. Receptacle not included.

525A Four-Piece Communication Service Fitting

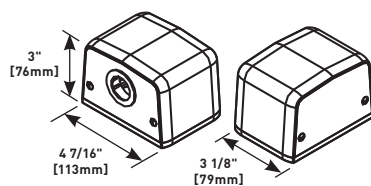

1" [25mm] I.D. grommeted hole one side. Blank plate other side.

525G Four-Piece Power Service Fitting

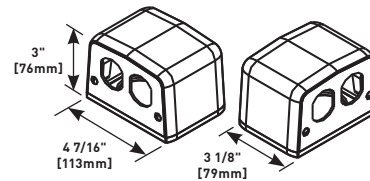

Duplex opening both sides. Receptacles not included.

525B Four-Piece Communication Service Fitting

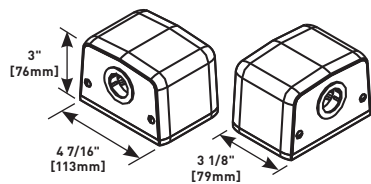

1" [25mm] I.D. grommeted hole two sides.

525H Four-Piece Power Service Fitting

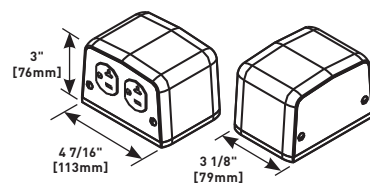

20A 125V duplex plate one side. Blank plate other side. 20A 125V Receptacle included.

525C Four-Piece Communication Service Fitting

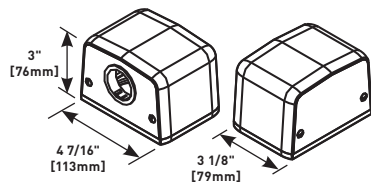

1 1/4" [32mm] I.D. grommeted hole one side. Blank plate other side.

525I Four-Piece Power Service Fitting

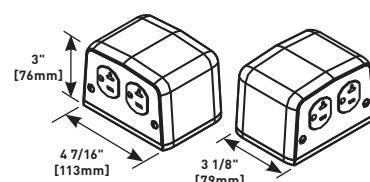

20A 125V duplex plate two sides. 20A 125V Receptacles included.

NOTE: Four-piece service fittings include: housing and base plate. Receptacles included when indicated in part number description. 525 Series Service Fittings have 27 cubic inches [442ml] of capacity.

525 SERIES™ SERVICE FITTINGS

525 Series Service Fittings Ordering Information (continued)

525J Four-Piece Power Service Fitting

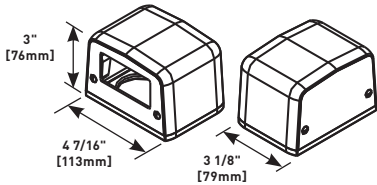

GFI device plate one side. Blank plate other side.

500RT Communication Device Plate

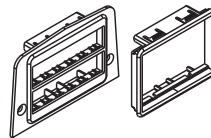

Single opening. Ortronics® Series II and TracJack adapters included.

525HB Service Fitting Housing

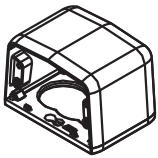

Housing and base plate for all four-piece fittings.

500ACT Communication Device Plate

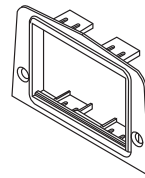

6A opening with mini adapter. Will accommodate Wiremold CM2 Open System communication modules.

500B Blank Faceplate

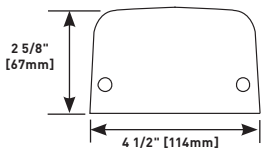

Blank faceplate for all four-piece fittings.

500-MAAP Extron® Device Plate

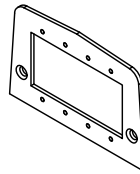

Accepts four (4) Extron® Electronics MAAP plates.

500DR Duplex Faceplate

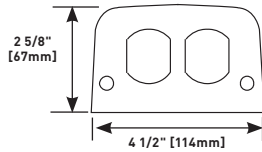

Accepts duplex receptacles.

500SP-1/2 Single Receptacle Device Plate

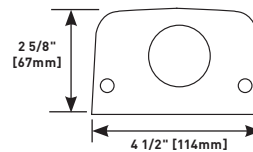

Single receptacle faceplate. Suffix indicates hole diameter.

500T Communication Faceplate

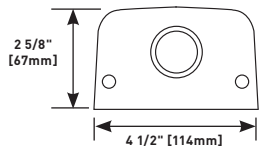

1" [25mm] I.D. grommited opening.

500-GFI GFI Faceplate

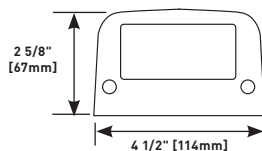

Accepts GFI Decora style receptacle.

ORDERING INFORMATION

CAT. NO.	METRIC DIAMETER
500SP-1.0625	[27mm]
500SP-1.39	[35mm]
500SP-1/2	[12.7mm]
500SP-7/8	[22.2mm]
500SP-1 7/8	[29mm]
500SP-1 7/16	[36mm]
500SP-1 1/2	[38mm]
500SP-1 9/16	[40mm]
500SP-1 5/8	[41mm]
500SP-2	[51mm]

* Other sizes custom sizes are available. Consult factory for more information.

NOTE: Four-piece service fittings include: housing and base plate. Receptacles included when indicated in part number description. 525 Series Service Fittings have 27 cubic inches [442ml] of capacity.

1200 SERIES™



1200 Series Service Fittings are bell-cap style pedestal fittings used to provide power or communications to a work station.

CODE REFERENCE

cULus Listed Underfloor Raceway Fittings:
File E11912, Guide RQKX
Meets Article 390 of NEC

1200 Series Service Fittings Assembly Details

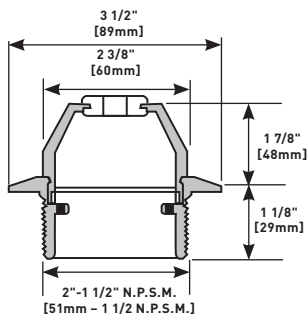

Traditional pedestal style fitting available for single service applications. 1204BF/1204AL shown for dimensional purposes.

1223BF Power Service Fitting

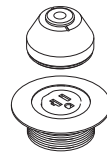

Brass finish fitting includes housing, bell cap, grommet, and single U-slot, three-wire grounded, 20A, 125V receptacle.

1223AL Power Service Fitting



Aluminum fitting includes housing, bell cap, grommet, and single U-slot, three-wire grounded, 20A, 125V receptacle.

1200 Series Service Fittings Ordering Information

1204BF Communication Service Fitting

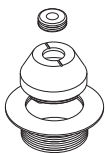

Brass finish communication fitting furnished with split bell cap and grommet. No device plate is included.

1230BF Screw Plug

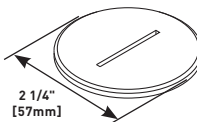

Brass screw plug to abandon service fitting. Screws into housing.

1204AL Communication Service Fitting

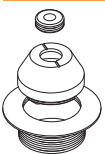

Aluminum communication fitting furnished with split bell cap and grommet. No device plate is included.

1230AL Screw Plug

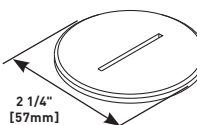

Aluminum screw plug to abandon service fitting. Screws into housing.

COLOR OPTIONS

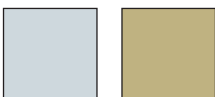

All 1200 Series Service Fittings are available in either an aluminum or brass finish as specified in the part number description.

MULTIPLEX™ SERIES



Multiplex Series Service Fittings are designed to be installed on the various types of infloor systems and can handle large capacity single and dual service power and/or communication requirements needed at the point-of-use.

CODE REFERENCE

cULus Listed Underfloor Raceway Fittings:

File E11912, Guide RQKX
Meets Article 390 of NEC

Multiplex Series Service Fittings Ordering Information

MP4 Single-Service Multiplex Service Fitting

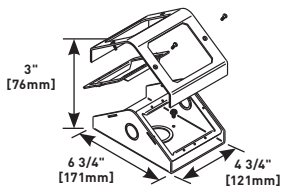

Single-service fitting includes housing, base, two mounting frames, and mounting hardware. For use on 2" [51mm] IPS or PK Preset Systems. For PK activation, use in conjunction with FloorPort Partition Feed and PK Kit. Has 1/2" and 3/4" trade size conduit knockouts on each end. 53.3 cu. in. [906cm³] capacity.

MP8-1 Dual-Service Multiplex Service Fitting

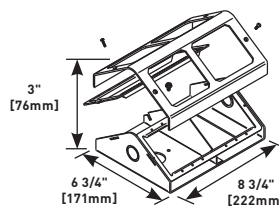

Same as MP8 except mounts on PK, or one No. 2 or one No. 4 Pro Series Duct.

MP8 Dual-service Multiplex Service Fitting

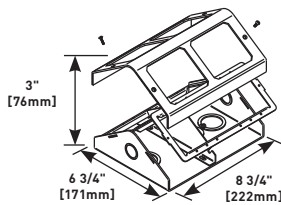

Dual-service fitting includes housing, base, two mounting frames, divider, and mounting hardware. For use on one No. 2 and one No. 4 Duct. Has 1/2" and 3/4" trade size conduit knockouts on each end. 104.3 cu. in. [1709cm³] capacity.

LTF48-B Blank Faceplate

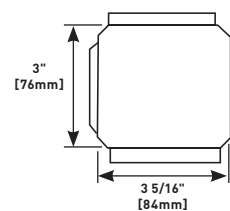

Blank Faceplate.

COLOR OPTIONS

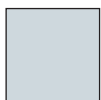

Multiplex Series Service Fittings are available in a brushed aluminum finish unless otherwise indicated in the part number description.

WALKERDUCT® MULTIPLEX™ SERIES

1200 Series Service Fittings Ordering Information (continued)

LTF48-RT Faceplate

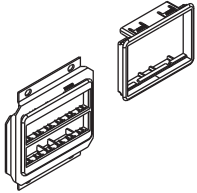

Single opening with Ortronics® MAB6TJ TracJack and MAB3S2 Series II adapters.

M-DR Faceplate

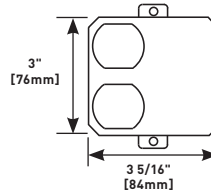

Single duplex opening faceplate.

LTF48-ACT Communication Faceplate

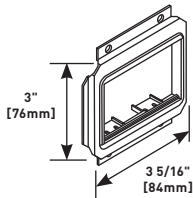

Faceplate with 6a mini adapter for Wiremold Open System CM2 communication modules.

M-2DR Faceplate

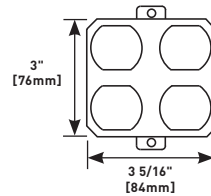

Double duplex opening faceplate.

LTF48-MAAP Extron® Device Plate

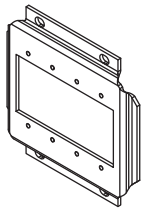

Accepts four (4) Extron® Electronics MAAP plates.

M-GFI Faceplate

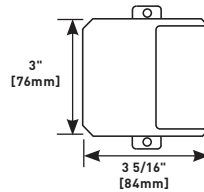

Single GFI opening faceplate.

LTF48-1 Faceplate

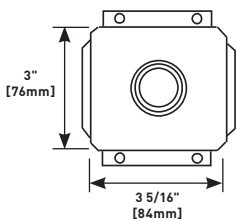

1" [25mm] diameter bushed opening.

M-2GFI Faceplate

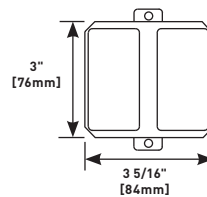

Double GFI opening faceplate.

LTF48-2 Faceplate

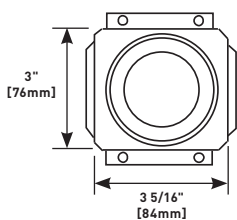

2" [51mm] diameter bushed opening.

M-DR/GFI Faceplate

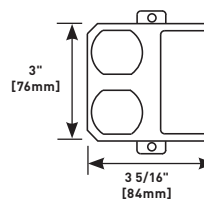

Duplex and GFI openings faceplate.

525 & MULTIPLEX™ SERIES



525 and Multiplex™ Series Activation Accessories are designed to complete the installation of the service fittings onto various types of in floor systems offered by Wiremold as well as the various systems sold by competitors.

CODE REFERENCE

cULus Listed Underfloor Raceway Fittings:

File E11912, Guide RQKX
Meets Article 390 of NEC

525 & Multiplex Series Activation Accessories Ordering Information

AFTERSSET INSERTS



436-2-2

CAT. NO.	DESCRIPTION
436-2 7/8	2" [51mm] IPS afterset insert - 7/8" [22.2mm] high.
436-2-1 1/2	2" [51mm] IPS afterset insert - 1 1/2" [38mm] high.
436-2-2	2" [51mm] IPS afterset insert - 2" [51mm] high.
436-2-3/8	2" [51mm] IPS afterset insert - 2 3/8" [60mm] high.
436-2-3	2" [51mm] IPS afterset insert - 3" [76mm] high.

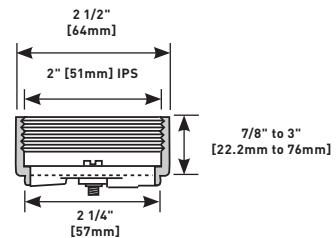

ADAPTERS FOR 2" [51mm] IPS PRESETS OR AFTERSSET INSERTS



1126A-1 1/2

CAT. NO.	DESCRIPTION
1126A-1/4	2" [51mm] IPS to 1/4" [6.4mm].
1126A-3/4	2" [51mm] IPS to 3/4" [19.1mm].
1126A-1	2" [51mm] IPS to 1" [25mm].
1126A-1 1/4	2" [51mm] IPS to 1 1/4" [32mm].
1126A-1 1/2	2" [51mm] IPS to 1 1/2" [38mm].

NOTE: IPS, Internal Pipe Size, is a trade size, not an actual size.

COLOR OPTIONS

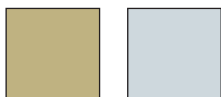

525 & Multiplex™ Series Activation Accessories are available in either a brass or stainless steel finish as indicated in the part number description.

525 & MULTIPLEX™ SERIES

525 & Multiplex Series Activation Accessories Ordering Information

LOCKING NIPPLES



CAT. NO.	DESCRIPTION
1124-1	1" [25mm] IPS - 1" [25mm] long.
1124L-1	1" [25mm] IPS - 1 1/2" [38mm] long.
1124-1 1/4	1 1/4" [32mm] IPS - 1" [25mm] long.
1124L-1 1/4	1 1/4" [32mm] IPS - 1 1/2" [38mm] long.
1124-2	2" [51mm] IPS - 1" [25mm] long.
1124L-2	2" [51mm] IPS - 1 1/2" [38mm] long.

NOTE: IPS, Internal Pipe Size, is not actual size.

BLANKING PLATES



CAT. NO.	DESCRIPTION
1043B, 1043S	Brass or stainless steel blanking plate with threaded base for 2" [51mm] IPS.
1043BPO, 1043SPO	Brass or stainless steel blanking plate only. Includes 1/4-20 screw.
1044B, 1044S	Brass or stainless steel blanking plate with threaded base for 3/4" [19.1mm] IPS.
1045B, 1045S	Brass or stainless steel blanking plate with threaded base for 1" [25mm] IPS.
1046B, 1046S	Brass or stainless steel blanking plate with threaded base for 1 1/4" [32mm] IPS.

B = Brass, S = Stainless Steel.

2" [51mm] IPS EXTENSIONS FOR AFTERSET INSERTS



CAT. NO.	DESCRIPTION
424-3/4	3/4" [19.1mm] 1 5/16" [33mm]
424-1	1" [25mm] 1 9/16" [40mm]

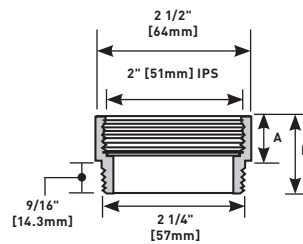

NOTE: IPS, Internal Pipe Size, is a trade size, not an actual size.

SOURCE 1® SERVICE FITTINGS

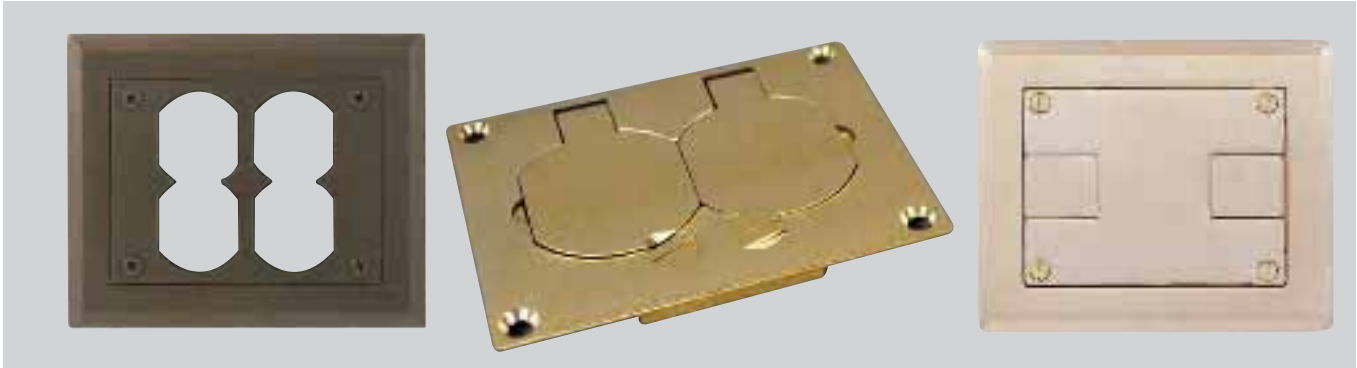

Source 1® Series Flush Activations offer a wide variety of single and dual service power and communications for infloor raceways in both new construction and renovations.

CODE REFERENCE

cULus Listed Underfloor Raceway Fittings:
File E11912, Guide RQKX
Meets Article 390 of NEC

Source 1 Series Service Fittings Ordering Information

S175 Double Duplex Power Activation

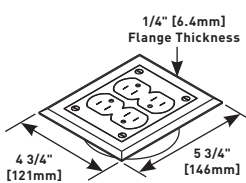

Double duplex polycarbonate assembly, 7/8" to 3 3/8" [22.2mm to 86mm] concrete topping. 15A, 125V receptacles included. Available in black (S175BLK) or brown (S175BRN).

S166 Complete Flush Activation

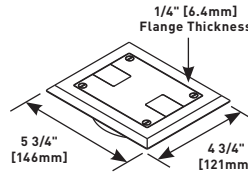

Flush polycarbonate communication slides black (S166BLK) or brown (S166BRN).

S165 Complete Flush Activation

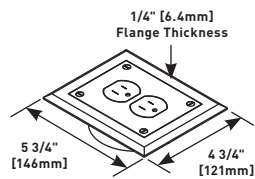

Flush polycarbonate power – single duplex black (S165BLK) or brown (S165BRN). 15A, 125V receptacles included.

S166B Complete Flush Activation

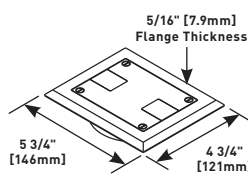

Flush brass communication (slides). Used for data cable pass-through.

S165B Complete Flush Activation

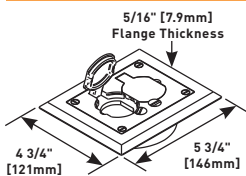

Flush brass power – single duplex flip lids. May be used with 106 type adapters for data applications.

S124 Carpet Flange

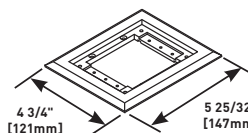

Flush polycarbonate carpet flange only with mounting screws. Black (S124BLK) or brown (S124BRN).

COLOR OPTIONS



Source 1® Series Service Fittings are available in brass, brown polycarbonate or black as indicated in the part number description.

SOURCE I® SERVICE FITTINGS

Source 1 Series Service Fittings Ordering Information (continued)

S124B Carpet Flange

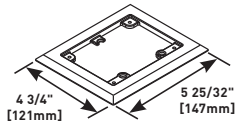

Flush brass carpet flange only with mounting screws.

S125B Cover Plate

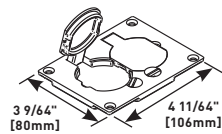

Flush brass power cover plate only (flip lid) with four mounting screws.

S125 Cover Plate

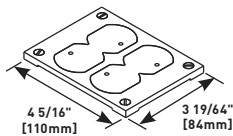

Nonmetallic double duplex membrane cover plate. Available in black (S125BLK) or brown (S125BRN).

S130 Cover Plate

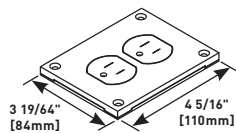

Nonmetallic double duplex membrane cover plate. Available in black (S130BLK) or brown (S130BRN).

829PSTC Cover Plate

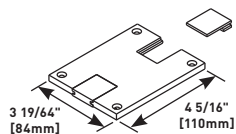

Flush polycarbonate communication cover plate with slides and four mounting screws. Black (829PSTC-BLK) or brown (829PSTC-BRN).

829STC Cover Plate

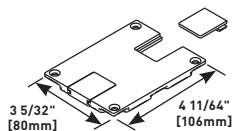

Flush brass communication cover plate with slides and four mounting screws.

829CK Cover Plate

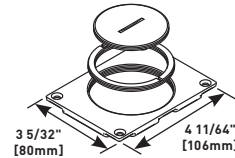

Flush brass communication cover plate (2 5/8" and 2 1/4" diameter trade size screw plugs) with four mounting screws.

829CK-3/4 Cover Plate

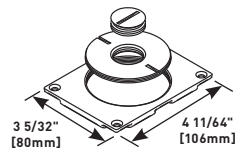

Flush brass communication cover plate (2 5/8" and 3/4" diameter trade size screw plugs) with four mounting screws.

829CK-1 Cover Plate

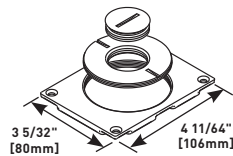

Flush brass communication cover plate (2 5/8" and 1" diameter trade size screw plugs) with four mounting screws.

829CK-1/2 Cover Plate

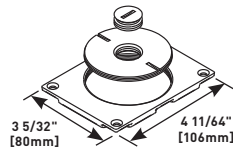

Flush brass communication cover plate (2 5/8" and 1/2" diameter trade size screw plugs) with four mounting screws.

828SPTC Cover Plate

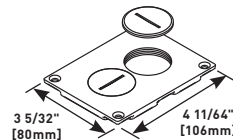

Flush brass communication cover plate. 1 1/2" diameter trade size screw plugs.

437 Attaching Rings



Attaching Rings for Source I (Preset or Afterset) zinc die-cast. 4" [102mm] O.D. Add suffix to Cat. No. to indicate ring depth: 7/8", 1 1/8", 1 1/2", 2", 2 3/8", or 3 1/8".

SOURCE I® SERVICE FITTINGS

Source 1 Series Service Fittings Ordering Information (continued)

S1MC Mudcap



For Source I 437 Attaching Ring. 4" [102mm] O.D.

S1MC-MS Mudcap



For Source I Attaching Ring with marker screw. 4" [102mm] O.D. Use with 437 Attaching Rings only.

439 Attaching Ring



For polycarbonate afterset use only. No adjusting ring required. 4" [102mm] O.D. Four #6-32 hold-down screws provided.

897AR Adjusting Ring



Adjusting ring (with three adjusting screws) for use with 437 Attaching Rings – power for brass fitting only. 3 25/32" [96mm] O.D.

898AR Adjusting Ring



Adjusting ring (with three adjusting screws) for use with 437 Attaching Rings – communication only (brass and polycarbonate fittings) and power for polycarbonate fitting only. 3 25/32" [96mm] O.D.

S1ER Extension Ring



Extension ring – mounts on top of 437 Attaching Ring. Includes extension ring and three mounting screws. 4" [102mm] O.D. Add suffix to indicate ring height: 7/8", 1 1/8", 1 1/2", 2", 2 3/8", 3 1/8". We recommend using a shallow Attaching Ring and deep extension ring whenever possible.

SOURCE 1[®] SERVICE FITTINGS

Source 1 Series Service Fittings Installation Details

S175 Double Duplex Power Activation

1. Establish location for the fitting, then core drill a 4" [102mm] diameter hole through the concrete to the top of the duct.
2. Next, drill a 2 1/2" [64mm] diameter opening in the top of the duct, making sure this opening is in the center of the 4" [102mm] hole.
3. Install the 439 Attaching Ring using the two locking tabs to secure it to the duct.
4. Connect the carpet flange to the attaching rings using the four screws provided.
5. Install the two duplex receptacles and the double duplex plate to complete the installation.

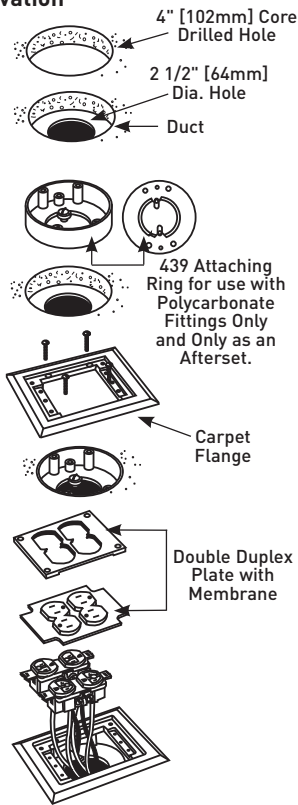

Activation Guidelines – Flush Using 437 Ring

1. Pull wires through the hole in the bottom of the attaching rings. The adjusting ring should then be installed at the desired height. Wire device and attach to the adjusting ring.
2. After the gasket is put in place, attach the flange to the adjusting ring.
For Power: The flip lid cover plate can be attached to the flange.
3. **For Communication:** Turn self storing slides upside down with thin edge to the inside. Attach cover plate to flange.

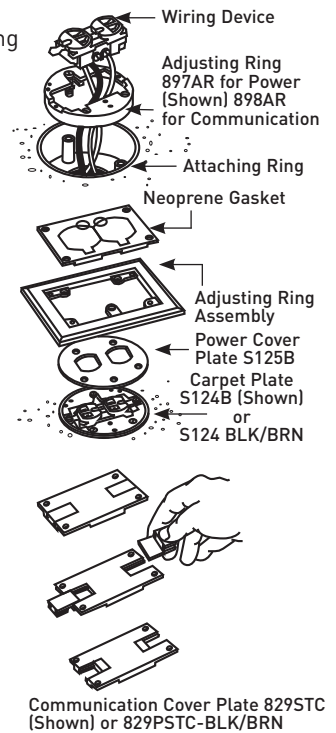

Polycarbonate — Using a 439 Afterset Attaching Ring

1. Establish location for the fitting, then core drill a 4" [102mm] diameter hole through the concrete to the top of the duct.
2. Next, drill a 2 1/2" [64mm] diameter opening in the top of the duct, making sure this opening is in the center of the 4" [102mm] hole.
3. Install the 439 Attaching Ring, using the two locking tabs to secure it to the duct.
4. Connect the carpet flange to the attaching ring, using the four screws (#6-32 flathead) provided.
5. For duplex cover plate: Install the wiring device onto the carpet flange and secure the cover plate over it, making sure the plug-through membrane is in place.
6. For communication cover plate: Reverse the communication slides as necessary to allow cable egress, and install the cover plate, taking care to avoid pinching any cables.

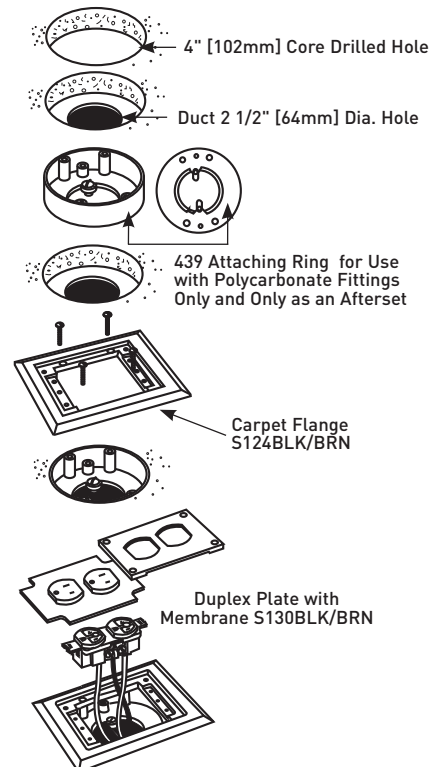

NOTE: The receptacle mounting shelf can be broken out to create additional cable space when the communication cover plate is used.

FLOORPORT™ SERIES

Wiremold products bearing the TopGuard Protection logo meet or exceed the UL scrub water exclusion requirement.



FloorPort Service Fittings for Resource RFB® Series Floor Boxes, Walkercell® Cellular Raceway, and Walkerdeck Systems provide flexibility in recessed and furniture feed applications.

CODE REFERENCE

cULus Listed Metallic Outlet Boxes:
File E2961, Guide QCIT

cULus Listed Outlet Boxes & Fittings Classified for Fire Resistance:
File R8209, Guide CEYY

Meets Article 341.40, 314.41 & 374 of NEC



New FloorPort™ Series Cover Assemblies feature **a full 180° opening cover** with a **new recessed handle** for easier opening and new **cable egress openings** that protect cabling while holding them securely in place.



COLOR OPTIONS



FloorPort Series Service Fittings are available in aluminum, black, brass, bronze, gray and nickel as indicated in the part number description.

FLOORPORT™ SERIES

FloorPort™ Series Flanged Cover Plates Ordering Information

Floorport Part Number Configurator

FloorPort Series:	Cover Style:	Top Style:	Cover Color:
	Blank Top = B Cutout Top = C Furniture Feed = FF	Tile (flangeless) = T Tile/Carpet (flanged) = TC	Brushed Aluminum = AL Black = BK Brass = BS Bronze = BZ Gray = GY Nickel = NK

Load Capacities for FloorPort Cover Assemblies

CATALOG NUMBERS	MAXIMUM LOAD IN POUNDS
FPCTC	1000
FPBTC	750
FPFFT	1000

NOTE: Load applied through a 2" [51mm] mandrel in center of service fitting. Loads above are static loads only and do not pertain to rolling loads.

FPCTC Cutout Cover Assembly

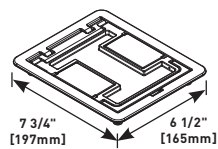

FPCTCBK, FPCTCBZ, FPCTCBS, FPCTCNK, FPCTCGY, FPCTCAL
Flanged cover for use in tile or carpet installation. Die-cast aluminum assembly available in black, bronze, brass, nickel, gray or brushed aluminum. Insert in lid allows for carpet or tile cutouts to match finished floor.

FPFFTC Furniture Feed Cover Assembly

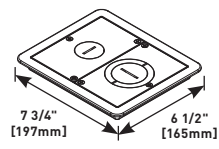

FPFFTCBK, FPFFTCBZ, FPFFTCBS, FPFFTCNK, FPFFTCGY, FPFFTCAL
Flanged cover for use in tile or carpet installation. Die-cast aluminum assembly available in black, bronze, brass, nickel, gray or brushed aluminum. Provided with one 1" trade size screw plug for power or communication type cabling and one combination 1 1/4" and 2" trade size screw plug for communication type cabling. Allows for feeding both power and communication cabling.

FPBTC Blank Cover Assembly

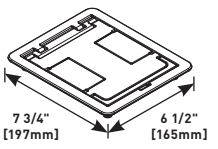

FPBTCBK, FPBTCBZ, FPBTCBS, FPBTCNK, FPBTCGY, FPBTCAL
Flanged cover for use in tile or carpet installation. Die-cast aluminum assembly available in black, bronze, brass, nickel, gray, or brushed aluminum. Lid area is flush with the finished floor, no cutouts provided.

FloorPort™ Series Flangeless Cover Assemblies Ordering Information

FPCT Cutout Cover Assembly

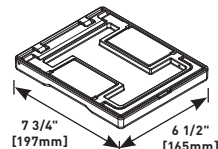

FPCTCBK, FPCTCBZ, FPCTCBS, FPCTCNK, FPCTCGY, FPCTCAL
Flangeless cover for use in tile or carpet installations. Die-cast aluminum assembly available in black, bronze, brass, nickel, gray, or brushed aluminum. Insert in lid allows for carpet or tile cutouts to match finished floor.

FPFFT Furniture Feed Cover Assembly

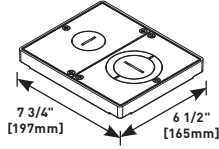

FPFFTCBK, FPFFTCBZ, FPFFTCBS, FPFFTCNK, FPFFTCGY, FPFFTCAL
Flangeless cover for use in tile or carpet installation. Die-cast aluminum assembly available in black, bronze, brass, nickel, gray, or brushed aluminum. Provided with one 1" trade size screw plug for power or communication type cabling and one combination 1 1/4" and 2" trade size screw plug for communication type cabling. Allows for feeding both power and communication cabling.

FPBT Blank Cover Assembly

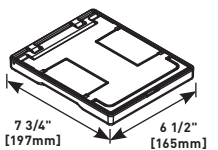

FPBTCBK, FPBTCBZ, FPBTCBS, FPBTCNK, FPBTCGY, FPBTCAL
Flangeless cover for use in tile or carpet installation. Die-cast aluminum assembly available in black, bronze, brass, nickel, gray, or brushed aluminum. Lid area is flush with the finished floor, no cutouts provided.

FLOORPORT™ SERIES

North American Made FloorPort™ Series Flanged Cover Plates Ordering Information

Floorport Part Number Configurator

FloorPort Series:	Cover Style:	Top Style:	Cover Color:	Origin:
	Blank Top = B Cutout Top = C Furniture Feed = FF	Tile (flangeless) = T Tile/Carpet (flanged) = TC	Nickel = NK Brass = BS Black = BK Bronze = BZ Gray = GY	North American Made NA

FPCTC-NA Cutout Cover Assembly

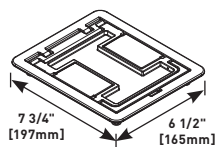

FPCTCBK-NA, FPCTCBZ-NA, FPCTCBS-NA, FPCTCNK-NA, FPCTCGY-NA

Flanged cover for use in tile or carpet installation. Die-cast aluminum assembly available in black, bronze, brass, nickel or gray. Insert in lid allows for carpet or tile cutouts to match finished floor.

FPFFTC Furniture Feed Cover Assembly

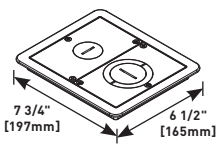

FPFFTCBK, FPFFTCBZ, FPFFTCBS, FPFFTCNK, FPFFTCGY, FPFFTCAL

Flanged cover for use in tile or carpet installation. Die-cast aluminum assembly available in black, bronze, brass, nickel or gray. Provided with one 1" trade size screw plug for power or communication type cabling and one combination 1 1/4" and 2" trade size screw plug for communication type cabling. Allows for feeding both power and communication cabling.

FPBTC-NA Blank Cover Assembly

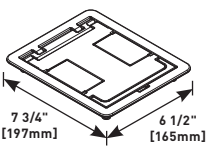

FPBTCBK-NA, FPBTCBZ-NA, FPBTCBS-NA, FPBTCNK-NA, FPBTCGY-NA

Flanged cover for use in tile or carpet installation. Die-cast aluminum assembly available in black, bronze, brass, nickel or gray. Lid area is flush with the finished floor, no cutouts provided.

FP-CTR Bare Concrete & Terrazzo Ring

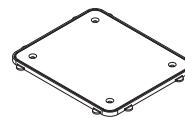

Nonmetallic ring for use on bare polished concrete and terrazzo floor applications.

Load Capacities for North American Made FloorPort Cover Assemblies

CATALOG NUMBERS	MAXIMUM LOAD IN POUNDS
FPCTC	1000
FPBTC	750
FPFFT	1000

NOTE: Load applied through a 2" [51mm] mandrel in center of service fitting.

Loads above are static loads only and do not pertain to rolling loads.

S3AXBP Blanking Plate

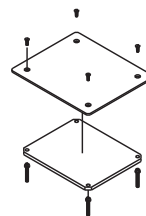

Aluminum top plate with steel support plate and four (4) adjusting screws.

PSRC9 SERIES™



PSRC9 Series Poke-Thru Style Service Fittings provide flush preset or afterset activations for Walkerdect and Walkercell infloor systems.

CODE REFERENCE

cULus Listed Underfloor Raceway Fittings:
File E11912, Guide RQKX
Meets Article 390 of NEC

PSRC9 Series Service Fittings Ordering Information

PSRC9TC Quad Power Fitting

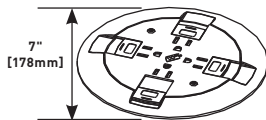

Available in gray (PSRC9TCGY), aluminum (PSRC9TCAL), black (PSRC9TCBK) or brass (PSRC9TCBS). Quad 15A receptacle included for standard or isolated ground wiring. Unit complete with link straps, adapter plate and receptacle bracket to attach preset or afterset.

PSRC9FFTC Flush Furniture Feed Fitting

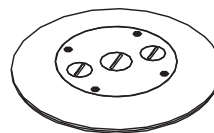

Available in gray (PSRC9FFTCGY), aluminum (PSRC9FFTCAL), black (PSRC9FFTCBK) or brass (PSRC9FFTCBS). Unit complete with link straps, adapter plate and conduit assembly featuring (1) 3/4" trade size and (2) 1/2" trade size conduit connectors and closure plugs.

PSRC9AMDTC Quad Communication Fitting

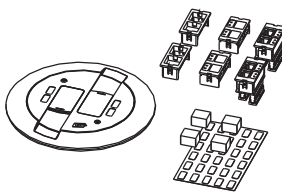

Available in gray (PSRC9AMDTCGY), aluminum (PSRC9AMDTCAL), black (PSRC9AMDTCBK) or brass (PSRC9AMDTCBS). Unit includes link straps and adapter plate to attach preset or afterset. Includes two (2) Ortronics® TracJack adapters, two (2) Ortronics® Series II adapters and Wiremold Open System adapters. Modular jacks, sold separately.

PSRC9FF2TC 2" [51mm] Flush Furniture Feed Fitting

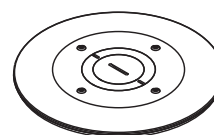

Available in gray (PSRC9FF2TCGY), aluminum (PSRC9FF2TCAL), or black (PSRC9FF2TCBK). Unit complete with link straps, adapter plate and features concentric screw plugs that allow for 1 1/4" or 2" trade size conduit fitting connection.

NOTE: When using as a preset, the duct presets need to be staggered.

COLOR OPTIONS



PSRC9 Series Service Fittings are available in gray, aluminum, black, or brass as indicated in the part number description.

WALKERDUCT® PSRC9 SERIES™

PSRC9 Series Activation Accessories Ordering Information

4225, 4230 Aftersets

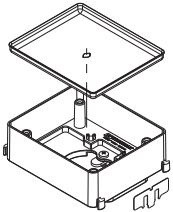

2 1/2" and 3" [64mm, and 76mm] Aftersets. Installed either before or after concrete pour to create activation from duct (minimum concrete depth of 2 1/2" [64mm]). Requires 6 1/2" [165mm] core drilled hole in concrete and 2 1/2" [64mm] diameter hole in duct. Grout fill required around afterset once installed to fill voids and support fitting flange. Attaches to duct using locking tabs. Extensions can be attached to increase height (see below). Aftersets include alignment clip and mudcap.

425, 426 Extensions

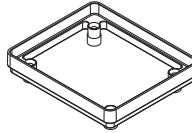

1/2" and 1" [12mm and 25mm] high extensions. Used to increase height of preset or afterset. Die cast construction. Attach to preset or afterset with push on metal sleeves (included). Cat. No. 426 can be stacked, Cat. No. 425 cannot be stacked.

421 Mudcap

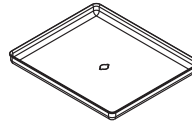

Steel replacement cap for preset. Recessed to hold 3/8" [9.5mm] concrete.

PSRC9 Series Service Fittings Installation Details

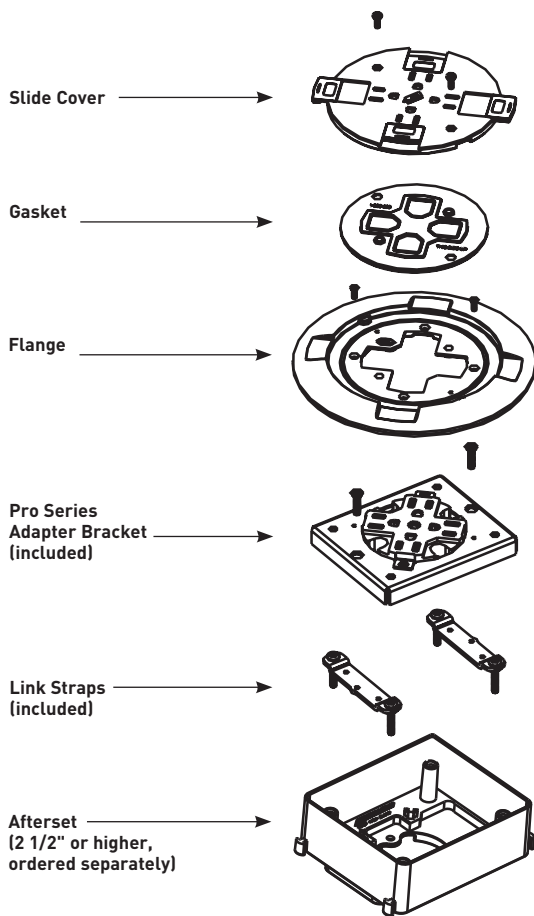

WALKERDUCT® PRO SERIES SERVICE FITTINGS



Walkerduct® Pro Series Service Fittings offer a complete range of service fittings to meet all power and communication requirements while providing flush flanges with interchangeable covers offering an aesthetic appearance.

CODE REFERENCE

cULus Listed Underfloor Raceway Fittings:
File E11912, Guide RQKX
cULus Listed Metallic Outlet Boxes:
File E2961, Guide QCIT
Meets Articles 390 of NEC

Walkerduct Pro Series Solid Brass Cover Plate Flanges & Metal Cover Plates Ordering Information

817B One-Gang Brass Carpet & Tile Flange

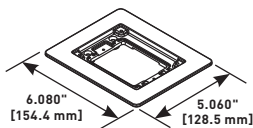

Accepts Ortronics® MAB6TJ TracJack and MAB3S2 Series II adapters and Wiremold CM Series inserts, sold separately.

828R Brass Duplex Cover Plate

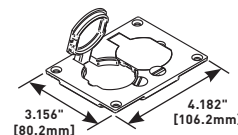

Flip lids. Can also be used with a 106 type frame for communication adapter.

827B Two-Gang Brass Carpet & Tile Flange

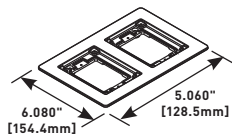

Accepts Ortronics® MAB6TJ TracJack and MAB3S2 Series II adapters and Wiremold CM Series inserts, sold separately.

828GFITC Brass GFI Cover Plate

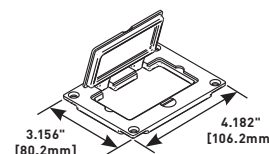

May be used with Wiremold CM Series inserts and Ortronics® Connectivity Systems in conjunction with 817B, 827B, and 837B Flanges.

837B Three-Gang Brass Carpet & Tile Flange

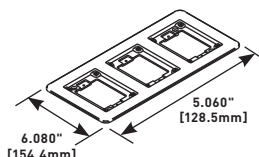

Accepts Ortronics® MAB6TJ TracJack and MAB3S2 Series II adapters and Wiremold CM Series inserts, sold separately.

828DPGFITC Brass Rectangular Cover Plate

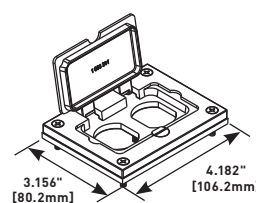

Brass (828DPGFITC) or brushed aluminum (828DPGFITCAL). Allows for mounting of a duplex style receptacle with a rectangular style flip lid cover plate.

COLOR OPTIONS



Walkerduct® Pro Series Service Fittings are available in brushed aluminum, brass, black or brown as indicated in the part number description.

WALKERDUCT® PRO SERIES SERVICE FITTINGS

Walkerduct Pro Series Metal Cover Plates Ordering Information

828DLR Brass Single Locking Receptacle Cover Plate

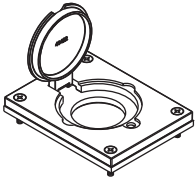

Single flip lid cover for 20A or 30A single locking receptacles. Device opening is 2 5/8" [67mm]. For use with maximum female locking device of 1.58" diameter, and maximum male plug face of 2.25" diameter

829CK-1 Brass Communication Cover Plate

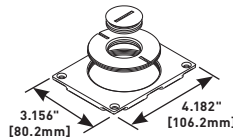

2 5/8" and 1" [67mm and 25mm] plugs.

828SPTC Brass Duplex Cover Plate

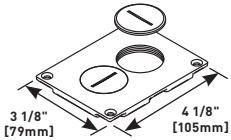

Screw plugs. Screw plugs are 1 1/2" [38mm] in diameter.

829CK-3/4 Brass Communication Cover Plate

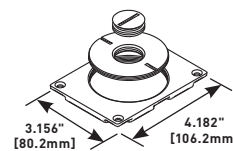

2 5/8" and 3/4" [67mm and 19.1mm] plugs.

829STC Brass Communication Cover Plate

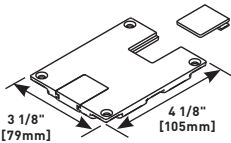

Data slides. Feed through only, not for use with a mounting plate for communication jacks.

829CK-1/2 Brass Communication Cover Plate

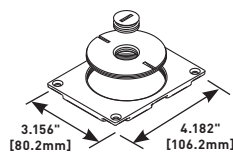

2 5/8" and 1/2" [67mm and 12.7mm] plugs.

829CK Brass Communication Cover Plate

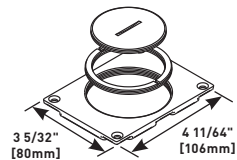

2 5/8" and 2 1/4" [67mm and 57mm] plugs.

828MAAP A/V Adapter Plate

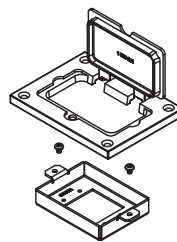

Sheet metal adapter plate that accepts two (2) Extron® Electronics MAAP style device plates, sold separately. For use with 828GFITC or 828GFITCAL cover plates, sold separately. For use with minimum 2 1/2" [64mm] preset depths.

WALKERDUCT® PRO SERIES SERVICE FITTINGS

Walkerduct Pro Series Brushed Aluminum Cover Plate Flanges Ordering Information

818TCAL One-Gang Brushed Aluminum Combination Carpet & Tile Flange

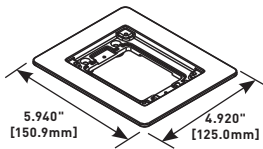

Accepts Ortronics® MAB6TJ TracJack and MAB3S2 Series II adapters and Wiremold CM Series inserts, sold separately.

NOTE: Brushed aluminum flange comes with a beveled edge.

838TCAL Three-Gang Brushed Aluminum Combination Carpet & Tile Flange

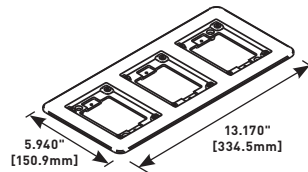

Accepts Ortronics® MAB6TJ TracJack and MAB3S2 Series II adapters and Wiremold CM Series inserts, sold separately.

NOTE: Brushed aluminum flange comes with a beveled edge.

828TCAL Two-Gang Brushed Aluminum Combination Carpet & Tile Flange

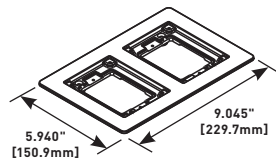

Accepts Ortronics® MAB6TJ TracJack and MAB3S2 Series II adapters and Wiremold CM Series inserts, sold separately.

NOTE: Brushed aluminum flange comes with a beveled edge.

Walkerduct Pro Series Brushed Aluminum Cover Plates Ordering Information

828R-TCAL Brushed Aluminum Duplex Cover Plate

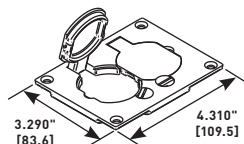

Flip lids. Can also be used with a 106 type communication adapter.

828DPGFITCAL Brushed Aluminum Rectangular Cover Plate

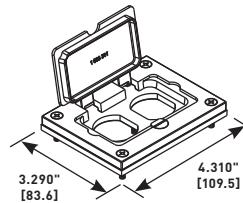

Allows for mounting of a duplex style receptacle with a rectangular style flip lid cover.

828GFITCAL Brushed Aluminum GFI Cover Plate

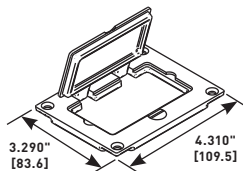

May be used with Activate and Ortronics® Connectivity Systems in conjunction with 817B, 827B, and 837B Flanges.

828DLRAL Brushed Aluminum Single Locking Receptacle Cover Plate

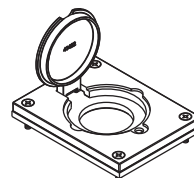

Single flip lid cover for 20A or 30A single locking receptacles. Device opening is 2 5/8" [67mm]. For use with maximum female locking device of 1.58" diameter, and maximum male plug face of 2.25" diameter.

COLOR OPTIONS



Walkerduct® Pro Series Service Fittings are available in brushed aluminum, brass, black or brown as indicated in the part number description.

WALKERDUCT® PRO SERIES SERVICE FITTINGS

Walkerduct Pro Series Brushed Aluminum Cover Plates Ordering Information (continued)

830CKTCAL Brushed Aluminum Cover Plate

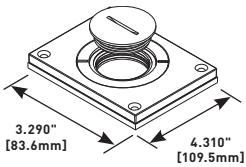

Power or communication plate with 2" [51mm] and 1 1/4" [32mm] plugs.

NOTE: Acceptable for use with threaded conduit when passing through power cables.

830CKTCAL-1/2 Brushed Aluminum Cover Plate

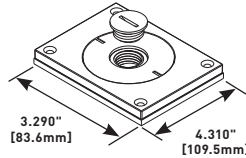

Power or communication plate with 2" [51mm] and 1/2" [12.7mm] plugs.

830CKTCAL-1 Brushed Aluminum Cover Plate

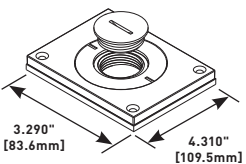

Power or communication plate with 2" [51mm] and 1" [25mm] plugs.

NOTE: Acceptable for use with threaded conduit when passing through power cables.

828MAAP A/V Adapter Plate

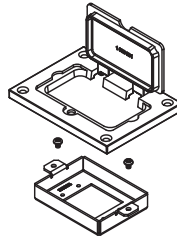

Sheet metal adapter plate that accepts two (2) Extron® Electronics MAAP style device plates, sold separately. For use with 828GFITC or 828GFITCAL cover plates, sold separately. For use with minimum of 2 1/2" [64mm] preset depth.

830CKTCAL-3/4 Brushed Aluminum Cover Plate

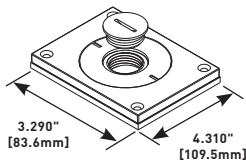

Power or communication plate with 2" [51mm] and 3/4" [19.1mm] plugs.

Walkerduct Pro Series Powder-Coated Aluminum Cover Plate Flanges Ordering Information

817TCAL One-Gang Powder-Coated Aluminum Combination Carpet and Tile Flange

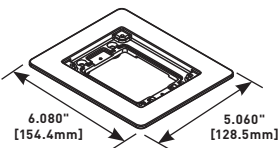

Accepts Ortronics® MAB6TJ TracJack and MAB3S2 Series II adapters and Wiremold CM Series inserts, sold separately. Flanges are available in five decorative colors: black (817TCAL-BK), gray (817TCAL-GY), brass (817TCAL-BS), nickel (817TCAL-NK) and bronze (817TCAL-BZ).

827TCAL Two-Gang Powder-Coated Aluminum Combination Carpet and Tile Flange

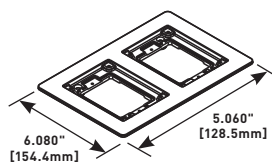

Accepts Ortronics® MAB6TJ TracJack and MAB3S2 Series II adapters and Wiremold CM Series inserts, sold separately. Flanges are available in five decorative colors: black (827TCAL-BK), gray (827TCAL-GY), brass (827TCAL-BS), nickel (827TCAL-NK) and bronze (827TCAL-BZ).

NOTE: Brass covers and flanges are not interchangeable with aluminum or nonmetallic covers and flanges. Nonmetallic covers are interchangeable with aluminum flanges.

WALKERDUCT® PRO SERIES SERVICE FITTINGS

Walkerduct Pro Series Powder-Coated Aluminum Cover Plate Flanges Ordering Information (continued)

837TCAL Three-Gang Powder-Coated Aluminum Combination Carpet and Tile Flange

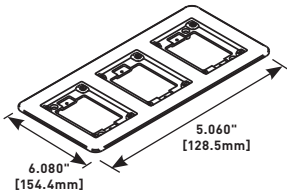

Accepts Ortronics® MAB6TJ TracJack and MAB3S2 Series II adapters and Wiremold CM Series inserts, sold separately. Flanges are available in five decorative colors: black (837TCAL-BK), gray (837TCAL-GY), brass (837TCAL-BS), nickel (837TCAL-NK) and bronze (837TCAL-BZ).

829CKAL-3/4 Powder-Coated Aluminum Cover Plate

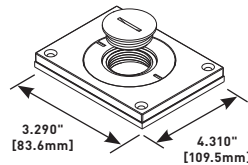

Power or communication plate with 2" [51mm] and 3/4" [19.1mm] plugs. Covers are available in five decorative colors: black (829CKAL-3/4BK), gray (829CKAL-3/4GY), brass (829CKAL-3/4BS), nickel (829CKAL-3/4NK) and bronze (829CKAL-3/4BZ).

NOTE: Acceptable for use with threaded conduit when passing through power cables.

828R-TCAL Powder-Coated Aluminum Duplex Cover Plate

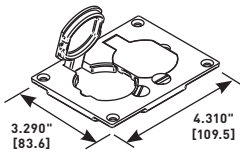

Flip lids. Can also be used with a 106 type communication adapter. Available in black (828R-TCAL-BK), gray (828R-TCAL-GY), brass (828R-TCAL-BS), nickel (828R-TCAL-NK) and bronze (828R-TCAL-BZ).

828MAAP A/V Adapter Plate

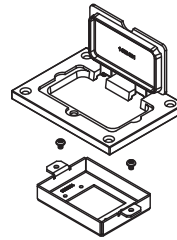

Sheet metal adapter plate that accepts two (2) Extron® Electronics MAAP style device plates, sold separately. For use with 828GFITC or 828GFITCAL cover plates, sold separately. For use with minimum 2 1/2" [64mm] preset depths.

828GFITCAL Powder-Coated Aluminum Rectangular Cover Plate

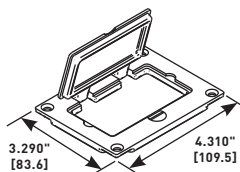

Allows for mounting a duplex receptacle (Decorator or GFCI style) with a rectangular flip cover. Available in black (828GFITCAL-BK), gray (828GFITCAL-GY), brass (828GFITCAL-BS), nickel (828GFITCAL-NK) and bronze (828GFITCAL-BZ).

829CKAL-1 Powder-Coated Aluminum Cover Plate

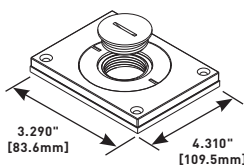

Power or communication plate with 2" [51mm] and 1" [25mm] plugs. Covers are available in five decorative colors: black (829CKAL-BK), gray (829CKAL-GY), brass (829CKAL-BS), nickel (829CKAL-NK) and bronze (829CKAL-BZ).

NOTE: Acceptable for use with threaded conduit when passing through power cables.

WALKERDUCT® PRO SERIES SERVICE FITTINGS

Walkerduct Pro Series Nonmetallic Cover Plate Flanges Ordering Information

817PCC One-Gang Nonmetallic Carpet Flange

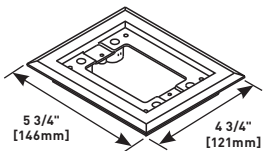

Available in black (817PCC-BLK) or brown (817PCC-BRN). For Ortronics® connectivity use with 829PFLRT Cover. For Wiremold CM Series inserts use with 829PFL Cover. Accepts Ortronics® MAB6TJ TracJack and MAB3S2 Series II adapters and Wiremold CM Series inserts, sold separately.

828PRGFI Nonmetallic GFI cover plate

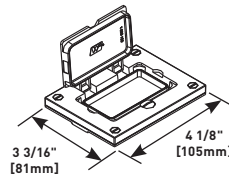

Available in black (828PRGFI-BLK) or brown (828PRGFI-BRN). May be used with Ortronics® Connectivity systems in conjunction with 817, 827, and 837PCC Series flanges.

827PCC Two-Gang Nonmetallic Carpet Flange

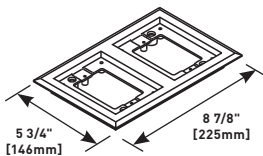

Available in black or brown. For Ortronics® connectivity use with 829PFLRT Cover. For Wiremold CM Series inserts use with 829PFL Cover. Accepts Ortronics® MAB6TJ TracJack and MAB3S2 Series II adapters and Wiremold CM Series inserts, sold separately.

829PFL Nonmetallic Communications Cover Plate

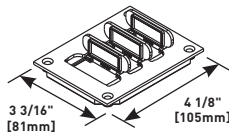

Individual flip lids.* Available in black (829PFL-BLK) or brown (829PFL-BRN). Gasket included.

837PCC Three-Gang Nonmetallic Flange

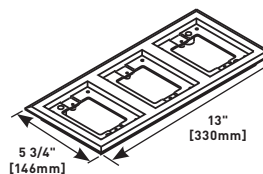

Available in black (837PCC-BLK) or brown (837PCC-BRN). For Ortronics® connectivity use with 829PFLRT Cover. For Wiremold CM Series inserts use with 829PFL Cover. Accepts Ortronics® MAB6TJ TracJack and MAB3S2 Series II adapters and Wiremold CM Series inserts, sold separately.

829PFLRT Nonmetallic Communications Cover Plate

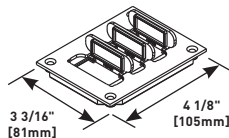

Individual flip lids.* Available in black (829PFLRT-BLK) or brown (829PFLRT-BRN). Gasket included. Ortronics® MAB6TJ TracJack and MAB3S2 Series II adapters included.

NOTE: UL Listed for tile, terrazzo, and carpet floors. Brass covers and flanges are not interchangeable with aluminum or nonmetallic covers and flanges. Nonmetallic covers are interchangeable with aluminum flanges.

829PCK Nonmetallic Communications Cover Plate

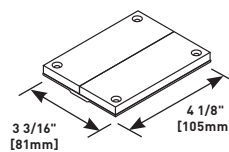

Breakouts. Available in black (829PCK-BLK) or brown (829PCK-BRN). Feed through only, not for use with a mounting plate for communication jacks.

828PR Nonmetallic Duplex Cover Plate

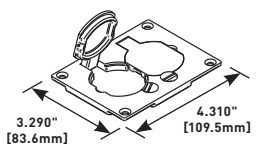

Flip lids. Available in black (828PR-BLK) or brown (828PR-BRN). Can also be used with a 106 type frame for communications.

829PSTC Nonmetallic Communications Cover Plate

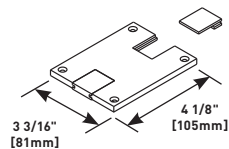

Data slides. Available in black (829PSTC-BLK) or brown (829PSTC-BRN). Feed through only, not for use with a mounting plate for communication jacks.

*Replacement flip lids can be ordered under Cat. No. PFL-BLK and PFL-BRN. Each Cat. No. comes with three flip lids. The above cover plates are listed for tile, terrazzo, and carpet floors.

NOTE: Brass covers and flanges are not interchangeable with aluminum or nonmetallic covers and flanges. Nonmetallic covers are interchangeable with aluminum flanges

WALKERDUCT® PRO SERIES SERVICE FITTINGS

Walkerduct Pro Series Trim Plates and Accessories Ordering Information

430 Single Blanking Plate

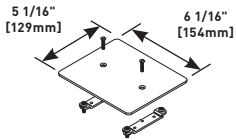

Brass (430BR) or aluminum (430AL) plate to cover single Walkerduct Pro Series Presets.

432 Triple Blanking Plate

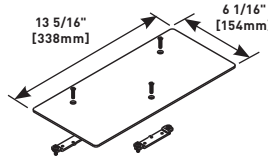

Brass (432BR) or aluminum (432AL) plate to cover three Walkerduct Pro Series Presets.

431 Double Blanking Plate

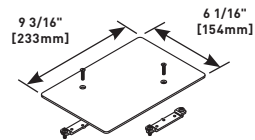

Brass (431BR) or aluminum (431AL) plate to cover two Walkerduct Pro Series Presets.

430075 Single Trim Plate

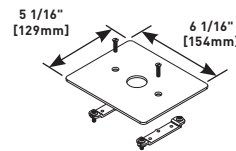

Brass (430BR075) or aluminum (430AL075) plate with opening for 3/4" trade size conduit or liquidtight connection. Fits over single Walkerduct Pro Series Preset.

Trim Plates and Accessories Ordering Information

431075 Double Trim Plate

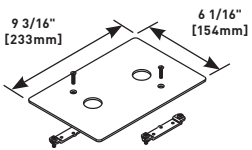

Brass (431BR075) or aluminum (431AL075) plate with opening for 3/4" trade size conduit or liquidtight connection. Fits over two Walkerduct Pro Series Presets.

427 Fiber Loop Kit

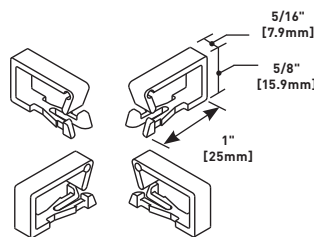

Nonmetallic clips snap into tabs in preset base. Hold up to one meter of cable. Maintain 1 1/4" [32mm] bend radius. Four clips included in kit.

430S505 Single 525 Trim Plate

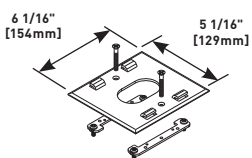

Aluminum plate with opening to attach 525 Series Service Fitting Housing. Fits over single Walkerduct Pro Series Preset.

421 Mudcap

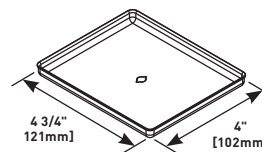

Steel mudcap for Walkerduct Pro Series Preset.

431D505 Double 525 Trim Plate

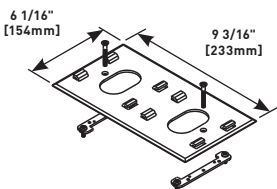

Aluminum plate with openings to attach two 525 Series Service Fitting Housings. Fits over two Walkerduct Pro Series Presets.

WALKERDUCT® PRO SERIES SERVICE FITTINGS

Walkerduct Pro Series Flush Carpet Plates Ordering Information

428DR, 428DR2 Flush Duplex Carpet Plate

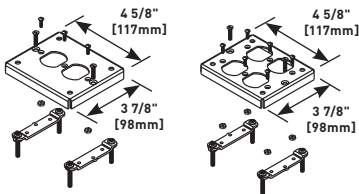

Single or double duplex opening. For carpet floors only. Steel plate mounts inside preset and is adjustable to floor height.

428B525 Flush 525 Series Carpet Plate

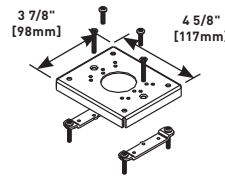

Openings to attach 525 Series Service Fitting on carpet plate. For carpet floors only. Steel plate mounts inside preset and is adjustable to floor height.

428B075 Flush Conduit Carpet Plate

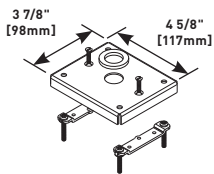

Opening fits 3/4" trade size conduit or liquidite. Includes spacer for liquidite connections. For carpet floors only. Steel plate mounts inside preset and is adjustable to floor height.

433DR, 433DR2 Flush Duplex Carpet Trim Plate

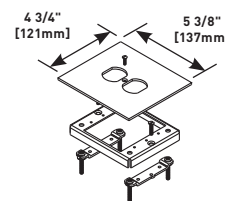

Carpet plate and finishing plate for single or double duplex openings. Flush steel plate mounts inside preset and is adjustable to floor height. Brushed aluminum finishing plate covers carpet plate and mounts over carpet.

428BL Blank Flush Carpet Plate

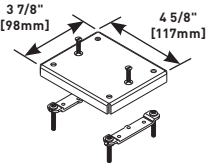

Blank carpet plate for custom punched openings or for abandoning preset. For carpet floors when used for activations. Steel plate mounts inside preset and is adjustable to floor height.

Important: A minimum 1 1/2" [38mm] preset or afterset is required on Pro Series Underfloor Duct to support standard duplex receptacles and communication devices when using flush activations. The 1" [25mm] preset or afterset should be specified for pedestal style fittings or when cabling will be pulled through the activation point.

Walkerduct Pro Series Service Fittings Installation Details

Brass or Aluminum Conduit Trim Plate Cat. No. 431AL075

Openings Fit 3/4" trade size Conduit. Conduit and Lock Washers Not Included

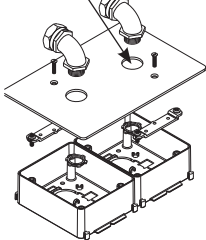

Brass Flange and Covers Cat. Nos. 827B, 828R and 829STC

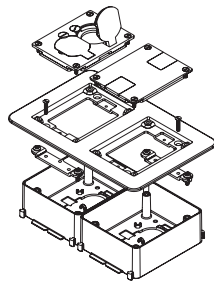

525 Trim Plate Cat. No. 430S505

525 Series Service Fitting Less Base Plate

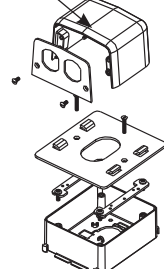

Flush Carpet Plate Cat. No. 428BL

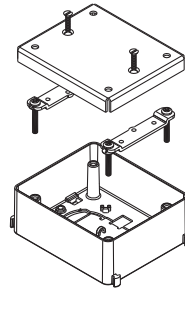

Flush Double Duplex Carpet Plate Cat. No. 428DR2

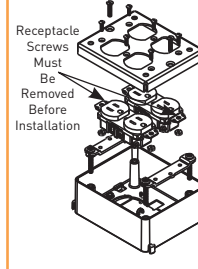

Flush Carpet Plate Cat. No. 428B075

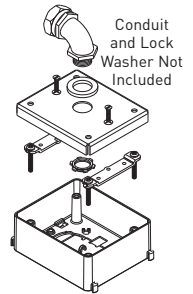

Important: Flush carpet plates are to be used only within a protected, enclosed environment such as under a retail counter with carpeted floors.

INFLOOR DUCT SYSTEMS



Wiremold® Infloor Duct Systems are cost-effective and flexible solutions for any wiring and communication needs throughout an open space environment which will accommodate needs now and into the future.

Featured Products



**Walkerduct
Underfloor Duct
Systems**

516



**Walkercell Cellular
Raceway Systems**

547

INFLOOR DUCT SYSTEMS

Table of Contents

Walkerduct® Underfloor Duct Systems



Walkerduct® Carpet / Tile Holders



Flushduct Infloor Duct Systems



Wallduct Raceway Systems



Trenchduct Feeder Systems

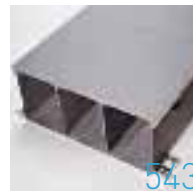

Walkercell® Cellular Raceway Systems



INFLOOR DUCT SYSTEMS

Quick Selection Guide

Walkerduct Underfloor Duct

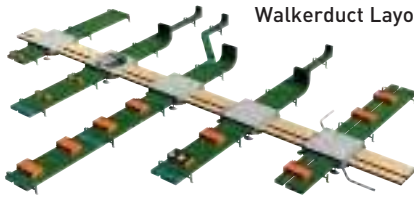

Walkerduct Layout with Junction Boxes

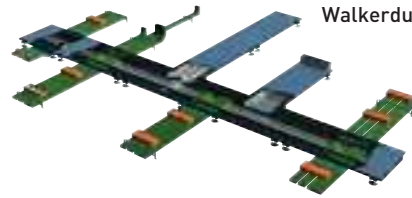

Walkerduct Layout with Trenchduct

Walkerduct with Junction Boxes offers capacity and flexibility for casinos, retail, libraries, light industrial, and small-to-medium office space.

Walkerduct with Trenchduct provides a high capacity of wire and cable management. Perfect for an open space setting, power and communications can be easily rewired through steel access plates.

Features:

- Two Sizes of Underfloor Ducts
- Multiple Duct Combinations/Configurations
- Quality Construction
- Ample Bend Radius throughout System
- Round or Square Junction Box Access Openings
- Choice of Preset Shape or Size
- Wide Variety of Activations

Service Fitting/Activation Options:

- 817 Series™ Flush Fittings
- 525 Series™ Pedestal Fittings
- 1200 Series™ Pedestal Fittings
- PSRC9 Series™ Flush Fittings
- Trench Access Hood
- Multiplex™ Pedestal Fittings

FlushDuct Infloor Duct Systems

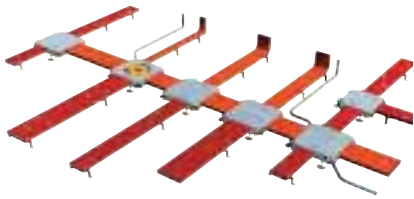

Walker Flushduct with Junction Boxes lay level with the concrete on the floor. It provides easy access through the duct and simple installation of wires and cables. It also offers an aesthetically pleasing option for any open space application.

Features:

- 1, 2, or 3 Duct Combinations
- Feed and Distribution Ducts Located Flush with Finished Floor
- Easy Access to Ducts through Factory Installed Screw Plugs
- Variety of Pedestal Activations
- 1 3/8" [35mm] Minimum System Depth [2 5/8" when using a junction box]
- Trenchduct Feed Maximizes Capacity

Service Fitting/Activation Options:

- 525 Series™ Pedestal Fittings
- Multiplex™ Pedestal Fittings

Walkercell Cellular Raceway

Walkercell Layout with Junction Box Header

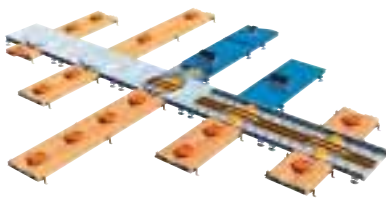

Walkercell Layout with Trenchduct

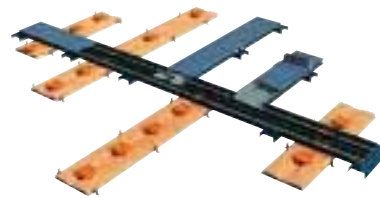

Walkercell Feed & Distribution Layout

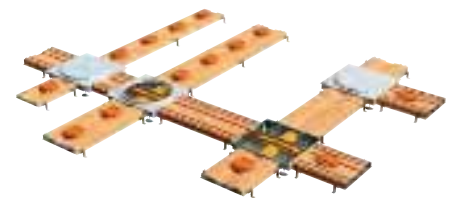

Walkercell with Junction Box Header provides fast installation and high flexibility along with high capacity for commercial and educational facilities. Easy access to cables and wires manage the changing business needs of commercial buildings.

Walkercell with Trenchduct provides fast installation and high flexibility along with high capacity for commercial and educational facilities. Easy access to cables and wires manage the changing business needs of commercial buildings.

Walkercell Feed and Distribution also provides fast installation and high flexibility along with high capacity for commercial and educational facilities. Easy access to cables and wires manage the changing business needs of commercial buildings.

Features:

- Three-in-One Configuration Raceway
- Triple Service Preset with Recessed Activations
- Large Capacity Feeder System
- Flexible Trenchduct Design
- Custom Options Available
- Ample Bend Radius throughout System

Service Fitting/Activation Options:

- FloorPort™ Recessed Fittings
- Multiplex™ Pedestal Fittings

INFLOOR DUCT SYSTEMS

Quick Selection Guide

Frequently Ordered Catalog Numbers

2-0 – No. 2 Duct without Presets?

No. 2 Walkerduct Pro Series with Presets

SPACING PRESETS	12" [305mm] OC	24" [610mm] OC
1" [25mm]	D21210	D22410
1 1/2" [38mm]	D21215	D22415
2" [51mm]	D21220	D22420
2 1/2" [64mm]	D21225	D22425
3" [76mm]	D21230	D22430

4-0 – No. 4 Duct without Presets?

No. 4 Walkerduct Pro Series with Presets

SPACING PRESETS	12" [305mm] OC	24" [610mm] OC
1" [25mm]	D41210	D42410
1 1/2" [38mm]	D41215	D42415
2" [51mm]	D41220	D42420
2 1/2" [64mm]	D41225	D42425
3" [76mm]	D41230	D42430

No. 2 Walkerduct with 2" IPS Presets

SPACING PRESETS	12" [305mm] OC	24" [610mm] OC
1" [25mm]	2-12 x 2 x 7/8	2-24 x 2 x 7/8
1 1/2" [38mm]	2-12 x 2 x 1 1/2	2-24 x 2 x 1 1/2
2" [51mm]	2-12 x 2 x 2	2-24 x 2 x 2
2 1/2" [64mm]	2-12 x 2 x 2 1/2	2-24 x 2 x 2 1/2
3" [76mm]	2-12 x 2 x 3	2-24 x 2 x 3

No. 4 Walkerduct with 2" IPS Presets

SPACING PRESETS	12" [305mm] OC	24" [610mm] OC
1" [25mm]	4-12 x 2 x 7/8	4-24 x 2 x 7/8
1 1/2" [38mm]	4-12 x 2 x 1 1/2	4-24 x 2 x 1 1/2
2" [51mm]	4-12 x 2 x 2	4-24 x 2 x 2
2 1/2" [64mm]	4-12 x 2 x 2 1/2	4-24 x 2 x 2 1/2
3" [76mm]	4-12 x 2 x 3	4-24 x 2 x 3

JUNCTION BOXES*	ROUND COVER PLATE	SQUARE COVER PLATE	ROUND HEAVY DUTY	SQUARE HEAVY DUTY	TWO-LEVEL
(1) No. 2 Duct	12JR-	12JS-	12HR-	12HS-	142L
(1) No. 4 Duct	14JR-	14JS-	14HR-	14HS-	142L
(2) No. 2 Ducts	222JR-	222JS-	222HR-	222HS-	
(2) No. 4 Ducts	244JR-	244JS-	244HR-	244HS-	
(1) No. 2 and (1) No. 4 Duct	224JR-	224JS-	224HR-	224HS-	
(3) No. 2 Ducts	3222JR-	3222JS-	3222HR-	3222HS-	
(2) No. 2 and (1) No. 4 Ducts	3224JR-	3224JS-	3224HR-	3224HS-	
(1) No. 2 and (2) No. 4 Ducts	3244JR-	3244JS-	3244HR-	3244HS-	
(1) No. 4, (1) No. 2, and (1) No. 4 Duct	3424JR-	3424JS-	3424HR-	3424HS-	
(3) No. 4 Ducts	3444JR-	3444JS-	3444HR-	3444HS-	
(4) No. 2 Ducts	42222JR-	42222JS-	42222HR-	42222HS-	
(5) No. 2 Ducts	522222JR-	522222JS-	522222HR-	522222HS-	

*Add suffix to indicate height of junction box.

Infloor Systems Terminology

Activation/Service Fitting – The device access point at which wires and cables egress from the infloor system. These products come in a variety of styles and sizes and can be recessed into the floor, flush with the floor or mounted above the floor.

Afterset – A metal fitting installed between the infloor raceway and the activation used to bring cables and wires from the raceway to the activation. It is installed after core drilling the concrete to reach the raceway buried in the concrete.

Crossunder – A design option of intersecting infloor raceways where one system drops down under the other instead of intersecting on the same plane.

Distribution Raceway – Raceway that carries wires and cables from the feeder system to the workstation area. Typically has presets attached to the raceway, but can also have aftersets.

Feeder System – Large capacity raceway used to carry cables and wires from the communication and power closets to the distribution raceway. Trenchduct, Headerduct, and No. 4 duct are commonly used as feeder systems.

Junction Box – A location in the raceway system that allows transition of pathways and access to cables.

Mudcap – A recessed lid installed on the top of a preset or afterset to prevent concrete from entering it. Mudcap is removed when access to the wires and cables is needed. The concrete above it is chipped out, and the mudcap is removed with a screwdriver.

Preset – A metal fitting is mounted on the infloor raceway that is buried in the concrete, designed to provide an access point to the cable and wires in the raceway. The concrete above it (1/8" deep) and the mudcap are removed, and a service fitting is mounted on it to provide cable and wire egress from the raceway.

Slab Depth – Total depth of the concrete.

System Depth – Depth of Walker Infloor System from base of duct/cell/trench to the top of the cover plates.

INFLOOR DUCT SYSTEMS

Quick Selection Guide

Walkerduct Pro Series Duct Systems

ACCESSORIES	SYSTEM										
	12	14	222	224	244	3222	3224	3244	3424	3444	
Adjustable Supports*	SC12-	SC14-	SC222-	SC224-	SC244-	SC3222-	SC3224-	SC3244-	SC3244-	SC3244-	*
Hold-Down Strap	HS12	HS14	HS222	HS224	HS244	HS3222	HS3224	HS3244	HS3244	HS3244	*
Couplings	302	H302	302	302 H302	H302	302	302 H302	302 H302	302 H302	302 H302	H302
Duct End Closures	304	H304	304	304 H304	H304	304	304 H304	304 H304	304 H304	304 H304	H304
Conduit Adapters	312- 314- 317- 322- 324-	H312- H317- H322	312- 314- 317- 322- 324-	312- 314- 317- 322- 324- H322- H317- H312-	H312- H317- H324-	312- 314- 317- 322- 324-	312- H312- 314- 317- H317- 322- H322- 324- H312-	312- 314- 317- H317- H322- 324- H312-	312- 314- 317- H317- H322- 324- H312-	H312- H317- H322	
Box Corner Conduit Adapter	255-	255-	255-	255-	255-	255-	255-	255-	255-	255-	
Terminal Bushings	334UF	H334	334UF	334UF H332	H334	334UF	334UF H334	334UF	334UF	334UF	H334
Vertical Elbows	332UF	H332	332UF	332UF H332	H332	332UF	332UF H332	332UF H332	332UF H332	332UF H332	H332
Horizontal Elbows (90° & 45°)	338UF 342UF	H338 H342	338UF 342UF	338UF H338 342UF H342	H338 H342	338UF 342UF	338UF H338 342UF H342	338UF H338 342UF H342	338UF H338 342UF H342	H338 H342	
Crossunder Offsets	372 375	H372 H375	372 375	372 H372 375 H375	H372 H375	372 375	372 H372 375 H375	372 H372	372 H372	H372 H375	
Expansion Joints	382	H382	382	382 H382	H382	382	382 H382	382 H382	382 H382	H382	
Mudcaps	421	421	421	421	421	421	421	421	421	421	
Marker Caps	422GR 422RD	422GR 422RD	422GR 422RD	422GR 422RD	422GR 422RD	422GR 422RD	422GR 422RD	422GR 422RD	422GR 422RD	422GR 422RD	
Box Opening Closures	203	H203	203	203 H203	H203	203	203 H203	203 H203	203 H203	H203	
Box Closure Adapters	— 275SR	275SL 275SR	—	275SL 275SR	275SL 275SR	—	275SL 275SR	275SL 275SR	275SL 275SR	275SL 275SR	
Sealant	290G	290G	290G	290G	290G	290G	290G	290G	290G	290G	
Tile & Carpet Trim/holders	square FT6- CT6- round SFCS5- SFCB5-	square FT10- CT10- round SFCS9- SFCB9-	square FT10- CT10- round SFCS9- SFCB9-	square FT15- CT15- round SFCS14- SFCB14-	square FT18- CT18- round SFCS17- SFCB17-	square FT15- CT15- round SFCS14- SFCB14-	square FT18- CT18- round SFCS17- SFCB17-	square FT21- CT21- round SFCS20- SFCB20-	square FT21- CT21- round SFCS20- SFCB20-	square FT25- CT25- round SFCS24- SFCB24-	
Junction Box Conduit Adapters	212- 232-	H232-	212- 232-	212- 232- H232-	H232	212 232	212 232 H232-	212 232 H232-	212 232 H232-	H232	

*Supports include built-in Coupling.

NOTE: Part numbers ending in a dash need to have the height adjustment size suffix included when ordering. Please see the individual support product descriptions for this information.

Walkerduct Raceways provide wire management for open space environments while maintaining aesthetics because they are buried in the floor, out of sight, and safe from abuse. The duct is designed to be used with Walkerduct Junction Boxes or Walker® Trenchduct to create an infloor wire management system. Duct runs provide a range of capacities to suit any situation and to future proof the wire management system. Duct can be used individually or combined with other duct to deliver power and communication services to workstations. Multiple duct runs may be all one size of duct or a mix of sizes. Activations may be located anywhere along the length of the duct to maximize flexibility and accessibility to wiring workstations. Flexibility is only limited by the grid pattern. Designed to be used with power and communications service fittings shown in Service Fittings section of this Product Guide.

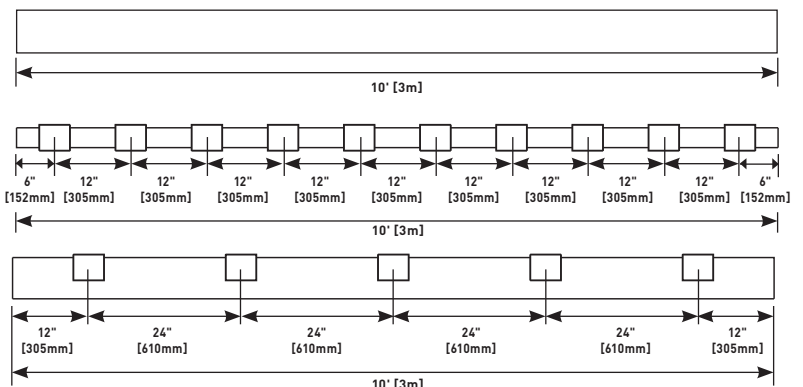

WALKERDUCT® UNDERFLOOR DUCT SYSTEMS



Walkerduct® Underfloor Duct Systems offer maximum capacity and configurability using two sizes of duct.

CODE REFERENCE

ULus Listed Underfloor Raceway:
File E7020 Guide RKCZ

cULus Listed Underfloor Raceway Fittings:
File E11912 Guide RKQX.
Meets Article 390 of NEC.

Walkerduct Pro Series System Layout with Junction Boxes

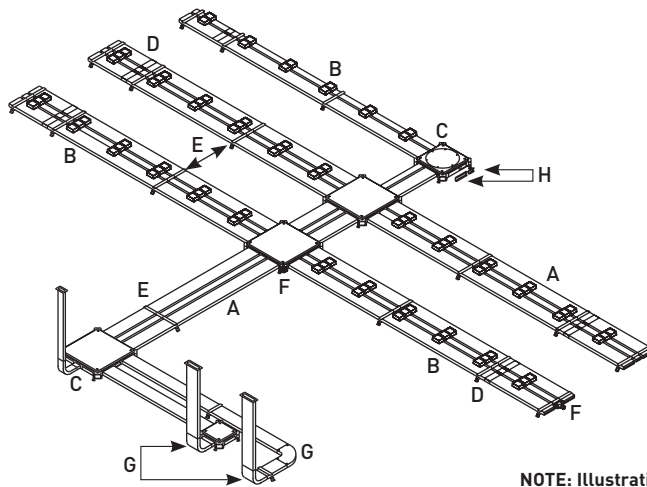

KEY

- A. Duct
- B. Pro Series Preset
- C. Junction Box
- D. Coupling
- E. Duct Support
- F. Conduit Adapter
- G. Elbow
- H. Junction Box Closure

NOTE: Illustration is for showing product applications only.

Walkerduct 2" [51mm] IPS Duct System Layout with Trenchduct

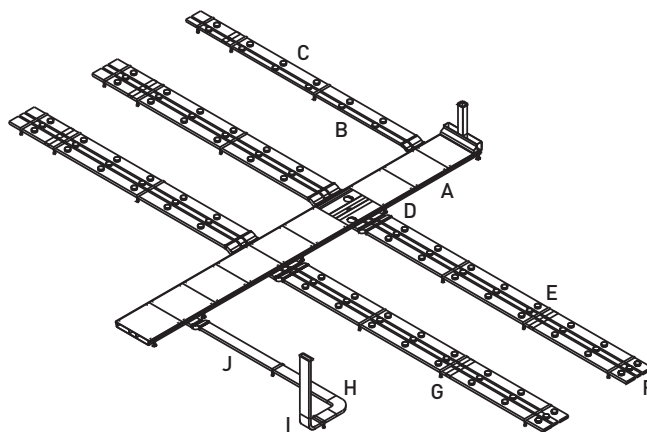

KEY

- A. Trenchduct
- B. #2 2" IPS Duct
- C. #4 2" IPS Duct
- D. Cross Under
- E. Couplings
- F. End Closure
- G. Duct Support
- H. Horizontal Flat Elbow
- I. Vertical Elbow
- J. Blank #4 Duct

NOTE: Illustration is for showing product applications only.

WALKERDUCT® UNDERFLOOR DUCT SYSTEMS

Walkerduct Underfloor Duct Systems Service Fitting Compatibility

PRODUCT FAMILY	CATALOG NUMBER	ACTIVATION LOCATION		SERVICE CAPACITY			SERVICE COMPATIBILITY			MATERIAL/COLORS				
		Flush	Pedestal	Single Service	Dual Service	Triple Service	Power	Communication	Audio/Visual	Polycarbonate	Aluminum	Brass	Gray	Black
	817B	•		•			•	•				•		
	827B	•			•		•	•				•		
	837B	•				•	•	•				•		
	817PCC	•		•			•	•		•				•
	827PCC	•			•		•	•		•				•
	837PCC	•				•	•	•		•				•
	818TCAL	•		•			•	•			•			
	828TCAL	•			•		•	•			•			
	838TCAL	•				•	•	•			•			
	S165B	•		•			•					•		
	S165BLK/BRN	•		•						•				•
	S166B	•		•				•				•		
	S166BLK/BRN	•		•				•		•				•
	S175BLK/BRN	•		•			•			•				•
	PSRC9TC	•		•			•				•	•	•	•
	PSRC9AMDTC	•		•				•			•	•	•	•
	PSRC9FFTC	•		•				•			•	•	•	•
	1204BF		•	•				•				•		
	1204AL		•	•				•				•		
	1223BF		•	•			•					•		
	1223AL		•	•			•					•		
	MP4		•	•			•	•	•		•			
	MP8		•		•		•	•	•		•			
	MP8-1		•		•		•	•	•		•			
	525A		•	•				•	•		•			
	525B		•	•				•	•		•			
	525C		•	•				•	•		•			
	525D		•	•				•	•		•			
	525F		•	•			•				•			
	25G		•	•			•				•			
	525H		•	•			•				•			
	525I		•	•			•				•			
	525J		•	•			•	•	•		•			
	525RT		•	•				•			•			
525ACT		•	•				•			•				

WALKERDUCT® UNDERFLOOR DUCT SYSTEMS

Walkerduct Cable Size/Fill Chart

	CABLE/WIRE SIZE	DIAMETER (Approx.)		AREA (In ²)		40% FILL	
		Inches	[mm]	Sq. In.	[Sq. mm]	No. 2	No. 4
UNSHIELDED TWISTED PAIR	4-pair, 24 AWG, Cat 5	0.220	[5.6]	.038	[24.5]	35	91
	4-pair, 24 AWG, Cat 6	0.250	[6.4]	.049	[31.7]	27	71
TELEPHONE	2-pair, 24 AWG	0.140	[3.6]	.015	[9.9]	89	232
	4-pair, 24 AWG	0.190	[4.8]	.028	[18.1]	47	124
	25-pair, 24 AWG	0.410	[10.4]	.132	[85.2]	10	26
COAXIAL	RG58/U	0.195	[4.9]	.030	[19.4]	44	116
	RG59/U	0.242	[6.1]	.046	[29.7]	29	75
	RG6/U	0.270	[6.8]	.057	[36.8]	23	61
SHIELDED TWISTED PAIR	TYPE 1	0.390	[9.9]	.119	[76.8]	11	29
	TYPE 2	0.465	[11.8]	.170	[109.7]	7	20
	TYPE 3	0.245	[6.2]	.047	[30.3]	28	74
FIBER	2 Strand	0.180	[4.6]	.025	[16.1]	53	139
	4 Strand	0.190	[4.8]	.028	[18.1]	47	124
	6 Strand	0.210	[5.3]	.035	[22.6]	38	99
	Fiber ZipCord	0.110	[2.8]	.010	[6.5]	133	348

Walkerduct Wire Size/Fill Chart

WIRE SIZE THHN/THWN/THWN-2	DIAMETER		AREA (In ²)		40% FILL	
	Inches	[mm]	Sq. In.	[Sq. mm]	NO. 2	NO. 4
14 AWG	0.111	[2.8]	.0097	[6.3]	137	359
12 AWG	0.130	[3.3]	.0133	[8.6]	100	262
10 AWG	0.164	[4.2]	.0211	[13.6]	63	165
8 AWG	0.216	[5.5]	.0366	[23.6]	36	95
6 AWG	0.254	[6.5]	.0507	[32.7]	26	68
4 AWG	0.324	[8.2]	.0824	[53.2]	16	42

Walkerduct Duct Configuration Options

2-0 Blank No. 2 Duct

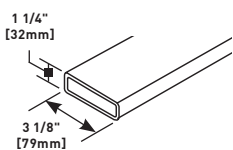

3 1/8" x 1 1/4" [79mm x 32mm]
16 gauge galvanized steel. One piece, continuously seam welded construction. 10' [3m] standard length. Used primarily for afterset applications or as a feeder run.

D21210 Pro Series No. 2 Duct, 12" [305mm] Spacing

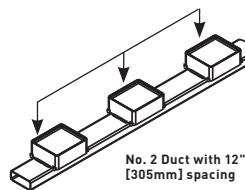

D21215, D21220, D21225, D21230
Factory-installed preset duct. Used for distribution runs. 10' [3m] standard length, 16 gauge galvanized construction with continuous seam weld. Last two digits of Catalog Number indicates preset height.

4-0 Blank No. 4 Duct

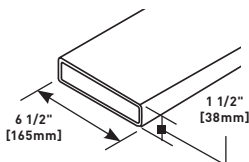

6 1/2" x 1 1/2" [165mm x 38mm]
16 gauge galvanized steel. One piece, continuously seam welded construction. 10' [3m] standard length. Used primarily for afterset applications or as a feeder run.

D22410 Pro Series No. 2 Duct, 24" [610mm] Spacing

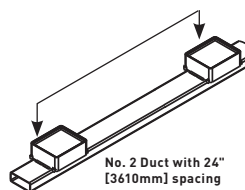

D22415, D22420, D22425, D22430
Factory-installed preset duct. Used for distribution runs. 10' [3m] standard length, 16 gauge galvanized construction with continuous seam weld. Last two digits of Catalog Number indicates preset height.

WALKERDUCT® UNDERFLOOR DUCT SYSTEMS

Walkerduct Duct Configuration Options (continued)

D41210 Pro Series No. 4 Duct, 12" [305mm] Spacing

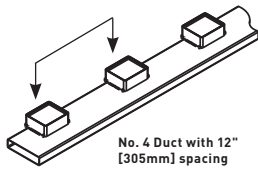

D41215, D41220, D41225, D41230
Factory-installed preset duct. Used for distribution runs. 10' [3m] standard length, 16 gauge galvanized construction with continuous seam weld. Last two digits of Catalog Number indicates preset height.

4-12x2x7/8 2" [51mm] IPS No. 4 Duct, 12" [305mm] Spacing

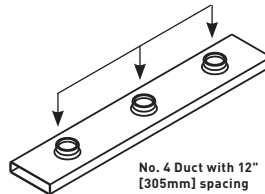

4-12x2x11/2, 4-12x2x2, 4-12x2x21/2, 4-12x2x3
Factory installed round preset duct with internal threads to accept standard connectors. 10' [3m] standard length, 16 gauge galvanized steel construction with continuous seam weld. Suffix indicates preset insert height. Preset I.D. is threaded for 2" [51mm] conduit.

D42410 Pro Series No. 4 Duct, 24" [610mm] Spacing

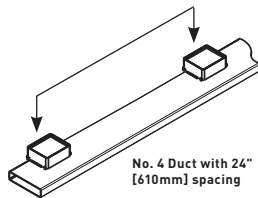

D42415, D42420, D42425, D42430
Factory-installed preset duct. Used for distribution runs. 10' [3m] standard length, 16 gauge galvanized construction with continuous seam weld. Last two digits of Catalog Number indicates preset height.

4-24x2x7/8 2" [51mm] IPS No. 4 Duct, 24" [610mm] Spacing

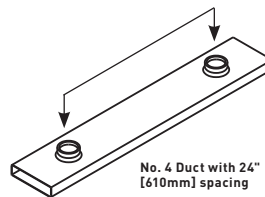

4-24x2x11/2, 4-24x2x2, 4-24x2x21/2, 4-24x2x3
Factory installed round preset duct with internal threads to accept standard connectors. 10' [3m] standard length, 16 gauge galvanized steel construction with continuous seam weld. Suffix indicates preset insert height. Preset I.D. is threaded for 2" [51mm] conduit.

2-12x2x7/8 2" [51mm] IPS No. 2 Duct, 12" [305mm] Spacing

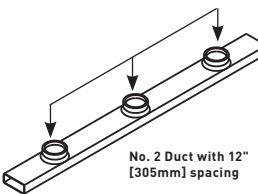

2-12x2x11/2, 2-12x2x2, 2-12x2x21/2, 2-12x2x3
Factory installed round preset duct with internal threads to accept standard connectors. 10' [3m] standard length, 16 gauge galvanized steel construction with continuous seam weld. Suffix indicates preset insert height. Preset I.D. is 2" [51mm].

IMPORTANT: Triple-gang flush activations are not compatible with 3222 and 3444 System layouts. Use combination of single- and two-gang activations to access all three ducts at one point.

IMPORTANT: A minimum 1 1/2" [38mm] preset or afterset is required on Pro Series Underfloor Duct to support standard duplex receptacles when using flush activations. Most communication devices will need a minimum of 2" preset or afterset on Pro Series Underfloor Duct when using flush activations.

NOTE: 1 1/2" preset is minimum height required for power.

2-24x2x7/8 2" [51mm] IPS No. 2 Duct, 24" [610mm] Spacing

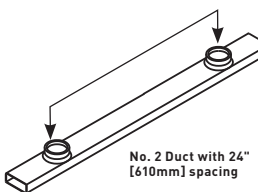

2-24x2x11/2, 2-24x2x2, 2-24x2x21/2, 2-24x2x3
Factory installed round preset duct with internal threads to accept standard connectors. 10' [3m] standard length, 16 gauge galvanized steel construction with continuous seam weld. Suffix indicates preset insert height. Preset I.D. is threaded for 2" [51mm] conduit.

DUCT CONFIGURATION NOTES

- Custom insert heights, duct lengths, and preset spacings are available. Contact factory for detailed information.
- Multi-gang Pro Series Duct Systems use an alignment clip to connect presets. One alignment clip is included with each piece of duct and prevents movement of presets during concrete pour.

End View with Alignment Clip in Place

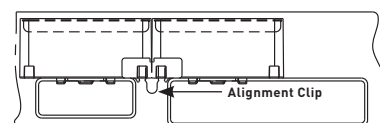

WALKERDUCT® UNDERFLOOR DUCT SYSTEMS

Walkerduct Duct Accessories Ordering Information

SC12 Adjustable Duct Supports with Built-in Coupling

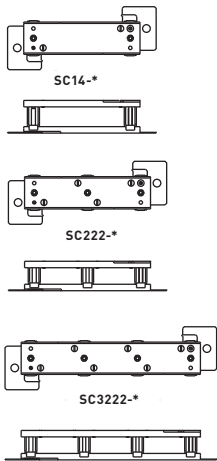

SC14, SC222, SC224, SC244, SC3222, SC3224, SC3244, SC3424

To support, couple, and hold duct in place before and during concrete pour. Steel construction. Leveling screws provide vertical adjustment. Different leg heights available. Supports may be fastened to form or to slab through holes in the feet. Top members maintain 1" [25mm] spacing between ducts. Locate duct supports on approximately 5' [1.5m] intervals.

*CATALOG NO. SUFFIX	HEIGHT ADJUSTMENT
-18	1/2" [12.7mm] to 1 7/8" [48mm]
-33	1 1/2" [38mm] to 3 3/4" [95mm]
-48	3" [76mm] to 4 7/8" [124mm]

Duct supports for deeper pours are available through the factory.

How to Determine Correct Support Heights

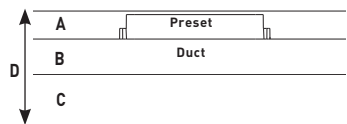

- A Height of preset.
- B Height of duct.
- C Distance from bottom of duct to form or slab. This dimension is the correct support height.
- D Distance between finished concrete floor line and floor slab. This dimension is the sum total of A, B, and C. Support Height (C) = D - (A and B)

HS12 Hold-Down Straps

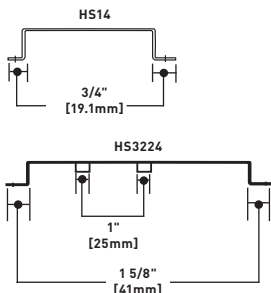

HS14, HS222, HS224, HS244, HS3222, HS342, HS3244

To fasten ducts to the slab in shallow concrete. Used in place of duct supports. Straps maintain 1" [25mm] spacing between ducts on multiple duct runs and prevent duct from floating during concrete pour. Attaches to slab with stakes or drive pins (not included). Locate Hold-Down Straps on approximate 5' [1.5m] centers. Duct systems with both #2 and #4 ducts will require a 1/4" thick shim to bring the top of the #2 duct level with the #4 duct. Consult factory for additional information.

NOTE: Steel shims (Cat. # Duct Shims) should be placed under #2 Duct to maintain proper preset height.

421 Pro Series Mudcap

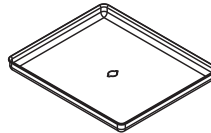

Steel replacement cap for preset or afterset. Recessed to hold 3/8" [9.5mm] concrete.

422GR, 422RD Pro Series Marker Cap

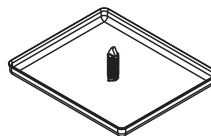

Replaces mudcap on preset to indicate location of the last insert in each run. Select color for each service.

425, 426 Preset Extensions

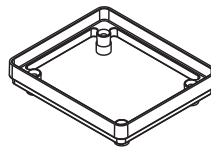

1/2" [12.7mm] (425) and 1" [25mm] (426) Preset Extensions. Steel replacement cap for preset or afterset. Recessed to hold 3/8" [9.5mm] concrete.

D2075, D4075 Duct Conduit Hub

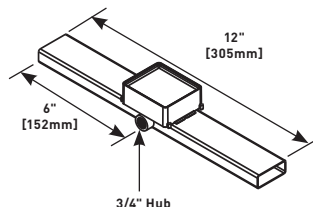

D2075 for No. 2 Duct, D4075 for No. 4 Duct. 12" [305mm] section of Duct with 1" [25mm] Preset. For rigid or PVC conduit. Used to provide feed to isolated outlets; maintains 12" [305mm] spacing of presets. Preset height is 1" [25mm]. Add extensions if higher preset needed.

404 2" [51mm] IPS Duct Mudcap

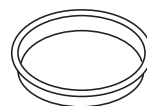

Steel replacement cap for 2" [51mm] IPS preset. Recessed to hold 3/8" [9.5mm] concrete.

415B, 415N 2" [51mm] IPS Duct Marker Cap

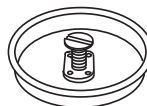

Replaces mudcap on preset to indicate location of run. NEC requires markers to locate the last preset in each run. Select color for each service. Available in brass (B) or steel (N).

WALKERDUCT® UNDERFLOOR DUCT SYSTEMS

Walkerduct Duct Accessories Ordering Information (continued)

317-3/4*, H317-3/4*

2" [51mm] IPS Duct Conduit Hub

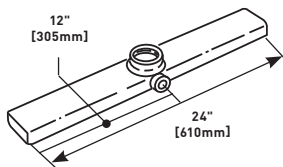

317-3/4-* for No. 2 Duct, H317-3/4-* for No. 4 Duct. 2' [610mm] Section of Duct with IPS Preset and 3/4" [19.1mm] Conduit Hub. For rigid conduit. Used to provide feed to isolated outlets; maintains 24" [610mm] spacing of presets. Heights from 7/8" [22.2mm] to 3 1/2" [89mm].
***Specify preset height.**

H322-11/4, H322-11/2

Female Conduit Adapter

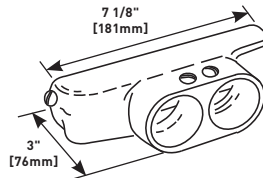

Fits on the outside of No. 4 Duct. For two rigid or PVC conduits. Suffix denotes conduit trade size.

312-3/4 Female Conduit Adapter

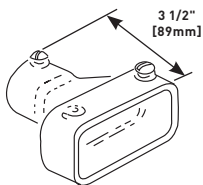

312-1, 312-11/4, 312-11/2, 312-2
 Fits on outside of No. 2 Duct. For one rigid or PVC conduit. Suffix denotes conduit trade size.

324-3/4 Male Conduit Adapter

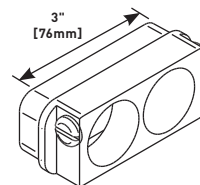

Fits into the end of No. 2 Duct. For two 3/4" trade size rigid or PVC conduits.

H312-3/4 Female Conduit Adapter

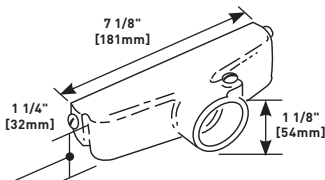

H312-1, H312-11/4, H312-11/2, H312-2
 Fits on outside of No. 4 Duct. For one rigid or PVC conduit. Suffix denotes conduit trade size.

300-4 Adapter Coupling

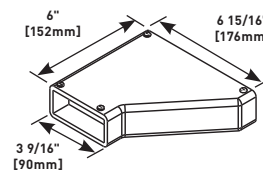

Couples No. 2 Duct to No. 4 Duct.

302, H302 Coupling

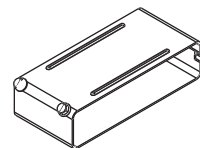

302- To Couple two No. 2 Ducts.
 H302- To Couple two No. 4 Ducts.

314-3/4 Male Conduit Adapter

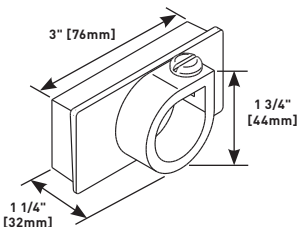

Fits into end of No. 2 Duct. For one 3/4" trade size rigid or PVC conduit.

304, H304 Duct End Plug

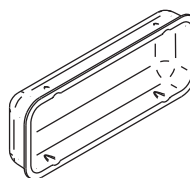

304- To seal the end of No. 2 Duct.
 H304- To seal the end of No. 4 Duct.

322-11/4, 322-11/2 Female Conduit Adapter

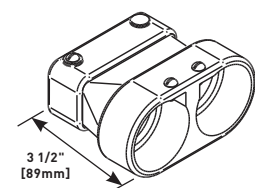

Fits on the outside of No. 2 Duct. For two rigid or PVC conduits. Suffix denotes conduit trade size.

334UF Panel connector

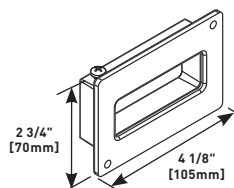

Secures No. 2 Duct to cabinet.

WALKERDUCT® UNDERFLOOR DUCT SYSTEMS

Walkerduct Duct Accessories Ordering Information (continued)

H334 Panel Connector

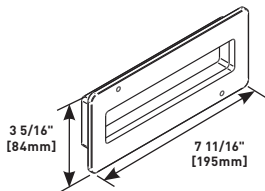

Secures No. 4 Duct to cabinet.

H338AU-1 90° Horizontal Elbow with Access Unit

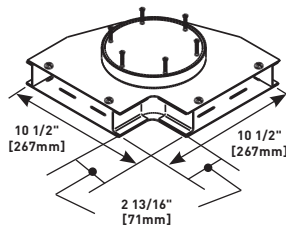

Used to make 90° horizontal turn in No. 4 Duct. Access cover can be removed to facilitate wire pulling.

332UF 90° Vertical Elbow

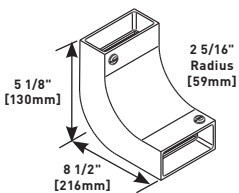

Creates 90° vertical turn in No. 2 Duct.

342UF Adjustable Horizontal Elbow

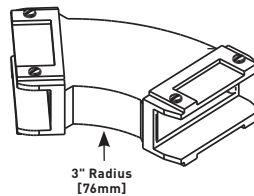

No. 2 Duct elbow angled for 45° turn. Angle may be varied from 22 1/2° to 67 1/2° by cutting duct ends at different angles.

H332 90° Vertical Elbow

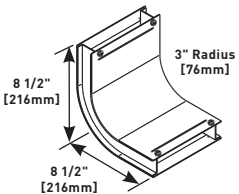

Creates 90° vertical turn in No. 4 Duct.

H342 Adjustable Horizontal Elbow

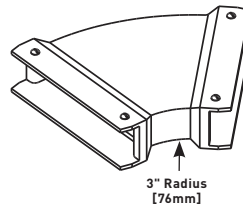

No. 4 Duct elbow angled for 45° turn. Angle may be varied from 22 1/2° to 67 1/2° by cutting duct ends at different angles.

338UF 90° Horizontal Elbow

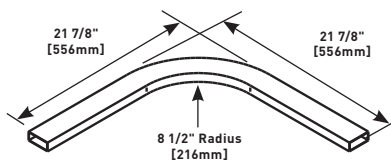

Creates 90° horizontal turn in No. 2 Duct.

372, H372 Offset

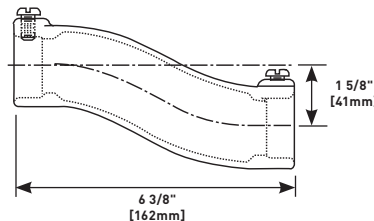

372 – for No. 2 Duct, H372 – for No. 4 Duct. Used to raise or lower a run of duct by 1 5/8" [41mm]. Two required for crossunders.

H338 90° Horizontal Elbow

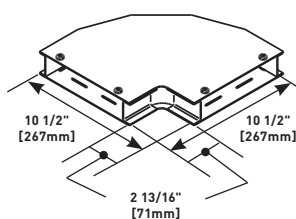

Creates 90° horizontal turn in No. 4 Duct.

WALKERDUCT® UNDERFLOOR DUCT SYSTEMS

Walkerduct Duct Accessories Ordering Information (continued)

375, H375 Variable Offset

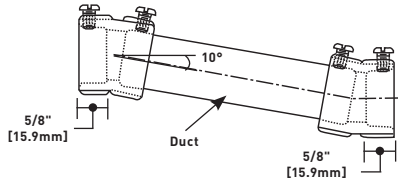

375 – for No. 2 Duct, H375 – for No. 4 Duct. Used to raise or lower a run of duct from 5/16 [7.9mm] to 3 1/2 [89mm]. Field cut duct based on chart below.

FOR OFFSET	DUCT CUT (LENGTH)	FOR OFFSET	DUCT CUT (LENGTH)
5/16" [7.9mm]	1 3/8" [35mm]	1"	5 3/8" [137mm]
3/8" [9.5mm]	1 3/4" [44mm]	1 1/4" [32mm]	6 13/16" [173mm]
7/16" [11.1mm]	2 1/8" [54mm]	1 1/2" [38mm]	8 1.4" [210mm]
1/2" [12.7mm]	2 1/2" [64mm]	1 3/4" [45mm]	9 11/16" [246mm]
9/16" [14.3mm]	2 7/8" [73mm]	2"	11 1/4" [286mm]
5/8" [15.9mm]	3 1/4" [83mm]	2 1/4" [57mm]	12 9/16" [319mm]
11/16" [17.5mm]	3 1/2" [89mm]	2 1/2" [64mm]	14" [356mm]
3/4" [19.1mm]	3 7/8" [98mm]	2 3/4" [70mm]	15 7/16" [392mm]
13/16" [20.6mm]	4 1/4" [108mm]	3"	16 7/8" [429mm]
7/8" [22.2mm]	4 5/8" [118mm]	3 1/4" [83mm]	18 5/16" [465mm]
15/16" [23.8mm]	5" [127mm]	3 1/2" [89mm]	19 3/4" [502mm]

382, H382 Expansion Sleeve Joints

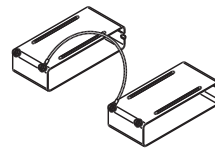

382 – for No. 2 Duct, H382 – for No. 4 Duct. Slip over two sections of duct. Outside screws fasten and ground sleeves of duct.

290C Waterproof Sealing Compound



Three tubes, 10.1 fluid ounces each. Will seal approximately 100 couplings, (12) three-duct boxes, (25) two-duct boxes, or (50) single-duct boxes.

Walkerduct Aftersets & Accessories Ordering Information

480 Electronic Insert Finder



Used to locate preset inserts which are buried in concrete. Magnetic field locates mudcap in concrete.

H14ABD Afterset Access Assembly



Provides access to pull large number of cables out of duct at one activation. Neoprene boot to protect wires not included. Use 6ER- Extension Ring when additional height is required.

4215 Pro Series Afterset

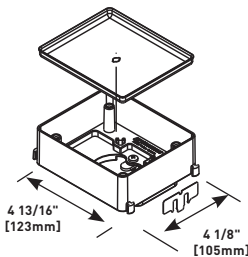

4220, 4225, 4230
Installed either before or after concrete pour to create activation from duct. 4215 = 1 1/2" [38mm], 4220 = 2" [51mm], 4225 = 2 1/2" [64mm], and 4230 = 3" [76mm].

NOTE: Drill a 6 1/2" [165mm] hole in concrete and a 2 1/2" [64mm] hole in duct.

NOTE: Need minimum of 1 1/2" height for power.

H14-BA Afterset Access Assembly Neoprene Boot

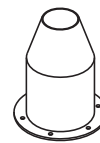

Used with H14ABD to protect cables coming out of duct.

436-2-7/8 2" [51mm] IPS Duct Round Afterset

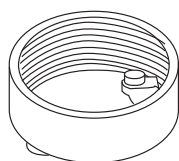

436-2-11/2, 436-2-2, 436-2-23/8, 436-2-3
Installed either before or after concrete pour to create activation from duct. 436-2-7/8 = 7/8" [22.2mm], 436-2-1 1/2 = 1 1/2" [38mm], 436-2-2 = 2" [51mm], 436-2-2 3/8 = 2 3/8" [60mm], and 436-2-3 = 3" [76mm].

NOTE: Drill a 2 1/2" [64mm] hole in concrete and a 2 1/4" [57mm] hole in duct.

H14-AS Complete Access Activation



For access to large number of cables for activation. Use 6ER- Extension Ring when additional height is required.

WALKERDUCT® UNDERFLOOR DUCT SYSTEMS

Walkerduct Aftersets Ordering Information

H14BC Blanking Cap



Closes 5" [127mm] hole in duct.

6ER-11/2 Extension Ring

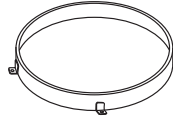

6ER-2, 6ER-2 1/2, 6ER-3, 6ER-3 1/2
Extension ring for H14ABD and H14-AS Boxes. Suffix refers to height of concrete over duct.

Walkerduct Junction Boxes Ordering Information

This chart provides the information needed to select the correct suffix for all of the Junction Box Catalog Numbers listed in this section.

NOTE: Square Tile/Carpet Trims for heavy duty Junction Boxes – need to increase depth of Pan by 1/8". Example: for 1/4" Carpet, use 3/8" deep Carpet Holder.

SUFFIX FOR JUNCTION BOXES*	DEPTH OF CONCRETE OVER DUCT	
1	1"	[25mm] min. to 1 1/2" [35mm] max.
1 1/2	1 1/2"	[38mm] min. to 2" [51mm] max.
2	2"	[51mm] min. to 2 1/2" [62mm] max.
2 1/2	2 1/2"	[64mm] min. to 3" [76mm] max.
3	3"	[76mm] min. to 3 1/2" [89mm] max.
3 1/2	3 1/2"	[89mm] min. to 4" [102mm] max.
4	4"	[102mm] min. to 4 1/2" [114mm] max.
4 1/2	4 1/2"	[114mm] min. to 5" [127mm] max.
5	5"	[127mm] min. to 5 1/2" [140mm] max.
5 1/2	5 1/2"	[140mm] min. to 6" [152mm] max.
6	6"	[152mm] min. to 6 1/2" [165mm] max.

*Other junction box heights are available. Consult factory for availability.

CAT. NO.	DESCRIPTION
12JS-	Square Access Plate
12JR-	Round Access Plate
12HS-	Heavy Duty – Square Access Plate
12HR-	Heavy Duty – Round Access Plate

NOTE: Suffix denotes height.

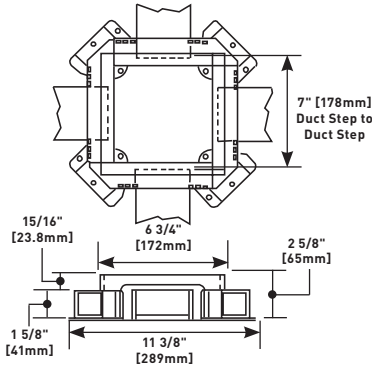

One No. 2 Duct per side. No interior partitioning. Square cover plate measures 6 3/4" x 6 3/4" [171mm x 171mm]. Diameter of round cover plate is 4.813" [122mm].

CAT. NO.	DESCRIPTION
222JS-	Square Access Plate
222JR-	Round Access Plate
222HS-	Heavy Duty – Square Access Plate
222HR-	Heavy Duty – Round Access Plate

NOTE: Suffix denotes height.

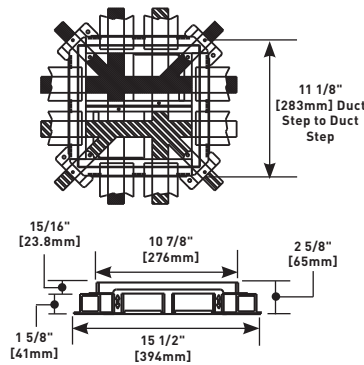

Two No. 2 Ducts per side. Square cover plate measures 10 7/8" x 10 7/8" [276mm x 276mm]. Diameter of round cover plate is 8.938" [227mm].

CAT. NO.	DESCRIPTION
14JS-	Square Access Plate
14JR-	Round Access Plate
14HS-	Heavy Duty – Square Access Plate
14HR-	Heavy Duty – Round Access Plate

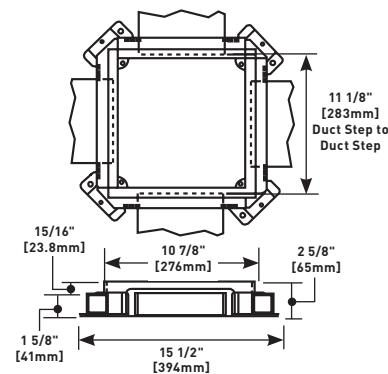

One No. 4 Duct per side. No interior partitioning. Square cover plate measures 10 7/8" x 10 7/8" [276mm x 276mm]. Diameter of round cover plate is 8.938" [227mm].

NOTE: For all 3 Duct Boxes – Center compartment cannot be accessed with Corner Conduit Adapter, part #255.

WALKERDUCT® UNDERFLOOR DUCT SYSTEMS

Walkerduct Junction Boxes Ordering Information (continued)

CAT. NO.	DESCRIPTION
224JS-	Square Access Plate
224JR-	Round Access Plate
224HS-	Heavy Duty – Square Access Plate
224HR-	Heavy Duty – Round Access Plate

NOTE: Suffix denotes height.

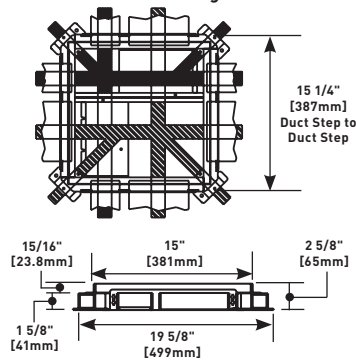

One No. 2 Duct and one No. 4 Duct per side. Square cover plate measures 15" x 15" [381mm x 381mm]. Diameter of round cover plate is 13.063" [332mm].

CAT. NO.	DESCRIPTION
3222JS-	Square Access Plate
3222JR-	Round Access Plate
3222HS-	Heavy Duty – Square Access Plate
3222HR-	Heavy Duty – Round Access Plate

NOTE: Suffix denotes height.

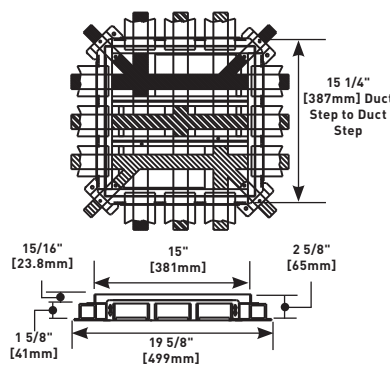

Three No. 2 Ducts per side. Square cover plate measures 15" x 15" [381mm x 381mm]. Diameter of round cover plate is 13.063" [332mm].

CAT. NO.	DESCRIPTION
244JS-	Square Access Plate
244JR-	Round Access Plate
244HS-	Heavy Duty – Square Access Plate
244HR-	Heavy Duty – Round Access Plate

NOTE: Suffix denotes height.

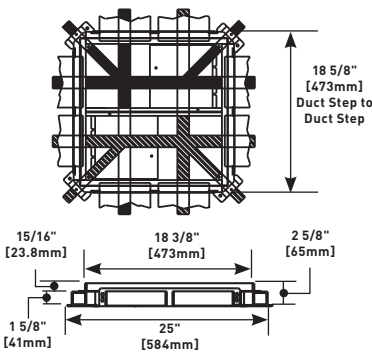

Two No. 4 Ducts per side. Square cover plate measures 18 3/8" x 18 3/8" [467mm x 467mm]. Diameter of round cover plate is 16.438" [418mm].

CAT. NO.	DESCRIPTION
3424JS-	Square Access Plate
3424JR-	Round Access Plate
3424HS-	Heavy Duty – Square Access Plate
3424HR-	Heavy Duty – Round Access Plate

NOTE: Suffix denotes height.

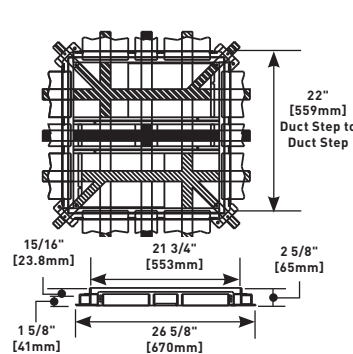

Two No. 4 Ducts and one No. 2 Duct per side. No. 2 Duct is centered between the No. 4 Ducts. Square cover plate measures 21 3/4" x 21 3/4" [553mm x 553mm]. Diameter of round cover plate is 19.813" [503mm].

CAT. NO.	DESCRIPTION
3224JS-	Square Access Plate
3224JR-	Round Access Plate
3224HS-	Heavy Duty – Square Access Plate
3224HR-	Heavy Duty – Round Access Plate

NOTE: Suffix denotes height.

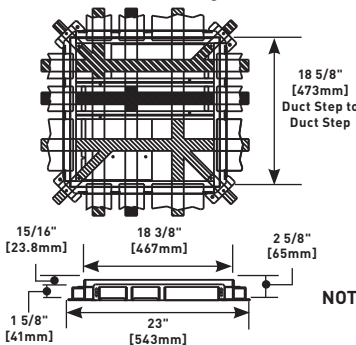

Two No. 2 Ducts and one No. 4 Duct per side. Square cover plate measures 18 3/8" x 18 3/8" [467mm x 467mm]. Diameter of round cover plate is 16.438" [418mm].

NOTE: For all 3 Duct Junction Boxes – Center compartment cannot be accessed with Corner Conduit Adapter, part #255.

CAT. NO.	DESCRIPTION
3244JS-	Square Access Plate
3244JR-	Round Access Plate
3244HS-	Heavy Duty – Square Access Plate
3244HR-	Heavy Duty – Round Access Plate

NOTE: Suffix denotes height.

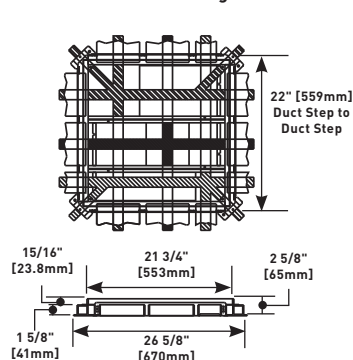

One No. 2 Duct and two No. 4 Ducts per side. Square cover plate measures 21 3/4" x 21 3/4" [553mm x 553mm]. Diameter of round cover plate is 19.813" [503mm].

WALKERDUCT® UNDERFLOOR DUCT SYSTEMS

Walkerduct Junction Boxes Ordering Information (continued)

142L-1 Two Level Junction Box

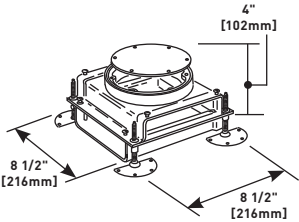

Adaptable for either No. 2 Duct or No. 4 Duct. No partitioning required. Requires a 4" [102mm] minimum pour. 3/8" [9.5mm] upward adjustment of cover plate is possible after pour. 5 3/4" [146mm] nominal diameter round cover plate. 1/8" [3.2mm] plate thickness. Use adjustable extension ring when additional height is needed. See Cat. No. 6AER-.

14H-1 Hand Hole Access Unit

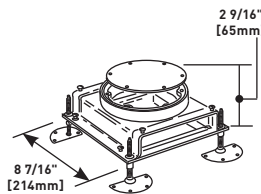

Hand hole units are installed on No. 4 Duct to facilitate feeding and splicing of wire and cable. 6 15/16" [176mm] distance between duct ends. 5 3/4" [146mm] diameter cover plate. Includes 1" [25mm] standard extension. For concrete pours over 1" [25mm] an extension ring is required. See Cat. No. 6AER-.

Walkerduct Junction Box Accessories Ordering Information

12EXT-* Side Rail Extension

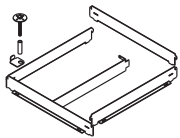

222EXT-*, 3222EXT-*, 3224EXT-*, 3244EXT-*

Kit to adapt JS, JR, HS, and HR style junction boxes for deep concrete pours. 12EXT for 12 size boxes, 222EXT for 14 or 222 size boxes, 3222EXT for 224 or 3222 size boxes, 3224EXT for 244 or 3224 size boxes, and 3244EXT for 3424 or 3244 size boxes.

SUFFIX FOR SIDE RAIL EXTENSION*	DEPTH OF CONCRETE OVER DUCT	
1 1/2	1 1/2" [38mm] min. to 2"	[51mm] max.
2	2" [51mm] min. to 2 1/2"	[62mm] max.
2 1/2	2 1/2" [64mm] min. to 3"	[76mm] max.
3	3" [76mm] min. to 3 1/2"	[89mm] max.
3 1/2	3 1/2" [89mm] min. to 4"	[102mm] max.

6AER-11/2-21/8, 6AER-23/8-3 Adjustable Extension Ring

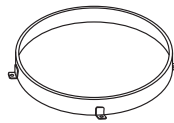

For 142L-1, H338AU-1, H14-AS, and 14H-1 Boxes. Suffix refers to adjustable height range of concrete over duct. Select hardware bag below to attach ring to box.

AERHB-120 Hardware Bag

AERHB-128, AERHB-144, AERHB-152, AERHB-052

For adjustable extension ring. Suffix indicates depth concrete over duct. Use chart below to determine hardware bag required. For 142L-1, H338AU-1, H14-AS, and 14H-1 Boxes.



RTT4 Terrazzo Holder

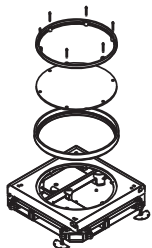

6RTT, RTT8, RTT13, RTT16, RTT20
For round JR style junction boxes. Two-piece brass rings mount to junction box cover plate. Inner ring is filled with terrazzo. Screws are recessed into innerring and allow the holder to be removed after floor is ground and polished. Terrazzo units hold 3/4" [19.1mm] deep terrazzo, but increase the height of the junction box by 1 1/4" [32mm]. 6RTT is for 142L or 14H box, RTT4 is for 12JR box, RTT8 is for 14JR or 222JR box, RTT13 is for 224JR or 3222JR box, RTT16 is for 244JR or 3224JR box, RTT20 is for 3244 or 3424JR box.

HARDWARE BAG CATALOG NO.	CONCRETE DEPTH OVER DUCT						
	1 1/2"	1 5/8"	1 3/4"	1 7/8"	2"	2 1/8"	2 3/8" -3"
AERHB-120	X	X					
AERHB-128			X	X			
AERHB-144					X		
AERHB-152						X	
AERHB-052							X

203UFD Blank Washer

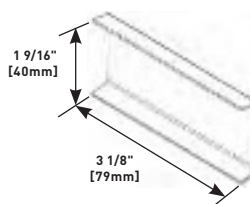

For closing unused junction box No. 2 Duct opening.

NOTE: Use Cat. No. H202 Blank Washer for 142L and 14H Junction Boxes.

WALKERDUCT® UNDERFLOOR DUCT SYSTEMS

Walkerduct Junction Box Accessories Ordering Information (continued)

H203 Blank Washer

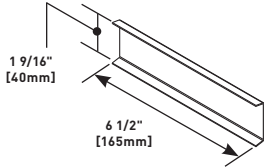

For closing unused junction box No. 4 Duct opening.

NOTE: Use Cat. No. H202 Blank Washer for 142L and 14H Junction Boxes.

232-1, 232-1 1/4, 232-1 1/2 Male Adapter

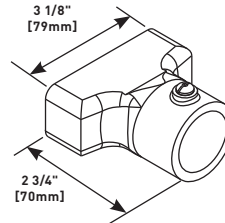

For No. 2 Duct opening to one conduit. Suffix indicates conduit trade size.

275SL, 275SR Adapter

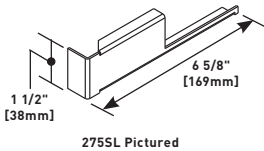

To reduce a No. 4 Duct opening in a junction box to a No. 2 Duct opening. Specify 275SL for left hand or 275SR for right hand.

H232-2 Male Adapter

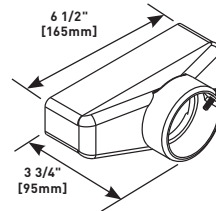

For No. 4 Duct opening to one 2" trade size conduit.

255-3/4 Box Conduit Corner Adapter

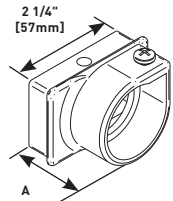

255-1, 255-1 1/4, 255-1 1/2, 255-2
For one conduit. "A" dimension is 1 7/8" [48mm] for -3/4 and -1; 2 1/4" [57mm] for -1 1/4 and -1 1/2, and 2" [51mm] for -2. Suffix indicates conduit trade size.

242-1 1/4 Male Adapter

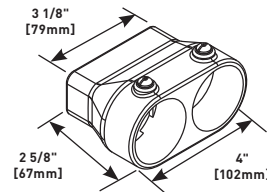

For No. 2 Duct opening to two 1 1/4" trade size conduits.

212-3/4 Adapter

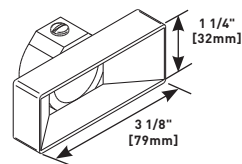

For No. 2 Duct opening to one 3/4" trade size conduit.

222-3/4 Adapter

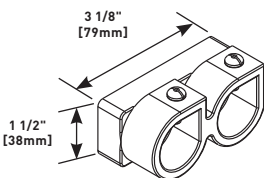

For No. 2 Duct opening to two 3/4" trade size conduits.

WALKERDUCT® CARPET/TILE HOLDERS



Walkerduct® Carpet/Tile Holders provide an aesthetic solution for identification and for accessing major pull points (Junction Boxes) within a Walkerduct System.

NOTE: Square Tile/Carpet Trims for heavy duty Junction Boxes – need to increase depth of Pan by 1/8". Example: for 1/4" Carpet, use 3/8" deep Carpet Holder.



Walkerduct Flanged Round Carpet / Tile Holders Ordering Information

Flanged round carpet/tile pans in brass or stainless steel for 12S, 14H, 142L, H338AU, 12FB or H14 Boxes. Mount onto cover plate. Available in 1/4" or 1/8" [6.4mm or 3.2mm] depths for carpet or tile floors. 5 23/32" [144mm] diameter (does not include flange). Flange is 3/8" [9.5mm] wide.

CAT. NO.	DESCRIPTION
6LHS-1/8	Stainless 1/8" [3.2mm] deep 6 39/64 [168mm] O.D.
6LHS-1/4	Stainless 1/4" [6.4mm] deep 6 39/64 [168mm] O.D.
6LHB-1/8	Brass 1/8" [3.2mm] deep 6 39/64 [168mm] O.D.
6LHB-1/4	Brass 1/4" [6.4mm] deep 6 39/64 [168mm] O.D.

Flanged round carpet/tile pans in brass or stainless steel for 222FB Boxes. Mount onto cover plate. Available in 1/4" or 1/8" [6.4mm or 3.2mm] depths for carpet or tile floors. 7 1/2" [191mm] diameter (does not include flange). Flange is 3/8" [9.5mm] wide.

CAT. NO.	DESCRIPTION
7LHS-1/8	Stainless 1/8" [3.2mm] deep 8 11/64 [208mm] O.D.
7LHS-1/4	Stainless 1/4" [6.4mm] deep 8 11/64 [208mm] O.D.
7LHB-1/8*	Brass 1/8" [3.2mm] deep 8 11/64 [208mm] O.D.
7LHB-1/4*	Brass 1/4" [6.4mm] deep 8 11/64 [208mm] O.D.

Flanged round carpet/tile pans in brass or stainless steel for 14S, 222S, and 3222FB Boxes. Mount onto cover plate. Available in 1/4" or 1/8" [6.4mm or 3.2mm] depths for carpet or tile floors. 10 1/2" [267mm] diameter (does not include flange). Flange is 3/8" [9.5mm] wide.

CAT. NO.	DESCRIPTION
10LHS-1/8	Stainless 1/8" [3.2mm] deep 11 15/64 [295mm] O.D.
10LHS-1/4	Stainless 1/4" [6.4mm] deep 11 15/64 [295mm] O.D.
10LHB-1/8*	Brass 1/8" [3.2mm] deep 11 15/64 [295mm] O.D.
10LHB-1/4*	Brass 1/4" [6.4mm] deep 11 15/64 [295mm] O.D.

Flanged round carpet/tile pans in brass or stainless steel for 224S and 3222S Boxes. Also fits 2-1JB2510 Walkercell Boxes and 18" [457mm] wide Junction Box Headers. Mount onto cover plate. Available in 1/4" or 1/8" [6.4mm or 3.2mm] depths for carpet or tile floors. 14 1/2" [368mm] diameter (does not include flange). Flange is 3/8" [9.5mm] wide.

CAT. NO.	DESCRIPTION
14LHS-1/8	Stainless 1/8" [3.2mm] deep x 15.234" O.D. [387mm]
14LHS-1/4	Stainless 1/4" [6.4mm] deep x 15.234" O.D. [387mm]
14LHB-1/8*	Brass 1/8" [3.2mm] deep x 15.234" O.D. [387mm]
14LHB-1/4*	Brass 1/4" [6.4mm] deep x 15.234" O.D. [387mm]

NOTE: Prior to completing installation, proper floor covering should be installed in pan.

* Add suffix "-HD" for .090 thick material (.025 standard material thickness) to accommodate high traffic and/or heavy loads.

WALKERDUCT® CARPET/TILE HOLDERS

Walkerduct Flanged Round Carpet/Tile Holders Ordering Information (continued)

Flanged round carpet/tile pans in brass or stainless steel for 244S, 3224S, 3244S, 3424S and 3444S Boxes. Also fits 33JB3510, 32JB3510, 22JB2510, 1 1/2 JB2510, 11JB2510, Walkercell Boxes and 24" [610mm] wide and wider Junction Box Headers. Mount onto cover plate. Available in 1/4" or 1/8" [6.4mm or 3.2mm] depths for carpet or tile floors. 22" [559mm] diameter (does not include flange). Flange is 3/8" [9.5mm] wide.

CAT. NO.	DESCRIPTION
22LHS-1/8	Stainless 1/8" [3.2mm] deep x 23.234" O.D. [590mm]
22LHS-1/4	Stainless 1/4" [6.4mm] deep x 23.234" O.D. [590mm]
22LHB-1/8	Brass 1/8" [3.2mm] deep x 23.234" O.D. [590mm]
22LHB-1/4*	Brass 1/4" [6.4mm] deep x 23.234" O.D. [590mm]

Flanged round carpet/tile pans in brass or stainless steel for 12JR boxes. Mount onto cover plate. Available in 1/4" or 1/8" [6.4mm or 3.2mm] depths for carpet or tile floors. 4 3/4" [121mm] diameter (does not include flange). Flange is 3/8" [9.5mm] wide.

CAT. NO.	DESCRIPTION
SFCS5-1/8	Stainless 1/8" [6.4mm] deep x 5.561" O.D. [141mm]
SFCS5-1/4	Stainless 1/4" [3.2mm] deep x 5.561" O.D. [141mm]
SFCB5-1/8*	Brass 1/8" [6.4mm] deep x 5.561" O.D. [141mm]
SFCB5-1/4*	Brass 1/4" [3.2mm] deep x 5.561" O.D. [141mm]

Flanged round carpet/tile pans in brass or stainless steel for 14JR and 222JR boxes. Mount onto cover plate. Available in 1/4" or 1/8" [6.4mm or 3.2mm] depths for carpet or tile floors. 8 7/8" [225mm] diameter (does not include flange). Flange is 3/8" [9.5mm] wide.

CAT. NO.	DESCRIPTION
SFCS9-1/8	Stainless 1/8" [6.4mm] deep x 9.686" O.D. [246mm]
SFCS9-1/4	Stainless 1/4" [3.2mm] deep x 9.686" O.D. [246mm]
SFCB9-1/8*	Brass 1/8" [6.4mm] deep x 9.686" O.D. [246mm]
SFCB9-1/4*	Brass 1/4" [3.2mm] deep x 9.686" O.D. [246mm]

Flanged round carpet/tile pans in brass or stainless steel for 224JR and 3222JR boxes. Mount onto cover plate. Available in 1/4" or 1/8" [6.4mm or 3.2mm] depths for carpet or tile floors. 13" [330mm] diameter (does not include flange). Flange is 3/8" [9.5mm] wide.

CAT. NO.	DESCRIPTION
SFCS14-1/8	Stainless 1/8" [6.4mm] deep x 13.812" O.D. [351mm]
SFCS14-1/4	Stainless 1/4" [3.2mm] deep x 13.812" O.D. [351mm]
SFCB14-1/8	Brass 1/8" [6.4mm] deep x 13.812" O.D. [351mm]
SFCB14-1/4*	Brass 1/4" [3.2mm] deep x 13.812" O.D. [351mm]

Flanged round carpet/tile pans in brass or stainless steel for 244JR and 3224JR boxes. Mount onto cover plate. Available in 1/4" or 1/8" [6.4mm or 3.2mm] depths for carpet or tile floors. 16 3/8" [416mm] diameter (does not include flange). Flange is 3/8" [9.5mm] wide.

CAT. NO.	DESCRIPTION
SFCS17-1/8	Stainless 1/8" [6.4mm] deep x 17.187" O.D. [437mm]
SFCS17-1/4	Stainless 1/4" [3.2mm] deep x 17.187" O.D. [437mm]
SFCB17-1/8	Brass 1/8" [6.4mm] deep x 17.187" O.D. [437mm]
SFCB17-1/4*	Brass 1/4" [3.2mm] deep x 17.187" O.D. [437mm]

Flanged round carpet/tile pans in brass or stainless steel for 324JR and 3244JR boxes. Mount onto cover plate. Available in 1/4" or 1/8" [6.4mm or 3.2mm] depths for carpet or tile floors. 19 3/4" [502mm] diameter (does not include flange). Flange is 3/8" [9.5mm] wide.

CAT. NO.	DESCRIPTION
SFCS20-1/8	Stainless 1/8" [6.4mm] deep x 17.936" O.D. [456mm]
SFCS20-1/4	Stainless 1/4" [3.2mm] deep x 17.936" O.D. [456mm]
SFCB20-1/8	Brass 1/8" [6.4mm] deep x 17.936" O.D. [456mm]
SFCB20-1/4	Brass 1/4" [3.2mm] deep x 17.936" O.D. [456mm]

Flanged round carpet/tile pans in brass or stainless steel for 3444JR boxes. Mount onto cover plate. Available in 1/4" or 1/8" [6.4mm or 3.2mm] depths for carpet or tile floors. 23 1/8" [587mm] diameter (does not include flange). Flange is 3/8" [9.5mm] wide.

CAT. NO.	DESCRIPTION
SFCS24-1/8	Stainless 1/8" [6.4mm] deep x 20.560" O.D. [522mm]
SFCS24-1/4	Stainless 1/4" [3.2mm] deep x 20.560" O.D. [522mm]
SFCB24-1/8	Brass 1/8" [6.4mm] deep x 20.560" O.D. [522mm]
SFCB24-1/4	Brass 1/4" [3.2mm] deep x 20.560" O.D. [522mm]

* Add suffix "-HD" for .090 thick material (.025 standard material thickness) to accommodate high traffic and/or heavy loads.

WALKERDUCT® CARPET/TILE HOLDERS

Walkerduct Square Carpet/Tile Trim Ordering Information

Flanged square carpet/tile trim in aluminum for Walkerduct JS Series Boxes. Mount onto junction box. Available in 1/4" or 1/8" [6.4mm or 3.2mm] depths for carpet or tile floors. Flange is 1/2" [12.7mm] wide. Dimensions below do not include flange.

CAT. NO.	DESCRIPTION	JUNCTION BOX
CT6-1/8	6 13/16" x 6 13/16" x 1/8" [173mm x 173mm x 3.2mm]	12JS
CT6-1/4	6 13/16" x 6 13/16" x 1/4" [173mm x 173mm x 6.4mm]	12JS
CT10-1/8	10 15/16" x 11 15/16" x 1/8" [278mm x 278mm x 3.2mm]	14JS, 222JS
CT10-1/4	10 15/16" x 11 15/16" x 1/4" [278mm x 278mm x 6.4mm]	14JS, 222JS
CT15-1/8	15 1/16" x 15 1/16" x 1/8" [383mm x 383mm x 3.2mm]	224JS, 3222JS
CT15-1/4	15 1/16" x 15 1/16" x 1/4" [383mm x 383mm x 6.4mm]	224JS, 3222JS
CT18-1/8	18 7/16" x 18 7/16" x 1/8" [468mm x 468mm x 3.2mm]	244JS, 3224JS
CT18-1/4	18 7/16" x 18 7/16" x 1/4" [468mm x 468mm x 6.4mm]	244JS, 3224JS
CT21-1/8	21 13/16" x 21 13/16" x 1/8" [554mm x 554mm x 3.2mm]	3424JS, 3244JS
CT21-1/4	21 13/16" x 21 13/16" x 1/4" [554mm x 554mm x 6.4mm]	3424JS, 3244JS
CT25-1/8	25 3/16" x 25 3/16" x 1/8" [640mm x 640mm x 3.2mm]	3444JS
CT25-1/4	25 3/16" x 25 3/16" x 1/4" [640mm x 640mm x 6.4mm]	3444JS

NOTE: 1/8" or 1/4" is depth of tile or carpet when used with JS Boxes (1/4" thick cover plate). For HS Boxes, depth will be reduced by 1/8" to accommodate the 3/8" thick cover plate.

Flangeless square carpet/tile trim in aluminum for Walkerduct JS Series Boxes. Mount onto junction box. Available in 1/4" [6.4mm] or 1/8" [3.2mm] depths for carpet or tile floors.

CAT. NO.	DESCRIPTION	JUNCTION BOX
FT6-1/8	6 13/16" x 6 13/16" x 1/8" [173mm x 173mm x 3.2mm]	12JS
FT6-1/4	6 13/16" x 6 13/16" x 1/4" [173mm x 173mm x 6.4mm]	12JS
FT10-1/8	10 15/16" x 11 15/16" x 1/8" [278mm x 278mm x 3.2mm]	14JS, 222JS
FT10-1/4	10 15/16" x 11 15/16" x 1/4" [278mm x 278mm x 6.4mm]	14JS, 222JS
FT15-1/8	15 1/16" x 15 1/16" x 1/8" [383mm x 383mm x 3.2mm]	224JS, 3222JS
FT15-1/4	15 1/16" x 15 1/16" x 1/4" [383mm x 383mm x 6.4mm]	224JS, 3222JS
FT18-1/8	18 7/16" x 18 7/16" x 1/8" [468mm x 468mm x 3.2mm]	244JS, 3224JS
FT18-1/4	18 7/16" x 18 7/16" x 1/4" [468mm x 468mm x 6.4mm]	244JS, 3224JS
FT21-1/8	21 13/16" x 21 13/16" x 1/8" [554mm x 554mm x 3.2mm]	3424JS, 3244JS
FT21-1/4	21 13/16" x 21 13/16" x 1/4" [554mm x 554mm x 6.4mm]	3424JS, 3244JS
FT25-1/8	25 3/16" x 25 3/16" x 1/8" [640mm x 640mm x 3.2mm]	3444JS
FT25-1/4	25 3/16" x 25 3/16" x 1/4" [640mm x 640mm x 6.4mm]	3444JS

NOTE: 1/8" or 1/4" is depth of tile or carpet when used with JS Boxes (1/4" thick cover plate). For HS Boxes, depth will be reduced by 1/8" to accommodate the 3/8" thick cover plate.

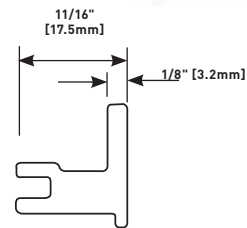
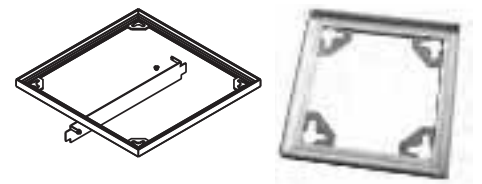
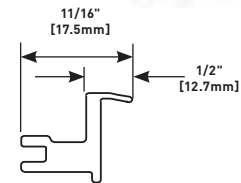
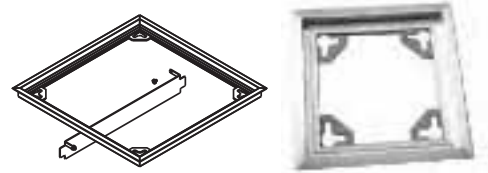

FLUSHDUCT INFLOOR DUCT SYSTEMS



Flushduct Infloor Duct Systems provide wire and cable management in open space environments using 1, 2, or 3 #2 duct. It is ideal for renovations to existing facilities where concrete depth is minimal.

CODE REFERENCE

ULus Listed Underfloor Raceway:
File E7020 Guide RKCZ
cULus Listed Underfloor Raceway
Fittings: File E11912 Guide RKQX.
Meets Article 390 of NEC.

Flushduct System Layout

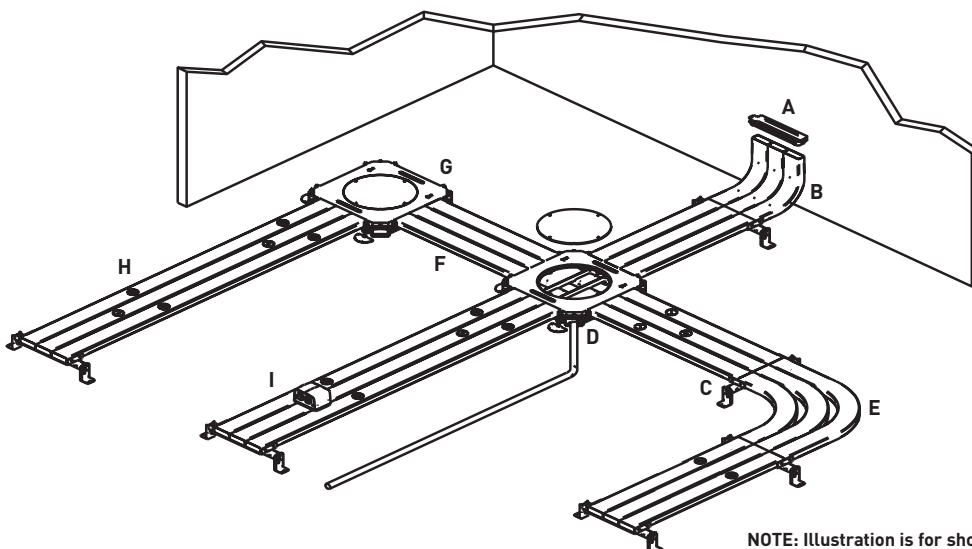

KEY

A. 334F-1-3 Triple Duct Terminal Bushing
B. 336F-3 Triple Duct 90° Vertical Elbow
C. 3222FCSA-28 Support
D. 255-1 Corner Conduit Connector

E. 338F-3 Triple Duct Horizontal 90° Elbow
F. 3222F-0 10' Triple Blank Duct
G. 3222FB Triple Duct Junction Box

H. 3222FST 10' Triple Duct with staggered threaded openings
I. 525 Series Service Fitting

FLUSHDUCT INFLOOR DUCT SYSTEMS

Flushduct Quick Selection Guide

DUCT	1-DUCT SYSTEM	2-DUCT SYSTEM	3-DUCT SYSTEM
BLANK	12F-0	222F-0	3222F-0
STAGGERED 1 5/8" [41mm] OPENINGS	12FST	222FST	3222FST
JUNCTION BOX	12FB	222FB	3222FB 3222FBCC
ACCESSORIES	1-DUCT SYSTEM	2-DUCT SYSTEM	3-DUCT SYSTEM
COUPLINGS	12FC	222FC	3222FC
COUPLINGS/SUPPORTS	12FCS 12FCSA-*	222FCS 222FCSA-*	3222FCS 3222FCSA-*
BOX OPENING CLOSURES	12F-WS	222F-WS	3222F-WS
DUCT CONDUIT ADAPTERS	312F-* 314F-* 324-	312F-* 314F-* 324-	312F-* 314F-* 324-*
BOX CORNER CONDUIT ADAPTER	255-*	255-*	255-*
DUCT END CLOSURE	304	304	304
VERTICAL ELBOWS	332F 336F	333F-2 336F-2	336F-3
TERMINAL BUSHINGS	334UF	334F-1-2	334F-1-3
HORIZONTAL ELBOWS	338UF 342F	338F-2 342F-2	338F-3 342F-3
OFFSET	372F	372F	372F
CROSSUNDERS	362F	362F-2	362F-3
DUCT OUTLET FLANGE	455F-1	455F-1	455F-1
FERRULE	450F-1	450F-1	450F-1
CRIMPING TOOL	470F-1	470F-1	470F-1
DUCT OPENING PLUGS	7140F 7141F 455FP-1 450FP-1	7140F 7141F 455FP-1 450FP-1	7140F 7141F 455FP-1 450FP-1
SEALANT	290G	290G	290G
TAPE	H296	H296	H296

Flushduct Infloor Duct Systems Service Fitting Compatibility

PRODUCT FAMILY	CATALOG NUMBER	ACTIVATION LOCATION	SERVICE CAPACITY		SERVICE COMPATIBILITY			MATERIAL/ COLORS
		Pedestal	Single Service	Dual Service	Power	Communication	Audio/Visual	Aluminum
Multiplex	MP4	•	•		•	•	•	•
	MP8	•		•	•	•	•	•
	MP8-1	•		•	•	•	•	•
525 Series	525A	•	•			•	•	•
	525B	•	•			•	•	•
	525C	•	•			•	•	•
	525D	•	•			•	•	•
	525F	•	•		•			•
	525G	•	•		•			•
	525H	•	•		•			•
	525I	•	•		•			•
	525J	•	•		•	•	•	•
	525RT	•	•			•		•
	525ACT	•	•			•		•

FLUSHDUCT INFLOOR DUCT SYSTEMS

Flushduct Duct Configuration Options

12F-0, 222F-0, 3222F-0 Blank Duct

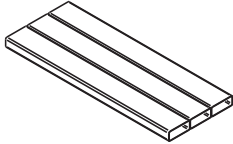

For feeder runs with precise placement of openings. Double or Triple Duct Systems are welded together. 10' [3.05m] standard length. 12F-0 is Single Duct, 222F-0 is Double Duct, and 3222F-0 is Triple Duct.

12FST, 222FST, 3222FST Staggered Ducts

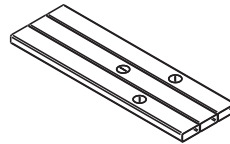

Provided with 1 5/8" [41mm] diameter threaded openings and removable plugs for service fitting attachment. Openings are staggered 24" [610mm] to facilitate placement of service fittings. 10' [3.05m] standard length. 12FST is Single Duct, 222FST is Double Duct, and 3222FST is Triple Duct.

Flushduct Accessories Ordering Information

12FC, 222FC, 3222FC Couplings

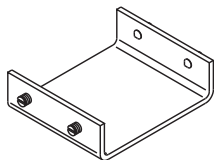

Used to couple ends of duct together. Set screws used to hold duct in place. 12FC is Single Duct, 222FC is Double Duct, and 3222FC is Triple Duct.

314-3/4 Male Conduit Adapter

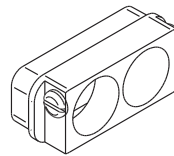

Fits into end of Duct. For 3/4" trade size rigid or PVC conduits.

12FCS, 222FCS Couplings/Supports

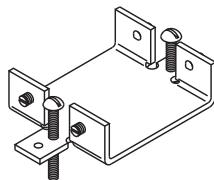

Provides 1" [25mm] vertical adjustment 3222FCS and couple ends of duct together. Recommended at 5' [1.524m] intervals. 12FCS is Single Duct, 222FCS is Double Duct, and 3222FCS is Triple Duct.

332F, 333F-2 Vertical 90° Elbow

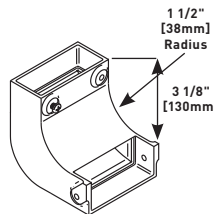

For extending Flushduct up a wall. 1 1/2" [38mm] bend radii. 332F is for Single Duct and 332F-2 is for Double Duct.

304 Endcap

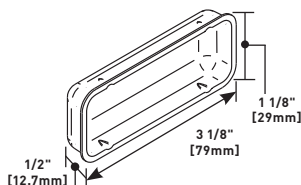

To close off ends of duct.

334UF, 334F-1-2, 334-1-3 Terminal Bushing

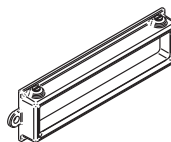

For securing Flushduct to cabinet. 334UF is for Single Duct, 334F-1-2 is for Double Duct, and 334F-1-3 is for Triple Duct.

312F-1, 312F-11/4, 312F-11/2 Conduit Adapter

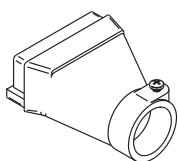

Used to feed single conduit into end of duct. Suffix denotes conduit trade size.

CATALOG NUMBER	A DIMENSION	B DIMENSION
312F-1	1 3/8" [35mm]	2 1/4 [57mm]
312F-11/4	1 11/16" [43mm]	2 7/16 [62mm]
312F-11/2	3 1/8" [79mm]	2 3/4 [70mm]

336F, 336F-2, 336F-3 Vertical 90° Elbow

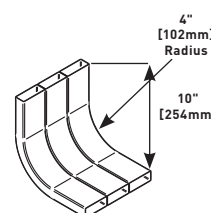

For extending Flushduct up a wall. 4" [102mm] bend radii. 336F is for Single Duct, 336F-2 is for Double Duct, and 336F-3 is for Triple Duct.

FLUSHDUCT INFLOOR DUCT SYSTEMS

Flushduct Accessories Ordering Information (continued)

338UF, 338UF-2, 338UF-3 Horizontal 90° Elbow

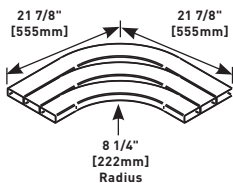

For turning corner with duct. 338UF is for Single Duct, 338F-2 is for Double Duct, and 338F-3 is for Triple Duct.

342F, 342F-2, 342F-3 Horizontal 45° Elbow

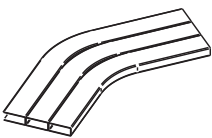

For turning corner with duct. 342F is for Single Duct, 342F-2 is for Double Duct, and 342F-3 is for Triple Duct.

362F, 362F-2, 362F-3 Vertical Offset

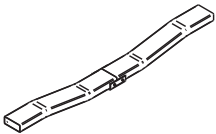

To accommodate 1 3/8" [35mm] change in system depth. 362F is for Single Duct, 362F-2 is for Double Duct, and 362F-3 is for Triple Duct.

372F Vertical Offset

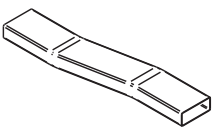

To accommodate 1 3/8" [35mm] change in system depth.

400F Screw Plug

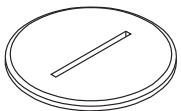

1 1/4" [32mm] screw plug for threaded openings in Flushduct. Supports obsolete "F Series" Flushduct system.

7107F Screw Plug

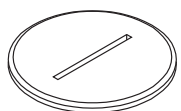

1 5/8" [32mm] screw plug for threaded openings in Flushduct. Supports current "FST Series" Flushduct system.

7140F, 7141F Marker Screw Plug

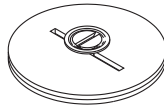

1 5/8" [41mm] screw plug for threaded openings in Flushduct. Used to designate service in each duct. 7140F is Brass, 7141F is Zinc.

455F-3/4, 455F-1 Threaded Outlet Flange



For locking nipple or standpipe. Requires 1 5/8" [41mm] hole.

455FP-3/4, 455FP-1 Die-Cast Plug

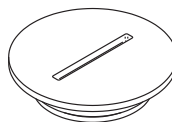

Threads into 455F Threaded Outlet Flange.

450F-1, 450F-11/4 Brass Ferrule

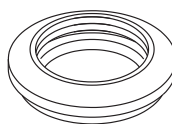

Used to create access into duct at a custom location. Internal threads for 1" [25mm] [450F-1 or 1 1/4" [32mm] [450F-11/4] nipple or standpipe. To install, field cut 1 1/2" [38mm] for 1" [25mm] ferrule (450F-1) or 1 7/8" [48mm] hole for 1 1/4" [32mm] ferrule (450F-11/4).

450FP-1, 450FP-11/4 Brass Plug

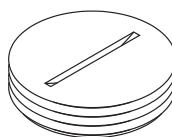

Threads into brass ferrule to close deactivated opening.

470F-1, 470F-11/4 Crimping Tool

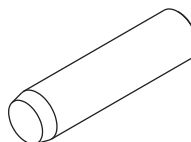

Used to install 450F Brass Ferrule.

1124F-3/4, 1124F-1 Locking Nipple

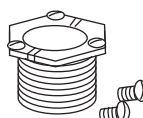

1124F-3/4 is for 3/4" [19.1mm] IPS opening. 1124F-1 is for 1" [25mm] IPS opening. Both are 5/8" [15.9mm] long.

FLUSHDUCT INFLOOR DUCT SYSTEMS

Junction Boxes & Accessories Ordering Information

12FB Single Duct Junction Box

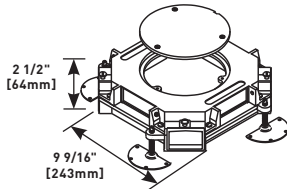

Used at duct intersections. Provides access to system for pulling and splicing of wires. Constructed of cast iron. Conduit openings at each corner of box.

6LH*-, 7LH*-, 10LH*- Carpet or Tile Holder

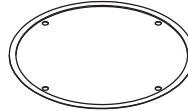

Flanged stainless steel or brass holders recessed to hold carpet or tile. 6LH* is for 12FB Junction Box, 7LH* is for 222FB Junction Box, and 10LH* is for 3222FB Junction Box. For "*", specify "S" for steel or "B" for brass. Specify 1/8 or 1/4 depth.

222FB Double Duct Junction Box

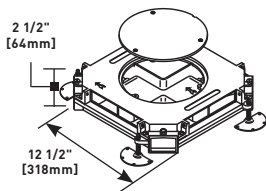

Used at duct intersections. Provides access to system for pulling and splicing of wires. Constructed of cast iron. Interiors of two- and three-duct boxes have partitions isolating each duct and forming a continuous raceway through the box. Conduit openings at each corner of box.

12F-WS, 222F-WS, 3222F-WS Blank Washer

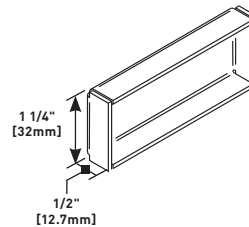

For closing off unused junction box opening. 12F-WS is for Single Duct, 222F-WS is for Double Duct, and 3222F-WS is for Triple Duct.

3222FB Triple Duct Junction Box

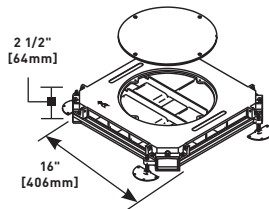

Used at duct intersections. Provides access to system for pulling and splicing of wires. Constructed of cast iron. Interiors of two- and three-duct boxes have partitions isolating each duct and forming a continuous raceway through the box. Conduit openings at each corner of box.

255-3/4, 255-1, 255-1 1/4, 255-1 1/2, 255-2 Box Conduit Corner Adapter

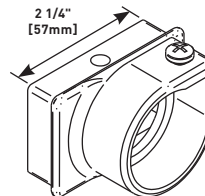

For one conduit. Suffix denotes conduit trade size.

WALLDUCT RACEWAY SYSTEMS



Wallduct Raceway Systems are high capacity raceway for use in or on walls that is ideal for distributing power and communication cables in healthcare facilities, under raised floors or as a large capacity feeder system.

CODE REFERENCE

cULus Listed Raceway:
File E4376 Guide RJBT

cULus Listed Fittings:
File E41751 Guide RJPR.

Meets Article 386 of NEC.

Wallduct Raceway System Layout

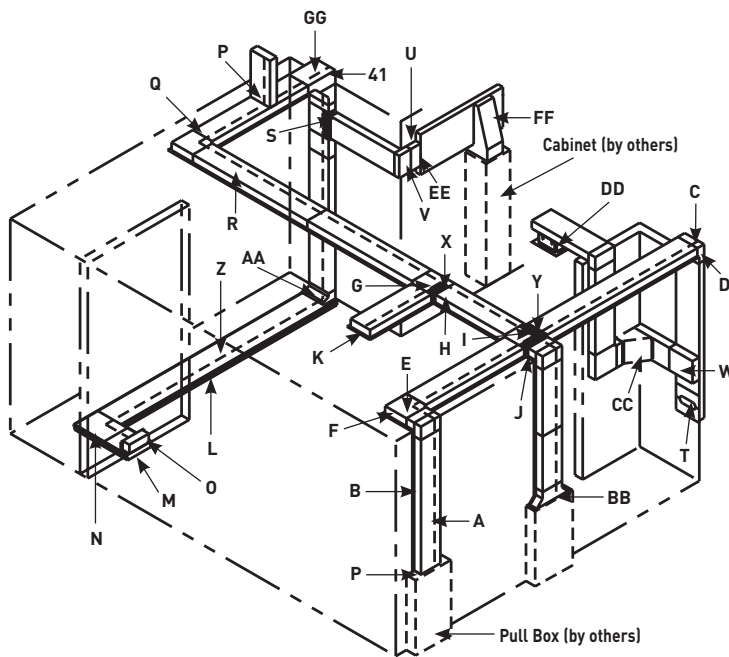

NOTE: Illustration is for showing product applications only.

NOTE: Wallduct can be installed in the wall exposing only the cover plate, or it can be wall mounted exposing the entire surface. Wallduct may also be installed overhead or under a raised floor (but not infloor) to connect cables/wires between rooms. Trenchduct can be used in combination with Wallduct as a feeder or for access points in the floor to feed equipment.

KEY

- A. WD10W350-60 5'-0" [1524mm] Straight Length
- B. CP10-F30 30" [762mm] L Flush Cover Plate
- C. WD10W350-IL Internal Wallduct Elbow
- D. CP10-ILF Internal Wallduct Elbow Cover Flush
- E. WD10W350-HL Horizontal Wallduct Elbow
- F. CP10-HLF Horizontal Wallduct Elbow Cover Flush
- G. WD10W350-T Wallduct T-Unit
- H. CP10-TF Wallduct T-Unit Cover Flush
- I. WD10W350-X Wallduct X-Unit
- J. CP10-XF Wallduct X-Unit Cover Flush
- K. WD10W350-ECF Wallduct End Closure
- L. VA12W250H-5 VA Style Trenchduct 12" Wide x 2 1/2" Deep [304mm x 63mm]
- M. VA12W250H-EC VA Style Trenchduct End Closure
- N. VA12W250H-LL VA Style Trenchduct Horizontal Elbow (Left Hand)
- O. VA12W-VR10 VA Style Trenchduct Vertical Riser
- P. WD10W350-CC/DO Wallduct Cabinet Connector
- Q. WD350-CP Corner Partition
- R. WD350-P60 Straight Partition
- S. WD10W350-TUN T-Unit Straight Tunnel
- T. WD10-ACPF Access Cover Plate with Grommet
- U. WD10W350-EL Wallduct External Elbow
- V. CP10W350-ELF Wallduct External Elbow Cover Flush
- W. WD10W350-FST Wallduct Flush to Surface Transition
- X. WD10W350-LTUN T-Unit Left Hand Tunnel
- Y. WD10W350-XTUN X-Unit Tunnel
- Z. T250H2P-5 Trenchduct Partition
- AA. VA12W-VL10 Trenchduct Vertical Riser
- BB. WD10W350-FCCF Flanged Cabinet Connector Flush
- CC. WD10W350-SWTS Sweep Surface Tee
- DD. WD-10CDO Ceiling Drop Out
- EE. WD350-R04 Wallduct Reducer
- FF. WD18W350-SWCCS Sweep Cabinet Connector Surface
- GG. WD10W350-SES Sweep Elbow Surface

WALLDUCT RACEWAY SYSTEMS

Steel Wallduct Wire Fill Capacities for Communications

	CABLE/WIRE SIZE	DIAMETER (Approx.)		AREA (In ²)		40% FILL	
		Inches	[mm]	Sq. In.	[Sq. mm]	No. 2	No. 4
UNSHIELDED TWISTED PAIR	4-pair, 24 AWG, Cat 6	0.250	[6.4]	0.0491	[31.7]	27	71
	4-pair, 24 AWG, Cat 6	0.250	[6.4]	0.0491	[31.7]	27	71
TELEPHONE	2-pair, 24 AWG	0.140	[3.6]	0.0154	[9.9]	89	232
	4-pair, 24 AWG	0.190	[4.8]	0.0263	[18.2]	47	124
	25-pair, 24 AWG	0.410	[10.4]	0.1321	[85.2]	10	26
COAXIAL	RG58/U	0.195	[4.9]	0.0298	[19.2]	44	116
	RG59/U	0.242	[6.1]	0.0459	[29.6]	29	75
	RG6/U	0.270	[6.9]	0.0572	[36.9]	23	61
SHIELDED TWISTED PAIR	TYPE 1	0.390	[9.9]	0.1194	[77.0]	11	29
	TYPE 2	0.465	[11.8]	0.1698	[109.5]	7	20
	TYPE 3	0.245	[6.2]	0.0471	[30.4]	28	74
FIBER	2 Strand	0.180	[4.6]	0.0254	[16.4]	53	139
	4 Strand	0.190	[4.8]	0.0263	[15.3]	47	124
	6 Strand	0.187	[4.8]	0.0346	[22.3]	38	99
	Fiber ZipCord	0.256	[6.5]	0.0095	[6.1]	133	348

Steel Wallduct Wire Fill Capacities for Power

WIRE SIZE AWG	DIAMETER		AREA (In ²)		40% FILL	
	Inches	[mm]	Sq. In.	[Sq. mm]	No. 2	No. 4
14	0.111	[2.8]	0.0097	[6.3]	41.24	20.62
12	0.130	[3.3]	0.0133	[8.6]	30.08	15.04
10	0.164	[4.2]	0.0211	[13.6]	18.96	9.48
8	0.216	[5.5]	0.0366	[23.6]	10.93	5.46
6	0.254	[6.5]	0.0507	[32.7]	7.89	3.94
4	0.324	[8.2]	0.0824	[53.2]	4.85	2.43
3	0.352	[8.9]	0.0973	[62.8]	4.11	2.06
2	0.384	[9.8]	0.1158	[74.7]	3.45	1.73



Wallduct Bodies & Covers Ordering Information

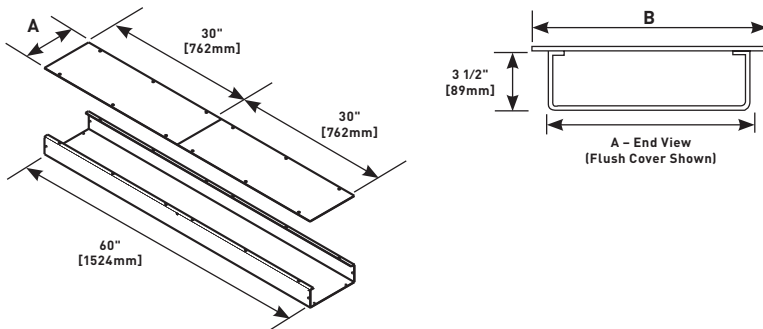

NOTE: To order aluminum products, add the letter "A" to the beginning of the catalog number. Custom sizes are available. Consult the factory for more information.

BODIES			
WD06W350-60	6"	[152mm]	
WD10W350-60	10"	[254mm]	
WD18W350-60	18"	[457mm]	
SURFACE COVERS		"A"	
CP06-S30	6"	[152mm]	
CP10-S30	10"	[254mm]	
CP18-S30	18"	[457mm]	
FLUSH COVERS		"B"	
CP06-F30	8"	[203mm]	
CP10-F30	12"	[305mm]	
CP18-F30	20"	[508mm]	

WALLDUCT RACEWAY SYSTEMS

Wallduct Fittings Ordering Information

WD350P60 Straight Partition

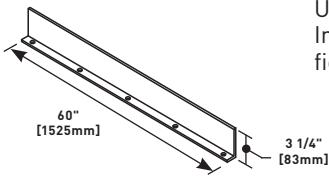

Used to separate services. Includes assembly screws for field installation.

WD350-CP Corner partition

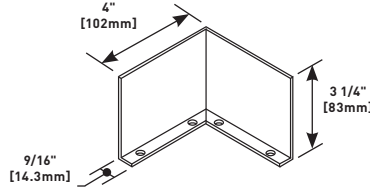

Used in horizontal elbow to form corner partition. Assembly screws included.

WD350-CA Coupling Angle

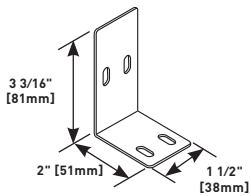

Used to connect two pieces of Wallduct. Includes assembly screws. Two coupling angles included with every straight body assembly.

Surface & Flush Enclosures

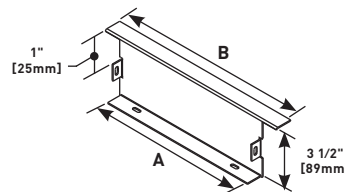

Used to close off end of Wallduct run. Includes assembly screws.

WD06-WR, WD10-WR, WD18-WR Wire Retainer

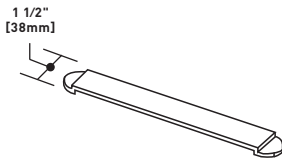

Used to hold wires in place during installation and to close gap between cover plates if more than 1/8" [3.2mm]. Snap in place prior to installing cover plates. Two wire retainers are included with every straight body assembly.

SURFACE END CLOSURES	"A"	"B"
WD06W350-ECS	6" [152mm]	6" [152mm]
WD10W350-ECS	10" [254mm]	10" [254mm]
WD18W350-ECS	18" [457mm]	18" [457mm]
FLUSH END CLOSURES	"A"	"B"
WD06W350-ECF	6" [152mm]	8" [203mm]
WD10W350-ECF	10" [254mm]	12" [305mm]
WD18W350-ECF	18" [457mm]	20" [508mm]

Horizontal Elbows

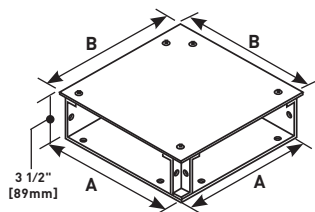

Used to change direction of Wallduct runs 90° on same plane. Includes one pair of coupling angles, one retainer, and assembly screws. Complete unit requires one body and one cover plate.

BODIES	"A"
WD06W350-HL	6" [152mm]
WD10W350-HL	10" [254mm]
WD18W350-HL	18" [457mm]
SURFACE COVERS	"B"
CP06-HLS	7" [178mm]
CP10-HLS	11" [279mm]
CP18-HLS	19" [482mm]
FLUSH COVERS	"B"
CP06-HLF	8" [203mm]
CP10-HLF	12" [305mm]
CP18-HLF	20" [508mm]

Internal Elbow

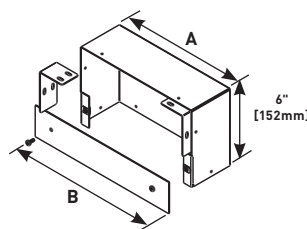

Used to connect vertical and horizontal run at 90° when cover plates are on inside of run. Includes one pair of coupling angles, wire retainer, and assembly screws. Complete unit requires one elbow body and one cover plate.

BODIES	"A"
WD06W350-IL	6" [152mm]
WD10W350-IL	10" [254mm]
WD18W350-IL	18" [457mm]
SURFACE COVERS	"B"
CP06-ILS	6" [152mm]
CP10-ILS	10" [254mm]
CP18-ILS	18" [457mm]
FLUSH COVERS	"B"
CP06-ILF	8" [203mm]
CP10-ILF	12" [305mm]
CP18-ILF	20" [508mm]

NOTE: To order aluminum products, add the letter "A" to the beginning of the catalog number. Custom sizes are available. Consult the factory for more information.

WALLDUCT RACEWAY SYSTEMS

Wallduct Fittings Ordering Information (continued)

Internal External Elbow

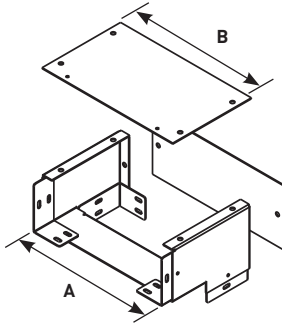

Internal elbow used to change direction 90° while also allowing for a change in coverplate orientation. Shipped as complete unit.

BODIES	"A"
WD06W350-IEL	6" [152mm]
WD10W350-IEL	10" [254mm]
WD18W350-IEL	18" [457mm]
SURFACE COVERS	"B"
CP06W350-IELS	6" [152mm]
CP10W350-IELS	10" [254mm]
CP18W350-IELS	18" [457mm]
FLUSH COVERS	"B"
CP06W350-IELF	8" [203mm]
CP10W350-IELF	12" [305mm]
CP18W350-IELF	20" [508mm]

T-Unit

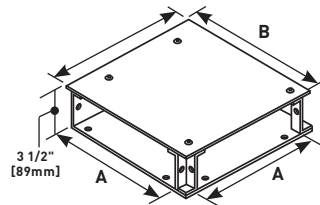

Used to connect a second run of Wallduct at 90° angle to first run. Includes one pair of coupling angles, one wire retainer, and assembly screws. Complete unit requires one body and one cover plate.

BODIES	"A"
WD06W350-T	6" [152mm]
WD10W350-T	10" [254mm]
WD18W350-T	18" [457mm]
SURFACE COVERS	"B"
CP06-TS	7" [178mm]
CP10-TS	11" [279mm]
CP18-TS	19" [482mm]
FLUSH COVERS	"B"
CP06-TF	8" [203mm]
CP10-TF	12" [305mm]
CP18-TF	20" [508mm]

External Elbow

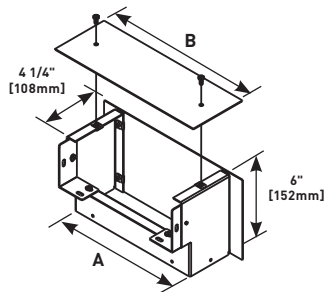

Used to connect vertical and horizontal run at 90° when cover plates are on outside of run. Includes attached coupling angles, wire retainer, and assembly screws. Complete unit requires one elbow body and two cover plates. Flush and Surface Cover catalog numbers include two covers.

BODIES	"A"
WD06W350-EL	6" [152mm]
WD10W350-EL	10" [254mm]
WD18W350-EL	18" [457mm]
SURFACE COVERS	"B"
CP06W350-ELS	6" [152mm]
CP10W350-ELS	10" [254mm]
CP18W350-ELS	18" [457mm]
FLUSH COVERS	"B"
CP06W350-ELF	8" [203mm]
CP10W350-ELF	12" [305mm]
CP18W350-ELF	20" [508mm]

T-Unit Straight Tunnel

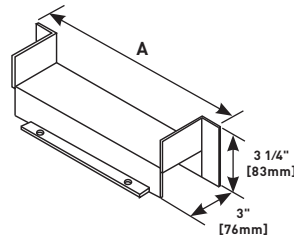

Provides 3" [76mm] straight through compartment for one service with crossover for a second service. Assembly screws included.

T-UNIT STRAIGHT TUNNEL	"A"
WD06W350-TUN	7 7/8" [200mm]
WD10W350-TUN	11 7/8" [301mm]
WD18W350-TUN	19 7/8" [457mm]

Right Hand Tunnel

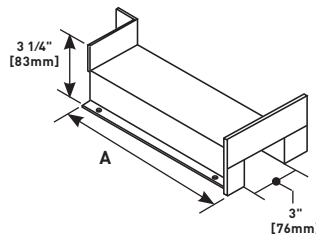

Used in conjunction with straight partition to form 90° angle - 3" [76mm] compartment with crossover in T-Unit. Assembly screws included.

RIGHT HAND TUNNEL	"A"
WD06W350-RTUN	4 7/8" [123mm]
WD10W350-RTUN	7 7/8" [200mm]
WD18W350-RTUN	15 7/8" [403mm]

NOTE: To order aluminum products, add the letter "A" to the beginning of the catalog number. Custom sizes are available. Consult the factory for more information.

WALLDUCT RACEWAY SYSTEMS

Wallduct Fittings Ordering Information (continued)

Left Hand Tunnel

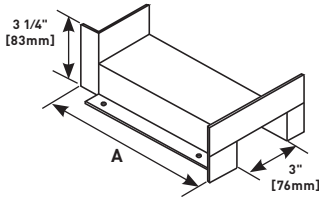

Used in conjunction with straight partition to form 90° angle - 3" [76mm] compartment with crossover in T-Unit. Assembly screws included.

LEFT HAND TUNNEL	"A"
WD06W350-LTUN	4 7/8" [123mm]
WD10W350-LTUN	7 7/8" [200mm]
WD18W350-LTUN	15 7/8" [403mm]

X-Unit

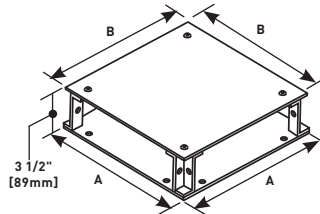

Used to connect two intersecting runs of Wallduct at 90° angle. Includes one pair of coupling angles, one wire retainer, and assembly screws. Complete unit requires one body and one cover plate.

BODIES	"A"
WD06W350-X	6" [152mm]
WD10W350-X	10" [254mm]
WD18W350-X	18" [457mm]
SURFACE COVERS	"B"
CP06-XS	8" [203mm]
CP10-XS	12" [304mm]
CP18-XS	20" [508mm]
FLUSH COVERS	"B"
CP06-XF	8" [203mm]
CP10-XF	12" [305mm]
CP18-XF	20" [508mm]

WD10W350-3TUN, WD18W350-3TUN T-Unit Tunnel

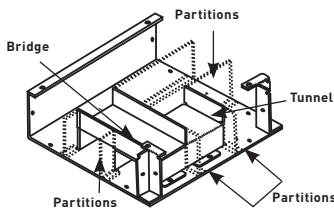

Provides three equal compartments for separation of services in T-Unit. Assembly screws included. Purchase Partition Catalog No. WD350-P60 to complete installation. Not available for 6" [162mm] wide Wallduct. Not available for 6" [152mm] wide Wallduct.

WD10W350-3TUN, WD18W350-3TUN X-Unit Tunnel

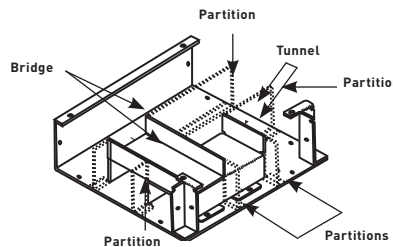

Provides three equal compartments for separation of services in X-Unit. Assembly screws included. Purchase Partition, Catalog No. WD350-P60 separately to complete installation. Not available for 6" [162mm] wide Wallduct. **Complete X-Unit assembly requires two X-Unit Tunnel units.**

WD350-PSE Internal Sweep Elbow Partition

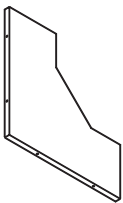

Used in conjunction with WDX-350SES to provide partition within the elbow.

X-Unit Crossover

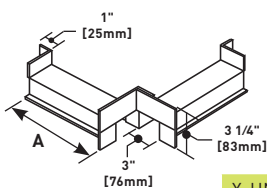

Used to provide a 90° angle - 3" [76mm] compartment with crossover in X-Unit. Assembly screws included.

X-UNIT CROSSOVER	"A"
WD06W350-XTUN	3 7/8" [98mm]
WD10W350-XTUN	6 7/8" [174mm]
WD18W350-XTUN	14 7/8" [377mm]

NOTE: To order aluminum products, add the letter "A" to the beginning of the catalog number. Custom sizes are available. Consult the factory for more information.

WALLDUCT RACEWAY SYSTEMS

Wallduct Fittings Ordering Information (continued)

Sweep Elbow

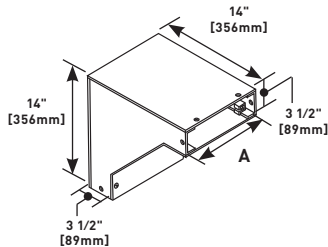

Used to connect vertical and horizontal runs of Wallduct at a 90° angle with a 45° internal sweep radius. Includes one pair of coupling angles and assembly screws. For partition, use Catalog No. WDXW350-PSE Series.

SWEEP ELBOW	"A"	
WD06W350-SES	6"	[152mm]
WD10W350-SES	10"	[254mm]
WD18W350-SES	18"	[457mm]

Sweep Cabinet Connector

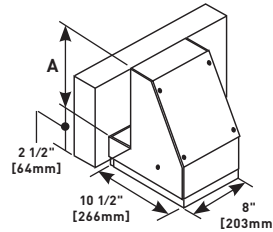

For use with GE medical equipment. Attaches to 6" x 3 1/2" [152mm x 89mm], 10" x 3 1/2" [254mm x 89mm], or 18" x 3 1/2" [457mm x 89mm] horizontal surface Wallduct. Not available in aluminum.

SWEEP CONNECTOR	"A"	
WD06W350-SWCCS	6"	[152mm]
WD10W350-SWCCS	10"	[254mm]
WD18W350-SWCCS	18"	[457mm]

Reducer Coupling

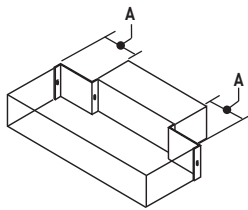

Used to reduce Wallduct width by 4" [102mm] or 8" [204mm]. Two-piece unit allows 18" [457mm] wide Wallduct to be reduced to 10" [254mm] wide, or 10" [254mm] wide to be reduced to 6" [152mm] wide. Can also be used on other sizes as needed. Assembly screws included.

REDUCER COUPLING	"A"	
WD350-RO2	2"	[51mm]
WD350-RO4	4"	[102mm]

Transition

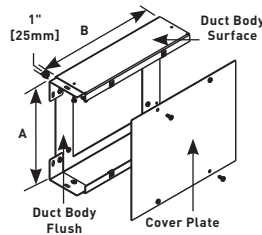

Used to form a junction between flush and surface Wallduct at a 90° angle. Includes assembly screws, clips, one wire retainer, and two coupling angles.

TRANSITION	"A"		"B"	
WD06W350-FST	6"	[152mm]	8"	[203mm]
WD10W350-FST	10"	[254mm]	12"	[304mm]
WD18W350-FST	18"	[457mm]	20"	[508mm]

Cabinet Connector/Dropout

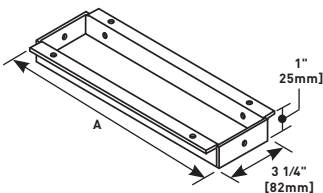

Used to connect ends of Wallduct run to panel/cabinet. Also used to connect two runs of Wallduct at 90° angle when one run butts up to the bottom or top of the other. Assembly screws included.

CONNECTOR/DROP OUT	"A"	
WD06W350-CC/DO	5 3/4"	[146mm]
WD10W350-CC/DO	9 3/4"	[247mm]
WD18W350-CC/DO	17 3/4"	[450mm]

Access Cover Plate

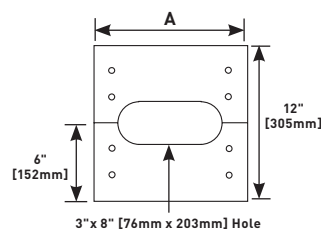

Two-piece cover with grommets hole in center. Can be installed at any location by match drilling eight holes in duct body flanges and attaching speed nuts. Includes assembly screws and grommet.

SURFACE COVERS	"A"	
WD06-ACPS	6"	[152mm]
WD10-ACPS	10"	[254mm]
WD18-ACPS	18"	[457mm]
FLUSH COVERS	"A"	
WD06-ACPF	8"	[254mm]
WD10-ACPF	12"	[305mm]
WD18-ACPF	20"	[508mm]

NOTE: To order aluminum products, add the letter "A" to the beginning of the catalog number. Custom sizes are available. Consult the factory for more information.

WALLDUCT RACEWAY SYSTEMS

Wallduct Fittings Ordering Information (continued)

Sweep Tee

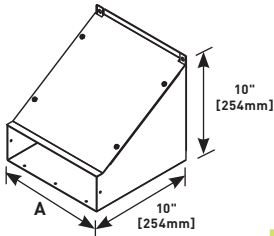

Used to connect horizontal and vertical runs of Wallduct at a 90° angle with sweep radius. Includes one pair of coupling angles and assembly screws. Not available in flush cover version.

SWEEP TEE	"A"
WD06W350-SWTS	6" [152mm]
WD10W350-SWTS	10" [254mm]
WD18W350-SWTS	18" [457mm]

Flanged Cabinet Connector

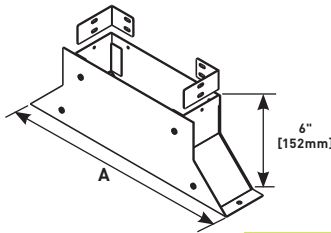

Used to connect end of Wallduct run to panel cabinet. Assembly screws included. Use .166" [4.2mm] diameter (#19 drill) for assembly. Not available in flush cover version or in aluminum.

FLANGED CONNECTOR	"A"
WD06W350-FCCS	16" [406mm]
WD10W350-FCCS	22" [559mm]
WD10W350-FCCS	22" [559mm]
WD06W350-FCCF	18" [457mm]
WD10W350-FCCF	24" [610mm]
WD18W350-FCCF	26" [660mm]

Ceiling Drop Out

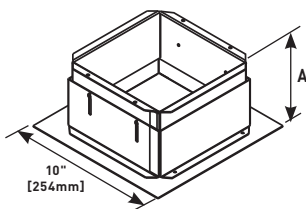

Used to drop cables and wires from Wallduct in ceiling to imaging equipment. Available in 10" [254mm] width only. Units have adjustable depth.

CEILING DROP OUT	"A"
WD-10CDO	4" [102mm] to 5 3/4" [146mm]
WD-10CDOD	5 1/2" [140mm] to 7 1/4" [184mm]

NOTE: To order aluminum products, add the letter "A" to the beginning of the catalog number. Custom sizes are available. Consult the factory for more information.

1000883 Wallduct Replacement Hardware

Hardware bag with twelve (12) 10/32 x 1/4" palnut chips.

1002412 Steel Wallduct Replacement Hardware

Hardware bag with twelve (12) 10/32 x 7/8" panhead screws.

1002414 Aluminum Wallduct Replacement Hardware

Hardware bag with twelve (12) panhead screws.

686039-100FT Wallduct Grommet

Applied to edges of Wallduct and fittings where cables egress to protect against damage to cable insulation. Packed 100' of grommet per unit.



TRENCHDUCT



Trenchduct is a large capacity feeder system used to distribute power and /or communication services in an open space environment.

CODE REFERENCE

cULus Listed Cellular Metal Floor Raceway & Fittings:
 File E26663 Guide RINV
 Meets Article 374 of NEC.

Trenchduct Feeder System Layout

Trenchduct Side Feed into Walkerduct® Pro Series

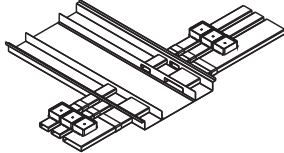

Trenchduct Crossunder Feed into Walkercell

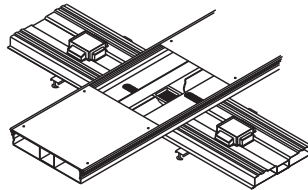

Trenchduct Crossunder Feed into Walkerduct Pro Series

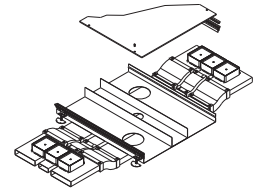

Cable Size/Fill Chart

	CABLE/WIRE SIZE	DIAMETER (Approx.)		AREA (In ²)	
		Inches	[mm]	Sq. In.	[Sq. mm]
UNSHIELDED TWISTED PAIR	4-pair, 24 AWG, Cat 5	0.220	[5.6]	0.038	[24.5]
	4-pair, 4 AWG, Cat 6	0.250	[6.4]	0.049	[31.7]
TELEPHONE	2-pair, 24 AWG	0.140	[3.6]	0.015	[9.9]
	4-pair, 24 AWG	0.190	[4.8]	0.028	[18.1]
	25-pair, 24 AWG	0.410	[10.4]	0.132	[85.2]
COAXIAL	RG58/U	0.195	[4.9]	0.030	[19.4]
	RG59/U	0.242	[6.1]	0.046	[29.7]
	RG6/U	0.270	[6.8]	0.057	[36.8]
SHIELDED TWISTED PAIR	TYPE 1	0.390	[9.9]	0.119	[76.8]
	TYPE 2	0.465	[11.8]	0.170	[109.7]
	TYPE 3	0.245	[6.2]	0.047	[30.3]
FIBER	2 Strand	0.180	[4.6]	0.025	[16.1]
	4 Strand	0.190	[4.8]	0.028	[18.1]
	6 Strand	0.210	[5.3]	0.035	[22.6]
	Fiber ZipCord	0.110	[2.8]	0.010	[6.5]

Trench Capacity Chart

WIDTH		DEPTH		TOTAL CAPACITY	
Inches	[mm]	Inches	[mm]	Sq. In.	[Sq. mm]
6	[152]	2 1/2	[64]	11.1	[7161]
12	[305]	2 1/2	[64]	24.1	[15548]
18	[457]	2 1/2	[64]	37.2	[24000]
24	[610]	2 1/2	[64]	50.3	[32452]
6	[152]	3 1/4	[83]	14.9	[9613]
12	[305]	3 1/4	[83]	32.5	[20968]
18	[457]	3 1/4	[83]	50.1	[32323]
24	[610]	3 1/4	[83]	67.7	[43677]

Wire Size Chart

WIRE SIZE AWG	DIAMETER		AREA	
	Inches	[mm]	Sq. In.	[Sq. mm]
14 AWG	0.111	[2.8]	0.010	[6.5]
12 AWG	0.130	[3.3]	0.013	[8.4]
10 AWG	0.164	[4.1]	0.021	[13.5]
8 AWG	0.216	[5.4]	0.037	[23.9]
6 AWG	0.254	[6.4]	0.051	[32.9]
4 AWG	0.324	[8.2]	0.082	[52.9]

TRENCHDUCT FEEDER SYSTEMS

Trenchduct Load Capacities (lbs)

COVER PLATE THICKNESS	LOAD TYPE	TRENCHDUCT WIDTH				
		6" [152mm] No Supports	12" [305mm] No Supports	18" [457mm] One Row Supports	24" [610mm] One Row Supports	36" [914mm] Two Row Supports
1/4" [6.4mm]	Concentrated	1300	1300	1300	800	1200
1/4" [6.4mm]	Rolling	800	840	800	500	780
3/8" [9.5mm]	Concentrated	2400	2400	2400	2000	2000
3/8" [9.5mm]	Rolling	1500	1560	1500	1300	1300

Trenchduct Body & Cover Assembly Ordering Information

VA12W250H Body & Cover Assembly

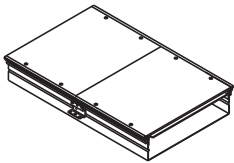

VA12W250H-1, VA12W250H-2, VA12W250H-5, VA12W250H-6, VA12W325H-1, VA12W325H-2, VA12W325H-5, VA12W325H-6

Flush floor raceway with removable cover plates. Cover plate is 1/4" [6.4mm] thick and three pieces are supplied for 5' [1.5m] and 6' [1.8m] lengths [5' cover is two 24" and one

12" sections and 6' cover is three 24" sections). Partitions and supports not included. Length, width, and depth described in catalog number represent outside cover plate and body dimensions. The interior size of the trenchduct bodies is always 13/16" [21mm] narrower than the cover plate. The interior depth of the trenchduct bodies is always 5/16" [7.9mm] shallower than depth specified by catalog number. Body is 16 gauge steel. Vinyl trim and leveling feet are included. Can be leveled to screed depth using leveling foot or support coupling up to 3/4" [19.1mm]. Use catalog numbering system to select product. Consult Wiremold® sales representative for custom sizes.

Catalog Number System

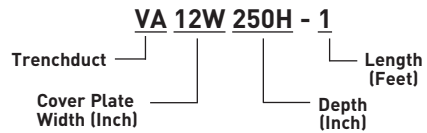

Standard Selection Options:

- Cover Plate Width = 6", 12", 18", or 24" [152mm, 305mm, 457mm, or 610mm]
- Depth = 250 or 325 [2 1/2" or 3 1/4" [64mm or 83mm]]
- Length = 1', 2', 5' or 6' [.3m, .6m, 1.5m, or 1.8m]

NOTE: For other widths, substitute cover plate width in above catalog numbers with 12, 18, or 24.

NOTE: Covers are not intended to be used without floor covering.

Trenchduct Components & Fittings Ordering Information

Adjustable Partition

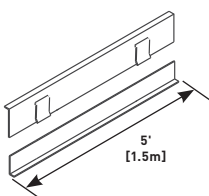

Used to separate Trenchduct and fittings into two or more compartments. Allows 3/4" [19.1mm] upward adjustment. Field installed to base and adjusted up to bottom of cover plate of Trenchduct with welds or screws. Available in 5' [1.5m] length. Field modified for use in T-Units, risers, and elbows.

T250HWP-5	2 1/2" [64mm] Depth
T325HWP-5	3 1/4" [83mm] Depth

Support Strips

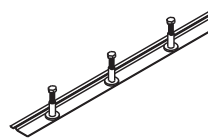

Used to provide strength to support cover plate. Required for clear spans of 14" [456mm] or greater, or any trench wider than 14" [456mm], without partitions or when heavy loads will be applied, such as in casinos. Available in 6" or 12" [152mm or 305mm] on center bolt spacing. 12" [305mm] O.C. spacing is adequate for most applications. Select 6" [152mm] O.C. spacing for heavy loads. Support bolts should be located 2" [51mm] from ends of cover plates. Strip is field installed to base and adjusted up to bottom of cover plate of Trenchduct with welds or screws. Available in 5' [1.5m] lengths.

VA06SSS250-5	6" [152mm] O. C.	2 1/2"	[64mm] Depth
VA06SSS325-5	6" [152mm] O. C.	3 1/4"	[83mm] Depth
VA12SSS250-5	12" [305mm] O. C.	2 1/2"	[64mm] Depth
VA12SSS325-5	12" [305mm] O. C.	3 1/4"	[83mm] Depth

TRENCHDUCT FEEDER SYSTEMS

Trenchduct Components & Fittings Ordering Information (continued)

VA06W250HEC End Closure

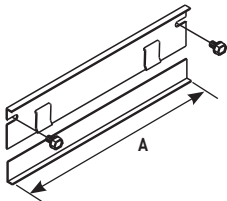

VA06W250HEC, VA06W325HEC, VA12W250HEC, VA12W325HEC, VA18W250HEC, VA18W325HEC, VA24W250HEC, VA24W325HEC
Used to close off end of Trenchduct. Two-piece design allows 3/4" [19.1mm] vertical adjustment. "A" dimension is Trenchduct width.

VA250PEC Partial End Closure

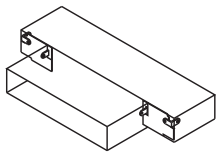

VA250PEC-LH3, VA250PEC-RH3, VA325PEC-LH3, VA325PEC-RH3, VA250PEC-LH6, VA250PEC-RH6, VA325PEC-LH6, VA325PEC-RH6
Used to reduce Trenchduct from one piece to the next in a linear direction. Order left or right side in widths of 3" [76mm] or 6" [152mm].

T-Unit

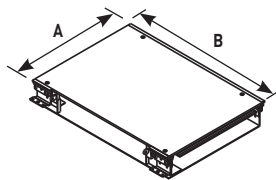

VA06W250H-T, VA06W325H-T, VA12W250H-T, VA12W325H-T, VA18W250H-T, VA18W325H-T, VA24W250H-T, VA24W325H-T
Used to connect intersecting runs of Trenchduct at 90° angles on three sides. Length, width, and depth specified by catalog number. Closed side is length. Use partition or tunnel to separate services (ordered separately for standard product).

A	6" [152mm]	12" [305mm]	18" [457mm]	24" [610mm]
B	12" [305mm]	18" [457mm]	24" [610mm]	30" [762mm]

VAT12W250H3CT T-Unit Tunnel

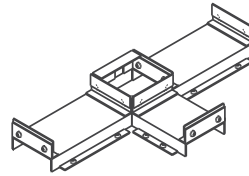

VAT12W250H3CT, VAT12W325H3CT, VAT18W250H3CT, VAT18W325H3CT, VAT24W250H3CT, VAT24W325H3CT
Used to separate three services within T-Unit. Field attached with screws or welds. See chart for width of power compartment. Not available for 6" [152mm] wide Trenchduct.

TRENCH WIDTH	12" [305mm]	18" [457mm]	24" [610mm]
POWER CHANNEL WIDTH	3 1/2" [89mm]	4" [102mm]	5" [127mm]

VA06W250H-X X-Unit

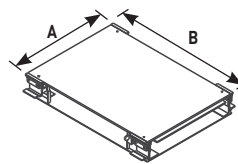

VA06W250H-X, VA06W325H-X, VA12W250H-X, VA12W325H-X, VA18W250H-X, VA18W325H-X, VA24W250H-X, VA24W325H-X
Used to connect intersecting runs of Trenchduct at 90° angles on all four sides. Length, width, and depth specified by catalog number. Use tunnel and partition as needed to separate services (ordered separately for standard product).

A	6" [152mm]	12" [305mm]	18" [457mm]	24" [610mm]
B	5" [127mm]	7 1/2" [191mm]	10" [254mm]	12 1/2" [318mm]

VAT12W250H3CX X-Unit Tunnel

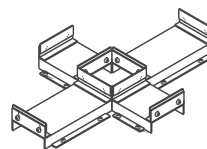

VAT12W250H3CX, VAT12W325H3CX, VAT18W250H3CX, VAT18W325H3CX, VAT24W250H3CX, VAT24W325H3CX
Used to separate three services within X-Unit. Field attached to base of Trenchduct with screws or welds. See chart for width of power compartment. Not available for 6" [152mm] wide Trenchduct.

TRENCH WIDTH	12" [305mm]	18" [457mm]	24" [610mm]
POWER CHANNEL WIDTH	3 1/2" [89mm]	4" [102mm]	5" [127mm]

NOTE: Custom sizes are available. Consult the factory for more information. Covers are not intended to be used without floor coverings.

TRENCHDUCT FEEDER SYSTEMS

Trenchduct Components & Fittings Ordering Information (continued)

VA06W250H Horizontal Elbow

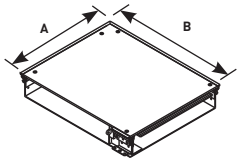

Right Hand Elbow

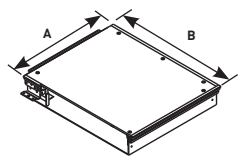

Left Hand Elbow

Right Hand Elbow Catalog Nos.
VA06W250H-RL, VA06W325H-RL,
VA12W250H-RL, VA12W325H-RL,
VA18W250H-RL, VA18W325H-RL,
VA24W250H-RL, VA24W325H-RL

Left Hand Elbow Catalog Nos.
VA06W250H-LL, VA06W325H-LL,
VA12W250H-LL, VA12W325H-LL,
VA18W250H-LL, VA18W325H-LL,
VA24W250H-LL, VA24W325H-LL

Used to change direction of Trenchduct run 90° to the right or left. Length, width, and depth specified by catalog number. Use partition to separate services (ordered separately for standard product).

A	6" [152mm]	12" [305mm]	18" [457mm]	24" [610mm]
B	9" [229mm]	15" [381mm]	21" [533mm]	27" [686mm]

VA06W Sweep Vertical Riser

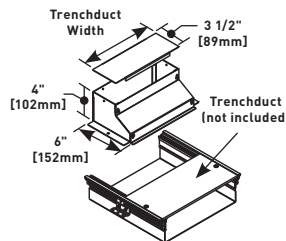

VA06W-VL, VA12W-VL10*, VA18W-VL, VA24W-VL

Used to transition from Trenchduct into perpendicular run of Wallduct or into riser to panel. Includes removable cover plate.

Important! 12" [305mm] Wide Rises to 10" [254mm] Wide to Attach to Wallduct.

NOTE: To continue separation/partition from trenchduct, use Partition # WD350-PSE.

VA06W Straight Vertical Riser

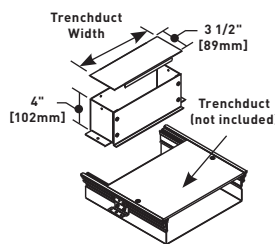

VA06W-VR, VA12W-VR10*, VA18W-VR, VA24W-VR

Used to transition from Trenchduct into perpendicular run of Wallduct or into riser to panel. Use partition to separate services (ordered separately for standard product).

Important! 12" [305mm] Wide Rises to 10" [254mm] Wide to Attach to Wallduct.

VAT12W250H4CT Four Compartment Fitting Tunnel

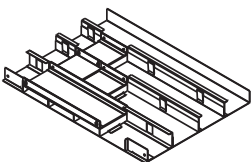

VAT12W250H4CT, VAT12W325H4CT, VAT18W250H4CT, VAT18W325H4CT, VAT24W250H4CT, VAT24W325H4CT

Used to divide services into 4 equal compartments. Field attached with screws or welds. Order one set for T-Unit and two sets for X-Unit. Not available for 6" [152mm] wide Trenchduct. Fittings sold separately.

VA06W-AH3 Access Hood

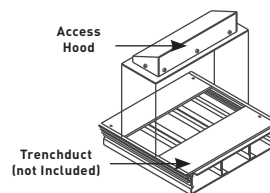

VA06W-AH3, VA12W-AH3, VA18W-AH3, VA24W-AH3

Service fitting can be mounted on Trenchduct in place of the cover plate. Removable back plate allows access into the Trenchduct body.

VA06W250H 45° Mitred Horizontal Elbow

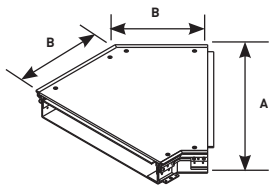

VA06W250H-L45, VA06W325H-L45, VA12W250H-L45, VA12W325H-L45, VA18W250H-L45, VA18W325H-L45, VA24W250H-L45, VA24W325H-L45

Used to change direction of Trenchduct run 45° in either direction. Length, width, and depth determined by the catalog number. Use partition to separate services (ordered separately for standard product).

A	6" [152mm]	12" [305mm]	18" [457mm]	24" [610mm]
B	5" [127mm]	7 1/2" [191mm]	10" [254mm]	12 1/2" [318mm]

485 Cover Plate Lifter

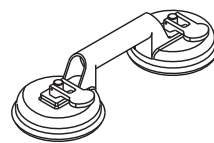

Used to assist in removing cover plates from Trenchduct.

686052-100FT Trenchduct Grommet

Applied to edges of Trenchduct and fittings where cables egress to protect against damage to cable insulation. 0.281" wide by 0.188" deep. Packed 100' of grommet per unit.



NOTE: Custom sizes are available. Consult the factory for more information. Covers are not intended to be used without floor coverings.

WALKERCELL® CELLULAR RACEWAY SYSTEMS

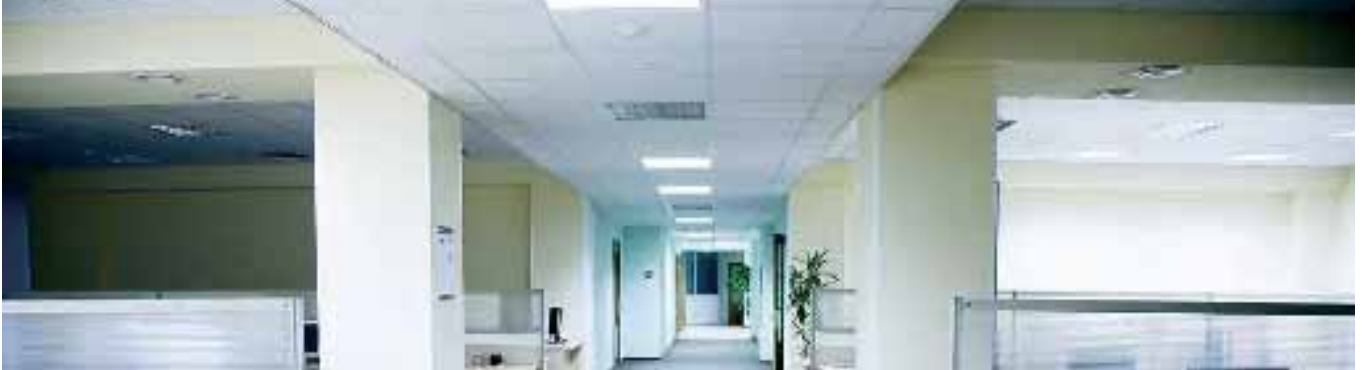

Walkercell® Cellular Raceway Systems offer maximum capacity for distributing power and communication services throughout any open space environment while maintaining separation and security between services and provides point-of-use services in a recessed activation.

CODE REFERENCE

cULus Listed Cellular Metal Floor Raceway: File E26702 Guide RHZX
Meets Article 12-1800 to 12-1820 of CEC
Meets Article 374 of NEC.

Walkercell Cellular Raceway System Layout

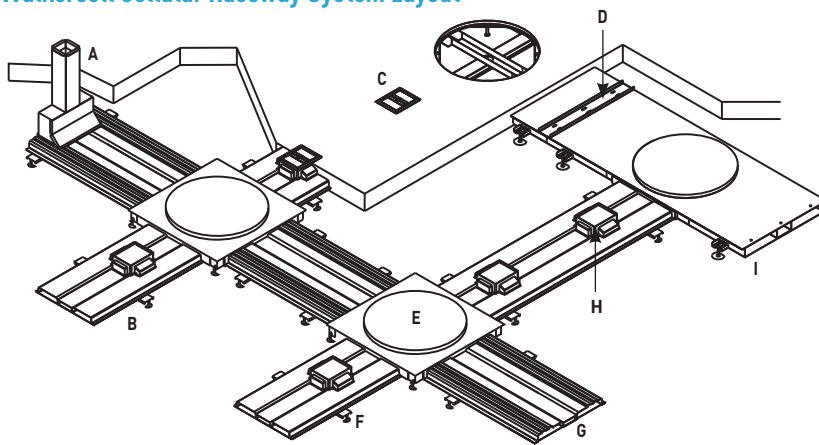

KEY

- A. CBR-LHT Vertical Boot Riser
- B. WCR11/2-10/24 Cellular Raceway
- C. FBTCAL FloorPort Activation Cover
- D. JBHCC24 Junction Box Header (WCR 11/2)
- E. 2-11/2JB2510 Junction Box
- F. RSCB-28 Support
- G. WCR2-10/B Cellular Raceway
- H. PK200 Preset
- I. 11/2JBH242510-60 Junction Box Header

NOTE: Illustration is for showing product applications only.





Walkercell Cellular Raceway Selection Guide

WALKERCELL SYSTEM	SYSTEM DEPTH	PRESET CATALOG NO.	DEPTH OVER TOP OF SYSTEM	EXTENSION RING HARDWARE BAG	EXTENSION RING SIZE
WCR11/2	3 1/2"	PK150	2"	AERHB-148	22AER-11/2-21/4
WCR11/2	4"	PK200	2 1/2"	AERHB-048	22AER-23/8-31/8
WCR11/2	4 1/2"	PK250	3"	AERHB-048	22AER-23/8-31/8
WCR2	3 1/2"	PK150	1 1/2"	AERHB-116	22AER-11/2-21/4
WCR2	4"	PK200	2"	AERHB-148	22AER-11/2-21/4
WCR2	4 1/2"	PK250	2 1/2"	AERHB-048	22AER-23/8-31/8
WCR2	5"	PK300	3"	AERHB-048	22AER-23/8-31/8
WCR3	4 1/2"	PK150	1 1/2"	AERHB-116	22AER-11/2-21/4
WCR3	5"	PK200	2"	AERHB-148	22AER-11/2-21/4
WCR3	5 1/2"	PK250	2 1/2"	AERHB-048	22AER-23/8-31/8
WCR3	6"	PK300	3"	AERHB-048	22AER-23/8-31/8

Other sizes are available. Consult your local Wiremold representative.

WALKERCELL® CELLULAR RACEWAY SYSTEMS

Walkercell Service Fitting Compatibility

PRODUCT FAMILY	CATALOG NUMBER	ACTIVATION LOCATION			SERVICE CAPACITY			SERVICE COMPATIBILITY			MATERIAL/COLORS						
		Flush	Recessed	Pedestal	Single Service	Dual Service	Triple Service	Power	Communication	Audio/Visual	Aluminum	Brass	Gray	Black	Nickel	Bronze	
	FloorPort	FPCTC Series		•				•	•	•	•	•	•	•	•	•	
		FPBTC Series	•					•	•	•	•	•	•	•	•	•	•
		FPFFTC Series	•					•	•	•	•	•	•	•	•	•	•
		FPCT Series		•				•	•	•	•	•	•	•	•	•	•
		FPBT Series		•				•	•	•	•	•	•	•	•	•	•
		FPFFT Series	•					•	•	•	•	•	•	•	•	•	•
	1200 Series	1204BF			•	•			•			•					
		1204AL			•	•			•		•						
		1223BF			•	•			•			•					
		1223AL			•	•			•			•					
	Multiplex	MP4			•	•		•	•	•	•						
		MP8			•		•	•	•	•	•						
		MP8-1			•		•	•	•	•	•						
	525 Series	525A			•	•			•	•	•						
		525B			•	•			•	•	•						
		525C			•	•			•	•	•						
		525D			•	•			•	•	•						
		525F			•	•			•			•					
		525G			•	•			•			•					
		525H			•	•			•			•					
		525I			•	•			•			•					
		525J			•	•			•	•	•	•					
		525RT			•	•				•		•					
		525ACT			•	•				•		•					

WALKERCELL® CELLULAR RACEWAY SYSTEMS

Walkercell Cable Fill Capacities – Communications

	CABLE/WIRE SIZE	DIAMETER (Approx.)		AREA (In ²)		40% FILL		
		Inches	[mm]	Sq. In.	[Sq. mm]	WCR11/2	WCR2	WCR3
UNSHIELDED TWISTED PAIR	4-pair, 24 AWG, Cat 5	0.220	[5.6]	0.038	[24.5]	85	115	197
	4-pair, 24 AWG, Cat 6	0.250	[6.4]	0.049	[31.7]	66	89	153
TELEPHONE	2-pair, 24 AWG	0.140	[3.6]	0.015	[9.9]	217	285	488
	4-pair, 24 AWG	0.190	[4.8]	0.028	[18.1]	116	155	265
	25-pair, 24 AWG	0.410	[10.4]	0.132	[85.2]	24	33	56
COAXIAL	RG58/U	0.195	[4.9]	0.030	[19.4]	108	146	252
	RG59/U	0.242	[6.1]	0.046	[29.7]	70	96	162
	RG6/U	0.270	[6.8]	0.057	[36.8]	57	77	130
SHIELDED TWISTED PAIR	TYPE 1	0.390	[9.9]	0.119	[76.8]	27	37	63
	TYPE 2	0.465	[11.8]	0.170	[109.7]	19	26	44
	TYPE 3	0.245	[6.2]	0.047	[30.3]	69	93	159
FIBER	2 Strand	0.180	[4.6]	0.025	[16.1]	130	173	296
	4 Strand	0.190	[4.8]	0.028	[18.1]	116	155	264
	6 Strand	0.210	[5.3]	0.035	[22.6]	93	127	216
	Fiber ZipCord	0.110	[2.8]	0.010	[6.5]	326	463	791

Walkercell Wire Fill Capacities – Power

WIRE SIZE AWG	DIAMETER		AREA (In ²)		40% FILL		
	Inches	[mm]	Sq. In.	[Sq. mm]	WCR11/2	WCR2	WCR3
14	0.111	[2.8]	0.010	[6.5]	4.22 in. ² [2722mm ²]	4.3 in. ² [2774mm ²]	8.5 in. ² [5484mm ²]
12	0.130	[3.3]	0.013	[8.4]	168	172	351
10	0.164	[4.2]	0.021	[13.5]	80	82	161
8	0.216	[5.4]	0.037	[23.9]	45	47	93
6	0.254	[6.4]	0.051	[32.9]	33	34	67
4	0.324	[8.2]	0.082	[52.9]	20	21	41

NOTE: When using a Junction Box, calculate fill capacity according to the smallest compartment.

Walkercell Cellular Raceway Preset Selection Guide

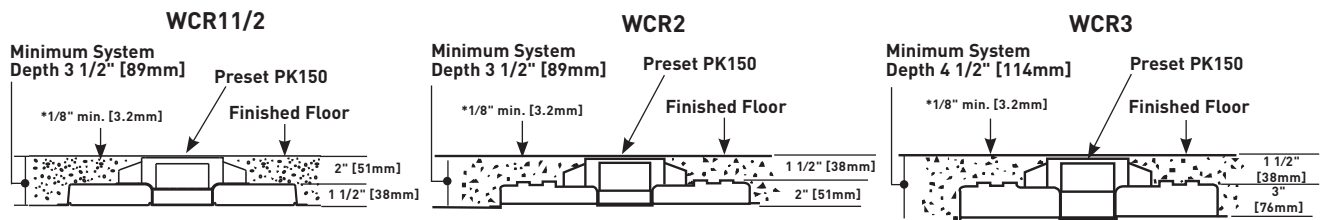

OTHER SYSTEM DEPTHS FOR WCR11/2		
SYSTEM DEPTH	PRESET CAT. NO.	FILL OVER CELL
3 1/2" [89mm]	PK150	2" [51mm]
4" [102mm]	PK200	2 1/2" [64mm]
4 1/2" [114mm]	PK250	3" [76mm]
5" [127mm]	PK300	3 1/2" [89mm]
5 1/4" [133mm]	PK325	3 3/4" [95mm]
5 1/2" [140mm]	PK350	4" [102mm]

OTHER SYSTEM DEPTHS FOR WCR2		
SYSTEM DEPTH	PRESET CAT. NO.	FILL OVER CELL
3 1/2" [89mm]	PK150	1 1/2" [38mm]
4" [102mm]	PK200	2" [51mm]
4 1/2" [114mm]	PK250	2 1/2" [64mm]
5" [127mm]	PK300	3" [76mm]
5 1/4" [133mm]	PK325	3 1/4" [83mm]
5 1/2" [140mm]	PK350	4" [102mm]

OTHER SYSTEM DEPTHS FOR WCR3		
SYSTEM DEPTH	PRESET CAT. NO.	FILL OVER CELL
3 1/2" [89mm]	PK150	1 1/2" [38mm]
4" [102mm]	PK200	2" [51mm]
4 1/2" [114mm]	PK250	2 1/2" [64mm]
5" [127mm]	PK300	3" [76mm]
5 1/4" [133mm]	PK325	3 1/4" [83mm]
5 1/2" [140mm]	PK350	3 1/2" [89mm]

Recommend a minimum of 1/8" [3.2mm] concrete over preset.

* If concrete depth over preset is over 3/4" [19.1mm] it may be difficult to break-out concrete and excessive spalling may occur. For system depth greater than above standard preset height use PK Extension Ring.

WALKERCELL® CELLULAR RACEWAY SYSTEMS

Walkercell Cellular Raceway Ordering information

WCR11/2-10B, WCR11/2-10/24 Walkercell Raceway

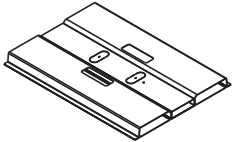

WCR11/2-10/24 Walkercell Raceway Top View

Walkercell Raceway – Profile WCR11/2. 10' [3m] long without preset openings (WCR11/2-10/B) or with prepunched preset openings 24" [610mm] on center (WCR11/2-10/24). First preset is 12" [305mm] from end.

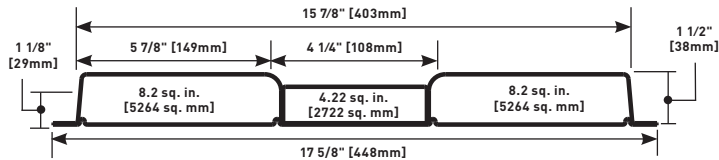

WCR2-10B, WCR2-10/24 Walkercell Raceway

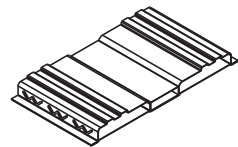

WCR2-10/B Walkercell Raceway Top View

Walkercell Raceway – Profile WCR2. 10' [3m] long without preset openings (WCR2-10/B) or with prepunched preset openings 24" [610mm] on center (WCR2-10/24). First preset is 12" [305mm] from end.

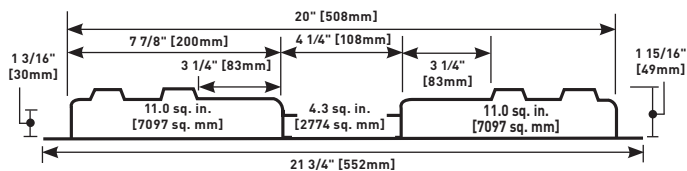

WCR3-10B, WCR3-10/24 Walkercell Raceway

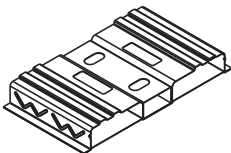

WCR3-10/24 Walkercell Raceway Top View

Walkercell Raceway – Profile WCR3. 10' [3m] long without preset openings (WCR3-10/B) or with prepunched preset openings 24" [610mm] on center (WCR3-10/24). First preset is 12" [305mm] from end.

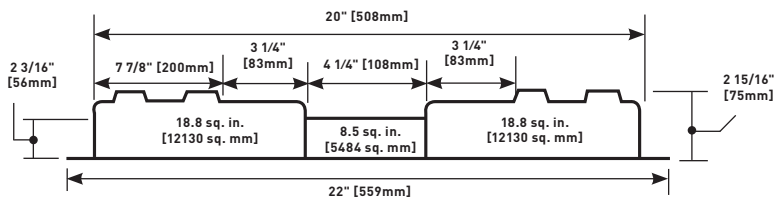

NOTE: PK Presets ordered separately. Order one PK Preset for each preset opening in the Walkercell.

Walkercell Cellular Raceway Presets & Fittings Ordering information

PK150, PK200, PK250, PK300, PK325 Triple Service Preset

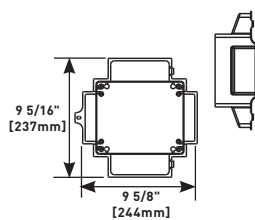

Zinc die-cast construction with a removable steel cap that is recessed for concrete. Each preset is capable of housing two duplex power receptacles and up to eight communication connectors. Each preset has tapped openings for mounting brackets, adjusting ring and trim rings. The presets are field installed using one 3/16" [4.8mm] pop rivet (not provided). Preset extensions can be used to add height to presets as needed.

PKER-10, PKER-15, PKER-20, PKER-25, PKER-30 PKER Extensions

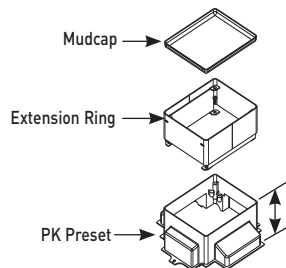

Attaches to preset to add height. Can be field installed.

EXTENSION	HEIGHT ABOVE PRESET A
PKER-10	1" [25mm]
PKER-15	1 1/2" [38mm]
PKER-20	2" [51mm]
PKER-25	2 1/2" [64mm]
PKER-30	3" [76mm]

NOTE: Suffix indicates depth of concrete over WCR2 and WCR3. For WCR11/2, concrete depth is 1/2" greater. (Example PK150 = 2" of concrete)

WALKERCELL® CELLULAR RACEWAY SYSTEMS

Walkercell Cellular Raceway Presets & Fittings Ordering information (continued)

PKCAP Mudcap

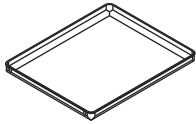

Used to close off Walkercell PK Preset.

PMS-415N Marker Cap

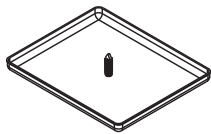

Replaces standard mudcap at ends of runs and near feeder to locate cellular runs after concrete placement.

RSCB-18, RSCB-33, RSCB-48 Raceway Supports

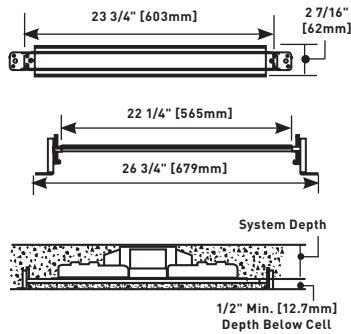

Holds raceway at proper elevation during concrete placement. Fasten raceway to support using four self-drilling screws supplied. Supports are used at raceway butt joints and maximum 5' [1.524m] spacing between butt joint locations. See selection guide below. Suffix indicates distance between Walkercell and slab on grade.

CAT NO.	DEPTH BELOW CELL			
RSCB-18	1/2"	[12.7mm]	to	1 7/8" [48mm]
RSCB-33	1 1/2"	[38mm]	to	3 3/8" [86mm]
RSCB-48	3 1/2"	[89mm]	to	4 7/8" [124mm]

RGP Grounding Plate

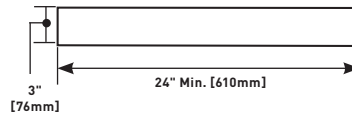

Installed at raceway butt joints when Walkercell is placed on a mud slab or concrete sidewalks and RSCBs are not required. Used to maintain ground continuity between Walkercell Raceways. Fasten raceway to slab through 20 gauge grounding plate with power actuated fastener (not provided). Field installed.

REC11/2, REC Blank End Closures

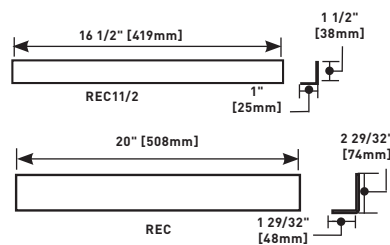

Used to close off ends of raceway. End closures are held in place during concrete placement using blind rivets or welds. REC 11/2 is for WCR11/2 and REC is for WCR2, and WCR3.

REC11/2-CA, REC2-CA, REC3-CA End Closures for Duct Stubs

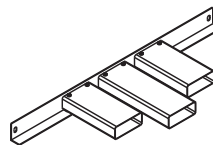

Provide ability to feed conduit from ends of raceway. Use with 312 Fittings below.

312-3/4, 312-1, 312-11/4, 312-11/2, 312-2 Female Conduit Adapter

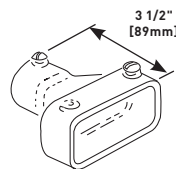

Fits on outside of No. 2 duct. For one rigid or PVC conduit. Suffix indicates conduit size.

WALKERCELL® CELLULAR RACEWAY SYSTEMS

Walkercell Cellular Raceway Presets & Fittings Ordering information (continued)

CBR-HT, CBR-LT, CBR11/2-LHT, CBR-LHT Cell Boot Risers

Allow access into one, two, or three cells simultaneously. Field cut oblong opening in raceway and rivet or weld riser to raceway. Void closures included (not shown).

CBR-HT (For Power Only)

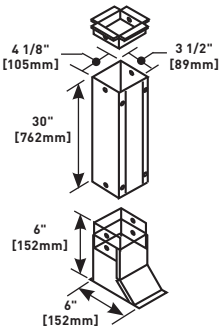

CBR-LT (Access to Two Communication Compartments)

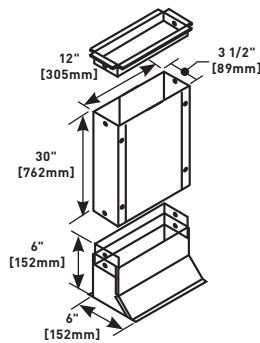

CBR11/2-LHT (Access to All Three Compartments with Power Separated)

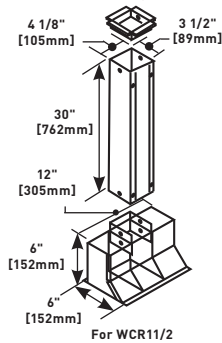

CBR-LHT (Access to All Three Compartments with Power Separated)

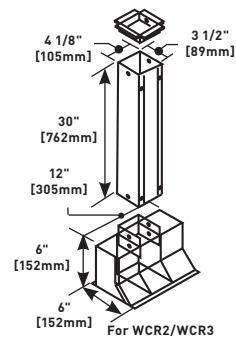

REC11/2-C, REC2-C, REC3-C End closures

Used to close off ends of raceway and provide conduit knockouts. End closures are held in place with blind rivets or welds.

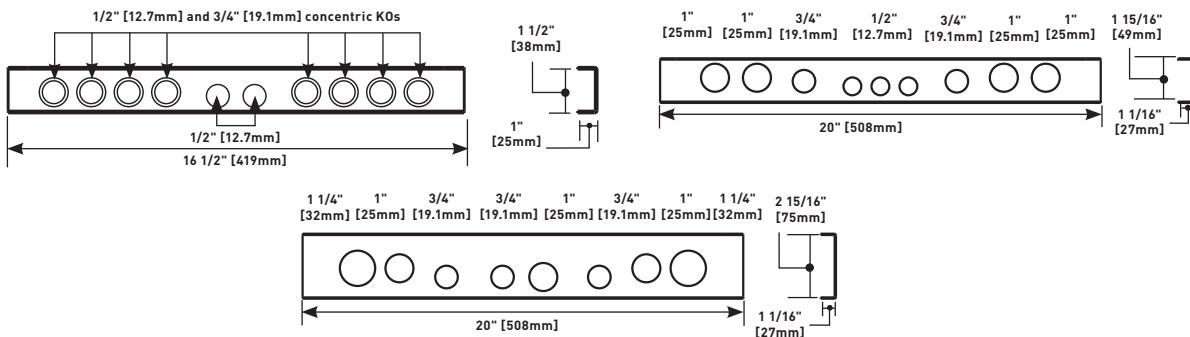

22LHS-1/8, 22LHS-1/4 Carpet & Tile Holder

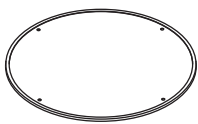

Placed on top of junction box cover plates to provide trim for flooring. Recessed to hold carpet or tile. Specify "B" for brass or "S" for steel. Suffix indicates depth.

22AER-11/2-21/4, 22AER-23/8-31/8 Adjustable Extension Ring

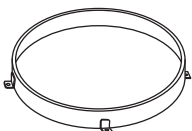

For Walkercell junction boxes and junction box header. Suffix refers to adjustable height range of concrete over duct. Select appropriate AERHB-Hardware Bag (next column) to attach ring to box.

1001757, 929046 Junction Box Adapters

Side adapter to attach Walkercell Raceway to the box. Allows junction box side opening to be converted to another size by replacing adapter. WCR3 cannot be used with 2 1/2" [64mm] deep box. 1001757 is for WCR11/2 and 929046 is for WCR2 or WCR3.

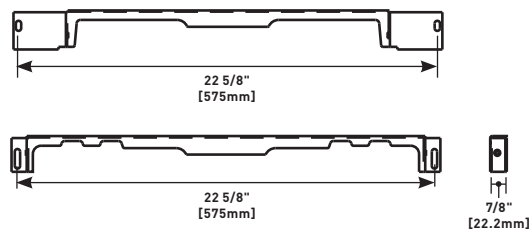

WALKERCELL® CELLULAR RACEWAY SYSTEMS

FloorPort Activation Accessories for Use with Walkercell and Walkerdeck Systems

WPACR-1G Internal Bracket

Two duplex receptacle brackets, receptacle insulators, power grommets, and bend radius control grommets. For use with recessed activations. Communication brackets ordered separately. See next page.

WPACR-2G Internal Bracket

Two 15A, 120V duplex receptacles, two duplex receptacle brackets, receptacle insulators, power grommets, and bend radius control grommets. For use with recessed activations. Communication brackets ordered separately. See next page.

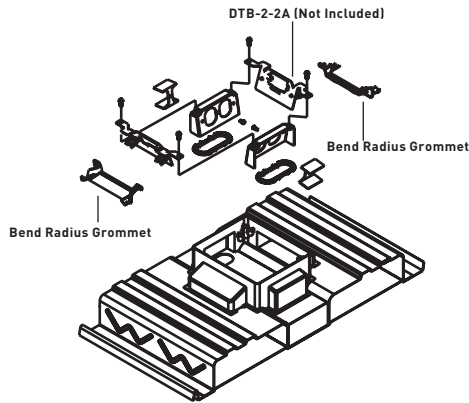

WPACR-2G Internal Bracket

Two 20A, 120V duplex receptacles, two duplex receptacle brackets, receptacle insulators, power grommets, and bend radius control grommets. For use with recessed activations. Communication brackets ordered separately. See next page.

Bend Radius Control Grommets

PKGRBR PK Preset Grommet

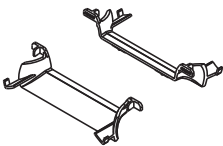

Bend radius control grommet used with PK preset. Maintains 1 1/4" [32mm] minimum cable lay-in radius.

NOTE: Not for use with communication brackets DTB-2-2AB or DTB-2-2RT.

FloorPort Bracket Compatibility

Fittings intended for a cellular raceway system must have a minimum of 2 1/2" [64 mm] of concrete topping over the top of the deck. A typical UL Fire Classified floor activation will consist of the following components:

PK Series Preset Inserts			
"()" Maximum Quantity of Units Allowed Inside of Preset Insert			
Cover Assembly	Activation Assembly	Barrier Assembly	Communication Bracket
FPBTC FPCTC FPBT FPCT	(1) WPACR	-	(2) DTB-2
FPPFTC FPPFT		(1) PKKIT	(1) DTB-2FP

WALKERCELL® CELLULAR RACEWAY SYSTEMS

FloorPort Activation Accessories for Use with Walkercell and Walkerdeck Systems

PKKIT Barrier Kit

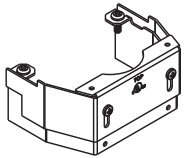

Used to separate power and communication wires in partition feed covers. Supplied with base and three extensions to adjust to cover height. Kit should be used on PK Presets (Walkercell, Walkerdeck). Kits are sold separately.

DTB-2-2AB, DTB-2-RT Communication Bracket

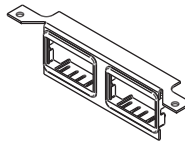

Bracket for Activate (DTB-2-2AB) or Ortronics® (DTB-2-2RT) devices. Ortronics® and Activate adapters included.

WPACR-1G Internal Bracket

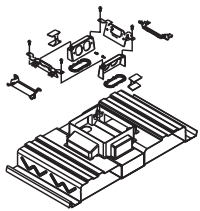

Two duplex receptacle brackets, receptacle insulators, power grommets, and bend radius control grommets. Communication brackets ordered separately.

11/2JBC-CA, 22JBC-CA, 33JBC-CA Junction Box Closure with Duct Stubs

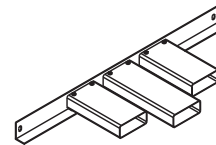

Provides ability to feed conduit from junction box. Use with 312 Fittings.

DTB-2-2A Communication Bracket

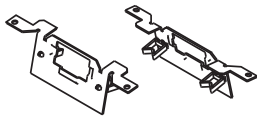

Plastic clips on back of bracket provide cable storage loop. For use with WPACR. Activate 2A jacks snap directly into bracket.

AERHB-116, AERHB-132, AERHB-148, AERHB-200, AERHB-048 Hardware Bag



For adjustable extension ring. Suffix indicates depth of concrete over junction box cover. Use chart below to determine hardware bag required.

HARDWARE BAG CAT. NO.	Cover Depth Over Walkercell						
	1 1/2"	1 5/8"	1 3/4"	1 7/8"	2"	2 1/8"	2 3/8-3"
AERHB-116	X						
AERHB-132		X	X				
AERHB-148				X	X		
AERHB-200						X	
AERHB-048							X

DTB-2-B Communication Bracket

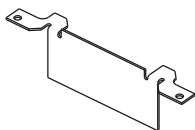

Blank bracket for customization in field. For use with WPACR. Wiremold Open System inserts sold separately.

DTB-2-4TKO Communication Bracket

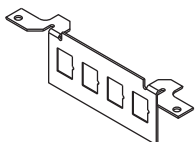

Four knockouts for RJ style jacks. For use with WPACR. Wiremold Open System inserts sold separately.

11/2JBC, 22JBC, 33JBC Junction Box Closure

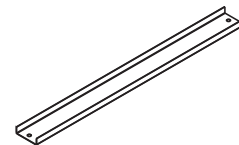

Attaches to side of junction box to close access. 11/2JBC is for WCR11/2, 22JBC is for WCR2, and 33JBC is for WCR3.

WALKERCELL® CELLULAR RACEWAY SYSTEMS

Walkercell Cellular Raceway Headerduct Ordering Information

Walkercell Headerduct

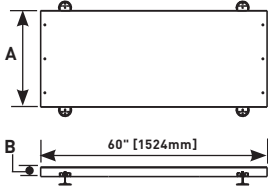

Used as a feeder raceway for Walkercell Systems. Standard length is 60" [1524mm]. All Headerduct is furnished with 1/4-20 threaded holes at each end to fasten coupling channels.

Walkercell Headerduct

CATALOG NO.	A	B
WCHD2425-60	24" [610mm]	2 1/2" [64mm]
WCHD3025-60	30" [762mm]	2 1/2" [64mm]
WCHD3625-60	36" [915mm]	2 1/2" [64mm]

Headerduct End Closure

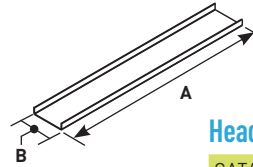

Used to close end of Headerduct, Header Junction Boxes, or Junction Box Header. Secured with blind rivet or weld

Headerduct End Closure

CATALOG NO.	A	B
JBHEC2425	24" [610mm]	2 1/2" [64mm]
JBHEC3025	30" [762mm]	2 1/2" [64mm]
JBHEC3625	36" [915mm]	2 1/2" [64mm]

Coupling Channels

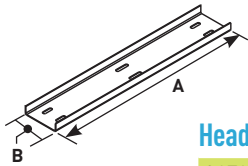

Used to connect ends of Headerduct Junction Boxes together. Channels are furnished with 1/4-20 screws.

Headerduct Coupling Channel

CATALOG NO.	A	B
JBHCC24	24" [610mm]	2 1/2" [64mm]
JBHCC30	30" [762mm]	2 1/2" [64mm]
JBHCC36	36" [915mm]	2 1/2" [64mm]

Junction Boxes

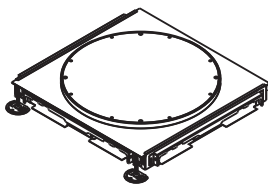

Used at intersections of Walkercell Raceway. Partitions inside box maintain separation of services. 22" [559mm] dia. cover provides access inside box. Access ring is 1" [25mm] over box. Order extension ring for additional height. Cover plates have 1/2" [12.7mm] upward adjustment for precise leveling after the pour. Side openings on junction boxes can be replaced to fit other Walkercell profiles. Cell dimensions are 24" x 26" [610mm x 660mm].

CATALOG NO.	SIDE OPENINGS	HEIGHT OF BOX
11/2JB2510	Four - WCR11/2	2 1/2" [64mm]
33JB3510	Four - WCR3	3 1/2" [89mm]
2-11/2JB2510*	Two - WCR11/2, Two - WCR2	2 1/2" [64mm]
32JB3510*	Two - WCR2, Two - WCR3	3 1/2" [76mm]

* WCR2 feeds WCR11/2 distribution and WCR3 feeds WCR2 distribution.

NOTE: The minimum depth of Junction Box is 1/2" [12.7mm] higher than WCR2 and WCR3, and is 1" [25mm] higher than WCR11/2.

WALKERCELL® CELLULAR RACEWAY SYSTEMS

Walkercell Cellular Raceway Headerduct Ordering Information (continued)

JBH Series Junction Box Header

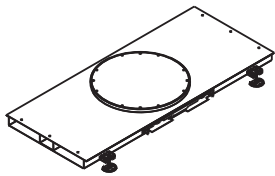

Used as a large capacity feeder system for Walkercell. Cellular raceway attaches to side of box. 22" [559mm] dia. cover plate access at center of unit. Standard length is 60" [1524mm]. The minimum depth of any JB, JHB, or HJB is 1/2" [12.7mm] higher than WCR2 and WCR3 and 1" higher than WCR11/2.

Junction Box Headers Used with WCR11/2

CATALOG NUMBER	BODY WIDTH	BODY DEPTH	RING HEIGHT	SYSTEM DEPTH	POWER CAPACITY	POWER COMP. WIDTH	COMMUNICATION CAPACITY
11/2JBH24251060	24" [610mm]	2 1/2" [64mm]	1" [25mm]	3 1/2" [89mm]	6.64 [4283.9mm ²]	4 1/4" [108mm]	18.60 [12000.0mm ²]
11/2JBH30251560	30" [762mm]	2 1/2" [64mm]	1 1/2" [38mm]	3 1/2" [89mm]	8.64 [5574.2mm ²]	5 1/8" [130mm]	27.91 [18006.4mm ²]
11/2JBH36251560	36" [915mm]	2 1/2" [64mm]	1 1/2" [38mm]	4" [102mm]	10.62 [6851.6mm ²]	6" [152mm]	31.25 [20161.3mm ²]

Junction Box Headers Used with WCR2

CATALOG NUMBER	BODY WIDTH	BODY DEPTH	RING HEIGHT	SYSTEM DEPTH	POWER CAPACITY	POWER COMP. WIDTH	COMMUNICATION CAPACITY
2JBH242510-60	24" [610mm]	2 1/2" [64mm]	1" [25mm]	3 1/2" [89mm]	6.64 [4283.9mm ²]	4 1/4" [108mm]	18.60 [12000.0mm ²]
2JBH302515-60	30" [762mm]	2 1/2" [64mm]	1 1/2" [38mm]	4" [102mm]	8.64 [5574.2mm ²]	5 1/8" [130mm]	26.49 [17090.3mm ²]
2JBH362515-60	36" [915mm]	2 1/2" [64mm]	1 1/2" [38mm]	4" [102mm]	10.62 [6851.6mm ²]	6" [152mm]	28.53 [18406.4mm ²]

NOTE: All capacities based on a minimum 80% allowance where cables may encounter a restriction point inside of junction box. Consult factory for WCR3 capacities.

MODULAR WIRING SYSTEMS



Walkerflex® Modular Wiring Systems offer cost-effective wire management capabilities for power distribution. This system can be utilized with a wide variety of **Wiremold®** point-of-use products enabling maximum flexibility relating to adds, moves and changes.

Table of Contents

Walkerflex® Modular Wiring System



WALKERFLEX® MODULAR WIRING SYSTEM



Walkerflex® Modular Wiring Systems are designed to provide the highest level of flexibility for power distribution as well as reducing the cost relating to future adds, moves, and changes.

CODE REFERENCE

cULus Listed Manufactured Wiring Systems:
 File E51105 Guide QQVX
 Meets Article 300.22(c), 314 & 604 of NEC.

Walkerflex Modular Wiring System Layout

NOTE: Illustration is for showing product applications only.

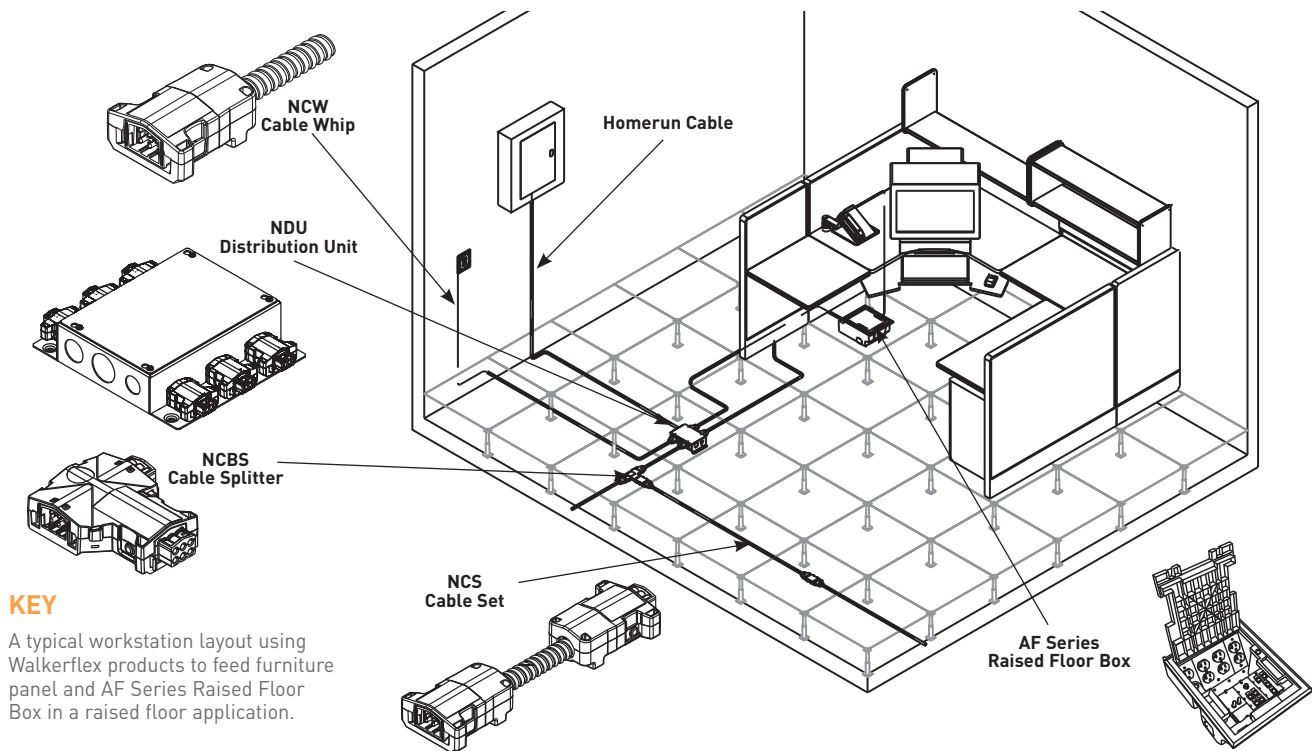

WALKERFLEX® MODULAR WIRING SYSTEM

Walkerflex Modular Wiring System Components

Prewired Distribution Unit

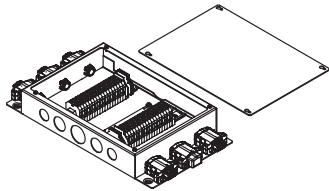

NOTE: All distribution units are wired with #10 AWG wire and a #12 Equipment ground.

Conversion point from electrical closet to the Walkerflex System. Unit can be prewired to buss bar system or be prewired with home run cable. Consult factory for prewiring home run cable.

Example: NDUP222WC6

Unwired Distribution Unit

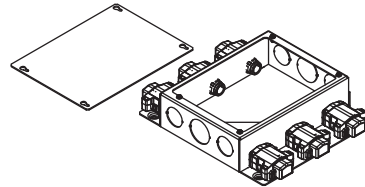

NOTE: All distribution units are wired with #10 AWG wire and a #12 Equipment ground.

Conversion point from electrical closet to the Walkerflex System. Unit is for field wiring.

Example: NDU222WC6

<u>NDU</u>	<u>P</u>	<u>2</u>	<u>2</u>	<u>2</u>	<u>WC</u>	<u>6</u>
Identifies the Distribution Unit NDU=120V LDU=277V	Identifies how unit is wired: [] Unwired – No identifier needed (see unwired example above (P) Prewired)	Number of Circuits, also number of Hot Conductors per Connector. Insert "1" for single circuit, "2" for two-circuit, "3" for three-circuit, "4" for four-circuit, or "6" for six-circuit.	Identifies Number of Neutral Conductors per Connector, Four (4) Conductors maximum. All Neutrals #10 AWG.	Number of Ground Conductors per Connector. Insert "1" for one System Ground or "2" for one System Ground and one Isolated Ground.	"WC" stands for Wire Connector. Remains constant.	Identifies Number of Power "OUT" Wire Connectors.

NOTE: For available wiring configuration options, see Wiring Configurations Chart in this section.

Receptacle Distribution Unit

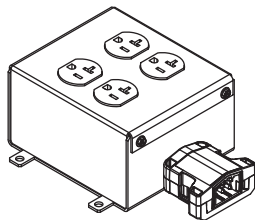

Prewired receptacle unit that is fed with the flex system.

Example: RECDU111

NOTE: Not suitable for use in air handling spaces.

<u>RECDU</u>	<u>1</u>	<u>1</u>	<u>1</u>
Identifies the Receptacle Distribution Unit. Remains constant.	Number of Circuits, also number of Hot Conductors. Insert "1" for single circuit, "2" for two-circuit, "3" for three-circuit, "4" for four-circuit, or "6" for six-circuit.	Identifies number of Neutral Conductors. Four (4) Conductors maximum. All Neutrals #10 AWG.	Number of Ground Conductors. Insert "1" for one System Ground or "2" for one System Ground and one Isolated Ground.

NOTE: For available wiring configuration options, see Wiring Configurations Chart in this section.

Furniture Feed Distribution Unit

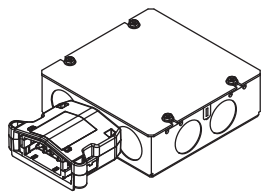

Conversion point from rigid EMT, BX, or other listed manufactured wiring systems to the Walkerflex Modular Wiring System.

Example: NDU332FF

NOTE: Units need to be field wired.

<u>NDU</u>	<u>3</u>	<u>3</u>	<u>2</u>	<u>FF</u>
Identifies the Furniture Feed Distribution Unit. NDU=120V LDU=277V	Number of Circuits, also number of Hot Conductors. Insert "1" for single circuit, "2" for two-circuit, "3" for three-circuit, "4" for four-circuit, or "6" for six-circuit.	Identifies number of Neutral Conductors. Four (4) Conductors maximum. All Neutrals #10 AWG.	Number of Ground Conductors. Insert "1" for one System Ground or "2" for one System Ground and one Isolated Ground.	"FF" stands for Furniture Feed. Remains constant.

NOTE: For available wiring configuration options, see Wiring Configurations Chart in this section.

WALKERFLEX® MODULAR WIRING SYSTEM

Walkerflex Modular Wiring System Components (continued)

Cable Whip

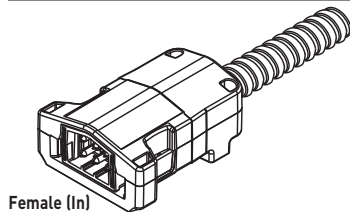

Female (In)

Carries Power from distribution unit to other components in flex system. Standard lengths: 1, 5, 10, 15, 20, 25, 30, 40, and 50 ft. [305mm, 1.52m, 3.05m, 4.57m, 7.62m, 9.14m, 12.19m, and 15.24m]. Consult factory for all other lengths. Cable Whips have a modular connector on one end and pigtails on the other end. Coded "M" (male) for power "OUT" or "F" (female) for power "IN".

Example: NCW111AL10F

<u>NCW</u>	<u>1</u>	<u>1</u>	<u>1</u>	<u>A</u>	<u>L</u>	<u>10</u>	<u>F</u>
Identifies the Cable Whip. NCW=120V LCW=277V	Number of Circuits, also number of Hot Conductors, insert "1" for single circuit, "2" for two-circuit, "3" for three-circuit, "4" for four-circuit, or "6" for six-circuit.	Identifies Number of Neutral Conductors, Four (4) Conductors maximum. All Neutrals #10 AWG.	Number of Ground Conductors, insert "1" for one System Ground, or "2" for one System Ground and one Isolated Ground.	Identifies Gage of Hot and Ground Conductors. (A) = #12 AWG (B) = #10 AWG	"L" stands for Length, remains constant.	Length of MC Cable in feet.	Insert "M" for Power Out or "F" for Power In.

NOTE: For available wiring configuration options, see Wiring Configurations Chart in this section.

Cable Sets

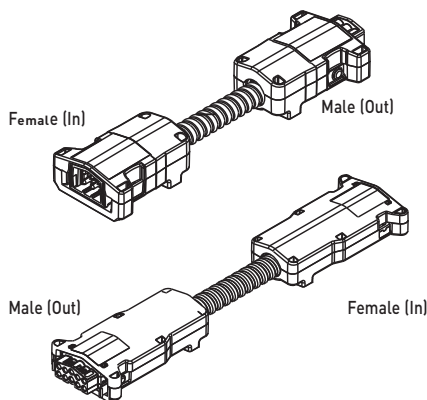

Female (In)

Male (Out)

Male (Out)

Female (In)

Carries power from distribution unit to other components in flex system. Standard lengths: 1, 5, 10, 15, 25, 30, 40, and 50 ft. [305mm, 1.52m, 3.05m, 4.57m, 7.62m, 9.14m, 12.19m, 15.24m]. Consult factory for all other lengths.

Cable set will have a plug on both ends. Coded "M" (Male) on one end ("Power Out") and coded "F" (Female) on the other end ("Power In") which allows proper connections.

Example: NCS111AL10

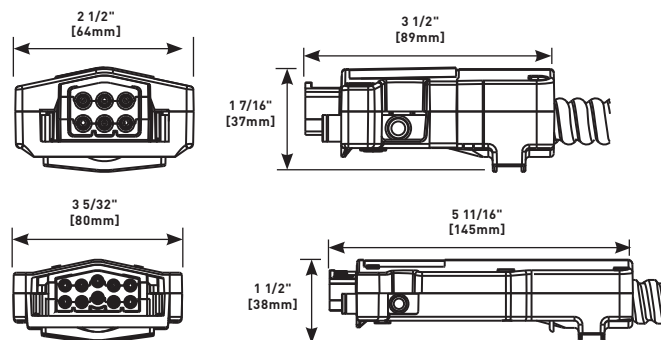

<u>NCS</u>	<u>1</u>	<u>1</u>	<u>1</u>	<u>A</u>	<u>L</u>	<u>10</u>
Identifies the Cable Whip. NCW=120V LCW=277V	Number of Circuits, also number of Hot Conductors, insert "1" for single circuit, "2" for two-circuit, "3" for three-circuit, "4" for four-circuit, or "6" for six-circuit.	Identifies Number of Neutral Conductors, Four (4) Conductors maximum. All Neutrals #10 AWG.	Number of Ground Conductors, insert "1" for one System Ground, or "2" for one System Ground and one Isolated Ground.	Identifies Gage of Hot and Ground Conductors. (A) = #12 AWG (B) = #10 AWG	"L" stands for Length, remains constant.	Length of MC Cable in feet.

NOTE: For available wiring configuration options, see Wiring Configurations Chart in this section.

WALKERFLEX[®] MODULAR WIRING SYSTEM

Walkerflex Modular Wiring System Components

Power Adapters

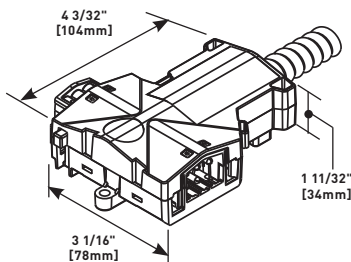

All adapters are interface components that connect the flex system to an item that is to be energized, such as raised floor boxes, power poles, convenience outlets and various lighting fixtures. Power adapters are for 120V & 277V, 20A applications with a standard 8' [2.4m] MC cable whip and 12" [305mm] leads on the end. Not available in 8-10 wire.

Example: NPA222AL15

NOTE: Only available in up to 6-wire configurations.

<u>NPA</u>	<u>2</u>	<u>2</u>	<u>2</u>	<u>A</u>	<u>L</u>	<u>15</u>
Identifies the Power Adapter NPA=120V LPA=277V	Number of Circuits, Also Number of Hot Conductors. Insert "1" for single circuit, "2" for two-circuit.	Identifies Number of Neutral Conductors, Two (2) Conductors maximum. All Neutrals #10 AWG.	Number of Ground Conductors. Insert "1" for one System Ground, or "2" for one System Ground and one Isolated Ground.	Identifies Gage of Hot and Ground Conductors. (A) = #12 AWG (B) = #10 AWG	"L" stands for Length, remains constant.	Length of MC Cable in feet.

NOTE: For available wiring configuration options, see Wiring Configurations Chart in this section.

Modular Power Adapter

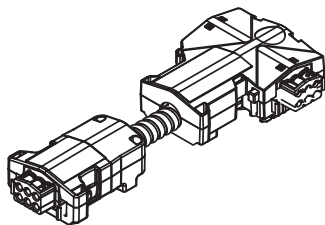

All adapters are interface components that connect the flex system to an item that is to be energized, such as raised floor boxes, power poles, convenience outlets and various lighting fixtures. Power adapters are for 120V & 277V, 20A applications with a male "Power Out" head at one end and the power adapter at the other end.

NOTE: Only available in up to 6-wire configurations.

Example: NPA222AL10M

<u>NPA</u>	<u>2</u>	<u>2</u>	<u>2</u>	<u>A</u>	<u>L</u>	<u>10</u>	<u>M</u>
Identifies the Power Adapter NPA = 120V LPA = 277V	No. of Circuits, also No. of Hot Conductors. Insert "1" for single circuit, "2" for two-circuit, "3" for three-circuit.	Identifies No. of Neutral Conductors, Two (2) Conductors maximum. All Neutrals #10 AWG.	Number of Ground Conductors. Insert "1" for one System Ground, or "2" for one System Ground and one Isolated Ground.	Identifies Gage of Hot and Ground Conductors. (A) = #12 AWG (B) = #10 AWG	"L" stands for Length, remains constant.	Length of MC Cable in feet.	M = Male Power Out

NOTE: For available wiring configuration options, see Wiring Configurations Chart in this section.

WALKERFLEX® MODULAR WIRING SYSTEM

Walkerflex Modular Wiring System Components (continued)

Cable Splitter

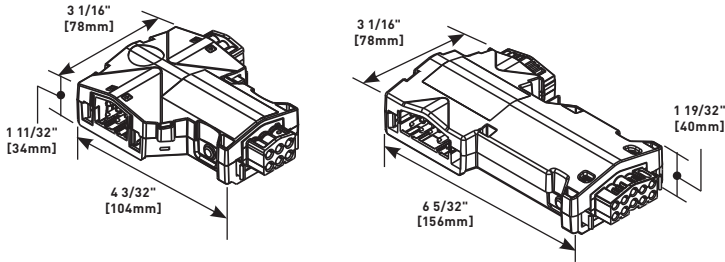

Used to split one or more circuits so that it can be used in more than one direction from a given point.

Example: NCBS111

<u>NCBS</u>	<u>1</u>	<u>1</u>	<u>1</u>
Identifies the Cable Splitter Unit. NCBS=120V LCBS=277V	Number of Hot Conductors. Insert "1" for single circuit, "2" for two-circuit, "3" for three-circuit, "4" for four-circuit, or "6" for six-circuit.	Identifies Number of Neutral Conductors, Four (4) Conductors maximum. All Neutrals #10 AWG.	Number of Ground Conductors. Insert "1" for one System Ground, or "2" for one System Ground and one Isolated Ground.

NOTE: For available wiring configuration options, see Wiring Configurations Chart in this section.

Power Tap

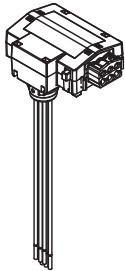

All taps are interface components that connect the flex system to an item that is to be energized, such as raised floor boxes, power poles, and lighting fixtures. Power Taps are for 120V & 277V applications with standard 8" leads on the end. Not available in 8-10 wire configurations.

Example: NPT18B111

<u>NPT</u>	<u>18</u>	<u>B</u>	<u>1</u>	<u>1</u>	<u>1</u>
Identifies the Power Tap NPT = 120V Unit LPT = 277V Unit	Identifies Size of Wires 18 = #18AWG 12 = #12AWG	Egress Options B = Bottom Egress S = Side Egress	Identifies Number of Hot Conductors 1 = Single Circuit 2 = Two Circuits 3 = Three Circuits	Identifies Number of Neutral Conductors Two (2) Conductors maximum.	Identifies Number of Grounds. 1 = 1 System Ground 2 = 2 System Ground & Isolated Ground

WALKERFLEX[®] MODULAR WIRING SYSTEM

Walkerflex Modular Wiring System Components (continued)

Wire Connectors

Connectors are used to transition between the distribution units, cable sets, and end devices (floor boxes, poles, or raceway). Standard wire lengths are 8", 12" and 18" [203mm, 305mm, and 457mm].

NOTE: Locking Ring style is only available up to 6 wire configurations.

SNAP RING STYLE

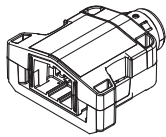

Example: NWC222AL12FS
LOCKING RING STYLE

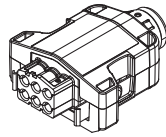

Example: NWC222AL12MS

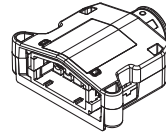

Example: NWC332AL12FS

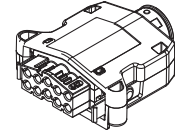

Example: NWC332AL12MS

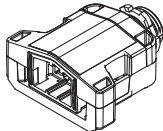

Example: NWC222AL12FL

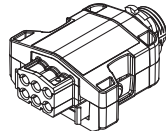

Example: NWC222AL12ML

<u>NWC</u>	<u>2</u>	<u>2</u>	<u>2</u>	<u>A</u>	<u>L</u>	<u>12</u>	<u>F</u>	<u>S</u>
Identifies the Wire Connector. NWC=120V LWC=277V	Number of Circuits, also number of Hot Conductors. Insert "1" for single circuit, "2" for two-circuit, "3" for three-circuit, "4" for four-circuit, or "6" for six-circuit.	Identifies number of Neutral Conductors. Four (4), Conductors maximum. All Neutrals #10 AWG.	Number of Ground Conductors. Insert "1" for one System Ground or "2" for one System Ground and one Isolated Ground.	Identifies Gage of Hot and Ground Conductors. (A) = #12 AWG (B) = #10AWG	Identifies Length. "L" remains constant.	Identifies Length of Wires (in inches) protruding out of back side of the Connector.	Identifies Power Direction "F" (Female) for Power "IN", "M" (Male) for Power "OUT".	Identifies method of securing in device. "L" for Lock Nut, "S" for Snap Ring.

NOTE: For available wiring configuration options, see Wiring Configurations Chart in this section.

Walkerflex Wiring Configurations

3-6 WIRE CONFIGURATION					
KEY COLOR	WIRING CONFIGURATION	WIRING VOLTAGE	H	N	G
BLACK	111	120V	1	1	1
	211	120V	2	1	1
	311	120V	3	1	1
ORANGE	112	120V/IG	1	1	2
	212	120V/IG	2	1	2
	222	120V/IG	2	2	2
NATURAL	221	120V/2N	2	2	1
YELLOW	111	277V	1	1	1
	211	277V	2	1	1
	311	277V	3	1	1
GREEN	112	277V/IG	1	1	2
	212	277V/IG	2	1	2
	222	277V/IG	2	2	2
BLUE	221	277V/2N	2	2	1

8-10 WIRING CONFIGURATION					
KEY COLOR	WIRING CONFIGURATION	WIRING VOLTAGE	H	N	G
BLACK	422	120V	4	2	2
ORANGE	442	120V/IG	4	4	2
NATURAL	332	120V	3	3	2
BLUE	631	120V	6	3	1
IVORY	622	120V	6	2	2

WALKERFLEX® MODULAR WIRING SYSTEM

Prewired Raised Floor Boxes

AF Series

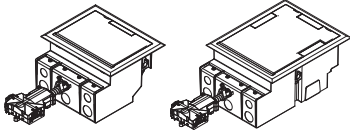

Standard Product Offerings: AF2

- AF2KC2111PA
- AF2YC2111PA
- AF2NC2111PA
- AF2KT2111PA
- AF2YT2111PA
- AF2NT2111PA
- AF2KC2222PA
- AF2YC2222PA
- AF2NC2222PA
- AF2KT2222PA
- AF2YT2222PA
- AF2NT2222PA
- AF2KC4222PA
- AF2YC4222PA
- AF2NC4222PA
- AF2KT4222PA
- AF2YT4222PA
- AF2NT4222PA

Standard Product Offerings: AF4

- AF4KC2111PA
- AF4YC2111PA
- AF4NC2111PA
- AF4KT2111PA
- AF4YT2111PA
- AF4NT2111PA
- AF4KC2222PA
- AF4YC2222PA
- AF4NC2222PA
- AF4KT2222PA
- AF4YT2222PA
- AF4NT2222PA
- AF4KC4222PA
- AF4YC4222PA
- AF4NC4222PA
- AF4KT4222PA
- AF4YT4222PA
- AF4NT4222PA

AF2 and AF4 prewired raised floor/raised stage boxes have been designed to work with power, communications and AV devices. The housings are made from die-cast aluminum material with a polycarbonate cover and flange assembly. Comes with a 1 ft. modular Walkerflex power adapter.

AF2 & AF4 Prewired Raised Floor Boxes

DESCRIPTION	DIMENSIONS	
	AF2	AF4
Overall Trim Ring	8 3/4" x 6 3/4" [222mm x 171mm]	9 1/8" x 11" [232mm x 279mm]
Module Depth	5" [127mm]	5" [127mm]
Panel Opening	8" x 6" [203mm x 152mm]	8" x 10" [203mm x 254mm]
Cover Size	7 1/2" x 5" [191mm x 127mm]	7 1/2" x 9 1/2" [191mm x 242mm]
Activation Chamber	130 cu in. [2130ml]	220 cu in. [3604ml]
User Volume	78.6 cu in. [1288ml]	180 cu in. [2948ml]
Total Volume	208.6 cu in. [3418ml]	300 cu in. [4915ml]
Knockout Sizes	Seven (7) 1/2" & Two (2) 3/4" Trade Size KOs (Power Side only)	Seven (7) 1/2" & Two (2) 3/4" Trade Size KOs (Power Side only)
Depth Behind Plate	2 3/4" [69.8mm]	2 3/4" [69.8mm]
Service	Triple	Triple
Capacity	4 Gangs	8 Gangs
Connectivity	6 Ports Unloaded	12 Ports Unloaded
Max. Floor Thickness	1 1/2" [38mm] (Floor covering included)	1 1/2" [38mm] (Floor covering included)

<u>AF2</u>	<u>K</u>	<u>C</u>	<u>2</u>	<u>111</u>	<u>PA</u>
AF Series: AF2 or AF4	Cover Color: K = Black Y = Gray N = Brown	Cover Insert: C =Carpet Insert T =Tile (No Insert)	No. of Receptacles: 2 = 2 Receptacles 4 = 4 Receptacles	Power Delivery System: 111 = 1 Circuit, 1 Neutral, System Ground 222 = 2 Circuits, 2 Neutrals, Isolated Ground	Style of Feed: PA = Power Adapter

SAF Series

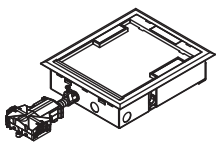

SAF prewired shallow raised floor/raised stage boxes have been designed to work with power, communications and AV devices in a minimum 2 1/2" deep floor. The housings are made from formed galvanized steel with a polycarbonate cover

Standard Product Offerings: SAF

- SAFKC2111PA
- SAFYC2111PA
- SAFNC2111PA
- SAFKT2111PA
- SAFYT2111PA
- SAFNT2111PA
- SAFKC2222PA
- SAFYC2222PA
- SAFNC2222PA
- SAFKT2222PA
- SAFYT2222PA
- SAFNT2222PA

DESCRIPTION	DIMENSIONS
Overall Trim Ring	9 1/8" x 11" [232mm x 279mm]
Module Depth Overall	2.5" [64mm]
Panel Opening	8" x 10" [203mm x 254mm]
Cover Size	7 1/2" x 9 1/2" [191mm x 242mm]
Activation Volume	18.5 cu in. [303ml]
Power Volume	29 cu in. [475ml]
Maximum Floor Panel Thickness with Floor Covering	1 3/16" [30mm]
Knockout Sizes	Power – Four (4) 1/2"-3/4" Trade Size Concentric KOs Communication – Two (2) 1/2"-3/4" Trade Size Concentric KOs
Depth Behind Plate	2" [51mm]
Service	Triple
Capacity	3 Gangs
Connectivity	6 Ports Unloaded
Mx. Floor Thickness	1 3/8" [35mm] (Floor covering included)

<u>SAF</u>	<u>K</u>	<u>C</u>	<u>2</u>	<u>111</u>	<u>PA</u>
SAF Series	Cover Color: K = Black Y = Gray N = Brown	Cover Insert: C =Carpet Insert T =Tile (No Insert)	No. of Receptacles: 2 = 2 Receptacles 4 = 4 Receptacles	Power Delivery System: 111 = 1 Circuit, 1 Neutral, System Ground 222 = 2 Circuits, 2 Neutrals, Isolated Ground	Style of Feed: PA = Power Adapter

WALKERFLEX® MODULAR WIRING SYSTEM

Prewired Raised Floor Boxes (continued)

AC8X8 Series

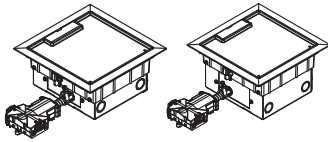

Standard Product Offerings: AC8840
AC8840YC2111PA
AC8840YC2222PA

Standard Product Offerings: AC8850
AC8850YC2111PA
AC8850YC2222PA
AC8850YC42222PA

The AC Series Floor Box is an 8" x 8" [203mm x 203mm] single-service, prewired raised floor/raised stage box designed to work with power devices in a minimum 4" [102mm] deep floor. The housings are made from formed galvanized steel with a die-cast aluminum cover and flange assembly.

AC8840 & AC8850 Prewired Raised Floor Boxes

DESCRIPTION	AC8840 DIMENSIONS	AC8850 DIMENSIONS
Box Dimensions	8" x 8" x 4" [203mm x 203mm x 102mm]	8" x 8" x 5" [203mm x 203mm x 127mm]
Overall Trim Ring	9 1/4" x 9 1/4" [235mm x 235mm]	9 1/4" x 9 1/4" [235mm x 235mm]
Module Depth	4" [102mm]	5" [127mm]
Panel Opening	8" x 8" [203mm x 203mm]	8" x 8" [203mm x 203mm]
Cover Size	7 11/16" x 7 11/16" [195mm x 195mm]	7 11/16" x 7 11/16" [195mm x 195mm]
Activation Chamber	63.92 cu in. [1047ml]	97.22 cu in. [1593ml]
User Volume	84.34 cu in. [1382ml]	102.22 cu in. [1674ml]
Total Volume	152.34 cu in. [2496ml]	199.22 cu in. [3264ml]
Knockout Sizes	Power – Four (4) 1/2"-3/4" Trade Size Concentric KOs Communication – Two (2) 1/2"-3/4" Trade Size Concentric KOs	Power – Four (4) 1/2"-3/4" Trade Size Concentric KOs Communication – Four (4) 1/2"-3/4" Trade Size Concentric KOs
Depth Behind Plate	2" [51mm]	2" [51mm]
Service	Single	Single
Capacity	4 Gangs	4 Gangs
Max. Floor Thickness	2" [51mm] (floor covering included)	2" [51mm] (floor covering included)

AC	88	50	Y	C	2	111	PA
AC Series	Cover Size: 88 = 8" x 8"	Box Depth: 40 = 4" Deep 50 = 5" Deep	Cover Color: Y = Gray	Cover Insert: C = Carpet Insert	No. of Receptacles: 2 = 2 Receptacles 4 = 4 Receptacles	Power Delivery System: 111 = 1 Circuit, 1 Neutral, System Ground 222 = 2 Circuits, 2 Neutrals, Isolated Ground	Style of Feed: PA = Power Adapter

AC8X10 Series

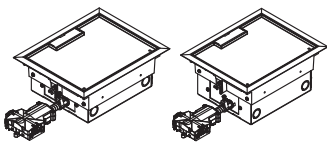

Standard Product Offerings: AC8104
AC8104YC2111PA
AC8104YC2222PA

Standard Product Offerings: AC8105
AC8105YC2111PA
AC8105YC2222PA
AC8105YC42222PA

The AC810 Series Prewired Raised Floor/Raised Stage Boxes are designed to work with power and communications devices in a minimum 4" [102mm] deep floor. The housings are made from formed galvanized steel with a die-cast aluminum cover and flange assembly. Comes with a 1 ft. modular Walkerflex power adapter.

AC8104 & AC8105 Prewired Raised Floor Boxes

DESCRIPTION	AC8104 DIMENSIONS	AC8105W DIMENSIONS
Box Dimensions	8" x 10" x 4" [203mm x 254mm x 102mm]	8" x 10" x 5" [203mm x 254mm x 127mm]
Overall Trim Ring	9 1/4" x 11 1/4" [235mm x 286mm]	9 1/4" x 11 1/4" [235mm x 286mm]
Module Depth	4" [102mm]	5" [127mm]
Panel Opening	8" x 10" [203mm x 254mm]	8" x 10" [203mm x 254mm]
Cover Size	7 11/16" x 9 11/16" [195mm x 246mm]	7 11/16" x 9 11/16" [195mm x 246mm]
Activation Chamber	76.87 cu in. [1593ml]	111.08 cu in. [1820ml]
User Volume	130.09 cu in. [2131ml]	151.97 cu in. [2490ml]
Total Volume	201.09 cu in. [3295ml]	262.97 cu in. [4309ml]
Knockout Sizes	Power – Four (4) 1/2"-3/4" Trade Size Concentric KOs Communication – Four (4) 1/2"-3/4" Trade Size Concentric KOs	Power – Four (4) 1/2"-3/4" Trade Size Concentric KOs Communication – Four (4) 1/2"-3/4" Trade Size Concentric KOs
Depth Behind Plate	1 3/4" [44mm]	2" [51mm]
Service	Dual	Triple
Capacity	6 Gangs	6 Gangs
Connectivity	12 Ports Unloaded	18 Ports Unloaded
Max. Floor Thickness	2" [51mm] (floor covering included)	2" [51mm] (floor covering included)

AC	810	5	Y	C	2	111	PA
AC Series	Cover Size: 810 = 8" x 10"	Box Depth: 4" = 4" Deep 5" = 5" Deep	Cover Color: Y = Gray	Cover Insert: C = Carpet Insert	No. of Receptacles: 2 = 2 Receptacles 4 = 4 Receptacles	Power Delivery System: 111 = 1 Circuit, 1 Neutral, System Ground 222 = 2 Circuits, 2 Neutrals, Isolated Ground	Style of Feed: PA = Power Adapter

WALKERFLEX® MODULAR WIRING SYSTEM

Prewired Raised Floor Boxes (continued)

AC10105

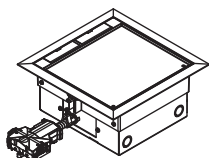

Standard Product Offerings: AC10105
 AC10105YC2111PA
 AC10105YC2222PA
 AC10105YC42222PA

AC10105 prewired raised floor/raised stage boxes. The AC10105 is a 10" x 10" [203mm x 254mm] box that has been designed to work with power, communications and audio visual devices in a minimum 5" [127mm] deep floor. The housings are made from formed galvanized steel with a die-cast aluminum cover and flange assembly. Comes with a 1 ft. modular Walkerflex power adapter.

DESCRIPTION	DIMENSIONS
Box Dimensions	10" x 10" x 5" [254mm x 254mm x 127mm]
Overall Trim Ring	11 1/2" x 11 1/2" [292mm x 292mm]
Module Depth	5" [127mm]
Panel Opening	10" x 10" [254mm x 254mm]
Cover Size	9 5/8" x 9 5/8" [245mm x 245mm]
Activation Chamber	115 cu in. [1884ml]
User Volume	243 cu in. [3981ml]
Total Volume	358 cu in. [5865ml]
Knockout Sizes	Power - Four (4) 1/2" Trade Size Concentric KOs Communication - Four (4) 1/2"-3/4" Trade Size Concentric KOs
Depth Behind Plate Service	2" [51mm] Triple
Capacity	6 Gangs
Connectivity	18 Ports Unloaded
Max. Floor Thickness	2" [51mm] (Floor covering included)

AC	1010	5	Y	C	2	111	PA
AC Series	Cover Size: 1010 = 10" x 10"	Box Depth: 5 = 5" Deep	Cover Color: Y = Gray	Cover Insert: C = Carpet Insert	No. of Receptacles: 2 = 2 Receptacles 4 = 4 Receptacles	Power Delivery System: 111 = 1 Circuit, 1 Neutral, System Ground 222 = 2 Circuits, 2 Neutrals, Isolated Ground	Style of Feed: PA = Power Adapter

CRFB

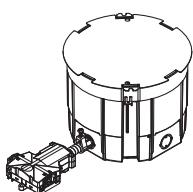

Standard Product Offerings: CRFB
 CRFB4P2111PA
 CRFB4P2222PA
 CRFB4P42222PA

NOTE: Covers are sold separately. For more information on cover options, see the next page.

Prewired round raised floor/wood floor stage boxes. Die-cast aluminum is designed to work with power, communication, and A/V devices in a minimum 6 1/2" [165mm] deep floor. Comes with a 1 foot modular Walkerflex power adapter.

DESCRIPTION	DIMENSIONS
Box Dimensions	9 1/2" [241mm] Diameter x 6 5/8" [168mm] Tall
Overall Trim Ring	9 1/2" [241mm] Diameter
Module Depth	3 3/4" [95mm]
Panel Opening	9 1/2" [241mm]
Cover Size	9 1/4" [235mm] Diameter
Activation Chamber:	
Chambers 1 and 2	23.5 cu in. [385ml]
Chamber 3	17.5 cu in. [287ml]
Chamber 4	32.8 cu in. [538ml]
User Volume	30 cu in. [762ml]
Total Volume	127.3 cu in. [3233ml]
Knockout Sizes	Four (4) Concentric 1/2" - 3/4" Trade Size Three (3) Concentric 3/4" - 1" Trade Size One (1) 2" Trade Size
Depth Behind Plate Service	2 1/4" [57mm] Triple
Capacity	4 Gangs
Communication Device	6 Ports Unloaded
Max. Floor Thickness	2" [51mm] (Floor covering included)

CRFB4P	2	111	PA
Cover Size: 7 11/16" diameter	No. of Receptacles: 2 = 2 Receptacles 4 = 4 Receptacles	Power Delivery System: 111 = 1 Circuit, 1 Neutral, System Ground 222 = 2 Circuits, 2 Neutrals, Isolated Ground	Style of Feed: PA = Power Adapter

WALKERFLEX® MODULAR WIRING SYSTEM

Prewired Raised Floor Boxes (continued)

CRFBCTC Surface Style Cover Assembly

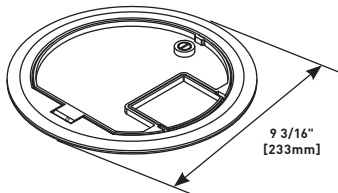

Available in die cast aluminum with a painted black (CRFBCTCBK), brass (CRFBCTCBS), nickel (CRFBCTCNK), bronze (CRFBCTCBZ) or gray (CRFBCTCGY) finish. Insert areas allow for tile or carpet cutouts to match finished floor.

CRFBBTCTR Tamper Resistant Surface Style Cover Assembly

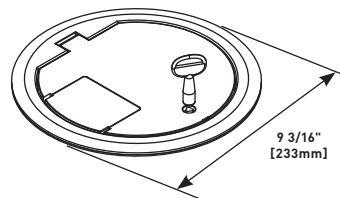

Available in die cast aluminum with a painted black (CRFBBTCBKTR), brass (CRFBBTCBSTR), nickel (CRFBBT CNKTR), bronze (CRFBBT CBZTR) or gray (CRFBBT CGYTR) finish. No cutouts are provided. Lid has built-in key locking feature for tamper resistance.

CRFBBTC Surface Style Cover Assembly

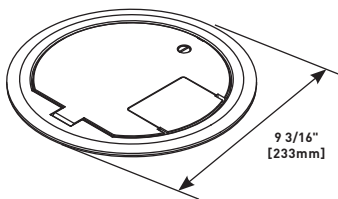

Available in die cast aluminum with a painted black (CRFBBTCBK), brass (CRFBBTCBS), nickel (CRFBBTCNK), bronze (CRFBBTCBZ) or gray (CRFBBTCGY) finish. No cutouts are provided for floor coverings.

8CTC* Surface Style Cover Assembly

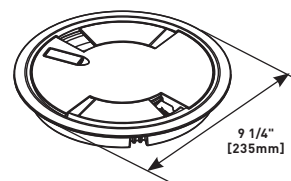

Die-cast aluminum cover assembly. Cover assembly is available in the following painted finishes: black (8CTCBK), gray (8CTCGY), nickel (8CTCNK), brass (8CTCBS), or bronze (8CTCBZ).

CRFBCTCTR Tamper Resistant Surface Style Cover Assembly

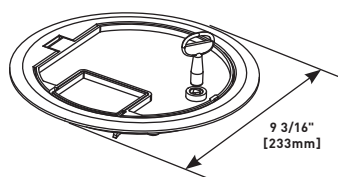

Available in die cast aluminum with a painted black (CRFBCTCBKTR), brass (CRFBCTCBSTR), nickel (CRFBCTCNKTR), bronze (CRFBCTCBZTR) or gray (CRFBCTCGYTR) finish. Lid has built-in key locking feature for tamper resistance. Insert areas allow for tile or carpet cutouts to match finished floor.

8CT* Flush Style Cover Assembly

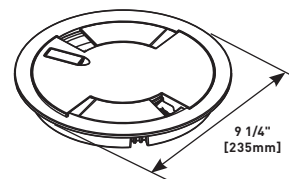

Die-cast aluminum cover assembly. Cover assembly is available in the following painted finishes: black (8CTCBK), gray (8CTCGY), nickel (8CTCNK), brass (8CTCBS), or bronze (8CTCBZ).

* Add suffix "TR" to the end of the part number to indicate tamper-resistant cover assembly. Tamper-resistant versions are secured with a single tamper-resistant screw.

WALKERFLEX® MODULAR WIRING SYSTEM

Evolution Series Poke-Thru Devices

6STCP

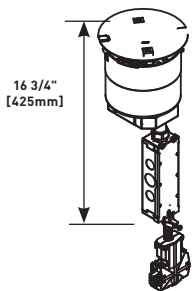

Recessed modular stem assembly – includes 6" [152mm] core hole poke-thru stem assembly with a disposable plate and two proprietary 20A duplex receptacles. Devices are recessed 3 1/4" [83mm] below the surface, no cover assembly included. For use with the following cover assemblies (Purchased separately): 6CTC and 6CT series. Comes with 1 ft. modular Walkerflex power adapter. Included: For Side Compartments: Two (2) proprietary 20 Amp duplex receptacles installed. For Center Compartment: One (1) 6ACT8A Mounting Plate, One (1) 6TRAC Mounting Plate, and One (1) 6SER Mounting Plate. For Bottom Feed Compartment: One (1) 5BLH 1/2-Gang Blank Housing, One (1) 1PTHA 1-Gang Pass-Through Housing Assembly, and One (1) 575CHA 1/2-Gang 3/4" Conduit Housing Assembly.

NOTE: UL Fire Classified for up to 2 hour rated floors.
NOTE: Receptacles can be wired as a standard or isolated ground devices.
NOTE: Assembled with a scrub water gasket. For use on tile, wood or carpeted covered floors. Maximum floor covering thickness range 1" [25mm], not designed for use on bare concrete or terrazzo finished floors.

<u>6</u>	<u>S</u>	<u>TC</u>	<u>P</u>	<u>222</u>	<u>PA</u>
Diameter of Poke-Thru Device: 6 = 6" [152mm]	S = Stem Assembly	Unit is approved tile, wood, and carpet covered floors	Unit is prewired with 2 20A Duplex Receptacles installed to a Walkerflex connector	Power Delivery System: 111 = 1 Circuit, 1 Neutral, System Ground 222 = 2 Circuits, 2 Neutrals, Isolated Ground	Style of Feed: PA = Power Adapter

6STCPAV

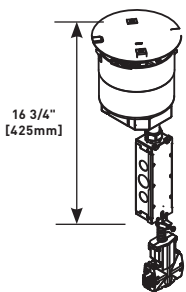

Recessed modular stem assembly – includes 6" [152mm] core hole poke-thru stem assembly with a disposable plate and one proprietary 20A duplex receptacle. Devices are recessed 3 1/4" [83mm] below the surface, no cover assembly included. For use with the following cover assemblies (Purchased separately): 6CTC and 6CT series. Comes with 1 ft. modular Walkerflex power adapter. Included: For Side Compartments: One (1) proprietary 20 Amp duplex receptacle installed, 682A Device Plate, and 68MAAP Device Plate. For Center Compartment: 6DEC Mounting Plate, 6AAP Mounting Plate, and 6MAAP Mounting Plate. For Bottom Feed Compartment: One (1) 5PTHA 1/2-Gang Pass-Through Housing Assembly, One (1) 1PTHA 1-Gang Pass-Through Housing Assembly, and One (1) 575CHA 1/2-Gang 3/4" Conduit Housing Assembly.

NOTE: UL Fire Classified for up to 2 hour rated floors.
NOTE: Receptacles can be wired as a standard or isolated ground devices.
NOTE: Assembled with a scrub water gasket. For use on tile, wood or carpeted covered floors. Maximum floor covering thickness range 1" [25mm], not designed for use on bare concrete or terrazzo finished floors.

<u>6</u>	<u>S</u>	<u>TC</u>	<u>P</u>	<u>AV</u>	<u>111</u>	<u>PA</u>
Diameter of Poke-Thru Device: 6 = 6" [152mm]	S = Stem Assembly	Unit is approved tile, wood, and carpet covered floors	Unit is prewired with 1 20A Duplex Receptacle installed to a Walkerflex connector	AV = Audio/Visual	Power Delivery System: 111 = 1 Circuit, 1 Neutral, System Ground	Style of Feed: PA = Power Adapter

WALKERFLEX® MODULAR WIRING SYSTEM

Evolution Series Poke-Thru Devices

6ATCFF

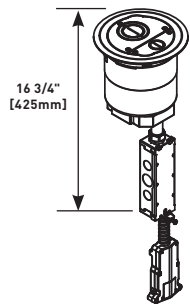

Recessed modular stem assembly with disposable plate – includes 6" [152mm] core hole poke-thru stem assembly with a disposable plate. Devices are recessed 3 1/4" [83mm] below the surface, no cover assembly included. For use with the following cover assemblies (Purchased separately): 6CTC and 6CT series. Comes with 1 ft. modular Walkerflex cable whip.

Included For Bottom Feed Compartment: One (1) 5PTHA 1/2-Gang Pass Through Housing Assembly, One (1) 15FFHA 1 1/2-Gang Pass Through Housing Assembly, One (1) 575CHA 1/2-Gang 3/4" Conduit Housing Assembly

NOTE: UL Fire Classified for up to 2 hour rated floors.

NOTE: Assembled with a scrub water gasket. For use on tile, wood or carpeted covered floors. Maximum floor covering thickness range 1" [25mm], not designed for use on bare concrete or terrazzo finished floors.

<u>6</u>	<u>A</u>	<u>TC</u>	<u>FF</u>	<u>BK</u>	<u>422</u>	<u>CW</u>
Diameter of Poke-Thru Device: 6 = 6" [152mm]	A = Assembled Unit	Unit is approved tile, wood, and carpet covered floors	Furniture Feed Style Poke-Thru Device	Color of Cover Assembly = BK = Black GY = Gray BS = Brass NK = Nickel BE = Bronze	Power Delivery System: 422 = 4 Circuits, 2 Neutrals, Isolated Ground	Style of Feed: CW = Cable Whip

Flush Poke-Thru Devices

8STCP

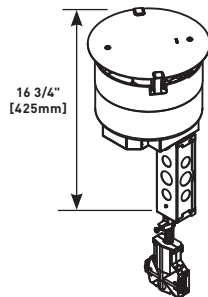

Recessed modular stem assembly with disposable plate – includes 8" core hole poke-thru stem assembly with a disposable plate. Devices are recessed 3 1/4" [83mm] below the surface, no cover assembly included. For use with the following cover assemblies (Purchased separately): 8CTC and 8CT series. Comes with 1 ft. modular Walkerflex power adapter.

Included For Bottom Feed Compartments: One (1) 5PTHA 1/2-Gang Pass Through Housing Assembly, One (1) 1PTHA 1-Gang Pass Through Housing Assembly, One (1) 575CHA 1/2-gang 3/4" Conduit Housing Assembly.

NOTE: UL Fire Classified for up to 2 hour rated floors.

NOTE: Assembled with a scrub water gasket. For use on tile, wood or carpeted covered floors. Maximum floor covering thickness range 1" [25mm], not designed for use on bare concrete or terrazzo finished floors.

<u>8</u>	<u>S</u>	<u>TC</u>	<u>P</u>	<u>222</u>	<u>PA</u>
Diameter of Poke-Thru Device: 8 = 8" [203mm]	S = Stem Assembly	Unit is approved tile, wood, and carpet covered floors	Unit is prewired with 2 20A Duplex Receptacles installed to a Walkerflex connector	Power Delivery System: 222 = 2 Circuits, 2 Neutrals, Isolated Ground	Style of Feed: PA = Power Adapter

WALKERFLEX® MODULAR WIRING SYSTEM

Surface Style Poke-Thru Devices

RC9A15TC

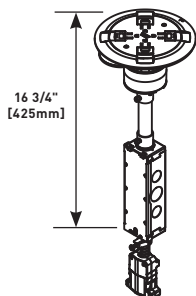

Surface style poke-thru assembly – Prewired 15A quad receptacle with a 1 ft. modular Walkerflex cable whip. Poke-thru unit fits into a 3" [76.2 mm] diameter core hole. Unit also includes two openings for pass through capability for one (1) 4-pair category 5e or category 6 cable per opening. Comes with 1 ft. modular Walkerflex cable whip.

Standard Offerings: RC9A15TCBK111CW, RC9A15TCGY111CW, RC9A15TCBS111CW, RC9A15TCAA111CW, RC9A15TCAL111CW, RC9A15TCAB111CW

NOTE: Assembled with a scrub water gasket. For use on tile, wood or carpeted covered floors. Floor covering thickness range 1/8" to 3/4", not designed for use on bare concrete or terrazzo finished floors.

RC9A	15	TC	BK	111	CW
Surface Style Poke-Thru, Model: RC9A	15 = 15A Quad Power Receptacle	Unit is approved tile, wood, and carpet covered floors	Color of Cover Assembly: BK = Black GY = Gray AL = Aluminum BS = Brass AA = All Aluminum AB = All Brass	Power Delivery System: 111 = 1 Circuit, 1 Neutral, System Ground	Style of Feed: CW = Cable Whip

RC4ATC

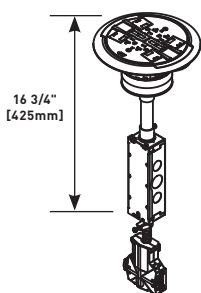

Surface style poke-thru assembly – Two (2) prewired 20A proprietary receptacles with a 1 ft. modular Walkerflex connector. The duplex receptacle on the "A" side is wired to the system ground and the duplex receptacle on the "B" side is wired to isolated ground. The poke-thru unit fits into a 4" [101.6 mm] diameter core hole. Comes with 1 ft. modular Walkerflex power adapter.

Unit also includes:

- Open inserts unloaded to accept discrete keystone connectors from most manufacturers
- Ortronics Tracjacks mounting bezel
- Ortronics Series II communication housing

Standard Offerings: RC4ATCBK222PA, RC4ATCGY222PA, RC4ATCBS222PA, RC4ATCAL222PA, RC4ATCAA222PA, RC4ATCAB222PA

NOTE: Assembled with a scrub water gasket. For use on tile, wood or carpeted covered floors. Floor covering thickness range 1/8" to 3/4", not designed for use on bare concrete or terrazzo finished floors. Modular Jacks sold separately.

RC4	A	TC	BK	222	PA
Surface Style Poke-Thru, Model: RC4	A = Assembled Unit	Unit is approved tile, wood, and carpet covered floors	Color of Cover Assembly: BK = Black GY = Gray AL = Aluminum BS = Brass AA = All Aluminum AB = All Brass	Power Delivery System: 222 = 2 Circuits, 2 Neutrals, Isolated Ground	Style of Feed: PA = Power Adapter

WALKERFLEX® MODULAR WIRING SYSTEM

Surface Style Poke-Thru Devices

AV3ATC

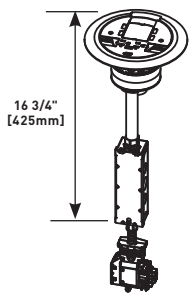

Surface style AV poke-thru assembly – One (1) prewired 20A proprietary receptacle with a 1 ft. modular Walkerflex power adapter. The poke-thru unit fits into a 4" [101.6mm] diameter core hole.

Unit also includes:

- One (1) Extron adapter to accept Extron MAAP mini architectural adapter plates. (Extron devices sold separately, only through authorized Extron dealers).
- One (1) Wiremold open system adapter and inserts unloaded to accept discrete keystone connectors from most manufacturers
- One (1) Ortronics Tracjacks adapter
- One (1) Ortronics Series II adapter

Standard Offerings: AVATCBK111PA, AV3ATCGY111PA, AV3ATCBS111PA, AV3ATCAL111PA, AV3ATCAA111PA, AV3ATCAB111PA

NOTE: Assembled with a scrub water gasket. For use on tile, wood or carpeted covered floors. Floor covering thickness range 1/8" to 3/4", not designed for use on bare concrete or terrazzo finished floors. Modular Jacks sold separately.

<u>AV3</u>	<u>A</u>	<u>TC</u>	<u>BK</u>	<u>111</u>	<u>PA</u>
Surface Style Poke-Thru, Model: AV3	A = Assembled Unit	Unit is approved tile, wood, and carpet covered floors	Color of Cover Assembly: BK = Black GY = Gray AL = Aluminum BS = Brass AA = All Aluminum AB = All Brass	Power Delivery System: 111 = 1 Circuit, 1 Neutral, System Ground	Style of Feed: PA = Power Adapter

RC7ATC

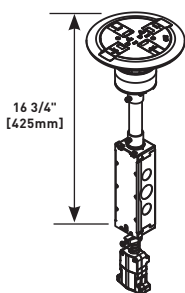

Surface style poke-thru assembly – One (1) prewired 20A proprietary receptacle with a 1 ft. modular Walkerflex cable whip. The Poke-thru unit fits into a 3" [76.2 mm] diameter core hole.

Unit also includes:

- One (1) Wiremold open system adapter and inserts unloaded to accept discrete keystone connectors from most manufacturers
- Two (2) Cat. 6 TechChoice discrete keystone modular jacks
- One (1) Ortronics TracJack adapter

Standard Offerings: RC7ATCBK111CW, RC7ATCGY111CW, RC7ATCBS111CW, RC7ATCAL111CW, RC7ATCAA111CW, RC7ATCAB111CW

NOTE: Assembled with a scrub water gasket. For use on tile, wood or carpeted covered floors. Floor covering thickness range 1/8" to 3/4", not designed for use on bare concrete or terrazzo finished floors.

<u>RC7</u>	<u>A</u>	<u>TC</u>	<u>BK</u>	<u>111</u>	<u>CW</u>
Surface Style Poke-Thru, Model: RC7	A = Assembled Unit	Unit is approved tile, wood, and carpet covered floors	Color of Cover Assembly: BK = Black GY = Gray AL = Aluminum BS = Brass AA = All Aluminum AB = All Brass	Power Delivery System: 111 = 1 Circuit, 1 Neutral, System Ground	Style of Feed: CW = Cable Whip

WALKERFLEX® MODULAR WIRING SYSTEM

Furniture Feed Style Poke-Thru Devices

4FFATC

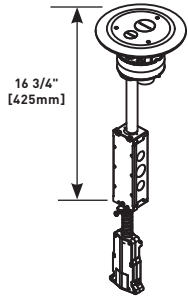

Furniture feed style poke-thru assembly – Complete with one-piece finish flange and conduit assembly. Finish covers flange provided with one (1) 3/4" trade size screw plug opening and one (1) 1 1/4" trade size screw plug opening. The poke-thru unit fits into a 4" [102 mm] diameter core hole. Comes with 1 ft. modular Walkerflex cable whip.

Unit also includes:

- One (1) 3/4" trade size conduit adapter.
- One (1) 1 1/4" trade size conduit adapter.

Standard Offerings: 4FFATCBK422CW, 4FFATCGY422CW, 4FFATCBS422CW, 4FFATCAL422CW,

NOTE: Assembled with a scrub water gasket. For use on tile, wood or carpeted covered floors. Floor covering thickness range 1/8" to 3/4", not designed for use on bare concrete or terrazzo finished floors.

<u>4FF</u>	<u>A</u>	<u>TC</u>	<u>BK</u>	<u>422</u>	<u>CW</u>
4FF = Furniture Feed Style Poke-Thru Device	A = Assembled Unit	Unit is approved tile, wood, and carpet covered floors	Color of Cover Assembly: BK = Black GY = Gray AL = Aluminum BS = Brass	Power Delivery System: 422 = 4 Circuits, 2 Neutrals, Isolated Ground	Style of Feed: CW = Cable Whip

WALKERFLEX[®] MODULAR WIRING SYSTEM

Surface Style Poke-Thru Devices Specifications

Copper Cross Section

The copper cross-sectional area determines the amount of wire fill capacity in a poke-thru device. Unlike other wire and cable management systems that utilize wire fill capacity, a poke-thru device is UL tested under fire conditions to determine the maximum amount of copper conductors that will pass through a poke-thru device, while maintaining the fire-rating of the floor assembly. All Walker Flush Style Devices are UL Classified to U.S. and Canadian safety standards (see complete marking on product) to accommodate at a maximum rating as follows:

RC7 SERIES

Maximum Allowable Copper Cross-Sectional Area:
 RC7 Power Compartment Only = .01536 sq. in. [9.91mm²]
 RC7 Each Communication Compartment Only = .0040 sq. in. [2.58mm²]

NOTE: The RC7 Series requires a 3" [76mm] cored hole.
 (American made core bit having an outside diameter of 3 1/16" [78mm].)

RC9 SERIES

Maximum Allowable Copper Cross-Sectional Area:
 RC9 Power Compartment Only = .01536 sq. in. [9.91mm²]
 RC9 Each Communication Compartment Only = .0040 sq. in. [2.58mm²]

NOTE: The RC9 Series requires a 3" [76mm] cored hole.
 (American made core bit having an outside diameter of 3 1/16" [78mm].)

AV3 SERIES

Maximum Allowable Copper Cross-Sectional Area:
 AV3 Power Compartment Only = .01536 sq. in. [9.91mm²]
 AV3 Communication Compartment Only = .01938 sq. in. [12.503mm²]

NOTE: The AV3 Series requires a 4" [102mm] cored hole.
 (American made core bit having an outside diameter of 4 1/16" [103mm].)

RC4 SERIES

Maximum Allowable Copper Cross-Sectional Area:
 RC4 Power Compartment Only = .03072 sq. in. [19.82mm²]
 RC4 Each Communication Compartment Only = .008 sq. in. [5.16mm²]

NOTE: The RC4 Series requires a 4" [102mm] cored hole.
 (American made core bit having an outside diameter of 4 1/16" [103mm].)

Copper Cross Sectional Area
of Commonly Used Conductors

SIZE	SOLID	
#24	0.00032 sq. in.	[0.206mm ²]
#22	0.00050 sq. in.	[0.322mm ²]
#14	0.00323 sq. in.	[2.083mm ²]
#12	0.00512 sq. in.	[3.303mm ²]
#10	0.00815 sq. in.	[5.258mm ²]
#8	0.01296 sq. in.	[8.361mm ²]

NOTE: Use above values for solid or stranded conductors.

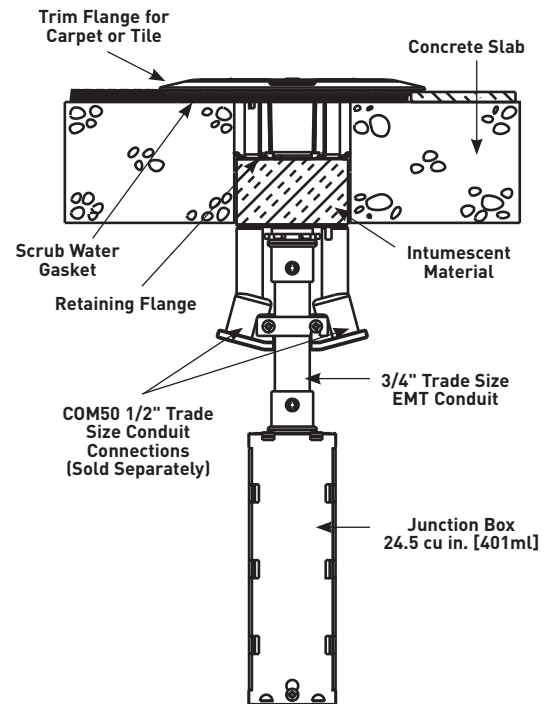

Concrete Thickness Min/Max:

1-Hour Rated Floor – 2 1/4" [57mm] min over top of deck (or 3" [76mm] thick reinforced concrete slab) to a maximum of 7 1/2" [191mm].

2-Hour Rated Floor – 3 1/4" [83mm] min over top of deck (or 4" [102mm] thick reinforced concrete slab) to a maximum of 7 1/2" [191mm].

Floor Coverings:

The poke-thru device is fire rated for carpet and wood covered concrete floors, and tile floor coverings 1/8" to 3/4" [3.2mm to 19.1mm] thickness. For floor coverings not listed above, consult factory.

IMPORTANT!

The above maximum copper cross sectional area values are for each individual power and communication compartment. DO NOT add values together for any one compartment.

CAUTION! Core bits vary in size from manufacturer to manufacturer:

- Use a 3" [76mm] American made core bit having an outside diameter of 3 1/16" [78mm]. Minimum hole diameter: 3 1/16" [78mm].
- Use a 4" [102mm] American made core bit having an outside diameter of 4 1/16" [103mm]. Minimum hole diameter: 4 1/16" [103mm].

CAUTION! These devices are suitable for 1, 1 1/2, and 2 hour rated floor assemblies as described in the UL Fire Resistance directory for each service.

These devices meet all UL scrub water requirements, but are not suitable for wet or damp locations, or other areas subject to saturation with water or other liquids such as commercial kitchens.

VERTICAL SOLUTIONS



Wiremold® Vertical Solutions are innovative pathways for delivering power and communication services to open office or retail environments.

Featured Products



Tele-Power Poles provide a wide range of options for distributing services from overhead systems to open space office, commercial, and retail areas.



Tele-Power® Pole
Extender

601



Vista Point5™
Architectural
Columns

593

VERTICAL SOLUTIONS

Table of Contents

Vista™ Architectural Columns



Vista™ CP Consolidation Point

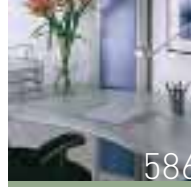

Vista™ Point5 Architectural Columns



Tele-Power® Poles



Vertical Drop Poles



Custom Tele-Power® Poles



VERTICAL SOLUTIONS

Quick Selection Guide

Vista™ Architectural Column

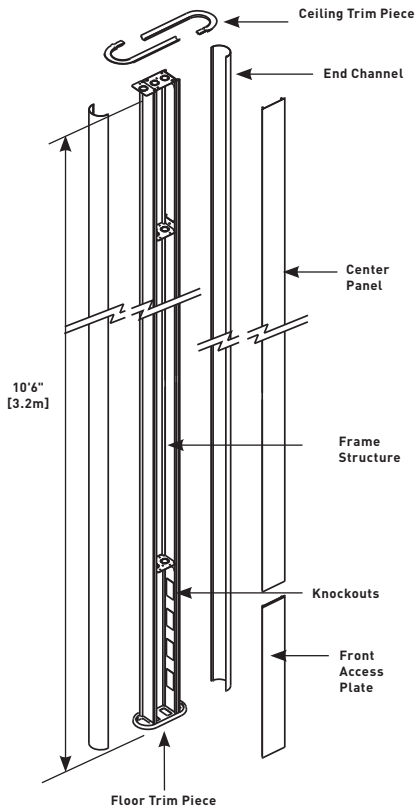

Square

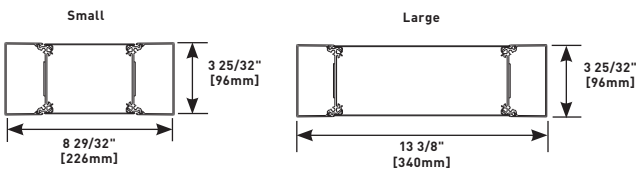

Round

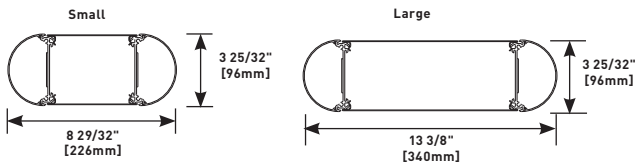

Steel Tele-Power™ Poles

30TP-4V

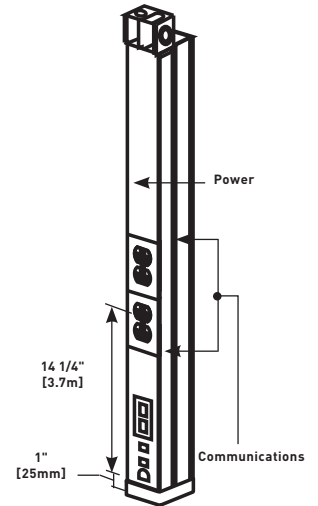
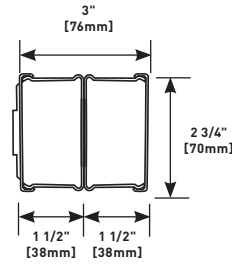

25DTP-4

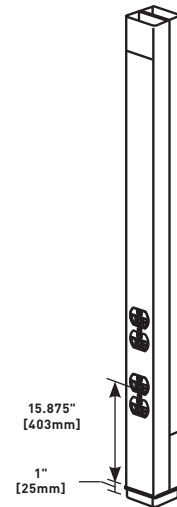
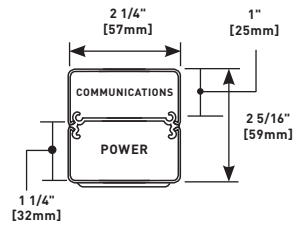

30TP-2V

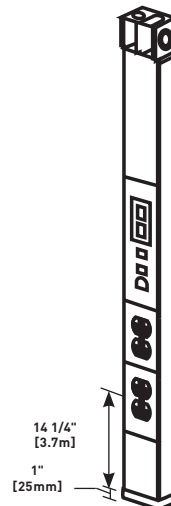
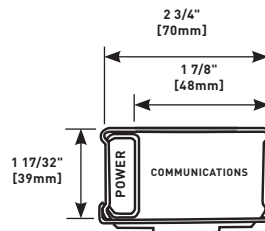

VERTICAL SOLUTIONS

Quick Selection Guide

Aluminum Tele-Power® Poles

AMDTP-4

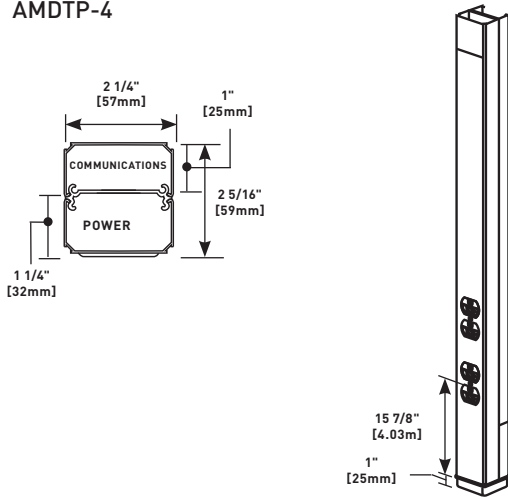

NP800C-10-2B

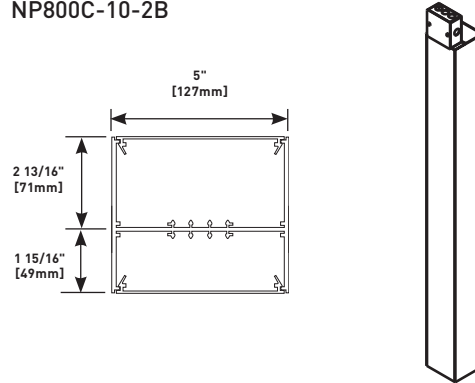

ALTP SERIES

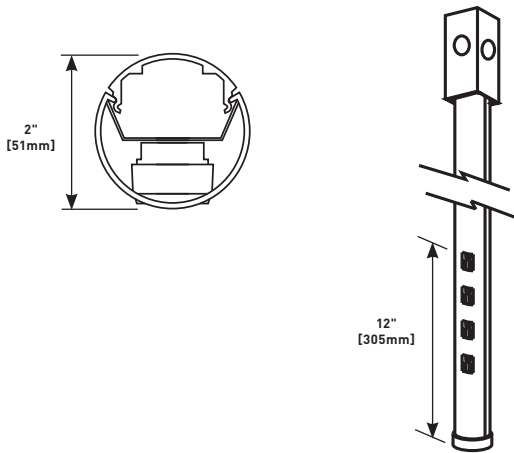

2CRTL1 SERIES

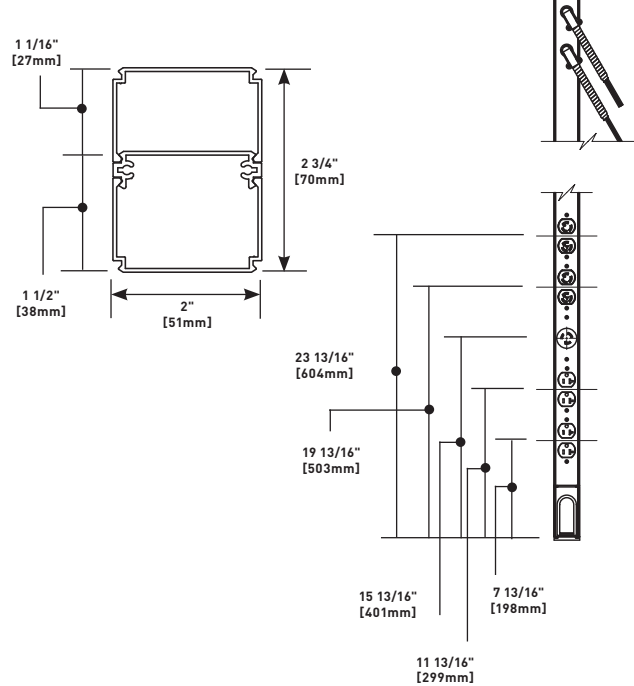

VISTA™ ARCHITECTURAL COLUMNS



Vista™ Architectural Columns provide aesthetically pleasing configurable solutions for power and communication services in open spaces.



CODE REFERENCE

cULus Listed Multioutlet Assemblies:
File E15191 Guide PVGT
Meets Article 380 of NEC.

Vista Architectural Column System layout

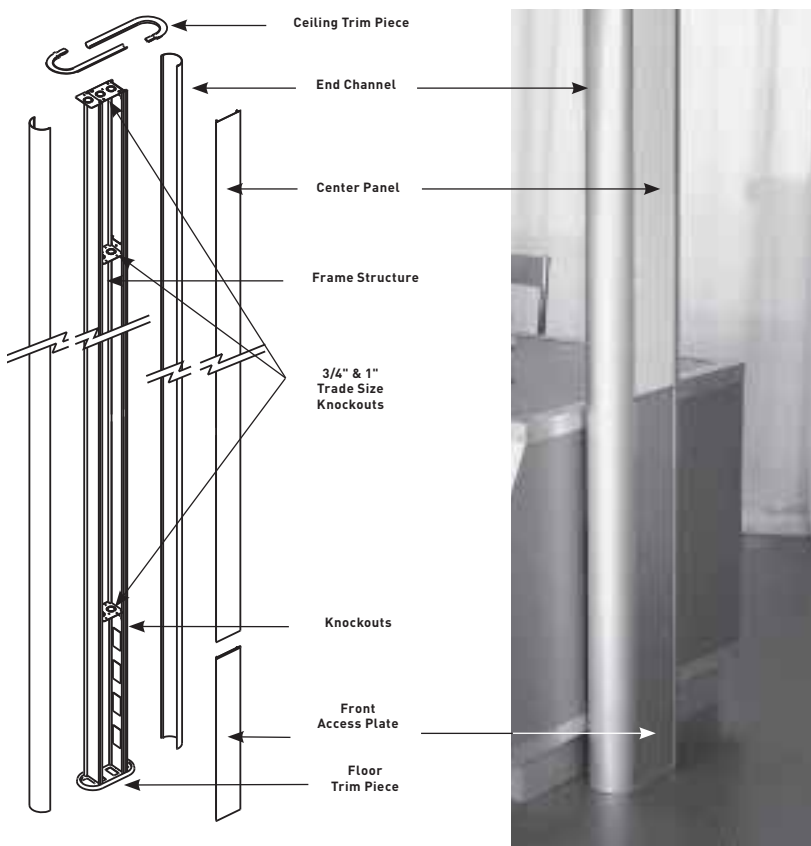

Overall Dimensions

Round

Small

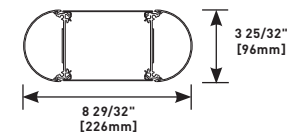

Large

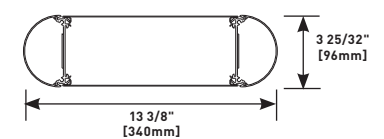

SQUARE

Small

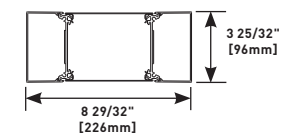

Large

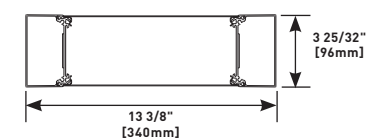

VISTA™ ARCHITECTURAL COLUMNS

Vista Wire Fill Capacity for Communication

	CABLE/WIRE SIZE	O.D.		ONE SQUARE END CHANNEL	ONE ROUND END CHANNEL	LARGE CENTER	SMALL CENTER	ONE SQUARE EXTENSION	ONE ROUND EXTENSION
		Inches	[mm]						
Un-Shielded Twisted Pair	2-pair, 24 AWG, Cat 3	0.140	[3.6]	190	150	80	40	131	94
	3-pair, 24 AWG, Cat 3	0.150	[3.8]	165	131	68	34	114	82
	4-pair, 24 AWG, Cat 3	0.190	[4.8]	103	81	44	22	71	51
	25-pair, 24 AWG, Cat 3	0.410	[10.4]	22	17	8	4	15	11
	4-pair, 24 AWG, Cat 5e	0.220	[5.6]	77	61	32	16	53	38
	4-pair, 24 AWG, Cat 6	0.250	[6.3]	59	47	24	12	41	29
Shielded Twisted Pair	Type 1, 22 AWG	0.390	[9.9]	24	19	8	4	16	12
	Type 2, 22 AWG	0.465	[11.8]	17	13	4	2	11	8
	Type 3, 22 AWG	0.245	[6.2]	62	49	24	12	42	30
Coaxial	RG58/U, 20 AWG	0.195	[5.0]	98	77	40	20	67	48
	RG58/U, 22 AWG	0.242	[6.1]	63	50	24	12	43	31
	RG6/U, 22 AWG	0.242	[6.1]	63	50	24	12	43	31
	RG6/U, 18 AWG	0.270	[6.9]	51	40	20	10	25	25
Twinaxial	100 Ohm	0.330	[8.4]	34	27	12	6	23	71
Fiber Optic		0.180	[4.6]	103	81	44	22	71	51

NOTE: Capacity range is calculated at 40% of raceway area as stated in a proposed revisions to the Commercial Building Standard for Telecommunication Pathways & Spaces, EIA/TIA-569. Actual wire fill capacity may vary based on applications, cable types, and number, as well as type of fittings. (Fittings may cause additional variances to the fill capacity.)

Vista Wire Fill Capacity for Power

WIRE SIZE THHN/THWN	6 AWG	8 AWG	10 AWG	12 AWG	14 AWG
One End Channel Round or Square	7	9	16	26	35
Center (Large)	28	36	64	104	140
Center (Small)	14	18	32	52	70
One Extension Round or Square	4	6	10	16	22

Vista Architectural Columns In-Stock Columns Ordering Information

VS662345 In-Stock Small Vista Column



Small profile frame, round end channels, anodized aluminum finish. Accepts all adapters. Two 20A duplex receptacles located 27" [686mm] above floor. Includes one VSFF plate at bottom back side of pole. Dimensions: 10'6" x 8 29/32" x 3 25/32" [3200mm x 276mm x 96mm].

VS662345FF In-Stock Small Vista Column



Small profile frame, round end channels, anodized aluminum finish. Furniture feed. Includes one VSFF plate at bottom back side of pole. Dimensions: 10'6" x 8 29/32" x 3 25/32" [3200mm x 226mm x 96mm].

VL662345 In-Stock Large Vista Column



Large profile frame, round end channels, anodized aluminum finish. Accepts all adapters. Three 20A duplex receptacles located 27" [686mm] above floor. Includes one VLFF plate at bottom back side of pole. Dimensions: 10'6" x 13 3/8" x 3 25/32" [3200mm x 340mm x 96mm].

VL662345FF In-Stock Large Vista Column



Large profile frame, round end channels, anodized aluminum finish. Furniture feed. Includes one VLFF plate at bottom back side of pole. Dimensions: 10'6" x 13 3/8" x 3 25/32" [3200mm x 340mm x 96mm].

VISTA™ ARCHITECTURAL COLUMNS

Vista Architectural Columns In-Stock Columns Ordering Information

VES66234524 In-Stock Small Vista Column Ext.



Small profile 24" [610mm] frame extension, round end channels, anodized aluminum finish.

VLV Vista Wireless Access Point Enclosure



Vista solution for mounting wireless access points. Large frame Vista with anodized round end channels and center panels. Furniture feed style access, 10'6" [3.2m] tall. Has tempered glass panels to conceal access point. Front panel is hinged and lockable. Compartment measures 17 1/2" x 7 1/4" x 2 1/2" [445mm x 183mm x 64mm].

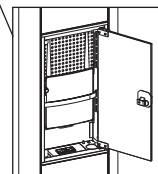

VEL66234524 In-Stock Large Vista Column Ext.

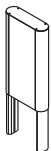

Large profile 24" [610mm] frame extension, round end channels, anodized aluminum finish.

Vista Architectural Columns In-Stock Columns Ordering Information

Small Frame

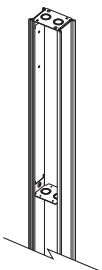

Tempered aluminum with heavy gauge steel cross supports with two (2) 3/4" and 1" trade size concentric KOs. Accepts 4 3/4" [121mm] wide center panel.

Round End Channel

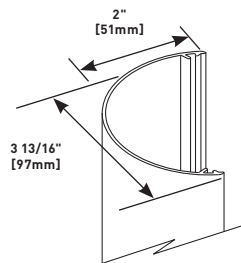

Tempered aluminum. Anodized finish or painted. Channel snaps onto frame.

Large Frame

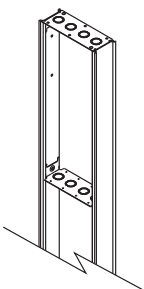

Empered aluminum with heavy gauge steel cross supports with two (2) 3/4" and 1" trade size concentric KOs. Accepts 4 3/4" [121mm] wide center panel.

Square End Channel

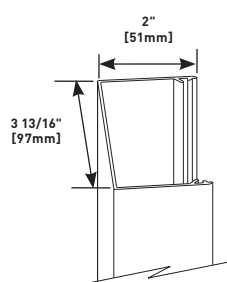

Tempered aluminum. Anodized finish or painted. Channel snaps onto frame.

VISTA™ ARCHITECTURAL COLUMNS

Vista Architectural Column Frame Options Ordering Information

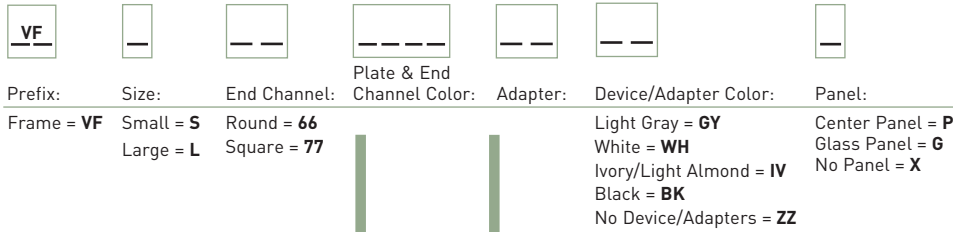

COLOR - REFERENCE	CODE
White	= 3333
Black	= 9999
Ivory	= 5555
No Color - Anodized Aluminum	= 2345
Warm White - Steelcase 4700	= 3136
Moss - Steelcase 4722	= 5169
Lt. Tone - Herman Miller LT	= 2486
Mist - Steelcase 4606	= 5895
GSA Lt. Blue - GSA 25183	= 5911
Woodrose - Steelcase 4601	= 6137
Slate - Steelcase 4726	= 6142
Light Blue - Shaw Walker A751	= 1988
Greytone - Haworth - G	= 2884

Furniture Feed	= FF	Crestron® Quick Media - (Has openings for 1 two gang or 2 single gang wall plates. 1 MAAP Adapter included.)	= CR
Data Device Plates - Ortronics® Series II or TracJack Adapters	= RT*		
Open System Adapters	= CM*		
AV Device Plates			
Extron® Electronics MAAP - (Has openings for 8 Legrand AVIP or Extron MAAP Modules. 1 MAB Adapter included.)	= EM		
Extron® Electronics AAP - (Has openings for 6 AAP Modules. 1 MAB Adapter included.)	= EA		
		* RT and CM options include one each electrical device plate with spec grade duplex receptacle(s), single 120V circuit and communications plate with adapter(s) installed.	
		Duplex receptacles are located at 27" [686mm] above the finish floor.	
		Communications modules are located at 21" [533mm] above the finish floor.	

Vista Architectural Column Panel Options Ordering Information

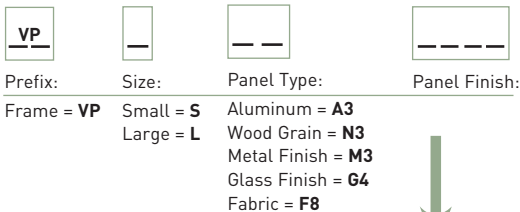

COLOR - REFERENCE	CODE	COLOR - REFERENCE	CODE	COLOR - REFERENCE	CODE
Aluminum:		Maple Fusion	= 4401	Fabric:	
White	= 3333	Shaker Cherry	= 4408	Quartz	= 3805
Black	= 9999	Fonthill Pear	= 4406	Lavender Natural	= 4055
Ivory	= 5555	Congo Spruce	= 4451	Blue Neutral	= 4105
No Color - Anodized Aluminum	= 2345	Copper Bubinga	= 4456	Wedgewood	= 1505
Warm White - Steelcase 4700	= 3136	Natural Pear	= 4411	Grey Mix	= 2385
Moss - Steelcase 4722	= 5169	Biltmore Cherry	= 4413	Lake	= 0995
Lt. Tone - Herman Miller LT	= 2486	Asian Sun	= 4467	Malibu	= 0375
Mist - Steelcase 4606	= 5895			Globe	= 0245
GSA Lt. Blue - GSA 25183	= 5911	Metal Laminate:		Flax	= 0615
Woodrose - Steelcase 4601	= 6137	Vertical Corrugated Matte Aluminum	= 4748	Daylight Blue	= 0305
Slate - Steelcase 4726	= 6142	Ragged Copper	= 1999		
Light Blue - Shaw Walker A751	= 1988	Matte Aluminum Footplate	= 2046	Glass:	
Greytone - Haworth - G	= 2884	Light Hammer Copper	= 2121	Heavy Frost	= 8675
		Double Brushed Aluminum	= 2171		
Woodgrain Laminate:					
Amber Cherry	= 4407				
Mahogany	= 4410				

NOTE: These are suggested colors. If there are other colors not indicated here, send in a color chip as most colors can be matched.

VISTA™ ARCHITECTURAL COLUMNS

Vista Architectural Column Add-On Plates for Large Frame Vista Series Ordering Information

VL3D Device Cover

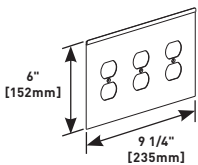

Has three (3) duplex receptacle cutouts

VLCR** AV Device Cover

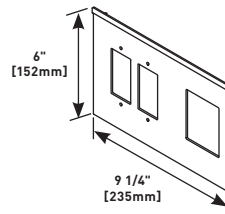

Has openings for one (1) two-gang or two (2) single-gang Crestron® Quick Media wall plate(s) and one mini adapter (included). Standard color/material is anodized aluminum or black.

VLRT* Device Cover

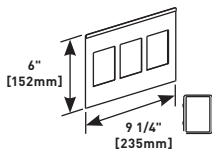

Has three (3) mini adapters for Ortronics® Series II or TracJack devices.

VLEA** AV Device Cover

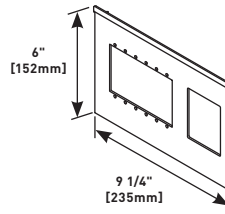

Has openings for six (6) Extron® Electronics AAP modules and one mini adapter (included). Standard color/material is anodized aluminum or black.

VLCM* Device Cover

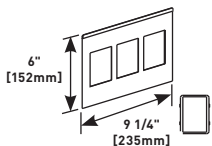

Has three (3) mini adapters for Wiremold CM Series Open System communications devices.

VLEM** AV Device Cover

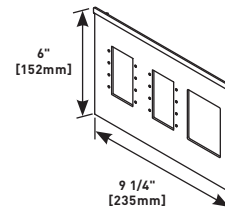

Has openings for eight (8) Legrand AVIP or Extron® Electronics MAAP modules and one mini adapter (included). Standard color/material is anodized

VLFF Furniture Feed Plate

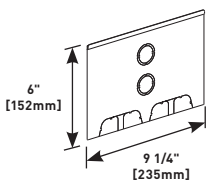

Has two (2) concentric 1" and 3/4" trade size knockouts, and two (2) multiple twistout mouse holes. One furniture feed plate is installed on the assembly.

*Refer to the list of colors in chart above for the four-digit code number.
 Add "C" prefix to catalog number to denote Canadian version - Agency approved for sale in Canada.

**Products are ETL Listed.

VISTA™ ARCHITECTURAL COLUMNS

Vista Architectural Column Add-On Plates for Small Frame Vista Series Ordering Information

VS2D* Device Cover

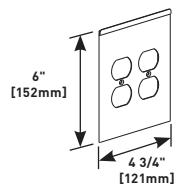

Has two (2) duplex receptacle cutouts.

VSCR** AV Device Plate

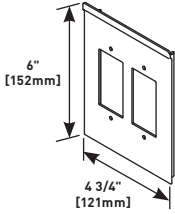

Has openings for one (1) two-gang or two (2) single-gang Crestron® Quick Media wall plate(s). Standard color/material is anodized aluminum or black.

VSRT* Device Cover

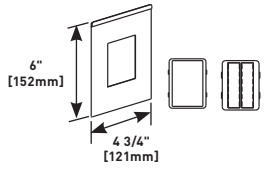

Has one mini adapter for Ortronics® Series II or TracJack devices.

VSEM** AV Device Plate

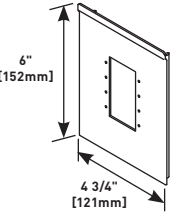

Has openings for four (4) Legrand AVIP or Extron® Electronics MAAP modules. Standard color/material is anodized aluminum or black.

VSCM* Device Cover

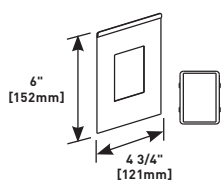

Has one mini adapter for Wiremold CM Series Open System communication devices.

VSLB* Lighting Bracket

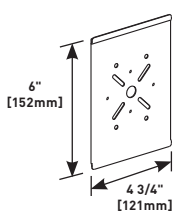

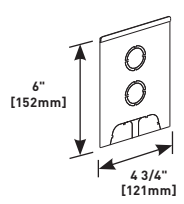

Accommodates commercially available lights weighing up to 10 lbs. [4.5kg].

VSFF* Furniture Feed Plate

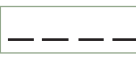

Has two concentric and 3/4" trade size KOs, and one multiple twistout mouse hole. One furniture feed plate is installed on the assembly.

Device Plate Part Number Configurator

			
Base:	Plate Color:	Adapter Color:	
Enter Catalog Number from above choices	Refer to color list on the previous page, enter 4-digit code	Light Gray = GY White = WH Ivory/Lt. Almond = IV Black = BK No Device Adapter = ZZ	

VSEA** AV Device Plate

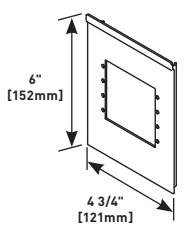

Has openings for four (4) Extron® Electronics AAP modules. Standard color/material is anodized aluminum or black.

*Refer to the list of colors in chart above for the four-digit code number.
 Add "C" prefix to catalog number to denote Canadian version - Agency approved for sale in Canada.
 **Products are ETL Listed.

VISTA™ ARCHITECTURAL COLUMNS

Vista Architectural Column Extension Kit Ordering Information



COLOR - REFERENCE	CODE
White	= 3333
Black	= 9999
Ivory	= 5555
No Color - Anodized Aluminum	= 2345
Warm White - Steelcase 4700	= 3136
Moss - Steelcase 4722	= 5169
Lt. Tone - Herman Miller LT	= 2486
Mist - Steelcase 4606	= 5895
GSA Lt. Blue - GSA 25183	= 5911
Woodrose - Steelcase 4601	= 6137
Slate - Steelcase 4726	= 6142
Light Blue - Shaw Walker A751	= 1988
Greystone - Haworth - G	= 2884

NOTE: These are suggested colors. If there are other colors not indicated here, send in a color chip as most colors can be matched.

Woodgrain Laminate:	
Amber Cherry	= 4407
Mahogany	= 4410
Maple Fusion	= 4401
Shaker Cherry	= 4408
Fonthill Pear	= 4406
Congo Spruce	= 4451
Copper Bubinga	= 4456
Natural Pear	= 4411
Biltmore Cherry	= 4413
Asian Sun	= 4467
Metal Laminate:	
Vertical Corrugated Matte Aluminum	= 4748
Ragged Copper	= 1999
Matte Aluminum Footplate	= 2046
Light Hammer Copper	= 2121
Double Brushed Aluminum	= 2171
Fabric:	
Quartz	= 3805
Lavender Neutral	= 4055
Blue Neutral	= 4105
Wedgewood	= 1505
Grey Mix	= 2385
Lake	= 0245
Malibu	= 0375
Globe	= 0245
Flax	= 0615
Daylight Blue	= 0305

Extension Kit Options -

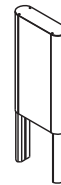

Accommodates ceiling heights between 10' [3m] and 15' [4.5m]. Includes hardware for attaching to main section. Round or square shapes available. Includes a center panel.

Design your own Vista Architectural Column online at www.legrand.us/tools-resources/ wiremold & click on vista configurator

Vista Architectural Columns Part Configuration

For a full color view, bill of materials, or to request a quote for Vista Open-Space Power and Communication Delivery, check out www.legrand.us.

Configuration Example

The product shown at the right is made of the following components:

Frame

Large Frame with Square Anodized Aluminum End Channels
 Catalog number: **VFL772345FFZP**

Center Panel

Large Wood Grain Laminate Panel
 Catalog number: **VPLA34410**

Extension Kit (Optional)

Large Square Anodized End Channels with Mahogany Wood Laminate Panels and 24" [610mm] extension
 Catalog number: **VEL772345441024**

All solutions include a furniture feed plate.



VISTA CP™ CONSOLIDATION POINT



Vista CP™ Consolidation Point provides configurable solutions for zoned cabling in open spaces.

CODE REFERENCE

cULus Listed Multioutlet Assemblies:
File E15191 Guide PVGT
Meets Article 380 of NEC.

Vista CP Consolidation Point System Layout

Front View

Rear View

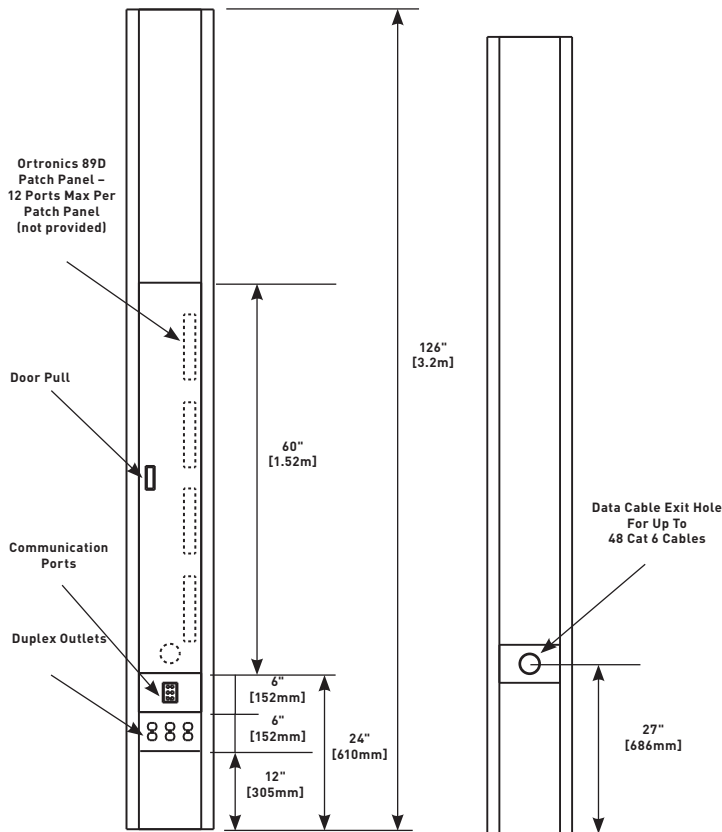

Open and closed views of a Vista CP installation.

Round

Large

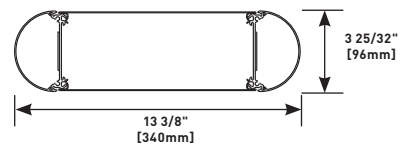

Square

Large

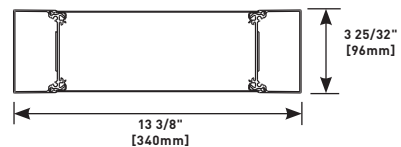

VISTA CP™ CONSOLIDATION POINT

Vista CP Consolidation Point Wire Fill Capacity for Communication

	CABLE/WIRE SIZE	O.D.		ONE SQUARE END CHANNEL	ONE ROUND END CHANNEL	LARGE CENTER	ONE SQUARE EXTENSION	ONE ROUND EXTENSION
		Inches	[mm]					
Unshielded Twisted Pair	2-pair, 24 AWG, Cat 3	0.140	[3.6]	190	150	80	131	94
	3-pair, 24 AWG, Cat 3	0.150	[3.8]	165	131	68	114	82
	4-pair, 24 AWG, Cat 3	0.190	[4.8]	103	81	44	71	51
	25-pair, 24 AWG, Cat 3	0.410	[10.4]	22	17	8	15	11
	4-pair, 24 AWG, Cat 5e	0.220	[5.6]	77	61	32	53	38
	4-pair, 24 AWG, Cat 6	0.250	[6.3]	59	47	24	41	29
Shielded Twisted Pair	Type 1, 22 AWG	0.390	[9.9]	24	19	8	16	12
	Type 2, 22 AWG	0.465	[11.8]	17	13	4	11	8
	Type 3, 22 AWG	0.245	[6.2]	62	49	24	42	30
Coaxial	RG58/U, 20 AWG	0.195	[5.0]	98	77	40	67	48
	RG58/U, 22 AWG	0.242	[6.1]	63	50	24	43	31
	RG6/U, 22 AWG	0.242	[6.1]	63	50	24	43	31
	RG6/U, 18 AWG	0.270	[6.9]	51	40	20	25	25
Twinaxial	100 Ohm	0.330	[8.4]	34	27	12	23	71
Fiber Optic		0.180	[4.6]	103	81	44	71	51

NOTE: Capacity range is calculated at 40% of raceway area as stated in a proposed revisions to the Commercial Building Standard for Telecommunication Pathways & Spaces, EIA/TIA-569. Actual wire fill capacity may vary based on applications, cable types, and number, as well as type of fittings. (Fittings may cause additional variances to the fill capacity.)

Vista CP Consolidation Point Wire Fill Capacity for Power

WIRE SIZE THHN/THWN	6 AWG	8 AWG	10 AWG	12 AWG	14 AWG
One End Channel Round or Square	7	9	16	26	35
Center (Large)	28	36	64	104	140
One Extension Round or Square	4	6	10	16	22

Patch Panel Options

The Vista Column Consolidation Point accommodates the 89D style patch panel, 12 ports maximum, and up to 4 panels per column.

Ortronics® Clarity5E™ or Clarity6™ Modular to 110 Mini Patch Panels are an ideal solution.



Vista CP Consolidation Point In-Stock Columns Ordering Information

Vista Consolidation Point (CP)

Columns provide channels that conceal wires and cables behind a decorative center panel and incorporate a user-installed patch panel with easy, secured access through a lockable door. They can be placed anywhere in an open space, providing maximum communication flexibility and unique design elements. These modular columns are easily relocated to accommodate changing space requirements.

VLCP662345

VEL66234524

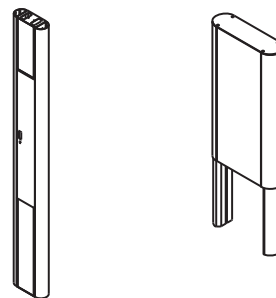

CAT. NO.	DETAILS
VLCP662345	Large Anodized Aluminum Frame with round channels, Ortronics TracJack and Series 2 adapters in gray. Accommodates a 10' [3m] ceiling. Anodized Aluminum Panel for the back of the Vista Column. Anodized Aluminum Door with a keyed lock and flush, black door pull, 60" [5.2m] length.
VEL6623524	Extension for the column to accommodate up to 12' [3.7m] ceilings.

VISTA CP™ CONSOLIDATION POINT

Vista CP Consolidation Point Frame Options Ordering Information

Large Frame

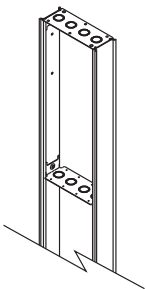

Tempered aluminum with heavy gauge steel cross supports with four (4) 3/4" and 1" trade size concentric KOs. Accepts 9 1/4" [235mm] wide center panel.

Round End Channel

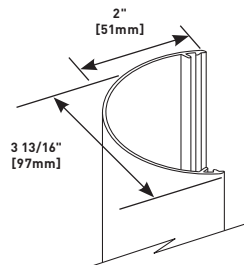

Tempered aluminum. Anodized finish or painted. Channel snaps onto frame.

Square End Channel

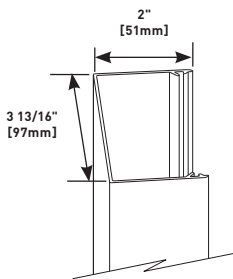

Tempered aluminum. Anodized finish or painted. Channel snaps onto frame.

Vista CP Consolidation Point Part Configuration

For a full color view of the Vista CP Consolidation Point, check out www.legrand.us.

Configuration Example

The product shown at the right is made of the following components:

Frame

Large Frame with Round Anodized Aluminum End Channels
Catalog Number: **VFL662345FFZZD**

Center Panel

Large Locked Door Panel
Catalog Number: **VY602345L2Y**

Rear Center Panel

Large Aluminum Panel
Catalog Number: **VPLY2345**

Extension Kit (Optional)

Large Round End Channels
Catalog Number: **VEL662345234524**

All solutions include a furniture feed plate.



VISTA CP™ CONSOLIDATION POINT

Vista CP Consolidation Point Frame Options Ordering Information

Prefix:	Size:	End Channel:	Plate & End	Style:	Device/Adapter Color:	Panel:
Frame = VF	Large = L	Round = 66 Square = 77	Channel Color:		Light Gray = GY White = WH Ivory/Light Almond = IV Black = BK No Device/Adapters = ZZ	Door Panel = D

COLOR - REFERENCE	CODE
White	= 3333
Black	= 9999
Ivory	= 5555
No Color - Anodized Aluminum	= 2345
Warm White - Steelcase 4700	= 3136
Moss - Steelcase 4722	= 5169
Lt. Tone - Herman Miller LT	= 2486
Mist - Steelcase 4606	= 5895
GSA Lt. Blue - GSA 25183	= 5911
Woodrose - Steelcase 4601	= 6137
Slate - Steelcase 4726	= 6142
Light Blue - Shaw Walker A751	= 1988
Greytone - Haworth - G	= 2884

Furniture Feed	= FF	AV Device Plates	
Data Device Plates - Ortronics® Series II or TracJack Adapters	= RT*	Extron® Electronics MAAP - (Has openings for 8 Legrand AVIP or Extron MAAP Modules. 1 MAB Adapter included.)	= EM
Open System Adapters	= CM*	Extron® Electronics AAP - (Has openings for 6 AAP Modules. 1 MAB Adapter included.)	= EA
* RT and CM options include one each electrical device plate with spec grade duplex receptacle(s), single 120V circuit and communications plate with adapter(s) installed.		Crestron® Quick Media - (Has openings for 1 two gang or 2 single gang wall plates. 1 MAAP Adapter included.)	= CR
Duplex receptacles are located at 27" [686mm] above the finish floor.			
Communications modules are located at 21" [533mm] above the finish floor.			

Vista CP Consolidation Point Center Panel Door Options Ordering Information

Door = VY	Height:	Color:	Opening:	Handle:	Keyed Lock:
Door = VY	60" [1.25m] = 60		Left Hinged = L Right Hinged = R	Black Flush Door Pull = 1 Nickel-Plated Knob = 2	Yes = Y No = N

Aluminum:	
White	= 3333
Black	= 9999
Ivory	= 5555
No Color - Anodized Aluminum	= 2345
Warm White - Steelcase 4700	= 3136
Moss - Steelcase 4722	= 5169
Lt. Tone - Herman Miller LT	= 2486
Mist - Steelcase 4606	= 5895
GSA Lt. Blue - GSA 25183	= 5911
Woodrose - Steelcase 4601	= 6137
Slate - Steelcase 4726	= 6142
Light Blue - Shaw Walker A751	= 1988
Greytone - Haworth - G	= 2884

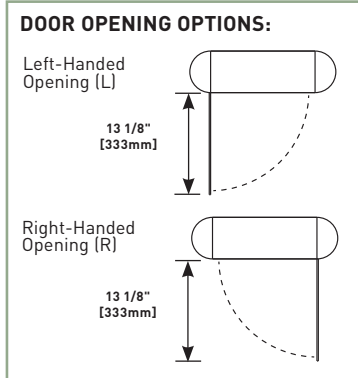

NOTE: Send in a color chip. Most colors can be matched.

NOTE: The bottom of the door is located 24" [610mm] from the finish floor.

VISTA CP™ CONSOLIDATION POINT

Vista CP Consolidation Point Rear Center Panel Options Ordering Information

VP	L	Y	---	----
Prefix:	Size:	Panel:	Panel Type:	Panel Finish:
Frame = VP	Large = L	Rear Center = Y	Wood Grain = N3 Metal Finish = M3 Glass Finish = G4 Fabric = F8	

COLOR - REFERENCE	CODE	COLOR - REFERENCE	CODE
Aluminum:		Natural Pear	= 4411
White	= 3333	Bitmore Cherry	= 4413
Black	= 9999	Asian Sun	= 4467
Ivory	= 5555	Metal Laminate:	
No Color - Anodized Aluminum	= 2345	Vertical Corrugated	
Warm White - Steelcase 4700	= 3136	Matte Aluminum	= 4748
Moss - Steelcase 4722	= 5169	Ragged Copper	= 1999
Lt. Tone - Herman Miller LT	= 2486	Matte Aluminum Footplate	= 2046
Mist - Steelcase 4606	= 5895	Light Hammer Copper	= 2121
GSA Lt. Blue - GSA 25183	= 5911	Double Brushed Aluminum	= 2171
Woodrose - Steelcase 4601	= 6137	Fabric:	
Slate - Steelcase 4726	= 6142	Quartz	= 3805
Light Blue - Shaw Walker A751	= 1988	Lavender Natural	= 4055
Greytone - Haworth - G	= 2884	Blue Neutral	= 4105
Woodgrain Laminate:		Wedgewood	= 1505
Amber Cherry	= 4407	Grey Mix	= 2385
Mahogany	= 4410	Lake	= 0995
Maple Fusion	= 4401	Malibu	= 0375
Shaker Cherry	= 4408	Globe	= 0245
Fonthill Pear	= 4406	Flax	= 0615
Congo Spruce	= 4451	Daylight Blue	= 0305
Copper Bubinga	= 4456		

NOTE: These are suggested colors. If there are other colors not indicated here, send in a color chip as most colors can be matched.

Vista CP Consolidation Point Extension Kit Ordering Information

Extension Kit Options -



Accommodates ceiling heights greater than 10' [3m] to 15' [4.5m]. Includes hardware for attaching to main section. Round or square shapes available. Includes a center panel.

VE	L	---	----	----	---
Prefix:	Size:	Shape:	End Channel	Panel Finish:	Height:
Frame = VE	Large = L	Round = 66 Square = 77	Finish:		24" [610mm] = 24 60" [1.52m] = 60

COLOR - REFERENCE	CODE
White	= 3333
Black	= 9999
Ivory	= 5555
No Color - Anodized Aluminum	= 2345
Warm White - Steelcase 4700	= 3136
Moss - Steelcase 4722	= 5169
Lt. Tone - Herman Miller LT	= 2486
Mist - Steelcase 4606	= 5895
GSA Lt. Blue - GSA 25183	= 5911
Woodrose - Steelcase 4601	= 6137
Slate - Steelcase 4726	= 6142
Light Blue - Shaw Walker A751	= 1988
Greytone - Haworth - G	= 2884

NOTE: These are suggested colors. If there are other colors not indicated here, send in a color chip as most colors can be matched.

WOODGRAIN LAMINATE:	
Amber Cherry	= 4407
Mahogany	= 4410
Maple Fusion	= 4401
Shaker Cherry	= 4408
Fonthill Pear	= 4406
Congo Spruce	= 4451
Copper Bubinga	= 4456
Natural Pear	= 4411
Bitmore Cherry	= 4413
Asian Sun	= 4467
METAL LAMINATE:	
Vertical Corrugated Matte Aluminum	= 4748
Ragged Copper	= 1999
Matte Aluminum Footplate	= 2046
Light Hammer Copper	= 2121
Double Brushed Aluminum	= 2171
FABRIC:	
Quartz	= 3805
Lavender Neutral	= 4055
Blue Neutral	= 4105
Wedgewood	= 1505
Grey Mix	= 2385
Lake	= 0245
Malibu	= 0375
Globe	= 0245
Flax	= 0615
Daylight Blue	= 0305

Design your own Vista Architectural Column online at www.legrand.us/tools-resources/wiremold & click on vista configurator

For additional system options, contact your local Wiremold sales representative.

VISTA CP™ CONSOLIDATION POINT

Vista CP Consolidation Point Extension Kit Ordering Information

COLOR REFERENCE Woodgrain Laminate	CODE	COLOR REFERENCE Fabric	CODE
Amber Cherry	4407	Quartz	3805
Mahogany	4410	Lavendar Natural	4055
Maple Fusion	4401	Blue Neutral	4105
Shaker Cherry	4408	Wedgewood	1505
Fonthill Pear	4406	Grey Mix	2385
Congo Spruce	4451	Lake	0995
Copper Bubinga	4456	Malibu	0375
Natural Pear	4411	Globe	0245
Biltmore Cherry	4413	Flax	0615
Asian Sun	4467	Daylight Blue	0305

Design your own Vista Architectural Column online at www.legrand.us/tools-resources/wiremold & click on vista configurator

For additional system options, contact your local Wiremold sales representative.

EXTENSION KIT OPTIONS

Accommodates ceiling heights between 10' [3m] and 15' [4.5m]. Includes hardware for attaching to main section. Round or square shapes available. Includes a center panel.



NOTE: These are suggested colors. If there are other colors not indicated here, send in a color chip as most colors can be matched.

Vista CP Consolidation Point Add-On Plates Ordering Information

VL3D* Device Cover

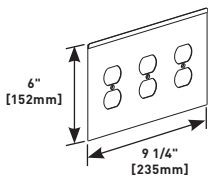

Has three (3) duplex receptacle cutouts.

VLEA** AV Device Cover

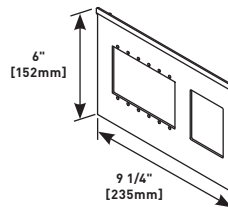

Has openings for six (6) Extron® Electronics AAP modules and one mini adapter (included). Standard color/material is anodized aluminum or black.

VLRT* Device Cover

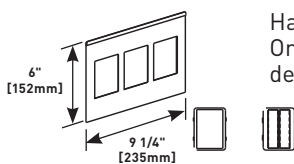

Has three mini jack adapters for Ortronics® Series II or TracJack devices.

VLEM** AV Device Cover

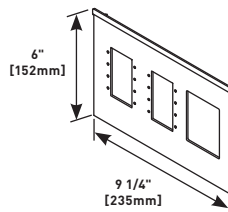

Has openings for eight (8) Legrand AVIP or Extron® Electronics MAAP modules and one mini adapter (included). Standard color/material is anodized aluminum or black.

VLCR** AV Device Cover

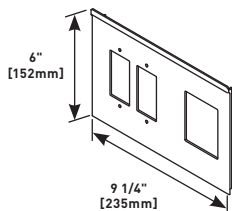

Has openings for one (1) two-gang or two (2) single-gang Crestron® Quick Media wall plate(s) and one mini adapter (included). Standard color/material is anodized aluminum or black.

VLFF* Furniture Feed Plate

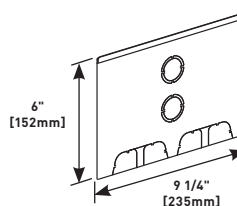

Has two concentric 1" and 3/4" trade size KO's, and two multiple twistout mouse holes. One furniture feed plate installed on the assembly.

*Refer to the list of colors in chart above for the four-digit code number. Add "C" prefix to catalog number to denote Canadian version - Agency approved for sale in Canada.

**Products are ETL Listed.

VISTA CP™ CONSOLIDATION POINT

Vista CP Consolidation Point Add-On Plates Ordering Information (continued)

VLCM* Furniture Feed Plate

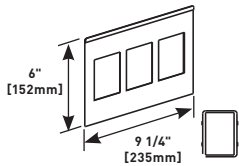

Has three mini adapters for Wiremold CM Series Open System Communication Modules.

DEVICE PLATE PART NUMBER CONFIGURATOR	INSTRUCTIONS
Base	Enter 4-digit Catalog Number
Plate Color	Enter 4-digit Color Code
Adapter Color	Light Gray = GY White = WH Ivory/Light Almond = V Black = BK No Device Adapter = ZZ

VLLB* Lighting Brackets

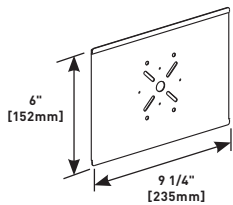

Accommodates commercially available lights weighing up to lbs. [4.5kg].

*Refer to the list of colors in chart above for the four-digit code number.
 Add "C" prefix to catalog number to denote Canadian version - Agency approved for sale in Canada.
 **Products are ETL Listed.

VISTA POINT5™ ARCHITECTURAL COLUMNS



Vista Point5™ Architectural Columns provide configurable solutions for power and communication services in open spaces.

CODE REFERENCE

cULus Listed Multioutlet Assemblies:
File E15191 Guide PVGT
Meets Article 380 of NEC.

Vista Point5 Architectural Columns System Layout

Small

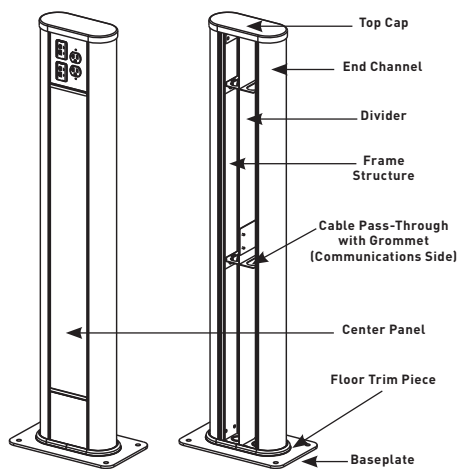

Large

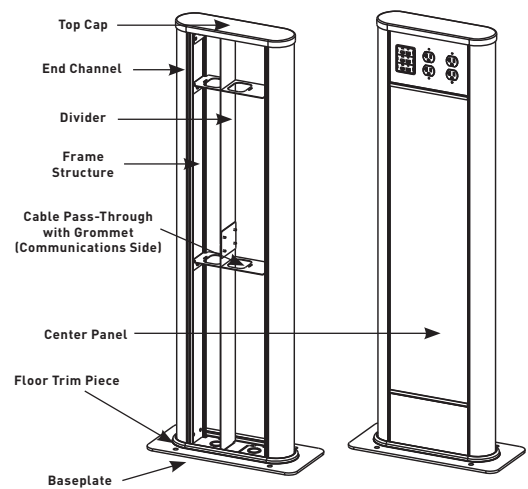

Small Vista Point5

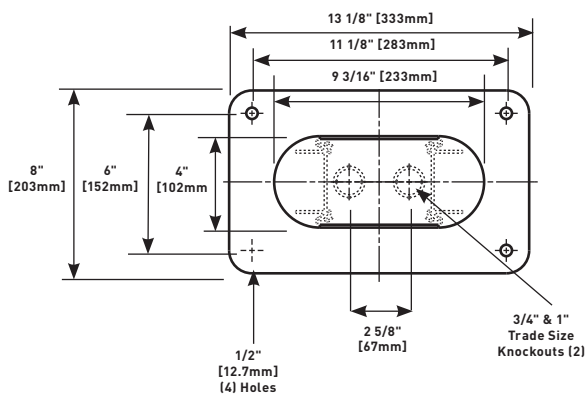

Large Vista Point5

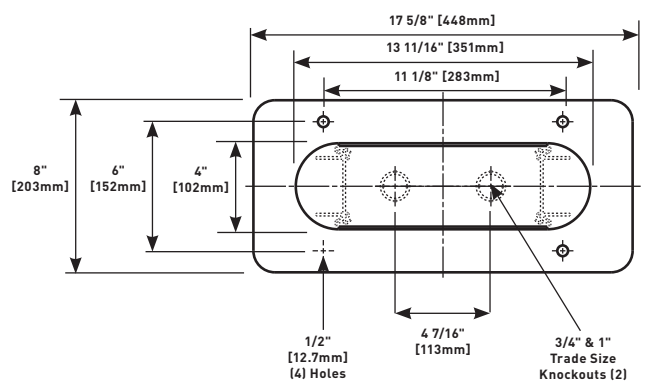

VISTA POINT5™ ARCHITECTURAL COLUMNS

Options for Fill Capacity

Vista Point5 Wire Fill Capacity for Communication

	CABLE/WIRE SIZE	O.D.		LARGE CENTER	SMALL 1/2 CENTER	LARGE 1/2 CENTER
		Inches	[mm]			
Unshielded Twisted Pair	2-pair, 24 AWG, Cat 3	0.140	[3.6]	80	131	94
	3-pair, 24 AWG, Cat 3	0.150	[3.8]	68	114	82
	4-pair, 24 AWG, Cat 3	0.190	[4.8]	44	71	51
	25-pair, 24 AWG, Cat 3	0.410	[10.4]	8	15	11
	4-pair, 24 AWG, Cat 5e	0.220	[5.6]	32	53	38
	4-pair, 24 AWG, Cat 6	0.250	[6.3]	24	41	29
Shielded Twisted Pair	Type 1, 22 AWG	0.390	[9.9]	8	16	12
	Type 2, 22 AWG	0.465	[11.8]	4	11	8
	Type 3, 22 AWG	0.245	[6.2]	24	42	30
Coaxial	RG58/U, 20 AWG	0.195	[5.0]	40	67	48
	RG58/U, 22 AWG	0.242	[6.1]	24	43	31
	RG6/U, 22 AWG	0.242	[6.1]	24	43	31
	RG6/U, 18 AWG	0.270	[6.9]	20	25	25
Twinaxial	100 Ohm	0.330	[8.4]	12	23	71
Fiber Optic		0.180	[4.6]	44	71	51

NOTE: Capacity range is calculated at 40% of raceway area as stated in a proposed revisions to the Commercial Building Standard for Telecommunication Pathways & Spaces, EIA/TIA-569. Actual wire fill capacity may vary based on applications, cable types, and number, as well as type of fittings. (Fittings may cause additional variances to the fill capacity.)

Vista Point5 Wire Fill Capacity for Power

WIRE SIZE THHN/THWN	6 AWG	8 AWG	10 AWG	12 AWG	14 AWG
Small 1/2 Center	7	9	16	26	35
Large 1/2 Center	7	9	16	26	35

Vista Point5 Architectural Columns Component Data

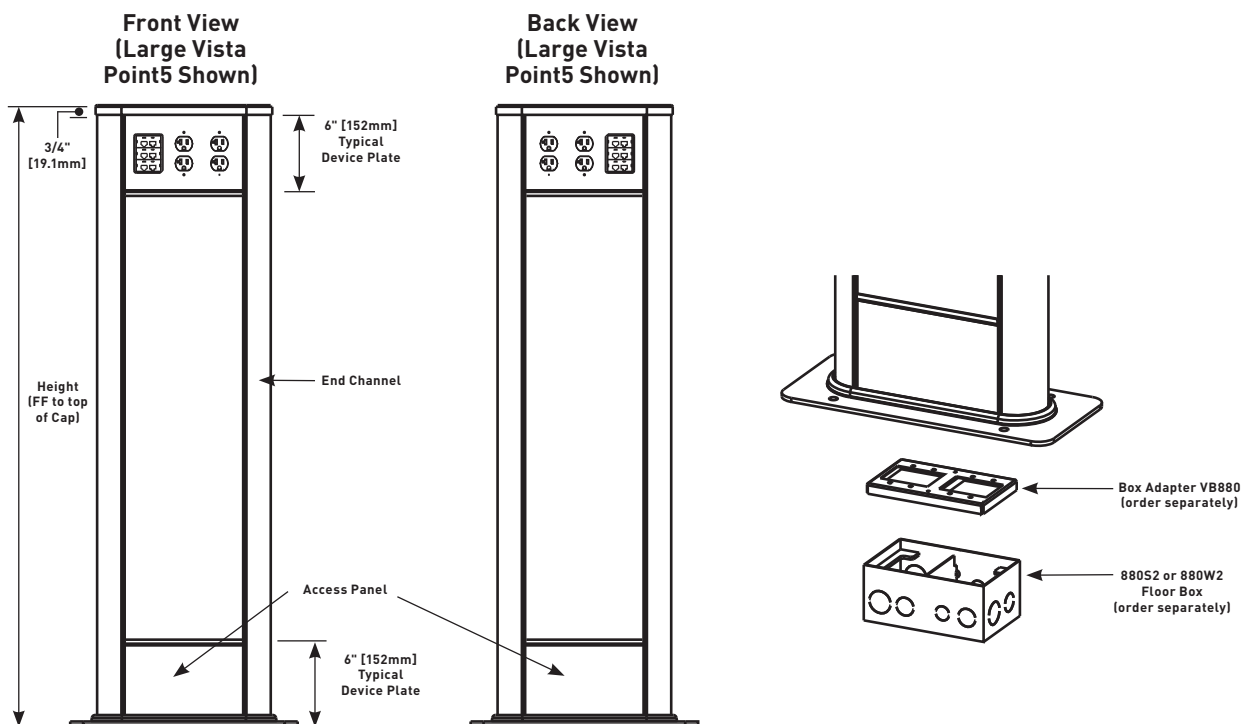

VISTA POINT5™ ARCHITECTURAL COLUMNS

Options for Fill Capacity

Vista Point5 Architectural Columns In-Stock Columns Ordering Information

VSP5662345 Small Points Column

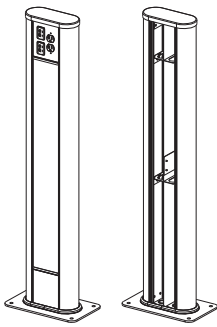

Small, round, 36" [914mm] high, anodized aluminum. Has four adapter adapters for Wiremold Open System communication modules, or Ortronics® Series II or TracJack devices. Two 20A Duplex receptacles located 32 1/4" [819mm] above floor.

VLP5662345 Large Points Column

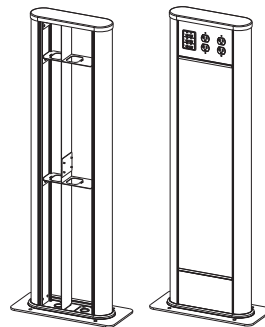

Large, round, 36" [914mm] high, anodized aluminum. Has two adapter adapters for Wiremold Open System communication modules, or Ortronics® Series II or TracJack devices. Four 20A Duplex receptacles located 32 1/4" [819mm] above floor.

VF	66					
Prefix:	Size:	End Channel:	End Channel Color:	Adapter:	Device/Adapter Color:	Height:
Frame = VF	Small = S Large = L	Small = S Round = 66 Large = L			Light Gray = GY White = WH Ivory/ Lt. Almond = IV Black = BK No Device/Adapter = ZZ	24" [607m] from finished Floor = 24 Up to 84" [2134mm] from finished Floor = 84

COLOR - REFERENCE	CODE
White	= 3333
Black	= 9999
Ivory	= 5555
No Color - Anodized Aluminum	= 2345
Warm White - Steelcase 4700	= 3136
Moss - Steelcase 4722	= 5169
Lt. Tone - Herman Miller LT	= 2486
Mist - Steelcase 4606	= 5895
GSA Lt. Blue - GSA 25183	= 5911
Woodrose - Steelcase 4601	= 6137
Slate - Steelcase 4726	= 6142
Light Blue - Shaw Walker A751	= 1988
Greytone - Haworth - G	= 2884

Furniture Feed	= FF	AV Device Plates
Data Device Plates - Ortronics® Series II or TracJack Adapters	= RT*	Extron® Electronics MAAP - (Has openings for 8 Legrand AVIP or Extron MAAP Modules.)
Open System Adapters	= CM*	1 MAB Adapter included.) = EM
* RT and CM options include one each electrical device plate with spec grade duplex receptacle(s), single 120V circuit and communications plate with adapter(s) installed.		Extron® Electronics AAP - (Has openings for 6 AAP Modules. 1 MAB Adapter included.) = EA
Duplex receptacles are located at 27" [686mm] above the finish floor.		Crestron® Quick Media - (Has openings for 1 two gang or 2 single gang wall plates. 1 MAAP Adapter included.) = CR
Communications modules are located at 21" [533mm] above the finish floor.		



A Vista Point5 installation provides unobtrusive access to power and communication services in a conference room.

VISTA POINT5™ ARCHITECTURAL COLUMNS

Vista Point5 Architectural Columns Center Panel Options Ordering Information

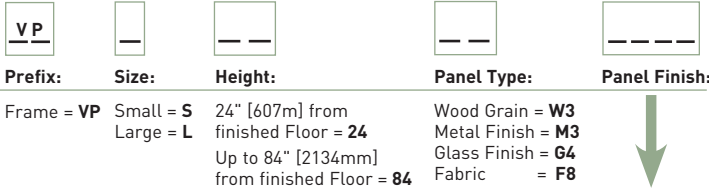

COLOR - REFERENCE	CODE	COLOR - REFERENCE	CODE	COLOR - REFERENCE	CODE
Aluminum:		Woodgrain Laminate:		Mirror Aluminum	= 2021
White	= 3333	Amber Cherry	= 4407	Matte Footplate	= 2046
Black	= 9999	Mahogany	= 4410	Light Hammer Copper	= 2121
Ivory	= 5555	Maple Fusion	= 4401	Double Brushed Aluminum	= 2171
No Color - Anodized Aluminum	= 2345	Shaker Cherry	= 4408	Fabric:	
Warm White - Steelcase 4700	= 3136	Fonhill Pear	= 4406	Quartz	= 3805
Moss - Steelcase 4722	= 5169	Congo Spruce	= 4451	Lavender Natural	= 4055
Lt. Tone - Herman Miller LT	= 2486	Copper Bubinga	= 4456	Blue Neutral	= 4105
Mist - Steelcase 4606	= 5895	Natural Pear	= 4411	Wedgewood	= 1505
GSA Lt. Blue - GSA 25183	= 5911	Biltmore Cherry	= 4413	Grey Mix	= 2385
Woodrose - Steelcase 4601	= 6137	Asian Sun	= 4467	Lake	= 0995
Slate - Steelcase 4726	= 6142	Metal Laminate:		Malibu	= 0375
Light Blue - Shaw Walker A751	= 1988	Vertical Corrugated Matte Aluminum	= 4748	Globe	= 0245
Greystone - Haworth - G	= 2884	Ragged Copper	= 1999	Flax	= 0615
				Daylight Blue	= 0305

NOTE: These are suggested colors. If there are other colors not indicated here, send in a color chip as most colors can be matched.

Device Plate Part Number Configurator

— — — — **— — — —** **— —** **—**

Base: **Plate Color:** **Adapter Color:** **Orientation:**

Enter Catalog Number from above choices Refer to color list on page 4, enter 4-digit code Light Gray = GY White = WH Ivory/Lt. Almond = IV Black = BK No Device Adapter = ZZ Left = L Right = R

VISTA POINT5™ ARCHITECTURAL COLUMNS

Vista Point5 Architectural Columns Add-On Plates for Large Frame Vista Series Ordering Information

VL2A Device Cover

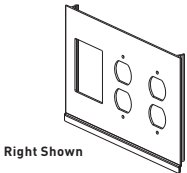

Right Shown

Has two cutouts for duplex receptacles and one adapter for Wiremold CM Series Open Systems communication modules, and Ortronics® Series II or TracJack devices.

VB880 Adapter Plate

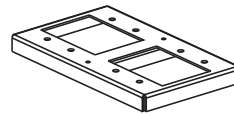

Adapts Vista Point5 to 880 Series Floor Boxes.

VLCR** AV Device Cover

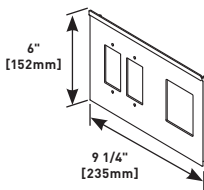

Has openings for one (1) two-gang or two (2) single-gang Crestron® Quick Media wall plate(s) and one mini adapter (included). Standard color/material is anodized aluminum or black.

VLEAP5 AV Device Cover

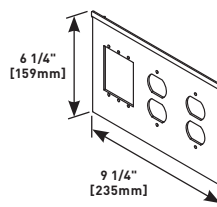

Has two (2) duplex receptacle cutouts and openings for three (3) Extron® Electronics AAP modules. Standard color/material is anodized aluminum or black.

VLEA** AV Device Cover

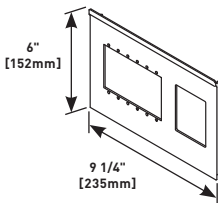

Has openings for six (6) Extron® Electronics AAP modules and one mini adapter (included). Standard color/material is anodized aluminum or black.

VLEMP5 AV Device Cover

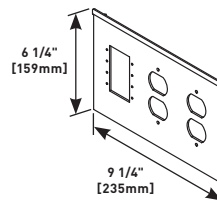

Has two (2) duplex receptacle cutouts and openings for four (4) Legrand AVIP Extron® Electronics MAAP modules. Standard color/material is anodized aluminum or black.

VLEM** AV Device Cover

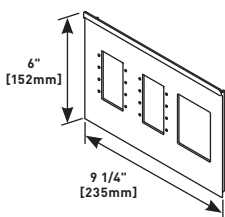

Has openings for eight (8) Legrand AVIP or Extron® Electronics MAAP modules and one mini adapter (included). Standard color/material is anodized aluminum or black.

*Refer to the list of colors in the chart on the previous page for the four-digit code number.

**Products are ETL Listed.

NOTE: VLCR, VLEA or VLEM Device Covers, are only for use for A/V connectivity. No power outlets are accessible or available with these covers.

VISTA POINT5™ ARCHITECTURAL COLUMNS

Vista Point5 Architectural Columns Add-On Plates for Small Frame Vista Series Ordering Information

VS1A Device Cover



Right Shown

Has one cutout for duplex receptacle and two adapters for Wiremold CM Series Open Systems communication modules, and Ortronics® Series II or TracJack devices.

VB880 Adapter Plate

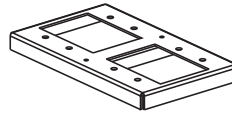

Adapts Vista Point5 to 880 Series Floor Boxes.

VSEA** AV Device Cover

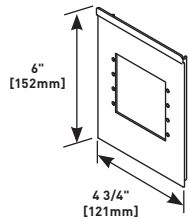

Has openings for four (4) Extron® Electronics AAP modules. Standard color/material is anodized aluminum or black.

VSEAP5 AV Device Cover

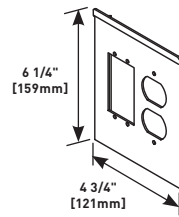

Has one (1) duplex receptacle cutout and openings for two (2) Extron® Electronics AAP modules. Standard color/material is anodized aluminum or black.

VSCR** AV Device Cover

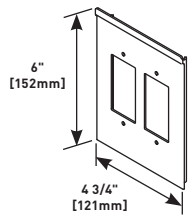

Has openings for one (1) two-gang or two (2) single-gang Crestron® Quick Media wall plate(s). Standard color/material is anodized aluminum or black.

VSEMP5 AV Device Cover

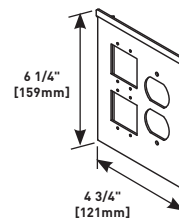

Has one (1) duplex receptacle cutout and openings for four (4) Legrand AVIP or Extron® Electronics MAAP modules. Standard color/material is anodized aluminum or black.

VSEM** AV Device Cover

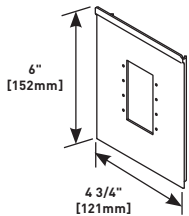

Has openings for four (4) Legrand AVIP or Extron® Electronics MAAP modules. Standard color/material is anodized aluminum or black.

*Refer to the list of colors in the chart on the previous page for the four-digit code number.

**Products are ETL Listed.

NOTE: If selecting VSEA, VSCR or VSEM Device Covers, such covers will allow for only A/V connectivity. No power outlets are accessible or available with these covers.

TELE-POWER® POLES



Tele-Power® Poles provides a cost-effective, configurable solution for distributing power and communication services to open spaces.



CODE REFERENCE

cULus Listed Multioutlet Assemblies: File E15191, E178348 Guide PVGT

Raceway Fittings: File E41751 Guide RJPR

Accessories: File E53857 Guide RVUR

Meets Article 380 & 386 of NEC.

Steel Tele-Power Poles Ordering Information

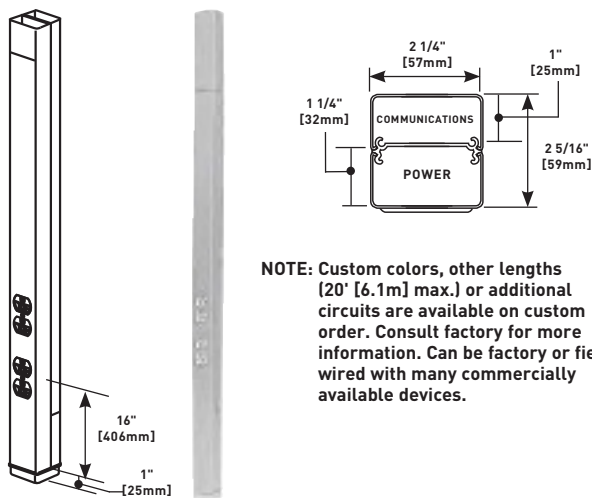

NOTE: Custom colors, other lengths (20' [6.1m] max.) or additional circuits are available on custom order. Consult factory for more information. Can be factory or field wired with many commercially available devices.



Tele-Power Poles provide a wide range of options for distributing services from overhead systems to open space office, commercial, and retail areas.

COLOR OPTIONS



25DTP/DTC Series Tele-Power Poles are now available in two colors: ivory and designer gray. Custom color options are also available. Consult the factory for more information.

TELE-POWER® POLES

Steel Tele-Power Poles

25DTP Series Tele-Power Poles Wire Fill Capacities

CATALOG NUMBER	NO. & TYPE OF POWER OUTLETS	POLE HEIGHT		FINISH	WIRE SIZE THHN/THWN		CAT 5		CAT 6		RG58/U		RG62A/U		RG62/U	
		Inches	mm		#10	#12	0.22" [5.6mm] 20%*	0.25" [6.3mm] 40%**	0.195" [5.0mm] 20%*	0.242" [6.1mm] 40%**	0.270" [6.9mm] 20%*	0.270" [6.9mm] 40%**				
25DTP-4	Two Duplex Receptacles (20A, 125V)	10' 5" [3.175m]		Ivory/Gray	10	15	10	19	9	17	13	25	8	16	7	13
25DTP-412		12' 5" [3.780m]		Ivory/Gray	10	15	10	19	9	17	13	25	8	16	7	13
25DTP-415		15' 5" [4.700m]		Ivory/Gray	10	15	10	19	9	17	13	25	8	16	7	13
25DTP-E10		10' 5" [3.175m]		Ivory/Gray	10	15	10	19	9	17	13	25	8	16	7	13
25DTP-4 D		10' 5" [3.175m]		Ivory/Gray	10	15	10	19	9	17	13	25	8	16	7	13
	Two Duplex Receptacles (20A, 125V), One Dedicated/ Isolated & One Standard Branch Circuit															
25DTP-4ACT	Two Duplex Receptacles (20A, 125V), One Communications Insert Mounting Adapter, One Dual Cat 5e Insert, Two Blank Inserts & Labeling Supplies															

*20% cable fill is calculated to approximate reduction in cable capacity due to connectors mounted within pole section that may restrict cross-sectional areas.

**40% cable fill is the maximum designed cable fill based on a proposed revision to TIA/EIA 569-A.

25DTP Series Tele-Power Poles Ordering Information

25DTP-4, 25DTP-4-DG Tele-Power Pole

25DTP-412, 25DTP-412-DG, 25DTP-415, 25DTP 415-DG

Two-compartment pole (power and communications). Nominal material thickness .030" [0.8mm]. Ivory or gray boot base. Factory wired with fed-spec general grade 20A 125V duplex style receptacles. An 8" [203mm] cover at top front of pole is removable for making power wiring connections. KOs provided in removable cover for RJ11/RJ45 and modular furniture communication connectors. Mounting hardware, entrance end plate and two ceiling trim plates furnished. Available in standard lengths of 10' 5" [3.2m] (25DTP-4), 12' 5" [3.8m] (25DTP-412), and 15' 5" [4.7m] (25DTP-415). Also increase the length of any 25 Series pole with the 25DTC-E5 Tele-Power Pole Extender.

25DTP-4ACT, 25DTP-4ACT-DG Tele-Power Pole

Identical to 25DTP-4 except with one communications insert mounting adapter, one dual Cat 5e insert, two blank inserts and labels.

25DTP-4D, 25DTP-4D-DG Tele-Power Pole

Identical to 25DTP-4 except has one 20A 125V dedicated/isolated ground duplex receptacle and one 20A 125V standard duplex receptacle.

25DTP-E10, 25DTP-E10-DG Tele-Power Pole

Two sections of a two-compartment (power and communication) pole (5' 4" [1.626m] base + 5' [1.524m] extender) assemblies to form a 10' 4" [3.148m] pole. Nominal material thickness .040" [1.0mm]. Ivory or gray boot base. Factory wired with fed-spec general grade 20A 125V duplex style receptacles. An 8" [203mm] cover at top front (power side) of pole is removable for making power wiring connections. KOs provided in removable cover for RJ11/RJ45 and modular furniture communication connectors. Mounting hardware, entrance end plate and two ceiling trim plates furnished.

25DTP-4-C, 25DTP-4-DG-C Tele-Power Pole (Canada Only)



25DTP-412-C, 25DTP-412-DG-C, 25DTP-415-C, 25DTP-415-DG-C

Two-compartment pole (power and communications). Nominal material thickness .030" [0.8mm]. Ivory or gray boot base. Factory wired with fed-spec general grade 15A 125V duplex style receptacles. An 8" [203mm] cover at top front of pole is removable for making power wiring connections. KOs provided in removable cover for RJ11/RJ45 and modular furniture communication connectors. Mounting hardware, entrance end plate and two ceiling trim plates furnished. Available in standard lengths of 10' 5" [3.2m] (25DTP-4), 12' 5" [3.8m] (25DTP-412), and 15' 5" [4.7m] (25DTP-415). Comes with a 10' [3.0m] cord. Also increase the length of any 25 Series pole with the 25DTC-E5 Tele-Power Pole Extender.

TELE-POWER® POLES

Steel Tele-Power Poles

Tele-Power Express Poles and Tele-Power Pole Extenders

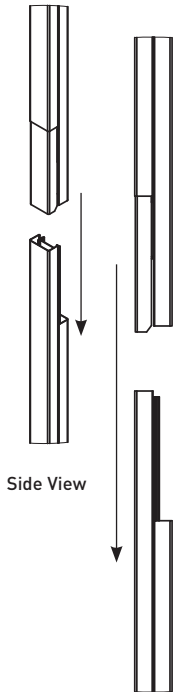

Side View

Easier jobsite handling + easier and more reliable shipping options Wiremold Tele-Power Express Pole and Tele-Power Pole Extender were introduced to make creating or altering poles easy. The TP Express Pole allows you to create a single 10' pole using two sections, which are easy to ship and easy to assemble on the jobsite.

Configurability of the TPP Extenders allows for on site modifications to accommodate a variety of ceiling heights. TP Express Poles and TPP Extenders can ship UPS or air freight. TPP Extenders have been designed to be compatible with existing poles, so relocating is literally, a snap – quick, easy, and done with in-stock components. Existing poles can also be retrofit/extended to be used in a location with a higher ceiling using TPP Extenders.

When you need a reliable open space power and/or data solution in the shortest amount of time, no matter the length needed, think Legrand/Wiremold TP Express Poles and TPP Extenders.

NOTE: When being used to modify or extend standard poles, the poles can only be modified or extended in 5' [1.524m] increments.



NOTE: No Tele-Power Pole can have more than three separate sections. 25DTP/C Series Poles cannot be combined with 25DTP/C-E10. The 25DTC-E5 can be used only to extend regular 25DTP/C poles.

TPP Extenders Ordering Information

25DTP-E10, 25DTP-E10-DG Tele-Power Express Pole

Two sections of a two-compartment (power and communication) pole (5' 4" [1.62m] base + 5' [1.52m] extender) assembles to form a 10' 4" [3.14m] pole. Nominal material thickness .040" [1.0mm]. Ivory or gray boot base. Factory wired with fed-spec general grade 20A 125V duplex style receptacles. An 8" [203mm] cover at top front (power side) of pole is removable for making power wiring connections. KOs provided in removable cover for RJ11/RJ45 and modular furniture communication connectors. Mounting hardware, entrance end plate and two ceiling trim plates furnished.

25DTC-E5, 25DTC-E5-DG Blank Steel Tele-Power Pole Extender

Two-compartment extender mounts onto existing 25DTP or 25DTC series pole. Nominal material thickness .040" [1.0mm]. Furnished unwired without outlets. Use existing pole mounting hardware, entrance end plate and ceiling trim plate. Available in 5' [1.52m] length. Can be cut to desired length.

25DTC-E10, 25DTC-E10-DG Blank Steel Tele-Power Express Pole

Two sections of a two-compartment pole (5' 4" [1.62m] base + 5' [1.52m] extender) assembles to form a 10' 4" [3.14m] pole. Nominal material thickness .040" [1.0mm]. Ivory boot base. Furnished unwired without outlets. Mounting hardware, entrance end plate and ceiling trim plate furnished. An 8" [203mm] cover at top front of pole is removable for making power wiring connections.

25AM-AP Accessory Pack

Accessory pack for 25 Series and AM Series poles. Contains ceiling trim plate, gripper pad, bracket, grommet, and end plate.

TELE-POWER® POLES

Steel Tele-Power Poles

30TP Series Tele-Power Poles Wire Fill Capacities

CATALOG NUMBER	NO. & TYPE OF POWER OUTLETS	POLE HEIGHT		FINISH	WIRE SIZE THHN/THWN		CAT 5		CAT 6		RG58/U		RG62A/U		RG62/U	
		Inches	mm		#10	#12	0.22" [5.6mm]	0.25" [6.3mm]	0.195" [5.0mm]	0.242" [6.1mm]	0.270" [6.9mm]	20%*	40%**	20%*	40%**	
30TP-2V	Two Duplex Receptacles (20A, 125V)	10' 5"	[3.175m]	Ivory	9	14	16	31	13	26	20	40	13	25	10	20
30TP-212V	Two Duplex Receptacles (20A, 125V)	12' 5"	[3.780m]	Ivory	9	14	16	31	13	26	20	40	13	25	10	20
30TP-4V	Two Duplex Receptacles (20A, 125V)	10' 5"	[3.175m]	Ivory	18	18	19	37	15	30	24	47	15	30	12	24
30TP-412V		12' 5"	[3.780m]	Ivory	18	18	19	37	15	30	24	47	15	30	12	24
30TP-4V3S2		10' 5"	[3.175m]	Ivory	18	18	19	37	15	30	24	47	15	30	12	24
30TP-412V3S2		12' 5"	[3.780m]	Ivory	18	18	19	37	15	30	24	47	15	30	12	24

* 20% cable fill is calculated to approximate reduction in cable capacity due to connectors mounted within pole section that may restrict cross-sectional areas.
 ** 40% cable fill is the maximum designed cable fill based on a proposed revision to TIA/EIA 569-A.

30TP Series Tele-Power Poles Ordering Information

30TP-2V

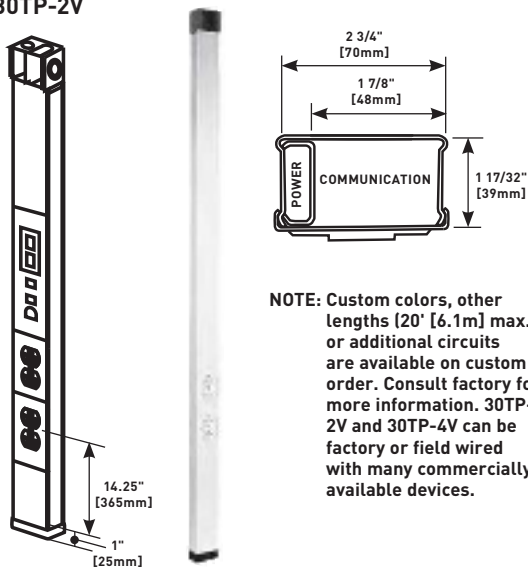

NOTE: Custom colors, other lengths (20' [6.1m] max.) or additional circuits are available on custom order. Consult factory for more information. 30TP-2V and 30TP-4V can be factory or field wired with many commercially available devices.

30TP-4V

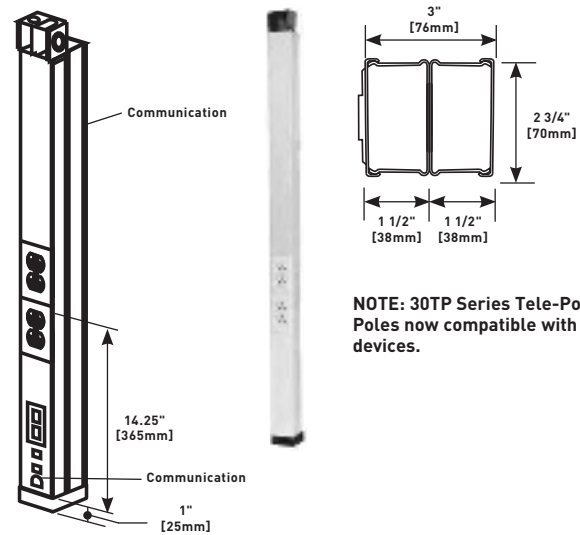

NOTE: 30TP Series Tele-Power Poles now compatible with A/V devices.

30TP-2V Tele-Power Pole

Two-compartment pole (power and communications). Nominal material thickness .040" [1.0mm]. Length 10'5" [3.2m]. Factory wired with two specification grade 20A, 125V duplex receptacles. Mounting hardware, entrance end fitting, and ceiling trim plate furnished.

30TP-4V3S2 Tele-Power Pole

Two duplex receptacles (20A, 125V). One Ortronics Series II adapter. One Ortronics Series II dual Cat 5e insert, two blank inserts and labeling supplies. Maximum ceiling height 10'5" [3.2m].

30TP-212V Tele-Power Pole

Identical to 30TP-2V except length is 12'5" [3.8m]. Maximum ceiling height 12' [3.7m].

30TP-412V Tele-Power Pole

Same as 30TP-4V except length is 12'5" [3.8m]. Maximum ceiling height 12'5" [3.8m].

30TP-4V Tele-Power Pole

Two-compartment pole (one power; one communication with cross over below power devices). Nominal material thickness .040" [1.0mm]. Length 10'5" [3.2m]. Factory wired with two specification grade 20A, 125V duplex receptacles. Mounting hardware, entrance end fitting, and ceiling trim plate furnished.

30TP-412V3S2 Tele-Power Pole

Two duplex receptacles (20A, 125V). One Ortronics Series II adapter. One Ortronics Series II dual Cat. 5e insert, two blank inserts and labeling supplies. Maximum ceiling height 12'5" [3.8m].

TELE-POWER[®] POLES

Aluminum Tele-Power Poles

Aluminum Tele-Power Poles Wire Fill Capacities

CATALOG NUMBER	NO. & TYPE OF POWER OUTLETS	POLE HEIGHT		FINISH	WIRE SIZE THHN/THWN		CAT 5		CAT 6		RG58/U		RG62A/U		RG62/U	
		Inches	mm		#10	#12	0.22" [5.6mm] 20%*	0.25" [6.3mm] 40%**	0.195" [5.0mm] 20%*	0.242" [6.1mm] 40%**	0.270" [6.9mm] 20%*	0.270" [6.9mm] 40%**				
AMDTP-4	Two Duplex Receptacles (20A, 125V)	10' 5"	[3.175m]	Satin Anodized Aluminum	10	15	10	19	8	16	13	25	8	16	7	13
AMDTP-412		12' 5"	[3.780m]		10	15	10	19	8	16	13	25	8	16	7	13
AMDTP-415		15' 5"	[4.700m]		10	15	10	19	8	16	13	25	8	16	7	13
AMDTP-4D	Two Duplex Receptacles (20A, 125V), One Dedicated/Isolated & One Standard Branch Circuit	10' 5"	[3.175m]	Satin Anodized Aluminum	10	15	10	19	8	16	13	25	8	16	7	13
ALTP-20W	Four Single Receptacles	10' 4"	[3.150m]	Painted Office White	-	-	2	5	2	4	3	6	2	4	1	3
ALTP-2P	Four Single Receptacles	10' 4"	[3.150m]	Polished Anodized Aluminum	-	-	2	5	2	4	3	6	2	4	1	3
ALTP-2S	Four Single Receptacles	10' 4"	[3.150m]	Polished Anodized Aluminum	-	-	2	5	2	4	3	6	2	4	1	3

* 20% cable fill is calculated to approximate reduction in cable capacity due to connectors mounted within pole section that may restrict cross-sectional areas.
 ** 40% cable fill is the maximum designed cable fill based on a proposed revision to TIA/EIA 569-A.

Aluminum Tele-Power Poles

When looking to dress up a vertical solution, Tele-Power Poles with a satin anodized aluminum finish in either rectangular or round styles can provide the answer. Light weight aluminum construction makes these poles easy to install and maneuver on the job site. Available prewired with electrical devices or blank to drop services feeding another wire and cable management system, such as electrified modular furniture. A full range of accessories enables field configurability, or have them delivered to your specifications.

AMDTP-4

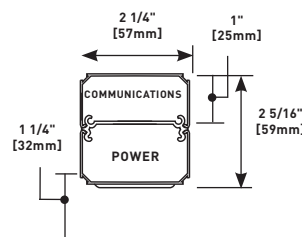

ALTP

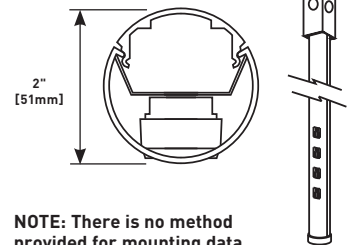

AMDTP-4 Series Tele-Power Poles Ordering Information

AMDTP-4 Tele-Power Pole

AMDTP-4, AMDTP-412, AMDTP-415

Two-compartment pole (power and communications). Nominal material thickness .050" [1.8mm]. Length: 10'5" [3.2m]. Factory wired with 20A 125V fed-spec general grade duplex style receptacles. An opening for communication and a 1/2" [12.7mm] hole for power is provided at top. The 8" [203mm] cover at top front of pole is removable for making power wiring connections. Communication KOs provided for RJ11/RJ45 and modular furniture connectors. Mounting hardware, entrance end fitting, and ceiling trim plates furnished. Anodized aluminum finish. Available in standard lengths of 10' 5" [3.2m] (AMDTP-4), 12' 5" [3.8m] (AMDTP-412), and 15' 5" [4.7m] (AMDTP-415).

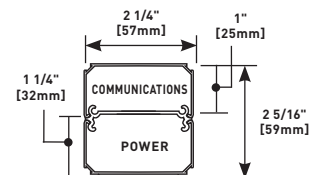

NOTE: Custom colors, other lengths [20' [6.1m] max.] or additional circuits are available on custom order. Consult factory for more information. Can be factory or field wired with many commercially available devices.

TELE-POWER® POLES

Aluminum Tele-Power Poles

AMDTP-4 Series Tele-Power Poles Ordering Information (continued)

AMDTP-4D Tele-Power Pole

Identical to AMDTP-4 except factory wired with one 20A 125V dedicated/ isolated ground duplex receptacle and one standard 20A 125V duplex receptacle.

AMDTP-4-C, AMDTP-412-C, AMDTP-415-C Tele-Power Pole



Available in Canada Only. Two-compartment pole (power and communications). Nominal material thickness .050" [1.8mm]. Length: 10'5" [3.2m]. Factory wired with 15A 125V fed-spec general grade duplex style receptacles. An opening for communication and a 1/2" [12.7mm] hole for power is provided at top. The 8" [203mm] cover at top front of pole is removable for making power wiring connections. Communication KOs provided for RJ11/RJ45 and modular furniture connectors. Mounting hardware, entrance end fitting, and ceiling trim plates furnished. Anodized aluminum finish. Maximum ceiling height 10' [3m]. Comes with a 10' [3.0m] cord. Available in standard lengths of 10'5" [3.2m] (AMDTP-4-C), 12'5" [3.8m] (AMDTP-412-C), and 15'5" [4.7m] (AMDTP-415-C).

ALTP Series Tele-Power Poles Ordering Information

ALTP-2S Tele-Power Pole

Satin anodized extruded aluminum pole. Nominal wall thickness .060" [1.5mm]. Length 10'5" [3.2m]. Two-compartment (power and communication channels) Factory wired with four 15A 125V NEMA 5-15R devices. Provided with one 1/2" [12.7mm] trade size KO in cover at base for communications. T-bar mounting hardware, ceiling trim kit, and feed box furnished.

ALTP-20W Tele-Power Pole

Identical to ALTP-2S, with painted office white finish.

ALTP-2P Tele-Power Pole

Identical to ALTP-2S, with polished aluminum anodized finish.

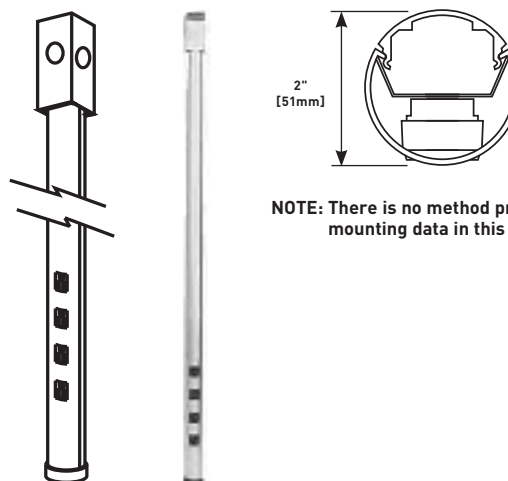

NOTE: There is no method provided for mounting data in this pole.

TELE-POWER® POLES

Tele-Power Poles Device Plate Covers and Accessories Ordering Information

AMDTP-A, 25DTP-A Add-On Power Cover



Add power receptacles or devices to existing modular Tele-Power Poles. Includes receptacle mounting bracket. Face diameter of single receptacle: 1.38"-1.40" [35mm-36mm].

	COLOR	DIMENSIONS
25DTP-A:	Ivory Steel (25DTP-4)	1" x 2 1/4" x 28" [25mm x 57mm x 711mm]
AMDTP-A:	Anodized Aluminum (AMDTP-4)	

AMDTP-B, 25DTP-B Add-On Power Cover



Add power receptacles or devices to existing modular Tele-Power Poles. Includes receptacle mounting bracket.

	COLOR	DIMENSIONS
25DTP-B:	Ivory Steel (25DTP-4)	1" x 2 1/4" x 28" [25mm x 57mm x 711mm]
AMDTP-B:	Anodized Aluminum (AMDTP-4)	

AMDTP-L, 25DTP-L Add-On Power Cover



Add power receptacles or devices to existing modular Tele-Power Poles. Includes receptacle mounting bracket.

	COLOR	DIMENSIONS
25DTP-L:	Ivory Steel (25DTP-4)	1" x 2 1/4" x 28" [25mm x 57mm x 711mm]
AMDTP-L:	Anodized Aluminum (AMDTP-4)	

30TP-A Single Receptacle Cover



Single receptacle cover for field installation of receptacles with face diameters of 1.38"-1.40" [35mm-36mm]. G3007C Device Bracket included. Ivory finish.

30TP-B Duplex Receptacle Cover



For installations of 15A and 20A duplex receptacles. G3007C Device Bracket included. Ivory finish.

30TP-C Single Gang Cover



Accepts up to 30A shallow-style device and flushplate. G3007C Device Bracket included. Ivory finish. Used to mount industry standard straight and angled communication faceplates.

30TP-J Single Receptacle Cover



For field installation of single receptacles with face diameters of 1.56" [40mm]. G3007C Device Bracket included. Ivory finish.

30TP-L Rectangular Device Cover



Rectangular faceplate to accommodate Sentrex surge receptacle, GFCI and other decorator style devices. G3007C Device Bracket included. Ivory finish.

30TP-AAP Add-on A/V Cover



Accepts three Extron® Electronics AAP plates 12" L x 2.75" W [305mm x 70mm]. Includes three adapters to accommodate Ortronics® or Wiremold Open System devices.

30TP-MAAP Add-on A/V Cover

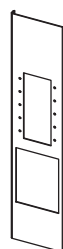

Accepts five Legrand AVIP or Extron® Electronics MAAP plates 12" L x 2.75" W [305mm x 70mm]. Includes three adapters to accommodate Ortronics® or Wiremold Open System devices.

TELE-POWER® POLES

Tele-Power Poles Installation Details

1. Remove ceiling panel. If necessary to avoid overhead obstructions, shorten Tele-Power Pole prior to installing.

(NOTE: Pole must extend above mounting bracket, with the bottom of pole resting on the floor.)

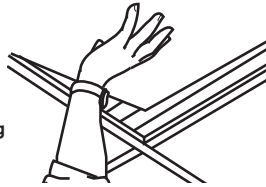

2. Align pole vertically (using a level) with top of pole resting against ceiling T-bar. After aligning pole, anchor gripper pad to hard surface floor with sticky pad (furnished) or two screws (not furnished).

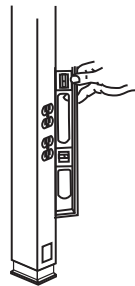

3. Assemble pole mounting bracket on T-bar at approximate location as shown. Tighten bracket, locking thumbscrew loosely so bracket is free to slide on T-bar.

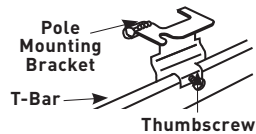

4. Place pole in mounting bracket (again check vertical alignment with level) and tighten T-bar, locking thumbscrew, and pole locking thumbscrew. If additional support is desired, bracket may be secured to true ceiling with 3/8" [9.5mm] threaded rod (not furnished).

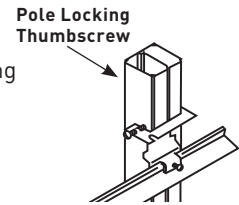

5. Notch ceiling tile as shown and install plates (Fig. 1). Tabs should be in a vertical position as trim plate is aligned around pole (Fig. 2). Following alignment, tabs should be bent to form a secure grip over ceiling tile (Fig.3).

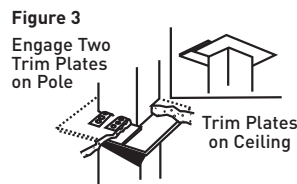
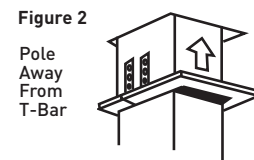
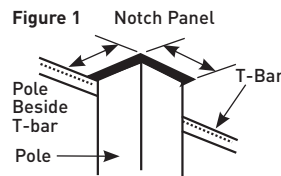

Field Modifications for Tele-Power Poles

MODIFICATION	TELE-POWER POLE SERIES									
	30TP-4V	30TC-4V	30TP-2V	30TC-2V	25DTP-4	25DTP-4D	25DTC-4	AMDTP-4	AMDTP-4D	AMTC-4
Can the receptacles in the standard pole be rewired in order to have a two circuit pole with standard duplexes?	Yes	N/A	Yes	N/A	No	Yes	N/A	No	Yes	N/A
Can the receptacles in the standard pole be replaced with other types? (i.e. Hospital Grade, TVSS, GFCI, etc.)	Yes - Using the proper device cover	N/A	Yes - Using the proper device cover	N/A	Yes - with 2507C Bracket & only with NEMA duplex receptacles	Yes - only with NEMA duplex receptacles	N/A	Yes - with 2507C Bracket & only with NEMA duplex receptacles	Yes - only with NEMA duplex receptacles	N/A
Can receptacles be added to blank poles?	N/A	Yes	N/A	Yes - Using the proper device cover	N/A	N/A	Yes	N/A	N/A	Yes
Can blank poles be used for furniture feed applications by field punching KO's on poles for power and voltage?	N/A	Yes	N/A	Yes	N/A	N/A	Yes	N/A	N/A	Yes
Can more than one add-on device cover be used?	N/A	N/A	N/A	N/A	Yes	Yes	N/A	Yes	Yes	N/A
Can receptacles be installed in both sides of the pole?	Yes - Power only on both sides	Yes - Power only on both sides	N/A	N/A	No	No	N/A	No	No	N/A
Can poles be field cut for use in lower ceiling applications?	Yes*	Yes*	Yes*	Yes*	Yes*	Yes*	Yes*	Yes*	Yes*	Yes*
Can poles be mounted to hard or open ceilings?	Yes*	Yes*	Yes*	Yes*	Yes*	Yes*	Yes*	Yes*	Yes*	Yes*

* Review instruction sheet for instructions for cutting poles.

** Pole housing cannot be penetrated. Ceiling mounting hardware must provide firm support and must be supplied by installer.

NOTE: All receptacles, additions, rewiring and other electrical modifications must be made by a qualified electrician in accordance with the NEC or other applicable local codes and adhering to the wire fill capacity charts for the respective pole.

VERTICAL DROP POLES



Vertical Drop Poles distribute power and communication services from overhead wiring systems to open spaces.

CODE REFERENCE

cULus Listed Multioutlet Assemblies:
File E15191, E178348 Guide PVGT
Raceway Fittings: File E41751 Guide RJPR
Accessories: File E53857 Guide RVUR
Meets Article 380 & 386 of NEC.

Vertical Drop Poles Wire Fill Capacities

CATALOG NUMBER	POLE HEIGHT		FINISH	CAT 5		CAT 6		RG58/U		RG62A/U		RG62/U	
	Inches	mm		0.22" COMP.	[5.6mm] LG. COMP.	0.25" SM. COMP.	[6.3mm] LG. COMP.	0.195" SM. COMP.	[5.0mm] LG. COMP.	0.242" SM. COMP.	[6.1mm] LG. COMP.	0.270" SM. COMP.	[6.9mm] LG. COMP.
25DTC-4	10' 5"	[3.175m]	Ivory/Gray	10	19	9	17	13	25	8	16	7	13
25DTC-412	12' 5"	[3.780m]	Ivory/Gray	10	19	9	17	13	25	8	16	7	13
25DTC-415	15' 5"	[4.700m]	Ivory/Gray	10	19	9	17	13	25	8	16	7	13
25DTC-E10	10' 5"	[3.175m]	Ivory/Gray	10	19	9	17	13	25	8	16	7	13
30TC-2V	10' 5"	[3.175m]	Ivory	N/A	33	N/A	30	N/A	47	N/A	30	N/A	24
30TC-2V212	12' 5"	[3.780m]	Ivory	N/A	34	N/A	31	N/A	48	N/A	31	N/A	25
30TC-4V	10' 5"	[3.175m]	Ivory	37	37	30	30	47	47	30	30	24	24
30TC-4V412	12' 5"	[3.780m]	Ivory	37	37	30	30	47	47	30	30	24	24
30TC-3S2	10' 5"	[3.175m]	Ivory	37	37	30	30	47	47	30	30	24	24
AMTC-4	10' 5"	[3.175m]	Aluminum	19	26	16	22	25	33	16	21	13	17
AMTC-412	12' 5"	[3.780m]	Aluminum	19	26	16	22	25	33	16	21	13	17
AMTC-415	15' 5"	[4.700m]	Aluminum	19	26	16	22	25	33	16	21	13	17
ALTP-20W	10' 4"	[3.150m]	White	10	8	13	8	6					
ALTP-2P	10' 4"	[3.150m]	Aluminum	10	8	13	8	6					
ALTP-2S	10' 4"	[3.150m]	Aluminum	10	8	13	8	6					
NP800C-12-2B	10' 2"	[3.098m]	Aluminum										
NP800C-12-8B	12' 8"	[3.860m]	Aluminum										
NP800C-15-2B	15' 2"	[4.620m]	Aluminum										

VERTICAL DROP POLES

Vertical Drop Steel Tele-Power Poles Ordering Information

25DTC-4 Blank Steel Pole



25DTC-4

25DTC-4-DG, 25DTC-412, 25DTC-412-DG, 25DTC-415, 25DTC-415-DG

Two-compartment pole. Nominal material thickness .040" [1.0mm] Ivory boot base. Furnished unwired without outlets. Mounting hardware, entrance end plate and ceiling trip plates furnished.

Available lengths:
 10'5" [3.2m] (25DTC-4)
 12'5" [3.8m] (25DTC-412)
 15'5" [4.7m] (25DTC-415)

30TC-2V Blank Steel Pole



30TC-2V

30TC-212V, 30TC-215V

Single-compartment pole. Furnished unwired without outlets. Nominal wall thickness .040" [1.0mm]. Mounting hardware, entrance end fitting and ceiling trim plates furnished.

Available lengths:
 10'5" [3.2m] (30TC-2V)
 12'5" [3.8m] (30TC-212V)
 15'5" [4.7m] (30TC-215V)

25DTC-E10 Blank Steel Tele-Power Express Pole

25DTC-E10, 25DTC-E10-DG

Two sections of a two-compartment pole [5'4" [1.63m] base + 5' [1.52m] extender] assembles to form a 10'4" [3.15m] pole. Nominal material thickness .040" [1.0mm]. Ivory boot base. Furnished unwired without outlets. Mounting hardware, entrance end plate and ceiling trip plate furnished. An 8" [203mm] cover at top front of pole is removable for making power wiring connections.

30TC-4V Blank Steel Pole



30TC-4V

30TC-412V, 30TC-415V

Two-compartment pole. Nominal wall thickness .040" [1.0mm]. Mounting hardware, entrance end fitting and ceiling trim plates furnished.

Available lengths:
 10'5" [3.2m] (30TC-4V)
 12'5" [3.8m] (30TC-412V)
 15'5" [4.7m] (30TC-415V)

NOTE: All poles have removable cover sections with KOs for modular jacks and openings to accept modular furniture adapters for communication devices.

Vertical Drop Aluminum Tele-Power Poles Ordering Information

AMTC-4 Blank Aluminum Pole



AMTC-4

AMTC-412, AMTC-415

Two-compartment pole. Nominal material thickness .050" [1.8mm]. Furnished unwired without outlets. Two 8" [203mm] removable covers with KOs for modular jacks and modular furniture communication outlets. Mounting hardware, entrance end plate and ceiling trip plates furnished.

Available lengths:
 10'5" [3.2m] (AMTC-4)
 12'5" [3.8m] (AMTC-412)
 15'5" [4.7m] (AMTC-415)

Custom options: Features such as colors or other lengths (20' [6.1m] maximum) available on custom order.

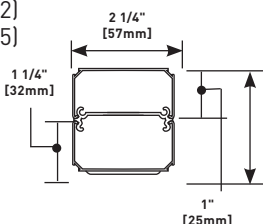

NP800C-10-2B Blank Aluminum Pole



Other heights available – consult factory; 30" [762mm] communication cover with industry standard knockouts.

NP800C-12-2B, NP800C-15-2B

Two-compartment large capacity pole. Furnished unwired without outlets. Box ended with industry sized knockouts. Standard heights:

10'2" [3.1m]
 12'8" [3.9m]
 15'2" [4.6m]

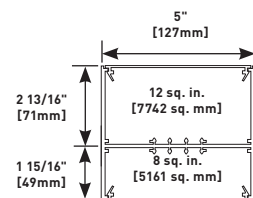

VERTICAL DROP POLES

Vertical Drop Aluminum Tele-Power Poles Ordering Information (continued)

ALTC-2S Blank Round Aluminum Pole

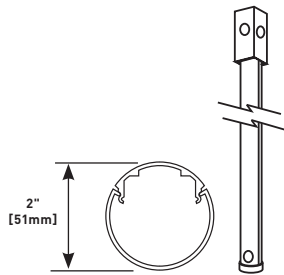

ALTC-20W, ALTC-2P
Nominal wall thickness .060" [1.5mm], length 10'3" [3.1mm]. Provided with one 1/2" [12.7mm] trade size KO at base. T-bar mounting hardware, ceiling trim kit, foot assembly, and grommet included. Feed box not furnished. ALTC-2S has satin anodized finish, ALTC-20W has painted white finish, and ALTC-2P has a polished aluminum finish.

Vertical Drop Tele-Power Poles Accessories Ordering Information

Covers for Communication Connectivity

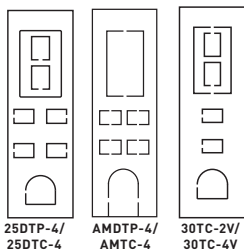

Communication covers for additional voice/data connectors. Each cover includes KOs for four RJ11/RJ45 connectors (.760" x .576" [19.3mm x 14.6mm]), mouse hole for exiting communication cables (grommet furnished).

CAT. NO.	DESCRIPTION
25DTC-CVR	8" [203mm] Cover for 25DTP-4 and 25DTC-4 Series.
30TC-CVR	For 30TP-2V / 30TC-2V and 30TP-4V / 30TC-4V Series. 12" [305mm] long.
AMTC-CVR	For AMDTP-4 and AMTC-4 Series 8" [203mm] long.

TPB Gasketed Box

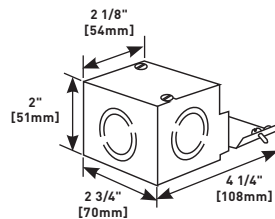

For 25DTP-4 and AMDTP-4 Poles where local codes require that electrical and communications connections be sealed when installed in an air handling plenum.

G3010C Entrance End Fitting

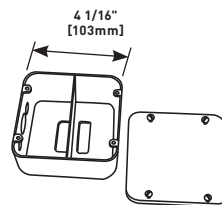

Use as a communications feed box for 30TP-4 Poles.

Add-on Plates for Power Poles

Accepts Wiremold Open System communications modules.



CAT. NO.	DESCRIPTION
25DTC-ACT	25DTP Kit with 8" [203mm] hole cut cover and mounting adapter
AMTC-ACT	AMDTP Kit with 8" [203mm] hole cut cover and mounting adapter

25DTC-ACT

Communications Covers for Ortronics® Series II modular connectivity solutions (adapter installed)



CAT. NO.	DESCRIPTION
25DTC-3S2	For 25DTP/25DTC Series
30TC-3S2	For 30 Series
AMTC-3S2	For AMDTP/AMTC Series

AMTC-3S2

25AM-AP, 30TP-AP Tele-Power Pole Accessory Packs

Accessory packs include two ceiling trim plates, hanger clamp assembly, feed end fitting, and floor mounting assembly. One Accessory Pack supplied with each Tele-Power Pole at no extra charge. Boots are not offered in accessory packs.

CAT. NO.	DESCRIPTION
25AM-AP	Accessory Pack for 25DTP-4 and AMDTP-4 Series
30TP-AP	Accessory Pack for 30TP-2V and 30TP-4V Series

CUSTOM TELE-POWER® POLES



Although **Wiremold®** has the most extensive selection of powerpole products available, Wiremold offers Custom Tele-Power® Poles to ensure proper distribution of power and communication services from overhead wiring systems to open spaces as needed.

Custom Tele-Power Poles Fabrication Capabilities

- Modify the number and type of receptacles. Virtually any type of approved receptacle may be installed in the pole, subject to size and voltage limitations. Receptacles may be standard specification, decorator style, isolated ground, or surge. They may utilize straight-blade or locking type plugs.
- Device spacings may be altered for your customer needs.
- Sectional poles ranging from 20' [6.1m] to 30' [9.2m] high.
- Communication cabling interface with your choice of hole cuts for modular RJ jacks, RS, IBM, and coax connectors and modular furniture configurations.
- Epoxy powder-coat or enamel paint capabilities to complement any interior decor.

Walkerflex Feed Options

- For "daisy-chain" activation, the NPA connector provides the feed-through capability to power a series of poles.
- For direct feed options.
 - Walkerflex NCW cable sets directly fastened to end of pole (instead of standard box or cordset).
 - NWC connector mounted along the length of the pole.

Contact your Wiremold sales representative for custom quotes and additional information.

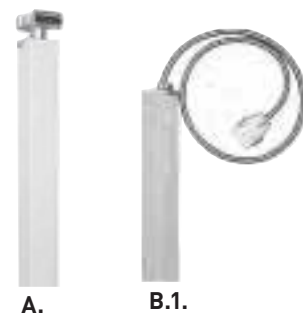

A.

B.1.

CUSTOM TELE-POWER[®] POLES

Custom Tele-Power Poles Ordering Information

NP800 Jumbo Aluminum Tele-Power Pole

Two separate compartments can accommodate up to 60A devices (#6 AWG maximum). Snap-in divider permits up to six channels of varying sizes.

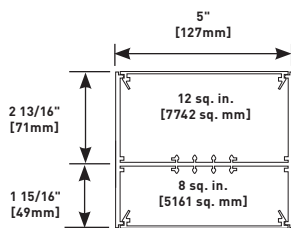

NP800 Series Wire Fill Capacities for Power

POWERING WIRING	WIRE SIZE THHN/THWN	40% FILL	CIRCUITS
	10 AWG	12	4
	12 AWG	13	4

NOTES: Wire fill capacities calculated for a pole with a 4" x 4" x 2 1/8" [102mm x 102mm x 54mm] box. Larger boxes can be used if higher capacity is needed.

All of the standard profiles can be easily modified. Contact the factory or the field sales representative for specifics.

General Specifications:

Receptacles: Each pole compartment may be wired with up to 12 receptacles, with the number of circuits limited by the feed method.

Feed method: All poles are provided with a utility box (4" x 4" x 2 1/8" [102mm x 102mm x 54mm]) for all poles with a cord up to 10' [3m].

Accessories:

Ceiling trim plates, pole clamp, and non-adjustable foot with carpet gripper/adhesive pad furnished.

NP800 Series Wire Fill Capacities for Communications

CABLE TYPE Description Nom. O.D. Inches	UNSHIELDED TWISTED PAIR (24 AWG)						SHIELDED TWISTED PAIR			COAXIAL CABLE				TWINAX	FIBER*
	Cat 3 2 Pair 0.14	Cat3 3 Pair 0.15	Cat3 4 Pair 0.19	Cat 5 4 Pair 0.22	Cat 6 4 Pair 0.25	Cat 3 25 Pair 0.41	Type 1 22 AWG 0.39	Type 2 22 AWG 0.465	Type 3 22 AWG 0.245	RG58/U 20 AWG 0.195	RG58/U 22 AWG 0.242	RG6/U 22AWG 0.242	RG6/U 18 AWG 0.27	100 OHM 0.33	0.19
Capacity of Cross-Section (IN ²)															
2.4	62	54	33	25	19	7	8	5	20	32	20	20	16	11	33
2.8	72	63	39	29	22	8	9	6	23	37	24	24	19	13	39
3.2	83	72	45	33	26	9	10	7	27	42	27	27	22	14	45
4.2	109	95	59	44	34	12	14	9	35	56	36	36	29	19	59
4.3	111	97	60	45	34	13	14	10	36	57	37	37	30	20	60
4.8	124	108	67	50	38	14	16	11	40	64	41	41	33	22	67
5.0	129	113	70	52	40	15	16	11	42	66	43	43	34	23	70
5.2	135	117	73	54	42	15	17	12	44	69	45	45	36	24	73
5.8	150	131	81	61	46	17	19	13	49	77	50	50	40	27	81
6.2	161	140	87	65	50	18	20	14	52	83	53	53	43	28	87
7.0	181	158	98	73	56	21	23	16	59	93	60	60	48	32	98
7.7	200	174	108	81	62	23	25	18	65	103	66	66	53	36	108
8.0	207	181	112	84	64	24	26	18	67	107	69	69	55	37	112
12.0	311	271	169	126	96	36	40	28	101	160	104	104	83	56	169

*Two Strand (Duplex) Multimode, 625/125µm. Capacity range is calculated at 40% of raceway areas as stated in the Commercial Buildings Standard for Telecommunication Pathways and Spaces, EIA/TIA 569-A.

CUSTOM TELE-POWER[®] POLES

NP800 Series Wire Fill Capacities for Communications (continued)

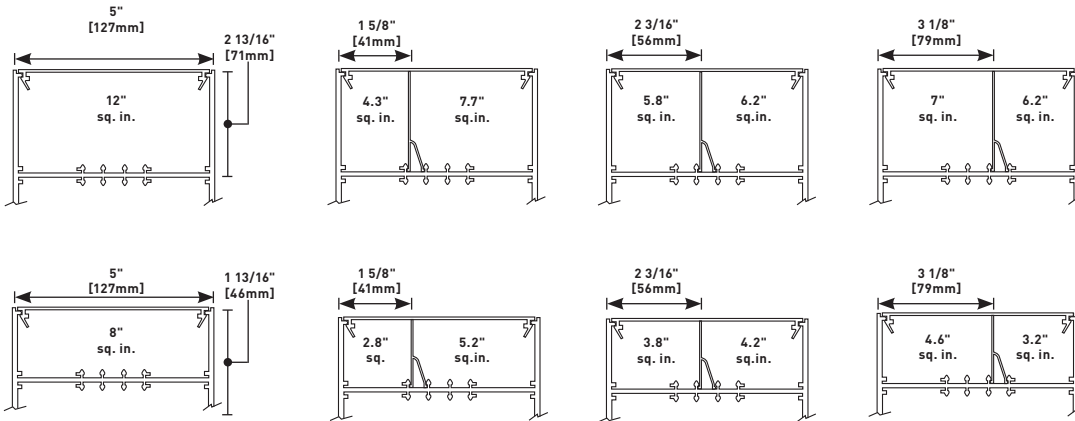

POWER DISTRIBUTION & SURGE PROTECTIVE DEVICES



Wiremold® Power Distribution & Surge Protective Devices are designed to provide complete power/protection solutions for your power/IT network from the service entrance to point-of-use.

Featured Products



**Power Commander®
Series High Amperage
Units**

622



**Medical Grade Plug-In
Outlet Centers**

637

POWER DISTRIBUTION & SURGE PROTECTIVE DEVICES

Table of Contents

Power Distribution Units for Data Centers



616
Power Commander®
IQ Series



619
Power Commander®
Plus Series

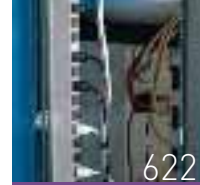

622
Power Commander®
Series High
Amperage Units



624
Meter Reader™
Series Current-
Monitoring Devices

Cabinet Power Solutions



625
Surge Protected
CabinetMATE®
Series



627
Power Only
CabinetMATE®
Series

Rack Mounted Power Solutions



628
Surge Protected
Products

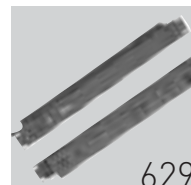

629
Power Only
Products

Workstation Power Solutions



631
Surge Protected
Plug-In Outlet
Center® Units



633
Power Only Plug-In
Outlet Center® Units

Hard-Wired Surge Protection



638
ZoneMaster®/
ZoneSentinel®
Series



640
ZoneDefender
Pro Series



641
PA/PB™ Series

POWER DISTRIBUTION & SURGE PROTECTIVE DEVICES

Quick Selection Guide

Hard-Wired Surge Protection

PA120T



ZoneMaster



Cabinet Power Solutions

UL2062BC

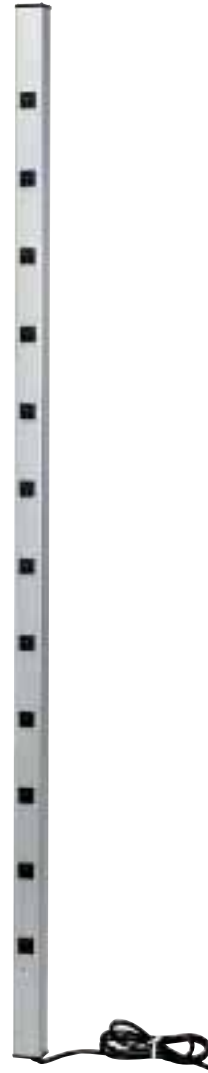

Rack-Mounted Power Solutions

J60B2B



7011ULBC



METL530



Work Station Solutions

M6S



PR609N



POWER COMMANDER® IQ SERIES



Power Commander® IQ Power Distribution Units offer remote current and temperature monitoring of connected equipment and individual outlet control for power recycling.

CODE REFERENCE

cTUVus Listed:
File 30783215.002 EN60950-1

NOTE: We are continually upgrading circuitry and features to provide the best possible power distribution solutions; therefore, the products in this section of the catalog may change without notice. Contact the factory for additional information.

Power Commander IQ Series Ordering Information

SPDU16-2U

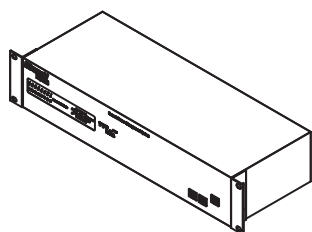

Sixteen (16) 15A simplex outlets in two banks of 8. Black housing.

Length: 19" [1.5m]
Width: 3 7/32" [82mm]
Depth: 6 1/4" [159mm]

AC Voltage Input	100 to 125V
AC Voltage Output	100 to 125V
Frequency	60 Hz
Load Capacity	15A
Output Receptacle	16 Pcs switched NEMA 5-15 (8 pieces each circuit)
Product Warranty	2 years
Power Cable – AWG Length & Plug Type	2 power cables, 14/3 SJT Type, 5-15P straight blade, 4 1/2 ft. [1.4m]
Console Interface Local Master Port	1 RS232 Port. RJ-45 Connector. Data: 7 or 8 bits. Stop Bits: 1 or 2. Parity: None, Odd or Even. Flow Control: None or RTS/CTS. Baud rate 2400 to 115200.
Temperature Sensing Port	Digital Input Port – RJ11
Network Interface	10-Base-T RJ45.
Display	16 Power Outlet On/Off status LEDs, 2 Network LEDs. 2 digit LED display (1.00" x 0.65") [25mm x 16.5mm] for AC Current Draw Status.
Network Protocols	ICMP, TCP/IP, DHCP Telnet, DNS, POP3/SMTP, SNMP, HTTPS/HTTP, and BootP
Weight	10 lbs. Shipping Weight
Operational Temperature Environment	32F° – 122F° (0C° – 50C°)
Storage Temperature	-20F° – 140F° (-29C° – 60C°)
Humidity	10% – 90% RH

POWER COMMANDER® IQ SERIES

Ordering Information

Power Commander IQ Series Ordering Information (continued)

SPDU8-1U

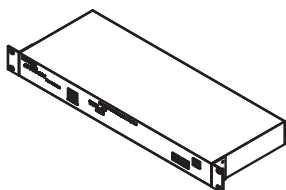

Eight (8) 15A simplex outlets. Black housing.

Length: 19" [1.5m]
 Width: 1 5/8" [41mm]
 Depth: 6 1/4" [159mm]

AC Voltage Input	100 to 125V
AC Voltage Output	100 to 125V
Frequency	60 Hz
Load Capacity	15A
Output Receptacle	8 switched NEMA 5-15
Product Warranty	2 years
Power Cable – AWG Length & Plug Type	14/3 SJT Type, 5-15P straight blade, 4 1/2 ft. [1.4m]
Console Interface Local Master Port	1 RS232 Port. RJ-45 Connector. Data: 7 or 8 bits. Stop Bits: 1 or 2. Parity: None, Odd or Even. Flow Control: None or RTS/CTS. Baud rate 2400 to 115200.
Temperature Sensing Port	Digital Input Port – RJ11
Network Interface	10-Base-T RJ45.
Display	8 Power Outlet On/Off status LEDs, 2 Network LEDs. 2 digit LED display (1.00" x 0.65") [25mm x 16.5mm] for AC Current Draw Status.
Network Protocols	ICMP, TCP/IP, DHCP Telnet, DNS, POP3/SMTP, SNMP, HTTPS/HTTP, and BootP
Weight	7 lbs. Shipping Weight
Operational Temperature Environment	32F° – 122F° [0C° – 50C°]
Storage Temperature	-20F° – 140F° [-29C° – 60C°]
Humidity	10% – 90% RH

POWER COMMANDER® IQ SERIES

Ordering Information

Power Commander IQ Series Ordering Information (continued)

SPDU20-0U

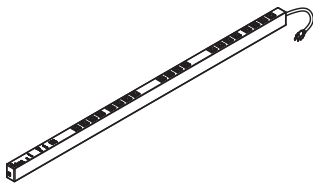

Twenty (20) 15A simplex outlets. Black housing.
 Length: 61" [1.5m]
 Width: 1 3/4" [44mm]
 Depth: 2 1/2" [60mm]



SPDU20-0U

AC Voltage Input	100 to 125V
AC Voltage Output	100 to 125V
Frequency	60 Hz
Load Capacity	20A
Output Receptacle	20 switched NEMA 5-15
Product Warranty	2 years
Power Cable AWG Length & Plug Type	12/3 SJT Type, L5-20P Locking plug, 9 1/2 ft. [2.9m]
AC Current Draw Monitoring	Measurement of True RMS from all Circuits
Console Interface Local Master Port	1 RS232 Port. RJ-45 Connector Type. Data: 7 or 8 bits. Stop Bits: 1 or 2. Parity: None, Odd or Even. Flow Control: None or RTS/CTS. Baud rate 2400 to 115200.
Audio Buzzer	85 Decibel
Display	20 Power Outlet ON/OFF status LEDs, 1 Power On/Off LED. 2 Network LEDs. 2 digit LED display (1.00" x 0.65") [25mm x 16.5mm] for AC Current Draw Status.
Temperature Sensing Port	Digital Input Port - RJ11
Network Interface	10-Base-T RJ45.
Network Protocols	ICMP, TCP/IP, DHCP Telnet, DNS, POP3/SMTP, SNMP, HTTP, and BootP
Weight	18 lbs. Shipping Weight
Operational Temperature Environment	32F° - 122F° (0C° - 50C°)
Storage Temperature	-20F° - 140F° [-29C° - 60C°]
Humidity	10% - 90% RH

POWER COMMANDER® PLUS SERIES



Power Commander® Plus High Current Power Distribution Units offer the capacity to meet the ever-increasing power demands of data centers.

CODE REFERENCE

cTUVus Listed:
File 30783215.002 EN60950-1

NOTE: We are continually upgrading circuitry and features to provide the best possible power distribution solutions; therefore, the products in this section of the catalog may change without notice. Contact the factory for additional information.

A Hub assembly of a Power Commander Plus PDU showing circuit breakers and LEDs.



C13 Receptacle
(Rated 15A)



C19 Receptacle
(Rated 20A)



POWER COMMANDER® PLUS SERIES

Ordering Information

Power Commander Plus Series 50 Amp PDU Ordering Information

5B11N, 5W11N



5W11n

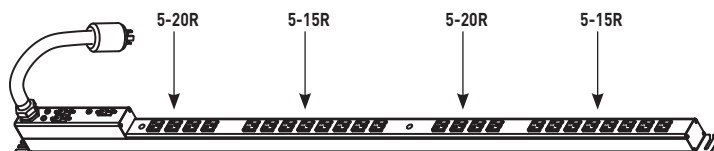

Eight (8) 5-20R outlets (Circuit 1), eight (8) 5-15R outlets each circuit (Circuits 2 & 3). Black (5B) or White (5W) top cover.

Length	64.12" [1.63m] overall, 67.12" [1.70m] with mounting ears.
Hub Length	10.12" [257mm]
Width	2.00" [50.8mm]
Depth	1.95" [49.5mm], 3.20" [81.3mm] with hub
Mounting	66.0" [1.68m] center-to-center

AC Voltage Input	100 to 127V
AC Voltage Output	100 to 127V
Frequency	60 Hz
Load Capacity	50 Amps, derated to 40 Amps: 1 – 20 Amp Circuit derated to 16 Amps (Circuit 1) 2 – 15 Amp Circuits derated to 12 Amps (Circuits 2 & 3)
Circuit Breaker	1 – 20 Amp (Circuit 1), 2 – 15 Amp (Circuits 2 & 3), UL489 Listed
Output Receptacles	NEMA 5-20R (Circuit 1), NEMA 5-15R (Circuits 2 & 3)
Product Warranty	2 years
Power Cord	6/3 SOOW Type, CS6361 Plug, 10' [3.05m]

Power Commander Plus Series 60 Amp PDU Ordering Information – 120/208 System, 120V Output

6B21N, 6W21N

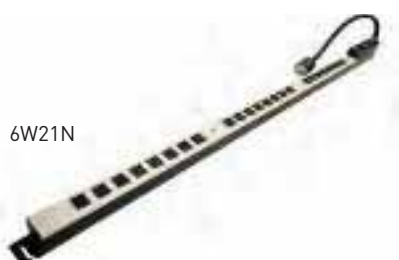

6W21N

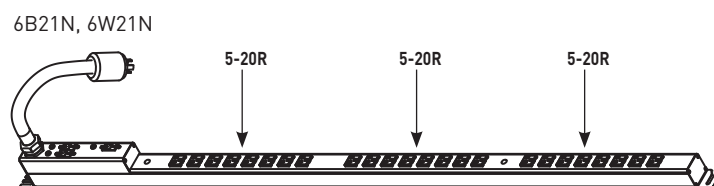

Eight (8) 5-20R outlets per circuit, twenty-four (24) total outlets. Black (6B) or White (6W) top cover.

Length	64.12" [1.63m] overall, 67.12" [1.70m] with mounting ears.
Hub Length	10.12" [257mm]
Width	2.00" [50.8mm]
Depth	1.95" [49.5mm], 3.20" [81.3mm] with hub
Mounting	66.0" [1.68m] center-to-center

AC Voltage Input	120/208V
AC Voltage Output	100 to 127V
Frequency	60 Hz
Load Capacity	30 Amps 3-phase, derated to 24 Amps: 3 – 20 Amp Circuits derated to 16 Amps (Circuits 1, 2 & 3)
Circuit Breaker	3 – 20 Amp (Circuits 1, 2 & 3), UL489 Listed
Output Receptacles	NEMA 5-20R, IEC C13 or IEC C19
Product Warranty	2 years
Power Cord	10/5 SOOW Type, L21-30P Plug, 10' [3.05m]

POWER COMMANDER® PLUS SERIES

Ordering Information

Power Commander Plus Series 60 Amp PDU Ordering Information – 120/208 System, 120V Output

6B21E, 6W21E

6B21E, 6W21E

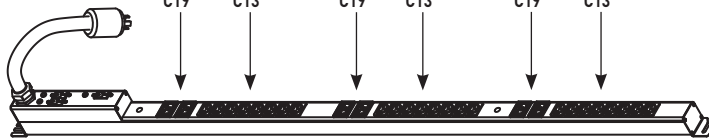

Two (2) C19 outlets per circuit, eight (8) C13 outlets per circuit. Black (6B) or White (6W) top cover.

Length	64.12"	[1.63m] overall, 67.12" [1.70m] with mounting ears.
Hub Length	10.12"	[257mm]
Width	2.00"	[50.8mm]
Depth	1.95" 3.20"	[49.5mm], [81.3mm] with hub
Mounting	66.0"	[1.68m] center-to-center

AC Voltage Input	120/208V
AC Voltage Output	100 to 127V
Frequency	60 Hz
Load Capacity	30 Amps 3-phase, derated to 24 Amps: 3 – 20 Amp Circuits derated to 16 Amps (Circuits 1, 2 & 3)
Circuit Breaker	3 – 20 Amp (Circuits 1, 2 & 3), UL489 Listed
Output Receptacles	NEMA 5-20R, IEC C13 or IEC C19
Product Warranty	2 years
Power Cord	10/5 SOOW Type, L21-30P Plug, 10' [3.05m]

Power Commander Plus Series 60 Amp PDU Ordering Information – 120/208 System, 208V Output

6B22E, 6W22E

6W22E

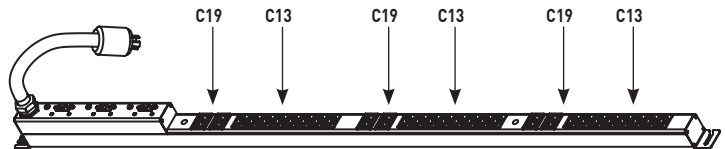

Two (2) C19 outlets per circuit, eight (8) C13 outlets per circuit. Black (6B) or White (6W) top cover.

Length	64.12"	[1.63m] overall, 67.12" [1.70m] with mounting ears.
Hub Length	14.12"	[359mm]
Width	2.00"	[50.8mm]
Depth	1.95" 3.20"	[49.5mm], [81.3mm] with hub
Mounting	66.0"	[1.68m] center-to-center

AC Voltage Input	120/208V
AC Voltage Output	200 to 230V
Frequency	60 Hz
Load Capacity	30 Amps 3-phase, derated to 24 Amps: 3 – 20 Amp Circuits derated to 16 Amps (Circuits 1, 2 & 3)
Circuit Breaker	3 – 20 Amp (Circuits 1, 2 & 3), UL489 Listed
Output Receptacles	IEC C13 or IEC C19
Product Warranty	2 years
Power Cord	10/5 SOOW Type, L21-30P Plug, 10' [3.05m]

POWER COMMANDER® SERIES

High Amperage Units



Power Commander® Series High Amperage Units (PDUs) have multiple circuits to provide increased capacity for today's high density server racks. Embedded or remote ammeters are available to monitor current draw.

CODE REFERENCE

cULus Listed:
File 173292 Guide: NWGQ

NOTE: We are continually upgrading circuitry and features to provide the best possible power distribution solutions; therefore, the products in this section of the catalog may change without notice. Contact the factory for additional information.

Power Commander Series Mounting Information

MOUNTING ACCESSORIES

Understanding that each cabinet, enclosure, rack and application is unique, Wiremold has designed four solutions for mounting the 30 Amp Power Distribution Units using the universal T-slot built into the unit. The mounting kits listed below are available for purchase as accessories.

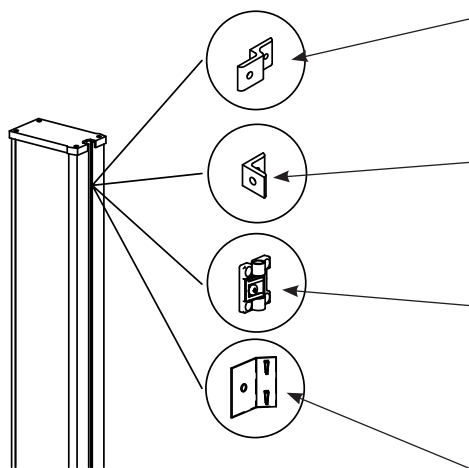

30A-MK1 Z Bracket

Sturdy anodized aluminum bracket offsets the unit for front access to the mounting. May be used for a side or end mount.

30A-MK2 L Bracket

Allows mounting at a right angle. May be used for a side or end mount.

30A-MK3 Swivel Bracket

Allows unit to be mounted then rotated up to 270° (dependent on mounting location) providing easy access to unit's face without losing space.

30A-MK4 Drop-In Clip

Clip is mounted directly on the unit and allows the strip to install with a 'drop and hold' method that requires no additional hardware.

NOTE: Accessory mounting kits are not UL Listed.

STANDARD HARDWARE INSTALLATION

Attach the Spring Clips to the cabinet frame or cabinet wall making sure the top clip is no more than 1 inch [25mm] from the top of the unit. Insert the 1/4 - 20 Phillips screw through the spring clip as shown, and then through the cabinet frame or cabinet wall. On the other side of the mounting surface, put the 1/4 lock washer over the exposed Phillips screw and tighten into place with the 1/4 - 20 nut. Once the spring clips are secure, place unit in one side of the clips and snap the other side into position.

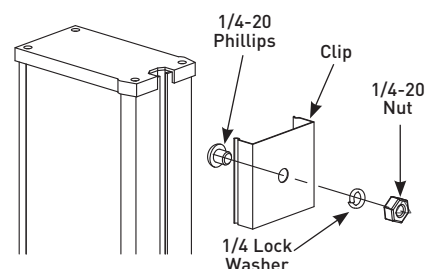

POWER COMMANDER® SERIES

High Amperage Units

Power Commander High Amperage Units Ordering Information

3A44B2-1 30 Amp Power Distribution Unit

Two 15A resettable circuit breakers. Twenty-four 20A outlets with T-slots, gray housing. 12' [3.6m] cord. Length 48" [1.2m].

3A86B2-1 30 Amp Power Distribution Unit

Two 15A resettable circuit breakers. Thirty-six 20A outlets with T-slots, gray housing. 12' [3.6m] cord. Length 70" [1.8m].

3B44B2-1 30 Amp Power Distribution Unit

Two circuits with two 15A resettable circuit breakers. Twenty-four 20A outlets with T-slots, black housing. 12' [3.6m] cord. Length 48" [1.2m].

3B86B2-1 30 Amp Power Distribution Unit

Two circuits with two 15A resettable circuit breakers. Thirty-six 20A outlets with T-slots, black housing. 12' [3.6m] cord. Length 70" [1.8m].

3B53B2-1-AM 30 Amp Power Distribution Unit

Two circuits with two 15A resettable circuit breakers and two lighted LCD digital ammeters. Eighteen 20A outlets with T-slots, black housing. 12' [3.6m] cord. Length 54" [1.4m].

3B43B2-1-RAM 30 Amp Power Distribution Unit

Two circuits with two 15A resettable circuit breakers and two lighted remote LCD digital ammeters. Eighteen 20A outlets with T-slots, black housing. 12' [3.6m] cord. Length 48" [1.2m]. Includes two (2) 7' [1.2m] patch cables, two (2) remote displays, and one (1) rack mountable faceplate.

4B44B2-2 40 Amp Power Distribution Unit

Two circuits with two 20A resettable circuit breakers. Twenty-four 20A outlets with T-slots, black housing. 12' [3.6m] cord. Length 48" [1.2m].

4B86B2-2 40 Amp Power Distribution Unit

Two circuits with two 20A resettable circuit breakers. Thirty-six 20A outlets with T-slots, black housing. 12' [3.6m] cord. Length 70" [1.8m].

4B53B2-2-AM 40 Amp Power Distribution Unit

Two circuits with two 20A resettable circuit breakers and two lighted LCD digital ammeters. Eighteen 20A outlets with T-slots, black housing. 12' [3.6m] cord. Length 54" [1.4m].

4B43B2-2-RAM 40 Amp Power Distribution Unit

Two circuits with two 20A resettable circuit breakers and two lighted remote LCD digital ammeters. Eighteen 20A outlets with T-slots, black housing. 12' [3.6m] cord. Length 48" [1.2m]. Includes two (2) 7' [1.2m] patch cables, two (2) remote displays, and one (1) rack mountable faceplate.

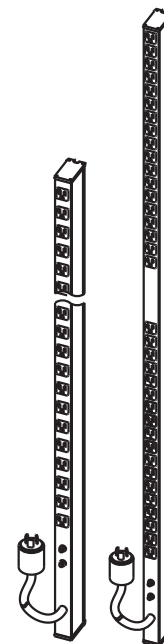

METER READER™ SERIES

Current Monitoring Devices



Meter Reader Series Current Monitoring Devices add current monitoring capability to any 20A or 30A power distribution unit or power strip.

NOTE: We are continually upgrading circuitry and features to provide the best possible power distribution solutions; therefore, the products in this section of the catalog may change without notice. Contact the factory for additional information.

CODE REFERENCE

cULus Listed: File E250477
Guide PICQ

Meter Reader Series Mounting Instructions

RACK MOUNT DISPLAY PLATE - INSTALLATION

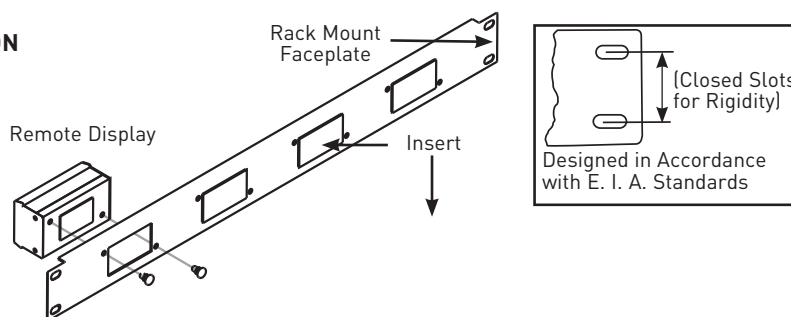

Meter Reader Series Current Monitoring Devices Ordering Information

METL520

Retro Current Monitoring Device (120 Vac)

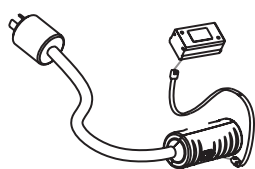

Retro current monitoring device (120 Vac) with an L5-20 plug and connector set. Unit will support any 20 Amp power strip with an L5-20 plug. Includes 7' [1.2m] patch cord and 19" [482mm] mountable faceplate and remote display.

METL620

Retro Current Monitoring Device (240 Vac)

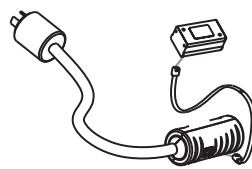

Retro current monitoring device (240 Vac) with an L6-20 plug and connector set. Unit will support any 20 Amp power strip with an L6-20 plug. Includes 7' [1.2m] patch cord and 19" [482mm] mountable faceplate and remote display.

METL530

Retro Current Monitoring Device (120 Vac)

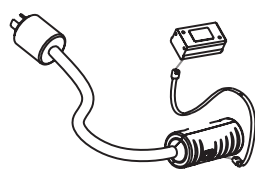

Retro current monitoring device (120 Vac) with an L5-30 plug and connector set. Unit will support any 30 Amp power strip with an L5-30 plug. Includes 7' [1.2m] patch cord and 19" [482mm] mountable faceplate and remote display.

METL630

Retro Current Monitoring Device (240 Vac)

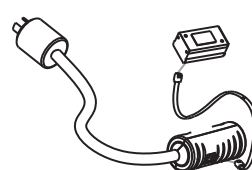

Retro current monitoring device (240 Vac) with an L6-30 plug and connector set. Unit will support any 30 Amp power strip with an L6-30 plug. Includes 7' [1.2m] patch cord and 19" [482mm] mountable faceplate and remote display.

CABINETMATE™ SERIES

Surge Protected Products



CabinetMate Series Plug-In Outlet Center Units offer a low profile aluminum housing to save space.

NOTE: We are continually upgrading circuitry and features to provide the best possible power distribution solutions; therefore, the products in this section of the catalog may change without notice. Contact the factory for additional information.

CODE REFERENCE

cULus Listed: File E66421
Guide XYBS, XUHT, VZCA

Surge Suppression Specifications

Surge Protection Circuitry	Single Stage
Maximum Surge Current	36,000 Amps (12,000 Amps L-N, 12,000 Amps L-G, 12,000 Amps N-G)
Noise Reduction	+35dB
Response Time	Less than 1 nanosecond

NOTE: See the Joule explanation later in this section.

CabinetMate Series Mounting Information

MOUNTING TYPES

Each Cabinet Power Solution can be mounted via included spring clip hardware. Complete mounting hardware and installation instructions are included with every unit.

8002 Spring Clip

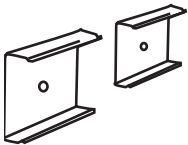

Mount unit in any position. Includes two spring steel mounting clips that snap onto the unit. Screws also included. Used for all units with 1 1/2" [38mm] narrow aluminum housing.

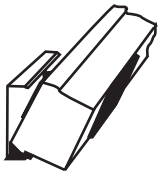

CABINETMATE™ SERIES

Surge Protected Products

CabinetMate Series Surge Protected Plug-In Outlet Centers Ordering Information

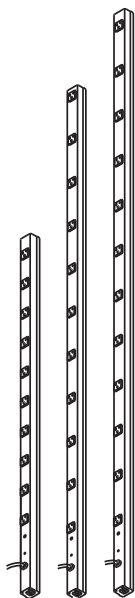

All units feature gray aluminum housing 1 1/2" x 1 3/16" [38mm x30mm] with black receptacles and black power cord with straight blade plug.

4810BCS, 4810BDS Plug-In Outlet Center Unit

Ten outlets. 6' [1.8m] (4810BCS) or 15' [4.6m] (4810BDS) cord. Length 48" [1.2m]. 15A resettable circuit breaker. Computer grade surge protection, 15 Amps.

7011BCS, 7011BDS Plug-In Outlet Center Unit

Eleven outlets. 6' [1.8m] (7011BCS) or 15' [4.6m] (7011BDS) cord. Length 70" [1.8m]. 15A resettable circuit breaker. Computer grade surge protection, 15 Amps.

7712BCS, 7712BDS Plug-In Outlet Center Unit

Twelve outlets. 6' [1.8m] (7712BCS) or 15' [4.6m] (7712BDS) cord. Length 77" [2m]. 15A resettable circuit breaker. Computer grade surge protection, 15 Amps.

2008BCS20R, 2008BDS20R Plug-In Outlet Center Unit

Eight 20A outlets with t-slots. 6' [1.8m] (2008BCS20R) or 15' [4.6m] (2008BDS20R) cord. Length 20" [508mm]. Computer grade surge protection, 20 Amps.

4810BCS20R, 4810BDS20R Plug-In Outlet Center Unit

Ten 20A outlets with t-slots. 6' [1.8m] (4810BCS20R) or 15' [4.6m] (4810BDS20R) cord. Length 48" [1.2m]. Computer grade surge protection, 20 Amps.

7011BCS20R, 7011BDS20R Plug-In Outlet Center Unit

Eleven outlets with t-slots. 6' [1.8m] (7011BCS20R) or 15' [4.6m] (7011BDS20R) cord. Length 70" [1.8m]. Computer grade surge protection, 20 Amps.

7712BCS20R, 7712BDS20R Plug-In Outlet Center Unit

Twelve outlets with t-slots. 6' [1.8m] (7712BCS) or 15' [4.6m] (7712BDS) cord. Length 77" [2m]. 20A resettable circuit breaker. Computer grade surge protection, 20 Amps.

Why Don't We Specify Joules?

The Joule rating does not provide an accurate indication of the robustness of a surge suppressor. The Joule rating is energy over time and it is very easy to artificially inflate the Joule rating by changing the time base. The Institute of Electrical and Electronics Engineers (IEEE) as well as the National Electrical Manufacturers Association (NEMA) both warn against using Joules to compare surge suppressors.

CABINETMATE™ SERIES

Power Only Products

CabinetMate Series Power Only Plug-In Outlet Centers Ordering Information

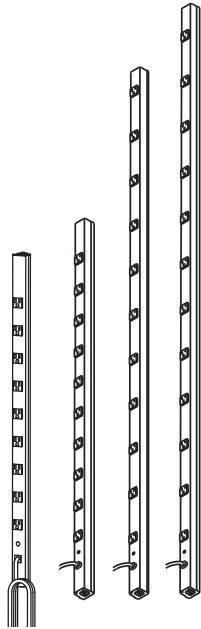

Locking Plug

All units feature gray aluminum housing 1 1/2" x 1 3/16" [38mm x 30mm] with black receptacles and black power cord with straight blade plug.

Units with "-TL" suffix have twist lock plug

3609ULBC, 3609ULBD Plug-In Outlet Center Unit

Nine outlets, 6' [1.8m] (3609ULBC) or 15' [4.6m] (3609ULBD) cord. Length 36" [915mm]. Receptacle center-to-center 3" [76mm]. 15 Amp unit with a 15A resettable circuit breaker.

4810ULBC, 4810ULBD Plug-In Outlet Center Unit

Ten outlets, 6' [1.8m] (4810ULBC) or 15' [4.6m] (4810ULBD) cord. Length 48" [1.2m]. Receptacle center-to-center 4" [101mm]. 15 Amp unit with a 15A resettable circuit breaker.

7011ULBC, 7011ULBD Plug-In Outlet Center Unit

Eleven outlets, 6' [1.8m] (7011ULBC) or 15' [4.6m] (7011ULBD) cord. Length 70" [1.8m]. Receptacle center-to-center 6" [152mm]. 15 Amp unit with a 15A resettable circuit breaker.

7712ULBC, 7712ULBD Plug-In Outlet Center Unit

Twelve outlets, 6' [1.8m] (7712ULBC) or 15' [4.6m] (7712ULBD) cord. Length 77" [2m]. Receptacle center-to-center 6" [152mm]. 15 Amp unit with a 15A resettable circuit breaker.

2008ULBC20R, 2008ULBD20R, 2008ULBC20R-TL, 2008ULBD20R-TL Plug-In Outlet Center Unit

Eight 20A outlets with t-slots, 6' [1.8m] (2008ULBC20R, 2008ULBC20R-TL) or 15' [4.6m] (2008ULBD20R, 2008ULBD20R-TL) cord. Length 20" [508mm]. Receptacle center-to-center 1 1/4" [32mm]. 20 Amp unit with a 20A resettable circuit breaker. Units available with straight blade or Locking Plug (2008ULBC20R-TL, 2008ULBD20R-TL).

4810ULBC20R, 4810ULBD20R, 4810ULBC20R-TL, 4810ULBD20R-TL Plug-In Outlet Center Unit

Ten 20A outlets with t-slots, 6' [1.8m] (4810ULBC20R, 4810ULBC20R-TL) or 15' [4.6m] (4810ULBD20R, 4810ULBD20R-TL) cord. Length 48" [1.2m]. Receptacle center-to-center 4" [101mm]. 20 Amp unit with a 20A resettable circuit breaker. Units available with straight blade or Locking Plug (4810ULBC20R-TL, 4810ULBD20R-TL).

7011ULBC20R, 7011ULBD20R, 7011ULBC20R-TL, 7011ULBD20R-TL Plug-In Outlet Center Unit

Eleven 20A outlets with t-slots, 6' [1.8m] (7011ULBC20R, 7011ULBC20R-TL) or 15' [4.6m] (7011ULBD20R, 7011ULBD20R-TL) cord. Length 70" [1.8m]. Receptacle center-to-center 6" [152mm]. 20 Amp unit with a 20A resettable circuit breaker. Units available with straight blade or Locking Plug (7011ULBC20R-TL, 7011ULBD20R-TL).

7712ULBC20R, 7712ULBD20R, 7712ULBC20R-TL, 7712ULBD20R-TL Plug-In Outlet Center Unit

Twelve 20A outlets with t-slots, 6' [1.8m] (7712ULBC20R, 7712ULBC20R-TL) or 15' [4.6m] (7712ULBD20R, 7712ULBD20R-TL) cord. Length 77" [2m]. Receptacle center-to-center 6" [152mm]. 20 Amp unit with a 20A resettable circuit breaker. Units available with straight blade or Locking Plug (7712ULBC20R-TL, 7712ULBD20R-TL).

RACK MOUNTED POWER SOLUTIONS



Rack Mounted Power Solutions are designed to fit a standard 19" rack. The compact 1U design takes up a minimum amount of rack space

CODE REFERENCE

cULus Listed: File E66421
Guide XBYS2, XUHT2, VZCA2

NOTE: We are continually upgrading circuitry and features to provide the best possible power distribution solutions; therefore, the products in this section of the catalog may change without notice. Contact the factory for additional information.

Sentrex® High Performance Surge Specifications

Surge Protection Circuitry	3 Element, 3-Stage Hybrid Circuit
Maximum Surge Current	56,000 Amps (32,000 Amps L-N, 12,000 Amps L-G, 12,000 Amps N-G)
Noise Reduction	+50dB
Response Time	Less than 1 nanosecond

Perma-Power® Computer Grade Surge Specifications

Surge Protection Circuitry	Single Stage
Maximum Surge Current	36,000 Amps (12,000 Amps L-N, 12,000 Amps L-G, 12,000 Amps N-G)
Noise Reduction	+35dB
Response Time	Less than 1 nanosecond

NOTE: See the Joule explanation on page 626.

Mounting Information

MOUNTING TYPES

Each Rack Mounted Power Solution can be mounted to standard 19" [482mm] racks via the closed slots. Power Commander High Amperage Unit can also be mounted in a 0U position as shown below. Complete mounting hardware and installation instructions are included with every unit.

Rack Mounting

Fits standard 19" [482mm] rack.
Hardware not included.

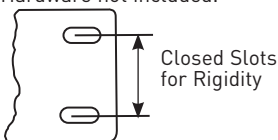

Designed in accordance with E.I.A. standards.

RACK MOUNTED POWER SOLUTIONS

Surge Protected and Power Only Products

Surge Protected Products Ordering Information

R5S, R5S-15 Plug-In Outlet Center Unit

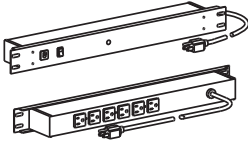

Six rear outlets, lighted switch, 15A. 6' [1.8m] (R5S) or 15' [4.6m] (R5S-15) cord. Sentrex® high performance surge protection.

R8BZ, R8BZ-15 Plug-In Outlet Center Unit

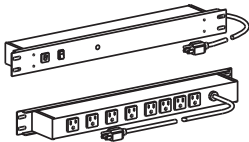

Eight rear outlets, lighted switch, 15A. Receptacles rotated 90° and 4 outlets spaced to accommodate transformers. 6' [1.8m] (R8BZ) or 15' [4.6m] (R8BZ-15) cord. Perma Power® computer grade surge protection.

R5BZ, R5BZ-15 Plug-In Outlet Center Unit

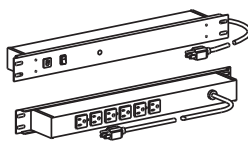

Six rear outlets, lighted switch, 15A. 6' [1.8m] (R5BZ) or 15' [4.6m] (R5BZ-15) cord. Perma Power® computer grade, surge protection.

R5BZX, R5BZX-15 Plug-In Outlet Center Unit

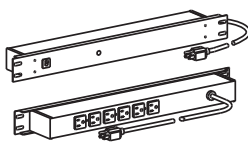

Six rear outlets, 15A. 6' [1.8m] (R5BZX) or 15' [4.6m] (R5BZX-15) cord. Perma Power® computer grade, surge protection.

R5BZ20, R5BZ20-15 Plug-In Outlet Center Unit

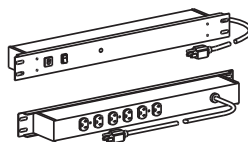

Six 20A rear outlets, on/off switch. 6' [1.8m] (R5BZ20) or 15' [4.6m] (R5BZ20-15) cord. Perma Power® computer grade surge protection.

R5BZ20X, R5BZ20X-15 Plug-In Outlet Center Unit

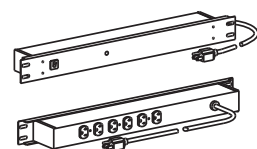

Six 20A rear outlets. 6' [1.8m] (R5BZ20X) or 15' [4.6m] (R5BZ20X-15) cord. Perma Power® computer grade surge protection.

Power Only Products Ordering Information

J08B0B, J08B2B Plug-In Outlet Center Unit

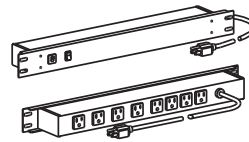

Eight rear outlets, lighted switch, 15A, receptacles rotated 90° and 4 outlets spaced to accommodate transformers. 6' (J08B0B) or 15' (J08B2B) [1.8m or 4.6m] cord. Receptacle center-to-center 1 1/2" [38mm] and 2" [51mm].

J06B0B, J06B2B Plug-In Outlet Center Unit

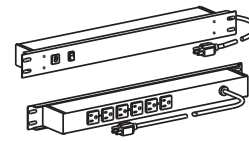

Six rear outlets, lighted switch, 15A, 6' (J06B0B) or 15' (J06B2B) [1.8m or 4.6m] cord. Receptacle center-to-center 1 1/2" [38mm].

J60B0B, J60B2B Plug-In Outlet Center Unit

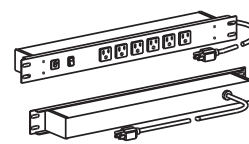

Six front outlets, lighted switch, 15A, 6' (J60B0B) or 15' (J60B2B) [1.8m or 4.6m] cord. Receptacle center-to-center 1 1/2" [38mm].

J24B0B, J24B2B Plug-In Outlet Center Unit

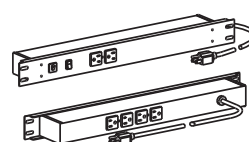

Two front, four rear outlets, lighted switch, 15A, 6' (J24B0B) or 15' (J24B2B) [1.8m or 4.6m] cord. Receptacle center-to-center 1 1/2" [38mm].

J06B0BX, J06B2BX Plug-In Outlet Center Unit

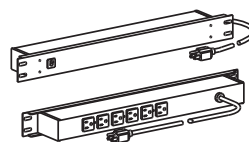

Six rear outlets, 15A, 6' (J06B0BX) or 15' (J06B2BX) [1.8m or 4.6m] cord. Receptacle center-to-center 1 1/2" [38mm].

RACK MOUNTED POWER SOLUTION

Power Only Products

Power Only Products Ordering Information (continued)

J60B0B-90, J60B2B-90 Plug-In Outlet Center Unit

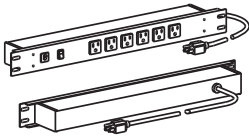

Six front outlets, 15A, receptacles rotated 90° and spaced to accommodate transformers. 6' (J60B0B-90) or 15' (J60B2B-90) [1.8m or 4.6m] cord. Receptacle center-to-center 1 1/2" [38mm].

J60B0B20, J60B2B20 Plug-In Outlet Center Unit

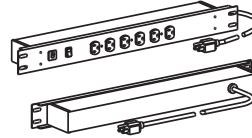

Six front 20A outlets, on/off switch, 6' (J60B0B20) or 15' (J60B2B20) [1.8m or 4.6m] cord. Receptacle center-to-center 1 1/2" [38mm].

J06B0B20, J06B2B20 Plug-In Outlet Center Unit

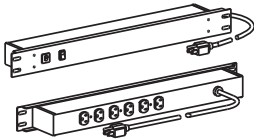

Six rear 20A outlets, on/off switch, 6' (J06B0B20) or 15' (J06B2B20) [1.8m or 4.6m] cord. Receptacle center-to-center 1 1/2" [38mm].

J60B0B20X, J60B2B20X Plug-In Outlet Center Unit

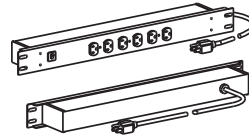

Six front 20A outlets, 6' (J60B0B20X) or 15' (J60B2B20X)[1.8m or 4.6m] cord. Receptacle center-to-center 1 1/2" [38mm].

J06B0B20X, J06B2B20X Plug-In Outlet Center Unit

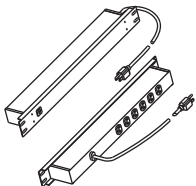

Six rear 20A outlets, 6' (J06B0B20X) or 15' (J06B2B20X)[1.8m or 4.6m] cord. Receptacle center-to-center 1 1/2" [38mm].

J06B0B20X-AM Plug-In Outlet Center Unit

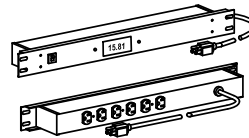

Digital ammeter with LCD readout of current draw. Six 20A rear outlets. 6' [1.8m] cord. Receptacle center-to-center 1 1/2" [38mm].

WORKSTATION POWER SOLUTIONS



Work Station Power Solutions are point-of-use, plug-in outlet centers available with and without surge suppression.

CODE REFERENCE

cULus Listed: File E66421
Guide XYBS, XUHT, VZCA

Surge Suppression Specifications

Sentrex® High Performance Surge Specifications

Surge Protection Circuitry	3 Element, 3-Stage Hybrid Circuit
Maximum Surge Current	56,000 Amps (32,000 Amps L-N, 12,000 Amps L-G, 12,000 Amps N-G)
Noise Reduction	+50dB
Response Time	Less than 1 nanosecond

NOTE: See the Joule explanation located on the Cabinet Power Solutions page 626.

Perma-Power® Computer Grade Surge Specifications

Surge Protection Circuitry	Single Stage
Maximum Surge Current	36,000 Amps (12,000 Amps L-N, 12,000 Amps L-G, 12,000 Amps N-G)
Noise Reduction	+35dB
Response Time	Less than 1 nanosecond

Mounting Information

MOUNTING TYPES

Each Plug-In Outlet Center unit has one of three different mounting types. Each mounting method has been designed to optimize the performance of the product. Complete mounting hardware and installation instructions are included with every unit.

Snap-On/Slide-Off

Mount unit in any position. Catalog No. 8004 includes two aluminum mounting clips that snap onto mounting rails on the back of the unit. Screws also included. Used for all units with 2" [51mm] aluminum housing.

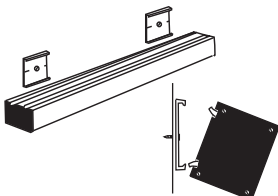

Keyhole Mounting

Mount unit in almost any position. Screws not included. Available on all plastic units and units with 3 1/2" [89mm] aluminum housing.

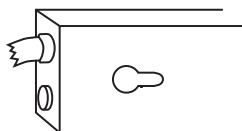

Spring Clip Mounting

Mount unit in any position. Catalog No. 8002 includes two spring steel mounting clips that snap onto the unit. Screws also included. Used for all units with 1 1/2" [38mm] narrow aluminum housing.

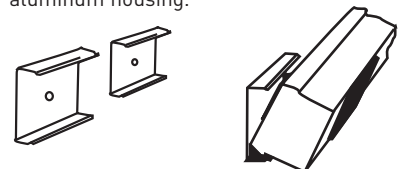

COLOR OPTIONS



Workstation Power Solutions Plug-In Outlet Center Units Part Number descriptions indicate available color options.

WORKSTATION POWER SOLUTIONS

Ordering Information

Work Station Power Solutions – Surge Protected Plug-In Outlet Center Units Ordering Information

M5S Plug-In Outlet Center Units



Sentrex® high performance surge protection. Five outlets, lighted switch, durable putty white aluminum housing, 15A. Receptacles rotated 90° and spaced to accommodate transformers. Length 24" [610mm]. 6' [1.8m] 14/3 SJT putty white cord with NEMA5-15 plug. Snap-on, slide-off mounting.

M6BZNET, M6BZNET-15 Plug-In Outlet Center Units



Six outlets, two spaced for transformers. Lighted switch, data line protector with RJ45 jacks. 6' [1.8m] (M6BZNET) or 15' [4.6m] (M6BZNET-15) power cord with 45° right angle plug. Length 18" [457mm].

Right Angle Plug

M6S, M6S-15 Plug-In Outlet Center Units

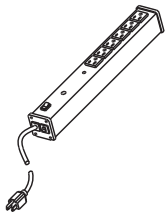

Sentrex® high performance surge protection. Six outlets, lighted switch, durable putty white aluminum housing, 15A. 6' [1.8m] (M6S) or 15' [4.6m] (M6S-15) 14/3 SJT putty white cord with NEMA5-15 plug. Length 15 1/4" [387mm]. Snap-on, slide-off mounting.

M6BZR, M6BZR-15 Plug-In Outlet Center Units

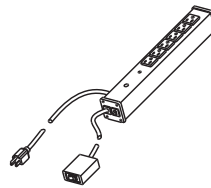

Perma Power® computer grade surge protection. Six outlets, remote switch, durable putty white aluminum housing, 15A, 6' [1.8m] (M6BZR) or 15' [4.6m] (M6BZR-15) 14/3 SJT putty white cord with NEMA5-15 plug. Length 13 1/4" [337mm]. Snap-on, slide-off mounting.

M5BZ Plug-In Outlet Center Units

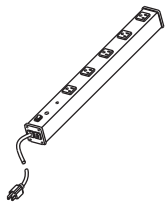

Perma Power® computer grade surge protection. Five outlets, lighted switch, durable putty white aluminum housing, 15A. Receptacles rotated 90° and spaced to accommodate transformers. 6' [1.8m] 14/3 SJT putty white cord with NEMA5-15 plug. Length 21" [533mm]. Snap-on, slide-off mounting.

M620BZLS, M620BZLS-15 Plug-In Outlet Center Units

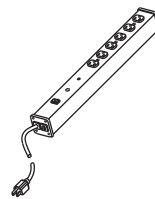

Perma Power® computer grade surge protection. Six outlets, lighted switch, durable putty white aluminum housing, 20A. 6' [1.8m] (M620BZLS) or 15' [4.6m] (M620BZLS-15) 12/3 SJT putty white cord with NEMA5-20 plug. Length 18" [457mm]. Snap-on, slide-off mounting.

M6BZ, M6BZ-15 Plug-In Outlet Center Units

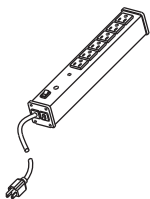

Perma Power® computer grade surge protection. Six outlets, lighted switch, durable putty white aluminum housing, 15A. 6' [1.8m] (M6BZ) or 15' (M6BZ-15) [4.6m] 14/3 SJT putty white cord with NEMA5-15 plug. Length 13 1/4" [337mm]. Snap-on, slide-off mounting.

SR10N Plug-In Outlet Center Units

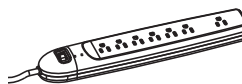

Basic surge protection. Six outlets, lighted switch, impact-resistant putty white polymeric housing, 15A. 6' [1.8m] 14/3 SJT putty white cord with NEMA5-15 plug. Maximum surge current 6500 Amps. 13 1/4" x 2 1/2" x 1 9/16" [337mm x 64mm x 40mm]. Keyhole mounting.

WORKSTATION POWER SOLUTIONS

Ordering Information

Work Station Power Solutions – Power Only Plug-In Outlet Center Units Ordering Information

SRD10N Plug-In Outlet Center Units

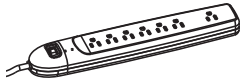

Basic surge protection. Six outlets, lighted switch, impact-resistant putty white polymeric housing, 15A. 6' [1.8m] 14/3 SJT putty white cord with NEMA5-15 plug. Maximum surge current 6500 Amps. Phone/fax protection. 13 1/4" x 2 1/2" x 1 9/16" [337mm x 64mm x 40mm]. Keyhole mounting.

PR609N Plug-In Outlet Center Units

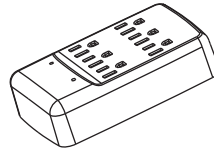

Perma Power® basic surge protection. Six outlet wall plug, impact-resistant putty white polymeric housing, 15A. Maximum surge current 6500 Amps. 5" x 3 3/8" x 1 3/4" [127mm x 86mm x 44mm].

PR610N Plug-In Outlet Center Units

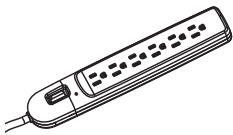

Basic surge protection. Six outlets, lighted switch, impact-resistant putty white polymeric housing, 15A. 6' [1.8m] 14/3 SJT putty white cord with NEMA5-15 plug. Maximum surge current 6500 Amps. 11 3/4" x 2 1/4" x 1 1/2" [298mm x 57mm x 38mm]. Keyhole mounting.

Work Station Power Solutions – Power Only Plug-In Outlet Center Units Ordering Information

UL300BC, UL300BD Plug-In Outlet Center Units



Eight outlets, lighted switch, rugged gray aluminum housing, 15A, 6' [1.8m](UL300BC) or 15' [4.6m] (UL300BD) 14/3 SJT black cord with NEMA5-15 plug. Length 24" [609mm]. Receptacle center-to-center 2" [51mm]. Snap-on, slide-off mounting.

UL401BC, UL401BD Plug-In Outlet Center Units



Eight outlets, lighted switch, rugged gray aluminum housing, 15A, 6' [1.8m](UL401BC) or 15' [4.6m] (UL401BD) 14/3 SJT black cord with NEMA5-15 plug. Length 48" [1.2m]. Receptacle center-to-center 5 1/4" [133mm]. Snap-on, slide-off mounting.

UL309BC, UL309BD Plug-In Outlet Center Units



Nine outlets, lighted switch, rugged gray aluminum housing, 15A, 6' [1.8m](UL309BC) or 15' [4.6m] (UL309BD) 14/3 SJT black cord with NEMA5-15 plug. Length 36" [915mm]. Receptacle center-to-center 3" [76mm]. Snap-on, slide-off mounting.

UL402BC, UL402BD Plug-In Outlet Center Units



Sixteen outlets, lighted switch, rugged gray aluminum housing, 15A, 6' [1.8m](UL402BC) or 15' [4.6m] (UL402BD) 14/3 SJT black cord with NEMA5-15 plug. Length 48" [1.2m]. Receptacle center-to-center 2 1/2" [64mm]. Snap-on, slide-off mounting.

WORKSTATION POWER SOLUTIONS

Ordering Information

Work Station Power Solutions – Power Only Plug-In Outlet Center Units Ordering Information (continued)

UL403BC, UL403BD Plug-In Outlet Center Units



Eight outlets, rugged gray aluminum housing, 15A, 6' [1.8m] (UL403BC) or 15' [4.6m] (UL403BD) 14/3 SJT black cord with NEMA5-15 plug. Length 48" [1.2m]. Receptacle center-to-center 5 1/4" [133mm]. Snap-on, slide-off mounting.

UL2064BC, UL2064BD Plug-In Outlet Center Units



Twelve outlets, rugged gray aluminum housing, 15A, lighted switch, 6' [1.8m] (UL2064BC) or 15' [4.6m] (UL2064BD) 14/3 SJT black cord with NEMA5-15 plug. Length 72" [1.8m]. Receptacle center-to-center 5 1/4" [133mm]. Snap-on, Slide-off mounting.

UL404BC, UL404BD Plug-In Outlet Center Units



Sixteen outlets, rugged gray aluminum housing, 15A, 6' [1.8m] (UL404BC) or 15' [4.6m] (UL404BD) 14/3 SJT black cord with NEMA5-15 plug. Length 48" [1.2m]. Receptacle center-to-center 2 1/2" [64mm]. Snap-on, slide-off mounting.

UL2065BC, UL2065BD Plug-In Outlet Center Units



Twenty-four outlets, rugged gray aluminum housing, 15A, lighted switch, 6' [1.8m] (UL2065BC) or 15' [4.6m] (UL2065BD) 14/3 SJT black cord with NEMA5-15 plug. Length 72" [1.8m]. Receptacle center-to-center 2 1/2" [64mm]. Snap-on, Slide-off mounting.

UL2062BC, UL2062BD Plug-In Outlet Center Units



Twelve outlets, rugged gray aluminum housing, 15A, 6' [1.8m] (UL2062BC) or 15' [4.6m] (UL2062BD) 14/3 SJT black cord with NEMA5-15 plug. Length 72" [1.8m]. Receptacle center-to-center 5 1/4" [133mm].

V20-C2, G20-C2 Plug-In Outlet Center Units



Six outlets, steel housing with ivory (V20-C2) or gray finish (G20-C2). 6' [1.8m] cord. Length 40" [1m]. Receptacle center-to-center 6" [152mm].

UL2063BC, UL2063BD Plug-In Outlet Center Units



Twenty-four outlets, rugged gray aluminum housing, 15A, 6' [1.8m] (UL2063BC) or 15' [4.6m] (UL2063BD) 14/3 SJT black cord with NEMA5-15 plug. Length 72" [1.8m]. Receptacle center-to-center 2 1/2" [64mm].

NM20-C3 Plug-In Outlet Center Units



Six (3 duplex) outlets, nonmetallic housing with ivory finish. 6' [1.8m] cord, Length 36" [915mm]. Receptacle center-to-center 12" [305mm].

NM20-C4 Plug-In Outlet Center Units



Eight (4 duplex) outlets, nonmetallic housing with ivory finish. 6' [1.8m] cord. Length 48" [1.2m]. Receptacle center-to-center 12" [305mm].

WORKSTATION POWER SOLUTIONS

Ordering Information

Work Station Power Solutions – Power Only Plug-In Outlet Center Units Ordering Information (continued)

NM20-C5 Plug-In Outlet Center Units



Ten (5 duplex) outlets, nonmetallic housing with ivory finish. 6' [1.8m] cord, Length 60" [1.5m]. Receptacle center-to-center 12" [305mm].

NM20-C6 Plug-In Outlet Center Units



Twelve (6 duplex) outlets, nonmetallic housing with ivory finish. 6' [1.8m] cord. Length 72" [1.8m]. Receptacle center-to-center 12" [305mm].

UL100BC, UL100BD Plug-In Outlet Center Units

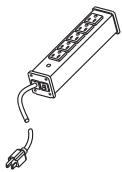

Five outlets, rugged gray aluminum housing, 15A. 6' [1.8m] (UL100BC) or 15' [4.6m] (UL100BD) 14/3 SJT black cord with NEMA5-15 plug. Length 9 1/4" [235mm]. Receptacle center-to-center 1 1/4" [32mm]. Snap-on, slide-off mounting.

UL101BC, UL101BD Plug-In Outlet Center Units

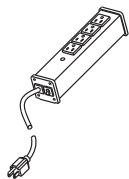

Four outlets, rugged gray aluminum housing, 15A. 6' (UL101BC) or 15' (UL101BD) [1.8m or 4.6m] 14/3 SJT black cord with NEMA5-15 plug. Length 9 1/4" [235mm]. Receptacle center-to-center 1 1/4" [32mm]. Snap-on, slide-off mounting.

UL104BC, UL104BD Plug-In Outlet Center Units

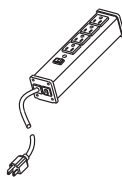

Four outlets, rugged gray aluminum housing, 15A, lighted switch. 6' [1.8m] (UL104BC) or 15' [4.6m] (UL104BD) 14/3 SJT black cord with NEMA5-15 plug. Length 9 1/4" [235mm]. Receptacle center-to-center 1 1/4" [32mm]. Snap-on, slide-off mounting.

UL204BC, UL204BD Plug-In Outlet Center Units

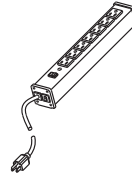

Seven outlets, rugged gray aluminum housing, 15A, lighted switch. 6' [1.8m] (UL204BC) or 15' [4.6m] (UL204BD) 14/3 SJT black cord with NEMA5-15 plug. Length 13" [330mm]. Receptacle center-to-center 1 1/4" [32mm]. Snap-on, slide-off mounting.

UL205BC, UL205BD Plug-In Outlet Center Units

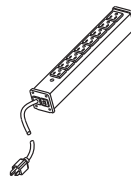

Eight outlets, rugged gray aluminum housing, 15A. 6' [1.8m] (UL205BC) or 15' [4.6m] (UL205BD) 14/3 SJT black cord with NEMA5-15 plug. Length 13" [330mm]. Receptacle center-to-center 1 1/4" [32mm]. Snap-on, slide-off mounting.

UL206BC, UL206BD Plug-In Outlet Center Units

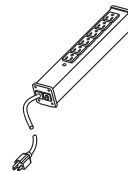

Six outlets, rugged gray aluminum housing, 15A. 6' [1.8m] (UL206BC) or 15' [4.6m] (UL206BD) 14/3 SJT black cord with NEMA5-15 plug. Length 12 1/4" [311mm]. Receptacle center-to-center 1 1/4" [32mm]. Snap-on, slide-off mounting.

UL207BC, UL207BD Plug-In Outlet Center Units

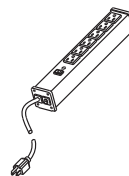

Six outlets, rugged gray aluminum housing, 15A, lighted switch. 6' [1.8m] (UL207BC) or 15' [4.6m] (UL207BD) 14/3 SJT black cord with NEMA5-15 plug. Length 12 1/4" [311mm]. Receptacle center-to-center 1 1/4" [32mm]. Snap-on, slide-off mounting.

WORKSTATION POWER SOLUTIONS

Ordering Information

Work Station Power Solutions – Power Only Plug-In Outlet Center Units Ordering Information (continued)

UL218BC, UL218BD Plug-In Outlet Center Units

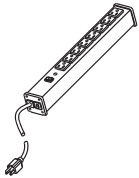

Eight outlets, rugged gray aluminum housing, 15A, lighted switch. 6' [1.8m] (UL218BC) or 15' [4.6m] (UL218BD) 14/3 SJT black cord with NEMA5-15 plug. Length 15" [381mm]. Receptacle center-to-center 1 1/4" [32mm]. Snap-on, slide-off mounting.

UL209BC, UL209BD Plug-In Outlet Center Units

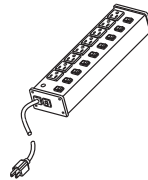

Eight individually switched outlets, lighted on/off switch, putty white finish aluminum housing, 15A. 6' [1.8m] (UL209BC) or 15' [4.6m] (UL209BD) 14/3 SJT black cord with NEMA5-15 plug. Length 13" [330mm], width 3 1/2" [89mm]. Receptacle center-to-center 1 5/16" [33mm]. Snap-on, slide-off mounting.

UL210BC, UL210BD Plug-In Outlet Center Units

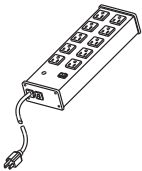

Ten outlets, rugged gray aluminum housing, 15A, lighted switch. 6' [1.8m] (UL210BC) or 15' [4.6m] (UL210BD) 14/3 SJT black cord with NEMA5-15 plug. Length 13" [330mm], width 3 1/2" [89mm]. Receptacle center-to-center 1 15/16" [49mm]. Snap-on, slide-off mounting.

UL215BC, UL215BD Plug-In Outlet Center Units

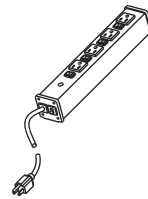

Four individually switched outlets, lighted on/off switch, rugged gray aluminum housing, 15A. 6' [1.8m] (UL215BC) or 15' [4.6m] (UL215BD) 14/3 SJT black cord with NEMA5-15 plug. Length 13" [330mm], width 2" [51mm]. Receptacle center-to-center 2 1/8" [54mm]. Snap-on, slide-off mounting.

R610, R612 Plug-In Outlet Center Units

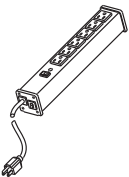

Six outlets, putty white aluminum housing, 15A, lighted switch. 6' [1.8m] (R610) or 15' [4.6m] (R612) 14/3 SJT putty white cord with NEMA5-15 plug. Length 12 1/4" [311mm]. Receptacle center-to-center 1 1/4" [32mm]. Snap-on, slide-off mounting.

ULB420-6, ULB420-15 Plug-In Outlet Center Units

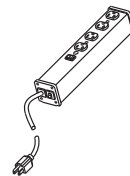

Four 20A, 120V, 60Hz, 2500 watt outlets, lighted switch, putty white aluminum housing, 6' [1.8m] (ULB420-6) or 15' [4.6m] (ULB420-15) 12/3 SJT black cord with NEMA5-15 plug. Length 10 3/4" [273mm]. Receptacle center-to-center 1 1/2" [38mm]. Snap-on, slide-off mounting.

P6, P6-15 Plug-In Outlet Center Units

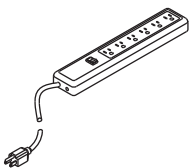

Six outlets, putty white impact-resistant polymeric housing, 15A, lighted switch, 6' [1.8m] (P6) or 15' [4.6m] (P6-15) 14/3 SJT putty white cord with NEMA5-15 plug. Length 12" [305mm]. Receptacle center-to-center 1 1/4" [32mm]. Keyhole mounting.

ULB620-6, ULB620-15 Plug-In Outlet Center Units

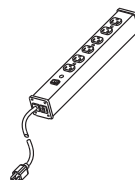

Six 20A, 120V, 60Hz, 2500 watt outlets, lighted switch, putty white aluminum housing, 6' [1.8m] (ULB620-6) or 15' [4.6m] (ULB620-15) 12/3 SJT black cord with NEMA5-15 plug. Length 13 1/4" [337mm]. Receptacle center-to-center 1 1/2" [38mm]. Snap-on, slide-off mounting.

UL1090BC, UL1090BD Plug-In Outlet Center Units

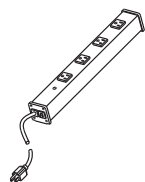

Four outlets, rugged gray aluminum housing, 15A, receptacles rotated 90° and spaced to accommodate transformers. 6' [1.8m] (UL1090BC) or 15' [4.6m] (UL1090BD) 14/3 SJT black cord with NEMA5-15 plug. Length 16" [406mm]. Receptacle center-to-center 3" [76mm]. Snap-on, slide-off mounting.

WORKSTATION POWER SOLUTIONS

Ordering Information

Work Station Power Solutions – Power Only Plug-In Outlet Center Units Ordering Information (continued)

ULB820-6, ULB820-15 Plug-In Outlet Center Units

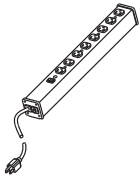

Eight 20A, 120V, 60Hz, 2500 watt outlets, lighted switch, putty white aluminum housing, 6' [1.8m] (ULB820-6) or 15' [4.6m] (ULB820-15) 12/3 SJT black cord with NEMA5-20 plug. Length 17 1/4" [438mm]. Receptacle center-to-center 1 1/2" [38mm]. Snap-on, slide-off mounting.

IEC5 Plug-In Outlet Center Units

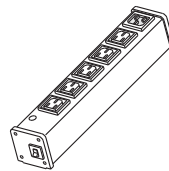

Five 250V, IEC 320 outlets, gray finish, 10A single pole circuit breaker, power cord not included. Length 11" [279mm]. Receptacle center-to-center 1 1/2" [38mm]. Input is provided with a male IEC320 Receptacle. Appropriate input cord must be purchased separately. Output receptacles are female IEC320. Snap-on, slide-off mounting. Power cord not included. cULus Listed, TUV Nord Certified EN60950.

Special Use/Medical Grade Power Solutions – Power Only Plug-In Outlet Center Units Ordering Information

ULBH4-6, ULBH4-15 Special Use Plug-In Outlet Center Units

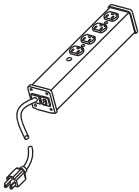

Four outlets. Rugged white aluminum housing. 6' [1.8m] (ULBH4-6) or 15' [4.6m] (ULBH4-15) 14/3 SJT white cord with NEMA5-15 plug. Length 10 3/4" [237mm]. Receptacle center-to-center 1 1/2" [38mm]. Snap-on, slide-off mounting. Not for use in critical care environments. Not for use where Article 517 of NEC requires Hospital Grade Outlets.

ULM4-6, ULM4-15 Medical Grade Plug-In Outlet Center Units

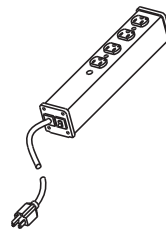

Four outlets. Rugged white aluminum housing. 6' [1.8m] (ULMH4-6) or 15' [4.6m] (ULMH4-15) 14/3 SJT white cord with NEMA5-15 plug. Length 10 3/4" [237mm]. Receptacle center-to-center 1 1/2" [38mm]. Snap-on, slide-off mounting. cTUVus Listed as Medical Electrical Equipment. **Suitable for use where Article 517 of NEC requires Hospital Grade Outlets.**

ULBH6-6, ULBH6-15 Special Use Plug-In Outlet Center Units

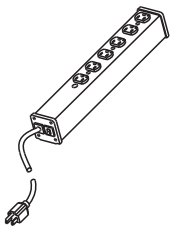

Six outlets. Rugged white aluminum housing. 6' [1.8m] (ULBH6-6) or 15' [4.6m] (ULBH6-15) 14/3 SJT white cord with NEMA5-15 plug. Length 13 1/4" [337mm]. Receptacle center-to-center 1 1/2" [38mm]. Snap-on, slide-off mounting. Not for use in critical care environments. Not for use where Article 517 of NEC requires Hospital Grade Outlets.

ULM6-6, ULM6-15 Medical Grade Plug-In Outlet Center Units

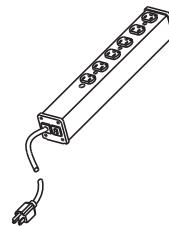

Six outlets. Rugged white aluminum housing. 6' [1.8m] (ULMH6-6) or 15' [4.6m] (ULMH6-15) 14/3 SJT white cord with NEMA5-15 plug. Length 13 1/4" [337mm]. Receptacle center-to-center 1 1/2" [38mm]. Snap-on, slide-off mounting. cTUVus Listed as Medical Electrical Equipment. **Suitable for use where Article 517 of NEC requires Hospital Grade Outlets.**

ULM620-6, ULM620-15 Medical Grade Plug-In Outlet Center Units

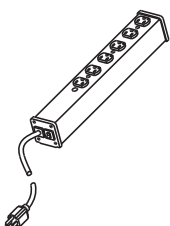

20A configuration. Four outlets, white finish. 6' [1.8m] (ULM620-6) or 15' [4.6m] (ULM620-15) cord. Length 10 3/4" [237mm]. Receptacle center-to-center 1 1/2" [38mm]. cTUVus Listed as Medical Electrical Equipment. **Suitable for use where Article 517 of the NEC requires Hospital Grade Outlets.**

ZONEMASTER® SERIES

Hard Wired Surge Protection



ZoneMaster® Series Hard-Wired Surge Protection provides superior protection and ease-of-installation for both main and sub-panel applications. Meets UL1449 Third Edition requirements

CODE REFERENCE

cULus Listed: File E322765
Guide VZCA

All ZoneMaster® and ZoneSentinel® Units feature all-mode protection. ZoneMaster® Pro models come standard in a NEMA 1 metal enclosure with surge counter, display diagnostics, and internal audible alarm.

Hard Wired Surge Protection Units



ELECTRICAL SERVICE	ZONEMASTER PRO 400 400KA	ZONEMASTER 400 400KA	ZONEMASTER PRO 340 340KA	ZONEMASTER 340 340KA	ZONEMASTER PRO 200 200KA	ZONEMASTER 200 200KA	ZONESENTINEL 100 100KA
20/240V, Single Ø	ZEM120T	ZE120T	ZCM120T	ZC120T	ZBM120T	ZB120T	ZA120T
120/208V 3Ø, Wye	ZEM120Y	ZE120Y	ZCM120Y	ZC120Y	ZBM120Y	ZB120Y	ZA120Y
277/480V, 3Ø, Wye	ZEM277Y	ZE277Y	ZCM277Y	ZC277Y	ZBM277Y	ZB277Y	ZA277Y
Options & Features							
A-Remote Alarm	0	0	0	0	0	0	0
B-Filter	0	0	0	0	0	0	0
C-Counter	S	N/A	S	N/A	S	N/A	N/A
F-Fused Disconnect	0	N/A	0	N/A	0	N/A	N/A
G-Flush Mount	0	N/A	0	N/A	0	N/A	0
H-NEMA 4 Metal Enclosure	0	N/A	0	N/A	0	N/A	N/A

S = Standard Feature, 0 = Available Option, N/A = Not available on this Model



ZoneSentinel 100



ZoneMaster 340



ZoneMaster Pro 400

ZONEMASTER® SERIES

Hard Wired Surge Protection

ZoneMaster & ZoneSentinel Replacement Modules

UNIT CAT. NO.	MODULE CAT. NO.	MODULE DESCRIPTION	QUANTITY USED	MODE USED
ZEM120T/ZE120T	81144A	ZoneMaster ZE/ZC Module 120V L-N	2	L-N
	81145A	ZoneMaster ZE/ZC Module 120V L-G	2	L-G
	81148A	ZoneMaster ZE/ZC/ZB Module 120V N-G	1	N-G
ZEM120Y/ZE120Y	81144A	ZoneMaster ZE/ZC Module 120V L-N	3	L-N
	81145A	ZoneMaster ZE/ZC Module 120V L-G	3	L-G
	81148A	ZoneMaster ZE/ZC/ZB Module 120V N-G	1	N-G
ZEM277Y/ZE277Y	81146A	ZoneMaster ZE/ZC Module 277V L-N	3	L-N
	81147A	ZoneMaster ZE/ZC Module 277V L-G	3	L-G
	81149A	ZoneMaster ZE/ZC/ZB Module 277V N-G	1	N-G
ZCM120T/ZC120T	81144A	ZoneMaster ZE/ZC Module 120V L-N	2	L-N
	81145A	ZoneMaster ZE/ZC Module 120V L-G	2	L-G
	81148A	ZoneMaster ZE/ZC/ZB Module 120V N-G	1	N-G
ZCM120Y/ZC120Y	81144A	ZoneMaster ZE/ZC Module 120V L-N	3	L-N
	81145A	ZoneMaster ZE/ZC Module 120V L-G	3	L-G
	81148A	ZoneMaster ZE/ZC/ZB Module 120V N-G	1	N-G
ZCM277Y/ZC277Y	81146A	ZoneMaster ZE/ZC Module 277V L-N	3	L-N
	81147A	ZoneMaster ZE/ZC Module 277V L-G	3	L-G
	81149A	ZoneMaster ZE/ZC/ZB Module 277V N-G	1	N-G
ZBM120T/ZB120T	81148A	ZoneMaster ZE/ZC/ZB Module 120V N-G	1	N-G
	81173A	ZoneMaster ZB Module 120V L-N/L-G	2	L-N/L-G
ZBM120Y/ZB120Y	81148A	ZoneMaster ZE/ZC/ZB Module 120V N-G	1	N-G
	81173A	ZoneMaster ZB Module 120V L-N/L-G	3	L-N/L-G
ZBM277Y/ZB277Y	81149A	ZoneMaster ZE/ZC/ZB Module 277V N-G	1	N-G
	81174A	ZoneMaster ZB Module 277V L-N/L-G	3	L-N/L-G
ZA120T	81170A	ZoneSentinel ZA Module 120V L-N/L-G	1	L-N/L-G
	81175A	ZoneSentinel ZA Module 120V L-N/N-G	1	L-N/N-G
ZA120Y	81170A	ZoneSentinel ZA Module 120V L-N/L-G	1	L-N/L-G
	81173A	ZoneSentinel ZA Module 120V L-N/N-G	1	L-N/N-G
ZA277Y	81171A	ZoneSentinel ZA Module 277V L-N/L-G	1	L-N/L-G
	81174A	ZoneSentinel ZA Module 277V L-N/N-G	1	L-N/N-G

ZONEDEFENDER PRO SERIES

Hard Wired Surge Protection



ZoneDefender Pro Series Hard-Wired Surge Protection provide superior protection plus built-in EMI filtering for sub-panel applications. Standard with NO/NC Contacts for Remote Monitoring. Meets UL1449 Third Edition requirements.

CODE REFERENCE

cULus Listed: File E322765
Guide VZCA

ZPA Series, ZPB Series

80kA Surge Protection, 160kA Surge Protection

For surge protection at the sub panel or near sensitive equipment. Designed for commercial/industrial applications.

Dimensions: 9 5/16" x 4 7/8" x 3 1/16"
[237mm x 124mm x 78mm].



CATALOG NO.	ELECTRICAL SERVICE	SURGE PROTECTION
ZPA120T	120/240V, Single Ø 3-Wire & Ground	80kA
ZPA120Y	120/208V, 3Ø, 4-Wire & Ground	80kA
ZPA240DCT	120/240/120V, Hi-Leg Delta	80kA
ZPA277Y	277/480V, 3Ø, 4-Wire & Ground	80kA
ZPB120T	120/240V, Single Ø 3-Wire & Ground	160kA
ZPB120Y	120/208V, Single 3Ø, 4-Wire & Ground	160kA
ZPB240DCT	120/240/120V, Hi-Leg Delta	160kA
ZPB277Y	277/480V, 3Ø, 4-Wire & Ground	160kA

PA/PB™ SERIES

Hard Wired Surge Protection



PA/PB Series Hard-Wired Surge Protection provide superior protection and ease-of-installation for sub-panel applications. Meets UL1449 Third Edition requirements.

CODE REFERENCE

cETLus Listed:

PA Series, PB Series 80kA Surge Protection, 160kA Surge Protection



For surge protection at the sub panel or near sensitive equipment. Designed for residential and light commercial/ industrial applications. Dimensions: 6 5/16" x 4 3/4" x 3 9/16" [160mm x 120mm x 90mm]. Ten year unconditional product warranty.

CATALOG NO.	ELECTRICAL SERVICE	SURGE PROTECTION
PA120T	120/240V, Single Ø 3-Wire & Ground	80kA
PA120Y	120/208V, 3Ø, 4-Wire & Ground	80kA
PA240DCT	120/240/120V, Hi-Leg Delta	80kA
PA277Y	277/480V, 3Ø, 4-Wire & Ground	80kA
PB120T	120/240V, Single Ø 3-Wire & Ground	160kA
PB120Y	120/208V, Single 3Ø, 4-Wire & Ground	160kA
PB240DCT	120/240/120V, Hi-Leg Delta	160kA
PB277Y	277/480V, 3Ø, 4-Wire & Ground	160kA

NOTE: Add suffix "-A" to part number for NO/NC dry contact relay for connecting remote monitoring device. Add suffix "-B" to part number for EMI/RFI noise filter. Add "-AB" to part number for both options.

PABFMC Flush Mount Cover

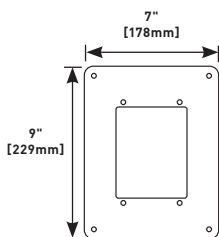

For installing PA/PB units on sheetrock or firewall construction. Cover hides the hole cut and gives the unit a finished look.

MEETING ROOM SOLUTIONS



Wiremold® Meeting Room Solutions bring technology closer to the user's work area. The routing of power, communication and A/V connections is virtually transparent and increasingly more accessible. Solutions offer flexibility in meeting connectivity configurations and décor needs.



Featured Products	 Under Table Cable Management 646	 Meeting Room Transition Channel 647	 Work Surface Modular Power 648
--------------------------	---	---	---

Table of Contents

Under Table Cable Management (UTCM)



Meeting Room Transition Channel (MRTC)

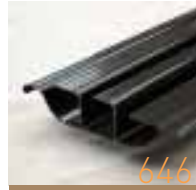
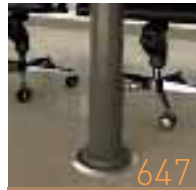

Work Surface Modular Power (WSMP)

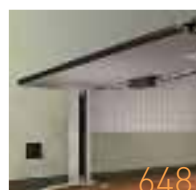

MEETING ROOM SOLUTIONS

Table of Contents

Evolution™ Series Work Surface Portals



deQuorum™ Work Surface Portals



deQuorum™
Recessed Work
Surface Portals



deQuorum™
Flip-Up Work
Surface Portals

TableSource™ Work Surface Portals



Lab Bench Work Surface Portals



Desktop Power Center Work Surface Portals



Desk Module Work Surface Portal



MEETING ROOM SOLUTIONS

Quick Selection Guide

Work Surface Portals

Work Surface Portal Model	Svc. Location @ Table	Cord Length	Field Wired Whip length	Cover Color/ Material	Electrical Outlets	Communication Openings	AV Openings
 Evolution 6" Portals Evolution 8" Portals	Recessed 6" Diameter Recessed 8" Diameter	12' 12'	6' 6'	Nickel, Bronze, Gray, Black, Brass Powder Coat Nickel, Bronze, Gray, Black, Brass Powder Coat	[2] 15A Duplex [2] 15A Duplex	[2] Ortronics® Cat 6 RJ45 jacks [6] Ortronics® Cat 6 RJ45 jacks	[5] Legrand AVIP Plates or Extron® Electronics MAAP modules [10] Legrand AVIP Plates or Extron® Electronics MAAP modules
 deQuorum Recessed Portals	Recessed	12'	6'	Gray, Black	[2] 20A Duplexes Gasketed	Adapters for Ortronics® Series II, TracJack or Wiremold Open System	Cable Cord Keeper or Legrand AVIP Plates or Extron® Electronics MAAP modules - (6) single or (3) double
 deQuorum Flip Up Portals	Above	12'	N/A	Black, Stainless	[1] 15A or 20A Duplex	Adapters for Ortronics® Series II or TracJack and Wiremold Open System	N/A
 TableSource Portals (Standard)	Above	12'	N/A	Clear Anodized Aluminum	[1] 15A Duplex	2 Openings with Adapters for Ortronics® Series II, TracJack or Wiremold Open System	N/A
 TableSource Portals (Configurable)	Above	2'-12'	Specify	Clear Anodized Aluminum	[1-4] 15A Duplexes Gasketed	1-4 Openings with Adapters for Ortronics® Series II, TracJack or Wiremold Open System	N/A
 Bench Top Portals (Configurable)	Above	N/A	N/A	Clear Anodized Aluminum	Fits [1-4] 15A Duplexes or Decorator Style Outlets	See product pages for device plate selection	See product pages for device plate selection
 Desktop Power Center Portal	Above	12'	N/A	Black with Magnesium Side Panels	[3] 15A Outlets with [2] USB Charging Outlets or [4] 15A Outlets	N/A	
 Desk Module	Flush	12'	N/A	Brushed Silver with Black Cover	[1] 15A Duplex	RJ45 (Retractor available)	USB Charging (USB Retractor available)
 Work Surface Cord Ended	Recessed	6'	N/A	Silver	[2] 15A Duplex	Egress	N/A
 Work Surface Modular Power	Recessed	N/A	accommodates 5' & 6' tables	Silver	[2] 20A Duplex**	Egress	N/A

* Extron® Electronics MAAP modules are sold separately.

** One (1) duplex is located on the bottom of unit for convenience power.

UNDER TABLE CABLE MANAGEMENT



Wiremold® Under Table Cable Management (UTCM) is an integral component to manage cabling below the work surface.



CODE REFERENCE

UTCM is not UL Listed and is designed only for use in protecting electrical cords, low voltage wiring and cabling.

UTCM5 Under Table Cable management Kit



Consists of a 5' [1.524mm] length of divided base, 5' [1.524mm] length of mounting hinge rail and four (4) latching clips. Black, nonmetallic construction.



Base



Hinge Rail



Latching Clips

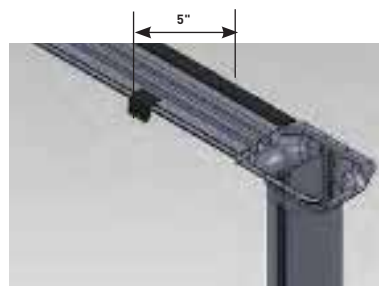

Base width without Rail & Clips: 5" [127mm]
Base width with Rail & Clips: 6 1/4" [159mm]

COLOR OPTIONS



Under Table Cable Management components are available in a black finish.

MEETING ROOM TRANSITION CHANNEL



Wiremold® Meeting Room Transition Channel (MRTC) is an integral component in a “last meter” solution for bringing power and technology closer to the user’s work area.

CODE REFERENCE

UTCM is not UL Listed and is designed only for use in protecting electrical cords, low voltage wiring and cabling.

MRTC Meeting Room Transition Channel Kit

Consists of aluminum center spine with steel mounting plate and four (4) screws, black aluminum side channels, black nonmetallic bottom boot and two (2) black nonmetallic transition covers.

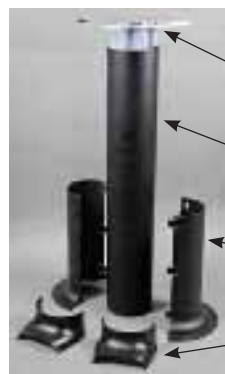

Center Spine with
Mounting Plate

Side Channel

Bottom Boot

Transition Cover

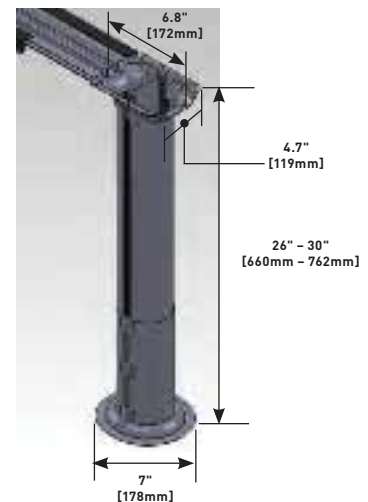
**COLOR OPTIONS**

Meeting Room Transition Channel components are available in a black finish.

WORK SURFACE MODULAR POWER



Wiremold® Work Surface Modular Power Kits (WSMP) make rearranging meeting rooms fast, easy, and safe by providing both under table power and cable management in one package.



CODE REFERENCE

UL Listed :
 Manufactured Wiring Systems
 File E51105 Guide: QQVX
 CSA Certified File 257563
 Cord Ended Units are UL & cUL Listed
 Furniture Feed Distribution Units
 File: E349493 Guide: IYNC

Work Surface Modular Power Part Number Configurator

WS	ME	D	TC	72	SL	SK	-2
Work Surface Series = WS	Power: Modular Power Enhanced Portal = ME Modular Power Standard Unit = MP Corder Power Enhanced Unit = CE	Data: 2 Keystone Openings = D	Style: Under Table (No Flange) = UT Through Table (Contour Flange) = TC	Table Size: 72" = 72 60" = 60	Portal Color: Black = BK Silver = SL	Kit Config.: Single Portal Kit = SL Double Portal Kit = DK	Wiring Config.: Portals wired for circuit 2 = 2 Portals wired for circuit 1 = Blank

NOTE: Part Number Configurator can be used both to identify stock product configurations and also to request custom configurations from the factory. Consult the factory for more information.

Work Surface Modular Power Kits Ordering Information

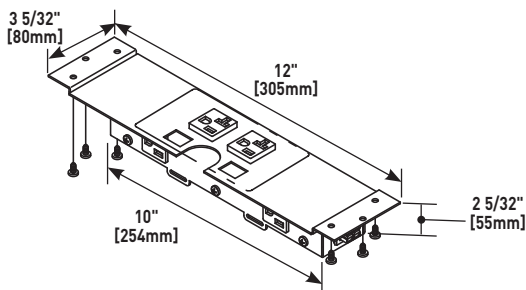

NOTE: Kits include portal(s), flange(s) cables and mounting clips. Enhanced Portal Kit shown.



Shown with existing table grommet (supplied by others).

NOTE: Kit configurations assume there is 1/2" of cabling on each side of the table to make the table-to-table connections.

NOTE: Cable and Connectors are wired for two circuits. Portals are either Circuit 1 or Circuit 2. (They pass through the other circuit.)

WORK SURFACE MODULAR POWER

Ordering Information

Work Surface Modular Power Kits Ordering Information

WSMEDTC60SLSK, WSMEDTC60SLSK-2 Through Table Access – Single Enhanced Portal Kits

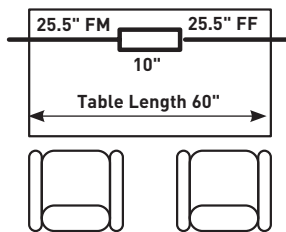

Modular Power & Work Surface Portal Quick Kit for 5' Table – Kit contains two 4 wire, 2 circuit connectorized cables each 25.5" in length (one M/F and one F/F) with black cable covers and 4 cable clamps for mounting. Also one work surface portal with 2 power outlets accessible from table surface and 2 convenience power outlets accessible from under the table, 2 keystone openings for communications and one silver flange cover. Portal is wired for circuit 1. For circuit 2 wired portals, order the "-2" suffixed part number.

WSMEDTC72SLSK, WSMEDTC72SLSK-2 Through Table Access – Single Enhanced Portal Kits

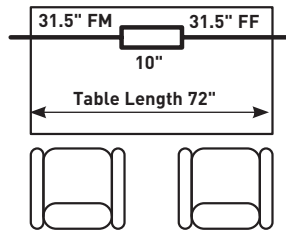

Modular Power & Work Surface Portal Quick Kit for 6' Table – Kit contains two 4 wire, 2 circuit connectorized cables each 31.5" in length (one M/F and one F/F) with black cable covers and 4 cable clamps for mounting. Also one work surface portal with 2 power outlets accessible from table surface and 2 convenience power outlets accessible from under the table, 2 keystone openings for communications and one silver flange cover. Portal is wired for circuit 1. For circuit 2 wired portals, order the "-2" suffixed part number.

WSMEDTC60SLDK, WSMEDTC60SLDK-2 Through Table Access – Double Enhanced Portal Kits

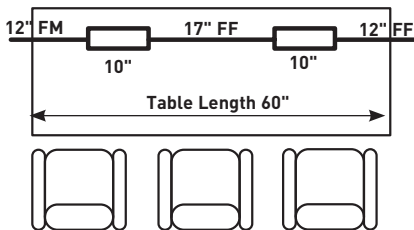

Modular Power & Double Work Surface Portal Quick Kit for 5' Table – Kit contains three 4 wire, 2 circuit connectorized cables; two 12" in length (one M/F and one F/F) and one 17" (F/F), all with black cable covers and 8 cable clamps for mounting. Also two work surface portals each with 2 power outlets accessible from table surface and 2 convenience power outlets accessible from under the table, 2 keystone openings for communications and one silver flange cover. Portals are wired for circuit 1. For circuit 2 wired portals, order the "-2" suffixed part number.

WSMEDTC72SLDK, WSMEDTC72SLDK-2 Through Table Access – Double Enhanced Portal Kits

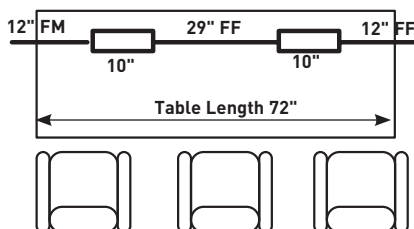

Modular Power & Double Work Surface Portal Quick Kit for 6' Table – Kit contains three 4 wire, 2 circuit connectorized cables; two 12" in length (one M/F and one F/F) and one 29" (F/F), all with black cable covers and 8 cable clamps for mounting. Also two work surface portals each with 2 power outlets accessible from table surface and 2 convenience power outlets accessible from under the table, 2 keystone openings for communications and one silver flange cover. Portals are wired for circuit 1. For circuit 2 wired portals, order the "-2" suffixed part number.

NOTE: Kit configurations assume there is 1/2" of cabling on each side of the table to make the table-to-table connections.

WORK SURFACE MODULAR POWER

Ordering Information

Work Surface Modular Power Kits Ordering Information (continued)

WSMPDUT60BKSK, WSMPDUT60BKSK-2 Under Table Access (No Flange) – Portal Kits

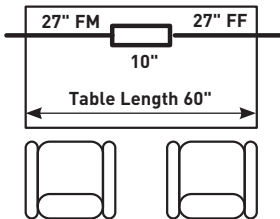

Modular Power & Work Surface Portal Quick Kit for 5' Table – Kit contains two 4 wire, 2 circuit connectorized cables each 27" in length (one M/F and one F/F) with black cable covers and 4 cable clamps for mounting, one black work surface portal with 2 power and 2 keystone openings for communications. Portal is wired for circuit 1. For circuit 2 wired portals, order the "-2" suffixed part number. Kits can be used with existing grommets table openings or with portals rotated and edge mounted.

WSMPDUT72BKSK, WSMPDUT72BKSK-2 Under Table Access (No Flange) – Portal Kits

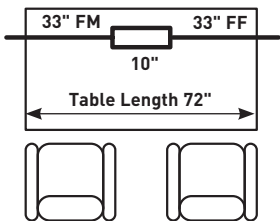

Modular Power & Work Surface Portal Quick Kit for 6' Table – Kit contains two 4 wire, 2 circuit connectorized cables each 33" in length (one M/F and one F/F) with black cable covers and 4 cable clamps for mounting, one black work surface portal with 2 power and 2 keystone openings for communications. Portal is wired for circuit 1. For circuit 2 wired portals, order the "-2" suffixed part number. Kits can be used with existing grommets table openings or with portals rotated and edge mounted.

Cord-Ended Enhanced Work Surface Portals – For Use at Workstations Ordering Information

WSCEDTCSL, WSCEDTCBK Cord-Ended Enhanced Work Surface Portals – For Use at Workstations*



Cord-Ended Enhanced Work Surface Portals – For Use at Workstations – Cord-ended silver flange and portal (SL) or black flange and portal (BK), with 2 power outlets accessible from table surface and 3 convenience power outlets accessible from under the table, 2 keystone openings, 4 cable clamps and 72" power cord.

Portal Dimensions:

Top with Mounting Flange: 12" L x 3 13/100" W

Base: 9 63/100" L x 2 17/100" D

Flange: 5 68/100" L x 3 39/100" W

* Cord-Ended Units are UL and cUL Listed.

WORK SURFACE MODULAR POWER

Ordering Information

Work Surface Modular Power Components Ordering Information

WSMPHWSC72 Hardwire Starter Cable



72", multi-circuit, black starter cable with cover with 12" leads on one end and a female connector on the other.

WSMP-QD Quick Disconnect Connector



Male connector in decorator sized plate with 18" leads. (Decorator faceplate not included.)

WSMPQDSFF Quick Disconnect Insert & Cable



Single connector with 18" leads in decorator footprint for wall or floor outlets with 72" female/female interconnecting cable and cable cover.

WSMP-T T Connector



MFM connectors for starting power runs from the center of a table or auditorium seating applications.

WSMPCMM12 Connector Cable



12" MM connectorized cable to accommodate "U" or cornered runs.

EVOLUTION™ SERIES WORK SURFACE PORTALS



Evolution™ Work Surface Portals offer extra capacity and style with seamless integration of power, voice, communication and A/V into workstation activations.



CODE REFERENCE

cETLus Listed :
Furniture Power Distribution Unit
Listed to US and Canadian Safety Standards

Evolution Work Surface Portals Part Number Configurator

Work Surface Series	Wiring:	Size: (Diameter)	Cover Style:	Cover Color:
WS	Field-Wired = F	6" [152mm] = 6	Surface/	Nickel = NK
	Cord-Ended = Blank	8" [203mm] = 8	Beveled = S	Bronze = BZ
			Flush = F	Gray = GY
				Black = BK
				Brass = BS

NOTE: Surface/Beveled and Flush cover styles can both be used on a variety of table surfaces and provide different aesthetic options. There are differences in the installation of each style of cover. Please refer to the installation instructions for these products for more detailed information. Evolution Work Surface Portals are not for use in floors.

NOTE: Part Number Configurator can be used both to identify stock product configurations and also to request custom configurations from the factory. Consult the factory for more information.



Evolution Series Work Surface Portals provide recessed access to power, A/V and communications services.

COLOR OPTIONS



Evolution Work Surface Portal Covers are available in the following powder coated finishes: "BK" black, "GY" gray, "NK" nickel, "BS" brass, and "BZ" bronze.

EVOLUTION™ SERIES WORK SURFACE PORTALS

Ordering Information

Evolution™ Work Surface Portals Field-Wired Units Ordering Information

WSF6F Flush Field-Wired Work Surface Portal

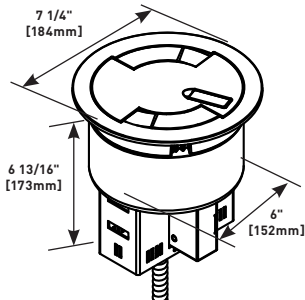

Portal has 7 1/4" [184mm] cover with two (2) duplex receptacles and two (2) Ortronics® category 6 RJ45 jacks and can accept up to five (5) Legrand AVIP plates or Extron® Electronics MAAP device plates. Units have 6' [1.8m] whip for field-wiring and are available with die-cast aluminum cover with durable powder coat finishes of nickel (WSF6FNK), bronze (WSF6FBZ), gray (WSF6FGY), black (WSF6FBK), or brass (WSF6FBS).

WSF6S Surface/Beveled Field-Wired Work Surface Portal

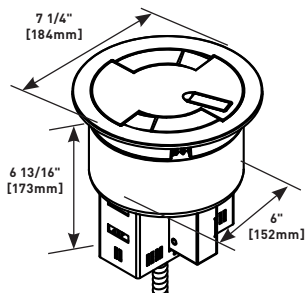

Portal has 7 1/4" [189mm] cover with two (2) duplex receptacles and two (2) Ortronics® category 6 RJ45 jacks and can accept up to five (5) Legrand AVIP plates or Extron® Electronics MAAP device plates. Units have 6' [1.8m] whip for field-wiring and are available with die-cast aluminum cover with durable powder coat finishes of nickel (WSF6SNK), bronze (WSF6SBZ), gray (WSF6SGY), black (WSF6SBK), or brass (WSF6SBS).

WSF8F Flush Field-Wired Work Surface Portal

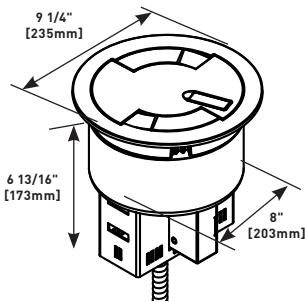

Portal has 9 1/4" [235mm] cover with two (2) duplex receptacles and six (6) Ortronics® category 6 RJ45 jacks and can accept up to ten (10) Legrand AVIP plates or Extron® Electronics MAAP device plates. Units have 6' [1.8m] whip for field-wiring and are available with die-cast aluminum cover with durable powder coat finishes of nickel (WSF8FNK), bronze (WSF8FBZ), gray (WSF8FGY), black (WSF8FBK), or brass (WSF8FBS).

WSF8S Surface/Beveled Field-Wired Work Surface Portal

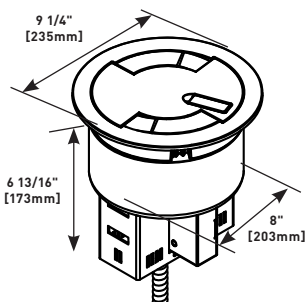

Portal has 9 1/4" [235mm] cover with two (2) duplex receptacles and six (6) Ortronics® category 6 RJ45 jacks and can accept up to ten (10) Legrand AVIP plates or Extron® Electronics MAAP device plates. Units have 6' [1.8m] whip for field-wiring and are available with die-cast aluminum cover with durable powder coat finishes of nickel (WSF8SNK), bronze (WSF8SBZ), gray (WSF8SGY), black (WSF8SBK), or brass (WSF8SBS).

NOTE: Core hole size for 6" units is 6 1/4" [159mm]. Core hole size for 8" units is 8 1/4" [210mm]. Flanges for both the 6" and 8" units extend 3/4" [19.1mm] from body of unit. Evolution Work Surface Portals are not for use in floors.

EVOLUTION™ SERIES WORK SURFACE PORTALS

Ordering Information

Evolution™ Work Surface Portals Cord-Ended Units Ordering Information

WS6F Flush Cord-Ended

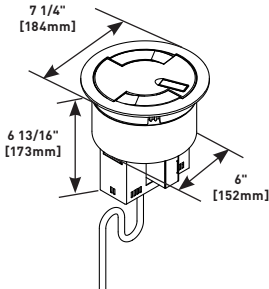

Portal has 7 1/4" [184mm] cover with two (2) duplex receptacles and two (2) Ortronics® category 6 RJ45 jacks and can accept up to five (5) Legrand AVIP plates or Extron® Electronics MAAP device plates. Units are prewired with 12' [3.7m] cord with NEMA 5-15P plug and are available with die-cast aluminum cover with durable powder coat finishes of nickel (WS6FNK), bronze (WS6FBZ), gray (WS6FGY), black (WS6FBK), or brass (WS6FBS).

WS6S Surface/Beveled Cord-Ended Work Surface Portal

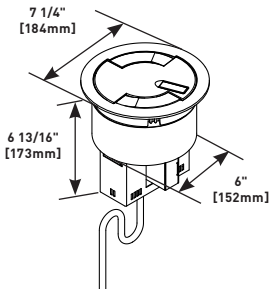

Portal has 7 1/4" [184mm] cover with two (2) duplex receptacles and two (2) Ortronics® category 6 RJ45 jacks and can accept up to five (5) Legrand AVIP plates or Extron® Electronics MAAP device plates. Units are prewired with 12' [3.7m] cord with NEMA 5-15P plug and are available with die-cast aluminum cover with durable powder coat finishes of nickel (WS6SNK), bronze (WS6SBZ), gray (WS6SGY), black (WS6SBK), or brass (WS6SBS).

WS8F Flush Cord-Ended Work Surface Portal

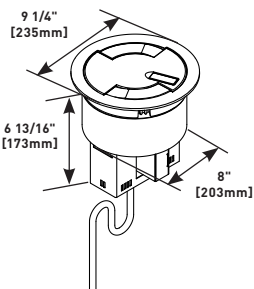

Portal has 9 1/4" [235mm] cover with two (2) duplex receptacles and six (6) Ortronics® category 6 RJ45 jacks and can accept up to ten (10) Legrand AVIP plates or Extron® Electronics MAAP device plates. Units are prewired with 12' [3.7m] cord with NEMA 5-15P plug and are available with die-cast aluminum cover with durable powder coat finishes of nickel (WS8FNK), bronze (WS8FBZ), gray (WS8FGY), black (WS8FBK), or brass (WS8FBS).

WS8S Surface/Beveled Cord-Ended Work Surface Portal

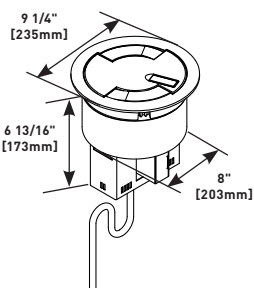

Portal has 9 1/4" [25mm] cover with two (2) duplex receptacles and six (6) Ortronics® category 6 RJ45 jacks and can accept up to ten (10) Legrand AVIP plates or Extron® Electronics MAAP device plates. Units are prewired with 12' [3.7m] cord with NEMA 5-15P plug and are available with die-cast aluminum cover with durable powder coat finishes of nickel (WS8SNK), bronze (WS8SBZ), gray (WS8SGY), black (WS8SBK), or brass (WS8SBS).

NOTE: Core hole size for 6" units is 6 1/4" [159mm]. Core hole size for 8" units is 8 1/4" [210mm]. Flanges for both the 6" and 8" units extend 3/4" [19.1mm] from body of unit. Evolution Work Surface Portals are not for use in floors.

deQUORUM™ RECESSED WORK SURFACE PORTALS



deQuorum™ Recessed Work Surface Portals provide flexibility in décor, communication and A/V connectivity options, and installation to meet specific functional and aesthetic needs.

CODE REFERENCE

cULus Listed Relocatable Power Tap:
File E66421 Guide XBYS
cULus Listed Multioutlet Assembly:
File E15191 Guide PVGT
Listed to US and Canadian Safety Standards
Meets Article 380 of NEC.

deQuorum Recessed Work Surface Portals Part Number Configurator



deQuorum Series:

KC = Cord Ended
KF = Field Installed



Cover Style:

Flush = 1
Contoured = 4



Cover Color:

Black = 0
Gray = 5



Communication:

Ortronics = RT
Wiremold = CM Open System



Top Style:

Recessed = 2
Blank = 8

NOTE: Part Number Configurator can be used both to identify stock product configurations and also to request custom configurations from the factory. Consult the factory for more information.

deQuorum Recessed Work Surface Portals Cover Options

Flush Covers - Available finishes: Black or Gray.
Shown with flange.

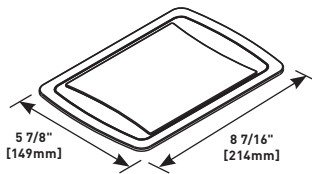

Blank Top

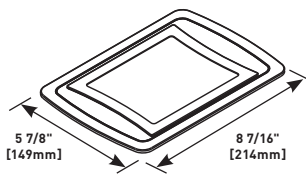

Decorative Recess for Table Laminate Insert

Contoured Covers - Available finishes: Black or Gray.
Shown with flange.

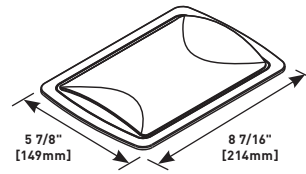

Blank Top

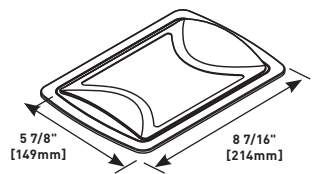

Decorative Recess for Table Laminate Insert

COLOR OPTIONS



deQuorum Work Surface Portal Covers are available in Black or Gray

For information regarding communication inserts, go to:
www.legrand.us/wiremold

deQUORUM™ RECESSED WORK SURFACE PORTALS

Ordering Information

deQuorum Recessed Work Surface Portals – In-Stock Configurations Ordering Information

KC10CM2

Cord-ended with black, flush cover with decorative recess. Unit comes with two 20A gasketed prewired receptacles with a 12' [3.65m] 14/3 SJT black cord. Includes adapter for Wiremold CM Series Open System communications outlets. Communication modules sold separately.

KF10CM8

Field-wired with black, flush cover. Unit comes with two 20A gasketed prewired receptacles with a 3/8" [9.5mm] diameter 6' [1.83m] flexible whip. Includes adapter for Wiremold CM Series Open System communications outlets. Communication modules sold separately.

KC10RT8

Cord-ended with black, flush cover. Unit comes with two 20A gasketed prewired receptacles with a 12' [3.65m] 14/3 SJT black cord. Includes adapter for Ortronics® Series II and TracJack inserts. Communication modules sold separately.

KF15RT2

Field-wired with gray, flush cover with decorative recess. Unit comes with two 20A gasketed prewired receptacles with a 3/8" [9.5mm] diameter 6' [1.83m] flexible whip. Includes adapter for Ortronics® Series II and TracJack inserts. Communication modules sold separately.

KC15RT8

Cord-ended with gray, flush cover. Unit comes with two 20A gasketed prewired receptacles with a 12' [3.65m] 14/3 SJT black cord. Includes adapter for Ortronics® Series II and TracJack inserts. Communication modules sold separately.

Field-Wired Unit

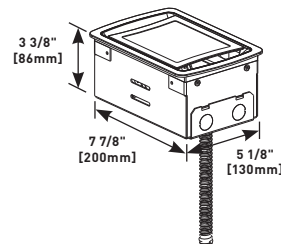

Cord-Ended Unit

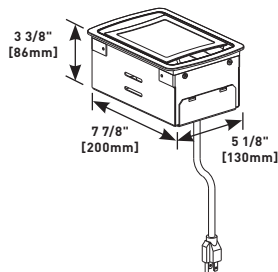

Above unit shown with KA700, 20A Gasketed Receptacle Plate and KA305, Legrand AVIP Adapter Plate installed.

deQUORUM™ RECESSED WORK SURFACE PORTALS

Ordering Information

deQuorum Recessed Work Surface Portals – Communication Plates Ordering Information

KA102RT

Replacement Ortronics Communications Plate

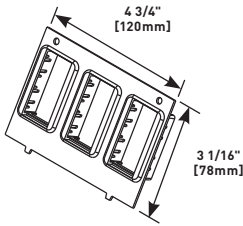

Installed adapters will accommodate either Ortronics® Series II front-loading module system or the TracJack individual jack system. Includes black plate and three (3) Series II and three (3) TracJack adapters.

KA302 Cable Cord Keeper Plate

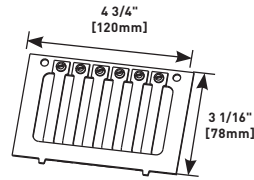

Holds cables captive for easy access. Pull the cable out for use. Keeper bars provide seven adjustable openings for cables ranging from .150" to .350" [3.8mm to 8.9mm] in diameter.

KA104CM Replacement Wiremold Open System Communications Plate

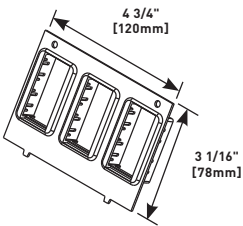

Installed adapters accept Wiremold CM Series modules to accommodate a wide range of communications outlets. Includes black plate and three (3) Wiremold Open System CM2 adapters.

KA305 Legrand AVIP Adapter Plate

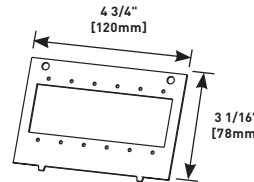

Accepts six (6) single size Legrand AVIP plates or Extron® Electronics MAAP or three (3) double size MAAP modules, or any combination. Includes necessary hardware.

KA700 Replacement 20A Gasketed Receptacle Plate

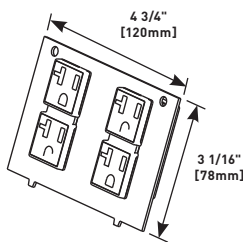
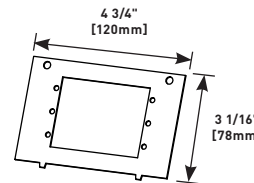

Plate has factory-installed receptacles ready to connect with installed unit. Can be used for field-installed or cord-ended units.

KA305-AAP Extron® AAP Adapter Plate



Accepts three (3) AAP plates. Includes necessary hardware.

KA301 Single-Gang Opening Plate

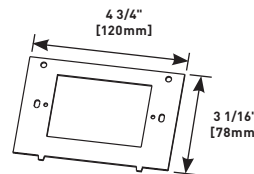

Use this plate to install any communication and/or multimedia connectivity that requires a single-gang wallplate. Includes necessary mounting hardware.

deQUORUM™ FLIP-UP WORK SURFACE PORTALS



deQuorum™ Flip-Up Work Surface Portals provide flexibility in décor, communication connectivity options, and installation to meet specific functional and aesthetic needs.

CODE REFERENCE

cULus Listed Relocatable Power Tap:
File E66421 Guide XBYS
cULus Listed Multioutlet Assembly:
File E15191 Guide PVGT
Listed to US and Canadian Safety Standards
Meets Article 380 of NEC.

deQuorum Flip-Up Work Surface Portals Part Number Configurator

K P

deQuorum Series:

KP = Flip Up Portal

— — — —

Unit Color:

Black = 9999
Stainless = 2345

— —

Communications:

Ortronics = RT
Wiremold
Open System = CM

— —

Receptacle:

20 Amp = 20
15 Amp = 15

NOTE: Part Number Configurator can be used both to identify stock product configurations and also to request custom configurations from the factory. Consult the factory for more information.

deQUORUM™ FLIP-UP WORK SURFACE PORTALS

Ordering Information

deQuorum™ Flip-Up Work Surface Portals Ordering Information

KP9999, KP9999-15 Single Flip-Up Unit

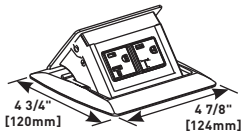

Black cover. KP9999 includes one 20A black gasketed duplex receptacle. KP9999-15 includes one 15A black gasketed duplex receptacle. Both units come with a 12' [3.66m] cord.

KP2345, KP2345-15 Single Flip-Up Unit

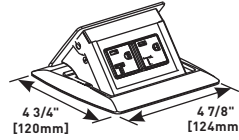

Stainless finish cover. KP2345 includes one 20A black gasketed duplex receptacle. KP2345-15 includes one 15A gasketed duplex receptacle. Both units come with a 12' [3.66m] cord.

KP9999RT, KP9999RT-15 Dual Flip-Up Unit

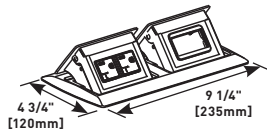

Black cover. KP9999RT includes one 20A black gasketed duplex receptacle and one (1) Ortronics® Series II and one (1) Tracjack adapter to accommodate either Series II front-loading modules or TracJack individual jack. KP9999RT-15 includes one 15A black gasketed duplex receptacle. Both units come with a 12' [3.66m] cord.

KP2345RT, KP2345RT-15 Dual Flip-Up Unit

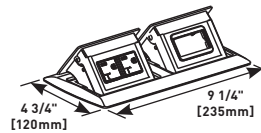

Stainless finish cover. KP2345RT includes one 20A black gasketed duplex receptacle and one 2A adapter to accommodate either Ortronics® Series II front-loading modules or TracJack individual jacks. KP2345RT-15 includes one 15A black gasketed duplex receptacle. Both units come with a 12' [3.66m] cord.

KP9999CM, KP9999CM-15 Dual Flip-Up Unit

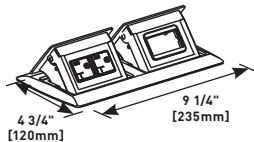

Black cover. Wiremold CM Series Open System 2A modules for a wide range of communications outlets. KP9999CM-15 is the same as KP9999CM except with a 15A black gasketed duplex receptacle. Both units come with a 12' [3.66m] cord.

KP2345CM, KP2345CM-15 Dual Flip-Up Unit

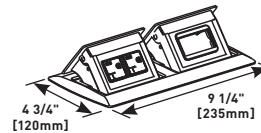

Stainless finish cover. Wiremold CM Series Open System Communication 2A modules for a wide range of communications outlets. KP2345CM-15 includes one 15A black gasketed duplex receptacle. Both units come with a 12' [3.66m] cord.

COLOR OPTIONS



deQuorum Flip-Up Work Surface Portal Covers are available in the following finishes: Black and Stainless.

TABLESOURCE™ WORK SURFACE PORTALS



TableSource™ Work Surface Portals provide flexibility in décor, datacom connectivity options, and installation to meet specific functional and aesthetic needs.

CODE REFERENCE

cULus Listed Relocatable Power Tap:
File E66421 Guide XBY5

cULus Listed Multioutlet Assembly:
File E15191 Guide PVGT
Listed to US and Canadian Safety Standards
Meets Article 380 of NEC.

TableSource Work Surface Portals Ordering Information

TableSource Portals listed in this chart are packaged with a mounting clip that attaches to the work surface.

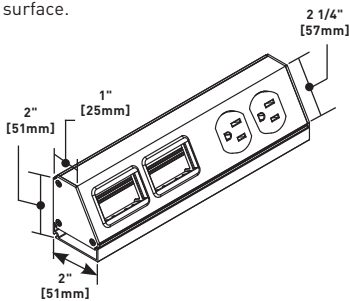

CATALOG NUMBER	FINISH	UNIT LENGTH Inches [mm]	15A DUPLEX	CORD LENGTH Feet [mm]	COMM. OPENINGS	COMM. SYSTEM
TS2345AX1L1GYRT	Clear Anodized	6 23/32" [170mm]	1	12' [3.7m]	1	Ortronics TracJack & Series II
TS2345AX1L1GYCM	Clear Anodized	6 23/32" [170mm]	1	12' [3.7m]	1	Wiremold Open System CM2 communications outlets
TS2345AX1L2GYRT	Clear Anodized	9 3/32" [231mm]	1	12' [3.7m]	2	Ortronics TracJack & Series II
TS2345AX1L2GYCM	Clear Anodized	9 3/32" [231mm]	1	12' [3.7m]	2	Wiremold Open System CM2 communications outlets

TableSource Portals listed in this chart are packaged to include the backslash mounting bracket.

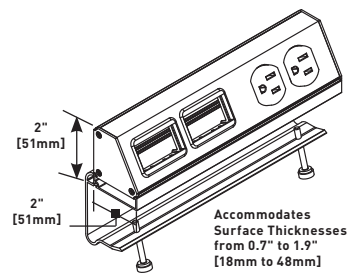

CATALOG NUMBER	FINISH	UNIT LENGTH Inches [mm]	15A DUPLEX	CORD LENGTH Feet [mm]	COMM. OPENINGS	COMM. SYSTEM
TS2345AM1L1GYRT	Clear Anodized	6 23/32" [170mm]	1	12' [3.7m]	1	Ortronics TracJack & Series II
TS2345AM1L1GYCM	Clear Anodized	6 23/32" [170mm]	1	12' [3.7m]	1	Wiremold Open System CM2 communications outlets
TS2345AM1L2GYRT	Clear Anodized	9 3/32" [231mm]	1	12' [3.7m]	2	Ortronics TracJack & Series II
TS2345AM1L2GYCM	Clear Anodized	9 3/32" [231mm]	1	12' [3.7m]	2	Wiremold Open System CM2 communications outlets

COLOR OPTIONS



TableSource Work Surface Portal Covers are available in a clear anodized finish.

TABLESOURCE™ WORK SURFACE PORTALS

Ordering Information

TableSource Work Surface Portals Configurator

Design a Cord-Ended TableSource Solution Sample Part: **TS6137BX2D2BKCM**

IMPORTANT
The portal length is determined by the number of power and communications devices specified. Use the following considerations for your design:
To determine approximate length:
[No. of duplexes x 4.4" [111.8mm]] + [no. of communications adapters x 2.25" [57.1mm]] + .75" [19.1mm] = overall length of unit in inches [mm]
For more than 2 duplexes – add 2" [51mm] for circuit breaker.

Data Cables egress out the back (the side opposite the devices)

Color – Reference

Color – Reference	Code
White	= 3333
Black	= 9999
Ivory	= 5555
No Color – Anodized Aluminum	= 2345
Warm White – Steelcase 4700	= 3136
Moss – Steelcase 4722	= 5169
Lt. Tone – Herman Miller LT	= 2486
Mist – Steelcase 4606	= 5895
Woodrose – Steelcase 4601	= 6137
Slate – Steelcase 4726	= 6142
Light Blue – Shaw Walker A751	= 1988
Greystone – Haworth – G	= 2884

Note: Send in a color chip. Most colors can be matched.

1. Choose color from the list below. Input the four-digit number.

2. Select face for mounting device. Input letter.

3. Do you want optional mounting bracket for backsplash application?

4. Number of duplexes (from 1-4). Input number.

5. Choose a length and input the corresponding letter for that length.

Length Feet [metric]	Code Letter
2 [0.6m]	B
3 [0.9m]	C
4 [1.2m]	D
5 [1.5m]	E
6 [1.8m]	F
7 [2.1m]	G
8 [2.4m]	H
9 [2.7m]	I
10 [3.0m]	J
11 [3.4m]	K
12 [3.7m]	L

NOTE: Cord color is black.

6. Choose number of communication adapters (from 1-4). Input number.

7. Choose color of duplex and communication adapters. Input two-letter color code.

Black = BK
Gray = GY

8. Communication brand. Input two letters.

RT = Ortronics Series II and TracJack Solutions
CM = Wiremold Open System 2A communications modules

NOTE: Part Number Configurator can be used both to identify stock product configurations and also to request custom configurations from the factory. Consult the factory for more information.

TABLESOURCE™ WORK SURFACE PORTALS

Ordering Information

TableSource Work Surface Portals Configurator

Design a Hard-Wired TableSource Solution

Sample Part: **TS5911BT3Z2BKCM**

IMPORTANT

The portal length is determined by the number of power and communications devices specified. Use the following considerations for your design:

To determine approximate length:
 (No. of duplexes x 4.4" [111.8mm])
 + (no. of communications adapters x 2.25" [57.1mm]) + .75" [19.1mm]
 = overall length of unit in inches [mm].

Data Cables egress out the back (the side opposite the devices)

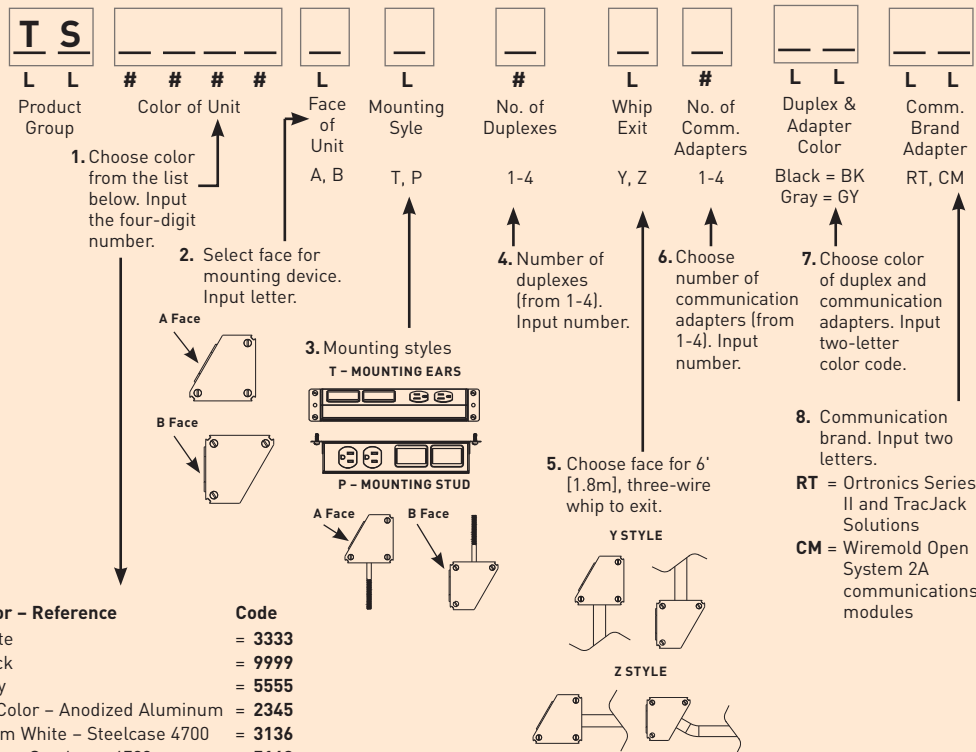
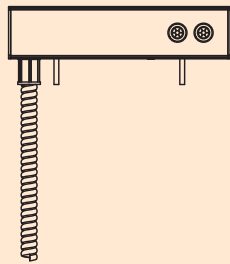

Color - Reference	Code
White	= 3333
Black	= 9999
Ivory	= 5555
No Color - Anodized Aluminum	= 2345
Warm White - Steelcase 4700	= 3136
Moss - Steelcase 4722	= 5169
Lt. Tone - Herman Miller LT	= 2486
Mist - Steelcase 4606	= 5895
Woodrose - Steelcase 4601	= 6137
Slate - Steelcase 4726	= 6142
Light Blue - Shaw Walker A751	= 1988
Greytone - Haworth - G	= 2884

Note: Send in a color chip. Most colors can be matched.

NOTE: Part Number Configurator can be used both to identify stock product configurations and also to request custom configurations from the factory. Consult the factory for more information.

LAB BENCH WORK SURFACE PORTALS



Lab Bench Work Surface Portals provide access to multiple services in a variety of configurations to meet the demanding needs of laboratory activity.

CODE REFERENCE

cULus Listed Outlet Box:
File E2961 Guide QCIT
Listed to US and Canadian
Safety Standards

Lab Bench Work Surface Portals Ordering Information

AL241S-HB Lab Bench Work Surface Portals

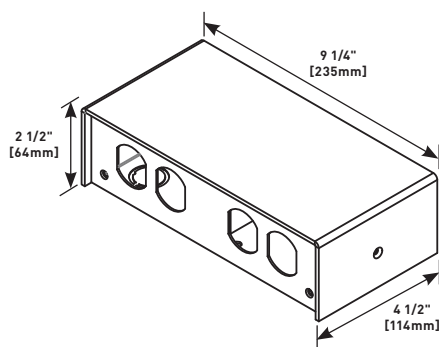

Aluminum housing and base 9 1/4" x 4 1/2" x 2 1/2" [235mm x 114mm x 64mm] are provided with four (4) 1" trade size knockouts in base for hardwiring unit and two dividers which allow units to be divided on either the "X" or "Y" axis/plane. Accommodates a variety of power (NEMA or decorator), and supports Ortronics® and Wiremold Open Systems connectivity. Portals are field configurable by ordering the corresponding faceplates.

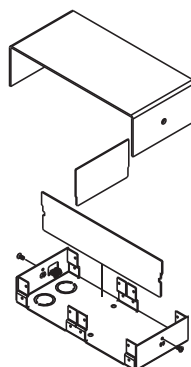

AL241S-HB exploded view
showing dividers

COLOR OPTIONS

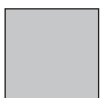

Lab Bench Work Surface Portal Covers are available with a clear anodized aluminum finish.

LAB BENCH WORK SURFACE PORTALS

Ordering Information

Faceplates for Lab Bench Work Surface Portals Ordering Information

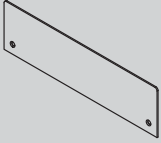
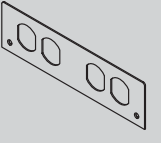
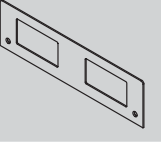
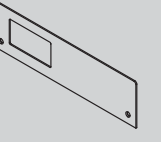
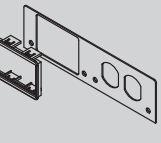
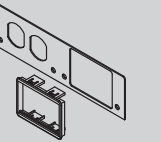
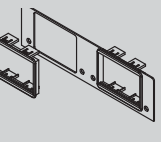
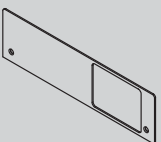
PART NUMBER		LEFT OPENING	RIGHT OPENING
AL241FPB-B		Blank	Blank
AL241FPD-D		Duplex	Duplex
AL241FPDEC-DEC		Decorator	Decorator
AL241FPDEC-B		Decorator	Blank
AL241FP6A-D		Ortronics® or Wiremold Open System Communication 6A Module. Adapters included.	Duplex
AL241FPD-6A		Duplex	Ortronics® or Wiremold Open System Communication 6A Module. Adapters included.
AL241FP6A-6A		Ortronics® or Wiremold Open System Communication 6A Module. Adapters included.	Ortronics® or Wiremold Open System Communication 6A Module. Adapters included.
AL241FPB-6A		Blank	Ortronics® or Wiremold Open System Communication 6A Module. Adapters included.

LAB BENCH WORK SURFACE PORTALS

Ordering Information

Faceplates for Lab Bench Work Surface Portals Ordering Information (continued)

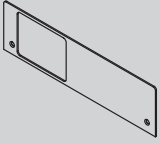
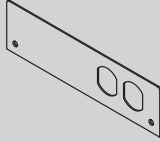
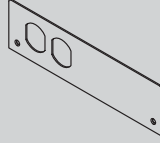
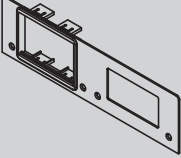
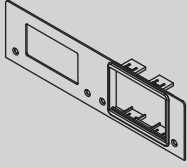
PART NUMBER		LEFT OPENING	RIGHT OPENING
AL241FP6A-B		Ortronics® or Wiremold Open System Communication 6A Module. Adapters included.	Blank
AL241FPB-D		Blank	Duplex
AL241FPD-B		Duplex	Blank
AL241FP6A-DEC		Ortronics® or Wiremold Open System Communication 6A Module. Adapters included.	Decorator
AL241FPDEC-6A		Decorator	Ortronics® or Wiremold Open System Communication 6A Module. Adapters included.

DESKTOP POWER CENTER WORK SURFACE PORTALS



Desktop Power Center Work Surface Portals bring surge-protected power and USB charging outlets up to the work surface by utilizing existing cord drop openings in office desks and table tops or by mounting onto the edge of a desk or table top.

CODE REFERENCE

**cETLus Listed
Furniture Power Distribution Unit:**
Listed to US and Canadian Safety Standards

Desktop Power Center Work Surface Portals Ordering Information



WSC400-S Desktop Power Center Portal with mounting components

NOTE: USB circuit is designed to the USB 2.0 standard and can provide 1.4 amps shared across the two USB ports.

WSC400-S Work Surface Portal

Has four (4) surge-protected 15Amp power outlets and a 12' [3.66m] cord. Units come with accessories for mounting into round cutouts in desk or edge mounting on desks or other work surfaces.

WSC320-S Work Surface Portal

Has three (3) surge-protected 15Amp power outlets, two USB charging outlets and a 12' [3.66m] cord. Units come with accessories for mounting into round cutouts in desk or edge mounting on desks or other work surfaces.

Mounting Options:

Installs through an existing cord drop opening.

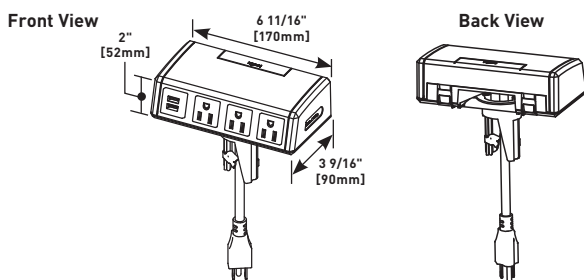

Installs on the edge of a work surface.

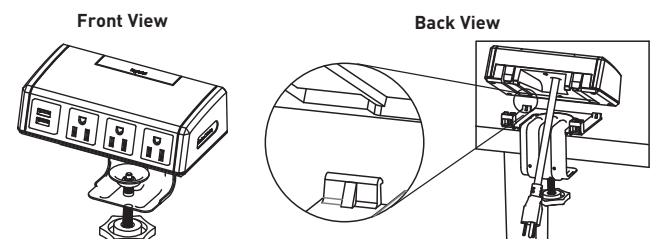

COLOR OPTIONS

Desktop Power Center Portals are available in black with magnesium side panels.



DESK MODULE



Wiremold® Desk Module upgrades workstations to well connected spaces so users can focus on the business at hand.

CODE REFERENCE

cETLus Listed :
Furniture Power Distribution Unit
Listed to US and Canadian Safety Standards



Desk Module Ordering Information

WSDM210BK Desk Module



Desk module, black/silver, with two (2) 15A outlets and 12' cord.

WSDM211BK Desk Module



Desk module, black/silver, with two (2) 15A outlets, one UB charging outlet and 12' cord.



COLOR OPTIONS



Desk Modules are available in a black finish with silver trim elements

DESK MODULE

Ordering Information

Desk Module Ordering Information

WSDM210BKR Desk Module



Desk module, black/silver, with two (2) 15A outlets and 12' cord. Includes RJ45 retractor cassette.

WSDM211BKR Desk Module



Desk module, black/silver, with two (2) 15A outlets, one USB charging outlet and 12' cord. Includes RJ45 retractor cassette.



WSDMDC RJ45 Retractor Cassette



Retractor with Category 6 cable extending to 4.4' [1.35m]

WSDMUC USB Retractor Cassette



Retractor with USB charging cable extending to 4.4' [1.35m]

FIRE STOP SOLUTIONS



Wiremold® FlameStopper™ Series Thru-Wall/Thru-Floor Fittings are designed to provide a firestopping solution in a unique integral fitting that can be used for both new and retrofit construction.

Table of Contents

**FlameStopper™ Series
Thru-Wall & Thru-Floor Fittings**



FIRE STOP SOLUTIONS

FlameStopper FS2R & FS4R Series Through-Wall UL Ratings

- Flame:** The F Rating (F and FH in Canada) is expressed in hours. This number indicates the specific length of time that a barrier can withstand fire before being consumed or before permitting the passage of flame through the opening.
- Temperature:** The T Rating (FT and FTH in Canada) is expressed in hours. This number indicates the length of time that the temperature on the non-fire side of the penetration does not exceed 325 degrees F above the ambient temperature.
- Air Leakage:** The L Rating is expressed in CFM. This number indicates the amount of air (or cold smoke) that can leak through a penetration.

Through-Wall Ratings for FS2R & FS4R Series

(UL Ratings for FS2R and FS4R Series when used alone for new construction or when used with heat shield for retrofit applications.)

UL RATINGS (US RATINGS)	MAX. RATING	UL RATINGS (CANADIAN RATINGS)	MAX. RATING
F Rating with & without cables	4 Hours	F & FH Rating with & without cables	4 Hours
T Rating with coax cable	4 Hours	FT & FTH Rating with coax cable	4 Hours
T Rating with fiber optic cable	4 Hours	FT & FTH Rating with fiber optic cable	4 Hours
T Rating with Max. 1" fiber optic rcwy. with fiber optic fill	4 Hours	FT & FTH Rating with Max. 1" fiber optic raceway with fiber optic fill	4 Hours
T Rating with Max. 4-pair cable (22 ga & smaller)	3 Hours	FT & FTH Rating with Max. 4-pair cable (22 ga & smaller)	3 Hours
T Rating with Max. 4 conductor (2AWG & smaller)	1 Hour	FT & FTH Rating with Max. 4 conductor (2AWG & smaller)	1 Hour
T Rating with Max. 100-pair cable (24 ga & smaller)	1 Hour	FT & FTH Rating with Max. 100-pair cable (24 ga & smaller)	1 Hour
T Rating with Max. 400-pair cable (24 ga & smaller)	45 Minutes	FT & FTH Rating with Max. 400-pair cable (24 ga & smaller)	45 Minutes
T Rating with MC cable (8 wire max. 12 ga & smaller)	15 Minutes	FT & FTH Rating with MC cable (8 wire max. 12 ga & smaller)	15 Minutes
L Rating at ambient without cables (doors closed)	2.6 cfm	L Rating at ambient without cables (doors closed)	2.6 cfm
L Rating at 400°F without cables (doors closed)	1.9 cfm	L Rating at 400°F without cables (doors closed)	1.9 cfm
L Rating at ambient with cables	2.8 cfm	L Rating at ambient with cables	2.8 cfm
L Rating at 400°F with cables	1.3 cfm	L Rating at 400°F with cables	1.3 cfm
Suitable for use in air handling spaces (plenums)	Yes	Suitable for use in air handling spaces (plenums)	Yes

Through-Wall Ratings for FS2R & FS4R Series

(When used with wall plate for retrofit applications.)

UL RATINGS (US RATINGS)	MAX. RATING	UL RATINGS (CANADIAN RATINGS)	MAX. RATING
F Rating with & without cables	2 Hours	F & FH Rating with & without cables	2 Hours
T Rating with Max. 4-pair cable (22 ga & smaller)	1.25 Hours	FT & FTH Rating with Max. 4-pair cable (22 ga & smaller)	1.25 Hours
T Rating with coax cable	1 Hour	FT & FTH Rating with coax cable	1 Hour
T Rating with fiber optic cable	1.25 Hours	FT & FTH Rating with fiber optic cable	1.25 Hours
T Rating with Max. 1" fiber optic raceway with fiber optic fill	1.25 Hours	FT & FTH Rating with Max. 1" fiber optic raceway with fiber optic fill	1.25 Hours
T Rating with MC cable (8 wire max. 12 ga & smaller)	15 Minutes	FT & FTH Rating with MC cable (8 wire max. 12 ga & smaller)	15 Minutes
L Rating at ambient without cables (doors closed)	1.7 cfm	L Rating at ambient without cables (doors closed)	2.6 cfm
L Rating at 400°F without cables (doors closed)	1.8 cfm	L Rating at 400°F without cables (doors closed)	1.9 cfm
L Rating at ambient with cables	3.3 cfm	L Rating at ambient with cables	2.8 cfm
L Rating at 400°F with cables	2.0 cfm	L Rating at 400°F with cables	1.3 cfm
Suitable for use in air handling spaces (plenums)	Yes	Suitable for use in air handling spaces (plenums)	Yes

Through-Floor Ratings for FS2R & FS4R Series

(When used alone.)

UL RATINGS (US RATINGS)	MAX. RATING	UL RATINGS (CANADIAN RATINGS)	MAX. RATING
F Rating with & without cables	3 Hours	F Rating with & without cables	3 Hours
T Rating without cables	3 Hours	T Rating without cables	3 Hours
T Rating with coax cable	3 Hour	T Rating with coax cable	3 Hour
T Rating with fiber optic cable	3 Hours	T Rating with fiber optic cable	3 Hours
T Rating with Max. 4-pair cables (22 ga. or smaller)	3 Hours	T Rating with Max. 4-pair cables (22 ga. or smaller)	3 Hours
T Rating with Max. 4-conductor (2 ga. or smaller)	45 Minutes	T Rating with Max. 4-conductor (2 ga. or smaller)	45 Minutes
T Rating with Max. 100-pair cables (24 ga. or smaller)	1 Hour	T Rating with Max. 100-pair cables (24 ga. or smaller)	1 Hour
T Rating with Max. 400-pair cables (24 ga. or smaller)	45 Minutes	T Rating with Max. 400-pair cables (24 ga. or smaller)	45 Minutes
T Rating with MC cable (8 wire Max. 12 ga. or smaller)	15 Minutes	T Rating with MC cable (8 wire Max. 12 ga. or smaller)	15 Minutes
L Rating at ambient without cables (doors closed)	2.6 cfm	L Rating at ambient without cables (doors closed)	2.6 cfm
L Rating at 400°F without cables (doors closed)	1.9 cfm	L Rating at 400°F without cables (doors closed)	1.9 cfm
L Rating at ambient with cables	2.8 cfm	L Rating at ambient with cables	2.8 cfm
L Rating at 400°F with cables	1.3 cfm	L Rating at 400°F with cables	1.3 cfm
Suitable for use in air handling spaces (plenums)	Yes	Suitable for use in air handling spaces (plenums)	Yes

NOTE: Minimum 4 1/2" [114mm] thick reinforced lightweight or normal weight (100-150 pcf) [1600-2400 kg/m3] concrete floor. Maximum diameter of opening is 4 1/2" [114mm].

FLAMESTOPPER™ SERIES

FlameStopper™ Thru-Wall and Thru-Floor Fittings



FlameStopper™ Thru-Wall and Thru-Floor Fittings provide superior fire protection and ease-of-installation.

CODE REFERENCE

**UL Listed Classified
Fire Stop Devices:**
File R21765.

FlameStopper Series Wire Fill Capacities for Communications

	CABLE TYPE	O.D. (APPROX. DIA.)		FS2 MAXIMUM FILL	FS4 MAXIMUM FILL
		INCHES	[MM]		
UNSHIELDED TWISTED PAIR	4-pair, 24 AWG, Cat 3	0.190	[4.8]	71	312
	4-pair, 24 AWG, Cat 5e	0.210	[5.3]	58	255
	4-pair, 24 AWG, Cat 6	0.250	[6.3]	41	180
TELEPHONE	2-pair, 24 AWG	0.140	[3.6]	130	574
	25-pair, 24 AWG	0.410	[10.4]	15	67
	50-pair, 24 AWG	0.580	[14.7]	7	33
	100-pair, 24 AWG	0.700	[17.8]	5	22
	400-pair, 24 AWG	1.470	[37.3]	1	5
COAXIAL	RG58/U	0.195	[5.0]	197	296
	RG59/U	0.242	[6.1]	43	192
	RG62/U	0.242	[6.1]	43	192
	RG6/U	0.270	[6.9]	32	140
FIBER OPTIC	2 Count	0.180	[4.6]	79	347
	4 Count	0.210	[5.3]	58	255
	24 Count	0.400	[10.2]	16	70
	48 Count	0.450	[11.4]	12	55
	96 Count	0.560	[14.2]	8	35

FlameStopper Series Wire Fill Capacities for Power

	CABLE TYPE	O.D. (APPROX. DIA.)		FS2 MAXIMUM FILL	FS4 MAXIMUM FILL
		INCHES	[MM]		
MAXIMUM 4 COND. NO. 2 AWG (OR SMALLER) COPPER CONDUCTOR CABLE WITH XLPE/PVX INSULATION AND PVC JACKET		0.375	[9.5]	18	80
		0.500	[12.7]	10	45
		0.625	[15.9]	6	28
		0.750	[19.1]	4	20
		0.875	[22.2]	3	14
MAXIMUM 8 COND. NO. 12 AWG MC (METAL CLAD) CABLE		1.000	[25.4]	12	11
		1.125	[28.6]	2	8
		0.375	[9.5]	18	80
		0.500	[12.7]	10	45
	0.625	[15.9]	6	28	
	0.655	[16.9]	5	26	

COLOR OPTIONS

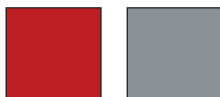

FlameStopper Series™ Thru-Wall and Thru-Floor Fittings are available in either red or a paintable A60 galvaneal finish.

FLAMESTOPPER™ SERIES

Ordering Information

FS4R Firestop 4" Trade Size EMT Conduit Fitting

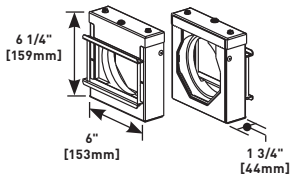

For transitioning cable through fire rated walls/floors for both new and retrofit applications. Available in red (FS4R-RED), or a paintable A60 galvanneal finish (FS4R-GA). UL System W-L-3264 and W-J-3137.

WBSBC Split Bolt Connector

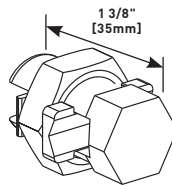

For use with Cablofil® brand wire basket trays to provide ground continuity. Electroplated aluminum. Dual rated for copper and aluminum conductors, No. 2 to 8 gage cable.

FS2R Firestop 2" Trade Size EMT Conduit Fitting

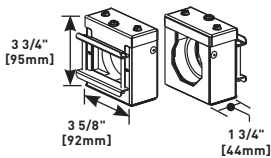

For transitioning cable through fire rated walls/floors for both new and retrofit applications. Available in red (FS2R-RED), or a paintable A60 galvanneal finish (FS2R-GA). UL System W-L-3264 and W-J-3137.

FS4RHS Heat Shield 4" Trade Size Conduit

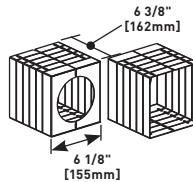

Used only when an existing installed conduit extends 1" [25mm] to 6" [152mm] beyond the wall surface.

FSPCC4758 Precut Conduit 4" Trade Size EMT

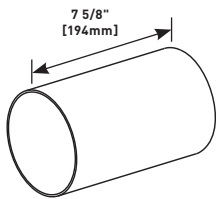

Precut to 7 5/8" [194mm] to fit standard gypsum fire walls with a two-hour fire rating (6" [152mm] wall thickness).

FS2RHS Heat Shield 2" Trade Size Conduit

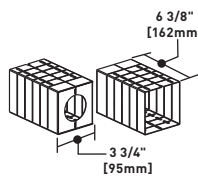

Used only when an existing installed conduit extends 1" [25mm] to 6" [152mm] beyond the wall surface.

FSPCC2758 Precut Conduit 2" Trade Size EMT

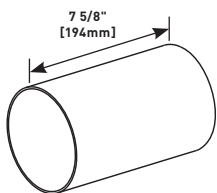

Precut to 7 5/8" [194mm] to fit standard gypsum fire walls with a two-hour fire rating (6" [152mm] wall thickness).

FS4RWP12 Retrofit Kit for Existing Installations

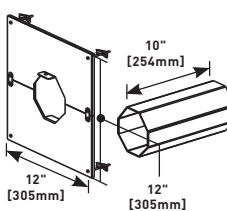

Kit includes 4" trade size split conduit sleeve to enclose existing cables, and 12" x 12" [305mm x 305mm] ceramic heat protected wall plate to cover irregular hole cuts. For use with FS4R Series Firestop.

SPMGL Grounding Lug

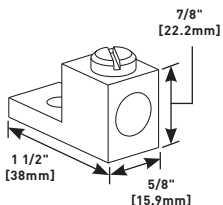

For use with SpecMate™ or Cablofil® brand cable trays to provide ground continuity. Electroplated aluminum. Dual rated for copper and aluminum conductors, No. 2 to 14 gage cable.

FS2RWP8 Retrofit Kit for Existing Installations

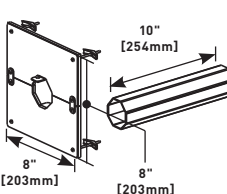

Kit includes 2" trade size split conduit sleeve to enclose existing cables, and 8" x 8" [203mm x 203mm] ceramic heat protected wall plate to cover irregular hole cuts. For use with FS2R Series Firestop.

WIRELESS & ZONE CABLING SOLUTIONS



Wiremold® Wireless & Zone Cabling Enclosures provide a range of alternatives to meet a variety of wireless connectivity strategies.

Featured Products



WAPE Series Wireless Access Point Ceiling Enclosures

676



NME1250AP Nonmetallic Wireless Access Point Enclosure

679

WIRELESS & ZONE CABLING SOLUTIONS

Table of Contents

Wireless Enclosures



VLWAP Vista™
Wireless Access
Point Enclosure



WAPE Series
Wireless Access
Point Ceiling
Enclosures

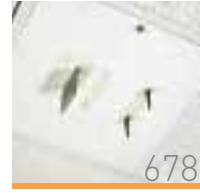

WAPENCL Series
Wireless Access
Point Ceiling
Enclosures



NME1250AP
Wall-Mounted
Nonmetallic
Wireless Access
Point Enclosure



WAPBRKT Wireless
Access Point
Mounting Bracket
for Overhead
Applications

Zone Cabling Enclosures



CZE Series Zone
Cabling Enclosures



RFE Series Zone
Cabling Enclosures

VLWAP VISTA™ WIRELESS ACCESS POINT ENCLOSURE



VLWAP Vista™ Wireless Access Point Mounting Enclosure provides an ideal solution for integrating access points necessary for wireless connectivity into a building's communication infrastructure.

CODE REFERENCE

cULus Listed Multioutlet Assemblies:
File E15191 Guide PVGT
Meets Article 380 of NEC.

Vista Wireless Access Point Enclosure (VLWAP) Ordering Information

VLWAP Vista Wireless Access Point Enclosure

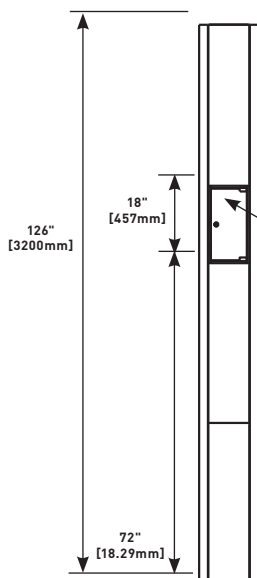

Vista solution for mounting wireless access points. Large frame Vista with anodized round end channels and center panels. Furniture feed style access, 10'6" [3.2m] tall. Has tempered glass panels to conceal access point. Front panel is hinged and lockable. Compartment measures 17 1/2" x 7 1/4" x 2 1/2" [445mm x 183mm x 64mm].

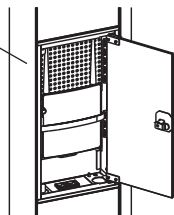

The Vista Wireless Enclosure (VLWAP) offers an aesthetically-pleasing solution that can be customized for any office environment as well as providing an optimal location for wireless signals.

NOTE: For information on configuring a VLWAP within a Vista Architectural Column, visit the Open Space Section of this catalog and review the Vista Architectural Column configuration options.

WAPE SERIES WIRELESS ACCESS POINT CEILING ENCLOSURES



Wiremold® WAPE Series Ceiling Enclosures provide a secure enclosure to house a wide selection of wireless access points. These ceiling enclosures are plenum rated by UL and may be used in environmental air spaces.

CODE REFERENCE

cULus Listed Communication Circuit Accessories:
 File E145222 Guide DUXR
 Meets Article 800 of NEC.
 Meets Article 60-308 of CEC.

WAPE Series Wireless Access Point Ceiling Enclosures Ordering Information

WAPE5-BLKIT, WAPE10-BLKIT Wireless Access Point Enclosure

WAPE5-BLKIT

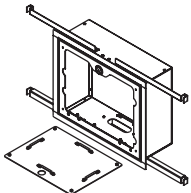

5" (WAPE5-BLKIT) or 10" (WAPE10-BLKIT) deep enclosure for 2' x 2' drop ceiling tile with blank mounting cover, 12"W x 14"L [305mm x 356mm].

WAPE10-BLKIT

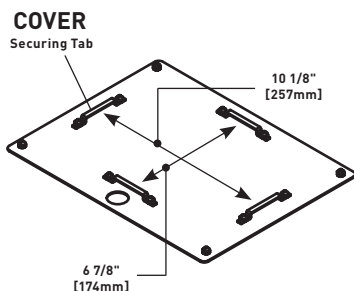
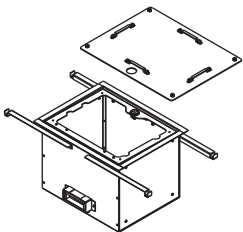

WAPE5-1200KIT, WAPE10-1200KIT Wireless Access Point Enclosure

WAPE5-1200KIT

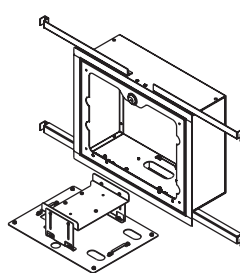

5" (WAPE5-1200KIT) or 10" (WAPE10-1200KIT) deep enclosure for 2' x 2' drop ceiling tile with faceplate for mounting CISCO Aironet 1200, 12"W x 14"L [305mm x 356mm].

WAPE10-1200KIT

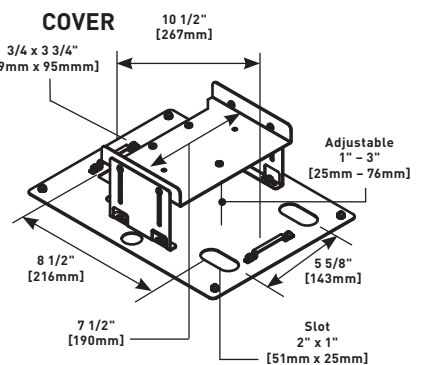
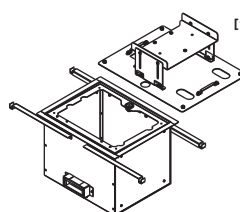

WAPE SERIES WIRELESS ACCESS POINT CEILING ENCLOSURES

Ordering Information

WAPE Series Wireless Access Point Ceiling Enclosures Ordering Information (continued)

WAPE5-1250KITD, WAPE5-1250KITR Wireless Access Point Enclosure

WAPE5-1250KITD

5" deep enclosure for 2'x 2' drop ceiling tile with faceplate for mounting Cisco® Aironet 1250 and 3500 Series using dipole antennas (WAPE5-1250KITD) or remote antennas (WAPE5-1250KITR), 13"W x 14"L [330mm x 356mm].

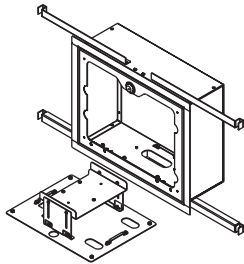

WAPE5-UNIKIT, WAPE10-UNIKIT Wireless Access Point Enclosure

WAPE5-UNIKIT

5" (WAPE5-UNIKIT) or 10" (WAPE10-UNIKIT) deep enclosure for 2'x 2' drop ceiling tile with universal faceplate, 12"W x 14"L [305mm x 356mm].

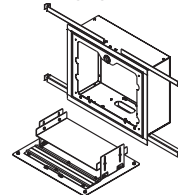

WAPE10-UNIKIT

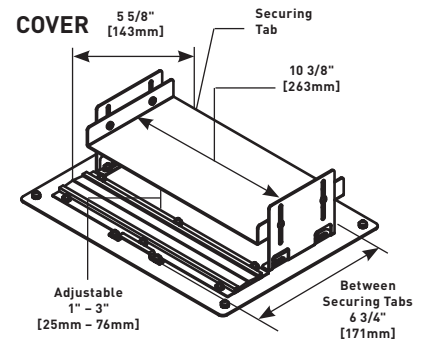
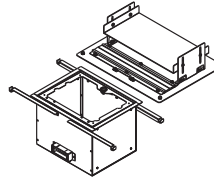

WAPE5-1232KIT, WAPE10-1232KIT Wireless Access Point Enclosure

WAPE5-1232KIT

5" (WAPE5-1232KIT) or 10" (WAPE10-1232KIT) deep enclosure for 2'x 2' drop ceiling tile with faceplate for mounting CISCO® Aironet 1232, 12"W x 14" L [305mm x 356mm].

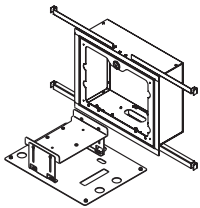

WAPE10-1232KIT

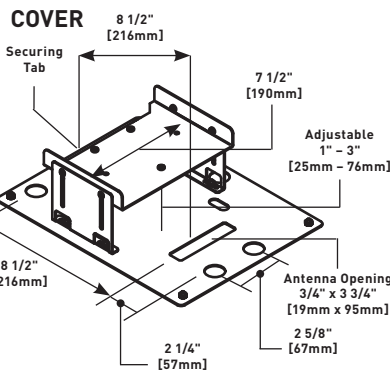
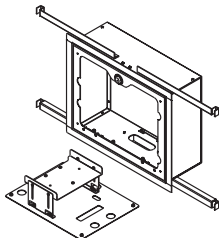

WAPE10-DOME Wireless Access Point Enclosure – with Dome Cover

3" deep enclosure for 2'x 2' drop ceiling tile. 14" diameter by 6 1/2" deep transmission dome.

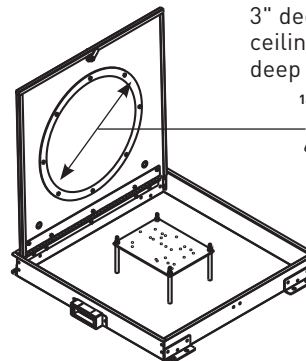

WAPE5-1242KIT, WAPE10-1242KIT Wireless Access Point Enclosure

WAPE5-1242KIT

5" (WAPE5-1242KIT) or 10" (WAPE10-1242KIT) deep enclosure for 2'x 2' drop ceiling tile with faceplate for mounting CISCO® Aironet 1242, 12"W x 14" L [305mm x 356mm].

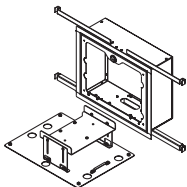

WAPE10-1242KIT

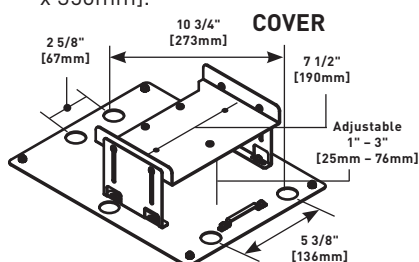
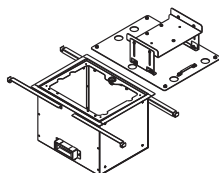

WAPENCL SERIES WIRELESS ACCESS POINT CEILING ENCLOSURES



Wiremold® WAPENCL Series Ceiling Enclosures provide a secure enclosure to house a wide selection of wireless access points including the Cisco® Aironet 1250 and 3500 Series. These ceiling enclosures are plenum rated by UL and may be used in environmental air spaces.

CODE REFERENCE

cULus Listed Communication Circuit Accessories:
 File E145222 Guide DUXR
 Meets Article 800 of NEC.
 Meets Article 60-308 of CEC.

WAPENCL Series Wireless Access Point Ceiling Enclosures Ordering Information

WAPENCL Wireless Access Point Ceiling Enclosure for Drop Ceilings

Provides a permanent and secure location for mounting wireless access points into a grid ceiling system.

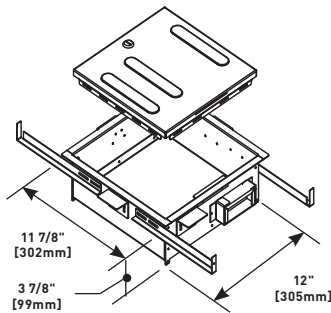

NOTE: Internal dimensions shown.

Front Exterior Dimensions

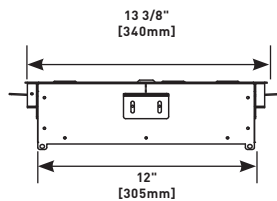

Side Exterior Dimensions

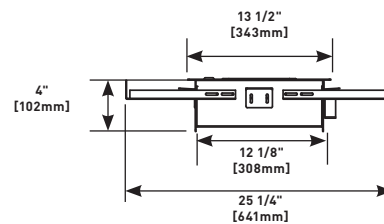

WAPENCL-24-24-4 Wireless Access Point Ceiling Enclosure for Drop Ceilings

Provides a permanent and secure location for mounting wireless access points into a grid ceiling system.

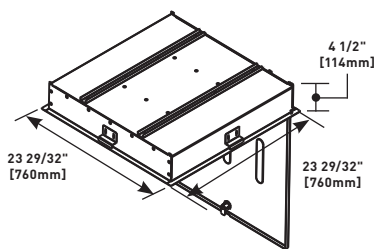

Side Exterior Dimensions

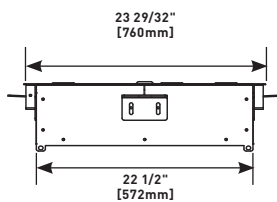

WAPENCL's innovative device mounting system is designed to securely retain most wireless devices.



NME1250AP WALL-MOUNTED NONMETALLIC WIRELESS ACCESS POINT ENCLOSURE



Wiremold® NME1250AP Wireless Access Point Enclosure conceals wireless access points in a durable ETL/cETL listed enclosure.

CODE REFERENCE

cETLus Listed Communication Circuit Accessories:

Meets Article 800 of NEC.

Meets Article 60-308 of CEC.

NME1250AP Nonmetallic Wireless Access Point Mounting Enclosure Ordering Information

NME1250AP Nonmetallic Wireless Access Point Mounting Enclosure

Wall-mounted access point enclosure constructed of durable ETL/cETL thermoplastic. Supports a wide variety of access point configurations for most leading manufacturers of access point products including the Cisco® Aironet 1250 and 3500 Series.

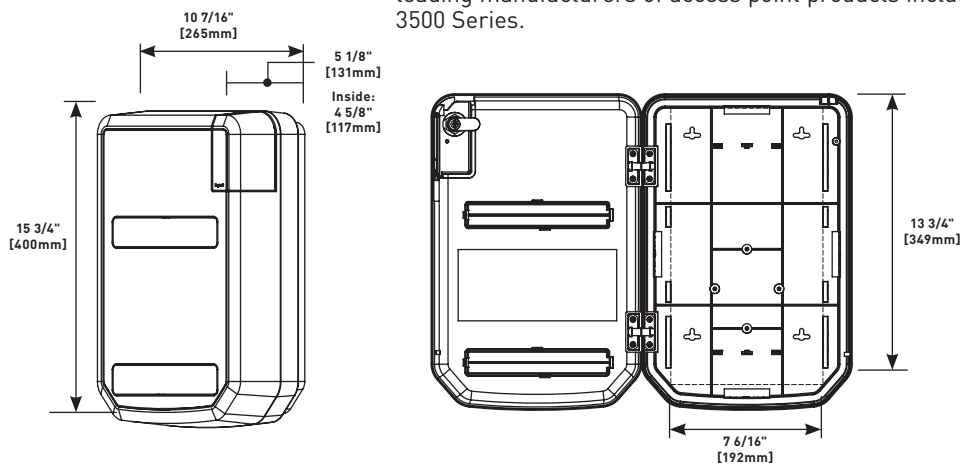

Nonmetallic Wireless Access Point Mounting Enclosure (NME1250AP), loaded with a wireless access point, for vertical applications.

WAPBRKT WIRELESS ACCESS POINT MOUNTING BRACKET FOR OVERHEAD APPLICATIONS



Wiremold® WAPBRKT Wireless Access Point Mounting Bracket provides a secure support for mounting wireless access points in overhead applications.

CODE REFERENCE

cULus Listed Communication Circuit Accessories:
 File E145222 Guide DUXR
 Meets Article 800 of NEC.
 Meets Article 60-308 of CEC.

WAPBRKET Overhead Wireless Access Point Mounting Bracket Ordering Information

WAPBRKT Overhead System Wireless Access Point Bracket

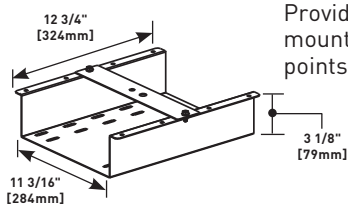

Provides secure support for mounting wireless access points in overhead applications.



The WAPBRKT is designed to work with most tray and basket overhead systems.

CZE SERIES ZONE CABLING ENCLOSURES



Wiremold® CZE Series Ceiling Zone Cabling Enclosures create an intermediate or remote consolidation point that may be tested and secured prior to adding drops for voice and data outlets.

CODE REFERENCE

cULus Listed Communication Circuit Accessories:
File E145222 Guide DUXR
Meets Article 800 of NEC.
Meets Article 60-308 of CEC.

CZE Series Ceiling Zone Cabling Enclosures Ordering Information

CZE-242412A

Ceiling Zone Cabling Enclosure for Active Equipment

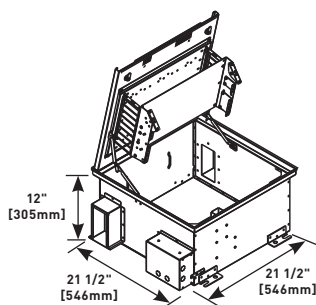

12" deep telecommunications enclosure for 2' x 2' drop ceiling tile. One removable 7 RMU bracket for 19" patch panels and equipment. Includes junction box and fan.

CZE-242412PP Ceiling Zone Cabling Enclosure for Mounting Patch Panels

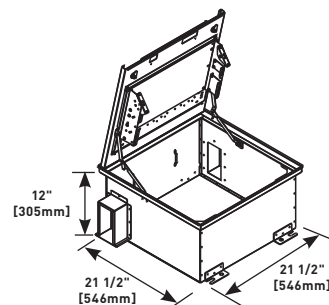

12" deep patch panel enclosure for 2' x 2' drop ceiling tile. One bracket for 19" patch panels. Bracket supports 5 RMU.

CZE-242412WB

Ceiling Zone Cabling Enclosure with Wiring Blocks

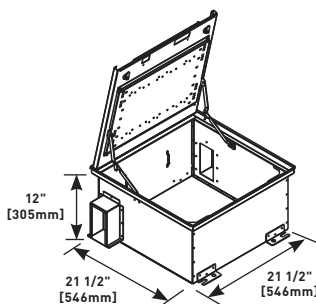

12" deep termination block enclosure for 2' x 2' drop ceiling tile. One removable mounting plate for two 300 pair 1100 style termination blocks (without legs).

RFE SERIES ZONE CABLING ENCLOSURES



Wiremold® RFE Series Raised Floor Zone Cabling Enclosures create an intermediate or remote consolidation point that may be tested and secured prior to adding drops for voice and data outlets.

CODE REFERENCE

cULus Listed Communication Circuit Accessories:
 File E145222 Guide DUXR
 Meets Article 800 of NEC.
 Meets Article 60-308 of CEC.

RFE Series Raised Floor Zone Cabling Enclosures Ordering Information

RFE-25256

Raised Floor Enclosure for Zone Cabling

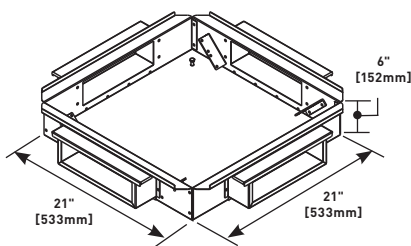

Enclosure for 6" deep floor. Two pairs of pivoting mounting rails for 19" patch panels. Rails support 2 RMU each.

RFE-242412

Raised Floor Enclosure for Zone Cabling

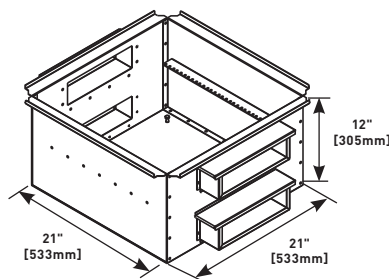

Enclosure for 14" deep floor. A single mounting rail for 19" patch panels. Rail supports 11 RMU.

RFE-25257RB

Raised Floor Enclosure for Zone Cabling

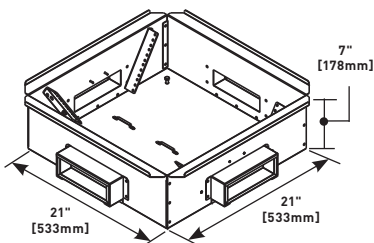

Enclosure for 8" deep floor. Two pairs of pivoting mounting rails for 19" patch panels. Rails support 4 RMU each.

TECHNICAL INFORMATION



Table of Contents

Raceway Cross Sectional Areas/Wire and Cable Cross-Sectional Areas	684
Raceway Wire and Cable Dimensions	685
Device Box Cubic Inch Capacities	686
Calculating Wire and Cable Capacities	687
Master Format 2004 Design Checklist	688
Conductor Derating (Lighting and Power Circuits) National Electrical Code Articles	689
Mounting Methods for Wiremold Raceways	690
Electrical Symbols in Accordance with ANSI Y32.9 – 1972	691
Steel Raceway Color Specifications	692



TECHNICAL INFORMATION

Raceway Cross - Sectional Area

METAL RACEWAY - CROSS-SECTIONAL AREA			
RACEWAY SERIES		CROSS-SECTIONAL AREA	
		sq. in.	[mm ²]
500		0.19	[122.6]
700		0.26	[167.7]
1500		0.22	[141.9]
2000		0.80	[516.1]
2400		1.39	[896.8]
2400D	1/3 Compartment	0.37	[238.7]
	2/3 Compartment	0.86	[554.8]
2600		0.72	[464.5]
3000		3.70	[2387.1]
4000	Undivided	7.20	[4645.2]
	Each Compartment	3.50	[2258.1]
6000	Undivided	16.00	[10322.6]
	Each Compartment	7.20	[4645.2]
DS4000	Each Compartment with Down Crossover, Power with Down Crossover, Comm*	5.02	[3235.5]
		1.13	[729.0]
		2.04	[1316.0]
AL2000		1.10	[709.7]
AL2400	Divided 1/3 Compartment	1.70	[1096.8]
AL3300	Single Compartment	4.40	[2838.7]
ALA3800/ALA4800	Each Compartment	6.10	[3935.5]
AL5200	Undivided	8.50	[5483.9]
	Center Divided	3.90	[2516.1]
	Offset Divided	3.78	[2438.7]
	Offset Divided	4.85	[3129.0]
ALDS4000	Each Compartment	4.85	[3129.0]

* Without Devices.

NONMETALLIC RACEWAY - CROSS-SECTIONAL AREA			
RACEWAY SERIES		CROSS-SECTIONAL AREA	
		sq. in.	[mm ²]
400		0.13	[83.9]
800		0.27	[174.2]
2300	Undivided	0.85	[548.4]
2300D	Each Compartment	0.425	[274.2]
NM2000		1.14	[735.5]
PN03		0.22	[141.9]
PN05		0.44	[283.9]
PN10		0.99	[638.7]
2700		0.16	[103.2]
2800		0.35	[219.4]
2900		0.87	[561.3]
5000	Power Compartment	1.94	[1251.6]
	Data Compartment	1.40	[903.2]
5400	Divided 1/2 Compartment	3.72	[2400.0]
	Undivided	7.44	[4800.0]
5500	Divided 1/3 Compartment	2.64	[1703.2]
	Undivided	8.14	[5251.6]
40N2	Single Compartment (no Communications Box)	3.22	[2077.4]
	Single Compartment (with Communications Box)	1.71	[1103.2]
60N2	Single Compartment (no Communications Box)	4.31	[2780.6]
	Single Compartment (with Communications Box)	1.71	[1103.2]
2300D	Each Compartment	0.425	[274.2]
OFR	Each Compartment	0.216	[5.5]

NOTE: Cross-Sectional Area for use in low voltage cable capacity calculations only, not for use in power cable capacity calculations.

TECHNICAL INFORMATION

Raceway Wire & Cable Dimensions

DIMENSIONS OF RUBBER-COVERED & THERMOPLASTIC CONDUCTORS (2005 EDITION OF THE NATIONAL ELECTRICAL CODE)

SIZE AWG	TYPES: THHM, THWN			
	APPROX.		APPROX.	
	dia. in.	[mm]	sq. in.	[mm ²]
14	0.111	[2.8]	0.0097	[6.258]
12	0.130	[3.3]	0.0133	[8.581]
10	0.164	[4.2]	0.0211	[13.613]
8	0.216	[5.5]	0.0366	[23.613]
6	0.254	[6.5]	0.0507	[32.710]
4	0.324	[8.2]	0.0824	[53.162]
3	0.352	[8.9]	0.0973	[62.775]
2	0.384	[9.8]	0.1158	[74.711]
1	0.446	[11.3]	0.1562	[100.776]
1/0	0.486	[12.3]	0.1855	[119.679]
2/0	0.532	[13.5]	0.2223	[143.421]
3/0	0.584	[14.8]	0.2679	[172.841]
4/0	0.642	[17.3]	0.3237	[208.842]
250	0.711	[18.1]	0.3970	[256.132]
300	0.766	[19.5]	0.4608	[297.294]

DIMENSIONS OF LOW VOLTAGE CABLES & SIGNAL WIRE*

	CABLE/WIRE SIZE	APPROX. DIA		APPROX. AREA	
		Inches	[mm]	sq. in.	[mm ²]
UNSHIELDED TWISTED PAIR (UTP) 24 AWG	2-Pair 24 AWG	0.150	3.8	0.0177	11.419
	3-Pair 24 AWG, Cat 3	0.160	4.1	0.0201	12.986
	4-Pair 24 AWG, Cat 3	0.190	4.8	0.0284	18.323
	4-Pair 24 AWG, Cat 5	0.210	5.3	0.0346	22.323
	4-Pair 24 AWG, Cat 5e	0.210	5.3	0.0346	22.323
	4-Pair 24 AWG, Cat 6	0.250	6.3	0.0490	31.613
	4-Pair 24 AWG, Cat 6a*	0.354	9.0	0.0980	63.226
	25-Pair 24 AWG, Cat 3	0.360	9.1	0.1018	65.677
	25-Pair 24 AWG, Cat 5	0.337	8.6	0.0892	57.548
	50-Pair 24 AWG	0.500	12.7	0.1963	126.645
75-Pair 24 AWG	0.600	15.2	0.2827	182.387	
100-Pair 24 AWG	0.680	17.3	0.3632	234.322	
SHIELDED TWISTED PAIR (STP) 22 AWG	TYPE 1	0.390	9.9	0.1195	77.097
	TYPE 2	0.465	11.8	0.1698	109.548
	TYPE 3	0.275	7.0	0.0573	36.968
COAXIAL	RG58/U	0.195	5.0	0.0299	19.290
	RG59/U	0.242	6.1	0.0460	29.677
	RG62/U	0.242	6.1	0.0460	29.677
	RG6/U	0.270	6.9	0.0573	36.968
TWINAXIAL	100 Ohm	0.240	6.1	0.0452	29.161
SIGNAL WIRE	24 AWG	0.044	1.1	0.0015	0.968
	22 AWG	0.050	1.3	0.0020	1.290
	20 AWG	0.057	1.4	0.0026	1.677
	18 AWG	0.066	1.7	0.0034	2.194
FIBER	2 Strand (ZipCord)	0.118 x 0.236	3 x 6	0.0278	18.0
	Round 4 Strand Fiber	0.187	4.8	0.0275	18.1
	Round 6 Strand Fiber	0.256	6.5	0.0514	32.2

* Category 6 augmented (6a) cable for 10 gigabit ethernet –
max allowed cable diameter per addenda No. 11 ANSI TIA/EIA 568-B.2.

TECHNICAL INFORMATION

Wiremold Device Boxes – Cubic Inch Capacities

CUBIC INCH CAPACITY OF WIREMOLD BOXES						
CAT. NO.	AVAILABLE INSIDE VOLUME		MAXIMUM NUMBER OF CONDUCTORS			
	cu. in.	[cm ³]	NO. 14	NO. 12	NO. 10	NO. 8
1542D	5.7	[93.0]	2	2	2	1
1546A	15.6	[255.0]	7	6	6	5
1546B	15.6	[255.0]	7	6	6	5
2337A	22.2	[364.0]	11	9	8	7
2338	15.9	[260.0]	7	7	6	5
2344	32.5	[532.0]	16	14	13	10
2344-2	53.1	[870.0]	26	23	21	17
2347	16.1	[264.0]	8	7	6	5
2347-2	26.4	[432.0]	13	11	10	8
2348	20.2	[331.0]	10	9	8	6
2348-2	32.9	[538.7]	16	14	13	11
2348-3	49.8	[816.8]	24	22	19	16
2348S/51	10.0	[164.0]	5	4	4	3
2642D	11.8	[194.0]	5	5	4	4
AL2044	28.3	[464.0]	14	12	11	9
AL2044-2	51.6	[846.0]	25	23	20	17
AL2044-3	82.3	[1348.0]	41	36	32	27
AL2047	17.3	[283.0]	8	7	6	5
AL2047-2	27.9	[458.0]	14	12	11	9
G2048	22.3	[366.0]	11	9	8	7
G2048-2	37.8	[619.0]	18	16	15	12
G3028	71.8	[1177.0]	35	31	28	23
G3044-2	107.4	[1760.0]	53	47	43	35
NM2044	32.5	[532.0]	16	14	13	10
NM2044-2	53.1	[870.0]	26	23	21	17
NM2048	20.2	[331.0]	10	9	8	6
NM2048-2	32.9	[538.7]	16	14	13	11
PSB1	20.2	[331.0]	10	9	8	6
PSB2	32.9	[538.7]	16	14	13	11
PSB3	49.8	[816.8]	24	22	19	16
R5752	29.7	[486.0]	14	13	11	9
R5753	59.9	[982.0]	30	26	24	20
V2048	22.3	[366.0]	11	9	8	7
V2048-2	37.8	[619.0]	18	16	15	12
V2448	22.3	[366.0]	11	9	8	7
V2448-2	37.8	[619.0]	18	16	15	12
V5719	10.3	[168.0]	5	4	4	3
V57240	10.2	[166.7]	5	4	4	3

CUBIC INCH CAPACITY OF WIREMOLD BOXES						
CAT. NO.	AVAILABLE INSIDE VOLUME		MAXIMUM NUMBER OF CONDUCTORS			
	cu. in.	[cm ³]	NO. 14	NO. 12	NO. 10	NO. 8
V57242	10.2	[167.1]	5	4	4	3
V57243G	10.2	[167.1]	5	4	4	3
V5733	5.7	[94.0]	2	2	2	1
V5734	17.2	[282.0]	8	7	6	5
V5734A	17.2	[282.0]	8	7	6	5
V5735	29.5	[484.0]	14	13	11	9
V5737	17.2	[282.0]	8	7	6	5
V5737A	22.2	[364.0]	11	9	8	7
V5738	17.2	[282.0]	8	7	6	5
V5738A	22.2	[364.0]	11	9	8	7
V5738AF	22.2	[364.0]	11	9	8	7
V5739	29.8	[488.0]	14	13	11	9
V5739A	29.8	[488.0]	14	13	11	9
V5741	17.7	[290.0]	8	7	7	5
V5744	34.4	[564.0]	17	15	13	11
V5744-2	58.9	[966.0]	29	26	23	19
V5744-3	80.3	[1316.0]	40	35	32	26
V5744S	28.8	[472.0]	14	12	11	9
V5744S-2	48.3	[792.0]	24	21	19	16
V5744S-3	66.9	[1096.0]	33	29	26	22
V5745	22.3	[366.0]	11	9	8	7
V5747	17.9	[294.0]	9	7	7	5
V5747-2	30.0	[491.0]	15	13	12	10
V5747-3	40.9	[670.0]	20	18	16	13
V5748	22.3	[366.0]	11	9	8	7
V5748-2	37.5	[614.0]	18	16	15	12
V5748-3	52.2	[856.0]	26	23	20	17
V5748-4	67.4	[1104.0]	33	29	27	22
V5748-5	80.9	[1324.9]	40	35	32	27
V5748-6	95.3	[1561.8]	47	42	38	31
V5748S	11.9	[195.0]	6	5	4	4
V5751	11.9	[195.0]	6	5	4	4
V5751-2	18.3	[300.0]	9	8	7	6
V5751-3	28.0	[458.8]	14	12	11	9
V5752	29.7	[486.0]	14	13	11	9
V5753	59.9	[982.0]	30	26	24	20
V5760	11.9	[195.0]	6	5	4	4

NOTE: When planning a layout, it is important to remember that it is permissible to make splices and taps in surface raceway equipped with a removable cover. Refer to article 386-56 of the National Electrical Code.

TECHNICAL INFORMATION

Calculating Wire & Cable Capacities

How to Determine Wire Capacities (Power) Formula*

To find the maximum Number of Conductors when devices are utilized, use the following formula:

$$\frac{40\% (\text{cross-sectional area of Raceway} - \text{cross-sectional area of Device})^{**}}{\text{cross-sectional area of Conductor}}$$

How to Determine Wire Capacities (Low-Voltage) Formula

$$\text{Number of Conductors} = \frac{20\text{-}40\% \text{ cross-sectional area of Raceway}}{\text{cross-sectional area of Cable}}$$

This allows room for bending radii and future expansion. The raceways may be filled to their maximum physical capacity providing the cables may be readily installed or removed without damage to the insulation or conductors.

NOTE: Use fill capacities as stated on ordering data pages of this catalog only.

*This formula cannot be used with nonmetallic raceways with a material thickness of .025" (.6mm) or less (i.e., 2000 Raceway).

**Obtain cross-sectional area of devices from device manufacturer.

Important Notes for Understanding Wire Fill Capacities & Calculations

General:

- Wire Fill Charts are rounded down to the nearest whole number.
- All cross sectional areas have been calculated using CAD models.

Power:

- Wire Fill capacities are calculated using stranded wire diameters per NEC Chapter 9, Table 5.
- Wire capacities are actual maximum fills in nonmetallic raceways. This is based on heat rise testing as required by Underwriters Laboratories Standard UL5A for Nonmetallic Raceways.
- Wire capacities in metal raceways are calculated at 40% of cross-sectional area per the NEC and verified to fit as required by Underwriters Laboratories Standard UL5 for Metal Raceways.

Data/Communications:

- Cable diameters used are approximate and represent a typical cable for each category. Check with cable manufacturer for more accurate dimensions.
- Cable fills as stated in charts are theoretical and should be achievable in straight raceway sections without devices or when using radiused full capacity fittings. Unless noted in each section, raceway fittings will offer full wire fill capacity.
- The wire fill specifications cited in this Buyer's Guide are based on calculated theoretical wire fills of each raceway. Actual real world testing done by Wiremold/Legrand has shown that a raceway considered completely "full" is typically using only 60% of its available theoretical area. For this reason a 60% maximum fill should be only used to determine the absolute maximum number of cables a raceway is capable of containing. Therefore, the practical capacity for telecommunications cabling in perimeter raceway systems ranges from 20% - 40% wire fill. Wiremold/Legrand recommends following EIA/TIA guidelines that specify a 40% wire fill be used as a maximum in planning and specifying the raceway. This fill will accommodate adds, moves, and changes, and the combination in certain raceway fittings, may restrict the usable cross section of the raceway in that location. Designers utilizing raceway systems should use this information along with the expected life of the raceway, to properly select the appropriate system to fit their needs.

TECHNICAL INFORMATION

Master Format 2004 – Design Checklist

DIVISION 07 Thermal and Moisture Protection:

- 07 84 13 Penetration Firestopping
- 07 84 13.16 Penetration Firestopping Devices

DIVISION 25 Integrated Automation:

- 25 05 28 Pathways for Integrated Automation
- 25 05 28.29 Hangers and Supports for Integrated Automation
- 25 05 28.33 Conduits and Backboxes for Integrated Automation
- 25 05 28.36 Cable Trays for Integrated Automation
- 25 05 28.39 Surface Raceways for Integrated Automation
- 25 05 48 Vibration and Seismic Controls for Integrated Automation

DIVISION 26 Electrical:

- 26 05 29 Hangers and Supports for Electrical Systems
- 26 05 33 Raceway and Boxes for Electrical Systems
- 26 05 36 Cable Trays for Electrical Systems
- 26 05 39 Underfloor Raceways for Electrical Systems
- 26 05 48 Vibration and Seismic Controls for Electrical Systems
- 26 06 20.23 Electrical Circuit Schedule
- 26 06 20.26 Wiring Device Schedule
- 26 09 23 Lighting Control Devices
- 26 09 26 Lighting Control Panelboards
- 26 09 33.13 Multichannel Remote-Controlled Dimmers
- 26 09 33.16 Remote-Controlled Dimming Stations
- 26 09 36 Modular Dimming Controls
- 26 09 36.13 Manual Modular Dimming Controls
- 26 09 36.16 Integrated Multipreset Modular Dimming Controls
- 26 09 43 Network Lighting Controls
- 26 09 43.13 Digital-Network Lighting Controls
- 26 09 43.16 Addressable Fixture Lighting Control
- 26 09 61 Theatrical Lighting Controls
- 26 18 19 Medium-Voltage Lightning Arresters
- 26 18 23 Medium-Voltage Surge Arresters
- 26 27 16 Electrical Cabinets and Enclosures
- 26 27 19 Multi-Outlet Assemblies

DIVISION 26 Electrical: (continued)

- 26 27 23 Indoor Service Poles
- 26 27 26 Wiring Devices
- 26 35 23 Electromagnetic-Interference Filters
- 26 35 46 Radio-Frequency-Interference Filters
- 26 41 23 Lightning Protection Surge Arresters and Suppressors
- 26 43 13 Transient-Voltage Suppression for Low-Voltage

DIVISION 27 Communications:

- 27 05 28 Pathways for Communications Systems
- 27 05 28.29 Hangers and Supports for Communications Systems
- 27 05 28.33 Conduits and Backboxes for Communications Systems
- 27 05 28.36 Cable Trays for Communications Systems
- 27 05 28.39 Surface Raceways for Communications Systems
- 27 05 48 Vibration and Seismic Controls for Communications Systems
- 27 11 16 Communications Cabinets, Racks, Frames and Enclosures
- 27 11 19 Communications Termination Blocks and Patch Panels
- 27 11 23 Communications Cable Management and Ladder Rack
- 27 11 26 Communications Rack Mounted Power Protection and Power Strips

DIVISION 28 Electronic Safety and Security:

- 28 05 28 Pathways for Electronic Safety and Security
- 28 05 28.29 Hangers and Supports for Electronic Safety and Security
- 28 05 28.33 Conduits and Backboxes for Electronic Safety and Security
- 28 05 28.36 Cable Trays for Electronic Safety and Security
- 28 05 28.39 Surface Raceways for Electronic Safety and Security
- 28 05 48 Vibration and Seismic Controls for Electronic Safety and Security

TECHNICAL INFORMATION

National Electrical Code Articles

ARTICLE 90 - Introduction

90-4: Enforcement

ARTICLE 100 - Definitions

Accessible	Conductor
Branch Circuit	Grounding Conductor,
Concealed	Equipment
Device	Locations:
Exposed Outlet	Damp, Dry, Wet
Feeder	Multioutlet Assembly
Fitting	Raceway
Ground	Receptacle
Grounded	Receptacle Outlet
Grounding	

ARTICLE 110 - Requirements for Electrical Installation

110-12: Mechanical Execution of Work

110-13: Mounting of Equipment

ARTICLE 200 - Use and Identification of Grounded Conductors

ARTICLE 210 - Branch Circuits

210-20: Overcurrent Protection

210-21: Outlet Devices

210-22: Maximum Loads

210-23: Permissible Loads

210-24: Branch Circuit Requirements—Summary

210-50: Receptacle Outlets Required

ARTICLE 220 - Branch Circuit, Feeder and Service Calculations

220-3(c): Exception No. 1. Computation of Branch Circuits using Multioutlet Systems.

ARTICLE 250 - Grounding

250-2: Effective Grounding Path

250-118(14): Types of Equipment

Grounding Conductors

250-120: Equipment Grounding Conductor

250-8: Attachment to Conductors and Equipment

ARTICLE 300 - Wiring Methods

300-10: Electrical Continuity of Metal Raceways and Enclosures

300-11: Secured in Place

300-12: Mechanical Continuity – Raceways and Cables

300-15(a): Boxes of Fittings – Where Required. Exception No. 1

300-17: Number and Size of Conductors in Raceway

300-18: Inserting Conductors in Raceway

300-22(c): Hollow Spaces Used as Ducts or Plenums for Environmental Air

ARTICLE 310 - Conductors for General Wiring

310-4: Conductors in Parallel

310-13: Conductor Application Table

310-15 – Ampacities for Conductors Rated 0-2000 Volts

ARTICLE 386 - Surface Metal Raceways

ARTICLE 388 - Surface Nonmetallic Raceways

ARTICLE 380 - Multioutlet Assembly

ARTICLE 390 - Underfloor Raceways

ARTICLE 374 - Cellular Metal Floor Raceway

ARTICLE 376 - Metal Wireways and Nonmetallic Wireways

ARTICLE 363 - Flat Cable Assemblies, Type FC

Entire Section

ARTICLE 370 - Boxes and Fittings Table 370-16(b)

ARTICLE 517 - Health Care Facilities

517-13(b): Methods for Grounding Receptacles and Fixed Electric Equipment.

ARTICLE 518 - Places of Assembly

518-4: Wiring Methods

ARTICLE 645 - Information Technology Equipment

645-5: Data Processing Supply Circuits and Interconnecting Cables.

ARTICLE 700 - Emergency Systems

700-1: Scope

700-9: Wiring

ARTICLE 701 - Legally Required Standby Systems

701-1: Scope

701-10: Wiring

ARTICLE 702 - Optional Standby Systems

702-1: Scope

702-9: Wiring

ARTICLE 725 - Class 1, Class 2, and Class 3 Remote Control, Signaling and Power-Limiting Circuits

725-26: Conductors of Different Circuits in Same Enclosure, Cable or Raceway

725-28: Number of Conductors in Raceways and Cables, and Derating.

725-54(a): Separation from Light, Power, and Class Conductors in Enclosures, Raceways and Cables.

725-54(b): Conductors of Different Class 2 and Class 3 Circuits in Same Cables, Enclosure or Raceway.

ARTICLE 770 - Optical Fiber Cables and Raceways

ARTICLE 780 - Closed Loop and Programmed Power Distribution

ARTICLE 800 - Communication Circuits

800-52(a)1: Installation of Conductors in Raceways and Boxes.

CHAPTER 9 – Tables and Examples

The excerpts contained in this catalog from the National Electrical Code have been reprinted with the specific approval of the copyright owner, the National Fire Protection Association. Copies of the entire edition of the National Electrical Code are available from the Association of Battery Park, Quincy, MA 02269.

TECHNICAL INFORMATION







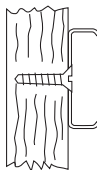
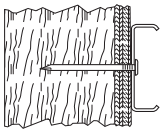
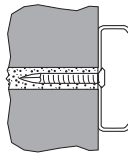
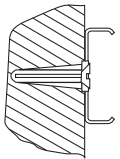
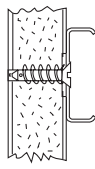
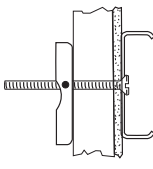
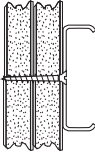
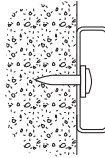









Wiremold Raceways – Mounting Methods

Legrand/Wiremold Raceways can be mounted to any type of surface in an interior dry location through the use of the fastening means shown below. Although a two-piece raceway is illustrated, the same means can be used – with the couplings, clips, or straps – for fastening one-piece raceways to these surfaces.

CAUTION: Make sure that the correct size of screw or nail is used (noted in installation details).

Wood	Use flathead wood screw.		Use common nail.		Brick/Concrete/Cinder Block	Use masonry nail.		Use plastic shield with flathead sheet metal screw.	
Dry Wall	Use plastic anchor with flathead sheet metal screw.				Tile	Use toggle bolt.			
Plaster	Use plastic shield with flathead sheet metal screw.				Reinforced Concrete	Use drive pin fastener.			

Electrical Symbols – In accordance with ANSI* Standard Y32.9 – 1972

Receptacle Outlets, Grounded**			
Single Receptacle Outlet		Range Outlet (Typical)	
Duplex Receptacle Outlet		Special-Purpose Connection or Provision for Connection	
Triplex Receptacle Outlet		Multioutlet Assembly	
Quadruplex Receptacle Outlet		(Extend arrows to limit of installation. Use appropriate symbol to indicate type of outlet. Also indicate spacing of outlets as x inches.)	
Duplex Receptacle Outlet – Split Wired		Clock Hanger Receptacle	
Triplex Receptacle Outlet – Split Wired		Fan Hanger Receptacle	
Single Special-Purpose Receptacle Outlet***		Floor Single Receptacle Outlet	
Duplex Special-Purpose Receptacle Outlet***		Floor Duplex Receptacle Outlet	
		Floor Special-Purpose Outlet	

*American National Standards Institute, Inc.

**For ungrounded receptacle outlets use UNG subscript next to symbol. Example: 

***Use number or letter either within the symbol or as a subscript alongside the symbol keyed to explanation in the drawing list of symbols to indicate the type of receptacle or usage.

TECHNICAL INFORMATION

Electrical Symbols – In accordance with ANSI* Standard Y32.9 – 1972 (continued)

Lighting Outlets	Ceiling	Wall	Ceiling	Wall
Surface or Pendant Incandescent, Mercury-Vapor, or Similar Lamp Fixture				
Recessed Incandescent, Mercury-Vapor, or Similar Lamp Fixture				
Surface or Pendant Individual Fluorescent Fixture				
Recessed Individual Fluorescent Fixture				
Surface or Pendant Continuous-Row Fluorescent Fixture				

Switch Outlets	
Single-Pole Switch:	S
Double-Pole Switch:	S2
Three-Way Switch:	S3
Four-Way Switch:	S4
Key-Operated Switch:	SK
Switch and Pilot Lamp:	SP
Switch for Low Voltage Switching System:	SL
Master Switch for Low Voltage Switching System:	SLM
Switch and Single Receptacle:	S
Switch and Double Receptacle:	S
Door Switch:	SD
Time Switch:	ST
Circuit Breaker Switch:	SCB
Momentary Contact Switch or Push Button for Other than Signaling System:	SMC
Ceiling Pull Switch:	

Miscellaneous	
Outside Telephone:	
Interconnecting Telephone:	
Radio Outlet:	
Television Outlet:	

Circuiting	
Wiring Concealed in Ceiling or Wall:	-----
Wiring Concealed in Floor:	-----
Wiring Exposed:	-----
NOTE: Use heavy-weight line to identify service and feeders. Indicate empty conduit by notation CO (conduit only).	
Branch circuit home run to panel board. Number of arrows indicates number of circuits. (A number at each arrow may be used to identify circuit number.)	

Miscellaneous	
Surface Mounted Panel Board and Cabinet: **	
Push Button:	
Buzzer:	
Bell:	
Combination Bell-Buzzer:	
Chime:	
Annunciator:	
Electric Door Opener:	
Maid's Signal Plug:	
Interconnection Box:	
Bell-Ringing Transformer:	

NOTE: Any circuit without further identification indicates two-wire circuit. For a greater number of wires, indicate with cross lines, e.g.:	
--	--

Unless indicated otherwise, the wire size of the circuit is the minimum size required by the specification. Identify different functions or wiring system, e.g. signalling system, by notation or other means.	
Wiring Turned Up:	
Wiring Turned Down:	

*American National Standards Institute, Inc.
 **For ungrounded receptacle outlets use UNG subscript next to symbol. Example:
 ***Use number or letter either within the symbol or as a subscript alongside the symbol keyed to explanation in the drawing list of symbols to indicate the type of receptacle or usage.

TECHNICAL INFORMATION

Steel Raceway Color Specifications

COLOR	MUNSELL NOTATION	TOLERANCE L	TOLERANCE A	TOLERANCE B	TOLERANCE E
Ivory	6.7Y8.98/1.4	±1.00	±0.5	±0.5	1.00
White	N9 Matte	±1.00	±0.5	±0.5	1.00
International White	61/9.24/0.4	±1.00	±0.5	±0.5	1.00
Black	3.2PB1.99/0.2	±1.00	±0.5	±0.5	1.00
Gray	8.3G6.10/0.54	±1.00	±0.5	±0.5	1.00
Light Gray	8.0Y7.09/0.4	±1.00	±0.5	±0.5	1.00
Fog White	L = 89.13 A = -0.02 B = 6.88	±1.00	±0.5	±0.5	1.00

NOTE: The color swatches shown throughout this catalog are as close to the product colors as is possible through the printing process. They should not be used by customers to make color decisions. Legrand/Wiremold always recommends that customers request color samples to review for accuracy in circumstances where color matching is critical.

NOTE: Munsell Standards were generated with gloss 30 ± 5 on 60 degree meter. See document "Spectraflash SF600X Calibration Setup" for spectrometer calibration readings.

Wiremold/Legrand assumes no liability for color accuracy and provides this information as a baseline to assist customers in making initial color decisions. Wiremold/Legrand recommends that customers request samples to review for color accuracy in circumstances where color matching is critical.

INDEX



INDEX

1 – 2

CAT. NO.	PAGE	CAT. NO.	PAGE	CAT. NO.	PAGE	CAT. NO.	PAGE	CAT. NO.	PAGE		
1											
1000883	542	1230BF	489	1BLHN	305	20GB206	257	2300	684		
1001757	552	125CRR	386	1PTHA	297, 298, 305, 568, 569	20GB30	257	2300BAC	128, 132, 152		
1002412	542	12EXT	526			20GB306	257	2300BAC-WH	128		
1002414	542	12F-0	532, 533	2						2300BACD	128, 132, 154
1 1/2 JB2510	529	12F-WS	532, 535	2-0	518	20GB306TRGFI	276	2300BACD-WH	128		
10-20R	200	12FB	532, 535	2-11/2JB2510	547, 555	20GB506	34, 257	2300D	684		
10-30R	200	12FC	532, 533	2-12X2X11/2	519	20GB506TR	276	2300WC	128		
10-50R	200	12FCS	532, 533	2-12X2X2	519	20GB512	257	2306	124, 128, 132		
1043B	493	12FCSA	532	2-12X2X21/2	519	20GB606	257	2306-WH	128		
1043BPO	493	12FST	532, 533	2-12X2X3	519	20GB606TR	276	2310A	124, 128, 131		
1043S	493	12HR	514, 524	2-12X2X7/8	519	20GB609	257	2310B	128		
1043SPO	493	12HS	514, 524	2-24X2X11/2	519	20GB612	257	2310B-WH	128		
1044B	493	12JR	514, 524, 526	2-24X2X2	519	20GB618	257	2310DFO	124, 129		
1044S	493	12JS	514, 524, 530	2-24X2X21/2	519	20GBA12	257	2310DFO-WH	129		
1045B	493	14-20R	200	2-24X2X3	519	20GBA512	257	2311	124, 128		
1045S	493	142L	514, 526	2-24X2X7/8	519	20GBA609	257	2315	124, 128		
1046B	493	142L-1	526	200-H/BTC	329	20GBA612	257	2317	124, 128		
1046S	493	14H	526	2000	684	20GBA618	257	2318	124, 128		
10LH	535	14H-1	526	2000B-10	258	20IG306	257	2311-WH	128		
10LHB-1/4	528	14HR	514, 524	2000B-5	258	20IG512	257	2311DFO	124, 129		
10LHB-1/8	528	14HS	514, 524	2000BC	258	20IG606	257	2311DFO-WH	129		
10LHS-1/4	528	14JR	514, 524, 526, 529	2000C	258	212	515	23120A-WH	128		
10LHS-1/8	528	14JS	514, 524, 530	2000WC	35, 258	212-3/4	527	2315-WH	128		
11/2JB2510	555	14LHB-1/4	528	2001	35, 258, 277	2135	29	2317-WH	128		
11/2JBC	554	14LHB-1/8	528	2003	35, 258	221-21	330	2317DFO	124, 129		
11/2JBC-CA	554	14LHS-1/4	528	2006	34, 258	222-3/4	527	2317DFO-WH	129		
11/2JBH242510-60	547	14LHS-1/8	528	2008BCS20R	626	222EXT	526	2318-WH	128		
11/2JBH24251060	556	15-20R	200	2008BDS20R	626	222F-0	532, 533	2318DFO	124, 129		
11/2JBH30251560	556	1500-10	99	2008ULBC20R	627	222F-WS	532, 535	232-1	527		
11/2JBH36251560	556	1500	98, 102, 684	2008ULBC20R-TL	627	222FC	532, 533	232-11/2	527		
1124-1	493	1500WC	99, 100	2008ULBD20R	627	222FCS	532, 533	232-11/4	527		
1124-1 1/4	493	1502	99	2008ULBD20R-TL	627	222FCSA	532	2336	129		
1124-2	493	1504	99	2009	36, 259, 277	222FST	532, 533	2336-WH	129		
1124F-1	534	1511	98, 99	2010A2	34, 259, 277	222HR	514, 524	2337A	124, 129, 131, 686		
1124F-3/4	534	1517	98, 99	2010A3	34, 36, 259	222HS	514, 524	2337A-WH	129		
1124L-1	493	1517B	28	2010B	34, 259, 277	222JR	514, 524, 526, 529	2338	686		
1124L-1 1/4	493	1518	98, 99	2011	34, 259	222JS	514, 524, 530	2338A	124, 129		
1124L-2	493	1528	98, 100	2015	34, 259	224HR	514, 525	2338A-WH	129		
1126A-1	492	152CHA	297	2017TC	34, 36, 256, 259	224HS	514, 525	2344	124, 129, 686		
1126A-1 1/2	492	1542D	100, 686	2018C	34, 259	224JR	514, 525, 526, 529	2344-2	129, 686		
1126A-1 1/4	492	1543GL	100, 102, 104	203	515	224JS	514, 525, 530	2344-2-WH	129		
1126A-1/4	492	1546A	98, 100, 102, 104	203UFD	526	22AER-11/2-21/4	552	2344-WH	129		
1126A-3/4	492	1546B	98, 100, 104, 686	2040B	277	22AER-23/8-31/8	552	2344D	130		
11JB2510	529	1546T	100, 104	2048	34, 259	22CHA	305	2344D-WH	130		
1204AL	489, 517, 548	1585	98, 100	2048-2	34, 260	22JB2510	529	2344SD-2A	16, 19, 130		
1204BF	489, 517, 548	15FFHA	297, 569	2051H	34, 260	22JBC	554	2344SD-2A-WH	130		
1223AL	489, 517, 548	175CHA	297, 298, 305	2089A	34	22JBC-CA	554	2347	124, 130, 686		
1223BF	489, 517, 548	175CHA-LJB	297, 298, 305	2089E	24, 34	22LHB-1/4	529	2347-2	130, 686		
1230AL	489	18-20R	200	20GB12	257	22LHB-1/8	529	2347-2-WH	130		
		1BHA	298	20GB18	257	22LHS-1/4	529, 552	2347-WH	130		
		1BLH	297, 298			22LHS-1/8	529, 552	2348	124, 130, 686		

INDEX

2 – 3

CAT. NO.	PAGE	CAT. NO.	PAGE	CAT. NO.	PAGE	CAT. NO.	PAGE	CAT. NO.	PAGE
2348-2.....	130, 686	2444-FW	41	25DTP-415-DG-C	600	2906-WH.....	114	3033JE	50, 51
2348-2-WH	130	2444D.....	44	25DTP-4ACT	600	290C.....	523	3036HE	50, 51
2348-3.....	130, 686	2444D-2A.....	16	25DTP-4ACT-DG	600	290G.....	515, 532	3040CE.....	51
2348-3-WH	130	2444D-2AFW.....	47	25DTP-4D	600, 606	2911	111, 114, 117	3043	51
2348-WH.....	130	2444D-2NFW.....	47	25DTP-4D-DG.....	600	2915	111, 115, 117	3043GE.....	50
2348AMP.....	130	2444D-FW.....	41, 47	25DTP-A	605	2917	111, 115, 117	3044-2	50
2348AMP-WH	130	2448	38	25DTP-B	605	2918	111, 115, 117	3046	51
2348D	130	2448-2	38	25DTP-E10.....	600, 601	291-H/BTC.....	332	3046KD	50
2348S/51.....	130, 131	2448-2FW	42	25DTP-E10-DG.....	600, 601	2910B.....	111, 114, 117	3048R.....	51
2348S/51	686	2448-FW	42	25DTP-L	605	2910B-WH	114	3082	50
2348S/51-WH	130	244HR	514, 525	25G	517	2911-WH	114	3051LE.....	51
2389	128, 131	244HS	514, 525	2600	98, 102, 684	2911FO.....	115, 117	311	157
2389-WH.....	128	244JR	514, 525, 526, 529	2602	103	2911FO-WH	115	312	515
2389A	129, 131	244JS	514, 525, 530	2611	102, 103	2915-WH	115	312-1	521, 551
2389A-WH.....	129	2450-FW	47	2600-10.....	103	2915FO.....	115, 117	312-11/2	521, 551
2400	98, 102, 684	2451H.....	38	2600WC.....	103	2915FO-WH	115	312-11/4	521, 551
2400B	265	2451H-FW.....	42	2642D.....	98, 102, 103, 686	2917-WH	115	312-2	521, 551
2400B-10FW.....	39	2475D.....	38	2686FO.....	38, 42	2917FO.....	115, 117	312-3/4	521, 551
2400B-FW.....	39	2475D-FW.....	42, 48	2686FO.....	98, 102, 103	2917FO-WH	115	312F.....	532
2400BC	38	2489	38	2686FO.....	266	2918-WH	115	312F-1	533
2400BC-FW	39	24DWND	38, 44	2700	112, 684	2918FO.....	115, 117	312F-11/2	533
2400BD	265	24DWND-FW	41, 47	2706	111, 112, 117	2918FO-WH	115	312F-11/4	533
2400BD-FW	45	24DWNR	38, 44	2711	111, 117	292-H/BTC.....	332	314	515
2400C-FW.....	39, 45	24DWNR-FW	41, 47	2715	111, 112, 117	2986	111, 115, 116, 117	314-3/4	521, 533
2400D	94, 684	24DWNS-FW	11	2717	111, 112, 117	2986-WH.....	115	314F.....	532
2400WC.....	39, 45, 264	24DWNS-FW	41, 47	2718	111, 112, 117	2989	115, 116	317	157, 515
2401	39, 264	24DWNU-FW	11	2786	111, 112, 116, 117	2989-WH.....	115	317-3/4	521
2401D	45	24DWNU-FW	41, 47	2700-WH	112	2989A	115, 116	318	157
2406-FW	39, 46	24S3612GBA99IV	263	2700L8	112	2989A-WH.....	115	322	515
2407-2CMFW	43	24S3612GBX99IV	263	2700L8-WH.....	112	2CRR	386	322-11/2	521
2407-2TJFW.....	43	24S6012GBA99IV	263	2700WC.....	136, 138	2HUB	386, 408	322-11/4	521
2407-3TJFW.....	43	24S6012GBX99IV	263	2706-WH	112	2JBH242510-60	556	322EXT	526
2409	39, 264	24S6012IGX99IV	263	2710B.....	111, 112, 117	2JBH302515-60	556	3222F-0.....	532, 533
241-H/BTC.....	329	24S7212GBA99IV	263	2710B-WH.....	112	2JBH362515-60	556	3222F-0 10.....	531
2410A-FW.....	39	24S7212GBX99IV	263	2711-WH	112			3222F-WS	532, 535
2410B-FW.....	40	24S7212IGX99IV	263	2715-WH.....	112			3222FB.....	531, 532, 535
2410BD-FW	46	24S7218GBA99IV	263	2717-WH	112			3222FBCC.....	532
2410C	38	24S7218GBX99IV	38	2718-WH	112			3222FC.....	532, 533
2410C-FW.....	40	24S7218GBX99IV	262, 263	275SL	515, 527			3222FCS.....	532
2410D-FW.....	46	24S7218IGX99IV	263	275SR	515, 527			3222FCSA.....	532
2410DFO.....	44	24S7224GBA99IV	263	2786-WH	112			3222FCSA-28.....	531
2410DFO-FW	40, 46	24S7224GBX99IV	263	2800	113, 684			3222FST.....	531, 532, 533
2410FC-FW.....	46	24S7224IGX99IV	263	2806	111, 113, 117			3222HR	514, 525
2411D-FW.....	40	255	515, 532	2811	111, 113, 117			3222HS	514, 525
2411DFO.....	44	255-1.....	527, 531, 535	2815	111, 113, 117			3222JR... ..	514, 525, 526, 529
2411DFO-FW	46	255-1 1/2.....	527	2817	111, 113, 117			3222JS	514, 525, 530
2411FO.....	38	255-1 1/4.....	527	2818	111, 114, 117			3224EXT	526
2411FO-FW.....	40	255-11/2	535	2886	111, 114, 117			3224HR	514, 525
2411M	38	255-11/4	535	2889	114, 116			3224HS	514, 525
2411M-FW.....	40	255-2	527, 535	2800-WH	113			3224JR... ..	514, 525, 526, 529
2415DFO.....	44	255-3/4	527, 535	2800L8	113			3224JS	514, 525, 530
2415DFO-FW	46	25AM-AP.....	601, 609	2800L8-WH.....	113			324	515, 532
2415FO.....	38	25DTC-3S2.....	609	2800WC.....	136, 138			324-3/4	521
2415FO-FW.....	40	25DTC-4.....	606, 607, 608	2806-WH	113			3244	526
2415H	38	25DTC-4-DG	608	2810B.....	111, 113, 117			3244EXT	526
2415M	38	25DTC-412	607, 608	2810B-WH.....	113			3244HR	514, 525
2415M-FW	40	25DTC-412-DG	608	2811-WH	113			3244HS	514, 525
2417D-FW.....	46	25DTC-415	607, 608	2811FO	113, 117			3244JR... ..	514, 525, 529
2417DFO.....	44	25DTC-415-DG	608	2811FO-WH.....	113			3244JS	514, 525, 530
2417DFO-FW	46	25DTC-ACT.....	609	2815-WH	113			32JB3510.....	529, 555
2417FO.....	38	25DTC-CVR	609	2815FO	113, 117			332F	532, 533
2417M	38	25DTC-E10.....	600, 601,	2815FO-WH.....	113			332UF	515, 522
2417M-FW.....	40	607, 608	2817-WH	113			333F-2	532, 533
2418DFO.....	44	25DTC-E10-DG	601, 608	2817FO	113, 117			334-1-3	533
2418DFO-FW	46	25DTC-E5	601	2817FO-WH.....	113			334F-1-2.....	532, 533
2418FO.....	38	25DTC-E5-DG	601	2818-WH	114			334F-1-3.....	531, 532
2418FO-FW.....	41	25DTP-4.....	577, 600,	2818FO	114, 117			334UF	515, 521, 532, 533
2418M	38	606, 609	2818FO-WH.....	114			336F	532, 533
2418M-FW.....	41	25DTP-4 D	600	2886-WH	114			336F-2	532, 533
242-11/4	527	25DTP-4-C.....	600	2886C	116			336F-3	531, 532, 533
2426	38	25DTP-4-DG	600	2889-WH	114			338F-2	532
2426-FW.....	41	25DTP-4-DG-C.....	600	2900	114, 684			338F-3	531, 532
2427GA-FW.....	43	25DTP-412	600	2900-WH	114			3000	684
2427GT-FW.....	43	25DTP-412-C.....	600	2900L8	114			3010B.....	50
2444	44	25DTP-412-DG-C.....	600	2900L8-WH.....	114			3011E.....	50
2444-2FW	42	25DTP-415.....	600	2900WC.....	136, 138			3015E.....	50
2444-2LSFW.....	42	25DTP-415-C.....	600	2906	111, 114, 117			3017TCE.....	50
								3018AE.....	50
								3027AE.....	50, 51

3

INDEX

3 — 5

CAT. NO.	PAGE	CAT. NO.	PAGE	CAT. NO.	PAGE	CAT. NO.	PAGE	CAT. NO.	PAGE
33JBC-CA	554	4074A	50	436-2-2	492, 523	5004WH	136	5400	684
3424HR	514, 525	4075DA	61	436-2-23/8	523	5005	136, 138	5400C	142, 143, 147
3424HS	514, 525	4089	38, 44	436-2-3	492, 523	5005BK	136	5400C-WH	143
3424JR	514, 525, 526, 529	40N2	16, 684	436-2-3/8	492, 523	5005GY	136	5400HR824	230
3424JS	514, 525, 530	40N2B08	139, 140	437	495	5005WH	136	5400TB	142, 143, 144, 147, 152, 154
342F	532, 534	40N2B08V	140	439	496	5006	134, 137	5400TB-WH	143
342F-2	532, 534	40N2B08WH	140	450F-1	532, 534	5006A	134, 137	5400TC	142, 143, 147
342F-3	532, 534	40N2C08	139, 140	450F-1/4	534	5006BK	134	5400TC-WH	143
342UF	515, 522	40N2C08V	140	450FP-1	532, 534	5006GY	134	5400TD8	230
3444HR	514	40N2C08WH	140	450FP-11/4	534	5006WH	134	5400TWC	142, 143, 147
3444HS	514	40N2F05	139, 140	455F-1	532, 534	5007C	136, 138	5406A	142, 143, 147
3444JR	514, 529	40N2F05V	140	455F-3/4	534	5007C-1A	133, 135, 138	5406A-WH	143
3444JS	514, 530	40N2F05WH	140	455FP-1	532, 534	5007C-1ABK	135	5406T	142, 143, 147
3609ULBC	627	40N2F06	139, 140	455FP-3/4	534	5007C-1AGY	135	5406T-WH	143
3609ULBD	627	40N2F06V	140	470F-1	532, 534	5007C-1AWH	135	5406TB	144, 147
362F	532, 534	40N2F06WH	140	470F-11/4	534	5007C-2AB	133, 135, 138	5406TB-WH	144
362F-2	532, 534	40N2F11	139, 141	480	523	5007C-2ABBK	135	5407A3	147
362F-3	532, 534	40N2F11V	141	4810BCS	626	5007C-2ABGY	135	5408L	144, 146, 148
372	515, 522	40N2F11WH	141	4810BCS20R	626	5007C-2ABWH	135	5408L-WH	144
372F	532, 534	40N2F15	139, 141	4810BDS	626	5007C-2RT	133, 136, 138	5408R	144, 146, 148
375	515, 523	40N2F15V	141	4810BDS20R	626	5007C-2RTBK	136	5408R-WH	144
382	515, 523	40N2F15WH	141	4810ULBC	627	5007C-2RTGY	136	5410	142, 144, 147, 148
3A44B2-1	623	40N2F17	139, 141	4810ULBC20R	627	5007C-2RTWH	136	5410-WH	144
3A86B2-1	623	40N2F17V	141	4810ULBC20R-TL	627	500ACT	488	5410DFO	142, 144, 148
3B43B2-1-RAM	623	40N2F17WH	141	4810ULBD	627	500B	488	5410DFO-WH	144
3B44B2-1	623	40N2F19	139, 141	4810ULBD20R	627	500DR	488	5411FO	142, 144, 147
3B53B2-1-AM	623	40N2F19V	141	4810ULBD20R-TL	627	500RT	14, 488	5411FO-WH	144
3B86B2-1	623	40N2F19WH	141	485	546	500SP-1/2	488	5415	142, 144, 148
		40N2F20	139, 141	4B43B2-2-RAM	623	500T	488	5415-WH	144
		40N2F20V	141	4B44B2-2	623	5010A	133, 134, 138	5415FO	144
		40N2F20WH	141	4B53B2-2-AM	623	5010ABK	134	5415FO-WH	144
		40N2F21	139, 141	4B86B2-2	623	5010AGY	134	5417FO	142, 144
		40N2F21V	141	4FFATC	321	5010AWH	134	5417FO-WH	144
		40N2F21WH	141	4FFATC	572	5010L	133, 135, 137	5418	142, 144, 148
		40N2F31	139, 141, 152, 155	4FFATCAL	321	5010LBK	135	5418FO	142, 145, 148
		40N2F31V	141	4FFATCAL422CW	572	5010LGY	135	5418FO-WH	145
		40N2F31WH	141	4FFATCBK	321	5010LWH	135	5450	16, 19, 142, 145, 147, 152, 155
		40N2F55	141	4FFATCBK422CW	572	5010RBK	134	5450-ORAP	145
		40N2F74	139, 141	4FFATCBS	321	5010RGY	134	5450-WH	145
		40N2F74V	141	4FFATCBS422CW	572	5010RWH	134	5450A3	142, 145, 147
		40N2F74WH	141	4FFATCGY	321	5017B	133, 135, 137	5450A3-WH	145
		40N2FWC	140	4FFATCGY422CW	572	5017C	133, 135, 137	5450T	142, 145, 147, 152, 155
		410B	125	4FFCTC	321	5017CBK	135	5450T-WH	145
		410B-WH	125	4FFCTCAL	321	5017CGY	135	5474	142, 145, 148
		411	124, 125	4FFCTCBK	321	5017CWH	135	5474-WH	145
		411-WH	125	4FFCTCBS	321	5017WG	135, 138	5500	684
		415	124, 125	4FFCTCGY	321	5018B	133, 135, 137	5500BD3	150, 152, 153, 154
		415-WH	125			5018C	133, 135, 137	5500BD3-WH	150
		415B	520			5018CBK	135	5500C	150, 153
		415N	520			5018CGY	135	5500C-WH	150
		417	124, 125			5018CWH	135	5500WCA	149, 150, 153
		417-WH	125	5-15R	195, 200	5018WG	135, 137	5506	149, 150, 153
		418	124, 126	5-20R	43, 195, 200	502	25	5506-WH	150
		418-WH	126	5-30R	195, 200	504	24	5506B	151
		421	502, 509, 515, 520	5-50R	200	506	24	5506B-WH	151
		4215	523	500	61, 102, 262, 684	511	24	5507-4TJ	49, 155
		4220	523	500-GFI	488	517	24	5507-4TJ-FW	155
		42222HR	514	500-MAAP	14, 488	518	24, 34	5507-4TJ-G	155
		42222HS	514	5000	154, 684	522222HR	514	5507-4TJ-WH	155
		42222JR	514	5000B	134, 137, 138	522222HS	514	5507-4TJFW	49
		42222JS	514	5000C	134, 137, 138	522222JR	514	5507-6TJ	49, 155
		4222GR	515, 520	5000CBK	134	522222JS	514	5507-6TJ-FW	155
		422RD	515, 520	5000CGY	134	525	531	5507-6TJ-G	155
		4225	502, 523	5000COA	134	525A	487, 517, 532, 548	5507-6TJ-WH	155
		4230	502, 523	5000CW	134	525ACT	487, 517, 532, 548	5507-6TJFW	49
		424-1	493	5000CWH	134	525B	487, 517, 532, 548	5507-6TJWH	155
		424-3/4	493	5000T	134, 137, 138	525C	487, 517, 532, 548	5507-6TJFW	49
		425	502, 520	5000TBK	134	525D	487, 517, 532, 548	55074TJ-WH	355
		426	502, 520	5000TGY	134	525F	487, 517, 532, 548	55076TJ-WH	355
		427	509	5000TOA	134	525G	487, 532, 548	5507AAAP	12, 13, 49, 155
		430075	509	5000TW	134	525H	487, 517, 532, 548	5507AAAP-BK	13, 155
		430S505	509	5000TWH	134	525HB	488	5507AAAP-FW	13, 155
		431075	509	5001	134, 137	525J	488, 517, 532, 548	5507AAAP-G	12, 13, 155
		431D505	509	5004	136, 138	525RT	487, 517, 532, 548	5507AAAP-GY	13, 155
		432	509	5004BK	136	5400	230	5507AAAP-WH	13, 155
		436-2	492	5004GY	136				
		436-2 7/8	492	5004OA	136				
		436-2-1 1/2	492, 523	5004W	136				

4

5

INDEX

5 — 8

CAT. NO.	PAGE	CAT. NO.	PAGE	CAT. NO.	PAGE	CAT. NO.	PAGE	CAT. NO.	PAGE
5507AD	48, 154	5518-WH	151	5782A	28	6AER-23/8-3	526	6PPS	294
5507AD-FW	48, 154	5518FO	149, 151, 153	5785	24, 61	6AT	292	6RTT	526
5507AD-G	154	5518FO-WH	151	5785WH	29	6ATBK	292	6S1	295
5507AD-WH	154	5550-WH	152	5791	28, 29	6ATBS	292	6S2	295
5507AVIP	49	5550A4	149, 152, 153	5786WH	29	6ATBZ	292	6SER	9, 295, 568
5507B	48, 154	5550A4-WH	152	5790B	28, 29	6ATC	292	6STC	293, 294
5507B-FW	48, 154	5574-WH	151	57242	24	6ATCBK	292, 293	6STCP	294, 568
5507B-G	154	5574A	149, 152	5B11N	620	6ATCBS	292, 293	6STCPAV	294, 568
5507B-GY	154	5574A-WH	152	5BLH	297, 304	6ATCBZ	292, 293	6TRAC	296, 568
5507B-WH	154, 355	5700CG	25	5BLH	568	6ATCFF	293, 569	6TS	295, 409
5507D	48, 61, 79	5700LL	25	5PTH	297, 304	6ATCGY	292, 293	6W21E	621
5507D	138, 154	5703WH	27	5PTHA	568, 569	6ATCNK	292, 293	6W21N	620
5507D-BK	154	5709GC	27	5W11N	620	6ATCP	292	6W22E	621
5507D-FW	48, 154	5711LHA	27			6ATCPAV	293		
5507D-G	154	5711LHAWH	27			6ATCPAVBK	293		
5507D-GY	154	5711RHA	27			6ATCPAVBS	293		
5507D-WH	154, 355	5711RHAWH	27			6ATCPAVBZ	293		
5507FRJ	49, 154	5715WH	27			6ATCPAVGY	293		
5507FRJ-FW	49, 154	5719	24			6ATCPAVNK	293		
5507FRJ-G	154	5719WH	27			6ATCPBK	292		
5507FRJ-GY	154	57243G	24			6ATCPBS	292		
5507FRJ-WH	154	57240	24			6ATCPBZ	292		
5507MAAP ... 12, 13, 49, 155		5734A	24			6ATCPGY	292		
5507MAAP-BK	13, 155	5735	29			6ATCPNK	292		
5507MAAP-FW	13, 155	5736WH	29			6ATGY	292		
5507MAAP-G ... 12, 13, 155		5737	29, 30			6ATNK	292		
5507MAAP-GY	13, 155	5737A	29			6ATP	292		
5507MAAP-WH	13, 155	5737AWH	30			6ATPAV	293		
5507R	12, 13, 48, 138, 155	5737WH	30			6ATPAVBK	293		
5507R-BK	13	5738	24, 29, 30			6ATPAVBS	293		
5507R-FW	13, 48, 155	5738A	30			6ATPAVBZ	293		
5507R-G	12, 13, 155	5738AF	29			6ATPAVG	293		
5507R-GY	13	5738AFWH	30			6ATPAVNBK	293		
5507R-WH	13, 155, 355	5738AWH	30			6ATPAVBZ	293		
5507RJ	49, 61, 155	5738WH	30			6ATPAVGY	293		
5507RJ-FW	49, 155	5739A	29			6ATPAVNBK	293		
5507RJ-G	155	5739WH	30			6ATPAVZ	293		
5507RJ-GY	155	5741WH	30			6ATPAVGY	293		
5507RJ-WH	155	5744	24, 30, 38			6ATPAVNBK	293		
5507S	155	5744-2	30			6ATPBK	292		
5507S-BK	155	5744-2WH	30			6ATPBS	292		
5507S-FW	155	5744-3	30			6ATPBZ	292		
5507S-G	155	5744-WH	30			6ATPGY	292		
5507S-GY	155	5744S	31			6ATPNK	292		
5507S-WH	155, 355	5744S-2	31			6B21E	621		
5507SW	48, 79, 155	5744S-2WH	31			6B21N	620		
5507SW-FW	48, 155	5744S-3	31			6B22E	621		
5507SW-G	155	5744SWH	31			6CFFTC	295		
5507SW-WH	155	5745WH	31			6CFFTCB	409		
5507T1	48, 155	5747	24, 31, 38			6CFFTCBK	295		
5507T1-FW	48, 155	5747-2	31			6CFFTCBS	295		
5507T1-G	155	5747-2WH	31			6CFFTCBZ	295		
5507T1-WH	155, 355	5747-3	31			6CFFTCGY	295		
5507T2	49, 155	5747WH	31			6CFFTCNK	295		
5507T2-FW	49	5748	24, 31, 34			6CT	294, 409		
5507T2-G	155	5748-2	31			6CTBK	294		
5507T2-WH	155, 355	5748-3	31			6CTBS	294		
5510	149, 151, 152, 153	5748-4	31			6CTBZ	294		
5510-WH	151	5748-5	31			6CTC	294, 409		
5510D	149, 151, 152, 153	5748-6	31			6CTCBK	294		
5510D-WH	151	5748S	24			6CTCBS	294		
5511FO	149, 151, 153	5748SWH	31			6CTCBZ	294		
5514A	149, 151, 152, 153	5751	31			6CTCGY	294		
5514A-WH	151	5751-2	31			6CTCNK	294		
5515	149, 151, 153	5751-2WH	31			6CTGY	294		
5518	149, 151, 153	5751-3	31			6CTNK	294		
5550	16, 19	5751AWH	32			6DEC	9, 295, 568		
5550	149, 152, 153, 155	5751WH	31			6DP	295		
5574	149, 151, 152, 153	575CHA	297, 304			6ER-11/2	524		
5701	27	575CHA	568, 569			6ER-2	524		
5703	24	5781A	28			6ER-2 1/2	524		
5709	27	5752	24			6ER-3	524		
5715	24	5753	24			6ER-3 1/2	524		
5515-WH	151	5780	28			6LH	535		
5517FO	149, 151, 153	5781	24, 28			6LHB-1/4	528		
5517FO-WH	151	5782	24, 28			6LHB-1/8	528		
						6LHS-1/4	528		
						6LHS-1/8	528		
						6MAAP	9, 296, 568		
						6MAAP-2A	9		
						6MAAP2A	296		
						6MOS	295		
						6MOSBS	295		

INDEX

A

CAT. NO.	PAGE	CAT. NO.	PAGE	CAT. NO.	PAGE	CAT. NO.	PAGE	CAT. NO.	PAGE
AL2015	164, 275	AL3300C5	170	AL5200B	161	ALA-F	179, 183	ALTC-2P	609
AL2017	164, 275	AL3300D5	170, 205	AL5200B-10	187	ALA-G	179, 183	ALTC-2S	609
AL2018	164, 275	AL3300WC	170, 205	AL5200B-5	187	ALA-J	179, 183	ALTP	603
AL2038	164, 275	AL3301	170, 205	AL5200C	161	ALA-LPB	179, 184	ALTP-20W	603, 604, 607
AL2040A	164, 275	AL3301D	170, 205	AL5200C-10	187	ALA-LPB3S2	179, 184	ALTP-2P	603, 604, 607
AL2043	162, 164, 275	AL3309	170, 205	AL5200C-5	187	ALA-MAB	179, 184	ALTP-2S	603, 604, 607
AL2043IG	164, 275	AL3310B	171, 205	AL5200D-10	187	ALA-MABRT	179, 184	AMD8APTC	313
AL2044	165, 275, 686	AL3310B1	171, 205	AL5200D-5	187	ALA-N	179, 183	AMD8APTCBK	313
AL2044-2	165, 275, 686	AL3311	171, 206	AL5200WC	185, 187	ALA-SG	180, 184	AMD8APTCGY	313
AL2044-3	686	AL3315	171, 206	AL5200WC2	187	ALA-Z	180, 184	AMD8ATC	313
AL2047	165, 275, 278, 686	AL3316	171, 206	AL5200WC3	187	ALA01	178, 182, 203, 204, 217	AMD8ATCAA	10, 313
AL2047-2	165, 275, 686	AL3317	171, 206	AL5201	185, 187	ALA09	182, 203, 217	AMD8ATCAB	10, 313
AL2051H	165, 275, 278	AL3318	171, 206	AL5206	187	ALA11R	218	AMD8ATCAL	10, 313
AL20GB306	273	AL3320	197	AL5209	187	ALA11R1	184, 204	AMD8ATCBK	10, 313
AL20GB306TR	278	AL3346D	171	AL5210B	187	ALA17/18R	218	AMD8ATCBS	10, 313
AL20GB306TRGFI	276	AL3346DO	171	AL5210B1	188	ALA17/18R1	184, 204	AMD8ATCGY	10, 313
AL20GB506	273	AL3346E	171	AL5210B2	185, 188	ALA17A	182	AMD8ATCVY	10, 313
AL20GB506TRTRGFI	276	AL3346G	171	AL5210B3	188	ALA17A	203, 217	AMD8CTC	313
AL20GB512	273	AL3346GO	172	AL5211	188	ALA3000	197	AMD8CTCAA	313
AL20GB606	273	AL3356-ACTLPB	172	AL5214	188	ALA3800	197, 200, 684	AMD8CTCAB	313
AL20GB612	273	AL3356-LPB3S2	172	AL5215	188	ALA3800B	160	AMD8CTCAL	313
AL20GB618	273	AL33562A	172	AL5216	188	ALA3800B-10	178	AMD8CTCBK	313
AL20GB618	273	AL3356ABRT	172	AL5217	188	ALA3800C	160	AMD8CTCBS	313
AL20GBA606	273	AL3356R	172	AL5217A	188	ALA3806	178, 203	AMD8CTCGY	313
AL20GBA612	273	AL3356Z	172	AL5217N	188	ALA3810B	178, 203	AMD8CTCVY	313
AL20GBA618	273	AL4000	197, 200	AL5218	188	ALA3810B1	178, 204	AMD8SHTC	313
AL20IG306	273	AL4000C	197, 198	AL5246-B	188	ALA3811	178, 204	AMD8SHTCAL	313
AL20IG506	273	AL4001	207	AL5246-D	188	ALA3811	178, 204	AMD8SHTCBK	313
AL20IG606	273	AL4010B	207	AL5246-DD	188	ALA3815	178, 204	AMD8SHTCBS	313
AL2400	684	AL4010B2	207	AL5246-F	189	ALA3817	178, 204	AMD8SHTCGY	313
AL2400B	160	AL4011	207	AL5246-G	189	ALA3817N	178, 204	AMD8SHTCVY	313
AL2400B-10	167	AL4012A	207, 209	AL5256-2A	190	ALA3818	178, 204, 218	AMD8STC	313
AL2400B-5	167	AL4012B	207	AL5256-2LPB3S2	190	ALA4800	197, 200, 218, 229, 230	AMDTP-4	578, 603, 606, 609
AL2400C	160, 167	AL4015	208	AL5256-ABRT	189	ALA4800B	160	AMDTP-4-C	604
AL2400WC	167	AL4017	208	AL5256-ACT2LP	189	ALA4800B-10	182	AMDTP-412	603
AL2401	167	AL4018	208	AL5256-ACTLPB	189	ALA4800C	160	AMDTP-415	603
AL2406	167	AL4301	213	AL5256-ACTMAB	189	ALA4806	182, 217	AMDTP-4D	603, 604, 606
AL2409	167	AL4310B	213	AL5256-D2A	189	ALA4810B	182, 217	AMDTP-A	605
AL2410B	167	AL4310B2	213	AL5256-DABRT	190	ALA4810B2	182, 218	AMDTP-B	605
AL2410B2	167	AL4311	213	AL5256-DACT	189	ALA4811	182, 218	AMDTP-L	605
AL2411	167	AL4312A	213	AL5256-DMABRT	190	ALA4812A	218	AMTC-3S2	609
AL2415	167	AL4312B	214	AL5256-DZ	189	ALA4812B	218	AMTC-4	606, 607, 608
AL2416	167	AL4315	214	AL5256-G2A	190	ALA4815	182, 218	AMTC-412	607, 608
AL2417	167	AL4317	214	AL5256-GABRT	190	ALA4817	182, 218	AMTC-415	607, 608
AL2418	168	AL4318	214	AL5256-GACT	189	ALA4817N	183, 218	AMTC-ACT	609
AL241FP6A-6A	664	AL4320	200, 213	AL5256-GMABRT	190	ALA4818	183, 218	AMTC-CVR	609
AL241FP6A-B	665	AL4400	197, 200	AL5256-GZ	190	ALA48HR1024CM	230	AP-FITTC	330
AL241FP6A-D	664	AL4401	209	AL5256-LPB3S2	190	ALA48HR1024RT	230	APCB1TM4	282
AL241FP6A-DEC	665	AL4410B	209	AL5256-MABRT	190	ALA48TD8CM	229	APCB2TM2	282
AL241FPB-6A	664	AL4410B2	209	AL5256-Z	190	ALA48TD8RT	229	APCB3TM4	282
AL241FPB-B	664	AL4411	209	AL5260	190	ALAC-5	178, 182	APCB4TM1	282
AL241FPB-D	665	AL4412B	210	AL7301	221	ALAWC	178, 182, 203, 217	APCB5TM1	282
AL241FPD-6A	664	AL4415	210	AL7310B	221	ALDS4000	197, 200, 684	APCCTM4	281
AL241FPD-B	665	AL4417	210	AL7310B3	221	ALDS4000B	161, 175, 219	APDWCTM1	282
AL241FPD	664	AL4418	210	AL7311	221	ALDS4000C	161, 175, 197, 219	APME18TM2	281
AL241FPD-6A	665	AL4501	215	AL7312A	221	ALDS4010A	173, 175, 219	APMT12TM2	281
AL241FPD-DEC	664	AL4510B	215	AL7312B	222	ALDS4010B	173, 175, 219	APMT18TM4	281
AL241FPD-DEC-DEC	664	AL4510B2	215	AL7315	222	ALDS4011	173, 175, 219	APMT27TM2	281
AL2415-HB	663	AL4511	215	AL7317	222	ALDS4015	173, 175, 220	APTR15TM4	284
AL2446P-D	168	AL4512A	215	AL7318	222	ALDS4018	173, 175, 220	APUSB2TM4	284
AL2451H	168	AL4512B	216	AL7320	198, 200, 221	ALDS4047	173	ARA-S2	20, 152, 155
AL3000	200	AL4515	216	AL7401	223	ALDS4047E	173, 176	ARA-S2-BK	20, 155
AL3000C	197, 198	AL4517	216	AL7410B	223	ALDS4047F	173, 176	ARA-S2-FW	155
AL3001	202	AL4518	216	AL7410B3	223	ALDS4047M	173, 176	ARA-S2-G	20, 155
AL3010B	202	AL4520	197, 200	AL7411	223	ALDS4047MAB	173, 176	ARA-S2-GY	20, 155
AL3010B1	202	AL4701	211, 212	AL7412A	223	ALDS4047E	173, 176	ARA-S2-IV	155
AL3011	202	AL4710B	211	AL7412B	224	ALDS4047F	173, 176	ARA-S2-WH	20, 155
AL3012A	202	AL4710B2	211	AL7415	224	ALDS4047G	173, 176	AUDMTM1	284
AL3012B	202	AL4711	211	AL7417	224	ALDS4047H	173, 176	AV1000BK	2
AL3015	202	AL4712A	211	AL7418	224	ALDS4047I	173, 176	AV2002BK	3
AL3017	202	AL4712B	212	AL7450	198, 200, 224	ALDS4047J	173, 176	AV2003BK	3
AL3018	202	AL4715	212	ALA-2A	180, 184	ALDS4047K	173, 176	AV2004BK	5
AL3300	197, 200	AL4717	212	ALA-ABRT	183	ALDS4047L	173, 176	AV3000BK	3
AL3300	684	AL4718	212	ALA-BL	183	ALDS4047M	173, 176	AV3001BK	3
AL3300B	160	AL4718	212	ALA-C	197	ALDS4047N	173, 176	AV3002BK	3
AL3300B10	170	AL4750	197, 200	ALA-DR	179, 183	ALEXPLEDTM4	283	AV3003BK	3
AL3300C	160, 197	AL4750C	197	ALA-E	179, 183	ALLNLEDTM4	283	AV3004BK	3
		AL5200	684			ALPKLEDTM4	283	AV3APTC	315
						ALTC-20W	609	AV3APTCBK	315

INDEX

A — C

CAT. NO.	PAGE	CAT. NO.	PAGE	CAT. NO.	PAGE	CAT. NO.	PAGE	CAT. NO.	PAGE
AV3APTCGY	315	BK2000C	258	C11205	240	C14E45	240	CCBBS	477
AV3ATC	315, 571	BK2006	258	C112BH	242	C14E45VI	233, 241	CCBBS-DIV	480, 481
AV3ATCAA	10, 315	BK2010A2	259, 277	C112C	241	C14E45VO	233, 241	CCBBS-OG	477
AV3ATCAA111PA	571	BK2010A3	259	C112E	240	C14EB	233, 241	CCBBSCTCAL	478
AV3ATCAB	10, 315	BK2010B	277	C112E45	240	C14EVI	233, 241	CCFB-EBCH	475
AV3ATCAB111PA	571	BK2011	259	C112E45VI	241	C14EVO	241	CCFB-EBCI	475
AV3ATCAL	10, 315	BK2015	259	C112E45VO	241	C14F	242	CCFB-HB	475
AV3ATCAL111PA	571	BK2018C	259	C112EB	241	C14FB	243	CCFB-PH	475
AV3ATCBK	10, 315	BK2040B	277	C112EVI	241	C14H	233, 243	CCFB-QT	475
AV3ATCBS	10, 315	BK2048	259	C112EVO	241	C14R25	233, 242	CCFBC-BL-H-C1	474
AV3ATCBS111PA	571	BK2048-2	260	C112F	242	C14T	233, 242	CCFBC-BL-H-C2	474
AV3ATCGY	10, 315	BK2051H	260	C112FB	243	C14TH	242	CCFBC-BL-H-C3	474
AV3ATCGY111PA	571	BK20GB306TR	276	C112H	243	C14X	233, 242	CCFBC-BL-H-C4	474
AV3ATCVY	10, 315	BK20GB306TRGFI	276	C112R8	242	C1600	240	CCFBC-BL-H-C5	474
AV3CTC	315	BK20GB506TR	276	C112T	242	C1601	240	CCFBC-BL-N-C1	474
AV3CTCAA	10, 315	BK20GB506TRGFI	276	C112TH	242	C1602	240	CCFBC-BL-N-C2	474
AV3CTCAB	10, 315	BK20GB606TR	276	C112X	242	C1605	240	CCFBC-BL-N-C3	474
AV3CTCAL	10, 315	BKWE-P	60	C118-61	240	C16BH	242	CCFBC-BL-N-C4	474
AV3CTCBK	10, 315	BKWE-S	60	C118-62	240	C16C	241	CCFBC-BL-N-C5	474
AV3CTCBS	10, 315	BR1200-10	105	C118-65	240	C16E	240	CCFBC-CR-H-C1	474
AV3CTCGY	10, 315	BR1200-5	105	C118-6BH	242	C16E45	240	CCFBC-CR-H-C2	474
AV3CTCVY	10, 315	BR1200-50	105	C118-6C	241	C16E45VI	241	CCFBC-CR-H-C3	474
AV3SHTC	315	BR1200-5R	105	C118-6E	240	C16E45VO	241	CCFBC-CR-H-C4	474
AV3SHTCAL	315	BR1400-10	106	C118-6E45	240	C16EB	241	CCFBC-CR-H-C5	474
AV3SHTCBK	315	BR1400-5	106	C118-6E45VI	241	C16EVI	241	CCFBC-CR-N-C1	474
AV3SHTCBS	315	BR1400-50	106	C118-6E45VO	241	C16EVO	241	CCFBC-CR-N-C2	474
AV3SHTCGY	315	BR1600-10	106	C118-6EB	241, 242	C16F	242	CCFBC-CR-N-C3	474
AV3SHTCVY	315	BR1600-25	106	C118-6EVI	241	C16FB	243	CCFBC-CR-N-C4	474
AV3STC	315, 321	BR1600-5	106	C118-6EVO	241	C16H	243	CCFBC-CR-N-C5	474
AV4000BK	2			C118-6F	242	C16R4	242	CCFBC-NS-H-C1	474
AV4005BK	2			C118-6R12-6	242	C16T	242	CCFBC-NS-H-C2	474
AV5000BK	3			C118-6T	242, 243	C16TH	242	CCFBC-NS-H-C3	474
AV5001BK	3			C118-6TH	242, 243	C16X	242	CCFBC-NS-H-C4	474
AV5002BK	3			C118-6X	242	C1800	240	CCFBC-NS-H-C5	474
AV5004BK	3			C124-61	240	C1801	240	CCFBC-NS-N-C1	474
AV5005BK	5			C124-62	240	C1802	240	CCFBC-NS-N-C2	474
AV6001BK	4			C124-65	240	C1805	240	CCFBC-NS-N-C3	474
AV7000BK	4			C124-6BH	242	C18BH	242	CCFBC-NS-N-C4	474
AV7004BK	4			C124-6C	241	C18C	241	CCFBC-NS-N-C5	474
AV7005BK	4			C124-6E	240	C18E	240	CCM-DFF-BK	20
AV8008BK	4			C124-6E45	240	C18E45	240	CCM2-U2TJ-BK	18
AV8009BK	4			C124-6E45VI	241	C18E45VI	241	CCWB	476
AV8010BK	4			C124-6E45VO	241	C18E45VO	241	CIH/LT-B	402
AV9003BK	5			C124-6EB	241, 242	C18EB	241	CIHT-D	402
AV9004BK	5			C124-6EVI	241	C18EVI	241	CIHT-GFI	402
AV9008BK	5			C124-6EVO	241	C18EVO	241	CILT-2-RT	403
AV9010BK	3			C124-6F	242	C18F	242	CILT-2AB	402
AV9012BK	5			C124-6R18-6	242	C18FB	243	CILT-4TKO	403
AV9014BK	5			C124-6T	242, 243	C18H	243	CM-2AB	19
AV9015BK	5			C124-6TH	242, 243	C18R6	242	CM-2AB-BK	19
AV9016BK	4			C124-6X	242	C18T	242	CM-2AB-G	19
AVATCBK111PA	571			C1250	240	C18TH	242	CM-2AB-GY	19
				C1251	240	C18X	242	CM-2AB-WH	19
				C1252	240	C8004P-2ACT	466	CM-ARA	19, 152, 156
				C1255	240	C8004P-2DBP	466	CM-ARA-BK	19
				C125BH	242	C8004P-2RT	9	CM-ARA-FW	156
				C125C	241	C8004P-2RT	466	CM-ARA-G	19, 156
				C125E	240	C8005P-2RT	9	CM-ARA-GY	19, 156
				C125E45	240	C8005P-3ACT	465	CM-ARA-WH	19, 156
				C125E45VI	241	C8005P-3DBP	464	CM-DAP	20
				C125E45VO	241	C8005P-3RT	9	CM-DAP-BK	20
				C125EB	241	C8005P-3RT	464	CM-DAP-G	20
				C125EVI	241	C8005P-AAP-6A	9	CM-DAP-GY	20
				C125EVO	241	C8005P-AAP-6A	465	CM-DAP-WH	20
				C125F	242	C8005P-MAAP-6A	9	CM-DFF	20
				C125FB	243	C8005P-MAAP-6A	465	CM-DFF-G	20
				C125H	243	C8005P-MAAP-6A	465	CM-DFF-GY	20
				C125T	242	C8005P-RT	9	CM-DFF-WH	20
				C125TH	242	C8850P-2ACT	464	CM-DFF-WH	20
				C125X	242	C8850P-2RT	464	CM-EPLA	19, 49, 156,
				C1400	240	C8850P-ACT	464	252	
				C1401	240	C8850P-RT	464	CM-EPLA-FW	19, 49, 156
				C1402	240	CABS2-WH	19	CM-EPLA-G	19,
				C1405	240	CBR-HT	552	156	
				C14BH	233, 242	CBR-LHT	547, 552	CM-EPLA-WH	19, 156
				C14C	241	CBR-LT	552	CM-MAB	19
				C14E	233, 240	CBR11/2-LHT	552	CM-MAB-BK	19
						CCBBLCTCAL	478	CM-MAB-FW	19

C

B

INDEX

C – E

CAT. NO.	PAGE	CAT. NO.	PAGE	CAT. NO.	PAGE	CAT. NO.	PAGE	CAT. NO.	PAGE
CM-MAB-GY	19	CM2-U2SVGA-GY	18	CRFB-SR1-1	470	D42420	514, 519	DS4075-DG	60
CM-MMB-231	131	CM2-U2SVGA-WH	18	CRFB-SR1-2	471	D42425	514, 519	DS4075-DV	60
CM-MMB-231-WH	131	CM2-U2TJ	18	CRFB-SR1-3	471	D42430	514, 519	DS4075A	56, 60
CM-MMB-232	131	CM2-U2TJ-G	18	CRFB-SR1-4	472	DGT-2DP	459	DS4075A-BK	60
CM-MMB-232-WH	131	CM2-U2TJ-GY	18	CRFB-SR2-2	471	DGT-AAP	8, 459	DS4075A-DG	60
CM-MMB-233	131	CM2-U2TJ-WH	18	CRFB-TUN	470	DGT-ACT	459	DS4075A-DV	60
CM-MMB-233-WH	131	CM2, SERIES II	111	CRFB4	469	DGT-B	459	DS4089	60, 71
CM-MMB-291	116	COM50	307, 319, 323	CRFB4P2111PA	566	DGT-DP/B	459	DS4089-BK	60
CM-MMB-291-WH	116	COM75	307, 317, 319, 323	CRFB4P2222PA	566	DGT-MAAP	8, 459	DS4089-DG	60
CM-MMB-292	116			CRFB4P4222PA	566	DGT-RT	8	DS4089-DV	60
CM-MMB-292-WH	116	CP06-F30	537	CRFBBTC	469, 567	DGT-RT	460	DSDWND	59
CM-MMB-293	111, 116	CP06-HLF	538	CRFBBTC-TR	470	DGWE-S	60	DSDWND-BK	59
CM-MMB-293-WH	116	CP06-HLS	538	CRFBBTCBK	567	DR20A-G	55	DSDWND-DG	59
CM-MMB-571	32	CP06-ILF	538	CRFBBTCBKTR	567	DR20A-V	55	DSDWND-DV	59
CM-SAP	20	CP06-ILS	538	CRFBBTCBS	567	DRP20A-V	55	DSDWNDQ	59
CM-SAP-BK	20	CP06-S30	537	CRFBBTCBSTR	567	DS4000	93, 684	DSDWNDQ-BK	59
CM-SAP-G	20	CP06-TF	539	CRFBBTCBZ	567	DS4000B	58, 60	DSDWNDQ-DG	59
CM-SAP-GY	20	CP06-TS	539	CRFBBTCBZTR	567	DS4000C	58	DSDWNDQ-DV	59
CM-SAP-WH	20	CP06-XF	540	CRFBBTCGY	567	DS4000C-BK	58	DSDWNR	59
CM-SFP	20	CP06-XS	540	CRFBBTCGYTR	567	DS4000C-DG	58	DSDWNR-BK	12, 59
CM-SFP-BK	20	CP06W350-ELF	539	CRFBBTCNK	567	DS4000C-DV	58	DSDWNR-BZ	12
CM-SFP-G	20	CP06W350-ELS	539	CRFBBTCNKTR	567	DS4000WC	58, 175, 219	DSDWNR-DG	12, 59
CM-SFP-GY	20	CP06W350-IELF	539	CRFBBTCNTR	567	DS4001	58, 175, 219	DSDWNR-DV	12, 59
CM-SFP-WH	20	CP06W350-IELS	539	CRFBCTC	469, 567	DS4006	58	DSDWNS	60
CM2	133	CP10-F30	536, 537	CRFBCTC-TR	469	DS4006-BK	58	DSDWNS-BK	12, 60
CM2-BL	18	CP10-HLF	536, 538	CRFBCTCBK	567	DS4006-DG	58	DSDWNS-BZ	12
CM2-BL-BK	18	CP10-HLS	538	CRFBCTCBKTR	567	DS4006-DV	58	DSDWNS-DG	12, 60
CM2-BL-G	18	CP10-ILF	536, 538	CRFBCTCBS	567	DS4006B	58	DSDWNS-DV	12, 60
CM2-BL-GY	18	CP10-ILS	538	CRFBCTCBSTR	567	DS4006B-BK	58	DSDWNU	60
CM2-BL-WH	18	CP10-S30	537	CRFBCTCBZ	567	DS4006B-DG	58	DSDWNU-BK	12, 60
CM2-U1ATT	17	CP10-TF	536, 539	CRFBCTCBZTR	567	DS4006B-DV	58	DSDWNU-BZ	12
CM2-U1ATT-BK	17	CP10-TS	539	CRFBCTCGY	567	DS4010A	56, 58	DSDWNU-DG	12
CM2-U1ATT-G	17	CP10-XF	536, 540	CRFBCTGYTR	567	DS4010A-BK	58	DSDWNU-DV	12, 60
CM2-U1ATT-GY	17	CP10-XS	540	CRFBCTCNK	567	DS4010A-DG	58	DSDWNX	60
CM2-U1ATT-WH	17	CP10W350-ELF	539	CRFBCTCNKTR	567	DS4010A-DV	58	DSTRK	60
CM2-U1KEYA	17	CP10W350-ELS	539	CRFBCTCTR	567	DS4010B	56, 58	DTB-2-2A	554
CM2-U1KEYA-BK	17	CP10W350-IELF	539	CT10	515	DS4010B-BK	58	DTB-2-2AB	400, 554
CM2-U1KEYA-G	17	CP10W350-IELS	539	CT10-1/4	530	DS4010B-DG	58	DTB-2-2RT	400
CM2-U1KEYA-GY	17	CP18-F30	537	CT10-1/8	530	DS4010B-DV	58	DTB-2-4TKO	400, 554
CM2-U1KEYA-WH	17	CP18-HLF	538	CT15	515	DS4011	56, 58	DTB-2-AAP	400
CM2-U1NOR	18	CP18-HLS	538	CT15-1/4	530	DS4011-DG	58	DTB-2-B	554
CM2-U1NOR-BK	18	CP18-ILF	538	CT15-1/8	530	DS4011-DV	58	DTB-2-DECORA	400
CM2-U1NOR-G	18	CP18-ILS	538	CT18	515	DS4014A	58, 175, 220	DTB-2-DT	400
CM2-U1NOR-GY	18	CP18-S30	537	CT18-1/4	530	DS4015	56, 58	DTB-2-EXT	400
CM2-U1NOR-WH	18	CP18-TF	539	CT18-1/8	530	DS4015-BK	58	DTB-2-RT	554
CM2-U2AMP	18	CP18-TS	539	CT21-1/4	530	DS4015-DG	58	DTB-2-SD	400
CM2-U2AMP-BK	18	CP18-XF	540	CT21-1/8	530	DS4015-DV	58	DVWE-P	43, 45, 48, 60
CM2-U2AMP-G	18	CP18-XS	540	CT25-1/4	530	DS4017	56, 59	DVWE-S	43, 45, 48, 60
CM2-U2AMP-GY	18	CP18W350-ELF	539	CT25-1/8	530	DS4017-BK	59		
CM2-U2AMP-WH	18	CP18W350-ELS	539	CT6	515	DS4017-DG	59		
CM2-U2ATT	17	CP18W350-IELF	539	CT6-1/4	530	DS4017-DV	59		
CM2-U2ATT-BK	17	CP18W350-IELS	539	CT6-1/8	530	DS4018	56, 59		
CM2-U2ATT-G	17	CRFB	566	CZE-242412A	681	DS4018-BK	59	ED799	229
CM2-U2ATT-GY	17	CRFB-6COM-4	472	CZE-242412PP	681	DS4018-DG	59	EFB-50A	351, 356
CM2-U2ATT-WH	17	CRFB-AB-1	470	CZE-242412WB	681	DS4018-DV	59	EFB-AAP	6, 347, 351
CM2-U2KEYA	17	CRFB-AB-2	471			DS4047-BK	59	EFB-B	348, 351
CM2-U2KEYA-BK	17	CRFB-AB-3	472			DS4047-DG	59	EFB-CLL	351, 356
CM2-U2KEYA-G	17	CRFB-B-1	470			DS4047-DV	59	EFB-MAAP	6
CM2-U2KEYA-GY	17	CRFB-B-2	471			DS4047C	56, 59	EFB-MAAP	348, 351
CM2-U2KEYA-WH	17	CRFB-B-3	471			DS4047C-BK	59	EFB-MOS	348, 351
CM2-U2NOR	18	CRFB-B-4	472			DS4047C-DG	59	EFB-TEMPLATE	357
CM2-U2NOR-BK	18	CRFB-BEZ-6A-4	9, 472			DS4047C-DV	59	EFB10-DEC	354
CM2-U2NOR-G	18	CRFB-CGFI-4	9			DS4047D	56, 59	EFB10-2C	354
CM2-U2NOR-GY	18	CRFB-D-1	470			DS4047DQ	59	EFB10-3S2	354
CM2-U2NOR-WH	18	CRFB-D-2	471			DS4047DQ-BK	59	EFB10-6AB	354
CM2-U2SC	18	CRFB-D-3	471			DS4047DQ-DG	59	EFB10-AAP	6, 354
CM2-U2SC-BK	18	CRFB-D-4	472			DS4047DQ-DV	59	EFB10-B	354
CM2-U2SC-G	18	CRFB-GFI-1	9			DS4047MAB	56, 59	EFB10-DEC	6
CM2-U2SC-GY	18	CRFB-GFI-1	470			DS4047MAB-BK	59	EFB10-DP	354
CM2-U2SC-WH	18	CRFB-GFI-2	9, 471			DS4047MAB-DG	59	EFB10-MAAP	6, 354
CM2-U2ST	18	CRFB-GFI-3	9, 471			DS4047MAB-DV	59	EFB10-MB	353
CM2-U2ST-BK	18	CRFB-GFI-4	472			DS4047R	56, 59	EFB10-MOS	355
CM2-U2ST-G	18	CRFB-HOUSING	469			DS4047R-BK	59	EFB10-S1	354
CM2-U2ST-GY	18	CRFB-MAAP-4	9, 472			DS4047R-DG	59	EFB10-S2	354
CM2-U2ST-WH	18	CRFB-RT-1	470			DS4047R-DV	59	EFB10M	353
CM2-U2SVGA	18	CRFB-RT-2	471			DS4075	56, 60	EFB10S	352
CM2-U2SVGA-G	18	CRFB-RT-3	472			DS4075-BK	60	EFB10S-23GMB	353
								EFB10S-5GMB	353

INDEX

L — P

CAT. NO.	PAGE	CAT. NO.	PAGE	CAT. NO.	PAGE	CAT. NO.	PAGE	CAT. NO.	PAGE
L5-20R	195	NE1010DT	86	NM2048-2WH	116	P6	636	PN03F17-V	121
L5-30R	195	NE1011	86	NM2048-WH	116	P6-15	636	PN03F17-WH	121
L6-15R	195, 200	NE1011FO	86	NM2051H	267, 270, 271	P8104-2DP	466	PN03F18	119, 121
L6-20R	195	NE1011FOT	86	NM2051V	267, 270	P8105-4DP	464	PN03F18-FW	121
L6-30R	195	NE1011RFO	86	NM20GB12	268	P8840-2DP	466	PN03F18-V	121
L7-15R	200	NE1011RFOT	86	NM20GB412	268	P8850-4DP	464	PN03F18-WH	121
LPB	201	NE1011T	86	NM20GB512	268	PA120T	615, 641	PN03F19	119, 121
LPB3S2	201	NE1014	86	NM20GB515	268	PA120Y	641	PN03F19-F	121
LTF48-1	491	NE1014T	86	NM20GB530	268	PA240DCT	641	PN03F20	119, 121
LTF48-2	491	NE1015	86	NM20GB609	268	PA277Y	641	PN03F20-FW	121
LTF48-ACT	491	NE1015FO	86	NM20GB612	268	PABFMC	641	PN03F20-V	121
LTF48-B	490	NE1015FOT	86	NM20GB618	268	PB120T	641	PN03F20-WH	121
LTF48-MAAP	14, 491	NE1015L	87	NM20GBA12	268	PB120Y	641	PN03L08	119, 120
LTF48-RT	491	NE1015LFO	87	NM20GBA412	268	PB240DCT	641	PN03L08-FW	120
		NE1015LFOT	87	NM20GBA512	268	PB277Y	641	PN03L10	119, 120
		NE1015LT	87	NM20GBA609	268	PBB2S2	119, 123	PN03L10-FW	120
		NE1015T	86	NM20GBA612	268	PBB2S2-FW	123	PN05	152, 684
M		NE1017	87	NM20IG612	268	PBB2S2-V	123	PBB2S2-WH	123
M-2DR	491	NE1017FO	87	NM20IG612	268	PBB2S2-WH	123	PBB2S2-WH	123
M-2GFI	491	NE1017FOT	87	NM20IG612	268	PBB4TJ	119, 123	PBB4TJ-FW	123
M-DR	491	NE1017P	87	NM24GB412	268	PBB4TJ-FW	123	PBB4TJ-V	123
M-DR/GFI	491	NE1017PT	87	NM24GB512	268	PBB4TJ-V	123	PBB4TJ-WH	123
M-GFI	491	NE1017T	87	NM24GB530	268	PBB4TJ-WH	123	PDB1CM	119, 122
M5BZ	632	NE1018	87	NM24GB612	268	PDB1CM-FW	122	PDB1CM-FW	122
M5S	632	NE1018FO	87	NM24GB618	268	PDB1CM-V	122	PDB1CM-V	122
M620BZLS	632	NE1018FOT	87	NM24GBA412	268	PDB1CM-WH	122	PDB1S2	119, 122
M620BZLS-15	632	NE1018T	87	NM24GBA512	268	PDB1S2	119, 122	PDB1S2-FW	122
M6BZ	632	NE1046	88	NM24GBA612	268	NP800	611	PDB1S2-V	122
M6BZ-15	632	NE1046-2	88	NME1250AP	679	NP800C-10-2B	578, 608	PDB1S2-WH	122
M6BZNET	632	NE1046-2T	88	NP800	611	NP800C-12-2B	607	PDB2CM	119, 122
M6BZNET-15	632	NE1046AP	88	NP800C-12-8B	607, 608	NP800C-15-2B	607, 608	PDB2CM-FW	122
M6BZR	632	NE1046APN	88	NE1046HT	87	NPA222AL10M	561	PDB2CM-V	122
M6BZR-15	632	NE1046H	87	NE1046T	88	NPA222AL15	561	PDB2CM-WH	122
M6S	615, 632	NE1046HT	87	NE1047	87	NPT188111	562	PDB2S2	119, 122
M6S-15	632	NE1046T	88	NE1047T	87	NWC222AL12FL	563	PDB2S2-FW	122
MAB3S2	19	NE1047	87	NE1047WC	87	NWC222AL12FS	563	PDB2S2-V	122
MAB3S2-BK	19	NE1047T	87	NE1047WCT	87	NWC222AL12MS	563	PDB2S2-WH	122
MAB3S2-G	19	NE1047WC	87	NE1086A	88	NWCT22AL12ML	563	PDB2TJ	122
MAB3S2-GY	19	NE1047WCT	87	NE1407	87	NWCT22AL12MS	563	PDB2TJ-FW	122
MAB6TJ	19	NE1407	87	NE1407T	87	NWC332AL12FS	563	PDB2TJ-V	122
MAB6TJ-BK	19	NE1C	84	NE1C	84	NWC332AL12MS	563	PDB2TJ-WH	122
MAB6TJ-G	19	NE1CT	84	NE1CT	84	OFR1	97	PDB4TJ	119, 123
MAB6TJ-GY	19	NE1CTW	84	NE1CTW	84	OFR10A	96	PDB4TJ-FW	123
MAB6TJ-WH	19	NE1CW	84	NE1CW	84	OFR10W	96	PDB4TJ-V	123
METL520	624	NE610	88	NE610	88	OFR11	94, 97	PDB4TJ-WH	123
METL530	615, 624	NE610C	88	NE610C	88	OFR47-2A	97	PIP36	260
METL620	624	NEMA 5-15R	30	NEMA 5-15R	30	OFR47-B	97	PIP36BK	260
METL630	624	NEMA 5-20R	30	NEMA 5-20R	30	OFR47-D	97	PIP36V	260
MP4	490, 517, 532, 548	NM20-C3	634	NM20-C3	634	OFR47-R	12, 97	PIP36WH	260
MP8	490, 517, 532, 548	NM20-C4	634	NM20-C4	634	OFR47-U	12, 97	PK150	550
MP8-1	490, 517, 532, 548	NM20-C5	635	NM20-C5	635	OFR47-U2A	12, 97	PK200	547, 550
MRTC	647	NM20-C6	635	NM2000	269, 270, 684	OFR47-V	12, 97	PK250	550
MXN2A08	146, 148	NM2000B	269	NM2000BC	269	OFR48-2	94, 96	PK300	550
MXN2A08-WH	146	NM2000C	268, 269	NM2000WC	268, 269	OFR48-4	93, 94, 96	PK325	550
MXN2F21	146	NM2003	269	NM2003	269	OFR48-4GX	96	PKCAP	551
MXN2F21-WH	146	NM2006	267, 269, 271	NM2006	267, 269, 271	OFR6	95	PKER-10	550
MXN2FWC	146	NM2010A	267, 269, 271	NM2010A	267, 269, 271	OFR6	95	PKER-15	550
		NM2010B	267, 269, 271	NM2010B	267, 269, 271	OFR89	93, 94	PKER-20	550
		NM2011	267, 269, 271	NM2011	267, 269, 271	OFR89-2400	94, 96	PKER-25	550
		NM2015	267, 270, 271	NM2015	267, 270, 271	OFR89-4000	96	PKER-30	550
		NM2017	267, 270, 271	NM2017	267, 270, 271	OFR89-DS4000	96	PKGRBR	553
		NM2018	267, 270, 271	NM2018	267, 270, 271	OFR89-VFL	97	PKKIT	554
		NM2027-15	270	NM2027-15	270	OFR89-VIS	96	PM48T	264
		NM2027-20	270	NM2027-20	270	OFR9	97	PMS-415N	551
		NM2044	116, 270, 686	NM2044	116, 270, 686	OFR8	93, 95	PN03	152, 684
		NM2044-2	116, 270, 686	NM2044-2	116, 270, 686	OFRB-8	93, 95	PN03F06	119, 120
		NM2044-2WH	116	NM2044-2WH	116	OFRBC-8	94, 95	PN03F06-FW	120
		NM2044-WH	116	NM2044-WH	116	OFR8-8	94, 95	PN03F06-V	120
		NM2048	111, 116, 118, 267, 270, 271, 686	NM2048	111, 116, 118, 267, 270, 271, 686	OFR8-8	94, 95	PN03F06-WH	120
		NM2048-2	116, 267, 270, 686	NM2048-2	116, 267, 270, 686	OFR8	93, 95	PN03F11	119, 120
			270, 686		270, 686	OFRWC	96	PN03F11FW	120
								PN03F15	119, 121
								PN03F15-FW	121
								PN03F17	119, 121
								PN03F17-FW	121
								PN10105-4DP	467
								PN10105-5DP	467

INDEX

P – S

CAT. NO.	PAGE	CAT. NO.	PAGE	CAT. NO.	PAGE	CAT. NO.	PAGE	CAT. NO.	PAGE
PN10L10-FW	120	RC4APTCVY	317	RC7CTCVY	307	RC9SHTCBK	309	RFB4-4DB	399
PN153R	119, 121	RC4ATC	317, 570	RC7SHTC	307	RC9SHTCBS	309	RFB4-4DBFC	368
PN153R-FW	121	RC4ATCAA	317	RC7SHTCAA	307	RC9SHTCGY	309	RFB4-CI-1	402
PN153R-V	121	RC4ATCAA222PA	570	RC7SHTCBK	307	RC9SHTCVY	309	RFB4-GFI-4DB	6
PN153R-WH	121	RC4ATCAB	317	RC7SHTCBS	307	RC9STC	309	RFB4-LPB	400
PPDU-620	476	RC4ATCAB222PA	570	RC7SHTCGY	307	RCAPFFTC	325, 327	RFB4-LPBS2	400
PR609N	615, 633	RC4ATCAL	317	RC7SHTCVY	307	RCAPFFTCBK	325, 327	RFB4-SS	403
PR610N	633	RC4ATCAL222PA	570	RC7STC	307, 323	REC	551	RFB4-SS-AAP	6, 370, 404
PSB1	119, 122, 139, 686	RC4ATCBK	317	RC91GHBTC	332	REC11/2	551	RFB4-SS-MAAP	6, 370, 404
PSB1-FW	122	RC4ATCBK222PA	570	RC92GHBTC	332	REC11/2-C	552		404
PSB1-V	122	RC4ATCBS	317	RC9A	570	REC11/2-CA	551	RFB4-SSFC	369
PSB1-WH	122	RC4ATCBS222PA	570	RC9A15TC	309, 570	REC2-C	552	RFB4E	407
PSB2	119, 122, 686	RC4ATCGY	317	RC9A15TCAA	309	REC2-CA	551	RFB4E-CTR	408
PSB2-FW	122	RC4ATCGY222PA	570	RC9A15TCAA111CW	570	REC3-C	552	RFB4EKIT	408
PSB2-V	122	RC4ATCVY	317	RC9A15TCAB	309	REC3-CA	551	RFB6	410
PSB2-WH	122	RC4C	316	RC9A15TCAB111CW	570	RECDU111	559	RFB6-AAP	7, 408, 411
PSB3	119, 122, 686	RC4CTC	317	RC9A15TCAL	309	RFB-2-SSRT	370, 404	RFB6-OG	410
PSB3-FW	122	RC4CTCAA	317	RC9A15TCAL111CW	570	RFB-2AB-SS	370, 404	RFB62A	408, 411
PSB3-V	122	RC4CTCAB	317	RC9A15TCBK	309	RFB-4TKO-SS	370, 404	RFB6B	408, 411
PSB3-WH	122	RC4CTCAL	317	RC9A15TCBK111CW	570	RFB-B	400	RFB6DP	408, 411
PSRC9AMDT	517	RC4CTCBK	317	RC9A15TCBS	309	RFB-B-SS	370, 404	RFB6E	410
PSRC9AMDTG	501	RC4CTCBS	317	RC9A15TCBS111CW	570	RFB-DR	400	RFB6E-CTR	411
PSRC9FF2TC	501	RC4CTCGY	317	RC9A15TCGY	309	RFB-DR-4DB	369	RFB6E-OG	410
PSRC9FFTC	501, 517	RC4CTCVY	317	RC9A15TCGY111CW	570	RFB-GFI	400	RFB6EXT	7, 408, 411
PSRC9TC	501, 517	RC4KTCAL	317	RC9A15TCVY	309	RFB-GFI-4DB	369, 401	RFB6GFI	7, 408, 411
PVC-1	112, 113, 114, 125, 126, 128, 157	RC4KTCBK	317	RC9AFFTC	325	RFB-GFI-SS	6, 370, 404	RFB6RT	7, 408, 411
		RC4KTCBS	317	RC9AFFTCBK	325	RFB-RB-SS	370, 404	RFB6S1	408, 411
		RC4KTCG	317	RC9AFFTCGY	325	RFB-WTB	369, 401	RFB6S2	408, 411
		RC4KTCGY	317	RC9AM2STC	311, 327	RFB11	415	RFB9	416
		RC4KTCVY	317	RC9AM2TC	327	RFB11-OG	415	RFB9-OG	416
		RC4REC2	317	RC9AM2TCAL	327	RFB119-2SAB	418, 480	RFBCIKI	403
		RC4REC2-25	317	RC9AM2TCBK	327	RFB119-2SB	417, 480	RFBKIT	396, 401, 404
		RC4SHTC	316	RC9AM2TCGY	327	RFB119-2SRT	418, 480	RFE-242412	682
		RC4SHTCAL	316	RC9AMDT	311	RFB119-3B	481	RFE-25256	682
		RC4SHTCBK	316	RC9AMDTCAA	10, 311	RFB119-3D	418, 481	RFE-25257RB	682
		RC4SHTCBS	316	RC9AMDTTAB	311	RFB119-3GFI	7, 418, 481	RGP	551
		RC4SHTCGY	316	RC9AMDTCAL	10, 311	RFB119-3SB	480	RJ11	138
		RC4STC	316	RC9AMDTCBK	10, 311	RFB119-AAP	418, 480	RJ45	138
		RC7AFFTC	323	RC9AMDTCBS	10, 311	RFB119-AB	419, 481	RP-DIV	386
		RC7AFFTCAL	323	RC9AMDTCGY	10, 311	RFB119-B	418, 481	RP4FFCTC	385
		RC7AFFTCBK	323	RC9AMDTCVY	10, 311	RFB119-D	418, 481	RP7CTC	384
		RC7AFFTCBS	323	RC9APTC	309, 311	RFB119-GFI	7, 418, 481	RPAMD4CTC	385
		RC7AFFTCGY	323	RC9APT	309, 311	RFB119-KO	419, 481	RPAMD8CTC	385
		RC7AM2TC	327	RC9APT	309, 311	RFB119-MAAP	419, 481	RPV3CTC	384
		RC7AM2TCAL	327	RC9CFFTC	325	RFB119-PAN	417	RPSFB	383
		RC7AM2TCBK	327	RC9CFFTCBK	325	RFB119-RT	419, 481	RPSFB-OG	383
		RC7AM2TCBS	327	RC9CFFTCGY	325	RFB119-SB	417, 480, 481	RRPNFB	384
		RC7AM2TCGY	327	RC9CM2TC	327	RFB119-SGFI	7, 417, 480	RSCB-18	551
		RC7APT	307	RC9CM2TCAL	327	RFB119-SKO	418	RSCB-28	547
		RC7APTCBK	307	RC9CM2TCBK	327	RFB119-SPACER	419, 481, 482	RSCB-33	551
		RC7APTCGY	307	RC9CM2TCGY	327			RSCB-48	551
		RC7ATC	307, 571	RC9CMD	311	RFB119-SR1	418, 481	RTT13	526
		RC7ATCAA	307	RC9CMDTC	311	RFB119-SR2	418, 481	RTT16	526
		RC7ATCAA111CW	571	RC9CMDTCAA	311	RFB119-SR3	418, 481	RTT20	526
		RC7ATCAB	307	RC9CMDTCAB	311	RFB119-SSR1	417, 480	RTT4	526
		RC7ATCAB111CW	571	RC9CMDTCBK	311	RFB119-SSR2	417, 480	RTT8	526
		RC7ATCAL	307	RC9CMDTCBS	311	RFB119-SXLR	7		
		RC7ATCAL111CW	571	RC9CMDTCGY	311	RFB119-TS	417		
		RC7ATCBK	307	RC9CMDTCVY	311	RFB119-XLR	7		
		RC7ATCBK111CW	571	RC9CTC	309	RFB119-XLR	419, 480, 482		
		RC7ATCBS	307	RC9CTCAA	309			S124B	495
		RC7ATCBS111CW	571	RC9CTCAB	309	RFB119BTC	416	S124BLK	494
		RC7ATCGY	307	RC9CTCAL	309	RFB119CTC	416	S125	495
		RC7ATCGY111CW	571	RC9CTCBK	309	RFB119SD	417, 480	S125B	495
		RC7ATCVY	307	RC9CTCGY	309	RFB2	395	S130	495
		RC7CFFTC	323, 327	RC9CTCVY	309	RFB2-AAP	6, 367, 396	S165	494
		RC7CFFTCAL	323, 327	RC9FFS	325, 332	RFB2-OG	395	S165B	494, 517
		RC7CFFTCBK	323, 327	RC9REC	309	RFB2-SS	394	S165BLK/BRN	517
		RC7CFFTCBS	323, 327	RC9REC-25	309	RFB2-SSFC	367	S166	494
		RC7CFFTCGY	323, 327	RC9SHMDTC	311	RFB22AB	368, 396	S166B	494, 517
		RC7CTC	307	RC9SHMDTCAA	311	RFB2B	367, 396	S166BLK/BRN	517
		RC7CTCAA	307	RC9SHMDTCBK	311	RFB2DP	367, 396	S175	494
		RC7CTCAB	307	RC9SHMDTCBS	311	RFB2EXT	6, 368, 396	S175BLK/BRN	517
		RC7CTCAL	307	RC9SHMDTCGY	311	RFB2FC	367	S1ER	496
		RC7CTCBK	307	RC9SHMDTCVY	311	RFB2GFI	6, 367, 396	S1MC	496
		RC7CTCBS	307	RC9SHTC	309	RFB2RT	6, 368, 396	S1MC-MS	496
		RC7CTCGY	307	RC9SHTCAA	309	RFB4	399	S2-EPL	49
								S2-EPL	156, 252

R

S

INDEX

V — W

CAT. NO.	PAGE	CAT. NO.	PAGE	CAT. NO.	PAGE	CAT. NO.	PAGE	CAT. NO.	PAGE
V2417D	46	V4006	64	V5737A	28, 30, 686	VA06W325HEC	545	VAT18W325H4CT	546
V2417DFO	46	V4010B	64	V5738	30, 686	VA12SSS250-5	544	VAT24W250H3CT	545
V2417M	40, 265	V4010DFO	64	V5738A	686	VA12SSS325-5	544	VAT24W250H3CX	545
V2418	262	V4011	64	V5738AF	30, 686	VA12W-AH3	546	VAT24W250H4CT	546
V2418DFO	46	V4011FO	64	V5739	24, 28, 686	VA12W-VL10	536, 546	VAT24W325H3CT	545
V2418FO	41	V4012TX	64	V5739A	30, 686	VA12W-VR10	536, 546	VAT24W325H3CX	545
V2418M	41, 265	V4014A	64	V5741	30, 686	VA12W250H	544	VAT24W325H4CT	546
V2426	41, 266	V4015	64	V5744	686	VA12W250H-1	544	VB880	597, 598
V2427GA	43, 265	V4015D	64	V5744-2	28, 686	VA12W250H-2	544	VEL662345234524	588
V2427GT	43, 266	V4015DFO	65	V5744-3	686	VA12W250H-5	536, 544	VEL66234524	581, 587
V2444	41, 265	V4015FO	65	V5744S	31, 686	VA12W250H-6	544	VEL6623524	587
V2444-2	42, 265	V4017	65	V5744S-2	28, 31, 686	VA12W250H-EC	536	VEL772345441024	585
V2444-2LS	42	V4017FO	65	V5744S-3	31, 686	VA12W250H-L45	546	VES66234524	581
V2444D	41, 47	V4017N	65	V5745	31, 686	VA12W250H-LL	536, 546	VFL662345FFZD	588
V2444D-2A	19, 47	V4018	65	V5747	31, 262, 686	VA12W250H-RL	546	VFL772345FFZZP	585
V2444D-2N	47	V4018FO	65	V5747-2	28, 31, 686	VA12W250H-T	545	VL2A	14, 597
V2448	42, 262, 265, 686	V4046H-2	67	V5747-3	31, 686	VA12W250H-X	545	VL3D	583, 591
V2448-2	42, 262, 265, 686	V4047-2BBB	69	V5748	31, 256, 686	VA12W250HEC	545	VLCP662345	580
V2450	47	V4047-2BBFF	70	V5748-2	28, 31, 686	VA12W325H-1	544	VL662345FF	580
V2451H	42, 265	V4047-2BBMM	70	V5748-2WH	31	VA12W325H-2	544	VLCM	583, 592
V2475D	42, 48	V4047-2BBSS	70	V5748-3	31, 686	VA12W325H-5	544	VLCP662345	587
V2489	42, 262, 265	V4047-2BBTT	70	V5748-3WH	31	VA12W325H-6	544	VLCR	13, 14, 583,
V2489TB	42	V4047-2BBXX	70	V5748-4	31, 686	VA12W325H-L45	546	591, 597
V24DWND	41, 47	V4047-2RRXX	70	V5748-5	31, 686	VA12W325H-LL	546	VLEA	13, 14, 583,
V24DWNR	41, 47	V4047-2WWFF	70	V5748-6	31, 686	VA12W325H-RL	546	591, 597
V24DWNS	11, 41, 47	V4047-2WWMM	70	V5748S	31, 686	VA12W325H-T	545	VLEAP5	14, 597
V24DWNU	11, 41, 47	V4047-2WWSS	70	V5748WH	31	VA12W325H-X	545	VLEM	13, 14, 583,
V24GB306	263	V4047-2WWTT	71	V5751	28, 31, 686	VA12W325HEC	545	591, 597
V24GB506	263	V4047-2WWXX	71	V5751-2	686, 31	VA18W-AH3	546	VLEMP5	14, 597
V24GB512	263	V4047AX	67	V5751-3	31, 686	VA18W-VL	546	VLFF	583, 591
V24GB606	263	V4047BB	67	V5751A	32	VA18W-VR	546	VLLB	592
V24GB612	263	V4047BF	68	V5752	32, 686	VA18W250H-L45	546	VLP5662345	595
V24GB618	263	V4047BM	68	V5753	32, 686	VA18W250H-LL	546	VLRT	13, 583, 591
V24GBA512	263	V4047BS	68	V5760	28, 686	VA18W250H-RL	546	VLV	581
V24GBA612	263	V4047BT	68	V5783	28	VA18W250H-T	545	VLWAP	675
V24GBA618	263	V4047BX	67	V5784	28	VA18W250H-X	545	VPLA34410	585
V3000B	51	V4047C-1	68	V5785	28, 29, 71	VA18W250HEC	545	VPLY2345	588
V3000C075	51	V4047C-2	68	V5786	24, 28, 29	VA18W325H-L45	546	VS1A	598
V3000C195	51	V4047JX	68	V6000B-10	80	VA18W325H-LL	546	VS2D	584
V3000CE	51	V4047RF	69	V6000C	80	VA18W325H-RL	546	VS662345	580
V3003	52	V4047RX	68	V6006	81	VA18W325H-T	545	VSP662345FF	580
V3006E	52	V4047UX	12, 71, 82	V6007C-1	81	VA18W325H-X	545	VSCM	584
V3010AE	52	V4047VX	12, 71, 82	V6007C-2	81	VA18W325HEC	545	VSCR	13, 14, 584, 598
V3010B	52	V4047WF	69	V6010B	81	VA24W-AH3	546	VSEA	13, 14, 584, 598
V3010C	52	V4047WM	69	V6011TX	81	VA24W-VR	546	VSEAP5	14, 598
V3011E	53	V4047WS	69	V6012TX	82	VA24W250H-L45	546	VSEM	13, 14, 584, 598
V3014C	53	V4047WT	69	V6014A	82	VA24W250H-LL	546	VSEMP5	14, 598
V3015E	53	V4047WX	69	V6017TX	82	VA24W250H-RL	546	VSFF	584
V3017TCE	53	V4050	67, 72, 82, 88	V6046KD	82	VA24W250H-T	545	VSLB	584
V3018AE	53	V4074A	66	V6074	82	VA24W250H-X	545	VSP5662345	595
V3027AE	53	V4075D	66	V6074A	83	VA24W250HEC	545	VSRT	13, 584
V3028	53	V4075DA	66	V6086	83	VA24W325H-L45	546	VY602345L2Y	588
V3033JE	53	V4086A	66	V700	26	VA24W325H-LL	546		
V3036HE	53	V4089	43, 48, 66	V704	26	VA24W325H-RL	546		
V3040CE	54	V500	25, 98, 256	V706	26	VA24W325H-T	545		
V3043BE	54	V500-5	25	V711	27	VA24W325H-X	545		
V3043GE	54	V504	25	V712	27	VA24W325HEC	545		
V3044-2	54	V506	25	V717	27	VA250PEC	545		
V3046BE	54	V511	25	V718	27	VA250PEC-LH3	545		
V3046H-2	54	V512	25	VA06SSS250-5	544	VA250PEC-LH6	545		
V3046KD	54	V517	25	VA06SSS325-5	544	VA250PEC-RH3	545		
V3046KTSQ	54	V518	25, 256	VA06W	546	VA250PEC-RH6	545		
V3046QOU	54	V5400	230	VA06W-AH3	546	VA325PEC-LH3	545		
V3046S	11, 55	V5700F	27	VA06W-VL	546	VA325PEC-LH6	545		
V3046U	11, 55	V5703	27	VA06W-VR	546	VA325PEC-RH3	545		
V3046V	11, 55	V5715	27	VA06W250H	546	VA325PEC-RH6	545		
V3048R	54	V5719	27, 686	VA06W250H-L45	546	VAT12W250H3CT	545		
V3051LE	54	V57240	30, 686	VA06W250H-LL	546	VAT12W250H3CX	545		
V4000	229, 230	V57242	30, 686	VA06W250H-RL	546	VAT12W250H4CT	546		
V4000B-10	63	V57243G	30, 686	VA06W250H-T	545	VAT12W325H3CT	545		
V4000C	63	V5731	29	VA06W250H-X	545	VAT12W325H3CX	545		
V4000C075	63	V5733	686	VA06W250HEC	545	VAT12W325H4CT	546		
V4000C135	63	V5734	686	VA06W325H-L45	546	VAT18W250H3CT	545		
V4000C195	63	V5734A	686	VA06W325H-LL	546	VAT18W250H3CX	545		
V4000C315	63	V5735	28, 29, 686	VA06W325H-RL	546	VAT18W250H4CT	546		
V4000HR1024	230	V5736	29	VA06W325H-T	545	VAT18W325H3CT	545		
V4000TD8	229	V5737	28, 30, 686	VA06W325H-X	545	VAT18W325H3CX	545		

W

W30	261, 269, 274
W30/W30G	35, 163, 258
W30G	35, 261, 269, 274
WAPBRKT	680
WAPE10-1200KIT	676
WAPE10-1232KIT	677
WAPE10-1242KIT	677
WAPE10-BLKIT	676
WAPE10-DOME	677
WAPE10-UNIKIT	677
WAPE5-1200KIT	676
WAPE5-1232KIT	677
WAPE5-1242KIT	677
WAPE5-1250KITD	677
WAPE5-1250KITR	677
WAPE5-BLKIT	676
WAPE5-UNIKIT	677
WAPENCL	678
WAPENCL-24-24-4	678
WBSBC	672
WCHD2425	555
WCHD3025	555

INDEX

W — Z

CAT. NO.	PAGE	CAT. NO.	PAGE	CAT. NO.	PAGE	CAT. NO.	PAGE	CAT. NO.	PAGE
WCHD3625.....	555	WD10W350-SWTS	536,	WH20GB506TR	276	WSA07-4AWH.....	251	WSMEDTC72SLDK-2....	649
WCR11/2.....	547, 552, 554	542	WH20GB506TRGFI	276	WSA07A.....	16	WSMEDTC72SLSK	649
WCR11/2-10/24	550	WD10W350-T.....	536, 539	WH20GB606TR	276	WSA42-4.....	251	WSMEDTC72SLSK-2....	649
WCR11/2-10B	550	WD10W350-TUN ...	536, 539	WMFB1DRB.....	454	WSA42-6.....	252	WSMP-QD.....	651
WCR2.....	547, 552, 554	WD10W350-X.....	536, 540	WMFB1DRN.....	454	WSA86	252	WSMP-T.....	651
WCR2-10/24	550	WD10W350-XTUN	536,	WMFB1KS2B.....	455	WSB07-2A.....	252	WSMPCMM12.....	651
WCR2-10/B.....	547	540	WMFB1KS2N.....	455	WSB07-2ABK	252	WSMPDUT60BKSK	650
WCR2-10B.....	550	WD18-ACPF.....	541	WMFB1KS4B.....	455	WSB07-2AG.....	252	WSMPDUT60BKSK-2...	650
WCR3.....	547, 552, 554	WD18-ACPS.....	541	WMFB1KS4N.....	455	WSB07-2AGY.....	252	WSMPDUT72BKSK	650
WCR3-10/24	550	WD18-WR.....	538	WMFB1SRB.....	454	WSB07-2AWH.....	252	WSMPDUT72BKSK-2...	650
WCR3-10B.....	550	WD18W350-3TUN	540	WMFB1SRKS1B	454	WSB42-2.....	251	WSMPDUT72BKSK-2...	650
WD-10CDO	536, 542	WD18W350-60.....	537	WMFB1SRKS1N	454	WSC07-6A.....	251	WSMPDUT72BKSK	650
WD-10CDOD.....	542	WD18W350-CC/DO.....	541	WMFB1SRN.....	454	WSC07-6AG.....	251	WSMPDUT72BKSK-2...	650
WD06-ACPF.....	541	WD18W350-ECF.....	538	WMFB2DR2B.....	454	WSC07-6AGY.....	251	WSMPDUT72BKSK	650
WD06-ACPS.....	541	WD18W350-ECS.....	538	WMFB2DR2N	454	WSC07-6AWH.....	251	WSMPDUT72BKSK	650
WD06-WR.....	538	WD18W350-EL.....	539	WMFB2DRKS4B.....	455	WSC320-S.....	666	WSMPDUT72BKSK-2...	650
WD06W350-60.....	537	WD18W350-FCCF.....	542	WMFB2DRKS4N.....	455	WSC400-S.....	666	WSMPDUT72BKSK	650
WD06W350-CC/DO.....	541	WD18W350-FST.....	541	WMFB2KS8B.....	455	WSC42-6.....	252	WSMPDUT72BKSK	650
WD06W350-ECF.....	538	WD18W350-HL.....	538	WMFB2KS8N.....	455	WSCEDTCBK.....	650	WSMPDUT72BKSK	650
WD06W350-ECS.....	538	WD18W350-IEL.....	539	WPACR.....	554	WSCEDTCSL.....	650	WSMPDUT72BKSK	650
WD06W350-EL.....	539	WD18W350-IL.....	538	WPACR-1G.....	553, 554	WSDM210BK.....	668	WSMPDUT72BKSK	650
WD06W350-FCCF.....	542	WD18W350-LTUN.....	540	WPACR-2G.....	553	WSDM210BKR.....	668	WSMPDUT72BKSK	650
WD06W350-FCCS.....	542	WD18W350-RTUN.....	539	WS6F.....	654	WSDM211BK.....	668	WSMPDUT72BKSK	650
WD06W350-FST.....	541	WD18W350-SES.....	541	WS6FBK.....	11	WSDM211BKR.....	668	WSMPDUT72BKSK	650
WD06W350-HL.....	538	WD18W350-SWCCS	536,	WS6FBS.....	11	WSDMDC.....	668	WSMPDUT72BKSK	650
WD06W350-IEL.....	539	541	WS6FBZ.....	11	WSDMUC.....	668	WSMPDUT72BKSK	650
WD06W350-IL.....	538	WD18W350-SWTS	542	WS6FGY.....	11	WSF6F.....	653	WSMPDUT72BKSK	650
WD06W350-LTUN.....	540	WD18W350-T.....	539	WS6FNK.....	11	WSF6FBK.....	11	WSMPDUT72BKSK	650
WD06W350-RTUN.....	539	WD18W350-TUN	539	WS6S.....	654	WSF6FBS.....	11	WSMPDUT72BKSK	650
WD06W350-SES.....	541	WD18W350-X.....	540	WS6SBK.....	11	WSF6FBZ.....	11	WSMPDUT72BKSK	650
WD06W350-SWCCS	541	WD18W350-XTUN	540	WS6SBS.....	11	WSF6FGY.....	11	WSMPDUT72BKSK	650
WD06W350-SWTS	542	WD350-CA.....	538	WS6SBZ.....	11	WSF6FNK.....	11	WSMPDUT72BKSK	650
WD06W350-T.....	539	WD350-CP.....	536, 538	WS6SGY.....	11	WSF6S.....	653	WSMPDUT72BKSK	650
WD06W350-TUN.....	539	WD350-P60.....	536	WS6SNK.....	11	WSF6SBK.....	11	WSMPDUT72BKSK	650
WD06W350-X.....	540	WD350-PSE.....	540	WS8F.....	654	WSF6SBS.....	11	WSMPDUT72BKSK	650
WD06W350-XTUN.....	540	WD350-R04.....	536	WS8FBK.....	11	WSF6SBZ.....	11	WSMPDUT72BKSK	650
WD10-ACPF.....	536, 541	WD350-R02.....	541	WS8FBS.....	11	WSF6SGY.....	11	WSMPDUT72BKSK	650
WD10-ACPS.....	541	WD350-R04.....	541	WS8FBZ.....	11	WSF6SNK.....	11	WSMPDUT72BKSK	650
WD10-WR.....	538	WD350P60.....	538	WS8FGY.....	11	WSF8F.....	653	WSMPDUT72BKSK	650
WD10W350-3TUN.....	540	WH2000B-10.....	258	WS8FNK.....	11	WSF8FBK.....	11	WSMPDUT72BKSK	650
WD10W350-60.....	536, 537	WH2000B-5.....	258	WS8S.....	654	WSF8FBS.....	11	WSMPDUT72BKSK	650
WD10W350-CC/DO.....	536,	WH2000BC.....	258	WS8SBK.....	11	WSF8FBZ.....	11	WSMPDUT72BKSK	650
.....	541	WH2000C.....	258	WS8SBS.....	11	WSF8FGY.....	11	WSMPDUT72BKSK	650
WD10W350-ECF.....	536, 538	WH2006.....	258	WS8SBZ.....	11	WSF8FNK.....	11	WSMPDUT72BKSK	650
WD10W350-ECS.....	538	WH2010A2.....	259, 277	WS8SGY.....	11	WSF8S.....	653	WSMPDUT72BKSK	650
WD10W350-EL.....	536, 539	WH2010A3.....	259	WS8SNK.....	11	WSF8SBK.....	11	WSMPDUT72BKSK	650
WD10W350-FCCF.....	536, 542	WH2010B.....	259	WSA00-4.....	252	WSF8SBS.....	11	WSMPDUT72BKSK	650
WD10W350-FCCS.....	542	WH2011.....	259	WSA00-4BK.....	252	WSF8SBZ.....	11	WSMPDUT72BKSK	650
WD10W350-FST.....	536, 541	WH2015.....	259	WSA00-4GY.....	252	WSF8SGY.....	11	WSMPDUT72BKSK	650
WD10W350-HL.....	536, 538	WH2018C.....	259	WSA00-4WH.....	252	WSF8SNK.....	11	WSMPDUT72BKSK	650
WD10W350-IEL.....	539	WH2040B.....	277	WSA07-4A.....	19	WSMEDTC60SLDK.....	649	WSMPDUT72BKSK	650
WD10W350-IL.....	536, 538	WH2048.....	259	WSA07-4A.....	251	WSMEDTC60SLDK-2...	649	WSMPDUT72BKSK	650
WD10W350-LTUN.....	536, 540	WH2048-2.....	260	WSA07-4ABK.....	251	WSMEDTC60SLSK.....	649	WSMPDUT72BKSK	650
WD10W350-RTUN.....	539	WH2051H.....	260	WSA07-4AG.....	251	WSMEDTC60SLSK-2...	649	WSMPDUT72BKSK	650
WD10W350-SES.....	536, 541	WH206B306TR.....	276	WSA07-4AGY.....	251	WSMEDTC72SLDK.....	649	WSMPDUT72BKSK	650
WD10W350-SWCCS	541	WH206B306TRGFI	276						

Y

YL1200-50.....	105
YL1400-50.....	106
YL1600-25.....	106

Z

ZA120T.....	638, 639
ZA120Y.....	638, 639
ZA277Y.....	638, 639
ZB120T.....	638, 639
ZB120Y.....	638, 639
ZB277Y.....	638, 639
ZBM120T.....	638, 639
ZBM120Y.....	638, 639
ZBM277Y.....	638, 639
ZC120T.....	638, 639
ZC120Y.....	638, 639
ZC277Y.....	638, 639
ZCM120T.....	638, 639
ZCM120Y.....	638, 639
ZCM277Y.....	638, 639
ZE120T.....	638, 639
ZE120Y.....	638, 639
ZE277Y.....	638, 639
ZEM120T.....	638, 639
ZEM120Y.....	638, 639
ZEM277Y.....	638, 639
ZPA120T.....	640
ZPA120Y.....	640
ZPA240DCT.....	640
ZPA277Y.....	640
ZPB120T.....	640
ZPB120Y.....	640
ZPB240DCT.....	640
ZPB277Y.....	640

WARRANTY & TRADEMARK INFORMATION

Wiremold® Limited Warranty & Liability Statement

Wiremold warrants, to the original purchaser or owner only, that any product manufactured and sold by Wiremold will be substantially free from defects in material and workmanship under normal use and service, for a period of one year from the date of original installation or two years from the date of purchase, whichever is sooner. This limited warranty applies only to products, which have been installed properly in accordance with Installation Instructions supplied by Wiremold and any applicable codes and standards.

This limited warranty is void and Wiremold shall not be liable for any damages or held responsible for the quality, performance or safety of products that have been repaired, altered or tampered with outside of Wiremold facilities or which have been intermixed (used within a system) with products or materials not approved by Wiremold or have been subjected to accident, negligence, misuse or abuse.

Wiremold's sole obligation (and the sole and exclusive remedy of the purchaser or owner of the product) with respect to any products which are proven to be defective, shall be the repair or replacement of the defective products, at the sole option of Wiremold. Returned products will not be accepted unless Wiremold is notified and authorizes the return, prior to shipment.

Wiremold shall not be liable for any damages in excess of the purchase price of the defective products, and under no circumstances shall Wiremold be liable for incidental, consequential, special or punitive damages.

Certain products of Wiremold may have a specific limited warranty or limitation of liability which is included with such products and which differs from that set forth in this Statement. The terms of any such specific limited warranty or limitation of liability will supersede that set forth in this Statement.

Except as set forth in the preceding paragraph, THIS LIMITED WARRANTY IS EXCLUSIVE AND WIREMOLD MAKES NO OTHER WARRANTIES WITH RESPECT OF ITS PRODUCTS, EXPRESSED OR IMPLIED, INCLUDING NO WARRANTY OF MERCHANTABILITY OR OF FITNESS FOR A PARTICULAR PURPOSE.

Wiremold® Trademarks

Wiremold® Raceways and Fittings are listed by Underwriters Laboratories Inc. and the Canadian Standards Association. Registered Trademarks of Wiremold and its subsidiaries include: 500, 700, 2000, 3000, 4000, 6000, 4000 Designer Series, Access, CabinetMATE, CableSmart, Centerex, Chan-L-Wire, CordMate, CordMate II, Conduit, DS4000, EZ-Pole, FiberReady, Flushduct, HideAcord, Isoduct, On-Wall, Pancake, Perma Power, Plug-In Outlet Center, Plugmold, Plugmold Plus, Plugmold Tough, Power Commander, Resource RFB, Sentrex, Snapicoil, Source II, Sure-Snap, Synergy, Tele-Power, Uniduct, V500, V700, Walker, Walkercell, Walkerdeck, Walkerduct, Walkerduct Pro, Walkerflex, Walkerflex AWS, Wiremold, and Wiring Projects Made Easy.

Trademarks of Wiremold include 300 Series, 400 Series, 525 Series, 800 Series, 800W Series, 861 Series, 862 Series, 863 Series, 880 Series, 882C Series, 884C Series, 1200 Series, 1400 Series, 1500 Series, 1600 Series, 2300 Series, 2300D Series, 2400 Series, 2400D Series, 2600 Series, 4047 Series, 4FFATC Series, 5400 Series, 5500 Series, 5507 Series, AC Series, AF Series, AL2000 Series, AL2400 Series, AL3000 Series, AL3300 Series, AL4000 Series, AL4320 Series, AL4400 Series, AL4520 Series, AL4750 Series, AL5200 Series, AL7320 Series, AL7450 Series, ALA3800 Series, ALA4800 Series, ALDS4000 Series, AMD8 Series, AnySize, AV3 Series, CableMate, CornerMate, CM Series, CRFB Series, CZE Series, Data-Fense, deQuorum, Eclipse, Evolution, FieldMate, FIT Series, FlameStopper, FloorPort, FloorSource, Isoduct, MeterReader, Modulink, Multiplex, NM2000 Series, OFR Series, Omnibox, PA/PB Series, PSRC9 Series, Prewired Select, RC3 Series, RC4 Series, RC7 Series, RC7AFFTC Series, RC700XR Series, RC9 Series, RC9AFFTC Series, RC9AM2TC Series, RC9AMD Series, RC91GHBTC Series, RC92GHBTC Series, RFE Series, ScuffCoat, TableSource, TopGuard, Vista Architectural, WallSource and WMFB Series.

Wiremold Prewired XPress is a Service Mark of Wiremold.

All brand and product names are registered trademarks or trademarks of their respective holders.

All Wiremold products, unless specifically noted, are listed by Underwriters Laboratories Inc. and conform to Federal Specifications W-C-582 and the National Electrical Code. Products designed for use in telephone or communications wiring normally do not require UL listing. Most products in this catalog are also certified by the Canadian Standards Association. Special ordering information for products to be installed in Canada is available upon request.

© Copyright 2013 Legrand All Rights Reserved



Wiremold Catalog on the Web!

The latest version of the Wiremold Catalog is also available in online. You can access it through our website: www.legrand.us/wiremold, then click on the link for the online catalog. The online version is fully searchable, has lots of special features and makes locating and accessing product information fast and easy. Give it a try!

designed to be better.™



Wiremold®
60 Woodlawn Street
West Hartford, CT 06110
800.621.0049

©2013 Legrand All Rights Reserved ED15.00R5 0413



Legrand, North America

60 Woodlawn Street
West Hartford, CT 06110
1.877.BY.LEGRAND (295.3472)
www.legrand.us

570 Applewood Crescent
Vaughan, Ontario L4K 4B4
905.738.9195
www.legrand.ca

