

# Calbrite™

A division of

**CALPIPE INDUSTRIES**  
Incorporated

The Leader in Stainless Steel  
Conduit Systems

2015 Product Catalog



[calbrite.com](http://calbrite.com)

[calpipe.com](http://calpipe.com)

## **Broadest Selection. Better Response. Best Performance.**

Headquartered in Hammond, IN, Calbrite™ is the leading name in stainless steel conduit systems for harsh and corrosive environments. We provide the largest stainless steel conduit systems offering in the industry, with over 2,800 SKU's manufactured to strict guidelines set forth by UL and NEMA. Many of our products are ARRA-compliant.

Calbrite supports its customers throughout the USA and Canada from three manufacturing and distribution centers in the USA. Calbrite is committed to providing quality products with the shortest lead times, combined with friendly, personal, and reliable service. If you have a need for a unique product, or need a product converted to stainless steel, we can work with you to develop custom products quickly and at a competitive price.

Our quality assurance program complies with industry standards established by Underwriters Laboratories UL®, ANSI, and NEMA.

UL® listings:

- Approval file number for stainless rigid conduit, nipples, elbows and couplings is E230584 (ANSI / UL 6A & cUL 6A)
- Approval file number for stainless steel EMT is E315441 (ANSI / UL 797A & cUL 797A)
- Approval file number for stainless steel IMC is E363502 (ANSI / UL 1242A / cUL 1242A)
- Approval file number for stainless conduit bodies and device boxes is E307133 (ANSI / UL 514A & cUL 514A)
- Approval file number for stainless steel locknuts is E308159 (ANSI / UL 514B & cUL 514B)
- Approval file number for stainless steel three piece couplings is E472077 (ANSI / UL 514B & cUL 514B)
- Approval file number for stainless steel Explosion Proof Fittings is E468171 (UL 1203 / CSA C22.2)

Many of our products are produced to NEMA 4X standards, which ensures protection against corrosion, wind-blown dust and rain, splashing water, hose-directed water and damage from external ice formation in outdoor or indoor environments.

The durability, cost-effectiveness, and design flexibility makes Calbrite's stainless steel the preferred choice for a range of applications and industries.



### **Food and Beverage**

Our stainless steel conduit, fittings, and applicable accessories are ideal for food and beverage processing applications due to stainless steel's ability to stand up to the often acidic content of wash-down chemicals commonly used in these environments. Cleaning agents and chemical disinfectants can quickly corrode other equipment, promoting bacterial growth and enabling food contamination. Stainless steel is a safer, more hygienic choice in these applications as it provides resistance to pitting and stress corrosion cracking, and is easily sterilized to prevent bacteria growth.

- There are typically three constants and requirements when working with food or beverage processing work stations and equipment: extremely easy to clean, corrosion and damage resistance, and easy to sanitize. Cleanliness and hygiene are critical in these environments, and stainless steel has proven to have a wide range of preferred qualities in comparison to traditional conduit systems used, such as galvanized, aluminum and PVC Coated.
- The smooth, polished surface of Calbrite's stainless conduit and fittings not only promote cleanliness, but also greatly reduce the risk of corrosion.

### **Pharmaceutical, Petrochemical, and Chemical Industries**



Stainless steel resists corrosion in aqueous, gaseous and high-temperature environments, maintains its mechanical properties in all temperatures and its long-term value attribute allows for substantial cost savings. In these applications, use of acidic, toxic and flammable chemical combinations can rapidly deteriorate traditional conduit systems.

Stainless steel's corrosion-resistance, weld ability, strength, ductility, fabrication versatility and composition stability can significantly guard against product contamination. It is also important that the surfaces of the conduit and fittings are smooth, easy to maintain and clean, to minimize microbial contamination, reduce corrosion and prevent the adherence of particulates to the surfaces of the equipment and product.

# Systems for Harsh Environments

## Pulp and Paper



In pulp and paper applications, stainless steel is used extensively because of its good mechanical properties and its resistance to liquor used in the process. These benefits will become even more of a priority as pulp mills move into the realm of bio-refineries.

Stainless steel's properties prevent contamination of the end product and are resistant to process corrosion. Although the process is mostly standard at all mills, there can be small mill-to-mill differences that may affect levels of corrosion. Stainless steel is able to withstand these differences in a stable, uniform manner that makes it the most reliable choice for these applications.

Some of the more common applications for stainless steel conduit in the pulp and paper industry include:

- Batch and continuous digesters
- Brown stock washers
- Black liquor equipment and tanks and recovery circuits
- Bleach plant
- Lime kiln (for high temperature properties)
- Air and water pollution control equipment
- Waste paper recycling
- Stock preparation equipment
- Paper machines including suction rolls

## Water and Waste Water



In recent years, the use of stainless steel in water and wastewater treatment plants (WWTP) has grown significantly, as type 304 and 316 grades are increasingly utilized as standard materials of construction due to superior performance and cost-saving factors. A WWTP is a complex, sophisticated system with a high-level of standards for the entire plant, including technical installations. The materials needed to construct a WWTP must be able to withstand the wide range of corrosive conditions.

For a clean, environmentally safe and cost-effective plant, there is no better material than stainless steel. Stainless steel will improve efficiency, reduce maintenance, and in many cases, provide the most cost-effective solution.

Benefits to this industry include:

- Corrosion resistance to a wide range of waters, chemicals, such as Hydrogen Sulphide (H<sub>2</sub>S)
- A protective layer forms naturally on all stainless steels because of the inclusion of chromium. Even if damaged and oxygen is present, the invisible passive layer self-heals and protects the steel from corrosion, ensuring a long life
- Stainless steel is not harmful to people during its production or use, recycling and ultimate disposal
- Good strength and ductility
- Ease of fabrication
- Lightweight and easy to transport
- Availability in a wide range of product forms
- Durability
- Fully recyclable

## Transportation / Infrastructure

Structure owners and users are becoming increasingly aware of the liabilities and the costs of corrosion. Carrying out remedial work particularly on highway structures, bridges and tunnels has led to a renewed interest in the use of stainless steel reinforcement, to minimize the risk of corrosion to structures exposed to marine / coastal environments, road de-icing salts, chlorides, and other harsh elements. The use of stainless steel conduit systems drastically reduces or even eliminates the need for difficult future maintenance.

## Power Plants, Energy and Power Generation



Whether the form of energy production is nuclear, fossil or renewable, safety, long-term value and efficiency are the utmost concerns for energy and power generation companies with the nuclear power industry requiring absolute reliability. These characteristics are provided by high quality stainless steel.

Stainless steel is now extensively used in the power generation industry to combat corrosion, particularly at elevated temperatures. In particular, type 304 & 316 stainless are used for high temperature, strength and oxidation resistance in fossil fuelled power plants.

The nuclear power industry also uses large quantities of stainless, often specified for both power generation and radiation containment. Steam and gas turbines also use stainless because of its corrosion-resistant and heat-resistant qualities.

## Stainless Steel in Harsh Environments

### Non-corrosive - Durable - UL®-approved

Stainless steel is the highest quality, most durable, easiest to install, UL-approved conduit material available. Corrosion damages equipment, which results in downtime and expensive maintenance and repairs. That is why stainless steel conduit systems, designed for harsh environments, are the material of choice for a wide range of industries.



- Corrosion-resistance. Both 304 and 316 stainless steel alloys provide excellent resistance to corrosives, at extreme temperatures and in most industrial environments. When scratched, stainless steel's exposed metal "self-heals", oxidizing over the abrasion to protect against further corrosion.
- Longevity. The durability of a stainless steel conduit system, frequently in excess of 50 years, reduces the need for costly maintenance or replacement needs, providing long-term protection for your facility and optimizing your equipment investment.
- Lowest total cost of ownership. For many applications, stainless steel has the lowest maintenance cost and the lowest total lifecycle cost of any other UL-approved conduit material. This is due to the durability of stainless steel. It will outlast other materials, require little, if any, maintenance, and is easy to install (contractors only need their standard tools).
- Environmentally-friendly. Stainless steel retains structural and anti-corrosive properties in temperatures ranging from cryogenic to hundreds of degrees and does not burn and emit dangerous smoke and carcinogens. Additionally, stainless steel is recyclable.
- Easy to install. Calbrite stainless steel conduit and fittings do not require installers to use special tools or labor-intensive procedures for installation, and stainless is in full NEC compliance for all facilities.

## The Calbrite Difference

Known for our custom machining and fabrication capabilities and developing products that meet specific customer requirements, we take pride in being able to listen and understand our customers' special requests and quickly respond with solutions designed to meet their needs. With manufacturing and distribution centers in Indiana, California and Florida, we have established a customer-centric product development process that enables us to react and respond to custom requirements with the shortest lead times in the industry.

If you do not find the exact part you are looking for in our product catalog, call us (800-536-2248) and we'll develop a special solution for you...fast.



## Table Of Contents

### STAINLESS STEEL CONDUIT, ELBOWS AND NIPPLES

Rigid Conduit . . . . .	6
Nipples . . . . .	6
IMC Conduit . . . . .	7
EMT Conduit . . . . .	7
Rigid Elbows . . . . .	8
EMT Elbows . . . . .	8

### STAINLESS STEEL CONDUIT FITTINGS

Compression Fittings . . . . .	9
EMT Compression Fittings . . . . .	9
EMT Set Screw Fittings . . . . .	9
Flex Conduit . . . . .	10
Flexible Connectors . . . . .	10
3-Piece Couplings . . . . .	11
Couplings . . . . .	11
Grounding Hubs . . . . .	11
Line Terminator Hubs . . . . .	11
Conduit Bodies – Form 8 Style . . . . .	12
C & X Conduit Bodies - Form 8 Style . . . . .	13

### CALSTRUT™ STAINLESS STEEL STRUT

Slotted Strut . . . . .	13
Solid Strut . . . . .	13
Back-to-Back Strut . . . . .	13
Post Bases for Channel . . . . .	13
Food Grade Channel . . . . .	13

### STAINLESS STEEL STRUT ACCESSORIES

4-Hole Flat Angle Plate . . . . .	14
4-Hole Splice Plate . . . . .	14
3-Hole Flat Angle Plate . . . . .	14
Cross Plate . . . . .	14
Tee Plate . . . . .	14
4-Hole & 2-Hole Angle Bracket . . . . .	14
Saddle Washers . . . . .	14
Channel Nuts with Spring . . . . .	14
U-Fitting . . . . .	14
Wall Spacers . . . . .	14
L-Bracket . . . . .	14
Hanger Rod . . . . .	14

### STAINLESS STEEL CORD GRIP CONNECTORS

Cord Grip Connectors . . . . .	15
--------------------------------	----

### STAINLESS STEEL DEVICE BOXES

FS Single Gang Box . . . . .	16
FDC Single Gang Box . . . . .	16
FDCC & FSCC Single Gang Boxes . . . . .	16
FSCT & FDCT Single Gang Boxes . . . . .	16

FD Single Gang Box . . . . .	16
FDC Double Gang Box . . . . .	16
FDX & FSX Single Gang Boxes . . . . .	16
In-Use Covers . . . . .	16
Device Box Covers & Plates . . . . .	16

### STAINLESS STEEL ACCESSORIES

Locknuts . . . . .	17
Standard, Lock, & Fender Washers . . . . .	17
Grounding Locknuts . . . . .	17
Hex Nuts . . . . .	17
Square Washers . . . . .	17
Hex Head Cap Screws . . . . .	17
Slotted Machine Screws . . . . .	17
Split Ring Clamps . . . . .	18
Split Ring Extensions . . . . .	18
Split Ring Mounting Plates . . . . .	18
Right Angle Clamps . . . . .	18
Beam Clamps . . . . .	18
Parallel Clamps . . . . .	18
Right Angle Beam Clamps . . . . .	18
Strut Clamps . . . . .	18
Clamp Backs & Clamp Back Spacers . . . . .	19
2-Hole Straps & 1-Hole Straps . . . . .	19
Conduit Hangers . . . . .	19

### MISCELLANEOUS

Counter Sunk Hex Plugs . . . . .	20
Box Connectors . . . . .	20
Threaded Conduit Caps . . . . .	20
Face Bushings . . . . .	20
Pulling Elbows . . . . .	20
Conduit Body Cover, Gasket & Screw Sets . . . . .	20
Threaded Rod . . . . .	21
Rod Couplings . . . . .	21
Wedge & Drop-In Anchors . . . . .	21
Wall Flanges & Floor Flanges . . . . .	21
Grounding Bushings . . . . .	21
U-Bolts . . . . .	21
Drain Plugs . . . . .	22
GUAT Explosion Proof Outlet Box . . . . .	22
UNY Explosion Proof Union . . . . .	22
EYS Explosion Proof Sealing Fitting . . . . .	22
Thread Covers . . . . .	22
Ground Rod . . . . .	22
Tubing and Tube Fittings . . . . .	22
Cut Sheet Sample . . . . .	23

## STAINLESS STEEL RIGID CONDUIT

Trade Size	Metric Size	Diameters		Wt./Ft.	10' Length w/ Coupling		5' Length w/ Coupling	
		OD	ID		Type 304	Type 316	Type 304	Type 316
½"	16	0.840"	0.622"	0.82	S40510CT00	S60510CT00	S40505CT00	S60505CT00
¾"	21	1.050"	0.824"	1.09	S40710CT00	S60710CT00	S40705CT00	S60705CT00
1"	27	1.315"	1.049"	1.61	S41010CT00	S61010CT00	S41005CT00	S61005CT00
1-¼"	35	1.660"	1.380"	2.18	S41210CT00	S61210CT00	S41205CT00	S61205CT00
1-½"	41	1.900"	1.610"	2.63	S41510CT00	S61510CT00	S41505CT00	S61505CT00
2"	53	2.375"	2.067"	3.50	S42010CT00	S62010CT00	S42005CT00	S62005CT00
2-½"	63	2.875"	2.469"	5.59	S42510CT00	S62510CT00	S42505CT00	S62505CT00
3"	78	3.500"	3.068"	7.27	S43010CT00	S63010CT00	S43005CT00	S63005CT00
4"	103	4.500"	4.026"	10.08	S44010CT00	S64010CT00	S44005CT00	S64005CT00
5"	129	5.563"	5.073"	14.61	S45010CT00	S65010CT00	S45005CT00	S65005CT00
6"	155	6.625"	6.093"	18.97	S46010CT00	S66010CT00	S46005CT00	S66005CT00

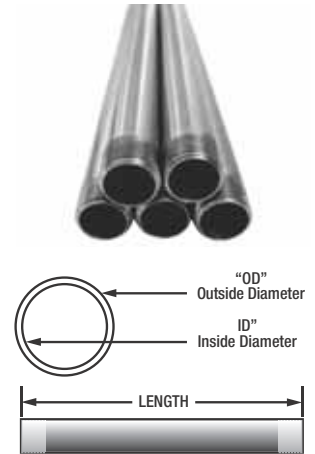

Calbrite™ stainless steel rigid conduit is manufactured in type 304 & 316 stainless to meet stringent sanitary requirements and withstand harsh corrosive environments. The conduit is polished to a bright, easily maintainable finish that allows for minimal cleaning, enhances the appearance, and improves the surface's resistance to pitting & bacterial corrosion in CIP (clean-in-place) and SIP (sterilize-in-place) systems.

Calbrite stainless steel rigid conduit is highly resistant to damage from impact. Easy to cut, form and join, stainless steel conduit avoids the labor-intensive procedures that come with PVC-coated installation. No special tools or complicated maintenance and repair procedures are required. In addition to the ease of installation and maintenance, stainless steel is 100% recyclable. Standard rigid conduit threads allow for trouble-free installations.

- \* Trade sizes ½" to 6"
- \* Includes one coupling with each length purchased
- \* Custom lengths and diameters are available
- \* Conduit is domestically manufactured in our USA manufacturing facilities

Compliances: Underwriter Laboratories Listed for  
USA and Canada standard UL6A File # E230584  
American National Standards Institute (ANSI) specification C80.1

## STAINLESS STEEL RIGID NIPPLES Custom lengths available upon request



Type 304 SS 		1-½"	2"	2-½"	3"	3-½"	4"	5"	6"
Trade Size	Close								
½"	S405CLCN00	S40515CN00	S40520CN00	S40525CN00	S40530CN00	S40535CN00	S40540CN00	S40550CN00	S40560CN00
¾"	S407CLCN00	S40715CN00	S40720CN00	S40725CN00	S40730CN00	S40735CN00	S40740CN00	S40750CN00	S40760CN00
1"	S410CLCN00		S41020CN00	S41025CN00	S41030CN00	S41035CN00	S41040CN00	S41050CN00	S41060CN00
1-¼"	S412CLCN00		S41220CN00	S41225CN00	S41230CN00	S41235CN00	S41240CN00	S41250CN00	S41260CN00
1-½"	S415CLCN00		S41520CN00	S41525CN00	S41530CN00	S41535CN00	S41540CN00	S41550CN00	S41560CN00
2"	S420CLCN00				S42030CN00	S42035CN00	S42040CN00	S42050CN00	S42060CN00
2-½"	S425CLCN00							S42550CN00	S42560CN00
3"	S430CLCN00							S43050CN00	S43060CN00
4"	S440CLCN00							S44050CN00	S44060CN00

Type 316 SS 		1-½"	2"	2-½"	3"	3-½"	4"	5"	6"
Trade Size	Close								
½"	S605CLCN00	S60515CN00	S60520CN00	S60525CN00	S60530CN00	S60535CN00	S60540CN00	S60550CN00	S60560CN00
¾"	S607CLCN00	S60715CN00	S60720CN00	S60725CN00	S60730CN00	S60735CN00	S60740CN00	S60750CN00	S60760CN00
1"	S610CLCN00		S61020CN00	S61025CN00	S61030CN00	S61035CN00	S61040CN00	S61050CN00	S61060CN00
1-¼"	S612CLCN00		S61220CN00	S61225CN00	S61230CN00	S61235CN00	S61240CN00	S61250CN00	S61260CN00
1-½"	S615CLCN00		S61520CN00	S61525CN00	S61530CN00	S61535CN00	S61540CN00	S61550CN00	S61560CN00
2"	S620CLCN00				S62030CN00	S62035CN00	S62040CN00	S62050CN00	S62060CN00
2-½"	S625CLCN00							S62550CN00	S62560CN00
3"	S630CLCN00							S63050CN00	S63060CN00
4"	S640CLCN00							S64050CN00	S64060CN00

\* Contact factory for 5" & 6" Conduit Nipple info.

## STAINLESS STEEL IMC CONDUIT

Threaded IMC Conduit						
Trade Size	Metric Size	Outside Dia.	Inside Dia.	Wt./Ft.	Type 304	Type 316
½"	16	0.815"	0.660"	0.62	S50510CTWT	S70510CTWT
¾"	21	1.029"	0.864"	0.84	S50710CTWT	S70710CTWT
1"	27	1.290"	1.120"	1.19	S51010CTWT	S71010CTWT
1-½"	41	1.883"	1.703"	1.94	S51510CTWT	S71510CTWT
2"	53	2.360"	2.170"	2.56	S52010CTWT	S72010CTWT



Non-Threaded IMC Conduit 						
Trade Size	Metric Size	Outside Dia.	Inside Dia.	Wt./Ft.	Type 304	Type 316
½"	16	0.815"	0.660"	0.62	S50510CT00	S70510CT00
¾"	21	1.029"	0.864"	0.84	S50710CT00	S70710CT00
1"	27	1.290"	1.120"	1.19	S51010CT00	S71010CT00
1-½"	41	1.883"	1.703"	1.94	S51510CT00	S71510CT00
2"	53	2.360"	2.170"	2.56	S52010CT00	S72010CT00



Stainless steel IMC conduit is often specified in corrosive environments where it's subject to harsh chemical treatments or wash-downs due to its lighter weight, precise tolerances, and ease of installation.

Stainless IMC conduit is more impact resistant compared to stainless EMT conduit, and is 100% recyclable.

Calbrite's IMC conduit is manufactured with or without threads. The non-threaded conduit is joined together by utilizing compression fittings, and the threaded conduit can be used with standard threaded couplings, allowing for lowered costs and simplified installations.

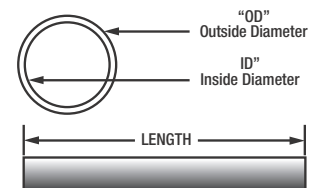

\* Custom lengths available

\* Trade sizes ½", ¾", 1", 1-½", 2"

\* Conduit is domestically manufactured in our USA manufacturing facilities

\* Underwriter Laboratories listed for USA and Canada standard 1242A - File # E363502

## STAINLESS STEEL EMT CONDUIT

EMT Conduit							
Trade Size	Diameters		Wt./Ft.	10' Length		5' Length	
	O.D.	I.D.		Type 304	Type 316	Type 304	Type 316
½"	0.706"	0.622"	0.30	S10510CT00	S20510CT00	S10505CT00	S20505CT00
¾"	0.922"	0.824"	0.50	S10710CT00	S20710CT00	S10705CT00	S20705CT00
1"	1.163"	1.050"	0.68	S11010CT00	S21010CT00	S11005CT00	S21005CT00
1-¼"	1.510"	1.380"	1.00	S11210CT00	S21210CT00	S11205CT00	S21205CT00
1-½"	1.740"	1.610"	1.10	S11510CT00	S21510CT00	S11505CT00	S21505CT00
2"	2.200"	2.067"	1.40	S12010CT00	S22010CT00	S12005CT00	S22005CT00

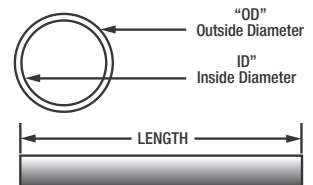

Calbrite's stainless steel EMT conduit and fittings combine strength with ductility, resulting in a lightweight and easy-to-handle conduit assembly. EMT conduit can be installed indoors and outdoors in accordance with NEC®, providing it will not be subject to severe physical damage during and after installation.

Calbrite's stainless steel EMT conduit provides superior performance in applications subject to corrosive environments, harsh chemical treatments, and required wash-downs. In addition to the ease of installation and maintenance, stainless steel is 100% recyclable. Calbrite EMT conduit enhances the appearance and the surface's resistance to pitting & bacterial corrosion in CIP (clean-in-place) and SIP (sterilize-in-place) systems.

\* Trade sizes ½" - 2"

\* Conduit is domestically manufactured in our USA manufacturing facilities

\* Underwriter Laboratories Listed for USA and Canada standard UL797A - File # E315441

## STAINLESS STEEL RIGID ELBOWS (Type 304 & 316)

Standard Radius Elbows 90°			cULus				
Trade Size	Metric Size	Outside Dia.	Inside Dia.	A	B	Type 304 Part Number	Type 316 Part Number
½"	16	0.840"	0.622"	3.79"	4.00"	S40590EL00	S60590EL00
¾"	21	1.050"	0.824"	3.94"	4.50"	S40790EL00	S60790EL00
1"	27	1.315"	1.049"	5.05"	5.75"	S41090EL00	S61090EL00
1-¼"	35	1.660"	1.380"	6.38"	7.25"	S41290EL00	S61290EL00
1-½"	41	1.900"	1.610"	7.26"	8.25"	S41590EL00	S61590EL00
2"	53	2.375"	2.067"	8.27"	9.50"	S42090EL00	S62090EL00
2-½"	63	2.875"	2.469"	9.02"	10.50"	S42590EL00	S62590EL00
3"	78	3.500"	3.068"	11.21"	13.00"	S43090EL00	S63090EL00
4"	103	4.500"	4.026"	13.71"	16.00"	S44090EL00	S64090EL00

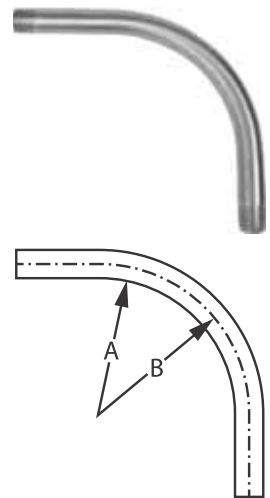

Standard Radius Elbows 45°			cULus				
Trade Size	Metric Size	Outside Dia.	Inside Dia.	A	B	Type 304 Part Number	Type 316 Part Number
½"	16	0.840"	0.622"	3.79"	4.00"	S40545EL00	S60545EL00
¾"	21	1.050"	0.824"	3.94"	4.50"	S40745EL00	S60745EL00
1"	27	1.315"	1.049"	5.05"	5.75"	S41045EL00	S61045EL00
1-¼"	35	1.660"	1.380"	6.38"	7.25"	S41245EL00	S61245EL00
1-½"	41	1.900"	1.610"	7.26"	8.25"	S41545EL00	S61545EL00
2"	53	2.375"	2.067"	8.27"	9.50"	S42045EL00	S62045EL00
2-½"	63	2.875"	2.469"	9.02"	10.50"	S42545EL00	S62545EL00
3"	78	3.500"	3.068"	11.21"	13.00"	S43045EL00	S63045EL00
4"	103	4.500"	4.026"	13.71"	16.00"	S44045EL00	S64045EL00

\*Large radius rigid stainless elbows are available upon request in 24", 36", 48" and 60"  
 \*Contact factory for 5" & 6" Conduit Elbow info.

## STAINLESS STEEL EMT ELBOWS

Standard Radius Elbows 90°			cULus			
Trade Size	Outside Dia.	Inside Dia.	Min. Radius	Straight Leg Each End	Type 304 Part Number	Type 316 Part Number
½"	0.706"	0.622"	4"	2"	S10590EL00	S20590EL00
¾"	0.922"	0.824"	4-½"	2"	S10790EL00	S20790EL00
1"	1.163"	1.050"	5-¾"	2"	S11090EL00	S21090EL00



Standard Radius Elbows 45°			cULus			
Trade Size	Outside Dia.	Inside Dia.	Min. Radius	Straight Leg Each End	Type 304 Part Number	Type 316 Part Number
½"	0.706"	0.622"	4"	2"	S10545EL00	S20545EL00
¾"	0.922"	0.824"	4-½"	2"	S10745EL00	S20745EL00
1"	1.163"	1.050"	5-¾"	2"	S11045EL00	S21045EL00

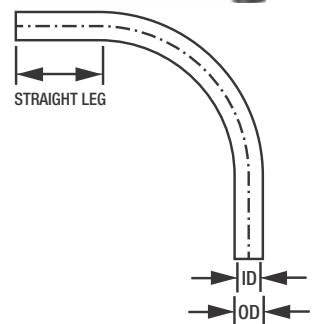

\*IMC elbows are also available upon request  
 \*Contact factory for 1-1/4" - 2" EMT Elbow info.



## STAINLESS STEEL COMPRESSION FITTINGS (Type 316SS)

Male Compression Connectors			NEMA4X		
Trade Size	Metric Size	Wt. (lbs)	A	B	Part Number
½"	16	0.17	1.725"	1.200"	S60500MC00
¾"	21	0.28	1.920"	1.450"	S60700MC00
1"	27	0.40	2.000"	1.750"	S61000MC00
1-½"	41	0.71	2.250"	2.390"	S61500MC00
2"	53	1.12	2.530"	2.950"	S62000MC00

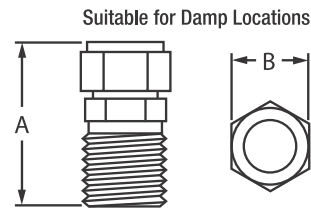

Compression Unions			NEMA4X		
Trade Size	Metric Size	Wt. (lbs)	A	B	Part Number
½"	16	0.28	2.150"	1.200"	S60500CC00
¾"	21	0.42	2.400"	1.450"	S60700CC00
1"	27	0.60	2.650"	1.750"	S61000CC00
1-½"	41	1.04	3.000"	2.390"	S61500CC00
2"	53	1.63	3.000"	2.920"	S62000CC00

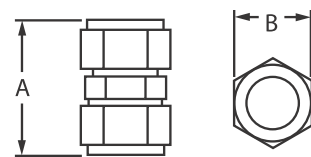

\* Compatible for use with stainless steel IMC and rigid conduit

## STAINLESS STEEL EMT COMPRESSION FITTINGS (Type 316SS)

EMT Male Compression Connectors			NEMA4X		
Trade Size	Metric Size	Wt. (lbs)	A	B	Part Number
½"	16	0.11	1.620"	1.050"	S20500MC00
¾"	21	0.15	1.700"	1.250"	S20700MC00
1"	27	0.23	1.840"	1.540"	S21000MC00
1-¼"	35	0.33	1.850"	1.925"	S21200MC00
1-½"	41	0.43	2.050"	2.250"	S21500MC00
2"	53	0.59	2.140"	2.750"	S22000MC00

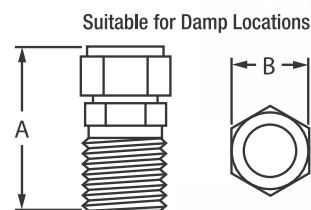

EMT Compression Unions			NEMA4X		
Trade Size	Metric Size	Wt. (lbs)	A	B	Part Number
½"	16	0.16	2.100"	1.050"	S20500CC00
¾"	21	0.21	2.100"	1.250"	S20700CC00
1"	27	0.31	2.200"	1.550"	S21000CC00
1-¼"	35	0.47	2.500"	1.930"	S21200CC00
1-½"	41	0.65	2.700"	2.250"	S21500CC00
2"	53	0.87	2.770"	2.750"	S22000CC00

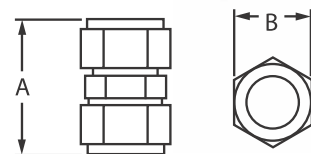

\* Compatible for use with stainless steel EMT conduit

EMT Set Screw Male Connectors		
Trade Size	Metric Size	Part Number Type 316S
½"	16	S20500MCSS
¾"	21	S20700MCSS
1"	27	S21000MCSS
1-¼"	35	S21200MCSS
1-½"	41	S21500MCSS
2"	53	S22000MCSS



EMT Set Screw Couplings		
Trade Size	Metric Size	Part Number Type 316S
½"	16	S20500CCSS
¾"	21	S20700CCSS
1"	27	S21000CCSS
1-¼"	35	S21200CCSS
1-½"	41	S21500CCSS
2"	53	S22000CCSS



\* Not suitable for damp locations

## STAINLESS STEEL FLEXIBLE CONDUIT

Coated Flex Conduit 25' Length			NEMA4X		Suitable for damp locations	
Trade Size	Metric Size	Outside Dia.	Inside Dia.	Bend	Wt. 25' Coil (lbs)	Part Number
½"	16	0.840"	0.610"	4-½"	5.50	S40500CTFC
¾"	21	1.050"	0.790"	6"	7.00	S40700CTFC
1"	27	1.315"	1.010"	10"	9.00	S41000CTFC
1-¼"	35	1.660"	1.330"	11"	11.00	S41200CTFC
1-½"	41	1.900"	1.520"	12"	12.00	S41500CTFC
2"	53	2.370"	2.060"	14"	20.00	S42000CTFC



Clear Coated Flex Conduit 25' Length			NEMA4X		Suitable for damp locations	
Trade Size	Metric Size	Outside Dia.	Inside Dia.	Bend	Wt. 25' Coil (lbs)	Part Number
½"	16	0.840"	0.610"	4-½"	5.50	S40500CTCC
¾"	21	1.050"	0.790"	6"	7.00	S40700CTCC
1"	27	1.315"	1.010"	10"	9.00	S41000CTCC
1-¼"	41	1.900"	1.520"	12"	12.00	S41500CTCC
2"	53	2.370"	2.060"	14"	20.00	S42000CTCC



Bare Flex Conduit 25' Length			NEMA4X		Suitable for damp locations	
Trade Size	Metric Size	Outside Dia.	Inside Dia.	Bend	Wt. 25' Coil (lbs)	Part Number
½"	16	0.744"	0.610"	4"	4.50	S60500CTFX
¾"	21	0.960"	0.790"	4-½"	5.50	S60700CTFX
1"	27	1.160"	1.010"	6"	7.00	S61000CTFX
1-¼"	35	1.500"	1.330"	7-½"	8.50	S61200CTFX
1-½"	41	1.750"	1.520"	9"	10.00	S61500CTFX
2"	53	2.125"	2.020"	10"	13.00	S62000CTFX

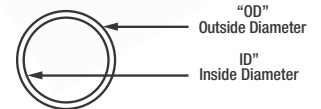

## STAINLESS STEEL FLEXIBLE CONNECTORS (Type 316SS)

Flex Connector Male 90° Elbow		NEMA4X		Suitable for damp locations		
Trade Size	Metric Size	Wt. (lbs)	A	B	C	Part Number
½"	16	0.27	1.950"	1.250"	2.150"	S60500FC90
¾"	21	0.50	2.250"	1.540"	2.630"	S60700FC90
1"	27	0.72	2.800"	1.860"	3.000"	S61000FC90
1-¼"	35	0.95	3.150"	2.250"	3.150"	S61200FC90
1-½"	41	1.55	3.750"	2.580"	3.750"	S61500FC90
2"	53	2.35	4.450"	3.050"	4.750"	S62000FC90

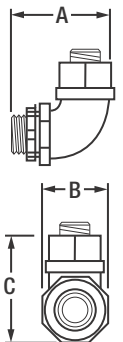

Flex Connector Male Straight		NEMA4X		Suitable for damp locations		
Trade Size	Metric Size	Wt. (lbs)	A	B	Part Number	
½"	16	0.17	1.530"	1.250"	S60500FCS0	
¾"	21	0.24	1.580"	1.540"	S60700FCS0	
1"	27	0.33	1.800"	1.650"	S61000FCS0	
1-¼"	35	0.58	2.000"	2.250"	S61200FCS0	
1-½"	41	0.85	2.175"	2.650"	S61500FCS0	
2"	53	1.19	2.350"	3.210"	S62000FCS0	

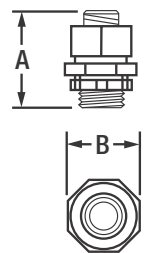

\*45° Flex Connectors available in ½", ¾" and 1"

## STAINLESS STEEL 3-PIECE COUPLINGS (Union) (Type 316SS)

3-Piece Couplings			
Trade Size	Metric Size	Wt. (lbs)	Part Number
½"	16	0.44	S605003U00
¾"	21	0.58	S607003U00
1"	27	0.94	S610003U00
1-¼"	35	1.19	S612003U00
1-½"	41	1.47	S615003U00
2"	53	2.27	S620003U00
2-½"	63	3.09	S625003U00
3"	78	2.50	S630003U00
4"	103	6.44	S640003U00



## STAINLESS STEEL COUPLINGS (Type 316SS)

Standard Couplings				
Trade Size	Metric Size	Wt. (lbs)	A	Part Number
½"	16	0.17	1.570"	S60500CP00
¾"	21	0.29	1.630"	S60700CP00
1"	27	0.34	2.000"	S61000CP00
1-¼"	35	0.51	2.050"	S61200CP00
1-½"	41	0.61	2.063"	S61500CP00
2"	53	0.90	2.125"	S62000CP00
2-½"	63	1.87	3.190"	S62500CP00
3"	78	1.93	3.250"	S63000CP00
4"	103	3.97	3.540"	S64000CP00
5"	129	5.96	3.970"	S65000CP00
6"	155	9.94	4.270"	S66000CP00



## STAINLESS STEEL GROUNDING HUBS (Type 316SS)

Grounding Hubs	
Trade Size	Part Number
½"	S60500LTV2
¾"	S60700LTV2
1"	S61000LTV2
1-¼"	S61200LTV2
1-½"	S61500LTV2
2"	S62000LTV2
2-½"	S62500LTV2
3"	S63000LTV2
4"	S64000LTV2



## STAINLESS STEEL LINE TERMINATOR HUBS (Type 316SS)

LT Hubs								
Trade Size	Metric	Wt. (lbs)	A	B	a	T1	T2	Part Number
½"	16	0.19	1.580"	1.625"	0.625"	1.040"	0.770"	S60500LT00
¾"	21	0.25	1.525"	1.875"	0.625"	1.280"	0.980"	S60700LT00
1"	27	0.45	1.830"	2.125"	0.650"	1.600"	1.240"	S61000LT00
1-¼"	35	0.67	2.050"	2.500"	0.850"	1.970"	1.580"	S61200LT00
1-½"	41	0.72	2.070"	2.625"	0.870"	2.210"	1.820"	S61500LT00
2"	53	1.08	2.100"	3.125"	0.800"	2.750"	2.300"	S62000LT00
2-½"	63	1.91	2.250"	3.625"	0.850"	3.310"	2.730"	S62500LT00
3"	78	2.43	2.880"	4.375"	0.930"	3.880"	3.350"	S63000LT00
4"	103	4.09	3.180"	5.500"	1.060"	5.000"	4.340"	S64000LT00

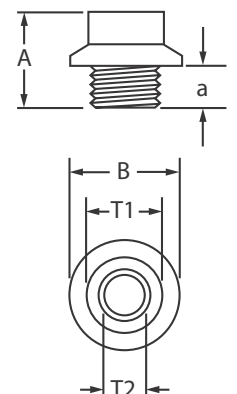

## STAINLESS STEEL CONDUIT BODIES - FORM 8 STYLE NEMA4X (Type 316SS)



	Trade Size	Wt. (lbs)	Cubic In.	A	B	C	a	Part Number
LB Body	½"	0.98	4"	4.970"	1.330"	2.330"	4.320"	S60500LB00
	¾"	1.25	7"	5.570"	1.570"	2.750"	4.950"	S60700LB00
	1"	1.90	11"	6.500"	1.750"	3.050"	5.650"	S61000LB00
	1-¼"	2.90	20"	7.500"	2.150"	3.630"	6.530"	S61200LB00
	1-½"	4.30	35"	8.850"	2.560"	4.030"	7.810"	S61500LB00
	2"	8.00	71"	11.360"	3.480"	4.460"	10.000"	S62000LB00
	2-½"	13.25	157"	13.430"	4.650"	5.750"	12.000"	S62500LB00
	3"	13.94	177"	13.560"	4.650"	5.800"	12.000"	S63000LB00
	4"	29.50	380"	16.330"	5.850"	7.375"	14.630"	S64000LB00

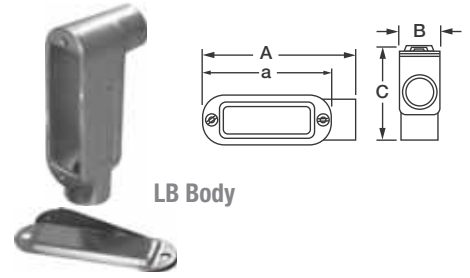

LB Body

	Trade Size	Wt. (lbs)	Cubic In.	A	B	C	a	Part Number
TEE Body	½"	1.26	5"	5.620"	2.000"	2.030"	4.320"	S60500TE00
	¾"	1.86	9"	6.200"	2.330"	2.320"	4.950"	S60700TE00
	1"	2.50	13"	7.300"	2.650"	2.330"	5.650"	S61000TE00
	1-¼"	3.50	24"	8.520"	3.190"	2.900"	6.530"	S61200TE00
	1-½"	5.00	35"	9.810"	3.580"	3.000"	7.810"	S61500TE00
	2"	9.82	77"	12.300"	4.700"	3.880"	10.000"	S62000TE00
	2-½"	14.32	160"	15.290"	6.200"	4.550"	12.000"	S62500TE00
	3"	15.00	177"	15.330"	6.280"	4.520"	12.000"	S63000TE00
	4"	30.00	382"	18.340"	7.610"	5.930"	14.630"	S64000TE00

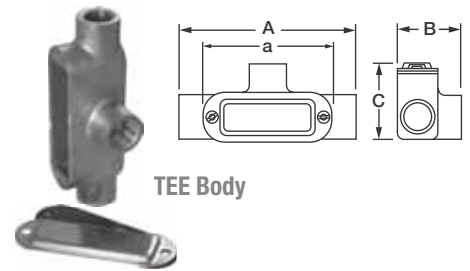

TEE Body

	Trade Size	Wt. (lbs)	Cubic In.	A	B	C	a	Part Number
LL Body	½"	1.04	4"	4.950"	2.150"	1.690"	4.320"	S60500LL00
	¾"	1.34	7"	5.590"	2.320"	1.950"	4.950"	S60700LL00
	1"	1.91	11"	6.480"	2.670"	2.250"	5.650"	S61000LL00
	1-½"	4.45	35"	8.940"	3.650"	3.040"	7.810"	S61500LL00
	2"	9.02	71"	11.170"	4.710"	3.860"	10.000"	S62000LL00

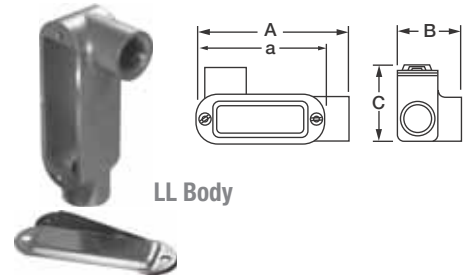

LL Body

	Trade Size	Wt. (lbs)	Cubic In.	A	B	C	a	Part Number
LR Body	½"	1.04	4"	4.950"	2.150"	1.690"	4.320"	S60500LR00
	¾"	1.34	7"	5.590"	2.320"	1.950"	4.950"	S60700LR00
	1"	1.91	11"	6.480"	2.670"	2.250"	5.650"	S61000LR00
	1-½"	4.45	35"	8.940"	3.650"	3.040"	7.810"	S61500LR00
	2"	9.02	71"	11.170"	4.710"	3.860"	10.000"	S62000LR00

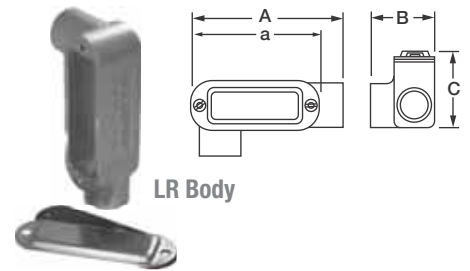

LR Body

	Trade Size	Wt. (lbs)	Cubic In.	A	B	C	a	Part Number
TB Body	½"	1.08	5"	5.690"	1.350"	2.500"	4.320"	S60500TB00
	¾"	1.50	9"	6.270"	1.600"	2.720"	4.950"	S60700TB00
	1"	2.28	13"	7.320"	1.770"	3.100"	5.650"	S61000TB00
	1-½"	4.90	35"	10.400"	2.560"	4.290"	7.810"	S61500TB00
	2"	9.32	77"	12.300"	3.500"	4.640"	10.000"	S62000TB00

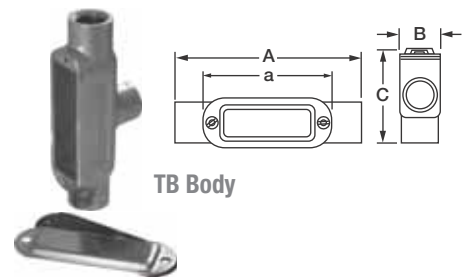

TB Body

\* Conduit bodies continued on page 13.

\*Cover, gasket and screws included with all models

	Trade Size	Wt. (lbs)	Cubic In.	A	B	C	a	Part Number
<b>C Body</b>	½"	1.15	5"	5.690"	1.330"	1.720"	4.320"	S60500CE00
	¾"	1.64	9"	6.280"	1.560"	2.020"	4.950"	S60700CE00
	1"	2.19	13"	7.330"	1.740"	2.020"	5.630"	S61000CE00
	1-¼"	3.19	24"	8.520"	2.120"	2.630"	6.530"	S61200CE00
	1-½"	4.63	35"	10.500"	2.530"	2.740"	7.810"	S61500CE00
	2"	8.66	77"	12.300"	3.480"	3.550"	10.000"	S62000CE00

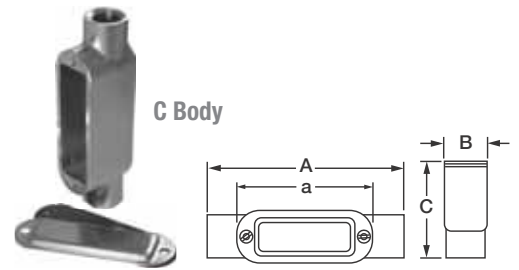

	Trade Size	Wt. (lbs)	Cubic In.	A	B	C	a	Part Number
<b>X Body</b>	½"	1.36	5"	5.640"	2.630"	2.050"	4.320"	S60500XB00
	¾"	1.86	9"	6.200"	3.070"	2.300"	4.940"	S60700XB00
	1"	2.77	13"	7.300"	3.540"	2.330"	5.650"	S61000XB00
	1-¼"	5.24	35"	9.810"	4.500"	3.060"	7.810"	S61500XB00
	2"	9.63	77"	12.250"	5.810"	3.700"	10.000"	S62000XB00

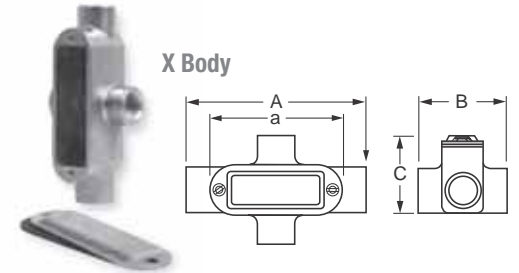

## CALSTRUT™ STAINLESS STEEL STRUT Available in other sizes, styles and gauges upon request. Available in 10' lengths.

Slotted Strut			
Trade Size	Gauge	Type	Part Number
1-5/8" x 1-5/8"	12 ga	SS304	S45810ST58
1-5/8" x 7/8"	14 ga	SS304	S45810ST78
1-5/8" x 1-5/8"	12 ga	SS316	S65810ST58
1-5/8" x 7/8"	14 ga	SS316	S65810ST78



Solid Strut			
Trade Size	Gauge	Type	Part Number
1-5/8" x 1-5/8"	12 ga	SS304	S45810SL58
1-5/8" x 7/8"	14 ga	SS304	S45810SL78
1-5/8" x 1-5/8"	12 ga	SS316	S65810SL58
1-5/8" x 7/8"	14 ga	SS316	S65810SL78



Back-To-Back Strut			
Trade Size	Gauge	Type	Part Number
1-5/8" x 1-5/8"	12 ga	SS304	S45810SB58
1-5/8" x 7/8"	14 ga	SS304	S45810SB78
1-5/8" x 1-5/8"	12 ga	SS316	S65810SB58
1-5/8" x 7/8"	14 ga	SS316	S65810SB78



Post Base for Channel		
Trade Size	Type	Part Number
Fits 1-5/8" channel holes - 3/4" dia.	SS304	S45800PB00
	SS316	S65800PB00



Square Post Base for Channel		
Trade Size	Type	Part Number
Fits 1-5/8" channel holes - 3/4" dia.	SS304	S45800PBSQ
	SS316	S65800PBSQ



## STAINLESS STEEL FOOD GRADE CHANNEL

Wall Mount Channel is manufactured in type 304 12-gauge stainless steel. Available in 12", 24" & 120" lengths

SS304 Wall Mount Food Grade Channel		
12" Length Type 304 Part Number	24" Length Type 304 Part Number	120" Length Type 304 Part Number
S4FG12STWM	S4FG24STWM	S4FG10STWM

Trapeze Mount Channel is manufactured in type 304 12-gauge stainless steel. Available in 12", 24" & 120" lengths

SS304 Trapeze Mount Food Grade Channel		
12" Length Type 304 Part Number	24" Length Type 304 Part Number	120" Length Type 304 Part Number
S4FG12STTR	S4FG24STTR	S4FG10STTR



## STAINLESS STEEL STRUT & FOOD GRADE CHANNEL ACCESSORIES (Type 316SS)

4-Hole Flat Angle Plate	
Hole Diameter	Part Number
9/16"	S600004BF0

4-Hole Splice Plate	
Hole Diameter	Part Number
9/16"	S60000PL4S

3-Hole Flat Angle Plate	
Hole Diameter	Part Number
9/16"	S600003BF0

Cross Plate	
Hole Diameter	Part Number
9/16"	S60000PLCR

Tee Plate	
Hole Diameter	Part Number
9/16"	S60000PLTE

4-Hole Angle Bracket	
Hole Diameter	Part Number
9/16"	S600004B00

2-Hole Angle Bracket	
Hole Diameter	Part Number
9/16"	S600002B00

Saddle Washers	
Hole Diameter	Part Number
3/8"	S60300STSW
1/2"	S60500STSW
5/8"	S60600STSW

Channel Nuts with Spring	
Thread Diameter	Part Number
1/4"-20"	S60000CN11
3/8"-16"	S60000CN31
1/2"-13"	S60000CN41
5/8"-11"	S60000CN51
7/8"-9"	S60000CN61

U-Fitting	
Hole Diameter	Part Number
Fits 1-5/8" channel holes - 9/16" dia.	S60000UF00



Wall Spacers	
Type	Part Number
Standard	S60000WS00
Heavy Duty	S60000WSHD



L-Bracket	
Part Number	
S60000BRL0	



Hanger Rod	
Part Number	
S60000HR00	

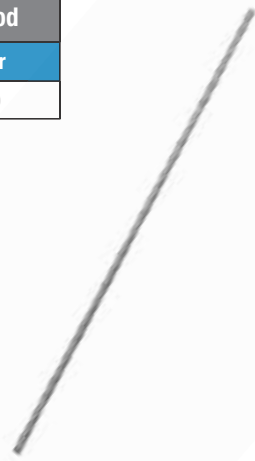

## STAINLESS STEEL CORD GRIP CONNECTORS

Cord Grip Connectors		
Trade Size	Cable Range	Part Number
½"	0.125" - 0.188"	S40501GR00
½"	0.188" - 0.250"	S40502GR00
½"	0.250" - 0.312"	S40503GR00
½"	0.312" - 0.375"	S40504GR00
½"	0.375" - 0.438"	S40505GR00
½"	0.438" - 0.500"	S40506GR00
½"	0.500" - 0.562"	S40507GR00
½"	0.562" - 0.625"	S40508GR00
¾"	0.438" - 0.500"	S40701GR00
¾"	0.500" - 0.562"	S40702GR00
¾"	0.500" - 0.625"	S40703GR00
¾"	0.562" - 0.688"	S40704GR00
¾"	0.625" - 0.750"	S40705GR00
¾"	0.688" - 0.812"	S40706GR00
1"	0.438" - 0.562"	S41001GR00
1"	0.500" - 0.562"	S41002GR00
1"	0.500" - 0.625"	S41003GR00
1"	0.562" - 0.688"	S41004GR00
1"	0.625" - 0.750"	S41005GR00
1"	0.688" - 0.812"	S41006GR00
1"	0.750" - 0.875"	S41007GR00
1"	0.812" - 0.938"	S41008GR00
1"	0.875" - 1.000"	S41009GR00
1-¼"	0.562" - 0.688"	S41201GR00
1-¼"	0.688" - 0.812"	S41202GR00
1-¼"	0.750" - 0.875"	S41203GR00
1-¼"	0.875" - 1.000"	S41204GR00
1-¼"	1.000" - 1.125"	S41205GR00
1-¼"	1.125" - 1.250"	S41206GR00
1-¼"	1.250" - 1.375"	S41207GR00
1-½"	0.562" - 0.688"	S41501GR00
1-½"	0.688" - 0.812"	S41502GR00
1-½"	0.750" - 0.875"	S41503GR00
1-½"	0.875" - 1.000"	S41504GR00
1-½"	1.000" - 1.125"	S41505GR00
1-½"	1.125" - 1.250"	S41506GR00
1-½"	1.250" - 1.375"	S41507GR00
2"	1.250" - 1.375"	S42001GR00
2"	1.438" - 1.562"	S42002GR00
2"	1.562" - 1.688"	S42003GR00
2"	1.688" - 1.812"	S42004GR00
2"	1.812" - 1.938"	S42005GR00
2"	1.938" - 2.062"	S42006GR00
2"	2.062" - 2.188"	S42007GR00
2"	2.188" - 2.312"	S42008GR00
2"	2.312" - 2.438"	S42009GR00

(Type 304SS)



## STAINLESS STEEL CORD GRIP CONNECTORS W/ MESH

Cord Grip Connectors with Mesh		
Trade Size	Cable Range	Part Number
½"	.188" - .250"	S40502GRWM
½"	.250" - .312"	S40503GRWM
½"	.312" - .375"	S40504GRWM
½"	.375" - .438"	S40505GRWM
½"	.438" - .500"	S40506GRWM
½"	.500" - .562"	S40507GRWM
½"	.562" - .625"	S40508GRWM
¾"	.438" - .500"	S40701GRWM
¾"	.500" - .562"	S40702GRWM
¾"	.500" - .625"	S40703GRWM
¾"	.562" - .688"	S40704GRWM
¾"	.625" - .750"	S40705GRWM
¾"	.688" - .812"	S40706GRWM
1"	.438" - .562"	S41001GRWM
1"	.500" - .562"	S41002GRWM
1"	.500" - .625"	S41003GRWM
1"	.562" - .688"	S41004GRWM
1"	.625" - .750"	S41005GRWM
1"	.688" - .812"	S41006GRWM
1"	.750" - .875"	S41007GRWM
1"	.812" - .938"	S41008GRWM
1"	.875" - 1.000"	S41009GRWM
1-¼"	.562" - .688"	S41201GRWM
1-¼"	.688" - .812"	S41202GRWM
1-¼"	.750" - .875"	S41203GRWM
1-¼"	.875" - 1.000"	S41204GRWM
1-¼"	1.000" - 1.125"	S41205GRWM
1-¼"	1.125" - 1.250"	S41206GRWM
1-¼"	1.250" - 1.375"	S41207GRWM
1-½"	.562" - .688"	S41501GRWM
1-½"	.688" - .812"	S41502GRWM
1-½"	.750" - .875"	S41503GRWM
1-½"	.875" - 1.000"	S41504GRWM
1-½"	1.000" - 1.125"	S41505GRWM
1-½"	1.125" - 1.250"	S41506GRWM
1-½"	1.250" - 1.375"	S41507GRWM
2"	1.250" - 1.375"	S42001GRWM
2"	1.438" - 1.562"	S42002GRWM
2"	1.562" - 1.688"	S42003GRWM
2"	1.688" - 1.812"	S42004GRWM
2"	1.812" - 1.938"	S42005GRWM
2"	1.938" - 2.062"	S42006GRWM
2"	2.062" - 2.188"	S42007GRWM
2"	2.188" - 2.312"	S42008GRWM
2"	2.312" - 2.438"	S42009GRWM

(Type 304SS)



## STAINLESS STEEL DEVICE BOXES

(Type 316SS) S = Shallow, D = Deep

FS Single Gang Box			
Size	Wt. (lbs)	Cubic In.	Part Number
¾"	2.03	18"	S60700FS00



FD Single Gang Box			
Size	Wt. (lbs)	Cubic In.	Part Number
¾"	2.45	25"	S60700FD00



FDC Single Gang Boxes			
Size	Wt. (lbs)	Cubic In.	Part Number
¾"	2.40	25"	S60700FDCS
1"	3.10	25"	S61000FDCS



FDC Double Gang Boxes			
Size	Wt. (lbs)	Cubic In.	Part Number
¾"	3.52	45"	S60700FDCD
1"	4.02	45"	S61000FDCD



FDCC & FSXC Single Gang Boxes				
Model	Size	Wt. (lbs)	Cubic In.	Part Number
FDCC	¾"	2.50	25"	S60700FDCC
FSXC	¾"	2.10	18"	S60700FSXC



FDX & FSX Single Gang Boxes				
Model	Size	Wt. (lbs)	Cubic In.	Part Number
FDX	¾"	2.60	25"	S60700FDX0
FSX	¾"	2.22	18"	S60700FSX0



FSCT & FDCT Gang Boxes				
Model	Size	Wt. (lbs)	Cubic In.	Part Number
FDCT	¾"	2.50	25"	S60700FDCT
FSCT	¾"	2.16	18"	S60700FSCT



In-Use Covers		
Style	Size	Part Number
Single Gang	Shallow	S60000FVCS
Single Gang	Deep	S60000FVCD
Double Gang	Shallow	S60000FV2S



**NEMA4X** (Suitable for Damp Environments)

## STAINLESS STEEL DEVICE BOX COVERS

## STAINLESS STEEL DEVICE BOX PLATES

<p><b>Duplex Receptacle</b> (Horizontal) #S607HDCVRS</p> 	<p><b>Two Gang Blank</b> (2 Gang) #S607BLPLTD</p> 	<p><b>Two Toggle Switch</b> (2 Gang) #S6072TPLTD</p> 	<p><b>Two Toggle Receptacle</b> (2 Gang) #S6072DPLTD</p> 
<p><b>GFCI Receptacle</b> (Vertical) #S607VGCVRS</p> 	<p><b>Duplex Receptacle</b> (Vertical) #S607VDCVRS</p> 	<p><b>One Toggle Switch</b> (1 Gang) #S6071TPLTS</p> 	<p><b>One Duplex Receptacle</b> (1 Gang) #S6072DPLTS</p> 
<p><b>Toggle Switch</b> (Vertical) #S6071TCVRS</p> 	<p><b>Single Gang Blank</b> (1 Gang) #S607BLPLTS</p> 	<p><b>One Toggle Switch &amp; One Duplex Receptacle</b> (2 Gang) #S607TGPLTD</p> 	<p><b>Two GFCI Receptacle</b> (2 Gang) #S6072GPLTD</p> 
<p><b>Two Toggle Switch</b> (Vertical) #S6072TCVRD</p> 	<p><b>Duplex Receptacle</b> (Horizontal) #S607HDCVLS</p> 	<p><b>One Toggle Switch &amp; One Duplex Receptacle</b> (2 Gang) #S607TDPLTD</p> 	<p><b>One GFCI Receptacle</b> (1 Gang) #S6071GPLTS</p> 
<p><b>Toggle Switch</b> (Horizontal) #S6071TCVLS</p> 	<p><b>GFCI Receptacle</b> (Vertical) #S607VGCVLS</p> 		



## STAINLESS STEEL WASHERS, NUTS & SCREWS (Type 316SS)

Locknuts	
Trade Size	Part Number
1/2"	S60500LN00
3/4"	S60700LN00
1"	S61000LN00
1-1/4"	S61200LN00
1-1/2"	S61500LN00
2"	S62000LN00
2-1/2"	S62500LN00
3"	S63000LN00
4"	S64000LN00



Grounding Locknuts	
Trade Size	Part Number
1/2"	S60500LNWG
3/4"	S60700LNWG
1"	S61000LNWG
1-1/4"	S61200LNWG
1-1/2"	S61500LNWG
2"	S62000LNWG
2-1/2"	S62500LNWG
3"	S63000LNWG
4"	S64000LNWG



Standard Washers	
Trade Size	Part Number
1/4"	S60200WA00
3/8"	S60300WA00
1/2"	S60500WA00
5/8"	S60600WA00



Hex Nuts	
Trade Size	Part Number
1/4"	S60200HN00
3/8"	S60300HN00
1/2"	S60500HN00
5/8"	S60600HN00



Lock Washers	
Trade Size	Part Number
1/4"	S60200LW00
3/8"	S60300LW00
1/2"	S60500LW00
5/8"	S60600LW00



Square Washers	
Trade Size	Part Number
1/4"	S60200SW00
3/8"	S60300SW00
1/2"	S60500SW00
5/8"	S60600SW00



Fender Washers	
Trade Size	Part Number
1/4" x 1"	S60200FW10
1/4" x 1-1/4"	S60200FW12
3/8" x 1-1/4"	S60300FW12



Hex Head Cap Screws	
Trade Size	Part Number
Various	S60000HC00



Slotted Machine Screws 316SS	
Trade Size	Part Number
Various	S60000MS00



## STAINLESS STEEL CLAMPS (Type 316SS)

Split Ring Clamps	
Trade Size	Part Number
½"	S60500SP00
¾"	S60700SP00
1"	S61000SP00
1-¼"	S61200SP00
1-½"	S61500SP00
2"	S62000SP00
2-½"	S62500SP00
3"	S63000SP00
4"	S64000SP00



Right Angle Clamps	
Trade Size	Part Number
½"	S60500RA00
¾"	S60700RA00
1"	S61000RA00
1-¼"	S61200RA00
1-½"	S61500RA00
2"	S62000RA00
2-½"	S62500RA00
3"	S63000RA00
4"	S64000RA00



Right Angle Beam Clamp	
Trade Size	Part Number
1- <sup>5</sup> / <sub>8</sub> " x 1- <sup>5</sup> / <sub>8</sub> "	S60000RB00



Split Ring Extensions		
Trade Size	Description	Part Number
¾" x 1"	For Clamps ½" - 2"	S60301SPX0
¾" x 2"	For Clamps ½" - 2"	S60302SPX0
¾" x 4"	For Clamps ½" - 2"	S60304SPX0
¾" x 6"	For Clamps ½" - 2"	S60306SPX0
½" x 2"	For Clamps 2-½" - 4"	S60502SPX0
½" x 4"	For Clamps 2-½" - 4"	S60504SPX0
½" x 6"	For Clamps 2-½" - 4"	S60506SPX0

Beam Clamps	
Trade Size	Part Number
¼" - 20"	S60200BC00
¾" - 16"	S60300BC00
½" - 13"	S60500BC00



Strut Clamps	
Trade Size	Part Number
½"	S60500SC00
¾"	S60700SC00
1"	S61000SC00
1-¼"	S61200SC00
1-½"	S61500SC00
2"	S62000SC00
2-½"	S62500SC00
3"	S63000SC00
3-½"	S63500SC00
4"	S64000SC00

Split Ring Mounting Plates		
Trade Size	Description	Part Number
¾"	For Clamps - ½" - 2"	S60300SPMP
½"	For Clamps - 2-½" - 4"	S60500SPMP



Parallel Clamps	
Trade Size	Part Number
¾"	S60700PC00
1"	S61000PC00



(Also available in SS EMT)



## STAINLESS STEEL CLAMPS (Type 316SS)

Clamp Backs	
Trade Size	Part Number
½"	S60500CB00
¾"	S60700CB00
1"	S61000CB00



Clamp Back Spacers		
Trade Size	Description	Part Number
½" - 1"	Universal Clamp Back Spacer	S60510CBSP



## STAINLESS STEEL STRAPS AND HANGERS (Type 316SS)

2-Hole Straps		(Also Available in SS EMT)			
Trade Size	A	B	C	Bolt Hole	Part Number
½"	2.427"	0.627"	0.840"	¼"	S605002S00
¾"	2.925"	0.750"	1.050"	¼"	S607002S00
1"	3.580"	0.750"	1.300"	¼"	S610002S00
1-¼"	4.440"	0.875"	1.660"	¼"	S612002S00
1-½"	4.440"	1.240"	1.900"	¼"	S615002S00
2"	5.290"	1.245"	2.370"	¼"	S620002S00
2-½"	6.250"	1.250"	2.874"	¼"	S625002S00
3"	7.190"	1.250"	3.500"	¼"	S630002S00
4"	9.750"	1.250"	4.500"	¼"	S640002S00

1-Hole Straps		(Also available in SS EMT)			
Trade Size	A	B	C	Bolt Hole	Part Number
½"	0.750"	0.060"	0.840"	¼"	S605001S00
¾"	0.750"	0.080"	1.050"	¼"	S607001S00
1"	0.750"	0.080"	1.300"	¼"	S610001S00
1-¼"	0.875"	0.100"	1.660"	½"	S612001S00
1-½"	0.880"	0.125"	1.900"	½"	S615001S00
2"	0.880"	0.125"	2.370"	9/16"	S620001S00
2-½"	1.250"	0.190"	2.874"	9/16"	S625001S00
3"	1.250"	0.190"	3.500"	9/16"	S630001S00
4"	1.250"	0.190"	4.500"	9/16"	S640001S00

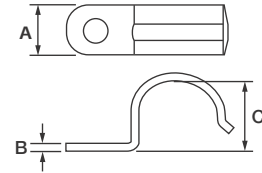
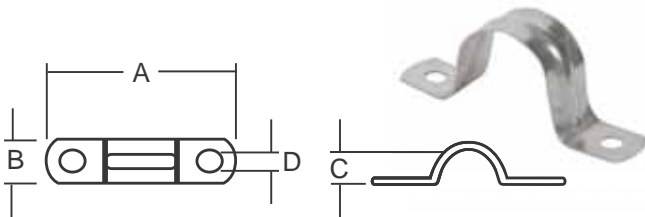

## Conduit Hangers (Also available in SS EMT)

Trade Size	Part Number
½"	S60500MH00
¾"	S60700MH00
1"	S61000MH00
1-¼"	S61200MH00
1-½"	S61500MH00
2"	S62000MH00
2-½"	S62500MH00
3"	S63000MH00
4"	S64000MH00



## MISCELLANEOUS (Type 316SS)

Counter-Sunk Hex Plugs		
Trade Size	a	Part Number
½"	0.375"	S60500CSHP
¾"	0.563"	S60700CSHP
1"	0.625"	S61000CSHP
1-¼"	0.750"	S61200CSHP
1-½"	1.000"	S61500CSHP
2"	1.000"	S62000CSHP
2-½"	1.000"	S62500CSHP
3"	1.000"	S63000CSHP
4"	1.000"	S64000CSHP
5"	1.000"	S65000CSHP
6"	1.000"	S66000CSHP



Box Connectors	
Trade Size	Part Number
½"	S60500CH00
¾"	S60700CH00
1"	S61000CH00
1-¼"	S61200CH00
1-½"	S61500CH00
2"	S62000CH00
2-½"	S62500CH00
3"	S63000CH00
4"	S64000CH00



Face / Reducing Bushings	
Trade Size	Part Number
¾" x ½"	S60700FB05
1" x ½"	S61000FB05
1" x ¾"	S61000FB07
1-¼" x ½"	S61200FB05
1-¼" x ¾"	S61200FB07
1-¼" x 1"	S61200FB10
1-½" x ½"	S61500FB05
1-½" x ¾"	S61500FB07
1-½" x 1"	S61500FB10
1-½" x 1-¼"	S61500FB12
2" x ½"	S62000FB05
2" x ¾"	S62000FB07
2" x 1"	S62000FB10
2" x 1-¼"	S62000FB12
2" x 1-½"	S62000FB15
2-½" x ½"	S62500FB05
2-½" x ¾"	S62500FB07
2-½" x 1"	S62500FB10

Face / Reducing Bushings	
Trade Size	Part Number
2-½" x 1-¼"	S62500FB12
2-½" x 1-½"	S62500FB15
2-½" x 2"	S62500FB20
3" x ½"	S63000FB05
3" x ¾"	S63000FB07
3" x 1"	S63000FB10
3" x 1-¼"	S63000FB12
3" x 1-½"	S63000FB15
3" x 2"	S63000FB20
3" x 2-½"	S63000FB25
4" x ½"	S64000FB05
4" x ¾"	S64000FB07
4" x 1"	S64000FB10
4" x 1-¼"	S64000FB12
4" x 1-½"	S64000FB15
4" x 2"	S64000FB20
4" x 2-½"	S64000FB25
4" x 3"	S64000FB30

Pulling Elbows		
Trade Size	Wt. (lbs)	Part Number
¾"	0.31	S60700P900
1"	0.64	S61000P900



Threaded Conduit Caps	
Trade Size	Part Number
½"	S60500CA00
¾"	S60700CA00
1"	S61000CA00
1-¼"	S61200CA00
1-½"	S61500CA00
2"	S62000CA00
2-½"	S62500CA00
3"	S63000CA00
4"	S64000CA00



Conduit Body Cover, Gasket & Screw Sets	
Trade Size	Part Number
½"	S60500CG00
¾"	S60700CG00
1"	S61000CG00
1-½"	S61500CG00
2"	S62000CG00



\* 5" & 6" Bushings available upon request  
 \*SS Hex Bushings also available

## MISCELLANEOUS

Threaded Rod		
Trade Size	Type 304 Part Number	Type 316 Part Number
1/4"	S40212TR00	S60212TR00
3/8"	S40312TR00	S60312TR00
1/2"	S40512TR00	S60512TR00

\* Sold in 12' Lengths



Escutcheon Plates/ Wall Flanges		
Trade Size	OD	Part Number
1/2"	3"	S40500EP00
3/4"	3"	S40700EP00
1"	3"	S41000EP00
1-1/4"	6"	S41200EP00
1-1/2"	6"	S41500EP00
2"	6"	S42000EP00
2-1/2"	6"	S42500EP00
3"	6"	S43000EP00
4"	6"	S44000EP00



Floor Flanges	
Trade Size	Part Number
1/2"	S60500FF00
3/4"	S60700FF00
1"	S61000FF00
1-1/4"	S61200FF00
1-1/2"	S61500FF00
2"	S62000FF00



Standard U-Bolts		(Figure 137 Style)							
Trade Size	A	B	C	D	E	F	Wt. (lbs)	Part Number	
1/2"	1/4"	0.950"	1.400"	2.750"	2.250"	2.313"	10	S60500UB00	
3/4"	1/4"	1.250"	1.650"	2.500"	2.250"	2.219"	11	S60700UB00	
1"	1/4"	1.375"	1.825"	2.750"	2.500"	2.094"	12	S61000UB00	
1-1/4"	3/8"	1.750"	2.350"	3.000"	2.500"	2.031"	28	S61200UB00	
1-1/2"	3/8"	2.000"	2.700"	3.000"	2.500"	2.063"	29	S61500UB00	
2"	3/8"	2.438"	2.813"	3.250"	2.500"	2.063"	32	S62000UB00	
2-1/2"	1/2"	3.000"	3.875"	3.750"	3.000"	2.250"	73	S62500UB00	
3"	1/2"	3.650"	4.500"	4.000"	3.000"	2.250"	79	S63000UB00	
3-1/2"	1/2"	4.063"	4.563"	4.250"	3.000"	2.250"	82	S63500UB00	
4"	1/2"	4.500"	5.375"	4.750"	3.000"	2.250"	50	S64000UB00	

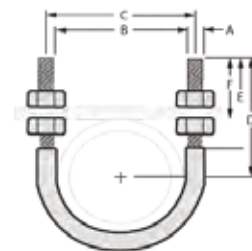

Rod Couplings	
Trade Size	Part Number
1/4"	S60200RC00
3/8"	S60300RC00
1/2"	S60500RC00
3/4"	S60700RC00



Wedge Anchors	
Trade Size	Part Number
Various	S60000WR00

Drop-In Anchors	
Trade Size	Part Number
1/4"	S60200DR00
3/8"	S60300DR00
1/2"	S60500DR00
5/8"	S60600DR00
3/4"	S60700DR00



Grounding Bushings	
Trade Size	Part Number
3/4"	S60700GB00
1"	S61000GB00



## MISCELLANEOUS

Drain Plugs	
Trade Size	Part Number
1/2"	S60500DP00
3/4"	S60700DP00



GUAT Explosion Proof Outlet Box	
Trade Size	Part Number
3/4"	S60700GUAT



UNY Explosion Proof Union	
Trade Size	Part Number
3/4"	S60700UNY0



EYS Explosion Proof Sealing Fitting	
Trade Size	Part Number
3/4"	S60700EYS0



Thread Covers	
Trade Size	Part Number
1/2"	S60500TC00
3/4"	S60700TC00
1"	S61000TC00
1-1/4"	S61200TC00
1-1/2"	S61500TC00
2"	S62000TC00



Ground Rod		
Trade Size	Part Number	Weight/100(lbs)
5/8" X 8'	S40608RD00	850
5/8" X 10'	S40610RD00	1060
3/4" X 8'	S40708RD00	1200
3/4" X 10'	S40710RD00	1500
1" X 8'	S41008RD00	2300
1" X 10'	S41010RD00	2700



\* Contact factory for 2-1/2" - 6" info

## TUBING AND TUBE FITTINGS



**Available in 1/8" – 1" - Offering Includes:**

Stainless steel Tubing, Male and Female Connectors, Straight and Reducing Unions, Ball and Needle Valves, Elbow and Tee Connectors, Caps and Plugs

## The Stainless Steel Resource Center

Visit our resource section on Calbrite.com for product submittal sheets, a custom Conduit Lifecycle Calculator and a database of valuable documents on stainless steel and its benefits.



### Stainless Steel Rigid Conduit

**Features:**

- Manufactured in type 304 & 316 stainless steel to meet any stringent sanitary condition
- Polished to a bright, easily maintainable finish that is modern, attractive, easy to clean, and that also enhances the surface's resistance to pitting & bacterial corrosion
- Calbrite stainless steel rigid conduit functions in exactly the same way as any other metallic conduit. There are none of the labor-intensive procedures that come with PVC-coated installations, nor the complicated maintenance and repair procedures
- Standard NPT threads allow for trouble-free installations
- Approx. Heat Tolerance = -150°F to 1600°F
- Includes one coupling with each length purchased

**Certifications and Compliances:**

UL / CUL 6A approved  
 UL file number = E230584  
 Full NEC code compliance  
 Inclusive for installation in accordance with Article 344 of ANSI/NFPA 70, "National Electrical Code" (NEC).  
 Manufactured in the United States

**Applications:**

Stainless conduit is often recommended when corrosive applications exceed the limitations of aluminum, rigid steel, pvc, & PVC Coated conduit. Calbrite's type 304 & 316 UL-listed stainless steel conduit meets & exceeds current requirements for wash down, is food-safe/potable water-safe and satisfies the strictest mandates for plant cleanliness by HACCP, FDA, various state agencies, and hundreds of common regulatory requirements.

**Industries Commonly Served:**

- Food & Beverage Production & Distribution
- Chemical Plants
- Water & Wastewater Treatment
- Pharmaceuticals & Cosmetics
- Refining & Extraction Sites
- Petrochemical
- Pulp & Paper Mills
- Marine & Coastal Facilities
- Along with other corrosive environments

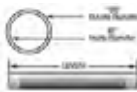
Size	Type 304 Part Number	Type 316 Part Number	Outside Diameter	Inside Diameter	Threads per Inch	Length w/o Coupling	Weight per FT (lbs.)
1/2"	S40510CT00	S60510CT00	0.840"	0.622"	14	9' 11-1/4"	0.82
3/4"	S40710CT00	S60710CT00	1.050"	0.824"	14	9' 11"	1.09
1"	S41010CT00	S61010CT00	1.315"	1.049"	11.5	9' 11"	1.61
1-1/4"	S41210CT00	S61210CT00	1.660"	1.380"	11.5	9' 11"	2.18
1-1/2"	S41510CT00	S61510CT00	1.900"	1.610"	11.5	9' 11"	2.63
2"	S42010CT00	S62010CT00	2.375"	2.067"	11.5	9' 11"	3.50
2-1/2"	S42510CT00	S62510CT00	2.875"	2.469"	8	9' 10-1/2"	5.59
3"	S43010CT00	S63010CT00	3.500"	3.068"	8	9' 10-1/2"	7.27
4"	S44010CT00	S64010CT00	4.500"	4.026"	8	9' 10-1/2"	10.08
5"	S45010CT00	S65010CT00	5.563"	5.073"	8	9' 10-1/2"	14.61
6"	S46010CT00	S66010CT00	6.625"	6.093"	8	9' 10-1/2"	18.97

All dimensions are for informational purposes only \*Tolerances +/- .5%

Calbrite • 2207 165<sup>th</sup> St. Hammond, IN 46320 • Ph: 219-844-6800 • www.calbrite.com

Submittal sheet sample

Each Calbrite submittal sheet includes a product image, feature and benefit summary, certifications and compliances, common applications, industry recommendations and part number specs. Each is formatted to be easily printed and kept as a reference.

## INDUSTRIES SERVED

Food, Dairy & Beverage Industries  
Water & Wastewater Treatment Facilities  
Mining  
Marine & Coastal Facilities  
Chemical Plants  
Petrochemical  
Steel Mills  
Offshore Platforms  
Breweries  
Cooling Towers  
Transportation  
Pharmaceuticals & Cosmetics  
Architectural & Structural Design  
Power Plants  
Solar Farms  
Pulp and Paper Mills  
Fertilizer Plants  
and other corrosive & harsh environments

UL® 6A & cUL® 6A, UL® 514A & cUL® 514A , UL® 514B & cUL® 514B, UL® 1203, UL® 797A, cUL® 797A, NEMA 4X, ANSI



Three USA Manufacturing Locations  
Keep America Working



**MIDWEST (Sales Office)**  
2207 165th St.  
Hammond, IN 46320  
(219) 844-6800  
(800) 536-2248  
(219) 844-6884 fax

**SOUTHEAST**  
301 Mears Blvd., Suite A  
Oldsmar, FL 34677  
(219) 844-6800  
(800) 536-2248  
(219) 844-6884 fax

**CORPORATE HEADQUARTERS**  
19440 S. Dominguez Hills Dr.  
Rancho Dominguez, CA 90220  
(800) Calpipe