

Sta-Kon® Wire Termination & Insulation

In this section...



Sta-Kon® Wire Termination & Insulation

Overview	G-2-G-3
Ring Terminals	G-4-G-13
Flag Terminals.....	G-14
Fork Terminals.....	G-15-G-19
Pin Terminals.....	G-19
Splice Connectors.....	G-20-G-21
Wire Joints	G-22-G-23
Heat-Shrinkable Terminals, Splices, Disconnects.....	G-24-G-25
Disconnects and Male Tabs	G-26-G-29
Luminaire Disconnects	G-30-G-31
Ferrules	G-32-G-35
Wire Termination Tools and Installation Kits.....	G-36-G-45
Wire Termination Technical Information.....	G-46-G-57
Shrink-Kon® Heat-Shrinkable Tubing	G-58-G-70
Shrink-Kon® Splice Insulators and Insulating Covers	G-71-G-74
Shrink-Kon® Installation Tools.....	G-75-G-77
Shield-Kon® Shield Termination System.....	G-78-G-91
Dragon-Tooth® Magnet Wire Termination System.....	G-92-G-104

Overview

Experience the Sta-Kon® advantage!

Thomas & Betts developed the first tool-applied solderless terminals and connectors more than 70 years ago in response to industry awareness of the need for better performance of electrical systems.

Key Features and Benefits

- Metal insulation grip sleeve is included on all-nylon terminal for strain relief
- Long barrel selectively annealed
- UL® Listed E9809 unless otherwise specified



Deep Internal Serrations

After the insertion of a wire into the terminal's barrel, a deep, serrated interior ensures a large area of contact that lowers the resistance of a connection. With the mechanical force of the tool, the wire strands cold flow into the serrated interior. This guarantees electrical resistance lower than the wire to which it is applied. This feature also prevents pullout from vibration and mechanical strain. Deep internal serrations can be compared to the effective holding power of a well-treaded tire on a wet highway.

Funneled Terminal Barrel Entry

This feature makes wire insertion faster and easier. A funneled barrel eliminates wire strand "hang up" upon insertion into the terminal's barrel. The loss of even a couple of wire strands can have negative results on electrical efficiency and resistance to mechanical strain.

Sta-Kon® Long Barrel Design

If lowering electrical resistance, preventing wire pullout, eliminating a "missed" crimp and having an insulator that stays on the barrel during installation are your goals, then you must design a terminal with a long barrel. This also provides the insulator with additional surface area, holding tight to the barrel. Most competitive barrel lengths range from 20–50% shorter than Sta-Kon® terminals. The results are usually a stream of electrical failure, rework and added expense. Many competitive insulators come off during crimping due to a limited barrel length.

Note: Listed for solid wire up to #10 AWG, terminals only.

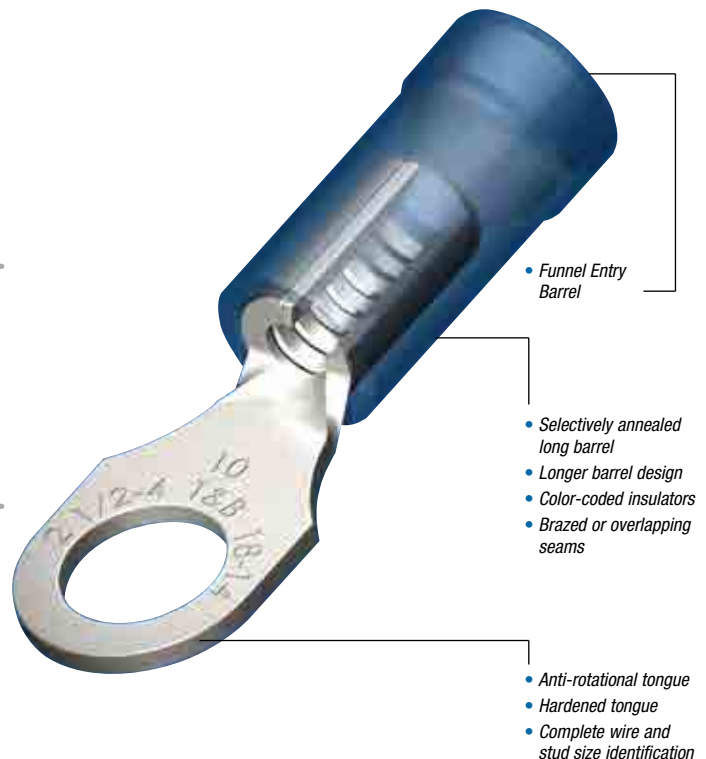

Overview

Superior terminals for superior connections!

Brazed or Overlapped Seam

A long barrel design is of little value unless it is one solid piece. That is why Thomas & Betts brazes the seam on our vinyl-insulated Sta-Kon® terminals and overlaps the seam on nylon-insulated terminals. Many competitive terminals have butted seams. This means increased chances for wirestrand loss, poor resistance, wire pullout, and electrical failure. If the installer doesn't position the tool exactly on the correct spot on the barrel, there's likely going to be an improper termination. The butted seam can also fold due to tool-applied pressure piercing the terminals insulation from the inside out. With Thomas & Betts' brazed or overlapped seam, the installer can crimp anywhere along the barrel's surface. This provides up to 2.5 times the tensile strength of a butted seam terminal, guaranteeing proper electrical flow, void free.

Selective Annealing

Because of the mechanical strength of copper, an installer can experience fatigue associated with repeated installations. For this reason, Thomas & Betts puts its terminals through one more step called selective annealing. This process leaves the barrel soft enough to crimp and form around the wire. However, we "cold form" the tongue during the manufacturing process so it remains strong. This is done so the tongue can withstand repeated bends and bolt tightening strain common in most electrical installations. Many competitors attempt to accomplish similar goals by removing valuable material or using a softer copper, which has lower conductivity. This increases electrical resistance as well as the odds for shorting and downtime.



Strands enter as a homogeneous group and compact tightly under compression due to fully braze seam

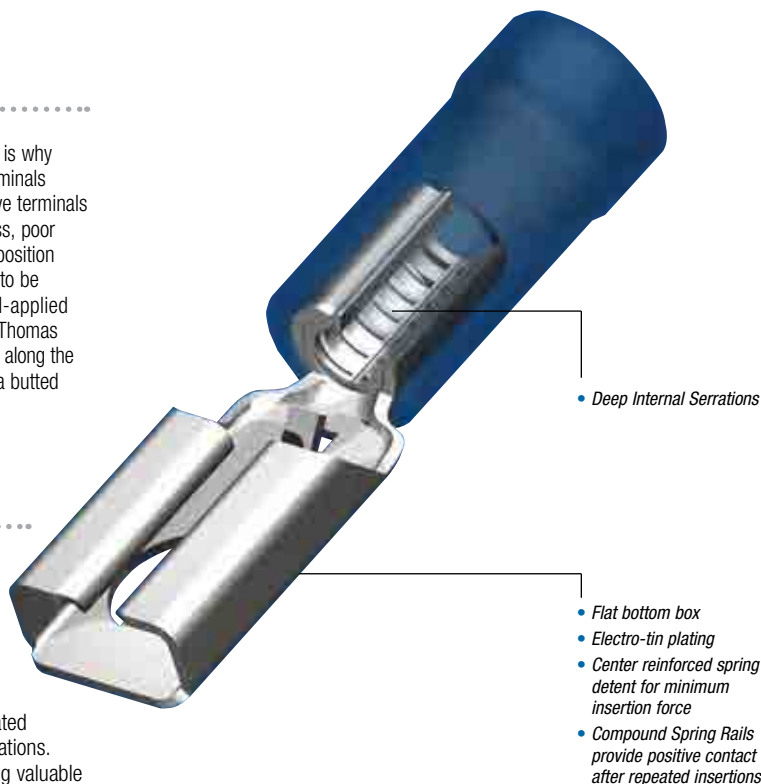

Anti-Rotational Tongues

This is a unique feature to the Thomas & Betts ring tongue terminal. This design prevents terminal shorting by keeping the terminal secure in the terminal block. The installer can place a greater number of terminals closer together without worry.

Proper Identification

We identify all terminals with Thomas & Betts initials, T & B. We also indicate wire and stud sizes. These markings are clearly visible on the surface of the tongue, taking any guesswork out of replacing or reordering additional parts. Our superior bright plating also assists in visibility.

All Sta-Kon® Terminals are Deburred and Degreased

To ensure a Sta-Kon® terminal is properly plated and insulated, all our parts are put through a process that cleans and smooths the terminal of any manufacturing by-products — mainly grease, oils and sharp edges. Many competitive products do not put their product through such rigorous finishing.

Wire Termination — Sta-Kon® Wire Termination & Insulation

Ring Terminals

Sta-Kon® Rings, Forks and Locking Forks

- Complete line of installing tools engineered to match tool with terminal
- First to gain military approval for pressure connections... many styles available for military applications
- Sta-Kon® products exceed test specification requirements of military, UL and CSA
- Include extra metal sleeve to grip insulation
- Vinyl insulated and bare Sta-Kon® terminals feature brazed seam wire barrels that can be crimped at any place on the barrel circumference
- Can be installed with crimping tools having a single indenter or double indenter (recommended for solid wire)
- Serrated barrel increases grip on wire
- Wire range identification on the tongue of each terminal
- Can be installed with crimping tools having a single indenter or double indenter (recommended for solid wire)
- Constructed of electrolytic copper for high conductivity
- Wire range identification on the tongue of each terminal



Listing

Sta-Kon® Rings, Forks and Locking Forks are tested and listed to UL® 486A/B, two-way splices to UL 486C, disconnects to UL 310 and all applicable products to CSA 22.2.



Nylon-Insulated Ring Terminals

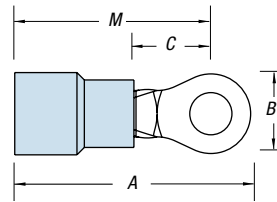

CAT. NO.	PKG. QTY.	WIRE RANGE	MAX. INS.	BOLT HOLE	REC. TOOL	DIMENSIONS				STOCK THICK.
						A	B	C	M	
RZ22-2**	100	26-22	.083	#2		.57	.14	.13	.49	.02
RZ22-4**	100	26-22	.083	#4		.65	.21	.20	.54	
RZ22-6**	100	26-22	.083	#6	ERG4006	.65	.21	.20	.54	
RZ22-8**	100	26-22	.083	#8		.75	.25	.23	.62	
RZ22-10**	100	26-22	.083	#10		.75	.25	.23	.62	
RAX23*	1,000	26-24	.125	#2		.66	.14	.14	.59	.02
RAX43*	1,000	26-24	.125	#4		.74	.20	.19	.64	
RAX63*	1,000	26-24	.125	#6	WT145A	.84	.25	.22	.72	
RAX83*	1,000	26-24	.125	#8		.84	.25	.22	.72	
RAX103*	1,000	26-24	.125	#10		.84	.25	.24	.72	
RA18-4	100	22-16	.136	#4		.72	.23	.14	.59	.03
RA323	1,000	22-16	.136	#4	ERG4001	.72	.23	.14	.59	
RA333	1,000	22-16	.136	#6		.72	.23	.14	.59	
RA18-6	100	22-16	.136	#6		.86	.26	.25	.71	

* Not listed by UL or CSA

** CSA Listed only

CAT. NO.	PKG. QTY.	WIRE RANGE	MAX. INS.	BOLT HOLE	REC. TOOL	DIMENSIONS				STOCK THICK.
						A	B	C	M	
RA853	1,000	22-16	.136	#6		.86	.26	.25	.71	.03
RA18-8	100	22-16	.136	#8		.89	.26	.25	.71	
RA833	1,000	22-16	.136	#8		.86	.26	.25	.71	
RA863	1,000	22-16	.136	#8		.89	.26	.25	.71	
RA18-10	100	22-16	.136	#10	WT145A	.89	.31	.25	.71	
RA873	1,000	22-16	.136	#10		.89	.31	.25	.71	.03
RA18-14	100	22-16	.136	1/4"		1.10	.46	.31	.84	
RA713	1,000	22-16	.136	1/4"		1.10	.46	.31	.84	
RA18-516	100	22-16	.136	5/16"		1.10	.46	.31	.84	
RA723	1,000	22-16	.136	5/16"		1.10	.46	.31	.84	
RA18-38	100	22-16	.136	3/8"		1.20	.53	.35	.87	.03
RA733	1,000	22-16	.136	3/8"	ERG4001	1.20	.53	.35	.87	
RA18-12	100	22-16	.136	1/2"		1.30	.72	.50	.92	
RA753	1,000	22-16	.136	1/2"		1.30	.72	.50	.92	

Ring Terminals

Nylon-Insulated Ring Terminals (continued)

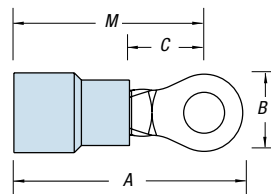

CAT. NO.	PKG. QTY.	WIRE RANGE	MAX. INS.	BOLT HOLE	REC. TOOL	DIMENSIONS				STOCK THICK.
						A	B	C	M	
RB14-4	100	18-14	.162	#4	ERG4001	.72	.26	.14	.59	.03
RB1323	1,000	18-14	.162	#4		.72	.26	.14	.59	
RB14-6	100	18-14	.162	#6		.89	.31	.25	.71	
RB853	1,000	18-14	.162	#6		.89	.31	.25	.71	
RB1333	1,000	18-14	.162	#6		.74	.26	.14	.59	
RB14-8	100	18-14	.162	#8		.89	.31	.25	.71	
RB863	1,000	18-14	.162	#8		.89	.31	.25	.71	
RB14-10	100	18-14	.162	#10		.89	.31	.25	.71	
RB873	1,000	18-14	.162	#10		.89	.31	.25	.71	
RB14-14	100	18-14	.162	1/4"		1.08	.47	.31	.81	
RB713	1,000	18-14	.162	1/4"		1.08	.47	.31	.81	
RB14-516	100	18-14	.162	5/16"		1.08	.47	.31	.84	
RB723	1,000	18-14	.162	5/16"		1.08	.47	.31	.84	
RB14-38	100	18-14	.162	3/8"		1.17	.53	.35	.87	
RB733	1,000	18-14	.162	3/8"		1.17	.53	.35	.87	
RB14-12	100	18-14	.162	1/2"		1.25	.72	.50	.90	
RB753	1,000	18-14	.162	1/2"		1.25	.72	.50	.90	

CAT. NO.	PKG. QTY.	WIRE RANGE	MAX. INS.	BOLT HOLE	REC. TOOL	DIMENSIONS				STOCK THICK.
						A	B	C	M	
RC10-6	50	12-10	.210	#6	ERG4001	1.00	.37	.27	.81	.04
RC333	500	12-10	.210	#6		1.00	.37	.27	.81	
RC10-8	50	12-10	.210	#8		1.00	.37	.27	.81	
RC863	500	12-10	.210	#8		1.00	.37	.27	.81	
RC10-10	50	12-10	.210	#10		1.00	.37	.27	.81	
RC363	500	12-10	.210	#10		1.00	.37	.27	.81	
RC10-14	50	12-10	.210	1/4"		1.12	.53	.32	.86	
RC713	500	12-10	.210	1/4"		1.12	.53	.32	.86	
RC10-516	50	12-10	.210	5/16"		1.21	.53	.31	.94	
RC703	500	12-10	.210	5/16"		1.21	.53	.31	.94	
RC10-38	50	12-10	.210	3/8"		1.27	.59	.35	.98	
RC733	500	12-10	.210	3/8"		1.27	.59	.35	.98	
RC10-12	50	12-10	.210	1/2"		1.37	.72	.52	1.02	
RC753	500	12-10	.210	1/2"		1.37	.72	.52	1.02	

Nylon-Insulated Ring Terminals — Expanded Entry

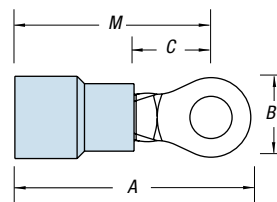

CAT. NO.	PKG. QTY.	WIRE RANGE	MAX. INS.	BOLT HOLE	REC. TOOL	DIMENSIONS				STOCK THICK.
						A	B	C	M	
RB14-4X	100	18-14	.190	#4	ERG4001	.80	.26	.14	.67	.03
RB14-6X	100	18-14	.190	#6		.95	.31	.25	.79	
RB854	1,000	18-14	.190	#6		.95	.31	.25	.79	
RB14-8X	100	18-14	.190	#8		.95	.31	.25	.79	
RB864	1,000	18-14	.190	#8		.95	.31	.25	.79	
RB14-10X	100	18-14	.190	#10		.95	.31	.25	.79	
RB874	1,000	18-14	.190	#10		.95	.31	.25	.79	
RB14-14X	100	18-14	.190	1/4"		1.16	.47	.31	.92	
RB714	1,000	18-14	.190	1/4"		1.16	.47	.31	.92	
RB14-516X	100	18-14	.190	5/16"		1.16	.47	.31	.92	
RB724	1,000	18-14	.190	5/16"		1.16	.47	.31	.92	
RB14-38X	100	18-14	.190	3/8"		1.25	.53	.42	.95	
RB734	1,000	18-14	.190	3/8"		1.25	.53	.42	.95	

CAT. NO.	PKG. QTY.	WIRE RANGE	MAX. INS.	BOLT HOLE	REC. TOOL	DIMENSIONS				STOCK THICK.
						A	B	C	M	
RC10-6X	50	12-10	.250	#6	ERG4001	1.10	.37	.27	.91	.04
RC334	500	12-10	.250	#6		1.10	.37	.27	.91	
RC10-8X	50	12-10	.250	#8		1.10	.37	.27	.91	
RC864	500	12-10	.250	#8		1.10	.37	.27	.91	
RC10-10X	50	12-10	.250	#10		1.10	.37	.27	.91	
RC364	500	12-10	.250	#10		1.10	.37	.27	.91	
RC10-14X	50	12-10	.250	1/4"		1.22	.53	.32	.96	
RC714	500	12-10	.250	1/4"		1.22	.53	.32	.96	
RC10-516X	50	12-10	.250	5/16"		1.32	.53	.31	1.05	
RC704	500	12-10	.250	5/16"		1.32	.53	.31	1.05	
RC10-38X	50	12-10	.250	3/8"		1.38	.59	.48	1.09	
RC734	500	12-10	.250	3/8"		1.38	.59	.48	1.09	
RC10-12X	50	12-10	.250	1/2"		1.48	.72	.52	1.13	

UL Listed E9809

Ring Terminals

Nylon-Insulated Large Ring Terminals

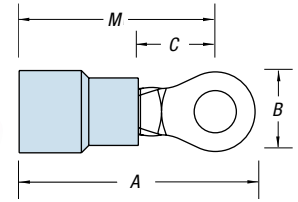

CAT. NO.	PKG. QTY.	WIRE RANGE	MAX. INS.	BOLT HOLE	REC. TOOL	DIMENSIONS				STOCK THICK.		
						A	B	C	M			
Flex Class 41/24												
RD167	200	8	.340	#8	ERG4007	1.48	.42	.28	1.29	.04		
RD8-10	25	8	.340	#10		1.48	.42	.28	1.29			
RD367	200	8	.340	#10		1.48	.42	.28	1.29			
RD8-14	25	8	.340	1/4"		1.54	.46	.36	1.32			
RD717	200	8	.340	1/4"		1.54	.46	.36	1.32			
RD8-516	25	8	.340	5/16"		1.63	.57	.36	1.35			
RD727	200	8	.340	5/16"		1.63	.57	.36	1.35			
RD8-38	25	8	.340	3/8"		1.63	.57	.36	1.35			
RD737	200	8	.340	3/8"		1.63	.57	.36	1.35			
RD8-12*	25	8	.310	1/2"		TBM6S	1.79	.82	.55		1.39	
RD757*	200	8	.310	1/2"	1.79		.82	.55	1.39			
RD10161	200	8AN	.270	#8	ERG4007	1.40	.41	.24	1.20	.04		
RD10361	200	8AN	.270	#10		1.40	.41	.24	1.20			
RD10711	200	8AN	.270	1/4"		1.45	.45	.27	1.22			
RD10721	200	8AN	.270	5/16"		1.53	.56	.34	1.25			
RD10731	200	8AN	.270	3/8"		1.53	.56	.34	1.25			
Flex Class 63/24												
RE6-10	20	6	.420	#10		ERG4007	1.65	.49	.28		1.40	.04
RE267	200	6	.420	#10	1.65		.49	.28	1.40			
RE6-14	20	6	.420	1/4"	1.65		.49	.28	1.40			
RE717	200	6	.420	1/4"	1.65		.49	.28	1.40			
RE6-516	20	6	.420	5/16"	1.76		.61	.34	1.47			
RE727	200	6	.420	5/16"	1.76		.61	.34	1.47			
RE6-38	20	6	.420	3/8"	1.76		.61	.34	1.47			
RE737	200	6	.420	3/8"	1.76		.61	.34	1.47			
RE6-12*	20	6	.395	1/2"	TBM6S	1.83	.82	.55	1.43			
RE757*	200	6	.395	1/2"		1.83	.82	.55	1.43			
RE10261	200	6AN	.315	#10	ERG4007	1.55	.49	.24	1.31	.04		
RE10711	200	6AN	.315	1/4"		1.55	.49	.27	1.31			
RE10721	200	6AN	.315	5/16"		1.70	.60	.34	1.40			
RE10731	200	6AN	.315	3/8"		1.70	.60	.34	1.40			
Flex Class 105/24												
RF4-10	15	4	.510	#10	TBM6S	1.76	.56	.36	1.49	.04		
RF267	100	4	.510	#10		1.76	.56	.36	1.49			
RF4-14	15	4	.510	1/4"		1.76	.56	.36	1.49			
RF717	100	4	.510	1/4"		1.76	.56	.36	1.49			
RF4-516	15	4	.510	5/16"		1.84	.62	.35	1.53			
RF727	100	4	.510	5/16"		1.84	.62	.35	1.53			
RF4-38	15	4	.510	3/8"		1.84	.62	.35	1.53			
RF737	100	4	.510	3/8"		1.84	.62	.35	1.53			
RF757*	100	4	.500	1/2"		1.90	.82	.55	1.49			
RF10261	100	4AN	.380	#10		1.78	.55	.30	1.51			
RF10711	100	4AN	.380	1/4"	1.78	.55	.30	1.51				
RF10721	100	4AN	.380	5/16"	1.80	.62	.34	1.49				
RF10731	100	4AN	.380	3/8"	1.80	.62	.34	1.49				

CAT. NO.	PKG. QTY.	WIRE RANGE	MAX. INS.	BOLT HOLE	REC. TOOL	DIMENSIONS				STOCK THICK.
						A	B	C	M	
RG2-10	10	2	.588	#10	TBM6S	2.15	.69	.40	1.83	.05
RG267	50	2	.588	#10		2.15	.69	.40	1.83	
RG2-14	10	2	.588	1/4"		2.15	.69	.40	1.83	
RG717	50	2	.588	1/4"		2.15	.69	.40	1.83	
RG2-516	10	2	.588	5/16"		2.15	.69	.40	1.83	
RG727	50	2	.588	5/16"		2.15	.69	.40	1.83	
RG2-38	10	2	.588	3/8"		2.15	.69	.40	1.83	
RG737	50	2	.588	3/8"		2.15	.69	.40	1.83	
RG2-12	10	2	.588	1/2"		2.35	.80	.49	1.93	
RG757	50	2	.588	1/2"		2.35	.80	.49	1.93	
RG9711	50	2AN	.453	1/4"	2.07	.69	.40	1.74	.05	
RG9731	50	2AN	.453	3/8"	2.07	.69	.40	1.74		
RG9751	50	2AN	.453	1/2"	2.26	.80	.49	1.84		
RH717	50	1/0	.629	1/4"	TBM6S	2.14	.77	.43	1.81	.06
RH727	50	1/0	.629	5/16"		2.14	.77	.43	1.81	
RH737	50	1/0	.629	3/8"		2.14	.77	.43	1.81	
RH757	50	1/0	.629	1/2"		2.34	.77	.54	1.90	
RH9711	50	1AN	.500	1/4"		2.14	.77	.44	1.81	
RH9731	50	1AN	.500	3/8"		2.14	.77	.44	1.81	
RH9751	50	1AN	.500	1/2"		2.34	.77	.54	1.90	
RJ717	100	2/0	.675	1/4"		2.34	.83	.46	1.96	
RJ727	100	2/0	.675	5/16"		2.34	.83	.46	1.96	
RJ737	100	2/0	.675	3/8"		2.34	.83	.46	1.96	
RJ757	100	2/0	.675	1/2"	2.48	.89	.54	2.03		
RJ9711	50	1/0AN	.550	1/4"	2.35	.83	.46	1.97	.06	
RJ9731	50	1/0AN	.550	3/8"	2.35	.83	.46	1.97		
RJ9751	50	1/0AN	.550	1/2"	2.49	.89	.55	2.04		
RK717	25	3/0	.765	1/4"	TBM6S	2.60	.93	.54	2.21	.07
RK727	25	3/0	.765	5/16"		2.60	.93	.54	2.21	
RK737	25	3/0	.765	3/8"		2.60	.93	.54	2.21	
RK9731	100	2/0AN	.610	3/8"		2.52	.93	.55	2.14	
RK9751	100	2/0AN	.610	1/2"		2.60	.93	.55	2.15	
RL737	25	4/0	.785	3/8"		2.83	1.04	.57	2.35	
RL757	25	4/0	.785	1/2"		2.83	1.04	.57	2.35	
RL9731	25	3/0AN	.680	3/8"		2.83	1.04	.57	2.36	
RL9751	25	3/0AN	.680	1/2"		2.83	1.04	.57	2.36	
RM737	20	250kcmil	.868	3/8"		3.00	1.13	.65	2.51	
RM747	20	250kcmil	.868	7/16"	3.00	1.13	.65	2.51		
RM757	20	250kcmil	.868	1/2"	3.00	1.13	.65	2.51		
RM9731	20	4/0AN	.750	3/8"	3.00	1.13	.66	2.51		
RM9751	20	4/0AN	.750	1/2"	3.00	1.13	.66	2.51		

*Brazeed Seam

AN=Aircraft Wire

Ring Terminals

Extra-length PVC sleeve offers extra protection.

Vinyl-Insulated Ring Terminals

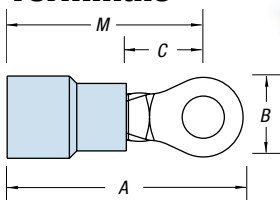

CAT. NO.	PKG. QTY.	WIRE RANGE	MAX. INS.	BOLT HOLE	REC. TOOL	DIMENSIONS				STOCK THICK.
						A	B	C	M	
18RA-4	100	22-16	.150	#4		.97	.31	.27	.81	.03
RA77	1,000	22-16	.150	#4		.97	.31	.27	.81	
18RA-6	100	22-16	.150	#6		.94	.25	.27	.81	
RA857	1,000	22-16	.150	#6		.94	.25	.27	.81	
18RA-8	100	22-16	.150	#8		.97	.31	.27	.81	
RA867	1,000	22-16	.150	#8		.97	.31	.27	.81	
18RA-10	100	22-16	.150	#10		.97	.31	.27	.81	
RA877	1,000	22-16	.150	#10		.97	.31	.27	.81	
18RA-14	100	22-16	.150	1/4"		1.13	.50	.37	.88	
RA717	1,000	22-16	.150	1/4"		1.13	.50	.37	.88	
18RA-516	100	22-16	.150	5/16"		1.13	.50	.37	.88	
RA727	1,000	22-16	.150	5/16"		1.13	.50	.37	.88	
18RA-38	100	22-16	.150	3/8"		1.24	.54	.37	.91	
RA737	1,000	22-16	.150	3/8"		1.24	.54	.37	.91	
14RB-4	100	18-14	.170	#4	ERG4001	.94	.25	.27	.81	
RB1327	1,000	18-14	.170	#4		.94	.25	.27	.81	
14RB-6	100	18-14	.170	#6		.97	.31	.27	.81	
RB857	1,000	18-14	.170	#6		.97	.31	.27	.81	
14RB-8	100	18-14	.170	#8		.97	.31	.27	.81	
RB867	1,000	18-14	.170	#8		.97	.31	.27	.81	
14RB-10	100	18-14	.170	#10		.97	.31	.27	.81	
RB877	1,000	18-14	.170	#10		.97	.31	.27	.81	
14RB-14	100	18-14	.170	1/4"		1.14	.50	.38	.89	
RB717	1,000	18-14	.170	1/4"		1.14	.50	.38	.89	
14RB-516	100	18-14	.170	5/16"		1.15	.50	.38	.89	
RB727	1,000	18-14	.170	5/16"		1.15	.50	.38	.89	
14RB-38	100	18-14	.170	3/8"		1.16	.54	.38	.91	
RB737	1,000	18-14	.170	3/8"		1.16	.54	.38	.91	
10RC-6	50	12-10	.210	#6		1.06	.31	.27	.90	
RC337	500	12-10	.210	#6		1.06	.31	.27	.90	
10RC-8	50	12-10	.210	#8		1.06	.31	.27	.90	
RC777	500	12-10	.210	#8		1.06	.31	.27	.90	
10RC-10	50	12-10	.210	#10		1.06	.31	.27	.90	
RC367	500	12-10	.210	#10		1.06	.31	.27	.90	
10RC-14	50	12-10	.210	1/4"		1.16	.50	.27	.90	
RC717	500	12-10	.210	1/4"		1.16	.50	.27	.90	
10RC-516	50	12-10	.210	5/16"		1.17	.50	.37	.92	
RC707	500	12-10	.210	5/16"		1.17	.50	.37	.92	
10RC-38	50	12-10	.210	3/8"		1.29	.59	.44	.99	
RC737	500	12-10	.210	3/8"		1.29	.59	.44	.99	

A wider wire entry for heavy-wall insulation.

Vinyl-Insulated Ring Terminals — Expanded Insulation

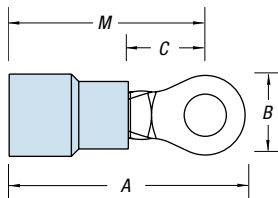

CAT. NO.	PKG. QTY.	WIRE RANGE	MAX. INS.	BOLT HOLE	REC. TOOL	DIMENSIONS				STOCK THICK.
						A	B	C	M	
18RA-4X	100	22-16	.170	#4		.97	.31	.27	.81	.03
18RA-6X	100	22-16	.170	#6		.97	.31	.27	.81	
18RA-8X	100	22-16	.170	#8		.97	.31	.27	.81	
18RA-38X	100	22-16	.170	3/8"		1.15	.54	.35	.90	
RA857-170	1,000	22-16	.170	#6		.97	.31	.27	.81	
RA867-170	1,000	22-16	.170	#8		.97	.31	.27	.81	
18RA-10X	1,000	22-16	.170	#10		.97	.31	.27	.81	
RA877-170	1,000	22-16	.170	#10		.97	.31	.27	.81	
18RA-14X	100	22-16	.170	1/4"		1.13	.50	.37	.88	
RA727-170	1,000	22-16	.170	5/16"		1.13	.50	.37	.88	
14RB-4X	100	18-14	.200	#4	ERG4001	.94	.25	.27	.81	
14RB-6X	100	18-14	.200	#6		.97	.31	.27	.81	
RB857-200	1,000	18-14	.200	#6		.97	.31	.27	.81	
14RB-8X	100	18-14	.200	#8		.97	.31	.27	.81	
RB867-200	1,000	18-14	.200	#8		.97	.31	.27	.81	
14RB-10X	100	18-14	.200	#10		.97	.31	.27	.81	
RB877-200	1,000	18-14	.200	#10		.97	.31	.27	.81	
14RB-14X	100	18-14	.200	1/4"		1.14	.50	.38	.89	
RB717-200	1,000	18-14	.200	1/4"		1.14	.50	.38	.89	
14RB-516X	100	18-14	.200	5/16"		1.15	.50	.38	.89	
14RB-38X	100	18-14	.200	3/8"		1.16	.54	.35	.91	
10RC-6X	50	12-10	.250	#6			1.06	.31	.27	.90
RC337-250	500	12-10	.250	#6			1.06	.31	.27	.90
10RC-8X	50	12-10	.250	#8			1.06	.31	.27	.90
RC777-250	500	12-10	.250	#8	1.06		.31	.27	.90	
10RC-10X	50	12-10	.250	#10	1.06		.31	.27	.90	
RC367-250	500	12-10	.250	#10	1.06		.31	.27	.90	
10RC-14X	50	12-10	.250	1/4"	1.16		.50	.27	.90	
RC717-250	500	12-10	.250	1/4"	1.16		.50	.27	.90	
10RC-516X	50	12-10	.250	5/16"	1.17		.50	.37	.92	
10RC-38X	50	12-10	.250	3/8"	1.29		.59	.44	.99	
RC737-250	500	12-10	.250	3/8"	1.29		.59	.44	.99	

For multiple wire combinations per UL File E9609, see page G-8.

Ring Terminals

Vinyl-Insulated Large Ring Terminals

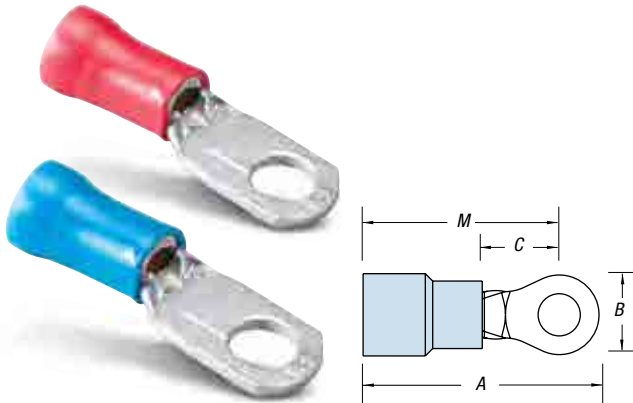

CAT. NO.	WIRE RANGE	MAX. INS.	BOLT HOLE	REC. TOOL	DIMENSIONS				STOCK THICK.
					A	B	C	M	
RDV167	8	.340	#8	ERG4007	1.48	.42	.28	1.17	.04
RDV367	8	.340	#10		1.48	.42	.28	1.17	
RDV717	8	.340	1/4"		1.54	.46	.36	1.20	
RDV727	8	.340	5/16"		1.63	.57	.36	1.23	
RDV737	8	.340	3/8"		1.63	.57	.36	1.23	
RDV757*	8	.310	1/2"	TBM6S	1.79	.82	.55	1.27	
REV267	6	.420	#10	ERG4007	1.65	.45	.28	1.23	
REV717	6	.420	1/4"		1.65	.49	.28	1.23	
REV727	6	.420	5/16"		1.76	.61	.34	1.30	
REV737	6	.420	3/8"		1.76	.61	.34	1.30	
REV757*	6	.395	1/2"		TBM6S	1.83	.82	.55	1.26

*Brazead Seam

Multiple Wire Combinations Listing per UL File E9609

TYPE (INSULATION)	WIRE RANGE (AWG) EACH SIDE
RA (Vinyl) Rings & Forks	(1) #22 (1) #22 with (1) #20
RB (Vinyl) Rings & Forks	(1) #16 with (1) #20 (2) #18 (1) #18 with (1) #20 (3) #20 (2) #20 (2) #20 with (2) #22 (1) #20 with (3) #22 (3) #22
RC (Vinyl) Rings & Forks	(1) #12 with (1) #16 (1) #14 with (1) or (2) #16 (1) #14 with (1) or (2) #18 (2) #14 (3) #16 (2) #16 (1) #16 with (3) #18 (1) #16 with (2) #18 (1) #16 with (4) #18 (1) #16 with (3) #18
RCC (Vinyl)	(1) #12 with (1) #16 (1) #14 with (1) or (2) #16 (1) #14 with (1) or (2) #18 (2) #14 (3) #16 (2) #16 (1) #16 with (3) #18 (1) #16 with (2) #18 (4) #18
RAA (Vinyl)	(2) #22 (1) #22 with (1) #20
RBB (Vinyl)	(1) #16 with (1) #20 (2) #18 (1) #18 with (1) #20 (3) #20 (2) #20 (2) #20 with (2) #22 (1) #20 with (3) #22 (3) #22

Recommended Hand Tools are WT145C and WT2000.

- No UL testing on disconnects for multiple wires
- No UL testing on nylon terminals for multiple wires
- No UL testing on non-insulated terminals for multiple wires

Ring Terminals

Constructed of electrolytic copper for high conductivity!

Non-Insulated Ring Terminals

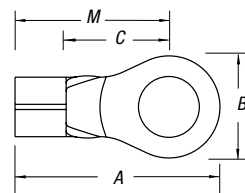

CAT. NO.	PKG. QTY.	WIRE RANGE	BOLT HOLE	REC. TOOL	DIMENSIONS				STOCK THICK.
					A	B	C	M	
A18-4	100	22-16	#4	ERG4002	.75	.31	.27	.59	.03
A18-6	100	22-16	#6		.72	.25	.27	.59	
A85	1,000	22-16	#6		.72	.25	.27	.59	
A18-8	100	22-16	#8		.75	.31	.27	.59	
A86	1,000	22-16	#8		.75	.31	.27	.59	
A18-10	100	22-16	#10		.75	.31	.27	.59	
A87	1,000	22-16	#10		.75	.31	.27	.59	
A18-14	100	22-16	1/4"		.92	.50	.37	.67	
A71	1,000	22-16	1/4"		.92	.50	.37	.67	
A18-516	100	22-16	5/16"		.92	.50	.37	.67	
A72	1,000	22-16	5/16"		.92	.50	.37	.67	
A18-38	100	22-16	3/8"		.99	.54	.35	.67	
A73	1,000	22-16	3/8"		.99	.54	.35	.67	
A18-12	100	22-16	1/2"		1.06	.72	.38	.70	
A75	1,000	22-16	1/2"		1.06	.72	.38	.70	
B14-4	100	18-14	#4	ERG4005	.72	.25	.27	.59	.03
B132	1,000	18-14	#4		.72	.25	.27	.59	
B14-6	100	18-14	#6		.72	.25	.27	.59	
B133	1,000	18-14	#6		.72	.25	.27	.59	
B14-8	100	18-14	#8		.75	.31	.27	.59	
B86	1,000	18-14	#8		.75	.31	.27	.59	
B14-10	100	18-14	#10		.75	.31	.27	.59	
B87	1,000	18-14	#10		.75	.31	.27	.59	
B14-14	100	18-14	1/4"		.93	.50	.38	.68	

Brazed Seam

CAT. NO.	PKG. QTY.	WIRE RANGE	BOLT HOLE	REC. TOOL	DIMENSIONS				STOCK THICK.	
					A	B	C	M		
B71	1,000	18-14	1/4"	ERG4002 ERG4005	.93	.50	.38	.68	.03	
B14-516	100	18-14	5/16"		.93	.50	.38	.68		
B72	1,000	18-14	5/16"		.93	.50	.38	.68		
B14-38	100	18-14	3/8"		.96	.54	.35	.68		
B73	1,000	18-14	3/8"		.96	.54	.35	.68		
B14-12	100	18-14	1/2"		1.06	.72	.38	.70		
B75-TB	1,000	18-14	1/2"		1.06	.72	.38	.70		
B85	1,000	18-14	#6		.75	.31	.27	.59		
B134	1,000	18-14	#8		.72	.25	.27	.59		
C10-6-SK	50	12-10	#6		.82	.31	.27	.66		.04
C33	500	12-10	#6		.82	.31	.27	.66		
C10-8-SK	50	12-10	#8		.82	.31	.27	.66		
C77	500	12-10	#8		.82	.31	.27	.66		
C10-10	50	12-10	#10		.85	.38	.27	.66		
C26	500	12-10	#10		.85	.38	.27	.66		
C36	500	12-10	#10	.82	.31	.27	.66			
C10-14	50	12-10	1/4"	.91	.50	.27	.66			
C71	500	12-10	1/4"	.91	.50	.27	.66			
C10-516	50	12-10	5/16"	.98	.50	.38	.73			
C70	500	12-10	5/16"	.98	.50	.38	.73			
C72	500	12-10	3/8"	1.10	.59	.45	.80			
C10-38	50	12-10	3/8"	1.10	.59	.45	.80			
C73	500	12-10	3/8"	1.10	.59	.45	.80			
C10-12	50	12-10	1/2"	1.21	.72	.38	.84			
C75	500	12-10	1/2"	1.21	.72	.38	.84			

Ring Terminals

Non-Insulated Large Ring Terminals — Brazed Seam



Wire Termination — Sta-Kon® Wire Termination & Insulation



CAT. NO.	PKG. QTY.	WIRE RANGE	BOLT HOLE	REC. TOOL	DIMENSIONS				STOCK THICK.
					A	B	C	M	
D8-10	25	8	#10	TBM6S	1.09	.42	.34	.90	.06
D36	200	8	#10		1.09	.42	.34	.90	
D26	200	8	#10		1.13	.48	.36	.90	
D8-14-SK	25	8	1/4"		1.13	.48	.36	.90	
D71	200	8	1/4"		1.13	.48	.36	.90	
D8-516	25	8	5/16"		1.32	.59	.49	1.03	
D72	200	8	5/16"		1.32	.59	.49	1.03	
D8-38	25	8	3/8"		1.32	.59	.49	1.03	
D73	200	8	3/8"		1.32	.59	.49	1.03	
D8-12	25	8	1/2"		1.49	.82	.55	1.09	
D75	200	8	1/2"		1.49	.82	.55	1.09	
E6-10	20	6	#10		1.13	.48	.36	.90	
E26	200	6	#10		1.13	.48	.36	.90	
E6-14	20	6	1/4"		1.13	.48	.36	.90	
E71	200	6	1/4"	1.13	.48	.36	.90		
E6-516	20	6	5/16"	1.32	.60	.49	1.03		

CAT. NO.	PKG. QTY.	WIRE RANGE	BOLT HOLE	REC. TOOL	DIMENSIONS				STOCK THICK.	
					A	B	C	M		
E72	200	6	5/16"	TBM6S	1.32	.60	.49	1.03	.06	
E6-38	20	6	3/8"		1.32	.60	.49	1.03		
E73	200	6	3/8"		1.32	.60	.49	1.03		
E6-12	20	6	1/2"		1.49	.82	.55	1.08		
E75	200	6	1/2"		1.49	.82	.55	1.08		
F4-10	20	4	#10		1.16	.48	.36	.93		.07
F26	200	4	#10		1.16	.48	.36	.93		
F4-14	20	4	1/4"		1.16	.48	.36	.93		
F71-TB	200	4	1/4"		1.16	.48	.36	.93		
F4-516	20	4	5/16"		1.35	.60	.49	1.06		
F72	200	4	5/16"		1.35	.60	.49	1.06		
F4-38	20	4	3/8"		1.35	.60	.49	1.06		
F73	200	4	3/8"		1.35	.60	.49	1.06		
F4-12	20	4	1/2"		1.52	.82	.55	1.11		
F75	200	4	1/2"	1.52	.82	.55	1.11			

Select the configuration you need!

Non-Insulated Large Ring Terminals — Tubular

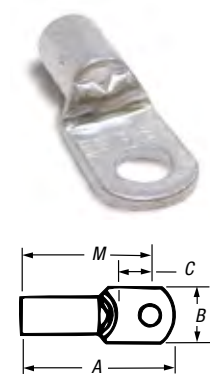

CAT. NO.	PKG. QTY.	WIRE RANGE	BOLT HOLE	REC. TOOL	DIMENSIONS				STOCK THICK.	
					A	B	C	M		
D10161	200	8/8AN	#8	ERG 4005	1.15	.41	.28	.95	.04	
D10361	200	8/8AN	#10		1.15	.41	.28	.95		
D10711	200	8/8AN	1/4"		1.20	.45	.36	.97		
D10721	200	8/8AN	5/16"		1.28	.56	.36	1.00		
D10731	200	8/8AN	3/8"		1.28	.56	.36	1.00		
D975*	200	8/8AN	1/2"	TBM6S	1.46	.83	.49	1.06		
E10261	200	6/6AN	#10	ERG 4005	1.26	.49	.24	1.02	.04	
E10711	200	6/6AN	1/4"		1.26	.49	.27	.99		
E10721	200	6/6AN	5/16"		1.38	.60	.34	1.04		
E10731	200	6/6AN	3/8"		1.38	.60	.34	1.04		
F10261	100	4/4AN	#10	ERG 4008	1.37	.55	.30	1.07	.06	
F10711	100	4/4AN	1/4"		1.37	.55	.30	1.07		
F10721	100	4/4AN	5/16"		1.42	.62	.34	1.08		
F10731	100	4/4AN	3/8"		1.42	.62	.34	1.08		
F975*	200	4/4AN	1/2"		TBM6S	1.49	.83	.45		1.10
G926	100	2/2AN	#10	ERG 4008	1.59	.69	.40	1.26	.07	
G2-14	10	2/2AN	1/4"		1.59	.69	.40	1.26		
G971	100	2/2AN	5/16"		1.59	.69	.40	1.26		
G2-516	10	2/2AN	5/16"		1.59	.69	.40	1.26		
G972	100	2/2AN	5/16"		1.59	.69	.40	1.26		
G2-38	10	2/2AN	3/8"		TBM6S	1.59	.69	.40		1.26
G973	100	2/2AN	3/8"		1.59	.69	.40	1.26		
G2-12	10	2/2AN	1/2"		1.79	.80	.49	1.36		
G975	100	2/2AN	1/2"		1.79	.80	.49	1.36		

*Brazed Seam

AN — Aircraft Wire

CAT. NO.	PKG. QTY.	WIRE RANGE	BOLT HOLE	REC. TOOL	DIMENSIONS				STOCK THICK.
					A	B	C	M	
H10-14	10	1AN-1/0	1/4"	ERG 4008	1.65	.77	.43	1.32	.05
H971	100	1AN-1/0	1/4"		1.65	.77	.43	1.32	
H972	100	1AN-1/0	5/16"		1.65	.77	.43	1.32	
H973	100	1AN-1/0	3/8"		1.65	.77	.43	1.32	
H975	100	1AN-1/0	1/2"		1.85	.77	.54	1.41	
J971	50	1/0AN-2/0	1/4"	TBM6S	1.94	.84	.48	1.53	.06
J972	50	1/0AN-2/0	5/16"		1.94	.84	.48	1.53	
J20-38	10	1/0AN-2/0	3/8"		1.84	.83	.46	1.46	
J973	50	1/0AN-2/0	3/8"		1.99	.84	.53	1.58	
J974	50	1/0AN-2/0	7/16"		1.99	.89	.51	1.56	
J975	50	1/0AN-2/0	1/2"		1.99	.89	.51	1.56	
J976	50	1/0AN-2/0	5/8"		1.99	.89	.51	1.56	
K971	50	2/0AN-3/0	1/4"		2.08	.93	.54	1.69	
K972	50	2/0AN-3/0	5/16"		2.08	.93	.54	1.69	
K30-38	5	2/0AN-3/0	3/8"		2.08	.93	.54	1.69	
K973	50	2/0AN-3/0	3/8"		2.08	.93	.54	1.69	
K974	50	2/0AN-3/0	7/16"		2.08	.93	.54	1.70	
K975	50	2/0AN-3/0	1/2"		2.08	.93	.54	1.70	
L971	50	3/0AN-4/0	1/4"		TBM6S	2.25	1.04	.57	
L972	50	3/0AN-4/0	5/16"	2.25		1.04	.57	1.77	
L40-38	5	3/0AN-4/0	3/8"	2.25		1.04	.57	1.77	
L973	50	3/0AN-4/0	3/8"	2.25		1.04	.57	1.77	
L974	50	3/0AN-4/0	7/16"	2.25		1.04	.57	1.77	
L975	50	3/0AN-4/0	1/2"	2.25		1.04	.57	1.77	
M972	50	4/0AN-250kcmil	5/16"	2.28		1.12	.62	1.90	
M250-38	5	4/0AN-250kcmil	3/8"	2.40		1.12	.65	1.91	
M973	50	4/0AN-250kcmil	3/8"	2.40		1.12	.65	1.91	
M974	50	4/0AN-250kcmil	7/16"	2.40		1.12	.65	1.91	
M975	50	4/0AN-250kcmil	1/2"	2.40		1.12	.65	1.91	

Ring Terminals

Insulated Heavy-Duty Ring Terminals

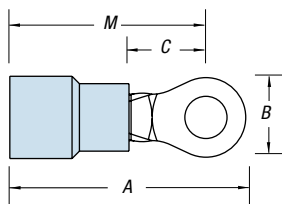

CAT. NO.	PKG. QTY.	WIRE RANGE	MAX. INS.	BOLT HOLE	REC. TOOL	DIMENSIONS				STOCK THICK.
						A	B	C	M	
<i>Nylon</i>										
RBC14-6	50	16-14 Heavy-duty	.210	#6	WT2130A	.98	.25	.29	.85	.05
RBC14-8	50	16-14 Heavy-duty	.210	#8		1.04	.39	.29	.85	
RBC863	500		.210	#8		1.04	.39	.29	.85	
RBC14-10	50	16-14 Heavy-duty	.210	#10		1.04	.39	.29	.85	
RBC14-14	50	16-14 Heavy-duty	.210	1/4"		1.10	.51	.29	.85	
RBC713	500		.210	1/4"		1.10	.51	.29	.85	
RBC14-516	50	16-14 Heavy-duty	.210	5/16"		1.21	.54	.38	.94	
RBC14-38	50	16-14 Heavy-duty	.210	3/8"		1.26	.63	.38	.94	
RBC14-12	50	16-14 Heavy-duty	.210	1/2"		1.49	.76	.54	1.11	
RBC753	500		.210	1/2"		1.49	.76	.54	1.11	
<i>Vinyl</i>										
14RBC-6	50	16-14 Heavy-duty	.210	#6	WT2130A	1.06	.25	.29	.93	.05
RBC857	500		.210	#6		1.06	.25	.29	.93	
14RBC-8	50	16-14 Heavy-duty	.210	#8		1.13	.39	.29	.93	
RBC867	500		.210	#8		1.13	.39	.29	.93	
14RBC-10	50	16-14 Heavy-duty	.210	#10		1.13	.39	.29	.93	
RBC877	500		.210	#10		1.13	.39	.29	.93	
14RBC-14	50	16-14 Heavy-duty	.210	1/4"		1.19	.51	.29	.93	
RBC717	500		.210	1/4"		1.19	.51	.29	.93	
14RBC-516	50	16-14 Heavy-duty	.210	5/16"		1.29	.54	.38	1.03	
RBC727	500		.210	5/16"		1.29	.54	.38	1.03	
14RBC-38	50	16-14 Heavy-duty	.210	3/8"		1.34	.63	.38	1.03	
RBC797	500		.210	3/8"		1.34	.63	.38	1.03	
14RBC-12	50	16-14 Heavy-duty	.210	1/2"		1.57	.76	.54	1.19	
RB757	500		.210	1/2"		1.57	.76	.54	1.19	

Wire Termination — Sta-Kon® Wire Termination & Insulation

The heavy-duty terminal solution!

Non-Insulated Heavy-Duty Ring Terminals

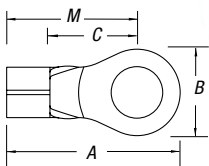

CAT. NO.	PKG. QTY.	WIRE RANGE	BOLT HOLE	REC. TOOL	DIMENSIONS				STOCK THICK.
					A	B	C	M	
BC14-6	50	16-14 Heavy-duty	#6	ER4002 ERG4005	.81	.25	.29	.68	.05
BC85	500		#6		.81	.25	.29	.68	
BC14-8	50	16-14 Heavy-duty	#8		.87	.39	.29	.68	
BC86	500		#8		.87	.39	.29	.68	
BC14-10	50	16-14 Heavy-duty	#10		.87	.39	.29	.68	
BC87	500		#10		.87	.39	.29	.68	
BC14-14	50	16-14 Heavy-duty	1/4"		.93	.51	.29	.68	
BC71	500		1/4"		.93	.51	.29	.68	
BC14-516	50	16-14 Heavy-duty	5/16"		1.04	.54	.38	.77	
BC72	500		5/16"		1.04	.54	.38	.77	
BC14-38	50	16-14 Heavy-duty	3/8"		1.09	.63	.38	.77	
BC79	500		3/8"		1.09	.63	.38	.77	
BC14-12	50	16-14 Heavy-duty	1/2"		1.32	.76	.54	.94	
BC75	500		1/2"		1.32	.76	.54	.94	



Ring Terminals

Terminals for nichrome wire NW Series.

High-Temperature Non-Insulated Rings — 1200° F Max.

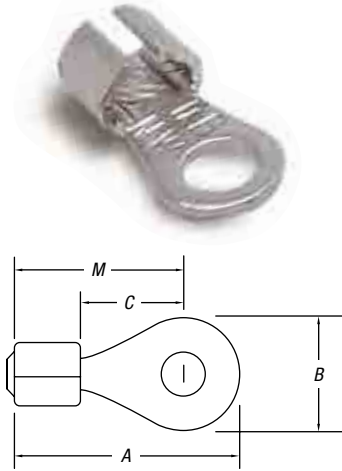

CAT. NO.	PKG. QTY.	WIRE RANGE	WT./LBS. PER 1,000	BOLT HOLE	REC. TOOL	DIMENSIONS				STOCK THICK.
						A	B	C	M	
NW18-10	100	20-18	2.5	#10	WT1377	.63	.31	.28	.38	.032
NW52	1,000	20-18	2.5	#8		.63	.31	.28	.38	
NW81	1,000	16-14	2.5	#6		.66	.31	.28	.51	.040
NW14-8	100	16-14	2.5	#8		.66	.31	.28	.51	
NW14-10	100	16-14	2.5	#10		.66	.31	.28	.51	
NW83	1,000	16-14	2.5	#10		.66	.31	.28	.51	
NW14-12	100	16-14	2.5	#12*		.66	.31	.28	.51	
NW84	1,000	16-14	2.5	#12*		.66	.31	.28	.51	
NW10-8	50	12-10	3	#8		.66	.31	.28	.51	
NW10-10	50	12-10	3	#10		.66	.31	.28	.51	
NW10-12	50	12-10	3	#12*		.66	.31	.28	.51	

* #12 stud is smaller than 1/4" stud.

Tefzel® Insulated Rings — Insulation Grip

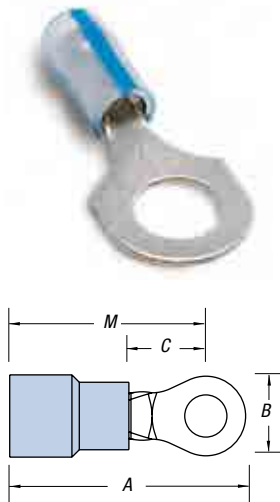

CAT. NO.	PKG. QTY.	WIRE RANGE	MAX. INS.	BOLT HOLE	REC. TOOL	DIMENSIONS				STOCK THICK.
						A	B	C	M	
RAT853	1,000	22-18	.140	#6	WT145C	.81	.25	.25	.69	.03
RAT863	1,000	22-18	.140	#8		.84	.31	.25	.69	
RAT873	1,000	22-18	.140	#10		.84	.31	.25	.69	
RAT713	1,000	22-18	.140	1/4"		1.07	.46	.31	.84	
RBT853	1,000	16-14	.170	#6		.84	.31	.25	.69	
RBT863	1,000	16-14	.170	#8		.84	.31	.25	.69	
RBT873	1,000	16-14	.170	#10		.84	.31	.25	.69	
RBT713	1,000	16-14	.170	1/4"		1.08	.46	.31	.81	
RCT333	500	12-10	.210	#6		1.00	.37	.27	.81	.04
RCT863	500	12-10	.210	#8		1.00	.37	.27	.81	
RCT363	500	12-10	.210	#10		1.00	.37	.27	.81	
RCT713	500	12-10	.210	1/4"		1.11	.52	.32	.85	
RCT703	500	12-10	.210	5/16"	1.23	.52	.31	.96		
RCT733	500	12-10	.210	3/8"	1.29	.58	.35	1.00		

Tefzel® is a registered trademark of DuPont.

Ring Terminals

Nylon-Insulated Rectangular Rings

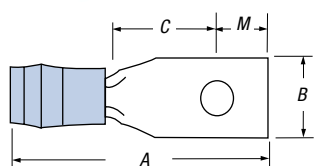

CAT. NO.	PKG. QTY.	BOLT HOLE	WIRE RANGE	REC. TOOL	DIMENSIONS				BU-SHIPS TONGUE SHAPE	STOCK THICK.	
					A	B	C	M			
RA486	1,000	#4	22-18		.796	.237	.237	.143	L86P-1	.03	
RA485	1,000	#4	22-18		1.015	.237	.404	.195	L85P-1		
RA483	1,000	#5	22-18		.859	.277	.277	.143	L83P-1		
RA484	1,000	#6	22-18		1.015	.237	.404	.195	L84P-1		
RA481	1,000	#6	22-18		1.109	.302	.465	.227	L81P-1		
RA482	1,000	#8	22-18		1.109	.302	.465	.227	L82P-1		
RA480*	1,000	#8	22-18		1.359	.390	.621	.310	L80P-1		
RB486	1,000	#4	16-14		.796	.237	.237	.143	L86P-2		
RB485	1,000	#4	16-14		1.015	.237	.404	.195	L85P-2		
RB483	1,000	#5	16-14		.859	.277	.277	.143	L83P-2		
RB484	1,000	#6	16-14	ERG4001	1.015	.237	.404	.195	L84P-2		
RB481	1,000	#6	16-14		1.109	.302	.465	.227	L81P-2		
RB482	1,000	#8	16-14		1.109	.302	.465	.227	L82P-2		
RB480*	1,000	#8	16-14		1.359	.390	.621	.310	L80P-2		
RC486	500	#4	12-10		.984	.237	.237	.143	L86P-3		.04
RC485	500	#4	12-10		1.187	.237	.404	.195	L85P-3		
RC483	500	#5	12-10		1.046	.277	.277	.143	L83P-3		
RC484	500	#6	12-10		1.203	.237	.404	.195	L84P-3		
RC481	500	#6	12-10		1.281	.302	.465	.227	L81P-3		
RC482	500	#8	12-10		1.281	.302	.465	.227	L82P-3		
RC480*	500	#8	12-10		1.531	.390	.621	.310	L80P-3		

* Not available on tape.

Note: RA, RB, RC486 for use with BU-Ships terminal board types 26TB. RA, RB, RC485 for use with 25TB and 27TB. RA, RB, RC483 for use with 8TB. RA, RB, RC484 for use with 10TB and 11TB. RA, RB, RC481 for use with 6TB, 7TB and 9TB. RA, RB, RC482 for use with 15TB. RA, RB, RC480 for use with 3TB, 4TB, 5TB, 16TB, 17TB and 18TB.

Note:

22-18 ga. = 1-2 Navy
 16-14 ga. = 2/-4 Navy
 12-10 ga. = 6-9 Navy

Non-Insulated Rectangular Rings

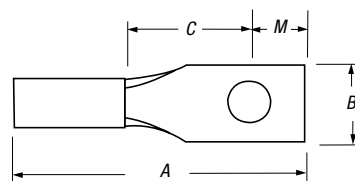

CAT. NO.	PKG. QTY.	BOLT HOLE	WIRE RANGE	REC. TOOL	DIMENSIONS				BU-SHIPS TONGUE SHAPE	STOCK THICK.	
					A	B	C	M			
A486	1,000	#4	22-18		.65	.237	.237	.143	L86	.03	
A485	1,000	#4	22-18		.87	.237	.404	.195	L85		
A483	1,000	#5	22-18		.70	.277	.277	.143	L83		
A484	1,000	#6	22-18	ERG4002	.87	.237	.404	.195	L84		
A481	1,000	#6	22-18		.96	.302	.465	.227	L81		
A482	1,000	#8	22-18		.96	.302	.465	.227	L82		
A480*	1,000	#8	22-18		1.21	.390	.621	.310	L80		
B486	1,000	#4	16-14		.65	.237	.237	.143	L86		
B485	1,000	#4	16-14		.87	.237	.404	.195	L85		
B483	1,000	#5	16-14		.70	.277	.277	.143	L83		
B484	1,000	#6	16-14		.87	.237	.404	.195	L84		
B481	1,000	#6	16-14		.96	.302	.465	.227	L81		
B482	1,000	#8	16-14		.96	.302	.465	.227	L82		
B480*	1,000	#8	16-14	ERG4002	1.21	.390	.621	.310	L80		
C486	500	#4	12-10	ERG4005	.73	.237	.237	.143	L86		.04
C485	500	#4	12-10		.90	.237	.404	.195	L85		
C483	500	#5	12-10		.76	.277	.277	.143	L83		
C484	500	#6	12-10		.94	.237	.404	.195	L84		
C481	500	#6	12-10		1.03	.302	.465	.227	L81		
C482	500	#8	12-10		1.03	.302	.465	.227	L82		
C480*	500	#8	12-10		1.27	.390	.621	.310	L80		

* Not available on tape.

Note: A, B, C486 for use with BU-Ships terminal board types 26TB. A, B, C485 for use with 25TB, 27TB. A, B, C483 for use with 8TB. A, B, C484 for use with 10TB and 11TB. A, B, C481 for use with 6TB, 7TB and 9TB. A, B, C482 for use with 15TB. A, B, C480 for use with 3TB, 5TB, 16TB, 17TB and 18TB.

Note:

22-18 ga. = 1-2 Navy
 16-14 ga. = 2/-4 Navy
 12-10 ga. = 6-9 Navy

Flag Terminals

Non-Insulated Flags

Wire Termination — Sta-Kon® Wire Termination & Insulation

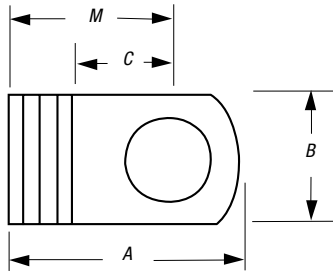
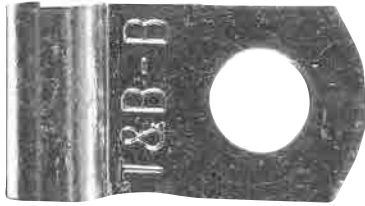

CAT. NO.	PKG. QTY.	WIRE RANGE	BOLT HOLE	REC. TOOL	DIMENSIONS				STOCK THICK.	
					A	B	C	M		
AB14-6A	100	22-14	#6	ERG4004	.55	.31	.22	.39	.03	
AB51	1,000	22-14	#6		.55	.31	.22	.39		
AB14-8A	100	22-14	#8		.55	.31	.22	.39		
AB52	1,000	22-14	#8		.55	.31	.22	.39		
AB14-10A	100	22-14	#10		.55	.31	.22	.39		
AB53	1,000	22-14	#10		.55	.31	.22	.39		
C51	500	12-10	#6	WT129	.66	.31	.25	.48	.04	
C10-8A	50	12-10	#8		.66	.31	.25	.48		
C52	500	12-10	#8		.66	.31	.25	.48		
C10-10A	50	12-10	#10		.66	.31	.25	.48		
C53	500	12-10	#10		.66	.31	.25	.48		
D236	200	8	#10		13642M	.83	.50	.25		.59
D226	200	8	#10	.90		.50	.29	.64		
D271	200	8	1/4"	.92		.50	.33	.68		
E226	200	6	#10	.93		.50	.29	.69		
E271	200	6	1/4"	.99		.50	.33	.73		
E272	200	6	5/16"	1.05		.50	.41	.81		
F226	200	4	#10	1.07		.56	.33	.80	.07	
F271	200	4	1/4"	1.10		.63	.33	.80		
F272	200	4	5/16"	1.18		.63	.41	.88		
F273	200	4	3/8"	1.20		.63	.43	.90		
G671	100	2	1/4"	13642M	1.20	.63	.33	.89	.08	
G672	100	2	5/16"		1.28	.63	.41	.97		
G673	100	2	3/8"		1.32	.63	.46	1.02		
H672	50	1/0	5/16"		1.31	.63	.41	1.01		.10
H673	50	1/0	3/8"		1.36	.63	.46	1.06		
J672	50	2/0	5/16"		1.46	.75	.41	1.10		
J673	50	2/0	3/8"		1.51	.75	.46	1.15		
J675	50	2/0	1/2"		1.67	.75	.55	1.24		.11
K672	50	3/0	5/16"		1.59	.81	.41	1.19		
K673	50	3/0	3/8"		1.64	.81	.46	1.24		
K675	50	3/0	1/2"	1.76	.81	.55	1.34			
M673	50	250kcmil	3/8"	13642M	1.89	1.0	.46	1.43	.13	
M675	50	250kcmil	1/2"		1.99	1.0	.55	1.52		

Fork Terminals

- Fork terminals enable easy installation because the mounting screw does not have to be completely removed
- Brazed-seam barrel is serrated for high pull-out value. Terminal is high-conductivity electrolytic copper, electro-tin plated.
- Insulation is color coded
- Vinyl-insulated fork terminals have extra-long PVC insulation sleeve for protection and stress relief at wire's flex point
- Suffix "X" indicates an expanded insulation support, meaning a wider wire entry to accommodate heavy wall insulation



Nylon-Insulated Forks

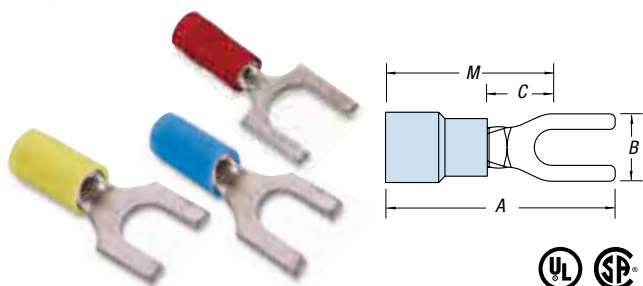

CAT. NO.	PKG. QTY.	WIRE RANGE	MAX. INS.	BOLT HOLE	REC. TOOL	DIMENSIONS				STOCK THICK.	
						A	B	C	M		
RA18-6F	100	22-16	.136	#6	ERG4001	.83	.25	.25	.71	.02	
RA1103	1,000	22-16	.136	#6		.83	.25	.25	.71		
RA18-8F	100	22-16	.136	#8		.86	.31	.25	.71		
RA1123	1,000	22-16	.136	#8		.86	.31	.25	.71		
RA18-10F	100	22-16	.136	#10		.86	.31	.25	.71		
RA1153	1,000	22-16	.136	#10		.86	.31	.25	.71		
RA18-14F	100	22-16	.136	1/4"		.95	.44	.31	.70		
RA1163	1,000	22-16	.136	1/4"		.95	.44	.31	.70		
RB14-6F	100	18-14	.162	#6		.87	.31	.25	.71		.03
RB1113	1,000	18-14	.162	#6		.87	.31	.25	.71		
RB14-8F	100	18-14	.162	#8	.87	.31	.25	.71			
RB1123	1,000	18-14	.162	#8	.87	.31	.25	.71			
RB14-10F	100	18-14	.162	#10	.87	.38	.25	.71			
RB1153	1,000	18-14	.162	#10	.87	.38	.25	.71			
RB14-14F	100	18-14	.162	1/4"	.95	.44	.28	.74			
RB1163	1,000	18-14	.162	1/4"	.95	.44	.28	.74			
RB1103	1,000	18-14	.162	#6	.74	.28	.16	.60			
RB1124	1,000	18-14	.190	#8	.95	.31	.25	.79			
RB1154	1,000	18-14	.190	#10	.95	.31	.25	.79			
RC10-6F	50	12-10	.210	#6	ERG4001	.97	.31	.27	.81	.04	
RC1113	500	12-10	.210	#6		.97	.31	.27	.81		
RC10-8F	50	12-10	.210	#8		1.00	.37	.27	.81		
RC1123	500	12-10	.210	#8		1.00	.37	.27	.81		
RC10-10F	50	12-10	.210	#10		1.00	.37	.27	.81		
RC1153	500	12-10	.210	#10		1.00	.37	.27	.81		
RC10-14F	50	12-10	.210	1/4"		1.12	.50	.27	.86		
RC1163	500	12-10	.210	1/4"		1.12	.50	.27	.86		
RC1124	1,000	12-10	.250	#8		1.10	.37	.27	.91		
RC1154	1,000	12-10	.250	#10		1.10	.37	.27	.91		
RC10-6FL	50	12-10	.210	#6		.97	.31	.27	.81		.04
RC2203	500	12-10	.210	#6		.97	.31	.27	.81		
RC2204	1,000	12-10	.250	#6		1.07	.31	.27	.91		
RC10-8FL	50	12-10	.210	#8		1.00	.37	.27	.81		
RC2213	500	12-10	.210	#8		1.00	.37	.27	.81		
RC10-10FL	50	12-10	.210	#10	1.00	.37	.27	.81			
RC2223	500	12-10	.210	#10	1.00	.37	.27	.81			
RC2224	1,000	12-10	.250	#10	1.10	.37	.27	.91			
RC10-14FL	50	12-10	.210	1/4"	1.12	.50	.32	.86			
RC2233	500	12-10	.210	1/4"	1.12	.50	.32	.86			

Nylon-Insulated Locking Forks

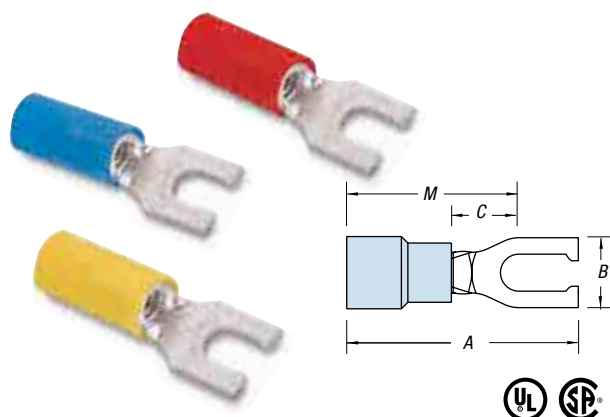

CAT. NO.	PKG. QTY.	WIRE RANGE	MAX. INS.	BOLT HOLE	REC. TOOL	DIMENSIONS				STOCK THICK.	
						A	B	C	M		
RA18-6FL	100	22-16	.136	#6	ERG4001	.86	.25	.25	.71	.02	
RA2213	1,000	22-16	.136	#6		.86	.25	.25	.71		
RA18-8FL	100	22-16	.136	#8		.86	.29	.25	.71		
RA2243	1,000	22-16	.136	#8		.86	.29	.25	.71		
RA18-10FL	100	22-16	.136	#10		.86	.29	.25	.71		
RA2253	1,000	22-16	.136	#10		.86	.29	.25	.71		
RB14-6FL	100	18-14	.162	#6		.87	.25	.25	.71		.03
RB2213	1,000	18-14	.162	#6		.87	.25	.25	.71		
RB2214	1,000	18-14	.190	#6		.95	.25	.25	.79		
RB14-8FL	100	18-14	.162	#8		.87	.29	.25	.71		
RB2233	1,000	18-14	.162	#8	.87	.29	.25	.71			
RB14-10FL	100	18-14	.162	#10	.87	.29	.25	.71			
RB2253	1,000	18-14	.162	#10	.87	.29	.25	.71			
RB2254	1,000	18-14	.190	#10	.95	.29	.25	.71			
RC10-6FL	50	12-10	.210	#6	.97	.31	.27	.81	.04		
RC2203	500	12-10	.210	#6	.97	.31	.27	.81			
RC2204	1,000	12-10	.250	#6	1.07	.31	.27	.91			
RC10-8FL	50	12-10	.210	#8	1.00	.37	.27	.81			
RC2213	500	12-10	.210	#8	1.00	.37	.27	.81			
RC10-10FL	50	12-10	.210	#10	1.00	.37	.27	.81			
RC2223	500	12-10	.210	#10	1.00	.37	.27	.81			
RC2224	1,000	12-10	.250	#10	1.10	.37	.27	.91			
RC10-14FL	50	12-10	.210	1/4"	1.12	.50	.32	.86			
RC2233	500	12-10	.210	1/4"	1.12	.50	.32	.86			

Fork Terminals

Nylon-Insulated Forks — Flanged Tongue

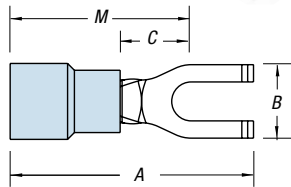
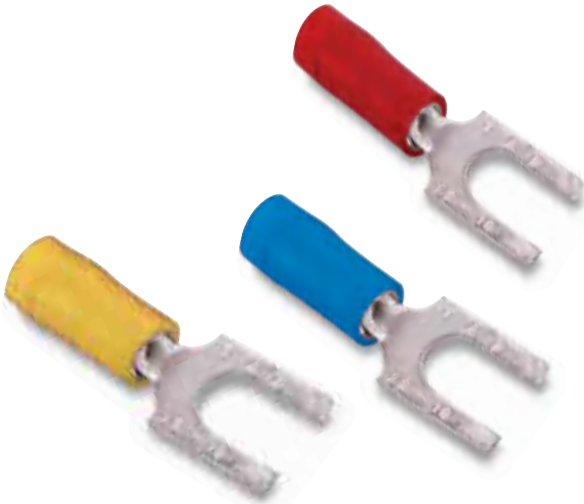

CAT. NO.	PKG. QTY.	WIRE RANGE	MAX. INS.	BOLT HOLE	REC. TOOL	DIMENSIONS				STOCK THICK.
						A	B	C	M	
RA18-6FS	100	22-16	.136	#6	ERG4001	.75	.28	.16	.62	.02
RA1203	1,000	22-16	.136	#6		.75	.28	.16	.62	
RA18-8FS	100	22-16	.136	#8		.89	.31	.23	.65	
RA1223	1,000	22-16	.136	#8		.89	.31	.23	.65	
RA18-10FS	100	22-16	.136	#10		.93	.38	.26	.68	
RA1253	1,000	22-16	.136	#10		.93	.38	.26	.68	
RB14-6FS	100	18-14	.162	#6		.74	.28	.16	.60	.03
RB1203	1,000	18-14	.162	#6		.74	.28	.16	.60	
RB14-8FS	100	18-14	.162	#8		.89	.31	.23	.66	
RB1223	1,000	18-14	.162	#8		.89	.31	.23	.66	
RB14-10FS	100	18-14	.162	#10		.94	.38	.27	.69	
RB1253	1,000	18-14	.162	#10		.94	.38	.27	.69	
RB1204	1,000	18-14	.190	#6	.79	.28	.16	.67		
RB1224	1,000	18-14	.190	#8	.94	.31	.23	.71		
RC10-8FS	50	12-10	.210	#8		.97	.34	.23	.73	.04
RC1223	500	12-10	.210	#8		.97	.34	.23	.73	
RC10-10FS	50	12-10	.210	#10		1.00	.38	.26	.74	
RC1253	500	12-10	.210	#10		1.00	.38	.26	.74	
RC1224	1,000	12-10	.250	#8		1.08	.34	.23	.80	
RC1254	1,000	12-10	.250	#10		1.12	.38	.26	.86	

Vinyl-Insulated Forks

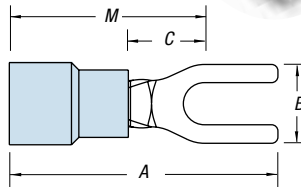

CAT. NO.	PKG. QTY.	WIRE RANGE	MAX. INS.	BOLT HOLE	REC. TOOL	DIMENSIONS				STOCK THICK.
						A	B	C	M	
18RA-6F	100	22-16	.150	#6	ERG4001	.94	.25	.27	.81	.02
RA1167	1,000	22-16	.150	#6		.94	.25	.27	.81	
18RA-8F	100	22-16	.150	#8		.97	.31	.27	.81	
RA1147	1,000	22-16	.150	#8		.97	.31	.27	.81	
18RA-10F	100	22-16	.150	#10		.97	.31	.27	.81	
RA1157	1,000	22-16	.150	#10		.97	.31	.27	.81	
14RB-6F	100	18-14	.170	#6		.97	.31	.27	.81	.03
RB647	1,000	18-14	.170	#6		.97	.31	.27	.81	
14RB-6FS	100	18-14	.170	#6		.89	.30	.25	.75	
14RB-8F	100	18-14	.170	#8		.97	.31	.27	.81	
RB657	1,000	18-14	.170	#8		.97	.31	.27	.81	
14RB-10F	100	18-14	.170	#10		.97	.31	.27	.81	
RB1157	1,000	18-14	.170	#10	.97	.31	.27	.81		
14RB-14F	100	18-14	.170	¼"	1.11	.44	.38	.89		
RB1717	1,000	18-14	.170	¼"	1.11	.44	.38	.89		
10RC-6F	50	12-10	.210	#6		1.09	.31	.27	.90	.04
RC1337	500	12-10	.210	#6		1.09	.31	.27	.90	
10RC-8F	50	12-10	.210	#8		1.09	.38	.27	.90	
RC1147	500	12-10	.210	#8		1.09	.38	.27	.90	
10RC-10F	50	12-10	.210	#10		1.09	.38	.27	.90	
RC1157	500	12-10	.210	#10		1.09	.38	.27	.90	
10RC-14F	50	12-10	.210	¼"		1.15	.50	.37	.90	
RC1167	500	12-10	.210	¼"		1.15	.50	.37	.90	

For multiple wire combinations per UL File E9609, see page G-8.

Fork Terminals

Vinyl-Insulation Forks — Expanded Insulation

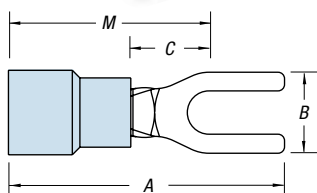

CAT. NO.	PKG. QTY.	WIRE RANGE	MAX. INS.	BOLT HOLE	REC. TOOL	DIMENSIONS				STOCK THICK.	
						A	B	C	M		
18RA-6FX	100	22-16	.170	#6	ERG4001	.94	.25	.27	.81	.02	
RA1167-170	1,000	22-16	.170	#6		.94	.25	.27	.81		
18RA-8FX	100	22-16	.170	#8		.97	.31	.27	.81		
RA1147-170	1,000	22-16	.170	#8		.97	.31	.27	.81		
18RA-10FX	100	22-16	.170	#10		.97	.31	.27	.81		
RA1157-170	1,000	22-16	.170	#10		.97	.31	.27	.81		
14RB-6FX	100	18-14	.200	#6		.97	.31	.27	.81		.03
RB647-200	1,000	18-14	.200	#6		.97	.31	.27	.81		
14RB-8FX	100	18-14	.200	#8		.97	.31	.27	.81		
RB657-200	1,000	18-14	.200	#8		.97	.31	.27	.81		
14RB-10FX	100	18-14	.200	#10	.97	.31	.27	.81			
RB1157-200	1,000	18-14	.200	#10	.97	.31	.27	.81			
10RC-8FX	50	12-10	.250	#8		1.11	.38	.27	.90	.04	
RC1147-250	500	12-10	.250	#8		1.11	.38	.27	.90		
10RC-10FX	50	12-10	.250	#10		1.11	.38	.27	.90		
RC1157-250	500	12-10	.250	#10		1.11	.38	.27	.90		
10RC-14FX	50	12-10	.250	¼"		1.17	.50	.37	.90		

For multiple wire combinations per UL File E9609, see page G-8.

Vinyl-Insulated Locking Forks

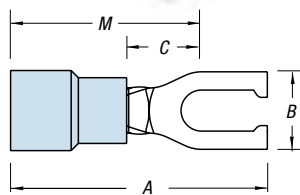

CAT. NO.	PKG. QTY.	WIRE RANGE	MAX. INS.	BOLT HOLE	REC. TOOL	DIMENSIONS				STOCK THICK.	
						A	B	C	M		
18RA-6FL	100	22-16	.150	#6	ERG4001	.97	.25	.25	.81	.02	
RA2217	1,000	22-16	.150	#6		.97	.25	.25	.81		
RA2227	1,000	22-16	.155	#6		.97	.29	—	.81		
18RA-8FL	100	22-16	.150	#8		.97	.29	.25	.81		
RA2247	1,000	22-16	.150	#8		.97	.29	.25	.81		
18RA-10FL	100	22-16	.150	#10		.97	.29	.25	.81		
RA2257	1,000	22-16	.150	#10		.97	.29	.25	.81		
14RB-6FL	100	18-14	.170	#6		.97	.25	.27	.81		.03
RB2207	1,000	18-14	.170	#6		.97	.25	.27	.81		
RB2217	1,000	18-14	.170	#6		.97	.29	.27	.81		
14RB-8FL	100	18-14	.170	#8	.97	.29	.27	.81			
RB2237	1,000	18-14	.170	#8	.97	.29	.27	.81			
14RB-10FL	100	18-14	.170	#10	.97	.29	.27	.81	.04		
RB2257	1,000	18-14	.170	#10	.97	.29	.27	.81			
10RC-6FL	50	12-10	.220	#6	1.09	.31	.27	.90			
RC2207	500	12-10	.220	#6	1.09	.31	.27	.90			
10RC-8FL	50	12-10	.220	#8	1.09	.37	.27	.90			
RC2217	500	12-10	.220	#8	1.09	.37	.27	.90			
10RC-10FL	50	12-10	.220	#10	1.09	.37	.27	.90			
RC2227	500	12-10	.220	#10	1.09	.37	.27	.90			
10RC-14FL	50	12-10	.220	¼"	1.09	.49	.27	.90	.04		
RC2237	500	12-10	.220	¼"	1.09	.49	.27	.90			

For multiple wire combinations per UL File E9609, see page G-8.

Fork Terminals

Vinyl-Insulated Locking Forks — Expanded Insulation

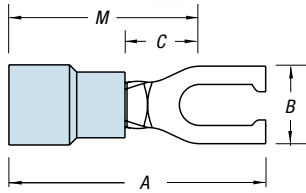

CAT. NO.	PKG. QTY.	WIRE RANGE	MAX. INS.	BOLT HOLE	REC. TOOL	DIMENSIONS				STOCK THICK.
						A	B	C	M	
18RA-6FLX	100	22-16	.170	#6	ERG4001	.97	.25	.25	.81	.02
RA2217-170	1,000	22-16	.170	#6		.97	.25	.25	.81	
18RA-8FLX	100	22-16	.170	#8		.97	.29	.25	.81	
18RA-10FLX	100	22-16	.170	#10		.97	.29	.25	.81	
RA2257-170	1,000	22-16	.170	#10		.97	.29	.25	.81	
14RB-6FLX	100	18-14	.200	#6		.97	.31	.27	.81	.03
RB2207-200	1,000	18-14	.200	#6		.97	.31	.27	.81	
RB2217-200	1,000	18-14	.200	#6		.97	.29	.27	.81	
14RB-8FLX	100	18-14	.200	#8		.97	.31	.27	.81	
RB2237-200	1,000	18-14	.200	#8		.97	.31	.27	.81	
14RB-10FLX	100	18-14	.200	#10	.97	.31	.27	.81	.04	
RB2257-200	1,000	18-14	.200	#10	.97	.31	.27	.81		
10RC-6FLX	50	12-10	.250	#6	1.07	.31	.27	.91		
RC2207-250	500	12-10	.250	#6	1.07	.31	.27	.91		
10RC-8FLX	50	12-10	.250	#8	1.10	.37	.27	.91		
10RC-10FLX	50	12-10	.250	#10	1.10	.37	.27	.91	.04	
RC2227-250	500	12-10	.250	#10	1.10	.37	.27	.91		
10RC-14FLX	50	12-10	.250	1/4"	1.22	.50	.32	.96		

For multiple wire combinations per UL File E9609, see page G-8.

Non-Insulated Forks

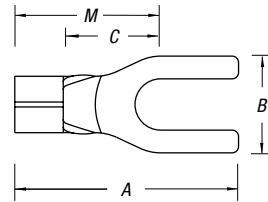

CAT. NO.	PKG. QTY.	WIRE RANGE	BOLT HOLE	REC. TOOL	DIMENSIONS				STOCK THICK.
					A	B	C	M	
A18-6F	100	22-16	#6	ERG4002	.72	.25	.27	.59	.02
A116	1,000	22-16	#6		.72	.25	.27	.59	
A18-8F	100	22-16	#8		.75	.31	.27	.59	
A114	1,000	22-16	#8		.75	.31	.27	.59	
A18-10F	100	22-16	#10		.75	.31	.27	.59	
A115-TB	1,000	22-16	#10	.75	.31	.27	.59	.03	
B14-6F	100	18-14	#6	.75	.31	.27	.59		
B64	1,000	18-14	#6	.75	.31	.27	.59		
B19	1,000	18-14	#6	.66	.25	.13	.50		
B14-8F	100	18-14	#8	.75	.31	.27	.59		
B65-TB	1,000	18-14	#8	.75	.31	.27	.59	.04	
B14-10F	100	18-14	#10	.75	.31	.27	.59		
B115	1,000	18-14	#10	.75	.31	.27	.59		
B14-14F	100	18-14	1/4"	ERG4005	.90	.44	.38		.68
C10-6F	50	12-10	#6	.77	.31	.27	.63		.04
C133	500	12-10	#6	.77	.31	.27	.63		
C10-8F	50	12-10	#8	.82	.38	.27	.63		
C114	500	12-10	#8	.82	.38	.27	.63		
C10-10F	50	12-10	#10	.82	.38	.27	.63		
C115	500	12-10	#10	.82	.38	.27	.63		
C10-14F	50	12-10	1/4"	.98	.50	.37	.73		
C116-TB	500	12-10	1/4"	.98	.50	.37	.73		

Fork Terminals and Pin Terminals

Non-Insulated Locking Fork Terminals

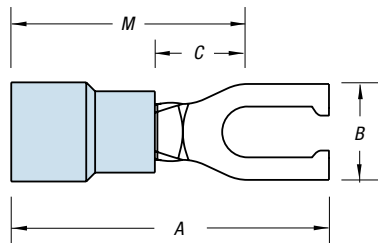

CAT. NO.	PKG. QTY.	WIRE RANGE	BOLT HOLE	REC. TOOL	DIMENSIONS				STOCK THICK.
					A	B	C	M	
A18-6FL	100	22-16	#6	ERG4002	.75	.25	.27	.59	.02
A221	1,000	22-16	#6		.75	.25	.27	.59	
A18-8FL	100	22-16	#8		.75	.29	.27	.59	
A224	1,000	22-16	#8		.75	.29	.27	.59	
A18-10FL	100	22-16	#10		.75	.29	.27	.59	
A225	1,000	22-16	#10	.75	.29	.27	.59	.03	
B14-6FL	100	18-14	#6	ERG4002	.75	.25	.27		.59
B220	1,000	18-14	#6		.75	.25	.27		.59
B14-8FL	100	18-14	#8		.75	.29	.27		.59
B223	1,000	18-14	#8		.75	.29	.27		.59
B14-10FL	100	18-14	#10		.75	.29	.27	.59	
B225	1,000	18-14	#10	.75	.29	.27	.59	.04	
C10-6FL	50	12-10	#6	ERG4005	.85	.31	.27		.66
C220-TB	500	12-10	#6		.85	.31	.27		.66
C10-8FL	50	12-10	#8		.85	.37	.27		.66
C221	500	12-10	#8		.85	.37	.27		.66
C10-10FL	50	12-10	#10		.85	.37	.27	.66	
C222	500	12-10	#10	.85	.37	.27	.66	.04	
C10-14FL	50	12-10	¼"	.85	.49	.27	.66		

Pin Terminals

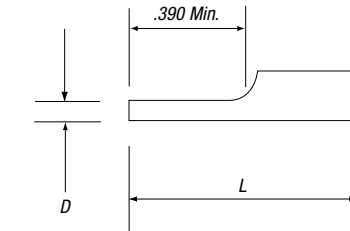

Non-Insulated Pin Terminal

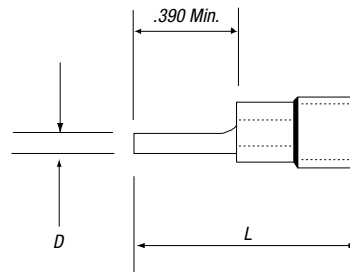

Insulated Pin Terminal



CAT. NO.	PKG. QTY.	WIRE RANGE	D (DIA.)	L	REC. TOOLS	STOCK THICK.
Non-Insulated						
A47PT	1,000	22-18	.075	.63	ERG4002	.02
B47PT	1,000	16-14	.075	.63		.03
C55PT	500	12-10	.106	.76		.04
Vinyl						
18RA-47PT	100	22-18	.075	.85	ERG4001	.02
RA47PT	1,000	22-18	.075	.85		.03
14RB-47PT	100	16-14	.075	.87		
RB47PT	1,000	16-14	.075	.87		.04
10RC-55PT	50	12-10	.106	1.04		
RC55PT	500	12-10	.106	1.04		
Nylon						
RA18-47PT	100	22-18	.075	.85	ERG4001	.02
RA147PT	1,000	22-18	.075	.85		.03
RB14-47PT	100	16-14	.075	.87		
RB147PT	1,000	16-14	.075	.87		.04
RC10-55PT	50	12-10	.106	1.04		
RC155PT	500	12-10	.106	1.04		

Splice Connectors

Butt Splices

- Wires are butted together and crimped at each end of the splice
- Available either non-insulated or insulated with nylon or PVC
- Nylon insulated splices meet or exceed the requirements of MIL-T-7928
- Color coded according to wire size

Parallel Splices

- Wires are laid side by side in the connector, and the connection is made in one crimp
- Offer advantages in simplicity of installation and small size
- One crimp completes the splice



Vinyl-Insulated Butt Splices — Expanded Insulation

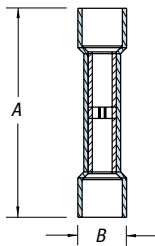

CAT. NO.	PKG. QTY.	WIRE RANGE	MAX. INS.	REC. TOOL	DIMENSIONS	
					A	B
2RA18X	100	22-18	.170	ERG4001	1.13	.25
RAA217-170	1,000	22-18	.170		1.13	.25
RAA217	1,000	22-18	.150		1.13	.23
2RB14X	100	16-14	.200		1.13	.26
RBB217-200	1,000	16-14	.200		1.13	.26
RBB217	1,000	16-14	.170		1.13	.24
2RC10X	50	12-10	.250		1.31	.31
RCC217-250	500	12-10	.250		1.31	.31
RCC217	1,000	12-10	.210		1.31	.28

Note: RCC217 is not expanded.

Nylon-Insulated Aircraft Splices

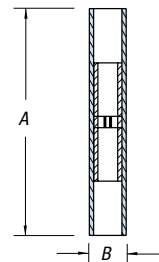
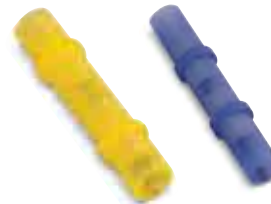

CAT. NO.	PKG. QTY.	WIRE RANGE	REC. TOOL	DIMENSIONS	
				A	B
2RZZ	50	26-22	ERG4006	1.22	.15
RZZ23	500	26-22		1.22	.15
2RAA	50	22-18	ERG4001	1.52	.25
RAA23	500	22-18		1.52	.25
2RBB	50	16-14		1.52	.28
RBB23	500	16-14		1.52	.28
2RCC	25	12-10		1.54	.35
RCC23	250	12-10		1.54	.35

Nylon-Insulated Butt Splices

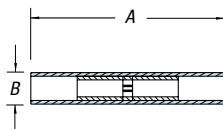
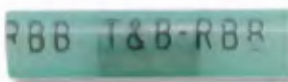

CAT. NO.	PKG. QTY.	MAX. INS. DIA.	WIRE RANGE	REC. TOOL	DIMENSIONS	
					A	B
2RA18	100	.115	22-18	ERG4001	1.19	.18
RAA21	1,000	.115	22-18		1.19	.18
2RB14	100	.148	16-14		1.19	.21
RBB21	1,000	.148	16-14		1.19	.21
2RC10	50	.210	12-10	ERG4007	1.26	.28
RCC21	500	.210	12-10		1.26	.28
2RD8	25	.340	8	TBMGS	1.69	.36
RDD27	200	.340	8		1.69	.36
2RE6	20	.420	6	TBMGS	1.85	.45
REE28	200	.420	6		1.85	.45
2RF4	15	.510	4		1.85	.52

Tefzel® Insulated Butt Splices

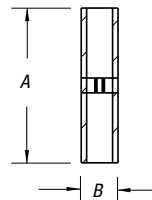

CAT. NO.	PKG. QTY.	WIRE RANGE	MAX. INS. DIA.	REC. TOOL	DIMENSIONS	
					A	B
RAAT21	1,000	22-18	1.22	WT145C	1.22	.115
RBBT21	1,000	16-14	1.22		1.22	.148
RCCT21	1,000	12-10	1.22		1.22	.210

Tefzel® is a registered trademark of DuPont.

Splice Connectors

Non-Insulated Butt Splices

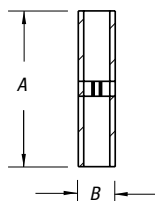

CAT. NO.	PKG. QTY.	WIRE RANGE	REC. TOOL	DIMENSIONS	
				A	B
2A-18	100	22-18	ERG4002	.62	.12
AA2	1,000	22-18		.62	.12
2B-14	100	16-14	ERG4002	.62	.16
BB2	1,000	16-14		.62	.16
2C-10	50	12-10	ERG4005	.72	.22
CC2	500	12-10		.72	.22
2D-8	25	9-8-7	ERG4005	1.03	.28
DD102	200	9-8-7		1.03	.28
2E-6	20	6-5	TBM6S	1.12	.37
EE2	200	6-5		1.12	.37
2F-4	15	4-3	TBM6S	1.25	.44
FF2	200	4-3		1.25	.44
2G21	5	2-1	TBM6S	1.72	.55
GG2	25	2-1		1.72	.55

Nylon-Insulated Parallel Splices

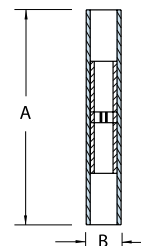

CAT. NO.	PKG. QTY.	WIRE RANGE	REC. TOOL	DIMENSIONS	
				A	B
2A20	100	22-20	ERG4001	.84	.20
RAA24	1,000	22-20		.84	.20
2B-16	100	18-16		.84	.23
RBB25	1,000	18-16		.84	.23
2C-12	50	14-12		.90	.28
RCC26	500	14-12		.90	.28

Sta-Kon® Parallel Splices

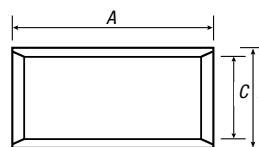

CAT. NO.	WIRE RANGE	CIR. MIL RANGE	REC. TOOL	LENGTH (A)	O.D. (B)	I.D. (C)	PKG. QTY.
A18-PS-M	22-16 AWG	509-3,260	ERG4002	.314	.129	.086	1,000
B14-PS-M	16-14 AWG	2,050-5,180	ERG4002	.315	.155	.113	1,000
C10-PS-D	12-10 AWG	5,180-13,100	ERG4005	.380	.220	.170	500
D8-PS-D	8 AWG	13,100-20,800	ERG4005	.375	.260	.180	500
E6-PS-D	6 AWG	20,800-33,100	WT115A	.500	.365	.266	500
F4-PS-W	4 AWG	33,100-52,600	WT115A	.531	.410	.302	250
G2-PS-W	2 AWG	52,600-83,700		.640	.521	.396	250
H1/0-PS-C	1/0 AWG	83,700-119,500	TBM8-750M-1	.750	.571	.446	100
J2/0-PS-C	2/0 AWG	119,500-150,500		.750	.632	.507	100
K3/0-PS-L	3/0 AWG	150,500-190,000		.750	.701	.564	50
L4/0-PS-L	4/0 AWG	190,000-231,100		.770	.766	.629	50
M250-PS-Q	250 kcmil	231,100-300,000		1.063	.926	.749	25
N300-PS-X	300 kcmil	300,000-380,000		1.125	1.100	.882	10
P400-PS-X	400 kcmil	380,000-478,000		1.250	1.200	.956	10
R500-PS-V	500 kcmil	478,000-600,000		1.438	1.330	1.060	5

The total combined cross sectional area of all wires must be within the CMA range.

Rated at 150° C.

Wire Joints

Crimp-On Wire Joints, One-Piece Nylon Self-Insulated

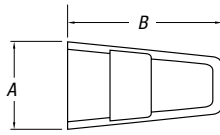

CAT. NO.	PKG. QTY.	WIRE RANGE		REC. TOOL	DIMENSIONS	
		MIN.	MAX.		A	B
RB44	100	2#18	2#16	WT2000	.31	.78
RB4-TB	1,000	2#18	2#16		.31	.78
RC55	50	4#18	2#12	WT2130A	.43	.95
RC6	500	4#18	2#12		.43	3
RP12	100	3#14	4#12		.53	1.00
RP7	1,000	3#14	4#12		.53	1.00

CAT. NO.	ALLOWABLE WIRE COMBINATIONS						
	#22	#20	#18	#16	#14	#12	#10
RB4-TB/ RB44			2-3				
			1-2	2			
		3					
		3					
		3	1				
		2	3				
		1-2		2			
		2			1		
			3	1			
		1	2				

CAT. NO.	ALLOWABLE WIRE COMBINATIONS						
	#22	#20	#18	#16	#14	#12	#10
RC6/RC55			1-4			1	
				1-3		1	
					1-2	1	
						2	
				3-5		1	
				2-4		1	
						3	
				1-4		2	
					1-3	2	
				1-3		3	
					1	3	
					2-5		
				4-6			

CAT. NO.	ALLOWABLE WIRE COMBINATIONS						
	#22	#20	#18	#16	#14	#12	#10
RP7/RP12							2
						1	1
					1		1
						2-4	
					2-4	1	
					1-3	2	
					1	3	
						3-6	
					1	2-3	
						2	1-2

PT Series Crimp-On Wire Joints

Two-Piece Nylon Insulator



One-Piece Non-Insulated

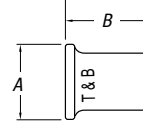
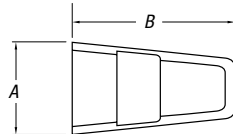
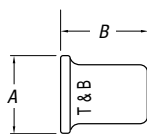

CAT. NO.	PKG. QTY.	WIRE RANGE		REC. TOOL	DIMENSIONS	
		MIN.	MAX.		A	B
PT66M	100	2#18	3#12 combination	WT161M	.50	.93
PT6M	100	—	Insulator only		.50	.93
PT60M	100	2#14	3#12 connector only		.31	.37
PT70	200	2#14	3#12		.29	.34
PT70M	200	3#18	4#12		.31	.37
PT80	50	2#16	4#10		.35	.62

90° C rated.

Installation Procedure for "PT" Connectors



Twist wires, insert through serrated barrel of wire joint. (PT60M, PT70, PT70M, PT80.)



Crimp and trim off excess wire with WT161M hand tool.



Screw PT6 insulator firmly onto PT160M barrel.

Wire Joints

High-Temperature Wire Joints

- Rated for temperatures up to 150° C (302° F), 600V maximum
- Molded, one-piece nylon construction for electrical insulation, UL94-V2
- Brazed copper sleeve prevents separation of connection during crimping
- Internal serrations enable cold flow for increased conductivity and pull-out strength



CAT. NO.	PKG. QTY.	WIRE RANGE		REC. TOOL	DIMENSIONS	
		MIN.	MAX.		A	B
RB4-HT	1,000	2#18	2#16	WT2000	.36"	.82"
RB44-HT	100	2#18	2#16	WT2000	.36"	.82"
RC6-HT	500	3#16	3#14	ERG4001, WT2130A	.48"	.95"
RC551-HT	100	3#16	3#14	ERG4001, WT2130A	.48"	.95"
RP7-HT	500	3#14	3#12	ERG4007, WT2130A	.53"	1.00"
RP12-HT	100	3#14	3#12	ERG4007, WT2130A	.53"	1.00"

Wire Joints UL Listed Combinations

CAT. NO.	SOLID OR STRANDED AWG
RB4, RB44, RB4-10M	(2) or (3) #18 (2) #16 (1) #16 and (1) or (2) #18 (3) #22 (3) #20 (3) #22 and (1) #18 (2) #22 and (3) #20 (1) or (2) #22 and (2) #18 (2) #22 and (1) #16 (3) #20 and (1) #18 (2) #20 and (1) #22 (2) #20 and (1) #16 (1) #20 and (2) #18
RC6, RC6-5M, RC55	(1) #14 with (2), (3) or (4) #16 (1) #14 with (3), (4) or (5) #18 (2) #14 with (1), (2), (3) or (4) #18 (2) #14 with (1), (2) or (3) #16 (3) #14 (4) to (7) #18 (3) #14 with (1) or (2) #18 (3) #14 with (1) #16 (1) #12 with (1), (2), (3) or (4) #18 (1) #12 with (1), (2) or (3) #16 (1) #12 with (1) or (2) #14 (5) #16

CAT. NO.	SOLID OR STRANDED AWG
RP7, RP-12	(2) to (4) #12 AWG (3) to (6) #14 AWG (3) #12 and (1) #14 (2) #12 and (1) #14 (2) #12 and (2) #14 (2) #12 and (3) #14 (1) #12 and (2) #14 (1) #12 and (3) #14 (1) #12 and (4) #14 (2) #10 (1) #10 and (1) #12 (1) #10 and (1) #14 (1) #8 Str. and (1) #16 (1) #10 and (1) #16 (1) #12 and (1) #16

Heat-Shrinkable Terminals, Splices, Disconnects

The heat-shrinkable advantage!

- These ring terminals, butt splices and disconnects are self-insulated with heat-shrinkable polyolefin and internally coated sealant
- Upon completed installation, a fully sealed connection is achieved to protect the joint against the degrading effects of galvanic action, corrosion and environmental exposure

Note: Not approved for outdoor use.



Heat-Shrinkable Ring Terminals

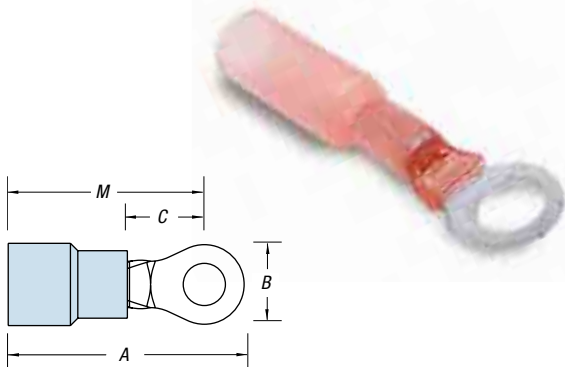

CAT. NO.	PKG. QTY.	WIRE RANGE	MAX. INS.	BOLT HOLE	REC. TOOL	DIMENSIONS				STOCK THICK.
						A	B	C	M	
RAS18-6X	100	22-18	.170	#6	ERG4255	1.23	.25	.27	1.10	.03
RAS18-8X	100	22-18	.170	#8		1.26	.31	.27	1.10	
RAS18-10X	100	22-18	.170	#10		1.26	.31	.27	1.10	
RBS14-6X	100	16-14	.200	#6		1.23	.25	.27	1.10	
RBS14-8X	100	16-14	.200	#8		1.23	.25	.27	1.10	
RBS14-10X	100	16-14	.200	#10		1.26	.31	.27	1.10	
RCS10-6X	50	12-10	.250	#6		1.34	.31	.27	1.15	.04
RCS10-8X	50	12-10	.250	#8		1.34	.37	.27	1.15	
RCS10-10X	50	12-10	.250	#10		1.34	.37	.27	1.15	
RCS10-14X	50	12-10	.250	1/4"		1.34	.49	.32	1.15	

Heat-Shrinkable Locking Fork Terminals

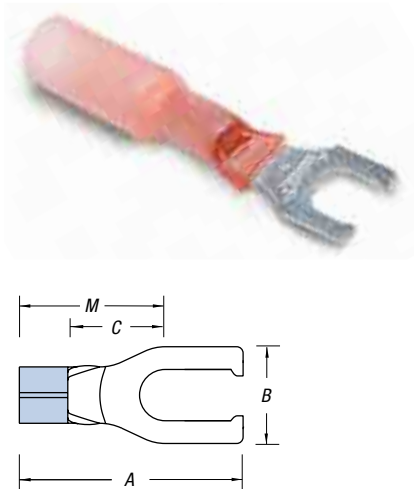

CAT. NO.	PKG. QTY.	WIRE RANGE	MAX. INS.	BOLT HOLE	REC. TOOL	DIMENSIONS				STOCK THICK.
						A	B	C	M	
RAS18-6FLX	100	22-18	.170	#6	ERG4255	1.350	.25	—	—	.03
RAS18-8FLX	100	22-18	.170	#8		1.350	.29	—	—	
RAS18-10FLX	100	22-18	.170	#10		1.350	.29	—	—	
RBS14-6FLX	100	16-14	.200	#6		1.350	.25	—	—	
RBS14-8FLX	100	16-14	.200	#8		1.350	.29	—	—	
RBS14-10FLX	100	16-14	.200	#10		1.350	.29	—	—	
RCS10-6FLX	50	12-10	.250	#6		1.350	.31	—	—	.04
RCS10-8FLX	50	12-10	.250	#8		1.350	.37	—	—	
RCS10-10FLX	50	12-10	.250	#10		1.350	.37	—	—	
RCS10-14FLX	50	12-10	.250	1/4"		1.350	.49	—	—	

Heat-Shrinkable Terminals, Splices, Disconnects

Heat-Shrinkable Fully Insulated Female Disconnects



CAT. NO.	PKG. QTY.	WIRE RANGE	MAX. INS.	TAB SIZE	REC. TOOL	A
RAS18-250AX	25	22-18	.170	.250 x .032	ERG4255	1.82
RBS14-250AX	25	16-14	.200	.250 x .032		1.77
RCS10-250AX	25	12-10	.250	.250 x .032		1.80

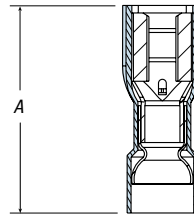

Heat-Shrinkable Fully Insulated Male Tabs



CAT. NO.	PKG. QTY.	WIRE RANGE	MAX. INS.	TAB SIZE	REC. TOOL	A
18RAS-251TX	25	22-18	.170	.250 x .032	ERG4255	1.80
14RBS-251TX	25	16-14	.200	.250 x .032		1.75
10RCS-251TX	25	12-10	.250	.250 x .032		1.80

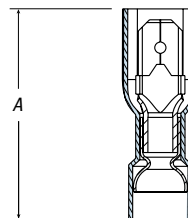

Heat-Shrinkable Butt Splices



CAT. NO.	PKG. QTY.	WIRE RANGE	MAX. INS.	REC. TOOL	DIMENSIONS	
					A	B
2RAS18X	50	22-18	.170	ERG4255	1.50	.25
RAAS22X	500	22-18	.170		1.50	.25
2RBS14X	50	16-14	.200		1.50	.26
RBBS22X	500	16-14	.200		1.50	.26
2RCS10X	25	12-10	.250		1.60	.31
RCCS22X	250	12-10	.250	1.60	.31	

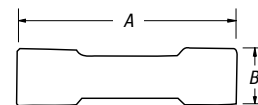

Everything you need to make fully sealed connections in one handy kit.

Heat-Shrink Terminal Kit with Tools

- Tools: (1) butane torch; (1) wire stripper; (1) ratchet crimp tool
- Butt Splices: (20) #22-#18 AWG; (20) #16-#14 AWG; (15) #12-#10 AWG
- Ring Terminals: (20) #16-#14 AWG #10 stud; (2) #16-#14 AWG #8 stud; (15) #12-#10 AWG ¼" stud

CAT. NO.	DESCRIPTION	STD. PKG. QTY.
STAPOUCH-HS	Heat-Shrink Terminal Kit with Tools	1



Wire Termination — Sta-Kon® Wire Termination & Insulation

Disconnects and Male Tabs

Disconnects

- Internal barrel serrations and long barrel provide for maximum tensile strength
- Complete line of installing tools, engineered to match tool with terminal
- Funnel-entry insulators enable easier inserting of wire into barrel
- Color coded for easy installation

250 Series — Female Disconnects

- Female disconnect terminals and matching male tabs accommodate a range of #22–#10 AWG, and are available in non-insulated, partially insulated and fully insulated styles, in both nylon and vinyl
- Unique construction of the female disconnect offers long-term dependability
- Brazed-seam serrated barrel provides maximum tensile strength

187 Series — Female Disconnects

- Quick, reliable method of connection to terminal blocks and boards without the use of tools
- Female disconnect terminals and matching male tabs accommodate a range of #22–#10 AWG, and are available in non-insulated, partially insulated and fully insulated styles, in both nylon and vinyl
- Unique construction of the female disconnect offers long-term dependability



250 Series — Female Disconnects

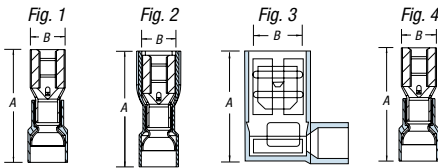

CAT. NO.	PKG. QTY.	WIRE RANGE	MAX. INS.	TAB SIZE	FIG.	REC. TOOL	DIMENSIONS	
							A	B
RA18-250F	100	22-18	.136	.250 x .032	1	ERG4001	.91	.29
RA250	1,000	22-18	.136	.250 x .032	1		.91	.29
RB14-250F	100	16-14	.162	.250 x .032	1		.91	.29
RB250	1,000	16-14	.162	.250 x .032	1		.91	.29
RC10-250F	50	12-10	.215	.250 x .032	1		1.04	.29
RC250	500	12-10	.215	.250 x .032	1		1.04	.29
18RA-250F	100	22-18	.150	.250 x .032	1		.96	.29
RA257	1,000	22-18	.150	.250 x .032	1		.96	.29
RA257-170	1,000	22-18	.170	.250 x .032	1		.96	.29
14RB-250F	100	16-14	.170	.250 x .032	1		.96	.29
RB257	1,000	16-14	.170	.250 x .032	1		.96	.29
RB257-200	1,000	16-14	.200	.250 x .032	1		.96	.29
10RC-250F	50	12-10	.250	.250 x .032	1		1.03	.29
RC257	500	12-10	.250	.250 x .032	1		1.03	.29
18RA-2577	100	22-18	.165	.250 x .032	2		1.01	.38
RA2573	1,000	22-18	.165	.250 x .032	2		1.01	.38
14RB-2577	100	16-14	.185	.250 x .032	2		1.01	.38
RB2573	1,000	16-14	.185	.250 x .032	2		1.01	.38
10RC-2577	50	12-10	.225	.250 x .032	2		1.04	.38
RC2573	500	12-10	.225	.250 x .032	2		1.04	.38
RA18-250A	50	22-18	.170	.250 x .032	3	.80	.71	
RA2577F	500	22-18	.170	.250 x .032	3	.80	.71	
RB14-250A	50	16-14	.190	.250 x .032	3	.80	.72	
RB2577F	500	16-14	.190	.250 x .032	3	.80	.72	
RC10-250A	50	12-10	.245	.250 x .032	3	.80	.88	
RC2577F	500	12-10	.245	.250 x .032	3	.80	.88	
A18-250	100	22-18	—	.250 x .032	1	ERG4002	.73	.31
A250	1,000	22-18	—	.250 x .032	1		.73	.31
B14-250	100	16-14	—	.250 x .032	1		.73	.31
B250	1,000	16-14	—	.250 x .032	1		.73	.31
C10-250F	50	12-10	—	.250 x .032	1		.73	.31
C250	500	12-10	—	.250 x .032	1		.73	.31
B14-250F	100	16-14	—	.250 x .032	4	WT110M	.87	.31
B250G	1,000	16-14	—	.250 x .032	4		.87	.31

(Continued on facing page)

Disconnects and Male Tabs

250 Series — Female Disconnects (continued)

7 Non-insulated 90° flag



7

CAT. NO.	PKG. QTY.	WIRE RANGE	MAX. INS.	TAB SIZE	FIG.	REC. TOOL	DIMENSIONS	
							A	B
A18-250A	50	22-18	—	.250 x .032	3	ERG4002	.58	.61
A252G	500	22-18	—	.250 x .032	3		.58	.61
B14-250A	50	16-14	—	.250 x .032	3	ERG4002	.58	.62
B252G	500	16-14	—	.250 x .032	3		.58	.62
C10-250A	50	12-10	—	.250 x .032	3	ERG4005	.64	.63
C252G	500	12-10	—	.250 x .032	3		.64	.63

250 Series — Nylon Piggy Back Disconnects

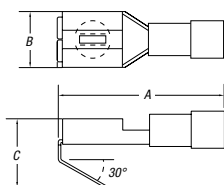

CAT. NO.	PKG. QTY.	WIRE RANGE	MAX. INS.	TAB SIZE	REC. TOOL	DIMENSIONS		
						A	B	C
RA18-250FP	100	22-18	.136	.250 x .032	WT112M	.87	.30	.43
RA250P	1,000	22-18	.136	.250 x .032		.87	.30	.43
RB14-250FP	100	16-14	.163	.250 x .032	ERG4001	.87	.30	.43
RB250P	1,000	16-14	.163	.250 x .032		.87	.30	.43

187 Series — Female Disconnects

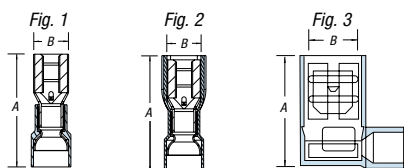

1 Nylon self-insulated



2 Vinyl self-insulated



3 Nylon fully insulated

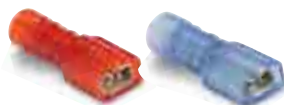

4 Non-insulated



5 Nylon fully insulated 90° flag



1

2

3

4

5

CAT. NO.	PKG. QTY.	WIRE RANGE	MAX. INS.	TAB SIZE	FIG.	REC. TOOL	DIMENSIONS	
							A	B
RAD18-183	100	22-18	.136	.187 x .032	1	ERG4001	.83	.23
RAD1833	1,000	22-18	.136	.187 x .032	1		.83	.23
RAD18-182	100	22-18	.136	.187 x .020	1		.83	.23
RAD1823	1,000	22-18	.136	.187 x .020	1		.83	.23
RBD14-183	100	16-14	.163	.187 x .032	1		.83	.23
RBD1833	1,000	16-14	.163	.187 x .032	1		.83	.23
RBD14-182	100	16-14	.163	.187 x .020	1		.83	.23
RBD1823	1,000	16-14	.163	.187 x .020	1		.83	.23
18RAD-183	100	22-18	.150	.187 x .032	1		.85	.23
RAD1837	1,000	22-18	.150	.187 x .032	1		.85	.23
18RAD-182	100	22-18	.150	.187 x .020	1		.85	.23
RAD1827	1,000	22-18	.150	.187 x .020	1		.85	.23
14RBD-183	100	16-14	.170	.187 x .032	1	.85	.23	
RBD1837	1,000	16-14	.170	.187 x .032	1	.85	.23	
14RBD-182	100	16-14	.170	.187 x .020	1	.85	.23	
RBD1827	1,000	16-14	.170	.187 x .020	1	.85	.23	
18RAD-18377	100	22-18	.150	.187 x .032	2	.89	.30	
RAD18377	1,000	22-18	.150	.187 x .032	2	.89	.30	
18RAD-18277	100	22-18	.150	.187 x .020	2	.89	.30	
RAD18277	1,000	22-18	.150	.187 x .020	2	.89	.30	
14RBD-18377	100	16-14	.170	.187 x .032	2	.89	.30	
RBD18377	1,000	16-14	.170	.187 x .032	2	.89	.30	
14RBD-18277	100	16-14	.170	.187 x .020	2	.89	.30	
RBD18277	1,000	16-14	.170	.187 x .020	2	.89	.30	
AD18-183	100	22-18	—	.187 x .032	1	ERG4002	.64	.23
AD183	1,000	22-18	—	.187 x .032	1		.64	.23
AD18-182	100	22-18	—	.187 x .020	1		.64	.23
AD182	1,000	22-18	—	.187 x .020	1		.64	.23
BD14-183	100	16-14	—	.187 x .032	1		.64	.23
BD183	1,000	16-14	—	.187 x .032	1		.64	.23
BD14-182	100	16-14	—	.187 x .020	1	.64	.23	
RAD18-187A	50	22-18	.150	.187 x .032	3	ERG4001	.74	.59
RAD1877F	500	22-18	.150	.187 x .032	3		.74	.59
RAD18-188A	50	22-18	.150	.187 x .020	3		.74	.59
RAD1887F	500	22-18	.150	.187 x .020	3		.74	.59
RBD14-187A	50	16-14	.170	.187 x .032	3		.74	.61
RBD1877F	500	16-14	.170	.187 x .032	3		.74	.61
RBD14-188A	50	16-14	.170	.187 x .020	3		.74	.61
RBD1887F	500	16-14	.170	.187 x .020	3		.74	.61

UL Listed E66716

Disconnects and Male Tabs

Select the tabs you need!

250 Series — Male Tabs

1 Vinyl self-insulated

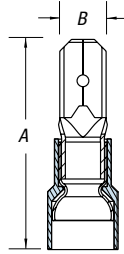

2 Nylon fully insulated



3 Non-insulated/insulated grip



4 Non-insulated



CAT. NO.	PKG. QTY.	WIRE RANGE	MAX. INS.	TAB SIZE	REC. TOOL	DIMENSIONS	
						A	B
18RA-250T	100	22-18	.150	.250 x .032	ERG4001	.95	—
RA2517	1,000	22-18	.150	.250 x .032		.95	—
14RB-250T	100	16-14	.170	.250 x .032		.95	—
RB2517	1,000	16-14	.170	.250 x .032		.95	—
10RC-250T	50	12-10	.250	.250 x .032		1.08	—
RC2517	500	12-10	.250	.250 x .032		1.08	—
18RA-251T	50	22-18	.150	.250 x .032		1.13	.45
RA25177	500	22-18	.150	.250 x .032		1.13	.45
14RB-251T	50	16-14	.170	.250 x .032		1.13	.45
RB25177	500	16-14	.170	.250 x .032		1.13	.45
10RC-251T	25	12-10	.210	.250 x .032	1.17	.45	
RC25177	500	12-10	.210	.250 x .032	1.17	.45	
A18-250T	100	22-18	—	.250 x .032	WT110M	.87	—
B14-250T	100	20-14	—	.250 x .032		.87	—
A18-251T	100	22-18	—	.250 x .032	ERG4002	.68	—
A251	1,000	22-18	—	.250 x .032		.68	—
B14-251T	100	16-14	—	.250 x .032		.68	—
B251	1,000	16-14	—	.250 x .032		.68	—
C10-251T	50	12-10	—	.250 x .032		.68	—

187 Series — Male Tabs

5 Vinyl insulated

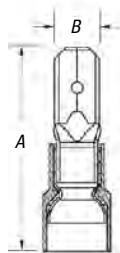

CAT. NO.	PKG. QTY.	TAB SIZE	WIRE RANGE	MAX. INS.	REC. TOOL	DIA.	
						A	B
18RAD-187	100	.187 x .032	22-18	.150	ERG4001	.87	—
18RAD-188	100	.187 x .020	22-18	.150		.87	—
14RBD-187	100	.187 x .032	16-14	.170		.87	—
14RBD-188	100	.187 x .020	16-14	.170		.87	—

Disconnects and Male Tabs

Insulated coupler requires no tool!
250 Series — Adapters and Coupler†

6 Non-insulated



7 Insulated coupler

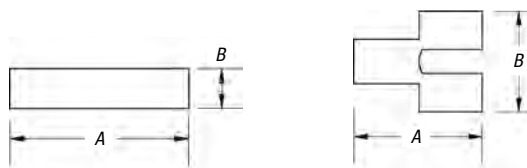

CAT. NO.	PKG. QTY.	TAB SIZE	DIA.	
			A	B
F250TA	50	.250 x .032	.82	.56
FTA250	1,000	.250 x .032	.82	.56
RB14-250	50	.250 x .032	2.35	.51
RBB250	500	.250 x .032	2.35	.51

† Not UL Listed

Cat. No. F250TA — **Material:** brass **Finish:** tin plated

Cat. No. RB14-250 — **Material:** brass **Finish:** none **Insulation:** vinyl

Available in variety of wire ranges!

110 Series — Disconnects*

8 Nylon-insulated



9 Non-insulated



CAT. NO.	PKG. QTY.	TAB SIZE	WIRE RANGE	MAX. INS.	REC. TOOL	DIA.	
						A	B
RA18-110F	100	.110 x .032	22-18	.110	ERG4006	.75	.15
RA10-SK	1,000	.110 x .032	22-18	.110		.75	.15
RA18-111F	100	.110 x .020	22-18	.110		.75	.15
RA11	1,000	.110 x .020	22-18	.110		.75	.15
RB14-110F	100	.110 x .032	16-14	.135	ERG4006	.75	.15
RB10-SK	1,000	.110 x .032	16-14	.135		.75	.15
RB14-111F	100	.110 x .020	16-14	.135		.75	.15
RB11-TB	1,000	.110 x .020	16-14	.135		.75	.15
A18-110F	100	.110 x .032	22-18	—	WT111M WT112M WT2000	.59	.15
A10-TB	1,000	.110 x .032	22-18	—		.59	.15
A18-111F	100	.110 x .020	22-18	—		.59	.15
A11	1,000	.110 x .020	22-18	—		.59	.15
B14-110F	100	.110 x .032	16-14	—	WT111M WT112M WT2000	.59	.15
B10-TB	1,000	.110 x .032	16-14	—		.59	.15
B14-111F	100	.110 x .020	16-14	—		.59	.15
B11-TB	1,000	.110 x .020	16-14	—		.59	.15

* Not UL Listed or CSA approved.

Choose from nylon-insulated or non-insulated!

Wristlock Disconnects†

10 Nylon-Insulated wristlock disconnects



11 Non-Insulated wristlock disconnects



Picture shows wristlock disconnect assembled as two pieces. Parts are sold by the piece not by assemblies.

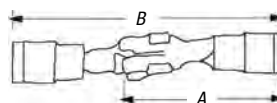

CAT. NO.	PKG. QTY.	WIRE RANGE	MAX. INS.	REC. TOOL	DIA.	
					A	B
RA18D	50	22-18	.136	WT2000	.99	1.70
RA23	1,000	22-18	.136		.99	1.70
RB14D	50	16-14	.162		.99	1.70
RB23	1,000	16-14	.162	WT110M	.99	1.70
B14-D	50	16-14	.187		.97	1.66
B23	1,000	16-14	.187		.97	1.66

† Not UL Listed

Luminaire Disconnects

Disconnect ballasts under load for safe servicing — in compliance with NEC® requirements.

Push-In Luminaire Disconnect

Each year, electricians sustain injuries while attempting to change ballasts without tripping the breaker because they're trying to avoid disconnecting other lighting and equipment from power. That's why recent changes to NEC® and UL standards require a means of disconnecting power to non-residential fluorescent lighting ballasts.

In 2006, Thomas & Betts developed the first UL Listed product to meet this need. Now, in response to customer demand, the new Sta-Kon® Push-In Luminaire Disconnect provides all the same safety benefits as the original, but installs even faster and easier.

- Enables electricians changing ballasts to easily disconnect incoming power for safe servicing without having to trip the main power breaker
- Installs easily — just strip de-energized wires and insert
- Disconnect halves snap together and separate easily — but won't accidentally disconnect
- Foolproof design eliminates the potential for incorrect installation and reverse polarity
- Fits through ½" knockouts for easy retrofit
- Ballast hot-lead wire entry is color-coded black for easy visibility
- Finger-safe on both sides
- For use in all non-residential fluorescent lighting applications and in ordinary location HID lighting applications — both up to 600V, 4A maximum
- Complies with NEC®, CEC, UL and CSA requirements
- Sold in mated pairs (male/line and female/load sides)



Specifications

- Housing: Polycarbonate
- Temperature Rating: 105° C (221° F) max.
- Electrical Rating: 600V, 4A max.
- Flammability Rating: UL94V-2
- Contacts: Copper alloy
- Wire Range: #18–#12 AWG solid copper
#14–#12 AWG stranded copper
(19 strands or fewer)
- Standards: Complies with 2008 NEC® 410.130(G), CEC 30-308(4) and UL 2459
- Certifications: UL Listed, CSA Certified



This cutaway shows how the Sta-Kon® Luminaire Disconnect grips and holds the pushed-in wires securely after installation.

Sta-Kon® Push-In Luminaire Disconnect



CAT. NO.	DESCRIPTION	STD. PKG. QTY.
LD2P-Q	2-Wire Push-In Luminaire Disconnect, Distributor Pack	25
LD2P-D	2-Wire Push-In Luminaire Disconnect, Bulk Packaging	500

Note: If you prefer lead wires instead of a push-in design and/or need a 3-wire disconnect for switching or dimming applications, order the original Sta-Kon® Luminaire Disconnect, 2-wire Cat. No. LD2 (Cat. No. LD2-D for bulk packaging) or 3-wire Cat. No. LD3 (Cat. No. LD3-D for bulk packaging). See following page.

NEC and National Electrical Code are registered trademarks of the National Fire Protection Association, Inc.

Luminaire Disconnects

Meets 2011 NEC® requirements for fluorescent fixtures and ballasts!

Luminaire Disconnects

- Oversized electrical contacts improve conductivity and reduce temperature rise
- Integral wire leads ease installation — even with multiple wire sizes — and support connection to copper or aluminum wiring
- Foolproof design ensures mating halves of disconnect are installed correctly, preventing reverse polarization
- Finger-safe line side protects installer and enables safe servicing without disconnecting power
- Line and load indications clearly identified on each half
- Rounded, compact design fits in tight spaces
- Bright orange for instant identification as a safety device

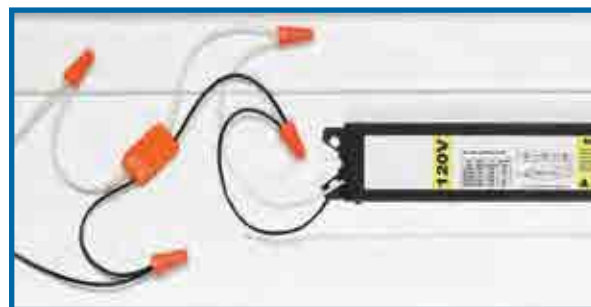
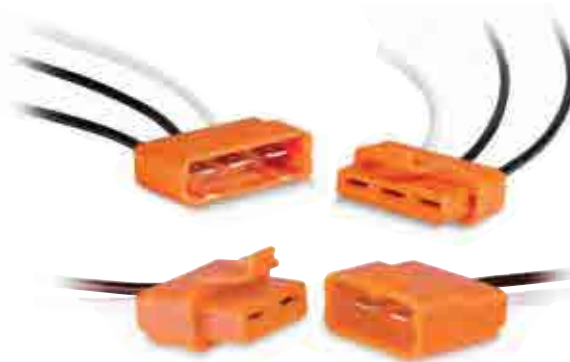

Specifications

- Housing: Polycarbonate
- Contacts: Tin-plated brass
- Integral Leads: Insulated #18 AWG solid copper
- Temp. Rating: 105° C
- Flammability: UL94V-2 (V-0 available on request)
- Electrical Rating: 4A, 600V
- Standards: UL Listed E07134, CSA Certified, NEC® Section 410.130(G) 2011 edition compliant



CAT. NO.	DESCRIPTION	PKG. QTY.
Bulk Packaging for OEMs		
LD2-D	2-Pole Luminaire Disconnect	500
LD3-D	3-Pole Luminaire Disconnect	500
<i>Kits for Servicing Electricians (includes two male/line half and two female/load half of the luminaire disconnect, polybagged with installation instructions)</i>		
LD2	2-Pole Luminaire Disconnect Kit	20
LD3	3-Pole Luminaire Disconnect Kit	20

NEC and National Electrical Code are registered trademarks of the National Fire Protection Association, Inc.

Faster, easier and safer than manual seating of disconnects!

Disconnect Installation Tool

- Perfect for wire-harness assemblers and panel builders
- Dual-ended with slots to fit red and blue (male and female) or yellow disconnects
- Color-coded dots for easy matching of disconnect with correct tool end
- Lightweight and only 5½" long — fits in a shirt pocket like a pen



This one-of-a-kind tool may be used to seat all sizes of Thomas & Betts disconnects.

CAT. NO.	DESCRIPTION	PKG. QTY.
DT22-10	Sta-Kon® Disconnect Installation Tool	1

Ferrules

Features

- Ferrules ensure reliable electrical connections when terminating conductors in screw clamp terminal blocks
- Fraying and breaking of wire strands is prevented and the possibility of an unreliable connection is minimized
- Insulated ferrules prevent conductor breakage due to bending, wire stress or vibration, while facilitating wire insertions into the terminal block clamp
- Ferrules are the preferred alternative to twisting wire stands or tinning the wire end before terminating into a terminal block
- Ferrules are thin-walled copper tubes, which are mechanically crimped onto the ends of stranded wires
- They are easy to use — simply strip the wire, slide the ferrule onto the end of the wire and crimp
- Meets emerging global standards, requiring wire-to-metric style terminal block installations to be terminated with a "pin" style terminal
- Vinyl insulated, nylon insulated, and non-insulated styles
- All styles offered in #22 AWG to #10 AWG and compatible with existing Sta-Kon® tooling

How to Apply a Ferrule

- Strip the insulation from the end of the wire and insert into the insulated end of the ferrule
- Using the designated crimping tool, place the metal shaft into the tool's appropriate slot. Compress the tool to make a crescent-shape depression along the length of the ferrule
- Insert the crimped ferrule into the terminal block
- Tighten the ferrule and wire into the terminal block

Materials

- High-conductivity copper
- Tin plating

Insulated Ferrules

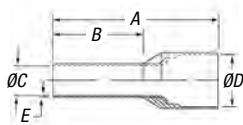

CAT. NO.	CONDUCTOR SECTION		COLOR	DIMENSIONS INCHES/MM					INSTALLATION TOOLING	PKG. QTY.
	AWG	MM ²		A	B	ØC	ØD	E		
F4004	26	.14	Gray	.413/10.5	.236/6.0	.031/.80	.079/2.0	.010/.25	T3, ERG4	500
F4005	26	.14	Gray	.492/12.5	.315/8.0	.031/.80	.079/2.0	.010/.25	T3, ERG4	500
F4006	24	.25	Yellow	.413/10.5	.236/6.0	.031/.80	.079/2.0	.010/.25	T3, ERG4	500
F4007	24	.25	Yellow	.492/12.5	.315/8.0	.031/.80	.079/2.0	.010/.25	T3, ERG4	500
F4008	22	.34	Purple	.413/10.5	.236/6.0	.031/.80	.079/2.0	.010/.25	T3, ERG4	500
F4009	22	.34	Purple	.492/12.5	.315/8.0	.031/.80	.079/2.0	.010/.25	T3, ERG4	500
F2020	20	.50	White	.453/11.5	.236/6.0	.043/1.1	.098/2.5	.006/.15	T1, T3 & ERG4	500
F2021	20	.50	White	.531/13.5	.315/8.0	.043/1.1	.098/2.5	.006/.15	T1, T3 & ERG4	500
F2022	20	.50	White	.610/15.5	.394/10.0	.043/1.1	.098/2.5	.006/.15	T1, T3 & ERG4	500
F2023	18	.75	Gray	.472/12.0	.236/6.0	.051/1.3	.110/2.8	.006/.15	T1, T3 & ERG4	500
F2024	18	.75	Gray	.551/14.0	.315/8.0	.051/1.3	.110/2.8	.006/.15	T1, T3 & ERG4	500
F2025	18	.75	Gray	.630/16.0	.394/10.0	.051/1.3	.110/2.8	.006/.15	T1, T3 & ERG4	500
F2026	18	.75	Gray	.728/18.0	.472/12.0	.051/1.3	.110/2.8	.006/.15	T1, T3 & ERG4	500
F2027	18	1.00	Red	.492/12.5	.236/6.0	.059/1.5	.118/3.0	.006/.15	T1, T3 & ERG4	500
F2028	18	1.00	Red	.571/14.5	.315/8.0	.059/1.5	.118/3.0	.006/.15	T1, T3 & ERG4	500
F2029	18	1.00	Red	.650/16.5	.394/10.0	.059/1.5	.118/3.0	.006/.15	T1, T3 & ERG4	500
F2030	18	1.00	Red	.728/18.5	.472/12.0	.059/1.5	.118/3.0	.006/.15	T1, T3 & ERG4	500
F2031	16	1.50	Black	.571/14.5	.315/8.0	.071/1.8	.134/3.4	.006/.15	T1, T3 & ERG4	500
F2032	16	1.50	Black	.650/16.5	.394/10.0	.071/1.8	.134/3.4	.006/.15	T1, T3 & ERG4	500
F2033	16	1.50	Black	.728/18.5	.472/12.0	.071/1.8	.134/3.4	.006/.15	T1, T3 & ERG4	500
F2034	16	1.50	Black	.965/24.5	.708/18.0	.071/1.8	.134/3.4	.006/.15	T1, T3 & ERG4	500
F2035	14	2.50	Blue	.591/15.0	.315/8.0	.091/2.3	.165/4.2	.006/.15	T1, T3 & ERG4	500
F2036	14	2.50	Blue	.748/19.0	.472/12.0	.091/2.3	.165/4.2	.006/.15	T1, T3 & ERG4	500
F2037	14	2.50	Blue	.984/25.0	.708/18.0	.091/2.3	.165/4.2	.006/.15	T1, T3 & ERG4	500
F2038	12	4.00	Gray	.889/17.5	.394/10.0	.114/2.9	.189/4.8	.008/.20	T3 & ERG4	500
F2039	12	4.00	Gray	.787/20.0	.472/12.0	.114/2.9	.189/4.8	.008/.20	T3 & ERG4	500
F2040	12	4.00	Gray	1.024/26.0	.708/18.0	.114/2.9	.189/4.8	.008/.20	T3 & ERG4	100
F2041	10	6.00	Yellow	.787/20.0	.472/12.0	.142/3.6	.244/6.2	.008/.20	T3 & ERG4	100
F2042	10	6.00	Yellow	.984/25.0	.708/18.0	.142/3.6	.244/6.2	.008/.20	T3 & ERG4	100
F2043	8	10.00	Red	.827/21.0	.472/12.0	.181/4.6	.295/7.5	.008/.20	T3 & ERG4	100
F2044	8	10.00	Red	1.063/27.0	.708/18.0	.181/4.6	.295/7.5	.008/.20	T3 & ERG4	100
F2045	6	16.00	Blue	.906/23.0	.472/12.0	.236/6.0	.346/8.8	.008/.20	ERG4	100
F2046	6	16.00	Blue	1.142/29.0	.708/18.0	.236/6.0	.346/8.8	.008/.20	ERG4	50
F2047	4	25.00	Yellow	1.142/29.0	.630/18.0	.295/7.5	.433/11.0	.008/.20	ERG4	50
F2048	4	25.00	Yellow	1.220/31.0	.708/18.0	.295/7.5	.433/11.0	.008/.20	ERG4	50
F2049	4	25.00	Yellow	1.378/35.0	.866/22.0	.295/7.5	.433/11.0	.008/.20	ERG4	50
F2050	2	35.00	Red	1.181/30.0	.630/16.0	.335/8.5	.492/12.5	.008/.20	ERG4	50
F2051	2	35.00	Red	1.260/32.0	.708/18.0	.335/8.5	.492/12.5	.008/.20	ERG4	50
F2052	2	35.00	Red	1.535/39.0	.984/25.0	.335/8.5	.492/12.5	.008/.20	ERG4	50
F2053	1/0	50.00	Blue	1.417/36.0	.787/20.0	.413/10.5	.591/15.0	.014/.35	ERG4	50
F2054	1/0	50.00	Blue	1.614/41.0	.984/25.0	.413/10.5	.591/15.0	.014/.35	ERG4	50

Ferrule dimensions conform to DIN 46228, Part 4.

Ferrules

Strip Lengths on Insulated Ferrules

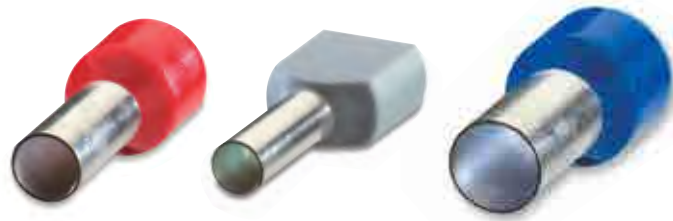

CAT. NO.	PIN LENGTH (IN.)	MIN. STRIP LENGTH (IN.)	MAX. STRIP LENGTH (IN.)
F2020	.236	.3147	.354
F2021	.315	.3937	.433
F2022	.394	.4727	.512
F2023	.236	.3147	.354
F2024	.315	.3937	.433
F2025	.394	.4727	.512
F2026	.472	.5507	.59
F2027	.236	.3147	.354
F2028	.315	.3937	.433
F2029	.394	.4727	.512
F2030	.472	.5507	.59
F2031	.315	.3937	.433
F2032	.394	.4727	.512
F2033	.472	.5507	.59
F2034	.708	.7867	.826
F2035	.315	.3937	.433
F2036	.472	.5507	.59
F2037	.708	.7867	.826
F2038	.394	.4727	.512
F2039	.472	.5507	.59
F2040	.708	.7867	.826
F2041	.472	.5507	.59
F2042	.708	.7867	.826
F2043	.472	.5507	.59
F2044	.708	.7867	.826
F2045	.472	.5507	.59
F2046	.708	.7867	.826
F2047	.63	.7087	.748
F2048	.708	.7867	.826
F2049	.866	.9447	.984
F2050	.53	.6087	.648
F2051	.708	.7867	.826
F2052	.984	1.0627	1.102
F2053	.787	.8657	.905
F2054	.984	1.0627	1.102

Note: The thicker the insulation, the longer the strip length should be.

CAT. NO.	PIN LENGTH (IN.)	MIN. STRIP LENGTH (IN.)	MAX. STRIP LENGTH (IN.)
F4000	.315	.3937	.433
F4001	.315	.3937	.433
F4002	.315	.3937	.433
F4003	.315	.3937	.433
F4004	.236	.3147	.354
F4005	.315	.3937	.433
F4006	.236	.3147	.354
F4007	.315	.3937	.433
F4008	.236	.3147	.354
F4009	.315	.3937	.433
F4020	.315	.3937	.433
F4021	.315	.3937	.433
F4022	.315	.3937	.433
F4023	.315	.3937	.433
F4024	.315	.3937	.433
F4027	.315	.3937	.433
F4028	.315	.3937	.433

Ferrules

Insulated Twin Ferrules

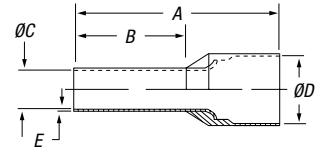

CAT. NO.	CONDUCTOR SECTION		COLORS	DIMENSIONS INCHES/MM					INSTALLATION TOOLING	PKG. QTY.
	AWG	MM		A	B	ØC	ØD	E		
F8000	2x 20	2x 0.50	White	.591/15.0	.315/8.0	.059/1.5	.177/4.5	.010/.25	T3	500
F8001	2x 18	2x 0.75	Gray	.591/15.0	.315/8.0	.071/1.8	.201/5.1	.010/.25	T3	500
F8002	2x 18	2x 0.75		.669/17.0	.394/10.0	.071/1.8	.201/5.1	.006/.15	T3	500
F8003	2x 17	2x 1.00	Red	.591/15.0	.315/8.0	.081/2.05	.201/5.1	.006/.15	T3	500
F8005	2x 17	2x 1.00	Black	.669/17.0	.394/10.0	.081/2.05	.201/5.1	.006/.15	T3	500
F8006	2x 16	2x 1.50		.630/16.0	.315/8.0	.091/2.3	.252/6.4	.006/.15	T3	500
F8007	2x 16	2x 1.50	Blue	.787/20.0	.472/12.0	.091/2.3	.252/6.4	.006/.15	T3	500
F8008	2x 14	2x 2.50		.728/18.5	.394/10.0	.114/2.9	.295/7.5	.006/.15	T3	500
F8009	2x 14	2x 2.50	Gray	.846/21.5	.512/13.0	.114/2.9	.295/7.5	.006/.15	T3	500
F8010	2x 12	2x 4.00		.906/23.0	.472/12.0	.150/3.8	.339/8.6	.006/.15	ERG4/6MM DIE	100
F8011	2x 10	2x 6.00	Yellow	.984/25.0	.551/14.0	.193/4.9	.378/9.6	.008/.20	ERG4/10MM DIE	100

Ferrule dimensions conform to DIN 46228, Part 4.

Insulated Ferrules (Old DIN and French Standards)

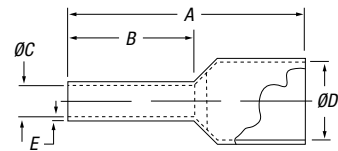

CAT. NO.	STYLE	CONDUCTOR SECTION			DIMENSIONS INCHES/MM					INSTALLATION TOOLING	PKG. QTY.
		AWG	MM	COLORS	A	B	ØC	ØD	E		
F4000	OLD DIN	20	0.50	Orange	.571/14.5	.315/8.0	.043/1.1	.102/2.6	.006/.15	T1, T3 & ERG4	500
F4001	OLD DIN	18	0.75	White	.571/14.5	.315/8.0	.051/1.3	.110/2.8	.006/.15	T1, T3 & ERG4	500
F4002	OLD DIN	18-17	1.00	Yellow	.571/14.5	.315/8.0	.059/1.5	.118/3.0	.006/.15	T1, T3 & ERG4	500
F4003	OLD DIN	16	1.50	Red	.571/14.5	.315/8.0	.071/1.8	.134/3.4	.006/.15	T1, T3 & ERG4	500
F4020	OLD DIN	14	2.50	Blue	.571/14.5	.315/8.0	.091/2.3	.165/4.2	.006/.15	T1, T3 & ERG4	500
F4021	FRENCH	20	0.50	White	.571/14.5	.315/8.0	.043/1.1	.102/2.6	.006/.15	T1, T3 & ERG4	500
F4023	FRENCH	18	0.75	Lt. Blue	.571/14.5	.315/8.0	.051/1.3	.110/2.8	.006/.15	T1, T3 & ERG4	500
F4024	FRENCH	18-17	1.00	Red	.571/14.5	.315/8.0	.059/1.5	.118/3.0	.006/.15	T1, T3 & ERG4	500
F4027	FRENCH	16	1.50	Black	.571/14.5	.315/8.0	.071/1.8	.134/3.4	.006/.15	T1, T3 & ERG4	500
F4028	FRENCH	14	2.50	Gray	.571/14.5	.315/8.0	.091/2.3	.165/4.2	.006/.15	T1, T3 & ERG4	500

Ferrule dimensions conform to DIN 46228, Part 4.

The crimping tools you need!

Tooling for Sta-Kon® Insulated Ferrules

CAT. NO.	DESCRIPTION	PKG. QTY.
T1	Sta-Kon® Crimp Tool for wire ferrules #20-#14 AWG — insulated handle.	1
T3	Sta-Kon® Crimp Tool for wire ferrules #26-#10 AWG — insulated handle.	1
ERG4	Comfort Crimp® Sta-Kon® Crimp Tool with Shure-Stake® mechanism, for installing wire ferrules #26-1/0 AWG. Four interchangeable die sets included. Insulated handle. Packaged in sturdy plastic carrying case.	1



Ferrules

Non-Insulated Ferrules

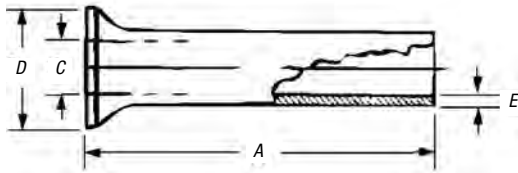

CAT. NO.	CONDUCTOR SECTION		DIMENSIONS INCHES/MM				INSTALLATION TOOLING	PKG. QTY.
	AWG	MM	A	C	D	E		
F9000	24	.25	.196/5	.030/7.5	.067/1.7	.006/.15	T1, ERG4 T3	1,000
F9001	22	.5	.236/6	.039/1.0	.083/2.1	.006/.15	T1, T3, ERG4	1,000
F9002	22	.5	.394/10	.039/1.0	.083/2.1	.006/.15	T1, T3, ERG4	1,000
F9003	18	.75	.236/6	.047/1.2	.091/2.3	.006/.15	T1, T3, ERG4	1,000
F9004	18	.75	.394/10	.047/1.2	.091/2.3	.006/.15	T1, T3, ERG4	1,000
F9005	18	1	.236/6	.055/1.4	.098/2.5	.006/.15	T1, T3, ERG4	1,000
F9006	18	1	.394/10	.055/1.4	.098/2.5	.006/.15	T1, T3, ERG4	1,000
F9007	16	1.5	.276/7	.067/1.7	.110/2.8	.006/.15	T1, T3, ERG4	1,000
F9008	16	1.5	.394/10	.067/1.7	.110/2.8	.006/.15	T1, T3, ERG4	1,000
F9009	16	1.5	.473/12	.067/1.7	.110/2.8	.006/.15	T1, T3, ERG4	1,000
F9010	16	1.5	.709/18	.067/1.7	.110/2.8	.006/.15	T1, T3, ERG4	1,000
F9011	14	2.5	.276/7	.087/2.2	.139/3.4	.006/.15	T1, T3, ERG4	1,000
F9012	14	2.5	.394/10	.087/2.2	.139/3.4	.006/.15	T1, T3, ERG4	1,000
F9013	14	2.5	.472/12	.087/2.2	.139/3.4	.006/.15	T1, T3, ERG4	1,000
F9014	14	2.5	.709/18	.087/2.2	.139/3.4	.006/.15	T1, T3, ERG4	1,000
F9015	12	4	.354/9	.110/2.8	.158/4	.008/.2	T3, ERG4	1,000
F9016	12	4	.472/12	.110/2.8	.158/4	.008/.2	T3, ERG4	1,000
F9017	12	4	.591/15	.110/2.8	.158/4	.008/.2	T3, ERG4	1,000
F9018	12	4	.709/18	.110/2.8	.158/4	.008/.2	T3, ERG4	1,000
F9019	10	6	.472/12	.138/3.5	.185/4.7	.008/.2	T3, ERG4	1,000
F9020	10	6	.591/15	.138/3.5	.185/4.7	.008/.2	T3, ERG4	1,000
F9021	10	6	.709/18	.138/3.5	.185/4.7	.008/.2	T3, ERG4	1,000
F9022	8	10	.472/12	.177/4.5	.228/5.8	.008/.2	ERG4	500
F9023	8	10	.591/15	.177/4.5	.228/5.8	.008/.2	ERG4	500
F9024	8	10	.709/18	.177/4.5	.228/5.8	.008/.2	ERG4	500
F9025	6	16	.472/12	.228/5.8	.295/7.5	.008/.2	ERG4	250
F9026	6	16	.591/15	.228/5.8	.295/7.5	.008/.2	ERG4	250
F9027	6	16	.709/18	.228/5.8	.295/7.5	.008/.2	ERG4	250
F9028	6	16	.984/25	.228/5.8	.295/7.5	.008/.2	ERG4	250
F9029	6	16	1.26/32	.228/5.8	.295/7.5	.008/.2	ERG4	250
F9030	4	25	.591/15	.287/7.3	.374/9.5	.010/.25	ERG4	100
F9031	4	25	.709/18	.287/7.3	.374/9.5	.010/.25	ERG4	100
F9032	4	25	.984/25	.287/7.3	.374/9.5	.010/.25	ERG4	100
F9033	4	25	1.26/32	.287/7.3	.374/9.5	.010/.25	ERG4	100
F9034	2	35	.709/18	.327/8.3	.433/11	.010/.25	ERG4	100
F9035	2	35	.984/25	.327/8.3	.433/11	.010/.25	ERG4	100
F9036	2	35	1.26/32	.327/8.3	.433/11	.010/.25	ERG4	100
F9037	1/0	50	.709/18	.406/10.3	.512/13	.012/.3	TB5095, ERG4	100
F9038	1/0	50	.984/25	.406/10.3	.512/13	.012/.3	TB5095, ERG4	100
F9039	1/0	50	1.18/30	.406/10.3	.512/13	.012/.3	TB5095, ERG4	100

Wire Termination Tools and Installation Kits

Convenient 20-count packaging!

Sta-Kon® Mini-Pack Terminals



- Wire ranges from #22 AWG to #10 AWG
- Vinyl insulated ring and forked-tongued terminals, female disconnects, butt-type splice connectors

Note: "CP" designates mini-pack quantities. Refer to other catalog pages for description and dimensional information.

CAT. NO.	UNIT QTY.	PKG. QTY.	WIRE RANGE	BOLT HOLE
18RA-6FCP	20	100	22-18	#6
18RA-8CP	20	100	22-18	#8
18RA-10CP	20	100	22-18	#10
14RB-6CP	20	100	16-14	#6
14RB-8CP	20	100	16-14	#8
14RB-10CP	20	100	16-14	#10
10RC-10CP	20	100	12-10	#10
10RC-14CP	20	100	12-10	¼
18RA-8FCP	20	100	22-18	#8
18RA-10FCP	20	100	22-18	#10
14RB-6FCP	20	100	16-14	#6
14RB-8FCP	20	100	16-14	#8
14RB-10FCP	20	100	16-14	#10
10RC-8FCP	20	100	12-10	#8
10RC-10FCP	20	100	12-10	10
2RA18XCP	20	100	22-18	—
2RB14XCP	20	100	16-14	—
2RC10XCP	20	100	12-10	—
18RA-250FCP	20	100	22-18	—
14RB-250FCP	20	100	16-14	—
10RC-250FCP	20	100	12-10	—

Perfect for residential or light commercial installations!

Sta-Kit® Installing Kit

- Assortment of popular Sta-Kon® vinyl terminals
- Kit includes a WT112M crimping tool
- Includes cable ties and wire marker book



CAT. NO.	DESCRIPTION	PKG. QTY.
STAKIT	Assortment of Sta-Kon® vinyl terminals, splices and disconnects. Includes crimp tool, cable ties and wire book marker	1

Lightweight, durable, nylon construction!

Sta-Org® Terminal and Splice Organizer Kit

- Ideal for contractors, OEMs or any other user of terminals and splices
- Slips in a tool box or sits on your bench — only 6.6"L x 3" dia.
- Bench-mountable (hardware included)

Kit Contents

- (1) blue nylon organizer/carrier
- (6) see-through nylon canisters with lids
- (20) #12-#10 AWG vinyl ring terminals (Cat. No. 10RC-10)
- (25) #18-#14 AWG vinyl butt splices (Cat. No. 2RB-14X)
- (25) #18-#14 AWG vinyl ring terminals (Cat. No. 14RB-10)
- (20) #12-#10 AWG vinyl fork terminals (Cat. No. 10RC-10F)
- (15) #12-#10 AWG vinyl butt splices (Cat. No. 2RC-10X)
- (25) #18-#14 AWG vinyl fork terminals (Cat. No. 14RB-10F)



CAT. NO.	DESCRIPTION	PKG. QTY.
STA-ORG	Sta-Kon® Sta-Org® Terminal and Splice Organizer Kit	1

Wire Termination Tools and Installation Kits

Recommended Tools

The Shure-Stake® mechanism on mechanical ratchet tools and power tools prevents the dies from releasing the terminal until the proper compression has been completed. With this method, an operator achieves a reliable crimp every time. Thomas & Betts tooling techniques correctly match tools, wire size, and terminal to produce optimum mechanical and electrical performance.



Plier type if installations are fewer than 20 per day



WT112M

Ratchet type if installations are more than 20 per day



ERG4001

Power type if installations are more than 200 per day



12050

Used for installation of various Sta-Kon® terminal series.

Plier-Type Tools



WT110M



WT111M



WT112M



WT161M



WT2000

CAT. NO.	DESCRIPTION	PKG. QTY.
WT110M	A, B, C non-insulated terminal and splices and A, B non-insulated terminals with insulation grip	1
WT111M	A, B, C, PT non-insulated terminal and splices; includes cutters	1
WT112M	A, B, C non-insulated and RA, RB, RC insulated nylon and vinyl terminal and splices; includes cutters	1
WT161M	A, B, C, PT non-insulated terminal and splices; includes plier grip and cutters	1
WT2000	A, B, C, AB, PT, RA, RB, RC insulated and non-insulated terminal and splices; includes wire cutters, bolt cutters and wire stripper	1

Wire Termination Tools and Installation Kits

Redesigned family of termination tools sets a new standard for manual crimping tools!

Comfort Crimp® Compression Tools

The most comfortable crimp available from a manual compression tool!

Sta-Kon® Comfort Crimp® Compression Tools previously set the standard for manual crimp tools. Now, Thomas & Betts engineers have made a great line of tools even better with the newly redesigned Sta-Kon® Comfort Crimp® Compression Tools. We kept all the performance features that made the tools industry leaders such as the Shure-Stake® mechanism and interchangeable dies with color-coded die nests, and focused on creating the best possible user experience in terms of comfort and reduction of strain.

Ergonomic handles position the user's hands correctly to minimize the risk of strain, and soft, over-molded grips cushion fingers and palm for user comfort. A new Crimp-Assist™ foot stabilizes the tool when the user needs to place it on a work surface for leverage to crimp larger connectors. Best of all, the redesigned Comfort Crimp® tools require 25% less handle force to complete the crimp cycle than the previous generation — and up to 75% less handle force than competing tools!

Requiring the lowest handle force of any tool in its class, the new Comfort Crimp® family provides maximum comfort to installers, without sacrificing the durability or performance associated with Thomas & Betts tools.



- Perfect for OEM, MRO and field use
- UL Listed for use with Sta-Kon® connectors
- Shure-Stake® mechanism ensures a complete crimp cycle before release for a proper crimp every time
- Color-coded die nests for easy matching with Sta-Kon® insulated terminals
- Creates integrity dots for quick verification of proper crimp
- Advanced manufacturing methods for improved durability and tool life
- Lanyard hole in handle for easy tethering to workstation
- Calibration service available through T&B Tool Services



ERG4002



ERG4004



ERG4005



ERG4007



ERG4008

CAT. NO.	FOR USE WITH STA-KON® SERIES	PKG. QTY.
ERG4001	RA, RB, RC nylon & vinyl terminals, splices & disconnects	1
ERG4002	A, B, C non-insulated terminals, splices, disconnects	1
ERG4004	A, B and C flag terminals	1
ERG4005	B, C, D, E non-insulated terminals, splices, (D & E tubular only)	1
ERG4006	RA, RB .110 disconnects and RZ Terminals	1
ERG4007	RD & RE insulated terminals (tubular only)	1
ERG4008	Non-insulated terminals #8–1/0 AWG (tubular only)	1

Note: Contact Tool Services for gauging.

Wire Termination Tools and Installation Kits

WT1377 Ratchet Hand Tool

Correct compression every time — the Shure-Stake® mechanism principle prevents opening of the handles until full staking action is completed. Installs self-insulated and non-insulated Sta-Kon® terminal series in the #26–#10 AWG wire range.



CAT. NO.	FOR USE WITH STA-KON® SERIES	PKG. QTY.
WT1377	NW ring terminals	1

ERG4006 Hand Tool



CAT. NO.	FOR USE WITH STA-KON® SERIES	PKG. QTY.
ERG4006	RZ terminals/splices RA, RB .110 insulated disconnects	1

ERG4255 Ratchet Hand Tool



CAT. NO.	FOR USE WITH STA-KON® SERIES	PKG. QTY.
ERG4255	RA, RB, RC heat-shrinkable nylon-insulated terminals, butt splices, and disconnects	1

WT2130A Ratchet Hand Tool



CAT. NO.	FOR USE WITH STA-KON® SERIES	PKG. QTY.
WT2130A	RC, RBC and RD insulated terminals, RC6, RP7 wire joints	1

WT3185 Ratchet Hand Tool



CAT. NO.	FOR USE WITH STA-KON® SERIES	PKG. QTY.
WT3185	For #8 AWG to 250 kcmil non-insulated Sta-Kon® Terminals	1

Note: For gauging information, contact Tool Services.

WT129 Flag Terminal Type Hand Tool



CAT. NO.	FOR USE WITH STA-KON® SERIES	PKG. QTY.
WT129	D, E, F & G non-insulated flag terminals	1

Wire Termination — Sta-Kon® Wire Termination & Insulation

Wire Termination Tools and Installation Kits

Single operation to cut and strip at the same time!

SWS01/DWS02 Wire Stripping/Cutting Tools

- Automatic adjustment to the diameter of the wire, with neither setting nor selection
- Sharply cuts and strips insulator without damaging the conductors
- DWS02 is a double-side stripper



SWS01



DWS02

CAT. NO.	DESCRIPTION	PKG. QTY.
SWS01	Single-Side Stripper	1
DWS02	Double-Side Stripper	1

Integral wire cutter lets user cut and strip with the same tool!

Sta-Kon® ERG1-WS Wire Stripping/Cutting Tool

- Interchangeable cassettes enable the user to strip a wide range of insulations without having to change tools
- Tool automatically strips wire to preset length



"V" Blade Cassette

CAT. NO.	DESCRIPTION	PKG. QTY.
ERG1-WS	Ergonomic Wire Stripping Tool	1
VBC-1	Replacement "V" Blade Cassette	1

ERG1-WS Wire Stripping/Cutting Tool is shipped with one Straight Blade Cassette (SBC-1). "V" Blade Cassettes sold separately.

WT115A Toggle-Type Hand Tool



CAT. NO.	FOR USE WITH STA-KON® SERIES	PKG. QTY.
WT115A	D, E, F & G Non-Insulated Terminals	1

TBM6 & TBM6S Toggle-Type Hand Tools



TBM6

Installing Dies for Non-Insulated Code and Aircraft Sta-Kon® Terminals

CAT. NO.		
NEST STATIONARY DIE	INDENTOR MOVABLE DIE	TERM SIZE
11803		D, E (Tubular)
11805		E (Brazeed), F (Tubular)
11806	11802	F (Brazeed), G
11807		H
11808		J
11809		K
11810		L
11811		M

Installing Dies for Nylon-Insulated Sta-Kon® Terminals TBM6 & TM6S Tools

DIE SET	
CAT. NO.	TERM. SIZE
11821	RD (Tubular)
11822	RD (Brazeed Seam) RE (Tubular)
11823	RF
11824	RG
11825	RH
11826	RJ
11827	RK
11828	RL
11829	RM

CAT. NO.	FOR USE WITH STA-KON® SERIES	PKG. QTY.
TBM6	D through M, RD through RM	1
TBM6S	D through M, RD through RM with Shure-Stake®	1

Dies not included.
Note: This tool can also be used to crimp Blackburn® Lugs and Splices. See **page F-85** for dies.

Wire Termination Tools and Installation Kits

Safe, fast, high-volume crimping machine!

Shure-Stake® Auto-Feed Tool

- Shure-Stake® mechanism
- Fully guarded foot pedal
- Clear plastic safety guard over die area
- Dies color coded to terminals
- #26–#10 AWG wire range
- Installs insulated and non-insulated terminals and disconnects



Wire Termination — Sta-Kon® Wire Termination & Insulation

Installing Dies for 12050

DIE CAT. NO.	STA-KON® TERMINAL TYPE	AWG WIRE SIZE	PKG. QTY.
12051	RA — Nylon	22–18	1
12054*	RA — Vinyl	22–18	1
12061	RA Disconnect	22–18	1
12052	RB — Nylon	16–14	1
12055*	RB — Vinyl	16–14	1
12062	RB Disconnect	16–14	1
12056	RC — Nylon and Vinyl Insulated	12–10	1
12057	A — Non-Insulated	22–18	1
12058	B — Non-Insulated	16–14	1
12059	C — Non-Insulated	12–10	1
12060	C Disconnect, Non-Insul.	12–10	1

* Can also be used on nylon.

CAT. NO.	DESCRIPTION	PKG. QTY.
12050	Compact, pneumatically operated unit for crimping tape-mounted Sta-Kon® terminals; equipped with a Shure-Stake® mechanism, which ensures a full compression each time	1

Space Requirement: 30" W x 20" H x 20" D

Weight: 55 lbs.

Air Pressure: 90–125 psi input air supply

Wire Termination Tools and Installation Kits

1½ tons of grip that weighs less than three pounds!

Battery-Powered Crimping Tool — BAT22-6

T&B's newest battery-powered tool is fast and portable for making high-volume and difficult-to-reach terminal installations in a snap. The Sta-Kon® BAT22-6 delivers 1.5 tons of crimping force with an easy, pushbutton trigger. The lightweight, ergonomic design minimizes the risk of repetitive motion injuries that can occur with traditional hand crimping tools. And at less than three pounds, one-hand operation is easy while still packing enough power to crimp up to #6 AWG terminals in seconds.

- Interchangeable dies can be quickly changed to crimp non-insulated and insulated terminals up to #6 AWG
- Dies are the same as our hand tools — crimps will be exactly the same between Sta-Kon® hand tools such as our ERG4001 and the BAT22-6
- 360° rotating head gives the user the added flexibility when crimping hard-to-reach connections
- Short cycle time equates to crimping times of less than two seconds
- Quick, lightweight, and maneuverable
- NiCd battery operation provides long-lasting battery life to complete up to 150 crimps on a single charge
- Extra battery and charger are included with the tool, ensuring round-the-clock operation
- Battery charger provides full battery life in under an hour
- Linear crimping motion gives a symmetric, high-quality crimp every time



Easy to rotate with your wrist — delivers fast and effective crimping power.



Uses the exact dies of the Comfort Crimp line of ergonomic tools for Sta-Kon® and Dragon Tooth® terminals.

Included Accessories

- Sturdy, plastic carrying case for portability
- Two 9.6V NiCd batteries and battery charger
- Sturdy tray for convenient storage of crimp dies

CAT. NO.	DESCRIPTION	PKG. QTY.
BAT22-6	Battery Crimping Tool, 1.5 Ton with 120-VAC Charger	1

Crimp Dies*

DIE2001	Insulated #22-#10 AWG Sta-Kon® Terminals	1
DIE2002	Non-Insulated #22-#10 AWG Sta-Kon® Terminals	1
DIE2005	Non-Insulated #16-#14/#12-#10/#8-#6 Sta-Kon® Terminals (Tubular Only)	1
DIE2007	Insulated #8-#6 AWG Sta-Kon® Terminals (Tubular Only)	1

*Dies sold separately.

Note: Battery-powered tools BPI42300CR, BPLT6BSCR and BPLT62BSCR can also be used to crimp non-insulated Sta-Kon® terminals. See pages F-86-F-88.

Portable heavy-duty air tool.

PAIR22-6 Heavy-Duty Portable Air Crimp Tool

- 1.25 tons output force at 100 psi
- Crimps #22-#6 AWG terminals
- Installs Sta-Kon® terminals as well as ferrules and Dragon Tooth® connectors
- Interchangeable dies
- Open yoke enables easy access to insert and remove terminals for crimping



CAT. NO.	DESCRIPTION	PKG. QTY.
PAIR22-6	Open yoke, hand actuated	1

Crimp Dies*

DIE2001	Insulated #22-#10 AWG Sta-Kon® Terminals	1
DIE2002	Non-Insulated #22-#10 AWG Sta-Kon® Terminals	1
DIE2005	Non-Insulated #16-#10/#8-#6 Sta-Kon® Terminals (Tubular Only)	1
DIE2007	Insulated #8-#6 AWG Sta-Kon® Terminals (Tubular Only)	1

*Dies sold separately.

Note: The dies for the PAIR22-6, PAIR22-6 and BAT22-6 are interchangeable.

Note: Battery-powered tools BPI42300CR, BPLT6BSCR and BPLT62BSCR can also be used to crimp non-insulated Sta-Kon® terminals. See pages F-86-F-88.

Wire Termination Tools and Installation Kits

Crimps #22–#6 AWG terminals!

BAIR22-6 Bench-Mounted Air Tool

- 1.8 tons output force at 100 psi
- Bench-mounted heavy-duty air tool
- Short cycle time
- Shure-Stake® mechanism
- Foot actuated
- Accepts T&B standard hand tool dies
- Installs Sta-Kon® and Spec-Kon® terminals as well as ferrules and Dragon Tooth® connectors



CAT. NO.	DESCRIPTION	PKG. QTY.
BAIR22-6	Heavy-duty, high-speed production tool installs a wide range of Sta-Kon® terminals, from #26–#6 gauge; uses the DIE2000 series dies for both non-insulated and insulated terminals; supplied complete with foot pedal, air hose/air lubricator	1

Crimp Dies*

DIE2001	Insulated #22–#10 AWG Sta-Kon® Terminals	1
DIE2002	Non-Insulated #22–#10 AWG Sta-Kon® Terminals	1
DIE2005	Non-Insulated #16–#10/#8–#6 Sta-Kon® Terminals (Tubular Only)	1
DIE2007	Insulated #8–#6 AWG Sta-Kon® Terminals (Tubular Only)	1

* Dies sold separately.

Note: The dies for the BAIR22-6, PAIR22-6 and BAT22-6 are interchangeable.

Note: Battery-powered tools BPI42300CR, BPLT6BSCR and BPLT62BSCR can also be used to crimp non-insulated Sta-Kon® terminals. See pages F-86–F-88.

Crimps #8 AWG–250 kcmil!

Air-Operated Bench-Mounted Tool

Convenience and Economy

The tool accepts a full range of interchangeable dies, the same as used in the TBM6 or TBM6S tools. To install the dies, simply pull the spring-loaded pin and remove the indenter die. Then, flex the retaining spring and remove the die nest.

Shure-Stake® Mechanism Means Quality Connections

The Shure-Stake® mechanism senses inlet air pressure, and if insufficient, is designed to prevent the tool from cycling. Thus you avoid “undercrimping.” An 85–90-psi air pressure source is required.

Safety Features Increase Productivity, Reduce Downtime

Safety features include a guard over the die area, an air shutdown switch activated by a slight push with the finger and a foot pedal that’s enclosed to prevent accidental tool operation. In addition, the tool may be bench-mounted for stability and control. For convenience when crimping large size terminals on heavy wire, the head assembly may overhang the workbench.



CAT. NO.	DESCRIPTION	PKG. QTY.
25000	This compact heavy-duty air tool installs nylon insulated Sta-Kon® terminals on wire sizes from #8 AWG to 250 kcmil; non-insulated styles are also installed just as quickly and dependably; heavy-duty air tool installs non-insulated and insulated Sta-Kon® terminals from #8 AWG to 250 kcmil	1

Note: This tool uses the same dies as the TBM6 and TBM6S hand tools on page F-85.

Wire Termination Tools and Installation Kits

Installs insulated and non-insulated Sta-Kon® Terminals!

12-Ton Hydraulic Head

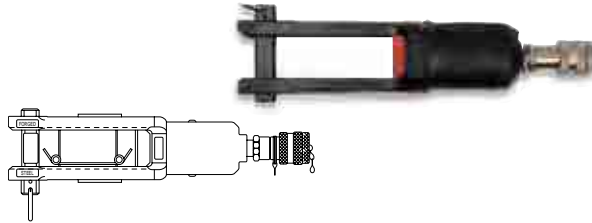

CAT. NO.	DESCRIPTION	PKG. QTY.
13400	12-ton crimping tool supplied with adapter TBM12D-AR is used for installing both insulated and non-insulated Sta-Kon® terminals #8 AWG to 250 kcmil (dies ordered separately)	1

Military listed and 12 tons of crimping power!

12-Ton Crimping Tool (Military Spec. MS25441-1)



CAT. NO.	DESCRIPTION	PKG. QTY.
13642M	Hydraulic-operated 12-ton tool installs #8 AWG through 250 kcmil Sta-Kon® terminals (dies ordered separately)	1

Hex Dies for Non-Insulated Sta-Kon® Terminals to Fit 13642M and 13400

DIE CAT. NO.		STA-KON® SIZE	WIRE SIZE	HEX DIE CODE
FOR TUBULAR TERM	FOR BRAZED SEAM			
11732	—	D	8	21
—	11733	D	8	24
11733	—	E	6	24
—	11734	E	6	29
11734	—	F	4	29
—	11735	F	4	33
11736	—	G	2-1	37
11737	—	H	1/0	42
11738	—	J	2/0	45
11739	—	K	3/0	50
11740	—	L	4/0	54
11771	—	M	250 kcmil	62

Installing Dies for Insulated Sta-Kon® Terminals to Fit 13642M (Military Listed)

DIE CAT. NO.	STA-KON® SIZE	WIRE SIZE	PKG. QTY.
21707M	RD	8	1
21708M	RE	6	1
21709M	RF	4	1
21710M	RG	2-1	1
21711M	RH	1/0	1
21712M	RJ	2/0	1
21713M	RK	3/0	1
21714M	RL	4/0	1
21715M	RM	250 kcmil	1

Hex Dies for Non-Insulated Sta-Kon® Terminals to Fit 13642M (Military Listed)

DIE CAT. NO.	STA-KON® SIZE	WIRE SIZE	PKG. QTY.
11781M	D	8	1
11782M	E	6AN	1
11783M	F	4AN	1
11784M	G	2AN	1
11785M	H	1AN	1
11786M	J	1/OAN	1
11787M	K	2/OAN	1
11788M	L	3/OAN	1
11789M	M	4/OAN	1

Indent Style Dies for Sta-Kon® Brazed Seam Non-Insulated Terminals to Fit 13642M and 13400

NEST CAT. NO.	INDENT. CAT. NO.	STA-KON® SIZE	WIRE SIZE	PKG. QTY.
13643	13650	D	8	1
13644		E	6	1
13645		F	4	1

Indent Style Dies for Sta-Kon® Tubular Non-Insulated Terminals to Fit 13642M and 13400

NEST CAT. NO.	INDENT. CAT. NO.	STA-KON® SIZE	WIRE SIZE	PKG. QTY.
13654	13650	G	2-1	1
13655		H	1/0	1
13656		J	2/0	1
13657		K	3/0	1
13658		L	4/0	1
13659		M	250 kcmil	1

Indent Style Dies for Flag Type Sta-Kon® Terminals — Use with 13642M and 13400

NEST CAT. NO.	INDENT. CAT. NO.	STA-KON® SIZE	WIRE SIZE	PKG. QTY.
21733	21731	D	8	1
21734		E	6	1
21735		F	4	1
21736	21732	G	2	1
21737		H	1	1
21738		J	1/0	1
21739**		K	2/0	1
21740**		L	3/0	1
21741**		M	4/0	1

** Cat. Nos. 21739, 21740 and 21741 dies must be left in 13642 head with 21732 indenter when gauging.

Wire Termination Tools and Installation Kits

13600 Electric Hydraulic Pump

- Designed for use with single-acting cylinders and tools rated for 10,000-psi operation
- Supplied with metal carrying case
- 13620 hand switch and 13619 hydraulic hose, both sold separately, required for operation

.....Specifications.....

- Motor: ½ hp, 115V 50–60 Hz, 10 amps
- Pumping Capacity:
170 cu. in./min. at 100 psi
32 cu. in./min. at 1,000 psi
25 cu. in./min. at 5,000 psi
18 cu. in./min. at 10,000 psi
- Reservoir Volume: 104 cu. in. (.45 gal.)
- Basic Pump Dimension: 6" x 8" x 16"
- Weight: 25 lbs.



CAT. NO.	DESCRIPTION	PKG. QTY.
13600	Electric Hydraulic Pump — hand or foot switch and non-metallic hose (sold separately) required for operation	1

13610A Electric Hydraulic Pump with Shure-Stake® Control

- Shure-Stake® control mechanism requires 9,800-psi pump pressure before recycling to prevent under-crimping
- Designed for use with single-acting cylinders and tools rated for 10,000-psi operation
- Supplied with metal carrying case



.....Specifications.....

- Motor Rating: ½ hp, 115V, 50–60 Hz, 12.5 amps
- Pumping Capacity:
170 cu. in./min. at 100 psi
32 cu. in./min. at 1,000 psi
25 cu. in./min. at 5,000 psi
18 cu. in./min. at 10,000 psi
- Reservoir Volume: 104 cu. in. (.45 gal.)
- Basic Pump Dimension: 8½" x 10½" x 16"
- Weight: 35 lbs.

CAT. NO.	DESCRIPTION	PKG. QTY.
13610A	Electric Hydraulic Pump with Shure-Stake® control — hand or foot switch and non-metallic hose (sold separately) required for operation	1

13810 Heavy-Duty Electric Hydraulic Pump with Shure-Stake® Control



- Designed for perfect crimps every time in heavy-duty OEM applications
- Heavy-duty OEM two-stage pump with high flow rate
- Shure-Stake® control mechanism requires 9,800-psi pump pressure before recycling to prevent under-crimping
- Requires hand or foot control (sold separately)

.....Specifications.....

- Motor Rating: 1½ hp, 115V, 60 Hz, 23 amps
- Pumping Capacity:
235 cu.in./min. at 200 psi
6 cu.in./min. at 8,000 psi
- Reservoir Volume: 462 cu.in./2 gal.
- Dimensions (L x W x H): 10¾" x 15" x 20¾"
- Weight: 60 lbs.

CAT. NO.	DESCRIPTION	PKG. QTY.
13810	Heavy-duty electric hydraulic pump with Shure-Stake® control — hand or foot switch and non-metallic hose (sold separately) required for operation	1

Accessories for the pumps on this page

CAT. NO.	DESCRIPTION	PKG. QTY.
<i>You may also need...for 13600</i>		
13620	Hand Switch	1
13589A	Foot Switch	1
13619	10-ft. Non-Metallic Hose	1
13618	20-ft. Non-Metallic Hose	1
13600S	"Sled" type stand for 13600 pump	1
<i>You may also need...for 13610A & 13810</i>		
13611	Hand Switch	1
13612	Foot Switch	1
13619	10-ft. Non-Metallic Hose	1
13618	20-ft. Non-Metallic Hose	1

Wire Termination Technical Information

Platings/Finish

Electroplated-Tin is standard finish. All others require minimum order quantities and are generally not stocked. Alternative platings are as follows: Gold, Silver, Tin-Alloys, Nickel or plain finish. See table **(below)** for specification information.

FINISH	SUFFIX	SPEC.	TEMP. RATING
Gold Plate	GP	MIL-G-45204 Type II, Grade B, C, D, Class O	260° C
Nickel Plate	NP	QQ-N-290 Class 2, Grade G	260° C
Plain Finish	PF	None	150° C
Silver Plate	SP	MIL-T-16366 Type I or II, 400° F, 204° C	150° C

Listing

Sta-Kon® Rings, Forks and Locking Forks are tested and listed to UL 486A, two-way splices to UL 486C, disconnects to UL 310 and all applicable products to CSA 22.2.

Sta-Kon® Technical Data



TERMINALS & SPLICES INSULATION RATING	UL® 94 FLAMMABILITY	VOLTAGE	TEMPERATURE
Nylon	V-2	600V*	105° C
Vinyl	V-0	600V*	105° C
Tefzel®	V-0	600V*	150° C
Disconnects		300V	105° C
Non-Insulated	—	600V	150° C

*1000V fixture or sign

Minimum pull-out test — UL 486A and UL 486C

Wire Termination Technical Information

The proper installation procedure for the quality-assured connection!

The proper installation of terminals, splices and connectors is very important to the efficient performance of an electrical system. The properly installed connector will enable good conductivity through the termination. Certain basic requirements must be met to make a good termination.

- Strip the insulation carefully to avoid nicking or cutting conductor strands
- Strip the insulation to the proper length so the conductors can be inserted fully into the connector barrel; the wire/cable should be visible in the inspection hole of the lug; the proper strip length can be found on **page G-51**.

A poor termination results in a high-resistance connection.
A poor connector installation may cause damage or failure of an entire system.

Installation Procedure

1. Strip the insulation carefully to avoid nicking or cutting conductor strands.
2. Strip the insulation to the proper length so the conductors can be inserted fully into the connector barrel; the wire/cable should be visible in the inspection hole of the lug; the proper strip length can be found on **page G-51**.
3. Train the wires to eliminate fanning of strands.
4. Open handles fully.
5. Insert terminal in proper die nest and locate it as shown above. When crimping a butt splice, position in proper die nest with window facing indentor.
6. Close handles slightly to secure terminal. Do not deform terminal.
7. Insert properly stripped wire into terminal.
8. Complete crimp by closing handles.

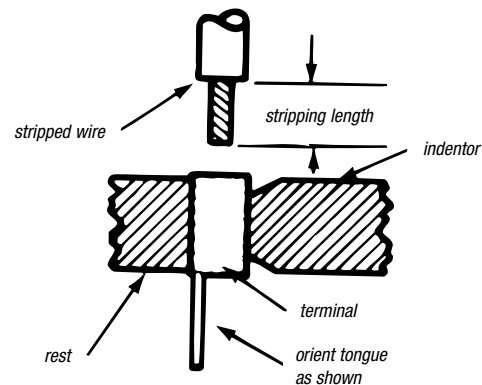

Shure-Stake® tools are matched to terminals.

Wire Termination Technical Information

Critical information for determining the products you need!

TERMINAL TYPE	TERMINAL SERIES	PLIERS					ERGONOMIC RATCHET HAND TOOLS						RATCHET HAND TOOLS	
		WT110M	WT111M	WT112M	WT161M	WT2000	ERG4001	ERG4002	ERG4004	ERG4005	ERG4006	ERG4255	WT1377	WT145A
Nylon Terminals	RZ										•			
	RA, RAX			•		•	•							•
	RB			•		•	•							•
	RBC, RC			•		•	•							•
Nylon Butt Splices	RA			•		•	•							
	RB			•		•	•							
	RC			•		•	•							
Nylon Parallel Splices	RAA					•								
	RBB					•								
	RCC					•								
All Nylon Disconnects (except .110 size)	RA			•		•	•							
	RB			•		•	•							
	RC			•		•	•							
Heat-Shrinkable Terminals, Splices, Disconnects	RAS											•		
	RBS											•		
	RCS											•		
Vinyl Terminals and Splices	RA, RAA			•		•	•							
	RB, RBB			•		•	•							
	RC, RCC, RBC			•		•	•							
Bare Terminals and Splices	A, AA	•	•	•	•	•		•						
	B, BB	•	•	•	•	•		•		•				
	C, CC	•	•	•	•	•		•		•				
Wire Joints	RB			•		•	•							
	RC			•		•								
	RP			•		•								
	PT		•		•									
Hi-Temp Terminals and Splices	NW-Rings												•	
	NW-Splices												•	
Insulation Grip	A	•												
	B	•												
.110 Disconnects	A, B	•	•	•										
	RA, RB										•			
Flag Terminals	AB									•				
	C									•				
Tefzel® Terminals and Splices	RAT, RAAT			•		•								
	RBT, RBBT			•		•								
	RCT, RCCT			•		•								
Vinyl Disconnects	RA			•		•	•							
	RB			•		•	•							
	RC			•		•	•							
Bare Disconnects	A	•	•	•	•	•		•						
	B	•	•	•	•	•		•		•				
	C	•	•	•	•	•		•		•				

Tefzel® is a registered trademark of DuPont.

Wire Termination Technical Information

TERMINAL TYPE	TERMINAL SERIES	RATCHET HAND TOOLS (CONT.)		BAT22-6 BAIR22-6 PAIR22-6				12050 MYLAR TAPE AUTO TOOL								
		WT145C	WT2130A	DIE2001	DIE2002	DIE2005	DIE2009	12051	12052	12054	12055	12056	12057	12058	12059	12060
Nylon Terminals	RZ															
	RA, RAX	•		•				•		•						
	RB	•		•					•		•					
	RBC, RC	•	•	•								•				
Nylon Butt Splices	RA	•		•												
	RB	•		•												
	RC	•	•	•												
Nylon Parallel Splice	RAA															
	RBB															
	RCC															
All Nylon Disconnects (except .110 size)	RA	•		•				•		•						
	RB	•		•					•		•					
	RC	•	•	•								•				
Heat Shrinkable Terminals, Splices, Disconnects	RAS															
	RBS															
	RCS															
Vinyl Terminals and Splices	RA, RAA	•		•						•						
	RB, RBB	•		•							•					
	RC, RCC, RBC	•	•	•								•				
Bare Terminals and Splices	A, AA				•								•			
	B, BB				•	•								•		
	C, CC				•	•	•								•	
Wire Joints	RB			•			•									
	RC		•				•									
	RP		•				•									
	PT															
Hi-Temp Terminals and Splices	NW-Rings															
	NW-Splices															
Insulation Grip	A															
	B															
.110 Disconnects	A, B															
	RA, RB															
Flag Terminals	AB															
	C															
Tefzel® Terminals and Splices	RAT, RAAT	•														
	RBT, RBBT	•														
	RCT, RCCT	•														
Vinyl Disconnects	RA	•		•						•						
	RB	•		•							•					
	RC	•	•	•								•				
Bare Disconnects	A				•								•			
	B				•	•								•		
	C				•	•										•

Tefzel® is a registered trademark of DuPont.

Wire Termination Technical Information

Select the die numbers you need!

Wire Termination — Sta-Kon® Wire Termination & Insulation

DESCRIPTION	TERMINAL		HAND TOOL WITH DIES	25000 AIR TOOL TBM6 TOGGLE HAND TOOL TBM6S TOGGLE HAND TOOL DIE CAT. NOS.		BPI42300CR, BPLT6BSCR AND BPLT62BSCR CRIMP TOOLS		13642M (MS25441-1) AND 13400 HYDRAULIC TOOL		
	SERIES	TYPE		NEST (STATIONARY)	INDENTOR (MOVABLE)	HEX DIES	DIE CODE	HEX DIES	NEST	INDENTOR
Non-Insulated Terminals and Splices	D	Tubular	ERG4005	11803	11802	—	—	11781M*	13651	13650**
	D	Tubular	ERG4008	11803	11802	—	—	11781M*	13651	13650**
	D	Tubular	WT3185/WT115A	11803	11802	TBM6221	21	11732	13651	13650**
	D	Brazed	WT3185/WT115A	11803	11802	TBM6224	24	11733	13643	13650**
	E	Tubular	ERG4005	11803	11802	—	—	11782M	13652	13650**
	E	Tubular	ERG4008	11803	11802	—	—	11782M	13652	13650**
	E	Tubular	WT3185/WT115A	11803	11802	TBM6224	24	11733*	13652	13650**
	E	Brazed	WT3185/WT115A	11804	11802	TBM6229	29	11734	13644	13650**
	F	Tubular	ERG4008	11805	11802	—	—	11783	13653	13650**
	F	Tubular	WT3185/WT115A	11805	11802	TBM6229	29	11734*	13653	13650**
	F	Brazed	WT3185/WT115A	11806	11802	TBM6233	33	11735	13645	13650**
	G	Tubular	ERG4008	11806	11802	—	—	11784M*	13654	13650**
	G	Tubular	WT3185/WT115A	11806	11802	TBM6237	37	11736	13654	13650**
	H	Tubular	ERG4008	11807	11802	—	—	11785M*	13655	13650**
	H	Tubular	WT3185	11807	11802	—	—	11785M*	13655	13650**
	H	Tubular	WT3185	11807	11802	TBM6242	42	11737	13655	13650**
	J	Tubular	WT3185	11808	11802	—	—	11786M*	13656	13650**
	J	Tubular	WT3185	11808	11802	TBM6245	45	11738	13656	13650**
K	Tubular	—	11809	11802	—	—	11787M*	13657	13650**	
K	Tubular	—	11809	11802	TBM6250	50	11739	13657	13650**	
L	Tubular	—	11810	11802	—	50	11788M*	13658	13650**	
L	Tubular	—	11810	11802	TBM6254	54	11740	13658	13650**	
M	Tubular	—	11811	11802	—	54	11789M*	13659	13650**	
M	Tubular	—	11811	11802	TBM6262	62	11771	13659	13650**	
Tefzel® Nylon Insulated Terminals and Splices	RD	Tubular	ERG4007	11821	(Set)	—	—	21707M* (Set)	—	—
	RD	Brazed & Tubular	—	11822	(Set)	—	—	21708M* (Set)	—	—
	RE	Tubular	ERG4007	11822	(Set)	—	—	21708M* (Set)	—	—
	RE	Brazed	—	11823	(Set)	—	—	21709M* (Set)	—	—
	RF	Tubular	—	11823	(Set)	—	—	21709M* (Set)	—	—
	RF	Brazed	—	11824	(Set)	—	—	21710M* (Set)	—	—
	RG	Tubular	—	11824	(Set)	—	—	21710M* (Set)	—	—
	RH	Tubular	—	11825	(Set)	—	—	21711M* (Set)	—	—
	RJ	Tubular	—	11826	(Set)	—	—	21712M* (Set)	—	—
	RK	Tubular	—	11827	(Set)	—	—	21713M* (Set)	—	—
RL	Tubular	—	11828	(Set)	—	—	21714M* (Set)	—	—	
RM	Tubular	—	11829	(Set)	—	—	21715M* (Set)	—	—	
Non-Insulated Flag Terminals	D	—	WT129	—	—	—	—	21733	21731	21731
	E	—	WT129	—	—	—	—	21734	21731	21731
	F	—	WT129	—	—	—	—	21735	21731	21731
	G	—	WT129	—	—	—	—	21736	21732	21732
	H	—	—	—	—	—	—	21737	21732	21732
	J	—	—	—	—	—	—	21738	21732	21732
	K	—	—	—	—	—	—	21739	21732	21732
	L	—	—	—	—	—	—	21740	21732	21732
M	—	—	—	—	—	—	21741	21732	21732	

* Indicates military listed die.

** To order the military version, suffix the indentor catalog number with an "M" (13650M). Nest catalog number does not change.

† Tefzel® is a registered trademark of DuPont.

Stud Size and Clearance Hole Chart

STUD SIZE	2	4	6	8	10	1/4	5/16	3/8	7/16	1/2	5/8	3/4
Min. hole diam. — in.	.92	.116	.143	.169	.196	.262	.323	.388	.453	.516	.650	.775
Min. hole diam. — mm	2.337	2.946	3.632	4.292	4.978	6.655	8.204	9.855	11.506	13.106	16.510	19.685

Wire Termination Technical Information

Wire Strip Length Chart



WIRE STRIP LENGTH	TERMINAL SERIES	RECOMMEND WIRE STRIP LENGTH "A" STANDARD TERMINALS
Non-Insulated	A	¼
	B	¼
	C, BC	⅝
Vinyl Insulated — Add ⅛" for Funnel Entry Type	RA	¼
	RB	¼
Nylon Insulated and Tefzel® Insulated	RC, RBC	⅛
	RA	⅞
Nylon Insulated and Tefzel® Insulated when using Aircraft and Code Wire	RB	⅞
	RC, RBC	⅝
	RD	⅞
	RE	⅞
	RF	⅝
	RG	⅞
	RH	⅞
RJ	¾	
Non-Insulated, when using Aircraft Code Wire	RK	⅞
	RL	⅞
	RM	1
	D	⅞
	E	⅞
	F	½
	G	⅞
H	⅞	
J	⅞	
K	⅞	
L	⅞	
M	⅞	

Tefzel® is a registered trademark of DuPont.

AWG OR AN	NAVY SHIPBOARD†	INDIVIDUAL STRANDS		WHOLE CONDUCTOR		
		NO.	DIA. IN.	CIR. MIL. AREA	DIA. IN.	DIA. MM
22 Wire Size						
22	⅝ (1)	1	.025	642	.025	.635
22	⅝ (7)	7	.010	703	.030	.762
AN-22*		7	**	704	.032	.813
	½ (21)	21	.005	525	.028	.711
20 Wire Size						
20	1 (1)	1	.032	1,022	.032	.813
20		7	.012	1,024	.036	.914
20		10	.010	1,005	.040	1.016
20		19	.007	1,022	.037	.940
20		26	.006	1,034	.039	.991
AN-20*		7	**	1,119	.040	1.016
	1 (7)	7	.013	1,119	.038	.965
	1 (10)	10	.010	1,005	.038	.965
	1 (26)	26	.006	1,034	.042	1.067
18 Wire Size						
18	1½ (1)	1	.040	1,624	.040	1.016
18	1½ (7)	7	.016	1,624	.049	1.245
18	1½ (16)	16	.010	1,608	.049	1.245
18		19	.009	1,624	.046	1.168
18	1½ (41)	41	.006	1,630	.049	1.245
AN-18*	2 (7)	7	.016	1,779	.048	1.219
16 Wire Size						
16	2½ (1)	1	.051	2,583	.051	1.295
16		7	.019	2,583	.058	1.473
16		19	.012	2,601	.058	1.473
16		26	.010	2,613	.059	1.499
16		65	.006	2,580	.058	1.473
AN-16*	2½ (19)	19	.011	2,407	.061	1.549
	2½ (26)	26	.010	2,613	.061	1.549
14 Wire Size						
14		1	.064	4,107	.064	1.626
14		7	.024	4,107	.073	1.854
14		19	.015	4,107	.074	1.880
14		37	.011	4,107	.074	1.880
14		14	.009	4,157	.083	2.108
14		104	.006	4,128	.074	1.880
AN-14*		19	**	3,830	.076	1.930
	3 (7)	7	.020	2,828	.060	1.524
	3 (19)	19	.013	3,036	.063	1.600
	4 (1)	1	.064	4,107	.064	1.626
	4 (7)	7	.025	4,497	.076	1.930
	4 (19)	19	.014	3,828	.072	1.829
	4 (41)	41	.010	4,121	.077	1.956
12 Wire Size						
12		1	.081	6,530	.081	2.057
12		7	.031	6,530	.092	2.337
12		19	.019	6,530	.093	2.362
12		37	.013	6,530	.093	2.362
12		49	.012	6,593	.104	2.642
12		65	.010	6,533	.093	2.362
12		104	.008	6,574	.094	2.388
12		165	.006	6,559	.095	2.413
AN-12*	6 (19)	19	.018	6,088	.096	2.438
	6 (7)	7	.031	6,512	.092	2.337
	6 (65)	65	.010	6,533	.097	2.964
10 Wire Size						
10		1	.102	10,380	.102	2.591
10		7	.039	10,380	.116	2.946
10		19	.023	10,380	.117	2.972
10		37	.017	10,443	.117	2.972
10		49	.015	10,445	.131	3.327
10		104	.010	10,452	.116	2.946
AN-10*		37	**	10,380	.117	2.972
	9 (7)	7	.036	9,016	.108	2.743
	9 (37)	37	.016	9,402	.109	2.769
	9 (90)	90	.010	9,045	.120	3.048

* MIL-W-5086. ** Strand diameter not specified. † MIL-E-16366 A.

Wire Termination Technical Information

AWG OR AN	NAVY SHIPBOARD†	INDIVIDUAL STRANDS		WHOLE CONDUCTOR		
		NO.	DIA. IN.	CIR. MIL. AREA	DIA. IN.	DIA. MM
9 Wire Size						
9		7	.043	13,090	.130	3.302
	14 (7)	7	.045	14,340	.136	3.454
8 Wire Size						
8		7	.049	16,510	.146	3.712
8		19	.030	16,510	.148	3.763
8		37	.021	16,510	.148	3.763
7 Wire Size						
7		1	.144	20,820	.144	3.662
	14 (7)	7	.045	14,340	.136	3.454
	14 (140)	140	.010	14,070	.145	3.787
6 Wire Size						
6		7	.061	25,250	.184	4.672
6		19	.037	26,250	.186	4.722
6		37	.027	26,250	.186	4.722
6		49	.023	26,146	.208	5.283
6		661	.006	26,274	.259	6.579
5 Wire Size						
5		1	.181	33,100	.181	4.595
	20 (49)	7x7	.020	19,800	.180	4.570
	23 (7)	7	.057	22,800	.171	4.345
	23 (228)	19x12	.010	22,190	.190	4.830
	26 (49)	7x7	.023	26,250	.210	5.330
4 Wire Size						
4		7	.077	41,740	.232	5.891
4		19	.047	41,740	.235	5.967
4		37	.034	41,740	.235	5.967
3 Wire Size						
3		1	.229	52,630	.229	5.819
	30 (304)	19x16	.010	30,550	.220	5.590
	33 (336)	7x48	.010	33,370	.235	5.967
	40 (19)	19	.045	38,910	.226	5.742
	42 (49)	7x7	.029	41,740	.260	6.600
	42 (209)	19x11	.014	42,110	.260	6.600
	50 (19)	19	.051	49,080	.254	6.452
2 Wire Size						
2		7	.097	66,370	.292	7.421
2		19	.059	66,370	.296	7.522
2		37	.042	66,370	.297	7.548
2		49	.037	66,356	.331	8.405
2		133	.022	66,140	.335	8.507
AN-2*		663	**	66,832	.345	8.767
	53 (532)	19x28	.010	53,470	.304	7.772
	60 (37)	37	.040	60,090	.282	7.161
	60 (304)	19x16	.014	61,260	.310	7.870
	66 (133)	19x7	.022	66,370	.330	8.380
	75 (37)	37	.045	75,780	.317	8.048
1 Wire Size						
1		7	.109	83,690	.328	8.333
1		19	.066	83,690	.332	8.431
1		37	.048	83,690	.333	8.456
1		61	.037	83,690	.333	8.456
1		133	.025	83,690	.377	9.578
1		259	.018	83,916	.378	9.603
AN-1*		812	**	81,807	.384	9.752
	83 (418)	19x22	.014	84,230	.380	9.650
	84 (2,107)	2107	**	83,690	.410	10.41

* MIL-W-5086.

** Strand diameter not specified.

† MIL-E-16366 A

Wire Termination Technical Information

AWG OR AN	NAVY SHIPBOARD†	INDIVIDUAL STRANDS			WHOLE CONDUCTOR	
		NO.	DIA. IN.	CIR. MIL. AREA	DIA. IN.	DIA. MM
1/0 Wire Size						
1/0		7	.123	105,500	.368	9.343
1/0		19	.075	105,500	.373	9.476
1/0		37	.053	105,500	.374	9.502
1/0		61	.042	105,500	.374	9.502
1/0		133	.028	105,761	.423	10.721
1/0		259	.020	105,672	.424	10.772
AN-0*		1,033	**	104,118	.432	10.971
	100 (61)	61	.040	99,060	.363	9.216
	105 (259)	37x7	**	105,500	.410	10.410
2/0 Wire Size						
	105 (2,646)	2,646	**	105,500	.460	11.680
2/0		7	.138	133,100	.414	10.512
2/0		19	.084	133,100	.419	10.639
2/0		37	.060	133,100	.420	10.670
2/0		61	.047	133,100	.420	10.670
2/0		133	.032	132,800	.474	12.042
2/0		259	.023	133,462	.477	12.118
AN-00*		1,327	**	133,665	.490	12.450
	125 (61)	61	.045	124,900	.407	10.338
	133 (259)	37x7	**	133,100	.460	11.680
	133 (684)	19x36	.014	137,800	.480	12.190
	133 (3,325)	3,325	**	133,100	.520	13.210
	150 (61)	61	.051	157,600	.457	11.608
3/0 Wire Size						
3/0		7	.155	167,800	.464	11.782
3/0		19	.094	167,800	.470	11.940
3/0		37	.067	167,800	.471	11.965
3/0		61	.052	167,800	.472	11.991
3/0		133	.036	167,607	.533	13.536
3/0		259	.026	167,402	.536	13.612
3/0		4,227	.006	168,023	.610	15.490
	150 (760)	19x40	.014	153,100	.510	12.950
	168 (427)	61x7	**	167,800	.520	13.210
4/0 Wire Size						
4/0		7	.174	211,600	.522	13.261
4/0		19	.106	211,600	.528	13.413
4/0		37	.076	211,600	.529	13.439
4/0		61	.059	211,600	.530	13.460
4/0		133	.040	211,736	.599	15.219
4/0		259	.029	211,845	.601	15.265
AN-000*		1,661	**	167,332	.548	13.923
	200 (61)	61	.057	198,700	.514	13.652
	200 (988)	19x52	.014	199,100	.580	14.730
250 kcmil Wire Size						
250,000		19	.115	250,000	.574	14.582
250,000		37	.2	250,000	.575	14.607
250,000		61	.064	250,000	.576	14.632
250,000		91	.052	250,000	.576	14.632
AN-0000*		2,104	**	211,954	.615	15.617
	220 (259)	37x7	.029	220,700	.610	15.490
	250 (61)	61	.064	250,000	.577	14.658

* MIL-W-5086.

** Strand diameter not specified.

† MIL-E-16366 A.

Wire Termination Technical Information

MIL-T-7928	CAT. NO.
MS-25036	T&B CLASS 1 & 2
-101	RA333
-102	RA853
-103	RA873
-104	RA723
-105	RA733
-106	RB1333
-107	RB853
-108	RB873
-109	RB723
-110	RB733
-111	RC333
-112	RC363
-113	RC703
-114	RC733
-115	RD10361
-116	RD10711
-117	RD10721
-118	RD10731
-119	RE10261
-120	RE10711
-121	RE10721
-122	RE10731
-123	RF10711
-124	RF10721
-125	RF10731
-126	RG9711
-127	RG9731
-128	RG9751
-129	RH9711
-130	RH9731
-131	RH9751
-132	RJ9711
-133	RJ9731
-135	RK9721
-136	RK9731
-137	RK9751
-138	RL9731
-139	RL9751
-140	RM9731
-141	RM9751
-142	—
-143	—
-144	—
-145	—
-146	—
-147	—
-148	RA323
-149	RA863
-150	RA713
-151	RA753
-152	RB1323
-153	RB863
-154	RB713
-155	RB753
-156	RC863
-157	RC713
-158	RC753

MIL-T-7928	CAT. NO.
MS-20659	T&B CLASS 1 & 2
-101	A85G
-102	A87G
-103	B85G
-104	B87G
-105	C26
-106	C70
-107	D10361
-108	D10721
-109	E10711
-110	E10731
-111	F10711
-112	F10731
-113	G971
-114	G973
-115	H971
-116	H973
-117	J971
-118	J973
-119	K972
-120	K973
-121	L973
-122	L975
-123	M973
-124	M975
-128	C73
-129	D10731
-130	E10261
-131	E10721
-132	F10721
-133	G975
-134	H975
-135	J975
-136	K975
-140	D10161
-141	D10711
-144	F10261
-146	G926
-147	G972
-148	G974
-149	H972
-151	J972
-152	J974
-153	K971
-154	K974
-155	L972
-156	L974
-157	M972
-158	M974
-165	C33
-166	C75

MIL-T-22909	CAT. NO.
MS-90485	T&B
-8	11781M
-6	11782M
-4	11783M
-2	11784M
-1	11785M
-01	11786M
-02	11787M
-03	11788M
-04	11789M

MIL-T-7928	CAT. NO.
MS-17143	T&B
-1	RA480
-2	RB480
-3	RC480
-4	RA481
-5	RB481
-6	RC481
-7	RA482
-8	RB482
-9	RC482
-10	RA483
-11	RB483
-12	RC483
-13	RA484
-14	RB484
-15	RC484
-16	RA485
-17	RB485
-19	RA486
-20	RB486

MIL-T-7928	CAT. NO.
MS-21004	T&B
-1	A486
-2	A483
-3	A482
-4	A481
-5	A485
-6	A484
-7	A480
-8	B486
-9	B483
-10	B482
-11	B481
-12	B485
-13	B484
-14	B480
-15	C486
-16	C483
-17	C482
-18	C481
-19	C485
-20	C484
-21	C480

MIL-T-22909	CAT. NO.
-MS-23002	T&B
-8	21707M
-6	21708M
-4	21709M
-2	21710M
-1	21711M
-01	21712M
-02	21713M
-03	21714M
-04	21715M

Wire Termination Technical Information

Note: All catalog numbers do not appear in this cross reference. This means it may not be available in one of the package options.

CAT. NO. T&B DISTRIBUTOR PACKAGE	CAT. NO. T&B BULK PACKAGE	CAT. NO. T&B DISTRIBUTOR PACKAGE	CAT. NO. T&B BULK PACKAGE	CAT. NO. T&B DISTRIBUTOR PACKAGE	CAT. NO. T&B BULK PACKAGE	CAT. NO. T&B DISTRIBUTOR PACKAGE	CAT. NO. T&B BULK PACKAGE
10RC-10	RC367	14RBD-183	RBD1837	A18-10	A87	B14-8FL	B223
10RC-10F	RC1157	14RBD-18377	RBD18377	A18-10F	A115-TB	B14-D	B23
10RC-10FL	RC2227	18RA-10	RA877	A18-10FL	A225	BC14-10	BC87
10RC-10FLX	RC2227-250	18RA-10F	RA1157	A18-110F	A10-TB	BC14-12	BC75
10RC-10FX	RC1157-250	18RA-10FL	RA2257	A18-111F	A11	BC14-14	BC71
10RC-10X	RC367-250	18RA-10FLX	RA2257-170	A18-12	A75	BC14-38	BC79
10RC-14	RC717	18RA-10X	RA877-170	A18-14	A71	BC14-516	BC72
10RC-14F	RC1167	18RA-14	RA717	A18-250	A250-TB	BC14-6	BC85
10RC-14FL	RC2237	18RA-250F	RA257	18RA-6FLX	RA2217-170	BC14-8	BC86
10RC-14X	RC717-250	18RA-250T	RA2517	18RA-6FX	RA1167-170	BD14-183	BD183
10RC-250F	RC257	18RA-251T	RA25177	18RA-6X	RA857-170	C10-10	C26
10RC-250T	RC2517	18RA-2577	RA2573	18RA-8	RA867	C10-10A	C53
10RC-251T	RC25177	18RA-38	RA737	18RA-8F	RA1147	C10-10F	C115
10RC-2577	RC2573	18RA-4	RA77	18RA-8FL	RA2247	C10-10FL	C222-TB
10RC-38	RC737	18RA-47PT	RA47PT	18RA-8FX	RA1147-170	C10-12	C75
10RC-38X	RC737-250	18RA-516	RA727	18RA-8X	RA867-170	C10-14	C71
10RC-516	RC707	18RA-516X	RA727-170	18RAD-182	RAD1827	BC14-10	BC87
10RC-55PT	RC55PT	18RA-6	RA857	18RAD-18277	RAD18277	BC14-14	BC71
10RC-6	RC337	18RA-6F	RA1167	18RAD-183	RAD1837	BC14-38	BC79
10RC-6F	RC1337	18RA-6FL	RA2217	18RAD-18377	RAD18377	BC14-516	BC72
10RC-6FL	RC2207	18RA-6FLX	RA2217-170	2A-18	AA2	BC14-6	BC85
10RC-6FLX	RC2207-250	18RA-6FX	RA1167-170	2A-18	AA2	BC14-8	BC86
10RC-6X	RC337-250	18RA-6X	RA857-170	2A20	RAA24	BD14-183	BD183
10RC-8	RC777	18RA-8	RA867	2A22-20	A1A	C10-10	C26
10RC-8F	RC1147	18RA-8F	RA1147	2B-14	BB2	C10-10A	C53
10RC-8FL	RC2217	18RA-8FL	RA2247	2B-16	RBB25	C10-10F	C115
10RC-8FLX	RC2217-250	18RA-8FX	RA1147-170	2B18-16	B1B	C10-10FL	C222-TB
10RC-8X	RC777-250	18RA-8X	RA867-170	2C-10	CC2-TB	C10-12	C75
14RB-10	RB877	18RAD-182	RAD1827	2C-12	RCC26	C10-14	C71
14RB-10F	RB1157	18RAD-18277	RAD18277	A18-250A	A252G	C10-14F	C116-TB
14RB-10FL	RB2257	18RAD-183	RAD1837	A18-251T	A251	C10-250A	C252G
14RB-10FLX	RB2257-200	18RAD-18377	RAD18377	A18-38	A73	C10-250F	C250
14RB-10FX	RB1157-200	2A-18	AA2	A18-516	A72	C10-38	C73
14RB-10X	RB877-200	2A-18	AA2	A18-6	A85	C10-516	C70
14RB-14	RB717	2A20	RAA24	A18-6F	A116	C10-6F	C133
14RB-14F	RB1717	2A22-20	A1A	A18-6FL	A221	C10-6FL	C220-TB
14RB-14X	RB717-200	2B-14	BB2	A18-8	A86	C10-6-SK	C33
14RB-250F	RB257	2B-16	RBB25	A18-8F	A114	C10-8A	C52-TB
14RB-250T	RB2517	2B18-16	B1B	A18-8FL	A224	C10-8F	C114
14RB-251T	RB25177	2C-10	CC2-TB	AB14-10A	AB53	C10-8FL	C221
14RB-2577	RB2573	2C-12	RCC26	AB14-6A	AB51	C10-8-SK	C77
14RB-38	RB737	2C14-12	C1C	AB14-8A	AB52	D8-10	D36
14RB-4	RB1327	2D10-9	D1D	AD18-182	AD182	D8-12	D75
14RB-47PT	RB47PT	2D-8	DD102	AD18-183	AD183	D8-14-SK	D71
14RB-516	RB727	2E-6	EE2	B14-10	B87	D8-38	D73
14RB-6	RB857	2E8-7	E1E	B14-10F	B115	D8-516	D72
14RB-6F	RB647	2F-4	FF2	B14-10FL	B225	E6-10	E26
14RB-6FL	RB2207	2F6-5	F1F	B14-10G	B87G	E6-12	E75
14RB-6FLX	RB2207-200	2G21	GG2	B14-110F	B10TB	E6-14	E71
14RB-6FX	RB647-200	2G4-2	G1G	B14-111F	B11-TB	E6-12	E75
14RB-6X	RB857-200	2RA18	RAA21	B14-12	B75TB	E6-14	E71
14RB-8	RB867	2RA18X	RAA217-170	B14-14	B71	E6-38	E73
14RB-8F	RB657	2RAA	RAA23	B14-250	B250	E6-516	E72
14RB-8FL	RB2237	2RAS18X	RAAS22X	B14-250A	B252G	F250TA	FTA250
14RB-8FLX	RB2237-200	2RB14	RBB21	B14-250F	B250G	F4-10	F26
14RB-8FX	RB657-200	2RB14X	RBB217-200	B14-250T	B251G	F4-12	F75
14RB-8X	RB867-200	2RBB	RBB23	B14-251T	B251	F4-14	F71-TB
14RBC-10	RBC877	2RBS14X	RBBS22X	B14-38	B73	F4-38	F73
14RBC-12	RBC757	2RC10	RCC21	B14-4	B132	F4-516	F72
14RBC-14	RBC717	2RC10X	RCC217-250	B14-516	B72	G2-12	G975
14RBC-38	RBC797	2RCC	RCC23	B14-6	B133	G2-14	G971
14RBC-516	RBC727	2RCS10X	RCCS22X	B14-6F	B64	G2-38	G973
14RBC-6	RBC857	2RD8	RDD27	B14-6FL	B220	G2-516	G972
14RBD-182	RBD1827	2RE6	REE28	B14-8	B86	H10-14	H971
14RBD-18277	RBD18277	2RZZ	RZZ23	B14-8F	B65TB	J20-38	J973

Wire Termination — Sta-Kon® Wire Termination & Insulation

Wire Termination Technical Information

CAT. NO. T&B DISTRIBUTOR PACKAGE	CAT. NO. T&B BULK PACKAGE
K30-38	K973
L40-38	L973
M250-38	M973
NW14-10	NW83
NW14-12	NW84
NW22-10	NW23
RA18-10	RA873
RA18-10F	RA1153
RA18-10FL	RA2253
RA18-10FS	RA1253
RA18-110F	RA10SK
RA18-111F	RA11
RA18-12	RA753
RA18-14	RA713
RA18-14F	RA1163
RA18-250A	RA2577F
RA18-250F	RA250TB
RA18-250FP	RA250P
RA18-38	RA733
RA18-4	RA323
RA18-47PT	RA147PT
RA18-516	RA723
RA18-6	RA853
RA18-6F	RA1103
RA18-6FL	RA2213
RA18-6FS	RA1203
RA18-8	RA863
RA18-8F	RA1123
RA18-8FL	RA2243
RA18-8FS	RA1223
RA18D	RA23
RAD18-182	RAD1823
RAD18-183	RAD1833
RAD18-188A	RAD1887F
RB4-HT	RB44-HT
RB14-10	RB873
RB14-10F	RB1153
RB14-10FL	RB2253
RB14-10FS	RB1253
RB14-10X	RB874
RB14-110F	RB10-SK
RB14-111F	RB11-TB
RB14-12	RB753
RB14-14	RB713
RB14-14F	RB1163
RB14-14X	RB714
RB14-250	RBB250
RB14-250A	RB2577F
RB14-250F	RB250
RB14-250FP	RB250P
RB14-38	RB733
RB14-38X	RB734
RB14-4	RB1323
RB14-47PT	RB147PT
RB14-516	RB723
RB14-516X	RB724
RB14-6	RB853
RB14-38	RB733
RB14-38X	RB734
RB14-4	RB1323
RB14-47PT	RB147PT
RB14-516	RB723
RB14-516X	RB724
RB14-6	RB853
RB14-6F	RB1113

CAT. NO. T&B DISTRIBUTOR PACKAGE	CAT. NO. T&B BULK PACKAGE
RB14-6F	RB1113
RB14-6FL	RB2213
RB14-6FS	RB1203
RB14-6X	RB854
RB14-8	RB863
RB14-8F	RB1123
RB14-8FL	RB2233
RB14-8FS	RB1223
RB14-8X	RB864
RB14D	RB23
RB44	RB4-TB
RBC14-12	RBC753
RBC14-14	RBC713
RBC14-8	RBC863
RBD14-182	RBD1823
RBD14-183	RBD1833
RC6-T	RC551-HT
RC10-10	RC363
RC10-10F	RC1153
RC10-10FL	RC2223
RC10-10FS	RC1253
RC10-10X	RC364
RC10-12	RC753
RC10-14	RC713
RC10-14F	RC1163
RC10-14FL	RC2233
RC10-14X	RC714
RC10-250A	RC2577F
RC10-250F	RC250
RC10-38	RC733
RC10-38X	RC734
RC10-516	RC703
RC10-516X	RC704
RC10-55PT	RC155PT
RC10-6	RC333
RC10-6F	RC1113
RC10-6FL	RC2203
RC10-6X	RC334
RC10-8	RC863
RC10-8F	RC1123
RC10-8FL	RC2213
RC10-8FS	RC1223
RC10-8X	RC864
RC55	RC6
RD8-10	RD367
RD8-12	RD757
RD8-14	RD717
RD8-38	RD737
RD8-516	RD727
RE6-10	RE267
RE6-12	RE757
RE6-14	RE717
RE6-38	RE737
RE6-516	RE727
RF4-10	RF267
RF4-14	RF717
RF4-38	RF737
RF4-516	RF727
RG2-10	RG267
RG2-12	RG757
RG2-14	RG717
RG2-38	RG737
RG2-516	RG727
RP7-T	RP12-HT
RP12	RP7

CAT. NO. T&B BULK PACKAGE	CAT. NO. T&B DISTRIBUTOR PACKAGE
A10-TB	A18-110F
A11	A18-111F
A114	A18-8F
A115-TB	A18-10F
A116	A18-6F
A1A	2A22-20
A221	A18-6FL
A224	A18-8FL
A225	A18-10FL
A250-TB	A18-250
A251	A18-251T
A252G	A18-250A
A71	A18-14
A72	A18-516
A73	A18-38
A75	A18-12
A85	A18-6
A86	A18-8
A87	A18-10
AA2	2A-18
AB51	AB14-6A
AB52	AB14-8A
AB53	AB14-10A
AD182	AD18-182
AD183	AD18-183
B10TB	B14-110F
B115	B14-10F
B11-TB	B14-111F
B132	B14-4
B133	B14-6
B1B	2B18-16
B220	B14-6FL
B223	B14-8FL
B225	B14-10FL
B23	B14-D
B250	B14-250
B250G	B14-250F
B251	B14-251T
B251G	B14-250T
B252G	B14-250A
B64	B14-6F
B65TB	B14-8F
B71	B14-14
B72	B14-516
B73	B14-38
B75TB	B14-12
B86	B14-8
B87	B14-10
B87	B14-10
B87G	B14-10G
BB2	2B-14
BC71	BC14-14
BC72	BC14-516
BC75	BC14-12
BC79	BC14-38
BC85	BC14-6
BC86	BC14-8
BC87	BC14-10
BD183	BD14-183
C114	C10-8F
C115	C10-10F
C116-TB	C10-14F
C133	C10-6F
C1C	2C14-12
C220-TB	C10-6FL

CAT. NO. T&B BULK PACKAGE	CAT. NO. T&B DISTRIBUTOR PACKAGE
C221	C10-8FL
C222-TB	C10-10FL
C250	C10-250F
C252G	C10-250A
C26	C10-10
C33	C10-6-SK
C52-TB	C10-8A
C53	C10-10A
C70	C10-516
C71	C10-14
C73	C10-38
C75	C10-12
C77	C10-8-SK
CC2-TB	2C-10
D1D	2D10-9
D36	D8-10
D71	D8-14-SK
D72	D8-516
D73	D8-38
D75	D8-12
DD102	2D-8
E1E	2E8-7
E26	E6-10
E71	E6-14
E72	E6-516
E73	E6-38
E75	E6-12
EE2	2E-6
F1F	2F6-5
F26	F4-10
F71-TB	F4-14
F72	F4-516
F73	F4-38
F75	F4-12
FF2	2F-4
FTA250	F250TA
G1G	2G4-2
G971	G2-14
G972	G2-516
G973	G2-38
G975	G2-12
GG2	2G21
H971	H10-14
J973	J20-38
K973	K30-38
L973	L40-38
M973	M250-38
NW23	NW22-10
NW83	NW14-10
NW84	NW14-12
RA1153	RA18-10F
RA1157	18RA-10F
RA1163	RA18-14F
RA1167	18RA-6F
RA1167-170	18RA-6FX
RA1203	RA18-6FS
RA1223	RA18-8FS
RA1253	RA18-10FS
RA147PT	RA18-47PT
RA2213	RA18-6FL
RA2217	18RA-6FL
RA2217-170	18RA-6FLX
RA2243	RA18-8FL
RA2247	18RA-8FL
RA2253	RA18-10FL

Wire Termination Technical Information

CAT. NO. T&B BULK PACKAGE	CAT. NO. T&B DISTRIBUTOR PACKAGE
RA2257	18RA-10FL
RA2257-170	18RA-10FLX
RA23	RA18D
RA250P	RA18-250FP
RA250TB	RA18-250F
RA2517	18RA-250T
RA25177	18RA-251T
RA257	18RA-250F
RA2573	18RA-2577
RA2577F	RA18-250A
RA323	RA18-4
RA47PT	18RA-47PT
RA713	RA18-14
RA717	18RA-14
RA723	RA18-516
RA727	18RA-516
RA727-170	18RA-516X
RA733	RA18-38
RA737	18RA-38
RA753	RA18-12
RA77	18RA-4
RA853	RA18-6
RA857	18RA-6
RA857-170	18RA-6X
RA863	RA18-8
RA867	18RA-8
RA867-170	18RA-8X
RA873	RA18-10
RA877	18RA-10
RA877-170	18RA-10X
RAA21	2RA18
RAA217-170	2RA18X
RAA23	2RAA
RAA24	2A20
RAAS22X	2RAS18X
RAD1823	RAD18-182
RAD1827	18RAD-182
RAD18277	18RAD-18277
RAD1833	RAD18-183
RAD1837	18RAD-183
RA10SK	RA18-110F
RA10SK	RA18-110F
RA11	RA18-111F
RA1103	RA18-6F
RA1123	RA18-8F
RA1147	18RA-8F
RA1147-170	18RA-8FX
RAD18377	18RAD-18377
RAD1887F	RAD18-188A
RB10-SK	RB14-110F
RB1113	RB14-6F
RB1123	RB14-8F
RB1153	RB14-10F
RB1157	14RB-10F
RB1153	RB14-10F
RB1157	14RB-10F
RB1157-200	14RB-10FX
RB1163	RB14-14F
RB11-TB	RB14-111F
RB1203	RB14-6FS
RB1223	RB14-8FS
RB1253	RB14-10FS
RB1323	RB14-4
RB1327	14RB-4
RB147PT	RB14-47PT

CAT. NO. T&B BULK PACKAGE	CAT. NO. T&B DISTRIBUTOR PACKAGE
RB1717	14RB-14F
RB2207	14RB-6FL
RB2207-200	14RB-6FLX
RB2213	RB14-6FL
RB2233	RB14-8FL
RB2237	14RB-8FL
RB2237-200	14RB-8FLX
RB2253	RB14-10FL
RB2257	14RB-10FL
RB2257-200	14RB-10FLX
RB23	RB14D
RB250	RB14-250F
RB250P	RB14-250FP
RB2517	14RB-250T
RB25177	14RB-251T
RB257	14RB-250F
RB2573	14RB-2577
RB2577F	RB14-250A
RB47PT	14RB-47PT
RB4-TB	RB44
RB647	14RB-6F
RB647-200	14RB-6FX
RB657	14RB-8F
RB657-200	14RB-8FX
RB713	RB14-14
RB714	RB14-14X
RB717	14RB-14
RB717-200	14RB-14X
RB723	RB14-516
RB724	RB14-516X
RB727	14RB-516
RB733	RB14-38
RB734	RB14-38X
RB737	14RB-38
RB753	RB14-12
RB853	RB14-6
RB854	RB14-6X
RB857	14RB-6
RB857-200	14RB-6X
RB863	RB14-8
RB864	RB14-8X
RB867	14RB-8
RB867-200	14RB-8X
RB873	RB14-10
RB874	RB14-10X
RB877	14RB-10
RB877-200	14RB-10X
RBB21	2RB14
RBB217-200	2RB14X
RBB23	2RBB
RBB25	2B-16
RBB250	RB14-250
RBBS22X	2RBS14X
RBC713	RBC14-14
RBC717	14RBC-14
RBC727	14RBC-516
RBC757	14RBC-12
RBC797	14RBC-38
RBC857	14RBC-6
RBC863	RBC14-8
RBC877	14RBC-10
RBD1823	RBD14-182
RBD1827	14RBD-182
RBD18277	14RBD-18277
RBD1833	RBD14-183

CAT. NO. T&B BULK PACKAGE	CAT. NO. T&B DISTRIBUTOR PACKAGE
RBD1837	14RBD-183
RBD18377	14RBD-18377
RC1113	RC10-6F
RC1123	RC10-8F
RC1147	10RC-8F
RC1153	RC10-10F
RC1157	10RC-10F
RC1157-250	10RC-10FX
RC1163	RC10-14F
RC1167	10RC-14F
RC1223	RC10-8FS
RC1253	RC10-10FS
RC1337	10RC-6F
RC155PT	RC10-55PT
RC2203	RC10-6FL
RC2207	10RC-6FL
RC2207-250	10RC-6FLX
RC2213	RC10-8FL
RC2217	10RC-8FL
RC2217-250	10RC-8FLX
RC2223	RC10-10FL
RC2227	10RC-10FL
RC2227-250	10RC-10FLX
RC2233	RC10-14FL
RC2237	10RC-14FL
RC250	RC10-250F
RC2517	10RC-250T
RC25177	10RC-251T
RC257	10RC-250F
RC2573	10RC-2577
RC2577F	RC10-250A
RC333	RC10-6
RC334	RC10-6X
RC337	10RC-6
RC337-250	10RC-6X
RC363	RC10-10
RC364	RC10-10X
RC367	10RC-10
RC367-250	10RC-10X
RC55PT	10RC-55PT
RC6	RC55
RC703	RC10-516
RC704	RC10-516X
RC707	10RC-516
RC713	RC10-14
RC714	RC10-14X
RC717	10RC-14
RC717-250	10RC-14X
RC733	RC10-38
RC734	RC10-38X
RC737	10RC-38
RC737-250	10RC-38X
RC753	RC10-12
RC777	10RC-8
RC777-250	10RC-8X
RC863	RC10-8
RC864	RC10-8X
RCC21	2RC10
RCC217-250	2RC10X
RCC23	2RCC
RCC26	2C-12
RCCS22X	2RCS10X
RD367	RD8-10
RD717	RD8-14
RD727	RD8-516

CAT. NO. T&B BULK PACKAGE	CAT. NO. T&B DISTRIBUTOR PACKAGE
RD737	RD8-38
RD757	RD8-12
RDD27	2RD8
RE267	RE6-10
RE717	RE6-14
RE727	RE6-516
RE737	RE6-38
RCC23	2RCC
RCC26	2C-12
RCCS22X	2RCS10X
RD367	RD8-10
RD717	RD8-14
RD727	RD8-516
RD737	RD8-38
RD757	RD8-12
RDD27	2RD8
RE267	RE6-10
RE717	RE6-14
RE727	RE6-516
RE737	RE6-38
RE757	RE6-12
REE28	2RE6
RF267	RF4-10
RF717	RF4-14
RF727	RF4-516
RF737	RF4-38
RG267	RG2-10
RG717	RG2-14
RG727	RG2-516
RG737	RG2-38
RG757	RG2-12
RP7	RP12

Wire Termination — Sta-Kon® Wire Termination & Insulation

Shrink-Kon® Heat-Shrinkable Tubing

Protect against moisture, corrosion and abrasion!

T&B has you covered when it comes to insulation!

- Easy to use
- Heat shrinkable
- Products for heavy, medium and thin walls
- Covers available for H-type taps and splices



Shrink-Kon® Heavy-Wall Heat-Shrinkable Insulators

When it comes to moisture-proofing connections and terminations, T&B's heat-shrinkable tubing, boots and end caps have proven themselves over years of service to the industry. Made of thermally stabilized cross-linked polyolefin, these heat-shrinkable insulators can be used over lead, steel, aluminum, copper, standard plastic and elastomeric insulating materials.

T&B heat-shrinkable insulators are designed to be easy to use. They provide an appropriate level of insulation and abrasion protection.

Where applicable, T&B heat-shrink insulators are UL Listed. Also, all standard-size insulators have an internally applied adhesive sealant.

Shrink-Kon® Heavy-Wall Heat-Shrinkable End Cap and Boots

Redesigned for superior durability and performance!

Seals and insulates cable ends at a 600V rating. Installs fast, while providing insulation resistance to moisture, corrosion and abrasion. The extra thickness at the tip of the end cap prevents sharp ends of the cable from puncturing the seal.

Seals and insulates multiconductor cables and conduit with the same cost savings and superior properties of T&B's heat-shrinkable tubing. These boots replace time-consuming tapes, epoxies, encapsulations and dips. The boots are internally coated with sealant.



T&B Heat-Shrinkable Insulators Offer:

- Heavy-duty protection
- A full range of sizes from #14 to 2500 kcmil
- Field-proven reliability
- Internal sealant provides protection against moisture

Featured Products Include:

- High Shrink Ratio HSHR series with 6:1 shrink ratio designed for applications with extreme differences between cable, connector and back shell sizes
- Flame Retardant HSFR series provides maximum flame retardancy

Shrink-Kon® Heat-Shrinkable Tubing

Shrink-Kon® Medium Wall Tubing

More flexible than heavy-wall products, with excellent resistance to impact and abrasion.

- Seals and protects cable splices and terminations
- Thermoplastic adhesive liner guarantees complete environmental protection and insulation



Shrink-Kon® Thin Wall Tubing

Manufactured from stabilized Polyolefin, these insulators are used to insulate bare Sta-Kon® and Blackburn® connectors and splices. They also provide a degree of strain relief and may be used to harness wires. Available in cut pieces or reels.

Featured Products Include:

- Standard non-lined 2:1 thin wall tubing
- 3:1 adhesive-lined thin wall CPO-A series provides excellent flexibility with environmental sealing capability
- Extra-clear heat shrink for use on power connections and data connections

Covers

These new insulating covers provide hard-shell insulated protection for "H" type compression taps and splices, and, because there is no taping required, you get uniform quality and appearance each time. The exclusive locking design provides the range-taking capability. Only six H-tap insulating catalog numbers accommodate the range of #6 AWG – 1000 kcmil in the main and #12 AWG – 500 kcmil in the branch.

- Hard-shell outer covers guard against impact, inner seal keeps out dust
- Installs quickly and easily without special tools — simply snap together
- Eliminates time-consuming taping
- Provides high-quality, neat, uniform installations
- Range-taking design reduces inventory



Shrink-Kon® Heat-Shrinkable Tubing

HS Series

- Made of thermally stabilized cross-linked polyolefin, enabling a recovered wall thickness greater than the cable jacket replaced
- Withstands severe mechanical requirements of U.R.D., submersible, and direct-burial installations
- Tubing, featuring an internally applied sealant, offers protection against moisture, and may be used over lead, steel, aluminum, copper, standard plastic and elastomeric insulating materials
- Shrink temperature of 120° C
- High impact, abrasion, corrosion and chemical resistance
- Rated for 600V, 90° C continuous use. Maximum rating 1kV at 90° C
- Thermoplastic adhesive liner provides complete environmental protection and insulation
- Meets: UL® 486D, CSA C22.2 No. 198.2, ANSI C119.1, Western Underground Guide Numbers 2.4, 2.5, ICEA and NEMA insulation thickness requirements
- Continuous operating temperature: -55° C to 110° C

3:1 Shrink Ratio



HS Series Specifications

PROPERTY	TEST METHOD	TYPICAL PERFORMANCES	PROPERTY	TEST METHOD	TYPICAL PERFORMANCES
Physical			Chemical		
• Tensile Strength	ASTM D412, ISO 37	2100 psi (14.5MPa)	• Fluid Resistance	MIL-DTL-23053	Good to Excellent
• Elongation	ASTM D412, ISO 37	600%	• Fungus Resistance	ASTM G21	No Growth
• Elongation after Heat Aging (168 hrs. at 150° C)	ASTM D2671	500%	• Copper Corrosion	ASTM D2671	No Corrosion
• Heat Shock (4 hrs. at 225° C)	ASTM D2671	No cracking or flowing	• Water Absorption	ASTM D570	0.1%
• Longitudinal Change	ASTM D2671	+1%, -10%	Adhesive		
• Low Temperature Flexibility (4 hrs. at -55° C)	ASTM D2671	No cracking	• Adhesive Lap Shear (1 in./min. at 23° C)	ASTM D1002	125 psi (.875 MPa)
• Specific Gravity	ASTM D792	1.1	• Adhesive Softening Point	ASTM E28	92° C ±5° C
• Hardness (Shore D)	ASTM D2240	50D	• Adhesive Peel Strength (300mm/min. at 23° C) — to steel, aluminum, P.E. — PVC	ASTM D1000	35 pli 20 pli
Electrical			• Water Penetration	STM 706	No penetration after 236 hrs. of continuous immersion
• Dielectric Strength	ASTM D149	500V/Mil (20kV/mm)			
• Dielectric Voltage Withstand	UL 486D	No Breakdown, (2500V, 60 Hz, 1 Min.)			
• Volume Resistivity	ASTM D257	1016 ohm-cm			

Shrink-Kon® Heat-Shrinkable Tubing

HS Series Heavy-Wall Heat-Shrinkable Tubing — Black

CAT. NO.	MIN. EXPANDED I.D. (IN.)	MAX. RECOVERED I.D. (IN.)	NOM. RECOVERED WALL (IN.)	STD. LENGTH (IN.)	FITS ANY LISTED OR CERTIFIED AL OR CU SPLICE WITH DIM NO LARGER THAN		STD. CABLE RANGE	PKG. QTY.
					O.D. (IN.)	LENGTH (IN.)		
HS16-12	.35	.12	.07	3	.27	1.00	#16 to #12 AWG	25
HS16-12L	.35	.12	.07	6	.27	1.00	#16 to #12 AWG	25
HS16-12-4	.35	.12	.07	48	.27	1.00	#16 to #12 AWG	5
HS12-6	.51	.16	.09	3	.38	1.75	#12 to #6 AWG	25
HS12-6L	.51	.16	.09	6	.38	1.75	#12 to #6 AWG	25
HS12-6-4	.51	.16	.09	48	.38	1.75	#12 to #6 AWG	5
HS6-1	.75	.24	.09	4	.63	2.50	#6 to #1 AWG	25
HS6-1L	.75	.24	.09	8	.63	2.50	#6 to #1 AWG	25
HS6-1-4	.75	.24	.09	48	.63	2.50	#6 to #1 AWG	5
HS4-30	1.10	.35	.12	5	.75	3.25	#4 to 3/0 AWG	20
HS4-30L	1.10	.35	.12	9	.75	3.25	#4 to 3/0 AWG	10
HS4-30-4	1.10	.35	.12	48	.75	3.25	#4 to 3/0 AWG	5
HS40-400	1.50	.47	.16	8	—	—	4/0 AWG to 400 kcmil	10
HS40-400L	1.50	.47	.16	12	—	—	4/0 AWG to 400 kcmil	10
HS40-400-4	1.50	.47	.16	48	—	—	4/0 AWG to 400 kcmil	5
HS500-1000	2.00	.63	.16	9	—	—	500–1000 kcmil	5
HS500-1000L	2.00	.63	.16	15	—	—	500–1000 kcmil	2
HS500-1000-4	2.00	.63	.16	48	—	—	500–1000 kcmil	2
HS12-30*	3.54	1.18	.16	12	—	—	800–1250 kcmil	2
HS30-30*	3.54	1.18	.16	30	—	—	800–1250 kcmil	2
HS30-4*	3.54	1.18	.16	48	—	—	800–1250 kcmil	1
HS12-40*	4.72	1.57	.17	12	—	—	1500–2500 kcmil	1
HS30-40*	4.72	1.57	.17	30	—	—	1500–2500 kcmil	1
HS40-4-TB*	4.72	1.57	.17	48	—	—	1500–2500 kcmil	1

Order multiple is std. pkg.
All lengths have factory-applied sealant.
UL File No. E9809, UL 486D.
* Not UL Listed.



Wire Termination — Sta-Kon® Wire Termination & Insulation

HS Series Heavy-Wall Heat-Shrinkable Tubing — Red

CAT. NO.	MIN. EXPANDED I.D. (IN.)	MAX. RECOVERED I.D. (IN.)	LENGTH (IN.)	FOR 2-WAY CONNECTOR CABLE SIZES	STD. PKG. QTY.
HS12-6LR	.51	.16	6	#8–#6 AWG	25
HS6-1LR	.75	.24	8	#6–#2 AWG	25
HS4-30LR	1.10	.35	9	#1–3/0 AWG	10

Order multiple is std. pkg.
All lengths have factory-applied sealant.
UL File No. E9809, UL 486D



Heavy-Wall Tubing (25' rolls) — Black

CAT. NO.	MIN. EXPANDED I.D. (IN.)	MAX. RECOVERED I.D. (IN.)	NOMINAL RECOVERED WALL (IN.)	CODE CABLE SIZE	STD. PKG. (ROLLS)
HS16-12-25	.35	.12	.07	#14–#10 AWG	1
HS12-6-25	.51	.16	.09	#8–#6 AWG	1
HS6-1-25	.75	.24	.09	#6–#2 AWG	1
HS4-30-25	1.10	.35	.12	#1–3/0 AWG	1
HS40-400-25	1.50	.47	.16	2/0 AWG–350 kcmil	1
HS500-1000-25	2.00	.63	.16	250–500 kcmil	1

Order by reel, not by feet. 25' reels **not** supplied with factory-applied sealant.
Not UL Listed.



Shrink-Kon® Heat-Shrinkable Tubing

HSHR Series — High Shrink Ratio

- Accommodates a wide variety of connector shapes and configurations
- Thermoplastic adhesive liner for complete environmental protection and insulation
- Continuous operating temperature: -55° C to 110° C
- Shrink temperature: 120° C
- Flame retardant: UL94 – V0

6:1 Shrink Ratio



HSHR Series Heavy-Wall Heat-Shrinkable Tubing

CAT. NO.	MIN. EXPANDED I.D. (IN.)	MAX. RECOVERED I.D. (IN.)	NOMINAL RECOVERED WALLED (IN.)	CODE CABLE SIZE	STANDARD LENGTH (IN.)	STD. PKG. QTY.
HSHR750-4	.75	.13	.10	#22-#46 AWG	48	25
HSHR1300-4	1.30	.22	.12	#8 AWG-700 kcmil	48	25
HSHR1750-4	1.75	.29	.13	#4 AWG-1000 kcmil	48	25
HSHR2000-4	2.00	.33	.13	#2 AWG-1250 kcmil	48	25
HSHR2750-4	2.75	.46	.14	1/0 AWG-1500 kcmil	48	15
HSHR3500-4	3.50	.58	.15	3/0 AWG-1750 kcmil	48	10
HSHR4700-4	4.70	.78	.15	300-2000 kcmil	48	5

Order multiple is std. pkg.
Standard color: black.

HSHR Series Specifications

PROPERTY	TEST METHOD	TYPICAL PERFORMANCE
Physical		
• Tensile Strength	ASTM D412, ISO 37	2100 psi (14.5MPa)
• Elongation	ASTM D412, ISO 37	600%
• Elongation after Heat Aging (168 hrs. at 175° C)	ASTM D2671	500%
• Heat Shock (4 hrs. at 225° C)	ASTM D2671	No cracking or flowing
• Longitudinal Change	ASTM D2671	+1%, -10%
• Low-Temperature Flexibility (4 hrs. at -55° C)	ASTM D2671	No cracking
• Specific Gravity	ASTM D792	1.10
• Hardness (Shore D)	ASTM D2240	50D
Electrical		
• Dielectric Strength	ASTM D149, IEC 243	500V/Mil (20kV/mm)
• Dielectric Voltage Withstand	UL 486D	No Breakdown
• Volume Resistivity	ASTM D257	1016 ohm-cm

PROPERTY	TEST METHOD	TYPICAL PERFORMANCE
Chemical		
• Fluid Resistance	MIL-DTL-23053/15	Good to Excellent
• Fungus Resistance	ASTM G21	No Growth
• Copper Corrosion	ASTM D2671	No Corrosion
• Water Absorption	ASTM D570	0.1%
Adhesive		
• Adhesive Lap Shear (1 in./min. at 23° C)	ASTM D1002	125 psi (.875 MPa)
• Adhesive Softening Point	ASTM E28	92° C/-5° C
• Adhesive Peel Strength (300mm/min. at 23° C) — to steel, aluminum, P.E. — PVC	ASTM D1000	35 pli 20 pli
• Adhesive Blocking (30° C)	ASTM D1146	No Blocking
• Water Penetration	STM 706	No penetration after 236 hrs. of continuous immersion

Shrink-Kon® Heat-Shrinkable Tubing

HSFR Series — Flame-Retardant Heavy Wall

- Insulates and protects electrical splices and terminations
- High impact and abrasion resistance
- Thermoplastic adhesive liner
- Rated for 600V, 90° C continuous use. Continuous operating temperature: -55° C to 110° C
- Shrink temperature of 120° C
- Meets: UL® 486D, CSA 22.2 No. 198.2, ANSI C119.1, Western Underground Guide Nos. 2.4, 2.5, MIL-DTL-23053/15, IEEE 383 Vertical Flame Test, ANSI C37.20.2, ICEA S-19-8 and NEMA insulation thickness requirements

3:1 Shrink Ratio



Wire Termination — Sta-Kon® Wire Termination & Insulation

HSFR Series Heavy-Wall Heat-Shrinkable Tubing

CAT. NO.	MIN. EXPANDED I.D. (IN.)	MAX RECOVERED I.D. (IN.)	NOMINAL RECOVERED WALLED (IN.)	CODE CABLE SIZE	STANDARD LENGTH (IN.)	STD. PKG. QTY.
HSFR16-12-4	.35	.12	.07	#14-#10 AWG	48	25
HSFR12-6-4	.51	.16	.09	#8-#6 AWG	48	25
HSFR6-1-4	.75	.24	.09	#6-#2 AWG	48	25
HSFR4-30-4	1.10	.35	.12	#1-3/0 AWG	48	25
HSFR40-400-4	1.50	.47	.16	2/0 AWG-350 kcmil	48	25
HSFR500-1000-4	2.00	.63	.16	250-500 kcmil	48	25

Custom lengths available, subject to factory quotations.
Minimum quantities may apply.



HSFR Series Specifications

PROPERTY	TEST METHOD	TYPICAL PERFORMANCE	PROPERTY	TEST METHOD	TYPICAL PERFORMANCE
Physical			Chemical		
• Tensile Strength	ASTM D412, ISO 37	2100 psi (14.5MPa)	• Fluid Resistance	MIL-DTL-23053/5	Good to Excellent
• Elongation	ASTM D412, ISO 37	600%	• Copper Corrosion	ASTM D2671	No Corrosion
• Longitudinal Change	ASTM D2671	+1%, -10%	• Fungus Resistance	ASTM G21	No Growth
• Specific Gravity	ASTM D792	1.2	• Water Absorption	ASTM D570	0.2%
• Elongation after Heat Aging (168 hrs. at 175° C)	ASTM D2671, ISO 37	500%	Adhesive		
• Heat Shock (4 hrs. at 225° C)	ASTM D2671	No cracking or flowing	• Adhesive Lap Shear (1 in./min. at 23° C)	ASTM D1002	125 psi (.875 MPa)
• Low Temperature Flexibility (4 hrs. at -55° C)	ASTM D2671	No cracking or splitting	• Adhesive Softening Point	ASTM E28	92° C ±5° C
• Hardness (Shore D)	ASTM D2240	50D	• Adhesive Peel Strength (300mm/min. at 23° C) — to steel, aluminum, P.E. — PVC	ASTM D1000	35 pli 20 pli
• Oxygen Index	ASTM D2863	27.00	• Adhesive Blocking (30° C)	ASTM D1146	No Blocking
• Flamibility	ASTM D2671	Flame Retardant	• Adhesive Water Absorption	ASTM D570	Less than 0.3%
Electrical			• Water Penetration	STM 706	No penetration after 286 hrs. of continuous immersion
• Dielectric Strength	ASTM D149	500 V/Mil (20kV/mm)			
• Dielectric Voltage Withstand (2500V, 60 Hz, 1 Min.)	UL 486D	No Breakdown 24kV — 1 min., 15kV — 4 hrs.			
• Volume Resistivity	ASTM D257	1016 ohm-cm			

Shrink-Kon® Heat-Shrinkable Tubing

HSC Series End Caps

- Provides effective method for sealing cable ends, pipe conduit, etc.
- Extra thickness at the tip of the end cap prevents sharp ends of the cable from puncturing the seal
- Flame retardant
- Rated from 600/1000V, 90° continuous use
- Shrink temperature of 120° C
- Resistant to common fluids and solvents
- Adhesive liner provides complete environmental protection and insulation
- Heat indicating lines. Continuous operating temperature: -55° C to 110° C



HSC Series Heat-Shrinkable End Caps



CAT. NO.	MIN. EXPANDED I.D. (IN.)	MAX. RECOVERED I.D. (IN.)	RECOVERED WALLED (IN.)	CODE CABLE SIZE	STANDARD LENGTH (IN.)	STD. PKG. QTY.
HSC8-4	.51	.16	.09	#8-#6 AWG	2.50	10
HSC2-20	.75	.24	.09	#6-#2 AWG	2.50	10
HSC30-250	1.10	.35	.12	#1-3/0 AWG	3.00	5
HSC300-600	1.50	.47	.16	2/0 AWG-350 kcmil	3.50	5
HSC700-1000	2.00	.63	.16	250-500 kcmil	3.50	5
HSC750	2.70	.87	.16	600-1000 kcmil	4.00	10
HSC300*	3.50	1.18	.16	800-1250 kcmil	4.50	5
HSC500*	4.70	1.57	.17	1500-2500 kcmil	5.50	5

Order multiple is std. pkg.

*Not UL Listed or CSA Certified.

HSC Series Specifications

PROPERTY	TEST METHOD	TYPICAL PERFORMANCE
Physical		
• Tensile Strength	ASTM D412, ISO 37	2100 psi (14.5MPa)
• Elongation	ASTM D412, ISO 37	550%
• Elongation after Heat Aging (168 hrs. at 150° C)	ASTM D2671	500%
• Heat Shock (4 hrs. at 225° C)	ASTM D2671	No cracking or flowing
• Longitudinal Change on Recovery	ASTM D2671	+1%, -10% on Recovery
• Low-Temperature Flexibility (4 hrs. at -55° C)	ASTM D2671	No cracking
• Specific Gravity	ASTM D792	1.10
• Hardness (Shore D)	ASTM D2240	50D
Electrical		
• Dielectric Strength	ASTM D149	500V/Mil (20kV/mm)
• Dielectric Voltage Withstand	UL 486D	No Breakdown (2500V, 60 Hz, 1 Min.)
• Volume Resistivity	ASTM D257	1016 ohm-cm

PROPERTY	TEST METHOD	TYPICAL PERFORMANCE
Chemical		
• Fluid Resistance	MIL-DTL-23053	Good to Excellent
• Fungus Resistance	ASTM G21	No Growth
• Copper Corrosion	ASTM D2671	No Corrosion
• Water Absorption	ASTM D570	.1%
Seal Integrity		
• Adhesive Lap Shear (1 in./min. at 23° C)	ASTM D1002	130 psi (.91 MPa)
• Adhesive Softening Point	ASTM E28	92° C ±5° C
• Adhesive Peel Strength (300mm/min. at 23° C)	ASTM D1000 (mod.)	
— to steel, aluminum, P.E.		35 pli
— PVC		20 pli
• Adhesive Blocking (30° C)	ASTM D1146	No Blocking
• Water Penetration	STM 706	No penetration after 236 hrs. of continuous immersion
• Room Temperature	168 hrs./40 psi	No leaks
• Temp. Cycling (-40° C to 60° C)	50 cycles/15 psi	No leaks
• Burst Pressure		100 psi (0.70 MPa)

Shrink-Kon® Heat-Shrinkable Tubing

HSB Series — Heat-Shrinkable Breakout Boots

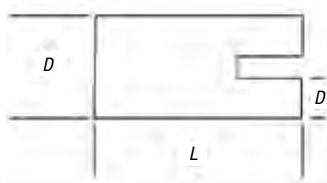
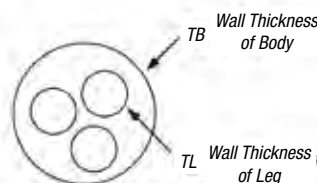

- Boots for 2-, 3- and 4-way cable breakouts
- Thermoplastic adhesive liner provides complete environmental protection and insulation
- Meets ESI 09-11
- Strain relief and mechanical protection
- Continuous operating temperature: -55° C to 100° C
- Shrink temperature of 135° C

HSB Series Heat-Shrinkable Breakout Boots

CAT. NO.	NO. LEGS	D		d		L	TB	TL	APPLICATION LEGS 600V CONDUCTOR AWG/KCMIL	STD. PKG. QTY.
		MIN. EXPANDED I.D. (IN.)	MAX. RECOVERED I.D. (IN.)	EXPANDED DIA. (MAX.) (IN.)	RECOVERED DIA. (MAX.) (IN.)					
HSB200-75-2	2	1.97	.83	.90	.20	4.69	.13	.13	#3-300	10
HSB120-50-3	3	1.50	.65	.50	.16	4.47	.11	.11	#8-3/0	10
HSB170-82-3	3	2.20	1.20	.89	.35	7.09	.12	.12	#1-600	10
HSB240-112-3	3	2.83	1.46	1.38	.69	7.01	.16	.12	300-1000	10
HSB125-50-4	4	1.38	.59	.47	.12	3.74	.10	.08	#12-2/0	10
HSB175-82-4	4	2.36	1.18	.90	.25	7.95	.16	.13	#4-600	10
HSB265-120-4	4	3.10	1.50	1.40	.49	9.45	.13	.13	3/0-1000	10
HSB350-138-3	3	3.54	1.38	1.34	.55	7.87	.12	.08	4/0-1000	5
HSB430-157-3	3	4.33	1.57	1.38	.69	7.01	.16	.12	300-1000	5
HSB490-200-3	3	4.92	2.00	2.32	1.00	11.14	.15	.15	750-1000	5
HSB520-135-4	4	5.25	1.35	3.00	.55	10.02	.13	.16	4/0-1000	5

Order multiple is std. pkg.

Heat-Shrinkable Breakout Boots Specifications

PROPERTY	TEST METHOD	TYPICAL PERFORMANCE	PROPERTY	TEST METHOD	TYPICAL PERFORMANCE
Physical			Electrical		
• Tensile Strength	ASTM D412, IEC 540	2120 psi (14.6 MPa)	• Dielectric Strength	ASTM D2671	280V/Mil (11kV/mm)
• Ultimate Elongation	ASTM D412, IEC 540	600%	Chemical		
• Elongation after Heat Aging (168 hrs. at 175° C)	ASTM D412, IEC 540	520%	• Water Absorption	ASTM D570	.03%
• Heat Shock (4 hrs. at 225° C)	ASTM D2671	No dripping, cracking, flowing			
• Low-Temperature Flexibility (-55° C)	ASTM D2671	No cracking			
• Flammability	ASTM D630	Self ext. within 1.97"			

Shrink-Kon® Heat-Shrinkable Tubing

HSMW Series — Medium-Wall Tubing

- More flexible than heavy-wall products
- Seals and protects cable splices and terminations
- High resistance to impact and abrasion
- Shrink temperature of 120° C
- Continuous operating temperature: -55° C to 110° C
- Thermoplastic adhesive liner guarantees complete environmental protection and insulation

3:1 Shrink Ratio



HSMW Series Medium-Wall Heat-Shrinkable Tubing

CAT. NO.	MIN. EXPANDED I.D. (IN.)	MAX RECOVERED I.D. (IN.)	NOMINAL RECOVERED WALLED (IN.)	CODE CABLE SIZE	STANDARD LENGTH (IN.)	STD. PKG. QTY.
HSMW400-48	.40	.15	.080	#4-#14 AWG	48	25
HSMW750-48	.75	.22	.080	4/0-#8 AWG	48	25
HSMW1100-48	1.10	.40	.095	400 kcmil-#1 AWG	48	25
HSMW1300-48	1.30	.40	.095	600 kcmil-#1 AWG	48	25
HSMW1500-48	1.50	.50	.095	750 kcmil-3/0 AWG	48	25
HSMW1700-48	1.70	.50	.100	1000 kcmil-2/0 AWG	48	25
HSMW2050-48	2.05	.75	.100	250-600 kcmil	48	25
HSMW2750-48	2.75	1.00	.100	500-1000 kcmil	48	15
HSMW3500-48	3.50	1.18	.100	750-1250 kcmil	48	10
HSMW4700-48	4.70	1.57	.110	1500-2500 kcmil	48	5
HSMW6700-48	6.70	2.30	.120	—	48	5
HSMW9000-48	9.00	3.00	.130	—	48	5

Order multiple is std. pkg.

HSMW Series Specifications

PROPERTY	TEST METHOD	TYPICAL PERFORMANCE
Physical		
• Tensile Strength	ASTM D412, ISO 37	2100 psi (14.5MPa)
• Elongation	ASTM D412, ISO 37	550%
• Longitudinal Change	ASTM D2671	+1%, -10%
• Specific Gravity	ASTM D792, ISO/R1183	1.1
• Elongation after Heat Aging (168 hrs. at 150° C)	ASTM D2671, ISO 37	500%
• Heat Shock (4 hrs. at 225° C)	ASTM D2671	No Cracking or Flowing
• Low-Temperature Flexibility (4 hrs. at -55° C)	ASTM D2671	No Cracking
• Hardness (Shore D)	ASTM D2240	50D
Electrical		
• Dielectric Strength	ASTM D149, IEC 243	500V/Mil (20kV/mm)
• Dielectric Voltage Withstand (2500V, 60 Hz, 1 Min.)	UL 486D	No Breakdown
• Volume Resistivity	ASTM D257	10 ¹⁶ ohm-cm

PROPERTY	TEST METHOD	TYPICAL PERFORMANCE
Chemical		
• Fluid Resistance	MIL-DTL-23053/5, ISO 1817, ISO 37	Good to Excellent
• Copper Corrosion	ASTM D2671	No Corrosion
• Fungus Resistance	ASTM G21	No Growth
• Water Absorption	ASTM D570	.1%
Adhesive		
• Adhesive Lap Shear (1 in./min. at 23° C)	ASTM D1002 (mod)	125 psi (.875 MPa)
• Adhesive Softening Point	ASTM E28	92° C/-5° C
• Adhesive Peel Strength (300mm/min. at 23° C)	ASTM D1000	35 pli
— to steel, aluminum, P.E.		20 pli
— PVC		No Blocking
• Adhesive Blocking (30° C)	ASTM D1146	No penetration after 286 hrs. of continuous immersion
• Water Penetration	STM 706	

Shrink-Kon® Heat-Shrinkable Tubing

CPO Series — Thin-Wall Tubing, Non-Lined

- Flame-retardant, cross-linked polyolefin
- Continuous operating temperature: -55° C to 135° C
- Shrink temperature of 120° C
- Meets UL 224, 125° C; CSA C22.2 No. 198.1, 125° C; MIL-DTL-23053/5 Class 1&2; AMS 3636 & 3637; DEF STAN 59-97, Issue 3, Type 2a



Wire Termination — Sta-Kon® Wire Termination & Insulation

CPO Series Thin-Wall Heat-Shrinkable Tubing



CAT. NO.	MIN. EXPANDED I.D. (IN.)	MAX RECOVERED I.D. (IN.)	NOM. RECOVERED WALLED (IN.)	CODE CABLE SIZE
CPO63-_-	.06	.03	.02	—
CPO93-_-	.09	.05	.02	—
CPO125-_-	.13	.06	.02	#24-#30 AWG
CPO187-_-	.19	.09	.02	#14-#22 AWG
CPO250-_-	.25	.13	.03	#10-#16 AWG
CPO375-_-	.38	.19	.03	#6-#12 AWG
CPO500-_-	.50	.25	.03	#1-#6 AWG
CPO750-_-	.75	.38	.03	4/0-#2 AWG
CPO1000-_-	1.00	.50	.04	350 kcmil-2/0 AWG

See catalog construction to complete.

UL Recognized File Number E137759 and CSA Certified. (Note: Clear material not UL Recognized.)

When ordering standard package, order by package not feet.

Larger diameters available upon special request; consult Technical Services.

Order multiple for 4' sticks is 25 sticks.

Order multiple for reels is 1 reel.

Catalog Number Construction

SERIES	COLOR	LENGTH FT.	FINAL ORDER NO.
CPO63	+ 0 +	C	= CPO63-0-C

Available Colors

- 0 = Black
- C = Clear
- 2 = Red
- 4 = Yellow
- 5 = Green
- 6 = Blue
- 8 = Gray**
- 9 = White
- S = Green & Yellow Striped*

Available Packaging

- A = 4'
- 25 = 25' reel
- C = 100' reel
- B = Bulk reel

* Contact customer service for bulk reel quantity.

** Minimum order required.

Thin-Wall Heat-Shrinkable Tubing Kit



CAT. NO.	DESCRIPTION	STD. PKG.
HS-KIT	Assortment of six different sizes (from 3/16" to 1") of black thin-wall heat-shrinkable tubing pre-cut to 6" lengths. Exceptional value; also includes handy plastic storage case.	1
CHS-KIT	Assortment of six different sizes (from 3/16" to 1") of multi-colored thin-wall heat-shrinkable tubing pre-cut to 6" lengths. Exceptional value; also includes handy plastic storage case.	1

Order multiple is std. pkg.

Thin-Wall Heat-Shrinkable Tubing — 6" Lengths

CAT. NO.	MINIMUM EXPANDED I.D. (IN.)	MAXIMUM REDUCED I.D. (IN.)	NOM. RECOVERED WALL THICKNESS (IN.)	STD. PKG. QTY.
CPO63-0-6	.06	.03	.02	20
CPO93-0-6	.09	.05	.02	20
CPO125-0-6	.13	.06	.02	20
CPO187-0-6	.19	.09	.02	20
CPO250-0-6	.25	.13	.03	20
CPO375-0-6	.38	.19	.03	20
CPO500-0-6	.50	.25	.03	10
CPO750-0-6	.75	.38	.03	10
CPO1000-0-6	1.00	.50	.04	5

Order multiple is std. pkg.

Catalog numbers listed are Black color; other colors available upon request.

Shrink-Kon® Heat-Shrinkable Tubing

Custom order lengths for those special jobs!

Custom-Cut Length of Bulk Packaging — Thin-Wall Tubing

To best meet your requirements for thin-wall heat-shrinkable tubing, Thomas & Betts welcomes the opportunity to cut bulk reels of tubing. Minimum order requirement is one standard bulk reel, and multiples thereof. See table for bulk reel length by size. Tubing cannot be cut smaller than 1/2".

When ordering custom-cut lengths of tubing, order by piece, not by length. To determine the minimum number of pieces to order, simply figure how many pieces of a specific length of tubing are required to make use of a complete bulk reel. See examples to convert bulk reels to cut pieces.

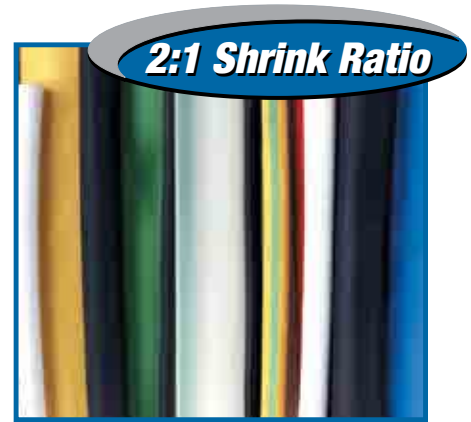

SERIES	BULK REEL LENGTH (FT.)	SERIES	BULK REEL LENGTH (FT.)
CP063 = 1/16"	1,000	CP0375 = 3/8"	500
CP093 = 3/32"	1,000	CP0500 = 1/2"	400
CP0125 = 1/8"	1,000	CP0750 = 3/4"	300
CP0187 = 3/16"	1,000	CP01000 = 1"	300
CP0250 = 1/4"	1,000		

Minimum order quantity for cut pieces.

Example 1

If a bulk length of tubing is 1,000' and the desired length of each individual piece is 6", the minimum order requirement is 2,000 pieces.

Given (length of reel).....1,000'
 Convert to inches by multiplying by 12.....12 x 1,000
 Length of reel in inches.....= 12,000
 Divide by desired length.....12,000 ÷ 6
 Total number of 6" pieces
 in a 1,000' reel (Minimum Order).....= 2,000

Example 2

If a bulk reel of tubing is 400' and the desired length of each individual piece is 2", the minimum order requirement is 2,400 pieces.

Given (length of reel).....400'
 Convert to inches by multiplying by 12.....12 x 400
 Length of reel in inches.....= 4,800
 Divide by desired length.....4,800 ÷ 2
 Total number of 2" pieces
 in a 400' reel (Minimum Order).....= 2,400

Contact tech services for pricing and availability on cut pieces.

THINWALL SERIES	CUT PIECE CATALOG NO. CONSTRUCTION		
	MINIMUM EXPANDED I.D. (IN.)	COLOR	LENGTH (IN.)
CPO =	63 = .063 93 = .093 125 = .125 187 = .187 250 = .250 375 = .375 500 = .500 750 = .750 1,000 = 1.000	0 = Black C = Clear 2 = Red 4 = Yellow 5 = Green 6 = Blue 8 = Gray 9 = White S = Green & Yellow Striped*	XXXX — 4 digits specify length of cut in inches

Example: CPO + 125 + 2 + 1.500 = CP0125-2-1.500
 CPO Thinwall Shrink, size 125 (.125"), red color, 1.5" long
 *Contact customer service for bulk reel quantity.

..... Thin-Wall Tubing Specifications

PROPERTY	TEST METHOD	TYPICAL PERFORMANCE
Physical		
• Tensile Strength	ASTM D2671, ISO 37	2,200 psi (15.0 MPa)
• Elongation	ASTM D2671, ISO 37	400%
• Longitudinal Change	ASTM D2671	+1%, -10%
• 2% Secan Modulus	ASTM D2671	16,000 psi (110 MPa)
• Specific Gravity	ASTM D792, ISO/R1183	1.3" (colors) .95" (clear)
• Restricted Shrinkage	ASTM D2671	No Cracking
• Elongation after Heat Aging (168 hrs. at 175° C)	ASTM D2671	350%
• Heat Shock (4 hrs. at 250° C)	ASTM D2671	No Cracking or Flowing
• Low-Temperature Flexibility (4 hrs. at -55° C)	ASTM D2671	No Cracking or Splitting
• Flammability	ASTM D2671	Flame Retardant (except Clear)
Electrical		
• Dielectric Strength	ASTM D2671, IEC 243	600V/Mil (24kV/mm)
• Volume Resistivity	ASTM D2671	1016 Ω HM-CM
Chemical		
• Fluid Resistance	MIL-DTL-23053/5, ISO 1817, ISO 37	Good to Excellent
• Copper Corrosion	ASTM D2671	No Corrosion
• Water Absorption	ASTM D570	.2%
• Fungus Resistance	ASTM G21	No Growth

Shrink-Kon® Heat-Shrinkable Tubing

CPO-A Series — Thin-Wall, Adhesive Lined

- Adhesive lined for moisture-proof environmental seal
- High 3:1 shrink ratio for covering irregularly shaped objects
- Continuous operating temperature: -55° C to 110° C
- Shrink temperature 120° C

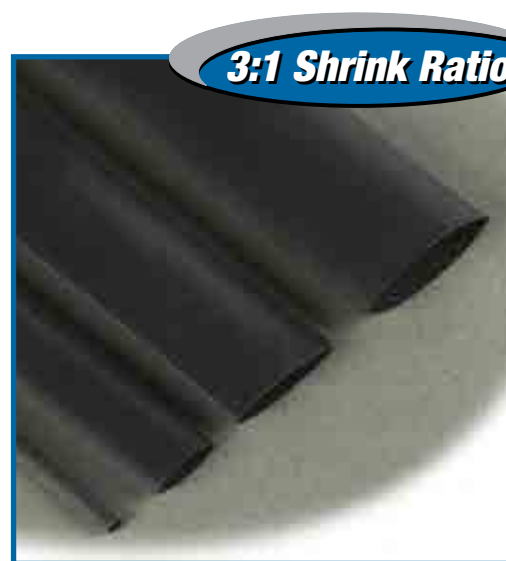

Wire Termination — Sta-Kon® Wire Termination & Insulation

CPO-A Series Thin-Wall Heat-Shrinkable Tubing

CAT. NO.	MIN. EXPANDED I.D. (IN.)	MAX RECOVERED I.D. (IN.)	NOMINAL RECOVERED WALLED (IN.)	CODE CABLE SIZE	STANDARD LENGTH (IN.)	STD. PKG. QTY.
CPO-A-125-48	.13	.02	.04	#24-#30 AWG	48	25
CPO-A-187-48	.18	.06	.05	#14-#22 AWG	48	25
CPO-A-250-48	.25	.08	.05	#10-#22 AWG	48	25
CPO-A-375-48	.38	.14	.05	#6-#16 AWG	48	25
CPO-A-500-48	.50	.19	.07	#2-#12 AWG	48	25
CPO-A-750-48	.75	.31	.07	3/0-#4 AWG	48	25

*Note: Non-standard colors, sizes and lengths available subject to factory quotation.
Standard color: Black*

CPO-A Series Specifications

PROPERTY	TEST METHOD	TYPICAL PERFORMANCE	PROPERTY	TEST METHOD	TYPICAL PERFORMANCE
Physical			Electrical		
• Tensile Strength	ASTM D2671, ISO 37	2200 psi (15.0 MPa)	• Dielectric Strength	ASTM D2671, IEC 243	600V/Mil (24kV/mm)
• Elongation	ASTM D2671, ISO 37	400%	• Volume Resistivity	ASTM D2671	1016 ohm-cm
• Heat Shock (4 hrs. at 250° C)	ASTM D2671	No Cracking or Flowing	Chemical		
• Longitudinal Change	ASTM D2671	±5%	• Fluid Resistance	MIL-DTL-23053/4, ISO 1817, ISO 37	Good to Excellent
• Low-Temperature Flexibility (4 hrs. at -55° C)	ASTM D2671	No Cracking	• Fungus Resistance	ASTM G21	No Growth
• Specific Gravity	ASTM D792, ISO R1183	1.1	• Copper Corrosion	ASTM D2671	No Corrosion
• 2% Secant Modulus	ASTM 2671	1600 psi (110 MPa)	• Water Absorption	ASTM D570	.2%
• Heat-Resistant Properties (168 hrs. at 175° C)	MIL-DTL-23053/4	240%			
• Flammability	ASTM D2671	Moderately Flame Retardant			

Shrink-Kon® Heat-Shrinkable Tubing

CHS Series — Clear Thin-Wall PVC Heat Shrink

- Clear shrink enables user to inspect die and crimp details after installation
- Flexible PVC tubing is suitable for industrial and electronic applications
- UL standard UL224, VW-1 rated
- CSA standard C22.2 no. 198.1 oft
- Flame retardant
- Low shrink temperature of 110° C
- Dielectric strength — 600V/MIL



CHS Series Thin-Wall Heat-Shrinkable Tubing



CAT. NO.	MIN. EXPANDED I.D. (IN.)	MAX RECOVERED I.D. (IN.)	NOMINAL RECOVERED WALLED (IN.)	CODE CABLE SIZE	STANDARD LENGTH (IN.)	STD. PKG. QTY.
CHS18	.13	.06	.02	#22-#18 AWG	50	1
CHS18B	.13	.06	.02	#22-#18 AWG	250	1
CHS14	.25	.13	.03	#16-#10 AWG	50	1
CHS14B	.25	.13	.03	#16-#10 AWG	250	1
CHS38	.38	.19	.03	#8-#6 AWG	50	1
CHS38B	.38	.19	.03	#8-#6 AWG	250	1
CHS12	.50	.25	.03	#4-#2 AWG	50	1
CHS12B	.50	.25	.03	#4-#2 AWG	250	1
CHS34	.75	.38	.04	#1-3/0 AWG	50	1
CHS34B	.75	.38	.04	#1-3/0 AWG	250	1
CHS100	1.00	.50	.04	4/0 AWG-300 kcmil	25	1
CHS100B	1.00	.50	.04	4/0 AWG-300 kcmil	100	1
CHS112	1.50	.75	.04	350-700 kcmil	25	1
CHS112B	1.50	.75	.04	350-700 kcmil	100	1
CHS200	2.00	1.00	.05	750-1000 kcmil	25	1
CHS200B	2.00	1.00	.05	750-1000 kcmil	100	1

Standard package is in reels.
Order by reel; not by feet.

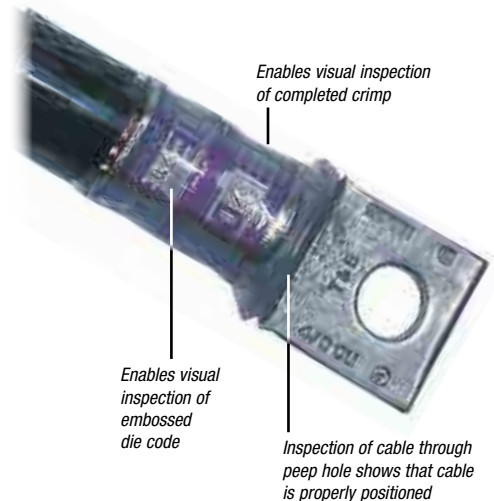

CHS Series Specifications

PROPERTY	TEST METHOD	TYPICAL PERFORMANCE
Physical		
• Tensile Strength	ASTM D2671, ISO 37	3300 psi (23.0 MPa)
• Elongation	ASTM D2671, ISO 37	300%
• Longitudinal Change	ASTM D2671	±10%
• 2% Secant Modulus	ASTM D2671	16,000 psi (110 MPa)
• Specific Gravity	ASTM D792, ISO R1183	1.31
• Elongation after Heat Aging (168 hrs. at 136° C)	ASTM D2671, ISO 37	250%
• Heat Shock (4 hrs. at 250° C)	ASTM D2671	No Cracking or Flowing
• Low-Temperature Flexibility (1 hr. at 10° C)	ASTM D2671	No Cracking or Splitting
• Flammability	ASTM D2671	Self Extinguishing

PROPERTY	TEST METHOD	TYPICAL PERFORMANCE
Electrical		
• Dielectric Strength	ASTM D2671, IEC 243	600V/Mil (24kV/mm)
• Volume Resistivity	ASTM D2671	1016 ohm-cm
Chemical		
• Fluid Resistance	MIL-DTL-23053, ISO 1817, ISO 37	Good to Excellent
• Copper Corrosion	ASTM D2671	No Corrosion
• Water Absorption	ASTM D570	.3%
• Fungus Resistance	ASTM G21	No Growth

Shrink-Kon® Splice Insulators and Insulating Covers

Adhesive Insulating Covers

- Seals against moisture
- Voltage rating up to 600
- Workable from 14° F to 120° F
- Maximum operating temperature of 176° F
- No installing tools required
- Also available in 10' rolls; consult customer service

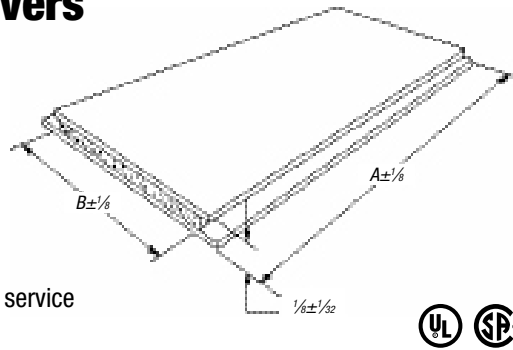

Specifications

Electrical

- Dielectric Constant: 3.2 ASTM-D150 (60 Hz)
- Power Factor: 007 ASTM-D150 (60 Hz)
- Dielectric Strength: 340 Volts/mil ASTM-D1373

Chemical

- Water Absorption: .06% ASTM-570
- Ozone Resistance — Excellent: 03% ASTM-D1373
- Corrosion None Visible: per ASTM-D 69

CAT. NO.	A	B	STD. PKG.
AC 5 X 3	5"	3"	10
AC 5 X 7	5"	7"	10
AC 85 X 75	8.5"	7.5"	5
AC 85 X 105	8.5"	10.5"	5

Order multiple is std. pkg.

*UL Listed for use with T&B Covers.

For "H" Taps, "C" Taps, two-way connectors, mechanical taps and Color-Keyed® lugs and joints.

Material: 6 mil electrical vinyl backing, butyl rubber mastic adhesive thickness 1/8" approx. Polyethylene release sheet.

UL Listed — File No. E9809.

Not for submersion in liquid.

ADHESIVE INSULATOR CAT. NOS.	COMPRESSION LUG CAT. NOS.										COMPRESSION TWO-WAY CONNECTOR CAT. NOS.		"H" TAP CAT. NOS.	"C" TAP CAT. NOS.	COMPRESSION CABLE JOINTS CAT. NOS.	
	60096	60113	60130	60150	54132	54145	54160	54207	54906	54860	60500	54806	63105	54710	54610	
AC 5 X 3 SIZE KEY #2	60097	60114	60132	60151	54134	54108	54162	54208	54942	54862	60501	54807	—	54715	54615	
	60099	60116	60134	60230	54105	54147	54163	54255	54947	54864	60507	54806	—	54720	54620	
	60101	60117	60135	60236	54135	54148	54111	54209	54909	54866	60512	54504	—	54725	54625	
	60102	60118	60136	60238	54136	54150	54165	54210	54910	—	60516	54505	—	54730	54630	
	60103	60120	60138	60242	54138	54152	54167	54260	54965	—	60905	54506	—	54735	54635	
	60104	60122	60140	60244	54106	54153	54168	54211	54970	—	60910	54507	—	54740	—	
	60106	60123	60141	60248	54139	54109	54112	54265	54850	—	60915	54506	—	54745	—	
	60107	60124	60142	60250	54140	54155	54170	54212	54852	—	60920	54509	—	54750	—	
	60108	60126	60144	54104	54107	54157	54204	54270	54854	—	60925	54510	—	—	—	
	60109	60128	60147	54130	54142	54158	54205	54930	54856	—	54804	54511	—	—	—	
	60112	60129	60148	54131	54143	54110	54206	54905	54858	—	54805	—	—	—	—	
AC 5 X 7 SIZE KEY #4	—	60152	60169	60267	54173	54115	54129	54222	54920	—	60522	60945	54516	63110	54755	54640
	—	60153	60171	60268	54174	54183	54213	54291	54923	—	60530	60950	54518	63115	54760	54645
	—	60154	60172	60269	54113	54116	54275	54223	54928	—	60538	60955	54809	63120	54765	54650
	—	60156	60174	60271	58161	54185	54214	54295	54868	—	60542	60960	54810	63125	54770	—
	—	60157	60176	60273	58162	54118	54280	54224	54870	—	60548	60965	54811	—	54775	—
	—	60159	60178	60274	58163	54187	54215	54226	54872	—	60554	60970	54812	—	54780	—
	—	60160	60180	60275	58165	54120	54282	54228	54874	—	60560	54509	54813	—	—	—
	—	60162	60254	60276	58166	54122	54216	54913	54876	—	60565	54510	54814	—	—	—
	—	60163	60256	60277	54178	54123	54218	54914	54878	—	60568	54511	54815	—	—	—
	—	60165	60260	60278	54179	54124	54286	54915	54880	—	60571	54512	54816	—	—	—
	—	60166	60262	60280	54114	54126	54220	54916	54882	—	60930	54513	54817	—	—	—
	—	60168	60265	54172	54181	54128	54289	54918	—	—	60935	54514	—	—	—	—
	—	—	—	—	—	—	—	—	—	—	60940	54515	—	—	—	—
AC 85 X 75 SIZE KEY #6	—	—	—	—	60184	—	—	—	—	—	60574	54522	63130	—	—	—
	—	—	—	—	60284	—	—	—	—	—	60576	54523	63135	—	—	—
	—	—	—	—	—	—	—	—	—	—	60578	54524	63140	—	—	—
	—	—	—	—	—	—	—	—	—	—	60580	54526	63145	—	—	—
	—	—	—	—	—	—	—	—	—	—	60584	54528	63150	—	—	—
	—	—	—	—	—	—	—	—	—	—	60975	54820	—	—	—	—
	—	—	—	—	—	—	—	—	—	—	60980	54823	—	—	—	—
	—	—	—	—	—	—	—	—	—	—	60985	54828	—	—	—	—
	—	—	—	—	—	—	—	—	—	—	54520	—	—	—	—	—
AC 85 X 105 SIZE KEY #8	—	—	—	—	—	—	—	—	—	—	—	—	63155	—	—	—
	—	—	—	—	—	—	—	—	—	—	—	—	63160	—	—	—
	—	—	—	—	—	—	—	—	—	—	—	—	63165	—	—	—

Shrink-Kon® Splice Insulators and Insulating Covers

Quick and easy insulation — no heat or adhesive required!

Self-Fusing Insulation Tape

- Just two layers form a moisture-proof, abrasion-resistant, dielectric seal
- Easy-release, non-static-sensitive liner peels right off
- Creates an immediate, permanent bond even when wet
- Suitable for high- and low-voltage applications
- Resistant to UV, moisture and saltwater
- Easily removable — just slice with a knife and pull off — leaves no residue
- Smooth filler putty compound available for use under tape when insulating bolted or dimensionally inconsistent splices and terminations



TBFT421-36



Typical Applications

- Repair deteriorated insulation on cables and conductors
- Insulate and seal underwater, underground and above-ground bonding installations
- Insulate harnessing, bundling, cabling and wiring in aircraft, automotive, marine and other industrial machinery/equipment



Specifications

- Material: Modified silicone rubber compound
- Tensile Strength: 1200 psi
- Dielectric Strength: 20 mil: 600 vpm; 40 mil: 400 vpm
- Abrasion Resistance: 110 lbs./in.
- Water Absorption: < .5%
- Temperature Rating: 80° C max.
- Voltage Rating: 600V max.



TBFP9-2

CAT. NO.	WIDTH (IN.)	LENGTH (FT.)	THICKNESS (MILS)	COLOR	STD. PKG. QTY.
Self-Fusing Insulation Tape					
TBFT421-36	1	36	40	Red	10
TBFT201-36	1	36	20	Black	10
Smooth Filler Putty Compound					
TBFP9-2	1	2.08	—	White	1

Standard package is rolls. Order by rolls; not by feet.

HSTS25 — Tape Sealant



- Available in a 25-ft. roll
- Used in conjunction with T&B Heat-Shrinkable Insulators for better moisture sealing

Specifications

Physical

- Description: Butyl Rubber Polymer
- Application Temperature: 40° F to 100° F
- Service Temperature: -40° F to 180° F
- Environmental Resistance: Resists ozone and all normal aging processes

Electric

- Dielectric Strength: 250V/mil minimum
- Volume Resistivity: 1014 ohms/cm

Chemical

- Chemical Resistance: Resists acids, bases and alcohols; Passes Fed. Spec. SS-S-00210, section 3.6

Installation Guidelines

1. The cable jacket and conductors should be relatively clean and free of greases, oils and other foreign substances.
2. It is best to overlap each wrap of tape by ¼ to ½ of the width for the best seal.
3. When using heat-shrinkable products, most applications require only one or two layers of tape prior to sliding tubing in place.
4. Shrink the tubing, cap, boot, etc., following the installation procedure for the applicable heat-shrinkable part.

To seal the junction or crotch of an application requiring two or more cables, conductors, etc. without a common jacket.

1. Apply the overlapped one or two layers around each cable, conductor, etc., at the same distance from the connector, or ball up the sealant and press into crotch or junction of the joint.
2. Apply two overlapping wraps over the bundle.
3. Slide the expanded heat-shrinkable part over the joint and shrink.

CAT. NO.	DESCRIPTION	WIDTH (IN.)	THICKNESS (IN.)	LENGTH (FT.)	STD. PKG. QTY.
HSTS25	Tape Sealant	1	.06	25	1

Standard package is reels. Order by reel; not by feet.

Shrink-Kon® Insulators and Insulating Covers

Quick and dependable way to insulate and waterproof motor lead connections up to 5kV.

Medium-Voltage Motor Stub Splice Insulator

- Installs in seconds
- Flame retardant
- Flexible boot and impact-resistant cap
- Long lasting and reusable
- Waterproof and abrasion resistant
- One size fits all hookups — reduces inventory
- Enables easy inspection of connection



This first-generation multi-splice insulator is designed to give you a quick, dependable means of protecting medium-voltage motor stub splice connections up to 5kV. You can install it in seconds simply by pushing the cover and boot together. Once installed, it completely waterproofs the connection and provides excellent protection against abrasion or mechanical abuse.

One size reduces inventory

The insulator accommodates wire sizes #2 AWG–350 kcmil having outer diameters of .375" to .840". This range-taking feature should accommodate all of your medium-voltage motor hookups.

Inspectable and reusable

The insulator consists of just two parts: an elastomer boot and thermoplastic cap. The boot has two tapered cable entry legs that fit snugly around the cable to form a watertight seal. The legs are designed to be trimmed during installation to fit the required cable size tightly. The cap simply pushes into a groove in the boot — and pulls out easily when you want to inspect the connection. Removal of the cap does not disturb the seal around the cables, nor does it interrupt the bolted splice connection.

Quality engineered

The boot is made of flexible, abrasion-resistant elastomer, and the cap is made of high impact-resistant thermoplastic — high-performance materials you can depend on. Use the insulator for pigtail applications in motor junction boxes, manholes or wherever a waterproof, impact-resistant insulator is required.



Specifications

- 5kV Wire Range: #8–2/0 AWG
- Rating: 90° C Applications
- UL Listed to: 600V
- CSA Certified to: 600V
- T&B Recommended to: 5000V @ 90° C
- Material: Cap — NORYL, UL 94V-1
Boot — EPDM Elastomer, UL94V-2 Lubricant — Silicone Grease

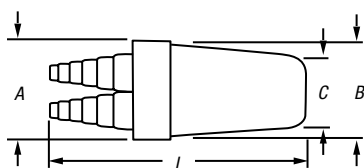

Wide Range Splice



CAT. NO.	WIRE RANGE	INSULATION O.D. RANGE (IN.)	BOLT MAX. LENGTH (IN.)	LENGTH L (IN.)	DIA. A (IN.)	DIA. B (IN.)	DIA. C (IN.)	STD. PKG. QTY.
MSCV20	#2 AWG–350 kcmil	.38–.84	1.25	6.5	3	2 ²¹ / ₃₂	2	5

Order in multiples of std. pkg.

Shrink-Kon® Splice Insulators and Insulating Covers

Motor Stub Splice Insulators

- Re-enterable motor stub insulator
- Easy installation
- No special tools required

This innovative product has been designed to insulate motor stub splices quickly, easily, and dependably. It consists of a boot-type insulator with integral Ty-Rap® cable ties. To install, simply position the insulator over the bolted splice and tighten the cable ties. That's all there is to it. It produces uniform, high-quality installations every time... in about 30 seconds. The completed installation is immediately ready for inspection and use. If required, the insulator can be easily removed. Simply snip the cable ties and slide the insulator off the splice. It leaves no sticky residue.



CAT. NO.	WIRE RANGE	LENGTH (IN.)	BOLT MAX. A (IN.)	B DIA. (IN.)	C DIA. (IN.)	D (IN.)	E (IN.)	STD. PKG. QTY.
MSC14*	#14-#10 AWG	3.38	1.5	.56	.50	.38	.35	15
MSC8	#12-#8 AWG	3.38	2.39	.73	.67	.38	1.20	10
MSC2	#12-#2 AWG	.75	3.25	.95	.88	.38	1.5	10
MSC20	#2-2/0 AWG	1.5	4.25	1.39	1.05	.43	1.70	4
MSC250	3/0 AWG-300 kcmil	1.5	7.56	1.88	1.80	.45	1.90	2
MSC500	350-500 kcmil	1.75	8.88	2.56	2.48	.45	2.10	5

Order in multiples of std. pkg.
*One Ty-Rap® cable tie only

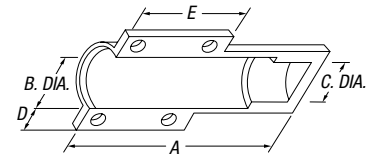

Specifications

- UL File E9809. UL and CSA Certified (94V-1 Flammability Class)
- Rated for 600V and 90° C application

Material

- Body: Modified Neoprene Elastomer
Straps: Nylon

Insulator Connectors

INSULATOR CAT. NO.	WIRE RANGE	LUGS						TERMINALS		BOLT MAXIMUM LENGTH (IN.)
		2-HOLE COLOR-KEYED® LUGS (AL-CU WIRE)	1-HOLE COLOR-KEYED® LUGS (AL-CU WIRE)	2-HOLE CAST COPPER LUGS (CU WIRE)	1-HOLE CAST COPPER LUGS (CU WIRE)	2-HOLE COLOR-KEYED® LUGS (CU WIRE)	1-HOLE COLOR-KEYED® LUGS (AL-CU WIRE)			
MSC14	#14-#10 AWG	—	—	—	—	—	—	14RB4-14RB10 RB14-4-RB14-10	10RC6-10R1C0 RC10-6-RC10-10	3/8
MSC8	#12-#8 AWG	—	60096 60097 60101 60102	—	53104	—	54104	—	—	3/8
MSC2	#12-#2 AWG	—	60099 60103-60118	53204 53205 53206	54105 54106	54204 54205 54206	54105 54106	—	—	3/4
MSC20	#2-2/0 AWG	60230 60236	60118-60138	53207 53208	53107 53108	54207 54208	54107 54108	—	—	1
MSC250	3/0 AWG-300 kcmil	20238-60256	60140-60157	53209-53113	53109-53113	53209-54214	54109-54114	—	—	1 1/2
MSC500	350-500 kcmil	60260-60273	60165-60172	53115-53118	53115 53118	54215-54218	54115-54118	—	—	1 3/4

Shrink-Kon® Installation Tools

Electric Heat Gun

- UL® Listed
- 600° F to 950° F heat range
- 120VAC 60 Hz



CAT. NO.	DESCRIPTION	PKG. QTY.
WT1400	Dual-Temp. heat gun. 600° F/950° F, 1,300W, 120VAC, 60 Hz	1

Order multiple is std. pkg.

Separate fuel- and air-flow controls enable precise adjustment of flame and temperature up to 2,500° F!

Portable Heat-Shrink Torch

- 2,500° F output capacity satisfies virtually any heat-shrink, brazing or soldering requirement
- Dual fuel- and air-flow controls enable separate adjustment of temperature and flame precision
- Brass and steel construction provides durability



Specifications

- Dimensions (without base): 3.9"L x 1.4"W x 5.4"H
- Weight (when filled): 9.88 oz.
- Fuel Tank Capacity: 2.03 fl. oz.
- Operating Time (per full fuel tank): Up to 220 minutes
- Operates on standard butane refills

Portable Heat-Shrink Torch

CAT. NO.	DESCRIPTION	STD. PKG. QTY.
WT-PTORCH	Portable Heat-Shrink Torch	1

Order multiple is std. pkg.

Shrink-Kon® Installation Tools

Installation

- 1 Remove any oil, grease, water, dirt, etc., by wiping the cable ends and connector. Remove all sharp edges and burrs from connector.
- 2 Center tubing over splice connector.
- 3 Use the light blue outer portion of the flame when using the SIT-1 torch. Do not hold the torch still in one position or concentrate the hot inner flame of the torch on the tubing; this may cause scorching.
- 4 Begin heating tubing in the center. Recover the central portion of the tubing first by heating around the circumference of the splice. (Keep heat source moving constantly around the circumference of the insulator to ensure uniform shrinkage of the insulator.)
- 5 Continue heating around the tubing and out toward one end. Move torch around the tubing until one end is completely recovered.
- 6 Repeat the above procedure on the opposite end of the splice, again working from the center outward and around the tubing.
- 7 Installation is complete when the tubing conforms to splice and sealant flow is apparent at both ends.

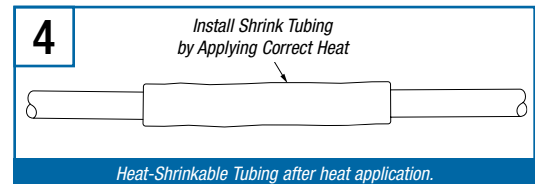
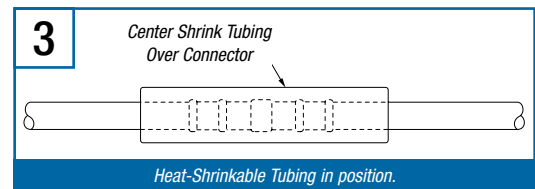
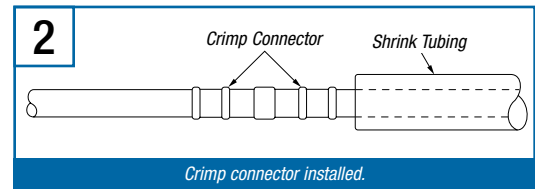
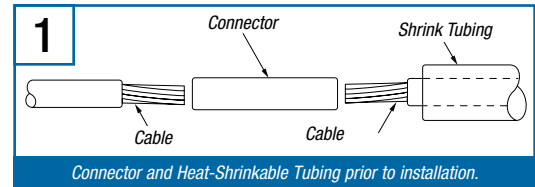

Shrink-Kon® Installation Tools

Typical Specifications

Insulating and sealing of all 600V, in-line cable splices from #16 AWG through 1000 kcmil shall be done in accordance with the instructions provided with the Shrink-Kon® heat-shrinkable insulators, catalog series HS.

The connector insulator must be made of thermally stabilized, homogeneous polyolefin having internally applied sealant. It must have Underwriter's Laboratories Listing (UL® 486, 90° C, 600V) and be approved for the use. It must be usable without additional covering or adhesive both indoors and outdoors, in overhead, direct-burial or submersed applications at rated voltage. It must not be adversely affected by moisture, ozone, oils, fuels, mild acids and alkalis or ultraviolet light. It must be compatible with all commonly used cable jacket materials, including rubber, plastic, lead, steel, aluminum and copper.

Factory-Applied Sealant

A standard sealant is coated on the entire inside surface of most precut sizes. Tubing is also available without sealant — consult factory. The sealant is rated for continuous 90° C operation on non-pressurized cable systems and aids in sealing out moisture and corrosion.

Cost and Reliability of Heat-Shrinkable Tubing Compared to Tape

The cost differential in the installation of T&B heat-shrinkable tubing over taping can result in up to a 34% savings in labor and overhead. For example, on a 2/0 AWG aluminum splice, heat-shrinkable tubing can be installed in three minutes, versus 10 minutes of taping. In addition to the direct cost reduction, there are the advantages of assured uniformity of wall thickness and moisture sealing.

Cross Reference

T&B	PANDUIT	3M	RAYCHEM	SUMITOMO	ALPHA	COLEFLEX	INSULTAB
CPO	HSTT	FP 301 (1 & 2)	RNF 100 (1 & 2)	A2 & B2	FIT 221	ST221 / STS221 STU221 / STSU221	HS 101
CPO-A	HSTTA & HSTTVA	EPS300	TAT 125 ATUM 3:1	W3B2	FIT321	ST303	HS101 MW 3:1
HSMW	—	—	MWTM (U) BSTS-M / SST-M	—	—	—	CTV
HS	—	—	WSCM / SST	—	FIT 700	—	—
HS FR	HST	HDT	BSTS FR / SSTFR WCSF / FCSM	—	—	—	CTVH
HSC	HSEC	ICEC	S3C/ESC SSC-FR / ESC-FR	—	—	TYT	—
CPO-HF	—	—	—	NH	—	—	—
HSM-HF	—	—	XFFR	—	—	—	—
CHS	HSTTPN	—	—	—	—	—	—

These competitor names are the property of the respective competitor.

Shield-Kon® Shield Termination System

Shield-Kon® — Save time and money over traditional connection methods!

Wherever shielded cables and wires are fitted, there is the problem of finding a permanent, repeatable, safe and quick connection of the braided shield.

Conventional connection methods use soldering, which is more time-consuming and more expensive, and can often result in damage to the dielectric or to the internal shield conductor caused by heat. Moreover, the use of lead-based soldering methods can be in conflict with the latest safety regulations.

The Shield-Kon® solution from Thomas & Betts involves a crimp technique for shield termination on shielded cables. The reliability of Shield-Kon® terminals has led to a specification for the aeronautical and space technology industry and for military applications (MIL-F-21608).



One-Piece Shield-Kon® Connector



Two-Piece Shield-Kon® Connector

Thomas & Betts offers two solutions:

- The one-piece Shield-Kon® connector wraps around the shield and has a specific pocket for the ground wire
- The two-piece Shield-Kon® connector consists of two sleeves that are compressed between the shielded braid and the drain wire

The essential advantages are clearly visible:

- Saves time and reduces assembly costs
- Safe monitoring
- Simple operation
- Low-profile and compact connectors
- Tried and tested technology
- Quality grounded connections



Shield-Kon® Shield Termination System

Terminate shielded cable in seconds without heat or power!

This solderless, wraparound connector terminates shielded cable in seconds... with uniform precision. It's particularly well suited for production work in aircraft, aerospace and electronic industries where size and weight are important.

Once crimped, it provides a compact, lightweight, low-resistance, high-strength connection, which meets and exceeds the performance requirements of MIL-F-21608.

The connector works equally well on braided, wrapped or foil shields and has the added advantage of being able to be used as a mid-span termination.

Only four sizes, which can be easily identified by the color of their insulation, are needed to cover a range of shielding diameters from .05" to .3".

- Compact, low-profile connector
- One piece wraparound design
- Tough polyester insulation (Mylar® type)
- Inventory savings: only four sizes
- Transparent insulation, easily inspected
- MIL-specified, industry-approved technology
- No heat or power required to install
- No damage to inner conductor
- Less installation time required
- Uniform, precise connection every time
- Low installed cost
- Mid-span termination possible, eliminating the need to demount a cable already installed



The one-piece Shield-Kon® connectors meet the MIL-F-21608 standards for the following environmental specifications:

Specifications

- Voltage Drop: 9 mV max. at 1A after environmental exposure
- Insulation Dielectric Strength: 500 VRMS at 60 Hz for 1 minute
- Corrosion Resistance: 48 hours in 5% salt fog
- Pullout Strength: 15 lbs. min. for #22 AWG, and 19 lbs. min. for #20 AWG
- Vibration: .03" double amplitude between 10 and 55 Hz for 6 hours on each of two axis
- Material: Copper, conform to CDA No. 110
- Plating: Tin, electro-plated (thickness 3 to 8 µm), in accordance with MIL-T-10727A
- Insulation: Polyester film (Mylar® type), color coded for size identification
- Temperature: -85° F to +257° F (-65° C to +125° C)

In addition, hypot tests have shown that the cable manufacturers' specified working voltage rating is maintained after the installation of Shield-Kon® RSK connectors. It is, however, still advisable to evaluate the suitability of these connectors and verify their performance for the particular application.

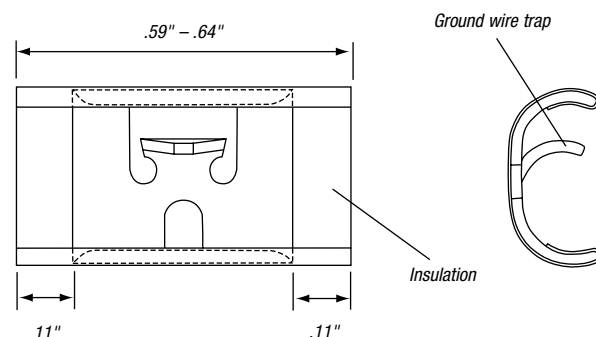

Shield-Kon® Shield Termination System

Maintains voltage and is easy to install!

Shield-Kon® RSK Connectors



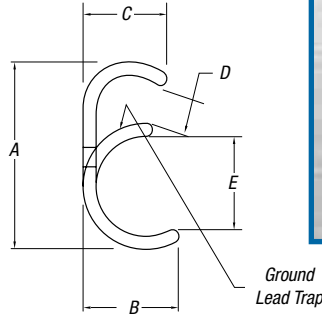

How to use connector die and tool selection chart:

1. Use a calibrated measuring tool lightly over shield for most accurate measurement. Rotate shielded wire to pick up high spots on cable. Use "Shield Diameter" column to match the measured dimension.
2. Select connector and die for ERG740 tool.

Note: 1. Do not solder-dip ends of ground leads.
2. For ground wire combinations not covered in table, consult Technical Service.



One-Piece Shield-Kon® Connectors & Die Selection Table

CONNECTOR & COLOR CAT. NO.	SHIELD DIAMETER	METAL DIES FOR ERG740	GROUND WIRE RANGE	APPLICATION TOOL CAT. NO.
RSK101 	1.27–1.78mm (.050–.070 in.)	D-101A	(1) or (2) #24 AWG Str.	Hand Tool ERG740
	1.80–2.26mm (.071–.089 in.)	D-101B	or (1) #22 AWG Str.	
RSK201 	2.29–2.54mm (.090–.100 in.)	D-201C	(1) or (2) #22 AWG Str. or (1) #20 AWG Str.	
	2.56–3.00mm (.101–.118 in.)	D-201D		
	3.022–3.33mm (.119–.131 in.)	D-201E		
	3.35–3.63mm (.132–.143 in.)	D-201F		
RSK301 	3.66–4.11mm (.144–.162 in.)	D-301G	(1) or (2) #22 AWG Str. or (1) or (2) #20 AWG Str.	
	4.14–4.70mm (.163–.185 in.)	D-301H		
	4.72–5.10mm (.186–.201 in.)	D-301J		
RSK401 	5.13–5.84mm (.202–.230 in.)	D-401K	(1) or (2) #20 AWG Str. or (1) #18 AWG Str.	
	5.87–6.35mm (.231–.250 in.)	D-401L		
	6.37–6.98mm (.251–.275 in.)	D-401M		
	7.01–7.62mm (.276–.300 in.)	D-401N		

CAT. NO.	COLOR	DIMENSIONS (IN.)					THICKNESS	STD. PKG.
		A	B	C	D	E		
RSK-101	Red	.31	.16	.18	.06	.15	.02	1,000
RSK-201	Blue	.38	.22	.18	.06	.18	.02	1,000
RSK-301	Yellow	.47	.28	.24	.07	.22	.03	1,000
RSK-401	Green	.69	.43	.37	.08	.37	.03	500

Order multiple is std. pkg.

Shield-Kon® Shield Termination System

Installation that's as easy as 1-2-3!

Installation Methods

Standard Method

Use the standard method when the shielded cable or the inner conductors are embedded in a dielectric.

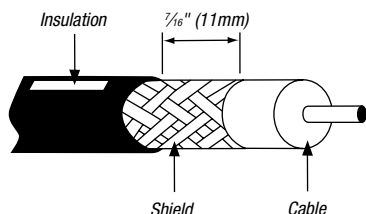

Fold-Back Method 1

If there is no common dielectric for several interior cables but the gaps are filled by textile threads or something similar, care should be taken to ensure that the insulating thickness of the individual cables is not less than .38mm for PVC, and not less than .25mm for Teflon. If this insulation thickness falls below this value, Fold-Back Method 1 should be used.

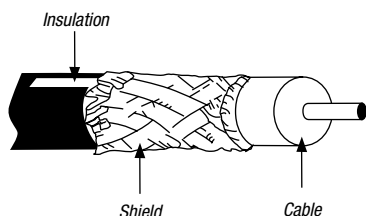

Fold-Back Method 2

Fold-Back Method 2 should be used if the cable shield is applied spirally or if a foil shield is being used.

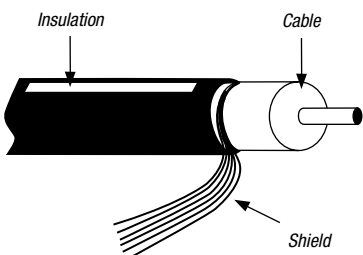

Mid-Span Method

Enables installation anywhere along the cable.

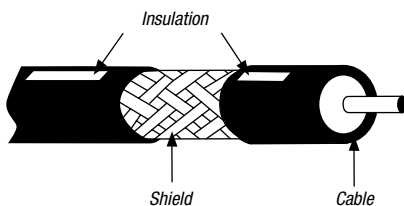

Installation Procedure

Step 1

Prepare shielded wire and ground wire insulation as shown.

If two ground wires are required in a Shield-Kon® connection, twist both conductors before insertion into the connector.

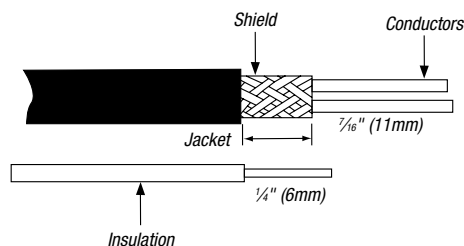

Step 2

Select the appropriate connector according to the size of the shielded cable (see **page G-80**). Place the ground wire around the trap hook and the shielded wire into the bottom of the connector.

When inserting the shielded cable and grounding wire, care must be taken to ensure that their insulation is overlapped by the connector's Polyester insulation film.

100% insulation is possible after crimping when the stripped length of outer jacket (visible shielding) is 1/16" (11mm) maximum.

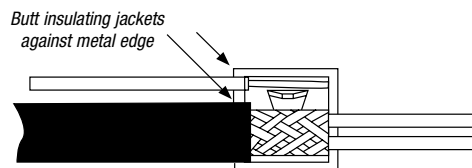

For a complete listing of One-Piece Connectors, see page G-80.

Step 3

Select the appropriate die set for the crimp tool, according to the size of the shielded cable (see **page G-80**) and mount the dies on the tool. Insert the connector (with the shielded cable and the ground wire) between the dies of the tool.

Squeeze the tool handles firmly to crimp the connector around the shielding and the ground wire.

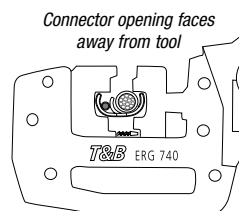

For a complete listing of One-Piece Connector Dies, see page G-80.

Shield-Kon® Shield Termination System

Comfort and versatility!

Shield-Kon® Ergonomic Hand Tool for One-Piece Connectors

- Robust construction: metallic frame, partially covered with plastic
- Use with metal dies for low-, medium- or high-volume applications
- All dies are easily interchangeable (to be ordered separately)
- Parallel action crimp
- ShureStake® mechanism: once pressing has commenced, the tool can be re-opened only after successful completion of the crimping cycle



CAT. NO.	DESCRIPTION	STD. PKG.
ERG740	Ergonomic Hand Tool	1

Specifications

- Dimensions of Tool: 8.27"L x 6.10"W x .98"H
- Weight of Tool: 1.04 lbs.

Everything you need in a handy kit!

Ergonomic Hand Tool Kit

Same as ERG740, but supplied in a plastic case with one tool, one benchmount stand for easier use in mass production, one RSK-LEHRE gauge for instant selection of the die and four metal dies: D-101A, D-201C, D-301J, D-401M.



Specifications

- Dimensions of Plastic Case: 9.65"L x 8.27"W x 2.17"H
- Weight of Plastic Case & Contents: 2.65 lbs.

CAT. NO.	DESCRIPTION	STD. PKG.
ERG740-01	Ergonomic Hand Tool Kit	1

Shield-Kon® Shield Termination System

Metal Dies for ERG740

- For mass production and medium to high volumes
- Made of hardened steel — does not wear
- Only for the ERG740 hand tool
- The Product Ref. is engraved on the upper part and on the lower part of the die set
- Marked with a dot having the same color as the corresponding connector
- Weight — approximately 2.6 oz.



DIE CAT. NO.	DIE COLOR	SHIELD DIAMETER (IN.)	FOR CONNECTOR	STD. PKG.
D-101A	Red	.050-.070	RSK 101 Red	1
D-101B		.071-.089	RSK 101 Red	1
D-201C	Blue	.090-.100	RSK 202 Blue	1
D-201D		.101-.118	RSK 202 Blue	1
D-201E		.119-.131	RSK 202 Blue	1
D-201F		.132-.143	RSK 202 Blue	1
D-301G	Yellow	.144-.162	RSK 301 Yellow	1
D-301H		.163-.185	RSK 301 Yellow	1
D-301J		.186-.201	RSK 301 Yellow	1
D-401K	Green	.202-.230	RSK 401 Green	1
D-401L		.231-.250	RSK 401 Green	1
D-401M		.251-.275	RSK 401 Green	1
D-401N		.276-.300	RSK 401 Green	1

Order multiple is std. pkg.

Select the connectors you need quickly!

RSK-LEHRE Gauge



The choice of the appropriate connector and die set mainly depends on the size of the shielded cable. The selection can be done very quickly with the RSK-LEHRE gauge.

- 1 Remove the outer jacket from the shielded cable, making the shielding visible.
- 2 Insert this stripped end of the cable into the slots located around the gauge. The correct slot will be found when the cable can slide only in the upper part of the slot. If the cable can slide completely to the bottom of the slot, you should try with the smaller adjacent slot.
- 3 Once the appropriate slot is found, the corresponding RSK connector is defined by the color of the strip around the slot, whereas the corresponding plastic die set is given by the number marked below the slot (for the metal die set, add prefix "D" to this number).
- 4 The table on **page G-80** summarizes the different combinations of connector/die set, as well as the size of ground wire that can be used.

CAT. NO.	DESCRIPTION	STD. PKG.
RSK-LEHRE	Connector & Die Gauge	1

Shield-Kon® Shield Termination System

Unique shield termination system gets the job done right!

The Shield-Kon® two-piece shield termination system from Thomas & Betts consists of two sleeves: an inner sleeve with a smaller diameter, and an outer sleeve that has a larger diameter but is shorter and less hard than the inner sleeve. All inner and outer sleeves are color coded according to their size.

The conductors of the cable are inserted through the inner sleeve, whereas the shield (braided or foiled) and the ground wire are inserted between the two sleeves. The crimp operation is done by compressing the outer sleeve with a tool, while the inner sleeve provides mechanical protection for the inner conductors.

This unique shield termination system can be used with cables having a diameter of dielectric (after removing the outer insulation and the shield) between .043" and 2.87".

In the "Hexagonal Range" (diameters of dielectric between .043" and .38"), the outer sleeve is crimped with a hand tool and the result is a hexagonal-shaped crimp. This range is used to crimp shielded and coaxial cables.

The "Circular Range" for Multiple or Overall shielded cables refers to larger diameters of dielectric (between .39" and 2.87") and owes its name to the circular shape of the crimp.



Circular Range



Hexagonal Range

Two-piece connector — the Hexagonal Range

The Thomas & Betts hexagonal compression (for diameters of dielectric up to .37") is a reliable method for grounding, terminating and insulating shielded and coaxial cable.

It has literally millions of installations in communications, aerospace, electronic, telephone, radio and TV applications.

Shield-Kon® Shield Termination System

Quick and neat terminations made easy!

Three installation methods are possible in the hexagonal range for a quick, neat and accurately completed termination... at a greatly reduced production cost.

Method 1: Standard

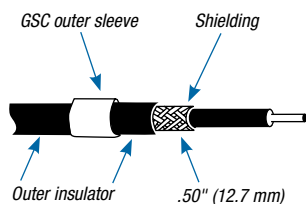

- 1 After stripping the shield (.50" in length), slip the outer sleeve over the outer insulation. If this is too big, slip the outer sleeve on, after technique described in Method 3.

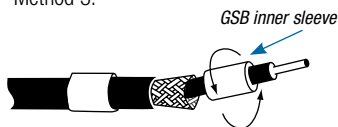

- 2 Widen the braided shield by gently rotating the inner conductor, then slip the inner sleeve under the braided shield.



- 3 Position the inner sleeve so that about .06" protrudes beyond the end of the braided shield.

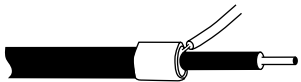

- 4 Slip the ground wire (#22–#20 AWG) under the outer sleeve (from the front or behind) and slip the outer sleeve over the braided shield.

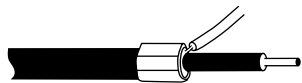

- 5 Position the outer sleeve and ensure that the ends of all wires in the braided shield and ground wire are covered. Crimp both sleeves with the correct tool and die. Finished.

Method 2: Fold Back

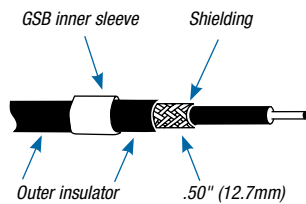

- 1 After stripping the shield (.50" in length), slip the inner sleeve over the outer insulation.

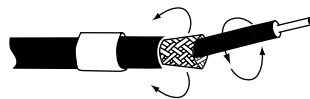

- 2 Widen the braided shield by gently rotating the inner conductor.



- 3 Fold back the braided shield over the inner sleeve and slip the outer sleeve over the braided shield.

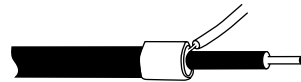

- 4 Slip the drain wire (#22–#20 AWG) under the outer sleeve (from the front or behind) and slip the outer sleeve over the braided shield.

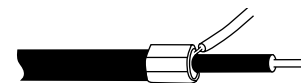

- 5 Position the outer sleeve and ensure that the ends of all wires in the braided shield and ground wire are covered. Crimp both sleeves with the correct tool and die. Finished.

Method 3: Large Insulation

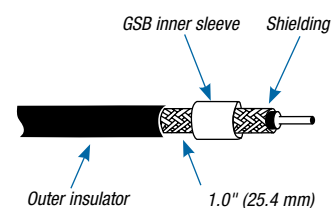

- 1 After stripping the shield (1.0" in length), slip the inner sleeve over the braided shield.

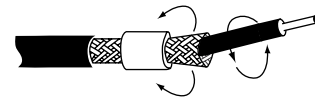

- 2 Widen the braided shield by gently rotating the inner conductor.



- 3 Fold back the braided shield over the inner sleeve and slip the outer sleeve over the braided shield.



- 4 Slip the ground wire (#22–#20 AWG) under the outer sleeve (from the front or behind) and slip the outer sleeve over the braided shield.



- 5 Position the outer sleeve and ensure that the ends of all wires in the braided shield and ground wire are covered. Crimp both sleeves with the correct tool and die. Finished.

Shield-Kon® Shield Termination System

Select connectors and dies in three easy steps!

The choice of the appropriate combination of inner sleeve, outer sleeve and crimp tool/die will depend on the diameter of the dielectric.

However, a direct correlation with the diameter of the dielectric is not possible, because several different inner sleeves can be combined with the same outer sleeve (*according to the type of shield*).

With the directions shown **below**, a measuring instrument (*caliper*) is all that is required to make the right selection in three steps:



1. Selection of the inner sleeve (GSB)

- Strip the outer insulator and remove the shield
- Measure the maximum value of the diameter of the dielectric (diameter without shield) by gently rotating the cable. When doing so, it should be possible to turn the cable easily between the jaws of the caliper
- Add .01" to the measured value. The sum will give the Inner Diameter (I.D.) of the GSB inner sleeve
- In the table on **page G-87**, select the GSB inner sleeve having this I.D. or the nearest larger I.D.

2. Selection of the outer sleeve (GSC)

Normal method:

- Slide the selected inner sleeve underneath the shield of the cable
- Measure the maximum diameter with the shield over the inner sleeve
- Add .03" to the measured value. The sum will give the Inner Diameter (I.D.) of the GSC sleeve
- In the table on **page G-87**, select the GSC outer sleeve having this I.D. or the nearest larger I.D.

Quick method:

In most cases, a quicker method can be used to define the correct GSC outer sleeve:

- Once the appropriate GSB inner sleeve is found, the table on **page G-87** will give the Outer Diameter (O.D.) of this GSB sleeve
- Add .06" to this O.D. and the sum will give the Inner Diameter (I.D.) of the GSC sleeve
- In the table on **page G-87**, select the GSC sleeve having this I.D. or the nearest larger I.D.

3. Selection of the die

Dies for GSB/GSC Shield-Kon® can be found on **page G-87**.

Tools for GSB/GSC Shield-Kon® can be found on **page G-88**. See GSC outer sleeve table.

Shield-Kon® Shield Termination System

Stay grounded with easy-to-install connectors!

Connector Inner and Outer Sleeves



Non-Insulated Inner Sleeve — GSB

- Hard bronze inner sleeve is installed under braid
- Length 5/16"
- Tin plated per MIL-T-10727A



Non-Insulated Outer Sleeve — GSC

- Soft bronze outer sleeve slips over the braid and ground wire
- Length 1/4"
- Tin plated per MIL-T-10727A

CAT. NO.	COLOR CODE	I.D. (IN.)	O.D. (IN.)	MILITARY SPEC. NO.	STD. PKG.
Inner Sleeves					
GSB046	Gray	.046	.075	21981-046	1,000
GSB058	Yellow	.058	.083	21981-058	1,000
GSB063	Red	.063	.088	21981-063	1,000
GSB071	Green	.071	.096	21981-071	1,000
GSB080	Blue	.080	.103	21981-080	1,000
GSB090	Orange	.090	.113	21981-090	1,000
GSB096	Purple	.096	.119	21981-096	1,000
GSB101	Yellow	.101	.124	21981-101	1,000
GSB109	Red	.109	.131	21981-109	1,000
GSB115	Gray	.115	.146	21981-115	1,000
GSB124	Green	.124	.145	21981-124	1,000
GSB128	Gray	.128	.152	21981-128	1,000
GSB134	Orange	.134	.156	21981-134	1,000
GSB149	Blue	.149	.179	21981-149	1,000
GSB156	Red	.156	.193	21981-156	1,000
GSB165	Gray	.165	.194	21981-165	1,000
GSB175	Green	.175	.215	21981-175	1,000
GSB187	Yellow	.187	.227	21981-187	1,000
GSB194	Blue	.194	.226	21981-194	1,000
GSB205	Orange	.205	.245	21981-205	1,000
GSB219	Gray	.219	.250	21981-219	1,000
GSB225	Yellow	.225	.256	21981-225	1,000
GSB232	Red	.232	.263	21981-232	1,000
GSB250	Green	.250	.281	21981-250	1,000
GSB261	Blue	.261	.297	21981-261	1,000
GSB266	Gray	.266	.297	21981-266	1,000
GSB275	Orange	.275	.306	21981-275	1,000
GSB281	Yellow	.281	.331	21981-281	1,000
GSB287	Gray	.287	.327	21981-287	1,000
GSB297	Red	.297	.335	21981-297	1,000
GSB312	Purple	.312	.362	21981-312	1,000
GSB348	Orange	.348	.400	21981-348	1,000
GSB375	Blue	.375	.406	21981-375	1,000

Order multiple is standard package.

CAT. NO.	COLOR CODE	I.D.	O.D.	TOOLS		MILITARY SPEC. NO.	STD. PKG.
				DIE NOS. FOR WT440/WT540*	DIE NOS. FOR 11901A		
Outer Sleeves							
GSC101	Gray	.101	.124	4419	11989	21980-101	1,000
GSC128	Blue	.128	.152	4400	11970	21980-128	1,000
GSC149	Purple	.149	.179	4401	11971	21980-149	1,000
GSC156	Yellow	.156	.193	4402	11972	21980-156	1,000
GSC175	Blue	.175	.215	4403	11973	21980-175	1,000
GSC187	Orange	.187	.227	4406	11976	21980-187	1,000
GSC194	Red	.194	.226	4406	11976	21980-194	1,000
GSC199	Gray	.199	.235	4406	11976	21980-199	1,000
GSC205	Yellow	.205	.245	4408	11978	21980-205	1,000
GSC219	Green	.219	.250	4408	11978	21980-219	1,000
GSC225	Purple	.225	.256	4409	11979	21980-225	1,000
GSC232	Orange	.232	.263	4410	11980	21980-232	1,000
GSC261	Yellow	.261	.297	4411	11981	21980-261	1,000
GSC275	Gray	.275	.306	4412	11982	21980-275	1,000
GSC281	Purple	.281	.331	4414	11984	21980-281	1,000
GSC287	Blue	.287	.327	4414	11984	21980-287	1,000
GSC297	Green	.297	.335	4414	11984	21980-297	1,000
GSC312	Yellow	.312	.362	4415	11985	21980-312	1,000
GSC327	Gray	.327	.372	4416	11986	21980-327	1,000
GSC348	Orange	.348	.393	4417	11987	21980-348	1,000
GSC359	Purple	.359	.399	5450	—	21980-359	1,000
GSC375	Yellow	.375	.406	5451	—	21980-375	1,000
GSC405	Red	.405	.453	5452	11988	21980-405	1,000
GSC415	Blue	.415	.463	5452	11988	21980-415	1,000
GSC425	Gray	.425	.475	5454	—	—	1,000
GSC460	Gray	.460	.510	5456	—	21980-460	1,000
GSC500	Green	.500	.550	5457	—	21980-500	1,000

*Dies 4419 to 4417 are for WT440. Dies 5450 to 5457 are for WT540.

Order multiple is standard package.

Shield-Kon® Shield Termination System

WT440 and WT540 Ratchet Hand Tools

- Parallel-action hand tools
- MIL specified
- Frame, with the option of interchangeable steel dies
- A versatile tool, one frame with a selection of dies covers the whole range of shield diameters in the Hexagonal Range
- ShureStake® mechanism: once pressing has started, the tool can be re-opened only after successful completion of the crimping cycle
- Packaging: wood box containing one frame (dies to be ordered separately; see Specifications for Die Nos.)



Specifications

WT440

- Length: 8"
- Weight: 1.0 lbs.
- Dies: Series 4400

WT540

- Length: 10.4"
- Weight: 1.19 lbs.
- Dies: Series 5450

CAT. NO.	DESCRIPTION	STD PKG.
WT440	Ratchet Hand Tool	1
WT540	Ratchet Hand Tool	1

Shield-Kon® Shield Termination System

Terminate multiple-conductor shielded cable quickly and easily!

The design advantages are:

- Positive selection of inner and outer sleeves and installing die by a complete color-coded system
- A more reliable grounding termination because only one ground wire connection is made — conventional daisychain jumper method is eliminated
- Smaller, more compact bundle is easy to inspect
- Only one ground wire is required; however, additional ground wires may be used if needed
- Smooth insulator protects conductor insulation
- With one stroke of the tool, the interlace die will produce a 360° compression, uniformly securing all individual shields around the connector

The Shield-Kon® Connector System for multiple-conductor shielded cable is based on the principle of cold swaging. It utilizes a two-piece compression connector color coded to match the proper die. The connector consists of a hard brass collector inner ring with a tough, smooth insulator and a soft copper compression outer ring. Each set of rings and matching installing die will connect a minimum of five shielding braids with one ground wire. The maximum number of braids is limited only by the space between the inner and outer rings.

Multi-Shielded Cable Connector Installation Procedure

Step 1

After overall insulation is removed to expose shielded cables, each conductor must be freed from the shielding braid. The Thomas & Betts lead extractor tool simplifies this operation by pushing the inner conductor through an opening in the shielding braid. The braid is then folded back until all conductors are freed.



Step 2

Flattened shielding braids are evenly distributed around the periphery of the inner collector ring.



Step 3

Position outer compression ring over the flattened shielding braid, locating it over the center of the inner collector ring. Braid may be trimmed even with the edge of the outer compression ring before or after compression. Ground wire or wires may be inserted between the outer compression ring and the shield prior to compression.

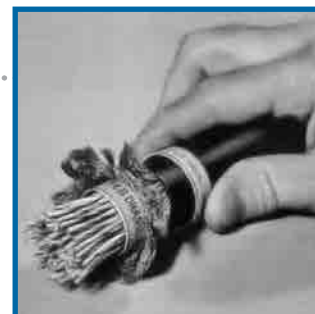

Step 4

Selection of compression dies is determined by color coding on rings. The dies are color coded to match the rings. The appropriate dies are easily inserted or removed by depressing die-locking button shown.



Step 5

The prepared cable is placed in the installing die and compressed. Tool operates on hydraulic power output, developing 9800 ±200 psi operating pressure.



Step 6

Completed installation of the "single fold-fold forward" method typifies the reliability, compactness and neatness that is obtained with all Thomas & Betts recommended installation methods.

Shield-Kon® Shield Termination System

Connectors come full circle with circular connectors!

Two-Piece Connectors for Multiple Conductor Shielded Cable

Connector and Die Selection in the Circular Range

The choice of the appropriate combination of inner ring, outer ring and crimp tool/die depends on the overall diameter of the inner conductors (underneath the shield).

In the case of the Circular range, there is a direct correlation between the diameter of the inner conductors and the inner and outer rings. With the directions (shown **below**), a measuring instrument (caliper) is all that is required to make the right selection.

Selection of the GSB Inner Ring

- Measure the maximum value of the overall diameter of the inner conductors (underneath the flattened shield) by gently rotating the cable. When doing so, it should be possible to turn the cable easily between the jaws of the caliper.
- Add .060" to the measured value. The sum will give the Inner Diameter (I.D.) of the GSB inner ring.
- In the table, select the GSB inner ring having this I.D. or the nearest larger I.D.

Selection of the GSC Outer Ring and of the Die

Once the appropriate GSB inner ring is found, the table (**below**) immediately gives the corresponding GSC outer ring and the appropriate die for the 13640 Hydraulic Head.



Specifications

Inner Sleeve

- Material: Copper alloy ASTM B135
- Finish: Electro tin-plated (per MIL-T-10727A)

Outer Sleeve

- Material: Copper ASTM B188
- Finish: Electro tin-plated (per MIL-T-10727A)

CAT. NO.	COLOR CODE	I.D. (IN.)	O.D. (IN.)	STD. PKG.
<i>Inner Sleeves</i>				
GSB430	Red	.430	.500	50
GSB550	Blue	.550	.620	50
GSB670	Gray	.670	.750	50
GSB810	Brown	.810	.880	50
GSB920	Green	.920	1.000	50
GSB1040	Pink	1.040	1.120	50
GSB1353	Yellow	1.353	1.423	50
GSB1425	Red	1.425	1.545	50

Order multiple is std. pkg.

CAT. NO.	COLOR CODE	I.D. (IN.)	O.D. (IN.)	DIES NOS. FOR 1340	STD. PKG.
<i>Outer Ring</i>					
GSC590	Red	.590	.670	GS590	50
GSC710	Blue	.710	.790	GS710	50
GSC840	Gray	.840	.920	GS840	50
GSC1010	Brown	1.010	1.090	GS1010	50
GSC1130	Green	1.130	1.210	GS1130	50
GSC1250	Pink	1.250	1.330	GS1250	50
GSC1440	Purple	1.440	1.520	GS1440	50
GSC1563	Yellow	1.563	1.643	GS1563	50
GSC1670	Red	1.670	1.750	GS1670	5

Order multiple is std. pkg.

Shield-Kon® Shield Termination System

Hydraulic Head Installing Tool

- 3.5-ton nominal pressure (output)
- For two-piece Shield-Kon® terminals in the circular range
- Coupling for quick assembly
- Requires a 9,800-psi (approx. 690 bar) operating service pressure
- Quick interchangeable steel dies (to be ordered separately)
- Interlace die with 360° compression — provides uniform pressure around circumference of connector



All the two-piece Shield-Kon® in the circular range need to be crimped with the 13640 hydraulic head equipped with the appropriate die.

CAT. NO.	DESCRIPTION	STD. PKG.
13640	Installing Head (order dies separately)	1
13606	Hand-Foot Pump	1
13600	Electric Hydraulic Pump	1
13620	Hand Switch	1
13589A	Foot Switch	1
13619	10-ft. Non-Metallic Hydraulic Hose	1
13760	Air-Operated Hydraulic Pump	1

Order multiple is std. pkg.

Dragon Tooth® Magnet Wire Termination System

Splice, tap and terminate magnet wire quickly and easily!

The tough, high-temperature insulation on magnet wire used by electrical motor and transformer manufacturers creates problems in splicing and terminating. The durability of magnet wire insulation has made dip-soldering or brazing extremely difficult without stripping the insulation.

Another splicing and terminating challenge involves the use of aluminum for magnet applications. A manufacturer connecting aluminum magnet wire to copper is faced with the problem of the different coefficients of thermal expansion of the two metals, galvanic corrosion, cold flow, and the rapid formation of oxide film on the wire surface.

T&B offers a solution for a highly reliable connection method for magnet wire. It eliminates welding, no longer requires removal of insulation and it can be installed in seconds. No special operator skills are needed. The connector and matching tooling do the entire job. To meet the essential requirements of magnet wire connections, T&B offers the insulation piercing Dragon Tooth® compression connector.

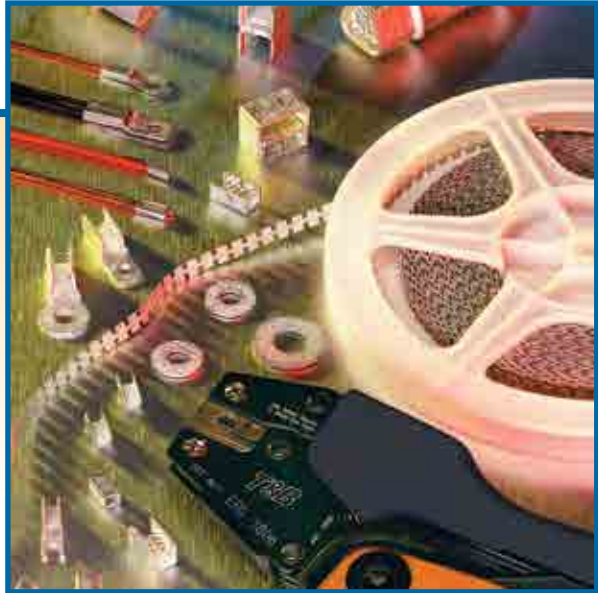

Transformer manufacturers depend on Dragon Tooth® connectors for reliable magnet wire applications.

Dragon Tooth® Magnet Wire Connectors

Dragon Tooth® connectors and installing tools are designed to splice, tap and terminate magnet wire from #32 AWG to 460,000 CMA copper and from #18 AWG to 460,000 CMA aluminum conductors in motor and transformer applications. Dragon Tooth® Magnet Wire Connectors penetrate the insulation and oxide layers to make electrical contact on magnet wiring. The result is permanent, low-resistance electrical connections, capable of maintaining contact integrity throughout the life of the connection.

- Designed to penetrate magnet wire insulation during application, eliminating the need for stripping, brazing, welding or other methods of joining magnet wire
- Can be installed in seconds
- Requires minimal training for installation
- Made of copper alloy, tin plated, with teeth on the inner surface
- Splices and taps have an open side enabling easy access to wire and making internal coil tapping possible
- For aluminum to copper, aluminum to aluminum or copper to copper magnet wire connections
- Supplied with bolt holes to accommodate #6 through 1/2" studs and includes male and female .250" x .032" disconnects
- Rings and fork terminals accommodate wire sizes #24 to #12 AWG in a variety of combinations, including combining magnet wire with stripped wire lead. For solid or stranded wire #20 to 4/0 AWG
- Larger connectors accommodate circular mil range from 50,000 to 460,000 CMA
- Connector and matching tooling do the entire job

Typical Applications

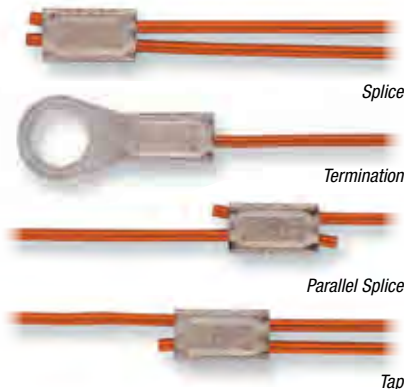

Dragon Tooth® Magnet Wire Termination System

Dragon Tooth® connectors transform the perpendicular compression force, which would normally contribute to conductor creep, into distributive forces that effectively resist cold flow, as indicated by the illustration **below**.

These connectors are made of copper alloy, tin plated, with a number of teeth on the inner surface. When compressed onto an insulated magnet wire, the sharp, hardened teeth penetrate both the insulation and oxide and bite into the conductor. An electrically sound, low-resistance connection is established as a result of the combination of high pressures at the edges of the teeth, and the sliding action between the teeth and the conductor. The open barrel design permits midspan splicing and tapping.

These connectors are made of copper alloy, tin plated, with a number of teeth on the inner surface. When the connector is compressed onto an insulated magnet wire, the sharp, hardened teeth penetrate the insulation and the oxide and bite into the conductor. An electrically sound, low-resistance connection is established as a result of the combination of high pressures at the tip and edges of the teeth, and the sliding action between the teeth and the conductor.

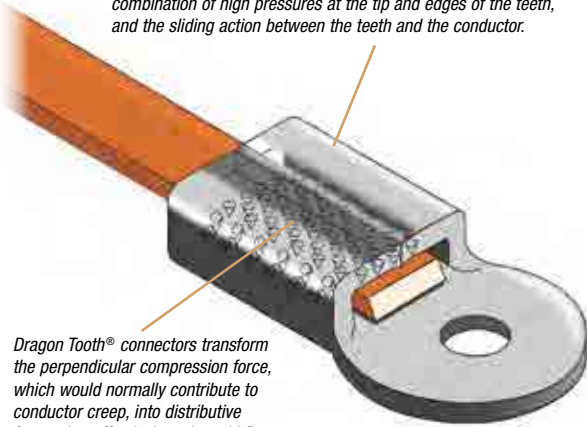

Dragon Tooth® connectors transform the perpendicular compression force, which would normally contribute to conductor creep, into distributive forces that effectively resist cold flow.

For wire sizes and combinations other than shown, contact Thomas & Betts Technical Services at 888-862-3289.

Formula for Calculating Circular Mil Area (CMA)

For square or rectangular wire:
 $Thickness \times Width \times 1.273 \times 10^6 = CMA$

For round wire:
 $Diameter^2 \times 10^6 = CMA$
 (or see chart on p. E-88)



How to Select a Connector

- 1 Determine total circular mil area (CMA). All wires to be installed in a connector barrel including stripped, stranded wire. For example, two #6 AWG = 52,480 CMA.
- 2 Refer to Circular Mil column of chart and find the connector series corresponding to the total CMA. For example, 204XXX.
- 3 Next, refer to either Round Wire column or Rectangular Wire column, depending on the type you are using, and check for any limitations, (such as max. wire width/height). If there are limitations, you may have to make a selection from the next larger size.
- 4 Select the tool and die appropriate for the application.



Dragon Tooth® Magnet Wire Termination System

Splices for copper and aluminum magnet wire!

Wire Termination — Sta-Kon® Wire Termination & Insulation

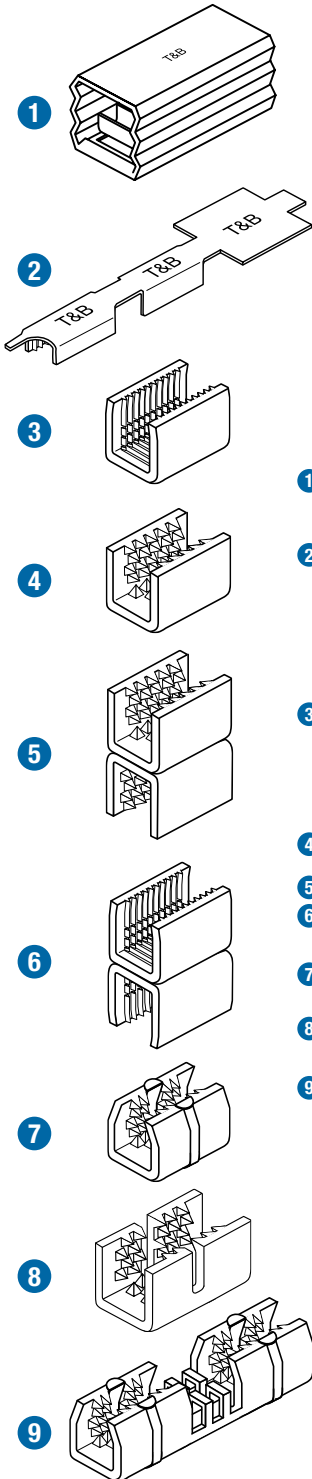

Splices

- Penetrate all standard copper and aluminum magnet wire insulations
- Perfect for heavy Formvar, poly-thermaleze, polyester and polyurethane insulations

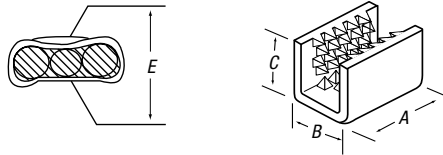

For special insulations, consult Technical Services.

CAT. NO.	DIMENSIONS (IN.)				CIRCULAR MIL AREA	ROUND WIRE RANGE (AWG)		RECTANGULAR WIRE RANGE (IN.)		PKG. QTY.
	A	B	C	D*		MIN.	MAX.	THICKNESS	WIDTH	
1 214420	.43	.25	.22	.135	—	21 (4)–13 (2)	—	—	1000	
220004	.17	.11	.08	.03	468–1,724	32–24**	—	—	8400†	
2 220001	.34	.17	.14	.09	1,277–4,205	26–17**	.02–.04	.02–.09	3000†	
220002-TB	.34	.25	.18	.09	2,985–6,687	24–14**	.02–.05	.02–.10	3000†	
220006	.47	.25	.19	.09	5,162–12,330	16–12	.05–.08	.05–.16	2500†	
22L004	.15	.11	.09	.03	128–2,028	32–24**	—	—	1000	
22L001	.32	.16	.16	.10	808–5,162	26–17**	.02–.04	.02–.10	1000	
22L002	.32	.25	.19	.10	2,048–9,110	24–15**	.02–.05	.02–.11	1000	
3 22L006	.44	.25	.22	.13	2,580–12,330	16–12	.05–.08	.05–.16	1000	
22L008	.70	.50	.35	.13	12,960–30,550	18–14	.04–.06	.06–.38	100	
22L009	.70	.55	.46	.20	36,120–86,000	16–5	.08–.18	.08–.38	100	
22L010	.70	.78	.71	.22	69,750–173,090 (f)	—	.10–.23 (CU) .10–.18 (AL)	.30–.63	50	
4 210214S	.63	.38	.37	.17	4,110–20,760	14(a)–10	.08–.09	.08–.18	250	
204210S	.69	.53	.53	.25	10,380–52,480	12(b)–4(e)	.10–.16	.10–.26	100	
5 204210SH	.69	.53	1.05	.48	20,760–104,960	12(c)–2(d)	.10–.16	.10–.26	100	
6 22L009H	.70	.55	.93	.37	72,000–132,000	16–5	.08–.18	.08–.38	100	
220015	1.50	.88	.77	(e)	50,000–115,000	10–6	.100–.175	.300–.625	50	
7 220019	1.50	.88	.85	(e)	110,000–175,000	6–2	.175–.250	.300–.625	25	
220023	1.75	.88	.93	(e)	165,000–230,000	2–1/0	.250–.325	.300–.625	25	
8 314118S	.63	.38	.30	.14	3,260–12,330	15–13	.05–.06	.05–.18	250	
220016	3.13	.88	.77	(e)	50,000–115,000	10–6	.100–.175	.300–.625	25	
9 220020	3.13	.88	.85	(e)	110,000–175,000	6–2	.175–.250	.300–.625	25	
220024	3.63	.88	.93	(e)	165,000–230,000	2–1/0	.250–.325	.300–.625	25	

* Reference dimension. See installing die illustration for gauging.

** Not recommended for aluminum magnet wire finer than 21 gauge. (a) Four wires max. (b) Six wires max. (c) Six wires max. each barrel.

(d) Conductors heavier than #6 AWG require special dies. Contact Thomas & Betts for assistance.

(e) Crimping dies may not bottom. Connector height will depend on number and size of wires in barrel. Pump must deliver 9800 psi minimum.

(f) Copper CMA, aluminum CMA=52,136–124,561.

† On a reel.

Note: Wire sizes and combinations shown have been tested to and meet or exceed Thomas & Betts specifications. Connectors may be suitable for other wire sizes or combinations. Thomas & Betts sells these connectors with the understanding that the user will perform necessary tests to determine their suitability for the intended purpose.

Dragon Tooth® Magnet Wire Termination System

Splices (continued)

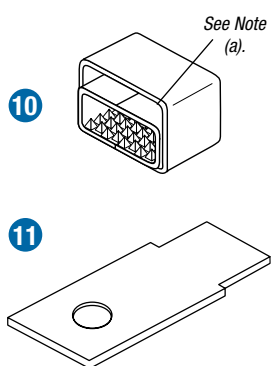
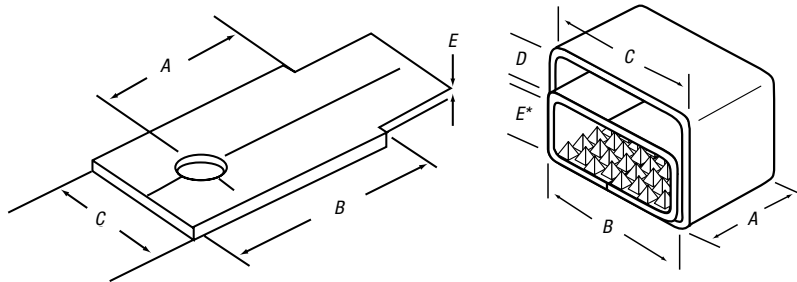

CAT. NO.	STUD SIZE	DIMENSIONS (IN.)					CIRCULAR MIL AREA	ROUND WIRE RANGE (AWG)	RECTANGULAR WIRE RANGE (IN.)		PKG. QTY.
		A	B	C	D	E			THICKNESS	WIDTH	
10 210214MT	—	.63	.63	.75	.25	.19*	20,000–105,000	5–13	Lower Half	250	
									Upper Half		
									.25 max .75 max.		
11 210MT14	1/4	1.00	1.44	.81	—	.08	5–13	For Conn	25		
11 210MT38	3/8	1.00	1.44	.81	—	.08	5–13	210214MT	25		
10 204210MT	—	.92	.94	1.03	.25	.25*	90,000–215,000	3–10	Lower Half	100	
									Upper Half		
									.25 max 1.03 max.		
11 204MT14	1/4	1.00	1.44	.91	—	.10	3–10	For Conn	25		
11 204MT38	3/8	1.00	1.44	.91	—	.10	3–10	204210MT	25		

(a) This space may be used for terminal tongue insert, stripped stranded copper wire, stripped copper magnet wire or left empty.

* Between teeth.

Note: Wire sizes and combinations shown have been tested to and meet or exceed Thomas & Betts specifications. Connectors may be suitable for other wire sizes or combinations. Thomas & Betts sells these connectors with the understanding that the user will perform necessary tests to determine their suitability for the intended purpose.

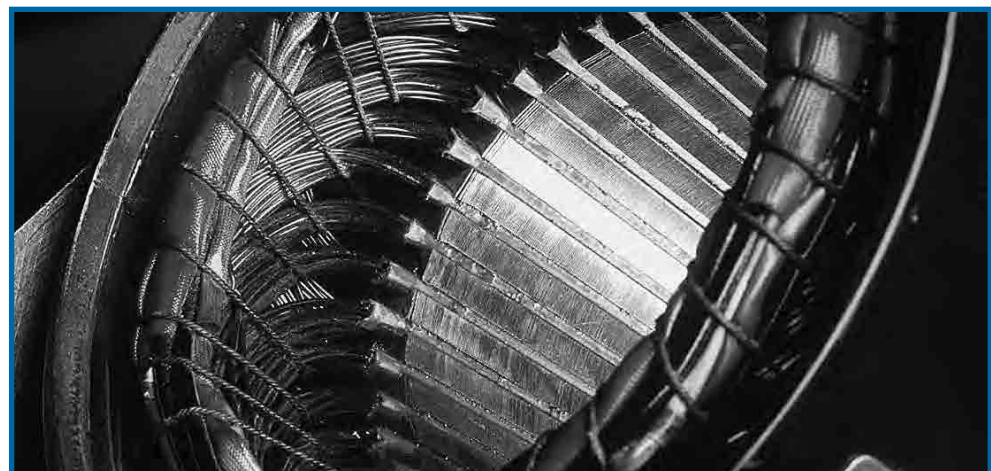

Dragon Tooth® Magnet Wire Termination System

Secure connections easily! Ring Terminals

Wire Termination — Sta-Kon® Wire Termination & Insulation

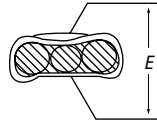
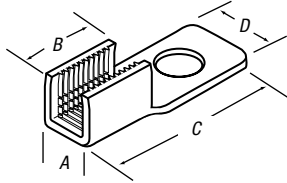
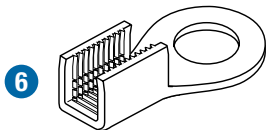
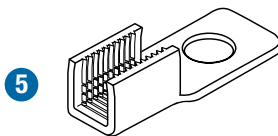
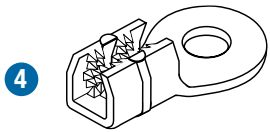
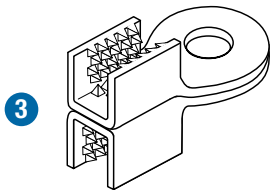
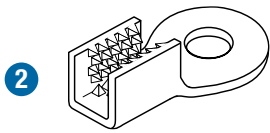
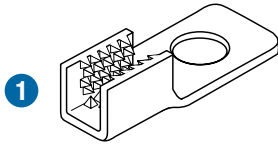

CAT. NO.	STUD SIZE	DIMENSIONS (IN.)					CIRCULAR MIL AREA	ROUND WIRE RANGE (AWG)	RECTANGULAR WIRE RANGE (IN.)		PKG. QTY.	
		A	B	C	D	E*			THICKNESS	WIDTH		
1	314125	10	.38	.56	1.22	.41	.14	3,260–12,330	15–13	.05–.06	.05–.18	250
	314123	¼"	.38	.56	1.41	.41	.14	3,260–12,330	15–13	.05–.06	.05–.18	250
	210219	8	.38	.56	1.22	.41	.17	4,110–20,760	14(a)–10	.08–.09	.08–.18	250
1	210217	10	.38	.56	1.22	.41	.17	4,110–20,760	14(a)–10	.08–.09	.08–.18	250
	210216	¼"	.38	.56	1.41	.41	.17	4,110–20,760	14(a)–10	.08–.09	.08–.18	250
1	204217	10	.53	.61	1.58	.50	.25	10,380–52,480	12(b)–4(c)	.10–.16	.10–.26	100
	204212	¼"	.53	.61	1.58	.50	.25	10,380–52,480	12(b)–4(c)	.10–.16	.10–.26	100
	210214-1	¼"	.38	.56	1.41	.69	.17	4,110–20,760	14(a)–10	.08–.09	.08–.18	250
2	210214-2	⅝"	.38	.56	1.41	.69	.17	4,110–20,760	14(a)–10	.08–.09	.08–.18	250
	210214-3	⅜"	.38	.56	1.41	.69	.17	4,110–20,760	14(a)–10	.08–.09	.08–.18	250
	204210-1	¼"	.53	.61	1.58	.81	.25	10,380–52,480	12(b)–4(c)	.10–.16	.10–.26	100
2	204210-2	⅝"	.53	.61	1.58	.81	.25	10,380–52,480	12(b)–4(c)	.10–.16	.10–.26	100
	204210-3	⅜"	.53	.61	1.58	.81	.25	10,380–52,480	12(b)–4(c)	.10–.16	.10–.26	100
	204210-5	½"	.53	.61	1.58	.81	.25	10,380–52,480	12(b)–4(c)	.10–.16	.10–.26	100
3	204210-1H	¼"	.53	.61	1.58	.81	.47	20,760–104,960	12(b)–4(c)	.10–.16	.10–.26	100
	204210-3H	⅜"	.53	.61	1.58	.81	.47	20,760–104,960	12(b)–4(c)	.10–.16	.10–.26	100
	220017	⅜"	.88	1.50	2.76	1.06	(d)	50,000–115,000	.100–.175	—	.300–.625	25
	220018	½"	.88	1.50	2.76	1.06	(d)	50,000–115,000	.100–.175	—	.300–.625	25
4	220021	⅝"	.88	1.50	2.76	1.06	(d)	110,000–175,000	—	.175–.250	.300–.625	25
	220022	½"	.88	1.50	2.76	1.06	(d)	110,000–175,000	—	.175–.250	.300–.625	25
	220025	⅝"	.88	1.50	2.76	1.06	(d)	110,000–230,000	—	.175–.325	.300–.625	25
	220026	½"	.88	1.50	2.76	1.06	(d)	110,000–230,000	—	.175–.325	.300–.625	25
	22R061**	6	.16	.32	.78	.30	.10	404–4100	15–24	.02–.05	.02–.10	1000
5	22R081**	8	.16	.32	.78	.30	.10	404–4100	15–24	.02–.05	.02–.10	1000
	22R101**	10	.16	.32	.78	.30	.10	404–4100	15–24	.02–.05	.02–.10	1000
	22R086	8	.25	.45	.91	.30	.13	2,580–12,330	12–16	.05–.08	.05–.16	1000
5	22R106	10	.25	.45	.91	.30	.13	2,580–12,330	12–16	.05–.08	.05–.16	1000
6	22R146	¼"	.25	.45	.95	.42	.13	2,580–12,330	12–16	.05–.08	.05–.16	1000

* Reference dimension. See installing die illustration for gauging. (a) Four wires max. (b) Six wires max. (c) Conductors heavier than #6 AWG require special dies. Contact Thomas & Betts for assistance. (d) Crimping dies may not bottom. Connector height will depend on number and size of wires in barrel. Pump must deliver 9800 psi minimum.

Note: Wire sizes and combinations shown have been tested to and meet or exceed Thomas & Betts specifications. Connectors may be suitable for other wire sizes or combinations. Thomas & Betts sells these connectors with the understanding that the user will perform necessary tests to determine their suitability for the intended purpose.

** #22–#24 AWG and equivalent rectangular CMA, copper only.

Dragon Tooth® Magnet Wire Termination System

Connectors for every application!

Fork Terminals

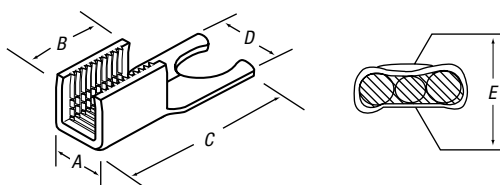
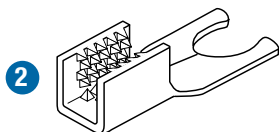
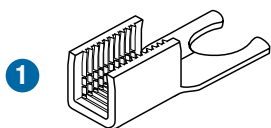

CAT. NO.	STUD SIZE	DIMENSIONS (IN.)					CIRCULAR MIL AREA	ROUND WIRE RANGE (AWG)	RECTANGULAR WIRE RANGE (IN.)		PKG. QTY.
		A	B	C	D	E*			THICKNESS	WIDTH	
22F061**	6	.16	.32	.78	.30	.10	404-4100	15-24	.02-.05	.02-.10	1000
22F081**	8	.16	.32	.78	.30	.10	404-4100	15-24	.02-.05	.02-.10	1000
22F101**	10	.16	.32	.78	.30	.10	404-4100	15-24	.02-.05	.02-.10	1000
22F066	6	.25	.45	.91	.30	.13	2,580-12,330	12-16	.05-.08	.05-.16	1000
22F086	8	.25	.45	.91	.30	.13	2,580-12,330	12-16	.05-.08	.05-.16	1000
22F106	10	.25	.45	.91	.30	.13	2,580-12,330	12-16	.05-.08	.05-.16	1000
210219F	6	.25	.45	.91	.30	.13	2,580-12,330	12-16	.05-.08	.05-.16	1000
210217F	8	.25	.45	.91	.30	.13	2,580-12,330	12-16	.05-.08	.05-.16	1000
210216F	10	.25	.45	.91	.30	.13	2,580-12,330	12-16	.05-.08	.05-.16	1000

* Reference dimension. See installing die illustration for gauging.

** #22-#24 AWG and equivalent rectangular CMA, copper only.

Durable and convenient!

Disconnects

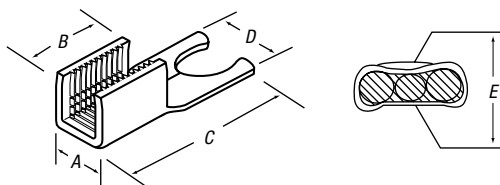
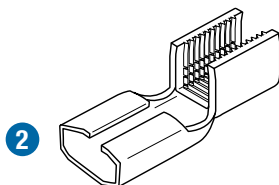
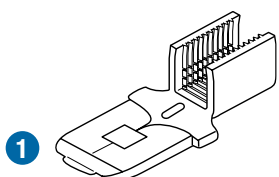

CAT. NO.	TAB SIZE	DIMENSIONS (IN.)					CIRCULAR MIL AREA	ROUND WIRE RANGE (AWG)	RECTANGULAR WIRE RANGE (IN.)		PKG. QTY.
		A	B	C	D	E*			THICKNESS	WIDTH	
22LM01**	.250 x .032	.16	.32	.76	.25	.10	404-4100	15-24	.02-.05	.02-.10	1000
22LM06	.250 x .032	.25	.45	.91	.25	.13	2,580-12,330	12-16	.05-.08	.05-.16	1000
22LF01**	.250 x .032	.16	.32	.79	.25	.10	404-4100	15-24	.02-.05	.02-.10	1000
22LF06	.250 x .032	.25	.45	.91	.25	.13	2,580-12,330	12-16	.05-.08	.05-.16	1000

* Reference dimension. See installing die illustration for gauging.

Note: Wire sizes and combinations shown have been tested to and meet or exceed Thomas & Betts specifications. Connectors may be suitable for other wire sizes or combinations. Thomas & Betts sells these connectors with the understanding that the user will perform necessary tests to determine their suitability for the intended purpose.

** #22-#24 AWG and equivalent rectangular CMA, copper only.

Dragon Tooth® Magnet Wire Termination System

Quick and easy connections!

Taps

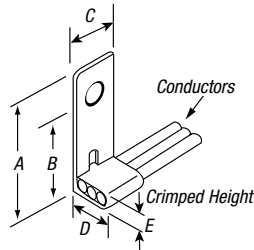

CAT. NO.	STUD SIZE (IN.)	DIMENSIONS (IN.)					CIRCULAR MIL AREA	RECTANGULAR WIRE RANGE (IN.)		PKG. QTY.
		A	B	C	D	E*		THICKNESS	WIDTH	
204T14	1/4	1.62	1.22	.70	.50	.22	10,310-52,480	.090-.114	.090-.320	100
204T38	3/8	1.62	1.22	.70	.50	.22	10,310-52,480	.090-.114	.090-.320	100

* Reference dimension. See installing die illustration for gauging.

Copper to aluminum connections!

Washers

- Teeth on the transition washers penetrate aluminum and copper oxides
- Enables copper to aluminum connections to be made in a bolted joint without the use of inhibiting compounds
- Accommodates the difference in thermal expansion between copper and aluminum, and enhances the efficiency of bolted grounding connections

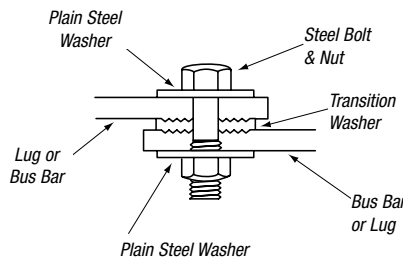
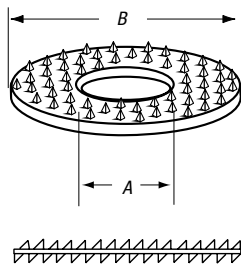

CAT. NO.	BOLT SIZE (IN.)	DIMENSIONS (IN.)		RECOMMENDED INSTALLING TORQUE IN.-LBS.	PKG. QTY.
		A	B		
FPW14	1/4	.27	.68	50-80	250
FPW516	5/16	.34	1.00	125-160	250
FPW38	3/8	.43	1.00	160-240	250
FPW12	1/2	.56	1.25	390-540	250
FPW58	5/8	.68	1.40	540-730	250

Note: Wire sizes and combinations shown have been tested to and meet or exceed Thomas & Betts specifications. Connectors may be suitable for other wire sizes or combinations. Thomas & Betts sells these connectors with the understanding that the user will perform necessary tests to determine their suitability for the intended purpose.

Additional Magnet Wire Ordering Information

- For wire sizes and combinations other than shown, consult factory.
- Maximum of two layers of conductors in each connector.
- Consult factory for gauging other than shown.
- When terminating wires with an AWG size difference of four or more, samples should be tested in completed connections before using.

Conversion of AWG to Circular Mils

WIRE SIZE AWG	NOM. DIAMETER		CIRCULAR MILS
	IN.	MM	
4/0	.4600	11.68	211,600
3/0	.4096	11.40	167,800
2/0	.3648	9.266	133,100
1/0	.3249	8.52	105,600
1	.2893	7.348	83,690
2	.2576	6.543	66,360
3	.2294	5.827	52,620
4	.2043	5.189	41,740
5	.1819	4.620	33,090
6	.1620	4.115	26,240
7	.1443	3.665	20,820
8	.1285	3.264	16,510
9	.1144	2.906	13,090
10	.1019	2.588	10,380
11	.0907	2.30	8230
12	.0808	2.05	6530
13	.0720	1.83	5180
14	.0641	1.63	4110
15	.0571	1.45	3260
16	.0508	1.29	2580
17	.0453	1.15	2050
18	.0403	1.02	1620
19	.0359	0.912	1290
20	.032	.813	1020
21	.0285	.724	812
22	.0253	.643	640
23	.0226	.574	511
24	.0201	.511	404

Decimal Equivalents

WIRE SIZE AWG	NOM. DIAMETER		CIRCULAR MILS
	IN.	MM	
1/64	.0156	3/16	.1875
1/32	.0312	13/64	.2031
3/64	.0469	7/32	.2188
1/16	.0625	15/64	.2344
5/64	.0784	1/4	.25
3/32	.0938	—	—
7/64	.1094	17/64	.2656
1/8	.125	9/32	.2812
9/64	.1406	19/64	.2969
5/32	.1562	5/16	.3125
11/64	.1719	21/64	.3281
11/32	.3438	33/64	.5156
23/64	.3594	17/32	.5312
3/8	.375	35/64	.5469
25/64	.3906	9/16	.5625
13/32	.4062	37/64	.5781
27/64	.4219	19/32	.5938
7/16	.4375	39/64	.6094
29/64	.4531	5/8	.625
15/32	.4688	41/64	.6406
31/64	.4844	21/32	.6562
1/2	.5	43/64	.6719

Note: Multiply inches x 25.4 to get millimeters. Example: .5" x 25.4 = 12.7 mm.

STUD SIZE	#6	#8	#10	1/4"	3/8"	1/2"
Hole Dia.	.143	.169	.196	.260	.323	.386

Dragon Tooth® Magnet Wire Termination System

Crimp with comfort!

Ergonomic Manual Installation Tools

- Fixed die tool
- Incorporates the ergonomically designed Comfort Crimp® tool handles, which distribute the force more evenly across the hand
- Shure-Stake® mechanism ensures a complete crimp cycle before the tool releases
- Rubberized thermoplastic handles combine maximum friction with a soft, comfortable feel that reduces muscle tension
- Two-piece movable die nest provides easy connector removal (ERG811 has a fixed die nest)



CAT. NO.	TOOL GAUGING	CONNECTOR	PKG. QTY.
ERG1801	.069 max.	22F, L, R-1 Series	1
ERG1802	.076 max.	22L002	1
ERG1804	.034 max.	22L004	1
ERG1806	.095 max.	22F, L, R-6 Series	1
ERG811	.103 max.	214420	1

Contact Customer Services for availability and most recent additions to the ergonomic tool series.

Wire Termination — Sta-Kon® Wire Termination & Insulation

Thomas & Betts Tool Warranty

You can choose Thomas & Betts tools with confidence, because we stand behind them with our warranty. The chart below shows the standard length of warranty for different types of tools. See below for additional warranty details.

90 Days	1 Year	2 Years	Lifetime
<ul style="list-style-type: none"> • Batteries • Individual Dies • Duct Tools 	<ul style="list-style-type: none"> • Pneumatic Tools • Cable Cutters & Strippers • Ty-Rap® Tools 	<ul style="list-style-type: none"> • Mechanical Hand Tools with Ratchet or Shure-Stake® Mechanism • Hydraulic Pumps • Battery-Operated Tools • Manual Hydraulic Tools 	<ul style="list-style-type: none"> • Mechanical Hand Tools without Ratchet or Shure-Stake® Mechanism

Limited Warranty for Tools

Thomas & Betts sells tools with the understanding that the user will perform all necessary tests to determine the suitability of each tool for the user's intended application. Thomas & Betts warrants that its tools will be free from defects in materials and workmanship for the period of time specified above. Upon prompt notification of any warranted defect, Thomas & Betts will, at its option, repair or replace the defective product or refund the purchase price. Proof of purchase is required. Misuse or unauthorized modification of the product voids all warranties.

Limitations and Exclusions

The warranty above is the sole warranty concerning this product, and is in lieu of all other warranties expressed or implied, including but not limited to any implied warranty of merchantability or fitness for a particular purpose, which are specifically disclaimed. Liability for breach of the above warranty is limited to cost of repair or replacement of the product, and under no circumstances will Thomas & Betts be liable for any indirect, special, incidental or consequential damages.

Direct all warranty inquiries to Thomas & Betts Tool Services: **1-800-284-TOOL (8665)**.

Replacement batteries and chargers can be purchased from T&B Tool Services

Call Toll-Free **1-800-284-TOOL (8665)**

For more information about Thomas & Betts Tool Services:

E-Mail us at toolservice@tnb.com

Dragon Tooth® Magnet Wire Termination System

1½ tons of grip that weighs less than three pounds!



Battery-Powered Crimping Tool — BAT22-6

T&B's newest battery-powered tool is fast and portable for making high-volume and difficult-to-reach terminal installations in a snap. The BAT22-6 delivers 1.5 tons of crimping force with an easy, pushbutton trigger. The lightweight, ergonomic design minimizes the risk of repetitive motion injuries that can occur with traditional hand crimping tools. And at less than three pounds, one-hand operation is easy while still packing enough power to crimp up to #6 AWG terminals in seconds.

- Interchangeable dies can be quickly changed to crimp non-insulated and insulated terminals up to #6 AWG
- Dies are the same as our hand tools — crimps will be exactly the same between Dragon Tooth® hand tools such as our ERG1804 and the BAT22-6
- 360° rotating head gives the user the added flexibility when crimping hard-to-reach connections
- Short cycle time equates to crimping times of less than two seconds
- Quick, lightweight, and maneuverable
- NiCd battery operation provides long-lasting battery life to complete up to 150 crimps on a single charge
- Extra battery and charger are included with the tool, ensuring round-the-clock operation
- Battery charger provides full battery life in under an hour
- Linear crimping motion gives a symmetric, high-quality crimp every time

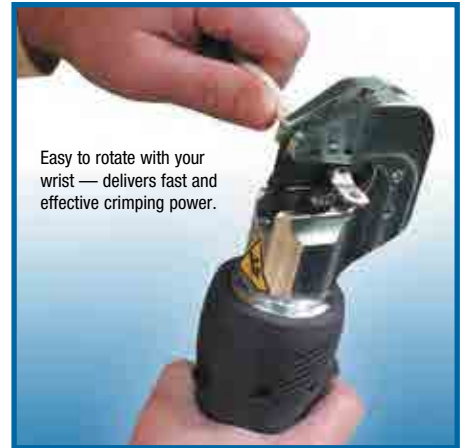

Easy to rotate with your wrist — delivers fast and effective crimping power.



Uses the exact dies of the Comfort Crimp® line of ergonomic tools for Sta-Kon® and Dragon Tooth® Connectors.

Included Accessories

- Sturdy, plastic carrying case for portability
- Two 9.6V NiCd batteries and battery charger
- Sturdy tray for convenient storage of crimp dies

Specifications

- Crimping Force: 2,900 lbs. max.
- Wire Crimping Range: Up to #6 AWG
- Crimp Cycle Time: 2 seconds
- Power Supply: 9.6V NiCd battery
- Recharging Time: 1 hour
- Crimps per Charge: 150
- Dimensions: 25.4" (645mm) Length, 3.1" (79mm) Width, 2.1" (53mm) Height
- Tool Weight (With Battery): 2¾ lbs.

CAT. NO.	DESCRIPTION	PKG. QTY.
BAT22-6	Battery Crimping Tool 1.5 Ton with 120VAC Charger	1
Crimp Dies*		
DIE1801	22 F, L, R-1 Series	1
DIE1802	22L002	1
DIE1804	22L004	1
DIE1806	22 F,L,R-6 Series	1

Tool purchase includes crimping tool, two 9V batteries, charger and case.

** Dies sold separately.*

Dragon Tooth® Magnet Wire Termination System

Perfect for high-speed installation!

BAIR22-6 — Heavy-Duty Bench-Top Air Crimp Tool

- Bench mounted for stability and operator control
- Compact size, all-metallic construction
- Delivers 1.8 tons of crimping force at 100 psi
- Heavy-duty and installs wide range of Dragon Tooth® connectors

Specifications

- Height: 12"
- Base: 8" Square
- Operating Pressure: 85–100 psi
- Weight: 17 lbs.

CAT. NO.	DESCRIPTION
BAIR22-6	Equipped with Shure-Stake® Mechanism, Ensuring Full Crimp Cycle Before Release



BAIR22-6

Pneumatic power!

PAIR22-6 — Heavy-Duty Portable Air Crimp Tool

- Installs Dragon Tooth® terminals
- Hand actuated
- Delivers 1.25 tons of crimping force at 100 psi
- Three interchangeable dies can crimp the 22xxx1, 22xxx2, 22xxx4 and 22xxx6 series terminals

Specifications

- Overall Length: 14"
- Operating Pressure: 90–100 psi
- Diameter: 2¼"
- Weight: 2.5 lbs.

CAT. NO.	DESCRIPTION
PAIR22-6	Open "C" Yoke; Hand Actuated



PAIR 22-6

Installing Dies for BAIR22-6 and PAIR22-6

CAT. NO.	DESCRIPTION	PKG. QTY.
<i>Crimp Dies</i>		
DIE1801	22 F, L, R-1 Series	1
DIE1802	22L002	1
DIE1804	22L004	1
DIE1806	22 F,L,R-6 Series	1

Dragon Tooth® Magnet Wire Termination System

Rugged and portable!

6-Ton Hydraulic Head

- Lightweight design—weighs less than 7 lbs. including dies
- Includes steel carrying case
- Tool carrying case included
- Dies are ordered as a set (two pieces)



Specifications

- Output Force: 6 tons nominal
- Operating Pressure: 10,000 psi nominal
- Tool Weight: 6½ lbs. (without dies)
- Tool Dimensions: 13½" long, 3½" wide

CAT. NO.	DESCRIPTION
TBM6H	The TBM6H Remote Hydraulic Crimping Head is a lightweight but powerful compression tool. The TBM6H operates from any 10,000-psi hydraulic pump.

See die chart on **page G-104** for complete listing of dies and connectors used with TBM6H.

Powerful and reliable!

12-Ton Hydraulic Head

- 12 tons output (nominal)
- 10,000 psi max. hydraulic operating pressure
- Weighs 15 lbs.

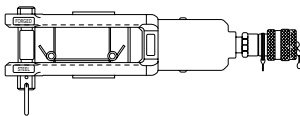

Specifications

- Output: 12 tons (nominal)
- Hydraulic Operating Pressure: 10,000 psi (max.)
- Length (with coupling): 14½"
- Width: 3¼"
- Weight (without dies): 15 lbs.

CAT. NO.	DESCRIPTION	PKG. QTY.
13400	12-ton crimping tool supplied with adapter TBM12D-AR is used for installing both insulated and non-insulated Sta-Kon® terminals #8 AWG to 250 kcmil (dies ordered separately)	1

See die chart on **page G-104** for complete listing of dies and connectors used with 13400.

Military listed and 12 tons of crimping power!

12-Ton Crimping Tool

(Military Spec. MS25441-1)



13642M

CAT. NO.	DESCRIPTION	PKG. QTY.
13642M	Hydraulic-operated 12-ton tool installs #8 AWG through 250 kcmil Sta-Kon® terminals (dies ordered separately)	1

See die chart on **page G-104** for complete listing of dies and connectors used with 13642M.

Lightweight design!

14-Ton Hydraulic Head

- 14 tons output (nominal)
- 10,000-psi max. hydraulic operating pressure
- Weighs 10 lbs.



Specifications

- Output: 14 tons (nominal)
- Hydraulic Operating Pressure: 10,000 psi (max.)
- Length (with Coupling): 11½"
- Width: 2½"
- Height: 4¼"
- Weight (without Dies): 10 lbs.

CAT. NO.	DESCRIPTION	PKG. QTY.
13100A	Remote 14-Ton Hydraulic Head (Dies Ordered Separately)	1

See die chart on **page G-104** for complete listing of dies and connectors used with 13100A.

Dragon Tooth® Magnet Wire Termination System

Crimp larger connectors easily!

15-Ton Hydraulic Head

- Longer, slimmer profile enables easier access into tight spaces
- Wider jaw opening eases crimping of larger connectors
- Head made of forged steel and insulated with rubber boot
- Steel carrying case is included
- Longer, slimmer profile enables easier access into tight spaces



Specifications

- Output Force: 15 tons nominal
- Operating Pressure: 10,000 psi nominal
- Tool Weight: 16½ lbs. (without dies)
- Installs: #8 AWG–1500 kcmil copper; #10 AWG–1000 kcmil Aluminum

CAT. NO.	DESCRIPTION	PKG. QTY
TBM15I	Insulated 15-Ton Hydraulic Tool; Carrying Case Included	1

See die chart on **page G-104** for complete listing of dies and connectors used with TBM15I.

Electric Hydraulic Pumps

- Up to 10,000-psi output pressure
- Durable construction
- Hand or foot actuated



CAT. NO.	DESCRIPTION
13810	Heavy-duty electric hydraulic pump with Shure-Stake® control — hand or foot switch and non-metallic hose (sold separately) required for operation

You may also need...

13611	Hand Switch
13612	Foot Switch
13613	High Pressure, Steel Reinforced Hydraulic Hose; 6 ft.
13614	High Pressure, Steel Reinforced Hydraulic Hose; 10 ft.
13619	High Pressure, Plastic Hydraulic Hose; 10 ft.

13600 Electric Hydraulic Pump — hand or foot switch and non-metallic hose (sold separately) required for operation

You may also need...

13620	Hand Switch
13589A	Foot Switch
13619	10-ft. Non-Metallic Hose
13618	20-ft. Non-Metallic Hose

A remote control switch is required. Order Cat. No. 13620 for hand operation or Cat. No. 13589A for foot operation.

All pumps are supplied with a metal carrying case.

13610A Shure-Stake® electric hydraulic pump has same features as 13600, but includes the Shure-Stake® control mechanism; hand or foot switch and non-metallic hose (sold separately) required for operation

You may also need...

13611	Hand Switch
13612	Foot Switch
13797	In-line hydraulic pressure inspection gauge with male and female pioneer-type coupler.

A remote control switch is required to operate this unit. Use either a 13611 (hand) or 13612 (foot) switch.

Dragon Tooth® Magnet Wire Termination System

An easy-to-use reference guide for tools and connectors!

Wire Termination — Sta-Kon® Wire Termination & Insulation

Connector	Dies					
	MANUAL	BAT 22-6 BAIR 22-6 PAIR 22-6	TBM6H	13100A	13400 13642M	TBM15I
204210MT	-	-	-	-	13682	-
204210S	-	-	-	13671B	13671A	13671B with 15500TB
204210SH	-	-	-	13673B	13673	13673B with 15500TB
204210-1	-	-	-	13671B	13671A	13671B with 15500TB
204210-1H	-	-	-	13673B	13673	13673B with 15500TB
204210-2	-	-	-	13671B	13671A	13671B with 15500TB
204210-3	-	-	-	13671B	13671A	13671B with 15500TB
204210-3H	-	-	-	13673B	13673	13673B with 15500TB
204210-5	-	-	-	13671B	13671A	13671B with 15500TB
204212	-	-	-	13671B	13671	13671B with 15500TB
204217	-	-	-	13671B	13671A	13671B with 15500TB
204MT14	-	-	-	-	-	-
204MT38	-	-	-	-	-	-
204T14	-	-	-	13689B	-	13689B with 15500TB
204T38	-	-	-	13689B	-	13689B with 15500TB
210214MT	-	-	-	13681B	13681	13681B with 15500TB
210214S	-	-	-	13670B	13670A	13670B with 15500TB
210214-2	-	-	-	13670B	13670A	13670B with 15500TB
210214-3	-	-	-	13670B	13670A	13670B with 15500TB
210216, 210216F	-	-	-	13670B	13670A	13670B with 15500TB
210217, 210217F	-	-	-	13670B	13670A	13670B with 15500TB
210219, 210219F	-	-	-	13670B	13670A	13670B with 15500TB
210MT14	-	-	-	-	-	-
210MT38	-	-	-	-	-	-
214420	ERG811/WT811	DIE 811	-	-	-	-
220001	-	-	-	-	-	-
220002-TB	-	-	-	-	-	-
220004	-	-	-	-	-	-
220005	-	-	-	-	-	-
220006	-	-	-	-	-	-
220015	-	-	-	13713B	-	13713
220016	-	-	-	13713B	-	13713
220017	-	-	-	13713B	-	13713
220018	-	-	-	13713B	-	13713
220019	-	-	-	13713B	-	13713
220020	-	-	-	13713B	-	13713
220021	-	-	-	13713B	-	13713
220022	-	-	-	13713B	-	13713
220023	-	-	-	13713B	-	13713
220024	-	-	-	13713B	-	13713
220025	-	-	-	13713B	-	13713
220026	-	-	-	13713B	-	13713
22F061	ERG1801	DIE1801	-	-	-	-
22F066	ERG1806	DIE1806	-	-	-	-
22F081	ERG1801	DIE1801	-	-	-	-
22F086	ERG1806	DIE1806	-	-	-	-
22F101	ERG1801	DIE1801	-	-	-	-
22F106	ERG1806	DIE1806	-	-	-	-
22L001	ERG1801	DIE1801	-	-	-	-
22L002	ERG1802	DIE1802	-	-	-	-
22L004	ERG1804	DIE1804	-	-	-	-
22L006	ERG1806	DIE1806	-	-	-	-
22L008	-	-	6TON-MW-08	13683B	13683	13683B with 15500TB
22L009	-	-	6TON-MW-09	13684B	13684	13684B with 15500TB
22L009H	-	-	-	13686B	13686	13686B with 15500TB
22L010	-	-	-	13690B	-	-
22LF01	ERG1801	DIE1801	-	-	-	-
22LF06	ERG1806	DIE1806	-	-	-	-
22LM01	ERG1801	DIE1801	-	-	-	-
22LM06	ERG1806	DIE1806	-	-	-	-
22R061	ERG1801	DIE1801	-	-	-	-
22R106	ERG1806	DIE1806	-	-	-	-
22R146	ERG1806	DIE1806	-	-	-	-
314118S	-	-	-	13685B	13685	13685B with 15500TB
314123	-	-	-	13685B	13685	13685B with 15500TB
314125	-	-	-	13685B	13685	13685B with 15500TB

Note: Dies that fit 13100A also work in TBM15I with use of adapter 15500TB.