

# Tools *for solar professionals*

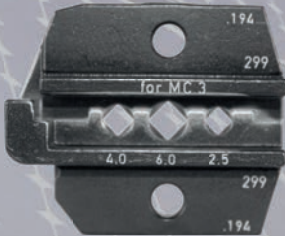

For MC4 (Solarline 2)



For MC3 (Solarline 1)

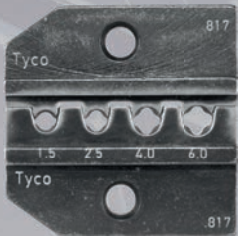

For Tyco (Solarlok®)



For Wieland (gesis®)

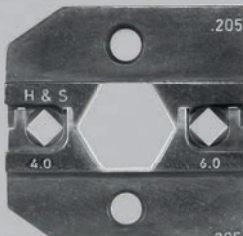

For Huber+Suhner (Radox®)

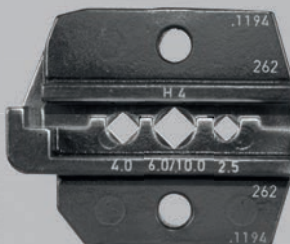

For Amphenol (Helios H4)



# RENNSTEIG

*The Right Tool.*

# When it's a RENNSTEIG, YOU can feel it.

## Content

Amphenol H4 (machined contacts)	5   7   9   11   13   14   17
Amphenol H4 (stamped&formed)	5   7   11   14
Hirschmann	7
Hosiden	5   13
HTS	7   11
Huber+Suhner (Radox®)	5   7   11   13   14   17   19
Lumberg	5   7   11   14
MC3 (Solarline 1)	5   7   11   13   14   17   19   28
MC4 (Solarline 2)	5   7   9   11   13   14   17   19
SMK	5   7   11   13   14
TongLing TL4	5   7   11   14
Tyco (Solarlok®)	5   7   11   13   14   17   19
Tyco (Solarlok® PV4)	5   7   11   14
Wieland (gesis®)	5   7   9   11   13   14   17
Yukita	5   7   11   13   14

## Complete Crimp Tools

When you buy this tool you will receive a complete tool with installed Die Set and Locator. So you are ready to crimp right away.

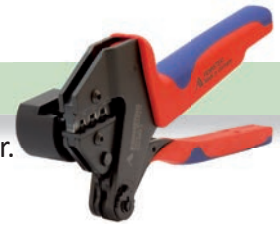

The Rennsteig Solar Crimp System is unique in the industry. We offer the possibility (different Crimp Die Sets) to crimp all common terminals/contacts on the solar market. With interchangeable die sets, you won't need to buy more than one crimp tool. You can just get an additional die set to fit your existing crimp tool. In addition to our standard Crimp System Tool frame the Die Sets fits as well in the following available products.

### Hand Tool



### Electromechanical Driven Tool



### Toggle Press



### Pneumatic Crimping Machine



That means you have the option to use different crimp die sets with one tool or one crimp die set with different tools whatever your needs are.

## Single Components

You already own a RENNSTEIG Crimp System Tool? Here you will find additional Die Sets and Locators which one fits in your tool.



## Complete Preassembled Cases

You need to work with different kind of connectors? With these cases you do not need to carry several single tools. In this category you will find heavy duty carrying cases in different configurations.



## Cable Cutters and Stripping Tools

Here you will find specially designed cable cutters and wire stripper.



## Assembly Tools

In this section you will find other helpful tools to do your job faster, better and easier.



## Solar System Tool

This crimp tool is recommended for crimping solar contacts. The excellent handling, easy exchange of the crimping die sets and the possibility of adding a positioning aid are facts in favor of these crimping pliers.

- High-precision ratchet mechanism for complete crimps
- 1.2 metric tons pressure at crimping face, with minimal hand effort
- **Interchangeable high-precision Crimping Die Set**
- Parallel jaws for even crimps
- Interchangeable Locator for precision positioning of terminals
- Well balanced, approx. 1.5 lbs.
- Compact build, 8" long
- Made in Germany - made by Rennsteig



Double-plated ratchet gear extends tool life



Easy grip even when fully open



Parallel crimping

### Locator

(for the correct positioning of the specific contact)

### Interchangeable Crimp Dies

### Solid construction

### Two component ergonomic handles

### Ratchet action inside

### Emergency Release (if jam occurs)

Instruction videos





PATENTED

For Multi-Contact MC3 (Solarline 1)		
		
Wire Gauge	14/12/10	
Part #	624 194 3	Tool w/ Die Set
	624 194 3 1	Tool w/ Die Set + Locator
For Wire Gauge 12/10/8	624 348 3	Tool w/ Die Set
	624 348 3 1	Tool w/ Die Set + Locator

For Multi-Contact MC4 (Solarline 2)		
		
Wire Gauge	14/12/10	
Part #	624 570 3	Tool w/ Die Set
	624 570 3 1	Tool w/ Die Set + Locator
For Wire Gauge 12/10/8	624 1193 3	Tool w/ Die Set
	624 1193 3 1	Tool w/ Die Set + Locator

For Amphenol H4 (machined contacts)		
		
Wire Gauge	14/12/10/8	
Part #:	624 1194 3	Tool w/ Die Set
	624 1194 3 1	Tool w/ Die Set + Locator

For Amphenol H4 (stamped&formed)		
		
Wire Gauge	14/12/10	
Part #:	624 1175 3	Tool w/ Die Set
	624 1175 3 1	Tool w/ Die Set + Locator

For Wieland (gesis® solar)		
		
Wire Gauge	12/10/8	
Part #	624 073-1 3	Tool w/ Die Set
	624 073-1 3 16	Tool w/ Die Set + Locator

For Huber+Suhner (Radox®-Twist Lock)		
		
Wire Gauge	12/10	
Part #	624 205 3	Tool w/ Die Set

 approved with Rennsteig Crimp System Tool.

For Tyco (Solarlok®)		
		
Wire Gauge	16/14/12/10	
Part #	624 817 3	Tool w/ Die Set
	624 817 3 1	Tool w/ Die Set + Locator

For Tyco (Solarlok® PV4) <span style="float: right;">COMING SOON</span>		
		
Wire Gauge	12/10	
Part #	624 969 3	Tool w/ Die Set
	624 969 3 1	Tool w/ Die Set + Locator

For Hosiden (HSC2009,HSC2010,HSC2013,HSC2014)		
		
Wire Gauge	14/12/10	
Part #	625 51190 3 1	Tool w/ Die Set + Locator

 approved with Rennsteig Crimp System Tool.

For SMK		
		
Wire Gauge	14/12/10	
Part #	624 1188 3	Tool w/ Die Set
	624 1188 3 1	Tool w/ Die Set + Locator

For Yukita (YS-25)		
		
Wire Gauge	16/14/12/10	
Part #	624 369 3	Tool w/ Die Set
	624 369 3 1	Tool w/ Die Set + Locator

For Yukita		
<div style="display: flex; justify-content: space-between;"> <span>540820-2MA 540821-2MA</span> <span>540920-2MA 540921-2MA</span> </div>		
Wire Gauge	2/2.5/3.5/4/6 mm <sup>2</sup> (similar to 14/13/12/10)	
Part #	624 1173 3	Tool w/ Die Set
	624 1173 3 1	Tool w/ Die Set + Locator

For TongLing TL4		
		
Wire Gauge	12/10	
Part #	624 1186 3	Tool w/ Die Set
	624 1186 3 1	Tool w/ Die Set + Locator

For Lumberg		
		
Wire Gauge	14/12/10	
Part #	624 231 3 1 <b>(LC3)</b>	Tool w/ Die Set + Locator
	624 232 3 1 <b>(LC4)</b>	Tool w/ Die Set + Locator

**Other applications on request.**

At Rennsteig, we stay on top of the market. When new connectors come out and gain ground, you can be sure we'll make die sets for them. What does this mean? It means you don't have to invest in a whole new crimp tool. You can just get an additional die set to fit your existing crimp tool, and you're ready to install the latest gear.

\* Assembly tool for couplers/housing also available (P/N 693 213 3)

## Single components: Tool Frame, Crimping Die Sets & Locators

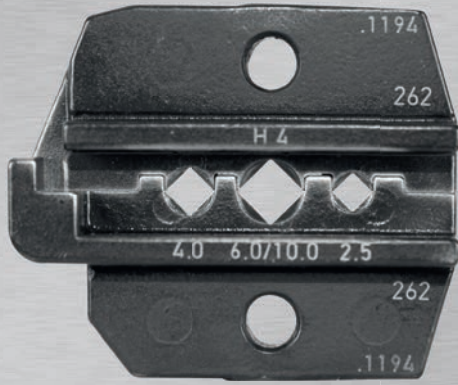

### **Interchangeable Crimping Die Set:**

Each type and size of terminals needs its own crimp. Just squeezing it isn't enough - you have to get exactly the right dimension crimp, if you want a good connection that gives good conductivity year after year, under all conditions.





### **Locator:**

The Locator holds the terminal in the tool so that you don't need 3 hands to make a crimp. But it also does more. It positions the terminal so you always crimp it in the right place, for a high-quality connection every time.

Basic Item		
		
Compatible with all Die Sets and Locators		
Length	1 ½"	
Weight	1.37 lbs.	
Part #	624 000 3	Empty Tool Frame for all Rennsteig Die Sets and Locators

For Tyco (Solarlok®)		
		
Wire Gauge	16/14/12/10	
Part #	624 817 3 0	Die Set only
	624 817 0 01	Locator only

For SMK		
		
Wire Gauge	14/12/10	
Part #	624 1188 3 0	Die Set only
	624 1188 0 01	Locator only

For Radox®-Twist Lock (Huber+Suhner)		
		
Wire Gauge	12/10	
Part #	624 205 3 0	Die Set only

For Yukita (YS-25)		
Wire Gauge	16/14/12/10	
Part #	624 369 3 0	Die Set only
	624 369 0 01	Locator only

For Lumberg LC3		
Wire Gauge	14/12/10	
Part #	624 231 3 0	Die Set only
	624 231 0 01	Locator only

For Multi-Contact MC3 (Solarline 1)		
		
Wire Gauge	14/12/10	
Part #	624 194 3 0	Die Set only
	624 194 0 01	Locator only
Wire Gauge	624 348 3 0	Die Set only
12/10/8	624 348 0 01	Locator only

For Tyco (Solarlok® PV4) <span style="color: green; font-weight: bold;">COMING SOON</span>		
		
Wire Gauge	12/10	
Part #	624 969 3 0	Die Set only
	624 969 0 01	Locator only

For Amphenol H4 (machined contacts)		
		
Wire Gauge	14/12/10/8	
Part #:	624 1194 3 0	Die Set only
	624 1194 0 01	Locator only

For TongLing TL4		
		
Wire Gauge	12/10	
Part #	624 1186 3 0	Die Set only
	624 1186 0 01	Locator only

For Yukita		
<small>540820-2MA / 540821-2MA / 540920-2MA / 540921-2MA</small>		
Wire Gauge	2/2.5/3.5/4/6 mm <sup>2</sup> (similar to 14/13/12/10)	
Part #	624 1173 3 0	Die Set only
	624 1173 0 01	Locator only

For Lumberg LC4		
Wire Gauge	14/12/10	
Part #	624 232 3 0	Die Set only
	624 232 0 01	Locator only

For Multi-Contact MC4 (Solarline 2)		
		
Wire Gauge	14/12/10	
Part #	624 570 3 0	Die Set only
	624 570 0 01	Locator only
Wire Gauge	624 1193 3 0	Die Set only
12/10/8	624 1193 0 01	Locator only

For Wieland (gesis® solar)		
		
Wire Gauge	12/10/8	
Part #	624 073-1 3 0	Die Set only
	624 071 0 016	Locator only

For Amphenol H4 (stamped&formed)		
		
Wire Gauge	14/12/10	
Part #:	624 1175 3 0	Die Set only
	624 1175 0 01	Locator only

 approved with Rennsteig Crimp System Tool.

**Other applications on request.**

At Rennsteig, we stay on top of the market. When new connectors come out and gain ground, you can be sure we'll make die sets for them. What does this mean? It means you don't have to invest in a whole new crimp tool. You can just get an additional die set to fit your existing crimp tool, and you're ready to install the latest gear.

# CSC Multifunction Tool

No more carrying around 3 different tools, when all you really want to do is make a connection. "CSC" stands for Cut - Strip - Crimp, and that's what this tool does. *Unique in the industry!*



- For cutting, stripping and crimping of solar contacts with just one tool
- Includes Die Set
- Options include other wire sizes and connector types
- Burnished finish, solid construction, easy to handle
- Made in Germany - made by Rennsteig

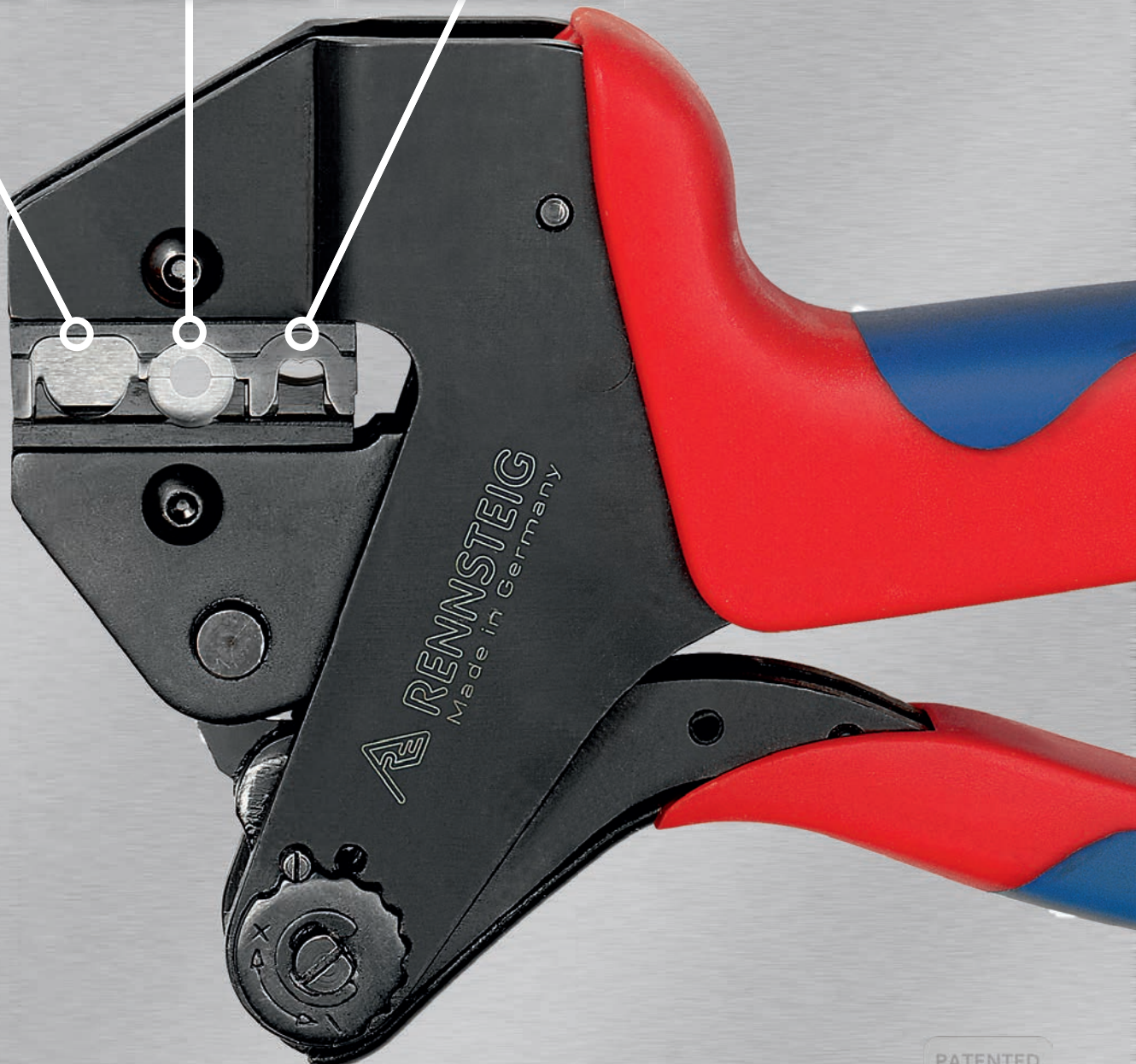



Instruction video







For Multi-Contact MC4 (Solarline 2)		
		
Wire Gauge	12 (similar to 4 mm <sup>2</sup> )	
Length	8"	
Weight	1.43 lbs.	
Part #	624 004 3	Tool w/ Die Set
	624 004 3 1	Tool w/ Die Set + Locator

For Multi-Contact MC4 (Solarline 2)		
		
Wire Gauge	10 (similar to 6 mm <sup>2</sup> )	
Length	8"	
Weight	1.43 lbs.	
Part #	624 006 3	Tool w/ Die Set
	624 006 3 1	Tool w/ Die Set + Locator

Spare Parts for MC4		
		
Part #	624 004 3 0	Die Set only (AWG 12)
	624 004 0 01	Locator only (AWG 12)
	624 006 3 0	Die Set only (AWG 10)
	624 006 0 01	Locator only (AWG 10)

For Wieland (gesis® solar)		
		
Wire Gauge	12 (similar to 4 mm <sup>2</sup> )	
Length	8"	
Weight	1.43 lbs.	
Part #	624 1197 3 1	Tool w/ Die Set + Locator

For Wieland (gesis® solar)		
		
Wire Gauge	10 (similar to 6 mm <sup>2</sup> )	
Length	8"	
Weight	1.43 lbs.	
Part #	624 1196 3 1	Tool w/ Die Set + Locator

Spare Parts for Wieland		
		
Part #	624 1197 3 0	Die Set only (AWG 12)
	624 1197 0 01	Locator only (AWG 12)
	624 1196 3 0	Die Set only (AWG 10)
	624 1196 0 01	Locator only (AWG 10)

For Amphenol (machined contacts)		
		
Wire Gauge	12 (similar to 4 mm <sup>2</sup> )	
Length	8"	
Weight	1.43 lbs.	
Part #	624 1184 3 1	Tool w/ Die Set + Locator

For Amphenol (machined contacts)		
		
Wire Gauge	10 (similar to 6 mm <sup>2</sup> )	
Length	8"	
Weight	1.43 lbs.	
Part #	624 1185 3 1	Tool w/ Die Set + Locator

Spare Parts for Amphenol		
		
Part #	624 1184 3 0	Die Set only (AWG 12)
	624 1184 0 01	Locator only (AWG 12)
	624 1185 3 0	Die Set only (AWG 10)
	624 1185 0 01	Locator only (AWG 10)

Other applications on request.

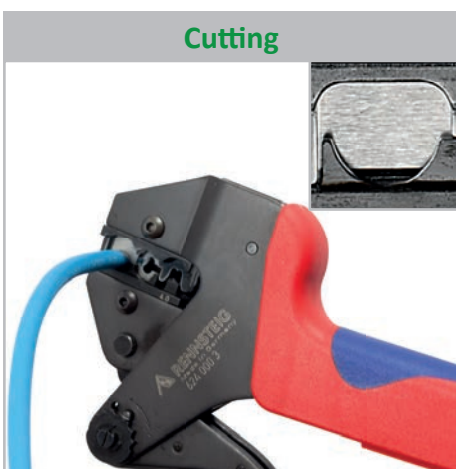

At Rennsteig, we stay on top of the market. When new connectors come out and gain ground, you can be sure we'll make die sets for them. What does this mean? It means you don't have to invest in a whole new crimp tool. You can just get an additional die set to fit your existing crimp tool, and you're ready to install the latest gear.

# eForce

Compatible with all Die Sets and Locators

Dimensions (L x W x H)	Complete case: 20" x 16.5" x 5"   Tool only: 11" x 6" x 2"	
Weight	Complete case: 10.4 lbs.   Tool only: 4.3 lbs.	
Part #	6370 0300 1 RT (1 Battery) 6370 0300 1-2 RT (2 Batteries)	Battery Powered Crimping Tool in Portable Plastic Case Content: 1x eForce Battery Powered Crimping Tool, 1x Battery Charger (CLI 12), Milwaukee M12 Li-Ion Battery, Space for Die Sets and Locators

## For SMK

Wire Gauge	14/12/10	
Part #	624 1188 3 0	Die Set only
	624 1188 0 01	Locator only

## For Yukita

540820-2MA / 540821-2MA / 540920-2MA / 540921-2MA

Wire Gauge	2/2.5/3.5/4/6 mm <sup>2</sup> (similar to 14/13/12/10)	
Part #	624 1173 3 0	Die Set only
	624 1173 0 01	Locator only

## For Yukita (YS-25)

Wire Gauge	16/14/12/10	
Part #	624 369 3 0	Die Set only
	624 369 0 01	Locator only

## For HTS

Wire Gauge	16/14/12/10	
Part #	624 072 3 0	Die Set only
	624 072 0 01	Locator only

## For Lumberg LC3

Wire Gauge	14/12/10	
Part #	624 231 3 0	Die Set only
	624 231 0 01	Locator only

## For Lumberg LC4

Wire Gauge	14/12/10	
Part #	624 232 3 0	Die Set only
	624 232 0 01	Locator only



- 1 Takes all existing interchangeable crimp Die Sets and Locators (more than 1000) from Rennteig's Crimp System Tool (P/N 624 000 3)
- 2 Ergonomically designed handle with soft grip, provides comfort and increases control
- 3 Removable battery (12v Li-Ion) eliminates downtime due to recharging



Powerful electromechanical drive mechanism. No accident-sensitive hydraulic components.



Start Button with integrated multifunction LED-Display for indication of:

- Function standby
- Remaining battery capacity
- Overloading



- 4** Drop protection ring
- 5** Reset button, Emergency release
- 6** Handy to use and has a level, steady base for bench top production
- 7** Compact work area



Ergonomic working height when used for bench top production

### For Multi-Contact MC3 (Solarline 1)

Wire Gauge	14/12/10	
Part #	624 194 3 0	Die Set only
	624 194 0 01	Locator only
Wire Gauge 12/10/8	624 348 3 0	Die Set only
	624 348 0 01	Locator only

### For Multi-Contact MC4 (Solarline 2)

Wire Gauge	14/12/10	
Part #	624 570 3 0	Die Set only
	624 570 0 01	Locator only
Wire Gauge 12/10/8	624 1193 3 0	Die Set only
	624 1193 0 01	Locator only

### For Tyco (Solarlok®)

Wire Gauge	16/14/12/10	
Part #	624 817 3 0	Die Set only
	624 817 0 01	Locator only

### For Wieland (gesis® solar)

Wire Gauge	12/10/8	
Part #	624 073-1 3 0	Die Set only
	624 071 0 016	Locator only

### For Radox®-Twist Lock (Huber+Suhner)

Wire Gauge	12/10	
Part #	624 205 3 0	Die Set only

COMING SOON

### For Tyco (Solarlok® PV4)

Wire Gauge	12/10	
Part #	624 969 3 0	Die Set only
	624 969 0 01	Locator only

### For Amphenol H4 (machined contacts)

Wire Gauge	14/12/10/8	
Part #:	624 1194 3 0	Die Set only
	624 1194 0 01	Locator only

### For TongLing TL4

Wire Gauge	12/10	
Part #	624 1186-1 3 0	Die Set only
	624 1186 0 016	Locator only

### For Amphenol H4 (stamped&formed)

Wire Gauge	14/12/10	
Part #:	624 1175 3 0	Die Set only
	624 1175 0 01	Locator only

# Solar Crimp Sets (preassembled)

This professional set has everything you need for making solar wire connections. All components are top-quality Rennsteig tools designed Made in Germany and specially for the solar industry.

## Protective case

3 ¼" Height,  
13 ½" Length,  
10 ¾" Width



Free space for MC4  
Assembly Keys

Solar System Tool

Storage space for  
up to 5 Locators

Storage space for  
up to 5 Die Sets

Additional  
storage space

Instruction videos



**Empty Solar Crimp Case**  
for all customers who already  
own our Crimp System Tool

Free space for 1 Crimp System Tool, 5 Die Sets, 5 Locator, Additional storage space

Content Spare Parts

Weight 1.45 lbs.

Part # 624 105-25 Solar Crimp Set (empty)

**Solar Crimp Set for  
Multi-Contact MC3 (Solarline 1)  
Multi-Contact MC4 (Solarline 2)  
Tyco (Solarlok®)**



Content	Crimp Tool MC3-Die Set, MC3-Locator MC4-Die Set, MC4-Locator Tyco-Die Set, Tyco-Locator Spare Parts
Wire Gauge	MC3/MC4 - 14/12/10 Tyco - 16/14/12/10
Weight	4 lbs.
Part #	624 105-13

**Solar Crimp Set for  
Amphenol H4 (machined contacts)  
Multi-Contact MC4 (Solarline 2)  
Tyco (Solarlok®)**



Content	Crimp Tool H4-Die Set, H4-Locator MC4-Die Set, MC4-Locator Tyco-Die Set, Tyco-Locator Spare Parts
Wire Gauge	H4 - 14/12/10/8 MC4 - 14/12/10 Tyco - 16/14/12/10
Weight	4 lbs.
Part #	624 105-40

NEW

**Solar Crimp Set for  
Multi-Contact MC4 (Solarline 2)  
Amphenol H4 (machined contacts)  
Wieland (gesis® solar)**



Content	Crimp Tool MC4-Die Set, MC4-Locator H4-Die Set, H4-Locator Wieland-Die Set, Wieland-Locator, Spare Parts
Wire Gauge	MC4 - 14/12/10 H4 - 14/12/10/8 Wieland - 12/10/8
Weight	4 lbs.
Part #	624 105-18

**Solar Crimp Set for  
Multi-Contact MC3 (Solarline 1)  
Multi-Contact MC4 (Solarline 2)  
Amphenol H4 (machined contacts)**



Content	Crimp Tool MC3-Die Set, MC3-Locator MC4-Die Set, MC4-Locator H4-Die Set, H4-Locator Spare Parts
Wire Gauge	MC3/MC4 - 14/12/10 H4 - 14/12/10/8
Weight	4 lbs.
Part #	624 105-20

**Solar Crimp Set for  
Multi-Contact MC4 (Solarline 2)  
Tyco (Solarlok®)  
Wieland (gesis® solar)**



Content	Crimp Tool MC4-Die Set, MC4-Locator Tyco-Die Set, Tyco-Locator Wieland-Die Set, Wieland-Locator, Spare Parts
Wire Gauge	MC4 - 14/12/10 Tyco - 16/14/12/10 Wieland - 12/10/8
Weight	4 lbs.
Part #	624 105-21

**Solar Crimp Set for  
Multi-Contact MC4 (Solarline 2)  
Amphenol H4 (machined contacts)  
Huber+Suhner (Radox®-Twist Lock)**



Content	Crimp Tool MC4-Die Set, MC4-Locator H4-Die Set, H4-Locator H+S-Die Set, H+S-Locator, Spare Parts
Wire Gauge	MC4 - 14/12/10 H4 - 14/12/10/8 Huber+Suhner - 12/10
Weight	4 lbs.
Part #	624 105-22

**Solar Crimp Set for  
Multi-Contact MC3 (Solarline 1)  
Amphenol H4 (machined contacts)  
SMK**



Content	Crimp Tool MC3-Die Set, MC3-Locator H4-Die Set, H4-Locator SMK-Die Set, SMK-Locator, Spare Parts
Wire Gauge	MC3/SMK - 14/12/10 Amphenol H4 - 14/12/10/8
Weight	4 lbs.
Part #	624 105-33

**Solar Crimp Set for  
Multi-Contact MC4 (Solarline 2)  
Tyco (Solarlok®)  
Yukita (YS-25)**



Content	Crimp Tool MC4-Die Set, MC4-Locator Tyco-Die Set, Tyco-Locator, Yukita-Die Set, Yukita-Locator, Spare Parts
Wire Gauge	MC4 - 14/12/10 Tyco/Yukita - 16/14/12/10
Weight	4 lbs.
Part #	624 105-41

**Solar Crimp Set for  
Hosiden (HSC2009, HSC2010, HSC2013)**



Content	Crimp Tool Hosiden-Die Set, Hosiden-Locator, Cap Wrench, Multi Tool, 2 Storage Boxes, Spare Parts
Wire Gauge	14/12/10
Weight	4 lbs.
Part #	625 51190 3 1 RT

Other combinations on request.

At Rennsteig, we stay on top of the market. When new connectors come out and gain ground, you can be sure we'll make die sets for them. What does this mean? It means you don't have to invest in a whole new crimp tool. You can just get an additional die set to fit your existing crimp tool, and you're ready to install the latest gear.

2

## Locators

Multi-Contact MC3 (Solarline 1)	14/12/10 AWG	Part # 624 194 0 01
	12/10/8 AWG	Part # 624 348 0 01
Mutli-Contact MC4 (Solarline 2)	14/12/10 AWG	Part # 624 570 0 01
	12/10/8 AWG	Part # 624 1193 0 01
Amphenol H4 (machined)	14/12/10/8 AWG	Part # 624 1194 0 01
Amphenol H4 (stamped & formed)	14/12/10	Part # 624 1175 0 01
Tyco (Solarlok®)	16/14/12/10 AWG	Part # 624 817 0 01
<b>COMING SOON</b> Tyco (Solarlok® PV4)	12/10 AWG	Part # 624 969 0 01
TongLing TL4	12/10 AWG	Part # 624 1186 0 01
Wieland (gesis® solar)	12/10/8 AWG	Part # 624 071 0 016
Lumberg LC3	14/12/10 AWG	Part # 624 231 0 01
Lumberg LC4	14/12/10 AWG	Part # 624 232 0 01
SMK	14/12 AWG	Part # 624 1188 0 01
Yukita	16/14/12/10 AWG	Part # 624 369 0 01
Yukita 540820-2MA 540821-2MA 540920-2MA 540921-2MA	2/2.5/3.5/4/6 mm <sup>2</sup> (similar to 14/13/12/10 AWG)	Part # 624 1173 0 01

Other applications on request.

1

## Die Sets

Multi-Contact MC3 (Solarline 1)	14/12/10 AWG	Part # 624 194 3 0
	12/10/8 AWG	Part # 624 348 3 0
Mutli-Contact MC4 (Solarline 2)	14/12/10 AWG	Part # 624 570 3 0
	12/10/8 AWG	Part # 624 1193 3 0
Amphenol H4 (machined)	14/12/10/8 AWG	Part # 624 1194 3 0
Amphenol H4 (stamped & formed)	14/12/10	Part # 624 1175 3 0
Tyco (Solarlok®)	16/14/12/10 AWG	Part # 624 817 3 0
<b>COMING SOON</b> Tyco (Solarlok® PV4)	12/10	Part # 624 969 3 0
TongLing TL4	12/10	Part # 624 1186 3 0
Wieland (gesis® solar)	12/10/8 AWG	Part # 624 073-1 3 0
Huber+Suhner (Radox®-Twist Lock)	12/10 AWG	Part # 624 205 3 0
Lumberg LC3	14/12/10 AWG	Part # 624 231 3 0
Lumberg LC4	14/12/10 AWG	Part # 624 232 3 0
SMK	14/12 AWG	Part # 624 1188 3 0
Yukita	16/14/12/10 AWG	Part # 624 369 3 0
Yukita 540820-2MA 540821-2MA 540920-2MA 540921-2MA	2/2.5/3.5/4/6 mm <sup>2</sup> (similar to 14/13/12/10 AWG)	Part # 624 1173 3 0

Basic Spare Parts are included in all cases

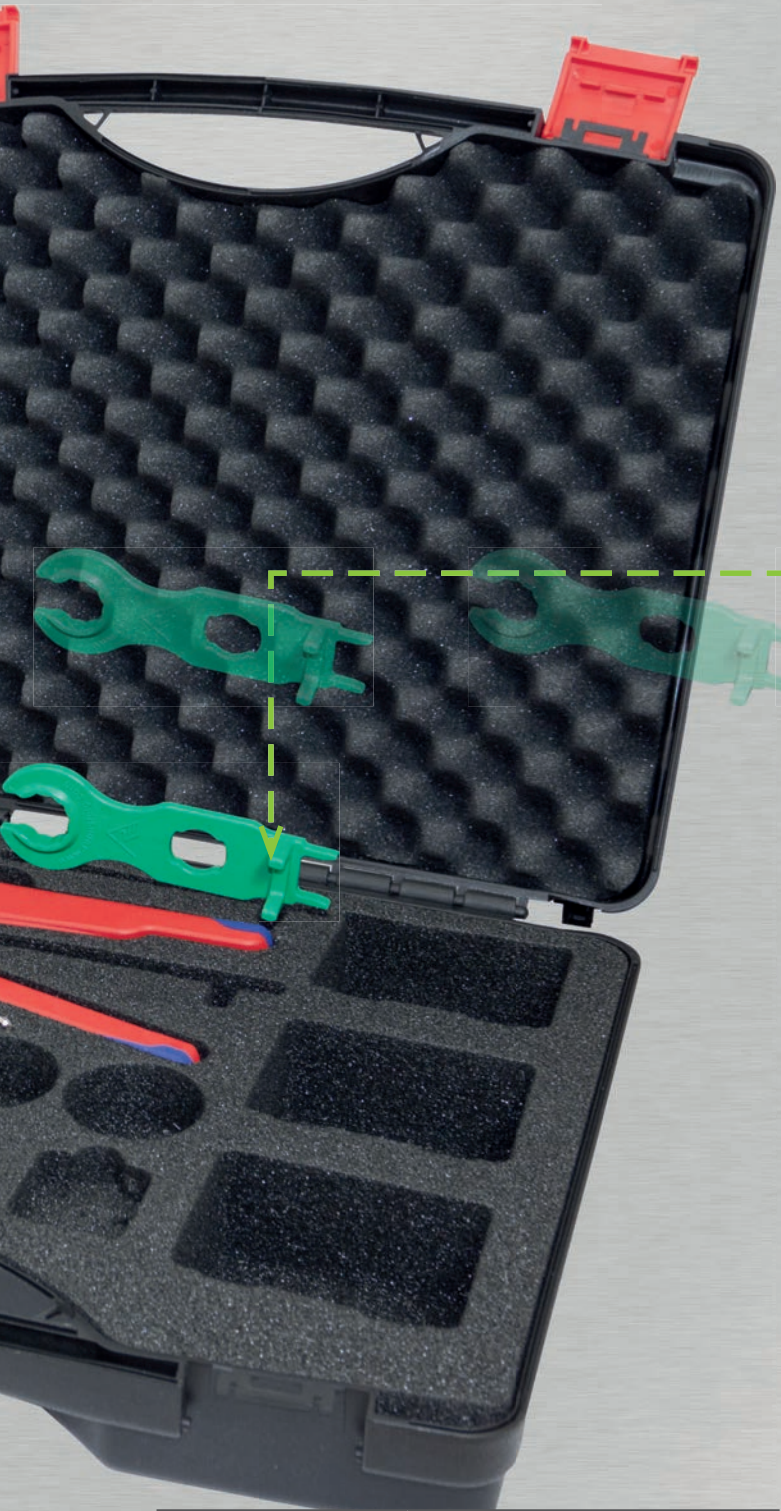

## Custom Solar Crimp Set "ONE FOR ALL"

Our "Custom Solar Crimp Set ", gives YOU the opportunity to create your own set. With a top-quality Rennsteig Solar System Crimp Tool, Crimp Dies and Locators of your choice, up to 5 different combinations are possible. YOU decide which ones you need. We offer tools for all common manufacturers like Multi-Contact, Tyco, Amphenol, Wieland and many others.

***You decide which ones you need!***

3

### Assembly Key for MC4 couplers

Multi-Contact MC4 (Solarline 2)	Part # 690 001
------------------------------------	----------------

### Basic Item

Empty Tool Frame in portable plastic case	Part # 624 105-12
---	-------------------

### Step by Step

1. Choose your application, you can add a maximum of 5 different Die Sets in the case
2. You can also add a maximum of 5 different Locators in the case
3. If you have added a MC4 Die Set or Locator, you can also add a maximum of 2 Assembly Keys for MC4 couplers.
4. Place an order by using Part# R624 105-12 and the Part#'s shown in the tables after having finished step 1-3.

*At Rennsteig, we stay on top of the market. When new connectors come out and gain ground, you can be sure we'll make die sets for them. What does this mean? It means you don't have to invest in a whole new crimp tool. You can just get an additional die set to fit your existing crimp tool, and you're ready to install the latest gear.*

# Professional Solar Wiring/Crimping Kits (preassembled)

A "Must" for Installers

Save money...by fabricating your own PV wires. This professional kit has everything you need for making solar wire connections, from cutting to stripping to crimping. All components are top-quality Rennsteig tools designed and made in Germany specially for the solar industry.

Every Kit includes:

- Crimping Die Sets
- Locators (for correct positioning of the terminal)
- Insulation stripper
- Cable cutter
- Different spare parts
- Made in Germany - made by Rennsteig

**Protective case**

3 ¼" Height,  
13 ½" Length,  
10 ¾" Width

**Solar System Tool**

**Additional Crimp Die Sets (interchangeable)**

**Insulation Stripper**

**Cable Cutter**

**Additional Locators**



Instruction videos



**Empty Solar Wiring/Crimping Case**  
for all customers who already own our Crimp System Tool

Free space for 1 Crimp System Tool, 1 Insulation Stripper, 1 Cable Cutter, 2 Die Sets, 2 Locators, Additional storage space

Content	Spare Parts
Weight	1.45 lbs.
Part #	624 105-26      Solar Kit (empty)



**Solar Wiring/Crimping Kit for Multi-Contact MC3 (Solarline 1) Multi-Contact MC4 (Solarline 2)**



Content	Crimp Tool MC3-Die Set, MC3-Locator MC4-Die Set, MC4-Locator Insulation Stripper Cable Cutter RG
Wire Gauge	MC3 - 14/12/10 MC4 - 14/12/10
Weight	4.80 lbs.
Part #	624 105-02

**Solar Wiring/Crimping Kit for Tyco (Solarlok®)**



Content	Crimp Tool Tyco-Die Set, Tyco-Locator Insulation Stripper Cable Cutter RG
Wire Gauge	Tyco - 16/14/12/10
Weight	4.58 lbs.
Part #	624 105-03

**Solar Wiring/Crimping Kit for Huber+Suhner**

(Radox®-Twist Lock / Push Pull)



Content	Crimp Tool Huber+Suhner-Die Set Insulation Stripper Cable Cutter RG
Wire Gauge	Huber+Suhner - 14/12/10
Weight	4.52 lbs.
Part #	624 105-04

**Solar Wiring/Crimping Kit for Multi-Contact MC3 (Solarline 1) Multi-Contact MC4 (Solarline 2) Tyco (Solarlok®)**



Content	Crimp Tool MC3-Die Set, MC3-Locator MC4-Die Set, MC4-Locator Tyco-Die Set, Tyco-Locator Insulation Stripper Cable Cutter RG
Wire Gauge	MC3/MC4 - 14/12/10 Tyco - 16/14/12/10
Weight	4.80 lbs.
Part #	624 105-06

**Solar Wiring/Crimping Kit for Multi-Contact MC3 (Solarline 1) Multi-Contact MC4 (Solarline 2) Amphenol H4 (machined contacts)**



Content	Crimp Tool MC3-Die Set, MC3-Locator MC4-Die Set, MC4-Locator H4-Die Set, H4-Locator Insulation Stripper Cable Cutter RG
Wire Gauge	MC3/MC4 - 14/12/10 H4 - 14/12/10/8
Weight	4.94 lbs.
Part #	624 105-15

**Solar Wiring/Crimping Kit for Multi-Contact MC3 (Solarline 1) Multi-Contact MC4 (Solarline 2) Wieland (gesis® solar)**



Content	Crimp Tool MC3-Die Set, MC3-Locator MC4-Die Set, MC4-Locator Wieland-Die Set, Wieland-Locator, Insulation Stripper Cable Cutter RG
Wire Gauge	MC3/MC4 - 14/12/10 Wieland - 12/10/8
Weight	4.94 lbs.
Part #	624 105-16

*Other combinations on request.*

**Solar Wiring/Crimping Kit for Multi-Contact MC4 (Solarline 2) Amphenol H4 (machined contacts) Wieland (gesis® solar)**



Content	Crimp Tool MC4-Die Set, MC4-Locator H4-Die Set, H4-Locator Wieland-Die Set, Wieland-Locator, Insulation Stripper Cable Cutter RG
Wire Gauge	MC4 - 14/12/10 H4 - 14/12/10/8 Wieland - 12/10/8
Weight	4.94 lbs.
Part #	624 105-17

**Solar Wiring/Crimping Kit for Amphenol H4 (machined contacts) Multi-Contact MC4 (Solarline 2) Tyco (Solarlok®)**



**NEW**

Content	Crimp Tool H4-Die Set, H4-Locator MC4-Die Set, MC4-Locator Tyco-Die Set, Tyco-Locator, Insulation Stripper Cable Cutter RG
Wire Gauge	H4 - 14/12/10/8 MC4 - 14/12/10 Tyco - 16/14/12/10
Weight	4.94 lbs.
Part #	624 105-32

*At Rennsteig, we stay on top of the market. When new connectors come out and gain ground, you can be sure we'll make die sets for them. What does this mean? It means you don't have to invest in a whole new crimp tool. You can just get an additional die set to fit your existing crimp tool, and you're ready to install the latest gear.*

# Professional Solar Wiring/Crimping Kits <sup>Plus</sup> (preassembled)

Save money...by fabricating your own PV wires. This professional kit has everything you need for making solar wire connections, from cutting to stripping to crimping. All components are top-quality Rennsteig tools designed and made in Germany specially for the solar industry.

Every Kit includes:

- Crimping Die Sets
- Locators (for correct positioning of the terminal)
- Insulation stripper
- Assembly Tool for MC3 coupler
- Cable cutter
- Different spare parts
- Made in Germany - made by Rennsteig

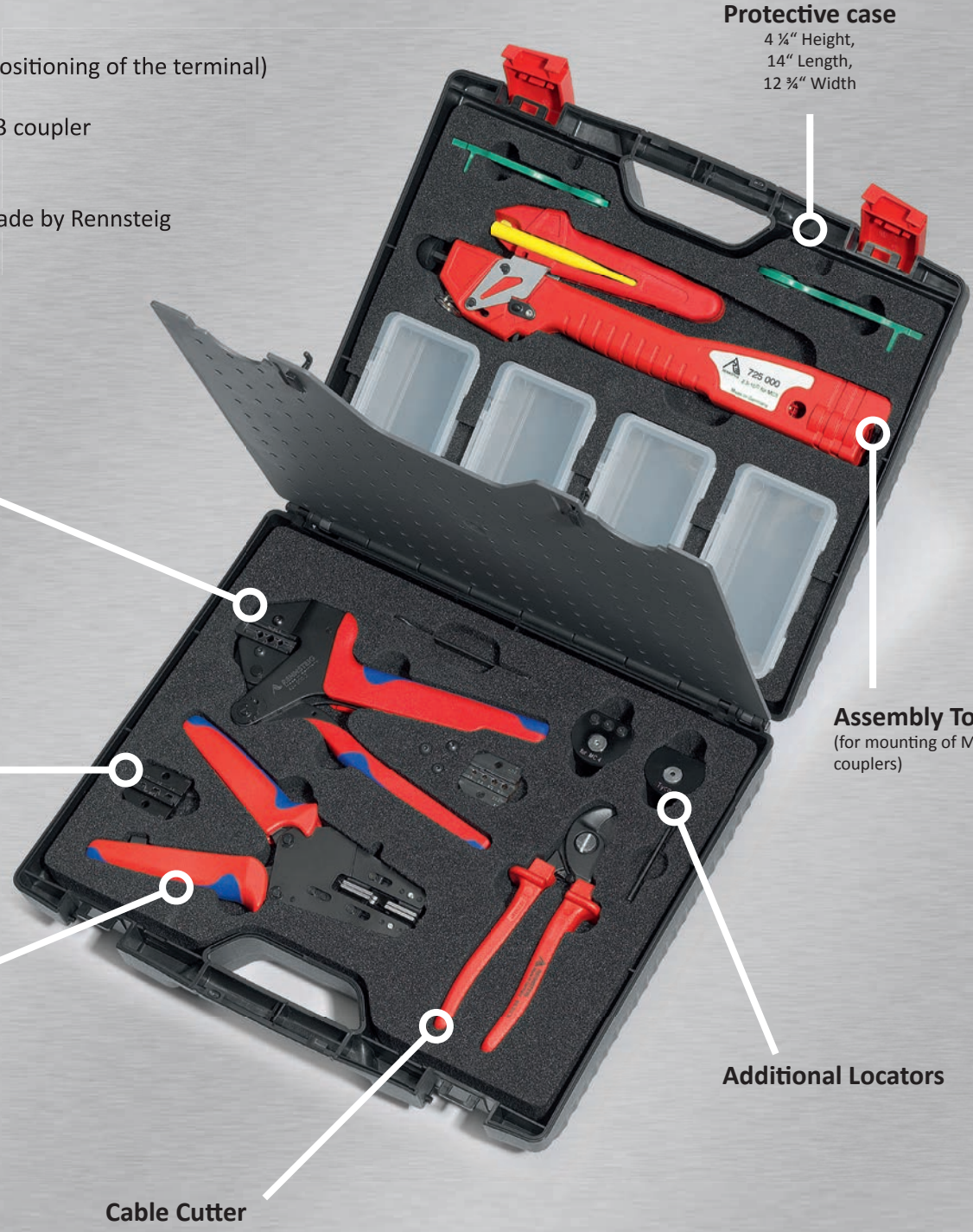

**Protective case**

4 1/4" Height,  
14" Length,  
12 3/4" Width

**Solar System Tool**

**Assembly Tool**  
(for mounting of MC3 couplers)

**Additional Crimp Die Sets** (interchangeable)

**Insulation Stripper**

**Additional Locators**

**Cable Cutter**

## Empty Solar Wiring/Crimping Case <sup>Plus</sup>

for all customers who already own our Crimp System Tool

Free space for 1 Crimp System Tool, 1 Insulation Stripper, 1 Cable Cutter, 2 Die Sets, 2 Locators, 1 Assembly Tool for mounting MC3 couplers, Additional storage space

Content Spare Parts

Weight 2.25 lbs.

Part # 624 105-28

Solar Kit <sup>Plus</sup> Empty

**Solar Wiring/Crimping Kit <sup>Plus</sup> for  
Multi-Contact MC3 (Solarline 1)  
Multi-Contact MC4 (Solarline 2)**



Content	Crimp Tool MC3-Die Set, MC3-Locator MC4-Die Set, MC4-Locator Assembly Tool for mounting of MC3 Couplers Insulation Stripper Cable Cutter RG
Wire Gauge	MC3 - 14/12/10 MC4 - 14/12/10
Dimension	4 ¼" Height, 14" Length, 12 ¾" Width
Weight	7.84 lbs.
Part #	624 105-11

**Solar Wiring/Crimping Kit <sup>Plus</sup> for  
Multi-Contact MC3 (Solarline 1)  
Multi-Contact MC4 (Solarline 2)  
Tyco (Solarlok®)**



Content	Crimp Tool MC3-Die Set, MC3-Locator MC4-Die Set, MC4-Locator Tyco-Die Set, Tyco-Locator Assembly Tool for mounting of MC3 Couplers, Insulation Stripper, Cable Cutter RG
Wire Gauge	MC3 - 14/12/10 MC4 - 14/12/10 Tyco - 16/14/12/10
Dimension	4 ¼" Height, 14" Length, 12 ¾" Width
Weight	7.84 lbs.
Part #	624 105-23

**Solar Wiring/Crimping Kit <sup>Plus</sup> for  
Multi-Contact MC3 (Solarline 1)  
Multi-Contact MC4 (Solarline 2)  
Huber+Suhner (Radox®-TwistLock)**



Content	Crimp Tool MC3-Die Set, MC3-Locator MC4-Die Set, MC4-Locator Radox-Die Set, Radox-Locator Assembly Tool for mounting of MC3 Couplers, Insulation Stripper, Cable Cutter RG
Wire Gauge	MC3 - 14/12/10 MC4 - 14/12/10 Radox - 12/10
Dimension	4 ¼" Height, 14" Length, 12 ¾" Width
Weight	7.84 lbs.
Part #	624 105-27

*Other combinations on request.*

*At Rennsteig, we stay on top of the market. When new connectors come out and gain ground, you can be sure we'll make die sets for them. What does this mean? It means you don't have to invest in a whole new crimp tool. You can just get an additional die set to fit your existing crimp tool, and you're ready to install the latest gear.*

## Insulation Stripper with Replaceable Blades

Unlike other strippers that only cut insulation partially and tear the rest, this Rennsteig stripper cuts the insulation around the entire circumference of the wire, and then pulls it gently off the end. There is never any damage to the leads.

Replaceable stripping blades let you configure the stripper to your needs. When the blades wear out, you can replace them without needing to get a new stripper - for significant savings.

- For two-stage stripping action
- Specialized tool with length stop, for precise stripping and dismantling of single and multi-strand cables
- No pinching or deformation of cable ends
- Interchangeable blades for different wire gauges
- **Custom blade design upon request**
- Burnished finish, ergonomically designed two-component handles
- Solid construction, easy to handle
- Made in Germany - made by Rennsteig

Precise cutting of the insulation to a complete extent.



Positive stripping thanks to precise shape of the blades.



Automatic stripping of the insulation.



Length scale

Adjustable length stop

Interchangeable Stripping Blades

Dual component comfort grip handles

PATENTED



Adjustable length stop with scale

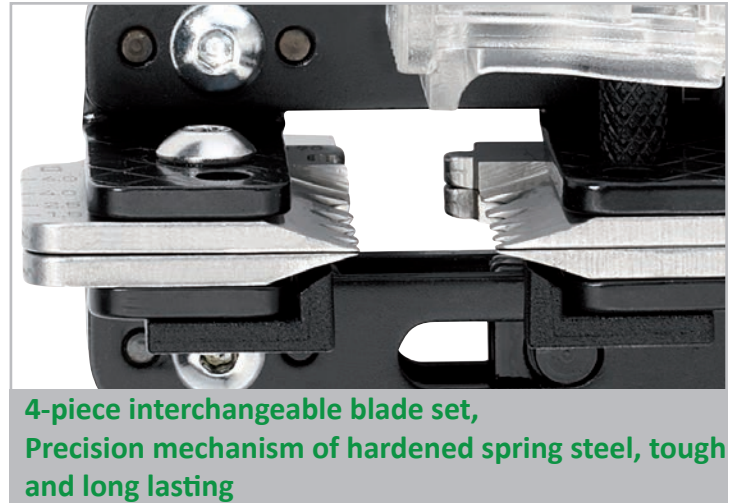

4-piece interchangeable blade set, Precision mechanism of hardened spring steel, tough and long lasting

**Tool for metric solar cable**

Max. Wire Cross	1.5/2.5/4/6 mm <sup>2</sup> (similar to AWG 16/14/12/10)	
Length	8"	
Weight	0.9 lbs.	
Part #	708 226 3	Tool for metric solar cable

**Tool for solar cable**

Max. Wire Cross	AWG 16/14/12/10	
Length	8"	
Weight	0.9 lbs.	
Part #	708 226-1 6 RT	Tool for solar cable

**Tool for metric solar cable**

Max. Wire Cross	4/6/10 mm <sup>2</sup> (similar to AWG 12/10/8)	
Length	8"	
Weight	0.9 lbs.	
Part #	708 269 3	Tool for metric solar cable

Two pairs of blades (1) cut the insulation to a complete extent. Then the blade pairs move apart, and thus the insulation is removed form-fit (2). The pliers opens automatically after the stripping procedure.

The shaped blades cuts the insulation completely. (The red area will be cut, no damaging of the cable strands)

Already now more than 250 different stripping blades available!  
**Custom blade design upon request.**

## Cable Cutters

This specially-designed Rennsteig Cable Cutter gives you clean, straight, burr-free cuts, with no wire end deformation. Wires stay round, so they fit better and more securely in terminals. The ergonomic form factor makes your job easier, too.

- Perfect for cutting almost all cables (\*Not for steel wire or hard-drawn copper cables)
- Plastic coated handles
- Easy, clean, one hand cuts
- Sharp, hardened, precision-ground blades
- No crushing or deformation of cables
- Material: special tool steel, forged
- Made in Germany - made by Rennsteig



Ergonomic grips

Spring loaded  
(opening spring inside the tool)

Precision ground  
blades

Safety lock

### Cable Cutter



Max. Wire Cross	50 mm <sup>2</sup> (similar to AWG 1/0)	
Length	6 ¾"	
Weight	0.5 lbs.	
Part #	700 015 3	burnished, plastic coated

### Cable Cutter RG



Max. Wire Cross	50 mm <sup>2</sup> (similar to AWG 1/0)	
Length	6 ¾"	
Weight	0.5 lbs.	
Part #	700 015 36	burnished, reinforced plastic grips

### Cable Cutter OS

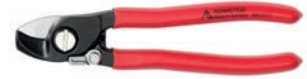

Max. Wire Cross	50 mm <sup>2</sup> (similar to AWG 1/0)	
Length	6 ¾"	
Weight	0.5 lbs.	
Part #	700 016 3	burnished, spring loaded, plastic coated

### Cable Cutter RGO



Max. Wire Cross	50 mm <sup>2</sup> (similar to AWG 1/0)	
Length	6 ¾"	
Weight	0.5 lbs.	
Part #	700 016 36	burnished, spring loaded, plastic grips



We also offer Cutters for larger cable sizes! Take a look at our website [www.rennsteig.us](http://www.rennsteig.us)

### Cable shears D27



Capacity: 27 mm (similar to 1 1/16")  
150 mm<sup>2</sup> (similar to 5/0 AWG)

### Cable shears D38

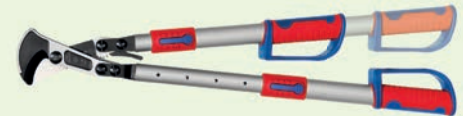

Capacity: 38 mm (similar to 1 ½")  
280 mm<sup>2</sup> (similar to 11024 AWG) 550 MCM

### Cable shears D60



Capacity: 60 mm (similar to 2 3/8")  
740 mm<sup>2</sup> (similar to 1400 MCM)

### Cable shears D100



Capacity: 100 mm (similar to 4")  
960 mm<sup>2</sup> (similar to 1900 MCM)

## Cable Cutters for larger sizes

### Cable Cutter D20



Max. Wire Cross	20 mm (similar to 13/16") 70 mm <sup>2</sup> (similar to 2/0 AWG)	
Length	6 ¾"	
Weight	0.7 lbs.	
Part #	700 20 3	burnished, plastic coated

### Cable Cutter D20RG



Max. Wire Cross	20 mm (similar to 13/16") 70 mm <sup>2</sup> (similar to 2/0 AWG)	
Length	6 ¾"	
Weight	0.8 lbs.	
Part #	700 020 36	burnished, reinforced plastic grips

#### Phase 1: Initial cut

The use of the front blade means that an ergonomic handle width is retained even when handling large diameter



#### Phase 2: Final cut

If greater force is required, it is possible to adjust the profile at the joint. Initial cut at the front, final cut at the rear



## Assembly key for MC4 couplers

This absolutely ergonomic plastic open end spanner is for tightening and loosening of the cable gland. You can use this key also for breaking connections (open the locking) after they have already been locked together.

To tighten the cable gland, we recommend using two assembly keys.

The Key comes in green.



### Assembly Key for MC4 couplers

Wire Gauge	14/12/10	
Part #	690 001	Complete Tool

## Automatic Center Punch with Hand Guard NEW

The automatic center punch is a selfstriking tool, used for fast and precise marking. It is mainly used in precision mechanics, steel engineering, by tool makers and for similar applications. The striking force is continuously adjustable.

- Machine steel
- Precision design
- Activated by downward pressure (you don't need a hammer)
- Replaceable hardened pin
- Single handed operation
- Nickel plated finish
- Rugged self striking mechanism
- Impact force adjustable
- Hand guard prevents insurance
- Made in Germany - made by Rennsteig



### Automatic Center Punch I

Striking Force	20 - 50 N
Length	3 ¾"
Part #	430 229



### Automatic Center Punch II

Striking Force	60 - 130 N
Length	5"
Part #	430 230



### Automatic Center Punch III

Striking Force	180 - 250 N
Length	5 ¾"
Part #	430 231





# Adjustable Centering Punches

The best way to determine the center of a hole.

- A better solution compared to a transfer punch
- For exactly, offset-free centering on workpieces
- Perfect alignment of the slitted centering sleeve in masterpiece or drilling jig with knurled screw
- Special hardened and tempered, passing centering punch - resharpenable
- Available in 3 different sizes
- Material: special tool steel
- Made in Germany - made by Rennsteig



Centering Punch I	
Cross section	6 - 8 mm (similar to 0.23" - 0.31")
Length	3 ¾"
Weight	0.04 lbs.
Part #	430 140
	Centering Punch I

Centering Punch II	
Cross section	8 - 10 mm (similar to 0.32" - 0.43")
Length	4 ¼"
Weight	0.08 lbs.
Part #	430 141
	Centering Punch II



Centering Punch III	
Cross section	11 - 16 mm (similar to 0.43" - 0.62")
Length	4 ½"
Weight	0.17 lbs.
Part #	430 142
	Centering Punch III



Centering Punch Set	
Cross section	6 - 16 mm (similar to 0.23" - 0.62")
Length	6 ¾"
Weight	0.31 lbs.
Part #	430 143
	Set includes: Centering Punch I, II, III

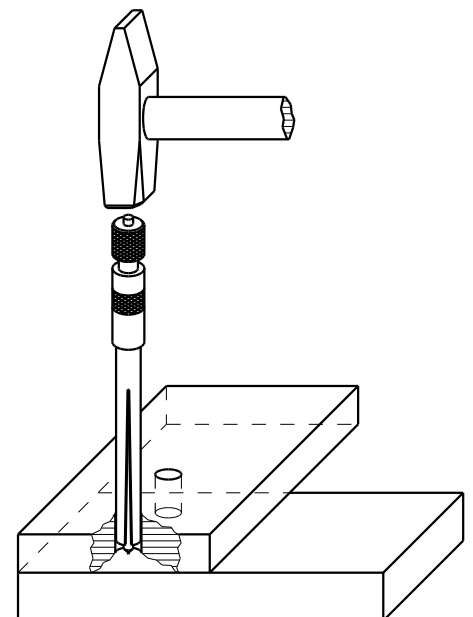

# Dual-Edged Screw Extractor (Easy-Outs)

This Dual-Edged Screw Extractor represents a new generation of its kind used to remove ruined screws or bolts out of threads. This technology provides for use with right-hand and left-hand threads.

- For unscrewing ruined screws and bolts without damaging threads
- Unique design allows both left and right-handed turning
- Extractor is driven into the bore hole for a safe and secure hold
- Integrated center punch pin for precision work
- Non-slip and dual-edged engagement with the screw or bolt to be removed
- Material: chrome vanadium steel, for longer tool life
- Surface: burnished, cutting edges polished
- Made in Germany - made by Rennsteig



PATENTED



Size 1 - 5

Screw Extractor sets in plastic tube					
		Content	3 Screw Extractors (Size 1 to 5)	Content	5 Screw Extractors (Size 1 to 5)
		Weight	0.51 lbs.	Weight	0.78 lbs.
		Part #	471 903 3 RT	Part #	471 904 3 RT



Application Range (for example)

<b>Vinyl Storage Pouch</b>		Content	5 Screw Extractors (Size 1 to 5)	
		Weight	0.76 lbs.	
		Part #	471 900 3	Screw Extractor Set

Instruction video



P/N	Description	Drill Ø Inch		Screw Size inch		Screw Size	
		Min	Max	Min	Max	Min	Max
471 001 3	Dual Edged Screw Extractor size 1	1/8	3/16	3/16	1/4	M5	M6
471 002 3	Dual Edged Screw Extractor size 2	3/16	9/32	5/16	3/8	M8	M10
471 003 3	Dual Edged Screw Extractor size 3	1/4	3/8	7/16	1/2	M10	M12
471 004 3	Dual Edged Screw Extractor size 4	11/32	1/2	1/2	9/16	M12	M16
471 005 3	Dual Edged Screw Extractor size 5	7/16	5/8	5/8	3/4	M16	M20

# XXL Snap- (Retaining) Ring Tool (Circlip Tool for internal and external circlips)

- Usable with any snap rings from a diameter of 400 - 1000 mm (15-40 inch)
- Securely opens, closes and holds rings thanks to a self-locking precision spindle action
- For fitting and removing circlips in one operation
- Holds rings securely due to short, direct-contact sockets
- High-strength, hardened and tempered tips
- Opening width up to 10" (with scale on request)
- Can be operated with Allen key (Hexagonal key), ratchet wrench or cordless screwdriver
- Interchangeable paired tips to cover different diameter ranges (custom designs are also available)
- Areas of application are wherever very high forces and torques are transmitted with large shafts and bearings

**Tool in Case**



**Replaceable Tips**



**Operated with Allen key**



Instruction video



**Operated with Cordless Screwdriver**



PATENTED



**Set in plastic case**

Content	Retaining ring tool, paired tips with diameter of 6 and 9 mm, Allen key (6 mm), Bit for Screwdriver (6 1/4")
Weight	4.7 lbs
Part #	783 000 61

**Set of replacement tips 1**

Content	Set of replacement tips, diameter 6 mm for Retaining Rings up to 690 mm
Weight	0.2 lbs
Part #	783 006 3 0

**Set of replacement tips 2**

Content	Set of replacement tips, diameter 9 mm for Retaining Rings up to 700 mm (DIN)
Weight	0.2 lbs
Part #	783 009 3 0

# Assembly Tool for mounting of MC3 couplers

The MC3 Assembly Tool is a high quality device that is used for inserting the crimped solar PV cable into the rubber housing necessary to fully insulate an MC3 connection.

- Suitable for assembling MC3 connectors from 14/12/10/8 AWG (similar to 2.5/4/6/10 mm<sup>2</sup>)
- Can be used for both male and female connections
- Ergonomic and facile
- Up to 3 spindles ca be stored in grip
- Made in Germany - made by Rennsteig

Suitable for on-site use, on roofs, etc.

Assembly Tool for mounting of MC3 couplers	
	
Wire Gauge	14/12/10/8
Length	13"
Weight	1.01 lbs.
Part #	725 000
	Complete Tool w/ all spindles for mounting of MC3 couplers

Instruction video



## Private Label

To enhance our customers marketing position, we offer a private labeling service which provides you the following options:

- Your logo on the tool
- Ergonomic 2- component handles can be varied in color
- Customized labeling

## Custom Design

In addition to our standard product line, we offer custom design tooling.

We have the knowledge, skill and capacity to meet any customer specifications, and we specialized in meeting customer requirements.



## Rennsteig Tools, Inc. - Precision Tools Made in Germany



A leading US and German producer of high quality hand tools, Rennsteig Werkzeuge designs and manufactures state of the art crimping, cutting, and stripping tools. The company follows a long tradition of specialty hand tool development and manufacturing which enables it to craft exceptionally dynamic hand tools.

In January 2006, Rennsteig Werkzeuge established Rennsteig Tools Inc. with a sales office in Hudson, Ohio to better serve the North American market (including Canada and Mexico). From this location, the company provides precision tools that conform to USCAR 21 and other North American specifications. Rennsteig Tools Inc. supplies distributors, dealers, OEMs, secondary suppliers and individuals across various industries.

**In November 2009, Rennsteig underscored its commitment to US market with the opening of a new warehouse in Somerdale NJ.**

**In August 2010, Rennsteig moved from Hudson, OH to a new Sales Office in Rutherford, NJ.**

Rennsteig offers the right tools to help you do a professional job, by making electrical connections neat, durable, and fast.



## State-of-the-art production - The core of our company!



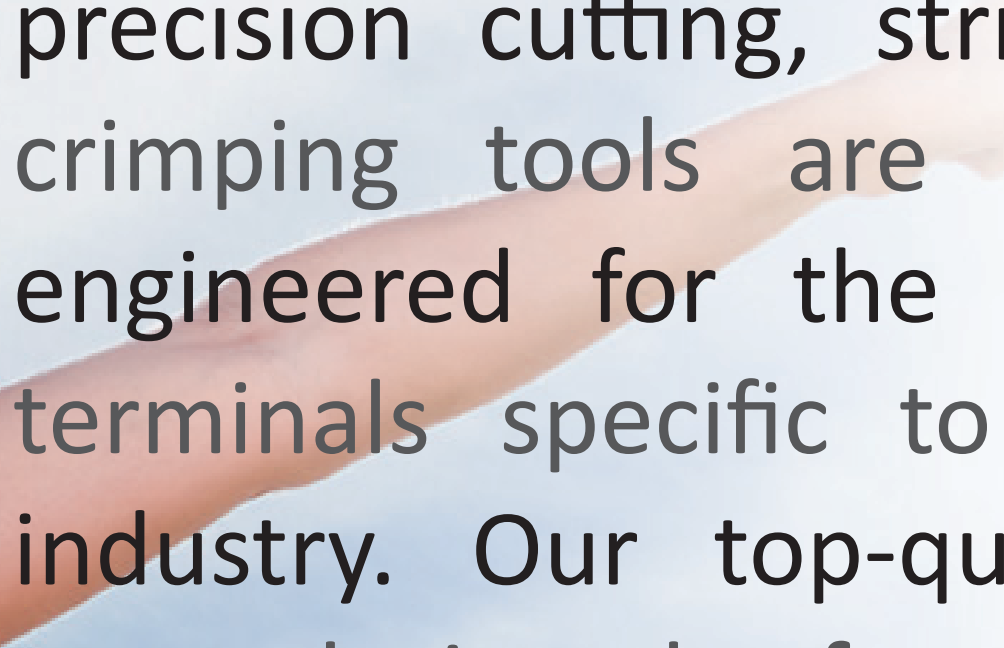

A hand with a pointing finger is visible on the left side of the image, pointing towards the text. The background is a light blue gradient.

Rennsteig can help you streamline your solar installs, by giving you the tools you need to do a fast, professional job. These precision cutting, stripping and crimping tools are specifically engineered for the wires and terminals specific to the solar industry. Our top-quality tools are designed for durability and efficiency, and give you consistently excellent results.

**RENNSTEIG TOOLS MEET THE REQUIREMENTS OF EVERY PROFESSIONAL USER.**

**RENNSTEIG TOOLS, INC.**

*Technical Support*  
63 Horseshoe Court  
Tinton Falls, NJ 07753  
fon: 330-974-0100  
mobil: 201-275-5980

web: [www.rennsteig.us](http://www.rennsteig.us)  
mail: [tech@rennsteig.us](mailto:tech@rennsteig.us)

**RENNSTEIG TOOLS, INC.**

*Warehouse*  
403 Kennedy BLVD  
Somerdale, NJ 08083

web: [www.rennsteig.us](http://www.rennsteig.us)  
mail: [warehouse@rennsteig.us](mailto:warehouse@rennsteig.us)



**RENNSTEIG TOOLS, INC.**

*Technical Support*  
3620 Huffines Blvd., Apt. 115  
Carrollton, TX 75010  
fon: 201-623-9583  
mobil: 201-275-5982

web: [www.rennsteig.us](http://www.rennsteig.us)  
mail: [ludger@rennsteig.us](mailto:ludger@rennsteig.us)

**RENNSTEIG WERKZEUGE GMBH**

*Headquarter*  
An der Koppel 1  
98547 Viernau

fon: 011 49 3 68 47 441 0  
fax: 011 49 3 68 47 441 17  
web: [www.rennsteig.com](http://www.rennsteig.com)  
mail: [info@rennsteig.com](mailto:info@rennsteig.com)

**RENNSTEIG TOOLS, INC.**

*Sales Office*  
301 Route 17 North, Suite 800  
Rutherford, NJ 07070

fon: 330-315-3044  
fax: 330-319-8135  
mobil: 201-275-5981  
web: [www.rennsteig.us](http://www.rennsteig.us)  
mail: [sales@rennsteig.us](mailto:sales@rennsteig.us)



*We are the manufacturer. WE KNOW HOW!*