

ASHRAE Standard 90.1 2010 Solutions Guide

Real-World Applications and
Single Source Compliance Strategies

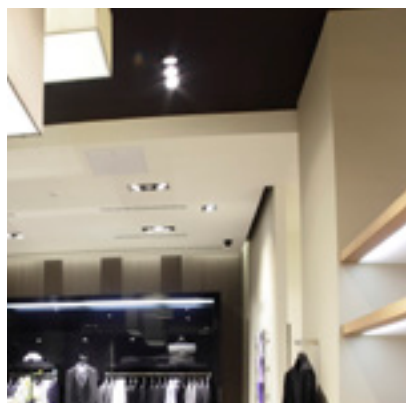



Leviton Excellence For ASHRAE Standards

ASHRAE Standard 90.1 2010 provides the minimum requirements for energy-efficient design of most buildings (excluding low-rise residential buildings). ASHRAE standards define the minimum energy efficiency requirements for new construction, as well as new systems installed in existing buildings.

Leviton offers a wide spectrum of lighting and energy control solutions to bring any project up to standard. This reference guide provides examples of common applications, ASHRAE 90.1 code compliance considerations, and Leviton solutions to meet the functionality and standards compliance needs of the space.

Disclaimer: This document is for informational purposes only. Each project will have its own specific requirements for satisfying ASHRAE Standard 90.1 compliance based on a variety of factors. Other exceptions or details may apply. Review the standard for specific requirements and/or consult with a professional advisor. Leviton Mfg. Co., Inc. is not responsible for any loss resulting from the use of any information found in this document.

Solutions are subject to change without notice. For additional assistance, contact your local Leviton representative.

ASHRAE Standards by State

Commercial State Energy Code Status as of January 1, 2015

Note: For Canadian code compliance, refer to your provincial code

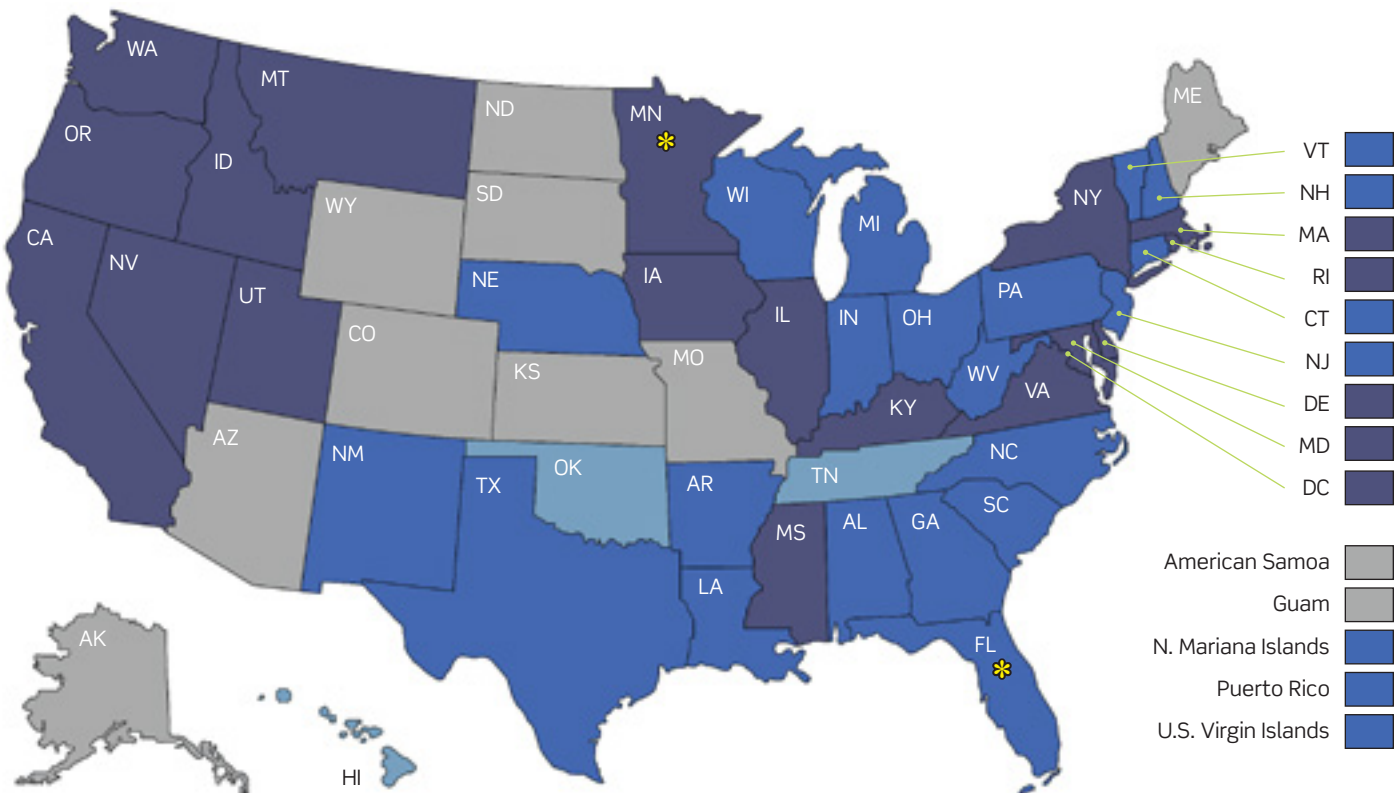

19 meets or exceeds ASHRAE Standard 90.1-2010 or equivalent	23 meets or exceeds ASHRAE Standard 90.1-2007 or equivalent	state has adopted new code to be effective at a later date
3 meets or exceeds ASHRAE Standard 90.1-2004 or equivalent	11 no statewide code or precedes ASHRAE Standard 90.1-2004	





SOURCE: Online Code Environment and Advocacy Network, www.energycodesocean.org

Evolution of ASHRAE Standards: Current Requirements





The latest version of ASHRAE 90.1, released in 2010 and currently in effect nationwide, has introduced more stringent guidelines on energy usage and lighting control for new and retrofit projects.

2007 Standard	2010 Standard (Changes Highlighted)
ASHRAE 90.1 compliance applies to all new construction projects and retrofit projects involving alteration of >50% of lighting loads	ASHRAE 90.1 compliance applies to all new construction projects and retrofit projects involving alteration of >10% of lighting loads
Auto-OFF lighting control in buildings > 5,000 sq ft	Auto-OFF lighting control in all buildings
Enclosed spaces must have a lighting control that is either manual-ON or auto-ON	All spaces must have a lighting control that is either manual-ON or auto-ON to <50% of lighting load
Spaces that require an occupancy sensor that activates after 30 minutes of vacancy include: <ul style="list-style-type: none"> - Classrooms - Conference and meeting rooms - Employee lunch and break rooms 	Spaces that require an occupancy sensor that activates after 30 minutes of vacancy include: <ul style="list-style-type: none"> - Classrooms - Conference and meeting rooms - Employee lunch and break rooms - Lecture halls - Training rooms - Storage and supply rooms between 50 and 1,000 sq ft - Copy rooms - Offices < 250 sq ft - Restrooms - Dressing/fitting/locker rooms
Not included	In addition to controls that switch OFF all lighting, enclosed spaces must have controls that reduce the lighting by 30 to 70% of the full lighting load
Not included	Automatic, multi-level daylighting controls must be installed in enclosed spaces with sidelit areas > 250 sq ft and all skylit areas > 900 sq ft

ASHRAE Standard 90.1 2010 Requirement Quick Reference

Control Type	Summary	Quick Take
8.4.2 Automatic Receptacle Control 	50% of all receptacles in private offices, open offices and computer classrooms must be controlled by occupancy sensor, time of day control, or by signal from another building control or alarm system that indicates that the space has become unoccupied: <ul style="list-style-type: none"> • Includes receptacles installed in modular partitions • Controlled receptacles must be marked to indicate that they are controlled 	50% of all receptacles in private offices, open offices and computer classrooms must be controlled by an occupancy sensor.
9.4.1.1 Automatic Shutoff 	Interior lighting must have an automatic control device to turn lights OFF. This device can be one of three options: <ul style="list-style-type: none"> • A scheduled basis controlling not more than 25,000 sq ft but not more than one floor • An occupancy sensor with a maximum timeout of 30 minutes • A signal from another building system that indicates the space is unoccupied 	Interior lighting must have an automatic control to turn the lights OFF. The device can be a scheduling control, an occupancy sensor, or a BAS/BMS system signal.
9.4.1.2 Space Control 	Each space enclosed by ceiling height partitions must have at least one readily accessible control device to control General Lighting. Must meet the following requirements: <ul style="list-style-type: none"> • (a) Controlled lighting shall have at least one step between 30% and 70% of Full and OFF* • (b) Lights must be turned off within 30 minutes of vacancy by use of an occupant sensor or timer switch* • (c) For all other spaces not included in (b): <ul style="list-style-type: none"> - Each control device can be either manually or automatically activated - Maximum control area of 2,500 sq ft for spaces <10,000 sq ft, or 10,000 sq ft for spaces \geq 10,000 sq ft - Maximum override for time of day schedules is two hours 	All spaces shall include visible control devices: (1) occupancy sensor, (2) continuous or stepped dimming control device (photocell, entry station or system controller)
9.4.1.3 Parking Garage Control 	<ul style="list-style-type: none"> • Lighting must be controlled in zones no larger than 3,600 sq ft • Lighting within a zone must be controlled by a device that reduces power to all luminaires by 30% after 30 minutes of vacancy • Daylight transition areas must be controlled so lights are ON during the day and OFF at night • Automatic daylight harvesting is required within 20 ft of open exterior walls that meet the open space to wall ratio requirement <p>Note: Lighting for parking garages must also comply with Section 9.4.1.1.</p>	Parking garage lighting zones must be controlled by a device that reduces power by 30% after 30 minutes of vacancy, and open exterior walls must utilize automatic daylight harvesting.
9.4.1.4 & 9.4.1.5 Automatic Daylight Control 	General lighting in Primary Sidelighted areas must be separately controlled by a multi-level photocontrol, which can be dimming. <ul style="list-style-type: none"> • The light sensor shall be remote from where the calibration adjustments are made • Calibration adjustment device must be readily accessible • Photocontrol must provide for at least one step between 50% to 70% of design lighting power <p>NOTE: Sidelit means the natural daylight enters a space through the side of the building, generally through windows.</p> <p>Toplit is when the natural daylight enters the space through the top of the building, most often through skylights. ASHRAE 90.1 distinguishes how control zones should be set up under both conditions.</p>	Sidelit and Toplit areas must be separately controlled by a photocontrol, which can be stepped or continuous dimming. Calibration cannot be located on the photocell.

ASHRAE Standard 90.1 2010 Requirement Quick Reference

Control Type	Summary	Quick Take
<p>9.4.1.6 Additional Control</p> 	<p>The following lighting require additional control:</p> <ul style="list-style-type: none"> • Display/accent/case lighting • Task lighting • Non-visual lighting (plant growth, food warming, etc.) • Demonstration lighting • Guest room lighting • Master switch required to control all permanently installed luminaires and switched receptacles • Automatic control required for bathroom lighting • Stairwell lighting - Requires automatic control device to reduce lighting by at least 50% within 30 minutes of vacancy 	<p>Separate controls are required for special applications (displays, guestrooms, tasks and stairwell lighting).</p>
<p>9.4.1.7 Exterior Lighting Control</p> 	<ul style="list-style-type: none"> • Exterior lighting must be controlled by a photocell to turn lighting OFF when sufficient daylight is available • Facade and landscape lighting must be turned OFF between 12 am and 6 am, or opening and closing of business <p>Advertising and sign lighting must have a control device to reduce power by 30% in one of two ways:</p> <ul style="list-style-type: none"> • Using a time clock to reduce lighting power between 12 am and business opening • Occupancy sensors to reduce lighting power after 15 minutes of vacancy in outdoor area 	<p>Exterior lighting must be controlled by a photocell to turn lighting OFF when sufficient daylight is available, and reduce advertising/sign lighting power by 30% during closing.</p>
<p>9.4.1 Lighting Controls</p> 	<p>Spaces requiring Automatic Control Devices as identified in sections 9.4.1.1, 9.4.1.2, and 9.4.1.6 shall be either manual-ON or auto-ON to no more than 50% power. The following exceptions allow for full auto-ON:</p> <ul style="list-style-type: none"> • Public corridors or stairwells • Restrooms • Primary building entrances and lobbies • Areas where manual-ON operation would be a safety or security issue <p>Note: All Leviton ASHRAE 90.1 Solutions meet Section 9.4.1 for Lighting Controls.</p>	<p>More controls are required in every project. Manual-ON (Vacancy) or Auto-ON (Occupancy) to not more than 50% (with many exceptions).</p>
<p>9.4.4 Functional Testing</p> 	<p>All lighting controls must be tested to ensure they are working properly:</p> <ul style="list-style-type: none"> • Construction documents must call out who is responsible for the testing • The party responsible for the testing cannot be a member of the design or construction team <p>Note: All Leviton solutions are manufactured to the highest quality and performance standards, which can be easily demonstrated at the time of installation to fulfill ASHRAE 90.1 section 9.4.4.</p>	<p>All lighting controls must be tested by a party not involved with the design or construction team to ensure that the products are working properly.</p>

Note: ASHRAE Standard 90.1 2010 mandates the implementation of energy saving design and control techniques.

For complete codes and more information, refer to www.ashrae.org

*Code includes some exceptions; please refer to ASHRAE Standard 90.1 2010 for more information

Typical Applications

Application	Solution Example		Page
Private Office	Daylight Control Solution		9
Private Office Retrofit	Energy Harvesting Wireless Control Solution		10
Open Office with Cubicles	Sector Distributed Control System		11
Open Office with Cubicles Retrofit	Daylight Control Solution		12
Classroom	Integrated Room Control (IRC)		13
Conference Room	Architectural Dimming		14
Classroom Retrofit	Energy Harvesting Wireless Solution		15
College Commons and Library	IRC Control Solution		16
Retail Space	Relay Control Solution		17
Stairwell	Integrated Room Control (IRC)		18
Sidelit Walkway	Integrated Room Control (IRC)		19
Restroom	Provolt™ Self-Contained Occupancy Sensors		20
Warehouse	Relay Control Solution		21
Parking Garage	Relay Control		22
Retail Parking Lot	Relay Control with Time Clock		23

Product Solutions at a Glance

ASHRAE Standards									
	8.4.2 Automatic Receptacle Control 	9.4.1.1 Automatic Shutoff 	9.4.1.2 Space Control 	9.4.1.3 Parking Garage Control 	9.4.1.4 & 9.4.1.5 Automatic Daylight Control 	9.4.1.6 Additional Control 	9.4.1.7 Exterior Lighting Control 	9.4.1 Lighting Controls 	9.4.4 Functional Testing 
Product Solutions									
Occupancy Sensors	X	X	X	X	X	X	X	X	
Vacancy Sensors	X	X	X		X	X		X	
Wall Box Dimmers			X			X			
Photocells				X	X		X		
Marked "Controlled" Receptacles	X					X	X		
LevNet RF™ Energy Harvesting Wireless Controls	X	X	X	X	X	X		X	
Integrated Room Control (IRC)	X	X	X	X	X	X	X	X	
EZ-MAX® Plus	X	X	X	X	X	X	X	X	
GreenMAX®	X	X	X	X	X	X	X	X	
Track Light Limiting Panel (TLLP)						X			
Sector®	X	X	X		X	X		X	

All Leviton solutions are manufactured to the highest quality and performance standards, which can be easily demonstrated at the time of installation to fulfill ASHRAE 90.1 section 9.4.4.

Private Office

Daylight Control Solution

Features:

- Daylight Harvesting
- Vacancy Sensing
- Manual-ON
- 1-10V Dimming Control
- Vacancy or Occupancy Sensing with Auto-OFF
- Daylight Harvesting with Photocell
- Auto Calibration
- Emergency Input
- Decora® 4 Button Entry Station
- Daylighting Set Point Adjustment through Entry Station
- Plug Load Control with Power Pack
- Time Clock Input
- Demand Response
- HVAC and Emergency Interface

Meets the following ASHRAE 90.1 requirements:



8.4.2
Automatic Receptacle Control



9.4.1
Lighting Controls



9.4.1.1
Automatic Shutoff



9.4.4
Functional Testing



9.4.1.2
Space Control



9.4.1.4 & 9.4.1.5
Automatic Daylight Control

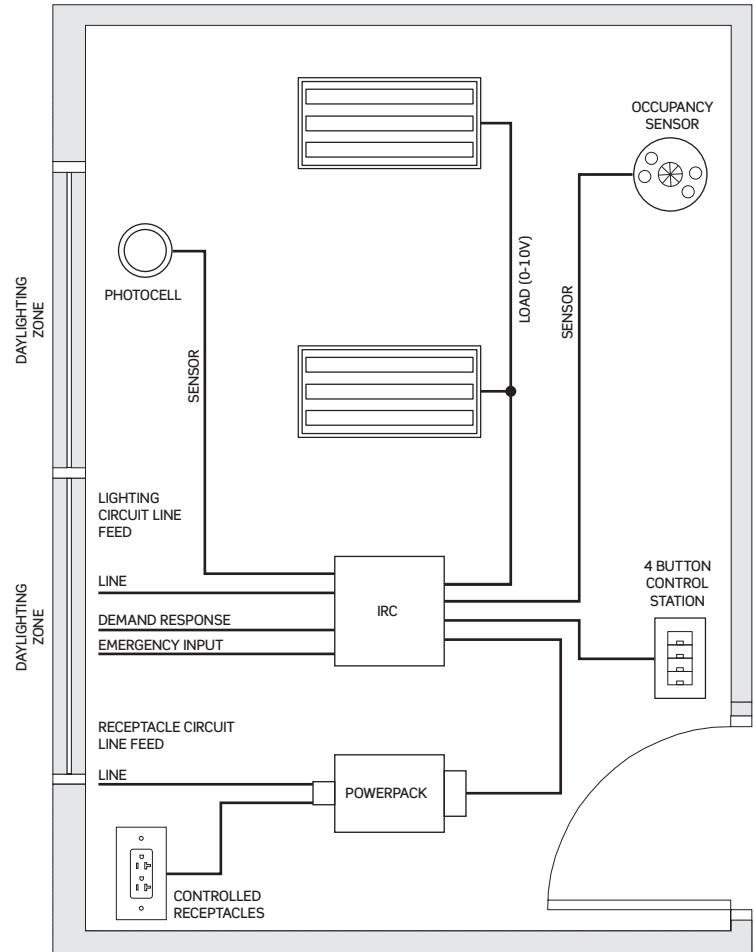

► Featured Leviton Control Solution

Integrated Room Control (IRC)

Items You Will Need	Description	Cat. No.	Quantity
	IRC Kit for 2 Zones, 2 Relays — Includes IRC, sensor, photocell and control station	RCD20-102 (RCD20-C02 — 347V)	1
	Integrated Room Control (IRC)	MZD20-xxx	
	Ceiling Mount Multi-Tech Occupancy Sensor	OSC20-M0W	
	Photocell	ODC0P-00W	
	Lighting Control Station	RLVSW-4LW	
	OPP20 Super Duty Power Pack	OPP20-OD2 (OSP15-R30 — 347V)	1
	Marked “Controlled” Receptacles	16352-2PW	5

Note: 50% of all receptacles in applicable spaces must be controlled by an occupancy sensor (or other qualifying control signal). See page 5 for more details.

Private Office Retrofit

Energy Harvesting Wireless Control Solution

Features:

- 1-10V Dimming Control
- Vacancy or Occupancy Sensing with Auto-OFF
- Energy Harvesting (Sensors & Entry Station)
- Decora® Rocker Entry Station
- Plug Load Control w/ Receptacle or Power Pack
- WiFi Access Point

Meets the following ASHRAE 90.1 requirements:



8.4.2
Automatic Receptacle Control



9.4.1.1
Automatic Shutoff



9.4.1.2
Space Control



9.4.1
Lighting Controls



9.4.4
Functional Testing



9.4.1.4 & 9.4.1.5
Automatic Daylight Control

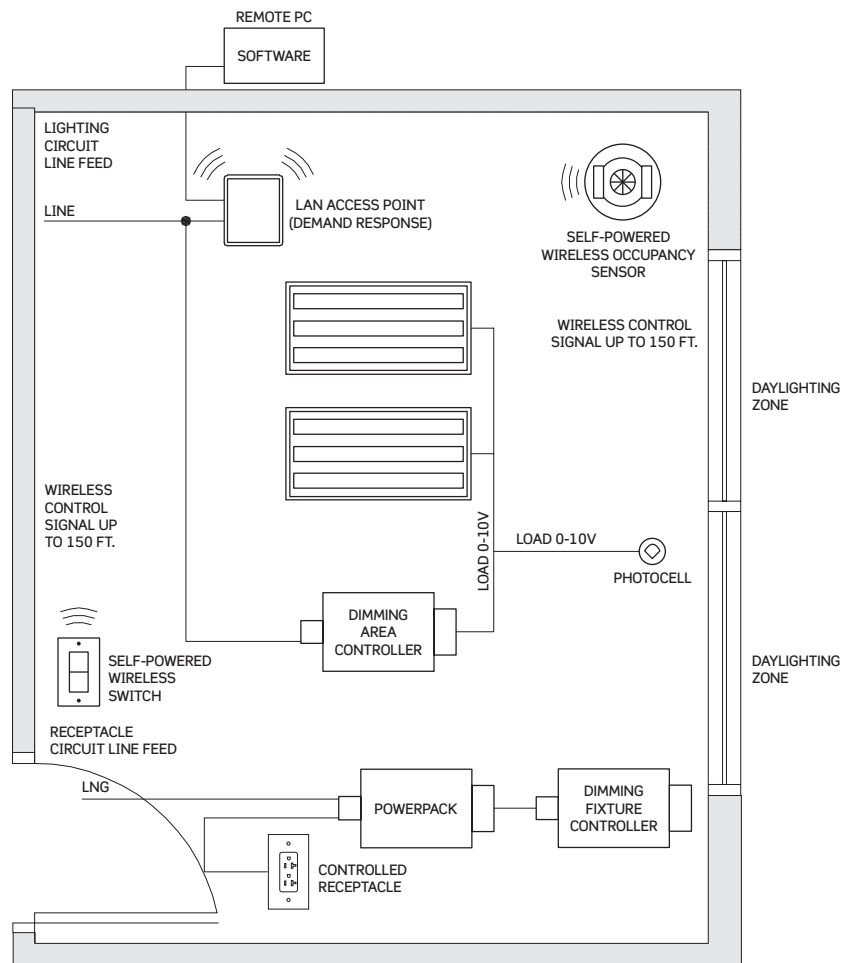

► Featured Leviton Control Solution

LevNet RF™ Energy Harvesting Wireless Solutions

Items You Will Need	Description	Cat. No.	Quantity
	Self-Powered Wireless Occupancy Sensor	WSC12-M9N	1
	Photocell	ODC0P-D0W	1
	Wireless 1-10V Dimming Fixture Controller	WSD05-9D0	1
	Wireless 1-10V Dimming Area Controller	WSD20-9D0	1
	Self-Powered Wireless Switch	WSS0S-S9W	1
	LAN Access Point	WSAP0-I9E	1
	OPP20 Super Duty Power Pack	OPP20-RD4	1
	Marked "Controlled" Receptacles	16352-2PW	5

Note: 50% of all receptacles in applicable spaces must be controlled by an occupancy sensor (or other qualifying control signal). See page 5 for more details.

Open Office with Cubicles

Sector® Distributed Control System

Features:

- Digital Address Control to the Device
- 1-10V Dimming Control
- Vacancy or Occupancy Sensing with Auto-OFF
- Daylight Harvesting with Photocell
- Software for User Interface (UI) and Commissioning
- Decora® 5 Button Entry Station
- Plug Load Control with Sector Relay
- Scheduling (Behavioral Control)
- Demand Response

Meets the following ASHRAE 90.1 requirements:



8.4.2
Automatic
Receptacle Control



9.4.1
Lighting Controls



9.4.1.1
Automatic Shutoff



9.4.4
Functional Testing



9.4.1.2
Space Control



9.4.1.4 & 9.4.1.5
Automatic Daylight Control

TITLE 24/ASHRAE
OPEN OFFICE
SECTOR DISTRIBUTED CONTROL SYSTEM

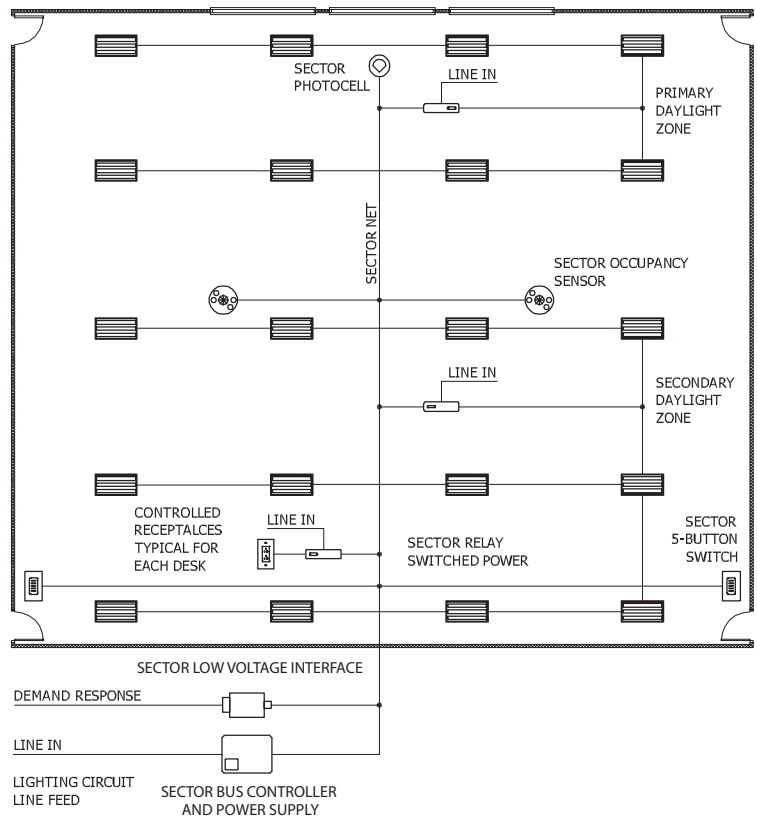

► Featured Leviton Control Solution

Sector Distributed Control System

Items You Will Need	Description	Cat. No.	Quantity
	Sector Bus Controller	SPB00-00M	1
	Sector Low Voltage Interface	SLIQS-000	1
	Sector Occupancy Sensor	OSC20-MSW	2
	Sector Photocell	ODC0P-0SW	1
	Sector 5-Button Switch	SDS00-15W	2
	Sector Relay	SBCS0-L00	3
	Marked "Controlled" Receptacles	CR020-1PW	1 Per Each Desk

Note: 50% of all receptacles in applicable spaces must be controlled by an occupancy sensor (or other qualifying control signal). See page 5 for more details.

Open Office with Cubicles Retrofit Daylight Control Solution (IRC)

Features:

- 1-10V Dimming Control
- Vacancy or Occupancy Sensing with Auto-OFF
- Daylight Harvesting with Photocell
- Auto Calibration
- Decora® 4 Button Entry Station
- Emergency Input
- Daylighting Set Point Adjustment through Entry Station
- Plug Load Control with Power Pack
- Time Clock Input
- Demand Response
- HVAC and Emergency Interface

Meets the following ASHRAE 90.1 requirements:



8.4.2
Automatic Receptacle Control



9.4.1.1
Automatic Shutoff



9.4.1.2
Space Control



9.4.1
Lighting Controls



9.4.4
Functional Testing



9.4.1.4 & 9.4.1.5
Automatic Daylight Control

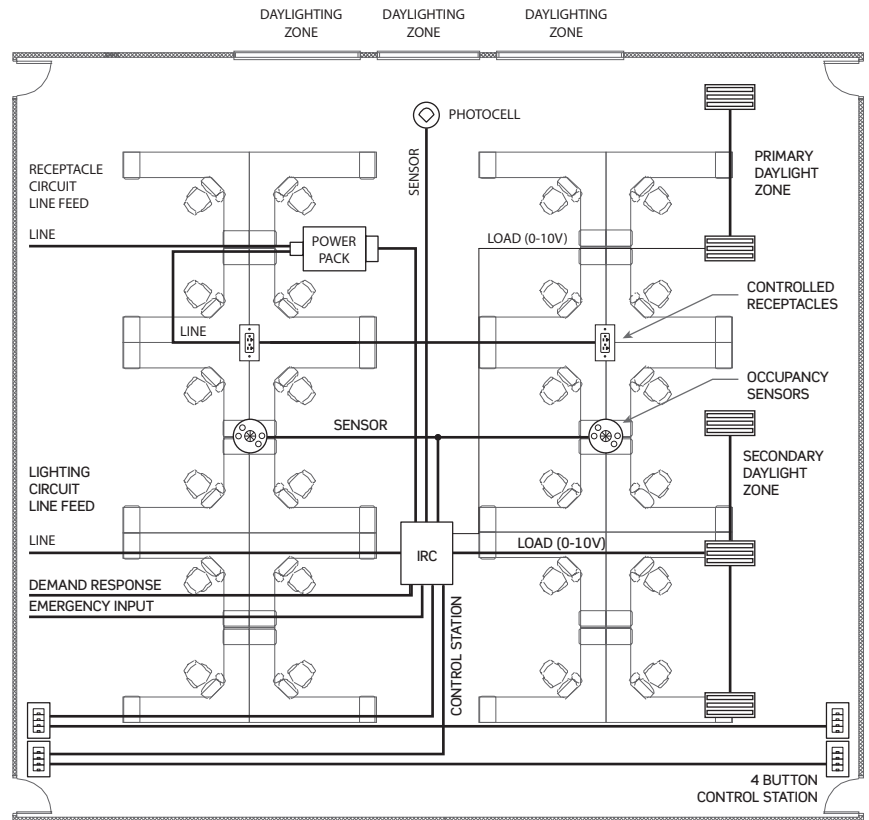

► Featured Leviton Control Solution Integrated Room Control (IRC)

Items You Will Need	Description	Cat. No.	Quantity
	IRC Kit for 2 Zones, 2 Relays — Includes IRC, sensor, photocell and control station	RCD20-102 (RCD20-C02 — 347V)	1
	Integrated Room Control (IRC)	MZD20-xxx	1
	Ceiling Mount Multi-Tech Occupancy Sensor	OSC20-M0W	2
	Photocell	ODC0P-00W	1
	Lighting Control Station	RLVSW-4LW	4
	OPP20 Super Duty Power Pack	OPP20-OD2	1
	Marked "Controlled" Receptacles	16352-2PW	1 Per Each Desk

Note: 50% of all receptacles in applicable spaces must be controlled by an occupancy sensor (or other qualifying control signal). See page 5 for more details.

Classroom

IRC Room Control Solution

Features:

- 1-10V Dimming Control
- Vacancy or Occupancy Sensing with Auto-OFF
- Auto Calibration
- Daylighting Set Point Adjustment through Entry Station
- Daylight Harvesting with Photocell
- Emergency Input
- Decora® 4 Button Entry Station
- Plug Load Control with Power Pack
- HVAC and Emergency Interface
- Time Clock Input
- Demand Response

Meets the following ASHRAE 90.1 requirements:



8.4.2
Automatic Receptacle Control



9.4.1
Lighting Controls



9.4.1.1
Automatic Shutoff



9.4.4
Functional Testing



9.4.1.2
Space Control



9.4.1.4 & 9.4.1.5
Automatic Daylight Control

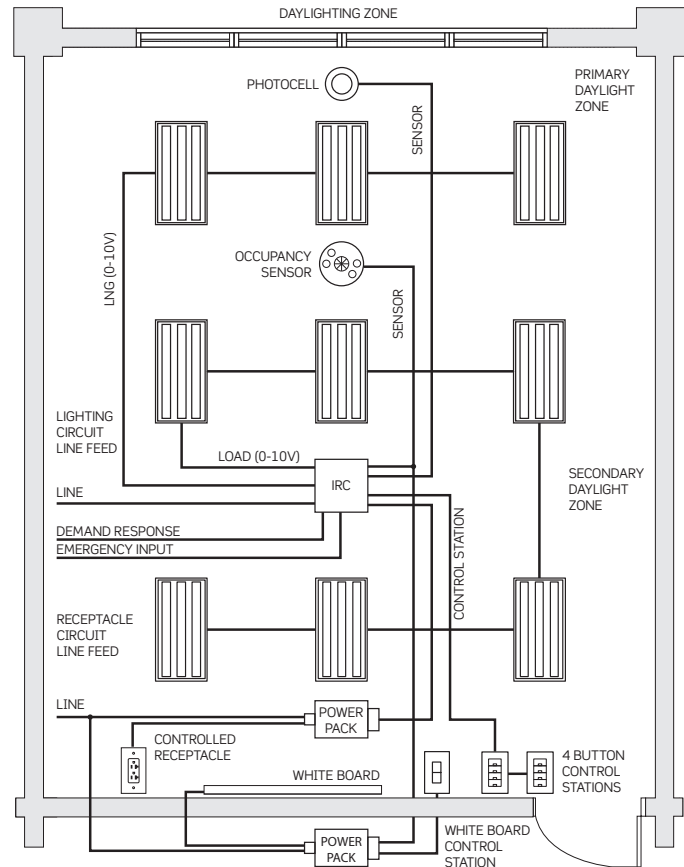

► Featured Leviton Control Solution

Integrated Room Control (IRC)

Items You Will Need	Description	Cat. No.	Quantity
	IRC Kit for 2 Zones, 2 Relays — Includes IRC, sensor, photocell and control station	RCD20-102 (RCD20-C02 — 347V)	1
	Integrated Room Control (IRC)	MZD20-xxx	1
	Ceiling Mount Multi-Tech Occupancy Sensor	OSC20-M0W	1
	Photocell	ODC0P-00W	1
	Lighting Control Station (1 included in kit, 1 additional required)	RLVSW-4LW	2
	Lighting Control Station	RDGSW-2DW	1
	OPP20 Super Duty Power Pack	OPP20-OD2 (OSP15-R30 — 347V)	2
	Marked "Controlled" Receptacles	5362-2PW	5

Note: 50% of all receptacles in applicable spaces must be controlled by an occupancy sensor (or other qualifying control signal). See page 5 for more details.

Conference Room

Architectural Dimming

Features:

- Architectural Touchscreen Interface
- 1-10V Continuous Dimming Control
- Multi-Level Dimming (Stepped) Control
- Vacancy or Occupancy Sensing with Auto-OFF
- Daylight Harvesting with Photocell
- Software & Handheld Remote Programming
- Plug Load Control
- Astronomical Time Clock
- Scheduling (Behavior Control)
- Demand Response
- HVAC and Emergency Interface
- Building Automation (BACnet)

Meets the following ASHRAE 90.1 requirements:



8.4.2
Automatic
Receptacle Control



9.4.1
Lighting Controls



9.4.1.1
Automatic Shutoff



9.4.4
Functional Testing





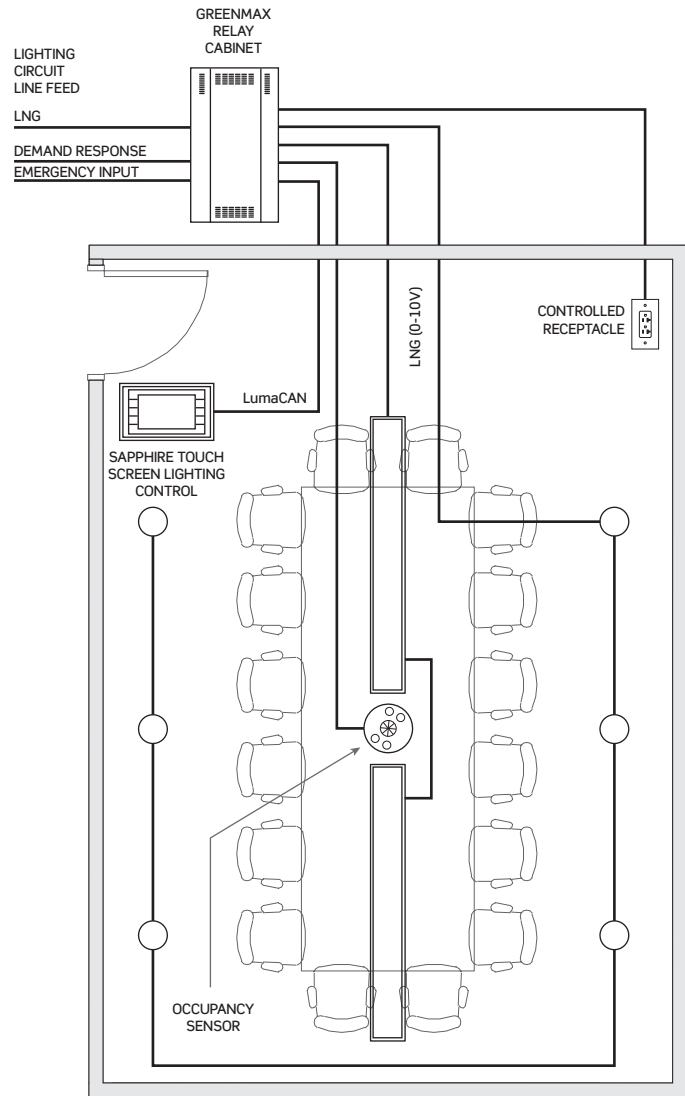





9.4.1.2
Space Control



► Featured Leviton Control Solution

Sapphire™ Touch Screen Lighting Control — GreenMAX® Relay Control System

Items You Will Need	Description	Cat. No.	Quantity
	Sapphire Touch Screen Lighting Control	TS007-000	1
	GreenMAX Relay Control Panel	RxxTC-100	2
	GreenMAX Command Module	RPM16-316	1
	GreenMAX Relays Note: Latching relays available in standard and metering models—see data sheet for more information	RELAY-xxx	16
	GreenMAX Relay Insert Panel	R1616-1DS	1
	GreenMAX Handheld Display Unit	RHDU1-300	1
	Ceiling Mount Multi-Tech Occupancy Sensor Note: Refer to data sheet for part number information	OSCxx-M0W	1
	Marked "Controlled" Receptacles	16352-2PW	5

Note: 50% of all receptacles in applicable spaces must be controlled by an occupancy sensor (or other qualifying control signal). See page 5 for more details.

Classroom Retrofit

Energy Harvesting Wireless Solution

Features:

- 1-10V Dimming Control
- Vacancy or Occupancy Sensing with Auto-OFF
- Energy Harvesting (Sensors & Entry Station)
- Decora® Rocker Entry Station
- Plug Load Control with Receptacle or Power Pack
- WiFi Access Point

Meets the following ASHRAE 90.1 requirements:



8.4.2
Automatic
Receptacle Control



9.4.1
Lighting Controls



9.4.1.1
Automatic Shutoff



9.4.4
Functional Testing



9.4.1.2
Space Control



9.4.1.4 & 9.4.1.5
Automatic Daylight Control

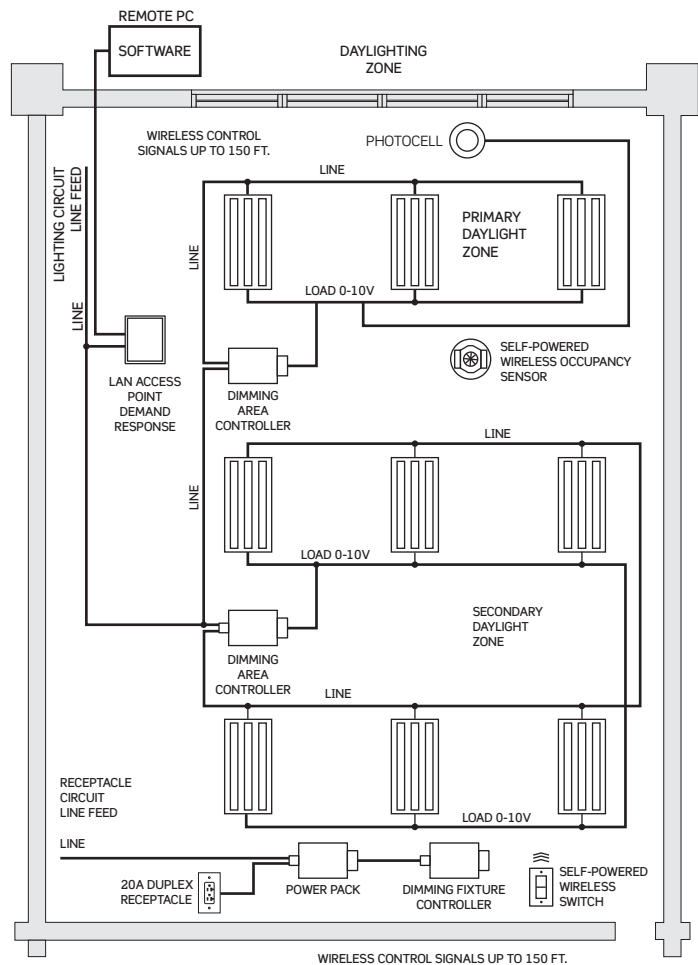

► Featured Leviton Control Solution

LevNet RF™ Energy Harvesting Wireless Solutions

Items You Will Need	Description	Cat. No.	Quantity
	Self-Powered Wireless Occupancy Sensor	WSC12-M9N	1
	Photocell	ODC0P-D0W	1
	Wireless 1-10V Dimming Fixture Controller	WSD05-9D0	2
	Wireless 1-10V Dimming Area Controller	WSD20-9D0	1
	Self-Powered Wireless Switch	WSS0S-S9W	1
	LAN Access Point	WSAP0-I9E	1
	OPP20 Super Duty Power Pack	OPP20-RD4	1
	Marked "Controlled" Receptacles	16352-1PW	5

Note: 50% of all receptacles in applicable spaces must be controlled by an occupancy sensor (or other qualifying control signal). See page 5 for more details.

College Commons and Library

IRC Control Solution

Features:

- 1-10V Dimming Control
- Vacancy or Occupancy Sensing with Auto-OFF
- Daylight Harvesting with Photocell Auto Calibration
- Decora® 4 Button Entry Station
- Daylighting Set Point Adjustment through Entry Station
- Plug Load Control with Power Pack
- Time Clock Input
- Demand Response
- HVAC & Emergency Interface
- Emergency Input

Meets the following ASHRAE 90.1 requirements:



8.4.2
Automatic Receptacle Control



9.4.1
Lighting Controls



9.4.1.1
Automatic Shutoff



9.4.4
Functional Testing



9.4.1.2
Space Control



9.4.1.4 & 9.4.1.5
Automatic Daylight Control

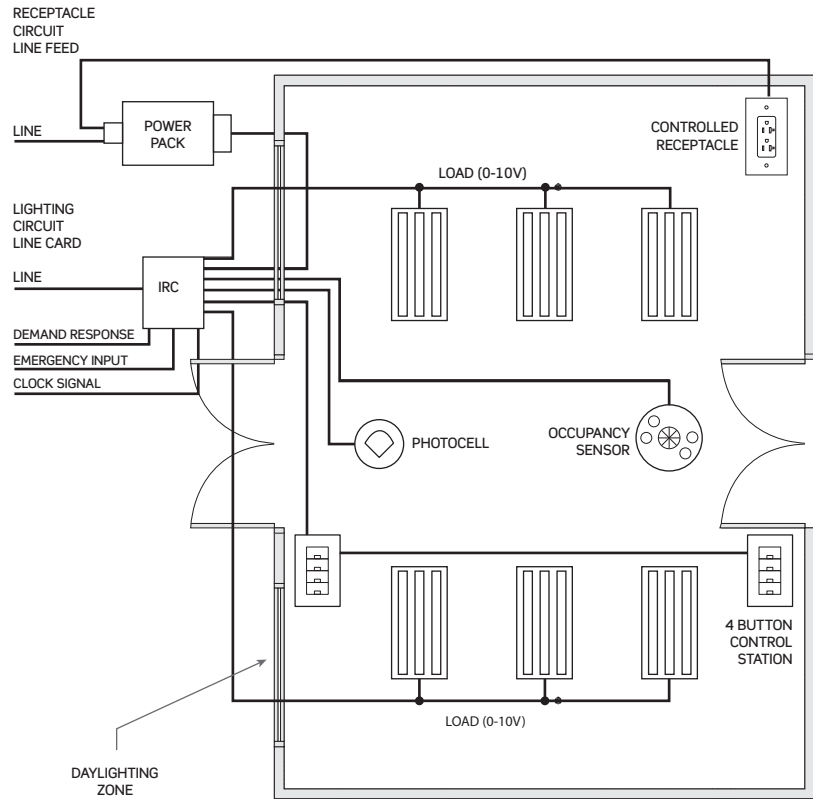

► Featured Leviton Control Solution

Integrated Room Control (IRC)

Items You Will Need	Description	Cat. No.	Quantity
	IRC Kit for 2 Zones, 2 Relays — Includes IRC, sensor, photocell and control station	RCD20-102 (RCD20-C02 — 347V)	1
	Integrated Room Control (IRC)	MZD20-xxx	1
	Ceiling Mount Multi-Tech Occupancy Sensor	OSC20-M0W	1
	Photocell	ODC0P-00W	1
	Lighting Control Station	RLVSW-4LW	2
	OPP20 Super Duty Power Pack	OPP20-OD2 (OSP15-R30 — 347V)	1
	Marked "Controlled" Receptacles	5362-2PW	5

Note: 50% of all receptacles in applicable spaces must be controlled by an occupancy sensor (or other qualifying control signal). See page 5 for more details.

Retail Space

Relay Control Solution

Features:

- Relay Control
- Separate Control for Display Lighting
- Vacancy or Occupancy Sensing with Auto-OFF
- Architectural 1-10V Dimming Entry Station
- Daylight Harvesting with Photocell
- Configuration Tree Setup
- Plug Load Control
- Astronomical Time Clock
- Scheduling (Behavior Control)
- Demand Response
- HVAC and Emergency Interface

Meets the following ASHRAE 90.1 requirements:



8.4.2
Automatic Receptacle Control



9.4.1.1
Automatic Shutoff



9.4.1.2
Space Control



9.4.1.6
Additional Control



9.4.1
Lighting Controls



9.4.4
Functional Testing



9.4.1.4 & 9.4.1.5
Automatic Daylight Control

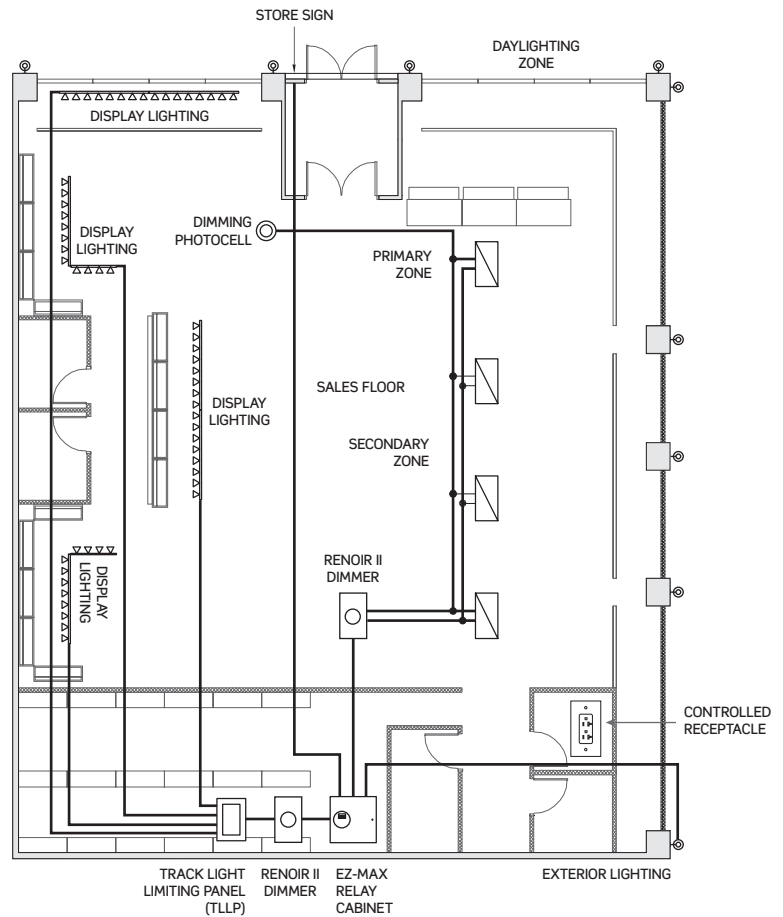

► Featured Leviton Control Solution

EZ-MAX® Plus Relay Control Panel — Renoir™ II Dimming — Track Light Limiting Panel

Items You Will Need	Description	Cat. No.	Quantity
	EZ-MAX Plus Relay Control Panel	R08BD-L08	1
	Track Light Limiting Panel Note: For part number information visit leviton.com	GXXXX-XXX	1
	Renoir II Wall Station Dimmer Note: The Renoir II Wall Station Dimmer is available in for all common load types, voltages and sink styles. Visit leviton.com/renoirii for a complete list of part numbers	XXXXX-XXW	2
	Photocell	ODC0P-00W	1
	Marked "Controlled" Receptacles	CR020-1PW	1

Note: 50% of all receptacles in applicable spaces must be controlled by an occupancy sensor (or other qualifying control signal). See page 5 for more details.

Stairwell

Integrated Room Control (IRC)

Features:

- Partial-OFF
- 1-10V Dimming Control
- Fail Safe Circuitry
- Vacancy or Occupancy Sensing with Auto-OFF
- Decora® 2 Button Entry Station
- Time Clock
- Demand Response
- Emergency Input

Meets the following ASHRAE 90.1 requirements:



9.4.1.1
Automatic Shutoff



9.4.1
Lighting Controls



9.4.1.2
Space Control



9.4.4
Functional Testing



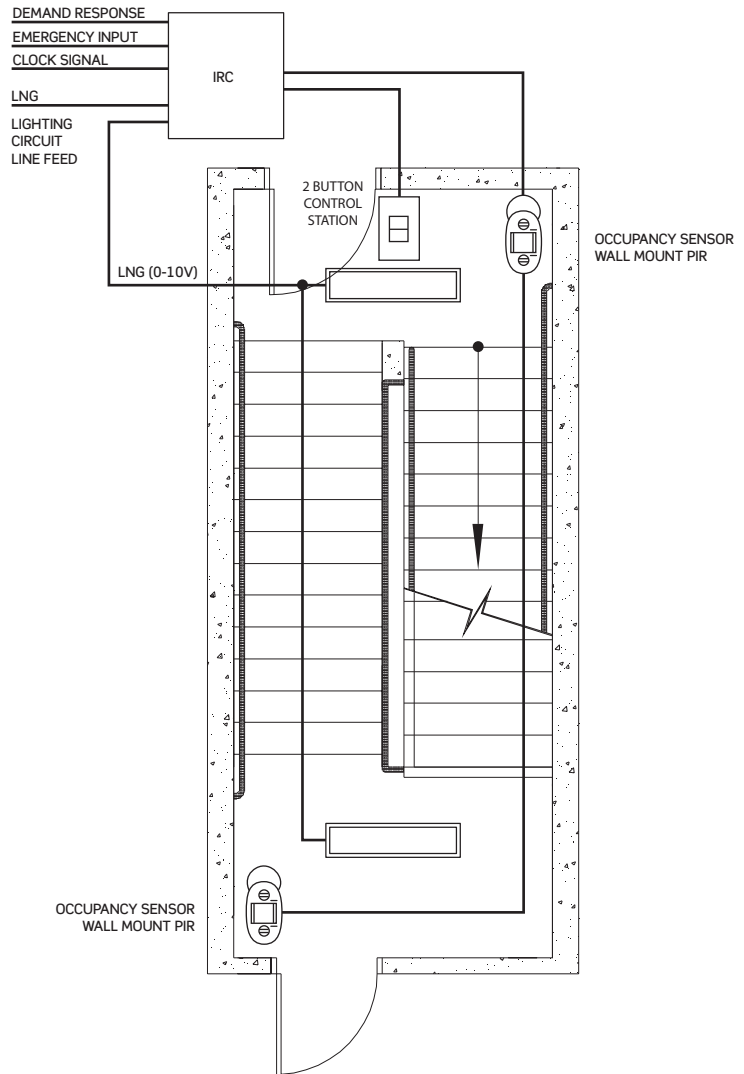

9.4.1.6
Additional Control



► Featured Leviton Control Solution

Integrated Room Control (IRC)

Items You Will Need	Description	Cat. No.	Quantity
	Integrated Room Control (IRC) Note: For part number information, visit leviton.com/irc	MZD20-xxx (MZD20-C02 — 347V)	1
	Lighting Control Station	RLVSW-2LW	1
	Wall Mount PIR Occupancy Sensor	OSWLR-RIW	2

Sidelit Walkway

Integrated Room Control (IRC)

Features:

- Partial-OFF
- 1-10V Dimming Control
- Vacancy or Occupancy Sensing with Auto-OFF
- Daylight Harvesting with Photocell Auto Calibration
- Decora® 4 Button Entry Station
- Daylighting Set Point Adjustment through Entry Station
- Plug Load Control with Power Pack
- Time Clock
- Demand Response
- Emergency Input

Meets the following ASHRAE 90.1 requirements:



9.4.1.1
Automatic Shutoff



9.4.1
Lighting Controls



9.4.1.2
Space Control



9.4.4
Functional Testing



9.4.1.4 & 9.4.1.5
Automatic Daylight Control

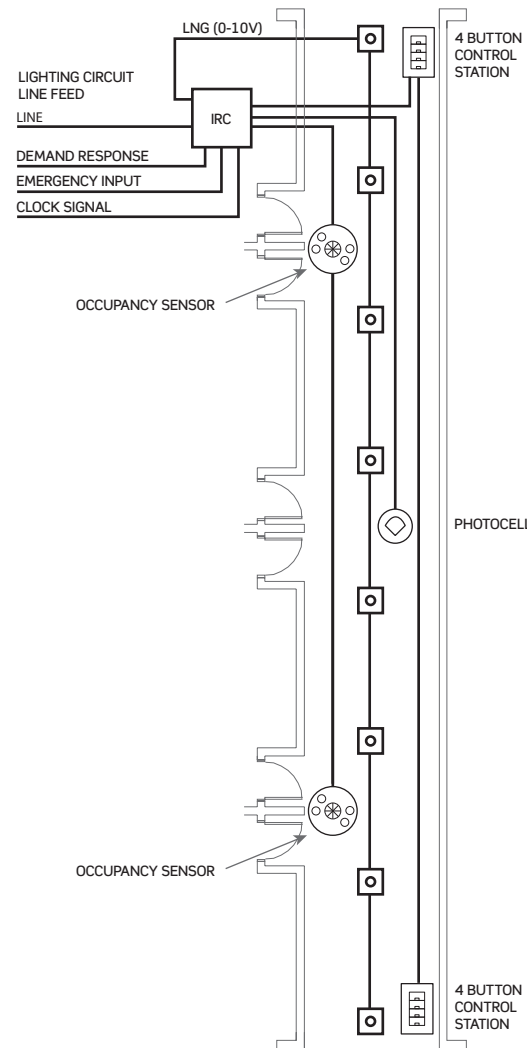

► Featured Leviton Control Solution

Integrated Room Control (IRC)

Items You Will Need	Description	Cat. No.	Quantity
	IRC Kit for 2 Zones, 2 Relays — Includes IRC, sensor, photocell and control station	RCD20-102 (RCD20-C02 — 347V)	1
	Integrated Room Control (IRC)	MZD20-xxx	1
	Ceiling Mount Multi-Tech Occupancy Sensor (1 included in kit, 1 additional required)	OSC20-M0W	2
	Photocell	ODC0P-00W	1
	Lighting Control Station (1 included in kit, 1 additional required)	RLVSW-4LW	2

Restroom

Provolt™ Self-Contained Occupancy Sensors

Features:

- Industry-exclusive self-contained design combines a line voltage occupancy sensor, power pack and photocell into a simple, single unit
- Eliminates separate power pack and occupancy sensor wiring for saving labor, time and materials
- Control Lights Auto-ON/Auto-OFF
- Ultrasonic (Active) Control

Meets the following ASHRAE 90.1 requirements:



9.4.1.1
Automatic Shutoff



9.4.1
Lighting Controls



9.4.4
Functional Testing

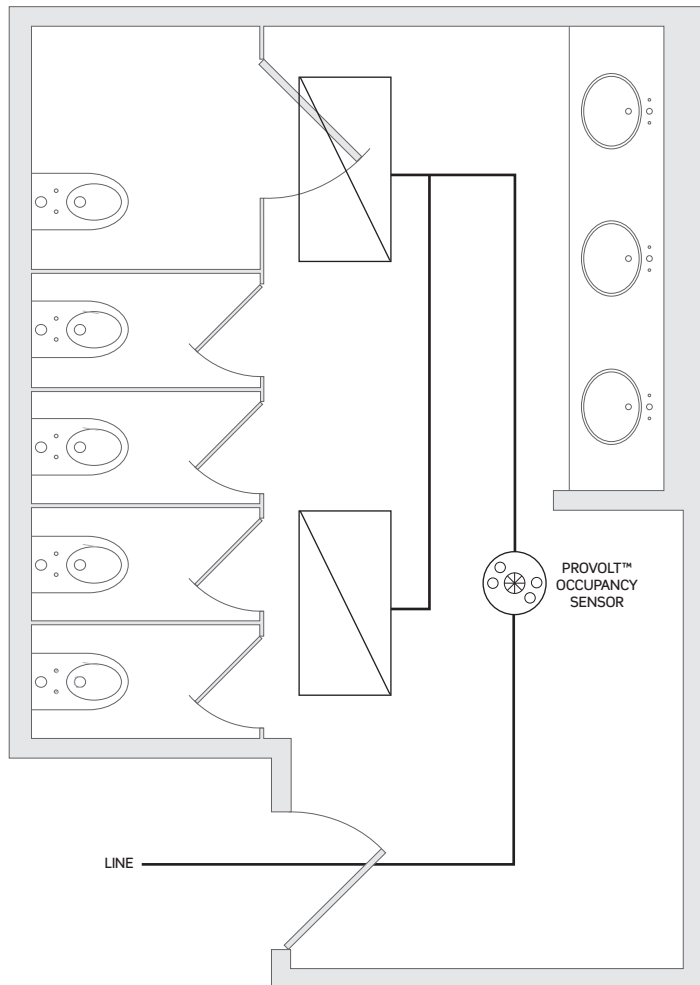

► Featured Leviton Control Solution

Provolt Self-Contained Occupancy Sensor

Items You Will Need	Description	Cat. No.	Quantity
	Provolt Self-Contained Ceiling Mount Line Voltage Ultrasonic Occupancy Sensor	OSC05-UDW	1

Warehouse

Relay Control Solution

Features:

- Relay Control
- Occupancy Sensing
- Daylight Harvesting
- Decora® 4 Button Entry Stations
- Software and Handheld Remote Programming
- Plug Load Control
- Astronomical Time Clock
- Scheduling (Behavior Control)
- Demand Response
- HVAC and Emergency Interface
- Building Automation (BACnet)
- Fail-Safe Circuitry (NFPA Compliant)
- Partial-OFF

Meets the following ASHRAE 90.1 requirements:



9.4.1.1
Automatic Shutoff



9.4.1
Lighting Controls



9.4.1.2
Space Control



9.4.4
Functional Testing



9.4.1.4 & 9.4.1.5
Automatic Daylight Control

► Featured Leviton Control Solution

GreenMAX® Relay Control System

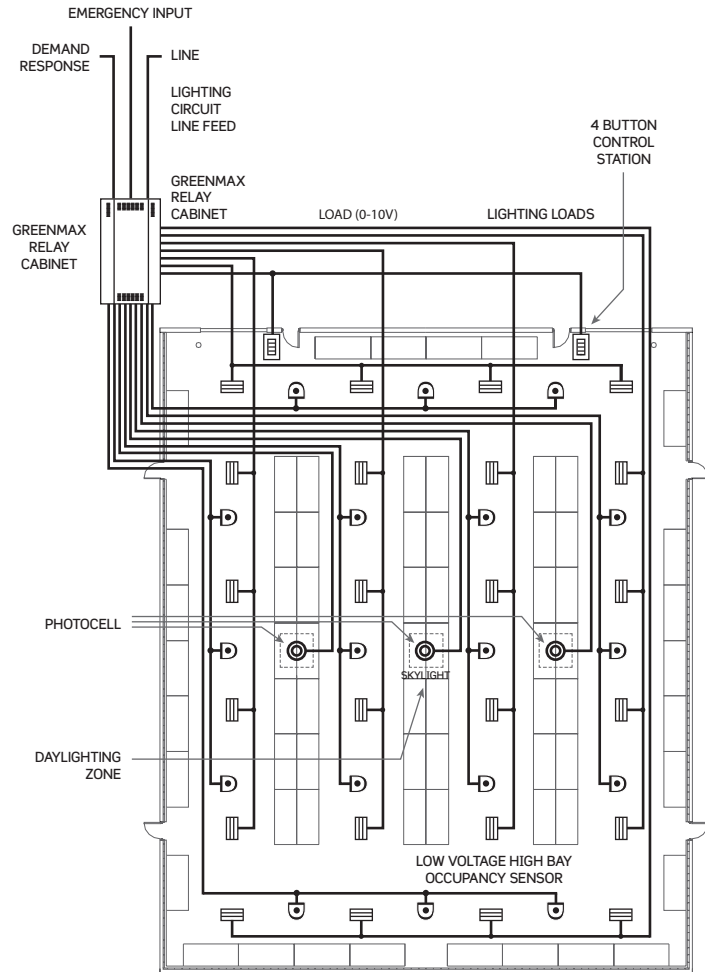

Items You Will Need	Description	Cat. No.	Quantity
	GreenMAX Relay Control Panel	R16TC-100	1
	GreenMAX Command Module	RPM16-316	1
	GreenMAX Relays Note: Latching relays available in standard and metering models—see data sheet for more information	RELAY-xxx	16
	GreenMAX Relay Insert Panel	R1616-1DS	1
	GreenMAX Handheld Display Unit	RHDU1-300	1
	Lighting Control Station	RLVSW-4LW	2
	Low Voltage High Bay Occupancy Sensor	OSFHD-xxW	18
	Photocell	ODCOP-xxW	3

Note: For Canadian 347V applications, include the RGACC-347 347V adapter. Speak to your Leviton representative for more details.

Parking Garage

Relay Control

Features:

- Occupancy Sensing
- Scheduling
- Daylight Harvesting
- Decora® 4 Button Entry Stations
- Software & Handheld Remote Programming
- Plug Load Control
- Astronomical Time Clock
- Scheduling (Behavior Control)
- Demand Response
- HVAC and Emergency Interface
- Building Automation (BACnet)
- Fail-Safe Circuitry (NFPA Compliant)
- Partial-OFF

Meets the following ASHRAE 90.1 requirements:



8.4.2
Automatic Receptacle Control



9.4.1
Lighting Controls



9.4.1.1
Automatic Shutoff



9.4.4
Functional Testing



9.4.1.2
Space Control



9.4.1.4 & 9.4.1.5
Automatic Daylight Control

► Featured Leviton Control Solution

GreenMAX® Relay Control System

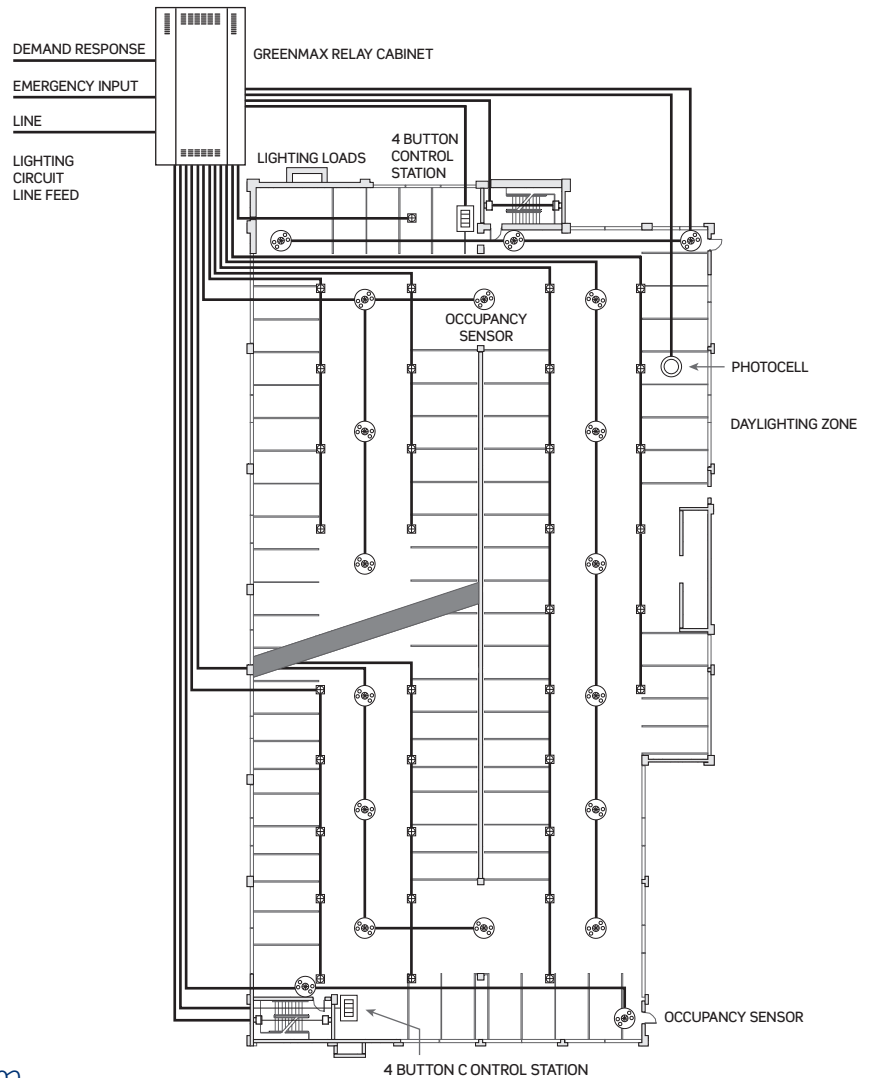

Items You Will Need	Description	Cat. No.	Quantity
	GreenMAX Relay Control Panel	R16TC-xxx	1
	GreenMAX Command Module	RPM16-316	1
	GreenMAX Relays Note: Latching relays available in standard and metering models—see data sheet for more information	RELAY-xxx	16
	GreenMAX Relay Insert Panel	R1616-1DS	1
	GreenMAX Handheld Display Unit	RH DU1-300	1
	Lighting Control Station	RLVSW-4LW	2
	Ceiling Mount Multi-Tech Occupancy Sensor	OSC20-RMW	19
	Photocell	ODC0P-0xW	1
	Marked "Controlled" Receptacles	CR020-1PW	5

Retail Parking Lot

Relay Control with Time Clock

Features:

- Smart Metering Integration
- Daylight Harvesting with Photocell
- Configuration Menu Setup
- Astronomical Time Clock
- Scheduling
- Demand Response
- Emergency Input

Meets the following ASHRAE 90.1 requirements:



9.4.1.2
Space Control



9.4.1.7
Exterior Lighting Control



9.4.1
Lighting Controls



9.4.4
Functional Testing

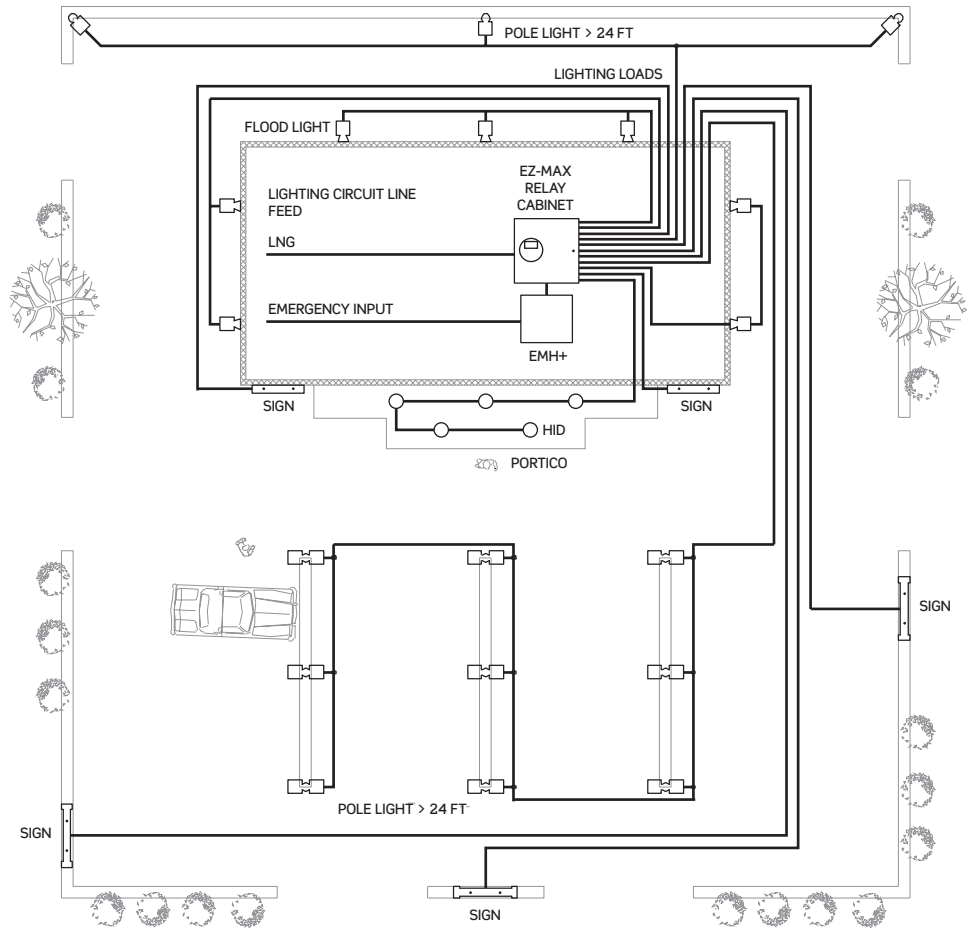

► Featured Leviton Control Solution
EZ-MAX® Plus Relay Control Panel

Items You Will Need	Description	Cat. No.	Quantity
	EMH+ All-in-One Meter and HUB	A8814-1S3	1
	EZ-MAX Plus Relay Control Panel Note: Can operate at 347V	R24BD-L24	1

Leviton Advantage Solutions

for ASHRAE Standard 90.1 2010 Compliance

Sensing Control

- Broadest range of sensors for any application
- Provolt™ integrates occupancy sensing, daylight harvesting, and manual-ON/auto-OFF override control in a single unit - no special control stations required
- Plug load control with OPP20 Super Duty Power Pack
- 24V AC/DC input for integration with HVAC/BAS systems
- Industry leading layout and application services



Renoir® II Commercial Architectural Wall Box Dimmers

- LED Ready
- Universal voltage — 120-277V, 60Hz
- Supports virtually all common load types without power extenders
- Multi-location dimming — up to 5-way dimming
- Low voltage dimming control for LEDs
- Patented Super-Silent Fan Control Technology (SST)



Sapphire™ Architectural Lighting Controls

- Modern touchscreen user interface integrates with multiple Leviton lighting control systems
- Online and offline configuration
- Supports multiple interfaces - LumaCAN®, Ethernet, A/V, HVAC, wireless (LevNet RF), and analog systems
- Software update through USB interface behind front panel



LevNet RF™ Energy Harvesting Wireless Solutions

- No wires to run and no batteries required - install in 1/4th the time, eliminating time and expense of control wiring
- Broad range of switches and control modules to meet virtually any control need
- Enables rapid retrofit with minimal impact



Integrated Room Control (IRC)

- Combines occupancy sensing, daylight harvesting, 0-10V dimming, partial-ON, partial-OFF, and demand response capabilities in a stand-alone package
- Kitted with factory configured sensor, photocell, and 4-button switch
- Autocal™ automatic photocell calibration and Ladderless Commissioning™
- Easy automatic closed or open loop multi-zone daylight harvesting control
- Auto 100 hour burn-in



EZ-MAX® Plus Stand-Alone Relay System

- Centralized building lighting control and daylight harvesting in a contractor-friendly, quick to install, simple to configure compact enclosure
- Low voltage inputs allow connection of photocells, occupancy sensors, low-voltage switches and digital switches for a comprehensive yet easily installed energy management solution
- Built-in astronomical time clock and scheduler
- Auto-detection and auto-assign of installed network switches



Track Light Limiting Panel (TLLP)

- Prevents overloaded circuits
- Provides tamper-proof current limiting protection for track lighting
- Sets a fixed power consumption limit for designer lighting installations by using the volt-ampere rating of the breaker instead of watts per linear feet
- Factory configured to customer specifications - arrives ready to install
- Reduces installation costs - no programming required



GreenMAX® Relay Control System

- Integrates common sensing, dimming, switching, and advanced daylight harvesting applications from the same cabinet
- BACnet IP native in each cabinet for seamless BMS integration
- Industry leading 25,000A Short Circuit Current Rating (SCCR) at 277V
- Integrated 0-10V dimming/switching relay
- Built-in override switch allows manual control of each load individually
- Programming is done with preset “Behaviors” via the industry-exclusive Handheld Display Unit (HDU)



Sector® Distributed Lighting Control System

- Topology-free, polarity-free distributed control
- Combines all lighting management functions into a single system with the fewest connection points, simplest installation, greatest flexibility and simple specification
- All components connect directly to the topology free 2-wire bus, not the ballast
- Relay controllers allow zone dimming and control for cost-effective system design



VerifEye™ Submetering Solutions

- Comprehensive line of submeters, communication products, and software solutions
- Simple installation in new or existing facilities
- Measurement & Verification (M&V) capabilities with data collection and storage
- Ideal for real-time energy monitoring and tenant billing
- Integrate with Building Management Systems (BMS) for energy efficiency and savings



Marked “Controlled” Receptacles

- Meets requirements for identifying receptacles that will be automatically be de-energized as part of an overall plug load control program
- 2014 NEC requires all 15A and 20A, 125V receptacles that are automatically controlled to be marked with a specific symbol (⏻)
- Ideal for new construction and renovation applications
- Available in back and side wired, side wired standard, tamper-resistant and Decora® versions



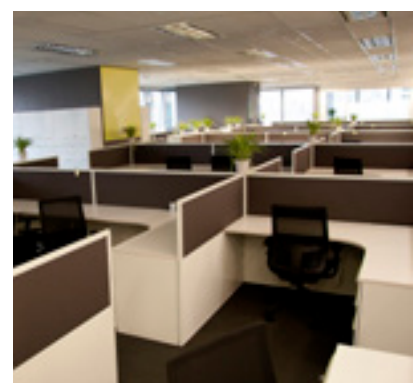
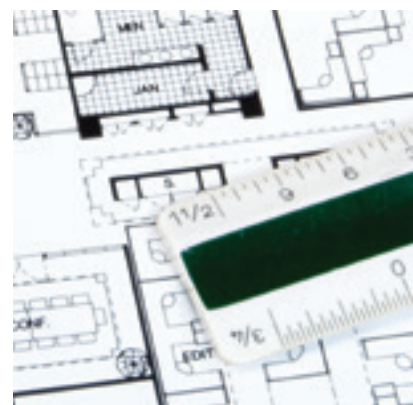
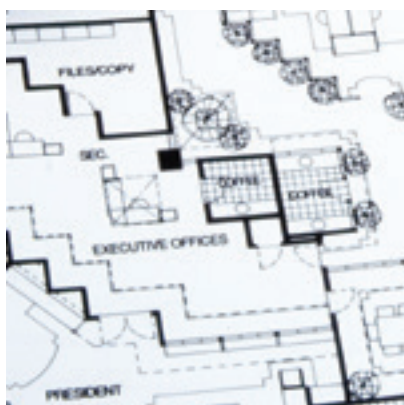
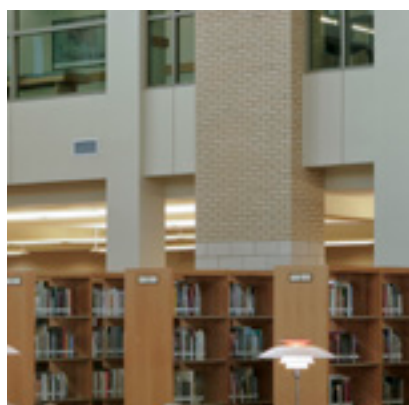
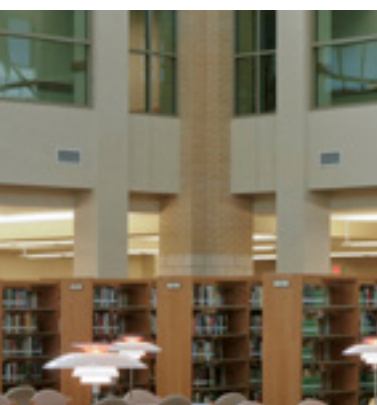
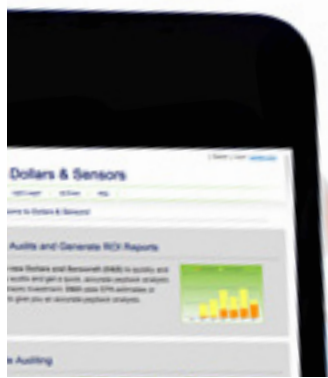

Service and Support During Every Step of the Process

There is much more to making lighting more energy efficient than just installing a simple device or two. System design, product selection, installation and service: it all has to come together. That's where Leviton service and support options come in. We'll help you design your system and make the right product selections so you can create a lighting control system that does exactly what you want it to do while saving electricity, meeting codes and standards, and even garnering rebates.

It all starts with the Leviton sales representative. Our lighting control specialists are here to support you every step of the way. They can perform on-site facility audits and suggest specific products and strategies for improving lighting energy efficiency.

Exclusive Wealth of Resources

- **Dollars & Sensors® Online Energy Audit Tool** — makes energy audits easier than ever — use your smart device (Android, Apple, Windows or Blackberry) to enter audit information and your desktop to generate ROI reports, analyses, Bill of Materials, and a submittal package — go to www.leviton.com/dollarsandsensors
- **Occupancy Sensor Layout Services** — have a team of experts create occupancy sensor layouts directly on your CAD drawings, complete with a List of Equipment at no cost — go to portal.leviton.com
- **LightLogger® Program** — get an accurate estimate of your energy-savings potential with this exclusive payback analysis tool — go to www.leviton.com/logger
- **ez-Learn™** — get Leviton smart from the comfort of your home or office with this exclusive 24/7 online training — go to www.leviton.com/ezlearn
- **ASAP Lighting Design Software** — point-and-click software allows you to quickly and simply design, specify and enter orders — go to www.leviton.com/asap
- Find more exclusive, no-cost design tools at www.leviton.com/lesdesign
- Lighting control specialists at your disposal
- Field service engineers for top-level support
- Factory commissioning service
- Dedicated technical support via phone at 1-800-959-6004

Leviton Manufacturing Co., Inc. Global Headquarters

201 North Service Road, Melville, NY 11747-3138

Telephone: 1-800-323-8920

Fax: 1-800-832-9538

Tech Line: (8:30am - 7:00pm E.T. Monday to Friday) 1-800-824-3005

Leviton Manufacturing of Canada, Ltd.

165 Hymus Boulevard, Pointe Claire, Quebec H9R 1E9

Telephone: 1-800-469-7890

Fax: 1-800-563-1853

Leviton S. de R.L. de C.V.

Lago Tana 43, Mexico DF, Mexico CP 11290

Telephone: (+52) 55-5082-1040

Fax: (+52) 55-5386-1797

Visit our website at www.leviton.com