

IRRIGATION PRODUCT CATALOG

 **Oldcastle**® Enclosure Solutions



UNDERSTANDING OUR PRODUCT BRANDS



CARSON®

A NAME YOU TRUST. DURABILITY YOU EXPECT.

Carson® high-density polyethylene (HDPE) enclosures deliver reliable, chemical and water resistant performance and install with ease. The Carson® brand offers a wide variety of sizes and is preferred and specified by industry professionals nationwide. You can depend on the trusted Carson® brand, delivering reliable hand holes, valve boxes, meter boxes and vaults for nearly 50 years.



CHRISTY®

RELIABLE AND COST-EFFECTIVE.

Christy® concrete enclosures deliver reliable, cost-effective performance. The Christy® brand offers a wide variety of sizes making it the preferred choice for many applications. You can depend on the trusted Christy® brand, delivering reliable hand holes, valve boxes, meter boxes and vaults to the utility market for over 40 years.



FIBRELYTE®

STRONG AND EASY TO HANDLE.

Fibrelyte® manufactured from an exclusive composite formulation of polyester resin, fiberglass and calcium carbonate yields lightweight, high strength enclosures. This proprietary composite material is stronger, easier to handle and much lighter than concrete, saving both time and money during installation, service work and transportation.



UNDERSTANDING OUR PRODUCT BRANDS



CARSON® HEAVYWALL

CUSTOMIZABLE AND AMR FRIENDLY.

Carson® Heavywall meter boxes are a lightweight alternative to concrete. Made using our Structural foam molding process and designed to exceed 20,000 lb. vertical load (20k); these boxes also providing the Best in Class lateral load rating of any plastic box on the market today. Extra wide shoulders beneath the lid seat as well as increased footer on the bottom provide the largest amount of anti-setting surface area of any meter box on the market today.



SYNERTECH®

EXCEPTIONAL STRENGTH AND DURABILITY.

Our SYNERTECH® brand of DUO MOLD® polymer boxes combine the exceptional strength and durability of High Density Polymer Concrete with the tough and lightweight qualities of Sheet Molding Compound to create exceptional equipment enclosures. Combining the two patented materials with a patented manufacturing process, our SYNERTECH® products represent the toughest and lightest underground enclosures on the market today. Sizes range from 11x18x12 to 36x60x72 with SCTE Tier 15 performance load rating.



H-SERIES™

DURABILITY DELIVERED THROUGH INNOVATION.

H-Series™ polymer concrete enclosures deliver strength and durability like traditional concrete, but at a fraction of the weight. The H-Series™ brand offers a broad range of sizes and configurations to meet your needs. These enclosures provide medium to heavy duty solutions for vaults, splice boxes and meter boxes ideal for any industry – municipal water, telecommunications, and other commercial and industrial applications.



SELECTING THE RIGHT PRODUCT AND ACCESSORIES

CHOOSE YOUR SIZE AND BRAND

A wide variety of sizes are offered in round, square, and rectangular configurations. Choose the size and brand that best fits your need.

KNOW YOUR REQUIRED PERFORMANCE LEVEL

Our bodies and lids are rated for performance. Look for the load rating that matches your project application.



SELECT A LID STYLE AND MARKING

Lids are available in a variety of materials and colors. Some are available with specialty markings, marking plates, and special locking options.

CHOOSE ACCESSORIES, HARDWARE, AND OTHER OPTIONS

Hardware & other additional items can be found for our enclosures in the back of this booklet.

PRODUCT AVAILABILITY

Oldcastle Enclosure Solutions divides products into two availability groups: Quick Ship and Made to Order.

The Oldcastle Enclosure Solutions Quick Ship Program is designed to provide customers with some of our most popular items quickly, supporting projects with tight schedules. Our Quick Ship items can be easily identified in this document by locating the items with this truck  next to them. Items that are identified as Quick Ship will be shipped from an Oldcastle facility within 3 business days.

Made to Order items are identified as all items that do not have the Quick Ship icon next to them. The lead time for these items can be obtained by reaching out to our customer service team.

ADDITIONAL INFORMATION

For Christy Brand and Fibrelyte Brand products, please see the latest Oldcastle Enclosure Solutions Christy Products Catalog.

For more detailed information on a product, see the individual specification sheet located in the Oldcastle Enclosure Solutions Catalog Binder or online at oldcastleenclosures.com

PERFORMANCE LEVEL AND LOAD RATINGS



LIGHT DUTY: PEDESTRIAN / GREENBELT APPLICATIONS

Pedestrian	-	-	300 lb/ft	-	ASTM C 857	A-0.3
Pedestrian	-	-	-	3000 lbf	ANSI/SCTE 77	Light Duty, Pedestrian
Pedestrian	-	-	850 lb	2200 lb	Telcordia GR-902	Greenway
Passenger Vehicle	6000	2400	2000lbf	4340 lbf	WUC, Guide 3.6	Ped.Greenway

MEDIUM DUTY: ANSI/SCTE TIER 5, 8, AND 15

Light Duty Truck up to Class 3	1400	5600	5000	7500	ANSI/SCTE 77	Tier 5
			8000	12000	Telcordia GR-902	Tier 8
			3900	10400		Pedestrian/Light Duty Incidental
Medium Duty Truck up to Class 5	19500	7800	7800	20800	Telcordia GR-902	Non-Continuous Traffic
			8000	17360	ASTM C 857	A-8
			8000	17360	WUC, Guide 3.6	Non-Continuous Traffic
Medium Duty Truck up to Class 7	33000	13200	15000	22500	ANSI/SCTE 77	Tier 15

HEAVY DUTY: ANSI/SCTE TIER 22

Heavy Duty Truck up to Class 8	40000	16000	16000	34720	ASTM C 857	A-16
			22500	33750	ANSI/SCTE 77	Tier 22
			16000	16000	WUC, Guide 3.6	In shoulder or parking area outside traffic lane

TRAFFIC RATED: AASHTO H20*

Vehicles up to Class 8	40000	16000	16000	34720	ASTM C 857	A-16
------------------------	-------	-------	-------	-------	------------	------

**Units must include a steel frame and steel cover.*

Load Ratings are determined by the lowest component rating

The Rural Utility Service (RUS) is a department of the US Department of Agriculture organized to facilitate rural developments. You will find Oldcastle Enclosure Solutions brand Enclosures listed by the RUS. Please reference brand specific product data sheets for additional clarifications. All Oldcastle Enclosure Solutions brand Enclosures conform to the RUS "Tamper Resistant" fastener design for buried pedestals found listed by code and group.

The "Test Load" term is used in ANSI/SCTE 77-2010 to designate the minimum load that an Enclosure must be able to sustain to qualify for a particular performance rating. The term is synonymous with (minimum) Failure Load. It should be noted that within the ANSI/SCTE 77-2010 specification, the "Test Load" is 1.5 x the Design Load. Some specification and Operating Companies select a higher multiple or Safety Factor for Proof of Design Load.

PRODUCT MATRIX BY BRAND

Select the appropriate size and shape for your application from our list of available products in each brand.

Brand	Material	Model	Size (LxW)	Shape	Wall Type	Depths	Design Load	Rating				
CARSON®	HDPE	510	5" Dia	○	Flared ▤	9"	300 lb/ft²	Ped				
		708	6" Dia	○		9"						
		809	7" Dia	○		9"						
		0011	10" Dia	○		10"						
		910	10" Dia	○		10" 18" 20" 36"						
		2200	12" Dia	○		15" 18" 21" 30" 36"						
		1012	10" x 12"	□		6" 10" 16"						
		1015	10" x 15"	□		6" 12"						
		1220	12" x 20"	□		6" 12" 18" 24"						
		1324	13" x 24"	□		12" 15" 24" 30"						
		1419	14" x 19"	□		6" 12" 24"						
		0012	14" x 20"	□		6" 12" 18"						
		1730	17" x 30"	□		12" 15" 18" 24" 36" 48"						
		2436	24" x 36"	□		18" 24" 30" 36" 42" 48" *						
CHRISTY®	Concrete	F08	8" Dia	○	Straight	12"	300 lb/ft²	Ped				
		B03	9" x 14"	□		12"						
		B09	10" x 15"	□		12" 24" 36" 48" 60"						
		B12	12" x 18"	□		12" 24" 36" 48" 60"						
		B16	11" x 21"	□		12" 24" 36" 48" 60"						
		B24	18" x 19"	□		12" 24" 36" 48" 60"						
		N30	13" x 24"	□		12"						
		N36	17" x 30"	□		12"						
		N40	22" x 35"	□		12" 24" 36" 48" 60"						
B65	15" x 27"	□	12" 24" 36" 48" 60"									
CARSON®	HDPE Hybrid	1324	13" x 24"	□	Flared ▤	12" 14" 15" 17"	8,000 lbf	Tier 8				
		1730	17" x 30"	□		12" 15" 18" 24" 36"						
		2424	24" x 24"	□		18" 24" 30" 36" 42" 48" *						
		2436	24" x 36"	□		18" 24" 30" 36" 42" 48" *						
		2448	24" x 48"	□		18" 24" 30" 36" 42" 48" *						
		2460	24" x 60"	□		18" 24" 30" 36" 42" 48" *						
		3636	36" x 36"	□		18" 24" 30" 36" 42" 48" *						
		3648	36" x 48"	□		18" 24" 30" 36" 42" 48" *						
3660	36" x 60"	□	18" 24" 30" 36" 42" 48" *									
FIBRELYTE®	Composite	FL08	9" Dia	○	Straight	12" 18" 20" 24" 30"	8,000 lbf	Tier 8				
		FL09	10" x 15"	□	Flared ▤	12"						
		FL12	11" x 18"	□	Straight	12"						
		FL30	13" x 24"	□	Flared ▤	12" 18" 20" 24"						
		FL36	17" x 30"	□	Flared ▤	12" 18" 20" 24"						
DURAVULT FRP	Fiberglass Reinforced Polymer w/ Polymer Concrete Ring	1118	11" x 18"	□	Straight	12" 18"	Medium Duty	Tier 15				
		1324	13" x 24"	□	Straight/Flared ▤	12" 18" 24"						
		1419	14" x 19"	□	Flared ▤	18" 24"						
		1730	17" x 30"	□	Straight/Flared ▤	12" 18" 24"						
		2424	24" x 24"	□	Straight	24"						
		2436	24" x 36"	□	Straight/Flared ▤	18" 24" 30" 36" 48"						
		3048	30" x 48"	□	Straight/Flared ▤	18" 24" 30" 36" 48"						
		3060	30" x 60"	□	Straight	30" 36"						
		3660	36" x 60"	□		24" 30" 36"						
		4872	48" x 72"	□		36" 48"						
		4896	48" x 96"	□		48"						
		1000	10" Dia	○	Flared ▤	18"			Medium Duty	Tier 15		
		1800	18" Dia	○		36" 48"						
		2200	22" Dia	○		30"					Lt/Med Duty	T8 / T15
		2400	24" Dia	○		36"					Medium Duty	Tier 15
		2700	27" Dia	○		36" 48"					Lt/Med Duty	T8 / T15
		3900	39" Dia	○		24" 36" 48" 72"					Medium Duty	Tier 15
		4000	40" Dia	○		48"						
		5400	54" Dia	○	Straight	36" 46"						

Blue - Stacked Body Units (Stacked body units are currently not rated.) Orange - Extension Units

*Models can be increased by 6" to a height you desire. **Tier 15 Design Load: 15,000 lbf Tier 22 Design Load: 22,500 lbf

PRODUCT MATRIX BY BRAND

Select the appropriate size and shape for your application from our list of available products in each brand.

Brand	Material	Model	Size (LxW)	Shape	Wall Type	Depths	Design Load	Rating
SYNERTECH®	Composite	Duo 11x18	11" x 18"	□	Straight	12" 18" 24" 30" 36"	15,000 lbf	Tier 15
		Duo 12x12	12" x 12"	□		12" 18" 24" 30" 36"		
		Duo 13x24	13" x 24"	□		12" 18" 24" 30" 36" 42"		
		Duo 17x30	17" x 30"	□		12" 18" 24" 30" 36" 42"		
		Duo 24x36	24" x 36"	□		18" 24" 36" 42" 48" 60"	22,500 lbf	Tier 22
		Duo 30x48	30" x 48"	□		18" 24" 36" 42" 48" 60"		
		Duo 36x60	36" x 60"	□		24" 36" 48" 60" 72"		
H-SERIES™	Polymer	910	9" Dia	○	Flared ▽	10"	**	T15 / 22
		1118	11" x 18"	□	Straight	12" 18" 24"		
		1212	12" x 12"	□		12" 24" 36"	8,000	T8
		1324	13" x 24"	□	Straight/Flared ▽	12" 15" 18" 24" 30"	**	T15 / 22
		1730	17" x 30"	□	Straight/Flared ▽	12" 18" 24" 30" 36"	**	T15 / 22
		2424	24" x 24"	□	Straight	24" 36" 48" 60"	**	Tier 15 / 22
		2436	24" x 36"	□		18" 24" 36" 42"		
		3048	30" x 48"	□		18" 24" 36" 42" 48"		
		3060	30" x 60"	□		24" 30" 36" 48"		
		3636	36" x 36"	□		36" 48" 72" 84" 96"		
4848	48" x 48"	□		36" 48" 72" 84" 96"				
CHRISTY®	Concrete	G03	10" Dia	○	Straight	12"	16,000 lbf	N/A
		G04	11" Tri	○		12"		
		G05	11" Dia	○		12" 24" 36"		
		G08	11" Dia	○		12" 24" 36"		
		G12	13" Dia	○		12"		
		B1017	10" x 17"	□		12" 24" 36"		
		B1324	13" x 24"	□		12" 24" 36"		
		B1730	17" x 30"	□		12" 24" 36"		
		B2436	24" x 36"	□		12" 24" 36"		
B3048	30" x 48"	□	12" 24" 36"					

Blue - Stacked Body Units (Stacked body units are currently not rated.) Orange - Extension Units

*Models can be increased by 6" to a height you desire. **Tier 15 Design Load: 15,000 lbf Tier 22 Design Load: 22,500 lbf

LID STYLE AND MARKINGS

HDPE



CONCRETE



COMPOSITE



POLYMER



STEEL



STANDARD MARKINGS

Lids are available with standard markings:

Blank/No Mark

Reclaimed Water Do Not Drink

Irrigation Control Valve

Water

Electric



MARKING PLATE

4" x 8" Plate

Standard markings include two lines of one inch text with a max of thirteen characters per line.

Custom markings are available.

Contact Customer Service for detailed information.

SECURITY, HARDWARE, AND ACCESSORIES

Enclosures come equipped with standard lid fastening hardware (varies per box type). Standard assembly is shown below.



🔒 STANDARD HEX HEAD:
3/8 - 1/2 Stainless Steel Hex Head Bolt with Washer

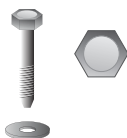

🔒🔒 DROP-N-LOCK™:
Automatic locking system (available on select HDPE covers only)



🔒🔒 STANDARD PENTA HEAD:
3/8 - 1/2 Stainless Penta Head Bolt with Washer

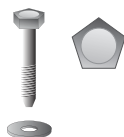

🔒🔒🔒 PADLOCK & EYE:
Eye bolt and padlock (available on steel covers only)

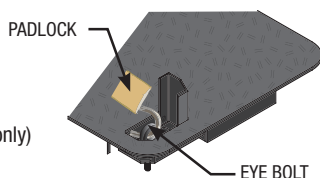

🔒🔒🔒 VANDAL PROOF:
Oldcastle Enclosures Vandal Proof bolt with specialty key.



Security Level

Typical Tool

🔒 Low	Fingers, Car Key, Pen Knife
🔒🔒 Medium	Screwdriver, Hammer, Hacksaw, Pliers
🔒🔒🔒 High	Power Tools, Crowbar, Wedge, Hammer
🔒🔒🔒🔒 Extreme	Sledge Hammer, Disc Grinder, Bolt Cutter

A. Rack Mount

B. Cable Racks/ Cable Arms

C. Unistrut

D. Pulling Eye - 1,000 lb. and 3,000 lb

E. Electronic Marker

F. Ground Buss

G. Mouseholes / Circular Holes

H. Dividers

I. Solid Bottom (H-Series and Synertech)

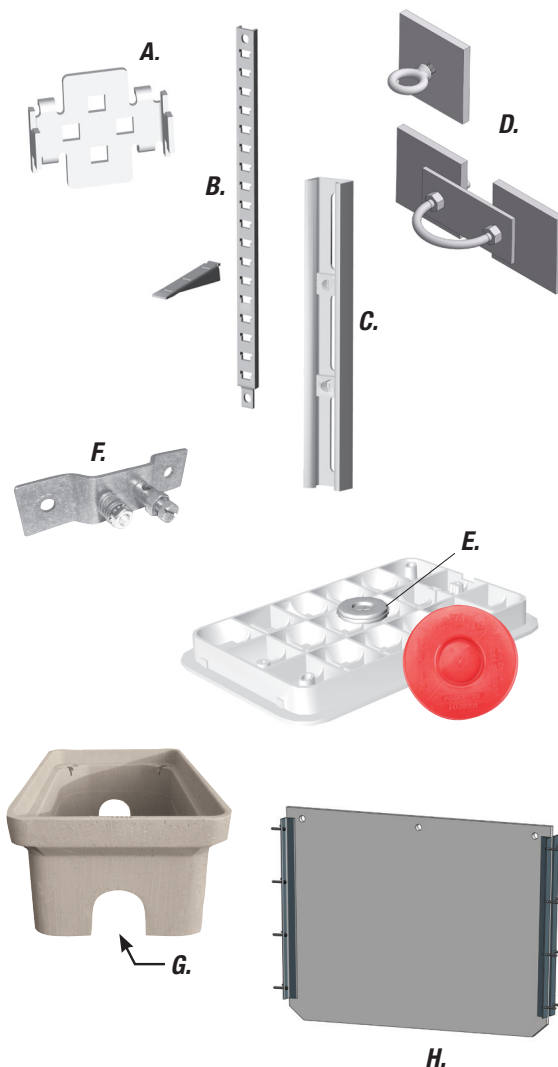

UNDERSTANDING OUR PRODUCT GUIDE

CARSON PRODUCTS: SKU FORMAT AND DESCRIPTION FORMAT

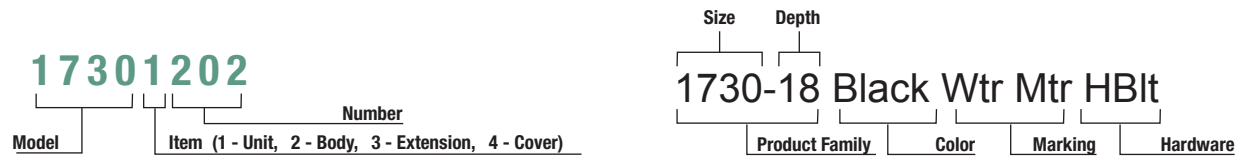

H-SERIES & SYNERTECH: DESCRIPTION FORMAT

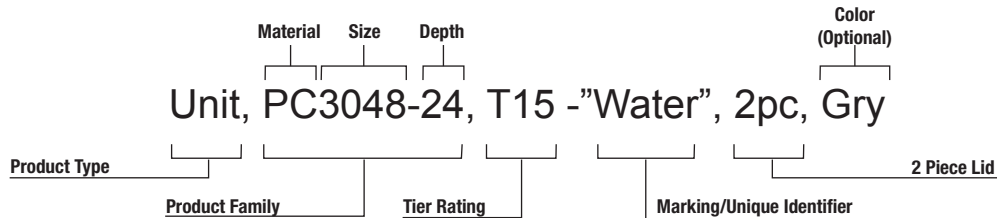

CARSON ABBREVIATIONS

Abbreviation	Description	Refers to:
HP	HDPE Body Polymer Ring & Cover	Product Material
HPC	Plastic Body Polymer Concrete Cover	
HLPC	Plastic Body Light Weight Polymer Concrete Cover	
PC	Polymer Concrete	
PPC	Polymer Concrete Body Polymer Concrete Cover	
PSC	Polymer Concrete Body Steel Cover	Product Color
Blk	Black	
Blk-Grn	Black Body Green Cover	
Grn	Green	
Gry	Gray	
Pur	Purple	
Tan	Tan	Marking
Blank	Blank	
Elec	Electric	
ICV	Irrigation Control Valve	
Swr	Sewer	
Wtr	Water	
Wtr Mtr	Water Meter	
RW	Reclaimed Water	
RWDND ES	Reclaimed Water Do Not Drink English & Spanish	

Abbreviation	Description	Refers to:
CHBlt	Captive Hex Bolt	Hardware Type
CLPnta	Captive Large Penta Bolt	
Cpnta	Captive Penta Bolt	
Dlock	Dallas Lock	
Flick	Fargo Lock	
FtnNut	Floating Nut	
HBlt	Hex Bolt	
Hnut	Hex Nut	
Bnut	Brass Nut	
LBlt	L Bolt	
Lpnta	Large Penta Bolt	Cover Type/Options
CI T Cover	Cast Iron T Cover	
Cast Iron Rdr	Cast Iron Reader	
Fish Cvr	Flush Cover	
Plastic Rdr	Plastic Reader	
Plt Mkr	Plate Marker	
Rnd Plt	Round Plate	
T Cov	T Cover	
EMS	E Marker	
TRH	Touch Read Hole	
MsHl	Mouse Hole	

H-SERIES ABBREVIATIONS

Abbreviation	Description	Refers to:
D	Drop In Lid	Lids
T	Bolt Down Lid	
FW	Flared Wall Body	Bodies
SW	Straight Wall Body	

LINE ITEM DISCOUNT CHART

Line Item Discount	Product Group	Line Item Discount	Product Group
OC01	Concrete	OC07	MD - SMC/HY
OC02	Drainage	OC08	Other
OC03	HD - Polymer	OC09	Resale
OC04	Heavy Wall	OC10	Synertech
OC06	LD - Plastic	OC11	Fibrelyte
		OC12	HVAC



HosEnclose™ Underground Garden Hose Storage System offers quick, convenient access to water and garden hose in a variety of settings. Handy near potted plants & flower beds for daily watering, hardscapes & patios for occasional cleaning, and driveways for washing vehicles. Easily installs in landscapes and wood patio decks.



ENCLOSURE:

Molded structural foam HDPE are rigid, strong, and durable. Tapered box design ideal for both turf and deck installations.

HOSE:

Fifty-foot commercial-grade polyurethane hose coils neatly inside the enclosure.

NOZZLE:

High-quality brass “Fire Hose” nozzle allows for simple flow adjustment; resists breakage if dropped.

LID:

Hinged with recessed handle for easy access. Strong enough to withstand pedestrian and light incidental traffic when closed.

BUILT-IN-PLUMBING:

Quarter-turn (on or off) ball shut-off valve conveniently located inside the enclosure for easy access. Internal 3/4” PVC union connects easily to the water line.

FLOOR:

Molded polyethylene floor allows for excess water drainage and discourages pests from nesting inside.

WARRANTY:

Limited One-Year Warranty on enclosure & hinged lid. Limited Six-Month Warranty on garden hose, nozzle, and internal plumbing components.

BUILDING CODES:

Installer must ensure all safety rules and applicable national & local building codes are observed during installation. Most existing irrigation systems include a backflow prevention device; however, for those that do not or for new systems, the Uniform Plumbing Code recommends installation of a backflow prevention device.

LANDSCAPE EDGE™ AND PAVER FRAME™



Landscape Edge

Define space in your lawn and garden with a crisp clean edge. Installation is easy and requires no digging. Will conform easily to virtually any shape to keep mulch, stone and landscape fabric in place.



Paver Frame

Makes any paver installation look like a professional installation. Designed for quick and easy installation, it secures your hardscapes while protecting its outer edges. Limits intrusion of other ground cover and prevents paver discoloration from direct contact with mulch.



Oldcastle® Spikes

Secure Landscape Edge and Paver Frame sections with these durable spikes. The glass-filled nylon design will not rust while withstanding exposure to extreme weather. Oldcastle Spikes are strong enough to nail through a 2x4 wood board.

CARSON 0510



LIGHT DUTY
PEDESTRIAN / GREENBELT



HDPE
5" DIAMETER

Rating	Part #	Desc 1	Desc 2	Color	Depth	Item Weight	Pallet Qty	Line Item Discount	Design Load	Quick Ship
Unit - 0510 ResCom										
Ped	05101001	510-09 Black Blank	2 MsHI T Cover	Black	9	1.2	500	OC06	300 lb/ft2	
Body - 0510 ResCom										
Ped	05102001	510-09 Body Black 2 MsHI	-	Black	9	0.9	500	OC06	300 lb/ft2	
Lid - 0510 ResCom										
Ped	05104001	510 T Cover Black Blank	-	Black	-	0.4	1200	OC06	300 lb/ft2	

CARSON 1012



LIGHT DUTY
PEDESTRIAN / GREENBELT

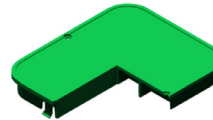

HDPE
10" X 12"

Rating	Part #	Desc 1	Desc 2	Color	Depth	Item Weight	Pallet Qty	Line Item Discount	Design Load	Quick Ship
Unit - 1012 ResCom										
Ped	10121001	1012-6x Blk-Grn ICV	0 MsHI T Cover	Blk-Grn	6	3.3	84	OC06	300 lb/ft2	
Ped	10121002	1012-10 Blk-Grn ICV	2 MsHI T Cover	Blk-Grn	10	4.9	120	OC06	300 lb/ft2	
Body - 1012 ResCom										
Ped	10122001	1012-10 Body Black 2 MsHI	-	Black	10	3.2	120	OC06	300 lb/ft2	
Extension - 1012 ResCom										
Ped	10123001	1012-6 Ext Black	-	Black	6	1.7	240	OC06	300 lb/ft2	
Lid - 1012 ResCom										
Ped	10124001	1012 T Cover Green ICV	-	Green	-	1.6	240	OC06	300 lb/ft2	



**LIGHT DUTY
PEDESTRIAN / GREENBELT**

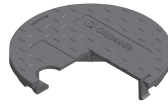

Snap-On

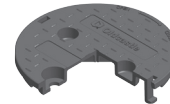

Twist-On
Accommodates
Optional Bolt Down

Rating	Part #	Desc 1	Desc 2	Color	Depth	Item Weight	Pallet Qty	Line Item Discount	Design Load	Quick Ship
Unit - 0708 TrussT with TWIST-ON LID (accommodates optional bolt)										
Ped	07081101	708-09 Unit Green "ICV"	2MsHI TWL 216	Green	9	1.2	540	OC06	300 lb/ft2	
Ped	07081102	708-09 Unit Blk-Grn "ICV"	2 MsHI TWL 216	Blk-Grn	9	1.2	540	OC06	300 lb/ft2	
Ped	07081105	708-09 Unit Black/Green "NO MARK"	2MsHI TWL 000	Blk-Grn	9	1.2	540	OC06	300 lb/ft2	
Ped	07081106	708-09 Unit Black "ICV"	2MsHI TWL 216	Black	9	1.2	540	OC06	300 lb/ft2	
Ped	07081107	708-09 Unit Tan "ICV"	2MsHI TWL 216	Tan	9	1.2	540	OC06	300 lb/ft2	
Ped	07081108	708-09 Unit Purple "RECLAIMED WATER"	2MsHI TWL 037	Purple	9	1.2	540	OC06	300 lb/ft2	
Ped	07081110	708-09 Unit Green "NO MARK"	2MsHI TWL 000	Green	9	1.2	540	OC06	300 lb/ft2	
Ped	07081123	708-09 Unit Tan "NO MARK"	2MsHI TWL 000	Tan	9	1.2	540	OC06	300 lb/ft2	
Unit - 0708 TrussT with SNAP-ON LID										
Ped	07081131	708-09 Unit Green "ICV"	2MsHI SNP 216	Green	9	1.2	540	OC06	300 lb/ft2	
Ped	07081132	708-09 Unit Blk-Grn "ICV"	2 MsHI SNP 216	Blk-Grn	9	1.2	540	OC06	300 lb/ft2	
Ped	07081135	708-09 Unit Black/Green "NO MARK"	2MsHI SNP 000	Blk-Grn	9	1.2	540	OC06	300 lb/ft2	
Ped	07081136	708-09 Unit Black "ICV"	2MsHI SNP 216	Black	9	1.2	540	OC06	300 lb/ft2	
Ped	07081137	708-09 Unit Tan "ICV"	2MsHI SNP 216	Tan	9	1.2	540	OC06	300 lb/ft2	
Ped	07081138	708-09 Unit Purple "RECLAIMED WATER"	2MsHI SNP 037	Purple	9	1.2	540	OC06	300 lb/ft2	
Ped	07081140	708-09 Unit Green "NO MARK"	2MsHI SNP 000	Green	9	1.2	540	OC06	300 lb/ft2	
Ped	07081143	708-09 Unit Tan "NO MARK"	2MsHI SNP 000	Tan	9	1.2	540	OC06	300 lb/ft2	
Body - 0708 TrussT features removable bolt provision										
Ped	07082101	708-09 Body Black	2MsHI	Black	9	1.0	540	OC06	300 lb/ft2	
Ped	07082102	708-09 Body Tan	2MsHI	Tan	9	1.0	540	OC06	300 lb/ft2	
Ped	07082103	708-09 Body Purple	2MsHI	Purple	9	1.0	540	OC06	300 lb/ft2	
Ped	07082105	708-09 Body Green	2MsHI	Green	9	1.0	540	OC06	300 lb/ft2	
Ped	07084146	708 T Cover Green Sewer	Snap Lock	Green	-	0.2	600	OC06	300 lb/ft2	
Ped	07084139	708 T Cover Purple RW	Snap Lock	Purple	-	0.2	600	OC06	300 lb/ft2	
Lid - 0708 TrussT Twist-On Style (accommodates optional bolt)										
Ped	07084119	708 T Cover PUR "RECLAIMED WATER"	TWL 037	Purple	-	0.2	600	OC06	300 lb/ft2	
Ped	07084120	708 T Cover Tan "NO MARK"	TWL 000	Tan	-	0.2	600	OC06	300 lb/ft2	
Ped	07084121	708 T Cover Tan "ICV"	TWL 216	Tan	-	0.2	600	OC06	300 lb/ft2	
Ped	07084123	708 T Cover Black "NO MARK"	TWL 000	Black	-	0.2	600	OC06	300 lb/ft2	
Ped	07084124	708 T Cover Black "ICV"	TWL 216	Black	-	0.2	600	OC06	300 lb/ft2	
Ped	07084125	708 T Cover Green "NO MARK"	TWL 000	Green	-	0.2	600	OC06	300 lb/ft2	
Ped	07084128	708 T Cover Green "ICV"	TWL 216	Green	-	0.2	600	OC06	300 lb/ft2	
Lid - 0708 TrussT Snap-On Style										
Ped	07084139	708 T Cover Purple "RECLAIMED WATER"	SNP 037	Purple	-	0.2	600	OC06	300 lb/ft2	
Ped	07084140	708 T Cover Tan "NO MARK"	SNP 000	Tan	-	0.2	600	OC06	300 lb/ft2	
Ped	07084141	708 T Cover Tan "ICV"	SNP 216	Tan	-	0.2	600	OC06	300 lb/ft2	
Ped	07084143	708 T Cover Black "NO MARK"	SNP 000	Black	-	0.2	600	OC06	300 lb/ft2	
Ped	07084144	708 T Cover Black "ICV "	SNP 216	Black	-	0.2	600	OC06	300 lb/ft2	
Ped	07084145	708 T Cover Green "NO MARK"	SNP 000	Green	-	0.2	600	OC06	300 lb/ft2	
Ped	07084148	708 T Cover Green "ICV"	SNP 216	Green	-	0.2	600	OC06	300 lb/ft2	

*Products are rated by the lowest component rating. A tier 15 cover with a tier 22 body is rated tier 15. A tier 22 cover with a tier 22 body is rated tier 22.

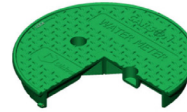
**LIGHT DUTY
PEDESTRIAN / GREENBELT**

Rating	Part #	Desc 1	Desc 2	Color	Depth	Item Weight	Pallet Qty	Line Item Discount	Design Load	Quick Ship
Unit - 0011 TrussT										
Ped	00111011	011-10 Green ICV	2 MsHI T Cover Twist-Lock	Green	10	2.8	120	OC06	300 lb/ft2	
Ped	00111012	011-10 Blk-Grn ICV	2 MsHI T Cover Twist-Lock	Blk-Grn	10	2.8	120	OC06	300 lb/ft2	
Ped	00111015	011-10 Purple RWDNDES	2 MsHI T Cover Twist-Lock	Purple	10	2.8	120	OC06	300 lb/ft2	
Body - 0011 TrussT										
Ped	00112006	011-10 Body Green 2 MsHI	Twist-Lock	Green	10	2.0	120	OC06	300 lb/ft2	
Ped	00112007	011-10 Body Black 2 MsHI	Twist-Lock	Black	10	2.0	120	OC06	300 lb/ft2	
Ped	00112008	011-10 Body Purple 2 MsHI	Twist-Lock	Purple	10	2.0	120	OC06	300 lb/ft2	
Lid - 0011 TrussT										
Ped	00114011	011 T Cover Green ICV	Twist-Lock	Green	-	0.8	240	OC06	300 lb/ft2	
Ped	00114014	Cover, 011 T Cover Purple RWDNDES	Twist-Lock	Purple	-	0.8	240	OC06	300 lb/ft2	

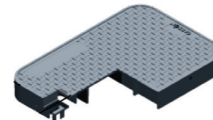
**LIGHT DUTY
PEDESTRIAN / GREENBELT**

Rating	Part #	Desc 1	Desc 2	Color	Depth	Item Weight	Pallet Qty	Line Item Discount	Design Load	Quick Ship
Unit - 1015 TrussT										
Ped	10151233	1015-07 Blk-Pur RWDNDES	0 MsHI T Cover	Blk-Pur	7	5.7	66	OC06	300 lb/ft2	
Ped	10151234	1015-07 Blk-Grn ICV	0 MsHI T Cover	Blk-Grn	7	5.7	66	OC06	300 lb/ft2	
Ped	10151235	1015-07 Tan ICV	0 MsHI T Cover	Tan	7	5.7	66	OC06	300 lb/ft2	
Ped	10151236	1015-07 Grn ICV	0 MsHI T Cover	Green	7	5.7	66	OC06	300 lb/ft2	
Ped	10151022	1015-12 Blk-Pur RWDNDES	2 6 MsHI T Cover	Blk-Pur	12	7.8	84	OC06	300 lb/ft2	
Ped	10151088	1015-12 Blk-Grn ICV	2 6 MsHI T Cover	Blk-Grn	12	7.8	84	OC06	300 lb/ft2	
Ped	10151089	1015-12 Green_'Irrigation Control Valve'	2 6 MsHI T Cover_548	Green	12	7.8	84	OC06	300 lb/ft2	
Ped	10151092	1015-12 Blk-Pur RWDNDES	2 6 MsHI 0 Blt Prov T Cover	Blk-Pur	12	7.8	84	OC06	300 lb/ft2	
Ped	10151232	1015-12 Purple RWDNDES	2 6 MsHI T Cover	Purple	12	7.8	84	OC06	300 lb/ft2	
Ped	10151237	1015-12 Green Blank	2 6 MsHI T Cover	Green	12	7.8	84	OC06	300 lb/ft2	
Body - 1015 TrussT										
Ped	10152024	1015-12 Body Green 2 MsHI	4 Knock Outs	Green	12	5.6	84	OC06	300 lb/ft2	
Ped	10152026	1015-12 Body Black 2 MsHI	4 Knock Outs	Black	12	5.6	84	OC06	300 lb/ft2	
Ped	10152030	1015-12 Body Purple 2 MsHI	4 Knock Outs	Purple	12	5.6	84	OC06	300 lb/ft2	
Ped	10152032	1015-12 Body Black 0 MsHI	6 Knock Outs	Black	12	5.6	84	OC06	300 lb/ft2	
Extension - 1015 TrussT										
Ped	10153004	1015-3 Ext Black	-	Black	3	2.5	54	OC06	300 lb/ft2	
Ped	10153010	1015-07 Body/ 6x Ext Black	-	Black	7	4.0	78	OC06	300 lb/ft2	
Lid - 1015 TrussT										
Ped	10154010	1015 Fish Cover Purple RWDNDES	-	Purple	-	2.1	200	OC06	300 lb/ft2	
Ped	10154014	1015 Fish Cover Green Blank	-	Green	-	2.1	200	OC06	300 lb/ft2	
Ped	10154027	1015 T Cover Black Blank	-	Black	-	2.1	200	OC06	300 lb/ft2	
Ped	10154069	1015 T Cover Green Blank	-	Green	-	2.1	200	OC06	300 lb/ft2	
Ped	10154072	1015 T Cover Green ICV	-	Green	-	2.1	200	OC06	300 lb/ft2	
Ped	10154073	1015 T Cover Purple RWDNDES	-	Purple	-	2.1	200	OC06	300 lb/ft2	
Ped	10154010	1015 Fish Cover Purple RW	-	Purple	-	2.0	200	OC06	300 lb/ft2	

CARSON 0012

HDPE

15" X 19"



LIGHT DUTY
PEDESTRIAN / GREENBELT

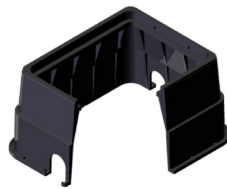

Rating	Part #	Desc 1	Desc 2	Color	Depth	Item Weight	Pallet Qty	Line Item Discount	Design Load	Quick Ship
Unit - 0012 TrussT										
Ped	00121001	012-06R Blk-Grn ICV	0 MsHI T Cover	Blk-Grn	6	8.5	78	OC06	300 lb/ft2	
Ped	00121002	012-6xR Blk-Grn ICV	0 MsHI T Cover	Blk-Grn	6	8.5	78	OC06	300 lb/ft2	
Ped	00121003	012-12R Blk-Grn ICV	2 MsHI T Cover	Blk-Grn	12	13.7	36	OC06	300 lb/ft2	
Ped	00121006	012-12R Green ICV	2 MsHI T Cover	Green	12	13.7	36	OC06	300 lb/ft2	
Body - 0012 TrussT										
Ped	00122002	012-12R Body Black 2 MsHI	-	Black	12	8.5	36	OC06	300 lb/ft2	
Ped	00122003	012-12R Body Green 2 MsHI	-	Green	12	8.5	36	OC06	300 lb/ft2	
Extension - 0012 TrussT										
Ped	00123001	012-6R Ext Black	-	Black	6	3.6	42	OC06	300 lb/ft2	
Lid - 0012 TrussT										
Ped	00124001	012R T Cover Green ICV	-	Green	-	5.1	120	OC06	300 lb/ft2	
Ped	00124003	012R T Cover Purple RWDNDES	-	Purple	-	5.1	120	OC06	300 lb/ft2	

CARSON 0809

HDPE

7" DIAMETER



LIGHT DUTY
PEDESTRIAN / GREENBELT



Rating	Part #	Desc 1	Desc 2	Color	Depth	Item Weight	Pallet Qty	Line Item Discount	Design Load	Quick Ship
Unit - 0012 TrussT										
Ped	08091001	809-09 Green ICV	2 MsHI T Cover	Green	9	2.6	240	OC06	300 lb/ft2	
Ped	08091003	809-09 Green Blank	2 MsHI T Cover	Green	9	2.6	240	OC06	300 lb/ft2	
Ped	08091004	809-09 Blk-Grn ICV	2 MsHI T Cover	Blk-Grn	9	2.6	240	OC06	300 lb/ft2	
Ped	08091008	809-09 Blk-Grn Blank	2 MsHI T Cover	Blk-Grn	9	2.6	240	OC06	300 lb/ft2	
Ped	08091013	809-09 Tan ICV	2 MsHI T Cover	Tan	9	2.6	240	OC06	300 lb/ft2	
Ped	08091014	809-09 Purple RCWDNDES	2 MsHI T Cover	Purple	9	2.6	240	OC06	300 lb/ft2	
Body - 0012 TrussT										
Ped	08092001	809-09 Body Green 2 MsHI	-	Green	9	2.1	240	OC06	300 lb/ft2	
Ped	08092002	809-09 Body Black 2 MsHI	-	Black	9	2.1	240	OC06	300 lb/ft2	
Ped	08092003	809-09 Body Purple 2 MsHI	-	Purple	9	2.1	240	OC06	300 lb/ft2	
Ped	08092005	809-09 Body Tan 2 MsHI	-	Tan	9	2.1	240	OC06	300 lb/ft2	
Lid - 0012 TrussT										
Ped	08094001	809 T Cover Green ICV	-	Green	-	0.5	600	OC06	300 lb/ft2	
Ped	08094003	809 T Cover Green Blank	-	Green	-	0.5	600	OC06	300 lb/ft2	
Ped	08094004	809 T Cover Purple RCWDNDES	-	Purple	-	0.5	600	OC06	300 lb/ft2	
Ped	08094005	809 T Cover Black ICV	-	Black	-	0.5	600	OC06	300 lb/ft2	
Ped	08094013	809 T Cover Tan ICV	-	Tan	-	0.5	600	OC06	300 lb/ft2	

*Products are rated by the lowest component rating. A tier 15 cover with a tier 22 body is rated tier 15. A tier 22 cover with a tier 22 body is rated tier 22.

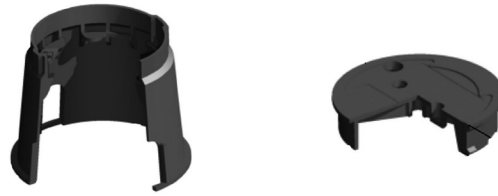
**LIGHT DUTY
PEDESTRIAN / GREENBELT**

Rating	Part #	Desc 1	Desc 2	Color	Depth	Item Weight	Pallet Qty	Line Item Discount	Design Load	Quick Ship
Unit - 0910 Spec Grade										
Ped	09101001	910-10 Green ICV	2 MsHI T Cover	Green	10	3.9	99	OC06	300 lb/ft2	
Ped	09101005	910-10 Green Blank	0 MsHI T Cover	Green	10	3.9	99	OC06	300 lb/ft2	
Ped	09101006	910-10 Black Blank HBlit	2 MsHI Fish Cover	Black	10	3.9	99	OC06	300 lb/ft2	
Ped	09101010	910-10 Green ICV HBlit	0 MsHI T Cover	Green	10	3.9	99	OC06	300 lb/ft2	
Ped	09101015	910-10 Green Blank HBlit	0 MsHI T Cover	Green	10	3.9	99	OC06	300 lb/ft2	
Ped	09101026	910-10 Green Blank	2 MsHI T Cover	Green	10	3.9	99	OC06	300 lb/ft2	
Ped	09101027	910-10 Black ICV	2 MsHI T Cover	Black	10	3.9	99	OC06	300 lb/ft2	
Ped	09101028	910-10 Tan ICV	2 MsHI T Cover	Tan	10	3.9	99	OC06	300 lb/ft2	
Ped	09101029	910-10 Tan Blank	2 MsHI T Cover	Tan	10	3.9	99	OC06	300 lb/ft2	
Ped	09101030	910-10 Purple RWDNDES	2 MsHI T Cover	Purple	10	3.9	99	OC06	300 lb/ft2	
Ped	09101032	910-10 Green ICV	2 MsHI Fish Cover	Green	10	3.9	99	OC06	300 lb/ft2	
Ped	09101033	910-10 Black ICV	2 MsHI Fish Cover	Black	10	3.9	99	OC06	300 lb/ft2	
Ped	09101034	910-10 Green ICV HBlit	2 MsHI T Cover	Green	10	3.9	99	OC06	300 lb/ft2	
Ped	09101037	910-10 Black ICV HBlit	2 MsHI T Cover	Black	10	3.9	99	OC06	300 lb/ft2	
Ped	09101038	910-10 Tan ICV HBlit	2 MsHI T Cover	Tan	10	3.9	99	OC06	300 lb/ft2	
Ped	09101042	910-10 Green ICV HBlit	2 MsHI Fish Cover	Green	10	3.9	99	OC06	300 lb/ft2	
Ped	09101043	910-10 Purple RWDNDES HBlit	2 MsHI T Cover	Purple	10	3.9	99	OC06	300 lb/ft2	
Ped	09101074	910-10 Purple Blank HBlit	2 MsHI T Cover	Purple	10	3.9	99	OC06	300 lb/ft2	
Ped	09101078	910-10 Black Blank HBlit	2 MsHI T Cover	Black	10	3.9	99	OC06	300 lb/ft2	
Body - 0910 Spec Grade										
Ped	09102001	910-10 Body Green 0 MsHI	-	Green	10	2.7	99	OC06	300 lb/ft2	
Ped	09102002	910-10 Body Black 0 MsHI	-	Black	10	2.7	99	OC06	300 lb/ft2	
Ped	09102004	910-10 Body Purple 0 MsHI	-	Purple	10	2.7	99	OC06	300 lb/ft2	
Ped	09102006	910-10 Body Green 2 MsHI	-	Green	10	2.7	99	OC06	300 lb/ft2	
Ped	09102007	910-10 Body Black 2 MsHI	-	Black	10	2.7	99	OC06	300 lb/ft2	
Ped	09102008	910-10 Body Purple 2 MsHI	-	Purple	10	2.7	99	OC06	300 lb/ft2	
Ped	09102014	910-10 Body Tan 0 MsHI	-	Tan	10	2.7	99	OC06	300 lb/ft2	
Ped	09102017	910-10 Body Tan 2 MsHI	-	Tan	10	2.7	99	OC06	300 lb/ft2	
Lid - 0910 Spec Grade										
Ped	09104001	910 T Cover Green ICV	-	Green	-	1.2	250	OC06	300 lb/ft2	
Ped	09104007	910 T Cover Green Blank	-	Green	-	1.2	250	OC06	300 lb/ft2	
Ped	09104008	910 T Cover Black ICV	-	Black	-	1.2	250	OC06	300 lb/ft2	
Ped	09104012	910 T Cover Black Blank	-	Black	-	1.2	250	OC06	300 lb/ft2	
Ped	09104013	910 T Cover Tan ICV	-	Tan	-	1.2	250	OC06	300 lb/ft2	
Ped	09104014	910 T Cover Tan Blank	-	Tan	-	1.2	250	OC06	300 lb/ft2	
Ped	09104015	910 T Cover Purple RWDNDES	-	Purple	-	1.2	250	OC06	300 lb/ft2	
Ped	09104017	910 T Cover Purple Blank	-	Purple	-	1.2	250	OC06	300 lb/ft2	
Ped	09104024	910 Fish Cover Green ICV	-	Green	-	1.0	250	OC06	300 lb/ft2	
Ped	09104025	910 Fish Cover Black ICV	-	Black	-	1.0	250	OC06	300 lb/ft2	
Ped	09104026	910 Fish Cover Green Blank	-	Green	-	1.0	250	OC06	300 lb/ft2	



LIGHT DUTY
PEDESTRIAN / GREENBELT



Rating	Part #	Desc 1	Desc 2	Color	Depth	Item Weight	Pallet Qty	Line Item Discount	Design Load	Quick Ship
Unit - 1419 Spec Grade										
Ped	14191001	1419-06 Green ICV	0 MsHI T Cover	Green	6	6.6	90	OC06	300 lb/ft2	
Ped	14191002	1419-6x Green ICV	0 MsHI T Cover	Green	6	6.6	90	OC06	300 lb/ft2	
Ped	14191003	1419-6x Tan ICV	0 MsHI T Cover	Tan	6	6.6	90	OC06	300 lb/ft2	
Ped	14191004	1419-06 Green ICV HBlit	0 MsHI T Cover	Green	6	6.6	90	OC06	300 lb/ft2	
Ped	14191005	1419-6x Green ICV HBlit	0 MsHI T Cover	Green	6	6.6	90	OC06	300 lb/ft2	
Ped	14191006	1419-6x Tan ICV HBlit	0 MsHI T Cover	Tan	6	6.6	90	OC06	300 lb/ft2	
Ped	14191007	1419-12 Green ICV	0 MsHI T Cover	Green	12	9.7	78	OC06	300 lb/ft2	
Ped	14191008	1419-12 Green Blank	0 MsHI T Cover	Green	12	9.7	78	OC06	300 lb/ft2	
Ped	14191010	1419-12 Green ICV HBlit	0 MsHI T Cover	Green	12	9.7	78	OC06	300 lb/ft2	
Ped	14191014	1419-12 Green Blank HBlit	0 MsHI T Cover	Green	12	9.7	78	OC06	300 lb/ft2	
Ped	14191020	1419-12 Green ICV	2 MsHI T Cover	Green	12	9.7	78	OC06	300 lb/ft2	
Ped	14191021	1419-12 Green ICV	2 MsHI Fish Cover	Green	12	9.7	78	OC06	300 lb/ft2	
Ped	14191024	1419-12 Green Blank	2 MsHI T Cover	Green	12	9.7	78	OC06	300 lb/ft2	
Ped	14191025	1419-12 Black ICV	2 MsHI T Cover	Black	12	9.7	78	OC06	300 lb/ft2	
Ped	14191026	1419-12 Tan ICV	2 MsHI T Cover	Tan	12	9.7	78	OC06	300 lb/ft2	
Ped	14191027	1419-12 Purple RWDNDES	2 MsHI T Cover	Purple	12	9.7	78	OC06	300 lb/ft2	
Ped	14191034	1419-12 Green ICV HBlit	2 MsHI T Cover	Green	12	9.7	78	OC06	300 lb/ft2	
Ped	14191037	1419-12 Green Blank HBlit	2 MsHI T Cover	Green	12	9.7	78	OC06	300 lb/ft2	
Ped	14191038	1419-12 Black ICV HBlit	2 MsHI T Cover	Black	12	9.7	78	OC06	300 lb/ft2	
Ped	14191039	1419-12 Tan ICV HBlit	2 MsHI T Cover	Tan	12	9.7	78	OC06	300 lb/ft2	
Ped	14191040	1419-12 Purple RWDNDES HBlit	2 MsHI T Cover	Purple	12	9.7	78	OC06	300 lb/ft2	
Unit - 1419 Spec Grade with Drop-N-Lock Lid										
Ped	14191422	1419-12 Green ICV	0 MsHI 1x DNL	Green	12	9.9	78	OC06	300 lb/ft2	
Ped	14191423	1419-12 Black ICV	2 MsHI T Cover 1x DNL	Black	12	9.9	78	OC06	300 lb/ft2	
Ped	14191425	1419-12 Green Blank	1x DNL T Cover	Green	12	9.9	78	OC06	300 lb/ft2	
Body - 1419 Spec Grade										
Ped	14192002	1419-12 Body Green 0 MsHI	-	Green	12	7.0	78	OC06	300 lb/ft2	
Ped	14192004	1419-12 Body Green 2 MsHI	-	Green	12	7.0	78	OC06	300 lb/ft2	
Ped	14192005	1419-12 Body Black 2 MsHI	-	Black	12	7.0	78	OC06	300 lb/ft2	
Ped	14192006	1419-12 Body Tan 2 MsHI	-	Tan	12	7.0	78	OC06	300 lb/ft2	
Ped	14192009	1419-12 Body Black 0 MsHI	-	Black	12	7.0	78	OC06	300 lb/ft2	
Ped	14192014	1419-12 Body Purple 2 MsHI	-	Purple	12	7.0	78	OC06	300 lb/ft2	
Ped	14192024	1419-12 Body Tan 0 MsHI	-	Tan	12	7.0	78	OC06	300 lb/ft2	
Ped	14192027	1419-12 Body Purple 0 MsHI	-	Purple	12	7.0	78	OC06	300 lb/ft2	
Ped	14192011	1419-24 Body Black 2 MsHI	-	Black	24	15.2	48	OC06	300 lb/ft2	
Extension - 1419 Spec Grade										
Ped	14193001	1419-6 Ext Green	-	Green	6	4.0	54	OC06	300 lb/ft2	
Ped	14193002	1419-6 Ext Black	-	Black	6	4.0	54	OC06	300 lb/ft2	
Ped	14193003	1419-6 Ext Tan	-	Tan	6	4.0	54	OC06	300 lb/ft2	
Ped	14193006	1419-6 Ext Purple	-	Purple	6	4.0	54	OC06	300 lb/ft2	
Lid - 1419 Spec Grade										
Ped	14194001	1419 T Cover Green ICV	-	Green	-	2.7	200	OC06	300 lb/ft2	
Ped	14194005	1419 T Cover Green Blank	-	Green	-	2.7	200	OC06	300 lb/ft2	
Ped	14194006	1419 T Cover Black ICV	-	Black	-	2.7	200	OC06	300 lb/ft2	
Ped	14194009	1419 T Cover Tan ICV	-	Tan	-	2.7	200	OC06	300 lb/ft2	
Ped	14194010	1419 T Cover Purple RWDNDES	-	Purple	-	2.7	200	OC06	300 lb/ft2	
Ped	14194013	1419 Fish Cover Green ICV	-	Green	-	2.2	200	OC06	300 lb/ft2	
Ped	14194016	1419 Fish Cover Purple RWDNDES	-	Purple	-	2.2	200	OC06	300 lb/ft2	
Ped	14194051	1419 T Cover Tan Blank	-	Tan	-	2.7	200	OC06	300 lb/ft2	
Ped	14194060	1419 Fish Cover Black ICV	-	Black	-	2.2	200	OC06	300 lb/ft2	
Ped	14194088	1419 T Cover Green RCWDNDES	-	Green	-	2.7	200	OC06	300 lb/ft2	
Drop-N-Lock Lid - 1419 Spec Grade										
Ped	14194323	1419 T Cover Green Blank	1x DNL	Green	-	2.4	200	OC06	300 lb/ft2	
Ped	14194327	1419 T Cover Black Blank	1x DNL	Black	-	2.4	200	OC06	300 lb/ft2	
Ped	14194328	1419 T Cover Green ICV	1x DNL	Green	-	2.4	200	OC06	300 lb/ft2	
Ped	14194329	1419 T Cover Black ICV	1x DNL	Black	-	2.4	200	OC06	300 lb/ft2	

*Products are rated by the lowest component rating. A tier 15 cover with a tier 22 body is rated tier 15. A tier 22 cover with a tier 22 body is rated tier 22.

**LIGHT DUTY
PEDESTRIAN / GREENBELT**

Rating	Part #	Desc 1	Desc 2	Color	Depth	Item Weight	Pallet Qty	Line Item Discount	Design Load	Quick Ship
Unit - 1220 Spec Grade										
Ped	12201002	1220-6x Green ICV	0 MsHI T Cover	Green	6	10.7	60	OC06	300 lb/ft2	
Ped	12201003	1220-6x Tan ICV	0 MsHI T Cover	Tan	6	10.7	60	OC06	300 lb/ft2	
Ped	12201006	1220-6x Green ICV HBlit	0 MsHI T Cover	Green	6	10.7	60	OC06	300 lb/ft2	
Ped	12201007	1220-6x Tan ICV HBlit	0 MsHI T Cover	Tan	6	10.7	60	OC06	300 lb/ft2	
Ped	12201014	1220-12 Green ICV	2 MsHI T Cover	Green	12	15.0	48	OC06	300 lb/ft2	
Ped	12201017	1220-12 Tan ICV	2 MsHI T Cover	Tan	12	15.0	48	OC06	300 lb/ft2	
Ped	12201020	1220-12 Green ICV	2 MsHI Fish Cover	Green	12	15.0	48	OC06	300 lb/ft2	
Ped	12201021	1220-12 Green ICV HBlit	2 MsHI T Cover	Green	12	15.0	48	OC06	300 lb/ft2	
Ped	12201022	1220-12 Green Blank HBlit	2 MsHI T Cover	Green	12	15.0	48	OC06	300 lb/ft2	
Ped	12201024	1220-12 Tan ICV HBlit	2 MsHI T Cover	Tan	12	15.0	48	OC06	300 lb/ft2	
Ped	12201028	1220-12 Black ICV	2 MsHI T Cover	Black	12	15.0	48	OC06	300 lb/ft2	
Ped	12201029	1220-12 Black ICV	2 MsHI Fish Cover	Black	12	15.0	48	OC06	300 lb/ft2	
Ped	12201030	1220-12 Black ICV HBlit	2 MsHI T Cover	Black	12	15.0	48	OC06	300 lb/ft2	
Ped	12201034	1220-12 Green Blank	2 MsHI Fish Cover	Green	12	15.0	48	OC06	300 lb/ft2	
Ped	12201040	1220-12 Green ICV LBlit	2 MsHI Fish Cover	Green	12	15.0	48	OC06	300 lb/ft2	
Ped	12201064	1220-12 Black Blank	0 MsHI T Cover	Black	12	15.0	48	OC06	300 lb/ft2	
Ped	12201070	1220-12 Purple RWDNDES HBlit	2 MsHI T Cover	Purple	12	15.0	48	OC06	300 lb/ft2	
Ped	12201090	1220-12 Purple RWDNDES	2 MsHI T Cover	Purple	12	15.0	48	OC06	300 lb/ft2	
Ped	12201203	1220-12 Green Blank HBlit	0 MsHI T Cover	Green	12	15.0	48	OC06	300 lb/ft2	
Unit - 1220 Spec Grade with Drop-N-Lock Lid										
Ped	12201205	1220-6x Green ICV	1x DNL T Cover	Green	6	10.1	28	OC06	300 lb/ft2	
Ped	12201206	1220-12 Green ICV	2 MsHI 1x DNL T Cover	Green	12	13.5	48	OC06	300 lb/ft2	
Ped	12201207	1220-12 Tan ICV	2 MsHI 1x DNL T Cover	Tan	12	13.5	48	OC06	300 lb/ft2	
Ped	12201208	1220-12 Purple RWDNDES	2 MsHI 1x DNL T Cover	Purple	12	13.5	48	OC06	300 lb/ft2	
Body - 1220 Spec Grade										
Ped	12202002	1220-12 Body Green 0 MsHI	-	Green	12	9.3	48	OC06	300 lb/ft2	
Ped	12202004	1220-12 Body Green 2 MsHI	-	Green	12	9.3	48	OC06	300 lb/ft2	
Ped	12202005	1220-12 Body Black 2 MsHI	-	Black	12	9.3	48	OC06	300 lb/ft2	
Ped	12202006	1220-12 Body Tan 2 MsHI	-	Tan	12	9.3	48	OC06	300 lb/ft2	
Ped	12202007	1220-12 Body Black 0 MsHI	-	Black	12	9.3	48	OC06	300 lb/ft2	
Ped	12202012	1220-12 Body Purple 0 MsHI	-	Purple	12	9.3	48	OC06	300 lb/ft2	
Ped	12202017	1220-12 Body Purple 2 MsHI	-	Purple	12	9.3	48	OC06	300 lb/ft2	
Extension - 1220 Spec Grade										
Ped	12203001	1220-6 Ext Green	-	Green	6	6.5	32	OC06	300 lb/ft2	
Ped	12203002	1220-6 Ext Black	-	Black	6	6.5	32	OC06	300 lb/ft2	
Ped	12203003	1220-6 Ext Tan	-	Tan	6	6.5	32	OC06	300 lb/ft2	
Ped	12203006	1220-6 Ext Purple	-	Purple	6	6.5	32	OC06	300 lb/ft2	
Lid - 1220 Spec Grade										
Ped	12204001	1220 T Cover Green ICV	-	Green	-	4.7	150	OC06	300 lb/ft2	
Ped	12204003	1220 T Cover Green Blank	-	Green	-	4.7	150	OC06	300 lb/ft2	
Ped	12204004	1220 T Cover Tan ICV	-	Tan	-	4.7	150	OC06	300 lb/ft2	
Ped	12204008	1220 Fish Cover Green ICV	-	Green	-	4.5	150	OC06	300 lb/ft2	
Ped	12204010	1220 T Cover Black Blank	-	Black	-	4.7	150	OC06	300 lb/ft2	
Ped	12204012	1220 T Cover Black ICV	-	Black	-	4.7	150	OC06	300 lb/ft2	
Ped	12204013	1220 Fish Cover Black ICV	-	Black	-	4.5	150	OC06	300 lb/ft2	
Ped	12204016	1220 Fish Cover Green Blank	-	Green	-	4.5	150	OC06	300 lb/ft2	
Ped	12204019	1220 Fish Cover Green ICV	L Bolt	Green	-	4.5	150	OC06	300 lb/ft2	
Ped	12204028	1220 Fish Cover Purple RWDNDES	-	Purple	-	4.5	150	OC06	300 lb/ft2	
Ped	12204044	1220 Fish Cover Green Blank	L Bolt	Green	-	4.5	150	OC06	300 lb/ft2	
Ped	12204050	1220 T Cover Green ICV	L Bolt	Green	-	4.7	150	OC06	300 lb/ft2	
Ped	12204069	1220 T Cover Purple RWDNDES	-	Purple	-	4.7	150	OC06	300 lb/ft2	
Drop-N-Lock Lid - 1220 Spec Grade										
Ped	12204176	1220 T Cover Green ICV	1x DNL	Green	-	4.7	150	OC06	300 lb/ft2	
Ped	12204177	1220 T Cover Tan ICV	1x DNL	Tan	-	4.7	150	OC06	300 lb/ft2	
Ped	12204178	1220 T Cover Purple RWDNDES	1x DNL	Purple	-	4.7	150	OC06	300 lb/ft2	



LIGHT DUTY
PEDESTRIAN / GREENBELT



Rating	Part #	Desc 1	Desc 2	Color	Depth	Item Weight	Pallet Qty	Line Item Discount	Design Load	Quick Ship
Unit - 1324 Spec Grade										
Ped	13241001	1324-12 Green ICV HBit	0 MsHI Fish Cover	Green	12	20.4	16	OC06	300 lb/ft2	
Ped	13241002	1324-12 Green ICV LBit	0 MsHI Fish Cover	Green	12	20.4	16	OC06	300 lb/ft2	
Ped	13241004	1324-12 Green Blank HBit	0 MsHI Fish Cover	Green	12	20.4	16	OC06	300 lb/ft2	
Ped	13241034	1324-12 Black Blank HBit	0 MsHI T Cover	Black	12	20.4	16	OC06	300 lb/ft2	
Ped	13241039	1324-12 Black ICV HBit	0 MsHI Fish Cover	Black	12	20.4	16	OC06	300 lb/ft2	
Ped	13241082	1324-12 Purple RWDNDES LBit	0 MsHI Fish Cover	Purple	12	20.4	16	OC06	300 lb/ft2	
Ped	13241084	1324-12 Tan ICV LBit	0 MsHI Fish Cover	Tan	12	20.4	16	OC06	300 lb/ft2	
Ped	13241085	1324-12 Purple RWDNDES HBit	0 MsHI Fish Cover	Purple	12	20.4	16	OC06	300 lb/ft2	
Ped	13241281	1324-12 Purple RWDNDES HBit	0 MsHI T Cover	Purple	12	20.4	16	OC06	300 lb/ft2	
Ped	13241006	1324-15 Green ICV HBit	0 MsHI Fish Cover	Green	15	23.1	16	OC06	300 lb/ft2	
Ped	13241007	1324-15 Green ICV LBit	0 MsHI Fish Cover	Green	15	23.1	16	OC06	300 lb/ft2	
Ped	13241008	1324-15 Green ICV LBit	0 MsHI T Cover	Green	15	23.1	16	OC06	300 lb/ft2	
Ped	13241040	1324-15 Black ICV LBit	0 MsHI Fish Cover	Black	15	23.1	16	OC06	300 lb/ft2	
Ped	13241041	1324-15 Black ICV HBit	0 MsHI Fish Cover	Black	15	23.1	16	OC06	300 lb/ft2	
Ped	13241043	1324-15 Green ICV HBit	0 MsHI T Cover	Green	15	23.1	16	OC06	300 lb/ft2	
Ped	13241083	1324-15 Tan ICV HBit	0 MsHI Fish Cover	Tan	15	23.1	16	OC06	300 lb/ft2	
Ped	13241086	1324-15 Purple RWDNDES LBit	0 MsHI Fish Cover	Purple	15	23.1	16	OC06	300 lb/ft2	
Ped	13241154	1324-15 Black ICV HBit	0 MsHI T Cover	Black	15	23.1	16	OC06	300 lb/ft2	
Unit - 1324 Spec Grade with Drop-N-Lock Lid										
Ped	13241279	1324-12 Blk-Grn Blank	0 MsHI T Cover 2x DNL	Blk-Grn	12	22.0	16	OC06	300 lb/ft2	
Ped	13241280	1324-15 Blk-Grn Blank	2x DNL T Cover	Blk-Grn	15	22.0	16	OC06	300 lb/ft2	
Body - 1324 Spec Grade										
Ped	13242001	1324-12 Body Green 0 MsHI	-	Green	12	14.5	16	OC06	300 lb/ft2	
Ped	13242014	1324-12 Body Tan 0 MsHI	-	Tan	12	14.5	16	OC06	300 lb/ft2	
Ped	13242015	1324-12 Body Purple 0 MsHI	-	Purple	12	14.5	16	OC06	300 lb/ft2	
Ped	13242019	1324-12 Body Black 0 MsHI	-	Black	12	14.5	16	OC06	300 lb/ft2	
Ped	13242002	1324-15 Body Green 0 MsHI	-	Green	15	16.8	16	OC06	300 lb/ft2	
Ped	13242004	1324-15 Body Black 0 MsHI	-	Black	15	16.8	16	OC06	300 lb/ft2	
Ped	13242018	1324-15 Body Purple 0 MsHI	-	Purple	15	16.8	16	OC06	300 lb/ft2	
Lid - 1324 Spec Grade										
Ped	13244001	1324 Fish Cover Green "IRRIGATION CONTROL VALVE"	FLD_548	Green	-	6.0	100	OC06	300 lb/ft2	
Ped	13244004	1324 Fish Cover Green ICV	L Bolt	Green	-	6.0	100	OC06	300 lb/ft2	
Ped	13244018	1324 Fish Cover Green Blank	-	Green	-	6.0	100	OC06	300 lb/ft2	
Ped	13244019	1324 T Cover Green Blank	-	Green	-	6.4	100	OC06	300 lb/ft2	
Ped	13244026	1324 T Cover Green ICV	L Bolt	Green	-	6.4	100	OC06	300 lb/ft2	
Ped	13244027	1324 T Cover Green ICV	-	Green	-	6.4	100	OC06	300 lb/ft2	
Ped	13244049	1324 Fish Cover Pur RWDNDES	-	Purple	-	6.0	100	OC06	300 lb/ft2	
Ped	13244051	1324 T Cover Black Blank	-	Black	-	6.4	100	OC06	300 lb/ft2	
Ped	13244052	1324 Fish Cover Black Blank	L Bolt	Black	-	6.0	100	OC06	300 lb/ft2	
Ped	13244055	1324 Fish Cover Black ICV	-	Black	-	6.0	100	OC06	300 lb/ft2	
Ped	13244201	1324 T Cover Black ICV	-	Black	-	6.4	100	OC06	300 lb/ft2	
Ped	13244210	1324 T Cover Purple RWDNDES	-	Purple	-	6.4	100	OC06	300 lb/ft2	
Drop-N-Lock Lid - 1324 Spec Grade										
Ped	13244333	1324 T Cover Green Blank	2X DNL	Green	-	6.4	100	OC06	300 lb/ft2	

*Products are rated by the lowest component rating. A tier 15 cover with a tier 22 body is rated tier 15. A tier 22 cover with a tier 22 body is rated tier 22.



**LIGHT DUTY
PEDESTRIAN / GREENBELT**



Rating	Part #	Desc 1	Desc 2	Color	Depth	Item Weight	Pallet Qty	Line Item Discount	Design Load	Quick Ship
--------	--------	--------	--------	-------	-------	-------------	------------	--------------------	-------------	------------

Unit - 1730 Spec Grade

Ped	17301001	1730-12 Green ICV HBlit	0 MsHI Fish Cover	Green	12	29.4	16	OC06	300 lb/ft2	
Ped	17301002	1730-12 Green ICV LBlit	0 MsHI Fish Cover	Green	12	29.4	16	OC06	300 lb/ft2	
Ped	17301003	1730-12 Green Blank HBlit	0 MsHI Fish Cover	Green	12	29.4	16	OC06	300 lb/ft2	
Ped	17301062	1730-12 Green ICV HBlit	0 MsHI T Cover	Green	12	29.4	16	OC06	300 lb/ft2	
Ped	17301093	1730-12 Black Blank HBlit	0 MsHI Fish Cover	Black	12	29.4	16	OC06	300 lb/ft2	
Ped	17301005	1730-15 Green ICV HBlit	0 MsHI Fish Cover	Green	15	34.4	16	OC06	300 lb/ft2	
Ped	17301006	1730-15 Green ICV LBlit	0 MsHI Fish Cover	Green	15	34.4	16	OC06	300 lb/ft2	
Ped	17301010	1730-15 Green Blank HBlit	0 MsHI Fish Cover	Green	15	34.4	16	OC06	300 lb/ft2	
Ped	17301095	1730-15 Black Blank HBlit	0 MsHI Fish Cover	Black	15	34.4	16	OC06	300 lb/ft2	
Ped	17301109	1730-15 Green Blank LPnta	0 MsHI Fish Cover	Green	15	34.4	16	OC06	300 lb/ft2	
Ped	17301110	1730-15 Green Blank HBlit	0 MsHI T Cover	Green	15	34.4	16	OC06	300 lb/ft2	
Ped	17301111	1730-15 Green Blank LBlit	0 MsHI T Cover	Green	15	34.4	16	OC06	300 lb/ft2	
Ped	17301014	1730-18 Green ICV HBlit	0 MsHI Fish Cover	Green	18	37.3	16	OC06	300 lb/ft2	
Ped	17301015	1730-18 Green ICV LBlit	0 MsHI Fish Cover	Green	18	37.3	16	OC06	300 lb/ft2	
Ped	17301016	1730-18 Green ICV HBlit	0 MsHI T Cover	Green	18	37.3	16	OC06	300 lb/ft2	
Ped	17301023	1730-18 Green Blank HBlit	0 MsHI Fish Cover	Green	18	37.3	16	OC06	300 lb/ft2	
Ped	17301041	1730-18 Black Blank HBlit	0 MsHI Fish Cover	Black	18	37.3	16	OC06	300 lb/ft2	
Ped	17301042	1730-18 Black ICV LBlit	0 MsHI Fish Cover	Black	18	37.3	16	OC06	300 lb/ft2	
Ped	17301048	1730-18 Green Blank LBlit	0 MsHI T Cover	Green	18	37.3	16	OC06	300 lb/ft2	
Ped	17301064	1730-18 Green ICV LBlit	0 MsHI T Cover	Green	18	37.3	16	OC06	300 lb/ft2	
Ped	17301091	1730-18 Purple RCWDNDES LBlit	0 MsHI Fish Cover	Purple	18	37.3	16	OC06	300 lb/ft2	
Ped	17301097	1730-18 Black Blank LBlit	0 MsHI T Cover	Black	18	37.3	16	OC06	300 lb/ft2	
Ped	17301113	1730-18 Green Blank HBlit	0 MsHI T Cover	Green	18	37.3	16	OC06	300 lb/ft2	
Ped	17301194	1730-18 Purple Blank LBlit	0 MsHI Fish Cover	Purple	18	37.3	16	OC06	300 lb/ft2	

Unit - 1730 Spec Grade with Drop-N-Lock Lid

Ped	17301433	1730-24 Blk-Grn Blank	2X DNL T Cover	Blk-Grn	24	64.1	5	OC06	300 lb/ft2	
-----	----------	-----------------------	----------------	---------	----	------	---	------	------------	--

Body - 1730 Spec Grade

Ped	17302001	1730-12 Body Green 0 MsHI	-	Green	12	19.0	16	OC06	300 lb/ft2	
Ped	17302014	1730-12 Body Black 0 MsHI	-	Black	12	19.0	16	OC06	300 lb/ft2	
Ped	17302025	1730-12 Body Purple 0 MsHI	-	Purple	12	19.0	16	OC06	300 lb/ft2	
Ped	17302002	1730-15 Body Green 0 MsHI	-	Green	15	24.0	16	OC06	300 lb/ft2	
Ped	17302015	1730-15 Body Black 0 MsHI	-	Black	15	24.0	16	OC06	300 lb/ft2	
Ped	17302004	1730-18 Body Green 0 MsHI	-	Green	18	26.9	16	OC06	300 lb/ft2	
Ped	17302013	1730-18 Body Black 0 MsHI	-	Black	18	26.9	16	OC06	300 lb/ft2	
Ped	17302026	1730-18 Body Purple 0 MsHI	-	Purple	18	26.9	16	OC06	300 lb/ft2	

Lid - 1730 Spec Grade

Ped	17304001	1730 Fish Cover Green ICV	-	Green	-	10.5	120	OC06	300 lb/ft2	
Ped	17304005	1730 Fish Cover Green ICV	L Bolt	Green	-	10.5	120	OC06	300 lb/ft2	
Ped	17304008	1730 Fish Cover Green Blank	-	Green	-	10.5	120	OC06	300 lb/ft2	
Ped	17304009	1730 Fish Cover Green Blank	L Bolt	Green	-	10.5	120	OC06	300 lb/ft2	
Ped	17304012	1730 Fish Cover Black Blank	-	Black	-	10.5	120	OC06	300 lb/ft2	
Ped	17304014	1730 Fish Cover Black ICV	-	Black	-	10.5	120	OC06	300 lb/ft2	
Ped	17304026	1730 T Cover Green Blank	L Bolt	Green	-	11.3	120	OC06	300 lb/ft2	
Ped	17304032	1730 T Cover Green ICV	-	Green	-	11.3	120	OC06	300 lb/ft2	
Ped	17304033	1730 T Cover Green ICV	L Bolt	Green	-	11.3	120	OC06	300 lb/ft2	
Ped	17304233	1730 T Cover Black Blank	-	Black	-	11.3	120	OC06	300 lb/ft2	
Ped	17304243	1730 Fish Cover Purple RWDNDES	-	Purple	-	10.5	120	OC06	300 lb/ft2	

Drop-N-Lock Lid - 1730 Spec Grade

Ped	17304326	1730 T Cover Green Blank	2X DNL	Green	-	13.0	60	OC06	300 lb/ft2	
-----	----------	--------------------------	--------	-------	---	------	----	------	------------	--

CARSON 2436

HDPE
24" X 36"



LIGHT DUTY
PEDESTRIAN / GREENBELT

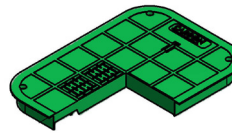
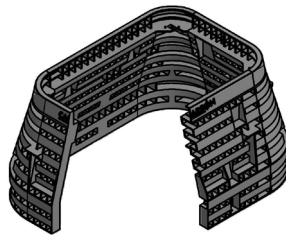

2436 & HYBRID MODELS

CARSON

Rating	Part #	Desc 1	Desc 2	Color	Depth	Item Weight	Pallet Qty	Line Item Discount	Design Load	Quick Ship
Unit - 2436 Spec Grade										
Ped	24361003	2436-18 Gray Blank HBlt	2x 3 8 in. Flsh Cover	Gray	18	63.6	5	OC06	300 lb/ft2	
Ped	24361285	2436-18 Gray Blank HBlt	4x 3 8 in. T Cover	Gray	18	63.6	5	OC06	300 lb/ft2	
Ped	24361073	2436-24 Blk-Grn Blank	4x EzLck T Cover	Blk-Grn	24	82.5	5	OC06	300 lb/ft2	
Ped	24361180	2436-24 Blk-Grn Blank	6x EzLck TCvr 2pc Plug	Blk-Grn	24	82.5	5	OC06	300 lb/ft2	
Body - 2436 Spec Grade										
Ped	24362022	2436-18 Body Gray	4x 3 8 in. Speed Nut	Gray	18	47.3	5	OC06	300 lb/ft2	
Ped	24362002	2436-24 Body Gray	2x 3 8 in. Fltg Nut	Gray	24	62.2	4	OC06	300 lb/ft2	
Ped	24362044	2436-24 Body Black	4x EzLck Clip	Black	24	62.2	4	OC06	300 lb/ft2	
Lid - 2436 Spec Grade										
Ped	24364082	2436 T Cover Green Blank	4x Bolt Hole	Green	-	37.0	25	OC06	300 lb/ft2	
Ped	24364087	2436 T Cover Gray Blank	4x Bolt Hole	Gray	-	37.0	25	OC06	300 lb/ft2	

CARSON 1324, 1730, 2436

HYBRID



MEDIUM DUTY
ANSI/SCTE TIER 5, 8, AND 15

Carson® Hybrids are specially designed to interchange various lid materials with a HDPE body to maximize load ratings and at the highest value.

Rating	Part #	Desc 1	Desc 2	Color	Depth	Item Weight	Pallet Qty	Line Item Discount	Design Load	Quick Ship
Unit - 1324										
T5	13241033	1324-18 HIP Gray Blank HBlt	Plastic Body PC Rng Flsh Cover	Gray	18	133	10	OC07	5000	
Unit - 1730										
T5	17301345	1730-24 HLPC Blk-Gry Blank	2x HBlt FCvr T5	Blk-Gry	24	93	2	OC07	5000	
Unit - 2436										
T8	24361181	2436-24 HLPC Blk-Gry Blank	2x HBlt FCvr T8	Blk-Gry	24	164	2	OC07	8000	
20K	24361015	2436-18 HPC Gray Blank HBlt	2x 1 2 in. FCvr 20K	Gray	18	233	2	OC07	20000	
20K	24361017	2436-24 HPC Gray Blank HBlt	2x 1 2 in. FCvr 20K	Gray	24	104	2	OC07	20000	

*Products are rated by the lowest component rating. A tier 15 cover with a tier 22 body is rated tier 15. A tier 22 cover with a tier 22 body is rated tier 22.

FIBRELYTE FL08



MEDIUM DUTY
ANSI/SCTE TIER 5, 8, AND 15

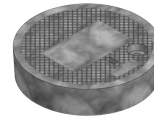

COMPOSITE
8" DIAMETER

Rating	Part #	Desc 1	Desc 2	Color	Depth	Item Weight	Pallet Qty	Line Item Discount	Design Load	Quick Ship
Body - FL08										
T8	02006005	Box, FL08 T	FL08TBOX	Gray	12	6.0	64	OC11	8000	
Lid - FL08										
T8	02001175	Lid, FL08 D - No Mark	FL08D000	Gray	-	2.1	100	OC11	8000	
T8	02001183	Lid, FL08 D - "Irrigation"	FL08D005	Gray	-	2.1	100	OC11	8000	
T8	02006125	Lid, FL08 T - No Mark	FL08T000	Gray	-	2.1	100	OC11	8000	
T8	02500160	Lid, FL08 T - SPECIAL	FL08T099	Gray	-	2.1	100	OC11	8000	

FIBRELYTE FL09



MEDIUM DUTY
ANSI/SCTE TIER 5, 8, AND 15

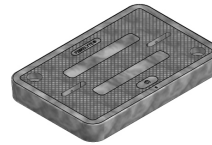
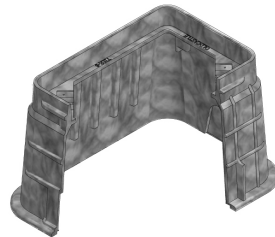

COMPOSITE
10" X 15"

Rating	Part #	Desc 1	Desc 2	Color	Depth	Item Weight	Pallet Qty	Line Item Discount	Design Load	Quick Ship
Body - FL09										
T8	02011000	Box, FL09 T	FL09TBOX	Gray	12	16.0	48	OC11	8000	
Lid - FL09										
T8	02001245	Lid, FL09 D - No Mark	FL09D000	Gray	-	8.1	120	OC11	8000	
T8	02001285	Lid, FL09 D - "Irrigation"	FL09D005	Gray	-	8.1	120	OC11	8000	
T8	02001300	Lid, FL09 D - "Sprinkler Control"	FL09D062	Gray	-	8.1	120	OC11	8000	
T8	02001360	Lid, FL09 D (Purple) - "Reclaimed Water"	FL09D090P	Purple	-	8.1	120	OC11	8000	
T8	02006160	Lid, FL09 T (Purple) - "Reclaimed Water"	FL09T090P	Purple	-	8.1	120	OC11	8000	
T8	02006165	Lid, FL09 T - No Mark	FL09T000	Gray	-	8.1	120	OC11	8000	
T8	02006525	Lid, FL09 T - "Sprinkler Control"	FL09T062	Gray	-	8.1	120	OC11	8000	
T8	02500240	Lid, FL09 D - SPECIAL	FL09D099	Gray	-	8.1	120	OC11	8000	
T8	02500580	Lid, FL09 T - SPECIAL	FL09T099	Gray	-	8.1	120	OC11	8000	

FIBRELYTE FL12

COMPOSITE
12" X 20"



MEDIUM DUTY
ANSI/SCTE TIER 5, 8, AND 15

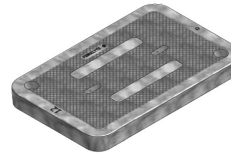
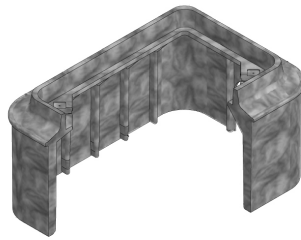

FL12 & FL30

Rating	Part #	Desc 1	Desc 2	Color	Depth	Item Weight	Pallet Qty	Line Item Discount	Design Load	Quick Ship
Body - FL12										
T8	02001029	Box, FL12 T 12 (No Mouseholes)	FL12TBOX12 - NM	Gray	12	25.6	30	OC11	8000	
T8	02001032	Box, FL12 T 12" (W/Mouseholes)	FL12TBOX12 WM	Gray	12	25.6	30	OC11	8000	
Lid - FL12										
T8	02001029	Box, FL12 T 12 (No Mouseholes)	FL12TBOX12 - NM	Gray	12	25.6	30	OC11	8000	
T8	02001032	Box, FL12 T 12" (W/Mouseholes)	FL12TBOX12 WM	Gray	12	25.6	30	OC11	8000	
T8	02001375	Lid, FL12 G - "Water Meter"	FL12G378	Gray	-	10.0	80	OC11	8000	

FIBRELYTE FL30

COMPOSITE
13" X 24"



MEDIUM DUTY
ANSI/SCTE TIER 5, 8, AND 15

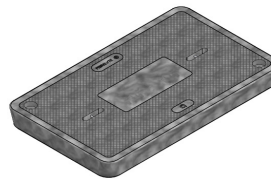
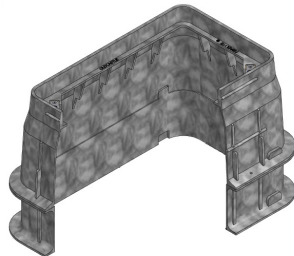

FIBRELYTE

Rating	Part #	Desc 1	Desc 2	Color	Depth	Item Weight	Pallet Qty	Line Item Discount	Design Load	Quick Ship
Body - FL30										
T8	02006040	Box, FL30 T 12"	FL30TBOX12	Gray	12	26	24	OC11	8000	
T8	02006045	Box, FL30 T 18"	FL30TBOX18	Gray	18	34	18	OC11	8000	
T8	02006050	Box, FL30 T 20"	FL30TBOX20	Gray	20	35	18	OC11	8000	
T8	02006052	Box, FL30 T 24"	FL30TBOX24	Gray	24	41	12	OC11	8000	
Extension - FL30										
T8	02001090	Extension, FL30 6"	FL30X6	Gray	6	8	42	OC11	8000	
T8	02001095	Extension, FL30 8"	FL30X8	Gray	8	9	27	OC11	8000	
Lid - FL30										
T8	02001435	Lid, FL30 D - No Mark	FL30D000	Gray	-	20	60	OC11	8000	
T8	02001480	Lid, FL30 D - "Sprinkler Control"	FL30D062	Gray	-	20	60	OC11	8000	
T8	02001505	Lid, FL30 D (Green) - "Irrigation"	FL30D005G	Green	-	20	60	OC11	8000	
T8	02001520	Lid, FL30 D (Purple) - "Reclaimed Water"	FL30D090P	Purple	-	20	60	OC11	8000	
T8	02006260	Lid, FL30 T - No Mark	FL30T000	Gray	-	20	60	OC11	8000	
T8	02006288	Lid, FL30 T - "Irrigation"	FL30T005	Gray	-	20	60	OC11	8000	
T8	02006313	Lid, FL30 T - "Sprinkler Control"	FL30T062	Gray	-	20	60	OC11	8000	
T8	02500760	Lid, FL30 D - SPECIAL	FL30D099	Gray	-	20	60	OC11	8000	
T8	02501120	Lid, FL30 T - SPECIAL	FL30T099	Gray	-	20	60	OC11	8000	

*Products are rated by the lowest component rating. A tier 15 cover with a tier 22 body is rated tier 15. A tier 22 cover with a tier 22 body is rated tier 22.



MEDIUM DUTY
ANSI/SCTE TIER 5, 8, AND 15

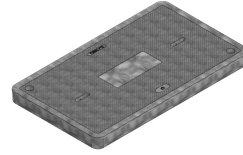
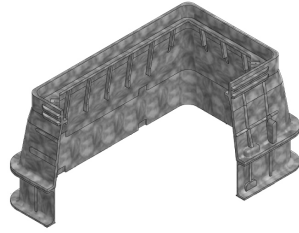

Rating	Part #	Desc 1	Desc 2	Color	Depth	Item Weight	Pallet Qty	Line Item Discount	Design Load	Quick Ship
Body - FL36										
T8	02006095	Box, FL36 T 12"	FL36TBOX12	Gray	12	42	16	OC11	8000	
T8	02006100	Box, FL36 T 18"	FL36TBOX18	Gray	18	52	12	OC11	8000	
T8	02006105	Box, FL36 T 20"	FL36TBOX20	Gray	20	57	10	OC11	8000	
T8	02006110	Box, FL36 T 24"	FL36TBOX24	Gray	24	63	8	OC11	8000	
Extension - FL36										
T8	02001160	Extension, FL36 6"	FL36X6	Gray	6	11	28	OC11	8000	
T8	02001165	Extension, FL36 8"	FL36X8	Gray	8	16	18	OC11	8000	
Lid - FL36										
T8	02001525	Lid, FL36 D - No Mark	FL36D000	Gray	-	34	30	OC11	8000	
T8	02001551	Lid, FL36 D - "Irrigation"	FL36D005	Gray	-	34	30	OC11	8000	
T8	02006385	Lid, FL36 T - No Mark	FL36T000	Gray	-	34	30	OC11	8000	
T8	02501220	Lid, FL36 D - SPECIAL	FL36D099	Gray	-	34	30	OC11	8000	
T8	02501520	Lid, FL36 T - SPECIAL	FL36T099	Gray	-	34	30	OC11	8000	

H-SERIES 0910

POLYMER CONCRETE

9" DIAMETER

0910 & 1118



HEAVY DUTY
ANSI/SCTE TIER 22

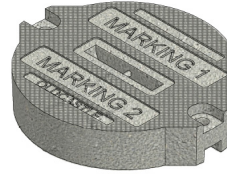
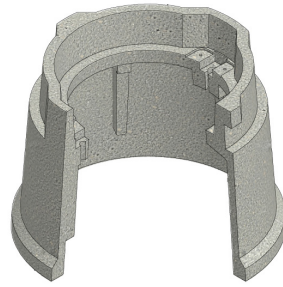

Rating	Part #	Desc 1	Desc 2	Color	Depth	Item Weight	Pallet Qty	Line Item Discount	Design Load	Quick Ship
Unit - 0910 (Units come standard with Body-Open Bottom, Lid, and SS Hex Bolt Floating Nut Hardware)										
T22	09101049	Unit, PC 910-10 w/ CHBlit - No Mark	PC0910T-T22	Gray	10	34	36	OC03	22500	
Body - 0910										
T22	09102011	Body, PC 910-10	PC091010FW	Gray	10	23	36	OC03	22500	
Lid - 0910										
T22	09104029	Lid, PC 910 - No Mark	PC0910-T22	Gray	-	11	100	OC03	22500	

H-SERIES 1118

POLYMER CONCRETE

11" X 18"

H-SERIES



MEDIUM DUTY
ANSI/SCTE TIER 5, 8, AND 15



HEAVY DUTY
ANSI/SCTE TIER 22

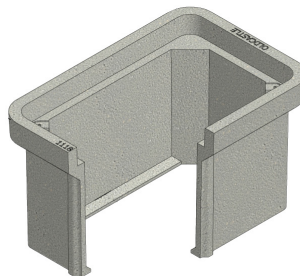

Rating	Part #	Desc 1	Desc 2	Color	Depth	Item Weight	Pallet Qty	Line Item Discount	Design Load	Quick Ship
Unit - 1118 (Units come standard with Body-Open Bottom, Lid, and SS Hex Bolt Floating Nut Hardware)										
T15	11181604	Unit, PC1118-12, T15 - Blank	PC111812-T15	Gray	12	67	28	OC03	15000	
T22	11181003	Unit, PC1118-12, T22 - Blank	PC111812-T22	Gray	12	73	28	OC03	22500	
Body - 1118										
T22	11182001	Body, PC1118-12,SW	PC111812SW	Gray	12	47	28	OC03	22500	
T22	11182003	Body, PC 1118-18, SW	PC111818SW	Gray	18	70	28	OC03	22500	
Lid - 1118										
T15	11184612	Lid, PC1118-T, T15, - Blank	PC1118T-T15	Gray	-	20	60	OC03	15000	
T22	11184003	Lid, PC1118-T, T22 - Blank	PC1118T-T22	Gray	-	28	60	OC03	22500	

*Products are rated by the lowest component rating. A tier 15 cover with a tier 22 body is rated tier 15. A tier 22 cover with a tier 22 body is rated tier 22.

H-SERIES 1212

POLYMER CONCRETE

12" X 12"



MEDIUM DUTY
ANSI/SCTE TIER 5, 8, AND 15



HEAVY DUTY
ANSI/SCTE TIER 22

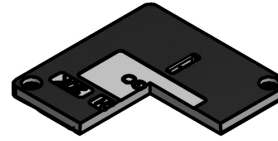
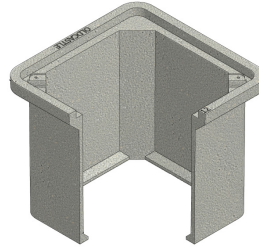

Rating	Part #	Desc 1	Desc 2	Color	Depth	Item Weight	Pallet Qty	Line Item Discount	Design Load	Quick Ship
Unit - 1212 (Units come standard with Body-Open Bottom, Lid, and SS Hex Bolt Floating Nut Hardware)										
T8	12121003	Unit, PC 1212-12 HLW w/HBlt - No Mark	PC1212T-T8	Gray	12	46	36	OC03	8000	
Body - 1212										
T22	12122001	Body, PC 1212-12 SW, HLW	PC1212T-T22	Gray	12	35	36	OC03	22500	
Lid - 1212 (Units come standard with Body-Open Bottom, Lid, and SS Hex Bolt Floating Nut Hardware)										
T8	12124003	Lid, PC 1212 HLW - No Mark	PC1212T-T8	Gray	-	11	40	OC03	8000	

H-SERIES 1324

POLYMER CONCRETE

13" X 24"

STRAIGHT WALL (SW)



MEDIUM DUTY
ANSI/SCTE TIER 5, 8, AND 15



HEAVY DUTY
ANSI/SCTE TIER 22

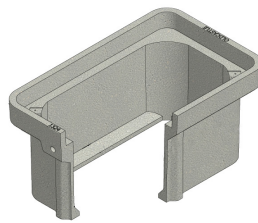

(SW)

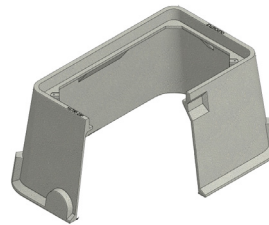

(FW)



FLARED WALL (FW)



MEDIUM DUTY
ANSI/SCTE TIER 5, 8, AND 15

Rating	Part #	Desc 1	Desc 2	Color	Depth	Item Weight	Pallet Qty	Line Item Discount	Design Load	Quick Ship
Unit - 1324 (Units come standard with Body-Open Bottom, Lid, and SS Hex Bolt Floating Nut Hardware)										
T15	13241600	Unit, PC1324-12, T15 - Blank	PC132412-T15	Gray	12	90	20	OC03	15000	
T15	13241610	Unit, PC1324-18, T15 - Blank	PC132418-T15	Gray	18	109	15	OC03	15000	
T15	13241611	Unit, PC1324-18, T15 - Blank, FW	PC132418-T15	Gray	18	116	15	OC03	15000	
T15	13241635	Unit, PC1324-24, T15 - Blank	PC132424-T15	Gray	24	127	10	OC03	15000	
T22	13241023	Unit, PC1324-12, T22 - Blank	PC132412-T22	Gray	12	99	20	OC03	22500	
T22	13241164	Unit, PC1324-24, T22 - Blank	PC132424-T22	Gray	24	140	10	OC03	22500	
Body - 1324										
T15	13242600	Body, PC1324-18,FW	PC132418FW	Gray	18	71	15	OC03	15000	
T22	13242020	Body, PC1324-12,SW	PC132412SW	Gray	12	50	20	OC03	22500	
T22	13242023	Body, PC1324-18,SW	PC132418SW	Gray	18	52	15	OC03	22500	
T22	13242038	Body, PC1324-24,SW	PC132424SW	Gray	24	89	10	OC03	22500	
Lid - 1324										
T15	13244603	Lid, PC1324-T, T15 - Blank	PC1324T-T15	Gray	-	38	30	OC03	15000	
T22	13244014	Lid, PC1324-T, T22 - Blank	PC1324T-T22	Gray	-	51	30	OC03	22500	

H-SERIES 1730

POLYMER CONCRETE

17" X 30"

STRAIGHT WALL (SW)



MEDIUM DUTY
ANSI/SCTE TIER 5, 8, AND 15



HEAVY DUTY
ANSI/SCTE TIER 22

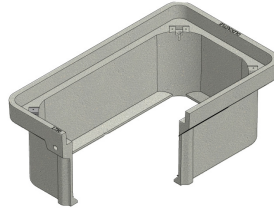

(SW)

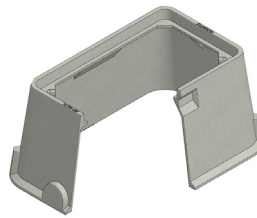

(FW)



FLARED WALL (FW)



MEDIUM DUTY
ANSI/SCTE TIER 5, 8, AND 15

Rating	Part #	Desc 1	Desc 2	Color	Depth	Item Weight	Pallet Qty	Line Item Discount	Design Load	Quick Ship
Unit - 1730 (Units come standard with Body-Open Bottom, Lid, and SS Hex Bolt Floating Nut Hardware)										
T15	17301600	Unit, PC1730-12, T15 - Blank	PC173012-T15	Gray	12	129	12	OC03	15000	
T15	17301613	Unit, PC1730-18, T15 - Blank	PC173018-T15	Gray	18	154	9	OC03	15000	
T15	17301614	Unit, PC1730-18, T15 - Blank, FW	PC173018-T15	Gray	18	154	6	OC03	15000	
T15	17301633	Unit, PC1730-24, T15 - Blank	PC173024-T15	Gray	24	181	6	OC03	15000	
T22	17301028	Unit, PC1730-12, T22 - Blank	PC173012-T22	Gray	12	152	12	OC03	22500	
T22	17301031	Unit, PC1730-18, T22 - Blank	PC173018-T22	Gray	18	177	9	OC03	22500	
T22	17301034	Unit, PC1730-24, T22 - Blank	PC173024-T22	Gray	24	204	6	OC03	22500	
Body - 1730										
T15	17302600	Body, PC1730-18 FW	PC173018FW	Gray	18	88	6	OC03	15000	
T22	17302006	Body, PC1730-12, SW	PC173012SW	Gray	12	65	12	OC03	22500	
T22	17302030	Body, PC1730-18, SW	PC173018SW	Gray	18	96	9	OC03	22500	
T22	17302031	Body, PC1730-24, SW	PC173024SW	Gray	24	119	6	OC03	22500	
T22	17302046	Body, PC1730-30, SW	PC173030SW	Gray	30	166	6	OC03	22500	
Lid - 1730										
T15	17304604	Lid, PC1730-T, T15 - Blank	PC1730T-T15	Gray	-	62	25	OC03	15000	
T22	17304018	Lid, PC1730-T, T22 - Blank	PC1730T-T22	Gray	-	85	25	OC03	22500	

H-SERIES 2424

POLYMER CONCRETE

24" X 24"



MEDIUM DUTY
ANSI/SCTE TIER 5, 8, AND 15



HEAVY DUTY
ANSI/SCTE TIER 22

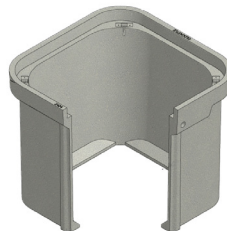

Rating	Part #	Desc 1	Desc 2	Color	Depth	Item Weight	Pallet Qty	Line Item Discount	Design Load	Quick Ship
Unit - 2424 (Units come standard with Body-Open Bottom, Lid, and SS Hex Bolt Floating Nut Hardware)										
T15	24241600	Unit, PC2424-24, T15 - Blank	PC242424-T15	Gray	24	224	8	OC03	15000	
T15	24241614	Unit, PC2424-36, T15 - Blank	PC242436-T15	Gray	36	282	8	OC03	15000	
T22	24241613	Unit, PC2424-24, T22 - Blank	PC242424-T22	Gray	24	272	8	OC03	22500	
T22	24241627	Unit, PC2424-36, T22 - Blank	PC242436-T22	Gray	36	273	8	OC03	22500	
Body - 2424										
T22	24242600	Body, PC2424-24, SW	PC242424SW	Gray	24	156	8	OC03	22500	
T22	24242601	Body, PC2424-36, SW	PC242436SW	Gray	36	219	8	OC03	22500	
Lid - 2424										
T15	24244605	Lid, PC2424-T, T15 - Blank	PC2424T-T15	Gray	-	75	20	OC03	15000	
T22	24244623	Lid, PC2424-T, T22 - Blank	PC2424T-T22	Gray	-	99	20	OC03	22500	

*Products are rated by the lowest component rating. A tier 15 cover with a tier 22 body is rated tier 15. A tier 22 cover with a tier 22 body is rated tier 22.

H-SERIES 2436

POLYMER CONCRETE

24" X 36"



MEDIUM DUTY
ANSI/SCTE TIER 5, 8, AND 15



HEAVY DUTY
ANSI/SCTE TIER 22

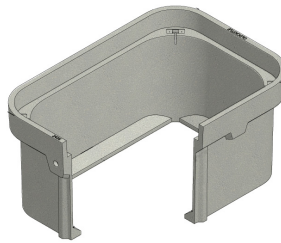

Rating	Part #	Desc 1	Desc 2	Color	Depth	Item Weight	Pallet Qty	Line Item Discount	Design Load	Quick Ship
Unit - 2436 (Units come standard with Body-Open Bottom, Lid, and SS Hex Bolt Floating Nut Hardware)										
T15	24361600	Unit, PC2436-18, T15 - Blank	PC243618-T15	Gray	18	295	6	OC03	15000	
T15	24361610	Unit, PC2436-24, T15 - Blank	PC243624-T15	Gray	24	330	4	OC03	15000	
T15	24361630	Unit, PC2436-36, T15 - Blank	PC243636-T15	Gray	36	399	2	OC03	15000	
T22	24361027	Unit, PC2436-18, T22 - Blank	PC243618-T22	Gray	18	345	6	OC03	22500	
T22	24361030	Unit, PC2436-24, T22 - Blank	PC243624-T22	Gray	24	380	4	OC03	22500	
T22	24361642	Unit, PC2436-36, T22 - Blank	PC243630-T22	Gray	36	449	2	OC03	22500	
Body - 2436										
T22	24362016	Body, PC2436-18,SW	PC243618SW	Gray	18	142	4	OC03	22500	
T22	24362214	Body, PC2436-24,SW	PC243624SW	Gray	24	180	4	OC03	22500	
T22	24362212	Body, PC2436-30,SW	PC243630SW	Gray	30	221	2	OC03	22500	
T22	24362227	Body, PC2436-36,SW	PC243636SW	Gray	36	249	2	OC03	22500	
Lid - 2436										
T15	24364604	Lid, PC2436-T, T15 - Blank	PC2436T-T15	Gray	-	150	10	OC03	15000	
T22	24364010	Lid, PC2436-T, T22 - Blank	PC2436T-T22	Gray	-	204	10	OC03	22500	

H-SERIES 3048

POLYMER CONCRETE

30" X 48"



MEDIUM DUTY
ANSI/SCTE TIER 5, 8, AND 15



HEAVY DUTY
ANSI/SCTE TIER 22

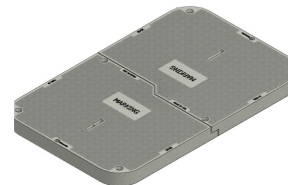
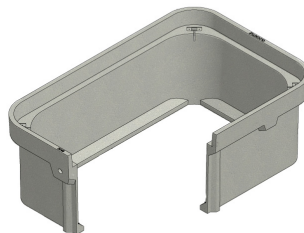

Rating	Part #	Desc 1	Desc 2	Color	Depth	Item Weight	Pallet Qty	Line Item Discount	Design Load	Quick Ship
Unit - 3048 (Units come standard with Body-Open Bottom, Lid, and SS Hex Bolt Floating Nut Hardware)										
T15	30481600	Unit, PC3048-18, T15 - Blank	PC304818-T15	Gray	18	408	4	OC03	15000	
T15	30481612	Unit, PC3048-24, T15 - Blank	PC304824-T15	Gray	24	454	4	OC03	15000	
T15	30481634	Unit, PC3048-36, T15 - Blank	PC304836-T15	Gray	36	543	2	OC03	15000	
T22	30481003	Unit, PC3048-18, T22 - Blank	PC304818-T22	Gray	18	526	4	OC03	22500	
T22	30481006	Unit, PC3048-24, T22 - Blank	PC304824-T22	Gray	24	572	4	OC03	22500	
T22	30481012	Unit, PC3048-36, T22 - Blank	PC304836-T22	Gray	36	661	2	OC03	22500	
Body - 3048										
T22	30482008	Body, PC3048-18,SW	PC304818SW	Gray	18	188	3	OC03	22500	
T22	30482021	Body, PC3048-24,SW	PC304824SW	Gray	24	234	3	OC03	22500	
T22	30482020	Body, PC3048-30,SW	PC304830SW	Gray	30	301	1	OC03	22500	
T22	30482017	Body, PC3048-36,SW	PC304836SW	Gray	36	307	1	OC03	22500	
Lid - 3048										
T15	30484009	Lid, PC 3048 - No Mark	1 pc Cover	Gray	-	340	10	OC03	15000	
T15	30484602	Lid, PC3048-T, T15 - Blank,2pc	PC3048T-T15	Gray	-	220	10	OC03	15000	
T22	30484003	Lid, PC3048-T, T22 - Blank,2pc	PC3048T-T22	Gray	-	220	10	OC03	22500	

H-SERIES 3060

POLYMER CONCRETE

30"X 60"

3060



HEAVY DUTY
ANSI/SCTE TIER 22

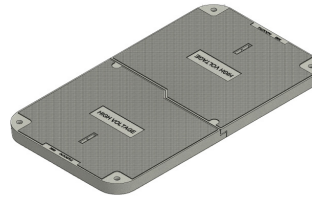
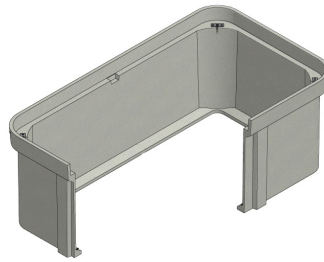

Rating	Part #	Desc 1	Desc 2	Color	Depth	Item Weight	Pallet Qty	Line Item Discount	Design Load	Quick Ship
--------	--------	--------	--------	-------	-------	-------------	------------	--------------------	-------------	------------

Unit - 3060 (Units come standard with Body-Open Bottom, Lid, and SS Hex Bolt Floating Nut Hardware)										
T22	30601002	Unit, PC 3060-24 w/HBlt- No Mark	4x 1 2 in. 2pc FCvr H20	Gray	24	805	1	OC03	22500	
T22	30601006	Unit, PC 3060-36 w/HBlt - No Mark	4x 1 2 in. 2pc FCvr H20	Gray	36	889	1	OC03	22500	
Body - 3060										
T22	30602001	Body, PC 3060-24	4x 1 2 in. Fltg Nut	Gray	24	325	3	OC03	22500	
T22	30602002	Body, PC 3060-30	4x 1 2 in. Fltg Nut	Gray	30	367	1	OC03	22500	
T22	30602006	Body, PC 3060-36	4x 1 2 in. Fltg Nut	Gray	36	409	1	OC03	22500	
Lid - 3060										
T22	30604002	Lid, PC 3060 2pc Kit - No Mark	2pc Assembly	Gray	-	480	10	OC03	22500	

H-SERIES

*Products are rated by the lowest component rating. A tier 15 cover with a tier 22 body is rated tier 15. A tier 22 cover with a tier 22 body is rated tier 22.

SYNERTECH 1118

DUO MOLD
11" X 18"



MEDIUM DUTY
ANSI/SCTE TIER 5, 8, AND 15

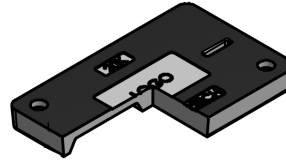
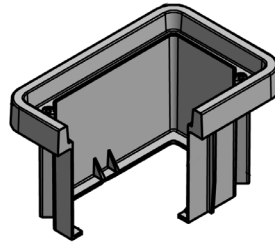

Rating	Part #	Desc 1	Desc 2	Color	Depth	Item Weight	Pallet Qty	Line Item Discount	Design Load	Quick Ship
Unit - 1118 (Units come standard with Body-Open, Lid, and SS Hex Bolt Floating Nut Hardware)										
T15	38101100	Unit, SYN1118-12,T15 - Blank	SYN111812-T15	Gray	12	51	32	OC10	15000	
T15	38101190	Unit, SYN1118-18,T15 - Blank	SYN111818-T15	Gray	18	56	32	OC10	15000	
Body - 1118										
T15	32108101	Box, SYN1118 T 12" Duo	SYN1118TBOX12	Gray	12	25	32	OC10	15000	
T15	32112101	Box, SYN1118 T 18" Duo	SYN1118TBOX18	Gray	18	30	32	OC10	15000	
T15	32116101	Box, SYN1118 T 24" (2)	SYN1118T 2 STKDBXS	Gray	24	49	24	OC10	15000	
T15	32117101	Box, SYN1118 T 30" (2)	SYN1118T 2 STKDBXS	Gray	30	55	24	OC10	15000	
T15	32118101	Box, SYN1118 T 36" Duo (2)	SYN1118T 2 STKDBXS	Gray	36	60	16	OC10	15000	
Lid - 1118										
T15	31050121	Lid, SYN1118 T - No Mark	SYN1118T000	Gray	-	26	56	OC10	15000	

SYNERTECH 1212

DUO MOLD
12" X 12"



MEDIUM DUTY
ANSI/SCTE TIER 5, 8, AND 15

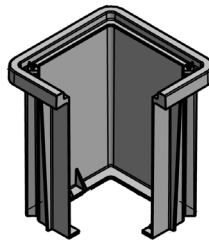

Rating	Part #	Desc 1	Desc 2	Color	Depth	Item Weight	Pallet Qty	Line Item Discount	Design Load	Quick Ship
Unit - 1212 (Units come standard with Body-Open, Lid, and SS Hex Bolt Floating Nut Hardware)										
T15	38101100	Unit, SYN1118-12,T15 - Blank	SYN111812-T15	Gray	12	51	32	OC10	15000	
T15	38101190	Unit, SYN1118-18,T15 - Blank	SYN111818-T15	Gray	18	56	32	OC10	15000	
Body - 1212										
T15	32120101	Box, SYN1212 T 12" Duo	SYN1212TBOX12	Gray	12	16	36	OC10	15000	
T15	32124101	Box, SYN1212 T 18" Duo	SYN1212TBOX18	Gray	18	20	36	OC10	15000	
T15	32128101	Box, SYN1212 T 24" Duo (2)	SYN1212T 2 STKDBXS	Gray	24	33	27	OC10	15000	
T15	32129101	Box, SYN1212 T 30" Duo (2)	SYN1212T 2 STKDBXS	Gray	30	36	18	OC10	15000	
T15	32130101	Box, SYN1212 T 36" Duo (2)	SYN1212T 2 STKDBXS	Gray	36	40	18	OC10	15000	
Lid - 1212										
T15	31100121	Lid, SYN1212 T - No Mark	SYN1212T000	Gray	-	15	200	OC10	15000	
T15	31101721	Lid, SYN1212 T - Irrigation	SYN1212T005	Gray	-	15	200	OC10	15000	

SYNERTECH 1324

1324 & 1730

DUO MOLD
13" X 24"



MEDIUM DUTY
ANSI/SCTE TIER 5, 8, AND 15

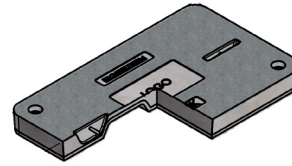
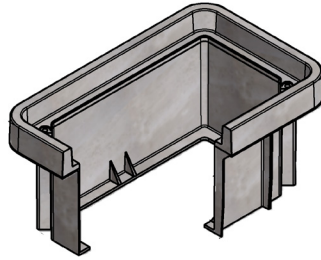

Rating	Part #	Desc 1	Desc 2	Color	Depth	Item Weight	Pallet Qty	Line Item Discount	Design Load	Quick Ship
Unit - 1324 (Units come standard with Body-Open, Lid, and SS Hex Bolt Floating Nut Hardware)										
T15	38103100	Unit, SYN1324-12,T15 - Blank	SYN132412-T15	Gray	12	71	30	OC10	15000	
T15	38103170	Unit, SYN1324-18,T15 - Blank	SYN132418-T15	Gray	18	75	16	OC10	15000	
T15	38103240	Unit, SYN1324-24,T15 - Blank	SYN132424-T15	Gray	24	80	12	OC10	15000	
Body - 1324										
T15	32132101	Box, SYN1324 T 12" Duo	SYN1324TBOX12	Gray	12	33	30	OC10	15000	
T15	32136101	Box, SYN1324 T 18" Duo	SYN1324TBOX18	Gray	18	37	16	OC10	15000	
T15	32140101	Box, SYN1324 T 24" Duo	SYN1324TBOX24	Gray	24	42	12	OC10	15000	
T15	32141101	Box, SYN1324 T 30" Duo (2)	SYN1324T 2 STKDBXS	Gray	30	70	8	OC10	15000	
T15	32142101	Box, SYN1324 T 36" Duo (2)	SYN1324T 2 STKDBXS	Gray	36	74	8	OC10	15000	
Lid - 1324										
T15	31150121	Lid, SYN1324 T - No Mark	SYN1324T000	Gray	-	38	50	OC10	15000	
T15	31151721	Lid, SYN1324 T - Irrigation	SYN1324T005	Gray	-	38	50	OC10	15000	

SYNERTECH 1730

DUO MOLD
17" X 30"



MEDIUM DUTY
ANSI/SCTE TIER 5, 8, AND 15

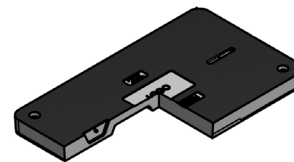
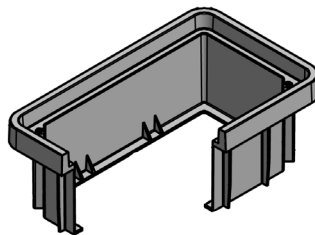

Rating	Part #	Desc 1	Desc 2	Color	Depth	Item Weight	Pallet Qty	Line Item Discount	Design Load	Quick Ship
Unit - 1730 (Units come standard with Body-Open, Lid, and SS Hex Bolt Floating Nut Hardware)										
T15	38104100	Unit, SYN1730-12,T15 - Blank	SYN173012-T15	Gray	12	115	12	OC10	15000	
T15	38104170	Unit, SYN1730-18,T15 - Blank	SYN173018-T15	Gray	18	122	8	OC10	15000	
T15	38104240	Unit, SYN1730-24,T15 - Blank	SYN173024-T15	Gray	24	127	6	OC10	15000	
Body - 1730										
T15	32144101	Box, SYN1730 T 12" Duo	SYN1730TBOX12	Gray	12	42	12	OC10	15000	
T15	32148101	Box, SYN1730 T 18" Duo	SYN1730TBOX18	Gray	18	49	8	OC10	15000	
T15	32152101	Box, SYN1730 T 24" Duo	SYN1730TBOX24	Gray	24	54	6	OC10	15000	
T15	32154101	Box, SYN1730 T 30" Duo (2)	SYN1730T 2 STKDBXS	Gray	30	91	4	OC10	15000	
T15	32156101	Box, SYN1730 T 36" Duo (2)	SYN1730T 2 STKDBXS	Gray	36	98	4	OC10	15000	
T15	32157101	Box, SYN1730 T 42" Duo (2)	SYN1730T 2 STKDBXS	Gray	42	103	2	OC10	15000	
Lid - 1730										
T15	31200121	Lid, SYN1730 T - No Mark	SYN1730T000	Gray	-	73	42	OC10	15000	
T15	31201721	Lid, SYN1730 T - Irrigation	SYN1730T005	Gray	-	73	42	OC10	15000	

*Products are rated by the lowest component rating. A tier 15 cover with a tier 22 body is rated tier 15. A tier 22 cover with a tier 22 body is rated tier 22.

SYNERTECH 2436



HEAVY DUTY
ANSI/SCTE TIER 22

DUO MOLD
24" X 36"

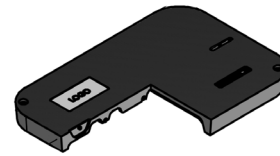
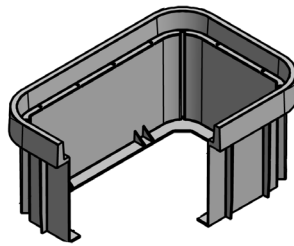

Rating	Part #	Desc 1	Desc 2	Color	Depth	Item Weight	Pallet Qty	Line Item Discount	Design Load	Quick Ship
Unit - 2436 (Units come standard with Body-Open, Lid, and SS Hex Bolt Floating Nut Hardware)										
T22	38104370	Unit, SYN2436-18,T22 - Blank	SYN243618-T22	Gray	18	227	4	OC10	22500	
T22	38104440	Unit, SYN2436-24,T22 - Blank	SYN243624-T22	Gray	24	238	3	OC10	22500	
T22	38104510	Unit, SYN2436-36,T22 - Blank	SYN243636-T22	Gray	36	259	2	OC10	22500	
Body - 2436										
T22	32164101	Box, SYN2436 T 18" Duo	SYN2436TBOX18	Gray	18	80	4	OC10	22500	
T22	32168101	Box, SYN2436 T 24" Duo	SYN2436TBOX24	Gray	24	91	3	OC10	22500	
T22	32172101	Box, SYN2436 T 36" Duo	SYN2436TBOX36	Gray	36	112	2	OC10	22500	
T22	32173101	Box SYN2436 T 42" DUO (2)	SYN2436T 2 STKDBXS	Gray	42	171	1	OC10	22500	
T22	32174101	Box, SYN2436 T 48" Duo (2)	SYN2436T 2 STKDBXS	Gray	48	181	1	OC10	22500	
T22	32175101	Box, SYN2436 T 54" Duo (2)	SYN2436T 2 STKDBXS	Gray	54	240	1	OC10	22500	
T22	32176101	Box, SYN2436 T 60" Duo (2)	SYN2436T 2 STKDBXS	Gray	60	262	1	OC10	22500	
T22	32177101	Box, SYN2436 T 72" Duo (2)	SYN2436T 2 STKDBXS	Gray	72	320	1	OC10	22500	
Lid - 2436										
T22	31250121	Lid, SYN2436 T - No Mark	SYN2436T000	Gray	-	147	20	OC10	22500	
T22	31251721	Lid, SYN2436 T - Irrigation	SYN2436T005	Gray	-	147	20	OC10	22500	

SYNERTECH 3048



HEAVY DUTY
ANSI/SCTE TIER 22

DUO MOLD
30" X 48"

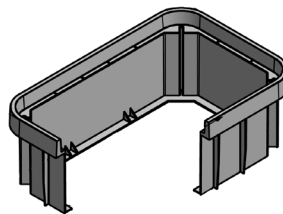

Rating	Part #	Desc 1	Desc 2	Color	Depth	Item Weight	Pallet Qty	Line Item Discount	Design Load	Quick Ship
Unit - 3048 (Units come standard with Body-Open, Lid, and SS Hex Bolt Floating Nut Hardware)										
T22	38104580	Unit, SYN3048-18,T22 - Blank	SYN304818-T22	Gray	18	332	4	OC10	22500	
T22	38104650	Unit, SYN3048-24,T22 - Blank	SYN304824-T22	Gray	24	346	3	OC10	22500	
T22	38104720	Unit, SYN3048-36,T22 - Blank	SYN304836-T22	Gray	36	373	2	OC10	22500	
Body - 3048										
T22	32180101	Box, SYN3048 T 18" Duo	SYN3048TBOX18	Gray	18	119	4	OC10	22500	
T22	32184101	Box, SYN3048 T 24" Duo	SYN3048TBOX24	Gray	24	145	3	OC10	22500	
T22	32188101	Box, SYN3048 T 36" Duo	SYN3048TBOX36	Gray	36	160	2	OC10	22500	
T22	32185101	Box, SYN3048 T 42" Duo (2)	SYN3048T 2 STKDBXS	Gray	42	252	2	OC10	22500	
T22	32187101	Box, SYN3048 T 48" Duo (2)	SYN3048T 2 STKDBXS	Gray	48	265	1	OC10	22500	
T22	32179101	Box, SYN3048 T 72" Duo (2)	SYN3048T 2 STKDBXS	Gray	72	320	1	OC10	22500	
Lid - 3048										
T22	31300121	Lid, SYN3048 T - No Mark	SYN3048T000	Gray	-	213	10	OC10	22500	
T22	31301721	Lid, SYN3048 T - Irrigation	SYN3048T005	Gray	-	213	10	OC10	22500	

CHRISTY F08

CONCRETE
9" DIAMETER

F08 & B03



LIGHT DUTY
PEDESTRIAN / GREENBELT

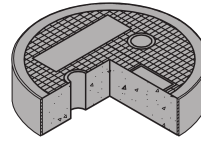
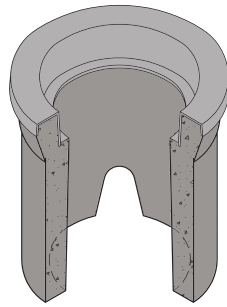

Rating	Part #	Desc 1	Desc 2	Color	Depth	Item Weight	Pallet Qty	Line Item Discount	Design Load	Quick Ship
Body - F08 with Plastic Cap										
Ped	1000370	Box, F08 Curb Valve	F08BOX	Gray	12	34	48	OC01	300 lb/ft2	
Lid - F08 with Plastic Cap										
Ped	1008820	Lid, F08 R - "Irrigation" *	F08R005	Gray	-	8	100	OC01	300 lb/ft2	
Ped	1008980	Lid, F08 R - No Mark	F08R000	Gray	-	8	100	OC01	300 lb/ft2	

CHRISTY B03

CONCRETE
9" X 14"



LIGHT DUTY
PEDESTRIAN / GREENBELT

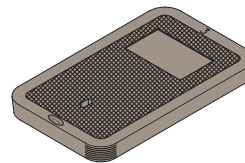
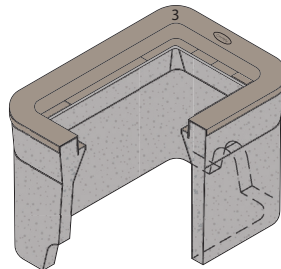

Rating	Part #	Desc 1	Desc 2	Color	Depth	Item Weight	Pallet Qty	Line Item Discount	Design Load	Quick Ship
Body - B03 with Plastic Cap										
Ped	1000000	Box, B03 Utility	B03BOX	Gray	12	88	28	OC01	300 lb/ft2	
Lid - B03 with Plastic Cap										
Ped	1001060	Lid, B03 D - "Irrigation"	B03D005	Gray	-	12	120	OC01	300 lb/ft2	
Ped	1001170	Lid, B03 D - No Mark	B03D000	Gray	-	12	120	OC01	300 lb/ft2	

CHRISTY

*Products are rated by the lowest component rating. A tier 15 cover with a tier 22 body is rated tier 15. A tier 22 cover with a tier 22 body is rated tier 22.

CHRISTY B09

CONCRETE
10" X 15"



LIGHT DUTY
PEDESTRIAN / GREENBELT

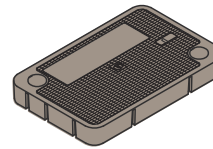
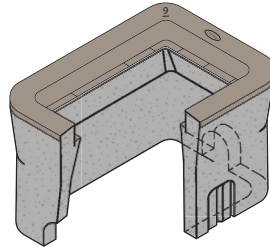

Rating	Part #	Desc 1	Desc 2	Color	Depth	Item Weight	Pallet Qty	Line Item Discount	Design Load	Quick Ship
Body - B09 with Plastic Cap										
Ped	1000005	Box, B09 Utility	B09BOX	Gray	12	92	28	OC01	300 lb/ft2	
Extension - B09										
Ped	1000045	Extension, B09 X 12"	B09X12	Gray	12	87	28	OC01	300 lb/ft2	
Lid - N09 with Plastic Cap										
Ped	1020000	Lid, N09 R - No Mark	N09R000	Gray	-	23	60	OC01	300 lb/ft2	
Ped	1020055	Lid, N09 R - "Irrigation"	N09R005	Gray	-	23	60	OC01	300 lb/ft2	

CHRISTY B12

CONCRETE
12" X 18"



LIGHT DUTY
PEDESTRIAN / GREENBELT

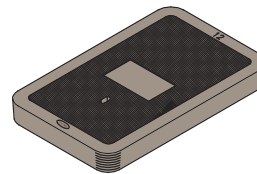
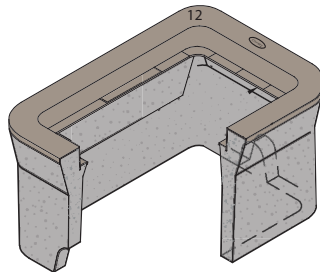

Rating	Part #	Desc 1	Desc 2	Color	Depth	Item Weight	Pallet Qty	Line Item Discount	Design Load	Quick Ship
Body - B12 with Plastic Cap										
Ped	1000050	Box, B12 Utility	B12BOX	Gray	12	110	20	OC01	300 lb/ft2	
Extension - B12										
Ped	1000070	Extension, B12 X 12"	B12X12	Gray	12	103	20	OC01	300 lb/ft2	
Lid - B12										
Ped	1002630	Lid, B12 D - "Water"	B12D001	Gray	-	30.0	-	OC01	300 lb/ft2	
Ped	1002570	Lid, B12 D - "Irrigation" *	B12D005	Gray	-	28	40	OC01	300 lb/ft2	
Ped	1002640	Lid, B12 D - No Mark *	B12D000	Gray	-	28	40	OC01	300 lb/ft2	

CHRISTY B16

CONCRETE

11" X 21"

B16 & B24



LIGHT DUTY
PEDESTRIAN / GREENBELT

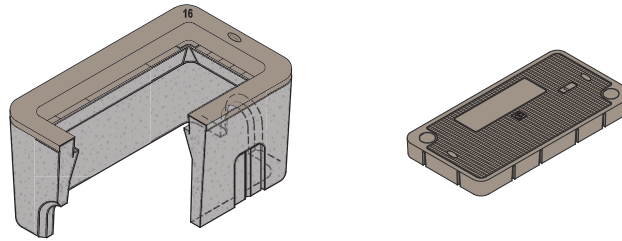

Rating	Part #	Desc 1	Desc 2	Color	Depth	Item Weight	Pallet Qty	Line Item Discount	Design Load	Quick Ship
Body - B16 with Plastic Cap										
Ped	1000075	Box, B16 Utility	B16BOX	Gray	12	134	20	OC01	300 lb/ft2	
Extension - B16										
Ped	1000100	Extension, B16 X 12	B16X12	Gray	12	113	20	OC01	300 lb/ft2	
Lid - N16 with Plastic Cap										
Ped	1020400	Lid, N16 R - No Mark	N16R000	Gray	-	36	40	OC01	300 lb/ft2	
Ped	1020519	Lid, N16 R - "Irrigation"	N16R005	Gray	-	36	40	OC01	300 lb/ft2	

CHRISTY B24

CONCRETE

18" X 19"



LIGHT DUTY
PEDESTRIAN / GREENBELT

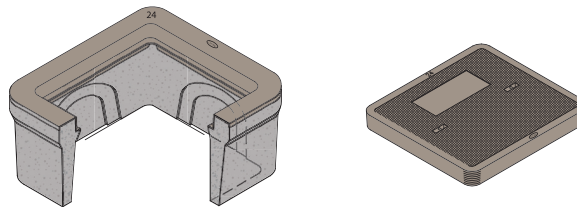

Rating	Part #	Desc 1	Desc 2	Color	Depth	Item Weight	Pallet Qty	Line Item Discount	Design Load	Quick Ship
Body - B24 with Plastic Cap										
Ped	1000110	Box, B24 Dual Utility	B24BOX	Gray	12	148	12	OC01	300 lb/ft2	
Extension - B24										
Ped	1000113	Extension, B24 X 12"	B24X12	Gray	12	164	12	OC01	300 lb/ft2	
Lid - B24										
Ped	1003570	Lid, B24 D - "Irrigation" **	B24D005	Gray	-	56	20	OC01	300 lb/ft2	
Ped	1003640	Lid, B24 D - No Mark	B24D000	Gray	-	56	20	OC01	300 lb/ft2	

*Products are rated by the lowest component rating. A tier 15 cover with a tier 22 body is rated tier 15. A tier 22 cover with a tier 22 body is rated tier 22.

CHRISTY N30

CONCRETE
13" X 24"



LIGHT DUTY
PEDESTRIAN / GREENBELT

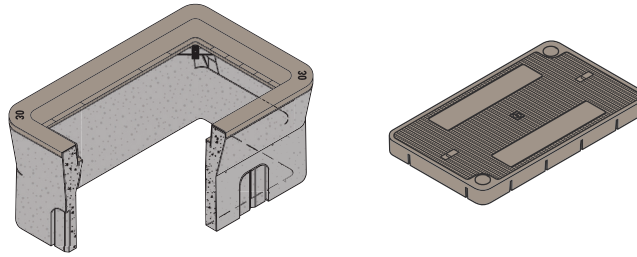

Rating	Part #	Desc 1	Desc 2	Color	Depth	Item Weight	Pallet Qty	Line Item Discount	Design Load	Quick Ship
Body - N30 with Plastic Cap										
Ped	1000115	Box, N30 Electric	N30BOX	Gray	12	134	16	OC01	300 lb/ft2	
Lid - N30 with Plastic Cap										
Ped	1020700	Lid, N30 R - No Mark	N30R000	Gray	-	44	30	OC01	300 lb/ft2	
Ped	1020780	Lid, N30 R - "Irrigation"	N30R005	Gray	-	44	30	OC01	300 lb/ft2	

CHRISTY N36

CONCRETE
17" X 30"



LIGHT DUTY
PEDESTRIAN / GREENBELT

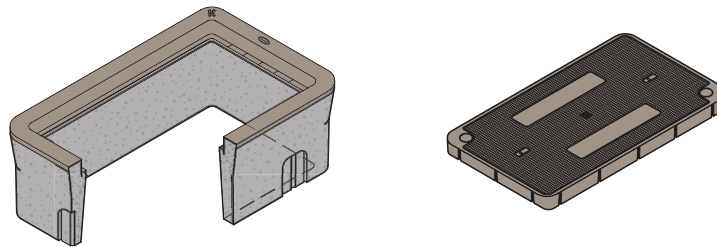

Rating	Part #	Desc 1	Desc 2	Color	Depth	Item Weight	Pallet Qty	Line Item Discount	Design Load	Quick Ship
Body - N36 with Plastic Cap										
Ped	1000155	Box, N36 Utility	N36BOX	Gray	12	175	8	OC01	300 lb/ft2	
Lid - N36 with Plastic Cap										
Ped	1021000	Lid, N36 R - No Mark	N36R000	Gray	-	76	10	OC01	300 lb/ft2	
Ped	1021062	Lid, N36 R - "Irrigation"	N36R005	Gray	-	76	10	OC01	300 lb/ft2	

CHRISTY B65

CONCRETE
15" X 27"

B65 & G03



LIGHT DUTY
PEDESTRIAN / GREENBELT

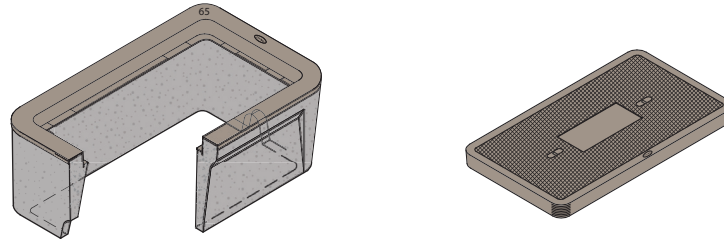

Rating	Part #	Desc 1	Desc 2	Color	Depth	Item Weight	Pallet Qty	Line Item Discount	Design Load	Quick Ship
Body - B65 with Plastic Cap										
Ped	1000190	Box, B65 Utility	B65BOX	Gray	12	164	8	OC01	300 lb/ft2	
Extension - B65										
Ped	1000195	Extension, B65 X 12"	B65X12	Gray	12	141	8	OC01	300 lb/ft2	
Lid - B65										
Ped	1006750	Lid, B65 D - No Mark **	B65D000	Gray	-	65	10	OC01	300 lb/ft2	

CHRISTY G03

CONCRETE
10" DIAMETER



TRAFFIC RATED
AASHTO H20

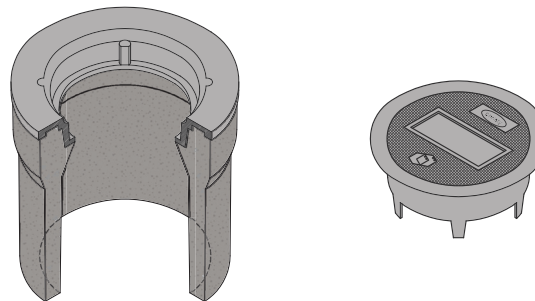

Rating	Part #	Desc 1	Desc 2	Color	Depth	Item Weight	Pallet Qty	Line Item Discount	Design Load	Quick Ship
Body - G03										
Traffic	1000401	Box, G03T Bolt Down Traffic Valve	G03TBOX	Gray	12	75	36	OC01	16000	
Lid - G03										
Traffic	3000620	Lid, G03 C - No Mark IMPT	G03C000IMPT	Black	-	15	-	OC01	16000	

*Products are rated by the lowest component rating. A tier 15 cover with a tier 22 body is rated tier 15. A tier 22 cover with a tier 22 body is rated tier 22.

CHRISTY G05

CONCRETE
11" DIAMETER



TRAFFIC RATED
AASHTO H20



Rating	Part #	Desc 1	Desc 2	Color	Depth	Item Weight	Pallet Qty	Line Item Discount	Design Load	Quick Ship
Body - G05										
Traffic	1000415	Box, G05 T Bolt Down Traffic Valve	G05TBOX	Gray	12	63	36.0	OC01	16000	
Extension - G05										
Traffic	1000445	Extension, G05 X 12"	G05X12	Gray	12	47	36	OC01	16000	
Lid - Compatible with G05 and G08										
Traffic	3001100	Lid, G05 CT Bolt Down - No Mark IMPT	G05CT000	Black	-	10	-	OC01	16000	

CHRISTY G08

CONCRETE
11" DIAMETER



TRAFFIC RATED
AASHTO H20

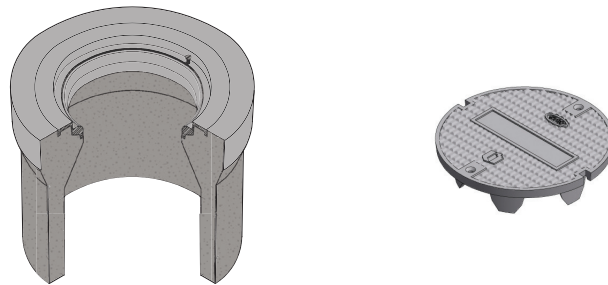

Rating	Part #	Desc 1	Desc 2	Color	Depth	Item Weight	Pallet Qty	Line Item Discount	Design Load	Quick Ship
Body - G08										
Traffic	1000435	Box, G08 T Bolt Down Traffic Valve	G08TBOX	Gray	12	93	10	OC01	16000	
Extension - G08										
Traffic	1000435	Box, G08 T Bolt Down Traffic Valve	G08TBOX	Gray	12	93	10	OC01	16000	
Lid - Compatible with G05 and G08										
Traffic	3001100	Lid, G05 CT Bolt Down - No Mark IMPT	G05CT000	Black	-	10	-	OC01	16000	

CHRISTY G12

CONCRETE
13" DIAMETER

G12 & B1017



TRAFFIC RATED
AASHTO H20

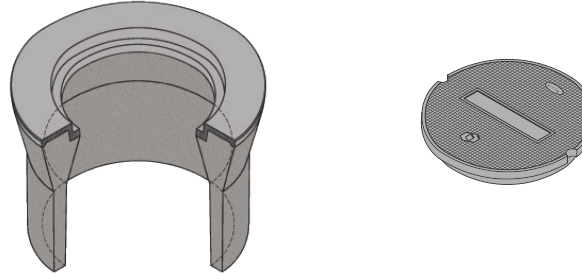

Rating	Part #	Desc 1	Desc 2	Color	Depth	Item Weight	Pallet Qty	Line Item Discount	Design Load	Quick Ship
Body - G12										
Traffic	1000450	Box, G12 Traffic Valve	G12BOX	Gray	12	112	10.0	OC01	16000	
Lid - G12										
Traffic	1000456	Extension, G12 X 12"	G12X12	Gray	12	110	10	OC01	16000	
Lid - G12										
Traffic	3001170	Lid, G12 C - No Mark	G12C000	Black	-	25	-	OC01	16000	

CHRISTY B1017

CONCRETE
10" X 17"



TRAFFIC RATED
AASHTO H20

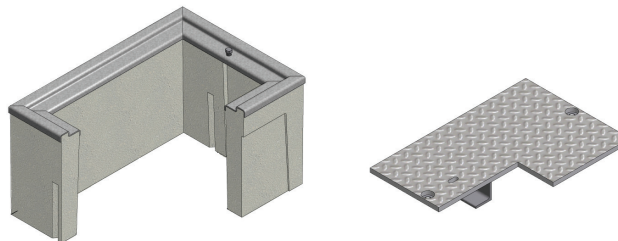

Rating	Part #	Desc 1	Desc 2	Color	Depth	Item Weight	Pallet Qty	Line Item Discount	Design Load	Quick Ship
Body - B1017										
Traffic	1000295	Box, B1730 Utility H20 Load	B1730BOX	Gray	12	280	6	OC01	16000	
Extension - B1017										
Traffic	1000300	Extension, B1730 X 12"	B1730X12	Gray	12	250	6	OC01	16000	
Lid - B1017										
Traffic	2001890	Cover, B1730 51JH - No Mark	B173051JH000	Steel	-	111	-	OC01	16000	
Traffic	2002030	Cover, B1730 51JH Galv - No Mark *	B173051JH000G	Steel	-	111	-	OC01	16000	

*Products are rated by the lowest component rating. A tier 15 cover with a tier 22 body is rated tier 15. A tier 22 cover with a tier 22 body is rated tier 22.

CHRISTY B1324



TRAFFIC RATED
AASHTO H20

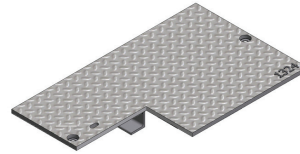
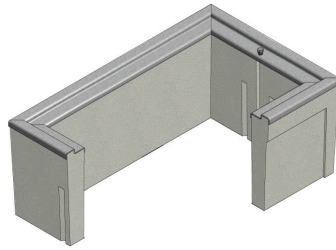

CONCRETE
13" X 24"

Rating	Part #	Desc 1	Desc 2	Color	Depth	Item Weight	Pallet Qty	Line Item Discount	Design Load	Quick Ship
Body - B1324										
Traffic	1000285	Box, B1324 Utility H20 Load	B1324BOX	Gray	12	168	16	OC01	16000	
Extension - B1324										
Traffic	1000290	Extension, B1324 X 12 "	B1324X12	Gray	12	163	16	OC01	16000	
Lid - B1324										
Traffic	2001130	Cover, B1324 51JH - No Mark	B132451JH000	Steel	-	70	-	OC01	16000	
Traffic	2001330	Cover, B1324 51JH Galv - No Mark	B132451JH000G	Galv	-	70	-	OC01	16000	

CHRISTY B1730



TRAFFIC RATED
AASHTO H20

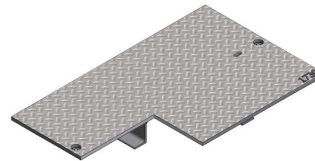
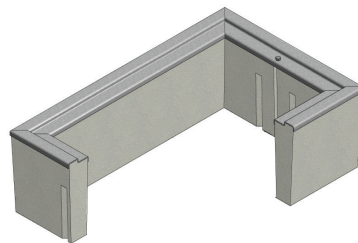

CONCRETE
17" X 30"

Rating	Part #	Desc 1	Desc 2	Color	Depth	Item Weight	Pallet Qty	Line Item Discount	Design Load	Quick Ship
Body - B1730										
Traffic	1000295	Box, B1730 Utility H20 Load	B1730BOX	Gray	12	280	6	OC01	16000	
Extension - B1730										
Traffic	1000300	Extension, B1730 X 12"	B1730X12	Gray	12	250	6	OC01	16000	
Lid - B1730										
Traffic	2001890	Cover, B1730 51JH - No Mark	B173051JH000	Steel	-	111	-	OC01	16000	
Traffic	2002030	Cover, B1730 51JH Galv - No Mark *	B173051JH000G	Steel	-	111	-	OC01	16000	

CHRISTY B2436

CONCRETE
24" X 36"



TRAFFIC RATED
AASHTO H20

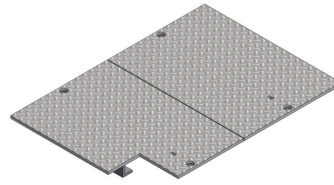
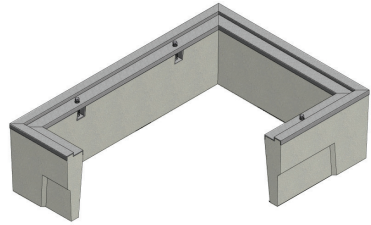

B2436 & B3048

Rating	Part #	Desc 1	Desc 2	Color	Depth	Item Weight	Pallet Qty	Line Item Discount	Design Load	Quick Ship
Body - B2436										
Traffic	1000305	Box, B2436 Utility H20 Load	B2436BOX	Gray	12	258	3	OC01	16000	
Extension - B2436										
Traffic	1000310	Extension, B2436 X 12"	B2436X12	Gray	12	250	3	OC01	16000	
Lid - B2436										
Traffic	2002240	Cover, B2436 52JH - No Mark	B243652JH000	Steel	-	328	-	OC01	16000	
Traffic	2002300	Cover, B2436 52JH Galv - No Mark **	B243652JH000G	Galv	-	328	-	OC01	16000	

CHRISTY B3048

CONCRETE
30" X 48"



TRAFFIC RATED
AASHTO H20

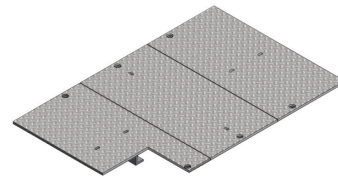
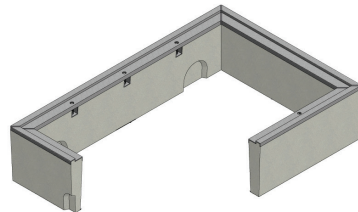

CHRISTY

Rating	Part #	Desc 1	Desc 2	Color	Depth	Item Weight	Pallet Qty	Line Item Discount	Design Load	Quick Ship
Body - B3048										
Traffic	1000315	Box, B3048 Utility H20 Load	B3048BOX	Gray	12	458	3	OC01	16000	
Extension - B3048										
Traffic	1000320	Extension, B3048 X 12"	B3048X12	Gray	12	458	3	OC01	16000	
Lid - B3048										
Traffic	2002890	Cover, B3048 53JH - No Mark	B304853JH000	Steel	-	445	-	OC01	16000	
Traffic	2002930	Cover, B3048 53JH Galv - "SPECIAL"	B304853JH099G	Galv	-	445	-	OC01	16000	

*Products are rated by the lowest component rating. A tier 15 cover with a tier 22 body is rated tier 15. A tier 22 cover with a tier 22 body is rated tier 22.

HOSENCLOSE UNDERGROUND HOSE STORAGE SYSTEM



**LIGHT DUTY
PEDESTRIAN / GREENBELT**

**HDPE
10" X 17"**

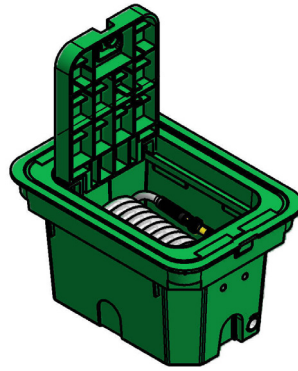

Rating	Part #	Desc 1	Desc 2	Color	Depth	Item Weight	Pallet Qty	Line Item Discount	Design Load	Quick Ship
Ped	38001001	HosEnclose Green 1017	50 ft 1/2 in Hose Brass Nozzle	Green	12	13	30	OC06	300 lb/ft2	

LANDSCAPE EDGE & PAVER FRAME RESTRAINTS



Landscape Edge



Paver Frame



Oldcastle Spike



Rating	Part #	Desc 1	Desc 2	Color	Depth	Item Weight	Pallet Qty	Line Item Discount	Design Load	Quick Ship
Landscape Edge										
-	38006200	Oldcastle Landscape Edging	20' 6-Pack with 14 - 8" Spikes	Black	-	44.6	-	OC06	-	
Paver Frame										
-	38006130	Oldcastle PAVER FRAME Bundle	30 Qty Bundle-6' Single Stick	Black	-	45	-	OC06	-	
Oldcastle Spikes										
-	80006010	Oldcastle Spikes 8 ct. Mstr Crtn (24 bags)	Carton (24 bags of 8)	Black	8	-	-	OC06	-	

Rating	Part #	Desc 1	For Use With	Line Item Discount	Design Load	Quick Ship
Carson Hardware						
-	80002006	Kit, L-Series Bolt, Hex, 3/8", 1015, 1220, 1419 - Qty 1	1015, 1220, 1419	OC09	-	
-	80002008	Kit, L-Series Bolt, Hex, 3/8", 910 - Qty 1	0910	OC09	-	
-	80002025	Kit, H-Series Bolt, Hex, 1/2", 1324, 1730 - Qty 2	1324, 1730	OC09	-	
-	80002007	Kit, L-Series Bolt, Penta Lg, 3/8", 1015, 1220, 1419 - Qty 1	1015, 1220, 1419	OC09	-	
H-Series Hardware						
-	80002005	Kit, H-Series Bolt, Hex, 1/2", 1324, 1730 - Qty 1	1324, 1730	OC09	-	
-	80002025	Kit, H-Series Bolt, Hex, 1/2", 1324, 1730 - Qty 2	1324, 1730	OC09	-	
-	80002052	Kit, H-Series/SYN Bolt, Hex, 1/2", 1118, 1212 - Qty 2	1118, 1212	OC09	-	
-	80002033	Kit, SYN Bolt, Hex, 1/2", 1118, 1324, 1730 - Qty 2	1118, 1324, 1730	OC09	-	
-	80002029	Kit, H-Series/SYN Bolt, Hex, 1/2", 2436, 3048, 3060 - Qty 2	2436, 3048, 3060	OC09	-	
-	80002026	Kit, H-Series Bolt, Penta Lg, 1/2", 1324, 1730 - Qty 2	1324, 1730	OC09	-	
-	80002054	Kit, H-Series/SYN Bolt, Penta Lg, 1/2", 1118, 1212 - Qty 2	1118, 1212	OC09	-	
-	80002034	Kit, SYN Bolt, Penta Lg, 1/2", 1118, 1324, 1730 - Qty 2	1118, 1324, 1730	OC09	-	
-	80002030	Kit, H-Series/SYN Bolt, Penta Lg, 1/2", 2436, 3048, 3060 - Q	2436, 3048, 3060	OC09	-	
Synertech Hardware						
-	80002052	Kit, H-Series/SYN Bolt, Hex, 1/2", 1118, 1212 - Qty 2	1118, 1212	OC09	-	
-	80002033	Kit, SYN Bolt, Hex, 1/2", 1118, 1324, 1730 - Qty 2	1118, 1324, 1730	OC09	-	
-	80002029	Kit, H-Series/SYN Bolt, Hex, 1/2", 2436, 3048, 3060 - Qty 2	2436, 3048, 3060	OC09	-	
-	80002054	Kit, H-Series/SYN Bolt, Penta Lg, 1/2", 1118, 1212 - Qty 2	1118, 1212	OC09	-	
-	80002034	Kit, SYN Bolt, Penta Lg, 1/2", 1118, 1324, 1730 - Qty 2	1118, 1324, 1730	OC09	-	
-	80002030	Kit, H-Series/SYN Bolt, Penta Lg, 1/2", 2436, 3048, 3060 - Q	2436, 3048, 3060	OC09	-	

H-SERIES STEEL LIDS

Rating	Part #	Desc 1	Desc 2	For Use With	Line Item Discount	Design Load	Quick Ship		
-	11184054	1118 Steel T Cover Gal SPECIAL	PC BOX	1118	-	41	OC01	-	
-	13244180	1324 Steel T Cover Gal Blank	PC Box	1324	-	49	OC01	-	
-	17304186	1730 Steel T Cover Gal Blank	2x Prov	1730	-	65	OC01	-	
-	24364011	2436 Steel T Cover, Galv., "SPECIAL"	Galvanized	2436	-	124	OC01	-	
-	30484019	3048 Steel T Cover Gal Blank	2 Piece Over Under	3048	-	196	OC01	-	
-	30604013	3060 Steel T Cover "Marked"	2 Piece Over Under	3060	-	246	OC01	-	

For solid bottom, dividers, and other H-Series options contact customer service.

*Products are rated by the lowest component rating. A tier 15 cover with a tier 22 body is rated tier 15. A tier 22 cover with a tier 22 body is rated tier 22.

H-SERIES MARKING PLATE LIDS

Rating	Part #	Desc 1	Desc 2	Color	Depth	Item Weight	Pallet Qty	Line Item Discount	Design Load	Quick Ship
1118 - Marking Plate Lid										
T15	11184694	Lid, PC1118-T, T15 -SPECIAL w/MARKING PLATE	PC1118T-T15	Gray	-	20	60	OC03	15000	
T22	11184695	Lid, PC1118-T, T22 - SPECIAL w/MARKING PLATE	PC1118T-T22	Gray	-	28	60	OC03	22500	
1324 - Marking Plate Lid										
T15	13244694	Lid, PC1324-T, T15 -SPECIAL w/MARKING PLATE	PC1324T-T15	Gray	-	38	30	OC03	15000	
T22	13244695	Lid, PC1324-T, T22 - SPECIAL w/MARKING PLATE	PC1324T-T22	Gray	-	51	30	OC03	22500	
1730 - Marking Plate Lid										
T15	17304694	Lid, PC1730-T, T15 -SPECIAL w/MARKING PLATE	PC1730T-T15	Gray	-	62	25	OC03	15000	
T22	17304695	Lid, PC1730-T, T22 - SPECIAL w/MARKING PLATE	PC1730T-T22	Gray	-	85	25	OC03	22500	
2424 - Marking Plate Lid										
T15	24244694	Lid, PC2424-T, T15 -SPECIAL w/MARKING PLATE	PC2424T-T15	Gray	-	75	20	OC03	15000	
T22	24244695	Lid, PC2424-T, T22 - SPECIAL w/MARKING PLATE	PC2424T-T22	Gray	-	112	20	OC03	22500	
2436 - Marking Plate Lid										
T15	24364694	Lid, PC2436-T, T15 -SPECIAL w/MARKING PLATE	PC2436T-T15	Gray	-	150	10	OC03	15000	
T22	24364695	Lid, PC2436-T, T22 - SPECIAL w/MARKING PLATE	PC2436T-T22	Gray	-	204	10	OC03	22500	
3048 - Marking Plate Lid										
T15	30484694	Lid, PC3048-T, T15 -SPECIAL,2pc w/MARKING PLATE	PC3048T-T15	Gray	-	274	10	OC03	15000	
T22	30484695	Lid, PC3048-T, T22 - SPECIAL,2pc w/MARKING PLATE	PC3048T-T22	Gray	-	338	10	OC03	22500	

Standard Marking Plate: 4" x 8", 2 rows of lettering, max 13 characters each row. Options Available. Call Customer Service for Custom and Specialty Marking Orders.

SYNERTECH MARKING PLATE LIDS

Rating	Part #	Desc 1	Desc 2	Color	Depth	Item Weight	Pallet Qty	Line Item Discount	Design Load	Quick Ship
1118 - Marking Plate Lid										
T15	31059922	Lid, SYN1118 T T15 - SPECIAL w/MARKING PLATE	SYN1118T099	Gray	-	26	26	OC10	15000	
1212 - Marking Plate Lid										
T15	31109922	Lid, SYN1212 T T15 - SPECIAL w/MARKING PLATE	SYN1212T-T15 999	Gray	-	15	160	OC10	15000	
T22	31109832	Lid, SYN1212 T T22 - SPECIAL w/MARKING PLATE	SYN1212T-T22 999	Gray	-	15	160	OC10	15000	
1324 - Marking Plate Lid										
T15	31159922	Lid, SYN1324 T T15 - SPECIAL w/MARKING PLATE	SYN1324T099	Gray	-	42	65	OC10	15000	
1730 - Marking Plate Lid										
T15	31209922	Lid, SYN1730 T T15 - SPECIAL w/MARKING PLATE	SYN1730T099	Gray	-	64	33	OC10	15000	
2436 - Marking Plate Lid										
T22	31259922	Lid, SYN2436 T T22 - SPECIAL w/MARKING PLATE	SYN2436T099	Gray	-	125	20	OC10	22500	
3048 - Marking Plate Lid										
T22	31309922	Lid, SYN3048 T T22 - SPECIAL w/MARKING PLATE	SYN3048T099	Gray	-	193	12	OC10	22500	

Standard Marking Plate: 4" x 8", 2 rows of lettering, max 13 characters each row. Options Available. Call Customer Service for Custom and Specialty Marking Orders.

H-SERIES & SYNERTECH MARKING PLATES

Rating	Part #	Desc 1	Desc 2	Color	Depth	Item Weight	Pallet Qty	Line Item Discount	Design Load	Quick Ship
Marking Plates										
-	31901090	Marking Plate-Special	4"x8"	-	-	-	-	OC10	-	
Marking Plate Adhesive										
-	31900100	Sealant, Surebond SB-12 10.2oz Cartridge	Sealant Adhesive	-	-	-	-	OC09	-	

*Products are rated by the lowest component rating. A tier 15 cover with a tier 22 body is rated tier 15. A tier 22 cover with a tier 22 body is rated tier 22.

LIGHT DUTY PLASTIC PRODUCT

Typical grass surround installation

Crushed rock backfill is shown as specified in the Company's Installation Procedure. The tamped crushed rock supports the vault, preventing subsidence and allowing for drainage. The excavated spoils have been used for backfill.

Note the soil is free of rocks larger than three inches.

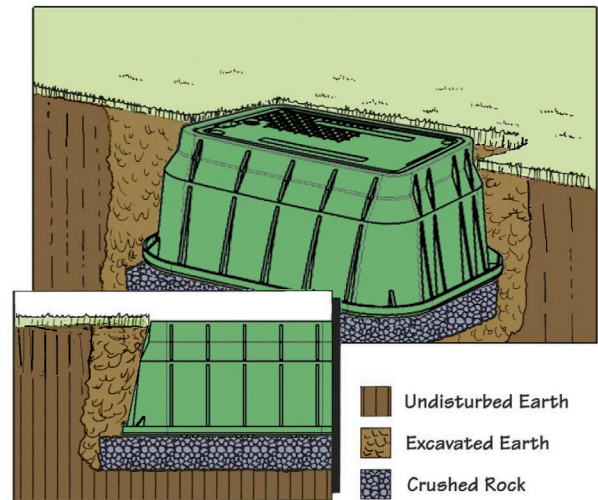

LIGHT DUTY HYBRID PRODUCT

Alternative for greenbelt location

Lateral load resistance is enhanced in this range of products. The polymer concrete cover offers an increased coefficient of friction (over HDPE) for foot traffic.

Note that backfill, although not crushed rock, is changed to specify compaction, thereby enhancing vault performance.

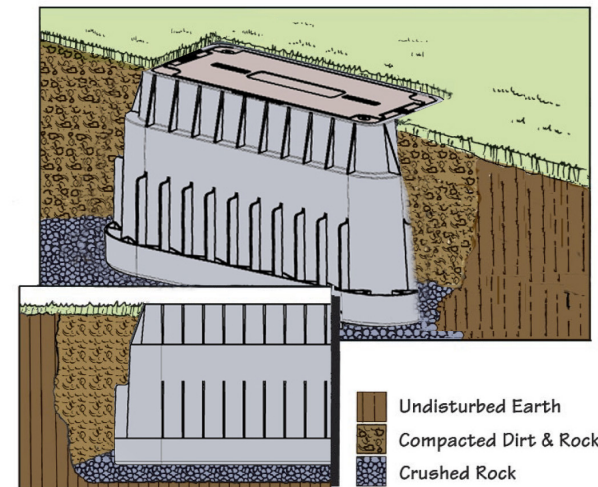

LIGHT DUTY HYBRID PRODUCT

Concrete or Asphalt Surround (shown)

Note compacted crushed rock surround. Dry mix could be added to crushed rock under "ring" to improve vertical load bearing.

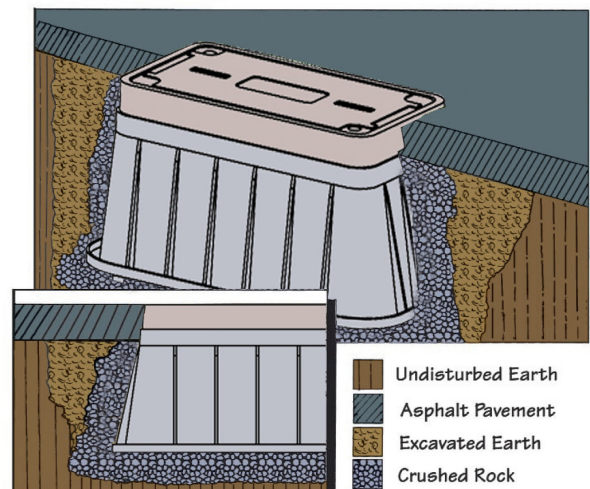

CARSON® PLASTIC PRODUCTS ARE NOT INTENDED FOR INSTALLATION IN ANY DELIBERATE TRAFFIC AREA.

Oldcastle® underground enclosures are suitable for delivery to job sites on any construction vehicle. Enclosures can be safely handled by hand by the proper number of trained workers or proper lifting equipment for loading and unloading.

Site preparation

- Follow local guidelines and job requirements.

Excavation and preparation of enclosure hole (fig 1).

- Remove material to provide 1 – 2' of clearance all around the enclosure and 6" – 8" in additional depth allowing for bedding and rodent barrier.
- Place a suitable bedding material, such as crushed stone, at the base of the excavated hole.

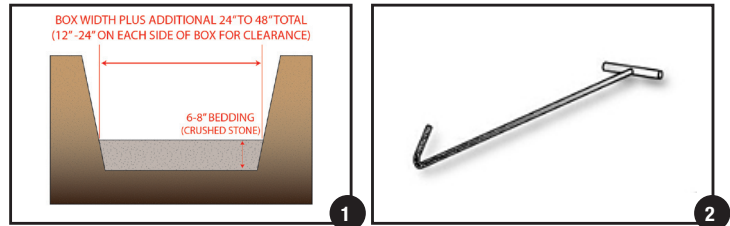

Removing enclosure from delivery vehicle and pallet.

- Remove shipping band from enclosure.
- Use proper hook to remove lid from the enclosure base (fig 2).
- Using proper lifting techniques, secure and remove box from truck. Lifting bolts are provided for boxes 2424 and larger (fig 3).
- The angle of the lifting lines should not exceed 65°.
- Optional : Install temporary brace supports in the interior of the enclosure to provide additional lateral rigidity and if 95% compaction is required (fig 4).

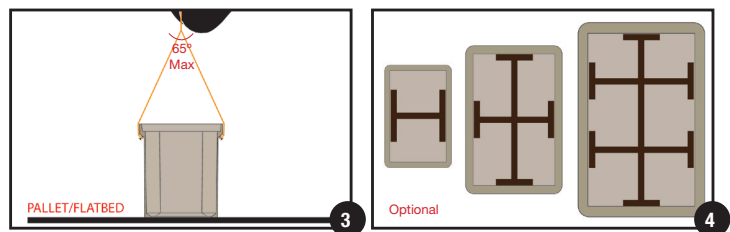

Enclosure placement into prepared hole.

- Reinstall the lid to the base of the enclosure prior to uniformly backfilling on all four sides. Nut, bolt threads, and cover seat should always be free of dirt and debris before tightening down the bolt.
- Bed the base of the hole with crushed stone. Then lift and place the enclosure into the bedded hole.
- Place crushed stone around the sides (fig 7 & 8).
- Position the enclosure to the proper grade level and check.
- Remove lid with proper lifting-eye tool.
- Make the necessary elevation adjustments and recheck the elevation.
- After the enclosure is set to the proper elevation, remove the temporary brace supports if used and reinstall the cover.
- Compact backfill per engineering specifications.
- Proper tamping tools such as a mechanical tamping device or hand operated device should be used. (fig 9)
- A hand shovel or backhoe should never be used for tamping as damage will occur.

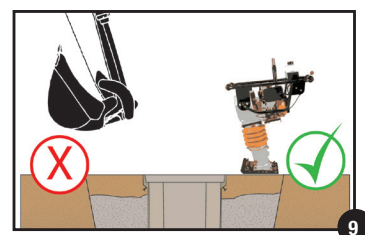
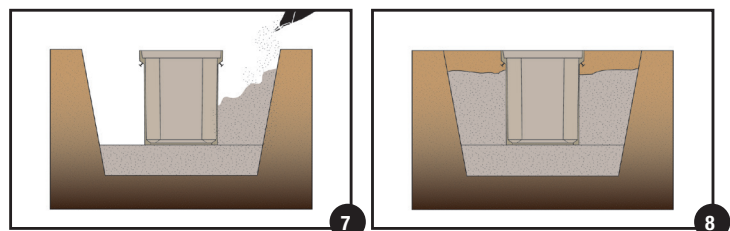
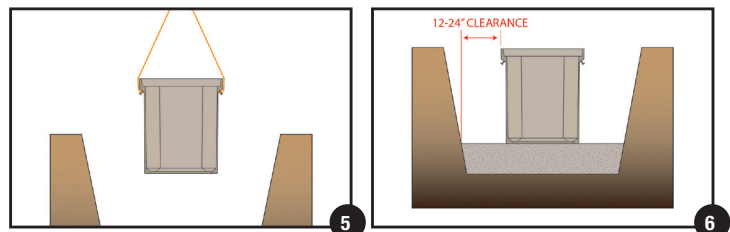

Vibrator plate may also be used.

- 1** Synertech® underground enclosures can be delivered to the site on any construction maintenance vehicle and are easily handled by hand or boom truck for unloading.
-

- 2** Mark location and begin excavation, prepare excavation so there is room for at least 6" of bedding material. Depth of excavation = Box Height plus 6".
-

- 3** Place a suitable bedding material (compacted pea gravel or crushed rock) beneath the enclosure and level it to ensure that the enclosure is well supported beneath its walls. Install wire mesh on the level bedding material. Wire mesh is utilized to help prevent intrusion by pests and rodents after installation. On larger enclosures, utilize a boom to install enclosure into the excavated hole.
-

- 4** Install temporary supports in the interior of the underground enclosure to provide greater lateral rigidity. The number of supports varies depending on the size of Underground Enclosure.
-

- 5** Place a temporary cover or the actual cover on the enclosure before backfilling uniformly on all four sides. Backfill to grade level. Compact every 6 inches to ensure well compacted backfill. A mechanical tamping device or alternative hand operated mechanical devices should be used. Do not use a tire or the shovel of a backhoe as tamping tools!
-

- 6** Be sure that the soil or pavement is to grade level before allowing vehicles in the vicinity of the enclosure.

PEDESTRIAN RATED ENCLOSURES

Installation in concrete or pavement for driveways, parking lots, and off-roadway applications where subject to occasional non-deliberate light vehicles.

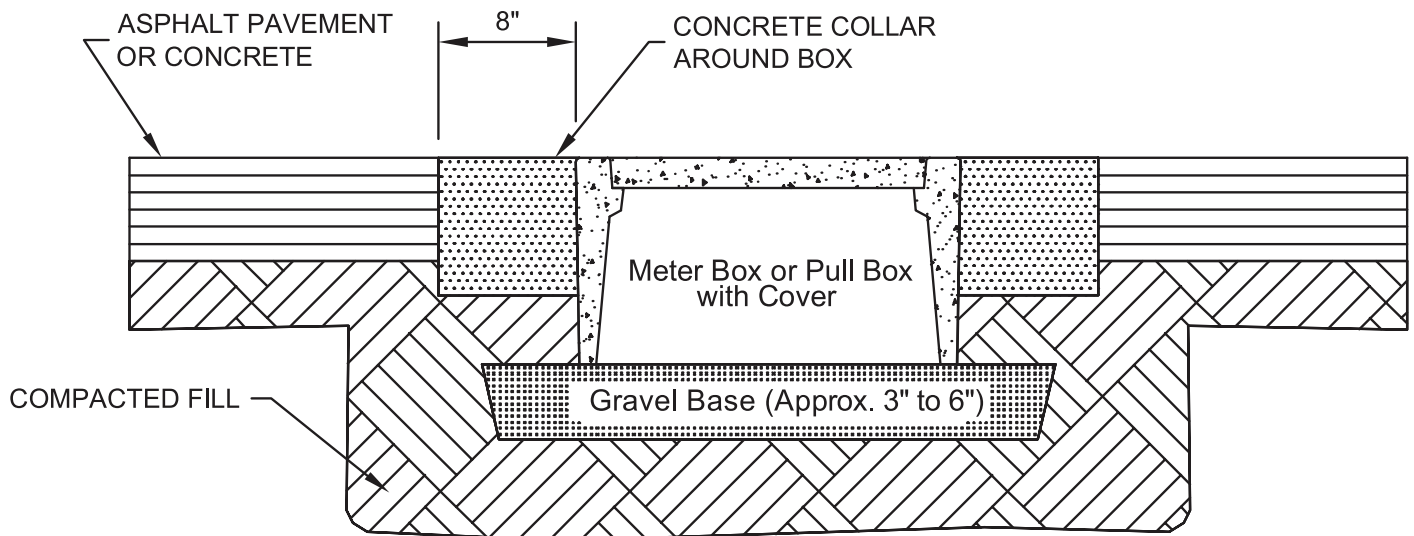

Field preparation

- Prepare the excavation approximately 6" deeper than the overall height of the enclosure.
- The length and width of the excavation should be determined by adding 4" to 6" to the overall length and width of the box.

Installation Recommendations

- Place 3" to 6" of compacted material such as sand or gravel because of its drainage characteristics.
- The compacted material should be leveled so the top of the box is flush to grade.

Backfilling

- Place select backfill into the excavation in 12" lifts and compact.
- The final 8" of the excavation should be finished with concrete
- This may be accomplished by providing a form around the enclosure that would produce an eight-inch wide collar (fig 1).

Quick Specification

Underground enclosures are manufactured by Oldcastle Enclosure Solutions. Boxes and covers shall be concrete and have a pedestrian rated minimum vertical test load of 350 pounds per square foot. The concrete shall test to a minimum of 4500 psi compressive strength.

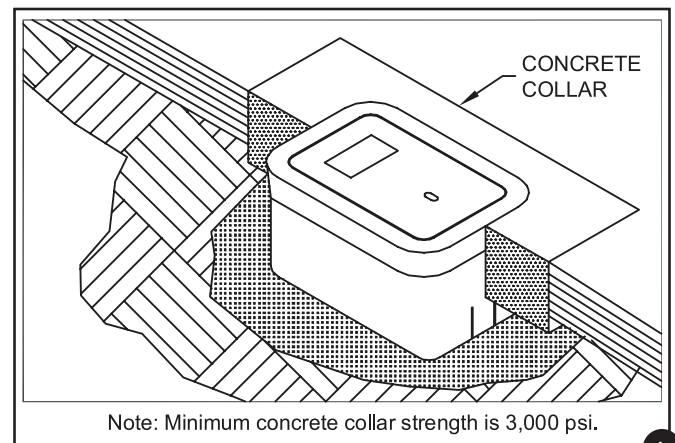

TRAFFIC RATED VALVE BOXES

Installation in concrete or pavement for full traffic applications. This procedure is consistent with Caltrans Standard Plan ES-8B.

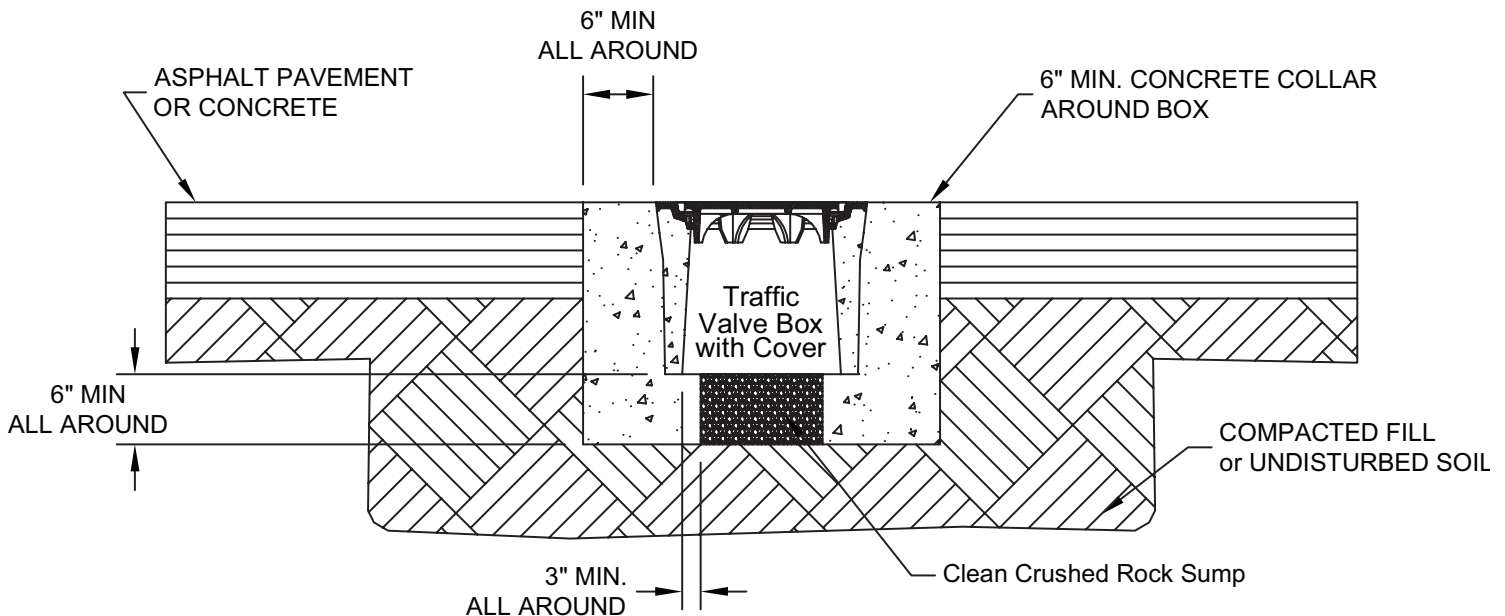

Field preparation

- Prepare the excavation approximately 6" deeper than the overall height of the enclosure.
- The diameter of the excavation should be determined by adding 12" to the overall diameter of the box.

Installation Recommendations

- Place at least 6" of compacted clean crushed rock, coarse gravel, or angular stone material because of its drainage characteristics.
- The compacted material should be leveled so the top of the box is flush to grade.

Backfilling

- Place select backfill into the excavation in 4" to 6" lifts and compact.
- The final 6" to 8" of the excavation should be finished with concrete collar. This may be accomplished by providing a form around the enclosure that would produce a six-inch minimum wide collar (fig 1).

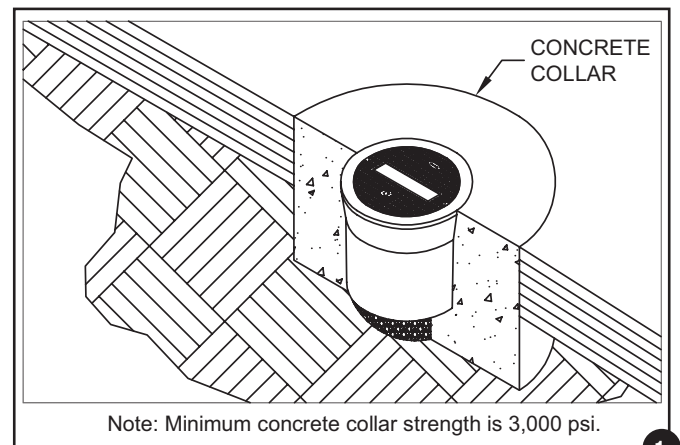

Quick Specification

Traffic-rated underground enclosures are manufactured by Oldcastle Enclosure Solutions. The box shall be precast concrete with a cast iron frame and cover with a 16,000 lbs design load. Traffic-rated enclosures shall be used where the box and cover may be exposed to vehicular traffic. The precast concrete mix shall exceed 4,500 PSI compressive strength. The concrete collar mix used in the installation shall exceed a minimum of 3,000 PSI compressive strength. Please contact Oldcastle Enclosure Solutions for a product cut sheet and possible applications.

TRAFFIC RATED ENCLOSURES

Traffic box installation procedure for installation in concrete or pavement for full traffic application. This procedure is consistent with Caltrans Standard Plan ES-8B.

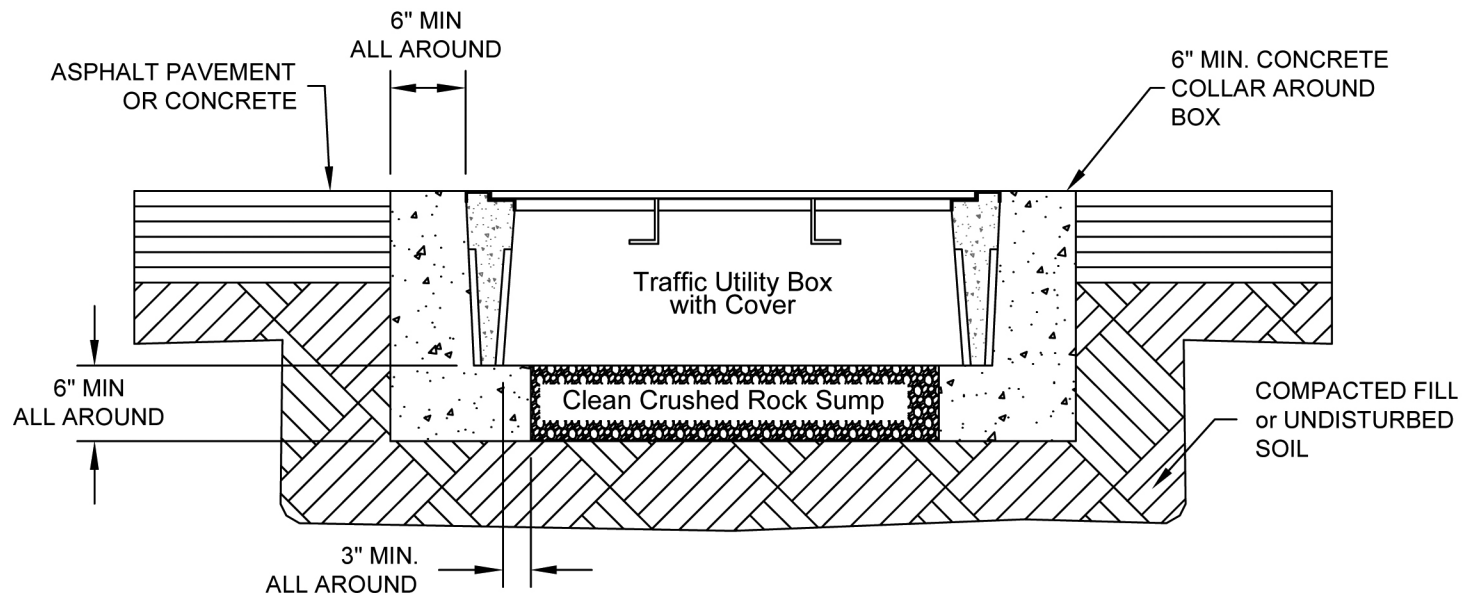

Field preparation

- Prepare the excavation approximately 6" deeper than the overall height of the enclosure.
- The length and width of the excavation should be determined by adding 12" to the overall length and width of the box.

Installation Recommendations

- Place at least 6" of compacted clean crushed rock, coarse gravel, or angular stone material because of drainage characteristics.
- The compacted material should be leveled so the top of the box is flush to grade.

Backfilling

- Place select backfill into the excavation in 4" to 6" lifts and compact.
- The final 6" to 8" of the excavation should be finished with concrete collar. This may be accomplished by providing a form around the enclosure that would produce a six-inch minimum wide collar (fig 1).

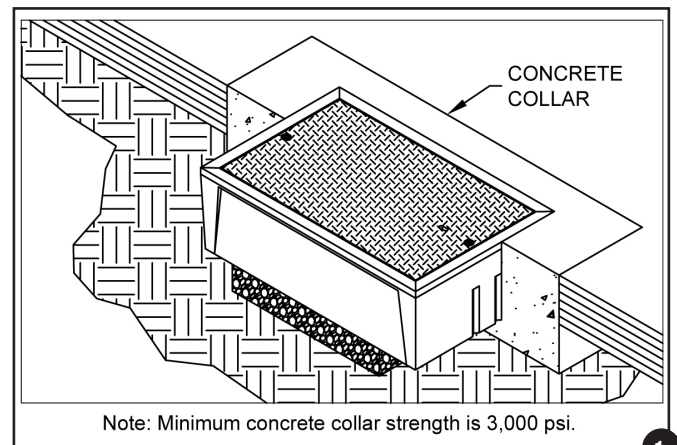

Quick Specification

Traffic-rated underground enclosures are manufactured by Oldcastle Enclosure Solutions. The box shall be precast concrete with a steel frame and cover with a 16,000 lbs design load. Traffic-rated enclosures shall be used where the box and cover may be exposed to vehicular traffic. The precast concrete mix shall exceed 4,500 PSI compressive strength. The concrete collar mix used in the installation shall exceed a minimum of 3,000 PSI compressive strength. Please contact Oldcastle Enclosure Solutions for a product cut sheet and possible applications.

BOLT DOWN MARKING PLATE SYSTEM

Simplify lid inventory and customize your enclosures at the time of installation. Our polymer concrete and composite lids available on the Duralite™ boxes feature a molded-in recess to allow marking plates to be installed at the factory, distribution center, or customer location. A wide variety of standard markings are available as listed in this document in addition to custom plate markings.

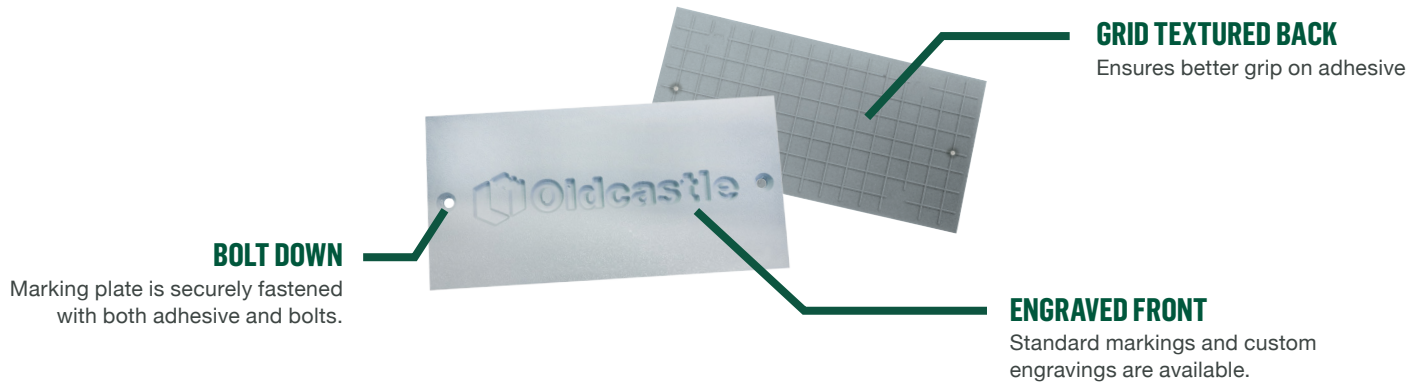

INSTALLATION GUIDELINES AND INSTRUCTIONS

For optimum results, the lid and marking plate should be clean and dry. The marking plate will have a grid pattern on the back side.

- 1** Apply a moderate amount of Surebond SB-12 adhesive (approximately 1/8" bead) in a wave-like pattern with a border (see figure 2) starting and ending approximately 3/8" from pocket sides. Using excessive adhesive will slow curing process.
- 2** Place marking plate in pocket (figure 3) and apply continual pressure to the top of the plate for 10 seconds.
- 3** Adjust marking plate to the center of the pocket and ensure it is below or flush with the lid surface before adhesive sets.
- 4** Tack-free time is 10-20 minutes and full cure is approximately 24 hour.
- 5** Using the spanner bit, screw the two spanner bolts hand-tight into the holes of the marking plate.

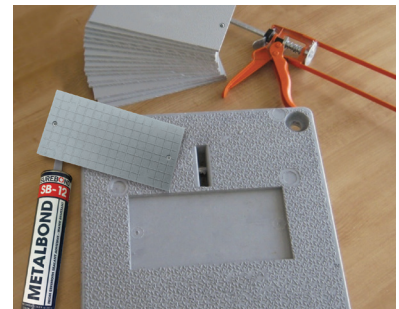

Figure 1

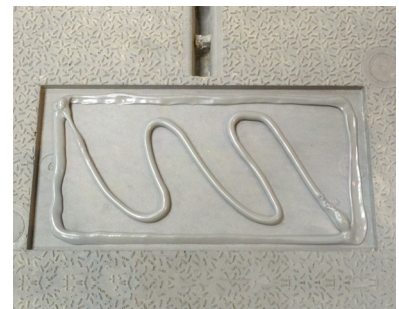

Figure 2



Figure 3

- Prices subject to change without notice.
- F.O.B. Oldcastle Facilities.
- Pre-Paid Freight minimums vary by product origin. Please contact your sales representative for assistance.
- Credit Terms: Net 30 days to approved customers.
- MINIMUM ORDER SIZE \$100.00 NET.
- Special requirements for color, materials, or hardware will be quoted upon request.
- Other sizes or type of bolt heads will be quoted upon request.
- Products being requested for return must have prior authorization and are subject to 25% restocking fee for standard products returned within 180 days of purchase. Products must be in saleable condition.
- Special order products cannot be returned.



Oldcastle®
Enclosure Solutions

Count on Oldcastle Enclosure Solutions to deliver reliable, high-performance products to allow for a safer and more successful project.



FOR MORE INFORMATION CALL

(800) 735-5566



VISIT OUR WEBSITE

OldcastleEnclosures.com

At Oldcastle Enclosure Solutions, we understand what makes your projects successful — the right enclosure, for the right location, for the right application. That's why we're dedicated to providing innovative, high-quality solutions to meet every application and the reliable service to back it up.

We leverage our footprint and manufacturing portfolio of the world's leading brands in grade-level utility boxes to create optimal solutions for Electrical, Communications, Water and Irrigation markets.

We believe our solutions do more than simply support infrastructure, that our solutions keep our communities running strong.

The information provided in this document is intended for informational purposes only and is subject to change without notice. Oldcastle may also make improvements and/or changes in the products, described in this information at any time without notice. Revision 10/2017