

Plusrite®

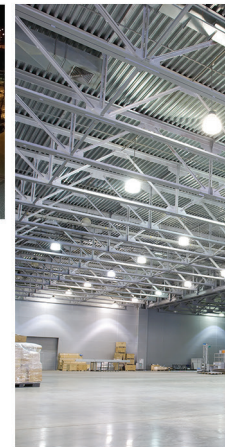

Product Catalog
Edition XV

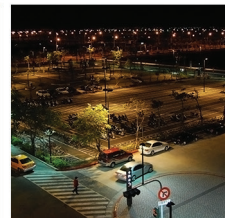
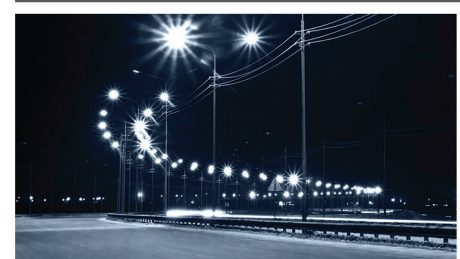





Table of Content

Introduction	
Glossary of Terms	2
High Intensity Discharge	6
Halogen	40
Compact Fluorescent	68
Linear Fluorescent	86
Ballast.....	92
Germicidal.....	120
Warranty.....	126





Plusrite®





CATALOG

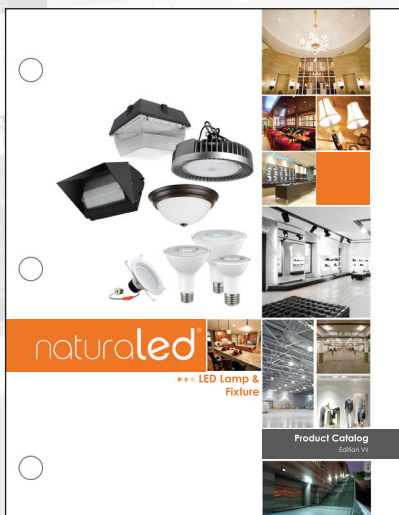
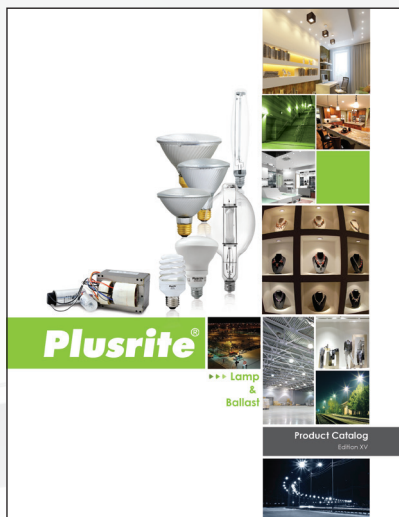

Plusrite USA provides a wide range of products to satisfy all of our customers' needs. Please check out our other product lines which include: naturaLED Lamps and Fixtures, Global Electrical & Industrial Products.





Manufacturing



With products manufactured in different locations all over the world, Plusrite USA produces and carries a variety of quality products in the lighting Industry. Our products include Traditional Lamps, Ballasts, LED's, LED Fixtures and Electrical products.



Certification

Our products are high quality, reliable and durable. To ensure our products meet industry standards, Plusrite USA participates in many different programs and association memberships.



Company Profile



California



Canada



North Carolina



Distribution

Plusrite USA distribution centers are located on the East and West coasts of the United States, in addition to Canada and Mexico. Over the last 10 years, new locations have been added and we plan to expand in the coming years. Our expansion goal is to ship quickly and affordably for our customers in all regions of the United States.



Lamp Measurement Terms

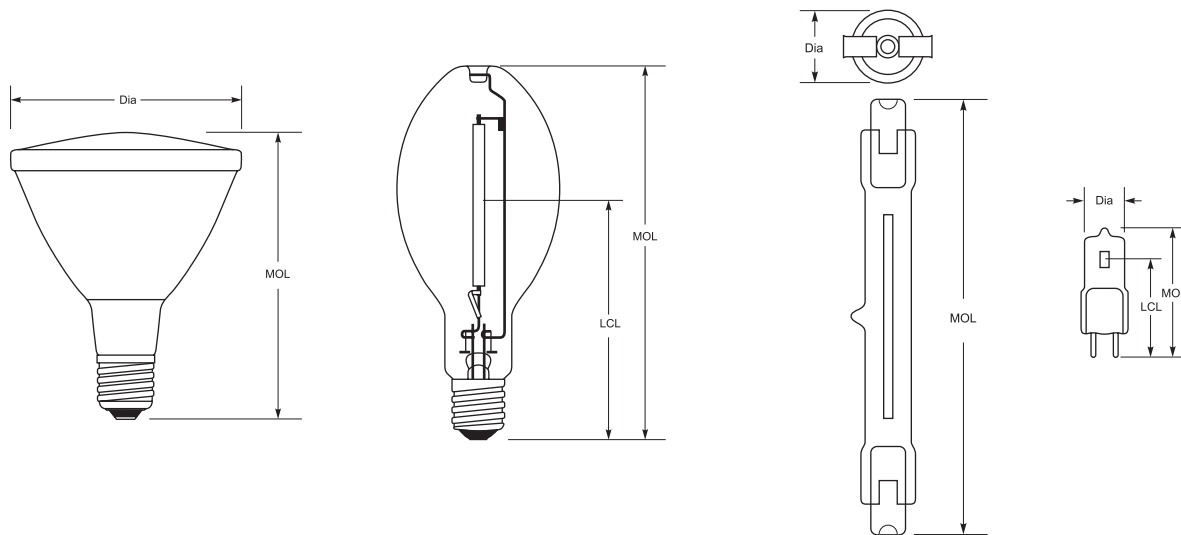

MOL - Maximum overall length in inches

LCL - Distance from the light center to the bottom, measured in inches

Dia - Maximum overall diameter in inches

Common Lighting Terms & Definitions

AMP - Watts Divided by Volts.

ANSI - American National Standards Institute. The organization that develops voluntary guidelines and produces performance standards for the electrical and other industries.

AVERAGE RATED LIFE - An average rating, in hours, indicating when 50% of a large group of lamps have failed, when operated at nominal lamp voltage and current.

BALLAST — A device which provides the necessary starting voltage and appropriate current to a fluorescent or high intensity discharge (HID) luminaire.

BALLAST FACTOR — A ratio used to calculate the expected real-world performance of a lamp. Calculated as the difference between the expected performance of a lamp with a commercial ballast versus the measured performance of that lamp with a reference ballast.
Rated Lamp Lumens x Ballast Factor = Net Lumens.



Glossary of Terms

CRI — Color Rendering Index, sometimes CIE. The ability of a light source to accurately render an object's color in comparison with a natural light source. Measured on a scale of 1 -100 with 100 being the ideal.

COLOR TEMPERATURE - The temperature at which a black body would emit radiation of the same color as a given object. With higher color temperature, the light is whiter or bluer.

DAYLIGHT SENSOR — A device which senses the amount of daylight in a room and controls the luminaire accordingly.

HID — High Intensity Discharge lamps. Includes HPS, PSMH and MH lamps.

HPS — High Pressure Sodium HID Lighting.

INITIAL LUMENS - The lumens produced by a lamp after an initial burn in period (usually 100 hours).

INPUT WATTS — The total wattage required by both the ballast and the lamp in a luminaire.

INSTANT START— Ballast starting type. Applies high voltage across the lamp with no preheating of the cathode.

KELVIN TEMPERATURE— A numerical scale used to describe the color of light. Light with a lower Kelvin rating will have a more yellow tint, while light with a higher Kelvin rating will have a more blue tint.

LAMP — The source of light in a fixture, colloquially called a “light bulb.”

LUMENS - A unit of luminous flux; overall light output; quantity of light, expressed in lumens.

POWER FACTOR - A measure of the effectiveness with which an electrical device converts volt-amperes to watts; devices with power factors (< 0.90) are “high power factor” devices.

T5 — 5/8” diameter fluorescent lamps. “T” stands for tubular, while the number “5” stands for the 5 in 5/8”. Therefore a T8 lamp would be a Tubular 8/8”, or 1” diameter lamp.

T8 — 1” diameter fluorescent lamps.

T12 — 1 1/2” diameter fluorescent lamps.

THERMAL CHARACTERISTICS — The manner in which a luminaire manages heat, either dissipating heat or retaining it.

HIGH INTENSITY DISCHARGE

The catalog format and related terminology will assist the reader by providing brief description toward understanding of information in this section. The lamp identification is simplified by listing all the lamp families in ascending wattage and followed by alphabetical bulb designation. Tests conducted under controlled conditions on AC circuits with auxiliary equipment provides performance rating which meets current published ANSI specifications.

Typical service conditions may cause the variation of lamp performance against rated values. Ratings and specifications are subject to change without any further notice.

ANSI CODE

ANSI CODE is a unique code developed and assigned by the American National Standards Institute. This code describes the class and electrical characteristics of lamps and ballast as well as fixture requirements. The ANSI CODE consists type of lamps as S=HPS, H=Mercury, M=Metal Halide, L=LPS and followed by ballast number. For metal halide lamps are followed by the fixture requirement (O, E, S, F).

ARC LENGTH

The dimension of the arc discharge measured from one electrode tip to the other is called Arc length. It is useful for optical design of reflectors and effects fixture efficiency as well.

AVERAGE LIFE (HOURS)

Average life is defined as the total operation hours at which 50% of any group of lamps is still under operation (There are exceptions for most High Pressure Sodium and Mercury Vapor lamps, which 65% of the lamps are operating at the end of the life). The average life of a lamp is based upon vertical operation of representative lamps operated under controlled conditions of at least 10 hours per start (Except MH1500 which based on 5 hours per start).

Following list shows the reduced lamp life caused by lamp operating cycles less than 10 hours per start.

- 5 hours/start ----- Approximately 75% of rating
- 2.5 hours/start ----- Approximately 55% of rating
- 1.25 hour/start ----- Approximately 40% of rating

Line voltage, and all the variations regarding lamp operation conditions such as bulb base or base temperatures could have an affect on lamp life. Regular operation lamp with off time less than 15 minutes will shorten lamp life.

BASE

E26 Medium - Medium (MED) bases are usually used on lamps in E17 bulbs and are limited to 200W maximum.

E39 Mogul - Mogul (MOG) bases are usually used on lamps in ED28 and bigger and are limited to 1500w.

Ex39 Exclusionary Mogul Base - Exclusionary Mogul bases (EX MOG) are bases used on metal halide lamps having shrouded arc tubes, Permitting them to be used in open fixture applications. These bases are compatible with exclusionary or standard mogul sockets.

Rx7s / R7s Recessed Single Contact - Plusrite double-ended HID lamps with recessed single contact (RSC) bases have silver plated contacts to provide maximum electrical contact.

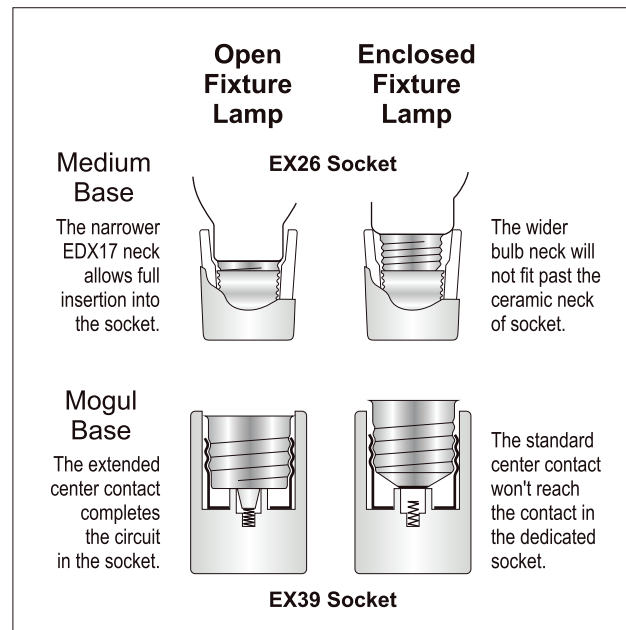

BULB

Glass enclosure contains chemical elements as lighting source. Each bulb description consists of both a letter to indicate bulb shape and number to show the maximum bulb diameter in 1/8 inches increments. For instance, BT37 bulb indicates a blown shape with tubular top, 37/8 of an inch or 4 5/8 inches in diameter.

Plusrite HID bulbs are made of glass designed to resist thermal shock in normal applications. They must be shielded from direct contact with liquids (such as rain) during operation to avoid bulb breakage.

LIGHT CENTER LENGTH (LCL)

The light center length of HID lamps is a measurement from the center of the arc tube to the bottom of the lamp base.

MAXIMUM OVERALL LENGTH (MOL)

The maximum overall length of single-ended lamps is the maximum distance from the top of the bulb to the bottom of the base. For double-ended lamps, it is the maximum distance from end-to-end (excluding any lead-wires).

WARM UP TIME

Most HID lamps do not have instant on capabilities. It may take several minutes for the arc tube to stabilize before optimal light output is achieved

WATTS

A unit of electrical power which equal to 1 joule per second. Lamps are rated in watts to indicate power consumption.

COLOR RENDERING INDEX (CRI)

Color Rendering Index (CRI) is an international scale (numbering system) up to 100 indicating the relative color rendering quality of a light source when compared to a standard reference light source of the same chromaticity (color temperature). The CRI expresses the degree to which colors will appear "familiar" or "natural" under the light source selected. In general, the higher the CRI number, the better the color rendering properties of the light source being measured. The color rendering index of any two like sources should only be compared if those sources have the same correlated color temperature (CCT).

Applications	CRI Range	Color Rendering Properties
Art Galleries	90-100	Excellent
Banks	70-80	Good
Car Dealerships	70-80	Good
Classrooms	70-80	Good
Grocery Stores	70-90	Good - Very Good
Hospitals	70-90	Good - Very Good
Manufacturing Areas	70-80	Good
Offices	70-80	Good
Parking Lot Lighting	<60-70	Poor
Printing Companies	90-100	Excellent
Restaurants	80-90	Good - Very Good
Retail Stores	80-100	Very Good - Excellent
Roadway Lighting	<60-70	Poor
Security Lighting	70-80	Good
Sporting Arenas	70-80	Good
Warehouses	<60-70	Poor

CORRELATED COLOR TEMPERATURE (CCT)

The correlated color temperature of a light source, expressed in Kelvin (K), is a means of describing the appearance or chromaticity of the source. The correlated color temperature of the light source contributes to the visual appearance of the lighted space. "Warm" light sources have a low color temperature (2000-3000K) and feature more light in the red / orange / yellow range. Light with a higher color temperature (>4000K) features more blue and is referred to as "cool."

With new installations, or group relamps, all color performance evaluations should be made after at least 100 hours of operation (at recommended operating cycles) to allow the lamps to stabilize. Additional changes in chemistry within the arc tube over the life of the lamp may also cause the color temperature to shift as the lamp gets closer to the end of it's rated life. To minimize color variation within an installation, it is recommended that HID lamps be group relamped and run on equal operating cycles.

Color Temperature	Common Color Description	Typical Applications
2700K - 3400K	Warm; Warm White	Specialty Retailers, Restaurants, Hotel Lobbies, Residential
3500K	Neutral; Neutral White	Grocery Stores & Produce Markets, Retail Stores, Bank Lobbies
4100K	Cool; Cool White	Offices, Manufacturing, Schools, Hospitals
5000K - 6500K	Daylight; Daylight Plus; Full Spectrum	Printers, Paint Studios, Art Galleries, Car Dealerships

HOT RESTRIKE

In most instances, if an HID lamp experiences a momentary power interruption or sudden voltage drop, the lamp may extinguish. A lamp that is still hot will not restart immediately. Because the arc tube within the lamp must cool down before it can restart, HID lamps have hot restrike times ranging from 1-15 minutes depending on the product type.

FIXTURE REQUIREMENT

Developed by the American National Standard institute (ANSI), the fixture requirement code describes the type of fixture required for each lamp type.

See lamp warnings for additional information and proper operating instructions.

E = Lamps classified as E-type are to be used ONLY in suitably rated enclosed luminaires.

O = Lamps classified as O-type, comply with ANSI Standard C78.387 for a containment testing and may be used in open luminaires.

S = When operated within 15 degrees of vertical, this lamp may be operated in an open luminaires provided the installation is not near people or flammable or combustible material, otherwise it must be operated in a suitably enclosed luminaires.

LUMENS (lm)

A unit of luminous flux; overall light output; quantity of light, expressed in lumens. For example, a dinner candle provides about 12 lumens and 60-watt soft white incandescent lamp provides about 840 lumens.

LUMEN DEPRECIATION

The decrease in lumen output of a light source over time. Every lamp type has a unique lumen depreciation curve (sometimes called a lumen maintenance curve) depicting the pattern of decreasing light output.

HID

HALOGEN

CFL

FL

BALLAST

GERMICIDAL



HIGH INTENSITY DISCHARGE





HIGH INTENSITY DISCHARGE

HID

HALOGEN

CFL

FL

BALLAST

GERMICIDAL

CONTENTS

- | | |
|---|--|
| 10 - Ceramic Metal Halide | 28 - Reflector Metal Halide |
| 14 - Pulse Start Metal Halide | 29 - Metal Halide Retrofit for HPS Ballast |
| 20 - Protected Pulse Start Metal Halide | 30 - High Pressure Sodium |
| 23 - Standard Metal Halide | 32 - High Pressure Sodium ECO (TCLP Compliant) |
| 25 - Protected Standard Metal Halide | 33 - Standby HPS/ HPS Retrofit |
| 26 - Color Metal Halide | 34 - Mercury Vapor |
| 27 - Metal Halide for Aquarium | 35 - Self-Ballasted Mercury Vapor |



BULBS

HID

HALOGEN

CFL

FL

BALLAST

GERMICIDAL

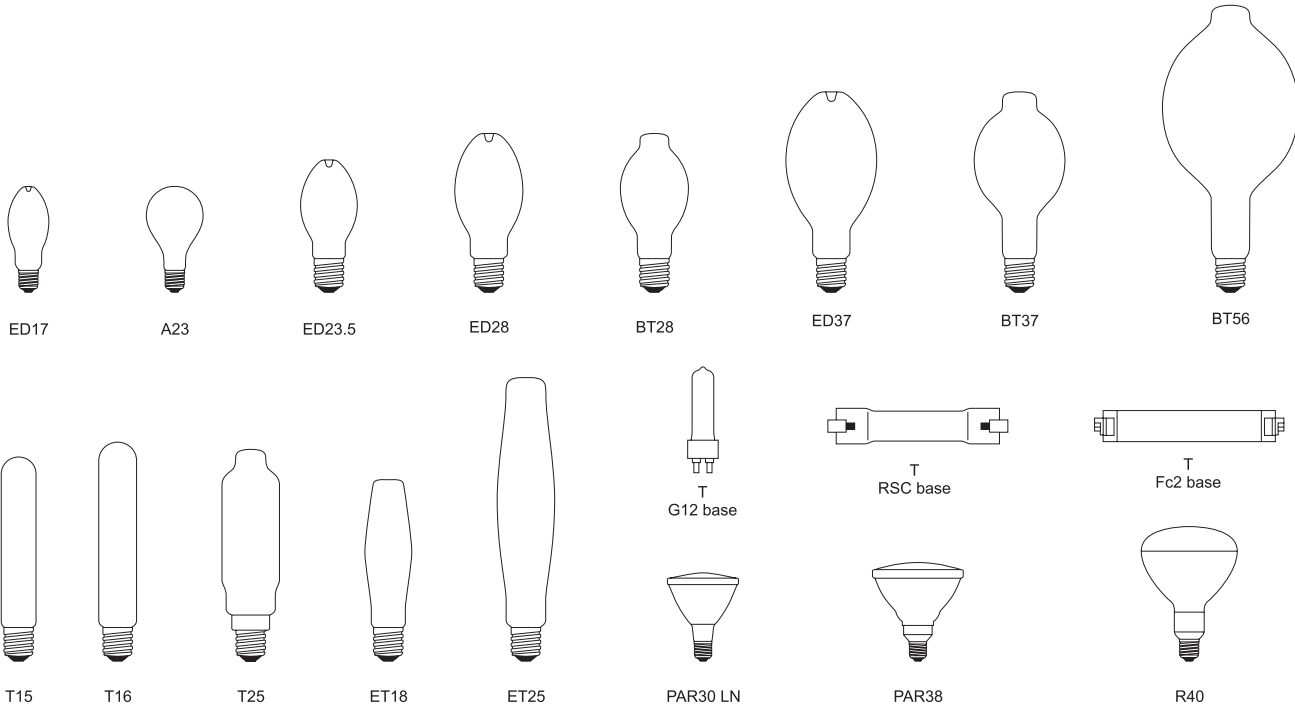

BASES

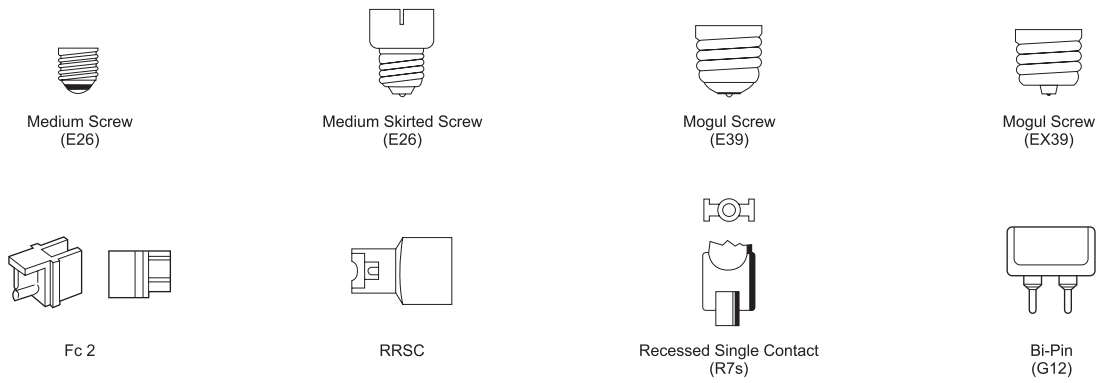

OPERATING POSITIONS

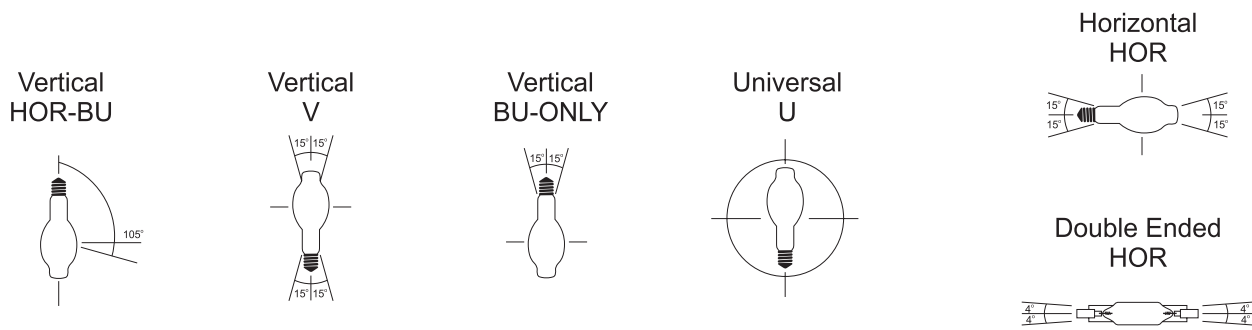

HIGH INTENSITY DISCHARGE

How to read the table



HID

HALOGEN

CFL

FL

BALLAST

GERMICIDAL

Product Information							Physical Information				Photometric Characteristics					
Watts	Bulb	Base	Item#	Description	ANSI	Case Qty.	Finish	Operating Position	MOL (in)	LCL (in)	Initial Lumens (lm)	Mean Lumens (lm)	Avg. Life (Hrs)	Color Temp (K)	CRI	UPC
70	ED17	E26	1256	CMH70/U/ED17/3K	M143/E	12	Clear	Universal	5.44	3.44	5900	4365	20000	3000	85	844366012563
70	ED17	E26	1257	CMH70/U/ED17/4K	M143/E	12	Clear	Universal	5.44	3.44	5800	4060	24000	4000	92	844366012570
100	ED17	E26	1258	CMH100/U/ED17/3K	M140/E	12	Clear	Universal	5.44	3.44	8600	6450	20000	3000	85	844366012587
100	ED17	E26	1259	CMH100/U/ED17/4K	M140/E	12	Clear	Universal	5.44	3.44	8200	6150	24000	4000	92	844366012594

Watts
Energy consumption during proper operation

Base
Type of base

Description
Model description

Case Qty.
Number of product units packed in a case

Operating Position
Abbreviation for proper operation position

LCL
Maximum light center Length in inches

Mean Lumens
Average light output at 40% of rated life for MH and 50% of rated life for HPS and MV

CRI
An International system used to rate a lamp's ability to render object colors

Bulb
Type of bulb for different size and shape

Item#
Use this code when placing order

ANSI Code
The standardization code for the class and electrical characteristics of lamps and ballast as well as fixture requirements

Finish
Bulb's surface finish type

MOL
Maximum overall length in inches

Initial Lumens
Average Light output after the initial 100 hours of operation

Average Life
An average rating operated at normal lamp voltage and current

Color Temp.
Light temperature measured in Kelvin

UPC
Universal Product Code

Plusrite®

Ceramic Metal Halide

HID

HALOGEN

CFL

FL

BALLAST

GERMICIDAL



MR16/GU10



PAR20/E26

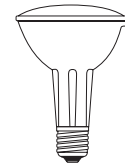

PAR30L/E26

Product Information							Physical Information			Photometric Characteristics						
Watts	Bulb	Base	Item#	Description	ANSI		Case Qty.	Operating Position	MOL (in)	Initial Lumens (lm)	Beam Angle	CBCP (cd)	Avg. Life (Hrs)	Color Temp (K)	CRI	UPC
20	MR16	GX10 (GU10)	1200	CMH20MR16/SP/830	C156/0	-	20	Universal	2.55	1200	10°	20000	12000	3000	85	844366012006
20	MR16	GX10 (GU10)	1201	CMH20MR16/FL/830	C156/0	-	20	Universal	2.55	1200	30°	4000	12000	3000	85	844366012013
20	PAR20	E26	1202	CMH20PAR20/SP/830	C156/0	-	12	Universal	3.75	1200	10°	15000	10000	3000	85	844366012020
20	PAR20	E26	1203	CMH20PAR20/FL/830	C156/0	-	12	Universal	3.75	1200	30°	3000	10000	3000	85	844366012037
20	PAR20	E26	1204	* CMH20PAR20/SP/842	C156/0	-	12	Universal	3.75	1200	10°	15000	10000	4000	85	844366012044
20	PAR20	E26	1205	* CMH20PAR20/FL/842	C156/0	-	12	Universal	3.75	1200	30°	3000	10000	4000	85	844366012051
20	PAR30L	E26	1206	CMH20PAR30L/SP/830	C156/0	-	12	Universal	4.75	1200	10°	4000	10000	3000	85	844366012068
20	PAR30L	E26	1207	CMH20PAR30L/FL/830	C156/0	-	12	Universal	4.75	1200	30°	24000	10000	3000	85	844366012075
39	PAR20	E26	1208	CMH39PAR20/SP/830	M130/0	-	12	Universal	3.75	2000	10°	23000	9000	3000	81	844366012082
39	PAR20	E26	1209	CMH39PAR20/FL/830	M130/0	-	12	Universal	3.75	2000	30°	5000	9000	3000	81	844366012099
39	PAR30L	E26	1210	CMH39PAR30L/SP/830	M130/0	-	6	Universal	4.75	2200	10°	44000	9000	3000	81	844366012105
39	PAR30L	E26	1211	* CMH39PAR30L/FL/830	M130/0	-	6	Universal	4.75	2200	30°	7400	9000	3000	81	844366012112
39	PAR30L	E26	1212	CMH39PAR30L/SP/942	M130/0	-	6	Universal	4.75	2200	10°	44000	9000	4000	85	844366012129
39	PAR30L	E26	1213	CMH39PAR30L/FL/942	M130/0	-	6	Universal	4.75	2200	30°	7400	9000	4000	85	844366012136

*Items only available for special orders



PAR30L/E26

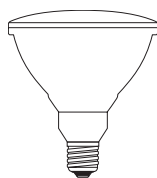

PAR38/E26

HIGH INTENSITY DISCHARGE

Ceramic Metal Halide ■ ■ ■

Product Information						Physical Information			Photometric Characteristics							
Watts	Bulb	Base	Item#	Description	ANSI	Case Qty.	Operating Position	MOL (in)	Initial Lumens (lm)	Beam Angle	CBCP (cd)	Avg. Life (Hrs)	Color Temp (K)	CRI	UPC	
70	PAR30L	E26	1214	CMH70PAR30L/SP/830	M143/0	-	6	Universal	4.75	5000	10°	68000	10000	3000	85	844366012143
70	PAR30L	E26	1215	CMH70PAR30L/FL/830	M143/0	-	6	Universal	4.75	5000	35°	68000	10000	3000	85	844366012150
70	PAR30L	E26	1216	CMH70PAR30L/SP/942	M139/0	-	6	Universal	4.75	5000	10°	63000	9000	4200	90	844366012167
70	PAR30L	E26	1217	CMH70PAR30L/FL/942	M139/0	-	6	Universal	4.75	5000	30°	63000	9000	4200	90	844366012174
70	PAR38	E26	1218	CMH70PAR38/SP/830	M143/0	M98/0	6	Universal	5.44	4100	15°	42000	12500	3000	85	844366012181
70	PAR38	E26	1219	CMH70PAR38/FL/830	M143/0	M98/0	6	Universal	5.44	4100	25°	18000	12500	3000	85	844366012198
70	PAR38	E26	1220	CMH70PAR38/SP/942	M143/0	M98/0	6	Universal	5.44	3700	15°	40000	12500	4000	92	844366012204
70	PAR38	E26	1221	CMH70PAR38/FL/942	M143/0	M98/0	6	Universal	5.44	3700	25°	15000	12500	4000	92	844366012211
100	PAR38	E26	1222	CMH100PAR38/SP/830	M140/0	M90/0	6	Universal	5.44	6200	15°	65000	12500	3000	85	844366012228
100	PAR38	E26	1223	CMH100PAR38/FL/830	M140/0	M90/0	6	Universal	5.44	6200	25°	24000	12500	3000	85	844366012235
100	PAR38	E26	1224	CMH100PAR38/SP/942	M140/0	M90/0	6	Universal	5.44	5700	15°	52000	12500	4000	92	844366012242
100	PAR38	E26	1225	CMH100PAR38/FL/942	M140/0	M90/0	6	Universal	5.44	5700	25°	19000	12500	4000	92	844366012259
150	PAR38	E26	1226	CMH150PAR38/SP/830	M102/0	-	6	Universal	5.44	9100	15°	50000	12000	3000	88	844366012266
150	PAR38	E26	1227	CMH150PAR38/FL/830	M102/0	-	6	Universal	5.44	9100	30°	28000	10000	3000	85	844366012273

*Items only available for special orders

HID

HALOGEN

CFL

FL

BALLAST

GERMICIDAL

Plusrite®

■ ■ ■ Ceramic Metal Halide

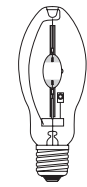

ED17/E26

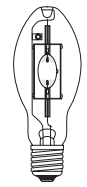

EDX17/E26

HID

HALOGEN

CFL

FL

BALLAST

GERMICIDAL

Product Information							Physical Information				Photometric Characteristics					
Watts	Bulb	Base	Item#	Description	ANSI	Case Qty.	Finish	Operating Position	MOL (in)	LCL (in)	Initial Lumens (lm)	Mean Lumens (lm)	Avg. Life (Hrs)	Color Temp (K)	CRI	UPC
70	ED17	E26	1256	CMH70/U/ED17/3K	M143/E M98/E	12	Clear	Universal	5.44	3.44	5900	4365	20000	3000	85	844366012563
70	ED17	E26	1257	CMH70/U/ED17/4K	M143/E M98/E	12	Clear	Universal	5.44	3.44	5800	4060	24000	4000	92	844366012570
100	ED17	E26	1258	CMH100/U/ED17/3K	M140/E M90/E	12	Clear	Universal	5.44	3.44	8600	6450	20000	3000	85	844366012587
100	ED17	E26	1259	CMH100/U/ED17/4K	M140/E M90/E	12	Clear	Universal	5.44	3.44	8200	6150	24000	4000	92	844366012594
150	ED17	E26	1260	CMH150/U/ED17/3K	M142/E M102/E	12	Clear	Universal	5.44	3.44	12900	9545	20000	3000	85	844366012600
150	ED17	E26	1261	CMH150/U/ED17/4K	M142/E M102/E	12	Clear	Universal	5.44	3.44	12000	9000	24000	4000	92	844366012617
70	EDX17	E26	1228	*CMP70/U/ED17/3K	M143/O M98/O	12	Clear	Universal	5.44	3.44	5900	4365	20000	3000	85	844366012280
70	EDX17	E26	1229	*CMP70/U/ED17/4K	M143/O M98/O	12	Clear	Universal	5.44	3.44	5800	4060	24000	4000	92	844366012297
100	EDX17	E26	1230	*CMP100/U/ED17/3K	M140/O M90/O	12	Clear	Universal	5.44	3.44	8600	6450	20000	3000	85	844366012303
100	EDX17	E26	1231	*CMP100/U/ED17/4K	M140/O M90/O	12	Clear	Universal	5.44	3.44	8200	6150	24000	4000	92	844366012310
150	EDX17	E26	1232	*CMP150/U/ED17/3K	M142/O M102/O	12	Clear	Universal	5.44	3.44	12900	9545	20000	3000	85	844366012327
150	EDX17	E26	1233	*CMP150/U/ED17/4K	M142/O M102/O	12	Clear	Universal	5.44	3.44	12000	9000	24000	4000	92	844366012334

*Items only available for special orders



T4/G8.5



T4/GU6.5



T6/G12



TD6/RX7s

HIGH INTENSITY DISCHARGE

Ceramic Metal Halide ■ ■ ■

HID

HALOGEN

CFL

FL

BALLAST

GERMICIDAL

Product Information								Physical Information				Photometric Characteristics					
Watts	Bulb	Base	Item#	Description	ANSI	Case Qty.	Finish	Operating Position	MOL (in)	LCL (in)	Initial Lumens (lm)	Mean Lumens (lm)	Avg. Life (Hrs)	Color Temp (K)	CRI	UPC	
20	T4	GU6.5	1234	CMH20T4/GU6.5/830	C156/E	-	12	Clear	Universal	2.20	1.18	1750	1480	12000	3000	85	844366012341
20	T4	GU6.5	1235	*CMH20T4/GU6.5/842	C156/E	-	12	Clear	Universal	2.20	1.18	1750	1480	12000	4200	85	844366012358
20	T4	G8.5	1236	CMH20T4/G8.5/830	C156/E	-	12	Clear	Universal	3.34	2.00	1750	1480	12000	3000	85	844366012365
20	T4	G8.5	1237	*CMH20T4/G8.5/842	C156/E	-	12	Clear	Universal	3.34	2.00	1750	1480	12000	4200	85	844366012372
35	T4	G8.5	1238	CMH39T4/G8.5/830	M130/E	-	12	Clear	Universal	3.34	2.00	3300	2300	10000	3000	81	844366012389
35	T4	G8.5	1239	CMH39T4/G8.5/942	M130/E	-	12	Clear	Universal	3.34	2.00	3300	2640	10000	4000	85	844366012396
70	T4	G8.5	1240	CMH70T4/G8.5/830	M139/E	-	12	Clear	Universal	3.34	2.00	6500	4500	10000	3000	85	844366012402
70	T4	G8.5	1241	CMH70T4/G8.5/942	M139/E	-	12	Clear	Universal	3.34	2.00	6500	5525	10000	4000	90	844366012419
35	T6	G12	1242	CMH39T6/G12/830	M130/E	-	12	Clear	Universal	3.98	2.22	3300	2600	12000	3000	81	844366012426
35	T6	G12	1243	CMH39T6/G12/942	M130/E	-	12	Clear	Universal	3.98	2.22	3300	2800	12000	4000	84	844366012433
70	T6	G12	1244	CMH70T6/G12/830	M139/E	-	12	Clear	Universal	3.98	2.22	6500	4950	12000	3000	85	844366012440
70	T6	G12	1245	CMH70T6/G12/942	M139/E	-	12	Clear	Universal	3.98	2.22	6500	5525	12000	4200	90	844366012457
150	T6	G12	1246	CMH150T6/G12/830	M142/E	-	12	Clear	Universal	3.98	2.22	14000	11900	15000	3200	85	844366012464
150	T6	G12	1247	CMH150T6/G12/942	M142/E	-	12	Clear	Universal	3.98	2.22	13500	11475	15000	4200	90	844366012471
70	TD6	RX7s	1248	CMH70TD/RX7s/830	M139/E	M85/E	12	Clear	Universal	3.93	2.22	6500	5200	15000	3200	85	844366012488
70	TD6	RX7s	1249	*CMH70TD/RX7s/842	M139/E	M85/E	12	Clear	Universal	3.93	2.22	6500	5525	15000	4200	90	844366012495
150	TD7	RX7s	1250	CMH150TD/RX7s/830	M142/E	M102/E	12	Clear	Universal	5.43	2.59	13500	11475	15000	3200	85	844366012501
150	TD7	RX7s	1251	*CMH150TD/RX7s/842	M142/E	M102/E	12	Clear	Universal	5.43	2.59	13000	11050	15000	4200	90	844366012518

*Items only available for special orders

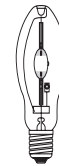

ED17/E26

HID

HALOGEN

CFL

FL

BALLAST

GERMICIDAL

Product Information							Physical Information				Photometric Characteristics					
Watts	Bulb	Base	Item#	Description	ANSI	Case Qty.	Finish	Operating Position	MOL (in)	LCL (in)	Initial Lumens (lm)	Mean Lumens (lm)	Avg. Life (Hrs)	Color Temp (K)	CRI	UPC
50	ED17	E26	1000	MH50/ED17/U/4K	M110/E	12	Clear	Universal	5.43	3.39	3400	2200	10000	4200	65	844366010002
50	ED17	E26	1001	MH50/ED17/C/U/4K	M110/E	12	Coated	Universal	5.43	3.39	3200	2100	10000	3800	70	844366010019
70	ED17	E26	1069	*MH70/ED17/U/3K	M98/E	12	Clear	Universal	5.43	3.39	5600	3600	15000	3200	65	844366010699
70	ED17	E26	1070	*MH70/ED17/C/U/3K	M98/E	12	Coated	Universal	5.43	3.39	5300	3400	15000	3200	70	844366010705
70	ED17	E26	1002	MH70/ED17/U/4K	M98/E	12	Clear	Universal	5.43	3.39	5600	3600	15000	4200	65	844366010026
70	ED17	E26	1003	MH70/ED17/C/U/4K	M98/E	12	Coated	Universal	5.43	3.39	5300	3400	15000	3800	70	844366010033
100	ED17	E26	1071	*MH100/ED17/U/3K	M90/E	12	Clear	Universal	5.43	3.39	9000	5900	15000	3200	65	844366010712
100	ED17	E26	1072	*MH100/ED17/C/U/3K	M90/E	12	Coated	Universal	5.43	3.39	8500	5500	15000	3200	70	844366010729
100	ED17	E26	1004	MH100/ED17/U/4K	M90/E	12	Clear	Universal	5.43	3.39	9000	5900	15000	4200	65	844366010040
100	ED17	E26	1005	MH100/ED17/C/U/4K	M90/E	12	Coated	Universal	5.43	3.39	8500	5500	15000	3800	70	844366010057
125	ED17	E26	1638	*MS125/ED17/PS/HBU/4K	M150/E	12	Clear	HOR-BU	5.43	3.39	12000	8400	15000	4200	65	844366016387
125	ED17	E26	1639	*MS125/ED17/C/PS/HBU/4K	M150/E	12	Coated	HOR-BU	5.43	3.39	11400	8000	15000	3800	70	844366016394
150	ED17	E26	1006	MH150/ED17/U/4K	M102/E	12	Clear	Universal	5.43	3.39	14000	10500	15000	4200	65	844366010064
150	ED17	E26	1007	MH150/ED17/C/U/4K	M102/E	12	Coated	Universal	5.43	3.39	13300	10000	15000	3800	70	844366010071
175	ED17	E26	1655	MS175/ED17/PS/U/4K	M152/E	12	Clear	Universal	5.43	3.39	17000	12500	15000	4200	65	844366016554
175	ED17	E26	1567	*MS175/ED17/PS/BU/4K	M152/E	12	Clear	BU ±15°	5.43	3.39	17000	12500	15000	4200	65	844366015670
175	ED17	E26	1568	*MS175/ED17/C/PS/BU/4K	M152/E	12	Coated	BU ±15°	5.43	3.39	16000	12000	15000	3800	70	844366015687
175	ED17	E26	1676	*MS175/ED17/PS/BU/5K	M152/E	12	Clear	BU ±15°	5.43	3.39	17000	12500	15000	5000	65	844366016769
200	ED17	E26	1669	MS200/ED17/PS/U/4K	M136/E	12	Clear	Universal	5.43	3.39	19000	13500	15000	4200	65	844366016691
200	ED17	E26	1569	*MS200/ED17/PS/BU/4K	M136/E	12	Clear	BU ±15°	5.43	3.39	19000	13500	15000	4200	65	844366015694
200	ED17	E26	1570	*MS200/ED17/C/PS/BU/4K	M136/E	12	Coated	BU ±15°	5.43	3.39	18000	12800	15000	3900	70	844366015700

*Items only available for special orders

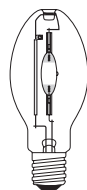

ED28/E39



T15/E39

HIGH INTENSITY DISCHARGE

Pulse Start Metal Halide ■■■

Product Information							Physical Information				Photometric Characteristics					
Watts	Bulb	Base	Item#	Description	ANSI	Case Qty.	Finish	Operating Position	MOL (in)	LCL (in)	Initial Lumens (lm)	Mean Lumens (lm)	Avg. Life (Hrs)	Color Temp (K)	CRI	UPC
50	ED28	E39	1010	MH50/ED28/U/4K	M110/E	12	Clear	Universal	8.31	5.00	3400	2000	10000	4200	60	844366010101
70	ED28	E39	1011	MH70/ED28/U/4K	M98/E	12	Clear	Universal	8.31	5.00	5600	4760	15000	4200	65	844366010118
70	ED28	E39	1073	* MH70/ED28/C/U/4K	M98/E	12	Coated	Universal	8.31	5.00	5300	4200	15000	3800	70	844366010736
100	ED28	E39	1012	MH100/ED28/U/4K	M90/E	12	Clear	Universal	8.31	5.00	9000	7500	15000	4200	65	844366010125
100	ED28	E39	1074	* MH100/ED28/C/U/4K	M90/E	12	Coated	Universal	8.31	5.00	8500	7100	15000	3800	70	844366010743
125	ED28	E39	1640	* MS125/ED28/PS/HBU/4K	M150/E	12	Clear	HOR-BU	8.31	5.00	12000	8400	15000	4200	65	844366016400
150	ED28	E39	1013	MH150/ED28/U/4K	M102/E	12	Clear	Universal	8.31	5.00	14000	10500	15000	4200	65	844366010132
150	ED28	E39	1075	* MH150/ED28/C/U/4K	M102/E	12	Coated	Universal	8.31	5.00	13300	10000	15000	3800	70	844366010750
175	ED28	E39	1656	MS175/ED28/PS/U/4K	M152/E	12	Clear	Universal	8.31	5.00	17000	12500	15000	4200	65	844366016561
175	ED28	E39	1525	* MS175/ED28/PS/BU/4K	M152/E	12	Clear	BU ±15°	8.31	5.00	17000	12500	15000	4200	65	844366015250
175	ED28	E39	1571	* MS175/ED28/C/PS/BU/4K	M152/E	12	Coated	BU ±15°	8.31	5.00	16000	12000	15000	3800	70	844366015717
175	T15	E39	1572	MS175/T15/PS/H75/4K	M152/E	24	Clear	HOR ±75°	8.31	5.00	15300	11250	15000	4200	65	844366015724
200	ED28	E39	1672	MS200/ED28/PS/U/4K	M136/E	12	Clear	Universal	8.31	5.00	21000	16000	15000	4200	65	844366016721
200	ED28	E39	1671	* MS200/ED28/C/PS/U/4K	M136/E	12	Coated	Universal	8.31	5.00	20000	15000	15000	3800	70	844366016714
200	ED28	E39	1573	* MS200/ED28/PS/BU/4K	M136/E	12	Clear	BU ±15°	8.31	5.00	21000	16000	15000	4200	65	844366015731
200	ED28	E39	1574	* MS200/ED28/C/PS/BU/4K	M136/E	12	Coated	BU ±15°	8.31	5.00	20000	15000	15000	3800	70	844366015748
200	ED28	E39	1526	* MS200/ED28/PS/V/4K	M136/E	12	Clear	VER ±15°	8.31	5.00	21000	16000	15000	4200	65	844366015267
200	ED28	E39	1527	* MS200/ED28/C/PS/V/4K	M136/E	12	Coated	VER ±15°	8.31	5.00	20000	15000	15000	3800	70	844366015274
200	T15	E39	1528	MS200/T15/PS/H75/4K	M136/E	24	Clear	HOR ±75°	8.31	5.00	19000	14500	15000	4200	65	844366015281

*Items only available for special orders

HID

HALOGEN

CFL

FL

BALLAST

GERMICIDAL

Plusrite®

■ ■ ■ Pulse Start Metal Halide

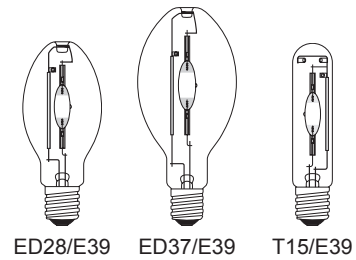

ED28/E39 ED37/E39 T15/E39

Product Information							Physical Information				Photometric Characteristics					
Watts	Bulb	Base	Item#	Description	ANSI	Case Qty.	Finish	Operating Position	MOL (in)	LCL (in)	Initial Lumens (lm)	Mean Lumens (lm)	Avg. Life (Hrs)	Color Temp (K)	CRI	UPC
250	ED28	E39	1575	MS250/ED28/PS/U/4K	M153/E M138/E	12	Clear	Universal	8.31	5.00	25000	20000	15000	4200	65	844366015755
250	ED28	E39	1576	* MS250/ED28/PS/BU/4K	M153/E M138/E	12	Clear	BU ±15°	8.31	5.00	25000	20000	15000	4200	65	844366015762
250	ED28	E39	1577	* MS250/ED28/C/PS/BU/4K	M153/E M138/E	12	Coated	BU ±15°	8.31	5.00	23000	19000	15000	3800	70	844366015779
250	ED28	E39	1529	* MS250/ED28/PS/V/4K	M153/E M138/E	12	Clear	VER ±15°	8.31	5.00	25000	20000	15000	4200	65	844366015298
250	ED28	E39	1530	* MS250/ED28/C/PS/V/4K	M153/E M138/E	12	Coated	VER ±15°	8.31	5.00	23000	19000	15000	3800	70	844366015304
250	ED28	E39	1531	MS250/ED28/PS/H75/4K	M153/E M138/E	12	Clear	HOR ±75°	8.31	5.00	22000	17600	15000	4200	65	844366015311
250	T15	E39	1532	MS250/T15/PS/H75/4K	M153/E M138/E	24	Clear	HOR ±75°	9.76	5.75	22000	17600	15000	4200	65	844366015328
320	ED28	E39	1578	MS320/ED28/PS/U/4K	M154/E M132/E	12	Clear	Universal	8.31	5.00	32000	26000	20000	4200	65	844366015786
320	ED28	E39	1659	* MS320/ED28/C/PS/U/4K	M154/E M132/E	12	Coated	Universal	8.31	5.00	31000	24800	20000	3800	70	844366016592
320	ED28	E39	1579	* MS320/ED28/PS/HBU/3K	M154/E M132/E	12	Clear	HOR-BU	8.31	5.00	33000	26000	20000	3200	65	844366015793
320	ED28	E39	1580	* MS320/ED28/C/PS/HBU/3K	M154/E M132/E	12	Coated	HOR-BU	8.31	5.00	31000	24800	20000	3200	70	844366015809
320	ED28	E39	1581	* MS320/ED28/PS/HBU/4K	M154/E M132/E	12	Clear	HOR-BU	8.31	5.00	32000	26000	20000	4200	65	844366015816
320	ED28	E39	1582	* MS320/ED28/C/PS/HBU/4K	M154/E M132/E	12	Coated	HOR-BU	8.31	5.00	31000	24800	20000	3800	70	844366015823
320	ED28	E39	1533	* MS320/ED28/PS/V/4K	M154/E M132/E	12	Clear	VER ±15°	8.31	5.00	33000	26000	20000	4200	65	844366015335
320	ED28	E39	1534	* MS320/ED28/C/PS/V/4K	M154/E M132/E	12	Coated	VER ±15°	8.31	5.00	32000	24800	20000	3800	70	844366015342
320	ED28	E39	1537	MS320/ED28/PS/H75/4K	M154/E M132/E	12	Clear	HOR ±75°	8.31	5.00	30000	22000	20000	4200	65	844366015373
320	ED28	E39	1538	* MS320/ED28/C/PS/H75/4K	M154/E M132/E	12	Coated	HOR ±75°	8.31	5.00	27000	20000	20000	3800	70	844366015380
320	ED28	E39	1673	* MS320/ED28/PS/HBU/5K	M154/E M132/E	12	Clear	HOR-BU	8.31	5.00	30000	22000	20000	5000	65	844366016738
320	ED37	E39	1535	MS320/ED37/PS/V/4K	M154/E M132/E	12	Clear	VER ±15°	11.50	7.01	33000	26000	20000	4200	65	844366015359
320	ED37	E39	1536	* MS320/ED37/C/PS/V/4K	M154/E M132/E	12	Coated	VER ±15°	11.50	7.01	32000	24800	20000	3800	70	844366015366
320	T15	E39	1540	* MS320/T15/PS/H75/4K	M154/E M132/E	24	Clear	HOR ±75°	11.50	7.01	31000	24000	20000	4200	65	844366015403

*Items only available for special orders

HID

HALOGEN

CFL

FL

BALLAST

GERMICIDAL

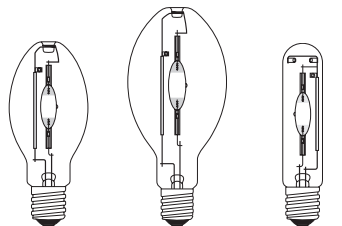

ED28/E39 ED37/E39 T15/E39

HIGH INTENSITY DISCHARGE

Pulse Start Metal Halide ■ ■ ■

Product Information								Physical Information				Photometric Characteristics				
Watts	Bulb	Base	Item#	Description	ANSI	Case Qty.	Finish	Operating Position	MOL (in)	LCL (in)	Initial Lumens (lm)	Mean Lumens (lm)	Avg. Life (Hrs)	Color Temp (K)	CRI	UPC
350	ED28	E39	1583	*MS350/ED28/C/PS/BU/3K	M131/E	- 12	Coated	BU ±15°	8.31	5.00	35200	28200	20000	3200	70	844366015830
350	ED28	E39	1584	MS350/ED28/PS/BU/4K	M131/E	- 12	Clear	BU ±15°	8.31	5.00	37000	29000	20000	4200	65	844366015847
350	ED28	E39	1585	*MS350/ED28/C/PS/BU/4K	M131/E	- 12	Coated	BU ±15°	8.31	5.00	35200	28200	20000	3800	70	844366015854
350	ED28	E39	1543	*MS350/ED28/PS/V/4K	M131/E	- 12	Clear	VER ±15°	8.31	5.00	37000	29600	20000	4200	65	844366015434
350	ED28	E39	1544	MS350/ED28/PS/H75/4K	M131/E	- 12	Clear	HOR ±75°	8.31	5.00	33000	25000	20000	4200	65	844366015441
350	ED37	E39	1586	*MS350/ED37/C/PS/BU/3K	M131/E	- 12	Coated	BU ±15°	11.50	7.01	35200	28200	20000	3200	70	844366015861
350	ED37	E39	1657	*MS350/ED37/PS/U/4K	M131/E	- 12	Clear	Universal	11.50	7.01	37000	29000	20000	4200	65	844366016578
350	ED37	E39	1587	MS350/ED37/PS/BU/4K	M131/E	- 12	Clear	BU ±15°	11.50	7.01	37000	29600	20000	4200	65	844366015878
350	ED37	E39	1588	*MS350/ED37/C/PS/BU/4K	M131/E	- 12	Coated	BU ±15°	11.50	7.01	35200	28200	20000	3800	70	844366015885
350	ED37	E39	1541	*MS350/ED37/PS/V/4K	M131/E	- 12	Clear	VER ±15°	11.50	7.01	37000	29600	20000	4200	65	844366015410
350	ED37	E39	1542	*MS350/ED37/C/PS/V/4K	M131/E	- 12	Coated	VER ±15°	11.50	7.01	35200	28200	20000	3800	70	844366015427
350	ED37	E39	1679	MS350/ED37/PS/H75/4K	M131/E	- 12	Clear	HOR ±75°	11.50	7.01	33000	25000	20000	4200	65	844366016790
350	ED37	E39	1545	*MS350/ED37/C/PS/H75/4K	M131/E	- 12	Coated	HOR ±75°	11.50	7.01	31000	25000	20000	3800	70	844366015458
350	T15	E39	1546	*MS350/T15/PS/H75/4K	M131/E	- 24	Clear	HOR ±75°	11.50	7.01	33000	25000	20000	3800	65	844366015465

*Items only available for special orders

HID

HALOGEN

CFL

FL

BALLAST

GERMICIDAL

Plusrite®

■ ■ ■ Pulse Start Metal Halide

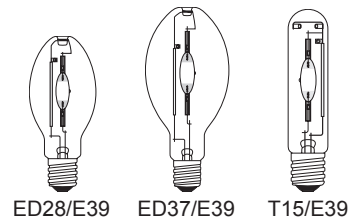

HID

HALOGEN

CFL

FL

BALLAST

GERMICIDAL

Product Information							Physical Information				Photometric Characteristics						
Watts	Bulb	Base	Item#	Description	ANSI		Case Qty.	Finish	Operating Position	MOL (in)	LCL (in)	Initial Lumens (lm)	Mean Lumens (lm)	Avg. Life (Hrs)	Color Temp (K)	CRI	UPC
400	ED28	E39	1589	MS400/ED28/PS/U/4K	M155/E	M135/E	12	Clear	Universal	8.31	5.00	39000	27000	20000	4200	65	844366015892
400	ED28	E39	1624	*MS400/ED28/C/PS/U/4K	M155/E	M135/E	12	Coated	Universal	8.31	5.00	37000	25700	20000	3800	70	844366016240
400	ED28	E39	1590	*MS400/ED28/PS/BU/4K	M155/E	M135/E	12	Clear	BU ±15°	8.31	5.00	44000	35000	20000	4200	65	844366015908
400	ED28	E39	1591	*MS400/ED28/C/PS/BU/4K	M155/E	M135/E	12	Coated	BU ±15°	8.31	5.00	42000	33000	20000	3800	70	844366015915
400	ED28	E39	1547	*MS400/ED28/PS/V/4K	M155/E	M135/E	12	Clear	VER ±15°	8.31	5.00	44000	35000	20000	4200	65	844366015472
400	ED28	E39	1548	*MS400/ED28/C/PS/V/4K	M155/E	M135/E	12	Coated	VER ±15°	8.31	5.00	42000	33000	20000	3800	70	844366015489
400	ED28	E39	1552	MS400/ED28/PS/H75/4K	M155/E	M135/E	12	Clear	HOR ±75°	8.31	5.00	40000	32000	20000	4200	65	844366015526
400	ED28	E39	1553	*MS400/ED28/C/PS/H75/4K	M155/E	M135/E	12	Coated	HOR ±75°	8.31	5.00	39000	31000	20000	3800	70	844366015533
400	ED37	E39	1592	MS400/ED37/PS/U/4K	M155/E	M135/E	12	Clear	Universal	11.50	7.01	39000	27000	20000	4200	65	844366015922
400	ED37	E39	1593	*MS400/ED37/PS/BU/4K	M155/E	M135/E	12	Clear	BU ±15°	11.50	7.01	42000	29000	20000	4200	65	844366015939
400	ED37	E39	1594	*MS400/ED37/C/PS/BU/4K	M155/E	M135/E	12	Coated	BU ±15°	11.50	7.01	42000	29000	20000	3800	70	844366015946
400	ED37	E39	1549	*MS400/ED37/PS/V/4K	M155/E	M135/E	12	Clear	VER ±15°	11.50	7.01	42000	31000	20000	4200	65	844366015496
400	ED37	E39	1625	*MS400/ED37/C/PS/V/4K	M155/E	M135/E	12	Coated	VER ±15°	11.50	7.01	42000	29000	20000	3800	70	844366016257
400	ED37	E39	1551	MS400/ED37/PS/H75/4K	M155/E	M135/E	12	Clear	HOR ±75°	11.50	7.01	40000	32000	20000	4200	65	844366015519
400	ED37	E39	1550	*MS400/ED37/C/PS/H75/4K	M155/E	M135/E	12	Coated	HOR ±75°	11.50	7.01	39000	31000	20000	3800	70	844366015502
400	T15	E39	1653	*MS400/T15/PS/H75/4K	M155/E	M135/E	24	Clear	HOR ±75°	11.50	7.01	39000	31000	20000	4200	65	844366016530

*Items only available for special orders

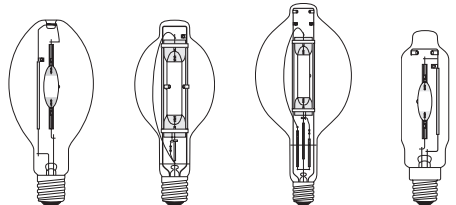

ED37/E39 BT37/E39 BT56/E39 T25/E39

HIGH INTENSITY DISCHARGE

Pulse Start Metal Halide ■ ■ ■ ■

Product Information							Physical Information				Photometric Characteristics					
Watts	Bulb	Base	Item#	Description	ANSI	Case Qty.	Finish	Operating Position	MOL (in)	LCL (in)	Initial Lumens (lm)	Mean Lumens (lm)	Avg. Life (Hrs)	Color Temp (K)	CRI	UPC
450	ED37	E39	1677	MS450/ED37/PS/U/4K	M144/E	12	Clear	Universal	11.50	7.01	50000	40000	20000	4200	65	844366016776
450	ED37	E39	1626	*MS450/ED37/PS/V/4K	M144/E	12	Clear	VER ±15°	11.50	7.01	50000	40000	20000	4200	65	844366016264
450	ED37	E39	1627	*MS450/ED37/C/PS/V/4K	M144/E	12	Coated	VER ±15°	11.50	7.01	47000	37000	20000	3800	70	844366016271
750	BT37	E39	1508	MS750/BT37/PS/HBU/4K	M149/E	12	Clear	BU ±15°	11.50	7.01	80000	60000	16000	4200	65	844366015083
750	BT37	E39	1596	*MS750/BT37/C/PS/HBU/4K	M149/E	12	Coated	BU ±15°	11.50	7.01	75000	56000	16000	3800	70	844366015960
875	BT37	E39	1628	*MS875/BT37/PS/BU/4K	M166/E	12	Clear	BU ±15°	11.50	7.01	100000	80000	20000	4000	65	844366016288
875	BT37	E39	1629	*MS875/BT37/PS/BD/4K	M166/E	12	Clear	BD ±15°	11.50	7.01	100000	80000	20000	4000	65	844366016295
875	BT37	E39	1630	*MS875/BT37/PS/HOR/4K	M166/E	12	Clear	HOR ±75°	11.50	7.01	95000	76000	12000	4000	65	844366016301
1000	BT37	E39	1509	MS1000/BT37/PS/U/4K	M141/E	12	Clear	Universal	11.50	7.01	110000	96000	15000	4200	65	844366015090
1000	BT56	E39	1598	*MS1000/BT56/PS/BU/4K	M141/E	6	Clear	BU ±15°	15.35	9.49	110000	86000	15000	4200	65	844366015984
1000	BT56	E39	1599	*MS1000/BT56/C/PS/BU/4K	M141/E	6	Coated	BU ±15°	15.35	9.49	105000	80000	15000	3800	70	844366015991
1000	T25	E39	1600	*MS1000/T25/PS/HOR/3K	M141/E	24	Clear	BU ±15°	15.35	9.49	92000	73000	10000	3200	65	844366016004

*Items only available for special orders

HID

HALOGEN

CFL

FL

BALLAST

GERMICIDAL

Plusrite®

Protected Pulse Start Metal Halide

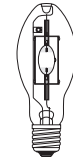

EDX17/E26

HID

HALOGEN

CFL

FL

BALLAST

GERMICIDAL

Product Information							Physical Information				Photometric Characteristics					
Watts	Bulb	Base	Item#	Description	ANSI	Case Qty.	Finish	Operating Position	MOL (in)	LCL (in)	Initial Lumens (lm)	Mean Lumens (lm)	Avg. Life (Hrs)	Color Temp (K)	CRI	UPC
50	EDX17	E26	1031	MP50/ED17/U/4K	M110/0	12	Clear	Universal	5.43	3.39	3200	2100	15000	4200	60	844366010316
50	EDX17	E26	1032	MP50/ED17/C/U/4K	M110/0	12	Coated	Universal	5.43	3.39	3000	2000	15000	3800	70	844366010323
75	EDX17	E26	1033	MP70/ED17/U/4K	M98/0	12	Clear	Universal	5.43	3.39	5300	3400	15000	4200	65	844366010330
75	EDX17	E26	1034	MP70/ED17/C/U/4K	M98/0	12	Coated	Universal	5.43	3.39	5000	3300	15000	3800	70	844366010347
100	EDX17	E26	1035	MP100/ED17/U/4K	M90/0	12	Clear	Universal	5.43	3.39	8500	5500	15000	4200	65	844366010354
100	EDX17	E26	1036	MP100/ED17/C/U/4K	M90/0	12	Coated	Universal	5.43	3.39	8100	5300	15000	3800	70	844366010361
125	EDX17	E26	1641	* MP125/ED17/PS/BU/4K	M150/0	12	Clear	BU ±15°	5.43	3.39	11400	8000	15000	4200	65	844366016417
125	EDX17	E26	1642	* MP125/ED17/C/PS/BU/4K	M150/0	12	Coated	BU ±15°	5.43	3.39	10800	7600	15000	3800	70	844366016424
150	EDX17	E26	1037	MP150/ED17/U/4K	M102/0	12	Clear	Universal	5.43	3.39	13300	10000	15000	4200	65	844366010378
150	EDX17	E26	1038	MP150/ED17/C/U/4K	M102/0	12	Coated	Universal	5.43	3.39	12600	9500	15000	3800	70	844366010385
175	EDX17	E26	1601	* MP175/ED17/PS/BU/3K	M152/0	12	Clear	BU ±15°	5.43	3.39	17000	12500	10000	3200	65	844366016011
175	EDX17	E26	1602	* MP175/ED17/C/PS/BU/3K	M152/0	12	Coated	BU ±15°	5.43	3.39	16000	12000	10000	3200	70	844366016028
175	EDX17	E26	1603	MP175/ED17/PS/U/4K	M152/0	12	Clear	Universal	5.43	3.39	16000	10800	15000	4200	65	844366016035
175	EDX17	E26	1604	* MP175/ED17/PS/BU/4K	M152/0	12	Clear	BU ±15°	5.43	3.39	17000	12500	10000	4200	65	844366016042
175	EDX17	E26	1605	* MP175/ED17/C/PS/BU/4K	M152/0	12	Coated	BU ±15°	5.43	3.39	16000	12000	10000	3800	70	844366016059

*Items only available for special orders

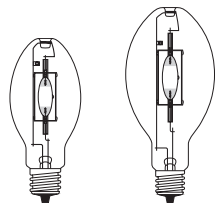

ED28/EX39 ED37/EX39

HIGH INTENSITY DISCHARGE

Protected Pulse Start Metal Halide ■ ■ ■

Product Information								Physical Information				Photometric Characteristics						
Watts	Bulb	Base	Item#	Description	ANSI	Case Qty.	Finish	Operating Position	MOL (in)	LCL (in)	Initial Lumens (lm)	Mean Lumens (lm)	Avg. Life (Hrs)	Color Temp (K)	CRI	UPC		
125	ED28	EX39	1643	* MP125/ED28/PS/V/4K	M150/0	-	12	Clear	VER ±15°	8.31	5.00	11400	8000	15000	4200	65	844366016431	HID
175	ED28	EX39	1606	* MP175/ED28/C/PS/BU/3K	M152/0	-	12	Coated	BU ±15°	8.31	5.00	16000	12000	15000	3200	70	844366016066	HALOGEN
175	ED28	EX39	1607	MP175/ED28/PS/BU/4K	M152/0	-	12	Clear	BU ±15°	8.31	5.00	17000	12500	15000	4200	65	844366016073	HALOGEN
175	ED28	EX39	1608	MP175/ED28/C/PS/BU/4K	M152/0	-	12	Coated	BU ±15°	8.31	5.00	16000	12000	15000	3800	70	844366016080	HALOGEN
200	ED28	EX39	1609	* MP200/ED28/C/PS/BU/3K	M136/0	-	12	Coated	BU ±15°	8.31	5.00	19000	15200	15000	3200	70	844366016097	HALOGEN
200	ED28	EX39	1610	* MP200/ED28/PS/BU/4K	M136/0	-	12	Clear	BU ±15°	8.31	5.00	20000	16000	15000	4200	65	844366016103	HALOGEN
200	ED28	EX39	1611	* MP200/ED28/C/PS/BU/4K	M136/0	-	12	Coated	BU ±15°	8.31	5.00	19000	15200	15000	3800	70	844366016110	HALOGEN
200	ED28	EX39	1556	* MP200/ED28/C/PS/V/3K	M136/0	-	12	Coated	VER ±15°	8.31	5.00	19000	15200	15000	3200	70	844366015564	CFL
200	ED28	EX39	1554	MP200/ED28/PS/V/4K	M136/0	-	12	Clear	VER ±15°	8.31	5.00	20000	16000	15000	4200	65	844366015540	CFL
200	ED28	EX39	1555	* MP200/ED28/C/PS/V/4K	M136/0	-	12	Coated	VER ±15°	8.31	5.00	19000	15200	15000	3800	70	844366015557	CFL
250	ED28	EX39	1557	MP250/ED28/PS/BU/4K	M153/0	M138/0	12	Clear	BU ±15°	8.31	5.00	23500	19000	15000	4200	65	844366015571	FL
250	ED28	EX39	1612	MP250/ED28/C/PS/BU/4K	M153/0	M138/0	12	Coated	BU ±15°	8.31	5.00	22500	17000	15000	3800	70	844366016127	FL
320	ED28	EX39	1613	MP320/ED28/PS/BU/4K	M154/0	M132/0	12	Clear	BU ±15°	8.31	5.00	31000	25000	20000	4200	65	844366016134	FL
320	ED28	EX39	1614	MP320/ED28/C/PS/BU/4K	M154/0	M132/0	12	Coated	BU ±15°	8.31	5.00	29000	23000	20000	3800	70	844366016141	FL
320	ED37	EX39	1617	* MP320/ED37/C/PS/BU/3K	M154/0	M132/0	12	Coated	BU ±15°	11.50	7.01	29000	23000	20000	3200	70	844366016172	FL
320	ED37	EX39	1615	MP320/ED37/PS/BU/4K	M154/0	M132/0	12	Clear	BU ±15°	11.50	7.01	31000	25000	20000	4200	65	844366016158	FL
320	ED37	EX39	1616	MP320/ED37/C/PS/BU/4K	M154/0	M132/0	12	Coated	BU ±15°	11.50	7.01	29000	23000	20000	3800	70	844366016165	FL

*Items only available for special orders

HID

HALOGEN

CFL

FL

BALLAST

GERMICIDAL

Plusrite®

Protected Pulse Start Metal Halide

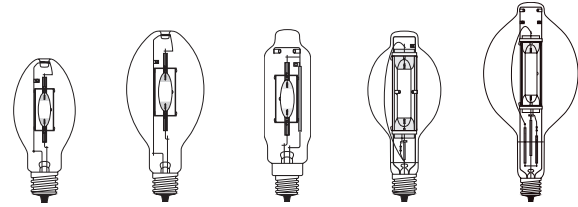

ED28/EX39 ED37/EX39 T25/EX39 BT37/EX39 BT56/EX39

Product Information							Physical Information				Photometric Characteristics						
Watts	Bulb	Base	Item#	Description	ANSI	Case Qty.	Finish	Operating Position	MOL (in)	LCL (in)	Initial Lumens (lm)	Mean Lumens (lm)	Avg. Life (Hrs)	Color Temp (K)	CRI	UPC	
350	ED28	EX39	1649	* MP350/ED28/C/PS/BU/3K	M131/0	-	12	Coated	BU ±15°	8.31	5.00	33000	26000	20000	3200	70	844366016493
350	ED28	EX39	1619	MP350/ED28/PS/BU/4K	M131/0	-	12	Clear	BU ±15°	8.31	5.00	35000	28000	20000	4200	65	844366016196
350	ED28	EX39	1620	MP350/ED28/C/PS/BU/4K	M131/0	-	12	Coated	BU ±15°	8.31	5.00	33000	26000	20000	3800	70	844366016202
350	ED28	EX39	1558	* MP350/ED28/PS/V/4K	M131/0	-	12	Clear	VER ±15°	8.31	5.00	35000	28000	20000	4200	65	844366015588
350	ED28	EX39	1559	* MP350/ED28/C/PS/V/4K	M131/0	-	12	Coated	VER ±15°	8.31	5.00	33000	26000	20000	3800	70	844366015595
350	ED37	EX39	1621	* MP350/ED37/C/PS/BU/3K	M131/0	-	12	Coated	BU ±15°	11.50	7.01	33000	26000	20000	3200	70	844366016219
350	ED37	EX39	1622	MP350/ED37/PS/BU/4K	M131/0	-	12	Clear	BU ±15°	11.50	7.01	38000	28000	20000	4200	65	844366016226
350	ED37	EX39	1623	MP350/ED37/C/PS/BU/4K	M131/0	-	12	Coated	BU ±15°	11.50	7.01	33000	26000	20000	3800	70	844366016233
350	ED37	EX39	1562	* MP350/ED37/C/PS/V/3K	M131/0	-	12	Coated	VER ±15°	11.50	7.01	33000	26000	20000	3200	70	844366015625
350	ED37	EX39	1560	* MP350/ED37/PS/V/4K	M131/0	-	12	Clear	VER ±15°	11.50	7.01	35000	28000	20000	4200	65	844366015601
350	ED37	EX39	1561	* MP350/ED37/C/PS/V/4K	M131/0	-	12	Coated	VER ±15°	11.50	7.01	33000	26000	20000	3800	70	844366015618
400	ED28	EX39	1565	MP400/ED28/PS/BU/4K	M155/0	M135/0	12	Clear	BU ±15°	8.31	5.00	42000	33600	20000	4200	65	844366015656
400	ED28	EX39	1566	MP400/ED28/C/PS/BU/4K	M155/0	M135/0	12	Coated	BU ±15°	8.31	5.00	40000	32000	20000	3800	70	844366015663
400	ED37	EX39	1563	MP400/ED37/PS/BU/4K	M155/0	M135/0	12	Clear	BU ±15°	11.50	7.01	42000	33600	20000	4200	65	844366015632
400	ED37	EX39	1564	MP400/ED37/C/PS/BU/4K	M155/0	M135/0	12	Coated	BU ±15°	11.50	7.01	40000	32000	20000	3800	70	844366015649
450	ED37	EX39	1631	* MP450/ED37/PS/BU/4K	M144/0	-	12	Clear	BU ±15°	11.50	7.01	47000	37000	20000	4200	65	844366016318
450	ED37	EX39	1632	* MP450/ED37/C/PS/BU/4K	M144/0	-	12	Coated	BU ±15°	11.50	7.01	45000	36000	20000	3800	70	844366016325
575	BT37	EX39	1674	* MP575/BT37/C/PS/BU/4K	M178/0	-	12	Coated	BU ±15°	11.50	7.01	57000	45000	20000	3800	70	844366016745
575	BT37	EX39	1633	MP575/BT37/PS/V/4K	M178/0	-	12	Clear	VER ±15°	11.50	7.01	60000	48000	20000	4200	65	844366016332
575	BT37	EX39	1634	* MP575/BT37/C/PS/V/4K	M178/0	-	12	Coated	VER ±15°	11.50	7.01	57000	45000	20000	3800	70	844366016349
575	T25	EX39	1678	MP575/T25/PS/H75/4K	M178/0	-	24	Clear	HOR ±75°	11.50	7.01	55000	41250	20000	4200	65	844366016783
875	BT37	EX39	1635	* MP875/BT37/PS/BU/4K	M166/0	-	12	Clear	BU ±15°	11.50	7.01	95000	76000	20000	4200	65	844366016356
875	BT37	EX39	1636	* MP875/BT37/C/PS/BU/4K	M166/0	-	12	Coated	BU ±15°	11.50	7.01	90000	72000	20000	3800	70	844366016363
1000	BT37	EX39	1637	* MP1000/BT37/PS/BU/4K	M141/0	-	12	Clear	BU ±15°	11.50	7.01	105000	80000	20000	4200	65	844366016370
1000	BT56	EX39	1524	MP1000/BT56/PS/BU/4K	M141/0	-	6	Clear	BU ±15°	15.43	7.13	105000	80000	12000	4200	65	844366015243

*Items only available for special orders

HID

HALOGEN

CFL

FL

BALLAST

GERMICIDAL

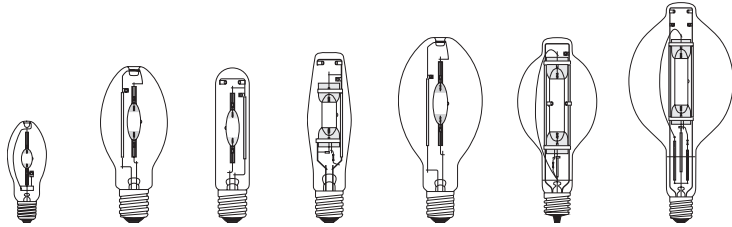

ED17/E26 ED28/E39 T15/E39 ET18/E39 ED37/E39 BT37/EX39 BT56/E39

HIGH INTENSITY DISCHARGE

Standard Metal Halide ■ ■ ■

HID

HALOGEN

CFL

FL

BALLAST

GERMICIDAL

Product Information								Physical Information				Photometric Characteristics					
Watts	Bulb	Base	Item#	Description	ANSI	Case Qty.	Finish	Operating Position	MOL (in)	LCL (in)	Initial Lumens (lm)	Mean Lumens (lm)	Avg. Life (Hrs)	Color Temp (K)	CRI	UPC	
175	ED17	E26	1008	MH175/ED17/U/4K	M57/E	-	12	Clear	Universal	5.43	3.39	14000	9100	10000	4200	65	844366010088
175	ED17	E26	1009	MH175/ED17/C/U/4K	M57/E	-	12	Coated	Universal	5.43	3.39	13300	8600	10000	3800	70	844366010095
175	ED28	E39	1014	MH175/ED28/U/4K	M57/E	-	12	Clear	Universal	8.31	5.00	14000	9100	10000	4200	65	844366010149
175	ED28	E39	1015	MH175/ED28/C/U/4K	M57/E	-	12	Coated	Universal	8.31	5.00	13600	8800	10000	3800	70	844366010156
175	T15	E39	1016	MH175/T15/HOR/4K	M57/E	-	24	Clear	HOR ±15°	8.31	5.00	14000	9100	10000	4200	65	844366010163
250	ED28	E39	1017	MH250/ED28/U/4K	M58/E	-	12	Clear	Universal	8.31	5.00	22000	17000	10000	4200	65	844366010170
250	ED28	E39	1018	MH250/ED28/C/U/4K	M58/E	-	12	Coated	Universal	8.31	5.00	21500	17000	10000	3800	70	844366010187
250	T15	E39	1019	MH250/T15/HOR/4K	M58/E	-	24	Clear	HOR ±15°	8.31	5.00	20000	14100	10000	4200	65	844366010194
250	ET18	E39	1020	MH250/ET18/HOR/4K	M58/E	-	24	Clear	HOR ±15°	9.72	5.75	20000	13500	10000	4200	65	844366010200
360	ED28	E39	1150	MS360/ED28/ES/U/4K	M59/E	M165/E	12	Clear	Universal	8.31	5.00	36000	23500	20000	4200	65	844366011504
360	ED37	E39	1021	MS360/ED37/ES/U/4K	M59/E	M165/E	12	Clear	Universal	11.50	7.01	36000	23500	20000	4200	65	844366010217
400	ED28	E39	1022	MH400/ED28/U/4K	M59/E	-	12	Clear	Universal	8.31	5.00	36000	23500	20000	4200	65	844366010224
400	ED28	E39	1023	MH400/ED28/C/U/4K	M59/E	-	12	Coated	Universal	8.31	5.00	34000	22000	20000	3800	70	844366010231
400	ED37	E39	1024	MH400/ED37/U/4K	M59/E	-	12	Clear	Universal	11.50	7.01	36000	23500	20000	4200	65	844366010248
400	ED37	E39	1025	MH400/ED37/C/U/4K	M59/E	-	12	Coated	Universal	11.50	7.01	34000	22000	20000	3800	70	844366010255
400	BT37	E39	2414	*MS400/BT37/HOR/4K	M59/E	-	12	Clear	HOR ±15°	11.50	7.01	36000	23500	20000	4200	65	844366024146
400	T15	E39	1026	MH400/T15/HOR/4K	M59/E	-	24	Clear	HOR ±15°	9.76	5.75	36000	23500	15000	4200	65	844366010262
400	ET18	E39	1027	MH400/ET18/HOR/4K	M59/E	-	12	Clear	HOR ±15°	9.72	5.75	33000	21500	15000	4200	65	844366010279
1000	BT37	E39	1028	MH1000/BT37/U/4K	M47/E	-	12	Clear	Universal	11.50	7.01	110000	93500	15000	4200	65	844366010286
1000	BT56	E39	1029	MH1000/BT56/U/4K	M47/E	-	6	Clear	Universal	15.43	7.13	110000	93500	15000	4200	65	844366010293
1000	BT56	E39	1076	*MH1000/BT56/C/U/4K	M47/E	-	6	Coated	Universal	15.43	7.13	107000	8000	15000	3800	70	844366010767
1500	BT56	E39	1030	MH1500/BT56/HBU/4K	M48/E	-	6	Clear	HOR-BU	15.43	7.13	167000	140000	3000	4200	65	844366010309

*Items only available for special orders

Plusrite®

Standard Metal Halide

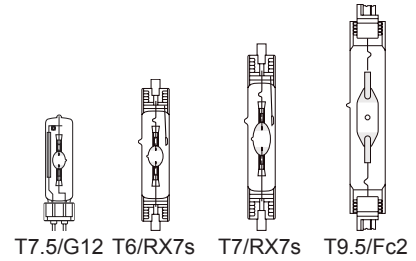

T7.5/G12 T6/RX7s T7/RX7s T9.5/Fc2

HID

HALOGEN

CFL

FL

BALLAST

GERMICIDAL

Product Information							Physical Information				Photometric Characteristics					
Watts	Bulb	Base	Item#	Description	ANSI	Case Qty.	Finish	Operating Position	MOL (in)	LCL (in)	Initial Lumens (lm)	Mean Lumens (lm)	Avg. Life (Hrs)	Color Temp (K)	CRI	UPC
70	T6	RX7s	1045	MHDE70/UVS/3K	M85/E	12	Clear	HOR ±15°	4.63	2.24	5500	4250	12000	3200	65	844366010453
70	T6	RX7s	1046	MHDE70/UVS/4K	M85/E	12	Clear	HOR ±15°	4.63	2.24	5500	4250	12000	4200	60	844366010460
70	T6	RX7s	1081	* MHDE70/UVS/5K	M85/E	12	Clear	HOR ±15°	4.63	2.24	4600	3900	12000	5200	70	844366010811
100	T6	RX7s	1082	* MHDE100/UVS/3K	M90/E	12	Clear	HOR ±15°	4.63	2.24	8500	7500	12000	3200	65	844366010828
100	T6	RX7s	1066	MHDE100/UVS/4K	M90/E	12	Clear	HOR ±15°	4.63	2.24	8500	7500	12000	4200	60	844366010668
100	T6	RX7s	1083	* MHDE100/UVS/5K	M90/E	12	Clear	HOR ±15°	4.63	2.24	8000	6800	12000	5200	70	844366010835
150	T7	RX7s	1047	MHDE150/UVS/3K	M81/E	12	Clear	HOR ±15°	5.33	2.60	13500	10625	12000	3200	65	844366010477
150	T7	RX7s	1048	MHDE150/UVS/4K	M81/E	12	Clear	HOR ±15°	5.33	2.60	13500	10625	12000	4200	60	844366010484
150	T7	RX7s	1084	* MHDE150/UVS/5K	M81/E	12	Clear	HOR ±15°	5.33	2.60	10000	8500	12000	5200	70	844366010842
250	T9.5	Fc2	1085	* MHDE250/UVS/4K	M80/E	12	Clear	HOR ±15°	5.33	2.60	20000	17000	10000	4200	60	844366010859
400	T9.5	Fc2	1086	* MHDE400/UVS/4K	M59/E	12	Clear	HOR ±15°	5.33	2.60	28000	23800	10000	4200	60	844366010866
70	T7.5	G12	1087	* MH70/G12/UVS/3K	M85/E	12	Clear	Universal	5.33	2.60	6000	5100	9000	3200	65	844366010873
70	T7.5	G12	1049	MH70/G12/UVS/4K	M85/E	12	Clear	Universal	5.33	2.60	6000	5100	9000	4200	65	844366010491
100	T7.5	G12	1088	* MH100/G12/UVS/3K	M90/E	12	Clear	Universal	5.33	2.60	9000	7650	9000	3200	65	844366010880
100	T7.5	G12	1050	MH100/G12/UVS/4K	M90/E	12	Clear	Universal	5.33	2.60	9000	7650	9000	4200	65	844366010507
150	T7.5	G12	1089	* MH150/G12/UVS/3K	M81/E	12	Clear	Universal	5.33	2.60	14000	9000	9000	3200	65	844366010897
150	T7.5	G12	1051	MH150/G12/UVS/4K	M81/E	12	Clear	Universal	5.33	2.60	14000	9000	9000	4200	65	844366010514

*Items only available for special orders

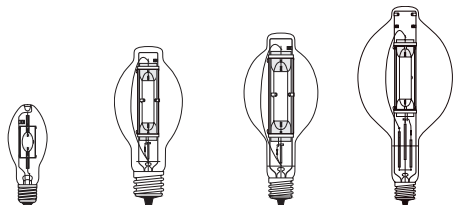

EDX17/E26 BT28/EX39 BT37/EX39 BT56/EX39

HIGH INTENSITY DISCHARGE

Protected Standard Metal Halide ■ ■ ■

Product Information							Physical Information				Photometric Characteristics					
Watts	Bulb	Base	Item#	Description	ANSI	Case Qty.	Finish	Operating Position	MOL (in)	LCL (in)	Initial Lumens (lm)	Mean Lumens (lm)	Avg. Life (Hrs)	Color Temp (K)	CRI	UPC
175	EDX17	E26	1039	MP175/ED17/U/4K	M57/O	12	Clear	Universal	5.43	3.39	14400	9300	10000	4200	65	844366010392
175	EDX17	E26	1077	* MP175/ED17/C/U/4K	M57/O	12	Coated	Universal	5.43	3.39	12800	8400	10000	3800	70	844366010774
175	BT28	EX39	1040	MP175/BT28/BU/4K	M57/O	12	Clear	BU ±15°	8.31	5.00	14400	10200	10000	4200	65	844366010408
175	BT28	EX39	1078	* MP175/BT28/C/BU/4K	M57/O	12	Coated	BU ±15°	8.31	5.00	12800	7800	10000	3800	70	844366010781
250	BT28	EX39	1041	MP250/BT28/BU/4K	M58/O	12	Clear	BU ±15°	8.31	5.00	23000	17000	10000	4200	65	844366010415
250	BT28	EX39	1079	* MP250/BT28/C/BU/4K	M58/O	12	Coated	BU ±15°	8.31	5.00	20000	14300	10000	3800	70	844366010798
400	BT37	EX39	1042	MP400/BT37/BU/4K	M59/O	12	Clear	BU ±15°	11.50	7.01	38500	25000	20000	4200	65	844366010422
400	BT37	EX39	1080	* MP400/BT37/C/BU/4K	M59/O	12	Coated	BU ±15°	11.50	7.01	38500	25000	20000	3800	70	844366010804
1000	BT56	EX39	1044	MP1000/BT56/BU/4K	M47/O	6	Clear	BU ±15°	15.43	7.13	100000	80000	12000	4200	65	844366010446

*Items only available for special orders

HID

HALOGEN

CFL

FL

BALLAST

GERMICIDAL

Plusrite®

Color Metal Halide

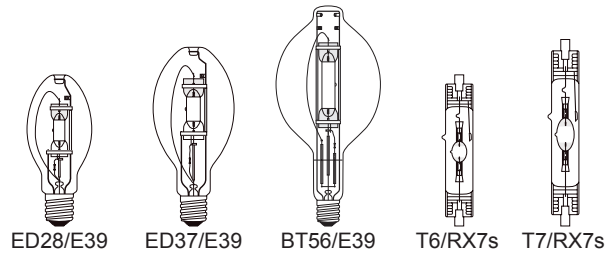

HID

HALOGEN

CFL

FL

BALLAST

GERMICIDAL

Product Information							Physical Information				Photometric Characteristics			UPC
Watts	Bulb	Base	Item#	Description	ANSI	Case Qty.	Finish	Operating Position	MOL (in)	LCL (in)	Wave-length	Saturation %	Avg. Life (Hrs)	
175	ED28	E39	1090	* MH175/ED28/BU/BDX	M57/E	12	Clear	BU±15°	8.31	5.00	450	77	5000	844366010903
175	ED28	E39	1091	* MH175/ED28/BU/GDX	M57/E	12	Clear	BU±15°	8.31	5.00	535	46	5000	844366010910
175	ED28	E39	1092	* MH175/ED28/BU/RDX	M57/E	12	Clear	BU±15°	8.31	5.00	590	70	5000	844366010927
250	ED28	E39	1093	* MH250/ED28/BU/BDX	M58/E	12	Clear	BU±15°	8.31	5.00	450	77	5000	844366010934
250	ED28	E39	1094	* MH250/ED28/BU/GDX	M58/E	12	Clear	BU±15°	8.31	5.00	535	46	5000	844366010941
250	ED28	E39	1095	* MH250/ED28/BU/RDX	M58/E	12	Clear	BU±15°	8.31	5.00	590	70	5000	844366010958
400	ED37	E39	1052	MH400/ED37/U/BDX	M59/E	12	Clear	Universal	11.50	7.01	450	77	5000	844366010521
400	ED37	E39	1053	MH400/ED37/U/GDX	M59/E	12	Clear	Universal	11.50	7.01	535	46	5000	844366010538
400	ED37	E39	1054	MH400/ED37/U/RDX	M59/E	12	Clear	Universal	11.50	7.01	590	70	5000	844366010545
1000	BT56	E39	1055	MH1000/BT56/BU/BDX	M47/E	6	Clear	BU ±15°	15.35	9.49	450	77	5000	844366010552
1000	BT56	E39	1056	MH1000/BT56/BU/GDX	M47/E	6	Clear	BU ±15°	15.35	9.49	535	46	5000	844366010569
1000	BT56	E39	1057	MH1000/BT56/BU/RDX	M47/E	6	Clear	BU ±15°	15.35	9.49	590	70	5000	844366010576
70	T6	RX7s	1096	* MHDE70/UVS/BDX	M85/E	12	Clear	HOR ±15°	4.63	2.24	450	77	5000	844366010965
70	T6	RX7s	1097	* MHDE70/UVS/GDX	M85/E	12	Clear	HOR ±15°	4.63	2.24	535	46	5000	844366010972
70	T6	RX7s	1098	* MHDE70/UVS/RDX	M85/E	12	Clear	HOR ±15°	4.63	2.24	590	70	5000	844366010989
150	T7	RX7s	1099	* MHDE150/UVS/BDX	M81/E	12	Clear	HOR ±15°	5.33	2.60	450	77	5000	844366010996
150	T7	RX7s	1100	* MHDE150/UVS/GDX	M81/E	12	Clear	HOR ±15°	5.33	2.60	535	46	5000	844366011009
150	T7	RX7s	1101	* MHDE150/UVS/RDX	M81/E	12	Clear	HOR ±15°	5.33	2.60	590	70	5000	844366011016

*Items only available for special orders

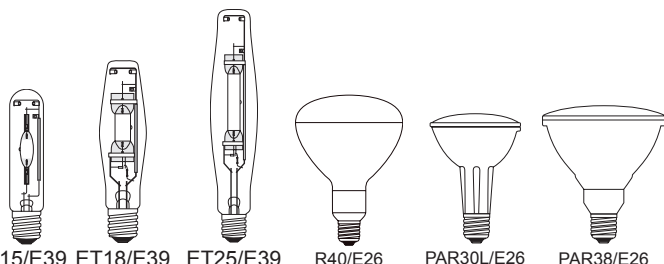

HIGH INTENSITY DISCHARGE

Metal Halide for Aquarium ■ ■ ■

T15/E39 ET18/E39 ET25/E39 R40/E26 PAR30L/E26 PAR38/E26

Product Information								Physical Information				Photometric Characteristics				
Watts	Bulb	Base	Item#	Description	ANSI	ANSI 2	Case Qty.	Finish	Operating Position	MOL (in)	LCL (in)	Initial Lumens (lm)	Avg. Life (Hrs)	Color Temp (K)	CRI	UPC
250	T15	E39	2403	MH250/T15/HOR/10K	M58/E	-	24	Clear	HOR ±15°	8.31	5.00	10500	8000	10000	85	844366024030
250	T15	E39	2404	MH250/T15/HOR/14K	M58/E	-	24	Clear	HOR ±15°	8.31	5.00	10500	8000	14000	85	844366024047
250	T15	E39	2405	MH250/T15/HOR/20K	M58/E	-	24	Clear	HOR ±15°	8.31	5.00	10500	8000	20000	85	844366024054
400	T15	E39	2406	MH400/T15/HOR/10K	M59/E	-	24	Clear	HOR ±15°	9.76	5.75	18500	8000	10000	85	844366024061
400	T15	E39	2407	MH400/T15/HOR/14K	M59/E	-	24	Clear	HOR ±15°	9.76	5.75	18500	8000	14000	85	844366024078
400	T15	E39	2408	MH400/T15/HOR/20K	M59/E	-	24	Clear	HOR ±15°	9.76	5.75	18500	8000	20000	85	844366024085
400	ET18	E39	2412	* MH400/ET18/HOR/10K	M59/E	-	24	Clear	HOR ±15°	9.65	5.70	18500	8000	10000	85	844366024122
1000	ET25	E39	2413	* MH1000/ET25/HOR/10K	M47/E	-	12	Clear	HOR ±15°	15.06	8.75	46000	3000	10000	85	844366024139
70	R40	E26	1058	MH70/R40/C/U/70°	M98/E	-	12	Coated	Universal	7.48	-	-	10000	4000	60	844366010583
100	R40	E26	1059	MH100/R40/C/U/70°	M90/E	-	12	Coated	Universal	7.48	-	-	10000	4000	60	844366010590
150	R40	E26	1105	* MH150/R40/C/U/70°	M102/E	-	12	Coated	Universal	7.48	-	-	10000	4000	60	844366011054
175	R40	E26	1060	MH175/R40/C/U/70°	M57/E	-	12	Coated	Universal	7.48	-	-	10000	4000	60	844366010606
70	PAR30LN	E26	1067	MH70/PAR30LN/FL/3K	M98/E	-	12	Clear	Universal	4.72	-	-	6000	3200	60	844366010675
70	PAR30LN	E26	1068	MH70/PAR30LN/FL/4K	M98/E	-	12	Clear	Universal	4.72	-	-	6000	4200	60	844366010682
70	PAR38	E26	1061	MH70/PAR38/U/FL/3K	M98/E	-	12	Clear	Universal	5.35	-	-	6000	3200	60	844366010613
70	PAR38	E26	1062	MH70/PAR38/U/FL/4K	M98/E	-	12	Clear	Universal	5.35	-	-	6000	4200	60	844366010620
100	PAR38	E26	1063	MH100/PAR38/U/FL/3K	M90/E	-	12	Clear	Universal	5.35	-	-	6000	3200	60	844366010637
100	PAR38	E26	1064	MH100/PAR38/U/SP/4K	M90/E	-	12	Clear	Universal	5.35	-	-	6000	4200	60	844366010644
100	PAR38	E26	1065	MH100/PAR38/U/FL/4K	M90/E	-	12	Clear	Universal	5.35	-	-	6000	4200	60	844366010651

*Items only available for special orders

HID

HALOGEN

CFL

FL

BALLAST

GERMICIDAL

Plusrite®

■ ■ ■ Reflector Metal Halide

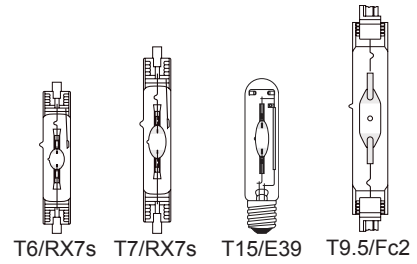

T6/RX7s T7/RX7s T15/E39 T9.5/Fc2

Product Information							Physical Information			Photometric Characteristics				
Watts	Bulb	Base	Item#	Description	ANSI	Case Qty.	Finish	Operating Position	MOL (in)	Beam Angle	Avg. Life (Hrs)	Color Temp (K)	CRI	UPC
70	T6	RX7s	1140	MHDE70/UVS/10K	M85/E	12	Clear	HOR ±15°	4.63	3100	6000	10000	75	844366011405
70	T6	RX7s	1141	MHDE70/UVS/20K	M85/E	12	Clear	HOR ±15°	4.63	3100	6000	20000	75	844366011412
150	T7	RX7s	1142	MHDE150/UVS/10K	M81/E	12	Clear	HOR ±15°	5.33	7000	6000	10000	85	844366011429
150	T7	RX7s	1143	MHDE150/UVS/14K	M81/E	12	Clear	HOR ±15°	5.33	7000	6000	14000	65	844366011436
150	T7	RX7s	1144	MHDE150/UVS/20K	M81/E	12	Clear	HOR ±15°	5.33	7000	6000	20000	75	844366011443
175	T15	E39	2400	MH175/T15/HOR/10K	M57/E	24	Clear	HOR ±15°	5.00	7500	6000	10000	85	844366024009
175	T15	E39	2401	MH175/T15/HOR/14K	M57/E	24	Clear	HOR ±15°	5.00	7500	6000	14000	85	844366024016
175	T15	E39	2402	MH175/T15/HOR/20K	M57/E	24	Clear	HOR ±15°	5.00	7500	6000	20000	85	844366024023
250	T9.5	Fc2	2409	MHDE250/UVS/10K	M80/E	12	Clear	HOR ±15°	6.40	11000	6000	10000	85	844366024092
250	T9.5	Fc2	2410	MHDE250/UVS/14K	M80/E	12	Clear	HOR ±15°	6.40	11000	6000	14000	65	844366024108
250	T9.5	Fc2	2411	MHDE250/UVS/20K	M80/E	12	Clear	HOR ±15°	6.40	11000	6000	20000	75	844366024115

HID

HALOGEN

CFL

FL

BALLAST

GERMICIDAL

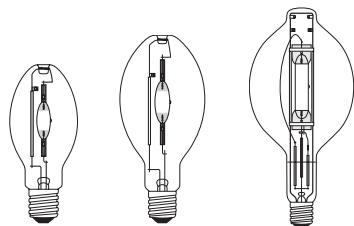

ED28/E39

ED37/E39

BT56/E39

HIGH INTENSITY DISCHARGE

Metal Halide Retrofit for HPS Ballast

HID

HALOGEN

CFL

FL

BALLAST

GERMICIDAL

Product Information							Physical Information				Photometric Characteristics					
Watts	Bulb	Base	Item#	Description	ANSI	Case Qty.	Finish	Operating Position	MOL (in)	LCL (in)	Initial Lumens (lm)	Mean Lumens (lm)	Avg. Life (Hrs)	Color Temp (K)	CRI	UPC
250	ED28	E39	1124	*MH250/ED28/U/LU	S50/E	12	Clear	Universal	8.31	5.00	19100	14300	10000	4200	65	844366011245
250	ED28	E39	1125	*MH250/ED28/C/U/LU	S50/E	12	Coated	Universal	8.31	5.00	18100	13600	10000	4000	70	844366011252
400	ED28	E39	1126	*MH400/ED28/U/LU	S51/E	12	Clear	Universal	8.31	5.00	36600	27200	10000	4200	65	844366011269
400	ED28	E39	1127	*MH400/ED28/C/U/LU	S51/E	12	Coated	Universal	8.31	5.00	34800	25900	20000	4000	70	844366011276
400	ED37	E39	1128	*MH400/ED37/U/LU	S51/E	12	Clear	Universal	11.50	5.91	36600	27300	20000	4200	65	844366011283
400	ED37	E39	1129	*MH400/ED37/C/U/LU	S51/E	12	Coated	Universal	11.50	5.91	34800	25900	20000	4000	70	844366011290
1000	BT56	E39	1130	*MH1000/BT56/U/LU	S52/E	6	Clear	Universal	15.43	9.49	110200	85500	20000	4200	65	844366011306
1000	BT56	E39	1131	*MH1000/BT56/C/U/LU	S52/E	6	Coated	Universal	15.43	9.49	104700	81200	12000	4000	70	844366011313

*Items only available for special orders

Plusrite®

High Pressure Sodium



ED17/E26

HID

HALOGEN

CFL

FL

BALLAST

GERMICIDAL

Product Information							Physical Information			Photometric Characteristics					
Watts	Bulb	Base	Item#	Description	ANSI	Case Qty.	Finish	MOL (in)	LCL (in)	Initial Lumens (lm)	Mean Lumens (lm)	Avg. Life (Hrs)	Color Temp (K)	CRI	UPC
35	ED17	E26	2000	LU35/ED17	S76	12	Clear	5.43	3.43	2050	2050	16000+	2000	22	844366020001
35	ED17	E26	2016	* LU35/D/ED17	S76	12	Diffuse	5.43	3.43	2100	1935	16000+	2000	22	844366020162
50	ED17	E26	2001	LU50/ED17	S68	12	Clear	5.43	3.43	4000	3600	24000+	2000	22	844366020018
50	ED17	E26	2017	* LU50/D/ED17	S68	12	Diffuse	5.43	3.43	3700	3420	24000+	2000	22	844366020179
70	ED17	E26	2002	LU70/ED17	S62	12	Clear	5.43	3.43	6300	5350	24000+	2000	22	844366020025
70	ED17	E26	2018	* LU70/D/ED17	S62	12	Diffuse	5.43	3.43	5800	4900	24000+	2000	22	844366020186
100	ED17	E26	2003	LU100/ED17	S54	12	Clear	5.43	3.43	9500	8000	24000+	2000	22	844366020032
100	ED17	E26	2019	* LU100/D/ED17	S54	12	Diffuse	5.43	3.43	8800	7500	24000+	2000	22	844366020193
150	ED17	E26	2004	LU150/ED17	S55	12	Clear	5.43	3.43	15800	13400	24000+	2000	22	844366020049
150	ED17	E26	2020	* LU150/D/ED17	S55	12	Diffuse	5.43	3.43	14500	12300	24000+	2000	22	844366020209

*Items only available for special orders

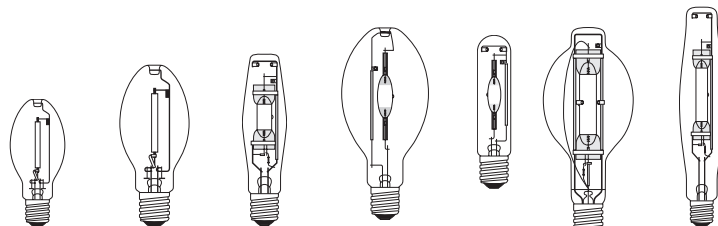

ED23.5/E39 ED28/E39 ET18/E39 ED37/E39 T15/E39 BT37/E39 ET25/E39

HIGH INTENSITY DISCHARGE

High Pressure Sodium ■ ■ ■

Product Information							Physical Information			Photometric Characteristics					
Watts	Bulb	Base	Item#	Description	ANSI	Case Qty.	Finish	MOL (in)	LCL (in)	Initial Lumens (lm)	Mean Lumens (lm)	Avg. Life (Hrs)	Color Temp (K)	CRI	UPC
50	ED23.5	E39	2021	*LU50/ED23.5	S68	12	Clear	7.75	5.00	4000	3600	24000+	2000	22	844366020216
50	ED23.5	E39	2022	*LU50/D/ED23.5	S68	12	Diffuse	7.75	5.00	3700	3420	24000+	2000	22	844366020223
70	ED23.5	E39	2005	LU70/ED23.5	S62	12	Clear	7.75	5.00	6300	5500	24000+	2000	22	844366020056
70	ED23.5	E39	2023	*LU70/D/ED23.5	S62	12	Diffuse	7.75	5.00	5500	4900	24000+	2000	22	844366020230
100	ED23.5	E39	2006	LU100/ED23.5	S54	12	Clear	7.75	5.00	9500	8000	24000+	2000	22	844366020063
100	ED23.5	E39	2024	*LU100/D/ED23.5	S54	12	Diffuse	7.75	5.00	8800	7500	24000+	2000	22	844366020247
150	ED23.5	E39	2007	LU150/55/ED23.5	S55	12	Clear	7.75	5.00	16000	13800	24000+	2000	22	844366020070
150	ED23.5	E39	2025	*LU150/55/D/ED23.5	S55	12	Diffuse	7.75	5.00	14000	12500	24000+	2000	22	844366020254
150	ED28	E39	2026	*LU150/100/ED28	S56	12	Clear	8.31	5.00	15700	14100	24000+	2000	22	844366020261
200	ET18	E39	2015	LU200/ET18	S66	24	Clear	9.65	5.70	22000	19800	24000+	2000	22	844366020155
250	ET18	E39	2009	LU250/ET18	S50	24	Clear	9.65	5.70	29000	26100	24000+	2000	22	844366020094
250	ET18	E39	2027	*LU250/D/ET28	S50	12	Diffuse	9.00	5.00	26000	23400	24000+	2000	22	844366020278
310	ET18	E39	2028	LU310/ET18	S67	24	Clear	9.65	5.70	37000	33300	24000+	2000	22	844366020285
400	ET18	E39	2010	LU400/ET18	S51	24	Clear	9.65	5.70	50000	45000	24000+	2000	22	844366020100
400	ED37	E39	2029	*LU400/D/ED37	S51	12	Diffuse	11.31	7.00	47500	40000	24000+	2000	22	844366020292
600	T15	E39	2011	LU600/T15	S106	24	Clear	11.06	6.62	90000	81000	24000+	2000	22	844366020117
750	BT37	E39	2030	*LU750/BT37	S111	12	Clear	11.06	6.62	105000	94500	24000+	2000	22	844366020308
1000	ET25	E39	2012	LU1000/ET25	S52	12	Clear	15.06	8.75	130000	124000	24000+	2000	22	844366020124
1000	ED37	E39	2013	LU1000/ED37	S52	12	Clear	11.50	7.00	127000	115000	24000+	2000	22	844366020131

*Items only available for special orders

HID

HALOGEN

CFL

FL

BALLAST

GERMICIDAL

Plusrite®

High Pressure Sodium ECO (TCLP Compliant)

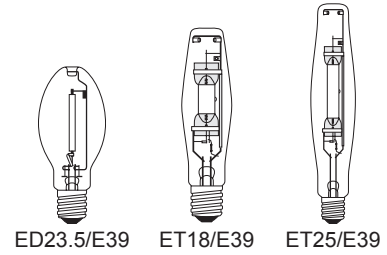

HID

HALOGEN

CFL

FL

BALLAST

GERMICIDAL

Product Information							Physical Information			Photometric Characteristics					
Watts	Bulb	Base	Item#	Description	ANSI	Case Qty.	Finish	MOL (in)	LCL (in)	Initial Lumens (lm)	Mean Lumens (lm)	Avg. Life (Hrs)	Color Temp (K)	CRI	UPC
70	ED23.5	E39	2044	LU70/ED23.5/ECO	S62	12	Clear	7.75	5.00	6300	5500	24000	2000	22	844366020445
100	ED23.5	E39	2045	LU100/ED23.5/ECO	S54	12	Clear	7.75	5.00	9500	8000	24000	2000	22	844366020452
150	ED23.5	E39	2046	LU150/ED23.5/ECO	S55	12	Clear	7.75	5.00	16000	13800	24000	2000	22	844366020469
200	ET18	E39	2049	LU200/ET18/ECO	S66	12	Clear	9.75	5.75	22000	19800	24000	2000	22	844366020490
250	ET18	E39	2047	LU250/ET18/ECO	S50	12	Clear	9.75	5.75	29000	26100	24000	2000	22	844366020476
400	ET18	E39	2048	LU400/ET18/ECO	S51	12	Clear	9.75	5.75	50000	45000	24000	2000	22	844366020483
1000	ET25	E39	2050	LU1000/ET25/ECO	S52	12	Clear	15.06	8.75	130000	124000	24000	2000	22	844366020506

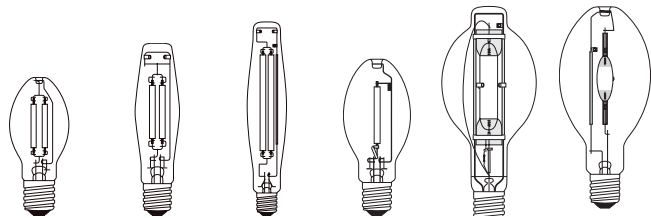

ED23.5/E39 ET18/E39 ET25/E39 ED28/E39 BT37/E39 ED37/E39

HIGH INTENSITY DISCHARGE

Standby HPS/ HPS Retrofit ■ ■ ■

Product Information							Physical Information			Photometric Characteristics					
Watts	Bulb	Base	Item#	Description	ANSI	Case Qty.	Finish	MOL (in)	LCL (in)	Initial Lumens (lm)	Mean Lumens (lm)	Avg. Life (Hrs)	Color Temp (K)	CRI	UPC
Standby High Pressure Sodium Lamps															
70	ED23.5	E39	2031	* LU70/E/SB	S62	12	Clear	7.75	5.00	6050	4950	40000	2000	22	844366020315
100	ED23.5	E39	2032	* LU100/E/SB	S54	12	Clear	7.75	5.00	9500	7600	40000	2000	22	844366020322
150	ED23.5	E39	2033	* LU150/E/SB	S55	12	Clear	7.75	5.00	15700	12100	40000	2000	22	844366020339
200	ET18	E39	2034	* LU200/E/SB	S66	24	Clear	9.65	5.70	21500	18000	40000	2000	22	844366020346
250	ET18	E39	2035	* LU250/E/SB	S50	24	Clear	9.65	5.70	27500	23200	40000	2000	22	844366020353
400	ET18	E39	2036	* LU400/E/SB	S51	24	Clear	9.65	5.70	47500	40000	40000	2000	22	844366020360
1000	ET25	E39	2037	* LU1000/E/SB	S52	12	Clear	15.06	8.75	127000	115000	24000+	2000	22	844366020377
High Pressure Sodium Lamps - Mercury Retrofit															
150	ED28	E39	2038	* LU150/ED28/Retro	H39	12	Clear	9.00	5.00	11800	10600	24000	1900	20	844366020384
215	ED28	E39	2039	* LU215/ED28/Retro	H37	12	Clear	9.00	5.00	20000	17000	16000	1900	20	844366020391
360	BT37	E39	2014	* LU360/BT37/Retro	H33	12	Clear	11.31	7.00	36500	32800	16000	2100	20	844366020148
220	ED28	E39	2050	LU220/ED28/Retro	M58	12	Clear	9.00	5.00	17000	-	24000	1900	20	844366020506
360	ED37	E39	2051	* LU360/ED37/Retro	M59	12	Clear	11.31	7.00	32000	-	16000	1900	20	844366020513
940	ET25	E39	2052	* LU940/ET25/Retro	M47	12	Clear	15.06	8.75	91000	-	16000	2100	20	844366020520

*Items only available for special orders

HID

HALOGEN

CFL

FL

BALLAST

GERMICIDAL

Plusrite®

Mercury Vapor

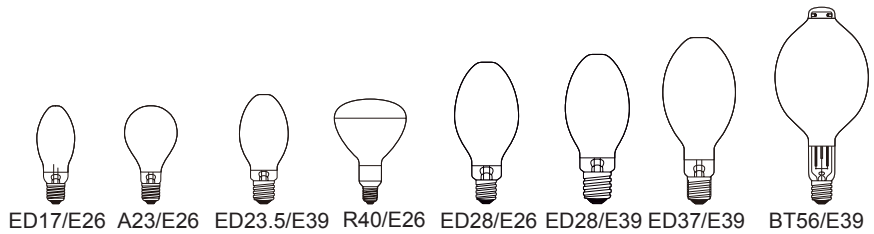

ED17/E26 A23/E26 ED23.5/E39 R40/E26 ED28/E26 ED28/E39 ED37/E39 BT56/E39

HID

HALOGEN

CFL

FL

BALLAST

GERMICIDAL

Product Information									Physical Information			Photometric Characteristics				
Watts	Bulb	Base	Item#	Description	Generic Designation	ANSI	Case Qty.	Finish	MOL (in)	LCL (in)	Initial Lumens (lm)	Mean Lumens (lm)	Avg. Life (Hrs)	Color Temp (K)	CRI	UPC
50	ED17	E26	2312	*MV50/DX/46/ED17	H46DL-40-50/DX	H46	12	Deluxe Coated	5.43	3.50	1580	1300	24000+	3900	50	844366023125
75	ED17	E26	2300	MV75/DX/43/ED17	H43AV-75/DX	H43	12	Deluxe Coated	5.43	3.50	2700	2250	24000+	3900	50	844366023002
80	ED17	E26	2311	MV80/DX/ED17	-	H43	12	Deluxe Coated	5.43	3.50	2700	2250	24000+	3900	50	844366023118
80	A23	E26	2309	MV80/DX/A23	-	H43	12	Deluxe Coated	5.43	3.50	2700	2250	24000+	3900	50	844366023095
100	ED17	E26	2301	MV100/DX/38/ED17	H38AV-100/DX	H38	12	Deluxe Coated	5.43	3.50	4000	3560	24000+	3900	50	844366023019
100	A23	E26	2302	MV100/DX/38/A23	H38MP-100/DX	H38	12	Deluxe Coated	5.43	3.50	4000	3400	24000+	3900	50	844366023026
100	ED23.5	E39	2313	*MV100/DX/38/ED23.5	H38JA-100/DX	H38	12	Deluxe Coated	7.50	5.00	4000	3000	24000+	3900	50	844366023132
100	R40	E26	2314	*MV100/DX/38/R40	H38BP-100/DX	H38	12	Deluxe Coated	7.00	5.00	2450	2050	24000+	3900	50	844366023149
175	ED28	E26	2315	*MV175/DX/39/ED28/MED	-	H39	12	Deluxe Coated	8.25	5.00	7800	6800	24000+	3900	50	844366023156
175	ED28	E39	2303	MV175/DX/39/ED28	H39KC-175/DX	H39	12	Deluxe Coated	8.25	5.00	7800	6800	24000+	3900	50	844366023033
175	ED28	E39	2316	*MV175/39/ED28	H39KB-175	H39	12	Clear	8.25	5.00	7800	6800	24000+	6000	20	844366023163
175	R40	E26	2317	*MV175/DX/39/R40/FL	H39BP-175/DX	H39	12	Deluxe Coated	7.00	5.00	5700	4350	24000+	3900	50	844366023170
250	ED28	E39	2304	MV250/DX/37/ED28	H37KC-250/DX	H37	12	Deluxe Coated	8.25	5.00	11200	10800	24000+	3900	50	844366023040
250	ED28	E39	2318	*MV250/37/ED28	H37KB-250	H37	12	Clear	8.25	5.00	11200	10800	24000+	6000	20	844366023187
400	ED28	E39	2305	MV400/DX/33/ED28	-	H33	12	Deluxe Coated	8.25	5.00	22600	14400	24000+	3900	50	844366023057
400	ED37	E39	2306	MV400/DX/33/ED37	H33GL-400/DX	H33	12	Deluxe Coated	11.31	7.00	22600	14400	24000+	3900	50	844366023064
400	ED37	E39	2319	*MV400/33/ED37	H33CD-400	H33	12	Clear	11.31	7.00	22600	14400	24000+	6000	20	844366023194
1000	BT56	E39	2310	MV1000/DX/36/BT56	H36GW-1000/DX	H36	6	Deluxe Coated	15.38	9.50	58000	48500	24000+	3900	50	844366023101
1000	BT56	E39	2320	*MV1000/36/BT56	H36GV-1000	H36	6	Clear	15.38	9.50	58000	48500	24000+	6000	20	844366023200

*Items only available for special orders

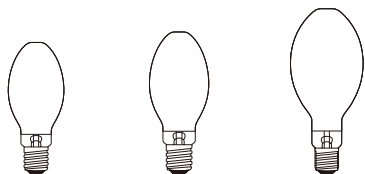

ED23.5/E39

ED28/E26

ED37/E39

HIGH INTENSITY DISCHARGE

Self-Ballasted Mercury Vapor ■ ■ ■

Product Information							Physical Information			Photometric Characteristics					
Watts	Bulb	Base	Item#	Description	Voltage (V)	Case Qty.	Finish	MOL (in)	LCL (in)	Initial Lumens (lm)	Mean Lumens (lm)	Avg. Life (Hrs)	Color Temp (K)	CRI	UPC
100	ED23.5	E26	2321	* MV100/DX/SB/ED23.5	120	12	Deluxe Coated	7.75	5.00	1000	700	10000	3200	50	844366023217
160	ED23.5	E26	2307	* MV160/DX/SB/ED23.5	120	12	Deluxe Coated	7.75	5.00	2300	1500	10000	3200	50	844366023071
250	ED28	E26	2322	* MV250/DX/SB/ED28/MED	120	12	Deluxe Coated	8.50	5.18	5000	3700	10000	3200	50	844366023224
250	ED28	E39	2308	* MV250/DX/SB/ED28	120	12	Deluxe Coated	8.50	5.18	5000	3700	10000	3200	50	844366023088
450	ED37	E39	2323	* MV450/DX/SB/ED37	120	12	Deluxe Coated	11.46	7.28	10000	9100	10000	3200	50	844366023231

*Items only available for special orders

HID

HALOGEN

CFL

FL

BALLAST

GERMICIDAL

Warning ANSI Luminaire Code O Open Fixture

Protected Pulse Start Metal Halide

THE FOLLOWING INSTRUCTIONS MUST BE FOLLOWED TO AVOID RISK OF PERSONAL INJURY, PROPERTY DAMAGE AND POOR LAMP PERFORMANCE.

If the outer bulb is broken or punctured, immediately turn power off and remove lamp after it has cooled. Do not scratch the outer bulb or subject it to pressure as this could cause the outer bulb to crack or shatter.

RUPTURE RISKS:

Metal Halide arc tubes are designed to operate under high pressure and at temperatures up to 2012 °F, 1100°C and can unexpectedly rupture due to internal or external factors such as a ballast failure or misapplication. An arc tube rupture can burst and shatter the outer glass bulb resulting in the discharge of glass fragments and extremely hot particles. If such a rupture were to happen, *THERE IS A RISK OF PERSONAL INJURY, PROPERTY DAMAGE, BURNS AND FIRE.*

RELAMP FIXTURES AT OR BEFORE THE END OF RATED LIFE.

Allowing lamps to operate until they fail is not advised and may increase the possibility of inner arc tube rupture.

CAUTION

- Only operate lamp in the specified burning position with compatible electrical equipment.
- The ANSI code on the Plusrite lamp must match the code on the ballast or luminaire.
- Do not look directly at the operating lamp for any period of time. This may cause eye injury.
- Lamp must be turned off for a minimum of 15min. at least once a week.
- Never expose an operating lamp to moisture such as rain, sleet or snow.
- Protect lamp base, socket and wiring against moisture, corrosive atmospheres and excessive heat.
- Periodically inspect the outer envelope. Replace lamp if scratched, cracked, or damaged.
- Electrically insulate any metal support in contact with the outer bulb to avoid glass decomposition.
- Before lamp installation/replacement, shut power off and allow lamp and fixture to cool to avoid electrical shock and potential burn hazards
- Install lamp firmly but not forcibly into the socket.
- If an arc tube is broken, avoid skin contact with any of the contents or fragments.
- Do not store combustible or flammable materials directly below the luminaire.
- Never install the lamp into an ordinary household socket.
- All pulse start lamps require a socket rated to withstand a 4000 volt pulse.
- Safety glasses and gloves should be used when installing or removing HID lamps

LAMP OPERATING CHARACTERISTICS

Lamp requires several minutes to come to full brightness. Time should be allowed for lamps to stabilize in color when turned on for the first time. This may require several hours of operation, with more than one start. Color appearance may vary between individual lamps. It is further influenced by variation in the operating conditions and is not an indication of system or lamp failure. Lamp may require 10 to 20 minutes to restart if there is a power interruption.

R WARNING

This lamp can cause serious skin burn and eye inflammation from shortwave ultraviolet radiation if outer envelope of the lamp is broken or punctured. Do not use where people will remain for more than a few minutes unless adequate shielding or other safety precautions are used. Lamps that will automatically extinguish when the outer envelope is broken or punctured are commercially available. This lamp complies with USA Federal Standard 21 CFR 1040.30 and Canada Standard SOR/80-381.

HG LAMP CONTAINS MERCURY

Manage in Accord with Disposal Laws Kr-85
see www.lamprecycle.org or 1-888-529-6660

HIGH INTENSITY DISCHARGE

HID

HALOGEN

CFL

FL

BALLAST

GERMICIDAL

Warning ANSI Luminaire Code O Open Fixture

Protected Standard Metal Halide

THE FOLLOWING INSTRUCTIONS MUST BE FOLLOWED TO AVOID RISK OF PERSONAL INJURY, PROPERTY DAMAGE AND POOR LAMP PERFORMANCE.

If the outer bulb is broken or punctured, immediately turn power off and remove lamp after it has cooled. Do not scratch the outer bulb or subject it to pressure as this could cause the outer bulb to crack or shatter.

RUPTURE RISKS:

Metal Halide arc tubes are designed to operate under high pressure and at temperatures up to 212 °F, 1100°C and can unexpectedly rupture due to internal or external factors such as a ballast failure or misapplication. An arc tube rupture can burst and shatter the outer glass bulb resulting in the discharge of glass fragments and extremely hot particles. If such a rupture were to happen, *THERE IS A RISK OF PERSONAL INJURY, PROPERTY DAMAGE, BURNS AND FIRE.*

RELAMP FIXTURES AT OR BEFORE THE END OF RATED LIFE.

Allowing lamps to operate until they fail is not advised and may increase the possibility of inner arc tube rupture.

CAUTION

- Only operate lamp in the specified burning position with compatible electrical equipment.
- The ANSI code on the Plusrite lamp must match the code on the ballast or luminaire.
- Do not look directly at the operating lamp for any period of time. This may cause eye injury.
- Lamp must be turned off for a minimum of 15min. at least once a week.
- Never expose an operating lamp to moisture such as rain, sleet or snow.
- Protect lamp base, socket and wiring against moisture, corrosive atmospheres and excessive heat.
- Periodically inspect the outer envelope. Replace lamp if scratched, cracked, or damaged.
- Electrically insulate any metal support in contact with the outer bulb to avoid glass decomposition.
- Before lamp installation/replacement, shut power off and allow lamp and fixture to cool to avoid electrical shock and potential burn hazards
- Install lamp firmly but not forcibly into the socket.
- If an arc tube is broken, avoid skin contact with any of the contents or fragments.
- Do not store combustible or flammable materials directly below the luminaire.
- Do not use this lamp in a fixture that contains a Pulse Start metal halide ballast or in a fixture that is specifically designed for use with pulse start metal halide lamps.
- Never install the lamp into an ordinary household socket.
- Safety glasses and gloves should be used when installing or removing HID lamps

LAMP OPERATING CHARACTERISTICS

Lamp requires several minutes to come to full brightness. Time should be allowed for lamps to stabilize in color when turned on for the first time. This may require several hours of operation, with more than one start. Color appearance may vary between individual lamps. It is further influenced by variation in the operating conditions and is not an indication of system or lamp failure. Lamp may require 10 to 20 minutes to restart if there is a power interruption.

R WARNING

This lamp can cause serious skin burn and eye inflammation from shortwave ultraviolet radiation if outer envelope of the lamp is broken or punctured. Do not use where people will remain for more than a few minutes unless adequate shielding or other safety precautions are used. Lamps that will automatically extinguish when the outer envelope is broken or punctured are commercially available. This lamp complies with USA Federal Standard 21 CFR 1040.30 and Canada Standard SOR/80-381.

HG LAMP CONTAINS MERCURY

Manage in Accord with Disposal Laws Kr-85
see www.lamprecycle.org or 1-888-529-6660

Warning ANSI Luminaire Code E Open Fixture

Pulse Start Metal Halide

THE FOLLOWING INSTRUCTIONS MUST BE FOLLOWED TO AVOID RISK OF PERSONAL INJURY, PROPERTY DAMAGE AND POOR LAMP PERFORMANCE.

If the outer bulb is broken or punctured, immediately turn power off and remove lamp after it has cooled. Do not scratch the outer bulb or subject it to pressure as this could cause the outer bulb to crack or shatter.

RUPTURE RISKS:

Metal Halide arc tubes are designed to operate under high pressure and at temperatures up to 2012 °F, 1100°C and can unexpectedly rupture due to internal or external factors such as a ballast failure or misapplication. An arc tube rupture can burst and shatter the outer glass bulb resulting in the discharge of glass fragments and extremely hot particles. If such a rupture were to happen, *THERE IS A RISK OF PERSONAL INJURY, PROPERTY DAMAGE, BURNS AND FIRE.*

RELAMP FIXTURES AT OR BEFORE THE END OF RATED LIFE.

Allowing lamps to operate until they fail is not advised and may increase the possibility of inner arc tube rupture.

CAUTION

- Only operate lamp in an enclosed fixture capable of withstanding particles of glass having temperatures up to 2012 °F, 1100 °C. If you are uncertain, contact your fixture manufacturer.
- Only operate lamp in the specified burning position with compatible electrical equipment. The ANSI code on the Plusrite lamp must match the code on the ballast or luminaire.
- Only operate lamp in an enclosed fixture with ultraviolet absorbing filter glass.
- Do not look directly at the operating lamp for any period of time. This may cause eye injury.
- Lamp must be turned off for a minimum of 15min. at least once a week.
- Never expose an operating lamp to moisture such as rain, sleet or snow.
- Protect lamp base, socket and wiring against moisture, corrosive atmospheres and excessive heat.
- Periodically inspect the outer envelope. Replace lamp if scratched, cracked, or damaged.
- Electrically insulate any metal support in contact with the outer bulb to avoid glass decomposition.
- Before Lamp installation/replacement, shut power off and allow lamp and fixture to cool to avoid electrical shock and potential burn hazards
- Install lamp firmly but not forcibly into the socket.
- If an arc tube is broken, avoid skin contact with any of the contents or fragments.
- Do not store combustible or flammable materials directly below the luminaire.
- Never install the lamp into an ordinary household socket.
- Safety glasses and gloves should be used when installing or removing HID lamps

LAMP OPERATING CHARACTERISTICS

Lamp requires several minutes to come to full brightness. Time should be allowed for lamps to stabilize in color when turned on for the first time. This may require several hours of operation, with more than one start. Color appearance may vary between individual lamps. It is further influenced by variation in the operating conditions and is not an indication of system or lamp failure. Lamp may require 10 to 20 minutes to restart if there is a power interruption.

R WARNING

This lamp can cause serious skin burn and eye inflammation from shortwave ultraviolet radiation if outer envelope of the lamp is broken or punctured. Do not use where people will remain for more than a few minutes unless adequate shielding or other safety precautions are used. Lamps that will automatically extinguish when the outer envelope is broken or punctured are commercially available. This lamp complies with USA Federal Standard 21 CFR 1040.30 and Canada Standard SOR/80-381.

HG LAMP CONTAINS MERCURY

Manage in Accord with Disposal Laws Kr-85
see www.lamprecycle.org or 1-888-529-6660

HIGH INTENSITY DISCHARGE

HID

HALOGEN

CFL

FL

BALLAST

GERMICIDAL

Warning ANSI Luminaire Code E Open Fixture

Standard Metal Halide

THE FOLLOWING INSTRUCTIONS MUST BE FOLLOWED TO AVOID RISK OF PERSONAL INJURY, PROPERTY DAMAGE AND POOR LAMP PERFORMANCE.

If the outer bulb is broken or punctured, immediately turn power off and remove lamp after it has cooled. Do not scratch the outer bulb or subject it to pressure as this could cause the outer bulb to crack or shatter.

RUPTURE RISKS:

Metal Halide arc tubes are designed to operate under high pressure and at temperatures up to 2012 °F, 1100°C and can unexpectedly rupture due to internal or external factors such as a ballast failure or misapplication. An arc tube rupture can burst and shatter the outer glass bulb resulting in the discharge of glass fragments and extremely hot particles. If such a rupture were to happen, *THERE IS A RISK OF PERSONAL INJURY, PROPERTY DAMAGE, BURNS AND FIRE.*

RELAMP FIXTURES AT OR BEFORE THE END OF RATED LIFE.

Allowing lamps to operate until they fail is not advised and may increase the possibility of inner arc tube rupture.

CAUTION

- Only operate lamp in an enclosed fixture capable of withstanding particles of glass having temperatures up to 2012 °F, 1100 °C. If you are uncertain, contact your fixture manufacturer.
- Only operate lamp in the specified burning position with compatible electrical equipment. The ANSI code on the Plusrite lamp must match the code on the ballast or luminaire.
- Only operate lamp in an enclosed fixture with ultraviolet absorbing filter glass.
- Do not look directly at the operating lamp for any period of time. This may cause eye injury.
- Lamp must be turned off for a minimum of 15min. at least once a week.
- Never expose an operating lamp to moisture such as rain, sleet or snow.
- Protect lamp base, socket and wiring against moisture, corrosive atmospheres and excessive heat.
- Periodically inspect the outer envelope. Replace lamp if scratched, cracked, or damaged.
- Electrically insulate any metal support in contact with the outer bulb to avoid glass decomposition.
- Before Lamp installation/replacement, shut power off and allow lamp and fixture to cool to avoid electrical shock and potential burn hazards
- Install lamp firmly but not forcibly into the socket.
- If an arc tube is broken, avoid skin contact with any of the contents or fragments.
- Do not store combustible or flammable materials directly below the luminaire.
- Do not use this lamp in a fixture that contains a Pulse Start metal halide ballast or in a fixture that is specifically designed for use with Pulse Start metal halide lamps.
- Never install the lamp into an ordinary household socket.
- Safety glasses and gloves should be used when installing or removing HID lamps

LAMP OPERATING CHARACTERISTICS

Lamp requires several minutes to come to full brightness. Time should be allowed for lamps to stabilize in color when turned on for the first time. This may require several hours of operation, with more than one start. Color appearance may vary between individual lamps. It is further influenced by variation in the operating conditions and is not an indication of system or lamp failure. Lamp may require 10 to 20 minutes to restart if there is a power interruption.

R WARNING

This lamp can cause serious skin burn and eye inflammation from shortwave ultraviolet radiation if outer envelope of the lamp is broken or punctured. Do not use where people will remain for more than a few minutes unless adequate shielding or other safety precautions are used. Lamps that will automatically extinguish when the outer envelope is broken or punctured are commercially available. This lamp complies with USA Federal Standard 21 CFR 1040.30 and Canada Standard SOR/80-381.

HG LAMP CONTAINS MERCURY

Manage in Accord with Disposal Laws Kr-85
see www.lamprecycle.org or 1-888-529-6660

HID

HALOGEN

CFL

FL

BALLAST

GERMICIDAL



INCANDESCENT HALOGEN

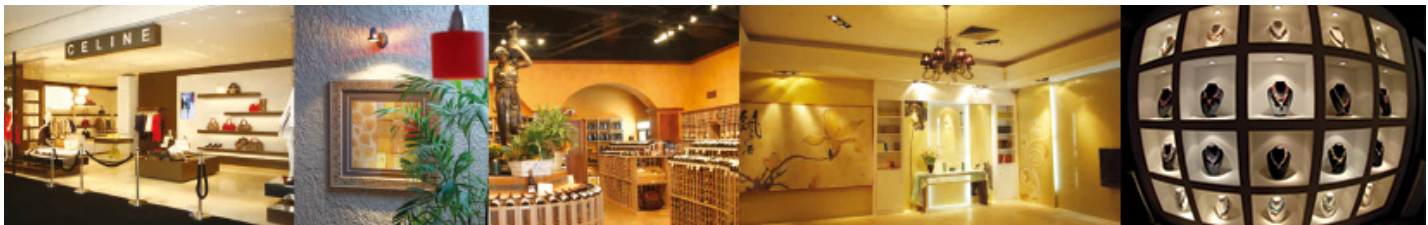



HALOGEN

HID

HALOGEN

CFL

FL

BALLAST

GERMICIDAL

CONTENTS

- | | |
|--|--|
| 44 - Xenon Festoon | 55 - Energy Saving MR16 with Infrared Technology |
| 45 - Xenon JC Bi-Pin | 56 - JDR E14 & E26 |
| 46 - Bi-Pin JC (Low Voltage Capsule) | 57 - JDR GU10 & JC DR |
| 47 - Bi-Pin JCD (Line Voltage Capsule Lamps) | 58 - PAR16 |
| 49 - J Double Ended | 59 - PAR20 |
| 50 - JD (Single-Ended Linear) | 60 - PAR30 |
| 51 - MR11 | 61 - PAR30 Long Neck |
| 52 - MR16 | 62 - PAR38 |
| 53 - MR16 X-Life™ 4000Hrs | 65 - Standard PAR - Meet EISA 2007 |
| 54 - MR16 S-Life™ 10000Hrs | 66 - Longlife PAR - Meet EISA 2007 |



FILAMENTS



CC-8

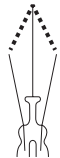

CC-2V

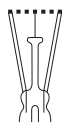

CC-6



Axial (AX)



Transverse (AR)



C-8 Double End

BULBS



J Type



MR-11

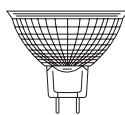

MR-16



JC G4/G5.3/GY6.35



JCD G8S



JCD G8



JCD G9



JD BA15d

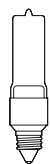

JD E11

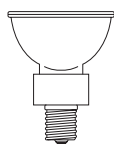

JDR E14

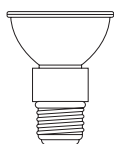

JDR E26

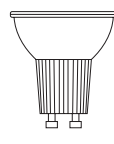

JDR GU10



PAR14



PAR16



PAR20



PAR30

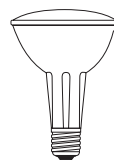

PAR30 Long Neck



PAR36

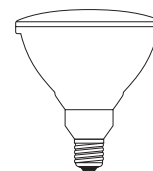

PAR38

BASES



G4



G6.35



G8



G9



GU4

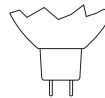

GU5.3

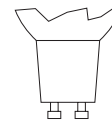

GU10



RSC



E11



BA15d



E14



E26



Screw Term



Festoon



HALOGEN

How to read the table



HID

HALOGEN

CFL

FL

BALLAST

GERMICIDAL

Product Information				Physical Information			Photometric Characteristics					UPC				
Watts	Bulb	Base	Item#	Description	Voltage (V)	Case Qty.	Finish	Dia (in)	MOL (in)	CBCP (cd)	Beam Angle	Spread	Initial Lumens (lm)	Avg. Life (Hrs)	Color Temp (K)	UPC
38	PAR20	E26	3498	38PAR20/ECO/SP/120	120	15	2.5	2.5	3.30	2100	10°	Spot	520	1500	2800	844366034985
38	PAR20	E26	3499	38PAR20/ECO/FL/120	120	15	2.5	2.5	3.30	1000	40°	Flood	520	1500	2800	844366034992
38	PAR30	E26	3500	38PAR30/ECO/SP/120	120	15	3.7	3.7	3.60	2100	10°	Spot	520	1500	2800	844366035005

Watts
Energy consumption during proper operation

Base
Type of base

Description
Model description

Case Qty
Number of product units packed in a case

Diameter
Lamps diameter in inches

CBCP
Maximum candle power of lamp at radius

Average Life
An average rating operated at normal lamp voltage and current

Spread
Type of lamp that related to the beam angle

UPC
Universal Product Code

Bulb
Type of bulb for different size and shape

Item#
Use this code when placing order

Voltage
Voltage

Finish
Bulb's surface finish type

MOL
Maximum overall length in inches

Beam Angle
The degree of width in which light emanates from the light source

Initial Lumens
Average Light output after the initial 100 hours of operation

Color Temp
Light temperature measured in Kelvin





T3.25/Festoon

HID

HALOGEN

CFL

FL

BALLAST

GERMICIDAL

Product Information							Physical Information		Photometric Characteristics		
Watts	Bulb	Base	Item#	Description	Voltage (V)	Case Qty.	Finish	MOL (in)	Initial Lumens (lm)	Avg. Life (Hrs)	UPC
Festoon Base											
3	T3.25	Festoon	5100	XFT03/T3.25/CL/12	12	100	Clear	1.72	25	10000	844366051005
3	T3.25	Festoon	5101	XFT03/T3.25/FR/12	12	100	Frost	1.72	25	10000	844366051012
3	T3.25	Festoon	5106	XFT03/T3.25/CL/24	24	100	Clear	1.72	25	10000	844366051067
3	T3.25	Festoon	5107	XFT03/T3.25/FR/24	24	100	Frost	1.72	25	10000	844366051074
5	T3.25	Festoon	5102	XFT05/T3.25/CL/12	12	100	Clear	1.72	50	10000	844366051029
5	T3.25	Festoon	5103	XFT05/T3.25/FR/12	12	100	Frost	1.72	50	10000	844366051036
5	T3.25	Festoon	5108	XFT05/T3.25/CL/24	24	100	Clear	1.72	50	10000	844366051081
5	T3.25	Festoon	5109	XFT05/T3.25/FR/24	24	100	Frost	1.72	50	10000	844366051098
10	T3.25	Festoon	5104	XFT10/T3.25/CL/12	12	100	Clear	1.72	120	10000	844366051043
10	T3.25	Festoon	5105	XFT10/T3.25/FR/12	12	100	Frost	1.72	120	10000	844366051050
10	T3.25	Festoon	5110	XFT10/T3.25/CL/24	24	100	Clear	1.72	120	10000	844366051104
10	T3.25	Festoon	5111	XFT10/T3.25/FR/24	24	100	Frost	1.72	120	10000	844366051111

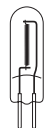

T2/G4

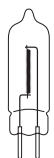

T3/GY6.35

HALOGEN

Xenon JC Bi-Pin ■ ■ ■

Product Information							Physical Information		Photometric Characteristics		
Watts	Bulb	Base	Item#	Description	Voltage (V)	Case Qty.	Finish	MOL (in)	Initial Lumens (lm)	Avg. Life (Hrs)	UPC
JC Bi-Pin (G4)											
5	T2	G4	5112	XJC5/CL/G4/12	12	10	Clear	1.19	45	10000	844366051128
5	T2	G4	5113	XJC5/CL/G4/24	24	10	Clear	1.19	45	10000	844366051135
5	T2	G4	5128	* XJC5/FR/G4/12	12	10	Frost	1.19	45	10000	844366051289
5	T2	G4	5114	XJC10/CL/G4/12	12	10	Clear	1.19	100	10000	844366051142
10	T2	G4	5115	XJC10/CL/G4/24	24	10	Clear	1.19	100	10000	844366051159
10	T2	G4	5129	* XJC10/FR/G4/12	12	10	Frost	1.19	100	10000	844366051296
15	T2	G4	5116	XJC15/CL/G4/12	12	10	Clear	1.19	150	10000	844366051166
15	T2	G4	5117	XJC15/CL/G4/24	24	10	Clear	1.19	150	10000	844366051173
15	T2	G4	5130	* XJC15/FR/G4/12	12	10	Frost	1.19	150	10000	844366051302
15	T2	G4	5131	* XJC15/FR/G4/24	24	10	Frost	1.19	150	10000	844366051319
20	T2	G4	5118	XJC20/CL/G4/12	12	10	Clear	1.19	200	10000	844366051180
20	T2	G4	5119	XJC20/CL/G4/24	24	10	Clear	1.19	200	10000	844366051197
20	T2	G4	5132	* XJC20/FR/G4/12	12	10	Frost	1.19	200	10000	844366051326
20	T2	G4	5133	* XJC20/FR/G4/24	24	10	Frost	1.19	200	10000	844366051333
JC Bi-Pin (GY6.35)											
35	T3	GY6.35	5120	XJC35/CL/GY6.35/12	12	10	Clear	1.50	420	10000	844366051203
35	T3	GY6.35	5121	XJC35/FR/GY6.35/12	12	10	Frost	1.50	420	10000	844366051210
35	T3	GY6.35	5122	XJC35/CL/GY6.35/24	24	10	Clear	1.50	420	10000	844366051227
35	T3	GY6.35	5123	XJC35/FR/GY6.35/24	24	10	Frost	1.50	420	10000	844366051234
50	T3	GY6.35	5124	XJC50/CL/GY6.35/12	12	10	Clear	1.50	600	10000	844366051241
50	T3	GY6.35	5125	XJC50/FR/GY6.35/12	12	10	Frost	1.50	600	10000	844366051258

*Items only available for special orders

HID

HALOGEN

CFL

FL

BALLAST

GERMICIDAL

■ ■ ■ Bi-Pin JC (Low Voltage Capsule)

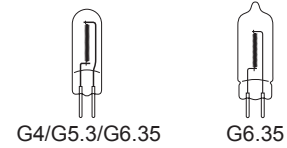

HID

HALOGEN

CFL

FL

BALLAST

GERMICIDAL

Product Information							Physical Information				Photometric Characteristics		UPC
Watts	Bulb	Base	Item#	Description	Voltage (V)	Case Qty.	Finish	Dia (in)	MOL (in)	LCL (in)	Initial Lumens (lm)	Avg. Life (Hrs)	
Capsule Lamps -G4, G5.3, & G6.35													
5	T3	G4	3300	JC5/CL/G4	12	100	Clear	0.31	1.30	0.87	80	2000	844366033001
10	T3	G4	3301	JC10/CL/G4	12	100	Clear	0.31	1.30	0.87	160	2000	844366033018
20	T3	G4	3302	JC20/CL/G4	12	100	Clear	0.31	1.30	0.87	350	2000	844366033025
20	T3	G5.3	3303	JC20/CL/G5.3	12	100	Clear	0.39	1.73	1.06	350	2000	844366033032
20	T3	G6.35	3309	JC20/CL/G6.35	12	100	Clear	0.39	1.73	1.18	350	2000	844366033094
30	T3	G4	3310	* JC30/CL/G4	12	100	Clear	0.31	1.30	0.87	510	2000	844366033100
35	T3	G5.3	3304	JC35/CL/G5.3	12	100	Clear	0.39	1.73	1.06	595	2000	844366033049
35	T3	G6.35	3305	JC35/CL/G6.35	12	100	Clear	0.39	1.73	1.18	595	2000	844366033056
50	T3	G5.3	3311	* JC50/CL/G5.3	12	100	Clear	0.39	1.73	1.06	900	2000	844366033117
50	T3	G6.35	3306	JC50/CL/G6.35	12	100	Clear	0.39	1.73	1.18	900	2000	844366033063
75	T3	G5.3	3312	* JC75/CL/G5.3	12	100	Clear	0.39	1.73	1.06	1350	2000	844366033124
75	T3	G6.35	3307	JC75/CL/G6.35	12	100	Clear	0.39	1.73	1.18	1350	2000	844366033070
100	T4	G5.3	3313	* JC100/CL/G5.3	12	100	Clear	0.45	1.73	1.18	2000	2000	844366033131
100	T4	G6.35	3308	JC100/CL/G6.35	12	100	Clear	0.45	1.73	1.18	2000	2000	844366033087

*Items only available for special orders



HALOGEN

Bi-Pin JCD (Line Voltage Capsule) ■ ■ ■

Product Information							Physical Information				Photometric Characteristics		
Watts	Bulb	Base	Item#	Description	Voltage (V)	Case Qty.	Finish	Dia (in)	MOL (in)	LCL (in)	Initial Lumens (lm)	Avg. Life (Hrs)	UPC
Capsule Lamps - G8													
20	T4	G8	3400	JCD20/CL/G8/120	120	100	Clear	0.53	1.77	1.34	240	2000	844366034008
20	T4	G8	3403	JCD20/CL/G8/130	130	100	Clear	0.53	1.77	1.34	240	2000	844366034039
20	T4 Short	G8	3401	JCD20/CL/G8S/120	120	100	Clear	0.53	1.59	1.04	240	2000	844366034015
20	T4 Short	G8	3402	JCD20/FR/G8S/120	120	100	Clear	0.53	1.59	1.04	240	2000	844366034022
20	T4 Short	G8	3404	JCD20/CL/G8S/130	130	100	Clear	0.53	1.59	1.04	240	2000	844366034046
20	T4 Short	G8	3405	JCD20/FR/G8S/130	130	100	Clear	0.53	1.59	1.04	240	2000	844366034053
25	T4	G8	3406	JCD25/CL/G8/120	120	100	Clear	0.53	1.77	1.34	240	2000	844366034060
25	T4	G8	3407	JCD25/CL/G8/130	130	100	Clear	0.53	1.77	1.34	240	2000	844366034077
35	T4	G8	3408	JCD35/CL/G8/120	120	100	Clear	0.53	1.77	1.34	550	2000	844366034084
35	T4	G8	3409	JCD35/CL/G8/130	130	100	Clear	0.53	1.77	1.34	550	2000	844366034091
35	T4 Short	G8	3427	*JCD35/CL/G8S/120	120	100	Clear	0.53	1.59	1.04	550	2000	844366034275
50	T4	G8	3410	JCD50/CL/G8/120	120	100	Clear	0.53	1.77	1.34	950	2000	844366034107
50	T4	G8	3411	JCD50/CL/G8/130	130	100	Clear	0.53	1.77	1.34	950	2000	844366034114
75	T4	G8	3412	JCD75/CL/G8/120	120	100	Clear	0.53	1.77	1.34	1300	2000	844366034121
75	T4	G8	3413	JCD75/CL/G8/130	130	100	Clear	0.53	1.77	1.34	1300	2000	844366034138
100	T4	G8	3428	*JCD100/CL/G8/120	120	100	Clear	0.53	1.77	1.34	1500	2000	844366034282

*Items only available for special orders

HID

HALOGEN

CFL

FL

BALLAST

GERMICIDAL

■ ■ ■ Bi-Pin JCD (Line Voltage Capsule Lamps)

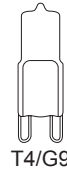

HID

HALOGEN

CFL

FL

BALLAST

GERMICIDAL

Product Information							Physical Information				Photometric Characteristics		
Watts	Bulb	Base	Item#	Description	Voltage (V)	Case Qty.	Finish	Dia (in)	MOL (in)	LCL (in)	Initial Lumens (lm)	Avg. Life (Hrs)	UPC
Capsule Lamps - G9													
20	T4	G9	3429	* JCD20/CL/G9/120	120	100	Clear	0.53	1.77	1.34	240	2000	844366034299
25	T4	G9	3414	JCD25/CL/G9/120	120	100	Clear	0.53	1.77	1.34	240	2000	844366034145
25	T4	G9	3422	JCD25/CL/G9/130	130	100	Clear	0.53	1.77	1.34	240	2000	844366034220
35	T4	G9	3415	JCD35/CL/G9/120	120	100	Clear	0.53	1.77	1.34	550	2000	844366034152
35	T4	G9	3423	JCD35/CL/G9/130	130	100	Clear	0.53	1.77	1.34	550	2000	844366034237
40	T4	G9	3416	JCD40/CL/G9/120	120	100	Clear	0.53	1.77	1.34	600	2000	844366034169
50	T4	G9	3417	JCD50/CL/G9/120	120	100	Clear	0.53	1.77	1.34	950	2000	844366034176
50	T4	G9	3424	JCD50/CL/G9/130	130	100	Clear	0.53	1.77	1.34	950	2000	844366034244
60	T4	G9	3418	JCD60/CL/G9/120	120	100	Clear	0.53	1.77	1.34	1150	2000	844366034183
75	T4	G9	3419	JCD75/CL/G9/120	120	100	Clear	0.53	1.77	1.34	1300	2000	844366034190
75	T4	G9	3425	JCD75/CL/G9/130	130	100	Clear	0.53	1.77	1.34	1300	2000	844366034251
100	T4	G9	3430	* JCD100/CL/G9/120	120	100	Clear	0.53	1.77	1.34	1500	2000	844366034305

*Items only available for special orders



HALOGEN

J Double-Ended ■ ■ ■



R7s

Product Information							Physical Information			Photometric Characteristics		
Watts	Bulb	Base	Item#	Description	Voltage (V)	Case Qty.	Finish	Dia (in)	MOL (in)	Initial Lumens (lm)	Avg. Life (Hrs)	UPC
Double-Ended Linear Lamps												
75	T3	R7s	3370	* J120V-75/CL/SHORT	120	100	Clear	0.31	3.16	1200	2000	844366033704
100	T3	R7s	3350	J120V-100/CL/SHORT	120	100	Clear	0.31	3.16	1600	2000	844366033506
100	T3	R7s	3361	* J130V-100/CL/SHORT	130	100	Clear	0.31	3.16	1600	2000	844366033612
100	T3	R7s	3354	J120V-100/CL/LONG	120	100	Clear	0.31	4.71	1600	2000	844366033544
100	T3	R7s	3365	J130V-100/CL/LONG	130	100	Clear	0.31	4.71	1600	2000	844366033650
150	T3	R7s	3351	J120V-150/CL/SHORT	120	100	Clear	0.31	3.16	2400	2000	844366033513
150	T3	R7s	3362	* J130V-150/CL/SHORT	130	100	Clear	0.31	3.16	2400	2000	844366033629
150	T3	R7s	3355	J120V-150/CL/LONG	120	100	Clear	0.31	4.71	2400	2000	844366033551
150	T3	R7s	3366	J130V-150/CL/LONG	130	100	Clear	0.31	4.71	2400	2000	844366033667
200	T3	R7s	3352	J120V-200/CL/SHORT	120	100	Clear	0.31	3.16	3400	2000	844366033520
200	T3	R7s	3363	J130V-200/CL/SHORT	130	100	Clear	0.31	3.16	3400	2000	844366033636
200	T3	R7s	3356	J120V-200/CL/LONG	120	100	Clear	0.31	4.71	3400	2000	844366033568
200	T3	R7s	3367	J130V-200/CL/LONG	130	100	Clear	0.31	4.71	3400	2000	844366033674
250	T3	R7s	3353	J120V-250/CL/SHORT	120	100	Clear	0.31	3.16	4500	2000	844366033537
250	T3	R7s	3364	* J130V-250/CL/SHORT	130	100	Clear	0.31	3.16	4500	2000	844366033643
300	T3	R7s	3371	* J120V-300/CL/SHORT	120	100	Clear	0.31	3.16	5500	2000	844366033711
300	T3	R7s	3357	J120V-300/CL/LONG	120	100	Clear	0.31	4.71	5950	2000	844366033575
300	T3	R7s	3368	* J130V-300/CL/LONG	130	100	Clear	0.31	4.71	5950	2000	844366033681
500	T3	R7s	3358	J120V-500/CL/LONG	120	100	Clear	0.31	4.71	10500	2000	844366033582
500	T3	R7s	3369	* J130V-500/CL/LONG	130	100	Clear	0.31	4.71	10500	2000	844366033698
1000	T3	R7s	3372	* J120V-1000/CL	120	50	Clear	0.39	7.52	21000	2000	844366033728
1000	T3	R7s	3373	* J240V-1000/CL	240	50	Clear	0.39	7.52	21000	2000	844366033735
1500	T3	R7s	3359	J130V-1500/CL	130	50	Clear	0.39	10.10	33000	2000	844366033599
1500	T3	R7s	3360	J240V-1500/CL	240	50	Clear	0.39	10.10	33000	2000	844366033605
1500	T3	R7s	3374	* J277V-1500/CL	277	50	Clear	0.39	10.10	33000	2000	844366033742

*Items only available for special orders

HID

HALOGEN

CFL

FL

BALLAST

GERMICIDAL

Plusrite®

JD (Single-Ended Linear)



BA15d



E11

HID

HALOGEN

CFL

FL

BALLAST

GERMICIDAL

Product Information							Physical Information				Photometric Characteristics			UPC
Watts	Bulb	Base	Item#	Description	Voltage (V)	Case Qty.	Finish	Dia (in)	MOL (in)	LCL (in)	Initial Lumens (lm)	Avg. Life (Hrs)	Color Temp (K)	
Double Contact Bayonet Base-BA15d (D.C. Bay)														
35	T4	BA15d	3483	*JD35/CL/BA15d	120	100	Clear	0.53	2.60	1.26	500	2000	2800	844366034831
50	T4	BA15d	3484	*JD50/CL/BA15d	120	100	Clear	0.53	2.60	1.26	700	2000	2800	844366034848
75	T4	BA15d	3450	JD75/CL/BA15d	120	100	Clear	0.53	2.60	1.26	1100	2000	2800	844366034503
75	T4	BA15d	3465	JD75/CL/BA15d/130	130	100	Clear	0.53	2.60	1.26	1100	2000	2800	844366034657
100	T4	BA15d	3451	JD100/CL/BA15d	120	100	Clear	0.53	2.60	1.38	1600	2000	2900	844366034510
100	T4	BA15d	3466	JD100/CL/BA15d/130	130	100	Clear	0.53	2.60	1.38	1600	2000	2900	844366034664
150	T4	BA15d	3452	JD150/CL/BA15d	120	100	Clear	0.53	2.60	1.38	2700	2000	2900	844366034527
150	T4	BA15d	3467	JD150/CL/BA15d/130	130	100	Clear	0.53	2.60	1.38	2700	2000	2900	844366034671
250	T4	BA15d	3453	JD250/CL/BA15d	120	100	Clear	0.53	2.60	1.38	5000	2000	2900	844366034534
250	T4	BA15d	3468	JD250/CL/BA15d/130	130	100	Clear	0.53	2.60	1.38	5000	2000	2900	844366034688
Mini Candelabra Base - E11 (Mini-Can)														
35	T4	E11	3454	JD35/CL/E11	120	100	Clear	0.53	2.60	1.26	500	2000	2800	844366034541
35	T4	E11	3469	JD35/CL/E11/130	130	100	Clear	0.53	2.60	1.26	500	2000	2800	844366034695
50	T4	E11	3485	*JD50/CL/E11	120	100	Clear	0.53	2.60	1.26	700	2000	2800	844366034855
75	T4	E11	3455	JD75/CL/E11	120	100	Clear	0.53	2.60	1.26	1100	2000	2800	844366034558
75	T4	E11	3470	JD75/CL/E11/130	130	100	Clear	0.53	2.60	1.26	1100	2000	2800	844366034701
100	T4	E11	3456	JD100/CL/E11	120	100	Clear	0.53	2.60	1.38	1600	2000	2900	844366034565
100	T4	E11	3471	JD100/CL/E11/130	130	100	Clear	0.53	2.60	1.38	1600	2000	2900	844366034718
150	T4	E11	3457	JD150/CL/E11	120	100	Clear	0.53	2.60	1.38	2700	2000	2900	844366034572
150	T4	E11	3472	JD150/CL/E11/130	130	100	Clear	0.53	2.60	1.38	2700	2000	2900	844366034725
250	T4	E11	3458	JD250/CL/E11	120	100	Clear	0.53	2.60	1.38	5000	2000	2900	844366034589
250	T4	E11	3473	JD250/CL/E11/130	130	100	Clear	0.53	2.60	1.38	5000	2000	2900	844366034732
500	T4	E11	3487	*JD500/CL/E11	120	100	Clear	0.53	2.60	1.38	9500	2000	2900	844366034879

*Items only available for special orders



HALOGEN

MR11 ■ ■ ■



MR11/GU4

Product Information								Photometric Characteristics					
Watts	Bulb	Base	Item#	Description	ANSI	Voltage (V)	Case Qty.	CBCP (cd)	Beam Angle	Spread	Avg. Life (Hrs)	Color Temp (K)	UPC
Standard MR11 Without Cover													
20	MR11	GU4	3200	20MR11/NSP	FTB	12	20	3000	10°	Narrow Spot	2000	2925	844366032004
20	MR11	GU4	3201	20MR11/SP	FTC	12	20	1500	20°	Spot	2000	2925	844366032011
20	MR11	GU4	3202	20MR11/NFL	FTD	12	20	600	30°	Narrow Flood	2000	2925	844366032028
35	MR11	GU4	3203	35MR11/NSP	FTE	12	20	6000	10°	Narrow Spot	2000	2950	844366032035
35	MR11	GU4	3204	35MR11/SP	FTF	12	20	2400	20°	Spot	2000	2950	844366032042
35	MR11	GU4	3205	35MR11/NFL	FTH	12	20	1300	30°	Narrow Flood	2000	2950	844366032059
Standard MR11 With Cover													
20	MR11	GU4	3206	20MR11/NSP/C	FTB	12	20	3000	10°	Narrow Spot	2000	2925	844366032066
20	MR11	GU4	3207	20MR11/SP/C	FTC	12	20	1500	20°	Spot	2000	2925	844366032073
20	MR11	GU4	3208	20MR11/NFL/C	FTD	12	20	600	30°	Narrow Flood	2000	2925	844366032080
35	MR11	GU4	3209	35MR11/NSP/C	FTE	12	20	6000	10°	Narrow Spot	2000	2950	844366032097
35	MR11	GU4	3210	35MR11/SP/C	FTF	12	20	1200	20°	Spot	2000	2950	844366032103
35	MR11	GU4	3211	35MR11/NFL/C	FTH	12	20	1300	30°	Narrow Flood	2000	2950	844366032110

HID

HALOGEN

CFL

FL

BALLAST

GERMICIDAL

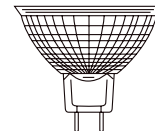

MR16/GU5.3

Product Information								Photometric Characteristics					
Watts	Bulb	Base	Item#	Description	ANSI	Voltage (V)	Case Qty.	CBCP (cd)	Beam Angle	Spread	Avg. Life (Hrs)	Color Temp (K)	UPC
Standard MR16 Without Cover													
20	MR16	GU5.3	3212	20MR16/SP	ESX	12	20	3500	12°	Spot	2000	2950	844366032127
20	MR16	GU5.3	3213	20MR16/NFL	BBF	12	20	1200	24°	Narrow Flood	2000	2950	844366032134
20	MR16	GU5.3	3214	20MR16/FL	BAB	12	20	600	36°	Flood	2000	2950	844366032141
35	MR16	GU5.3	3215	35MR16/SP	FMT	12	20	6000	12°	Spot	2000	2950	844366032158
35	MR16	GU5.3	3216	35MR16/NFL	FMV	12	20	2300	24°	Narrow Flood	2000	2950	844366032165
35	MR16	GU5.3	3217	35MR16/FL	FMW	12	20	1300	36°	Flood	2000	2950	844366032172
50	MR16	GU5.3	3218	50MR16/SP	EXT	12	20	11000	12°	Spot	2000	3000	844366032189
50	MR16	GU5.3	3219	50MR16/NFL	EXZ	12	20	3600	24°	Narrow Flood	2000	3000	844366032196
50	MR16	GU5.3	3220	50MR16/FL	EXN	12	20	2000	36°	Flood	2000	3000	844366032202
50	MR16	GU5.3	3263	* 50MR16/WFL	FNV	12	20	850	60°	Wide Flood	2000	3000	844366032639
75	MR16	GU5.3	3221	75MR16/SP	EYF	12	20	13000	12°	Spot	2000	3000	844366032219
75	MR16	GU5.3	3222	75MR16/NFL	EYJ	12	20	4800	24°	Narrow Flood	2000	3000	844366032226
75	MR16	GU5.3	3223	75MR16/FL	EYC	12	20	2700	36°	Flood	2000	3000	844366032233
Standard MR16 With Cover													
20	MR16	GU5.3	3224	20MR16/SP/C	ESX	12	20	3500	12°	Spot	2000	2950	844366032240
20	MR16	GU5.3	3225	20MR16/NFL/C	BBF	12	20	1200	24°	Narrow Flood	2000	2950	844366032257
20	MR16	GU5.3	3226	20MR16/FL/C	BAB	12	20	600	36°	Flood	2000	2950	844366032264
35	MR16	GU5.3	3227	35MR16/SP/C	FMT	12	20	6000	12°	Spot	2000	2950	844366032271
35	MR16	GU5.3	3228	35MR16/NFL/C	FMV	12	20	2300	24°	Narrow Flood	2000	2950	844366032288
35	MR16	GU5.3	3229	35MR16/FL/C	FMW	12	20	1300	36°	Flood	2000	2950	844366032295
50	MR16	GU5.3	3230	50MR16/SP/C	EXT	12	20	11000	12°	Spot	2000	3000	844366032301
50	MR16	GU5.3	3231	50MR16/NFL/C	EXZ	12	20	3600	24°	Narrow Flood	2000	3000	844366032318
50	MR16	GU5.3	3232	50MR16/FL/C	EXN	12	20	200	36°	Flood	2000	3000	844366032325
50	MR16	GU5.3	3264	* 50MR16/WFL/C	FNV	12	20	850	60°	Wide Flood	2000	3000	844366032646
75	MR16	GU5.3	3233	75MR16/SP/C	EYF	12	20	13000	12°	Spot	2000	3000	844366032332
75	MR16	GU5.3	3265	75MR16/NFL/C	EYJ	12	20	4800	24°	Narrow Flood	2000	3000	844366032653
75	MR16	GU5.3	3234	75MR16/FL/C	EYC	12	20	2700	36°	Flood	2000	3000	844366032349

*Items only available for special orders

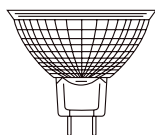

MR16/GU5.3

HALOGEN

MR16 X-Life™ 4000Hrs ■ ■ ■

Product Information								Photometric Characteristics					UPC
Watts	Bulb	Base	Item#	Description	ANSI	Voltage (V)	Case Qty.	CBCP (cd)	Beam Angle	Spread	Avg. Life (Hrs)	Color Temp (K)	UPC
Extra Long Life MR16 Without Cover *													
20	MR16	GU5.3	3262	20MR16X-LIFE/SP	ESX	12	20	3500	12°	Spot	4000	2950	844366032622
20	MR16	GU5.3	3257	20MR16X-LIFE/NFL	BBF	12	20	870	24°	Narrow Flood	4000	2950	844366032578
20	MR16	GU5.3	3258	20MR16X-LIFE/FL	BAB	12	20	510	36°	Flood	4000	2950	844366032585
35	MR16	GU5.3	3259	35MR16X-LIFE/SP	FMT	12	20	6000	12°	Spot	4000	2950	844366032592
35	MR16	GU5.3	3260	35MR16X-LIFE/NFL	FMV	12	20	2000	24°	Narrow Flood	4000	2950	844366032608
35	MR16	GU5.3	3261	35MR16X-LIFE/FL	FMW	12	20	1200	36°	Flood	4000	2950	844366032615
50	MR16	GU5.3	3235	50MR16X-LIFE/SP	EXT	12	20	11000	12°	Spot	4000	3000	844366032356
50	MR16	GU5.3	3236	50MR16X-LIFE/NFL	EXZ	12	20	3000	24°	Narrow Flood	4000	3000	844366032363
50	MR16	GU5.3	3237	50MR16X-LIFE/FL	EXN	12	20	1580	36°	Flood	4000	3000	844366032370
50	MR16	GU5.3	3266	* 50MR16X-LIFE/WFL	FNV	12	20	750	60°	Wide Flood	4000	3000	844366032660
75	MR16	GU5.3	3238	75MR16X-LIFE/SP	EYF	12	20	12000	12°	Spot	4000	3000	844366032387
75	MR16	GU5.3	3267	* 75MR16X-LIFE/NFL	EYJ	12	20	4600	24°	Narrow Flood	4000	3000	844366032677
75	MR16	GU5.3	3239	75MR16X-LIFE/FL	EYC	12	20	2200	36°	Flood	4000	3000	844366032394
Extra Long Life MR16 With Cover													
20	MR16	GU5.3	3240	20MR16X-LIFE/SP/C	ESX	12	20	3500	12°	Spot	4000	2950	844366032400
20	MR16	GU5.3	3241	20MR16X-LIFE/NFL/C	BBF	12	20	870	24°	Narrow Flood	4000	2950	844366032417
20	MR16	GU5.3	3242	20MR16X-LIFE/FL/C	BAB	12	20	510	36°	Flood	4000	2950	844366032424
35	MR16	GU5.3	3243	35MR16X-LIFE/SP/C	FMT	12	20	6000	12°	Spot	4000	2950	844366032431
35	MR16	GU5.3	3244	35MR16X-LIFE/NFL/C	FMV	12	20	2000	24°	Narrow Flood	4000	2950	844366032448
35	MR16	GU5.3	3245	35MR16X-LIFE/FL/C	FMW	12	20	1200	36°	Flood	4000	2950	844366032455
50	MR16	GU5.3	3246	50MR16X-LIFE/SP/C	EXT	12	20	11000	12°	Spot	4000	3000	844366032462
50	MR16	GU5.3	3247	50MR16X-LIFE/NFL/C	EXZ	12	20	3000	24°	Narrow Flood	4000	3000	844366032479
50	MR16	GU5.3	3248	50MR16X-LIFE/FL/C	EXN	12	20	1580	36°	Flood	4000	3000	844366032486
50	MR16	GU5.3	3268	* 50MR16X-LIFE/WFL/C	FNV	12	20	750	60°	Wide Flood	4000	3000	844366032684
75	MR16	GU5.3	3249	75MR16X-LIFE/SP/C	EYF	12	20	12000	12°	Spot	4000	3000	844366032493
75	MR16	GU5.3	3269	* 75MR16X-LIFE/NFL/C	EYJ	12	20	4600	24°	Narrow Flood	4000	3000	844366032691
75	MR16	GU5.3	3250	75MR16X-LIFE/FL/C	EYC	12	20	2200	36°	Flood	4000	3000	844366032509

*Items only available for special orders

HID

HALOGEN

CFL

FL

BALLAST

GERMICIDAL

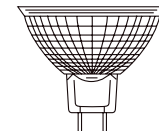

MR16/GU5.3

HID

HALOGEN

CFL

FL

BALLAST

GERMICIDAL

Product Information								Photometric Characteristics					
Watts	Bulb	Base	Item#	Description	ANSI	Voltage (V)	Case Qty.	CBCP (cd)	Beam Angle	Spread	Avg. Life (Hrs)	Color Temp (K)	UPC
Super Long Life MR16 Without Cover													
20	MR16	GU5.3	3270	* 20MR16S-LIFE/SP	ESX	12	20	2400	12°	Spot	10000	2850	844366032707
20	MR16	GU5.3	3271	* 20MR16S-LIFE/NFL	BBF	12	20	1000	24°	Narrow Flood	10000	2850	844366032714
20	MR16	GU5.3	3272	* 20MR16S-LIFE/FL	BAB	12	20	400	36°	Flood	10000	2850	844366032721
35	MR16	GU5.3	3273	* 35MR16S-LIFE/SP	FMT	12	20	3200	12°	Spot	10000	2850	844366032738
35	MR16	GU5.3	3274	* 35MR16S-LIFE/NFL	FMV	12	20	1600	24°	Narrow Flood	10000	2850	844366032745
35	MR16	GU5.3	3275	* 35MR16S-LIFE/FL	FMW	12	20	900	36°	Flood	10000	2850	844366032752
50	MR16	GU5.3	3276	* 50MR16S-LIFE/SP	EXT	12	20	5500	12°	Spot	10000	2850	844366032769
50	MR16	GU5.3	3277	* 50MR16S-LIFE/NFL	EXZ	12	20	2500	24°	Narrow Flood	10000	2850	844366032776
50	MR16	GU5.3	3278	* 50MR16S-LIFE/FL	EXN	12	20	1400	36°	Flood	10000	2850	844366032783
50	MR16	GU5.3	3279	* 50MR16S-LIFE/WFL	FNV	12	20	700	60°	Wide Flood	10000	2850	844366032790
75	MR16	GU5.3	3280	* 75MR16S-LIFE/SP	EYF	12	20	6000	12°	Spot	10000	2850	844366032806
75	MR16	GU5.3	3281	* 75MR16S-LIFE/NFL	EYJ	12	20	2500	24°	Narrow Flood	10000	2850	844366032813
75	MR16	GU5.3	3282	* 75MR16S-LIFE/FL	EYC	12	20	1400	36°	Flood	10000	2850	844366032820
Super Long Life MR16 With Cover													
20	MR16	GU5.3	3283	* 20MR16S-LIFE/SP/C	ESX	12	20	2300	12°	Spot	10000	2850	844366032837
20	MR16	GU5.3	3284	* 20MR16S-LIFE/NFL/C	BBF	12	20	900	24°	Narrow Flood	10000	2850	844366032844
20	MR16	GU5.3	3251	20MR16S-LIFE/FL/C	BAB	12	20	360	36°	Flood	10000	2850	844366032516
35	MR16	GU5.3	3285	* 35MR16S-LIFE/SP/C	FMT	12	20	3000	12°	Spot	10000	2850	844366032851
35	MR16	GU5.3	3286	* 35MR16S-LIFE/NFL/C	FMV	12	20	1200	24°	Narrow Flood	10000	2850	844366032868
35	MR16	GU5.3	3252	35MR16S-LIFE/FL/C	FMW	12	20	900	36°	Flood	10000	2850	844366032523
50	MR16	GU5.3	3287	* 50MR16S-LIFE/SP/C	EXT	12	20	5000	12°	Spot	10000	2850	844366032875
50	MR16	GU5.3	3288	* 50MR16S-LIFE/NFL/C	EXZ	12	20	2400	24°	Narrow Flood	10000	2850	844366032882
50	MR16	GU5.3	3253	50MR16S-LIFE/FL/C	EXN	12	20	1300	36°	Flood	10000	2850	844366032530
50	MR16	GU5.3	3289	* 50MR16S-LIFE/WFL/C	FNV	12	20	600	60°	Wide Flood	10000	2850	844366032899
75	MR16	GU5.3	3290	* 75MR16S-LIFE/SP/C	EYF	12	20	5800	12°	Spot	10000	2850	844366032905
75	MR16	GU5.3	3291	* 75MR16S-LIFE/NFL/C	EYJ	12	20	2400	24°	Narrow Flood	10000	2850	844366032912
75	MR16	GU5.3	3292	* 75MR16S-LIFE/FL/C	EYC	12	20	1300	36°	Flood	10000	2850	844366032929

*Items only available for special orders

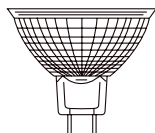

MR16/GU5.3

HALOGEN

Energy Saving MR16 with Infrared Technology

Product Information							Photometric Characteristics					
Watts	Bulb	Base	Item#	Description	Voltage (V)	Case Qty.	CBCP (cd)	Beam Angle	Spread	Avg. Life (Hrs)	Color Temp (K)	UPC
Energy Saving MR16 with Infrared Technology												
20	MR16	GU5.3	3298	20MR16/IRH/SP10/C	12	20	6000	10	Spot	4000	3000	844366032981
20	MR16	GU5.3	3299	20MR16/IRH/NFL25/C	12	20	2300	25	Narrow Flood	4000	3000	844366032998
20	MR16	GU5.3	3120	20MR16/IRH/FL35/C	12	20	1000	35	Flood	4000	3000	844366031205
20	MR16	GU5.3	3121	* 20MR16/IRH/WFL60/C	12	20	600	60	W.Flood	4000	3000	844366031212
35	MR16	GU5.3	3122	35MR16/IRH/SP10/C	12	20	12500	10	Spot	4000	3000	844366031229
35	MR16	GU5.3	3123	35MR16/IRH/NFL25/C	12	20	4400	25	Narrow Flood	4000	3000	844366031236
35	MR16	GU5.3	3124	35MR16/IRH/FL35/C	12	20	2050	35	Flood	4000	3000	844366031243
35	MR16	GU5.3	3125	* 35MR16/IRH/WFL60/C	12	20	1300	60	W.Flood	4000	3000	844366031250
50	MR16	GU5.3	3126	* 50MR16/IRH/SP10/C	12	20	15000	10	Spot	4000	3000	844366031267
50	MR16	GU5.3	3127	* 50MR16/IRH/NFL25/C	12	20	5700	25	Narrow Flood	4000	3000	844366031274
50	MR16	GU5.3	3128	* 50MR16/IRH/FL50/C	12	20	2600	35	Flood	4000	3000	844366031281
50	MR16	GU5.3	3129	* 50MR16/IRH/WFL60/C	12	20	1850	60	W.Flood	4000	3000	844366031298
24V MR16 With Cover												
20	MR16	GU5.3	3293	* 20MR16/SP/C/24V	24	20	3700	12°	Spot	2000	3050	844366032936
20	MR16	GU5.3	3254	20MR16/FL/C/24V	24	20	600	36°	Flood	2000	3050	844366032547
35	MR16	GU5.3	3294	* 35MR16/SP/C/24V	24	20	4600	12°	Spot	2000	3050	844366032943
35	MR16	GU5.3	3255	35MR16/FL/C/24V	24	20	870	36°	Flood	2000	3050	844366032554
50	MR16	GU5.3	3295	* 50MR16/SP/C/24V	24	20	7000	12°	Spot	2000	3050	844366032950
50	MR16	GU5.3	3256	50MR16/FL/C/24V	24	20	1600	36°	Flood	2000	3050	844366032561
75	MR16	GU5.3	3296	* 75MR16/SP/C/24V	24	20	8000	12°	Spot	2000	3050	844366032967
75	MR16	GU5.3	3297	* 75MR16/FL/C/24V	24	20	2500	36°	Flood	2000	3050	844366032974

*Items only available for special orders

HID

HALOGEN

CFL

FL

BALLAST

GERMICIDAL

Plusrite®

JDR E14 & E26

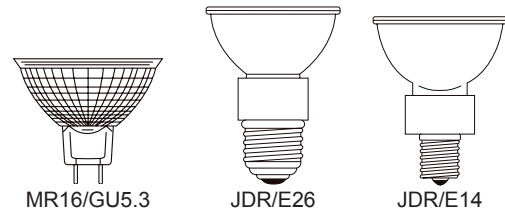

MR16/GU5.3

JDR/E26

JDR/E14

Product Information							Physical Information		Photometric Characteristics							
Watts	Bulb	Base	Item#	Description	Voltage (V)	Case Qty.	Dia (in)	MOL (in)	CBCP (cd)	Beam Angle	Spread	Initial Lumens (lm)	Avg. Life (Hrs)	Color Temp (K)	UPC	
JDR - E14 & E26 Without Cover							-	-								
35	JDR	E14	3488	*JDR35/E14/FL40	120	20	2	2.90	500	40°	Flood	320	2000	3000	844366034886	
35	JDR	E26	3491	*JDR35/E26/FL40	120	20	2	3.00	500	40°	Flood	320	2000	3000	844366034916	
50	JDR	E14	3489	*JDR50/E14/FL40	120	20	2	2.90	1000	40°	Flood	590	2000	3000	844366034893	
50	JDR	E26	3459	*JDR50/E26/WFL50	120	20	2	3.00	1000	50°	Wide Flood	590	2000	3000	844366034596	
50	JDR	E26	3496	*JDR50/E26/WFL50/130	130	20	2	3.00	1000	50°	Wide Flood	590	2000	3000	844366034961	
75	JDR	E14	3490	*JDR75/E14/FL40	120	20	2	2.90	1220	40°	Flood	990	2000	3000	844366034909	
75	JDR	E26	3460	*JDR75/E26/WFL50	120	20	2	3.00	1220	50°	Wide Flood	990	2000	3000	844366034602	
75	JDR	E26	3497	*JDR75/E26/WFL50/130	130	20	2	3.00	1220	50°	Wide Flood	990	2000	3000	844366034978	
100	JDR	E26	3461	*JDR100/E26/WFL50	120	20	2	3.00	1750	50°	Wide Flood	2000	2000	3000	844366034619	
100	JDR	E26	3495	*JDR100/E26/WFL50/130	130	20	2	3.00	1750	50°	Wide Flood	2000	2000	3000	844366034954	
JDR - E26 With Cover																
50	JDR	E26	3474	JDR50/E26/WFL50/WC	120	20	2	3.00	1000	50°	Wide Flood	590	2000	3000	844366034749	
50	JDR	E26	3475	JDR50/E26/WFL50/WC/130	130	20	2	3.00	1000	50°	Wide Flood	590	2000	3000	844366034756	
75	JDR	E26	3476	JDR75/E26/WFL50/WC	120	20	2	3.00	1220	50°	Wide Flood	990	2000	3000	844366034763	
75	JDR	E26	3477	JDR75/E26/WFL50/WC/130	130	20	2	3.00	1220	50°	Wide Flood	990	2000	3000	844366034770	
100	JDR	E26	3478	JDR100/E26/WFL50/WC	120	20	2	3.00	1750	50°	Wide Flood	2000	2000	3000	844366034787	
100	JDR	E26	3479	JDR100/E26/WFL50/WC/130	130	20	2	3.00	1750	50°	Wide Flood	2000	2000	3000	844366034794	

*Items only available for special orders

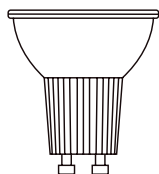

JDR/GU10

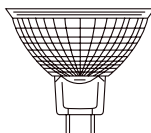

MR16/GU5.3

HALOGEN

JDR GU10 & JCDR ■ ■ ■

Product Information							Physical Information		Photometric Characteristics						UPC
Watts	Bulb	Base	Item#	Description	Voltage (V)	Case Qty.	Dia (in)	MOL (in)	CBCP (cd)	Beam Angle	Spread	Initial Lumens (lm)	Avg. Life (Hrs)	Color Temp (K)	UPC
JDR - GU10 With Cover															
35	JDR (MR16)	GU10	3462	JDR35/GU10/NFL25	120	20	2	2.10	1500	25°	Narrow Flood	320	2000	3000	844366034626
35	JDR (MR16)	GU10	3480	JDR35/GU10/NFL25/130	130	20	2	2.10	1500	25°	Narrow Flood	320	2000	3000	844366034800
35	JDR (MR16)	GU10	3492	*JDR35/GU10/WFL50	120	20	2	2.10	500	50°	Wide Flood	320	2000	3000	844366034923
50	JDR (MR16)	GU10	3463	JDR50/GU10/NFL25	120	20	2	2.10	2500	25°	Narrow Flood	590	2000	3000	844366034633
50	JDR (MR16)	GU10	3481	JDR50/GU10/NFL25/130	130	20	2	2.10	2500	25°	Narrow Flood	590	2000	3000	844366034817
50	JDR (MR16)	GU10	3464	JDR50/GU10/WFL50	120	20	2	2.10	1000	50°	Wide Flood	590	2000	3000	844366034640
50	JDR (MR16)	GU10	3482	JDR50/GU10/WFL50/130	130	20	2	2.10	1000	50°	Wide Flood	590	2000	3000	844366034824
75	JDR (MR16)	GU10	3493	*JDR75/GU10/NFL25	120	20	2	2.10	28000	25°	Narrow Flood	990	2000	3000	844366034930
75	JDR (MR16)	GU10	3494	*JDR75/GU10/WFL50	120	20	2	2.10	1300	50°	Wide Flood	990	2000	3000	844366034947
JCDR - With Cover															
35	MR16	G5.3	3420	JCDR35/G5.3/FL38	120	20	2	1.78	500	38°	Flood	580	2000	3000	844366034206
50	MR16	G5.3	3421	JCDR50/G5.3/FL38	120	20	2	1.78	1000	38°	Flood	980	2000	3000	844366034213
50	MR16	G5.3	3426	*JCDR50/G5.3/FL38/130	130	20	2	1.78	1000	38°	Flood	980	2000	3000	844366034268
75	MR16	G5.3	3431	*JCDR75/G5.3/FL38	120	20	2	1.78	1220	38°	Flood	1500	2000	3000	844366034312
100	MR16	G5.3	3432	*JCDR100/G5.3/FL38	120	20	2	1.78	1750	38°	Flood	2000	2000	3000	844366034329

*Items only available for special orders

HID

HALOGEN

CFL

FL

BALLAST

GERMICIDAL

Plusrite®

PAR16

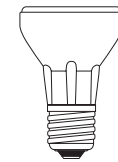

PAR16/E26

HID

HALOGEN

CFL

FL

BALLAST

GERMICIDAL

Product Information							Physical Information		Photometric Characteristic				
Watts	Bulb	Base	Item#	Description	Voltage (V)	Case Qty.	Dia (in)	MOL (in)	Beam Angle	Spread	Initial Lumens (lm)	Avg. Life (Hrs)	UPC
PAR16 Series - Medium Screw Base													
60	PAR16	E26	3000	* 60PAR16/NSP/120	120	40	2.88	2.00	10°	Narrow Spot	650	2000	844366030000
60	PAR16	E26	3001	* 60PAR16/NFL/120	120	30	2.88	2.00	30°	Narrow Flood	650	2000	844366030017
60	PAR16	E26	3062	* 60PAR16/NSP/130 @ 120 volts approximate 53 watts, 495 lumens, 4000 hours	130	12	2.88	2.00	10°	Narrow Spot	650	2000	844366030628
60	PAR16	E26	3063	* 60PAR16/NFL/130 @ 120 volts approximate 53 watts, 495 lumens, 4000 hours	130	12	2.88	2.00	30°	Narrow Flood	650	2000	844366030635
75	PAR16	E26	3002	* 75PAR16/NSP/120	120	40	2.88	2.00	10°	Narrow Spot	900	2000	844366030024
75	PAR16	E26	3003	* 75PAR16/NFL/120	120	30	2.88	2.00	30°	Narrow Flood	900	2000	844366030031
75	PAR16	E26	3064	* 75PAR16/NSP/130 @ 120 volts approximate 66 watts, 685 lumens, 4000 hours	130	12	2.88	2.00	10°	Narrow Spot	900	2000	844366030642
75	PAR16	E26	3065	* 75PAR16/NFL/130 @ 120 volts approximate 66 watts, 685 lumens, 4000 hours	130	12	2.88	2.00	30°	Narrow Flood	900	2000	844366030659

*Items only available for special orders

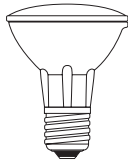

PAR20/E26

HALOGEN

PAR20 ■ ■ ■

Product Information							Physical Information		Photometric Characteristics				
Watts	Bulb	Base	Item#	Description	Voltage (V)	Case Qty.	Dia (in)	MOL (in)	Beam Angle	Spread	Initial Lumens (lm)	Avg. Life (Hrs)	UPC
PAR20 Series - Medium Screw Base													
35	PAR20	E26	3004	* 35PAR20/SP/120	120	30	3.3	2.50	10°	Spot	380	2500	844366030048
35	PAR20	E26	3066	* 35PAR20/NFL/120	120	30	3.3	2.50	30°	Narrow Flood	380	2500	844366030666
35	PAR20	E26	3005	* 35PAR20/FL/120	120	30	3.3	2.50	40°	Flood	380	2500	844366030055
35	PAR20	E26	3006	* 35PAR20/SP/130 @ 120 volts approximate 31 watts, 275 lumens, 5000 hours	130	30	3.3	2.50	10°	Spot	380	2500	844366030062
35	PAR20	E26	3067	* 35PAR20/NFL/130 @ 120 volts approximate 31 watts, 275 lumens, 5000 hours	130	30	3.3	2.50	30°	Narrow Flood	380	2500	844366030673
35	PAR20	E26	3007	* 35PAR20/FL/130 @ 120 volts approximate 31 watts, 275 lumens, 5000 hours	130	30	3.3	2.50	40°	Flood	380	2500	844366030079
50	PAR20	E26	3008	* 50PAR20/SP/120	120	30	3.3	2.50	10°	Spot	550	2500	844366030086
50	PAR20	E26	3009	* 50PAR20/NFL/120	120	30	3.3	2.50	30°	Narrow Flood	550	2500	844366030093
50	PAR20	E26	3010	* 50PAR20/FL/120	120	30	3.3	2.50	40°	Flood	550	2500	844366030109
50	PAR20	E26	3011	* 50PAR20/SP/130 @ 120 volts approximate 44 watts, 470 lumens, 5000 hours	130	30	3.3	2.50	10°	Spot	550	2500	844366030116
50	PAR20	E26	3012	* 50PAR20/NFL/130 @ 120 volts approximate 44 watts, 470 lumens, 5000 hours	130	30	3.3	2.50	30°	Narrow Flood	550	2500	844366030123
50	PAR20	E26	3013	* 50PAR20/FL/130 @ 120 volts approximate 44 watts, 470 lumens, 5000 hours	130	30	3.3	2.50	40°	Flood	550	2500	844366030130

***Items only available for special orders**

HID

HALOGEN

CFL

FL

BALLAST

GERMICIDAL

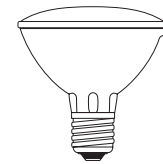

PAR30/E26

HID

HALOGEN

CFL

FL

BALLAST

GERMICIDAL

Product Information							Physical Information		Photometric Characteristics				
Watts	Bulb	Base	Item#	Description	Voltage (V)	Case Qty.	Dia (in)	MOL (in)	Beam Angle	Spread	Initial Lumens (lm)	Avg. Life (Hrs)	UPC
PAR30 Series - Medium Screw Base													
50	PAR30	E26	3014	* 50PAR30/SP/120	120	30	3.6	3.70	10°	Spot	660	2500	844366030147
50	PAR30	E26	3080	* 50PAR30/NFL/120	120	30	3.6	3.70	25°	Narrow Flood	660	2500	844366030802
50	PAR30	E26	3015	* 50PAR30/FL/120	120	30	3.6	3.70	40°	Flood	660	2500	844366030154
50	PAR30	E26	3016	* 50PAR30/SP/130 @ 120 volts approximate 44 watts, 500 lumens, 5000 hours	130	30	3.6	3.70	10°	Spot	660	2500	844366030161
50	PAR30	E26	3081	* 50PAR30/NFL/130	130	30	3.6	3.70	25°	Narrow Flood	660	2500	844366030819
50	PAR30	E26		@ 120 volts approximate 44 watts, 500 lumens, 5000 hours									
50	PAR30	E26	3017	* 50PAR30/FL/130 @ 120 volts approximate 44 watts, 500 lumens, 5000 hours	130	30	3.6	3.70	40°	Flood	660	2500	844366030178
60	PAR30	E26	3018	* 60PAR30/SP/120	120	30	3.6	3.70	10°	Spot	860	2500	844366030185
60	PAR30	E26	3074	* 60PAR30/NFL/120	120	30	3.6	3.70	25°	Narrow Flood	860	2500	844366030741
60	PAR30	E26	3019	* 60PAR30/FL/120	120	30	3.6	3.70	40°	Flood	860	2500	844366030192
60	PAR30	E26	3020	* 60PAR30/SP/130 @ 120 volts approximate 53 watts, 660 lumens, 5000 hours	130	30	3.6	3.70	10°	Spot	860	2500	844366030208
60	PAR30	E26	3075	* 60PAR30/NFL/130 @ 120 volts approximate 53 watts, 660 lumens, 5000 hours	130	30	3.6	3.70	25°	Narrow Flood	860	2500	844366030758
60	PAR30	E26	3021	* 60PAR30/FL/130 @ 120 volts approximate 53 watts, 660 lumens, 5000 hours	130	30	3.6	3.70	40°	Flood	860	2500	844366030215
75	PAR30	E26	3022	* 75PAR30/SP/120	120	30	3.6	3.70	10°	Spot	1100	2500	844366030222
75	PAR30	E26	3082	* 75PAR30/NFL/120	120	30	3.6	3.70	25°	Narrow Flood	1100	2500	844366030826
75	PAR30	E26	3023	* 75PAR30/FL/120	120	30	3.6	3.70	40°	Flood	1100	2500	844366030239
75	PAR30	E26	3024	* 75PAR30/SP/130 @ 120 volts approximate 66 watts, 860 lumens, 5000 hours	130	30	3.6	3.70	10°	Spot	1100	2500	844366030246
75	PAR30	E26	3083	* 75PAR30/NFL/130 @ 120 volts approximate 66 watts, 860 lumens, 5000 hours	130	30	3.6	3.70	25°	Narrow Flood	1100	2500	844366030833
75	PAR30	E26	3025	* 75PAR30/FL/130	130	30	3.6	3.70	40°	Flood	1100	2500	844366030253

*Items only available for special orders

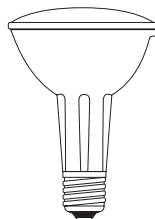

PAR30L/E26

HALOGEN

PAR30 Long Neck ■■■

Product Information							Physical Information		Photometric Characteristics				UPC
Watts	Bulb	Base	Item#	Description	Voltage (V)	Case Qty.	Dia (in)	MOL (in)	Beam Angle	Spread	Initial Lumens (lm)	Avg. Life (Hrs)	
PAR30 Long Neck Series - Medium Screw Base													
50	PAR30LN	E26	3026	* 50PAR30LN/SP/120	120	15	4.5	3.74	10°	Spot	660	2500	844366030260
50	PAR30LN	E26	3084	* 50PAR30LN/NFL/120	120	15	4.5	3.74	25°	Narrow Flood	660	2500	844366030840
50	PAR30LN	E26	3027	* 50PAR30LN/FL/120	120	15	4.5	3.74	40°	Flood	660	2500	844366030277
50	PAR30LN	E26	3028	* 50PAR30LN/SP/130 @ 120 volts approximate 44 watts, 500 lumens, 5000 hours	130	15	4.5	3.74	10°	Spot	660	2500	844366030284
50	PAR30LN	E26	3085	* 50PAR30LN/NFL/130 @ 120 volts approximate 44 watts, 500 lumens, 5000 hours	130	15	4.5	3.74	25°	Narrow Flood	660	2500	844366030857
50	PAR30LN	E26	3029	* 50PAR30LN/FL/130 @ 120 volts approximate 44 watts, 500 lumens, 5000 hours	130	15	4.5	3.74	40°	Flood	660	2500	844366030291
75	PAR30LN	E26	3030	* 75PAR30LN/SP/120	120	15	4.5	3.74	10°	Spot	1100	2500	844366030307
75	PAR30LN	E26	3086	* 75PAR30LN/NFL/120	120	15	4.5	3.74	25°	Narrow Flood	1100	2500	844366030864
75	PAR30LN	E26	3031	* 75PAR30LN/FL/120	120	15	4.5	3.74	40°	Flood	1100	2500	844366030314
75	PAR30LN	E26	3032	* 75PAR30LN/SP/130 @ 120 volts approximate 66 watts, 1100 lumens, 5000 hours	130	15	4.5	3.74	10°	Spot	1100	2500	844366030321
75	PAR30LN	E26	3087	* 75PAR30LN/NFL/130 @ 120 volts approximate 66 watts, 1100 lumens, 5000 hours	130	15	4.5	3.74	25°	Narrow Flood	1100	2500	844366030871
75	PAR30LN	E26	3033	* 75PAR30LN/FL/130 @ 120 volts approximate 66 watts, 1100 lumens, 5000 hours	130	15	4.5	3.74	40°	Flood	1100	2500	844366030338

***Items only available for special orders**

HID

HALOGEN

CFL

FL

BALLAST

GERMICIDAL

Plusrite®

PAR38

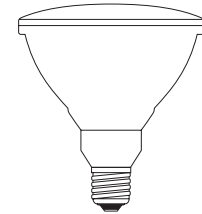

PAR38/E26

HID

HALOGEN

CFL

FL

BALLAST

GERMICIDAL

Product Information							Physical Information		Photometric Characteristics				
Watts	Bulb	Base	Item#	Description	Voltage (V)	Case Qty.	Dia (in)	MOL (in)	Beam Angle	Spread	Initial Lumens (lm)	Avg. Life (Hrs)	UPC
PAR38 Series - Medium Screw Base													
45	PAR38	E26	3034	* 45PAR38/SP/120	120	15	5.32	4.76	12°	Spot	560	2500	844366030345
45	PAR38	E26	3035	* 45PAR38/FL/120	120	15	5.32	4.76	30°	Flood	560	2500	844366030352
45	PAR38	E26	3088	* 45PAR38/WFL/120	120	15	5.32	4.76	50°	Wide Flood	560	2500	844366030888
45	PAR38	E26	3036	* 45PAR38/SP/130 @ 120 volts approximate 40 watts, 425 lumens, 5000 hours	130	15	5.32	4.76	12°	Spot	560	2500	844366030369
45	PAR38	E26	3037	* 45PAR38/FL/130 @ 120 volts approximate 40 watts, 425 lumens, 5000 hours	130	15	5.32	4.76	30°	Flood	560	2500	844366030376
45	PAR38	E26	3076	* 45PAR38/WFL/130 @ 120 volts approximate 40 watts, 425 lumens, 5000 hours	130	15	5.32	4.76	50°	Wide Flood	560	2500	844366030765
60	PAR38	E26	3038	* 60PAR38/SP/120	120	15	5.32	4.76	12°	Spot	850	2500	844366030383
60	PAR38	E26	3039	* 60PAR38/FL/120	120	15	5.32	4.76	30°	Flood	850	2500	844366030390
60	PAR38	E26	3089	* 60PAR38/WFL/120	120	15	5.32	4.76	50°	Wide Flood	850	2500	844366030895
60	PAR38	E26	3040	* 60PAR38/SP/130 @ 120 volts approximate 53 watts, 645 lumens, 5000 hours	130	15	5.32	4.76	12°	Spot	850	2500	844366030406
60	PAR38	E26	3041	* 60PAR38/FL/130 @ 120 volts approximate 53 watts, 645 lumens, 5000 hours	130	15	5.32	4.76	30°	Flood	850	2500	844366030413
60	PAR38	E26	3077	* 60PAR38/WFL/130 @ 120 volts approximate 53 watts, 645 lumens, 5000 hours	130	15	5.32	4.76	50°	Wide Flood	850	2500	844366030772
75	PAR38	E26	3042	* 75PAR38/SP/120	120	15	5.32	4.76	12°	Spot	1060	2500	844366030420
75	PAR38	E26	3043	* 75PAR38/FL/120	120	15	5.32	4.76	30°	Flood	1060	2500	844366030437
75	PAR38	E26	3044	* 75PAR38/WFL/120	120	15	5.32	4.76	50°	Wide Flood	1060	2500	844366030444
75	PAR38	E26	3045	* 75PAR38/SP/130 @ 120 volts approximate 66 watts, 805 lumens, 5000 hours	130	15	5.32	4.76	12°	Spot	1060	2500	844366030451
75	PAR38	E26	3046	* 75PAR38/FL/130 @ 120 volts approximate 66 watts, 805 lumens, 5000 hours	130	15	5.32	4.76	30°	Flood	1060	2500	844366030468
75	PAR38	E26	3047	* 75PAR38/WFL/130 @ 120 volts approximate 66 watts, 805 lumens, 5000 hours	130	15	5.32	4.76	50°	Wide Flood	1060	2500	844366030475

***Items only available for special orders**

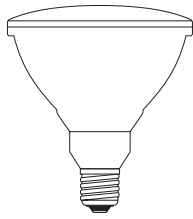

PAR38/E26

HALOGEN

PAR38 ■ ■ ■ ■

Product Information							Physical Information		Photometric Characteristics				
Watts	Bulb	Base	Item#	Description	Voltage (V)	Case Qty.	Dia (in)	MOL (in)	Beam Angle	Spread	Initial Lumens (lm)	Avg. Life (Hrs)	UPC
PAR38 Series - Medium Screw Base													
90	PAR38	E26	3078	* 90PAR38/NSP/120	120	15	5.32	4.76	9°	Narrow Spot	1270	2500	844366030789
90	PAR38	E26	3048	* 90PAR38/SP/120	120	15	5.32	4.76	12°	Spot	1270	2500	844366030482
90	PAR38	E26	3049	* 90PAR38/FL/120	120	15	5.32	4.76	30°	Flood	1270	2500	844366030499
90	PAR38	E26	3050	* 90PAR38/WFL/120	120	15	5.32	4.76	50°	Wide Flood	1270	2500	844366030505
90	PAR38	E26	3079	* 90PAR38/NSP/130 @ 120 volts approximate 79 watts, 1000 lumens, 5000 hours	130	15	5.32	4.76	9°	Narrow Spot	1270	2500	844366030796
90	PAR38	E26	3051	* 90PAR38/SP/130 @ 120 volts approximate 79 watts, 1000 lumens, 5000 hours	130	15	5.32	4.76	12°	Spot	1270	2500	844366030512
90	PAR38	E26	3052	* 90PAR38/FL/130 @ 120 volts approximate 79 watts, 1000 lumens, 5000 hours	130	15	5.32	4.76	30°	Flood	1270	2500	844366030529
90	PAR38	E26	3053	* 90PAR38/WFL/130 @ 120 volts approximate 79 watts, 1000 lumens, 5000 hours	130	15	5.32	4.76	50°	Wide Flood	1270	2500	844366030536

***Items only available for special orders**

HID

HALOGEN

CFL

FL

BALLAST

GERMICIDAL

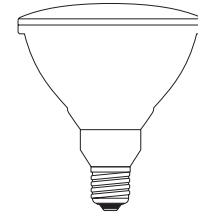

PAR38/E26

HID

HALOGEN

CFL

FL

BALLAST

GERMICIDAL

Product Information							Physical Information		Photometric Characteristics						
Watts	Bulb	Base	Item#	Description	Voltage (V)	Case Qty.	Dia (in)	MOL (in)	CBCP (cd)	Beam Angle	Spread	Initial Lumens (lm)	Avg. Life (Hrs)	Color Temp (K)	UPC
PAR38 Series - Medium Screw Base															
100	PAR38	E26	3054	*100PAR38/SP/120	120	15	5.32	4.76	-	12°	Spot	1500	2500	-	844366030543
100	PAR38	E26	3055	*100PAR38/FL/120	120	15	5.32	4.76	-	30°	Flood	1500	2500	-	844366030550
100	PAR38	E26	3056	*100PAR38/WFL/120	120	15	5.32	4.76	-	50°	Wide Flood	1500	2500	-	844366030567
100	PAR38	E26	3057	*100PAR38/SP/130 @ 120 volts approximate 88 watts, 1200 lumens, 5000 hours	130	15	5.32	4.76	-	12°	Spot	1500	2500	-	844366030574
100	PAR38	E26	3058	*100PAR38/FL/130 @ 120 volts approximate 88 watts, 1200 lumens, 5000 hours	130	15	5.32	4.76	-	30°	Flood	1500	2500	-	844366030581
100	PAR38	E26	3059	*100PAR38/WFL/130 @ 120 volts approximate 88 watts, 1200 lumens, 5000 hours	130	15	5.32	4.76	-	50°	Wide Flood	1500	2500	-	844366030598

***Items only available for special orders**

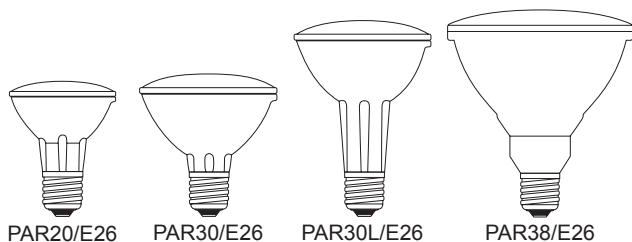

HALOGEN

Standard PAR - Meet EISA 2007 ■ ■ ■

Product Information							Physical Information		Photometric Characteristics						
Watts	Bulb	Base	Item#	Description	Voltage (V)	Case Qty.	Dia (in)	MOL (in)	CBCP (cd)	Beam Angle	Spread	Initial Lumens (lm)	Avg. Life (Hrs)	Color Temp (K)	UPC
38	PAR20	E26	3498	38PAR20/ECO/SP/120	120	15	2.5	3.30	2100	10°	Spot	520	1500	2800	844366034985
38	PAR20	E26	3499	38PAR20/ECO/FL/120	120	15	2.5	3.30	1000	40°	Flood	520	1500	2800	844366034992
38	PAR30	E26	3500	38PAR30/ECO/SP/120	120	15	3.7	3.60	2100	10°	Spot	520	1500	2800	844366035005
38	PAR30	E26	3501	38PAR30/ECO/FL/120	120	15	3.7	3.60	1000	40°	Flood	520	1500	2800	844366035012
55	PAR30	E26	3502	55PAR30/ECO/SP/120	120	15	3.7	3.60	9000	10°	Spot	960	1000	2900	844366035029
55	PAR30	E26	3503	55PAR30/ECO/FL/120	120	15	3.7	3.60	1200	40°	Flood	960	1000	2900	844366035036
38	PAR30L	E26	3504	38PAR30L/ECO/SP/120	120	15	3.74	4.50	2000	10°	Spot	520	1500	2800	844366035043
38	PAR30L	E26	3505	38PAR30L/ECO/FL/120	120	15	3.74	4.50	1000	40°	Flood	520	1500	2800	844366035050
55	PAR30L	E26	3506	55PAR30L/ECO/SP/120	120	15	3.74	4.50	9000	10°	Spot	960	1000	2900	844366035067
55	PAR30L	E26	3507	55PAR30L/ECO/FL/120	120	15	3.74	4.50	1200	40°	Flood	960	1000	2900	844366035074
38	PAR38	E26	3508	38PAR38/ECO/SP/120	120	15	4.76	5.32	2000	12°	Spot	520	1500	2800	844366035081
38	PAR38	E26	3509	38PAR38/ECO/FL/120	120	15	4.76	5.32	1000	30°	Flood	520	1500	2800	844366035098
60	PAR38	E26	3510	60PAR38/ECO/SP/120	120	15	4.76	5.32	9000	12°	Spot	1080	1000	2900	844366035104
60	PAR38	E26	3511	60PAR38/ECO/FL/120	120	15	4.76	5.32	1200	30°	Flood	1080	1000	2900	844366035111
70	PAR38	E26	3512	70PAR38/ECO/SP/120	120	15	4.76	5.32	10000	12°	Spot	1310	1000	2950	844366035128
70	PAR38	E26	3513	70PAR38/ECO/FL/120	120	15	4.76	5.32	2000	30°	Flood	1310	1000	2950	844366035135

HID

HALOGEN

CFL

FL

BALLAST

GERMICIDAL

Plusrite®

Long Life PAR - Meet EISA 2007

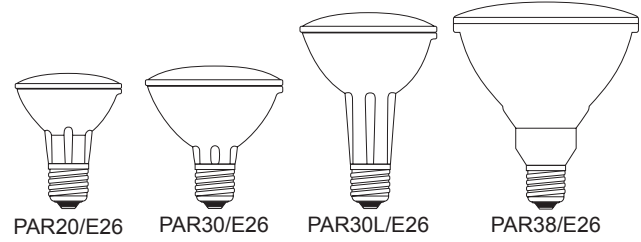

PAR20/E26 PAR30/E26 PAR30L/E26 PAR38/E26

Product Information							Physical Information		Photometric Characteristics					UPC	
Watts	Bulb	Base	Item#	Description	Voltage (V)	Case Qty.	Dia (in)	MOL (in)	CBCP (cd)	Beam Angle	Spread	Initial Lumens (lm)	Avg. Life (Hrs)		Color Temp (K)
42	PAR20	E26	3524	42PAR20/IRH/SP/120	120	15	2.5	3.30	3600	10°	Spot	620	3000	2750	844366035241
42	PAR20	E26	3525	42PAR20/IRH/FL/120	120	15	2.5	3.30	1200	35°	Flood	620	3000	2750	844366035258
42	PAR30	E26	3514	42PAR30/IRH/SP/120	120	15	3.7	3.60	3600	10°	Spot	700	3000	2800	844366035142
42	PAR30	E26	3515	42PAR30/IRH/FL/120	120	15	3.7	3.60	1100	35°	Flood	700	3000	2800	844366035159
53	PAR30	E26	3516	53PAR30/IRH/SP/120	120	15	3.7	3.60	11000	10°	Spot	920	3000	2850	844366035166
53	PAR30	E26	3517	53PAR30/IRH/FL/120	120	15	3.7	3.60	1200	35°	Flood	920	3000	2850	844366035173
42	PAR30L	E26	3518	42PAR30L/IRH/SP/120	120	15	3.74	4.50	3600	10°	Spot	700	3000	2800	844366035180
42	PAR30L	E26	3519	42PAR30L/IRH/FL/120	120	15	3.74	4.50	1100	35°	Flood	700	3000	2800	844366035197
53	PAR30L	E26	3520	53PAR30L/IRH/SP/120	120	15	3.74	4.50	11000	10°	Spot	920	3000	2850	844366035203
53	PAR30L	E26	3521	53PAR30L/IRH/FL/120	120	15	3.74	4.50	1200	35°	Flood	920	3000	2850	844366035210
70	PAR38	E26	3522	70PAR38/IRH/SP/120	120	15	4.76	5.32	18000	10°	Spot	1310	3000	2850	844366035227
70	PAR38	E26	3523	70PAR38/IRH/FL/120	120	15	4.76	5.32	1500	35°	Flood	1310	3000	2850	844366035234

HID

HALOGEN

CFL

FL

BALLAST

GERMICIDAL



HALOGEN

 NOTE

A series of horizontal lines for notes, starting with a top line below the 'NOTE' section and followed by 25 more lines.

HID

HALOGEN

CFL

FL

BALLAST

GERMICIDAL



Plusrite®

HID

HALOGEN

CFL

FL

BALLAST

GERMICIDAL



COMPACT FLUORESCENT LAMPS

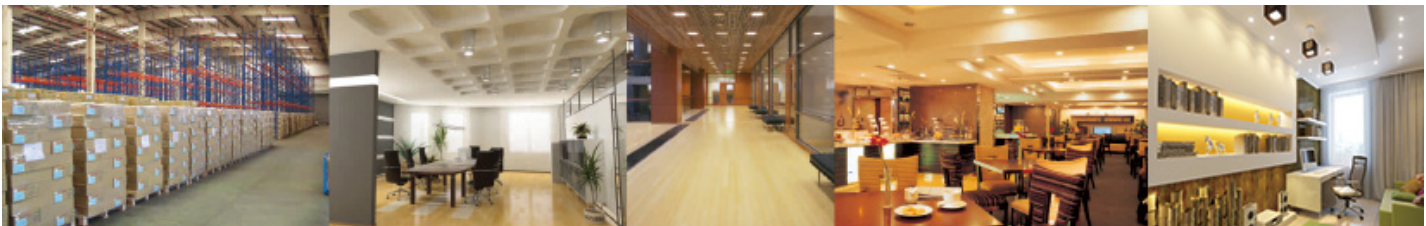



COMPACT FLUORESCENT LAMPS

HID

HALOGEN

CFL

FL

BALLAST

GERMICIDAL

CONTENTS

- 72 - Self-Ballasted T2 Mini Spiral
- 73 - Self-Ballasted T3 Spiral
- 74 - Self-Ballasted Reflector Lamps
- 75 - Self-Ballasted G25 & Spriral GU24
- 76 - Self-Ballasted Dimmable
- 77 - High Wattage Self-Ballasted CFL
- 78 - Plug-in Lamps
- 85 - Plug-in Long (FTL) Lamps

BULBS

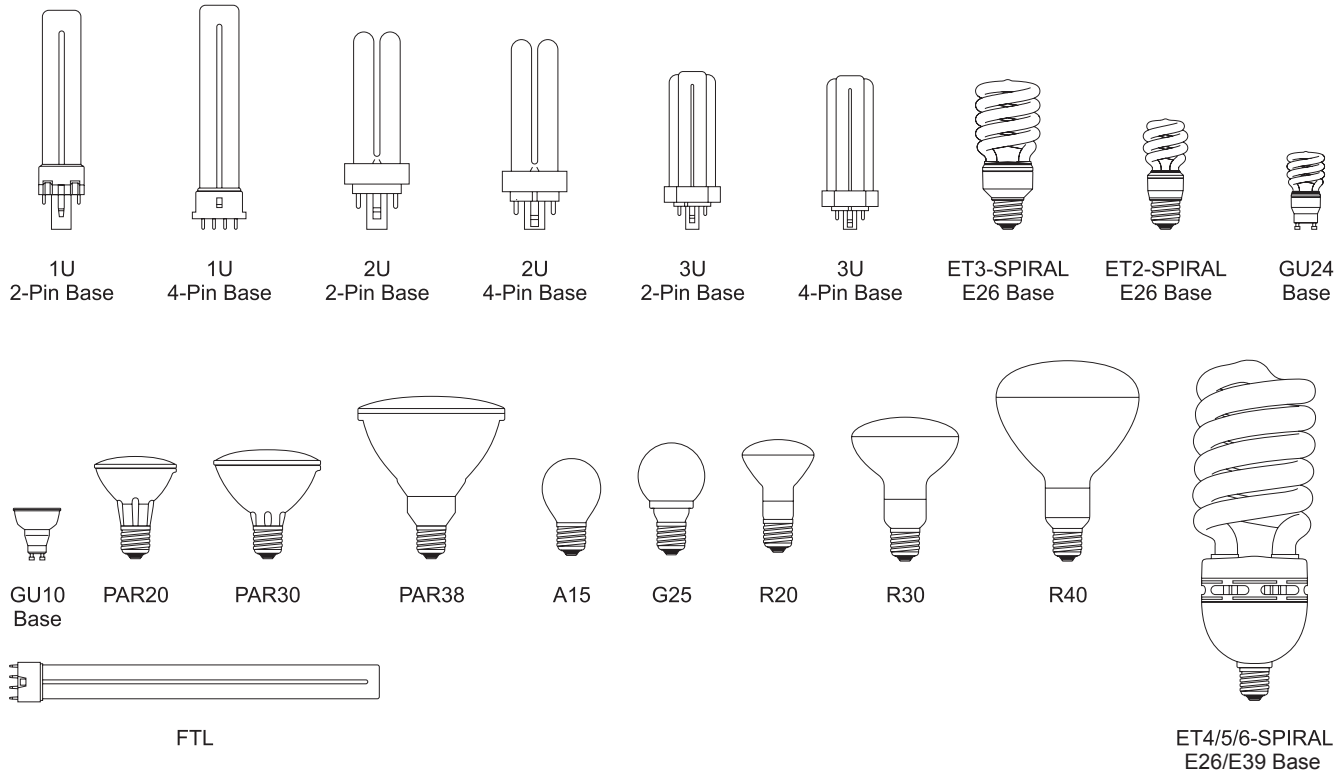

BASES

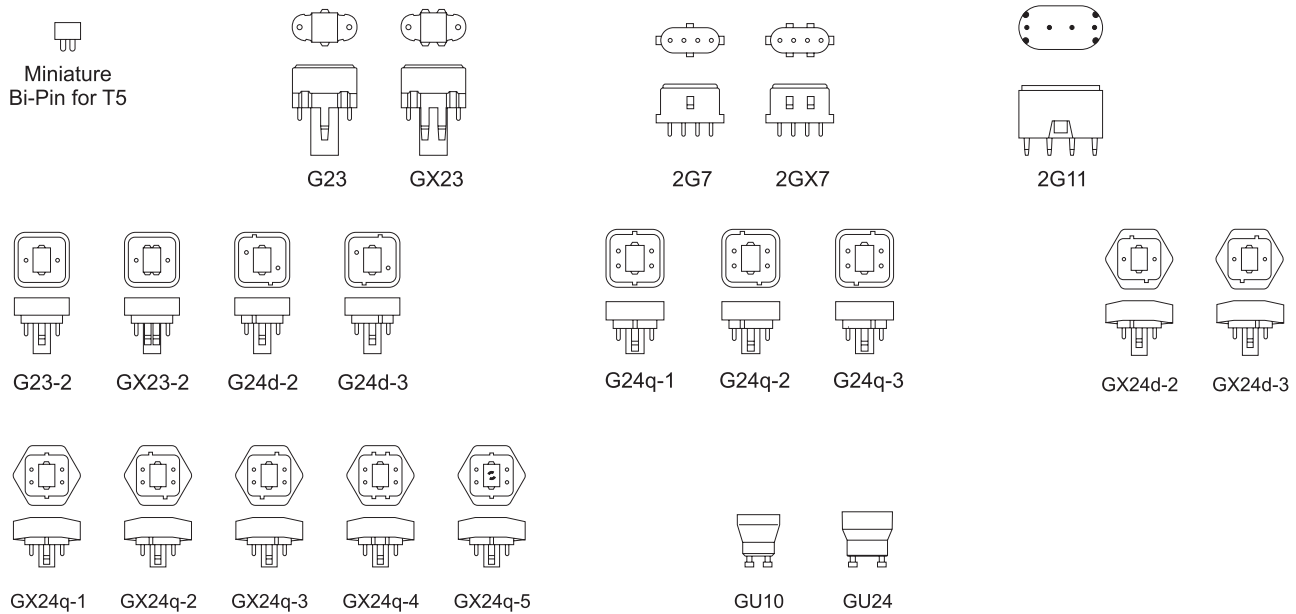



COMPACT FLUORESCENT LAMPS

How to read the table



HID

HALOGEN

CFL

FL

BALLAST

GERMICIDAL

Product Information										Photometric Characteristics				UPC
Watts	Bulb	Base	Item#	Description	Voltage (V)	Case Qty.	Energy Star	Equivalent to Incand.	MOL (in)	Initial Lumens (lm)	Avg. Life (Hrs)	Color Temp (K)	CRI	UPC
T2 Mini Spiral														
9	T2	E26	4223	CF9ET2/SP/SW	120	12/48	ES	40W	3.78	540	12000	2700	82	844366042232
9	T2	E26	4224	CF9ET2/SP/841	120	12/48	-	40W	3.78	540	12000	4100	82	844366042249
9	T2	E26	4225	CF9ET2/SP/850	120	12/48	-	40W	3.78	540	12000	5000	82	844366042256

Watts
Energy consumption during proper operation

Base
Type of base

Description
Model description

Case Qty.
Number of product units packed in a case

Equivalent Incand.
The wattage that incandescent bulbs needed to produce the equivalent lumens

Color Temp.
Light temperature measured in Kelvin

Initial Lumens
Average Light output after the initial 100 hours of operation

UPC
Universal Product Code

Bulb
Type of bulb for different size and shape

Item#
Use this code when placing order

Voltage
Voltage

Energy Star
Products meet energy efficiency guidelines from government

MOL
Maximum overall length in inches

Average Life
An average rating operated at normal lamp voltage and current

CRI
An International system used to rate a lamp's ability to render object colors

Plusrite®

Self-Ballasted T2 Mini Spiral

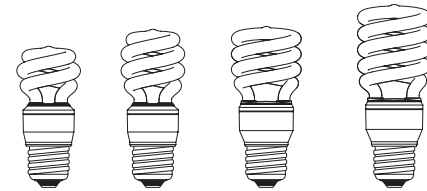

ET2/E26 (9W-26W)

Product Information										Photometric Characteristics				
Watts	Bulb	Base	Item#	Description	Voltage (V)	Case Qty.	Energy Star	Equivalent to Incand.	MOL (in)	Initial Lumens (lm)	Avg. Life (Hrs)	Color Temp (K)	CRI	UPC
T2 Mini Spiral														
9	T2	E26	4223	CF9ET2/SP/SW	120	12/48	-	40W	3.78	540	12000	2700	82	844366042232
9	T2	E26	4224	CF9ET2/SP/841	120	12/48	-	40W	3.78	540	12000	4100	82	844366042249
9	T2	E26	4225	CF9ET2/SP/850	120	12/48	-	40W	3.78	540	12000	5000	82	844366042256
13	T2	E26	4226	CF13ET2/SP/27K	120	12/48	ES	60W	4.02	930	12000	2700	82	844366042263
13	T2	E26	4227	CF13ET2/SP/841	120	12/48	-	60W	4.02	825	10000	4100	82	844366042270
13	T2	E26	4228	CF13ET2/SP/27K	120	12/48	-	60W	4.02	900	12000	5000	82	844366042287
15	T2	E26	4229	* CF15ET2/SP/SW	120	12/48	-	60W	4.25	900	12000	2700	82	844366042294
15	T2	E26	4230	* CF15ET2/SP/841	120	12/48	-	60W	4.25	900	12000	4100	82	844366042300
15	T2	E26	4231	* CF15ET2/SP/850	120	12/48	-	60W	4.25	900	12000	5000	82	844366042317
18	T2	E26	4398	CF18ET2/SP/SW	120	12/48	ES	75W	4.52	1100	10000	2700	82	844366042324
18	T2	E26	4399	CF18ET2/SP/841	120	12/48	-	75W	4.52	1200	10000	4100	82	844366042331
18	T2	E26	4400	CF18ET2/SP/850	120	12/48	-	75W	4.52	1200	10000	5000	82	844366042348
20	T2	E26	4325	CF20ET2/SP/27K	120	12/48	-	90W	5.4	1300	12000	2700	82	844366043253
20	T2	E26	4326	CF20ET2/SP/841	120	12/48	-	90W	5.4	1400	12000	4100	82	844366043260
20	T2	E26	4327	CF20ET2/SP/850	120	12/48	-	90W	5.4	1400	12000	5000	82	844366043277
23	T2	E26	4235	CF23ET2/SP/27K	120	12/48	ES	100W	4.84	1600	10000	2700	82	844366042355
23	T2	E26	4236	CF23ET2/SP/841	120	12/48	-	100W	4.84	1600	10000	4100	82	844366042362
23	T2	E26	4237	CF23ET2/SP/850	120	12/48	-	100W	4.84	1600	10000	5000	82	844366042379
26	T2	E26	4238	* CF26ET2/SP/SW	120	12/48	-	100W	5.1	1650	10000	2700	82	844366042386
26	T2	E26	4239	* CF26ET2/SP/841	120	12/48	-	100W	5.1	1650	10000	4100	82	844366042393
26	T2	E26	4240	* CF26ET2/SP/850	120	12/48	-	100W	5.1	1650	10000	5000	82	844366042409

*Items only available for special orders

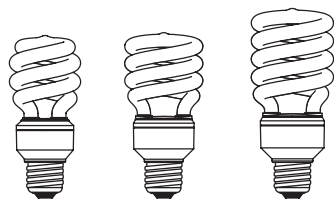

ET3/E26 (13W-26W)

COMPACT FLUORESCENT LAMPS

Self-Ballasted T3 Spiral ■■■

Product Information										Photometric Characteristics				
Watts	Bulb	Base	Item#	Description	Voltage (V)	Case Qty.	Energy Star	Equivalent to Incand.	MOL (in)	Initial Lumens (lm)	Avg. Life (Hrs)	Color Temp (K)	CRI	UPC
T3 Spiral														
13	T3	E26	4276	* CF13ET3/SP/SW	120	12/48	-	60W	4.5	850	12000	2700	82	844366042768
13	T3	E26	4298	* CF13ET3/SP/841	120	12/48	-	60W	4.5	850	10000	4100	82	844366042980
13	T3	E26	4299	* CF13ET3/SP/850	120	12/48	-	60W	4.5	850	10000	5000	82	844366042997
15	T3	E26	4200	* CF15ET3/SP/SW	120	12/48	-	60W	4.61	900	10000	2700	82	844366042003
15	T3	E26	4201	* CF15ET3/SP/841	120	12/48	-	60W	4.61	900	10000	4100	82	844366042010
15	T3	E26	4202	* CF15ET3/SP/850	120	12/48	-	60W	4.61	900	10000	5000	82	844366042027
18	T3	E26	4384	* CF18ET3/SP/SW	120	12/48	-	75W	4.92	1200	10000	2700	82	844366043840
18	T3	E26	4385	* CF18ET3/SP/841	120	12/48	-	75W	4.92	1200	10000	4100	82	844366043857
18	T3	E26	4386	* CF18ET3/SP/850	120	12/48	-	75W	4.92	1200	10000	5000	82	844366043864
20	T3	E26	4203	* CF20ET3/SP/SW	120	12/48	-	75W	4.92	1200	10000	2700	82	844366042034
20	T3	E26	4204	* CF20ET3/SP/841	120	12/48	-	75W	4.92	1200	10000	4100	82	844366042041
20	T3	E26	4205	* CF20ET3/SP/850	120	12/48	-	75W	4.92	1200	10000	5000	82	844366042058
23	T3	E26	4277	* CF23ET3/SP/SW	120	12/48	-	100W	5.4	1600	12000	2700	82	844366042775
23	T3	E26	4322	* CF23ET3/SP/841	120	12/48	-	100W	5.4	1600	10000	4100	82	844366043222
23	T3	E26	4323	* CF23ET3/SP/850	120	12/48	-	100W	5.4	1600	10000	5000	82	844366043239
26	T3	E26	4206	* CF26ET3/SP/SW	120	12/48	-	100W	5.4	1750	10000	2700	82	844366042065
26	T3	E26	4207	* CF26ET3/SP/841	120	12/48	-	100W	5.4	1750	10000	4100	82	844366042072
26	T3	E26	4208	* CF26ET3/SP/850	120	12/48	-	100W	5.4	1750	10000	5000	82	844366042089

*Items only available for special orders

HID

HALOGEN

CFL

FL

BALLAST

GERMICIDAL

Plusrite®

Self-Ballasted Reflector Lamps

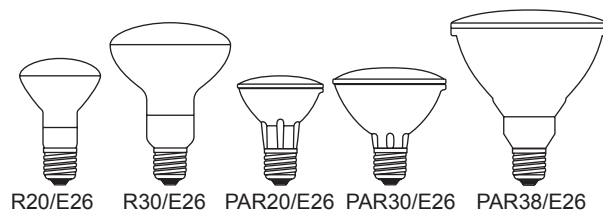

R20/E26 R30/E26 PAR20/E26 PAR30/E26 PAR38/E26

Product Information										Photometric Characteristics				
Watts	Bulb	Base	Item#	Description	Voltage (V)	Case Qty.	Energy Star	Equivalent to Incand.	MOL (in)	Initial Lumens (lm)	Avg. Life (Hrs)	Color Temp (K)	CRI	UPC
R20														
11	R20	E26	4254	* CF11R20/SW	120	12	-	40W	5	340	10000	2700	80	844366042546
11	R20	E26	4405	CF11R20/830	120	12	-	40W	5	340	10000	3000	80	844366044052
11	R20	E26	4255	* CF11R20/841	120	12	-	40W	5	340	10000	4100	80	844366042553
11	R20	E26	4406	CF11R20/850	120	12	-	40W	5	340	10000	5000	80	844366044069
R30														
15	R30	E26	4215	CF15R30/SW	120	12	ES	65W	5.5	700	10000	2700	80	844366042157
15	R30	E26	4407	CF15R30/830	120	12	-	65W	5.5	700	10000	3000	80	844366044076
15	R30	E26	4216	CF15R30/841	120	12	-	65W	5.5	700	10000	4100	80	844366042164
15	R30	E26	4217	CF15R30/850	120	12	-	65W	5.5	700	10000	5000	80	844366042171
PAR20 (Hard Glass)														
11	PAR20	E26	4241	CF11PAR20/SW	120	12	-	35W	4	380	10000	2700	82	844366042416
11	PAR20	E26	4242	CF11PAR20/841	120	12	-	35W	4	380	10000	4100	82	844366042423
11	PAR20	E26	4243	CF11PAR20/850	120	12	-	35W	4	380	10000	5000	82	844366042430
PAR30 (Hard Glass)														
15	PAR30	E26	4244	CF15PAR30/SW	120	12	-	50W	4.7	700	10000	2700	82	844366042447
15	PAR30	E26	4245	CF15PAR30/841	120	12	-	50W	4.7	660	10000	4100	82	844366042454
15	PAR30	E26	4246	CF15PAR30/850	120	12	-	50W	4.7	660	10000	5000	82	844366042461
PAR38 (Hard Glass)														
23	PAR38	E26	4213	CF23PAR38/27K	120	12	-	75W	5.1	1100	10000	2700	82	844366042133
23	PAR38	E26	4247	* CF23PAR38/841	120	12	-	75W	5.1	1100	10000	4100	82	844366042478
23	PAR38	E26	4214	CF23PAR38/850	120	12	-	75W	5.1	1100	10000	5000	82	844366042140

*Items only available for special orders



G25/E26



T2/GU24



T3/GU24

COMPACT FLUORESCENT LAMPS

Self-Ballasted G25 & Spiral GU24 ■ ■ ■

Product Information										Photometric Characteristics				
Watts	Bulb	Base	Item#	Description	Voltage (V)	Case Qty.	Energy Star	Equivalent to Incand.	MOL (in)	Initial Lumens (lm)	Avg. Life (Hrs)	Color Temp (K)	CRI	UPC
G25														
9	G25	E26	4251	CF9G25/SW	120	12/48	-	40W	4.9	500	10000	2700	82	844366042515
9	G25	E26	4252	* CF9G25/841	120	12/48	-	40W	4.9	500	10000	4100	82	844366042522
9	G25	E26	4253	* CF9G25/850	120	12/48	-	40W	4.9	500	10000	5000	82	844366042539
T2 & T3 Spiral GU24						12/48	-							
13	T2	GU24	4281	CF13ET2/SP/GU24/SW	120	12/48	ES	60W	3.8	800	10000	2700	81	844366042812
13	T2	GU24	4283	CF13ET2/SP/GU24/35K	120	12/48	-	60W	3.8	800	10000	3500	85	844366042836
13	T2	GU24	4282	CF13ET2/SP/GU24/841	120	12/48	-	60W	3.8	800	10000	4100	85	844366042829
13	T2	GU24	4404	* CF13ET2/SP/GU24/50K	120	12/48	-	60W	3.8	800	10000	5000	82	844366044045
18	T2	GU24	4284	CF18ET2/SP/GU24/SW	120	12/48	ES	75W	3.8	1200	10000	2700	82	844366042843
18	T2	GU24	4285	* CF18ET2/SP/GU24/41K	120	12/48	-	75W	3.8	1200	10000	4100	82	844366042850
18	T2	GU24	4286	* CF18ET2/SP/GU24/50K	120	12/48	-	75W	3.8	1200	10000	5000	82	844366042867
23	T2	GU24	4287	CF23ET2/SP/GU24/SW	120	12/48	ES	100W	4.21	1600	10000	2700	83	844366042874
23	T2	GU24	4288	* CF23ET2/SP/GU24/41K	120	12/48	-	100W	4.21	1600	10000	4100	82	844366042881
23	T2	GU24	4289	* CF23ET2/SP/GU24/50K	120	12/48	-	100W	4.21	1600	10000	5000	82	844366042898
26	T3	GU24	4401	CF26ET3/SP/GU24/SW	120	12/48	ES	100W	4.9	1610	10000	2700	82	844366044014
26	T3	GU24	4291	* CF26ET3/SP/GU24/41K	120	12/48	-	100W	4.9	1725	10000	4100	82	844366042911
26	T3	GU24	4296	* CF26ET3/SP/GU24/50K	120	12/48	-	100W	4.9	1700	10000	5000	82	844366042966

*Items only available for special orders

HID

HALOGEN

CFL

FL

BALLAST

GERMICIDAL

Plusrite®

Self-Ballasted Dimmable



ET4/E26



R30/E26

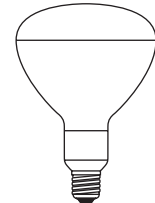

R40/E26

HID

HALOGEN

CFL

FL

BALLAST

GERMICIDAL

Product Information										Photometric Characteristics				
Watts	Bulb	Base	Item#	Description	Voltage (V)	Case Qty.	Energy Star	Equivalent to Incand.	MOL (in)	Initial Lumens (lm)	Avg. Life (Hrs)	Color Temp (K)	CRI	UPC
T4 Spiral Dimmable														
15	T4	E26	4257	*CF15ET4DIM/SP/SW	120	12	-	60W	6.2	900	10000	2700	82	844366042577
15	T4	E26	4258	*CF15ET4DIM/SP/841	120	12	-	60W	6.2	900	10000	4100	82	844366042584
15	T4	E26	4259	*CF15ET4DIM/SP/850	120	12	-	60W	6.2	900	10000	5000	82	844366042591
23	T4	E26	4260	*CF23ET4DIM/SP/SW	120	12	-	100W	6.1	1600	10000	2700	82	844366042607
23	T4	E26	4261	*CF23ET4DIM/SP/841	120	12	-	100W	6.1	1600	10000	4100	82	844366042614
23	T4	E26	4262	*CF23ET4DIM/SP/850	120	12	-	100W	6.1	1600	10000	5000	82	844366042621
R30 Dimmable														
15	R30	E26	4218	*CF15R30DIM/SW	120	12	ES	65W	6.2	610	6000	2700	82	844366042188
15	R30	E26	4263	*CF15R30DIM/841	120	12	-	65W	6.2	610	6000	4100	82	844366042638
15	R30	E26	4219	*CF15R30DIM/850	120	12	-	65W	6.2	610	6000	5000	82	844366042195
R40 Dimmable														
23	R40	E26	4264	*CF23R40DIM/SW	120	12	-	90W	7.2	1050	6000	2700	82	844366042645
23	R40	E26	4265	*CF23R40DIM/841	120	12	-	90W	7.2	1050	6000	4100	82	844366042652
23	R40	E26	4266	*CF23R40DIM/850	120	12	-	90W	7.2	1050	6000	5000	82	844366042669

*Items only available for special orders



T4/T5/T6/E26



T4/T5/T6/E39

COMPACT FLUORESCENT LAMPS

High Wattage Self-Ballasted CFL ■ ■ ■

Product Information										Photometric Characteristics				
Watts	Bulb	Base	Item#	Description	Voltage (V)	Case Qty.	Energy Star	Equivalent to Incand.	MOL (in)	Initial Lumens (lm)	Avg. Life (Hrs)	Color Temp (K)	CRI	UPC
T4 Spiral														
40	T4	E26	4270	CF40ET4/SP/SW	120	12	-	150W	7.4	2600	10000	2700	82	844366042706
40	T4	E26	4271	* CF40ET4/SP/841	120	12	-	150W	7.4	2600	10000	4100	82	844366042713
40	T4	E26	4272	* CF40ET4/SP/850	120	12	-	150W	7.4	2600	10000	5000	82	844366042720
40	T4	E26	4395	CF40ET4/SP/E26/50/277	277	12	-	150W	7.4	2600	10000	5000	82	844366043956
T5 Spiral														
55	T5	E26	4273	CF55ET5/SP/SW	120	12	-	2000	9.7	3600	10000	2700	82	844366042737
55	T5	E26	4274	* CF55ET5/SP/841	120	12	-	250W	9.7	3600	10000	4100	82	844366042744
55	T5	E26	4275	* CF55ET5/SP/850	120	12	-	250W	9.7	3600	10000	5000	82	844366042751
55	T5	E26	4356	CF55ET5/SP/E26/50/277	277	12	-	250W	9.7	3600	10000	5000	82	844366043567
85	T5	E26	4391	CF85ET5/SP/E26/50/120	120	6	-	340W	10.5	5800	10000	5000	82	844366043918
85	T5	E39	4279	CF85ET5/SP/E39/50/120	120	6	-	340W	10.5	5800	10000	5000	82	844366042799
85	T5	E39	4373	CF85ET5/SP/E39/41/277	277	6	-	340W	10.5	5800	10000	4100	82	844366043734
105	T5	E39	4280	CF105ET5/SP/E39/50/120	120	6	-	420W	11.5	7150	10000	5000	82	844366042805
105	T5	E39	4382	CF105ET5/SP/E39/50/277	277	6	-	420W	11.5	7150	10000	5000	82	844366043826
T6 Spiral														
150	T6	E39	4402	CF150ET6/SP/E39/50/120	120	6	-	-	13	8800	10000	5000	82	844366044021
180	T6	E39	4403	CF180ET6/SP/E39/50/120	120	6	-	-	14.5	11100	10000	5000	82	844366044038

*Items only available for special orders

HID

HALOGEN

CFL

FL

BALLAST

GERMICIDAL

Plusrite®

■ ■ ■ Plug-in Lamps

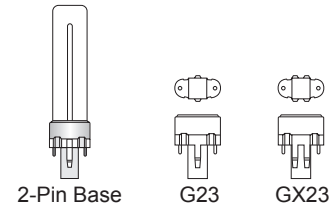

HID

HALOGEN

CFL

FL

BALLAST

GERMICIDAL

Product Information								Photometric Characteristics				
Watts	Bulb	Base	Item#	Description	Generic Designation	Case Qty.	MOL (in)	Initial Lumens (lm)	Mean Lumens (lm)	Avg. Life (Hrs)	Color Temp (K)	UPC
Single Tube 2-Pin G23 Base												
5	T4	G23	4000	PL5W/1U/2P/827	CFT5W/G23/827	50	4.33	250	210	10000	2700	844366040009
5	T4	G23	4001	PL5W/1U/2P/835	CFT5W/G23/835	50	4.33	250	210	10000	3500	844366040016
5	T4	G23	4002	PL5W/1U/2P/841	CFT5W/G23/841	50	4.33	250	210	10000	4100	844366040023
5	T4	G23	4051	* PL5W/1U/2P/865	CFT5W/G23/865	50	4.33	240	200	10000	6500	844366040511
7	T4	G23	4003	PL7W/1U/2P/827	CFT7W/G23/827	50	5.47	400	340	10000	2700	844366040030
7	T4	G23	4004	PL7W/1U/2P/835	CFT7W/G23/835	50	5.47	400	340	10000	3500	844366040047
7	T4	G23	4005	PL7W/1U/2P/841	CFT7W/G23/841	50	5.47	400	340	10000	4100	844366040054
7	T4	G23	4052	* PL7W/1U/2P/865	CFT7W/G23/865	50	5.47	380	320	10000	6500	844366040528
9	T4	G23	4006	PL9W/1U/2P/827	CFT9W/G23/827	50	6.69	600	510	10000	2700	844366040061
9	T4	G23	4007	PL9W/1U/2P/835	CFT9W/G23/835	50	6.69	600	510	10000	3500	844366040078
9	T4	G23	4008	PL9W/1U/2P/841	CFT9W/G23/841	50	6.69	600	510	10000	4100	844366040085
9	T4	G23	4053	* PL9W/1U/2P/865	CFT9W/G23/865	50	6.69	570	485	10000	6500	844366040535
Single Tube 2-Pin GX23 Base												
13	T4	GX23	4009	PL13W/1U/2P/827	CFT13W/G23/827	50	7.1	800	720	10000	2700	844366040092
13	T4	GX23	4010	PL13W/1U/2P/835	CFT13W/G23/835	50	7.1	800	720	10000	3500	844366040108
13	T4	GX23	4011	PL13W/1U/2P/841	CFT13W/G23/841	50	7.1	800	720	10000	4100	844366040115
13	T4	GX23	4054	* PL13W/1U/2P/865	CFT13W/G23/865	50	7.1	760	680	10000	6500	844366040542

*Items only available for special orders

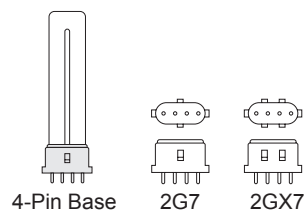

COMPACT FLUORESCENT LAMPS

Plug-in Lamps ■ ■ ■

Product Information								Photometric Characteristics				
Watts	Bulb	Base	Item#	Description	Generic Designation	Case Qty.	MOL (in)	Initial Lumens (lm)	Mean Lumens (lm)	Avg. Life (Hrs)	Color Temp (K)	UPC
Single Tube 4-Pin 2G7 Base for Electronic Ballasts-Dimmable												
5	T4	2G7	4055	* PL5W/1U/4P/827	CFT5W/2G7/827	50	3.43	250	210	10000	2700	844366040559
5	T4	2G7	4056	* PL5W/1U/4P/835	CFT5W/2G7/835	50	3.43	250	210	10000	3500	844366040566
5	T4	2G7	4057	* PL5W/1U/4P/841	CFT5W/2G7/841	50	3.43	250	210	10000	4100	844366040573
7	T4	2G7	4058	* PL7W/1U/4P/827	CFT7W/2G7/827	50	4.57	400	340	10000	2700	844366040580
7	T4	2G7	4059	* PL7W/1U/4P/835	CFT7W/2G7/837	50	4.57	400	340	10000	3500	844366040597
7	T4	2G7	4060	* PL7W/1U/4P/841	CFT7W/2G7/841	50	4.57	400	340	10000	4100	844366040603
9	T4	2G7	4061	* PL9W/1U/4P/827	CFT9W/2G7/827	50	5.75	600	510	10000	2700	844366040610
9	T4	2G7	4062	* PL9W/1U/4P/835	CFT9W/2G7/839	50	5.75	600	510	10000	3500	844366040627
9	T4	2G7	4063	* PL9W/1U/4P/841	CFT9W/2G7/841	50	5.75	600	510	10000	4100	844366040634
Single Tube 4-Pin 2GX7 Base for Electronic Ballasts-Dimmable												
13	T4	2GX7	4012	PL13W/1U/4P/827	CFT13W/2GX7/827	50	6.38	800	720	10000	2700	844366040122
13	T4	2GX7	4064	* PL13W/1U/4P/830	CFT13W/2GX7/830	50	6.38	800	720	10000	3000	844366040641
13	T4	2GX7	4013	PL13W/1U/4P/835	CFT13W/2GX7/850	50	6.38	800	720	10000	3500	844366040139
13	T4	2GX7	4014	PL13W/1U/4P/841	CFT13W/2GX7/841	50	6.38	800	720	10000	4100	844366040146

*Items only available for special orders

HID

HALOGEN

CFL

FL

BALLAST

GERMICIDAL

Plusrite®

■ ■ ■ Plug-in Lamps

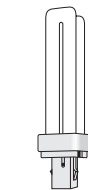

2-Pin Base



G23-2



GX23-2



G24d-2



G24d-3

Product Information								Photometric Characteristics				
Watts	Bulb	Base	Item#	Description	Generic Designation	Case Qty.	MOL (in)	Initial Lumens (lm)	Mean Lumens (lm)	Avg. Life (Hrs)	Color Temp (K)	UPC
Double Tube 2-Pin G23-2 Base												
9	T4	G23-2	4015	PL9W/2U/2P/827	CFQ9W/G23/827	50	4.33	525	440	10000	2700	844366040153
9	T4	G23-2	4016	PL9W/2U/2P/835	CFQ9W/G23/835	50	4.33	525	440	10000	3500	844366040160
9	T4	G23-2	4017	PL9W/2U/2P/841	CFQ9W/G23/841	50	4.33	525	440	10000	4100	844366040177
9	T4	G23-2	4065	* PL9W/2U/2P/865	CFQ9W/G23/865	50	4.33	500	420	1000	6500	844366040658
Double Tube 2-Pin GX23-2 Base												
13	T4	GX23-2	4018	PL13W/2U/2P/827	CFQ13W/GX23/827	50	4.72	780	665	10000	2700	844366040184
13	T4	GX23-2	4019	PL13W/2U/2P/835	CFQ13W/GX23/835	50	4.72	780	665	10000	3500	844366040191
13	T4	GX23-2	4020	PL13W/2U/2P/841	CFQ13W/GX23/841	50	4.72	780	665	10000	4100	844366040207
13	T4	GX23-2	4066	* PL13W/2U/2P/865	CFQ13W/GX23/865	50	4.72	740	650	10000	6500	844366040665
Double Tube 2-Pin G24d-2 Base												
18	T4	G24d-2	4021	PL18W/2U/2P/827	CFQ18W/G24d/827	50	6.06	1200	1080	10000	2700	844366040214
18	T4	G24d-2	4022	PL18W/2U/2P/835	CFQ18W/G24d/835	50	6.06	1200	1080	10000	3500	844366040221
18	T4	G24d-2	4023	PL18W/2U/2P/841	CFQ18W/G24d/841	50	6.06	1200	1080	10000	4100	844366040238
18	T4	G24d-2	4067	* PL18W/2U/2P/865	CFQ18W/G24d/865	50	6.06	1140	1030	10000	6500	844366040672
Double Tube 2-Pin G24d-3 Base												
26	T4	G24d-3	4024	PL26W/2U/2P/827	CFQ26W/G24d/827	50	6.89	1800	1620	10000	2700	844366040245
26	T4	G24d-3	4025	PL26W/2U/2P/835	CFQ26W/G24d/835	50	6.89	1800	1620	10000	3500	844366040252
26	T4	G24d-3	4026	PL26W/2U/2P/841	CFQ26W/G24d/841	50	6.89	1800	1620	10000	4100	844366040269
26	T4	G24d-3	4068	* PL26W/2U/2P/865	CFQ26W/G24d/865	50	6.89	1710	1540	10000	6500	844366040689

*Items only available for special orders

HID

HALOGEN

CFL

FL

BALLAST

GERMICIDAL

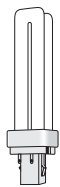

4-Pin Base



G24q-1



G24q-2



G24q-3

COMPACT FLUORESCENT LAMPS

Plug-in Lamps ■ ■ ■ ■

Product Information								Photometric Characteristics				
Watts	Bulb	Base	Item#	Description	Generic Designation	Case Qty.	MOL (in)	Initial Lumens (lm)	Mean Lumens (lm)	Avg. Life (Hrs)	Color Temp (K)	UPC
Double Tube 4-Pin G24q-1 Base for Electronic Ballasts-Dimmable												
10	T4	G24q-1	4069	* PL10W/2U/4P/827	CFQ10W/G24q/827	50	4.13	600	540	10000	2700	844366040696
10	T4	G24q-1	4070	* PL10W/2U/4P/835	CFQ10W/G24q/835	50	4.13	600	540	10000	3500	844366040702
10	T4	G24q-1	4071	* PL10W/2U/4P/841	CFQ10W/G24q/841	50	4.13	600	540	10000	4100	844366040719
13	T4	G24q-1	4027	PL13W/2U/4P/827	CFQ13W/G24q/827	50	5.28	900	810	10000	2700	844366040276
13	T4	G24q-1	4028	PL13W/2U/4P/835	CFQ13W/G24q/835	50	5.28	900	810	10000	3500	844366040283
13	T4	G24q-1	4029	PL13W/2U/4P/841	CFQ13W/G24q/841	50	5.28	900	810	10000	4100	844366040290
13	T4	G24q-1	4072	* PL13W/2U/4P/865	CFQ13W/G24q/865	50	5.28	860	770	10000	6500	844366040726
Double Tube 4-Pin G24q-2 Base for Electronic Ballasts-Dimmable												
18	T4	G24q-2	4030	PL18W/2U/4P/827	CFQ18W/G24q/827	50	5.87	1200	1080	10000	2700	844366040306
18	T4	G24q-2	4031	PL18W/2U/4P/835	CFQ18W/G24q/835	50	5.87	1200	1080	10000	3500	844366040313
18	T4	G24q-2	4032	PL18W/2U/4P/841	CFQ18W/G24q/841	50	5.87	1200	1080	10000	4100	844366040320
Double Tube 4-Pin G24q-3 Base for Electronic Ballasts-Dimmable												
26	T4	G24q-3	4033	PL26W/2U/4P/827	CFQ26W/G24q/827	50	6.57	1800	1620	10000	2700	844366040337
26	T4	G24q-3	4034	PL26W/2U/4P/835	CFQ26W/G24q/835	50	6.57	1800	1620	10000	3500	844366040344
26	T4	G24q-3	4035	PL26W/2U/4P/841	CFQ26W/G24q/841	50	6.57	1800	1620	10000	4100	844366040351
26	T4	G24q-3	4073	* PL26W/2U/4P/865	CFQ26W/G24q/865	50	6.57	1710	1540	10000	6500	844366040733

*Items only available for special orders

HID

HALOGEN

CFL

FL

BALLAST

GERMICIDAL

Plusrite®

■ ■ ■ Plug-in Lamps

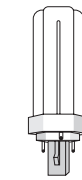

2-Pin Base



GX24d-2



GX24d-3

HID

HALOGEN

CFL

FL

BALLAST

GERMICIDAL

Product Information								Photometric Characteristics				
Watts	Bulb	Base	Item#	Description	Generic Designation	Case Qty.	MOL (in)	Initial Lumens (lm)	Mean Lumens (lm)	Avg. Life (Hrs)	Color Temp (K)	UPC
Triple Tube 2-Pin GX24d-2 Base												
18	T4	GX24d-2	4074	* PL18W/3U/2P/827	CFTR18W/GX24d/827	50	4.84	1200	1080	10000	2700	844366040740
18	T4	GX24d-2	4075	* PL18W/3U/2P/835	CFTR18W/GX24d/835	50	4.84	1200	1080	10000	3500	844366040757
18	T4	GX24d-2	4076	* PL18W/3U/2P/841	CFTR18W/GX24d/841	50	4.84	1200	1080	10000	4100	844366040764
Triple Tube 2-Pin GX24d-3 Base												
26	T4	GX24d-3	4077	* PL26W/3U/2P/827	CFTR26W/GX24d/827	50	5.47	1800	1620	10000	2700	844366040771
26	T4	GX24d-3	4078	* PL26W/3U/2P/835	CFTR26W/GX24d/835	50	5.47	1800	1620	10000	3500	844366040788
26	T4	GX24d-3	4079	* PL26W/3U/2P/841	CFTR26W/GX24d/841	50	5.47	1800	1620	10000	4100	844366040795

*Items only available for special orders

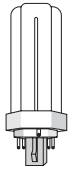

4-Pin Base

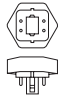

GX24q-1

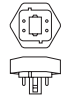

GX24q-2

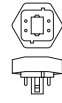

GX24q-3

COMPACT FLUORESCENT LAMPS

Plug-in Lamps ■ ■ ■

Product Information								Photometric Characteristics				UPC
Watts	Bulb	Base	Item#	Description	Generic Designation	Case Qty.	MOL (in)	Initial Lumens (lm)	Mean Lumens (lm)	Avg. Life (Hrs)	Color Temp (K)	UPC
Triple Tube 4-Pin GX24q-1 Base for Electronic Ballasts - Dimmable												
13	T4	GX24q-1	4080	* PL13W/3U/4P/827	CFTR13W/GX24q/827	50	4.45	900	810	10000	2700	844366040801
13	T4	GX24q-1	4081	* PL13W/3U/4P/835	CFTR13W/GX24q/835	50	4.45	900	810	10000	3500	844366040818
13	T4	GX24q-1	4082	* PL13W/3U/4P/841	CFTR13W/GX24q/841	50	4.45	900	810	10000	4100	844366040825
Triple Tube 4-Pin GX24q-2 Base for Electronic Ballasts - Dimmable												
18	T4	GX24q-2	4036	PL18W/3U/4P/827	CFTR18W/GX24q/827	50	4.65	1200	1080	10000	2700	844366040368
18	T4	GX24q-2	4083	* PL18W/3U/4P/830	CFTR18W/GX24q/830	50	4.65	1200	1080	10000	3000	844366040832
18	T4	GX24q-2	4037	PL18W/3U/4P/835	CFTR18W/GX24q/835	50	4.65	1200	1080	10000	3500	844366040375
18	T4	GX24q-2	4038	PL18W/3U/4P/841	CFTR18W/GX24q/841	50	4.65	1200	1080	10000	4100	844366040382
18	T4	GX24q-2	4084	* PL18W/3U/4P/865	CFTR18W/GX24q/865	50	4.65	1140	1025	10000	6500	844366040849
Triple Tube 4-Pin GX24q-3 Base for Electronic Ballasts - Dimmable												
26	T4	GX24q-3	4039	PL26W/3U/4P/827	CFTR26W/GX24q/827	50	5.28	1800	1620	10000	2700	844366040399
26	T4	GX24q-3	4085	* PL26W/3U/4P/830	CFTR26W/GX24q/830	50	5.28	1800	1620	10000	3000	844366040856
26	T4	GX24q-3	4040	PL26W/3U/4P/835	CFTR26W/GX24q/835	50	5.28	1800	1620	10000	3500	844366040405
26	T4	GX24q-3	4041	PL26W/3U/4P/841	CFTR26W/GX24q/841	50	5.28	1800	1620	10000	4100	844366040412
26	T4	GX24q-3	4086	* PL26W/3U/4P/865	CFTR26W/GX24q/865	50	5.28	1710	1540	10000	6500	844366040863
32	T4	GX24q-3	4042	PL32W/3U/4P/827	CFTR32W/GX24q/827	50	5.87	2400	2160	10000	2700	844366040429
32	T4	GX24q-3	4087	* PL32W/3U/4P/830	CFTR32W/GX24q/830	50	5.87	2400	2160	10000	3000	844366040870
32	T4	GX24q-3	4043	PL32W/3U/4P/835	CFTR32W/GX24q/835	50	5.87	2400	2160	10000	3500	844366040436
32	T4	GX24q-3	4044	PL32W/3U/4P/841	CFTR32W/GX24q/841	50	5.87	2400	2160	10000	4100	844366040443
32	T4	GX24q-3	4088	* PL32W/3U/4P/865	CFTR32W/GX24q/865	50	5.87	2280	2052	10000	6500	844366040887

*Items only available for special orders

HID

HALOGEN

CFL

FL

BALLAST

GERMICIDAL

■ ■ ■ Plug-in Lamps

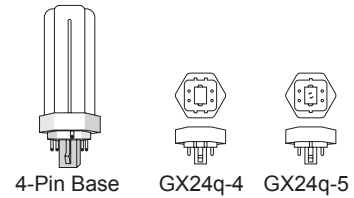

HID

HALOGEN

CFL

FL

BALLAST

GERMICIDAL

Product Information								Photometric Characteristics				
Watts	Bulb	Base	Item#	Description	Generic Designation	Case Qty.	MOL (in)	Initial Lumens (lm)	Mean Lumens (lm)	Avg. Life (Hrs)	Color Temp (K)	UPC
Triple Tube 4-Pin GX24q-4 Base for Electronic Ballasts - Dimmable												
42	T4	GX24q-4	4045	PL42W/3U/4P/827	CFTR42W/GX24q/827	50	6.77	3200	2880	10000	2700	844366040450
42	T4	GX24q-4	4089	* PL42W/3U/4P/830	CFTR42W/GX24q/830	50	6.77	3200	2880	10000	3000	844366040894
42	T4	GX24q-4	4046	PL42W/3U/4P/835	CFTR42W/GX24q/835	50	6.77	3200	2880	10000	3500	844366040467
42	T4	GX24q-4	4047	PL42W/3U/4P/841	CFTR42W/GX24q/841	50	6.77	3200	2880	10000	4100	844366040474
42	T4	GX24q-4	4090	* PL42W/3U/4P/865	CFTR42W/GX24q/865	50	6.77	3040	2740	10000	6500	844366040900
Triple Tube 4-Pin GX24q-5 Base for Electronic Ballasts - Dimmable												
57	T4	GX24q-5	4048	PL57W/3U/4P/827	CFTR57W/GX24q/827	50	7.76	4300	3700	10000	2700	844366040481
57	T4	GX24q-5	4091	* PL57W/3U/4P/830	CFTR57W/GX24q/830	50	7.76	4300	3700	10000	3000	844366040917
57	T4	GX24q-5	4049	PL57W/3U/4P/835	CFTR57W/GX24q/835	50	7.76	4300	3700	10000	3500	844366040498
57	T4	GX24q-5	4050	PL57W/3U/4P/841	CFTR57W/GX24q/841	50	7.76	4300	3700	10000	4100	844366040504
57	T4	GX24q-5	4092	* PL57W/3U/4P/865	CFTR57W/GX24q/865	50	7.76	4085	3600	10000	6500	844366040924

*Items only available for special orders

COMPACT FLUORESCENT LAMPS

Plug-in Long (FTL) Lamps ■ ■ ■

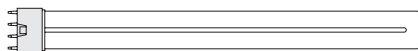

FTL/2G11

Product Information								Photometric Characteristics					UPC
Watts	Bulb	Base	Item#	Description	Generic Designation	Case Qty.	MOL (in)	Initial Lumens (lm)	Mean Lumens (lm)	Avg. Life (Hrs)	Color Temp (K)	CRI	UPC
Compact Fluorescent Lamps - FTL (2G11)													
18	2G11	FTL	4306	* FTL18/2G11/830	FT18W/2G11/830	50	8.7	1300	1075	12000	3000	85	844366043062
18	2G11	FTL	4307	* FTL18/2G11/830/L	FT18W/2G11/RS/830	50	10.33	1300	1075	20000	3000	85	844366043079
18	2G11	FTL	4308	* FTL18/2G11/835	FT18W/2G11/835	50	8.7	1300	1075	12000	3500	85	844366043086
18	2G11	FTL	4309	* FTL18/2G11/835/L	FT18W/2G11/RS/835	50	10.33	1300	1075	20000	3500	85	844366043093
18	2G11	FTL	4310	* FTL18/2G11/841	FT18W/2G11/841	50	8.7	1300	1075	12000	4100	85	844366043109
18	2G11	FTL	4311	* FTL18/2G11/841/L	FT18W/2G11/RS/841	50	10.33	1300	1075	20000	4100	85	844366043116
24	2G11	FTL	4312	* FTL24/2G11/830	FT24W/2G11/830	50	12.7	1800	1548	12000	3000	85	844366043123
24	2G11	FTL	4313	* FTL24/2G11/835	FT24W/2G11/835	50	12.7	1800	1548	12000	3500	85	844366043130
24	2G11	FTL	4314	* FTL24/2G11/841	FT24W/2G11/841	50	12.7	1800	1548	12000	4100	85	844366043147
36	2G11	FTL	4315	* FTL36/2G11/830	FT36W/2G11/830	50	16.34	2800	2494	12000	3000	85	844366043154
36	2G11	FTL	4316	* FTL36/2G11/835	FT36W/2G11/835	50	16.34	2800	2494	12000	3500	85	844366043161
36	2G11	FTL	4317	* FTL36/2G11/841	FT36W/2G11/841	50	16.34	2800	2494	12000	4100	85	844366043178
40	2G11	FTL	4300	FTL40/2G11/830	FT40W/2G11/RS/830	50	22.44	3500	2709	20000	3000	85	844366043000
40	2G11	FTL	4301	FTL40/2G11/835	FT40W/2G11/RS/835	50	22.44	3500	2709	20000	3500	85	844366043017
40	2G11	FTL	4302	FTL40/2G11/841	FT40W/2G11/RS/841	50	22.44	3500	2709	20000	4100	85	844366043024
40	2G11	FTL	4318	* FTL40/2G11/850	FT40W/2G11/RS/RS/850	50	22.44	3500	2709	20000	5000	85	844366043185
55	2G11	FTL	4303	FTL55/2G11/830	FT55W/2G11/RS/830	50	20.77	4700	4128	12000	3000	85	844366043031
55	2G11	FTL	4304	FTL55/2G11/835	FT55W/2G11/RS/835	50	20.77	4700	4128	12000	3500	85	844366043048
55	2G11	FTL	4305	FTL55/2G11/841	FT55W/2G11/RS/841	50	20.77	4700	4128	12000	4100	85	844366043055
80	2G11	FTL	4319	* FTL80/2G11/830	FT80W/2G11/RS/830	50	22.24	6000	5160	12000	3000	85	844366043192
80	2G11	FTL	4320	* FTL80/2G11/835	FT80W/2G11/RS/835	50	22.24	6000	5160	12000	3500	85	844366043208
80	2G11	FTL	4321	* FTL80/2G11/841	FT80W/2G11/RS/841	50	22.24	6000	5160	12000	4100	85	844366043215

*Items only available for special orders

HID

HALOGEN

CFL

FL

BALLAST

GERMICIDAL

HID

HALOGEN

CFL

FL

BALLAST

GERMICIDAL



LINEAR FLUORESCENT





FLUORESCENT LAMPS

CONTENTS

- 89 - Linear Fluorescent Lamps - T5 (TCLP Compliant)
- 91 - Linear Fluorescent Lamps - T8



T5 Mini Bi-Pin Base



T8 Med Bi-Pin Base

HID

HALOGEN

CFL

FL

BALLAST

GERMICIDAL

How to read the table



HID

HALOGEN

CFL

FL

BALLAST

GERMICIDAL

Product Information							Photometric Characteristics					
Watts	Bulb	Base	Item#	Description	Case Qty.	MOL (in)	Initial Lumens (lm)	Mean Lumens (lm)	Avg. Life (Hrs)	Color Temp (K)	CRI	UPC
Fluorescent Lamps												
14	T5	Mini Bi-Pin	4100	FL14/T5/830	25	21.61	1350	1269	20000	3000	85	844366041006
14	T5	Mini Bi-Pin	4101	FL14/T5/835	25	21.61	1350	1269	20000	3500	85	844366041013
14	T5	Mini Bi-Pin	4102	FL14/T5/841	25	21.61	1350	1269	20000	4100	85	844366041020

Watts
Energy consumption during proper operation.

Base
Type of base.

Description
The lamps identification code.

MOL
Maximum overall length in inches.

Mean Lumens
Average light output at 40% of rated life for MH and 50% of rated life for HPS and MV.

Color Temp
Light temperature measured in Kelvin.

UPC
Universal Product Code

Bulb
Type of bulb for different size and shape.

Item#
Use this code when placing order

Case Qty
Number of product units packed in a case.

Initial Lumens
Average Light output after the initial 100 hours of operation

Average Life
An average rating operated at normal lamp voltage and current.

CRI
An International system used to rate a lamp's ability to render object colors.

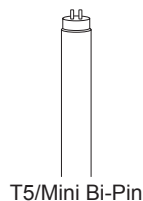

T5/Mini Bi-Pin

FLUORESCENT LAMPS

Linear Fluorescent Lamps - T5 (TCLP Compliant) ■ ■ ■

Product Information							Photometric Characteristics					
Watts	Bulb	Base	Item#	Description	Case Qty.	MOL (in)	Initial Lumens (lm)	Mean Lumens (lm)	Avg. Life (Hrs)	Color Temp (K)	CRI	UPC
Fluorescent Lamps												
14	T5	Mini Bi-Pin	4100	FL14/T5/830	25	21.61	1350	1269	20000	3000	85	844366041006
14	T5	Mini Bi-Pin	4101	FL14/T5/835	25	21.61	1350	1269	20000	3500	85	844366041013
14	T5	Mini Bi-Pin	4102	FL14/T5/841	25	21.61	1350	1269	20000	4100	85	844366041020
14	T5	Mini Bi-Pin	4103	FL14/T5/850	25	21.61	1350	1269	20000	5000	85	844366041037
14	T5	Mini Bi-Pin	4104	FL14/T5/865	25	21.61	1350	1269	20000	6500	85	844366041044
21	T5	Mini Bi-Pin	4105	FL21/T5/830	25	33.39	2100	1974	20000	3000	85	844366041051
21	T5	Mini Bi-Pin	4106	FL21/T5/835	25	33.39	2100	1974	20000	3500	85	844366041068
21	T5	Mini Bi-Pin	4107	FL21/T5/841	25	33.39	2100	1974	20000	4100	85	844366041075
21	T5	Mini Bi-Pin	4108	FL21/T5/850	25	33.39	2100	1974	20000	5000	85	844366041082
21	T5	Mini Bi-Pin	4109	FL21/T5/865	25	33.39	2100	1974	20000	6500	85	844366041099
28	T5	Mini Bi-Pin	4110	FL28/T5/830	25	45.2	2900	2726	20000	3000	85	844366041105
28	T5	Mini Bi-Pin	4111	FL28/T5/835	25	45.2	2900	2726	20000	3500	85	844366041112
28	T5	Mini Bi-Pin	4112	FL28/T5/841	25	45.2	2900	2726	20000	4100	85	844366041129
28	T5	Mini Bi-Pin	4113	FL28/T5/850	25	45.2	2900	2726	20000	5000	85	844366041136
28	T5	Mini Bi-Pin	4114	FL28/T5/865	25	45.2	2900	2726	20000	6500	85	844366041143
35	T5	Mini Bi-Pin	4130	* FL35/T5/830	25	57.09	3650	3431	20000	3000	85	844366041303
35	T5	Mini Bi-Pin	4131	* FL35/T5/835	25	57.09	3650	3431	20000	3500	85	844366041310
35	T5	Mini Bi-Pin	4132	* FL35/T5/841	25	57.09	3650	3431	20000	4100	85	844366041327
35	T5	Mini Bi-Pin	4133	* FL35/T5/850	25	57.09	3650	3431	20000	5000	85	844366041334
35	T5	Mini Bi-Pin	4134	* FL35/T5/865	25	57.09	3650	3431	20000	6500	85	844366041341

*Items only available for special orders

HID

HALOGEN

CFL

FL

BALLAST

GERMICIDAL

Plusrite®

Linear Fluorescent Lamps - T5 (TCLP Compliant)

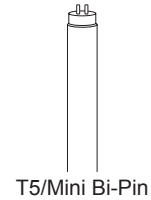

HID

HALOGEN

CFL

FL

BALLAST

GERMICIDAL

Product Information							Photometric Characteristics					
Watts	Bulb	Base	Item#	Description	Case Qty.	MOL (in)	Initial Lumens (lm)	Mean Lumens (lm)	Avg. Life (Hrs)	Color Temp (K)	CRI	UPC
Fluorescent Lamps - High Output (T5)												
24	T5	Mini Bi-Pin	4115	FL24/T5/830/HO	25	21.61	2000	1880	20000	3000	85	844366041150
24	T5	Mini Bi-Pin	4116	FL24/T5/835/HO	25	21.61	2000	1880	20000	3500	85	844366041167
24	T5	Mini Bi-Pin	4117	FL24/T5/841/HO	25	21.61	2000	1880	20000	4100	85	844366041174
24	T5	Mini Bi-Pin	4118	FL24/T5/850/HO	25	21.61	2000	1880	20000	5000	85	844366041181
24	T5	Mini Bi-Pin	4119	FL24/T5/865/HO	25	21.61	2000	1880	20000	6500	85	844366041198
39	T5	Mini Bi-Pin	4120	FL39/T5/830/HO	25	33.39	4900	4606	20000	3000	85	844366041204
39	T5	Mini Bi-Pin	4121	FL39/T5/835/HO	25	33.39	4900	4606	20000	3500	85	844366041211
39	T5	Mini Bi-Pin	4122	FL39/T5/841/HO	25	33.39	4900	4606	20000	4100	85	844366041228
39	T5	Mini Bi-Pin	4123	FL39/T5/850/HO	25	33.39	4900	4606	20000	5000	85	844366041235
39	T5	Mini Bi-Pin	4124	FL39/T5/865/HO	25	33.39	4900	4606	20000	6500	85	844366041242
54	T5	Mini Bi-Pin	4125	FL54/T5/830/HO	25	45.2	5000	4700	20000	3000	85	844366041259
54	T5	Mini Bi-Pin	4126	FL54/T5/835/HO	25	45.2	5000	4700	20000	3500	85	844366041266
54	T5	Mini Bi-Pin	4127	FL54/T5/841/HO	25	45.2	5000	4700	20000	4100	85	844366041273
54	T5	Mini Bi-Pin	4128	FL54/T5/850/HO	25	45.2	5000	4700	20000	5000	85	844366041280
54	T5	Mini Bi-Pin	4129	FL54/T5/865/HO	25	45.2	5000	4700	20000	6500	85	844366041297
80	T5	Mini Bi-Pin	4135	* FL80/T5/830/HO	25	57.09	7000	6580	20000	3000	85	844366041358
80	T5	Mini Bi-Pin	4136	* FL80/T5/835/HO	25	57.09	7000	6580	20000	3500	85	844366041365
80	T5	Mini Bi-Pin	4137	* FL80/T5/841/HO	25	57.09	7000	6580	20000	4100	85	844366041372
80	T5	Mini Bi-Pin	4138	* FL80/T5/850/HO	25	57.09	7000	6580	20000	5000	85	844366041389
80	T5	Mini Bi-Pin	4139	* FL80/T5/865/HO	25	57.09	7000	6580	20000	6500	85	844366041396

*Items only available for special orders

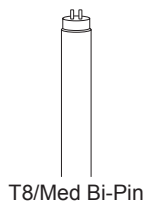

FLUORESCENT LAMPS

Linear Fluorescent Lamps - T8

Product Information							Photometric Characteristics					
Watts	Bulb	Base	Item#	Description	Case Qty.	MOL (in)	Initial Lumens (lm)	Mean Lumens (lm)	Avg. Life (Hrs)	Color Temp (K)	CRI	UPC
T8 700 Series												
32	T8	Med Bi-Pin	4183	* FL32T8/741/ECO	25	37.66	2850	2750	20000	4100	75	844366041839
32	T8	Med Bi-Pin	4184	* FL32T8/750/ECO	25	37.66	2750	2690	20000	5000	75	844366041846
T8 800 Series												
32	T8	Med Bi-Pin	4180	* FL32T8/835/ECO	25	37.66	3000	2850	20000	3500	82	844366041808
32	T8	Med Bi-Pin	4181	* FL32T8/841/ECO	25	37.66	3000	2850	20000	4100	82	844366041815
32	T8	Med Bi-Pin	4182	FL32T8/850/ECO	25	37.66	3000	2850	20000	5000	82	844366041822
32	T8	Med Bi-Pin	4185	* FL32T8/865/ECO	25	37.66	3000	2850	20000	6000	82	844366041853
32	T8	Med Bi-Pin	4187	* FL32T8/835/HO/ECO	25	37.66	3200	3050	20000	3500	82	844366041877
32	T8	Med Bi-Pin	4188	* FL32T8/841/HO/ECO	25	37.66	3200	3050	20000	4100	82	844366041884
32	T8	Med Bi-Pin	4189	* FL32T8/850/HO/ECO	25	37.66	3200	3050	20000	5000	82	844366041891
T8 800 Energy Saving												
28	T8	Med Bi-Pin	4191	* FL28T8/835/ES/ECO	25	37.66	2700	2565	20000	3500	82	844366041914
28	T8	Med Bi-Pin	4192	* FL28T8/841/ES/ECO	25	37.66	2675	2550	20000	4100	82	844366041921
28	T8	Med Bi-Pin	4193	* FL28T8/850/ES/ECO	25	37.66	2650	2520	20000	5000	82	844366041938
28	T8	Med Bi-Pin	4190	* FL28T8/865/ES/ECO	25	37.66	2650	2520	20000	6000	82	844366041907

*Items only available for Canada

HID

HALOGEN

CFL

FL

BALLAST

GERMICIDAL

HID

HALOGEN

CFL

FL

BALLAST

GERMICIDAL



BALLAST





ELECTRONIC FL BALLASTS

HID

HALOGEN

CFL

FL

BALLAST

GERMICIDAL

CONTENTS

- 96 - Electronic FL Ballasts
- 108 - HID Core & Coil Ballasts
- 113 - Capacitors
- 116 - Ignitors

ELECTRONIC FL BALLASTS

HID

HALOGEN

CFL

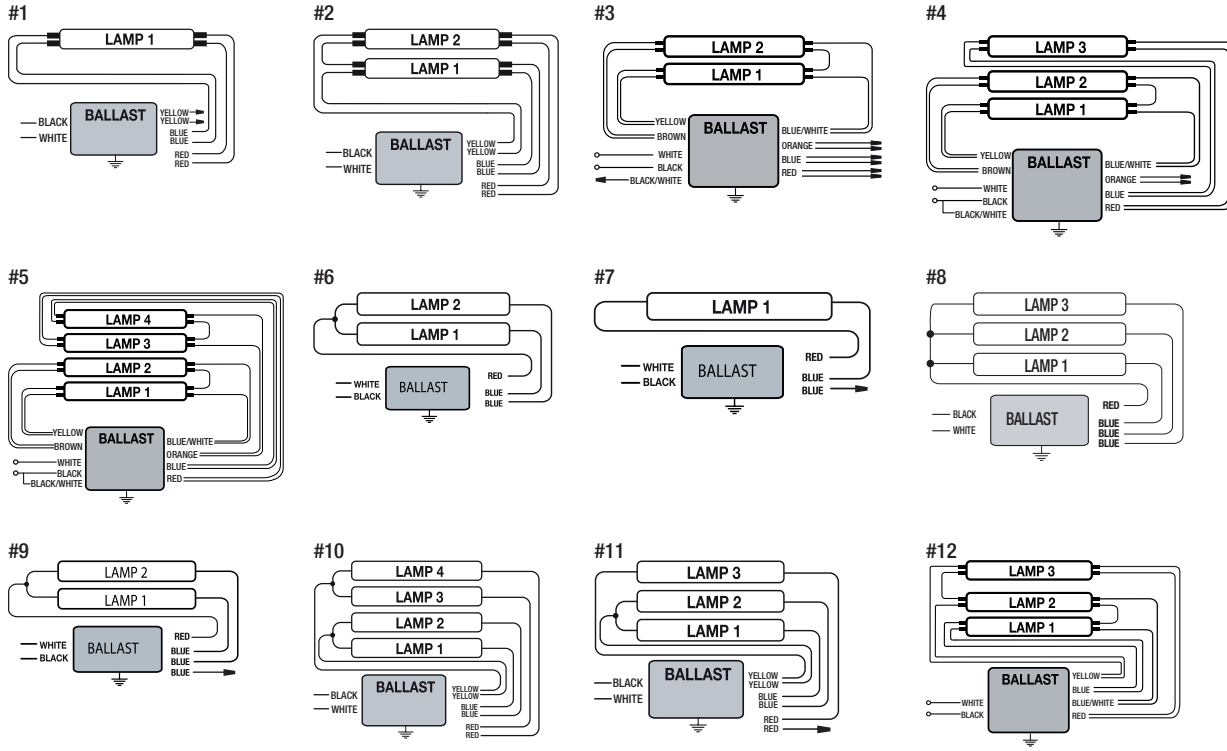

HID CORE & COIL BALLASTS

FL

BALLAST

GERMICIDAL

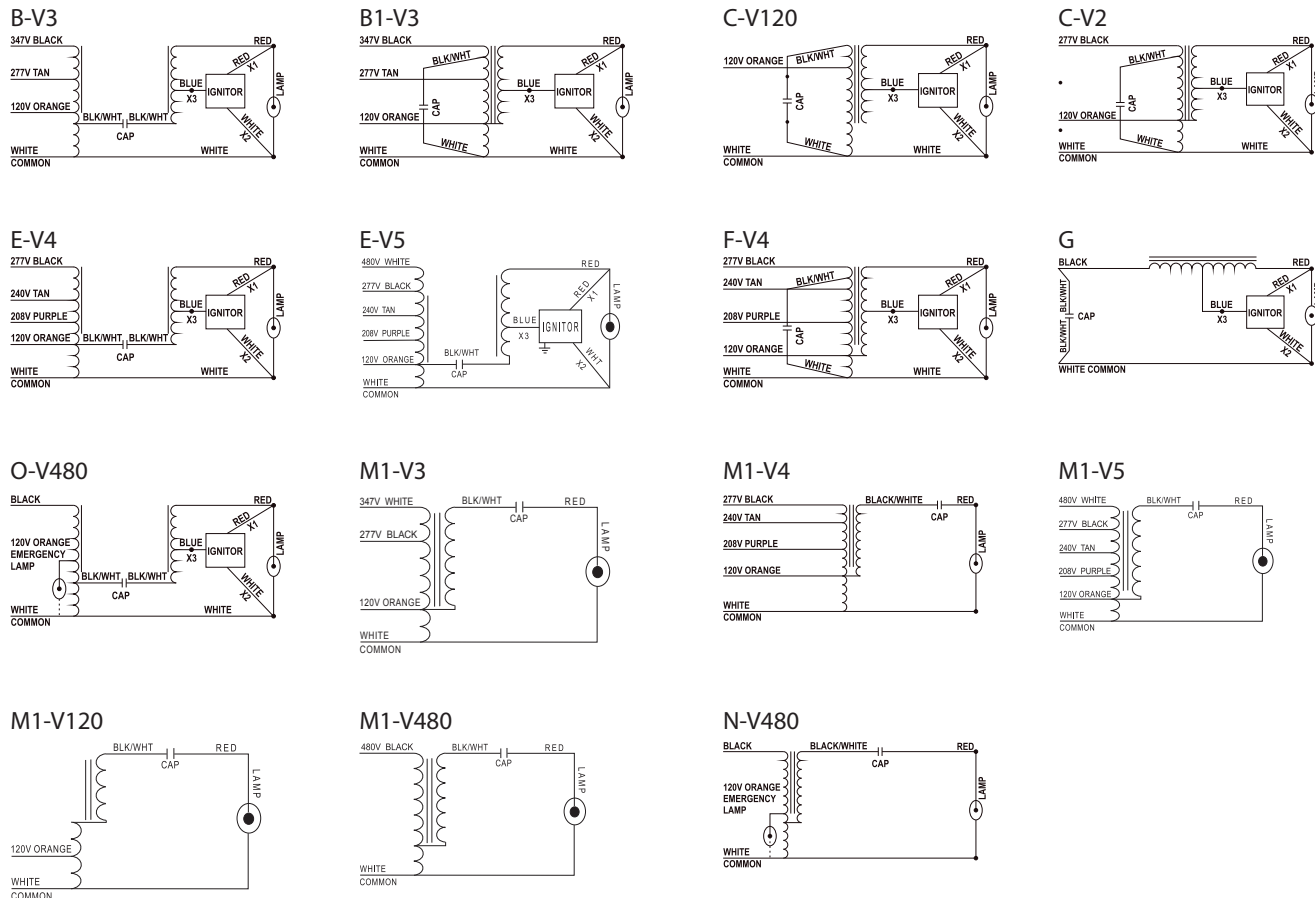



ELECTRONIC FL BALLASTS

How to read the table



HID

HALOGEN

CFL

FL

BALLAST

GERMICIDAL

Product Information															
Watts	ANSI Code	Item#	Description	Case Qty.	Input Voltage	Circuit Type	Input Watts	Max. Line Current	A (in)	B (in)	Wt (lbs)	Coil Temp Code	Cap Requirement. (µfd/Vmin)	Wiring Diagram	UPC
Pulse Start Metal Halide Ballast Kits - 5 Tap															
250	M138/M153	7281	*BAPS250-CWA/V5	1	120/208/240/277/480	CWA	285	2.45/1.45/1.25/1.05/0.60	2	3.58	11	A/A/A/ A/A	16/370	E-V5	844366072819
320	M132/154	7268	*BAPS320-CWA/V5	1	120/208/240/277/480	CWA	364	3.1/1.8/1.55/1.35/0.80	2	3.58	10	B/B/B/ C/C	22/330	E-V5	844366072680
350	M131	7269	*BAPS350-CWA/V5	1	120/208/240/277/480	CWA	398	3.60/2.10/1.80/1.55/0.85	2	3.58	10.5	B/C/ C/C/C	24/330	E-V5	844366072697

Item#
Use this code when placing order

Watts
Energy consumption during proper operation.

Case Qty
Number of product units packed in a case.

Circuit Type
Circuit Type

Max. Line Current
The maximum line current for the ballast

Coil Temp Code
Temperature code for the coil

Wiring Diagram
Wiring diagram reference

B
Core and Coil dimension (B)

UPC
Universal Product Code

ANSI Code
The standardization code for the class and electrical characteristics of lamps and ballast as well as fixture requirements.

Description
The lamps identification code.

Input Voltage
Input Voltage

Input Watts
Input Wattage

A
Core and Coil dimension (A)

Weight
Core and Coil weight in lbs

Cap Requirement
Capacitor requirement

■ ■ ■ For 54W T5 Lamps

HID

HALOGEN

CFL

FL

BALLAST

GERMICIDAL

Product Information												
Lamp Type	Number of lamps	Input voltage (V)	Lamp Start Method	Item#	Description	Wattage (W)	Ballast Factor	ATHD (%)	Line Current (A)	Min Start Temp (F/C)	Wiring Diagram	UPC
T5	F54T5 - 54W											
	1	120-277	Program Start	7318	* BAF254PS/MV	62	1.03	10	0.52-0.23	0/-18	1	844366073182
	1	120-277	Program Start	7318	* BAF254PS/MV	62	1.03	10	0.52-0.23	0/-18	1	844366073182
	1	120-277	Program Start	7318	* BAF254PS/MV	62	1.03	10	0.52-0.23	0/-18	1	844366073182
	1	120-277	Program Start	7318	* BAF254PS/MV	62	1.03	10	0.52-0.23	0/-18	1	844366073182
	1	120-277	Program Start	7318	* BAF254PS/MV	62	1.03	10	0.52-0.23	0/-18	1	844366073182

*Items only available for special orders

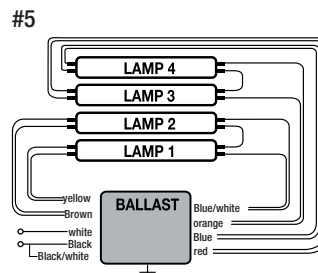
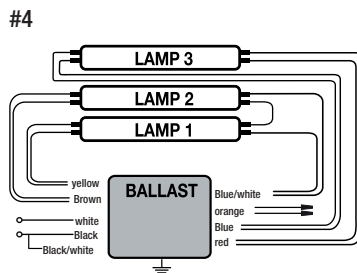
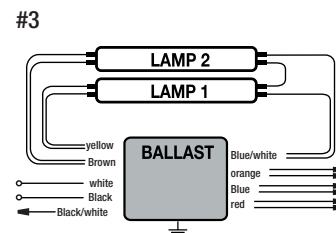
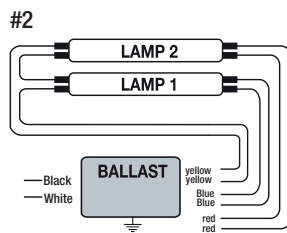
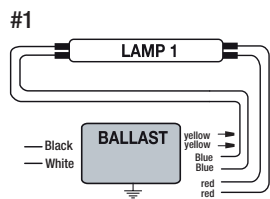



ELECTRONIC FL BALLASTS

For 32W T8 Lamps ■ ■ ■

Product Information												
Lamp Type	Number of lamps	Input voltage (V)	Lamp Start Method	Item#	Description	Wattage (W)	Ballast Factor	ATHD (%)	Line Current (A)	Min Start Temp (F/C)	Wiring Diagram	UPC
T8	F32T8 - 32W											
	1	120-277	Instant Start	7282	*BAF232IS/MV	35-34	1.08	10	0.29-0.13	0/-18	7	844366072826
		120-277	Instant Start	7283	*BAF232IS/MV/L	31-30	0.93	10	0.26-0.12	0/-18	7	844366072833
		120-277	Instant Start	7284	*BAF232IS/MV/H	45	1.38	10	0.37-0.17	0/-18	7	844366072840
	2	120-277	Instant Start	7282	*BAF232IS/MV	56-55	0.89	10	0.46-0.20	0/-18	6	844366072826
		120-277	Instant Start	7283	*BAF232IS/MV/L	48-47	0.77	10	0.40-0.17	0/-18	6	844366072833
		120-277	Instant Start	7284	*BAF232IS/MV/H	74-73	1.18	10	0.62-0.27	0/-18	6	844366072840
		120-277	Instant Start	7288	*BAF332IS/MV	63	1.02	10	0.53-0.24	0/-18	9	844366072888
		120-277	Instant Start	7289	*BAF332IS/MV/L	58-57	0.92	10	0.49-0.21	0/-18	9	844366072895
		120-277	Instant Start	7290	*BAF332IS/MV/H	83-81	1.4	10	0.69-0.30	0/-18	9	844366072901
	3	120-277	Instant Start	7288	*BAF332IS/MV	84-83	0.88	10	0.71-0.31	0/-18	8	844366072888
		120-277	Instant Start	7289	*BAF332IS/MV/L	76-74	0.78	10	0.64-0.27	0/-18	8	844366072895
		120-277	Instant Start	7290	*BAF332IS/MV/H	108-106	1.18	10	0.91-1.39	0/-18	8	844366072901
		120-277	Instant Start	7294	*BAF432IS/MV	98-92	0.94	10	0.77-0.34	0/-18	11	844366072949
		120-277	Instant Start	7295	*BAF432IS/MV/L	81-80	0.82	10	0.68-0.29	0/-18	11	844366072956
		120-277	Instant Start	7296	*BAF432IS/MV/H	122-120	1.24	10	1.01-0.45	0/-18	11	844366072963
	4	120-277	Instant Start	7294	*BAF432IS/MV	112-108	0.88	10	0.93-0.40	0/-18	10	844366072949
		120-277	Instant Start	7295	*BAF432IS/MV/L	98-96	0.77	10	0.35-0.82	0/-18	10	844366072956
		120-277	Instant Start	7296	*BAF432IS/MV/H	145-144	1.16	10	1.24-0.53	0/-18	10	844366072963

*Items only available for special orders

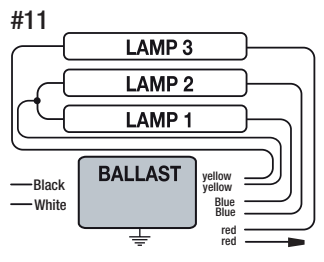
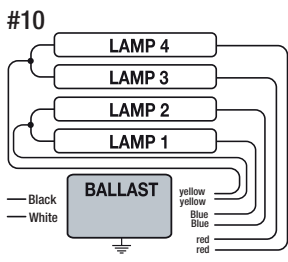
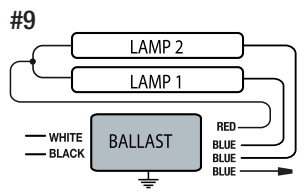
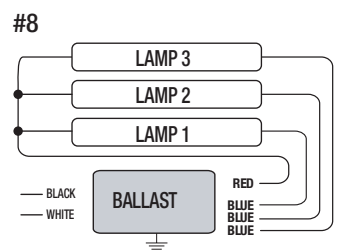
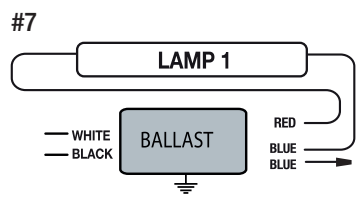
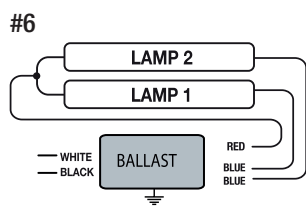

HID

HALOGEN

CFL

FL

BALLAST

GERMICIDAL

■ ■ ■ For 32W T8 Lamps

HID

HALOGEN

CFL

FL

BALLAST

GERMICIDAL

Product Information

Lamp Type	Number of lamps	Input voltage (V)	Lamp Start Method	Item#	Description	Wattage (W)	Ballast Factor	ATHD (%)	Line Current (A)	Min Start Temp (F/C)	Wiring Diagram	UPC
T8	F32T8 - 32W											
	2	120-277	Program Start	7300	*BAF232PS/MV	57-56	0.88	10	0.48-0.21	0/-18	2	844366073007
		120-277	Program Start	7301	*BAF232PS/MV/L	52-51	0.78	10	0.43-0.19	0/-18	2	844366073014
		120-277	Program Start	7302	*BAF232PS/MV/H	72-71	1.18	10	0.60-0.26	0/-18	2	844366073021
	3	120-277	Program Start	7303	*BAF332PS/MV	87-85	0.88	10	0.72-0.31	0/-18	12	844366073038
		120-277	Program Start	7304	*BAF332PS/MV/H	113-110	1.18	10	0.95-0.42	0/-18	12	844366073045
	1	347	Instant Start	7305	*BAF232IS/347	37	1.08	10	0.112	0/-18	7	844366073052
		347	Instant Start	7306	*BAF232IS/347/L	36	0.88	10	0.107	0/-18	7	844366073069
		347	Instant Start	7307	*BAF232IS/347/H	47	1.37	10	0.141	0/-18	7	844366073076
	2	347	Instant Start	7305	*BAF232IS/347	56	0.89	10	0.17	0/-18	6	844366073052
		347	Instant Start	7306	*BAF232IS/347/L	51	0.83	10	0.151	0/-18	6	844366073069
		347	Instant Start	7307	*BAF232IS/347/H	74	1.18	10	0.222	0/-18	6	844366073076
		347	Instant Start	7308	*BAF332IS/347	61	0.99	10	0.186	0/-18	9	844366073083
		347	Instant Start	7309	*BAF332IS/347/L	60	0.9	10	0.179	0/-18	9	844366073090
		347	Instant Start	7310	*BAF332IS/347/H	82	1.24	10	0.244	0/-18	9	844366073106
	3	347	Instant Start	7308	*BAF332IS/347	81	0.86	10	0.24	0/-18	8	844366073083
		347	Instant Start	7309	*BAF332IS/347/L	75	0.78	10	0.225	0/-18	8	844366073090
		347	Instant Start	7310	*BAF332IS/347/H	107	1.15	10	0.324	0/-18	8	844366073106
		347	Instant Start	7311	*BAF432IS/347	88	0.94	10	0.26	0/-18	11	844366073113
		347	Instant Start	7312	*BAF432IS/347/L	80	0.82	10	0.238	0/-18	11	844366073120
	4	347	Instant Start	7311	*BAF432IS/347	108	0.87	10	0.32	0/-18	10	844366073113
		347	Instant Start	7312	*BAF432IS/347/L	98	0.77	10	0.296	0/-18	10	844366073120

*Items only available for special orders

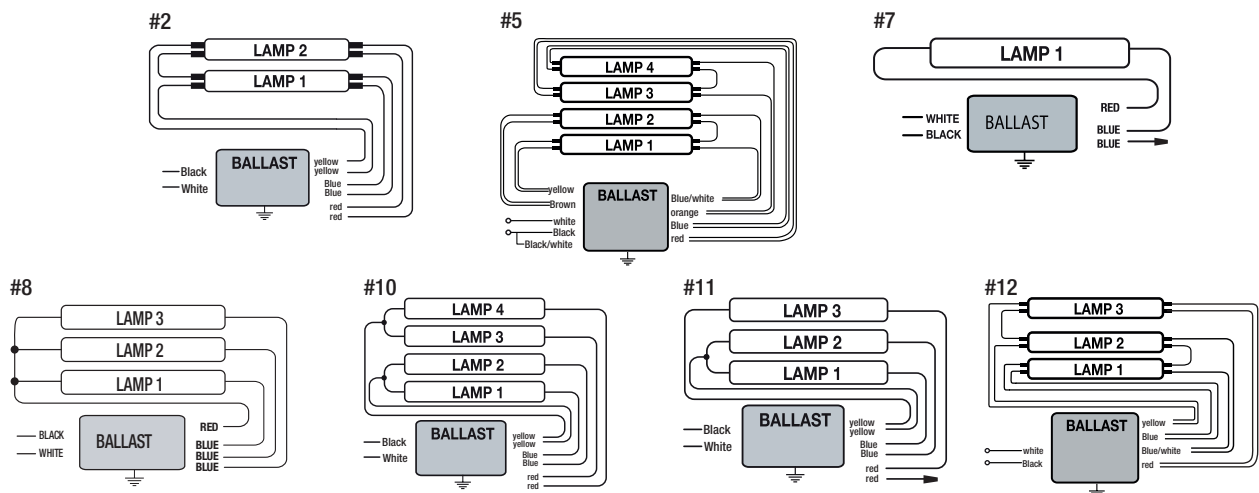



ELECTRONIC FL BALLASTS

For 17W T8 Lamps ■ ■ ■

Product Information												
Lamp Type	Number of lamps	Input voltage (V)	Lamp Start Method	Item#	Description	Wattage (W)	Ballast Factor	ATHD (%)	Line Current (A)	Min Start Temp (F/C)	Wiring Diagram	UPC
T8	F17T8 - 17W											
	1	120-277	Instant Start	7282	*BAF232IS/MV	19	1.06	15	0.17-0.08	0/-18	7	844366072826
		120-277	Instant Start	7283	*BAF232IS/MV/L	18	0.9	20	0.15-0.07	0/-18	7	844366072833
		120-277	Instant Start	7284	*BAF232IS/MV/H	25	1.42	20	0.22-0.11	0/-18	7	844366072840
	2	120-277	Instant Start	7282	*BAF232IS/MV	30	0.9	10	0.26-0.11	0/-18	6	844366072826
		120-277	Instant Start	7283	*BAF232IS/MV/L	27	0.85	10	0.23-0.10	0/-18	6	844366072833
		120-277	Instant Start	7284	*BAF232IS/MV/H	39	1.23	15	0.33-0.15	0/-18	6	844366072840
		120-277	Instant Start	7288	*BAF332IS/MV	36	1.07	15	0.31-0.14	0/-18	9	844366072888
		120-277	Instant Start	7289	*BAF332IS/MV/L	33	0.89	15	0.28-0.19	0/-18	9	844366072895
		120-277	Instant Start	7290	*BAF332IS/MV/H	48	1.38	10	0.39-0.20	0/-18	9	844366072901
	3	120-277	Instant Start	7288	*BAF332IS/MV	46	0.92	10	0.39-0.18	0/-18	8	844366072888
		120-277	Instant Start	7289	*BAF332IS/MV/L	43	0.89	15	0.37-0.16	0/-18	8	844366072895
		120-277	Instant Start	7290	*BAF332IS/MV/H	60-58	1.19	10	0.49-0.22	0/-18	8	844366072901
		120-277	Instant Start	7294	*BAF432IS/MV	54-52	1.04	15	0.49-0.19	0/-18	11	844366072949
		120-277	Instant Start	7295	*BAF432IS/MV/L	43	0.85	15	0.36-0.16	0/-18	11	844366072956
		120-277	Instant Start	7296	*BAF432IS/MV/H	63	1.29	10	0.52-0.24	0/-18	11	844366072963

*Items only available for special orders

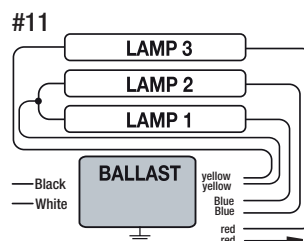
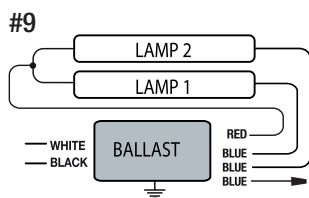
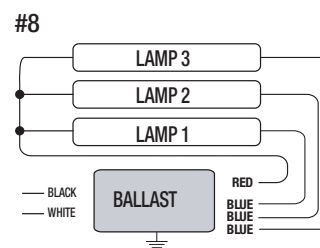
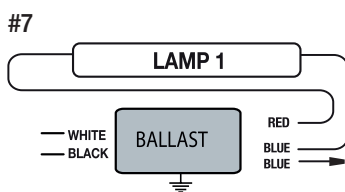
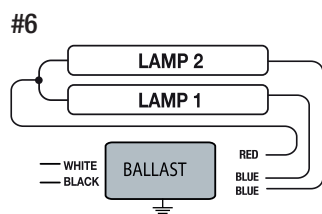

HID

HALOGEN

CFL

FL

BALLAST

GERMICIDAL

Plusrite®

■ ■ ■ For 17W T8 Lamps

HID

HALOGEN

CFL

FL

BALLAST

GERMICIDAL

Product Information												
Lamp Type	Number of lamps	Input voltage (V)	Lamp Start Method	Item#	Description	Wattage (W)	Ballast Factor	ATHD (%)	Line Current (A)	Min Start Temp (F/C)	Wiring Diagram	UPC
T8	F17T8 - 17W											
	4	120-277	Instant Start	7294	*BAF432IS/MV	59	0.91	10	0.50-0.22	0/-18	10	844366072949
		120-277	Instant Start	7295	*BAF432IS/MV/L	54-52	0.81	10	0.46-0.19	0/-18	10	844366072956
		120-277	Instant Start	7296	*BAF432IS/MV/H	79-75	1.18	10	0.63-0.29	0/-18	10	844366072963
	2	347	Instant Start	7305	*BAF232IS/347	33	0.91	10	0.101	0/-18	6	844366073052
		347	Instant Start	7306	*BAF232IS/347/L	32	0.88	10	0.094	0/-18	6	844366073069
		347	Instant Start	7307	*BAF232IS/347/H	43	1.22	10	0.128	0/-18	6	844366073076
	3	347	Instant Start	7308	*BAF332IS/347	46	0.92	10	0.137	0/-18	8	844366073083
		347	Instant Start	7309	*BAF332IS/347/L	43	0.84	10	0.126	0/-18	8	844366073090
		347	Instant Start	7310	*BAF332IS/347/H	60	1.2	10	0.178	0/-18	8	844366073106
	4	347	Instant Start	7311	*BAF432IS/347	60	0.91	10	0.176	0/-18	10	844366073113
		347	Instant Start	7312	*BAF432IS/347/L	55	0.79	10	0.162	0/-18	10	844366073120

*Items only available for special orders

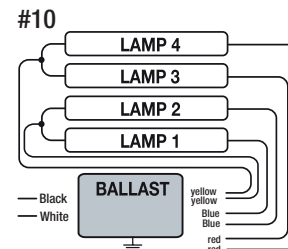
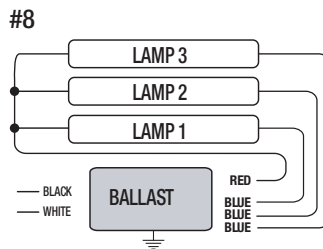
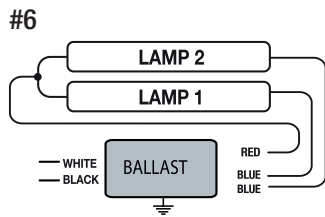



ELECTRONIC FL BALLASTS

For 25W T8 Lamps ■ ■ ■

Product Information												
Lamp Type	Number of lamps	Input voltage (V)	Lamp Start Method	Item#	Description	Wattage (W)	Ballast Factor	ATHD (%)	Line Current (A)	Min Start Temp (F/C)	Wiring Diagram	UPC
T8	F25T8 - 25W											
	1	120-277	Instant Start	7282	*BAF232IS/MV	28	1.05	10	0.23-0.10	0/-18	7	844366072826
		120-277	Instant Start	7283	*BAF232IS/MV/L	24	0.9	10	0.20-0.09	0/-18	7	844366072833
		120-277	Instant Start	7284	*BAF232IS/MV/H	35	1.4	15	0.29-0.13	0/-18	7	844366072840
	2	120-277	Instant Start	7282	*BAF232IS/MV	43	0.88	10	0.37-0.16	0/-18	6	844366072826
		120-277	Instant Start	7283	*BAF232IS/MV/L	39	0.78	10	0.32-0.14	0/-18	6	844366072833
		120-277	Instant Start	7284	*BAF232IS/MV/H	57	1.2	10	0.48-0.21	0/-18	6	844366072840
		120-277	Instant Start	7288	*BAF332IS/MV	50	1.02	10	0.43-0.19	0/-18	9	844366072888
		120-277	Instant Start	7289	*BAF332IS/MV/L	44	0.87	10	0.37-0.17	0/-18	9	844366072895
		120-277	Instant Start	7290	*BAF332IS/MV/H	64	1.32	10	0.54-0.24	0/-18	9	844366072901
	3	120-277	Instant Start	7288	*BAF332IS/MV	65	0.9	10	0.55-0.24	0/-18	8	844366072888
		120-277	Instant Start	7289	*BAF332IS/MV/L	57	0.8	10	0.48-0.22	0/-18	8	844366072895
		120-277	Instant Start	7290	*BAF332IS/MV/H	84	1.2	10	0.70-0.31	0/-18	8	844366072901
		120-277	Instant Start	7294	*BAF432IS/MV	72	0.98	10	0.60-0.27	0/-18	11	844366072949
		120-277	Instant Start	7295	*BAF432IS/MV/L	62-61	0.84	10	0.53-0.22	0/-18	11	844366072956
		120-277	Instant Start	7296	*BAF432IS/MV/H	89-87	1.26	10	0.75-0.32	0/-18	11	844366072963

*Items only available for special orders

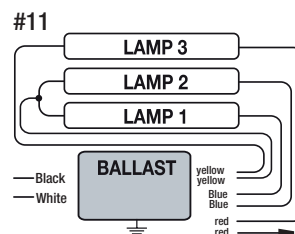
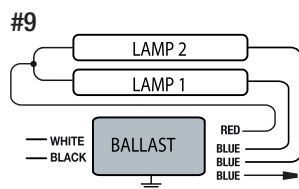
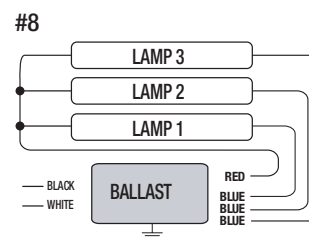
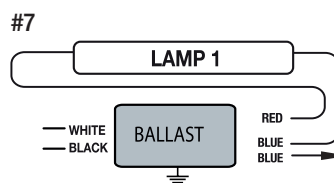
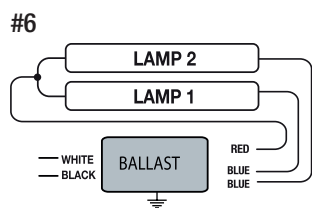

HID

HALOGEN

CFL

FL

BALLAST

GERMICIDAL

■ ■ ■ For 25W T8 Lamps

HID

HALOGEN

CFL

FL

BALLAST

GERMICIDAL

Product Information

Lamp Type	Number of lamps	Input voltage (V)	Lamp Start Method	Item#	Description	Wattage (W)	Ballast Factor	ATHD (%)	Line Current (A)	Min Start Temp (F/C)	Wiring Diagram	UPC
T8	F25T8 - 25W											
	4	120-277	Instant Start	7294	*BAF432IS/MV	86	0.89	10	0.73-0.32	0/-18	10	844366072949
		120-277	Instant Start	7295	*BAF432IS/MV/L	76-74	0.78	10	0.64-0.27	0/-18	10	844366072956
		120-277	Instant Start	7296	*BAF432IS/MV/H	109	1.17	10	0.92-0.40	0/-18	10	844366072963
	2	120-277	Program Start	7300	*BAF232PS/MV	50-49	1	10	0.42-0.18	0/-18	2	844366073007
		120-277	Program Start	7302	*BAF232PS/MV/H	63-60	1.18	10	0.53-0.22	0/-18	2	844366073021
	3	120-277	Program Start	7303	*BAF332PS/MV	75-73	0.88	10	0.63-0.27	0/-18	12	844366073038
		120-277	Program Start	7304	*BAF332PS/MV/H	88-87	1.18	10	0.76-0.33	0/-18	12	844366073045
	1	347	Instant Start	7305	*BAF232IS/347	30	1.08	10	0.09	0/-18	7	844366073052
		347	Instant Start	7306	*BAF232IS/347/L	28	0.89	10	0.085	0/-18	7	844366073069
		347	Instant Start	7307	*BAF232IS/347/H	38	1.39	10	0.112	0/-18	7	844366073076
	2	347	Instant Start	7305	*BAF232IS/347	45	0.89	10	0.134	0/-18	6	844366073052
		347	Instant Start	7306	*BAF232IS/347/L	43	0.84	10	0.125	0/-18	6	844366073069
		347	Instant Start	7307	*BAF232IS/347/H	58	1.19	10	0.172	0/-18	6	844366073076
		347	Instant Start	7308	*BAF332IS/347	49	1	10	0.146	0/-18	9	844366073083
		347	Instant Start	7309	*BAF332IS/347/L	46	0.93	10	0.137	0/-18	9	844366073090
		347	Instant Start	7310	*BAF332IS/347/H	62	1.25	10	0.184	0/-18	9	844366073106
	3	347	Instant Start	7308	*BAF332IS/347	65	0.9	10	0.188	0/-18	8	844366073083
		347	Instant Start	7309	*BAF332IS/347/L	60	0.8	10	0.176	0/-18	8	844366073090
		347	Instant Start	7310	*BAF332IS/347/H	81	1.17	10	0.234	0/-18	8	844366073106
	4	347	Instant Start	7311	*BAF432IS/347	82	0.87	10	0.24	0/-18	10	844366073113
		347	Instant Start	7312	*BAF432IS/347/L	76	0.78	10	0.225	0/-18	10	844366073120

*Items only available for special orders

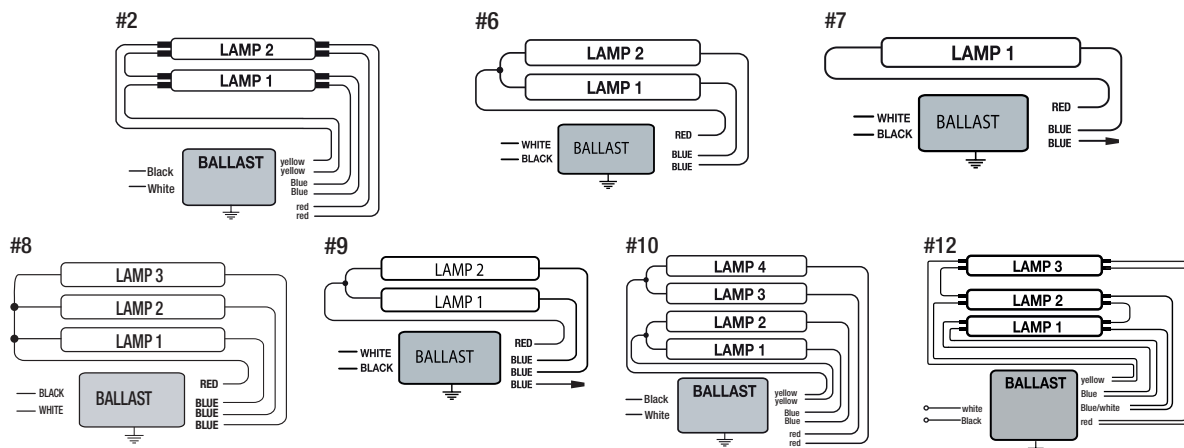



ELECTRONIC FL BALLASTS

For 28W T8 Lamps ■ ■ ■

Product Information												
Lamp Type	Number of lamps	Input voltage (V)	Lamp Start Method	Item#	Description	Wattage (W)	Ballast Factor	ATHD (%)	Line Current (A)	Min Start Temp (F/C)	Wiring Diagram	UPC
T8	F28T8 - 28W											
	1	120-277	Instant Start	7282	*BAF232IS/MV	31	1.05	10	0.26-0.11	0/-18	7	844366072826
		120-277	Instant Start	7283	*BAF232IS/MV/L	26	0.9	10	0.22-0.10	0/-18	7	844366072833
		120-277	Instant Start	7284	*BAF232IS/MV/H	40	1.1	15	0.34-0.16	0/-18	7	844366072840
	2	120-277	Instant Start	7282	*BAF232IS/MV	48	0.89	10	0.41-0.18	0/-18	6	844366072826
		120-277	Instant Start	7283	*BAF232IS/MV/L	43	0.77	10	0.37-0.16	0/-18	6	844366072833
		120-277	Instant Start	7284	*BAF232IS/MV/H	67	1.19	10	0.57-0.25	0/-18	6	844366072840
		120-277	Instant Start	7288	*BAF332IS/MV	56	1.02	10	0.48-0.21	0/-18	9	844366072888
		120-277	Instant Start	7289	*BAF332IS/MV/L	48	0.87	10	0.41-0.19	0/-18	9	844366072895
		120-277	Instant Start	7290	*BAF332IS/MV/H	74	1.3	10	0.63-0.28	0/-18	9	844366072901
	3	120-277	Instant Start	7288	*BAF332IS/MV	74	0.88	10	0.63-0.27	0/-18	8	844366072888
		120-277	Instant Start	7289	*BAF332IS/MV/L	66	0.78	10	0.56-0.24	0/-18	8	844366072895
		120-277	Instant Start	7290	*BAF332IS/MV/H	97	1.17	10	0.82-0.36	0/-18	8	844366072901
		120-277	Instant Start	7294	*BAF432IS/MV	80	0.98	10	0.67-0.29	0/-18	11	844366072949
		120-277	Instant Start	7295	*BAF432IS/MV/L	69-68	0.85	0	0.57-0.25	0/-18	11	844366072956
		120-277	Instant Start	7296	*BAF432IS/MV/H	98-95	1.24	10	0.80-0.36	0/-18	11	844366072963

*Items only available for special orders

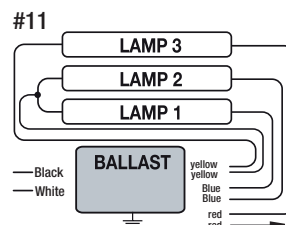
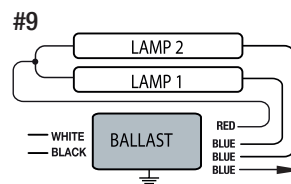
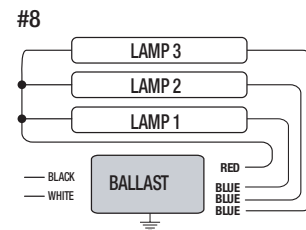
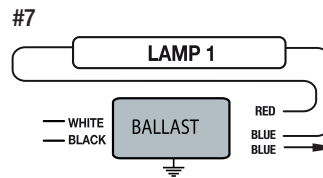
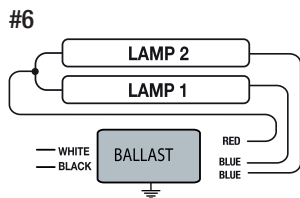

HID

HALOGEN

CFL

FL

BALLAST

GERMICIDAL

■ ■ ■ For 28W T8 Lamps

HID

HALOGEN

CFL

FL

BALLAST

GERMICIDAL

Product Information

Lamp Type	Number of lamps	Input voltage (V)	Lamp Start Method	Item#	Description	Wattage (W)	Ballast Factor	ATHD (%)	Line Current (A)	Min Start Temp (F/C)	Wiring Diagram	UPC
T8	F28T8 - 28W											
	4	120-277	Instant Start	7294	*BAF432IS/MV	97-96	0.88	10	0.82-0.36	0/-18	10	844366072949
		120-277	Instant Start	7295	*BAF432IS/MV/L	84-82	0.77	10	0.71-0.30	0/-18	10	844366072956
		120-277	Instant Start	7296	*BAF432IS/MV/H	116-115	1.16	10	0.98-0.42	0/-18	10	844366072963
	2	120-277	Program Start	7300	*BAF232PS/MV	52-51	0.9	10	0.44-0.19	0/-18	2	844366073007
		120-277	Program Start	7302	*BAF232PS/MV/H	67	1.19	10	0.57-0.25	0/-18	2	844366073021
	3	120-277	Program Start	7303	*BAF332PS/MV	72-71	0.88	10	0.60-0.26	0/-18	12	844366073038
		120-277	Program Start	7304	*BAF332PS/MV/H	97	1.17	10	0.82-0.36	0/-18	12	844366073045
	1	347	Instant Start	7305	*BAF232IS/347	32	1.08	10	0.098	60/16	7	844366073052
		347	Instant Start	7306	*BAF232IS/347/L	30	0.88	10	0.09	60/16	7	844366073069
		347	Instant Start	7307	*BAF232IS/347/H	41	1.37	10	0.123	60/16	7	844366073076
	2	347	Instant Start	7305	*BAF232IS/347	50	0.89	10	0.148	60/16	6	844366073052
		347	Instant Start	7306	*BAF232IS/347/L	46	0.83	10	0.136	60/16	6	844366073069
		347	Instant Start	7307	*BAF232IS/347/H	66	1.18	10	0.193	60/16	6	844366073076
		347	Instant Start	7308	*BAF332IS/347	54	0.99	10	0.16	60/16	9	844366073083
		347	Instant Start	7309	*BAF332IS/347/L	49	0.9	10	0.147	60/16	9	844366073090
		347	Instant Start	7310	*BAF332IS/347/H	70	1.24	10	0.209	60/16	9	844366073106
	3	347	Instant Start	7308	*BAF332IS/347	71	0.86	10	0.207	60/16	8	844366073083
		347	Instant Start	7309	*BAF332IS/347/L	65	0.79	10	0.192	60/16	8	844366073090
		347	Instant Start	7310	*BAF332IS/347/H	92	1.15	10	0.273	60/16	8	844366073106
		347	Instant Start	7311	*BAF432IS/347	77	0.94	10	0.226	60/16	11	844366073113
		347	Instant Start	7312	*BAF432IS/347/L	68	0.82	10	0.201	60/16	11	844366073120
	4	347	Instant Start	7311	*BAF432IS/347	93	0.87	10	0.273	60/16	10	844366073113
		347	Instant Start	7312	*BAF432IS/347/L	84	0.77	10	0.248	60/16	10	844366073120

*Items only available for special orders

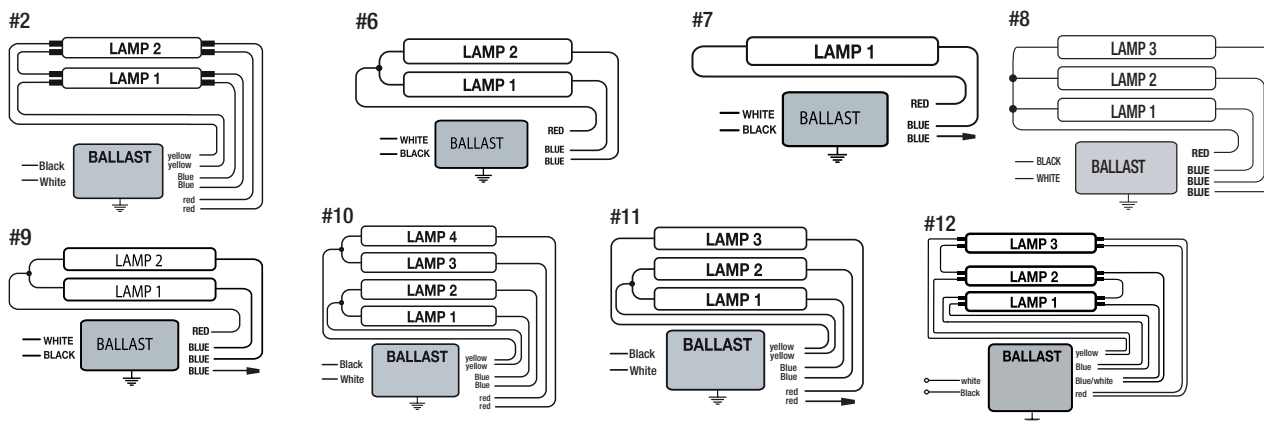



ELECTRONIC FL BALLASTS

For 30W T8 Lamps ■ ■ ■

Product Information												
Lamp Type	Number of lamps	Input voltage (V)	Lamp Start Method	Item#	Description	Wattage (W)	Ballast Factor	ATHD (%)	Line Current (A)	Min Start Temp (F/C)	Wiring Diagram	UPC
T8	F30T8 - 30W											
	1	120-277	Instant Start	7282	*BAF232IS/MV	33	1.05	10	0.28-0.12	0/-18	7	844366072826
		120-277	Instant Start	7283	*BAF232IS/MV/L	28	0.9	10	0.24-0.11	0/-18	7	844366072833
		120-277	Instant Start	7284	*BAF232IS/MV/H	42	1.38	10	0.25-0.16	0/-18	7	844366072840
	2	120-277	Instant Start	7282	*BAF232IS/MV	51	0.89	10	0.43-0.19	0/-18	6	844366072826
		120-277	Instant Start	7283	*BAF232IS/MV/L	46	0.77	10	0.39-0.17	0/-18	6	844366072833
		120-277	Instant Start	7284	*BAF232IS/MV/H	72	1.19	10	0.61-0.27	0/-18	6	844366072840
		120-277	Instant Start	7288	*BAF332IS/MV	59	1.02	10	0.49-0.22	0/-18	9	844366072888
		120-277	Instant Start	7289	*BAF332IS/MV/L	52	0.87	10	0.44-0.20	0/-18	9	844366072895
		120-277	Instant Start	7290	*BAF332IS/MV/H	78	1.3	10	0.65-0.29	0/-18	9	844366072901
	3	120-277	Instant Start	7288	*BAF332IS/MV	80	0.88	10	0.68-0.28	0/-18	8	844366072888
		120-277	Instant Start	7289	*BAF332IS/MV/L	71	0.78	10	0.60-0.26	0/-18	8	844366072895
		120-277	Instant Start	7290	*BAF332IS/MV/H	104	1.17	10	0.88-0.38	0/-18	8	844366072901
		120-277	Instant Start	7294	*BAF432IS/MV	84	0.98	10	0.71-0.31	0/-18	11	844366072949
		120-277	Instant Start	7295	*BAF432IS/MV/L	75-74	0.84	10	0.62-0.27	0/-18	11	844366072956
		120-277	Instant Start	7296	*BAF432IS/MV/H	105-101	1.24	10	0.88-0.37	0/-18	11	844366072963
	4	120-277	Instant Start	7294	*BAF432IS/MV	105	0.88	10	0.89-0.39	0/-18	10	844366072949
		120-277	Instant Start	7295	*BAF432IS/MV/L	90-88	0.77	10	0.76-0.32	0/-18	10	844366072956
		120-277	Instant Start	7296	*BAF432IS/MV/H	120	1.16	10	1.01-0.44	0/-18	10	844366072963
	2	120-277	Program Start	7300	*BAF232PS/MV	54-53	0.9	10	0.45-0.20	0/-18	2	844366073007
		120-277	Program Start	7302	*BAF232PS/MV/H	72	1.19	10	0.61-0.27	0/-18	2	844366073021

*Items only available for special orders

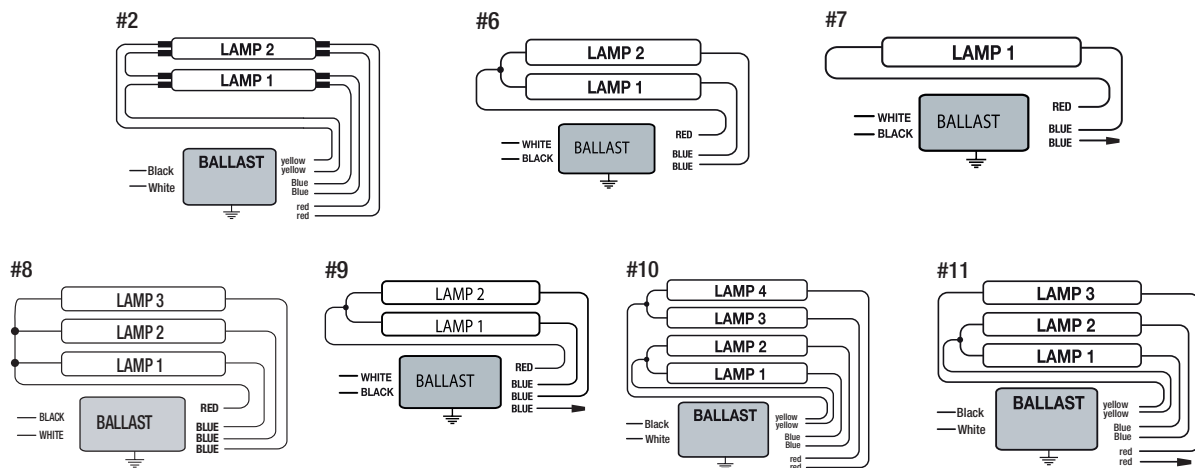

HID

HALOGEN

CFL

FL

BALLAST

GERMICIDAL

■ ■ ■ For 30W T8 Lamps

HID

HALOGEN

CFL

FL

BALLAST

GERMICIDAL

Product Information

Lamp Type	Number of lamps	Input voltage (V)	Lamp Start Method	Item#	Description	Wattage (W)	Ballast Factor	ATHD (%)	Line Current (A)	Min Start Temp (F/C)	Wiring Diagram	UPC
T8	F30T8 - 30W											
	3	120-277	Program Start	7303	*BAF332PS/MV	77-76	0.88	10	0.64-0.28	0/-18	12	844366073038
		120-277	Program Start	7304	*BAF332PS/MV/H	104	1.17	10	0.88-0.38	0/-18	12	844366073045
	1	347	Instant Start	7305	*BAF232IS/347	34	1.08	10	0.105	60/16	7	844366073052
		347	Instant Start	7306	*BAF232IS/347/L	33	0.88	10	0.098	60/16	7	844366073069
		347	Instant Start	7307	*BAF232IS/347/H	44	1.37	10	0.132	60/16	7	844366073076
	2	347	Instant Start	7305	*BAF232IS/347	54	0.89	10	0.16	60/16	6	844366073052
		347	Instant Start	7306	*BAF232IS/347/L	50	0.83	10	0.147	60/16	6	844366073069
		347	Instant Start	7307	*BAF232IS/347/H	71	1.18	10	0.21	60/16	6	844366073076
		347	Instant Start	7308	*BAF332IS/347	56	0.99	10	0.172	60/16	9	844366073083
		347	Instant Start	7309	*BAF332IS/347/L	54	0.9	10	0.16	60/16	9	844366073090
		347	Instant Start	7310	*BAF332IS/347/H	76	1.24	10	0.224	60/16	9	844366073106
	3	347	Instant Start	7308	*BAF332IS/347	77	0.86	10	0.226	60/16	8	844366073083
		347	Instant Start	7309	*BAF332IS/347/L	71	0.79	10	0.208	60/16	8	844366073090
		347	Instant Start	7310	*BAF332IS/347/H	101	1.15	10	0.299	60/16	8	844366073106
		347	Instant Start	7311	*BAF432IS/347	82	0.94	10	0.243	60/16	11	844366073113
		347	Instant Start	7312	*BAF432IS/347/L	74	0.82	10	0.222	60/16	11	844366073120
	4	347	Instant Start	7311	*BAF432IS/347	100	0.87	10	0.296	60/16	10	844366073113
		347	Instant Start	7312	*BAF432IS/347/L	90	0.77	10	0.267	60/16	10	844366073120

*Items only available for special orders

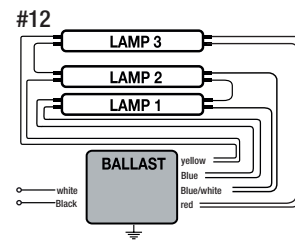
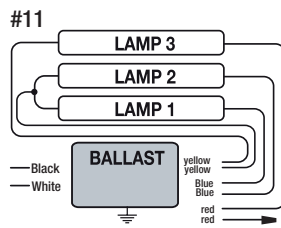
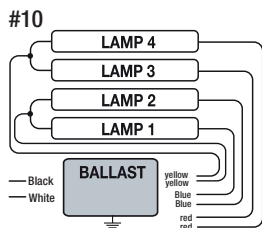
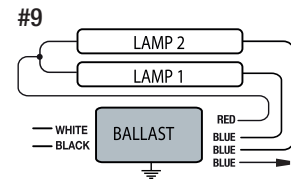
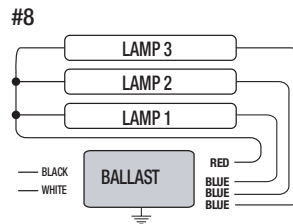
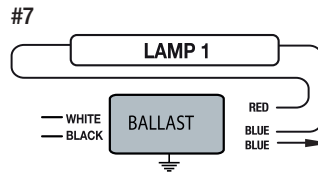
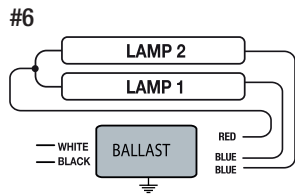



ELECTRONIC FL BALLASTS

For 40W T8 Lamps ■ ■ ■

Product Information												
Lamp Type	Number of lamps	Input voltage (V)	Lamp Start Method	Item#	Description	Wattage (W)	Ballast Factor	ATHD (%)	Line Current (A)	Min Start Temp (F/C)	Wiring Diagram	UPC
T8	F40T8 - 40W											
	1	120-277	Instant Start	7282	*BAF232IS/MV	41	1.01	10	0.35-0.15	32/0	7	844366072826
		120-277	Instant Start	7283	*BAF232IS/MV/L	36	0.88	10	0.29-0.13	32/0	7	844366072833
		120-277	Instant Start	7284	*BAF232IS/MV/H	56-55	1.35	10	0.47-0.21	0/-18	7	844366072840
	2	120-277	Instant Start	7288	*BAF332IS/MV	75-74	1.03	10	0.65-0.28	32/0	9	844366072888
		120-277	Instant Start	7289	*BAF332IS/MV/L	68	0.87	10	0.50-0.26	32/0	9	844366072895
		120-277	Instant Start	7290	*BAF332IS/MV/H	102	1.3	10	0.86-0.37	32/0	9	844366072901
	3	120-277	Instant Start	7294	*BAF432IS/MV	110	0.94	10	0.93-0.39	32/0	11	844366072949
		120-277	Instant Start	7295	*BAF432IS/MV/L	98-96	0.84	10	0.82-0.35	32/0	11	844366072956
	120-277	Instant Start	7296	*BAF432IS/MV/H	143-139	1.25	10	1.22-0.51	0/-18	11	844366072963	

*Items only available for special orders

HID

HALOGEN

CFL

FL

BALLAST

GERMICIDAL

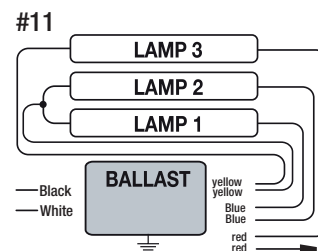
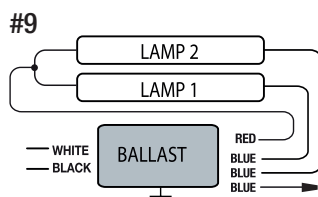
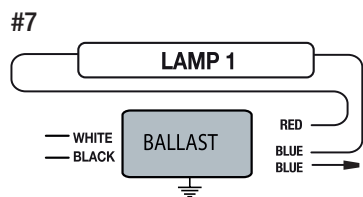

■ ■ ■ For Pulse Start Metal Halide

HID

HALOGEN

CFL

FL

BALLAST

GERMICIDAL

Product Information															
Watts	ANSI Code	Item#	Description	Case Qty.	Input Voltage	Circuit Type	Input Watts	Max. Line Current	A (in)	B (in)	Wt (lbs)	Coil Temp Code	Cap Requirement. (µfd/Vmin)	Wiring Diagram	UPC
Pulse Start Metal Halide Ballast Kits - 120V															
70	M98	7321	*BAPS70-HX/V120	1	120	HX-HPF	92	0.8	1.5	2.56	4.6	C	16/240	C-V120	844366073212
100	M90	7322	*BAPS100-HX/V120	1	120	HX-HPF	125	1.15	1.71	3.1	4.6	C	25/240	C-V120	844366073229
150	M102	7323	*BAPS150-HX/V120	1	120	HX-HPF	175	1.6	2.24	3.9	6.4	B	22/240	C-V120	844366073236
Pulse Start Metal Halide Ballast Kits - 4 Tap															
50	M110	7200	*BAPS50-HX/V4	1	120/208/240/277	HX-HPF	68	1.20/0.65/0.60/0.50	1.05	2.45	3.5	A	6/280	F-V4	844366072000
70	M98	7202	*BAPS70-HX/V4	1	120/208/240/277	HX-HPF	92	1.65/0.95/0.8/0.7	1.45	2.85	4.6	A	8/280	F-V4	844366072024
100	M90	7204	*BAPS100-HX/V4	1	120/208/240/277	HX-HPF	125	2.6/1.5/1.3/1.15	1.7	3.1	5.2	A	12/280	F-V4	844366072048
150	M102	7208	*BAPS150-HX/V4	1	120/208/240/277	HX-HPF	185	3.5/2.15/1.75/1.55	2.25	3.9	7.1	B/D/ C/C	16/280	F-V4	844366072086
175	M137/ M152	7212	*BAPS175-CWA/V4	1	120/208/240/277	CWA	199	1.80/1.05/0.90/0.80	3	4.4	9	A	12.5/330	E-V4	844366072123
200	M136	7214	*BAPS200-CWA/V4	1	120/208/240/277	CWA	227	1.9/1.1/0.95/0.85	2.5	3.9	8	A/A/ A/A	15/330	E-V4	844366072147
250	M138/ M153	7220	*BAPS250-CWA/V4	1	120/208/240/277	CWA	285	2.45/1.45/1.25/1.05	2	4.15	11	A/A/ A/A	16/370	E-V4	844366072208
320	M132/ M154	7222	*BAPS320-CWA/V4	1	120/208/240/277	CWA	364	3.1/1.8/1.55/1.35	2	4.15	10	B/B/ B/C	22/330	E-V4	844366072222
350	M131	7226	*BAPS350-CWA/V4	1	120/208/240/277	CWA	398	3.60/2.10/1.80/1.55	2	3.8	10.5	B/C/ C/C	24/330	E-V4	844366072260
400	M135/ M155	7232	*BAPS400-CWA/V4	1	120/208/240/277	CWA	453	4.00/2.30/2.00/1.75	2	3.9	10.7	C/C/ C/C	26/330	E-V4	844366072321
450	M144	7234	*BAPS450-CWA/V4	1	120/208/240/277	CWA	506	4.40/2.50/2.20/1.90	2.3	4.2	12.4	A/A/ B/B	32/300	E-V4	844366072345
575	M178	7236	*BAPS575-HX/V4	1	120/208/240/277	HX-HPF	635	8.75/4.70/4.45/3.80	3.25	5	18	A/A/ A/A	38/330	F-V4	844366072369
750	M149	7237	*BAPS750-CWA/V4	1	120/208/240/277	CWA	815	6.80/4.00/3.40/3.00	2.8	4.8	18	B/C/ B/B	24/480	E-V4	844366072376
1000	M141	7240	*BAPS1000-CWA/V4	1	120/208/240/277	CWA	1082	9.00/5.20/4.50/3.90	2.8	4.8	21	D/A/ B/B	24/480	E-V4	844366072406

*Items only available for special orders

E-V4

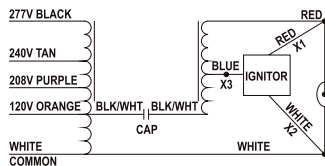

F-V4

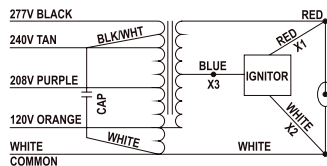

C-V120

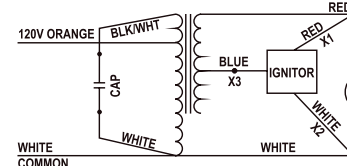

HID CORE & COIL BALLASTS

For Pulse Start Metal Halide ■ ■ ■

Product Information															
Watts	ANSI Code	Item#	Description	Case Qty.	Input Voltage	Circuit Type	Input Watts	Max. Line Current	A (in)	B (in)	Wt (lbs)	Coil Temp Code	Cap Require-ment. (ufd/Vmin)	Wiring Diagram	UPC
Pulse Start Metal Halide Ballast Kits - 5 Tap															
250	M138/M153	7281	*BAPS250-CWA/V5	1	120/208/240/277/480	CWA	285	2.45/1.45/1.25/1.05/0.60	2	3.58	11	A/A/A/A/A	16/370	E-V5	844366072819
320	M132/154	7268	*BAPS320-CWA/V5	1	120/208/240/277/480	CWA	364	3.1/1.8/1.55/1.35/0.80	2	3.58	10	B/B/B/C/C	22/330	E-V5	844366072680
350	M131	7269	*BAPS350-CWA/V5	1	120/208/240/277/480	CWA	398	3.60/2.10/1.80/1.55/0.85	2	3.58	10.5	B/C/C/C/C	24/330	E-V5	844366072697
400	M135/M155	7271	*BAPS400-CWA/V5	1	120/208/240/277/480	CWA	453	4.00/2.30/2.00/1.75/0.95	2	3.9	10.7	C/C/C/C/D	24/330	E-V5	844366072710
450	M144	7278	*BAPS450-CWA/V5	1	120/208/240/277/480	CWA	504	4.40/2.50/2.20/1.90/1.10	2	3.9	11.5	D/D/C/C/C	26/330	E-V5	844366072789
575	M178	7279	*BAPS575-CWA/V5	1	120/208/240/277/480	CWA	640	5.65/3.15/2.85/2.45/1.50	2.75	4.8	16.5	E/E/E/C/C	38/330	E-V5	844366072796
750	M149	7272	*BAPS750-CWA/V5	1	120/208/240/277/480	CWA	815	6.80/4.00/3.40/3.00/1.80	2.83	4.41	18	B/C/B/B/C	24/480	E-V5	844366072727
1000	M141/E	7273	*BAPS1000-CWA/V5	1	120/208/240/277/480	CWA	1080	8.95/5.55/4.55/3.95/2.25	2.8	4.8	21	D/D/D/D/C	24/480	E-V5	844366072734
Pulse Start Metal Halide Ballast Kits - 3 Tap															
50	M110	7201	*BAPS50-HX/V3	1	120/277/347	HX-HPF	70	0.65/0.27/0.22	1.06	2.45	3.4	A/A/A	6/280	B1-V3	844366072017
70	M98	7203	*BAPS70-HX/V3	1	120/277/347	HX-HPF	98	0.85/0.37/0.30	1.46	2.85	4.4	H/G/G	8/280	B1-V3	844366072031
100	M90	7205	*BAPS100-HX/V3	1	120/277/347	HX-HPF	130	1.15/0.51/0.40	1.71	3.1	5.1	K/V/G	12/280	B1-V3	844366072055
150	M102	7209	*BAPS150-HX/V3	1	120/277/347	HX-HPF	182	1.60/0.70/0.55	2.24	3.9	6.9	G/G/G	16/280	B1-V3	844366072093
250	M153/M138	7221	*BAPS250-CWA/V3	1	120/277/347	CWA	288	2.50/1.10/0.86	2	4.15	11	A/B/B	16/370	B-V3	844366072215
320	M132/M154	7223	*BAPS320-CWA/V3	1	120/277/347	CWA	368	3.20/1.31/1.05	2	4.15	10	B/C/D	22/330	B-V3	844366072239
350	M131	7227	*BAPS350-CWA/V3	1	120/277/347	CWA	400	3.38/1.47/1.17	2	3.8	10.5	D/D/E	24/330	B-V3	844366072277
400	M135/M155	7233	*BAPS400-CWA/V3	1	120/277/347	CWA	451	4.36/1.90/1.50	2	3.9	10.7	E/E/E	26/330	B-V3	844366072338
750	M149	7238	*BAPS750-CWA/V3	1	120/277/347	CWA	815	7.04/3.13/2.5	2.8	4.8	18	E/E/E	24/480	B-V3	844366072383
1000	M141	7241	*BAPS1000-CWA/V3	1	120/277/347	M141	1080	8.9/3.90/3.15	2.93	4.95	24.5	E/E/E	24/480	B-V3	844366072413
Pulse Start Metal Halide Ballast Kits - 480V															
1000	M141	7242	*BAPS1000-CWA/V480	1	480	M141	1082	3.9	2.82	4.85	21	D	24/480	o-V480	844366072420

*Items only available for special orders

E-V5

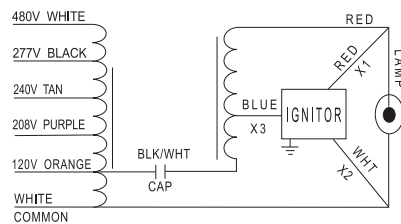

B1-V3

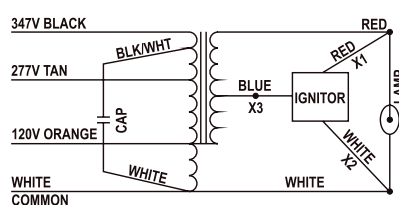

B-V3

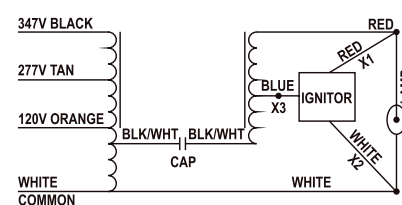

HID

HALOGEN

CFL

FL

BALLAST

GERMICIDAL

■ ■ ■ For Standard Metal Halide

HID

HALOGEN

CFL

FL

BALLAST

GERMICIDAL

Product Information															
Watts	ANSI Code	Item#	Description	Case Qty.	Input Voltage	Circuit Type	Input Watts	Max. Line Current	A (in)	B (in)	Wt (lbs)	Coil Temp Code	Cap Requirement. (µfd/Vmin)	Wiring Diagram	UPC
Standard Metal Halide Ballast Kits - 4 Tap															
175	M57	7210	*BAMH175-CWA/V4	1	120/208/240/277	CWA	215	1.85/1.10/0.90/0.80	2.4	3.8	7	B/C/C/B	10/400	M1-V4	844366072109
250	M58	7216	*BAMH250-CWA/V4	1	120/208/240/277	CWA	290	2.60/1.50/1.30/1.15	1.46	3.3	8.3	A	15/400	M1-V4	844366072161
400	M59	7230	*BAMH400-CWA/V4	1	120/208/240/277	CWA	458	3.95/2.30/2.00/1.75	2	4.1	10	D/E/E/E	24/360	M1-V4	844366072307
1000	M47	7243	*BAMH1000-CWA/V4	1	120/208/240/277	CWA	1080	9.00/5.20/4.50/3.90	2.8	4.8	20.5	D/A/A/A	24/480	M1-V4	844366072437
1500	M48	7247	*BAMH1500-CWA/V4	1	120/208/240/277	CWA	1605	13.40/7.75/6.70/5.80	4.33	6.33	31	G/E/E/E	32/525	M1-V4	844366072475
Standard Metal Halide Ballast Kits - 5 Tap															
175	M57	7266	*BAMH175-CWA/V5	1	120/208/240/277/480	CWA	215	1.85/1.10/0.90/0.80/0.40	2.44	4.02	7	B/C/C/B/B	10/400	M1-V5	844366072666
250	M58	7267	*BAMH250-CWA/V5	1	120/208/240/277/480	CWA	290	2.60/1.50/1.30/1.15/0.65	2	3.58	8.3	A	15/400	M1-V5	844366072673
400	M59	7270	*BAMH400-CWA/V5	1	120/208/240/277/480	CWA	458	3.95/2.30/2.00/1.75/1.00	2	3.58	10	D/E/E/E/E	24/360	M1-V5	844366072703
1000	M47	7274	*BAMH1000-CWA/V5	1	120/208/240/277/480	CWA	1080	9.00/5.20/4.50/3.90/2.36	3.35	4.92	20.5	D/A/A/A/A	24/480	M1-V5	844366072741
Standard Metal Halide Ballast Kits - 3 Tap															
175	M57	7211	*BAMH175-CWA/V3	1	120/277/347	CWA	210	1.85/0.83/0.69	2.42	3.8	7	C/D/D	10/400	M1-V3	844366072116
250	M58	7218	*BAMH250-CWA/V3	1	120/277/347	CWA	293	2.36/1.03/0.83	1.46	3.3	8.3	B/C/C	15/400	M1-V3	844366072185
400	M59	7231	*BAMH400-CWA/V3	1	120/277/347	CWA	458	3.95/1.72/1.37	2	4.1	10	D/E/E	24/360	M1-V3	844366072314
1000	M47	7244	*BAMH1000-CWA/V3	1	120/277/347	CWA	1080	9.00/3.95/3.18	2.8	4.8	20.5	E/E/E	24/480	M1-V3	844366072444
Standard Metal Halide Ballast Kits - 120V															
1000	M47	7280	*BAMH1000-CWA/V120	1	120	CWA	1080	9	2.83	4.8	20.5	D	24/480	M1-V120	844366072802
Standard Metal Halide Ballast Kits - 480V															

*Items only available for special orders

M1-V4

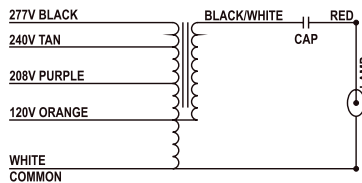

M1-V5

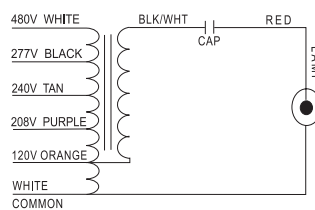

M1-V3

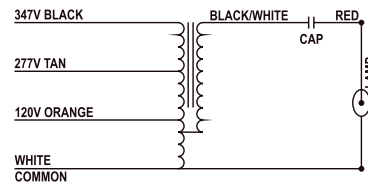

M1-V120

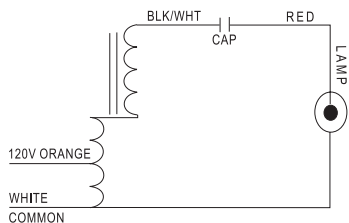



HID CORE & COIL BALLASTS

For High Pressure Sodium ■ ■ ■

Product Information															
Watts	ANSI Code	Item#	Description	Case Qty.	Input Voltage	Circuit Type	Input Watts	Max. Line Current	A (in)	B (in)	Wt (lbs)	Coil Temp Code	Cap Requirement. (ufd/Vmin)	Wiring Diagram	UPC
1500	M48	7329	*BAMH1500-CWA/V480	1	480	CWA	1610	3.45	4.33	6.33	31	H	32/525	M1-V480	844366073298
High Pressure Sodium Ballast Kits - 1 Tap															
35	S76	7324	*BALU35-R/V120	1	120	R-HPF	44	0.8	0.98	2.05	1.4	A	14/150	G	844366073243
50	S68	7325	*BALU50-R/V120	1	120	R-HPF	59.3	0.9	1.18	2.36	1.7	A	20/150	G	844366073250
70	S62	7326	*BALU70-R/V120	1	120	R-HPF	82.3	1.2	1.57	2.68	2.1	D	25/150	G	844366073267
100	S54	7327	*BALU100-R/V120	1	120	R-HPF	116	1.8	1.97	3.15	2.7	F	38/150	G	844366073274
150	S55	7328	*BALU150-R/V120	1	120	R-HPF	171	2.3	2.36	3.54	3.2	F	50/150	G	844366073281
High Pressure Sodium Ballast Kits - 2 Tap															
50	S68	7249	*BALU50-HX/V2	1	120/277	S68	66	1.00/0.45	1	2.4	3.6	A/A	5/280	C-V2	844366072499
High Pressure Sodium Ballast Kits - 4 Tap															
70	S62	7250	*BALU70-HX/V4	1	120/208/240/277	HX-HPF	90	1.50/0.85/0.75/0.65	1.5	2.95	4.6	A	7/280	F-V4	844366072505
100	S54	7252	*BALU100-HX/V4	1	120/208/240/277	HX-HPF	126	2.10/1.20/1.05/0.90	2	3.45	5.9	A	10/280	F-V4	844366072529
150	S55	7254	*BALU150-HX/V4	1	120/208/240/277	HX-HPF	188	2.80/1.60/1.40/1.25	2.5	3.8	7.4	D/B/C/C	14/280	F-V4	844366072543
250	S50	7257	*BALU250-CWA/V4	1	120/208/240/277	CWA	295	2.50/1.45/1.25/1.10	2.16	3.6	11	B	35/240	E-V4	844366072574
400	S51	7259	*BALU400-CWA/V4	1	120/208/240/277	CWA	460	3.80/2.20/1.90/1.70	2.75	4.65	14	C/C/D/C	55/240	E-V4	844366072598
1000	S52	7263	*BALU1000-CWA/V4	1	120/208/240/277	CWA	1100	9.50/5.50/4.75/4.20	4.33	6.33	27	C/B/C/C	26/525	E-V4	844366072635
High Pressure Sodium Ballast Kits - 5 Tap															
250	S50	7275	*BALU250-CWA/V5	1	120/208/240/277/480	CWA	295	2.50/1.45/1.25/1.10/0.66	2.16	3.74	11	B	35/240	E-V5	844366072758
400	S51	7276	*BALU400-CWA/V5	1	120/208/240/277/480	CWA	460	3.80/2.20/1.90/1.70/0.96	2.75	4.33	14	C/C/D/C/C	55/240	E-V5	844366072765

*Items only available for special orders

M1-V480

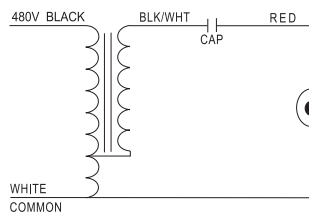

G

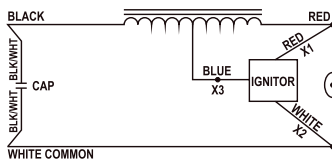

C-V2

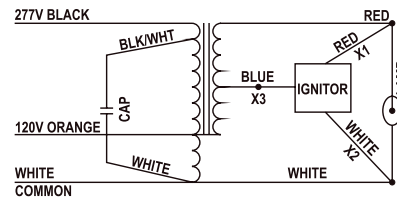

F-V4

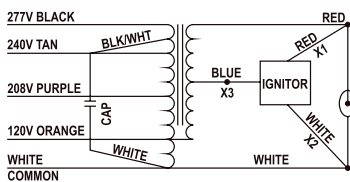

E-V4

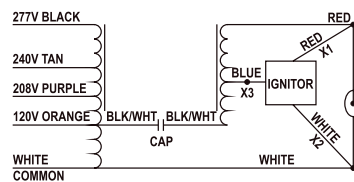

E-V5

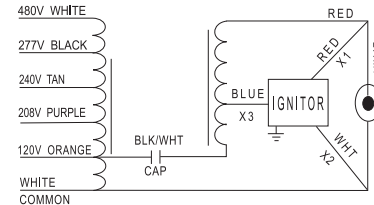

HID

HALOGEN

CFL

FL

BALLAST

GERMICIDAL

Plusrite®

■ ■ ■ For High Pressure Sodium

HID

HALOGEN

CFL

FL

BALLAST

GERMICIDAL

Product Information															
Watts	ANSI Code	Item#	Description	Case Qty.	Input Voltage	Circuit Type	Input Watts	Max. Line Current	A (in)	B (in)	Wt (lbs)	Coil Temp Code	Cap Requirement. (µfd/Vmin)	Wiring Diagram	UPC
1000	S52	7277	*BALU1000-CWA/V5	1	120/208/240/277/480	CWA	1100	9.50/5.50/4.75/4.20/2.31	4.33	5.91	27	C/B/ C/C/C	26/525	E-V5	844366072772
High Pressure Sodium Ballast Kits - 3 Tap															
70	S62	7251	*BALU70-HX/V3	1	120/277/347	S62	90	0.75/0.34/0.26	1.5	2.95	4.5	A/A/A	7/280	B1-V3	844366072512
100	S54	7253	*BALU100-HX/V3	1	120/277/347	S54	128	1.10/0.48/0.41	2.01	3.45	5.8	E/G/F	10/280	B1-V3	844366072536
150	S55	7255	*BALU150-HX/V3	1	120/277/347	S55	187	1.60/0.70/0.55	2.5	3.8	7.2	C/A/A	14/280	B1-V3	844366072550
250	S50	7258	*BALU250-CWA/V3	1	120/277/347	S50	295	2.70/1.15/0.95	2.17	4.08	11	B/B/B	35/300	B-V3	844366072581
400	S51	7260	*BALU400-CWA/V3	1	120/277/347	S51	460	3.96/1.71/1.36	2.75	4.65	14	D/E/E	55/300	B-V3	844366072604
1000	S52	7264	*BALU1000-CWA/V3	1	120/277/347	S52	1065	9.56/4.20/3.35	4.33	6.33	27	E/E/E	26/525	B-V3	844366072642
High Pressure Sodium Ballast Kits - 480V															
400	S51	7261	*BALU400-CWA/V480	1	480	S51	464	1	2.75	4.45	15	C	55/240	O-V480	844366072611
1000	S52	7265	*BALU1000-CWA/V480	1	480	S52	1100	2.3	4.33	6.33	28.8	C	26/525	O-V480	844366072659

*Items only available for special orders

E-V5

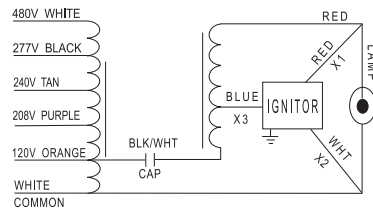

B1-V3

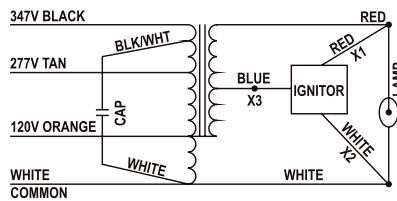

B-V3

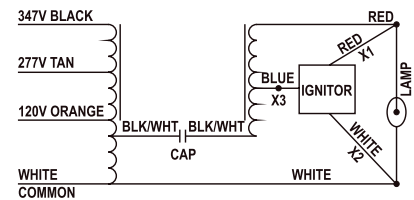

O-V480

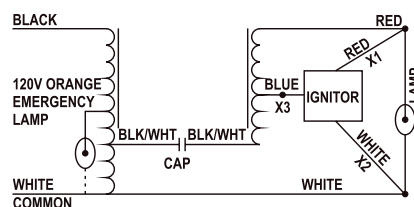

HID CORE & COIL BALLASTS

Capacitors ■ ■ ■

Product Information							Physical Information			
Item#	Description	µfd	Voltage	Plusrite Ballast	Plusrite Ballast Code	ANSI CODE	Cap. Type	Diam.(in)	Height (in)	UPC
Capacitors for Standard Metal Halide										
7850	CAP-D10R40	10	400	7211	BAMH175-CWA/V3	M57	DRY	1.57	2.76	844366078507
				7210	BAMH175-CWA/V4	M57		1.57	2.76	
				7266	BAMH175-CWA/V5	M57		1.57	2.76	
7857	CAP-D15R40	15	400	7217	BAMH250-CWA/V3	M58	DRY	1.65	3.15	844366078576
				7216	BAMH250-CWA/V4	M58		1.65	3.15	
				7267	BAMH250-CWA/V5	M58		1.65	3.15	
7868	CAP-R24R40	24	400	7231	BAMH400-CWA/V3	M59	DRY	1.77	3.66	844366078682
				7230	BAMH400-CWA/V4	M59		1.77	3.66	
				7270	BAMH400-CWA/V5	M59		1.77	3.66	
7880	CAP-Z93S4824PN	24	480	N/A	BAMH1000-CWA/V120	M47/H36	OIL Aluminum Oval	3.88	1.91	844366078804
				7244	BAMH1000-CWA/V3	M47/H36		3.88	1.91	
				7243	BAMH1000-CWA/V4	M47/H36		3.88	1.91	
				7274	BAMH1000-CWA/V5	M47/H36		3.88	1.91	
7881	CAP-Z93S5432PN CAP-Z93S5432PN	32	540	7247	BAMH1500-CWA/V4	M48	OIL Aluminum Oval	4.75	1.91	844366078811
				7329	BAMH1500-CWA/V480	M48		4.75	1.91	
Capacitors for Pulse Start Metal Halide										
7875	CAP-D6R30	6	300	7201	BAPS50-HX/V3	M110	DRY	1.38	2.76	844366078750
				7200	BAPS50-HX/V4	M110		1.38	2.76	
7858	CAP-D16R25	16	250	7321	BAPS70-HX/V120	M98	DRY	1.38	2.76	844366078583
7877	CAP-D8R30	8	300	7203	BAPS70-HX/V3	M98	DRY	1.38	2.76	844366078774
7866	CAP-D25R25	25	250	7322	BAPS100-HX/V120	M90	DRY	1.57	2.76	844366078668
7852	CAP-D12R30	12	300	7205	BAPS100-HX/V3	M90	DRY	1.57	2.76	844366078521
				7204	BAPS100-HX/V4	M90		1.57	2.76	
				7206	BAPS125-CWA/V4	M150		1.57	2.76	
7863	CAP-D22R25	22	250	7323	BAPS150-HX/V120	M102	DRY	1.57	2.76	844366078637
				7209	BAPS150-HX/V3	M102		1.57	2.76	
				7208	BAPS150-HX/V4	M102		1.57	2.76	

All Items only available for special orders

HID

HALOGEN

CFL

FL

BALLAST

GERMICIDAL

Plusrite®

Capacitors

HID

HALOGEN

CFL

FL

BALLAST

GERMICIDAL

Product Information							Physical Information			
Item#	Description	µfd	Voltage	Plusrite Ballast	Plusrite Ballast Code	ANSI CODE	Cap. Type	Diam.(in)	Height (In)	UPC
Capacitors for Pulse Start Metal Halide										
7853	CAP-D12.5R40	12.5	400	7212	BAPS175-CWA/V4	M137/M152	DRY	1.57	2.76	844366078538
7857	CAP-D15R40	15	400	7214	BAPS200-CWA/V4	M136	DRY	1.65	3.15	844366078576
7860	CAP-D16R10	16	400	7221	BAPS250-CWA/V3	M153/M138	DRY	1.65	3.15	844366078606
				7220	BAPS250-CWA/V4	M138/M153		1.65	3.15	
				7281	BAPS250-CWA/V5	M138/M153		1.65	3.15	
7865	CAP-D22R40	22	400	7223	BAPS320-CWA/V3	M132/M154	DRY	1.77	3.66	844366078651
				7222	BAPS320-CWA/V4	M132/M154		1.77	3.66	
				7268	BAPS320-CWA/V5	M132/M154		1.77	3.66	
7868	CAP-R24R40	24	400	7227	BAPS350-CWA/V3	M131	DRY	1.77	3.66	844366078682
				7226	BAPS350-CWA/V4	M131		1.77	3.66	
				7269	BAPS350-CWA/V5	M131		1.77	3.66	
				7271	BAPS400-CWA/V5	M135/M155		1.77	3.66	
7870	CAP-D26R40	26	400	7233	BAPS400-CWA/V3	M135/M155	DRY	1.77	3.66	844366078705
				7232	BAPS400-CWA/V4	M135/M155		1.77	3.66	
				7278	BAPS450-CWA/V5	M144		1.77	3.66	
7878	CAP-Z74S4038PN	38	400	7236	BAPS575-HX/V4	M178	OIL Aluminum Oval	2	3.95	844366078781
				7279	BAPS575-CWA/V5	M178		2	3.95	
7880	CAP-Z93S4824PN	24	480	7238	BAPS750-CWA/V3	M149	OIL Aluminum Oval	3.88	1.91	844366078804
				7237	BAPS750-CWA/V4	M149		3.88	1.91	
				7272	BAPS750-CWA/V5	M149		3.88	1.91	
				7241	BAPS1000-CWA/V3	M141		3.88	1.91	
				7240	BAPS1000-CWA/V4	M141		3.88	1.91	
				7273	BAPS1000-CWA/V5	M141		3.88	1.91	
				7242	BAPS1000-CWA/V480	M141		3.88	1.91	

All Items only available for special orders

HID CORE & COIL BALLASTS

Capacitors ■ ■ ■

Product Information							Physical Information			
Item#	Description	µfd	Voltage	Plusrite Ballast	Plusrite Ballast Code	ANSI CODE	Cap. Type	Diam.(in)	Height (in)	UPC
Capacitors for High Pressure Sodium										
7855	CAP-D14R15	14	150	7324	BALU35-R/V120	S76	DRY	1.18	2.36	844366078552
7861	CAP-D20R15	20	150	7325	BALU50-R/V120	S68	DRY	1.38	2.76	844366078613
7869	CAP-D25R15	25	150	7326	BALU70-R/V120	S62	DRY	1.38	2.76	844366078699
7876	CAP-D7R30	7	300	7251	BALU70-HX/V3	S62	DRY	1.38	2.76	844366078767
				7250	BALU70-HX/V4	S62		1.38	2.76	
7872	CAP-D38R15	38	150	7327	BALU100-R/V120	S54	DRY	1.57	2.76	844366078729
7850	CAP-D10R40	10	400	7252	BALU100-HX/V4	S54	DRY	1.57	2.76	844366078507
7851	CAP-D10R30	10	300	7253	BALU100-HX/V3	S54	DRY	1.57	2.76	844366078514
7873	CAP-D50R15	50	150	7328	BALU150-R/V120	S55	DRY	1.65	3.15	844366078736
7856	CAP-D14R30	14	300	7255	BALU150-HX/V3	S55	DRY	1.57	2.76	844366078569
				7254	BALU150-HX/V4	S55		1.57	2.76	
7871	CAP-D35R30	35	300	7258	BALU250-CWAV3	S50	DRY	1.77	3.66	844366078712
				7257	BALU250-CWAV4	S50		1.77	3.66	
				7275	BALU250-CWAV5	S50		1.77	3.66	
7874	CAP-D55R30	55	300	7260	BALU400-CWAV3	S51	DRY	1.97	3.94	844366078743
				7259	BALU400-CWAV4	S51		1.97	3.94	
				7276	BALU400-CWAV5	S51		1.97	3.94	
				7261	BALU400-CWAV480	S51		1.97	3.94	
7879	CAP-Z74S5226HN	26	525	7264	BALU1000-CWAV3	S52	OIL Aluminum Oval	2	4.75	844366078798
				7263	BALU1000-CWAV4	S52		2	4.75	
				7277	BALU1000-CWAV5	S52		2	4.75	
				7265	BALU1000-CWAV480	S52		2	4.75	

All Items only available for special orders

HID

HALOGEN

CFL

FL

BALLAST

GERMICIDAL

Plusrite®

Ignitors

HID

HALOGEN

CFL

FL

BALLAST

GERMICIDAL

Product Information				Physical Information		
Item#	Description	Plusrite Ballast Item No.	Plusrite Ballast Code	Diam.(in)	Height (In)	UPC
7800	HJH-103	7324	BALU35-RV120	1.38	2.25	844366078002
		7325	BALU50-RV120			
		7249	BALU50-HXV2			
		7326	BALU70-RV120			
		7251	BALU70-HXV3			
		7250	BALU70-HXV4			
		7327	BALU100-RV120			
		7253	BALU100-HXV3			
		7252	BALU100-HXV4			
		7328	BALU150-RV120			
		7255	BALU150-HXV3			
		7254	BALU150-HXV4			
		7801	HJH-203			
7200	BAPS50-HXV4					
7321	BAPS70-HXV120					
7203	BAPS70-HXV3					
7202	BAPS70-HXV4					
7322	BAPS100-HXV120					
7205	BAPS100-HXV3					
7204	BAPS100-HXV4					
7206	BAPS125-CWAV4					
7323	BAPS150-HXV120					
7209	BAPS150-HXV3					
7208	BAPS150-HXV4					
7212	BAPS175-CWAV4					
7214	BAPS200-CWAV4					
7221	BAPS250-CWAV3					
7220	BAPS250-CWAV4					
7281	BAPS250-CWAV5					
7223	BAPS320-CWAV3					
7222	BAPS320-CWAV4					

All Items only available for special orders

HID CORE & COIL BALLASTS

Igniters ■ ■ ■

HID

HALOGEN

CFL

FL

BALLAST

GERMICIDAL

Product Information				Physical Information		
Item#	Description	Plusrite Ballast Item No.	Plusrite Ballast Code	Diam.(in)	Height (In)	UPC
7801	HJH-203	7268	BAPS320-CWAV5			
		7227	BAPS350-CWAV3			
		7226	BAPS350-CWAV4			
		7269	BAPS350-CWAV5			
		7233	BAPS400-CWAV3			
		7232	BAPS400-CWAV4			
		7271	BAPS400-CWAV5			
		7234	BAPS450-CWAV4			
		7278	BAPS450-CWAV5			
		7236	BAPS575-HXV4			
		7279	BAPS575-CWAV5			
		7256	BALU200-CWAV4			
		7258	BALU250-CWAV3			
		7257	BALU250-CWAV4			
		7275	BALU250-CWAV5			
		7260	BALU400-CWAV3			
		7259	BALU400-CWAV4			
7276	BALU400-CWAV5					
7261	BALU400-CWAV480					
7802	HJH-303	7238	BAPS750-CWAV3	1.58	2.44	844366078026
		7237	BAPS750-CWAV4			
		7272	BAPS750-CWAV5			
		7241	BAPS1000-CWAV3			
		7240	BAPS1000-CWAV4			
		7273	BAPS1000-CWAV5			
		7242	BAPS1000-CWAV480			
		7264	BALU1000-CWAV3			
		7263	BALU1000-CWAV4			
		7277	BALU1000-CWAV5			
7265	BALU1000-CWAV480					

All Items only available for special orders



Plusrite®



HID

HALOGEN

CFL

FL

BALLAST

GERMICIDAL

NOTE 

Lined writing area for notes





NOTE

Lined writing area with horizontal lines

HID

HALOGEN

CFL

FL

BALLAST

GERMICIDAL



Plusrite®

HID

HALOGEN

CFL

FL

BALLAST

GERMICIDAL



GERMICIDAL LAMPS





GERMICIDAL LAMPS

HID

HALOGEN

CFL

FL

BALLAST

GERMICIDAL

CONTENTS

- 124 - Germicidal T5/T8/T10
- 125 - Germicidal Miniature and PL

HID

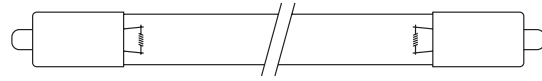

T5
Single Pin Base

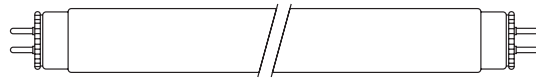

T5
Mini Bi-Pin Base

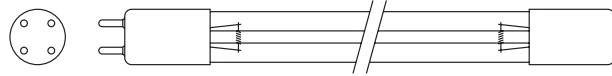

T5
4-Pin Base



T8 & T10
Med Bi-Pin G13 Base

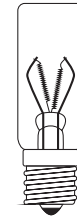

E17 Base

CFL

FL

BALLAST

GERMICIDAL

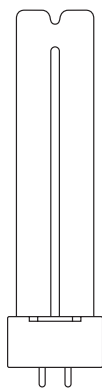

4-Pin Base



G23 Base



GX23 Base

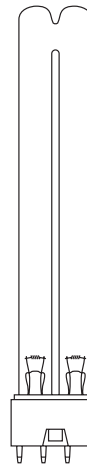

2G11 Base



GERMICIDAL LAMPS

How to read the table



HID

HALOGEN

CFL

FL

BALLAST

GERMICIDAL

Product Information							Physical Information		Photometric Characteristics				UPC
Watts	Bulb	Base	Item#	Description	Voltage (V)	Case Qty.	Dia (in)	MOL (in)	Current (A)	Spectral Peak (mm)	UV Output (W)	Avg. Life (Hrs)	UPC
T5 Miniature Bi-Pin G5 Base													
4	T5	G5	5000	G4T5	29	50	5.3	0.61	0.17	253.7	0.8	6000	844366050008
6	T5	G5	5007	* G6T5	42	50	8.29	0.61	0.16	253.7	1.8	8000	844366050077
7	T5	G5	5008	* G7T5	30	50	6.5	0.61	0.23	253.7	1.6	8000	844366050084

Watts
Energy consumption during proper operation

Base
Type of base

Description
Model description

Case Qty.
Number of product units packed in a case

MOL
Maximum overall length in inches

Current
The rate of flow of electricity, measure in amperes

UV Output
UV output intensity, indicated in watts

UPC
Universal Product Code

Bulb
Type of bulb for different size and shape

Item#
Use this code when placing order

Voltage
Voltage

Dia
Lamps diameter in inches

Spectral Peak
The peak of the germicidal effectiveness for UV absorption by DNA

Average Life
An average rating operated at normal lamp voltage and current



Plusrite®

■ Germicidal T5/T8/T10

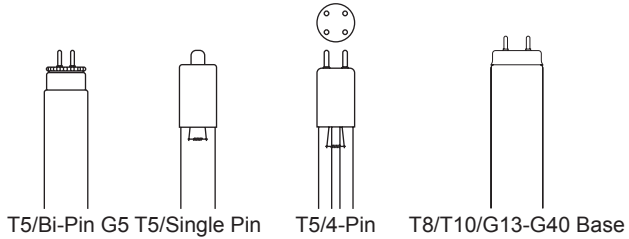

HID

HALOGEN

CFL

FL

BALLAST

GERMICIDAL

Product Information							Physical Information		Photometric Characteristics				UPC
Watts	Bulb	Base	Item#	Description	Voltage (V)	Case Qty.	Dia (in)	MOL (in)	Current (A)	Spectral Peak (mm)	UV Output (W)	Avg. Life (Hrs)	
T5 Miniature Bi-Pin G5 Base													
4	T5	G5	5000	G4T5	29	50	0.61	5.3	0.17	253.7	0.8	6000	844366050008
6	T5	G5	5007	* G6T5	42	50	0.61	8.29	0.16	253.7	1.8	8000	844366050077
7	T5	G5	5008	* G7T5	30	50	0.61	6.5	0.23	253.7	1.6	8000	844366050084
8	T5	G5	5009	* G8T5	57	50	0.61	11.3	0.145	253.7	202	8000	844366050091
11	T5	G5	5010	* G11T5	37	50	0.61	8.29	0.33	253.7	202	8000	844366050107
16	T5	G5	5011	* G16T5	50	50	0.61	11.3	0.32	253.7	3.2	8000	844366050114
20	T5	G5	5012	* G20T5	62	50	0.61	15.75	0.4	253.7	5.5	8000	844366050121
T5 Single-Pin Base													
10	T5	Single Pin	5013	* G10T5L	40	50	0.61	14.06	0.4	253.7	3	8000	844366050138
14	T5	Single Pin	5014	* G14T5L	55	50	0.61	11.3	0.425	253.7	5.3	9000	844366050145
22	T5	Single Pin	5015	* G22T5L	62	50	0.61	17.16	0.42	253.7	7	8000	844366050152
36	T5	Single Pin	5016	* G36T5L	115	50	0.61	33.31	0.425	253.7	13	9000	844366050169
64	T5	Single Pin	5017	* G64T5L	250	50	0.61	61.17	0.425	253.7	127	9000	844366050176
T5 4-Pin Base													
10	T5	4-Pin	5018	* G10T5L/4P	40	50	0.61	14.06	0.4	253.7	3	8000	844366050183
14	T5	4-Pin	5019	* G14T5L/4P	55	50	0.61	11.3	0.425	253.7	5.3	9000	844366050190
22	T5	4-Pin	5020	* G22T5L/4P	62	50	0.61	17.16	0.42	253.7	7	8000	844366050206
36	T5	4-Pin	5021	* G36T5L/4P	115	50	0.61	33.31	0.425	253.7	13	9000	844366050213
64	T5	4-Pin	5022	* G64T5L/4P	250	50	0.61	61.17	0.425	253.7	127	9000	844366050220
T8 Medium Bi-Pin G13 Base													
10	T8	G10T8	5023	* G10T8	46	15	1	12.99	0.23	8000	2.7	8000	844366016394
15	T8	G15T8	5001	G15T8	55	15	1	17.16	0.305	8000	4.9	8000	844366016394
25	T8	G25T8	5024	* G25T8	46	15	1	17.16	0.6	8000	6.9	8000	844366016394
30	T8	G30T8	5002	G30T8	99	200	1	35.16	0.355	8000	13.9	8000	844366016394
55	T8	G55T8	5025	* G55T8	83	15	1	35.16	0.77	8000	18	8000	844366016394
T10 G13 Base													
20	T10	G20T10	5026	* G20T10	58	15	1.28	23.17	0.36	8000	7.5	8000	844366016394
40	T10	G40T10	5027	* G40T10	106	15	1.28	47.17	0.42	8000	19.8	8000	844366016394

*Items only available for special orders

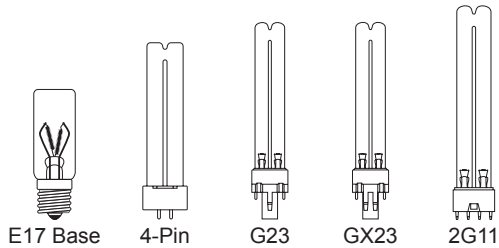

GERMICIDAL LAMPS

Germicidal Miniature and PL ■■■

Product Information							Physical Information		Photometric Characteristics				
Watts	Bulb	Base	Item#	Description	Voltage (V)	Case Qty.	Dia (in)	MOL (in)	Current (A)	Spectral Peak (mm)	UV Output (W)	Avg. Life (Hrs)	UPC
E17 Base													
3	-	E17	5003	GTL3	10.5	15	0.79	2.48	0.3	8000	0.16	3000	844366050039
PL 4-Pin Base													
6	PL	4-Pin	5028	* GUL6	42	15	0.65	1.38	0.16	253.7	1.6	3000	844366050282
PL G23/GX23 Base													
5	PL	G23	5029	* GPX5	35	15	0.51	1.1	0.18	253.7	1.2	8000	844366050299
7	PL	G23	5030	* GPX7	45	15	0.51	1.1	0.18	253.7	1.9	8000	844366050305
9	PL	G23	5004	GPX9	59	200	0.51	1.1	0.18	253.7	2.4	8000	844366050046
11	PL	G23	5031	* GPX11	91	15	0.51	1.1	0.155	253.7	3	8000	844366050312
13	PL	GX23	5032	* GPX13	59	15	0.51	1.1	0.285	253.7	3.6	8000	844366050329
PL 2G11 Base													
18	PL	2G11	5005	GPL18K	58	15	0.79	1.57	0.375	253.7	5.5	8000	844366050053

*Items only available for special orders

HID

HALOGEN

CFL

FL

BALLAST

GERMICIDAL

Lamp & Ballast Limited Warranty Terms & Conditions

The warranty as described herein shall only apply to PLUSRITE® USA branded lighting products. The warranty is only applicable to the "original" or "first purchaser". PLUSRITE® USA warrants that each Product will be free from defects in material and workmanship. Limited warranty is conditional upon proper storage, installation, usage, and maintenance. Warranty applies when the lamp(s) are properly wired, installed, and operated in environmental conditions such as temperature or humidity. The warranty cannot be applied for subjects to abnormal stress in excess maximum rated temperature, under or over voltage conditions, excessive switching cycles, or improper installation. Consumers will retain warranty from the distributor they purchased through. Warranty time period begins on the first day of purchase marked on the invoice.

PRODUCTS	WARRANTY				
HID	1 year	Ballast		LED (naturaLED®)	
Halogen		Electrical FL T8 (120-277V)	5 year	Lamp	3 year
1,000-2,000 hrs	1 month	Electrical FL T8 (347V)	5 year	Fixture	5 year
2,500-4,000 hrs	3 month	Electrical FL T5 (120-277V)	5 year	Compact Fluorescent	6 month
10,000 hrs	6 month	HID Magnetic Ballast	2 year		
Linear Fluorescent (T5/T8)	12 month	Capacitor/Ignitor	1 year	>8,000 hrs	12 month

TERMS & CONDITIONS

The foregoing lamp warranty applies only to PLUSRITE® USA lamps originally distributed by Authorized Plusrite Distributor, but does not apply to failures caused by acts of nature or as a result of any abuse, misuse, abnormal use, or use in violation of any applicable standard code, or instructions for use in installations, including, but not limited to, those contained in the National Electrical Code, the Standards for Safety of Underwriters Laboratory, Inc., Standards for the International Electrotechnical Commission, Standards for the American National Standards Institute or, in Canada, the Canadian Standards Association. PLUSRITE® USA reserves the right to examine failed lamps to determine the cause of failure and patterns of usage. The date of purchase and lamp installation date must be verified to validate the elapsed operating hours if a warranty claim is made. If lamp life is not validated, the lamp date code will be used to establish elapsed burning time based on estimated usage.

LIMITATION OF LIABILITY

Under no circumstances will PLUSRITE® USA be liable for any consequential, incidental, special or exemplary damages including but not limited to, loss of profits or revenues, loss of use or any other goods and associated equipment, damage to any associated equipment, cost of capital, cost of substitute products, facilities of services, down time cost, or claims of claimant's customers as a result of breach of contract, breach of warranty, tort, or strict liability. The warranty does not cover equipment, system, or component from other manufactures used in conjunction with the lamps. Any repair, alteration, or modification of the lamp not approved by PLUSRITE® will void the warranty.

TO MAKE A WARRANTY CLAIM

PLUSRITE® USA shall correct any defects by replacing or repairing in accordance to determine the product defective under the terms of this warranty. In order to make a claim under the warranty, the purchaser must contact PLUSRITE® USA to obtain Return Material Authorization Number (RMA Number) and buyer shall promptly return the product to PLUSRITE® USA for evaluation. Guarantee claims have to be reported and return to the office within 30 days with specify following information. Failure to follow this procedure shall void this warranty: Details of failed product, and (or) for System warranties also details of other components used, original invoice must be dated within corresponding period (check individual warranty apply for each item), detailed problem description; which includes: date code on lamp, application, burnt hours and switching cycle (if applies). Claimants should contact PLUSRITE® USA at (888) 758-7443 or email at info@fanlightinc.com



GENERAL WARRANTY

Ballast Limited Warranty

Ballast Limited Warranty

Plusrite® Corporation warrants our ballast will be free of defects from material and workmanship from the date of purchase, as indicated by the date on the original invoice, for the following periods specified below.

MANUFACTURE INFORMATION

2000 S. Grove Ave, Ste B, Ontario, CA 91761
(T) 855-758-7009 (F) 909-930-9988

HID

HALOGEN

CFL

FL

BALLAST

GERMICIDAL

Product

Warranty Period

Electrical Fluorescent Ballast T8 (120V-277V)	5 years
Electrical Fluorescent Ballast T8 (347V)	5 years
Electrical Fluorescent Ballast T5 (120-277V)	5 years
High Intensity Discharge (HID) Magnetic Ballast Core & Coil	2 years

TERMS AND CONDITIONS

Limited warranty applies to Plusrite® Corporation authorized to the original or first purchaser. Plusrite®'s ballast limited warranty must be installed and operated under suitable environment conditions. This warranty will not apply if conditions demonstrate abnormal use or stress, such as operating temperatures in excess of maximum rated temperatures, over/under voltage conditions, excessive switching cycles or operating hours, dirty or cracked sockets, or improper lamp or ballast installation. The warranty is not applicable to any ballast which is not installed and operated in accordance with the current edition of the Standards for Safety of Underwriter's Laboratory, Inc (UL), The National Electric Code (NEC), the Standards for the American National Standards Institute (ANSI), applicable federal, state, and local codes, and with Plusrite's most recent instructions and application guidelines for ballast installation.

WARRANTY CLAIM & SERVICE

PLUSRITE® USA shall correct any defects by replacing or repairing, at PLUSRITE® USA's option, any halogen lamp determined to be defective under the terms of this warranty. Plusrite® reserves the right to examine the failed lamp to determine the case of failure and patterns of usage, and to be the sole judge as to whether the lamp is defective and cover under this warranty.

Claim	In order to make a claim under the warranty, the purchaser must contact Plusrite® USA to obtain a Return Material Authorization Number (RMA Number) and buyer shall promptly return the product to Plusrite® USA for evaluation. Failure to follow this procedure shall void this warranty.
Testing	The conditions of any tests concerning ballasts, which are claimed to be defective in accordance with this warranty, shall be mutually agreed upon in writing and Plusrite® USA shall be notified of, and may be represented at such tests.

LIMITATION OF LIABILITY

Under no circumstances will Plusrite® be liable for any consequential, incidental, special or exemplary damages including but not limited to, loss of profits or revenues, loss of use of ballast or any other goods and associated equipment, damage to any associated equipment, cost of capital, cost of substitute products, facilities of services, down time cost, or claims of claimant's customers as a result of breach of contract, breach of warranty, tort, or strict liability.

RETURN MERCHANDISE AUTHORIZATION (RMA)

Claimants should contact PLUSRITE® USA at (855) 758-7009 or (909)930-6868 at 2000 S. Grove Ave, Ste B, Ontario, CA 91761





Plusrite®

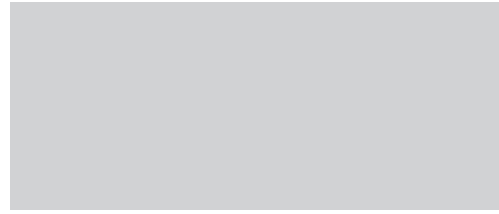

HID

HALOGEN

CFL

FL

BALLAST

GERMICIDAL

NOTE 

Lined writing area for notes, consisting of 20 horizontal lines.







Plusrite®

Lamp and Ballast Catalog

Contact Us

► Plusrite USA

Head Office and West Coast Distribution Center
2000 S. Grove Ave. Building B
Ontario, CA 91761
T. (909) 930-6868
F. (909) 930-9988
www.plusriteusa.com
info@fanlightinc.com

East Coast Distribution Center
2511 Reliance Ave.,
Apex, NC 27539

► Plusrite Canada

Unit #106, 6249-205th St.
Langley, BC V2Y 1N7
T: (604) 533-8898
F: (604) 533-1158

