

#1 IN LADDERS™

CLIMBING EQUIPMENT
PRODUCT CATALOG



LEADING THE WAY IN



Werner is revered for a broad product line that provides the best climbing solutions for both pros and consumers. Our commitment to safety, productivity, and quality is recognized throughout the industry. Never satisfied with resting on past successes, Werner leads the way by continuing to invest in new products, markets, categories, and technologies.

Werner takes great pride in developing new products for specific climbing situations. Our new 3-piece compact extension ladder is a revolutionary design that provides the same reach as a traditional extension ladder but in a smaller, compact design. This smaller design provides the ability to move through hallways, elevators and other tight areas you might not be able to take a traditional extension ladder. The 3-piece compact ladder fits in the back of most cars making transportation easier giving you all the benefits of this smaller design without sacrificing the features of a traditional extension ladder.



The Werner 3-piece compact extension ladder is available in both fiberglass and aluminum in various sizes.

Our new universal attic ladders feature various widths, heights and load capacities to suit any home. Choose from lightweight aluminum or economical wood. If your space is tight, Werner brings a new compact attic ladder solution for access openings of 18" x 24" or larger. This sleek, European design is new to the United States market and provides access where space is limited in closets, hallways and other narrow areas. Werner has taken the guess work out of attic ladder selection. With our new packaging, online attic selector and step by step installation videos, choosing the right attic ladder to gain additional space and organization is easy.



CLIMBING SOLUTIONS

wernerco.com

Werner is pleased to announce the launch of our newly, redesigned global website. This investment in online technology is complete with all the tools necessary to make the correct choice when purchasing climbing equipment. The new site features the ability to filter and compare products and provides more detailed information so the latest content is always available and ready when you need it. To learn more visit us at wernerco.com

Werner continues to expand and meet the needs of our end users around the world. Our strategic worldwide network of manufacturing, sales and warehouse facilities is constantly expanding to meet the market needs. With state of the art technologies and processes, Werner is strategically positioned for growth and new opportunities with each facility fully staffed to deliver millions of climbing products to end users everywhere.



#1 IN LADDERS™

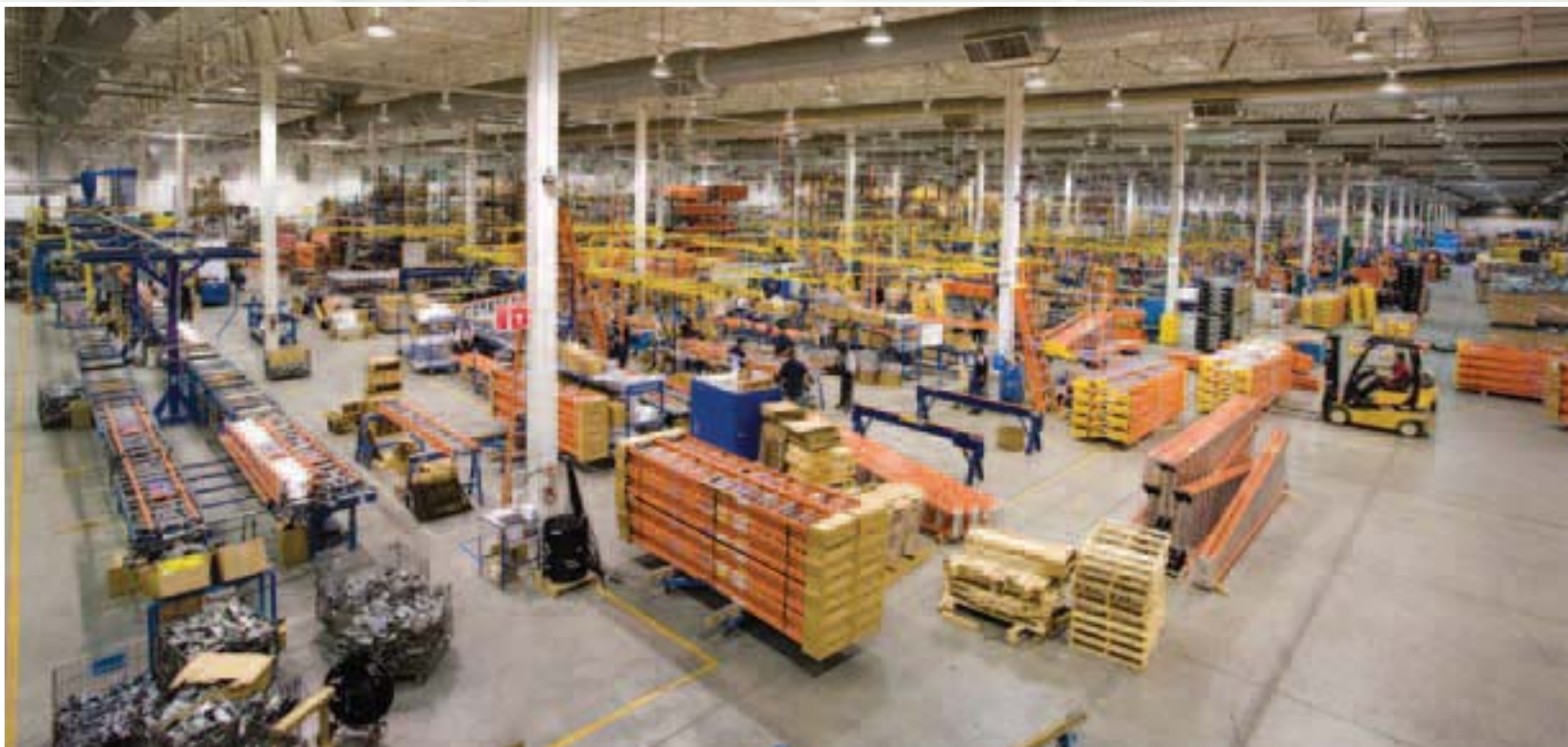



THE #1 BRAND IN PROFESSIONAL CLIMBING EQUIPMENT

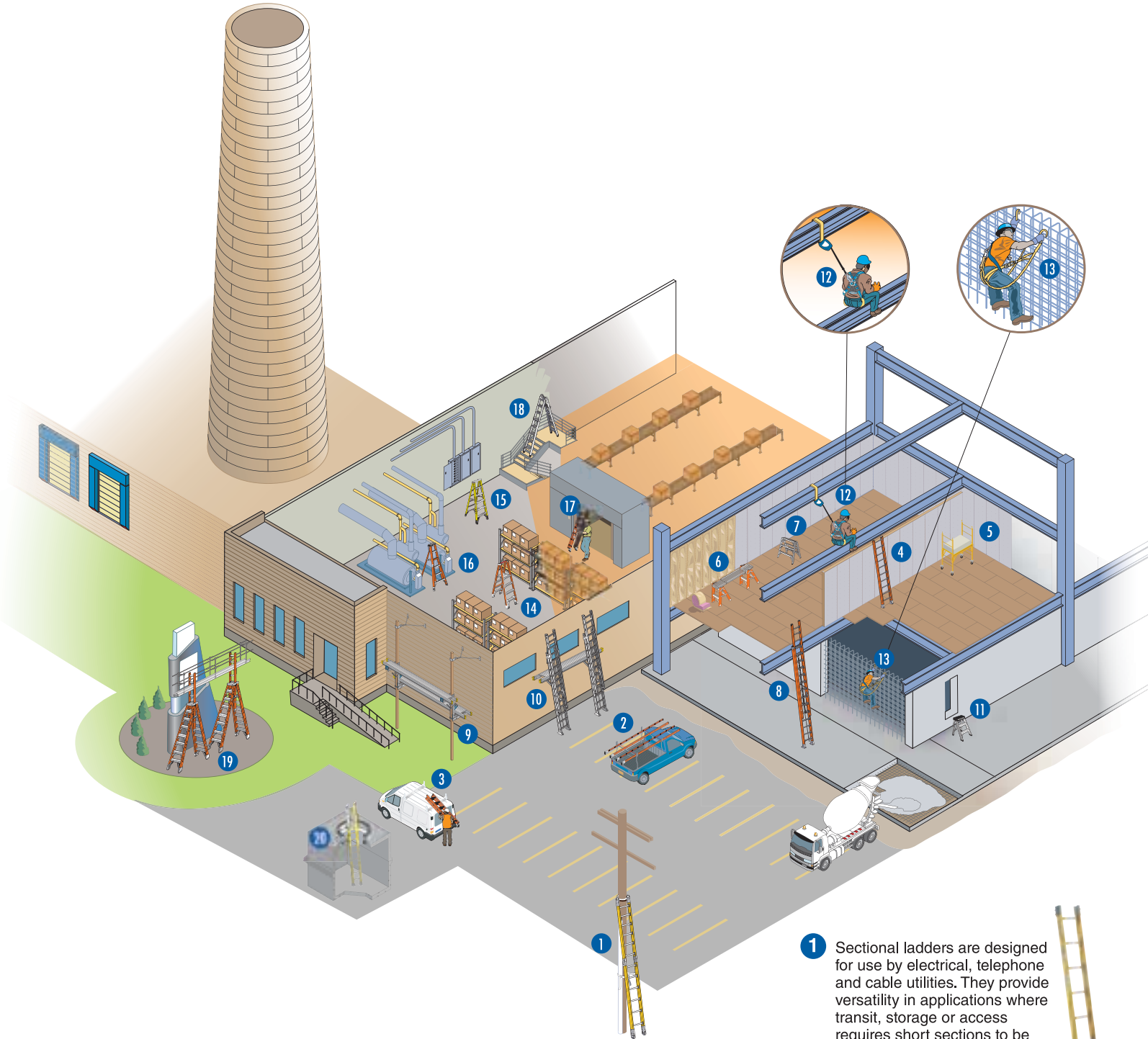

1 Sectional ladders are designed for use by electrical, telephone and cable utilities. They provide versatility in applications where transit, storage or access requires short sections to be coupled together.

STEP 1 SELECT HEIGHT (SIZE)

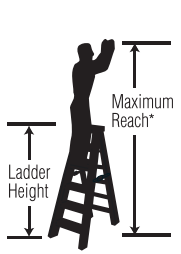

STEPLADDERS	
Ladder Height	Maximum Reach
4'	8'
6'	10'
7'	11'
8'	12'
10'	14'
12'	16'
14'	18'
16'	20'

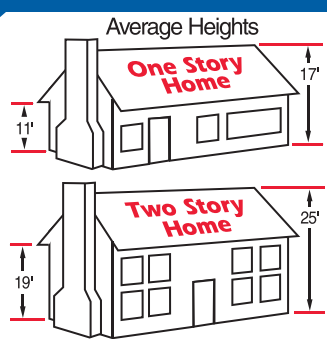

EXTENSION LADDERS		
Ladder Height	Maximum Reach	Height To Gutter or Top Support Point††
16'	15'	9' max.
20'	19'	9' to 13'
24'	23'	13' to 17'
28'	27'	17' to 21'
32'	31'	21' to 25'
36'	34'	25' to 28'
40'	37'	28' to 31'

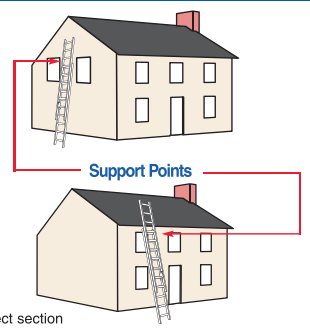

†† Support points for extension ladders reflect section number, ladder ends, or 2' extension above roof line.

CHOOSING THE RIGHT LADDER FOR THE JOB

2 Truck rack to transport ladders, lumber on top of vehicle to jobsite.

3 Van racks used primarily in the paint industry to transport ladders safely to jobsite.

4 Single one-section non-extendable ladders provide easy access to mid-range heights.



5 Steel rolling scaffold has 1000 lbs. load capacity. Sets up with 1 person. Add additional sections for more height. No tools required. Easily moves from one room to another for maximum productivity.



6 Twin step stools are ideal for using with planks.



7 Special purpose work stands are great for wallboard installers and general contractors.



8 Extension ladders are available in a wide assortment of types and sizes. They can handle an extremely wide range of tasks at varying elevations and are the most popular on construction and job sites.



9 Complete pump jack system designed for siding applications. Adjusts to easily work at the height specific to the job. Allows workers to work from side to side safely at various heights.



10 Create productive climbing equipment systems with extension ladders, ladder jacks and aluminum stages.



11 Lightweight, sturdy and compact step stools are handy for many applications. Unlike regular stepladders, you can stand on the top platform.



12 Fall protection self retracting lifeline(SRL), harness and anchor used on i-beam application.



13 Fall protection harness and positioning lanyard used at elevated heights for protection against falls. Ideal application on rebar.



14 Stockr's Ladder®s combine a twin stepladder with a revolutionary warehouse type ladder with a large platform.



15 Stepladders are the most popular of all ladder styles. These ladders are often used for applications at low or medium heights. Ladder tops and pail shelves can hold tools, small parts and paint buckets.



16 Tripod ladders with 3 legs go where traditional ladders cannot. The back rail fits easily into tight corners and other confined spaces. Often used by electricians for installing wire between framing studs.



17 Compact fiberglass extension ladder has a 3-piece design with all the same features as a traditional extension ladder. The smaller, compact design allows it to fit through tight spaces and maneuver more easily on jobsites. Easily fits on top of or in work vehicles.



18 The telescoping multi-ladder can be used as a stepladder, extension ladder, stairway ladder or two scaffold bases. 4 ladders in 1 with multiple heights.



19 The trestle ladder has an adjustable center trestle system often used in pairs with either a 12" or 14" wide stage or plank to work inside industrial buildings and by sign hangers to work for long periods of time at fixed heights.



20 Manhole ladder used to access manholes in roadways. Hoop style end caps for removing ladder from manhole easily.



STEP 2 SELECT PERFORMANCE (DUTY RATING)

WERNER PERFORMANCE SYSTEM

Color Match for Ladder Performance.

★ 200 lbs. ★★ 225 lbs. ★★★ 250 lbs. ★★★★ 300 lbs. ★★★★★ 375 lbs.

Includes User and Materials

STEP 3 SELECT MATERIAL

FIBERGLASS

For working around electricity
Non-conductive side rails



ALUMINUM

Not for use around electricity
Lightweight





THE #1 BRAND IN PROFESSIONAL CLIMBING EQUIPMENT

PRODUCT CERTIFICATIONS

Werner ladders are manufactured and tested to the strictest quality standards. All Werner ladders meet or exceed American National Standards Institute (ANSI) and Occupational Safety and Health Administration (OSHA) requirements, where applicable.



200 lbs.*	Economical design for lightweight use	Type III
225 lbs.*	Basic design for simple projects	Type II
250 lbs.*	Designed to handle most projects and jobs	Type I
300 lbs.*	Rugged performance designed with the pro in mind	Type IA
375 lbs.*	Maximum performance and durability for the toughest jobs	Type IAA

*Includes User and Materials



OCCUPATIONAL SAFETY AND HEALTH ADMINISTRATION CODE

All Type II, I, IA and IAA fiberglass, aluminum and wood ladders, ladder jacks and extension planks meet or exceed code. OSHA CODE applies to ladders used in the workplace. Werner Co. recommends Type II or heavier duty rated ladders for these applications.



AMERICAN NATIONAL STANDARDS INSTITUTE PRODUCT LINES MEET OR EXCEED ANSI CODE

- Fiberglass Ladders A14.5 (2007)
- Aluminum Ladders A14.2 (2007)
- Ladder Jacks A10.8 (2001)
- Extension Planks A10.8 (2001)
- Scaffolding A10.8 (2001)
- Stages A10.8 (2001)
- Work Platforms A10.8 (2001)
- Attic Ladders..... A14.9 (2010)



All Werner fiberglass ladders have electrically non-conductive rails. This is a great benefit for those working near electricity. Durable seven-layer fiberglass-constructed rails also maintain a smooth surface even after weathering.



CLIMBING PROSM

SAFETY TRAINING

AVAILABLE ONLINE OR AS A PRINTED KIT

English and Spanish versions available!

This training program is designed to help you provide state-of-the-art training. Whether it is online or from a kit, Climbing Pro offers an interactive way to educate users how to safely climb.

- New and improved courses
- New online training
- Updated training kits
- Monitoring and measurement tools for reporting to key customers

www.wernerclimbingpro.com

Online Courses

- Knowledge check points throughout courses
- Stop and restart as you need, keeps track of where you left off
- Multimedia and interactive simulations
- Ongoing updates for additional courses





TABLE OF CONTENTS

<i>SERIES/MODEL</i>	<i>PAGE</i>
FIBERGLASS STEPLADDERS	1
7400 SERIES	1
T7400 SERIES	2
P7400 SERIES	2
PT7400/PT7400-4C SERIES	3
E7400 SERIES	3
7300 SERIES	4
OBEL00 SERIES	4
OBPT00 SERIES	5
OBCN00 SERIES	5
SSF00 SERIES	6
TW6200 SERIES	6
6202 MODEL	6
T6202 MODEL	6
6200 SERIES	7
T6200 SERIES	7
P6200 SERIES	8
6100 SERIES	8
FTP6200 SERIES	9
6002 MODEL	9
6000 & 6000S SERIES	10
T6000 SERIES	10
PT6000/PT6000-4C SERIES	11
5900 & 5900S SERIES	11
FIBERGLASS STEPLADDER COMPARISON CHART	12
FIBERGLASS EXTENSION LADDERS	13
D7100-2LV SERIES	13
D7100-2 SERIES	13
7100-2/7100-1 SERIES	14
D8200-2EQ SERIES	14
D6200-2/D6200-1 SERIES	15
D6200-3 SERIES	15
D6000-2 SERIES	16
D5900-2 SERIES	16
FIBERGLASS EXT. LADDER COMPARISON CHART	17
FIBERGLASS SPECIALTY LADDERS	18
7800 SERIES	18
M7100-1 SERIES	18
S7900 SERIES	19
9500-2/9500-1 SERIES	19
SPF00-1/TPF00-1 SERIES	20
S7700 SERIES	20

<i>SERIES/MODEL</i>	<i>PAGE</i>
ALUMINUM STEPLADDERS	21
900AA SERIES	21
400 SERIES	21
T400 SERIES	22
P400 SERIES	22
370 SERIES	23
T370 SERIES	23
P370 SERIES	24
PT370 SERIES	24
SH378 MODEL	25
SSA00 SERIES	25
TW370-30 SERIES	25
150B MODEL	26
T372 MODEL	26
360 SERIES	26
350 SERIES	27
244 MODEL	27
260 SERIES	27
ALUMINUM STEPLADDER COMPARISON CHART	28
ALUMINUM EXTENSION LADDERS	29
500-1 SERIES	29
D500-2	29
D1500-2/D1500-1 SERIES	30
560-3 MODEL	30
D1800-2EQ SERIES	31
D1700-2EQ SERIES	31
D1300-2 SERIES	31
D1200-2 SERIES	32
D1200-3 SERIES	32
D1100-2 SERIES	33
D716-2 MODEL	33
ALUMINUM EXT. LADDER COMPARISON CHART	34
MULTILADDERS	35
MT SERIES	35
M1 SERIES	36

TABLE OF CONTENTS

SERIES/MODEL	PAGE
ATTIC LADDERS	37
AH SERIES	37
AA1510 MODEL	37
WH SERIES	38
W SERIES	38
ATTIC LADDER COMPARISON CHART	39
FIRE ESCAPE LADDERS	40
ESC SERIES	40
PORTABLE SCAFFOLDING	40
AP-20-MP6 MODEL	40
PS-48 MODEL	41
SRS-72 MODEL	41
WORK PLATFORMS	42
PA200 SERIES	42
5600 SERIES	42
5500 SERIES	42
5300 SERIES	42
PUMP JACKS	43
ALUMINUM PUMP JACK SYSTEM	43
STEEL PUMP JACK SYSTEM	44
SCAFFOLDING & STAGES	45
ALUMINUM TASK-MASTER® STAGES	45
GUARD RAIL SYSTEMS	46
ALUMINUM SCAFFOLD TOWERS	48
SCAFFOLD SECTIONS	49
SCAFFOLD COMPONENTS	50
SCAFFOLD/OUTRIGGER COMPONENT COMPARISON CHART	51
RAMPS, RACKS & MERCHANDISING	52
R522 MODEL - FOLDING ARCHED RAMPS	52
R402 MODEL - ARCHED RAMPS	52
R301 MODEL - STRAIGHT RAMPS	53
R102 MODEL - STRAIGHT RAMP KIT	53
TR401-S MODEL - TRUCK RACK	54
VR401-W MODEL - VAN RACK	55
MERCHANDISING MODULAR LADDER DISPLAYS & FIXTURES	55

SERIES/MODEL	PAGE
ACCESSORIES	56
HOW TO ORDER	56
FACTORY INSTALLED ACCESSORY KITS	
LOCK-IN ACCESSORIES (AC27-P, AC27-L, AC50-JB-3)	57
LOCK-IN ACCESSORIES (AC52-UB, AC54-JC, AC56-UH, AC58-TL)	58
STEPLADDER ACCESSORIES (AC11, PK76, 76, 21, 22, AC24, 40)	59
EXTENSION LADDER ACCESSORIES (LADDER JACKS, AC18MT, AC19, AC22, ROOF BRACKETS, AC20, AC78)	60
EXTENSION LADDER ACCESSORIES (AC96, PK70-1/APK70, PK70-2, PK70-3, PK80/APK80, 71/A71)	61
EXTENSION LADDER ACCESSORIES (72/A72, 74/A74, 81/A81, 86/A86, A61, A78, A83)	62
EXTENSION LADDER ACCESSORIES (89, 91, 92/A92, 94, 97P)	63
ATTIC LADDER ACCESSORIES (AC59, 36-82)	63
INDEX	64-65



THE BEST TOPS IN THE INDUSTRY



Customize your ladder top with the Lock-In Accessory System



Sturdy paint can hanger decreases chances of spilling



Paint roller tray slots make painting large surfaces simple



Keeps tools within easy reach with the HolsterTop®

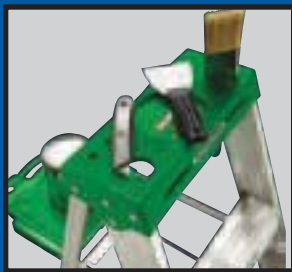

Convenient pail shelf provides additional work surface

WERNER®

7400SERIES

★★★★★ **375lbs.**

LOAD CAPACITY

TYPE IAA
DUTY RATING

STYLE: Stepladder



* Energy Diffusing Geometry

- Every rivet backed up by metal plate or washer to protect rails

SPECIFICATIONS

Model No.	Size	Approx. Width	Approx. Spread	Approx. Cu. Ft. Per Unit	Approx. Shipping Wt. Lbs.
7403	3'	19-3/4"	24-3/8"	2.5	13.5
7404	4'	21-1/2"	30-1/2"	3.5	16.5
7405	5'	23-1/4"	36-3/4"	4.6	20.0
7406	6'	25"	42-7/8"	5.8	23.5
7407	7'	26-3/4"	49"	7.1	28.0
7408	8'	28-1/2"	55-1/4"	8.5	32.0
7410	10'	32"	67-1/2"	11.4	40.5
7412	12'	35-1/2"	79-7/8"	14.8	49.5

DIMENSIONS

Top:	7-1/4" x 14-7/8"	Steps:	3" wide
Front Rails:	3-1/8" wide	Rear Rails:	1-7/8" wide
Front Flange:	1-3/16" wide	Rear Flange:	1-3/16" wide

T7400SERIES

★★★★★ **375lbs.** LOAD CAPACITY **TYPE IAA**
PER SIDE DUTY RATING

STYLE: Multi-Use Twin Stepladder††



- * Energy Diffusing Geometry
- Every rivet backed up by metal plate or washer to protect rails

SPECIFICATIONS NOTE: Type IAA duty rating is for stepladders up to 12 ft.

Model No.	Size	Approx. Width	Approx. Spread	Approx. Cu. Ft. Per Unit	Approx. Shipping Wt. Lbs.
T7404	4'	21-1/2"	36-1/8"	4.5	21.5
T7405	5'	23-1/2"	43-1/8"	5.8	29.0
T7406	6'	25"	50-1/8"	7.3	30.0
T7408	8'	28-1/2"	64-1/8"	10.5	40.5
T7410	10'	32"	78-1/4"	14.2	51.5
T7412	12'	35-1/2"	92-1/4"	18.3	63.5

★★★★★ **300lbs.** LOAD CAPACITY **TYPE IA**
PER SIDE DUTY RATING

T7414	14'	39"	106-1/4"	22.8	86.0
T7416	16'	42-1/2"	120-1/4"	27.7	103.5
T7418	18'	46"	136-1/8"	33.1	126.0
T7420	20'	49-1/2"	150-1/8"	38.8	149.0

††Designed for one or two person jobs. Note: When used as a double stepladder, the maximum load per side, including person and materials, shall not exceed the duty rating of ladder.

DIMENSIONS

Top:	8-1/4" x 14-1/2"	Steps:	3" wide
Rails:	3-1/8" wide	Flange:	1-3/16" wide

P7400SERIES

★★★★★ **375lbs.** LOAD CAPACITY **TYPE IAA**
PER SIDE DUTY RATING

STYLE: Platform Ladder



- * Energy Diffusing Geometry
- Every rivet backed up by metal plate or washer to protect rails
- Internal aluminum spreaders on 8' and 10' models

SPECIFICATIONS NOTE: Type IAA duty rating is for platforms ranging in size from 3' to 8'

Model No.	Height (Size) to Platform	Rail Length	Approx. Width	Approx. Spread	Approx. Cu. Ft. Per Unit	Approx. Shipping Wt. Lbs.
P7403	3'	5'	25-1/4"	35-7/8"	5.1	22.0
P7404	4'	6'	27"	42"	6.4	26.0
P7406	6'	8'	30-1/2"	54-3/8"	9.1	34.0
P7408	8'	10'	34"	66-5/8"	12.2	44.5

★★★★★ **300lbs.** LOAD CAPACITY **TYPE IA**
PER SIDE DUTY RATING

P7410	10'	12'	37-1/2"	79"	15.6	54.5
P7412	12'	14'	42"	91-1/4"	19.3	68.5

††Designed for one or two person jobs. Note: When used as a double stepladder, the maximum load per side, including person and materials, shall not exceed the duty rating of ladder.

DIMENSIONS

Platform:	14-5/8" x 15"	Steps:	3" wide
Front Rails:	3-1/8" wide	Rear Rails:	1-7/8" wide
Front Flange:	1-3/16" wide	Rear Flange:	1-3/16" wide



PT7400/PT7400-4C SERIES

★★★★ **300 lbs.** LOAD CAPACITY **TYPE IA**
PER SIDE DUTY RATING

STYLE: Stockr's Ladder®††



- Easy to handle and folds to a 12" width for storage
- Unique combination of one person, two person†† and platform ladder use
- Internal Pinch-Proof™ aluminum spreaders on 8' and 10' models
- Requires less floor space than heavy steel rolling ladders

SPECIFICATIONS

Model No.	Height (Size) to Platform	Rail Length	Approx. Width	Approx. Spread	Approx. Cu. Ft. Per Unit	Approx. Shipping Wt. Lbs.	Model No. with Casters	Approx. Shipping Wt. Lbs.
PT7404	4'	6'	25-1/4"	50"	8.4	31.0	PT7404-4C	37.0
PT7406	6'	8'	28-3/4"	64"	12.7	41.5	PT7406-4C	53.0
PT7408	8'	10'	32-1/4"	78-1/4"	17.8	54.5	PT7408-4C	60.5
PT7410	10'	12'	35-3/4"	92-1/4"	23.7	66.0	PT7410-4C	72.5

††Designed for one or two person jobs. Note: When used as a double stepladder, the maximum load per side, including person and materials, shall not exceed the duty rating of ladder.

DIMENSIONS

Platform:	12-3/4" x 22"	Steps:	3" wide
Rails:	3-1/8" wide	Flange:	1-3/16" wide

E7400 SERIES

★★★★ **300 lbs.** LOAD CAPACITY **TYPE IA**
PER SIDE DUTY RATING

STYLE: Extension Trestle Ladder††

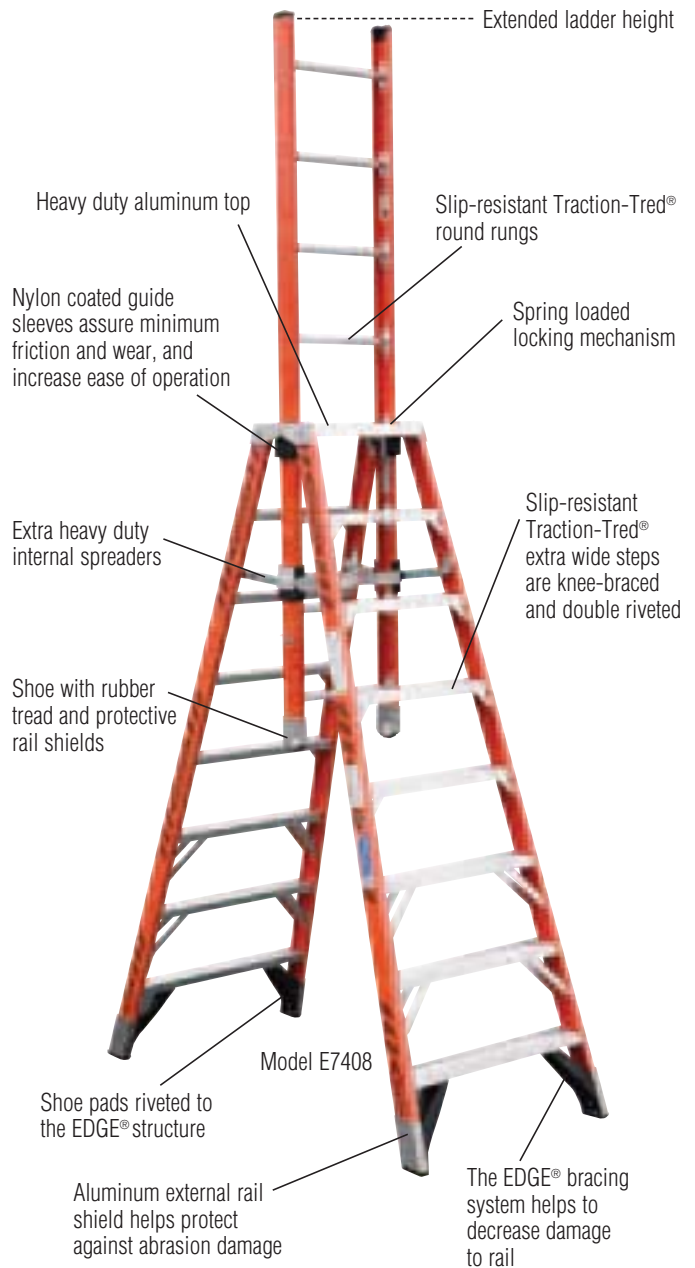

SPECIFICATIONS

Model No.	Stepladder Size	Base Section Bottom Width	Approx. Spread	Approx. Extended Ladder Height	Approx. Cu. Ft. Per Unit	Approx. Shipping Wt. Lbs.
E7408	8'	32-3/4"	67-3/4"	12'	16.6	74.0
E7410	10'	36-1/4"	81-7/8"	15'	22.2	95.5
E7412	12'	39-3/4"	95-7/8"	19'	28.3	113.5
E7414	14'	43-1/4"	109-3/4"	22'	35.1	135.5
E7416	16'	46-3/4"	123-3/4"	26'	42.4	158.0

††Designed for one or two person jobs. Note: When used as a double stepladder, the maximum load per side, including person and materials, shall not exceed the duty rating of ladder.

DIMENSIONS

Extended Ladder	Stepladder
Rails: 3-3/8" wide	Rails: 3-3/16" wide (8'-12') 3-5/16" wide (14'-16')
Rungs: 1-1/4"	Steps: 3" wide
Flange: 1-3/16" wide	Flange: 1-3/16" wide

7300SERIES

★★★★★ **375lbs.** LOAD CAPACITY TYPE IAA DUTY RATING

STYLE: Stepladder



* Energy Diffusing Geometry

- Every rivet backed up by metal plate or washer to protect rails

SPECIFICATIONS

Model No.	Size	Approx. Width	Approx. Spread	Approx. Cu. Ft. Per Unit	Approx. Shipping Wt. Lbs.	Model No. with Pail Shelf	Approx. Shipping Wt. Lbs.
7303	3'	19-3/4"	23-1/2"	2.5	13.0	7303S	16.5
7304	4'	21-1/2"	29-3/4"	3.5	16.0	7304S	19.5
7305	5'	23-1/4"	35-7/8"	4.6	19.5	7305S	23.0
7306	6'	25"	42"	5.8	22.5	7306S	26.0
7308	8'	28-1/2"	54-3/4"	8.5	31.0	7308S	34.0
7310	10'	32"	66-5/8"	11.4	40.5	7310S	43.5
7312	12'	35-1/2"	79"	14.8	50.0	7312S	53.0

DIMENSIONS

Top:	7-1/4" x 14-7/8"	Steps:	3" wide
Front Rails:	3-1/8" wide	Rear Rails:	1-7/8" wide
Front Flange:	1-3/16" wide	Rear Flange:	1-3/16" wide

OBEL00SERIES

★★★★★ **375lbs.** LOAD CAPACITY TYPE IAA DUTY RATING

STYLE: Old Blue® Series Electrician's Jobstation™



COMPATIBLE
SEE PAGES 57-58

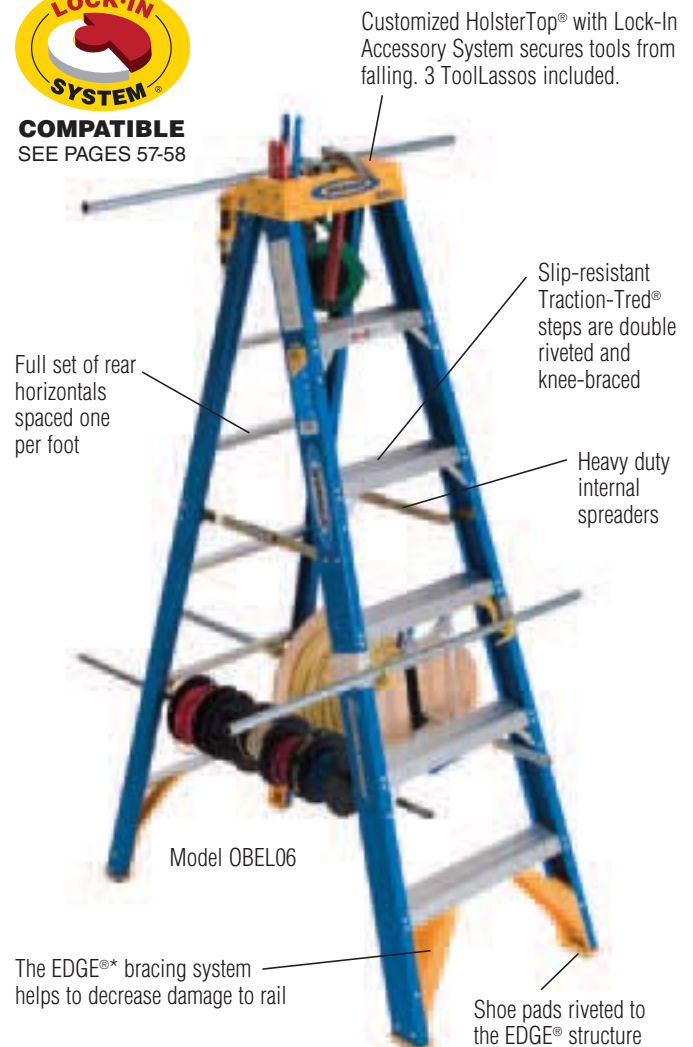

Convenient conduit cutting system

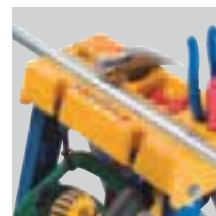

HolsterTop® customized for electricians

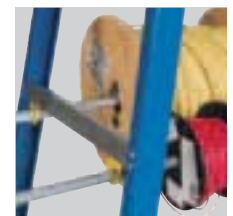

Built-in wire spool holders for both large and small spools

* Energy Diffusing Geometry

- Every rivet backed up by metal plate or washer to protect rails

© The blue and yellow ladder is an exclusive registered trademark of Werner Co.

SPECIFICATIONS

Model No.	Size	Approx. Width	Approx. Spread	Approx. Cu. Ft. Per Unit	Approx. Shipping Wt. Lbs.
OBEL04	4'	19-7/8"	29"	3.0	16.0
OBEL06	6'	23-3/8"	41-1/4"	5.3	24.0
OBEL08	8'	26-7/8"	53-5/8"	8.1	32.0
OBEL10	10'	30-3/8"	65-7/8"	12.5	41.0
OBEL12	12'	33-7/8"	78-1/4"	15.0	51.5

DIMENSIONS

Top:	5-3/4" x 13"	Steps:	3" wide
Front Rails:	3-1/8" wide	Rear Rails:	1-7/8" wide
Front Flange:	1-3/16" wide	Rear Flange:	1-3/16" wide



OBPT00SERIES

★★★★★ **375lbs.** LOAD CAPACITY TYPE IAA DUTY RATING

STYLE: Old Blue® Series Pipe Trade Jobstation™



COMPATIBLE
SEE PAGES 57-58

Customized HolsterTop® with Lock-In Accessory System secures tools from falling. 3 ToolLassos included.



Model OBPT06

The EDGE®* bracing system helps to decrease damage to rail

Shoe pads riveted to the EDGE® structure



Pipe cutting and assembly system fits 1/2" to 3" pipe

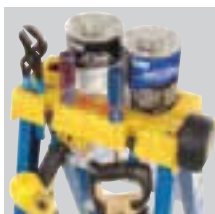

HolsterTop® customized for the pipe trade



Multi-use hook for saws, buckets, etc.

* Energy Diffusing Geometry

• Every rivet backed up by metal plate or washer to protect rails

© The blue and yellow ladder is an exclusive registered trademark of Werner Co.

SPECIFICATIONS

Model No.	Size	Approx. Width	Approx. Spread	Approx. Cu. Ft. Per Unit	Approx. Shipping Wt. Lbs.
OBPT06	6'	23-3/8"	41-1/4"	5.3	24.0
OBPT08	8'	26-7/8"	53-5/8"	8.1	32.0

DIMENSIONS

Top:	5-3/4" x 13"	Steps:	3" wide
Front Rails:	3-1/8" wide	Rear Rails:	1-7/8" wide
Front Flange:	1-3/16" wide	Rear Flange:	1-3/16" wide

OBCN00SERIES

★★★★★ **375lbs.** LOAD CAPACITY TYPE IAA DUTY RATING

STYLE: Old Blue® Series Contractor's Jobstation™



COMPATIBLE
SEE PAGES 57-58

Customized HolsterTop® with Lock-In Accessory System secures tools from falling. 3 ToolLassos included.



Model OBCN06

The EDGE®* bracing system helps to decrease damage to rail

Shoe pads riveted to the EDGE® structure



MagnaGrip™ heavy duty magnet secures hardware

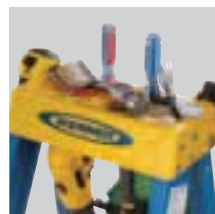

HolsterTop® customized for contractors



Multi-Use hook for hanging tools and buckets

* Energy Diffusing Geometry

• Every rivet backed up by metal part or washer to protect rails

© The blue and yellow ladder is an exclusive registered trademark of Werner Co.

SPECIFICATIONS

Model No.	Size	Approx. Width	Approx. Spread	Approx. Cu. Ft. Per Unit	Approx. Shipping Wt. Lbs.
OBCN06	6'	23-3/8"	41-1/4"	5.3	23.0
OBCN08	8'	26-7/8"	53-5/8"	8.1	31.0

DIMENSIONS

Top:	5-3/4" x 13"	Steps:	3" wide
Front Rails:	3-1/8" wide	Rear Rails:	1-7/8" wide
Front Flange:	1-3/16" wide	Rear Flange:	1-3/16" wide

SSF00SERIES

★★★★★ **375lbs.** LOAD CAPACITY **TYPE IAA** DUTY RATING

STYLE: Step Stand



SPECIFICATIONS

Model No.	Size	Maximum Standing Height	Approx. Width	Approx. Spread	Approx. Cu. Ft. Per Unit	Approx. Shipping Wt. Lbs.
SSF02	2'	20"	17"	21"	2.6	15.0
SSF03	3'	30"	18-3/4"	27-1/2"	4.0	19.5

DIMENSIONS

Top:	9" x 14"	Steps:	6" wide
Front Rails:	6" wide	Rear Rails:	1-7/8" wide
Front Flange:	1-1/8" wide	Rear Flange:	1-3/16" wide

TW6200SERIES

★★★★★ **300lbs.** LOAD CAPACITY **PER SIDE** **TYPE IA** DUTY RATING

STYLE: Portable Work Stand^{††}

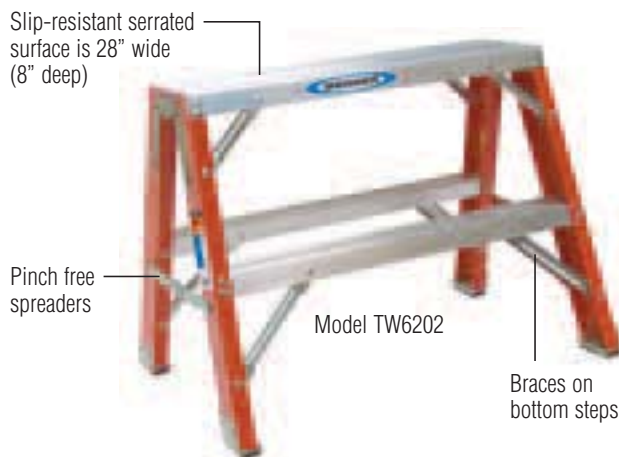

SPECIFICATIONS

Model No.	Size	Approx. Width	Approx. Spread	Approx. Cu. Ft. Per Unit	Approx. Shipping Wt. Lbs.
TW6202	2'	31-1/4"	22-1/4"	3.0	17.0
TW6203	3'	32-3/4"	29-3/4"	4.7	24.0

^{††} Designed for one or two person jobs. Note: When used as a double stepladder, the maximum load per side, including person and materials, shall not exceed the duty rating of ladder.

DIMENSIONS

Top:	8" x 28"	Steps:	3" wide
Rails:	3-1/4" wide	Flange:	1-3/16" wide

6202MODEL

★★★★★ **300lbs.** LOAD CAPACITY **TYPE IA** DUTY RATING

STYLE: Step Stool



SPECIFICATIONS

Model No.	Size	Approx. Width	Approx. Spread	Approx. Cu. Ft. Per Unit	Approx. Shipping Wt. Lbs.
6202	2'	17-1/4"	19-1/2"	1.4	9.0

DIMENSIONS

Top:	5-5/8" x 12-3/8"	Steps:	3" wide
Front Rails:	3-1/8" wide	Rear Rails:	1-3/4" wide
Front Flange:	1-3/16" wide	Rear Flange:	1-3/16" wide, 5/8" wide front

T6202MODEL

★★★★★ **300lbs.** LOAD CAPACITY **PER SIDE** **TYPE IA** DUTY RATING

STYLE: Twin Step Stool^{††}

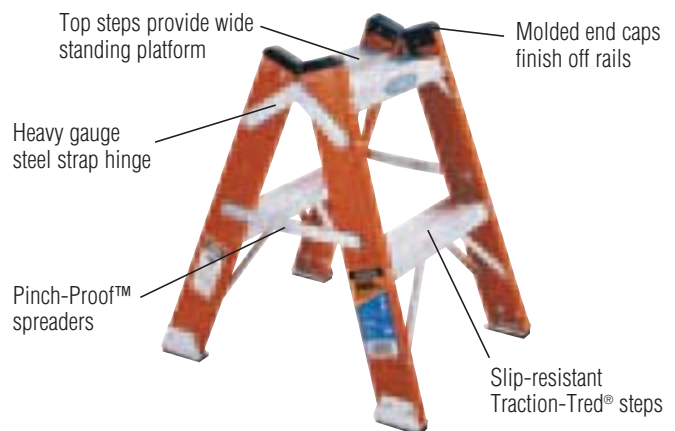

SPECIFICATIONS

Model No.	Size	Approx. Width	Approx. Spread	Approx. Cu. Ft. Per Unit	Approx. Shipping Wt. Lbs.
T6202	2'	21-1/8"	23"	2.1	11.5

^{††} Designed for one or two person jobs. Note: When used as a double stepladder, the maximum load per side, including person and materials, shall not exceed the duty rating of ladder.

DIMENSIONS

Steps:	3" wide
Rails:	3-1/8" wide
Flange:	1-3/16" wide

Note: Planks or platforms shall be secured to the step stools. The ends of each plank or platform shall extend beyond the outside edge of each step stool by a minimum of 4 inches and a maximum of 10 inches.



6200 SERIES

★★★★ **300 lbs.** LOAD CAPACITY **TYPE IA** DUTY RATING

STYLE: Stepladder



COMPATIBLE
SEE PAGES 57-58



- * Energy Diffusing Geometry
- Every rivet backed up by metal plate or washer to protect rails
 - Optional yellow molded pail shelf kit, model no. 76-2

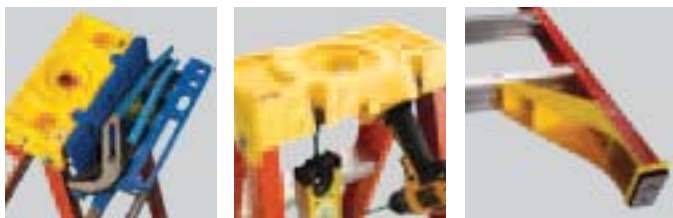

The Lock-In Accessory System lets you customize your ladder top and safely secure your tools.

EDGE® bracing provides enhanced strength and increased protection against damage

SPECIFICATIONS

Model No.	Size	Approx. Width	Approx. Spread	Approx. Cu. Ft. Per Unit	Approx. Shipping Wt. Lbs.
6203	3'	18-1/8"	23-1/8"	2.0	13.0
6204	4'	19-7/8"	29"	3.0	16.0
6205	5'	21-5/8"	35-1/8"	4.1	19.0
6206	6'	23-3/8"	41-1/4"	5.3	22.0
6207	7'	25-1/8"	47-1/2"	6.6	26.0
6208	8'	26-7/8"	53-5/8"	8.1	30.0
6210	10'	30-3/8"	65-7/8"	12.5	39.0
6212	12'	33-7/8"	78-1/4"	15.0	48.0

DIMENSIONS

Top:	5-3/4" x 13"	Steps:	3" wide
Front Rails:	3-1/8" wide	Rear Rails:	1-7/8" wide
Front Flange:	1-3/16" wide	Rear Flange:	1-3/16" wide

T6200 SERIES

★★★★ **300 lbs.** LOAD CAPACITY **PER SIDE** **TYPE IA** DUTY RATING

STYLE: Twin Stepladder††

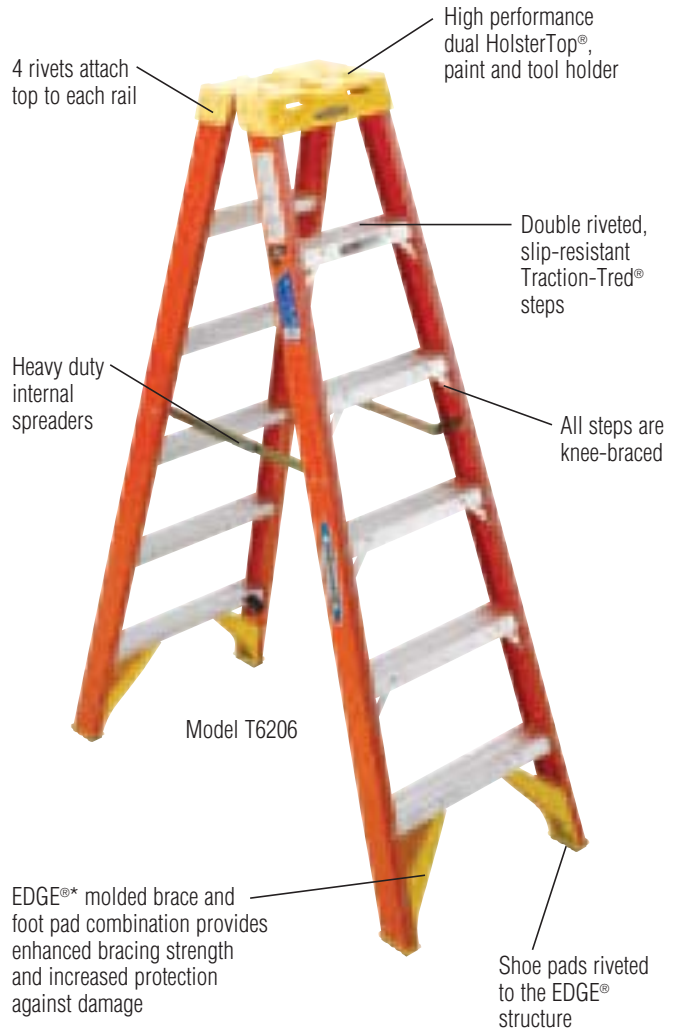

- * Energy Diffusing Geometry
- Every rivet backed up by metal plate or washer to protect rails

SPECIFICATIONS

Model No.	Size	Approx. Width	Approx. Spread	Approx. Cu. Ft. Per Unit	Approx. Shipping Wt. Lbs.
T6203	3'	18-1/8"	29"	3.1	16.0
T6204	4'	19-7/8"	36-1/8"	4.6	19.0
T6205	5'	21-5/8"	43-1/8"	6.2	23.0
T6206	6'	23-3/8"	50-1/8"	8.0	27.0
T6208	8'	26-7/8"	64-1/8"	12.3	37.0
T6210	10'	30-3/8"	78-1/8"	17.3	54.5
T6212	12'	33-7/8"	92-1/8"	23.2	68.5

††Designed for one or two person jobs. Note: When used as a double stepladder, the maximum load per side, including person and materials, shall not exceed the duty rating of ladder.

DIMENSIONS

Top:	8-1/2" x 13"	Steps:	3" wide
Rails:	3-1/8" wide	Flange:	1-3/16" wide

P6200SERIES

★★★★ **300lbs.** LOAD CAPACITY **TYPE IA** DUTY RATING

STYLE: Platform Ladder



- * Energy Diffusing Geometry
- Every rivet backed up by metal plate or washer to protect rails
 - Internal aluminum spreaders on 8' and 10' models

SPECIFICATIONS

Model No.	Height (Size) to Platform	Rail Length	Approx. Width	Approx. Spread	Approx. Cu. Ft. Per Unit	Approx. Shipping Wt. Lbs.
P6202	2'	4'	23-3/8"	29-3/4"	4.2	17.0
P6204	4'	6'	26-7/8"	42"	7.2	24.0
P6206	6'	8'	30-3/8"	54-3/4"	10.9	32.0
P6208	8'	10'	33-7/8"	66-5/8"	15.2	44.5
P6210	10'	12'	37-3/8"	79"	20.1	55.0

DIMENSIONS

Platform:	14-5/8" x 15"	Steps:	3" wide
Front Rails:	3-1/8" wide	Rear Rails:	1-7/8" wide
Front Flange:	1-3/16" wide	Rear Flange:	1-3/16" wide

6100SERIES

★★★★ **300lbs.** LOAD CAPACITY **TYPE IA** DUTY RATING

STYLE: Stepladder



COMPATIBLE
SEE PAGES 57-58



The Lock-In Accessory System lets you customize your ladder top and safely secure your tools.

SPECIFICATIONS

Model No.	Size	Approx. Width	Approx. Spread	Approx. Cu. Ft. Per Unit	Approx. Shipping Wt. Lbs.
6104	4'	19"	28-7/8"	2.6	15.0
6106	6'	22"	41-1/8"	4.5	21.0
6108	8'	25"	53-1/2"	6.8	30.0
6110	10'	28"	65-3/4"	13.0	35.5
6112	12'	31"	78-1/8"	17.3	44.0

DIMENSIONS

Top:	5-3/4" x 13"	Steps:	3" wide
Front Rails:	3-1/8" wide	Rear Rails:	1-7/8" wide
Flange:	1-3/16" wide		



FTP6200 SERIES

★★★★ **300lbs.** LOAD CAPACITY

TYPE IA
DUTY RATING

STYLE: Tripod Stepladder



Single rear rail allows FTP Series to rest where other ladders can't



Convenient spreader handle design improves setup and transportability



Makes working in tight spaces easy

- Every rivet backed up by metal plate or washer to protect rails
- Internal aluminum spreaders on 8' and 10' models

SPECIFICATIONS

Model No.	Size	Approx. Width	Approx. Spread	Approx. Cu. Ft. Per Unit	Approx. Shipping Wt. Lbs.
FTP6204	4'	31"	30-1/2"	3.7	17.0
FTP6206	6'	36"	43-3/4"	6.8	23.0
FTP6208	8'	40"	57"	10.1	31.0
FTP6210	10'	51"	71"	17.6	42.0
FTP6212	12'	54"	77-3/4"	22.6	51.0

DIMENSIONS

Top:	5-3/4" x 13"	Steps:	3" wide
Front Rails:	3-1/8" wide	Rear Rail:	1-1/2" square (4' to 8'), 2" square (10' and 12')
Flange:	1-3/16" wide		

6002 MODEL

★★★ **250lbs.** LOAD CAPACITY

TYPE I
DUTY RATING

STYLE: Step Stool



©The blue and yellow ladder is an exclusive registered trademark of Werner Co.

SPECIFICATIONS

Model No.	Size	Approx. Width	Approx. Spread	Approx. Cu. Ft. Per Unit	Approx. Shipping Wt. Lbs.
6002	2'	17-1/4"	19-1/2"	1.4	8.5

DIMENSIONS

Top:	5-5/8" x 12-3/8"	Steps:	3" wide
Front Rails:	3-1/8" wide	Rear Rails:	1-3/4" wide
Front Flange:	1-1/8" wide	Rear Flange:	1-3/16" wide back 5/8" wide front

6000 & 6000S SERIES

★★★ 250lbs. LOAD CAPACITY TYPE I DUTY RATING

STYLE: Stepladder



COMPATIBLE SEE PAGES 57-58

HolsterTop® with Lock-In Accessory System secures tools from falling

Sturdy paint can hanger on back side of top

Braces on top step, second step and top horizontal

External Pinch-Proof™ spreaders

Slip-resistant Traction-Tred® steps

Model 6006

Foot pads riveted to the EDGE® structure

*Energy Diffusing Geometry

©The blue and yellow ladder is an exclusive registered trademark of Werner Co.



The Lock-In Accessory System lets you customize your ladder top and safely secure your tools.

EDGE® bracing provides enhanced strength and increased protection against damage

SPECIFICATIONS

Model No.	Size	Approx. Width	Approx. Spread	Approx. Cu. Ft. Per Unit	Approx. Shipping Wt. Lbs.	Model No. with Pail Shelf	Approx. Shipping Wt. Lbs.
6004	4'	19"	28-7/8"	2.6	13.0	6004S	15.0
6005	5'	20-1/2"	35"	3.5	16.0	6005S	18.0
6006	6'	22"	41-1/8"	4.5	18.0	6006S	20.0
6008	8'	25"	53-1/2"	6.8	25.5	6008S	27.5

DIMENSIONS

Top:	5-3/4" x 13"	Steps:	3" wide
Front Rails:	3-1/8" wide	Rear Rails:	1-3/4" wide
Front Flange:	1-1/8" wide	Rear Flange:	1-3/16" wide back 5/8" wide front

T6000 SERIES

★★★ 250lbs. LOAD CAPACITY PER SIDE TYPE I DUTY RATING

STYLE: Multi-Use Twin Stepladder††

High performance dual HolsterTop®, paint and tool holder

Back-up aluminum plates reinforce all top connectors

Braces on top steps and bottom three steps

External Pinch-Proof™ spreaders

Slip-resistant Traction-Tred® steps on front and rear sections

Rubber step bumpers to resist damage

Model T6008

EDGE® molded brace and foot pad combination provides enhanced bracing strength and increased protection against damage

* Energy Diffusing Geometry

- Every rivet backed up by metal plate or washer to protect rails
- ©The blue and yellow ladder is an exclusive registered trademark of Werner Co.

SPECIFICATIONS

Model No.	Size	Approx. Width	Approx. Spread	Approx. Cu. Ft. Per Unit	Approx. Shipping Wt. Lbs.
T6004	4'	19"	36-1/8"	4.5	17.5
T6006	6'	22"	50-1/8"	7.9	24.5
T6008	8'	25"	64-1/8"	11.9	35.0

††Designed for one or two person jobs. Note: When used as a double stepladder, the maximum load per side, including person and materials, shall not exceed the duty rating of ladder.

DIMENSIONS

Top:	8-1/2" x 13"	Steps:	3" wide
Rails:	3-1/8" wide	Flange:	1-1/8" wide



PT6000/PT6000-4C SERIES

★★★ **250lbs.** LOAD CAPACITY **TYPE I**
PER SIDE DUTY RATING

STYLE: Stockr's Ladder®††



- Easy to handle and folds to a 12" width for storage
- Unique combination of one person, platform ladder or two person use††
- External Pinch-Proof™ spreaders on 8' model
- Requires less floor space than heavy steel rolling ladders

SPECIFICATIONS

Model No.	Height (Size) to Platform	Rail Length	Approx. Width	Approx. Spread	Approx. Cu. Ft. Per Unit	Approx. Shipping Wt. Lbs.	Model No. with Casters	Approx. Shipping Wt. Lbs.
PT6002	2'	4'	20"	36-1/2"	6.4	21.0	PT6002-4C	27.0
PT6004	4'	6'	23"	51"	11.1	28.0	PT6004-4C	35.0
PT6006	6'	8'	26"	65-1/2"	16.7	39.0	PT6006-4C	47.0
PT6008	8'	10'	29"	80"	23.4	52.0	PT6008-4C	64.5

†† Designed for one or two person jobs. Note: When used as a double stepladder, the maximum load per side, including person and materials, shall not exceed the duty rating of ladder.

DIMENSIONS

Platform:	12-3/4" x 22"	Steps:	3" wide
Rails:	3-1/8" wide	Flange:	1-1/8" wide

5900 & 5900S SERIES

★★ **225lbs.** LOAD CAPACITY **TYPE II**
DUTY RATING

STYLE: Stepladder



COMPATIBLE
SEE PAGES 57-58



Sturdy pail shelf with rag rack holds gallon paint can (5900S series only)

- * Energy Diffusing Geometry
- Optional yellow molded pail shelf kit, model no. 76-9 or PK76-9 available for 5900 series

SPECIFICATIONS

Model No.	Size	Approx. Width	Approx. Spread	Approx. Cu. Ft. Per Unit	Approx. Shipping Wt. Lbs.	Model No. with Pail Shelf	Approx. Shipping Wt. Lbs.
5904	4'	19"	28-7/8"	2.6	11.5	N/A	N/A
5906	6'	22"	41-1/8"	4.5	16.0	5906S	16.5
5908	8'	25"	53-1/2"	6.8	22.5	5908S	23.0

DIMENSIONS

Top:	5-3/8" x 13"	Steps:	3" wide
Front Rails:	3-1/8" wide	Rear Rails:	1-3/4" wide
Front Flange:	1-1/8" wide	Rear Flange:	1-3/16" wide

FIBERGLASS STEPLADDER COMPARISON CHART



Features and Benefits	7400 SERIES	T7400 SERIES	P7400 SERIES	7300 SERIES	6200 SERIES	T6200 SERIES	P6200 SERIES	6100 SERIES	6000 SERIES	T6000 SERIES	5900 SERIES
	TYPE IAA	TYPE IAA/IA	TYPE IAA/IA	TYPE IAA	TYPE IA	TYPE IA	TYPE IA	TYPE IA	TYPE I	TYPE I	TYPE II
Slip-resistant Traction-Tred® steps	★	★	★	★	★	★	★	★	★	★	★
Slip-resistant foot pad	★	★	★	★	★	★	★	★	★	★	★
Aluminum drill HolsterTop®	★			★							
HolsterTop®						★				★	★
Aluminum top		★									
HolsterTop® featuring Lock-In Accessory System					★			★	★		★
Designed for one or two person jobs		★				★				★	
Slip-resistant Traction-Tred® steps all knee braced	★	★	★	★	★	★	★				
Molded braces	★	★	★	★	★	★	★		★	★	★
Rail shields	★	★	★	★							
Internal spreaders	★	★		★	★	★		★			
External spreaders									★	★	★
Full set of rear horizontals	★		★	★	★		★	★			
Platform for comfortable work area			★				★				
Shoulder bolt and nut on top hinge	★	★	★	★	★	★	★			★	
Back-up plates to reinforce top connectors	★	★	★	★	★	★	★	★	★	★	★
Every rivet backed up by metal plate or washer to protect fiberglass	★	★	★	★	★	★	★	★	★	★	★
4 rivets attach top to each front rail	★	★	★	★	★	★	★	★			

D7100-2LV SERIES

★★★★★ **375 lbs.** LOAD CAPACITY **TYPE IAA** DUTY RATING

STYLE: D-Rung Extension Ladder with Integrated Leveling



Exclusive Alflo® rung joint means Twist-Proof® performance

External guides at top of base section securely interlock rails

Slip-resistant Traction-Tred® D-rungs

Rugged gravity spring locks operate smoothly

Nylon coated internal guides on bottom of fly section increase ease of operation

Factory installed LevelLok® Leveler enables ladder to adapt to uneven terrain.

With simple foot action, Leveler extends up to 10" in 3/16" increments

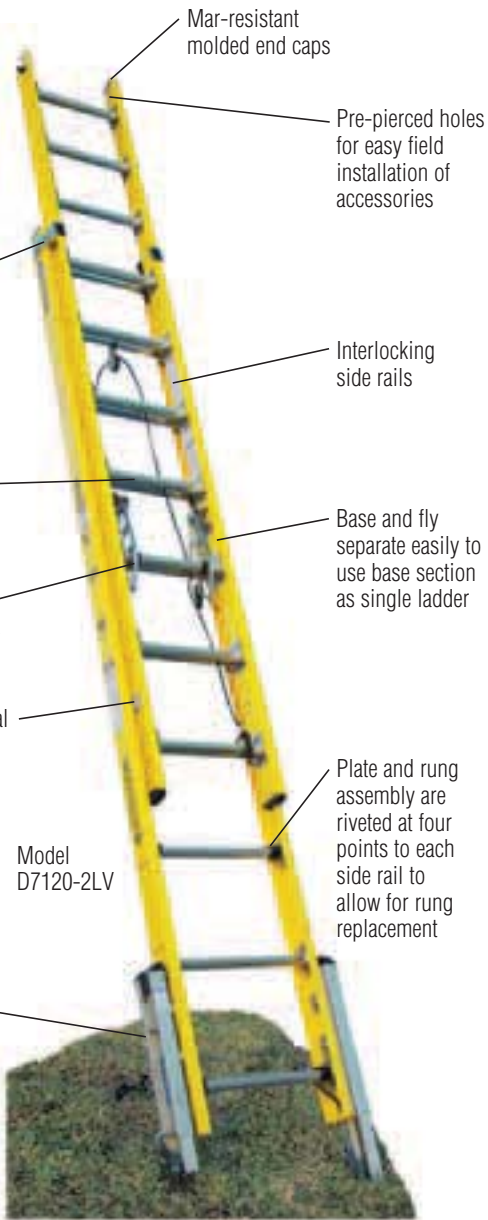

Model D7120-2LV

- Ideal for utility and telecommunication industries

LevelLok® is a registered trademark of the LevelLok Corporation.

SPECIFICATIONS NOTE: Type IAA duty rating is for extension ladders up to 32 feet

Model No.	Total Length of Sections	Max. Working Length	Approx. Cu. Ft. Per Unit	Approx. Shipping Wt. Lbs.
D7120-2LV	20'	17'	8.6	58.0
D7124-2LV	24'	21'	10.3	66.5
D7128-2LV	28'	25'	12.0	75.0
D7132-2LV	32'	29'	13.7	90.5

★★★★★ **300 lbs.** LOAD CAPACITY **TYPE IA** DUTY RATING

D7136-2LV	36'	32'	20.2	121.0
D7140-2LV	40'	35'	22.5	134.5

DIMENSIONS

	Rails:	Flange:	Rungs:	Fly Width:	Base Width:
20' to 32'	3-5/16"	1-3/16"	1-5/8"	16-1/8" outside rails	19" outside rails, 22-3/4" outside shoes
36' & 40'	4"	1-3/4"	1-3/4"	16-3/4" outside rails	22" outside rails, 25-3/4" outside shoes

D7100-2 SERIES

★★★★★ **375 lbs.** LOAD CAPACITY **TYPE IAA** DUTY RATING

STYLE: D-Rung Extension Ladder



Exclusive Alflo® rung joint means Twist-Proof® performance

External guides at top of base section securely interlock rails

Heavy duty pulley with rope

Interlocking side rails

Base and fly separate easily to use base section as single ladder

Nylon coated internal guides on bottom of fly section increase ease of operation

Durable rail shield and shoe bracket protects rail from damage

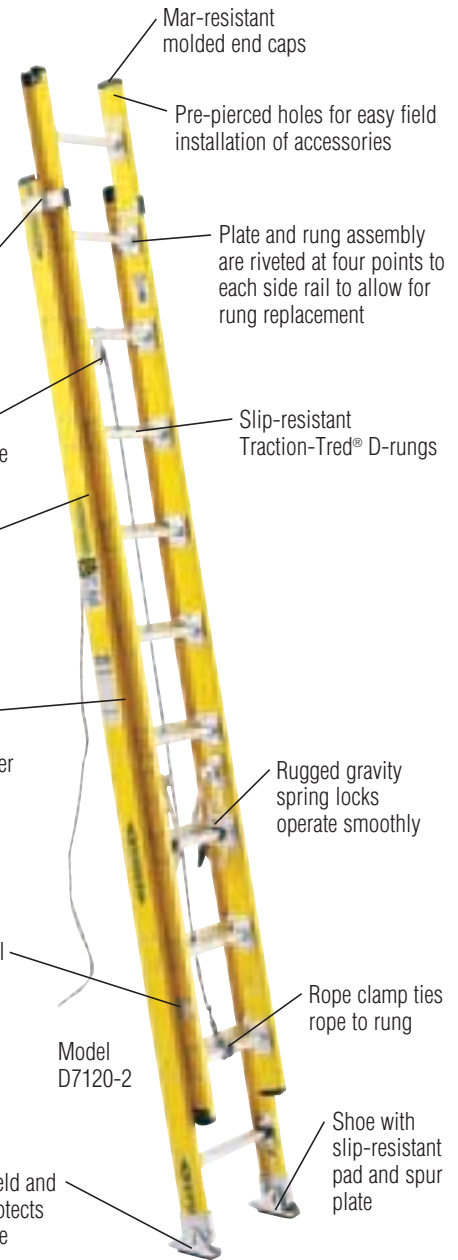

Model D7120-2

Mar-resistant molded end caps

Pre-pierced holes for easy field installation of accessories

Plate and rung assembly are riveted at four points to each side rail to allow for rung replacement

Slip-resistant Traction-Tred® D-rungs

Rugged gravity spring locks operate smoothly

Rope clamp ties rope to rung

Shoe with slip-resistant pad and spur plate

SPECIFICATIONS NOTE: Type IAA duty rating is for extension ladders up to 32 feet

Model No.	Total Length of Sections	Max. Working Length	Approx. Cu. Ft. Per Unit	Approx. Shipping Wt. Lbs.
D7116-2†	16'	13'	7.0	41.0
D7120-2	20'	17'	8.7	50.0
D7124-2	24'	21'	10.3	58.5
D7128-2	28'	25'	12.0	67.0
D7132-2	32'	29'	13.7	82.5

★★★★★ **300 lbs.** LOAD CAPACITY **TYPE IA** DUTY RATING

D7136-2	36'	32'	23.8	113.0
D7140-2	40'	35'	26.7	126.5

† Note: D7116-2CA is not equipped with rope and pulley

DIMENSIONS

	Rails:	Flange:	Rungs:	Fly Width:	Base Width:
16' to 32'	3-5/16"	1-3/16"	1-5/8"	16-1/8" outside rails	19" outside shoes
36' and 40'	4"	1-3/4"	1-3/4"	16-3/4" outside rails	22" outside shoes

7100-2/7100-1 SERIES

★★★★★ **375lbs.** LOAD CAPACITY TYPE IAA DUTY RATING

STYLE: Round Rung Extension/Straight Ladder



Exclusive Alflo® rung joint means Twist-Proof® performance

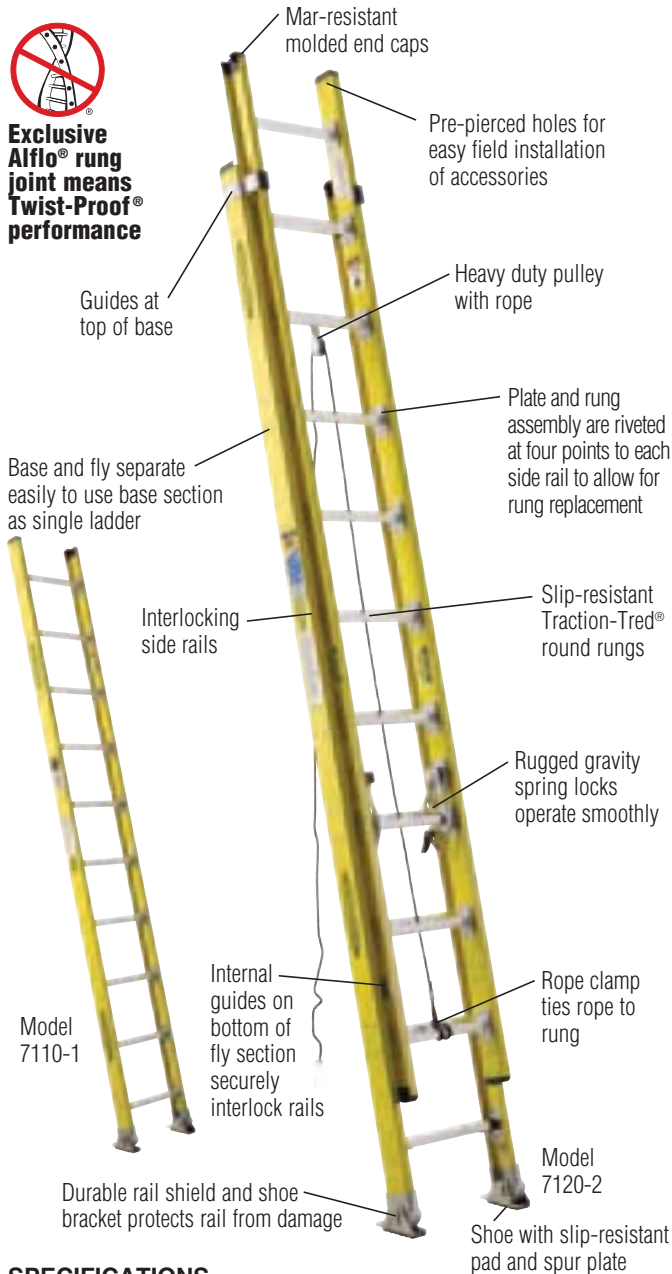

SPECIFICATIONS

Model No.	Total Length of Sections	Max. Working Length	Approx. Cu. Ft. Per Unit	Approx. Shipping Wt. Lbs.	Straight Ladder Model No.	Total Length	Approx. Cu. Ft. Per Unit	Approx. Shipping Wt. Lbs.
7116-2‡	16'	13'	7.0	38.5	7108-1	8'	4.5	20.0
7120-2	20'	17'	8.7	47.0	7110-1	10'	5.5	24.0
7124-2	24'	21'	10.3	55.0	7112-1	12'	6.5	28.0
7128-2	28'	25'	12.0	63.0	7114-1	14'	7.6	32.0
7132-2	32'	29'	13.7	78.0	7116-1	16'	8.6	40.0

★★★★★ **300lbs.** LOAD CAPACITY TYPE IA DUTY RATING

--	--	--	--	--	7118-1	18'	12.5	52.0
--	--	--	--	--	7120-1	20'	13.9	58.0

‡ Note: 7116-2 is not equipped with rope and pulley

DIMENSIONS

	Rails:	Flange:	Rungs:	Width (outside rails):	Width (outside shoes):
7100-2: ALL	3-5/16"	1-3/16"	1-1/4"	17-3/4" outside rails	19" outside shoes
7100-1: 8' to 16'	4"	1-3/4"	1-1/4"	16-13/16" outside rails	18-1/16" outside shoes

D8200-2EQ SERIES

★★★★★ **300lbs.** LOAD CAPACITY TYPE IA DUTY RATING

STYLE: Extension Ladder with Integrated Leveling



Exclusive Alflo® rung joint means Twist-Proof® performance

THE Equalizer®
ELIMINATES UNEVEN GROUND



Factory installed adjustable EverLevel® leveling system exceeds OSHA and ANSI requirements



Precisely adjusts in 3/8" increments up to 8-1/4", making it easy to use



Dual action feet for use on hard or penetrable surfaces



Model D8224-2EQ

®The blue and yellow ladder is an exclusive registered trademark of Werner Co.

SPECIFICATIONS

Model No.	Total Length of Sections	Max. Working Length	Approx. Cu. Ft. Per Unit	Approx. Shipping Wt. Lbs.
D8220-2EQ	20'	17'	10.0	54.0
D8224-2EQ	24'	21'	11.9	62.0
D8228-2EQ	28'	25'	13.8	70.0

DIMENSIONS

Rails:	3-5/16" wide	Fly Width:	16" outside rails
Flange:	1-3/16" wide	Base Width:	17-3/4" outside rails, 21-7/16" outside of feet
Rungs:	1-5/8"		



D6200-2/D6200-1 SERIES

★★★★ **300lbs.** LOAD CAPACITY **TYPE IA** DUTY RATING

STYLE: D-Rung Extension/Straight Ladder



Exclusive Alflo® rung joint means Twist-Proof® performance

Mar-resistant molded end caps

Pre-pierced holes for easy field installation of accessories

External guides at top of base section securely interlock rails. Two sets on 36' and 40' models

Direct rung to rail connections

Heavy duty pulley with rope

Interlocking side rails

Base and fly separate easily to use base section as single ladder

Slip-resistant Traction-Tred® D-rungs

Rugged gravity spring locks operate smoothly

Internal guides on bottom of fly section securely interlock rails

Rope clamp ties rope to rung

Durable rail shield bracket and shoe with Shu-Lok®, slip-resistant pad and spur plate

Molded rung braces

Model D6220-2

SPECIFICATIONS

Model No.	Total Length of Sections	Max. Working Length	Approx. Cu. Ft. Per Unit	Approx. Shipping Wt. Lbs.	Single Ladder Model No.	Total Length	Approx. Cu. Ft. Per Unit	Approx. Shipping Wt. Lbs.
D6216-2‡	16'	13'	7.0	36.5	D6208-1	8'	4.7	19.5
D6220-2	20'	17'	8.7	44.5	D6210-1	10'	5.8	23.0
D6224-2	24'	21'	10.3	52.0	D6212-1	12'	6.9	27.0
D6228-2	28'	25'	12.0	59.5	D6214-1	14'	8.0	31.0
D6232-2	32'	29'	13.7	71.5	D6216-1	16'	9.1	37.0
D6236-2	36'	32'	15.3	80.5	--	--	--	--
D6240-2	40'	35'	17.0	88.5	D6220-1	20'	11.5	45.5

‡ Note: D6216-2 is not equipped with rope and pulley

DIMENSIONS

Rails:	3-5/16" wide	Fly Width:	16" outside rails
Flange:	1-3/16" wide	Base Width:	19" outside shoes
Rungs:	1-5/8"		

D6200-3 SERIES

★★★★ **300lbs.** LOAD CAPACITY **TYPE IA** DUTY RATING

STYLE: D-Rung Compact Extension Ladder



Exclusive Alflo® rung joint means Twist-Proof® performance

3 PIECE COMPACT DESIGN

Same reach as a standard extension ladder but stores in less space than comparable 2 piece extension ladder



Mar-resistant molded end caps

Slip-resistant Traction-Tred® D-rungs

Interlocking side rails

Internal guides on bottom of fly section securely interlock rails

Durable rail shield bracket and shoe with Shu-Lok®, slip-resistant pad and spur plate



Convenient to maneuver and store



Easy to transport on compact vehicles

Rugged gravity spring locks operate smoothly

Direct rung to rail connections

Molded rung braces

Model D6216-3‡

‡ Note: D6216-3 is not equipped with rope and pulley

SPECIFICATIONS

Model No.	Total Length of Sections	Total Length in Storage Position 2 vs. 3 piece*	Max. Working Length	Approx. Cu. Ft. Per Unit	Approx. Shipping Wt. Lbs.
D6216-3	18'	8' / 6'	13'	8.5	40.5
D6220-3	23'	10' / 8'	17'	11.1	54.0
D6224-3	27'	12' / 9'	21'	12.4	61.0
D6228-3	31'	14' / 11'	26'	15.0	74.5
D6232-3	35'	16' / 12'	29'	13.7	81.0

* Total Length of ladder in storage position, comparison of Standard 2 - piece vs. New 3 - piece extension ladder.

DIMENSIONS

Rails:	3-5/16" wide	Fly Width:	16" outside rails
Flange:	1-3/16" wide	Base Width:	19" outside shoes
Rungs:	1-5/8"		

D6000-2SERIES

☆☆☆ **250lbs.** LOAD CAPACITY

TYPE I
DUTY RATING

STYLE: D-Rung Extension Ladder



Exclusive Alflo® rung joint means Twist-Proof® performance

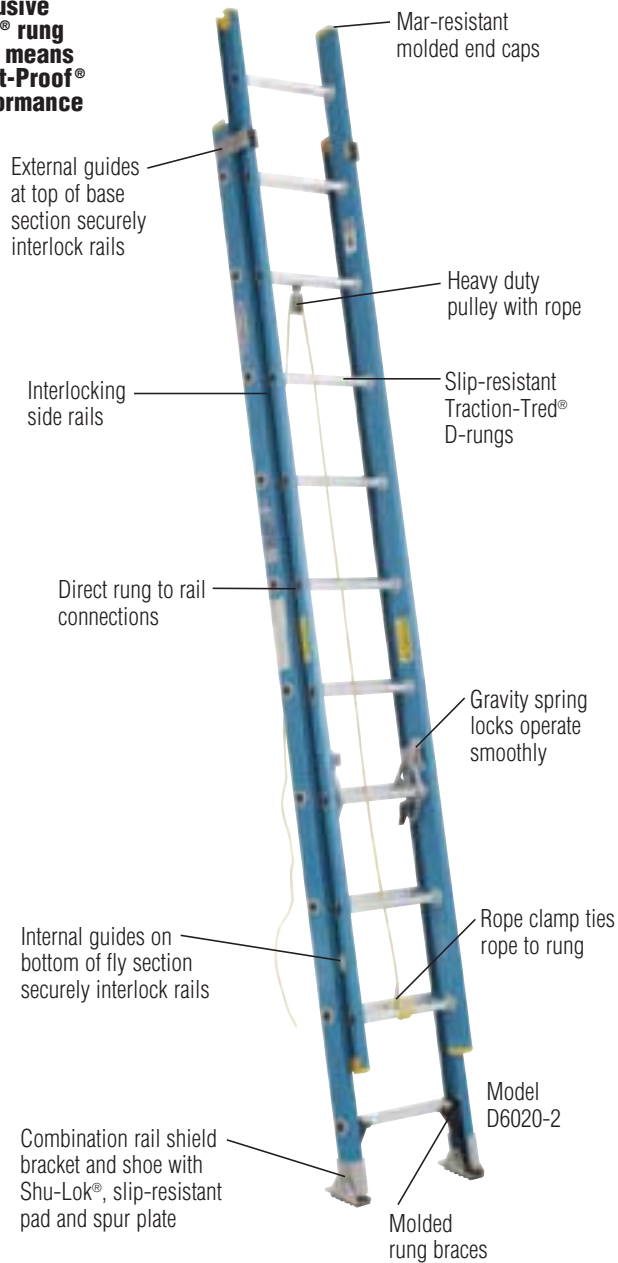

D5900-2SERIES

☆☆ **225lbs.** LOAD CAPACITY

TYPE II
DUTY RATING

STYLE: D-Rung Extension Ladder



Exclusive Alflo® rung joint means Twist-Proof® performance

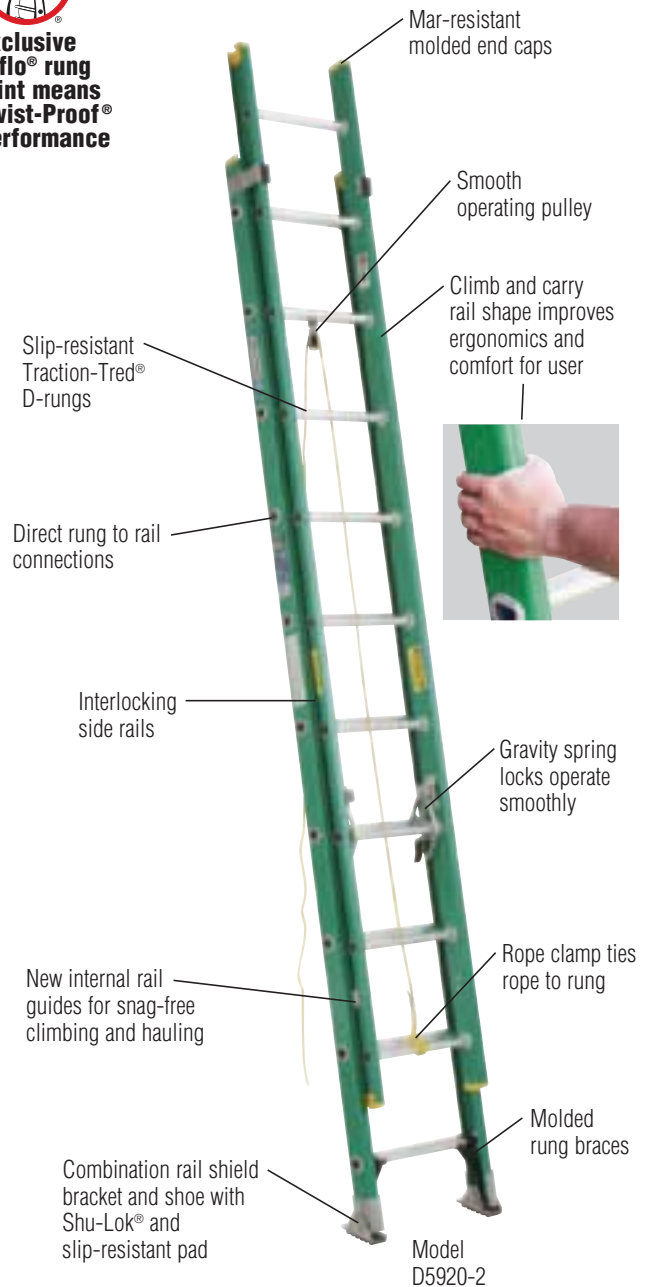

©The blue and yellow ladder is an exclusive registered trademark of Werner Co.

SPECIFICATIONS

Model No.	Total Length of Sections	Max. Working Length	Approx. Cu. Ft. Per Unit	Approx. Shipping Wt. Lbs.
D6016-2‡	16'	13'	7.0	32.5
D6020-2	20'	17'	8.7	39.0
D6024-2	24'	21'	10.3	46.0
D6028-2	28'	25'	12.0	55.5

‡ Note: D6016-2 is not equipped with rope and pulley

DIMENSIONS

Rails:	3-3/8" wide	Fly Width:	15-3/4" outside rails
Flange:	1-3/16" wide	Base Width:	18-1/8" outside shoes
Rungs:	1-1/2"		

SPECIFICATIONS

Model No.	Total Length of Sections	Max. Working Length	Approx. Cu. Ft. Per Unit	Approx. Shipping Wt. Lbs.
D5916-2‡	16'	13'	5.9	27.0
D5920-2	20'	17'	7.4	33.0
D5924-2	24'	21'	8.9	39.0

‡ Note: D5916-2 is not equipped with rope and pulley

















DIMENSIONS

Rails:	3-5/16" wide	Fly Width:	15-1/8" outside rails
Flange:	1-3/16" wide	Base Width:	17-3/4" outside shoes
Rungs:	1-1/2"		





FIBERGLASS EXTENSION LADDER COMPARISON CHART

Features and Benefits	D7100-2LV SERIES	D7100-2 SERIES	7100 SERIES	D8200-2EQ SERIES	D6200 SERIES	D6000-2 SERIES	D5900-2 SERIES
	TYPE IAA/IA	TYPE IAA/IA	TYPE IAA	TYPE IA	TYPE IA	TYPE I	TYPE II
 Guides at top of base section	★	★	★	★	★	★	
 Guides on bottom of fly section	★	★	★	★	★	★	★
 Pulley and rope systems	★	★	★	★	★	★	★
 Rail shield and shoe bracket protects rail	★	★	★	★	★	★	
 Shoe with slip-resistant pad and spur plate	★	★	★	★	★	★	★
 Rugged gravity spring locks	★	★	★	★	★	★	★
 Rope clamp ties rope to rung	★	★	★	★	★	★	★
 Alflo® rung joint for Twist-Proof® performance	★	★	★	★	★	★	★
Electrically non-conductive side rails	★	★	★	★	★	★	★
 Mar-resistant molded end caps	★	★	★	★	★	★	★
Base section may be used as a single ladder	★	★	★	★	★	★	★
 Pre-pierced holes for easy field installation of accessories	★	★	★	★	★		
 Plate and rung assembly to allow for rung replacement	★	★	★				
 Direct rung to rail connections				★	★	★	★
 Interlocking side rails	★	★	★	★	★	★	★
 Slip-resistant D-rungs	★	★		★	★	★	★
 Slip-resistant round rungs			★				
 Molded rung braces					★	★	★
 Integrated leveling	★			★			

7800SERIES

★★★★★ **375lbs.** LOAD CAPACITY **TYPE IAA** DUTY RATING

STYLE: Combination Step/Extension Ladder††



Exclusive Alflo® rung joint means Twist-Proof® performance



SPECIFICATIONS

Model No.	Stepladder Size	Width at Flared Base (outside rails)	Stepladder Spread to Outside of Shoes	Length of Ladder in Closed Position	Extended Ladder Working Length	Approx. Cu. Ft. Per Unit	Approx. Shipping Wt. Lbs.
7806	6'	23-1/4"	46-1/2"	72-3/4"	9-1/2'	8.6	33.5
7807	7'	24-1/4"	53-1/2"	84-3/4"	11-1/2'	10.3	37.0
7808	8'	25-1/4"	60-1/2"	96-3/4"	13-1/2'	12.1	40.5

††Designed for one or two person jobs. Note: When used as a double stepladder, the maximum load per side, including person and materials, shall not exceed the duty rating of ladder.

DIMENSIONS

	Parallel Section	Flared Section
Overlap	3'	--
Rails:	3-1/8" wide	3-1/8" wide
Flange:	1-3/16" wide	1-3/16" wide
Ladder Width:	14-1/2" outside rails	14-1/2" outside rails at top
Ladder in Closed Position:	--	7-7/8" deep

M7100-1SERIES

★★★★★ **375lbs.** LOAD CAPACITY **TYPE IAA** DUTY RATING

STYLE: Manhole Ladder



Exclusive Alflo® rung joint means Twist-Proof® performance



SPECIFICATIONS

Model No.	Total Length	Approx. Cu. Ft. Per Unit	Approx. Shipping Wt. Lbs.
M7108-1	8'	3.0	20.0
M7110-1	10'	3.7	24.0
M7112-1	12'	4.4	28.0
M7114-1	14'	5.2	32.0
M7116-1	16'	5.9	39.5

DIMENSIONS

Rails:	3-5/16" wide	Rungs:	1-1/4"
Flange:	1-3/16" wide	Ladder Width:	12-3/8" outside shoes



S7900 SERIES

★★★★★ **375 lbs.** LOAD CAPACITY
3 SECTIONS

★★★★★ **300 lbs.** LOAD CAPACITY
4 SECTIONS TYPE IA DUTY RATING

STYLE: Interchangeable Tapered Sectional Ladder



Exclusive Alflo® rung joint means Twist-Proof® performance

- Maximum number of sections to be used – 4

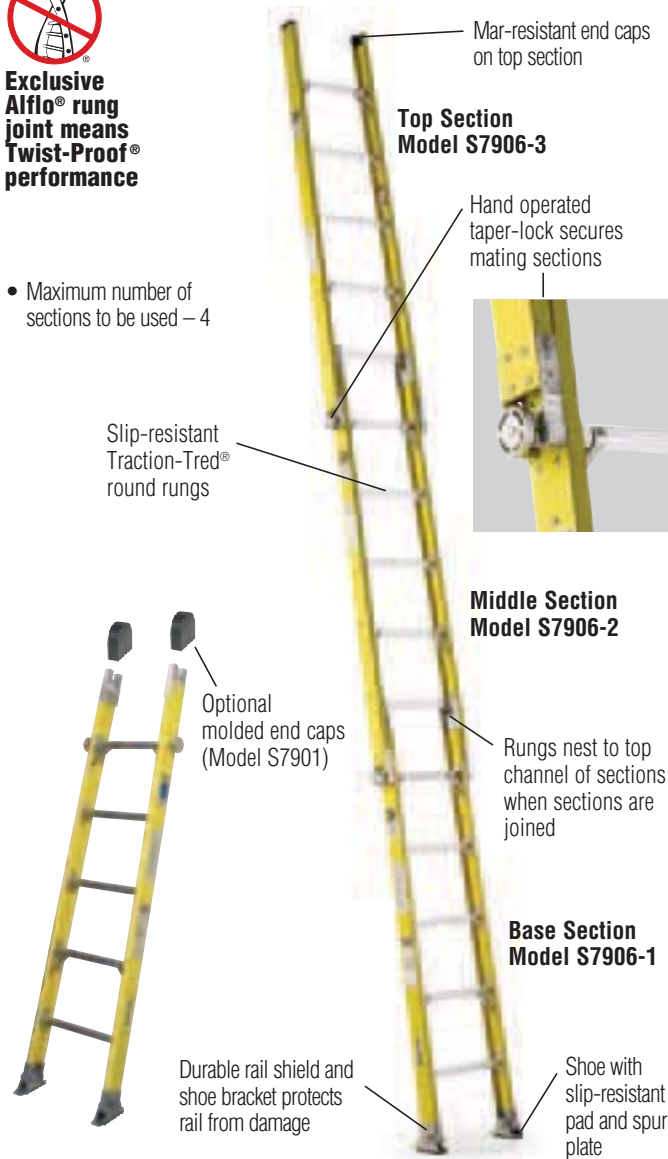

SPECIFICATIONS

Model No.	Description	Top of Section	Bottom of Section	Approx. Cu. Ft. Per Unit	Approx. Shipping Wt. Lbs.
S7906-1	6' tapered base with swivel shoes	15-3/4"	19-3/4"	2.3	17.0
S7906-2	6' intermediate	15-3/4"	18-3/4"	3.5	15.5
S7906-3	6' top with molded end caps	16-3/16"	18-3/4"	3.4	13.0
S7901 (Accessory)	End caps for middle or base sections	N/A	N/A	0.1	1.0 ea.

ASSEMBLY DESCRIPTION

Quantity of Sections	Model No.	Total Assembled Size
1	S7906-1 base	6' 2"
1	S7906-1 base	20' 11"
1	S7906-2 middle	
1	S7906-3 top	
1	S7906-1 base	
2	S7906-2 middle	20' 11"
1	S7906-3 top	

DIMENSIONS

Rails:	3-5/16" wide
Flange:	1-3/16" wide
Rungs:	1-1/4" diameter

9500-2/9500-1 SERIES

★★★★★ **300 lbs.** LOAD CAPACITY
TYPE IA DUTY RATING

STYLE: All-Fiberglass Extension/Straight Ladder

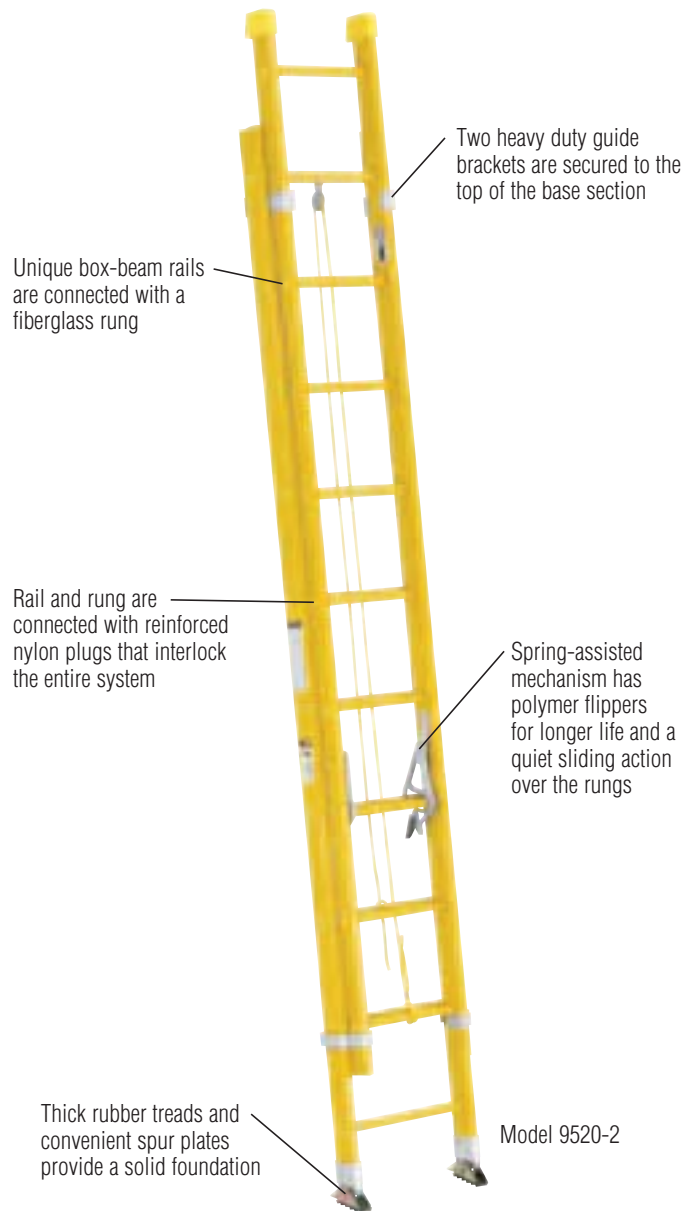

SPECIFICATIONS

Model No.	Total Length of Sections	Max. Working Length	Approx. Cu. Ft. Per Unit	Approx. Shipping Wt. Lbs.	Single Ladder Model No.	Total Length	Approx. Cu. Ft. Per Unit	Approx. Shipping Wt. Lbs.
9516-2	16'	13'	8.3	41.0	9508-1	8'	5.5	18.0
9520-2	20'	17'	10.2	49.0	9510-1	10'	6.8	22.0
9524-2	24'	21'	12.2	56.0	9512-1	12'	8.0	26.0
9528-2	28'	25'	14.1	64.0	9514-1	14'	9.4	30.0
9532-2	32'	29'	16.0	72.0	9516-1	16'	10.7	34.0
					9518-1	18'	11.2	38.0
					9520-1	20'	12.5	42.0

DIMENSIONS

Rails:	3-1/4" wide	Fly Width:	15-1/2" outside rails
Flange:	1-3/16" wide	Base Width:	19" outside shoes
Rungs:	1-1/4"		

SPF00-1/TPF00-1 SERIES

★★★★ **300lbs.** LOAD CAPACITY **TYPE IA** DUTY RATING

STYLE: Posting Ladder

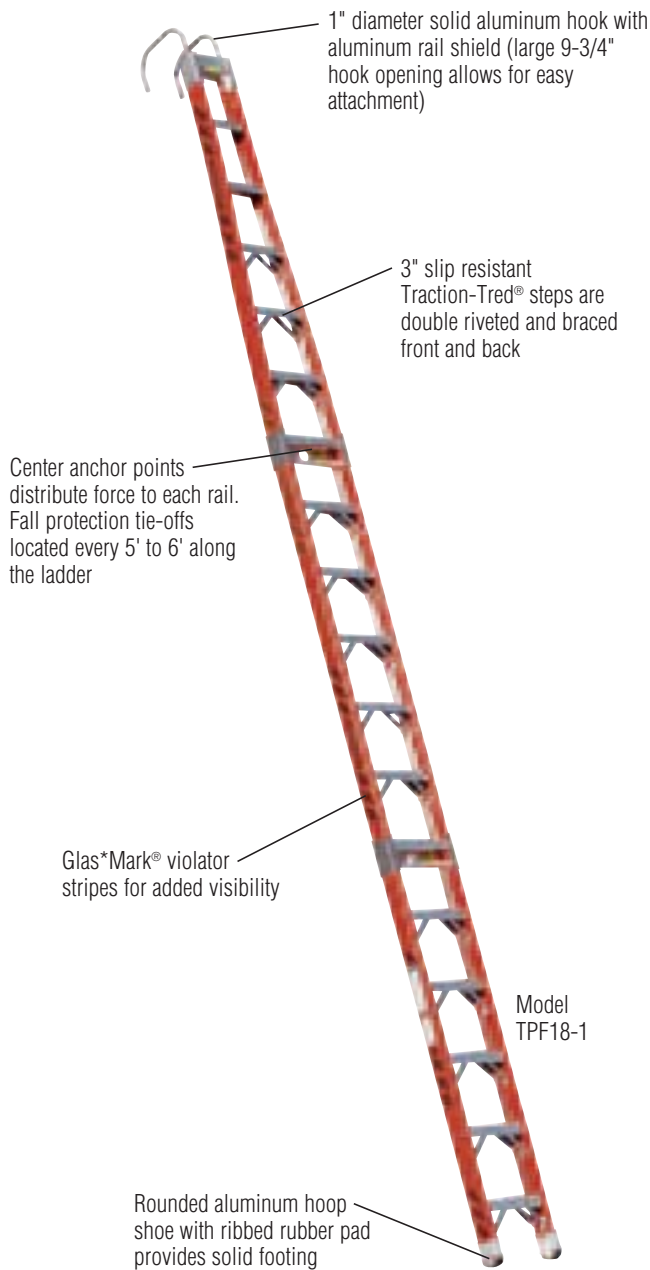

SPECIFICATIONS

Model No.	Total Length	Length for Shipping	Approx. Cu. Ft. Per Unit	Approx. Shipping Wt. Lbs.
Straight Posting Ladders (not shown above)				
SPF14-1	14'	15'	6.0	38.0
SPF16-1	16'	17'	6.8	43.0
SPF18-1	18'	19'	7.6	49.0
SPF20-1	20'	21'	8.4	58.0
Tapered Posting Ladders				
TPF14-1	14'	15'	6.0	37.0
TPF16-1	16'	17'	6.8	42.0
TPF18-1	18'	19'	7.6	48.0
TPF20-1	20'	21'	8.4	57.0

DIMENSIONS

Rails:	3-5/16" wide	Steps:	2-7/8" wide
Flange:	1-3/16" wide	Base Width:	14-5/8"

S7700 SERIES

★★★★ **250lbs.** LOAD CAPACITY **TYPE I** DUTY RATING

STYLE: Interchangeable Parallel Sectional Ladder



Exclusive Alflo® rung joint means Twist-Proof® performance

- Maximum number of sections to be used – 3

Slip-resistant Traction-Tred® round rungs

Sections joined by heavy duty extruded fittings and secured by a cam driven tension clamp

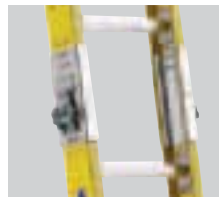

SPECIFICATIONS

Model No.	Description	Top of Section	Bottom of Section	Approx. Cu. Ft. Per Unit	Approx. Shipping Wt. Lbs.
S7706-1	For manhole use - 6' length	12" wide	12" wide	2.1	15.5
End Caps and Shoes					
S7701	End cap (2 required)	N/A	N/A	0.1	1.5 ea.
S7702-1	Shoe with black EPDM pad (2 required)	N/A	N/A	0.1	1.5 ea.
S7702-2	Shoe with gray EPDM pad (2 required) Buna N Pad - Oil resistant	N/A	N/A	0.1	1.5 ea.

ASSEMBLY DESCRIPTION

Max. No. of Sections	Approx. Max. Assembled Length
(3) assembled 6' sections with (1) pair of end caps and (1) pair of shoes	19'

DIMENSIONS

Rails:	3-5/16" wide
Flange:	1-3/16" wide
Rungs:	1-1/4" diameter



900AA SERIES

★★★★★ **375 lbs.** LOAD CAPACITY **TYPE IAA** DUTY RATING

STYLE: Aircraft Maintenance Ladder††



Model 900AA-06

SPECIFICATIONS

Model No.	Size	Approx. Width	Approx. Spread	Approx. Cu. Ft. Per Unit	Approx. Shipping Wt. Lbs.
900AA-03	3'	25-3/8"	41-3/8"		40.0
900AA-04	4'	26-7/8"	48-3/4"		47.0
900AA-05	5'	28-3/8"	56-3/8"		54.0
900AA-06	6'	29-7/8"	63-5/8"		61
900AA-08	8'	32-7/8"	78-1/2"		77.0
900AA-10	10'	35-7/8"	98-3/8"		94.0
900AA-12	12'	38-7/8"	107-3/4"		113.0

†† Designed for one or two person jobs. Note: When used as a double stepladder, the maximum load per side, including person and materials, shall not exceed the duty rating of ladder.

DIMENSIONS

Top:	20-3/4" x 19-3/4"	Steps:	3-9/16" wide
Rails:	3-11/16" wide	Flange:	1-1/8" wide

400 SERIES

★★★★★ **375 lbs.** LOAD CAPACITY **TYPE IAA** DUTY RATING

STYLE: Stepladder



Model 406

- Optional black molded pail shelf kit, model no. PK76-3

SPECIFICATIONS

NOTE: Type IAA duty rating is for stepladders up to 12 ft.

Model No.	Size	Approx. Width	Approx. Spread	Approx. Cu. Ft. Per Unit	Approx. Shipping Wt. Lbs.
404	4'	21-1/4"	30-1/8"	4.8	16.0
406	6'	24-3/4"	42-7/16"	8.1	24.0
408	8'	28-1/4"	54-3/4"	12.2	33.5
410	10'	31-3/4"	67"	17.0	43.5
412	12'	35-1/4"	79-3/8"	22.5	54.5

★★★★★ **300 lbs.** LOAD CAPACITY **TYPE IA** DUTY RATING

414	14'	38-5/8"	91-11/16"	28.2	65.0
416	16'	42-1/8"	104"	34.7	77.5

DIMENSIONS

Top:	7" x 14"	Steps:	3" wide
Front Rails:	3-1/8" wide	Rear Rails:	1-3/4" wide
Front Flange:	1-1/8" wide	Rear Flange:	1" wide

T400SERIES

★★★★★ **375lbs.** LOAD CAPACITY **TYPE IAA**
PER SIDE DUTY RATING

STYLE: Multi-Use Twin Stepladder††



SPECIFICATIONS

Model No.	Size	Approx. Width	Approx. Spread	Approx. Cu. Ft. Per Unit	Approx. Shipping Wt. Lbs.
T404	4'	21-1/4"	36-1/4"	5.0	21.5
T406	6'	24-3/4"	50-1/4"	8.8	31.0
T408	8'	28-1/4"	64-1/4"	13.3	42.0
T410	10'	31-3/4"	78-1/4"	18.7	55.0
T412	12'	35-1/4"	92-1/4"	25.0	69.0

††Designed for one or two person jobs. Note: When used as a double stepladder, the maximum load per side, including person and materials, shall not exceed the duty rating of ladder.

DIMENSIONS

Top:	8-1/4" x 14"	Steps:	3" wide
Rails:	3-1/8" wide	Flange:	1-1/8" wide

P400SERIES

★★★★★ **375lbs.** LOAD CAPACITY **TYPE IAA**
PER SIDE DUTY RATING

STYLE: Platform Ladder



- Internal spreaders on 8' and above

SPECIFICATIONS NOTE: Type IAA duty rating is for platforms ranging in size from 4' to 8'

Model No.	Height (Size) to Platform	Rail Length	Approx. Width	Approx. Spread	Approx. Cu. Ft. Per Unit	Approx. Shipping Wt. Lbs.
P404	4'	6'	24-3/4"	42-1/16"	7.1	25.0
P406	6'	8'	28-1/4"	54-3/4"	10.1	33.5
P408	8'	10'	31-3/4"	79-1/2"	20.3	45.5

★★★★★ **300lbs.** LOAD CAPACITY **TYPE IA**
PER SIDE DUTY RATING

P410	10'	12'	35-1/4"	79-3/8"	20.3	54.5
P412	12'	14'	38-3/4"	91-11/16"	25.2	66.0
P414	14'	16'	42-1/4"	104"	31.1	79.5

DIMENSIONS

Platform:	12-5/8" x 15"	Steps:	3" wide
Front Rails:	3-1/8" wide	Rear Rails:	1-3/4" wide
Front Flange:	1-1/8" wide	Rear Flange:	1" wide



370SERIES

★★★★ **300lbs.** LOAD CAPACITY TYPE IA DUTY RATING

STYLE: Stepladder



- External Pinch-Proof™ spreaders on 3', 7', 8' and 10' models

SPECIFICATIONS

Model No.	Size	Approx. Width	Approx. Spread	Approx. Cu. Ft. Per Unit	Approx. Shipping Wt. Lbs.
373	3'	17-3/4"	23-3/8"	1.5	9.0
374	4'	19-1/2"	29-1/2"	2.1	11.0
375	5'	21-1/4"	35-3/4"	2.8	13.5
376	6'	23"	41-7/8"	3.5	15.5
378	8'	26-1/2"	54-1/4"	5.1	22.5
310	10'	30"	66-1/2"	7.0	31.0

DIMENSIONS

Top:	5-1/8" x 12-1/8"	Steps:	3" wide
Front Rails:	3" wide	Rear Rails:	1-1/4" wide
Front Flange:	7/8" wide	Rear Flange:	1" wide

T370SERIES

★★★★ **300lbs. PER SIDE** LOAD CAPACITY TYPE IA DUTY RATING

STYLE: Multi-Use Twin Stepladder††



- External Pinch-Proof™ spreaders on 4' model

SPECIFICATIONS

Model No.	Size	Approx. Width	Approx. Spread	Approx. Cu. Ft. Per Unit	Approx. Shipping Wt. Lbs.
T374	4'	21-1/4"	36"	3.5	14.5
T376	6'	24-3/4"	50"	5.7	21.5
T378	8'	28-1/4"	64"	8.2	31.0
T310	10'	31-3/4"	78"	11.1	43.0

†† Designed for one or two person jobs. Note: When used as a double stepladder, the maximum load per side, including person and materials, shall not exceed the duty rating of ladder.

DIMENSIONS

Top:	8-1/4" x 14"	Steps:	3" wide
Rails:	3" wide	Flange:	7/8" wide

P370SERIES

★★★★ **300lbs.** LOAD CAPACITY TYPE IA DUTY RATING

STYLE: Platform Ladder



Model P376

- External Pinch-Proof™ spreaders on 8' model

SPECIFICATIONS

Model No.	Height (Size) to Platform	Rail Length	Approx. Width	Approx. Spread	Approx. Cu. Ft. Per Unit	Approx. Shipping Wt. Lbs.
P372	2'	4'	21-1/4"	30"	3.0	12.0
P373	3'	5'	23"	36-1/4"	3.9	14.5
P374	4'	6'	24-3/4"	42-3/4"	4.9	17.0
P376	6'	8'	28-1/4"	54-3/4"	7.1	23.0
P378	8'	10'	31-3/4"	67"	8.4	32.0

DIMENSIONS

Platform:	12-5/8" x 18"	Steps:	3" wide
Front Rails:	3" wide	Rear Rails:	1-1/4" wide
Front Flange:	7/8" wide	Rear Flange:	1" wide

PT370SERIES

★★★★ **300lbs.** LOAD CAPACITY PER SIDE TYPE IA DUTY RATING

STYLE: Stocker's Ladder®††



Model PT374

- Available with 4 casters to allow for easy 360° mobility
- Easy to handle and folds to a 10" width for storage
- Unique combination of one person, two person†† and platform ladder use
- Internal Pinch-Proof™ aluminum spreaders on 8' and 10' models

SPECIFICATIONS

Model No.	Height (Size) to Platform	Rail Length	Approx. Width	Approx. Spread	Approx. Cu. Ft. Per Unit	Approx. Shipping Wt. Lbs.	Model No. with Casters	Approx. Shipping Wt. Lbs.
PT372	2'	4'	21-1/4"	36"	5.1	21.0	PT372-4C	27.5
PT374	4'	6'	24-3/4"	50-1/2"	8.9	27.0	PT374-4C	33.5
PT376	6'	8'	28-1/4"	65-1/4"	13.5	36.0	PT376-4C	42.5
PT378	8'	10'	31-3/4"	81-1/2"	19.0	46.5	PT378-4C	54.0
PT310	10'	12'	34-1/4"	96"	24.5	58.5	PT310-4C	66.5

†† Designed for one or two person jobs. Note: When used as a double stepladder, the maximum load per side, including person and materials, shall not exceed the duty rating of ladder.

DIMENSIONS

Platform:	12-3/4" x 22"	Steps:	3" wide
Rails:	3" wide	Flange:	3/4" wide





SH378 MODEL

★★★★ **300lbs.** LOAD CAPACITY

TYPE IA
DUTY RATING

STYLE: Shelf Ladder



SPECIFICATIONS

Model No.	Size	Approx. Width	Approx. Cu. Ft. Per Unit	Approx. Shipping Wt. Lbs.
SH378	8'	28-1/4"	3.9	15.5

DIMENSIONS

Top:	7" x 14"	Steps:	3" wide
Rails:	3" wide	Flange:	7/8" wide

SSA00SERIES

★★★★★ **375lbs.** LOAD CAPACITY

TYPE IAA
DUTY RATING

STYLE: Step Stand



SPECIFICATIONS

Model No.	Size	Max. Standing Height	Approx. Width	Approx. Spread	Approx. Cu. Ft. Per Unit	Approx. Shipping Wt. Lbs.
SSA02	2'	20"	17"	21"	2.6	16.0
SSA03	3'	30"	18-3/4"	27-1/2"	4.0	21.0

DIMENSIONS

Top:	9" x 14"	Steps:	6" wide
Front Rails:	6" wide	Rear Rails:	1-7/8" wide
Front Flange:	1-1/8" wide	Rear Flange:	1-3/16" wide

TW370-30SERIES

★★★★ **300lbs.** LOAD CAPACITY **PER SIDE**

TYPE IA
DUTY RATING

STYLE: Portable Work Stand^{††}



- Extra wide for versatile use as work stand, stage or material support
- Lightweight and portable

SPECIFICATIONS

Model No.	Size	Approx. Width	Approx. Spread	Approx. Cu. Ft. Per Unit	Approx. Shipping Wt. Lbs.
TW372-30	2'	33"	22"	4.0	12.5
TW373-30	3'	34-3/4"	29"	5.6	17.5
TW374-30	4'	36-1/2"	36"	7.8	24.0

^{††}Designed for one or two person jobs. Note: When used as a double stepladder, the maximum load per side, including person and materials, shall not exceed the duty rating of ladder.

DIMENSIONS

Top:	8" x 30"	Steps:	3" wide
Rails:	3" wide	Flange:	7/8" wide

150B MODEL

★★★★ **300lbs.** LOAD CAPACITY **TYPE IA** DUTY RATING

STYLE: Step Stool



- Ideal for plant, office and home applications

SPECIFICATIONS

Model No.	Size	Approx. Width	Approx. Spread	Approx. Cu. Ft. Per Unit	Approx. Shipping Wt. Lbs.
150B	2'	17"	19"	1.9	5.5

DIMENSIONS

Top:	6" x 12-3/8"	Steps:	3" wide
Front Rails:	3" wide	Rear Rails:	1-1/8" wide
Front Flange:	3/4" wide	Rear Flange:	1" wide

T372 MODEL

★★★★ **300lbs.** LOAD CAPACITY **PER SIDE** **TYPE IA** DUTY RATING

STYLE: Twin Step Stool††

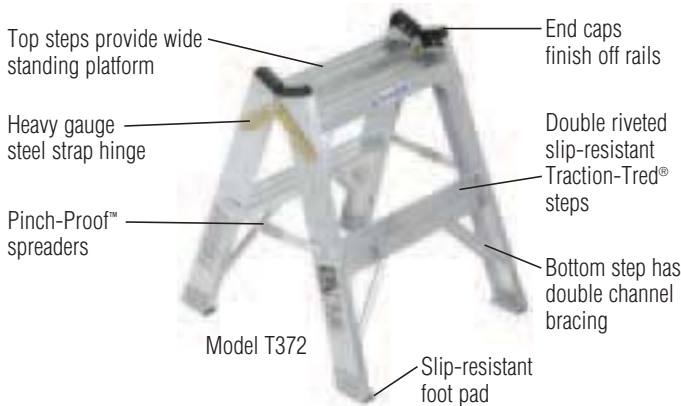

- Folds to 7-1/4" width for easy storage

Note: Planks or platforms shall be secured to the step stools. The ends of each plank or platform shall extend beyond the outside edge of each step stool by a minimum of 4 inches and a maximum of 10 inches.

SPECIFICATIONS

Model No.	Size	Approx. Width	Approx. Spread	Approx. Cu. Ft. Per Unit	Approx. Shipping Wt. Lbs.
T372	2'	21-1/4"	23-3/8"	2.3	9.0

††Designed for one or two person jobs. Note: When used as a double stepladder, the maximum load per side, including person and materials, shall not exceed the duty rating of ladder.

DIMENSIONS

Rails:	3" wide	Flange:	7/8" wide
Steps:	3" wide		

360 SERIES

★★★ **250lbs.** LOAD CAPACITY **TYPE I** DUTY RATING

STYLE: Stepladder



Model 366

SPECIFICATIONS

Model No.	Size	Approx. Width	Approx. Spread	Approx. Cu. Ft. Per Unit	Approx. Shipping Wt. Lbs.
363	3'	17"	23-1/4"	1.7	8.0
364	4'	18-1/2"	29-1/4"	2.4	10.5
365	5'	20"	35-1/2"	3.1	12.5
366	6'	21-1/2"	41-5/8"	3.9	14.5
368	8'	24-1/2"	54"	5.7	21.5

DIMENSIONS

Top:	5" x 12-3/8"	Steps:	3" wide
Front Rails:	3" wide	Rear Rails:	1-1/8" wide
Front Flange:	3/4" wide	Rear Flange:	1" wide



350 SERIES

★★ **225lbs.** LOAD CAPACITY **TYPE II** DUTY RATING

STYLE: Stepladder



SPECIFICATIONS

Model No.	Size	Approx. Width	Approx. Spread	Approx. Cu. Ft. Per Unit	Approx. Shipping Wt. Lbs.
354	4'	18-1/2"	29-1/4"	2.4	10.0
355	5'	20"	35-1/2"	3.1	12.0
356	6'	21-1/2"	41-5/8"	3.9	13.5

DIMENSIONS

Top:	4-5/8" x 12-1/2"	Steps:	3" wide
Front Rails:	3" wide	Rear Rails:	1-1/8" wide
Front Flange:	3/4" wide	Rear Flange:	1" wide

244 MODEL

★ **200lbs.** LOAD CAPACITY **TYPE III** DUTY RATING

STYLE: Utility Ladder



- Lightweight – easy action open-close
- Compact for convenient storage – folds to 3"

SPECIFICATIONS

Model No.	Rail Length	Approx. Width	Approx. Spread	Approx. Cu. Ft. Per Unit	Approx. Shipping Wt. Lbs.
244	3-1/2'	18-1/2"	22-1/2"	1.4	9.0

DIMENSIONS

Front Tubular Rails:	1-1/8" diameter	Steps:	6" wide
Rear Tubular Rails:	1" diameter	Height to 2nd Step:	23"

260 SERIES

★ **200lbs.** LOAD CAPACITY **TYPE III** DUTY RATING

STYLE: Platform Ladder

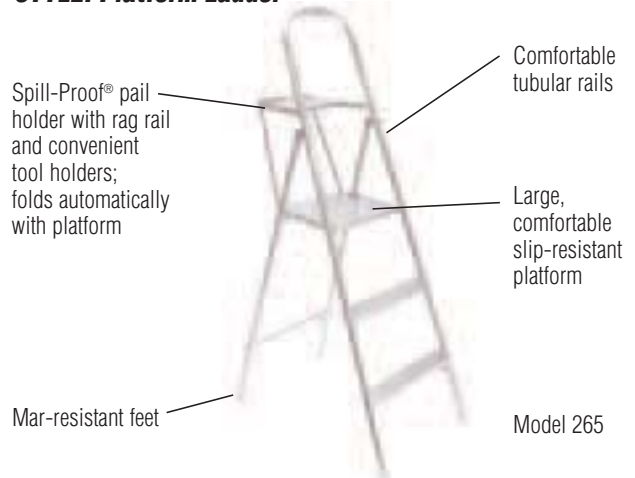

- Compact for convenient storage – folds to 3-1/2"

SPECIFICATIONS











Model No.	Height (Size) to Platform	Rail Length	Approx. Width	Approx. Spread	Approx. Cu. Ft. Per Unit	Approx. Shipping Wt. Lbs.
264	22-1/2"	4-1/2'	20"	25-1/2"	2.0	11.5
265	33-1/2"	5-1/2'	21-1/2"	33-1/4"	2.6	15.0

DIMENSIONS

Platform:	14-1/2" x 12"	Steps:	3" wide
Front Tubular Rails:	1-1/8" diameter	Rear Tubular Rails:	1" diameter

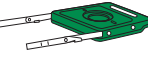
ALUMINUM STEPLADDER COMPARISON CHART

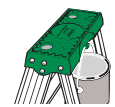
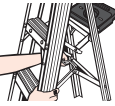

Features and Benefits	400 SERIES	T400 SERIES	P400 SERIES	370 SERIES	T370 SERIES	P370 SERIES	PT370 SERIES	360 SERIES	350 SERIES
	TYPE IAA/IA	TYPE IAA	TYPE IAA/IA	TYPE IA	TYPE IA	TYPE IA	TYPE IA	TYPE I	TYPE II
 Slip-resistant foot pad	★	★	★	★	★	★	★	★	★
 Slip-resistant Traction-Tred® steps	★	★	★	★	★	★	★	★	★
 Dual drill HolsterTop®	★								
 External spreaders	4', 5', 8' models	4', 6' models		3', 8', 10' models				★	★
Designed for one or two person jobs		★			★		★		
 Knee-braced top & bottom steps	★	★	★	★	★	★	★	★	★
 Aluminum top	★	★	★		★	★			
Full set of rear horizontals	★		★	★		★			
 Spill-Proof® pail shelf with rag rack				★				★	★
 Tool-Tra-Top®	★			★				★	★
 Safety guard rail			★			★	★		
 Platform for comfortable work area			★			★	★		
 Paint can hanger on top				★				★	★
 H-spreader for one-handed carry & close				★					

500-1 SERIES

★★★★★ **375 lbs.** LOAD CAPACITY **TYPE IAA** DUTY RATING

STYLE: Round Rung Straight Ladder



Exclusive Alflo® rung joint means Twist-Proof® performance



Extra heavy duty I-beam rails

Traction-Tred® deeply serrated aluminum round rungs

Model 508-1

SPECIFICATIONS NOTE: Type IAA duty rating is for single ladders up to 16 ft.

Model No.	Total Length	Approx. Cu. Ft. Per Unit	Approx. Shipping Wt. Lbs.
508-1	8'	2.9	16.5
510-1	10'	3.6	20.0
512-1	12'	4.3	24.0
514-1	14'	5.0	27.5
516-1	16'	5.7	37.0

★★★★★ **300 lbs.** LOAD CAPACITY **TYPE IA** DUTY RATING

518-1	18'	6.4	41.0
520-1	20'	7.1	45.5
524-1	24'	14.0	60.5

DIMENSIONS

	Rails:	Flange:	Round Rungs:	Base Width:
8' to 14'	3" wide	1-3/16"	1-1/4"	16-7/8"
16' to 20'	3" wide	1-1/4"	1-1/4"	16-7/8"
24'	4" wide	1-3/8"	1-1/4"	20-5/8"

D500-2 SERIES

★★★★★ **375 lbs.** LOAD CAPACITY **TYPE IAA** DUTY RATING

STYLE: Flat Rung Extension Ladder



Exclusive Alflo® rung joint means Twist-Proof® performance

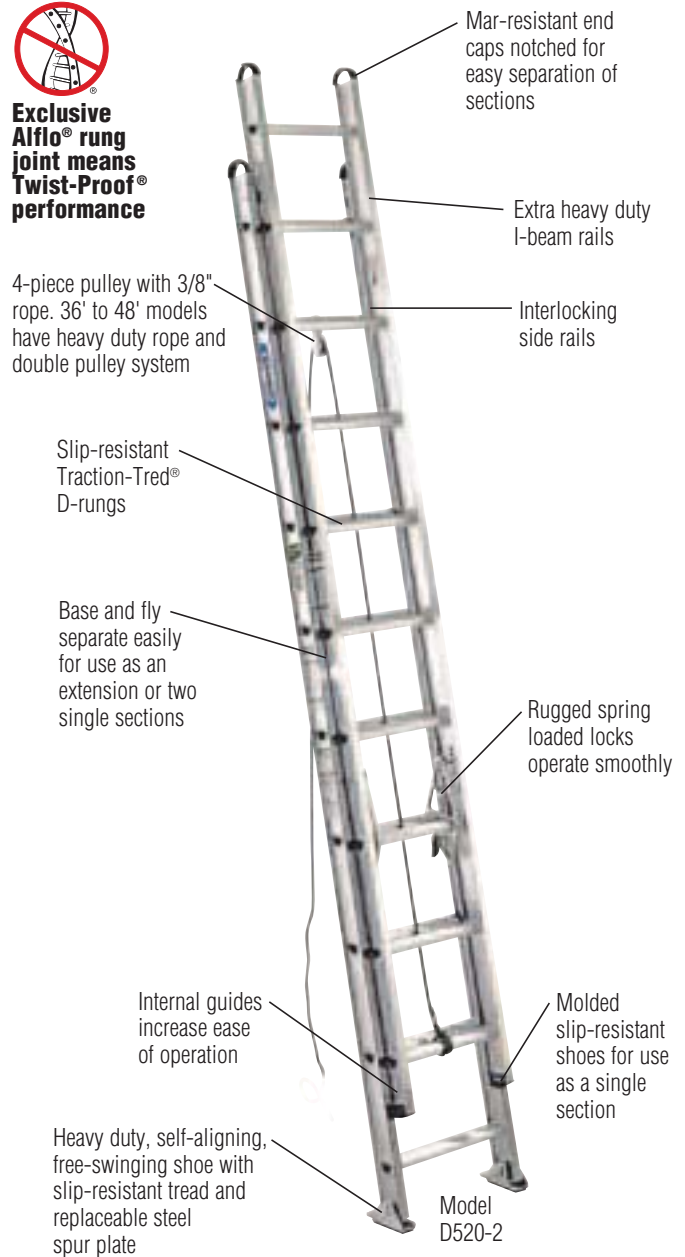

Mar-resistant end caps notched for easy separation of sections

Extra heavy duty I-beam rails

Interlocking side rails

4-piece pulley with 3/8" rope. 36' to 48' models have heavy duty rope and double pulley system

Slip-resistant Traction-Tred® D-rungs

Base and fly separate easily for use as an extension or two single sections

Rugged spring loaded locks operate smoothly

Internal guides increase ease of operation

Molded slip-resistant shoes for use as a single section

Heavy duty, self-aligning, free-swinging shoe with slip-resistant tread and replaceable steel spur plate

Model D520-2

SPECIFICATIONS NOTE: Type IAA duty rating is for extension ladders up to 32 ft.

Model No.	Total Length of Sections	Max. Working Length	Approx. Cu. Ft. Per Unit	Approx. Shipping Wt. Lbs.
D520-2	20'	17'	8.8	42.0
D524-2	24'	21'	10.4	49.0
D528-2	28'	25'	12.1	65.5
D532-2	32'	29'	13.8	74.0

★★★★★ **300 lbs.** LOAD CAPACITY **TYPE IA** DUTY RATING

D536-2	36'	32'	15.4	90.0
D540-2	40'	35'	17.0	99.5
D544-2	44'	39'	21.4	131.0
D548-2	48'	43'	23.3	142.5

DIMENSIONS

Rails:	3-1/4" wide	Rungs:	1-3/4"
Flange:	1-3/16" wide (20' & 24')	Base Section Width:	19-1/8" outside shoes 20-1/8" (44' & 48')
	1-1/4" wide (28' to 48')		

D1500-2/D1500-1 SERIES

★★★★ **300lbs.** LOAD CAPACITY **TYPE IA** DUTY RATING

STYLE: D-Rung Extension/Straight Ladder



Exclusive Alflo® rung joint means Twist-Proof® performance

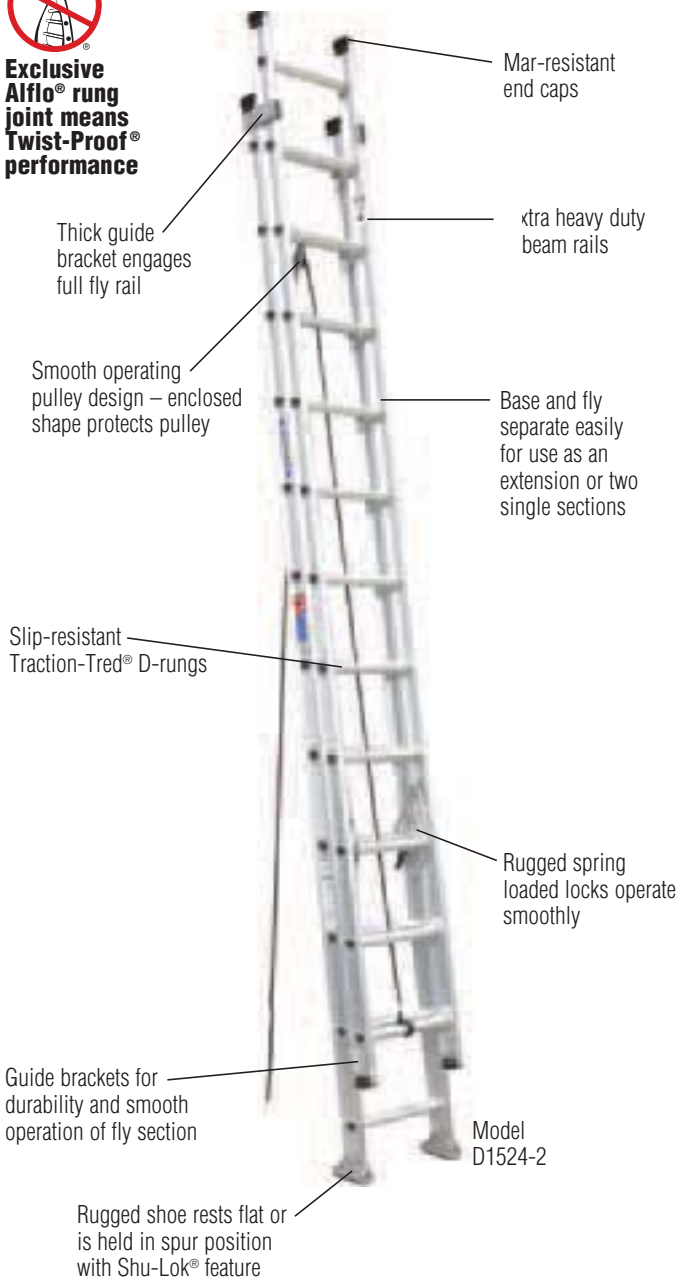

Model D1524-2

SPECIFICATIONS

Model No.	Total Length of Sections	Max. Working Length	Approx. Cu. Ft. Per Unit	Approx. Shipping Wt. Lbs.	Single Ladder Model No.	Total Length	Approx. Cu. Ft. Per Unit	Approx. Shipping Wt. Lbs.
D1516-2†	16'	13'	6.2	30.5	D1508-1	8'	3.6	14.5
D1520-2	20'	17'	7.7	37.0	D1510-1	10'	4.5	17.5
D1524-2	24'	21'	9.2	45.0	D1512-1	12'	5.4	21.5
D1528-2	28'	25'	10.7	56.0	D1514-1	14'	6.2	27.0
D1532-2	32'	29'	12.2	67.0	D1516-1	16'	7.1	32.5
D1536-2	36'	32'	13.7	80.0	D1518-1	18'	8.0	38.5
D1540-2	40'	35'	15.2	89.5	D1520-1	20'	8.9	43.5

† Note: D1516-2 is not equipped with rope and pulley

DIMENSIONS

Rails:	3" wide	Rungs:	1-3/4"
Flange:	1-1/8" wide	Base Width:	18-1/8" outside rails

560-3 MODEL

★★★ **250lbs.** LOAD CAPACITY **TYPE I** DUTY RATING

STYLE: Round Rung Extension Ladder



Exclusive Alflo® rung joint means Twist-Proof® performance

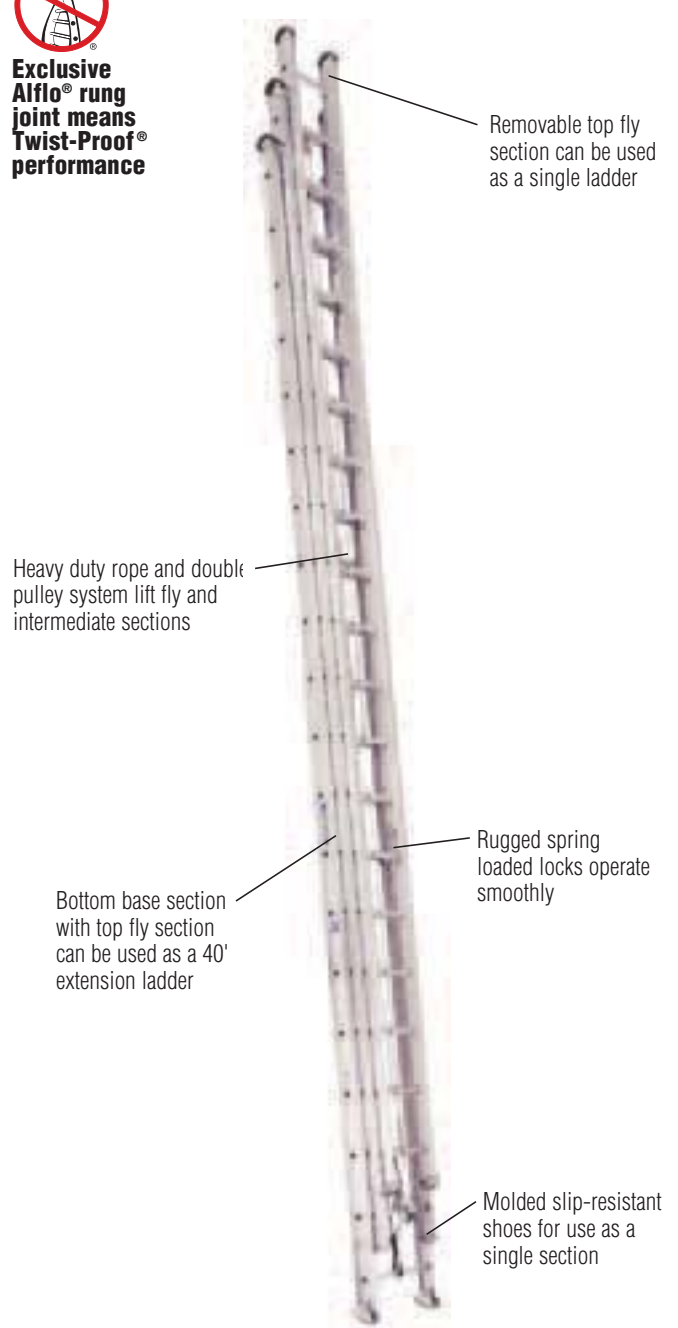

SPECIFICATIONS

Model No.	Total Length of Sections	Max. Working Length	Approx. Cu. Ft. Per Unit	Approx. Shipping Wt. Lbs.
560-3	60'	47'	26.8	179.0

DIMENSIONS

Rails:	4" wide	Rungs:	1-1/4"
Flange:	2" wide (base & intermediate sections) 1-3/8" wide (top fly section)	Base Width:	23-1/2"



D1800-2EQ/D1700-2EQ SERIES

*** 250lbs. LOAD CAPACITY TYPE I DUTY RATING

STYLE: Extension Ladder with Integrated Leveling



Exclusive Alflo® rung joint means Twist-Proof® performance

Lightweight aluminum

Slip-resistant Traction-Tred® D-rungs

Heavy duty spring-loaded locks operate smoothly

Model D1820-2EQ

THE Equalizer®
ELIMINATES UNEVEN GROUND



Factory installed adjustable EverLevel® leveling system exceeds OSHA and ANSI requirements

Easily adjustable in 3/8" increments up to 8-1/4"



Convenient built-in bubble level



Dual action foot for use on hard or penetrable surfaces

SPECIFICATIONS

Model No.	Total Length of Sections	Max. Working Length	Approx. Cu. Ft. Per Unit	Approx. Shipping Wt. Lbs.
D1816-2EQ‡	16'	13'	6.5	31.5
D1820-2EQ	20'	17'	8.1	37.5
D1824-2EQ	24'	21'	9.6	45.5
D1828-2EQ	28'	25'	11.2	56.0

*** 225lbs. LOAD CAPACITY TYPE II DUTY RATING

Model No.	Total Length of Sections	Max. Working Length	Approx. Cu. Ft. Per Unit	Approx. Shipping Wt. Lbs.
D1716-2EQ‡	16'	13'	6.5	27.5
D1720-2EQ	20'	17'	8.1	32.5
D1724-2EQ	24'	21'	9.6	39.0
D1728-2EQ	28'	25'	11.2	48.5

‡ Note: D1816-2EQ and D1716EQ are not equipped with rope and pulley

DIMENSIONS

Rails:	3" wide	Fly Width:	14-1/4" outside rails
Flange:	1-1/16" wide	Base Width:	17-3/8" outside rails
Rungs:	1-3/4"		(20-3/4" to outside of feet)

D1300-2SERIES

*** 250lbs. LOAD CAPACITY TYPE I DUTY RATING

STYLE: D-Rung Extension Ladder



Exclusive Alflo® rung joint means Twist-Proof® performance

Smooth operating pulley

Slip-resistant Traction-Tred® D-rungs

Durable shoe rests flat or is held in spur position with Shu-Lok® feature

Mar-resistant end caps

Interlocking side rails

Heavy duty modified I-beam side rails

Heavy duty spring loaded locks operate smoothly

Model D1320-2

SPECIFICATIONS

Model No.	Total Length of Sections	Max. Working Length	Approx. Cu. Ft. Per Unit	Approx. Shipping Wt. Lbs.
D1316-2‡	16'	13'	5.8	26.0
D1320-2	20'	17'	7.2	32.5
D1324-2	24'	21'	8.6	40.0
D1328-2	28'	25'	10.0	50.5
D1332-2	32'	29'	11.5	63.5
D1336-2	36'	32'	13.0	77.5
D1340-2	40'	35'	14.4	85.5

‡ Note: D1316-2 is not equipped with rope and pulley

DIMENSIONS

Rails:	3" wide	Rungs:	1-3/4"
Flange:	1-1/16" wide	Base Width:	17-3/8" outside rails

D1200-2SERIES

★★ **225lbs.** LOAD CAPACITY **TYPE II** DUTY RATING

STYLE: D-Rung Extension Ladder



Exclusive Alflo® rung joint means Twist-Proof® performance

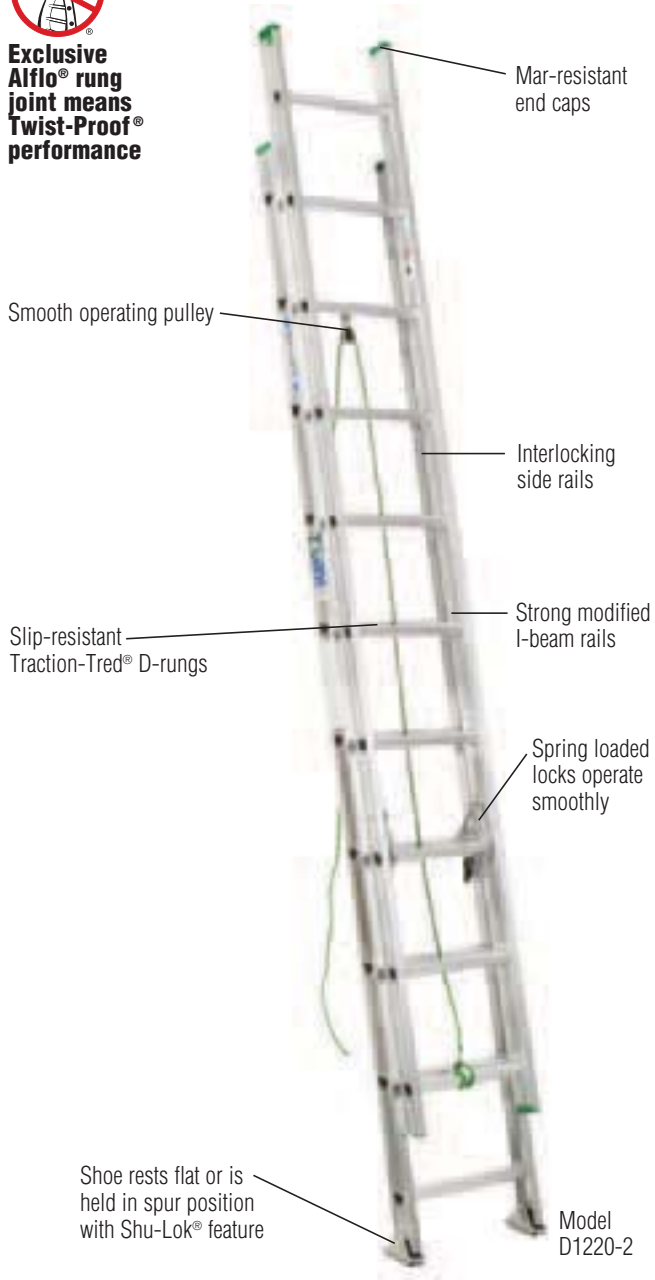

Model D1220-2

SPECIFICATIONS

Model No.	Total Length of Sections	Max. Working Length	Approx. Cu. Ft. Per Unit	Approx. Shipping Wt. Lbs.
D1216-2‡	16'	13'	5.8	22.0
D1220-2	20'	17'	7.2	27.0
D1224-2	24'	21'	8.6	33.5
D1228-2	28'	25'	10.0	43.0
D1232-2	32'	29'	11.5	54.0
D1236-2	36'	32'	13.0	62.5
D1240-2	40'	35'	14.4	73.5

‡ Note: D1216-2 is not equipped with rope and pulley

DIMENSIONS

Rails:	3" wide	Rungs:	1-3/4"
Flange:	1" wide	Base Width:	17-3/8" outside rails

D1200-3SERIES

★★ **225lbs.** LOAD CAPACITY **TYPE II** DUTY RATING

STYLE: D-Rung Compact Extension Ladder



Exclusive Alflo® rung joint means Twist-Proof® performance

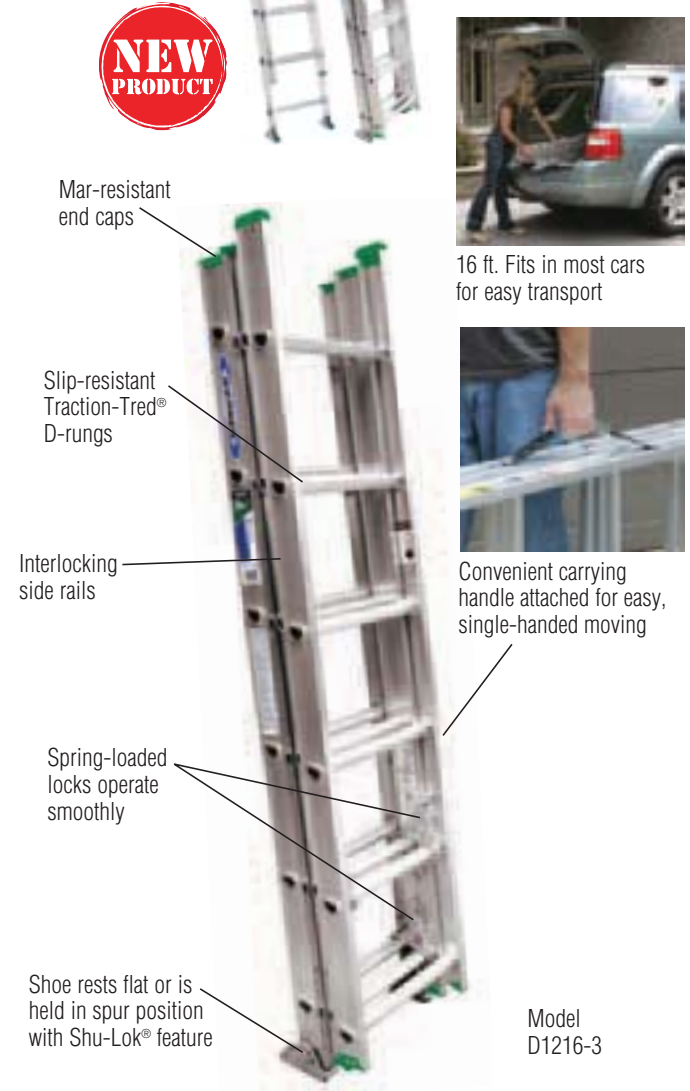

Model D1216-3



16 ft. Fits in most cars for easy transport



Convenient carrying handle attached for easy, single-handed moving

SPECIFICATIONS

Model No.	Total Length of Sections	Total Length in Storage Position 2 vs. 3 piece*	Max. Working Length	Approx. Cu. Ft. Per Unit	Approx. Shipping Wt. Lbs.
D1216-3	18'	8' / 6'	13'	5.9	26.5
D1224-3	27'	12' / 9'	21'	8.7	38.5

* Total Length of ladder in storage position, comparison of Standard 2 - piece vs. New 3 - piece extension ladder.

DIMENSIONS

Rails:	3" wide	Fly Width:	14-1/4" outside rails
Flange:	1-1/16" wide	Base Width:	17-3/8" outside rails
Rungs:	1-3/4"		(20-3/4" to outside of feet)





D1100-2SERIES

★ **200lbs.** LOAD CAPACITY **TYPE III** DUTY RATING

STYLE: D-Rung Extension Ladder



Exclusive Alflo® rung joint means Twist-Proof® performance

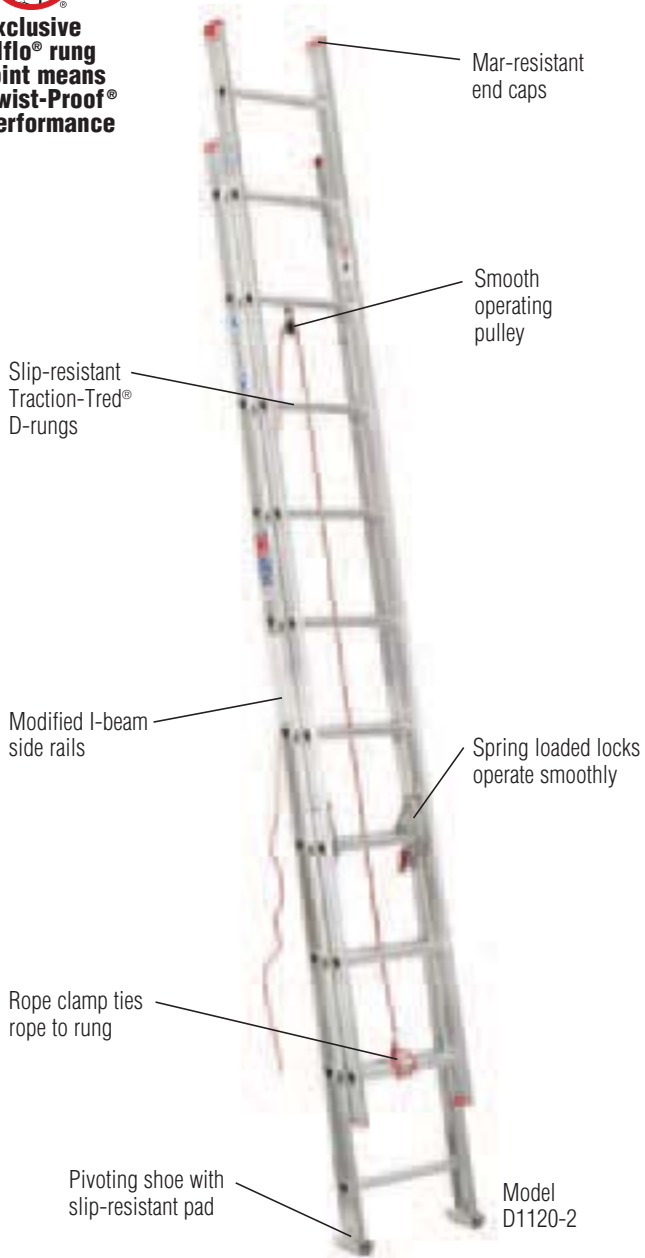

Model D1120-2

SPECIFICATIONS

Model No.	Total Length of Sections	Max. Working Length	Approx. Cu. Ft. Per Unit	Approx. Shipping Wt. Lbs.
D1116-2‡	16'	13'	4.9	18.5
D1120-2	20'	17'	6.2	23.0
D1124-2	24'	21'	7.4	30.0
D1128-2	28'	25'	9.0	38.5

‡ Note: D1116-2 is not equipped with rope and pulley

DIMENSIONS

Rails:	2-3/4" wide (16' & 20') 3" wide (24' & 28')	Rungs:	1-1/2"
Flange:	15/16" wide	Base Width:	16" outside rails

D716-2MODEL

★ **200lbs.** LOAD CAPACITY **TYPE III** DUTY RATING

STYLE: D-Rung Extension Ladder



Exclusive Alflo® rung joint means Twist-Proof® performance

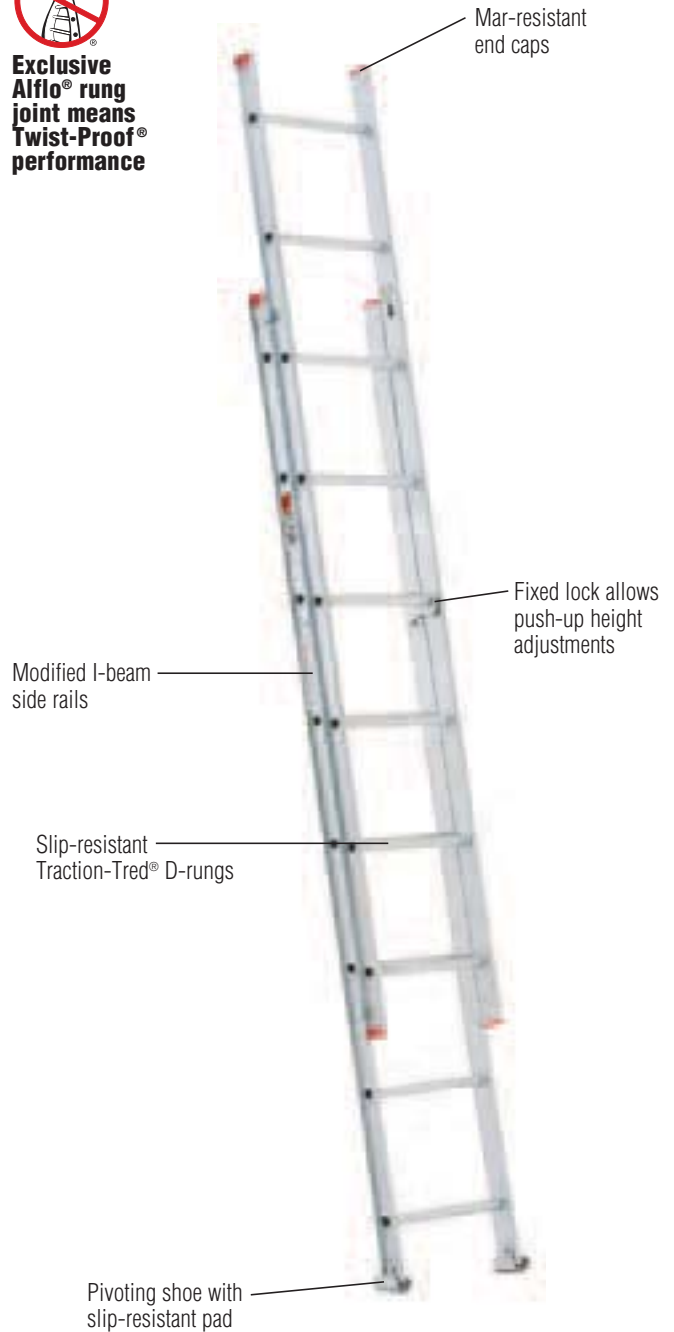

Pivoting shoe with slip-resistant pad

SPECIFICATIONS









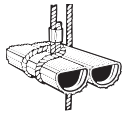

Model No.	Total Length of Sections	Max. Working Length	Approx. Cu. Ft. Per Unit	Approx. Shipping Wt. Lbs.
D716-2	16'	13'	4.6	17.5

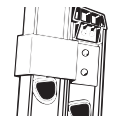
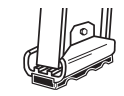
DIMENSIONS

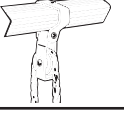
Rails:	2-1/2" wide	Rungs:	1-1/4"
Flange:	3/4" wide	Base Width:	15-3/4" outside rails

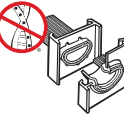
ALUMINUM EXTENSION LADDER COMPARISON CHART

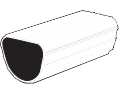

Features and Benefits	D500-2 SERIES	D1500 SERIES	D1800-2EQ SERIES	D1300-2 SERIES	D1700-2EQ SERIES	D1200-2 SERIES	D1100-2 SERIES	D716-2 MODEL
	TYPE IAA/IA	TYPE IA	TYPE I	TYPE I	TYPE II	TYPE II	TYPE III	TYPE III
 Rope clamp ties rope to rung	★	★	★	★	★	★	★	
 Heavy duty shoe with slip-resistant tread and spur plate	★							
Removable sections for use as a single ladder	★	★						
 External guide brackets		★						
 Pivoting shoe							★	★
 Slip-resistant shoe with Shu-lok® feature and spur plate		★	★	★	★	★		
 Interlocking side rails	★		★	★	★	★	★	
 Rope and pulley system	★	★	★	★	★	★	★	
 Spring loaded locks	★	★	★	★	★	★	★	
 Modified I-beam rails	★	★	★	★	★	★	★	★
 Alflo® rung joint for Twist-Proof® performance	★	★	★	★	★	★	★	★
 Mar-resistant end caps	★	★	★	★	★	★	★	★
 Slip-resistant Traction-Tred® D-rungs	★	★	★	★	★	★	★	★
 Integrated Leveling			★		★			

MTSERIES

★★★★ **300lbs.** LOAD CAPACITY
PER SIDE

TYPE IA
 DUTY RATING

STYLE: Telescoping MultiLadder^{††}



Position #1

Twin Stepladder



Position #2

Stairway Stepladder



Position #3

Extension Ladder



Position #4

Self-Supporting 2-Scaffold Base*
 (with Plank & Tiedowns)



*Position 4 requires plank and tie downs not included.

- Telescoping design for maximum versatility

SPECIFICATIONS

Model No.	Stepladder Height	Extension Height	Stair Height	Scaffold Length	Approx. Cu. Ft. Per Unit	Approx. Shipping Wt. Lbs.
MT-13	3' to 5'	7' to 11'	3' to 5'	1' to 2'	5.9	31.5
MT-17	4' to 7'	9' to 15'	4' to 7'	1' to 3'	6.9	39.5
MT-22	5' to 9'	11' to 19'	5' to 9'	1' to 4'	10.8	47.0
MT-26	6' to 11'	13' to 23'	6' to 11'	1' to 5'	12.3	62.6

††Designed for one or two person jobs. Note: When used as a double stepladder, the maximum load per side, including person and materials, shall not exceed the duty rating of ladder.

DIMENSIONS

Rails:	2-5/8" wide	Rungs:	1" wide
Flange:	1" wide	Ladder Width:	16" wide



STYLE: Folding MultiLadder^{††}



Model
M1-6-12

18 positions

- 1. Double stepladder^{††}
 - 2. Stepladder
 - 3. Stairwell ladder
 - 4. Multi-shelf
 - 5. Stand-off ladder
 - 6. Fully extended straight ladder
 - 7. 1/2 & 3/4 length straight ladder
 - 8. Self-supporting scaffold
 - 9. Extended span scaffold
 - 10. Stairwell scaffold
- PLUS OTHERS*

Note: Set-up of some positions requires additional equipment, not included



- Shippable by ground parcel services

SPECIFICATIONS

Model No.	Closed Height	Scaffold Height	Stepladder Height	Straight Ladder Length	Approx. Cu. Ft. Per Unit	Approx. Shipping Wt. Lbs.
M1-6-12	40-5/8"	3'	6'	12'	4.0	33.5
M1-8-16	52-5/8"	4'	8'	16'	5.2	39.5

^{††}Designed for one or two person jobs. Note: When used as a double stepladder, the maximum load per side, including person and materials, shall not exceed the duty rating of ladder.

DIMENSIONS

Rails:	2-1/2" wide	Rungs:	1-1/4" multi-directional round type
Flange:	1" wide	Ladder Width:	15" outside rails

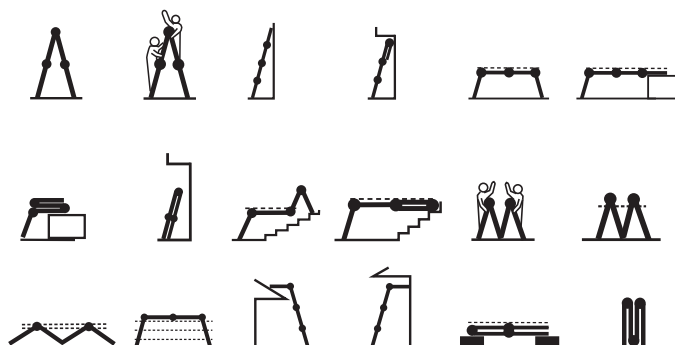

AH SERIES

★★★★★ **375lbs.** LOAD CAPACITY

STYLE: Aluminum Folding Attic Ladder
STANDARD / EXTRA WIDE OPENINGS



Model AH2510

Step-by-Step Installation Made Easy
Online Video
werneratticladders.com

- Lightweight – easy to open, close and install
- Attractive – will not splinter, decay or rust

SPECIFICATIONS

Model No.	Rough Opening Width x Length	Floor to Ceiling Height Range	Approx. Ladder Width	Approx. Cu. Ft. Per Unit	Approx. Shipping Wt. Lbs.
AH2210	22-1/2" x 54"	7'8" to 10'3"	14-1/8"	6.8	48.5
AH2510	25" x 54"	7'8" to 10'3"	17-1/8"	7.6	52.0
AH2512	25" x 66"	10'5" to 12'	17-1/8"	9.2	58.5

DIMENSIONS

Rails:	2-3/8" wide	Steps:	3" wide
Flange:	1-1/2" wide		

AA MODEL

★★★ **250lbs.** LOAD CAPACITY

STYLE: Compact Aluminum Attic Ladder
BUILT FOR SMALL OPENINGS



Step-by-Step Installation Made Easy
Online Video
werneratticladders.com

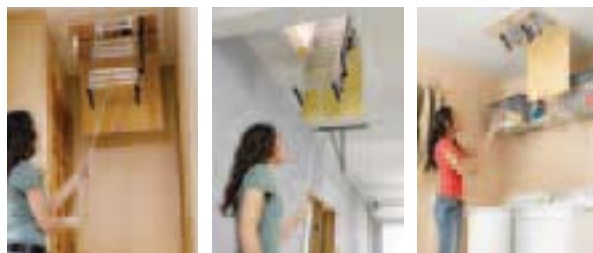

Hallways Garages Tight Spaces

SPECIFICATIONS

Model No.	Rough Opening Width x Length	Floor to Floor Height Range	Approx. Ladder Width	Approx. Cu. Ft. Per Unit	Approx. Shipping Wt. Lbs.
AA1510	18" x 24" Minimum	7" to 9'10"	12-1/8"	2.55	15.5

DIMENSIONS

Rails:	5/8" x 2-1/8" wide	Steps:	1-3/16" wide
--------	--------------------	--------	--------------

WH SERIES

350 lbs. LOAD CAPACITY

STYLE: Wood Folding Heavy Duty Attic Ladder
STANDARD / EXTRA WIDE OPENINGS

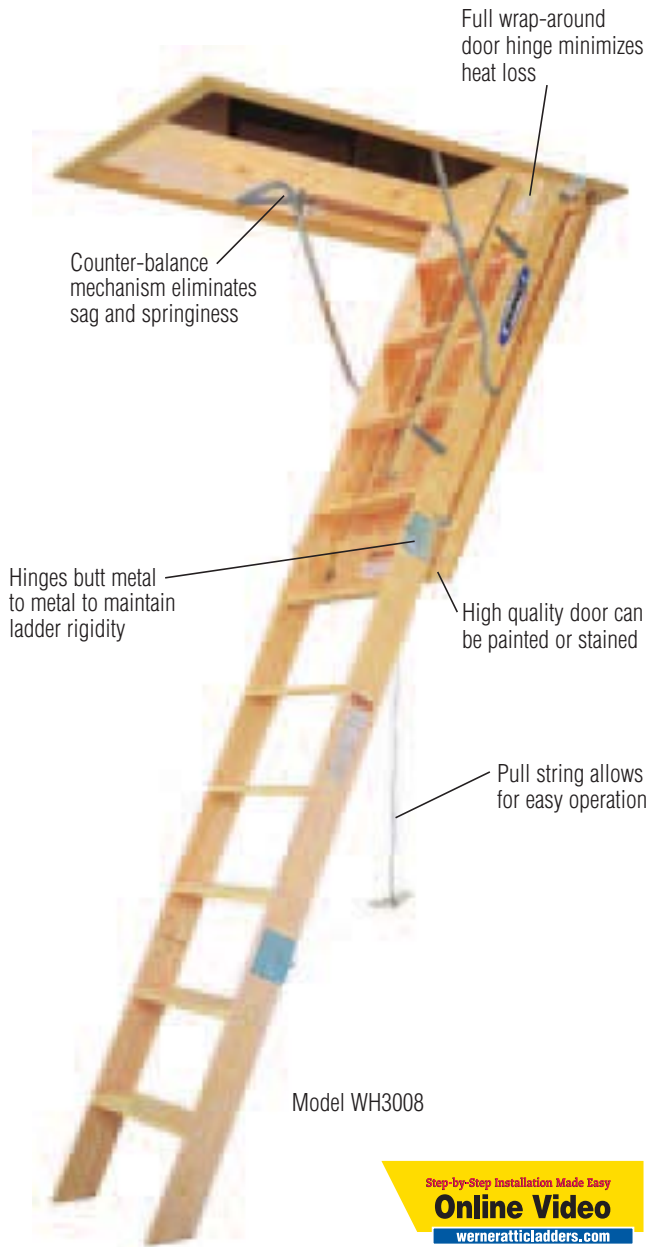

- Easy to open and close
- Fully assembled and ready to install

SPECIFICATIONS

Model No.	Rough Opening Width x Length	Floor to Ceiling Height Range	Approx. Ladder Width	Approx. Cu. Ft. Per Unit	Approx. Shipping Wt. Lbs.
WH2208	22-1/2" x 54"	7' to 8'9"	14-1/4"	10.55	59.5
WH2210	22-1/2" x 54"	8'9" to 10'3"	14-1/4"	10.55	64.5
WH2508	25" x 54"	7' to 8'9"	16-3/4"	11.96	62.5
WH2510	25" x 54"	8'9" to 10'3"	16-3/4"	11.96	67.5
WH3008	30-1/2" x 54"	7' to 8'9"	22 1/4"	14.30	73.5
WH3010	30-1/2" x 54"	8'9" to 10'3"	22 1/4"	14.30	76.5

NOMINAL DIMENSIONS

	Actual Lumber Size	Rough Lumber Size
Rails:	3/4" x 4-1/2"	1" x 5"
Grooved Steps:	3/4" x 4-1/2"	1" x 5"

W SERIES

★★★ **250 lbs.** LOAD CAPACITY

STYLE: Wood Folding Attic Ladder
STANDARD / EXTRA WIDE OPENINGS

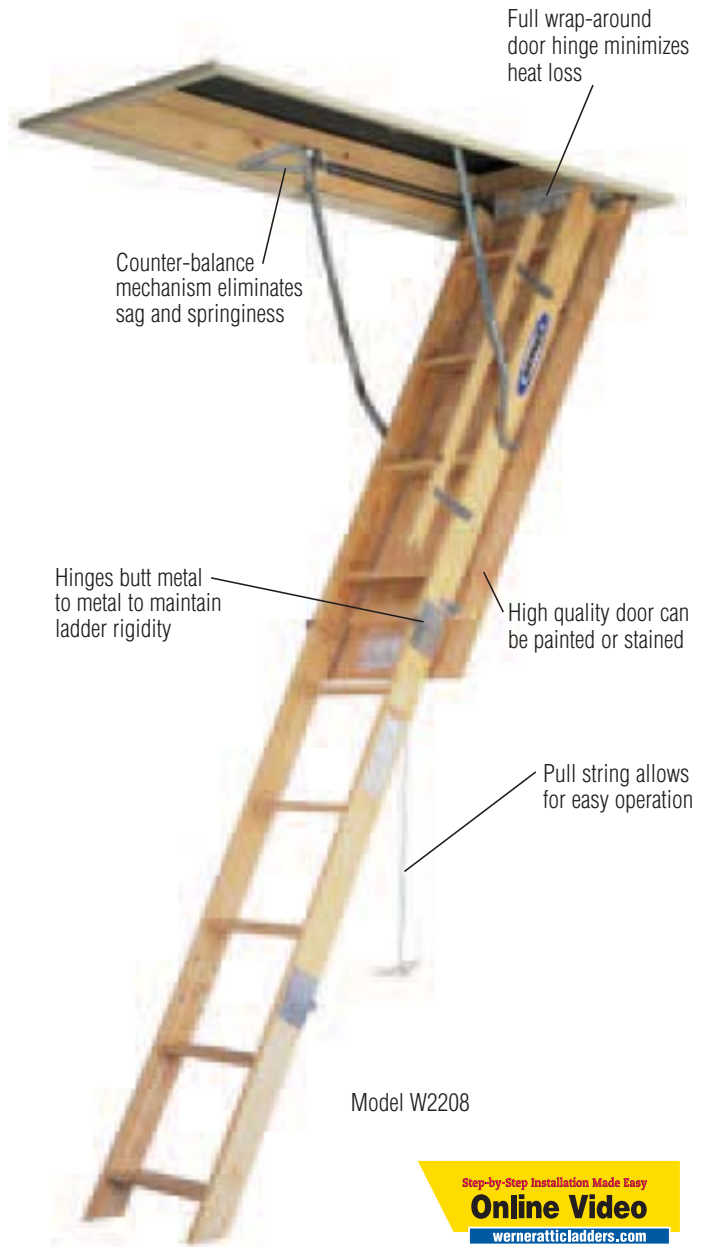

- Easy to open and close
- Fully assembled and ready to install

SPECIFICATIONS

Model No.	Rough Opening Width x Length	Floor to Ceiling Height Range	Approx. Ladder Width	Approx. Cu. Ft. Per Unit	Approx. Shipping Wt. Lbs.
W2208	22 1/2" x 54"	7' to 8'9"	14-1/4"	8.61	48.6
W2210	22 1/2" x 54"	8'9" to 10'4"	14-1/4"	8.61	51.3
W2508	25" x 54"	7' to 8'9"	16-3/4"	9.76	51.2
W2510	25" x 54"	8'9" to 10'4"	16-3/4"	9.76	53.9

NOMINAL DIMENSIONS

	Actual Lumber Size	Rough Lumber Size
Rails:	3/4" x 3-1/2"	1" x 4"
Grooved Steps:	3/4" x 3-1/2"	1" x 4"

ATTIC LADDER COMPARISON CHART

Product Advantages	AH SERIES	AA SERIES	WH SERIES	W SERIES
Material	Aluminum	Aluminum	Wood	Wood
Style	Folding	Sliding	Folding	Folding
Size	8 ft. 10 ft. 12 ft.	7' - 9' 10"	8 ft. 10 ft.	8 ft. 10 ft.
Load Capacity	375 lbs.	250 lbs.	350 lbs.	250 lbs.
Ceiling Height Range	7' to 12'	7' to 9'10" (floor to floor)	7' to 10' 3"	7' to 10' 4"
Locking Device	Gas Strut	N/A	Spring	Spring
Opening Device	Rope	Push/Pull Rod	Rope	Rope
Door Material	Plywood	Not Included (Door hardware included)	Plywood	Plywood
Frame Material	Pine	N/A	Pine	Pine
Full Width Door Hinge	Yes	N/A	Yes	Yes
Metal-to-Metal Rail Hinge	Yes	N/A	Yes	Yes
Requires Cutting Rail	Yes	No	Yes	Yes
Separate Foot Attachment	Yes	No	No	No
Number of People for Installation	Two	One	Two	Two
Step Depth	3"	1-3/16"	4-1/2"	3-1/2"
Finished Rails with Eased Edges	2-3/8" wide	2-1/8" wide	4-1/2" wide	3-1/2" wide
Approximate Shipping Weight	48-58 lbs.	15.5 lbs.	59-76 lbs.	48-54 lbs.

ESCSERIES

SUPPORTS UP TO **1200lbs.**

STYLE: Built-In Fire Escape Ladder

WERNER BUILT-IN FIRE ESCAPE LADDER™

Blends with room decor

Storage pan permanently installs in wall



Climbing assistance strap

Anti-slip rungs and standoffs

- Door included with unit.

EVERY SECOND COUNTS ESCAPE FASTER.™



Permanent installation. Always there when you need it.

Deploys in seconds. Easy to use.

Faster escape. Supports up to 1200 lbs.

SPECIFICATIONS

Model No.	Description	Ladder Length	Load Capacity Per Step	Product Weight Lbs.	Approx. Shipping Weight Lbs.
ESC220	2-story model	17' 2"	400 lbs.	16.0	17.5
ESC330	3-story model	24' 8"	400 lbs.	21.7	23.2

DIMENSIONS

	ESC220 (2-story)	ESC330 (3-story)
Storage Pan Height:	8-1/2"	11"
Storage Pan Width:	15-1/4"	15-1/4"
Storage Pan Recess:	3-1/2"	3-1/2"
Distance Between Steps:	14-1/4"	14-1/4"

AP-20-MP6 MODEL

★ ★ **225lbs.** LOAD CAPACITY

TYPE II DUTY RATING

STYLE: Work Platform

Large platform provides a non-skid area for standing



Platform legs lock securely in place when in use and fold underneath platform for compact storage

Non-marring feet provide slip-resistance and protect floor from damage

- Merchandised in closed, upright position
- Packaged in quantities of 6



Work comfortably along walls and windows. Ideal for painting.



Multi-use platform

SPECIFICATIONS

Model No.	Height	Width	Depth	Approx. Cu. Ft.	Approx. Shipping Wt. Lbs.
AP-20*	20-9/16"	50-1/4"	15-5/8"	2.1	12.8
AP-20-MP6 ‡	41"	16-5/8"	35-3/4"	14.1	75.0

* Note: Dimensions of individual unit

‡ Note: Dimensions for packaged unit of 6

DIMENSIONS

Top: 39-1/2" x 12"	Highest Standing Level: 20-9/16"
--------------------	----------------------------------

PS-48MODEL

500lbs. LOAD CAPACITY*

STYLE: Portable Scaffold

Multiple Working Heights



Mar-resistant wheels
High grade wheels prevent marring by locking securely into place



Multi-use S-Hooks make transportation easy and are ToolLasso® ready



Extra wide 10" plank for secure standing and comfort

- Versatile; can be used as push cart, storage shelf or work bench
- *250 lbs. per plank (500 lbs. combined)

SPECIFICATIONS

Model No.	Height	Width	Depth	Approx. Cu. Ft Per Packaged Unit	Approx. Shipping Wt. Lbs.
PS-48	50-1/8"	46-1/8"	25-1/2"	3.4	60.0

PLANK DIMENSIONS

	Length	Width
Narrow Plank	46"	6"
Wide Plank	46"	10"

SRS-72MODEL

1000lbs. LOAD CAPACITY*

STYLE: 6' Steel Rolling Scaffold

Sections stack easily when casters are removed (2 high maximum)

Platform height adjustable in 2" increments for unique working heights and uneven surfaces



Deck pins secure plywood to scaffold frame

Protected locking pins prevent accidental release

Locking casters swivel for convenient 360° mobility

- Easy one-person assembly- No tools required for quick setup and tear down.

*1000 lbs. load capacity distributed evenly

DIMENSIONS

Model No.	Approx. Width	Approx. Length	Approx. Height	Approx. Shipping Wt. Lbs.
SRS-72	29-1/2"	73-3/4"	74-7/8"	143.5

COMPONENT DIMENSIONS

Component	Quantity Included	Approx. Width	Approx. Length	Approx. Height
Frames	2	29"	68-3/4"	1-1/2"
Arm Braces	2	1-1/2"	73-7/8"	17-7/8"
Plywood Deck	1	28-1/2"	66-3/4"	1-1/2"
Locking Casters	4	5-1/8"	9-7/8"	--

ACCESSORIES (AVAILABLE SEPARATELY)

Model No.	Description	Approx. Width	Approx. Length	Approx. Height	Approx. Shipping Wt. Lbs.
SRO-72-4	Outriggers (4-pc master carton)	18"	20-3/4"	--	37.5
SRG-72	Guard Rail and Toeboard Kit	28-7/8"	69-5/8"	42"	70.5
SRC-72-4	Castors (4-pc master carton)	5-1/8"	1-1/8"	9-7/8"	20.0
SRD-72	Plywood Deck	28-1/2"	66-3/4"	2"	32.5

Note: Outriggers and Guard Rails are required when working height reaches 10'

PA200 SERIES – ALUMINUM EXTENSION PLANK

- 1 person, 250 lb. Load Capacity.
- For use on stepladders, telescoping multiladders, extension trestle ladders and extension and single ladders equipped with ladder jacks.



SPECIFICATIONS

Model No.	Closed Position	Open Position	Approx. Width	Inner Rails	Outer Flanged Rails	Approx. Cu. Ft. Per Unit	Approx. Shipping Wt. Lbs.
PA206	6'	9'	14"	1-1/8" x 2"	1-7/8" x 2"	1.5	31.0
PA208	8'	13'	14"	1-1/8" x 2"	1-7/8" x 2"	2.0	40.5
PA210	10'	17'	14"	1-1/8" x 2"	1-7/8" x 2"	2.5	56.5

Note: When assembled as scaffold or staging, these planks must be used in conjunction with suitable guard rail protection in compliance with applicable governmental codes, ordinances, regulations and safe practice.

5600 SERIES- 2-PIECE EXTRUDED ALUMA-BOARD™

SPECIFICATIONS

Model No.	Duty Rating/Sq. Ft.	Width	Side Rail Length	Side Rail Depth	Approx. Shipping Wt. Lbs.
5607-19	75 lbs.	19-1/16"	7'	2"	30.0
5608-19	75 lbs.	19-1/16"	8'	2"	34.0
5610-19	50 lbs.	19-1/16"	10'	2"	41.0



Model 5607-19

FOR USE WITH STEEL SCAFFOLDS

5500 SERIES - ALUMINUM DECKED ALUMA-PLANK®

SPECIFICATIONS

Model No.	Duty Rating/Sq. Ft.	Width	Side Rail Length	Side Rail Depth	Approx. Shipping Wt. Lbs.
5507-19	75 lbs.	19-1/16"	7'	3"	25.0
5508-19	75 lbs.	19-1/16"	8'	4"	34.0
5510-19	75 lbs.	19-1/16"	10'	4"	43.0



Model 5507-19

FOR USE WITH STEEL SCAFFOLDS

5300 SERIES - PLYWOOD DECKED ALUMA-PLANK®

SPECIFICATIONS

Model No.	Duty Rating/Sq. Ft.	Width	Side Rail Length	Side Rail Depth	Approx. Shipping Wt. Lbs.
5307-19	75 lbs.	19-1/16"	7'	3-1/2"	27.0
5308-19	75 lbs.	19-1/16"	8'	4-1/2"	38.0
5310-19	75 lbs.	19-1/16"	10'	4-1/2"	47.0
5307-24	75 lbs.	24"	7'	4"	32.0
5310-24	75 lbs.	24"	10'	4-1/2"	53.0



Model 5310-19

FOR USE WITH STEEL SCAFFOLDS

ALUMINUM PUMP JACK SYSTEM

- Versatile, dependable and easy to operate
- Field replaceable components
- Compatible and interchangeable with the leading competitor

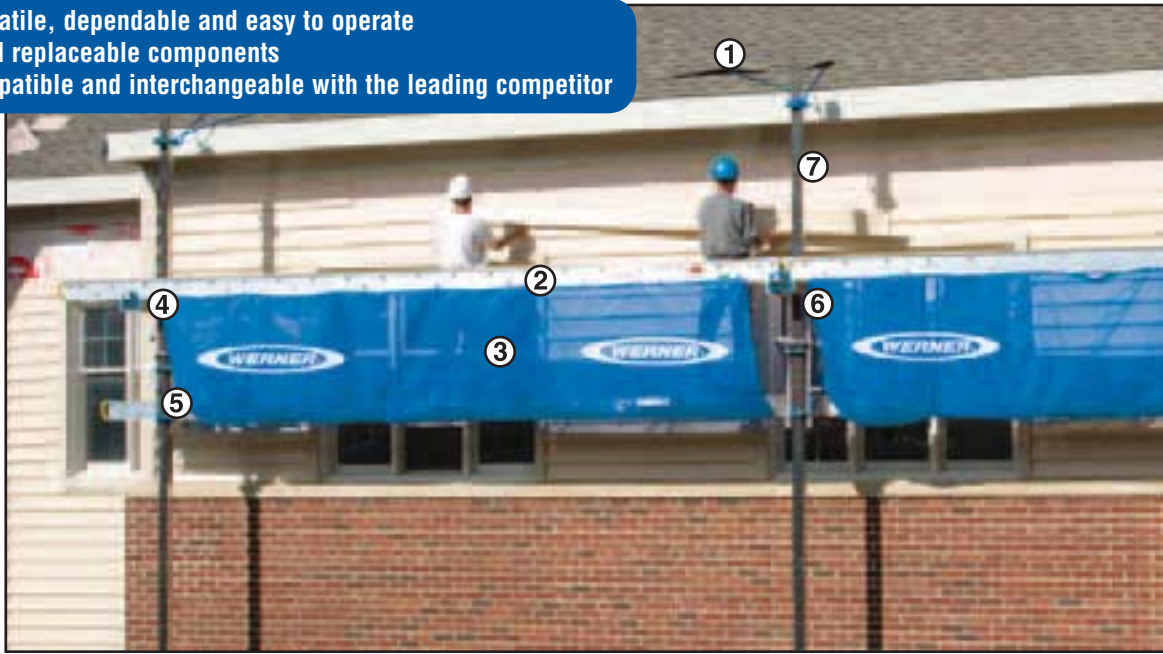

Note: When working 10 ft. and above, OSHA requires fall protection. Refer to product labels.

<p>① Foldable Support Brace (PJ-SBF)</p> <p>(Rigid Support Brace available)</p>	<p>② Nestable Stage (WNS 2512)</p> <p>(other sizes available)</p>	<p>③ Safety Net (PJ-SN)</p>	<p>④ Work Bench (PJ-WB)</p>	<p>⑤ Pump Jack (PJ-100)</p>	<p>⑥ End Rail Kit (narrow) (PJ-ERN)</p> <p>PJ-ERW kit for wide span available</p>	<p>⑦ 24' Aluminum Pole (PJ-24P)</p> <p>Also available: 6' (PJ-6P) 12' (PJ-12P) 18' (PJ-18P)</p>
---	---	-----------------------------	-----------------------------	-----------------------------	---	---

- Pump Jack
- Work Bench
- Poles and Braces
- End Rail Kits
- Safety Net



Nestable Stages



- Continuous work platform reduces trip hazard
- 2 Person – 500 lbs. Rated

PUMP JACK COMPONENTS

Model No.	Description	Approx. Shipping Wt. Lbs.
PJ-100	Pump jack	30.0
PJ-PF-4	Pole foot	3.0
PJ-6P	6' aluminum pole	14.0
PJ-12P	12' aluminum pole	28.0
PJ-18P	18' aluminum pole	42.0
PJ-24P	24' aluminum pole	56.0
PJ-PC	Pole connector	12.0
PJ-SBF	Foldable support brace	9.0
PJ-SBR	Rigid support brace	14.0
PJ-WB	Work bench	15.0
PJ-ERN	End rail kit (narrow)	15.0
PJ-ERW	End rail kit (wide)	17.0
PJ-SN	Safety net	14.0

NESTABLE STAGES

2-person - 500 lbs. rated

Model No.	Nestable Stage Description	Approx. Shipping Wt. Lbs.
WNS-2412	14" x 12'	46.0
WNS-2416	14" x 16'	63.0
WNS-2420	14" x 20'	86.0
WNS-2424	14" x 24'	115.0
WNS-2512	20" x 12'	54.0
WNS-2516	20" x 16'	75.0
WNS-2520	20" x 20'	103.0
WNS-2524	20" x 24'	122.0
WNS-2612	24" x 12'	62.0
WNS-2616	24" x 16'	81.0
WNS-2620	24" x 20'	116.0
WNS-2624	24" x 24'	139.0

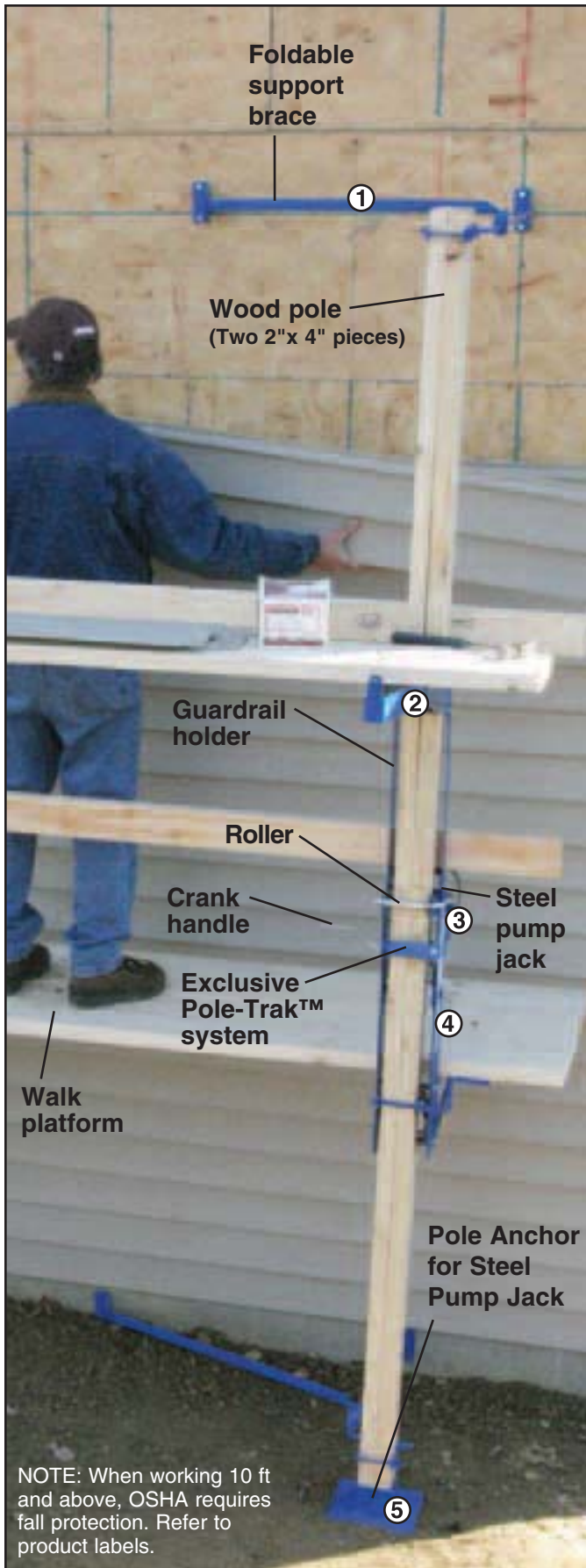

- Exclusive Pole-Trak™ system with rugged hand crank and safety brake
- Slip-resistant foot lever with oversized boot strap
- Accommodates up to a 24" wide plank
- Economical and easy to operate
- Meets ANSI and OSHA standards

- **Pump Jack**
- **Work Bench with Guard Rail Holder**
- **Pole Anchor**
- **Foldable Brace**

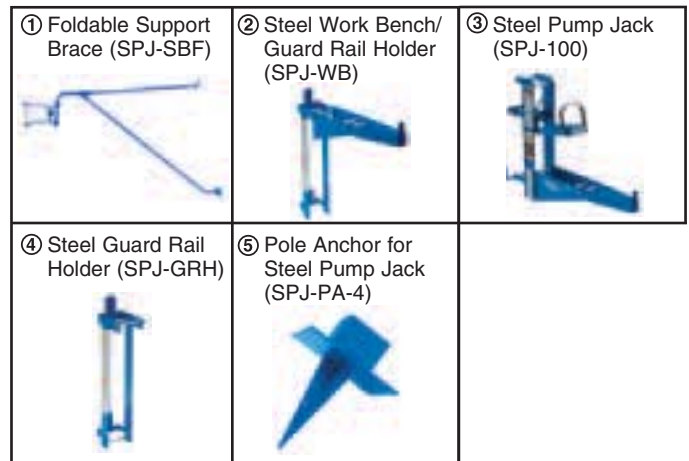

COMPONENTS SHOWN

Description	Model Number	Product Weight (lbs)
① Foldable Support Brace	SPJ-SBF	7.0
② Steel Work Bench/ Guard Rail Holder	SPJ-WB	11.0
③ Steel Pump Jack	SPJ-100	23.0
④ Steel Guard Rail Holder	SPJ-GRH	5.5
⑤ Pole Anchor for Steel Pump Jack (Shipped in 4-packs)	SPJ-PA-4	5.5 (4-pk weight: 23.0)

ALUMINUM TASK-MASTER® STAGES

- Twist-Proof® Stage Design
- Ideal for ladder jack applications, swing stages or catwalks

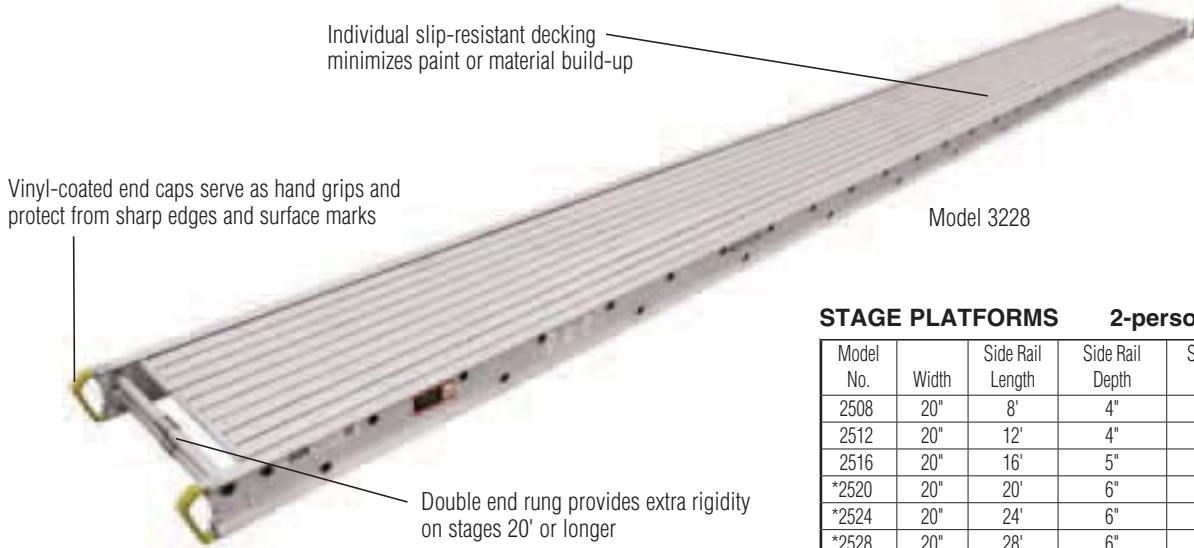

Model 3228

STAGE PLATFORMS 2-person - 500 lbs. rated

Model No.	Width	Side Rail Length	Side Rail Depth	Side Rail Flange	Approx. Shipping Wt. Lbs.
2508	20"	8'	4"	1-3/8"	33.0
2512	20"	12'	4"	1-3/8"	48.0
2516	20"	16'	5"	1-3/8"	70.0
*2520	20"	20'	6"	1-3/8"	102.0
*2524	20"	24'	6"	1-3/8"	121.0
*2528	20"	28'	6"	2"	157.0
*2532	20"	32'	6"	2"	179.0
2608	24"	8'	4"	1-3/8"	38.0
2612	24"	12'	4"	1-3/8"	56.0
2616	24"	16'	5"	1-3/8"	81.0
*2620	24"	20'	6"	1-3/8"	115.0
*2624	24"	24'	6"	1-3/8"	138.0
*2628	24"	28'	6"	2"	168.0
*2632	24"	32'	6"	2"	191.0
2708	28"	8'	4"	1-3/8"	41.0
2712	28"	12'	4"	1-3/8"	60.0
2716	28"	16'	5"	1-3/8"	87.0
*2720	28"	20'	6"	1-3/8"	124.0
*2724	28"	24'	6"	1-3/8"	147.0
*2728	28"	28'	6"	2"	187.0
*2732	28"	32'	6"	2"	213.0

3-person - 750 lbs. rated

3112	24"	12'	4"	2"	64.0
3116	24"	16'	5"	2"	92.0
*3120	24"	20'	5"	2"	115.0
*3124	24"	24'	6"	2"	145.0
*3128	24"	28'	6" Heavy Duty	2"	204.0
*3132	24"	32'	6" Heavy Duty	2"	236.0
*3136	24"	36'	6" Heavy Duty	2"	323.0
*3139	24"	39'	6" Heavy Duty	2"	365.0
3208	28"	8'	4"	2"	48.0
3212	28"	12'	4"	2"	71.0
3216	28"	16'	5"	2"	103.0
*3220	28"	20'	5"	2"	128.0
*3224	28"	24'	6"	2"	161.0
*3228	28"	28'	6" Heavy Duty	2"	220.0
*3232	28"	32'	6" Heavy Duty	2"	251.0
*3236†	28"	36'	6" Heavy Duty	2"	344.0
*3239†	28"	39'	6" Heavy Duty	2"	388.0

*Includes set of double rungs at the end of stage.

†Includes reinforcing channel

DECORATOR PLANKS 1-person - 250 lbs. rated

Model No.	Width	Side Rail Length	Side Rail Depth	Side Rail Flange	Approx. Shipping Wt. Lbs.
2008	12"	8'	4"	1-3/8"	25.0
2012	12"	12'	4"	1-3/8"	36.0
2016	12"	16'	4"	1-3/8"	48.0
2020	12"	20'	5"	1-3/8"	65.0
2024	12"	24'	5"	1-3/8"	78.0

SCAFFOLD PLANKS 2-person - 500 lbs. rated

Model No.	Width	Side Rail Length	Side Rail Depth	Side Rail Flange	Approx. Shipping Wt. Lbs.
2316	12"	16'	4"	1-3/8"	48.0
2320	12"	20'	6"	1-3/8"	79.0
2324	12"	24'	6" Heavy Duty	1-3/8"	112.0
2328	12"	28'	6" Heavy Duty	1-3/8"	131.0
2330	12"	30'	6" Heavy Duty	1-3/8"	140.0
2332	12"	32'	6" Heavy Duty	1-3/8"	149.0
2408	14"	8'	4"	1-3/8"	27.0
2412	14"	12'	4"	1-3/8"	40.0
2416	14"	16'	5"	1-3/8"	58.0
2420	14"	20'	6"	1-3/8"	85.0
2424	14"	24'	6"	2"	109.0
2428	14"	28'	6"	2"	127.0
2432	14"	32'	6" Heavy Duty	2"	182.0

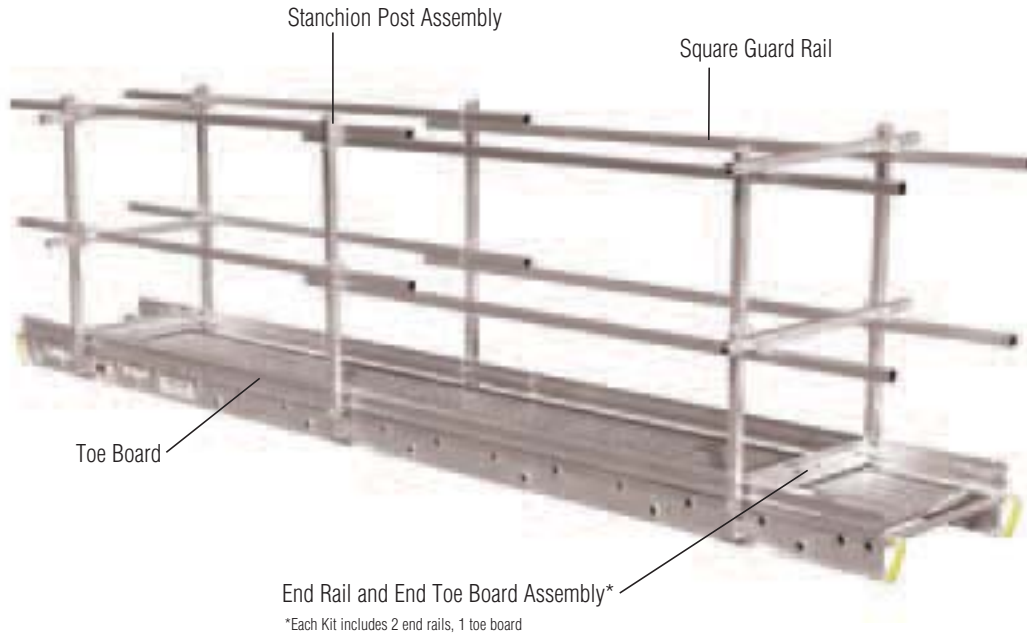

SQUARE MODULAR GUARD RAIL SYSTEM

System Sizing: How do I size a guard rail system?

The following steps show how to size a single-sided, three-sided, and four-sided guard rail system:

- Step 1: Determine the stage length and width.
- Step 2: Determine whether guardrail system is one-, two-, three-, or four -sided.
- Step 3: Read across the row to determine component requirements.
- Step 4: If ordering a three- or four-sided system, order two ERT-N for 12" and 14" wide stages, and two ERT-W for all stages 20" wide or greater.

Note: If ordering a two sided system, double the single sided component requirement.

Model No.	Description	Approx. Shipping Wt. Lbs.
ERT-N	End rail and end toe board assembly - narrow	4.5
ERT-W	End rail and end toe board assembly - wide	7.0
SSP-47	Stanchion post assembly	5.0
SGR-09	1-1/2" square guard rail cut length - 108"	6.0
SGR-13	1-1/2" square guard rail cut length - 156"	8.5
STB-09	3-1/2" toe board cut length - 108"	4.5
STB-13	3-1/2" toe board cut length - 156"	6.5

Stage Length	Single-sided					Three-sided					Four-sided						
	SSP-47	SGR-09	SGR-13	STB-09	STB-13	SSP-47	SGR-09	SGR-13	STB-09	STB-13	ERT-N/ ERT-W*	SSP-47	SGR-09	SGR-13	STB-09	STB-13	ERT-N/ ERT-W*
8'	2	2	0	1	0	4	2	0	1	0	2	4	4	0	2	0	2
12'	3	0	2	0	1	5	0	2	0	1	2	6	0	4	0	2	2
16'	3	4	0	2	0	5	4	0	2	0	2	6	8	0	4	0	2
20'	4	2	2	1	1	6	2	2	1	1	2	8	4	4	2	2	2
24'	5	4	2	2	1	7	4	2	2	1	2	10	8	4	4	2	2
28'	6	2	4	1	2	8	2	4	1	2	2	12	4	8	2	4	2
32'	6	2	4	1	2	8	2	4	1	2	2	12	4	8	2	4	2
36'	6	10	0	5	0	8	10	0	5	0	2	12	20	0	10	0	2
39'	7	4	4	2	2	9	4	4	2	2	2	14	8	8	4	4	2

*ERT-N is for 12" and 14" wide stages; ERT-W is for 20" wide and greater stages



ALUMINUM SCAFFOLDING

Werner aluminum scaffolding is best suited for construction and building maintenance applications, especially in high-traffic areas where mobility and appearance are important.

CONSTRUCTION:

- Drywall
- Insulation
- Drop ceilings
- Ductwork

BUILDING MAINTENANCE:

- Window and façade cleaning
- Changing light bulbs
- Painting
- Wallpapering

Aluminum scaffolding has benefits that steel scaffolding does not.

- More corrosion resistant
- Easier and quicker to install
- Convenient - 30-50% lighter
- Better on-site appearance

Werner offers scaffolding as towers, sections and individual components.

- Towers and sections for the one-time purchaser with limited scaffold knowledge
- Components for the regular purchaser with extensive knowledge on configuring a scaffold tower

Scaffolding can be used on inclines and stairs.

- For use on an incline, a scaffold tower must be secured to prevent movement.
- Scaffolding can be used on a stairway provided the horizontal braces from one end frame to the other are at the same level and adequate braces are used.

WERNER

**5-DAY
SHIPPING
PROGRAM**

**ORDER TO SHIPPING WITHIN
5 BUSINESS DAYS***

Minimum order for prepaid freight:
1000 lbs. on product lines listed.



- Aluminum scaffolding systems
- 6' steel rolling scaffold (SRS-72)
- Scaffold components
- Nestable and standard stages and guard rail systems
- Scaffolding platforms (5300, 5500, 5600)
- Aluminum and steel pump jacks and components

*Applicable to catalog items only - orders over 20 units will be evaluated for shipment confirmation. Please contact customer care for details.

- Easy and convenient to order.
- Takes the guesswork out of what is required to meet Code.
- Ideal for schools, hospitals and building maintenance.

Includes guard rails, toeboards and planks with access door that allows end users to climb from inside. 23' towers include additional fixed board (no access door). Outriggers included on all models except 4201-12, 4202-12 and 4203-12. These models meet the ANSI code as noted on Page 50 - "Notice".

Narrow Span Towers

Platform Length	Total Width (W)	Total Length (L)
6'	9' 6"	9' 6"
8'	9' 6"	11' 6"
10'	9' 6"	13' 6"

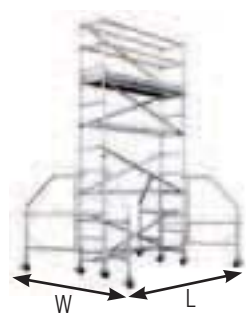

12' Platform Height

Model No.	Platform Length	Platform Width	Platform Height	Total Tower Height	Approx. Shipping Wt. Lbs.
4101-12	6'	29"	12'	15' 5"	359.0
4102-12	8'	29"	12'	15' 5"	389.0
4103-12	10'	29"	12'	15' 5"	410.5



18' Platform Height

Model No.	Platform Length	Platform Width	Platform Height	Total Tower Height	Approx. Shipping Wt. Lbs.
4101-18	6'	29"	17' 6"	20' 11"	405.0
4102-18	8'	29"	17' 6"	20' 11"	439.0
4103-18	10'	29"	17' 6"	20' 11"	462.5



23' Platform Height

Model No.	Platform Length	Platform Width	Platform Height	Total Tower Height	Approx. Shipping Wt. Lbs.
4101-23	6'	29"	23'	26' 4"	451.0
4102-23	8'	29"	23'	26' 4"	489.0
4103-23	10'	29"	23'	26' 4"	514.5

Load Capacity: 25 lbs. per sq. ft. or 500 lbs. maximum per deck & scaffold.

Wide Span Towers



12' Platform Height*

Model No.	Platform Length	Platform Width	Platform Height	Total Tower Height	Approx. Shipping Wt. Lbs.
4201-12	6'	4-1/2'	12'	15' 5"	299.5
4202-12	8'	4-1/2'	12'	15' 5"	338.0
4203-12	10'	4-1/2'	12'	15' 5"	366.0

*Outriggers not included with 12' high platform wide span towers (Per ANSI code, does not require outriggers).

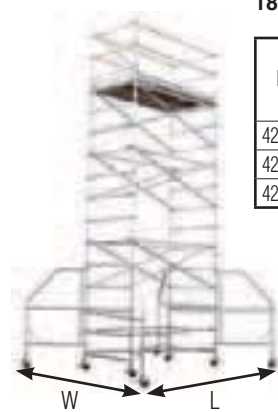

18' Platform Height

Model No.	Platform Length	Platform Width	Platform Height	Total Tower Height	Approx. Shipping Wt. Lbs.
4201-18	6'	4-1/2'	17' 6"	20' 11"	561.5
4202-18	8'	4-1/2'	17' 6"	20' 11"	610.0
4203-18	10'	4-1/2'	17' 6"	20' 11"	643.0

Platform Length	Total Width (W)	Total Length (L)
6'	10' 10"	10' 10"
8'	10' 10"	12' 10"
10'	10' 10"	14' 7"

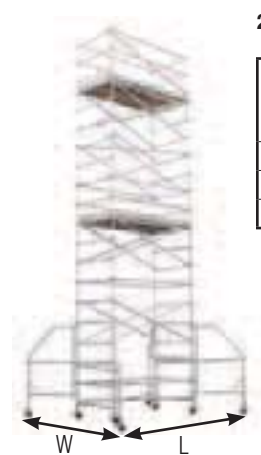

23' Platform Height

Model No.	Platform Length	Platform Width	Platform Height	Total Tower Height	Approx. Shipping Wt. Lbs.
4201-23	6'	4-1/2'	23'	26' 4"	695.0
4202-23	8'	4-1/2'	23'	26' 4"	778.0
4203-23	10'	4-1/2'	23'	26' 4"	862.0

Platform Length	Total Width (W)	Total Length (L)
6'	10' 10"	10' 10"
8'	10' 10"	12' 10"
10'	10' 10"	14' 7"

Load Capacity: 25 lbs. per sq. ft. or 500 lbs. per deck and 1,000 lbs. maximum per scaffold.

SCAFFOLD SECTIONS

- Easy and convenient to order.
- Enables user to easily add to an existing scaffold tower.
- Ideal for painting and remodeling contractors.

NARROW SPAN SCAFFOLD SECTIONS

Load Capacity: 25 lbs. per sq. ft. or 500 lbs. maximum per deck and scaffold

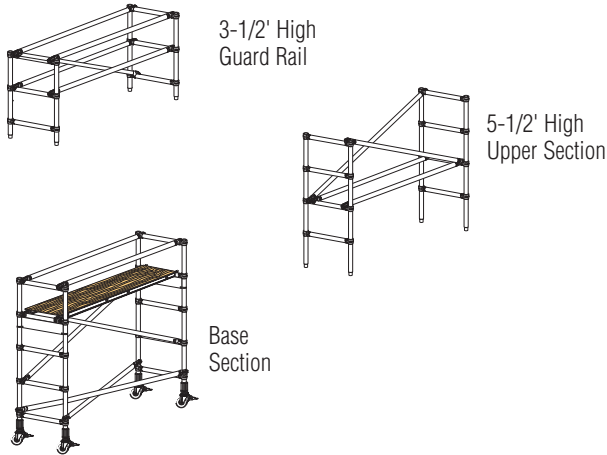

Model No.	Width	Length	Approx. Shipping Wt. Lbs.
6' 6" to 7' 6" High Adjustable Base Sections			
4101	29"	6'	121.0
4102	29"	8'	133.0
4103	29"	10'	145.0
6-3/4' High Upper Sections			
4127	29"	6'	60.0
4128	29"	8'	65.0
4129	29"	10'	68.0
5-1/2' High Upper Sections			
4104	29"	6'	53.0
4105	29"	8'	58.0
4106	29"	10'	62.0
4' High Upper Sections			
4107	29"	6'	47.0
4108	29"	8'	51.0
4109	29"	10'	55.0
3-1/2' High Guard Rails			
4110	29"	6'	44.0
4111	29"	8'	48.0
4112	29"	10'	52.0

SNAP-UP® NARROW SPAN FOLDING SCAFFOLDS

Load Capacity: 25 lbs. per sq. ft. or 500 lbs. maximum per deck and scaffold

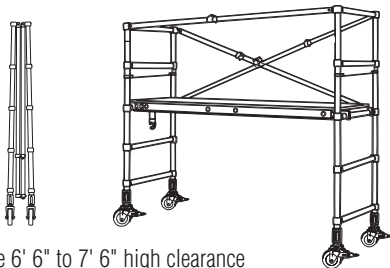

- Adjustable 6' 6" to 7' 6" high clearance

Model No.	Width	Length	Approx. Shipping Wt. Lbs.
SNB-6U	29"	6'	127.0
SNB-8U	29"	8'	139.0

WIDE SPAN SCAFFOLD SECTIONS

Load Capacity: 25 lbs. per sq. ft. or 500 lbs. maximum per deck and 1000 lbs. maximum per scaffold

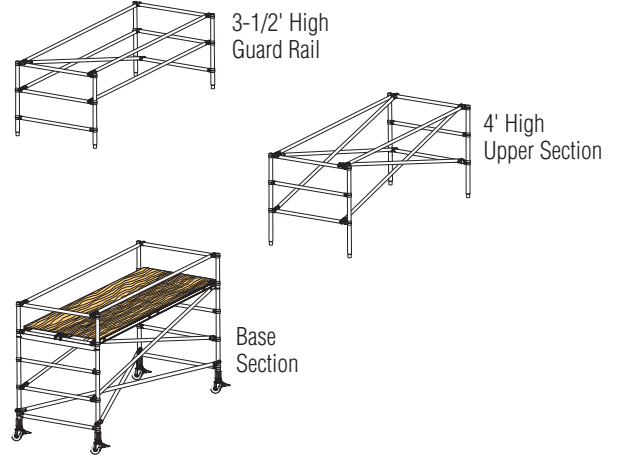

Model No.	Width	Length	Approx. Shipping Wt. Lbs.
6' 6" to 7' 6" High Base Sections			
4201	4-1/2'	6'	167.0
4202	4-1/2'	8'	188.0
4203	4-1/2'	10'	208.0
5-1/2' High Upper Sections			
4204	4-1/2'	6'	71.0
4205	4-1/2'	8'	76.0
4206	4-1/2'	10'	81.0
4' High Upper Sections			
4207	4-1/2'	6'	62.0
4208	4-1/2'	8'	68.0
4209	4-1/2'	10'	73.0
3-1/2' High Guard Rails			
4210	4-1/2'	6'	55.0
4211	4-1/2'	8'	60.0
4212	4-1/2'	10'	65.0

SNAP-UP® WIDE SPAN FOLDING SCAFFOLDS

Load Capacity: 25 lbs. per sq. ft. or 500 lbs. maximum per deck and 1000 lbs. maximum per scaffold

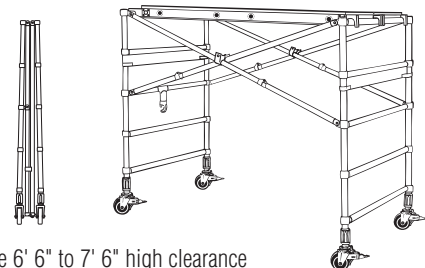

- Adjustable 6' 6" to 7' 6" high clearance

Model No.	Width	Length	Approx. Shipping Wt. Lbs.
SWB-6U	4-1/2'	6'	163.0
SWB-8U	4-1/2'	8'	181.0

- Provides most flexibility during installation.
- Enables end user to easily convert to different length or height scaffold towers.
- All components available separately.
- Ideal for rental yards and theatrical and entertainment applications.

FRAMES

Model No.	Description	Approx. Shipping Wt. Lbs.
For Narrow Span, 29" Wide		
FNB-80	Base end frame	35.0
FNU-81	6-3/4' H upper end frame	19.0
FNU-65	5-1/2' H upper end frame	15.0
FNU-49	4' H upper end frame	12.0
FNG-42	Guard rail end frame	11.5
For Wide Span, 4-1/2' Wide		
FWB-80	Base end frame	39.5
FWU-81	6-3/4' H wide span upper end frame	22.0
FWU-65	5-1/2' H upper end frame	19.0
FWU-49	4' H upper end frame	14.5
FWG-42	Guard rail end frame	14.5

SCAFFOLD BOARDS

Model No.	Description	Approx. Shipping Wt. Lbs.
P22W-6	6' scaffold board	28.5
P22W-8	8' scaffold board	36.0
P22W-10	10' scaffold board	42.5
PD22W-6	22" wood deck with access door - 6' board	33.0
PD22W-8	22" wood deck with access door - 8' board	41.0
PD22W-10	22" wood deck with access door - 10' board	49.0

BRACES

Model No.	Description	Approx. Shipping Wt. Lbs.
BD-6	6' diagonal brace	4.0
BD-8	8' diagonal brace	5.0
BD-10	10' diagonal brace	5.5
BH-6	6' horizontal brace	4.0
BH-8	8' horizontal brace	5.0
BH-10	10' horizontal brace	5.5
BN-6	6' narrow span horizontal-diagonal brace	4.0
BN-8	8' narrow span horizontal-diagonal brace	5.0
BN-10	10' narrow span horizontal-diagonal brace	6.0
BW-6	6' wide span horizontal-diagonal brace	5.0
BW-8	8' wide span horizontal-diagonal brace	5.5
BW-10	10' wide span horizontal-diagonal brace	6.0

OUTRIGGERS for Wide and Narrow Span Scaffolds

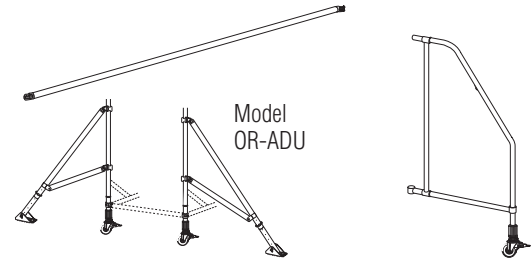

Note: Braces and Frames are ordered separately

Model No.	Description	Approx. Shipping Wt. Lbs.
BOR-N	Narrow span outrigger brace	4.0
BOR-W	Wide span outrigger brace	5.0
FRO	Rolling outrigger frame (with every frame, a brace is needed)	18.0
Knee-Type Outriggers		
OR-ADU	Adjustable 1' to 5' 6" wide for narrow or wide span scaffolds	11.0

TOE BOARD SYSTEMS

OSHA requires toe boards on scaffolds over 10' high

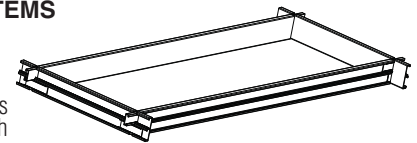

Model No.	Size	Approx. Shipping Wt. Lbs.
Aluminum Toe Board Assemblies for 4100 Series		
TN4A-6U	4" x 6'	18.0
TN4A-8U	4" x 8'	21.0
TN4A-10U	4" x 10'	25.0
Aluminum Toe Board Assemblies for 4200 Series		
TW4A-6U	4" x 6'	21.0
TW4A-8U	4" x 8'	25.0
TW4A-10U	4" x 10'	28.0

ACCESSORY KITS

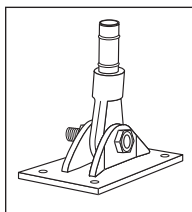

**Kit No. 41-1
ONE SWIVEL
BASE
PLATE**

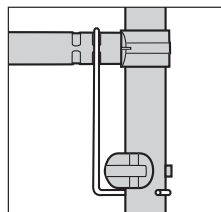

**Kit No. 43-1
GUARD RAIL HOLDER
A Werner Exclusive**

Includes four steel guard rail holders. With a set of guard rail holders, you can easily turn a horizontal brace into a guard rail.

NOTE: Guard Rail Holder fits Intermediate Scaffold Section Models: 4104-4109, 4127-4129, 4204-4209. They are not designed for Werner Co. Guard Rail Upper Section Models: 4110, 4111, 4112, 4210, 4211, 4212.

Kit No.	Description	Approx. Shipping Wt. Lbs.
41-1	One swivel base plate for stairway and span type scaffolds	8.0
43-1	Guard Rail Holder fits intermediate scaffold section models: 4104-4109, 4127-4129, 4204-4209.	1.2

NOTICE – ALL SCAFFOLDS: Maximum scaffold platform height is equal to 4x the smaller base section dimension of the scaffold or installed outrigger in most states except California which requires 3x. Check state and local codes.

SCAFFOLD/OUTRIGGER COMPONENT COMPARISON CHART

Scaffold Towers		Narrow Span (29" wide) Towers									Wide Span (4-1/2" wide) Towers									
Platform Length		6' Long			8' Long			10' Long			6' Long			8' Long			10' Long			
Component Model No.	Description	4101-12	4101-18	4101-23	4102-12	4102-18	4102-23	4103-12	4103-18	4103-23	4201-12	4201-18	4201-23	4202-12	4202-18	4202-23	4203-12	4203-18	4203-23	
FNB-80	Adjustable Base Section	2	2	2	2	2	2	2	2	2										
FNU-65	5-1/2' Upper Section	2	4	6	2	4	6	2	4	6										
FNG-42	Guard Rail	2	2	2	2	2	2	2	2	2										
FWB-80	Adjustable Base Section										2	2	2	2	2	2	2	2	2	2
FWU-65	5-1/2' Upper Section										2	4	6	2	4	6	2	4	6	6
FWG-42	Guard Rail										2	2	2	2	2	2	2	2	2	2
PD22W-6, -8, -10*	Access Door Plank	1	1	2	1	1	2	1	1	2	1	1	2	1	1	2	1	1	2	2
P22W-6, -8, -10*	Wood Deck										1	1	2	1	1	2	1	1	2	2
BH-6, -8, -10*	Horizontal Brace	8	10	12	8	10	12	8	10	12	8	10	12	8	10	12	8	10	12	12
BD-6, -8, -10*	Diagonal Brace	5	7	9	5	7	9	5	7	9	9	13	17	9	13	17	9	13	17	17
BN-6, -8, -10*	Horizontal-Diagonal	2	2	4	2	2	4	2	2	4										
BW-6, -8, -10*	Horizontal-Diagonal										2	2	4	2	2	4	2	2	4	4
FRO	Outrigger	4	4	4	4	4	4	4	4	4		4	4		4	4		4	4	4
BOR-N, -W	Outrigger Brace	4	4	4	4	4	4	4	4	4		4	4		4	4		4	4	4
TN4A-6U, -8U, -10U	Toe Board	1	1	2	1	1	2	1	1	2										
TW4A-6U, -8U, -10U	Toe Board										1	1	2	1	1	2	1	1	2	2

*-6, -8, -10 refers to platform length. Add suffix to model number for corresponding platform length.

RAMPS

ALUMINUM FOLDING ARCHED RAMPS MODEL R522

1500 lbs. Load Capacity Per Pair
(750 lbs. evenly distributed load capacity per ramp)
Shipping Weight: 35.0 lbs.

ARCHED FOR BOTH HIGH AND LOW CLEARANCE VEHICLES

- Folds and locks for easy transporting
- Center rail and transition plate for smooth loading
- Multi-purpose - Ideal for all wheel sizes
- Easily hook together for small wheelbases
- Includes 2 ramps - No assembly required

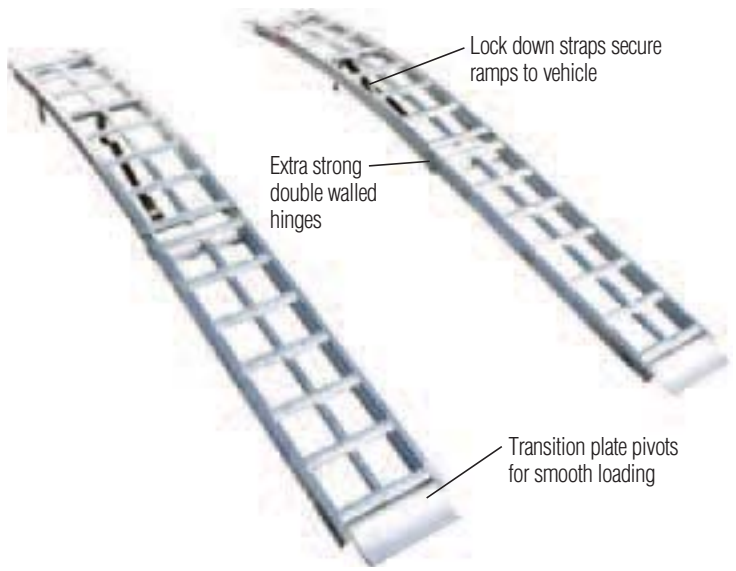

ALUMINUM ARCHED RAMPS MODEL R402

1400 lbs. Load Capacity Per Pair
(700 lbs. evenly distributed load capacity per ramp)
Shipping Weight: 22.0 lbs.

ARCHED FOR BOTH HIGH AND LOW CLEARANCE VEHICLES

- Multi-purpose
- Easily hook together for small wheelbases
- Includes 2 ramps - No assembly required

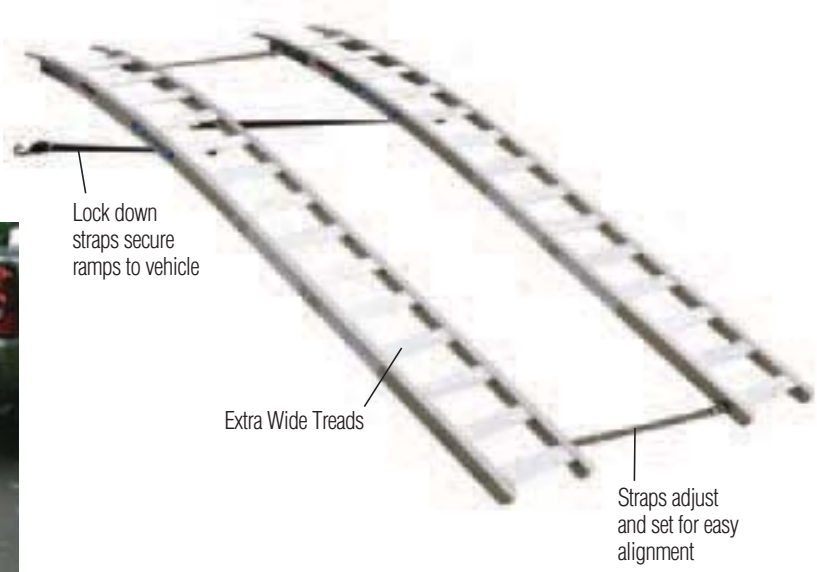

RAMPS

ALUMINUM STRAIGHT RAMPS MODEL R301

1300 lbs. Load Capacity Per Pair
(650 lbs. evenly distributed load capacity per ramp)
Shipping Weight: 20.0 lbs.

STRAIGHT FOR HIGH CLEARANCE VEHICLES

- Great for off-road vehicles
- Easily hook together for small wheelbases
- Includes 2 ramps - No assembly required



STEEL STRAIGHT RAMP KIT MODEL R102

Up to 1400 lbs. Load Capacity Per Pair*
(700 lbs. evenly distributed load capacity per ramp)
Shipping Weight: 6.0 lbs.

*depending on material, grade and length of board

STRAIGHT FOR HIGH CLEARANCE VEHICLES

- Works with two 2x8, 2x10 or 2x12 planks (not included).
- Ideal for many uses. Use as a single ramp or a pair.
- Great for off-road vehicles.
- Safety straps secure ramps to vehicle.
- Includes hardware for 2 ramps.



STEEL REMOVABLE PICKUP TRUCK RACK

250 lbs. Load Capacity
MODEL TR401-S (black)
Shipping Weight: 50.0 lbs.



Designed for work or play.



Cargo positioners & vinyl strips help protect cargo in transit.



Easily removes when not in use.



Some assembly required

KEY FEATURES (all racks)

- **Exclusive Vinyl Protector Strips:** Werner is the first in the industry to offer these as a standard feature to help protect your equipment against transit damage.
- **Universal Design:** Werner Van & Truck Racks fit all vans with rain gutters and most pickup trucks with 6-1/2' to 8' long beds.

STANDARD FEATURES

- All Werner Van & Truck Racks are made of welded 14 gauge square tubular steel for added strength.
- Double layer of glossy powder coated finish and corrosion resistant hardware are standard for added durability.

STEEL VAN RACK 600 lbs. Load Capacity MODEL VR401-W (white)

Shipping Weight: 40.0 lbs.



Includes predrilled uprights.



Cargo positioners & vinyl strips help protect cargo in transit.

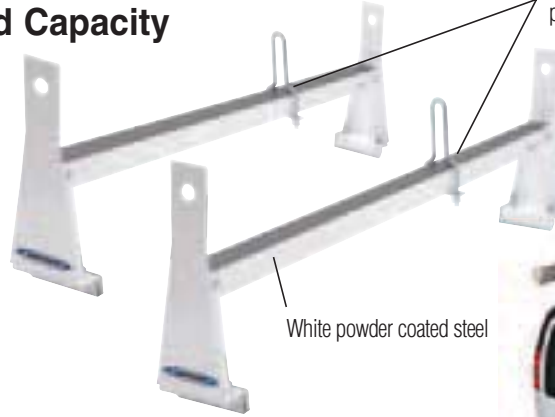

White powder coated steel

Cargo positioners & vinyl strips help protect cargo in transit



3rd Bar Option Available

Standard - Model No. VR403-W (white)

Model No. VR404-W (white)

Shipping Weight: 21.0 lbs.

Some assembly required

Van Rack Compatibility Chart

Van Year	Make	Model	Type	VR401-W	VR403-W	VR404-W
Up to 1997	Chevy	1500-3500	All	✓	✓	
1998 & Up	Chevy/GMC	Express/Savanna	All	✓		✓
1998 & Up	Chevy/GMC	Express/Savanna	Standard	✓		✓
1982 & Up	Ford	E-150, 250, 350	Standard	✓		✓
1982 & Up	Ford	Super	Long	✓		✓
Up to 1999	Dodge	B-150, 250, 350	Standard	✓	✓	
2000 to 2003	Dodge	B-150, 250, 350	Standard			
Up to 1999	Dodge	Maxie Van	Long	✓	✓	
2000 to 2003	Dodge	Maxie Van	Long			
2004 & Up	Dodge	Sprinter (Passenger & Cargo Models)	Standard Roof	✓	✓	
2004 & Up	Dodge	Sprinter (Passenger & Cargo Models)	High Roof & Mega Roof			
All	All	Gutterless/Mini	All			

MERCHANDISING MODULAR LADDER DISPLAYS & FIXTURES

55 END CAP DISPLAY



37 DISPLAY RACK



- Modular design for flexible retail footprint
- Easier access and organized ladder display
- Merchandises ladders and accessories
- Werner Performance System® signage included

SPECIFICATIONS

Model No.	No. of Ladders in Fixture	Overall dimensions	Method of Shipping	Approx. Shipping Wt. Lbs.
37 Display Rack	7	24-3/4" x 48" x 45-1/2"	UPS or Fed Ex	65.0
55 End Cap	14	50-1/2" x 49-1/2" x 85"	LTL	138.0

HOW TO ORDER *FACTORY INSTALLED ACCESSORY KITS*

Please follow these steps and refer to the chart below for purchasing a ladder accessory that is factory installed. Certain combinations of factory installed accessories to the same ladder are also available. Lead time for factory installed accessories may vary depending on availability. If you have a question or need assistance, please call customer service at 1-888-523-3371.

Step 1: Locate the ladder's model number and add an X on to the end of the model number.

Step 2: Use the chart provided and find the accessory you want attached. Add the 4 digit designator to the end of the ladder model number after the X.

Example: Ladder Model Number: D6220-2
Add the X to signify factory installation: D6220-2X
Accessory to install: APK80
Locate accessory on chart and find that "0004" designates this accessory being added.

MODEL TO ORDER: D6220-2X0004

Attached Accessories	Description	4-Digit Designator
A61	Combination Spur-Hoop Shoe	0038
A71	Padded Fixed V-Rung	0005
A72	Adjustable Pole Strap	0008
A74	Cable Hooks	0003
A78	Fly Section Shoe	0058
A81	Adjustable Pole Lashes	0089
A83	Rubber Padded Shoe	0049
A86	Spur Shoe	0007
A92	Cable Hook and V-Rung Assembly	0002
APK70	LevelLok® Ladder Leveler with 2 base units	0086
APK80	Level-Master Automatic Ladder Levelers	0004

See price list for added cost.

Werner's illustrations are representative and may not include all styles.

All accessories, attachments, and replacement parts are designed and tested for Werner Co. products only.

CUSTOMIZE YOUR LADDER TOP



PaintCup & PaintCupLiner



JobBucket



UtilityBucket



JobCaddy



UtilityHook



ToolLasso®



AC27-P

Paint Cup



- Great for trim painting and cut-in applications
- Built-in magnet to secure a paint brush
- Holds 1 quart of paint
- Can be used with disposable Paint Cup Liner AC27-L

Model No.	Fits on
AC27-P	OBEL00, OBPT00, OBCN00, 6200, 6100, 6000, AC24

Approx. Shipping Dimensions	Approx. Shipping Wt. Lbs.
9-1/8" x 13-3/4" x 10-7/8"	4.0

Shipping quantity
(6) units per carton

AC27-L

Paint Cup Liner



- Disposable liner makes clean up easy
- Each AC-27L unit includes 4 liners

Model No.	Fits on
AC27-L	AC27-P

Approx. Shipping Dimensions	Approx. Shipping Wt. Lbs.
5-1/8" x 13-3/8" x 10"	2.2

Shipping quantity
(10) units per carton
(40) liners per carton

AC50-JB-3

Job Bucket



- Increase ladder storage and maximize your work space
- Great for all trades: electrical, maintenance, plumbing, construction
- Integrated tape measure and screwdriver holders
- Top grooves hold round pipes in place
- 600 cubic inches of storage, 25 lbs. load capacity

Model No.	Fits on
AC50-JB-3	OBEL00, OBPT00, OBCN00, 6200, 6100, 6000

Approx. Shipping Dimensions	Approx. Shipping Wt. Lbs.
15-1/4" x 11-7/8" x 16-1/4"	6.6

Shipping quantity
(3) units per carton

TAKE LESS TRIPS UP THE LADDER



AC52-UB

Utility Bucket



- Expand your work surface
- Great for jobsite or household use
- Integrated Lock-In Socket for adding Paint Cup, ToolLasso® or Utility Hook
- Ideal for wet or dry applications
- Holds up to one gallon of liquid, 25 lbs. capacity

Model No.	Fits on
AC52-UB	OBEL00, OBPT00, OBCN00, 6200, 6100, 6000

Approx. Shipping Dimensions	Approx. Shipping Wt. Lbs.
13-1/2" x 10-3/4" x 10-3/4"	4.5

*Shipping quantity
(3) units per carton*

AC54-JC

Job Caddy



- Holds large or odd shaped items like fluorescent bulbs or ceiling fan blades
- 4 storage compartments keep small parts separated
- Screwdriver, pliers, putty knife & towel holders
- End hook built in for increased convenience
- Integrated Lock-In Socket for adding Paint Cup, ToolLasso® or Utility Hook

Model No.	Fits on
AC54-JC	OBEL00, OBPT00, OBCN00, 6200, 6100, 6000

Approx. Shipping Dimensions	Approx. Shipping Wt. Lbs.
15-1/2" x 8-3/8" x 10-3/8"	6.7

*Shipping quantity
(3) units per carton*

AC56-UH

Utility Hook



- Keep cords from getting tangled in your ladder
- Organize cords and keep them within reach
- Holds extension cords, air hoses, garden hoses, strands of lights, paint sprayers and other tools or project materials

Model No.	Fits on
AC56-UH	OBEL00, OBPT00, OBCN00, 6200, 6100, 6000

Approx. Shipping Dimensions	Approx. Shipping Wt. Lbs.
9-3/4" x 13-1/2" x 8"	2.8

*Shipping quantity
(10) units per carton*

AC58-TL

ToolLasso®



- Secures tools from falling
- Wraps around the grip of power tools, hand tools and caulk guns
- Locks into HolsterTop® to keep tools safe and ready to use
- Compatible with the ToolLasso® belt clip
- AC58-TL includes 1 belt clip and 2 ToolLassos

Model No.	Fits on
AC58-TL	OBEL00, OBPT00, OBCN00, 6200, 6100, 6000, AC24, PS-48

Approx. Shipping Dimensions	Approx. Shipping Wt. Lbs.
10-7/8" x 12-1/4" x 9-3/4"	4.0

*Shipping quantity
(12) units per carton*

STEPLADDER ACCESSORIES

AC11

Step ladder Hanger



Hanger can be mounted on a wall to hold stepladders. Industrial strength coated steel wire construction.

User Installed Only

Kit No.	Approx. Shipping Weight
AC11	1.8 lbs. each

Shipping quantity
(6) units per carton

22

Fiberglass Rail Shields

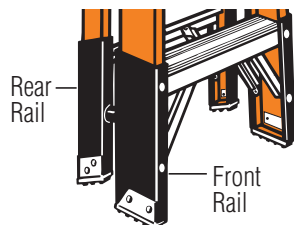

Designed to reinforce. Shields may also be used to repair ladder if rail cracks occur no higher than 3/4" below bottom rivet of bottom step or horizontal and all holes in the rail are intact. Rail shield(s) come with mounting hardware. (1 front and 1 rear kit per stepladder; 2 front kits needed for trestle ladder)

User Installed Only

Kit No.	Fits on Front Rail of Fiberglass Series	Approx. Shipping Wt.
22-2F	6000, T6000, 6200, 7300 T6200, 7400 (MK 13 & up) T7400 (MK 11 & up) P7400 (MK 13 & up) PT7400 (MK 4 & up) E7400 (MK 7 & up)	1.5 lbs.
22-3F	7400 (up through MK 12) T7400 (up through MK 10) P7400 (up through MK 12) PT7400 (up through MK 3) E7400 (up through MK 6)	1.5 lbs.
Kit No.	Fits on Rear Rail of Fiberglass Series	Approx. Shipping Wt.
22-2R	6200, 7300, 7400, P7400	1.0 lb.

PK76

Universal Auto-Closing Pail Shelf



Spill-Proof®, rugged construction, easy to keep clean, automatically closes with stepladder, built-in rag rack. Pail shelf comes with mounting hardware and instructions.

User Installed Only

Kit No.	Fits on	Approx. Shipping Wt.
PK76-3	Fiberglass Stepladders & Aluminum 400 Series Stepladders	2.5 lbs.

Shipping quantity
(4) units per carton

Universal Pail Shelf



Two piece, Spill-Proof®, rugged construction, aluminum arms, built-in rag rack. Pail shelf comes with mounting hardware and instructions.

User Installed Only

Kit No.	Fits on	Approx. Shipping Wt.
PK76-9	Fiberglass Stepladders & Aluminum 400 Series Stepladders	1.6 lbs.

Shipping quantity
(6) units per carton

76

Molded Plastic Pail Shelf



Spill-Proof®, rugged construction, easy to keep clean, automatically closes with stepladder. Pail shelf comes with mounting hardware and instructions.

User Installed Only

Kit No.	Fits on Fiberglass Series	Approx. Shipping Wt.
76-2	6000 6200	2.5 lbs.

Shipping quantity
(2) units per carton

AC24

Multipurpose Project Tray



Project Tray conveniently holds tools, paints and supplies. Made for Werner multiladders and stepladders. Attaches easily; works at multiple heights; includes ToolLasso®.

User Installed Only

Kit No.	Fits on	Approx. Shipping Wt.
AC24	MT Series M1 Series Type IA (300 lbs.) & Type IAA (375 lbs.) Stepladders	2.8 lbs.

21

Grating Shoes



User Installed Only

Kit No.	Fits on Series	Approx. Shipping Wt.
21-20	6200, P6200, 7300, 7400, P7400	1.5 lbs.
21-22	T6200, T7400, PT7400	1.5 lbs.

40

Casters/Bracket Kits



Heavy duty aluminum bracket with 4" caster allows 360° mobility of ladder. Soft rubber wheels are easy on floors; designed to roll over door thresholds. Casters may be used on all 4 legs; order 2 kits for this purpose. Two (2) casters/brackets come with mounting hardware and instructions.

Order models below as a "-4C" for factory installation.

User Installed Only

Kit No.	Fits on Series	Approx. Shipping Wt.
40-2HD	PT370 PT6000 PT7400 (MK 4 & up)	5.0 lbs.
40-4HD	PT7400 (up through MK 3)	5.0 lbs.

Note: Fits only ladder originally equipped with casters.

EXTENSION LADDER ACCESSORIES

LADDER JACKS

Recommended for use with 300 lbs. Type IA and 375 lbs. Type IAA extension ladders (OSHA and ANSI allow use with 250 lbs. Type I extension ladders also)

User Installed Only



2-Rung Model AC10-14-02
Short Body
Accepts Stages to 14" width



2-Rung Model AC10-20-02
Long Body
Accepts Stages to 20" width



3-Rung Model AC10-20-03
Long Body
Accepts Stages to 20" width

- Lightweight, sturdy, easy to use
- Designed for quick field adjustments
- Mounts on either side of extension ladder

Kit No.	Approx. Shipping Wt.
AC10-14-02	15.0 lbs.
AC10-20-02	18.0 lbs.
AC10-20-03	20.0 lbs.

Shipping quantity
2 per unit;
(1) unit per carton

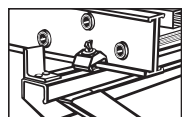

PLATFORM CLAMP SYSTEM
Clamp secures platform to ladder jacks and ties supporting ladders together to help secure entire ladder jack system

AC18MT

Platform



Slip-resistant surface. Aluminum construction. Kicks out of way for easy climbing. 300 lbs. load capacity.

User Installed Only

Kit No.	Fits on All	Approx. Shipping Wt.
AC18MT	MT Series	4.5 lbs.

ROOF BRACKETS



FRB4510-10

User Installed Only

ARB10-10
Adjustable Roof Bracket

Carton Dimensions	Approx. Shipping Wt.
4-5/8" x 19-1/2" x 14-1/4"	25.0 lbs.

Shipping quantity
(10) units per carton

FRB4510-10
Fixed Roof Bracket

Accommodates a 12/12, 45-degree roof pitch

Carton Dimensions	Approx. Shipping Wt.
9-3/8" x 18-1/4" x 9-1/4"	22.0 lbs.

Shipping quantity
(10) units per carton

AC19

Extension Ladder Covers



Helps prevent damage to support surfaces. Designed to 'snap' over extension ladder rail end caps. Resists paints, stains, thinners and solvents.

User Installed Only

Kit No.	Fits on	Approx. Shipping Wt.
AC19-2	ALL Single and Extension Fiberglass and Aluminum Ladders (except 500, D500, D7136-2, D7140-2)	1.2 lbs. each

Shipping quantity
1 pair per unit;
(6) units per carton

AC20

Paint Can Hook



Includes 2 steel hooks with can openers. Holds one gallon can. 3/16" diameter.

User Installed Only

Kit No.	Fits on	Approx. Shipping Wt.
AC20	ALL Extension Ladders	0.4 lbs. each

Shipping quantity
2 per unit;
(12) units per carton

AC22

Paint Can/Bucket Hanger



Holds one gallon can. Easy on and off. Right or left hand use. Plated steel.

User Installed Only

Kit No.	Fits on	Approx. Shipping Wt.
AC22	ALL Extension Ladders	0.5 lbs. each

Shipping quantity
(6) units per carton

AC78

Quickclick™ Stabilizer



Span: 44", Standoff: 10"
Requires no tools. Spring-loaded locking latch makes it easier and quicker to install/remove than any other stabilizer on the market. Mar-resistant rubber end caps protect work surface. Stabilizer comes with instructions. Paint can hook included.

User Installed Only

Kit No.	For use on Singles and Extensions with	Approx. Shipping Wt.
AC78	1-1/4" round rungs 1-1/2" flat rungs 1-3/4" flat rungs 1-5/8" flat rungs	6.4 lbs.

Not for use on Werner MultiLadders, Type III Aluminum or Type II Fiberglass extension ladders

Shipping quantity
(1) unit per carton

AC96

Aluminum Stabilizer



Span: 47", Standoff :10"
For use on aluminum ladders of all duty ratings. Attaches in minutes. Mar-resistant rubber caps protect work surface. Paint can hook included. Comes with mounting hardware and instructions.

User Installed Only

Kit No.	Fits on	Ladder Size	Approx. Shipping Wt.
AC96	Aluminum Series Extension Ladders with rails up to 3" x 1-3/16"	ALL	4.5 lbs.
	D716	16'	
	D1100	ALL	
	D1200	ALL	
	D1300	ALL	
	D1500	ALL	
	D500	20' - 24'	
	MT	ALL	
	M1	ALL	

Ideal for stabilizing M1 MultiLadder when in scaffold or stairway positions

Shipping quantity (6) units per carton

PK70-1/APK70

Leveler with Base Units



LevelLok® Ladder Leveler with 2 base attachments. Base unit stays attached to the ladder while leveler can be easily removed when not in use. Swivel shoe with ice pick on both ends. Leveler can be used on either side of ladder. Provides 8-1/2" of travel.

LevelLok® is a registered trademark of the LevelLok Corporation.

User or Factory Installed

Kit No.	Fits on All	Approx. Shipping Wt.
PK70-1 and APK70	MT Series, D7100, D6200, 7100, D1300, D1500, 7800	8.5 lbs.

PK70-2

Leveler Base Units



LevelLok® Ladder Leveler 2 base attachments. Base units attach to the ladder to be used with LevelLok® Leveler supplied with PK70-1.

LevelLok® is a registered trademark of the LevelLok Corporation.

User Installed Only

Kit No.	Fits on All	Approx. Shipping Wt.
PK70-2	MT Series, D7100, D6200, 7100, D1300, D1500, 7800	3.2 lbs.

PK70-3

Leveler



LevelLok® Ladder Leveler attaches to the base units supplied with PK70-1 and PK70-2.

LevelLok® is a registered trademark of the LevelLok Corporation.

Approximate Shipping Weight
6.2 lbs.

PK80/APK80

Level-Master® Automatic Ladder Levelers



Easily attaches to Werner fiberglass and aluminum extension ladders to level ladder on uneven surfaces.

Automatically adjusts up to 8-1/2". Easily levels and locks securely in place. The width of the ladder is increased by approximately 3-3/4". Note: The ladder's duty rating will remain the same after proper installation of leveler. Two (2) ladder levelers (one for each ladder rail) come with mounting hardware and instructions.

User or Factory Installed

Kit No.	Fits on Fiberglass Series	Ladder Size
PK80-2 & APK80	D5900, D6000	ALL
	D6200	ALL
	7100	ALL
	D7100	ALL

Kit No.	Fits on Aluminum Series	Ladder Size
PK80-2 & APK80	D1100	ALL
	D1200, D1300	ALL
	D1500, D500	ALL

Note: The original shoes of a D1500 series ladder may replace the steel shoes on a model PK80-2.

Approx. Shipping Weight
9.5 lbs.
Approx. Added Weight to Ladder for Factory Install
6.5 lbs.

Shipping quantity (1) unit per carton

71/A71

Padded Fixed V-Rung

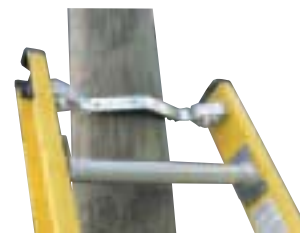

Slip-resistant rubber grip attached to steel v-rung for wood, metal or concrete poles. Pre-pierced holes in fiberglass top rails are provided to accept this accessory. V-rung assembly comes with mounting hardware and instructions.

User or Factory Installed

Kit No.	Fits on Fiberglass Series	Ladder Size
71-1	D6200-2 7100-2 D7100-2 7800	ALL ALL 16' - 32' ALL
71-4	D6200-1 7100-1	ALL Up to 16'

Factory Install No.	Fits on Fiberglass Series	Ladder Size
A71	D6200-1 D6200-2 7100-1 7100-2 D7100-2 7800	ALL ALL Up to 16' ALL 16' - 32' ALL

Approx. Shipping Weight
71-1: 1.5 lbs. 71-4: 2.0 lbs.
Approx. Added Weight to Ladder for Factory Install
1.4 lbs.

72/A72

Adjustable Pole Strap

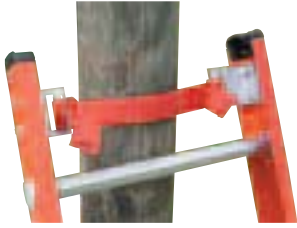

Adjustable strap design for all diameter poles. Slip-resistant rubber grip stitched to strap. Strap assembly comes with mounting hardware and instructions.

User or Factory Installed

Kit No.	Fits on Fiberglass Series	Ladder Size	Approx. Shipping Wt.
72-2	D6200-2 7100-2 D7100-2	ALL Up to 16' 16' - 32'	1.3 lbs.
72-1	D6200-1 7100-1	ALL Up to 16'	1.3 lbs.

Factory Install No.	Fits on Fiberglass Series	Ladder Size
A72	D6200-2 7100-1 7100-2 D7100-2	ALL Up to 16' ALL 16' - 32'

A61

Combination Spur-Hoop Shoe



Combination aluminum rail shield bracket and spur-hoop shoe assembly.

Factory Installed Only

Factory Install No.	Fits on Fiberglass Series	Ladder Size
A61	D6200-2 7100-2 D7100-2	16' - 32' ALL 16' - 32'

Approx. Added Weight to Ladder for Factory Install
3.0 lbs.

74/A74

Cable Hooks



Easily folds within side rails for storage. Cable hooks can be mounted above or below top rung. Consult Werner if using in conjunction with other accessories. Cable hooks come with mounting hardware and instructions.

User or Factory Installed

Kit No.	Fits on Fiberglass Series	Ladder Size	Approx. Shipping Wt.
74-1	D6200-2 7100-1 7100-2 D7100-2	ALL Up to 16' ALL 16' - 32'	2.6 lbs.
74-2	D7100-2	36' - 40'	2.6 lbs.

Factory Install No.	Fits on Fiberglass Series	Ladder Size
A74	D7100-2	ALL

A78

Fly Section Shoes with Quick Disconnect

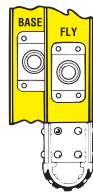

Combination aluminum rail shield bracket and hoop shoe with corrugated slip-resistant extruded rubber pad on fly section, allows use as a single or manhole ladder assembly.

Factory Installed Only

Factory Install No.	Fits on Fiberglass Series	Ladder Size
A78	D6200-2 7100-2 D7100-2	ALL ALL 16' - 32'

Approx. Added Weight to Ladder for Factory Install
1.5 lbs.

81/A81

Adjustable Pole Lashes



For use with ladders having hoop style end caps only. Adjustable strap design for all diameter poles. Adjustable pole lash comes with mounting hardware and instructions.

User or Factory Installed

Kit No.	Fits on Fiberglass Series	Ladder Size	Approx. Shipping Wt.
81-3	D7100-2	36' - 40'	1.5 lbs.

Factory Install No.	Fits on Fiberglass Series	Ladder Size
A81	D6200-2 7100-1 7100-2 D7100-2	ALL ALL ALL ALL

A83

Rubber Padded Shoe



Aluminum protective rail shield and rubber padded foot. Comes with two (2) padded shoes.

Factory Installed Only

Factory Install No.	Fits on Fiberglass Series	Ladder Size
A83	D6200-1 D6200-2 7100-1 7100-2 D7100-2	ALL 16' - 32' Up to 16' ALL 16' - 32'

Approx. Added Weight to Ladder for Factory Install
2.2 lbs.

86/A86

Spur Shoe



Plated steel spur for use on penetrable surfaces. Two (2) spur shoe assemblies, mounting hardware and instructions included.

User or Factory Installed

Kit No.	Fits on Fiberglass Series	Ladder Size
86-1	D6200-2 7100-2, D7100-2 7100-1	16' - 32' 16' - 32' Up to 16'

Factory Install No.	Fits on Fiberglass Series	Ladder Size
A86	D6200-1 D6200-2 7100-1 7100-2 D7100-2	ALL 16' - 32' Up to 16' ALL 16' - 32'

Approx. Shipping Weight
2.5 lbs.
Approx. Added Weight to Ladder for Factory Install
2.0 lbs.

91

Adjustable Pole Lash Assembly with Angle Brackets



This assembly comes with brackets for independent use; wraps around pole. Strap design for all diameter poles. Adjustable pole lash assembly comes with two (2) angle brackets, mounting hardware and instructions.

User Installed Only

Kit No.	Fits on Fiberglass Series	Ladder Size	Approx. Shipping Wt.
91-2	D6200-2 7100-2 D7100-2	ALL ALL 16' - 32'	2.0 lbs.

89

Rail Wear Sleeves



3' long replaceable plastic sleeves help avoid manhole rim damage to ladder rails. Two (2) sleeves, mounting hardware and instructions included.

User Installed Only

Kit No.	Fits on Fiberglass Series	Ladder Size	Approx. Shipping Wt.
89-1	M7100-1 7100-1	ALL Up to 16'	2.5 lbs.

92/A92

Cable Hook and V-Rung Assembly



Functions as both cable hook and v-rung. For use in applications where the diameter of the pole at the point of support does not exceed 10". Steel v-rung has rubber pad for slip-resistant performance. One (1) cable hook and v-rung assembly, mounting hardware and instructions included.

User or Factory Installed

Kit No.	Fits on Fiberglass Series	Ladder Size
92-88	D6200-2 D8200-2EQ	16' - 40' 20' - 28'
92-89	7100-2, D7100-2 D7100-2LV	16' - 32' 20' - 32'
92-91	7100-1	8' - 16'

Factory Install No.	Fits on Fiberglass Series	Ladder Size
A92	D6200-2 7100-2 7100-1 D8200-2EQ D7100-2 D7100-2LV	ALL ALL 8' - 16' ALL 16' - 32' 20' - 32'

Approx. Shipping Weight	4.0 lbs.
Approx. Added Weight to Ladder for Factory Install	3.0 lbs.

94

Ladder-Cinch™



Use as a quick tie down. Strap designed for all diameter poles. One (1) Ladder-Cinch™ assembly, storage bag and instructions.

User Installed Only

Kit No.	Fits All	Ladder Size	Approx. Shipping Wt.
94-2	Fiberglass Series Extension Ladders	ALL	1.0 lbs.

97P

Adjustable True Grip® Stabilizer and Surface Protectors

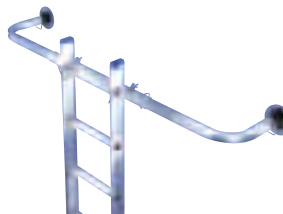

Span adjustment : 49", 57" or 65"
Stand-off distance: 12" or 29-1/2"
Rectangular stabilizer spans double windows. Quickly converts stand off distance for larger overhangs. Mounts quickly and easily. This comes with one (1) stabilizer, rubber pads, fleece bonnets, mounting hardware and instructions.

- Fits rail up to 3" x 1-3/16"

User Installed Only

Kit No.	Fits on Aluminum Series	Ladder Size
97P	D716-2 D1100 D1200 D1300 D1500 D500-2 D1700-2EQ D1800-2EQ	16' ALL ALL ALL ALL 20' - 24' ALL ALL

Note: Not to be used on Multi-Ladders

Approx. Shipping Weight	9.5 lbs.
-------------------------	----------

AC59

Attic Ladder Installation and Trim Kit



This kit includes temporary support boards, shims and fasteners for installing your attic ladder. Once installed, this kit also included mitered trim boards to improve the attic ladder's appearance.

User Installed Only

Kit No.	Fits on	Approx. Shipping Wt.
AC59	ALL Attic Ladders	8.25 lbs. each

36-82

Attic Ladder Assist Pole



3' assist pole allow easy access and smooth opening of attic ladder door.

User Installed Only

Kit No.	Fits on	Approx. Shipping Wt.
36-82	ALL Attic Ladders	3.0 lbs. each

SERIES/MODEL	STYLE	PAGE
150B	Aluminum Step Stool	26
21	Grating Shoes	59
22	Fiberglass Rail Shields	59
244	Aluminum Utility Ladder	27
260	Aluminum Platform Ladder	27
2000	1-Person Decorator Plank	45
2300	2-Person Scaffold Plank	45
2400	2-Person Scaffold Plank	45
2500	2-Person Stage Platform	45
2600	2-Person Stage Platform	45
2700	2-Person Stage Platform	45
36-82	Attic Ladder Assist Pole	63
37	Display Rack	55
350	Aluminum Stepladder	27
360	Aluminum Stepladder	26
370	Aluminum Stepladder	23
3100	3-Person Stage Platform	45
3200	3-Person Stage Platform	45
40-1	Swivel Locking Caster	50
41-1	Swivel Base Plate	50
43-1	Guard Rail Holder	50
400	Aluminum Stepladder	21
4100	Narrow Span Scaffold Sections	49
4100-12	Narrow Span Scaffold Tower 12' Platform Height	48
4100-18	Narrow Span Scaffold Tower 18' Platform Height	48
4100-23	Narrow Span Scaffold Tower 23' Platform Height	48
4200	Wide Span Scaffold Sections	49
4200-12	Wide Span Scaffold Tower 12' Platform Height	48
4200-18	Wide Span Scaffold Tower 18' Platform Height	48
4200-23	Wide Span Scaffold Tower 23' Platform Height	48
55	End Cap Display	55
500-1	Aluminum Round Rung Straight Ladder	29
560-3	Aluminum Round Rung Extension Ladder	30
5300	Plywood Decked Aluma-Plank™	42
5500	Aluminum Decked Aluma-Plank™	42
5600	2-Piece Extruded Aluma-Board™	42
5900	Fiberglass Stepladder	11
6000	Fiberglass Stepladder	10
6002	Fiberglass Step Stool	9
6100	Fiberglass Stepladder	8
6200	Fiberglass Stepladder	7
6202	Fiberglass Step Stool	6
71/A71	Padded Fixed V-Rung	61
72/A72	Adjustable Pole Strap	62
74/A74	Cable Hooks	62
76	Molded Plastic Pail Shelf	59
7100	Fiberglass Round Rung Extension/Straight Ladder	14
7300	Fiberglass Stepladder	4
7400	Fiberglass Stepladder	1
7800	Fiberglass Combination Step/Extension Ladder	18

SERIES/MODEL	STYLE	PAGE
81/A81	Adjustable Pole Lashes	62
86/A86	Spur Shoe	62
89	Rail Wear Sleeves	63
900AA	Aircraft Maintenance Ladder	21
91	Adjustable Pole Lash Assembly with Angle Brackets	63
92/A92	Cable Hook and V-Rung Assembly	63
94	Ladder-Cinch™	63
97P	Adjustable True Grip® Stabilizer and Surface Protectors	63
9500	All-Fiberglass Extension Ladder/Single Ladder	19
A61	Combination Spur-Hoop Shoe	62
A78	Fly Section Shoes with Quick Disconnect	62
A83	Rubber Padded Shoe	62
AA	Aluminum Compact Attic Ladder	37
AC10-14-02	2-Rung Short Body Ladder Jack	60
AC10-20-02	2-Rung Long Body Ladder Jack	60
AC10-20-03	3-Rung Long Body Ladder Jack	60
AC11	Stepladder Hanger	59
AC18MT	Platform	60
AC19	Extension Ladder Covers	60
AC20	Paint Can Hook	60
AC22	Paint Can/Bucket Hanger	60
AC24	Multipurpose Project Tray	59
AC27-L	Lock-In Paint Cup Liner	57
AC27-P	Lock-In Paint Cup	57
AC50-JB-3	Lock-In Job Bucket	57
AC52-UB	Lock-In Utility Bucket	58
AC54-JC	Lock-In Job Caddy	58
AC56-UH	Lock-In Utility Hook	58
AC58-TL	Lock-In ToolLasso®	58
AC59	Attic Ladder Installation and Trim Kit	63
AC78	Quickclick™ Stabilizer	60
AC96	Aluminum Stabilizer	61
AH2210	Aluminum Universal Attic Ladder	37
AP-20-MP6	Aluminum Work Platform	40
ARB10-10	Adjustable Roof Bracket	60
BD	Scaffold Diagonal Brace	50
BH	Scaffold Horizontal Brace	50
BN	Scaffold Narrow Span Horizontal-Diagonal Brace	50
BOR	Scaffold Outrigger Brace	50
BW	Scaffold Wide Span Horizontal-Diagonal Brace	50
D1100	Aluminum D-Rung Extension Ladder	33
D1200-2	Aluminum D-Rung Extension Ladder	32
D1200-3	Aluminum D-Rung Compact Extension Ladder	32
D1300	Aluminum D-Rung Extension Ladder	31
D1500	Aluminum D-Rung Extension Ladder/Straight Ladder	30
D1700-2EQ	Aluminum Extension Ladder with Integrated Leveling	31
D1800-2EQ	Aluminum Extension Ladder with Integrated Leveling	31
D500-2	Aluminum Flat Rung Extension Ladder	29
D5900	Fiberglass D-Rung Extension Ladder	16
D6000	Fiberglass D-Rung Extension Ladder	16

SERIES/MODEL	STYLE	PAGE
D6200-2	Fiberglass D-Rung Extension Ladder/Straight Ladder	15
D6200-3	Fiberglass D-Rung Compact Extension Ladder	15
D716-2	Aluminum D-Rung Extension Ladder	33
D7100-2	Fiberglass D-Rung Extension Ladder	13
D7100-2LV	Fiberglass D-Rung Ext. Ladder w/ Integrated Leveling	13
D8200-2EQ	Fiberglass Extension Ladder with Integrated Leveling	14
E7400	Fiberglass Extension Trestle Ladder	3
ESC	Built-In Fire Escape Ladder	40
ERT-N	End Rail and End Toe Board Assembly - Narrow	46
ERT-W	End Rail and End Toe Board Assembly - Wide	46
FNB-80	Scaffold Base End Frame	50
FNU	Scaffold Frames	50
FRB4510-10	Fixed Roof Bracket	60
FRO	Scaffold Rolling Outrigger Frame	50
FTP6200	Fiberglass Tripod Stepladder	9
FWB-80	Scaffold Base End Frame	50
FWG-42	Scaffold Guard Rail End Frame	50
FWU	Scaffold Frames	50
M1	Aluminum Folding MultiLadder	36
M7100	Fiberglass Manhole Ladder	18
MT	Aluminum Telescoping MultiLadder	35
OBCN00	Fiberglass Old Blue® Series Contractor's Jobstation™	5
OBEL00	Fiberglass Old Blue® Series Electrician's Jobstation™	4
OBPT00	Fiberglass Old Blue® Series Pipe Trade Jobstation™	5
OR-ADU	Scaffold Knee-Type Outriggers	50
P22W	Scaffold Board	50
P370	Aluminum Platform Ladder	24
P400	Aluminum Platform Ladder	22
P6200	Fiberglass Platform Ladder	8
P7400	Fiberglass Platform Ladder	2
PA200	Aluminum Extension Plank	42
PD22W	Scaffold Wood Deck with Access Door	50
PJ-6P	Aluminum Pump Jack 6' Aluminum Pole	43
PJ-12P	Aluminum Pump Jack 12' Aluminum Pole	43
PJ-18P	Aluminum Pump Jack 18' Aluminum Pole	43
PJ-24P	Aluminum Pump Jack 24' Aluminum Pole	43
PJ-100	Aluminum Pump Jack	43
PJ-ERN	Aluminum Pump Jack End Rail Kit (narrow)	43
PJ-ERW	Aluminum Pump Jack End Rail Kit (narrow)	43
PJ-PC	Aluminum Pump Jack Pole Connector	43
PJ-PF-4	Aluminum Pump Jack Pole Foot	43
PJ-SBF	Aluminum Pump Jack Foldable Support Brace	43
PJ-SBR	Aluminum Pump Jack Rigid Support Brace	43
PJ-SN	Aluminum Pump Jack Safety Net	43
PJ-WB	Aluminum Pump Jack Work Bench	43
PK70-1/APK70	Ladder Leveler with Base Units	61
PK70-2	Ladder Leveler Base Units	61
PK70-3	Ladder Leveler	61
PK76	Universal Pail Shelf	59
PK80/APK80	Level-Master® Automatic Ladder Levelers	61

SERIES/MODEL	STYLE	PAGE
PS-48	Steel Portable Scaffold	41
PT370	Aluminum Stockr's Ladder®	24
PT6000	Fiberglass Stockr's Ladder®	11
PT7400	Fiberglass Stockr's Ladder®	3
R102	Straight Ramp Kit	53
R301	Straight Ramps	53
R402	Arched Ramps	52
R522	Folding Arched Ramps	52
S7700	Fiberglass Interchangeable Parallel Sectional Ladder	20
S7900	Fiberglass Interchangeable Tapered Sectional Ladder	19
SGR-09	1-1/2" Square Guard Rail Cut Length - 108"	46
SGR-13	1-1/2" Square Guard Rail Cut Length - 156"	46
SH378	Aluminum Shelf Ladder	25
SNB	Snap-Up® Narrow Span Folding Scaffolds	49
SPF00	Fiberglass Posting Ladder	20
SPJ-100	Steel Pump Jack	44
SPJ-GRH	Steel Pump Jack Guard Rail Holder	44
SPJ-PA-4	Steel Pump Jack Pole Anchor	44
SPJ-SBF	Steel Pump Jack Foldable Support Brace	44
SPJ-WB	Steel Pump Jack Work Bench/Guard Rail Holder	44
SRS-72 & Accessories	6' Steel Rolling Scaffold	41
SSA00	Aluminum Step Stand	25
SSF00	Fiberglass Step Stand	6
SSP-47	Stanchion Post Assembly	46
STB-09	3-1/2" Toe Board Cut Length - 108"	46
STB-13	3-1/2" Toe Board Cut Length - 156"	46
SWB	Snap-Up® Wide Span Folding Scaffolds	49
T370	Aluminum Multi-Use Twin Stepladder	23
T372	Aluminum Twin Step Stool	26
T400	Aluminum Multi-Use Twin Stepladder	22
T6000	Fiberglass Multi-Use Twin Stepladder	10
T6200	Fiberglass Twin Stepladder	7
T6202	Fiberglass Twin Step Stool	6
T7400	Fiberglass Multi-Use Twin Stepladder	2
TN4A	Aluminum Toe Board Assemblies for 4100 Series	50
TPF00	Fiberglass Posting Ladder	20
TR401-S	Steel Removable Pickup Truck Rack	54
TW370-30	Aluminum Portable Work Stand	25
TW4A	Aluminum Toe Board Assemblies for 4200 Series	50
TW6200	Fiberglass Portable Work Stand	6
VR401-W	Steel Van Rack	55
W	Wood Folding Attic Ladder	38
WH	Wood Folding Heavy Duty Attic Ladder	38
WNS	Nestable Stage	43



CORPORATE HEADQUARTERS

Werner Co.

93 Werner Road

Greenville, PA 16125-9499

To contact us, please visit:

wernerco.com