

Miniature Circuit Breakers



3

3/2

Introduction

3/3

5SL miniature circuit breakers

3/5

Introduction

3/7

5SL3, 4 500 A

3/9

5SL6, 6 000 A

5SL4, 10 000 A **NEW**

3/13

5SY and 5SP miniature circuit breakers

3/15

Introduction

3/17

5SY6, 6 000 A

3/21

5SY4, 10 000 A

3/22

5SP4, high-current, 10 000 A

3/23

5SY5, universal current, 10 000 A

3/26

5SY7, 15 000 A

5SY8, 25 000 A

3/28

5SJ6...-KS miniature circuit breakers, with plug-in terminals

3/31

5SY miniature circuit breakers, 1+N in 1 MW

3/32

Introduction

3/33

5SY30, 4 500 A

5SY60, 6 000 A

3/35

Additional components

3/40

Electrical components

Mechanical components

3/43

Busbars

3/52

5ST standard busbars

3/56

5ST3 busbars acc. to UL 508

3/60

5ST2 distribution blocks

SIKclip wiring system

3/62

5SJ4...-HG miniature circuit breakers acc. to UL 489 and IEC and accessories

3/71

SHU 5SP3 main miniature circuit breakers

For further technical product information:

Configuration Manual

Miniature Circuit Breakers 2014
Article No.: 3ZW1012-5SL61-0AC1

Service & Support Portal:

www.siemens.com/lowvoltage/product-support

→ Product List:
Technical specifications

→ Entry List:
Certificates / Characteristics /
Download / FAQ / Manuals /
Updates

Miniature Circuit Breakers

Introduction

Overview

Devices	Page	Application	Standards	Used in		
				Non-residential buildings	Residential buildings	Industry
 <p>5SL miniature circuit breakers</p>	3/3	For all 0.3 to 63 A applications with B, C and D tripping characteristics with a rated breaking capacity of 4500 A, 6000 A and 10000 A acc. to EN 60898-1.	EN 60898-1	✓	✓	--
 <p>5SY and 5SP miniature circuit breakers</p>	3/13	For all applications from 0.3 to 125 A with a rated breaking capacity of 10000 A and 15000 A acc. to EN 60898-1. Applications for universal current from 0.3 to 63 A, Version 25 kA, acc. to EN 60947-2.	EN 60898-1/-2 EN 60947-2 UL 1077 CSA 22.2 GB 10963.1/2	--	✓	✓
 <p>5SJ6...-KS miniature circuit breakers, with plug-in terminals</p>	3/28	For socket outlet and lighting circuits in all building installations. The plug-in terminals offer easy front connection for manual insertion of conductors, which considerably reduces mounting times.	EN 60898-1	✓	✓	--
 <p>5SY miniature circuit breakers, 1+N in 1 MW</p>	3/31	For socket outlet and lighting circuits in all building installations where a switchable neutral conductor is required. The miniature circuit breaker 1+N saves space in the distribution board.	EN 60898-1	✓	✓	✓
 <p>Additional components</p>	3/35	Auxiliary switches, fault signal contacts, shunt trips, undervoltage releases for higher system availability, RC units for personal safety and remote controlled mechanisms for remote switching.		✓	--	✓
 <p>Busbars</p>	3/43	Busbars in 10 mm ² and 16 mm ² save space in the distribution board and time during mounting. Busbars in 18 mm ² and 25 mm ² acc. to UL 508 and CSA.	UL 508	✓	✓	✓
 <p>5SJ4...-HG miniature circuit breakers acc. to UL 489 and IEC, and accessories</p>	3/62	Miniature circuit breakers can be used as "branch circuit protection" and are approved for the connection type "same polarity" and "opposite polarity" in the characteristics B, C and D acc. to UL489, from 0.3 to 63 A.	UL 489	✓	✓	✓
 <p>SHU 5SP3 main miniature circuit breakers</p>	3/71	Voltage-independent selective main miniature circuit breakers (SHU) in the precounter area support downstream miniature circuit breakers by providing better current limitation.	DIN VDE 0641-21	✓	✓	--

Miniature Circuit Breakers

5SL Miniature Circuit Breakers

Introduction

3

Overview

The 5SL miniature circuit breakers are intended for use up to 6 kA/10 kA. These devices have system features that are characteristic of all Siemens miniature circuit breakers.

They are also suitable for the quick and easy mounting of additional components, such as auxiliary switches and fault signal contacts.

The 5SL4 miniature circuit breakers can also be combined with shunt trips, undervoltage releases and arc fault detection devices.

To facilitate cable entry, the devices are equipped with rectangular terminals for the accommodation of pin busbars with cables up to 35 mm². The rated current range is between 0.3 A and 63 A. The 5SL miniature circuit breakers are available in characteristics B, C and D.

Benefits



- Effective touch protection when grasping and manually operating the latching slide with latch-down option.

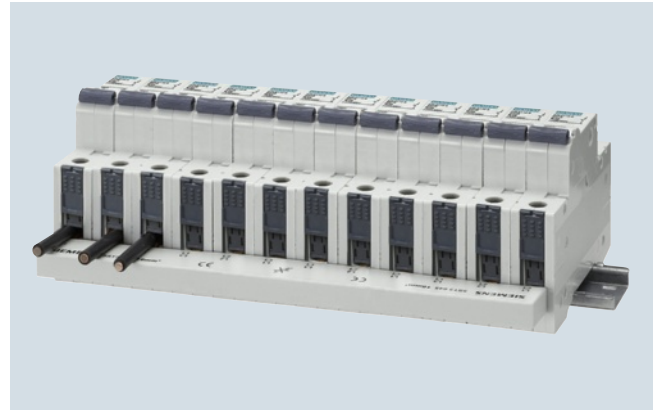

- Easy-to-mount busbar assembly
- Consistent bus mounting concept throughout the Siemens miniature circuit breaker range.

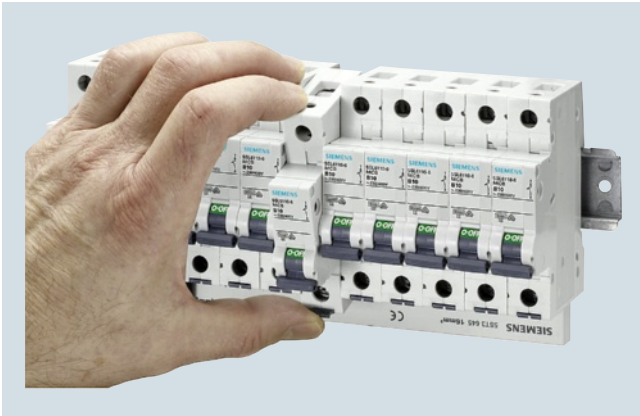

- Individual devices can be removed from the bus-mounted assembly without the use of tools.



- The 5SL miniature circuit breakers are suitable for the quick and easy mounting of arc fault detection devices, auxiliary switches, fault signal contacts, shunt trips and undervoltage releases.

Miniature Circuit Breakers

5SL Miniature Circuit Breakers

Introduction

3

Technical specifications

		5SL3	5SL6	5SL4
Standards		EN 60898-1		
Approvals		See appendix, chapter 20		
Tripping characteristic		B, C		B, C, D
Rated voltage U_n	V AC	230/400		
Operational voltage				
• Min.	V AC/DC per pole	24		
• Max.	V AC V DC/pole	250/440 60 ¹⁾		60 ¹⁾²⁾
Rated making and breaking capacity				
• I_{cn} acc. to IEC/EN 60898-1	kA AC	4.5	6	10
• I_{cu} acc. to IEC/EN 60947-2	kA AC	4.5	6	10
Insulation coordination				
• Rated insulation voltage	V AC	250/440		
• Pollution degree for overvoltage category		2/III		
Touch protection	Acc. to EN 50274	Yes		
Handle end position, sealable		Yes		
Degree of protection		IP20 with connected conductors IP40, in the handle range with distribution cover		
CFC and silicone-free		Yes		
Conductor cross-sections				
• 1-wire				
- Solid ($\leq 10 \text{ mm}^2$) / stranded ($\geq 16 \text{ mm}^2$)	mm ²	0.75 ... 35		
- Finely stranded with non-insulated end sleeve	mm ²	0.75 ... 25		
- Finely stranded with insulated end sleeve	mm ²	0.75 ... 25		
- Finely stranded without end sleeve	mm ²	1 ... 35		
• 2-wire, same cross-section				
- Solid ($\leq 10 \text{ mm}^2$) / stranded ($\geq 16 \text{ mm}^2$)	mm ²	0.75 ... 10		
- Finely stranded with non-insulated end sleeve	mm ²	0.75 ... 4		
- Finely stranded with insulated end sleeve	mm ²	0.75 ... 4		
- Finely stranded without end sleeve	mm ²	1 ... 4		
• 1-wire + busbar (pin thickness 1.5 mm)				
- Solid ($\leq 10 \text{ mm}^2$) / stranded ($\geq 16 \text{ mm}^2$)	mm ²	10 ... 25		
- Finely stranded with non-insulated end sleeve	mm ²	6 ... 25		
- Finely stranded with insulated end sleeve	mm ²	6 ... 16		
Terminals	±screw (Pozidriv)	2		
• Terminal tightening torque	Nm	2.5 ... 3		
Mounting position		Any		
Service life, on average, with rated load		20000 actuations		
Storage temperature	°C	-40 ... +75		
Ambient temperature	°C	-25 ... +45, occasionally +55, max. 95 % humidity		-25 ... +55, max. 95 % humidity
Resistance to climate	Acc. to IEC 60068-2-30	6 cycles		

¹⁾ The operational voltage 60 V DC/pole takes into account a battery charging voltage with a peak value of 72 V.

²⁾ Exempt: Characteristic C: 0.3 ... 1A, characteristic D: 0.3 ... 2A.

Miniature Circuit Breakers

5SL Miniature Circuit Breakers





5SL3, 4 500 A

3

Overview

The 5SL miniature circuit breakers are particularly suitable for the demands of 4.5 kA and 6 kA applications in infrastructure, such as residential buildings and small commercial buildings.

Selection and ordering data

 	I_n	Mounting width MW ¹⁾	Characteristic B		Characteristic C		PS*/ P. unit	Weight per PU approx. kg
			Article No.	Price per PU	Article No.	Price per PU		
MCBs 4 500 A								
	1P, 230/400 V AC							
	0.3	1	--		5SL3114-7		1 unit	0.161
	0.5		--		5SL3105-7		1 unit	0.156
	1		--		5SL3101-7		1 unit	0.135
	1.6		--		5SL3115-7		1 unit	0.160
	2		--		5SL3102-7		1 unit	0.165
	3		--		5SL3103-7		1 unit	0.159
	4		--		5SL3104-7		1 unit	0.140
	6		5SL3106-6		5SL3106-7		1 unit	0.132
	8		--		5SL3108-7		1 unit	0.132
	10		5SL3110-6		5SL3110-7		1 unit	0.131
	13		5SL3113-6		5SL3113-7		1 unit	0.131
	16		5SL3116-6		5SL3116-7		1 unit	0.117
	20		5SL3120-6		5SL3120-7		1 unit	0.105
	25		5SL3125-6		5SL3125-7		1 unit	0.132
	32		5SL3132-6		5SL3132-7		1 unit	0.161
40		5SL3140-6		5SL3140-7		1 unit	0.168	
50		5SL3150-6		5SL3150-7		1 unit	0.169	
63		5SL3163-6		5SL3163-7		1 unit	0.175	
	1P+N, 230 V AC							
	0.3	2	--		5SL3514-7		1 unit	0.330
	0.5		--		5SL3505-7		1 unit	0.330
	1		--		5SL3501-7		1 unit	0.281
	1.6		--		5SL3515-7		1 unit	0.330
	2		--		5SL3502-7		1 unit	0.262
	3		--		5SL3503-7		1 unit	0.330
	4		--		5SL3504-7		1 unit	0.330
	6		5SL3506-6		5SL3506-7		1 unit	0.234
	8		--		5SL3508-7		1 unit	0.330
	10		5SL3510-6		5SL3510-7		1/6 units	0.330
	13		5SL3513-6		5SL3513-7		1 unit	0.230
	16		5SL3516-6		5SL3516-7		1/6 units	0.223
	20		5SL3520-6		5SL3520-7		1 unit	0.209
	25		5SL3525-6		5SL3525-7		1 unit	0.250
	32		5SL3532-6		5SL3532-7		1 unit	0.320
40		5SL3540-6		5SL3540-7		1 unit	0.330	
50		5SL3550-6		5SL3550-7		1 unit	0.330	
63		5SL3563-6		5SL3563-7		1 unit	0.330	
	2P, 400 V AC							
	0.3	2	--		5SL3214-7		1 unit	0.330
	0.5		--		5SL3205-7		1 unit	0.306
	1		--		5SL3201-7		1 unit	0.299
	1.6		--		5SL3215-7		1 unit	0.330
	2		--		5SL3202-7		1 unit	0.308
	3		--		5SL3203-7		1 unit	0.299
	4		--		5SL3204-7		1 unit	0.330
	6		5SL3206-6		5SL3206-7		1 unit	0.253
	8		--		5SL3208-7		1 unit	0.330
	10		5SL3210-6		5SL3210-7		1 unit	0.250
	13		5SL3213-6		5SL3213-7		1 unit	0.250
	16		5SL3216-6		5SL3216-7		1 unit	0.212
	20		5SL3220-6		5SL3220-7		1 unit	0.240
	25		5SL3225-6		5SL3225-7		1 unit	0.246
	32		5SL3232-6		5SL3232-7		1 unit	0.304
40		5SL3240-6		5SL3240-7		1 unit	0.314	
50		5SL3250-6		5SL3250-7		1 unit	0.332	
63		5SL3263-6		5SL3263-7		1 unit	0.328	





¹⁾ 1 MW (modular width) = 18 mm.

Miniature Circuit Breakers

5SL Miniature Circuit Breakers

5SL3, 4 500 A

3

4 500 3		I_n	Mounting width DT	Characteristic B		Characteristic C		PS*/ P. unit	Weight per PU approx. kg
				Article No.	Price per PU	Article No.	Price per PU		
MCBs 4 500 A									
	3P, 400 V AC								
	1	--			5SL3301-7		1 unit	0.451	
	2	--			5SL3302-7		1 unit	0.455	
	3	--			5SL3303-7		1 unit	0.465	
	4	--			5SL3304-7		1 unit	0.465	
	6	5SL3306-6			5SL3306-7		1 unit	0.370	
	10	5SL3310-6			5SL3310-7		1 unit	0.361	
	16	5SL3316-6			5SL3316-7		1 unit	0.381	
	20	5SL3320-6			5SL3320-7		1 unit	0.362	
	25	5SL3325-6			5SL3325-7		1 unit	0.372	
	32	5SL3332-6			5SL3332-7		1 unit	0.437	
	40	5SL3340-6			5SL3340-7		1 unit	0.468	
	50	5SL3350-6			5SL3350-7		1 unit	0.480	
63	5SL3363-6			5SL3363-7		1 unit	0.472		
	3P+N, 400 V AC								
	1	--			5SL3601-7		1 unit	0.660	
	2	--			5SL3602-7		1 unit	0.660	
	3	--			5SL3603-7		1 unit	0.660	
	4	--			5SL3604-7		1 unit	0.660	
	6	5SL3606-6			5SL3606-7		1 unit	0.660	
	8	--			5SL3608-7		1 unit	0.660	
	10	5SL3610-6			5SL3610-7		1 unit	0.529	
	13	5SL3613-6			5SL3613-7		1 unit	0.660	
	16	5SL3616-6			5SL3616-7		1 unit	0.660	
	20	5SL3620-6			5SL3620-7		1 unit	0.575	
	25	5SL3625-6			5SL3625-7		1 unit	0.660	
	32	5SL3632-6			5SL3632-7		1 unit	0.566	
40	5SL3640-6			5SL3640-7		1 unit	0.588		
50	5SL3650-6			5SL3650-7		1 unit	0.607		
63	5SL3663-6			5SL3663-7		1 unit	0.601		
	4P, 400 V AC								
	1	--			5SL3401-7		1 unit	0.660	
	2	--			5SL3402-7		1 unit	0.660	
	3	--			5SL3403-7		1 unit	0.660	
	4	--			5SL3404-7		1 unit	0.660	
	6	--			5SL3406-7		1 unit	0.501	
	10	--			5SL3410-7		1 unit	0.489	
	13	--			5SL3413-7		1 unit	0.490	
	16	--			5SL3416-7		1 unit	0.479	
	20	--			5SL3420-7		1 unit	0.491	
	25	--			5SL3425-7		1 unit	0.500	
	32	--			5SL3432-7		1 unit	0.599	
	40	--			5SL3440-7		1 unit	0.616	
50	--			5SL3450-7		1 unit	0.640		
63	--			5SL3463-7		1 unit	0.630		

¹⁾ 1 MW (modular width) = 18 mm.





Miniature Circuit Breakers

5SL Miniature Circuit Breakers

5SL6, 6 000 A

3

Selection and ordering data

6 000 3			I_n	Mounting width	DT	Characteristic B			Characteristic C						
						Article No.	Price per PU	PG	DT	Article No.	Price per PU	PU (UNIT, SET, M)	PS*/P. unit	PG	Weight per PU approx.
			A	MW ¹⁾											kg
MCBs 6 000 A															
	1P, 230/400 V AC														
	0.3	1	--							5SL6114-7		1	1 unit	001	0.165
	0.5		--							5SL6105-7		1	1 unit	001	0.165
	1		--							5SL6101-7		1	1/12 units	001	0.165
	1.6		--							5SL6115-7		1	1 unit	001	0.165
	2		--							5SL6102-7		1	1/12 units	001	0.165
	3		--							5SL6103-7		1	1 unit	001	0.165
	4		--							5SL6104-7		1	1/12 units	001	0.165
	6		5SL6106-6			001				5SL6106-7		1	1/12 units	001	0.165
	8		--							5SL6108-7		1	1 unit	001	0.165
	10		5SL6110-6			001				5SL6110-7		1	1/12 units	001	0.165
	13		5SL6113-6			001				5SL6113-7		1	1/12 units	001	0.165
	16		5SL6116-6			001				5SL6116-7		1	1/12 units	001	0.165
	20		5SL6120-6			001				5SL6120-7		1	1/12 units	001	0.165
	25		5SL6125-6			001				5SL6125-7		1	1/12 units	001	0.120
32		5SL6132-6			001				5SL6132-7		1	1/12 units	001	0.165	
40		5SL6140-6			001				5SL6140-7		1	1/12 units	001	0.165	
50		5SL6150-6			001				5SL6150-7		1	1/12 units	001	0.165	
63		5SL6163-6			001				5SL6163-7		1	1/12 units	001	0.165	
	1P+N, 230 V AC														
	0.3	2	--							5SL6514-7		1	1 unit	001	0.330
	0.5		--							5SL6505-7		1	1 unit	001	0.330
	1		--							5SL6501-7		1	1 unit	001	0.330
	1.6		--							5SL6515-7		1	1 unit	001	0.330
	2		--							5SL6502-7		1	1 unit	001	0.330
	3		--							5SL6503-7		1	1 unit	001	0.330
	4		--							5SL6504-7		1	1 unit	001	0.330
	6		5SL6506-6			001				5SL6506-7		1	1/6 units	001	0.330
	8		--							5SL6508-7		1	1 unit	001	0.330
	10		5SL6510-6			001				5SL6510-7		1	1/6 units	001	0.330
	13		5SL6513-6			001				5SL6513-7		1	1/6 units	001	0.330
	16		5SL6516-6			001				5SL6516-7		1	1/6 units	001	0.330
	20		5SL6520-6			001				5SL6520-7		1	1 unit	001	0.330
	25		5SL6525-6			001				5SL6525-7		1	1 unit	001	0.330
32		5SL6532-6			001				5SL6532-7		1	1 unit	001	0.330	
40		5SL6540-6			001				5SL6540-7		1	1 unit	001	0.330	
50		5SL6550-6			001				5SL6550-7		1	1 unit	001	0.330	
63		5SL6563-6			001				5SL6563-7		1	1 unit	001	0.330	
	2P, 400 V AC														
	0.3	2	--							5SL6214-7		1	1 unit	001	0.330
	0.5		--							5SL6205-7		1	1 unit	001	0.330
	1		--							5SL6201-7		1	1 unit	001	0.330
	1.6		--							5SL6215-7		1	1 unit	001	0.330
	2		--							5SL6202-7		1	1/6 units	001	0.330
	3		--							5SL6203-7		1	1/6 units	001	0.330
	4		--							5SL6204-7		1	1/6 units	001	0.330
	6		5SL6206-6			001				5SL6206-7		1	1/6 units	001	0.330
	8		--							5SL6208-7		1	1 unit	001	0.330
	10		5SL6210-6			001				5SL6210-7		1	1/6 units	001	0.330
	13		5SL6213-6			001				5SL6213-7		1	1 unit	001	0.330
	16		5SL6216-6			001				5SL6216-7		1	1/6 units	001	0.330
	20		5SL6220-6			001				5SL6220-7		1	1/6 units	001	0.330
	25		5SL6225-6			001				5SL6225-7		1	1/6 units	001	0.240
32		5SL6232-6			001				5SL6232-7		1	1/6 units	001	0.330	
40		5SL6240-6			001				5SL6240-7		1	1 unit	001	0.330	
50		5SL6250-6			001				5SL6250-7		1	1 unit	001	0.330	
63		5SL6263-6			001				5SL6263-7		1	1 unit	001	0.330	





1) 1 MW (modular width) = 18 mm.

Miniature Circuit Breakers

5SL Miniature Circuit Breakers





5SL6, 6 000 A

3

6 000 3			I_n	Mounting width	DT	Characteristic B			Characteristic C						
						Article No.	Price per PU	PG	DT	Article No.	Price per PU	PU (UNIT, SET, M)	PS*/P. unit	PG	Weight per PU approx.
			A	MW ¹⁾											kg
MCBs 6 000 A															
3P, 400 V AC															
	0.3		3	--						5SL6314-7		1	1 unit	001	0.465
	0.5			--						5SL6305-7		1	1 unit	001	0.465
	1			--						5SL6301-7		1	1 unit	001	0.465
	1.6			--						5SL6315-7		1	1 unit	001	0.465
	2			--						5SL6302-7		1	1 unit	001	0.465
	3			--						5SL6303-7		1	1 unit	001	0.465
	4			--						5SL6304-7		1	1 unit	001	0.465
	6			5SL6306-6				001		5SL6306-7		1	1/4 units	001	0.465
	8			--						5SL6308-7		1	1 unit	001	0.465
	10			5SL6310-6				001		5SL6310-7		1	1/4 units	001	0.465
	13			5SL6313-6				001		5SL6313-7		1	1 unit	001	0.465
	16			5SL6316-6				001		5SL6316-7		1	1/4 units	001	0.360
	20			5SL6320-6				001		5SL6320-7		1	1/4 units	001	0.465
	25			5SL6325-6				001		5SL6325-7		1	1/4 units	001	0.465
32			5SL6332-6				001		5SL6332-7		1	1/4 units	001	0.465	
40			5SL6340-6				001		5SL6340-7		1	1/4 units	001	0.465	
50			5SL6350-6				001		5SL6350-7		1	1/4 units	001	0.465	
63			5SL6363-6				001		5SL6363-7		1	1/4 units	001	0.465	
3P+N, 400 V AC															
	0.3		4	--						5SL6614-7		1	1 unit	001	0.660
	0.5			--						5SL6605-7		1	1 unit	001	0.660
	1			--						5SL6601-7		1	1 unit	001	0.660
	1.6			--						5SL6615-7		1	1 unit	001	0.660
	2			--						5SL6602-7		1	1 unit	001	0.660
	3			--						5SL6603-7		1	1 unit	001	0.660
	4			--						5SL6604-7		1	1 unit	001	0.660
	6			5SL6606-6				001		5SL6606-7		1	1 unit	001	0.660
	8			--						5SL6608-7		1	1 unit	001	0.660
	10			5SL6610-6				001		5SL6610-7		1	1 unit	001	0.660
	13			5SL6613-6				001		5SL6613-7		1	1/3 units	001	0.660
	16			5SL6616-6				001		5SL6616-7		1	1/3 units	001	0.660
	20			5SL6620-6				001		5SL6620-7		1	1 unit	001	0.660
	25			5SL6625-6				001		5SL6625-7		1	1 unit	001	0.660
32			5SL6632-6				001		5SL6632-7		1	1 unit	001	0.660	
40			5SL6640-6				001		5SL6640-7		1	1 unit	001	0.660	
50			5SL6650-6				001		5SL6650-7		1	1 unit	001	0.660	
63			5SL6663-6				001		5SL6663-7		1	1 unit	001	0.660	
4P, 400 V AC															
	0.3		4	--						5SL6414-7		1	1 unit	001	0.660
	0.5			--						5SL6405-7		1	1 unit	001	0.660
	1			--						5SL6401-7		1	1 unit	001	0.660
	1.6			--						5SL6415-7		1	1 unit	001	0.660
	2			--						5SL6402-7		1	1 unit	001	0.660
	3			--						5SL6403-7		1	1 unit	001	0.660
	4			--						5SL6404-7		1	1 unit	001	0.660
	6			5SL6406-6				001		5SL6406-7		1	1 unit	001	0.660
	8			--						5SL6408-7		1	1 unit	001	0.660
	10			5SL6410-6				001		5SL6410-7		1	1/3 units	001	0.660
	13			5SL6413-6				001		5SL6413-7		1	1 unit	001	0.660
	16			5SL6416-6				001		5SL6416-7		1	1 unit	001	0.660
	20			5SL6420-6				001		5SL6420-7		1	1 unit	001	0.660
	25			5SL6425-6				001		5SL6425-7		1	1 unit	001	0.660
32			5SL6432-6				001		5SL6432-7		1	1 unit	001	0.660	
40			5SL6440-6				001		5SL6440-7		1	1 unit	001	0.660	
50			5SL6450-6				001		5SL6450-7		1	1 unit	001	0.660	
63			5SL6463-6				001		5SL6463-7		1	1 unit	001	0.660	

1) 1 MW (modular width) = 18 mm.

NEW**5SL4, 10 000 A****3****Selection and ordering data**

10 000 3		I_n	Mounting width	DT	Characteristic B			Characteristic C						
					Article No.	Price per PU	PG DT	Article No.	Price per PU	PU (UNIT, SET, M)	PS*/P. unit	PG	Weight per PU approx.	
		A	MW ¹⁾											
MCBs 10 000 A														
	1P, 230/400 V AC													
	0.3	1	--											
	0.5		--											
	1		5SL4101-6			002								
	1.6		--											
	2		5SL4102-6			002								
	3		5SL4103-6			002								
	4		5SL4104-6			002								
	6		5SL4106-6			002								
	8		5SL4108-6			002								
	10		5SL4110-6			002								
	13		5SL4113-6			002								
	16		5SL4116-6			002								
	20		5SL4120-6			002								
	25		5SL4125-6			002								
32		5SL4132-6			002									
40		5SL4140-6			002									
50		5SL4150-6			002									
63		5SL4163-6			002									
	1P+N, 230 V AC													
	0.3	2	--											
	0.5		--											
	1		5SL4501-6			002								
	1.6		--											
	2		5SL4502-6			002								
	3		5SL4503-6			002								
	4		5SL4504-6			002								
	6		5SL4506-6			002								
	8		5SL4508-6			002								
	10		5SL4510-6			002								
	13		5SL4513-6			002								
	16		5SL4516-6			002								
	20		5SL4520-6			002								
	25		5SL4525-6			002								
32		5SL4532-6			002									
40		5SL4540-6			002									
50		5SL4550-6			002									
63		5SL4563-6			002									
	2P, 400 V AC													
	0.3	2	--											
	0.5		--											
	1		5SL4201-6			002								
	1.6		--											
	2		5SL4202-6			002								
	3		5SL4203-6			002								
	4		5SL4204-6			002								
	6		5SL4206-6			002								
	8		5SL4208-6			002								
	10		5SL4210-6			002								
	13		5SL4213-6			002								
	16		5SL4216-6			002								
	20		5SL4220-6			002								
	25		5SL4225-6			002								
32		5SL4232-6			002									
40		5SL4240-6			002									
50		5SL4250-6			002									
63		5SL4263-6			002									

1) 1 MW (modular width) = 18 mm



Miniature Circuit Breakers

5SL Miniature Circuit Breakers

5SL4, 10 000 A

NEW

3





10 000		D'E		I_n	Mounting width	DT	Characteristic B		Characteristic C		PU	PS*/P. unit	PG	Weight per PU approx.	
				A	MW ¹⁾		Article No.	Price per PU	PG	DT	Article No.	Price per PU	(UNIT, SET, M)		kg
MCBs 10 000 A															
3P, 400 V AC															
				0.3	3		--				5SL4314-7		1	1 unit	0.465
				0.5			--				5SL4305-7		1	1 unit	0.465
				1			5SL4301-6		002		5SL4301-7		1	1 unit	0.465
				1.6			--				5SL4315-7		1	1 unit	0.465
				2			5SL4302-6		002		5SL4302-7		1	1 unit	0.465
				3			5SL4303-6		002		5SL4303-7		1	1 unit	0.465
				4			5SL4304-6		002		5SL4304-7		1	1 unit	0.465
				6			5SL4306-6		002		5SL4306-7		1	1 unit	0.465
				8			5SL4308-6		002		5SL4308-7		1	1 unit	0.465
				10			5SL4310-6		002		5SL4310-7		1	1 unit	0.465
				13			5SL4313-6		002		5SL4313-7		1	1 unit	0.465
				16			5SL4316-6		002		5SL4316-7		1	1 unit	0.465
				20			5SL4320-6		002		5SL4320-7		1	1 unit	0.465
				25			5SL4325-6		002		5SL4325-7		1	1 unit	0.465
				32			5SL4332-6		002		5SL4332-7		1	1 unit	0.465
				40			5SL4340-6		002		5SL4340-7		1	1 unit	0.465
				50			5SL4350-6		002		5SL4350-7		1	1 unit	0.465
				63			5SL4363-6		002		5SL4363-7		1	1 unit	0.465
3P+N, 400 V AC															
				0.3	4		--				5SL4614-7		1	1 unit	0.660
				0.5			--				5SL4605-7		1	1 unit	0.660
				1			5SL4601-6		002		5SL4601-7		1	1 unit	0.660
				1.6			--				5SL4615-7		1	1 unit	0.660
				2			5SL4602-6		002		5SL4602-7		1	1 unit	0.660
				3			5SL4603-6		002		5SL4603-7		1	1 unit	0.660
				4			5SL4604-6		002		5SL4604-7		1	1 unit	0.660
				6			5SL4606-6		002		5SL4606-7		1	1 unit	0.660
				8			5SL4608-6		002		5SL4608-7		1	1 unit	0.660
				10			5SL4610-6		002		5SL4610-7		1	1 unit	0.660
				13			5SL4613-6		002		5SL4613-7		1	1 unit	0.660
				16			5SL4616-6		002		5SL4616-7		1	1 unit	0.660
				20			5SL4620-6		002		5SL4620-7		1	1 unit	0.660
				25			5SL4625-6		002		5SL4625-7		1	1 unit	0.660
				32			5SL4632-6		002		5SL4632-7		1	1 unit	0.660
				40			5SL4640-6		002		5SL4640-7		1	1 unit	0.660
				50			5SL4650-6		002		5SL4650-7		1	1 unit	0.660
				63			5SL4663-6		002		5SL4663-7		1	1 unit	0.660
4P, 400 V AC															
				0.3	4		--				5SL4414-7		1	1 unit	0.660
				0.5			--				5SL4405-7		1	1 unit	0.660
				1			5SL4401-6		002		5SL4401-7		1	1 unit	0.660
				1.6			--				5SL4415-7		1	1 unit	0.660
				2			5SL4402-6		002		5SL4402-7		1	1 unit	0.660
				3			5SL4403-6		002		5SL4403-7		1	1 unit	0.660
				4			5SL4404-6		002		5SL4404-7		1	1 unit	0.660
				6			5SL4406-6		002		5SL4406-7		1	1 unit	0.660
				8			5SL4408-6		002		5SL4408-7		1	1 unit	0.660
				10			5SL4410-6		002		5SL4410-7		1	1 unit	0.660
				13			5SL4413-6		002		5SL4413-7		1	1 unit	0.660
				16			5SL4416-6		002		5SL4416-7		1	1 unit	0.660
				20			5SL4420-6		002		5SL4420-7		1	1 unit	0.660
				25			5SL4425-6		002		5SL4425-7		1	1 unit	0.660
				32			5SL4432-6		002		5SL4432-7		1	1 unit	0.660
				40			5SL4440-6		002		5SL4440-7		1	1 unit	0.660
				50			5SL4450-6		002		5SL4450-7		1	1 unit	0.660
				63			5SL4463-6		002		5SL4463-7		1	1 unit	0.660

1) 1 MW (modular width) = 18 mm

Miniature Circuit Breakers

5SL Miniature Circuit Breakers

NEW**5SL4, 10 000 A****3**

10 000 3			I_n	Mounting width	DT	Characteristic D		Price per PU	PU (UNIT, SET, M)	PS*/P. unit	PG	Weight per PU approx.
			A	MW ¹⁾		Article No.						kg
MCBs 10 000 A												
	1P, 230/400 V AC											
	0.3		1			5SL4114-8		1	1 unit	002	0.165	
	0.5					5SL4105-8		1	1 unit	002	0.165	
	1					5SL4101-8		1	1 unit	002	0.165	
	1.6					5SL4115-8		1	1 unit	002	0.165	
	2					5SL4102-8		1	1 unit	002	0.165	
	3					5SL4103-8		1	1 unit	002	0.165	
	4					5SL4104-8		1	1 unit	002	0.165	
	6					5SL4106-8		1	1 unit	002	0.165	
	8					5SL4108-8		1	1 unit	002	0.165	
	10					5SL4110-8		1	1 unit	002	0.165	
	13					5SL4113-8		1	1 unit	002	0.165	
	16					5SL4116-8		1	1 unit	002	0.165	
	20					5SL4120-8		1	1 unit	002	0.165	
	25					5SL4125-8		1	1 unit	002	0.165	
32					5SL4132-8		1	1 unit	002	0.165		
40					5SL4140-8		1	1 unit	002	0.165		
50					5SL4150-8		1	1 unit	002	0.165		
63					5SL4163-8		1	1 unit	002	0.165		
	1P+N, 230 V AC											
	0.3		2			5SL4514-8		1	1 unit	002	0.330	
	0.5					5SL4505-8		1	1 unit	002	0.330	
	1					5SL4501-8		1	1 unit	002	0.330	
	1.6					5SL4515-8		1	1 unit	002	0.330	
	2					5SL4502-8		1	1 unit	002	0.330	
	3					5SL4503-8		1	1 unit	002	0.330	
	4					5SL4504-8		1	1 unit	002	0.330	
	6					5SL4506-8		1	1 unit	002	0.330	
	8					5SL4508-8		1	1 unit	002	0.330	
	10					5SL4510-8		1	1 unit	002	0.330	
	13					5SL4513-8		1	1 unit	002	0.330	
	16					5SL4516-8		1	1 unit	002	0.330	
	20					5SL4520-8		1	1 unit	002	0.330	
	25					5SL4525-8		1	1 unit	002	0.330	
32					5SL4532-8		1	1 unit	002	0.330		
40					5SL4540-8		1	1 unit	002	0.330		
50					5SL4550-8		1	1 unit	002	0.330		
63					5SL4563-8		1	1 unit	002	0.330		
	2P, 400 V AC											
	0.3		2			5SL4214-8		1	1 unit	002	0.330	
	0.5					5SL4205-8		1	1 unit	002	0.330	
	1					5SL4201-8		1	1 unit	002	0.330	
	1.6					5SL4215-8		1	1 unit	002	0.330	
	2					5SL4202-8		1	1 unit	002	0.330	
	3					5SL4203-8		1	1 unit	002	0.330	
	4					5SL4204-8		1	1 unit	002	0.330	
	6					5SL4206-8		1	1 unit	002	0.330	
	8					5SL4208-8		1	1 unit	002	0.330	
	10					5SL4210-8		1	1 unit	002	0.330	
	13					5SL4213-8		1	1 unit	002	0.330	
	16					5SL4216-8		1	1 unit	002	0.330	
	20					5SL4220-8		1	1 unit	002	0.330	
	25					5SL4225-8		1	1 unit	002	0.330	
32					5SL4232-8		1	1 unit	002	0.330		
40					5SL4240-8		1	1 unit	002	0.330		
50					5SL4250-8		1	1 unit	002	0.330		
63					5SL4263-8		1	1 unit	002	0.330		

1) 1 MW (modular width) = 18 mm





Miniature Circuit Breakers

5SL Miniature Circuit Breakers

5SL4, 10 000 A

NEW

3

10 000 3		I_n	Mounting width	DT	Characteristic D					Weight per PU approx. kg
					Article No.	Price per PU	PU (UNIT, SET, M)	PS*/P. unit	PG	
		A	MW ¹⁾							
MCBs 10 000 A										
	3P, 400 V AC		3							
	0.3	5SL4314-8		1	1 unit	002	0.465			
	0.5	5SL4305-8		1	1 unit	002	0.465			
	1	5SL4301-8		1	1 unit	002	0.465			
	1.6	5SL4315-8		1	1 unit	002	0.465			
	2	5SL4302-8		1	1 unit	002	0.465			
	3	5SL4303-8		1	1 unit	002	0.465			
	4	5SL4304-8		1	1 unit	002	0.465			
	6	5SL4306-8		1	1 unit	002	0.465			
	8	5SL4308-8		1	1 unit	002	0.465			
	10	5SL4310-8		1	1 unit	002	0.465			
	13	5SL4313-8		1	1 unit	002	0.465			
	16	5SL4316-8		1	1 unit	002	0.465			
	20	5SL4320-8		1	1 unit	002	0.465			
	25	5SL4325-8		1	1 unit	002	0.465			
	32	5SL4332-8		1	1 unit	002	0.465			
40	5SL4340-8	1	1 unit	002	0.465					
50	5SL4350-8	1	1 unit	002	0.465					
63	5SL4363-8	1	1 unit	002	0.465					
	3P+N, 400 V AC		4							
	0.3	5SL4614-8		1	1 unit	002	0.660			
	0.5	5SL4605-8		1	1 unit	002	0.660			
	1	5SL4601-8		1	1 unit	002	0.660			
	1.6	5SL4615-8		1	1 unit	002	0.660			
	2	5SL4602-8		1	1 unit	002	0.660			
	3	5SL4603-8		1	1 unit	002	0.660			
	4	5SL4604-8		1	1 unit	002	0.660			
	6	5SL4606-8		1	1 unit	002	0.660			
	8	5SL4608-8		1	1 unit	002	0.660			
	10	5SL4610-8		1	1 unit	002	0.660			
	13	5SL4613-8		1	1 unit	002	0.660			
	16	5SL4616-8		1	1 unit	002	0.660			
	20	5SL4620-8		1	1 unit	002	0.660			
	25	5SL4625-8		1	1 unit	002	0.660			
	32	5SL4632-8		1	1 unit	002	0.660			
40	5SL4640-8	1	1 unit	002	0.660					
50	5SL4650-8	1	1 unit	002	0.660					
63	5SL4663-8	1	1 unit	002	0.660					
	4P, 400 V AC		4							
	0.3	5SL4414-8		1	1 unit	002	0.660			
	0.5	5SL4405-8		1	1 unit	002	0.660			
	1	5SL4401-8		1	1 unit	002	0.660			
	1.6	5SL4415-8		1	1 unit	002	0.660			
	2	5SL4402-8		1	1 unit	002	0.660			
	3	5SL4403-8		1	1 unit	002	0.660			
	4	5SL4404-8		1	1 unit	002	0.660			
	6	5SL4406-8		1	1 unit	002	0.660			
	8	5SL4408-8		1	1 unit	002	0.660			
	10	5SL4410-8		1	1 unit	002	0.660			
	13	5SL4413-8		1	1 unit	002	0.660			
	16	5SL4416-8		1	1 unit	002	0.660			
	20	5SL4420-8		1	1 unit	002	0.660			
	25	5SL4425-8		1	1 unit	002	0.660			
	32	5SL4432-8		1	1 unit	002	0.660			
40	5SL4440-8	1	1 unit	002	0.660					
50	5SL4450-8	1	1 unit	002	0.660					
63	5SL4463-8	1	1 unit	002	0.660					

1) 1 MW (modular width) = 18 mm

Miniature Circuit Breakers

5SY and 5SP Miniature Circuit Breakers

Introduction

3

Overview

MCBs are used to protect systems and installations in buildings and for industrial applications.

Used in industrial applications and plant engineering, miniature circuit breakers can be supplemented with additional components, such as auxiliary switches, fault signal contacts, shunt trips, undervoltage releases, remote controlled mechanism, RC units, and arc fault detection devices.

The devices are approved for worldwide use according to IEC standards for power supply systems up to 250/440 V AC. 72 V DC per pole is permitted in DC systems.

For North America, there is an additional approval according to UL 1077 for use as "supplementary protectors" in systems up to 480/277 V AC. For use in ship building, the devices also have numerous certifications according to shipping classifications; BV, DNV, GL and LRS. References to this can be found in the appendix, chapter 20.

Benefits

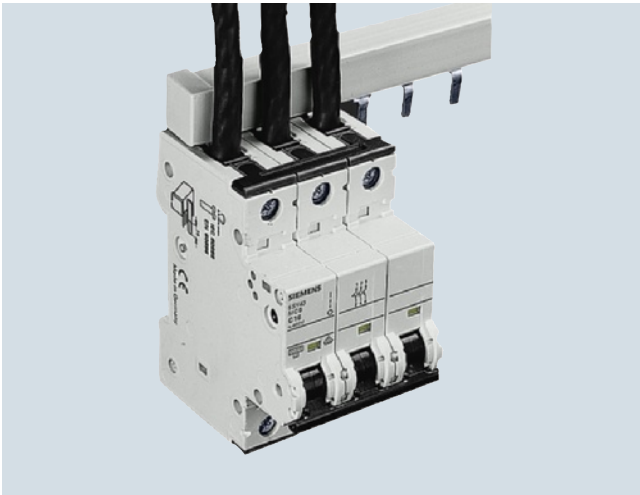

- Optional top or bottom infeed as the terminals are identical
- Clear and visible conductor connection in front of the rear busbar facilitates controls
- The conductor is easily inserted into the terminal thanks to the large and easily accessible wiring space.

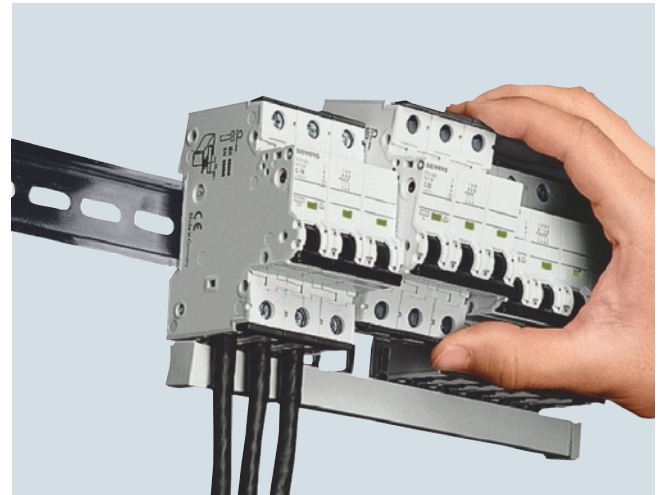

- Quick and easy manual removal of MCBs from the busbar assembly, for example if connections need to be changed
- Time-saving replacement of parts as busbars no longer need to be freed from adjacent devices.

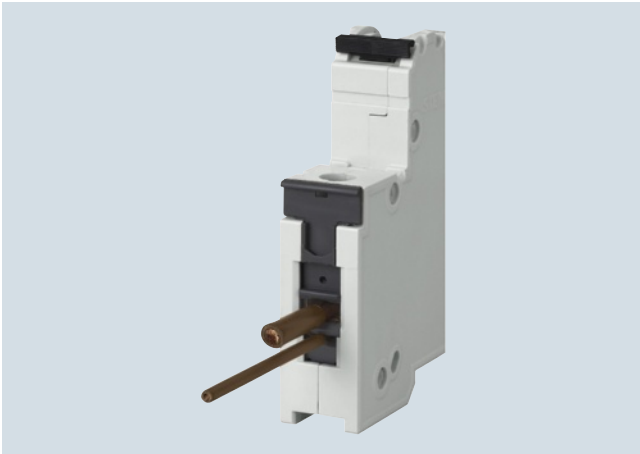

- Double terminal chambers permit accommodation of 2 wires of different cross-sections.



- The 5SY miniature circuit breakers are ideal for the quick and easy mounting of auxiliary switches and fault signal contacts. Captive metal brackets on the additional components ensure the quick and easy mounting of devices on the miniature circuit breakers without the need for tools.

Miniature Circuit Breakers

5SY and 5SP Miniature Circuit Breakers

Introduction

Technical specifications

		5SY6	5SY4	5SY5	5SY7	5SY8	5SP4
Standards		EN 60898-1	EN 60898-1	EN 60898-2	EN 60898-1	EN 60947-2	EN 60898-1
Approvals		See appendix, chapter 20					
Rated voltage U_n	V AC V DC	230/400 --	230/400 --	230/400 220/440/ 880 ⁵⁾	230/400 --	230/400 --	230/400 --
Operational voltage							
Acc. to EN 60898-1/-2 and EN 60947-2	Min. V AC/DC/pole	24	24	24	24	24	24
	Max. V DC/pole	72 ⁴⁾	72 ⁴⁾	250	72 ⁴⁾	72 ⁴⁾	72
	Max. V AC	250/440	250/440	250/440	250/440	250/440	250/440
Acc. to UL 1077 and CSA C22.2 No.235	Max. V AC	480/277	480/277	--	480/277	480/277	480/277
	Max. V DC	60	60	--	--	--	--
Breaking capacity¹⁾							
• I_{cn} acc. to IEC/EN 60898-1	kA AC	6	10	10	15	--	10
	kA DC	10	10	10	15	--	10
• I_{cu} acc. to IEC/EN 60947-2	kA AC	30 ... 10 ¹⁾	35 ... 10 ¹⁾	35 ... 10 ¹⁾	50 ... 15 ¹⁾	70 ... 20 ¹⁾	10
	kA DC	15	15	15	15	15	15
• Acc. to UL1077 and CSA C22.2 No.235	kA AC	5	5	--	5	5	5
Insulation coordination							
• Rated insulation voltage	V AC	250/440	--	250	--	--	--
	V DC/pole	--	--	--	--	--	--
Pollution degree for overvoltage category		3/III ³⁾					
Touch protection	Acc. to EN 50274	Yes					
Handle end position, sealable		Yes					
Degree of protection	Acc. to EN 60529	IP20 with connected conductors, IP40 in the handle range with distribution cover					
CFC and silicone-free		Yes					
Mounting							
• Snap-on fixing system		Yes					--
	• Standard mounting rail and screw fixing	--	--	--	--	--	Yes
Terminals	±screw (Pozidriv)	2					
• Tunnel terminals at both ends		--					Yes
	• Combined terminals at both ends	Yes					--
• Terminal tightening torque	Nm	2.5 ... 3					2.5 ... 3.5
	lb.in	22 ... 26					22 ... 31
Conductor cross-sections							
• Solid and stranded	mm ²	0.75 ... 35					4 ... 50
	mm ²	0.75 ... 25					1.5 ... 35
• AWG conductors (Cu 60/75 °C $I_n \leq 40$ A; 60 °C $I_n > 40$ A)	AWG	14 ... 4					14 ... 2
Mains connection							
• AC		Any					
	• DC	Any		2)	Any		
Mounting position		Any					
Endurance							
On average, with rated load	Actuations	20000					
	Actuations	10000 for 5SY5 at 40 A, 50 A and 63 A					
Ambient temperature	°C	-25 ... +55, max. 95 % humidity					
Storage temperature	°C	-40 ... +75					
Resistance to climate	Acc. to IEC 60068-2-30	6 cycles					
Shock	Acc. to IEC 60068-2-27	m/s ²	150 at 11 ms half-sine				
Resistance to vibrations	Acc. to IEC 60068-2-6	m/s ²	50 at 25 ... 150 Hz and 60 at 35 Hz (4 sec)				

¹⁾ For further information see Configuration Manual 2014 "Miniature circuit breakers" at: www.siemens.com/lowvoltage/manuals.

²⁾ Ensure compliance with the specified polarity when connecting DC.

³⁾ 5SY54.. 4-pole, degree of pollution 2 at overvoltage category III.

⁴⁾ Exempt: C/D 0.3 A ... 0.5 A

⁵⁾ 5SY54.. 4-pole 880 V is not a standardized voltage acc. to EN 60898-1, suitable for max. 1000 V DC, if the four poles are connected in series.





Miniature Circuit Breakers

5SY and 5SP Miniature Circuit Breakers

5SY6, 6 000 A

3

Selection and ordering data

6 000 3			I_n	Mounting width	DT	Characteristic B		Characteristic C		PS*/ P. unit	Weight per PU approx.	
A		MW ¹⁾				Article No.	Price per PU	DT	Article No.	Price per PU		kg
MCBs 6 000 A												
	1P, 230/400 V AC											
	0.3	1	--			5SY6114-7				1 unit	0.161	
	0.5		--			5SY6105-7				1/12 units	0.165	
	1		--			5SY6101-7				1/12 units	0.155	
	1.6		--			5SY6115-7				1 unit	0.162	
	2		5SY6102-6			5SY6102-7				1/12 units	0.153	
	3		--			5SY6103-7				1/12 units	0.155	
	4		5SY6104-6			5SY6104-7				1/12 units	0.159	
	6		5SY6106-6			5SY6106-7				1/12 units	0.149	
	8		--			5SY6108-7				1/12 units	0.158	
	10		5SY6110-6			5SY6110-7				1/12 units	0.158	
	13		5SY6113-6			5SY6113-7				1/12 units	0.152	
	16		5SY6116-6			5SY6116-7				1/12 units	0.159	
	20		5SY6120-6			5SY6120-7				1/12 units	0.126	
	25		5SY6125-6			5SY6125-7				1/12 units	0.149	
	32		5SY6132-6			5SY6132-7				1/12 units	0.149	
40		5SY6140-6			5SY6140-7				1/12 units	0.137		
50		5SY6150-6			5SY6150-7				1/12 units	0.173		
63		5SY6163-6			5SY6163-7				1/12 units	0.151		
	1P+N, 230 V AC											
	0.3	2	--			5SY6514-7				1 unit	0.328	
	0.5		--			5SY6505-7				1 unit	0.304	
	1		--			5SY6501-7				1 unit	0.319	
	1.6		--			5SY6515-7				1 unit	0.311	
	2		5SY6506-6			5SY6502-7				1 unit	0.341	
	3		--			5SY6503-7				1 unit	0.311	
	4		5SY6510-6			5SY6504-7				1 unit	0.294	
	6		5SY6513-6			5SY6506-7				1/6 units	0.306	
	8		--			5SY6508-7				1 unit	0.313	
	10		5SY6510-6			5SY6510-7				1/6 units	0.277	
	13		5SY6513-6			5SY6513-7				1/6 units	0.299	
	16		5SY6516-6			5SY6516-7				1/6 units	0.302	
	20		5SY6520-6			5SY6520-7				1 unit	0.313	
	25		5SY6525-6			5SY6525-7				1 unit	0.314	
	32		5SY6532-6			5SY6532-7				1 unit	0.321	
40		5SY6540-6			5SY6540-7				1 unit	0.293		
50		5SY6550-6			5SY6550-7				1 unit	0.323		
63		5SY6563-6			5SY6563-7				1 unit	0.344		
	2P, 400 V AC											
	0.3	2	--			5SY6214-7				1 unit	0.325	
	0.5		--			5SY6205-7				1 unit	0.326	
	1		--			5SY6201-7				1/6 units	0.306	
	1.6		--			5SY6215-7				1 unit	0.316	
	2		--			5SY6202-7				1/6 units	0.323	
	3		--			5SY6203-7				1/6 units	0.320	
	4		--			5SY6204-7				1/6 units	0.298	
	6		5SY6206-6			5SY6206-7				1/6 units	0.296	
	8		--			5SY6208-7				1 unit	0.282	
	10		5SY6210-6			5SY6210-7				1/6 units	0.310	
	13		5SY6213-6			5SY6213-7				1 unit	0.321	
	16		5SY6216-6			5SY6216-7				1/6 units	0.270	
	20		5SY6220-6			5SY6220-7				1/6 units	0.279	
	25		5SY6225-6			5SY6225-7				1/6 units	0.280	
	32		5SY6232-6			5SY6232-7				1/6 units	0.318	
40		5SY6240-6			5SY6240-7				1 unit	0.320		
50		5SY6250-6			5SY6250-7				1 unit	0.328		
63		5SY6263-6			5SY6263-7				1 unit	0.340		





1) 1 MW (modular width) = 18 mm.

Miniature Circuit Breakers

5SY and 5SP Miniature Circuit Breakers

5SY6, 6 000 A

3

6 000 3		I_n	Mounting width MW ¹⁾	DT	Characteristic B		Characteristic C		PS*/ P. unit	Weight per PU approx. kg
					Article No.	Price per PU	Article No.	Price per PU		
MCBs 6 000 A										
	3P, 400 V AC									
	0.3	3	--			5SY6314-7		1 unit	0.489	
	0.5		--			5SY6305-7		1 unit	0.478	
	1		--			5SY6301-7		1 unit	0.448	
	1.6		--			5SY6315-7		1 unit	0.470	
	2		--			5SY6302-7		1/4 units	0.441	
	3		--			5SY6303-7		1 unit	0.489	
	4		--			5SY6304-7		1/4 units	0.444	
	6		5SY6306-6		▶	5SY6306-7		1/4 units	0.453	
	8		--			5SY6308-7		1 unit	0.458	
	10		5SY6310-6		▶	5SY6310-7		1/4 units	0.151	
	13		5SY6313-6			5SY6313-7		1 unit	0.484	
	16		5SY6316-6	▶		5SY6316-7		1/4 units	0.441	
	20		5SY6320-6			5SY6320-7		1/4 units	0.435	
	25		5SY6325-6			5SY6325-7		1/4 units	0.464	
	32		5SY6332-6			5SY6332-7	▶	1/4 units	0.455	
40		5SY6340-6			5SY6340-7		1/4 units	0.470		
50		5SY6350-6			5SY6350-7		1/4 units	0.486		
63		5SY6363-6			5SY6363-7		1/4 units	0.484		
	3P+N, 400 V AC									
	0.3	4	--			5SY6614-7		1 unit	0.631	
	0.5		--			5SY6605-7		1 unit	0.636	
	1		--			5SY6601-7		1 unit	0.635	
	1.6		--			5SY6615-7		1 unit	0.631	
	2		--			5SY6602-7		1 unit	0.642	
	3		--			5SY6603-7		1 unit	0.590	
	4		--			5SY6604-7		1 unit	0.616	
	6		5SY6606-6			5SY6606-7		1 unit	0.610	
	8		--			5SY6608-7		1 unit	0.607	
	10		5SY6610-6			5SY6610-7		1 unit	0.582	
	13		5SY6613-6			5SY6613-7		1/3 units	0.600	
	16		5SY6616-6			5SY6616-7		1/3 units	0.612	
	20		5SY6620-6			5SY6620-7		1 unit	0.621	
	25		5SY6625-6			5SY6625-7		1 unit	0.623	
	32		5SY6632-6			5SY6632-7		1 unit	0.627	
40		5SY6640-6			5SY6640-7		1 unit	0.625		
50		5SY6650-6			5SY6650-7		1 unit	0.644		
63		5SY6663-6			5SY6663-7		1 unit	0.673		
	4P, 400 V AC									
	0.3	4	--			5SY6414-7		1 unit	0.640	
	0.5		--			5SY6405-7		1 unit	0.644	
	1		--			5SY6401-7		1 unit	0.626	
	1.6		--			5SY6415-7		1 unit	0.621	
	2		--			5SY6402-7		1 unit	0.644	
	3		--			5SY6403-7		1 unit	0.623	
	4		--			5SY6404-7		1 unit	0.600	
	6		5SY6406-6			5SY6406-7		1 unit	0.606	
	8		--			5SY6408-7		1 unit	0.608	
	10		5SY6410-6			5SY6410-7		1/3 units	0.630	
	13		5SY6413-6			5SY6413-7		1 unit	0.624	
	16		5SY6416-6			5SY6416-7		1/3 units	0.629	
	20		5SY6420-6			5SY6420-7		1/3 units	0.578	
	25		5SY6425-6			5SY6425-7		1/3 units	0.579	
	32		5SY6432-6			5SY6432-7		1/3 units	0.622	
40		5SY6440-6			5SY6440-7		1/3 units	0.627		
50		5SY6450-6			5SY6450-7		1 unit	0.628		
63		5SY6463-6			5SY6463-7		1/3 units	0.626		

1) 1 MW (modular width) = 18 mm.





Miniature Circuit Breakers

5SY and 5SP Miniature Circuit Breakers

5SY4, 10 000 A

3

Selection and ordering data

10 000 3			I_n	Mounting width	DT	Characteristic A		Characteristic B		PU (UNIT, SET, M)	PS*/P. unit	PG	Weight per PU approx.	
			A	MW ¹⁾		Article No.	Price per PU	PG	DT	Article No.	Price per PU			kg
MCBs 10 000 A														
	1P, 230/400 V AC													
		0.5	1			5SY4105-5		002		--				
		1				5SY4101-5		002		--				
		1.6				5SY4115-5		002		--				
		2				5SY4102-5		002		5SY4102-6	1	1 unit	002	0.153
		3				5SY4103-5		002		--				
		4				5SY4104-5		002		5SY4104-6	1	1 unit	002	0.150
		6				5SY4106-5		002 ▶		5SY4106-6	1	1/12 units	002	0.147
		8				5SY4108-5		002		--				
		10				5SY4110-5		002 ▶		5SY4110-6	1	1/12 units	002	0.146
		13				5SY4113-5		002		5SY4113-6	1	1 unit	002	0.161
		16				5SY4116-5		002 ▶		5SY4116-6	1	1/12 units	002	0.154
		20				5SY4120-5		002		5SY4120-6	1	1 unit	002	0.160
		25				5SY4125-5		002		5SY4125-6	1	1 unit	002	0.163
		32				5SY4132-5		002		5SY4132-6	1	1 unit	002	0.165
		40				5SY4140-5		002		5SY4140-6	1	1 unit	002	0.164
	50				5SY4150-5		002		5SY4150-6	1	1 unit	002	0.168	
	63				5SY4163-5		002		5SY4163-6	1	1 unit	002	0.173	
	80				--				5SY4180-6	1	1 unit	002	0.159	
	1P+N, 230 V AC													
		1	2			5SY4501-5		002		--				
		1.6				5SY4515-5		002		--				
		2				5SY4502-5		002		--				
		3				5SY4503-5		002		--				
		4				5SY4504-5		002		--				
		6				5SY4506-5		002		5SY4506-6	1	1 unit	002	0.315
		8				5SY4508-5		002		--				
		10				5SY4510-5		002		5SY4510-6	1	1 unit	002	0.312
		13				5SY4513-5		002		5SY4513-6	1	1/6 units	002	0.315
		16				5SY4516-5		002		5SY4516-6	1	1/6 units	002	0.311
		20				5SY4520-5		002		5SY4520-6	1	1 unit	002	0.316
		25				5SY4525-5		002		5SY4525-6	1	1 unit	002	0.317
	32				5SY4532-5		002		5SY4532-6	1	1 unit	002	0.325	
	40				5SY4540-5		002		5SY4540-6	1	1 unit	002	0.307	
	50				5SY4550-5		002		5SY4550-6	1	1 unit	002	0.319	
	63				5SY4563-5		002		5SY4563-6	1	1 unit	002	0.346	
	2P, 400 V AC													
		0.5	2			5SY4205-5		002		--				
		1				5SY4201-5		002		--				
		1.6				5SY4215-5		002		--				
		2				5SY4202-5		002		--				
		3				5SY4203-5		002		--				
		4				5SY4204-5		002		--				
		6				5SY4206-5		002		5SY4206-6	1	1 unit	002	0.314
		8				5SY4208-5		002		--				
		10				5SY4210-5		002		5SY4210-6	1	1/6 units	002	0.306
		13				5SY4213-5		002		5SY4213-6	1	1 unit	002	0.315
		16				5SY4216-5		002		5SY4216-6	1	1/6 units	002	0.295
		20				5SY4220-5		002		5SY4220-6	1	1 unit	002	0.313
		25				5SY4225-5		002		5SY4225-6	1	1 unit	002	0.318
		32				5SY4232-5		002		5SY4232-6	1	1 unit	002	0.323
		40				5SY4240-5		002		5SY4240-6	1	1 unit	002	0.323
	50				5SY4250-5		002		5SY4250-6	1	1 unit	002	0.330	
	63				5SY4263-5		002		5SY4263-6	1	1 unit	002	0.342	
	80				--				5SY4280-6	1	1 unit	002	0.328	



1) 1 MW (modular width) = 18 mm.

Miniature Circuit Breakers

5SY and 5SP Miniature Circuit Breakers

5SY4, 10 000 A

3

10 000		DVE		Characteristic A			Characteristic B					
I_n	Mounting width	DT	Article No.	Price per PU	PG	DT	Article No.	Price per PU	PU (UNIT, SET, M)	PS*/P. unit	PG	Weight per PU approx.
A	MW ¹⁾											kg
MCBs 10 000 A												
3P, 400 V AC												
	0.5	3	5SY4305-5			002	--					
	1		5SY4301-5			002	--					
	1.6		5SY4315-5			002	--					
	2		5SY4302-5			002	--					
	3		5SY4303-5			002	--					
	4		5SY4304-5			002	--					
	6		5SY4306-5			002	5SY4306-6		1	1 unit	002	0.467
	8		5SY4308-5			002	--					
	10		5SY4310-5			002	5SY4310-6		1	1 unit	002	0.463
	13		5SY4313-5			002	5SY4313-6		1	1 unit	002	0.469
	16		5SY4316-5			002	5SY4316-6		1	1/4 units	002	0.439
	20		5SY4320-5			002	5SY4320-6		1	1 unit	002	0.465
	25		5SY4325-5			002	5SY4325-6		1	1 unit	002	0.472
	32		5SY4332-5			002	5SY4332-6		1	1/4 units	002	0.475
	40		5SY4340-5			002	5SY4340-6		1	1 unit	002	0.478
	50		5SY4350-5			002	5SY4350-6		1	1 unit	002	0.490
	63		5SY4363-5			002	5SY4363-6		1	1 unit	002	0.499
	80		--				5SY4380-6		1	1 unit	002	0.481
3P+N, 400 V AC												
	1	4	5SY4601-5			002	--					
	1.6		5SY4615-5			002	--					
	2		5SY4602-5			002	--					
	3		5SY4603-5			002	--					
	4		5SY4604-5			002	--					
	6		5SY4606-5			002	5SY4606-6		1	1 unit	002	0.615
	8		5SY4608-5			002	--					
	10		5SY4610-5			002	5SY4610-6		1	1 unit	002	0.616
	13		5SY4613-5			002	5SY4613-6		1	1 unit	002	0.625
	16		5SY4616-5			002	5SY4616-6		1	1 unit	002	0.616
	20		5SY4620-5			002	5SY4620-6		1	1 unit	002	0.611
	25		5SY4625-5			002	5SY4625-6		1	1 unit	002	0.632
	32		5SY4632-5			002	5SY4632-6		1	1 unit	002	0.636
	40		5SY4640-5			002	5SY4640-6		1	1 unit	002	0.608
	50		5SY4650-5			002	5SY4650-6		1	1 unit	002	0.631
	63		5SY4663-5			002	5SY4663-6		1	1 unit	002	0.665
4P, 400 V AC												
	1	4	5SY4401-5			002	--					
	1.6		5SY4415-5			002	--					
	2		5SY4402-5			002	--					
	3		5SY4403-5			002	--					
	4		5SY4404-5			002	--					
	6		5SY4406-5			002	5SY4406-6		1	1 unit	002	0.621
	8		5SY4408-5			002	--					
	10		5SY4410-5			002	5SY4410-6		1	1 unit	002	0.609
	13		5SY4413-5			002	5SY4413-6		1	1 unit	002	0.650
	16		5SY4416-5			002	5SY4416-6		1	1 unit	002	0.612
	20		5SY4420-5			002	5SY4420-6		1	1 unit	002	0.619
	25		5SY4425-5			002	5SY4425-6		1	1 unit	002	0.617
	32		5SY4432-5			002	5SY4432-6		1	1 unit	002	0.636
	40		5SY4440-5			002	5SY4440-6		1	1 unit	002	0.634
	50		5SY4450-5			002	5SY4450-6		1	1 unit	002	0.645
	63		5SY4463-5			002	5SY4463-6		1	1 unit	002	0.669
	80		--				5SY4480-6		1	1 unit	002	0.651





¹⁾ 1 MW (modular width) = 18 mm.

Miniature Circuit Breakers

5SY and 5SP Miniature Circuit Breakers

5SY4, 10 000 A

3

10 000 3			I_n	Mounting width MW ¹⁾	DT	Characteristic C		Characteristic D		PU (UNIT, SET, M)	PS*/ P. unit	PG	Weight per PU approx. kg	
			A			Article No.	Price per PU	PG	DT	Article No.	Price per PU			
MCBs 10 000 A														
1P, 230/400 V AC														
			0.3	1		5SY4114-7		002		5SY4114-8	1	1 unit	002	0.167
			0.5			5SY4105-7		002		5SY4105-8	1	1 unit	002	0.166
			1			5SY4101-7		002		5SY4101-8	1	1 unit	002	0.165
			1.6			5SY4115-7		002		5SY4115-8	1	1 unit	002	0.163
			2		▶	5SY4102-7		002		5SY4102-8	1	1/12 units	002	0.155
			3			5SY4103-7		002		5SY4103-8	1	1 unit	002	0.160
			4		▶	5SY4104-7		002		5SY4104-8	1	1/12 units	002	0.158
			5			5SY4111-7		002		--				
			6		▶	5SY4106-7		002		5SY4106-8	1	1 unit	002	0.159
			8			5SY4108-7		002		5SY4108-8	1	1 unit	002	0.156
			10		▶	5SY4110-7		002		5SY4110-8	1	1/12 units	002	0.155
			13			5SY4113-7		002		5SY4113-8	1	1 unit	002	0.156
			15			5SY4118-7		002		--				
			16		▶	5SY4116-7		002		5SY4116-8	1	1 unit	002	0.156
			20			5SY4120-7		002		5SY4120-8	1	1 unit	002	0.162
			25			5SY4125-7		002		5SY4125-8	1	1 unit	002	0.161
			30			5SY4130-7		002		--				
			32			5SY4132-7		002		5SY4132-8	1	1 unit	002	0.165
			35			5SY4135-7		002		--				
			40			5SY4140-7		002		5SY4140-8	1	1 unit	002	0.166
			45			5SY4145-7		002		--				
			50			5SY4150-7		002		5SY4150-8	1	1 unit	002	0.164
			60			5SY4160-7		002		--				
			63			5SY4163-7		002		5SY4163-8	1	1 unit	002	0.166
			80			5SY4180-7		002		--				
1P+N, 230 V AC														
			0.3	2		5SY4514-7		002		5SY4514-8	1	1 unit	002	0.323
			0.5			5SY4505-7		002		5SY4505-8	1	1 unit	002	0.316
			1			5SY4501-7		002		5SY4501-8	1	1 unit	002	0.303
			1.6			5SY4515-7		002		5SY4515-8	1	1 unit	002	0.319
			2			5SY4502-7		002		5SY4502-8	1	1 unit	002	0.320
			3			5SY4503-7		002		5SY4503-8	1	1 unit	002	0.314
			4			5SY4504-7		002		5SY4504-8	1	1 unit	002	0.310
			6			5SY4506-7		002		5SY4506-8	1	1 unit	002	0.311
			8			5SY4508-7		002		5SY4508-8	1	1 unit	002	0.305
			10			5SY4510-7		002		5SY4510-8	1	1 unit	002	0.305
			13			5SY4513-7		002		5SY4513-8	1	1 unit	002	0.304
			16			5SY4516-7		002		5SY4516-8	1	1 unit	002	0.306
			20			5SY4520-7		002		5SY4520-8	1	1 unit	002	0.309
			25			5SY4525-7		002		5SY4525-8	1	1 unit	002	0.309
			32			5SY4532-7		002		5SY4532-8	1	1 unit	002	0.320
			40			5SY4540-7		002		5SY4540-8	1	1 unit	002	0.312
			50			5SY4550-7		002		5SY4550-8	1	1 unit	002	0.322
			63			5SY4563-7		002		5SY4563-8	1	1 unit	002	0.332
			80			5SY4580-7		002		--				
2P, 400 V AC														
			0.3	2		5SY4214-7		002		5SY4214-8	1	1 unit	002	0.325
			0.5			5SY4205-7		002		5SY4205-8	1	1 unit	002	0.325
			1			5SY4201-7		002		5SY4201-8	1	1 unit	002	0.320
			1.6			5SY4215-7		002		5SY4215-8	1	1 unit	002	0.319
			2		▶	5SY4202-7		002		5SY4202-8	1	1 unit	002	0.318
			3			5SY4203-7		002		5SY4203-8	1	1 unit	002	0.313
			4			5SY4204-7		002		5SY4204-8	1	1 unit	002	0.309
			5			5SY4211-7		002		--				
			6		▶	5SY4206-7		002		5SY4206-8	1	1 unit	002	0.312
			8			5SY4208-7		002		5SY4208-8	1	1 unit	002	0.305
			10		▶	5SY4210-7		002		5SY4210-8	1	1 unit	002	0.303
			13			5SY4213-7		002		5SY4213-8	1	1 unit	002	0.304
			15			5SY4218-7		002		--				
			16		▶	5SY4216-7		002		5SY4216-8	1	1 unit	002	0.305
			20			5SY4220-7		002		5SY4220-8	1	1 unit	002	0.317
			25			5SY4225-7		002		5SY4225-8	1	1 unit	002	0.318
			30			5SY4230-7		002		--				
			32			5SY4232-7		002		5SY4232-8	1	1 unit	002	0.324
			35			5SY4235-7		002		--				
			40			5SY4240-7		002		5SY4240-8	1	1 unit	002	0.326
			45			5SY4245-7		002		--				
			50			5SY4250-7		002		5SY4250-8	1	1 unit	002	0.324
			60			5SY4260-7		002		--				
			63			5SY4263-7		002		5SY4263-8	1	1 unit	002	0.325
			80			5SY4280-7		002		--				





¹⁾ 1 MW (modular width) = 18 mm.

Miniature Circuit Breakers

5SY and 5SP Miniature Circuit Breakers

5SY4, 10 000 A

3





10 000			I_n	Mounting width	DT	Characteristic C			Characteristic D			Weight per PU approx. kg			
3			A	MW ¹⁾		Article No.	Price per PU	PG	DT	Article No.	Price per PU		PU (UNIT, SET, M)	PS*/P. unit	PG
MCBs 10 000 A															
3P, 400 V AC															
	0.3	3				5SY4314-7		002		5SY4314-8		1	1 unit	002	0.481
	0.5					5SY4305-7		002		5SY4305-8		1	1 unit	002	0.474
	1					5SY4301-7		002		5SY4301-8		1	1 unit	002	0.478
	1.6					5SY4315-7		002		5SY4315-8		1	1 unit	002	0.474
	2					5SY4302-7		002		5SY4302-8		1	1 unit	002	0.476
	3					5SY4303-7		002		5SY4303-8		1	1 unit	002	0.466
	4					5SY4304-7		002		5SY4304-8		1	1 unit	002	0.460
	5					5SY4311-7		002		--					
	6					5SY4306-7		002		5SY4306-8		1	1 unit	002	0.461
	8					5SY4308-7		002		5SY4308-8		1	1 unit	002	0.451
	10					5SY4310-7		002		5SY4310-8		1	1 unit	002	0.447
	13					5SY4313-7		002		5SY4313-8		1	1 unit	002	0.455
	15					5SY4318-7		002		--					
	16					5SY4316-7		002		5SY4316-8		1	1/4 units	002	0.431
	20					5SY4320-7		002		5SY4320-8		1	1 unit	002	0.472
	25					5SY4325-7		002		5SY4325-8		1	1 unit	002	0.470
30					5SY4330-7		002		--						
32					5SY4332-7		002		5SY4332-8		1	1 unit	002	0.481	
35					5SY4335-7		002		--						
40					5SY4340-7		002		5SY4340-8		1	1 unit	002	0.481	
45					5SY4345-7		002		--						
50					5SY4350-7		002		5SY4350-8		1	1 unit	002	0.482	
60					5SY4360-7		002		--						
63					5SY4363-7		002		5SY4363-8		1	1 unit	002	0.486	
80					5SY4380-7		002		--						
3P+N, 400 V AC															
	0.3	4				5SY4614-7		002		5SY4614-8		1	1 unit	002	0.660
	0.5					5SY4605-7		002		5SY4605-8		1	1 unit	002	0.660
	1					5SY4601-7		002		5SY4601-8		1	1 unit	002	0.636
	1.6					5SY4615-7		002		5SY4615-8		1	1 unit	002	0.621
	2					5SY4602-7		002		5SY4602-8		1	1 unit	002	0.608
	3					5SY4603-7		002		5SY4603-8		1	1 unit	002	0.660
	4					5SY4604-7		002		5SY4604-8		1	1 unit	002	0.587
	6					5SY4606-7		002		5SY4606-8		1	1 unit	002	0.615
	8					5SY4608-7		002		5SY4608-8		1	1 unit	002	0.595
	10					5SY4610-7		002		5SY4610-8		1	1 unit	002	0.597
	13					5SY4613-7		002		5SY4613-8		1	1 unit	002	0.594
	16					5SY4616-7		002		5SY4616-8		1	1 unit	002	0.602
	20					5SY4620-7		002		5SY4620-8		1	1 unit	002	0.627
	25					5SY4625-7		002		5SY4625-8		1	1 unit	002	0.625
	32					5SY4632-7		002		5SY4632-8		1	1 unit	002	0.631
	40					5SY4640-7		002		5SY4640-8		1	1 unit	002	0.633
50					5SY4650-7		002		5SY4650-8		1	1 unit	002	0.641	
63					5SY4663-7		002		5SY4663-8		1	1 unit	002	0.639	
80					5SY4680-7		002		--						
4P, 400 V AC															
	0.3	4				5SY4414-7		002		5SY4414-8		1	1 unit	002	0.639
	0.5					5SY4405-7		002		5SY4405-8		1	1 unit	002	0.633
	1					5SY4401-7		002		5SY4401-8		1	1 unit	002	0.636
	1.6					5SY4415-7		002		5SY4415-8		1	1 unit	002	0.623
	2					5SY4402-7		002		5SY4402-8		1	1 unit	002	0.630
	3					5SY4403-7		002		5SY4403-8		1	1 unit	002	0.660
	4					5SY4404-7		002		5SY4404-8		1	1 unit	002	0.610
	6					5SY4406-7		002		5SY4406-8		1	1 unit	002	0.610
	8					5SY4408-7		002		5SY4408-8		1	1 unit	002	0.571
	10					5SY4410-7		002		5SY4410-8		1	1 unit	002	0.597
	13					5SY4413-7		002		5SY4413-8		1	1 unit	002	0.571
	16					5SY4416-7		002		5SY4416-8		1	1 unit	002	0.600
	20					5SY4420-7		002		5SY4420-8		1	1 unit	002	0.626
	25					5SY4425-7		002		5SY4425-8		1	1 unit	002	0.617
	32					5SY4432-7		002		5SY4432-8		1	1 unit	002	0.640
	40					5SY4440-7		002		5SY4440-8		1	1 unit	002	0.638
50					5SY4450-7		002		5SY4450-8		1	1 unit	002	0.636	
63					5SY4463-7		002		5SY4463-8		1	1 unit	002	0.644	
80					5SY4480-7		002		--						





¹⁾ 1 MW (modular width) = 18 mm.

Miniature Circuit Breakers

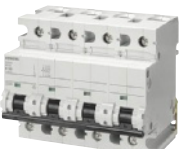
5SY and 5SP Miniature Circuit Breakers

5SP4, high-current, 10 000 A
3
Selection and ordering data

10 000		I_n	Mounting width	DT	Characteristic B		PU (UNIT, SET, M)	PS*/P. unit	PG	Weight per PU approx.				
					Article No.	Price per PU								
		A	MW ¹⁾							kg				
MCBs 10 000 A, high current														
	1P, 230/400 V AC		1.5											
	80	5SP4180-6									1	1 unit	002	0.263
	100	5SP4191-6									1	1 unit	002	0.265
	125	5SP4192-6									1	1 unit	002	0.269
	2P, 400 V AC		3											
	80	5SP4280-6									1	1 unit	002	0.532
	100	5SP4291-6									1	1 unit	002	0.527
	125	5SP4292-6									1	1 unit	002	0.534
	3P, 400 V AC		4.5											
	80	5SP4380-6									1	1 unit	002	0.800
	100	5SP4391-6									1	1 unit	002	0.787
	125	5SP4392-6									1	1 unit	002	0.793
	4P, 400 V AC		6											
	80	5SP4480-6									1	1 unit	002	1.046
	100	5SP4491-6									1	1 unit	002	1.038
	125	5SP4492-6									1	1 unit	002	1.062

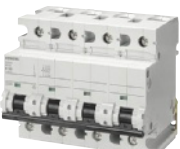
10 000		I_n	Mounting width	DT	Characteristic C		Characteristic D		PU (UNIT, SET, M)	PS*/P. unit	PG	Weight per PU approx.						
					Article No.	Price per PU	PG	DT					Article No.	Price per PU				
		A	MW ¹⁾								kg							
MCBs 10 000 A, high current																		
	1P, 230/400 V AC		1.5															
	80	5SP4180-7											002	5SP4180-8	1	1 unit	002	0.257
	100	5SP4191-7											002	5SP4191-8	1	1 unit	002	0.254
	125	5SP4192-7											002	--				
	2P, 400 V AC		3															
	80	5SP4280-7											002	5SP4280-8	1	1 unit	002	0.505
	100	5SP4291-7											002	5SP4291-8	1	1 unit	002	0.515
	125	5SP4292-7											002	--				
	3P, 400 V AC		4.5															
	80	5SP4380-7											002	5SP4380-8	1	1 unit	002	0.762
	100	5SP4391-7											002	5SP4391-8	1	1 unit	002	0.783
	125	5SP4392-7											002	--				
	4P, 400 V AC		6															
	80	5SP4480-7											002	5SP4480-8	1	1 unit	002	1.031
	100	5SP4491-7											002	5SP4491-8	1	1 unit	002	1.033
	125	5SP4492-7											002	--				

¹⁾ 1 MW (modular width) = 18 mm.

* You can order this quantity or a multiple thereof.





Miniature Circuit Breakers

5SY and 5SP Miniature Circuit Breakers

5SY5, universal current, 10 000 A

3

Selection and ordering data

10 000 3			I_n	Mounting width	DT	Characteristic B			Characteristic C						
			A	MW ¹⁾		Article No.	Price per PU	PG	DT	Article No.	Price per PU	PU (UNIT, SET, M)	PS*/P. unit	PG	Weight per PU approx. kg
MCBs 10 000 A, UC															
	1P, 230/400 V AC, 220 V DC														
	0.3	1	--							5SY5114-7		1	1 unit	002	0.169
	0.5		--							5SY5105-7		1	1 unit	002	0.168
	1		--							5SY5101-7		1	1 unit	002	0.166
	1.6		--							5SY5115-7		1	1 unit	002	0.164
	2		5SY5102-6					002		5SY5102-7		1	1 unit	002	0.167
	3		--							5SY5103-7		1	1 unit	002	0.162
	4		5SY5104-6					002		5SY5104-7		1	1 unit	002	0.163
	6		5SY5106-6					002		5SY5106-7		1	1 unit	002	0.163
	8		--							5SY5108-7		1	1 unit	002	0.162
	10		5SY5110-6					002		5SY5110-7		1	1 unit	002	0.160
	13		5SY5113-6					002		5SY5113-7		1	1 unit	002	0.164
	16		5SY5116-6					002		5SY5116-7		1	1 unit	002	0.161
	20		5SY5120-6					002		5SY5120-7		1	1 unit	002	0.163
25		5SY5125-6					002		5SY5125-7		1	1 unit	002	0.165	
32		5SY5132-6					002		5SY5132-7		1	1 unit	002	0.164	
40		5SY5140-6					002		5SY5140-7		1	1 unit	002	0.164	
50		5SY5150-6					002		5SY5150-7		1	1 unit	002	0.171	
63		5SY5163-6					002		5SY5163-7		1	1 unit	002	0.169	
	2P, 400 V AC, 440 V DC														
	0.3	2	--							5SY5214-7		1	1 unit	002	0.333
	0.5		--							5SY5205-7		1	1 unit	002	0.328
	1		--							5SY5201-7		1	1 unit	002	0.324
	1.6		--							5SY5215-7		1	1 unit	002	0.321
	2		--							5SY5202-7		1	1 unit	002	0.329
	3		--							5SY5203-7		1	1 unit	002	0.317
	4		--							5SY5204-7		1	1 unit	002	0.319
	6		5SY5206-6					002	▶	5SY5206-7		1	1/6 units	002	0.300
	8		--							5SY5208-7		1	1 unit	002	0.313
	10		5SY5210-6					002		5SY5210-7		1	1 unit	002	0.314
	13		5SY5213-6					002		5SY5213-7		1	1 unit	002	0.322
	16		5SY5216-6					002		5SY5216-7		1	1 unit	002	0.314
	20		5SY5220-6					002		5SY5220-7		1	1 unit	002	0.319
25		5SY5225-6					002		5SY5225-7		1	1 unit	002	0.321	
32		5SY5232-6					002		5SY5232-7		1	1 unit	002	0.322	
40		5SY5240-6					002		5SY5240-7		1	1 unit	002	0.323	
50		5SY5250-6					002		5SY5250-7		1	1 unit	002	0.333	
63		5SY5263-6					002		5SY5263-7		1	1 unit	002	0.342	
MCBs 10 000 A, UC															
	4P, 400 V AC, 880 V DC (max. 1000 V DC)														
	0.3	1	--							5SY5414-7		1	1 unit	002	0.660
	0.5		--							5SY5405-7		1	1 unit	002	0.660
	1		--							5SY5401-7		1	1 unit	002	0.660
	1.6		--							5SY5415-7		1	1 unit	002	0.660
	2		--							5SY5402-7		1	1 unit	002	0.660
	3		--							5SY5403-7		1	1 unit	002	0.660
	4		--							5SY5404-7		1	1 unit	002	0.660
	6		5SY5406-6					002		5SY5406-7		1	1 unit	002	0.660
	8		--							5SY5408-7		1	1 unit	002	0.660
	10		5SY5410-6					002		5SY5410-7		1	1 unit	002	0.660
	13		5SY5413-6					002		5SY5413-7		1	1 unit	002	0.660
	16		5SY5416-6					002		5SY5416-7		1	1 unit	002	0.660
	20		5SY5420-6					002		5SY5420-7		1	1 unit	002	0.660
25		5SY5425-6					002		5SY5425-7		1	1 unit	002	0.660	
32		5SY5432-6					002		5SY5432-7		1	1 unit	002	0.660	
40		5SY5440-6					002		5SY5440-7		1	1 unit	002	0.660	
50		5SY5450-6					002		5SY5450-7		1	1 unit	002	0.660	
63		5SY5463-6					002		5SY5463-7		1	1 unit	002	0.660	

¹⁾ 1 MW (modular width) = 18 mm.

Note:

The 5ST3600 and 5ST3630 busbars enable simple wiring of 4-pole miniature circuit breakers, [see page 3/45](#).

For application examples, [see engineering manual at: www.siemens.com/lowvoltage/manuals](#).





Miniature Circuit Breakers

5SY and 5SP Miniature Circuit Breakers

5SY7, 15 000 A

3

Selection and ordering data

15 000		I_n	Mounting width	DT	Characteristic B		PU (UNIT, SET, M)	PS*/P. unit	PG	Weight per PU approx.
					Article No.	Price per PU				
MCBs 15 000 A		A	MW ¹⁾							kg
	1P, 230/400 V AC									
	6	1		5SY7106-6		1	1 unit	003	0.161	
	10			5SY7110-6		1	1 unit	003	0.160	
	13			5SY7113-6		1	1 unit	003	0.159	
	16			5SY7116-6		1	1 unit	003	0.159	
	20			5SY7120-6		1	1 unit	003	0.161	
	25			5SY7125-6		1	1 unit	003	0.162	
	32			5SY7132-6		1	1 unit	003	0.164	
	40			5SY7140-6		1	1 unit	003	0.212	
50			5SY7150-6		1	1 unit	003	0.168		
63			5SY7163-6		1	1 unit	003	0.176		
	1P+N, 230 V AC									
	6	2		5SY7506-6		1	1 unit	003	0.314	
	10			5SY7510-6		1	1 unit	003	0.294	
	13			5SY7513-6		1	1 unit	003	0.330	
	16			5SY7516-6		1	1 unit	003	0.311	
	20			5SY7520-6		1	1 unit	003	0.314	
	25			5SY7525-6		1	1 unit	003	0.321	
	32			5SY7532-6		1	1 unit	003	0.321	
	40			5SY7540-6		1	1 unit	003	0.336	
50			5SY7550-6		1	1 unit	003	0.330		
63			5SY7563-6		1	1 unit	003	0.330		
	2P, 400 V AC									
	6	2		5SY7206-6		1	1 unit	003	0.312	
	10			5SY7210-6		1	1 unit	003	0.313	
	13			5SY7213-6		1	1 unit	003	0.296	
	16			5SY7216-6		1	1 unit	003	0.302	
	20			5SY7220-6		1	1 unit	003	0.313	
	25			5SY7225-6		1	1 unit	003	0.316	
	32			5SY7232-6		1	1 unit	003	0.325	
	40			5SY7240-6		1	1 unit	003	0.324	
50			5SY7250-6		1	1 unit	003	0.321		
63			5SY7263-6		1	1 unit	003	0.336		
	3P, 400 V AC									
	6	3		5SY7306-6		1	1 unit	003	0.468	
	10			5SY7310-6		1	1 unit	003	0.466	
	13			5SY7313-6		1	1 unit	003	0.449	
	16			5SY7316-6		1	1 unit	003	0.462	
	20			5SY7320-6		1	1 unit	003	0.465	
	25			5SY7325-6		1	1 unit	003	0.472	
	32			5SY7332-6		1	1 unit	003	0.488	
	40			5SY7340-6		1	1 unit	003	0.481	
50			5SY7350-6		1	1 unit	003	0.490		
63			5SY7363-6		1	1 unit	003	0.485		
	3P+N, 400 V AC									
	6	4		5SY7606-6		1	1 unit	003	0.614	
	10			5SY7610-6		1	1 unit	003	0.617	
	13			5SY7613-6		1	1 unit	003	0.622	
	16			5SY7616-6		1	1 unit	003	0.606	
	20			5SY7620-6		1	1 unit	003	0.622	
	25			5SY7625-6		1	1 unit	003	0.634	
	32			5SY7632-6		1	1 unit	003	0.638	
	40			5SY7640-6		1	1 unit	003	0.635	
50			5SY7650-6		1	1 unit	003	0.649		
63			5SY7663-6		1	1 unit	003	0.665		
	4P, 400 V AC									
	6	4		5SY7406-6		1	1 unit	003	0.621	
	10			5SY7410-6		1	1 unit	003	0.614	
	13			5SY7413-6		1	1 unit	003	0.633	
	16			5SY7416-6		1	1 unit	003	0.617	
	20			5SY7420-6		1	1 unit	003	0.587	
	25			5SY7425-6		1	1 unit	003	0.629	
	32			5SY7432-6		1	1 unit	003	0.615	
	40			5SY7440-6		1	1 unit	003	0.611	
50			5SY7450-6		1	1 unit	003	0.647		
63			5SY7463-6		1	1 unit	003	0.666		





1) 1 MW (modular width) = 18 mm.

Miniature Circuit Breakers

5SY and 5SP Miniature Circuit Breakers

5SY7, 15 000 A

3

15 000		I_n	Mounting width	DT	Characteristic C			Characteristic D			PU (UNIT, SET, M)	PS*/P. unit	PG	Weight per PU approx.
		A	MW ¹⁾		Article No.	Price per PU	PG	DT	Article No.	Price per PU			kg	
MCBs 15 000 A														
	1P, 230/400 V AC													
	0.3	1			5SY7114-7		003		5SY7114-8		1	1 unit	003	0.160
	0.5				5SY7105-7		003		5SY7105-8		1	1 unit	003	0.153
	1				5SY7101-7		003		5SY7101-8		1	1 unit	003	0.180
	1.6				5SY7115-7		003		5SY7115-8		1	1 unit	003	0.165
	2				5SY7102-7		003		5SY7102-8		1	1 unit	003	0.162
	3				5SY7103-7		003		5SY7103-8		1	1 unit	003	0.161
	4				5SY7104-7		003		5SY7104-8		1	1 unit	003	0.158
	6				5SY7106-7		003		5SY7106-8		1	1 unit	003	0.160
	8				5SY7108-7		003		5SY7108-8		1	1 unit	003	0.154
	10				5SY7110-7		003		5SY7110-8		1	1 unit	003	0.156
	13				5SY7113-7		003		5SY7113-8		1	1 unit	003	0.156
	16				5SY7116-7		003		5SY7116-8		1	1 unit	003	0.156
	20				5SY7120-7		003		5SY7120-8		1	1 unit	003	0.141
	25				5SY7125-7		003		5SY7125-8		1	1 unit	003	0.162
	32				5SY7132-7		003		5SY7132-8		1	1 unit	003	0.166
40				5SY7140-7		003		5SY7140-8		1	1 unit	003	0.166	
50				5SY7150-7		003		5SY7150-8		1	1 unit	003	0.167	
63				5SY7163-7		003		5SY7163-8		1	1 unit	003	0.165	
	1P+N, 230 V AC													
	0.3	2			5SY7514-7		003		5SY7514-8		1	1 unit	003	0.323
	0.5				5SY7505-7		003		5SY7505-8		1	1 unit	003	0.312
	1				5SY7501-7		003		5SY7501-8		1	1 unit	003	0.320
	1.6				5SY7515-7		003		5SY7515-8		1	1 unit	003	0.319
	2				5SY7502-7		003		5SY7502-8		1	1 unit	003	0.319
	3				5SY7503-7		003		5SY7503-8		1	1 unit	003	0.298
	4				5SY7504-7		003		5SY7504-8		1	1 unit	003	0.310
	6				5SY7506-7		003		5SY7506-8		1	1 unit	003	0.326
	8				5SY7508-7		003		5SY7508-8		1	1 unit	003	0.286
	10				5SY7510-7		003		5SY7510-8		1	1 unit	003	0.305
	13				5SY7513-7		003		5SY7513-8		1	1 unit	003	0.304
	16				5SY7516-7		003		5SY7516-8		1	1 unit	003	0.293
20				5SY7520-7		003		5SY7520-8		1	1 unit	003	0.317	
25				5SY7525-7		003		5SY7525-8		1	1 unit	003	0.313	
32				5SY7532-7		003		5SY7532-8		1	1 unit	003	0.325	
40				5SY7540-7		003		5SY7540-8		1	1 unit	003	0.308	
50				5SY7550-7		003		5SY7550-8		1	1 unit	003	0.330	
63				5SY7563-7		003		5SY7563-8		1	1 unit	003	0.308	
	2P, 400 V AC													
	0.3	2			5SY7214-7		003		5SY7214-8		1	1 unit	003	0.322
	0.5				5SY7205-7		003		5SY7205-8		1	1 unit	003	0.325
	1				5SY7201-7		003		5SY7201-8		1	1 unit	003	0.313
	1.6				5SY7215-7		003		5SY7215-8		1	1 unit	003	0.359
	2				5SY7202-7		003		5SY7202-8		1	1 unit	003	0.318
	3				5SY7203-7		003		5SY7203-8		1	1 unit	003	0.314
	4				5SY7204-7		003		5SY7204-8		1	1 unit	003	0.310
	6				5SY7206-7		003		5SY7206-8		1	1 unit	003	0.312
	8				5SY7208-7		003		5SY7208-8		1	1 unit	003	0.302
	10				5SY7210-7		003		5SY7210-8		1	1 unit	003	0.306
	13				5SY7213-7		003		5SY7213-8		1	1 unit	003	0.287
	16				5SY7216-7		003		5SY7216-8		1	1 unit	003	0.304
20				5SY7220-7		003		5SY7220-8		1	1 unit	003	0.314	
25				5SY7225-7		003		5SY7225-8		1	1 unit	003	0.313	
32				5SY7232-7		003		5SY7232-8		1	1 unit	003	0.328	
40				5SY7240-7		003		5SY7240-8		1	1 unit	003	0.325	
50				5SY7250-7		003		5SY7250-8		1	1 unit	003	0.308	
63				5SY7263-7		003		5SY7263-8		1	1 unit	003	0.326	





¹⁾ 1 MW (modular width) = 18 mm.

Miniature Circuit Breakers

5SY and 5SP Miniature Circuit Breakers

5SY7, 15 000 A

3

15 000		I_n	Mounting width	DT	Characteristic C	Price per PU	PG DT	Characteristic D	Price per PU	PU (UNIT, SET, M)	PS*/P. unit	PG	Weight per PU approx.
		A	MW ¹⁾		Article No.			Article No.					kg
MCBs 15 000 A													
		3P, 400 V AC											
		0.3	3		5SY7314-7		003	5SY7314-8		1	1 unit	003	0.473
		0.5			5SY7305-7		003	5SY7305-8		1	1 unit	003	0.495
		1			5SY7301-7		003	5SY7301-8		1	1 unit	003	0.458
		1.6			5SY7315-7		003	5SY7315-8		1	1 unit	003	0.495
		2			5SY7302-7		003	5SY7302-8		1	1 unit	003	0.451
		3			5SY7303-7		003	5SY7303-8		1	1 unit	003	0.458
		4			5SY7104-7		003	5SY7304-8		1	1 unit	003	0.441
		6			5SY7306-7		003	5SY7306-8		1	1 unit	003	0.457
		8			5SY7308-7		003	5SY7308-8		1	1 unit	003	0.442
		10			5SY7310-7		003	5SY7310-8		1	1 unit	003	0.453
		13			5SY7313-7		003	5SY7313-8		1	1 unit	003	0.445
		16			5SY7316-7		003	5SY7316-8		1	1 unit	003	0.445
		20			5SY7320-7		003	5SY7320-8		1	1 unit	003	0.463
		25			5SY7325-7		003	5SY7325-8		1	1 unit	003	0.464
		32			5SY7332-7		003	5SY7332-8		1	1 unit	003	0.482
		40			5SY7340-7		003	5SY7340-8		1	1 unit	003	0.484
		50			5SY7350-7		003	5SY7350-8		1	1 unit	003	0.480
		63			5SY7363-7		003	5SY7363-8		1	1 unit	003	0.479
		3P+N, 400 V AC											
		0.3	4		5SY7614-7		003	5SY7614-8		1	1 unit	003	0.660
		0.5			5SY7605-7		003	5SY7605-8		1	1 unit	003	0.660
		1			5SY7601-7		003	5SY7601-8		1	1 unit	003	0.660
		1.6			5SY7615-7		003	5SY7615-8		1	1 unit	003	0.660
		2			5SY7602-7		003	5SY7602-8		1	1 unit	003	0.632
		3			5SY7603-7		003	5SY7603-8		1	1 unit	003	0.660
		4			5SY7604-7		003	5SY7604-8		1	1 unit	003	0.660
		6			5SY7606-7		003	5SY7606-8		1	1 unit	003	0.590
		8			5SY7608-7		003	5SY7608-8		1	1 unit	003	0.600
		10			5SY7610-7		003	5SY7610-8		1	1 unit	003	0.593
		13			5SY7613-7		003	5SY7613-8		1	1 unit	003	0.610
		16			5SY7616-7		003	5SY7616-8		1	1 unit	003	0.585
		20			5SY7620-7		003	5SY7620-8		1	1 unit	003	0.618
		25			5SY7625-7		003	5SY7625-8		1	1 unit	003	0.628
		32			5SY7632-7		003	5SY7632-8		1	1 unit	003	0.644
		40			5SY7640-7		003	5SY7640-8		1	1 unit	003	0.645
		50			5SY7650-7		003	5SY7650-8		1	1 unit	003	0.678
		63			5SY7663-7		003	5SY7663-8		1	1 unit	003	0.643
		4P, 400 V AC											
		0.3	4		5SY7414-7		003	5SY7414-8		1	1 unit	003	0.642
		0.5			5SY7405-7		003	5SY7405-8		1	1 unit	003	0.660
		1			5SY7401-7		003	5SY7401-8		1	1 unit	003	0.660
		1.6			5SY7415-7		003	5SY7415-8		1	1 unit	003	0.660
		2			5SY7402-7		003	5SY7402-8		1	1 unit	003	0.630
		3			5SY7403-7		003	5SY7403-8		1	1 unit	003	0.660
		4			5SY7404-7		003	5SY7404-8		1	1 unit	003	0.624
		6			5SY7406-7		003	5SY7406-8		1	1 unit	003	0.615
		8			5SY7408-7		003	5SY7408-8		1	1 unit	003	0.603
		10			5SY7410-7		003	5SY7410-8		1	1 unit	003	0.608
		13			5SY7413-7		003	5SY7413-8		1	1 unit	003	0.608
		16			5SY7416-7		003	5SY7416-8		1	1 unit	003	0.592
		20			5SY7420-7		003	5SY7420-8		1	1 unit	003	0.615
		25			5SY7425-7		003	5SY7425-8		1	1 unit	003	0.628
		32			5SY7432-7		003	5SY7432-8		1	1 unit	003	0.639
		40			5SY7440-7		003	5SY7440-8		1	1 unit	003	0.642
		50			5SY7450-7		003	5SY7450-8		1	1 unit	003	0.603
		63			5SY7463-7		003	5SY7463-8		1	1 unit	003	0.642

1) 1 MW (modular width) = 18 mm.

Miniature Circuit Breakers

5SY and 5SP Miniature Circuit Breakers

5SY8, 25 000 A

3

Selection and ordering data

I_n	Mounting width	DT	Characteristic C			Characteristic D			PU (UNIT, SET, M)	PS*/P. unit	PG	Weight per PU approx.
			Article No.	Price per PU	PG DT	Article No.	Price per PU	PG				
MCBs 25 000 A												
1P, 230/400 V AC												
0.3	1		5SY8114-7		003	5SY8114-8		1	1 unit	003	0.167	
0.5			5SY8105-7		003	5SY8105-8		1	1 unit	003	0.165	
1			5SY8101-7		003	5SY8101-8		1	1 unit	003	0.152	
1.6			5SY8115-7		003	5SY8115-8		1	1 unit	003	0.165	
2			5SY8102-7		003	5SY8102-8		1	1 unit	003	0.163	
3			5SY8103-7		003	5SY8103-8		1	1 unit	003	0.161	
4			5SY8104-7		003	5SY8104-8		1	1 unit	003	0.158	
6			5SY8106-7		003	5SY8106-8		1	1 unit	003	0.159	
8			5SY8108-7		003	5SY8108-8		1	1 unit	003	0.156	
10			5SY8110-7		003	5SY8110-8		1	1 unit	003	0.157	
13			5SY8113-7		003	5SY8113-8		1	1 unit	003	0.142	
16			5SY8116-7		003	5SY8116-8		1	1 unit	003	0.155	
20			5SY8120-7		003	5SY8120-8		1	1 unit	003	0.165	
25			5SY8125-7		003	5SY8125-8		1	1 unit	003	0.162	
32			5SY8132-7		003	5SY8132-8		1	1 unit	003	0.166	
40			5SY8140-7		003	5SY8140-8		1	1 unit	003	0.155	
50			5SY8150-7		003	5SY8150-8		1	1 unit	003	0.158	
63			5SY8163-7		003	5SY8163-8		1	1 unit	003	0.160	
1P+N, 230 V AC												
0.3	2		5SY8514-7		003	5SY8514-8		1	1 unit	003	0.330	
0.5			5SY8505-7		003	5SY8505-8		1	1 unit	003	0.323	
1			5SY8501-7		003	5SY8501-8		1	1 unit	003	0.337	
1.6			5SY8515-7		003	5SY8515-8		1	1 unit	003	0.324	
2			5SY8502-7		003	5SY8502-8		1	1 unit	003	0.318	
3			5SY8503-7		003	5SY8503-8		1	1 unit	003	0.318	
4			5SY8504-7		003	5SY8504-8		1	1 unit	003	0.311	
6			5SY8506-7		003	5SY8506-8		1	1 unit	003	0.326	
8			5SY8508-7		003	5SY8508-8		1	1 unit	003	0.313	
10			5SY8510-7		003	5SY8510-8		1	1 unit	003	0.282	
13			5SY8513-7		003	5SY8513-8		1	1 unit	003	0.305	
16			5SY8516-7		003	5SY8516-8		1	1 unit	003	0.297	
20			5SY8520-7		003	5SY8520-8		1	1 unit	003	0.318	
25			5SY8525-7		003	5SY8525-8		1	1 unit	003	0.312	
32			5SY8532-7		003	5SY8532-8		1	1 unit	003	0.366	
40			5SY8540-7		003	5SY8540-8		1	1 unit	003	0.325	
50			5SY8550-7		003	5SY8550-8		1	1 unit	003	0.326	
63			5SY8563-7		003	5SY8563-8		1	1 unit	003	0.330	
2P, 400 V AC												
0.3	2		5SY8214-7		003	5SY8214-8		1	1 unit	003	0.337	
0.5			5SY8205-7		003	5SY8205-8		1	1 unit	003	0.325	
1			5SY8201-7		003	5SY8201-8		1	1 unit	003	0.313	
1.6			5SY8215-7		003	5SY8215-8		1	1 unit	003	0.316	
2			5SY8202-7		003	5SY8202-8		1	1 unit	003	0.322	
3			5SY8203-7		003	5SY8203-8		1	1 unit	003	0.346	
4			5SY8204-7		003	5SY8204-8		1	1 unit	003	0.314	
6			5SY8206-7		003	5SY8206-8		1	1 unit	003	0.311	
8			5SY8208-7		003	5SY8208-8		1	1 unit	003	0.306	
10			5SY8210-7		003	5SY8210-8		1	1 unit	003	0.305	
13			5SY8213-7		003	5SY8213-8		1	1 unit	003	0.305	
16			5SY8216-7		003	5SY8216-8		1	1 unit	003	0.304	
20			5SY8220-7		003	5SY8220-8		1	1 unit	003	0.305	
25			5SY8225-7		003	5SY8225-8		1	1 unit	003	0.318	
32			5SY8232-7		003	5SY8232-8		1	1 unit	003	0.324	
40			5SY8240-7		003	5SY8240-8		1	1 unit	003	0.308	
50			5SY8250-7		003	5SY8250-8		1	1 unit	003	0.331	
63			5SY8263-7		003	5SY8263-8		1	1 unit	003	0.327	

¹⁾ 1 MW (modular width) = 18 mm.

Miniature Circuit Breakers

5SY and 5SP Miniature Circuit Breakers

5SY8, 25 000 A

3

I_n	Mounting width	DT	Characteristic C			Characteristic D			PU (UNIT, SET, M)	PS*/P. unit	PG	Weight per PU approx. kg
			Article No.	Price per PU	PG DT	Article No.	Price per PU	PG DT				
MCBs 25 000 A												
3P, 400 V AC												
0.3	3		5SY8314-7		003	5SY8314-8		1	1 unit	003	0.495	
0.5			5SY8305-7		003	5SY8305-8		1	1 unit	003	0.482	
1			5SY8301-7		003	5SY8301-8		1	1 unit	003	0.478	
1.6			5SY8315-7		003	5SY8315-8		1	1 unit	003	0.495	
2			5SY8302-7		003	5SY8302-8		1	1 unit	003	0.471	
3			5SY8303-7		003	5SY8303-8		1	1 unit	003	0.467	
4			5SY8304-7		003	5SY8304-8		1	1 unit	003	0.460	
6			5SY8306-7		003	5SY8306-8		1	1 unit	003	0.442	
8			5SY8308-7		003	5SY8308-8		1	1 unit	003	0.495	
10			5SY8310-7		003	5SY8310-8		1	1 unit	003	0.455	
13			5SY8313-7		003	5SY8313-8		1	1 unit	003	0.487	
16			5SY8316-7		003	5SY8316-8		1	1 unit	003	0.449	
20			5SY8320-7		003	5SY8320-8		1	1 unit	003	0.452	
25			5SY8325-7		003	5SY8325-8		1	1 unit	003	0.472	
32			5SY8332-7		003	5SY8332-8		1	1 unit	003	0.482	
40			5SY8340-7		003	5SY8340-8		1	1 unit	003	0.464	
50			5SY8350-7		003	5SY8350-8		1	1 unit	003	0.465	
63			5SY8363-7		003	5SY8363-8		1	1 unit	003	0.467	
3P+N, 400 V AC												
0.3	4		5SY8614-7		003	5SY8614-8		1	1 unit	003	0.660	
0.5			5SY8605-7		003	5SY8605-8		1	1 unit	003	0.660	
1			5SY8601-7		003	5SY8601-8		1	1 unit	003	0.660	
1.6			5SY8615-7		003	5SY8615-8		1	1 unit	003	0.660	
2			5SY8602-7		003	5SY8602-8		1	1 unit	003	0.631	
3			5SY8603-7		003	5SY8603-8		1	1 unit	003	0.621	
4			5SY8604-7		003	5SY8604-8		1	1 unit	003	0.660	
6			5SY8606-7		003	5SY8606-8		1	1 unit	003	0.660	
8			5SY8608-7		003	5SY8608-8		1	1 unit	003	0.660	
10			5SY8610-7		003	5SY8610-8		1	1 unit	003	0.571	
13			5SY8613-7		003	5SY8613-8		1	1 unit	003	0.609	
16			5SY8616-7		003	5SY8616-8		1	1 unit	003	0.602	
20			5SY8620-7		003	5SY8620-8		1	1 unit	003	0.596	
25			5SY8625-7		003	5SY8625-8		1	1 unit	003	0.601	
32			5SY8632-7		003	5SY8632-8		1	1 unit	003	0.611	
40			5SY8640-7		003	5SY8640-8		1	1 unit	003	0.617	
50			5SY8650-7		003	5SY8650-8		1	1 unit	003	0.650	
63			5SY8663-7		003	5SY8663-8		1	1 unit	003	0.625	
4P, 400 V AC												
0.3	4		5SY8414-7		003	5SY8414-8		1	1 unit	003	0.660	
0.5			5SY8405-7		003	5SY8405-8		1	1 unit	003	0.660	
1			5SY8401-7		003	5SY8401-8		1	1 unit	003	0.636	
1.6			5SY8415-7		003	5SY8415-8		1	1 unit	003	0.660	
2			5SY8402-7		003	5SY8402-8		1	1 unit	003	0.681	
3			5SY8403-7		003	5SY8403-8		1	1 unit	003	0.660	
4			5SY8404-7		003	5SY8404-8		1	1 unit	003	0.660	
6			5SY8406-7		003	5SY8406-8		1	1 unit	003	0.660	
8			5SY8408-7		003	5SY8408-8		1	1 unit	003	0.598	
10			5SY8410-7		003	5SY8410-8		1	1 unit	003	0.597	
13			5SY8413-7		003	5SY8413-8		1	1 unit	003	0.660	
16			5SY8416-7		003	5SY8416-8		1	1 unit	003	0.601	
20			5SY8420-7		003	5SY8420-8		1	1 unit	003	0.627	
25			5SY8425-7		003	5SY8425-8		1	1 unit	003	0.627	
32			5SY8432-7		003	5SY8432-8		1	1 unit	003	0.641	
40			5SY8440-7		003	5SY8440-8		1	1 unit	003	0.647	
50			5SY8450-7		003	5SY8450-8		1	1 unit	003	0.646	
63			5SY8463-7		003	5SY8463-8		1	1 unit	003	0.644	

1) 1 MW (modular width) = 18 mm.

Miniature Circuit Breakers

5SJ6...-KS miniature circuit breakers, with plug-in terminals

3

Overview

Miniature circuit breakers with plug-in terminals are used for the protection of socket outlets and lighting circuits with the most common rated currents of 10 to 20 A.

Benefits

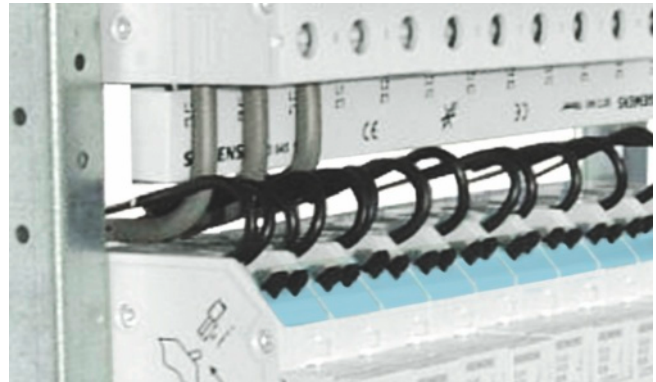
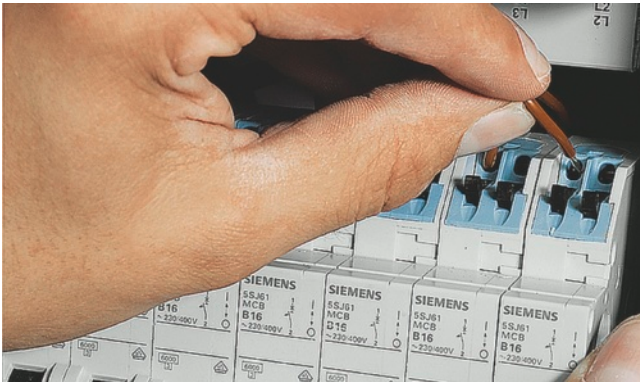

- Double, self-contained, screwless outgoing terminals for fast connection of conductors.
- Removal of individual conductors requires no tools and ensures high operating reliability
- No end sleeves required for finely stranded conductors. This saves mounting time.

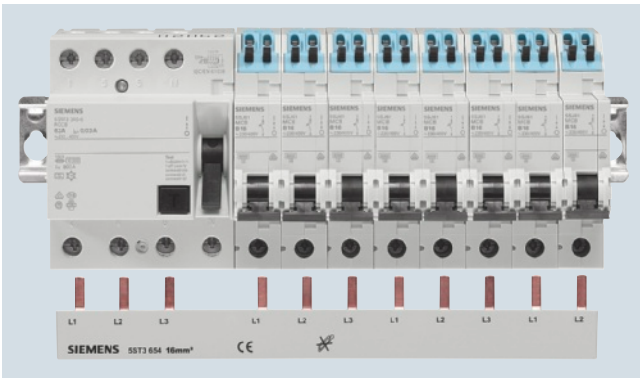

- Conventional pin busbars are used for the incoming terminal. This ensures clear, manageable and convenient access to all terminals as part of the uniform Siemens connection concept.

Technical specifications

		5SJ6 ...-KS	
Standards		EN 60898-1	
Approvals		See appendix, chapter 20	
Rated voltage U_n	V AC	230/400	
Operational voltage			
• Min.	V AC/DC/pole	24	
• Max.	V AC V DC/pole	250/440 60 ¹⁾	
Rated making and breaking capacity	Acc. to EN 60898-1	kA AC	6
Insulation coordination			
• Rated insulation voltage	V AC	250/440	
• Pollution degree for overvoltage category		2/III	
Touch protection	Acc. to EN 50274	Yes	
Handle end position , sealable		Yes	
Degree of protection	Acc. to EN 60529	IP20 with connected conductors, IP40 in the handle range with distribution cover	
CFC and silicone-free		Yes	
Terminals		Screwless terminals on the outgoing terminals for 1.5 ... 4 mm ²	
Conductor cross-sections			
• Top, plug-in terminals			
- Solid, stranded and finely stranded, without end sleeve	mm ²	1.5 ... 4	
- Finely stranded, with end sleeve	mm ²	1.5 ... 2.5	
• Bottom, tunnel terminal ±screw (Pozidriv)		2	
- Solid, stranded or finely stranded, with end sleeve	mm ²	0.75 ... 25	
Mounting position		Any	
Service life , on average, with rated load		20000 actuations	
Ambient temperature	°C	-25 ... +45, occasionally +55, max. 95 % humidity	
Storage temperature	°C	-40 ... +75	
Resistance to climate	Acc. to IEC 60068-2-30	6 cycles	





¹⁾ The operational voltage 60 V DC/pole takes into account a battery charging voltage with a peak value of 72 V.

Miniature Circuit Breakers

5SJ6...-KS miniature circuit breakers, with plug-in terminals

3

Selection and ordering data

6 000 3		I_n	Mounting width	DT	Characteristic B			Characteristic C						
					Article No.	Price per PU	PG DT	Article No.	Price per PU	PU (UNIT, SET, M)	PS*/P. unit	PG	Weight per PU approx.	
		A	MW ¹⁾											
Miniature circuit breakers with plug-in terminal														
	1P													
	10	1			5SJ6110-6KS		001	5SJ6110-7KS		1	1 unit	001	0.117	
	13				5SJ6113-6KS		001	5SJ6113-7KS		1	1 unit	001	0.098	
	16				5SJ6116-6KS		001	5SJ6116-7KS		1	1/12 units	001	0.123	
	20				5SJ6120-6KS		001	5SJ6120-7KS		1	1 unit	001	0.103	
	1P+N													
	10	2			5SJ6510-6KS		001	5SJ6510-7KS		1	1 unit	001	0.209	
	13				5SJ6513-6KS		001	5SJ6513-7KS		1	1 unit	001	0.210	
	16				5SJ6516-6KS		001	5SJ6516-7KS		1	1 unit	001	0.208	
	20				5SJ6520-6KS		001	5SJ6520-7KS		1	1 unit	001	0.209	
	2P													
	10	2			5SJ6210-6KS		001	5SJ6210-7KS		1	1 unit	001	0.229	
	13				5SJ6213-6KS		001	5SJ6213-7KS		1	1 unit	001	0.228	
	16				5SJ6216-6KS		001	5SJ6216-7KS		1	1 unit	001	0.226	
	20				5SJ6220-6KS		001	5SJ6220-7KS		1	1 unit	001	0.226	
	3P													
	10	3			5SJ6310-6KS		001	5SJ6310-7KS		1	1/4 units	001	0.353	
	13				5SJ6313-6KS		001	5SJ6313-7KS		1	1/4 units	001	0.357	
	16				5SJ6316-6KS		001	5SJ6316-7KS		1	1/4 units	001	0.358	
	20				5SJ6320-6KS		001	5SJ6320-7KS		1	1/4 units	001	0.354	

¹⁾ 1 MW (modular width) = 18 mm.

Miniature Circuit Breakers

5SY Miniature Circuit Breakers, 1+N in 1 MW

Introduction

3

Overview

These miniature circuit breakers are used for the protection of systems and installations with switched neutral conductors in distribution boards with little space. They are just a single modular width.

Compact busbars facilitate installation in space-saving distribution boards.

Benefits



- Auxiliary switches and fault signal contacts from the high-capacity range can be freely mounted on these miniature circuit breakers. This increases availability and cuts down on logistics.

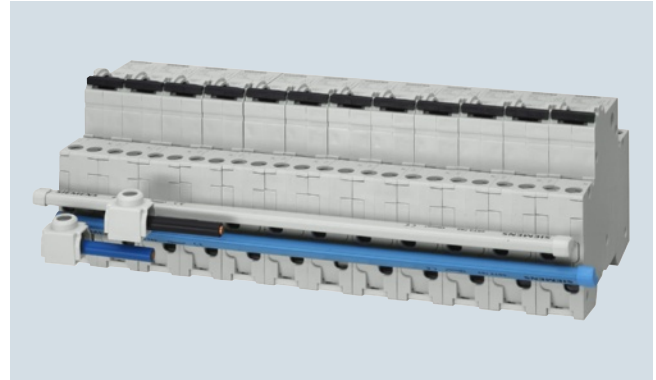

- The infeed can be implemented either from the top or the bottom. Additional terminals with lateral cable entry facilitate mounting when using large conductor cross-sections.

Technical specifications

		5SY30..	5SY60..
Standards		EN 60898-1	
Approvals		See appendix, chapter 20	
Rated voltage U_n	V AC	230	
Operational voltage			
• Min.	V AC/DC	24	
• Max.	V AC	250	
	V	72	
	DC/pole		
Rated making and breaking capacity I_{en}	kA AC	4.5	6
Insulation coordination			
• Rated insulation voltage	V AC	250	
• Pollution degree for overvoltage category		2/III	
Touch protection	Acc. to EN 50274	Yes	
Handle end position, sealable		Yes	
Degree of protection	Acc. to EN 60259	IP20 with connected conductors, IP40 in the handle range with distribution cover	
CFC and silicone-free		Yes	
Terminals	±screw (Pozidriv)	2	
• Solid and stranded, top and bottom terminal	mm ²	0.75 ... 16	
• Finely stranded, with end sleeve, top and bottom terminal	mm ²	0.75 ... 10	
• Terminal tightening torque	Nm	2.0 ... 2.5	
Mounting position		Any	
Service life			
On average, with rated load		20000 actuations at 2 A/4 A and 40 A: 8000 actuations	
Ambient temperature	°C	-25 ... +45, occasionally +55, max. 95 % humidity	
Storage temperature	°C	-40 ... +75	
Resistance to climate	Acc. to IEC 60068-2-30	6 cycles	
Resistance to vibrations	Acc. to IEC 60068-2-6	m/s ²	50 at 25 ... 150 Hz and 60 at 35 Hz (4 sec)



Miniature Circuit Breakers

5SY Miniature Circuit Breakers, 1+N in 1 MW

5SY30, 4 500 A

3

Selection and ordering data

4 500 3		I_n	Mounting width	DT	Characteristic B		Characteristic C		PS*/ P. unit	Weight per PU approx.
		A	MW ¹⁾		Article No.	Price per PU	DT	Article No.	Price per PU	kg
MCBs 4500 A										
1P+N, 230 V AC										
		N connection, right								
		2		--			5SY3002-7		1 unit	0.130
		4		--			5SY3004-7		1 unit	0.129
		6		5SY3006-6			5SY3006-7		1 unit	0.108
		8		--			5SY3008-7		1 unit	0.107
		10		5SY3010-6			5SY3010-7		1 unit	0.110
		13		5SY3013-6			5SY3013-7		1 unit	0.126
		16		5SY3016-6			5SY3016-7		1 unit	0.108
		20		5SY3020-6			5SY3020-7		1 unit	0.111
		25		5SY3025-6			5SY3025-7		1 unit	0.116
		32		5SY3032-6			5SY3032-7		1 unit	0.147
		40		5SY3040-6			5SY3040-7		1 unit	0.107
				N connection, left						
2				--			5SY3002-7KL		1 unit	0.112
4				--			5SY3004-7KL		1 unit	0.127
6				5SY3006-6KL			5SY3006-7KL		1 unit	0.117
8				--			5SY3008-7KL		1 unit	0.107
10				5SY3010-6KL			5SY3010-7KL		1 unit	0.110
13				5SY3013-6KL			5SY3013-7KL		1 unit	0.120
16				5SY3016-6KL			5SY3016-7KL		1 unit	0.106
20				5SY3020-6KL			5SY3020-7KL		1 unit	0.103
25				5SY3025-6KL			5SY3025-7KL		1 unit	0.110
32		5SY3032-6KL			5SY3032-7KL		1 unit	0.117		
40		5SY3040-6KL			5SY3040-7KL		1 unit	0.125		

¹⁾ 1 MW (modular width) = 18 mm.



Miniature Circuit Breakers

5SY Miniature Circuit Breakers, 1+N in 1 MW

5SY60, 6 000 A

3

Selection and ordering data

6 000 3		I_n	Mounting width	DT	Characteristic B			Characteristic C												
					Article No.	Price per PU	PG DT	Article No.	Price per PU	PU (UNIT, SET, M)	PS*/P. unit	PG	Weight per PU approx.							
Miniature circuit breakers, compact, 1+N (1P+N), 230 V AC																				
		N pole, right																		
		2	1	--				5SY6002-7		1	1 unit	001	0.107							
		4		--				5SY6004-7		1	1 unit	001	0.106							
		6		5SY6006-6		001		5SY6006-7		1	1 unit	001	0.100							
		8		--				5SY6008-7		1	1 unit	001	0.107							
		10		5SY6010-6		001		5SY6010-7		1	1 unit	001	0.100							
		13		5SY6013-6		001		5SY6013-7		1	1 unit	001	0.107							
		16		5SY6016-6		001		5SY6016-7		1	1 unit	001	0.100							
		20		5SY6020-6		001		5SY6020-7		1	1 unit	001	0.100							
		25		5SY6025-6		001		5SY6025-7		1	1 unit	001	0.100							
		32		5SY6032-6		001		5SY6032-7		1	1 unit	001	0.111							
		40		5SY6040-6		001		5SY6040-7		1	1 unit	001	0.100							
		N pole, left																		
		2	1	--				5SY6002-7KL		1	1 unit	001	0.106							
		4		--				5SY6004-7KL		1	1 unit	001	0.100							
		6		5SY6006-6KL		001		5SY6006-7KL		1	1 unit	001	0.100							
		8		--				5SY6008-7KL		1	1 unit	001	0.107							
		10		5SY6010-6KL		001		5SY6010-7KL		1	1 unit	001	0.100							
		13		5SY6013-6KL		001		5SY6013-7KL		1	1 unit	001	0.107							
		16		5SY6016-6KL		001		5SY6016-7KL		1	1 unit	001	0.100							
		20		5SY6020-6KL		001		5SY6020-7KL		1	1 unit	001	0.100							
		25		5SY6025-6KL		001		5SY6025-7KL		1	1 unit	001	0.100							
		32		5SY6032-6KL		001		5SY6032-7KL		1	1 unit	001	0.112							
		40		5SY6040-6KL		001		5SY6040-7KL		1	1 unit	001	0.100							







1) 1 MW (modular width) = 18 mm

Miniature Circuit Breakers

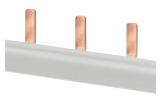
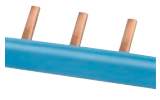
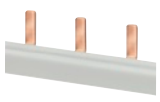
5SY Miniature Circuit Breakers, 1+N in 1 MW

5SY60, 6 000 A

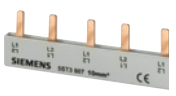
3

	Pin spacing	Length	DT	Article No.	Price per PU	PU (UNIT, SET, M)	PS*/P. unit	PG	Weight per PU approx.
	MW ¹⁾	mm							kg
5ST37 busbar system, 10 mm², for MCB 1+N in 1 MW of the compact range, can be cut, with end caps									
	Single-phase, 12 MW For 12 MCBs 1+N, gray	1	216	5ST3762		1	10 units	020	0.022
	For 12 MCBs 1+N, blue		216	5ST3763		1	10 units	020	0.033
	Single-phase For MCBs 1+N, gray	1	1016	5ST3764		1	10 units	020	0.134
	For MCBs 1+N, blue		1016	5ST3765		1	10 units	020	0.134
End caps for 5ST376 busbars									
	1 set comprises a right and a left cap Gray			5ST3766		1	10 sets	020	0.001
	Blue			5ST3767		1	10 sets	020	0.001
5ST36 busbar systems, 10 mm², for MCBs, fixed lengths, cannot be cut, fully insulated									
	Three-phase For 6 MCBs 1+N For 9 MCBs 1+N For 12 MCBs 1+N	1	102 257.5 210	5ST3613 5ST3614 5ST3615		1 1 1	10 units 10 units 10 units	020 020 020	0.030 0.056 0.075
Terminals for 5ST376									
	Side terminal version For conductors up to 25 mm ²			5ST3768		1	25 units	020	0.018

¹⁾ 1 MW (modular width) = 18 mm.

Dimensional drawings

5ST36 Pin spacing in MW

Dimensions of side view in mm (approx.).

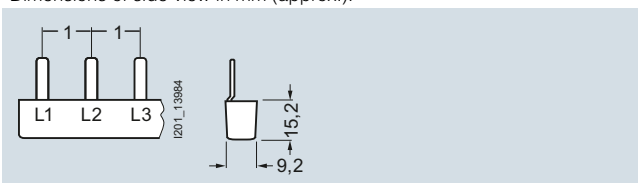

5ST3613
5ST3614
5ST3615

5ST37 Pin spacing in MW

Dimensions of side view in mm (approx.).

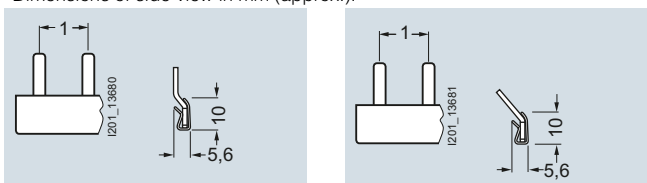

5ST3762
5ST3764

5ST3763
5ST3765

Miniature Circuit Breakers

Additional Components

Electrical components

3

Overview

The Siemens mounting concept supports the combination of all 5ST3 additional components with Siemens 5SY and 5SP miniature circuit breakers and with 5SU1 RCBOs.

5SL and 5SY60 . . miniature circuit breakers are suitable for mounting auxiliary switches and fault signal contacts. Auxiliary switches can also be mounted on 5TE8 flush-mounting circuit breakers and 5SG71 MINIZED switch disconnectors.

Auxiliary switches (AS)

The auxiliary switch (AS) always signals the contact position of the miniature circuit breaker, regardless of whether the miniature circuit breaker was tripped manually or as the result of a fault. An additional version is also available for the switching of small currents and voltages for the control of programmable control systems (PLCs) acc. to EN 61131-2. The auxiliary switch with test button enables the testing of control circuits without the need to switch the miniature circuit breaker.

Fault signal contacts (FC)

The fault signal contact (FC) signals the automatic tripping of the miniature circuit breaker in the event of a fault, such as an overload or a short circuit. If the fault signal contact is activated, the contact position does not change if the miniature circuit breaker is tripped manually. Fault signal contacts with TEST and RESET buttons enable the testing of control circuits without the need to trip the miniature circuit breaker. The red RESET button integrated in the handle also indicates the automatic tripping of the MCB. The signal can be acknowledged manually using the RESET button.

Shunt trips (ST)

Shunt trips are used for the remote tripping of miniature circuit breakers.

Undervoltage releases (UR)

Undervoltage releases are integrated (e.g. in EMERGENCY-OFF loops), thus ensuring that the MCB trips in the event of an emergency, which, in turn, ensures disconnection of the control circuit according to EN 60204. In the event that the voltage is interrupted or too low, it also trips, i.e. prevents activation of the MCB.

Remote controlled mechanisms (RC)

Remote controlled mechanisms are used for the remote ON/OFF switching of miniature circuit breakers and the remote ON switching of RC units, as well as the local manual switching of these devices. A blocking function permits maintenance work. In the event that a miniature circuit breaker or RC unit is tripped, an acknowledgment must be carried out prior to switching back on. The remote controlled mechanism has an operating mode selector switch with the functions: "Locked", "Manual" and "Remote Switching".

Selector switch position:

OFF: The remote controlled mechanism is switched off, blocked mechanically and can be sealed and/or locked.

RC OFF: Only manual operation is possible.

RC ON: Both manual and remote operation are possible.

In the event that a device is tripped by a fault (RC units, miniature circuit breakers), the handle of the basic device and remote controlled mechanism switches to the OFF position. The operator must then acknowledge the tripping by resetting the remote controlled mechanism (OFF command) before it can be reactivated. This serves the safety of the installation or to protect personnel during maintenance work.

In an RC unit/miniature circuit breaker combination, the RC unit is switched on asynchronously, i.e. prior to the miniature circuit breaker. The RC units for 5SY and 5SP4 can be switched ON via the MCB handle jumper using the supplied actuator attachment. There is no need to switch off the RC unit via the remote controlled mechanism as the MCB contacts ensure disconnection of the electrical circuit.

The switching frequency is max. 2 actuations per minute. If this actuation frequency is exceeded it may cause internal tripping of the remote controlled mechanism as a protection against possible overload. In this case, the remote controlled mechanism must be switched OFF at the function selector switch and not switched back on again for at least 5 minutes. More additional 5ST3 . . . components, such as AS, FC, ST and UR, can be added to the right-hand side of the remote controlled mechanism in line with the Siemens mounting concept.

RC units

RC units can be combined with miniature circuit breakers of characteristic A, B, C and D. They then form a combination of RCCB and MCB for personnel, fire and line protection. The combinations can be tailored to meet individual requirements.

For information on RC units, [please see chapter "Residual Current Protective Devices/Arc Fault Detection Devices \(AFDDs\)"](#).

Benefits

Can be universally retrofitted with all additional components



- The 5SL, 5SY and 5SP miniature circuit breakers are ideal for the quick and easy mounting of auxiliary switches and fault signal contacts.

Captive metal brackets on the additional components ensure the quick and easy mounting of devices on the miniature circuit breakers without the need for tools.

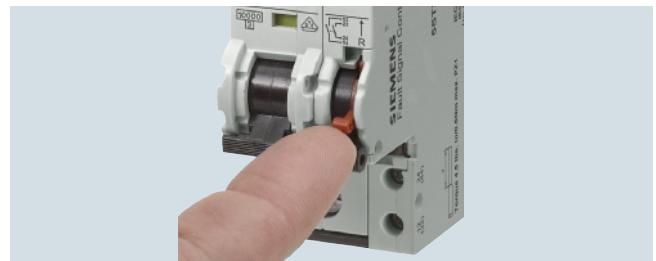

- Fault signal contacts with TEST and RESET button enable the simple testing of auxiliary circuits and, in the event of a fault, acknowledgement of the fault over the RESET button, without the need to switch the miniature circuit breakers.



- The auxiliary switches with TEST button enable the simple manual testing of control circuits during operation of the entire installation without the need to switch the miniature circuit breakers.

Miniature Circuit Breakers

Additional Components

Electrical components

Technical specifications

	Auxiliary switches (AS)		Fault signal contacts (FC)
	5ST3010, 5ST3010-2 5ST3011, 5ST3011-2 5ST3012, 5ST3012-2	5ST3013, 5ST3013-2 5ST3014, 5ST3014-2 5ST3015, 5ST3015-2	5ST3020, 5ST3020-2 5ST3021, 5ST3021-2 5ST3022, 5ST3022-2
Standards	EN 62019; IEC/EN 60947-5-1; UL 1077; CSA C22.2 No. 235		
Approvals	See appendix, chapter 20		
Short-circuit protection	Miniature circuit breaker or gG 6 A fuse		
Contact load			
• Min.	50 mA, 24 V	1 mA/5 V DC	50 mA, 24 V
• Max.	--	50 mA/30 V DC	--
• 400 V AC, AC-14, NO	A 2	--	2
• 230 V AC, AC-14, NO	A 6	--	6
• 400 V AC, AC-13, NC	A 2	--	2
• 230 V AC, AC-13, NC	A 6	--	6
• 220 V DC, DC-13, NO+NC	A 1	--	1
• 110 V DC, DC-13, NO+NC	A 1	--	1
• 60 V DC, DC-13, NO+NC	A 3	--	3
• 24 V DC, DC-13, NO+NC	A 6	--	6
Service life, on average, with rated load	20000 actuations	20000 actuations	20000 actuations
Conductor cross-sections	mm ² AWG	0.5 ... 2.5 22 ... 14	0.5 ... 2.5 22 ... 14
Terminals			
• Terminal tightening torque	Nm lb/in	0.5 4.5	0.5 4.5
Mounting position		Any	Any
Ambient temperature	°C	-25 ... +55	-25 ... +55
Storage temperature	°C	-40 ... +75	-40 ... +75
Resistance to climate	Acc. to IEC 60068-2-30 Cycles	28	
Shock	Acc. to IEC 60068-2-27 m/s	50 at 11 ms half-sine	
Resistance to vibrations	Acc. to IEC 60068-2-6 m/s ²	50 at 10 ... 150 Hz	

	Undervoltage releases (UR)		Shunt trips (ST)		Remote controlled mechanisms (RC)
	5ST304.	5ST3030	5ST3031	5ST3050	
Standards	EN 60947-1				
Rated voltages U_n	V AC	230	110 ... 415	24 ... 48	230
	V DC	24, 110	110	24 ... 48	--
• Operating range U_n		0.85 ... 1.1 × U_n	0.7 ... 1.1 × U_n		0.9 ... 1.15 × U_n
• Rated frequency f_n	Hz	--	50 ... 60		50 ... 60
Response limits					
• Tripping		< 0.35 ... 0.7 × U_n	--		--
Short-circuit protection	Miniature circuit breakers B/C 6 A or fuse gG 6 A				
Minimum contact load		50 mA, 24 V	50 mA, 24 V		--
Tripping operations		max. 2000	max. 2000		--
Service life, on average, with rated load		20000 actuations	20000 actuations		20000 actuations 5000 at RC unit
Conductor cross-sections	mm ² AWG	0.5 ... 2.5 22 ... 14	0.5 ... 2.5 22 ... 14		0.5 ... 2.5 22 ... 14
Terminals					
• Terminal tightening torque	Nm lb/in	0.8 6.8	0.8 6.8		0.4 ... 0.5 4.5
Mounting position		Any	Any		Any
Ambient temperature	°C	-25 ... +55	-25 ... +55		-20 ... +55
Storage temperature	°C	-40 ... +75	-40 ... +75		-40 ... +75
Resistance to climate	Acc. to IEC 60068-2-30 Cycles	28			
Shock	Acc. to IEC 60068-2-27 m/s	50 at 11 ms half-sine			
Resistance to vibrations	Acc. to IEC 60068-2-6 m/s ²	50 at 10 ... 150 Hz			
Switching frequency		--			2 actuations per minute
Switching duration	s	--			< 2
Minimum command duration	s	--			0.2 continuous command possible
Rated power dissipation	VA	--			No power consumption, in switching operation 26
Behavior in the event of control voltage failure		--			No change

For technical information on RC units, please see chapter "Residual Current Protective Devices/Arc Fault Detection Devices (AFDDs)".







Miniature Circuit Breakers

Additional Components

Electrical components

3

Selection and ordering data

	Rated voltage U_n V	Mounting width MW ¹⁾	DT	Article No.	Price per PU	PU (UNIT, SET, M)	PS*/P. unit	PG	Weight per PU approx. kg
	Auxiliary switches (AS) For 5SL, 5SY, 5SP miniature circuit breakers, 5SU1 RCBOs and 5TE8 switches								
	1 NO + 1 NC For low power	0.5	▶	5ST3010		1	1 unit	020	0.066
			▶	5ST3013		1	1 unit	020	0.055
	2 NO For low power			5ST3011		1	1 unit	020	0.055
				5ST3014		1	1 unit	020	0.054
	2 NC For low power			5ST3012		1	1 unit	020	0.055
			5ST3015		1	1 unit	020	0.060	
	Auxiliary switches (AS) with TEST button For 5SL, 5SY, 5SP miniature circuit breakers, 5SU1 RCBOs and 5TE8 switches								
	1 NO + 1 NC For low power	0.5		5ST3010-2		1	1 unit	020	0.045
				5ST3013-2		1	1 unit	020	0.045
	2 NO For low power			5ST3011-2		1	1 unit	020	0.045
				5ST3014-2		1	1 unit	020	0.045
	2 NC For low power			5ST3012-2		1	1 unit	020	0.045
			5ST3015-2		1	1 unit	020	0.045	
	Fault signal contacts (FC) For 5SL, 5SY, 5SP miniature circuit breakers and 5SU1 RCBOs								
	1 NO + 1 NC	0.5	▶	5ST3020		1	1 unit	020	0.056
	2 NO			5ST3021		1	1 unit	020	0.056
	2 NC			5ST3022		1	1 unit	020	0.057
	Fault signal contacts (FC) with test and acknowledge button For 5SL, 5SY, 5SP miniature circuit breakers and 5SU1 RCBOs								
	1 NO + 1 NC	0.5	▶	5ST3020-2		1	1 unit	020	0.050
	2 NO			5ST3021-2		1	1 unit	020	0.050
	2 NC			5ST3022-2		1	1 unit	020	0.050
	Undervoltage releases (UR) For 5SY, 5SP MCBs and 5SU1 RCBOs, but not suitable for use with 5SY60.. and 5SL6 miniature circuit breakers								
	With integrated auxiliary switch								
	230 AC	1	▶	5ST3040		1	1 unit	020	0.107
	110 DC			5ST3041		1	1 unit	020	0.105
	24 DC			5ST3042		1	1 unit	020	0.101
	Without integrated auxiliary switch								
	230 AC	1	▶	5ST3043		1	1 unit	020	0.092
	110 DC			5ST3044		1	1 unit	020	0.091
24 DC			5ST3045		1	1 unit	020	0.088	
	Shunt trips (ST) For 5SY, 5SP MCBs and 5SU1 RCBOs, but not suitable for use with 5SY60.. and 5SL6 miniature circuit breakers								
	110 ... 415 V AC	1	▶	5ST3030		1	1 unit	020	0.090
	24 ... 48 V AC/DC	1	▶	5ST3031		1	1 unit	020	0.090
	Remote controlled mechanisms (RC) For 5SY and 5SP MCBs and 5SU1 RCBOs, but not suitable for use with 5SL3, 5SL6, 5TE8...CC miniature circuit breakers								
	230 AC	3.5	▶	5ST3050		1	1 unit	020	0.461





¹⁾ 1 MW (modular width) = 18 mm.

Miniature Circuit Breakers

Additional Components

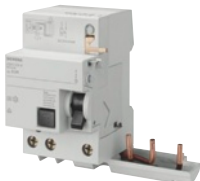
Electrical components

3

	Rated residual current	Rated current	Mounting width	DT	Article No.	Price per PU	PU (UNIT, SET, M)	PS*/P. unit	PG	Weight per PU approx.
	$I_{\Delta n}$ mA	I_n A		MW ¹⁾						kg
RC units, type A, instantaneous tripping										
	For 5SY miniature circuit breakers, not suitable for use with 5SY5, 5SY8 and 5SY60... and 5SL									
	2P, 230 ... 400 V AC, 50 ... 60 Hz									
	10	0.3 ... 16	2		5SM2121-6		1	1 unit	011	0.207
	30	0.3 ... 40			5SM2322-6		1	1 unit	011	0.209
	300				5SM2622-6		1	1 unit	011	0.199
	30	0.3 ... 63			5SM2325-6		1	1 unit	011	0.215
	100			5SM2425-6		1	1 unit	011	0.211	
	300			5SM2625-6		1	1 unit	011	0.203	
	500			5SM2725-6		1	1 unit	011	0.198	
	For 5SY miniature circuit breakers, not suitable for use with 5SY5, 5SY8 and 5SY60... and 5SL									
	3P; 230 ... 400 V AC; 50 ... 60 Hz									
	30	0.3 ... 40	3		5SM2332-6		1	1 unit	011	0.314
	300				5SM2632-6		1	1 unit	011	0.295
	30	0.3 ... 63			5SM2335-6		1	1 unit	011	0.359
	100				5SM2435-6		1	1 unit	011	0.327
	300			5SM2635-6		1	1 unit	011	0.298	
	500			5SM2735-6		1	1 unit	011	0.322	
	For 5SY miniature circuit breakers, not suitable for use with 5SY5, 5SY8 and 5SY60... and 5SL									
	4P, 230 ... 400 V AC, 50 ... 60 Hz									
	30	0.3 ... 40	3		5SM2342-6		1	1 unit	011	0.337
	300				5SM2642-6		1	1 unit	011	0.326
	30	0.3 ... 63			5SM2345-6		1	1 unit	011	0.397
	100				5SM2445-6		1	1 unit	011	0.357
	300			5SM2645-6		1	1 unit	011	0.328	
	500			5SM2745-6		1	1 unit	011	0.326	
	For 5SP4 miniature circuit breakers (characteristics B and C)									
	2P, 125 ... 230 V AC, 50 ... 60 Hz									
	30	80 ... 100	3.5		5SM2327-6		1	1 unit	011	0.529
	300			5SM2627-6		1	1 unit	011	0.458	
	For 5SP4 miniature circuit breakers (characteristics B and C)									
	4P, 230 ... 400 V AC, 50 ... 60 Hz									
	30	80 ... 100	5		5SM2347-6		1	1 unit	011	0.934
	300			5SM2647-6		1	1 unit	011	0.682	

1) 1 MW (modular width) = 18 mm.

Miniature Circuit Breakers

Additional Components

Electrical components

3

Rated residual current	Rated current	Mounting width	DT	Article No.	Price per PU	PU (UNIT, SET, M)	PS*/P. unit	PG	Weight per PU approx.
$I_{\Delta n}$ mA	I_n A		MW ¹⁾						kg
RC units, type A, super resistant K									
For 5SY miniature circuit breakers, not suitable for use with 5SY5, 5SY8 and 5SY60... and 5SL									
2P, 230 ... 400 V AC, 50 ... 60 Hz									
30	0.3 ... 40		2	5SM2322-6KK01		1	1 unit	011	0.215
30	0.3 ... 63			5SM2325-6KK01		1	1 unit	011	0.214
For 5SY miniature circuit breakers, not suitable for use with 5SY5, 5SY8 and 5SY60... and 5SL									
3P; 230 ... 400 V AC; 50 ... 60 Hz									
30	0.3 ... 40		3	5SM2332-6KK01		1	1 unit	011	0.365
30	0.3 ... 63			5SM2335-6KK01		1	1 unit	011	0.365
For 5SY miniature circuit breakers, not suitable for use with 5SY5, 5SY8 and 5SY60... and 5SL									
4P, 230 ... 400 V AC, 50 ... 60 Hz									
30	0.3 ... 40		3	5SM2342-6KK01		1	1 unit	011	0.390
30	0.3 ... 63			5SM2345-6KK01		1	1 unit	011	0.388



RC units, type A, selective S									
For 5SY miniature circuit breakers, not suitable for use with 5SY5, 5SY8 and 5SY60... and 5SL									
2P, 230 ... 400 V AC, 50 ... 60 Hz									
300	0.3 ... 40		2	5SM2622-8		1	1 unit	011	0.210
300	0.3 ... 63			5SM2625-8		1	1 unit	011	0.210
For 5SY miniature circuit breakers, not suitable for use with 5SY5, 5SY8 and 5SY60... and 5SL									
3P; 230 ... 400 V AC; 50 ... 60 Hz									
300	0.3 ... 63		3	5SM2635-8		1	1 unit	011	0.341
500				5SM2735-8		1	1 unit	011	0.323
1000				5SM2835-8		1	1 unit	011	0.304
For 5SY miniature circuit breakers, not suitable for use with 5SY5, 5SY8 and 5SY60... and 5SL									
4P, 230 ... 400 V AC, 50 ... 60 Hz									
300	0.3 ... 63		3	5SM2645-8		1	1 unit	011	0.373
500				5SM2745-8		1	1 unit	011	0.333
1000				5SM2845-8		1	1 unit	011	0.333
For 5SP4 miniature circuit breakers (characteristics B and C)									
2P, 125 ... 230 V AC, 50 ... 60 Hz									
300	80 ... 100		3.5	5SM2627-8		1	1 unit	011	0.519
For 5SP4 miniature circuit breakers (characteristics B and C)									
4P, 230 ... 400 V AC, 50 ... 60 Hz									
300	80 ... 100		5	5SM2647-8		1	1 unit	011	0.838
1000				5SM2847-8		1	1 unit	011	0.706

¹⁾ 1 MW (modular width) = 18 mm.

Miniature Circuit Breakers

Additional Components

Mechanical components

3

Selection and ordering data

Version	Mounting width MW ¹⁾	DT	Article No.	Price per PU	PU (UNIT, SET, M)	PS*/P. unit	PG	Weight per PU approx. kg
 <p>Terminal covers For miniature circuit breakers, not suitable for use with 5SY60... For additional covering of the screw openings per pole, sealable. In the case of 5SY, also prevents removal of device from the standard mounting rail.</p>		▶	5ST3800		1	10 units	020	0.002
 <p>Handle locking devices Sealable to prevent undesired mechanical ON/OFF switching For 5SP and 5SY miniature circuit breakers For padlock with max. 3 mm shackle</p>			5ST3801		1	1 unit	020	0.012
 <p>For 5SL miniature circuit breakers For padlock with 3 ... 6 mm shackle</p>			5ST3806		1	5 units	020	0.007
 <p>Padlocks For 5ST3801 and 5ST3806 handle locking device</p>			5ST3802		1	1 unit	020	0.031
<p>Locking devices For 5SP and 5SY miniature circuit breakers comprising 5ST3801 handle locking device and 5ST3802 padlock</p>			5ST3803		1	1 set	020	0.041
<p>Locking devices For 5SL miniature circuit breakers, comprising 5ST3806 handle locking device and 5ST3802 padlock</p>			5ST3807		1	1 set	020	0.034
 <p>Spacers Can be placed on either side of the standard mounting rail. Two spacers allow for convenient cable routing</p>	0.5		5TG8240		1	2 units	026	0.010
 <p>Fixing parts Made of plastic, for use on a mounting plate</p>			5ST2201		1	1 unit	020	0.013
 <p>Inscription labels 15 mm x 9 mm, 3 frames à 44 labels, can be mounted on casing collar, white, self-adhesive</p>			5ST2173		1	1 set	020	0.049

Labeling system

Inscription on self-adhesive labels for a uniform and tidy appearance in electrical power distribution. The labeling program can be downloaded to your PC free of charge at: www.siemens.com/labeling-tool

Recommended ELAT-3-747 labels for printing on normal printers can be ordered at:

Brady GmbH
Otto-Hahn-Str. 5-7
D-63222 Langen
Tel.: +49 (6103) 7598-660







¹⁾ 1 MW (modular width) = 18 mm

Miniature Circuit Breakers

Additional Components

Mechanical components

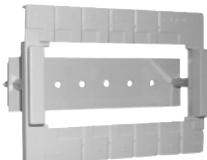
3

Version	DT	Article No.	Price per PU	PU (UNIT, SET, M)	PS*/P. unit	PG	Weight per PU approx. kg
 <p>Terminal covers, gray For surface mounting, degree of protection IP40, sealable, with 35 mm standard mounting rail</p> <ul style="list-style-type: none"> • Up to 2.5 MW • Up to 4.5 MW 		5SW3004		1	1 unit	015	0.091
		5SW3005		1	1 unit	015	0.171
 <p>Wall enclosures, gray For flush mounting, degree of protection IP40 with 35 mm standard mounting rail</p> <ul style="list-style-type: none"> • Up to 2.5 MW • Up to 4.5 MW 		5SW3006		1	1/4 units	015	0.133
		5SW3007		1	1 unit	015	0.162
 <p>Molded-plastic enclosures, gray For surface mounting, degree of protection IP54, with 35 mm standard mounting rail, sealable with transparent hinged lid For 4.5 MW</p>		5SW1200		1	1 unit	015	0.447
 <p>Covers Can be assembled as mini distribution board, suitable for all devices, cover parts prepared for rail mounting of conventional label caps, comprising:</p> <ul style="list-style-type: none"> • End plates (for snapping onto standard mounting rail) • Angled profile (approx. 1 m long) • Alternative flat profiles (as a cover between the rows of devices length approx. 1 m) 	▶	5ST2134		1	10 units	020	0.021
		5ST2135		1	5 units	020	0.288
		5ST2136		1	5 units	020	0.239
 <p>Holders for front panel installation Universal use for devices from 1 to 6 MW Cutout dimensions: Height 45^{+0.5} mm Width: 23, 41, 59, 77, 95 or 113 mm</p>		7LF9006		1	1 unit	025	0.070
 <p>Intermediate frames for 70 mm devices in 55 mm ALPHA SIMBOX distribution boards Versions</p> <ul style="list-style-type: none"> • 1-tier • 2-tier • 3-tier • 4-tier <p>For further information on ALPHA distribution boards, ALPHA SIMBOX small distribution boards and intermediate frames, see chapter "Distribution Boards".</p>		8GB4561		1	1 unit	032	0.900
		8GB4562		1	1 unit	032	1.100
		8GB4563		1	1 unit	032	1.300
		8GB4564		1	1 unit	032	1.500

Miniature Circuit Breakers

Additional Components

Mechanical components

3

More information

The Siemens mounting concept supports the combination of all 5ST3 additional components with miniature circuit breakers of the 5SY and 5SP series and RCBOs of the 5SU1 series.

5SL and 5SY60.. miniature circuit breakers are suitable for mounting auxiliary switches and fault signal contacts. Auxiliary switches can also be mounted on 5TE8 flush-mounting circuit breakers and 5SG71 MINIZED switch disconnectors.

The diagram shows which additional components can be mounted on either the right or the left.

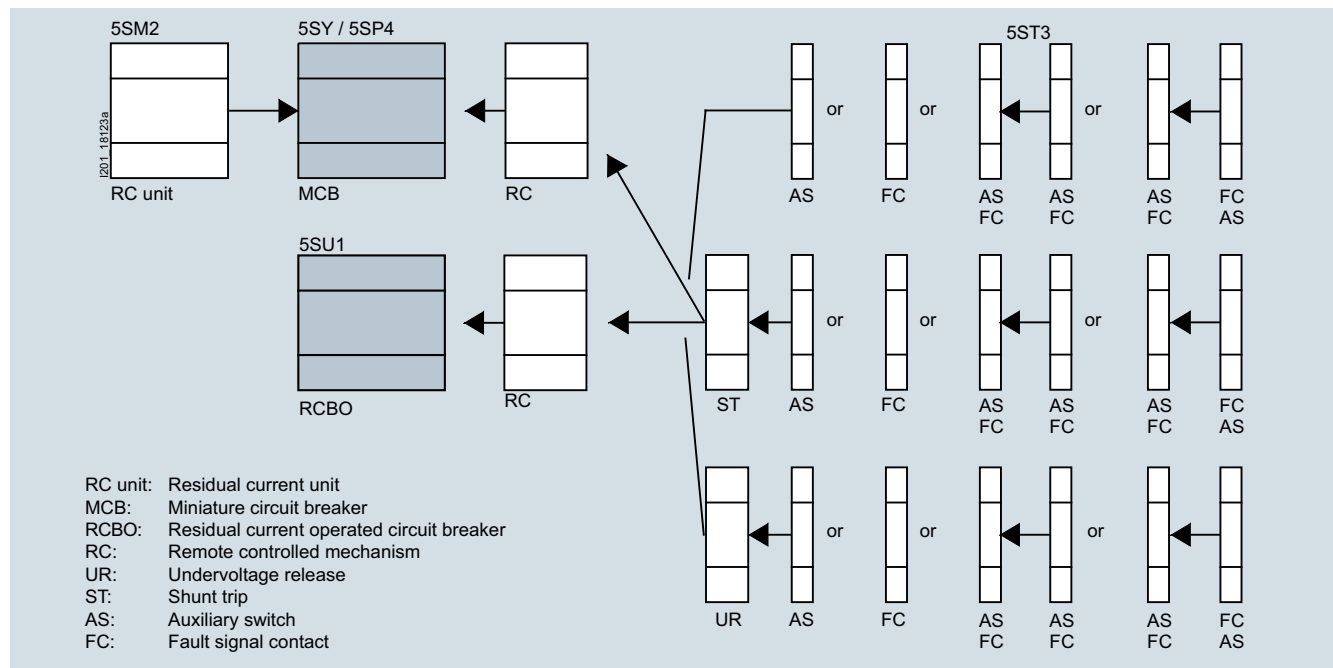

For further information on the mounting concept for RCBOs, see chapter, "Residual Current Protective Devices/Arc Fault Detection Devices (AFDDs)".

Overview

The busbar system with pin-type connections can be used for all 5SL6, 5SJ6...-KS and 5SY miniature circuit breakers with or without mounted auxiliary switch (AS) or fault signal contact (FC).

Busbars in 10 mm² and 16 mm² versions are available.

With bars that can be cut to length, the 5ST37 busbar system can be tailored to any requirements.

The extremely flexible 5ST36 busbar system with fixed lengths also enables installation in any length as the busbars can be overlapped.

No further need for time-consuming tasks, such as cutting, cutting to length, deburring, cleaning of cut surfaces and mounting of end caps.

Any free pins on the busbars can be made safe by covering with touch protection.

For further information on the bus-mounting of miniature circuit breakers with residual current operated circuit breakers, please refer to the chapter "Residual Current Protective Devices/Arc Fault Detection Devices (AFDDs)".

Benefits

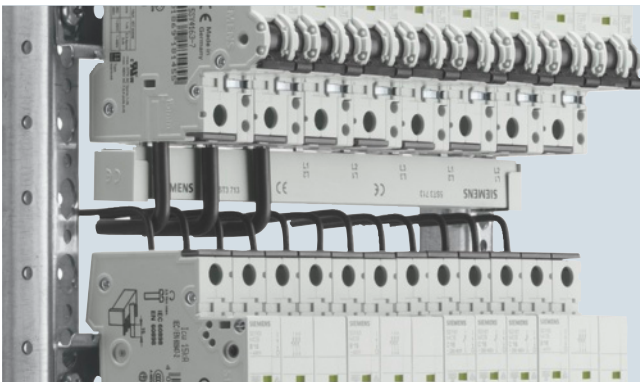

- Between the rows of devices, the busbar, that is located at the bottom and behind the conductor, provides an optimum wiring space with easy view of the inserted conductor. This enables easy control of connections.

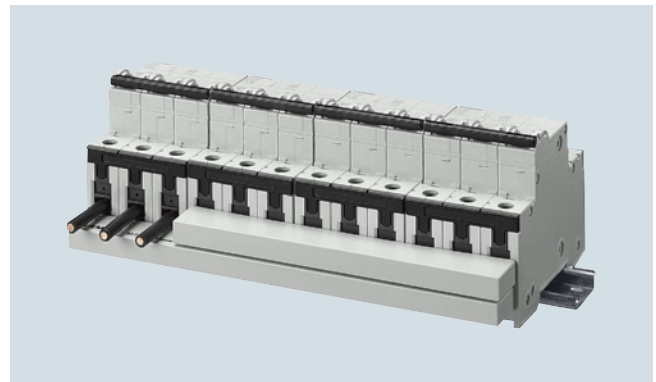

- The ability to overlap when mounting the busbars enables a cross-section enlargement of up to 32 mm² using the respective components, 10 mm² and 16 mm².

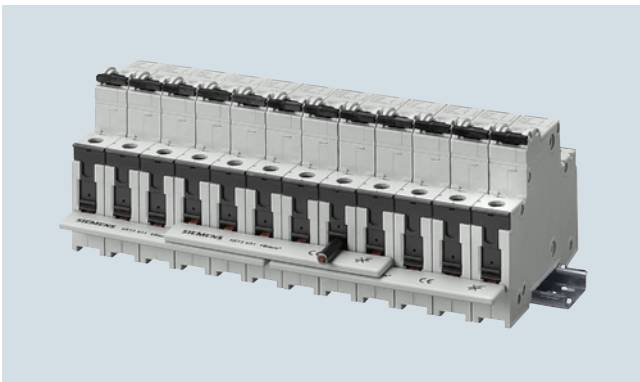

- By overlapping the busbars with fixed lengths, it is possible to achieve device combinations with any number of devices.

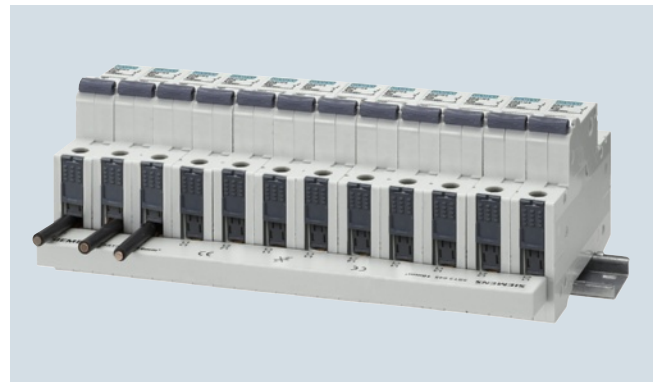

- The fact that the connection of the conductor is always clearly visible facilitates cable entry of all pole types and considerably reduces mounting times.

Miniature Circuit Breakers

Busbars

5ST standard busbars

3

Technical specifications

		5ST3
Standards		EN 60439-1 (VDE 0660-500): 2005-01
Busbar material		SF-Cu F 24
Partition material		Plastic, Cycloy 3600 heat-resistant over 90 °C flame-retardant and self-extinguishing, dioxin and halogen-free
Rated operational voltage U_c	V AC	400
Rated current I_n		
• Cross-section 10 mm ²	A	63
• Cross-section 16 mm ²	A	80
Rated impulse withstand voltage U_{imp}	kV	4
Test pulse voltage (1.2/50)	kV	6.2
Rated conditional short-circuit current I_{cc}	kA	25
Resistance to climate		
• Constant atmosphere	Acc. to DIN 50015	23/83; 40/92; 55/20
• Humid heat	Acc. to IEC 60068-2-30	28 cycles
Insulation coordination		
• Overvoltage category		III
• Pollution degree		2
Maximum busbar current I_S/phase		
• Infeed at the start of the busbar		
- Cross-section 10 mm ²	A	63
- Cross-section 16 mm ²	A	80
• Infeed at the center of the busbar		
- Cross-section 10 mm ²	A	100
- Cross-section 16 mm ²	A	130

Infeed at the start or end of the busbar

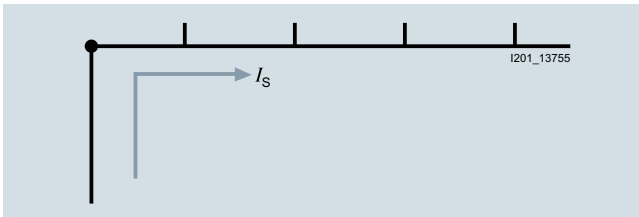

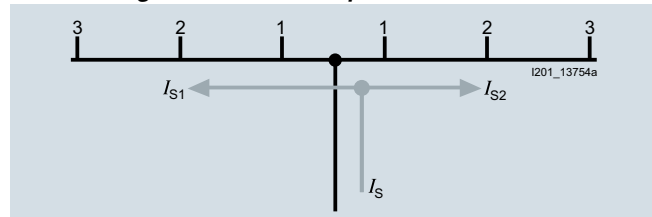

Infeed along the busbar or midpoint infeed



The sum of the outgoing current per branch (1, 2, 3 ... n) must not be greater than the max. busbar current I_S /phase.

Selection and ordering data

	Pin spacing	Length	DT	Article No.	Price per PU	PU (UNIT, SET, M)	PS*/P. unit	PG	Weight per PU approx.
	MW ¹⁾	mm							kg
5ST36 busbar systems, 10 mm², for MCBs, fixed lengths, cannot be cut, fully insulated									
	Single-phase								
	For 2 MCBs 1P	1	33	5ST3600		1	10 units	020	0.009
	For 6 MCBs 1P		105	5ST3601		1	10 units	020	0.019
	For 12 MCBs 1P		210	5ST3602		1	10 units	020	0.047
	Single-phase, for MCBs with AS or FC								
	For 2 MCBs 1P	1.5	40	5ST3603		1	10 units	020	0.010
	For 6 MCBs 1P		156.5	5ST3604		1	10 units	020	0.030
	For 9 MCBs 1P		237	5ST3605		1	10 units	020	0.044
	Two-phase								
	For 2 MCBs 2P	1	75.5	5ST3606		1	10 units	020	0.018
For 3 MCBs 2P		105	5ST3607		1	10 units	020	0.027	
For 6 MCBs 2P		210	5ST3608		1	10 units	020	0.063	
Three-phase									
For 2 MCBs 3P	1	102	5ST3613		1	10 units	020	0.030	
For 3 MCBs 3P		157.5	5ST3614		1	10 units	020	0.056	
For 4 MCBs 3P		210	5ST3615		1	10 units	020	0.075	
Three-phase, for MCBs with AS or FC									
For 2 MCBs 3P	1+1+1.5	115	5ST3616		1	10 units	020	0.038	
For 4 MCBs 3P		237	5ST3617		1	10 units	020	0.090	
For 6 MCBs 1P	1.5	125	5ST3618		1	10 units	020	0.046	
For 9 MCBs 1P		229	5ST3620		1	10 units	020	0.075	
Three-phase									
For 1 RCCB 4P N right and 8 MCBs 1P	1	210	5ST3624		1	10 units	020	0.077	
For 1 RCCB 4P N left and 8 MCBs 1P	1	192	5ST3667		1	10 units	020	0.061	
Four-phase									
For 2 MCBs 4P or 3P+N	1	145	5ST3621		1	10 units	020	0.055	
For 3 MCBs 4P or 3P+N		215	5ST3622		1	10 units	020	0.093	
For 6 MCBs 2P or 1P+N		215	5ST3623		1	10 units	020	0.087	
5ST36 busbars, 16 mm², for MCBs, fixed lengths, cannot be cut, fully insulated									
	Single-phase								
	For 2 MCBs 1P	1	33	5ST3630		1	10 units	020	0.007
	For 6 MCBs 1P		105	5ST3631		1	10 units	020	0.025
	For 12 MCBs 1P		210	5ST3632		1	10 units	020	0.048
	Single-phase, for MCBs with AS or FC								
	For 2 MCBs 1P	1.5	40	5ST3633		1	10 units	020	0.010
	For 6 MCBs 1P		156.5	5ST3634		1	10 units	020	0.029
	For 9 MCBs 1P		237	5ST3635		1	10 units	020	0.052
	Two-phase								
	For 2 MCBs 2P	1	75.5	5ST3636		1	10 units	020	0.012
For 3 MCBs 2P		105	5ST3637		1	10 units	020	0.037	
For 6 MCBs 2P		210	5ST3638		1	10 units	020	0.089	
Two-phase for MCBs with AS or FC									
For 2 MCBs 2P	1 + 1.5	75.5	5ST3640		1	10 units	020	0.024	
For 3 MCBs 2P		120.5	5ST3641		1	10 units	020	0.048	
For 5 MCBs 2P		210	5ST3642		1	10 units	020	0.081	

¹⁾ 1 MW (modular width) = 18 mm.

Miniature Circuit Breakers

Busbars

5ST standard busbars

3

	Pin spacing MW ¹⁾	Length mm	DT	Article No.	Price per PU	PU (UNIT, SET, M)	PS*/P. unit	PG	Weight per PU approx. kg
5ST36 busbars, 16 mm², for MCBs, fixed lengths, cannot be cut, fully insulated									
Three-phase									
For 2 MCBs 3P	1	102.5		5ST3643		1	10 units	020	0.047
For 3 MCBs 3P		157.5		5ST3644		1	10 units	020	0.085
For 4 MCBs 3P		210	▶	5ST3645		1	10 units	020	0.119
Three-phase, for MCBs with AS or FC									
For 2 MCBs 3P	1+1+1.5	115		5ST3646		1	10 units	020	0.052
For 4 MCBs 3P		237		5ST3647		1	10 units	020	0.126
For 6 MCBs 1P	1.5	156		5ST3648		1	10 units	020	0.067
For 9 MCBs 1P		245		5ST3650		1	10 units	020	0.110
Three-phase,									
For 1 RCCB 4P N right and 8 MCBs 1P	1	210		5ST3654		1	10 units	020	0.108
For 1 RCCB 4P N left and 8 MCBs 1P	1	210		5ST3668		1	10 units	020	0.099
Four-phase									
For 2 MCBs 4P or 3P+N	1			5ST3651		1	10 units	020	0.071
For 3 MCBs 4P or 3P+N				5ST3652		1	10 units	020	0.130
For 6 MCBs 2P or 1P+N				5ST3653		1	10 units	020	0.118
Touch protection									
For free connections, yellow (RAL 1004) 5 x 1 pin			▶	5ST3655		1	10 units	020	0.003
10 mm²									
20 x 5ST3613 + 10 x 5ST3614 + 50 x 5ST3615 + 50 x 5ST3655				5ST3656		1	1 set	020	5.460
16 mm²									
20 x 5ST3643 + 10 x 5ST3644 + 50 x 5ST3645 + 50 x 5ST3655				5ST3657		1	1 set	020	7.650
5ST37 busbar system, 10 mm², 12 MW for MCBs, can be cut, with end caps									
Single-phase, angled									
For 12 MCBs 1P	1	214		5ST3730		1	1 unit	020	0.032
For 9 MCBs 1P with AS or FC	1.5			5ST3732		1	1 unit	020	0.034
Two-phase									
For 6 MCBs 2P	1			5ST3734		1	1 unit	020	0.070
For 4 MCBs 2P with AS or FC	1+1.5			5ST3736		1	1 unit	020	0.072
Three-phase									
For 4 MCBs 3P	1		▶	5ST3738		1	1 unit	020	0.084
for 3 MCBs 3P with AS or FC	1+1+1.5			5ST3741		1	1 unit	020	0.078
For 3 MCBs 1P with AS or FC	1.5			5ST3743		1	1 unit	020	0.075
Four-phase									
For 3 MCBs 4P or 3P+N	1			5ST3745		1	1 unit	020	0.119
5ST37 busbar system, 10 mm², 56 MW for MCBs, can be cut, without end caps									
Single-phase, angled									
For MCBs 1P	1	1016		5ST3731		1	1 unit	020	0.153
For MCBs 1P with AS or FC	1.5			5ST3733		1	1 unit	020	0.157
Two-phase									
For MCBs 2P	1			5ST3735		1	1 unit	020	0.343
For MCBs 2P with AS or FC	1+1.5			5ST3737		1	1 unit	020	0.327
Three-phase									
For MCBs 3P	1		▶	5ST3740		1	1 unit	020	0.440
For MCBs 3P with AS or FC	1+1+1.5			5ST3742		1	1 unit	020	0.421
For MCBs 1P with AS or FC	1.5			5ST3744		1	1 unit	020	0.420
Four-phase									
For MCBs 4P or 3P+N	1			5ST3746		1	1 unit	020	0.600



¹⁾ 1 MW (modular width) = 18 mm.

Miniature Circuit Breakers

Busbars

5ST standard busbars

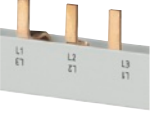
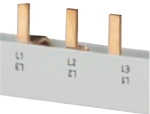
3

	Pin spacing	Length	DT	Article No.	Price per PU	PU (UNIT, SET, M)	PS*/P. unit	PG	Weight per PU approx.
	MW ¹⁾	mm							kg
5ST37 busbar system, 16 mm², 12 MW for MCBs, can be cut, with end caps									
	Single-phase, angled								
	For MCBs 1P	1	214	▶	5ST3700	1	1 unit	020	0.039
	For MCBs 1P with AS or FC	1.5			5ST3702	1	1 unit	020	0.040
	Two-phase								
	For MCBs 2P	1		▶	5ST3704	1	1 unit	020	0.092
	For MCBs 2P with AS or FC	1+1.5			5ST3706	1	1 unit	020	0.090
	Three-phase								
	For MCBs 3P	1		▶	5ST3708	1	1 unit	020	0.116
	For MCBs 3P with AS or FC	1+1+1.5			5ST3711	1	1 unit	020	0.098
	For MCBs 1P with AS or FC	1.5			5ST3713	1	1 unit	020	0.098
Four-phase									
For MCBs 4P or 3P+N	1			5ST3715	1	1 unit	020	0.142	
5ST37 busbar system, 16 mm², 56 MW for MCBs, can be cut, without end caps									
	Single-phase, angled								
	For MCBs 1P	1	1016	▶	5ST3701	1	1 unit	020	0.196
	For MCBs 1P with AS or FC	1.5		▶	5ST3703	1	1 unit	020	0.185
	Two-phase								
	For MCBs 2P	1		▶	5ST3705	1	1 unit	020	0.452
	For MCBs 2P with AS or FC	1+1.5			5ST3707	1	1 unit	020	0.446
	Three-phase								
	For MCBs 3P	1		▶	5ST3710	1	1 unit	020	0.610
	For MCBs 3P with AS or FC	1+1+1.5		▶	5ST3712	1	1 unit	020	0.580
	For MCBs 1P with AS or FC	1.5			5ST3714	1	1 unit	020	0.540
Four-phase									
For MCBs 4P or 3P+N	1			5ST3716	1	1 unit	020	0.798	
5ST37 busbar system, 10 mm², 56 MW, can be cut, without end caps, with touch protection									
Four-phase									
For MCBs 2P and RCBOs 1P+N	1	1008		5ST3770-2	1	10 units	020	0.400	
5ST37 busbar system, 16 mm², 56 MW, can be cut, without end caps, with touch protection									
Four-phase									
For MCBs 2P and RCBOs 1P+N	1	1008		5ST3770-3	1	10 units	020	0.550	
5ST37 busbar system, 10 mm², 16 MW, can be cut, without end caps, with touch protection									
Four-phase									
For RCCBs 4P, N right and 6 MCBs 1P+N	1	288		5ST3770-4	1	10 units	020	0.100	
5ST37 busbar system, 16 mm², 16 MW, can be cut, without end caps, with touch protection									
Four-phase									
For RCCBs 4P, N right and 6 MCBs 1P+N	1	288		5ST3770-5	1	10 units	020	0.160	
End caps for 5ST37, can be cut									
	For single-phase busbars		▶	5ST3748	1	10 units	020	0.001	
	For two-phase and three-phase busbars		▶	5ST3750	1	10 units	020	0.001	
	For four-phase busbars		▶	5ST3718	1	10 units	020	0.002	





¹⁾ 1 MW (modular width) = 18 mm.

Miniature Circuit Breakers

Busbars

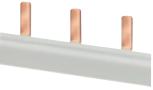
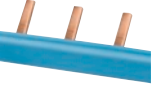
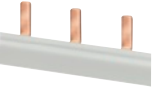
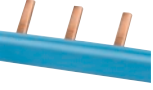
5ST standard busbars

3

	Pin spacing	Length	DT	Article No.	Price per PU	PU (UNIT, SET, M)	PS*/P. unit	PG	Weight per PU approx.
	MW ¹⁾	mm							kg
5ST37 busbar system, 10 mm², 12 MW for MCBs 1+N in 1 MW of the compact range, can be cut, with end caps									
Single-phase									
	For 12 MCBs 1+N, gray	1	216	5ST3762		1	10 units	020	0.022
	For 12 MCBs 1+N, blue	1		5ST3763		1	10 units	020	0.033
5ST37 busbar system, 10 mm², 56 MW for MCBs 1+N in 1 MW of the compact range, can be cut, without end caps									
Single-phase									
	For MCBs 1+N, gray	1	1016	5ST3764		1	10 units	020	0.134
	For MCBs 1+N, blue	1		5ST3765		1	10 units	020	0.134
End caps for 5ST376									
	1 set comprises a right and a left cap Gray			5ST3766		1	10 sets	020	0.001
	Blue			5ST3767		1	10 sets	020	0.001
Terminals for 5ST376									
	Terminal version S For conductors up to 25 mm ²			5ST3768		1	25 units	020	0.018

¹⁾ 1 MW (modular width) = 18 mm.

Dimensional drawings

5ST36

Pin spacing in MW (modular width; 1 MW = 18 mm)

Dimensions of side view in mm (approx.)

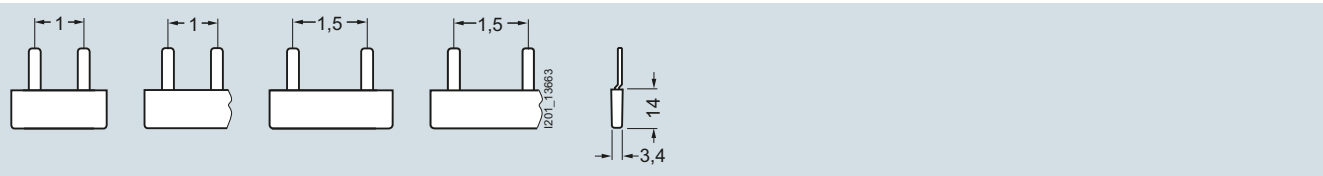

- | | | | |
|---------|---------|---------|---------|
| 5ST3600 | 5ST3601 | 5ST3603 | 5ST3604 |
| 5ST3630 | 5ST3602 | 5ST3633 | 5ST3605 |
| | 5ST3631 | | 5ST3634 |
| | 5ST3632 | | 5ST3635 |

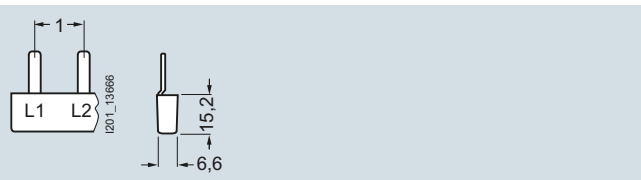

- 5ST3606
5ST3607
5ST3608

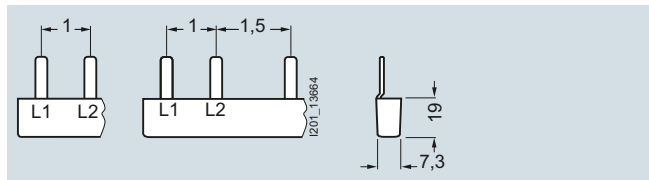

- | | |
|---------|---------|
| 5ST3636 | 5ST3640 |
| 5ST3637 | 5ST3641 |
| 5ST3638 | 5ST3642 |

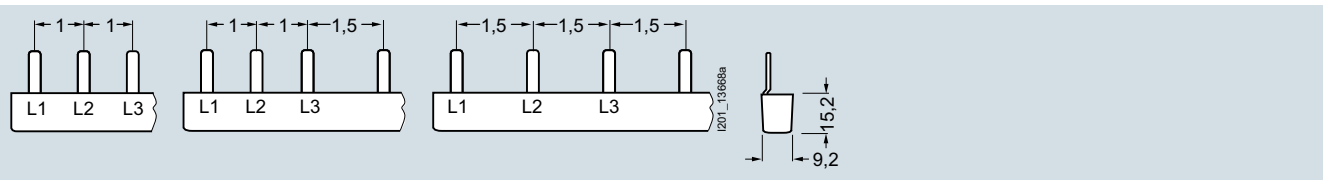

- | | | |
|---------|---------|---------|
| 5ST3613 | 5ST3616 | 5ST3618 |
| 5ST3614 | 5ST3617 | 5ST3620 |
| 5ST3615 | | |
| 5ST3667 | | |

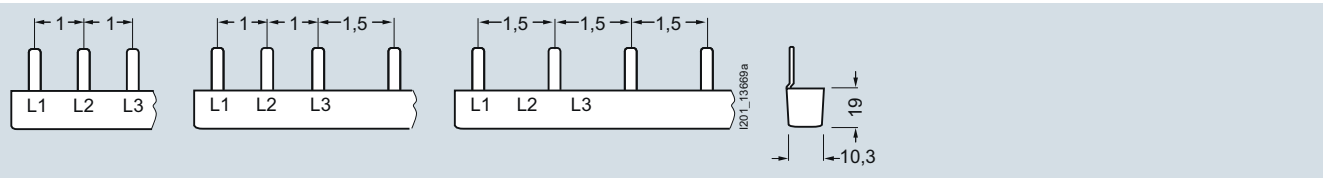

- | | | |
|---------|---------|---------|
| 5ST3643 | 5ST3646 | 5ST3648 |
| 5ST3644 | 5ST3647 | 5ST3650 |
| 5ST3645 | | |
| 5ST3668 | | |

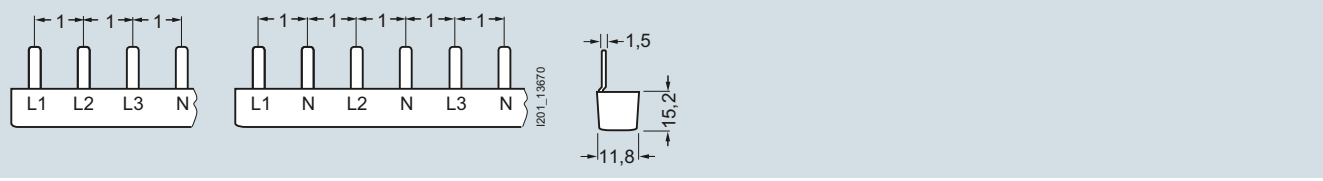

- 5ST3621 5ST3623
5ST3622

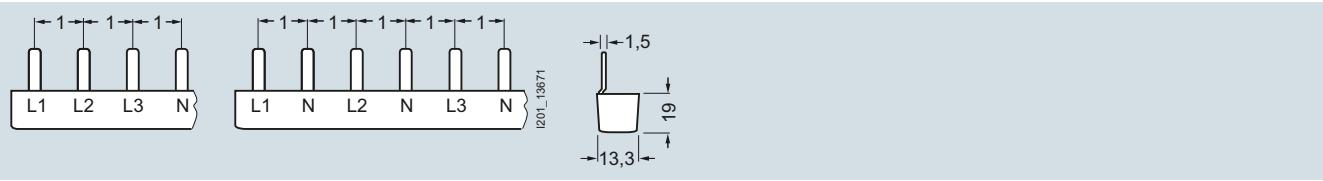

- 5ST3651 5ST3653
5ST3652

Miniature Circuit Breakers

Busbars

5ST standard busbars

3

5ST36

Pin spacing in MW (modular width; 1 MW = 18 mm)

Dimensions of side view in mm (approx.)

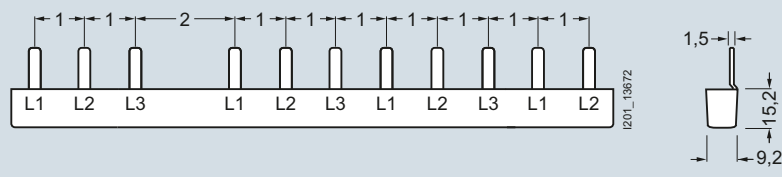

5ST3624

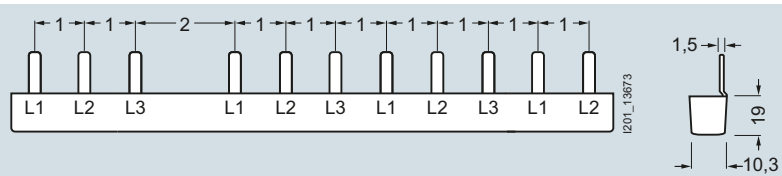

5ST3654

5ST37

Pin spacing in MW (modular width; 1 MW = 18 mm)

Dimensions of side view in mm (approx.)

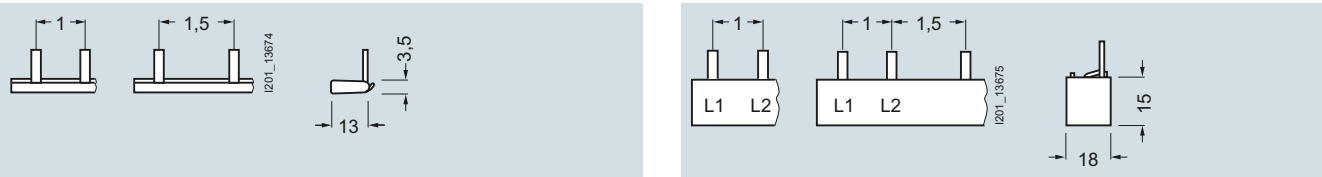

5ST3700 5ST3702
 5ST3701 5ST3703
 5ST3730 5ST3732
 5ST3731 5ST3733
 Single-phase Single-phase

5ST3704 5ST3706
 5ST3705 5ST3707
 5ST3734 5ST3736
 5ST3735 5ST3737
 Two-phase Two-phase

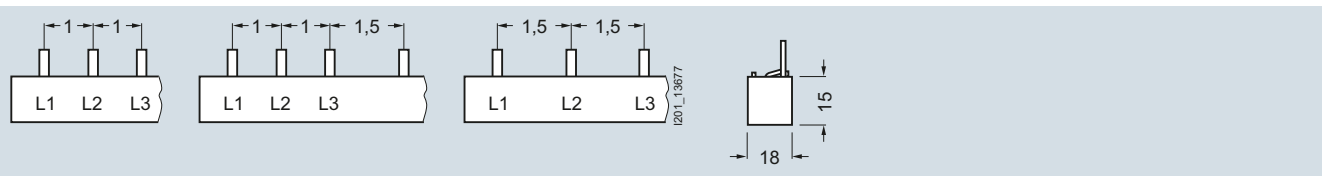

5ST3708 5ST3711 5ST3713
 5ST3710 5ST3712 5ST3714
 5ST3738 5ST3741 5ST3743
 5ST3740 5ST3742 5ST3744

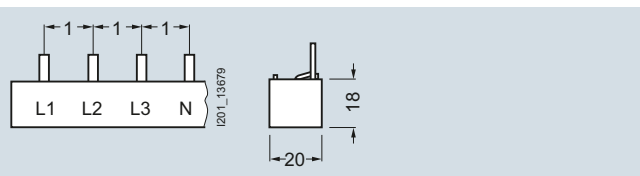

5ST3715
 5ST3716
 5ST3745
 5ST3746

5ST standard busbars

5ST37
Pin spacing in MW (modular width; 1 MW = 18 mm)
 Dimensions of side view in mm (approx.)

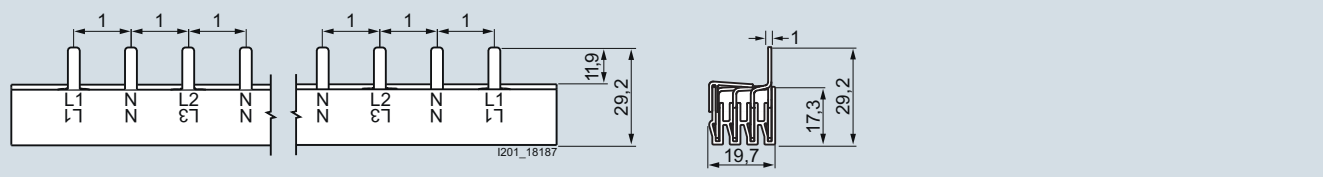

5ST3770-2

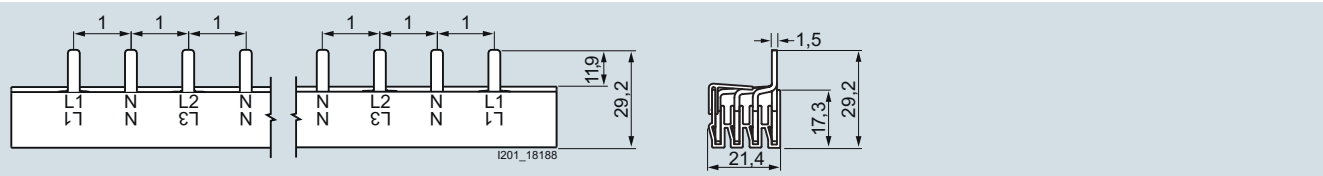

5ST3770-3

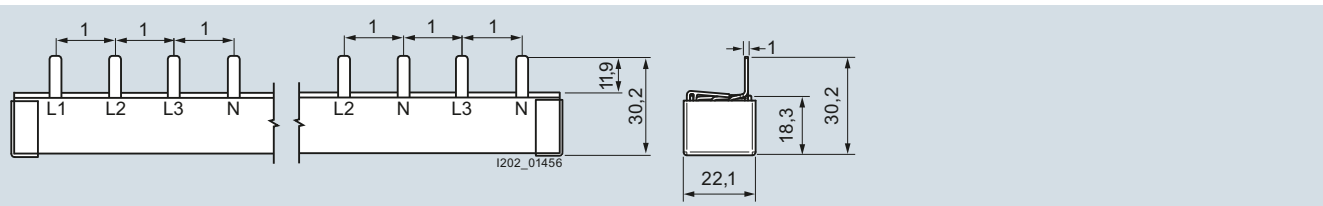

5ST3770-4

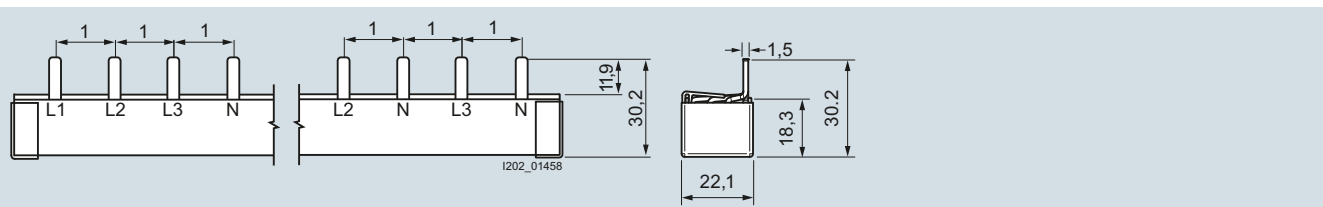

5ST3770-5

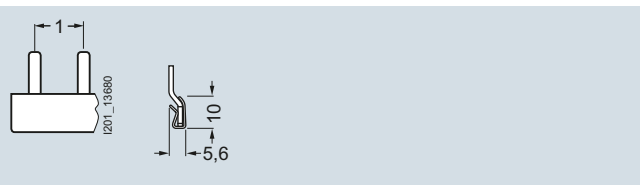

5ST3762
 5ST3764

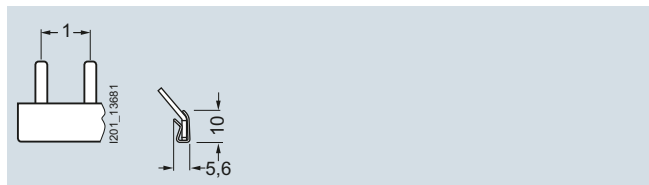

5ST3763
 5ST3765

Miniature Circuit Breakers

Busbars

5ST3 busbars acc. to UL 508

3

Overview

Products according to UL standards are used in North America, but also in several other countries. This is important in particular for exporting machines or electrical switchgear assemblies and equipment to the USA. Acceptance and delivery are possible only if the relevant UL standards are satisfied.

The 5ST37 busbar system according to UL 508 and CSA is suitable for both universal use worldwide with all 5SY and 5SP miniature circuit breakers for "Supplementary Protection" certified according to UL 1077 and for 3NW and 3NC fuse holders certified according to UL 512. Not approved for use in feeder circuits.

The busbars are available in single-, two- and three-phase versions with different pin spacings and with two cross-sections 18 mm² and 25 mm². Infeed can be directly into the terminals of the miniature circuit breaker or through connection terminals.

The connection terminals are available in two versions – for direct infeed at the busbar or for infeed directly at the miniature circuit breaker/fuse holder. Pins that are not required can be covered with touch protection covers.

Benefits

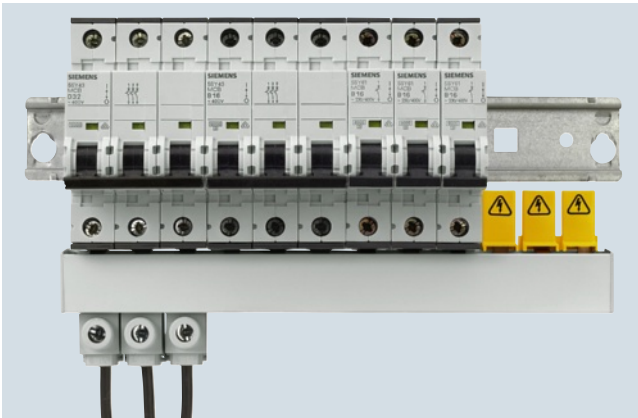

- Busbar with infeed through a connection terminal directly on the miniature circuit breaker up to a conductor cross-section of 35 mm²

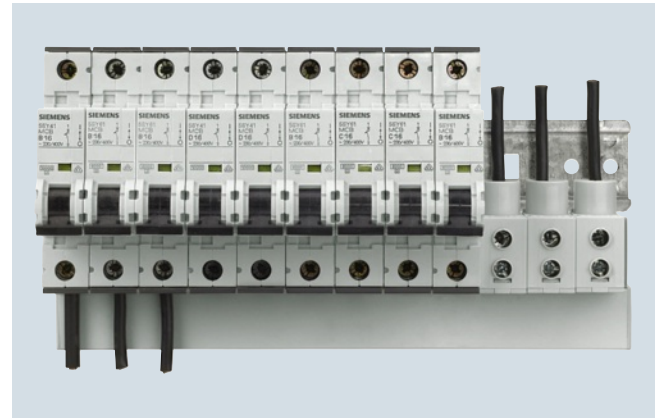

- Infeed directly on the miniature circuit breaker up to a cross-section of 35 mm² and connection terminal for connection directly on the busbar up to a conductor cross-section of 50 mm²
- Suitable for universal use according to both IEC and UL standards
- Can be used for 5SY, 5SP miniature circuit breakers and for Class CC, SITOR cylindrical and semiconductor fuse holders
- UL-tested combination – device and busbar
- Different cross-sections 18 mm² and 25 mm².



- Bus mounting with infeed at the fuse holder for conductor cross-sections up to 35 mm²

Technical specifications

		5ST37...-0HG	5ST37...-2HG	5ST3770-0HG	5ST3770-1HG
Standards		UL 508, CSA C22.2 No. 14-M 95			
Approvals		UL 508 File No. E328403 CSA			
Operational voltage					
• Acc. to IEC	V AC	690			
• Acc. to UL 508	V AC	600			
Rated conditional short-circuit current		10			
• Dielectric strength	kV/mm	25			
• Surge strength	kV	> 9.5			
Rated current	A	--	--	115	
Maximum busbar current I_S/phase					
• Infeed at the start of the busbar	A	80	100	--	--
• Infeed at the center of the busbar	A	160	200	--	--
Insulation coordination					
• Overvoltage category		III			
• Pollution degree		2			
Short-circuit current load capability		10 000 A RMS sym. 600 V for three connections			
	18 mm ²	100 000 A RMS sym. for protection with Class J 175 A			
	25 mm ²	100 000 A RMS sym. for protection with Class J 200 A			
Busbar cross-section	mm ² Cu	18	25	--	--
Infeed		Any			
Conductor cross-sections	AWG mm ²	--	--	10 ... 1/0 6 ... 35 (Cu 60 °C)	14 ... 1 6 ... 50 (Cu 75 °C)
Terminals		±screw (Pozidriv)			
• Terminal tightening torque	Nm lbs/in	--	--	2 5 50	2 3.5 35

Infeed at the start or end of the busbar

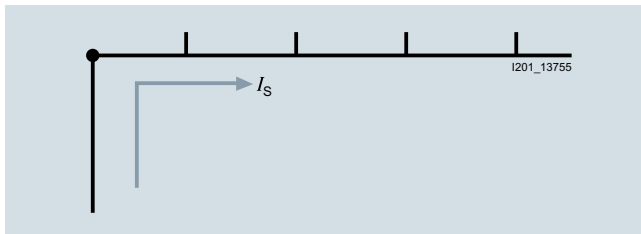

Infeed along the busbar or midpoint infeed

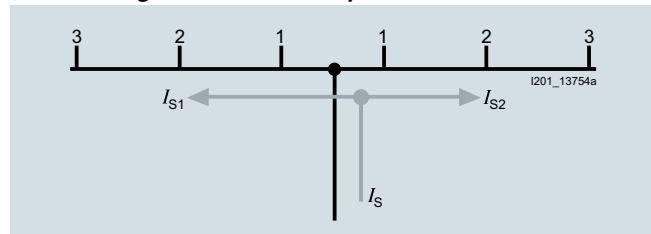

The sum of the outgoing current per branch (1, 2, 3 ... n) must not be greater than the max. busbar current I_S /phase.

Miniature Circuit Breakers

Busbars

5ST3 busbars acc. to UL 508

3

Selection and ordering data

	Pin spacing	Length	DT	Article No.	Price per PU	PU (UNIT, SET, M)	PS*/P. unit	PG	Weight per PU approx.
	MW ¹⁾	mm							kg
5ST37...-HG busbars acc. to UL 508, 18 mm², can be cut, without end caps									
	Single-phase								
	For MCBs 1P (5SY) or fuse holders 10 x 38 mm/class CC (3NC1091, 3NW7513-0HG)	1	1000	5ST3701-0HG		1	1 unit	005	0.330
	For MCBs 1P (5SY, 5SP) with AS or FC or fuse holders 14 x 51 mm (3NC1491, 3NW7111)	1.5	1000	5ST3703-0HG		1	1 unit	005	0.330
	Two-phase								
	For MCBs 2P (5SY) or fuse holders 10 x 38 mm/class CC (3NC1092, 3NW7523-0HG)	1	1000	5ST3705-0HG		1	1 unit	005	0.700
	For MCBs 2P (5SY) with AS or FC	1+1.5	1000	5ST3707-0HG		1	1 unit	005	0.690
	Three-phase								
	For MCBs 3P (5SY) or fuse holders 10 x 38 mm/class CC (3NC1093, 3NW7533-0HG)	1	1000	5ST3710-0HG		1	1 unit	005	0.850
	For MCBs 3P (5SY) with AS or FC	1+1+1.5	1000	5ST3712-0HG		1	1 unit	005	0.850
	For MCBs 1P (5SY, 5SP) with AS or FC or fuse holders 14 x 51 mm (3NC1493, 3NW7131)	1.5	1000	5ST3714-0HG		1	1 unit	005	0.850
5ST37...-HG busbars acc. to UL 508, 25 mm², can be cut, without end caps									
	Single-phase								
	For MCBs 1P (5SP) or fuse holders 14 x 51 mm (3NC1491, 3NW7111)	1.5	1000	5ST3701-2HG		1	1 unit	005	0.340
	Two-phase								
	For MCBs 2P (5SP) or fuse holders 14 x 51 mm (3NC1492, 3NW7121)	1.5	1000	5ST3705-2HG		1	1 unit	005	0.800
	Three-phase								
	For MCBs 3P (5SP) or fuse holders 14 x 51 mm (3NC1493, 3NW7131)	1.5	1000	5ST3710-2HG		1	1 unit	005	1.090
End caps for 5ST37...-HG									
	For single-phase busbars			5ST3748-0HG		1	10 units	005	0.001
	For two- and three-phase busbars			5ST3750-0HG		1	10 units	005	0.002
Terminals according to UL 508									
	Infeed to device 35 mm ²			5ST3770-0HG		1	10 units	005	0.035
	Infeed to busbar 50 mm ²			5ST3770-1HG		1	10 units	005	0.035
Touch protection cover for busbars according to UL 508									
	5 x 1 pin			5ST3655-0HG		1	10 units	005	0.005

¹⁾ 1 MW (modular width) = 18 mm.

Dimensional drawings

5ST37 busbars Pin spacing in MW (modular width; 1 MW = 18 mm)

Dimensions of side view in mm (approx.)

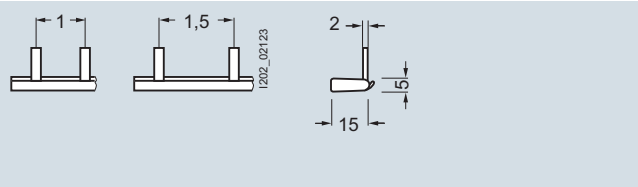

5ST3701-0HG 5ST3703-0HG

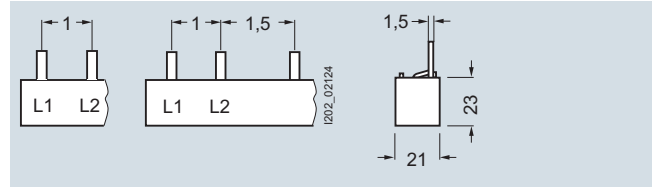

5ST3705-0HG 5ST3707-0HG

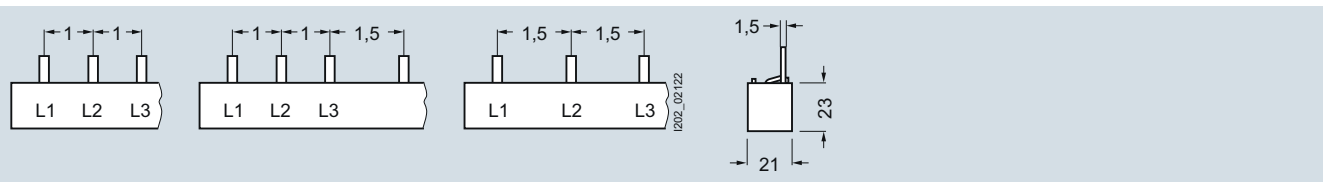

5ST3710-0HG 5ST3712-0HG 5ST3714-0HG

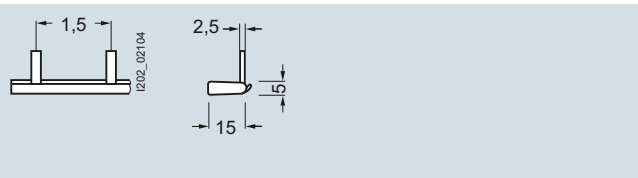

5ST3701-2HG

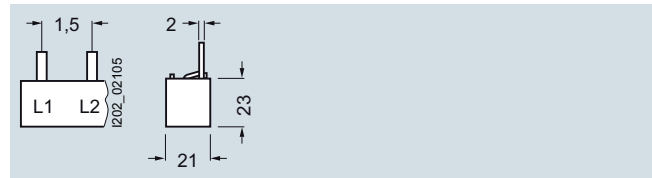

5ST3705-2HG

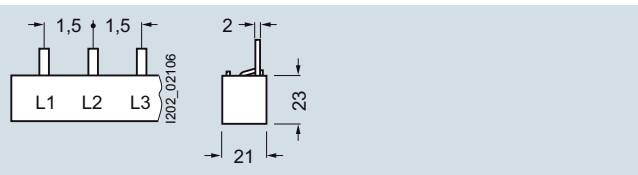

5ST3710-2HG

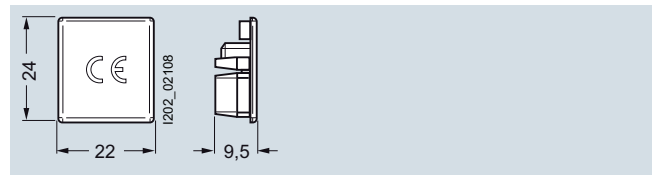

5ST3750-0HG

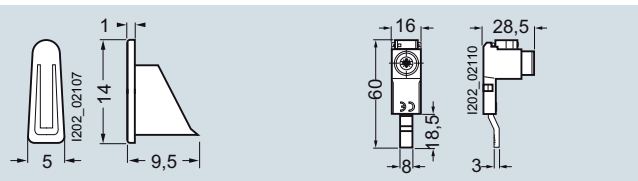

5ST3748-0HG

5ST3770-0HG

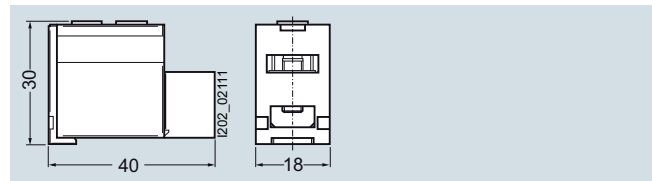

5ST3770-1HG

5ST36 touch protection covers Pin spacing in MW (modular width; 1 MW = 18 mm)

Dimensions of side view in mm (approx.)

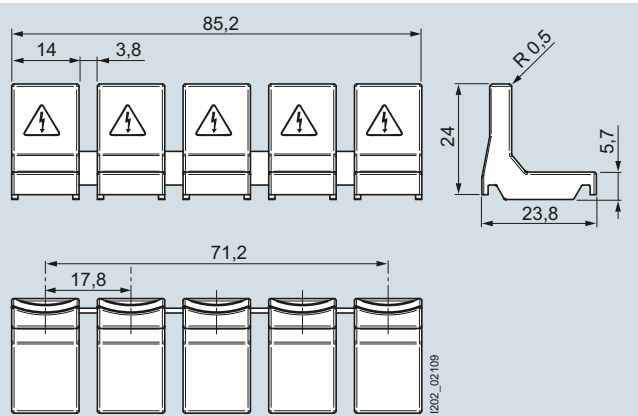

5ST3655-0HG

Miniature Circuit Breakers

Busbars

5ST2 distribution blocks

Overview

Distribution blocks for standard rail mounting

Using distribution blocks it is possible to implement one, two, three and four-phase systems with a rated current of up to 400 A. This allows supply terminals to be divided into several load circuits with different cable cross-sections.

The distribution blocks are made of thermoplastic with electrical and mechanical components, which enables their use under high thermal and mechanical load acc. to IEC 60947-7-1.

Technical specifications

			5ST2501	5ST2502	5ST2503
Standards, certifications			IEC 60947-7-1		
Degree of protection			IP 20		
Poles			4		
Approved cable			Copper		
Conductor cross-section					
• Inputs per pole					
- Solid/stranded conductor acc. to IEC	Neutral conductor	mm ²	1 x 1.5 ... 16/2.5 ... 16	1 x 6 ... 25/6 ... 35	1 x 10 ... 35/10 ... 50
		mm ²	--	1 x 6 ... 25/6 ... 35	--
• Outputs per pole					
- Solid/stranded conductor acc. to IEC	Large	mm ²	8 x 1.5 ... 10/2.5 ... 10	2 x 1.5 ... 10/1.5 ... 16	3 x 6 ... 25/10 ... 35
	Small	mm ²	--	5 x 1.5 ... 6/1.5 ... 6	8 x 1.5 ... 16/2.5 ... 16
	Neutral conductor	Large	--	6 x 1.5 ... 10/1.5 ... 16	--
		Small	--	4 x 1.5 ... 6/1.5 ... 6	--
Tightening torque					
• Inputs		lb/inch	13.5	13.5	17.5
		Nm	1.5	1.5	2
	Plug-in connection		PZ2	PZ2	Allen key (5 mm)
• Outputs	Large	lb/inch	7.2	13.5	13.5
		Nm	0.8	1.5	1.5
	Plug-in connection		PZ1	PZ2	PZ2
	Small	lb/inch	--	7.2	13.5
		Nm	--	0.8	1.5
	Plug-in connection		--	PZ1	PZ2
Operational voltage					
• IEC, max.	V		500	690	500
Overcurrent protection					
• Max. rated current	A		80	125	160
• Rated peak withstand (I_{pk})	kA		21.6	24	20
• Rated short-time withstand current (I_{cw} 1 s)	kA		3	4.2	6.2
Block dimensions (D x H x W)	mm		88 x 49 x 86	75 x 49 x 45	160.5 x 90 x 50

UL types

			5ST2504	5ST2505	5ST2507	5ST2508	5ST2511
Standards, certifications			UL 1059 / UL 486E / IEC 60947-7-1 UL File No. E80027 / XCFR2 C22.2 No. 158 -1987 / XCFR8			UL 486E / IEC 60947-7-1 UL File No. E80027 / XCFR2	
Degree of protection			IP 20				
Poles			1				
Approved cable			Copper				
Wiring type			Factory and field wiring				
• Front/back			Pressure wire connector				
Conductor cross-section							
• Inputs							
- Solid and stranded conductor acc. to UL	Large	AWG	1 x 8 ... 4	1 x 8 ... 2	1 x 8 ... 2 / 0	1 x 2 ... 4 / 0 ¹⁾	1 x 3 / 0 ... 350 MCM
- Solid and stranded conductor acc. to IEC		mm ²	2.5 ... 16	10 ... 35	10 ... 70	35 ... 120 ¹⁾	95 ... 185
- Solid and stranded conductor acc. to UL	Small	AWG	--	1 x 14 ... 4	--		
- Solid and stranded conductor acc. to IEC		mm ²	--	2.5 ... 25	--		
• Outputs							
- Solid and stranded conductor acc. to UL	Top	AWG	4 x 14 ... 10	6 x 14 ... 4	6 x 14 ... 4 ¹⁾	4 x 14 ... 6	4 x 10 ... 14
- Solid and stranded conductor acc. to IEC		mm ²	2.5 ... 6	2.5 ... 16	2.5 ... 25 ¹⁾	1.5 ... 16	2.5 ... 6
- Solid and stranded conductor acc. to UL	Medium	AWG	--			4 x 14 ... 8	
- Solid and stranded conductor acc. to IEC		mm ²	--			1.5 ... 10	
- Solid and stranded conductor acc. to UL	Bottom	AWG	3 x 8 ... 4	--		2 x 14 ... 2 / 1 x 14 ... 6	
- Solid and stranded conductor acc. to IEC		mm ²	2.5 ... 16	--		2 x 6 ... 35 / 1.5 ... 16	
Tightening torque							
• Inputs		lb/inch	13.5	31	35.7	170	230
		Nm	3	3.5	5	19	25
	Plug-in connection			Allen key (4 mm)	Allen key (5 mm)	Allen key (6 mm)	Allen key (8 mm)
• Outputs	Large	lb/inch	13.5	17.5		31	
		Nm	3	2		3.5	
	Plug-in connection		PZ2			Standard screwdriver	
	Small	lb/inch	7.2	--		31	
		Nm	0.8	--		3.5	
	Plug-in connection		PZ1	--		Standard screwdriver	
Ampere per pole, max.	A		80	115	160	230	310
Operational voltage							
• UL, max.	V		600				
• IEC, max.	V		690				
Overcurrent protection							
• Required Class		J					
• Max. rated current	A		80	125	160	250	350
• SCCR RMS Sym A	kA		100				
• Rated peak withstand (I_{pk})	kA		2.7	30		51	
• Rated short-time withstand current (I_{cw} 1 s)	kA		1.9	4.4	11	21	
Clearance							
• Air	inches (mm)		3 / 8 (9.5)				
• Creepage distance	inches (mm)		1 / 2 (12.7)				
Fire class			UL 94V-0				
Block dimensions (D x H x W)	mm		66 x 49 x 27	74 x 49 x 27	92 x 35 x 49	96 x 49 x 45	96 x 49 x 45
Connections			With cable up to 16 mm ²	With connector or cable up to 16 mm ² ²⁾	Lateral incoming feeder for parallel connection with copper bar (max. 16 x 5 mm)	--	--

¹⁾ Only stranded conductors

²⁾ Copper jumper is tested for a rated current of 100 A





Miniature Circuit Breakers

Busbars

5ST2 distribution blocks

3

Selection and ordering data

	Version	Standard	I	U	Mounting width	DT	Article No.	Price per PU	PU (UNIT, SET, M)	PS*/P. unit	PG	Weight per PU approx.
			A	V	MW ¹⁾							kg
Distribution blocks												
 5ST2504	1-pole	UL 1059 / UL 486E / IEC 60947-7-1	80	600	1.5		5ST2504		1	1 unit	020	0.072
		UL File No. E80027 / XCFR2	125	600	1.5		5ST2505		1	1 unit	020	0.146
		UL File No. E80027 / XCFR2	160	600	2	▶	5ST2507		1	1 unit	020	0.252
		UL 486E / IEC 60947-7-1	250	600	2.5	▶	5ST2508		1	1 unit	020	0.440
		UL File No. E80027 / XCFR2	350	600	2.5	▶	5ST2511		1	1 unit	020	0.418
 5ST2501	4-pole	IEC 60947-7-1	80	500	5		5ST2501		1	1 unit	020	0.246
		IEC 60947-7-1	125	690	5.5		5ST2502		1	1 unit	020	0.352
		IEC 60947-7-1	160	500	9		5ST2503		1	1 unit	020	0.690
 5ST2503	4-pole	IEC 60947-7-1	160	500	9		5ST2503		1	1 unit	020	0.690
		IEC 60947-7-1	160	500	9		5ST2503		1	1 unit	020	0.690
Accessories												
 5ST2506	Copper jumper 32 mm	Single-phase, for 5ST2505	--	--	--		5ST2506		1	10 units	020	0.012
		Single-phase, for 5ST2505	--	--	--		5ST2506		1	10 units	020	0.012

¹⁾ 1 MW (modular width) = 18 mm

5ST2 distribution blocks

Dimensional drawings

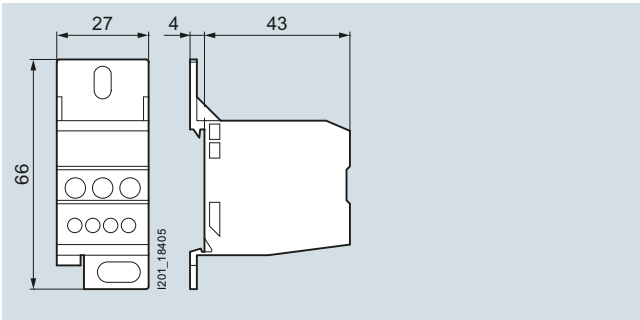

5ST2504

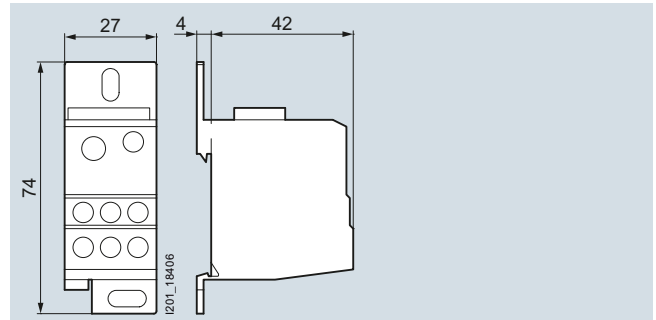

5ST2505

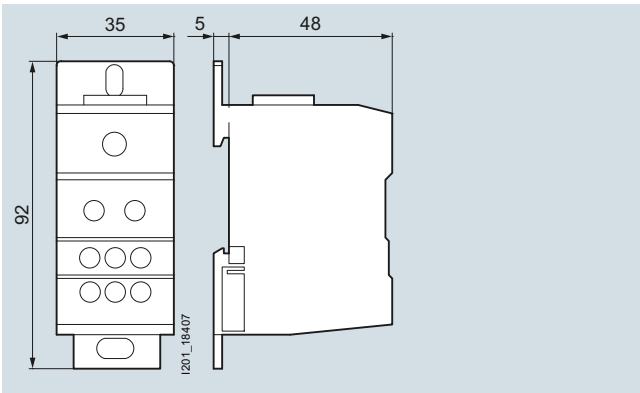

5ST2507

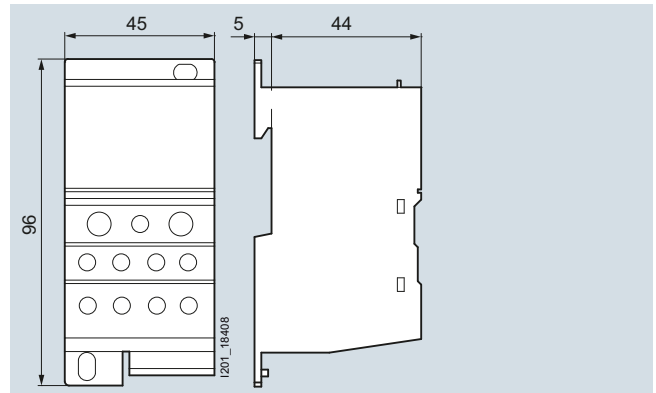

5ST2508

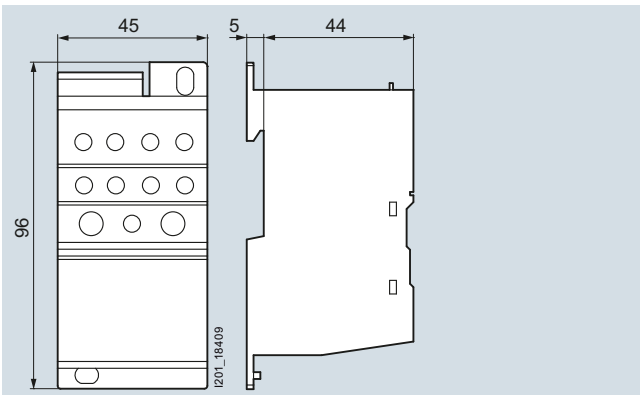

5ST2511

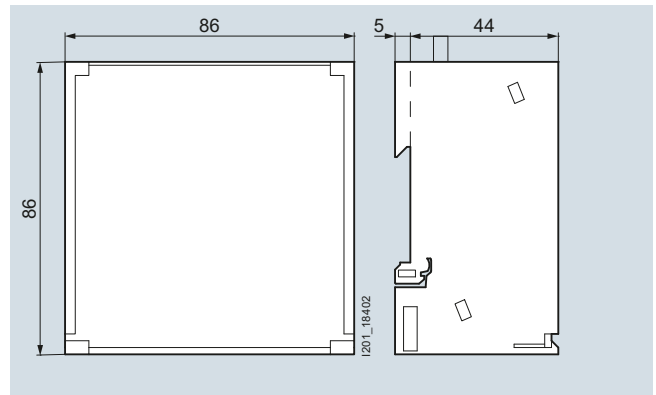

5ST2501

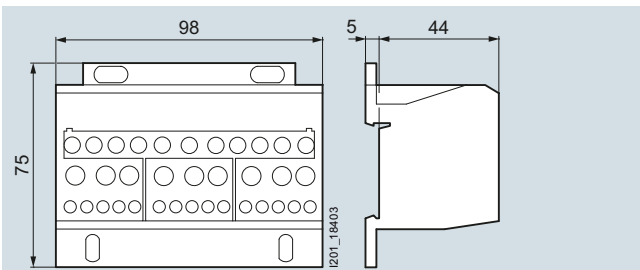

5ST2502

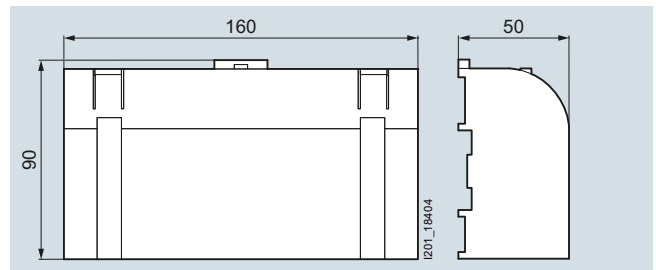

5ST2503

Miniature Circuit Breakers

Busbars

SIKclip wiring system

3

Overview

SIKclip is a fast wiring system that simplifies the connection of control switches:

- For mounting directly on the rear vertical CU busbar system
- Mounting using brackets on the rear of the DIN rail.

The 4-pole busbar can handle loads of up to 250 A, each individual contact up to 63 A.





High degree of protection because each contact is locked individually.

SIKclip is made of thermoplastic acc. to IEC 60439-3 and is suitable for high thermal loads.

Technical specifications

		5ST25..
Test specifications		EN 60947-1, EN 60439-3
Degree of protection		IP20
Max. rated current I_n	A	250 at 40 °C ambient temperature
Max. rated output current I_n	A	63 at 40 °C ambient temperature
Rated operational voltage U_n	V AC	400
Rated insulation voltage	V AC	660
Test voltage	kV	2.5, 50 Hz
Connecting cables		40 A (6 mm ²), 63 A (10 mm ²)
Connecting cable type		H07VK
Ambient temperature	°C	-5 ... +60

Selection and ordering data

	Length	Conductor cross-section	Color of insulation	DT	Article No.	Price per PU	PU (UNIT, SET, M)	PS*/P. unit	PG	Weight per PU approx.
	mm	mm ²								kg
	SIKclip busbar									
	12 MW				5ST2520		1	1 unit	020	0.772
	24 MW			▶	5ST2521		1	1 unit	020	1.400
	36 MW			▶	5ST2522		1	1 unit	020	2.041
	Connecting cables with plug									
	120	6	Black	▶	5ST2523		1	10 units	020	0.011
			Blue	▶	5ST2524		1	10 units	020	0.012
		10	Black		5ST2525		1	10 units	020	0.013
			Blue		5ST2526		1	10 units	020	0.017
	220	6	Black		5ST2527		1	10 units	020	0.019
			Blue		5ST2528		1	10 units	020	0.019
		10	Black		5ST2530		1	10 units	020	0.028
Blue				5ST2531		1	10 units	020	0.027	
	Crimp connectors									
					5ST2532		1	20 units	020	0.006
	For connection to cables 4/6 mm ²									
	Fixing brackets									
				▶	5ST2533		1	2 units	020	0.032
	For mounting on the rear of the standard mounting rail (pair)									

Note:

To install the SIKclip wiring system in the ALPHA AS, the busbars must be installed in a vertical rear position, but not recessed. If the busbars are in a recessed position the cables will not reach the circuit breakers.

Dimensional drawings

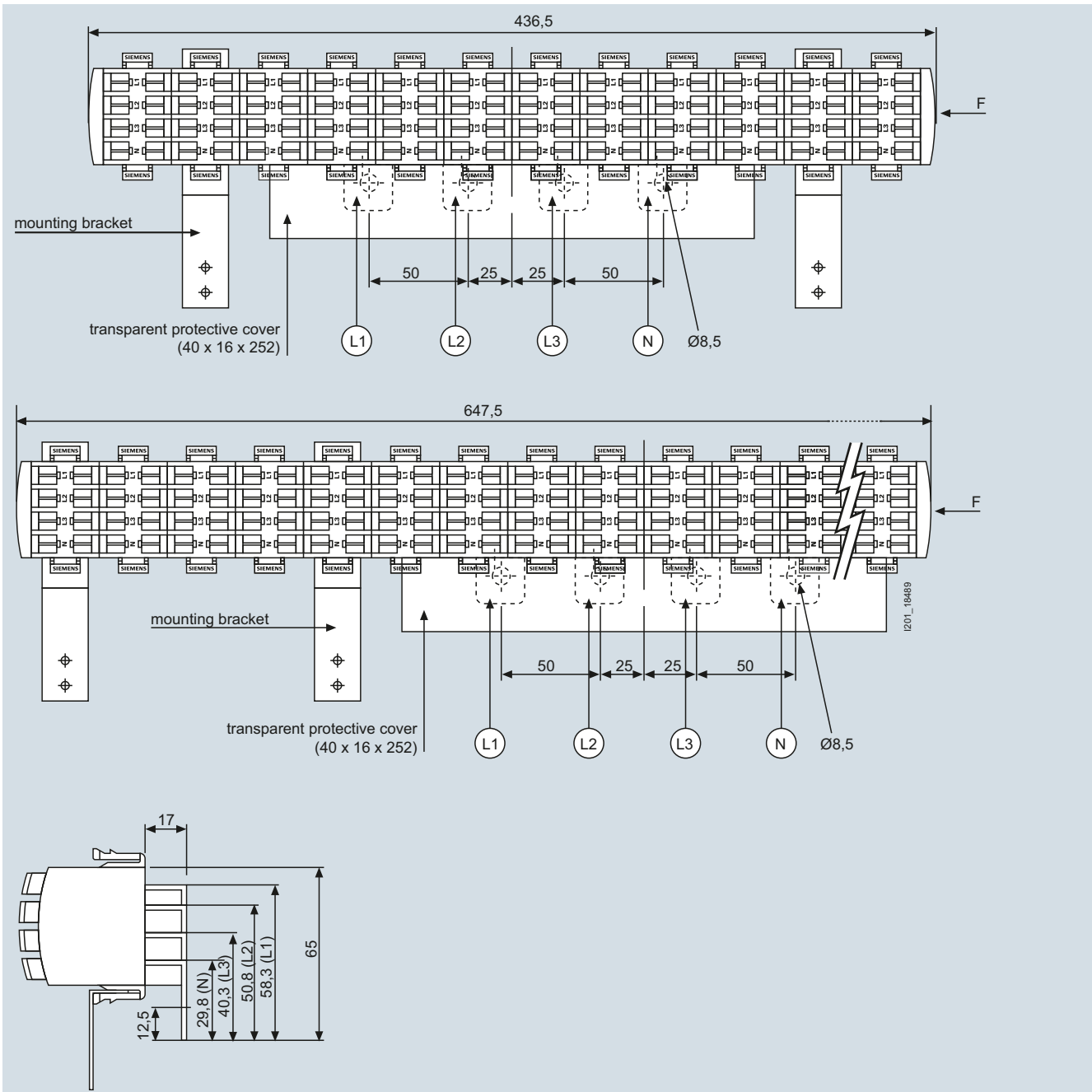

Miniature Circuit Breakers

5SJ4 . . . - .HG miniature circuit breakers acc. to UL 489 and IEC and accessories

3

Overview

UL standards are used in North America as well as in several other countries. This is of particular importance to European exporters of electrical switchgear assemblies and equipment for machines who export to the USA, as their products will only be accepted if they meet the relevant UL standards.

A wide range of low-voltage circuit protection devices from Siemens comply with UL standards and are therefore suitable for implementation worldwide in both IEC/EN and UL applications within the framework of their specified use.

Miniature circuit breakers certified to UL 489 permit use as an all-round solution for protection tasks in distribution boards, control cabinets and control systems to UL 508A as "branch protectors". In particular, they are also approved for the protection of electrical circuits in heating, ventilating and cooling systems (HVAC), as well as for DC applications up to 60 V/125 V.

This covers a wide range of protection tasks, in residential and non-residential buildings, as well as in industry. The tripping characteristics B, C and D to EN/IEC 60898-1 have been adapted so that they fall in the permissible tripping range according to UL 489, as well as for applications at 25 °C and 40 °C.

This means that the devices are approved for use according to both standards. The enclosure dimensions of the devices correspond to DIN format. This means that the device series are suitable for universal use worldwide according to IEC or UL standards.

The key difference between the three device series is their application in different power supply systems.

- 5SJ4 ...-HG40: 240/120 V AC, 1-pole, "same polarity only",
- 5SJ4 ...-HG41: 240 V AC, 1-, 2- and 3-pole,
- 5SJ4 ...-HG42: 480Y/277 V AC, 1-, 2- and 3-pole.

The terminals are suitable for "field wiring". This means that the devices can be installed not only in factory-built distribution boards and control cabinets, but also on-site in a customer system.

Using this mounting concept, all additional 5ST3 . . . -HG components can be combined with miniature circuit breakers of the 5SJ4 . . . -HG range. The auxiliary switch (AS) signals the contact position. In the event of a fault, the fault signal contact (FC) signals the automatic tripping of the MCB as well as the contact position. Shunt trips (ST) are used for the remote tripping of miniature circuit breakers. Captive metal brackets on the additional components ensure fast mounting on the devices.

Single, two and three-phase busbars in 3 lengths with 6, 12 or 18 pins are available as accessories for all device series for "field wiring". The infeed is via connection terminals, which are available in two versions, for direct infeed at either the busbar or the miniature circuit breakers. Pins that are not required can be covered with touch protection covers.

Benefits

- Can be used globally for all applications in residential, non-residential and industrial buildings. This facilitates the planning of installations and enhances export opportunities
- The devices can be used according to IEC/EN 60898-1 and UL 489, which means these devices can be installed anywhere in the world
- Miniature circuit breakers with 480Y/277 V up to 40 A, with 240/120 V and 240 V up to 63 A
- Can be used for both AC voltage and DC voltage up to 125 V
- Rated making and breaking capacity up to 14 kA in acc. with UL 489 and up to 15 kA in acc. with IEC 60947-2
- Fast mounting with busbars up to 115 A and feeder terminals up to 50 mm².

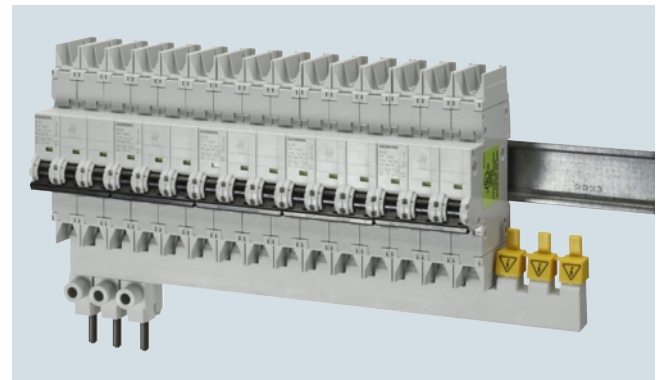

- Infeed direct at miniature circuit breaker for conductor cross-sections up to 35 mm²

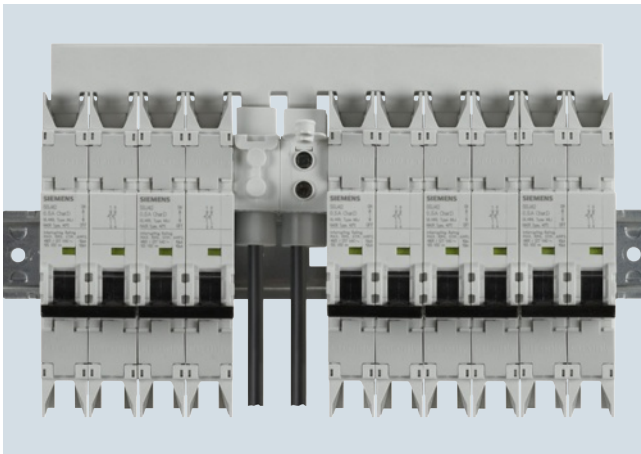

- Bus mounting with central infeed directly on the busbar up to conductor cross-section of 50 mm²



- Accessories: Auxiliary switches, fault signal contacts and shunt trips up to 480 V can be easily mounted onto the miniature circuit breaker.

Technical specifications

		5SJ4 ...-HG40	5SJ4 ...-HG41	5SJ4 ...-HG42
Standards		EN 60947-2; UL 489 (UL File E243414); UL 489A (UL File E332105); CSA C22.2 No. 5-02		
Approvals		See appendix, chapter 20		
Tripping characteristic		B, C, D	C, D	
Rated voltage				
• Acc. to EN 60947-2 • Acc. to UL 489 and CSA C22.2 No.5-02	V AC	230/400	230/400	230/400
	V AC	240/120	240	480/277
	DC V/1P	60	60	60
	DC V/2P	--	125	125
Operational voltage		Min. V AC/DC per pole	24	
• Acc. to IEC 60898-1	Max. V DC/pole	60		
	Max. V AC	250/440		
Rated making and breaking capacity				
• I_{cn} acc. to IEC 60898-1 • I_{cu} acc. to IEC 60947-2 • Acc. to UL 489/UL 489A and CSA C22.2 No. 5-02	kA AC	10		
	kA AC	15		
	kA AC	14/10 ¹⁾	14/10 ¹⁾	10 ¹⁾
Insulation coordination				
• Rated insulation voltage • Pollution degree for overvoltage category	V AC	250	250/440	
		3/III		
Touch protection according to EN 50274		Yes		
Handle end position, sealable		Yes		
Degree of protection in accordance with EN 60529		IP20 with connected conductors, IP40 in the handle range		
CFC and silicone-free		Yes		
Mounting		On standard mounting rail		
Terminals		±screw (Pozidriv)	2	
• Combined terminals at both ends • Terminal tightening torque, only for Cu, 60/75 °C			Yes	
	Nm		3.5	
	lb.in		31	
Conductor cross-sections				
• Solid and stranded, acc. to UL489 and CSA C22.2 No.5-02 • Solid and stranded, according to IEC 60898-1 • Finely stranded, with end sleeve	AWG	14 ... 4		
	mm ²	0.75 ... 35		
	mm ²	0.75 ... 25		
Mains connection		Any		
Mounting position		Any		
Service life, on average, with rated load		20000 actuations		
EMC environment		Suitable for environment "B" (immunity to interference not applicable)		
• Acc. to EN 60947-2				
Ambient temperature		°C	-25 ... +55, max. 95 % humidity	
Storage temperature		°C	-40 ... +75	
Resistance to climate acc. to IEC 60068-2-30		6 cycles		
Resistance to vibrations acc. to IEC 60068-2-6		m/s ²	50 at 25 ... 150 Hz and 60 at 35 Hz (4 sec)	

¹⁾ For detailed information on the rated making and breaking capacity, see engineering manual at: www.siemens.com/lowvoltage/manual.

Additional components		Auxiliary switches (AS)		Fault signal contacts (FC)		Shunt trips (ST)	
		5ST3010-0HG 5ST3011-0HG 5ST3012-0HG	5ST3020-0HG 5ST3021-0HG 5ST3022-0HG	5ST3030-0HG	5ST3031-0HG		
Standards		UL 489, UL File E321559; CSA 22.2 No. 5-02 IEC/EN 62019, IEC/EN 60947-5-1				IEC/EN 60947-1	
Operational voltage/operational current (load)							
• Acc. to IEC	V AC	400	230	110 ... 415		24 ... 60	
	A AC	2	6 (NC: 13 AC, S: AC14)	--		--	
	V DC	220	110 60 24	--		24 ... 60	
	A DC	1	1 3 6 (DC13)	--		--	
• Acc. to UL	V AC	480	277 240 120	110 ... 480		24 ... 60	
	A AC	1.5	3 4 6	--		--	
	V DC	125	60	--		24 ... 60	
	A DC	1	3	--		--	
Short-circuit protection		Miniature circuit breaker or 6 A fuse					
Minimum contact load		50 mA, 24 V					
Tripping operations		--		--		Max. 2000	
Service life, on average, with rated load		12000 actuations					
Primary operating range		x U_n	--			0.7 ... 1.1	
Conductor cross-sections		AWG mm ²	22 ... 14 0.5 ... 2.5		22 ... 14 0.5 ... 2.5		
Terminals		±screw (Pozidriv)	1	1		1	
• Terminal tightening torque	Nm	0.5			0.8		
	lb/in	4.5			6.8		

Miniature Circuit Breakers

5SJ4 . . . - .HG miniature circuit breakers acc. to UL 489 and IEC and accessories

3

Version	Busbars		Terminals	
Type	5ST3663-.HG 5ST3664-.HG 5ST3665-.HG		5ST3666-0HG	5ST3666-2HG
Standards	UL 489; UL File No. E321559			
Operational voltage				
• Acc. to IEC	V AC	690		
• Acc. to UL 489	V AC	480 V (60z)		
Rated conditional short-circuit current	kA	15 (with NH3 355 A gL/gG 500 V)		
• Dielectric strength	kV/mm	30		
• Surge strength	kV	> 9.5		
Rated current at 40 °C ambient temperature	A	115	115 (Cu 75 °C) 95 (Cu 60 °C)	115 (Cu 75 °C) 110 (Cu 60 °C)
Insulation coordination				
• Pollution degree		2		
• Overvoltage category		III		
Busbar cross-section (Cu)	mm ²	16		
Infeed		Any		
Conductor cross-sections				
• AWG cables	AWG	--	14 ... 2	14 ... 1
• Solid and stranded	mm ²	--	1.5 ... 35	1.5 ... 50
Terminals				
• Terminal tightening torque	Nm lb.in	-- --	6 mm Allen key 3,3 30	±screw (Pozidriv) 2 3,3 30
Temperature resistance	°C	200 – UL 94-V0/0.4 mm		
Interrupting rating		10 kA at 240 V AC or 480 V AC		

Note:

The busbars and terminals are suitable for applications up to 80 A if installed in distribution boards with min. dimensions of 18 x 18 x 6.25", or up to 115 A if installed in distribution boards with min. dimensions of 30 x 30 x 10".

Selection and ordering data



I_n	Mounting width	DT	Characteristic B	Price per PU	PU (UNIT, SET, M)	PS*/P. unit	PG	Weight per PU approx.
A	MW ¹⁾		Article No.					kg
MCBs "same polarity only" 1P, 240 V AC								
6	1		5SJ4106-6HG40		1	1 unit	005	0.153
10			5SJ4110-6HG40		1	1 unit	005	0.157
13			5SJ4113-6HG40		1	1 unit	005	0.152
15			5SJ4118-6HG40		1	1 unit	005	0.153
16			5SJ4116-6HG40		1	1 unit	005	0.149
20			5SJ4120-6HG40		1	1 unit	005	0.147
25			5SJ4125-6HG40		1	1 unit	005	0.154
30			5SJ4130-6HG40		1	1 unit	005	0.154
32			5SJ4132-6HG40		1	1 unit	005	0.154
35			5SJ4135-6HG40		1	1 unit	005	0.156
40			5SJ4140-6HG40		1	1 unit	005	0.156
45			5SJ4145-6HG40		1	1 unit	005	0.120
50			5SJ4150-6HG40		1	1 unit	005	0.159
60			5SJ4160-6HG40		1	1 unit	005	0.120
63			5SJ4163-6HG40		1	1 unit	005	0.162

¹⁾ 1 MW (modular width) = 18 mm.



5SJ4 . . . - HG miniature circuit breakers
acc. to UL 489 and IEC and accessories

3

I_n	Mounting width	DT	Characteristic C			Characteristic D			PU (UNIT, SET, M)	PS*/P. unit	PG	Weight per PU approx.
			Article No.	Price per PU	PG DT	Article No.	Price per PU	PG DT				
A	MW ¹⁾										kg	
MCBs "same polarity only" 1P, 240 V AC												
	0.3	1	5SJ4114-7HG40		005	5SJ4114-8HG40		1	1 unit	005	0.152	
	0.5		5SJ4105-7HG40		005	5SJ4105-8HG40		1	1 unit	005	0.152	
	1		5SJ4101-7HG40		005	5SJ4101-8HG40		1	1 unit	005	0.156	
	1.6		5SJ4115-7HG40		005	5SJ4115-8HG40		1	1 unit	005	0.151	
	2		5SJ4102-7HG40		005	5SJ4102-8HG40		1	1 unit	005	0.151	
	3		5SJ4103-7HG40		005	5SJ4103-8HG40		1	1 unit	005	0.139	
	4		5SJ4104-7HG40		005	5SJ4104-8HG40		1	1 unit	005	0.153	
	5		5SJ4111-7HG40		005	5SJ4111-8HG40		1	1 unit	005	0.150	
	6		5SJ4106-7HG40		005	5SJ4106-8HG40		1	1 unit	005	0.150	
	8		5SJ4108-7HG40		005	5SJ4108-8HG40		1	1 unit	005	0.152	
	10		5SJ4110-7HG40		005	5SJ4110-8HG40		1	1 unit	005	0.151	
	13		5SJ4113-7HG40		005	5SJ4113-8HG40		1	1 unit	005	0.147	
	15		5SJ4118-7HG40		005	5SJ4118-8HG40		1	1 unit	005	0.153	
	16		5SJ4116-7HG40		005	5SJ4116-8HG40		1	1 unit	005	0.152	
	20		5SJ4120-7HG40		005	5SJ4120-8HG40		1	1 unit	005	0.152	
	25		5SJ4125-7HG40		005	5SJ4125-8HG40		1	1 unit	005	0.152	
	30		5SJ4130-7HG40		005	5SJ4130-8HG40		1	1 unit	005	0.158	
	32		5SJ4132-7HG40		005	5SJ4132-8HG40		1	1 unit	005	0.156	
	35		5SJ4135-7HG40		005	5SJ4135-8HG40		1	1 unit	005	0.161	
40		5SJ4140-7HG40		005	5SJ4140-8HG40		1	1 unit	005	0.156		
45		5SJ4145-7HG40		005	5SJ4145-8HG40		1	1 unit	005	0.159		
50		5SJ4150-7HG40		005	5SJ4150-8HG40		1	1 unit	005	0.159		
60		5SJ4160-7HG40		005	5SJ4160-8HG40		1	1 unit	005	0.157		
63		5SJ4163-7HG40		005	5SJ4163-8HG40		1	1 unit	005	0.157		
MCBs 1P, 240 V AC												
	0.3	1	5SJ4114-7HG41		005	5SJ4114-8HG41		1	1 unit	005	0.155	
	0.5		5SJ4105-7HG41		005	5SJ4105-8HG41		1	1 unit	005	0.155	
	1		5SJ4101-7HG41		005	5SJ4101-8HG41		1	1 unit	005	0.175	
	1.6		5SJ4115-7HG41		005	5SJ4115-8HG41		1	1 unit	005	0.155	
	2		5SJ4102-7HG41		005	5SJ4102-8HG41		1	1 unit	005	0.168	
	3		5SJ4103-7HG41		005	5SJ4103-8HG41		1	1 unit	005	0.171	
	4		5SJ4104-7HG41		005	5SJ4104-8HG41		1	1 unit	005	0.170	
	5		5SJ4111-7HG41		005	5SJ4111-8HG41		1	1 unit	005	0.155	
	6		5SJ4106-7HG41		005	5SJ4106-8HG41		1	1 unit	005	0.169	
	8		5SJ4108-7HG41		005	5SJ4108-8HG41		1	1 unit	005	0.172	
	10		5SJ4110-7HG41		005	5SJ4110-8HG41		1	1 unit	005	0.173	
	13		5SJ4113-7HG41		005	5SJ4113-8HG41		1	1 unit	005	0.172	
	15		5SJ4118-7HG41		005	5SJ4118-8HG41		1	1 unit	005	0.155	
	16		5SJ4116-7HG41		005	5SJ4116-8HG41		1	1 unit	005	0.172	
	20		5SJ4120-7HG41		005	5SJ4120-8HG41		1	1 unit	005	0.171	
	25		5SJ4125-7HG41		005	5SJ4125-8HG41		1	1 unit	005	0.172	
	30		5SJ4130-7HG41		005	5SJ4130-8HG41		1	1 unit	005	0.155	
	32		5SJ4132-7HG41		005	5SJ4132-8HG41		1	1 unit	005	0.155	
	35		5SJ4135-7HG41		005	5SJ4135-8HG41		1	1 unit	005	0.155	
40		5SJ4140-7HG41		005	5SJ4140-8HG41		1	1 unit	005	0.175		
45		5SJ4145-7HG41		005	5SJ4145-8HG41		1	1 unit	005	0.155		
50		5SJ4150-7HG41		005	5SJ4150-8HG41		1	1 unit	005	0.155		
60		5SJ4160-7HG41		005	5SJ4160-8HG41		1	1 unit	005	0.155		
63		5SJ4163-7HG41		005	5SJ4163-8HG41		1	1 unit	005	0.155		

1) 1 MW (modular width) = 18 mm.

Miniature Circuit Breakers

5SJ4 . . . - HG miniature circuit breakers acc. to UL 489 and IEC and accessories

3

I_n	Mounting width	DT	Characteristic C			Characteristic D			PU (UNIT, SET, M)	PS*/P. unit	PG	Weight per PU approx. kg
			Article No.	Price per PU	PG DT	Article No.	Price per PU	PG DT				
MCBs 2P, 240 V AC												
0.3	2		5SJ4214-7HG41		005	5SJ4214-8HG41		1	1 unit	005	0.310	
0.5			5SJ4205-7HG41		005	5SJ4205-8HG41		1	1 unit	005	0.341	
1			5SJ4201-7HG41		005	5SJ4201-8HG41		1	1 unit	005	0.337	
1.6			5SJ4215-7HG41		005	5SJ4215-8HG41		1	1 unit	005	0.332	
2			5SJ4202-7HG41		005	5SJ4202-8HG41		1	1 unit	005	0.332	
3			5SJ4203-7HG41		005	5SJ4203-8HG41		1	1 unit	005	0.329	
4			5SJ4204-7HG41		005	5SJ4204-8HG41		1	1 unit	005	0.329	
5			5SJ4211-7HG41		005	5SJ4211-8HG41		1	1 unit	005	0.310	
6			5SJ4206-7HG41		005	5SJ4206-8HG41		1	1 unit	005	0.335	
8			5SJ4208-7HG41		005	5SJ4208-8HG41		1	1 unit	005	0.337	
10			5SJ4210-7HG41		005	5SJ4210-8HG41		1	1 unit	005	0.332	
13			5SJ4213-7HG41		005	5SJ4213-8HG41		1	1 unit	005	0.332	
15			5SJ4218-7HG41		005	5SJ4218-8HG41		1	1 unit	005	0.310	
16			5SJ4216-7HG41		005	5SJ4216-8HG41		1	1 unit	005	0.335	
20			5SJ4220-7HG41		005	5SJ4220-8HG41		1	1 unit	005	0.334	
25			5SJ4225-7HG41		005	5SJ4225-8HG41		1	1 unit	005	0.333	
30			5SJ4230-7HG41		005	5SJ4230-8HG41		1	1 unit	005	0.336	
32			5SJ4232-7HG41		005	5SJ4232-8HG41		1	1 unit	005	0.342	
35			5SJ4235-7HG41		005	5SJ4235-8HG41		1	1 unit	005	0.310	
40			5SJ4240-7HG41		005	5SJ4240-8HG41		1	1 unit	005	0.343	
45			5SJ4245-7HG41		005	5SJ4245-8HG41		1	1 unit	005	0.310	
50			5SJ4250-7HG41		005	5SJ4250-8HG41		1	1 unit	005	0.343	
60			5SJ4260-7HG41		005	5SJ4260-8HG41		1	1 unit	005	0.310	
63			5SJ4263-7HG41		005	5SJ4263-8HG41		1	1 unit	005	0.310	
MCBs 3P, 240 V AC												
0.3	3		5SJ4314-7HG41		005	5SJ4314-8HG41		1	1 unit	005	0.465	
0.5			5SJ4305-7HG41		005	5SJ4305-8HG41		1	1 unit	005	0.465	
1			5SJ4301-7HG41		005	5SJ4301-8HG41		1	1 unit	005	0.465	
1.6			5SJ4315-7HG41		005	5SJ4315-8HG41		1	1 unit	005	0.465	
2			5SJ4302-7HG41		005	5SJ4302-8HG41		1	1 unit	005	0.488	
3			5SJ4303-7HG41		005	5SJ4303-8HG41		1	1 unit	005	0.486	
4			5SJ4304-7HG41		005	5SJ4304-8HG41		1	1 unit	005	0.484	
5			5SJ4311-7HG41		005	5SJ4311-8HG41		1	1 unit	005	0.465	
6			5SJ4306-7HG41		005	5SJ4306-8HG41		1	1 unit	005	0.489	
8			5SJ4308-7HG41		005	5SJ4308-8HG41		1	1 unit	005	0.498	
10			5SJ4310-7HG41		005	5SJ4310-8HG41		1	1 unit	005	0.492	
13			5SJ4313-7HG41		005	5SJ4313-8HG41		1	1 unit	005	0.494	
15			5SJ4318-7HG41		005	5SJ4318-8HG41		1	1 unit	005	0.499	
16			5SJ4316-7HG41		005	5SJ4316-8HG41		1	1 unit	005	0.506	
20			5SJ4320-7HG41		005	5SJ4320-8HG41		1	1 unit	005	0.495	
25			5SJ4325-7HG41		005	5SJ4325-8HG41		1	1 unit	005	0.494	
30			5SJ4330-7HG41		005	5SJ4330-8HG41		1	1 unit	005	0.504	
32			5SJ4332-7HG41		005	5SJ4332-8HG41		1	1 unit	005	0.504	
35			5SJ4335-7HG41		005	5SJ4335-8HG41		1	1 unit	005	0.465	
40			5SJ4340-7HG41		005	5SJ4340-8HG41		1	1 unit	005	0.505	
45			5SJ4345-7HG41		005	5SJ4345-8HG41		1	1 unit	005	0.465	
50			5SJ4350-7HG41		005	5SJ4350-8HG41		1	1 unit	005	0.499	
60			5SJ4360-7HG41		005	5SJ4360-8HG41		1	1 unit	005	0.465	
63			5SJ4363-7HG41		005	5SJ4363-8HG41		1	1 unit	005	0.465	

¹⁾ 1 MW (modular width) = 18 mm.

5SJ4 . . . - HG miniature circuit breakers
acc. to UL 489 and IEC and accessories

3

I_n	Mounting width	DT	Characteristic C			Characteristic D			PU (UNIT, SET, M)	PS*/P. unit	PG	Weight per PU approx. kg
			Article No.	Price per PU	PG DT	Article No.	Price per PU	PG DT				
A	MW ¹⁾											
MCBs 1P, 480Y/277 V AC												
0.3	1		5SJ4114-7HG42		005	5SJ4114-8HG42		1	1 unit	005	0.155	
0.5			5SJ4105-7HG42		005	5SJ4105-8HG42		1	1 unit	005	0.155	
1			5SJ4101-7HG42		005	5SJ4101-8HG42		1	1 unit	005	0.155	
1.6			5SJ4115-7HG42		005	5SJ4115-8HG42		1	1 unit	005	0.155	
2			5SJ4102-7HG42		005	5SJ4102-8HG42		1	1 unit	005	0.155	
3			5SJ4103-7HG42		005	5SJ4103-8HG42		1	1 unit	005	0.155	
4			5SJ4104-7HG42		005	5SJ4104-8HG42		1	1 unit	005	0.155	
5			5SJ4111-7HG42		005	5SJ4111-8HG42		1	1 unit	005	0.155	
6			5SJ4106-7HG42		005	5SJ4106-8HG42		1	1 unit	005	0.155	
8			5SJ4108-7HG42		005	5SJ4108-8HG42		1	1 unit	005	0.155	
10			5SJ4110-7HG42		005	5SJ4110-8HG42		1	1 unit	005	0.155	
13			5SJ4113-7HG42		005	5SJ4113-8HG42		1	1 unit	005	0.155	
15			5SJ4118-7HG42		005	5SJ4118-8HG42		1	1 unit	005	0.155	
16			5SJ4116-7HG42		005	5SJ4116-8HG42		1	1 unit	005	0.155	
20			5SJ4120-7HG42		005	5SJ4120-8HG42		1	1 unit	005	0.155	
25			5SJ4125-7HG42		005	5SJ4125-8HG42		1	1 unit	005	0.155	
30			5SJ4130-7HG42		005	5SJ4130-8HG42		1	1 unit	005	0.155	
32			5SJ4132-7HG42		005	5SJ4132-8HG42		1	1 unit	005	0.155	
35			5SJ4135-7HG42		005	--						
40			5SJ4140-7HG42		005	--						
MCBs 2P, 480Y/277 V AC												
0.3	2		5SJ4214-7HG42		005	5SJ4214-8HG42		1	1 unit	005	0.310	
0.5			5SJ4205-7HG42		005	5SJ4205-8HG42		1	1 unit	005	0.310	
1			5SJ4201-7HG42		005	5SJ4201-8HG42		1	1 unit	005	0.310	
1.6			5SJ4215-7HG42		005	5SJ4215-8HG42		1	1 unit	005	0.310	
2			5SJ4202-7HG42		005	5SJ4202-8HG42		1	1 unit	005	0.310	
3			5SJ4203-7HG42		005	5SJ4203-8HG42		1	1 unit	005	0.310	
4			5SJ4204-7HG42		005	5SJ4204-8HG42		1	1 unit	005	0.310	
5			5SJ4211-7HG42		005	5SJ4211-8HG42		1	1 unit	005	0.310	
6			5SJ4206-7HG42		005	5SJ4206-8HG42		1	1 unit	005	0.310	
8			5SJ4208-7HG42		005	5SJ4208-8HG42		1	1 unit	005	0.310	
10			5SJ4210-7HG42		005	5SJ4210-8HG42		1	1 unit	005	0.310	
13			5SJ4213-7HG42		005	5SJ4213-8HG42		1	1 unit	005	0.310	
15			5SJ4218-7HG42		005	5SJ4218-8HG42		1	1 unit	005	0.310	
16			5SJ4216-7HG42		005	5SJ4216-8HG42		1	1 unit	005	0.310	
20			5SJ4220-7HG42		005	5SJ4220-8HG42		1	1 unit	005	0.310	
25			5SJ4225-7HG42		005	5SJ4225-8HG42		1	1 unit	005	0.310	
30			5SJ4230-7HG42		005	5SJ4230-8HG42		1	1 unit	005	0.310	
32			5SJ4232-7HG42		005	5SJ4232-8HG42		1	1 unit	005	0.310	
35			5SJ4235-7HG42		005	--						
40			5SJ4240-7HG42		005	--						

1) 1 MW (modular width) = 18 mm.

Miniature Circuit Breakers

5SJ4 . . . - . HG miniature circuit breakers acc. to UL 489 and IEC and accessories

3

I_n	Mounting width	DT	Characteristic C			Characteristic D			PU (UNIT, SET, M)	PS*/P. unit	PG	Weight per PU approx.
			Article No.	Price per PU	PG	DT	Article No.	Price per PU				
A	MW ¹⁾										kg	
MCBs 3P, 480Y/277 V AC												
	0.3	3	5SJ4314-7HG42		005	5SJ4314-8HG42		1	1 unit	005	0.465	
	0.5		5SJ4305-7HG42		005	5SJ4305-8HG42		1	1 unit	005	0.465	
	1		5SJ4301-7HG42		005	5SJ4301-8HG42		1	1 unit	005	0.465	
	1.6		5SJ4315-7HG42		005	5SJ4315-8HG42		1	1 unit	005	0.465	
	2		5SJ4302-7HG42		005	5SJ4302-8HG42		1	1 unit	005	0.465	
	3		5SJ4303-7HG42		005	5SJ4303-8HG42		1	1 unit	005	0.465	
	4		5SJ4304-7HG42		005	5SJ4304-8HG42		1	1 unit	005	0.465	
	5		5SJ4311-7HG42		005	5SJ4311-8HG42		1	1 unit	005	0.465	
	6		5SJ4306-7HG42		005	5SJ4306-8HG42		1	1 unit	005	0.465	
	8		5SJ4308-7HG42		005	5SJ4308-8HG42		1	1 unit	005	0.465	
	10		5SJ4310-7HG42		005	5SJ4310-8HG42		1	1 unit	005	0.465	
	13		5SJ4313-7HG42		005	5SJ4313-8HG42		1	1 unit	005	0.465	
	15		5SJ4318-7HG42		005	5SJ4318-8HG42		1	1 unit	005	0.465	
	16		5SJ4316-7HG42		005	5SJ4316-8HG42		1	1 unit	005	0.465	
	20		5SJ4320-7HG42		005	5SJ4320-8HG42		1	1 unit	005	0.465	
	25		5SJ4325-7HG42		005	5SJ4325-8HG42		1	1 unit	005	0.465	
	30		5SJ4330-7HG42		005	5SJ4330-8HG42		1	1 unit	005	0.465	
	32		5SJ4332-7HG42		005	5SJ4332-8HG42		1	1 unit	005	0.465	
	35		5SJ4335-7HG42		005	--						
	40		5SJ4340-7HG42		005	--						









	Mounting width	DT	Article No.	Price per PU	PU (UNIT, SET, M)	PS*/P. unit	PG	Weight per PU approx.
Auxiliary switches (AS) acc. to UL 489								
	0.5		5ST3010-0HG		1	1 unit	005	0.071
			5ST3011-0HG		1	1 unit	005	0.050
			5ST3012-0HG		1	1 unit	005	0.050
Fault signal contacts (FC) acc. to UL 489								
	0.5		5ST3020-0HG		1	1 unit	005	0.050
			5ST3021-0HG		1	1 unit	005	0.050
			5ST3022-0HG		1	1 unit	005	0.050
Shunt trips (ST) acc. to UL 489								
	1		5ST3030-0HG		1	1 unit	005	0.098
			5ST3031-0HG		1	1 unit	005	0.098

¹⁾ 1 MW (modular width) = 18 mm.

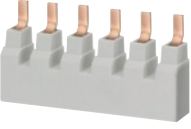
5SJ4 . . . - . HG miniature circuit breakers
acc. to UL 489 and IEC and accessories

3

Accessories

	Pin spacing	Length	DT	Article No.	Price per PU	PU (UNIT, SET, M)	PS*/P. unit	PG	Weight per PU approx.
	MW ¹⁾	mm							kg
Busbars acc. to UL 489 specially for 5SJ4...-HG.. miniature circuit breakers, fixed lengths, cannot be cut²⁾ UL File E321559									
	Single-phase								
	For 6 MCBs 1P	1	100	5ST3663-0HG		1	10 units	005	0.056
	For 12 MCBs 1P		205	5ST3663-1HG		1	10 units	005	0.112
	For 18 MCBs 1P		310	5ST3663-2HG		1	10 units	005	0.170
	Two-phase								
	For 3 MCBs 2P	1	100	5ST3664-0HG		1	10 units	005	0.065
	For 6 MCBs 2P		205	5ST3664-1HG		1	10 units	005	0.137
	For 9 MCBs 2P		310	5ST3664-2HG		1	10 units	005	0.211
	Three-phase								
For 2 MCBs 3P	1	100	5ST3665-0HG		1	10 units	005	0.067	
For 4 MCBs 3P		205	5ST3665-1HG		1	10 units	005	0.155	
For 6 MCBs 3P		310	5ST3665-2HG		1	10 units	005	0.243	
Terminals according to UL 489 specially for 5SJ4...-HG.. miniature circuit breakers									
	Infeed at the miniature circuit breaker								
	Max. 35 mm ²			5ST3666-0HG		1	10 units	005	0.033
	Infeed at the busbar								
	Max. 50 mm ²			5ST3666-2HG		1	10 units	005	0.034
Touch protection covers for busbars acc. to UL 489									
	3 × 1 pin								
				5ST3666-1HG		1	10 units	005	0.003
Handle locking devices according to UL, UL File E321559									
	Can be sealed against undesired manual ON/OFF switching, padlock with max. 3 mm shackle								
				5ST3801		1	1 unit	020	0.012
Padlocks									
	For 5ST3801 handle locking device								
				5ST3802		1	1 unit	020	0.031

1) 1 MW (modular width) = 18 mm.

2) All unassigned pins of the busbar must be covered with 5ST3666-1HG touch protection covers.

Miniature Circuit Breakers

5SJ4 . . . - .HG miniature circuit breakers acc. to UL 489 and IEC and accessories

3

More information

Mounting concept for mounting 5ST30. .-0HG accessories on 5SJ4 . . . - .HG miniature circuit breakers

The diagram shows which additional components can be mounted on the right.

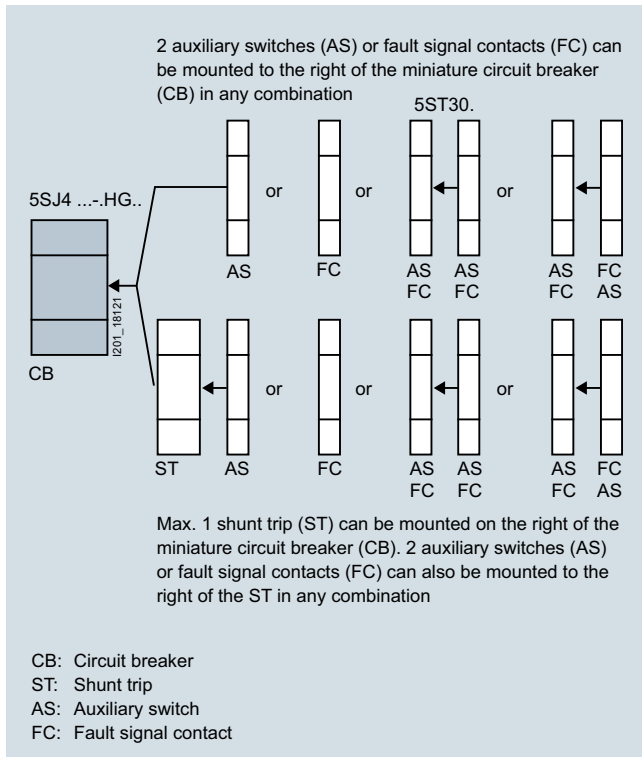

Overview

Selective main miniature circuit breakers are used as circuit breakers at meter panels and provide an optimum solution.

Characteristic E is adapted to the special application requirements for cascade circuits between melting fuses and miniature circuit breakers in distributor circuits.

An integrated adapter enables quick and easy mounting of the devices on 40 mm busbars. The reduced width of 1.5 MW creates lots of additional space in the meter cabinet. The screwless outgoing terminal provides optimum user-friendliness.

Used in conjunction with the downstream miniature circuit breaker, selective main miniature circuit breakers ensure effective protection and optimum availability of the system.

Benefits

- Quick and easy installation as can be snapped directly onto busbar
- Space-saving field installation due to reduced mounting width
- Tool-free connection of meter cable
- Reliable and high selectivity
- Optimum availability of customer system
- Voltage-independent operation of selective main miniature circuit breakers
- Practical locking options
- The selective main miniature circuit breakers support downstream miniature circuit breakers by providing excellent current limitation, thus enhancing system protection
- High and safe selectivity between sub-distribution and meter panel ensures the continued supply of the unaffected circuits in the event of a fault, thus improving system availability
- The selective main miniature circuit breaker prevents the affected circuit from being reconnected until the fault is eliminated. Greater safety during operation
- No previous knowledge required for operation of the selective main miniature circuit breakers. This ensures fast and safe disconnection and reconnection of loads.
- Complies with all the requirements of TAB 2007.

Technical specifications

			5SP37..., 5SP37...-1	5SP37...-2, 5SP37...-2KK0.	5SP38...-2
Standards			DIN VDE 0645	DIN VDE 0641-21	
Rated voltage U_n					
		V AC	230/400		--
		V AC	400	--	400
Operational voltage					
	Min.	V AC	110		
	Max.	V AC	440		
Rated frequency			Hz	50 ... 60	
Rated current I_n			A	16 ... 100	16 ... 63
Rated insulation voltage U_i			V AC	690	
Rated making and breaking capacity I_{en}			A	25000	
Insulation coordination					
			IV		
			3		
Surge strength U_{imp}			kV	6	
Impact resistance				30 g, at least 3 impacts, impact duration 11 ms	
Resistance to vibrations				2 g, 20 frequency cycles 5 ... 150 ... 15 Hz	
Switching position indication				OFF = green, ON = red	
Main switch characteristics			Acc. to EN 60204-1	Yes	
Handle end position, sealable				Yes	
Cutoff			ON/OFF	--	Locking slide with lock, additional wire seal, cable ties and Antilux
Device depth			mm	92	
Degree of protection				IP20, with connected conductors	
Mains connection				Any	
Mounting position				Any	
Mounting				On standard mounting rail or interface adapter	Direct tool-free mounting on the busbar system
Service life, on average, with rated load			Actuations	20000	
Wire connections				Saddle terminals at both ends	
					Screwless spring terminal for flexible cables, in particular for meter connecting cables acc. to DIN 43870-3
					Box terminal, also for infeed to the busbar system, up to 100 A infeed current

Miniature Circuit Breakers

SHU 5SP3 main miniature circuit breakers

3

		5SP37..., 5SP37...-1	5SP37...-2, 5SP37...-2KK0.	5SP38...-2
Conductor cross-sections	• Top and bottom, solid and stranded	mm ² 2.5 ... 70	--	
	• Top and bottom, finely stranded	mm ² 2.5 ... 50	--	
	• Top, finely stranded	mm ² --	2.5 ... 16	
	• Bottom, solid, stranded and finely stranded, with end sleeve	mm ² --	2.5 ... 50	
Storage temperature	°C	-40 ... +70		
Ambient temperature	°C	-25 ... +55		







Selection and ordering data

I_n	Mounting width	DT	Article No.	Price per PU	PU (UNIT, SET, M)	PS*/P. unit	PG	Weight per PU approx.
A	MW ¹⁾							kg
Main miniature circuit breakers, 1P, L1								
For direct busbar mounting (spacing: 40 mm), no further accessories required								
16	1.5		5SP3716-2KK01		1	1 unit	019	0.400
20			5SP3720-2KK01		1	1 unit	019	0.400
25			5SP3725-2KK01		1	1 unit	019	0.400
35			5SP3735-2KK01		1	1 unit	019	0.400
40			5SP3740-2KK01		1	1 unit	019	0.400
50			5SP3750-2KK01		1	1 unit	019	0.400
63			5SP3763-2KK01		1	1 unit	019	0.400
Main miniature circuit breakers, 1P, L2								
For direct busbar mounting (spacing: 40 mm), no further accessories required								
16	1.5		5SP3716-2KK02		1	1 unit	019	0.400
20			5SP3720-2KK02		1	1 unit	019	0.400
25			5SP3725-2KK02		1	1 unit	019	0.400
35			5SP3735-2KK02		1	1 unit	019	0.400
40			5SP3740-2KK02		1	1 unit	019	0.400
50			5SP3750-2KK02		1	1 unit	019	0.400
63			5SP3763-2KK02		1	1 unit	019	0.400
Main miniature circuit breakers, 1P, L3								
For direct busbar mounting (spacing: 40 mm), no further accessories required								
16	1.5		5SP3716-2KK03		1	1 unit	019	0.400
20			5SP3720-2KK03		1	1 unit	019	0.400
25			5SP3725-2KK03		1	1 unit	019	0.400
35			5SP3735-2KK03		1	1 unit	019	0.400
40			5SP3740-2KK03		1	1 unit	019	0.400
50			5SP3750-2KK03		1	1 unit	019	0.400
63			5SP3763-2KK03		1	1 unit	019	0.400
Main miniature circuit breakers, 1P each 1 x L1, L2, L3, packaged as a set								
For direct busbar mounting (spacing: 40 mm), no further accessories required								
16	3 x 1.5		5SP3716-2		1	1 set	019	1.275
20			5SP3720-2		1	1 set	019	1.275
25			5SP3725-2		1	1 set	019	1.275
35			5SP3735-2		1	1 set	019	1.275
40			5SP3740-2		1	1 set	019	1.275
50			5SP3750-2		1	1 set	019	1.275
63			5SP3763-2		1	1 set	019	1.275
Main miniature circuit breakers, 3 x 1P single-pole switching								
For direct busbar mounting (spacing: 40 mm), no further accessories required								
16	4.5		5SP3816-2		1	1 unit	019	1.275
20			5SP3820-2		1	1 unit	019	1.275
25			5SP3825-2		1	1 unit	019	1.275
35			5SP3835-2		1	1 unit	019	1.275
40			5SP3840-2		1	1 unit	019	1.275
50			5SP3850-2		1	1 unit	019	1.275
63			5SP3863-2		1	1 unit	019	1.275

¹⁾ 1 MW (modular width) = 18 mm.

SHU 5SP3 main miniature circuit breakers

3

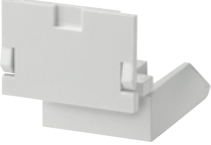
I_n	Mounting width	DT	Article No.	Price per PU	PU (UNIT, SET, M)	PS*/P. unit	PG	Weight per PU approx.
A	MW ¹⁾							kg
Main miniature circuit breakers, 1P								
For mounting on standard mounting rail, busbar (spacing: 40 mm, with 5ST1 busbar adapter), or for screw fixing								
	16	2	5SP3716		1	1 unit	019	0.474
	20		5SP3720		1	1 unit	019	0.461
	25		5SP3725		1	1 unit	019	0.497
	32		5SP3732		1	1 unit	019	0.465
	35		5SP3735		1	1 unit	019	0.497
	40		5SP3740		1	1 unit	019	0.461
	50		5SP3750		1	1 unit	019	0.501
	63		5SP3763		1	1 unit	019	0.517
	80		5SP3780		1	1 unit	019	0.512
	100		5SP3791		1	1 unit	019	0.487
Main miniature circuit breakers, 3 x 1P								
Premounted on 5ST1324 busbar adapter; can be clipped onto busbars (spacing: 40 mm); including three 5ST1323 transparent operating protective covers								
	80	6	5SP3780-1		1	1 set	019	1.827
	100		5SP3791-1		1	1 set	019	1.855
Mounting plates								
For mounting on standard mounting rails according to EN 50022								
	For 1 or 2 standard mounting rails, universal application, tier spacing 125 mm		▶ 5ST1322		1	10 units	019	0.025
Busbar adapters for 5SP37.. and 5SP37..-1								
Suitable for busbar spacing 40 mm can be equipped with 3 selective main miniature circuit breakers								
			5ST1328		1	1 unit	019	0.256
Breaker blocking covers for 5SP37.. and 5SP37..-1								
To prevent manual switching OFF								
			5ST1318		1	10 units	019	0.003
Operating protective covers, transparent, for 5SP37.. and 5SP37..-1								
Multiple locking options against accidental and intentional operation								
	<ul style="list-style-type: none"> • Padlocks • Phillips screwdrivers • Special wrenches (Antilux) • These can be installed by the operator or the power utility 		5ST1323		1	3 units	019	0.011
Terminal covers for 5SP37.. and 5SP37..-1								
2 units required per device Terminal covers in compliance with cladding dimensions acc. to DIN 43880								
			5ST1316		1	6 units	019	0.004

1) 1 MW (modular width) = 18 mm.

Miniature Circuit Breakers

Notes

3