

The Premium Choice in
Landscape Lighting™

KICHLER
LIGHTING





POWERED BY
DESIGN PRO LED
TECHNOLOGY

This installation illuminated exclusively
with Design Pro LED fixtures

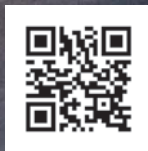

Meet the professionals
behind the lighting

A beautiful landscape starts with you.

Your vision. Your ideas. Kichler® technology. Together, there's nothing we can't do. From the latest, intelligent LED options to traditional incandescent choices, Kichler's complete landscape collection delivers exactly what you need. Leading the way is our Design Pro LED series of fixtures for virtually every outdoor application, including decorative path and spread, low profile hardscape, water feature, deck, patio and accent lighting. You'll find our growing Design Pro LED line also offers the best of both form and function: every fixture is built to deliver beautiful, pure white natural lighting effects and is engineered for optimum all-weather performance. Of course, all Kichler fixtures offer installation-friendly features that add ease to the project without compromising performance.

Start with your ideas and let Kichler help bring them to light.



Become a fan of Kichler Lighting at:
[facebook.com search Kichler Lighting](https://www.facebook.com/search/Kichler+Lighting)



Follow us on
twitter.com/kichlerlight



Watch us on
[youtube.com/KichlerLighting](https://www.youtube.com/KichlerLighting)

Table of Contents



Low Voltage

Design Pro LED Path & Spread8

Design Pro LED Deck & Patio18

Design Pro LED Hardscape,
Deck, Step & Bench24

Design Pro LED Accent32

Design Pro LED Well Lights38

Design Pro LED 2-in-1 Accent Lights
Path & Spread.....44

Speciality78

Deck & Patio84

Accent.....98

Well Lights112

Water Lights116

Transformers.....120

Accessories128

Light Bulbs & Photometrics136

120 Volt & HID

Path & Spread.....144

Accent.....150

Ballast156

Accessories158

Light Bulbs & Photometrics162

Index

Pictorial Index168

Numerical Index174



Design Pro LED
Path & Spread

8



Design Pro LED
Deck & Patio

18



Design Pro LED
Hardscape

24



Design Pro LED
Accent

32



Design Pro LED
2-in-1 Accent

40



Low Voltage Incandescent
Path & Spread

44



Low Voltage Incandescent
Deck & Patio

84



Low Voltage Incandescent
Accent

98



Low Voltage Incandescent
Well Lights

112



Low Voltage
Transformers

120



120 Volt & HID
Path & Spread

144



120 Volt & HID
Accent

150

LOW VOLTAGE

Design Pro LED

LED Landscape Lighting That Goes Above
And Beyond – For You And Your Customers

Path ... spread ... accent ... water ... in ground
... hardscape. You name the outdoor
application, and you'll discover a Kichler Design
Pro LED product to match. You'll not only find
an extensive collection of sought-after LED
choices, but you'll also get benefits you and
your clients will value:

For You

- Durable driver circuits provide a consistent output over a wider range (9 to 15 V) to help you control the voltage-drop headache.
- Easy to install – adapting to almost any application.
- Custom-designed optics put a solid punch of light exactly where you intend.
- Full selection of LED products help you complete a total landscape job.
- Sealed, bulletproof design resists moisture.

For Your Customers

- Pure, beautiful, consistent WHITE light enhances a landscape's natural colors.
- Uses 75% less energy than halogen for long-term cost savings.
- No light bulbs to buy or replace.
- Environmentally friendly design means less energy waste and no bulbs to throw away.
- Tested to withstand the elements for years of enjoyment.
- For complete warranty details, go to landscapelighting.com.

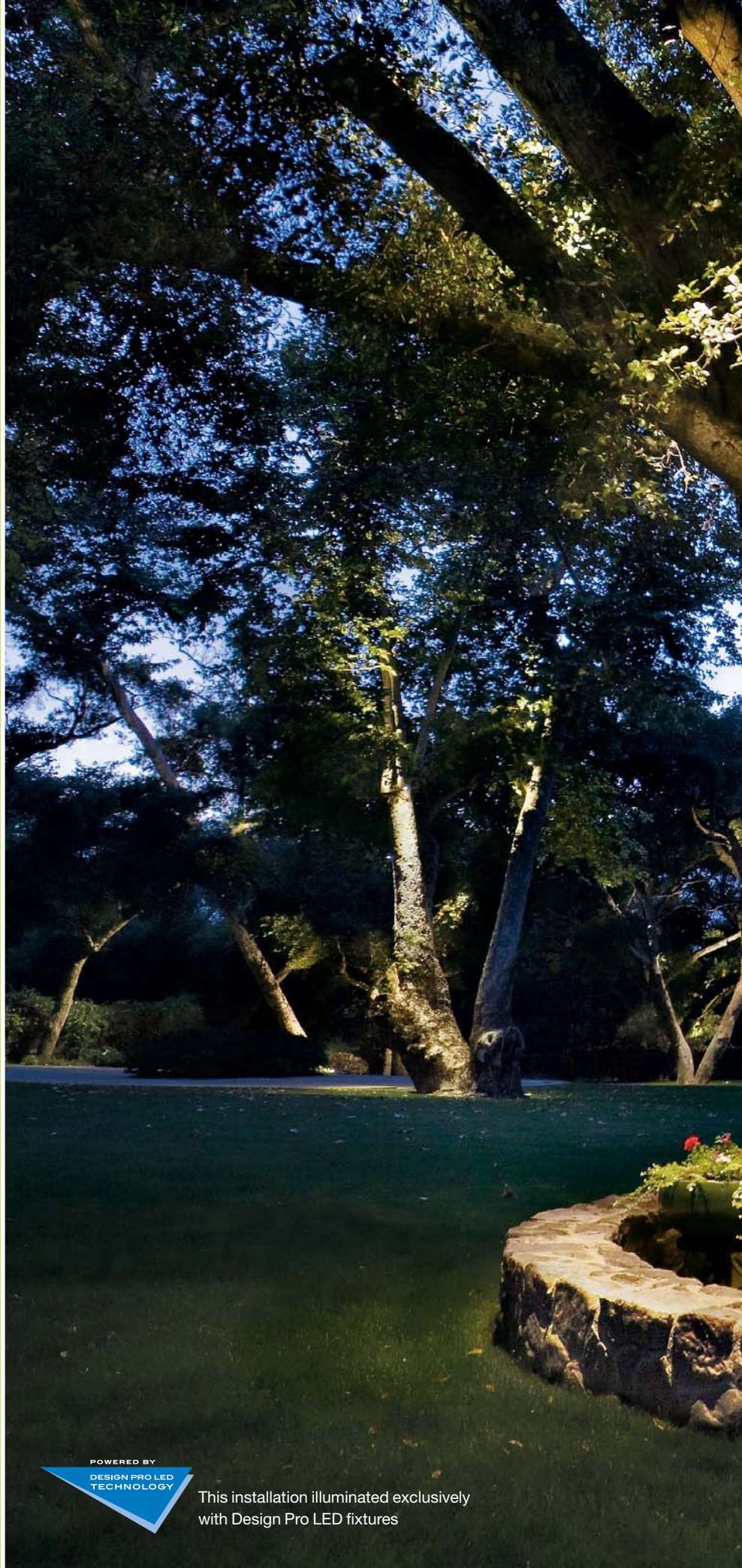

This installation illuminated exclusively
with Design Pro LED fixtures



Meet the professionals
behind the lighting

KICHLER
LIGHTING 

LOW VOLTAGE

Design Pro LED Path & Spread

Meet the new standard for path and spread applications.

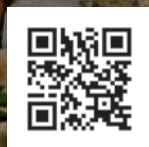

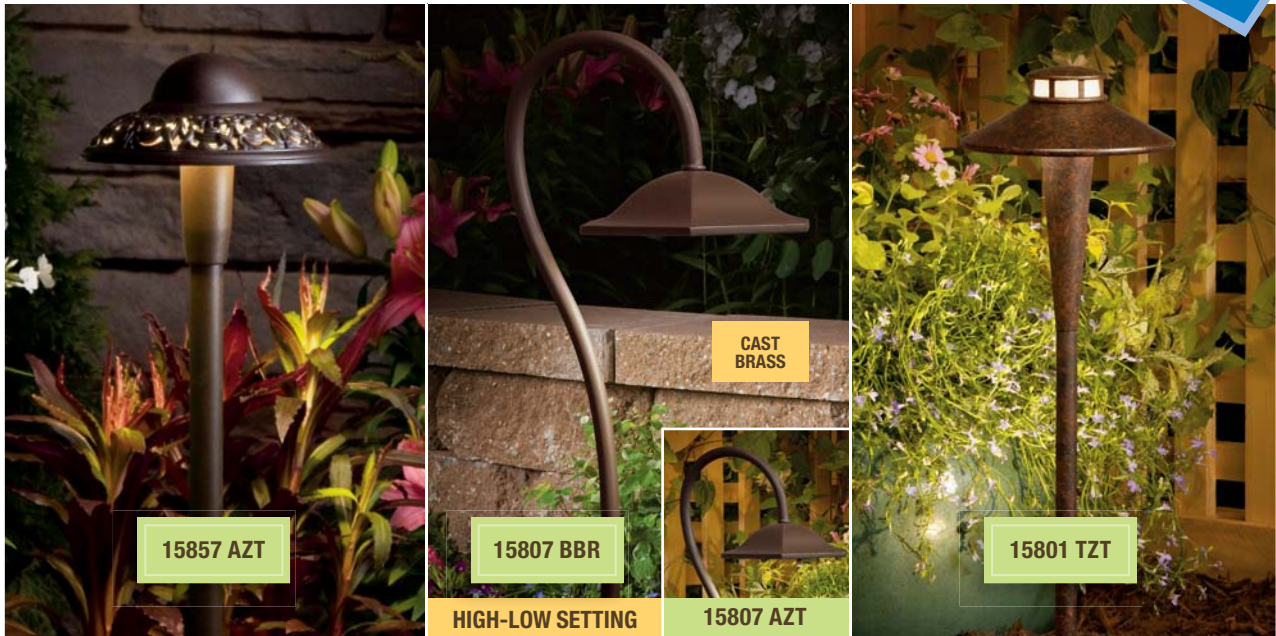

Name	LED PIERCED DOME A cast dome sculpted with a floral band and pierced to reveal a sophisticated pattern of LED light.	LED SHEPHERD'S CROOK Traditional flare with today's LED technology.	LED TIKI A warm, soft center glow adds just the right hint of detail to this center mount LED path and spread.
Ordering Guide	15857 AZT - Textured Architectural Bronze™	15807 AZT - Textured Architectural Bronze™ 15807 BBR - Bronzed Brass	15801 TZT - Textured Tannery Bronze™
Housing	Cast Aluminum	Cast Aluminum, Brass	Cast Aluminum
Finish	Textured Architectural Bronze™	Textured Architectural Bronze™	Textured Tannery Bronze™
Light Source	Integrated LEDs and Driver, 2950K (-150/+175), High CRI	Integrated LEDs and Driver, 2950K (-150/+175), High CRI	Integrated LEDs and Driver, 2950K (-150/+175), High CRI
Power Usage at 12V AC Input VA & Watts	5.8 VA, 4 W Multiply fixture VA by the number of fixtures used to determine size of transformer	High Low 5.8 VA 4 VA 4 W 2.5 W Multiply fixture VA by the number of fixtures used to determine size of transformer	5.8 VA 4 W Multiply fixture VA by the number of fixtures used to determine size of transformer
Operating Voltage Range	9V - 15V AC/DC	9V - 15V AC/DC	9V - 15V AC/DC
Wiring	30" of useable #18-2, SPT-1W leads. Cable connector supplied.	24" of useable #18-2, SPT-1W leads. Cable connector supplied.	24" of useable #18-2, SPT-1W leads. Cable connector supplied.
Mounting Accessories Included	8" In-ground stake	8" In-ground stake	8" In-ground stake
Optional Mounting Accessories	15601 - Surface Mounting Flange 15607 - Surface Mounting Bracket	15601 - Surface Mounting Flange 15607 - Surface Mounting Bracket	15601 - Surface Mounting Flange 15607 - Surface Mounting Bracket
Incandescent Option	15457 – on page 50	NA	NA
Notes	Not for use with electronic transformers.	Not for use with electronic transformers.	Not for use with electronic transformers.

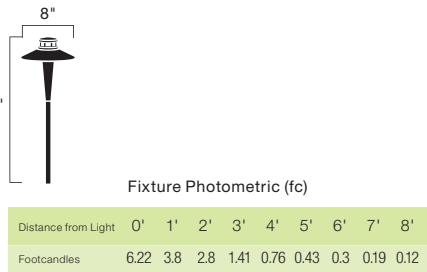
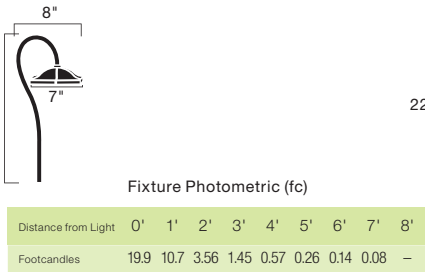
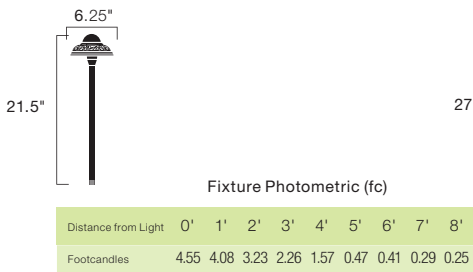



Name	LED DECORATIVE HAMMERED ROOF Pierced shade sheds decorative patterned light with the added benefit of LED technology. Coordinates with matching LED deck light 15763 on page 19.	LED CAST HAMMERED ROOF Pierced shade sheds decorative patterned LED light over shrubs, gardens, or walkways. Coordinates with matching LED deck light 15763 on page 19.
Ordering Guide	15843 CO Unfinished Copper 15843 NBK New Brick™ 15843 TZT Textured Tannery Bronze™ 15843 VG Verdigris	15871 BBR - Bronzed Brass 15871 TZT - Textured Tannery Bronze™
Housing	Brass or Copper (copper will naturally patina over time)	Cast Aluminum, Cast Brass
Finish	Unfinished Copper, New Brick™, Textured Tannery Bronze™ or Natural Verdigris	Bronzed Brass or Textured Tannery Bronze™
Light Source	Integrated LEDs and Driver, 2950K (-150/+175), High CRI	Integrated LEDs and Driver, 2950K (-150/+175), High CRI
Power Usage at 12V AC Input VA & Watts	5.8 VA 4 W Multiply fixture VA by the number of fixtures used to determine size of transformer	5.8 VA 4 W Multiply fixture VA by the number of fixtures used to determine size of transformer
Operating Voltage Range	9V - 15V AC/DC	9V - 15V AC/DC
Wiring	53" of usable #18-2, SPT-1-W leads. Cable connector supplied.	55" of useable #18-2, SPT-1W leads. Cable connector supplied.
Mounting Accessories Included	8" In-ground stake	8" In-ground stake
Optional Mounting Accessories	15601 – Surface Mounting Flange 15607 – Surface Mounting Bracket	15601 - Surface Mounting Flange 15607 - Surface Mounting Bracket
Incandescent Option	15443 – on page 54	15471 – on page 54
Notes	Not for use with electronic transformers.	Not for use with electronic transformers.

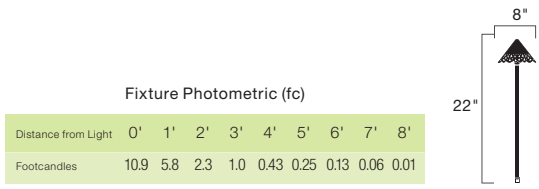
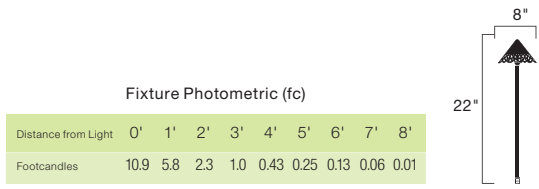

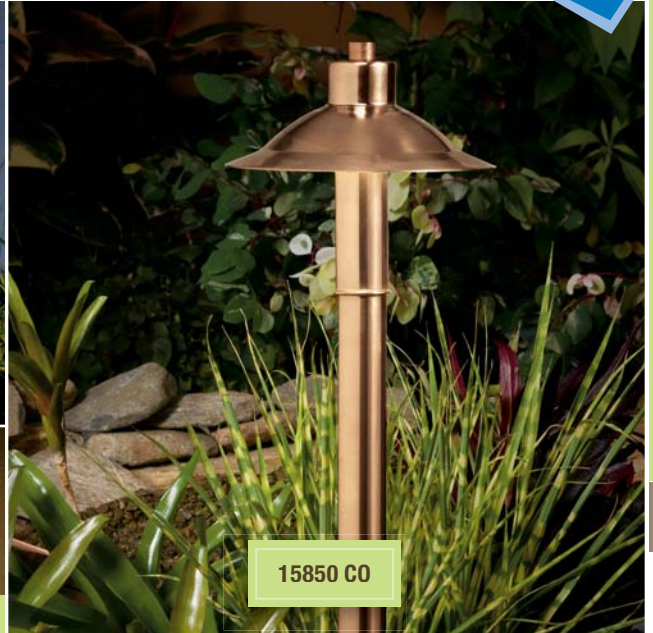

Name	LED FUNDAMENTALS™ Basic, uncomplicated design for versatility. Use along walkways or points of interest. Heavy gauge copper makes this proven look fit in any setting.	LED COPPER HAT Design Pro LED in a definitive yet unassuming copper housing. Will develop a natural verdigris over time.
Ordering Guide	15839 CO - Unfinished Copper 15839 TZT - Textured Tannery Bronze™	15850 CO - Unfinished Copper
Housing	Brass or Copper (copper will naturally patina over time)	Copper (copper will naturally patina over time)
Finish	Unfinished Copper or Textured Tannery Bronze™	Unfinished Copper
Light Source	Integrated LEDs and Driver, 2950K (-150/+175), High CRI	Integrated LEDs and Driver, 2950K (-150/+175), High CRI
Power Usage at 12VAC	5.8 VA, 4 W	5.8 VA, 4 W
Input VA & Watts	Multiply fixture VA by the number of fixtures used to determine size of transformer	Multiply fixture VA by the number of fixtures used to determine size of transformer
Operating Voltage Range	9V - 15V AC/DC	9V - 15V AC/DC
Wiring	55" of useable #18-2, SPT-1W leads. Cable connector supplied.	30" of useable #18-2, SPT-1W leads. Cable connector supplied.
Mounting Accessories Included	8" In-ground stake	8" In-ground stake
Optional Mounting Accessories	15601 - Surface Mounting Flange 15607 - Surface Mounting Bracket	15601 - Surface Mounting Flange 15607 - Surface Mounting Bracket
Incandescent Option	15439 – on page 70	15350 – on page 63
Notes	Not for use with electronic transformers.	Not for use with electronic transformers.

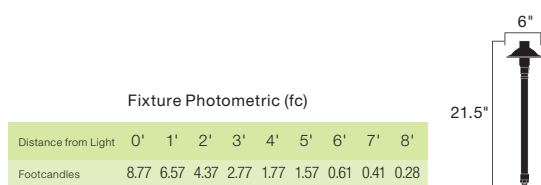
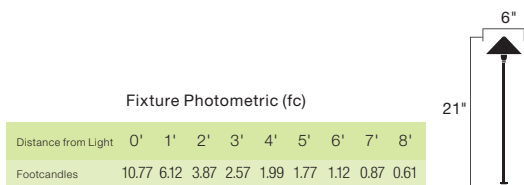



15803 AZT

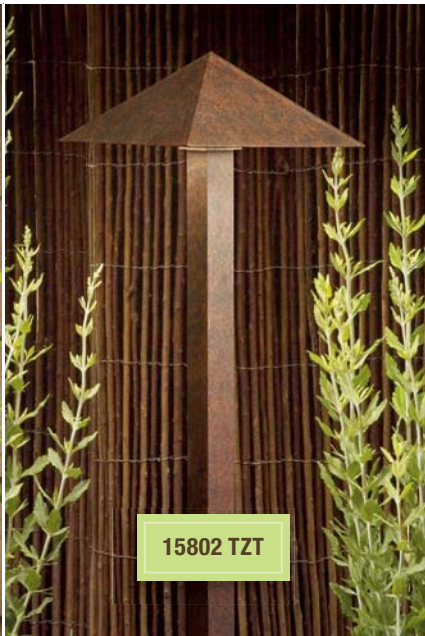

15802 TZT



CAST BRASS

15800 BBR



HIGH-LOW SETTING

15800 AZT

Name	LED FORGED A mission style offering in Design Pro LED. A substantial design supported by thick cast construction.	LED PYRAMID A style to fit a wide variety of tastes, the subtle look of this design will find a home in a wide variety of landscapes.	LED RIPLEY™ Inspired by the popular Kichler® Ripley outdoor lantern, the rich tones, clean lines and sturdy construction make this path light a welcome addition to any transitional outdoor lighting design.
Ordering Guide	15803 AZT - Textured Architectural Bronze™	15802 TZT - Textured Tannery Bronze™	15800 AZT - Textured Architectural Bronze™ 15800 BBR - Bronzed Brass
Housing	Cast Aluminum	Cast Aluminum	Cast Aluminum, Cast Brass
Finish	Textured Architectural Bronze™	Textured Tannery Bronze™	Textured Architectural Bronze™ Bronzed Brass
Light Source	Integrated LEDs and Driver, 2950K (-150/+175), High CRI	Integrated LEDs and Driver, 2950K (-150/+175), High CRI	Integrated LEDs and Driver, 2950K (-150/+175), High CRI
Power Usage at 12V AC	5.8 VA 4 W	5.8 VA 4 W	High Low 5.8 VA 4 VA
Input VA & Watts	Multiply fixture VA by the number of fixtures used to determine size of transformer	Multiply fixture VA by the number of fixtures used to determine size of transformer	4 W 2.5 W Multiply fixture VA by the number of fixtures used to determine size of transformer
Operating Voltage Range	9V - 15V AC/DC	9V - 15V AC/DC	9V - 15V AC/DC
Wiring	24" of useable #18-2, SPT-1W leads. Cable connector supplied.	30" of useable #18-2, SPT-1W leads. Cable connector supplied.	24" of useable #18-2, SPT-1W leads. Cable connector supplied.
Mounting Accessories Included	8" In-ground stake	8" In-ground stake	8" In-ground stake
Optional Mounting Accessories	15601 - Surface Mounting Flange 15607 - Surface Mounting Bracket	15601 - Surface Mounting Flange 15607 - Surface Mounting Bracket	15601 - Surface Mounting Flange 15607 - Surface Mounting Bracket
Notes	Not for use with electronic transformers.	Not for use with electronic transformers.	Not for use with electronic transformers.

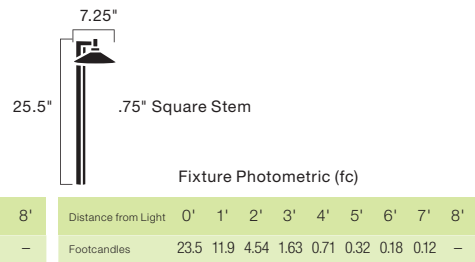
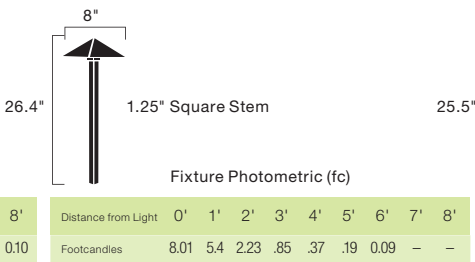
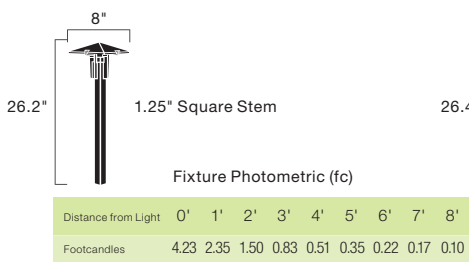

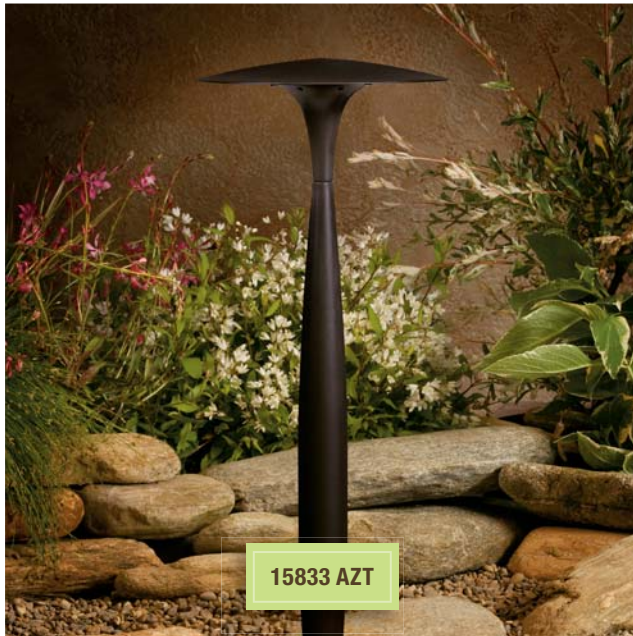

15833 AZT



15804 AZT

Name	LED BROAD ROOF A sculpted spindle center is capped by a broad, shallow roof that diffuses and spreads LED light.	LED TAPERED COLUMN A tapered column rises to a narrow point and then widens to expose LED illumination emanating from the reverse taper cap.
Ordering Guide	15833 AZT - Textured Architectural Bronze™	15804 AZT - Textured Architectural Bronze™
Housing	Cast Aluminum	Cast Aluminum
Finish	Textured Architectural Bronze™	Textured Architectural Bronze™
Light Source	Integrated LEDs and Driver, 2950K (-150/+175), High CRI	Integrated LEDs and Driver, 2950K (-150/+175), High CRI
Power Usage at 12V AC Input VA & Watts	5.8 VA 4 W Multiply fixture VA by the number of fixtures used to determine size of transformer	5.8 VA 4 W Multiply fixture VA by the number of fixtures used to determine size of transformer
Operating Voltage Range	9V - 15V AC/DC	9V - 15V AC/DC
Wiring	30" of usable #18-2, SPT-1-W leads. Cable connector supplied.	30" of usable #18-2, SPT-1-W leads. Cable connector supplied.
Mounting Accessories Included	8" In-ground stake	8" In-ground stake
Optional Mounting Accessories	15601 – Surface Mounting Flange 15607 – Surface Mounting Bracket	15601 – Surface Mounting Flange 15607 – Surface Mounting Bracket
Notes	Not for use with electronic transformers.	Not for use with electronic transformers.



Fixture Photometric (fc)

Distance from Light	0'	1'	2'	3'	4'	5'	6'	7'	8'
Footcandles	13.5	3.7	0.8	0.3	0.2	0.1	-	-	-

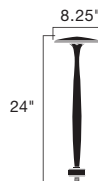

Fixture Photometric (fc)

Distance from Light	0'	1'	2'	3'	4'	5'	6'	7'	8'
Footcandles	7.2	3.5	1.4	0.8	0.5	0.3	-	-	-

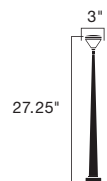



Name	LED SHALLOW SHADE - SMALL A design only made possible by today's LED technology, this fixture will surely captivate its audience with its unobtrusive styling. Coordinates with the 15806.	LED SHALLOW SHADE - LARGE A design only made possible by today's LED technology, this fixture will surely captivate its audience with its unobtrusive styling. Coordinates with the 15805.	LED GLASS & METAL A sleek, modern original that combines contemporary style with smooth LED illumination.
Ordering Guide	15805 BKT - Textured Black	15806 BKT - Textured Black	15817 AZT - Textured Architectural Bronze™ 15817 BN - Brushed Nickel
Housing	Cast Aluminum	Cast Aluminum	Aluminum (AZT) or Brass (BN) with glass diffuser
Finish	Textured Black	Textured Black	Textured Architectural Bronze™ or Brushed Nickel
Light Source	Integrated LEDs and Driver, 2950K (-150/+175), High CRI	Integrated LEDs and Driver, 2950K (-150/+175), High CRI	Integrated LEDs and Driver, 2950K (-150/+175), High CRI
Power Usage at 12V AC	5.8 VA 4 W	5.8 VA 4 W	5.8 VA 4 W
Input VA & Watts	Multiply fixture VA by the number of fixtures used to determine size of transformer	Multiply fixture VA by the number of fixtures used to determine size of transformer	Multiply fixture VA by the number of fixtures used to determine size of transformer
Operating Voltage Range	9V - 15V AC/DC	9V - 15V AC/DC	9V - 15V AC/DC
Wiring	30" of useable #18-2, SPT-1W leads. Cable connector supplied.	30" of useable #18-2, SPT-1W leads. Cable connector supplied.	30" of useable #18-2, SPT-1W leads. Cable connector supplied.
Mounting Accessories Included	8" In-ground stake	8" In-ground stake	8" In-ground stake
Optional Mounting Accessories	15601 - Surface Mounting Flange 15607 - Surface Mounting Bracket	15601 - Surface Mounting Flange 15607 - Surface Mounting Bracket	15601 - Surface Mounting Flange 15607 - Surface Mounting Bracket
Incandescent Option	NA	NA	15317 – on page 68
Notes	Not for use with electronic transformers.	Not for use with electronic transformers.	Not for use with electronic transformers.

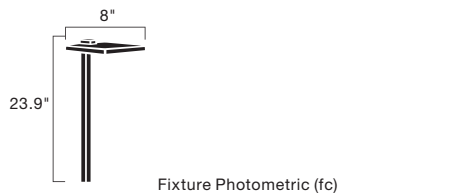

Distance from Light	0'	1'	2'	3'	4'	5'	6'	7'	8'
Footcandles	21.2	12.1	5.3	1.56	.23	.33	.11	.06	-

Distance from Light	0'	1'	2'	3'	4'	5'	6'	7'	8'
Footcandles	20.7	11.1	4.8	1.56	0.55	0.33	0.11	0.06	-

Distance from Light	0'	1'	2'	3'	4'	5'	6'	7'	8'
Footcandles	5.47	6.07	3.87	2.12	1.17	0.77	0.38	0.16	0.04



	15815 AZT	15815 BKT	15827 BBR
	HIGH-LOW SETTING	HIGH-LOW SETTING	HIGH-LOW SETTING
Name	LED SIDE MOUNT LED technology is combined with a side mount design for more directional lighting, without glare. Coordinates with matching LED deck light 15765 on page 20.		LED SIDE MOUNT CAST BRASS LED technology is combined with premium solid brass material, engineered to withstand harsh coastal conditions. Coordinates with matching LED deck light 15765 on page 20.
Ordering Guide	15815 AZT - Textured Architectural Bronze™ 15815 BE - Beach 15815 BKT - Textured Black		15827 BBR - Bronzed Brass
Housing	Cast Aluminum		Cast Brass
Finish	Textured Architectural Bronze™, Beach or Textured Black		Bronzed Brass
Light Source	Integrated LEDs and Driver, 2950K (-150/+175), High CRI		Integrated LEDs and Driver, 2950K (-150/+175), High CRI
Power Usage at 12V AC Input VA & Watts	High 5.8 VA 4 W	Low 4 VA 2.5 W	High 5.8 VA 4 W Low 4 VA 2.5 W
	Multiply fixture VA by the number of fixtures used to determine size of transformer		Multiply fixture VA by the number of fixtures used to determine size of transformer
Operating Voltage Range	9V - 15V AC/DC		9V - 15V AC/DC
Wiring	53" of usable #18-2, SPT-1-W leads. Cable connector supplied.		35" of usable #18-2, SPT-1-W leads. Cable connector supplied.
Mounting Accessories Included	8" In-ground stake		8" In-ground stake
Optional Mounting Accessories	15601 - Surface Mounting Flange 15607 - Surface Mounting Bracket		15601 - Surface Mounting Flange 15607 - Surface Mounting Bracket
Optional Lens Accessories	15695 CLR - Sprinkler Shield		15677 CLR - Sprinkler Shield
Incandescent Option	15315 - on page 71		N/A
Notes	Not for use with electronic transformers.		Not for use with electronic transformers.

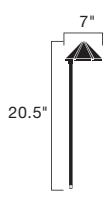
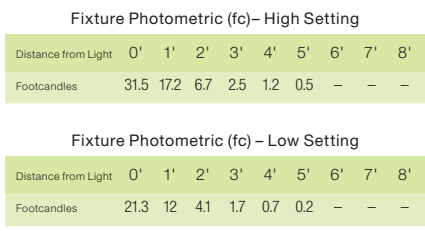
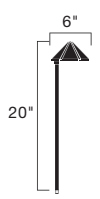
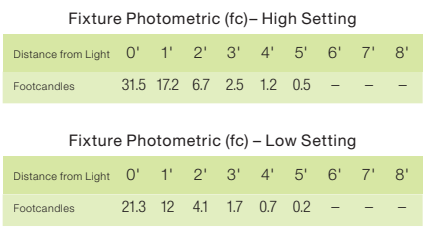



Name	LED CENTER MOUNT Unobtrusive, center mount fixture for maximum light spread with the added benefit of LED technology. Coordinates with matching LED deck light 15765 on page 20.	LED 6" DOME PATH LIGHT A popular look has a new addition with a smaller 6" shade and is available in LED. Coordinates with our 15810 & 15811 LED Domed Roof series.
Ordering Guide	15826 AZT - Textured Architectural Bronze™ 15826 BE - Beach 15826 BKT - Textured Black	15870 AZT - Textured Architectural Bronze™ 15870 BBR - Bronzed Brass 15870 BE - Beach 15870 BKT - Textured Black
Housing	Cast Aluminum	Cast Aluminum, Cast Brass
Finish	Textured Architectural Bronze™, Beach or Textured Black	Textured Architectural Bronze™, Bronzed Brass, Beach, Textured Black
Light Source	Integrated LEDs and Driver, 2950K (-150/+175), High CRI	Integrated LEDs and Driver, 2950K (-150/+175), High CRI
Power Usage at 12VAC Input VA & Watts	5.8 VA 4 W Multiply fixture VA by the number of fixtures used to determine size of transformer	5.8 VA 4 W Multiply fixture VA by the number of fixtures used to determine size of transformer
Operating Voltage Range	9V - 15V AC/DC	9V - 15V AC/DC
Wiring	50" of usable #18-2, SPT-1-W leads. Cable connector supplied.	30" of useable #18-2, SPT-1W leads. Cable connector supplied.
Mounting Accessories Included	8" In-ground stake	8" In-ground stake
Optional Mounting Accessories	15601 – Surface Mounting Flange 15607 – Surface Mounting Bracket	15601 - Surface Mounting Flange 15607 - Surface Mounting Bracket
Incandescent Option	15326 – on page 72	15470 – on page 75
Notes	Not for use with electronic transformers.	Not for use with electronic transformers.

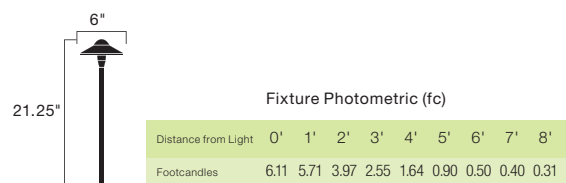
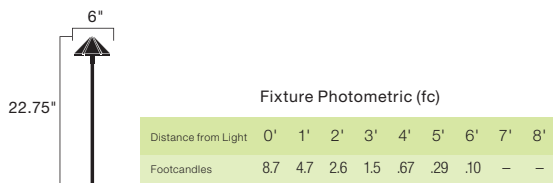



Name	LED DOME PATH LIGHT Now in Design Pro LED, a wider path and spread light that is unobtrusive in the landscape. Coordinates with the 15811 and 15870 path and spread fixtures.	LED DOME PATH LIGHT - SHORT STEM A shorter version of our LED 15810 designed for use in lower planting and smaller garden areas.
Ordering Guide	15810 AZT - Textured Architectural Bronze™ 15810 BBR - Bronzed Brass 15810 BE - Beach 15810 BKT - Textured Black	15811AZT - Textured Architectural Bronze™ 15811 BE - Beach
Housing	Cast Aluminum, Cast Brass	Cast Aluminum
Finish	Textured Architectural Bronze™, Bronzed Brass, Textured Black, Beach	Textured Architectural Bronze™ and Beach
Light Source	Integrated LEDs and Driver, 2950K (-150/+175), High CRI	Integrated LEDs and Driver, 2950K (-150/+175), High CRI
Power Usage at 12V AC Input VA & Watts	5.8 VA, 4 W Multiply fixture VA by the number of fixtures used to determine size of transformer	5.8 VA, 4 W Multiply fixture VA by the number of fixtures used to determine size of transformer
Operating Voltage Range	9V - 15V AC/DC	9V - 15V AC/DC
Wiring	30" of useable #18-2, SPT-1W leads. Cable connector supplied.	36" of useable #18-2, SPT-1W leads. Cable connector supplied.
Mounting Accessories Included	8" In-ground stake	8" In-ground stake
Optional Mounting Accessories	15601 - Surface Mounting Flange 15607 - Surface Mounting Bracket	15601 - Surface Mounting Flange 15607 - Surface Mounting Bracket
Incandescent Option	15310 – on page 74	15410 – on page 75
Notes	Not for use with electronic transformers.	Not for use with electronic transformers.

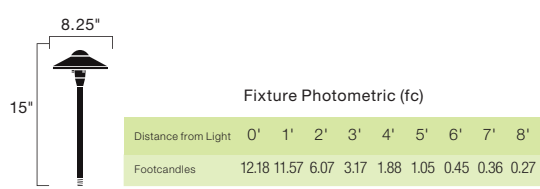
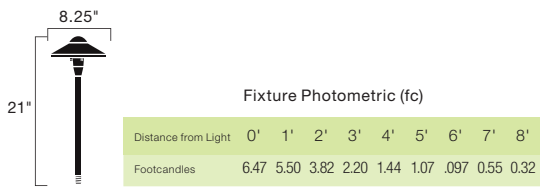

LOW VOLTAGE

Design Pro LED Deck & Patio

Guide and gather beneath the beauty of LED.





15750 TZT



15763 TZT

Name	LED VINTAGE PARK™ 19 th century charm with the energy efficient benefit of LED technology.	LED DECORATIVE HAMMERED ROOF Traditional designed pierced shade and scalloped edge combines with the energy efficient benefit of LED technology. Coordinates with matching LED path light 15871 and 15843 on page 10.
Ordering Guide	15750 TZT - Textured Tannery Bronze™	15763 TZT - Textured Tannery Bronze™
Housing	Cast Aluminum	Brass
Finish	Textured Tannery Bronze™	Textured Tannery Bronze™
Light Source	Integrated LEDs and Driver, 2950K (-150/+175), High CRI	Integrated LEDs and Driver, 2950K (-150/+175), High CRI
Power Usage at 12V AC Input VA & Watts	2.4 VA 1.9 W Multiply fixture VA by the number of fixtures used to determine size of transformer	2.4 VA 1.9 W Multiply fixture VA by the number of fixtures used to determine size of transformer
Operating Voltage Range	9V - 15V AC/DC	9V - 15V AC/DC
Wiring	72" of usable #18-2, SPT-1-W leads. Cable connector supplied.	72" of usable #18-2, SPT-1-W leads. Cable connector supplied.
Mounting Accessories Included	Stainless steel mounting bracket	Stainless steel mounting bracket
Incandescent Option	15050 – on page 85	15063 – on page 85
Notes	Not for use with electronic transformers.	Not for use with electronic transformers.

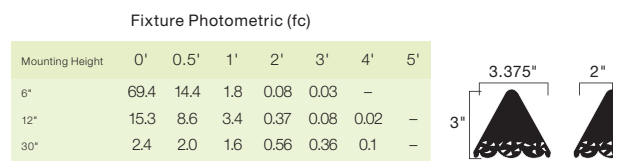
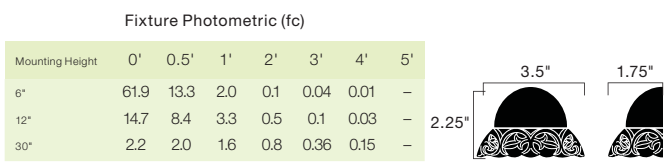



Name	LED MINI DECK LIGHT Versatile mini size and simple styling for multiple applications with the added benefit of LED technology.
Ordering Guide	15765 AZT - Textured Architectural Bronze™ 15765 BBR - Bronzed Brass 15765 BE - Beach 15765 BKT - Textured Black 15765 WHT - Textured White
Housing	Cast Aluminum or Cast Brass
Finish	Textured Architectural Bronze™, Bronze Brass, Beach, Textured Black or Textured White
Light Source	Integrated LEDs and Driver, 2950K (-150/+175), High CRI
Power Usage at 12V AC Input VA & Watts	2.4 VA 1.9 W Multiply fixture VA by the number of fixtures used to determine size of transformer
Operating Voltage Range	9V - 15V AC/DC
Wiring	72" of usable #18-2, SPT-1-W leads. Cable connector supplied. WHT has coordinating white leads.
Mounting Accessories Included	Stainless steel mounting bracket
Incandescent Option	15065 – on page 90
Notes	Not for use with electronic transformers.

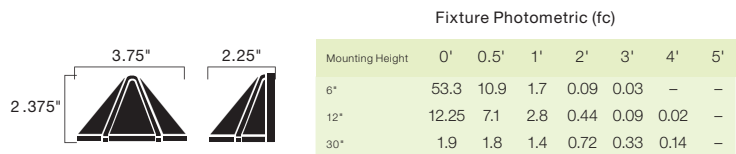



Name	LED HALF MOON Understated, transitional style for deck and patio with the added benefit of LED technology.	LED BRICK LIGHT Designed to be integrated into brick wall during construction. LED version is also usable in vertical risers. Casts a low, even spread of energy efficient LED light. Available with or without louvers.
Ordering Guide	15765 AZT - Textured Architectural Bronze™ 15765 BBR - Bronzed Brass 15765 WHT - Textured White	15773 AZT - Textured Architectural Bronze™ with louver face 15774 AZT - Textured Architectural Bronze™ with heat resistant glass lens
Housing	Aluminum or Cast Brass with satin-etched lens	Cast Aluminum
Finish	Textured Architectural Bronze™, Bronzed Brass, Textured White	Textured Architectural Bronze™
Light Source	Integrated LEDs and Driver, 2950K (-150/+175), High CRI	Integrated LEDs and Driver, 2950K (-150/+175), High CRI
Power Usage at 12V AC	2.4 VA 1.9 W	4.8 VA 3.8 W
Input VA & Watts	Multiply fixture VA by the number of fixtures used to determine size of transformer	Multiply fixture VA by the number of fixtures used to determine size of transformer
Operating Voltage Range	9V - 15V AC/DC	9V - 15V AC/DC
Wiring	72" of usable #18-2, SPT-1-W leads. Cable connector supplied. WHT has coordinating white leads.	Wire connection must be made inside fixture
Mounting Accessories Included	Stainless steel mounting bracket	Stainless steel mounting hardware and junction box
Incandescent Option	15064 – on page 90	15073 – on page 95 15074 – on page 95
Notes	Not for use with electronic transformers.	Not for use with electronic transformers.

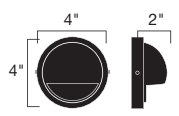

Fixture Photometric (fc)

Mounting Height	0'	0.5'	1'	2'	3'	4'	5'
6"	71.5	18.7	2.5	0.14	0.04	0.01	–
12"	16.1	10.8	4.2	0.57	0.13	0.04	0.04
30"	2.7	2.5	2.1	1.04	0.43	.2	0.9

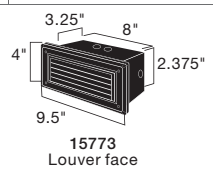

15773 – Fixture Photometric (fc)

Mounting Height	0'	0.5'	1'	1.5'	2'	2.5'	3'	4'
12"	0.22	2.08	1.87	1.85	1.3	0.85	–	–
24"	0.12	0.16	0.29	0.72	0.77	0.68	0.52	–
36"	0.04	0.05	0.09	0.12	0.16	.026	.026	–

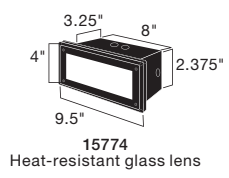

15774 – Fixture Photometric (fc)

Mounting Height	0'	0.5'	1'	1.5'	2'	2.5'	3'	4'
12"	2.02	4.17	3.0	2.0	1.0	0.68	0.48	–
24"	0.23	0.61	0.96	0.9	0.75	0.62	0.51	–
36"	0.05	0.16	0.27	0.38	0.38	0.35	0.31	–

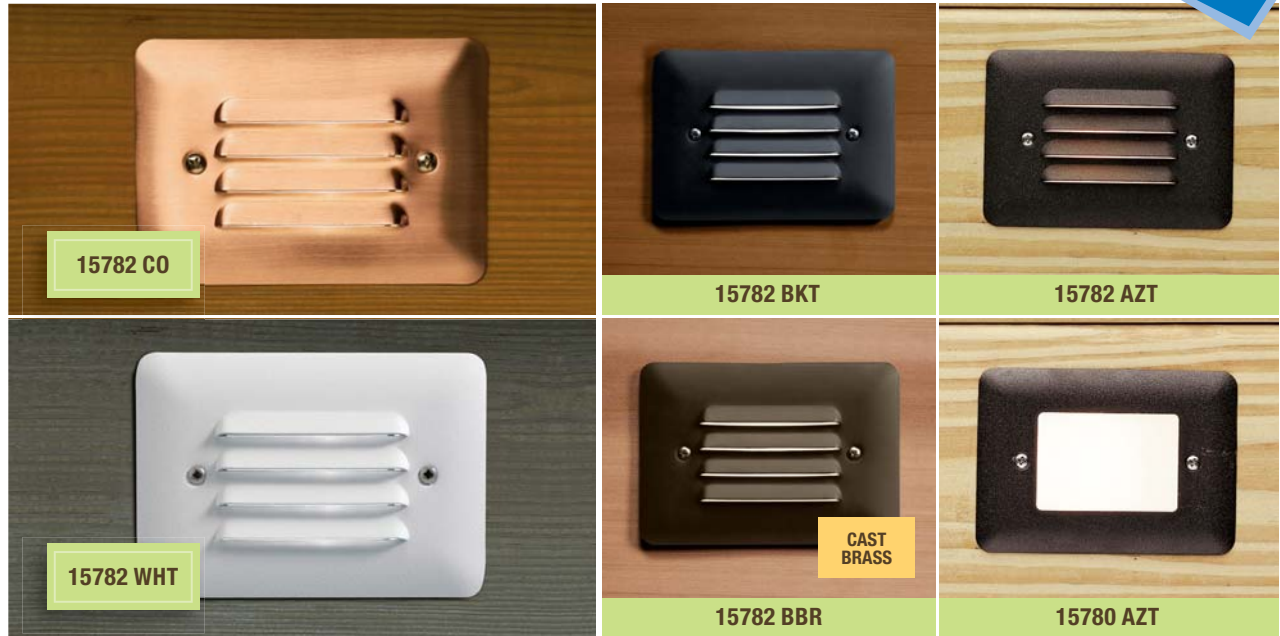

Name	LED MINI STEP LIGHT Designed to be integrated into outdoor steps. Casts a low, even spread of energy efficient LED light. Available with louvered faceplate or with acrylic lens as shown above.
Ordering Guide	15780 AZT - Acrylic Lens, Textured Architectural Bronze™ 15782 AZT - Louvered Lens, Textured Architectural Bronze™ 15782 BBR - Louvered Lens, Bronzed Brass 15782 BKT - Louvered Lens, Textured Black 15782 CO - Louvered Lens, Unfinished Copper 15782 WHT - Louvered Lens, Textured White
Housing	Aluminum, Brass or Copper with white reflector. Zinc plated steel housing. (Copper will naturally patina over time)
Finish	Textured Architectural Bronze™, Bronzed Brass, Textured Black, Copper or Textured White
Light Source	Integrated LED and Driver, 2950K (-150/+175), High CRI
Power Usage at 12V AC Input VA & Watts	2.4 VA 1.9 W Multiply fixture VA by the number of fixtures used to determine size of transformer
Operating Voltage Range	9V - 15V AC/DC
Wiring	Wire connection must be made inside fixture
Mounting Accessories Included	Mounting hardware and junction box
Incandescent Option	15072 – on page 94 15070 – on page 94
Notes	Not for use with electronic transformers.

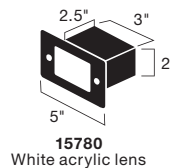

15780 – Fixture Photometric (fc)

Mounting Height	0'	0.5'	1'	1.5'	2'	2.5'	3'	4'
6"	2.9	3.6	1.63	0.8	0.4	0.26	0.17	-
12"	0.45	1.03	1.03	0.69	0.45	0.32	0.23	-

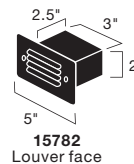

15782 – Fixture Photometric (fc)

Mounting Height	0'	0.5'	1'	1.5'	2'	2.5'	3'	4'
6"	1.2	1.96	0.9	0.4	0.16	0.07	0.04	-
12"	0.26	0.55	0.15	0.46	0.23	-	-	-



POWERED BY
DESIGN PRO LED
TECHNOLOGY

This installation illuminated exclusively
with Design Pro LED fixtures

LOW VOLTAGE

Design Pro LED Hardscape, Deck, Step & Bench

LED like you've never seen it.



Discover LED like you've never seen it.

Unique Hardscape LED light fixtures that are:

- Designed with a pure, warm, natural 2,950K white light
- Long-life LED light source — 40,000 hours at industry standard L70
- Tested to withstand the elements for years of enjoyment
- Easy to install
- Easily adapts to almost any hardscape, deck, step, or bench application
- Finishes compliment popular stone and decking options: Textured Architectural Bronze, Bronzed Brass, Copper, Gray, Sand and Textured White



DESIGN PRO LED HARDSCAPE,
DECK, STEP AND BENCH

D

Maximum Flexibility

The ease of installation, low voltage usage, low profile (.66" wide) and low heat output of Design Pro LED means they can be used in a variety of outdoor applications.

- Retaining walls of all types – new and existing construction
- Brick or stone columns
- Under all types of steps, including wood, composite, stone and brick, etc., with and without risers
- Under deck and chair/hand and fence rails
- Lips or the undersides of a wide variety of outdoor surfaces
- Pergolas
- Outdoor kitchen and bar areas (under lips and toe kicks)
- Raised beds/planters
- Boat docks (as permitted by local codes)
- Customize illumination by mounting farther back, for a scalloped effect, or forward, for a more even effect



Under decks, rails and foot bridges



Privacy fence

Easy to Install

Thoughtful installation, so whether new or existing construction, you can design effectively and install it efficiently.

A built-in driver and an operable voltage range of 9-15V virtually eliminates voltage drop in every Design Pro LED Hardscape, Deck, Step & Bench Light fixture.



NEW CONSTRUCTION

LED Light fixture and stainless steel mounting bracket are preassembled and ready to install.



RETROFIT

Need to mount on a flat or vertical surface? No problem. The available flat mount accessory brackets (15717 SS, 15718 SS, 15719 SS) allows for a variety of retrofit and new build applications.



DECK, STEP & BENCH INSTALLATION

Don't need the brackets? Don't pay for them. Kichler provides the product options that make it convenient for your specific job. For non-hardscape applications, the threaded screw holders also allow for easy install. In fact you can mount these LED fixtures on any surface where you can drill two holes.



Name	3 LED FIXTURE, W/OUT BRACKET	6 LED FIXTURE, W/OUT BRACKET
Ordering Guide	15735 AZT - Textured Architectural Bronze™ 15735 BBR - Bronzed Brass 15735 CO - Copper 15735 GRY - Gray 15735 SD - Sand 15735 WHT - Textured White	15736 AZT - Textured Architectural Bronze™ 15736 BBR - Bronzed Brass 15736 CO - Copper 15736 GRY - Gray 15736 SD - Sand 15736 WHT - Textured White
Width	.66"	.66"
Length	6.9"	12.9"
Height	.60"	.60"
Housing	Aluminum, Brass, Copper Plated Brass	Aluminum, Brass, Copper Plated Brass
Finish	Textured Architectural Bronze™, Bronzed Brass, Unfinished Copper, Gray, Sand, Textured White	Textured Architectural Bronze™, Bronzed Brass, Unfinished Copper, Gray, Sand, Textured White
Light Source	Integrated LEDs and Driver, 2950K (-150/+175), High CRI	Integrated LEDs and Driver, 2950K (-150/+175), High CRI
Power Usage at 12V AC Input VA & Watts	1.3 VA .75 W Multiply fixture VA by the number of fixtures used to determine size of transformer	2.4 VA 1.4 W Multiply fixture VA by the number of fixtures used to determine size of transformer
Operating Voltage Range	9V - 15V AC/DC	9V - 15V AC/DC
Wiring	70" of useable #18-2, SPT-1W leads. Cable connector supplied. WHT has coordinating white leads.	70" of useable #18-2, SPT-1W leads. Cable connector supplied. WHT has coordinating white leads.
Mounting Accessories Included	Stainless steel mounting screws.	Stainless steel mounting screws.
Optional Mounting Accessories	15717SS - 3 LED Accessory Bracket	15718SS - 6 LED Accessory Bracket
Notes	Not for use with electronic transformers. Copper will naturally patina over time. U.S. Patent Pending.	Not for use with electronic transformers. Copper will naturally patina over time. U.S. Patent Pending.

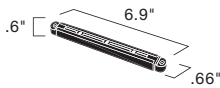

3 LED

Mounting Height	Distance from Light Source				
	0'	1'	2'	3'	4'
foot candles at 12"	38.00	4.3	1.60	0.82	0.50
foot candles at 24"	8.71	4.40	1.08	0.64	0.43
foot candles at 36"	4.00	2.39	1.45	0.52	0.32

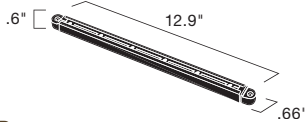

6 LED

Mounting Height	Distance from Light Source				
	0'	1'	2'	3'	4'
foot candles at 12"	56.90	13.60	2.02	1.02	0.61
foot candles at 24"	16.70	8.28	3.80	0.91	0.56
foot candles at 36"	7.50	4.40	2.80	1.56	0.54

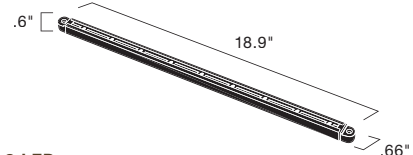

9 LED

Mounting Height	Distance from Light Source				
	0'	1'	2'	3'	4'
foot candles at 12"	79.40	21.90	2.81	1.40	0.82
foot candles at 24"	24.00	12.16	5.00	1.42	0.94
foot candles at 36"	11.64	7.32	4.48	2.87	1.10



15755 BBR	15755 CO	15755 GRY	15755 SD	15755 WHT
Name 9 LED FIXTURE, W/OUT BRACKET				
Ordering Guide 15755 AZT - Textured Architectural Bronze™ 15755 BBR - Bronzed Brass 15755 CO - Copper 15755 GRY - Gray 15755 SD - Sand 15755 WHT - Textured White				
Width .66"				
Length 18.9"				
Height .60"				
Housing Aluminum, Brass, Copper Plated Brass				
Finish Textured Architectural Bronze™, Bronzed Brass, Unfinished Copper, Gray, Sand, Textured White				
Light Source Integrated LEDs and Driver, 2950K (-150/+175), High CRI				
Power Usage at 12V AC Input VA & Watts 3.7 VA 2.2 W Multiply fixture VA by the number of fixtures used to determine size of transformer				
Operating Voltage Range 9V - 15V AC/DC				
Wiring 70" of useable #18-2, SPT-1W leads. Cable connector supplied. WHT has coordinating white leads.				
Mounting Accessories Included Stainless steel mounting screws.				
Optional Mounting Accessories 15719SS - 9 LED Accessory Bracket				
Notes Not for use with electronic transformers. Copper will naturally patina over time. U.S. Patent Pending.				

15717 SS	15718 SS	15719 SS
Name 3 LED FLAT MOUNT BRACKET	6 LED FLAT MOUNT BRACKET	9 LED FLAT MOUNT BRACKET
Fits Fits 15735 (3 LED)	Fits 15736 (6 LED)	Fits 15755 (9 LED)
Dimensions Width - .66", Length - 6.9", Height - .60"	Width - .66", Length - 12.9", Height - .60"	Width - .66", Length - 18.9", Height - .60"
Housing/Finish Stainless Steel	Stainless Steel	Stainless Steel
Notes Mounting hardware included. U.S. Patent Pending.	Mounting hardware included. U.S. Patent Pending.	Mounting hardware included. U.S. Patent Pending.



Name	3 LED FIXTURE, WITH BRACKET	6 LED FIXTURE, WITH BRACKET
Ordering Guide	15745 AZT - Textured Architectural Bronze™ 15745 BBR - Bronzed Brass 15745 CO - Unfinished Copper 15745 GRY - Gray 15745 SD - Sand 15745 WHT - Textured White	15746 AZT - Textured Architectural Bronze™ 15746 BBR - Bronzed Brass 15746 CO - Unfinished Copper 15746 GRY - Gray 15746 SD - Sand 15746 WHT - Textured White
Width	.66"	.66"
Length	6.9"	12.9"
Height	.60"	.60"
Housing	Aluminum, Brass, Copper Plated Brass	Aluminum, Brass, Copper Plated Brass
Finish	Textured Architectural Bronze™, Bronzed Brass, Unfinished Copper, Gray, Sand, Textured White	Textured Architectural Bronze™, Bronzed Brass, Unfinished Copper, Gray, Sand, Textured White
Light Source	Integrated LEDs and Driver, 2950K +/- 150, High CRI	Integrated LEDs and Driver, 2950K +/- 150, High CRI
Power Usage at 12V AC Input VA & Watts	1.3 VA .75 W Multiply fixture VA by the number of fixtures used to determine size of transformer	2.4 VA 1.4 W Multiply fixture VA by the number of fixtures used to determine size of transformer
Operating Voltage Range	9V - 15V AC/DC	9V - 15V AC/DC
Wiring	70" of useable #18-2, SPT-1W leads. Cable connector supplied. WHT has coordinating white leads.	70" of useable #18-2, SPT-1W leads. Cable connector supplied. WHT has coordinating white leads.
Mounting Accessories Included	Stainless steel masonry bracket and mounting screws	Stainless steel masonry bracket and mounting screws
Optional Mounting Accessories	NA	NA
Notes	Not for use with electronic transformers. Copper will naturally patina over time. U.S. Patent Pending.	Not for use with electronic transformers. Copper will naturally patina over time. U.S. Patent Pending.

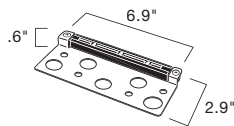

3 LED

Mounting Height	Distance from Light Source				
	0'	1'	2'	3'	4'
foot candles at 12"	38.00	4.3	1.60	0.82	0.50
foot candles at 24"	8.71	4.40	1.08	0.64	0.43
foot candles at 36"	4.00	2.39	1.45	0.52	0.32

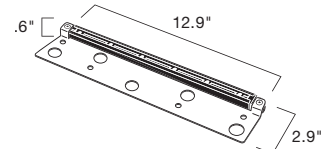

6 LED

Mounting Height	Distance from Light Source				
	0'	1'	2'	3'	4'
foot candles at 12"	56.90	13.60	2.02	1.02	0.61
foot candles at 24"	16.70	8.28	3.80	0.91	0.56
foot candles at 36"	7.50	4.40	2.80	1.56	0.54



Name	9 LED FIXTURE, WITH BRACKET
Ordering Guide	15755 AZT - Textured Architectural Bronze™ 15755 BBR - Bronzed Brass 15755 CO - Copper 15755 GRY - Gray 15755 SD - Sand 15755 WHT - Textured White
Width	.66"
Length	18.9"
Height	.60"
Housing	Aluminum, Brass, Copper Plated Brass
Finish	Textured Architectural Bronze™, Bronzed Brass, Unfinished Copper, Gray, Sand, Textured White
Light Source	Integrated LEDs and Driver, 2950K (-150/+175), High CRI
Power Usage at 12V AC Input VA & Watts	3.7 VA 2.2 W Multiply fixture VA by the number of fixtures used to determine size of transformer
Operating Voltage Range	9V - 15V AC/DC
Wiring	70" of useable #18-2, SPT-1W leads. Cable connector supplied. WHT has coordinating white leads.
Mounting Accessories Included	Stainless steel masonry bracket and mounting screws
Optional Mounting Accessories	NA
Notes	Not for use with electronic transformers. Copper will naturally patina over time. U.S. Patent Pending.

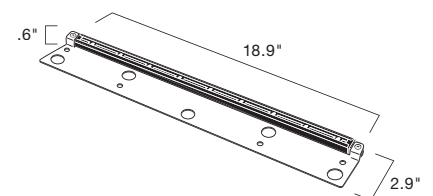

9 LED	Distance from Light Source				
	Mounting Height	0'	1'	2'	3'
foot candles at 12"	79.40	21.90	2.81	1.40	0.82
foot candles at 24"	24.00	12.16	5.00	1.42	0.94
foot candles at 36"	11.64	7.32	4.48	2.87	1.10



POWERED BY
DESIGN PRO LED
TECHNOLOGY

This installation illuminated exclusively
with Design Pro LED fixtures



Meet the professionals
behind the lighting



LOW VOLTAGE

Design Pro LED Accent

Discover the superior lighting quality and energy efficient advantage.



POWERED BY
DESIGN PRO LED
TECHNOLOGY

This installation illuminated exclusively
with Design Pro LED fixtures

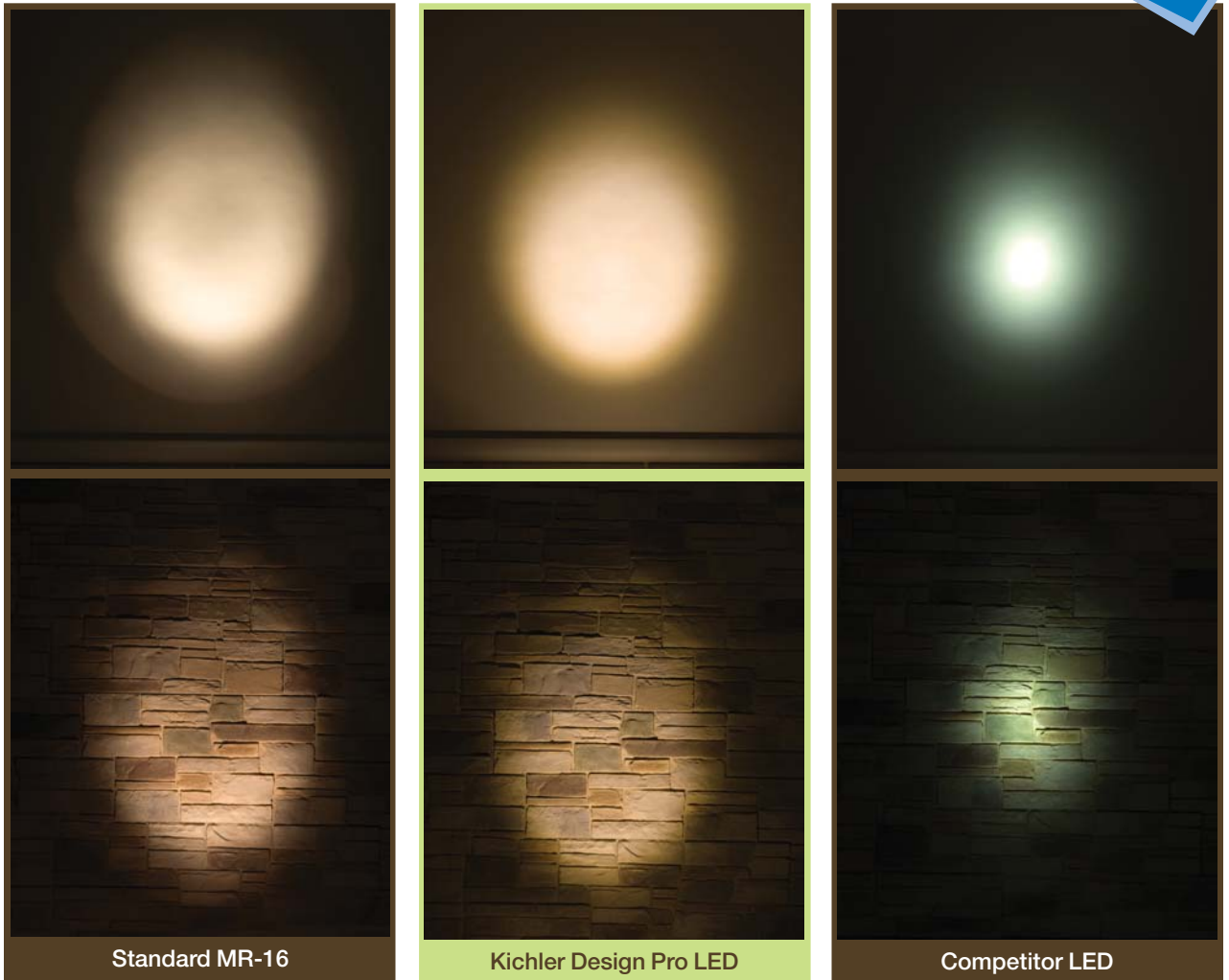

Standard MR-16

Kichler Design Pro LED

Competitor LED

Seeing is Believing

Kichler Design Pro LED performs and the proof is in the pictures! In a side-by-side comparison of a standard halogen MR-16, a Kichler Design Pro LED and a competitor's LED product, the quality of the Design Pro light is comparable to standard bulbs and the light spread is noticeably more defined.

MR-16

Note the irregular shape of the light in the MR-16 and the dark spot in the center of the beam. There are also a number of fractures and flaws in the light pool, including a lower portion that's brighter than the upper. Although the lighting is dense, the nature of the technology makes it somewhat inconsistent.

Design Pro LED

With Kichler Design Pro LED, these drawbacks are eliminated. The pool of light is a nearly perfect circle that gives you exacting results and precise

illumination. It's a consistent distribution of clear, warm and inviting light. And, with multiple beam spreads and wattages, you get maximum lumens customized to your needs.

Competitor

With the competitive LED, there's a distinctive blue-hue, giving the lighted surface little warmth. Despite drawing more power, the lumen output is decidedly lower. Plus, with limited beam-spread options, the light has a less natural, more conical appearance.

Note: all products were photographed against the same backdrops (plain flat backdrop and stone wall) at the same beam spread angle. No camera tricks or retouching were used.



BBR FINISH IS CAST BRASS

**15731 (10° spot) 15732 (35° flood)
15733 (60° wide flood) 4.5W AZT, BBR, BKT
(shown with optional snap-on cowl)**



BBR FINISH IS CAST BRASS

**15741 (10° spot) 15742 (35° flood)
15743 (60° wide flood)
8.5W AZT, BBR (shown), BKT**

Name	LED ACCENT LIGHTS A full collection of accent lights engineered to provide the spread of light needed with the amount of lumen or light output desired.		
Housing	Cast Aluminum or Cast Brass with clear tempered glass lens and polycarbonate mounting stem and locknut. Integrated driver.		
Finish	Textured Architectural Bronze™, Bronzed Brass, or Textured Black		
Light Source	Integrated LEDs and Driver, 2950K (-150/+175), High CRI		
Power Usage at 12V AC Input VA & Watts	15731, 15732, 15733 VA Total: 7.5 Watts Total: 4.5	15741, 15742, 15743 VA Total: 12.2 Watts Total: 8.5	15751, 15752, 15753 VA Total: 16.7 Watts Total: 12.4
	Multiply fixture VA by the number of fixtures used to determine size of transformer		
Operating Voltage Range	9V - 15V AC/DC		
Wiring	35" of usable #18-2, SPT-1 -W leads. Cable connector supplied.		
Wire Mounting Accessories Included	8" In-ground stake		
Optional Mounting Accessories	15601 – Surface Mounting Flange 15607 – Tree/Surface Mounting Bracket 15609 – Junction Box Mounting Bracket	15647 – 90° Elbow	
Optional Snap-On Cowl Accessories	15701 AZTP, BKTP Short Cowl for use with 4.5W and 8.5W size. Finishes to match accent fixtures. 15703 AZTP, BKTP Long Cowl for use with 4.5W and 8.5W size. Finishes to match accent fixtures.	15702 AZTP, BKTP Short Cowl for use with 12.4W size. Finishes to match accent fixtures. 15704 AZTP, BKTP Long Cowl for use with 12.4W size. Finishes to match accent fixtures.	For BBR fixture finishes, use AZTP
Optional Lens Accessories	Amber – Offers warmer hues of light 15875 AMB For use with 4.5W/8.5W size 15876 AMB For use with 12.4W size	Green – Intensify the greens of foliage 15885 GRN For use with 4.5W/8.5W size 15886 GRN For use with 12.4W size	Frosted – Diffuse light where you need it 15895 FRO For use with 4.5W/8.5W size 15896 FRO For use with 12.4W size
	Designed and tested to work with the wavelengths of LED lighting		
Notes	See photometrics on pages 139 U.S. Patent Pending Not for use with electronic transformers.		

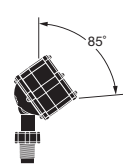

15647 BKT shown with 18" fixture mounting stem (15657 BKT) and LED Accent Light (15731 BKT), both sold separately.



DESIGN PRO LED ACCENT LOW VOLTAGE



**15751 (10° spot) 15752 (35° flood)
15753 (60° wide flood)
12.4W AZT(shown), BBR, BKT**

Improved Cowls with easy one step snap-on installation – glare shield rotates 360° in ring and retains its desired shield position.



DESIGN PRO LED ACCENT

Ordering Guide	Fixture Details	Beam Angle				
		10°	35°	60°		
Ordering Guide	15731 AZT, BBR, BKT 4.5W LED Accent fixture 10° spot 15732 AZT, BBR, BKT 4.5W LED Accent fixture 35° flood 15733 AZT, BBR, BKT 4.5W LED Accent fixture 60° wide flood 7.5 VA 4.5-W Design Pro LED is comparable to 20 W MR-16	<p>3" 5.5"</p> <p>4.5 W: 15731 15732 15733</p>	7.5 VA 4.5-W	15731	15732	15733
	15741 AZT, BBR, BKT 8.5W LED Accent fixture 10° spot 15742 AZT, BBR, BKT 8.5W LED Accent fixture 35° flood 15743 AZT, BBR, BKT 8.5W LED Accent fixture 60° wide flood 12.2 VA 8.5-W Design Pro LED is comparable to 35 W MR-16	<p>3" 5.5"</p> <p>8.5 W: 15741 15742 15743</p>	12.2 VA 8.5-W	15741	15742	15743
	15751 AZT, BBR, BKT 12.4W LED Accent fixture 10° spot 15752 AZT, BBR, BKT 12.4W LED Accent fixture 35° flood 15753 AZT, BBR, BKT 12.4W LED Accent fixture 60° wide flood 16.7 VA 12.4-W Design Pro LED is comparable to 50 W MR-16	<p>3.5" 6"</p> <p>12.4 W: 15751 15752 15753</p>	16.7 VA 12.4-W	15751	15752	15753



Amber – Offer warmer hues of light
15875 AMB For use with 4.5W/8.5W size
15876 AMB For use with 12.4W size



Green – Intensify the greens of foliage
15885 GRN For use with 4.5W/8.5W size
15886 GRN For use with 12.4W size



Frosted – Diffuse light where you need it
15895 FRO For use with 4.5W/8.5W size
15896 FRO For use with 12.4W size

Lenses include replacement gasket, Allen wrench, and extra ring screws. Colored lenses will slightly reduce light output.



Name	LED WALL WASH ACCENT LIGHT Our Design Pro LED Wall Wash creates a low, even light spread that illuminates shrubs, plants and textured wall surfaces and silhouettes special details. Fully adjustable knuckle.	
Ordering Guide	15861 AZT - Textured Architectural Bronze™ 15861 BKT - Textured Black	15861 BBR - Bronzed Brass
Housing	Cast Aluminum, Cast Brass	
Finish	Textured Architectural Bronze™, Textured Black, Bronzed Brass	
Light Source	Integrated LEDs and Driver, 2950K (-150/+175), High CRI	
Power Usage at 12V AC	High 5.8 VA	Low 4 VA
Input VA & Watts	4 W 2.5 W Multiply fixture VA by the number of fixtures used to determine size of transformer	
Operating Voltage Range	9V - 15V AC/DC	
Wiring	64" of usable #18-2, SPT-1-W leads.	
Mounting Accessories Included	8" In-ground stake	
Optional Mounting Accessories	15601 - Surface mounting flange 15607 - Surface mounting bracket 15647 - 90° Elbow	

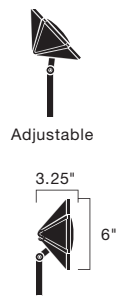

Fixture Photometric (fc)

Distance from Wall	0'	1'	2'	3'	4'	5'	6'	7'	8'	9'
4'	5.6	4.1	2.9	1.8	1.2	.81	.46	.35	.17	.12
8'	1.4	1.3	1.0	.90	.72	.58	.46	.38	.29	.23

Understanding LED Lighting

LED Energy & Cost Comparison

Understanding Watts and VA (volts x amps)

Kichler Landscape LED drivers convert the 12V AC current to a DC current specified by the LED chip manufacturer. When electric power is converted from AC to DC, there are losses and changes to the electrical properties; these effects are known as the "Power Factor".

In an LED lighting installation it is necessary to use the VA value of a fixture in order to compute and select a transformer with adequate power for the system. *For your convenience Kichler supplies the VA as well as the Wattage for each of the fixtures in our catalog.*

What does this mean to the system designer?

There are two areas to consider: the load on the transformer and Watts consumed according to the electric power company.

The load on the transformer

The "VA" (volts x amps) rating on Kichler Landscape products represents the value used when calculating the total system load. This VA number will help you determine the correct size transformer for an LED installation.

Example:		
Number of Fixtures	x VA value	= Transformer Load Requirement
(8) Fixtures	x 12.2VA ea.	= 97.8VA



15742
U.S. Patent Pending

This LED system requires at least a 100 Watt transformer

The Watts consumed according to the power company

When determining the cost of ownership use the Watt rating of the LED fixture. This represents the actual electric consumption for which the homeowner will be billed.

Example:		
Number of Fixtures	x Watts	= Actual Electric Consumption
(8) Fixture	x 8.5 Watts ea.	= 68 Watts



15742
U.S. Patent Pending

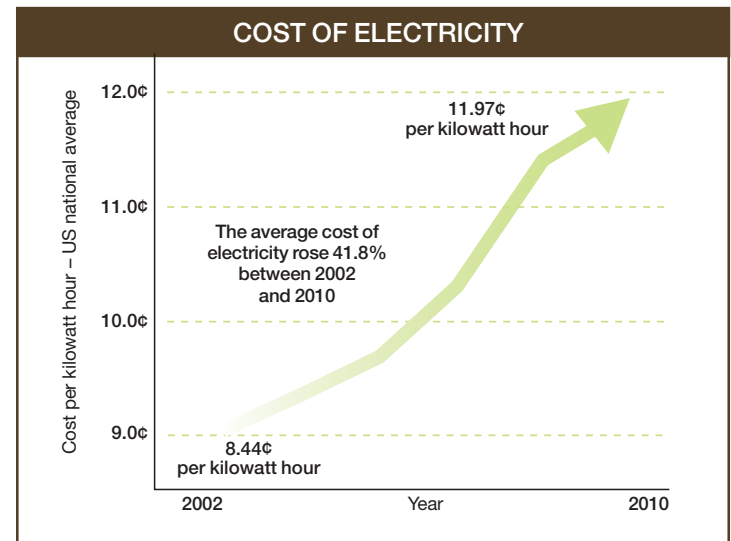
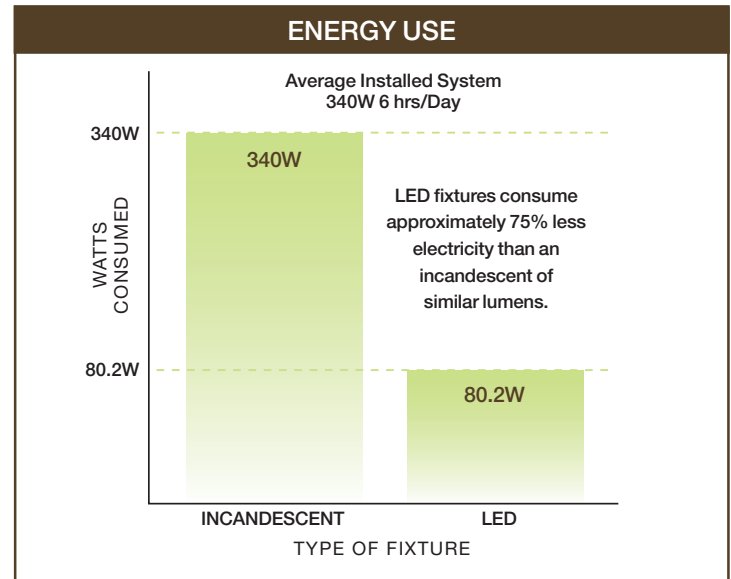

High Energy Efficiency:

- Create maximum impact on the landscape with a minimum effect on the environment
- 75% less energy consumption than traditional incandescent/halogen fixtures
- Long-term cost savings and superior long-life light source (40,000 hours, L70 life)

LOW VOLTAGE

Design Pro LED Well Lights

In-ground lighting that's above the norm.



POWERED BY
DESIGN PRO LED
TECHNOLOGY

This installation illuminated with
Design Pro LED Well Lights



Name	LED WELL LIGHT LED technology in a versatile design with reversible support sleeve to accommodate uplighting when flush mounting or angled lighting are desired in a semi-recessed application. Fully adjustable and available in a wide variety of outputs and beam spreads.		
Ordering Guide	4.5W Version 15767 BKT - 10° spot 15768 BKT - 35° flood 15769 BKT - 60° wide flood	8.5W Version 15728 BKT - 10° spot 15747 BKT - 35° flood 15748 BKT - 60° wide flood	12.4W Version 15729 BKT - 10° spot 15757 BKT - 35° flood 15758 BKT - 60° wide flood
Housing	Cast aluminum fixture body with a heavy duty polypropylene sleeve and stainless steel gimble ring.		
Finish	Textured Black		
Light Source	Integrated LEDs and Driver, 2950K (-150/+175), High CRI		
Power Usage at 12V AC Input VA & Watts	15767, 15768, 15769 7.5VA, 4.5W	15728, 15747, 15748 12.2VA, 8.5W	15729, 15757, 15758 16.7VA, 12.4W
Operating Voltage Range	9V - 15V AC/DC		
Wiring	35" of useable #18-2, SPT-1W leads. Cable connector supplied.		
Optional Accessories	Snap on Cowl: 15701BKTP - Short 4.5W/8.5W, 15702BKTP - Short 12.4W , 15703BKTP - Long 4.5W/8.5W, 15704BKTP - Long 12.4W Rockguards/ Glare Shield: 15787BK - Fits all versions Custom Lenses: Amber - 4.5W/8.5W - 15875AMB, Amber - 12.4W - 15876AMB, Green - 4.5W/8.5W - 15885GRN, Green - 12.4W - 15886GRN, Frosted - 4.5W/8.5W - 15895FRO, Frosted - 12.4W - 15896FRO		
Notes	See photometrics on page 139. Kichler LED Comparison: 4.5W is approximately comparable to a 20W MR16, a 8.5W to a 35W MR16, and a 12.4W to a 50W MR16 Not for use with electronic transformers.		

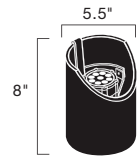
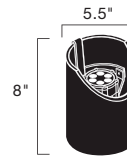
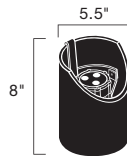

	15787 BK	Name	LED WELL LIGHT COVER
		Housing	Rock guard accessory for Design Pro LED Well Light Series
		Finish	High Strength Polycarbonate
			Black Polycarbonate
		For use with the following fixtures	15767BKT, 15768BKT, 15769BKT, 15728BKT, 15747BKT, 15748BKT, 15729BKT, 15757BKT, 15758BKT

15787 BK snaps easily into place on flat side of fixture's sleeve.

LOW VOLTAGE

Design Pro LED

2-in-1 Water/Accent Light

Versatile lighting that's at home in and out of water.

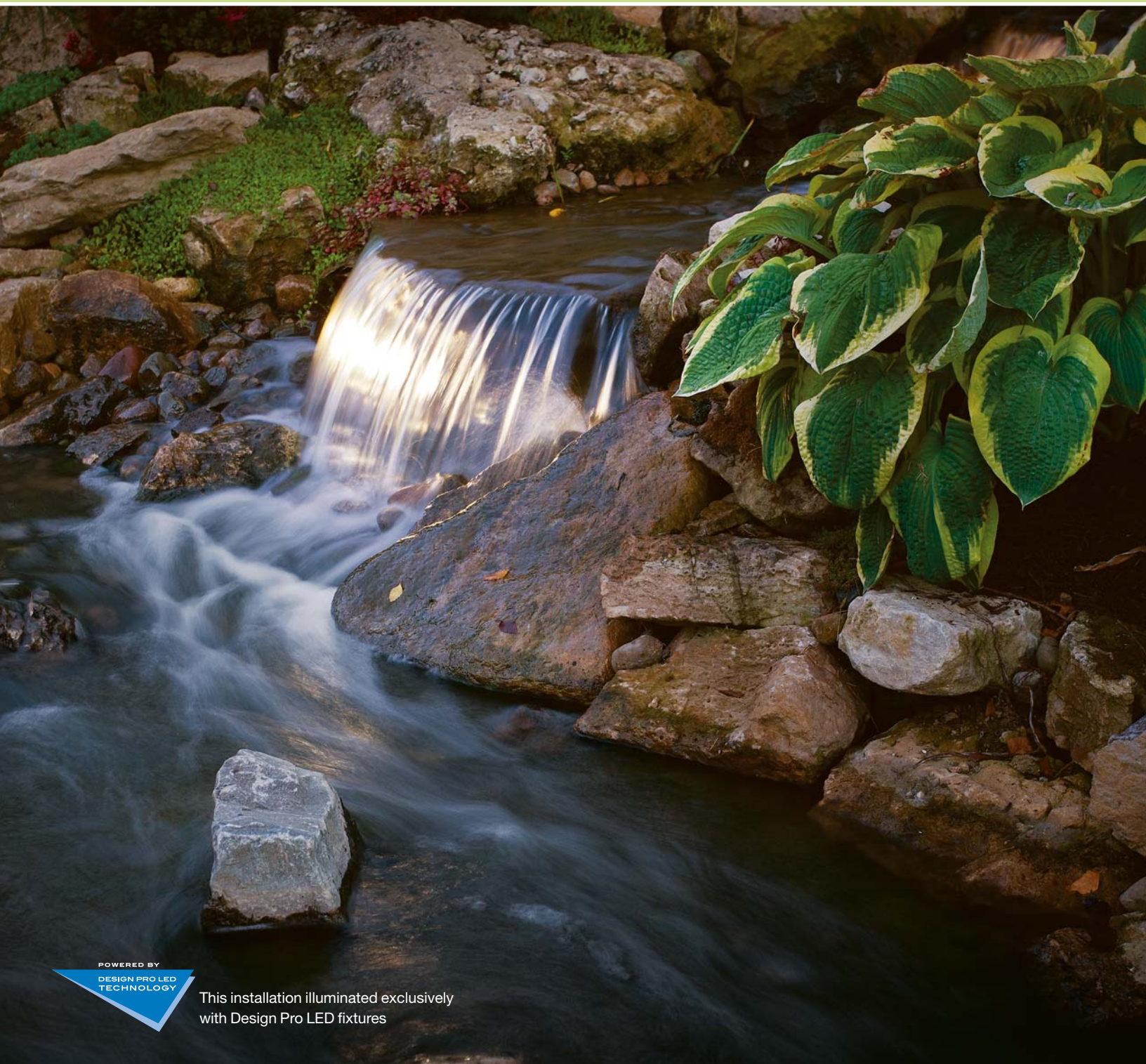

POWERED BY
DESIGN PRO LED
TECHNOLOGY

This installation illuminated exclusively
with Design Pro LED fixtures



15711 SS



15777 SS

Name	2-IN-1 WATER/ACCENT LIGHT Designed for underwater use in ponds, fountains, and other water features. Can also be used out of water as a mini accent light – ideal for wood decks and overhangs.
Ordering Guide	15711 SS - Stainless Steel
Housing	Stainless Steel housing with integrated cowl
Finish	SS - Stainless Steel with Brushed Finish
Light Source	Integrated LED's and Driver, 60° beam spread High CRI and tight color consistency 3000K color temp (+220/-175) Light output is equivalent to a 15 W MR11
Power Usage at 12V AC Input VA & Watts	4.9 VA 3.4 W
Operating Voltage Range	9V - 15V AC/DC
Wiring	25ft of usable #18-2, SPT-2W leads
Optional Mounting Accessories	15776 BK - Multi-fixture weighted base. U.S. Patent Pending 15777 SS- Out-of-water bracket. U.S. Patent Pending 15778 BK- Single-fixture weighted base. U.S. Patent Pending
Notes	Filled and sealed with two types of premium encapsulate to ensure fixture is completely watertight, 1/4 20 threaded mounting tap. Not for use with electronic transformers. U.S. Patent Pending

Stainless steel easy mount bracket for use above ground on any surface – ideal for wood and masonry when used on decks, patios or overhangs.



15776 BK

Unique heavy weighted 3 pronged underwater accessory for 2 or 3 fixtures to give maximum flexibility and directional capability.



15778 BK

Heavy weight 1 prong underwater light accessory for standard installations. Provides advanced directional capability.

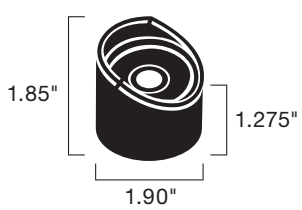

Distance from Source (ft)	Illuminance (footcandles)	Beam Width (ft)
4	5.6	3.3
8	1.5	6.5
16	0.4	13.0
24	0.2	19.5
32	0.1	26.0
40	0.1	32.5

Water reduces light output by 10% per foot of depth



POWERED BY
DESIGN PRO LED
TECHNOLOGY

This installation illuminated exclusively
with Design Pro LED fixtures.



Get Inspired.
See the lighting design story



KICHLER
LIGHTING



LOW VOLTAGE

Incandescent Path & Spread

Let stylish design and durable construction light the way.





15379 OZ



15446 OZ



15447 OZ

Name	GATE HOUSE Classic estate styling.	ARIES MANOR™ An elegant and stately path light featuring solid brass construction, a turned spindle stem.	ARIES MANOR™ An elegant and stately indirect path light featuring solid brass construction and a turned spindle stem.
Ordering Guide	15379 OZ - Olde Bronze®	15446 OZ - Olde Bronze®	15447 OZ - Olde Bronze®
Housing	Cast Brass	Brass with cocoa turned marble accent. Citrine glass.	Brass with cocoa turned marble accent.
Finish	Olde Bronze®	Olde Bronze®	Olde Bronze®
Light Source	12V Incandescent S-8 wedge base socket	12V Incandescent T-5 wedge base socket	12V Incandescent T-5 wedge base socket
Power Usage at 12V AC Input	VA MAX: 24.4-W(VA) Supplied: 24.4-W(VA) 3156K (15598 CLR) Krypton light source Optional: 18.5-W(VA) 3155K (15599 CLR)	VA MAX: 16.25-W(VA) Supplied: 921X (17025) Xenon light source Optional: 16.25-W(VA) 921X (17025) 6.5-W(VA) 918X (17022) 4-W(VA) 901X (17021)	VA MAX: 16.25-W(VA) Supplied: 11.6-W(VA) 912X (17023) Xenon light source Optional: 16.25-W(VA) 921X (17025) 6.5-W(VA) 918X (17022) 4-W(VA) 901X (17021)
Wiring	34" of usable #18-2, SPT-1-W leads. Cable connector supplied	24" of usable #18-2, SPT-1-W leads. Cable connector supplied.	24" of usable #18-2, SPT-1-W leads. Cable connector supplied.
Mounting Accessories Included	14" In-ground stake	8" In-ground stake	8" In-ground stake
Optional Mounting Accessories	15601 – Surface Mounting Flange 15607 – Surface Mounting Bracket	15601 – Surface Mounting Flange 15607 – Surface Mounting Bracket	15601 – Surface Mounting Flange 15607 – Surface Mounting Bracket
Notes	U.S. Patent No. D561,371		

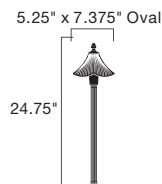

Photometric with Lamp Supplied (fc)

Distance from Light	0'	1'	2'	3'	4'	5'	6'	7'	8'
Footcandles	8.16	3.43	3.43	1.46	.33	-	-	-	-



Photometric with Lamp Supplied (fc)

Distance from Light	0'	1'	2'	3'	4'	5'	6'	7'	8'
Footcandles	0.5	1.1	0.8	0.4	0.1	0	-	-	-

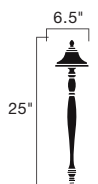

Photometric with Lamp Supplied (fc)

Distance from Light	0'	1'	2'	3'	4'	5'	6'	7'	8'
Footcandles	6.9	4.9	2.9	1.3	0.4	0.1	-	-	-

PATH & SPREAD LOW VOLTAGE



15314 MST

15314 AZT



15436 OZ



15347 VGB

Name	SINGLE-TIER LEAF Delicate leaf form casts a warm, diffused light along a walkway or near an entryway.	INTAGLIO BRASS CROOK NECK A richly detailed solid and heavy crookneck path light with a brass shade that has been engraved and etched with an organic pattern.	AINSLEY SQUARE Pierced brass dome and stem and verdigris finish for stylish path lighting.
Ordering Guide	15314 AZT - Textured Architectural Bronze™ 15314 MST - Textured Midnight Spruce™	15436 OZ - Olde Bronze®	15347 VGB - Verdigris with Aged Brass
Housing	Cast Aluminum	Brass	Brass
Finish	Textured Architectural Bronze™ or Textured Midnight Spruce™	Olde Bronze®	Verdigris with Aged Brass
Light Source	12V Incandescent S-8 wedge base socket	12V Incandescent T-5 wedge base socket	12V Incandescent S-8 wedge base socket
Power Usage at 12V AC Input	VA MAX: 24.4-W(VA) Supplied: 24.4-W(VA) 3156K (15598 CLR) Krypton light source Optional: 18.5-W(VA) 3155K (15599 CLR)	VA MAX: 16.25-W(VA) Supplied: 11.6-W(VA) 912X (17023) Xenon light source Optional: 16.25-W(VA) 921X (17025) 6.5-W(VA) 918X (17022) 4-W(VA) 901X (17021)	VA MAX: 24.4-W(VA) Supplied: 24.4-W(VA) 3156K (15598 CLR) Krypton light source Optional: 18.5-W(VA) 3155K (15599 CLR)
Wiring	35" of usable #18-2, SPT-1-W leads. Cable connector supplied.	26" of usable #18-2, SPT-1-W leads. Cable connector supplied.	32" of usable #18-2, SPT-1-W leads. Cable connector supplied.
Mounting Accessories Included	8" In-ground stake	8" In-ground stake	8" In-ground stake
Optional Mounting Accessories	15601 – Surface Mounting Flange 15607 – Surface Mounting Bracket	15601 – Surface Mounting Flange 15607 – Surface Mounting Bracket	15601 – Surface Mounting Flange 15607 – Surface Mounting Bracket
Notes			U.S. Patent Pending



Photometric with Lamp Supplied (fc)

Distance from Light	1'	2'	3'	4'	5'	6'	7'	8'	9'
Footcandles	2.6	3.2	1.2	.5	.2	-	-	-	-



Photometric with Lamp Supplied (fc)

Distance from Light	0'	1'	2'	3'	4'	5'	6'	7'	8'
Footcandles	8.9	5.3	2.1	0.5	.02	0	-	-	-



Photometric with Lamp Supplied (fc)

Distance from Light	0'	1'	2'	3'	4'	5'	6'	7'	8'
Footcandles	2.7	1.1	.3	.2	-	-	-	-	-



15369 TZT



15393 OZ



15426 BKT

Name	VINTAGE PARK™ Graceful curves and elegant detailing in a vintage design.	KENTUCKY Classic path light tastefully captures the traditional hunt club style.	ALMERIA™ Graceful curves and elegant detail are silhouetted by a tawny glow for a classic elegant look emulating Mediterranean sophistication.
Ordering Guide	15369 TZT - Textured Tannery Bronze™	15393 OZ - Olde Bronze®	15426 BKT - Textured Black
Housing	Cast Aluminum with tea dust glass	Cast Brass with light linen glass	Aluminum and Brass with light umber glass
Finish	Textured Tannery Bronze™	Olde Bronze®	Textured Black
Light Source	12V Incandescent S-8 wedge base socket	12V Incandescent T-5 wedge base socket	12V Incandescent T-5 wedge base socket
Power Usage at 12V AC Input	VA MAX: 18.5-W(VA) Supplied: 18.5-W(VA) 3155K (15599 CLR) Krypton light source	VA MAX: 16.25-W(VA) Supplied: 11.6-W(VA) 912X (17023) Xenon light source Optional: 16.25-W(VA) 921X (17025) 6.5-W(VA) 918X (17022) 4-W(VA) 901X (17021)	VA MAX: 11.6-W(VA) Supplied: 11.6-W(VA) 912X (17023) Xenon light source Optional: 6.5-W(VA) 918X (17022) 4-W(VA) 901X (17021)
Wiring	32" of usable #18-2, SPT-1-W leads. Cable connector supplied.	41" of usable #18-2, SPT-1-W leads. Cable connector supplied.	34" of usable #18-2, SPT-1-W leads. Cable connector supplied.
Mounting Accessories Included	8" In-ground stake	8" In-ground stake	8" In-ground stake
Optional Mounting Accessories	15601 – Surface Mounting Flange 15607 – Surface Mounting Bracket	15601 – Surface Mounting Flange 15607 – Surface Mounting Bracket	15601 – Surface Mounting Flange 15607 – Surface Mounting Bracket
Notes	U.S. Patent No. D570,517	U.S. Patent Pending	U.S. Patent No. D578,238



Photometric with Lamp Supplied (fc)

Distance from Light	0'	1'	2'	3'	4'	5'	6'	7'	8'
Footcandles	10.13	4	.9	.1	-	-	-	-	-

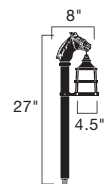

Photometric with Lamp Supplied (fc)

Distance from Light	6"	1'	2'	3'	4'	5'	6'	7'	8'
Footcandles	8.96	2.6	.43	.13	-	-	-	-	-



Photometric with Lamp Supplied (fc)

Distance from Light	0'	1'	2'	3'	4'	5'	6'	7'	8'
Footcandles	10	5.2	.8	.2	-	-	-	-	-

PATH & SPREAD LOW VOLTAGE

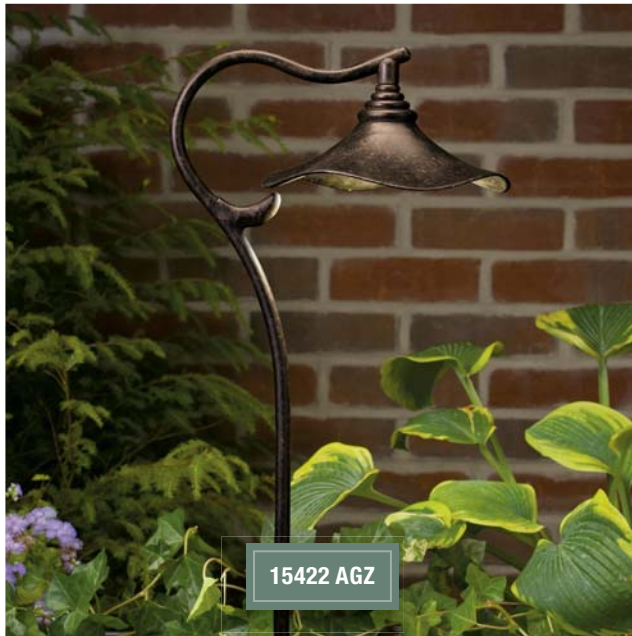

15422 AGZ

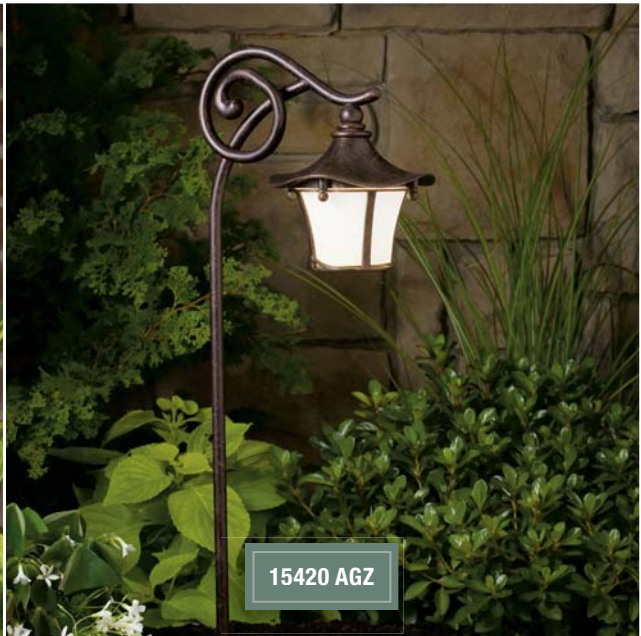

15420 AGZ

Name	COTSWOLD™ Curvy edition with old world charm, this path light spreads light with style that blends into nature for a lower profile light source.	COTSWOLD™ Lantern style path light with an old world, curvy cap. A curly stem adds unique charm to a popular traditional look.
Ordering Guide	15422 AGZ - Aged Bronze	15420 AGZ - Aged Bronze
Housing	Cast Aluminum	Cast Aluminum with weathered white glass
Finish	Aged Bronze	Aged Bronze
Light Source	12V Incandescent T-5 wedge base socket	12V Incandescent T-5 wedge base socket
Power Usage at 12V AC Input	VA MAX: 16.25-W(VA) Supplied: 11.6-W(VA) 912X (17023) Xenon light source Optional: 16.25-W(VA) 921X (17025) 6.5-W(VA) 918X (17022) 4-W(VA) 901X (17021)	VA MAX: 16.25-W(VA) Supplied: 11.6-W(VA) 912X (17023) Xenon light source Optional: 16.25-W(VA) 921X (17025) 6.5-W(VA) 918X (17022) 4-W(VA) 901X (17021)
Wiring	26" of usable #18-2, SPT-1-W leads. Cable connector supplied.	28" of usable #18-2, SPT-1-W leads. Cable connector supplied.
Mounting Accessories Included	8" In-ground stake	8" In-ground stake
Optional Mounting Accessories	15601 – Surface Mounting Flange 15607 – Surface Mounting Bracket	15601 – Surface Mounting Flange 15607 – Surface Mounting Bracket

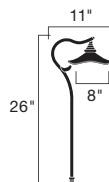

Photometric with Lamp Supplied (fc)

Distance from Light	0'	1'	2'	3'	4'	5'	6'	7'	8'
Footcandles	8.8	7	3.6	1.4	.4	-	-	-	-



Photometric with Lamp Supplied (fc)

Distance from Light	0'	1'	2'	3'	4'	5'	6'	7'	8'
Footcandles	14.9	2.5	1.3	.5	.1	-	-	-	-

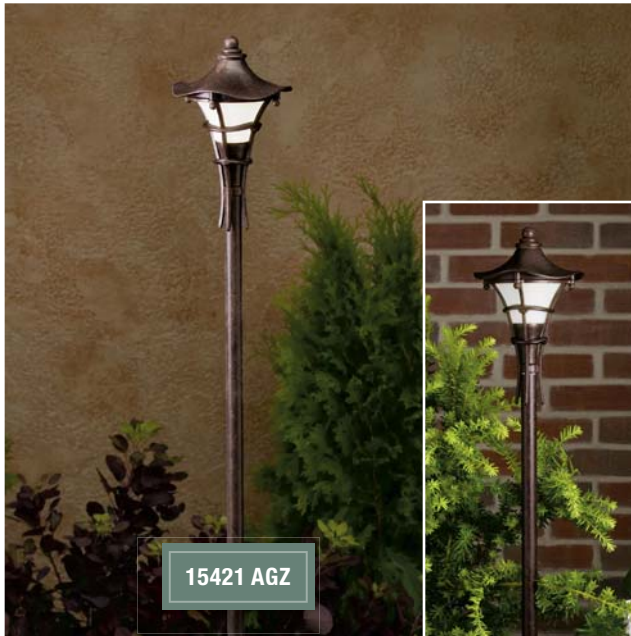

15421 AGZ

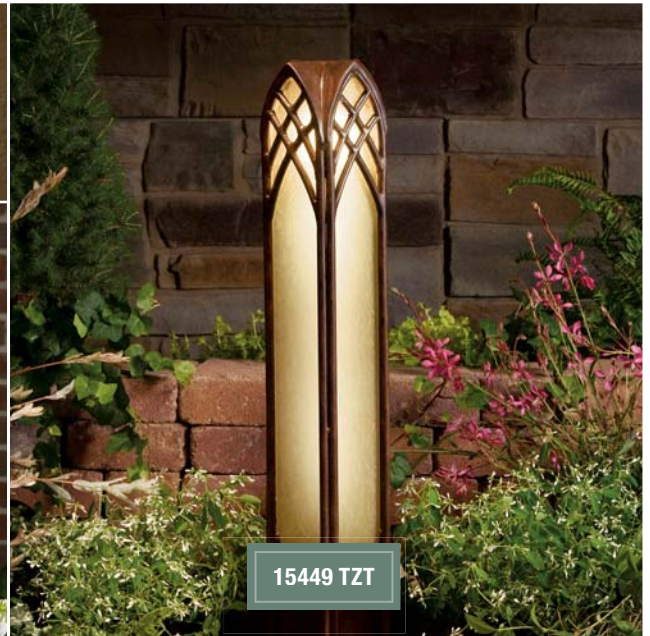

15449 TZT

Name	COTSWOLD™ CONVERTIBLE HEIGHT TIKI Adjustable-height stem converts path light to a Tiki torch style for use around patios, barbeque grills or outdoor dining areas.	CATHEDRAL BOLLARD Cathedral arches and interwoven bands created to form a transitional stanchion for the garden's edge.
Ordering Guide	15421 AGZ - Aged Bronze	15449 TZT - Textured Tannery Bronze™
Housing	Cast Aluminum with weathered white glass	Aluminum with dark citrine glass
Finish	Aged Bronze	Textured Tannery Bronze™
Light Source	12V Incandescent T-5 wedge base socket	12V Incandescent T-5 wedge base socket
Power Usage at 12V AC Input	VA MAX: 16.25-W(VA) Supplied: 11.6-W(VA) 912X (17023) Xenon light source Optional: 16.25-W(VA) 921X (17025) 6.5-W(VA) 918X (17022) 4-W(VA) 901X (17021)	VA MAX: 16.25-W(VA) Supplied: 11.6-W(VA) 912X (17023) (2) Xenon light source Optional: 16.25-W(VA) 921X (17025) 6.5-W(VA) 918X (17022) 4-W(VA) 901X (17021) (2 required)
Wiring	24" of usable #18-2, SPT-1-W leads at high position. 50" usable leads at low position. Cable connector supplied with fixture.	22" of usable #18-2, SPT-1-W leads. Cable connector supplied.
Mounting Accessories Included	14" In-ground stake	8" In-ground stake
Optional Mounting Accessories	15601 – Surface Mounting Flange 15607 – Surface Mounting Bracket	

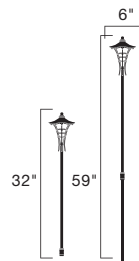

Photometric with Lamp Supplied (fc)

Distance from Light	0'	1'	2'	3'	4'	5'	6'	7'	8'
Footcandles	.25	.3	.2	.1	-	-	-	-	-

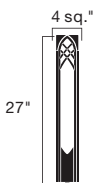

Photometric with Lamp Supplied (fc)

Distance from Light	0'	1'	2'	3'	4'	5'	6'	7'	8'
Footcandles	0.44	1.81	1.26	0.70	0.39	0.25	0.16	.012	0.10

PATH & SPREAD LOW VOLTAGE

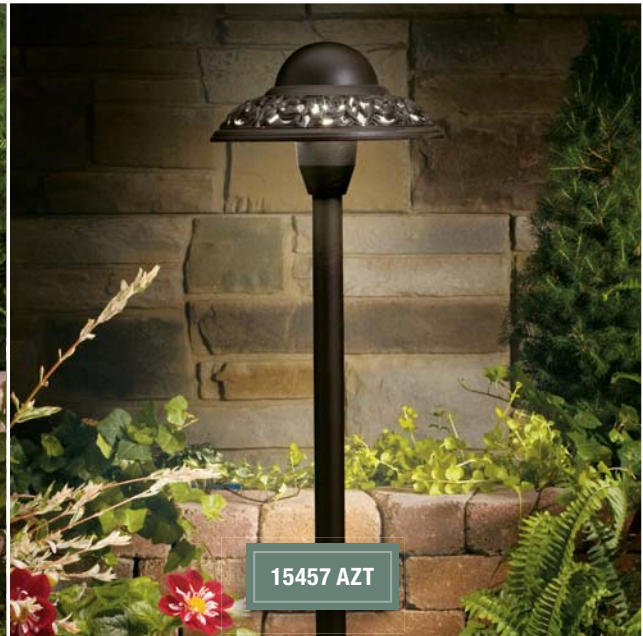
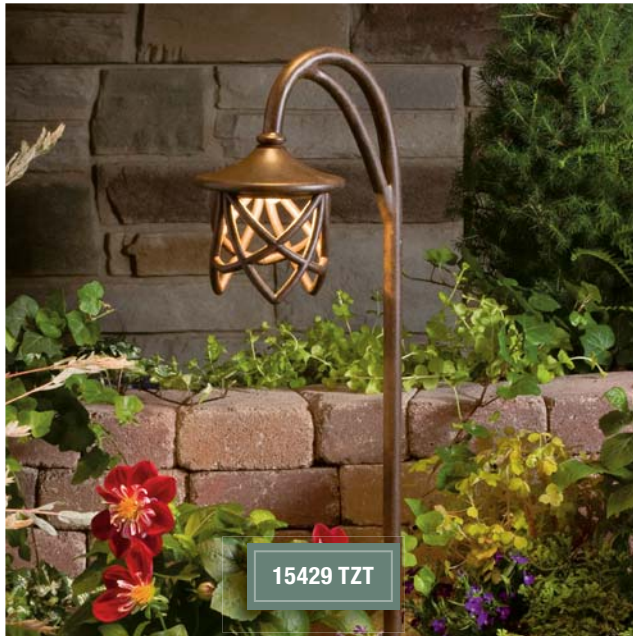

Name	CATHEDRAL™ Transitional styling with draped arches of interwoven bands.	PIERCED DOME A cast dome sculpted with a floral band and pierced to reveal a trickle of light.
Ordering Guide	15429 TZT - Textured Tannery Bronze™	15457 AZT - Textured Architectural Bronze™
Housing	Aluminum	Cast Aluminum
Finish	Textured Tannery Bronze™	Textured Architectural Bronze™
Light Source	12V Incandescent T-5 wedge base socket	12V Incandescent T-5 wedge base socket
Power Usage at 12V AC Input	VA MAX: 16.25-W(VA) Supplied: 11.6-W(VA) 912X (17023) Xenon light source Optional: 16.25-W(VA) 921X (17025) 6.5-W(VA) 918X (17022) 4-W(VA) 901X (17021)	VA MAX: 16.25-W(VA) Supplied: 16.25-W(VA) 921X (17025) Xenon light source Optional: 11.6-W(VA) 912X (17023) 6.5-W(VA) 918X (17022) 4-W(VA) 901X (17021)
Wiring	24" of usable #18-2, SPT-1-W leads. Cable connector supplied.	24" of usable #18-2, SPT-1-W leads. Cable connector supplied.
Mounting Accessories Included	8" In-ground stake	8" In-ground stake
Optional Mounting Accessories	15601 – Surface Mounting Flange 15607 – Surface Mounting Bracket	15601 – Surface Mounting Flange 15607 – Surface Mounting Bracket



Photometric with Lamp Supplied (fc)

Distance from Light	0'	1'	2'	3'	4'	5'	6'	7'	8'
Footcandles	7.52	5.42	0.47	1.15	0.32	0.05	-	-	-

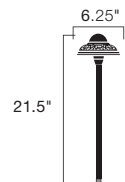

Photometric with Lamp Supplied (fc)

Distance from Light	0'	1'	2'	3'	4'	5'	6'	7'	8'
Footcandles	9.36	5.22	3.76	2.02	0.89	0.12	0.05	-	-



15437 TZT



15330 OZ



15332 OZ

Name	PIERCED SCROLLWORK Classic style scrollwork is pierced and shaped into a pyramid allowing the light to play against the sculpted textures.	ADJUSTABLE CRESENT Adjustable shade on this versatile fixture allows it to be used as a path or accent light or for wall washing.	FROG AT PLAY A mixture of whimsy and function creates a clever accent near a pond or along a path.
Ordering Guide	15437 TZT - Textured Tannery Bronze™	15330 OZ - Olde Bronze®	15332 OZ - Olde Bronze®
Housing	Cast Aluminum	Adjustable brass shade	Brass
Finish	Textured Tannery Bronze™	Olde Bronze®	Olde Bronze®
Light Source	12V Incandescent T-5 wedge base socket	12V Incandescent S-8 wedge base socket	12V Incandescent S-8 wedge base socket
Power Usage at 12V AC Input	VA MAX: 16.25-W(VA) Supplied: 16.25-W(VA) 921X (17025) Xenon light source Optional: 11.6-W(VA) 912X (17023) 6.5-W(VA) 918X (17022) 4-W(VA) 901X (17021)	VA MAX: 24.4-W(VA) Supplied: 24.4-W(VA) 3156K (15598 CLR) Krypton light source Optional: 18.5-W(VA) 3155K (15599 CLR)	VA MAX: 18.5-W(VA) Supplied: 18.5-W(VA) 3155K (15599 CLR) Krypton light source
Wiring	24" of usable #18-2, SPT-1-W leads. Cable connector supplied.	42" of usable #18-2, SPT-1-W leads. Cable connector supplied.	23" of usable #18-2, SPT-1-W leads. Cable connector supplied.
Mounting Accessories Included	8" In-ground stake	8" In-ground stake	14" In-ground stake
Optional Mounting Accessories	15601 – Surface Mounting Flange 15607 – Surface Mounting Bracket	15601 – Surface Mounting Flange 15607 – Surface Mounting Bracket	15601 – Surface Mounting Flange 15607 – Surface Mounting Bracket

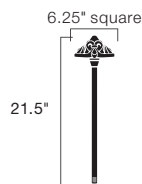

Photometric with Lamp Supplied (fc)

Distance from Light	0'	1'	2'	3'	4'	5'	6'	7'	8'
Footcandles	11.04	6.99	3.14	1.56	0.44	0.10	0.05	0.03	-

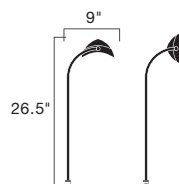

Photometric with Lamp Supplied (fc)

Distance from Light	0'	1'	2'	3'	4'	5'	6'	7'	8'
Footcandles	15.18	9.98	4.13	1.52	.6	.22	.03	-	-

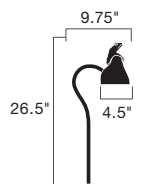

Photometric with Lamp Supplied (fc)

Distance from Light	.5'	1'	2'	3'	4'	5'	6'	7'	8'
Footcandles	13.5	8.3	3.8	1.7	.8	.4	.1	-	-



15307 CO



15325 PZ



15324 PZ

Name	FROG AND UMBRELLA Weathered verdigris frog perched under an umbrella to accent a path or sit in the landscape.	LEAF WITH OR WITHOUT LIZARD Organic leaf design integrates naturally into any garden setting as a path light. Add the lizard to create a unique focal point.
Ordering Guide	15307 CO - Unfinished Copper	15325 PZ - Patina Bronze with Lizard 15324 PZ - Patina Bronze without Lizard
Housing	Copper stem and umbrella. Composite resin frog.	Die-cast zinc shade and brass stem. Lizard made of composite resin.
Finish	Unfinished Copper (Copper will naturally patina over time)	Patina Bronze
Light Source	12V Incandescent S-8 wedge base socket	12V Incandescent S-8 wedge base socket
Power Usage at 12V AC Input	VA MAX: 24.4-W(VA) Supplied: 24.4-W(VA) 3156K (15598 CLR) Krypton light source Optional: 18.5-W(VA) 3155K (15599 CLR)	VA MAX: 24.4-W(VA) Supplied: 24.4-W(VA) 3156K (15598 CLR) Krypton light source Optional: 18.5-W(VA) 3155K (15599 CLR)
Wiring	34" of usable #18-2, SPT-1-W leads. Cable connector supplied.	41" of usable #18-2, SPT-1-W leads. Cable connector supplied.
Mounting Accessories Included	8" In-ground stake	8" In-ground stake
Optional Mounting Accessories	15601 – Surface Mounting Flange 15607 – Surface Mounting Bracket	15601 – Surface Mounting Flange 15607 – Surface Mounting Bracket

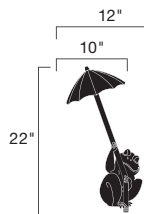

Photometric with Lamp Supplied (fc)

Distance from Light	0'	1'	2'	3'	4'	5'	6'	7'	8'
Footcandles	21.1	7.3	1.7	.7	.5	-	-	-	-

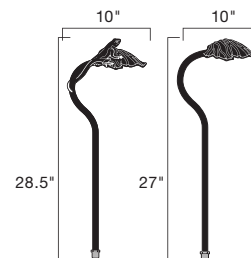

Photometric with Lamp Supplied (fc)

Distance from Light	0'	1'	2'	3'	4'	5'	6'	7'	8'
Footcandles	22.4	13.1	5.4	2	.8	.3	.1	-	-

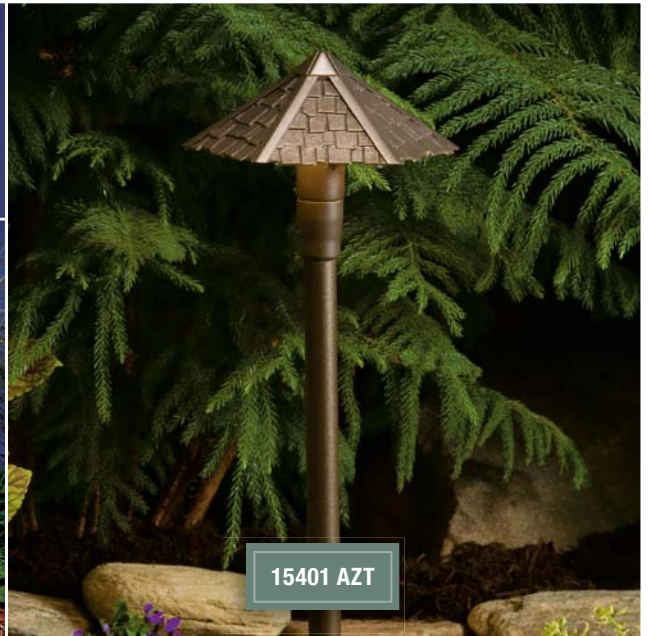

Name	ACORN WITH OR WITHOUT SQUIRREL Available with or without squirrel to create a strategically placed accent light and maintain a coordinated look.	THATCHED ROOF The casual style indicative of island life is reproduced in this cast aluminum lighting fixture. Coordinates with matching deck light 15461 on page 85.
Ordering Guide	15358 OZ - Olde Bronze® with Textured Weatherstone squirrel 15359 OZ - Olde Bronze® without squirrel	15401 AZT - Textured Architectural Bronze™
Housing	Cast Brass and linen glass. Squirrel made of durable outdoor resin.	Cast Aluminum with clear glass sprinkler shield
Finish	Olde Bronze® with Textured Weatherstone squirrel	Textured Architectural Bronze™
Light Source	12V Incandescent T-5 wedge base socket	12V Incandescent T-3 bi-pin, high temperature porcelain socket
Power Usage at 12V AC Input	VA MAX: 16.25-W(VA) Supplied: 16.25-W(VA) 921X (17025) Xenon light source Optional: 11.6-W(VA) 912X (17023) 6.5-W(VA) 918X (17022) 4-W(VA) 901X (17021)	VA MAX: 20-W(VA) Supplied: 20-W(VA) T-3 (17012) halogen Halogen light source Optional: 10-W(VA) T-3 (17011)
Wiring	38" of usable #18-2, SPT-1-W leads. Cable connector supplied.	20" of usable #18-2, SPT-1-W leads. Cable connector supplied.
Mounting Accessories Included	8" In-ground stake	8" In-ground stake
Optional Mounting Accessories	15601 – Surface Mounting Flange 15607 – Surface Mounting Bracket	15601 – Surface Mounting Flange 15607 – Surface Mounting Bracket
Notes	U.S. Patent Pending	

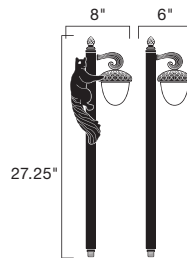

Photometric with Lamp Supplied (fc)

Distance from Light	0'	1'	2'	3'	4'	5'	6'	7'	8'
Footcandles	11.3	8.1	3.7	1.7	.7	.3	.1	-	-

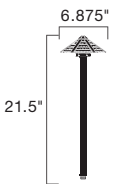

Photometric with Lamp Supplied (fc)

Distance from Light	0'	1'	2'	3'	4'	5'	6'	7'	8'
Footcandles	9.9	7.3	1.7	.76	.16	-	-	-	-



15373 BKT



15443 TZT



15443 VG



15443 OB/15443 OB6
15443 NBK



15443 CO

Name	TEXTURED TREE BARK Combines traditional shapes with natural textures for a popular lodge style.	DECORATIVE HAMMERED ROOF Pierced shade sheds decorative patterned light over shrubs or gardens. Coordinates with matching deck light 15063 on page 85.
Ordering Guide	15373 BKT Textured Black	15443 CO Unfinished Copper, Copper 15443 OB Olde Brick®, Brass 15443 OB 6 Same as 15443OB. Bulk packed in 6 (unbreakable master). 15443 NBK New Brick™, Brass, powder coat version of Olde Brick® 15443 TZT Textured Tannery Bronze™, Brass 15443 VG Verdigris, Brass
Housing	Resin and Aluminum	Brass or Copper
Finish	Textured Black Trim or simulated Textured Brown Bark	Unfinished Copper, Olde Brick®, Natural Verdigris, New Brick™ or Textured Tannery Bronze™ (Copper will naturally patina over time)
Light Source	12V Incandescent S-8 wedge base socket	12V Incandescent S-8 wedge base socket
Power Usage at 12V AC Input	VA MAX: 18.5-W(VA) Supplied: 18.5-W(VA) 3155K (15599 CLR) Krypton light source	VA MAX: 24.4-W(VA) Supplied: 24.4-W(VA) 3156K (15598 CLR) Krypton light source Optional: 18.5-W(VA) 3155K (15599 CLR)
Wiring	23" of usable #18-2, SPT-1-W leads. Cable connector supplied.	35" of usable #18-2, SPT-1-W leads. Cable connector supplied.
Mounting Accessories Included	8" In-ground stake	8" In-ground stake
Optional Mounting Accessories	15601 – Surface Mounting Flange 15607 – Surface Mounting Bracket	15601 – Surface Mounting Flange 15607 – Surface Mounting Bracket
LED Options	NA	15843 on page 10.
Notes	U.S. Patent Pending	U.S. Patent No. D408,573



Photometric with Lamp Supplied (fc)

Distance from Light	1'	2'	3'	4'	5'	6'	7'	8'	9'
Footcandles	6.93	4.33	.15	-	-	-	-	-	-



Photometric with Lamp Supplied (fc)

Distance from Light	1'	2'	3'	4'	5'	6'	7'	8'	9'
Footcandles	8.9	2.8	.6	.15	-	-	-	-	-



Name	CAST HAMMERED ROOF Pierced shade sheds decorative patterned light over shrubs, gardens, or walkways. Coordinates with matching deck light 15063 on page 85.	RIBBED ROOF Simple ribs and valleys are combined with a fluted column to blend with every landscape setting and any home exterior. Coordinates with matching deck light 15468 on page 95.	TULIP Traditionally elegant tulip shade on a grace-fully curved stem. Effective as a grouping in a flower bed or along a path.
Ordering Guide	15471 BBR - Bronzed Brass, Brass 15471 TZT - Textured Tannery Bronze™, Aluminum	15418 AZT - Textured Architectural Bronze™	15349 MST - Textured Midnight Spruce™
Housing	Cast Aluminum, Cast Brass	Cast Aluminum with clear glass sprinkler shield	Aluminum
Finish	Bronzed Brass or Textured Tannery Bronze™	Textured Architectural Bronze™	Textured Midnight Spruce™
Light Source	12V Incandescent S-8 wedge base socket	12V Incandescent T-3 bi-pin, high temperature porcelain socket	12V Incandescent S-8 wedge base socket
Power Usage at 12V AC Input	VA MAX: 24.4-W(VA) Supplied: 24.4-W(VA) 3156K (15598CLR) Krypton light source Optional: 18.5-W(VA) 3155K (15599CLR)	VA MAX: 20-W(VA) Supplied: 20-W(VA) T-3 (17012) halogen Halogen light source Optional: 10-W(VA) T-3 (17011)	VA MAX: 18.5-W(VA) Supplied: 18.5-W(VA) 3155K (15599 CLR) Krypton light source
Wiring	35" of useable #18-2, SPT-2W leads. Cable connector supplied.	20" of usable #18-2, SPT-1-W leads. Cable connector supplied.	37" of usable #18-2, SPT-1-W leads. Cable connector supplied.
Mounting Accessories Included	8" In-ground stake	8" In-ground stake	8" In-ground stake
Optional Mounting Accessories	15601 - Surface Mounting Flange 15607 - Surface Mounting Bracket	15601 - Surface Mounting Flange 15607 - Surface Mounting Bracket	15601 - Surface Mounting Flange 15607 - Surface Mounting Bracket
LED Option	15871 on page 10.	NA	NA



Photometric with Lamp Supplied (fc)

Distance from Light	1'	2'	3'	4'	5'	6'	7'	8'	9'
Footcandles	8.9	2.8	.6	.15	-	-	-	-	-



Photometric with Lamp Supplied (fc)

Distance from Light	1'	2'	3'	4'	5'	6'	7'	8'	9'
Footcandles	11.7	5.4	1.1	.2	-	-	-	-	-

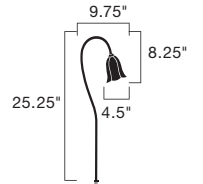

Photometric with Lamp Supplied (fc)

Distance from Light	1'	2'	3'	4'	5'	6'	7'	8'	9'
Footcandles	12.7	4.1	1	.2	.07	.02	-	-	-



Meet the professionals
behind the lighting



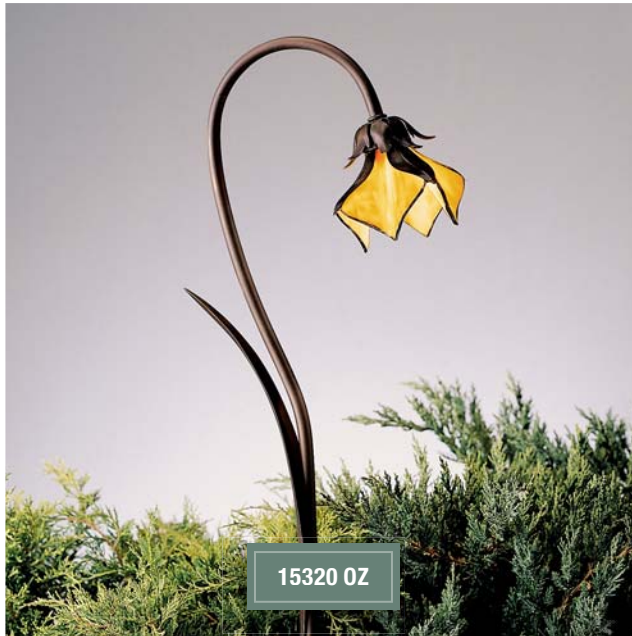

15320 OZ



15313 TZG

Name	TIFFANY PETALS Elegant flower petals recreated in Tiffany-style glass on a sweeping stem accented by a single leaf. Olde Bronze® finish adds to the look of an aged heirloom.	LAFAYETTE™ LANTERN A traditional lantern with French influence for a distinctive look. Matching 120V surface and post mount styles available.
Ordering Guide	15320 OZ - Olde Bronze®	15313 TZG - Tannery Bronze™ with Gold Accents
Housing	Brass. Tiffany-style glass shade. Glass colors may vary slightly due to production methods.	Cast Aluminum. Linen seeded glass.
Finish	Olde Bronze®	Tannery Bronze™ with Gold Accents
Light Source	12V Incandescent S-8 wedge base socket	12V Incandescent T-5 wedge base socket
Power Usage at 12V AC Input	VA MAX: 18.5-W(VA) Supplied: 18.5-W(VA) 3155K (15599 CLR) Krypton light source	VA MAX: 16.25-W(VA) Supplied: 16.25-W(VA) Xenon light source Optional: 11.6-W(VA) 912X (17023) 6.5-W(VA) 918X (17022) 4-W(VA) 901X (17021)
Wiring	38" of usable #18-2, SPT-1-W leads. Cable connector supplied.	35" of usable #18-2, SPT-1-W leads. Cable connector supplied.
Mounting Accessories Included	8" In-ground stake	8" In-ground stake
Optional Mounting Accessories	15601 – Surface Mounting Flange 15607 – Surface Mounting Bracket	15601 – Surface Mounting Flange 15607 – Surface Mounting Bracket
Notes		U.S. Patent Pending

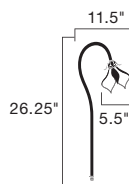

Photometric with Lamp Supplied (fc)

Distance from Light	1'	2'	3'	4'	5'	6'	7'	8'	9'
Footcandles	9.7	4.7	2	.8	.3	.1	-	-	-



Photometric with Lamp Supplied (fc)

Distance from Light	0'	1'	2'	3'	4'	5'	6'	7'	8'
Footcandles	1.3	3	1.96	.86	.33	-	-	-	-



15444 OZ

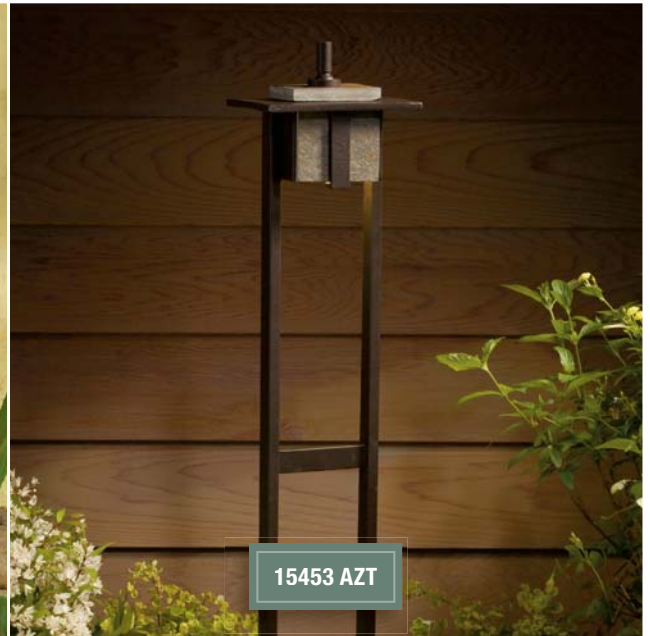

15453 AZT

Name	LARKIN ESTATE™ Classic prairie styling employing a rich dark bronze finish and warm amber glass.	MISSION SLATE The beauty of slate and the richness of mission aesthetics come together to create this exciting garden statement.
Ordering Guide	15444 OZ - Olde Bronze®	15453 AZT - Textured Architectural Bronze™
Housing	Cast Brass with amber etched glass	Cast Aluminum and natural, cut slate panels
Finish	Olde Bronze®	Textured Architectural Bronze™
Light Source	12V Incandescent T-5 wedge base socket	12V Incandescent T-5 wedge base socket
Power Usage at 12V AC Input	VA MAX: 16.25-W(VA) Supplied: 11.6-W(VA) 912X (17023) Xenon light source Optional: 16.25-W(VA) 921X (17025) 6.5-W(VA) 918X (17022) 4-W(VA) 901X (17021)	VA MAX: 16.25-W(VA) Supplied: 11.6-W(VA) 912X (17023) Xenon light source Optional: 6.5-W(VA) 918X (17022) 4-W(VA) 901X (17021)
Wiring	40" of usable #18-2, SPT-1-W leads. Cable connector supplied.	30" of usable #18-2, SPT-1-W leads. Cable connector supplied.
Mounting Accessories Included	8" In-ground stake	14" In-ground stake
Optional Mounting Accessories	15601 – Surface Mounting Flange 15607 – Surface Mounting Bracket	15601 – Surface Mounting Flange 15607 – Surface Mounting Bracket



Photometric with Lamp Supplied (fc)

Distance from Light	0'	1'	2'	3'	4'	5'	6'	7'	8'
Footcandles	10.8	6.9	0.7	0.4	0.2	0.1	-	-	-

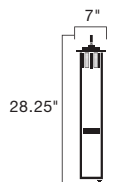

Photometric with Lamp Supplied (fc)

Distance from Light	0'	1'	2'	3'	4'	5'	6'	7'	8'
Footcandles	7.83	5.14	1.45	0.34	0.07	0.03	0.02	-	-

PATH & SPREAD LOW VOLTAGE



15391 OZ



15392 OZ



15319 PZ

Name	ZEN GARDEN Path lighting with Far Eastern style and amber glass offers soft light with good spread for illuminating paths and walkways.	ZEN GARDEN BOLLARD Bollard lighting with Far Eastern style and amber glass for soft lighting along a path.	MISSION LANTERN California mission-style with frosted glass coordinates with contemporary, craftsman or Southwest architecture.
Ordering Guide	15391 OZ - Olde Bronze®	15392 OZ - Olde Bronze®	15319 PZ - Patina Bronze
Housing	Brass with textured amber seedy linen glass	Brass with textured amber seedy linen glass	Brass with satin-etched glass
Finish	Olde Bronze®	Olde Bronze®	Patina Bronze
Light Source	12V Incandescent T-5 wedge base socket	12V Incandescent T-5 wedge base socket	12V Incandescent S-8 wedge base socket
Power Usage at 12V AC Input	VA MAX: 16.25-W(VA) Supplied: 11.6-W(VA) 912X (17023) Xenon light source Optional: 16.25-W(VA) 921X (17025) 6.5-W(VA) 918X (17022) 4-W(VA) 901X (17021)	VA MAX: 16.25-W(VA) Supplied: 11.6-W 912X (17023) Xenon light source Optional: 6.5-W(VA) 918X (17022) 4-W(VA) 901X (17021) 16.25-W(VA) 921X (17025)	VA MAX: 18.5-W(VA) Supplied: 18.5-W(VA) 3155K (15599 CLR) Krypton light source
Wiring	30" of usable #18-2, SPT-1-W leads. Cable connector supplied.	35" of usable #18-2, SPT-1-W leads. Cable connector supplied.	40" of usable #18-2, SPT-1-W leads. Cable connector supplied.
Mounting Accessories Included	8" In-ground stake	8" In-ground stake	8" In-ground stake
Optional Mounting Accessories	15601 – Surface Mounting Flange 15607 – Surface Mounting Bracket	15601 – Surface Mounting Flange 15607 – Surface Mounting Bracket	15601 – Surface Mounting Flange 15607 – Surface Mounting Bracket
Notes	U.S. Patent Pending	U.S. Patent Pending	

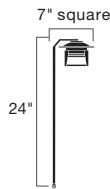

Photometric with Lamp Supplied (fc)

Distance from Light	1'	2'	3'	4'	5'	6'	7'	8'	9'
Footcandles	3.2	1.2	.26	-	-	-	-	-	-

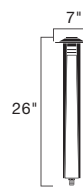

Photometric with Lamp Supplied (fc)

Distance from Light	.5'	1'	2'	3'	4'	5'	6'	7'	8'
Footcandles	.16	.36	.20	-	-	-	-	-	-

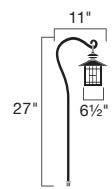

Photometric with Lamp Supplied (fc)

Distance from Light	1'	2'	3'	4'	5'	6'	7'	8'	9'
Footcandles	21.1	7.3	1.7	.7	.5	-	-	-	-



15322 AGZ



15365 CV



15458 OZ

Name	CROSS CREEK™ LANTERN Arts and crafts style in a path light for distinctive simplicity. Matching 120V surface and post mount styles available.	LA MESA™ LANTERN Arts and crafts-inspired light complements any architectural style. Matching 120V surface and post mount styles available.	MISSION BOLLARD The broad roof indicative of mission styling is blended into a garden bollard with honey beige glass.
Ordering Guide	15322 AGZ - Aged Bronze	15365 CV - Canyon View™	15458 OZ - Old Bronze®
Housing	Cast Aluminum with textured linen seeded glass panels	Solid Brass with Honey opalescent glass. Glass panel colors may vary due to production methods	Brass with honey beige glass
Finish	Aged Bronze	Canyon View™	Old Bronze®
Light Source	12V Incandescent T-5 wedge base socket	12V Incandescent S-8 wedge base socket	12V Incandescent T-5 wedge base socket
Power Usage at 12V AC Input	VA MAX: 16.25-W(VA) Supplied: 16.25-W(VA) 921X (17025) Xenon light source Optional: 11.6-W(VA) 921X (17023) 6.5-W(VA) 918X (17022) 4-W(VA) 901X (17021)	VA MAX: 24.4-W(VA) Supplied: 24.4-W(VA) 3156K (15598 CLR) Krypton light source Optional: 18.5-W(VA) 3155K (15599 CLR)	VA MAX: 16.25-W(VA) Supplied: 11.6-W(VA) 912X (17023) (qty 2) Xenon light source Optional: 16.25-W(VA) 921X (17025) 6.5-W(VA) 918X (17022) 4-W(VA) 901X (17021) (2 required)
Wiring	35' of usable #18-2, SPT-1-W leads. Cable connector supplied.	21' of usable #18-2, SPT-1-W leads. Cable connector supplied.	22' of usable #18-2, SPT-1-W leads. Cable connector supplied.
Mounting Accessories Included	8" In-ground stake	8" In-ground stake	14" In-ground stake
Optional Mounting Accessories	15601 – Surface Mounting Flange 15607 – Surface Mounting Bracket	15601 – Surface Mounting Flange 15607 – Surface Mounting Bracket	
Notes	U.S. Patent No. D580,084	U.S. Patent Pending	

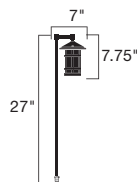

Photometric with Lamp Supplied (fc)

Distance from Light	0'	1'	2'	3'	4'	5'	6'	7'	8'
Footcandles	10.8	6.9	0.7	0.4	0.2	0.1	-	-	-

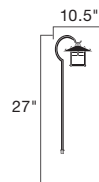

Photometric with Lamp Supplied (fc)

Distance from Light	1'	2'	3'	4'	5'	6'	7'	8'	9'
Footcandles	3.2	.5	.03	-	-	-	-	-	-

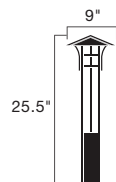

Photometric with Lamp Supplied (fc)

Distance from Light	0'	1'	2'	3'	4'	5'	6'	7'	8'
Footcandles	0.44	1.81	1.26	0.70	0.39	0.25	0.16	0.12	0.10

PATH & SPREAD LOW VOLTAGE



15430 CO



15431 CO



15351 CO

Name	SANTA BARBARA SMALL COPPER Durable, sleek and basic, low profile with surprising light throw. Ages outdoors gracefully over time by turning verdigris. Coordinates with 15431 CO.	SANTA BARBARA LARGE COPPER Influenced by Southern California, this wider spread path ages outdoors gracefully over time by turning verdigris. Coordinates with 15430 CO.	COPPER CENTER MOUNT This classic brushed copper path light develops a natural verdigris patina over time.
Ordering Guide	15430 CO - Unfinished Copper	15431 CO - Unfinished Copper	15351 CO - Unfinished Copper
Housing	Copper with stainless steel inner roof and clear glass	Copper with stainless steel inner roof and clear glass	Copper
Finish	Unfinished Copper	Unfinished Copper	Unfinished Copper
Light Source	12V Incandescent T-3 bi-pin, high temperature porcelain socket	12V Incandescent T-3 bi-pin, high temperature porcelain socket	12V Incandescent S-8 wedge base socket
Power Usage at 12V AC Input	VA MAX: 10-W(VA) Supplied: 10-W(VA) T-3 (17011) halogen Halogen light source	VA MAX: 20-W (VA) Supplied: 20-W (VA) T-3 (17012) halogen Halogen light source Optional: 10-W(VA) T-3 (17011)	VA MAX: 24.4-W(VA) Supplied: 24.4-W(VA) 3156K (15598 CLR) Krypton light source Optional: 18.5-W(VA) (15599 CLR)
Wiring	24" of usable #18-2, SPT-1-W leads. Cable connector supplied.	24" of usable #18-2, SPT-1-W leads. Cable connector supplied.	35" of usable #18-2, SPT-1-W leads. Cable connector supplied.
Mounting Accessories Included	8" In-ground stake	8" In-ground stake	8" In-ground stake
Optional Mounting Accessories	15601 – Surface Mounting Flange 15607 – Surface Mounting Bracket	15601 – Surface Mounting Flange 15607 – Surface Mounting Bracket	15601 – Surface Mounting Flange 15607 – Surface Mounting Bracket
Notes	Copper and brass will naturally patina over time.	Copper and brass will naturally patina over time.	Copper will naturally patina over time.

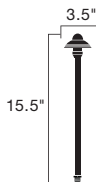

Photometric with Lamp Supplied (fc)

Distance from Light	0'	1'	2'	3'	4'	5'	6'	7'	8'
Footcandles	11.5	5	2.9	.8	.2	-	-	-	-

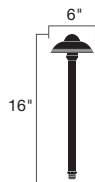

Photometric with Lamp Supplied (fc)

Distance from Light	0'	1'	2'	3'	4'	5'	6'	7'	8'
Footcandles	31.5	11.7	5.4	1.1	.2	-	-	-	-

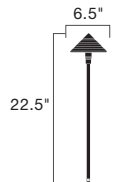

Photometric with Lamp Supplied (fc)

Stem Height	1'	2'	3'	4'	5'	6'	7'	8'	9'
18"	10.4	5.2	1.9	.83	.23	-	-	-	-

Light Bulb Conversion: 18.5W, 3155K Light Bulb, FCx66

PATH & SPREAD LOW VOLTAGE

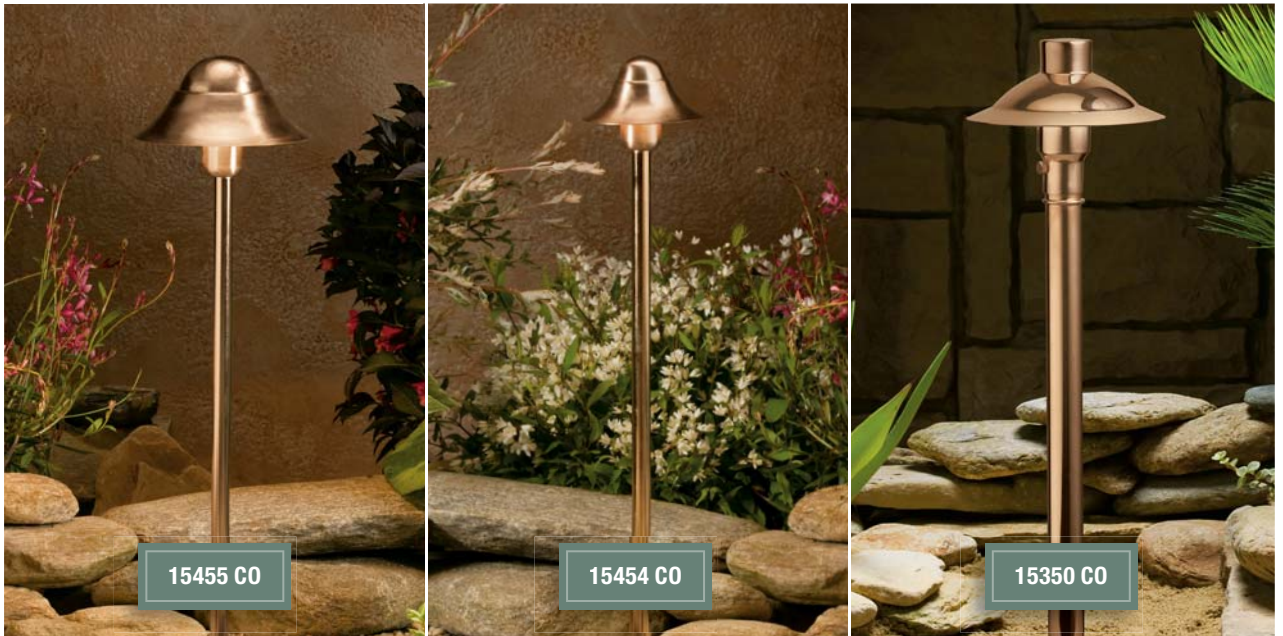

Name	TRANSITIONAL COPPER LARGE The deep domed transitional design roof will age into a beautiful patina as the copper oxidizes.	TRANSITIONAL COPPER SMALL The deep domed transitional design roof will age into a beautiful patina as the copper oxidizes.	ADJUSTABLE COPPER Shade adjusts up or down. This traditional style light offers versatility in light spread and will develop a natural verdigris patina over time.
Ordering Guide	15455 CO - Unfinished Copper	15454 CO - Unfinished Copper	15350 CO - Unfinished Copper
Housing	Copper	Copper	Copper
Finish	Unfinished Copper	Unfinished Copper	Unfinished Copper
Light Source	12V Incandescent T-5 wedge base socket	12V Incandescent T-5 wedge base socket	12V Incandescent S-8 wedge base socket
Power Usage at 12V AC Input	VA MAX: 16.25-W(VA) Supplied: 16.25-W(VA) 921X (17025) Xenon light source Optional: 11.6-W(VA) 912X (17023) 6.5-W(VA) 918X (17022) 4-W(VA) 901X (17021)	VA MAX: 11.6-W(VA) Supplied: 11.6-W(VA) 921X (17023) Xenon light source Optional: 11.6-W(VA) 912X (17023) 6.5-W(VA) 918X (17022) 4-W(VA) 901X (17021)	VA MAX: 24.4-W(VA) Supplied: 24.4-W(VA) 3156K (15598 CLR) Krypton light source Optional: 18.5-W 3155K (15599 CLR)
Wiring	39" of usable #18-2, SPT-1-W leads. Cable connector supplied.	40" of usable #18-2, SPT-1-W leads. Cable connector supplied.	21" of usable #18-2, SPT-1-W leads. Cable connector supplied.
Mounting Accessories Included	8" In-ground stake	8" In-ground stake	8" In-ground stake
Optional Mounting Accessories	15601 – Surface Mounting Flange 15607 – Surface Mounting Bracket	15601 – Surface Mounting Flange 15607 – Surface Mounting Bracket	15601 – Surface Mounting Flange 15607 – Surface Mounting Bracket
Notes	Copper will naturally patina over time.	Copper will naturally patina over time.	Copper will naturally patina over time.

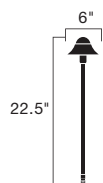

Photometric with Lamp Supplied (fc)

Distance from Light	0'	1'	2'	3'	4'	5'	6'	7'	8'
Footcandles	17.45	8.73	3.86	2.37	1.08	0.58	0.34	0.15	0.05



Photometric with Lamp Supplied (fc)

Distance from Light	1'	2'	3'	4'	5'	6'	7'	8'	9'
Footcandles	8.64	4.02	2.59	1.26	0.38	0.10	0.05	0.03	-

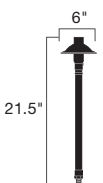

Photometric with Lamp Supplied (fc)

Shade Position on Stem	1'	2'	3'	4'	5'	6'	7'	8'	9'
Bottom	6.4	5.0	2.3	1.0	.4	.1	-	-	-
Middle	6.3	2.7	2.0	.9	.4	.1	-	-	-
Top	6.0	2.4	.8	.3	.1	-	-	-	-

Distance from surface 19"

PATH & SPREAD LOW VOLTAGE



15367 TZT



15438 OZ



15438 OB

Name	ROUND LANTERN Simple, elegant style blends with traditional or contemporary architecture.	TRADITIONAL MARINE LANTERN Traditional marine lantern for well-shielded illumination in a variety of finishes. Matching 120V surface and post mount styles.
Ordering Guide	15367 TZT - Textured Tannery Bronze™	15438 OB - Olde Brick®, Brass 15438 OZ - Olde Bronze®, Brass
Housing	Cast Aluminum with etched sunset glass	Brass with white polycarbonate diffuser
Finish	Textured Tannery Bronze™	Olde Brick® or Olde Bronze®
Light Source	12V Incandescent S-8 wedge base socket	12V Incandescent S-8 wedge base socket
Power Usage at 12V AC Input	VA MAX: 24.4-W(VA) Supplied: 24.4-W(VA) 3156K (15598 CLR) Krypton light source Optional: 18.5-W(VA) 3155K (15599 CLR)	VA MAX: 18.5-W(VA) Supplied: 18.5-W(VA) 3155K (15599 CLR) Krypton light source
Wiring	51" of usable #18-2, SPT-1-W leads. Cable connector supplied.	26" of usable #18-2, SPT-1-W leads. Cable connector supplied.
Mounting Accessories Included	8" In-ground stake	8" In-ground stake
Optional Mounting Accessories	15601 – Surface Mounting Flange 15607 – Surface Mounting Bracket	15601 – Surface Mounting Flange 15607 – Surface Mounting Bracket

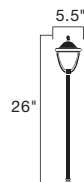

Photometric with Lamp Supplied (fc)

Distance from Light	1'	2'	3'	4'	5'	6'	7'	8'	9'
Footcandles	5.03	3.18	1.45	.68	.3	.13	.03	-	-

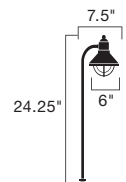

Photometric with Lamp Supplied (fc)

Distance from Light	1'	2'	3'	4'	5'	6'	7'	8'	9'
Footcandles	2.9	1.2	.3	-	-	-	-	-	-



15450 TZT



15352 OZ



15334 OB

Name	MICA MISSION A mission style roof combined with glass designed to replicate the umber glow of mica for a warm comfortable exterior look.	TRADITIONAL LANTERN Classic elegance complimented by etched seedy glass reminiscent of traditional craftsmanship.	CONCORD LANTERN Revolutionary design adds an early colonial flair to formal settings.
Ordering Guide	15450 TZT - Textured Tannery Bronze™	15352 OZ - Olde Bronze®	15334 OB - Olde Brick®
Housing	Cast Aluminum and mica finished glass	Brass with etched seedy glass	Brass with stainless steel rods and seedy glass
Finish	Textured Tannery Bronze™	Olde Bronze®	Olde Brick®
Light Source	12V Incandescent T-5 wedge base socket	12V Incandescent S-8 wedge base socket	12V Incandescent T-5 wedge base socket
Power Usage at 12V AC Input	VA MAX: 16.25-W(VA) Supplied: 11.6-W(VA) 912X (17023) Xenon light source Optional: 16.25-W(VA) 921X (17025) 6.5-W(VA) 918X (17022) 4-W(VA) 901X (17021)	VA MAX: 18.5-W(VA) Supplied: 18.5-W(VA) 3155K (15599 CLR) Krypton light source	VA MAX: 6.5-W(VA) Supplied: 6.5-W(VA) 918X (17022) Xenon light source Optional: 4-W(VA) 901X (17022)
Wiring	22" of usable #18-2, SPT-1-W leads. Cable connector supplied.	24" of usable #18-2, SPT-1-W leads. Cable connector supplied.	20" of usable #18-2, SPT-1-W leads. Cable connector supplied.
Mounting Accessories Included	8" In-ground stake	8" In-ground stake	8" In-ground stake
Optional Mounting Accessories	15601 – Surface Mounting Flange 15607 – Surface Mounting Bracket	15601 – Surface Mounting Flange 15607 – Surface Mounting Bracket	15601 – Surface Mounting Flange 15607 – Surface Mounting Bracket
Notes		U.S. Patent No. D420,160	

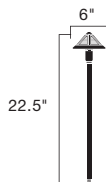

Photometric with Lamp Supplied (fc)

Distance from Light	0'	1'	2'	3'	4'	5'	6'	7'	8'
Footcandles	1.34	1.61	1.63	0.86	0.46	0.28	0.07	0.07	-

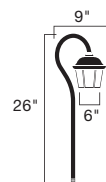

Photometric with Lamp Supplied (fc)

Distance from Light	.5'	1'	2'	3'	4'	5'	6'	7'	8'
Footcandles	2.7	1.3	.3	.1	-	-	-	-	-

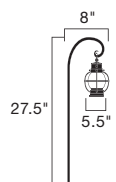

Photometric with Lamp Supplied (fc)

Distance from Light	1'	2'	3'	4'	5'	6'	7'	8'	9'
Footcandles	20.9	4.7	.6	.2	-	-	-	-	-



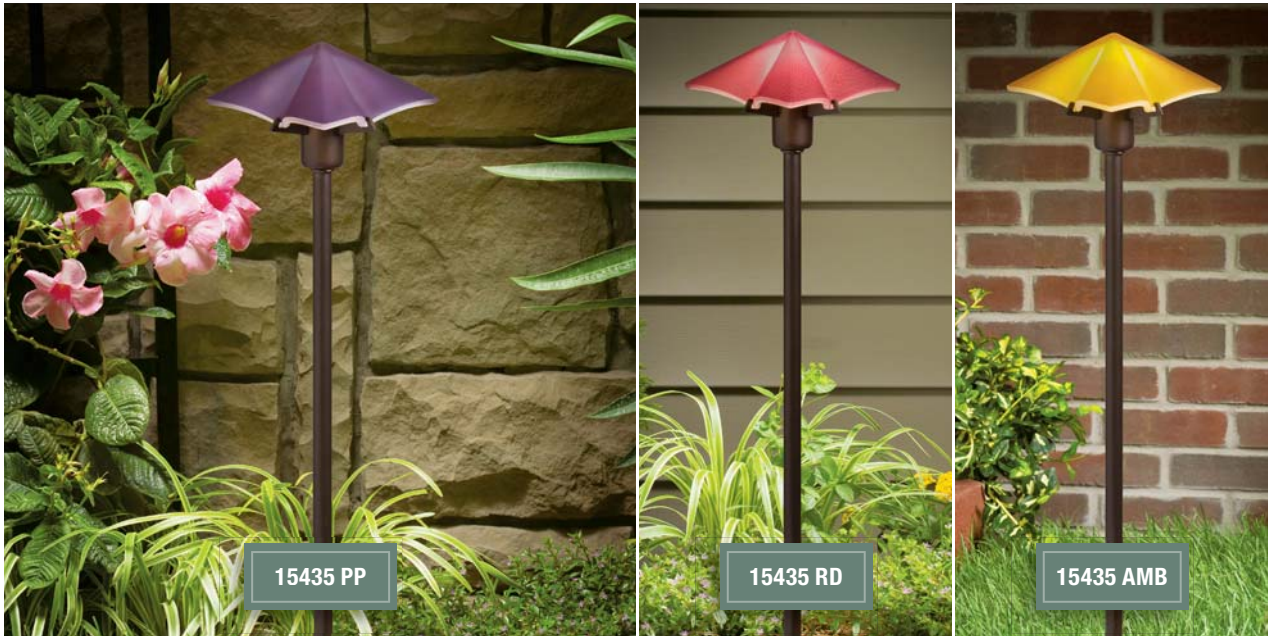

Name	POISES Dense purple, deep cranberry red and golden amber glass flowers will seamlessly blend into a flowerbed during the day and provide the punch of light needed in the evening. Mix or match colors or use the special mounting accessory to create an innovative centerpiece with different angles and heights.
Ordering Guide	15435 PP - Olde Bronze® with Dense Purple Glass 15435 RD - Olde Bronze® with Cranberry Red Glass 15435 AMB - Olde Bronze® with Golden Amber Glass
Housing	Brass
Finish	Olde Bronze® with Dense Purple, Cranberry Red or Golden Amber Art Glass Quality Cased Glass.
Light Source	12V Incandescent S-8 wedge base socket
Power Usage at 12V AC Input	VA MAX: 24.4-W(VA) Supplied: 24.4-W(VA) 3156K (15598 CLR) Krypton light source Optional: 18.5-W(VA) 3155K (15599 CLR)
Wiring	34" of usable #18-2, SPT-1-W leads. Cable connector supplied.
Mounting Accessories Included	8" In-ground stake
Optional Mounting Accessories	15601 – Surface Mounting Flange 15607 – Surface Mounting Bracket 15635 OZ – Three-Fixture Centerpiece Mounting Kit



THREE-FIXTURE CENTERPIECE MOUNTING KIT

The kit allows for the creation of an interesting garden centerpiece that replicates nature with Posies installed at an angle at varying heights. Can also be used to install three fixtures at the same height. Colors may be mixed or uniform. Kit includes a mounting plate, 14" In-ground stake for added stability, a 3" Olde Bronze® stem section and the necessary hardware and instructions to make a truly creative garden feature.

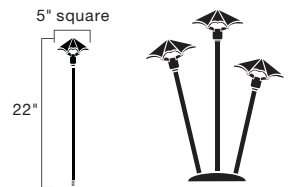

Photometric with Lamp Supplied (fc)

Distance from Light	0'	1'	2'	3'	4'	5'	6'	7'	8'
Footcandles	4.9	3.1	3.1	1.3	0.5	0.2	-	-	-

PATH & SPREAD LOW VOLTAGE



Name	GLASS & METAL A sleek, modern original that combines contemporary style with smooth illumination.	GALAXY Sophisticated, modern style in an understated fixture.	SIMPLICITY SIDE MOUNT Simple, uncomplicated design for perfect illumination along paths without troublesome glare.
Ordering Guide	15317 BN - Brushed Nickel 15317 AZT - Textured Architectural Bronze™	15318 AZT - Textured Architectural Bronze™	15360 AZT - Textured Architectural Bronze™
Housing	Aluminum (AZT) or Brass (BN) with glass diffuser	Aluminum	Aluminum
Finish	Textured Architectural Bronze™ or Brushed Nickel	Textured Architectural Bronze™	Textured Architectural Bronze™
Light Source	12V Incandescent S-8 wedge base socket	12V Incandescent S-8 wedge base socket	12V Incandescent S-8 wedge base socket
Power Usage at 12V AC Input	VA MAX: 24.4-W(VA) Supplied: 24.4-W(VA) 3156K (15598 CLR) Krypton light source Optional: 18.5-W(VA) 3155K (15599 CLR)	VA MAX: 24.4-W(VA) Supplied: 24.4-W(VA) 3156K (15598 CLR) Krypton light source Optional: 18.5-W(VA) 3155K (15599 CLR)	VA MAX: 24.4-W(VA) Supplied: 24.4-W(VA) 3156K (15598 CLR) Krypton light source Optional: 18.5-W(VA) 3155K (15599 CLR)
Wiring	35" of usable #18-2, SPT-1-W leads. Cable connector supplied.	35" of usable #18-2, SPT-1-W leads. Cable connector supplied.	35" of usable #18-2, SPT-1-W leads. Cable connector supplied.
Mounting Accessories Included	8" In-ground stake	8" In-ground stake	8" In-ground stake
Optional Mounting Accessories	15601 – Surface Mounting Flange 15607 – Surface Mounting Bracket	15601 – Surface Mounting Flange 15607 – Surface Mounting Bracket	15601 – Surface Mounting Flange 15607 – Surface Mounting Bracket
LED Option	15817 – on Page 14	NA	NA
Notes	U.S. Patent No. D406,374		



Photometric with Lamp Supplied (fc)

Distance from Light	1'	2'	3'	4'	5'	6'	7'	8'	9'
Footcandles	9.4	4.8	2	.72	.32	.16	-	-	-



Photometric with Lamp Supplied (fc)

Distance from Light	1'	2'	3'	4'	5'	6'	7'	8'	9'
Footcandles	2.6	3.2	1.2	.5	.2	-	-	-	-

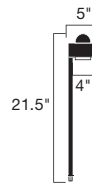

Photometric with Lamp Supplied (fc)

Distance from Light	.5'	1'	2'	3'	4'	5'	6'	7'	8'
Footcandles	20.7	10.6	3.5	1.1	.4	.1	-	-	-



Name	CONTEMPORARY ARCH A rounded dome diffuser is supported by an arched column that bisects a clean, straight upright for a contemporary look that gently fits in international style gardens and beyond.	CONTOURS A fresh interpretation of contemporary style. Equally effective as a path light or to highlight a flower bed.
Ordering Guide	15411 AZT - Textured Architectural Bronze™ 15411 SA - Satin Aluminum	15333 TZT - Textured Tannery Bronze™
Housing	Aluminum	Aluminum
Finish	Textured Architectural Bronze™ or Satin Aluminum	Textured Tannery Bronze™
Light Source	12V Incandescent T-5 wedge base socket	12V Incandescent S-8 wedge base socket
Power Usage at 12V AC Input	VA MAX: 16.25-W(VA) Supplied: 16.25-W(VA) 921X (17025) Xenon light source Optional: 11.6-W(VA) 912X (17023) 6.5-W(VA) 918X (17022) 4-W(VA) 901X (17021)	VA MAX: 24.4-W(VA) Supplied: 24.4-W(VA) 3156K (15598 CLR) Krypton light source Optional: 18.5-W(VA) 3155K (15599 CLR)
Wiring	30" of usable #18-2, SPT-1-W leads. Cable connector supplied.	34" of usable #18-2, SPT-1-W leads. Cable connector supplied.
Mounting Accessories Included	8" In-ground stake	8" In-ground stake
Optional Mounting Accessories	15601 – Surface Mounting Flange 15607 – Surface Mounting Bracket	15601 – Surface Mounting Flange 15607 – Surface Mounting Bracket
Notes		U.S. Patent Pending

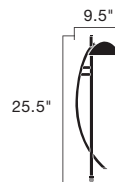

Photometric with Lamp Supplied (fc)

Distance from Light	.6'	1'	2'	3'	4'	5'	6'	7'	8'
Footcandles	30.30	18.17	7.20	3.16	1.37	0.70	0.39	0.27	0.17

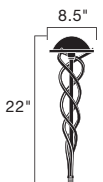

Photometric with Lamp Supplied (fc)

Distance from Light	1'	2'	3'	4'	5'	6'	7'	8'	9'
Footcandles	11.9	6.6	2.58	.88	.28	-	-	-	-

PATH & SPREAD LOW VOLTAGE



15439 TZT



15439 CO



15439 OB



15328 AZT

Name	FUNDAMENTALS™ Basic, uncomplicated design for versatility. Use along walkways or points of interest. Now with a heavier guage shade.	LARGE CENTER MOUNT Wide head for broad light spread to highlight beds and paths. Textured Architectural Bronze finish blends with landscape.
Ordering Guide	15439 CO - Polished Copper, Copper 15439 OB - Olde Brick®, Brass 15439 OB 6 - Same as 15439 OB. Bulk packed in 6 (unbreakable master). 15439 TZT - Textured Tannery Bronze, Brass	15328 AZT - Textured Architectural Bronze™
Housing	Brass or Unfinished Copper. Copper will naturally patina over time.	Aluminum
Finish	Unfinished Copper, Olde Brick® or Textured Tannery Bronze™	Textured Architectural Bronze™
Light Source	12V Incandescent S-8 wedge base socket	12V Incandescent S-8 wedge base socket
Power Usage at 12V AC Input	VA MAX: 24.4-W(VA) Supplied: 24.4-W(VA) 3156K (15598 CLR) Krypton light source Optional: 18.5-W(VA) 3155K (15599 CLR)	VA MAX: 24.4-W(VA) Supplied: 24.4-W(VA) 3156K (15598 CLR) Krypton light source Optional: 18.5-W(VA) 3155K (15599 CLR)
Wiring	35" of usable #18-2, SPT-1-W leads. Cable connector supplied.	35" of usable #18-2, SPT-1-W leads. Cable connector supplied.
Mounting Accessories Included	8" In-ground stake	8" In-ground stake and 18" stem
Optional Mounting Accessories	15601 – Surface Mounting Flange 15607 – Surface Mounting Bracket	15601 – Surface Mounting Flange 15607 – Surface Mounting Bracket
LED Option	15839 – on Page 11	NA

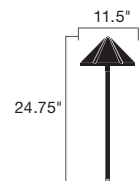

Photometric with Lamp Supplied (fc)

Distance from Light	0'	1'	2'	3'	4'	5'	6'	7'	8'
Footcandles	13.4	4.55	1.65	.58	.13	-	-	-	-

Photometric with Lamp Supplied (fc)

Stem Height	1'	2'	3'	4'	5'	6'	7'	8'	9'
12"	20.8	4.1	.27	-	-	-	-	-	-
18"	12.1	5.6	1.8	.67	-	-	-	-	-
24"	8.3	5.8	2.2	.97	.48	.02	-	-	-



Name	FUNDAMENTALS™ Louveres direct tiers of light downward for well-shielded, dramatic lighting. Blends nicely with shrubs or flowers along a pathway. Available in stem or deck mount or as a bollard. Mounting stems and bollard kits sold separately. Coordinates with matching deck light 15065 on page 90.	SIDE MOUNT A popular design in a side-mount fixture for more directional lighting without glare. Coordinates with matching deck light 15065 on page 90.
Ordering Guide	15005 AZT - Textured Architectural Bronze™ 15005 BKT - Textured Black	15315 AZT - Textured Architectural Bronze™ 15315 AZT 6 - Same as 15315 AZT. Bulk packed in 6 (unbreakable master) 15315 BE - Beach 15315 BKT - Textured Black
Housing	Cast Auminum with molded ribbed diffuser of clear UV stabilized high impact resistant polycarbonate	Cast Aluminum
Finish	Textured Architectural Bronze™ or Textured Black	Textured Architectural Bronze™, Beach or Textured Black
Ligh Source	12V Incandescent S-8 wedge base socket	12V Incandescent S-8 wedge base socket
Power Usage at 12V AC Input	VA MAX: 24.4-W(VA) Supplied: 24.4-W(VA) 3156K (15598 CLR) Krypton light source Optional: 18.5-W(VA) 3155K (15599 CLR)	VA MAX: 24.4-W(VA) Supplied: 24.4-W(VA) 3156K (15598 CLR) Krypton light source Optional: 18.5-W(VA) 3155K (15599 CLR)
Wiring	52" of usable #18-2, SPT-1-W leads. Cable connector supplied.	35" of usable #18-2, SPT-1-W leads. Cable connector supplied.
Mounting Accessories Included	8" In-ground stake and 18" stem	8" In-ground stake and 18" stem
Optional Mounting Accessories	15656, 15657, 15658 or 15570 – Stems 15575 BK, 15576 BK or 15578 – Stakes 15665, 15666 or 15667 – Bollard 15671 ST – Bollard Template Kit 15601 – Surface Mounting Flange 15602 – Flange Mounting Nipple 15607 – Surface Mounting Bracket	15601 – Surface Mounting Flange 15607 – Surface Mounting Bracket
LED Option	NA	15815 – on Page 15

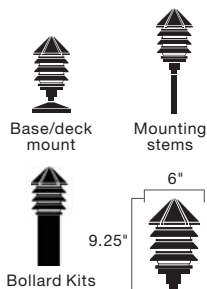

Photometric with Lamp Supplied (fc)

Stem Height	1'	2'	3'	4'	5'	6'	7'	8'	9'
12"	2.1	.93	.67	.18	-	-	-	-	-
18"	1.8	.73	.4	.27	0.3	-	-	-	-
24"	1.2	.67	.33	.35	.27	.15	-	-	-

Light Bulb Conversion: 18.5W, 3155K Light Bulb, FCx.66

Photometric with Lamp Supplied (fc)

Stem Height	1'	2'	3'	4'	5'	6'	7'	8'	9'
12"	18.7	4.3	1.4	.27	-	-	-	-	-
18"	15	5.2	1.8	.8	.27	.03	-	-	-
24"	11.6	5.1	2.2	.97	.48	.2	.07	-	-

PATH & SPREAD LOW VOLTAGE



Name	CENTER MOUNT Unobtrusive, center mount fixture for maximum light spread. Coordinates with matching deck light 15065 on page 90.	ONE TIER Versatile fixture with wider light distribution for paths and low areas of groundcover. Louver inverts to create more indirect light spread. Mounting stems and bollard kits sold separately. Coordinates with matching deck light 15065 on page 90.
Ordering Guide	15326 AZT - Textured Architectural Bronze™ 15326 AZT 6 - Same as 15326 AZT. Bulk packed in 6 (unbreakable master) 15326 BE - Beach 15326 BKT - Textured Black	15011 AZT - Textured Architectural Bronze™ 15011 BKT - Textured Black
Housing	Cast Aluminum	Cast Aluminum with molded ribbed diffuser of clear UV stabilized high impact resistant polycarbonate
Finish	Textured Architectural Bronze™, Beach, or Textured Black	Textured Architectural Bronze™, or Textured Black
Light Source	12V Incandescent S-8 wedge base socket	12V Incandescent S-8 wedge base socket
Power Usage at 12V AC Input	VA MAX: 24.4-W(VA) Supplied: 24.4-W(VA) 3156K (15598 CLR) Krypton light source Optional: 18.5-W(VA) 3155K (15599 CLR)	VA MAX: 24.4-W(VA) Supplied: 24.4-W(VA) 3156K (15598 CLR) Krypton light source Optional: 18.5-W(VA) 3155K (15599 CLR)
Wiring	35" of usable #18-2, SPT-1-W leads. Cable connector supplied.	52" of usable #18-2, SPT-1-W leads. Cable connector supplied.
Mounting Accessories Included	8" In-ground stake and 18" stem	NA
Optional Mounting Accessories	15601 – Surface Mounting Flange 15607 – Surface Mounting Bracket	15656, 15657, 15658 or 15570 – Stems 15575 BK, 15576 or 15578 BK – Stakes 15665, 15666 or 15667 – Bollard 15671 ST – Bollard Template Kit 15601 – Surface Mounting Flange 15602 – Flange Mounting Nipple 15607 – Surface Mounting Bracket
LED Option	15826 – on Page 16	NA

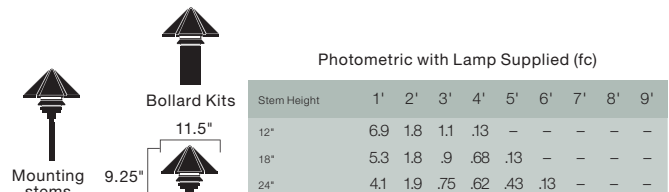
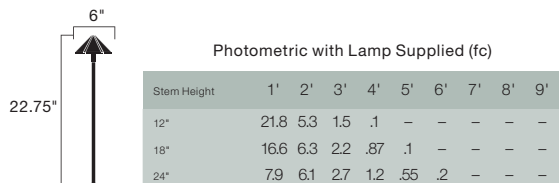

Light Bulb Conversion: 18.5W, 3155K Light Bulb, FCx.66



Name	LARGE ECLIPSE™ A larger version of our popular Eclipse design to cast a wider light spread on a wide path or patio.	ECLIPSE™ A smaller scale, contemporary design with a dome cap that creates a soft, warm circular glow of light.	SIDE MOUNT ECLIPSE™ Popular dome cap design in a side-mounted fixture for more directional lighting.
Ordering Guide	15336 BKT - Textured Black 15336 Tzt - Textured Tannery Bronze™	15323 AZT - Textured Architectural Bronze™ 15323 BKT - Textured Black 15323 Tzt - Textured Tannery Bronze™	15423 AZT - Textured Architectural Bronze™ 15423 BKT - Textured Black 15423 Tzt - Textured Tannery Bronze™
Housing	Cast Aluminum with clear glass	Cast Aluminum	Cast Aluminum
Finish	Textured Black or Textured Tannery Bronze™	Textured Architectural Bronze™, Textured Black, or Textured Tannery Bronze™	Textured Architectural Bronze™, Textured Black or Textured Tannery Bronze™
Light Source	12V Incandescent S-8 wedge base socket	12V Incandescent S-8 wedge base socket	12V Incandescent S-8 wedge base socket
Power Usage at 12V AC Input	VA MAX: 24.4-W(VA) Supplied: 24.4-W(VA) 3156K (15598 CLR) Krypton light source Optional: 18.5-W(VA) 3155K (15599 CLR)	VA MAX: 24.4-W(VA) Supplied: 24.4-W(VA) 3156K (15598 CLR) Krypton light source Optional: 18.5-W(VA) 3155K (15599 CLR)	VA MAX: 24.4-W(VA) Supplied: 24.4-W(VA) 3156K (15598 CLR) Krypton light source Optional: 18.5-W(VA) 3155K (15599 CLR)
Wiring	35" of usable #18-2, SPT-1-W leads. Cable connector supplied.	37" of usable #18-2, SPT-1-W leads. Cable connector supplied.	34" of usable #18-2, SPT-1-W leads. Cable connector supplied.
Mounting Accessories Included	8" In-ground stake	8" In-ground stake	8" In-ground stake
Optional Mounting Accessories	15601 – Surface Mounting Flange 15607 – Surface Mounting Bracket	15601 – Surface Mounting Flange 15607 – Surface Mounting Bracket	15601 – Surface Mounting Flange 15607 – Surface Mounting Bracket

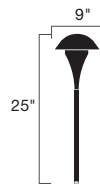

Photometric with Lamp Supplied (fc)

Distance from Light	1'	2'	3'	4'	5'	6'	7'	8'	9'
Footcandles	8.7	3.3	1.1	.4	.1	-	-	-	-



Photometric with Lamp Supplied (fc)

Distance from Light	1'	2'	3'	4'	5'	6'	7'	8'	9'
Footcandles	14.7	4.8	1.8	1	-	-	-	-	-

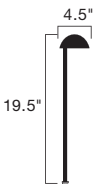

Photometric with Lamp Supplied (fc)

Distance from Light	0'	1'	2'	3'	4'	5'	6'	7'	8'
Footcandles	44.3	18.6	5.7	1.8	.3	.2	-	-	-

PATH & SPREAD LOW VOLTAGE



Name	DOME PATH LIGHT A wider path and spread light that is unobtrusive in the landscape. Coordinates with our 15410 & 15470 Domed Roof series..
Ordering Guide	15310 AZT - Textured Architectural Bronze™ 15310 AZT 6 - Same as 15310 AZT. Bulk packed in 6 (unbreakable master) 15310 BE - Beach 15310 BKT - Textured Black
Housing	Cast Aluminum
Finish	Textured Architectural Bronze™, Beach or Textured Black
Light Source	12V Incandescent T-5 wedge base socket
Power Usage at 12V AC Input	VA MAX: 16.25-W(VA) Supplied: 16.25-W(VA) 921X (17025) Xenon light source Optional: 11.6-W(VA) 912X (17023) 6.5-W(VA) 918X (17022) 4-W(VA) 901X (17021)
Wiring	24" of usable #18-2, SPT-1-W leads. Cable connector supplied.
Mounting Accessories Included	8" In-ground stake
Optional Mounting Accessories	15601 – Surface Mounting Flange 15607 – Surface Mounting Bracket
LED Option	15810 – on Page 17



Photometric with Lamp Supplied (fc)

Distance from Light	1'	2'	3'	4'	5'	6'	7'	8'	9'
Footcandles	8	4.1	1.6	.5	.4	.1	-	-	-

PATH & SPREAD LOW VOLTAGE



Name	15410 BE DOME PATH LIGHT A shorter version of our popular 15310 designed for use with lower planting and smaller garden areas. Coordinates with our 15310 & 15470 Domed Roof series.	15470 BBR 6" DOME PATH LIGHT A popular look has a new addition with a smaller 6" shade. Coordinates with our 15310 & 15410 Domed Roof series.
Ordering Guide	15410 AZT - Textured Architectural Bronze™ 15410 BE - Beach	15470 AZT - Textured Architectural Bronze™ 15470 BBR - Bronzed Brass 15470 BE - Beach 15470 BKT - Textured Black
Housing	Cast Aluminum	Cast Aluminum, Cast Brass
Finish	Textured Architectural Bronze™ or Beach	Textured Architectural Bronze, Bronzed Brass, Beach or Textured Black
Light Source	12V Incandescent T-5 wedge base socket	12V Incandescent T-5 wedge base socket
Power Usage at 12V AC Input	VA MAX: 16.25-W(VA) Supplied: 16.25-W(VA) 921X (17025) Xenon light source Optional: 11.6-W(VA) 912X (17023) 6.5-W(VA) 918X (17022) 4-W(VA) 901X (17021)	VA MAX: 16.25-W(VA) Supplied: 16.25-W(VA) 921X (17025) Xenon light source Optional: 11.6-W(VA) 912X (17023) 6.5-W(VA) 918X (17022) 4-W(VA) 901X (17021)
Wiring	30" of usable #18-2, SPT-1-W leads. Cable connector supplied.	24" of usable #18-2, SPT-1W leads. Cable connector supplied.
Mounting Accessories Included	8" In-ground stake	8" In-ground stake
Optional Mounting Accessories	15601 – Surface Mounting Flange 15607 – Surface Mounting Bracket	15601 - Surface Mounting Flange 15607 - Surface Mounting Bracket
LED Option	15811 – on Page 17	15870 – on Page 16



Photometric with Lamp Supplied (fc)

Distance from Light	0'	1'	2'	3'	4'	5'	6'	7'	8'
Footcandles	22.0	9.6	4.0	1.1	.03	0.1	-	-	-

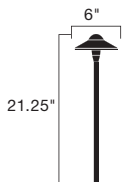

Fixture Photometric (fc)

Distance from Light	0'	1'	2'	3'	4'	5'	6'	7'	8'
Footcandles	6.17	4.85	4.34	2.51	1.58	1.35	0.77	0.43	0.28



POWERED BY
DESIGN PRO LED
TECHNOLOGY

This installation illuminated exclusively
with Design Pro LED fixtures



Meet the professionals
behind the lighting



LOW VOLTAGE

Incandescent Specialty

Fashion meets innovation.





15409 OZ

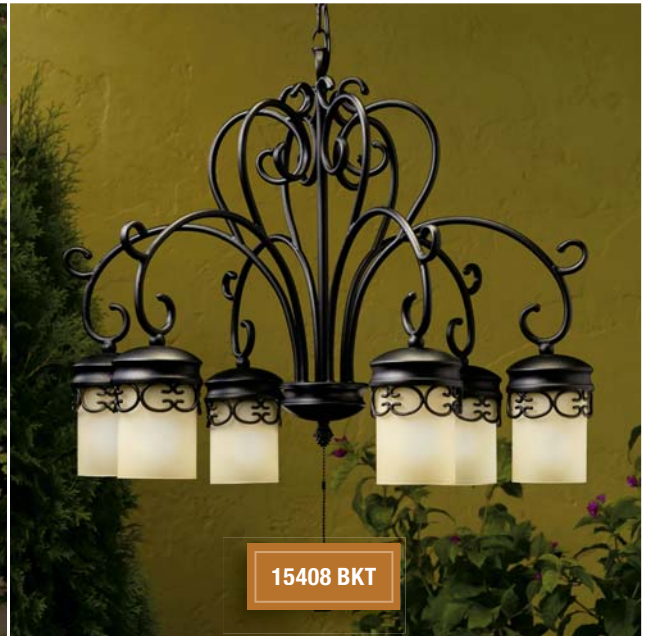

15408 BKT

Name	ZEN GARDEN™ 12V OUTDOOR CHANDELIER This minimal, arts and crafts design illuminates outdoors where weather exposure becomes an issue. Brass will patina over time if unprotected but will resist corrosion. Subtle contemporary Asian style accents any backyard room for sophisticated exterior designers. Pull chain switch allows easy on/off at the light source, even when tied to a larger 12V design layout. Suitable for wet locations. Matching path light available on page 60.	ALMERIA™ 12V OUTDOOR CHANDELIER A Spanish-style flair for outdoor living and dining to illuminate pergolas, gazebos or other out of reach, weather exposed areas. Pull chain switch allows easy on/off at the light source, even when tied into a larger 12V design layout. Suitable for wet locations. Matching path light available on page 47.
Ordering Guide	15409 OZ - Olde Bronze®	15408 BKT - Textured Black
Housing	Brass. Textured amber seedy linen glass.	Aluminum with light amber glass.
Finish	Olde Bronze®	Textured Black
Light Source	12V Incandescent T-5 wedge base socket	12V Incandescent T-5 wedge base socket
Power Usage at 12V AC Input	VA MAX: 16.25-W(VA) Supplied: 16.25-W(VA) 921X (17025) (4 required and supplied) Xenon light source Optional: 11.6-W(VA) 912X (17023) 6.5-W(VA) 918X (17022) 4-W(VA) 901X (17021)	VA MAX: 11.6-W(VA) Supplied: 11.6-W(VA) 912X (17023) (6 required and supplied) Xenon light source Optional: 6.5-W(VA) 918X (17022) 4-W(VA) 901X (17021)
Wiring	42" of usable #16-2, SPT-2W leads	42" of usable #16-2, SPT-1-W leads
Mounting Accessories Included	(2) 12" extensions and (2) 6" extensions.	Canopy Assembly 72" of matching chain
Notes		U.S. Patent Pending

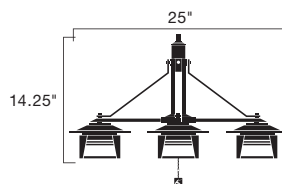

Photometric with Lamp Supplied (fc)

Distance from Light	1'	2'	3'	4'	5'	6'	7'	8'	9'
Footcandles	1.2	1.2	.9	.4	.3	.1	-	-	-

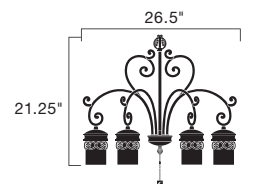

Photometric with Lamp Supplied (fc)

Distance from Light	0'	1'	2'	3'	4'	5'	6'	7'	8'
Footcandles	1.1	1	.8	.5	.3	.1	-	-	-

SPECIALTY LOW VOLTAGE



15499 TZT



15415 TZT



15402 OZ

Name	CATHEDRAL OUTDOOR PENDANT Illuminate covered outdoor living areas with this transitional styled pendant of interwoven arches and dark citrine glass. Suitable for wet location.	CATHEDRAL LIGHT RAISED PLANTER A tall planter that will allow draped foliage to interplay with the light emitting from within the arched interwoven bands.	OAK TRAIL™ 12V OUTDOOR CHANDELIER Rugged lodge design with candle-style lights to illuminate pergolas, gazebos or outdoor cooking and dining areas. Suitable for wet locations.
Ordering Guide	15499 TZT - Textured Tannery Bronze™	15415 TZT - Textured Tannery Bronze™	15402 OZ - Olde Bronze®
Housing	Aluminum with dark citrine glass	Aluminum	Brass. Beige glass candle with clear top, candle-drip trim.
Finish	Textured Tannery Bronze™	Textured Tannery Bronze™	Olde Bronze®
Light Source	12V Incandescent S-8 wedge base socket	12V Incandescent T-5 wedge base socket	12V Incandescent T-5 wedge base sockets
Power Usage at 12V AC Input	VA MAX: 24.4-W(VA) Supplied: 24.4-W(VA) 3156K (15598 CLR) Krypton light source Optional: 18.5-W(VA) 3155K (15599 CLR)	VA MAX: 16.25-W(VA) Supplied: 16.25-W(VA) 921X (17025) Xenon light source Optional: 11.6-W(VA) 912X (17023) 6.5-W(VA) 918X (17022) 4-W(VA) 901X (17021)	VA MAX: 11.6-W(VA) Supplied: 11.6-W(VA) 918X (17023) (9 required and supplied) Xenon light source Optional: 6.5-W(VA) 912X (17022) (9 required)
Wiring	94" of usable #18-2, SPT-1-W leads. Cable connector supplied.	27" of usable #18-2, SPT-1-W leads. Cable connector supplied.	42" of usable #16-2, SPT-1-W leads.
Mounting Accessories Included	72" of matching chain canopy assembly. No cable connector supplied.	14" In-ground stake	(2) 12" extensions and (2) 6" extensions.
Notes			U.S. Patent Pending

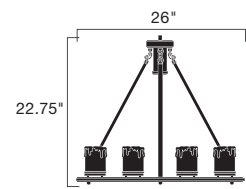
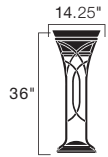
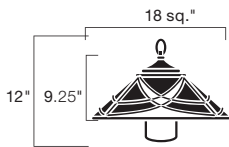

Photometric with Lamp Supplied (fc)

Distance from Light	.6'	1'	2'	3'	4'	5'	6'	7'	8'
Footcandles	8.87	5.16	1.11	1.84	1.14	0.69	0.46	0.34	0.25



15419 TZT



15452 BW



15123 BK

Name	CATHEDRAL™ LIGHTED WALL PLANTER Cathedral arches of interwoven bands with a backlit panel of dark citrine glass will compliment the wall surface and illuminate draped foliage.	WOODLAND OWL BOLLARD A majestic, full sized Great Horned Owl perched on a tree segment with light located on the underside of a branch.	MR-11 BARBECUE LIGHT Integrated surface mount BBQ light for direct connection to 12V landscape lighting system for rail or outdoor countertop mount only.
Ordering Guide	15419 TZT - Textured Tannery Bronze™	15452 BW - Hand painted natural finish	15123 BK - Black
Housing	Aluminum with dark citrine glass	Resin	Components of durable high heat thermoplastic resin. Lamp shielded by a high heat-resistant flat glass lens sealed for watertight outdoor use. Flexible stem is durable chrome plated steel with heat shrink rubber sleeving. On/off switch is protected by waterproof rubber boot.
Finish	Textured Tannery Bronze™	Hand painted natural finish	Black
Light Source	12V Incandescent T-5 wedge base socket	12V Incandescent T-5 wedge base socket	12V Incandescent bi-pin, high temperature porcelain socket
Power Usage at 12V AC Input	VA MAX: 16.25-W(VA) Supplied: 16.25-W(VA) 921X (17025) Xenon light source Optional: 11.6-W(VA) 912X (17023) 6.5-W(VA) 918X (17022) 4-W(VA) 901X (17021)	VA MAX: 11.6-W(VA) Supplied: 6.5-W(VA) 918X (17022) Xenon light source Optional: 11.6-W(VA) 912X (17023) 4-W(VA) 901X (17021)	VA MAX: 35-W(VA) Supplied: 20-W(VA) MR-11 Halogen light source Optional: 35-W(VA) MR-11 halogen-xenon
Wiring	66" of usable #18-2, SPT-1-W leads. Cable connector supplied.	24" of usable #18-2, SPT-1-W leads. Cable connector supplied.	25' of usable #18-2, SPT-1-W leads. Connector supplied.
Mounting Accessories Included	Mounting hardware included	23" Bollard mounting stake (15578 BK)	Mounting hardware and instructions provided for typical installations
Optional Mounting Accessories	NA	15671 ST – Bollard Template Kit	NA

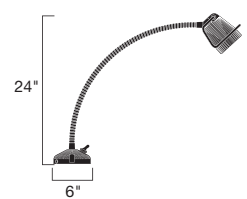
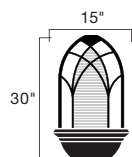

Photometric with Lamp Supplied (fc)

Distance from Light	0'	1'	2'	3'	4'	5'	6'	7'	8'
Footcandles	-	6.77	2.78	1.09	0.64	0.39	0.28	0.19	0.13



POWERED BY
DESIGN PRO LED
TECHNOLOGY

This installation illuminated exclusively
with Design Pro LED fixtures



KICHLER
LIGHTING



LOW VOLTAGE

Incandescent Deck & Patio

Bring outdoor living areas into the light.

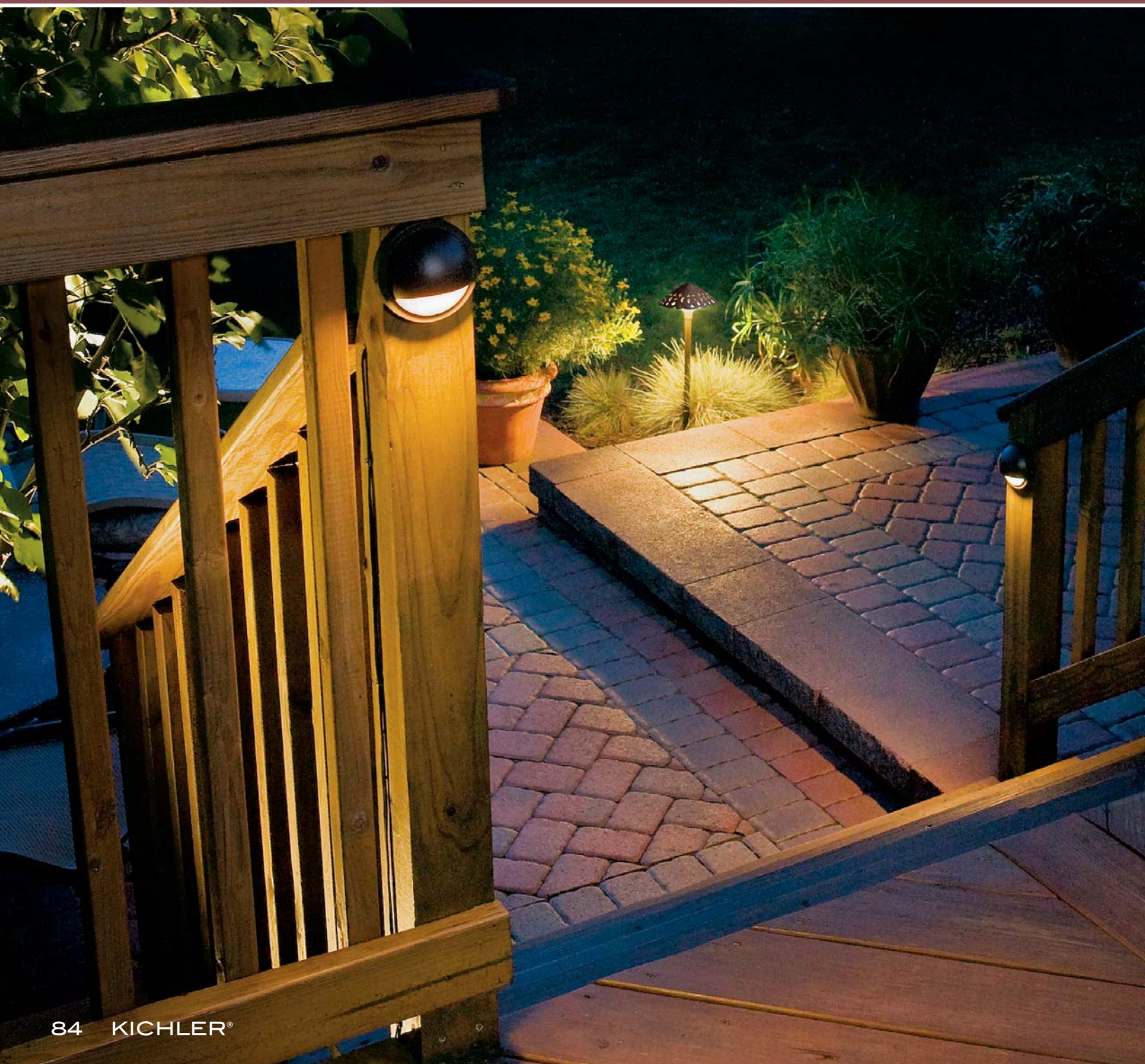

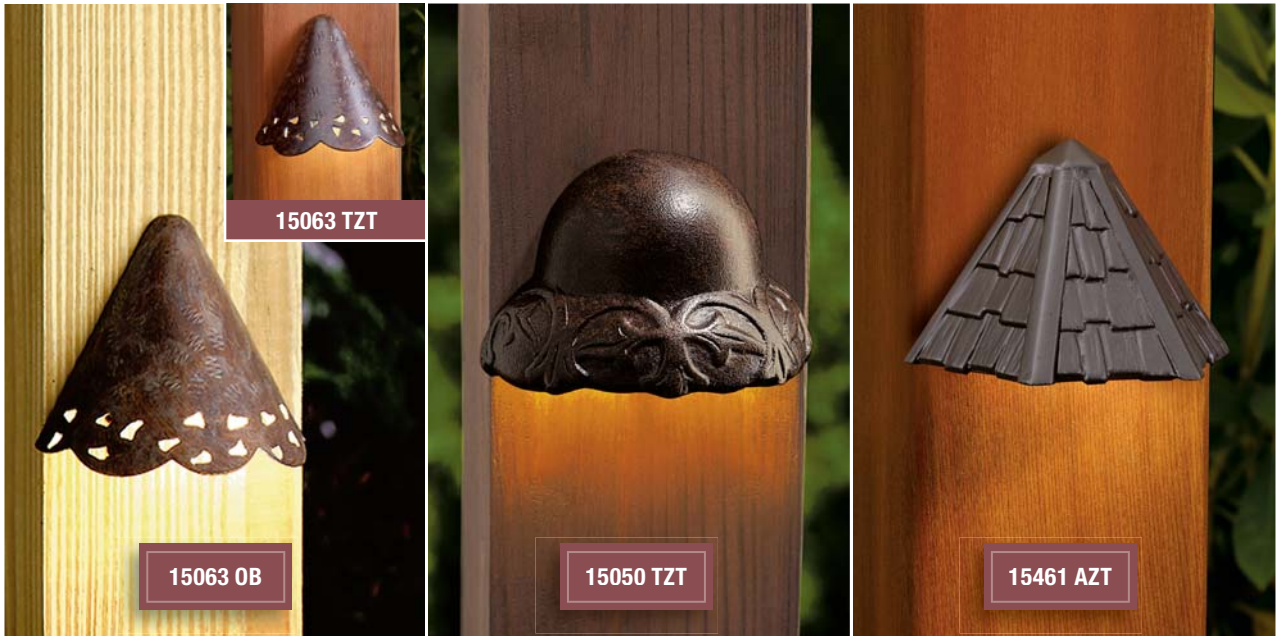

Name	DECORATIVE HAMMERED ROOF DECK LIGHT Traditional design pierced shade and scalloped edges with excellent light output. Coordinates with matching path light 15443 OB or 15443 TZT on page 54 and 15471 TZT on page 55.	VINTAGE PARK™ DECK LIGHT Decorative edging and Textured Tannery Bronze® finish bring 19th century charm to the deck or patio.	THATCHED ROOF DECK LIGHT The casual style indicative of island life has been reproduced in this deck light. Coordinates with matching path light 15401 AZT on page 53.
Ordering Guide	15063 OB - Olde Brick® 15063 TZT - Textured Tannery Bronze™	15050 TZT - Textured Tannery Bronze™	15461 AZT - Textured Architectural Bronze™
Housing	Pierced brass shade	Cast Aluminum	Cast Aluminum
Finish	Olde Brick® or Textured Tannery Bronze™	Textured Tannery Bronze™	Textured Architectural Bronze™
Light Source	12V Incandescent T-5 wedge base socket	12V Incandescent T-5 wedge base socket	12V Incandescent T-5 wedge base socket
Power Usage at 12V AC Input	VA MAX: 6.5-W(VA) Supplied: 6.5-W(VA) 918X (17023) Xenon light source Optional: 4-W(VA) 901X (17021)	VA MAX: 6.5-W(VA) Supplied: 6.5-W(VA) 918X (17022) Xenon light source Optional: 4-W(VA) 901X (17021)	VA MAX: 6.5-W(VA) Supplied: 6.5-W(VA) 918X (17022) Xenon light source Optional: 4-W(VA) 901X (17021)
Wiring	72" of usable #18-2, SPT-1-W leads. Cable connector supplied.	72" of usable #18-2, SPT-1-W leads. Cable connector supplied.	72" of usable #18-2, SPT-1-W leads. Cable connector supplied.
Mounting Accessories Included	Stainless steel mounting bracket	Stainless steel mounting bracket	Stainless steel mounting bracket
LED Option	15763 on page 19	15750 on page 19	NA
Notes		U.S. Patent Pending	

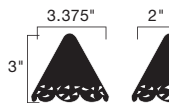

Photometric with Lamp Supplied (fc)

Mounting Height	0'	0.5'	1'	1.5'	2'	2.5'	3'	3.5'	4'
6"	117.3	40.9	4	.8	.2	-	-	-	-
12"	36.1	22.1	9.2	3.2	.8	.2	.1	-	-
30"	5.8	5.4	3.6	2.4	1.9	1.3	.8	.5	.1



Photometric with Lamp Supplied (fc)

Mounting Height	0'	1'	2'	3'	4'	5'	6'
6"	95.53	17.53	2.7	.23	-	-	-
12"	20.16	12.76	4.76	1.3	.33	-	-
30"	3.2	2.6	2.1	1.2	.43	-	-



Photometric with Lamp Supplied (fc)

Mounting Height	.6'	1'	2'	3'	4'	5'	6'	7'	8'
6"	53.30	11.28	1.08	0.13	0.03	-	-	-	-
12"	14.54	7.90	2.13	0.79	0.29	0.08	0.04	-	-
30"	2.90	2.37	1.45	0.83	0.50	0.32	0.20	0.14	0.10

DECK & PATIO LOW VOLTAGE

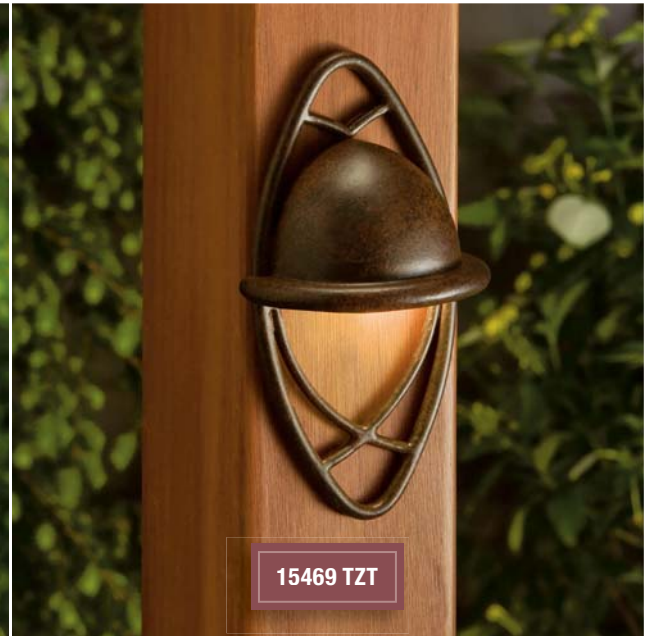
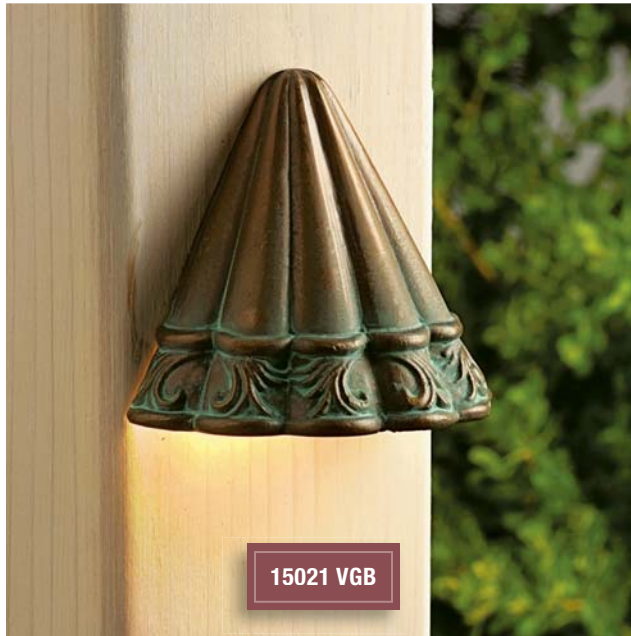

Name	"AINSLEY SQUARE™" DECK LIGHT Charming detail in a decorative sconce with a Verdigris and Aged Brass finish.	CATHEDRAL DECK LIGHT Arches of interwoven bands dress the post as light flows down from the integral dome. Coordinates with matching Bollard 15449 TZT on page 49 and with matching Path light 15429 TZT on page 50.
Ordering Guide	15021 VGB - Verdigris with Aged Brass	15469 TZT - Textured Tannery Bronze™
Housing	Cast Brass	Aluminum
Finish	Verdigris with Aged Brass	Textured Tannery Bronze™
Light Source	12V Incandescent T-5 wedge base socket	12V Incandescent T-5 wedge base socket
Power Usage at 12V AC Input	VA MAX: 6.5-W(VA) Supplied: 6.5-W(VA) 918X (17023) Xenon light source Optional: 4-W(VA) 901X (17021)	VA MAX: 6.5-W(VA) Supplied: 6.5-W(VA) 918X (17022) Xenon light source Optional: 4-W(VA) 901X (17021)
Wiring	72" of usable #18-2, SPT-1-W leads. Cable connector supplied.	72" of usable #18-2, SPT-1-W leads. Cable connector supplied.
Mounting Accessories Included	Stainless steel mounting bracket	Stainless steel mounting bracket
Notes	U.S. Patent Pending	



Photometric with Lamp Supplied (fc)

Mounting Height	0'	1'	2'	3'	4'	5'	6'
6"	11.7	4.65	1.9	-	-	-	-
12"	2.86	2.16	1.36	.2	-	-	-
30"	.26	.3	.16	.2	.1	-	-

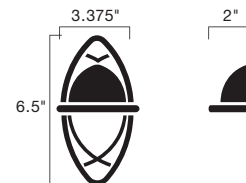

Photometric with Lamp Supplied (fc)

Mounting Height	.6'	1'	2'	3'	4'	5'	6'	7'
6"	37.3	8.88	1.39	.34	.10	.03	-	-
12"	13.6	6.17	1.85	.74	.35	.18	-	-
30"	2.39	2.01	1.29	.79	.47	.30	-	-

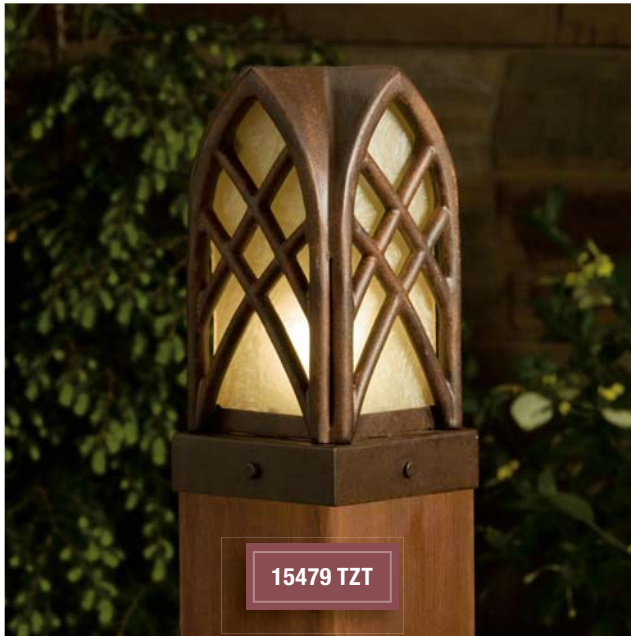

Name	CATHEDRAL POST LIGHT Cathedral arches and interwoven bands designed to crown deck posts and walls. Coordinates with matching Bollard 15449 TZT on page 49 and with matching Path light 15429 TZT on page 50.	LARKIN ESTATE™ POST LIGHT Classic prairie styling in a rich dark bronze finish with warm amber glass. Coordinates with matching Path light 15444 OZ on page 59.
Ordering Guide	15479 TZT - Textured Tannery Bronze™	15474 OZ - Olde Bronze®
Housing	Aluminum with dark citrine glass.	Brass with amber-etched glass.
Finish	Textured Tannery Bronze™	Olde Bronze®
Light Source	12V Incandescent T-5 wedge base socket	12V Incandescent T-5 wedge base socket
Power Usage at 12V AC Input	VA MAX: 16.25-W(VA) Supplied: 11.6-W(VA) 912X (17023) Xenon light source Optional: 16.25-W(VA) 921X (17025) 6.5-W(VA) 918X (17022) 4-W(VA) 901X (17021)	VA MAX: 16.25-W(VA) Supplied: 11.6-W(VA) 912X (17023) Xenon light source Optional: 16.25-W(VA) 921X (17025) 6.5-W(VA) 918X (17022) 4-W(VA) 901X (17021)
Wiring	71" of usable #18-2, SPT-1-W leads. Cable connector supplied.	71" of usable #18-2, SPT-1-W leads. Cable connector supplied.
Mounting Accessories Included	Stainless steel rail mounting bracket for 4" x 4" post and adaptor for 6" x 6" post	Stainless steel rail mounting bracket for 4" x 4" post and adaptor for 6" x 6" post

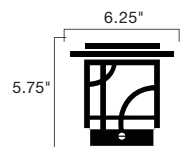
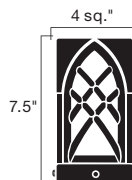



15110 OZ



15071 OZ

Name	ZEN GARDEN™ DECK LIGHT Asian-inspired minimalist design for subtle deck lighting. Coordinates with matching Bollard 15392 OZ and with matching Path light 15391 OZ on page 60.	ZEN GARDEN™ POST LIGHT Serene, minimalist design and added security to supplement deck sconces. Coordinates with matching Bollard 15392 OZ and with matching Path light 15391 OZ on page 60.
Ordering Guide	15110 OZ - Olde Bronze®	15071 OZ - Olde Bronze®
Housing	Brass with textured seedy linen glass.	Brass with textured linen seedy glass.
Finish	Olde Bronze®	Olde Bronze®
Light Source	12V Incandescent T-5 wedge base socket	12V Incandescent T-5 wedge base socket
Power Usage at 12V AC Input	VA MAX: 6.5-W(VA) Supplied: 4-W(VA) 901X (17021) Xenon light source Optional: 6.5-W(VA) 918X (17022)	VA MAX: 16.25-W(VA) Supplied: 11.6-W(VA) 912X (17023) Xenon light source Optional: 6.5-W(VA) 918X (17022) 4-W(VA) 901X (17021) 16.25-W(VA) 921X (17025)
Wiring	72" of usable #18-2, SPT-1-W leads. Cable connector supplied.	59" of usable #18-2, SPT-1-W leads. Cable connector supplied.
Mounting Accessories Included	Stainless steel mounting bracket	Post adaptor and Rail adaptor included are stainless steel. Fits standard 4"x 4" post.
Notes		U.S. Patent Pending



Photometric with Lamp Supplied (fc)

Mounting Height	0'	1'	2'	3'	4'	5'	6'
6"	26.53	7.26	1.33	.06	-	-	-
12"	7.63	4	1.46	.2	-	-	-
30"	1.06	.93	.7	.3	.03	-	-

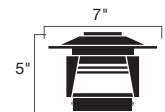

Photometric with Lamp Supplied (fc)

Distance from Light	1'	2'	3'	4'	5'	6'	7'	8'	9'
Footcandles	.23	.03	-	-	-	-	-	-	-

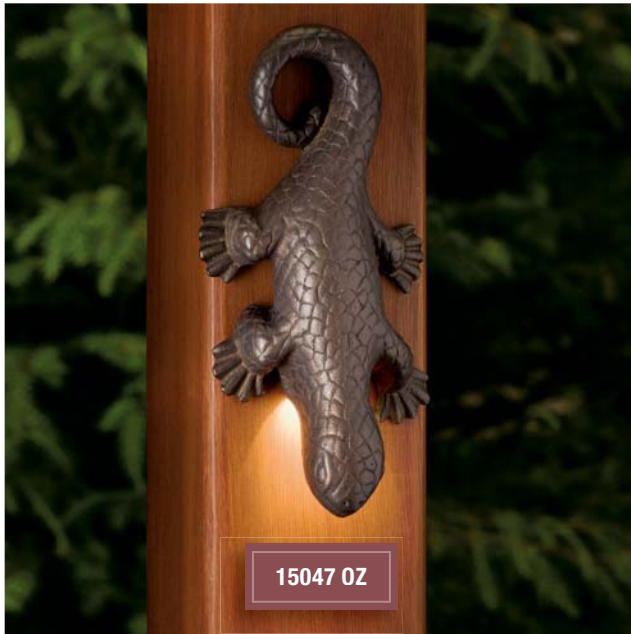

15047 OZ

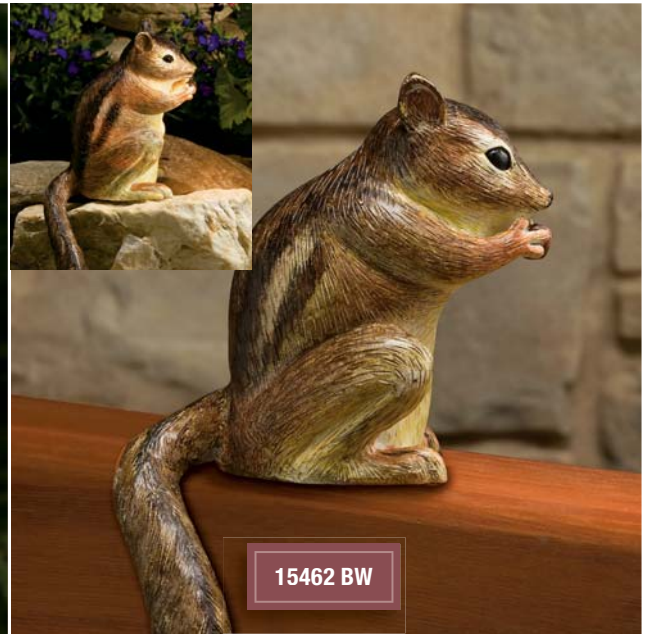

15462 BW

Name	OAK TRAIL™ ACCENT LIGHT Heavy duty, solid brass lizard to accent decks, breakwalls or other interest points. Patinas over time.	WOODLAND CHIPMUNK DECK LIGHT A full size chipmunk that can be perched on a deck rail, a stone wall, a rock in the garden or anywhere playful wildlife will enrich a setting. Light emits from it's belly.
Ordering Guide	15047 OZ - Olde Bronze®	15462 BW - Hand painted natural finish
Housing	Cast Brass	Resin
Finish	Olde Bronze®	Hand painted natural finish
Light Source	12V Incandescent T-5 wedge base socket	12V Incandescent T-5 wedge base socket
Power Usage at 12V AC Input	VA MAX: 6.5-W(VA) Supplied: 6.5-W(VA) 918X (17022) Xenon light source Optional: 4-W(VA) 901X (17021)	VA MAX: 16.25-W(VA) Supplied: 11.6-W(VA) 912X (17023) Xenon light source Optional: 6.5-W(VA) 918X (17022) 4-W(VA) 901X (17021) 16.25-W(VA) 921X (17025)
Wiring	71" of usable #18-2, SPT-1-W leads. Cable connector supplied.	70" of usable #18-2, SPT-1-W leads. Cable connector supplied.
Mounting Accessories Included	Stainless steel mounting bracket	Mounting hardware and instructions included for typical installations
Notes	U.S. Patent No. D573,293	

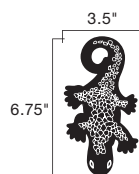

Photometric with Lamp Supplied (fc)

Mounting Height	0'	0.5'	1'	2'	3'	4'	5'
6"	3.6	.25	-	-	-	-	-
12"	2.1	.76	.15	-	-	-	-
30"	1.26	.76	.1	-	-	-	-

DECK & PATIO LOW VOLTAGE



Name	HALF MOON Understated, modern style for deck or patio in a choice of contemporary finishes.	MINI DECK LIGHT Versatile mini size and simple styling for multiple applications, available in a variety of finishes constructed of brass or aluminum.
Ordering Guide	15064 AZT - Textured Architectural Bronze™, Aluminum 15064 BBR - Bronzed Brass, Brass 15064 BN - Brushed Nickel 15064 WHT - Textured White, Aluminum	15065 AZT - Textured Architectural Bronze™, Aluminum 15065 BBR - Bronzed Brass, Brass 15065 BKT - Textured Black, Aluminum 15065 WHT - Textured White, Aluminum
Housing	Cast Aluminum or Cast Brass	Cast Aluminum or Cast Brass.
Finish	Textured Architectural Bronze™, Bronzed Brass, Beach or Textured White	Textured Architectural Bronze™, Bronzed Brass, Beach, Textured Black, or Textured White
Light Source	12V Incandescent T-3 bi-pin, high temperature porcelain socket	12V Incandescent T-5 wedge base socket
Power Usage at 12V AC Input	VA MAX: 10-W(VA) Supplied: 10-W(VA) Q10T3 (17011) halogen Halogen light source	VA MAX: 6.5-W(VA) Supplied: 6.5-W(VA) 918X (17022) Xenon light source Optional: 4-W(VA) 901X (17021)
Wiring	72" of usable #18-2, SPT-1-W leads. Cable connector supplied.	72" of usable #18-2, SPT-1-W leads. Cable connector supplied.
Matching Outdoor Path Lights	15360	15005, 15011, 15315, 15326, 15327, 15328
Mounting Accessories Included	Stainless Steel surface mounting bracket	Stainless Steel surface mounting bracket
LED Option	See 15764 on page 21.	See 15765 on page 20.



Photometric with Lamp Supplied (fc)

Mounting Height	0'	0.5'	1'	1.5'	2'	2.5'	3'	3.5'	4'	4.5'
6"	53	36.1	4.7	.9	.2	-	-	-	-	-
12"	13.8	17.3	6.9	2.5	.9	.3	.1	-	-	-
30"	2.2	3.2	2.6	2	1.4	.9	.6	.3	.2	.1



Photometric with Lamp Supplied (fc)

Mounting Height	1'	2'	3'	4'	5'	6'	7'
6"	2.8	.06	.03	-	-	-	-
12"	4.1	.73	.15	-	-	-	-
30"	1.7	.87	.37	.1	-	-	-

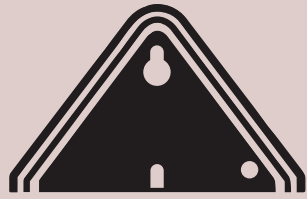

Integral full back for mounting on irregular surfaces.



15045 AZT



15468 AZT



15165 AZ

Name	FULL BACK MINI DECK LIGHT Versatile mini size and simple styling. Integral full back for mounting on irregular surfaces.	RIBBED ROOF Simple ribs and valleys are combined with a fluted column to blend with any deck setting.	MINI DECK LIGHT Small size, simple styling and economical thermoplastic resin construction. Ideal for lighting along decks, porch steps and above stairways in salt air environments.
Ordering Guide	15045 AZT - Textured Architectural Bronze™	15468 AZT - Textured Architectural Bronze™	15165 AZ - Architectural Bronze™
Housing	Cast Aluminum	Cast Aluminum.	Durable thermoplastic composite resin, one-piece construction. Extremely resistant to impact, weather and the effects of UV.
Finish	Textured Architectural Bronze™	Textured Architectural Bronze™	Architectural Bronze™
Light Source	12V Incandescent T-5 wedge base socket	12V Incandescent T-5 wedge base socket	12V Incandescent T-5 wedge base socket
Power Usage at 12V AC Input	VA MAX: 6.5-W(VA) Supplied: 6.5-W(VA) 918X (17022) Xenon light source Optional: 4-W(VA) 901X (17021)	VA MAX: 6.5-W(VA) Supplied: 6.5-W(VA) 918X (17022) Xenon light source Optional: 4-W(VA) 901X (17021)	VA MAX: 6.5-W(VA) Supplied: 6.5-W(VA) 918X (17022) Xenon light source Optional: 4-W(VA) 901X (17021)
Wiring	72" of usable #18-2, SPT-1-W leads. Cable connector supplied.	72" of usable #18-2, SPT-1-W leads. Cable connector supplied.	71" of usable #18-2, SPT-1-W leads. Cable connector supplied.
Matching Outdoor Path Lights	15005, 15011, 15315, 15326, 15327, 15328	15418	NA
Mounting Accessories Included	Stainless Steel surface mounting bracket	Stainless Steel surface mounting bracket	Stainless Steel surface mounting bracket

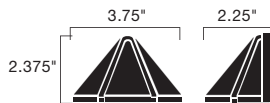

Photometric with Lamp Supplied (fc)

Mounting Height	1'	2'	3'	4'	5'	6'	7'
6"	2.8	.06	.03	-	-	-	-
12"	4.1	.73	.15	-	-	-	-
30"	1.7	.87	.37	.1	-	-	-

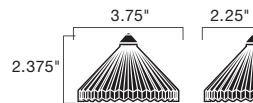

Photometric with Lamp Supplied (fc)

Mounting Height	1'	2'	3'	4'	5'	6'	7'
6"	10.52	1.21	.35	.14	.08	-	-
12"	7.56	1.92	.66	.28	.15	-	-
30"	2.61	1.54	.84	.48	.31	-	-

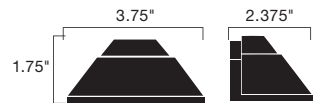

Photometric with Lamp Supplied (fc)

Mounting Height	1'	2'	3'	4'	5'	6'	7'
6"	1.9	.03	-	-	-	-	-
12"	2.4	.4	-	-	-	-	-
30"	.9	.4	.2	-	-	-	-

DECK & PATIO LOW VOLTAGE

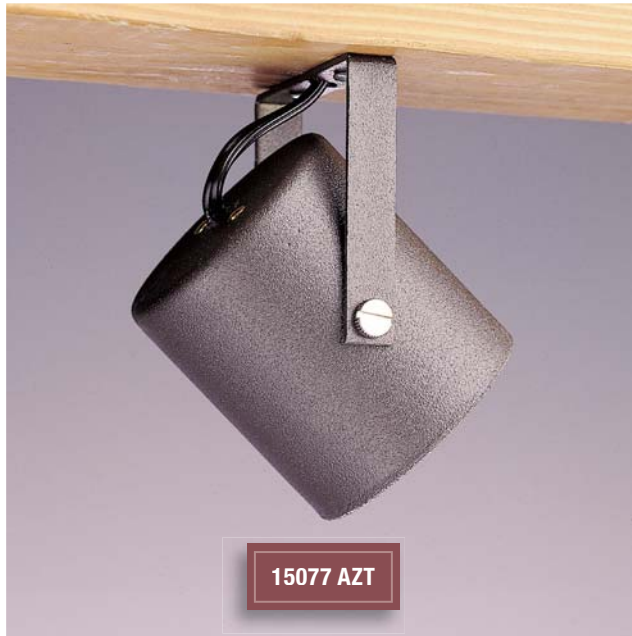

15077 AZT



15066 AZT

15066 WHT

Name	ADJUSTABLE UNDER RAILING LIGHT Adaptable, compact fixture for safety and security. Installs under deck railing or wall mount.	LOUVERED DOWN LIGHT Compact and contemporary, designed for lighting on rails, along decks, patios or stairways.
Ordering Guide	15077 AZT - Textured Architectural Bronze™	15066 AZT - Textured Architectural Bronze™ 15066 WHT - Textured White
Housing	Aluminum	Aluminum
Finish	Textured Architectural Bronze™	Textured Architectural Bronze™ or Textured White
Light Source	12V Incandescent S-8 wedge base socket	12V Incandescent T-5 wedge base socket
Power Usage at 12V AC Input	VA MAX: 18.5-W(VA) Supplied: 18.5-W(VA) 3155K (15599 CLR) Krypton light source	VA MAX: 6.5-W(VA) Supplied: 6.5-W(VA) 918X (17022) Xenon light source Optional: 4-W(VA) 901X (17021)
Wiring	72" of usable #18-2, SPT-1-W leads. Cable connector supplied.	72" of usable #18-2, SPT-1-W leads. Cable connector supplied.
Mounting Accessories Included	Mounting hardware	Stainless steel mounting plate
Notes		U.S. Patent No. D437,445

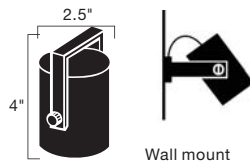

Photometric with Lamp Supplied (fc)

Distance from Light	1'	2'	3'	4'	5'	6'	7'	8'	9'
Footcandles	4.7	3.1	1.5	.35	.15	.08	-	-	-

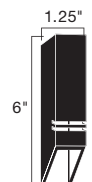

Photometric with Lamp Supplied (fc)

Mounting Height	.5'	1'	1.5'	2'	2.5'	3'	3.5'	4'
6"	5.2	.4	-	-	-	-	-	-
12"	19.	.6	.1	-	-	-	-	-
30"	2.4	.2	.1	-	-	-	-	-



15079 AZT



15123 BK



15237 OB

Name	UP/DOWN ACCENT Attractive and functional up and down light blends with a range of architectural styles.	MR-11 BARBECUE LIGHT Integrated surface mount BBQ light for direct connection to 12V landscape lighting system for rail or outdoor countertop mount only.	120V ADJUSTABLE HEIGHT UTILITY LIGHT Multipurpose, adjustable fixture for mounting to deck railings, post or porch for directional task lighting.
Ordering Guide	15079 AZT - Textured Architectural Bronze™	15123 BK - Black	15237 OB - Olde Brick®
Housing	Aluminum	Components of durable high heat thermoplastic resin. Lamp shielded by a high heat-resistant flat glass lens sealed for watertight outdoor use. Flexible stem is durable chrome plated steel with heat shrink rubber sleeving. On/off switch is protected by waterproof rubber boot.	Aluminum construction, G-40 light bulb required
Finish	Textured Architectural Bronze™	Black	Olde Brick®
Light Source	12V Incandescent T-5 wedge base socket	12V Incandescent bi-pin, high temperature porcelain socket	G-40 light bulb 150-W Max. (not supplied)
Power Usage at 12V AC Input	VA MAX: 11.6-W(VA) Supplied: 11.6-W(VA) 912X (17023) (2) Xenon light source Optional: 6.5-W(VA) 918X (17022) 4-W (VA) 901X (17021)	VA MAX: 35-W(VA) Supplied: 20-W(VA) MR11 Halogen light source Optional: 35-W(VA) MR11 halogen-xenon	NA
Wiring	70" of usable #18-2, SPT-1-W leads. Cable connector supplied with fixture.	25' of usable #18-2, SPT-1-W leads. Connector supplied	58" min. to 72" max. of usable 18AWG sleeved wire with 3 prong plug. 120V medium base socket with nickel plated screw shell, on-off pull chain.
Mounting Accessories Included	Stainless Steel surface mounting plate	(1) set wood screws and (1) set machine screws and nuts	Mounting Hardware
Optional Lens Accessories	15659 – Lens	NA	NA

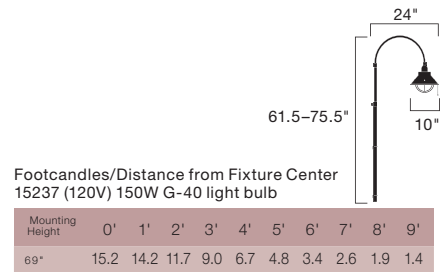
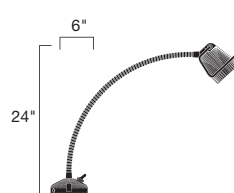
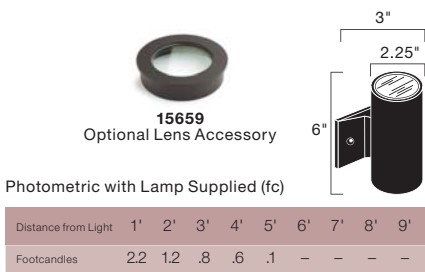

DECK & PATIO LOW VOLTAGE

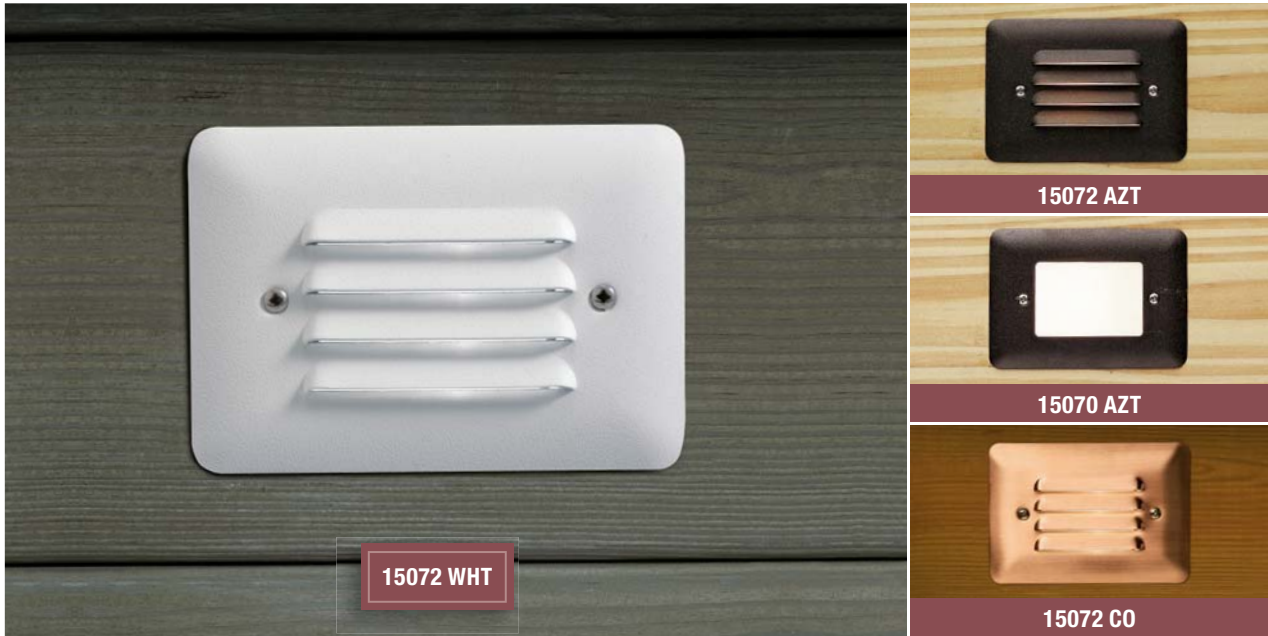

Name	MINI STEP LIGHT Designed to be integrated into outdoor steps. Casts a low, even spread of light. Available with louvered or white acrylic faceplate.
Ordering Guide	15070 AZT - Acrylic Lens, Textured Architectural Bronze™, Aluminum 15072 AZT - Louvered Lens, Textured Architectural Bronze™, Aluminum 15072 CO - Louvered Lens, Copper, Unfinished Copper 15072 WHT - Louvered Lens, Textured White, Aluminum
Housing	Aluminum or copper faceplate with white reflector. Zinc plated steel housing. White acrylic diffuser on 15070 only.
Finish	Textured Architectural Bronze™, Unfinished Copper or Textured White
Light Source	12V Incandescent T-5 wedge base socket.
Power Usage at 12V AC Input	VA MAX: 11.6-W(VA) Supplied: 11.6-W(VA) 912X (17023) 6.5-W(VA) 918X MAX supplied on copper Xenon light source Optional: 6.5-W(VA) 918X (17022) 4-W(VA) 901X (17021)
Wiring	Wire connection must be made inside fixture housing. 90° supply wire required.
Mounting Accessories Included	Mounting hardware and junction box
LED Option	15782 and 15780 – on page 22.
Notes	For recessed installation. For outdoor use only.

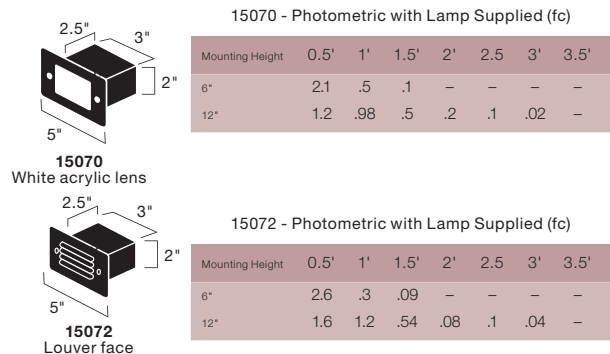



15074 AZT



15073 AZT

Name	BRICK LIGHT – GLASS LENS Designed to be integrated into brick walls during construction. Casts a low, even spread of light.	BRICK LIGHT – LOUVERED Designed to be integrated into brick walls during construction. Casts a low, even spread of light.
Ordering Guide	15074 AZT - Textured Architectural Bronze™	15073 AZT - Textured Architectural Bronze™
Housing	Cast Aluminum with a fully sealed heat-resistant glass lens	Cast Aluminum
Finish	Textured Architectural Bronze™	Textured Architectural Bronze™
Light Source	(2) 12V Incandescent T-3 bi-pin, high temperature porcelain sockets	(2) 12V Incandescent T-3 bi-pin, high temperature porcelain sockets
Power Usage at 12V AC Input	VA MAX: 10-W(VA) Supplied: 10-W(VA) Q10T3 (17011) halogen (2) Halogen light source	VA MAX: 10-W(VA) Supplied: 10-W(VA) Q10T3 (17011) halogen (2) Halogen light source
Wiring	Wire connection must be made inside fixture housing. 75° supply wire required.	Wire connection must be made inside fixture housing. 75° supply wire required.
Mounting Accessories Included	Stainless steel mounting bracket	Stainless steel mounting bracket
LED Options	15774 – on page 21.	15773 – on page 21.
Notes	For outdoor use only. Masonry or concrete use only.	For outdoor use only. Masonry or concrete use only.

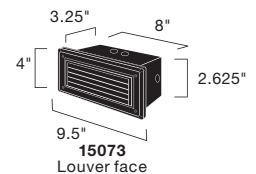
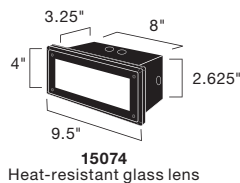

15074 - Photometric with Lamp Supplied (fc)

Mounting Height	0.5'	1'	1.5'	2'	2.5'	3'	3.5'	4'
12"	–	–	–	–	.01	.04	.04	–
24"	–	–	.06	.1	.09	.04	.04	–
36"	.02	.04	.04	.04	.04	.04	.01	–

15073 - Photometric with Lamp Supplied (fc)

Mounting Height	0.5'	1'	1.5'	2'	2.5'	3'	3.5'	4'	4.5'	5'
12"	.3	1.1	.8	.5	.1	.02	–	–	–	–
24"	–	–	.1	.2	.2	.2	.1	.03	.02	–
36"	–	–	–	–	.01	.01	.03	.06	.03	.01



POWERED BY
DESIGN PRO LED
TECHNOLOGY

This installation illuminated exclusively
with Design Pro LED fixtures



Meet the professionals
behind the lighting



LOW VOLTAGE

Incandescent Accent

Create dramatic effects that make a landscape come alive at night.



ACCENT LOW VOLTAGE



ACCENT - LOW VOLTAGE

A

Name	MINI ACCENT For uplighting only (spotlighting, cross-lighting, grazing).	
Ordering Guide	15384 AZT – Textured Architectural Bronze™, Aluminum 15384 AZT 20L – Same as 15384 AZT. 20-W MR-16, FL 36° included. 15384 AZT 24 – Same as 15384 AZT. Bulk packed in 24 (unbreakable master) 15384 BBR – Bronzed Brass, Brass 15384 BBR 20L – Same as 15384BBR. 20-W MR-16 FL 36° included. 15384 BBR 20L 12 – Same as 15384BBR 20L. Bulk packed in 12 (unbreakable master) 15384 BKT – Textured Black, Aluminum 15384 BKT 24 – Same as 15384 BKT. Bulk packed in 24 (unbreakable master) 15384 CO – Unfinished Copper. Extruded copper cowl. Die-cast brass knuckle/stem. 15384 MST – Textured Midnight Spruce™, Aluminum	
Housing	Cast Aluminum, Cast Brass or Unfinished Copper. Heat resistant flat glass lens is fully sealed.	
Finish	Textured Architectural Bronze™, Bronzed Brass, Textured Black, Unfinished Copper, or Textured Midnight Spruce	
Light Source	12V Incandescent bi-pin, high temperature porcelain socket	
Power Usage at 12VAC Input	VA MAX: 50-W(VA) MR-16 35-W(VA) Max. on 15384CO 20-W(VA) Max. Canada Lamp not supplied unless noted. Halogen light source.	
Wiring	35" of usable #18-2, SPT-1-W leads. Cable connector supplied.	
Mounting Accessories Included	8" In-ground stake	
Optional Mounting Accessories	15601 – Surface Mounting Flange 15607 – Tree/Surface Mounting Flange 15609 – Junction Box Mounting Bracket	15647 – 90° Elbow 15649 – Stem Coupler 15645, 15656, 15657, 15658 or 15570 – Stems
Optional Lens Accessories	15675 LIN – Linear Lens 15676 FRO – Frosted Lens 15679 BK – Hexcell Louver Shield 15686 BL – Blue Filter	
Notes	See pages 136-139 for more light bulb options and light bulb photometrics. Copper will naturally patina over time.	

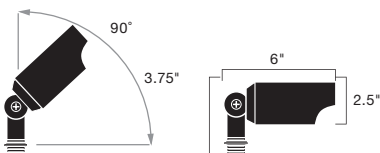

ACCENT LOW VOLTAGE

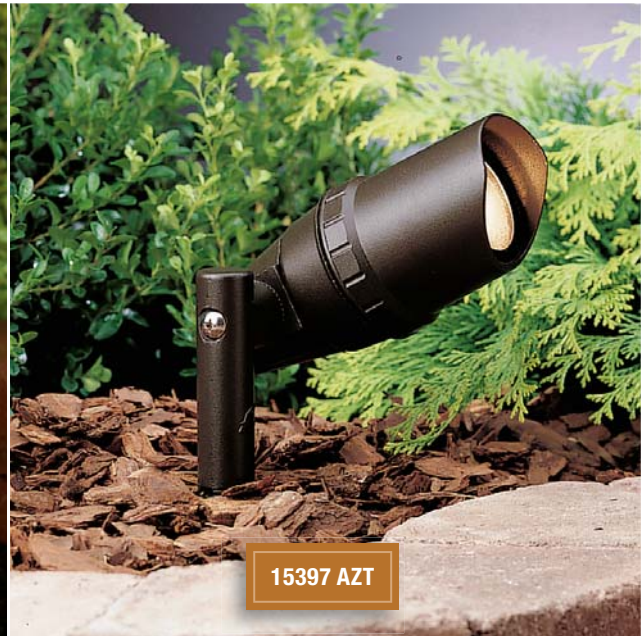
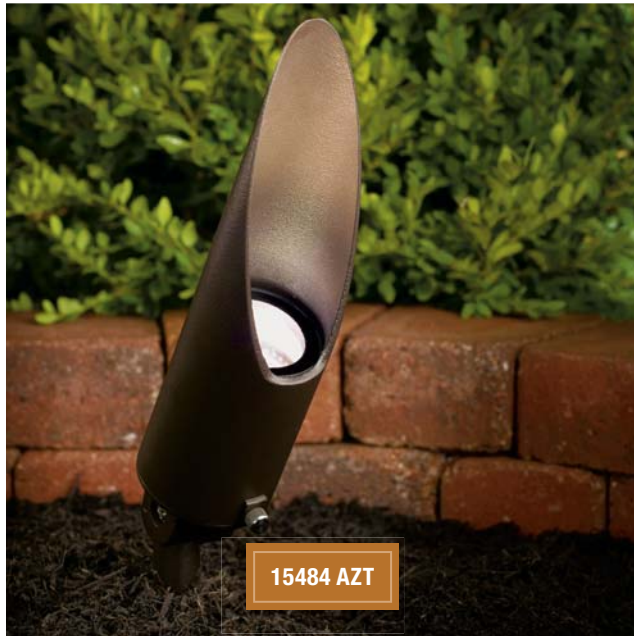

Name	LONG COWL MINI-ACCENT LIGHT (UP AND DOWN) A compact (2¼" diameter) accent light with extra long cowl for up and down lighting versatility.		ARCHITECTURAL GRADE ADJUSTABLE ACCENT LIGHT Recommend for up or down spotlighting, cross-lighting and grazing. Use with the 6" (15645), 12" (15656), 18" (15657) or 24" (15658) mounting stem for dramatic effects.	
Ordering Guide	15484 AZT – Textured Architectural Bronze™		15397 AZT – Textured Architectural Bronze™	
Housing	Cast Aluminum. Heat-resistant flat glass lens is fully sealed.		Machined aluminum. Heat-resistant glass is fully sealed and angled for easy water run-off. Cowl is fully adjustable.	
Finish	Textured Architectural Bronze™		Textured Architectural Bronze™	
Light Source	12V Incandescent bi-pin, high temperature porcelain socket		12V Incandescent bi-pin, high temperature porcelain socket	
Power Usage at 12V AC Input	VA MAX: 50-W(VA) MR-16 20-W(VA) Max. Canada 35-W(VA) MR-11 Not supplied unless noted		VA MAX: 50-W(VA) MR-16 Aluminum 35-W(VA) Max. Canada 35-W(VA) MR-11 Not supplied unless noted	
Wiring	35" of usable #18-2, SPT-1-W leads. Connector supplied.		51" of usable #18-2, SPT-1-W leads. Cable connector supplied.	
Mounting Accessories Included	8" In-ground stake		8" In-ground stake	
Optional Mounting Accessories	15601 – Surface Mounting Flange 15607 – Tree/Surface Mounting Flange 15609 – Junction Box Mounting Bracket	15647 – 90° Elbow 15649 – Stem Coupler 15645, 15656, 15657, 15658 or 15570 – Stems	15601 – Surface Mounting Flange 15607 – Tree/Surface Mounting Flange 15609 – Junction Box Mounting Bracket	15647 – 90° Elbow 15649 – Stem Coupler 15645, 15656, 15657, 15658 or 15570 – Stems
Optional Lens Accessories	15679 BK – Louver 15686 BL – Blue Filter 15676 FRO – Frosted Lens 15675 LIN – Linear Lens		15683 BK – Louver 15693 BL – Blue Filter	
Notes	See pages 136-139 for more light bulb options and light bulb photometrics		See pages 136-139 for more light bulb options and light bulb photometrics	

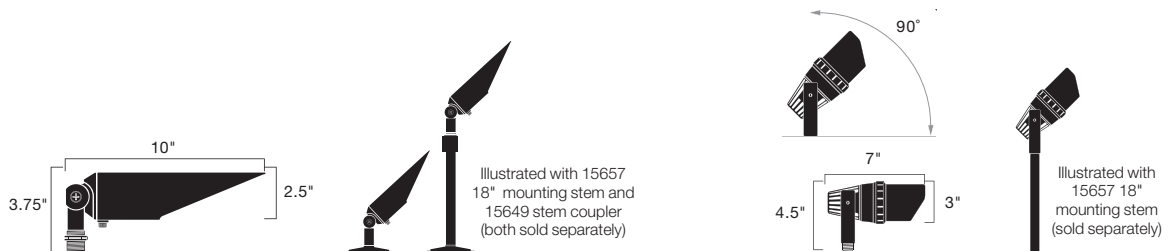



15398 AZT



15309 AZT



15309 BKT

Name	MICRO ACCENT - MR 11 ACCENT LIGHT Our smallest incandescent (17/8") accent light. Recommended for up or down narrow spotlighting, cross-lighting and grazing for specialty applications.		ACCENT LIGHT Accent light for up or down spotlighting, cross-lighting and grazing.	
Ordering Guide	15398 AZT – Textured Architectural Bronze™		15309 AZT – Textured Architectural Bronze™ 15309 AZT 12 – Same as 15309 AZT. Bulk packed in 12 (unbreakable master). 15309 BKT – Textured Black	
Housing	Cast Aluminum. Heat-resistant glass is fully sealed.		Cast Aluminum. Heat resistant flat glass lens is fully sealed.	
Finish	Textured Architectural Bronze™		Textured Architectural Bronze™ or Textured Black	
Light Source	12V Incandescent bi-pin, high temperature porcelain socket		12V Incandescent bi-pin, high temperature porcelain socket	
Power Usage at 12V AC Input	VA MAX: 35-W(VA) MR-11 20-W(VA) Max. Canada Not supplied unless noted		VA MAX: 35-W(VA) MR-16 35-W(VA) MR-11 Supplied: 20-W(VA) MR-16 Halogen light source	
Wiring	36" of usable #18-2, SPT-1-W leads. Cable connector supplied.		40" of usable #18-2, SPT-1-W leads. Cable connector supplied. 12V.	
Mounting Accessories Included	8" In-ground stake		8" In-ground stake	
Optional Mounting Accessories	15601 – Surface Mounting Flange 15607 – Tree/Surface Mounting Flange 15609 – Junction Box Mounting Bracket	15647 – 90° Elbow 15649 – Stem Coupler 15645, 15656, 15657, 15658 or 15570 – Stems	15601 – Surface Mounting Flange 15607 – Tree/Surface Mounting Flange 15609 – Junction Box Mounting Bracket	15647 – 90° Elbow 15649 – Stem Coupler 15645, 15656, 15657, 15658 or 15570 – Stems
Optional Lens Accessories	15631 BL – Blue Filter 15632 LIN – Linear Lens 15633 FRO – Frosted Lens 15634 BK – Louver			
Notes	See pages 136-139 for more light bulb options and light bulb photometrics		See pages 136-139 for more light bulb options and light bulb photometrics	

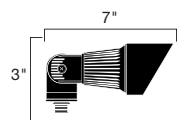
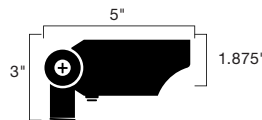

ACCENT LOW VOLTAGE



Name	MINI ACCENT LIGHT A compact (2¼" diameter) accent light for a variety of up and down lighting special effects such as spotlighting, cross-lighting and grazing.	
Ordering Guide	15374 AZT – Textured Architectural Bronze™ 15374 AZT 20L – Same as 15374 AZT. 20-W MR-16, FL 36° included 15374 AZT 20L 24 – Same as 15374 AZT. 20-W MR-16, FL 36° included. Bulk packed in 24 (unbreakable master). 15374 BE 20L - Beach, 20-W MR16, FL 36° 15374 BKT – Textured Black 15374 BKT 20L 24 – Same as 15374 BKT. 20-W MR-16, FL 36° included. Bulk packed in 24 (unbreakable master).	
Housing	Cast Aluminum. Heat resistant flat glass lens is fully sealed.	
Finish	Textured Architectural Bronze™, or Textured Black	
Light Source	12V Incandescent bi-pin, high temperature porcelain socket	
Power Usage at 12V AC Input	VA MAX: 50-W(VA) MR-16 20-W(VA) Max. Canada Lamp not supplied unless noted	
Wiring	31" of usable #18-2, SPT-1-W leads. Cable connector supplied.	
Mounting Accessories Included	8" In-ground stake	
Optional Mounting Accessories	15601 – Surface Mounting Flange 15607 – Tree/Surface Mounting Flange 15609 – Junction Box Mounting Bracket	15647 – 90° Elbow 15649 – Stem Coupler 15645, 15656, 15657, 15658 or 15570 – Stems
Optional Lens Accessories	15641 BL – Blue Filter 15642 LIN – Linear Lens 15643 FRO – Frosted Lens 15644 BK – Hexcell Louver Shield	
Notes	See pages 136-139 for more light bulb options and light bulb photometrics	

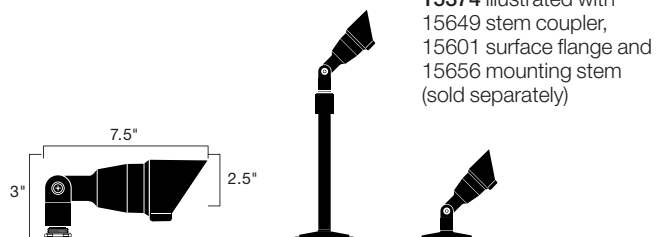



Name	COMPOSITE ACCENT LIGHT For up or down spotlighting, cross-lighting and grazing. A cost-effective, corrosion-resistant option in harsh environments.	
Ordering Guide	15382 BK – Black	
Housing	Components of durable high heat thermoplastic composite resin. Heat-resistant flat glass lens is fully sealed.	
Finish	Black	
Light Source	12V Incandescent bi-pin, high temperature porcelain socket	
Power Usage at 12V AC Input	VA MAX: 35-W(VA) MR-16 Lamp not supplied unless noted	
Wiring	30" usable #18-2, SPT-1-W leads. Cable connector supplied.	
Mounting Accessories Included	8" In-ground stake	
Optional Mounting Accessories	15601 – Surface Mounting Flange 15607 – Tree/Surface Mounting Flange 15609 – Junction Box Mounting Bracket	15647 – 90° Elbow 15649 – Stem Coupler 15645, 15656, 15657, 15658 or 15570 – Stems
Optional Lens Accessories	15673 BL – Blue Filter 15672 FRO – Frosted Lens 15674 LIN – Linear Lens	
Notes	U.S. Patent D417,519 See pages 136-139 for more light bulb options and light bulb photometrics	

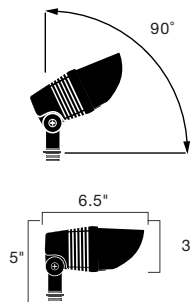



POWERED BY
DESIGN PRO LED
TECHNOLOGY

This installation illuminated exclusively
with Design Pro LED fixtures



Meet the professionals
behind the lighting





Name	MR-16 ACCENT LIGHT Larger (4½" diameter) for up or down wider light spread along walls, shrubs, and trees.	
Ordering Guide	15381 AZT – Textured Architectural Bronze™, Aluminum 15381 AZT 6 – Same as 15381AZT. Bulk packed in 6 (unbreakable master) 15381 BBR – Bronzed Brass, Brass 15381 BKT – Textured Black, Aluminum	
Housing	Cast Aluminum or Cast Brass. Heat resistant flat glass lens is fully sealed.	
Finish	Textured Architectural Bronze™, Bronzed Brass or Textured Black	
Light Source	12V Incandescent bi-pin, high temperature porcelain socket	
Power Usage at 12V AC Input	VA MAX: 75-W(VA) MR-16 Lamp not supplied unless noted	
Wiring	35" of usable #18-2, SPT-1-W leads. Cable connector supplied.	
Mounting Accessories Included	8" In-ground stake	
Optional Mounting Accessories	15601 – Surface Mounting Flange 15607 – Tree/Surface Mounting Flange 15609 – Junction Box Mounting Bracket	15647 – 90° Elbow 15649 – Stem Coupler 15645, 15656, 15657, 15658 or 15570 – Stems
Optional Lens Accessories	15680 BK – Hexcell Louver Shield 15687 BL – Blue Filter 15691 FRO – Frosted Lens 15692 LIN – Linear Lens	
Notes	See pages 136-139 for more light bulb options and light bulb photometrics	

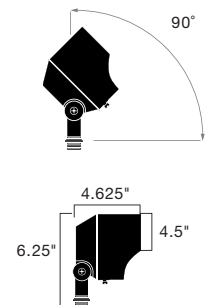



15383 AZT



15390 AZT

Name	BI-PIN ACCENT LIGHT The clarity of halogen in a larger (4½" diameter) size for wider up or down light spread.	PAR 36 ACCENT LIGHT A full-size (5¼" diameter) adjustable accent light, recommend for up or down wall washing and other wider beam spread applications.
Ordering Guide	15383 AZT – Textured Architectural Bronze™	15390 AZT – Textured Architectural Bronze™
Housing	Cast Aluminum. Heat-resistant flat glass is fully sealed.	Cast Aluminum.
Finish	Textured Architectural Bronze™	Textured Architectural Bronze™
Light Source	12V Incandescent bi-pin, high temperature porcelain socket	12V Incandescent PAR-36 lamp
Power Usage at 12V AC Input	VA MAX: 75-W(VA) BBR 20-W (VA) Max. Canada Supplied: 50-W(VA) Q50T4 (17015) Halogen light source	VA MAX: 50-W(VA) PAR-36 Lamp not supplied unless noted
Wiring	38" of usable #18-2, SPT-1-W leads. Cable connector supplied.	42" of usable #18-2, SPT-1-W leads. Cable connector supplied. Supply wire lugs attach directly to PAR 36 light bulb screw terminals. Light bulb secured in place with retaining ring.
Mounting Accessories Included	8" In-ground stake	8" In-ground stake
Optional Mounting Accessories	15601 – Surface Mounting Flange 15607 – Tree/Surface Mounting Flange 15609 – Junction Box Mounting Bracket	15647 – 90° Elbow 15649 – Stem Coupler 15645, 15656, 15657, 15658 or 15570 – Stems
Notes	See pages 136-139 for more light bulb options and light bulb photometrics	See pages 136-139 for more light bulb options and light bulb photometrics

Fixture Photometric (fc)

A-Aiming Angle	0°			30°			45°					
	D	FC	L	W	D	FC	L	W	D	FC	L	W
5°	8.76	4.45	4.45	5.69	6.36	5.14	3.1	11.11	6.3			
10°	2.19	8.9	8.9	1.42	12.71	10.28	.77	22.21	12.59			
20°	.55	17.81	17.81	.36	25.43	20.56	.19	44.42	25.19			

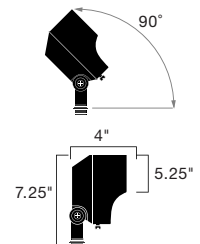
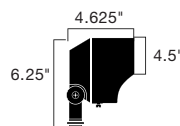

FLOOD LIGHT WALL WASH - ACCENT LOW VOLTAGE



15395 AZT



15396 AZT

Name	ADJUSTABLE WIDE FLOOD LIGHT Large (6¾" x 5") floodlight with wide beam spread for dramatic up or down wall washing in a vertical installation.		MINIATURE HOODED ADJUSTABLE WIDE FLOOD LIGHT Small (4½" x 5") eyebrow allows adjustment to upwards position without glare. Use for up or down wide-angle wall washing and young shrubs.	
Ordering Guide	15395 AZT – Textured Architectural Bronze™		15396 AZT – Textured Architectural Bronze™	
Housing	Cast Aluminum. Heat-resistant flat glass is fully sealed.		Cast Aluminum. Heat-resistant flat glass lens is fully sealed.	
Finish	Textured Architectural Bronze™		Textured Architectural Bronze™	
Light Source	12V Incandescent bi-pin, high temperature porcelain socket		12V Incandescent bi-pin, high temperature porcelain socket	
Power Usage at 12V AC Input	VA MAX: 75-W(VA) Supplied: 50-W(VA) QT4 (17015) Halogen light source		VA MAX: 35-W(VA) Supplied: 35-W(VA) QT3 (17013) Halogen light source	
Wiring	35" of usable #18-2, SPT-1-W leads. Cable connector supplied.		35" of usable #18-2, SPT-1-W leads. Cable connector supplied.	
Mounting Accessories Included	8" In-ground stake		8" In-ground stake	
Optional Mounting Accessories	15601 – Surface Mounting Flange 15607 – Tree/Surface Mounting Flange 15609 – Junction Box Mounting Bracket		15647 – 90° Elbow 15649 – Stem Coupler 15645, 15656, 15657, 15658 or 15570 – Stems	
Notes	See pages 136-139 for more light bulb options and light bulb photometrics		See pages 136-139 for more light bulb options and light bulb photometrics U.S. Patent Pending	

FLOOD LIGHT WALL WASH - ACCENT LOW VOLTAGE



15385 AZT

Name	HOODED ADJUSTABLE WIDE FLOOD LIGHT	
	Large (6¾" x 5") floodlight with wide beam spread for dramatic up or down wall-washing of taller walls and vertical stonework. Eyebrow shields glare to allow for horizontal use.	
Ordering Guide	15385 AZT – Textured Architectural Bronze™	
Housing	Cast Aluminum. Heat-resistant flat glass lens is fully sealed.	
Finish	Textured Architectural Bronze™	
Light Source	12V Incandescent bi-pin, high temperature porcelain socket	
Power Usage at 12V AC Input	VA MAX: 75-W(VA) Aluminum Supplied: 50-W(VA) QT3 or QT4 (17015) Halogen light source	
Wiring	35" of usable #18-2, SPT-1-W leads. Cable connector supplied.	
Mounting Accessories Included	8" In-ground stake	
Optional Mounting Accessories	15601 – Surface Mounting Flange 15607 – Tree/Surface Mounting Flange 15609 – Junction Box Mounting Bracket	15647 – 90° Elbow 15649 – Stem Coupler 15645, 15656, 15657, 15658 or 15570 – Stems
Notes	See pages 136-139 for more light bulb options and light bulb photometrics U.S. Patent Pending	

15395 AZT

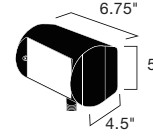

Vertical Illuminance (FC)

	Mounting Distance from Surface					
	A	B	C	D	E	F
3'	9.30	5.43	1.81	.9	.18	.09
4'	5.08	3.05	1.01	.51	.10	.05
5'	3.25	1.95	.65	.33	.07	.03
6'	2.26	1.35	.45	.23	.05	.02
7'	1.66	.99	.33	.17	.03	.03
8'	1.27	.76	.25	.13	.03	.01
9'	1	.6	.2	.1	.02	.01
10'	.81	.49	.16	.08	.02	.01

Light bulb conversion: 75W, T4 BI-PIN, FCX1.54

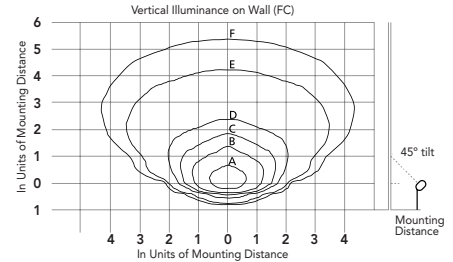

ACCENT - LOW VOLTAGE

A

15396 AZT

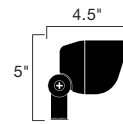

Vertical Illuminance (FC)

	Mounting Distance from Surface					
	A	B	C	D	E	F
3'	13.89	8.33	2.78	1.39	.28	.14
4'	7.81	4.69	1.56	.78	.16	.08
5'	5	3	1	.5	.1	.05
6'	3.47	2.08	.69	.35	.07	.03
7'	2.55	1.53	.51	.26	.05	.03
8'	1.95	1.17	.39	.2	.04	.02
9'	1.54	.93	.31	.15	.03	.02
10'	1.25	.75	.25	.13	.03	.01

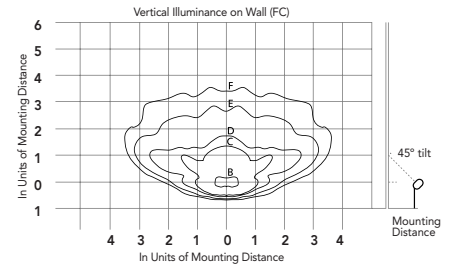

15385 AZT

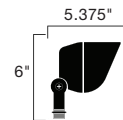

Vertical Illuminance (FC)

	Mounting Distance from Surface					
	A	B	C	D	E	F
3'	9.30	5.43	1.81	.9	.18	.09
4'	5.08	3.05	1.01	.51	.10	.05
5'	3.25	1.95	.65	.33	.07	.03
6'	2.26	1.35	.45	.23	.05	.02
7'	1.66	.99	.33	.17	.03	.03
8'	1.27	.76	.25	.13	.03	.01
9'	1	.6	.2	.1	.02	.01
10'	.81	.49	.16	.08	.02	.01

Light bulb conversion: 75W, T4 BI-PIN, FCX1.54

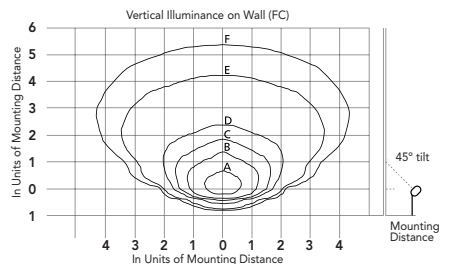

WALL WASH – ACCENT LOW VOLTAGE



15361 AZT



15361 BKT



CAST BRASS

15363 BBR

Name	ADJUSTABLE WALL WASH Creates a low, even light spread to illuminate shrubs, plants or textured wall surfaces to silhouette special details.		ADJUSTABLE CAST BRASS WALL WASH Engineered for harsh weather conditions, including salt air. Creates a low, even light spread to illuminate shrubs, plants or textured wall surfaces to silhouette special details.	
Ordering Guide	15361 AZT – Textured Architectural Bronze™ 15361 BKT – Textured Black		15363 BBR – Bronzed Brass	
Housing	Cast Aluminum with clear polycarbonate shield		Cast Brass with clear polycarbonate shield	
Finish	Textured Architectural Bronze™ or Textured Black		Bronzed Brass	
Light Source	12V Incandescent S-8 wedge base socket		12V Incandescent S-8 wedge base socket	
Power Usage at 12V AC Input	VA MAX: 24.4-W(VA) Supplied: 24.4-W(VA) 3156K (15598 CLR) Krypton light source Optional: 18.5-W(VA) 3155K (15599 CLR)		VA MAX: 24.4-W(VA) Supplied: 24.4-W(VA) 3156K (15598 CLR) Krypton light source Optional: 18.5-W(VA) 3155K (15599 CLR)	
Wiring	42" of usable #18-2, SPT-1-W leads. Cable connector supplied.		46" of usable #18-2, SPT-1-W leads. Cable connector supplied.	
Mounting Accessories Included	8" In-ground stake		8" In-ground stake	
Optional Mounting Accessories	15601 – Surface Mounting Flange 15607 – Tree/Surface Mounting Flange 15609 – Junction Box Mounting Bracket	15647 – 90° Elbow 15649 – Stem Coupler 15645, 15656, 15657, 15658 or 15570 – Stems	15601 – Surface Mounting Flange 15607 – Tree/Surface Mounting Flange 15647 – 90° Elbow 15649 – Stem Coupler 15645, 15657	15658 or 15570 – Stems

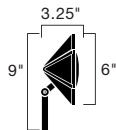

Photometric with Lamp Supplied (fc)

Distance from Wall	0'	1'	2'	3'	4'	5'	6'	7'	8'	9'
4'	4.9	3.6	2.5	1.6	1.0	.70	.40	.30	.15	.10
8'	1.2	1.1	.90	.78	.63	.50	.40	.33	.25	.20

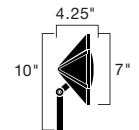

Photometric with Lamp Supplied (fc)

Distance from Wall	0'	1'	2'	3'	4'	5'	6'	7'	8'	9'
4'	6.37	4.68	3.25	2.08	1.30	.91	.52	.39	.19	.13
8'	1.60	1.43	1.17	1.02	.82	.65	.52	.43	.32	.26

DOWNLIGHT – ACCENT LOW VOLTAGE



15087 AZT



15093 WHT



15494 AZT

ACCENT - LOW VOLTAGE

A

Name	MR-16 MINI ACCENT (DOWN) Tree or surface mount for downlight application. Features open stainless steel lamp protection. For downlight use only.	MR-16 MINI ACCENT (DOWN) Tree or surface mount for downlight application. Features open stainless steel lamp protection. For downlight use only.	LONG COWL MINI-ACCENT A compact accent light with extra long cowl. Up or down lighting.
Ordering Guide	15087 AZT – Textured Architectural Bronze™	15093 WHT – Textured White	15494 AZT – Textured Architectural Bronze™
Housing	Cast Aluminum with stainless steel screen.	Cast Aluminum with Stainless Steel screen.	Cast Aluminum. Heat-resistant flat glass lens is fully sealed.
Finish	Textured Architectural Bronze™	Textured White	Textured Architectural Bronze™
Light Source	12V Incandescent bi-pin, high temperature porcelain socket	12V Incandescent bi-pin, high temperature porcelain socket	12V Incandescent bi-pin, high temperature porcelain socket
Power Usage at 12V AC Input	VA MAX: 50-W(VA) MR-16 20-W(VA) Max. Canada 35-W(VA) MR-11 Lamp not supplied unless noted	VA MAX: 50-W(VA) MR-16 20-W(VA) Max. Canada 35-W(VA) MR-11 Lamp not supplied unless noted	VA MAX: 50-W(VA) MR-16 20-W(VA) Max. Canada 35-W(VA) MR-11 Lamp not supplied unless noted
Wiring	35" of usable #18-2, SPT-1-W leads. Cable connector supplied.	35" of usable #18-2, SPT-1-W leads. Cable connector supplied. 12V porcelain universal bi-pin socket.	35" of usable #18-2, SPT-1-W leads. Connector supplied.
Mounting Accessories Included	15607 – Surface Mounting Bracket	White Surface Mounting Bracket and Hardware	15609 – Junction Box Mounting Bracket
Optional Mounting Accessories	15601 – Surface Mounting Flange 15609 – Junction Box Mounting Bracket 15647 – 90° Elbow 15649 – Stem Coupler 15645, 15656, 15657, 15658 or 15570 – Stems	N/A	15601 – Surface Mounting Flange 15607 – Tree/Surface Mounting Flange 15647 – 90° Elbow 15649 – Stem Coupler 15645, 15656, 15657, 15658 or 15570 – Stems
Optional Lens Accessories	N/A	N/A	15675 LIN – Linear Lens 15676 FRO – Frosted Lens 15679 BK – Louver 15686 BL – Blue Filter
Notes	See pages 136-139 for more light bulb options and light bulb photometrics	See pages 136-139 for more light bulb options and light bulb photometrics	See pages 136-139 for more light bulb options and light bulb photometrics

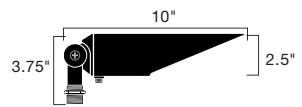
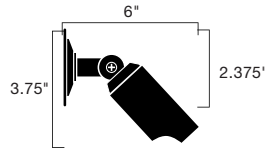
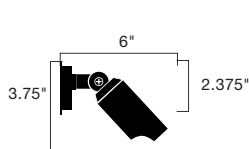

LOW VOLTAGE

Incandescent Well Lights

Bring the light center stage.



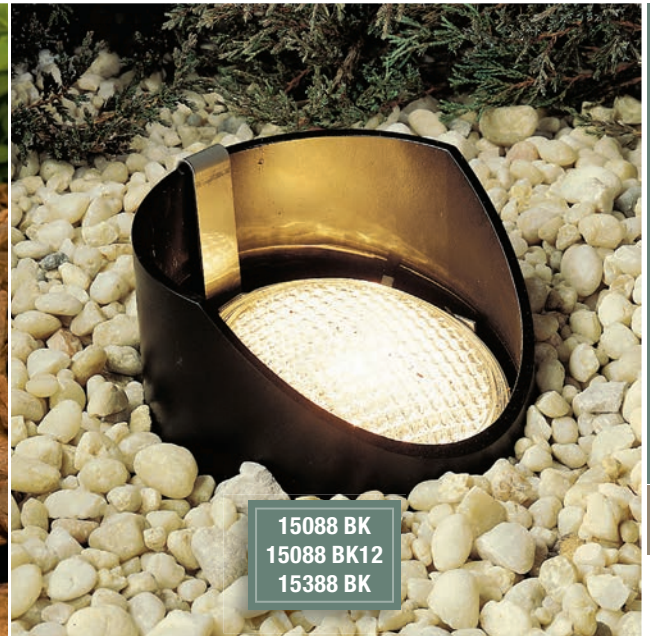

Name	RUBBER BOOT HELD PAR 36 WELL LIGHT Flush mounted or angled uplighting effects when semi-recessed.	YOKE HELD PAR 36 WELL LIGHT Versatile design with reversible support sleeve to accommodate uplighting when flush mounted or angled lighting effects when semi-recessed. Stainless steel gimble ring design holds lamp securely at desired angle.
Ordering Guide	15488 BK – Black 15488 BK 12 – Same as 15488 BK. Bulk packed in 12 (unbreakable master)	15088 BK – Black 15088 BK 12 – Same as 15088 BK. Bulk packed in 12 (unbreakable master) 15388 BK – Same as 15088 BK. 35-W PAR-36 included
Housing	Silicone rubber lamp holder. Heavy-duty polycarbonate ground support sleeve.	Stainless steel gimble ring with silicone rubber lamp support clips. Heavy-duty polycarbonate ground support sleeve.
Finish	Black	Black
Light Source	12V Incandescent PAR 36 lamp	12V Incandescent PAR 36 lamp
Power Usage at 12V AC Input	VA MAX: 50-W(VA) Supplied: 35-W (VA) PAR 36 wide flood supplied and installed Halogen light source	VA MAX: 36-W(VA) PAR-36. Lamp not supplied unless noted.
Wiring	39" of usable #18-2, SPT-1-W leads. Cable connector supplied. Supply wire with lugs attach directly to PAR 36 light bulb screw terminals.	42" of usable #18-2, SPT-1-W leads. Cable connector supplied. Supply wire with lugs attach directly to PAR 36 light bulb screw terminals.
Optional Lens Accessories	NA	15689 BK – Lens Cover 15690 BK – Rock Guard
Notes	See pages 136-139 for more light bulb options and light bulb photometrics	See pages 136-139 for more light bulb options and light bulb photometrics

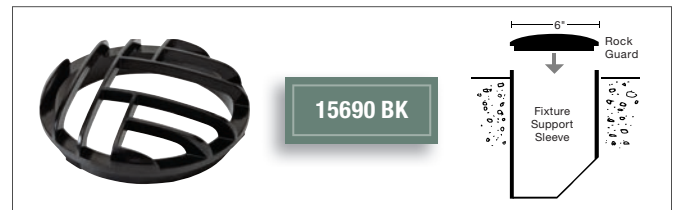

15690 BK snaps easily into place on flat side of fixture's sleeve.

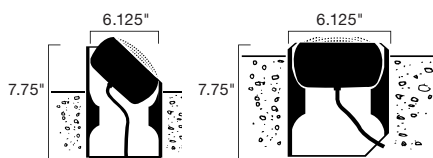

Lens Accessory 15689 BK available for Well Light 15088 and 15388. Heat-resistant glass lens provides protection from sprinklers and lawn debris.

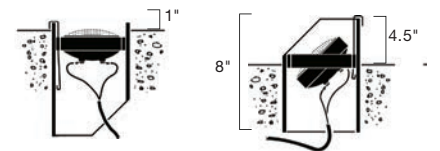

WELL LIGHTS LOW VOLTAGE



Name	ENCLOSED PAR 36 WELL Completely sealed well light creates unique lighting effects and reduces maintenance with Rock Guard/Glare Shield accessory (15694 AZ) on page 132.	MR-16 MINI WELL Smaller version of our popular standard well light to shed focused upwards illumination on special features in the landscape. Recommended for salt-air environments.
Ordering Guide	15194 AZ – Architectural Bronze™	15190 BK – Black
Housing	Durable thermoplastic composite resin. Glass lens for watertight outdoor inground use.	Durable high heat thermo-plastic composite resin. Heat resistant convex shaped glass lens. Fully sealed for watertight outdoor usage.
Finish	Architectural Bronze™	Black
Light Source	12V Incandescent PAR 36 lamp	12V Incandescent bi-pin, high temperature porcelain socket
Power Usage at 12V AC Input	VA MAX: 50-W(VA) PAR 36 Lamp not supplied unless noted	VA MAX: 50-W(VA) MR-16 35-W(VA) Max. 20-W(VA) Max. Canada Lamp not supplied unless noted
Wiring	34" of usable #18-2, SPT-1-W leads. Cable connector supplied. Supply wire with lugs attach directly to PAR 36 light bulb screw terminals.	36" of usable #18-2, SPT-1-W leads. Cable connector supplied.
Optional Lens Accessories	15694 – Rock Guard	
Notes	See pages 136-139 for more light bulb options and light bulb photometrics	U.S. Patent No. D437,652 See pages 136-139 for more light bulb options and light bulb photometrics



Rock Guard/Glare Shield Accessory

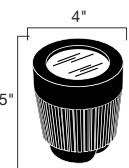
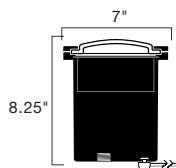

WELL LIGHTS LOW VOLTAGE



Name	MR-16 MINI WELL WITH COWL Same as 15190 with added glare shield for optimal viewing comfort. Recommended for salt air environments.	MR-16 WELL Versatile design with reversible support sleeve to accommodate uplighting when flush mounted or angled lighting effects when semi-recessed. Heavy-duty polypropylene sleeve provides in-ground support.
Ordering Guide	15192 BK – Black	15092 BKT – Textured Black
Housing	Components of durable high heat thermoplastic composite resin. Glare shield molded into lid. Light bulb shielded by a heat-resistant convex shaped glass lens for better debris run-off. Fully sealed for watertight outdoor usage.	Aluminum housing with heat resistant flat glass lens is fully sealed. Heavy duty polypropylene sleeve provides in-ground fixture support.
Finish	Black	Textured Black
Light Source	12V Incandescent bi-pin, high temperature porcelain socket	12V Incandescent bi-pin, high temperature porcelain socket
Power Usage at 12V AC Input	VA MAX: 50-W(VA) MR-16 10-W(VA) MAX Canada 35-W(VA) Max. 20-W(VA) Max. Canada Lamp not included unless noted	VA MAX: 50-W(VA) MR-16 Lamp not included unless noted
Wiring	36" of usable #18-2, SPT-1-W leads. Cable connector supplied.	38" of usable #18-2, SPT-1-W leads. Cable connector supplied.
Optional Lens Accessories		15675 LIN – Linear Lens 15676 FRO – Frosted Lens 15679 BK – Hexcell Louver Shield 15686 BL – Blue Filter
Notes	See pages 136-139 for more light bulb options and light bulb photometrics	See pages 136-139 for more light bulb options and light bulb photometrics

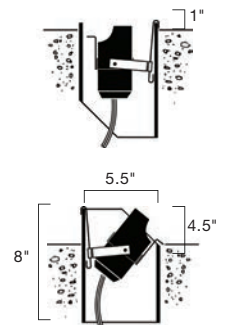
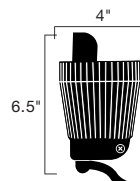

LOW VOLTAGE

Incandescent Water Feature Lighting

The perfect concert of sound, movement and light.





Name	UNDERWATER LIGHT Creates dramatic effects in or near water features.
Ordering Guide	15191 BK – Black
Housing	Components of durable high heat thermoplastic composite resin. Heat-resistant flat glass lens is fully sealed. Weighted base included.
Finish	Black
Light Source	12V Incandescent bi-pin, high temperature porcelain socket
Power Usage at 12V AC Input	VA MAX: 50-W(VA) MR-16 35-W(VA) Max. 20-W(VA) Max. Canada Lamp not included unless noted
Wiring	25' of #18-2, STW leads
Notes	See pages 136-139 for more light bulb options and light bulb photometrics Note: NOT for pool and spa use

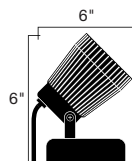



POWERED BY
DESIGN PRO LED
TECHNOLOGY

This installation illuminated exclusively
with Design Pro LED fixtures



LOW VOLTAGE

Transformers

Power to perform.



SAFE

- Runs feature one common transformer per circuit. ANSI/UL1838 requirements limit each circuit to 300-W and 15V.
- Secondary circuit breakers offer short-circuit protection as a standard feature.
- Magnetic circuit breakers provide a faster response to a fault in the system.
- An in-line primary thermostat protects against thermal over-load. These built-in thermostats are auto-resetting, eliminating the need for replacement or maintenance.
- Because compliance and safety are important long after the installation is complete all Kichler Landscape Lighting low voltage transformers are listed or certified by UL, ETL, and/or CSA to the appropriate ANSI/UL 1838 standard for both the United States and Canada.
- Internal wiring is rated for 150°C (302°F), which exceeds safety standard requirements and provides longer life.

POWERFUL

- Various wattage options are available including: 60, 75, 100, 200, 300, 600, 900, and 1200 in many options.
- Available in premium or economy options – convenient for larger, more complicated jobs or where smaller profile, lower-wattage units can be used.

DURABLE

- Full enclosure of the housing protects components from weather, sprinkling systems and debris.
- Professional Series housings are made of stainless steel grade 304 designed to run cooler and resist corrosion, and last longer in outdoor environments.
- Multi-tap transformers allow greater flexibility in managing multiple wire runs by moving cables up and down the multi-range. This assures that the correct voltage is applied to a lamp – creating a consistent light output and maximizing lamp life.

DEPENDABLE

- Every tap is tested on the assembly line to ensure that output is consistently accurate.
- Installation is simplified, thanks to 30°-tilted taps mounted on the 125-Amp terminal board. This gives you more space and greater visibility while inserting cables into taps.
- Units can be loaded up to the full maximum watts, including cable length, fixtures and cable loss. For ease in calculating runs, Kichler provides a Voltage Drop Tool that features pull-down menus and professional printouts for recordkeeping.

WARRANTY

- Limited lifetime warranty offered on Stainless Steel (SS) transformer models.
- A limited 10-Year Warranty on powder-coated Textured Architectural Bronze™ (AZT) transformer models.

CORE AND COIL CONSTRUCTION

All core and coil-types used in Kichler transformers, except economy series, feature epoxy encapsulation. This provides commercial-grade benefits such as:

- **PROTECTION:** Core, wire leads and inner parts are set inside epoxy to prevent exposure to moisture to resist corrosion and maintain a permanent seal.
- **QUIET:** Humming noises are eliminated, as well as vibration, keeping connections from loosening.
- **COOL:** Epoxy also keeps unit running cooler. Running cooler at full load is safer and conserves energy.

OTHER IMPORTANT INSTALLATION CONSIDERATIONS:

- National Electric Code and Underwriters Laboratories (UL) require that wiring, where concealed or extended through a building wall, must be enclosed in conduit.
- All Kichler transformers are rated for use with ANSI/UL 1838 listed fixtures including those for underwater use. Kichler transformers are NOT rated for use with fixtures for pools, spas, or bodies of water intended for immersion of humans.

TIP ON PRIMARY POWER:

Since 120-Volts can vary depending on time of day and local utility fluctuations, always measure the voltage on the primary side before and during job installation. Transformers reduce primary input in a ratio of 10:1 – Ex: 120 Volts:12 Volts.



High Efficient E.I. core and coil configuration is standard on most Kichler models

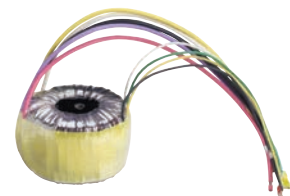

15PR900SS, 15PR1200SS, and 15PL900AZT/BE feature high efficiency Torid core and coil configuration



<p>Name</p>	<p>PROFESSIONAL SERIES PR Kichler's Professional Series provides the best options and flexibility needed for most installations. Output voltage range will suit most jobs. Features include a commercial grade core and coil, pluggable timer and photocell outlets, plus a lifetime warranty. For details see chart on pages 126-127.</p>	<p>PROFESSIONAL SERIES PR 75-W Professional Series transformer is ideal for use with Kichler Design Pro LED low voltage fixtures. Timer and photocell included. For details see chart on pages 126-127.</p>
<p>Features</p>	<ul style="list-style-type: none"> • Output voltage taps 12/13/14/15 Volts • Installation is made easy with 30° tilted taps mounted on a 125-Amp terminal board because there is more space and greater visibility while inserting cables into taps • Tilted terminal board and large capacity lugs inside the taps hold up to 8, #10-gauge wires or up to 10, #12-gauge wires per tap • In-line secondary magnetic breaker protects against short circuit • Fully enclosed housing constructed of #304 grade stainless steel • Epoxy encapsulant for greater protection and performance. • Drop down bottom panel with four pre-punched field knockouts sized for 1/2" or 3/4" conduit (trade sizes) and one large center 1-3/4" inlet • Professional Series units feature high efficiency E.I. core and coil and dedicated wire loop for quick access testing of primary load. This provides the best reliability and maintains improved regulation from no load to full load. High efficiency E.I. offers comparable efficiency to toroid models. High-efficiency E.I. run cooler because heat dissipates, run quieter since there's no hum, and run smoother due to less vibration • 900-W and 1200-W units feature high efficiency Toroid core and coils • 900-W and 1200-W Professional Series units feature relay (contactor), which reduces current amp draw through the timer, photocell, and receptacle – extending the life of these components • Mounting brackets are welded and riveted in place for extra strength. Mounting plate for indoor use is included. Transformers used indoors require cable to be routed through conduit. Check local government ordinances and codes to ensure proper standards are met • Compatible with plug-in timer and plug-in photocells. • Limited lifetime warranty 	<ul style="list-style-type: none"> • In-line secondary magnetic breaker protects against short circuit • Epoxy encapsulant for greater protection and performance. • Fully enclosed housing constructed of #304 grade stainless steel • Mounting brackets are welded and riveted in place for extra strength. Mounting plate for indoor use is included. Transformers used indoors require cable to be routed through conduit. Check local government ordinances and codes to ensure proper standards are met. • Limited lifetime warranty



<p>Name</p>	<p>PROFESSIONAL SERIES 2-IN-1 PR The Professional Series 2-In-1 Transformer provides one distinct model designed for unique applications where two separate 300-W circuits (zones) and control options are needed within the same housing. For details see chart on pages 126-127.</p>	<p>PLUS SERIES PL Kichler's Plus Series Transformers feature a 6' cord, pluggable options and a powder coated steel case. For details see chart on pages 126-127.</p>
<p>Features</p>	<ul style="list-style-type: none"> • 2 separate sets of multi-tap output – 12V, 13V, 14V, 15V on each circuit • 600-W total power and (2) independently controlled 300-W transformers for 2 separate scenes • (2) independent receptacles for pluggable photocells for multiple on/off options • (2) independent receptacles for pluggable timers • Limited lifetime warranty 	<ul style="list-style-type: none"> • Output voltage taps are 12V, 13V, 14V, 15V, 80 Amp. Max. per board • Powder-coated housing is painted steel with AZT or BE finish • Auto-resettable in-line primary overload protection • An in-line secondary magnetic breaker protects against short circuiting • Epoxy encapsulated for greater protection and performance • Compatible with plug-in timer and plug-in photocells • Mounting template included • 10-year limited warranty



<p>Name</p>	<p>MANUAL SERIES M Kichler's Manual Series Transformers are the ideal solution when on/off switching is desired from a switched electrical outlet. Timers and photocells are not offered as options for this unit. For details see chart on pages 126-127.</p>	<p>IN-GROUND SERIES IG Choose Kichler's In-Ground Series Transformers when direct burial is desired. Units are hardwired with flying leads so terminal lug taps are not provided. For details see chart on pages 126-127.</p>	<p>ECONOMY SERIES E Kichler's Economy Series Transformers for small jobs or single specialty piece applications. Built in photocell, timer and high-low switch. For details see chart on pages 126-127.</p>
<p>Features</p>	<ul style="list-style-type: none"> • Output voltage taps are 12V, 13V, 15V only on 15M300 AZT and 15M600 AZT. 15M100 AZT and 15M200 AZT are single 12V taps • Epoxy encapsulated for greater protection and performance • An in-line secondary magnetic breaker protects against short circuiting • Auto-resettable in-line primary overload protection • 10-year limited warranty 	<ul style="list-style-type: none"> • Output voltage taps are 12V, 13V, 14V, 15V • Epoxy encapsulated for greater protection and performance • Auto-resettable in-line primary overload protection • 10-year limited warranty • Housing constructed of #304 grade stainless steel 	<ul style="list-style-type: none"> • High and Low output settings • Integral timer and photocell • Durable black polymeric enclosure resists corrosion • An in-line push button thermal breaker on the secondary protects against short circuiting. • Auto-resettable in-line primary overload protection • 10-year limited warranty

Mechanical Transformer Timer



15557 BK

See Page 135

Plug-In Transformer Photocell



Photocells should be faced out (not up) for optimum life

15565 BK

See Page 135

Digital Transformer Timer



15556 WH

Integrated battery backup

Synchronizer Device



15511 BK

See Page 135

Remote Plug-In Transformer Photocell



Photocells should be faced out (not up) for optimum life.

10' cord

15534 BK

See Page 135

TRANSFORMER ACCESSORIES

Along with a wide variety of transformers, Kichler offers a full complement of control accessories. Used separately or in tandem; light may be controlled as desired.

Photocells allow the intensity of daylight to define transformer operation. Timers can be used for more exacting requirements. Regardless of which is chosen, each will assist the transformer in providing the desired result.

	PREMIUM								PLUS				
	15PR75 SS	15PR100 SS	15PR200 SS	15PR300 SS	15PRD600 SS ^{2-hi-1}	15PR600 SS	15PR900 SS	15PR1200 SS	15PL100 AZT	15PL200 AZT/BE	15PL300 AZT/BE	15PL600 AZT/BE	15PL900 AZT/BE
Wattage (VA)	75	100	200	300	600	600	900	1200	100	200	300	600	900
Automatic Timer	●	●	●	●	●	●	●	●	●	●	●	●	●
Photo Electric Eye	●	●	●	●	●	●	●	●	●	●	●	●	●
Compatible w/Plug-In Timers		●	●	●	●	●	●	●	●	●	●	●	●
High-Low-Off Switch	●												
On-Off-Auto Switch													
Multi-Tap Connection 12V, 13V, 15V													
Multi-Tap Connection 12V, 13V, 14V, 15V		●	●	●	●	●	●	●	●	●	●	●	●
Thermal Cut-Off on Primary Side	●	●	●	●	●	●	●	●	●	●	●	●	●
Thermal Reset Breaker on Secondary Side													
Magnetic Breaker on Secondary Side	●	●	●	●	●	●	●	●	●	●	●	●	●
Easy Connect Terminal Blocks	●	●	●	●	●	●	●	●	●	●	●	●	●
6', 3-Wire #16-3 SJTW Cord							●	●				●	●
6', 3-Wire #18-3 SJTW Cord		●	●	●	●	●			●	●	●		
3', 3-Wire #12-3 SJTW Cord	●												
6', 2-Wire #18-2 SJTW Cord													
Includes Mounting Plate for Indoor Use	●	●	●	●	●	●	●	●	●	●	●	●	●
Ground Terminal	●												
Direct Burial													
Textured Architectural Bronze or Beach Powder Coat									●	●	●	●	●
#304 Grade Stainless Steel	●	●	●	●	●	●	●	●					
Composite Housing													
10-Year Limited Warranty									●	●	●	●	●
Lifetime Warranty	●	●	●	●	●	●	●	●					
High Efficiency E.I. Core and Coil Configuration	●	●	●	●	●	●			●	●	●	●	
High Efficiency Toroid Core and Coil Configuration							●	●					●

TRANSFORMERS LOW VOLTAGE

ECONOMY				SPECIALTY	
15M100 AZT	15M200 AZT	15M300 AZT	15M600 AZT	15E60 BK	15E120 BK
8" x 3.25" x 3"	13.25" x 3.5" x 4"	13.5" x 4.5" x 4"	14.25" x 5.5" x 5"	6.75" x 3.75" x 3.75"	6.875" x 3" x 3"
100	200	300	600	60	120
IN GROUND Stainless Steel (SS)					
					15IG300 SS
					15IG600 SS
					10.75" x 4.5" x 4.75"
					10.25" x 4.5" x 4.75"



- = INCLUDED
- = OPTIONAL

Plug-in Kichler Accessories - Reference Accessories Descriptions, page 125: Plug-In Mechanical Timer 15557 BK, Plug-in Digital Timer 15556 WH, Plug-In Transformer Remote Photocell 15534 BK, Plug-In Transformer Photocell 15565 BK

600-W, 900-W and 1200-W Transformer models are manufactured in intervals of 300-W (VA) circuits.

National Electric Code and Underwriters Laboratories require that wiring, where concealed or extended through a building wall, must be enclosed in conduit.

All transformers are for use with outdoor low voltage lighting.

   All Kichler transformers are listed or certified to ANSI/UL 1838 The listing/certification agency may vary.

IMPORTANT: These units are not approved for use with fixtures placed within 10' of swimming pools or spas.

LOW VOLTAGE

Accessories

Experience Kichler from the ground up with genuine Kichler low voltage accessories.





15529 BL



Name	<p>PRO SERIES WIRE CONNECTOR</p> <p>Now, there's an alternate to silicone-filled wire connectors, soldered wire connections and costly shrink-wrap connections. Kichler exclusively offers the Pro Series Wire Connector – a reliable, quality connection that will compliment your installation of premium Kichler landscape lighting. Developed in concert with Blazing Products, Inc, this new method of making 12V connections is safer, faster, more reliable, and exclusive to Kichler.</p>
Ordering Guide	<p>15529 BL – Bulk pack of 100 connectors in sealed bags of 10</p> <p>ANSI/UL 486 D Sealed wire connector system.</p> <p>Sealed wire connector for direct burial applications.</p>
Safer & Faster	<ul style="list-style-type: none"> • Drastically reduces the potential for arcing • Improves safety and speed of installation
More Reliable	<ul style="list-style-type: none"> • Gel filled connection and semi-permanent seal provides a watertight long-lasting connection • Has a stronger strain relief (up to 30 lbs. of pressure) for a more secure connection • Stranded wire torques around metal insert • Reduces callbacks due to connections that become loose • An access hole for a voltmeter probe is integrated in each Pro Series Connector



Packed in sealed bags of 10

STEP 1

- Turn power off.
- Rotate wings fully apart.



STEP 2

Using the strip guide molded into the connector for reference, strip the wire to 11/16".



STEP 3

Insert wires into connector so that they are bottomed out. Connector must be open.

- #12 in large holes
- #18 in small holes



Repeat for second connector as part of complete splice.

STEP 4

(Optional if testing voltage at fixture) Turn power back on. With connector still open halfway, push voltmeter probe into connector probe port. Push probe all the way in and repeat on other connector.



STEP 5

Hold wires in place while squeezing handles together until the connector snaps shut. Use pliers if necessary to close. Repeat on other connector.



MOUNTING ACCESSORIES

Fixture Mounting Stems

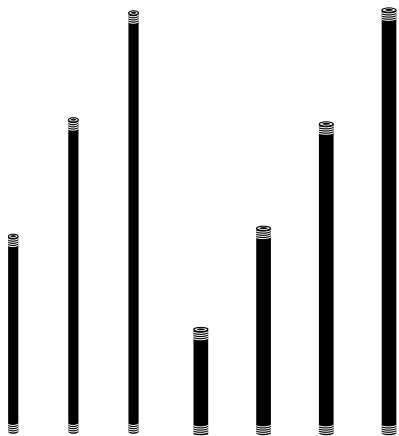

.25" NPSM THD. STEMS .5" DIA. OVERALL		.5" NPSM THD. STEMS .75" DIA. OVERALL	
12"	15651 AZT 15651 BKT	6"	15645 AZT 15645 BBR 15645 BKT
18"	15652 AZT 15652 BKT	12"	15656 AZT 15656 BBR 15656 BKT
24"	15653 AZT 15653 BKT	18"	15657 AZT *15657 BBR 15657 BKT
Reference fixture specifications for proper stem		24"	15658 AZT 15658 BBR 15658 BKT

All stems made of corrosion resistant aluminum alloy (except BBR, which is Cast Brass) with baked thermoset powder coating to match fixtures

Used with:

- In-ground support stakes (low voltage only)
- Surface mounting flange (low or line voltage)

0.5" stems will require additional Coupler (15649) or Elbow (15647) for accent light use

Adjustable Height Stems



Extends from 18" to 33"

15570 AZT
15570 BKT

For use with most 12V accent fixtures

Corrosion resistant aluminum alloy with baked thermoset powder coat finish

Stem allows fixture height to be extended for plant growth. Used with in-ground support stakes (order separately)

Bollard Mounting Kit



4.0625" ID
4.25" OD

18" 15665 AZT
15665 BKT
24" 15666 AZT
15666 BKT
36" 15667 AZT
15667 BKT

For use with fixtures 15005, 15011, 15205, 15211

Bollard kit is supplied with cast aluminum internal mounting plate including lag bolts for deck or surface mounting. Extruded aluminum bollard finished with baked thermoset powder coat. Order separate bollard template kit for installation into concrete or bollard mounting stake for installation in soil. UL and CSA listed

Bollard Template Kit



15671 ST

For use with all bollard mounting kits

For permanent installation into concrete. Template kit includes positioning template, anchor bolts, and mounting hardware.

Bollard Mounting Stake



23" H

15578 BK

For use with all bollard mounting kits on 12V and 120V fixtures.*

Improved extruded PVC stake is corrosion resistant and 23" length has increased support and stability. Fitting provided to mount bollard in soil.

*As allowed by local electrical codes

Polymeric Support Stakes











8" H & 14" H

15575 BK
15576 BK
8" In-ground Stake
14" In-ground Stake

For use with 12V fixtures

Injection molded stakes are corrosion resistant and provide maximum support and stability

U.S. Patent No. D415,018

MOUNTING ACCESSORIES		
<p>Elbow</p> <p>1.18" W 2.09" H 1.35" L</p> 	<p>15647 AZT 15647 BBR 15647 BKT</p>	<p>When combined with a stem, this accessory creates a 90° angle to offer more ways to utilize our accent fixtures as a path, area or down light. Cast Aluminum or Cast Brass housing. Textured Architectural Bronze, Bronzed Brass or Textured Black finish. Stabilizer set screw included.</p>
<p>Stem Coupler</p> <p>.5" NPSM thd. 1.5" H</p> 	<p>15649 AZT 15649 BBR 15649 BKT</p>	<p>Aluminum (except BBR, which is Cast Brass) coupler. For use with 1/2" NPSM stems.</p>
<p>Surface Mounting Flange</p> <p>4" D .5 NPSM thd.</p> 	<p>15601 AZT 15601 BBR 15601 BKT</p>	<p>For 12V or 120V installations, surface flange must be used with junction box (not included). Neoprene gasket supplied to ensure water tight seal. BBR is Bronzed Cast Brass AZT and BKT are Cast Aluminum</p>
<p>Flange Mounting Nipple</p> <p>1" x .5" NPSM thd.</p> 	<p>15602 AL</p>	<p>Anodized aluminum nipple. Used when attaching fixture directly to 15601 flange and 15607 bracket.</p>
<p>Tree/Surface Mounting Bracket</p> <p>1.5" x 2.5" x 1" .5 NPSM thd.</p> 	<p>15607 AZT 15607 BBR 15607 BKT</p>	<p>For use with low voltage fixtures Corrosion resistant Cast aluminum alloy with baked thermoset powder coat finish. Low voltage only. BBR is Bronzed Cast Brass</p>
<p>3 LED Flat Mounting Bracket</p> 	<p>15717 SS Use with fixture 15735 U.S. Patent Pending</p>	<p>Brackets mount to parallel surfaces and hold fixture in place. For use in hardscape installations where the masonry plate cannot be used or in non-hardscape applications where there is no or inadequate overhang surface area. Mounting hardware included.</p>
<p>6 LED Flat Mounting Bracket</p> 	<p>15718 SS Use with fixture 15736 U.S. Patent Pending</p>	<p>Brackets mount to parallel surfaces and hold fixture in place. For use in hardscape installations where the masonry plate cannot be used or in non-hardscape applications where there is no or inadequate overhang surface area. Mounting hardware included.</p>
<p>9 LED Flat Mounting Bracket</p> 	<p>15719 SS Use with fixture 15755 U.S. Patent Pending</p>	<p>Brackets mount to parallel surfaces and hold fixture in place. For use in hardscape installations where the masonry plate cannot be used or in non-hardscape applications where there is no or inadequate overhang surface area. Mounting hardware included.</p>
<p>Out of Water Bracket</p> <p>2.52" W</p> 	<p>15777 SS Use with fixture 15711 SS U.S. Patent Pending</p>	<p>Stainless steel easy mount bracket for use above ground on any surface – ideal for wood and masonry when used on decks, patios or overhangs.</p>

MOUNTING ACCESSORIES

Multi-Fixture Weighted Base

3.375" W



15776 BK
Use with fixture 15711 SS

Unique heavy weighted 3 pronged underwater accessory for 2 or 3 fixtures to give maximum flexibility and directional capability

Single Fixture Weighted Base

3.375" W



15778 BK
Use with fixture 15711 SS

Heavy weight 1 prong underwater light accessory for standard installations. Provides advanced directional capability.

Junction Box Mounting Bracket

2.39" W
5.56" H



15609 AZT
15609 BKT

For use with low voltage and line voltage fixtures
Corrosion resistant Cast Aluminum alloy with baked thermoset powder coat finish

Three Fixtures, Centerpiece Mounting Kit

6" W
14" L



15635 OZ for use with 15435 PP, 15435 RD and 15435 AMB Posies

The kit allows for the creation of an interesting garden centerpiece that replicates nature with Posies that can be installed at an angle at varying heights. Can also be used to install three fixtures at the same height. Colors may be mixed or uniform. Kit included a mounting plate, 14" In-ground stake for added stability, a 3" Olde Bronze® stem section and the necessary hardware and instructions to make a truly creative garden feature.

LENS/SHEILD ACCESSORIES

Incandescent Rock Guard

6.97" D
1.29" H



15694 AZ for use with fixture 15194 or 15268

Rock Guard/Glare Shield corrosion resistant for use with 15194 or 15268 well light. Architectural Bronze Polycarbonate Finish.

LED Well Light Rock Guard

5.90" D
1.686" H



15787 BK only for use with fixtures 15767BKT, 15768BKT, 15769BKT, 15728BKT, 15747BKT, 15748BKT, 15729BKT, 15757BKT, 15758BKT

Rock Guard/Glare Shield accessory for Design Pro LED Well Light Series. High-strength, UV and corrosion resistant polycarbonate housing. Black Polycarbonate finish.

Incandescent Well Light Rock Guard

5.90" D
1.686" H



15690 BK for use with fixtures 15088BK or 15388BK.







Rock Guard/Glare Shield accessory for 15088BK and 15388BK Well Lights. Polycarbonate housing. High-strength, UV and corrosion resistant polycarbonate housing. Black Polycarbonate finish.

45° Hexcell Louver Shield

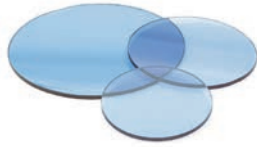

15679 BK for use with fixtures 15092, 15384, 15484, 15494
15680 BK for use with fixture 15381
15683 BK for use with fixture 15397
15644 BK for use with fixture 15374
15634 BK for use with fixture 15398

Expanded aluminum shield with high temperature black finish. Provides maximum glare reduction for accent lights.

LENS/SHEILD ACCESSORIES		
<p>Blue Filters</p> 	<p>15673 BL for use with fixture 15382 15686 BL for use with fixtures 15092, 15384, 15484, 15494 15687 BL for use with fixture 15381 15693 BL for use with fixture 15397 15641 BL for use with fixture 15374 15631 BL for use with fixture 15398</p>	<p>Blue glass filters act as color enhancers to bring out the true rich greens of foliage for incandescent light sources.</p>
<p>Frosted Lens</p> 	<p>INCANDESCENT 15672 FRO for use with fixture 15382 15676 FRO for use with fixtures 15092, 15384, 15484, 15494 15691 FRO for use with fixture 15381 15643 FRO for use with fixture 15374 15633 FRO for use with fixture 15398 LED 15895 FRO for use with LED fixtures 15731, 15732, 15733, 15741, 15742, 15743 15896 FRO for use with LED fixtures 15751, 15752, 15753</p>	<p>Creates a soft focus and diffuses the light to provide even, clean illumination</p>
<p>Incandescent Linear Lens</p> 	<p>15674 LIN clear ribbed for use with fixture 15382 15675 LIN clear ribbed for use with fixtures 15092, 15384, 15484, 15494 15692 LIN clear ribbed for use with fixture 15381 15642 LIN clear ribbed for use with fixture 15374 15632 LIN clear ribbed for use with fixture 15398</p>	<p>Create a directional beam to highlight or elongate the beam spread on columns, arches and taller trees</p>
<p>Polycarbonate Lens</p> 	<p>15677 CLR for use with fixture 15827 15695 CLR for use with fixture 15315/15815 15696 CLR for use with fixture 15362</p>	<p>Accessory lens of clear polycarbonate plastic. Provides additional internal protection from lawn sprinklers, etc.</p>
<p>LED Amber Lens</p> 	<p>15875 AMB for use with 15731, 15732, 15733, 15741, 15742, 15743 15876 AMB for use with 15751, 15752, 15753</p>	<p>Designed specifically for Kichler LED, lens offers the ability to create a warmer lighting effect.</p>
<p>LED Green Lens</p> 	<p>15885 GRN for use with 15731, 15732, 15733, 15741, 15742, 15743 15886 GRN for use with 15751, 15752, 15753</p>	<p>Designed specifically for Kichler LED, greens of foliage can be intensified to illustrate their true beauty.</p>
<p>Heat Resistant Lens</p> 	<p>15659 AZT for use with fixture 15079 15689 BK for use with fixtures 15088, 15388</p>	<p>Heat-resistant glass lens held in an aluminum ring</p>

LENS/SHEILD ACCESSORIES

LED Snap-On Cows



Short Cowl
15701 AZTP/BKTP for use with fixtures 15731, 15732, 15733, 15741, 15742, 15743

15702 AZTP/BKTP for use with fixtures 15751, 15752, 15753

For BBR fixture finishes, use AZTP

Long Cowl
15703 AZTP/BKTP for use with fixtures 15731, 15732, 15733, 15741, 15742, 15743

15704 AZTP/BKTP for use with fixtures 15751, 15752, 15753

For BBR fixture finishes, use AZTP

Finishes to match Design Pro LED accent fixtures. Easy one step snap-on installation – glare shield rotates 360° in ring and retains its desired shield position.

CONNECTION ACCESSORIES

Low Voltage Cable



12-gauge	10-gauge
15501 BK 100'	15504 BK 250'
15502 BK 250'	
15505 BK 500'	8-gauge
15506 BK 1000'	15503 BK 250'

For use with all 12V rated fixtures

#12-2, #10-2, 8-2 conductor SPT cable. UL listed for 12V outdoor lighting applications. UV stabilized PVC insulation. For direct burial.

Gel Filled Wire Connector



15579 BK for use when connecting:

- 8-gauge wire to 10- and 12-gauge
- connecting 10-gauge wire to 12-gauge wire

15589 BK for use when connecting:

- 10-gauge wire
- 12-gauge wire
- 10-gauge wire to 12-gauge wire
- 12-gauge wire to 18-gauge wire

Wire connector offers twist-on, waterproof, in-line cable splicing for direct burial. Services both 12V or 120V line voltage.

QUIC DISC® Connector



15509 BK for use with #12-2 or #10-2 low voltage cable only





Joins #18-2 fixture leads with #12-2 or #10-2 low voltage cable. Injection molded polycarbonate with nickel plated brass contacts to provide maximum corrosion protection and improved conductivity.

Pro Series Wire Connector



15529 BL Bulk pack of 100 connectors packed in sealed bags of 10.

Gel filled wire connector provides watertight long lasting connection. Suitable for direct burial. Connects two #12 gauge to one #18 gauge. Two connectors required per connection.

TRANSFORMER ACCESSORIES		
<p>Mechanical Transformer Timer</p>  <p>3" W 3.09" H 2.75" L</p>	15557 BK	Plug-in timer suitable for outdoor temperatures when enclosed in an outdoor transformer enclosure. For use in all Plus and Professional series transformers.
<p>Digital Transformer Timer</p>  <p>2.73" W 3.84" H 1.89" L</p>	15556 WH	Plug-in digital timer is for use with all Plus and Professional series transformers. Battery backup included. Straight forward programming and easy day light savings change over.
<p>Remote Plug-In Transformer Photocell</p> 	15534 BK	Plug-In Photocell with 10' cord is for use with all Plus and Professional Series Transformers
<p>Plug-In Transformer Photocell</p> 	15565 BK	Plug-In Photocell is for use with all Plus and Professional Series Transformers
<p>Synchronizer Device</p> 	15511 BK	Synchronize all transformers used in a landscape setting so they turn on and off at the same time. (Jumper wire is not included).
INSTALLATION ACCESSORIES		
<p>Kichler Landscape Flag Marker</p> 	15507 ONG	A great tool to use for designing your landscape lighting system. Plot out your landscape lighting needs with these green marker flags.
<p>Corrosion Preventative Compound</p> 	15670 BK	Specially formulated non-conductive sealant and corrosion preventative for all types of electrical contacts. Its grease-like consistency helps prevent intrusion of dust, moisture and rust. Apply to socket shell and bulb base. Acts to increase bulb and socket life. 2 oz. tube.











LOW VOLTAGE

Light Bulbs & Photometrics



LIGHT BULBS & PHOTOMETRICS LOW VOLTAGE

	Product ID	12V Bulb Type	Wattage	Beam Spread	Base	Average Life
	15599 CLR	3155K Krypton	18.5		Wedge	5,700
	15598 CLR	3156K Krypton	24.4		Wedge	5,000
	17011	Q10T3 Halogen	10		Bi-Pin	10,000
	17012	Q20T3 Halogen	20		Bi-Pin	5,000
	17013	Q35T3 Halogen	35		Bi-Pin	2,000
	17015	Q50T4 Halogen	50		Bi-Pin	2,000
	17017	Q75T4 Halogen	75		Bi-Pin	2,000
	17021	901X Xenon	4		Wedge	19,000
	17022	918X Xenon	6.5		Wedge	8,000
	17023	912X Xenon	11.6		Wedge	10,000
	17025	921X Xenon	16.25		Wedge	10,000
	17030	PAR-36 Halogen	20	Narrow Spot 8°	Screw Terminal	4,000
	17032	PAR-36 Halogen	20	Narrow Flood 20°	Screw Terminal	4,000
	17033	PAR-36 Halogen	20	Flood 30°	Screw Terminal	4,000
	17037	PAR-36 Halogen	35	Narrow Spot 8°	Screw Terminal	4,000
	17039	PAR-36 Halogen	35	Narrow Flood 20°	Screw Terminal	4,000
	17040	PAR-36 Halogen	35	Flood 30°	Screw Terminal	4,000
	17044	PAR-36 Halogen	50	Narrow Spot 8°	Screw Terminal	4,000
	17046	PAR-36 Halogen	50	Narrow Flood 20°	Screw Terminal	4,000
	17047	PAR-36 Halogen	50	Flood 30°	Screw Terminal	4,000
	17050	MR-11 Halogen	20	Narrow Spot 10°	Bi-Pin	2,000
	17051	MR-11 Halogen	20	Spot 17°	Bi-Pin	2,000
	17052	MR-11 Halogen	20	Flood 30°	Bi-Pin	2,000
	17055	MR-11 Halogen	35	Narrow Spot 12°	Bi-Pin	2,000
	17056	MR-11 Halogen	35	Spot 20°	Bi-Pin	2,000
	17057	MR-11 Halogen	35	Flood 30°	Bi-Pin	2,000
	17060	MR-16 Halogen	20	Narrow Spot 12°	Bi-Pin	5,000
	17061	MR-16 Halogen	20	Spot 24°	Bi-Pin	5,000
	17062	MR-16 Halogen	20	Flood 36°	Bi-Pin	5,000
	17063	MR-16 Halogen	20	Wide Flood 60°	Bi-Pin	5,000
	17070	MR-16 Halogen	35	Narrow Spot 12°	Bi-Pin	5,000
	17071	MR-16 Halogen	35	Spot 24°	Bi-Pin	5,000
	17072	MR-16 Halogen	35	Flood 36°	Bi-Pin	5,000
	17073	MR-16 Halogen	35	Wide Flood 60°	Bi-Pin	5,000
	17080	MR-16 Halogen	50	Narrow Spot 12°	Bi-Pin	5,000
	17081	MR-16 Halogen	50	Spot 24°	Bi-Pin	5,000
	17082	MR-16 Halogen	50	Flood 36°	Bi-Pin	5,000
	17083	MR-16 Halogen	50	Wide Flood 60°	Bi-Pin	5,000
	17090	MR-16 Halogen	75	Narrow Spot 12°	Bi-Pin	5,000
	17091	MR-16 Halogen	75	Spot 24°	Bi-Pin	5,000
	17092	MR-16 Halogen	75	Flood 36°	Bi-Pin	5,000
17093	MR-16 Halogen	75	Wide Flood 60°	Bi-Pin	5,000	
	17066	MR-16 Halogen	20	Spot 24°	Bi-Pin	10,000
	17067	MR-16 Halogen	20	Flood 36°	Bi-Pin	10,000
	17076	MR-16 Halogen	35	Spot 24°	Bi-Pin	10,000
	17077	MR-16 Halogen	35	Flood 36°	Bi-Pin	10,000
	17078	MR-16 Halogen	35	Wide Flood 60°	Bi-Pin	10,000
	17085	MR-16 Halogen	50	Narrow Spot 12°	Bi-Pin	10,000
	17086	MR-16 Halogen	50	Spot 24°	Bi-Pin	10,000
	17087	MR-16 Halogen	50	Flood 36°	Bi-Pin	10,000
	17088	MR-16 Halogen	50	Wide Flood 60°	Bi-Pin	10,000
	15572 FRO	A-19 12-V	25		Medium	

LIGHT BULBS & PHOTOMETRICS LOW VOLTAGE

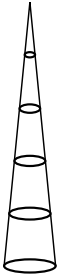
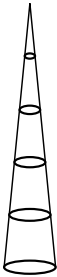
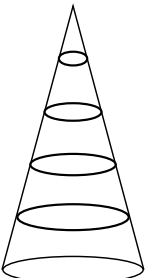
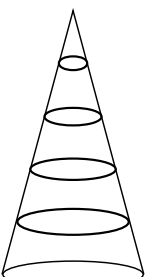
		Illuminance (footcandles)	Beam Width(feet)	Illuminance (footcandles)	Beam Width(feet)	Illuminance (footcandles)	Beam Width(feet)	Illuminance (footcandles)	Beam Width(feet)	Illuminance (footcandles)	Beam Width(feet)	Illuminance (footcandles)	Beam Width(feet)	
		MR11				MR16								
		20-W		35-W		20-W		35-W		50-W		75-W		
Narrow Spot		17050 Light Bulb FTB, JDR/M12V-20-W/G/SP10		17055 Light Bulb FTE, JDR/M12V-35-W/G/SP12		17060 Light Bulb ESX, JR12V-20-W/SP12		17070 Light Bulb FMT/FBR, JR12V-3-5W/SP12		17080 Light Bulb EXT, JR12V-50-W/SP12		17090 Light Bulb EYF, JR12V-75-W/SP12		
		8	47.3	1.39	75.7	1.68	55	1.68	95	1.68	174	1.68	205	1.68
		12	21	2.09	33.6	2.52	24	2.52	42	2.52	77	2.52	91	2.52
		24	5.25	4.19	8.41	5.04	6.1	5.04	10.5	5.04	19.3	5.04	22	5.04
		36	2.42	6.29	3.88	7.56	2.7	7.56	4.6	7.56	8.5	7.56	10.1	7.56
		48	1.31	8.39	2.1	10	1.5	10.09	2.6	10.09	4.8	10.09	5.7	10.09
	60	0.84	1.04	1.34	12.6	0.98	12.6	1.6	12.6	3	12.6	3.6	12.6	
Spot/Narrow Flood		17051 Light Bulb FTC, JDR/M12V-20-W/G/SP17		17056 Light Bulb FTF, JDR/M12V-35-W/G/SP20		17061 Light Bulb BBF, JR12V-20-W/NFL24		17071 Light Bulb FMV/FRA, JR12V-35-W/NFL24		17081 Light Bulb EXZ, JR12V-50-W/NFL24		17091 Light Bulb EYJ, JR12V-75-W/NFL24		
		8	22.1	2.39	37.7	2.82	18.8	3.4	36	3.4	57	3.4	76	3.4
		12	9.83	3.58	16.7	4.23	8.4	5.1	16	5.1	25	5.1	34	5.1
		24	2.45	7.17	4.19	8.46	2.1	10.2	4.04	10.2	6.3	10.2	8.4	10.2
		36	1.13	10.73	1.94	12.7	0.9	15.3	1.7	15.3	2.8	15.3	3.7	15.3
		48	0.61	14.4	1.04	16.9	0.5	20.4	1	20.4	1.6	20.4	2.1	20.4
	60	0.39	17.9	0.67	21.1	0.3	25.5	0.6	25.5	1	25.5	1.3	25.5	
Flood		17052 Light Bulb FTD, JDR/M12V-20-W/G/FL30		17057 Light Bulb FTH, JDR/M12V-35-W/G/FL30		17062 Light Bulb BAB, JR12V-20-W/FL36		17072 Light Bulb FMW, JR12V-35-W/FL36		17082 Light Bulb EXN, JR12V-50-W/FL36		17092 Light Bulb EYC, JR12V-75-W/FL36		
		4	37.9	2.14	81.6	2.14	38	2.6	82	2.6	126	2.6	170	2.13
		8	9.48	4.28	20.4	4.28	9.5	5.1	20	5.1	31	5.1	42	5.1
		16	2.37	8.57	5.1	8.57	2.4	10.4	5	10.4	8	10.4	10	10.4
		24	1.05	12.8	2.26	12.8	1	15.5	2	15.5	3.5	15.5	4.7	15.5
		32	0.59	17.1	1.27	17.1	0.6	20.7	1.3	20.7	2	20.7	2.6	20.7
	40	0.37	25.7	0.82	21.4	0.3	25	0.8	25	1.2	25	1.7	25	
Wide Flood						17063 Light Bulb BAB/60, JR12V-20-W/WFL60		17073 Light Bulb FMW/60, JR12V-35-W/WFL60		17083 Light Bulb FNV, JR12V-50-W/WFL60		17093 Light Bulb EYC/60, JR12V-75-W/WFL60		
		4					17	4.6	32	4.6	54	4.6	77	4.6
		8					4.2	9.2	8	9.2	13	9.2	19	9.2
		16					1.1	18.5	2	18.5	3.3	18.5	4.8	18.5
		24					0.5	27.7	0.8	27.7	1.5	27.7	2.1	27.7
		32					0.3	36	0.5	36	0.8	36	1.2	36
	40					0.17	46	0.4	39	0.5	46	0.7	46	

LIGHT BULBS & PHOTOMETRICS LOW VOLTAGE

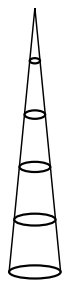
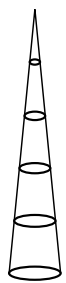
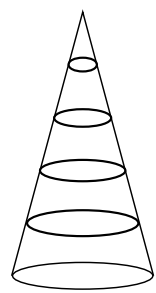
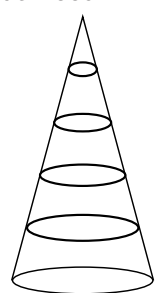
Illuminance (footcandles)		Beam Width(feet)		Illuminance (footcandles)		Beam Width(feet)		Illuminance (footcandles)		Beam Width(feet)		Illuminance (footcandles)		Beam Width(feet)		Illuminance (footcandles)		Beam Width(feet)	
PAR 36						LED													
						4.5-W		8.5-W		12.4-W									
17030 Light Bulb 20PAR36/ NSP8/12V		17037 Light Bulb 35PAR36/ NSP8/12V		17044 Light Bulb 50PAR36/ NSP8/12V		15731 LED 15767 LED		15741 LED 15728 LED		15751 LED 15729 LED		Narrow Spot							
55.3	1.11	118	1.11	213	1.11	33.6	1.2	68.3	1.2	100.6	1.3	8							
24.5	1.67	52.6	1.67	94.8	1.67	14.9	1.8	30.4	1.9	44.7	1.9	12							
6.14	3.35	13.1	3.35	23.7	3.35	3.73	3.6	7.60	3.8	11.18	3.8	24							
2.73	5.03	5.84	5.03	10.5	5.03	1.66	5.4	3.38	5.7	4.97	5.7	36							
1.53	6.71	3.28	6.71	5.92	6.71	0.93	7.2	1.90	7.6	2.79	7.6	48							
0.98	8.39	2.1	8.39	3.79	8.39	0.60	9	1.22	9.5	1.79	9.5	60							
17032 Light Bulb 20PAR36/ NFL20/12V		17039 Light Bulb 35PAR36/ NFL20/12V		17046 Light Bulb 50PAR36/ NFL20/12V								Spot/Narrow Flood							
20.4	2.82	39.4	2.82	78.9	2.82						8								
9.07	4.23	17.5	4.23	35	4.23						12								
2.26	8.46	4.38	8.46	8.77	8.46						24								
1	12.6	1.94	12.6	3.89	12.6						36								
0.56	16.9	1.09	16.9	2.19	16.9						48								
0.36	21.1	0.7	21.1	1.4	21.1						60								
17033 Light Bulb 20PAR36/ FL30/12V		17040 Light Bulb 35PAR36/ FL30/12V		17047 Light Bulb 50PAR36/ FL30/12V		15732 LED 15768 LED		15742 LED 15747 LED		15752 LED 15757 LED		Flood							
46.9	2.14	88.4	2.14	125	2.14	35.78	1.9	66.94	1.8	98.1	2.07	4							
11.7	2.48	22.1	4.28	31.4	4.28	9	3.9	16.75	3.6	24.5	4.1	8							
2.93	8.57	5.53	8.57	7.86	8.57	2.2	7.8	4.15	7.3	6.1	8.2	16							
1.3	12.8	2.45	12.8	3.49	12.8	0.98	11.7	1.84	10.95	2.71	12.3	24							
1.06	17.07	1.77	16.0	2.52	16.0	0.55	15.6	1.04	14.6	1.53	16.4	32							
.49	21.3	.93	21.37	1.32	21.37	0.35	19.5	0.66	18.25	0.98	20.5	40							
				15711 LED		15733 LED 15769 LED		15743 LED 15748 LED		15753 LED 15758 LED		Wide Flood							
				5.6	3.25	18.54	2.4	36.9	2.4	47.03	2.4	4							
				1.49	6.5	4.65	4.8	9.3	4.8	11.8	4.8	8							
				.40	12.98	1.15	9.6	2.3	9.6	2.9	9.6	16							
				.18	19.47	0.51	14.4	1.02	14.4	1.29	14.4	24							
				.11	25.96	0.29	19.2	0.58	19.2	0.73	19.2	32							
				.07	32.45	0.18	24	0.37	24	0.46	24	40							



POWERED BY
DESIGN PRO LED
TECHNOLOGY

This installation illuminated exclusively
with Design Pro LED fixtures

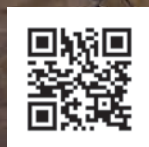

Meet the professionals
behind the lighting



120 Volt & HID Lighting





120 VOLT & HID

Path & Spread

Let powerful light inhabit space around walkways, landscapes, and office buildings.



HID BOLLARDS

Kichler offers a collection of HID bollards employing the same stylish designs, premium quality materials and product flexibility that you've come to expect from Kichler. You'll discover more than ninety possible product combinations to satisfy any construction or specification criteria – and ordering what you need is as simple as 1 – 2 – 3.

STEP 1

Select your head design and finish.

Choose from the signature Kichler segmented roof design in a small or large size, or the traditional rounded top. Two finishes are available: Textured Architectural Bronze™ or Textured Black. Head and louvers are commercial-grade Cast Aluminum construction.

Housing Cast Aluminum.

Lens Molded ribbed diffuser of clear heat resistant borosilicate lenses.

Finish Textured Architectural Bronze™ (AZT) or Textured Black (BKT)

Wiring 43" of usable 200°C 18 AWG wire leads

Socket 4000-Volt (4KV) pulse rated medium base porcelain socket

Lamp Type 50, 70, or 100-W. Max. E17 Metal Halide

Head Design

- 15215 AZT**
- 15215 BKT**
- 15221 AZT**
- 15221 BKT**
- 15226 AZT**
- 15226 BKT**



STEP 2

Determine the bollard size, height and diameter.

Bollards are available in 4" or 6" size and in lengths of 18", 24" or 36". Bollard kit is supplied with cast aluminum internal mounting plate including lag bolts for deck or surface mounting. Extruded aluminum bollard finished with baked thermoset powder coat. Order separate bollard template kit for installation into concrete or 15578 BK bollard mounting stake for installation in soil. UL listed.

For use with fixtures 15215, 15221, and 15226.

Finish Textured Architectural Bronze™ (AZT) or Textured Black (BKT)

Bollard Assembly

- 15603 AZT 4" x 18"**
- 15603 BKT 4" x 18"**
- 15604 AZT 4" x 24"**
- 15604 BKT 4" x 24"**
- 15605 AZT 4" x 36"**
- 15605 BKT 4" x 36"**
- 15613 AZT 6" x 18"**
- 15613 BKT 6" x 18"**
- 15614 AZT 6" x 24"**
- 15614 BKT 6" x 24"**
- 15615 AZT 6" x 36"**
- 15615 BKT 6" x 36"**

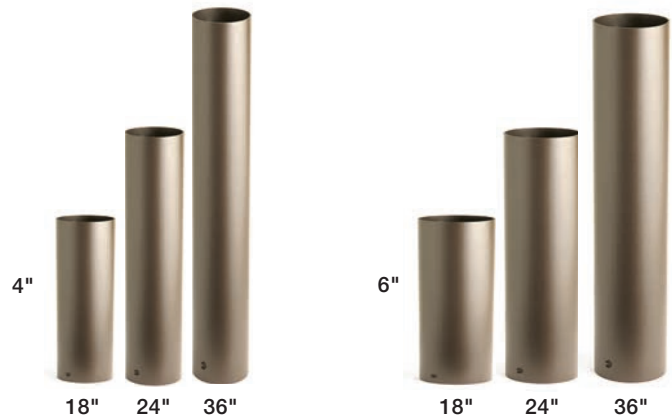

STEP 3

Determine your desired lamp/ballast combination.

50-W, 70-W and 100-W Metal Halide are offered. (Lamps are not included.) Each comes equipped with ballasts that will accept multiple voltage options: 120V, 208V, 240V or 277V. (Because of heat restrictions, 100-W lamping cannot be used in the 4" diameter bollard.) All mounting hardware is corrosion resistant.

Ballast Assembly

- 15BLMH50 BK** - 50-W Metal Halide
- 15BLMH70 BK** - 70-W Metal Halide
- 15BLMH100 BK** - 100-W Metal Halide (use only with 6" diameter bollard)

50 W and 70 W fixtures can be used with 4" and 6" diameter bollard.

In addition to the lighting fixtures, Kichler offers 4" and 6" Bollard Template Kits used for permanent installation in concrete. The kits include positioning template, anchor bolts and mounting hardware.

- **15671 ST** – 4" Bollard Template Kit
- **15678 ST** – 6" Bollard Template Kit



For complete photometrics, please see page 181.

PATH & SPREAD 120 VOLT & HID



Name	THREE TIER Versatile, louvered fixture with multiple mounting options for deck or path lighting, on optional post, stem or bollard. Stem or bollard ordered separately.	LARGE ONE TIER Versatile fixture with wider light distribution for paths and low areas of groundcover. Stem or bollard ordered separately.
Ordering Guide	15205 AZT – Textured Architectural Bronze™ 15205 BKT – Textured Black	15211 AZT – Textured Architectural Bronze™ 15211 BKT – Textured Black
Housing	Cast Aluminum. Molded ribbed diffuser of clear UV stabilized high impact resistant polycarbonate. Mounting stems and bollard kits sold separately.	Cast Aluminum. High impact resistant diffuser. Mounting stems and bollard kits sold separately.
Finish	Textured Architectural Bronze™ or Textured Black	Textured Architectural Bronze™ or Textured Black
Wiring	30" of usable 105°C 18 AWG wire leads. 120V medium base porcelain socket with nickel plated screw shell.	30" of usable 105°C 18 AWG wire leads. 120V medium base porcelain socket with nickel plated screw shell.
Lamp Type	75-W Max. A19 light bulb (not supplied)	75-W Max. A19 light bulb (not supplied)
Optional Mounting Accessories	15645, 15656, 15657 or 15658 – Stems 15276 – Power Post® 15665, 15666 or 15667 – Bollard Mounting Kits 15578 – Bollard Mounting Stakes 15671 – Bollard Template Kit 15601 – Surface Mounting Flange (for attachment to junction box, not included) 15602 – Flange Mounting Nipple See page 159-160 for more information.	15645, 15656, 15657 or 15658 – Stems 15276 – Power Post® 15665, 15666 or 15667 – Bollard 15578 – Bollard Mounting Stakes 15671 – Bollard Template Kit 15601 – Surface Mounting Flange (for attachment to junction box, not included) 15602 – Flange Mounting Nipple See page 159-160 for more information.

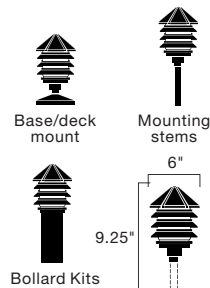

Footcandles/Distance from Fixture Center
15205 (120V) 75W A19 light bulb

Mounting Height	1'	2'	3'	4'	5'	6'	7'	8'	9'
12"	10.1	7.7	1.7	.82	.48	.21	.11	–	–
18"	4.9	4.7	2.8	1.0	.48	.27	.14	.07	–
24"	3.2	3.5	3.4	1.3	.62	.38	.21	.14	.07

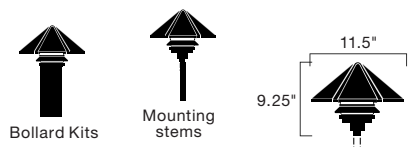

Footcandles/Distance from Fixture Center
15211 (120V) 75W A19 light bulb

Mounting Height	1'	2'	3'	4'	5'	6'	7'	8'	9'
12"	27.1	11.7	2.8	1.2	.89	.34	.18	.07	–
18"	19	9.5	4.6	1.7	.82	.45	.31	.18	.07
24"	14.6	7.8	4.8	2.4	1	.55	.27	.27	.14



15232 AGZ



15222 MST

Name	CROSS CREEK LANTERN Arts and crafts style path light adds simplicity to the landscape.	LARGE SIDE MOUNT Popular design in a side-mount fixture for more directional lighting without glare. Textured Midnight Spruce™ finish blends with landscape.
Ordering Guide	15232 AGZ – Aged Bronze	15222 MST – Textured Midnight Spruce™
Housing	Aluminum with textured linen seeded glass side panels and clear glass bottom panel	Aluminum with clear polycarbonate diffuser (stem supplied separately)
Finish	Aged Bronze	Textured Midnight Spruce™
Wiring	6" Min. of usable 105°C, 18 AWG wire leads. 120V medium base porcelain socket.	30" of usable 105°C, 18 AWG wire leads. 120V medium base porcelain socket with nickel plated screw shell.
Lamp Type	25-W Max. A19 light bulb (not supplied)	75-W Max. A19 light bulb (not supplied)
Optional Mounting Accessories	15601 – Surface Mounting Flange, for attachment to junction box (not included) 15276 – Power Post®	15656, 15657 or 15658 – Stems 15276 – Power Post® 15601 – Surface Mounting Flange (for attachment to junction box, not included)
Notes	U.S. Patent No. D580,084	

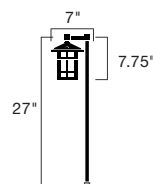

Footcandles/Distance from Fixture Center
15232 (120V) 25W A19 light bulb

Distance from Light	0'	1'	2'	3'	4'	5'	6'	7'	8'
Footcandles	2.8	1.9	.4	.1	-	-	-	-	-

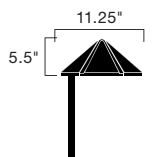

Footcandles/Distance from Fixture Center
15222 (120V) 75W A19 light bulb

Mounting Height	1'	2'	3'	4'	5'	6'	7'	8'	9'
12"	80.9	13.3	2.4	.5	.15	-	-	-	-
18"	60.4	18.6	5.1	1.7	.67	.2	.07	-	-
24"	47.8	19.8	7.6	2.9	1.2	.57	.27	.1	-



15237 OB

Name	ADJUSTABLE HEIGHT UTILITY LIGHT Multipurpose, adjustable fixture for mounting to deck railings, post or porch for directional task lighting.
Ordering Guide	15237 OB – Olde Brick®
Housing	Aluminum construction, G-40 light bulb required
Finish	Olde Brick®
Wiring	58" min. to 72" max. of usable 18AWG sleeved wire with 3 prong plug. 120V medium base socket with nickel plated screw shell, on-off pull chain.
Lamp Type	G-40 light bulb 150-W Max. (not supplied)
Optional Mounting Accessories	Mounting Hardware

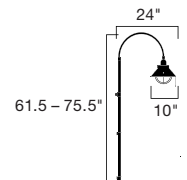

Footcandles/Distance from Fixture Center
15237 (120V) 150W G-40 light bulb

Mounting Height	0'	1'	2'	3'	4'	5'	6'	7'	8'	9'
69"	15.2	14.2	11.7	9.0	6.7	4.8	3.4	2.6	1.9	1.4



Name	ECLIPSE™ Large (9"), 120V version of our popular dome-cap Eclipse design to cast a wider light spread on a wide path or patio.	TRADITIONAL MARINE LANTERN Traditional marine lantern design for well-shielded illumination.
Ordering Guide	15236 BKT – Textured Black 15236 TZT – Textured Tannery Bronze™	15239 OB – Olde Brick® 15239 OZ – Olde Bronze®
Housing	Cast Aluminum with clear glass	Brass
Finish	Textured Black or Textured Tannery Bronze™	Olde Brick® or Olde Bronze®
Wiring	6" of usable 105°C, 18 AWG wire leads. 120V medium base porcelain socket with a nickel plated screw shell	6" of usable 105° C 18 AWG wire leads. 120V medium base porcelain socket with nickel plated screw shell.
Lamp Type	A19 light bulb 100-W Max. (not supplied)	G-40 light bulb 100-W Max. (not included)
Optional Mounting Accessories	15276 – Power Post® 15601 – Surface Mounting Flange (for attachment to junction box, not included)	15276 – Power Post® 15601 – Surface Mounting Flange (for attachment to junction box, not included)

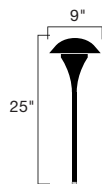

Footcandles/Distance from Fixture Center
15236 (120V) 100W A19 light bulb

Distance from Light	1'	2'	3'	4'	5'	6'	7'	8'	9'
Footcandles	30.8	11.5	3.9	1.5	.70	.30	1	-	-

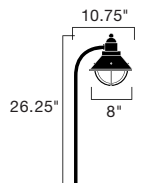

Footcandles/Distance from Fixture Center
15239 (120V) 100W G-40 light bulb

Distance from Light	1'	2'	3'	4'	5'	6'	7'	8'	9'
Footcandles	76	31	10.2	3.6	1.6	.7	3	.2	.1

120 VOLT & HID

Accent

Unlimited options for creating special lighting effects on buildings and landscapes.



ACCENT 120 VOLT & HID



Name	120V ACCENT – SMALL Small (4") accent light for cross-lighting, spotlighting or grazing	120V ACCENT – MEDIUM Medium-sized (5") accent light for cross-lighting, accenting or grazing
Ordering Guide	15231 AZT – Textured Architectural Bronze™ 15231 BKT – Textured Black 15231 MST – Textured Midnight Spruce™	15241 AZT – Textured Architectural Bronze™ 15241 BKT – Textured Black 15241 MST – Textured Midnight Spruce™
Housing	Cast Aluminum. Tempered convex glass lens	Cast Aluminum. Tempered convex glass lens
Finish	Textured Architectural Bronze™, Textured Black or Textured Midnight Spruce™	Textured Architectural Bronze™, Textured Black or Textured Midnight Spruce™
Wiring	8" of usable 200°C 18 AWG wire leads	8" of usable 200°C 18 AWG wire leads
Socket	4000V (4KV) pulse rated medium base porcelain socket	4000V (4KV) pulse rated medium base porcelain socket
Lamp Type	35-W Max. PAR20 Metal Halide or 50-W Max. PAR20/R20 Incandescent (not included)	70-W Max. PAR30L Metal Halide 75-W(VA) PAR30L/R30 Incandescent (not supplied)
Optional Mounting Accessories	15276 – Power Post® 15601 – Surface Mounting Flange, for attachment to junction box (not included) 15609 – Junctoin Box Mounting Bracket	15276 – Power Post® 15601 – Surface Mounting Flange, for attachment to junction box (not included) 15609 – Junctoin Box Mounting Bracket
Optional Lens Accessories	15620 – Medium Cowl 15628 – Long Cowl 15623 – Blue Filter 15637 – Hexcell Louver	15640 – Medium Cowl 15648 – Long Cowl 15624 – Blue Filter 15638 – Hexcell Louver
Notes	Accents require remote ballasts for High Intensity Discharge. See HID Ballast Guide on page 157 and 120V Lamp Guide on page 163. For Lamp Photometrics see pages 162-167.	Accents require remote ballasts for High Intensity Discharge. See HID Ballast Guide on page 157 and 120V Lamp Guide on page 163. For Lamp Photometrics see pages 162-167.

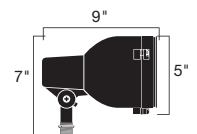
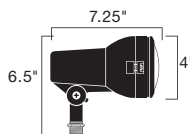

ACCENT 120 VOLT & HID



Name	120V ACCENT – LARGE Large (7") accent light for wider light spread along walls, shrubs, trees	120V ACCENT – SMALL COMPACT Adjustable, compact accent light (3¾" diameter) for up or downlighting
Ordering Guide	15251 AZT – Textured Architectural Bronze™ 15251 BKT – Textured Black 15251 MST – Textured Midnight Spruce™	15230 AZT – Textured Architectural Bronze™ 15230 MST – Textured Midnight Spruce™
Housing	Cast Aluminum. Tempered convex glass lens	Cast Aluminum
Finish	Textured Architectural Bronze™, Textured Black or Textured Midnight Spruce™	Textured Architectural Bronze™ or Textured Midnight Spruce™
Wiring	8" of usable 200°C 18 AWG wire leads	8" of usable 200°C 18 AWG wire leads
Socket	4000V (4KV) pulse rated medium base porcelain socket	4000V (4KV) pulse rated medium base porcelain socket
Lamp Type	175-W Max. PAR38 Metal Halide, 100-W Max. E17 Metal Halide or 150-W Max. PAR38/R40 Incandescent (not included) Reflector: for use with E17 lamp. Removable for PAR38/R40 use.	35-W Max. PAR20 Metal Halide or 50-W Max. PAR20 Incandescent (not included)
Optional Mounting Accessories	15276 – Power Post® 15601 – Surface Mounting Flange, for attachment to junction box (not included) 15609 – Junction Box Mounting Bracket	15276 – Power Post® 15601 – Surface Mounting Flange, for attachment to junction box (not included) 15609 – Tree Mounting Bracket
Optional Lens Accessories	15660 – Medium Cowl 15668 – Long Cowl 15625 – Blue Filter 15639 – Hexcell Louver	15630 – Cowl
Notes	Accents require remote ballasts for High Intensity Discharge. See HID Ballast Guide on page 157 and 120V Lamp Guide on page 163. For Lamp Photometrics see pages 162-167.	Accents require remote ballasts for High Intensity Discharge. See HID Ballast Guide on page 157 and 120V Lamp Guide on page 163. For Lamp Photometrics see pages 162-167.

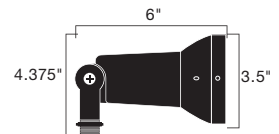
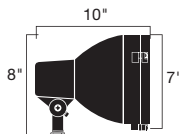

ACCENT 120 VOLT & HID



Name	120V ACCENT – LARGE COMPACT Adjustable accent light in a larger size (5" diameter) for up or downlighting	120V DOWNLIGHT Downlight or below horizontal effects with wide light spread. Available as surface or tree-mounted. Designed for below horizontal aiming only.
Ordering Guide	15250 AZT – Textured Architectural Bronze™ 15250 MST – Textured Midnight Spruce™	15255 AZT – Textured Architectural Bronze™ 15255 BKT – Textured Black 15255 MST – Textured Midnight Spruce™
Housing	Cast Aluminum	Cast Aluminum
Finish	Textured Architectural Bronze™ or Textured Midnight Spruce™	Textured Architectural Bronze™, Textured Black or Textured Midnight Spruce™
Wiring	8" of usable 200° C 18 AWG wire leads	8" of usable 200° C 18 AWG wire leads
Socket	4000V (4KV) pulse rated medium base porcelain socket	4000V (4KV) pulse rated medium base porcelain socket
Lamp Type	100-W Max. PAR38 Metal Halide or 100-W Max. PAR38 Incandescent (not included)	175-W Max. PAR38 Metal Halide, 100-W Max. E17 Metal Halide or 150-W Max. PAR38/R40 Incandescent (not included)
Optional Mounting Accessories	15276 – Power Post® 15601 – Surface Mounting Flange, for attachment to junction box (not included) 15609 – Junction Box Mounting Bracket	15601 – Surface Mounting Flange, for attachment to junction box (not included) 15609 – Junction Box Mounting Bracket
Optional Lens Accessories	15630 – Cowl	15660 – Medium Cowl 15668 – Long Cowl
Notes	Accents require remote ballasts for High Intensity Discharge. See HID Ballast Guide on page 157 and 120V Lamp Guide on page 163. For Lamp Photometrics see pages 162-167.	Accents require remote ballasts for High Intensity Discharge. See HID Ballast Guide on page 157 and 120V Lamp Guide on page 163. For Lamp Photometrics see pages 162-167.

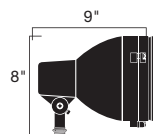
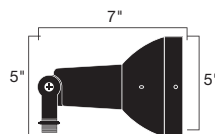



Name	IN GROUND 35-W MH 35-W metal halide in-ground light. Adjustable to 15° angle. Use with blue filter 15626 to intensify green color in the landscape.	IN GROUND 70-W MH 70-W metal halide in-ground light. Adjustable to 15° angle. Use with blue filter 15626 to intensify green color in the landscape.	IN GROUND 70-W MH QUAD-TAP 70-W metal halide in-ground light with quad taps. Adjustable to 15° angle. Use with blue filter 15626 to intensify green color in the landscape.
Ordering Guide	15262 AZ – Architectural Bronze™	15263 AZ – Architectural Bronze™	15266 AZ – Architectural Bronze™
Housing	Durable thermoplastic composite resin. Tempered convex glass lens fully sealed for watertight outdoor use.	Durable thermoplastic composite resin. Tempered convex glass lens fully sealed for watertight outdoor use.	Durable thermoplastic composite resin. Tempered convex glass lens, fully sealed for watertight outdoor use.
Finish	Architectural Bronze™	Architectural Bronze™	Architectural Bronze™
Wiring	4000V (4KV) pulse rated medium base porcelain socket	4000V (4KV) pulse rated medium base porcelain socket	4000V (4KV) pulse rated medium base porcelain socket
Ballast	Internal ANSI M130 Metal Halide ballast included with 120V tap.	Internal ANSI M98 Metal Halide ballast included with 120V tap.	Internal ANSI M98 Metal Halide ballast with 120V, 208V, 240V and 277V taps.
Lamp Type	35-W PAR20 Metal Halide (not included)	70-W PAR30 Metal Halide or 70-W E17 Metal Halide (not included)	70-W PAR30 Metal Halide or 70-W E17 Metal Halide (not included)
Aiming	With adjustable aim assembly, 15° angle, 358° rotation with wing-nut locking mechanism	With adjustable aim assembly, 15° angle, 358° rotation with wing-nut locking mechanism	With adjustable aim assembly, 15° angle, 358° rotation with wing nut locking mechanism
Optional Accessories	15608 – Concrete Pour Kit 15616 WH10 – Gel Encapsulant 10 pack	15608 – Concrete Pour Kit 15616 WH10 – Gel Encapsulant 10 pack	15608 – Concrete Pour Kit 15616 WH10 – Gel Encapsulant 10 pack
Optional Lens Accessories	15626 – Blue Filter with gasket 15688 – Rock Guard	15626 – Blue Filter with gasket 15688 – Rock Guard	15626 – Blue Filter with gasket 15688 – Rock Guard
Notes	Drive Over Capacity: 3000 lbs.	Drive Over Capacity: 3000 lbs.	Drive Over Capacity: 3000 lbs.

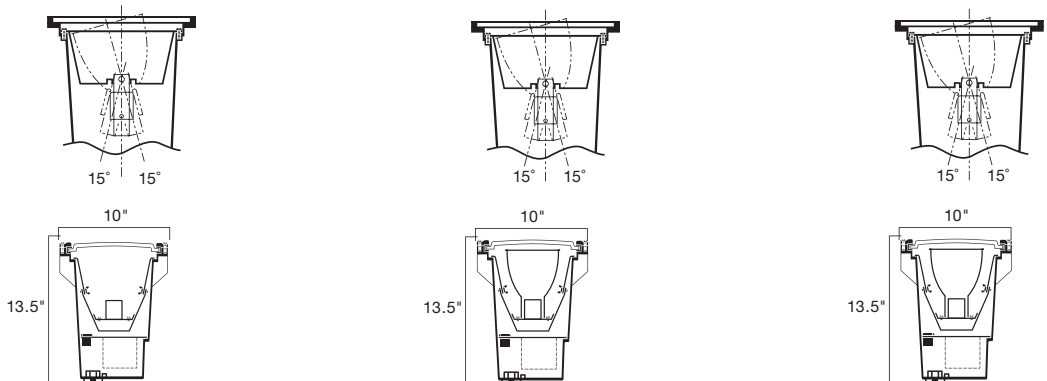



15295 AZ



15268 AZ

Name	IN GROUND INCANDESCENT – PAR30 Incandescent in-ground light. Adjustable to 15° angle. Use with blue filter 15626 to intensify green color in the landscape.	SMALL IN GROUND – PAR20/PAR30 Smaller 7" diameter in-ground light designed for use with PAR20 and PAR30 lamps.
Ordering Guide	15295 AZ – Architectural Bronze™	15268 AZ – Architectural Bronze™
Housing	Durable thermoplastic composite resin. Tempered convex glass lens fully sealed for watertight outdoor use.	Durable thermoplastic composite resin. Tempered convex glass lens fully sealed for watertight outdoor use.
Finish	Architectural Bronze™	Architectural Bronze™
Wiring	4000V (4KV) pulse rated medium base porcelain socket. Re-enterable encapsulant	Medium base porcelain socket
Lamp Type	150-W Max. PAR38 Incandescent (not included)	75-W Max. PAR20 or PAR30 and PAR30 longneck Incandescent (not included)
Aiming	With adjustable aim assembly, 15° angle, 358° rotation with wing-nut locking mechanism	With adjustable aim assembly, 25° angle, 358° rotation
Optional Accessories	15608 – Concrete Pour Kit 15616 WH10 – Gel Encapsulant 10 pack	NA
Optional Lens Accessories	15626 – Blue Filter with gasket 15688 – Rock Guard	15694 – Rock Guard
Notes	Drive over capacity 3,000 lbs.	U.S. Patent No. 5,230,559 Korea Patent No. 126459

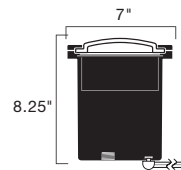
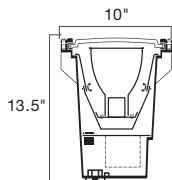
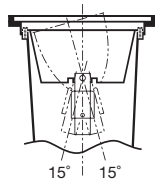

HID

Ballasts

Helping your HID system operate flawlessly.



Meet the professionals
behind the lighting



Name	HID ABOVE-GROUND BALLAST				HID IN-GROUND BALLAST			
Ordering Guide	Product ID	Description	Tap	ANSI#	Product ID	Description	Tap	ANSI#
	15MHS35AZT	Single 35-W MH	120V	M130	15IGMHS35 AZ	Single 35-W MH	120V	M130
	15MHS70AZT	Single 70-W MH	120V	M98	15IGMHS70 AZ	Single 70-W MH	120V	M98
	15MHS100AZT	Single 100-W MH	120V	M90	15IGMHS100 AZ	Single 100-W MH	120V	M90
	15MHS175AZT	Single 175-W MH	120V	M57	15IGMHS150 AZ	Single 150-W MH	120V	M102/142**
	15MHT35AZT	Twin 35-W MH	120V	M130	15IGMHS175 AZ	Single 175-W MH	120V	M57
	15MHT70AZT	Twin 70-W MH	120V	M98	** Complies with EISA 2007			
	15MHT100AZT	Twin 100-W MH	120V	M90				
	15MHT175AZT	Twin 175-W MH	120V	M57**				
	** Complies with EISA 2007							
Housing	Stamped steel. Textured Architectural Bronze™ thermoset powder coat finish.				Single piece Polyphenylene Sulphide (PPS) glass reinforced composite with molded in ribs to prevent ground shift. Two ¾" NPT entries for conduit attachment.			
Ballast	Copper wrapped core and coil with High Power Factor (HPF) 105° C High Heat capacitor and long range ignitor. Rated for -20° F starting. Available with single 120V tap.				Quick disconnect ballast with bracket handle. Available with single 120V tap.			
Mounting Brackets	Top and bottom				NA			
Composite Cover	NA				With .5" NPSM removable plug for both direct fixture mount and remote mount application			
Three Knockouts	.5" and .75" trade size combination knockouts for conduit entry.				NA			
Wiring Compartment	NA				Two threaded .75" NPT entries for conduit attachment. Re-enterable encapsulant 3M 8882 potting compound included.			
Gasket	NA				One piece, molded silicone "O" Ring			
Stainless Steel Screws	Mounting screws and anchors included				Captive and gasketed			
Dimensions	Single 120V: 6 .375" W x 9.5" L x 5.25" D Twin 120V: 6 .375" W x 9.5" L x 5.25" D				9.625" Dia. X 12" Hgt.			
Notes	Above ground ballasts carry a UL listing mark suitable for the US and Canadian marketplace. Maximum distance from lamp to ballast cannot exceed 15' on single (120V) models. Some lamp brands may perform better.				In-ground ballasts carry a CSA listing mark suitable for the US and Canadian marketplace Maximum distance from lamp to ballast cannot exceed 15 feet. Some lamp brands may perform better.			

120 VOLT & HID

Accessories

Create a customized installation.



MOUNTING ACCESSORIES

Fixture Mounting Stems

.50 NPSM thd. stems
.75 dia. overall

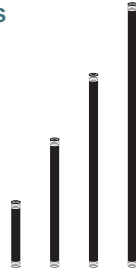

6"	15645 AZT 15645 BBR 15645 BKT	18"	15657 AZT 15657 BBR 15657 BKT
12"	15656 AZT 15656 BBR 15656 BKT	24"	15658 AZT 15658 BBR 15658 BKT

All stems made of corrosion resistant aluminum alloy (except BBR, which is Bronzed Cast Brass) with baked thermoset powder coating to match fixtures. Used with:

- In-ground support stakes (low voltage only)
- Surface mounting flange (low or line voltage)

0.5" stems will require additional Coupler (15649) or Elbow (15647) for accent light use

Power Post®



15276 BK

Fast, one-step connection. 2¼" inside diameter accepts conduit of different sizes. Made of impact and corrosion resistant PVC, suitable for wet locations. No unsightly junction boxes or time-taking assembly. Just a trouble-free installation.

Designed for line voltage (120V) landscape lighting. Eliminates need for above or below ground boxes. Built-in stabilizer removes need for concrete.

Accepts 1/2 NPSM thread.
UL and cUL listed

Bollard Mounting Stake



15578 BK

For use with all bollard mounting kits on 12V and 120V fixtures*

Improved extruded PVC stake is corrosion resistant and 23" length has increased support and stability. Fitting provided to mount bollard in soil.

*As allowed by local electrical codes

Bollard Mounting Kit



18"	15665 AZT 15665 BKT	36"	15667 AZT 15667 BKT
24"	15666 AZT 15666 BKT		

For use with fixtures 15005, 15011, 15205, 15211

Bollard kit is supplied with Cast Aluminum internal mounting plate including lag bolts for deck or surface mounting. Extruded aluminum bollard finished with baked thermoset powder coat. Order separate bollard template kit for installation into concrete or bollard mounting stake for installation in soil. UL listed.

HID Bollard Mounting Kit

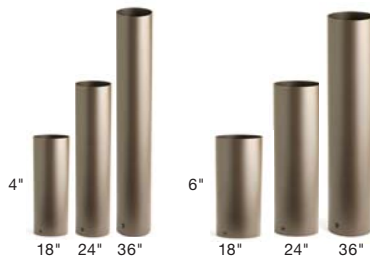

15603 AZT 4" x 18"	15613 AZT 6" x 18"
15603 BKT 4" x 18"	15613 BKT 6" x 18"
15604 AZT 4" x 24"	15614 AZT 6" x 24"
15604 BKT 4" x 24"	15614 BKT 6" x 24"
15605 AZT 4" x 36"	15615 AZT 6" x 36"
15605 BKT 4" x 36"	15615 BKT 6" x 36"

For use with fixtures 15215, 15221, 15226

Surface Mounting Flange

4" D
.50" NPSM thd



15601 AZT
15601 BBR
15601 BKT

On 120V installations, Cast Aluminum surface flange must be used with junction box (not included). Neoprene gasket supplied to ensure water tight seal.

BBR is Bronzed Cast Brass

MOUNTING ACCESSORIES

Flange Mounting Nipple



15602 AL

Anodized aluminum nipple. Used when attaching fixture directly to 15601 flange and 15607 bracket.

Junction Box Mounting Bracket



15609 AZT
15609 BKT

For use with low voltage and line voltage fixtures
Corrosion resistant Cast Aluminum alloy with baked thermoset powder coat finish

Bollard Template Kit



15671 ST

For use with all bollard mounting kits
For permanent installation into concrete. Template kit includes positioning template, anchor bolts, and mounting hardware.

Gel Encapsulant



15616 WH10 10 pack

Gel re-enterable encapsulant for in-ground installations. Two-part field mixable material in one convenient package.

PAR38 Well Light Concrete Pour Kit



15608 AZ for use with 15262, 15263,
15266, 15295

Injection molded concrete pour kit

LENS/SHIELD ACCESSORIES

Blue Lens Filter



15623 BL Small blue lens for use with 15231
15624 BL Medium blue lens for use with 15241
15625 BL Large blue lens for use with 15251, 15255

Blue glass filters act as color enhancers to bring out the true rich greens of foliage. Glass is tempered to resist heat and impact.

45° Hexcell Louver

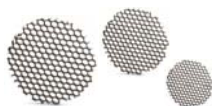

15637 BK Small Hexcell for use with 15231
15638 BK Medium Hexcell for use with 15241
15639 BK Large Hexcell for use with 15251, 15255

Expanded aluminum shield with high temperature black finish.

Well Light Blue Lens Filter



15626 BL Well light blue lens for use with
15262, 15263, 15266, 15295

Blue glass filter with rubber gasket. Glass is tempered to resist heat and impact.

LENS/SHIELD ACCESSORIES		
<p>Well Light Rock Guard</p> 	<p>15688 AZ</p>	<p>Rock Guard/Glare Shield for use with 15263 AZ, 15264 AZ, 15265 AZ and 15295 AZ</p>
<p>PAR20 Medium Cowl</p> <p>3.32" L</p> 	<p>15620 AZT 15620 BKT</p>	<p>PAR20/R20 Medium Cowl accessory for 15231 AZT, 15231 BKT, 15231 MST Aluminum does not include lens. Lens cowl sold with fixture. 360° rotation for precise light cutoff.</p>
<p>PAR20 Long Cowl</p> <p>7.45" L</p> 	<p>15628 AZT 15628 BKT</p>	<p>PAR20/R20 Long Cowl accessory for 15231 AZT, 15231 BKT, 15231 MST</p>
<p>PAR30 Medium Cowl</p> <p>3.87" L</p> 	<p>15640 AZT 15640 BKT</p>	<p>PAR30R/30 Medium Cowl accessory for 15241 AZT, 15241 BKT, 15241 MST</p>
<p>PAR30 Long Cowl</p> <p>8.99" L</p> 	<p>15648 AZT 15648 BKT</p>	<p>PAR30/R30 Long Cowl accessory for 15241 AZT, 15241 BKT, 15241 MST</p>
<p>PAR38 Medium Cowl</p> <p>4.92" L</p> 	<p>15660 AZT 15660 BKT</p>	<p>PAR38/R40 Medium Cowl accessory for 15251 AZT, 15251 BKT, 15251 MST, 15255A ZT, 15255 BKT, 15255 MST</p>
<p>PAR38 Long Cowl</p> <p>12" L</p> 	<p>15668 AZT 15668 BKT</p>	<p>PAR38/R40 Long Cowl accessory for 15251 AZT, 15251 BKT, 15251 MST, 15255 AZT, 15255 BKT, 15255 MST</p>
<p>PAR20 Cowl</p> <p>3.58" L</p> 	<p>15630 AZT</p>	<p>A PAR20 Cowl with heat-resistant clear lens accessory for 15230 AZT, 15230 MST</p>
<p>PAR38 Cowl</p> <p>3.58" L</p> 	<p>15650 AZT</p>	<p>A PAR38 Cowl with heat-resistant clear lens accessory for 15250 AZT, 15250 MST</p>

120 VOLT & HID

Light Bulbs & Photometrics

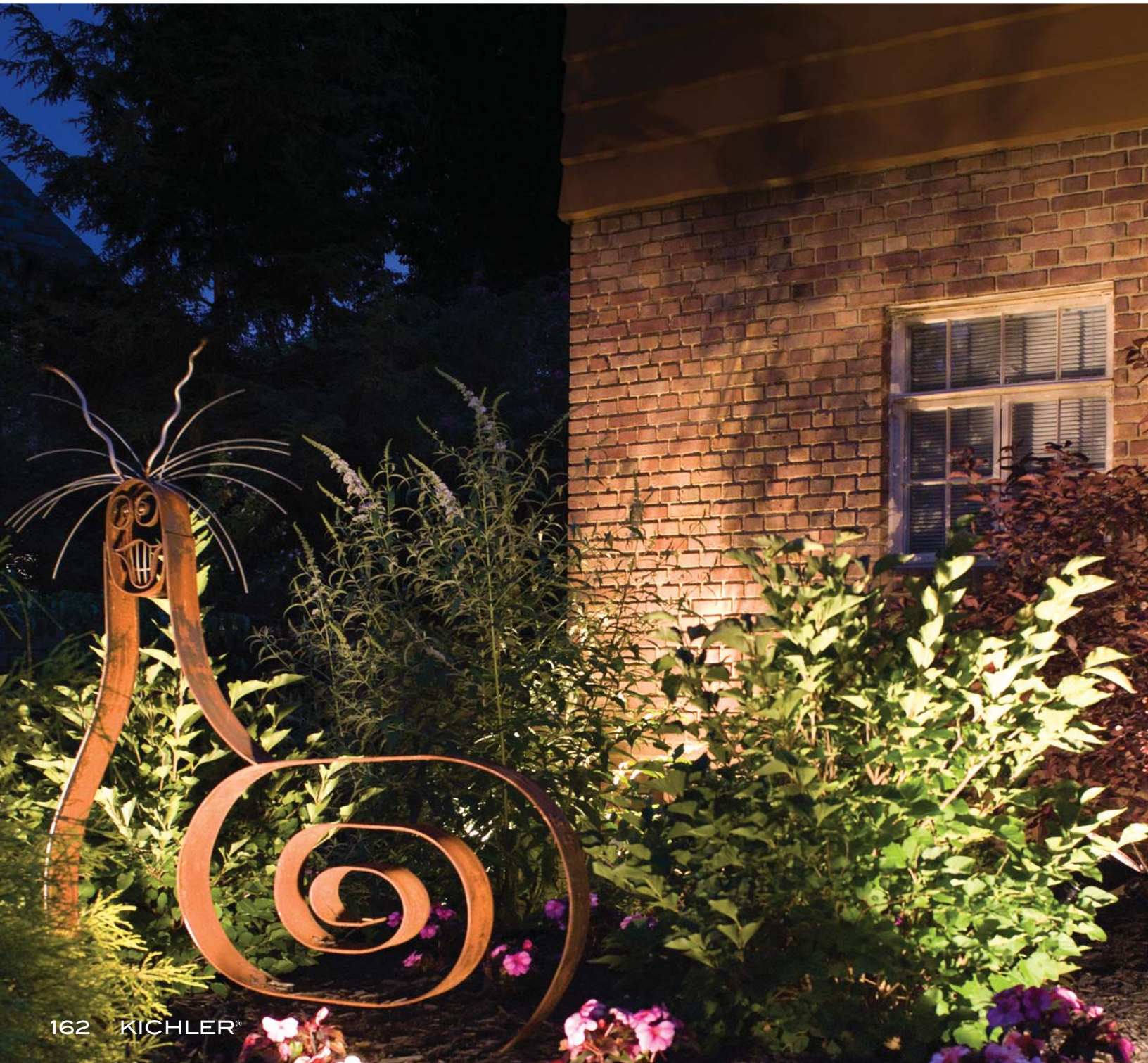

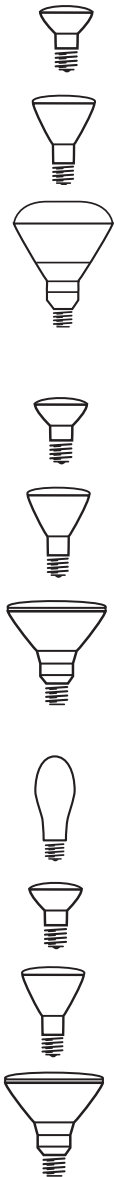

Lamp Type	Watts	Beam Spread	Base	Lumens	Avg. Life (hrs)
INCANDESCENT					
30R20-SP	30	Spot	Medium	300	2,000
30R20-FL	30	Flood	Medium	300	2,000
50R20-SP	50	Spot	Medium	550	2,000
50R20-FL	50	Flood	Medium	550	2,000
75R30-SP	75	Spot	Medium	770	2,000
75R30-FL	75	Flood	Medium	770	2,000
65R40-SP	65	Spot	Medium	500	2,000
65R40-FL	65	Flood	Medium	500	2,000
85R40-SP	85	Spot	Medium	700	2,000
85R40-FL	85	Flood	Medium	700	2,000
120R40-SP	120	Spot	Medium	1,000	2,000
120R40-FL	120	Flood	Medium	1,000	2,000
HALOGEN					
35PAR20-SP	35	9°	Medium	350	2,000
35PAR20-FL	35	30°	Medium	350	2,000
50PAR20-SP	50	9°	Medium	550	2,000
50PAR20-FL	50	30°	Medium	550	2,000
50PAR30L-SP	50	10°	Medium	630	2,000
50PAR30L-FL	50	30°	Medium	630	2,000
75PAR30L-SP	75	10°	Medium	965	2,000
75PAR30L-FL	75	30°	Medium	965	2,000
90PAR38-SP	90	12°	Medium	1,280	2,500
90PAR38-FL	90	28°	Medium	1,280	2,500
150PAR38-SP	150	12°	Medium	2,200	2,500
150PAR38-FL	150	28°	Medium	2,200	2,500
METAL HALIDE					
70-ED17	70	-	Medium	4,000	10,000
100-ED17	100	-	Medium	5,850	10,000
35PAR20-SP	35	10°	Medium	2,000	9,000
35PAR20-FL	35	30°	Medium	2,000	9,000
35PAR30L-SP	35	10°	Medium	2,200	9,000
35PAR30L-FL	35	30°	Medium	2,200	9,000
70PAR30L-SP	70	10°	Medium	4,850	9,000
70PAR30L-FL	70	40°	Medium	4,850	9,000
70PAR38-SP	70	15°	Medium	4,800	10,000
70PAR38-FL	70	25°	Medium	4,800	10,000
100PAR38-SP	100	15°	Medium	6,800	12,500
100PAR38-FL	100	25°	Medium	6,800	12,500
175PAR38-FL	175	65°	Medium	10,000	7,500

Code: VN-SP - Very narrow spot NSP - Narrow spot SP - Spot NFL - Narrow flood FL - Flood WFL - Wide flood
 VWFL - Very wide flood MEDIUM - Medium screwshell

Note: Lumens and lamp life may vary by manufacturer.
 Stated lumens are of bare lamp.

LIGHT BULBS & PHOTOMETRICS 120 VOLT & HID

70-W Metal Halide
PAR38 (15251)
Clear ED17 Metal Halide
based on 5600 lumens
per lamp

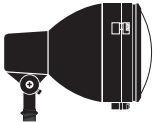

15251

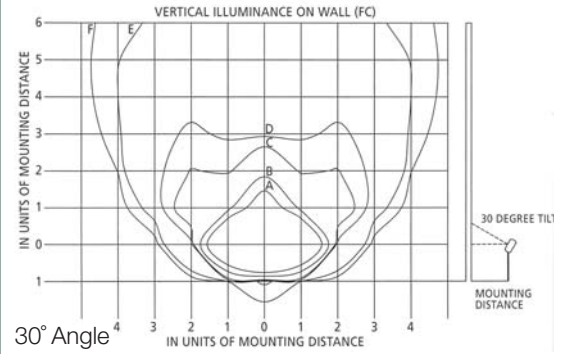
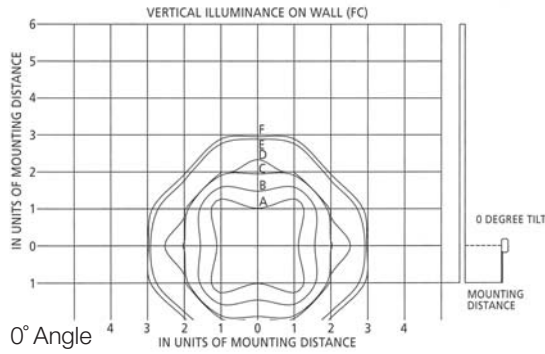

Vertical Illuminance (FC)

MD(FT)	A	B	C	D	E	F
3	13.89	8.33	2.78	1.39	0.28	0.14
4	7.81	4.69	1.56	0.78	0.16	0.08
5	5.00	3.00	1.00	0.50	0.10	0.05
6	3.47	2.08	0.69	0.35	0.07	0.03
7	2.55	1.53	0.51	0.26	0.05	0.03
8	1.95	1.17	0.39	0.20	0.04	0.02
9	1.54	0.93	0.31	0.15	0.03	0.02
10	1.25	0.75	0.25	0.13	0.03	0.01

Contours shown are for
this 5 ft. mounting
distance

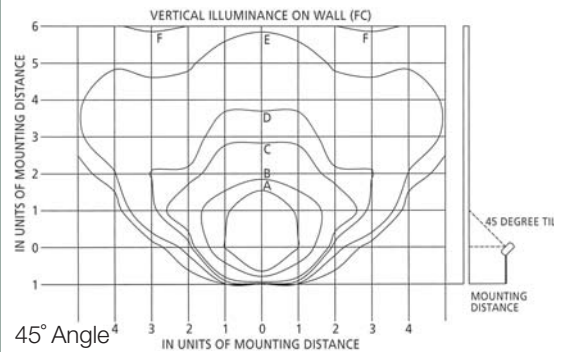

100-W Metal Halide
PAR38 (15251)
Clear ED17 Metal Halide
based on 9000 lumens
per lamp

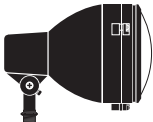

15251

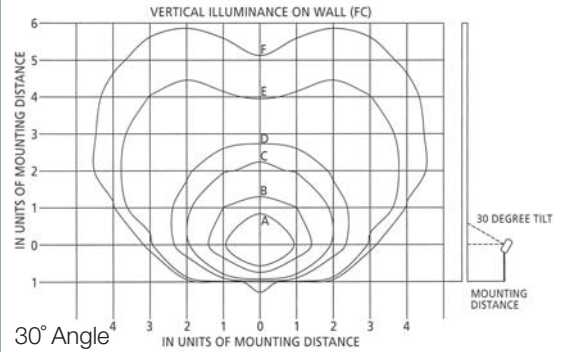
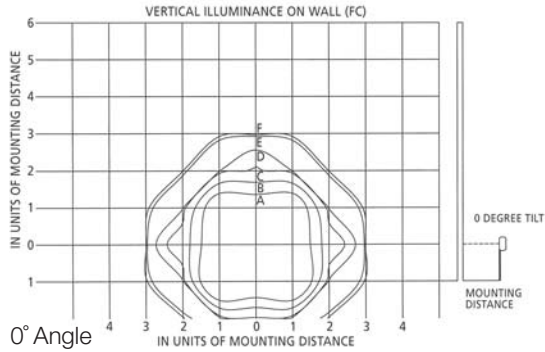

Vertical Illuminance (FC)

MD(FT)	A	B	C	D	E	F
3	13.89	8.33	2.78	1.39	0.28	0.14
4	7.81	4.69	1.56	0.78	0.16	0.08
5	5.00	3.00	1.00	0.50	0.10	0.05
6	3.47	2.08	0.69	0.35	0.07	0.03
7	2.55	1.53	0.51	0.26	0.05	0.03
8	1.95	1.17	0.39	0.20	0.04	0.02
9	1.54	0.93	0.31	0.15	0.03	0.02
10	1.25	0.75	0.25	0.13	0.03	0.01

Contours shown are for
this 5 ft. mounting
distance

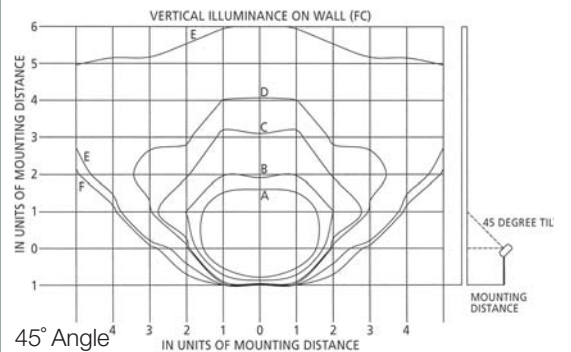

LIGHT BULBS & PHOTOMETRICS 120 VOLT & HID

175-W Metal Halide
PAR38 (15251)
Clear ED17 Metal Halide
based on 14000 lumens
per lamp

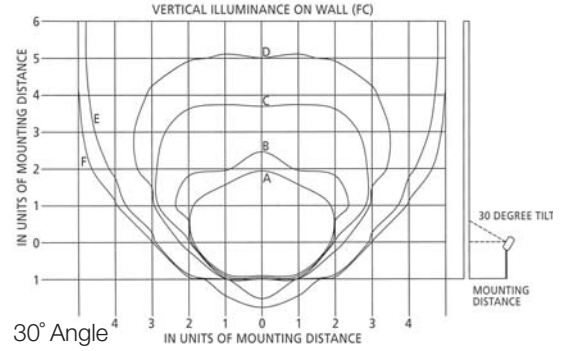
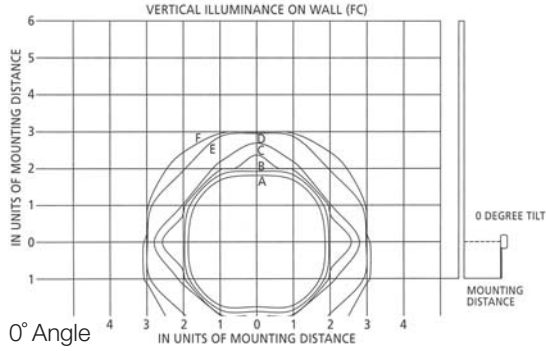
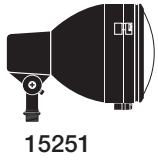

Vertical Illuminance (FC)

MD(FT)	A	B	C	D	E	F
3	13.89	8.33	2.78	1.39	0.28	0.14
4	7.81	4.69	1.56	0.78	0.16	0.08
5	5.00	3.00	1.00	0.50	0.10	0.05
6	3.47	2.08	0.69	0.35	0.07	0.03
7	2.55	1.53	0.51	0.26	0.05	0.03
8	1.95	1.17	0.39	0.20	0.04	0.02
9	1.54	0.93	0.31	0.15	0.03	0.02
10	1.25	0.75	0.25	0.13	0.03	0.01

Contours shown are for
this 5 ft. mounting
distance

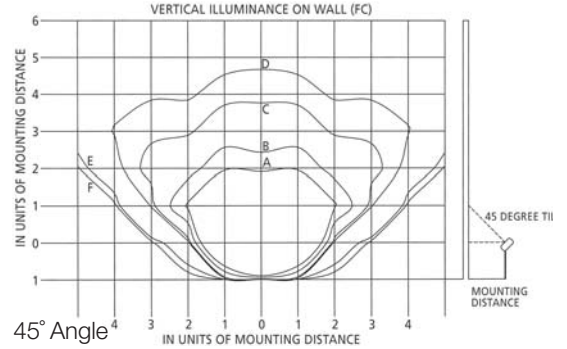

LIGHT BULBS & PHOTOMETRICS 120 VOLT & HID

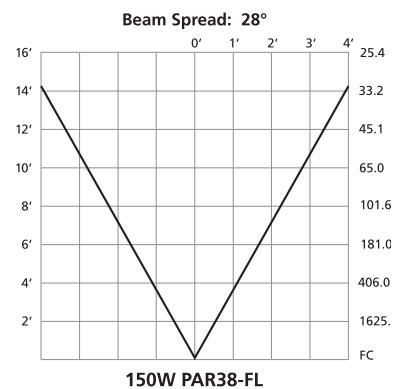
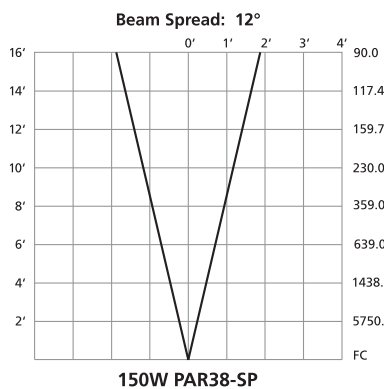
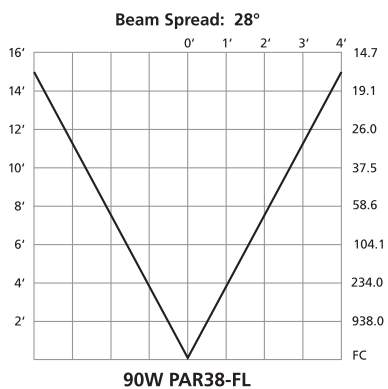
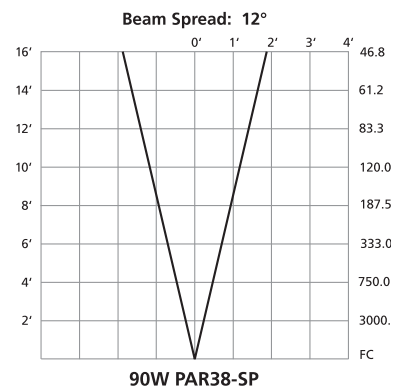
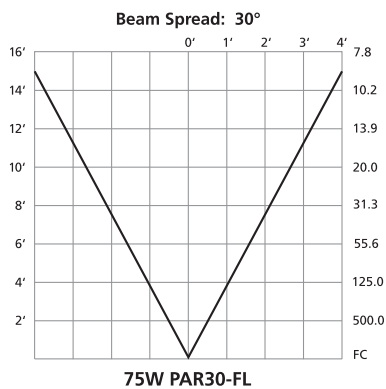
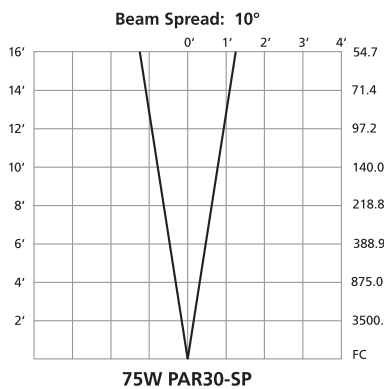
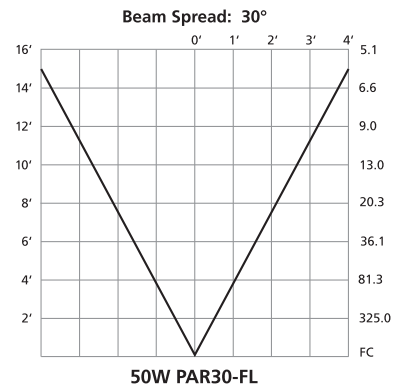
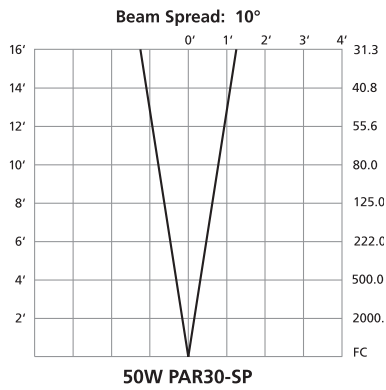
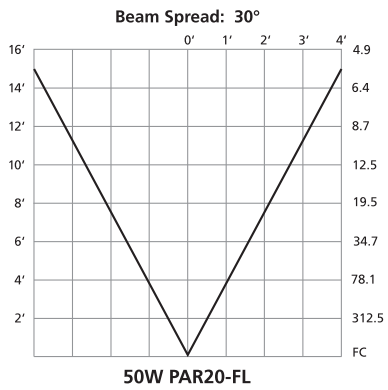
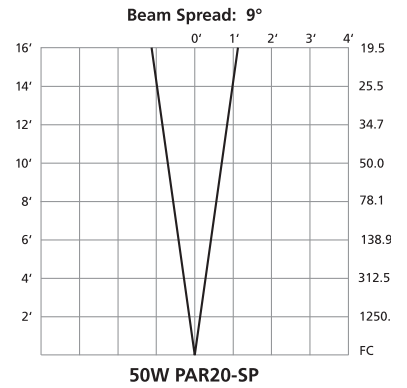
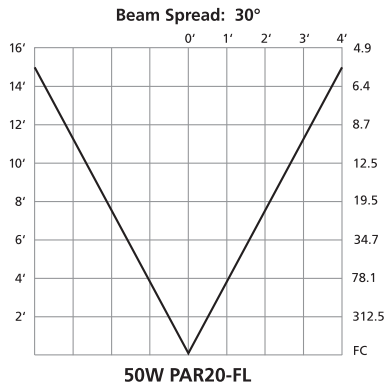
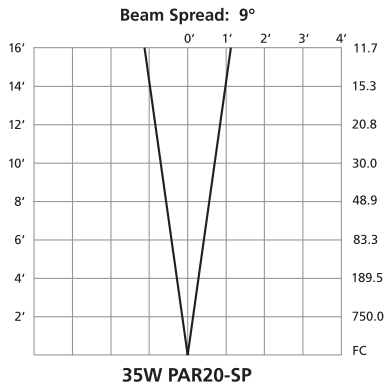

Note: Footcandle (FC) values may differ amongst lamp manufacturers.

HID BOLLARD PHOTOMETRICS from pg. 159

15215AZT & BKT - 50-W Metal Halide
Footcandles/Distance from Fixture Center

Bollard Height	1'-0"	2'-0"	3'-0"	4'-0"	5'-0"	6'-0"
18"	10.4	19.6	10.9	5.7	3.2	1.8
24"	6.1	12.4	11.3	6.3	3.8	2.5
36"	3.4	5.7	7.2	6.4	4.7	3.3

15215AZT & BKT - 70-W Metal Halide
Footcandles/Distance from Fixture Center

Bollard Height	1'-0"	2'-0"	3'-0"	4'-0"	5'-0"	6'-0"
18"	15.8	26.6	15.5	8.9	5.5	3.3
24"	8.4	16.4	17.2	8.8	5.9	4.2
36"	4.8	8.5	9.8	9.7	7.0	4.6

15215AZT & BKT - 100-W Metal Halide
Footcandles/Distance from Fixture Center

Bollard Height	1'-0"	2'-0"	3'-0"	4'-0"	5'-0"	6'-0"
18"	21.3	48.1	23.8	11.9	6.1	3.6
24"	12.4	29.0	24.8	13.4	8.1	4.7
36"	6.9	11.3	14.6	13.2	8.5	6.1

15221AZT & BKT - 50-W Metal Halide
Footcandles/Distance from Fixture Center

Bollard Height	1'-0"	2'-0"	3'-0"	4'-0"	5'-0"	6'-0"
18"	15.3	20.8	11.1	5.1	2.7	1.4
24"	9.5	13.6	11.7	5.9	3.5	2.3
36"	5.4	6.9	7.6	6.5	4.5	2.9

15221AZT & BKT - 70-W Metal Halide
Footcandles/Distance from Fixture Center

Bollard Height	1'-0"	2'-0"	3'-0"	4'-0"	5'-0"	6'-0"
18"	24.5	29.9	16.5	8.2	5.0	2.7
24"	14.5	19.8	19.2	8.8	5.7	4.0
36"	8.3	10.8	11.1	10.3	6.9	4.5

15221AZT & BKT - 100-W Metal Halide
Footcandles/Distance from Fixture Center

Bollard Height	1'-0"	2'-0"	3'-0"	4'-0"	5'-0"	6'-0"
18"	33.9	46.7	21.4	9.9	4.8	2.2
24"	20.9	28.4	25.5	12.3	6.7	4.2
36"	12.4	14.3	15.4	14.2	9.7	6.2

15226AZT & BKT - 50-W Metal Halide
Footcandles/Distance from Fixture Center

Bollard Height	1'-0"	2'-0"	3'-0"	4'-0"	5'-0"	6'-0"
18"	8.7	17.9	10.5	5.4	3.1	2.1
24"	5.3	11.6	10.5	5.9	3.6	2.5
36"	3.1	5.2	6.5	6.1	4.4	3.1

15226AZT & BKT - 70-W Metal Halide
Footcandles/Distance from Fixture Center

Bollard Height	1'-0"	2'-0"	3'-0"	4'-0"	5'-0"	6'-0"
18"	14.3	26.7	15.2	8.9	5.4	2.9
24"	8.3	16.3	8.9	8.8	6.0	4.0
36"	4.8	8.1	9.5	9.5	6.7	4.6

15226AZT & BKT - 100-W Metal Halide
Footcandles/Distance from Fixture Center

Bollard Height	1'-0"	2'-0"	3'-0"	4'-0"	5'-0"	6'-0"
18"	18.5	38.3	20.4	10.5	5.6	3.6
24"	10.5	23.6	22.0	12.4	7.5	4.5
36"	6.3	10.6	14.2	12.6	9.0	6.4

FLAG POLE ILLUMINATION

- Flag poles used in a residential yard can usually be effectively lit with two fixtures
- Poles positioned on commercial or large residential lots will typically require three lighting fixtures
- The fixtures should be placed 180° apart if using two and 120° apart if using three
- The fixtures should be located 6" to 3' from the flag pole in low-voltage residential applications. For large residential, commercial and line-voltage applications, fixtures should be from 12" to 3' from the base of the pole
- Aim the fixture at the ball at the top of the flagpole



Installation 6" to 3' from base of flagpole



Please use the chart below to determine the recommended quantity of fixtures, lamp wattage and lamp type.

Pole Height	Typical Flag Size	Quantity of Fixtures	Lamp Wattage	Lamp Beam Spread	Kichler LED Option
12' to 20'	3' x 5'	2	20-W	NSP 10° to 15°	15731
25'	4' x 6'	2	35-W	NSP 10° to 15°	15741
30'	5' x 8'	2 or 3	35-W	NSP 10° to 15°	15741
35'	6' x 10'	3	35-W	NSP 10° to 15°	15741
Taller than 35'	10' +	3	50-W	NSP 10° to 15°	15751

PICTORIAL INDEX

DESIGN PRO LED PATH & SPREAD



- 15800***
AZT, BBR
Page 12
- 15801***
Tzt
Page 9
- 15802***
Tzt
Page 12
- 15803***
AZT
Page 12
- 15804**
AZT
Page 13
- 15805***
BKT
Page 14
- 15806***
BKT
Page 14
- 15807***
AZT, BBR
Page 9
- 15810***
AZT, BBR,
BE, BKT
Page 17



- 15857***
AZT
Page 9
- 15870***
AZT, BBR,
BE, BKT
Page 16
- 15871***
BBR, Tzt
Page 10

DESIGN PRO LED DECK & PATIO



- 15750**
Tzt
Page 19
- 15763**
Tzt
Page 19
- 15764**
AZT, BBR*,
WHT*
Page 21
- 15765**
AZT, BBR*, BE,
BKT, WHT
Page 20
- 15773**
AZT
Page 21

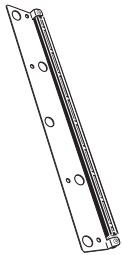

DESIGN PRO LED ACCENT



- 15731,
15732,
15733**
AZT, BBR, BKT
Page 34
- 15741,
15742,
15743**
AZT, BBR, BKT
Page 34
- 15751,
15752,
15753**
AZT, BBR, BKT
Page 35



- 15861**
AZT, BBR*,
BKT
Page 36

DESIGN PRO LED WELL LIGHT



- 15767,
15768,
15769**
BKT
Page 39
- 15728,
15747,
15748**
BKT
Page 39
- 15729,
15757,
15758**
BKT
Page 39



- 15317**
AZT, BN
Page 68
- 15318**
AZT
Page 68
- 15319**
PZ
Page 60
- 15320**
OZ
Page 58
- 15322**
AGZ
Page 61
- 15323**
AZT, BKT, Tzt
Page 73
- 15324**
PZ
Page 52
- 15325**
PZ
Page 52
- 15326**
AZT, BE, BKT
Page 72

* Denotes New Products

PICTORIAL INDEX

15811* AZT, BE Page 17	15815 AZT, BE, BKT Page 15	15817* AZT, BN Page 14	15826 AZT, BE, BKT Page 16	15827 BBR Page 15	15833 AZT Page 13	15839* CO, TZT Page 11	15843 CO, NBK, TZT, VG Page 10	15850* CO Page 11































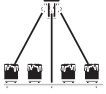

			DESIGN PRO LED HARDSCAPE					
15774 AZT Page 21	15780 AZT Page 22	15782 AZT, BBR*, BKT*, CO*, WHT Page 22		15735* AZT, BBR, CO, GRY, SD, WHT Page 26	15736* AZT, BBR, CO, GRY, SD, WHT Page 26	15745* AZT, BBR, CO, GRY, SD, WHT Page 28	15746* AZT, BBR, CO, GRY, SD, WHT Page 28	15755* AZT, BBR, CO, GRY, SD, WHT Page 27

DESIGN PRO LED WATER/ACCENT

	PATH & SPREAD							
15711* SS Page 41		15005 AZT, BKT, Page 71	15011 AZT, BKT, Page 72	15307 CO Page 52	15310 AZT, BE, BKT Page 74	15313 TZG Page 58	15314 AZT, MST Page 46	15315 AZT, BE, BKT, Page 71



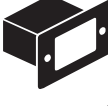





15328 AZT Page 70	15330 OZ Page 51	15332 OZ Page 51	15333 TZT Page 69	15334 OB Page 65	15336 BKT, TZT Page 73	15347 VGB Page 46	15349 MST Page 55	15350 CO Page 63	15351 CO Page 62

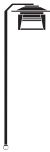





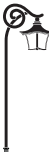

PICTORIAL INDEX







PATH & SPREAD								
								
15352 OZ Page 65	15358 OZ Page 53	15359 OZ Page 53	15360 AZT Page 68	15365 CV Page 61	15367 TZT Page 64	15369 TZT Page 47	15373 BKT Page 54	15379 OZ Page 45
								
15422 AGZ Page 48	15423 AZT, BKT, TZT Page 73	15426 BKT Page 47	15429 TZT Page 50	15430 CO Page 62	15431 CO Page 62	15435 AMB, PP, RD Page 67	15436 OZ Page 46	15437 TZT Page 51
						SPECIALTY  		
15454 CO Page 63	15455 CO Page 63	15457 AZT Page 50	15458 OZ Page 61	15470* AZT, BBR, BE, BKT Page 75	15471* BBR, TZT Page 55			
								
15047 OZ Page 89	15050 TZT Page 85	15063 OB, TZT Page 85	15064 AZT, BBR, BE, WHT Page 90	15065 AZT, BBR, BE, BKT, WHT Page 90	15066 AZT, WHT Page 92	15070 AZT Page 94	15071 OZ Page 88	15072 AZT, CO, WHT Page 94



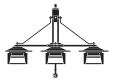



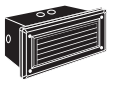

* Denotes New Products

PICTORIAL INDEX























								
15391 OZ Page 60	15392 OZ Page 60	15393 OZ Page 47	15401 TZZ Page 53	15410 AZT, BE Page 75	15411 AZT, SA Page 69	15418 AZT Page 55	15420 AGZ Page 48	15421 AGZ Page 49

								
15438 OB, OZ Page 64	15439 CO, OB, TZZ Page 70	15443 CO, OB, TZZ, NBK, VG Page 54	15444 OZ Page 59	15446 OZ Page 45	15447 OZ Page 45	15449 TZZ Page 49	15450 TZZ Page 65	15453 AZT Page 59







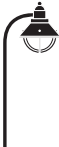

						DECK & PATIO		
15408 BKT Page 79	15409 OZ Page 79	15415 TZZ Page 80	15419 TZZ Page 81	15452 BW Page 81	15499 TZZ Page 80		15021 VGB Page 86	15045 AZT Page 91







								
15073 AZT Page 95	15074 AZT Page 95	15077 AZT Page 92	15079 AZT Page 93	15110 OZ Page 88	15123 BK Page 93	15165 AZ Page 91	15237 OB Page 93	15461 AZT Page 85











PICTORIAL INDEX

DECK & PATIO						ACCENT					
	15462 BW Page 89	15468 AZT Page 91	15469 TZT Page 86	15474 OZ Page 87	15479 TZT Page 87		15309 AZT, BKT Page 101	15374 AZT, BE 20L, BKT Page 102	15382 BK Page 103		
				ACCENT Downlight					WELL LIGHTS		
	15390 AZT Page 107	15395 AZT Page 108	15396 AZT Page 108		15087 AZT Page 111		15093 WH Page 111	15494 AZT Page 111		15088 BK Page 113	15092 BK Page 115
											
15215 AZT, BKT Page 145	15221 AZT, BKT Page 145	15222 MST Page 147	15226 AZT, BKT Page 145	15232 AGZ Page 147	15236 BKT, TZT Page 149	15237 OB Page 148	15239 OB, OZ Page 149	15230 AZT, MST Page 152			

PICTORIAL INDEX

				ACCENT Flood Light					
15384 AZT, BBR, BKT, CO, MST Page 99	15397 AZT Page 100	15398 AZT Page 101	15484 AZT Page 100		15361 AZT, BKT Page 110	15363 BBR Page 110	15381 AZT, BBR, BKT Page 106	15383 AZT Page 107	15385 AZT Page 109

				WATERACCENT		12 VOLT HID PATH & SPREAD		
15190 BK Page 114	15192 BK Page 115	15194 AZ Page 114	15488 BK Page 113		15191 BK Page 117		15205 AZT, BKT Page 146	15211 AZT, BKT Page 146

									
15231 AZT, BKT, MST Page 151	15241 AZT, BKT, MST Page 151	15250 AZT, MST Page 153	15251 AZT, BKT, MST Page 152	15255 AZT, BKT, MST Page 153	15262 AZ Page 154	15263 AZ Page 154	15266 AZ Page 154	15268 AZ Page 155	15295 AZ Page 155

LEGEND

Wattages stated are the maximum recommended, however, you may use lower wattage bulbs to suit your lighting needs..

All electrical products are cUL, UL, ETL or CSA listed.

Because compliance and safety are important long after the installation is complete all Kichler Landscape Lighting low voltage transformers are listed or certified by UL, ETL, and/or CSA to the appropriate ANSI/UL 1838 standard for both the United States and Canada.

Finishes for fixtures installed outdoors are subject to change due to prolonged exposure to sunlight, airborne pollutants and other forms of weathering.

To serve you better, Kichler® Lighting reserves the right to make improvements to the products in this catalog. Therefore, some products may change during the life of the catalog and the product information contained in this catalog may also have changed.

WARRANTY

For complete warranty details, go to www.landscapelighting.com.

NUMERIC INDEX

Product #	Page #	Product #	Page #	Product #	Page #	Product #	Page #	Product #	Page #	Product #	Page #
15005	71	15330	51	15455	63	15642	133	15752	35	15MHS70	157
15011	72	15332	51	15457	50	15643	133	15753	35	15MHT100	157
15021	86	15333	69	15458	61	15644	132	15755	27	15MHT175	157
15045	91	15334	65	15461	85	15645	130, 159	15756	29	15MHT35	157
15047	89	15336	73	15462	89	15647	131	15757	39	15MHT70	157
15050	85	15336	73	15468	91	15648	161	15758	39	15PL100	126
15063	85	15347	46	15469	86	15649	131	15763	19	15PL200	126
15064	90	15349	55	15470	75	15650	161	15764	21	15PL300	126
15065	90	15350	63	15471	55	15651	130	15765	20	15PL600	126
15066	92	15351	62	15474	87	15652	130	15767	39	15PL900	126
15070	94	15352	65	15479	87	15653	130	15768	39	15PR75	126
15071	88	15358	53	15484	100	15656	130, 159	15769	39	15PR100	126
15072	94	15359	53	15488	113	15657	130, 159	15773	21	15PR200	126
15073	95	15360	68	15494	111	15658	130, 159	15774	21	15PR300	126
15074	95	15361	110	15499	80	15659	133	15776	41, 132	15PR600	126
15077	92	15363	110	15501	134	15660	161	15777	41, 131	15PR900	126
15079	93	15365	61	15502	134, 160	15665	159	15778	41, 132	15PR1200	126
15087	111	15367	64	15503	134	15666	159	15780	22	15PRD600	126
15088	113	15369	47	15504	134	15667	159	15782	22	17011	137
15092	115	15373	54	15505	134	15668	161	15787	22, 39, 132	17012	137
15093	111	15374	102	15506	134	15670	135	15800	12	17013	137
15110	88	15379	45	15507	135	15671	130, 145, 160	15801	9	17015	137
15123	81, 93	15381	106	15509	134, 160	15672	133	15802	12	17017	137
15165	91	15382	103	15511	135	15673	133	15803	12	17021	137
15190	114	15383	107	15529	129, 134	15674	133	15804	13	17022	137
15191	117	15384	99	15534	135	15675	133	15805	14	17023	137
15192	115	15385	109	15556	135	15676	133	15806	14	17025	137
15194	114	15388	113	15557	135	15677	133	15807	9	17030	137
15205	146	15390	107	15565	135	15678	145	15810	17	17032	137
15205	146	15391	60	15570	130	15679	132	15811	17	17033	137
15211	146	15392	60	15572	137	15680	132	15815	15	17037	137
15215	145	15393	47	15575	130	15683	132	15817	14	17039	137
15221	145	15395	108, 109	15576	130	15686	133	15826	16	17040	137
15222	147	15396	108, 109	15578	130, 159	15687	133	15827	15	17044	137
15226	145	15397	100	15579	134	15688	161	15833	13	17046	137
15230	152	15398	101	15589	134	15689	133	15839	11	17047	137
15231	151	15401	53	15598	137	15690	132	15843	10	17050	137
15232	147	15402	80	15599	137	15691	133	15850	11	17051	137
15236	149	15408	79	15601	131, 159	15692	133	15857	9	17052	137
15237	93, 148	15409	79	15602	131, 160	15693	133	15861	36	17055	137
15239	149	15410	75	15603	145, 159	15694	132	15870	16	17056	137
15241	151	15411	69	15604	145, 159	15695	133	15871	10	17057	137
15250	153	15415	80	15605	145, 159	15696	133	15875	133	17060	137
15251	152	15418	55	15607	131	15701	134	15876	133	17061	137
15255	153	15419	81	15608	160	15702	134	15885	133	17062	137
15262	154	15420	48	15609	132, 160	15703	134	15886	133	17063	137
15263	154	15421	49	15613	145, 159	15704	134	15895	133	17066	137
15266	154	15422	48	15614	145, 159	15711	41	15896	133	17067	137
15268	155	15423	73	15615	145, 159	15717	27, 131	15BLMH100	145	17070	137
15276	159	15426	47	15616	160	15718	27, 131	15BLMH50	145	17071	137
15295	155	15429	50	15620	161	15719	27, 131	15BLMH70	145	17072	137
15307	52	15430	62	15623	160	15728	39	15E120	127	17073	137
15309	101	15431	62	15624	160	15729	39	15E60	127	17076	137
15310	74	15435	67	15625	160	15731	34	15IG300	127	17077	137
15313	58	15436	46	15626	160	15732	34	15IG600	127	17078	137
15314	46	15437	51	15628	161	15733	34	15IGMHS100	157	17080	137
15315	71	15438	64	15630	161	15735	26	15IGMHS175	157	17081	137
15317	68	15439	70	15631	133	15736	26	15IGMHS35	157	17082	137
15318	68	15443	54	15632	133	15741	34	15IGMHS70	157	17083	137
15319	60	15444	59	15633	133	15742	34	15IGMSH150	157	17085	137
15320	58	15446	45	15634	132	15743	34	15M100	127	17086	137
15322	61	15447	45	15635	132	15745	28	15M200	127	17087	137
15323	73	15449	49	15637	160	15746	28	15M300	127	17088	137
15324	52	15450	65	15638	160	15747	39	15M600	127	17090	137
15325	52	15452	81	15639	160	15748	39	15MHS100	157	17091	137
15326	72	15453	59	15640	161	15750	19	15MHS175	157	17092	137
15328	70	15454	63	15641	133	15751	35	15MHS35	157	17093	137



Design Pro LED



HARDSCAPE, DECK, STEP, BENCH & OUTDOOR KITCHEN LIGHTING

POWERED BY
DESIGN PRO LED
TECHNOLOGY

Discover LED like you've never seen it.

Unique and versatile LED light fixtures that are:

- Designed with a pure, warm, natural 2,950K white light
- Long-life 40,000 hour LED light source
- Tested to withstand the elements for years of enjoyment
- Easy to install
- Easily adapts to almost any hardscape, deck, step, bench or outdoor kitchen application
- Finishes complement popular stone and decking options: Textured Architectural Bronze™, Bronzed Brass, Copper, Gray, Sand and Textured White

For more information see page 24, or go to www.landscapelighting.com, where you can also view complete warranty information.



6-LED
12.9" Length

Textured
Architectural
Bronze

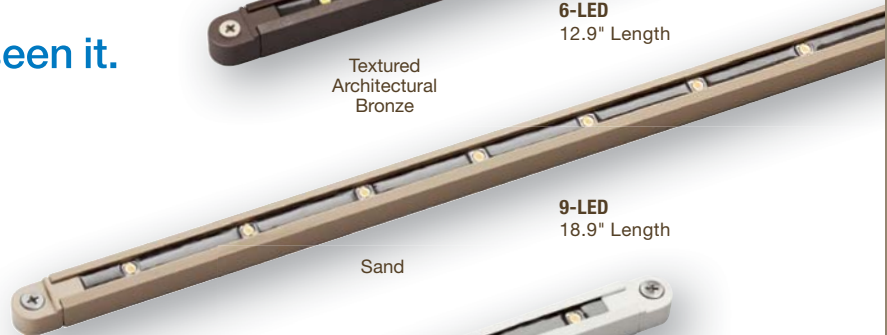

9-LED
18.9" Length

Sand



3-LED
6.9" Length

White

KICHLER 
LIGHTING

KICHLER LIGHTING

World Headquarters
7711 E. Pleasant Valley Road • PO Box 318010
Cleveland, Ohio 44131-8010
www.landscapelighting.com
125M/09-LD-1236. Catalog No. **K211**
Printed in USA. © Copyright All rights reserved. Kichler Lighting.



Become a fan of Kichler Lighting at:
[facebook.com](https://www.facebook.com/kichlerlighting)
search Kichler Lighting



Follow us on
twitter.com/kichlerlight



Watch us on
[youtube.com/KichlerLighting](https://www.youtube.com/KichlerLighting)

