

## 50 VA to 10 kVA

### Applications

- A comprehensive line of transformers for low voltage applications.
- Economical for stepping voltages up or down
- Solve over/under voltage problems efficiently
- Low voltage lighting applications
- International voltage adaptation

### Specifications

- Encapsulated with electrical grade resin
- 60 Hz standard
- Single-phase encapsulated isotransformer / autotransformer
  - 120 x 240V— 12/24V
  - 120 x 240V— 16/32V
  - 120 x 240V— 24/48V
- Three phase autotransformer configurations, using multiple single phase units
- 135°C temperature rise
- 180°C insulation class
- NEMA3R-rated enclosures
- Heat-cured ASA-61 gray powder coat finish
- Cores of high quality electrical steel

### Features, Functions, Benefits

- Slotted mounting holes for quick and easy installation
- Convenient wall mount design with lifting hooks for units 5 kVA and above
- **NOTE: Buck-Boost transformers do not compensate for fluctuating line voltages**



### Standards

- Built in accordance with NEMA, ANSI, UL and CSA standards

### Options and Accessories

- Other sizes, voltages available
- 50/60 Hz options
- Copper windings
- CE Marked units available as custom

### Approvals



Buck-Boost transformers are low voltage isolation transformers that can be connected in an autotransformer arrangement to provide a convenient and economical way to raise or lower single and three-phase voltages from 5-20%. The autotransformer arrangement allows smaller and less expensive Buck-Boost transformers to supply large power loads.

**Solve over/under line voltage problems efficiently and economically.**

Electrical equipment is manufactured to operate most efficiently when the line voltage is close to the nameplate rating of the equipment. A motor operated at a voltage substantially under its nameplate rating may run constantly on the starting windings, resulting in overheating and possible burn-out. The same motor operated at a voltage substantially over its nameplate rating is subject to excessive heat rise, often higher than the insulation temperature limits, which may eventually cause the motor to burn out.

**The difference between an autotransformer and an isolation transformer.**

In an autotransformer, the input (or primary) and the output (or secondary) are electrically connected.

In an isolation transformer they are completely separated, as shown to the right.

Only a portion of the electrical energy is changed in an autotransformer, the remainder flows directly between the primary and secondary. In an isolation transformer, all the energy is transformed. For these reasons, an autotransformer is smaller, lighter and less costly than a comparable isolation transformer.

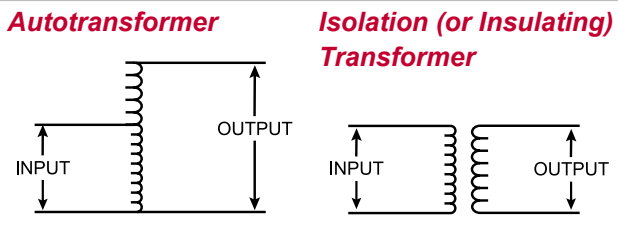

**Caution:** Buck-Boost transformers will not compensate for fluctuating line voltages. They should only be used when line voltage is relatively constant.

**Model Numbers Defined**

416-YYXX-ABC

**Buck-Boost Models**

Primary	Secondary	
120x240	12/24	11
120x240	16/32	12
240x480	24/48	14
120x240	12/24	21
120x240	16/32	22
240x480	24/48	24

**kVA Rating**

YY = 11, 12, 14	YY = 21, 22, 24
Digit XX kVA	Digit XX kVA
00 0.05	01 7.50
01 0.10	11 10.00
11 0.15	
21 0.25	
31 0.50	
41 0.75	
51 1.00	
61 1.50	
71 2.00	
81 3.00	
91 5.00	

**Wiring**

Default	0
Copper	8

**Temperature Rise**

135°C	0
115°C	1

**Shield**

No shield	0
Shield	5

## How to Use the Buck-Boost Rapid Selector Charts

You will need the following information:

### Line voltage:

This can be determined by measuring the supply line voltage with a voltmeter.

### Load voltage:

The voltage at which your equipment was designed to operate. Usually listed on the equipment nameplate.

### Load kVA or load amps:

One of these will usually be listed on the nameplate. You do not need both.

### Supply line and equipment frequencies:

This will be either 50 or 60 Hertz. The supply line frequency must be the same as the frequency of the equipment to be operated.

### Supply line and equipment phase:

Either single-phase or three-phase. The line phase must be the same as the equipment.

### The type of electrical configuration:

Delta or Wye.

## Follow These Five Easy Steps:

1. Find the appropriate single-phase, three-phase delta or three-phase wye table.
2. Read down the voltage column and find the nearest ratio of required load voltage to line voltage for the application desired. (High and low voltage may be either input or output voltage depending on the circumstances.)
3. Reading horizontally across the line beginning with your application voltage ratio, locate in one of the kVA columns a kVA capacity equal to or larger than your load requirement.
4. Note the two digit number at the top of the kVA column listing the kVA capacity you require.
5. In the catalog number column, add these two digits to the catalog number next to the voltage ratio you found in step one.

### Example:

Assume the following information

1. A reasonably constant line voltage of 440 volts.
2. A required equipment voltage of 480 volts.
3. 26.0 kVA load capacity needed.
4. Single-phase line and equipment.

In the voltage column, 437 is closest to our line voltage of 440. The 480 high voltage meets our requirements exactly.

Reading horizontally across this line, find 30.0 kVA, the closest larger kVA to our required 26.0.

Going to the very top of this column, take the two digit number, 81, and add it on the end of the catalog number on the same line as our high/low voltage. The catalog number 416-14, with 81 added on the end, is 416-1481.

**Single-phase kVA capacity of encapsulated Buck-Boost autotransformers**

Maximum load capabilities

Low Voltage (LV)	High Voltage (HV)	Catalog Number	Load Required	01	11	21	31	41	51	61	71	81	91	Wiring Diagram
				.100 kVA	.150 kVA	.250 kVA	.500 kVA	.750 kVA	1.0 kVA	1.5 kVA	2.0 kVA	3.0 kVA	5.0 kVA	
<b>Enclosure Figures</b>				<b>Use Figure 2</b>							<b>Use Figure 3</b>			
95	120	416-12XX	kVA	.37	.56	.94	1.8	2.8	3.7	5.6	7.5	11.2	18.8	2
			AMPS	3.95	5.93	9.89	19.7	29.6	39.5	59.3	79.1	118	197	
100	120	416-11XX	kVA	.50	.75	1.25	2.50	3.7	5.0	7.5	10.0	15.0	25.0	2
			AMPS	5.0	7.5	12.5	25.0	37.0	50.0	75.0	100	150	250	
106	120	416-12XX	kVA	.75	1.12	1.87	3.7	5.6	7.5	11.2	15.0	22.5	37.0	1
			AMPS	7.07	10.5	17.6	34.9	52.8	70.7	105	141	212	349	
109	120	416-11XX	kVA	1.00	1.50	2.50	5.0	7.5	10.0	15.0	20.0	30.0	50.0	1
			AMPS	9.17	13.7	22.9	45.8	68.8	91.7	137	183	275	458	
120	132	416-11XX	kVA	1.10	1.65	2.75	5.5	8.2	11.0	16.5	22.0	33.0	55.0	1
			AMPS	9.17	13.7	22.9	45.8	68.6	91.7	137	183	275	458	
120	136	416-12XX	kVA	.85	1.27	2.12	4.2	6.3	8.5	12.7	17.0	25.5	42.0	1
			AMPS	7.08	10.5	17.6	35.0	52.5	70.8	105	141	212	350	
120	144	416-11XX	kVA	.60	.90	1.50	3.0	4.5	6.0	9.0	12.0	18.0	30.0	2
			AMPS	5.0	7.5	12.5	25.0	37.5	50.0	75.0	100	150	250	
120	152	416-12XX	kVA	.47	.71	1.18	2.3	3.5	4.7	7.1	9.5	14.2	23.0	2
			AMPS	3.91	5.91	9.83	19.1	29.1	39.1	59.1	79.1	118	191	
200	240	416-14XX	kVA	.50	.75	1.25	2.5	3.7	5.0	7.5	10.0	15.0	25.0	2
			AMPS	2.50	3.75	6.25	12.5	18.7	25.0	37.5	50.0	75.0	125	
208	236	416-12XX	kVA	.7	1.10	1.84	3.6	5.5	7.3	11.0	14.7	22.1	36.8	4
			AMPS	3.53	5.28	8.82	17.4	26.4	35.3	52.8	70.7	106	174	
212	240	416-12XX	kVA	.75	1.12	1.87	3.7	5.6	7.5	11.2	15.0	22.5	37	4
			AMPS	3.53	5.28	8.82	17.4	26.4	35.3	52.8	70.7	106	174	
208	230	416-11XX	kVA	.95	1.4	2.3	4.7	7.1	9.5	14.3	19.0	28.6	47.6	4
			AMPS	4.58	6.88	11.4	22.9	34.4	45.8	68.8	91.7	137	229	
218	240	416-11XX	kVA	1.00	1.5	2.5	5.0	7.5	10.0	15.0	20.0	30.0	50.0	4
			AMPS	4.58	6.88	11.4	22.9	34.4	45.8	68.8	91.7	137	229	
225	240	416-12XX	kVA	1.5	2.25	3.75	7.5	11.2	15.0	22.5	30.0	45.0	75.0	3
			AMPS	6.66	10.0	16.6	33.3	49.7	66.6	100	133	200	333	
230	276	416-14XX	kVA	.57	.86	1.43	2.8	4.3	5.7	8.6	11.5	17.2	28.7	2
			AMPS	2.50	3.75	6.25	12.5	18.7	25.0	37.5	45.0	75.0	124	
240	252	416-11XX	kVA	2.1	3.15	5.25	10.5	15.7	21.0	31.5	42.0	63.0	105	3
			AMPS	8.75	13.1	21.8	43.7	65.4	87.5	131	175	262	437	
240	264	416-11XX	kVA	1.1	1.65	2.75	5.5	8.2	11.0	16.5	22.0	33.0	55.0	4
			AMPS	4.58	6.87	11.4	22.9	34.1	45.8	68.7	91.6	137	229	
240	272	416-12XX	kVA	.85	1.27	2.12	4.2	6.3	8.5	12.7	17.0	25.5	42.0	4
			AMPS	3.54	5.29	8.83	17.5	26.2	35.4	52.9	70.8	106	175	
240	288	416-14XX	kVA	.60	.90	1.50	3.0	4.5	6.0	9.0	12.0	18.0	30.0	2
			AMPS	2.5	3.75	6.25	12.5	18.7	25.0	37.5	50.0	75.0	125	
437	480	416-14XX	kVA	1.00	1.50	2.50	5.0	7.5	10.0	15.0	20.0	30.0	50.0	4
			AMPS	2.28	3.43	5.72	11.4	17.1	22.8	34.3	45.7	68.6	114	
457	480	416-14XX	kVA	2.0	3.0	5.0	10.0	15.0	20.0	30.0	40.0	60.0	100	3
			AMPS	4.37	6.56	10.9	21.8	32.8	43.7	65.6	87.5	131	218	
480	504	416-14XX	kVA	2.1	3.15	5.25	10.5	15.7	21.0	31.5	42.0	63.0	105	3
			AMPS	4.37	6.56	10.9	21.8	32.8	43.7	65.6	87.5	131	218	
480	528	416-14XX	kVA	1.1	1.65	2.75	5.5	8.2	11.0	16.5	22.0	33.0	55.0	4
			AMPS	2.29	3.43	5.72	11.4	17.0	22.9	34.3	45.8	68.7	114	

**Wiring Diagram 1**

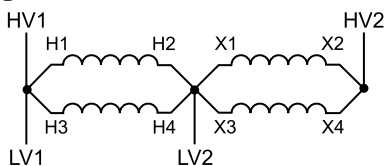

**Wiring Diagram 2**

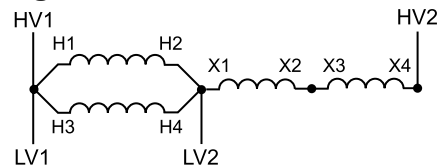

**Wiring Diagram 3**

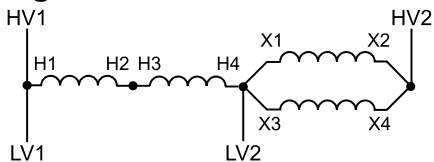

**Wiring Diagram 4**

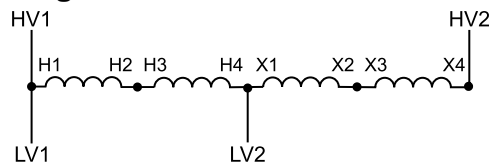

**Three-phase kVA capacity of encapsulated Buck-Boost autotransformers connected in open-delta**

Maximum load capabilities requiring two Buck-Boost Transformers

Low Voltage (LV)	High Voltage (HV)	Catalog Number	Load Required	01	11	21	31	41	51	61	71	81	91	Wiring Diagram
				.100 kVA	.150 kVA	.250 kVA	.500 kVA	.750 kVA	1.0 kVA	1.5 kVA	2.0 kVA	3.0 kVA	5.0 kVA	
<b>Enclosure Figures</b>				<b>Use Figure 2</b>						<b>Use Figure 3</b>				
200	240	416-14XX	kVA	.86	1.29	2.1	4.3	6.4	8.6	12.9	17.2	25.0	43.0	10
			AMPS	2.1	3.1	5.1	10.3	15.4	20.7	31.0	41.4	60.1	103.4	
208	236	416-12XX	kVA	1.27	1.91	3.1	6.3	9.5	12.7	19.1	225.5	38.2	63.7	12
			AMPS	3.1	4.7	7.6	15.4	23.2	31.1	46.7	62.4	93.4	155.8	
212	240	416-12XX	kVA	1.29	1.94	3.2	6.4	9.7	12.9	19.4	25.8	38.0	64.0	12
			AMPS	3.1	4.7	7.7	15.4	23.3	31.0	46.7	62.1	91.4	154.0	
208	230	416-11XX	kVA	1.65	2.47	4.1	8.2	12.3	16.5	24.7	33.0	29.5	82.5	12
			AMPS	4.1	6.2	10.3	20.6	30.9	41.4	62.0	82.8	124.3	207.1	
218	240	416-11XX	kVA	1.73	2.59	4.3	8.6	12.9	17.3	25.9	34.6	51.0	86.0	12
			AMPS	4.2	6.2	10.3	20.7	31.0	41.6	62.3	83.2	122.7	206.9	
225	240	416-12XX	kVA	2.59	3.89	6.4	12.9	19.4	25.9	38.9	51.9	77.0	129	11
			AMPS	6.2	9.4	15.4	31.0	46.7	62.3	93.6	124.8	185.2	310.3	
229	240	416-11XX	kVA	3.46	5.18	8.6	17.3	25.9	34.6	51.8	69.2	103	173	11
			AMPS	8.3	12.5	20.7	41.6	62.3	83.2	124.6	166.5	247.8	416.2	
230	253	416-14XX	kVA	1.81	2.72	4.5	9.0	13.6	18.1	27.2	36.3	54.0	90.0	9
			AMPS	4.1	6.2	10.3	20.5	31.0	41.3	62.1	82.8	123.2	205.4	
230	276	416-14XX	kVA	0.99	1.49	2.4	4.9	7.4	9.9	14.9	19.9	29.0	49.0	10
			AMPS	2.1	3.1	5.0	10.2	15.5	20.7	31.2	41.6	60.7	102.5	
240	252	416-11XX	kVA	3.64	5.47	9.1	18.2	27.2	36.4	54.7	72.8	109	182	11
			AMPS	8.3	12.5	20.8	41.7	62.3	83.4	125.3	166.8	249.7	417.0	
2240	264	416-11XX	kVA	1.9	2.86	4.7	9.5	14.2	19.0	28.6	38.1	57.0	95.0	12
			AMPS	4.2	6.3	10.3	20.8	31.1	41.6	62.5	83.3	124.7	207.8	
240	272	416-12XX	kVA	1.47	2.2	3.6	7.3	11.0	14.7	22.0	29.4	44.1	73.6	12
			AMPS	3.1	4.7	7.6	15.5	23.3	31.2	46.7	62.4	93.6	156.2	
240	288	416-14XX	kVA	1.03	1.55	2.5	5.1	7.7	10.3	15.5	20.7	31.0	51.0	10
			AMPS	2.1	3.1	5.0	10.2	15.4	20.6	31.1	41.5	62.3	102.2	
437	480	416-14XX	kVA	1.73	2.59	4.3	8.6	12.9	17.3	25.9	34.6	51.0	86.0	12
			AMPS	2.1	3.1	5.2	10.3	15.5	20.8	31.2	41.6	61.3	103.4	
457	480	416-14XX	kVA	3.46	5.18	8.6	17.3	25.9	34.6	51.8	69.2	103	173	11
			AMPS	4.2	6.2	10.3	20.8	31.2	41.6	62.3	83.2	123.9	208.1	
480	504	416-14XX	kVA	3.64	5.47	9.1	18.2	27.2	36.4	54.7	72.8	109	183	11
			AMPS	4.2	6.3	10.4	20.8	31.2	41.7	62.7	83.4	124.9	209.6	
480	528	416-14XX	kVA	1.9	2.86	4.7	9.5	14.2	19.0	28.6	38.1	57.0	95.0	12
			AMPS	2.1	3.1	5.1	10.4	15.5	20.8	31.3	41.7	62.3	103.9	

**Wiring Diagram 9**

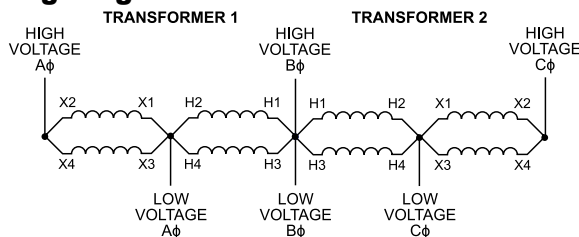

**Wiring Diagram 10**

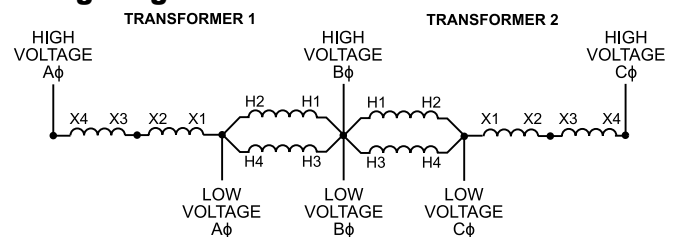

**Wiring Diagram 11**

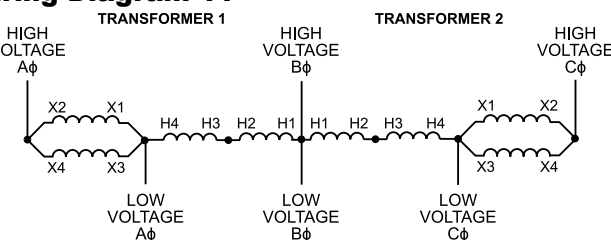

**Wiring Diagram 12**

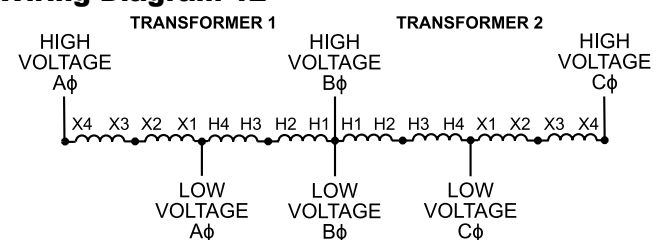

**Three-phase kVA capacity of encapsulated Buck-Boost autotransformers connected in Wye**

Maximum load capabilities requiring three Buck-Boost Transformers

Low Voltage (LV)	High Voltage (HV)	Catalog Number	Load Required	01	11	21	31	41	51	61	71	81	91	Wiring Diagram
				.100 kVA	.150 kVA	.250 kVA	.500 kVA	.750 kVA	1.0 kVA	1.5 kVA	2.0 kVA	3.0 kVA	5.0 kVA	
<b>Enclosure Figures</b>				<b>Use Figure 2</b>						<b>Use Figure 3</b>				
164	208	416-12XX	kVA	1.1	1.7	2.8	5.6	8.4	11.2	16.8	22.0	34.0	56.0	6
			AMPS	3.89	5.89	9.79	18.9	29.4	38.9	58.9	78.9	117	197	
173	208	416-11XX	kVA	1.5	2.2	3.7	7.5	11.2	15.0	22.5	30.0	45.5	75.0	6
			AMPS	5.0	7.5	12.5	25.0	37.0	50.0	75.0	100	150	250	
183	208	416-12XX	kVA	2.2	3.3	5.6	11.2	16.8	22.5	33.7	45.0	67.0	112	5
			AMPS	7.07	10.5	17.6	34.9	52.8	70.7	105	141	212	354	
189	208	416-11XX	kVA	3.0	4.5	7.5	15.0	22.5	30.0	45.0	60.0	90.0	150	5
			AMPS	9.17	13.7	22.9	45.8	68.8	91.7	137	183	275	458	
208	229	416-11XX	kVA	3.3	4.9	8.2	16.5	24.7	33.0	49.5	66.0	99.0	165	5
			AMPS	9.17	13.7	22.9	45.8	68.8	91.7	137	183	275	458	
208	235	416-12XX	kVA	2.5	3.8	6.3	12.7	19.1	25.5	38.2	51.0	76.5	127	5
			AMPS	7.08	10.5	17.6	35.0	52.5	70.8	105	141	212	350	
208	249	416-11XX	kVA	1.8	2.7	4.5	9.0	13.5	18.0	27.0	36.0	54.0	90.0	6
			AMPS	5.0	7.5	12.5	25.0	37.5	50.0	75.0	100	150	250	
208	263	416-12XX	kVA	1.4	2.1	3.5	7.1	10.6	14.2	21.4	28.0	42.0	71.0	6
			AMPS	3.91	5.91	9.83	19.1	29.1	39.1	59.1	79.1	118	191	
346	416	416-14XX	kVA	1.5	2.2	3.7	7.5	11.2	15.0	22.5	30.0	45.0	75.0	6
			AMPS	2.5	3.75	6.25	12.5	18.5	25.0	37.5	50.0	75.0	125	
367	416	416-12XX	kVA	2.2	3.3	5.6	11.2	16.8	22.5	33.7	45.0	67.0	112	8
			AMPS	3.53	5.28	8.82	17.4	26.4	35.3	52.8	70.7	106	174	
378	416	416-12XX	kVA	3.0	4.5	7.5	15.0	22.5	30.0	45.0	60.0	90.0	150	8
			AMPS	4.58	6.88	11.4	22.9	34.4	45.8	68.8	91.7	137	229	
390	416	416-11XX	kVA	4.5	6.7	11.2	22.5	33.7	45.0	67.5	90.0	135	225	7
			AMPS	6.66	10.0	16.6	33.3	49.7	66.6	100	133	200	333	
397	416	416-11XX	kVA	6.0	9.0	15.0	30.0	45.0	60.0	90.0	120	180	300	7
			AMPS	8.73	13.1	21.8	43.6	65.5	87.3	131	174	262	436	
398	438	416-12XX	kVA	3.1	4.7	7.8	15.7	23.6	31.5	47.2	63.0	94.0	157	5
			AMPS	4.56	6.82	11.3	22.6	33.9	45.6	68.2	91.3	136	229	
398	478	416-14XX	kVA	1.7	2.5	4.3	8.6	12.9	17.2	25.9	34.0	51.0	86.0	6
			AMPS	2.50	3.75	6.25	12.5	18.7	25.0	37.5	50.0	75.0	125	
416	437	416-11XX	kVA	6.3	9.4	15.7	31.5	47.2	63.0	94.5	126	189	315	7
			AMPS	8.75	13.1	21.8	43.7	65.4	87.5	131	175	262	437	
416	443	416-11XX	kVA	4.8	7.2	12.0	24.0	36.0	48.0	72.0	96.0	144	240	7
			AMPS	6.66	10.0	16.6	33.3	50.0	66.6	100	133	200	333	
416	457	416-12XX	kVA	3.3	4.9	8.2	16.5	24.7	33.0	49.5	66.0	99.0	165	8
			AMPS	4.58	6.87	11.4	22.9	34.1	45.8	68.7	91.6	137	229	
416	471	416-14XX	kVA	2.5	3.8	6.3	12.7	19.1	25.5	38.2	51.0	76.5	127	8
			AMPS	3.54	5.29	8.83	17.5	26.2	35.4	52.9	70.8	106	175	
416	498	416-14XX	kVA	1.8	2.7	4.5	9.0	13.5	18.0	27.0	36.0	54.0	90.0	6
			AMPS	2.5	3.75	6.25	12.5	18.7	25.0	37.5	50.0	75.0	125	

**Wiring Diagram 5**

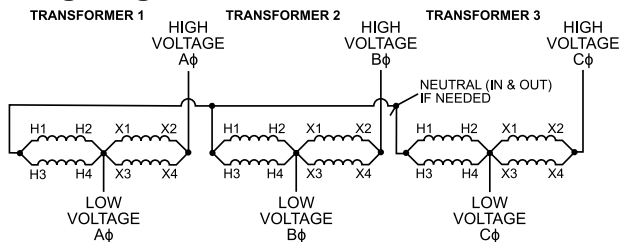

**Wiring Diagram 6**

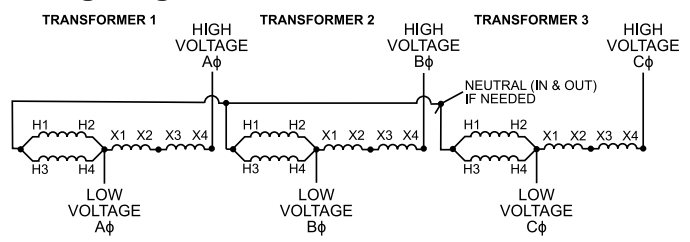

**Wiring Diagram 7**

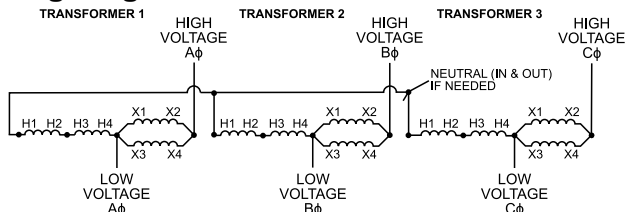

**Wiring Diagram 8**

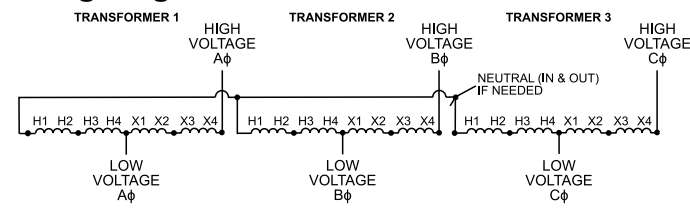



**Single-Phase — 600V Class Isolation Transformers**

.050 – 1 kVA: 130°C Insulation Class • 1.5 – 10 kVA: 180°C Insulation Class

120 x 240V — 12/24V 60 Hz											
kVA	Catalog Number	Temp Rise	Enclosure Figure	Height (A)	Width (B)	Depth (C)	(D)	(E)	(F)	Est Ship Wgt	Wiring Diagram
0.05	416-1100-000	95	2	8.03	3.31	3.08	6.81	6.19	2.25	4	S240B
0.1	416-1101-000	95	2	8.03	3.31	3.08	6.81	6.19	2.25	5	
0.15	416-1111-000	95	2	8.03	3.31	3.08	6.81	6.19	2.25	8	
0.25	416-1121-000	95	2	8.03	3.31	3.08	6.81	6.19	2.25	6	
0.5	416-1131-000	95	2	10.19	5.06	4.59	9.06	8.38	2.25	12	
0.75	416-1141-000	95	2	10.19	5.06	4.59	9.06	8.38	2.25	17	
1	416-1151-000	95	2	10.19	5.06	4.59	9.06	8.38	2.25	17.8	
1.5	416-1161-000	135	3	12.5	6.69	5.34	10.56	12.0	2.25	26.8	
2	416-1171-000	135	3	12.5	6.69	5.34	10.56	12.0	2.25	33.4	
3	416-1181-000	135	3	14.56	7.56	7.15	12.68	14.12	3.5	62	
5	416-1191-000	135	3	14.56	7.56	7.15	12.68	14.12	3.5	90	
7.5	416-2101-000	135	4	16.12	13.5	8.55	10.62	8.25	5.5	144	
10	416-2111-000	135	4	16.12	13.5	8.55	10.62	8.25	5.5	178	
120 x 240V — 12/24V 60 Hz											
kVA	Catalog Number	Temp Rise	Enclosure Figure	Height (A)	Width (B)	Depth (C)	(D)	(E)	(F)	Est Ship Wgt	Wiring Diagram
0.1	416-1201-000	135	2	8.03	3.31	3.08	6.81	6.19	2.25	5	S240C
0.15	416-1211-000	95	2	8.03	3.31	3.08	6.81	6.19	2.25	5	
0.25	416-1221-000	95	2	8.03	3.31	3.08	6.81	6.19	2.25	6	
0.5	416-1231-000	95	2	10.19	5.06	4.59	9.06	8.38	2.25	15	
0.75	416-1241-000	95	2	10.19	5.06	4.59	9.06	8.38	2.25	17	
1	416-1251-000	95	2	10.19	5.06	4.59	9.06	8.38	2.25	18	
1.5	416-1261-000	135	3	12.5	6.69	5.34	10.56	12.0	2.25	26.8	
2	416-1271-000	135	3	12.5	6.69	5.34	10.56	12.0	2.25	33.4	
3	416-1281-000	135	3	14.56	7.56	7.15	12.68	14.12	3.5	58	
5	416-1291-000	135	3	14.56	7.56	7.15	12.68	14.12	3.5	95	
7.5	416-2201-000	135	4	16.12	13.5	8.55	10.62	8.25	5.5	144	
10	416-2211-000	135	4	16.12	13.5	8.55	10.62	8.25	5.5	178	
240 x 480V — 24/48V 60 Hz											
kVA	Catalog Number	Temp Rise	Enclosure Figure	Height (A)	Width (B)	Depth (C)	(D)	(E)	(F)	Est Ship Wgt	Wiring Diagram
0.1	416-1401-000	95	2	8.03	3.31	3.08	6.81	6.19	2.25	4	S480E
0.15	416-1411-000	95	2	8.03	3.31	3.08	6.81	6.19	2.25	5	
0.25	416-1421-000	95	2	8.03	3.31	3.08	6.81	6.19	2.25	6	
0.5	416-1431-000	95	2	10.19	5.06	4.59	9.06	8.38	2.25	15	
0.75	416-1441-000	95	2	10.19	5.06	4.59	9.06	8.38	2.25	17	
1	416-1451-000	95	2	10.19	5.06	4.59	9.06	8.38	2.25	17.8	
1.5	416-1461-000	135	3	12.5	6.69	5.34	10.56	12.0	2.25	26.8	
2	416-1471-000	135	3	12.5	6.69	5.34	10.56	12.0	2.25	33.4	
3	416-1481-000	135	3	14.56	7.56	7.15	12.68	14.12	3.5	58	
5	416-1491-000	135	3	14.56	7.56	7.15	12.68	14.12	3.5	88	
7.5	416-2401-000	135	4	16.12	13.5	8.55	10.62	8.25	5.5	144	
10	416-2411-000	135	4	16.12	13.5	8.55	10.62	8.25	5.5	178	

See website for additional kVA, copper windings and temperature options.  
 Housing dimensions subject to change without notice. Consult website or factory where dimensions are critical.  
 Use the "Find a Product" tool for detailed specification sheets.  
 For further information, contact an Application Engineer at 800-892-3755, technical\_services@jeffersonelectric.com



## Buck-Boost Isolation Transformer Wiring Diagrams

### S240B Wiring Diagram & Connections

#### Wiring Diagram

Primary: 120 x 240 Volts Delta  
Secondary: 12/24 Volts

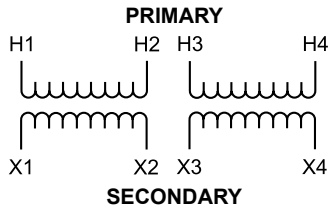

#### Connections

Primary Volts	Interconnect	Primary Lines Connect To
240	H2 to H3	H1, H4
120	H1 to H3 H2 to H4	H1, H4
Secondary Volts	Interconnect	Secondary Lines Connect To
24	X2 to X3	X1, X4
12	X1 to X3 X2 to X4	X1, X4

### S240C Wiring Diagram & Connections

#### Wiring Diagram

Primary: 120 x 240 Volts Delta  
Secondary: 16/32

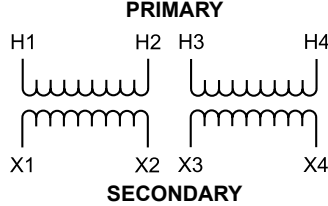

#### Connections

Primary Volts	Interconnect	Primary Lines Connect To
240	H2 to H3	H1, H4
120	H1 to H3 H2 to H4	H1, H4
Secondary Volts	Interconnect	Secondary Lines Connect To
32	X2 to X3	X1, X4
16	X1 to X3 X2 to X4	X1, X4

### S240E Wiring Diagram & Connections

#### Wiring Diagram

Primary: 240 x 480 Volts Delta  
Secondary: 24/48 Volts

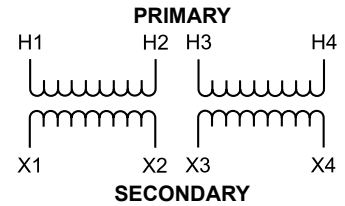

#### Connections

Primary Volts	Interconnect	Primary Lines Connect To
480	H2 to H3	H1, H4
240	H1 to H3 H2 to H4	H1, H4
Secondary Volts	Interconnect	Secondary Lines Connect To
48	X2 to X3	X1, X4
24	X1 to X3 X2 to X4	X1, X4

More wiring diagrams can be found in catalog's appendix, section 15.

Use the "Find a Product" tool on our website for detailed specification sheets.

For further information, contact an Application Engineer at 800-892-3755, [technical\\_services@jeffersonelectric.com](mailto:technical_services@jeffersonelectric.com)

## Enclosure Figures

**Figure 2**

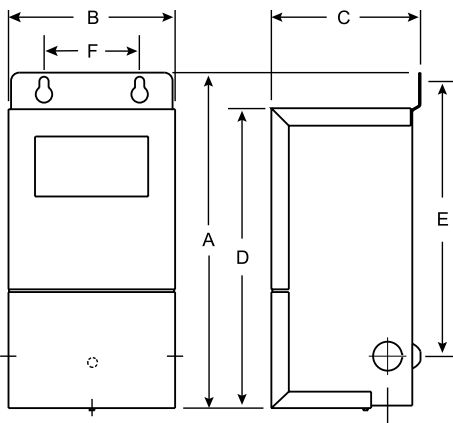

**Figure 3**

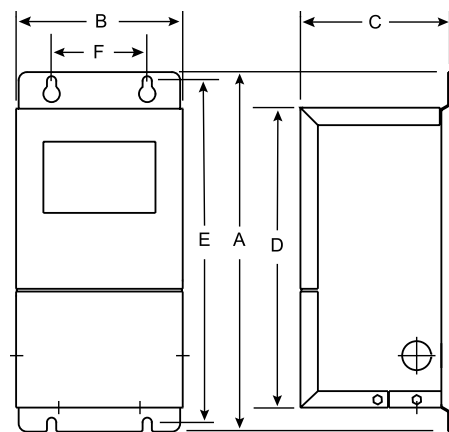

**Figure 4**

