

SIEMENS

SITOP power supply

SITOP PSU100S

Operating Instructions

SITOP PSU100S 24 V/2.5 A
6EP1332-2BA20
SITOP PSU100S 24 V/5 A
6EP1333-2BA20
SITOP PSU100S 24 V/10 A
6EP1334-2BA20
SITOP PSU100S 24 V/20 A
6EP1336-2BA10
SITOP PSU100S 12 V/7 A
6EP1322-2BA00
SITOP PSU100S 12 V/14 A
6EP1323-2BA00

07.2014

C98130-A7589-A1-5-7629



Overview

Safety instructions	1
Description, device design, dimension drawing	2
Mounting/removal	3
Mounting position, mounting clearances	4
Installation	5
Technical data	6
Safety, approvals, EMC	7
Ambient conditions	8
Applications	9
Environment	10
Service & Support	11

Legal information

Warning notice system

This manual contains notices you have to observe in order to ensure your personal safety, as well as to prevent damage to property. The notices referring to your personal safety are highlighted in the manual by a safety alert symbol, notices referring only to property damage have no safety alert symbol. These notices shown below are graded according to the degree of danger.

 DANGER
indicates that death or severe personal injury will result if proper precautions are not taken.
 WARNING
indicates that death or severe personal injury may result if proper precautions are not taken.
 CAUTION
indicates that minor personal injury can result if proper precautions are not taken.
NOTICE
indicates that property damage can result if proper precautions are not taken.

If more than one degree of danger is present, the warning notice representing the highest degree of danger will be used. A notice warning of injury to persons with a safety alert symbol may also include a warning relating to property damage.

Qualified Personnel

The product/system described in this documentation may be operated only by **personnel qualified** for the specific task in accordance with the relevant documentation, in particular its warning notices and safety instructions. Qualified personnel are those who, based on their training and experience, are capable of identifying risks and avoiding potential hazards when working with these products/systems.

Proper use of Siemens products

Note the following:

 WARNING
Siemens products may only be used for the applications described in the catalog and in the relevant technical documentation. If products and components from other manufacturers are used, these must be recommended or approved by Siemens. Proper transport, storage, installation, assembly, commissioning, operation and maintenance are required to ensure that the products operate safely and without any problems. The permissible ambient conditions must be complied with. The information in the relevant documentation must be observed.

Trademarks

All names identified by ® are registered trademarks of Siemens AG. The remaining trademarks in this publication may be trademarks whose use by third parties for their own purposes could violate the rights of the owner.

Disclaimer of Liability

We have reviewed the contents of this publication to ensure consistency with the hardware and software described. Since variance cannot be precluded entirely, we cannot guarantee full consistency. However, the information in this publication is reviewed regularly and any necessary corrections are included in subsequent editions.

Overview

Description



The 1-phase SITOP PSU100S from the SITOP smart product line is a powerful, regulated standard power supply for automated machines and systems. In addition to a high efficiency, these low-profile power supply units have an outstanding overload behavior.

The key benefits of the product include:

- Wide-range input, which allows them to be connected to almost any 1-phase line supply around the world
- Output voltage can be adjusted in the range 22.2 (24)...28 V or 11.5...15.5 V
- Brief overload capability of 150% for 5 s/min (extra power)
- Continuous overload capability of 120% up to an ambient temperature of +45° C
- Integrated signaling contact for "24 V OK" or "12 V OK"
- Ambient temperature -25 (0)...+70 °C
- To increase the system availability, these reliable power supplies can be expanded using SITOP supplementary modules (redundancy module, selectivity module, buffer module), as well as SITOP DC-UPS modules.

Ordering data

The following device options are available:

Regulated SITOP PSU100S power supply	
Type	Order number
1-phase 120/230 V AC input, 24 V/2.5 A DC output	6EP1332-2BA20
1-phase 120/230 V AC input, 24 V/5 A DC output	6EP1333-2BA20
1-phase 120/230 V AC input, 24 V/10 A DC output	6EP1334-2BA20
1-phase 120/230 V AC input, 24 V/20 A DC output	6EP1336-2BA10
1-phase 120/230 V AC input, 12 V/7 A DC output	6EP1322-2BA00
1-phase 120/230 V AC input, 12 V/14 A DC output	6EP1323-2BA00

Accessories	
Item	Order number
Device identification labels 10 mm × 7 mm, pastel turquoise	3RT1900-1SB10
Device identification labels 20 mm × 7 mm, pastel turquoise	3RT1900-1SB20

Table of contents

	Overview	3
1	Safety instructions	7
2	Description, device design, dimension drawing	9
2.1	Device description.....	9
2.2	Connections and terminal designation.....	10
2.3	Potentiometer.....	11
2.4	Status displays and signaling.....	12
2.5	Block diagram.....	13
2.6	Dimensions and weight.....	14
3	Mounting/removal	17
4	Mounting position, mounting clearances	19
4.1	Standard mounting position.....	19
4.2	Other mounting positions.....	22
4.2.1	6EP1332-2BA20.....	22
4.2.2	6EP1333-2BA20.....	24
4.2.3	6EP1334-2BA20.....	26
4.2.4	6EP1336-2BA10.....	28
4.2.5	6EP1322-2BA00.....	30
4.2.6	6EP1323-2BA00.....	32
5	Installation	35
5.1	Line-side connection.....	35
5.2	Output-side connection.....	37
6	Technical data	39
6.1	Input.....	39
6.2	Output.....	41
6.3	Efficiency.....	47
6.4	Closed-loop control.....	50
6.5	Protection and monitoring.....	51
6.6	MTBF.....	51
6.7	Mechanical system.....	52
6.8	Accessories.....	53
6.9	Dimension drawing.....	53

7	Safety, approvals, EMC	55
7.1	Safety	55
7.2	Test voltage.....	56
7.3	Approvals	57
7.4	EMC	58
8	Ambient conditions.....	59
9	Applications	61
9.1	Parallel connection to increase power rating	61
9.2	Parallel connection for redundancy.....	63
9.3	Series connection for increased voltage	64
9.4	Overload protection in the 24 V output circuit	65
9.5	Protection against short-time voltage dips	66
9.6	Protecting against longer power failures.....	67
10	Environment	69
11	Service & Support.....	71

Safety instructions

1

 WARNING
Correct handling of the devices When operating electrical devices, it is inevitable that certain components will carry dangerous voltages. Therefore, failure to handle the units properly can result in death or serious physical injury as well as extensive property damage. Only appropriately qualified personnel may work on or in the vicinity of this equipment. Perfect, safe, and reliable operation of this equipment is dependent on proper transportation, storage, installation and mounting. Before installation or maintenance work can begin, the system's main switch must be switched off and measures taken to prevent it being switched on again. If this instruction is not observed, touching live parts can result in death or serious injury.

Description, device design, dimension drawing

2.1 Device description

SITOP PSU100S is a primary-clocked power supply for connection to a 1-phase AC line supply. An electronically regulated DC voltage that can be set via a potentiometer is available at the output of the device. The output of the device is isolated, no-load proof and short-circuit proof. The LED display indicates the operating status. The operating state of the device can be processed via the signaling contact.

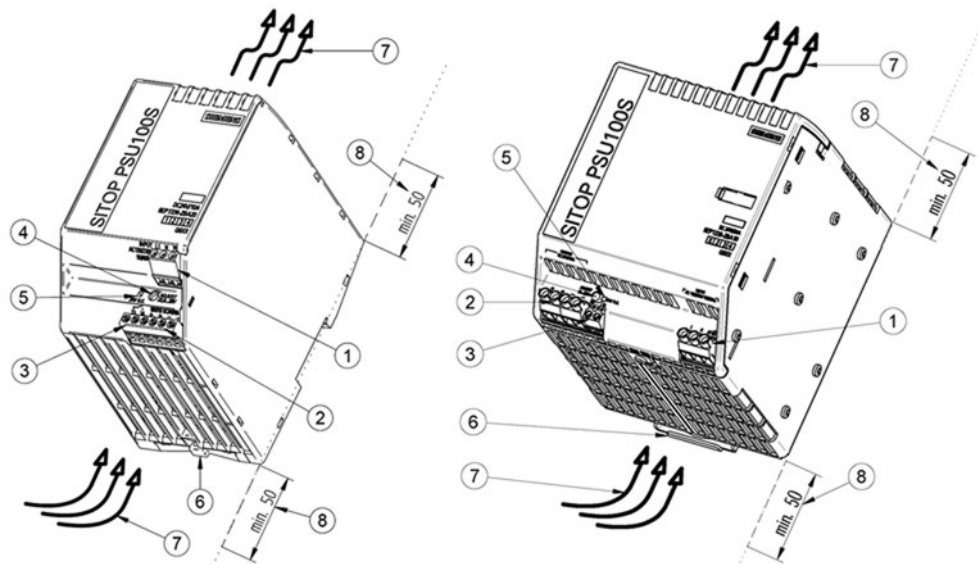

- ① Line input
- ② DC output
- ③ Signaling contacts
- ④ Potentiometer 22.2...28 / 24...28 V / 11.5...15.5 V
- ⑤ Indicator light (output voltage OK)
- ⑥ DIN rail slider
- ⑦ Natural convection
- ⑧ Clearance above/below





Figure 2-1 Design

2.2 Connections and terminal designation

The line input terminals ① can be used to establish the connection to supply voltage. The output terminals ② are used to connect to the loads to be supplied (see also Section Installation (Page 35)).





The operating state of the device can be processed via the signaling contact ③ (function and contact rating, see Chapter Status displays and signaling (Page 12)).

Connections and terminal designations	
① Line input L1, N, PE	One screw terminal each
② Output +	2 screw terminals
② Output -	2 screw terminals
③ Signaling contact 13, 14	One screw terminal each

	① + ② + ③	④
	SZS 0,6 x 3,5 / PZ1 / PH1	SZS 0,6 x 3 / PZ1 / PH1 max. Ø 3,5 mm
	1 x 0,5 - 2,5 mm ²	-
	1 x 0,5 - 2,5 mm ²	-
AWG	28 - 12	-
Nm	0,5 Nm	0,04 Nm ^{*)}
	8 mm	-

^{*)} Do not subject the end stop to higher loads

Figure 2-2 Terminal data for 6EP1332-2BA20, 6EP1333-2BA20, 6EP1334-2BA20, 6EP1322-2BA00, 6EP1323-2BA00

	① + ②	③	④
	SZS 0,6 x 3,5 / PZ1 / PH1	SZS 0,6 x 3,5	SZS 0,6 x 3 / PZ1 / PH1 max. Ø 3,5 mm
	1 x 0,2 - 6 mm ²	1 x 0,14 - 1,5 mm ²	-
	1 x 0,2 - 4 mm ²	1 x 0,14 - 1,5 mm ²	-
AWG	24 - 10	28 - 16	-
Nm	0,5 - 0,6 Nm	0,22 Nm	0,04 Nm ^{*)}
	8 mm	7 mm	-

^{*)} Do not subject the end stop to higher loads

Figure 2-3 Terminal data for 6EP1336-2BA10

2.3 Potentiometer

The potentiometer ④ on the front of the device is used to adjust the output voltage. The output voltage is set to the rated value at the factory and can be set within certain limits; for example, to compensate voltage drops across long supply lines to the connected load.

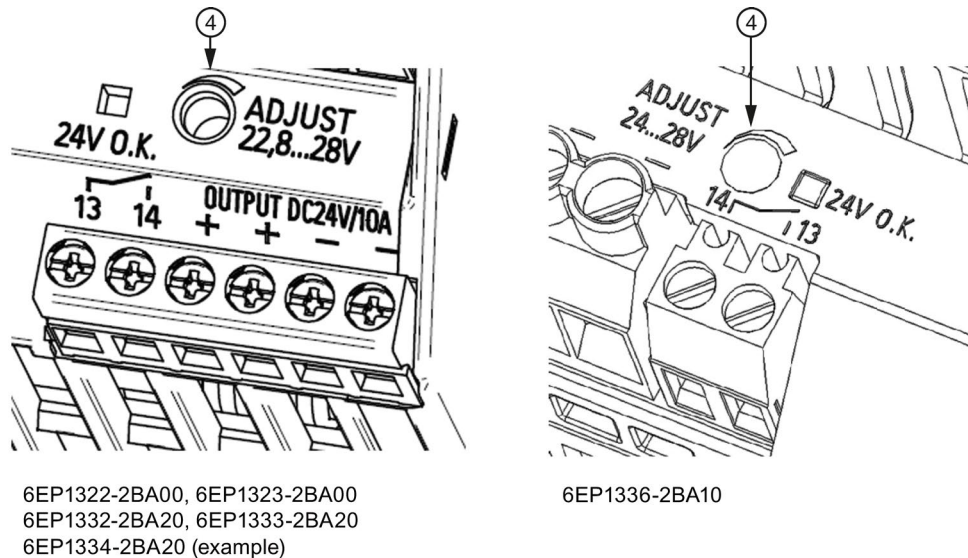

Figure 2-4 Potentiometer

Type	Factory setting	Adjustment range
6EP1322-2BA00 6EP1323-2BA00	12 V	11.5...15.5 V
6EP1332-2BA20 6EP1333-2BA20 6EP1334-2BA20	24 V	22.2...28 V
6EP1336-2BA10	24 V	24...28 V

NOTICE

Thermal overload possible

When adjusting the output voltage to greater than the rated voltage, the output current must be derated by 4 %/V, or the permissible ambient temperature must be taken into account with 3° C/V.

Note

It is only permissible to use an insulated screwdriver when actuating the potentiometer.

For notes on actuating the potentiometer (screwdriver, torque), refer to Figure 2-2 Terminal data for 6EP1332-2BA20, 6EP1333-2BA20, 6EP1334-2BA20, 6EP1322-2BA00, 6EP1323-2BA00 (Page 10) and Figure 2-3 Terminal data for 6EP1336-2BA10 (Page 10).

2.4 Status displays and signaling

	6EP1322-2BA00, 6EP1323-2BA00, 6EP1332-2BA20 6EP1333-2BA20, 6EP1334-2BA20, 6EP1336-2BA10
Status display	LED green for 24 V O.K. or 12 V O.K.
Signaling contact	Relay contact (NO contact, contact rating 30 V AC / 0.5 A, 60 V DC / 0.3 A, 30 V DC / 1 A) for 24 V O.K. or 12 V O.K.

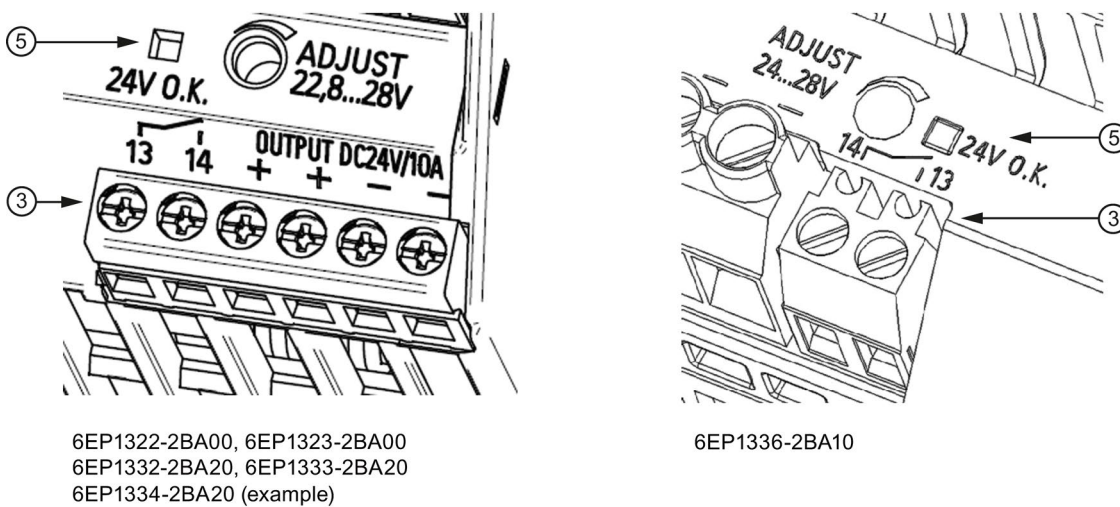

Figure 2-5 Status displays and signaling

Signaling	6EP1322-2BA00 6EP1323-2BA00	6EP1332-2BA20 6EP1333-2BA20 6EP1334-2BA20	6EP1336-2BA10
LED (5) lights up green Signaling contact (3), contacts 13-14 closed	Normal operation, Output voltage >10 V ±0.5 V	Normal operation, Output voltage >20 V ±0.5 V	Normal operation, Output voltage >20 V ±0.5 V
LED (5) dark Signaling contact (3), contacts 13-14 open (inactive position)	Overload operation or power supply voltage missing	Overload operation or power supply voltage missing	Overload / hiccup operation, power supply missing or the device has tripped due to overtemperature (reset possible with power OFF for approx. 30 min)

2.5 Block diagram

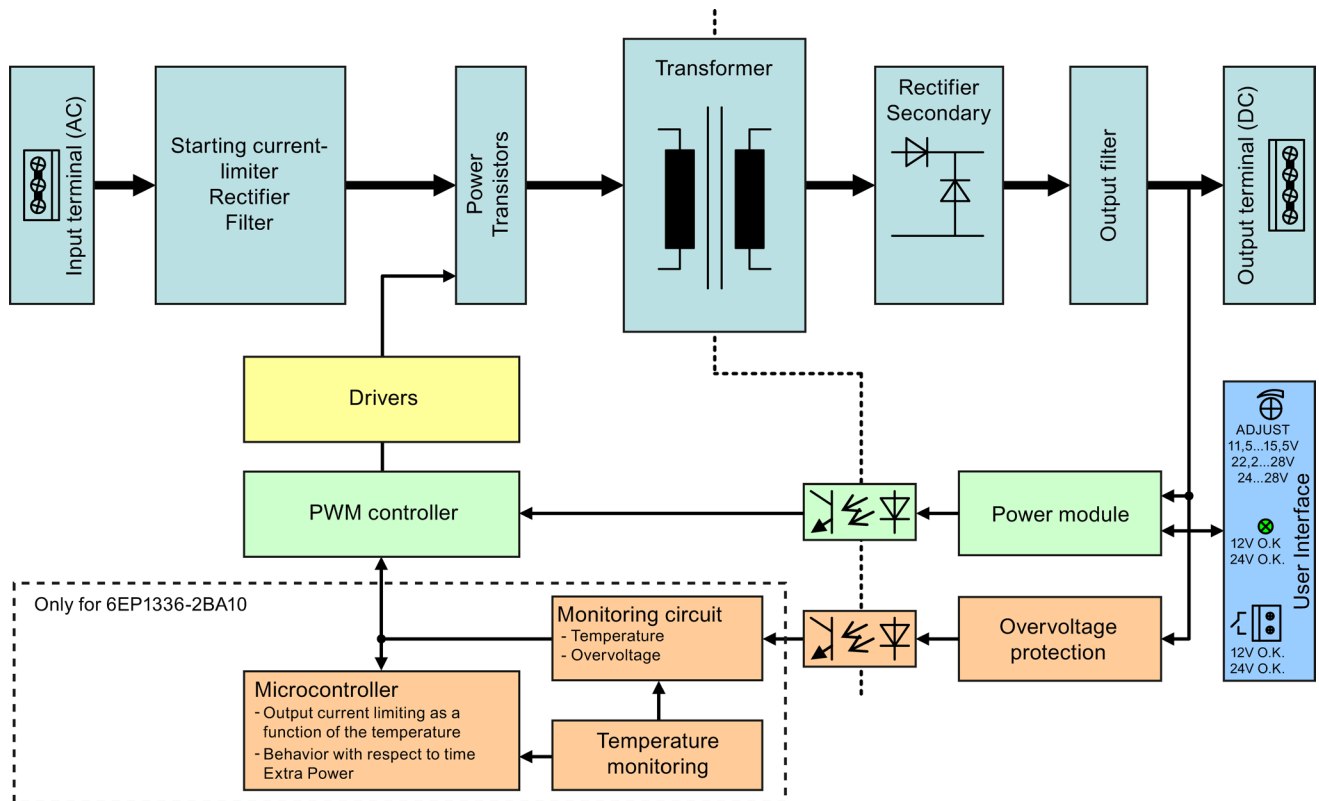

Figure 2-6 Block diagram

2.6 Dimensions and weight

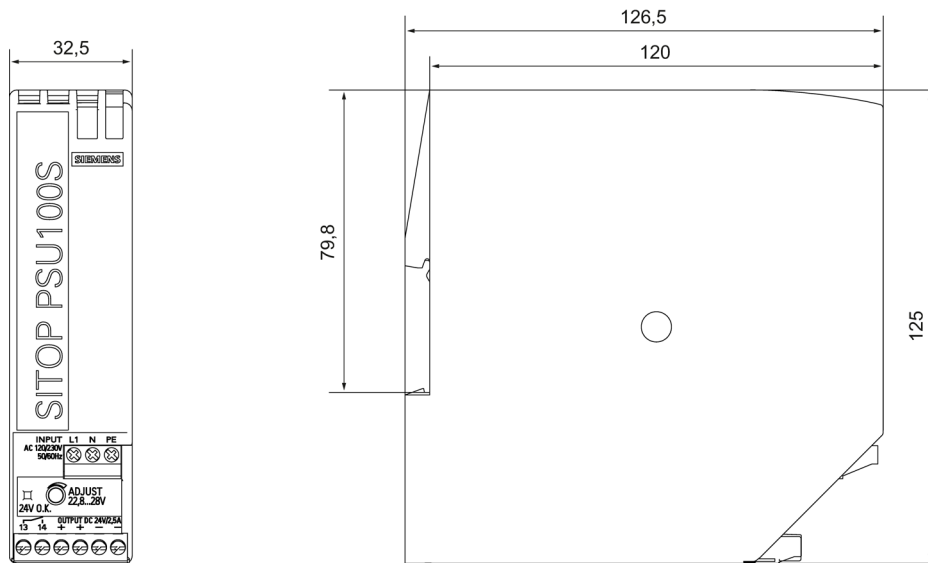

Figure 2-7 Dimension drawing 6EP1332-2BA20

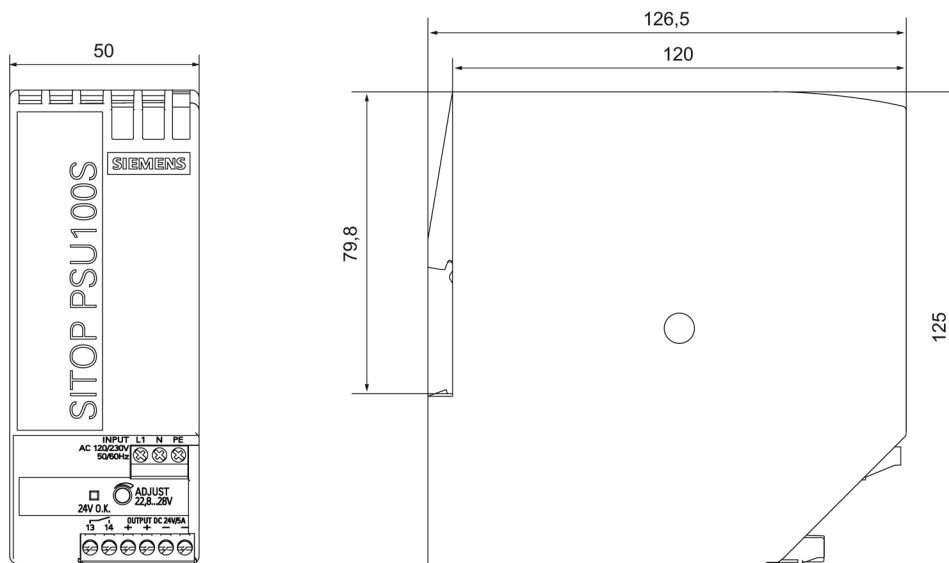

Figure 2-8 Dimension drawing 6EP1333-2BA20, 6EP1322-2BA00

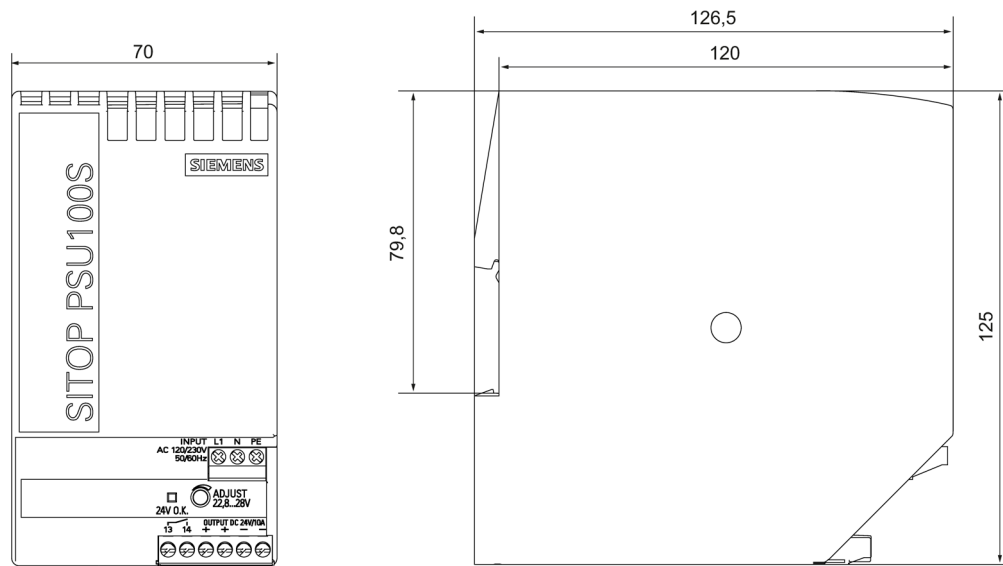

Figure 2-9 Dimension drawing 6EP1334-2BA20, 6EP1323-2BA00

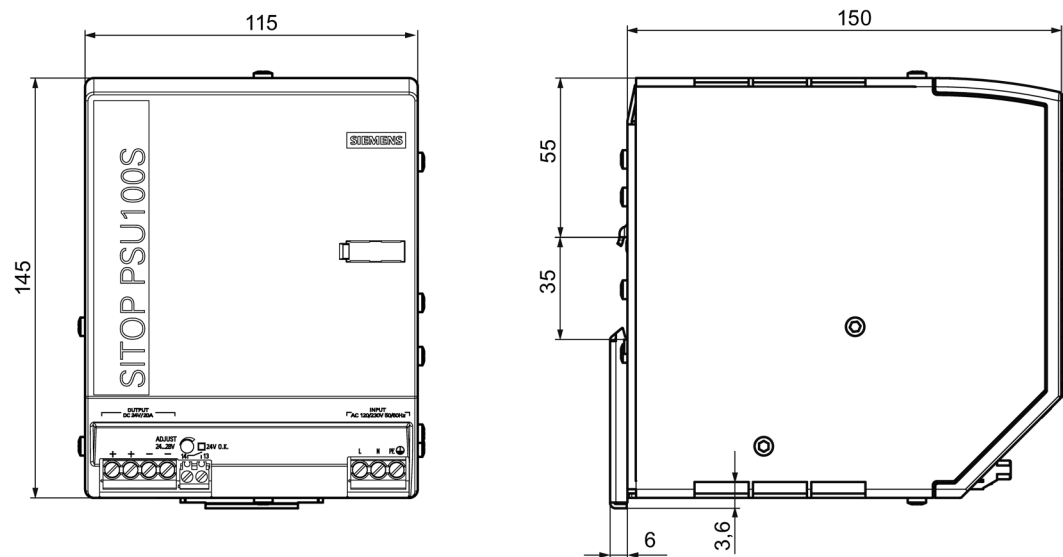

Figure 2-10 Dimension drawing 6EP1336-2BA10

	6EP1332-2BA20	6EP1333-2BA20 6EP1322-2BA00	6EP1334-2BA20 6EP1323-2BA00	6EP1336-2BA10
Dimensions (W × H × D) in mm	32.5 × 125 × 120	50 × 125 × 120	70 × 125 × 120	115 × 145 × 150
Weight	Approx. 0.3 kg	Approx. 0.4 kg	Approx. 0.7 kg	Approx. 2.4 kg

Mounting/removal

WARNING

Installing the device in a housing or a control cabinet

SITOP PSU100S power supplies are built-in units. They must be installed in a housing or control cabinet where only qualified personnel have access.

The device can be mounted in a control cabinet on standard mounting rails according to EN 60715.

Mounting

To mount the device, position it with the mounting rail guide at the upper edge of the standard mounting rail and press down to lock it into place. If this is too difficult, press slider ⑥ at the same time, as described under "Removal".

Removal

To remove, pull up the slider ⑥ using a screwdriver and disengage the device at the bottom edge of the standard mounting rail (see Removal diagram (Page 17)). Then you can remove the device from the upper edge of the standard mounting rail.

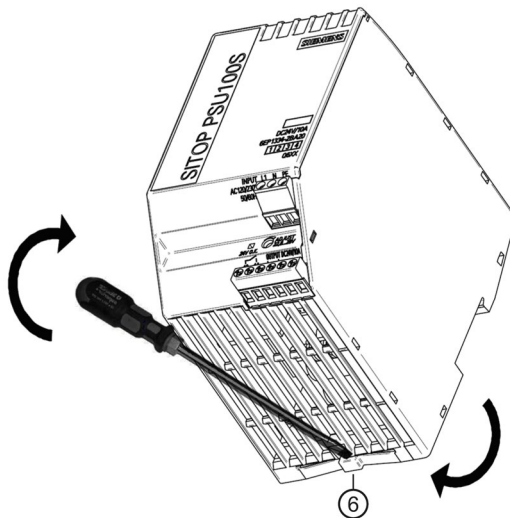

Figure 3-1 Removal

WARNING

Use in hazardous zones

If the device is to be used in a hazardous zone (Ex II 3G Ex nA nC IIC T4 Gc) it must be installed in a distributor box with degree of protection IP54 or higher.

Mounting position, mounting clearances

4.1 Standard mounting position

The device is designed for installation on standard EN 60715 35×7.5/15 mounting rails. The device must be mounted vertically to ensure proper cooling, and with the input terminals and output terminals at the bottom.

A clearance of at least 50 mm should be maintained above and below the device (maximum depth of the cable duct, 50 mm).

No space is required at the side.

Output current as a function of the ambient temperature and mounting height

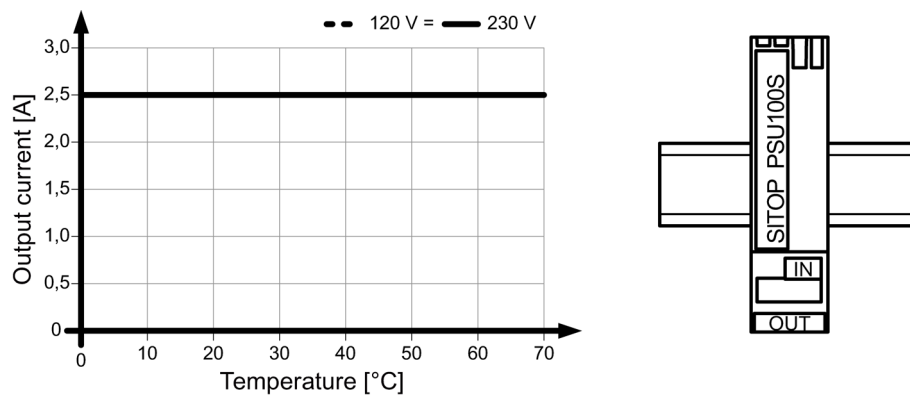

Figure 4-1 6EP1332-2BA20: Output current in the standard mounting position

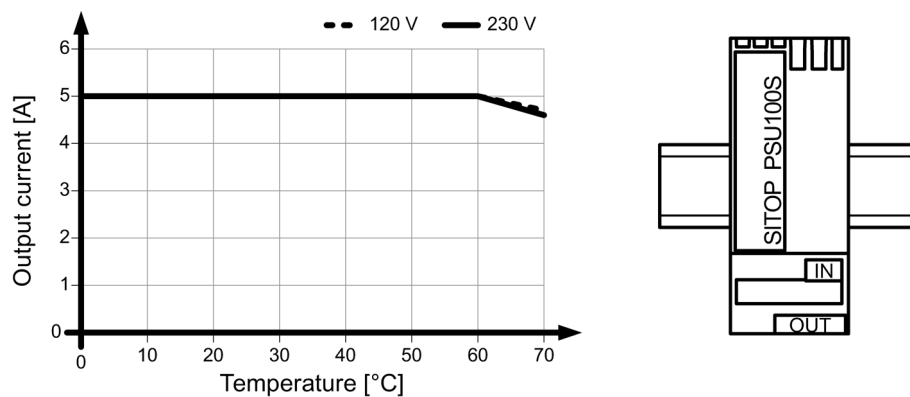

Figure 4-2 6EP1333-2BA20: Output current in the standard mounting position

4.1 Standard mounting position

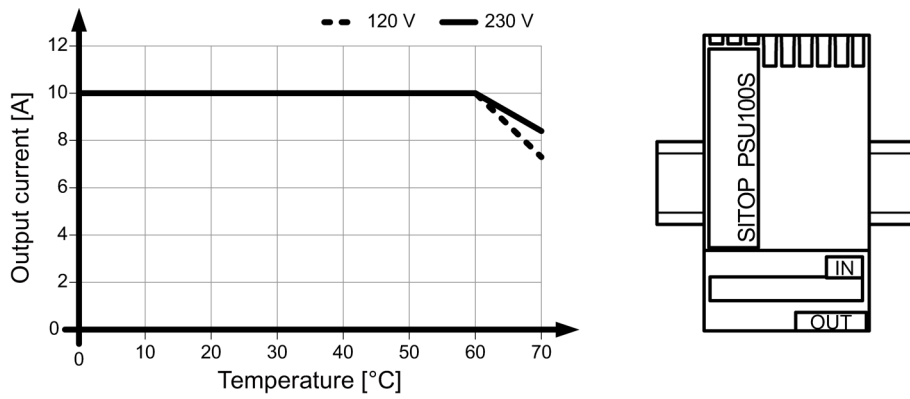

Figure 4-3 6EP1334-2BA20: Output current in the standard mounting position

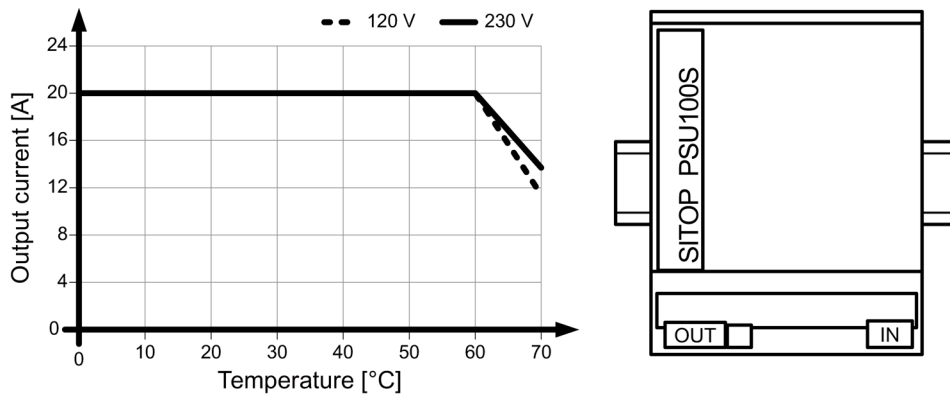

Figure 4-4 6EP1336-2BA10: Output current in the standard mounting position

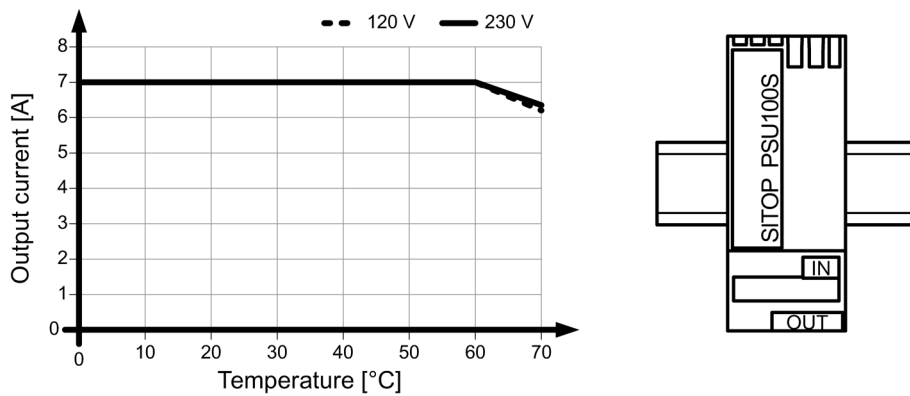

Figure 4-5 6EP1322-2BA00: Output current in the standard mounting position

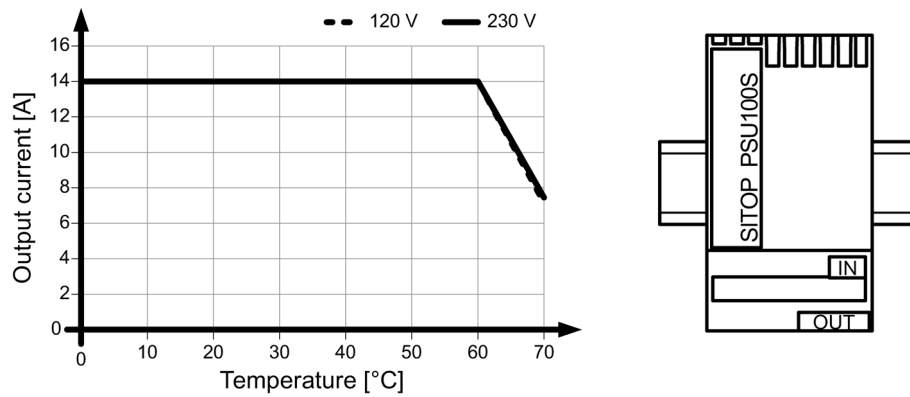

Figure 4-6 6EP1323-2BA00: Output current in the standard mounting position

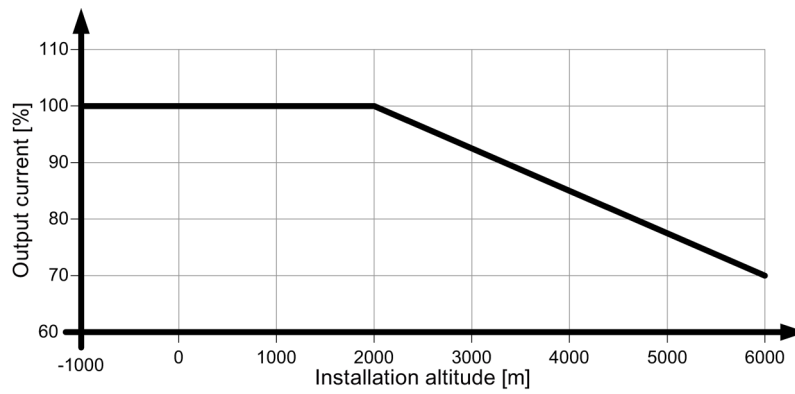

Figure 4-7 Mounting height derating

Details see chapter Ambient conditions (Page 59)

4.2 Other mounting positions

For mounting positions that deviate from the standard mounting position, derating factors (reduction of the output power or the permissible ambient temperature) must be observed in accordance with the following diagrams.

Note

In the case of mounting positions that deviate from the standard mounting position, reduced mechanical resistance of the devices against vibration and shock must be expected.

Particularly when installing on a vertically fastened standard mounting rail, additional measures may be required, e.g. to prevent the device from slipping on the standard mounting rail.

4.2.1 6EP1332-2BA20

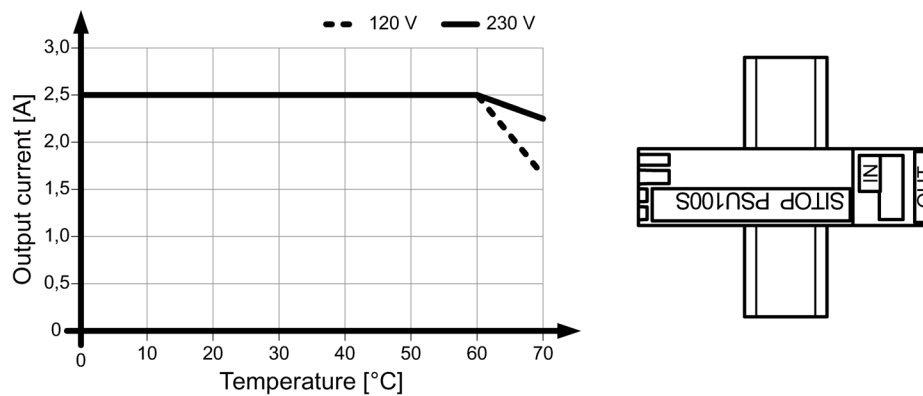

Figure 4-8 Mounting position (1)

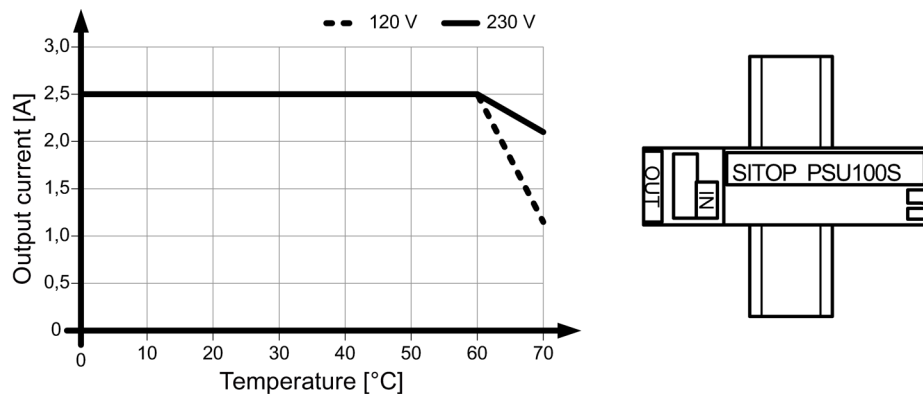

Figure 4-9 Mounting position (2)

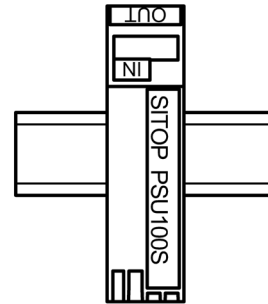
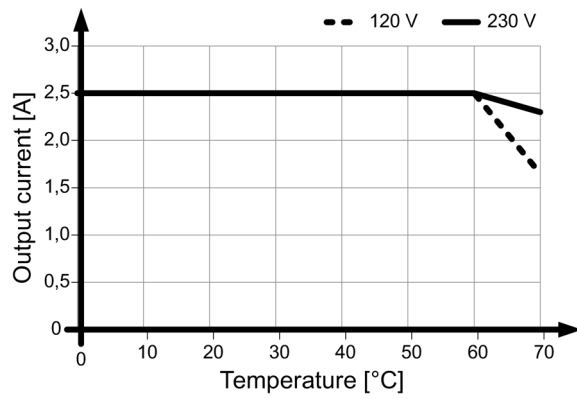

Figure 4-10 Mounting position (3)

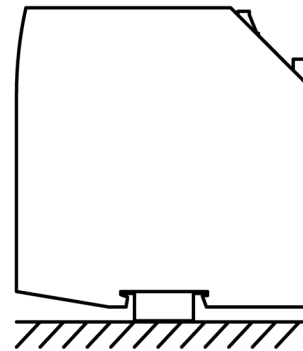
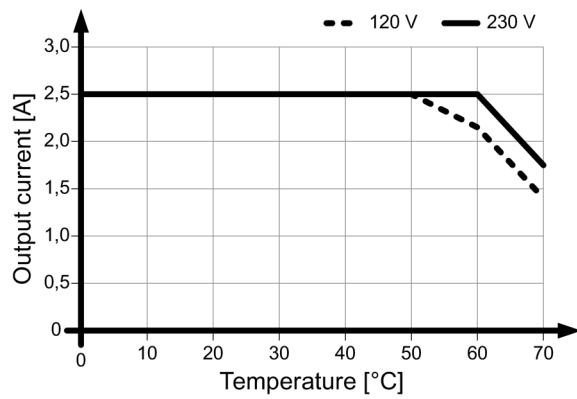

Figure 4-11 Mounting position (4)

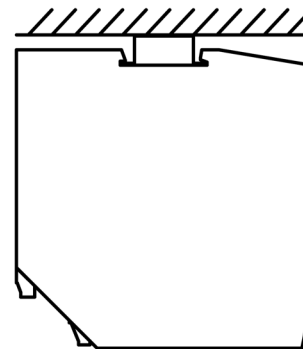
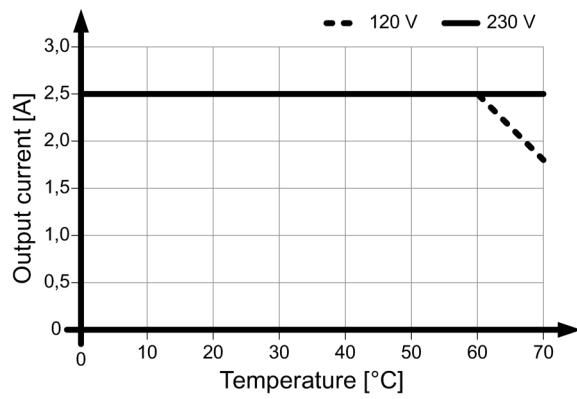

Figure 4-12 Mounting position (5)

4.2.2 6EP1333-2BA20

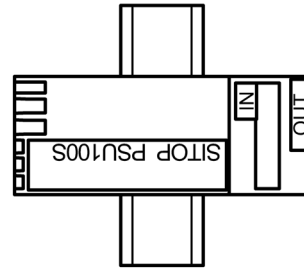
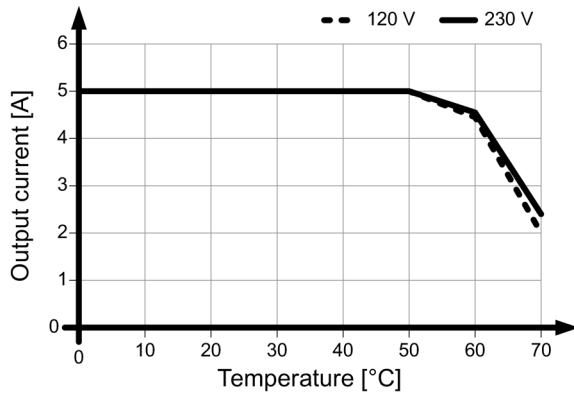

Figure 4-13 Mounting position (1)

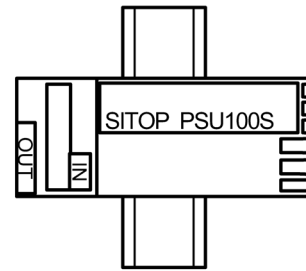
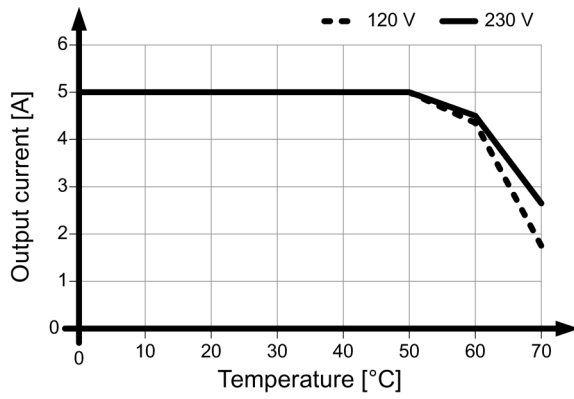

Figure 4-14 Mounting position (2)

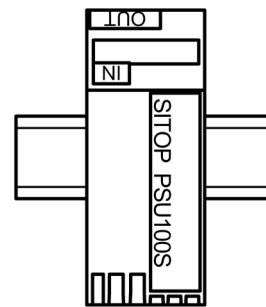
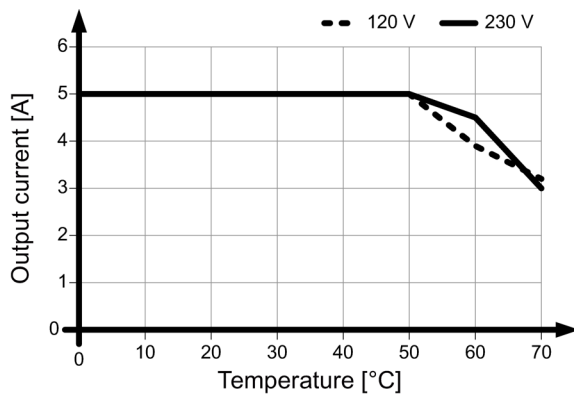

Figure 4-15 Mounting position (3)

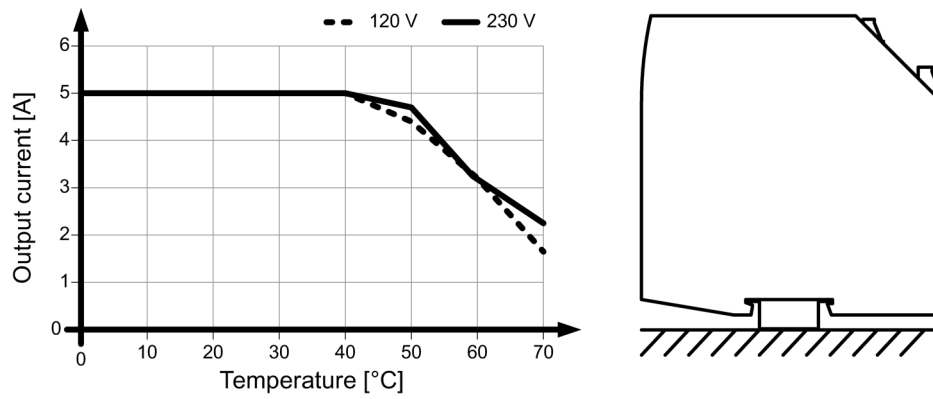

Figure 4-16 Mounting position (4)

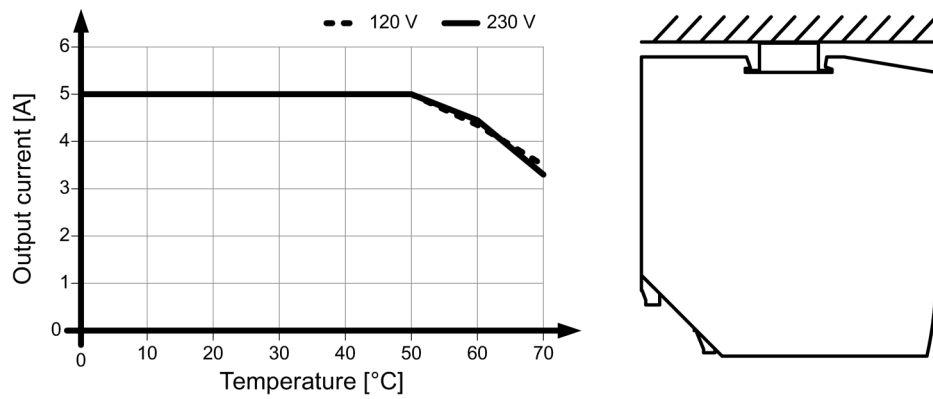

Figure 4-17 Mounting position (5)

4.2.3 6EP1334-2BA20

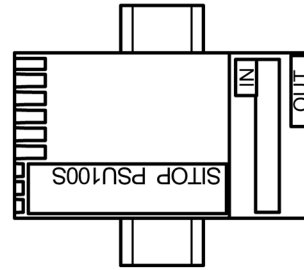
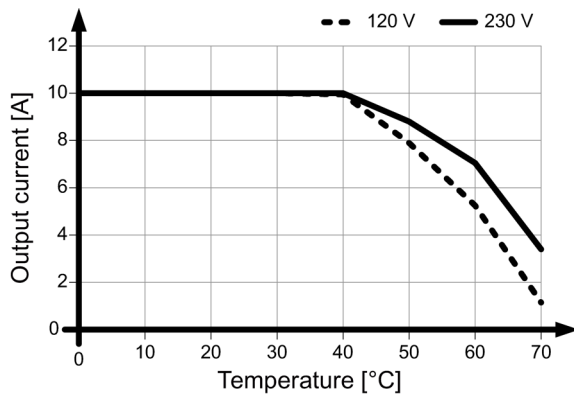

Figure 4-18 Mounting position (1)

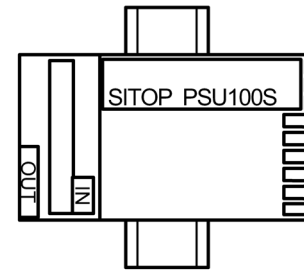
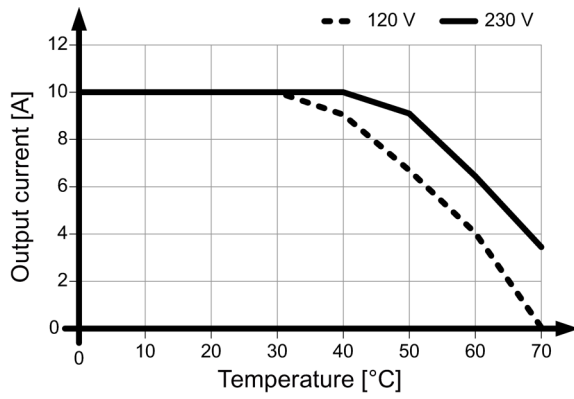

Figure 4-19 Mounting position (2)

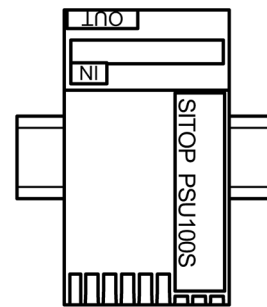
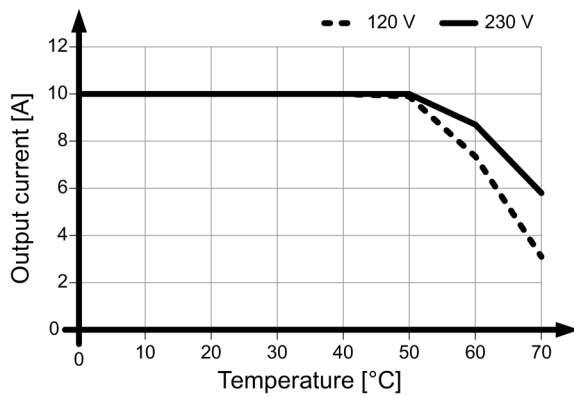

Figure 4-20 Mounting position (3)

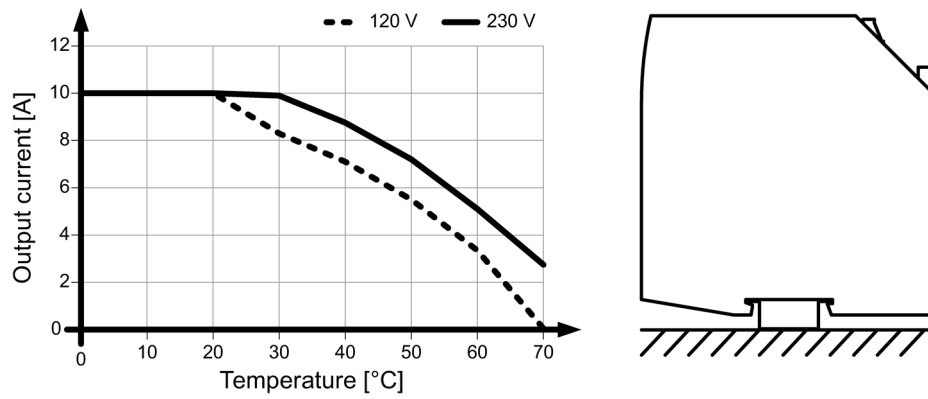

Figure 4-21 Mounting position (4)

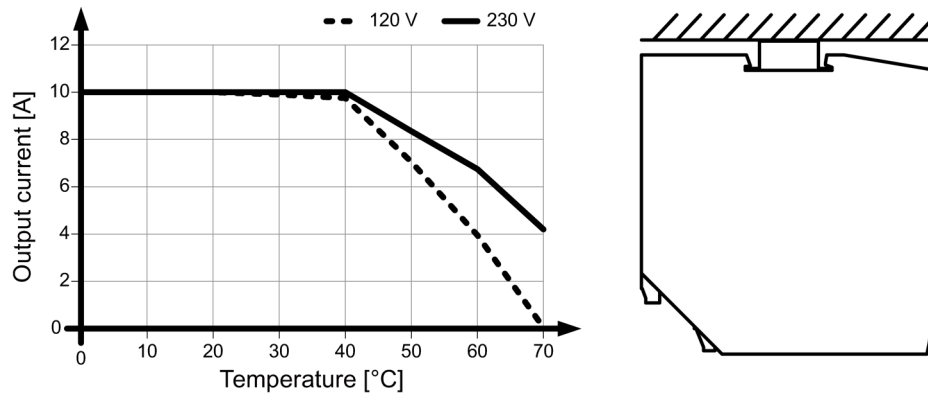

Figure 4-22 Mounting position (5)

4.2.4 6EP1336-2BA10

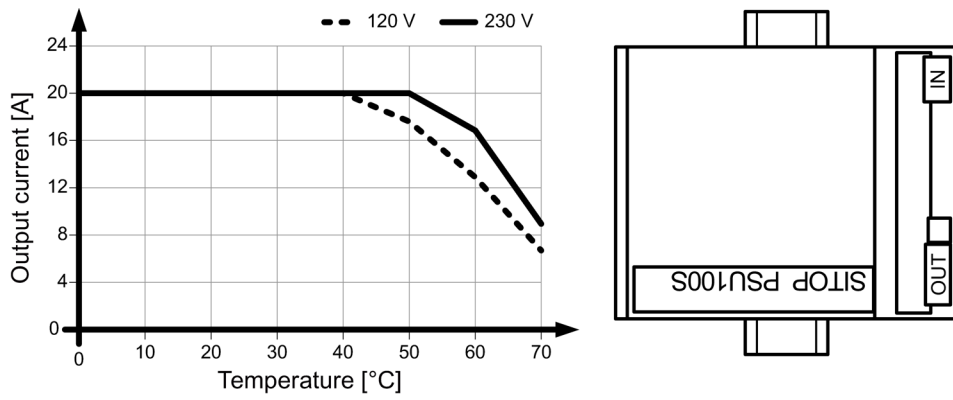

Figure 4-23 Mounting position (1)

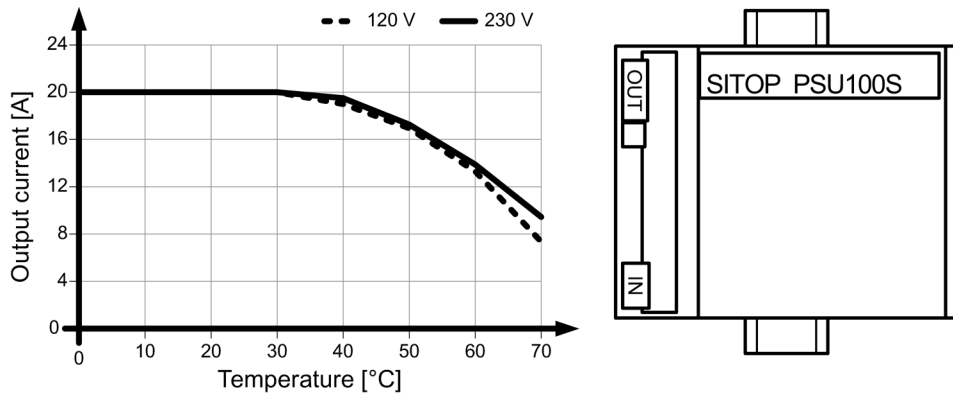

Figure 4-24 Mounting position (2)

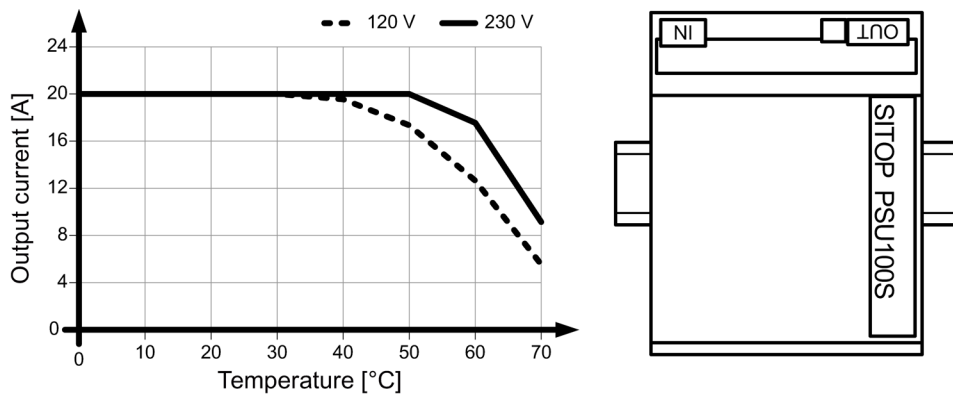

Figure 4-25 Mounting position (3)

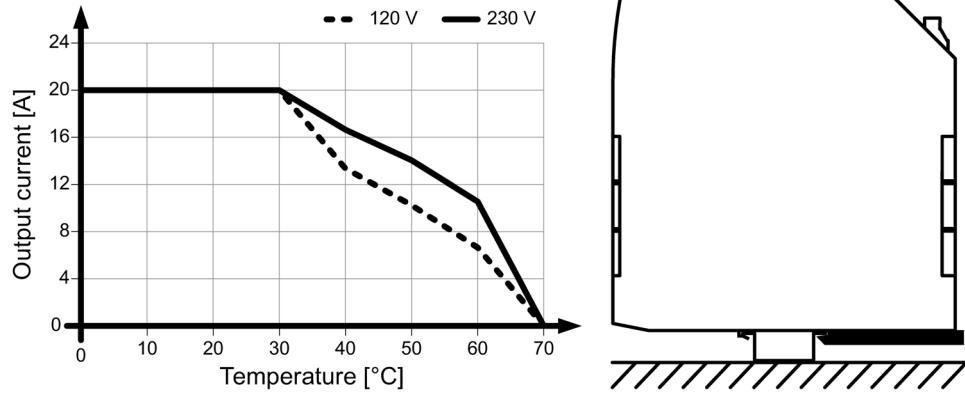

Figure 4-26 Mounting position (4)

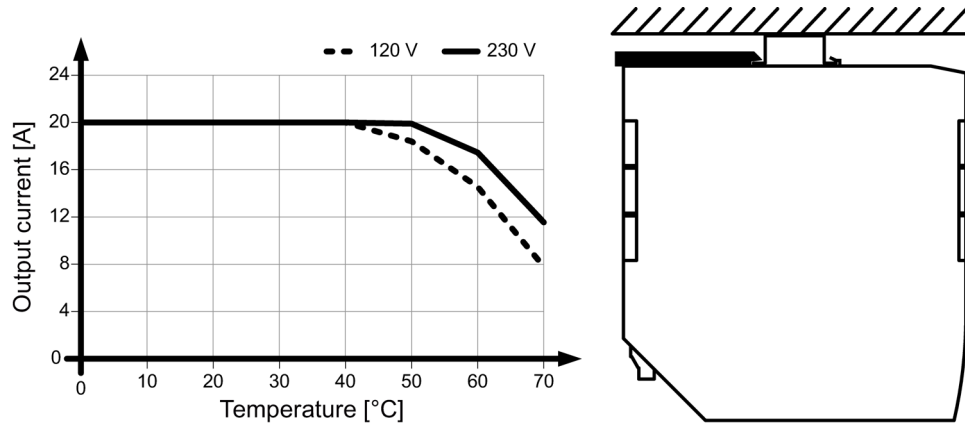

Figure 4-27 Mounting position (5)

4.2.5 6EP1322-2BA00

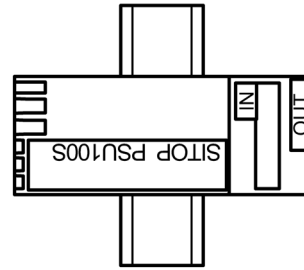
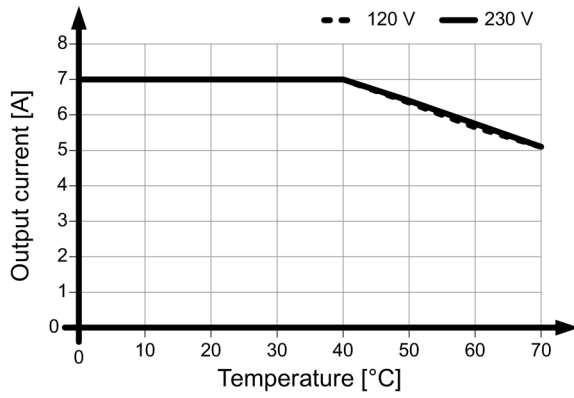

Figure 4-28 Mounting position (1)

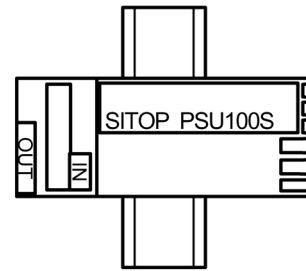
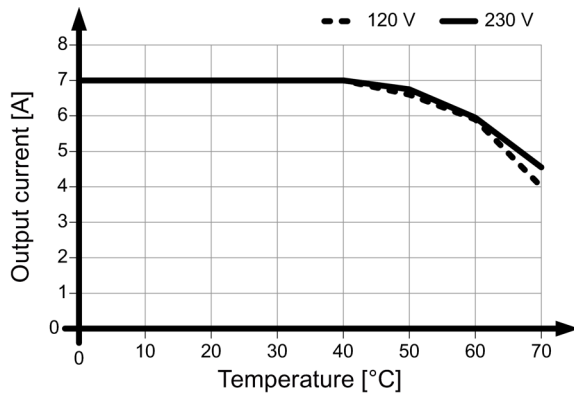

Figure 4-29 Mounting position (2)

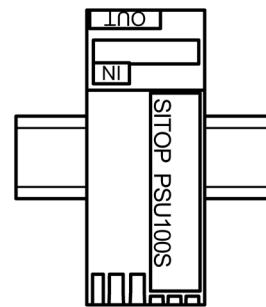
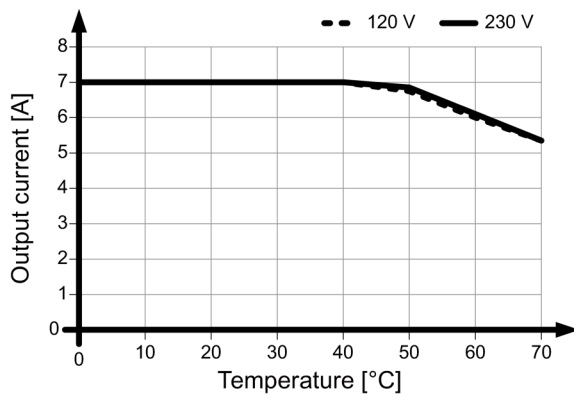

Figure 4-30 Mounting position (3)

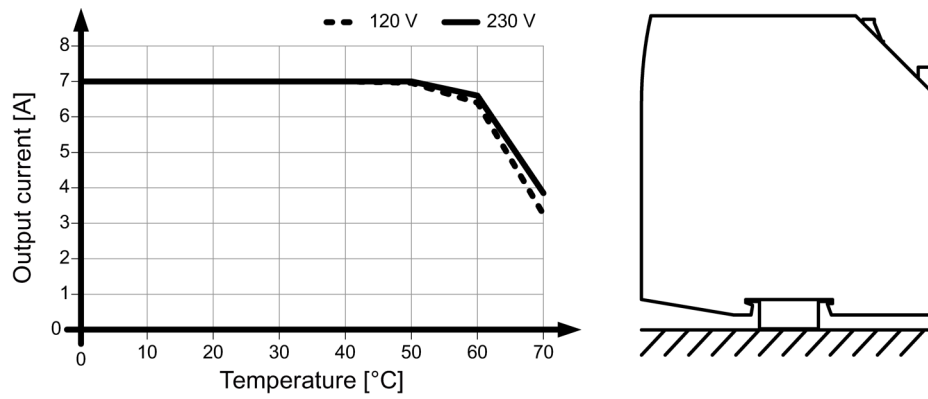

Figure 4-31 Mounting position (4)

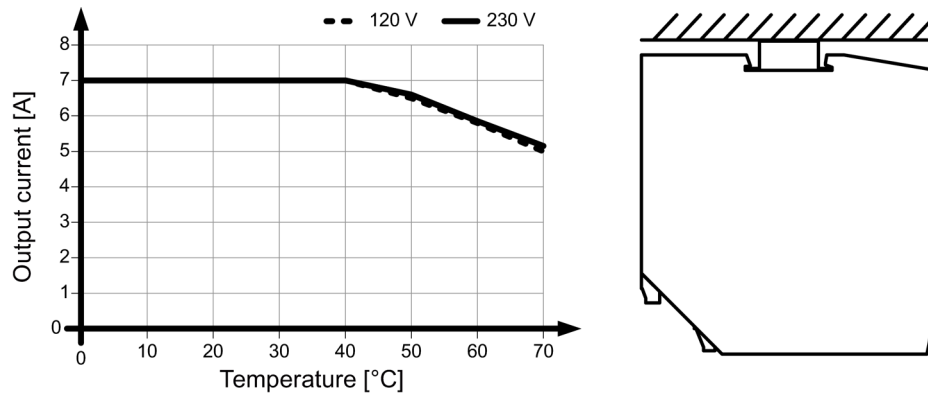

Figure 4-32 Mounting position (5)

4.2.6 6EP1323-2BA00

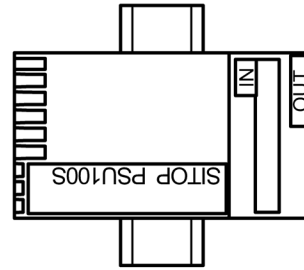
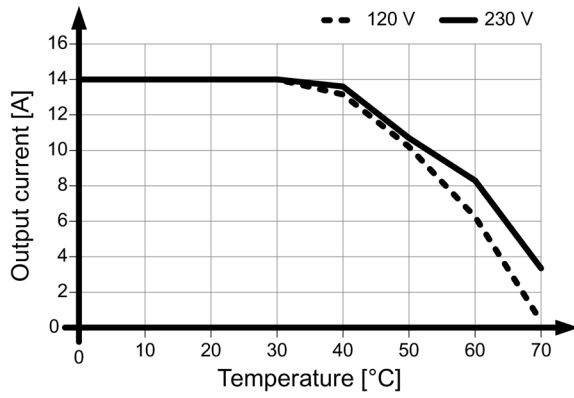

Figure 4-33 Mounting position (1)

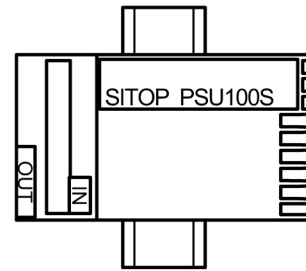
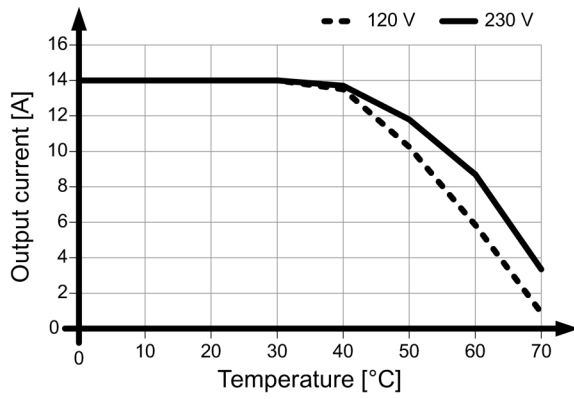

Figure 4-34 Mounting position (2)

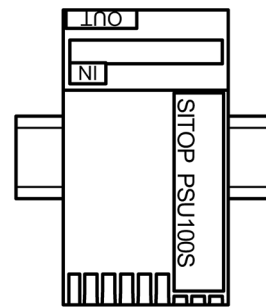
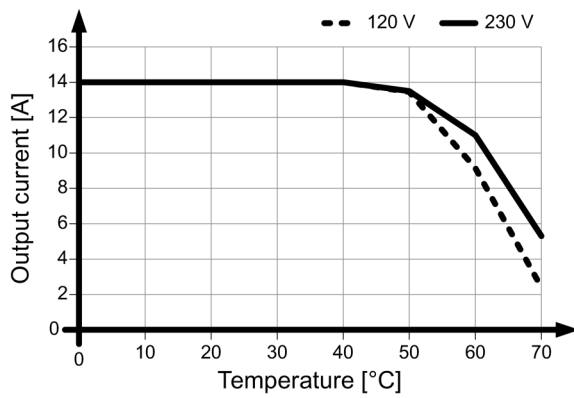

Figure 4-35 Mounting position (3)

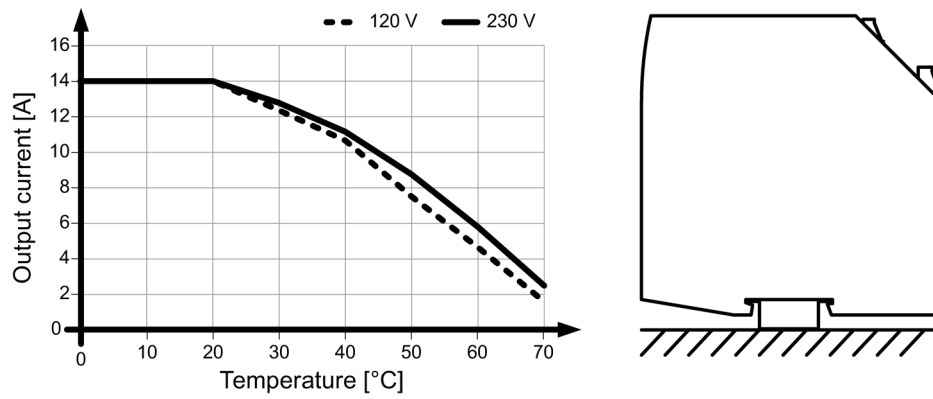

Figure 4-36 Mounting position (4)

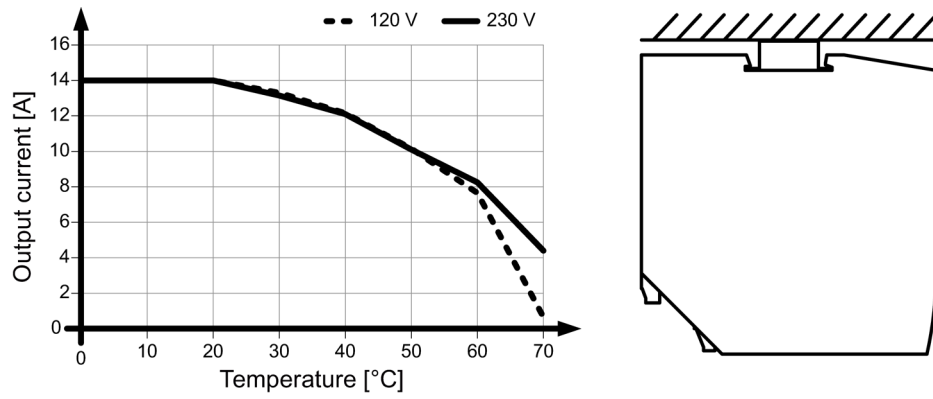



Figure 4-37 Mounting position (5)

 WARNING
Hazard due to electric shock Before installation or maintenance work can begin, the system's main switch must be switched off and measures taken to prevent it being switched on again. If this instruction is not observed, touching live parts can result in death or serious injury.

5.1 Line-side connection

The SITOP PSU100S power supply is designed for connection to a 1-phase AC line supply (TN or TT system according to VDE 0100 T 300 / IEC 364-3) with a rated voltage of 120/230 V AC, 50/60 Hz.

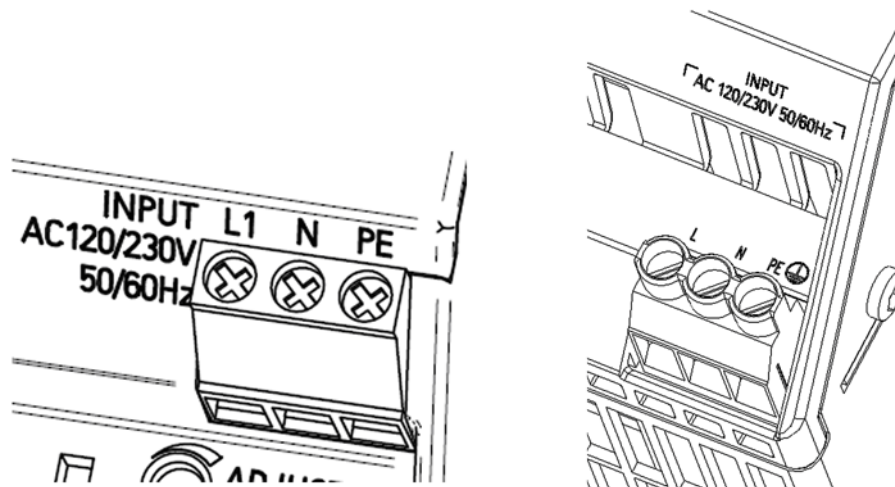

Figure 5-1 Line connection (examples 6EP1334-2BA20 and 6EP1336-2BA10)

The line supply is connected using terminals L1, N and PE (see Figure 5-1 Line connection (examples 6EP1334-2BA20 and 6EP1336-2BA10) (Page 35)), and must be implemented according to IEC 60364 and EN 50178 . A protective device (miniature circuit-breaker or circuit-breaker) and a disconnection unit for the power supply must be provided. A ground-fault circuit interrupter is not permissible against indirect contact as the only protective measure. This is true for the complete line supply protected by the ground-fault circuit interrupter.

Protection

SITOP PSU100S	Recommended line-side protection
6EP1332-2BA20	Miniature circuit breaker (IEC 898) characteristic C, 3 A
6EP1333-2BA20	Miniature circuit breaker (IEC 898) characteristic C, 6 A
6EP1334-2BA20	Miniature circuit breaker (IEC 898) characteristic C, 10 A
6EP1336-2BA10	Miniature circuit breaker (IEC 898) characteristic C, 10 A or circuit breaker 3RV2411-1JA10 (120 V) or 3RV2411-1FA10 (230 V)
6EP1322-2BA00	Miniature circuit breaker (IEC 898) characteristic C, 6 A
6EP1323-2BA00	Miniature circuit breaker (IEC 898) characteristic C, 10 A

The protective conductor of the line supply must be connected at the PE terminal.

Other country-specific regulations may have to be observed when installing the device.

5.2 Output-side connection

At its output, the SITOP PSU100S power supply provides an isolated (= non-grounded) SELV output voltage (Safety Extra Low Voltage). The output of the power supply is no-load, overload, and short-circuit proof. If an overload occurs, the electronic current limitation limits the output current to a maximum value (refer to chapter Technical data (Page 39)).

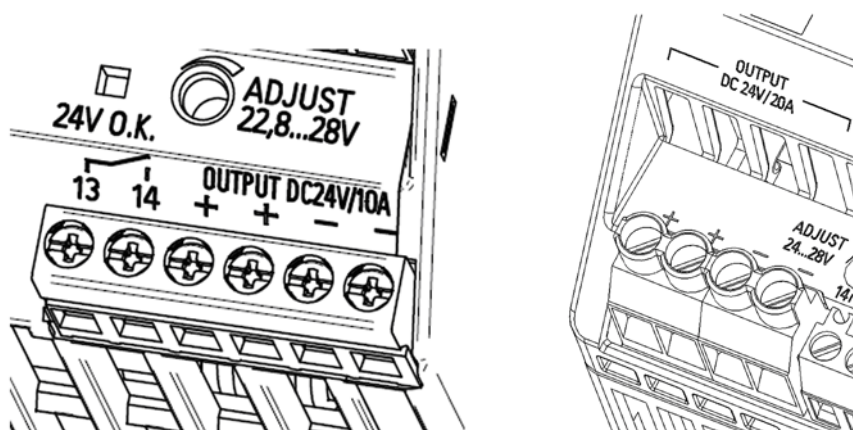

Figure 5-2 Connecting the output voltage (examples 6EP1334-2BA20 and 6EP1336-2BA10)

The output voltage is connected via the + and - terminals at the output of the power supply (see Figure 5-2 Connecting the output voltage (examples 6EP1334-2BA20 and 6EP1336-2BA10) (Page 37)). Ensure that the output cables are dimensioned correctly for the maximum output current rms value and fused accordingly.

Note

If the safety concept of the plant or system specifies that the DC output circuit should be grounded (PELV), then it is permissible that the output voltage of the SITOP power supply is grounded. In this case, ideally, the grounding at the output should be directly connected from terminal "-" of the power supply to a suitable connection point of the protective conductor system (PE) of the plant or system.

Technical data

Note

Technical data is applicable for a rated input voltage, rated load and +25° C ambient temperature (if nothing else is specified).

6.1 Input

	6EP1332-2BA20	6EP1333-2BA20	6EP1334-2BA20	6EP1336-2BA10
Input	1-phase, AC			
Rated voltage U _e rated	120 / 230 V			
Voltage range	85-132 / 170-264 V		85-132 / 176-264 V	
automatic range switchover	Yes			
Connect/shutdown threshold, typical	80 V / 61 V	77 V / 63 V	70 V / 66 V	80 V/78 V or 160 V/155 V
Power failure buffering at I _a rated, min	20 ms	20 ms	20 ms	20 ms
Power-failure buffering	at 93 / 187 V		at 120 / 230 V	
Rated line frequency	50/60 Hz			
Line frequency range	47...63 Hz			
Input current / at rated value of input voltage 120 V	1.25 A	2.34 A	4.49 A	7.5 A
Input current / at rated value of input voltage 230 V	0.74 A	1.36 A	1.91 A	3.5 A
Switch-on current limitation (+25 °C), max.	33 A	40 A	60 A	11 A
I ² t, at 120 V AC, max	0.1 A ² s	0.3 A ² s	1.6 A ² s	2.5 A ² s
I ² t, at 230 V AC, max.	0.4 A ² s	1.0 A ² s	5.6 A ² s	10 A ² s
Integrated input fuse	Fuse T 3.15 A	Fuse T 3.15 A	Fuse T 6 A	Fuse T 10 A

Technical data

6.1 Input

	6EP1332-2BA20	6EP1333-2BA20	6EP1334-2BA20	6EP1336-2BA10
Protection in the line feeder cable (IEC 898)	Recommended: Circuit breaker, C characteristic, 3 A	Recommended: Circuit breaker, C characteristic, 6 A	Recommended: Circuit breaker, C characteristic, 10 A	Recommended: Circuit breaker, C characteristic, 10 A or Circuit breaker 3RV2411-1JA10 (120 V) or 3RV2411-1FA10 (230 V)
Overvoltage strength	2.3 × U _e rated, 1.3 ms			

	6EP1322-2BA00	6EP1323-2BA00
Input	1-phase, AC	
Rated voltage U _e rated	120 / 230 V	
Voltage range	85-132 / 170-264 V	
automatic range switchover	Yes	
Connect/shutdown threshold, typical	82 V / 66 V	66 V / 63 V
Power failure buffering at I _a rated, min	20 ms	20 ms
Power-failure buffering	at 93 / 187 V	
Rated line frequency	50/60 Hz	
Line frequency range	47...63 Hz	
Input current / at rated value of input voltage 120 V	1.73 A	3.24 A
Input current / at rated value of input voltage 230 V	0.99 A	1.41 A
Switch-on current limitation (+25 °C), max.	45 A	60 A
I ² t, at 120 V AC, max.	0.3 A ² s	1.6 A ² s
I ² t, at 230 V AC, max.	1.0 A ² s	5.6 A ² s
Integrated input fuse	Fuse T 3.15 A	Fuse T 6 A
Protection in the line feeder cable (IEC 898)	Recommended: Circuit breaker, C characteristic, 3 A	Recommended: Circuit breaker, C characteristic, 6 A
Overvoltage strength	2.3 × U _e rated, 1.3 ms	

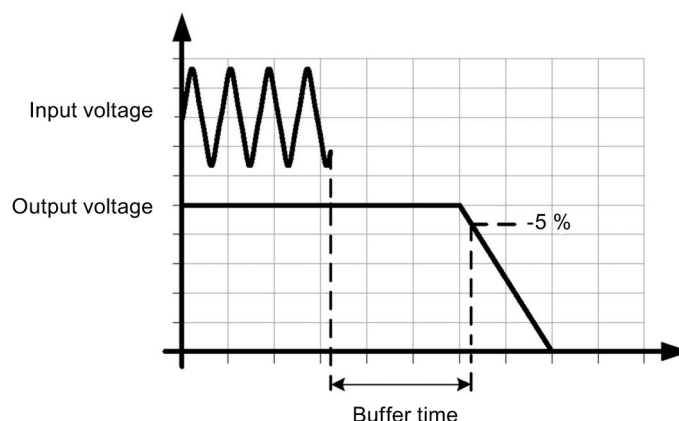

Figure 6-1 Power-failure buffering

6.2 Output

	6EP1332-2BA20	6EP1333-2BA20	6EP1334-2BA20	6EP1336-2BA10
Output	Regulated, isolated DC voltage			
Rated voltage value U _a rated DC	24 V			
Total tolerance, static ±	3 %	3 %	3 %	3 %
Static line regulation, approx. ±	0,1 %	0,1 %	0,1 %	0,5 %
Static load regulation, approx. ±	1 %	1 %	1 %	1 %
Residual ripple Peak-peak, max.	150 mV	150 mV	150 mV	150 mV in the load range >100 mA 300 mV in the load range up to 100 mA
Spikes peak-peak, max. (bandwidth, 200 MHz)	240 mV	240 mV	240 mV	240 mV
Adjustment range	22.8...28.0 V			24...28.0 V
Product function / output voltage can be adjusted	Yes			
Output voltage setting	Using a potentiometer			
• Remark	Max. 480 W			
Status display	LED green for 24 V O.K.			
Signaling	Relay contact (NO contact, rating 60 V DC /0.3 A) for 24 V O.K.			
Response when switching on/off	Overshoot of U _a <720 mV			No overshoot of U _a (soft start), with the exception of a capacitive load
Starting delay, max.	300 ms	300 ms	300 ms	1.5 s

Technical data

6.2 Output

	6EP1332-2BA20	6EP1333-2BA20	6EP1334-2BA20	6EP1336-2BA10
Start delay, typ.	200 ms	160 ms	150 ms	500 ms
Voltage rise 120 V / 230 V AC max.	100 ms	100 ms	100 ms	500 ms
Voltage rise 120 V / 230 V AC typ.	15 ms	15 ms	20 ms	50 ms
Rated current I _a rated	2.5 A	5 A	10 A	20 A
Current range	0...2.5 A	0...5 A	0...10 A	0...20 A
• Remark	3 A to +45° C +60 to +70 °C; derating: 3 % I _a rated/K	6 A to +45° C +60 to +70 °C; derating: 3 % I _a rated/K	12 A to +45° C +60 to +70 °C; derating: 3 % I _a rated/K	24 A to +45° C +60 to +70 °C; derating: 5 % I _a rated/K
Output active power / typical	60 W	120 W	240 W	480 W
Overload capability (Extra Power)	3.75 A for 5 s/min	7.5 A for 5 s/min	15 A for 5 s/min	30 A for 5 s/min
Short-time overload current / for a short circuit when powering up / typical	9 A	18 A	33 A	35 A
Duration of the overload capability, overcurrent / for a short circuit while powering up	800 ms	800 ms	800 ms	100 ms
• Remark	once-only	once-only	once-only	every 2.5 s
Short-time overload current / for a short circuit in operation / typical	9 A	18 A	33 A	35 A
Duration of the overload capability, overcurrent / for a short circuit in operation	800 ms	800 ms	800 ms	100 ms
• Remark	once-only	once-only	once-only	every 2.5 s
Can be connected in parallel to increase the power rating	Yes			
Number of devices that can be connected in parallel to increase the power rating, units	2			
Output characteristic	see diagram, output characteristic for 6EP1332-2BA20 (Page 44)	see diagram, output characteristic for 6EP1333-2BA20 (Page 45)	see diagram, output characteristic for 6EP1334-2BA20 (Page 45)	see diagram, output characteristic for 6EP1336-2BA20 (Page 45)
Capacitive load, max.	2 mF/A			

	6EP1322-2BA00	6EP1323-2BA00
Output	Regulated, isolated DC voltage	
Rated voltage value U _a rated DC	12 V	
Total tolerance, static ±	3 %	3 %
Static line regulation, approx. ±	0,1 %	0,1 %
Static load regulation, approx. ±	1 %	1 %
Residual ripple Peak-peak, max.	150 mV	150 mV
Spikes peak-peak, max. (bandwidth, 200 MHz)	240 mV	240 mV
Adjustment range	11.5...15.5 V	
Product function / output voltage can be adjusted	Yes	
Output voltage setting	Using a potentiometer	
Status display	LED green for 12 V O.K.	
Signaling	Relay contact (NO contact, rating 60 V DC /0.3 A) for 12 V O.K.	
Response when switching on/off	Overshoot of U _a <360 mV	
Starting delay, max.	300 ms	300 ms
Start delay, typ.	180 ms	170 ms
Voltage rise 120 V / 230 V AC max.	100 ms	100 ms
Voltage rise 120 V / 230 V AC typ.	10 ms	10 ms
Rated current I _a rated	7 A	14 A
Current range	0...7 A	0...14 A
• Remark	+55...+70 °C derating: 5 % I _a rated/K	+55...+70 °C derating: 5 % I _a rated/K
Output active power / typical	84 W	168 W
Overload capability (Extra Power)	10.5 A for 5 s/min	21 A for 5 s/min
Short-time overload current / for a short circuit when powering up / typical	26 A	48 A
Duration of the overload capability, overcurrent / for a short circuit while powering up	800 ms	800 ms
• Remark	once-only	once-only
Short-time overload current / for a short circuit in operation / typical	26 A	48 A

6.2 Output

	6EP1322-2BA00	6EP1323-2BA00
Duration of the overload capability, overcurrent / for a short circuit in operation	800 ms	800 ms
• Remark	once-only	once-only
Can be connected in parallel to increase the power rating	Yes	
Number of devices that can be connected in parallel to increase the power rating, units	2	
Output characteristic	see diagram, output characteristic for 6EP1322-2BA20 (Page 46)	see diagram, output characteristic for 6EP1323-2BA20 (Page 46)
Capacitive load, max.	2 mF/A	

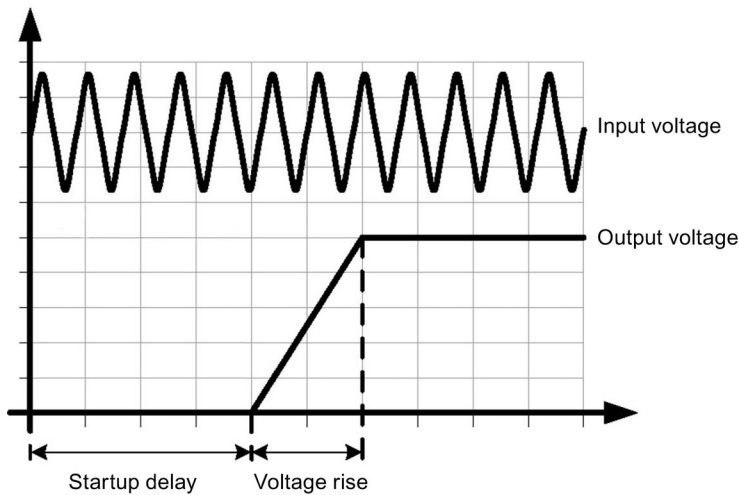

Figure 6-2 Startup delay/voltage rise

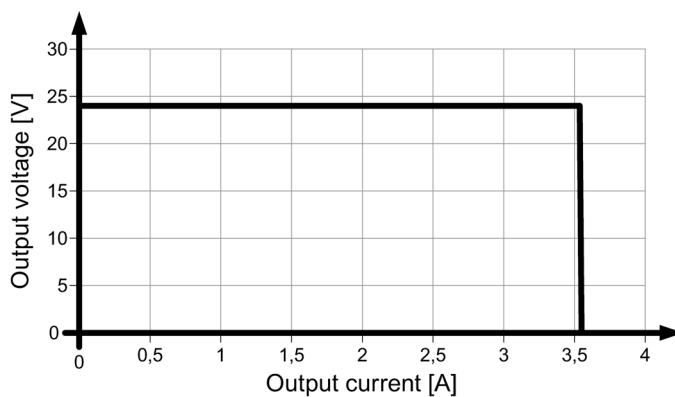

Figure 6-3 Output characteristic 6EP1332-2BA20

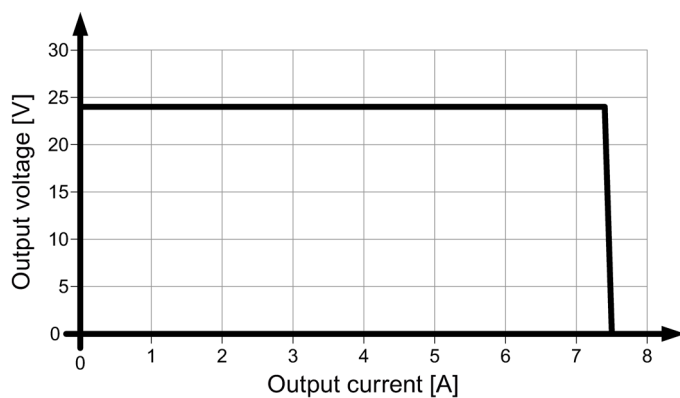

Figure 6-4 Output characteristic 6EP1333-2BA20

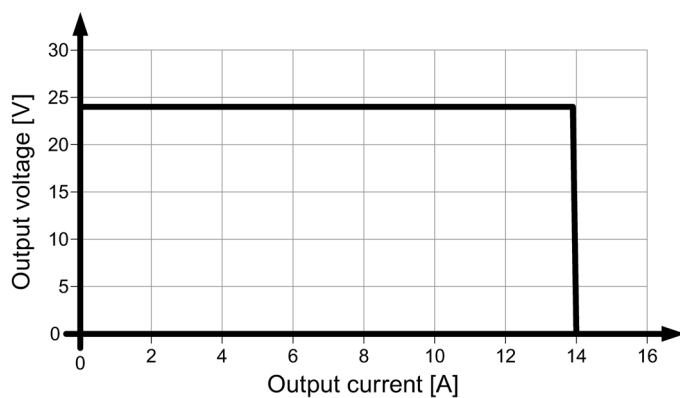

Figure 6-5 Output characteristic 6EP1334-2BA20

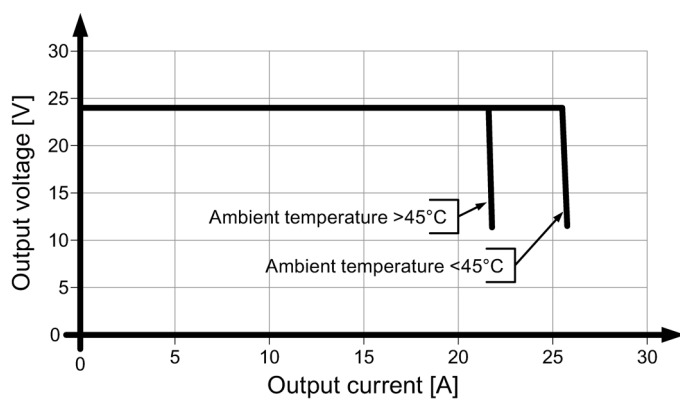

Figure 6-6 Output characteristic 6EP1336-2BA10

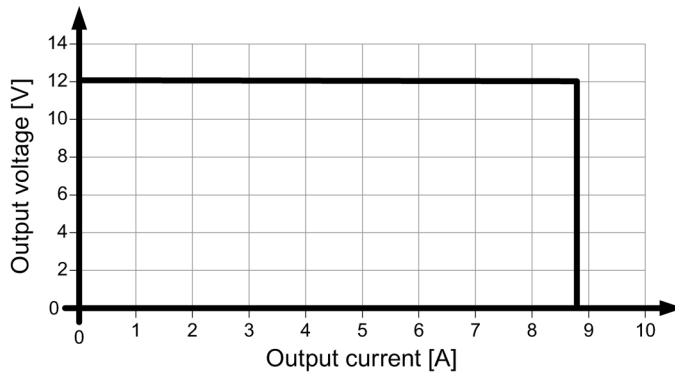

Figure 6-7 Output characteristic 6EP1322-2BA00

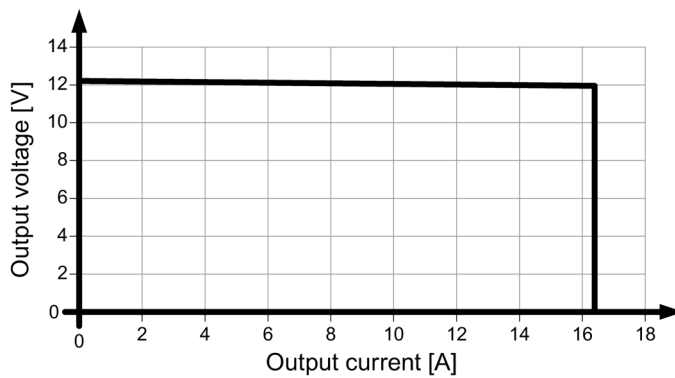

Figure 6-8 Output characteristic 6EP1323-2BA00

The device supplies a constant output voltage until the current limit is reached. In the event of an overload, the output current and the output voltage are reduced.

When the output voltage falls below approx. 10 V, the 6EP1336-2BA10 device switches off, and automatically restarts. This response is repeated as long as the overload condition is present.

6.3 Efficiency

	6EP1332-2BA20	6EP1333-2BA20	6EP1334-2BA20	6EP1336-2BA10
Efficiency at U _a rated, I _a rated 120 V / 230 V AC approx.	83 % / 85 %	86 % / 87 %	89 % / 90 %	89 % / 90 %
Power loss at U _a rated, I _a rated 120 V / 230 V AC approx.	11 W / 10 W	18 W / 16 W	27 W / 25 W	59 W / 53 W
Power loss when idling 120 V / 230 V AC approx.	1.7 W / 1.2 W	1.8 W / 1.3 W	3.0 W / 2.4 W	4.1 W / 3.6 W

	6EP1322-2BA00	6EP1323-2BA00
Efficiency at U _a rated, I _a rated 120 V / 230 V AC approx.	82 % / 83 %	86 % / 87 %
Power loss at U _a rated, I _a rated 120 V / 230 V AC approx.	16 W / 15 W	27 W / 15 W
Power loss when idling 120 V / 230 V AC approx.	1.5 W / 1.0 W	2.8 W / 2.3 W

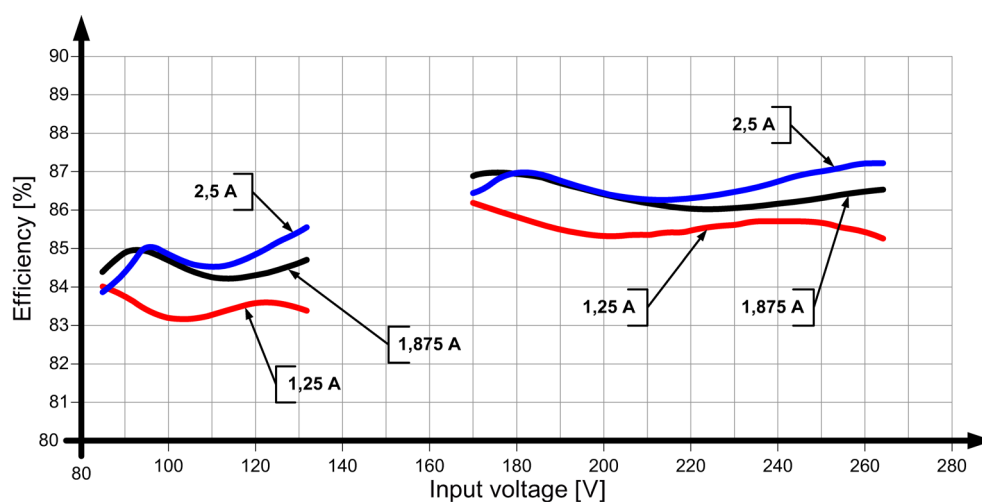

Figure 6-9 Efficiency 6EP1332-2BA20

6.3 Efficiency

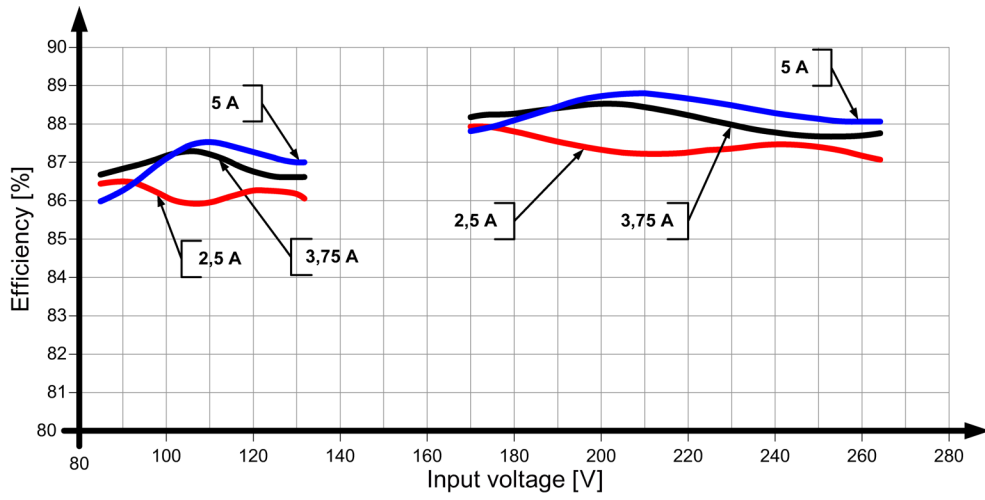

Figure 6-10 Efficiency 6EP1333-2BA20

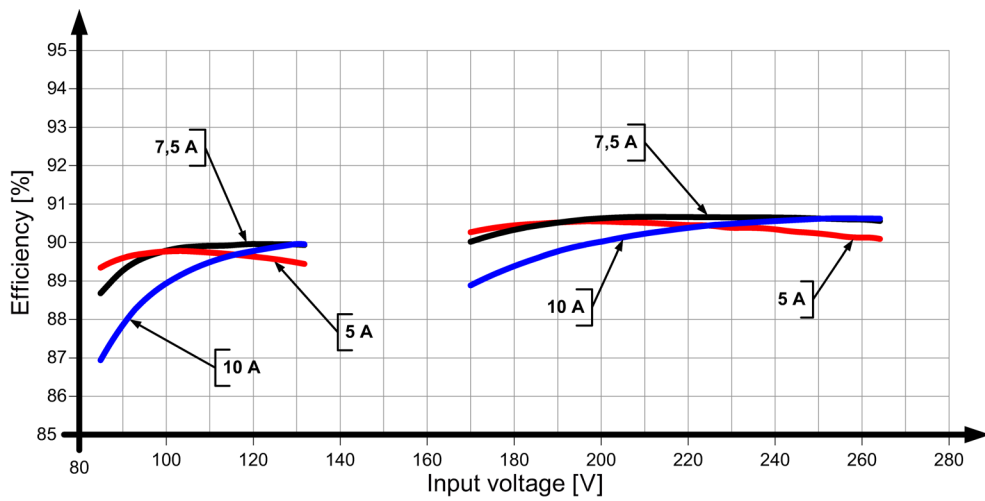

Figure 6-11 Efficiency 6EP1334-2BA20

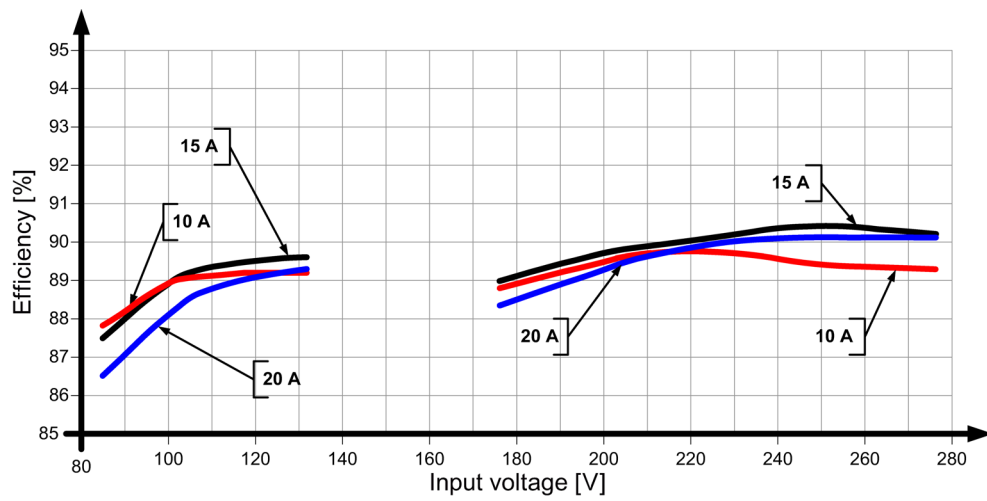

Figure 6-12 Efficiency 6EP1336-2BA10

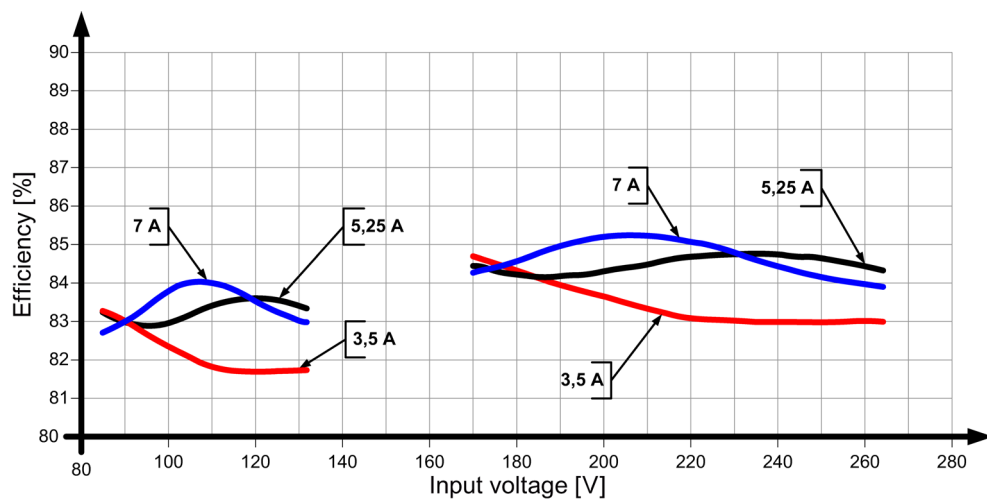

Figure 6-13 Efficiency 6EP1322-2BA00

6.4 Closed-loop control

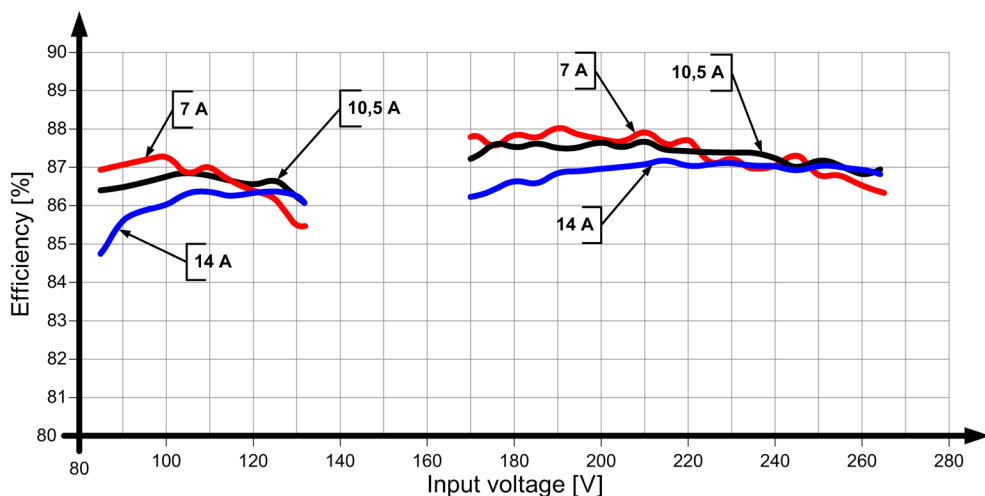

Figure 6-14 Efficiency 6EP1323-2BA00

6.4 Closed-loop control

	6EP1332-2BA20 6EP1333-2BA20 6EP1334-2BA20	6EP1336-2BA10	6EP1322-2BA00 6EP1323-2BA00
Dyn. line regulation (U _e rated ±15%), max.	0.3 % U _a	0.3 % U _a	0.3 % U _a
Dyn. load regulation (I _a : 10/90/10 %), max.	±5 % U _a	-	±15 % U _A
Dyn. load regulation (I _a : 10/90/10 %), typ.	-	±3 % U _a	-
Load-step settling time 10 to 90 %, max.	1 ms	10 ms	1 ms
Load-step settling time 10 to 90 %, typ.	-	2 ms	-
Load-step settling time 90 to 10 %, max.	1 ms	10 ms	1 ms
Load-step settling time 90 to 10 %, typ.	-	2 ms	-

6.5 Protection and monitoring

	6EP1332-2BA20	6EP1333-2BA20	6EP1334-2BA20	6EP1336-2BA10
Output overvoltage protection	in the case of an internal fault $U_a < 33\text{ V}$			Yes, according to EN 60950-1
Current limitation	3.75 A	7.5 A	15 A	21.5 A (>45 °C)
Typ.				25.5 A (<45 °C)
• Remark	Overload capability with 150 % I_a rated up to 5 s/min	Overload capability with 150 % I_a rated up to 5 s/min	Overload capability with 150 % I_a rated up to 5 s/min	Overload capability with 150 % I_a rated up to 5 s/min
Short-circuit protection	Yes, current is statically limited			Electronic trip, automatic restart (hiccup)
Continuous short-circuit current rms value, approx.	3.4 A	7.3 A	14.6 A	7 A
Overload / short-circuit display	-			

	6EP1322-2BA00	6EP1323-2BA00
Output overvoltage protection	< 20 V	< 20 V
Current limitation, typ.	10.5 A	21 A
• Remark	Overload capability with 150 % I_a rated up to 5 s/min	Overload capability with 150 % I_a rated up to 5 s/min
Short-circuit protection	Yes, current is statically limited	
Continuous short-circuit current rms value, approx.	8.8 A	16.4 A
Overload / short-circuit display	-	

6.6 MTBF

	6EP1332-2BA20 6EP1333-2BA20 6EP1334-2BA20 6EP1322-2BA00 6EP1323-2BA00	6EP1336-2BA10
Mean Time Between Failures	SN29500: > 1600000 h at 40 °C, rated load, 24 h operation	SN29500: > 500000 h (typ. 700000 h) at 40° C, rated load, 24 h operation

6.7 Mechanical system

	6EP1332-2BA20	6EP1333-2BA20 6EP1322-2BA00	6EP1334-2BA20 6EP1323-2BA00	6EP1336-2BA10
Connection system	Screw-type terminal			
Connections / line supply	L, N, PE: 1 screw terminal each for 0.5 ... 2.5 mm ² solid/finely stranded			L1, N, PE: 1 screw terminal each for 0.2 ... 4 mm ² solid/finely stranded
Connections / output	+, -: 2 screw terminals each for 0.5 ... 2.5 mm ²			+, -: 2 screw terminals each for 0.2 ... 4 mm ²
Connections / auxiliary contacts	Signaling contact: 2 screw terminals for 0.5 mm ... 2.5 mm ²			13, 14 (signaling contact): 1 screw terminal each for 0.14 ... 1.5 mm ²
Width of the housing	32.5 mm	50 mm	70 mm	115 mm
Height of the housing	125 mm	125 mm	125 mm	145 mm
Depth of the housing	120 mm	120 mm	120 mm	150 mm
Installation width	32.5 mm	50 mm	70 mm	120 mm
Mounting height	225 mm	225 mm	225 mm	245 mm
Weight, approx.	0.32 kg	0.5 kg	0.8 kg	2.4 kg
Product feature of the housing / housing that can be lined up next to one another	Yes			
Type of mounting / panel mounting	No			
Type of mounting / rail mounting	Yes			
Type of mounting / S7-300 rail mounting	No			
Mounting	Can be snapped onto standard EN 60715 35x7,5/15 mounting rails			

6.8 Accessories

Accessories

	6EP1332-2BA20	6EP1333-2BA20 6EP1334-2BA20 6EP1336-2BA10 6EP1322-2BA00 6EP1323-2BA00
Electrical accessories	Redundancy module, buffer module	
Mechanical accessories	Device identification labels 10 mm × 7 mm, pastel turquoise 3RT1900-1SB10	Device identification labels 20 mm × 7 mm, pastel turquoise 3RT1900-1SB20

6.9 Dimension drawing

See chapter Dimensions and weight (Page 14)

CAD data that can be downloaded from the Internet:

6EP1332-2BA20

(http://www.automation.siemens.com/bilddb/index.aspx?objKey=G_KT01_XX_00727)

6EP1333-2BA20

(http://www.automation.siemens.com/bilddb/index.aspx?objKey=G_KT01_XX_00730)

6EP1334-2BA20

(http://www.automation.siemens.com/bilddb/index.aspx?objKey=G_KT01_XX_00733)

6EP1336-2BA10

(http://www.automation.siemens.com/bilddb/index.aspx?objKey=G_KT01_XX_00720)

6EP1322-2BA00

(http://www.automation.siemens.com/bilddb/index.aspx?objKey=G_KT01_XX_00736)

6EP1323-2BA00

(http://www.automation.siemens.com/bilddb/index.aspx?objKey=G_KT01_XX_00739)

Safety, approvals, EMC

7.1 Safety

	6EP1332-2BA20, 6EP1333-2BA20, 6EP1334-2BA20, 6EP1336-2BA10, 6EP1322-2BA00, 6EP1323-2BA00
Primary/secondary galvanic isolation	Yes
Galvanic isolation	SELV output voltage U _a according to EN 60950-1 and EN 50178 Transformer according to EN 61558-2-16
Protection class	Class I
Degree of protection (EN 60529)	IP20
Leakage current, typ.	1 mA
Leakage current, max.	3.5 mA
Test voltage	See Table 7-1 Test voltage (Page 56)

7.2 Test voltage

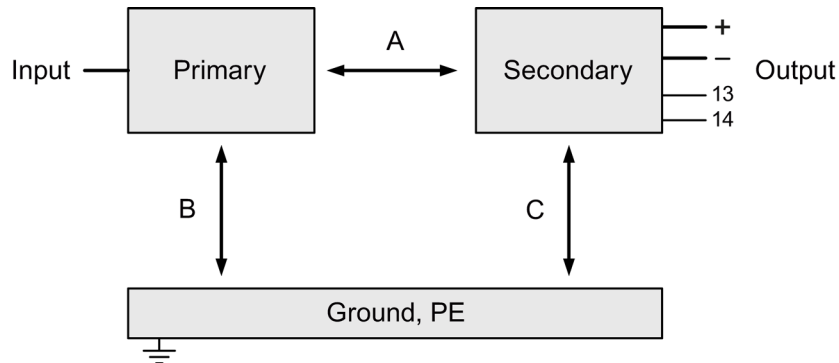

Figure 7-1 Test voltage diagram

Only the manufacturer can perform the type test and production test; users can also perform the field test.

Preconditions for performing the field test:

Tests (A) & (B)

- Connect the input terminals with one another (L, N)
- Connect the output terminals, signaling contact and PE with one another

Test (C)

- Connect the output terminals and signaling contact with one another and measure with respect to PE

Table 7- 1 Test voltage

	Test time	Prim ↔ sec (A)	Prim ↔ PE (B)	Sec ↔ PE (C)
Type test	60 s	4200 VDC	2200 VDC	700 VDC
	60 s	3000 VAC	1500 VAC	500 VAC
Production test	1 s	2200 VDC	2200 VDC	500 VDC
	1 s	1500 VAC	1500 VAC	350 VAC
Field test	1 s	2200 VDC	2200 VDC	500 VDC
	1 s	1500 VAC	1500 VAC	350 VAC

Remark:

Tripping current for DC measurement: 0 mA

Tripping current for AC measurement: <100 mA

7.3 Approvals

	6EP1332-2BA20	6EP1336-2BA10	6EP1322-2BA00
	6EP1333-2BA20		6EP1323-2BA00
	6EP1334-2BA20		
CE marking	Yes, (2004/108/EG and 2006/95/EG)		
CSA approval	Yes, CSA C22.2 No. 60950-1, cCSAus (ANSI/ISA 12.12.01)		
UL/cUL approval	cULus-listed (UL 508, CSA 22.2 No. 107.1), File E197259		
Explosion protection	ATEX EX II 3G Ex nA nC IIC T4 Gc; cCSAus Class I, Div. 2, GROUPS A, B, C, D, T4		
CB approval	Yes		
CB-Scheme	IEC 60950-1		
SEMI F47 compliance	Not tested	fulfilled	Not tested
Marine approvals	Germanischer Lloyd (GL), BV marine	Germanischer Lloyd (GL)	Germanischer Lloyd (GL)

7.4 EMC

		6EP1332-2BA20 6EP1333-2BA20 6EP1334-2BA20 6EP1322-2BA00 6EP1323-2BA00	6EP1336-2BA10
Electrostatic discharge	EN 61000-4-2	8 kV contact, 8 kV air	8 kV contact, 8 kV air
Electromagnetic fields	EN 61000-4-3	80...1,000 MHz 10 V/m 1400...2,000 MHz 10 V/m 2000...2700 MHz 10 V/m 895...905 MHz and 1.89 GHz 10 V/m	80...1,000 MHz 15 V/m 1000...2700 MHz 10 V/m
High-speed transient disturbance variables (burst)	EN 61000-4-4	2 kV at line connections 1 kV at DC output	4 kV at line connections 2 kV at DC output
Surge voltages	EN 61000-4-5	2 kV symmetrical at the line connections 4 kV asymmetrical at the line connections 500 V symmetrical/asymmetrical on DC output cables	
High-frequency fields	EN 61000-4-6	10 V; 0.15...80 MHz	10 V; 0.15...80 MHz
Magnetic fields	EN 61000-4-8	Not applicable	30 A/m; 50 Hz
Voltage dips	EN 61000-4-11	100% for 20 ms, 60% for 200 ms, 30% for 500 ms	100% for 20 ms, 60% for 200 ms, 30% for 500 ms
Voltage interruptions	EN 61000-4-11	100% for 5000 ms	100% for 5000 ms
Emitted interference	EN 55022	Class B	Class B
Line harmonics limitation	EN 61000-3-2	Class A	Class A
Generic standards	EN 61000-6-2	Immunity for industrial environments	
	EN 61000-6-3	Emission for residential areas	

Ambient conditions

	6EP1332-2BA20 6EP1333-2BA20 6EP1334-2BA20 6EP1322-2BA00 6EP1323-2BA00	6EP1336-2BA10
Ambient temperature	<p>-25 ... +70 °C with natural convection (self convection)</p> <p>Derating for 24 V versions: from +60°C: 3 % I_a, rated/K; from U_a>24 V: -10...+50 °C</p> <p>from U_e<100 V and lower, output power is reduced depending on the ambient temperature</p>	<p>0 ... +70 °C with natural convection (self convection)</p> <p>Derating: from +60°C: 5 % I_a, rated/K;</p> <p>from U_e<100 V or U_e<200 V and lower, output power is reduced depending on the ambient temperature</p>
	<p>Derating for 12 V versions: from +55 °C: 5 % I_a, rated/K</p>	
	<p>Tested according to:</p> <ul style="list-style-type: none"> • EN 60068-2-1 cold • EN 60068-2-2 dry heat • EN 60068-2-78 humid heat, constant • EN 60068-2-14 temperature change 	
Transport and storage temperature	<p>-40 ... +85° C</p> <p>Tests (packed for shipping) according to:</p> <ul style="list-style-type: none"> • EN 60068-2-1 cold • EN 60068-2-2 dry heat • EN 60068-2-30 humid heat, cyclic 	
Humidity class	Climatic class 3K3 according to EN 60721, without condensation	

	6EP1332-2BA20 6EP1333-2BA20 6EP1334-2BA20 6EP1322-2BA00 6EP1323-2BA00	6EP1336-2BA10
Mechanical stressing in operation	Tested according to: <ul style="list-style-type: none">• EN 60068-2-6 vibration, test Fc: 3.5 mm deflection in the range 5 – 8.4 Hz 2 g acceleration in the range 8.4 – 150 Hz• EN 60068-2-27 shock, test Ea: acceleration 150 m/s², test duration 11 ms	
Damaging gases	Tested according to: <ul style="list-style-type: none">• EN 60068-2-42 sulfur dioxide• EN 60068-2-43 hydrogen sulfide	
Atmospheric pressure	Operation: <ul style="list-style-type: none">• 1080 ... 795 hPa (-1000 ... +2000 m)• For operation at altitudes of 2000 m up to 6000 m above sea level: output must be derated by -7.5 % / 1000 m or the ambient temperature must be reduced by 5 K / 1000 m see Figure 4-7 Mounting height derating (Page 21)• Overvoltage category: III to 2000 m (EN 50178) II from 2000 m to 6000 m (EN 50178) II to 2000 m (EN 60950-1) I from 2000 m to 6000 m (EN 60950-1) Storage: <ul style="list-style-type: none">• 1080 ... 660 hPa (-1000 ... +3500 m)	

Applications

9.1 Parallel connection to increase power rating

To increase the power rating, two SITOP PSU100S power supplies of the same type can be directly connected in parallel.

The following must be observed:

- The cables connected to each power supply at terminals "+" and "-" must have identical lengths and the same cable cross-sections (or the same impedance) up to a common external connection point (terminal strip) if possible.
- The power supplies connected in parallel must be switched on simultaneously with a common switch in the line feeder cable (e.g. with the main switch available in control cabinets).
- The output voltages measured in no-load operation for the power supplies that are not yet connected in parallel should not deviate more than a maximum of 50 mV. This usually corresponds to the factory setting. If the output voltage is changed, you should connect the "-" terminals and then, in no-load operation, measure the voltage difference between the "+" terminals that have not yet been connected. The voltage difference should not exceed 50 mV.

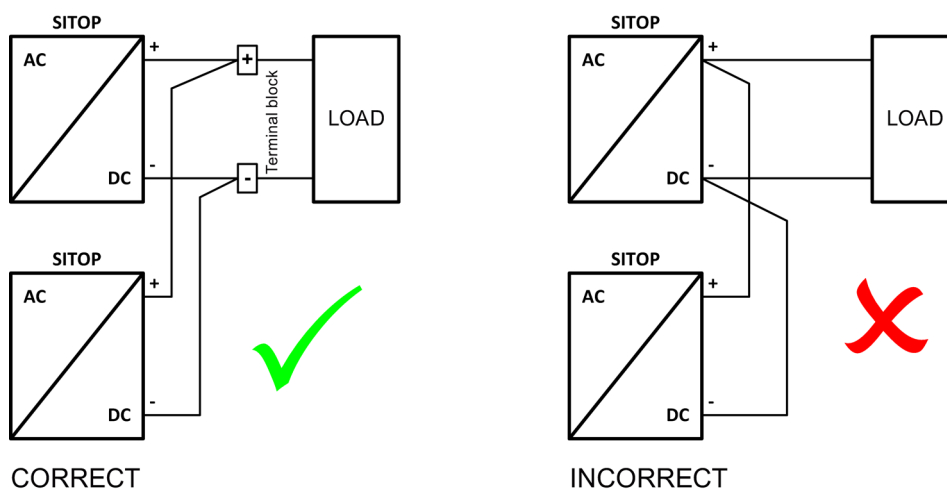

Figure 9-1 Parallel connection

Note

It is not permissible to take into account simultaneous overload capability (Extra-Power 150% for 5 s/min) of several power supplies connected in parallel when configuring the power supply system.

NOTICE

Protective circuit for the parallel connection of more than two power supplies

For connection of more than two power supplies in parallel, additional measures must be taken to prevent high backward feeding currents in the event of a secondary device fault. For this purpose, a suitable protective circuit (e.g. decoupling diode or DC-conform circuit-breaker) must be installed between each "+" terminal of the power supply and the common connection point.

9.2 Parallel connection for redundancy

Connecting several SITOP PSU100S power supplies in parallel for redundancy purposes is required if especially high demands are placed regarding the availability of a reliable 24 V power supply.

Using the SITOP PSE202U redundancy module, two 24 V power supplies of the same type up to 20 A can be decoupled (Figure 9-2 Redundant configuration with two power supplies and SITOP PSE202U redundancy module (Page 63)). When one of the devices fails, then the other automatically takes over the power supply. If one of the power supplies fails, then this is signaled using an LED on the redundancy module as well as an isolated relay contact.

When dimensioning the system, it must be ensured that $n+1$ redundant connected power supplies can handle the total power requirement of the remaining n power supplies.

Note

For a high reliability of the supply, it is recommended that the redundant switched power supplies are fused separately on the line-side and, if possible, be connected to different power supply networks.

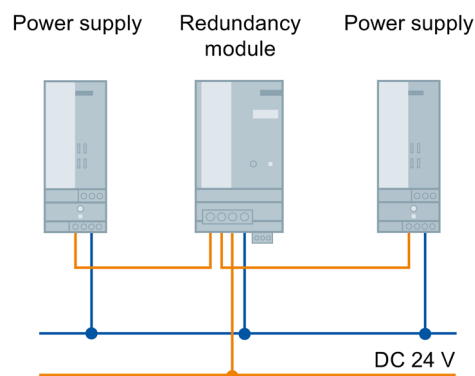

Figure 9-2 Redundant configuration with two power supplies and SITOP PSE202U redundancy module

You can find additional information at:

SITOP PSE202U manual (<http://support.automation.siemens.com/WW/view/en/42248598>)

9.3 Series connection for increased voltage

To achieve an output voltage of 48 V DC, two 24 V SITOP PSU100S power supplies of the same type can be connected in series. In this case, connect the "-" terminal of the first power supply to the "+" terminal of the second power supply. The "+" terminal of the first power supply and the "-" terminal of the second power supply are routed to the load.

Depending on the grounding point of the secondary output voltages, voltages of +48 V, ± 24 V or -48 V can be realized.

In the case of an asymmetric load distribution, it is not possible to guarantee correct functionality.

⚠ WARNING

SELV is not guaranteed in the case of a fault

When connecting two power supplies in series, the continuous, permissible SELV voltage of a maximum of 60 VDC according to EN 60950-1 cannot be guaranteed in the case of a fault.

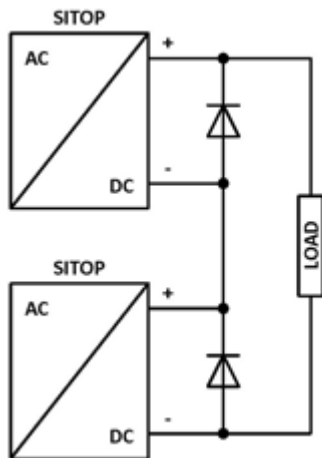

Figure 9-3 Series connection

9.4 Overload protection in the 24 V output circuit

If overload occurs, the electronic current limiting of the SITOP PSU100S power supply limits the output current to a maximum value (refer to chapter Technical data (Page 39)). The output cables are protected against a thermal overload if they are dimensioned corresponding to the maximum rms output current, or protected using additional components (for example, miniature circuit breaker, fuses).

However, a load circuit that fails as a result of overload, for instance, should frequently be reliably and quickly identified and specifically switched off before the power supply goes into current-limiting mode (in current-limiting mode, the supply voltage would also be reduced for all of the remaining 24 V loads).

The SITOP PSE200U selectivity module with 4 channels (versions with adjustable output current range for each channel from 0.5-3 A and 3-10 A) is available; this monitors the 24 V branches for overloading and short-circuiting (Figure 9-4 Electronic protection of 24 V loads using the SITOP PSE200U selectivity module (Page 65)). Brief current peaks, e.g. as a result of a high inrush current, are permitted, and branches with a longer overload are switched into a no-current condition. This is also ensured for cables in a high-ohmic condition and for short-circuits that slowly develop over time.

When a channel fails, the fault is signaled using a group signal contact or as a single channel signal, and the branch of the module involved is displayed using an LED.

For variants with single-channel signaling, function blocks for evaluation purposes are available for SIMATIC S7-1200/1500/300/400, for STEP 7 Classic and TIA Portal at no charge.

You can find additional information at:

SITOP PSE200U selectivity module manuals

(<http://support.automation.siemens.com/WW/view/en/10807226/130000>)

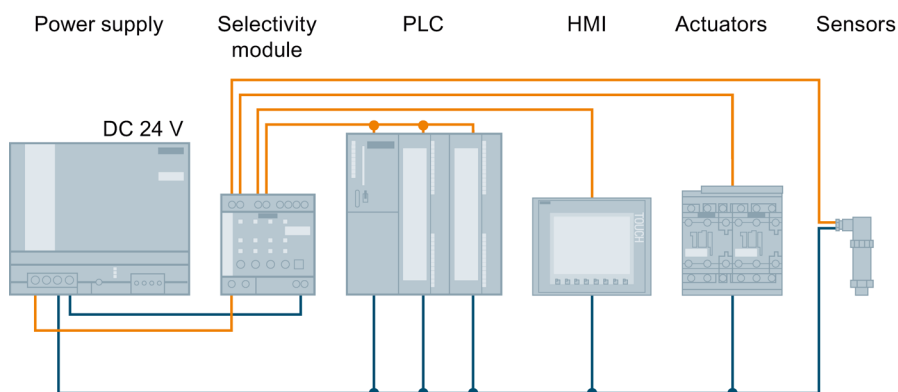

Figure 9-4 Electronic protection of 24 V loads using the SITOP PSE200U selectivity module

9.5 Protection against short-time voltage dips

For a drop in the line-side supply voltage, the SITOP PSU100S power supply still maintains the output voltage for a short time in the millisecond range (see Chapter Technical data (Page 39)).

For line supplies that manifest frequent brief voltage dips, in order to increase the power supply reliability, it may make sense to increase the line buffering time in the device using an additional SITOP PSE201U buffer module.

The SITOP PSE201U buffer module, based on electrolytic capacitors, is connected in parallel to the 24 V power supply output (Figure 9-5 Buffering brief power failures using the SITOP PSE201U buffer module (Page 66)). The buffer time is 200 ms at 40 A up to 1.6 s for a load current of 5 A. This time can be increased a multiple number of times by connecting buffer modules in parallel; the maximum buffer time is 10 s.

You can find additional information at:

SITOP PSE201U manual (<http://support.automation.siemens.com/WW/view/en/41129219>)

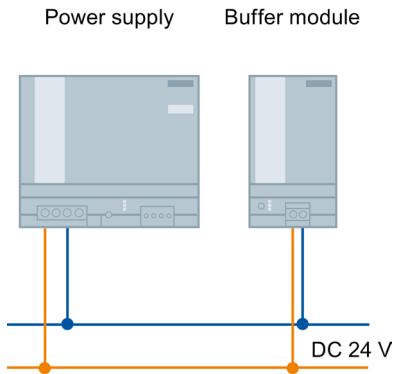

Figure 9-5 Buffering brief power failures using the SITOP PSE201U buffer module

9.6 Protecting against longer power failures

Sudden and longer failures of the line supply voltage can result in undefined states and significant danger as a result of the associated failure of the plant or system control. The SITOP power supply product portfolio includes various DC-UPS solutions to prevent the failure of the 24 V power supply voltage.

Power supply failures up into the minutes range can be buffered using the maintenance-free SITOP UPS500 DC-UPS modules based on capacitors (Figure 9-6 24 V buffering to allow the saving of process data and controlled shutdown of PCs (Page 67)).

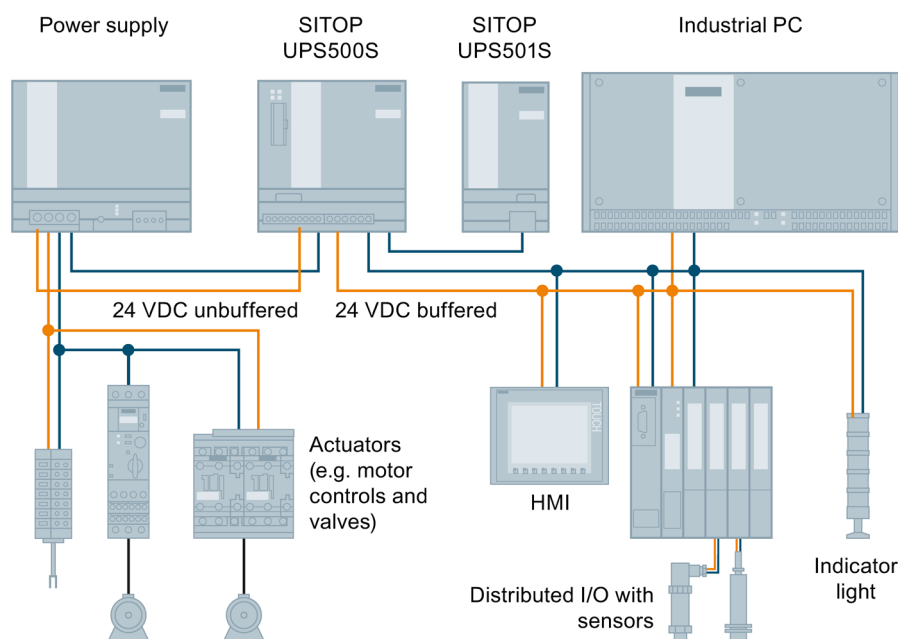

Figure 9-6 24 V buffering to allow the saving of process data and controlled shutdown of PCs

Using the free-of-charge SITOP DC-UPS software tool, DC-UPS systems can be simply integrated into PC-based automation solutions. This supports further processing of the status signals and safely running down the PC.

You can find additional information at:

DC UPS with capacitors manual

(<http://support.automation.siemens.com/WW/view/en/48932766/133300>)

9.6 Protecting against longer power failures

Using DC UPS SITOP UPS1600 and SITOP UPS100 battery modules, buffer times in the range of hours can be implemented. Intelligent battery management using Energy Storage Link automatically detects the UPS1100 energy storage device, and ensures optimum temperature-controlled charging and continuous monitoring. The UPS1600 can be flexibly integrated into the widest range of automation applications with its digital inputs/outputs as well as optional USB interface or Ethernet/PROFINET port.

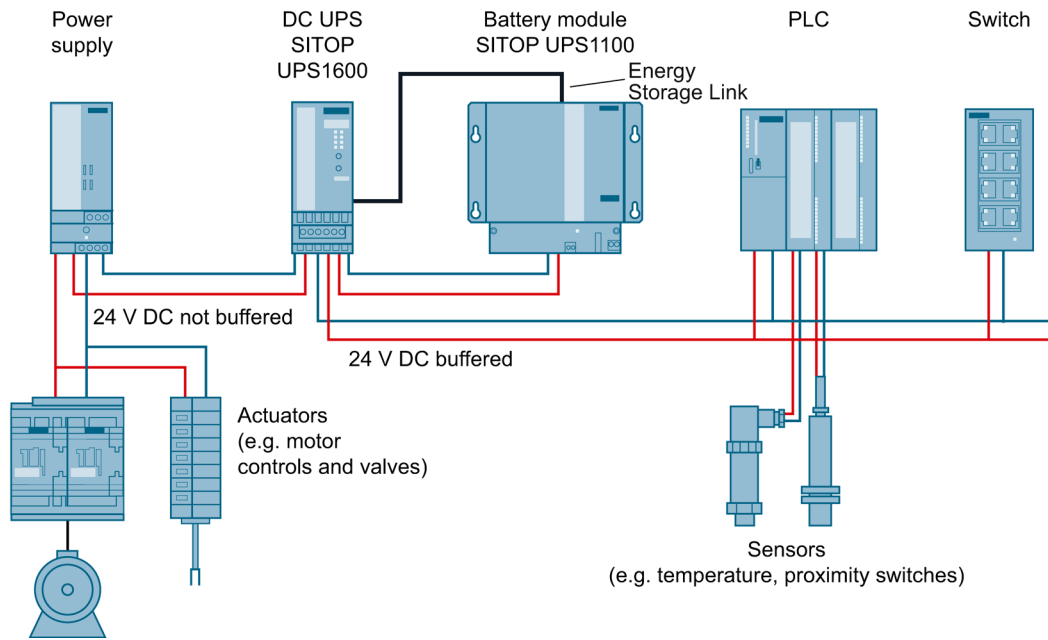

Figure 9-7 24 V buffering with SITOP UPS1600 to maintain communication, signaling functions, sensor measured values and position values

For open, PC-based automation systems, configuration and monitoring is realized using the SITOP UPS Manager PC software, which is available at no charge. This allows PC responses to the operating states of the DC UPS to be freely selected – and offers comprehensive diagnostic functions.

For TIA-based automation systems, the UPS1600 is engineered using the TIA Portal. Special function blocks for SIMATIC S7-300/400/1200 and S7-1500 – available at no charge – make it easy to integrate operating and diagnostics information into STEP 7 user programs. Preconfigured UPS faceplates for WinCC visualization can be downloaded at no charge.

You can find additional information at:

DC UPS SITOP UPS1600/UPS1100 Manual
(<http://support.automation.siemens.com/WW/view/en/84977415>)

Environment

The device is in conformance with RoHS.

As a rule, only non-silicon precipitating materials are used.

Disposal guidelines



Packaging and packaging aids can and should always be recycled. The product itself may not be disposed of as domestic refuse.

Technical support

Technical support for all IA/DT products can be accessed through the following communication channels:

- Phone: + 49 (0) 911 895 7222
- E-Mail (<mailto:support.automation@siemens.com>)
- Internet:
Online support request form (<http://www.siemens.de/automation/support-request>)

Technical documentation on the Internet

Operating instructions and manuals for SITOP are available in the Internet:
Operating instructions/manuals (<http://www.siemens.de/sitop/manuals>)

SITOP power supply homepage

General news about our power supplies is available in the Internet at the SITOP homepage:
SITOP (<http://www.siemens.de/sitop>)

Information material

SITOP information can be downloaded from the Internet:
Information and download center (<http://www.siemens.de/sitop-infomaterial>)

CAX data

2D/3D data and circuit diagram macros can be downloaded from the Internet:
Siemens image database (<http://www.siemens.de/sitop-cax>)

Request all CAX data via the CAX download manager:
CAX shopping cart (<http://www.siemens.de/cax>)

SITOP Selection Tool

Simply and quickly select the optimum the power supply or DC-UPS:
SITOP Selection Tool (<http://www.siemens.de/sitop-selection-tool>)

Online catalog and ordering system

The online catalog and the online ordering system are available through the Industry Mall homepage:
Industry Mall (<http://www.siemens.com/industrymall/de>)

Contact persons

If you have any questions regarding the use of our products, then contact the Siemens contact person in your regional Siemens sales office.

You can find these addresses as follows:

- On the Internet (<http://www.siemens.de/automation/partner>)
- In Catalog CA 01