

Leviton Security & Automation Solutions

2013/2014 Catalog

Security | Energy Management | Entertainment



Leviton Security & Automation 2013/2014 Catalog

Welcome to Leviton		
Letter from the President		
History		
Timeline		
Automation FAQ		
Global Products		
Safety & Security		
OmniPro II Control Systems		
Omni IIe Control Systems		
Omni LTe Control Systems		
Omni Accessories		
Wireless Security Sensors		
Video Surveillance		
Cellular Communication Center		
Access Control		
Convenient Interfaces		
OmniTouch 7		
Automation Studio		
OmniTouch Pro		
OmniTouch Accessories		
PC Access		
Snap-Link Mobile for iPhone®		
Snap-Link Mobile for Android™		
Snap-Link Mobile for Kindle Fire		
Snap-Link PC Software		
Free Apps		
Energy Management		
Lumina Automation Systems		
HAI Lighting Control		
Vizia RF+ Wireless Lighting Controls		
Omni-Bus Lighting Network		
Lighting Comparison		
Omnistat2 Thermostats		
Lumina RF Wireless Energy Management		
SmartGrid Solutions		
Revenue-Grade Meters		
Leviton Monitoring Hubs		
GreenMAX® Relay Control		
01 Entertainment		78
01 Hi-Fi 2 Distributed Audio Systems		80
04 In-Wall and In-Ceiling Speakers		86
05 Outdoor and Home Theater Speakers		88
06 HAI Dock		90
07 Home Theater Extender 2		91
10 Connected Home		92
14 Structured Media Enclosures		96
14 Routers and Switches		102
14 Mounting Brackets		104
16 Twist and Mount Patch Panels		106
20 Modules and Expansion Boards		108
22 Video Distribution and Splitters		110
23 Renu and QuickPort Wallplates		112
24 Decora Wallplates and QuickPlates		114
Cheetah Speed System		116
26 Mobile Device Station, Theater		
and Recessed Receptacles		118
30 Video Accessories		120
30 Audio Accessories		122
31 Support		124
32 Connectivity Partners		126
33 Developer Support		128
33 Five Star Dealer Program		128
34 Installation Resources		128
35 Marketing Materials		129
Training Opportunities		131
36 Technical Support Contacts		132
Demonstration Cases		133
48 Wiring Diagrams		134-152
65 Index by Part Number		153
66 Index by Product Type		165



Letter from the **President**



During our 28th year in operation, I would like to thank you for your continued business and support. As planned, we have become the Security & Automation business unit of the Leviton Manufacturing Company.

The Security & Automation business unit will continue to be based in New Orleans, Louisiana and offer security and energy management automation controllers with wireless sensors, access control, video surveillance, HVAC controls, lighting controls, Audio/Video controls, Smart Grid products and more. All controllers and many individual components are accessible using a smartphone or tablet.

We will use the HAI brand in residential dealer programs where it is widely recognized. Our products will begin using the Leviton brand. The Security and Automation designator reflects our core strengths, and our commitment to providing these products and technologies to you. In this catalog, you will see the synergies and breadth of products that we now offer as Leviton.

We are proud to be part of Leviton, and thankful to all of you who have worked with us to grow the Security and Automation business. We're not closing any books, we're just moving on to the next chapter! With Leviton's support and considerable product portfolio, we look forward to bringing you impressive innovations in the coming months and years and growing our businesses together.

Sincerely,

Jay McLellan
President, Leviton Security & Automation

A photograph of a man and a woman embracing in a living room. The man is on the left, wearing a white sweater, and the woman is on the right, also wearing a white sweater. They are sitting on a couch, and their heads are resting against each other. In the background, a fireplace with a fire is visible, and the room is softly lit. A semi-transparent white banner is overlaid across the middle of the image, containing the text.

Welcome to Leviton Security & Automation



Leviton Security & Automation brings decades of automation and control knowledge to provide the proper solution for homes or commercial buildings. The comprehensive integrated product line means there is a system for every budget. Each year, Leviton Security & Automation garners more recognition for developing and implementing innovative solutions.

- 04 History
- 05 Timeline
- 06 Automation FAQ
- 07 Global Products
- 08 Residential Diagram
- 09 Commercial Diagram

Welcome To Leviton Security & Automation



Leviton Security & Automation, a business unit of Leviton Manufacturing Co. Inc, is located in New Orleans, Louisiana, USA.

Leading with reliable solutions for security, energy management, and entertainment.

Combining over 100 years of electrical manufacturing experience with over 25 years of security and automation knowledge, Leviton Security & Automation offers comprehensive and reliable solutions. In 2012, HAI was acquired by Leviton, with the transitional name, "HAI by Leviton" applied. Mid 2013, "Leviton Security & Automation" was formalized.





1985: Home Automation, Inc. forms to provide products to the emerging home automation & controls market.



1995: The Omni system – providing twice the performance at half the cost of the Model 1503 – hits the market.



1997: The OmniPro controller is introduced, providing expanded features for large homes.



2003: Introduces the OmniTouch Touchscreen. It quickly becomes the international face of home automation.



1988: The Model 1503 is introduced as the first integrated security and automation system on the market.



1996: Omnistat is introduced – the first ENERGY STAR® programmable communicating thermostat line.



2001: Web-Link II: the first Internet remote access & control software for residences.



2007: OmniTouch 5.7 Touchscreen released; Snap-Link Mobile puts home control in the palm of your hand; HLC uses Gen II UPB™ for enhanced reliability and added features.



2011: Wireless energy management system with ZigBee® technology is introduced; Omni-Bus launches for 220V lighting control markets.



2013: Announced as fifth stand-alone business unit, “Leviton Security & Automation.” Leviton released the OmniTouch 7 Touchscreen.



2005: HAI Lighting Control (HLC) introduces the concept of affordable, elegant lighting control; OmniTouch with Video, allowing surveillance video to be displayed; Wireless products enhance security and automation applications.

2008: Introduction of Omnistat2 programmable communicating thermostat; New versions of PC Access software and OmniPro II/Iie controller boards released.

2012: Leviton acquires HAI, and transitional brand evolves to HAI by Leviton. Released Omni LTe security & automation controller, compact Hi-Fi 2 four zone, four source audio system, CFL/LED dimming switch, Kindle Fire e-reader app, and two free iOS® apps.



Welcome to Leviton Security & Automation



Common automation questions and answers

What are the benefits of an automated home or business?

Automation coordinates security, temperatures, lighting, and audio/video automatically for safety, energy savings, and convenience. Automatically dimming lights and changing heating and cooling setpoints while away can greatly reduce energy costs. Remote access lets the user view security video, dim lights, or lower temperatures via a laptop or mobile device.

Leviton Security & Automation products will make the property more energy efficient. If used properly, the system can practically pay for itself in energy savings, while increasing the resale value.

Is the system easy to understand and operate?

Yes. Easy-to-recognize icons allow manual control from familiar devices. Children can even learn and understand how to use basic features of the system. Day-to-day events are controlled with one button, such as Day, Night, Vacation, or Away. More specific activities are menu driven to change temperature, lights, audio and more. Don't forget, many home or business functions are automated based on schedule or any common event.

Can it be controlled over the Internet or telephone?

Yes. All Leviton Security & Automation systems can be monitored and controlled over the Internet or phone either inside or outside. Check and adjust lights, temperature, security, audio, and more from a tablet or smartphone with zero monthly fees.

Can the system expand easily?

Yes. You can add Touchscreens with pool, spa, or irrigation controls, window treatments, remotes, multi-room audio systems, home theater controls, access control, video surveillance, and more. Leviton Security & Automation has partnered with many other companies in related industries so you can expand and customize the automation system now, or at any time in the future.



Is the system affordable?

Yes. Leviton offers a security & automation system for every lifestyle. Price depends on the size of the home or business and options that are desired.

Leviton provides global automation solutions

Leviton Security & Automation multi-language support

Our security & automation control systems, programming software, and interfaces are available in a wide variety of world languages to suit international as well as domestic markets.

Leviton aims to make an automation system comfortable and familiar for every user and has security & automation systems available in several languages. For instance, the iOS® app for iPhone®, iPad®, and iPod® Touch® is available in seventeen different languages: Arabic, Catalan, Chinese (Simplified and Traditional), Croatian, Dutch, English, French, German, Greek, Hebrew, Italian, Portuguese, Russian, Spanish (European and Latin American), and Turkish.



Above: Leviton Security & Automation's iOS® app in Italian

Leviton has global sales offices and a team of knowledgeable sales managers and representatives to serve your market. Leviton conducts international trainings and invites you to our hands-on New Orleans factory training available in Spanish or English.

International market support

Leviton Security & Automation makes available a multitude of foreign language marketing documents including manuals, case histories and specification sheets.



As part of our continuing endeavor to support international markets, the KNX® Gateway allows Ethernet-enabled Omni and Lumina controllers to communicate with and control KNX® devices installed on the network, including lights, shades, shutters, pumps, and more. Utilize Omni-Bus for lighting control or tie in to DALI systems.



The International Omni Console features language neutral symbols to serve a full range of markets.



Welcome to Leviton Security & Automation



Total Home Control from a Single Interface

Enjoy the one-touch control of security, temperature, lighting, audio, and other home control functions, including draperies or irrigation, via easy to recognize icons.

Welcome to Leviton Security & Automation



Internet Access & Control

Multiple programs allow control from anywhere via the Internet with zero fees.



Motion Detection

Detect intrusion plus automatically turn on lights and activate automation functions when entering a room.



Home Theater

Use an iPad® to control A/V equipment, lower projection screens and close window coverings.



Energy Management

Be comfortable at home; save energy when away. Control temperatures in greenhouses, humidors, wine cellars, aquariums, & attics.



Multi-Room Audio

Share music throughout every zone of the home. Use Bluetooth® to distribute streaming or stored music via tablet or smartphone!



Pool & Spa

Control pumps, filters, timers, heaters, temperatures, and solar. Secure pool areas with access control.



Lighting

Set warm and comfortable moods for dining, movies or entertaining. Have lights automatically turn on when arriving home. Provide architectural quality lighting control and passive security for the "lived-in" look when on vacation.



Telephones

Check and adjust security, temperatures, and lights via any phone at home or away. Monitor and control with your smartphone or tablet.



Vehicle Detection

Announce visitors, turn on lights, and activate audio zones or pumps/fountains.



Surveillance Cameras

View and/or record guests arriving at the front door.



Security & Fire

Professional quality UL Listed security is built-in to Omni family controllers. If desired, Lumina family controllers can integrate with an existing security system.



Irrigation

Control solenoid valves for lawn sprinklers, plus inputs for rain sensing.



Access Control

Limit admission to designated areas. When a card or key tag is swiped, security arms or disarms and door strikes are activated.



Comprehensive Control Over All Commercial Buildings

Maximize energy savings and safety by integrating security, energy management and entertainment devices. Automate based upon schedules and activities. Remote access to the entire facility from a smartphone or tablet.

Internet Access & Control

Multiple programs allow control and status of from anywhere via the Internet.

Access Control

Restrict access to secure areas based on user and time/date.

Energy Management

Retrofits easily. Remote access control of all temperatures including wine cellars, humidors and chillers.

Distributed Audio

Use Bluetooth® to share music with 16 different zones.

Motion Detection

Detect intrusion. Automatically turn on lights and activate automation functions when entering a room.

A/V Control

Use an iPad® to control dozens of components.

Commercial Lighting

Integrated relay panels control commercial lighting including signage, interior and exterior lights, ventilation, fans, pumps, etc.

Surveillance Cameras

View and/or record to protect against theft, slip and falls, etc. View live video from any device.

Security

Professional quality UL Commercial Burglary is built-in to automation controllers. If desired, a Lumina controller can be used without security.



“I have found Leviton Security & Automation dependable both commercially and residentially... when you find a product that makes you look brilliant and works simply enough for your customer to use it right out of the gate - install it.”

Conley Secure Innovations, Lakeland, Florida USA



Safety & Security



Leviton Security & Automation offers a complete suite of products for safety and security. Whether checking an event log from a smartphone, watching video surveillance on an iPad®, or restricting access to a secure area, Leviton Security & Automation has you covered.

- 14** OmniPro II Control Systems
- 14** Omni IIe Control Systems
- 14** Omni LTE Control Systems
- 16** Omni Accessories
- 20** Wireless Security Sensors
- 22** Video Surveillance
- 23** Cellular Communication Center
- 24** Access Control

Safety & Security

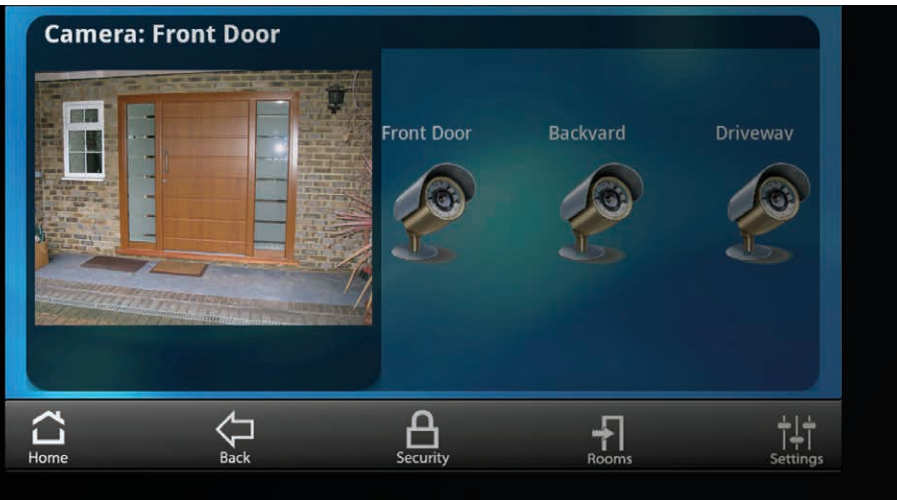

A Leviton Security & Automation Omni control system takes the place of a standard security system. Integrate video surveillance, access control, wireless door locks, and back-up communication devices for a secure property that's accessible from a tablet or smartphone.

Omni Security & Automation Controllers

The Omni family of control systems keeps the entire property safe around the clock, coordinating virtually everything for enhanced energy savings, safety, and entertainment. Omni automation systems are dedicated security alarm panels, featuring built-in UL Listed, CP-01 compliant security and fire systems to detect intrusion, smoke and fire, carbon monoxide, water, vehicles, and other hazards through wired and wireless sensors.

Prevent unauthorized access to sensitive areas or entire buildings by controlling doors and gates. Incorporate backup telephone communications, surveillance cameras, or wireless door locks for enhanced safety. If a built-in security system is not desired, use Leviton's energy-saving Lumina automation system.

Utilize Many Technologies and Protocols

Omni systems are versatile, controlling small condos with the same quality equipment capable of controlling warehouses that are hundreds of thousands of square feet. The scalable solution means you can add new features whenever you want, using a wide variety of open protocols. The reliable Omni automation controller is the brain of the property, coordinating ZigBee®, Z-Wave®, UPB™, KNX®, DALI, and many more standard home and building automation protocols to enhance energy savings and increase safety.

Automate to Simplify Life

Based on schedule or event, automate systems including security, access control, HVAC, lighting, irrigation, ventilation, pumps, fountains, window coverings, and more. Leviton automation systems can turn off lights, fans, water heaters, fountains and pool pumps when the property is unoccupied to save money. Push one button at night to turn off lights, turn off AV equipment, close window coverings, lower temperatures, lock doors, etc.

Remote Access: Anywhere, Anytime

Omni automation systems provide remote access, allowing one to view live surveillance footage, unlock a door, view event logs, or activate the alarm at any time from a tablet, smartphone, or PC with zero monthly fees.

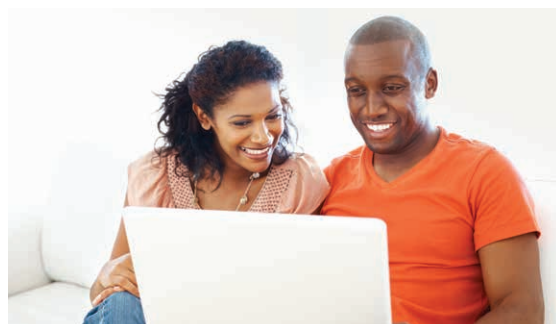

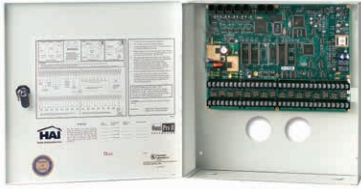

OmniPro II Controller

20A00-2

The flagship Leviton Security & Automation home automation controller. Includes the OmniPro II controller with enclosure, lock set with two keys, RJ31X cord and jack, manuals. Part 20A00-2 is English language. For other available languages add language code to part number: French (FR) and Latin American Spanish (SPA).



OmniPro II Commercial Controller

20A00-5

OmniPro II controller with commercial attack-proof enclosure, lock set with two keys, RJ31X cord and jack, manuals. Available in English.

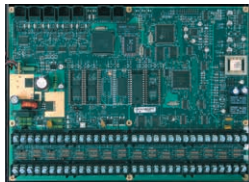

OmniPro II - Board Only

20A00-21

OmniPro II controller board only. Part 20A00-21 is English language. For other available languages, add language code to part number: Arabic (AR), Catalan (CAT), Simplified Chinese (CHS), Traditional Chinese (CHT), French (FR), German (GER), Hebrew (HE), Italian (IT), Portuguese (POR), Russian (RU), Latin American Spanish (SPA), and European Spanish (SPE).

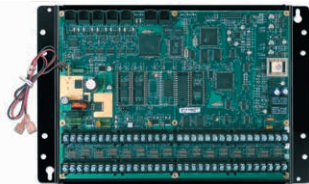

OmniPro II Controller for Leviton Structured Media Center

20A00-8

OmniPro II controller on mounting plate for structured wiring enclosures, RJ31X cord and jack, manuals, accessory kit, wiring diagram for enclosure door. Part 20A00-8 is English language. For other available languages add language code to part number: Arabic (AR), Catalan (CAT), Simplified Chinese (CHS), Traditional Chinese (CHT), French (FR), German (GER), Hebrew (HE), Italian (IT), Portuguese (POR), Russian (RU), Latin American Spanish (SPA), and European Spanish (SPE).

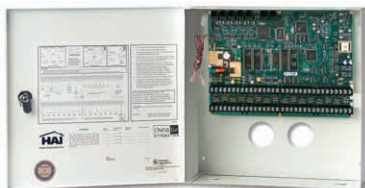

Omni IIe Controller

20A00-50

Omni IIe controller with enclosure, lock set with two keys, RJ31X cord and jack, manuals. For other available languages, add language code to part number: French (FR) and Latin American Spanish (SPA).



Omni Iie Controller for Structured Wiring Enclosures

20A00-52

Omni Iie controller on mounting plate for structured wiring enclosures, RJ31X cord and jack, manuals, accessory kit, wiring diagram for enclosure door. Part 20A00-52 is English language. For other available languages add language code to part number: Arabic (AR), Catalan (CAT), Simplified Chinese (CHS), Traditional Chinese (CHT), French (FR), German (GER), Hebrew (HE), Italian (IT), Portuguese (POR), Russian (RU), Latin American Spanish (SPA), and European Spanish (SPE).

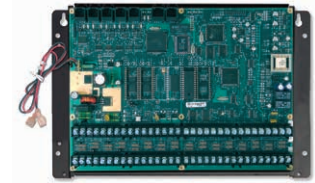

Omni Iie – Board Only

20A00-53

Omni Iie controller board only. Part 20A00-53 is English language. For other available languages add language code to part number: Arabic (AR), Catalan (CAT), Simplified Chinese (CHS), Traditional Chinese (CHT), French (FR), German (GER), Hebrew (HE), Italian (IT), Portuguese (POR), Russian (RU), Latin American Spanish (SPA), and European Spanish (SPE).

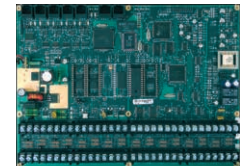

Omni LTe Controller

20A00-70

Omni LTe controller with enclosure, lock set with two keys, RJ31X cord and jack, manuals. Part number 20A00-70 is English language. For other available languages add language code to part number: French (FR) and Latin American Spanish (SPA).

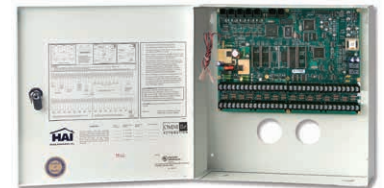

Omni LTe Controller for Structured Wiring Enclosures

20A00-72

Omni LTe controller on mounting plate for structured wiring enclosures, lock set with two keys, RJ31X cord and jack, manuals. Part number 20A00-72 is English language. For other available languages add language code to part number: Arabic (AR),Catalan (CAT), Simplified Chinese (CHS), Traditional Chinese (CHT), French (FR), German (GER),Hebrew (HE), Italian (IT), Portuguese (POR), Russian (RU), Latin American Spanish (SPA), and European Spanish (SPE).

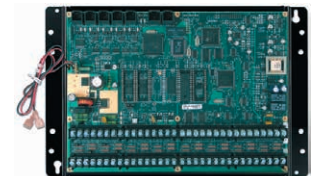

Omni LTe – Board Only

20A00-73

Omni LTe controller board only. Part 20A00-73 is English language. For other available languages add language code to part number: Arabic (AR),Catalan (CAT), Simplified Chinese (CHS), Traditional Chinese (CHT), French (FR), German (GER),Hebrew (HE), Italian (IT), Portuguese (POR), Russian (RU), Latin American Spanish (SPA), and European Spanish (SPE).

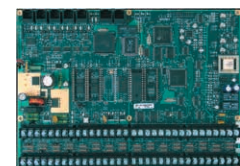



16 Zone Hardwire Expander

10A06-1

Terminals are provided for 16 additional zones that can be programmed for burglary, fire, temperature or auxiliary inputs (for use with all Leviton Security & Automation home controllers except Omni LTE and Omni LT.)

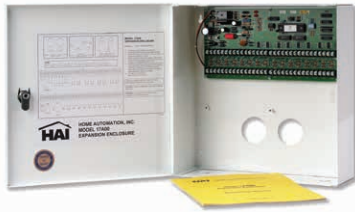

Expansion Enclosure

17A00-1

16 Input/16 Output Expansion Board with enclosure, lock set with two keys, accessory kit, instructions. Reduces wiring use in larger installations (for OmniPro II, Lumina Pro). Can be remotely located from controller. Provides additional battery-backed power for security and temperature sensors.



16 Zone/16 Output Expansion

17A00-9

16 Zone Input/16 Output Expansion Board on a universal mounting plate with accessory kit, instructions for installation in structured wiring enclosures (for OmniPro II, Lumina Pro). Can be remotely located from controller. Provides additional battery-backed power for security and temperature sensors.

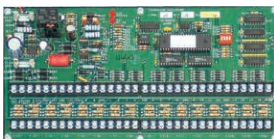

Expansion Board Only

17A00-8

16 Input/16 Output Expansion Board only (for OmniPro II, Lumina Pro). Can be remotely located from controller. Provides additional battery-backed power for security and temperature sensors.



Omni Console

33A00-1

Omni Console with Built-in Speaker/Microphone

33A00-4

International Market Omni Console

33A00-23

International Market Omni Console with Built-in Speaker/Microphone

33A00-24

Cool blue LCD surface mount console, connector kit, instructions. Controls security, lighting, temperatures, buttons, events, setup and other functions. International versions feature easy to understand symbols rather than text. Parts 33A00-4 and -24 require the Two-Way Voice Module (Leviton Security & Automation part #10A11-1). See special wiring instructions in wiring section.



Flush Mount Kit

33A00-3

White flush mount back box for use with 33A00-1, 33A00-4, 33A00-19, 33A00-20, 33A00-23, 33A00-24, 33A00-25, and 33A00-26 consoles and keypads (not included). Includes mounting bracket, instructions.



*Console not included.

Surface Speaker Microphone

28A00-1

Flush Speaker Microphone

28A00-2

A speaker and microphone assembly that allows two-way communication with a central station after an alarm, paging and listening from an on-premises or remote phone, annunciation of alarm and zone by voice, and voice messaging when connected to a Two-Way Voice Module (Leviton Security & Automation part #10A11-1). Includes speaker and microphone, surface mount enclosure, instructions.



Two-Way Voice Module

10A11-1

Talk or listen through the telephone interface either locally or remotely. Have your system announce messages based on events in the house. For example, "guest at door" or "back door open". Includes two-way voice board, mounting material, and instructions. Use with the 33A00-4 or 33A00-24 consoles, 33A00-20 keypad, 28A00-1 Surface Speaker/Mic, or 28A00-2 Flush Speaker/Mic.

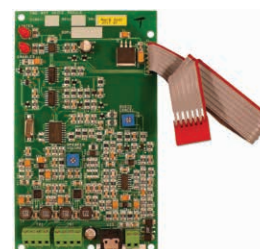

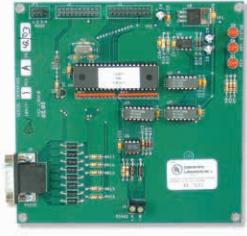

RS-232/RS-485 Serial Board

10A17-1

Allows an Omni or Lumina controller to be connected to a personal computer or other system to exchange data and commands. The controller can be accessed continuously and in real time through the interface without affecting the operation of the controller. Includes RS-232/485 serial board, accessory kit, 20 pin cable, instructions.



Four Relay Module

10A07-1

Eight Relay Module

19A00-1

Relay Modules are used to convert voltage outputs to Form C relay contacts for switching pumps, motors, commercial lighting, remote control breakers, and sprinkler systems. For use with Omni and Lumina controllers.



Universal Mounting Plate

20A07-2

Mounting plate, hardware kit & instructions. Used to mount Leviton Security & Automation's Omni, Lumina, and Hi-Fi 2 main board assemblies, expanders, and accessories for installation in structured wiring enclosures.



Enclosure Lock and Two Keys

21A06-1

Lock for enclosure and pair of matching keys. Included with 17A00-1 and 95A09-1.



Hardwired Load Control Module

72A00-1

20 AMP Relay Module that connects directly to voltage outputs on Leviton Security & Automation home controllers and expanders and includes a manual override switch. Can control 120, 240, or 277VAC loads. Ideal for lighting control in small commercial environments. Requires 120V and neutral wires.

Leviton Security & Automation Serial Server

93A00-1

RS232/RS485 to TCP/IP converter integrated with a robust system and network management features designed for serial equipment to be accessed and controlled via Intranet or Internet.



KNX® Gateway

97A00-1

The Leviton Security & Automation KNX® Gateway allows Omni and Lumina controllers (OmniPro II, Omni IIe, Omni LTe, Lumina Pro, and Lumina) to communicate with and control KNX® devices installed on the network. Lighting, temperature and energy management, and motors (window coverings, shades, shutters, etc.) are among the many KNX® devices that can be controlled from a Leviton Security & Automation interface or via controller programming.



Serial PC Cable

21A05-2

7 foot cable, modular to DB-9F - connects Omni or Lumina controller serial ports to computer RS-232 serial port for use with PC Access, and other Leviton Security & Automation Connectivity Partners.



UPB™ Powerline Interface Module to Computer Cable

36A05-2

7-foot cable, modular to DB-9F - connects Leviton Security & Automation UPB™ Powerline Interface Module to computer RS-232 serial port for use with UPStart software. UPStart may be downloaded for free. Also used for Leviton Security & Automation Connectivity Partners, as directed.



Serial Connectivity Cable

36A05-4

7-foot cable, modular to DB-9M - connects controller to serial ports for Russound, NuVo, RadioRA, CentralLite, Jandy, and other Leviton Security & Automation Connectivity Partners.





64-Zone Wireless Receiver

45A00-1

433 MHz for use in domestic and international installations. Allows up to 64 unique wireless security transmitters to report information to a Leviton Security & Automation controller. The wireless transmitters replace wired door and window sensors, as well as wired motion and glassbreak detectors. Includes Receiver Signal Strength Indicator (RSSI) capability, indicating signal strength of the transmitter as good, fair, or poor. That information is stored in the Leviton Security & Automation system and can be accessed from any Leviton Security & Automation console, OmniTouch Touchscreens or PC Access. This information is important to an installer to ensure optimum placement and performance of the transmitters and receivers.



Glass Break

61A00-1

The 61A00-1 Wireless Glassbreak Detector is an omnidirectional acoustic sensor and wireless transmitter. It is used for detecting the sound of breaking glass, providing 360° of coverage. Requires a Leviton Security & Automation 64 Zone Wireless Receiver (Leviton Security & Automation part #45A00-1). Uses a CR23A lithium ion battery, included.



PIR Motion Detector

47A00-2

Quad element detector reduces false alarms. 33lbs. and 55lbs. pet immune settings. 30'x 50' coverage. 3-year battery life. Includes quad motion detector with wall and ceiling mount hardware, wide-angle lens, battery, instructions. Requires an Leviton Security & Automation 64 Zone Wireless Receiver (Leviton Security & Automation part #45A00-1). Uses CR123A lithium ion battery, included.



Four-Button Wireless Keypad

69A00-1

May be programmed to control any Leviton Security & Automation Omni or Lumina home control system feature, such as lights, temperatures, macros, and the security features of an Omni family home control system. Requires a Leviton Security & Automation 64 Zone Wireless Receiver (Leviton Security & Automation part #45A00-1). Uses CR2032 lithium ion battery, included.



Four-Button Keyfob

48A00-1

Can be programmed to control any Leviton Security & Automation controller feature, such as lights, temperatures, macros, and security. Includes instructions. Requires a Leviton Security & Automation 64 Zone Wireless Receiver (Leviton Security & Automation part #45A00-1). Uses CR2025 lithium ion battery, included.



Panic/Alert Pendant

50A00-1

Can trigger outgoing phone calls to up to 8 different numbers, an e-mail notification, or video surveillance recording. Includes Panic/Alert pendant with lanyard, battery, and instructions. Requires a Leviton Security & Automation 64 Zone Wireless Receiver (Leviton Security & Automation part #45A00-1). Some features may require additional equipment. Uses CR2032 lithium battery, included.

Wireless Driveway Sensor

63A00-1

No digging or underground cable required. Uses earth's magnetic field to detect moving vehicles. Activate lighting, video surveillance, and more when a vehicle is detected in a driveway or parking area. Magnetic sensing range of 12 feet with three sensitivity modes for precise installation. Two unique mounting options including stake or post/wall mount. Operates in temperatures between -20-120°F. Requires a Leviton Security & Automation 64-Zone Wireless Receiver (Leviton Security & Automation part #45A00-1). Uses two C-cell alkaline batteries, included.



Door/Window Transmitter

46A00-1

3 Zone Door/Window Transmitter with a mercury tilt switch for garage doors. Includes Door/Window 3 Zone transmitter with tilt switch, magnet, mounting hardware, battery, instructions. Requires a Leviton Security & Automation 64 Zone Wireless Receiver (Leviton Security & Automation part #45A00-1). Uses CR123A lithium ion battery, included.



Mini Contact

58A00-1

The 58A00-1 Mini Door/Window Transmitter is a miniature (1.7"H x 1"W x .65"D) supervised wireless transmitter that comes with a case tamper switch, wall tamper switch, and a replaceable Lithium battery. The 58A00-1 is a single zone miniature version of the existing 46A00-1 Three Zone Door/Window Transmitter. Requires a Leviton Security & Automation 64 Zone Wireless Receiver (Leviton Security & Automation part #45A00-1). Uses CR2450N lithium ion battery, included. Two hard wire inputs in addition to built-in reed switch.



Vanishing Contact

57A00-1

The 57A00-1 Vanishing Door/Window Transmitter is an ultra-thin (1.5"H x 1"W x .38"D) supervised wireless contact. It has beveled edges that vanish into any décor. It also features a bypass button that allows you to manually bypass the transmitter, which automatically restores when the magnet is replaced. Requires a Leviton Security & Automation 64 Zone Wireless Receiver (Leviton Security & Automation part #45A00-1). Uses CR2032 lithium ion battery, included.



Wireless Recessed Door Contact

56A00-1

This recessed supervised wireless transmitter is used for the protection of doors and windows in installations where the contact must be totally hidden. The transmitter is concealed within the door or window frame for virtual transparency. It is supplied with a replaceable lithium battery that lasts for 5 years under normal conditions. Requires a Leviton Security & Automation 64 Zone Wireless Receiver (Leviton Security & Automation part #45A00-1). Uses CR23V lithium ion battery, included.



Video Surveillance Cameras

Imagine confirming the security and safety of a business location, residence, or vacation home in an instant. View surveillance video of the front entrance, business interior, nursery, or driveway. On vacation and concerned about the safety of the property? Want to check up on children, elderly relatives, or pets from the office? Leviton Security & Automation's surveillance video may be viewed remotely on a smartphone/tablet, or via Snap-Link on any Internet-connected computer in the world.



Indoor/Outdoor Mini Dome IP Camera

68A11-1

Full High Definition 1080p at up to 30 frames per second. View on your smartphone, tablet, or OmniTouch Touchscreen. Simultaneously streams H.264 and MJPEG video (dual stream). Thanks to the built-in web server, you can view live and recorded video from a PC and have still video frames emailed to you or uploaded to an FTP site when motion is detected in an area. Record video to a Micro SD card or PC. Camera automatically switches to black and white at night for enhanced viewing capabilities. Features a weatherproof dangle and is rated IP66 for outdoor use (operational temperature 14 degrees F to 122 degrees F). With Power over Ethernet, there is no need for power supplies or power outlets.



Indoor/Outdoor Day/Night Bullet Camera

68A02-2

1/3" Sony Super-HAD CCD; 3.8-9.5mm auto iris vari-focal lens; 560 TV lines; NTSC; 0 Lux under IR illumination; true day/night functionality with IR Cut Filter; 36 IR LEDs for night vision (up to 95 ft IR range); bracket mount with pan, tilt, and rotation adjustments (wire feed-through); sun shield included; 12VDC; power supply required, not included.



Indoor/Outdoor Day/Night Dome Camera

68A01-1

1/3" Sony Super-HAD CCD; 3.7-12mm auto iris lens; 420 TV lines; NTSC; 0 Lux under IR illumination; water resistance IP 66 protection; wide range viewing 3D covert bracket design; 12VDC/24VAC dual voltage; easy installation with attached cap design with anti-scratch cover coating; compact size; power supply required, not included.

Digital Video Recording

Network Video Storage Server

68A00-2

The Video Storage Server is a 4-channel D1 high resolution digital video recorder with H.264 video compression. It features real time monitoring with local recording and playback. It has a built-in web server and network interface that is used for monitoring real time high resolution video and bi-directional audio via the network and scheduling, searching, and playing recorded video. It stores recorded video and audio on its local drive, so you can search and playback files anytime and anywhere network access is available.

The Network Video Storage Server is designed to work with the OmniTouch 7 and composite analog cameras. It has four inputs that can be connected to a Leviton Security & Automation controller to activate events, and also has one alarm output that can be connected to the control system.

- Compact - Securely mounts into a Leviton Structured Media Enclosure
- High Resolution Video: D1 (720 x 480) at 120 Fps
- H.264 Video Compression
- Real Time Monitoring with Local Recording and Playback
- Supports PTZ (Pan/Tilt/Zoom)
- Built-in Web Server and Network Interface
- Pentaplex Operation: Live, Playback, Record, Archive, and Remote
- Alarm Inputs and Output; BNC, HDMI and VGA outputs; 2 USB
- Recording: Manual, Continual, Schedule, Motion, and Alarm
- Supports up to 2TB HDD

Alarm Panel and Telephone Backup Device

Cellular Communication Center (C3)

70A00-2

Now with Caller ID functionality, the wireless cellular communicator adds protection if a landline is disabled or not desired. Allows phone calls to be made over the GSM cellular network using the existing landline telephones. The C3 can be used when there is no land line or the land line is temporarily unavailable.

- Now includes Caller-ID!
- No programming!
- Functions as either primary or backup phone service
- Monitors land line and switches to cellular if land line is down
- Full telephone line (PSTN) simulation
- When tied to a security system, reports to central monitoring station
- Station can call homeowners via the C3 to verify alarm condition
- Supports prepaid GSM SIM cards
- Built-in battery charger automatically charges backup battery
- Full 2W power and remote antenna for superior call quality



Control Access Based on Time, Day, or Person

Proximity card readers and accessories connect to a Leviton Security & Automation system for complete access control. Popular uses of Leviton Security & Automation's access control include restricting access to outbuildings, gyms, theaters, cellars, and pools. Simplified wiring makes for efficient residential or small commercial use. Everything between the controller and the readers—including power—goes over a single four-conductor or CAT-5 cable.

Each card is attached to a user code in the Leviton Omni or Lumina automation controller which can be managed with specific privileges. For instance, users can be granted privileges based on time and date, and access can be restricted to specific readers. Each swipe can perform as many actions as desired and these results can be customized by time of day, arming condition, or any other event the Leviton Security & Automation control system is monitoring, including lighting, temperature, video surveillance, and audio.



Access Control Card Reader

75A00-2

125 KHz high security, digitally encrypted, 26-Bit proximity card reader that connects to a serial port on a Leviton security & automation system. The reader has durable and scratch resistant polycarbonate housing. Full epoxy potting ensures successful operation even in harsh environments. The 75A00-2 can be mounted to metal door frame (mullion) or to any flat wall surface. Two-color LED (green and red) and Piezo sounder guarantee accurate reliable door access operations.



Access Control Keypad

54A00-1

Weatherproof and vandal resistant piezoelectric keypad designed to interface with Leviton Security & Automation home controllers. Buttons work simply by tapping the surface. Sleek keys of the outdoor keypad can be operated with a bare finger or a snow-covered glove. Stainless steel outdoor keypad, cable assembly, instructions. Connects via serial port on Leviton controller (does not use console/keypad port on console bus).



Access Control Card, Pack of 10

78A00-1

125 KHz credit card size 1.7mm thick high security proximity card with fully encrypted format stored on the card. Thin, flexible, and light enough to be carried in a purse or wallet. Preprogrammed at the factory with a unique encryption code. Provides a read range up to 4".

Access Control Key Tag, Pack of 10

78A00-2

Very small (only 4 grams) 125 KHz high security digitally encrypted proximity key tag. Hole for a key ring or Leviton Security & Automation. Pre-programmed at the factory with a unique encryption code. Small and durable enough to fit on a key ring. Provides a read range up to 2”.



12VDC Electric Door Strike (Fail Secure)

79A00-1

When used with 75A00-2 Access Control Reader, this door strike securely locks and unlocks a door without the need of a key. Allows the door to be locked when closed, but can be automatically unlocked by the system, or manually unlocked with a key. 12VDC Fail-Secure device, which means the door unlocks when power is connected (i.e. the door is locked when power fails).



Power Hub in Enclosure Power Hub for Structured Wiring Enclosures

83A00-1
83A00-2

General purpose 12VDC power supply mounted in enclosure (83A00-1). Designed to provide power to several Leviton Security & Automation products, including Leviton Security & Automation Access Control Readers with electric or magnetic locks, Omni consoles, and many other devices. The Leviton Security & Automation Power Hub provides battery backed power for connected devices. Convenient connections and power terminals for a neat installation. Designed to eliminate unsightly transformers, power strips, external power supplies, battery backup units, and complex wiring normally associated with access control installations. Up to five (5) Amps total; Connectors for 2 sealed batteries, 12V@4-8Ah each (not supplied); Power for 8 Leviton Security & Automation Access Control Readers (75A00-2, with electric and magnetic locks) OR eight Omni Consoles and/or OR four Leviton Security & Automation Access Control Readers (75A00-2, with electric and magnetic locks) and four Omni Consoles.

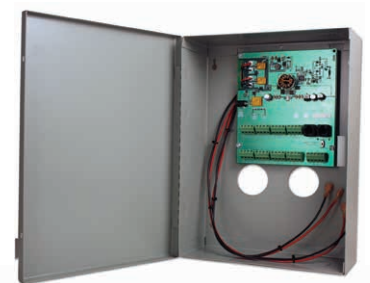

Convenient Interfaces

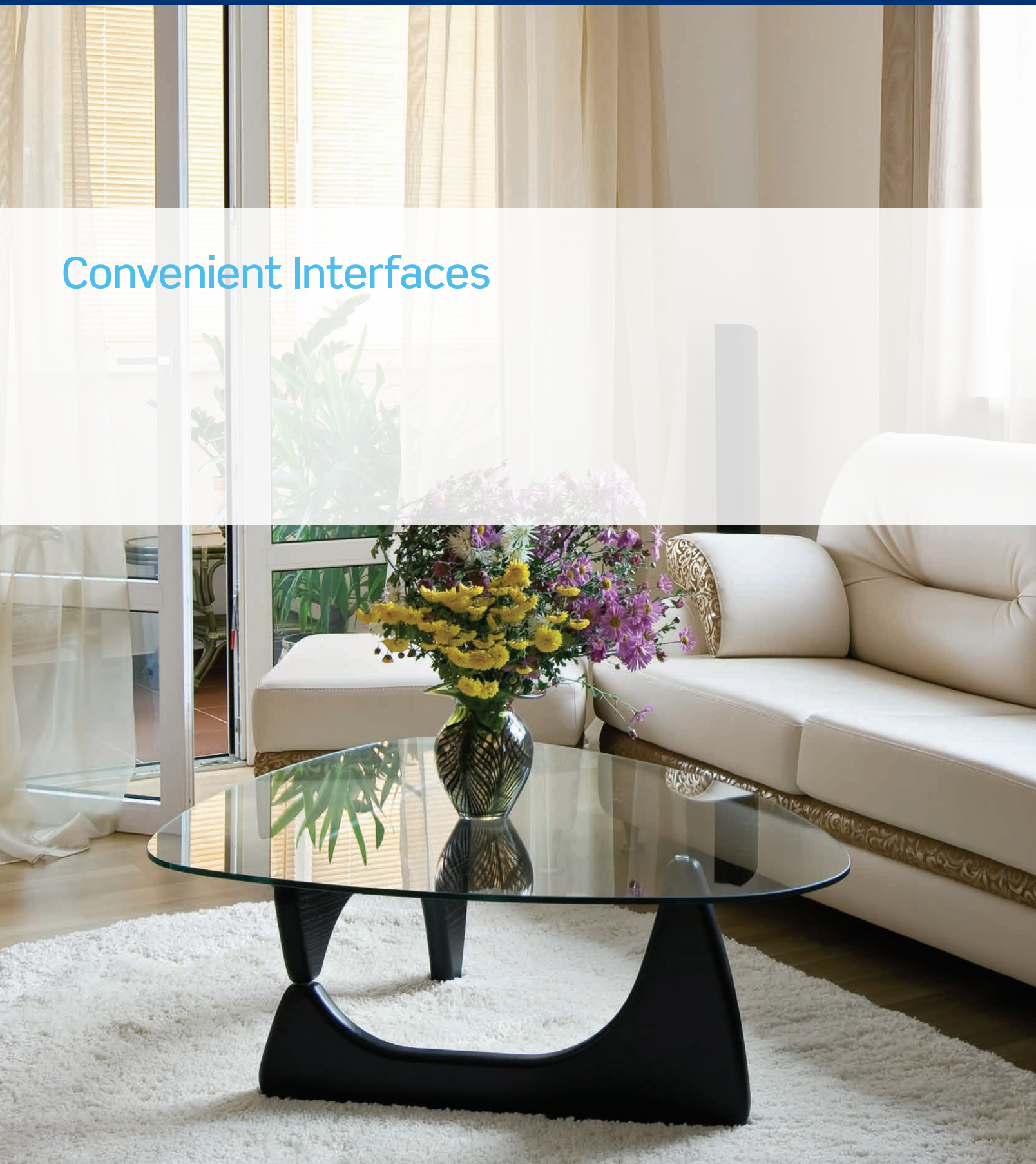



Leviton Security & Automation has many options to access and control a home or business. Choose from Touchscreens, consoles, keypads, software, and apps for mobile devices including smartphones, tablets, and e-readers. All interfaces and software are sold without subscription fees.

- 29 OmniTouch 7
- 30 OmniTouch Accessories
- 30 OmniTouch Pro
- 30 Automation Studio
- 31 PC Access
- 32 Snap-Link Mobile for iPhone®
- 33 Snap-Link Mobile for Android™
- 33 Snap-Link Mobile for Kindle Fire
- 34 Snap-Link PC Software
- 35 Free Apps

Convenient Interfaces



Whether you're using a Leviton Security & Automation in-wall Touchscreen, a tablet while on vacation half-way around the world, or a smartphone in the office, there is guaranteed total control over the house or commercial property. Remote access with zero monthly fees!

The New OmniTouch 7 Touchscreen

OmniTouch 7 Touchscreen 99A00-1 (White) / 99A00-2 (Black)

The new capacitive touch, glass front Touchscreen from Leviton Security & Automation features a 7" diagonal viewing area in high resolution for control of your security, energy, and entertainment settings. No setup required other than entering your automation controller's IP address and adjusting the port and encryption keys.

Designed for the OmniPro II, Omni IIe, Omni LTe, Lumina Pro, and Lumina automation systems.

Security:

- Arm or Disarm your security system or alert emergency personnel.
- Quickly check whether all doors are locked and either unlock or lock any door from one menu.
- View crisp IP surveillance video footage without any additional hardware. MJPEG and JPEG IP Cameras can be viewed, as well as analog with an analog to IP converter.
- Quick glance LED on the top right corner is green when security is disarmed and red when armed.

Energy Management:

- Utilize slider bars to adjust lighting load levels from 0 to 100%.
- Access up to 64 thermostats including humidity settings.
- Control irrigation, ventilation, and window coverings.

Entertainment:

- Control Leviton's Hi-Fi 2 Distributed Audio System or a compatible system from a Connectivity Partner.

Specifications:

- Large approx 7" diagonal viewing area with minimal plastic surround available in Black or White.
- 7.25"x5.125"x0.55" on exterior wall surface, and 6"x4"x1" behind surface of wall.
- Glass front capacitive touchscreen at 800x480 resolution.
- PoE connection provides all power and communication.
- Optional 12VDC power can be used if not utilizing PoE.
- Firmware updates via Ethernet.
- 2 watt mono digital amplifier and speaker.
- Two digital MEMS microphones for improved noise and echo cancellation.
- Light sensor allows automatic dimming of display backlight.

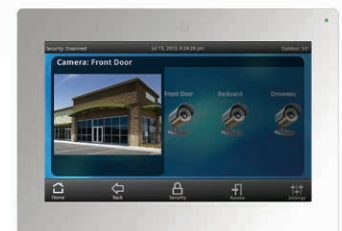
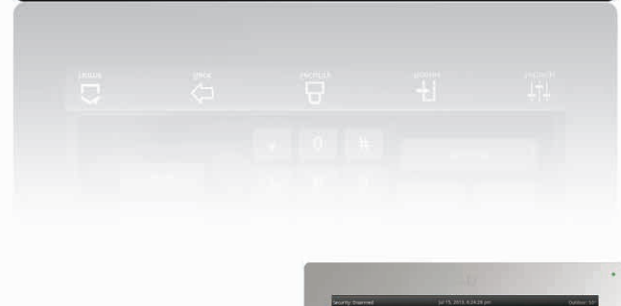
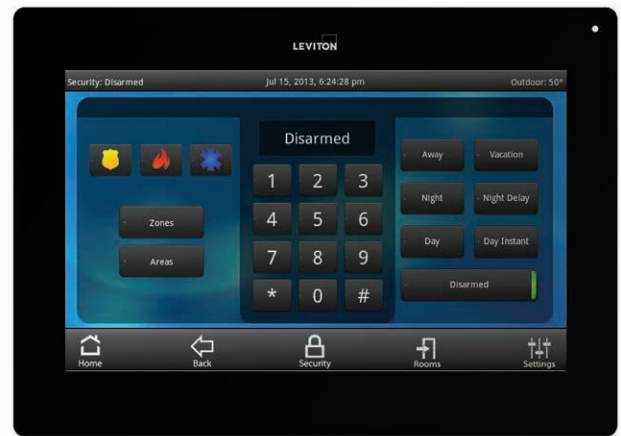

Convenient Interfaces



One Port PoE Injector

90A00-1

Single port PoE injector that is fully compatible with Powered Devices that comply with the IEEE 802.3af standard. Can provide power to one OmniTouch 7 Touchscreen or other Powered Devices (such as the Home Theater Extender 2, PoE IP cameras, PoE Wireless Access Points, PoE Printer, etc.) without requiring additional power wiring to the device. Provides up to 15.4 watts of power and 10/100M data transmission through the traditional CAT-5 cable.



Eight Port PoE Switch

91A00-1

Eight Port PoE Switch with Structured Wiring Backplate

91A00-2

Power Source Equipment (PSE) device that is fully compatible with IEEE 802.3af standard compliant devices. Powers up to seven OmniTouch 7 Touchscreens (one port must be connected to the network). PoE ports can also power other powered devices (such as the HTX2, PoE IP cameras, PoE Wireless Access Points, etc.) without additional power wiring to the device. Each PoE port can provide 15.4 watts of power and 10/100M data transmission through traditional CAT-5 cable to the Powered Device.



Leviton Security & Automation OmniTouch Pro shown on an iLi Touchscreen

OmniTouch Pro

1131

Leviton Security & Automation's OmniTouch Pro is an intuitive touchscreen interface application for a third-party PC or PC touchscreen that provides access to security, lighting, temperature, audio/video, surveillance cameras, and more.

OmniTouch Pro features Leviton Security & Automation default interface designs which are applicable to many Windows® tablets and Touchscreens.

This default interface can be customized using Leviton Automation Studio software (Leviton Security & Automation part number 1126). OmniTouch Pro is available in eight different languages and multiple resolutions.



Automation Studio

1126

Automation Studio is a software package developed to allow customization of graphic interfaces and foreign language support for OmniTouchPro Software on third party Touchscreens. With Automation Studio, complete control is gained over look, feel and function, IP or analog surveillance cameras are set up, and the Leviton Security & Automation Home Theater Extender 2 (HTX2) can be configured.



PC Access

1105W/1106W/1111

PC Access features set up, programming, and monitoring of a home control system over a modem or by a serial or network connection. PC Access is the only software product Leviton Security & Automation offers that has the ability to program a Leviton Security & Automation automation system.

Commands for comparing temperatures (example: indoor vs. outdoor), timers, humidity, thermostat settings, and more make innovative energy-saving strategies easier. Leviton Security & Automation has also made it easier for customers to make adjustments to their systems (altering wake-up times, "away" temperatures, holidays) without changing the system's programming.

With the auto-completion feature, PC Access speeds the programming process by jumping to a command after the first few letters of a program line are typed.

Enhanced automation programming features include:

- Multiple triggers, conditions, and commands in a single statement
- Save programs for re-use
- Add comments to programs
- Simplified program editing
- Search and replace
- ZIP code wizard
- Account summary page
- Easy tree-based navigation
- Fewer mouse clicks and keystrokes
- Integrated help and documentation
- All lists can be sorted and/or filtered
- Supports longer, more descriptive "friendly" names
- Ability to name UPB™ links and other lighting scenes
- Integrated firmware updater for new flash-enabled controllers
- Simplified set up: names and properties of an object edited on a single page

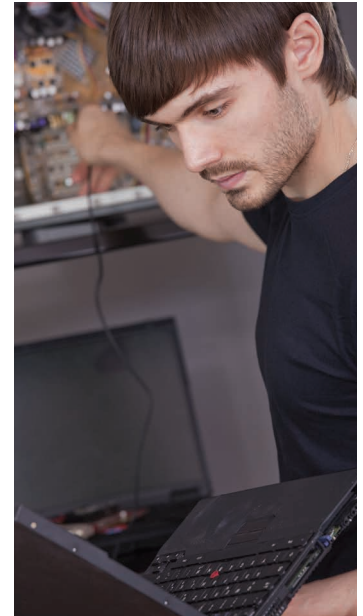

Registered users receive free updates.

Convenient Interfaces

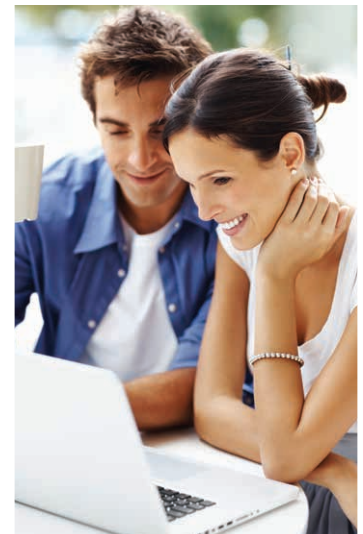

All versions of PC Access support multiple languages. Simply select your language of choice at installation.

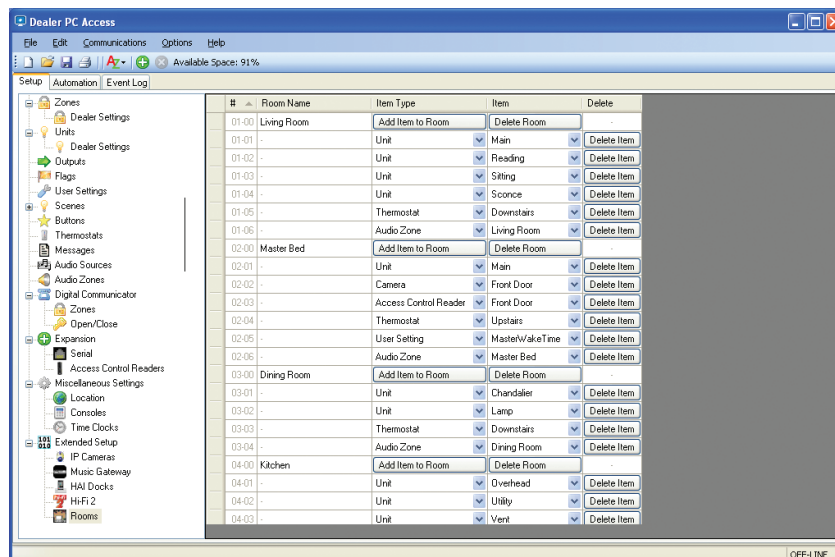

Native support
for iPad!



Convenient Interfaces

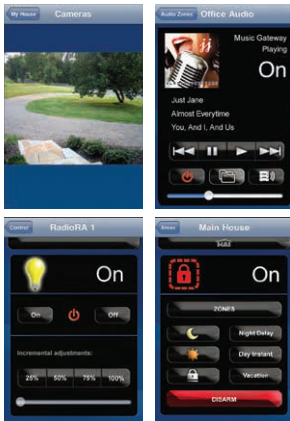

A single Snap-Link Mobile for iPhone® app account can operate on multiple devices.

Snap-Link Mobile for iPhone®

Snap-Link Mobile for iPhone® puts home and business control in the palm of your hand with zero monthly fees. Simply purchase the app from the iTunes® store, and get instant access to your control system. The comprehensive app provides complete control over your entire home or business. You can even access multiple properties from a single app!

Secure encrypted communication over Wi-Fi or 3G cellular data networks. The app is available in supported regions for multi-lingual support. No third parties other than cellular service are required for operation.

Requires a Leviton Security & Automation Omni Pro II, Omni Ile, Omni LTE, Lumina Pro, or Lumina control system.

Total Control with no monthly fees

- Set lighting levels or audio from 0-100% with a sliding scale - or use quick scene buttons.
- View real time surveillance camera video - front door, nursery, pool, boat dock, etc.*
- Adjusting heating and cooling and view humidity and outdoor temperatures.
- Arm/disarm the alarm. View a security log to monitor entry/exit activity.
- Select music sources and adjust volume levels in individual rooms or the entire property.
- Supports 17 different popular world languages with more being added.
- Access multiple accounts.

*Requires appropriate cellular provider plan and cameras.

Simplify with one app on multiple devices for one price

Purchase and maintain a single app for your iPad®, iPhone®, and iPod® Touch®. Utilize on any device that is attached to the iTunes® account.

Snap-Link Mobile for Android™

Snap-Link Mobile for Android™ allows monitoring and control of lights, security, audio, temperatures, and webcams on handheld mobile devices including tablets and smartphones. Snap-Link Mobile for Android™ puts control of all functions in the palm of your hand.

Access multiple properties from one application. It tunnels directly into the Leviton automation system through a secure AES encrypted connection. Requires a Leviton Security & Automation Omni Pro II, Omni IIe, Omni LTE, Lumina Pro, or Lumina control system.

The application is sold without subscription fees and users receive free updates. It features secure encrypted communications over Wi-Fi or cellular data networks. The app is available in Android™ supported regions for multi-lingual support.

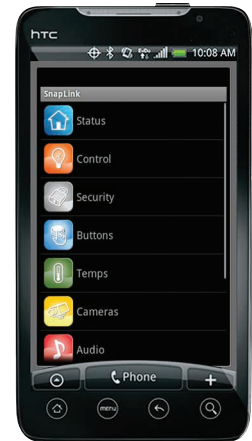

Android™ phones can harness the power of access and control.



Convenient Interfaces

Snap-Link Mobile for Kindle Fire

Reading a scary novel and hear a “bump in the night”? Immediately open the app to arm the security alarm, lock all doors, view a surveillance camera, turn on lights, and even alert authorities in case of emergency.

Download this Kindle Fire specific app in the Amazon Marketplace directly from your Kindle Fire! Simply open the app, and you have instant access to your home and/or business. Requires a Leviton Security & Automation Omni Pro II, Omni IIe, Omni LTE, Lumina Pro, or Lumina control system. The application is sold without subscription fees and users receive free updates.



Kindle Fire



See video from your IP cameras from anywhere an Internet connection is available.



Small and simple, the Snap-Link USB drive can be installed quickly and securely.



Log in and change your settings in lighting, temperature, audio, and security.

Snap-Link

Leviton Security & Automation's multi-award winning Snap-Link software can quickly adjust and check lights, temperature, audio, security, access control, humidity, and user settings on the go.

Insert the Snap-Link USB drive into any Windows® computer and it directly communicates through the Internet to the secure Ethernet port on your Leviton Security & Automation system. No on-site computer is needed. Snap-Link is easy to use and easy to set up because it is self-contained on the USB drive. There is no installation of the program, just unplug the drive and no residue of the application is left on the computer. 128-bit AES encryption is utilized making Snap-Link vastly safer than competing products which use web pages via non-encrypted connections.

Snap-Link has no subscription fees. Registered users of Snap-Link can update to the latest version for free at any time by clicking on the update link.

Snap-Link

Snap-Link requires an Ethernet-enabled Leviton Security & Automation home control system such as the OmniPro II, Omni IIe, Lumina Pro, or Lumina.

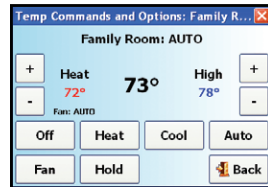

Conserve energy while maintaining the comfort level. Adjust heating and cooling by zone. View humidity and outdoor temperatures. Adjust settings before leaving work.



Select music source and adjust volume levels in rooms or whole house. Control Hi-Fi 2 by Leviton Security & Automation or a system from one of Leviton Security & Automation's Connectivity Partners.



Check and adjust lighting scenes. Dim lights, set timers, control each light, or turn all lights on/off by room or entire house.



Monitoring and controlling security features is easy. Arm or disarm the alarm, view a security log, or select to bypass or restore an individual zone (area).



Use the 68A11-1 Mini-Dome IP Cameras to see your home or business from anywhere in the world. Scroll through cameras to view boat docks, front doors, pool areas, etc. Check up on sick or elderly relatives when you can't be physically present. Record video based on motion, event, or time.

Control all of your A/V Equipment with One App!

When used with the HTX2 hardware, the free HTX2 app in the iTunes® store turns your iOS® device into a remote control for all of your audio/video components. Setup your user interface using the free software tool, Mobile Designer.

HTX2 Mobile Designer includes a visual GUI (Graphical User Interface) editor, which is used to create GUI pages (landscape and portrait) to control the HTX2 and its connected devices. Backgrounds, buttons, and functions can be adjusted, but templates are provided to ease the process. You can now create custom AV interfaces for an iPhone®, iPod® Touch®, or iPad®. Control TV, Blu-Ray, CD changers, projectors, receivers, and more.

Free stand-alone app to control your audio system!

Now, anyone can control their Hi-Fi 2 distributed audio system with a free iOS® application on their iPad®, iPod® Touch®, or iPhone®. Load the application on as many devices as you like.

Sitting on the couch and think your child's audio is too loud upstairs? Simply adjust the volume in their room from your iPad® in the den.

On your iPad®, iPod® Touch®, or iPhone®, the graphical user interface is incredibly familiar to Hi-Fi 2 users. That's because the iOS® interface replicates the built-in Volume Source Control that they're used to seeing on the wall. Use a single mobile device to control audio throughout the entire property and even receive meta-data information in the simulated OLED screen. This free app is available without subscription fees and users receive free updates.





Energy Management



Leviton energy management products make homes and businesses more comfortable while saving energy. Automatically coordinate lighting, temperatures, pumps, fountains, water heaters, irrigation, and other energy-consuming devices. Save money by automating based upon schedules or events.

- 40 Lumina Automation Systems
- 42 HAI Lighting Control
- 48 Vizia RF+ Wireless Lighting Controls
- 58 Omni-Bus Lighting Network
- 65 Lighting Comparison
- 66 Omnistat2 Thermostats
- 70 Lumina RF Wireless Energy Management
- 72 SmartGrid Solutions
- 74 Revenue Grade Meters
- 76 Leviton Monitoring Hubs
- 77 GreenMAX Relay Control

Lumina Control Systems



Cover 100% of Your Energy Management Needs

Leviton Security & Automation products make homes or work facilities more energy efficient. Save energy in each category of consumption. According to the U.S. Department of Energy, energy is consumed in several major ways, all of which can be monitored and controlled via Leviton Security & Automation.

Lumina Automation & Energy Controllers

The Lumina family of control systems' primary focus is to save money with sophisticated lighting and temperature control. Based on schedule or event, automate systems including HVAC, lighting, irrigation, ventilation, pumps, fountains, window coverings, and more to save money on the monthly energy bill. Utilize both Z-Wave® and ZigBee® devices with the Lumina, as well as popular powerline carrier technologies, enabling retrofit installations.



Incorporate Safety Features

Add surveillance video, wireless door locks and access control. Tie in a complete third party security system. If a built-in security system is desired, use Leviton's popular Omni Security & Automation system.

Save Money with the Omnistat2 Thermostat

When used with a Leviton Omni or Lumina automation system, the Omnistat2 programmable communicating thermostats and Leviton Control Modules add energy efficiency by adjusting temperatures, lamps, and appliances based on activity such as home, away or vacation. The ZigBee® wireless versions are ideal for retrofits in residential and small commercial operations.

The Leviton automation control system can turn off lights, water heaters and pool pumps when the property is unoccupied. Additionally, you can control ceiling and ventilation fans for comfort and energy efficiency.

Remote Access: Anywhere, Anytime

Lumina automation systems provide remote access to the property via telephone and Internet, so you may monitor and adjust the temperature or lighting levels at any time from a PC, tablet, or smartphone with zero monthly fees.

Use slider bars to adjust individual lighting loads or adjust the entire room or building with one button push. Access up to 64 thermostats and adjust temperature or humidity settings. Easily activate pumps or fountains. Push one button to enact a chain of events like "Bedtime" which sets back devices every night.



Leviton Covers 100% of Your Energy Management Needs

The Lumina Pro and Lumina control systems provide comprehensive automation like the Omni family systems. Lumina systems are primarily intended as lighting control and energy management systems.

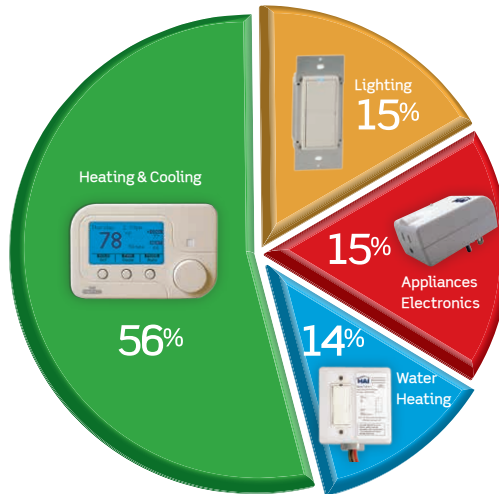

Residential Energy Usage

Source: US Department of Energy.

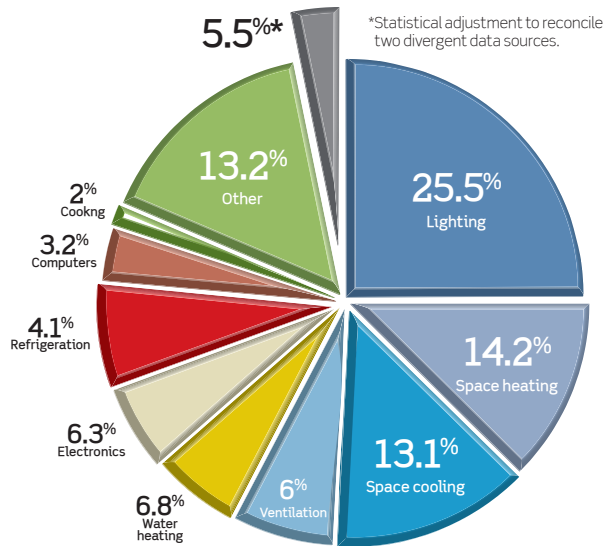

*Statistical adjustment to reconcile two divergent data sources.

Commercial Energy Usage

Source: US Department of Energy.

“From a technical perspective, Leviton Security & Automation products are superior. We are doing amazing things with your product line, particularly in the commercial space.”

TechnoStructure Incorporated, Naperville, IL

Lumina Pro Controller, In Enclosure 44A00-2

Lumina Pro Controller, On Backplate 44A00-4

Supports 31 rooms (256 lighting loads). Includes Ethernet port, controller in enclosure with lock & keys, LCD keypad, UPB™ Powerline Interface Module & cable, phase coupler, serial cable, manuals, and accessories.



Lumina Pro International, In Enclosure 44A00-22

Lumina Pro International, for Structured Wiring 44A00-23

Lumina Pro in enclosure with lock & keys OR on a backplate for structured wiring. Includes Lumina International Keypad, serial cable, manuals, and accessories. Does not include battery, transformer, PIM, or phase coupler. For other available languages add language code to part number: Arabic (AR), Catalan (CAT), Simplified Chinese (CHS), Traditional Chinese (CHT), French (FR), German (GER), Hebrew (HE), Italian (IT), Portuguese (POR), Russian (RU), Latin American Spanish (SPA), and European Spanish (SPE).



Lumina Controller, In Enclosure 44A00-1

Lumina Controller, On Backplate 44A00-3

Supports 8 rooms (64 lighting loads). Includes Ethernet port, controller in enclosure with lock & keys, LCD keypad, UPB™ Powerline Interface Module & cable, phase coupler, serial cable, manuals, and accessories.



Lumina International, In Enclosure 44A00-24

Lumina International, for Structured Wiring 44A00-25

Supports 8 rooms (64 lighting loads). Includes Ethernet port, controller in enclosure with lock & keys, LCD keypad, serial cable, manuals, and accessories. Does not include battery, transformer, PIM, or phase coupler. For other available languages add language code to part number: Arabic (AR), Catalan (CAT), Simplified Chinese (CHS), Traditional Chinese (CHT), French (FR), German (GER), Hebrew (HE), Italian (IT), Portuguese (POR), Russian (RU), Latin American Spanish (SPA), and European Spanish (SPE).



Lumina Keypad 33A00-19

Lumina Keypad w/Built-in Speaker/Microphone 33A00-20

International Market Lumina Keypad 33A00-25

International Market Lumina Keypad w/Speaker/Mic 33A00-26

Allows set up, programming and control of the Lumina and Lumina Pro system. LCD surface mount keypad, silk screened front, connector kit, instructions. International versions feature easy to understand icons rather than text. Two-Way Voice Module required for 33A00-20 and -26. See special wiring instructions in wiring section.



HAI Lighting Control



The HLC product line is designed for 110VAC applications and includes dimmers, switches, remote controls, and plug-in modules. HLC is a hard-wired powerline carrier solution that can be easily retrofitted without new wiring! HLC can operate stand-alone or with an Omni or Lumina control system for advanced scheduling and remote access. Enhance the enjoyment and property value. Add security for peace of mind, and contribute to savings on energy bills.

Why HLC?

Because HLC is reliable, full featured and cost effective. HLC technology is ideal for custom homes and small commercial because of its long range, ease of use, custom labeling and decorator colors.

Automatically set lights to any percentage, saving money every time a light is illuminated. In addition to controlling conventional bulbs, Leviton Security & Automation controls high efficiency incandescent as well as dimmable LED and CFL.

Leviton's Gen III UPB™ adds several features including automatic timeout and switching from dimming to non-dimming in the field. Leviton Gen III UPB™ also includes improvements to the core UPB™ technology, including improved drive for CFL and LED lamps and better tolerance for power frequency variations and interruptions in the dimmers.

Easy To Use - The Smart Switches!

HLC switches feature true rocker action via large panel style switches. Press and hold to brighten or dim. Press up to turn on. Press down to turn off. Easily change scene settings at any time without a service call.

Because HLC is a modular system, rooms and lights can be added anytime, updating as needs change. For retrofits or expansion, existing light switches can be replaced with HLC smart switches and plug-in lamp control modules can be added for accessory lighting.

Matches Your Style

Most switches accommodate standard Decora® wallplates for unlimited faceplate options. A full range of switch colors, including almond, black, brown, grey, ivory, light almond, and white, are available.

LED indicator lights at the top of the switches can be programmed to glow blue, red, magenta, or turned off entirely. Scene Switches and House Status Switches can even feature custom laser engraved buttons.

Color Choices

HLC devices are offered in a wide range of colors and finishes. Color change kits available:



White (-WH)



Ivory (-IV)



Almond (-AL)



Light Almond (-LTA)



Grey (-GR)



Black (-BL)



Brown (-BR)



Dim lights as movie begins, using a remote control, smartphone or tablet.



Set the mood for entertaining.

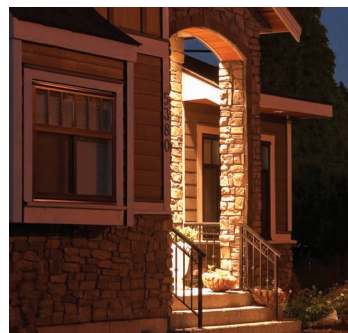

Front door and driveway lights come on at dusk and turn off at a set time to save energy.



Expansion is easy! Add a table lamp or small appliance with a plug-in module.



CFL/LED Dimmer

35A00-1CFL

UL Listed for CFL and LED bulbs. Special dimming curve, minimal brightness level, and optimized TRIAC drive. Can also control up to 600 watts of incandescent/Halogen brightness. White color. Color Change Kit available. Uses standard Decora® wallplate (not included).



600W UPB™ Dimmer Switch

35A00-1

Used for controlling and dimming lighting loads up to 600W. Optimized for incandescent/Halogen bulbs. White paddle, connectors, instructions. Color Change Kit available. Uses standard Decora wallplate (not included).



600W UPB™ Non-Dimming Switch

35A00-3

Used for controlling non-dimming loads, such as fluorescent lights, up to 600 watts. Includes a white paddle, connectors, instructions. Color Change Kit available. Uses standard Decora wallplate (not included).



15A Relay Switch

40A00-1

For controlling heavier loads (up to 15 amps) or motors, such as ceiling fans, that may hum when used with dimming or non-dimming switches. White color. Color Change Kit available. Uses standard Decora wallplate (not included).



Auxiliary Switch

37A00-1

Remotely operate 35A00, 40A00, and 55A00 dimmers and switches; connectors, instructions. White color. Color Change Kit available. Uses standard Decora wallplate (not included).

Switch Color Change Kit

35A14-color codeCS

Paddle, bezel assembly for 35A00, 37A00 and 40A00 series switches. Part number example: 35A14-ALCS.



**2400W UPB™ Dimmer Switch
Color-Matched Wallplate**

**55A00-3colorcode
55A03-1/-2**

With connectors, instructions. Requires a special back box or must be de-rated. Shown in white, also available in ivory. Switch uses special-sized wallplate, sold separately (below).

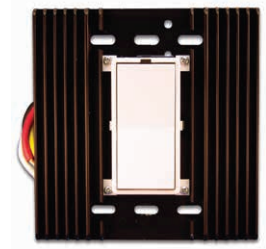

UPB™ Lamp Module

59A00-1

Plug-in Lamp Module controls and dims lamps up to 300 watts.



UPB™ Appliance Module

60A00-1

Plug-in Appliance Module controls appliances, fans, and lamps up to 15 amps, general purpose, ½ horsepower.



Scene Switch, 6-Button

38A00-1

Control all lights in a room or area. Lights may be turned on or off, dimmed, brightened, and set to four different scenes. Setting a scene is as simple as pressing the scene button on the Scene Switch five times. Has infrared receiver for use with Scene Switch Remote Control. Includes White bezel, connectors, instructions. Color Change Kit and custom engraving available.



House Status Switch, 8-Button

38A00-2

This master lighting control shows the status for up to eight rooms. If any light is on in an integrated room, the button for that room is illuminated. Pressing the room's button will turn on or off all of the lights in that room. Includes White bezel, connectors, instructions. Color Change Kit and custom engraving available.





Table Top Scene Switch and Cradle

38A16-colorcode

Cradle Only

38A15-colorcode

Table mount the Scene Switch (38A00-1), House Status Switch (38A00-2), or Lumina Mode Switch (38A00-3). Conveniently locate throughout the property (bedside nightstand, the office desk, next to a favorite chair). Plug directly into electrical outlet with six foot cord. Scene Switch sold separately or 38A16 includes both cradle and switch. Specify color code when ordering, WH or BL.



Custom Legend Kit for Scene/House Status Switches

38A06-2

Coupon and instructions for custom laser engraved buttons for 6 Button Scene Switch or 8 Button House Status Switch. Mail in coupon, receive custom button overlay by mail. Customized Scene Switches make creating an ambiance easy. Select "Task Lighting", or "Romantic Evening" to set the proper mood. Customizing House Status Switches is fun as well. "Sue's Bedroom", "Master Bath" and "Back Porch" allow for ultimate control of every room. Create your own!



Scene Switch & Lumina Mode Switch Color Change Kit (12 count)

38A04-color codeCS

Bezel for 38A00-1 or 38A00-3, instructions. Part number example: 38A04-ALCS.



House Status Switch Color Change Kit (12 count)

38A05-color codeCS

Bezel for 38A00-2, instructions. Part number example: 38A05-ALCS.



Scene Switch Remote

38A14-1

Works with Leviton Security & Automation's Scene Switch. Controls all lights in a room or area. White color.

HLC Load Control Module

71A00-1

30A module utilizing Leviton Security & Automation's Generation III UPB™ (Universal Powerline Bus) technology over existing power lines. Controls the power consumption of high wattage loads such as pool pumps and hot water heater. Can control 120 or 240V loads. Requires neutral wire.



Phase Coupler (1)

39A00-1

For 120/240V electrical systems, the Phase Coupler increases the speed and reliability of the HLC system. Although the HLC protocol is extremely robust and less susceptible to power line conditions, Leviton Security & Automation recommends the use of a Phase Coupler in every installation.



UPB™ Split-Phase Repeater

39A00-2

Designed to repeat UPB™ signal in installations requiring additional signal strength. Must be used on a 120/240VAC split-phase 60Hz powerline.



UPB™ Three-Phase Repeater

39A00-3

Required for use in three-phase installations when UPB™ devices are installed on separate phases. Must be used on a three-phase 120/208VAC delta-wye, 60Hz powerline.



UPB™ Powerline Interface Module with Cable (1)

36A00-1

UPB™ Powerline Interface Module (PIM) connects the lighting system to an automation system or computer, which can then control the lights - making the system accessible through the home computer or from a remote location over the Internet.



Wireless Lighting Control



Utilizing Z-Wave® technology, Vizia RF +® provides dramatic scene transitions, extended zone lighting control, industry standard 2-way status updating and true integration of household electrical devices.

Use Vizia RF +® to enhance new construction or to refresh existing homes and residences.

Enjoy stand-alone or tie in to Leviton's Omni or Lumina automation systems.

Vizia RF +® Wireless Lighting Controls

Join a revolution in the home automation industry with Vizia RF +® wireless lighting and home control technology. Innovative and affordable, with features that are desired by professional installers and appreciated by homeowners, Vizia RF +® helps reduce energy consumption.

Equipped with Z-Wave® home automation technology, Vizia RF +® allows tailoring of the perfect home control solution that can be used stand-alone or tied into a Leviton Omni or Lumina control system. Imagine a home in which the lighting automatically adapts to your needs. For example, in the kitchen, one button can slowly dim the ceiling light while subtly brightening the chandelier over the kitchen table. Vizia RF +® can control other rooms just as impressively. It also works well with exterior fixtures, enabling them to be controlled throughout the house.

The Vizia RF +® product line includes new customer-requested features that increase its options, such as 49 selectable fade rates, an Energy Save mode, customizable preset maximum and minimum brightness levels, and more control of locator LED activity.



Color Choices

Vizia RF +® devices are offered in a wide range of colors and finishes. To order colors, add suffix to Cat No.



White
(-W)



Ivory
(-I)



Light Almond
(-T)



Grey
(-GY)



Black
(-E)



Brown
(-B)





Red
(-R)

Vizia RF +® | Dimmers

Dimmers
Features and Benefits
• Universal design provides crisp actuation and minimal travel
• 49 possible combinations of fade rates, from soft to instant
• Separate fade up and fade down speeds
• Energy Save option reduces power consumption and extends bulb life
• Preset On Level option sets the brightness level when the device is turned on, regardless of the previous level
• Minimum Brightness Level option sets the minimum brightness level the dimmer will output prior to turning completely off
• LED Display options control the length of time they remain lit
• Push pad always returns to neutral position regardless of load status
• Compatible with Decora Plus™ screwless wallplates and Decora® wallplates
• Complements Vizia +® Lighting Controls
• Color change kits are available to allow fast color changeover and simplify stocking inventory
• Manual and remote ON/OFF/DIM/BRIGHT control of connected loads
• ON/OFF/DIM/BRIGHT scene and zone control capability
• Responds to Vizia RF +® Controllers as well as selected Z-Wave® certified controllers from other manufacturers
• Works with the Vizia RF +® 1-Button Zone Controller/Virtual Dimmer Remote (VRCZ1-1L) for RF virtual 3-way control without the need for traditional 3-way wiring or for a dedicated traveler wire
• Works with Vizia +® (non-RF) Matching and Coordinating Remotes (VP00R) for hardwired 3-way or up to 10-location control
• 2-way status
• Easy to clean, high gloss finish complements a wide range of décors
• DIM/BRIGHT bar allows user to select brightness level when lights are ON or OFF - green LED displays brightness level
• Power-failure memory allows light levels to return to the same levels set prior to a power interruption
• RFI filtering for radio, audio and video equipment
• Air gap switch disconnects power from load locally. It is concealed during normal operation and is accessible without removing the wallplate
• Limited Five-Year Warranty





Vizia RF +® Scene Capable Dimmers for Single Pole, 3-Way or Multi-Location Applications

Dimmers  			
Description	Rating	Cat. No.	Color
Incandescent Dimmer with LED locator and brightness display	600W - 120VAC 60Hz	VRI06-1L	Z
Incandescent Dimmer with LED locator and brightness display	1000W - 120VAC 60Hz	VRI10-1L	Z
Incandescent, Magnetic Low Voltage and Mark 10 Dimmer with LED locator and brightness display	1000W / 1000VA 60Hz	VRMX1-1L	Z
Electronic Low Voltage Dimmer with LED locator and brightness display	600W - 120VAC 60Hz	VRE06-1L	Z

Fan Speed Controls			
Description	Rating	Cat. No.	Color
Quiet Fan Speed Control with LED locator and fan speed display	1.5A - 120VAC 60Hz	VRF01-1L	Z

Color Change Kit for Vizia RF +® Dimmers

Color Change Kit  		
Description	Cat. No.	Color
Matching Dimmer/Fan Speed Control	VPKIT-MD	W, I, T, G, E, B, R
Color Change Kit with LED locator and brightness display		



VRI06-1L



VRMX1-1L

“We use the reliable, simple and powerful Leviton Security & Automation on ALL our security and automation installs. We will always utilize stand-alone or integrated with other automation products. We are pleased with the evolution.”

CMAtelcom, Ste-Therese, Quebec



Vizia RF +® | Switches

Switches
Features and Benefits
• Push pad always returns to neutral regardless of load status
• Compatible with Decora Plus™ screwless wallplates and Decora wallplates
• Vizia RF +® style push pad blends seamlessly with other devices in the Vizia +® collection
• Manual and remote ON/OFF control of connected loads
• ON/OFF scene and zone control compatibility
• LED Display options control the length of time they remain lit
• Universal design provides crisp actuation and minimal travel
• Responds to Vizia RF +® Controllers as well as selected Z-Wave® certified controllers from other manufacturers
• Works with the Vizia RF +® 1-Button Scene Controller/Virtual Switch Remote (VRCS1-1L) for wireless RF virtual 3-way control without the need for traditional 3-way wiring or for a dedicated traveler wire
• Works with Vizia + (non-RF) Matching and Coordinating Remote (VPOSR-10) for hardwired 3-way or up to 10-location control
• 2-way status
• Air gap switch disconnects power from load locally. It is concealed during normal operation and is accessible without removing the wallplate
• Color change kits are available to allow fast color changeover and simplify stocking inventory
• Limited Five-Year Warranty





VRS15-1L

Vizia RF +® Scene Capable Switch for Single Pole, 3-Way or Multi-Location Applications

Scene Capable Switches  			
Description	Rating	Cat. No.	Color
Scene Capable Switch with LED locator	15A 1800W Resistive 1800W Incandescent 1800VA Fluorescent 1800VA Inductive 1/2 HP Motor (9.8A)	VRS15-1L	Z
Incandescent Scene Capable Switch with LED locator	5A Incandescent only (no neutral required)	VRS05-1L	Z

Color Change Kit for Vizia RF +® Switches

Color Change Kit  		
Description	Cat. No	Color
Matching Switch Color Change Kit with LED locator	VPKIT-MS	W, I, T, G, E, B, R

Vizia RF +® | Programming and Handheld Remotes

Features and Benefits

RF + Installer Tool Software and USB for System Programming (VRUSB)

- Set up and program an unlimited number of Z-Wave® Home Automation Systems
- Utilize Windows® “drag and drop” functionality
- Create areas and scenes on or off the job site
- Use a checklist to guide the way through a Vizia RF +® installation or advanced programming
- Generate device, controller and area reports
- Schedule groups of devices to turn on/off at various times of the day (VRCPG required)
- Optimize, repair and recover Z-Wave® networks
- Perform diagnostic tests on a network

Remote Controller/Programmer (VRCPG)

- Primary device for creating and programming a Vizia RF +® system
- Provides user-level control of up to 128 devices
- Creates up to 128 areas
- Customizes up to 16 profiles
- Creates up to 255 scenes
- Integrated step-by-step setup guide
- Can operate as a secondary remote control
- Creates scheduled events including dusk and dawn (timer version VRCPG-OSG only)
- Provides remote control (ON/OFF/DIM/BRIGHT/SCENE/ZONE) of devices in the Vizia RF+® network

IR Remote Controller (VRMR1)

- Works with Vizia RF +® IR compatible controllers
- Controls four scenes and four zones

ThinkEssentials® Pro Edition Software by ControlThink® (CTTEP-20W)

- Self-tuning optimization for premium Z-Wave® performance
- Professional Z-Wave® system programming
- Superior integration with Vizia RF +® products
- Install, optimize, integrate and maintain a high performance Z-Wave® network
- Patent pending disaster recovery for many Z-Wave® system repairs
- Installer software requires Windows XP® or Vista® (32-bit and 64-bit)

Vizia RF +® Programming and Handheld Remote Controllers

Programming and Handheld Remote Controllers

Description	Cat. No.
RF + Installer Tool Software and USB for System programming*	VRUSB-000
RF Handheld Remote Controller, Programmer (Basic)	VRCPG-BSG
RF Handheld Remote Controller Programmer/Timer (Internal astronomical clock)	VRCPG-OSG
Vizia RF +® IR Handheld Remote Controller	VRMR1-OSG
ThinkEssentials® Professional Edition for installers	CTTEP-20W



VRCPG-SG

Vizia RF +® | Controllers

Features and Benefits

- Easy to clean, high gloss finish complements a wide range of décors
- Controller fits in standard wall box and utilizes existing 120VAC 60Hz wiring to replace a regular switch (when neutral wire is present) for easy “no-new-wires” installation
- 2-way status updates
- Compatible with Decora Plus™ screwless wallplates and Decora wallplates
- Popular Vizia + style push pad blends seamlessly with other devices in the Vizia + collection
- Custom Engraving available for the 2-Button and 4-Button Controllers
- Limited Five-Year Warranty

Vizia RF +® 1-Button Scene Controller/Virtual Switch Remote (VRCS1)

- Consistent form factor, excellent ergonomic traits and appealing tactile touch and feel
- Provides remote ON/OFF control of one scene
- Virtual 3-way and multi-location remote ON/OFF control of selected Vizia RF +® switches without the need for traditional 3-way wiring or a dedicated traveler wire
- Green LED illuminates to indicate controlled scene. When acting as a virtual remote, LED will illuminate when the load is OFF
- LED Display options control the length of time they remain lit

Vizia RF +® 1-Button Zone Dimming Controller (VRCZ1)

- Provides remote ON/OFF/DIM/BRIGHT control of ONE Vizia RF +® Dimmer
- Virtual 3-way remote dimming control of selected Vizia RF + dimmers without the need for traditional 3-way wiring or a dedicated traveler wire
- DIM/BRIGHT bar allows user to select brightness level when lights are ON or OFF – green LED displays brightness level
- Green LED locator illuminates to indicate controlled zone or load is OFF
- LED Display options control the length of time they remain lit

Vizia RF +® 4-Button Scene Controller (VRCS4)

- Provides remote ON/OFF/DIM/BRIGHT control of four scenes of selected Vizia RF +® devices
- Integrated infrared (IR) port
- Green LED illuminates when the assigned scene is ACTIVE



Vizia RF +® 4-Button Zone Controller (VRCZ4)

- Provides remote ON/OFF/DIM/BRIGHT control of four zones/areas of selected Vizia RF +® devices
- Integrated infrared (IR) port
- Green LED illuminates when assigned zone/area is ACTIVE

Combination Controllers

- Perfect for retrofit applications – local control of load and scene or zone capability
- Controller fits in standard wallbox and utilizes 120VAC-240VAC, 50/60Hz wiring
- Local and remote control of two loads in one wallbox (VRCS2)
- Button label kits available for VRCZ4-MR and VRCS4-MR



Vizia RF +® Wall Controllers

Wall Controllers  			
Description	Rating	Cat. No.	Color
1-Button Scene Controller/ Virtual Switch Remote	No Load Rating 120VAC-60Hz	VRCS1-1L	Z
Vizia RF +® 1-Button Zone Controller/ Virtual Dimmer Remote	No Load Rating 120VAC-60Hz	VRCZ1-1L	Z
Vizia RF +® 4-Button Scene Controller	No Load Rating 120VAC-60Hz	VRCS4-M0	Z
Vizia RF +® 4-Button Zone Controller	No Load Rating 120VAC-60Hz	VRCZ4-M0	Z



VRCZ4-MR



Vizia RF +® Combination Controllers

Combination Controllers  			
Description	Rating	Cat. No.	Color
4-Button Zone Controller with Switch and IR Remote Capability	1800W/1800VA 1/2 HP 120-240VAC 50/60 Hz	VRCZ4-MR	Z
4-Button Scene Controller with Switch and IR Remote Capability	1800W/1800VA 1/2 HP 120-240VAC 50/60 Hz	VRCS4-MR	Z
2-Button Scene Controller with Switches	1000W/1000VA 1/4 HP (per switch) 120-240VAC 50/60 Hz	VRCS2-MR	Z
Vizia RF +® 4-Button Zone Controller	No Load Rating 120VAC-60Hz	VRCZ4-M0	Z



VRCS4-MR

Color Change Kits for Vizia RF +® Controllers

Color Change Kits for Vizia RF Controllers  		
Description	Cat. No.	Color
1-Button Zone Controller/Virtual Dimmer Remote Color Change Kit with LED locator and brightness display for VRCZ1	VPKIT-MD	W, I, T, G, E, B, R
1-Button Scene Controller/Virtual Switch Remote Color Change Kit with LED locator for VRCS1	VPKIT-MS	W, I, T, G, E, B, R
4-Button Scene Controller Color Change Kit with LED locator for VRCS4	VPKIT-S4	W, I, T, G, E, B, R
4-Button Zone Controller Color Change Kit with LED for VRCZ4	VPKIT-Z4	W, I, T, G, E, B, R
4-Button Scene Controller Label Kit with LED locator for VRCS4	VPSLB-S4	W, I, T, G, E, B, R
4-Button Zone Controller Label Kit with LED for VRCZ4	VPZLB-Z4	W, I, T, G, E, B, R
2-Button Scene Controller with Switches Color Change Kit with LED for VRCS2	VRKIT-DS	W, I, T, G, E, B, R



VRCS2-MR

Vizia RF +® | Plug-In Modules

Features and Benefits

- Green Locator LED
- Limited Five-Year Warranty

Vizia RF +® Scene Capable Plug-in Appliance Module (VRP15)

- Supports beaming which is the ability to communicate with battery operated frequently listening nodes (FLiRS) such as door locks and sensors
- Provides 15A-120VAC NEMA 5-15R grounding receptacle for use with a wide variety of lamps and appliances
- Provides manual ON/OFF switching of plug-in load and remote scene and zone control compatibility
- 2-way status
- Protected memory maintains ON/OFF status of loads and during minor power fluctuations

Vizia RF +® Scene Capable Plug-in Lamp Dimming Module (VRP03)

- Supports beaming which is the ability to communicate with battery operated frequently listening nodes (FLiRS) such as door locks and sensors
- Provides NEMA polarized 1-15R 2-blade receptacle for use with incandescent lamps
- Load Sensing feature allows lamp to be turned ON manually using the lamp's switch or the integrated ON/OFF button
- Provides manual and remote ON/OFF/ DIM/BRIGHT control of plug-in lamps
- 2-way status
- Provides ON/OFF/DIM/BRIGHT scene and zone control capability
- Protected memory maintains ON/OFF/Brightness level status of connected loads and device ID programming during minor power fluctuations

Vizia RF +® Plug-In Serial Interface Module, ASCII to Z-Wave® Interface (VRCOP)

- Supports beaming which is the ability to communicate with battery operated frequently listening nodes (FLiRS) such as door locks and sensors
- Provides RJ11 connector for RS232 or selected HA1® component connection
- Ability to upgrade with the latest firmware to enhance your Z-Wave® network and integration capabilities
- Two-way communication between related Controller(s) and Module
- Protected memory and device ID programming during minor power fluctuations
- Transient surge protection to IEC Level 4
- ESD protection to IEC 1000 4-2 Level 4 to protect against damage and memory loss due to static discharges
- Includes serial cable
- Z-Wave® compatible

Vizia RF +® Scene Capable Receptacle

- LED display option allows the green LED to be turned OFF
- Load sensing option allows a lamp or other device plugged into the controlled side to be turned ON manually using the lamp's integrated ON/OFF button
- Controlled side can be used for wireless ON/OFF control of plugged-in electrical loads, such as lamps, appliances and electronics
- Non-controlled side is a tamper-resistant receptacle that provides constant power
- TR symbol on receptacle strap assures that it meets the 2008 NEC® code requirement
- Split Duplex tamper-resistant receptacle

Vizia RF +® Scene Capable Plug-In Modules

Plug-In Modules [®] SM			
Description	Rating	Cat. No.	Color
Vizia RF +® Scene Capable Plug-In Appliance Module	15A 1800W Incandescent 1800VA Fluorescent 1800W Resistive 1800VA Inductive and 1/2 HP motor loads @ 120VAC-60Hz	VRP15-1L	W
Vizia RF +® Scene Capable Plug-In Lamp Dimming Module	300W Incandescent @ 120VAC-60Hz	VRP03-1L	W
Vizia RF +® Plug-In Serial Interface Module, ASCII to Z-Wave® Interface	No Load Rating 120VAC-60Hz	VRC0P-1L	W
Vizia RF +® Split Duplex TR Receptacle with LED Locator	1800W, 1800VA, 1/2 HP motor loads @: 120VAC- 60Hz	VRR15-1L	Z



VRP15-1L



VRP03-1L



VRR15-1L



“We have great results with your products! Every single customer that has lighting control always wants to buy more and more dimmers. Lighting control has been a huge help in sales. Once we get a few dimmers in place, they always want more!”

Structured Wiring Inc, Cartersville, GA

Omni-Bus Lighting Network



Popular in domestic commercial operations and a variety of international applications, Omni-Bus controls up to 256 lights, shades, fans, shutters, pumps, and more. Omni-Bus features the benefits of central lighting control with the flexibility of distributed control systems. Modular Omni-Bus components can be located where needed to save wiring and installation costs.

The Universal Solution

The Leviton Omni-Bus Lighting Control Network is the hardwired and wireless lighting solution for 110/220/240V 50-60Hz. Utilizing the worldwide DIN rail standard for mounting, this bus and controller-based management offering will control CFL, LED, electronic low-voltage, Halogen, and incandescent lighting.

Omni-Bus Advantages

The Omni-Bus lighting system fully integrates with Leviton Security & Automation controllers, allowing control of Omni-Bus devices using standard Leviton Security & Automation interfaces or software applications. Power wiring is minimized as controllers can be localized to switches. Switches can be programmed to perform a number of actions. Omni-Bus features free setup software available online. With Omni-Bus there is no need for a third-party solution.

How Omni-Bus Works

Power modules feed power to dimming or non-dimming switches. Each switch wires up to a DIN rail module. Load Control and other DIN rail modules connect to the Omni-Bus network using standard CAT-5 UTP (Unshielded Twisted Pair) cable between each Omni-Bus device. The Omni-Bus network runs on a low supply voltage (24VDC) and is optically isolated from the mains supply side. Each hardwired switch connects to the Omni-Bus network using CAT-5. The use of splitters allows for a free topology architecture for ease of installation and expandability.



For ease of reference, Omni-Bus components are labeled using the following four categories:

- Core Components (Required)
- Accessories
- Load Control Modules
- Switch Interfaces



● **Interface Translator DIN Rail Module** 117A00-1

The “gateway” of the Omni-Bus system, this device allows Leviton Security & Automation Controllers (Omni LTE, Omni IIe, OmniPro II, Lumina, and Lumina Pro) to interface with an Omni-Bus network. Built in radio receiver for use with wireless switch interfaces 113A00-2, 113A00-4, 113A00-7, 125A00-1, 125A00-2. Features an Ethernet port and serial port.



● **Omni-Bus Scene Control DIN Rail Module** 126A00-1

Stores up to 32 lighting scenes or moods, controlling up to a total of 256 Omni-Bus load control modules. Each scene can be triggered from up to 8 different Omni-Bus input devices. Also works in conjunction with a Leviton Controller and Omni-Bus Interface Translator for added flexibility and control.



● **Power Supply 2.5A DIN Rail Module** 123A00-1

This 24VDC 2.5A power supply module provides power to the Omni-Bus network. Required Omni-Bus component.

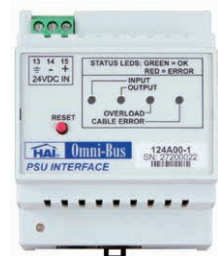

● **Power Supply Interface 2A DIN Rail Module** 124A00-1

Used to detect overloading and select cabling errors on the Omni-Bus network. Distributes power from 123A00-1. Detects low voltage power and overloading to Omni-Bus network. Required Omni-Bus component.



● **8-Way Splitter DIN Rail Module** 120A00-1

Eight-port splitter used for splitting the network into a star configuration. Required Omni-Bus component.

● Termination Plug

122A00-1

Used to terminate the Omni-Bus network. Each network must contain one and only one network Termination Plug. Required Omni-Bus component.



● Jumper Plugs

121A00-1

Used to terminate any open ends or open connectors on the Omni-Bus network. Required Omni-Bus component. Available in packs of ten. Not sold individually.



● RF Transceiver DIN Rail Module

115A00-1

Wireless transceiver for use with wireless switch interfaces 113A00-2, 113A00-4, 113A00-7, 125A00-1, 125A00-2. This added transceiver provides expanded wireless range for the Omni-Bus network.



● DALI Gateway DIN Rail Module

118A00-1

Controls DALI (Digital Addressable Lighting Interface) output devices: On/off switching, dimming, DALI group control, DALI broadcast control, and DALI scene control.



● USB Programming Interface Unit

116A00-1

Configure and maintain all user programmable parameters of the Omni-Bus network with a PC. Includes an Omni-Bus PC software license.



● 3-Way Splitter

119A00-1

Expand an Omni-Bus network with this splitter. Used where a T-junction or network split is required.



For ease of reference, Omni-Bus components are labeled using the following four categories:

- Core Components (Required)
- Accessories
- Load Control Modules
- Switch Interfaces

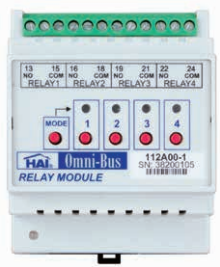

● **Omni-Bus Relay DIN Rail Module** 112A00-1

Control up to four general purpose resistive loads: 2A@230V~, 2A@110V~, 2A@28VDC or general purpose low voltage switching applications (irrigation valves, gates, garage doors, etc.).

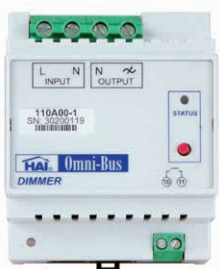

● **Omni-Bus Dimmer DIN Rail Module** 110A00-1

Controls 220V incandescent, 220V halogen, and low voltage transformers suitable for trailing-edge dimming: 400W@230V~ *This product is available for international (non-North American) markets only.*

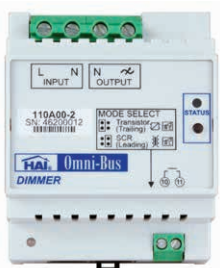

● **Omni-Bus Universal Dimmer DIN Rail Module** 110A00-2

Advanced dimming circuit controls most lighting loads. Selectable jumper for leading or trailing edge dimming. Controls incandescent, halogen, low voltage electronic transformers, low voltage magnetic transformers: 900W@230V~; 600W@110V~. Controls dimmable CFL/LED: 400W@230V~; 300W@110V~



● **Omni-Bus Power Switch DIN Rail Module** 111A00-1

Controls resistive/incandescent: 2000W@230V~; 1500W@110V~. Ballast (fluorescent lights): 2000W@230V~; 1500W@110V~. Low voltage transformer: 2000W@230V~; 1500W@110V~. DC resistive: 10A@30VDC.



● **Single-Gang Switch Box w/Cover, Metal** 95A20-1

Features holes and knockouts for mounting to desired surface. Can accommodate Hi-Fi 2 by Leviton Security & Automation interfaces, Omni-Bus hardwired switches, and UPB™ switches. Includes a metal cover with hardware for mounting to the box.



● **6-Channel Universal Switch Interface Module** **114A00-1**

Connects up to six third-party switches to the Omni-Bus network. Six LED outputs control two-lead bi-color or single color LED indicators for each switch.



● **1-Button, Hardwired, White** **113A00-1**

1-Button, Wireless, White **113A00-2**

Single button hardwired or wireless switch interface. Controls dimmer, power switch, relay, or an input into Leviton Security & Automation controller. LED light indicates operation status. Wireless switch operates with 117A00-1 or 115A00-1.



● **2-Button, Hardwired, White** **113A00-3**

2-Button, Wireless, White **113A00-4**

Two button hardwired or wireless switch interface. Controls dimmer, power switch, relay, or an input into Leviton Security & Automation controller. LED light indicates operation status. Wireless switch operates with 117A00-1 or 115A00-1.



● **3-Button, Hardwired, White** **113A00-5**

3-Button, Wireless, White **113A00-7**

Three button hardwired or wireless switch interface. Controls dimmer, power switch, relay, or an input into Leviton Security & Automation controller. LED light indicates operation status. Wireless switch operates with 117A00-1 or 115A00-1.



● **6-Button, Hardwired, White** **113A00-8**

Six button hardwired switch interface. Controls dimmer, power switch, relay, or an input into Leviton Security & Automation controller. LED light indicates operation status.





● 3-Button, Hardwired, Brushed Stainless

113A00-6

Three-button hardwired switch interface. Controls dimmer, power switch, relay, or inputs into Leviton Security & Automation controller. LED lights indicate operation status.



● 6-Button, Hardwired, Brushed Stainless

113A00-9

Six-button hardwired switch interface. Controls dimmer, power switch, relay, or inputs into Leviton Security & Automation controller. LED lights indicate operation status.



● Keyfob Remote Control, 6-Channel

125A00-1

Wireless RF transmitter built into a convenient keyfob. Up to six channels available. Controls dimmer, power switch, relay, or inputs into Leviton Security & Automation controller. Wireless switch operates with 117A00-1 or 115A00-1.



● Keyfob Remote Control, 16-Channel

125A00-2

Wireless RF transmitter built into a convenient keyfob. Up to 16 channels available. Controls dimmer, power switch, relay, or inputs into Leviton Security & Automation controller. Wireless switch operates with 117A00-1 or 115A00-1.



● Omni-Bus Cable Assemblies for Universal Switch Interface Module (12)

114A01-1

Pack of 12 cable assemblies for Omni-Bus Universal Switch Interface Module 114A00-1. 150mm cable assembly used to connect a switch input or LED output of the 114A00-1 to third-party switch. One cable is required for each input or LED output. Cables not sold separately.

Which Lighting Control System Is Best?

Now that you've seen several different lighting control solutions, how do you determine which is the top choice for your specific installation?

Lighting Control Features/Benefits					
Product	Page #	Ideal For	Voltage	Technology	Advantages
HLC	42	Single Family Homes	120/240	Universal Powerline Bus (UPB™)	Decora® form factor, works over long distances, affordable
Vizia RF+	48	Condominiums, Townhomes, Apartments	120	Z-Wave® (900 MHz)	Wireless, Compatible with products from 160 manufacturers
Omni-Bus	58	High-End Residential, Small Commercial	110/220-240	Low Voltage (Cat 5), Wireless (433MHz)	Flexible installation options, wide array of compatible wall stations
Lumina RF	70	Commercial, Heavy Duty Residential	120/240	ZigBee® HA Profile (2.4 GHz)	High-power mesh network, simple to configure



Have more questions? Visit the product pages to learn more at www.leviton.com

Temperature Control & Monitoring



Programmable Communicating Thermostats

The Omnistat2 programmable communicating thermostat combines Leviton Security & Automation's 20 plus years as a leader in energy management to provide sophisticated and intelligent function in an easy to use wired or wireless device.

Using advanced digital technology, the Omnistat2 "learns" heating and cooling patterns and adjusts control to maximize both HVAC efficiency and comfort. Omnistat2 can manage electric, gas, geothermal, and radiant heat energy sources. The most cost-effective way to control your energy usage is by managing the heating and cooling system. The Omnistat2 automatically adjusts the temperature and saves money!

A Simple Interface for Ease of Use

Simply turn the scroll wheel to the right or left to adjust the temperature. Three buttons facilitate easy to navigate menus on the large multi-color display. View information such as temperature setpoints, modes, outdoor temperature and humidity, run time by week, and more.

Unique Looks to Suit Your Home

Beyond the three different color options of black, silver, and white, choose from over one hundred customizable backlight colors. Change backlighting from blue to red or green—or any color in between with the turn of the scroll wheel.

	RC-2000	RC-1500*	RC-1000
Humidifier control	●		
Dehumidifier control	●		
Humidity sensing and display	●		
Supports up to two stages of cooling, and three stages of heating	●	●	
Supports dual fuel systems	●		●
Automatic heat/cool changeover	●	●	●
Filter reminder for peak efficiency	●	●	●
Digital precise temperature control	●	●	●
Seven day schedule with copy function	●	●	●
Fan cycle mode periodically circulates air	●	●	●
Graphical display of HVAC usage by week	●	●	●
Eco-friendly design-no batteries to replace	●	●	●
Multi-color backlight is adjustable at any time	●	●	●
Choose between Simple or Advanced displays	●	●	●
Temperature readings available in Fahrenheit or Celsius	●	●	●
Energy Efficient Control (EEC) for heat pump auxiliary heat	●	●	●
Learns a home's heating and cooling patterns for efficiency	●	●	●
Communicates with Leviton Security & Automation systems and other automation systems	●	●	●
Settings for Home, Night, Away, and Vacation (with a Leviton Security & Automation system)	●	●	●
Easy to use Vacation mode restores temperatures before your return	●	●	●
Serial Connection	●		●
Remote and averaged temperature sensors available	●	●	●
Motion activated backlight turns on when approached	●		●

*RC1500 available as ZigBee® wireless only.

Omnistat2 Thermostat Conventional & Heat Pump (w/ Aux)

RC-1000(colorcode)

Omnistat2 Thermostat Multi-Stage Heat Pump w/ Humidity Control

RC-2000(colorcode)

White (WH) Black (BL) Silver (SL)

Temperature Display/Control (TDC)

95A03-1TWH

Easy-to-use controls and OLED display make the control and adjustment of interior comfort settings both simple and beautiful. Remote interface for use with RC2000 (Wired and ZigBee®).





Thermostat Power Supply Module

30A00-2

Power booster for Omnistat2 thermostats, instructions (may be needed in retrofit applications when “HVAC common” wire is not available). Mounts at furnace/air handler and requires no external power source.



Omnistat2 Trim Ring

65A18-1

White Omnistat2 backplate used as a cover-up when retrofitting homes with existing thermostats. The Omnistat2 thermostat mounts gently on top, and is easy to install thanks to the properly positioned slots (Omnistat2 thermostat shown but not included).



Surface Mount Remote Indoor/Outdoor Temp Sensor

23A00-1

Surface indoor/outdoor temperature sensor for Omnistat and Omnistat2 thermostats. Can be used as outdoor sensor for dual-fuel heat pumps.



Flush Mount Remote Indoor/Outdoor Temp Sensor

23A00-2

For Leviton Security & Automation Omnistat and Omnistat2 thermostats. Can be painted or wallpapered to become virtually invisible.



Thermostat Isolation Module

29A00-1

Relay isolation module for Omnistat2 thermostats. Includes mounting clips, instructions (may be needed for HVAC systems using non-standard voltages).



The accessory products below are specifically designed for use with your Omni and Lumina automation systems. Sensors have been enhanced with a special mounting bracket for improved environmental readings - indoor or outdoor.

Water Temperature Sensor

14A00-8

Module, probe, accessories, instructions. Allows you to monitor and activate programs based on water temperature. Can be used for pools, spas, aquatic ponds, fish tanks, greenhouses, etc. Sensing range is 0-120°F.



Extended Range Indoor/Outdoor Temperature Sensor for Leviton Omni/Lumina Controllers

31A00-7

Sensor from -40° to 120°F, accessory kit, instruction sheet. Allows you to monitor and activate programs based on temperatures. Can be used outdoors, in attics, basements, wine cellars, etc. Must be connected directly to the Leviton controller using a four conductor wire. For enhanced accuracy, it may be calibrated after installation. Includes mounting bracket.



Extended Range Indoor/Outdoor Temperature & Humidity Sensor for Leviton Security & Automation Omni/Lumina Controllers

31A00-8

Sensor from -40° to 120°F and humidity sensor, accessory kit, instruction sheet. Must be connected directly to the Leviton Security & Automation controller using a four conductor wire. For enhanced accuracy, it may be calibrated after installation. Includes mounting bracket.



Residential & Commercial Wireless Devices



Leviton's powerful wireless Lumina RF products ensure energy savings in new construction and retrofit, controlling lights, lamps, fans, shades, pumps, and third-party window coverings/door locks with an optimum range of 200 feet. Use MicroControl™ as a stand-alone solution, or opt for the ZigBee® Interface Module if incorporating into a Leviton automation system. Leviton Security & Automation adheres to ZigBee® Pro and the standardized Home Automation profile.

Energy Management



Lumina RF MicroControl™

81A00-2WHZB

Lumina RF MicroControl™ Companion

81A00-4WHZB

MicroControl functions as an energy management coordinator. Turn energy loads on or off and view instantaneous consumption. Tabletop, bedside, or wall mount this display to control selected Leviton Security & Automation controller, Omnistat2, and Load Control Module functions. Includes two-way RF transceiver and plug-in power supply. The Companion functions as a remote controller for the MicroControl. Multiple Companions can be used—up to the 64 device limit of a MicroControl system. MicroControl devices use ZigBee® wireless communication.



Shown in White (WH) finish
Specify color when ordering.

Omnistat2 Wireless Multistage & Heat Pump w/Humidity Control

RC-2000colorcodeZB

All the features of the RC-2000 Omnistat2, plus uses ZigBee® wireless communication.



Lumina RF Universal Thermostat

RC-1500colorcodeZB

Lumina RF universal thermostats provide precise control over the heating, ventilation, & air conditioning (HVAC) system using advanced digital technology that learns the heating/cooling patterns to control the equipment for maximum efficiency and comfort. The Lumina RF communicates with control systems via ZigBee® Home Automation profile and has a high-power radio with a range of over 200 ft.



Omnistat2 Wireless Single-Stage Conventional & Heat Pump (w/Aux Heat)

RC-1000colorcodeZB

All the features of the RC-1000 Omnistat2 plus uses ZigBee® wireless communication.

ZigBee® Interface Module (ZIM)

81A00-3WHZB

Wireless interface and coordinator for ZigBee® products. Plugs into serial port on Leviton Security & Automation Omni or Lumina family controller and allows control of Leviton Security & Automation Wireless Energy Management Components. Display helps setup and installation of wireless systems. Uses ZigBee® wireless communication. Six foot cable included. Powered by the Leviton Security & Automation Omni controller.



Lumina RF 15A Plug-in Load Control Module

89A00-1ZB

Perfect for appliances, fans, and lamps up to 15A, general purpose. ½ horsepower. 120VAC/60hz. Uses ZigBee® wireless communication.



Lumina RF 300W Plug-in Lamp Module

88A00-1ZB

Plug-in dimmer controls lamps up to 300W. 120VAC/60hz. Uses ZigBee® wireless communication.



Lumina RF 30A Wireless Load Control Module

73A00-3ZB

Wireless controls for water heaters, pool pumps, outdoor fountains, lighting, and more. Ultra low stand-by power. Universal 96-250 VAC and 50/60 Hz. Can be used outdoors. Uses ZigBee® wireless communication.



Lumina RF 5A Wireless Load Control Module

73A00-4ZB

Controls low voltage circuits in outdoor air conditioning units, pool and spa heaters & pumps, generators, and more. Ultra low stand-by power. Universal 96-250VAC and 50/60Hz. Can be used outdoors. Uses ZigBee® wireless communication.



Innovations for utility companies and their customers



Leviton offers a full suite of Home Area Network products including In-Home Displays, Load Control Modules, and Programmable Communicating Thermostats designed to use ZigBee® Smart Energy profile and other RF network technologies for communication. These products are designed for Time of Use, AC Load Management, Peak Time Rebate, and Energy Awareness programs for utility companies interested in smart grid and tailoring load profiles for best use of assets.

Energy Management



In-Home Display (120/240V)

81A00-1WHS-EP

In-Home Display (110V)

81A00-1WHS-HP

The In-Home Display (IHD) lets utility customers track their energy usage in graph form based upon kWh used. Screens are customizable to provide any type of energy awareness information that a customer may require including total energy consumption. The IHD's internal backup battery notifies homeowners of power outages or remote disconnect. The large graphic energy display can change color as energy prices or events change. It can receive custom real-time messages from the utility company regarding billing, energy prices, and more. The IHD is portable, or can be wall-mounted. Comes with two-way RF transceiver and plug-in power supply. Uses ZigBee® to communicate wirelessly. ZigBee® radios have maximum transmit power of +20 dBm (100 mW) and receive sensitivity of -98 dBm.



Omnistat2 Multi Stage Universal With Humidity Thermostat

RC-2000WHS-HP

The Omnistat2 Programmable Communicating Thermostat (PCT) allows utilities to combine the display capabilities of an IHD and the load control capabilities of an LCM in one device. For the utility, the Omnistat2 provides reliable control and load shedding for demand response applications that can be customized for specific load profiles. For the consumer, the Omnistat2 has all of the information about usage and price from the utility along with a programmable thermostat that saves money. Uses ZigBee® to communicate wirelessly. ZigBee® radios have maximum transmit power of +20 dBm (100 mW) and receive sensitivity of -98 dBm.



Omnistat2 Multi Stage Universal Thermostat

RC-1500WHS-HP

Omnistat2 universal thermostats provide precise control over the heating, ventilation, & air conditioning (HVAC) system using advanced digital technology that learns the heating/cooling patterns to control the equipment for maximum efficiency and comfort. The Omnistat2 communicates with smart meters via ZigBee® Smart Energy profile and has a high-power radio with a range of over 200 ft.



Omnistat2 Single Stage Thermostat

RC-1000WHSHP

Uses ZigBee® to communicate wirelessly. ZigBee® radios have maximum transmit power of +20 dBm (100 mW) and receive sensitivity of -98 dBm



15A Plug-in Load Control Module

89A00-1SHP

The Indoor Plug-In LCM serves small appliance and lighting applications and can function as a repeater for ZigBee® systems, extending the range of control for sheddable loads. Wireless controls for water heaters, pool pumps, outdoor fountains, lighting, and more. Uses ZigBee® to communicate wirelessly. For indoor use only.



30A Wireless Utility Load Control Module

73A00-3SHP

Wireless controls for water heaters, pool pumps, outdoor fountains, lighting, and more. Load Control Modules on air conditioning units include current measuring, which senses the status of the load and allows for measure and display of current consumption. Additional features include very low power consumption and a compact size. Ultra low stand-by power. Universal 96-250 VAC 50/60 Hz. Can be used outdoors. Uses ZigBee® to communicate wirelessly.



5A Wireless Utility Load Control Module

73A00-4SHP

Controls low voltage circuits in outdoor air conditioning units, pool and spa heaters & pumps, generators, and more. Load Control Modules on air conditioning units include current measuring, which senses the status of the load and allows for measure and display of current consumption. Additional features include very low power consumption and a compact size. Ultra low stand-by power. Universal 96-250 VAC 50/60 Hz. Can be used outdoors. Uses ZigBee® to communicate wirelessly.





Series 1000 and 2000 Single Phase Meter Kits Various (See below)

The Leviton line of revenue-grade meters meets all measurement and verification-based opportunities. Designed to provide a simple and effective process for accurately capturing measurements of power consumption. Leviton meters utilize highly accurate current transformers for revenue-grade performance certified to ANSI standards.

Use Series 1000 Meters in commercial, institutional, industrial and government applications for: tenant cost allocation, load profiling and benchmarking, measurement and verification, usage aggregation, energy conservation and cost reduction. The large LCD display shows kWh and optional peak and instantaneous kW with Demand Reset. With the 2000 Series meters, Multiple Meter Unit (MMU) Configurations are possible with 2-4 Medium meters, 5-8 large meters, or 9-16 extra large meters. Additionally, data storage on the 1000 series is last reading, while the 2000 is last reading cumulative.

Leviton offers CTs in solid and split core styles to accommodate all phases of installation and construction. Solid core CTs are ideal for new construction, when power is not live and wires can easily be threaded through the core. Split core CTs can be installed at any time without having to disconnect wire terminations, making them the optimal choice for retrofitting an existing structure.

PART NUMBERS: Series 1000 Single Phase Meter Kits				
VOLTAGE	AMPS	CTS INCLUDED	INDOOR ENCLOSURE LEVITON P/N	OUTDOOR ENCLOSURE LEVITON P/N
120V 1 PH 2W	100	1 Split CT	1K120-01W	10120-01W
	200	1 Split CT	1K120-02W	10120-02W
	400	1 Split CT	1K120-04W	10120-04W
	800	1 Split CT	1K120-08W	1K120-08W
	100	1 SOLID CT	1K120-1SW	
	200	1 SOLID CT	1K120-2SW	
120/208V 1 PH 3 W or 120/240V 1 PH 3 W (Split Phase)	100	2 Split CTs	1K240-01W	10240-01W
	200	2 Split CTs	1K240-02W	10240-02W
	400	2 Split CTs	1K240-04W	10240-04W
	800	2 Split CTs	1K240-08W	10240-08W
	100	2 SOLID CTs	1K240-1SW	
	200	2 SOLID CTs	1K240-2SW	
277V 1 PH 2W	100	1 Split CT	1K277-01W	10277-01W
	200	1 Split CT	1K277-02W	10277-02W
	400	1 Split CT	1K277-04W	10277-04W
	800	1 Split CT	1K277-08W	10277-08W
	100	1 SOLID CT	1K277-1SW	
	200	1 SOLID CT	1K277-2SW	

PART NUMBERS: Series 2000 Single Phase Meter Kits				
VOLTAGE	AMPS	CTS INCLUDED	INDOOR ENCLOSURE LEVITON P/N	OUTDOOR ENCLOSURE LEVITON P/N
120/208V 3 PH 4 W WYE kWh Meter	100	3 Split CTs	2K208-01W	2O208-01W
	200	3 Split CTs	2K208-02W	2O208-02W
	400	3 Split CTs	2K208-04W	2O208-04W
	800	3 Split CTs	2K208-08W	2O208-08W
	1200	3 Split CTs	2K208-12W	2O208-12W
	100	3 SOLID CTs	2K208-1SW	
	200	3 SOLID CTs	2K208-2SW	
120/208V 1 PH 3 W or 120/240V 1 PH 3 W (Split Phase)	100	3 Split CTs	2K480-01W	2O480-01W
	200	3 Split CTs	2K480-02W	2O480-02W
	400	3 Split CTs	2K480-04W	2O480-04W
	800	3 Split CTs	2K480-08W	2O480-08W
	1200	3 Split CTs	2K480-12W	2O480-12W
	100	3 SOLID CTs	2K480-1SW	
	200	3 SOLID CTs	2K480-2SW	
120/208V 3 PH 4 W WYE Demand Meter	100	3 Split CTs	2K208-01D	
	200	3 Split CTs	2K208-02D	
	400	3 Split CTs	2K208-04D	
	800	3 Split CTs	2K208-08D	
	1200	3 Split CTs	2K208-12D	
277/480V 3 PH 4 W WYE Demand Meter	100	3 Split CTs	2K480-01D	
	200	3 Split CTs	2K480-02D	
	400	3 Split CTs	2K480-08D	
	800	3 Split CTs	2K480-08D	
	1200	3 Split CTs	2K480-12D	

“Leviton Security & Automation continues to have the most flexible automation panel on the market and the systems continue to be very reliable.”

Mountain Home Technology, Big Sky, Montana



EMB Hub and HubLite

Various (See Below)

The Leviton EMB Hub is an intelligent, flexible data acquisition server allowing users to collect energy data from meters and environmental sensors through ModBus protocol. The Leviton EMB HubLite is an intelligent, flexible data acquisition server allowing users to collect energy data from pulse output meters through 4 pulse inputs. Designed to connect to IP-based applications such as enterprise energy management, demand response and smart grid programs, the EMB Hub or HubLite server lets you connect thousands of energy points, benchmark energy usage and reduce energy costs. The EMB Hub and HubLite collect and log data from connected (wired or wireless) devices based on user selected intervals.

Applications	
EMB Hub	HubLite
Measurement and verification (M&V)	Create load profiles for energy purchases
Tenant billing	Utility submetering (electricity, gas, water, etc.)
Reduce energy costs	Measurement and verification (M&V)
Access energy information from local or remote sites	Tenant billing
Benchmark building energy usage	Access energy information from local or remote sites
View “real time” performance data	Benchmark building energy usage
Track energy use and peak demand for Demand Response programs	View “real time” performance data
Monitor performance of critical systems (lighting, HVAC, PDUs, inverters, etc.)	Track energy use and peak demand for Demand Response programs
Alarm notification for data points above or below target levels (including SNMP Traps)	Monitor utility meters for rebate program compliance
Monitor renewable energy performance and production	Alarm notification for data points above or below target levels (including SNMP Traps)
Push or pull meter data to energy dashboards, kiosks and software applications	Push or pull meter data to energy dashboards, kiosks and software applications
LEED / Energy Star certification	LEED / Energy Star certification
CAT. NO	DESCRIPTION
A8810-000	EMB Hub
YBM05-010	Power Brick
A7810-000	EMB HubLite

GreenMAX® Relay Control

New for 2013, the GreenMAX Relay Control Panels can now be integrated into a Leviton Omni or Lumina automation system. Integrate the GreenMax with features like temperature control, security and surveillance. Control locally with an OmniTouch 7 and control remotely from a smartphone or tablet. Designed for the contractor, specifier and end user, GreenMAX® Relay Control Panels deliver a robust solution to offer the best performance, reliability, flexibility and energy savings of any relay control system. Featuring an industry leading 25,000A Short Circuit Current Rating (SCCR) design, GreenMAX easily integrates multiple lighting control strategies - switching, dimming, pulse control, behavior controls, scheduling, occupancy sensing and daylight harvesting - in one system. Native BACnet IP allows for a seamless integration with building management systems. Programming is quick and simple with a portable Handheld Display Unit (HDU) allowing for onsite or remote access. The modular design allows total installation flexibility and labor savings as well as easy expansion opportunities.

Benefits of GreenMAX

- Ultimate energy-saving flexibility with lighting control capabilities, occupancy sensing and daylight harvesting all in one system
- Advanced bi-level switching and dimming controls
- Easy Behavior controls for scheduling

Smart Building Management & Integration

- Seamless integration with building management systems through native BACnet IP
- Scalable solutions offer future expansion opportunities
- Meets strict energy code performance requirements
- Smart And Simple Installation AND Manageability
- GreenMAX cabinets and components are shipped separately for ease of installation to meet contractor schedules, lighting demands and help manage cash flow
- Manage lighting systems in one space from a portable Handheld Display Unit - no more walking to and from the electrical room
- Programming logic by Behaviors reduces programming time and increases functionality

Smart Robust Design

- Industry leading 25,000A Short Circuit Rating (SCCR) at 277VAC for maximum equipment reliability withstands circuit faults for increased safety
- Robust latching Relay Modules are rated 30A general fluorescent ballast and 20A electronic ballast in 1-pole and 2-pole configurations with the same footprint, available with or without the Return to Closed (RTC) functionality
- Native communication network protocols - BACnet IP, Ethernet and LumaCAN offer unparalleled connectivity; no additional parts or adapters are needed to communicate with other products utilizing these protocols
- All network connections are made with RJ45 connectors and cabling is standard CAT6
- GreenMAX simplifies the combination of lighting control strategies into Behaviors programmed throughout the day; Behaviors can be set for the entire system or individual rooms/relays



The GreenMax Lighting Control System is individually configured from a broad range of enclosure sizes, functions and capacities.

For more information please visit:
www.leviton.com/greenmax

Entertainment



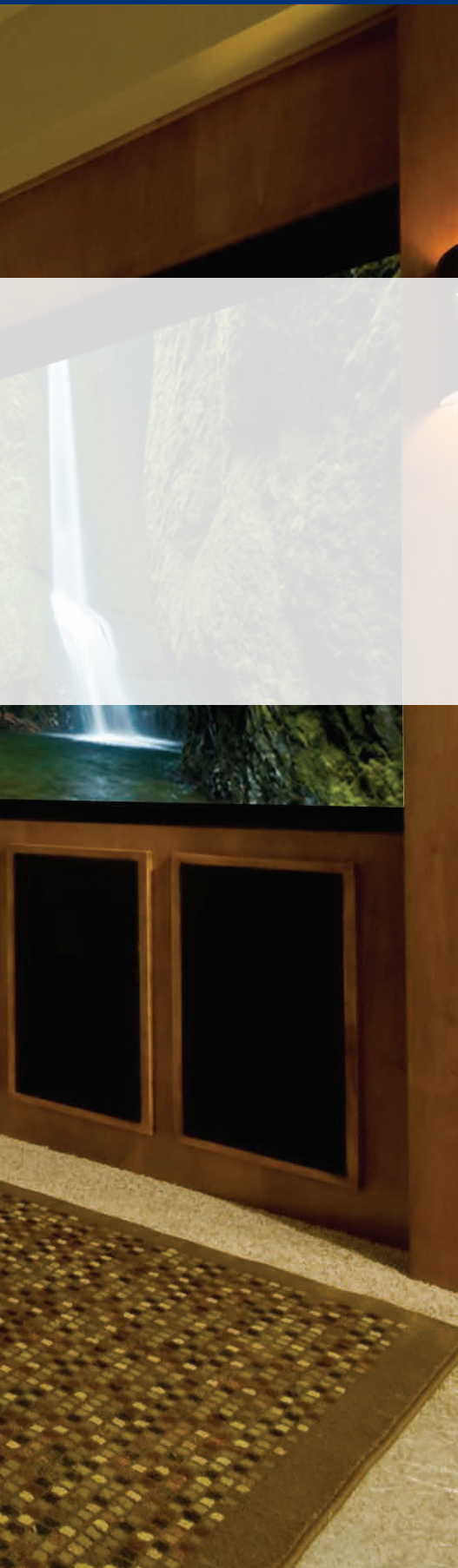

Use Bluetooth® to stream music from a tablet or smartphone to the built-in speakers. Many Leviton entertainment products can be used stand-alone or integrated into a complete control system for increased functionality. Make your A/V equipment more than a convenience, create an enhanced lifestyle experience.

- 82** Hi-Fi 2 Distributed Audio Systems
- 86** In-Wall and In-Ceiling Speakers
- 88** Outdoor and Home Theater Speakers
- 90** HAI Dock
- 91** Home Theater Extender 2

Hi-Fi 2 Distributed Audio

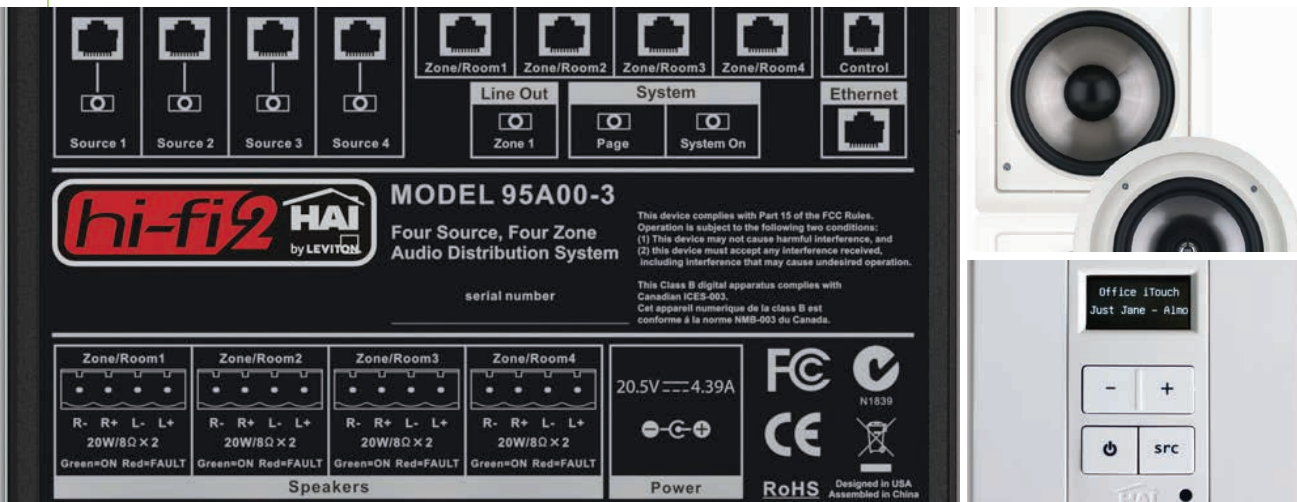

The revolutionary Hi-Fi 2 distributed audio systems mount in a structured wiring enclosure for a clean, built-in installation using in-wall and in-ceiling speakers and any audio source you want to share. Use the free iOS® app to control audio in every room.

Multiple Zones, to Suit Your Property

Revolutionary Hi-Fi 2 distributed audio systems are available in either 8 source/8 zone systems (expandable to 16 zones) or as a 4 source/4 zone system. Enjoy hard-wired reliability and clarity that's skip-free and not subject to distortion.

Both systems can work stand-alone and can be accessed via the free Hi-Fi 2 iOS® app.

Built-In Distributed Audio

The Hi-Fi 2 amplification is built-in to the main unit, mounted in a Leviton Structured Media Enclosure between the studs for a clean, sleek appearance. The Hi-Fi 2 requires no audio rack or closet full of audio equipment. Simply plug in your audio source or share via Bluetooth®.

The 8x8 version features 50 Watts per zone and mounts full-width in a Leviton Structured Media Center, while the 4x4 version features 40 Watts per zone and fits half-width.

Discreet Speaker Installations

Leviton manufactures speakers that sound fantastic when paired with these audio systems. Choose from in-wall, in-ceiling, or outdoor speakers from Leviton for a truly professional aesthetic and say goodbye to cluttered bookshelf speakers!

Free Stand-Alone iOS® App

Now, anyone can control their Hi-Fi 2 system via a free iOS® application on their iPad®, iPod® Touch®, or iPhone®. Load the application on as many devices as you like for free. Sitting on the couch and think the audio is too loud upstairs? Simply adjust the volume from your iPad® in the den. Grilling on the patio and want to listen to the big game? Pull out an iPhone® and change the audio source to the living room TV so that you never miss a play!





Hi-Fi 2 by Leviton Security & Automation
4 Zone, 4 Source Kit for Structured
Wiring Enclosures

95A00-3

The Hi-Fi 2 4x4 accommodates four sources, which can either be local at the amplifier or remote using a RIM connected to Cat5. 2 RIMS come with the Hi-Fi 2 4x4 for the most popular remote inputs (home theater, kitchen TV, iPod® dock, den entertainment center). More RIMs are available separately. Includes 4 OLED Display VSCs (Volume Source Control) with digital controls and remote control. Works with optional HAI Dock and Bluetooth® Remote Input Module. This product functions in many world locations with multiple voltage operating capacity. A suitable plug will be supplied, depending on your location, use -4 for UK, -5 for EU and -6 for AU.



Hi-Fi 2 by Leviton Security & Automation
8 Zone, 8 Source Kit with Enclosure

95A00-1

Includes 8 Inputs and 4 RIMs (Remote Input Module); use all 8 Inputs or 4 Inputs and 4 RIMs or any combination up to a total of 8 Inputs/RIMs. Also includes 8 OLED Display VSCs (Volume Source Control) with digital controls. Expandable to 16 zones using Expansion Amplifier Kit [sold separately]. Works with optional HAI Dock and Bluetooth® Remote Input Module.



Hi-Fi 2 by Leviton Security & Automation
8 Zone, 8 Source Kit for Structured
Wiring Enclosures

95A00-2

Includes 8 Inputs and 4 RIMs (Remote Input Module); use all 8 Inputs or 4 Inputs and 4 RIMs or any combination up to a total of 8 Inputs/RIMs. Also includes 8 OLED Display VSCs (Volume Source Control) with digital controls. Expandable to 16 zones using Expansion Amplifier Kit [sold separately]. Works with optional HAI Dock and Bluetooth® Remote Input Module.



Hi-Fi 2 by Leviton Security & Automation
Main Amplifier Assembly with Power Supply

95A01-1

Expandable to 16 zones using Expansion Amplifier Kit [sold separately].



Hi-Fi 2 by Leviton Security & Automation 8 Zone Expansion Amplifier Kit with Enclosure

95A12-1

Includes expansion PCA, 8 VSCs, and enclosure. Expands the Hi-Fi 2 to a total of 16 zones. Includes power cord, expansion cable, and two variable outputs. Expansion Amplifier must be mounted no more than six inches (15.24cm) below the Main Amplifier. Compatible with OmniPro II and Lumina Pro controllers only.



Hi-Fi 2 by Leviton Security & Automation 8 Zone Expansion Amplifier Kit for Structured Wiring Enclosures

95A12-2

Includes expansion PCA on back plate and 8 VSCs. Expands the Hi-Fi 2 to a total of 16 zones. Includes power cord, expansion cable, and two variable outputs. Expansion Amplifier must be mounted no more than six inches (15.24cm) below the Main Amplifier. Compatible with OmniPro II and Lumina Pro controllers only.



Hi-Fi 2 Expansion Amplifier Assembly w/Power Supply

95A18-1

Includes expansion PCA with power supply and power cord. Expands the Hi-Fi 2 to a total of 16 zones. Expansion Amplifier must be mounted no more than six inches (15.24cm) below the Main Amplifier. Compatible with OmniPro II and Lumina Pro controllers only.



Hi-Fi 2 Expansion Cable Assembly

95A16-1

24-pin ribbon cable connects the Main Amplifier board to the Expansion Amplifier board. This part is included with 95A12-1 and 95A12-2.



Vented Enclosure

95A09-1

Enclosure for Hi-Fi 2 with vents, door latch mounting plate, hardware kit and instructions. Features knock-outs on top, bottom, and back for multiple installation scenarios.

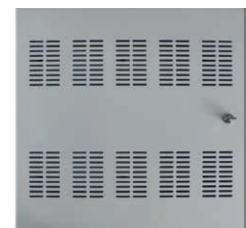



**Hi-Fi 2 by Leviton Security & Automation
Retractable Cable**

95A13-1

3.5mm male to 2 RCA male patch cable. Extends to 4 feet. Use to connect TVs, CD players, home theater and stereo components to Hi-Fi 2's RIM.



**Hi-Fi 2 by Leviton Security & Automation
Retractable Cable**

95A14-1

3.5mm male to 3.5mm male stereo patch cable. Extends to 4 feet. Use to connect MP3 players, iPods™, computers with headphone and/or audio outputs to Hi-Fi 2's RIM.



Hi-Fi 2 Remote Control

95A05-1

Remote Control for volume and source selection. One included in 95A00-1 and 95A00-2.



Volume-Source Control (VSC)

95A03-1

Four-button OLED keypad controls volume, power, source, and more. Features IR receiver. White wallplate, VSC Color Change Kits available. Supports foreign language (western characters) and unicode characters.



**VSC Color Change Kits
(Case of 12)**

95A11-colorcodeCS

Case of 12 wallplates. Specify color code when ordering, White (WH), Almond (AL), Light Almond (LTA), Black (BL), and Ivory (IV).

Bluetooth® Remote Input Module

95A04-2

Bluetooth® devices can connect and act as music servers for your Hi-Fi 2 distributed audio system. Play music from your device's Pandora, Spotify, Rhapsody, iTunes®, and YouTube playlists. No more learning new interfaces or being held back by localized controls. Now anyone can be the DJ!



BRIM Color Change Kit (Sold Individually)

95A15-colorcode

Single wallplate. Specify color code when ordering, White (WH), Almond (AL), Light Almond (LTA), Black (BL), and Ivory (IV).



Remote Input Module (RIM)

95A04-1

White Remote Audio Input/IR output module. Includes white wallplate. Additional colors are available through RIM Color Change Kits. Features a routed IR emitter jack and a flasher. Control your source equipment from any room that has a Volume-Source Control.



RIM Color Change Kits (Case of 12)

95A10-colorcodeCS

Case of 12 wallplates. Specify color code when ordering, White (WH), Almond (AL), Light Almond (LTA), Black (BL), and Ivory (IV).



In-Wall/Ceiling JBL® Speakers

JBL studio speakers have a reputation for incorporating the most advanced audio materials, technologies, and precision engineering available. These same features and technologies are built into the Leviton Architectural Edition® Powered by JBL Series audio equipment.

Features and Benefits

Leviton Architectural Edition Powered by JBL Wall & Ceiling Speakers

JBL titanium-laminate drivers maintain accuracy and clarity even at frequency extremes

Straight-line Signal Path™ (SSP®) crossover network for minimal signal distortion

Long-excursion woofers with butyl-rubber half-round surrounds and extended pole-piece magnetic structures for maximum bass impact and dynamic range

Low-diffraction, swivel-tweeter mounting system for optimum stereo imaging

Heavy-duty push-type input terminals for long-term connection integrity

Integrated dog-ear mounting brackets (optional rough-in kits available for pre-construction installation in new homes)

Acoustically transparent, paintable grills

Pre-Construction Kits

Pre-construction kits ensure that speaker locations and wiring are preserved and protected during construction, allowing for a cleaner, faster, and more precise installation during the trim-out stage

Fire Rated Back-Box enclosure meets fire code for MDU and residential installations

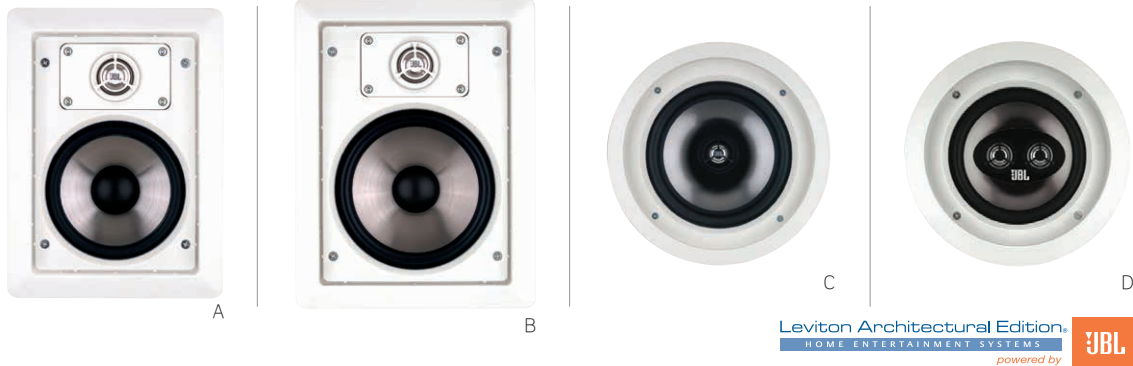

Leviton Architectural Edition Powered by JBL In-Wall and In-Ceiling Speakers		
Description		Cat. No.
[A]	Pair of 6.5" Two-Way In-Wall Loudspeakers, 80 watts, 8 ohms	AEI65-000
[B]	Pair of 8" Two-Way In-Wall Loudspeakers, 100 watts, 8 ohms	AEI80-000
[C]	Pair of 6.5" Two-Way In-Ceiling Loudspeakers, 80 watts, 8 ohms	AEC65-000
	Pair of 8" Two-Way In-Ceiling Loudspeakers, 100 watts, 8 ohms	AEC80-000
[D]	6.5" Two-Channel / Single Location Two-Way In-Ceiling Loudspeakers, two titanium tweeters, dual voice-coil titanium-laminate woofer 50 watts/channel, 8 ohms	AEM65-000
Pre-Construction Kits		
Description		Cat. No.
	6.5" Pre-Construction Speaker Kit for in-wall installations	AEPI6-KIT
	8" Pre-Construction Speaker Kit for in-wall installations	AEPI8-KIT
	Fire Rated Back-Box Enclosure (Required for 6.5" in-ceiling speakers AEC65, AEM65), (see page U-27 for photo)	AEBC6-000
	8" Pre-Construction Speaker Kit for In-Ceiling Speaker	AEPC8-KIT

In-Wall/Ceiling Spec-Grade™ Sound Speakers

When the specs call for quality audio, rely on Leviton's award-winning Spec-Grade Sound indoor speaker line for technical innovation and value.

Features and Benefits

Spec-Grade Sound Speakers

AeroNylon tweeter diaphragm provides crystal-clear treble response and exceptionally accurate tracking of even the most challenging musical transients

Built-in AutoSurge® circuit protection helps prevent speaker damage

Advanced phase/time alignment guide properly aligns sound without misaligning the tweeters

Precision dividing network ensures total audio signal electronic integrity up to the last microsecond before the signal is converted into sound

Inert mounting frame with “dogleg” installation points eliminates any transmitted vibrations that could alter in-wall or ceiling sound quality

Acoustically transparent, paintable grills

Pre-Construction Kits

Pre-construction kits ensure that speaker locations and wiring are preserved and protected during construction, allowing for a cleaner, faster, and more precise installation during the trim-out stage

Fire-Rated Back-Box enclosure meets fire code for MDU and residential installations



Spec-Grade Sound In-Wall/In-Ceiling Indoor Speakers

Description	Cat. No.
[A] Pair of 6.5" Spec-Grade Two-Way In-Ceiling Loudspeakers, 120 W peak/ 60 W RMS, 8 ohms	SGC65-00W
[B] Pair of 6.5" Spec-Grade Two-Way In-Wall Loudspeakers, 120 W peak/ 60 W RMS, 8 ohms	SGI65-00W
Replacement Grill for SGC65	SGC65-GRL
Replacement Grill for SGI65	SGI65-GRL
Replacement Grill for SGI80	SGI80-GRL

Pre-Construction Kits

Description	Cat. No.
Rough-in Bracket for 6.5" In-Wall Loudspeakers	PCI65-KIT
Rough-in Bracket for 8" In-Wall Loudspeakers	PCI80-KIT
[C] Fire-Rated Back-Box Enclosure (Required for 6.5" in-ceiling speakers SGC65)	AEBC6-000

Outdoor Speakers

Features and Benefits

Leviton Architectural Edition® Powered by JBL® Outdoor Speakers

Elliptical Oblate Spheroidal™ (EOS) Waveguide technology for high-frequency dispersion

Straight-line Signal Path™ (SSP) crossover networks for minimal signal distortion

5-way binding post input terminals for long-term connection integrity

Mounting brackets included

Leviton Spec-Grade® Sound Outdoor Utility Two-Way Loudspeakers

5.25" silicate-fiber cone low-frequency transducer with butyl rubber surround

5" poly-dome high-frequency transducer

Element-resistant polypropylene enclosure, gold-plated binding terminals, and aluminum mounting bracket with stainless-steel hardware



A



B

Leviton Architectural Edition Powered by JBL Outdoor Speakers

Description	Cat. No.
[A] Pair of Outdoor/All-Weather Two-Way Loudspeakers in Enclosure, 0.75" tweeter, 4" woofer, 150 watts, 8 ohms	AEN24-000

Leviton Spec-Grade Sound In-Wall/In-Ceiling Indoor Speakers

Description	Cat. No.
[B] Pair of Outdoor/Utility Two-Way Loudspeakers in Enclosure, 0.5" tweeter, 5.25" woofer, 120 watts, 8 ohms	SG099-00W
Replacement Grill for SG099-00W	SG099-GRL

Spotlight | Smartphone Convenience, Connected Home Performance



More homeowners are sending music and movies from their smartphones to HDTVs or home entertainment systems over Apple Airplay®, Airport Express®, or Apple TV® devices. Leviton offers wiring diagrams and equipment lists to help you integrate these Apple products with Leviton Structured Media® Systems and speakers.

We'll help you connect the dots to easily share music, videos, and photos on a grand scale.

To learn more, go to leviton.com/connectedhome.

Home Theater Speakers

Features and Benefits

In-Wall Speakers

Straight-line Signal Path™ (SSP) crossover network for minimal signal distortion

JBL® titanium-laminate drivers, pure titanium tweeter, and polymer-coated aluminum woofers maintain musical accuracy and clarity, even at frequency extremes

Low-diffraction, swivel-tweeter mounting system of optimum stereo imaging

Shelf-Mount Center Channel Speaker

Straight-line Signal Path (SSP) crossover network for minimal signal distortion

Dual 5" JBL PolyPlas cone woofers

FreeFlow flared port for increased bass response without added port noise

Subwoofer

JBL PolyPlas™ woofer for low frequencies

High-efficiency, high-current switching amplifier

Freeflow flared port for increased bass response without added port noise

Built-in technologies allow simple adjustment for room acoustics and personal preference

LFE and line level inputs for maximum connection flexibility

Surround-Sound Home Cinema System

Includes five 2-way magnetically shielded satellite speakers with 2.5" (63.5 mm) woofer and 0.5" (12.7 mm) tweeter; one 8" (200 mm) 100 watt powered subwoofer with LFE and a built-in crossover network, plus five adjustable mounting brackets and subwoofer input RCA cable

Five-channel system can be expanded to 6.1 or 7.1 surround sound with optional satellite speakers



Leviton Architectural Edition Powered by JBL Home Theater Speakers

Description		Cat. No.
[A]	Dual 5" Two-Way In-Wall Center Channel Home Theater Loudspeakers, 120 watts, 8 ohms	AEI55-000
[B]	Dual Channel Two-Way Shelf-Mounted Center Channel Loudspeaker w/ silver grill, 75 watts / 300 watts, 8 ohms	AECCS-VCE
[C]	Powered 12" Subwoofer w/ amplifier w/ silver grill, 400 watts RMS, 700 watts peak, 8 ohms	AESUB-012
[D]	Five-Channel Surround-Sound Home Cinema Speaker System w/ 100-watt powered subwoofer and 5 satellite speakers	AEH50-0**
	System-Matched Satellite Speaker for 6.1 and 7.1 surround sound expansion	AESS5-0**
	Single-Gang Decorative Satellite Speaker Adapter Wallplate/Bracket	AEPHK-0**
	Pre-Construction Kit, in-wall center channel shelf for use with AEI55-000	AEPIS-KIT

** = Color: Available in White (WH) or Black (BL)

Entertainment | Dock and Home Theater Extender 2



HAI Dock, US Wired	96A00-1
HAI Dock, US Wireless	96A00-2
HAI Dock, US Power Supply	96A01-1
HAI Dock, EU Wired	96A00-3
HAI Dock, EU Wireless	96A00-4
HAI Dock, EU Power Supply	96A01-2

The HAI Dock allows users to access music on an iPod® or iPhone® through IP-enabled devices over a wired or wireless network. When connected to a Hi-Fi 2 distributed audio system, the connected iPod® or iPhone® becomes a source that can be played in any audio zone connected to the Hi-Fi 2.

The Dock is also compatible with Leviton Security & Automation Connectivity Partner audio systems.

The attached iPod®/iPhone® is controlled from either the Volume Source Control or the iOS® app. Metadata (e.g. playlist, genre, artist, album, and track) is sent to IP-enabled devices on the network and displays on Hi-Fi 2 Volume Source Controls.

Send the iPod® control commands including play, pause, stop, next/previous track, rewind, fast forward, next/previous chapter. IP-enabled devices navigate and browse the iPod®/iPhone® music library by playlists, artists, albums, songs, podcasts, genres, composers, and audiobooks.

Compatible with: iPod® Nano (3G, 4G, 5G, 6G), iPod® Classic, iPhone® (1, 3G, 3GS, 4G), iPod® Touch® (1, 2G, 3G, 4G); Also compatible with iPhone® 5, iPad® 4, iPad® mini, iPod® Nano 7, and iPod® Touch® 5 utilizing Apple Lighting to 30-pin Adapter. Power supply included: U.S.: 120VAC, 60Hz, E.U.: 100-240VAC, 50-60Hz, universal.

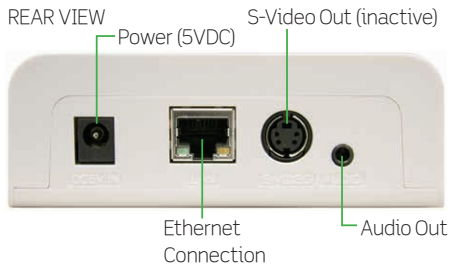

With the Hi-Fi 2 Stand-alone

- Enjoy music on iPod® in all zones while simultaneously charging its battery.
- See what's playing, pause, previous/next track on a Hi-Fi 2 VSC.



With an iPod® Touch® or iPad®...

- Control Hi-Fi 2 and HAI Dock remotely from iPod® Touch® or iPad®.



Home Theater Extender 2 (HTX2)

86A00-2

The Leviton Security & Automation Home Theater Extender2 (HTX2) lets you extend your control to the audio/video equipment. The HTX2 communicates over Ethernet with an iPhone®, iPod® Touch®, or iPad®. Easily add components with the built-in A/V Library of over 300,000 IR codes or add new codes with the built-in IR Learner.

A free iOS® app for iPhone®/iPad®/iPod® Touch® can be used to control your home theater equipment. Default templates are provided but may be completely customized in the provided Mobile Designer software.

Control of multiple AV systems is easy. Contact closures can even operate window coverings, lights, and home theater components. Multiple HTX2's can be linked together to control dozens of AV components in restaurants or sports bars.

iOS® devices send commands to the HTX2, which in turn controls A/V equipment using its serial ports, IR ports, and relays. The HTX2 includes four IR Flashers (emitters) that attach to the IR Receiver of any A/V equipment you wish to control.

The I/O ports on the HTX2 are used for power sensing for devices without discrete on/off IR commands. Relay ports on the HTX2 can be used to control any device that requires a contact closure, such as motorized screens or blinds.

Easily add audio/video components with the built-in A/V Library of over 300,000 IR codes or add new codes with the IR Learner.

Using a Leviton Security & Automation home control system? Easily tie in your audio/video equipment to your automation activities. With one button push at the end of the night, you can activate your security system, turn off all A/V equipment, and much more.

IR Flasher

62A08-1

IR Flasher for use with HTX2 and Hi-Fi 2 Remote Input Modules. Attaches to the IR receiver on audio and video components. (Four IR Flashers are included with the HTX2.)





Connected Home



Leviton Security & Automation makes available a wide range of structured media enclosures, networking devices and audio/video accessories to round out your residential or commercial installations.

- 96** Structured Media Enclosures
- 102** Routers and Switches
- 104** Mounting Brackets
- 106** Twist and Mount Patch Panels
- 108** Modules and Expansion Boards
- 110** Video Distribution and Splitters
- 112** Renu and QuickPort Wallplates
- 114** Decora Wallplates and QuickPlates
- 116** Cheetah Speed System
- 118** Mobile Device Station,
Theater and Recessed Receptacles
- 120** Video Accessories
- 122** Audio Accessories

Connected Home



Set yourself up for Connected Home high performance with the latest in residential technology: networking, HDTV, media servers, media streaming, VoIP, IPTV, Wi-Fi, gaming, broadband Internet, and the integration of your mobile devices in the home.

Leviton Connected Home solutions provide the ideal backbone support network for tomorrow's technology.

Structured Media® Enclosures

Leviton Structured Media enclosures provide a convenient termination location for wiring home runs from wall outlets, creating a distribution point for voice, data, audio, and video applications. Available in compact, 14", 21", 28", and 42" sizes to address a broad range of capacities for single family homes, MDUs, and light commercial applications, Leviton Structured Media enclosures support new and retrofit installations.

STRUCTURED MEDIA ENCLOSURES, COVERS, AND DOORS

Enclosures are constructed of white powder-coated 20-gauge steel

Covers and doors are constructed of white powder-coated 18-gauge steel, and feature 3/4" overlap to hide irregular drywall cuts

Modules mount vertically or horizontally

Multiple knock-outs on top and bottom facilitate cable entry and routing

Knock-out in base of enclosure accommodates single- and double-gang J-boxes and power modules

Six 3" self-healing foam grommets included to accommodate and protect cable bundles

Mounting tabs on housing sidewalls prevent enclosure from falling through the studs during installation

Can be surface-mounted or recessed

Combine two or more enclosures for larger installations or future expansion

Optional lock and key set available for additional security

Standards compliance: ACA and cULus Listed

For enclosure configuration assistance, go to leviton.com/homeconfig



A



B



C



D



E



F



G



H



I

Structured Media® Enclosures | 14" & 21" - Features and Benefits 14" & 21" Enclosures, Covers & Doors

- Entry-level home network enclosures create a central distribution point for low-voltage cabling
- Ideal for apartments, condos, and smaller homes
- 14" enclosure accommodates basic residential networking systems and accessories
- 21" enclosure provides additional room for larger modules and equipment

Compact Structured Media MDU Enclosures

- Economical solution for MDU connectivity
- Flexibility to accommodate a variety of telephone/video distribution configurations
- Available empty with cover or in two pre-configured kits
- Snap-on cover requires no tools or fasteners
- Molded-in brackets provide quick snap-in convenience for expansion boards
- Angled video-splitter shelf for easy installation
- Hosts three expansion boards and one TV splitter
- Constructed of sturdy white ABS molded plastic
- cULus Listed for communications equipment

14" STRUCTURED MEDIA ENCLOSURES, COVERS AND DOORS	
Description	Cat. No.
14" Enclosure and Flush-Mount Cover, 15.32" (389.1 mm) H x 15.62" (396.7 mm) W x 3.83" (97.3 mm) D	47605-140
[A] 14" Enclosure, 14.0" (355.6 mm) H x 14.38" (365.3 mm) W x 3.63" (92.2 mm) D	47605-14E
14" Multi-Dwelling Unit Configuration A Enclosure and Flush-Mount Cover, 15.32" (389.1 mm) H x 15.62" (396.7 mm) W x 3.83" (97.3 mm) D (see page U-7 for knock-out configurations)	47605-1MG
[B] 14" Flush-Mount Cover, 15.32" (389.1 mm) H x 15.62" (396.7 mm) W x 0.20" (5.1 mm) D	47605-14C
[C] 14" Economy Hinged Door, 15.32" (389.1 mm) H x 15.62" (396.7 mm) W x 0.25" (6.4 mm) D	47605-14D
14" Premium Hinged Door, 15.32" (389.1 mm) H x 15.62" (396.7 mm) W x 0.25" (6.4 mm) D	47605-14P
14" Premium Vented Hinged Door, 15.32" (389.1 mm) H x 15.62" (396.7 mm) W x 0.25" (6.4 mm) D	47605-14S
14" Enclosure, job packed, 6 per pack, 14.0" (355.6 mm) H x 14.38" (365.3 mm) W x 3.63" (92.2 mm) D	47605-14G
14" Flush-Mount Cover, job packed, 6 per pack, 15.32" (389.1 mm) H x 15.62" (396.7 mm) W x 0.20" (5.1 mm) D	47605-14B
Structured Media Enclosure Lock & Key for 14", 21", 28", and 42" hinged doors	5L000-LOK
21" Structured Media Enclosures, Covers and Doors	
Description	Cat. No.
[D] 21" Enclosure, 21.0" (533.4 mm) H x 14.38" (365.3 mm) W x 3.63" (92.2 mm) D	47605-21E
[E] 21" Flush-Mount Cover, 22.35" (567.7 mm) H x 15.62" (396.7 mm) W x 0.20" (5.1 mm) D	47605-21C
[F] 21" Premium Vented Hinged Door, 22.35" (567.7 mm) H x 15.62" (396.7 mm) W x 0.25" (6.4 mm) D	47605-21S
Structured Media Enclosure Lock & Key for 14", 21", 28", and 42" hinged doors	5L000-LOK
Compact Structured Media MDU Enclosures	
Description	Cat. No.
[G] Compact Structured Media Enclosure and Cover, empty, 8.02" (203.7 mm) H x 14.38" (365.2 mm) W x 3.71" (94.2 mm) D	47605-MDU
Compact Structured Media Enclosure Cover only, 15.375" (390.5 mm) H x 9" (228.6 mm) W x .5" (12.7 mm) D	47605-MDC
[H] MDU Kit (Compact Structured Media Enclosure and Cover plus 1x6 Telephone Expansion Board), 8.02" (203.7 mm) H x 14.38" (365.2 mm) W x 3.71" (94.2 mm) D	47604-0F6
[I] MDU Kit (Compact Structured Media Enclosure and Cover plus 1x6 Telephone Expansion Board and 6-Way 1 GHz Splitter), 8.02" (203.7 mm) H x 14.38" (365.2 mm) W x 3.71" (94.2 mm) D	47604-F6S



47605-28N



47605-28P



47605-2BP

Structured Media® Centers

Leviton 28" & 42" Structured Media Enclosures

The 28" enclosures can comfortably accommodate up to eight distribution modules, depending on selection and density. The 42" enclosures have generous capacity for up to 12 modules, and can also simultaneously accommodate many diverse functions. In larger homes, many contractors specify multiple Structured Media Center enclosures, sometimes separating coaxial cable-based CATV or Satellite TV equipment from the Cat 5e or Cat 6 UTP-based communications and networking equipment. Leviton's exclusive backplates allows for off-site configuration of components for reduced on-site labor.

Leviton 28" Structured Media Enclosures & Covers	
Description	Part No.
28" Enclosure and Flush Mount Cover, 29.32" (744.7mm) H x 15.62" (396.7mm) W x 3.68" (93.5mm) D	47605-28W
28" Enclosure only, 28.0" (711.2mm) H x 14.38" (365.3mm) W x 3.60" (91.4mm) D	47605-28N
28" Multi-Dwelling Unit Configuration A Enclosure and Flush Mount Cover, 29.32" (744.7mm) H x 15.62" (396.7mm) W x 3.68" (93.5mm) D	47605-2MG
28" Multi-Dwelling Unit Configuration B Enclosure only, 28.0" (711.2mm) H x 14.38" (365.3mm) W x 3.60" (91.4mm) D	47605-M28
28" Flush Mount Cover, 29.32" (744.7mm) H x 15.62" (396.7mm) W x 0.20" (5.1mm) D	47605-F28
28" Economy Hinged Cover, 29.32" (744.7mm) H x 15.62" (396.7mm) W x 0.25" (6.4mm) D	47605-28D
28" Premium Hinged Cover, 29.32" (744.7mm) H x 15.62" (396.7mm) W x 0.25" (6.4mm) D	47605-28P
28" Enclosure only, job packed, 3 per pack, 28.0" (711.2mm) H x 14.38" (365.3mm) W x 3.60" (91.4mm) D	47605-28G
28" Flush Mount Cover only job packed, 3 per pack, 29.32" (744.7mm) H x 15.62" (396.7mm) W x 0.20" (5.1mm) D	47605-28B
28" Pre-Fab Back Plate, 25" (635.0mm) H x 13.5" (342.9mm) W x 0.38" (9.65mm) D	47605-2BP

Spotlight - Choosing Your Structured Media Center Enclosure Cover or Door

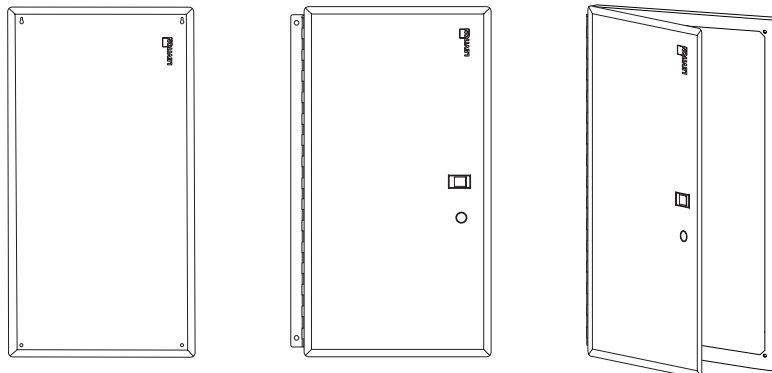

Leviton 42" Structured Media Enclosures & Covers	
Description	Part No.
42" Enclosure and Flush Mount Cover, 43.32" (1,100.3mm) H x 15.62" (396.7mm) W x 3.68" (93.5mm) D	47605-42W
42" Enclosure only, 42.16" (1,070.8mm) H x 14.38" (365.3mm) W x 3.60" (91.4mm) D	47605-42N
42" Multi-Dwelling Unit Configuration A Enclosure and Flush Mount Cover, 43.32" (1,100.3mm) H x 15.62" (396.7mm) W x 3.68" (93.5mm) D	47605-4MG
42" Multi-Dwelling Unit Configuration B, Enclosure only, 42.16" (1,070.8) H x 14.38" (365.3mm) W x 3.60" (91.4mm) D	47605-M42
42" Flush Mount Cover, 43.32" (1100.3mm) H x 15.62" (396.7mm) W x 0.20" (5.1mm) D	47605-F42
42" Economy Hinged Cover, 43.32" (1100.3mm) H x 15.62" (396.7mm) W x 0.25" (6.4mm) D	47605-42D
42" Premium Hinged Cover, 43.32" (1100.3mm) H x 15.62" (396.7mm) W x 0.25" (6.4mm) D	47605-42P
42" Pre-Fab Back Plate, 40.0" (1,016.0mm) H x 13.5" (342.9mm) W x 0.38" (9.65mm) D	47605-4BP



47605-42N

28" & 42" Extender Bracket Frames & SMC Accessories

Specifications & Features

- Extender Brackets provide additional 2" of depth
- Allows for better cable management and for large modules within the SMC
- Made of sturdy, white powder coated 18 gauge sheet metal
- Louvers enhance ventilation for added protection against heat build up from installed modules

28" & 42" Structured Media Center Extender Bracket Frames & SMC Accessories	
Description	Part No.
Extender Bracket, 2" depth extension package for 28" Structured Media Centers	47612-28B
Extender Bracket, 2" depth extension package for 42" Structured Media Centers	47612-42B
Structured Media Center Lock & Key	5L000-LOK

Extender Bracket Frame
(SMC sold separately)

Spotlight - Structured Media Center Enclosure Options

MDU Configuration A

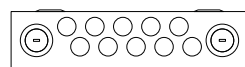

Top

MDU Configuration B

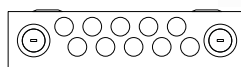

Top

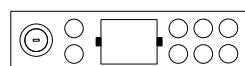

Bottom

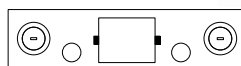

Bottom

Knockout sizes support 1" & 2" commercial conduit.





Structured Media® Enclosures

Multi-Bay FTTH Enclosures

Multi-Bay Enclosures provide excellent termination and mounting locations for both in-home structured wiring and fiber-to-the-home (FTTH) components. Structured wiring components typically mount in the upper section of the dual enclosure and optical network termination (ONT) mounts in the lower section. The dual enclosure can be surface-mounted or mounted between metal or wood wall studs using provided screws.

Features and Benefits

- Multi-bay enclosure design allows separate lockable sections for FTTH integration
- In a separate bay, a full Leviton structured wiring system can be easily connected and optimized up to gigabit speeds to maximize incoming fiber optic connection
- Ideal for new installations or retrofits
- Uses multiple covers or doors to provide access and security.
- Flush-Mount cover, economy, premium, and premium vented doors available

Multi-Bay Enclosures		
Description	Cat. No.	
14" + 14" Dual Multi-Bay Enclosure, 29.64" (752.8 mm) H x 14.30" (363.2 mm) W x 3.63" (92.2 mm) D	47FTH-440	
[A] 28" + 14" Dual Multi-Bay Enclosure, 46.64" (1,184.6 mm) H x 14.30" (363.2 mm) W x 3.63" (92.2 mm) D r	47FTH-840	
28" + 14" + 14" Triple Multi-Bay Enclosure, 59.22" (1,504.1 mm) H x 14.30" (363.2 mm) W x 3.63" (92.2 mm) D	47FTH-844	
42" + 14" Dual Multi-Bay Enclosure, 57.64" (1,464.1 mm) H x 14.30" (363.2 mm) W x 3.63" (92.2 mm) D	47FTH-420	
14" + 14" + 14" Triple Multi-Bay Enclosure, 45.22" (1,148 mm) H x 14.30" (363.2 mm) W x 3.63" (92.2 mm) D r	47FTH-240	
[B] 28" + 28" Dual Multi-Bay Enclosure, 57.64" (1,464.1 mm) H x 14.30" (363.2 mm) W x 3.63" (92.2 mm) D	47FTH-880	

Note: See pages U-4 to U-7 for covers and doors.
r = Minimum order quantity and lead times may apply.



Spotlight | Multi-Bay Enclosure Center Bracket

The specially engineered Multi-Bay Enclosure Center Bracket provides clearance for multiple enclosure covers, allowing in-suite connectivity to be cleanly integrated, while securing access to individual customer and service provider equipment. With multiple knock-outs for different configurations, the center bracket provides a self-contained housing for electrical receptacles, offering protection from Electromagnetic Interference (EMI) and Radio Frequency Interference (RFI).

FTTH Point of Entry Box & Media Versatile Panel

FTTH Point of Entry Box

The Fiber-to-the Home (FTTH) Point of Entry Box provides a location to terminate fiber coming from a service provider to pigtailed at the subscriber's premises. It's a convenient staging demarcation point with quick and easy access for activation as residents request FTTH service.

Features and Benefits

- Provides convenient staging prior to terminating incoming fiber from service provider
- Can mount inside the Structured Media enclosure or as a stand-alone unit on a wall
- Includes magnet for easy installation and place adjustments
- Includes an SC/APC adapter with two dust caps and two splice sleeves
- Made of ABS plastic

Fiber-to-The-Home Solution

Description	Cat. No.
FTTH Point of Entry Box, 3.94" (100 mm) H x 3.15" (80 mm) W x .84" (21 mm) D Δ	FTH00-00W

r = Minimum order quantity and lead times may apply

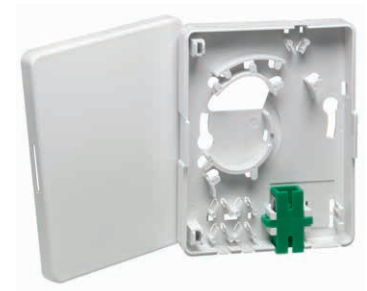

Media Versatile Panel

The Media Versatile Panel was made for custom retrofits and remodeling. Plywood backing and open architecture allow simple, flexible mounting of all components. This sturdy, industrial-grade panel can be surface mounted or recessed in the wall. Optional mounting brackets available for non-standard stud spacing.

Features and Benefits

- 24" high, 18 gauge steel panel available in black powder coat finish
- Eight 1" or 1.5" conduit fittings on top and bottom facilitate cable entry and routing
- Wall-mount or recess
- Ideal for new installations or retrofits
- Securable door provides maximum protection from dust and unauthorized entry
- 3/8" plywood backing allows open architecture for customizing layout and can accommodate a wide variety of Structured Media distribution modules

Media Versatile Panel

Description	Cat. No.
Media Versatile Panel w/cover, 24" (609.6mm) H x 14" (355.6mm) W x 6" (152.4mm) D	47602-24E
Mounting Brackets, set of four	47602-BKE





A



B



C



D

Routers & Switches

Features and Benefits

100 Mbps Router

10/100 Mbps data transfer rate

Enables multiple users to share a single, secure high-speed Internet connection

Includes four ports for in-home LAN connections

LEDs indicate power, status, LINK/Activity, 100 Mbps and WAN

Built-in NAT firewall protects networks from outside observation and provides secure communication for network users.

Customizes web access and filters unwanted sites with URL blocking feature

UPnP (universal plug-n-play) allows automatic discovery and configuration of the Gateway; UPnP supported by Windows® XP® or later

Gigabit Ethernet Switch

10/100/1000 Mbps data transfer rate

Five RJ-45 connector Mbps LAN ports

Power button arrows for easy power down

LEDs indicate power; LINK/Activity; and 10, 100, or 1000 Mbps

Plug-n-play installation

Auto detect uplink to easily cascade additional hubs, switches, and routers from any port

Features high-performance, store-and-forward switching architecture with CRC

100 Mbps Ethernet Switches

10/100 Mbps data transfer rate

Network additional PCs, printers, and other peripherals beyond router capacity

Connects to many home office Ethernet devices

Available in 5- and 8-port versions

Data Networking Routers and Switches

Description	Cat. No.
[A] Gigabit 5-Port Ethernet Switch, 2.52" (64 mm) H x 6.50" (165.1 mm) W x 3.54" (89.9 mm) D	47611-5GB
[B] 100 Mbps 4-Port Internet Router, 2.52" (64 mm) H x 6.50" (165.1 mm) W x 3.54" (89.9 mm) D	47611-GT4
[C] 100 Mbps 5-Port Ethernet Switch, 2.52" (64 mm) H x 6.50" (165.1 mm) W x 3.54" (89.9 mm) D	47611-5PT
[D] 100 Mbps 8-Port Ethernet Switch, 2.52" (64 mm) H x 6.50" (165.1 mm) W x 3.54" (89.9 mm) D	47611-8PT

Spotlight | Ultra High Flex Patch Cords

Leviton's HOME 6® and HOME 5e® Ultra High Flex Patch Cables offer extra flexible connectivity inside or outside a Structured Media® Center enclosure. The low profile cables support CAT 6 and CAT 5e data applications, and are available in a variety of colors for color-coding or organization.



Power Supplies & Surge Protection

Features and Benefits

Surge-Protection, Standard AC Power Modules & J-Box Kits

Fit in standard 14", 21", 28", and 42" Structured Media® Enclosures

Surge-protected versions provide enhanced protection and EMI/RFI filtering per UL 1449 standards

DC BUS Module

Eliminates need for more than two bulky AC/DC power adapters

Contains six 12 VDC power outputs at up 1500 mA total

Contains three 24 VDC power outputs at up to 1000 mA total including one F-connector

Output power cables included for all except 24 VDC F-connector connection

Versatile DC Power Supplies

120 VAC - 60 Hz input

Provides 12 VDC outputs with surge protection at 3.34A total

Includes NEMA 5-15 AC receptacles at 15A total

Eliminates the need for multiple bulky AC/DC power adapters

AC Surge Modules

Includes six surge-protected NEMA 5-15P receptacles

Allows six AC/DC power adapters to fit easily into Structured Media Enclosures

Powers routers, switches, modems, volume controls, camera hubs, and other Structured Media mounted devices

Universal Mini DC Power Supplies

90 - 264 VAC - 50/60 Hz input

Provides three 12 VDC outputs with surge protection at 833 mA total

Eliminates the need for multiple bulky AC/DC power adapters

Universal DC Power Supplies

100 - 240 VAC - 50/60 Hz input

Provides nine 12 VDC outputs with surge protection at 3.34A total

Includes one IEC AC power receptacle

For North American and international use

Eliminates the need for multiple bulky AC/DC power adapters



A



B



C



D



E



F, G

Power Supplies

Description	Cat. No.
[A] Surge J-Box Kit, one duplex receptacle, wallplate	47605-ACS
Non-Surge J-Box Kit, one duplex receptacle, wallplate	47605-ACN
[B] Surge AC Power Module, two duplex receptacles	47605-ODP
Non-Surge AC Power Module, two duplex receptacles	47605-NDP
[C] DC Bus Module, 12 VDC and 24 VDC	48212-124
[D] Versatile Power Supply, six 12 VDC connectors and two NEMA 15A receptacles	47605-PSC
[E] AC Surge Module, six receptacles	48212-06S
[F] Universal Mini DC Power Supply, three 12 VDC connectors	47605-PSB
[G] Universal DC Power Supply, nine 12 VDC connectors and one IEC AC receptacle	47605-PSA
IEC TO NEMA 15A Adapter Power Cord, 12" (accessory for 47605-PSA)	48212-IEC

Mounting Brackets & Patch Cords

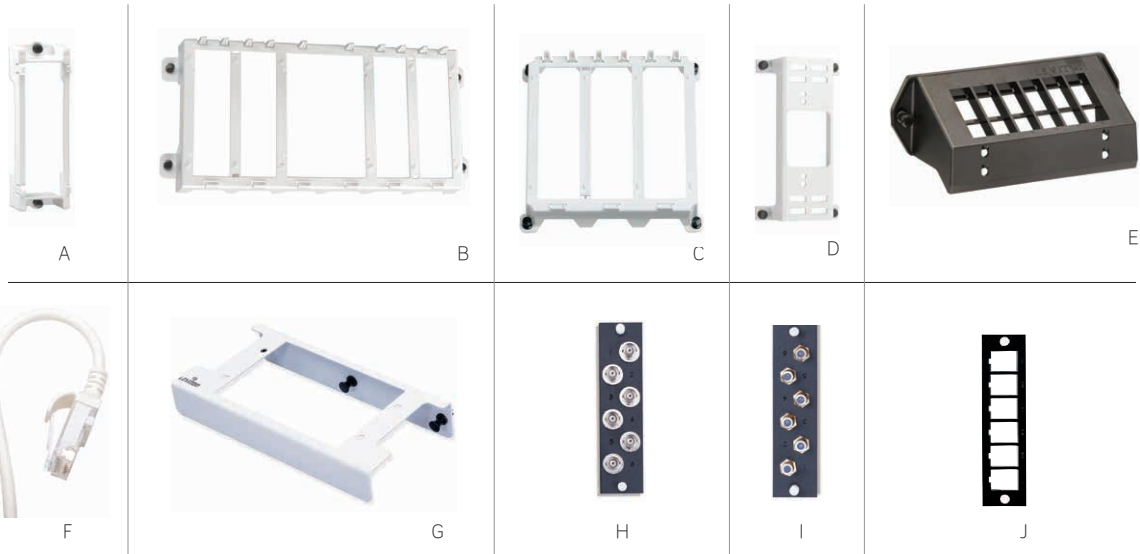

Mounting Brackets	
Description	Cat. No.
[A] Single Plastic Bracket, for single expansion board, white	47612-SBK
[B] Standard (12" width) Expansion Plastic Bracket, for up to five expansion boards, white	47612-EBK
Shelf Plastic Bracket, for up to three expansion boards and CATV splitter, white (compact width)	47612-VSB
[C] Compact (6" width) Expansion Plastic Bracket, for up to three expansion boards, white	47612-HBK
[D] Data Plastic Bracket, for mounting routers and switches	47612-DBK
[E] 12-Port QuickPort Mounting Bracket	47600-QPB

Mounting Brackets	
Made of sturdy white ABS plastic	
Include push-lock pins	
Snap-in installation in any Leviton 14", 21", 28", or 42" Structured Media® Enclosure	
Allow for cable management via routing under bracket	
12-port bracket made of black polycarbonate	
12-port bracket accepts all QuickPort® connectors	

Patch Cords	
Description	Cat. No.
[F] Home 6® Ultra High-Flex Patch Cord	6HHOM-xx*
Home 5e® Ultra High-Flex Patch Cord	5HHOM-xx*
8-Conductor Flat Telephone Patch Cord, 8" long	42400-8FG

Patch Cords	
Available in CAT 6 and CAT 5e	
Low-profile Ultra High-Flex Patch Cords allow tighter radius connections	
Available in five lengths and four colors	

xx = Length: 6" (6I), 1' (01), 2' (02), 3' (03), or 4' (04)
 * = Colors: Choose from any of the colors below.



Multimedia Adapter Bracket and Mounting Plates	
Description	Cat. No.
[G] Multimedia Adapter Bracket	47612-MMA
[H] BNC Mounting Plate, 6-pack, loaded	5F100-BNC
[I] F-Connector Mounting Plate, 6-pack, loaded	5F100-6VF
[J] QuickPort® Mounting Plate, 6-pack, unloaded	5F100-6QP

Multimedia Adapter Bracket and Mounting Plates	
Bracket is constructed of white powder-coated steel	
Plates are constructed of black powder-coated steel	
Bracket includes push-lock pins for mounting in Structured Media Enclosures	

Mounting Brackets & Tools

Universal Security & Shelf Brackets

Universal Shelf Bracket allows security batteries and other active products to be mounted inside any Structured Media® Enclosure

Shelf Bracket includes four 8" long Velcro® Brand strips, ensuring vertical and horizontal stability

Universal Security Board Mounting Plate includes four adhesive clips for mounting within any Leviton Structured Media Enclosure

Combo Bracket allows Leviton products to be installed in most non-Leviton structured wiring enclosures

Universal Mounting Brackets allow an unlimited number of upgrades (limited only by enclosure size) to be added to an existing security system terminated within any Leviton Structured Media Enclosure

Universal Brackets are sold in pairs with self-tapping screws and spacers to easily connect the largest number of security alarm manufacturers' panels

Universal Security and Shelf Brackets

Description	Cat. No.
[A] Universal Shelf Bracket	47612-UBK
[B] Compact (6" width) Universal Security Board Mounting Plate	47612-HSB
[C] Standard (12" width) Universal Security Board Mounting Plate	47612-FSB
[D] Combo Bracket	47612-CBK
[E] Compact (6" width) Universal Mounting Bracket	47612-6SB
[F] Standard (12" width) Universal Mounting Bracket	47612-1SB

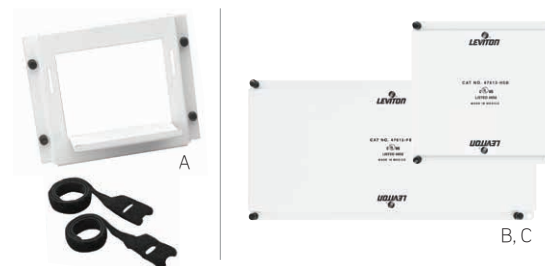

Residential Tools

Description	Cat. No.
[G] Residential Tool Kit includes Punchdown Tool w/ 110 blade, EZ-RJ45® Crimp Tool, two Level Coaxial Cable Strippers, UTP Stripping Tool, Coax and Round Wire Cable Cutter, EZ-RJ45 Connectors, and screwdriver	40812-RTK
Wire Punchdown / Termination Tool, blades sold separately	49553-814
110 IDC Blade	49553-110
66-Clip Blade	49553-066
BIX® Blade	49553-BIX
Krone® Blade	49553-KRN
Awl (woodscrew starter punch)	49553-AWL
Master Compression Tool	40989-CPT
UTP Stripping Tool	49660-00P
Coaxial Stripping Tool	C5914-000
EZ-RJ45 Crimp Tool	40989-ACT



Residential Accessories

Description	Cat. No.
EZ-RJ45 Connector, 50/pack	47613-EZC
EZ-RJ45 Connector Display Pack, 10/pack	47613-EZR
Push-Lock Pins for SMCs, 20/pack	47615-NYL
Reclosable Tie-Wrap, 5" Length, 25/pack	43105-005
[H] 4X4 Telephone Line Breakout Module	47609-4X4
Reclosable Tie-Wrap, 8" Length, 25/pack	43108-008
Reclosable Tie-Wrap, 12" Length, 25/pack	43112-012

Twist & Mount, TIDP, & Compact Structured Media® Panels

Features and Benefits

Twist & Mount Patch Panels

Low-profile, high-density, component-rated patching for both voice and gigabit ethernet connections

Feature simple twist and mount installation

Offered in Cat 6, Cat 5e, and Cat 6/Cat 5e combined configurations

Universal T568A and T568B wiring labels ensure compatibility in both residential and commercial installations

Manufactured from black ABS plastic

Meet or exceed all TIA-568-C.2 bend radius requirements

Available in 12- and 24-port versions

Telephone Input Distribution Panels (TIDP)

Supports four-line telephone distribution

Offers choice of inputs and outputs: one 4-pair 110-style IDC input, four industry-standard RJ-11 jack inputs for use with “triple play” modems, or 12 modular industry-standard RJ-45 jack outputs

Includes a security jack for interface with security systems

Test and auxiliary disconnect outlet (ADO) ports for isolation and testing of telephone line connections

Includes twelve 8” telephone patch cords



A



B



C

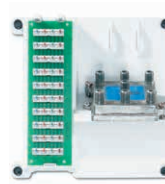

D



E

Twist & Mount Panels and Telephone Distribution Panels

Description	Cat. No.
Twist & Mount Patch Panel - 12 ports each of CAT 6 and CAT 5e (24 ports total)	476TM-654
[A] Twist & Mount Patch Panel - 24 ports of CAT 6	476TM-624
Twist & Mount Patch Panel - 24 ports of CAT 5e	476TM-524
Twist & Mount Patch Panel - 6 ports each of CAT 6 and CAT 5e (12 ports total)	476TM-652
Twist & Mount Patch Panel - 12 ports of CAT 6	476TM-612
[B] Twist & Mount Patch Panel - 12 ports of CAT 5e	476TM-512
[C] Telephone Input Distribution Panel (TIDP)	476TL-T12

Features and Benefits

Pre-configured Compact Structured Media Panels

Compact series (6” width) pre-configured panels are an ideal solution for basic telephone, data, security interface, and TV distribution in MDUs where space and budget are of primary concern

Space-saving profile provides four to nine bridged telephone connections, up to four CAT 5e data connections, and up to eight video connections

Pre-Configured Compact Structured Media Panels - Compact Width (6”)

Description	Cat. No.
1x9 Bridged Telephone and 4-way 1 GHz TV Splitter	47603-1G4
[D] 1x9 Bridged Telephone and 6-way 1 GHz TV Splitter	47603-1G6
1x9 Bridged Telephone and 8-way 1 GHz TV Splitter	47603-1G8
[E] 1x4 Bridged Telephone, 4 Data, and 6-way 1 GHz TV Splitter	47603-DP6
1x7 Bridged Telephone, Security Interface, and 6-way 1 GHz TV Splitter	47603-TSV

Standard Structured Media® Panels

Pre-Configured Standard Structured Media Panels

Standard series (12" width) pre-configured panels combine voice, data, and TV modules into a single, simple distribution point. Several pre-configured options are available with room for customization with additional expansion boards.

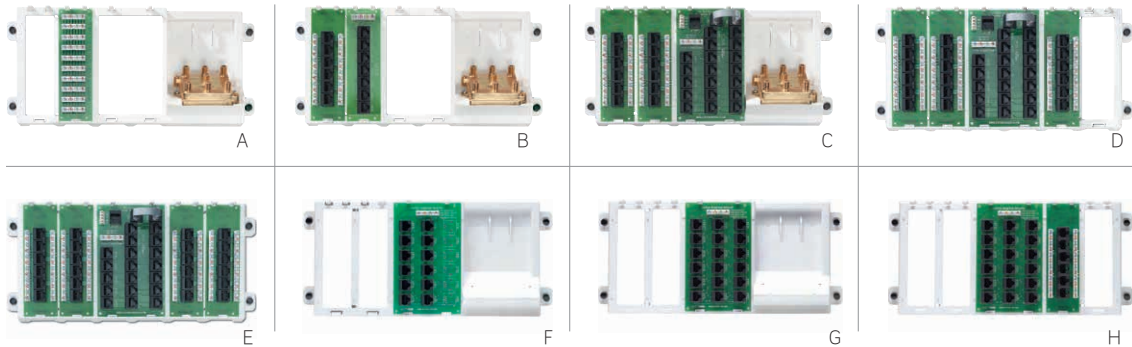

Pre-Configured Standard Structured Media Panels		
Description	Features	Cat. No.
[A] Basic Telephone & Video Panel	One 1x9 Bridged Telephone Board One 6-way 2 GHz TV Splitter	47606-BTV
[B] Basic Home Networking Plus Panel	One Telephone Patching Board One CAT 5e Voice & Data Board Six 4-line telephone connections One 6-way 2 GHz TV Splitter	47606-BNP
Advanced Home Telephone & Video Panel	One Telephone Line Distribution Board 19 multi-line telephone connections (in various combinations of two or four lines) One CAT 5e Voice & Data Board One 6-way 2 GHz TV Splitter	47606-AHT
[C] Advanced Home Office Panel	One Telephone Line Distribution Board 19 multi-line telephone connections (in various combinations of two or four lines) Two CAT 5e Voice & Data Boards One 6-way 2 GHz TV Splitter	47606-ASO
12-Port Structured Media Panel	- One Telephone Line Distribution Board - 19 multi-line telephone connections (in various combinations of two or four lines) - Two CAT 5e Voice & Data Boards	47603-12P
[D] 18-Port Structured Media Panel	One Telephone Line Distribution Board 19 multi-line telephone connections (in various combinations of two or four lines) Three CAT 5e Voice & Data Boards	47603-18P
[E] 24-Port Structured Media Panel	One Telephone Line Distribution Board 19 multi-line telephone connections (in various combinations of two or four lines) Four CAT 5e Voice & Data Boards	47603-24P
[F] 4x12 Telephone Distribution Panel	One 4x12 Telephone Distribution Board	47603-12M
4x12 Telephone Distribution Panel w/ Splitter	One 4x12 Telephone Distribution Board One 8-way 2 GHz TV Splitter	47603-412
[G] 4x18 Telephone Distribution Panel	One 4x18 Telephone Distribution Board	47603-18M
[H] 4x18 Telephone Distribution Panel w/ CAT 5e Board	One 4x18 Telephone Distribution Board One CAT 5e Voice & Data Board	47603-8C1

Modules & Expansion Boards

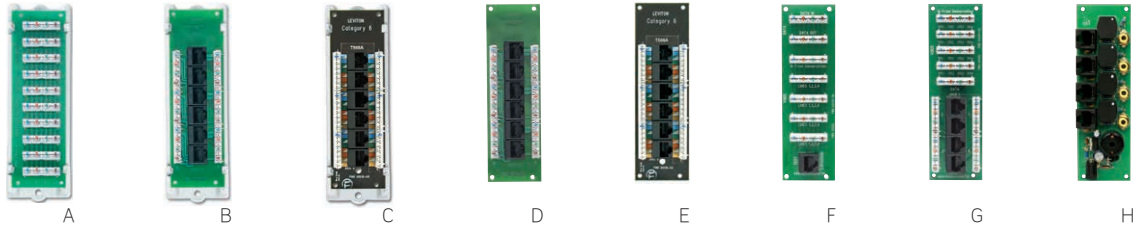

Modules		Cat. No.
Description		
[A]	1x9 Bridged Telephone Module	47689-00B
[B]	CAT 5e Voice & Data Module	47605-C5B
[C]	CAT 6 Voice & Data Module	47611-C6B
	DSL Filter Module	47616-DSB
	Telephone Security Module	47609-TSV

Expansion Boards				Cat. No.
Description	Application	Features		
[D]	CAT 5e Voice and Data Board	Data, Telephone, Fax, Modem	Patch phone or data connections to six locations Combine with a TLDM, key system, or network switches 4-pair 110-type IDC punchdowns Six CAT 5e RJ-45 ports Printed circuit board	47603-0C5
[E]	CAT 6 Voice and Data Board	Data, Telephone, Fax, Modem	TIA-568-C channel-rated for gigabit ethernet Combine with gigabit internet router or ethernet switch 4-pair 110-type IDC punchdowns and six CAT 6 connectors	47611-0C6
[F]	VDSL Board w/ 1x5 Bridged Phone w/ Data Passthrough IDCs	Data, Telephone, Modem	Bridge up to four telephone lines to five locations Connect up to five separate telephones per line IDC connectors for CAT 5 or CAT 5e wire Termination point and pass-through for a data connection via IDCs up to 150 MHz	47609-D5P
[G]	Combo Phone & Data Board w/ 1x4 Bridged Phone and 4-Port CAT 5e	Data, Telephone	Provides data and phone connections on a single board 1x4 phone portion provides four telephone lines to up to four locations via IDC punchdowns Four ports of CAT 5e 150 MHz data connections via modular RJ-45 connectors and 4-pair 110-type IDC punchdowns	47609-4DP
[H]	Camera Hub	Video	Injects power for cameras, provides video-out signals for other video equipment in the Structured Media® Enclosure	VSHUB-000
	Camera Hub w/ IDC Connectors	Video	Injects power for cameras, provides video-out signals for other video equipment in the Structured Media Enclosure Standard 110 IDC terminations or 8P8C jacks for connection to camera UTP cabling	VSHUB-IDC

Spotlight | Panels, Modules, Boards: What's the difference?

Pre-configured Structured Media Panels include multiple expansion boards combining voice, data, and TV boards into a single distribution point

Modules include an expansion board on a single ABS mounting bracket

Expansion Boards mount in Structured Media Panels or Mounting Brackets (see page U-12)

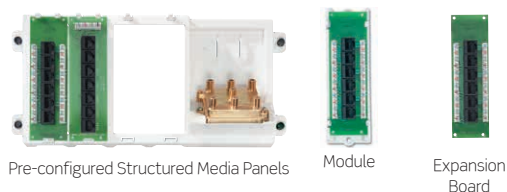

Pre-configured Structured Media Panels

Module

Expansion Board

Expansion Boards



Expansion Boards (Continued)			
Description	Applications	Features	Cat. No.
[A] 1x9 Bridged Telephone Board	Telephone, Fax, Modem	Bridge up to four telephone lines to nine locations Connect up to nine separate telephones per line Printed circuit board 4-pair 110-type IDC punchdowns	47603-110
[B] 1x6 Bridged Telephone Board	Telephone, Fax, Modem	Bridge up to four telephone lines to six locations Connect up to six separate telephones per line Printed circuit board IDC connectors for CAT 5 or CAT 5e wire RJ-45 expansion port	47609-0F6
[C] 1x10 Bridged Telephone Board	Telephone, Fax, Modem	Bridge up to six telephone lines to 10 locations Connect up to 10 separate telephones per line Printed circuit board IDC connectors for CAT 5 or CAT 5e wire Security port Punchdown security interface to accommodate alarm systems	47609-S10
[D] 1x4 Bridged Telephone Board	Telephone, Fax, Modem	Bridge up to four lines to four locations via IDC punchdowns	47609-004
[E] Telephone Patching Board/ Expanded 4-line Telephone Distribution	Telephone, Fax, Modem	Bridge up to four telephone lines to seven locations Printed circuit board module One incoming 4-pair 110-type IDC punchdown Seven outgoing RJ-45 connector connections Combine with a CAT 5e board to route telephone to remote locations	47609-EMP
DSL Filter Board	Telephone, Modem	Filters DSL signal from phone line before distribution throughout home or office Eliminates need for individual filters at wallplate Use with any phone distribution module Printed circuit board module w/ RJ-45 connector and 110-type punchdown	47616-DSF
Telephone Line Distribution Board	Telephone, Fax, Modem	19 multi-line telephone connections in combinations of two or four lines Bridge "line 1" service to 12 locations and four-line service to eight locations Connect to CAT 5e Voice & Data Board(s) or additional panels for more connections and easier moves/adds/changes Independent RJ-45 connector and punchdown security interface to accommodate alarm systems	47603-TDM
[F] 4x12 Telephone Distribution Board	Telephone, Fax	Bridge up to four telephone lines to 12 locations	47603-12B
[G] 4x18 Telephone Distribution Board	Telephone, Fax	Bridge up to four telephone lines to 18 locations	47603-18B

Video Distribution & Splitters

Features and Benefits	
<p>Premium Amplified CATV/HDTV Module</p> <p>Split and/or amplify signal to one, eight, or 16 TVs throughout the home</p> <p>Bi-directional circuitry supports advanced interactive applications, as well as standard TV and video inputs</p> <p>Forward path internal amplifier provides equal input and output level on all ports; reverse path is not affected</p> <p>Unity gain eliminates the need to manually adjust attenuation</p> <p>HDTV and digital cable ready, SCTE- and DOCSIS-compliant</p>	<p>3x1 Passive Combiner Module</p> <p>Digital CATV compatible</p> <p>Provides bi-directional signal path to support cable modem or digital cable communications</p> <p>F-ports provide up to 15 psi weather sealing</p>
<p>Passive CATV/HDTV Splitters</p> <p>Split signal to four, six, or eight TVs throughout the home</p> <p>Provide digital cable, cable TV, and other TV services via coaxial cable</p> <p>Lightweight, strong die-cast housing</p> <p>HDTV and digital cable ready SCTE-compliant</p> <p>Available with and without Structure Media® Enclosure mounting bracket</p>	<p>Video Amplifier Module</p> <p>Boosts strength of off-air antenna signal for video distribution throughout the home or office</p> <p>Boosts signal strength by up to 25 dB</p> <p>Features a variable attenuator for signal amplification level setting and an FM trap to eliminate unwanted FM interference</p>
	<p>Multi-Switch Module</p> <p>Passive 3x4 Multi-Switch combines signals from digital satellite with off-air antenna onto single coaxial cable</p> <p>Distributes digital satellite signals to up to four TVs</p> <p>Incorporates a separate input for TV antenna signals and is best used in combination with a Video Amplifier</p>

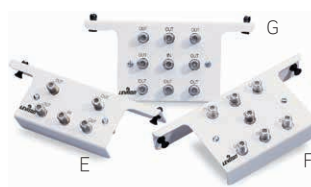

Premium Modules		
Description	1 GHZ	
[A] 1x1 Premium Video Module	47693-01P	
[B] 1x8 Premium Video Module	47693-08P	
[C] 1x16 Premium Video Module	47693-16P	
[D] 3x1 Passive Combiner	47693-31P	
Passive Splitters (with and without Mounting Bracket)		
Description	1 GHZ	2 GHZ
[E] 1x4 Passive Video Splitter w/ bracket for 14", 21", 28", and 42" SMCs	47690-04C	47690-4C2
[F] 1x6 Passive Video Splitter w/ bracket for 14", 21", 28", and 42" SMCs	47690-06C	47690-6C2
[G] 1x8 Passive Video Splitter w/ bracket for 14", 21", 28", and 42" SMCs	47690-08C	47690-8C2
[H] 1x4 Passive Video Splitter	47690-004	47690-0G4
[I] 1x6 Passive Video Splitter	47690-006	47690-0G6
[J] 1x8 Passive Video Splitter	47690-008	47690-0G8
Video Amplifier and Multi-Switch Modules		
Description	Cat. No.	
[K] Video Amplifier Module	48210-0VA	
[L] Multi-Switch Module	47691-3MS	



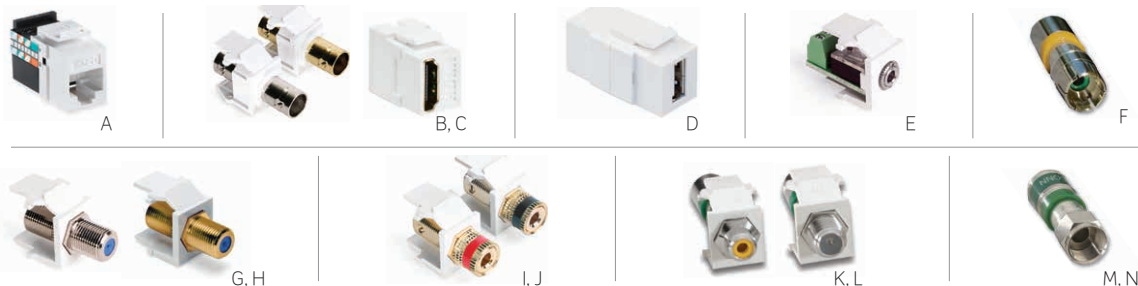

Data and A/V Connectors		
Description	Application	Cat. No.
QuickPort® Home 6 Connector, Tool-Free	Voice & low-speed data	61TLS-R†6
QuickPort Home 5e Connector, Standard	Voice & low-speed data	5EHOM-R†5
QuickPort CAT 5 Connector	Voice & low-speed data	41108-R#5
QuickPort CAT 3 Connector	Voice & low-speed data	41108-R#3
[A] QuickPort GigaMax® 5e CAT 5e Connector	High-speed data	5G108-R#5
QuickPort Voice Grade 6-Conductor Connector	Voice	41106-R#6
QuickPort Voice Grade 8-Conductor Connector	Voice	41108-R#8
[B] QuickPort BNC Bulkhead Module, standard	CCTV & video	41084-B*F
[C] QuickPort BNC Bulkhead Module, gold plated	CCTV & video	40832-0B°
[D] QuickPort HDMI Passthrough	TV, DVD, satellite & home theater	40834-00#
QuickPort S-Video Feedthrough	Enhanced video streams	40734-CV~
[E] QuickPort USB A-A Connector, feedthrough	Computers & peripherals	40835-00~
[F] QuickPort 3.5 mm Stereo, screw terminal	Computer audio	40839-S~S
[G] QuickPort F-Connector, standard, 3.0 GHz	TV, DVD, satellite & home theater	41084-F*F
[H] QuickPort F-Connector, gold plated, 3.0 GHz	TV, DVD, satellite & home theater	40831-0B°
QuickPort RCA to 110	Advanced audio & video	40735-Rx†
QuickPort RCA w/ black stripe	Advanced audio & video	40830-B*E
QuickPort RCA w/ red stripe	Advanced audio & video	40830-B*R
QuickPort RCA w/ yellow stripe	Advanced audio & video	40830-B*Y
QuickPort RCA w/ green stripe	Advanced audio & video	40830-B~V
QuickPort RCA w/ blue stripe	Advanced audio & video	40830-B~L
QuickPort Banana Jack Adapter, gold plated w/ black stripe	Advanced audio	40837-B°E
QuickPort Banana Jack Adapter, gold plated w/ red stripe	Advanced audio	40837-B°R
[I] QuickPort Binding Post Adapter, gold plated w/ black stripe	Advanced audio	40833-B°E
[J] QuickPort Binding Post Adapter, gold plated w/ red stripe	Advanced audio	40833-B°R
QuickPort Snap-in Blank Module	Secures unused ports	41084-B*B
[K] QuickPort Compression RCA Connector	Advanced audio & video	40782-R•W
[L] QuickPort Compression F-Connector (white only)	TV, DVD, satellite & home theater	40782-CPF
[M] RCA Compression Connector (colored rings included)	CCTV & video	40985-CRU
[N] Compression F-Connector	CCTV & video	40985-CPF



r = Minimum order quantity and lead times may apply.
 ~ = Color: White (W), Ivory (I)
 x = Inner Barrel Color: Orange (O), Red (R), White (W), Yellow (Y)
 † = Color: White (W), Light Almond (T), Ivory (I), Grey (G), Black (E)
 • = Inner Barrel Color: Black (E), Yellow (Y), Red (R), Blue (L), Green (V)
 # = Color: Choose from any of the 13 colors shown at left
 * = Color: White (W), Light Almond (T), Ivory (I), Grey (G), Black (E), Brown (B)
 ° = Color: White (W), Light Almond (T), Ivory (I)
 # = Color: White (W), Light Almond (T), Ivory (I), Black (E)

Renu® Wallplates & Inserts

Renu is Leviton's smart electrical and data connectivity screwless wallplate system. These QuickPort® compatible wallplates snap on and off quickly and easily with no tools, simplifying installation and ongoing maintenance. Choose from wallplates and inserts in White On White, Navajo Sand, and Onyx Black.

Features and Benefits

Renu Wallplates & Inserts

- Inserts accept all QuickPort connectors
- Screwless wallplates easily snap on to any Renu insert or device
- Slightly larger size covers wall imperfections
- Tongue and groove design simplifies alignment in multi-gang installations
- Adapter ring allows use of Decora® device with Renu wallplates
- Available in three standard colors to coordinate with the commercial-grade QuickPort line (white, light almond, black)
- Additional wallplate colors for switches, dimmers, and outlets available; visit leviton.com/renu
- cULus Listed

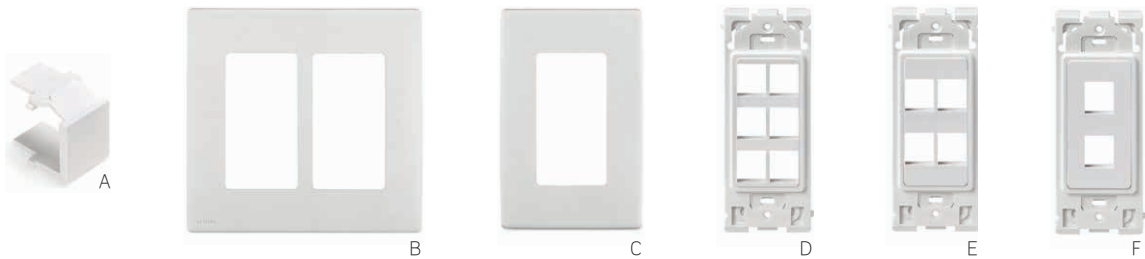

Renu Wallplates and Inserts				
Description		White on White	Navajo Sand	Onyx Black
[A]	Snap-In Blank Module	RE640-BWW	RE640-BNS	RE640-BOB
	Four-Gang Wallplate	REWP4-OWW	REWP4-ONS	REWP4-OOB
	Three-Gang Wallplate	REWP3-OWW	REWP3-ONS	REWP3-OOB
[B]	Dual-Gang Wallplate	REWP2-OWW	REWP2-ONS	REWP2-OOB
[C]	Single-Gang Wallplate	REWP1-OWW	REWP1-ONS	REWP1-OOB
[D]	6-Port Insert	RE640-WW6	RE640-NS6	RE640-OB6
[E]	4-Port Insert	RE640-WW4	RE640-NS4	RE640-OB4
	3-Port Insert	RE640-WW3	RE640-NS3	RE640-OB3
[F]	2-Port Insert	RE640-WW2	RE640-NS2	RE640-OB2
	1-Port Insert	RE640-WW1	RE640-NS1	RE640-OB1



Renu Wallplate and 2-Port Insert with QuickPort Connectors

QuickPort® Wallplates

Features and Benefits

QuickPort Flush-Mount & Angled Wallplates

Angled ports relieve stress on equipment cords
Manufactured from ABS plastic for superior durability

QuickPort Stainless Steel Wallplates

Manufactured from 304 stainless steel in a brushed finish to provide corrosion resistance in a non-magnetic material
Angled wallplate ports facilitate proper front and rear cable bend radius



QuickPort Angled Wallplates

Description	White	Light Almond	Ivory
[] 4-Port Wallplate	41081-4WP	41081-4TP	41081-4IP
[A] 2-Port Wallplate	41081-2WP	41081-2TP	41081-2IP
[B] 4-Port Wallplate w/ ID window	42081-4WS	42081-4TS	42081-4IS
[] 2-Port Wallplate w/ ID window	42081-2WS	42081-2TS	42081-2IS

QuickPort Flush-Mount Wallplates

Description	White	Light Almond	Ivory
[C] 6-Port Flush Mount	41080-6WP	41080-6TP	41080-6IP
[] 4-Port Flush Mount	41080-4WP	41080-4TP	41080-4IP
[D] 3-Port Flush Mount	41080-3WP	41080-3TP	41080-3IP
[] 2-Port Flush Mount	41080-2WP	41080-2TP	41080-2IP
[] 1-Port Flush Mount	41080-1WP	41080-1TP	41080-1IP

QuickPort Stainless Steel Wallphone Plate

Description	Recessed	Flush
[E, F] 1-Port Wallplate	4108W-1SP	4108W-0SP

QuickPort Single-gang Stainless Steel Wallplates

Description	1-Port	2-Port	3-Port	4-Port	6-Port
[G] Single-Gang Wallplate	43080-1S1	43080-1S2	43080-1S3	43080-1S4	43080-1S6

QuickPort Dual-Gang Stainless Steel Wallplates

Description	2-Port	4-Port	6-Port	8-Port	12-Port
[H] Dual-Gang Wallplate	43080-2S2	43080-2S4	43080-2S6	43080-2S8	43080-2S12

QuickPort Angled Stainless Steel Wallplates with ID Windows

Description	Cat. No.
[I] 4-Port Angled Wallplate, single-gang	43081-1L4

Midsized plates in plastic and high-impact nylon also available. See page K-7 or call Inside Sales at 800-722-2082.



Decora® Wallplates & Multimedia Inserts

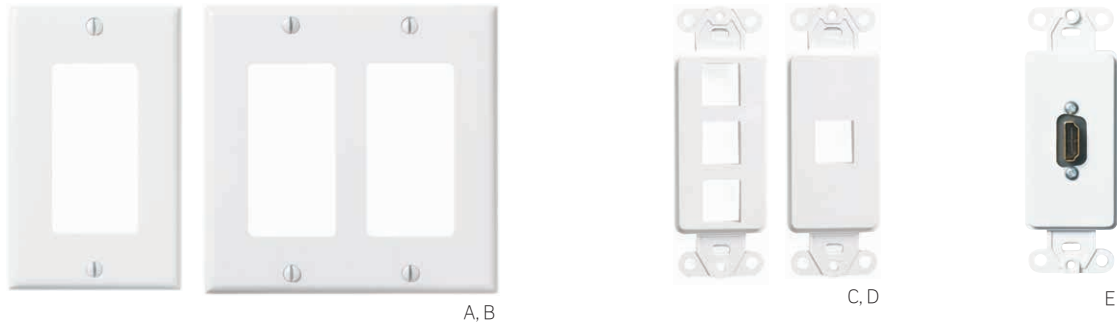

Decora Single- and Dual-Gang Wallplates			
Description	Single-Gang	Dual-Gang	
[A, B] Decora, standard size, urea	80401-00*	80409-00*	
Decora, standard size, nylon	80401-0N*	80409-0N*	
Decora, standard size, stainless	84401-040	84409-040	
Decora Plus, standard size, polycarbonate	80301-0S*	80309-0S*	
Decora, midway, urea	80601-0S*	80609-0S*	
Decora, midway, nylon	PJ26-00*	PJ262-00*	

* = Colors: Choose from any of the colors below.

QuickPort® Multimedia Wallplate Inserts				
Description	White	Light Almond	Ivory	
6-Port Insert, polybag, standard carton	41646-00W	41646-00T	41646-00I	
4-Port Insert, polybag, standard carton	41644-00W	41644-00T	41644-00I	
[C] 3-Port Insert, polybag, standard carton	41643-00W	41643-00T	41643-00I	
2-Port Insert, polybag, standard carton	41642-00W	41642-00T	41642-00I	
[D] 1-Port Insert, polybag, standard carton	41641-00W	41641-00T	41641-00I	
[E] HDMI Decora Insert, feedthrough	41647-00W	—	41647-00I	
DVI Decora Insert, feedthrough	41648-00W	—	41648-00I	

Wallplate Accessories	
Description	Cat. No.
[F] QuickPort Shutter Kit (50 shutters)	51084-ICN
White Label Kit	51084-XLB
[G] Color Label Kit †	51084-CLB
[H] Wallplate Mounting Brackets, single-gang, bulk polybag pack, 2 brackets per unit, rack pack carton	C0224-000
[I] Wallplate Mounting Bracket, dual-gang, individual polybag pack, rack pack carton	C0225-0CP

† = Color Label Kit includes grey, orange, red, yellow, green, blue, purple, and brown (2 sheets of each color).



Note: 80301 and 80309 are not available in black or brown

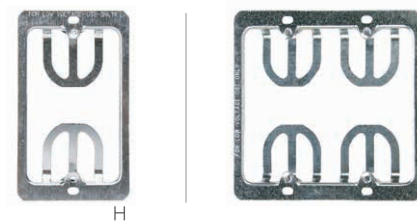
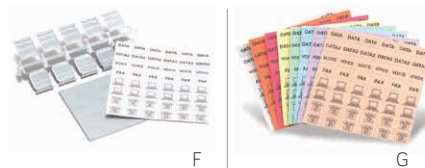

QuickPlates®

Features and Benefits

- QuickPlate Wallplates distribute data, phone and TV connections through a preassembled one-piece design
- Rear facing IDC punchdowns and consistent positioning of data and F-connectors reduce ordering problems and eliminate onsite assembly
- All QuickPlates have a pleasing matte finish
- Robust one-piece wallplate and lead-frame jack design
- Rear facing 110 IDC punchdown for voice and data jacks make termination quick and easy
- Data port accepts CAT 5e with T568A wiring
- Phone port accepts UTP with USOC wiring
- F-connector for video applications is an F-81 style bulkhead connector
- Includes captive screws painted to match wallplate color
- Standard dimensions — 4.61" (117.1mm) H x 2.75" (69.9mm) W x 0.26" (6.5mm) D
- Midway dimensions — 4.99" (126.7mm) H x 3.13" (79.4mm) W x 0.26" (6.5mm) D
- CAT 5e connectors meet or exceed applicable standards; labeled for T568A wiring
- Complies with applicable FCC Part 68 requirements
- Supports high megabit and shared-sheath applications
- F-style bulkhead connectors meet or exceed 10dB of return loss at 1 GHz and are SCTE compliant



QuickPlate			
Description		Standard Size Cat. No.	Midway Size Cat. No.
[A]	One Data	5EA20-S1*	5EA20-M1*
[B]	One Data, One F-Style	5EA20-S2*	5EA20-M2*
[C]	One Data, One Phone, One F-Style	5EA20-S3*	5EA20-M3*
[D]	Two Data, Two F-Style	5EA20-S4*	5EA20-M4*

* = COLORS: CHOOSE FROM ANY OF THE COLORS BELOW.



Cheetah Speed System®

Install attractive phone, data, and video wallplates quickly and easily with the patented Cheetah Speed System. Using a revolutionary speed anchor with a snap and lock system, the Cheetah Speed System reduces installation time by up to 50%, while at the same time offering the elegance and style of screwless wallplates. Decora® inserts in 1-6 ports and wallplates for phone and coax are available in white, ivory, and light almond.

Features and Benefits

Patented speed anchor enables devices and wallplates to be installed without screws

Self-aligning inserts increase installation speed by up to 50%

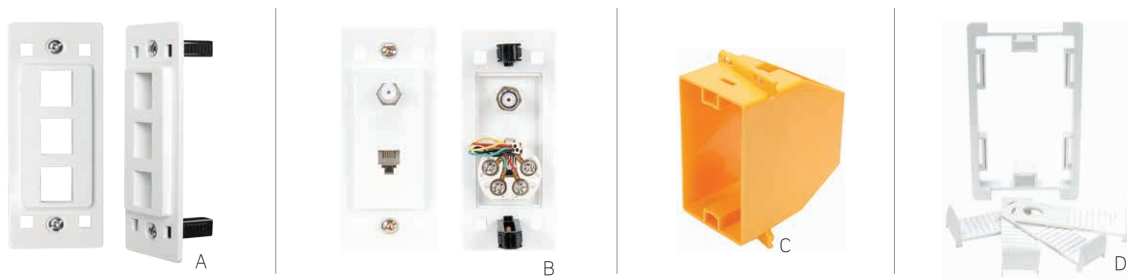

Cheetah Speed System Inserts

Description	White	Lt. Almond	Ivory	Black
[A] 3-Port Insert, includes blank insert	5020C-00W	5020C-00T	5020C-00I	5020C-00E
Decora Insert Coax	CH181-00W	CH181-00T	CH181-00I	CH181-00E
Decora Insert Telephone	CH149-00W	CH149-00T	CH149-00I	CH149-00E
[B] Decora Insert Telephone/ Coax Combo	CH159-00W	CH159-00T	CH159-00I	CH159-00E

Cheetah Speed System Boxes and Brackets

Description	White	Lt. Almond	Ivory	Black
[C] Single-Gang Non-Metallic Datacom Box, multiples of 50				3005C-C00
[D] Single-Gang Low-Voltage Datacom Cut-in Bracket, multiples of 50				4007C-C00

Δ = Minimum order quantity and lead times may apply.

Spotlight | Cheetah Speed System



Leviton offers a complete line of Cheetah Speed System products including data and audio inserts, dimmers and fan controls, switches, receptacles, and a broad selection of screwless wallplates. The entire system uses the innovative, electrician-developed speed anchor system that enables devices to be installed without screws in a minimum of time.

To learn more, go to leviton.com/cheetah.

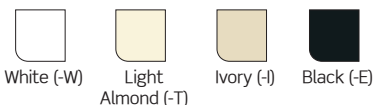

Home Theater & Recessed Receptacles, & Mobile Device Station

Features and Benefits

Home Theater, Multi-Room & Speaker Wallplates

Designed for easy installation of cables using low-voltage rings and standard low-voltage junction boxes

Home Theater Interface wallplate (AEHTK) accommodates 5.1 to 7.1 channel surround-sound systems, and features RCA connectors for subwoofer connection and two extra QuickPort® openings

Multi-room Audio wallplate (AEMRK) accommodates left and right audio speakers (± connections), and two extra openings for additional QuickPort connectors (e.g., adding a subwoofer or 3.5 mm stereo phone jack)

Speaker wallplate allows for simple, solderless connections to any home entertainment speaker system

Recessed Entertainment Box (REB)

Affordable solution manages home theater electronics in a single location

Ideal for new construction (stud-mounted) and retrofit (wall-mounted) applications

Low-profile frame provides neat, recessed installation

Optional high-profile cover includes sliding plastic front panels, and channels all wires through the bottom of the unit

Recessed Devices – Recessed Single-Gang Receptacle

Fits most standard electrical boxes

Supplies AC power for one or two components (flat panel TVs and video receiver)

cULus approved, code-compliant solution

Recessed Dual-Gang Duplex Receptacle with Six QuickPort Openings

Centralizes connection points for AC power, audio, video, data, and phone

Includes plastic electrical box for use in new and retrofit construction

UL approved, code-compliant solution

Mobile Device Station

Turns a receptacle outlet into a convenient storage location for smartphones and MP3 players

Installs without creating any new holes in the wall

Available in both Decora® and Renu® styles

Integrated cable management keeps charging cables organized and protected

Requires a Leviton wallplate, sold separately

Ideal with Leviton USB charger/tamper-resistant receptacle

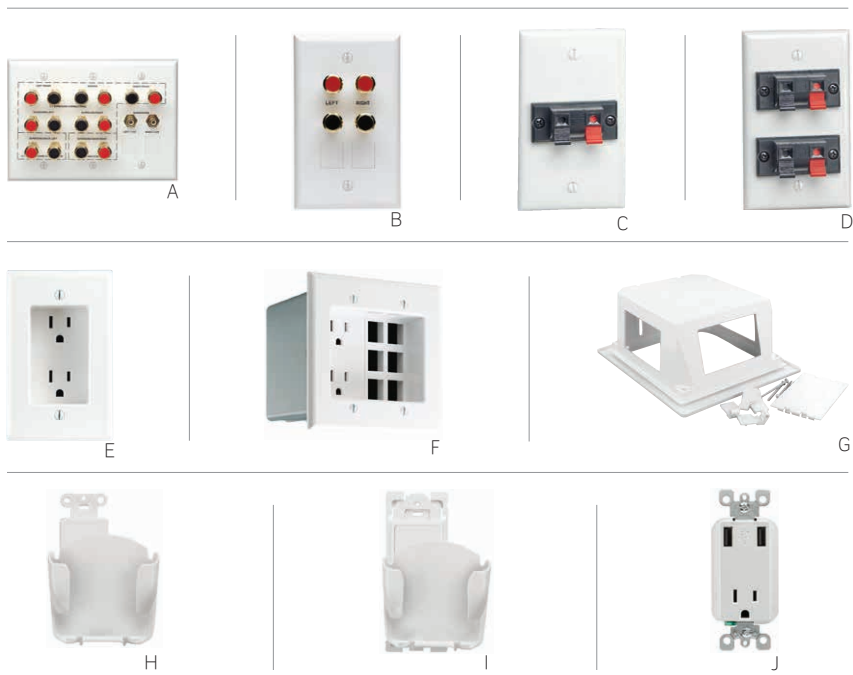

Home Theater & Recessed Receptacles, & Mobile Device Station

Home Theater and Multi-Room Wallplates	
Description	Cat. No.
[A] Home Theater Interface Wallplate, 14 gold-plated spring clips, two RCA connectors, two QuickPort® openings	AEHTK-000
[B] Multi-Room Install Wallplate, two gold-plated spring clips, two QuickPort openings	AEMRK-000
[C] Single-Gang Single Spring-Clip Device Audio/Video Wallplate, standard size, polymer break resistant, box mount	40951-1P*
[D] Single-Gang Double Spring-Clip Device Audio/Video Wallplate, standard size, polymer break resistant, box mount	40952-2P*

Recessed Devices and Entertainment Box	
Description	Cat. No.
Single-Gang Recessed Single Receptacle 15A-125VAC, 2-Pole, 3-Wire — NEMA 5-15R, includes clock hanger hook	00688-00*
Single-Gang Recessed Single Receptacle, Non-Magnetic Stainless Steel 15A-125VAC, 2-Pole, 3-Wire — NEMA 5-15R, includes clock hanger hook	05261-0CH
[E] Single-Gang Recessed Duplex Receptacle 15A-125VAC, 2-Pole, 3-Wire — NEMA 5-15R	00689-00†
Single-Gang Recessed Single Receptacle, Non-Magnetic Stainless Steel 20A-125VAC, 2-Pole, 3-Wire — NEMA 5-20R, includes clock hanger hook	05361-0CH
[F] Dual-Gang Recessed Duplex Receptacle and Openings for six QuickPort Modules 15A-125VAC, 2-Pole, 3-Wire — NEMA 5-15R (four blank inserts included)	00690-00*
[G] Recessed Entertainment Box w/ Low-Profile Frame	47617-REB
Recessed Entertainment Box w/ High-Profile Cover	47617-RBH
High-Profile Cover	47617-HPC
Low-Profile Frame	47617-LPF
Replacement Snap-in Plates, 2 per bag	47617-PLT

* = Color: White (W), Ivory (I)

† = Color: White (W), Lt. Almond (T), Ivory (I), Black (E)

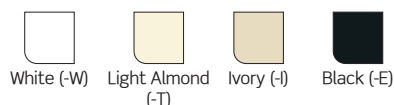

Mobile Device Station and USB Charger / Receptacle	
Description	Cat. No.
[H] Decora® Mobile Device Station, White	47112-00W
Decora Mobile Device Station, Light Almond	47112-00T
Decora Mobile Device Station, Black	47112-00E
[I] Renu® Mobile Device Station, White on White	47112-RWW
Renu Mobile Device Station, Navajo Sand	47112-RNS
Renu Mobile Device Station, Onyx Black	47112-ROB
[J] USB Charger/Tamper-Resistant Receptacle	T5630-00W

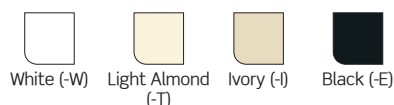



RG6 Coax Cable, Gold Plated

Description	Cat. No.
[A] RG6 Coax Cable, gold plated	C6851-xx*
xx = Length: 3' (G3), 6' (G6), 12' (1G), 25' (2G), 50' (5G) or 100' (GC).	
* = Colors: Choose from any of the colors below.	

RG6 Coax Cable, Nickel

Description	Cat. No.
[B] RG6 Coax Cable, nickel	C6851-xx*
xx = Length: 3' (03), 6' (06), 12' (12), 25' (25), 50' (50) or 100' (0C).	
* = Colors: Choose from any of the colors below.	

Two-Way Splitter | One 75 Ohm Input to Two 75 Ohm Outputs

Description	Cat. No.
Two-Way Splitter, carded unit pack	C5002-000
[C] Two-Way Splitter, gold plated, carded unit pack	C5002-0G0
Two-Way Splitter, gold plated, individual polybag pack	40987-002

Three-Way Splitter | One 75 Ohm Input to Three 75 Ohm Outputs

Description	Cat. No.
Three-Way Splitter, carded unit pack	C5003-000
[D] Three-Way Splitter, gold plated, individual polybag pack	40987-003

Four-Way Splitter | One 75 Ohm Input to Four 75 Ohm Outputs

Description	Cat. No.
[E] Four-Way Splitter, carded unit pack	C5004-000
Four-Way Splitter, gold plated, carded unit pack	C5004-0G0
Four-Way Splitter, gold plated, individual polybag pack	40987-004

75 Ohm Termination Cap for F-Connector Jacks

Description	Cat. No.
[F] 75 Ohm Termination Cap, 25 per polybag pack	40984-000

Video Accessories



Connects a 75 Ohm female jack to RCA plug connection RCA to F-Type Video Adapter	
Description	Cat. No.
[A] RCA to F-Type Video Adapter, carded unit pack	C5205-000
Converts 75 Ohm twist-on connection to 75 push-on connection 75 Ohm Push-On Connector	
Description	Cat. No.
[B] 75 Ohm Push-On Connector, 2 per carded unit pack	C5235-000
75 Ohm Push-On Connector, gold plated, 2 per carded unit pack	C5235-0G0
Double female F-connector for joining two cables together 75 Ohm In-Line Cable Connector	
Description	Cat. No.
[C] 75 Ohm In-Line Cable Connector, 100 per bulk polybag	40986-000*
*Note: Retainer nut for wallplate mounting not provided.	
Converts 75 Ohm incoming signal into 300 Ohm Indoor Matching Transformer	
Description	Cat. No.
[D] Indoor Matching Transformer, carded unit pack	C5052-000
Indoor Matching Transformer, gold plated, carded unit pack	C5052-0G0
Terminates 75 Ohm w/ Crimp-on male F-Connector 1-Piece and 2-Piece Crimp-on F-Connectors	
Description	Cat. No.
[E] One-Piece Crimp-On F-Connector for RG6Quad Shiled Bulk polybag order in increments of 100, nickel plated	40985-0Q6
[F] One-Piece Crimp-on F-Connector for RG59 Bulk polybag order in increments of 100, nickel plated 2 per carded unit pack, nickel plated 2 per carded unit pack, gold plated	40985-1P9 C5307-000 C5307-0G0
[G] One-Piece Crimp-on F-Connector for RG6 Bulk polybag order in increments of 100, nickel plated	40985-1P6
[H] Two-Piece Crimp-on F-Connector for RG59 Bulk polybag order in increments of 100, nickel plated 2 per carded unit pack, nickel plated 2 per carded unit pack, gold plated	40985-2P9 C5009-000 C5009-0G0
[I] Two-Piece Crimp-on F-Connector for RG6 Bulk polybag order in increments of 100, nickel plated 2 per carded unit pack, nickel plated 2 per carded unit pack, gold plated	40985-2P6 C5007-000 C5007-0G0



Converts 300 Ohm incoming signal into 75 Ohm. Includes waterproof slip-on boot. Outdoor Matching Transformer

Description	Cat. No.
[A] Outdoor Matching Transformer, carded unit pack	C5053-000

Two 75 Ohm incoming signals into one 75 Ohm output. A/B switch selects signal to be viewed. 75 Ohm A/B Switch

Description	Cat. No.
[B] 75 Ohm A/B Switch, carded unit pack	C5101-000

6' Stereo Dubbing Cable

Description	Cat. No.
[C] 6' Stereo Dubbing Cable, carded unit pack High quality wire and extra shielding. Cables and adapters needed to connect two VHS VCR's.	C5822-000
[D] 6' Stereo Dubbing Cable, gold plated, carded unit pack Molded gold plated RCA plugs with strain-relief.	C5856-0G0

6' S-Video Cable

Description	Cat. No.
[E] 6' S-Video Cable, carded unit pack	C5853-006

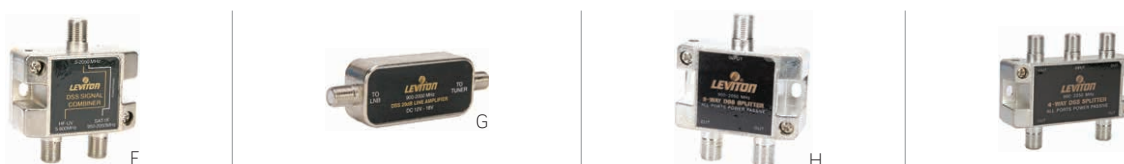

Connects one antenna/cable TV input and one DSS® 2.1 GHz input, to one combined output. DSS 75 Ohm and 2.0 GHz Combiner with DC Blocking

Description	Cat. No.
[F] DSS 75 Ohm and 2.0 GHz Combiner with DC Blocking, gold plated, carded unit pack	40856-DSS

Provides 12 dB in-line signal amplification. | DSS Signal Amplifier

Description	Cat. No.
[G] DSS Signal Amplifier, gold plated, carded unit pack	40866-DSS

DSS 2- and 4-Way Splitter

Description	Cat. No.
[H] DSS 2-Way Splitter, gold plated, carded unit pack, connects one input to two outputs. All ports 2.1 GHz.	40867-DSS
[I] DSS 4-Way Splitter, gold plated, carded unit pack, connects one input to four outputs. All ports 2.1 GHz.	40868-DSS

Audio Accessories

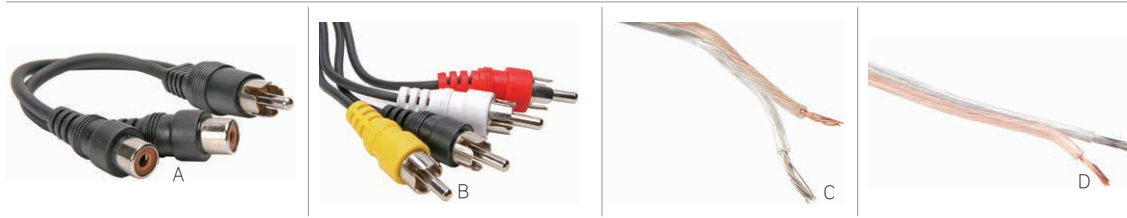

Splits audio signal into two outputs. One male RCA connector to two female RCA connectors. RCA Y Adapter, 1 RCA Plug to 2 RCA Jacks

Description	Cat. No.
[A] RCA Y Adapter, carded unit pack	C5405-000

Yellow, white, red and black plugs on both ends | RCA Patch Cable - 4 RCA Plugs to 4 RCA Plugs

Description	Cat. No.
[B] Black Cable with Color-Coded Plugs (Y-W-R-B), carded unit pack	C5454-003

AWG Speaker Wires

Description	Clear
[C] 18/2 AWG Speaker Wire, 25', sleeve unit pack	X3301-25C
18/2 AWG Speaker Wire, 100', sleeve unit pack	X3301-100
18/2 AWG Speaker Wire, 250', spool unit pack	W5212-250
[D] 14/2 AWG Speaker Wire, 50', sleeve unit pack	X3324-50C
14/2 AWG Speaker Wire, 100', sleeve unit pack	X3324-100
14/2 AWG Speaker Wire, 250', spool unit pack	W5214-250

“When installing into a new home or existing structure we are as confident as one can be with the products and reliability. Thanks to Leviton Security & Automation, I can say that our installations and customer harmony are definitely top of the line.”

Tangora Technologies, Delmar, NY

**Connects a 75 Ohm female jack to RCA plug connection.
RCA to F-Type Video Adapter**

Description	Cat. No.
RCA to F-Type Video Adapter, carded unit pack	C5205-000

**Converts 75 Ohm twist-on connection to 75 push-on connection.
75 Ohm Push-On Connector**

Description	Cat. No.
75 Ohm Push-On Connector, 2 per carded unit pack	C5235-000
75 Ohm Push-On Connector, gold plated, 2 per carded unit pack	C5235-0G0

**Double female F-connector for joining two cables together.
75 Ohm In-Line Cable Connector**

Description	Cat. No.
75 Ohm In-Line Cable Connector, 100 per bulk polybag	40986-000*

*Note: Retainer nut for wallplate mounting not provided.

**Converts 75 Ohm incoming signal into 300 Ohm.
Indoor Matching Transformer**

Description	Cat. No.
Indoor Matching Transformer, carded unit pack	C5052-000
Indoor Matching Transformer, gold plated, carded unit pack	C5052-0G0

**Terminates 75 Ohm w/ Crimp-on male F-Connector
1-Piece and 2-Piece Crimp-on F-Connectors**

Description	Cat. No.
One-Piece Crimp-On F-Connector for RG6Quad Shiled Bulk polybag order in increments of 100, nickel plated	40985-0Q6
(A) One-Piece Crimp-on F-Connector for RG59 Bulk polybag order in increments of 100, nickel plated 2 per carded unit pack, nickel plated 2 per carded unit pack, gold plated	40985-1P9 C5307-000 C5307-0G0
(B) One-Piece Crimp-on F-Connector for RG6 Bulk polybag order in increments of 100, nickel plated	40985-1P6
(C) Two-Piece Crimp-on F-Connector for RG59 Bulk polybag order in increments of 100, nickel plated 2 per carded unit pack, nickel plated 2 per carded unit pack, gold plated	40985-2P9 C5009-000 C5009-0G0
(D) Two-Piece Crimp-on F-Connector for RG6 Bulk polybag order in increments of 100, nickel plated 2 per carded unit pack, nickel plated 2 per carded unit pack, gold plated	40985-2P6 C5007-000 C5007-0G0

A close-up photograph of a person's hand touching a glowing blue circuit board. The circuit board is illuminated with a bright blue light, creating a futuristic and technological atmosphere. The background is dark, making the glowing lines of the circuit board stand out prominently. The hand is positioned in the upper right quadrant, with the index finger touching the board. The overall image conveys a sense of innovation and advanced technology.

Leviton Security & Automation Support

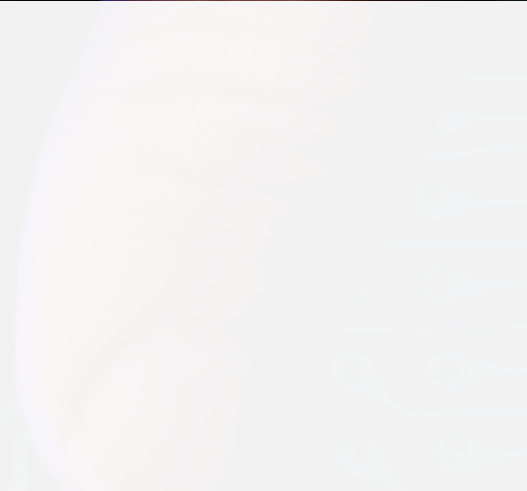

Leviton Security & Automation takes pride in our award-winning support programs, giving property owners and installing dealers the necessary tools for successful installations.

- 126** Connectivity Partners
- 128** Developer Support
- 128** Listed Dealers and Five Star Program
- 128** Installation Resources
- 129** Marketing Materials
- 131** Training Opportunities
- 132** Technical Support Contacts
- 133** Demonstration Cases

Connectivity Partners Expanding Automation

Leviton Security & Automation continues to develop relationships with other manufacturers in the industry to integrate our products with theirs. These efforts provide flexibility to add and upgrade products as desired.

Access Control

Black & Decker
www.bdhi.com

Yale Real Living
www.YaleResidential.com

Audio & Video

AMX
www.amx.com

Atlona
www.atlona.com

Audio Authority
www.audioauthority.com

Autonomic Controls
www.autonomichome.com

AVocation
www.avocation.com

Crestron
www.crestron.com

Elan
www.elanhomesystems.com

NuVo
www.nuvo.com

Philips
www.pronto.philips.com

Proficient Audio Systems
www.proficientaudio.com

Rave
www.ravetechnology.com

Russound
www.russound.com

SpeakerCraft
www.speakercraft.com

Vivotek
www.vivotek.com

Xantech
www.xantech.com

Zektor
www.zektor.com

Design Tools & Services

D-Tools
www.d-tools.com

GUI Ja Board
www.guijaboard.com

InfuseboX
www.infusebox.com

Mobile Technology
mrgolden@earthlink.net

Only One Remote
www.onlyoneremote.com

HVAC

Coolmaster
www.coolautomation.com

Interfaces

zN
www.zn.cz/en

AMX
www.amx.com

Borg Displays
www.borgdisplays.com

Charmed Quark Systems
www.charmedquark.com

Connected Hearth
www.connectedhearth.com

HAL4U
www.HAL4U.com

HomeLogic
www.homelogic.com

HomeSeer
www.homeseer.com

ili Limited
www.ili.co.nz

“When it comes to automation, Leviton Security & Automation products provide the greatest range of flexibility, integration and customization available in the market.”

Smart Homes Australia - Oakden, South Australia

Myro Control
www.meetmyro.com

Nullriver
www.nullriver.com

Omnipotence Software
www.omnipotencesoftware.com

Total Control
www.totalcontrolapp.com

Universal Remote Control
www.universalremote.com

Irrigation

GreenField Direct
www.greenfelddirect.com

WGL & Associates
www.wgl designs.com

Lighting (110VAC)

Centralite
www.centralite.com

Clipsal
www.clipsal.com

Lightolier Controls
www.lolcontrols.com

LiteTouch
www.litetouch.com

Lutron
www.lutron.com

PCS
www.pcslighting.com

Smarthome Mfg
www.smarthomemfg.com

Stewart Electronics
www.stuartelectronics.com

Lighting (220/230/240VAC)

Centralite
www.centralite.com

Clipsal
www.clipsal.com

Futurehome.gr
www.futurehome.gr

KNX®
www.knx.org

Eloka
www.eloka.net

Lutron
www.lutron.com

Philips Dynalite
www.lighting.philips.com

PLLC
www.pllc.com.au

Security

DSC
www.dsc.com

Cartell
www.cartell.com

iON Security
www.ion-digital.com

Luxul Wireless
www.luxulwireless.com

Telecom

NEC
www.necdsx.com

VoIPAlarm.com
www.VoIPAlarm.com

Window Coverings

Lutron
www.lutron.com

SOMFY
www.somfysystems.com



Unparalleled support: Leviton Security & Automation provides Dealers and Distributors a wealth of proven tools for success.

Downloads

Download all product materials including owners manuals, installation manuals, product technical sheets, and quick start guides. Also available for download are all marketing literature, integration notes for Connectivity Partner products, and return authorization forms.

Updates from Leviton Security & Automation

Dealers and Distributors each receive monthly newsletters, which bundle all of the month's notable information, including upcoming trade shows, new product releases, training dates, technical support, and press releases.

Technical Advisories are important alerts regarding installation issues, and Technical Bulletins are important alerts regarding product issues.

Knowledge Base: 24/7 support

Leviton's Knowledge Base includes documents formulated by Leviton Security & Automation's Technical Support team. Leviton Security & Automation's Online Forums also allow open sharing of ideas, applications, and setups.

Five Star Dealers

Every year, Leviton Security & Automation searches for and rewards exemplary installing dealers that go above and beyond with their services and product knowledge. These dealers are listed on the 'How to Buy' section of the Leviton website. They receive sales leads, direct access to free literature, and are offered monthly product promotions. Their valuable input during the application process helps shape product development, marketing material creation and overall business operations.

“Leviton Security & Automation products have been a stalwart in our company since I founded it in 2002. The products are reliable, robust, and the support is outstanding. We enjoy using Leviton Security & Automation and count on it in every new install.”

Boca Theater & Automation, Inc, Boca Raton, Florida

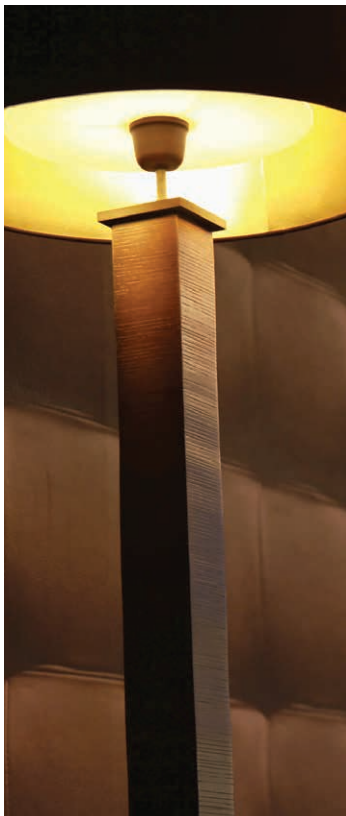

Sales leads

Leviton Security & Automation provides Five Star Dealers valuable sales leads for their area.

Program and adjust from anywhere in the world

Dealers and Distributors can download Leviton Security & Automation's Omni-Link serial protocol or Pro-Link protocol documents to learn how to create an application that communicates with a Leviton Security & Automation controller via a serial port. Omni-Link II and Omni-Link protocol supports Ethernet applications utilizing Internet protocols. For applications that communicate with an Ethernet port, Dealers and Distributors can download an API Kit.

The Application Directory is an invaluable document containing a host of applications and programs for PC Access. It also contains helpful information on troubleshooting and programming conventions.

Marketing materials

Leviton Security & Automation offers printed literature that can be ordered for FREE to use as informational sales material for end users. The following pieces are currently available:

- What is Home Automation? Handout
- Learn About Home Automation Booklet
- Building Management Booklet
- Leviton Security & Automation 2013 Product Guide

Dealers can order the Model Home Support Kit (part #SA-23) through regular distribution channels. This kit includes discreet wall displays to articulate the benefits of a Leviton Security & Automation automated home and a pair of attractive Leviton Security & Automation yard signs. Also included is a supply of the newest What is Home Automation? handout which introduces the concept of home automation to end users.

Leviton Security & Automation Yard Signs (part #SA-30) and Leviton Security & Automation Window Decals (part #SA-31) are also available. The Leviton e-store is your source for repair and replacement parts, as well as Leviton Security & Automation firmware upgrades.

Case Studies

Leviton Security & Automation will promote your installations by featuring projects on leviton.com. We will also create a professional PDF for your marketing purposes. Email SAMarketing@leviton.com with a synopsis of a unique installation.



Support

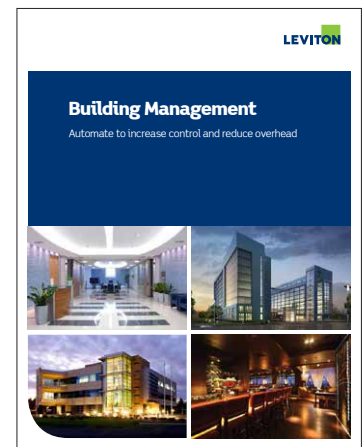



The resources software developers need to interface with the best in security & automation.

The Leviton Security & Automation Developer Support Program was created for software developers who want to generate software that works with Leviton Security & Automation products.

To join the Leviton Security & Automation Developer Support Program, complete an application for approval by Leviton Security & Automation. Every Developer Support application will be processed by Leviton Security & Automation's Director of Technical Services within two business days.

Once approved, the software developer will have access to the following resources:

- Programming protocols, SDK, documentation, and examples
- A forum for developers to share experiences or ask questions
- Dealer level access to Leviton Security & Automation's Knowledge Base
- All Leviton Security & Automation manuals, including installation manuals
- High-resolution versions of Leviton Security & Automation logos and product images

Leviton EZ-Learn provides online resources 24-7

Leviton EZ-Learn weaves together all of Leviton Security & Automation's many online resources including demonstration videos, recorded webinar presentations and more. All information is laid out in courses and categorized by product type.



Factory Training

Factory Training is a two-day event at Leviton Security & Automation's headquarters, located in New Orleans, Louisiana. Choose from Factory 201: Installation & Programming or Factory 301: Automation Studio. Detailed installation and system programming instruction is provided. Attendees work hands-on with an automation system and computer to install and set up a Leviton Security & Automation system. There is a fee for both classes. Seating is limited.

Free Classroom Training

Leviton Security & Automation offers FREE classroom training that may be directly sponsored by Leviton Security & Automation, or by a Leviton Security & Automation Wholesale Distribution Partner. All Leviton Security & Automation classes have the benefit of a Leviton Security & Automation employee instructor.

Classes include:

- Leviton Security & Automation Installation Training
- Leviton Security & Automation New Products
- Hands On Training
- Hi-Fi 2 by Leviton Security & Automation
- Introduction to Home Automation - Automation 101
- Leviton Security & Automation Application Programming
- Whole House Lighting Control & Home Automation
- Designing a Home Automation System

Online Training Videos & Presentations

Training and demonstration videos are available to Dealers and Distributors. Additionally, Leviton Security & Automation offers webinars that provide the same training that is available in its Free Classroom Training.

International Training

Visit www.leviton.com often for classes scheduled in various countries around the world.

“We have been able to change people’s minds about what they want in a security system. We wish everyone would do business like Leviton Security & Automation.”

Derence Systems Inc, Pittsburgh, Pennsylvania

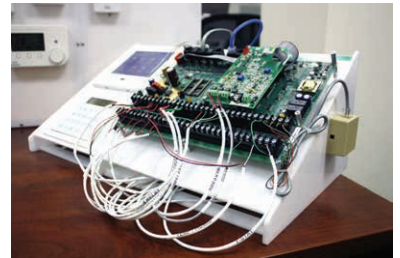
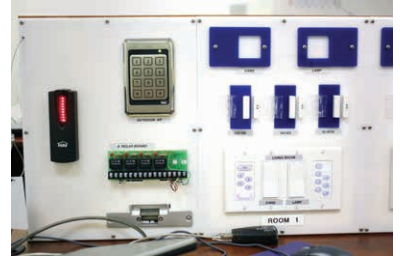

Support



Several classes are eligible for credits - and many classes carry state approvals.

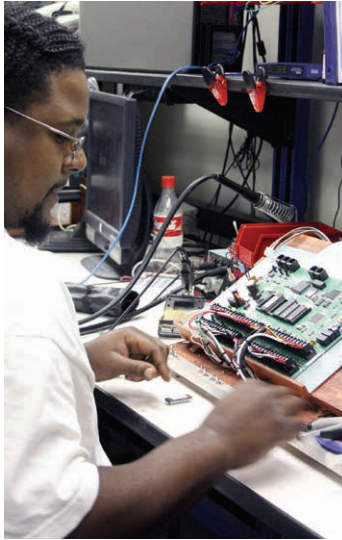

Leviton Security & Automation's Dudley Malveaux, Test & Repair Technician, performing quality assurance testing.



Leviton Security & Automation's Ernie Sieber, Technical Support Supervisor, inspects Leviton Security & Automation Access Control Readers.

Leviton Security & Automation stands behind our products with industry leading support and customer service.

Leviton Security & Automation provides several Technical Support resources for our network of professional installing dealers:

- Leviton Security & Automation Territory Sales Managers and Representatives
- Leviton Security & Automation 800 Technical Support: 1-800-824-3005
- Leviton Security & Automation Online Knowledge Base
- Leviton Security & Automation Parts & Repair Department
- Warranties on all Leviton Security & Automation products
- Leviton Security & Automation Dealer Online Forum
- Recorded and live product webinars
- Demonstration videos
- Award-winning training and support departments

Leviton Security & Automation's Tom Cressionnie, Technical Support Specialist, providing step-by-step assistance to a caller.

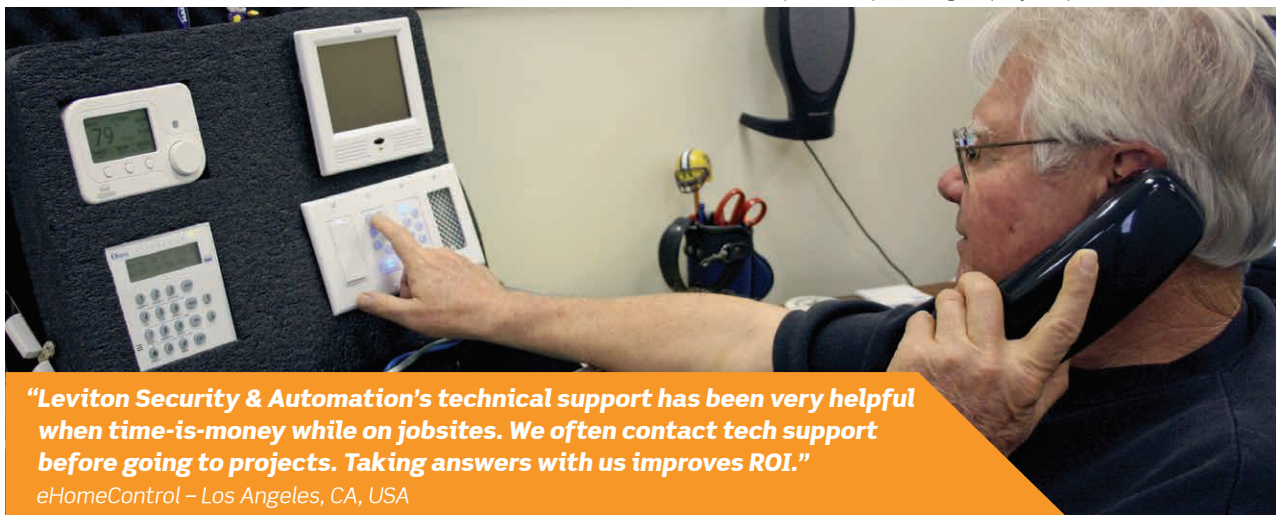

"Leviton Security & Automation's technical support has been very helpful when time-is-money while on jobsites. We often contact tech support before going to projects. Taking answers with us improves ROI."

eHomeControl - Los Angeles, CA, USA

Dealer Support Tools

MicroControl Energy Management Demo Case

18A00-20

Features several Leviton Security & Automation ZigBee® wireless products to demonstrate energy savings capabilities. Includes: Leviton Security & Automation MicroControl (81A00-2WHZB), Omnistat2 PCT (RC-1000WHZB), and 15A Plug-In Load Control Module (89A00-1ZB). Eye-catching color graphic adhered to a foam insert keeps everything secure during travel.



Hi-Fi 2 by Demo Case

18A00-15

Demonstrate the power of Hi-Fi 2 by Leviton Security & Automation with this complete stand-alone kit. Includes: Hi-Fi 2 by Leviton Security & Automation (95A01-1), one Volume Source Control (95A03-1), one Remote Input Module (95A04-1), and a Hi-Fi 2 Remote Control (95A05-1). Eye-catching color graphic adhered to a foam insert keeps everything secure during travel. Note: Touchscreen, HAI Dock, and MP3 player images are printed on graphic only and are not included.



OmniPro II Demo w/OmniTouch & Leviton Security & Automation Lighting Control

18A00-13

OmniPro II controller, LCD console with built-in speaker, OmniTouch Touchscreen, RC-2000WH Omnistat2 Thermostat, Leviton Security & Automation Lighting Control (Scene Switch and 600W Dimmer), UPB™ Powerline Interface Module with cable, wireless router, and Voice Module all in a travel case. Demo programs included. For other languages add language code to part number: Latin American Spanish (SPA), French (FR)



Lumina Demo Case

18A00-14

Lumina controller, LCD keypad w/built-in speaker, OmniTouch Touchscreen, RC-2000WH Omnistat2 Thermostat, Leviton Security & Automation Lighting Control (House Status Switch, Scene Switch, Mode Switch, 600W Dimmer), UPB™ Powerline Interface Module, and Phase Coupler all in a heavy duty travel case. Demo programs included.



International Demo Case

18A00-16

Includes all items from 18A00-13 but with Access Control in place of HLC. Features a universal worldwide power supply. A great demo solution for Leviton Security & Automation's international customers. Packaged in a heavy duty black travel case. For other languages add language code to part number: Latin American Spanish (SPA), European Spanish (SPE), Italian (IT), French (FR), Catalan (CAT)



Demo Adapter Kit

18A00-5

Demo adapter board, instructions. For Omni IIe, OmniPro II, Lumina, and Lumina Pro.



Wiring Diagrams

SPECIFICATIONS			
Leviton Security & Automation Controllers	OmniPro II	Omni IIe	Omni LTe
Leviton Security & Automation Lighting/Rooms	31	8	4
Lighting Scenes	128	64	32
Lighting Addresses	256	64	32
Zones	16	16	16
Zone Expansion Total	176	48	32
2 Wire Smoke Loops	4	4	4
4 Wire Smoke Loops	176	48	16
Thermostats	64	4	4
Consoles (Keypads)*	16	8	4
OmniTouch 7/OmniTouch Pro	16	16	16
12 Volt Triggers (w/ expansions)	8 (136)	8 (8)	8 (8)
Audio Control	Hi-Fi 2/Conn.Prtnrs	Hi-Fi, Hi-Fi 2	Hi-Fi, Hi-Fi 2
Audio Zones	16/36	8	8
Access Control Card Readers	16	4	4
Access Control Card/Keytag	99	16	16
Serial Ports	5	5	5
Serial Expansion Total	6	6	5
Ethernet Port	Yes	Yes	Yes
Flash Memory	Yes	Yes	Yes
User Codes	99	16	16
Programming Lines	1500	500	300
Vocabulary	550	550	550
Custom Vocabulary	Yes	No	No
Depluggable Terminal Strips	Yes	Yes	Yes
Format	Contact ID, 4/2,3/1	Contact ID, 4/2,3/1	Contact ID, 4/2,3/1
Transformer Required	24V (40VA)	24V (40VA)	24V (40VA)
Battery (Typical)	12V (7 Ah)	12V (7 Ah)	12V (7 Ah)
Aux Current Max	1A	1A	1A
Bell Current Max	1A	1A	1A
Aux Current (UL 24hr.)	250mA	250mA	250mA
Bell Current (UL 24hr.)	300mA	300mA	300mA
Total Expansion Boards (10A06-1)	2	2	0
Total Expansion Enclosures (17A00-X)	8	0	0
Total 64-Zone Wireless Receivers (45A00-1/42A00-2)	8**	1	1
110V/220V/240V	Yes	Yes	Yes
UL Listing	Res. Burg/Fire; Comm. Burg	Res. Burg/Fire; Comm. Burg	Res. Burglar/Fire
Warranty	3 years	2 years	2 years

* Systems must have one console to meet UL requirements.

** Wireless Receivers can support 64 Transmitters and can report to 16, 32, 48, or 64 zones, depending upon your setup. Each group of 16 zones counts as one expansion enclosure.

SPECIFICATIONS		
Lumina Control Systems	LUMINA PRO	LUMINA
Rooms	31	8
Loads (lights)	256	64
House Status Switches	31	8
Max Keypads	16	8
Max OmniTouch 7/OmniTouch Pro	16	16
Thermostats	64	4
Access Control Card Readers	16	4
Access Control Card/Key Tag	99	16
Audio Control	Hi-Fi 2/Conn Ptnrs	Hi-Fi, Hi-Fi 2
Audio Zones	16/36	8
Flash Memory	Yes	Yes
Inputs (with expansion)	16 (176)	16 (48)
Multipurpose Outputs (with expansion)	10 (136)	10
Ethernet Port	Yes	Yes
Serial Ports (w/ expansion)	5 (6)	5 (6)
Programming Lines	1500	500
Vocabulary	550	550
Customizable Vocabulary	Yes	No
Depluggable Terminal Strips	Yes	Yes
16 Zone Hardwire Expanders (10A06-1) Supported	2	2
Expansion Enclosures (17A00-X) Supported	8	0
64 Zone Wireless Receivers (45A00-1 or 42A00-2) Supported*	2	1
UL Listed	Yes	Yes
Warranty	3 Years	2 years

* Wireless Receivers can support 64 Transmitters and can report to 16, 32, 48, or 64 zones, depending upon your setup. Each group of 16 zones counts as one expansion enclosure.

SPECIFICATIONS				
Leviton Security & Automation Software Comparison Chart				
	Snap-Link	iPhone®/iPad® App	Android™ App	Kindle Fire
Part Number	1120	1120A	1120C	1120D
Access via Internet	Yes	Yes	Yes	Yes
Dedicated Computer On-site	No	No	No	No
Client Software	No (runs on client)*	No (runs on client)	No (runs on client)	No (runs on client)
Installation Components	No installation (Plug and Go)*	Application	Application	Application
Subscription Fee	No	No	No	No
Video Surveillance	Link to installed IP Web Camera	Yes	Yes	Yes
Video Recording	No	No	No	No
Notifications	E-mail, messaging, pop-up notifications, visual	No	No	Yes
User Interface	PC application	iPhone® App	Android™ App	Kindle Fire™
Additional Interfaces Supported	PC Touchscreen	Apple iPod® Touch® and iPad®	Android™ Mobile Devices	None
Configure System	No	No	No	No
Program System	No	No	No	No
Create Rules/Alerts	Yes	No	No	No
Change Description	No	Yes (hide/show)	No	No
Web Updates	Yes	Yes	Yes	Yes

* Does not require installation on PC. Application can run from thumb drive, flash drives, or other removable media.

** Displays RSS feeds such as latest news, weather reports, personal blogs, and much more.

	PC Access	OmniTouch Pro
Part Number	1105W, 1106W, 1111	1131
Access via Internet	Yes	Yes
Dedicated Computer On-site	No	No
Client Software	Yes (installed on client)	No (runs on client)
Installation Components	Application	Application
Subscription Fee	No	No
Video Surveillance	No	Yes
Video Recording	No	No
Notifications	No	Yes
User Interface	PC application	PC Application
Additional Interfaces Supported	None	PC Touchscreens
Configure System	Yes	No
Program System	Yes	No
Create Rules/Alerts	No	Yes
Change Description	Yes	Yes
Web Updates	Yes	Yes
RSS (Real Simple Syndication)**	No	Yes
Operating Systems	Windows® 98E, Windows® XP, Windows® Vista Ultimate, Windows® Vista Home Premium, Windows® 7	Microsoft Windows® XP, Vista, or Windows® 7

SPECIFICATIONS						
Leviton Security & Automation Product Wiring Requirements and Distances						
Product Name	Part Number	Wire Type	Conductors	Max. Length	Twist	Shield
Two-Way Voice Module	10A11-1	*	-	-	-	-
Water Temperature Sensor	14A00-8	22 AWG	3	N/A	No	No
Expansion Enclosure	17A00	22 AWG	210	1000'1	No	No
Remote Temperature Sensors	23A00	22 AWG5	2	250'5	Yes	Yes
ALC Branch Interface	25A00	20-24 AWG	2	500'3	Yes	No
Speaker/Microphone Module	28A00-ALL	*	-	-	-	-
Indoor/Outdoor Temperature Sensor	31A00-ALL	22 AWG	4	N/A	No	No
LCD Console*	33A00-ALL	22 AWG	4	1000'1	No	No
Wireless Receiver (GE)	42A00-1	22 AWG	4	1000'1	No	No
Wireless Receiver (Leviton Security & Automation)	45A00-1	22 AWG	4	1000'1	No	No
OmniTouch 7 Touchscreen	53A00-2	CAT-5 (patch)	8	328'7	N/A	N/A
Access Control Keypad	54A00-2	22 AWG	4	50'	N/A	N/A
IP Camera	68A11-1	CAT-5 (patch)	8	328'	N/A	N/A
Access Card Reader	75A00-2	22 AWG9	49	1000'9	N/A	N/A
12VDC Door Strike	79A00-1	16 AWG	2	-	-	-
Power Hub (Controller)	83A00	22 AWG	312	1000'1	No	No
Home Theater Extender 2 (HTX2)	86A00-2	CAT-5 (patch)8	8	328'	N/A	N/A
PoE Injector	90A00-1	CAT-5 (patch)	8	328'	N/A	N/A
8-Port PoE Switch	91A00-1	CAT-5 (patch)	8	328'	N/A	N/A
Serial Server	93A00-1	CAT-5 (patch)	8	328'	N/A	N/A
Hi-Fi 2 (Network)	95A00-1	CAT-5 (patch)	8	328'	N/A	N/A
Hi-Fi 2 (Controller)	95A00-1	22 AWG	4	50'	N/A	N/A
Hi-Fi 2 RIM	95A04-1	CAT-5 (patch)	8	500'	N/A	N/A
Speakers connected to Hi-Fi 2	-	16 AWG	46	-	N/A	N/A
Omnistat2 Thermostat (All Models)	-	22 AWG	4	10,000'	No	No
Speaker	*	18 AWG	2	50'	Yes	No
Microphone	*	24 AWG	2	100'	Yes	Yes

¹1000' limit for entire AB Bus combined. ²Exact wire determined by distance and wire type. ³Wire limit per branch. ⁴For distances up to 100' use 16 AWG. ⁵Size of wire required based on insulation and distance. ⁶Recommend stranded for each pair of speakers. ⁷Distance between 53A00-2 and PSE (Power Sensing Equipment) device. ⁸When connecting the HTX2 to a Leviton Security & Automation PoE Switch (91A00-1) a CAT-5 "crossover" cable is required. ⁹Exact wire determined by distance and wire type. ¹⁰Recommend 3 conductors (including common ground) for remote mounting the expansion enclosure. ¹¹Original Hi-Fi components use the same wiring. ¹²Two additional wires required for low battery notifications. *Speaker/Microphone wiring sizes should be used with Two-Way Voice Module (10A11-1), Speaker/Microphone Module (28A00-1/2), and LCD 33A00-4

SPECIFICATIONS					
Access Control Capacities					
	OmniPro II	Omni IIe	Omni LTe	Lumina Pro	Lumina
Card Reader	16	4	4	16	4
Access Card/Key Tag	99	16	16	99	16

Access Control Wiring Requirements				
<p>The 75A00-2 requires four wires for operation (two for power and two for communication). The maximum distance between the 75A00-2 and the connected 12V Power Supply or Leviton Security & Automation 83A00 Power Hub is based on two factors: 1) the current draw of the connected door lock device, and 2) the wire gauge/type used. To maintain proper operation of the 75A00-2 and the connected door lock device, do not exceed the "Maximum Cable Length" based on the Total Current Draw and the Wire Gauge/Type per the table below.</p>				
Wire Gauge	Wire Type	# Positive Conductors	# Ground Conductors	Max Cable Length (feet)
24	solid	1	1	233
24	solid	2	2	466
24	solid	3	3	699
22	solid	1	1	413
22	solid	2	2	826
22	stranded	1	1	381
18	solid	1	1	1000
18	stranded	1	1	963
16	solid	1	1	1000
16	stranded	1	1	1000

75A00-2 and 79A00-1 Electric Door Strike (450mA): 600mA Maximum				
Wire Gauge	Wire Type	# Positive Conductors	# Ground Conductors	Max Cable Length (feet)
24	solid	1	1	58
24	solid	2	2	117
24	solid	3	3	175
22	solid	1	1	103
22	solid	2	2	207
22	stranded	1	1	95
18	solid	1	1	261
18	stranded	1	1	241
16	solid	1	1	415
16	stranded	1	1	383

75A00-2 and Door Lock (800mA): 950mA Maximum				
Wire Gauge	Wire Type	# Positive Conductors	# Ground Conductors	Max Cable Length (feet)
24	solid	1	1	37
24	solid	2	2	74
24	solid	3	3	110
22	solid	1	1	65
22	solid	2	2	130
22	stranded	1	1	60
18	solid	1	1	165
18	stranded	1	1	152
16	solid	1	1	262
16	stranded	1	1	242

75A00-2 and Door Lock (1A): 1.15A Maximum				
Wire Gauge	Wire Type	# Positive Conductors	# Ground Conductors	Max Cable Length (feet)
24	solid	1	1	30
24	solid	2	2	61
24	solid	3	3	91
22	solid	1	1	54
22	solid	2	2	108
22	stranded	1	1	50
18	solid	1	1	136
18	stranded	1	1	126
16	solid	1	1	217
16	stranded	1	1	200

Note: If cable with multiple conductors is used (such as CAT-5), it is possible to connect multiple conductors together to achieve greater distance.

WIRING DIAGRAM

Lighting Control Switches

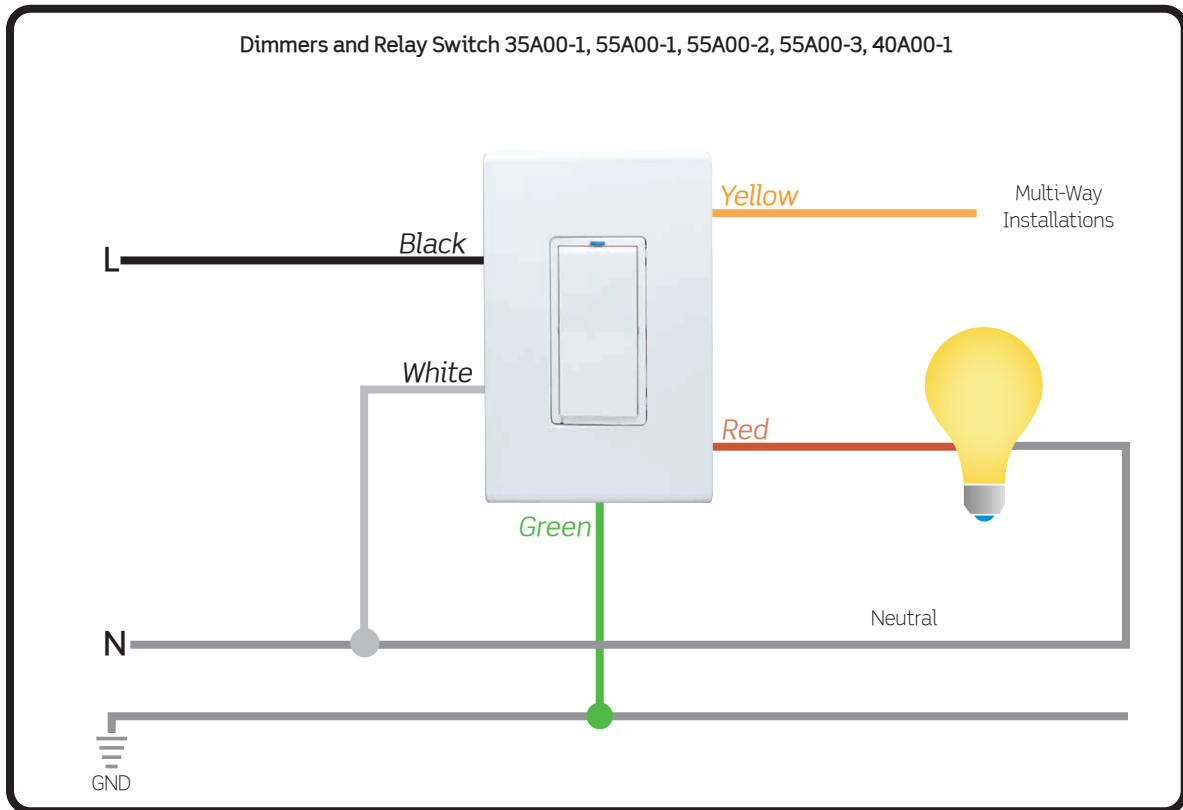
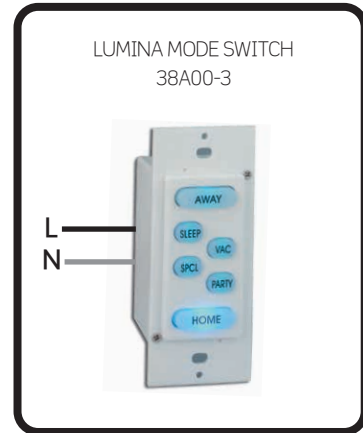
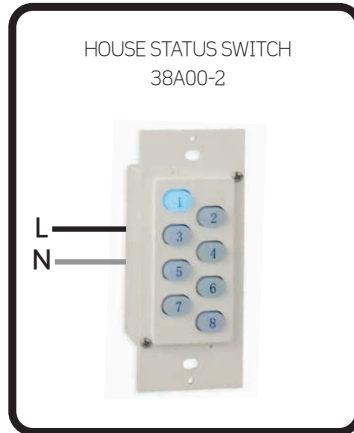
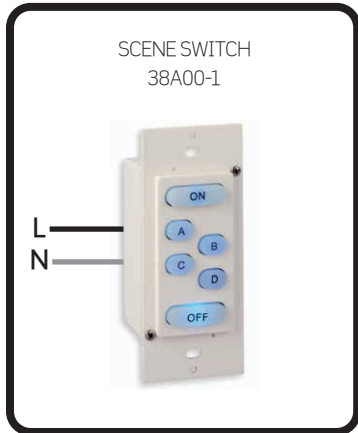

WIRING DIAGRAM

OmniPro II

Controller - In Enclosure

13.25" W x 13.375" H x 4.625" D
Approximate Weight: 13.30 lbs

Controller - Board Only

11.0" W x 8.0" H x 1.25" D
Approximate Weight: 1.6 lbs

SERIAL PORTS

HLC Lighting Control UPB™ PIM (#36A00-1)
Leviton Vizia RF + Z-Wave (#VRCOP)
ZigBee (#81A00-3)
Omni-Bus (#117A00-1)
Serial to PC Cable (#21A05-2)
Hi-Fi 2 (#95A00)
Access Control Readers (#75A00, #54A00)
Clipsal, Dynalite, Coolmaster, Serial Connectivity Cable (#36A05-4)

AUDIO

Omni Console w/ Spkr/Mic (#33A00-4)
Surface Speaker/Mic (#28A00-1)
Flush Speaker/Mic (#28A00-2)
Two-Way Voice Module (#10A11-1)

ETHERNET PORT

Snap-Link, Snap-Link Mobile for Android™ and iOS®, PC Access, OmniTouch Touchscreen, OmniTouch Pro, Omni-Bus

Two-Way X-10

12V BATTERY

EARTH GROUND

TRANSFORMER 24V/40VA

TELEPHONE INTERFACE

- Land line
- Cellular Communications Center (#70A00)
- PC Access

USER INTERFACE

Omni Consoles (#33A00)

COMFORT & CONVENIENCE

Omnistat2 Thermostats

EXPANSION

Wireless Receiver (#45A00-1)
Wireless Receiver for GE (#42A00-2)
Expansion Enclosure (#17A00)

SECURITY & ENERGY MANAGEMENT

Temperature Sensor (#31A00-7)
Temperature/Humidity Sensor (#31A00-8)
Standard Security/Fire/Environmental Sensors

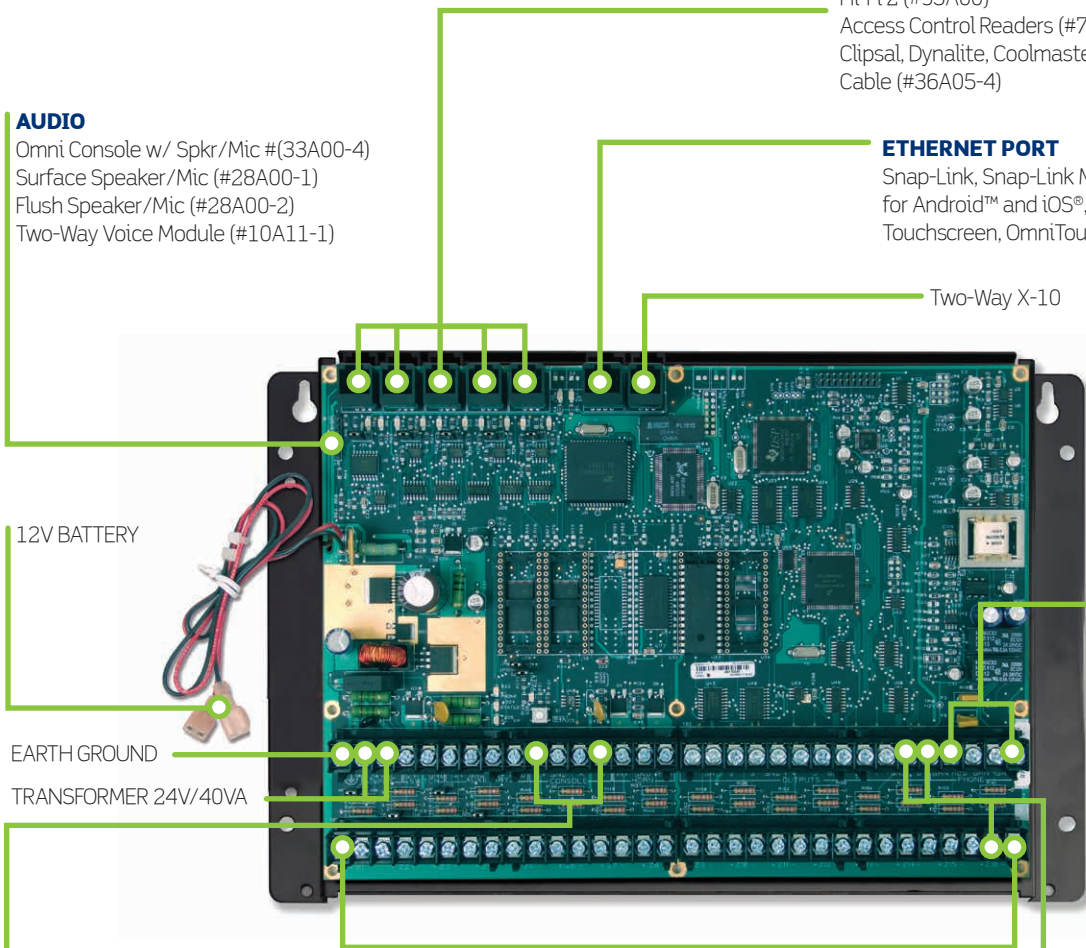

Visio stencils are available to our dealers.
Omni systems are designed for professional installation.
Licensing requirements vary by area.

WIRING DIAGRAM

Omni Commercial

Controller - In Enclosure

13.25" W x 13.375" H x 4.625" D
Approximate Weight: 13.30 lbs

Controller - Board Only

11.0" W x 8.0" H x 1.25" D
Approximate Weight: 1.6 lbs

SERIAL PORTS

HLC Lighting Control UPB™ PIM (#36A00-1)
Leviton Vizia RF + Z-Wave (#VRCOP)
ZigBee (#81A00-3)
Omni-Bus (#117A00-1)
Serial to PC Cable (#21A05-2)
Hi-Fi 2 (#95A00)
Access Control Readers (#75A00, #54A00)
Clipsal, Dynalite, Coolmaster, Serial Connectivity Cable (#36A05-4)

AUDIO

Omni Console w/ Spkr/Mic (#33A00-4)
Surface Speaker/Mic (#28A00-1)
Flush Speaker/Mic (#28A00-2)
Two-Way Voice Module (#10A11-1)

ETHERNET PORT

Snap-Link, Snap-Link Mobile for Android™ and iOS®, PC Access, OmniTouch Touchscreen, OmniTouch Pro, Omni-Bus

Two-Way X-10

12V BATTERY

EARTH GROUND

TRANSFORMER 24V/40VA

TELEPHONE INTERFACE

- Land line
- Cellular Communications Center (#70A00)
- PC Access

USER INTERFACE

Omni Consoles (#33A00)

COMFORT & CONVENIENCE

Omnistat2 Thermostats

EXPANSION

Wireless Receiver (#45A00-1)
Wireless Receiver for GE (#42A00-2)
Expansion Enclosure (#17A00)

SECURITY & ENERGY MANAGEMENT

Temperature Sensor (#31A00-7)
Temperature/Humidity Sensor (#31A00-8)
Standard Security/Fire/Environmental Sensors

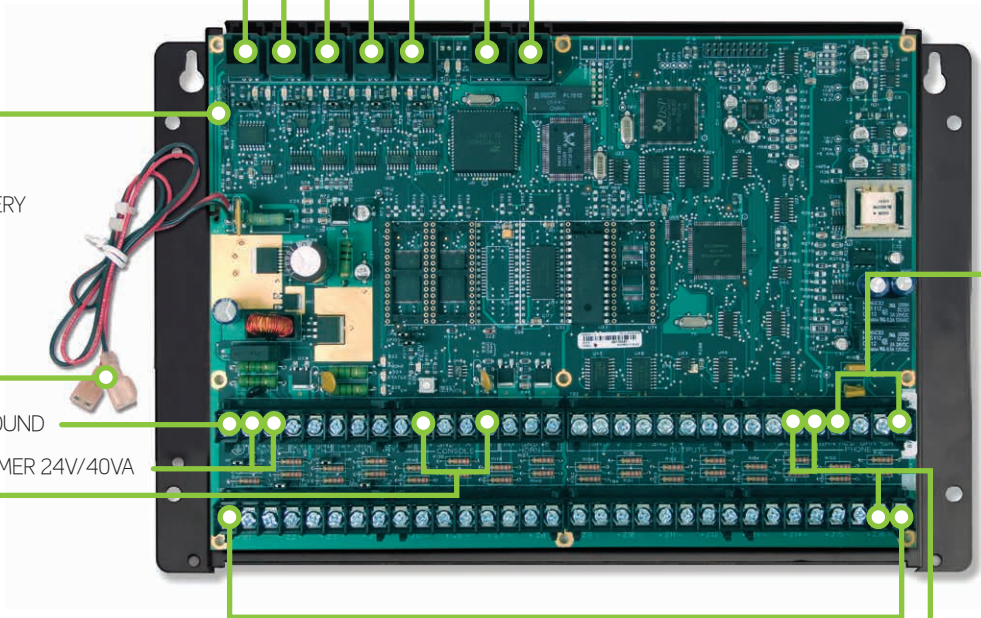

Visio stencils are available to our dealers.
Omni systems are designed for professional installation.
Licensing requirements vary by area.

WIRING DIAGRAM

Omni IIe

Controller - In Enclosure

13.25" W x 13.375" H x 4.625" D
Approximate Weight: 13.30 lbs

Controller - Board Only

11.0" W x 8.0" H x 1.25" D
Approximate Weight: 1.6 lbs

SERIAL PORTS

HLC Lighting Control UPB™ PIM (#36A00-1)
Leviton Vizia RF + Z-Wave (#VRCOP),
ZigBee (#81A00-3)
KNX® Gateway, (#97A00-1)
Access Control Readers (#75A00, #54A00)
Clipsal, Dynalite, Coolmaster, Serial Connectivity
Cable (#36A05-4), Serial to PC Cable (#21A05-2)

ETHERNET PORT

Snaplink for Windows, Snaplink
Mobile for Android™/iPhone®
and iOS®, PC Access, OmniTouch
7 Touchscreen, OmniTouch Pro,
Omni-Bus

AUDIO

Omni Console w/ Spkr/Mic (#33A00-4)
Surface Speaker/Mic (#28A00-1)
Flush Speaker/Mic (#28A00-2)
Two-Way Voice Module (#10A11-1)

12V BATTERY

EARTH GROUND TRANSFORMER 24V/40VA

USER INTERFACE

Omni Cosoles (#33A00)

EXPANSION

Wireless Receiver (#45A00-1)
Wireless Receiver for GE (#42A00-2)

SECURITY & ENERGY MANAGEMENT

Temperature Sensor (#31A00-7)
Temperature/Humidity Sensor (#31A00-8)
Standard Security/Fire/Environmental
Sensors

COMFORT & CONVENIENCE

OmniStat2 Thermostats

Two-Way X-10

TELEPHONE INTERFACE

- Land line
- Cellular
Communications
Center (#70A00)
- PC Access

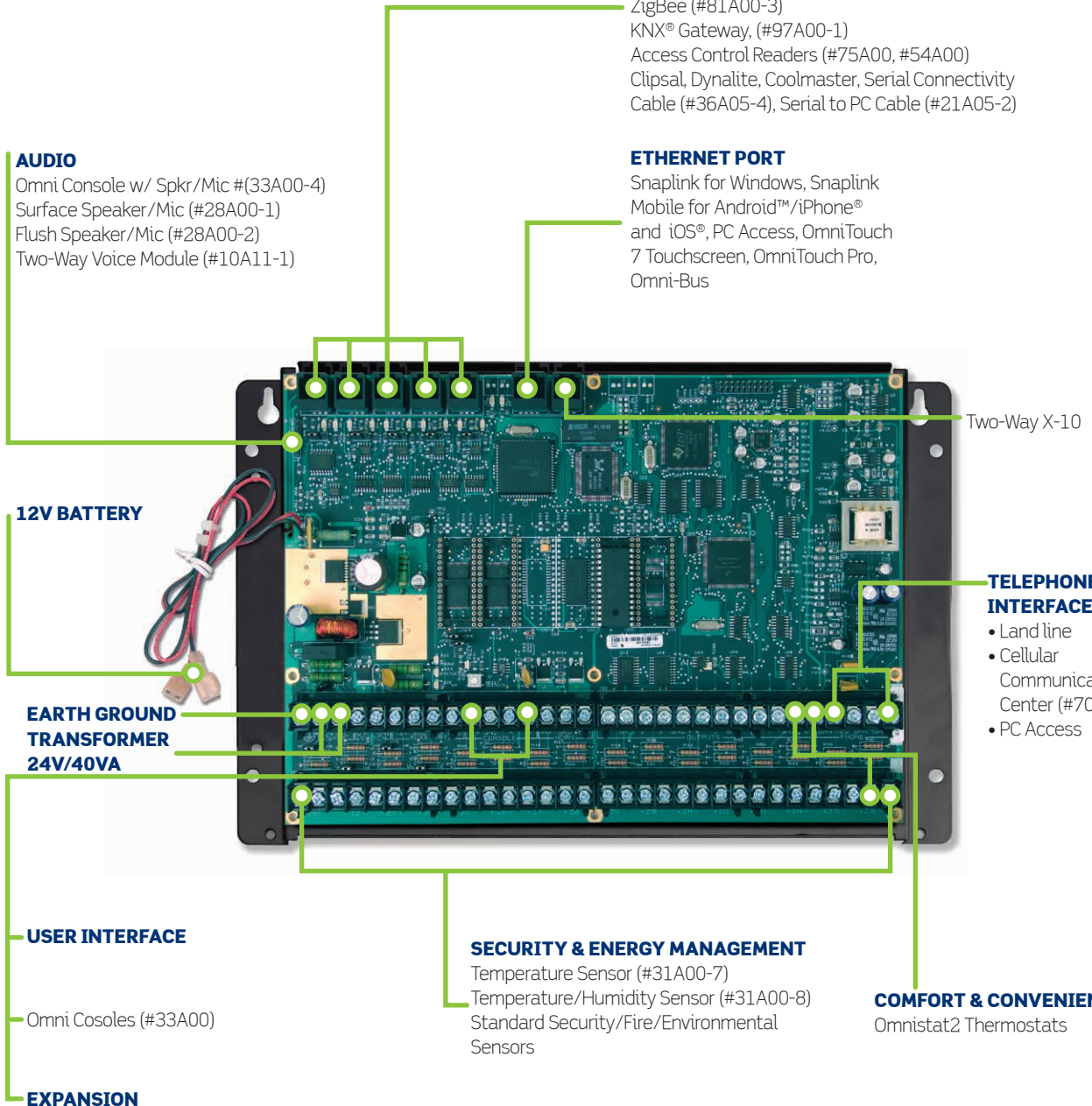

Omni systems are designed for professional installation. Licensing requirements vary by area.

WIRING DIAGRAM

Omni LTe

Controller - In Enclosure

13.25" W x 13.375" H x 4.625" D
Approximate Weight: 13.30 lbs

Controller - Board Only

11.0" W x 8.0" H x 1.25" D
Approximate Weight: 1.6 lbs

SERIAL PORTS

HLC Lighting Control UPB™ PIM (#36A00-1)
Leviton Vizia RF + Z-Wave (#VRCOP),
ZigBee (#81A00-3)
KNX® Gateway, (#97A00-1)
Access Control Readers (#75A00, #54A00)
Clipsal, Dynalite, Coolmaster, Serial Connectivity
Cable (#36A05-4), Serial to PC Cable (#21A05-2)

ETHERNET PORT

Snaplink for Windows, Snaplink
Mobile for Android™/iPhone®
and iOS®, PC Access, OmniTouch
7 Touchscreen, OmniTouch Pro,
Omni-Bus

AUDIO

Omni Console w/ Spkr/Mic (#33A00-4)
Surface Speaker/Mic (#28A00-1)
Flush Speaker/Mic (#28A00-2)
Two-Way Voice Module (#10A11-1)

12V BATTERY

EARTH GROUND

TRANSFORMER 24V/40VA

USER INTERFACE

Omni Cosoles (#33A00)

EXPANSION

Wireless Receiver (#45A00-1)
Wireless Receiver for GE (#42A00-2)

SECURITY & ENERGY MANAGEMENT

Temperature Sensor (#31A00-7)
Temperature/Humidity Sensor (#31A00-8)
Standard Security/Fire/Environmental
Sensors

COMFORT & CONVENIENCE

Omnistat2 Thermostats

Two-Way X-10

TELEPHONE INTERFACE

- Land line
- Cellular Communications Center (#70A00)
- PC Access

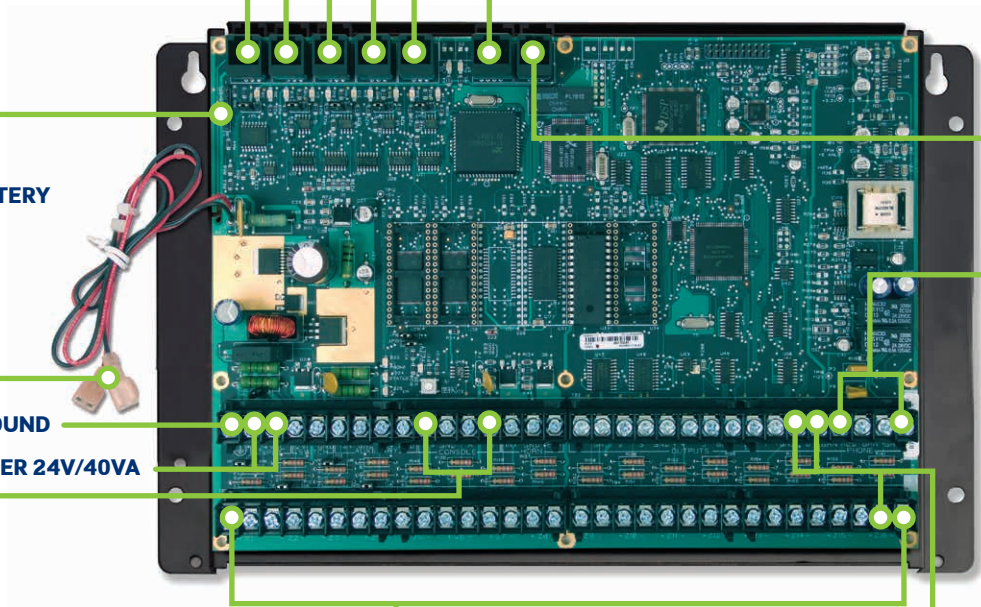

Omni systems are designed for professional installation. Licensing requirements vary by area.

WIRING DIAGRAM

Access Control via Leviton Security & Automation Power Hub (#83A00-X)

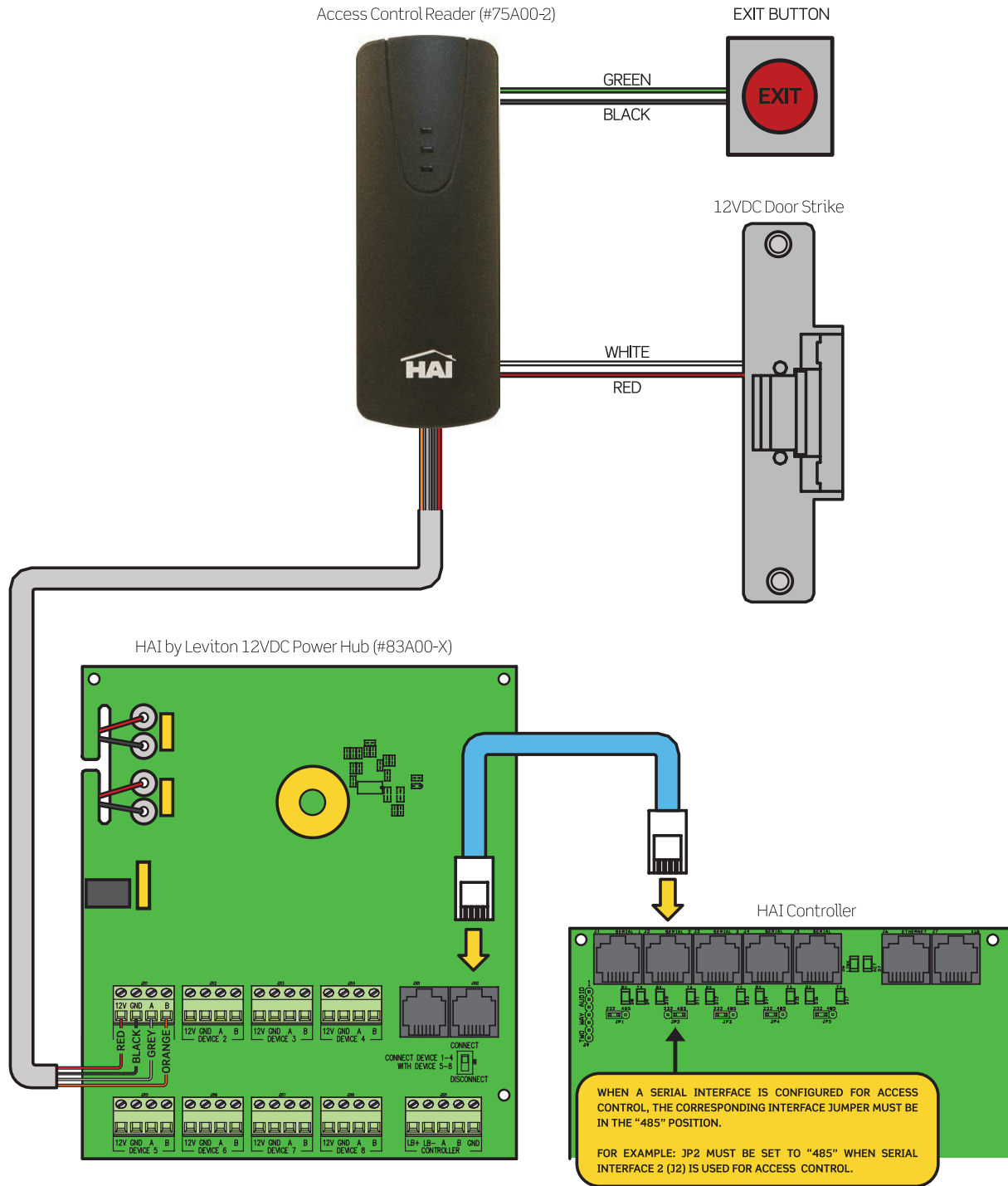

Wiring Diagrams

WIRING DIAGRAM

Access Control via non-Leviton Security & Automation Power Supply

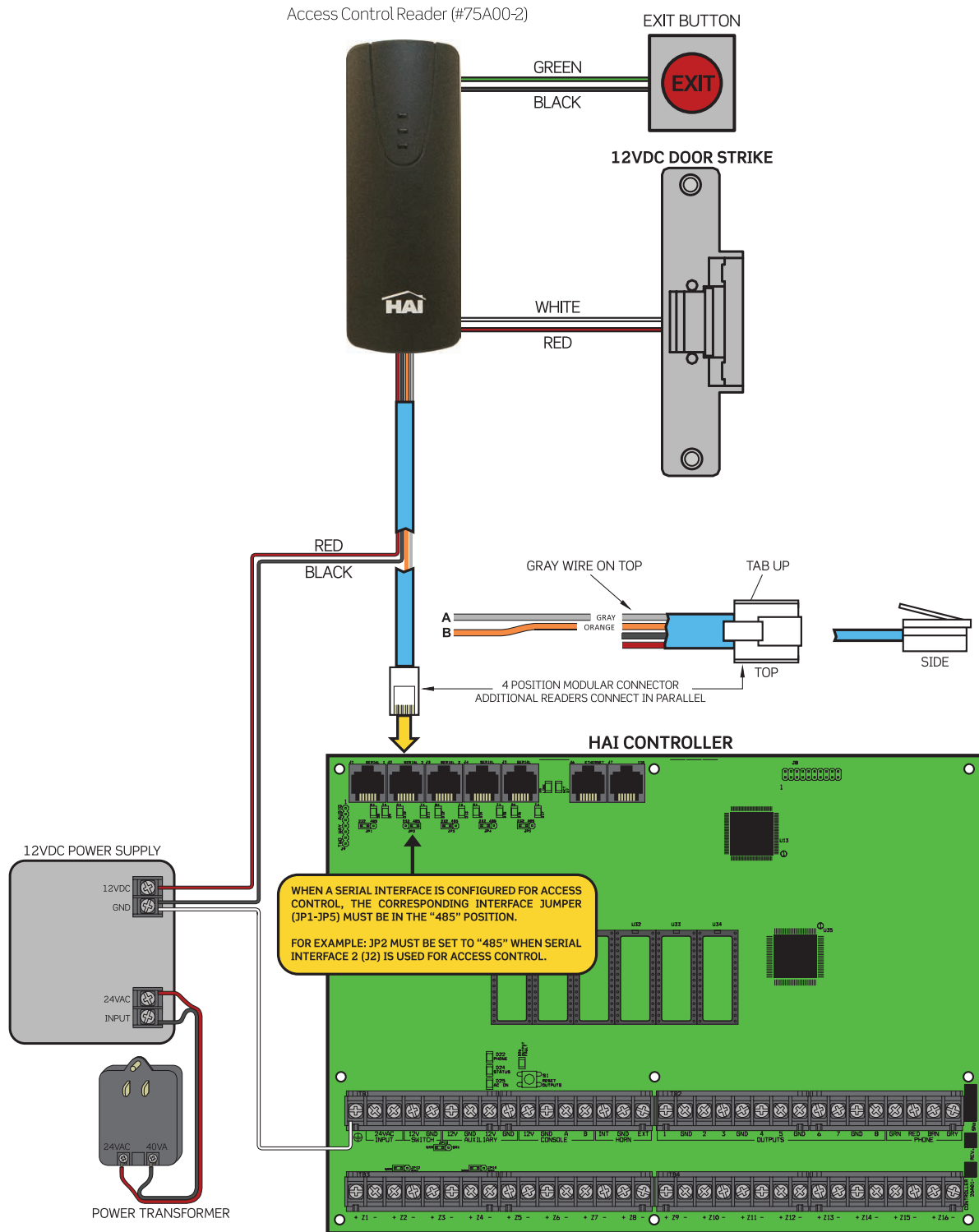

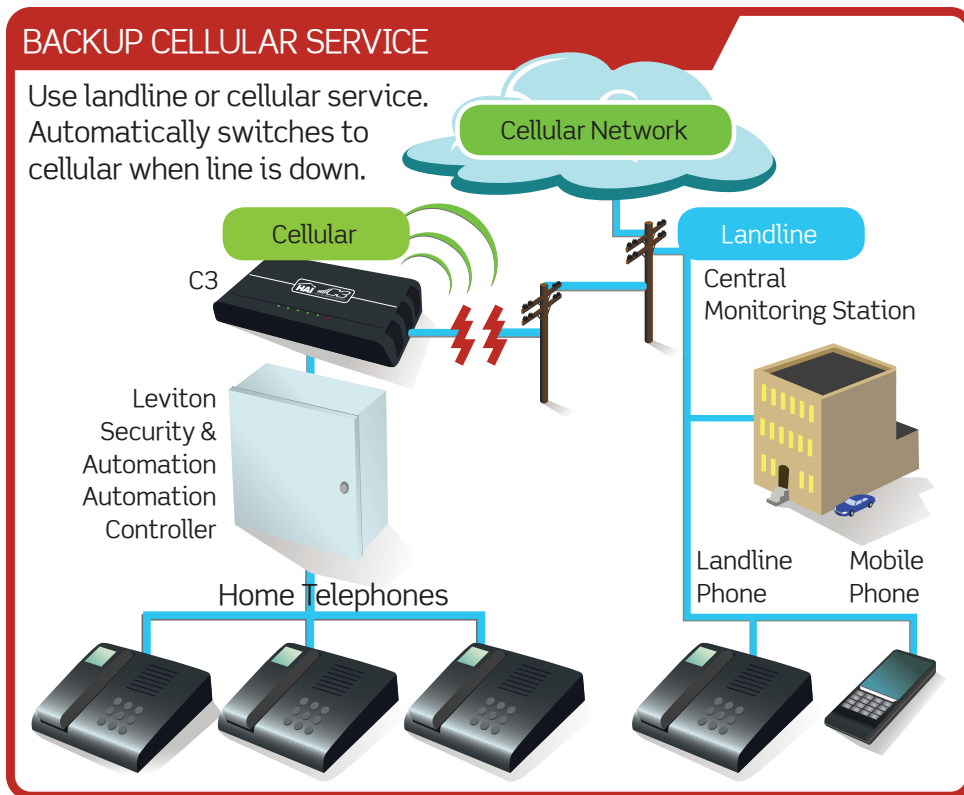
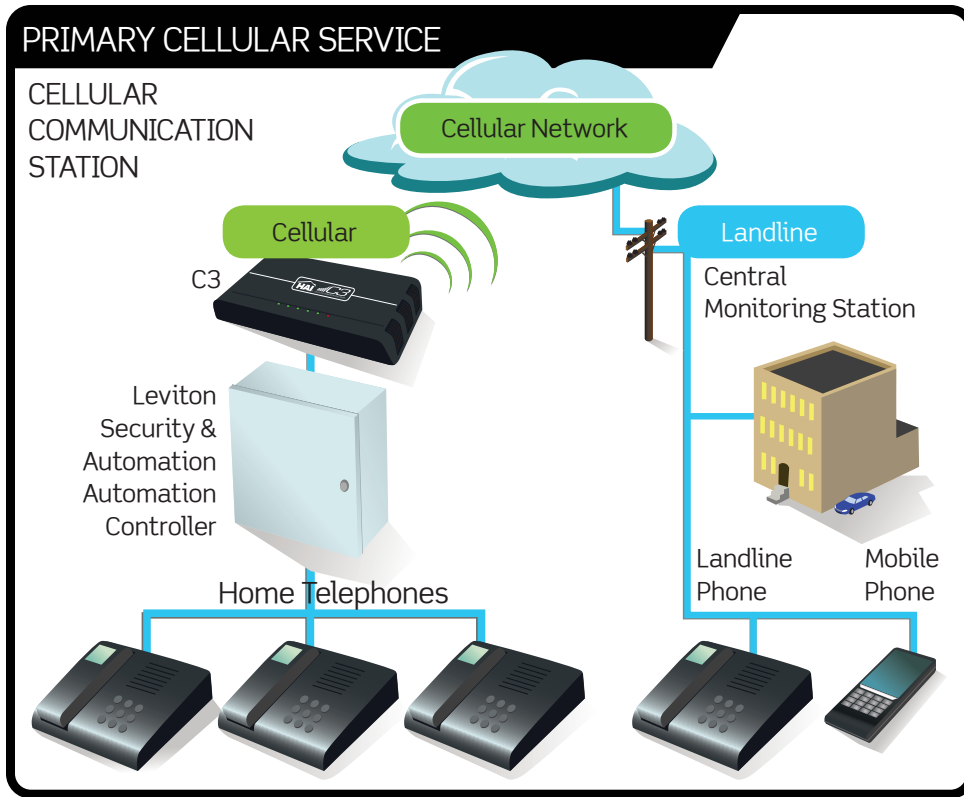

WIRING DIAGRAM

Lumina/Lumina Pro Energy Management Controllers

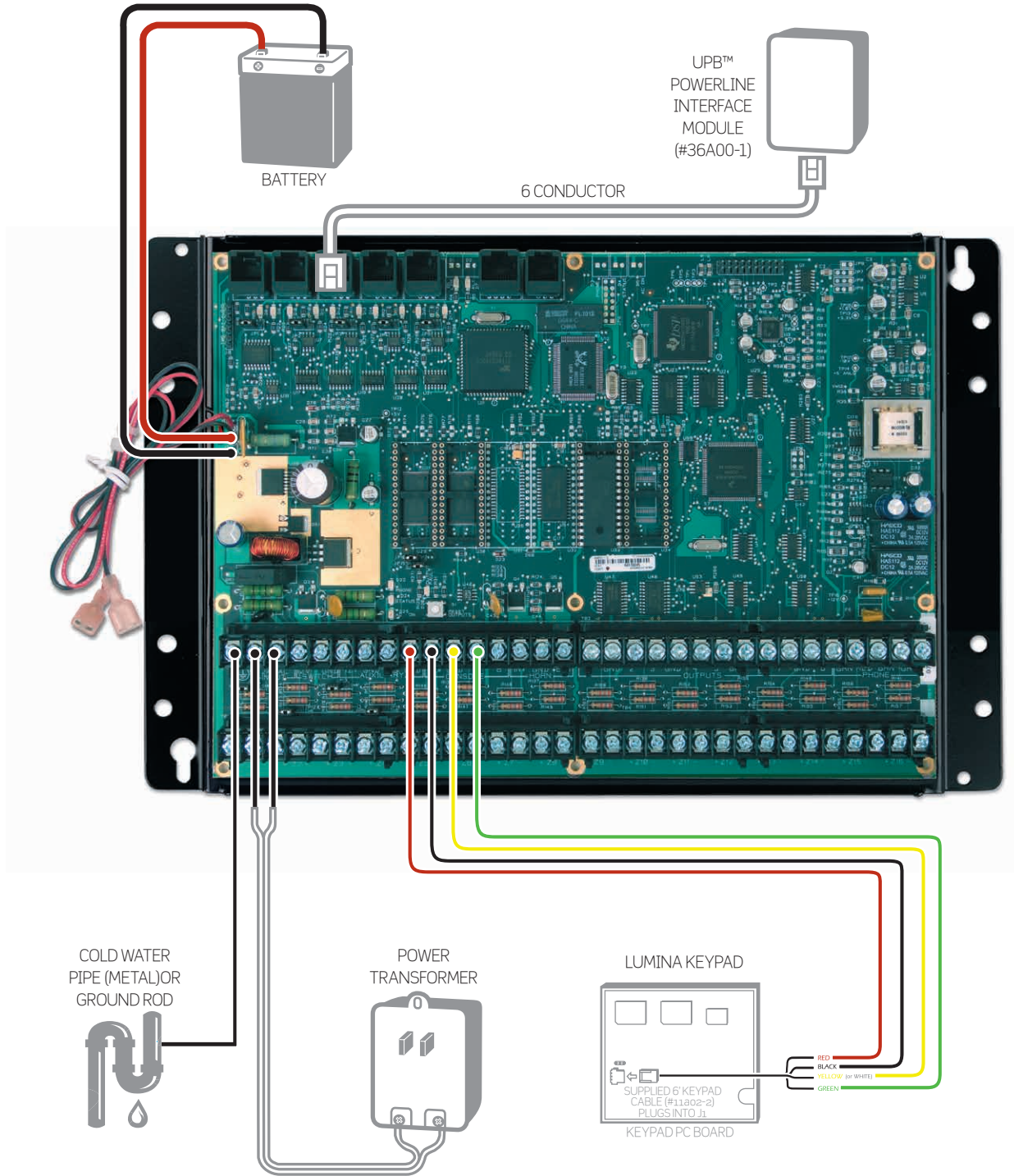

WIRING DIAGRAM

Hi-Fi 2 Four Zone, Four Source Distributed Audio System

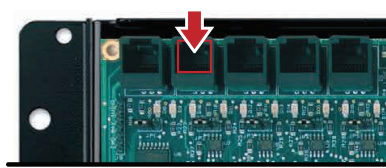

CONTROLLER (OPTIONAL)
 Connect to controller or other serial port device. With a controller select zone and source and control volume and power from an OmniTouch Touchscreen or via controller program.

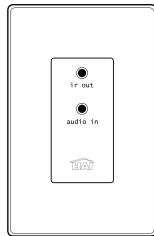

RIM
 Part #95A04-1
 • Remote Input Modules allow any source from anywhere in the house to be listened to in any or all zones.
 • Use Cat5 cable from the RIM to Remote Audio In on the Hi-Fi 2.
 • Add a max of 4 RIMs to the main board.

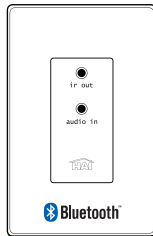

BRIM
 Part #95A04-2
 • Adds wireless connectivity to share streaming or stored music from smartphone, tablet, or computer.

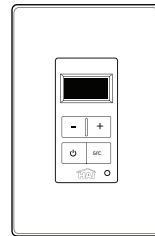

VSC
 Part #95A03-1
 • Volume-Source Controls allow selection of source and adjustment of volume, bass, treble, balance and source gain. VSCs also feature and IR receiver.
 • Use Cat5 cable from VSC to Zone Control In on the Hi-Fi-2.
 • Add a max of 4 VSCs to the main board.

LOCAL AUDIO INPUTS

Attach audio sources that are in the same location as the Hi-Fi2 4x4 system.

VARIABLE OUTPUT

Attach additional amplification to Zone 1.

PAGE INPUT

When triggered, all zones turn on at the preset paging volume and switch to source 4.

SYSTEM ON OUTPUT

When any audio zones turn on, this output activates an auxiliary amplifier equipped with a voltage trigger.

ZONE SPEAKERS

Total of 4 on the main board. Use 8-Ohm speakers and 16-gauge speaker wire (4-conductor stranded suggested for neat installation).

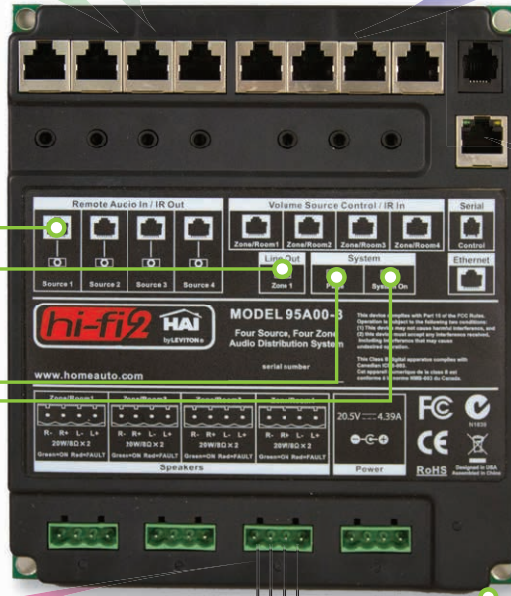

ETHERNET NETWORK PORT

Communicate with IP devices on the network. Free iOS app for controlling with iPhone, iPad, and iPod Touch.



POWER SUPPLY INPUT

WIRING DIAGRAM

Hi-Fi 2 Eight Zone, Eight Source Distributed Audio System

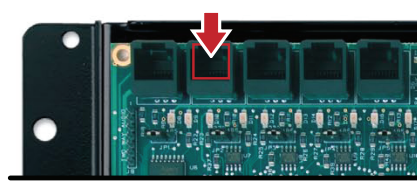

CONTROLLER (OPTIONAL)

Connect to controller or other serial port device. With a controller select zone and source and control volume and power from an OmniTouch Touchscreen or via controller program.

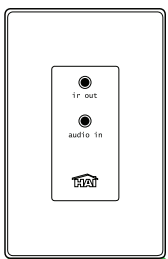

RIM

Part #95A04-1

- Remote Input Modules allow any source from anywhere in the house to be listened to in any or all zones.
- Use Cat5 cable from the RIM to Remote Audio In on the Hi-Fi 2.
- Add a max of 8 RIMs to the main board.

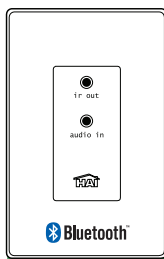

BRIM

Part #95A04-2

- Adds wireless connectivity to share streaming or stored music from smartphone, tablet, or computer.

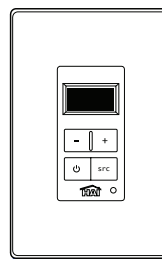

VSC

Part #95A03-1

- Volume-Source Controls allow selection of source and adjustment of volume, bass, treble, balance and source gain. VSCs also feature an IR receiver.
- Use Cat5 cable from VSC to Zone Control In on the Hi-Fi-2.
- Add a max of 8 VSCs to the main board.

LOCAL AUDIO INPUTS

Attach audio sources that are in the same location as the Hi-Fi2 8x8 system.

VARIABLE OUTPUTS

Attach additional amplification to Zone 1 and/or 8.

PAGE INPUT

When triggered, all zones turn on at the preset paging volume and switch to source 8.

SYSTEM ON OUTPUT

When any audio zones turn on, this output activates an auxiliary amplifier equipped with a voltage trigger.

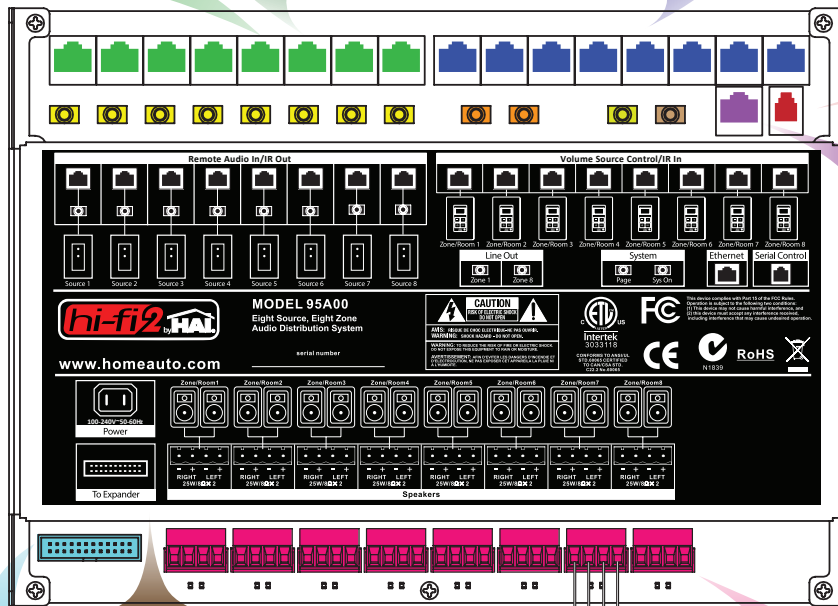

ETHERNET NETWORK PORT

Communicate with IP devices on the network. Free iOS app for controlling with iPhone, iPad, and iPod Touch.



POWER SUPPLY INPUT

100-240V~50-60Hz; Power cable supplied.

HI-FI 2 EXPANSION BOARD

Connect the Hi-Fi 2 Expansion Board via a supplied expansion cable to add an additional 8 zones to your Hi-Fi 2 audio system.

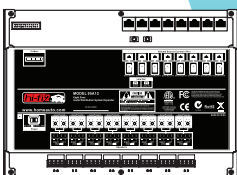

Part #95A12-1/-2

ZONE SPEAKERS

Total of 8 on the main board. Use 8-Ohm speakers and 16-gauge speaker wire (4-conductor stranded suggested for neat installation).

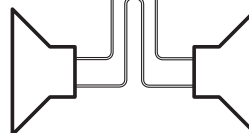

WIRING DIAGRAM

Omni-Bus Lighting Control Network

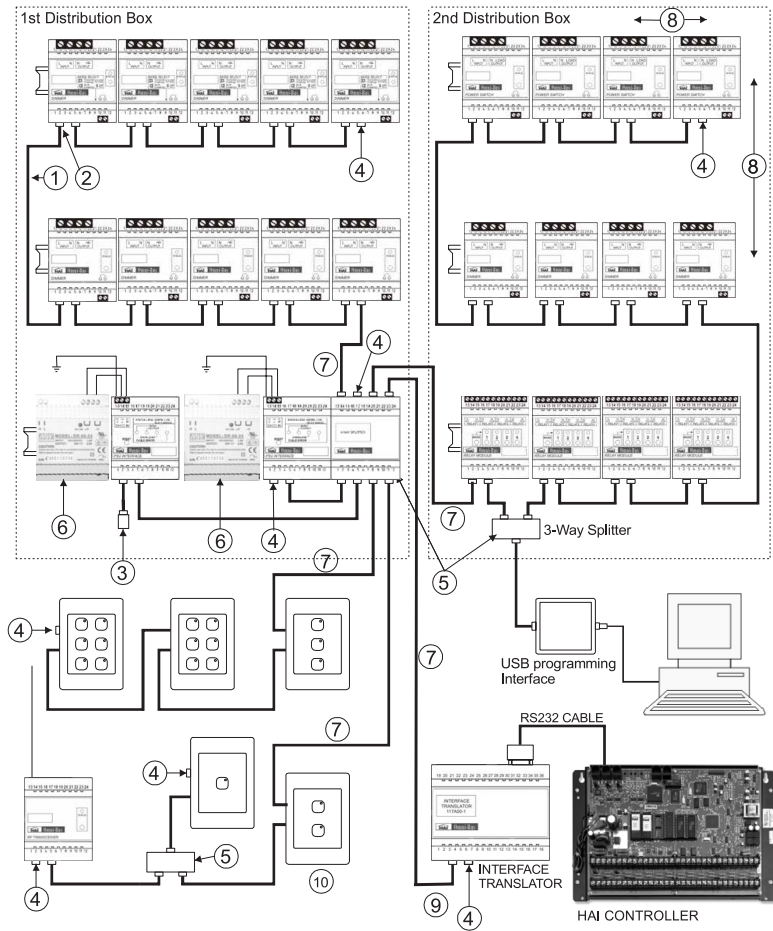

1. Network Cable
 - a. CAT5 UTP (Category 5 Unshielded Twisted pair (4 pairs), stranded or single core)
2. Crimp Connectors
 - a. All cable ends must be terminated with RJ45 plugs.
3. Network Termination Plug
 - a. Each network must have ONE and only one network Termination Plug (122A00-1).
 - b. It is recommended that the Termination Plug always be installed at the power supply interface.
4. Jumpers
 - a. No open ends or open connectors are allowed on the network.
 - b. All open ends or open connectors must be terminated with a Network Jumper Plug (121A00-1).
5. Splitters
 - a. Where a T-junction or network split is required, a Splitter box must be used (119A00-1 or 120A00-1).
 - b. A Splitter can be inserted anywhere on the network.
6. Power Supply
 - a. Each Power Supply Unit must be connected to the network via a separate Power Supply Interface unit (124A00-1).
 - b. Each power supply can supply up to 2A to the network.
 - c. More than one power supply can be used if the total network current consumption exceeds 2A

- d. To obtain the total current requirement, add up the individual current consumptions of all devices on the network.
- e. The power supply(s) must be installed at the point where most devices are located (usually the distribution board) to avoid excessive voltage drops over long cables.
- f. The supply voltage at any point on the cable (pin 1 and 8) must be between 15 and 24VDC.

7. Supply Distribution

- a. The total number of devices on a single network split from the power supplies must not exceed 50 devices.
- b. The total current consumption of devices on a single network split from the power supplies must not exceed 2A.

8. Device Placement and Isolation

- a. The Leviton Security & Automation Omni-Bus units have been designed to operate over an ambient temperature range between 0 °C and 40 °C at the rated maximum load capacities. Sufficient spacing and airflow between devices should be allowed for in the distribution board. The minimum recommended horizontal spacing between dimmer devices is one din rail module width (17mm or 2/3inches).
- b. All network connections and cabling are low voltage and optically isolated from the mains supply voltage and must thus be kept away from any mains wiring.
- c. Sufficient spacing must be allowed for this between consecutive din rails in the distribution board (minimum recommended spacing between din rail centers = 150mm or 6inches).
- d. Do NOT route any network cables via the same conduits as mains wiring.

9. Maximum Cable Length

- a. The total cable length on a single bus network may not exceed 1000m (3280feet).

10. Maximum Number of Devices

- a. The total number of devices on a single bus network may not exceed 256.

INDEX BY PART NUMBER

00688-00	Single-Gang Recessed Single Receptacle	118
00689-00	Single-Gang Recessed Duplex Receptacle	118
00690-00	Dual-Gang Recessed Duplex Receptacle and Openings for six QuickPort Modules	118
05261-0CH	Single-Gang Recessed Single Receptacle, Non-Magnetic Stainless Steel	118
05361-0CH	Single-Gang Recessed Single Receptacle, Non-Magnetic Stainless Steel	118
10A06-1	16 Zone Hardwire Expander	16
10A07-1	4 Relay Module	18
10A11-1	Two-Way Voice Module	17
10A17-1	RS-232/RS-485 Serial Board	18
1105W	Dealer PC Access Software	31
1106W	End User PC Access Software	31
1111	Lumina PC Access Software	31
1120	Snap-Link	34
1120A	Snap-Link Mobile for iPhone®	32
1120C	Snap-Link Mobile for Android™	33
1120D	Snap-Link Mobile for Kindle Fire™	33
1126	Automation Studio	30
1131	OmniTouch Pro	30
110A00-1	Omni-Bus Dimmer DIN Rail Module	62
110A00-2	Omni-Bus Universal Dimmer DIN Rail Module	62
111A00-1	Omni-Bus Power Switch DIN Rail Module	62
112A00-1	Omni-Bus Relay DIN Rail Module	62
113A00-1	1-Button Hardwired, White	63
113A00-2	1-Button Wireless, White	63
113A00-3	2-Button Hardwired, White	63
113A00-4	2-Button Wireless, White	63
113A00-5	3-Button Hardwired, White	63
113A00-6	3-Button Hardwired, Brushed Stainless	64
113A00-7	3-Button Wireless, White	63
113A00-8	6-Button Hardwired, White	63
113A00-9	6-Button Hardwired, Brushed Stainless	64
114A00-1	6-Channel Universal Switch Interface Module	63
114A01-1	Omni-Bus Cable Assemblies for Universal Switch Interface Module	64
115A00-1	RF Transceiver DIN Rail Module	61
116A00-1	USB Programming Interface Unit	61
117A00-1	Interface Translator DIN Rail Module	60
118A00-1	DALI Gateway DIN Rail Module	61
119A00-1	3-Way Splitter	61
120A00-1	8-Way Splitter DIN Rail Module	60
121A00-1	Jumper Plugs	61
122A00-1	Termination Plug	61
123A00-1	Power Supply 2.5A DIN Rail Module	60
124A00-1	Power Supply Interface 2A DIN Rail Module	60
125A00-1	Keypad Remote Control, 6-Channel	64
125A00-2	Keypad Remote Control, 16-Channel	64
126A00-1	Omni-Bus Scene Control Module	60
14A00-8	Water Temperature Sensor	69
17A00-1	Expansion Enclosure	16
17A00-8	Expansion Board Only	16
17A00-9	16 Zone/16 Output Expansion	16
18A00-5	Demo Adapter Kit	133
18A00-13	OmniPro II Demo System with OmniTouch and HLC	133
18A00-14	Lumina Demo Case	133
18A00-15	Hi-Fi 2 Demo Case	133
18A00-16	International Demo Case	133

18A00-20.....	MicroControl Energy Management Demo Case	133
19A00-1.....	8 Relay Module	18
1K120-01W.....	1000 120V 1 PH 2W 100A 1 split CT Indoor	74
1K120-02W.....	1000 120V 1 PH 2W 200A 1 split CT Indoor	74
1K120-04W.....	1000 120V 1 PH 2W 400A 1 split CT Indoor	74
1K120-08W.....	1000 120V 1 PH 2W 800A 1 split CT Indoor	74
1K120-1SW.....	1000 120V 1 PH 2W 100A 1 solid CT Indoor	74
1K120-2SW.....	1000 120V 1 PH 2W 200A 1 solid CT Indoor	74
1K240-01W.....	1000 120/240V 1 PH 3W 100A 2 split CT Indoor	74
1K240-02W.....	1000 120/240V 1 PH 3W 200A 2 split CT Indoor	74
1K240-04W.....	1000 120/240V 1 PH 3W 400A 2 split CT Indoor	74
1K240-08W.....	1000 120/240V 1 PH 3W 800A 2 split CT Indoor	74
1K240-1SW.....	1000 120/240V 1 PH 3W 100A 2 solid CT Indoor	74
1K240-2SW.....	1000 120/240V 1 PH 3W 200A 2 solid CT Indoor	74
1K277-01W.....	1000 277V 1PH 2W 100A 1 split CT Indoor	74
1K277-02W.....	1000 277V 1PH 2W 200A 1 split CT Indoor	74
1K277-04W.....	1000 277V 1PH 2W 400A 1 split CT Indoor	74
1K277-08W.....	1000 277V 1PH 2W 800A 1 split CT Indoor	74
1K277-1SW.....	1000 277V 1PH 2W 100A 1 solid CT Indoor	74
1K277-2SW.....	1000 277V 1PH 2W 200A 1 solid CT Indoor	74
1O120-01W.....	1000 120V 1 PH 2W 100A 1 split CT Outdoor	74
1O120-02W.....	1000 120V 1 PH 2W 200A 1 split CT Outdoor	74
1O120-04W.....	1000 120V 1 PH 2W 400A 1 split CT Outdoor	74
1O120-08W.....	1000 120V 1 PH 2W 800A 1 split CT Outdoor	74
1O240-01W.....	1000 120/240V 1 PH 3W 100A 2 split CT Outdoor	74
1O240-02W.....	1000 120/240V 1 PH 3W 200A 2 split CT Outdoor	74
1O240-04W.....	1000 120/240V 1 PH 3W 400A 2 split CT Outdoor	74
1O240-08W.....	1000 120/240V 1 PH 3W 800A 2 split CT Outdoor	74
1O277-01W.....	1000 277V 1PH 2W 100A 1 split CT Indoor	74
1O277-02W.....	1000 277V 1PH 2W 200A 1 split CT Indoor	74
1O277-04W.....	1000 277V 1PH 2W 400A 1 split CT Indoor	74
1O277-08W.....	1000 277V 1PH 2W 800A 1 split CT Indoor	74
20A00-2.....	OmniPro II Controller	14
20A00-21.....	OmniPro II Board Only	14
20A00-5.....	OmniPro II Commercial Controller	14
20A00-50.....	Omni IIe Controller	14
20A00-52.....	Omni IIe Controller for Structured Wiring Enclosure	15
20A00-53.....	Omni IIe Board Only	15
20A00-70.....	Omni LTe Controller	15
20A00-72.....	Omni LTe Controller for Structured Wireless Controllers	15
20A00-73.....	Omni LTe board Only	15
20A00-8.....	OmniPro II Controller for Structured Wiring Enclosure	14
20A07-2.....	Universal Mounting Plate	18
21A05-2.....	Serial PC Cable	19
21A06-1.....	Enclosure Lock and Two Keys	18
23A00-1.....	Surface Mount Remote Indoor Temp Sensor	68
23A00-2.....	Flush Mount Remote Indoor Temp Sensor	68
28A00-1.....	Surface Speaker Microphone	17
28A00-2.....	Flush Speaker Microphone	17
29A00-1.....	Thermostat Isolation Module	68
2K208-01W.....	2000 120/208V 3 PH 4W 100A 3 split CT Indoor	75
2K208-02W.....	2000 120/208V 3 PH 4W 200A 3 split CT Indoor	75
2K208-04W.....	2000 120/208V 3 PH 4W 400A 3 split CT Indoor	75
2K208-08W.....	2000 120/208V 3 PH 4W 800A 3 split CT Indoor	75
2K208-12W.....	2000 120/208V 3 PH 4W 1200A 3 split CT Indoor	75
2K208-1SW.....	2000 120/208V 3 PH 4W 100A 3 solid CT Indoor	75
2K208-2SW.....	2000 120/208V 3 PH 4W 200A 3 solid CT Indoor	75
2K480-01W.....	2000 120/240V 1 PH 3W 100A 3 split CT Indoor	75
2K480-02W.....	2000 120/240V 1 PH 3W 200A 3 split CT Indoor	75
2K480-04W.....	2000 120/240V 1 PH 3W 400A 3 split CT Indoor	75
2K480-08W.....	2000 120/240V 1 PH 3W 800A 3 split CT Indoor	75

2K480-12W	2000 120/240V 1 PH 3W 1200A 3 split CT Indoor	75
2K480-1SW	2000 120/240V 1 PH 3W 100A 3 solid CT Indoor	75
2K480-2SW	2000 120/240V 1 PH 3W 200A 3 solid CT Indoor	75
2K208-01D	2000 120/208V 3 PH 4W 100A 3 split CT Indoor	75
2K208-02D	2000 120/208V 3 PH 4W 200A 3 split CT Indoor	75
2K208-04D	2000 120/208V 3 PH 4W 400A 3 split CT Indoor	75
2K208-08D	2000 120/208V 3 PH 4W 800A 3 split CT Indoor	75
2K208-12D	2000 120/208V 3 PH 4W 1200A 3 split CT Indoor	75
2K480-01D	2000 277/480V 3PH 4W 100A 3 split CT Indoor	75
2K480-02D	2000 277/480V 3PH 4W 200A 3 split CT Indoor	75
2K480-08D	2000 277/480V 3PH 4W 400A 3 split CT Indoor	75
2K480-08D	2000 277/480V 3PH 4W 800A 3 split CT Indoor	75
2K480-12D	2000 277/480V 3PH 4W 1200A 3 split CT Indoor	75
2O208-01W	2000 120/208V 3 PH 4W 100A 3 split CT Outdoor	75
2O208-02W	2000 120/208V 3 PH 4W 200A 3 split CT Outdoor	75
2O208-04W	2000 120/208V 3 PH 4W 400A 3 split CT Outdoor	75
2O208-08W	2000 120/208V 3 PH 4W 800A 3 split CT Outdoor	75
2O208-12W	2000 120/208V 3 PH 4W 1200A 3 split CT Outdoor	75
2O480-01W	2000 120/240V 1 PH 3W 100A 3 split CT Outdoor	75
2O480-02W	2000 120/240V 1 PH 3W 200A 3 split CT Outdoor	75
2O480-04W	2000 120/240V 1 PH 3W 400A 3 split CT Outdoor	75
2O480-08W	2000 120/240V 1 PH 3W 800A 3 split CT Outdoor	75
2O480-12W	2000 120/240V 1 PH 3W 1200A 3 split CT Outdoor	75
3005C-C00	Single-Gang Non-Metallic Datacom Box	116
30A00-2	Thermostat Power Supply Module	68
31A00-7	Extended Range Indoor/Outdoor Temperature Sensor	69
31A00-8	Extended Range Indoor/Outdoor Temperature & Humidity Sensor	69
33A00-1	Omni Console	17
33A00-19	Lumina Keypad	41
33A00-20	Lumina Keypad with Built-in Speaker/Microphone	41
33A00-23	International Market Omni Console	17
33A00-24	International Market Omni Console w/Built-In Speaker/Mic	17
33A00-25	International Market Lumina Keypad	41
33A00-26	International Market Lumina Keypad w/Built-In Speaker/Mic	41
33A00-3	Flush Mount Kit	17
33A00-4	Omni Console with Built-in Speaker/Microphone	17
35A00-1600W UPB™ Dimmer Switch	44
35A00-1CFL	CFL/LED Dimmer	44
35A00-3600W UPB™ Non-Dimming Switch	44
35A14-color	Switch Color Change Kit	44
36A00-1	UPB™ Powerline Interface Module and Cable	47
36A05-2	UPB™ Powerline Interface Module to Computer Cable	19
36A05-4	Serial Connectivity Cable	19
37A00-1	Auxiliary Switch	44
38A00-1	Scene Switch, 6 Button	45
38A00-2	House Status Switch, 8 Button	45
38A04-color	Scene Switch & Lumina Mode Switch Color Change Kit	46
38A05-color	House Status Switch Color Change Kit	46
38A06-2	Custom Legend Kit for Scene or House Status Switch	46
38A14-1	Scene Switch Remote	46
38A15-color	Table Top Scene Switch Cradle	46
38A16-color	Table Top Scene Switch with Cradle	46
39A00-1	Phase Coupler	47
39A00-2	UPB™ Split Phase Repeater	47
39A00-3	UPB™ Three Phase Repeater	47
4007C-C00	Single-Gang Low-Voltage Datacom Cut-in Bracket	116
40734-CV	QuickPort S-Video Feedthrough	111
40735-Rx	QuickPort RCA to 110	111
40782-CPF	QuickPort Compression F-Connector (white only)	111
40782-R•W	QuickPort Compression RCA Connector	111

40812-RTK.....	Residential Tool Kit	105
40830-B*E.....	QuickPort RCA w/ black stripe	111
40830-B*R.....	QuickPort RCA w/ red stripe	111
40830-B*Y.....	QuickPort RCA w/ yellow stripe	111
40830-B~L.....	QuickPort RCA w/ blue stripe	111
40830-B~V.....	QuickPort RCA w/ green stripe	111
40831-0B°.....	QuickPort F-Connector, gold plated, 3.0 GHz	111
40832-0B°.....	QuickPort BNC Bulkhead Module, gold plated	111
40833-B°E.....	QuickPort Binding Post Adapter, gold plated w/ black stripe	111
40833-B°R.....	QuickPort Binding Post Adapter, gold plated w/ red stripe	111
40834-00#.....	QuickPort HDMI Passthrough	11
40835-00~.....	QuickPort USB A-A Connector, feedthrough	111
40837-B°E.....	QuickPort Banana Jack Adapter, gold plated w/ black stripe	111
40837-B°R.....	QuickPort Banana Jack Adapter, gold plated w/ red stripe	111
40839-S~S.....	QuickPort 3.5 mm Stereo, screw terminal	111
40984-000.....	75 Ohm Termination Cap, 25 per polybag pack	119
40951-1P.....	Single-Gang Single Spring-Clip Device Audio/Video Wallplate	118
40952-2P.....	Single-Gang Double Spring-Clip Device Audio/Video Wallplate	118
40866-DSS.....	DSS 75 Ohm and 2.0 GHz Combiner with DC Blocking	121
40866-DSS.....	DSS Signal Amplifier	121
40867-DSS.....	DSS 2-Way Splitter	121
40868-DSS.....	DSS 4-Way Splitter	121
40985-0Q6.....	One-Piece Crimp-On F-Connector for RG6	120, 123
40985-1P6.....	One-Piece Crimp-on F-Connector for RG6, 100, nickel	120, 123
40985-1P9.....	One-Piece Crimp-on F-Connector for RG59, 100, nickel	120, 123
40985-2P6.....	Two-Piece Crimp-on F-Connector for RG6, 100, nickel	120, 123
40985-2P9.....	Two-Piece Crimp-on F-Connector for RG59, 100, nickel	120, 123
40985-CPF.....	Compression F-Connector	111
40985-CRU.....	RCA Compression Connector (colored rings included)	111
40986-000.....	75 Ohm In-Line Cable Connector	120, 123
40987-002.....	Two-Way Splitter, gold plated, individual polybag pack	119
40987-003.....	Three-Way Splitter, gold plated, individual polybag pack	119
40987-004.....	Four-Way Splitter, gold plated, individual polybag pack	119
40989-ACT.....	EZ-RJ45 Crimp Tool	105
40989-CPT.....	Master Compression Tool	105
40A00-1.....	15A Relay Switch	44
41080-1WP, white.....	1-Port Flush Mount	113
41080-1TP, light almond.....	1-Port Flush Mount	113
41080-1IP, ivory.....	1-Port Flush Mount	113
41080-2WP, white.....	2-Port Flush Mount	113
41080-2TP, light almond.....	2-Port Flush Mount	113
41080-2IP, ivory.....	2-Port Flush Mount	113
41080-3IP.....	3-Port Flush Mount, ivory	113
41080-3TP.....	3-Port Flush Mount, light almond	113
41080-3WP.....	3-Port Flush Mount, white	113
41080-4IP.....	4-Port Flush Mount, ivory	113
41080-4TP.....	4-Port Flush Mount, light almond	113
41080-4WP.....	4-Port Flush Mount, white	113
41080-6IP.....	6-Port Flush Mount, ivory	113
41080-6TP.....	6-Port Flush Mount, light almond	113
41080-6WP.....	6-Port Flush Mount, white	113
41081-4WP.....	4-Port Wallplate, white	113
41081-4TP.....	4-Port Wallplate, light almond	113
41081-4IP.....	4-Port Wallplate, ivory	113
41081-2WP.....	2-Port Wallplate, white	113
41081-2TP.....	2-Port Wallplate, light almond	113
41081-2IP.....	2-Port Wallplate, ivory	113
41084-B*B.....	QuickPort Snap-in Blank Module	111
41084-B*F.....	QuickPort BNC Bulkhead Module, standard	111
41084-F*F.....	QuickPort F-Connector, standard, 3.0 GHz	111
4108W-1SP.....	1-Port Wallplate, recessed	113

4108W-OSP	1-Port Wallplate, flush	113
41106-R#6.....	QuickPort Voice Grade 6-Conductor Connector	111
41108-R#3.....	QuickPort CAT 3 Connector	111
41108-R#5.....	QuickPort CAT 5 Connector	111
41108-R#8.....	QuickPort Voice Grade 8-Conductor Connector	111
41641-00I.....	1-Port Insert, polybag, standard carton, ivory	114
41641-00T.....	1-Port Insert, polybag, standard carton, light almond	114
41641-00W	1-Port Insert, polybag, standard carton, white	114
41642-00I.....	2-Port Insert, polybag, standard carton, ivory	114
41642-00T.....	2-Port Insert, polybag, standard carton, light almond	114
41642-00W	2-Port Insert, polybag, standard carton, white	114
41643-00I.....	3-Port Insert, polybag, standard carton, ivory	114
41643-00T.....	3-Port Insert, polybag, standard carton, light almond	114
41643-00W	3-Port Insert, polybag, standard carton, white	114
41644-00I.....	4-Port Insert, polybag, standard carton, ivory	114
41644-00T.....	4-Port Insert, polybag, standard carton, light almond	114
41644-00W	4-Port Insert, polybag, standard carton, white	114
41646-00I.....	6-Port Insert, polybag, standard carton, ivory	114
41646-00T.....	6-Port Insert, polybag, standard carton, light almond	114
41646-00W	6-Port Insert, polybag, standard carton, white	114
41647-00I.....	HDMI Decora Insert, feedthrough, ivory	114
41647-00W	HDMI Decora Insert, feedthrough, white	114
41648-00I.....	DVI Decora Insert, feedthrough, ivory	114
41648-00W	DVI Decora Insert, feedthrough, white	114
42400-8FG.....	8-Conductor Flat Telephone Patch Cord	104
42081-4IS.....	4-Port Wallplate w/ ID window, ivory	113
42081-4TS.....	2-Port Wallplate w/ ID window, light almond	113
42081-4WS	2-Port Wallplate w/ ID window, white	113
42081-2IS.....	2-Port Wallplate w/ ID window, ivory	113
42081-2TS.....	2-Port Wallplate w/ ID window, light almond	113
42081-2WS	2-Port Wallplate w/ ID window, white	113
43080-1S1.....	Single-Gang Wallplate, 1-Port	113
43080-1S2.....	Single-Gang Wallplate, 2-Port	113
43080-1S3.....	Single-Gang Wallplate, 3-Port	113
43080-1S4.....	Single-Gang Wallplate, 4-Port	113
43080-1S6.....	Single-Gang Wallplate, 6-Port	113
43080-2S2.....	Dual-Gang Wallplate, 2-Port	113
43080-2S4.....	Dual-Gang Wallplate, 4-Port	113
43080-2S6.....	Dual-Gang Wallplate, 6-Port	113
43080-2S8.....	Dual-Gang Wallplate, 8-Port	113
43080-S12.....	Dual-Gang Wallplate, 12-Port	113
43081-1L4.....	4-Port Angled Wallplate, single-gang	113
43105-005.....	Reclosable Tie-Wrap, 5" Length, 25/pack	105
43108-008.....	Reclosable Tie-Wrap, 8" Length, 25/pack	105
43112-012.....	Reclosable Tie-Wrap, 12" Length, 25/pack	105
44A00-1.....	Lumina Energy Management Controller	41
44A00-2.....	Lumina Pro Energy Management Controller	41
44A00-3.....	Lumina Energy Management Controller on Backplate	41
44A00-4.....	Lumina Pro Energy Management Controller on Backplate	41
44A00-22.....	Lumina Pro International, In Enclosure	41
44A00-23.....	Lumina Pro International, for Structured Wiring Enclosure	41
45A00-1.....	.64 Zone Wireless Receiver	20
46A00-1.....	Door/Window Transmitter	21
47112-00E.....	Decora Mobile Device Station, Black	118
47112-00T.....	Decora Mobile Device Station, Light Almond	118
47112-00W	Decora® Mobile Device Station, White	118
47112-ROB	Renu Mobile Device Station, Onyx Black	118
47112-RNS.....	Renu Mobile Device Station, Navajo Sand	118
47112-RWW	Renu® Mobile Device Station, White on White	118
47600-QPB.....	12-Port QuickPort Mounting Bracket	104
47602-24E.....	Media Versatile Panel w/cover	101

47602-BKE.....	Mounting Brackets	101
47603-0C5.....	CAT 5e Voice and Data Board	108
47603-110.....	1x9 Bridged Telephone Board	109
47603-12B.....	4x12 Telephone Distribution Board	109
47603-12M.....	4x12 Telephone Distribution Panel	107
47603-12P.....	12-Port Structured Media Panel	107
47603-18B.....	4x18 Telephone Distribution Board	109
47603-18M.....	4x18 Telephone Distribution Panel	107
47603-18P.....	18-Port Structured Media Panel	107
47603-1G4.....	1x9 Bridged Telephone and 4-way 1 GHz TV Splitter	106
47603-1G6.....	1x9 Bridged Telephone and 6-way 1 GHz TV Splitter	106
47603-1G8.....	1x9 Bridged Telephone and 8-way 1 GHz TV Splitter	106
47603-24P.....	24-Port Structured Media Panel	107
47603-412.....	4x12 Telephone Distribution Panel w/ Splitter	107
47603-8C1.....	4x18 Telephone Distribution Panel w/ CAT 5e Board	107
47603-DP6.....	1x4 Bridged Telephone, 4 Data, and 6-way 1 GHz TV Splitter	106
47603-TDM.....	Telephone Line Distribution Board	109
47603-TSV.....	1x7 Bridged Telephone, Security Interface, and 6-way 1 GHz TV Splitter	106
47604-0F6.....	MDU Kit	97
47604-F6S.....	MDU Kit	97
47605-0DP.....	Surge AC Power Module, two duplex receptacles	103
47605-140.....	14" Enclosure and Flush-Mount Cover	97
47605-14B.....	14" Flush-Mount Cover, job packed, 6 per pack	97
47605-14C.....	14" Flush-Mount Cover	97
47605-14D.....	14" Economy Hinged Door	97
47605-14E.....	14" Enclosure	97
47605-14G.....	14" Enclosure, job packed, 6 per pack	97
47605-14P.....	14" Premium Hinged Door	97
47605-14S.....	14" Premium Vented Hinged Door	97
47605-1MG.....	14" Multi-Dwelling Unit Configuration A	97
47605-21C.....	21" Flush-Mount Cover	97
47605-21E.....	21" Enclosure	97
47605-21S.....	21" Premium Vented Hinged Door	97
47605-28B.....	28" Flush Mount Cover only job packed, 3 per pack	98
47605-28D.....	28" Economy Hinged Cover	98
47605-28G.....	28" Enclosure only, job packed, 3 per pack	98
47605-28N.....	28" Enclosure only	98
47605-28P.....	28" Premium Hinged Cover	98
47605-28W.....	28" Enclosure and Flush Mount Cover	98
47605-2BP.....	28" Pre-Fab Back Plate	98
47605-2MG.....	28" Multi-Dwelling Unit Configuration A	98
47605-42D.....	42" Economy Hinged Cover	99
47605-42N.....	42" Enclosure only	99
47605-42P.....	42" Premium Hinged Cover	99
47605-42W.....	42" Enclosure and Flush Mount Cover	99
47605-4BP.....	42" Pre-Fab Back Plate	99
47605-4MG.....	42" Multi-Dwelling Unit Configuration A	99
47605-ACS.....	Surge J-Box Kit, one duplex receptacle	103
47605-ACN.....	Non-Surge J-Box Kit, one duplex receptacle	103
47605-C5B.....	CAT 5e Voice & Data Module	108
47605-F28.....	28" Flush Mount Cover	98
47605-F42.....	42" Flush Mount Cover	99
47605-M28.....	28" Multi-Dwelling Unit Configuration B	98
47605-M42.....	42" Multi-Dwelling Unit Configuration B	99
47605-MDC.....	Compact Structured Media Enclosure Cover only	97
47605-MDU.....	Compact Structured Media Enclosure and Cover, empty	97
47605-PSA.....	Universal DC Power Supply, nine 12 VDC connectors and one IEC AC receptacle	103
47605-PSB.....	Universal Mini DC Power Supply, three 12 VDC connectors	103
47605-PSC.....	Versatile Power Supply, six 12 VDC connectors	

	and two NEMA 15A receptacles	103
47606-AHT	Advanced Home Telephone & Video Panel	107
47606-ASO	Advanced Home Office Panel	107
47606-BNP	Basic Home Networking Plus Panel	107
47606-BTV	Basic Telephone & Video Panel	107
47609-004	1x4 Bridged Telephone Board	109
47609-0F6	1x6 Bridged Telephone Board	109
47609-4DP	Combo Phone & Data Board w/ 1x4 Bridged Phone and 4-Port CAT 5e	108
47609-4X4	4X4 Telephone Line Breakout Module	105
47609-D5P	VDSL Board w/ 1x5 Bridged Phone w/ Data Passthrough IDCs	108
47609-EMP	Telephone Patching Board/Expanded 4-line Telephone Distribution	109
47609-S10	1x10 Bridged Telephone Board	109
47609-TSV	Telephone Security Module	108
47611-0C6	CAT 6 Voice and Data Board	108
47611-5GB	Gigabit 5-Port Ethernet Switch	102
47611-5PT	100 Mbps 5-Port Ethernet Switch	102
47611-8PT	100 Mbps 8-Port Ethernet Switch	102
47611-C6B	CAT 6 Voice & Data Module	108
47611-GT4	100 Mbps 4-Port Internet Router	102
47612-1SB	Standard Universal Mounting Bracket	105
47612-28B	Extender Bracket for 28" Structured Media Centers	99
47612-42B	Extender Bracket for 42" Structured Media Centers	99
47612-6SB	Compact Universal Mounting Bracket	105
47612-CBK	Combo Bracket	105
47612-DBK	Data Plastic Bracket, for mounting routers and switches	104
47612-EBK	Standard Expansion Plastic Bracket for up to five expansion boards	104
47612-FSB	Standard Universal Security Board Mounting Plate	105
47612-HBK	Compact Expansion Plastic Bracket for up to three expansion boards	104
47612-HSB	Compact Universal Security Board Mounting Plate	105
47612-MMA	Multimedia Adapter Bracket	104
47612-SBK	Single Plastic Bracket, for single expansion board	104
47612-UBK	Universal Shelf Bracket	105
47612-VSB	Shelf Plastic Bracket, for up to three expansion boards and CATV splitter	104
47613-EZC	EZ-RJ45 Connector, 50/pack	105
47613-EZR	EZ-RJ45 Connector Display Pack, 10/pack	105
47615-NYL	Push-Lock Pins for SMCs, 20/pack	105
47616-DSB	DSL Filter Module	108
47616-DSF	DSL Filter Board	109
47617-HPC	High-Profile Cover	118
47617-LPF	Low-Profile Frame	118
47617-PLT	Replacement Snap-in Plates	118
47617-RBH	Recessed Entertainment Box w/ High-Profile Cover	118
47617-REB	Recessed Entertainment Box w/ Low-Profile Frame	118
47689-00B	1x9 Bridged Telephone Module	108
47690-004	1x4 Passive Video Splitter, 1Ghz	110
47690-006	1x6 Passive Video Splitter, 1Ghz	110
47690-008	1x8 Passive Video Splitter, 1Ghz	110
47690-04C	1x4 Passive Video Splitter w/ bracket, 1Ghz	110
47690-06C	1x6 Passive Video Splitter w/ bracket, 1Ghz	110
47690-08C	1x8 Passive Video Splitter w/ bracket, 1Ghz	110
47690-0G4	1x4 Passive Video Splitter, 2Ghz	110
47690-0G6	1x6 Passive Video Splitter, 2Ghz	110
47690-0G8	1x8 Passive Video Splitter, 2Ghz	110
47690-4C2	1x4 Passive Video Splitter w/ bracket, 2Ghz	110
47690-6C2	1x6 Passive Video Splitter w/ bracket, 2Ghz	110
47690-8C2	1x8 Passive Video Splitter w/ bracket, 2Ghz	110

47690-0G4.....	1x4 Passive Video Splitter, 2Ghz	110
47690-0G6.....	1x6 Passive Video Splitter, 2Ghz	110
47690-0G8.....	1x8 Passive Video Splitter, 2Ghz	110
47691-3MS.....	Multi-Switch Module	110
47693-01P.....	1x1 Premium Video Module	110
47693-08P.....	1x8 Premium Video Module	110
47693-16P.....	1x16 Premium Video Module	110
47693-31P.....	3x1 Passive Combiner	110
476TL-T12.....	Telephone Input Distribution Panel	106
476TM-512.....	Twist & Mount Patch Panel - 12 ports of 6 CAT 5e	106
476TM-524.....	Twist & Mount Patch Panel - 24 CAT 5e	106
476TM-612.....	Twist & Mount Patch Panel - 12 ports of 6 CAT 6	106
476TM-624.....	Twist & Mount Patch Panel - 24 CAT 6	106
476TM-652.....	Twist & Mount Patch Panel - 6 CAT 6 and 6 CAT 5e	106
476TM-654.....	Twist & Mount Patch Panel - 12 CAT 6 and 12 CAT 5e	106
47A00-2.....	Quad Pet Immune Motion Detector	20
47FTH-420.....	42" + 14" Dual Multi-Bay Enclosure	100
47FTH-440.....	14" + 14" Dual Multi-Bay Enclosure	100
47FTH-840.....	28" + 14" Dual Multi-Bay Enclosure	100
47FTH-844.....	28" + 14" + 14" Triple Multi-Bay Enclosure	100
47FTH-880.....	28" + 28" Dual Multi-Bay Enclosure	100
48A00-1.....	4 Button Keyfob	20
48210-0VA.....	Video Amplifier Module	110
48212-06S.....	AC Surge Module, six receptacles	103
48212-124.....	DC Bus Module	103
48212-IEC.....	IEC TO NEMA 15A Adapter Power Cord	103
49553-066.....	.66-Clip Blade	105
49553-110.....	.110 IDC Blade	105
49553-814.....	Wire Punchdown/Termination Tool	105
49553-AWL.....	Awl (woodscrew starter punch)	105
49553-BIX.....	BIX® Blade	105
49553-KRN.....	Krone® Blade	105
49660-00P.....	UTP Stripping Tool	105
5020C-00W.....	3-Port Insert, includes blank insert, white	116
5020C-00T.....	3-Port Insert, includes blank insert, light almond	116
5020C-00I.....	3-Port Insert, includes blank insert, ivory	116
5020C-00E.....	3-Port Insert, includes blank insert, black	116
50A00-1.....	Panic/Alert Pendant	20
51084-CLB.....	Color Label Kit †	114
51084-ICN.....	QuickPort Shutter Kit	114
51084-XLB.....	White Label Kit	114
54A00-1.....	Access Control Keypad	24
55A00-3color.....	UPB™ 2400W Dimmer Switch	45
55A03-1.....	HLC 2400W Dimmer Wall Plate, White	45
55A03-2.....	HLC 2400W Dimmer Wall Plate, Ivory	45
56A00-1.....	Wireless Recessed Door Contact	21
57A00-1.....	Vanishing Contact	21
58A00-1.....	Mini Contact	21
59A00-1.....	UPB™ Lamp Module	45
5EA20-S1.....	One Data, standard	115
5EA20-M1.....	One Data, midway	115
5EA20-S2.....	One Data, One F-Style, standard	115
5EA20-M2.....	One Data, One F-Style, midway	115
5EA20-S3.....	One Data, One Phone, One F-Style, standard	115
5EA20-M3.....	One Data, One Phone, One F-Style, midway	115
5EA20-S4.....	Two Data, Two F-Style, standard	115
5EA20-M4.....	Two Data, Two F-Style, midway	115
5EHOM-R†5.....	QuickPort Home 5e Connector, Standard	111
5F100-6QP.....	QuickPort® Mounting Plate, 6-pack, unloaded	104
5F100-6VF.....	F-Connector Mounting Plate, 6-pack, loaded	104
5F100-BNC.....	BNC Mounting Plate, 6-pack, loaded	104

5G108-R#5	QuickPort GigaMax® 5e CAT 5e Connector	111
5HHOM-xx	Home 5e® Ultra High-Flex Patch Cord	104
5L000-L0K	Structured Media Center Lock & Key	97, 99
60A00-1	UPB™ Appliance Module	45
61A00-1	Glass Break Detector	20
62A08-1	IR Flashers	63
63A00-1	Driveway Sensor	21
65A18-1	Omnistat2 Trim Ring	68
68A00-2	Network Video Storage Server	23
68A01-1	Indoor/Outdoor Day/Night Dome Camera	22
68A02-2	Indoor/Outdoor Day/Night Bullet Camera	22
68A11-1	Indoor/Outdoor Mini Dome IP Camera	22
69A00-1	4 Button Wireless Keypad	20
6HHOM-xx	Home 6® Ultra High-Flex Patch Cord	104
70A00-2	Two-Way Cellular Communication Center	23
71A00-1	HLC Load Control Module	47
72A00-1	Hardwired Load Control Module	18
73A00-3SHP	30A Utility Load Control Module	73
73A00-3ZB	Lumina RF 30A Wireless Load Control Module	71
73A00-4SHP	5A Utility Load Control Module	73
73A00-4ZB	Lumina RF 5A Wireless Load Control Module	71
75A00-2	Access Control Card Reader	24
78A00-1	Access Control Card Pack of 10	24
78A00-2	Access Control Key Tag Pack of 10	25
79A00-1	12VDC Electric Door Strike	25
80301-0S	Decora Plus, standard size, polycarbonate, single-gang	114
80309-0S	Decora Plus, standard size, polycarbonate, dual-gang	114
80401-00	Decora, standard size, urea, single-gang	114
80401-0N	Decora, standard size, nylon, single-gang	114
80409-00	Decora, standard size, urea, dual-gang	114
80409-0N	Decora, standard size, nylon, dual-gang	114
80601-0S	Decora, single-gang, midway, urea, single-gang	114
80609-0S	Decora, dual-gang midway, urea, dual-gang	114
81A00-1WHS-EP	In-Home Display (120/240V)	72
81A00-1WHS	In-Home Display (110V)	72
81A00-2WHZB	Lumina RF MicroControl	70
81A00-3WHZB	ZigBee® Interface Module for Omni & Lumina Controllers	71
81A00-4WHZB	Lumina RF MicroControl Companion	70
83A00-1	Power Hub in Enclosure	25
83A00-2	Power Hub for Structured Wiring Enclosures	25
84401-040	Decora, standard size, stainless, single-gang	114
84409-040	Decora, standard size, stainless, dual gang	114
AEMRK-000	Multi-Room Install Wallplate, two QuickPort openings	118
86A00-2	Home Theater Extender 2 (HTX2)	91
88A00-1ZB	300W Plug-In Lamp Module	71
89A00-1SHP	15A Plug-In Load Control Module	73
89A00-1ZB	15A Plug-In Load Control Module	71
90A00-1	One Port PoE Injector	30
91A00-1	Eight Port PoE Switch	30
91A00-2	Eight Port PoE Switch with Structured Wiring Backplate	30
93A00-1	Leviton Security & Automation Serial Server	19
95A00-1	Hi-Fi 2 8 Zone, 8 Source Kit with Enclosure	82
95A00-2	Hi-Fi 2 8 Zone, 8 Source Kit for Structured Wiring Enclosure	82
95A00-3	Hi-Fi 2, Four Zone, Four Source	82
95A00-4	Hi-Fi 2, Four Zone, Four Source (UK)	82
95A00-5	Hi-Fi 2, Four Zone, Four Source (EU)	82
95A00-6	Hi-Fi 2, Four Zone, Four Source (AU)	82
95A01-1	Hi-Fi 2 Main Amplifier Assembly with Power Supply	82
95A03-1	Hi-Fi 2 Volume-Source Control (VSC)	84
95A03-1TWH	Temperature Display/Control (TDC)	67
95A04-1	Hi-Fi 2 Remote Input Module (RIM)	85

95A04-2.....	Hi-Fi 2 Bluetooth® Remote Input Module (BRIM)	85
95A05-1.....	Hi-Fi 2 Remote Control	84
95A09-1.....	Vented Enclosure	83
95A10-colorCS.....	Hi-Fi 2 RIM Color Change Kit (Case of 12)	85
95A11-colorCS.....	Hi-Fi 2 VSC Color Change Kit (Case of 12)	84
95A12-1.....	Hi-Fi 2 8 Zone Expansion Amplifier Kit with Enclosure	83
95A12-2.....	Hi-Fi 2 8 Zone Expansion Amplifier Kit for Structured Wiring	83
95A13-1.....	Hi-Fi 2 Retractable Cable	84
95A14-1.....	Hi-Fi 2 Retractable Cable	84
95A15-Color.....	Hi-Fi 2 BRIM Color Change Kit	85
95A16-1.....	Hi-Fi 2 Expansion Cable Assembly	83
95A18-1.....	Hi-Fi 2 Expansion Amplifier Assembly with Power Supply	83
95A20-1.....	Single-Gang Switch Box w/Cover, Metal	62
96A00-1.....	HAI Dock, U.S., Wired	90
96A00-2.....	HAI Dock, U.S., Wireless	90
96A00-3.....	HAI Dock, E.U., Wireless	90
96A00-4.....	HAI, E.U., Wired	90
96A01-1.....	U.S. Power Supply for HAI Dock	90
96A01-2.....	E.U. Power Supply for HAI Dock	90
97A00-1.....	KNX® Gateway	19
99A00-1.....	OmniTouch 7 White	29
99A00-2.....	OmniTouch 7 Black	29
A7810-000.....	EMB HubLite	76
A8810-000.....	EMB Hub	76
AEBC6-000.....	Fire Rated Back-Box Enclosure	86
AECCS-VCE.....	Dual Channel Two-Way Shelf-Mounted Center Channel Loudspeaker	89
AEC65-000.....	Pair of 6.5" Two-Way In-Ceiling Loudspeakers	86
AEC80-000.....	Pair of 8" Two-Way In-Ceiling Loudspeakers	86
AEH50-0.....	Five-Channel Surround-Sound Home Cinema Speaker System	89
AEHTK-000.....	Home Theater Interface Wallplate, two QuickPort® openings	118
AEI55-000.....	Dual 5" Two-Way In-Wall Center Channel Home Theater Loudspeakers	89
AEI65-000.....	Pair of 6.5" Two-Way In-Wall Loudspeakers	86
AEI80-000.....	Pair of 8" Two-Way In-Wall Loudspeakers	86
AEM65-000.....	6.5" Two-Channel / Single Location Two-Way In-Ceiling Loudspeakers	86
AEMRK-000.....	Multi-Room Install Wallplate, two QuickPort openings	118
AEN24-000.....	Pair of Outdoor/All-Weather Two-Way Loudspeakers in Enclosure	88
AEPHK-0.....	Single-Gang Decorative Satellite Speaker Adapter Wallplate/Bracket	89
AEPI6-KIT.....	6.5" Pre-Construction Speaker Kit	86
AEPI8-KIT.....	8" Pre-Construction Speaker Kit	86
AEPIS-KIT.....	Pre-Construction Kit, in-wall center channel shelf	89
AEPC8-KIT.....	8" Pre-Construction Speaker Kit	86
AESS5-0.....	System-Matched Satellite Speaker for 6.1 and 7.1 surround sound expansion	89
AESUB-012.....	Powered 12" Subwoofer w/ amplifier w/ silver grill	89
C0224-000.....	Wallplate Mounting Brackets, single-gang	114
C0225-OCP.....	Wallplate Mounting Bracket, dual-gang	114
C5002-000.....	Two-Way Splitter, carded unit pack	119
C5002-0GO.....	Two-Way Splitter, gold plated, carded unit pack	119
C5003-000.....	Three-Way Splitter, carded unit pack	119
C5004-000.....	Four-Way Splitter, carded unit pack	119
C5004-0GO.....	Four-Way Splitter, gold plated, carded unit pack	119
C5007-000.....	Two-Piece Crimp-on F-Connector for RG6, 2 nickel	120, 123
C5007-00G.....	Two-Piece Crimp-on F-Connector for RG6, 2 gold	120, 123
C5009-000.....	Two-Piece Crimp-on F-Connector for RG59, 2 nickel	123, 120
C5009-0G0.....	Two-Piece Crimp-on F-Connector for RG59, 2 gold	123, 120
C5052-000.....	Indoor Matching Transformer	120, 123

C5052-0G0	Indoor Matching Transformer	120, 123
C5053-000	Outdoor Matching Transformer	121
C5101-000	.75 Ohm A/B Switch	121
C5205-000	RCA to F-Type Video Adapter	120, 123
C5235-000	.75 Ohm Push-On Connector	120, 123
C5235-0G0	.75 Ohm Push-On Connector	120, 123
C5307-000	One-Piece Crimp-on F-Connector for RG59, 2 nickel	120, 123
C5307-0G0	One-Piece Crimp-on F-Connector for RG59, 2 gold	120, 123
C5405-000	RCA Y Adapter	122
C5454-003	Black Cable with Color-Coded Plugs	122
C5822-000	.6' Stereo Dubbing Cable	121
C5853-006	.6' S-Video Cable	121
C5856-0G0	.6' Stereo Dubbing Cable, gold plated RCA plugs	121
C5914-000	Coaxial Stripping Tool	105
C6851-xx	RG6 Coax Cable, gold plated	119
C6851-xx	RG6 Coax Cable, nickel	119
CH149-00E	Decora Insert Telephone, black	116
CH149-00I	Decora Insert Telephone, ivory	116
CH149-00T	Decora Insert Telephone, light almond	116
CH149-00W	Decora Insert Telephone, white	116
CH159-00E	Decora Insert Telephone/ Coax Combo, black	116
CH159-00I	Decora Insert Telephone/ Coax Combo, ivory	116
CH159-00T	Decora Insert Telephone/ Coax Combo, light almond	116
CH159-00W	Decora Insert Telephone/ Coax Combo	116
CH181-00E	Decora Insert Coax, black	116
CH181-00I	Decora Insert Coax, ivory	116
CH181-00T	Decora Insert Coax, light almond	116
CH181-00W	Decora Insert Coax, white	116
CTTEP-20W	ThinkEssentials® Professional Edition for installers	53
FTHOO-OOW	FTTH Point of Entry Box	101
PCI65-KIT	Rough-in Bracket for 6.5" In-Wall Loudspeakers	87
PCI80-KIT	Rough-in Bracket for 8" In-Wall Loudspeakers	87
PJ26-00	Decora, single-gang, midway, nylon	114
PJ262-00	Decora, dual-gang, midway, nylon	114
RC-1000(color)	Omnistat2 Single Stage Conventional, Heat Pump	67
RC-2000(color)	Omnistat2 Multi Stage, Humidity Control	67
RC-1000WHSHP	Omnistat2 Single Stage Thermostat	73
RC-1500WHSHP	Omnistat2 Universal Thermostat	72
RC-2000WHSHP	Omnistat2 Multi Stage with Humidity	72
RC-1000(color)ZB	Omnistat2 Wireless	70
RC-1500(color)ZB	Lumina RF Universal Thermostat	70
RC-2000(color)ZB	Omnistat2 Wireless	70
RE640-BWW	Snap-In Blank Module, white	112
RE640-BNS	Snap-In Blank Module, Navajo sand	112
RE640-BOB	Snap-In Blank Module, onyx black	112
RE640-NS1	1-Port Insert, navajo sand	112
RE640-OB1	1-Port Insert, onyx black	112
RE640-WW1	1-Port Insert, white	112
RE640-NS2	2-Port Insert, navajo sand	112
RE640-OB2	2-Port Insert, onyx black	112
RE640-WW2	2-Port Insert, white	112
RE640-NS3	3-Port Insert, navajo sand	112
RE640-OB3	3-Port Insert, onyx black	112
RE640-WW3	3-Port Insert, white	112
RE640-NS4	4-Port Insert, navajo sand	112
RE640-OB4	4-Port Insert, onyx black	112
RE640-WW4	4-Port Insert, white	112
RE640-NS6	6-Port Insert, navajo sand	112
RE640-OB6	6-Port Insert, onyx black	112
RE640-WW6	6-Port Insert, white	112
REWPI-ONS	Single-Gang Wallplate, navajo sand	112

REWP1-00B	Single-Gang Wallplate, onyx black	112
REWP1-0WW	Single-Gang Wallplate, white	112
REWP2-0NS	Dual-Gang Wallplate, navajo sand	112
REWP2-00B	Dual-Gang Wallplate, onyx black	112
REWP2-0WW	Dual-Gang Wallplate, white	112
REWP3-0NS	Three-Gang Wallplate, navajo sand	112
REWP3-00B	Three-Gang Wallplate, onyx black	112
REWP3-0WW	Three-Gang Wallplate, white	112
REWP4-0NS	Four-Gang Wallplate, navajo sand	112
REWP4-00B	Four-Gang Wallplate, onyx black	112
REWP4-0WW	Four-Gang Wallplate, white	112
SA-23	Leviton Security & Automation Model Home Wall Display	129
SA-30	Leviton Security & Automation Yard Sign	129
SA-31	Leviton Security & Automation Window Decal	129
SGC65-00W	Pair of 6.5" Spec-Grade Two-Way In-Ceiling Loudspeakers	87
SGI65-00W	Pair of 6.5" Spec-Grade Two-Way In-Wall Loudspeakers	87
SGC65-GRL	Replacement Grill for SGC65	87
SGI65-GRL	Replacement Grill for SGI65	87
SGI80-GRL	Replacement Grill for SGI80	87
SGO99-00W	Pair of Outdoor/Utility Two-Way Loudspeakers in Enclosure	88
SGO99-GRL	Replacement Grill for SGO99-00W	88
T5630-00W	USB Charger/Tamper-Resistant Receptacle	118
VPKIT-MD	Matching Dimmer/Fan Speed Control	51
VPKIT-MD	1-Button Zone Controller/Virtual Dimmer Remote Color Change Kit for VRCZ1	55
VPKIT-MS	1-Button Scene Controller/Virtual Switch Remote Color Change Kit with LED locator for VRCS1	55
VPKIT-MS	Matching Switch Color Change Kit with LED locator	52
VPKIT-S4	4-Button Scene Controller Color Change Kit for VRCS4	55
VPKIT-Z4	4-Button Zone Controller Color Change Kit for VRCZ4	55
VPSLB-S4	4-Button Scene Controller Label Kit for VRCS4	55
VPZLB-Z4	4-Button Zone Controller Label Kit with LED for VRCZ4	55
VSHUB-000	Camera Hub	108
VSHUB-IDC	Camera Hub w/ IDC Connectors	108
VRC0P-1L	Vizia RF +® Plug-In Serial Interface Module,	57
VRCPG-BSG	RF Handheld Remote Controller, Programmer (Basic)	53
VRCPG-OSG	RF Handheld Remote Controller Programmer/Timer	53
VRCS1-1L	1-Button Scene Controller / Virtual Switch Remote	55
VRCS2-MR	2-Button Scene Controller with Switches	55
VRCS4-MO	Vizia RF +® 4-Button Scene Controller	55
VRCS4-MR	4-Button Scene Controller with Switch and IR	55
VRCZ1-1L	Vizia RF +® 1-Button Zone Controller/Virtual Dimmer Remote	55
VRCZ4-MO	Vizia RF +® 4-Button Zone Controller	55
VRCZ4-MR	4-Button Zone Controller with Switch and IR	55
VRE06-1L	Electronic Low Voltage Dimmer	51
VRF01-1L	Quiet Fan Speed Control	51
VRI06-1L	Incandescent Dimmer	51
VRI10-1L	Incandescent Dimmer	51
VRKIT-DS	2-Button Scene Controller with Switches Color Change Kit with LED for VRCS2	55
VRMR1-OSG	Vizia RF +® IR Handheld Remote Controller	53
VRMX1-1L	Incandescent, Magnetic Low Voltage and Mark 10 Dimmer with LED locator and brightness display	51
VRP03-1L	Vizia RF +® Scene Capable Plug-In Lamp Dimming Module	57
VRP15-1L	Vizia RF +® Scene Capable Plug-In Appliance Module	57
VRR15-1L	Vizia RF +® Split Duplex TR Receptacle with LED Locator	57
VRS05-1L	Incandescent Scene Capable Switch with LED locator	52
VRS15-1L	Scene Capable Switch with LED locator	52
VRUSB-000	RF + Installer Tool Software and USB	53
W5212-250	18/2 AWG Speaker Wire, 250'	122
W5214-250	14/2 AWG Speaker Wire, 250'	122
X3301-100	18/2 AWG Speaker Wire, 100'	122

X3301-25C	18/2 AWG Speaker Wire, 25'	122
X3324-100	14/2 AWG Speaker Wire, 100'	122
X3324-50C	14/2 AWG Speaker Wire, 50'	122
YBM05-010	Power Brick	76

INDEX BY PRODUCT TYPE

Safety & Security

OmniPro II Controllers

OmniPro II Board Only.....	20A00-21	14
OmniPro II Commercial Controller	20A00-5	14
OmniPro II Controller.....	20A00-2	14
OmniPro II Controller for Structured Wiring	20A00-8	14

Omni ITe Controllers

Omni ITe Board Only.....	20A00-53	15
Omni ITe Controller.....	20A00-50	14
Omni ITe Controller for Structured Wiring	20A00-52	15

Omni LTe Controllers

Omni LTe Board Only.....	20A00-73	15
Omni LTe Controller.....	20A00-70	15
Omni LTe for Structured Wiring.....	20A00-72	15

Demo Adapter Kits & Demo Cases

Demo Adapter Kit.....	18A00-5	133
International Demo Case.....	18A00-16	133
OmniPro II Demo w/OmniTouch and Leviton Security & Automation Lighting Control.....	18A00-13	133

Omni Accessories

16 Zone Hardwire Expander.....	10A06-1	16
16 Zone/16 Output Expansion	17A00-9	16
4 Relay Module.....	10A07-1	18
8 Relay Module	19A00-1	18
Two-Way Cellular Communication Center	70A00-2	23
Enclosure Lock & 2 Keys.....	21A06-1	18
Expansion Board Only.....	17A00-8	16
Expansion Enclosure.....	17A00-1	16
Flush Mount Kit	33A00-3	17
Flush Speaker Microphone.....	28A00-2	17
Hardwired Load Control Module	72A00-1	40
International Omni Console	33A00-23	17
International Omni Console w/Built-In Speaker/Mic	33A00-24	17
KNX® Gateway.....	97A00-1	19
Omni Console.....	33A00-1	17
Omni Console w/Built-In Speaker/Mic.....	33A00-4	17
RS-232/RS-485 Serial Board.....	10A17-1	18
Serial Connectivity Cable.....	36A05-4	19
Serial PC Cable.....	21A05-2	19
Serial Server	93A00-1	19
Surface Speaker Microphone	28A00-1	17
Two-Way Voice Module	10A11-1	17
Universal Mounting Plate.....	20A07-2	18
UPB™ Powerline Interface Module to Computer Cable.....	36A05-2	20

Wireless Security Products

4 Button Keyfob.....	48A00-1	20
4 Button Wireless Keypad.....	69A00-1	20
64 Zone Wireless Receiver	45A00-1	20

Driveway Sensor	63A00-1	21
Door/Window Transmitter	46A00-1	21
Glass Break	61A00-1	20
Mini Contact.....	58A00-1	21
Panic/Alert Pendant.....	50A00-1	20
Quad Pet Immune Motion Detector	47A00-2	20
Vanishing Contact	57A00-1	21
Wireless Recessed Door Contacts	56A00-1	21

Leviton Security & Automation Surveillance

Indoor/Outdoor Day/Night Bullet Camera.....	68A02-2	22
Indoor/Outdoor Day/Night Dome Camera.....	68A01-1	22
Indoor/Outdoor Mini Dome IP Camera	68A11-1	22
Network Video Storage Server.....	68A00-2	23

Access Control

12VDC Electric Door Strike (Fail Secure)	79A00-1	25
Access Control Card Reader	75A00-2	24
Access Control Card Pack of 10	78A00-1	24
Access Control Key Tag Pack of 10	78A00-2	25
Access Control Keypad	54A00-1	24
Power Hub in Enclosure	83A00-1	25
Power Hub for Structured Wiring	83A00-2	25

Convenient Interfaces

Touchscreens & Accessories

OmniTouch 7 White.....	99A00-1	29
OmniTouch 7 Black.....	99A00-2	29
Eight Port PoE Switch.....	91A00-1	30
Eight Port PoE Switch w/Structured Wiring Backplate.....	91A00-2	30
One Port PoE Injector.....	90A00-1	30

Leviton Security & Automation Software

Automation Studio.....	1126	30
Dealer PC Access Software.....	1105W	31
End User PC Access Software	1106W	31
Lumina PC Access.....	1111	31
OmniTouch Pro	1131	30
Snap-Link	1120	34
Snap-Link Mobile for Android™.....	1120C	33
Snap-Link Mobile for iPhone®.....	1120A	32
Snap-Link Mobile for Kindle Fire™.....	1120D	33

Energy Management

Lumina Products

Lumina Energy Management Controller	44A00-1	41
Lumina Energy Management Controller on Backplate	44A00-3	41
Lumina International, In Enclosure	44A00-22	41
Lumina International, for Structured Wiring	44A00-23	41
Lumina Pro Energy Management Controller	44A00-2	41
Lumina Pro Energy Management Controller on Backplate.....	44A00-4	41
Lumina Demo Case.....	18A00-14	133

HAI Lighting Control Products

15A Relay Switch.....	40A00-1	44
2400W UPB™ Dimmer Switch.....	55A00-3 color	45
2400W Wallplate, Ivory	55A03-2	45
2400W Wallplate, White.....	55A03-1	45
CFL/LED Dimmer.....	35A00-1CFL	44

600W UPB™ Non-Dimming Switch.....	35A00-3	44
600W UPB™ Dimmer Switch.....	35A00-1	44
Auxiliary Switch.....	37A00-1	44
Custom Legend Kit for Scene or House Status Switch.....	38A06-2	46
HLC Load Control Module.....	71A00-1	47
House Status Switch Color Change Kit.....	38A05-colorcodeCS	46
House Status Switch, 8 Button.....	38A00-2	45
Phase Coupler.....	39A00-1	47
Scene Switch and Lumina Mode Switch Color Change Kit.....	38A04-colorcodeCS	46
Scene Switch Remote.....	38A14-1	46
Scene Switch, 6 Button.....	38A00-1	45
Switch Color Change Kit.....	35A14-colorcodeCS	44
Table Top Scene Switch Cradle.....	38A15-color	46
Table Top Scene Switch with Cradle.....	38A16-color	46
UPB™ Appliance Module.....	60A00-1	45
UPB™ Lamp Module.....	59A00-1	45
UPB™ Powerline Interface Module & Cable.....	36A00-1	47
UPB™ Split-Phase Repeater.....	39A00-2	47
UPB™ Three-Phase Repeater.....	39A00-3	47

Vizia RF+ Wireless Lighting

Incandescent Dimmer with LED locator and brightness display.....	VRI06-1L	51
Incandescent Dimmer with LED locator and brightness display.....	VRI10-1L	51
Incandescent, Magnetic Low Voltage and Mark 10 Dimmer with LED locator and brightness display.....	VRMX1-1L	51
Electronic Low Voltage Dimmer with LED locator and brightness display.....	VRE06-1L	51
Quiet Fan Speed Control with LED locator and fan speed display.....	VRF01-1L	51
Matching Dimmer/Fan Speed Control.....	VPKIT-MD	51
Scene Capable Switch with LED locator.....	VRS15-1L	52
Incandescent Scene Capable Switch with LED locator.....	VRS05-1L	52
Matching Switch Color Change Kit with LED locator.....	VPKIT-MS	52
RF + Installer Tool Software and USB for System programming*.....	VRUSB-000	53
RF Handheld Remote Controller, Programmer (Basic).....	VRCPG-BSG	53
RF Handheld Remote Controller Programmer/Timer (Internal astronomical clock).....	VRCPG-0SG	53
Vizia RF +® IR Handheld Remote Controller.....	VRMR1-0SG	53
ThinkEssentials® Professional Edition for installers.....	CTTEP-20W	53
1-Button Scene Controller/ Virtual Switch Remote.....	VRCS1-1L	55
Vizia RF +® 1-Button Zone Controller/ Virtual Dimmer Remote.....	VRCZ1-1L	55
Vizia RF +® 4-Button Scene Controller.....	VRCS4-M0	55
Vizia RF +® 4-Button Zone Controller.....	VRCZ4-M0	55
4-Button Zone Controller with Switch and IR Remote Capability.....	VRCZ4-MR	55
4-Button Scene Controller with Switch and IR Remote Capability.....	VRCS4-MR	55
2-Button Scene Controller with Switches.....	VRCS2-MR	55
Vizia RF +® 4-Button Zone Controller.....	VRCZ4-M0	55
1-Button Zone Controller/Virtual Dimmer Remote Color Change Kit with LED locator and brightness display for VRCZ1.....	VPKIT-MD	55
1-Button Scene Controller/Virtual Switch Remote Color Change Kit with LED locator for VRCS1.....	VPKIT-MS	55
4-Button Scene Controller Color Change Kit with LED locator for VRCS4.....	VPKIT-S4	55
4-Button Zone Controller Color Change Kit with LED for VRCZ4.....	VPKIT-Z4	55
4-Button Scene Controller Label Kit with LED locator for VRCS4.....	VPSLB-S4	55

4-Button Zone Controller Label Kit with LED for VRCZ4.....	VPZLB-Z4	55
2-Button Scene Controller with Switches		
Color Change Kit with LED for VRCS2.....	VRKIT-DS	55
Vizia RF +® Scene Capable Plug-In Appliance Module.....	VRP15-1L	57
Vizia RF +® Scene Capable Plug-In Lamp Dimming Module	VRP03-1L	57
Vizia RF +® Plug-In Serial Interface Module,		
ASCII to Z-Wave® Interface.....	VRCOP-1L	57
Vizia RF +® Split Duplex TR Receptacle with LED Locator.....	VRR15-1L	57

Omni-Bus Products

1-Button Hardwired, White	113A00-1	63
1-Button Wireless, White	113A00-2	63
2-Button Hardwired, White	113A00-3	63
2-Button Wireless, White	113A00-4	63
3-Button Hardwired, White	113A00-5	63
3-Button Wireless, White	113A00-7	63
3-Button Hardwired, Brushed Stainless	113A00-6	64
3-Way Splitter	119A00-1	61
6-Button Hardwired, White	113A00-8	63
6-Button Hardwired, Brushed Stainless	113A00-9	64
6-Channel Universal Switch Interface Module	114A00-1	63
8-Way Splitter DIN Rail Module	120A00-1	60
DALI Gateway DIN Rail Module	118A00-1	61
Interface Translator DIN Rail Module	117A00-1	60
Jumper Plugs	121A00-1	61
Keyfob Remote Control, 6-Channel	125A00-1	64
Keyfob Remote Control, 16-Channel.....	125A00-2	64
Omni-Bus Cable Assemblies for 114A00-1.....	114A01-1	64
Omni-Bus Dimmer DIN Rail Module.....	110A00-1	62
Omni-Bus Power Switch DIN Rail Module.....	111A00-1	62
Omni-Bus Relay DIN Rail Module.....	112A00-1	62
Omni-Bus Scene Control DIN Rail Module.....	126A00-1	60
Omni-Bus Universal Dimmer DIN Rail Module	110A00-2	62
Power Supply 2.5A DIN Rail Module	123A00-1	60
Power Supply Interface DIN Rail Module	124A00-1	60
RF Transceiver DIN Rail Module	115A00-1	61
Single-Gang Switch Box w/Cover, Metal	95A20-1	62
Termination Plug	122A00-1	61
USB Programming Interface Unit	116A00-1	61

Omnistat2 Thermostats

Omnistat2 Multistage, Humidity Control.....	RC-2000color	67
Omnistat2 Single Stage Conventional, Heat Pump.....	RC-1000color	67
Omnistat2 Wireless Multistage, Humidity Control.....	RC-2000colorZB	70
Lumina RF Universal Thermostat.....	RC-1500colorZB	70
Omnistat2 Wireless Single Stage Conventional, Heat Pump.....	RC-1000colorZB	70

Energy Management Accessories

Extended Range Indoor/Outdoor Temperature Sensor.....	31A00-7	69
Extended Range Indoor/Outdoor Temperature Sensor.....	31A00-8	69
Flush Mount Remote Indoor Temp Sensor	23A00-2	68
International Lumina Keypad	33A00-25	41
International Lumina Keypad w/Built-in Speaker/Mic	33A00-26	41
Lumina Keypad.....	33A00-19	41
Lumina Keypad w/Built-in Speaker/Mic.....	33A00-20	41
Omnistat2 Trim Ring	65A18-1	68
Surface Mount Remote Temp Sensor.....	23A00-1	68
Thermostat Isolation Module.....	29A00-1	68
Thermostat Power Supply Module.....	30A00-2	68
Temperature Display/Control.....	95A03-1TWH	67
Water Temperature Sensor.....	14A00-8	69

Lumina RF Wireless Energy Management Products

Lumina RF 30A Wireless Load Control Module	73A00-3ZB	71
Lumina RF 5A Wireless Load Control Module	73A00-4ZB	71
Lumina RF 15A Plug-In Load Control Module	89A00-1ZB	71
Lumina RF 300W Plug-In Lamp Module	88A00-1ZB	71
Lumina RF MicroControl.....	81A00-2WHZB	70
Lumina RF MicroControl Companion.....	81A00-4WHZB	70
Lumina RF MicroControl Energy Management Demo Case	18A00-20	133
ZigBee® Interface Module (ZIM) for Leviton Security & Automation Controllers	81A00-3WHZB	71

SmartGrid Solutions

In-Home Display (120/240V)	81A00-1WHS-EP	72
In-Home Display (110V)	81A00-1WHSHP	72
Omnistat2 Multistage Thermostat	RC-2000WHSHP	72
Omnistat2 Universal Thermostat	RC-1500WHSHP	72
Omnistat2 Single Stage Thermostat	RC-1000WHSHP	73
15A Plug-in Module	89A00-1SHP	73
30A Wireless Module	73A00-3SHP	73
5A Wireless Module	73A00-4SHP	73

1000 Series Meters

1000 120V 1 PH 2W 100A 1 split CT Indoor.....	1K120-01W	74
1000 120V 1 PH 2W 200A 1 split CT Indoor.....	1K120-02W	74
1000 120V 1 PH 2W 400A 1 split CT Indoor.....	1K120-04W	74
1000 120V 1 PH 2W 800A 1 split CT Indoor.....	1K120-08W	74
1000 120V 1 PH 2W 100A 1 solid CT Indoor.....	1K120-1SW	74
1000 120V 1 PH 2W 200A 1 solid CT Indoor.....	1K120-2SW	74
1000 120/240V 1 PH 3W 100A 2 split CT Indoor.....	1K240-01W	74
1000 120/240V 1 PH 3W 200A 2 split CT Indoor.....	1K240-02W	74
1000 120/240V 1 PH 3W 400A 2 split CT Indoor.....	1K240-04W	74
1000 120/240V 1 PH 3W 800A 2 split CT Indoor.....	1K240-08W	74
1000 120/240V 1 PH 3W 100A 2 solid CT Indoor.....	1K240-1SW	74
1000 120/240V 1 PH 3W 200A 2 solid CT Indoor.....	1K240-2SW	74
1000 277V 1PH 2W 100A 1 split CT Indoor.....	1K277-01W	74
1000 277V 1PH 2W 200A 1 split CT Indoor.....	1K277-02W	74
1000 277V 1PH 2W 400A 1 split CT Indoor.....	1K277-04W	74
1000 277V 1PH 2W 800A 1 split CT Indoor.....	1K277-08W	74
1000 277V 1PH 2W 100A 1 solid CT Indoor.....	1K277-1SW	74
1000 277V 1PH 2W 200A 1 solid CT Indoor.....	1K277-2SW	74
1000 120V 1 PH 2W 100A 1 split CT Outdoor	1O120-01W	74
1000 120V 1 PH 2W 200A 1 split CT Outdoor	1O120-02W	74
1000 120V 1 PH 2W 400A 1 split CT Outdoor	1O120-04W	74
1000 120V 1 PH 2W 800A 1 split CT Outdoor	1O120-08W	74
1000 120/240V 1 PH 3W 100A 2 split CT Outdoor.....	1O240-01W	74
1000 120/240V 1 PH 3W 200A 2 split CT Outdoor.....	1O240-02W	74
1000 120/240V 1 PH 3W 400A 2 split CT Outdoor.....	1O240-04W	74
1000 120/240V 1 PH 3W 800A 2 split CT Outdoor.....	1O240-08W	74
1000 277V 1PH 2W 100A 1 split CT Indoor.....	1O277-01W	74
1000 277V 1PH 2W 200A 1 split CT Indoor.....	1O277-02W	74
1000 277V 1PH 2W 400A 1 split CT Indoor.....	1O277-04W	74
1000 277V 1PH 2W 800A 1 split CT Indoor.....	1O277-08W	74

2000 Series Meters

2000 120/208V 3 PH 4W 100A 3 split CT Indoor	2K208-01W	75
2000 120/208V 3 PH 4W 200A 3 split CT Indoor	2K208-02W	75
2000 120/208V 3 PH 4W 400A 3 split CT Indoor	2K208-04W	75
2000 120/208V 3 PH 4W 800A 3 split CT Indoor	2K208-08W	75
2000 120/208V 3 PH 4W 1200A 3 split CT Indoor.....	2K208-12W	75
2000 120/208V 3 PH 4W 100A 3 solid CT Indoor.....	2K208-1SW	75
2000 120/208V 3 PH 4W 200A 3 solid CT Indoor.....	2K208-2SW	75

2000 120/240V 1 PH 3W 100A 3 split CT Indoor	2K480-01W	75
2000 120/240V 1 PH 3W 200A 3 split CT Indoor	2K480-02W	75
2000 120/240V 1 PH 3W 400A 3 split CT Indoor	2K480-04W	75
2000 120/240V 1 PH 3W 800A 3 split CT Indoor	2K480-08W	75
2000 120/240V 1 PH 3W 1200A 3 split CT Indoor	2K480-12W	75
2000 120/240V 1 PH 3W 100A 3 solid CT Indoor	2K480-1SW	75
2000 120/240V 1 PH 3W 200A 3 solid CT Indoor	2K480-2SW	75
2000 120/208V 3 PH 4W 100A 3 split CT Indoor	2K208-01D	75
2000 120/208V 3 PH 4W 200A 3 split CT Indoor	2K208-02D	75
2000 120/208V 3 PH 4W 400A 3 split CT Indoor	2K208-04D	75
2000 120/208V 3 PH 4W 800A 3 split CT Indoor	2K208-08D	75
2000 120/208V 3 PH 4W 1200A 3 split CT Indoor	2K208-12D	75
2000 277/480V 3PH 4W 100A 3 split CT Indoor	2K480-01D	75
2000 277/480V 3PH 4W 200A 3 split CT Indoor	2K480-02D	75
2000 277/480V 3PH 4W 400A 3 split CT Indoor	2K480-08D	75
2000 277/480V 3PH 4W 800A 3 split CT Indoor	2K480-08D	75
2000 277/480V 3PH 4W 1200A 3 split CT Indoor	2K480-12D	75
2000 120/208V 3 PH 4W 100A 3 split CT Outdoor	20208-01W	75
2000 120/208V 3 PH 4W 200A 3 split CT Outdoor	20208-02W	75
2000 120/208V 3 PH 4W 400A 3 split CT Outdoor	20208-04W	75
2000 120/208V 3 PH 4W 800A 3 split CT Outdoor	20208-08W	75
2000 120/208V 3 PH 4W 1200A 3 split CT Outdoor	20208-12W	75
2000 120/240V 1 PH 3W 100A 3 split CT Outdoor	20480-01W	75
2000 120/240V 1 PH 3W 200A 3 split CT Outdoor	20480-02W	75
2000 120/240V 1 PH 3W 400A 3 split CT Outdoor	20480-04W	75
2000 120/240V 1 PH 3W 800A 3 split CT Outdoor	20480-08W	75
2000 120/240V 1 PH 3W 1200A 3 split CT Outdoor	20480-12W	75

Monitoring Hubs

EMB HubLite.....	A7810-000	76
Power Brick.....	YBM05-010	76
EMB Hub.....	A8810-000	76

Entertainment

Hi-Fi 2 and HTX2

HAI Dock E.U. Power Supply	96A01-2	90
HAI Dock, E.U., Wired.....	96A00-4	90
HAI Dock, E.U., Wireless	96A00-3	90
HAI Dock, U.S. Power Supply	96A01-1	90
HAI Dock, U.S., Wired.....	96A00-1	90
HAI Dock, U.S., Wireless	96A00-2	90
Hi-Fi 2, 4 Zone, 4 Source Kit for Structured Wiring.....	95A00-3	82
Hi-Fi 2, 4 Zone, 4 Source Kit for Structured Wiring (UK).....	95A00-4	82
Hi-Fi 2, 4 Zone, 4 Source Kit for Structured Wiring (EU)	95A00-5	82
Hi-Fi 2, 4 Zone, 4 Source Kit for Structured Wiring (AU).....	95A00-6	82
Hi-Fi 2, 8 Zone, 8 Source Kit for Structured Wiring.....	95A00-2	82
Hi-Fi 2, 8 Zone, 8 Source Kit w/Enclosure.....	95A00-1	82
Hi-Fi 2, 8 Zone Expansion Amplifier Kit for Structured Wiring.....	95A12-2	83
Hi-Fi 2, 8 Zone Expansion Amplifier Kit w/Enclosure.....	95A12-1	83
Hi-Fi 2 Bluetooth® Remote Input Module.....	95A04-2	85
Hi-Fi 2 BRIM Color Change Kit	95A15-color	85
Hi-Fi 2 Demo Case.....	18A00-15	133
Hi-Fi 2 Expansion Amplifier Assembly w/Power Supply	95A18-1	83
Hi-Fi 2 Expansion Cable Assembly	95A16-1	83
Hi-Fi 2 Main Amplifier Assembly w/Power Supply	95A01-1	82
Hi-Fi 2 Retractable Cable	95A13-1	84
Hi-Fi 2 Retractable Cable	95A14-1	84
Hi-Fi 2 Remote Control.....	95A05-1	84
Home Theater Extender 2 (HTX2).....	86A00-2	91
IR Flashers.....	62A08-1	63

Remote Input Module (RIM)	95A04-1	85
RIM Color Change Kit	95A10-colorCS	85
Vented Enclosure	95A09-1	83
Volume-Source Control (VSC)	95A03-1	84
VSC Color Change Kit.....	95A11-colorCS	84

Speakers

Pair of 6.5" Two-Way In-Wall Loudspeakers	AEI65-000	86
Pair of 8" Two-Way In-Wall Loudspeakers.....	AEI80-000	86
Pair of 6.5" Two-Way In-Ceiling Loudspeakers.....	AEC65-000	86
Pair of 8" Two-Way In-Ceiling Loudspeakers	AEC80-000	86
6.5" Two-Channel / Single Location Two-Way In-Ceiling Loudspeakers.....	AEM65-000	86
6.5" Pre-Construction Speaker Kit.....	AEPI6-KIT	86
8" Pre-Construction Speaker Kit.....	AEPI8-KIT	86
Fire Rated Back-Box Enclosure	AEBC6-000	86
8" Pre-Construction Speaker Kit.....	AEPC8-KIT	86
Pair of 6.5" Spec-Grade Two-Way In-Ceiling Loudspeakers.....	SGC65-00W	87
Pair of 6.5" Spec-Grade Two-Way In-Wall Loudspeakers.....	SGI65-00W	87
Replacement Grill for SGC65	SGC65-GRL	87
Replacement Grill for SGI65.....	SGI65-GRL	87
Replacement Grill for SGI80.....	SGI80-GRL	87
Rough-in Bracket for 6.5" In-Wall Loudspeakers	PCI65-KIT	87
Rough-in Bracket for 8" In-Wall Loudspeakers.....	PCI80-KIT	87
Pair of Outdoor/All-Weather Two-Way Loudspeakers in Enclosure	AEN24-000	88
Pair of Outdoor/Utility Two-Way Loudspeakers in Enclosure	SGO99-00W	88
Replacement Grill for SGO99-00W	SGO99-GRL	88
Dual 5" Two-Way In-Wall Center Channel Home Theater Loudspeakers	AEI55-000	89
Dual Channel Two-Way Shelf-Mounted Center Channel Loudspeaker.....	AECCS-VCE	89
Powered 12" Subwoofer w/ amplifier w/ silver grill	AESUB-012	89
Five-Channel Surround-Sound Home Cinema Speaker System	AEH50-0	89
System-Matched Satellite Speaker for 6.1 and 7.1 surround sound expansion	AESS5-0	89
Single-Gang Decorative Satellite Speaker Adapter Wallplate/Bracket	AEPHK-0	89
Pre-Construction Kit, in-wall center channel shelf	AEPIS-KIT	89

Connected Home

Structured Media Enclosures

14" Enclosure and Flush-Mount Cover.....	47605-140	97
14" Enclosure	47605-14E	97
14" Multi-Dwelling Unit Configuration A.....	47605-1MG	97
14" Flush-Mount Cover	47605-14C	97
14" Economy Hinged Door	47605-14D	97
14" Premium Hinged Door.....	47605-14P	97
14" Premium Vented Hinged Door	47605-14S	97
14" Enclosure, job packed, 6 per pack.....	47605-14G	97
14" Flush-Mount Cover, job packed, 6 per pack.....	47605-14B	97
Structured Media Enclosure Lock & Key	5L000-LOK	97
21" Enclosure	47605-21E	97
21" Flush-Mount Cover	47605-21C	97
21" Premium Vented Hinged Door	47605-21S	97
Structured Media Enclosure Lock & Key	5L000-LOK	97
Compact Structured Media Enclosure and Cover, empty	47605-MDU	97
Compact Structured Media Enclosure Cover only	47605-MDC	97
MDU Kit	47604-0F6	97
MDU Kit.....	47604-F6S	97

28" Enclosure and Flush Mount Cover	47605-28W	98
28" Enclosure only.....	47605-28N	98
28" Multi-Dwelling Unit Configuration A.....	47605-2MG	98
28" Multi-Dwelling Unit Configuration B.....	47605-M28	98
28" Flush Mount Cover.....	47605-F28	98
28" Economy Hinged Cover	47605-28D	98
28" Premium Hinged Cover.....	47605-28P	98
28" Enclosure only, job packed, 3 per pack.....	47605-28G	98
28" Flush Mount Cover only job packed, 3 per pack.....	47605-28B	98
28" Pre-Fab Back Plate.....	47605-2BP	98
42" Enclosure and Flush Mount Cover	47605-42W	99
42" Enclosure only.....	47605-42N	99
42" Multi-Dwelling Unit Configuration A.....	47605-4MG	99
42" Multi-Dwelling Unit Configuration B.....	47605-M42	99
42" Flush Mount Cover.....	47605-F42	99
42" Economy Hinged Cover	47605-42D	99
42" Premium Hinged Cover.....	47605-42P	99
42" Pre-Fab Back Plate.....	47605-4BP	99
Extender Bracket for 28" Structured Media Centers.....	47612-28B	99
Extender Bracket for 42" Structured Media Centers.....	47612-42B	99
Structured Media Center Lock & Key	5L000-LOK	99
14" + 14" Dual Multi-Bay Enclosure.....	47FTH-440	100
28" + 14" Dual Multi-Bay Enclosure.....	47FTH-840	100
28" + 14" + 14" Triple Multi-Bay Enclosure	47FTH-844	100
42" + 14" Dual Multi-Bay Enclosure.....	47FTH-420	100
28" + 28" Dual Multi-Bay Enclosure.....	47FTH-880	100
FTTH Point of Entry Box.....	FTH00-OOW	101
Media Versatile Panel w/cover	47602-24E	101
Mounting Brackets	47602-BKE	101

Routers and Switches

Gigabit 5-Port Ethernet Switch,	47611-5GB	102
100 Mbps 4-Port Internet Router.....	47611-GT4	102
100 Mbps 5-Port Ethernet Switch,	47611-5PT	102
100 Mbps 8-Port Ethernet Switch,	47611-8PT	102

Power Supplies & Surge Protection

Surge J-Box Kit, one duplex receptacle	47605-ACS	103
Non-Surge J-Box Kit, one duplex receptacle.....	47605-ACN	103
Surge AC Power Module, two duplex receptacles.....	47605-ODP	103
DC Bus Module.....	48212-124	103
Versatile Power Supply, six 12 VDC connectors and two NEMA 15A receptacles.....	47605-PSC	103
AC Surge Module, six receptacles.....	48212-06S	103
Universal Mini DC Power Supply, three 12 VDC connectors.....	47605-PSB	103
Universal DC Power Supply, nine 12 VDC connectors and one IEC AC receptacle	47605-PSA	103
IEC TO NEMA 15A Adapter Power Cord.....	48212-IEC	103

Mounting Brackets, Patch Cords and Tools

Single Plastic Bracket, for single expansion board.....	47612-SBK	104
Standard Expansion Plastic Bracket for up to five expansion boards.....	47612-EBK	104
Shelf Plastic Bracket, for up to three expansion boards and CATV splitter.....	47612-VSB	104
Compact Expansion Plastic Bracket for up to three expansion boards.....	47612-HBK	104
Data Plastic Bracket, for mounting routers and switches.....	47612-DBK	104
12-Port QuickPort Mounting Bracket	47600-QPB	104
Home 6® Ultra High-Flex Patch Cord.....	6HHOM-xx	104
Home 5e® Ultra High-Flex Patch Cord	5HHOM-xx	104
8-Conductor Flat Telephone Patch Cord.....	42400-8FG	104

Multimedia Adapter Bracket	47612-MMA	104
BNC Mounting Plate, 6-pack, loaded	5F100-BNC	104
F-Connector Mounting Plate, 6-pack, loaded	5F100-6VF	104
QuickPort® Mounting Plate, 6-pack, unloaded	5F100-6QP	104
Universal Shelf Bracket.....	47612-UBK	105
Compact Universal Security Board Mounting Plate.....	47612-HSB	105
Standard Universal Security Board Mounting Plate	47612-FSB	105
Combo Bracket.....	47612-CBK	105
Compact Universal Mounting Bracket	47612-6SB	105
Standard Universal Mounting Bracket	47612-1SB	105
Residential Tool Kit.....	40812-RTK	105
Wire Punchdown/Termination Tool.....	49553-814	105
110 IDC Blade.....	49553-110	105
66-Clip Blade	49553-066	105
BIX® Blade.....	49553-BIX	105
Krone® Blade.....	49553-KRN	105
Awl (woodscrew starter punch)	49553-AWL	105
Master Compression Tool.....	40989-CPT	105
UTP Stripping Tool.....	49660-00P	105
Coaxial Stripping Tool	C5914-000	105
EZ-RJ45 Crimp Tool.....	40989-ACT	105
EZ-RJ45 Connector, 50/pack.....	47613-EZC	105
EZ-RJ45 Connector Display Pack, 10/pack.....	47613-EZR	105
Push-Lock Pins for SMCs, 20/pack.....	47615-NYL	105
Reclosable Tie-Wrap, 5" Length, 25/pack	43105-005	105
4X4 Telephone Line Breakout Module.....	47609-4X4	105
Reclosable Tie-Wrap, 8" Length, 25/pack	43108-008	105
Reclosable Tie-Wrap, 12" Length, 25/pack.....	43112-012	105
Twist & Mount, TIDP, & Compact Structured Media® Panels		
Twist & Mount Patch Panel - 12 CAT 6 and 12 CAT 5e	476TM-654	106
Twist & Mount Patch Panel - 24 CAT 6	476TM-624	106
Twist & Mount Patch Panel - 24 CAT 5e.....	476TM-524	106
Twist & Mount Patch Panel - 6 CAT 6 and 6 CAT 5e.....	476TM-652	106
Twist & Mount Patch Panel - 12 ports of 6 CAT 6.....	476TM-612	106
Twist & Mount Patch Panel - 12 ports of 6 CAT 5e.....	476TM-512	106
Telephone Input Distribution Panel	476TL-T12	106
1x9 Bridged Telephone and 4-way 1 GHz TV Splitter	47603-1G4	106
1x9 Bridged Telephone and 6-way 1 GHz TV Splitter	47603-1G6	106
1x9 Bridged Telephone and 8-way 1 GHz TV Splitter	47603-1G8	106
1x4 Bridged Telephone, 4 Data, and 6-way 1 GHz TV Splitter	47603-DP6	106
1x7 Bridged Telephone, Security Interface, and 6-way 1 GHz TV Splitter.....	47603-TSV	106
Standard Structured Media® Panels		
Basic Telephone & Video Panel.....	47606-BTV	107
Basic Home Networking Plus Panel	47606-BNP	107
Advanced Home Telephone & Video Panel.....	47606-AHT	107
Advanced Home Office Panel.....	47606-ASO	107
12-Port Structured Media Panel	47603-12P	107
18-Port Structured Media Panel.....	47603-18P	107
24-Port Structured Media Panel.....	47603-24P	107
4x12 Telephone Distribution Panel.....	47603-12M	107
4x12 Telephone Distribution Panel w/ Splitter.....	47603-412	107
4x18 Telephone Distribution Panel.....	47603-18M	107
4x18 Telephone Distribution Panel w/ CAT 5e Board.....	47603-8C1	107
Modules & Expansion Boards		
1x9 Bridged Telephone Module	47689-00B	108
CAT 5e Voice & Data Module.....	47605-C5B	108
CAT 6 Voice & Data Module	47611-C6B	108
DSL Filter Module.....	47616-DSB	108

Telephone Security Module.....	47609-TSV	108
CAT 5e Voice and Data Board.....	47603-0C5	108
CAT 6 Voice and Data Board.....	47611-0C6	108
VDSL Board w/ 1x5 Bridged Phone w/ Data Passthrough IDCs.....	47609-D5P	108
Combo Phone & Data Board w/ 1x4 Bridged Phone and 4-Port CAT 5e	47609-4DP	108
Camera Hub.....	VSHUB-000	108
Camera Hub w/ IDC Connectors.....	VSHUB-IDC	108
1x9 Bridged Telephone Board	47603-110	109
1x6 Bridged Telephone Board	47609-0F6	109
1x10 Bridged Telephone Board.....	47609-S10	109
1x4 Bridged Telephone Board	47609-004	109
Telephone Patching Board/Expanded 4-line Telephone Distribution.....	47609-EMP	109
DSL Filter Board.....	47616-DSF	109
Telephone Line Distribution Board.....	47603-TDM	109
4x12 Telephone Distribution Board	47603-12B	109
4x18 Telephone Distribution Board	47603-18B	109

Video Distribution & Splitters

1x1 Premium Video Module	47693-01P	110
1x8 Premium Video Module	47693-08P	110
1x16 Premium Video Module	47693-16P	110
3x1 Passive Combiner	47693-31P	110
1x4 Passive Video Splitter w/ bracket	(1Ghz) 47690-04C (2Ghz) 47690-4C2	110
1x6 Passive Video Splitter w/ bracket	(1Ghz) 47690-06C (2Ghz) 47690-6C2	110
1x8 Passive Video Splitter w/ bracket	(1Ghz) 47690-08C (2Ghz) 47690-8C2	110
1x4 Passive Video Splitter.....	(1Ghz) 47690-004 (2Ghz) 47690-0G4	110
1x6 Passive Video Splitter	(1Ghz) 47690-006 (2Ghz) 47690-0G6	110
1x8 Passive Video Splitter.....	(1Ghz) 47690-008 (2Ghz) 47690-0G8	110
Video Amplifier Module	48210-OVA	110
Multi-Switch Module.....	47691-3MS	110
QuickPort® Home 6 Connector, Tool-Free	61TLS-R+6	111
QuickPort Home 5e Connector, Standard.....	5EHOM-R+5	111
QuickPort CAT 5 Connector	41108-R#5	111
QuickPort CAT 3 Connector	41108-R#3	111
QuickPort GigaMax® 5e CAT 5e Connector	5G108-R#5	111
QuickPort Voice Grade 6-Conductor Connector	41106-R#6	111
QuickPort Voice Grade 8-Conductor Connector	41108-R#8	111
QuickPort BNC Bulkhead Module, standard.....	41084-B*F	111
QuickPort BNC Bulkhead Module, gold plated.....	40832-0B	111
QuickPort HDMI Passthrough	40834-00	111
QuickPort S-Video Feedthrough.....	40734-CV	111
QuickPort USB A-A Connector, feedthrough.....	40835-00	111
QuickPort 3.5 mm Stereo, screw terminal.....	40839-S~S	111
QuickPort F-Connector, standard, 3.0 GHz	41084-F*F	111
QuickPort F-Connector, gold plated, 3.0 GHz.....	40831-0B	111
QuickPort RCA to 110	40735-Rx+	111
QuickPort RCA w/ black stripe.....	40830-B*E	111
QuickPort RCA w/ red stripe	40830-B*R	111
QuickPort RCA w/ yellow striper.....	40830-B*Y	111
QuickPort RCA w/ green stripe	40830-B~V	111
QuickPort RCA w/ blue stripe	40830-B~L	111
QuickPort Banana Jack Adapter, gold plated w/ black stripe	40837-B*E	111
QuickPort Banana Jack Adapter, gold plated w/ red stripe.....	40837-B*R	111
QuickPort Binding Post Adapter, gold plated w/ black stripe.....	40833-B*E	111
QuickPort Binding Post Adapter, gold plated w/ red stripe.....	40833-B*R	111
QuickPort Snap-in Blank Module	41084-B*B	111
QuickPort Compression RCA Connector	40782-R*W	111
QuickPort Compression F-Connector (white only).....	40782-CPF	111
RCA Compression Connector (colored rings included).....	40985-CRU	111
Compression F-Connector	40985-CPF	111

Renu® Wallplates & Inserts

Snap-In Blank Module.....	RE640-BWW	RE640-BNS	RE640-BOB	112
Four-Gang Wallplate.....	REWP4-0WW	REWP4-ONS	REWP4-0OB	112
Three-Gang Wallplate.....	REWP3-0WW	REWP3-ONS	REWP3-0OB	112
Dual-Gang Wallplate.....	REWP2-0WW	REWP2-ONS	REWP2-0OB	112
Single-Gang Wallplate.....	REWP1-0WW	REWP1-ONS	REWP1-0OB	112
6-Port Insert.....	RE640-WW6	RE640-NS6	RE640-OB6	112
4-Port Insert.....	RE640-WW4	RE640-NS4	RE640-OB4	112
3-Port Insert.....	RE640-WW3	RE640-NS3	RE640-OB3	112
2-Port Insert.....	RE640-WW2	RE640-NS2	RE640-OB2	112
1-Port Insert.....	RE640-WW1	RE640-NS1	RE640-OB1	112

QuickPort® Wallplates

4-Port Wallplate.....	41081-4WP	41081-4TP	41081-4IP	113
2-Port Wallplate.....	41081-2WP	41081-2TP	41081-2IP	113
4-Port Wallplate w/ ID window.....	42081-4WS	42081-4TS	42081-4IS	113
2-Port Wallplate w/ ID window.....	42081-2WS	42081-2TS	42081-2IS	113
6-Port Flush Mount.....	41080-6WP	41080-6TP	41080-6IP	113
4-Port Flush Mount.....	41080-4WP	41080-4TP	41080-4IP	113
3-Port Flush Mount.....	41080-3WP	41080-3TP	41080-3IP	113
2-Port Flush Mount.....	41080-2WP	41080-2TP	41080-2IP	113
1-Port Flush Mount.....	41080-1WP	41080-1TP	41080-1IP	113
1-Port Wallplate.....	4108W-1SP	4108W-OSP		113
Single-Gang Wallplate.....	43080-1S1	43080-1S2	43080-1S3 43080-1S4 43080-1S6	113
Dual-Gang Wallplate.....	43080-2S2	43080-2S4	43080-2S6 43080-2S8 43080-S12	113
4-Port Angled Wallplate, single-gang.....	43081-1L4			113

Decora® Wallplates & Multimedia Inserts

Decora, standard size, urea.....	80401-00	80409-00		114
Decora, standard size, nylon.....	80401-0N	80409-0N		114
Decora, standard size, stainless.....	84401-040	84409-040		114
Decora Plus, standard size, polycarbonate.....	80301-0S	80309-0S		114
Decora, midway, urea.....	80601-0S	80609-0S		114
Decora, midway, nylon.....	PJ26-00	PJ262-00		114
6-Port Insert, polybag, standard carton.....	41646-00W	41646-00T	41646-00I	114
4-Port Insert, polybag, standard carton.....	41644-00W	41644-00T	41644-00I	114
3-Port Insert, polybag, standard carton.....	41643-00W	41643-00T	41643-00I	114
2-Port Insert, polybag, standard carton.....	41642-00W	41642-00T	41642-00I	114
1-Port Insert, polybag, standard carton.....	41641-00W	41641-00T	41641-00I	114
HDMI Decora Insert, feedthrough.....	41647-00W	41647-00I		114
DVI Decora Insert, feedthrough.....	41648-00W	41648-00I		114
QuickPort Shutter Kit.....	51084-ICN			114
White Label Kit.....	51084-XLB			114
Color Label Kit †.....	51084-CLB			114
Wallplate Mounting Brackets, single-gang.....	C0224-000			114
Wallplate Mounting Bracket, dual-gang.....	C0225-0CP			114

QuickPlates®

One Data.....	5EA20-S1	5EA20-M1		115
One Data, One F-Style.....	5EA20-S2	5EA20-M2		115
One Data, One Phone, One F-Style.....	5EA20-S3	5EA20-M3		115
Two Data, Two F-Style.....	5EA20-S4	5EA20-M4		115

Cheetah Speed System®

3-Port Insert, includes blank insert.....	5020C-00W	5020C-00T	5020C-00I	5020C-00E	116
Decora Insert Coax.....	CH181-00W	CH181-00T	CH181-00I	CH181-00E	116
Decora Insert Telephone.....	CH149-00W	CH149-00T	CH149-00I	CH149-00E	116
Decora Insert Telephone/ Coax Combo.....	CH159-00W	CH159-00T	CH159-00I	CH159-00E	116
Single-Gang Non-Metallic Datacom Box.....	3005C-C00				116
Single-Gang Low-Voltage Datacom Cut-in Bracket.....	4007C-C00				116

Home Theater & Recessed Receptacles, & Mobile Device Station

Home Theater Interface Wallplate, two QuickPort® openings.....	AEHTK-000	118
Multi-Room Install Wallplate, two QuickPort openings.....	AEMRK-000	118
Single-Gang Single Spring-Clip Device Audio/Video Wallplate.....	40951-1P	118
Single-Gang Double Spring-Clip Device Audio/Video Wallplate.....	40952-2P	118
Single-Gang Recessed Single Receptacle.....	00688-00	118
Single-Gang Recessed Single Receptacle, Non-Magnetic Stainless Steel.....	05261-0CH	118
Single-Gang Recessed Duplex Receptacle.....	00689-00†	118
Single-Gang Recessed Single Receptacle, Non-Magnetic Stainless Steel.....	05361-0CH	118
Dual-Gang Recessed Duplex Receptacle and Openings for six QuickPort Modules.....	00690-00	118
Recessed Entertainment Box w/ Low-Profile Frame.....	47617-REB	118
Recessed Entertainment Box w/ High-Profile Cover.....	47617-RBH	118
High-Profile Cover.....	47617-HPC	118
Low-Profile Frame.....	47617-LPF	118
Replacement Snap-in Plates.....	47617-PLT	118
Decora® Mobile Device Station, White.....	47112-00W	118
Decora Mobile Device Station, Light Almond.....	47112-00T	118
Decora Mobile Device Station, Black.....	47112-00E	118
Renu® Mobile Device Station, White on White.....	47112-RWW	118
Renu Mobile Device Station, Navajo Sand.....	47112-RNS	118
Renu Mobile Device Station, Onyx Black.....	47112-ROB	118
USB Charger/Tamper-Resistant Receptacle.....	T5630-00W	118
RG6 Coax Cable, gold plated.....	C6851-xx	119
RG6 Coax Cable, nickel.....	C6851-xx	119
Two-Way Splitter, carded unit pack.....	C5002-000	119
Two-Way Splitter, gold plated, carded unit pack.....	C5002-0G0	119
Two-Way Splitter, gold plated, individual polybag pack.....	40987-002	119
Three-Way Splitter, carded unit pack.....	C5003-000	119
Three-Way Splitter, gold plated, individual polybag pack.....	40987-003	119
Four-Way Splitter, carded unit pack.....	C5004-000	119
Four-Way Splitter, gold plated, carded unit pack.....	C5004-0G0	119
Four-Way Splitter, gold plated, individual polybag pack.....	40987-004	119
75 Ohm Termination Cap, 25 per polybag pack.....	40984-000	119

Video Accessories

RCA to F-Type Video Adapter.....	C5205-000	120
75 Ohm Push-On Connector.....	C5235-000	120
75 Ohm Push-On Connector.....	C5235-0G0	120
75 Ohm In-Line Cable Connector.....	40986-000	120
Indoor Matching Transformer.....	C5052-000	120
Indoor Matching Transformer.....	C5052-0G0	120
One-Piece Crimp-On F-Connector for RG6.....	40985-0Q6	120
One-Piece Crimp-on F-Connector for RG59, 100, nickel.....	40985-1P9	120
One-Piece Crimp-on F-Connector for RG59, 2 nickel.....	C5307-000	120
One-Piece Crimp-on F-Connector for RG59, 2 gold.....	C5307-0G0	120
One-Piece Crimp-on F-Connector for RG6.....	40985-1P6	120
Two-Piece Crimp-on F-Connector for RG59, 100, nickel.....	40985-2P9	120
Two-Piece Crimp-on F-Connector for RG59, 2 nickel.....	C5009-000	120
Two-Piece Crimp-on F-Connector for RG59, 2 gold.....	C5009-0G0	120
Two-Piece Crimp-on F-Connector for RG6, 100, nickel.....	40985-2P6	120
Two-Piece Crimp-on F-Connector for RG6, 2 nickel.....	C5007-000	120
Two-Piece Crimp-on F-Connector for RG6, 2 gold.....	C5007-0G0	120
Outdoor Matching Transformer.....	C5053-000	121
75 Ohm A/B Switch.....	C5101-000	121
6' Stereo Dubbing Cable.....	C5822-000	121
6' Stereo Dubbing Cable, gold plated RCA plugs.....	C5856-0G0	121
6' S-Video Cable.....	C5853-006	121

DSS 75 Ohm and 2.0 GHz Combiner with DC Blocking.....	40866-DSS	121
DSS Signal Amplifier.....	40866-DSS	121
DSS 2-Way Splitter	40867-DSS	121
DSS 4-Way Splitter	40868-DSS	121

Audio Accessories

RCA Y Adapter	C5405-000	122
Black Cable with Color-Coded Plugs.....	C5454-003	122
18/2 AWG Speaker Wire, 25'	X3301-25C	122
18/2 AWG Speaker Wire, 100'	X3301-100	122
18/2 AWG Speaker Wire, 250'	W5212-250	122
14/2 AWG Speaker Wire, 50'	X3324-50C	122
14/2 AWG Speaker Wire, 100'	X3324-100	122
14/2 AWG Speaker Wire, 250'	W5214-250	122
RCA to F-Type Video Adapter	C5205-000	123
75 Ohm Push-On Connector.....	C5235-000	123
75 Ohm Push-On Connector.....	C5235-0G0	123
75 Ohm In-Line Cable Connector.....	40986-000	123
Indoor Matching Transformer.....	C5052-000	123
Indoor Matching Transformer.....	C5052-0G0	123
One-Piece Crimp-On F-Connector.....	40985-0Q6	123
One-Piece Crimp-on F-Connector for RG59, 100, nickel.....	40985-1P9	123
One-Piece Crimp-on F-Connector for RG59, 2 nickel.....	C5307-000	123
One-Piece Crimp-on F-Connector for RG59, 2 gold.....	C5307-0G0	123
One-Piece Crimp-on F-Connector for RG6, 100, nickel.....	40985-1P6	123
Two-Piece Crimp-on F-Connector for RG59, 100, nickel.....	40985-2P9	123
Two-Piece Crimp-on F-Connector for RG59, 2 nickel.....	C5009-000	123
Two-Piece Crimp-on F-Connector for RG59, 2 gold.....	C5009-0G0	123
Two-Piece Crimp-on F-Connector for RG6, 100, nickel.....	40985-2P6	123
Two-Piece Crimp-on F-Connector for RG6, 2 nickel.....	C5007-000	123
Two-Piece Crimp-on F-Connector for RG6, 2 gold.....	C5007-0G0	123

Promo Bundles

Leviton Security & Automation Yard Sign	SA-30	133
Leviton Security & Automation Window Decal.....	SA-31	133
Model Home Support Kit.....	SA-23	133



**LAN TCP/IP BASED INTERFACES
(TOUCHSCREENS)**



**MOBILE INTERFACES
(NO FEES)**



**ENERGY MANAGEMENT
AUTOMATION CONTROLLER**

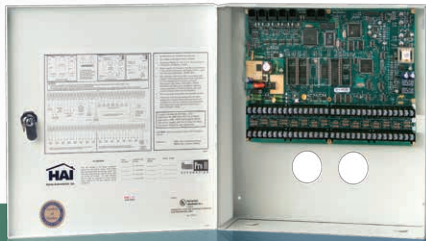

Lighting



Safety



Surveillance



Energy Management



Entertainment



Access Control

Leviton supports open standards

The best thing about technology standards is they are never in shortage. Over 28 years of experience in the home and building automation industry reinforces that. Leviton designs systems that successfully implement a vast multitude of home and building automation standards to ensure the system is useful and functional throughout its long life. Leviton's support of a wide variety of open standards allows each home or building owner to have all the automated systems they want, regardless of the limitations of one type of technology or another. Leviton has long been a supporter of standards such as UPB™, X-10, Z-Wave®, RS-232, TCP/IP, KNX, DALI and ZigBee®, and will continue to evaluate and add support for new technologies each year.

Approvals

- UL Residential Fire and Burglary (Omni family)
- UL Commercial Burglary (OmniPro II & Omni IIe)
- UL Energy Management (Lumina family)
- FCC Part 15J, Part 68 (Omni & Lumina families)
- California Title 24 Compliant (35A00-1, 35A00-1CFL, 35A00-2, 40A00-1, 55A00-1, 55A00-2, and 55A00-3, and Omni & Lumina family)
- California State Fire Marshall (Omni family)
- CP-01 Compliant (Omni family)
- CE (European Standard - Hi-Fi 2; Omni & Lumina families)
- IS-60 (Canadian Standard - Omni & Lumina families)
- Leviton Security & Automation's products are RoHS compliant
- ETL, NOM, and C-Tick Listings



Leviton Corporate Headquarters

leviton.com
T 800.323.8920
E customerservice@leviton.com

Leviton International Regional Headquarters

Middle East & Africa
T +971.4.886.4722
E lmeinfo@leviton.com

Latin America
T +52.55.5082.1040
E lsamarketing@leviton.com

China
T +86.755.3320.0588
E infochina@leviton.com

Canada
T +1.514.954.1840
E pcservice@leviton.com

India / SAARC
T +91.80.4322.5678
E lev_india@leviton.com

Leviton International Offices

ASEAN Countries
T +1.631.812.6228
E infoasean@leviton.com

Europe
T +47.900.94.924
E infoeurope@leviton.com

South Korea
T +82.2.3273.9963
E infokorea@leviton.com

Australia & New Zealand
T +64.4.562.8327
E infoausnz@leviton.com