

Halco®

LIGHTING TECHNOLOGIES

LAMP & BALLAST CATALOG



Table of Contents

Indoor Luminaires

ProLED Downlight Retrofit Replaceable Trim Series	6
ProLED Surface Downlights	14
ProLED Square Downlights	18
ProLED ECO Downlights	22
ProLED Adjustable Downlights	28
ProLED Commercial Downlight Retrofit	32
ProLED Linear LED High Bay Series	38
ProLED Round LED High Bay Series	44
ProLED Panel Light Series	50
ProLED Surface Mount Kit	55
ProLED Volumetric Light Series	56

Outdoor Luminaires

LED Wallpack Semi Cutoff Series	62
LED Wallpack Full Cutoff Series	64
LED Flood Series	66
LED Compact Flood	68
LED Low Profile Canopy	70
LED Large Canopy	72
LED Dusk to Dawn Series	74
LED Vaportight Series	76
DecoStrand	78



About Halco® Lighting Technologies

Established in 1974, Halco Lighting Technologies is a leader in lamp and ballast solutions. We are dedicated to providing you with the latest in energy efficient technologies; illustrated by our ProLED fixtures and full offering of ProLED lamps. Halco's fixture offering features indoor recessed solutions such as ProLED Panel, Volumetric Panel and Downlight Retrofit Series fixtures. Our broad selection of long life, energy efficient ProLED lamps is available in popular shapes with an array of color temperatures and beam spreads. Halco is your single source for LED lamps for replacement and retrofit applications.

Service

We measure our success by one standard - your satisfaction. Halco carries deep inventory of a broad SKU offering to assure we have what you need when you need it. With strategically located warehouses in Atlanta, Carlstadt, Cleveland, Houston, Los Angeles and Phoenix, orders placed by 2:00 PM local warehouse time ship the same day. Will-call and courier service is also available for your convenience.

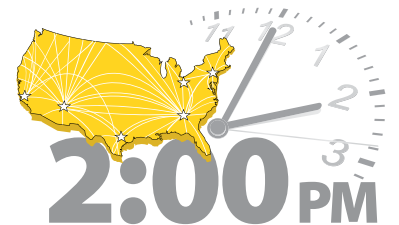

Quality

Our in-house lighting laboratory allows us to perform a variety of testing services including photometric, light output, color metrics and electrical measurements, including IES LM-79 testing. This product testing facility operates under a quality management system that meets the requirements of ISO 17025 and ensures continuous quality control and outstanding product performance.

Quality Assurance

Halco's Quality Assurance policy ensures we deliver on our commitment to your satisfaction. If our product does not perform according to specifications, rest assured we'll provide a replacement or credit.

• Performance

Halco luminaires and lamps are backed by a warranty you can rely on. Retrofit, Surface, Square, Panel and Volumetric lights are backed by a 5-year limited warranty, (some panels are backed by a 10-year limited warranty). Wallpack, Wallpack Cutoff, Flood, Compact, Low Profile, Large Canopy, Dusk to Dawn and Vaportight are also backed by a 5-year limited warranty. DecoStrand is backed by a 2-year limited warranty.

5
Limited Warranty

10 YR
WARRANTY

Indoor Luminaires





ProLED Downlight Retrofit Replaceable Trim Series

Applications

Home
Office
Lobby
Hospitality
Retail
Conference Room
Markets
Commercial
Residential

Long life and energy efficient replacement for lamps in existing 4", 5" or 6" recessed housings



Specifications

- 5" - 6" fixture includes 2 additional spring clips for recessed cans that do not use torsion springs Umbilical E26 socket assembly included, GU24 adapter available
- E26 Socket assembly included, GU24 Adapter available
- 2700K and 3000K lamps' performance meets California Quality Lamp Specifications
- UL Classified for wet locations
- Low profile design compatible with 4", 5" or 6" recessed downlight fixtures
- Dimmable to 5% for design flexibility
- All CCT versions are Title 24 Compliant; 2700K, 3000K and 4000K are CEC Listed
- ENERGY STAR certified
- 5-year limited warranty

Dimensions

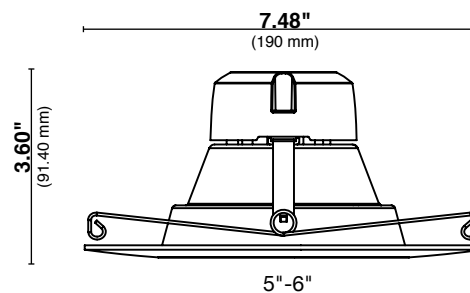
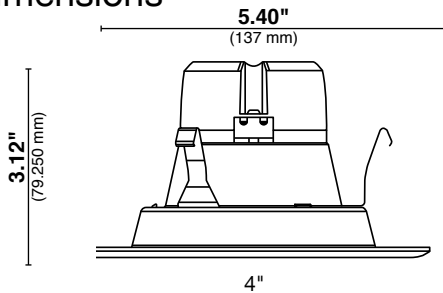

Ordering Information



Watt	Product #	Product Code	Volts	Color Temp.	CRI	Lumens	Useful Life*	Pkg. Qty.	Fixture Size	Equivalent Wattage
4" Series										
8.5	99823	DL4FR9/927/RT2/LED ♦	120	2700K	90	600	50,000	1/12	4"	50W
8.5	99824	DL4FR9/930/RT2/LED ♦	120	3000K	90	600	50,000	1/12	4"	50W
8.5	99825	DL4FR9/940/RT2/LED ♦	120	4000K	90	600	50,000	1/12	4"	50W
8.5	99826	DL4FR9/950/RT2/LED ♦	120	5000K	90	600	50,000	1/12	4"	50W
6" Series										
12	99819	DL6FR12/927/RT2/LED ♦	120	2700K	90	800	50,000	1/6	5"-6"	65W
12	99820	DL6FR12/930/RT2/LED ♦	120	3000K	90	800	50,000	1/6	5"-6"	65W
12	99821	DL6FR12/940/RT2/LED ♦	120	4000K	90	800	50,000	1/6	5"-6"	65W
12	99822	DL6FR12/950/RT2/LED ♦	120	5000K	90	800	50,000	1/6	5"-6"	65W
18	99829	DL6FR18/927/RT2/LED ♦	120	2700K	90	1200	50,000	1/6	5"-6"	120W
18	99830	DL6FR18/930/RT2/LED ♦	120	3000K	90	1200	50,000	1/6	5"-6"	120W
18	99827	DL6FR18/940/RT2/LED ♦	120	4000K	90	1200	50,000	1/6	5"-6"	120W
18	99828	DL6FR18/950/RT2/LED ♦	120	5000K	90	1200	50,000	1/6	5"-6"	120W

* Useful Life is defined as the point in time at which the LED will maintain at least 70% of its initial lumens. The LED will continue to burn past this point, but at decreased light levels.

Warranty – Commercial / Industrial: This product is warranted for 5 years from the date of purchase.

Represents lamps that are ENERGY STAR® certified.

♦ May not be compatible with all dimming systems, dimming performance may vary by system, please check the website www.halcolighting.com/ProLEDDim for up-to-date dimmer compatibility information. Use on incompatible systems may shorten lamp life.

ProLED Downlight Retrofit Replaceable Trim Series

Torsion springs are mounted to the housing assembly; friction clips are included and can easily be installed in place of the torsion springs

Positive locking mechanical adjustment of mounting hardware accommodates both 5" and 6" cans without binding

Mounting hardware adjusts to 5" and 6" cans, ensuring the trim fits snugly in the housing and to the ceiling surface

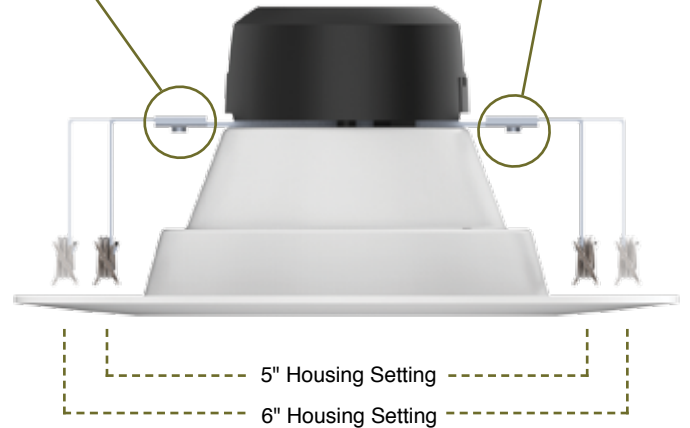
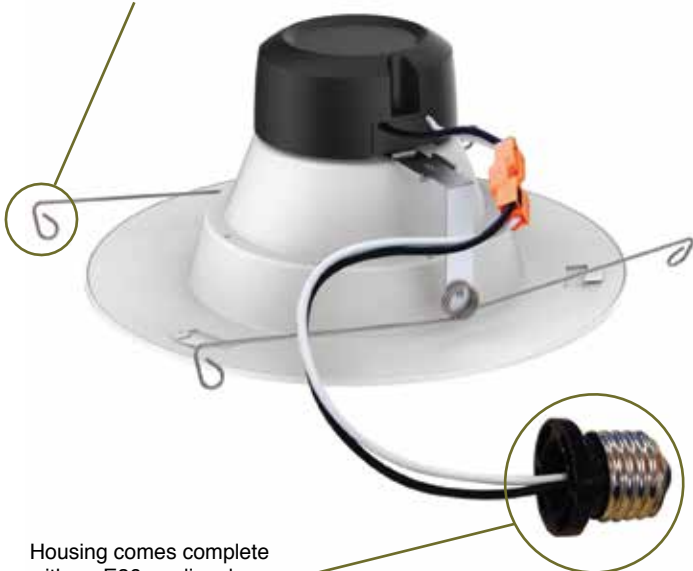

Housing comes complete with an E26 medium base socket adapter

Title 24 compliant quick plug connector is compatible with—and plugs directly into—dedicated LED recessed housings

Friction clips (included) shown installed in place of the torsion springs

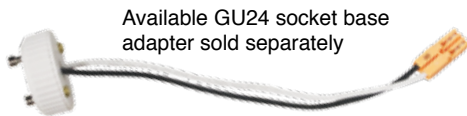

Available GU24 socket base adapter sold separately

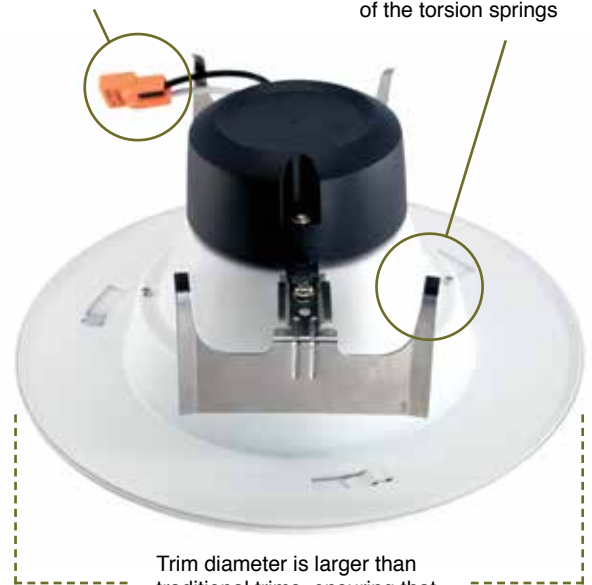

Trim diameter is larger than traditional trims, ensuring that even oversized housing holes are covered

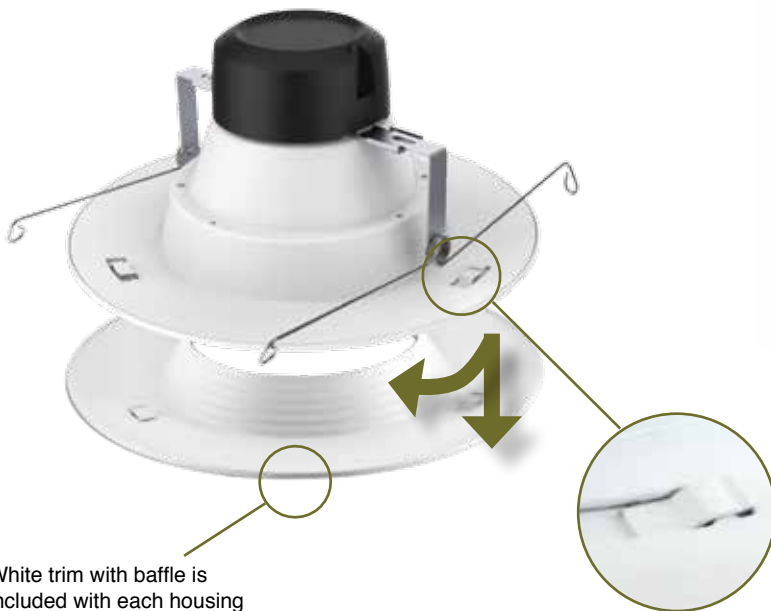

White trim with baffle is included with each housing assembly; optional trim configurations are available

Easy Twist Technology™ allows trims to be installed without tools, and can be changed after the housing is installed

ProLED Downlight Retrofit Replaceable Trim Series



Savings Comparison

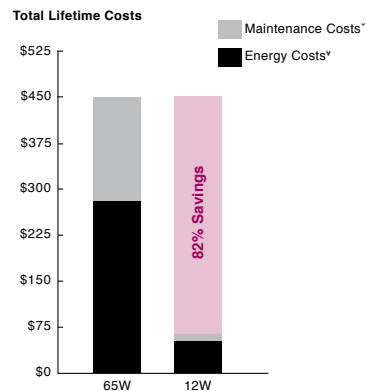

* Maintenance costs based on 15 minutes at \$40 per/hr
 † Energy costs based on \$0.11 kWh

5" - 6" Trims



White Trim -
White Stepped Baffle
(Included)



White Trim -
Black Stepped Baffle



White Trim -
Specular Silver Reflector



Brushed Nickel Trim -
Stepped Baffle



Oil Rubbed Bronze Trim -
Stepped Baffle



Black Trim -
Stepped Baffle

4" Trims



White Trim -
White Stepped Baffle
(Included)



White Trim -
Black Stepped Baffle



White Trim -
Specular Silver Reflector



Brushed Nickel Trim -
Stepped Baffle



Oil Rubbed Bronze Trim -
Stepped Baffle



Black Trim -
Stepped Baffle

Trim Specifications

- Low profile design is compatible with 5"- 6" Downlight Retrofit Replaceable Trim Series ¹
- Complement your existing décor with easy-to-install trim options
- Trims install and lock securely with twist on and off tabs, no tape or adhesive required
- Available in six popular finishes to complement any decor

ProLED Downlight Retrofit Replaceable Trim Series



Accessories

Product	Product Code	Description	Finish	Pkg. Quantity	Baffle Height	Diameter	Weight
Replaceable 4" Trim							
99934	DL4/WB	White Trim - Black Stepped Baffle	White/Black	1/24	0.56"	5.40"	0.10 lbs.
99935	DL4/WSS	White Trim - Specular Silver Baffle	White/Silver	1/24	0.56"	5.40"	0.10 lbs.
99936	DL4/BN	Brushed Nickel Trim - Stepped Baffle	Brushed Nickel	1/24	0.56"	5.40"	0.10 lbs.
99937	DL4/ORB	Oil Rubbed Bronze Trim - Stepped Baffle	Oil Rubbed Bronze	1/24	0.56"	5.40"	0.10 lbs.
99939	DL4/BLK	Black Trim - Stepped Baffle	Black	1/24	0.56"	5.40"	0.10 lbs.
Replaceable 5" - 6" Trim							
99930	DL6/WB	White Trim - Black Stepped Baffle	White/Black	1/24	0.77"	7.48"	0.15 lbs.
99931	DL6/WSS	White Trim - Specular Silver Baffle	White/Silver	1/24	0.77"	7.48"	0.15 lbs.
99932	DL6/BN	Brushed Nickel Trim - Stepped Baffle	Brushed Nickel	1/24	0.77"	7.48"	0.15 lbs.
99933	DL6/ORB	Oil Rubbed Bronze Trim - Stepped Baffle	Oil Rubbed Bronze	1/24	0.77"	7.48"	0.15 lbs.
99938	DL6/BLK	Black Trim - Stepped Baffle	Black	1/24	0.77"	7.48"	0.15 lbs.
GU24 Adapter							
91003	ADP/DL/GU24/LED GU24 Socket Adapter			1			

Trim Dimensions

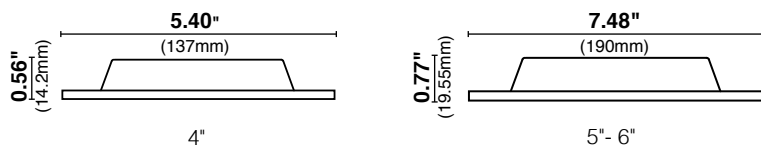

ProLED Downlight Retrofit Replaceable Trim Series

Photometrics

4" Downlight

99923, DL4FR9/927/RT2/LED

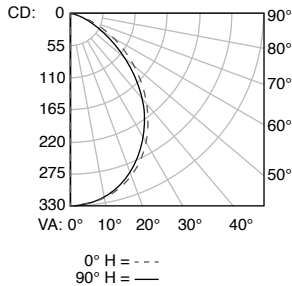

Coefficients of Utilization
Effective Floor Cavity Reflectance 0.20

RC	80			70			50		
RW	70	50	30	70	50	30	50	30	20
0	119	119	119	116	116	116	111	111	111
1	111	107	104	105	102	89	101	98	96
2	103	96	90	94	89	78	90	86	82
3	95	86	79	84	78	68	81	76	71
4	88	77	69	76	69	60	73	67	62
5	81	70	62	69	61	54	67	60	55
6	75	63	55	62	55	48	61	54	49
7	70	58	50	57	49	43	56	49	44
8	66	53	45	52	45	39	51	44	40
9	61	49	41	48	41	36	47	41	36
10	58	45	38	45	38	33	44	37	33

Zonal Lumen Summary

Zone	Lumens	% Lamp	% Luminaire
0-30	244.1	36.8	36.8
0-40	384.3	57.9	57.9
0-60	602.8	90.8	90.8
60-90	61.1	9.2	9.2
70-100	14.8	2.2	2.2
90-120	0.0	0	0
0-90	663.9	100	100
90-180	0.0	0	0
0-180	663.9	100	100

Total Luminaire Efficiency = 100.00%

99924, DL4FR9/930/RT2/LED

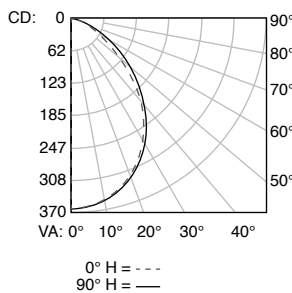

Coefficients of Utilization
Effective Floor Cavity Reflectance 0.20

RC	80			70			50		
RW	70	50	30	70	50	30	50	30	20
0	119	119	119	116	116	116	111	111	111
1	111	107	104	108	105	102	101	98	96
2	103	96	90	100	94	89	91	86	83
3	95	86	79	93	85	78	82	76	72
4	88	78	70	86	76	69	74	68	63
5	82	70	62	80	69	62	67	61	56
6	76	64	56	74	63	55	61	55	50
7	71	58	51	69	58	50	56	50	45
8	66	54	46	65	53	46	52	45	40
9	62	50	42	61	49	42	48	41	37
10	58	46	39	57	46	39	45	38	34

Zonal Lumen Summary

Zone	Lumens	% Lamp	% Luminaire
0-30	266.2	38	38
0-40	416.2	59.4	59.4
0-60	638.6	91.1	91.1
60-90	62.3	8.9	8.9
0-90	700.9	100	100

Total Luminaire Efficiency = 100.00%

99925, DL4FR9/940/RT2/LED

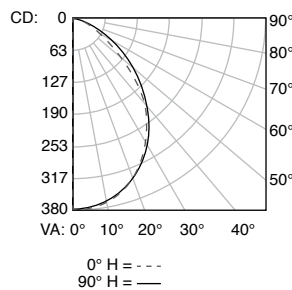

Coefficients of Utilization
Effective Floor Cavity Reflectance 0.20

RC	80			70			50		
RW	70	50	30	70	50	30	50	30	20
0	119	119	119	116	116	116	111	111	111
1	111	107	104	108	105	102	101	98	96
2	103	96	90	100	94	89	91	86	83
3	95	86	79	93	85	78	82	76	72
4	88	77	70	86	76	69	74	68	63
5	82	70	62	80	69	62	67	61	56
6	76	64	56	74	63	55	61	55	50
7	71	58	50	69	58	50	56	49	44
8	66	54	46	65	53	46	52	45	40
9	62	50	42	61	49	42	48	41	37
10	58	46	39	57	45	38	45	38	34

Zonal Lumen Summary

Zone	Lumens	% Lamp	% Luminaire
0-30	279.3	37.8	37.8
0-40	437.6	59.2	59.3
0-60	672.5	91.1	91.1
60-90	65.9	8.9	8.9
0-90	738.4	100	100

Total Luminaire Efficiency = 100.00%

99926, DL4FR9/950/RT2/LED

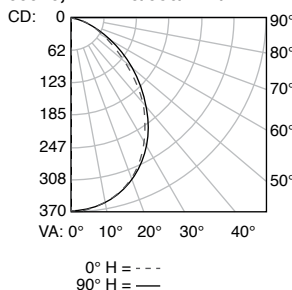

Coefficients of Utilization
Effective Floor Cavity Reflectance 0.20

RC	80			70			50		
RW	70	50	30	70	50	30	50	30	20
0	119	119	119	116	116	116	111	111	111
1	111	107	104	108	105	102	101	98	96
2	103	96	90	100	94	89	91	86	83
3	95	86	79	93	84	78	82	76	72
4	88	77	70	86	76	69	74	68	63
5	81	70	62	80	69	62	67	60	55
6	76	64	56	74	63	55	61	54	49
7	71	58	50	69	58	50	56	49	44
8	66	54	46	65	53	46	52	45	40
9	62	50	42	61	49	42	48	41	37
10	58	46	39	57	45	38	44	38	34

Zonal Lumen Summary

Zone	Lumens	% Lamp	% Luminaire
0-30	271.2	37.7	37.7
0-40	424.6	59.1	59.1
0-60	654.1	91	91
60-90	65.0	9	9
0-90	719.0	100	100

Total Luminaire Efficiency = 100.00%

ProLED Downlight Retrofit Replaceable Trim Series

Photometrics

5"-6" Downlight (12W)

99819, DL6FR12/927/RT2/LED

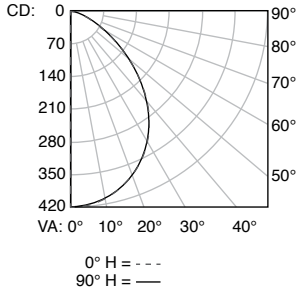

Coefficients of Utilization
Effective Floor Cavity Reflectance 0.20

RC	80			70			50			
RW	70	50	30	70	50	30	0	50	30	20
0	119	119	119	116	116	100	111	111	111	111
1	111	107	103	105	102	89	101	98	96	
2	102	96	90	94	88	78	90	86	82	
3	95	86	79	84	78	68	81	76	71	
4	88	77	69	76	69	60	73	67	62	
5	81	70	62	69	61	54	67	60	55	
6	75	63	55	63	55	48	61	54	49	
7	70	58	50	57	50	43	56	49	44	
8	66	53	45	53	45	39	51	45	40	
9	62	49	42	49	41	36	48	41	36	
10	58	46	38	45	38	33	44	38	33	

Zonal Lumen Summary

Zone	Lumens	% Lamp	% Luminaire
0-30	312.7	37.1	37.1
0-40	493.5	58.6	58.6
0-60	760.2	90.3	90.3
60-90	82.0	9.7	9.7
70-100	25.1	3	3
90-120	0.0	0	0
0-90	842.2	100	100
90-180	0.0	0	0
0-180	842.2	100	100

Total Luminaire Efficiency = 100.00%

99820, DL6FR12/930/RT2/LED

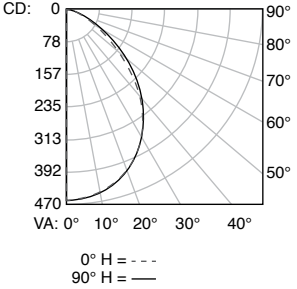

Coefficients of Utilization
Effective Floor Cavity Reflectance 0.20

RC	80			70			50			
RW	70	50	30	70	50	30	0	50	30	20
0	119	119	119	116	116	116	111	111	111	111
1	111	107	104	108	105	102	101	98	96	
2	102	96	90	100	94	89	90	86	82	
3	95	86	79	92	84	78	81	76	71	
4	88	77	69	85	76	69	73	67	62	
5	81	70	62	79	69	61	67	60	55	
6	75	63	55	74	63	55	61	54	49	
7	70	58	50	69	57	50	56	49	44	
8	66	53	46	64	53	45	51	45	40	
9	62	49	42	60	49	41	48	41	36	
10	58	46	38	57	45	38	44	38	33	

Zonal Lumen Summary

Zone	Lumens	% Lamp	% Luminaire
0-30	346.0	37.2	37.2
0-40	547.4	58.8	58.8
0-60	841.4	90.4	90.4
60-90	88.9	9.6	9.6
0-90	930.3	100	100

Total Luminaire Efficiency = 100.00%

99821, DL6FR12/940/RT2/LED

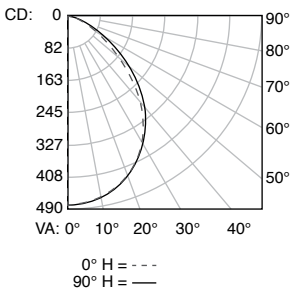

Coefficients of Utilization
Effective Floor Cavity Reflectance 0.20

RC	80			70			50			
RW	70	50	30	70	50	30	0	50	30	20
0	119	119	119	116	116	116	111	111	111	111
1	111	107	103	108	105	102	101	98	96	
2	102	96	90	100	94	88	90	86	82	
3	95	86	78	92	84	78	81	76	71	
4	87	77	69	85	76	68	73	67	62	
5	81	70	62	79	69	61	66	60	55	
6	75	63	55	74	62	55	61	54	49	
7	70	58	50	69	57	49	56	49	44	
8	66	53	45	64	52	45	51	44	40	
9	61	49	41	60	48	41	47	41	36	
10	58	45	38	57	45	38	44	37	33	

Zonal Lumen Summary

Zone	Lumens	% Lamp	% Luminaire
0-30	360.4	36.7	36.7
0-40	571.8	58.3	58.3
0-60	884.9	90.2	90.2
60-90	95.7	9.8	9.8
0-90	980.6	100	100

Total Luminaire Efficiency = 100.00%

99822, DL6FR12/950/RT2/LED

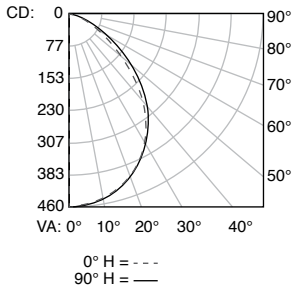

Coefficients of Utilization
Effective Floor Cavity Reflectance 0.20

RC	80			70			50			
RW	70	50	30	70	50	30	0	50	30	20
0	119	119	119	116	116	116	111	111	111	111
1	111	107	103	108	105	102	101	98	96	
2	102	95	90	100	94	88	90	86	82	
3	95	85	78	92	84	77	81	76	71	
4	87	77	69	85	76	68	73	67	62	
5	81	70	62	79	68	61	66	60	55	
6	75	63	55	73	62	55	61	54	49	
7	70	58	50	69	57	49	56	49	44	
8	66	53	45	64	52	45	51	44	40	
9	61	49	41	60	48	41	47	41	36	
10	58	45	38	57	45	38	44	37	33	

Zonal Lumen Summary

Zone	Lumens	% Lamp	% Luminaire
0-30	343.8	36.7	36.7
0-40	545.5	58.2	58.2
0-60	845.1	90.2	90.2
60-90	91.8	9.8	9.8
0-90	936.9	100	100

Total Luminaire Efficiency = 100.00%

ProLED Downlight Retrofit Replaceable Trim Series

Photometrics

5"-6" Downlight (18W)

99829, DL6FR18/927/RT2/LED

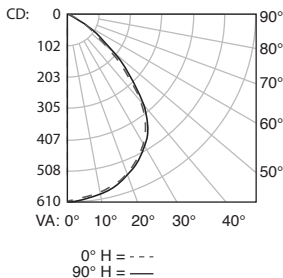

Coefficients of Utilization
Effective Floor Cavity Reflectance 0.20

RC	80			70			50		
RW	70	50	30	70	50	30	50	30	20
0	119	119	119	116	116	100	111	111	111
1	111	107	103	108	105	102	101	98	96
2	103	96	90	100	94	89	91	86	83
3	95	86	79	93	85	78	82	76	72
4	88	78	70	86	76	69	74	68	63
5	82	70	63	80	69	62	67	61	56
6	76	64	56	74	63	56	61	55	50
7	71	59	51	69	58	50	56	50	45
8	66	54	46	65	53	46	52	45	41
9	62	50	42	61	49	42	48	41	37
10	58	46	39	57	46	39	45	38	34

Zonal Lumen Summary

Zone	Lumens	% Lamp	% Luminaire
0-30	466.1	37.6	37.6
0-40	751.5	60.6	60.7
0-60	1,133.1	91.3	91.5
60-90	105.1	8.5	8.5
0-90	1,238.3	99.8	100

Total Luminaire Efficiency = 100.00%

99830, DL6FR18/930/RT2/LED

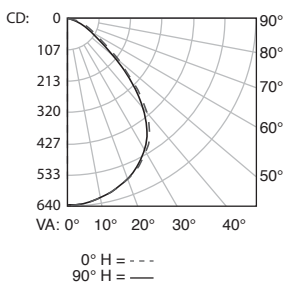

Coefficients of Utilization
Effective Floor Cavity Reflectance 0.20

RC	80			70			50		
RW	70	50	30	70	50	30	50	30	20
0	119	119	119	116	116	111	111	111	111
1	111	107	103	108	105	102	101	98	96
2	103	96	90	100	94	89	91	86	83
3	95	86	79	93	84	78	82	76	72
4	88	78	70	86	76	69	74	68	63
5	82	70	62	80	69	62	67	61	56
6	76	64	56	74	63	56	61	55	50
7	71	59	51	69	58	50	56	50	45
8	66	54	46	65	53	46	52	45	40
9	62	50	42	61	49	42	48	41	37
10	58	46	39	57	46	38	45	38	34

Zonal Lumen Summary

Zone	Lumens	% Lamp	% Luminaire
0-30	489.1	37.5	37.5
0-40	788.7	60.4	60.5
0-60	1,191.8	91.3	91.5
60-90	111.0	8.5	8.5
0-90	1,302.8	99.8	100

Total Luminaire Efficiency = 100.00%

99827, DL6FR18/940/RT2/LED

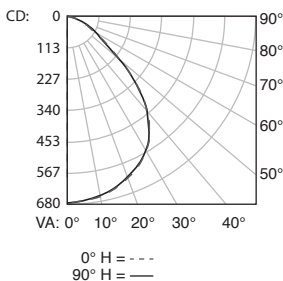

Coefficients of Utilization
Effective Floor Cavity Reflectance 0.20

RC	80			70			50		
RW	70	50	30	70	50	30	50	30	20
0	119	119	119	116	116	111	111	111	111
1	111	107	103	108	105	102	101	98	96
2	103	96	90	100	94	89	91	86	82
3	95	86	79	93	84	78	82	76	72
4	88	78	70	86	76	69	74	68	63
5	82	70	62	80	69	62	67	61	56
6	76	64	56	74	63	56	61	55	50
7	71	59	51	69	58	50	56	50	45
8	66	54	46	65	53	46	52	45	40
9	62	50	42	61	49	42	48	41	37
10	58	46	39	57	45	38	45	38	34

Zonal Lumen Summary

Zone	Lumens	% Lamp	% Luminaire
0-30	522.8	37.3	37.4
0-40	845.1	60.3	60.4
0-60	1,278.6	91.3	91.4
60-90	119.7	8.5	8.6
0-90	1,398.3	99.8	100

Total Luminaire Efficiency = 100.00%

99828, DL6FR18/950/RT2/LED

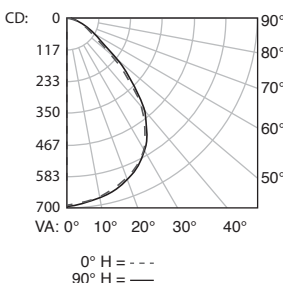

Coefficients of Utilization
Effective Floor Cavity Reflectance 0.20

RC	80			70			50		
RW	70	50	30	70	50	30	50	30	20
0	119	119	119	116	116	111	111	111	111
1	111	107	103	108	105	102	101	98	96
2	103	96	90	100	94	89	90	86	82
3	95	86	79	93	84	78	82	76	72
4	88	77	70	86	76	69	74	68	63
5	81	70	62	80	69	62	67	61	56
6	76	64	56	74	63	56	61	55	50
7	71	58	51	69	58	50	56	50	45
8	66	54	46	65	53	46	52	45	40
9	62	50	42	61	49	42	48	41	37
10	58	46	39	57	45	38	44	38	34

Zonal Lumen Summary

Zone	Lumens	% Lamp	% Luminaire
0-30	533.1	37.3	37.4
0-40	860.4	60.2	60.4
0-60	1,302.4	91.2	91.4
60-90	123.3	8.6	8.6
0-90	1,425.7	99.8	100

Total Luminaire Efficiency = 100.00%

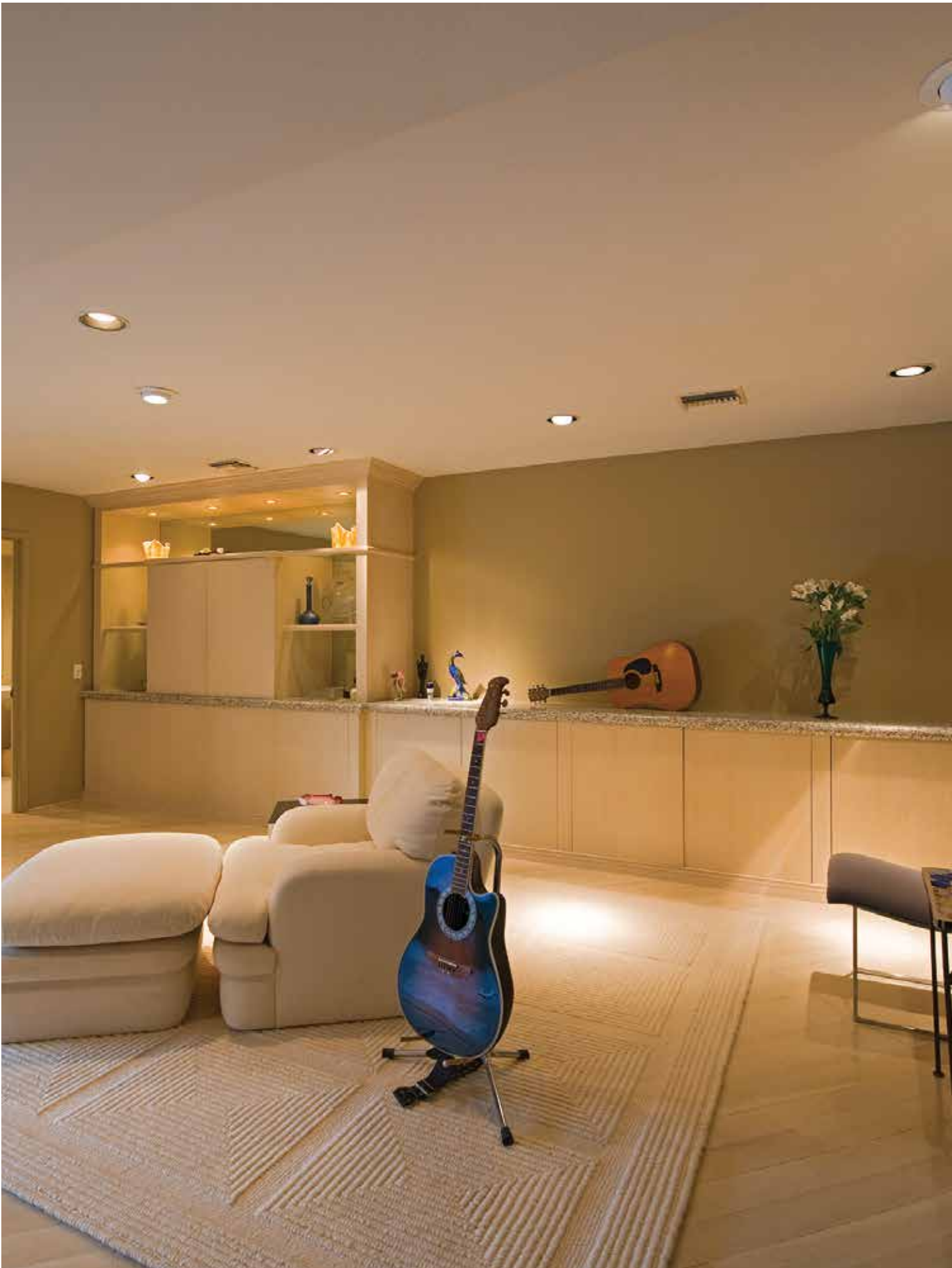

ProLED Surface Downlights

Applications

- Home
- Office
- Lobby
- Hospitality
- Conference Room

Markets

- Commercial
- Residential

ProLED 4" and 6" surface downlights help maximize lighting areas with a low profile design



Specifications

- Mounts to standard 4" junction box with easy to install snap-fit bracket
- Mounts in standard 4" and 6" recessed housings with optional housing mounting clips (included)
- 36,000 hour life results in lower maintenance costs over time
- Lamp is UL approved for damp locations
- Rated for indoor use only
- RoHS compliant
- Pre-wired E26 socket assembly included, GU24 adapter available
- Dimmable to 10%
- 5-year limited warranty

Dimensions

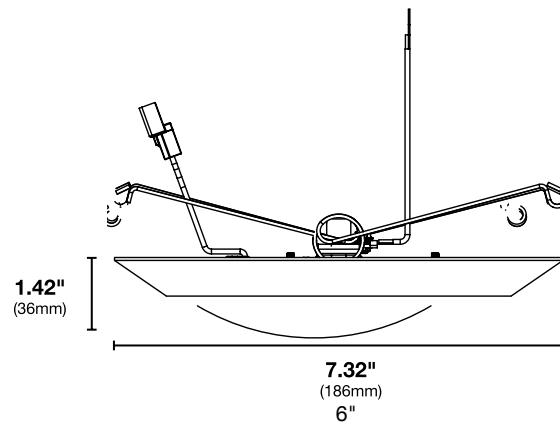
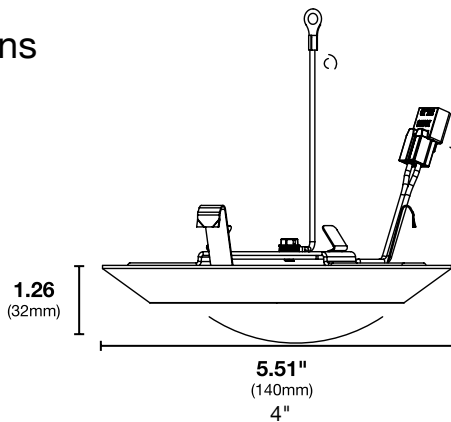

Ordering Information



Watt	Product #	Product Code	Volts	Color Temp.	CRI	Lumens	Useful Life*	Dimmable	Pkg. Qty.	Fixture Size	Beam Spread	Equivalent Wattage
7	99944	SDL4FR7/827/LED	120	2700K	80	500	36,000	Yes	1/6	4"	90°	50W
7	99945	SDL4FR7/830/LED	120	3000K	80	525	36,000	Yes	1/6	4"	90°	50W
7	99946	SDL4FR7/840/LED	120	4000K	80	570	36,000	Yes	1/6	4"	90°	50W
7	99947	SDL4FR7/850/LED	120	5000K	80	595	36,000	Yes	1/6	4"	90°	50W
11.5	99948	SDL6FR12/827/LED	120	2700K	80	740	36,000	Yes	1/6	6"	90°	65W
11.5	99949	SDL6FR12/830/LED	120	3000K	80	780	36,000	Yes	1/6	6"	90°	65W
11.5	99950	SDL6FR12/840/LED	120	4000K	80	845	36,000	Yes	1/6	6"	90°	56W
11.5	99951	SDL6FR12/850/LED	120	5000K	80	890	36,000	Yes	1/6	6"	90°	65W

Represents lamps that are ENERGY STAR® certified.

* Useful Life is defined as the point in time at which the LED will maintain at least 70% of its initial lumens. The LED will continue to burn past this point, but at decreased light levels.

Warranty – Commercial / Industrial: This product is warranted for 5 years from the date of purchase.

• May not be compatible with all dimming systems, dimming performance may vary by system, please check the website www.halcolighting.com/ProLEDdim for up-to-date dimmer compatibility information. Use on incompatible systems may shorten lamp life.

ProLED Surface Downlights



Photometrics

99944, SDL4FR7/827/LED

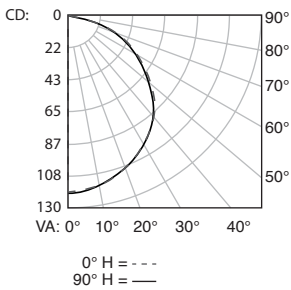

LUMENS PER ZONE

ZONE	LUMENS	% TOTAL	ZONE	LUMENS	% TOTAL
0-10	11.4	3.0%	90-100	4.5	1.2%
10-20	32.8	8.6%	100-110	0.6	0.1%
20-30	50.2	13.2%	110-120	0.0	0%
30-40	61.4	16.2%	120-130	0.0	0%
40-50	65.0	17.1%	130-140	0.0	0%
50-60	60.3	15.9%	140-150	0.0	0%
60-70	47.8	12.6%	150-160	0.0	0%
70-80	30.7	8.1%	160-170	0.0	0%
80-90	14.8	3.9%	170-180	0	0%

ZONAL LUMEN SUMMARY

ZONE	LUMENS	% LAMP	% LUMINAIRE
0-30	94.3	18.8%	24.8%
0-40	155.7	31.1%	41%
0-60	280.9	56%	74%
60-90	93.4	18.6%	24.6%
70-100	50.1	10%	13.2%
90-120	5.1	1%	1.3%
0-90	374.3	74.7%	98.7%
90-180	5.1	1%	1.3%
0-180	379.4	75.7%	100%

99945, SDL4FR7/830/LED

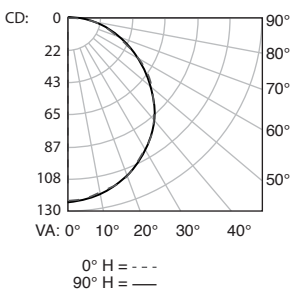

LUMENS PER ZONE

ZONE	LUMENS	% TOTAL	ZONE	LUMENS	% TOTAL
0-10	11.7	3.0%	90-100	4.7	1.2%
10-20	33.7	8.6%	100-110	0.6	0.1%
20-30	51.7	13.2%	110-120	0.0	0%
30-40	63.2	16.2%	120-130	0.0	0%
40-50	66.9	17.1%	130-140	0.0	0%
50-60	62.1	15.9%	140-150	0.0	0%
60-70	49.2	12.6%	150-160	0.0	0%
70-80	31.7	8.1%	160-170	0.0	0%
80-90	15.3	3.9%	170-180	0	0%

ZONAL LUMEN SUMMARY

ZONE	LUMENS	% LAMP	% LUMINAIRE
0-30	97.1	18.5%	24.8%
0-40	160.3	30.6%	41%
0-60	289.3	55.2%	74%
60-90	96.2	18.3%	24.6%
70-100	51.6	9.8%	13.2%
90-120	5.3	1%	1.3%
0-90	385.5	73.5%	98.7%
90-180	5.3	1%	1.3%
0-180	390.8	74.5%	100%

ProLED Surface Downlights

Photometrics

99946, SDL4FR7/840/LED

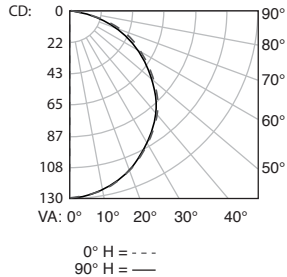

LUMENS PER ZONE

ZONE	LUMENS	% TOTAL	ZONE	LUMENS	% TOTAL
0-10	12.2	3.0%	90-100	4.9	1.2%
10-20	35.0	8.6%	100-110	0.6	0.1%
20-30	53.7	13.2%	110-120	0.0	0%
30-40	65.7	16.2%	120-130	0.0	0%
40-50	69.5	17.1%	130-140	0.0	0%
50-60	64.5	15.9%	140-150	0.0	0%
60-70	51.2	12.6%	150-160	0.0	0%
70-80	32.9	8.1%	160-170	0.0	0%
80-90	15.9	3.9%	170-180	0	0%

ZONAL LUMEN SUMMARY

ZONE	LUMENS	% LAMP	% LUMINAIRE
0-30	100.9	17.4%	24.8%
0-40	166.6	28.8%	41%
0-60	300.6	52%	74%
60-90	99.9	17.3%	24.6%
70-100	53.6	9.3%	13.2%
90-120	5.5	0.9%	1.3%
0-90	400.5	69.2%	98.7%
90-180	5.5	0.9%	1.3%
0-180	406.0	70.2%	100%

99947, SDL4FR7/850/LED

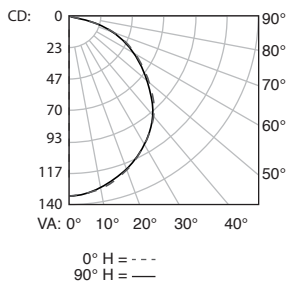

LUMENS PER ZONE

ZONE	LUMENS	% TOTAL	ZONE	LUMENS	% TOTAL
0-10	12.5	3.0%	90-100	5.0	1.2%
10-20	36.0	8.6%	100-110	0.6	0.1%
20-30	55.2	13.2%	110-120	0.0	0%
30-40	67.5	16.2%	120-130	0.0	0%
40-50	71.5	17.1%	130-140	0.0	0%
50-60	66.3	15.9%	140-150	0.0	0%
60-70	52.6	12.6%	150-160	0.0	0%
70-80	33.8	8.1%	160-170	0.0	0%
80-90	16.3	3.9%	170-180	0	0%

ZONAL LUMEN SUMMARY

ZONE	LUMENS	% LAMP	% LUMINAIRE
0-30	103.7	17.3%	24.8%
0-40	171.2	28.6%	41%
0-60	309.0	51.6%	74%
60-90	102.7	17.2%	24.6%
70-100	55.1	9.2%	13.2%
90-120	5.6	0.9%	1.3%
0-90	411.7	68.8%	98.7%
90-180	5.6	0.9%	1.3%
0-180	417.4	69.7%	100%

99948, SDL6FR12/827/LED

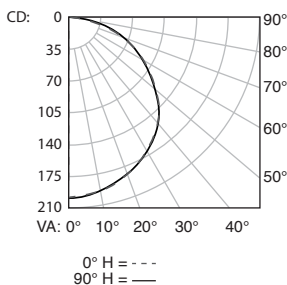

LUMENS PER ZONE

ZONE	LUMENS	% TOTAL	ZONE	LUMENS	% TOTAL
0-10	18.9	3.0%	90-100	4.3	0.7%
10-20	54.6	8.8%	100-110	0.2	0%
20-30	83.6	13.4%	110-120	0.0	0%
30-40	102.4	16.4%	120-130	0.0	0%
40-50	108.5	17.4%	130-140	0.0	0%
50-60	100.8	16.2%	140-150	0.0	0%
60-70	79.7	12.8%	150-160	0.0	0%
70-80	49.4	7.9%	160-170	0.0	0%
80-90	20.6	3.3%	170-180	0.0	0%

ZONAL LUMEN SUMMARY

ZONE	LUMENS	% LAMP	% LUMINAIRE
0-30	157.1	21.3%	25.2%
0-40	259.4	35.1%	41.6%
0-60	468.7	63.5%	75.2%
60-90	149.7	20.3%	24%
70-100	74.2	10.1%	11.9%
90-120	4.5	0.6%	0.7%
0-90	618.4	83.7%	99.3%
90-180	4.6	0.6%	0.7%
0-180	623.0	84.3%	100%

ProLED Surface Downlights

Photometrics

99949, SDL6FR12/830/LED

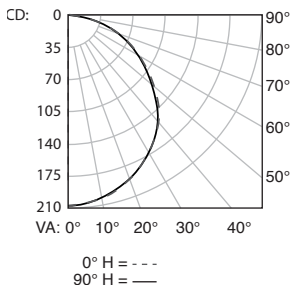

LUMENS PER ZONE

ZONE	LUMENS	% TOTAL	ZONE	LUMENS	% TOTAL
0-10	19.5	3.0%	90-100	4.4	0.7%
10-20	56.2	8.8%	100-110	0.2	0%
20-30	86.1	13.4%	110-120	0.0	0%
30-40	105.4	16.4%	120-130	0.0	0%
40-50	111.7	17.4%	130-140	0.0	0%
50-60	103.8	16.2%	140-150	0.0	0%
60-70	82.1	12.8%	150-160	0.0	0%
70-80	50.9	7.9%	160-170	0.0	0%
80-90	21.2	3.3%	170-180	0.0	0%

ZONAL LUMEN SUMMARY

ZONE	LUMENS	% LAMP	% LUMINAIRE
0-30	161.8	20.6%	25.2%
0-40	267.2	34%	41.6%
0-60	482.8	61.5%	75.2%
60-90	154.2	19.6%	24%
70-100	76.5	9.7%	11.9%
90-120	4.6	0.6%	0.7%
0-90	636.9	81.1%	99.3%
90-180	4.7	0.6%	0.7%
0-180	641.6	81.7%	100%

99950, SDL6FR12/840/LED

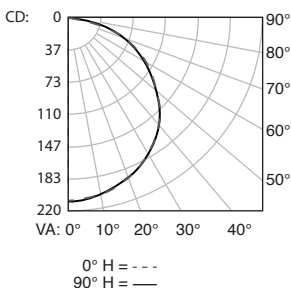

LUMENS PER ZONE

ZONE	LUMENS	% TOTAL	ZONE	LUMENS	% TOTAL
0-10	19.9	3.0%	90-100	4.5	0.7%
10-20	57.3	8.8%	100-110	0.2	0%
20-30	87.7	13.4%	110-120	0.0	0%
30-40	107.5	16.4%	120-130	0.0	0%
40-50	113.9	17.4%	130-140	0.0	0%
50-60	105.8	16.2%	140-150	0.0	0%
60-70	83.7	12.8%	150-160	0.0	0%
70-80	51.9	7.9%	160-170	0.0	0%
80-90	21.6	3.3%	170-180	0.0	0%

ZONAL LUMEN SUMMARY

ZONE	LUMENS	% LAMP	% LUMINAIRE
0-30	164.9	19.3%	25.2%
0-40	272.4	31.9%	41.6%
0-60	492.1	57.7%	75.2%
60-90	157.2	18.4%	24%
70-100	77.9	9.1%	11.9%
90-120	4.7	0.6%	0.7%
0-90	649.3	76.2%	99.3%
90-180	4.8	0.6%	0.7%
0-180	654.1	76.7%	100%

99951, SDL6FR12/850/LED

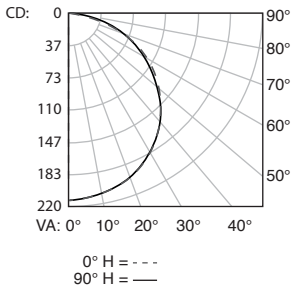

LUMENS PER ZONE

ZONE	LUMENS	% TOTAL	ZONE	LUMENS	% TOTAL
0-10	20.3	3.0%	90-100	4.6	0.7%
10-20	58.4	8.8%	100-110	0.2	0%
20-30	89.4	13.4%	110-120	0.0	0%
30-40	109.5	16.4%	120-130	0.0	0%
40-50	116.1	17.4%	130-140	0.0	0%
50-60	107.9	16.2%	140-150	0.0	0%
60-70	85.3	12.8%	150-160	0.0	0%
70-80	52.9	7.9%	160-170	0.0	0%
80-90	22.0	3.3%	170-180	0.0	0%

ZONAL LUMEN SUMMARY

ZONE	LUMENS	% LAMP	% LUMINAIRE
0-30	168.1	18.6%	25.2%
0-40	277.6	30.7%	41.6%
0-60	501.5	55.5%	75.2%
60-90	160.2	17.7%	24%
70-100	79.4	8.8%	11.9%
90-120	4.8	0.5%	0.7%
0-90	661.7	73.2%	99.3%
90-180	4.9	0.5%	0.7%
0-180	666.6	73.7%	100%

ProLED Square Downlights

Applications

Home
Office
Lobby
Hospitality
Retail
Conference Room
Markets
Commercial
Residential

ProLED 4" and 6" square downlights give a unique design element option



Specifications

- Energy efficient: save up to 80% in energy costs
- High lumen output
- RoHS Compliant
- Luminaire is UL approved for wet locations
- Die-cast aluminum housing
- Rotatable module for easy alignment
- 50,000 hours at 70% lumen maintenance rated life
- 5-year limited warranty

Dimensions

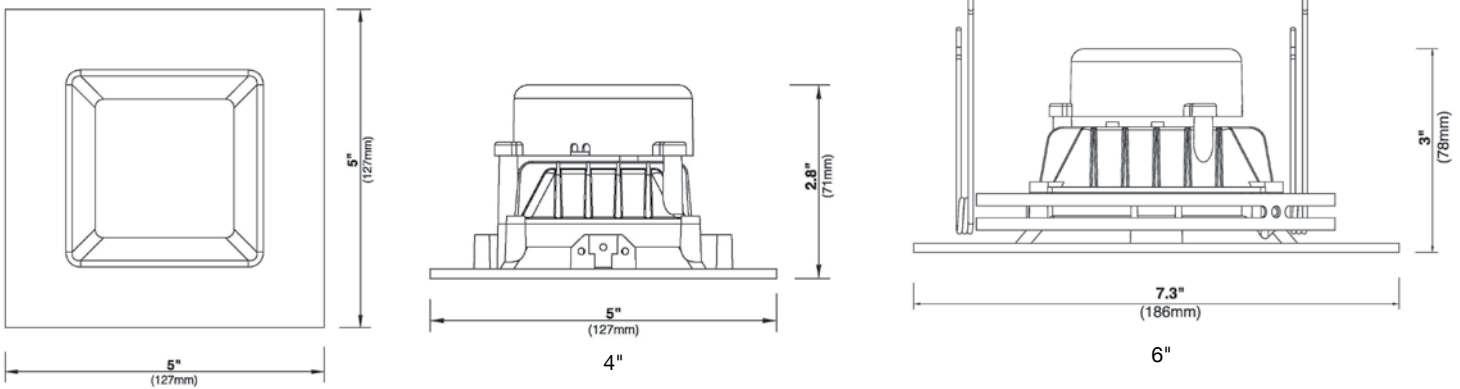

Ordering Information

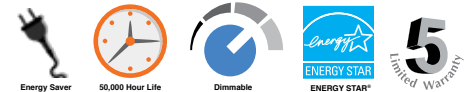

Watt	Product #	Product Code	Volts	Color Temp.	CRI	Lumens	Useful Life*	Pkg. Qty.	Dimmable	Fixture Size	Equivalent Wattage
10	99952	QDL4FR10/927/LED	120V	2700K	90	560	50,000	1/12	Yes	4"	50W
10	99953	QDL4FR10/930/LED	120V	3000K	90	560	50,000	1/12	Yes	4"	50W
10	99954	QDL4FR10/940/LED	120V	4000K	90	590	50,000	1/12	Yes	4"	50W
10	99955	QDL4FR10/950/LED	120V	5000K	90	630	50,000	1/12	Yes	4"	50W
15	99956	QDL6FR15/927/LED	120V	2700K	90	900	50,000	1/12	Yes	6"	65W
15	99957	QDL6FR15/930/LED	120V	3000K	90	930	50,000	1/12	Yes	6"	65W
15	99958	QDL6FR15/940/LED	120V	4000K	90	1000	50,000	1/12	Yes	6"	65W
15	99959	QDL6FR15/950/LED	120V	5000K	90	1040	50,000	1/12	Yes	6"	65W

Represents lamps that are ENERGY STAR® certified.

* Useful Life is defined as the point in time at which the LED will maintain at least 70% of its initial lumens. The LED will continue to burn past this point, but at decreased light levels.

Warranty – Commercial / Industrial: This product is warranted for 5 years from the date of purchase.

• May not be compatible with all dimming systems, dimming performance may vary by system, please check the website www.halcolighting.com/ProLEDdim for up-to-date dimmer compatibility information. Use on incompatible systems may shorten lamp life.

ProLED Square Downlights



Photometrics

99952, QDL4FR10/827/LED

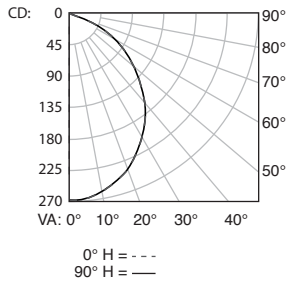

LUMENS PER ZONE

ZONE	LUMENS	% TOTAL	ZONE	LUMENS	% TOTAL
0-10	25.2	4.3%	90-100	0	0%
10-20	71.1	12.2%	100-110	0	0%
20-30	104.7	17.9%	110-120	0	0%
30-40	119.7	20.5%	120-130	0	0%
40-50	113.1	19.4%	130-140	0	0%
50-60	86.7	14.8%	140-150	0	0%
60-70	46.9	8.0%	150-160	0.1	0%
70-80	13.9	2.4%	160-170	0.3	0%
80-90	2.5	0.4%	170-180	0.1	0%

ZONAL LUMEN SUMMARY

ZON	LUMENS	% LAMP	% LUMINAIRE
0-30	201.1	34.3%	34.4%
0-40	320.7	54.8%	54.9%
0-60	520.6	88.9%	89.1%
60-90	63.3	10.8%	10.8%
70-100	16.4	2.8%	2.8%
90-120	0	0%	0%
0-90	583.9	99.7%	99.9%
90-180	0.5	0.1%	0.1%
0-180	584.4	99.8%	100%

Total Luminaire Efficiency = 100.00%

99953, QDL4FR10/830/LED

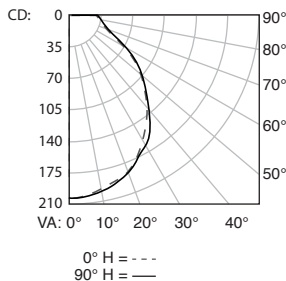

LUMENS PER ZONE

ZONE	LUMENS	% TOTAL	ZONE	LUMENS	% TOTAL
0-10	19.1	3.3%	90-100	8.9	1.6%
10-20	54.2	9.5%	100-110	0	0%
20-30	81.5	14.2%	110-120	0	0%
30-40	94.8	16.6%	120-130	0	0%
40-50	93.6	16.3%	130-140	0	0%
50-60	80.4	14.0%	140-150	0	0%
60-70	59.1	10.3%	150-160	0.1	0%
70-80	43.2	7.5%	160-170	0.3	0%
80-90	37.6	6.6%	170-180	0.1	0%

ZONAL LUMEN SUMMARY

ZONE	LUMENS	% LAMP	% LUMINAIRE
0-30	154.8	27.3%	27%
0-40	249.6	44%	43.6%
0-60	423.6	74.7%	73.9%
60-90	140.0	24.7%	24.4%
70-100	89.7	15.8%	15.7%
90-120	8.9	1.6%	1.6%
0-90	563.6	99.4%	98.4%
90-180	9.4	1.7%	1.6%
0-180	573.0	101.1%	100%

Total Luminaire Efficiency = 100.00%

ProLED Square Downlights

Photometrics

99954, QDL4FR10/840/LED

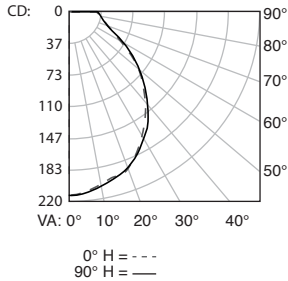

LUMENS PER ZONE

ZONE	LUMENS	% TOTAL	ZONE	LUMENS	% TOTAL
0-10	20.0	3.3%	90-100	9.3	1.6%
10-20	56.9	9.5%	100-110	0	0%
20-30	85.4	14.2%	110-120	0	0%
30-40	99.4	16.6%	120-130	0	0%
40-50	98.2	16.3%	130-140	0	0%
50-60	84.3	14.0%	140-150	0	0%
60-70	62.0	10.3%	150-160	0.1	0%
70-80	45.3	7.5%	160-170	0.3	0%
80-90	39.4	6.6%	170-180	0.1	0%

ZONAL LUMEN SUMMARY

ZONE	LUMENS	% LAMP	% LUMINAIRE
0-30	162.3	27.3%	27%
0-40	261.7	44%	43.6%
0-60	444.2	74.7%	73.9%
60-90	146.8	24.7%	24.4%
70-100	94.1	15.8%	15.7%
90-120	9.3	1.6%	1.6%
0-90	591.0	99.4%	98.4%
90-180	9.8	1.7%	1.6%
0-180	600.8	101.1%	100%
Total Luminaire Efficiency = 100.00%			

99955, QDL4FR10/850/LED

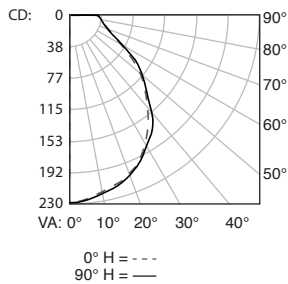

LUMENS PER ZONE

ZONE	LUMENS	% TOTAL	ZONE	LUMENS	% TOTAL
0-10	21.5	3.3%	90-100	10.0	1.6%
10-20	61.2	9.5%	100-110	0	0%
20-30	91.9	14.2%	110-120	0	0%
30-40	107.0	16.6%	120-130	0	0%
40-50	105.6	16.3%	130-140	0	0%
50-60	90.7	14.0%	140-150	0	0%
60-70	66.7	10.3%	150-160	0.1	0%
70-80	48.8	7.5%	160-170	0.3	0%
80-90	42.4	6.6%	170-180	0.1	0%

ZONAL LUMEN SUMMARY

ZONE	LUMENS	% LAMP	% LUMINAIRE
0-30	174.5	27.3%	27%
0-40	281.5	44%	43.6%
0-60	477.8	74.7%	73.9%
60-90	157.9	24.7%	24.4%
70-100	101.2	15.8%	15.7%
90-120	10.0	1.6%	1.6%
0-90	635.7	99.4%	98.4%
90-180	10.5	1.6%	1.6%
0-180	646.2	101.1%	100%
Total Luminaire Efficiency = 100.00%			

99956, QDL6FR15/827/LED

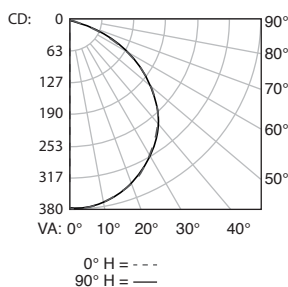

LUMENS PER ZONE

ZONE	LUMENS	% TOTAL	ZONE	LUMENS	% TOTAL
0-10	35.8	3.8%	90-100	0.1	0%
10-20	102.6	10.8%	100-110	0	0%
20-30	155.4	16.3%	110-120	0	0%
30-40	186.4	19.5%	120-130	0	0%
40-50	188.5	19.8%	130-140	0	0%
50-60	157.9	16.5%	140-150	0.2	0%
60-70	95.5	10.0%	150-160	0.4	0%
70-80	27.5	2.9%	160-170	0.3	0%
80-90	3.4	0.4%	170-180	0.1	0%

ZONAL LUMEN SUMMARY

ZONE	LUMENS	% LAMP	% LUMINAIRE
0-30	293.8	30.7%	30.8%
0-40	480.2	50.3%	50.3%
0-60	826.6	86.5%	86.6%
60-90	126.4	13.2%	13.2%
70-100	31.0	3.2%	3.3%
90-120	0.1	0%	0%
0-90	953.0	99.7%	99.9%
90-180	1.1	0.1%	0.1%
Total Luminaire Efficiency = 100.00%			

ProLED Square Downlights

Photometrics

99957, QDL6FR15/830/LED

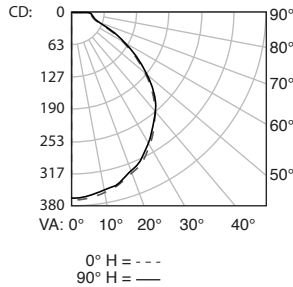

LUMENS PER ZONE

ZONE	LUMENS	% TOTAL	ZONE	LUMENS	% TOTAL
0-10	34.7	3.5%	90-100	10.8	1.1%
10-20	99.2	10.0%	100-110	0	0%
20-30	149.4	15.0%	110-120	0	0%
30-40	177.7	17.9%	120-130	0	0%
40-50	178.1	17.9%	130-140	0	0%
50-60	147.6	14.9%	140-150	0.2	0%
60-70	96.5	9.7%	150-160	0.4	0%
70-80	54.8	5.5%	160-170	0.3	0%
80-90	43.9	4.4%	170-180	0.1	0%

ZONAL LUMEN SUMMARY

ZONE	LUMENS	% LAMP	% LUMINAIRE
0-30	283.3	28.9%	28.5%
0-40	460.9	47%	46.4%
0-60	786.7	80.3%	79.2%
60-90	195.1	19.9%	19.6%
70-100	109.4	11.2%	11%
90-120	10.8	1.1%	1.1%
0-90	981.8	100.2%	98.8%
90-180	11.7	1.2%	1.2%
0-180	993.5	101.4%	100%
Total Luminaire Efficiency = 100.00%			

99958, QDL6FR15/840/LED

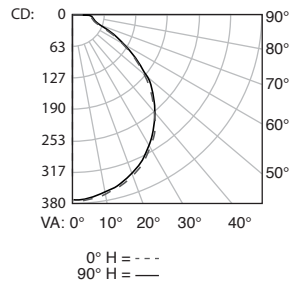

LUMENS PER ZONE

ZONE	LUMENS	% TOTAL	ZONE	LUMENS	% TOTAL
0-10	36.0	3.5%	90-100	11.2	1.1%
10-20	103.1	10.0%	100-110	0	0%
20-30	155.2	15.0%	110-120	0	0%
30-40	184.6	17.9%	120-130	0	0%
40-50	185.1	17.9%	130-140	0	0%
50-60	153.4	14.9%	140-150	0.2	0%
60-70	100.2	9.7%	150-160	0.4	0%
70-80	56.9	5.5%	160-170	0.3	0%
80-90	45.6	4.4%	170-180	0.1	0%

ZONAL LUMEN SUMMARY

ZONE	LUMENS	% LAMP	% LUMINAIRE
0-30	294.3	28.9%	28.5%
0-40	478.9	47%	46.4%
0-60	817.4	80.3%	79.2%
60-90	202.7	19.9%	19.6%
70-100	113.7	11.2%	11%
90-120	11.2	1.1%	1.1%
0-90	1,020.1	100.2%	98.8%
90-180	12.1	1.2%	1.2%
0-180	1,032.2	101.4%	100%
Total Luminaire Efficiency = 100.00%			

99959, QDL6FR15/850/LED

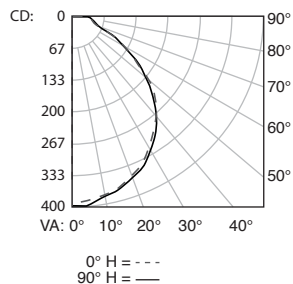

LUMENS PER ZONE

ZONE	LUMENS	% TOTAL	ZONE	LUMENS	% TOTAL
0-10	37.1	3.5%	90-100	11.5	1.1%
10-20	106.0	10.0%	100-110	0	0%
20-30	159.7	15.0%	110-120	0	0%
30-40	189.9	17.9%	120-130	0	0%
40-50	190.4	17.9%	130-140	0	0%
50-60	157.8	14.9%	140-150	0.2	0%
60-70	103.1	9.7%	150-160	0.4	0%
70-80	58.5	5.5%	160-170	0.3	0%
80-90	46.9	4.4%	170-180	0.1	0%

ZONAL LUMEN SUMMARY

ZONE	LUMENS	% LAMP	% LUMINAIRE
0-30	302.7	28.9%	28.5%
0-40	492.6	47%	46.4%
0-60	840.8	80.3%	79.2%
60-90	208.5	19.9%	19.6%
70-100	116.9	11.2%	11%
90-120	11.5	1.1%	1.1%
0-90	1,049.3	100.2%	98.8%
90-180	12.4	1.2%	1.2%
0-180	1,061.8	101.4%	100%
Total Luminaire Efficiency = 100.00%			

ProLED ECO Downlights

Applications

- Home
- Office
- Education
- Hospitality
- Healthcare
- Markets
- Commercial
- Residential

ProLED 4" and 6" downlights are high in performance at a low cost



Specifications

- 35,000 hour life results in lower maintenance costs over time
- Acceptable for use in insulated contact airtight (ICAT) rated luminaires
- Spun aluminum housing and thermoplastic trim ring
- Die-cast aluminum housing
- Dimmable to 10%
- 4" Luminaire is UL approved for damp locations
- 6" Luminaire is UL approved for wet locations
- RoHS Compliant
- 5-year limited warranty

Dimensions

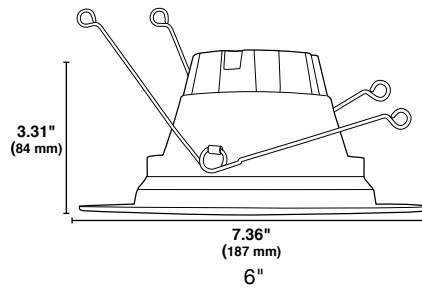
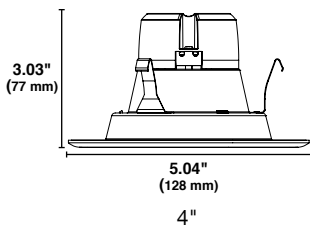

Ordering Information



Watt	Product #	Product Code	Volts	Color Temp.	CRI	Lumens	Useful Life*	Pkg. Qty.	Dimmable	Fixture Size	Equivalent Wattage	
9	83058	DL4FR9/827/ECO/LED	120V	2700K	82	650	35,000	1/12	Yes	4"	50W	
9	83059	DL4FR9/830/ECO/LED	120V	3000K	82	650	35,000	1/12	Yes	4"	50W	
9	83060	DL4FR9/840/ECO/LED	120V	4000K	82	650	35,000	1/12	Yes	4"	50W	
9	83061	DL4FR9/850/ECO/LED	120V	5000K	82	650	35,000	1/12	Yes	4"	50W	
9	83054	DL6FR9/827/ECO/LED	120V	2700K	82	650	35,000	1/6	Yes	6"	65W	
9	83055	DL6FR9/830/ECO/LED	120V	3000K	82	650	35,000	1/6	Yes	6"	65W	
9	83056	DL6FR9/840/ECO/LED	120V	4000K	82	650	35,000	1/6	Yes	6"	65W	
9	83057	DL6FR9/850/ECO/LED	120V	5000K	82	650	35,000	1/6	Yes	6"	65W	
⊛	12	83094	DL6FR12/927/ECO/LED	2700K	90	800	35,000	1/6	Yes	6"	65W	
⊛	12	83095	DL6FR12/930/ECO/LED	3000K	90	800	35,000	1/6	Yes	6"	65W	
⊛	12	83096	DL6FR12/940/ECO/LED	4000K	90	800	35,000	1/6	Yes	6"	65W	
⊛	12	83097	DL6FR12/950/ECO/LED	5000K	90	800	35,000	1/6	Yes	6"	65W	
91003		ADP/DL/GU24/LED	GU24 Socket Adapter					1				

⊛ NEW ITEM

Represents lamps that are ENERGY STAR® certified.

* Useful Life is defined as the point in time at which the LED will maintain at least 70% of its initial lumens. The LED will continue to burn past this point, but at decreased light levels.

Warranty – Commercial / Industrial: This product is warranted for 5 years from the date of purchase.

• May not be compatible with all dimming systems, dimming performance may vary by system, please check the website www.halcolighting.com/ProLEDdim for up-to-date dimmer compatibility information. Use on incompatible systems may shorten lamp life.

ProLED ECO Downlights



Standard with both models:
Title 24 compliant quick plug
connector plugs directly into
dedicated LED recessed housings

4"



Friction clips included with
4" version for mounting into
4" recessed housings



E26 medium base socket adapter
included with both models

6"

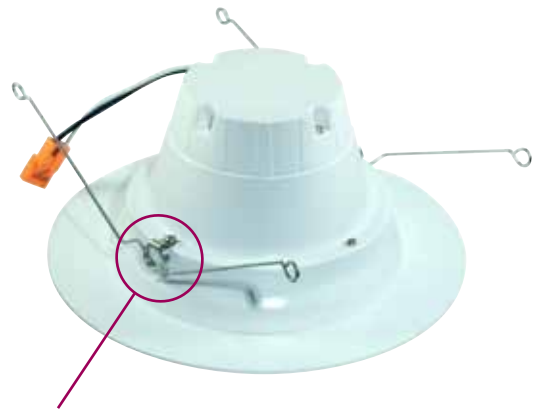

Torsion springs are included with the
6" version. They can be mounted into
5" or 6" recessed housings



Available GU24 socket base
adapter sold separately

ProLED ECO Downlights

Photometrics

83058, DL4FR9/827/ECO/LED

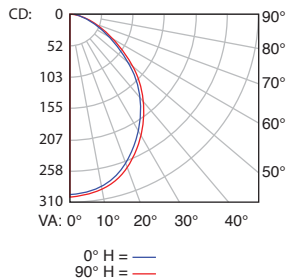

ZONAL LUMEN SUMMARY

ZONE	LUMENS	% LAMP	% LUMINAIRE
0-30	218.8	35.1%	35.1%
0-40	344.8	55.3%	55.3%
0-60	546.4	87.6%	87.7%
60-90	76.3	12.2%	12.2%
70-100	25.4	4.1%	4.1%
90-120	0.4	0.1%	0.1%
0-90	622.7	99.9%	99.9%
90-180	0.7	0.1%	0.1%
0-180	623.4	100%	100%

Total Luminaire Efficiency = 100.00%

LUMENS PER ZONE

ZONE	LUMENS	% TOTAL	ZONE	LUMENS	% TOTAL
0-10	27.9	4.5%	90-100	0.2	0%
10-20	78.2	12.5%	100-110	0.1	0%
20-30	112.8	18.1%	110-120	0.1	0%
30-40	126.0	20.2%	120-130	0.1	0%
40-50	115.1	18.5%	130-140	0.1	0%
50-60	86.5	13.9%	140-150	0.1	0%
60-70	51.0	8.2%	150-160	0.0	0%
70-80	19.7	3.2%	160-170	0.0	0%
80-90	5.6	0.9%	170-180	0.0	0%

83059, DL4FR9/830/ECO/LED

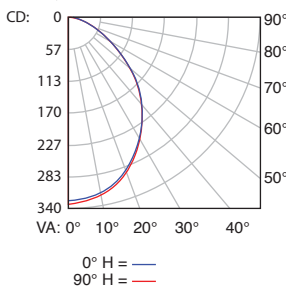

ZONAL LUMEN SUMMARY

ZONE	LUMENS	% LAMP	% LUMINAIRE
0-30	241.8	34.8%	34.8%
0-40	382.1	55%	55%
0-60	608.2	87.6%	87.6%
60-90	85.2	12.3%	12.3%
70-100	27.9	4%	4%
90-120	0.3	0%	0%
0-90	693.4	99.9%	99.9%
90-180	0.6	0.1%	0.1%
0-180	694.1	100%	100%

Total Luminaire Efficiency = 100.00%

LUMENS PER ZONE

ZONE	LUMENS	% TOTAL	ZONE	LUMENS	% TOTAL
0-10	30.8	4.4%	90-100	0.1	0%
10-20	86.3	12.4%	100-110	0.1	0%
20-30	124.8	18.0%	110-120	0.1	0%
30-40	140.2	20.2%	120-130	0.1	0%
40-50	128.8	18.6%	130-140	0.1	0%
50-60	97.4	14.0%	140-150	0.1	0%
60-70	57.4	8.3%	150-160	0.0	0%
70-80	21.6	3.1%	160-170	0.0	0%
80-90	6.1	0.9%	170-180	0.0	0%

83060, DL4FR9/840/ECO/LED

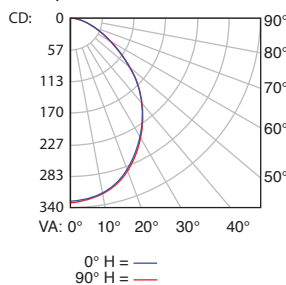

ZONAL LUMEN SUMMARY

ZONE	LUMENS	% LAMP	% LUMINAIRE
0-30	243.2	34.9%	34.9%
0-40	384.1	55.1%	55.1%
0-60	611.1	87.6%	87.6%
60-90	85.7	12.3%	12.3%
70-100	28.1	4%	4%
90-120	0.3	0%	0%
0-90	696.7	99.9%	99.9%
90-180	0.6	0.1%	0.1%
0-180	697.3	100%	100%

Total Luminaire Efficiency = 100.00%

LUMENS PER ZONE

ZONE	LUMENS	% TOTAL	ZONE	LUMENS	% TOTAL
0-10	30.9	4.4%	90-100	0.1	0%
10-20	86.8	12.4%	100-110	0.1	0%
20-30	125.5	18.0%	110-120	0.1	0%
30-40	140.9	20.2%	120-130	0.1	0%
40-50	129.3	18.5%	130-140	0.1	0%
50-60	97.6	14.0%	140-150	0.1	0%
60-70	57.6	8.3%	150-160	0.0	0%
70-80	21.8	3.1%	160-170	0.0	0%
80-90	6.2	0.9%	170-180	0.0	0%

83061, DL4FR9/850/ECO/LED

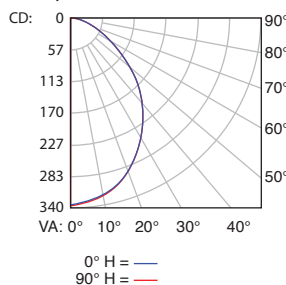

ZONAL LUMEN SUMMARY

ZONE	LUMENS	% LAMP	% LUMINAIRE
0-30	246.0	35%	35%
0-40	388.2	55.2%	55.2%
0-60	616.5	87.7%	87.7%
60-90	85.8	12.2%	12.2%
70-100	28.1	4%	4%
90-120	0.3	0%	0%
0-90	702.3	99.9%	99.9%
90-180	0.6	0.1%	0.1%
0-180	703.0	100%	100%

Total Luminaire Efficiency = 100.00%

LUMENS PER ZONE

ZONE	LUMENS	% TOTAL	ZONE	LUMENS	% TOTAL
0-10	31.3	4.5%	90-100	0.1	0%
10-20	87.8	12.5%	100-110	0.1	0%
20-30	126.9	18.0%	110-120	0.1	0%
30-40	142.2	20.2%	120-130	0.1	0%
40-50	130.2	18.5%	130-140	0.1	0%
50-60	98.1	14.0%	140-150	0.1	0%
60-70	57.8	8.2%	150-160	0.0	0%
70-80	21.8	3.1%	160-170	0.0	0%
80-90	6.2	0.9%	170-180	0.0	0%

ProLED ECO Downlights

Photometrics

83054, DL6FR9/827/ECO/LED

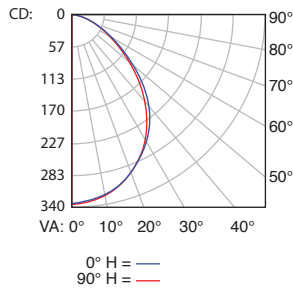

ZONAL LUMEN SUMMARY			
ZONE	LUMENS	% LAMP	% LUMINAIRE
0-30	250.2	35.4%	35.4%
0-40	397.5	56.2%	56.2%
0-60	628.0	88.8%	88.8%
60-90	79.0	11.2%	11.2%
70-100	24.4	3.5%	3.5%
90-120	0.0	0%	0%
0-90	707.0	100%	100%
90-180	0.0	0%	0%
0-180	707.0	100%	100%

Total Luminaire Efficiency = 100.00%

LUMENS PER ZONE

ZONE	LUMENS	% TOTAL	ZONE	LUMENS	% TOTAL
0-10	31.4	4.4%	90-100	0.0	0%
10-20	88.7	12.5%	100-110	0.0	0%
20-30	130.1	18.4%	110-120	0.0	0%
30-40	147.3	20.8%	120-130	0.0	0%
40-50	133.3	18.9%	130-140	0.0	0%
50-60	97.2	13.7%	140-150	0.0	0%
60-70	54.6	7.7%	150-160	0.0	0%
70-80	19.6	2.8%	160-170	0.0	0%
80-90	4.8	0.7%	170-180	0.0	0%

83055, DL6FR9/830/ECO/LED

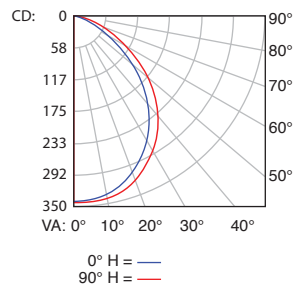

ZONAL LUMEN SUMMARY			
ZONE	LUMENS	% LAMP	% LUMINAIRE
0-30	254.7	34.9%	34.9%
0-40	404.4	55.4%	55.4%
0-60	644.3	88.3%	88.3%
60-90	85.0	11.6%	11.6%
70-100	27.0	3.7%	3.7%
90-120	0.2	0%	0%
0-90	729.3	100%	100%
90-180	0.2	0%	0%
0-180	729.5	100%	100%

Total Luminaire Efficiency = 100.00%

LUMENS PER ZONE

ZONE	LUMENS	% TOTAL	ZONE	LUMENS	% TOTAL
0-10	32.1	4.4%	90-100	0.2	0%
10-20	90.4	12.4%	100-110	0	0%
20-30	132.2	18.1%	110-120	0.0	0%
30-40	149.7	20.5%	120-130	0.0	0%
40-50	137.6	18.9%	130-140	0.0	0%
50-60	102.4	14.0%	140-150	0.0	0%
60-70	58.1	8.0%	150-160	0.0	0%
70-80	21.6	3.0%	160-170	0.0	0%
80-90	5.2	0.7%	170-180	0.0	0%

83056, DL6FR9/840/ECO/LED

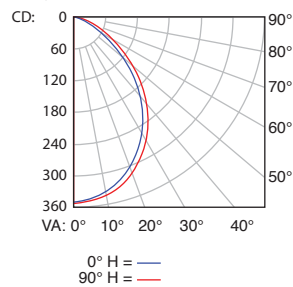

ZONAL LUMEN SUMMARY			
ZONE	LUMENS	% LAMP	% LUMINAIRE
0-30	261.6	35.3%	35.3%
0-40	415.2	56%	56%
0-60	656.5	88.6%	88.6%
60-90	84.0	11.3%	11.3%
70-100	26.7	3.6%	3.6%
90-120	0.1	0%	0%
0-90	740.6	100%	100%
90-180	0.2	0%	0%
0-180	740.7	100%	100%

Total Luminaire Efficiency = 100.00%

LUMENS PER ZONE

ZONE	LUMENS	% TOTAL	ZONE	LUMENS	% TOTAL
0-10	32.9	4.4%	90-100	0.1	0%
10-20	92.8	12.5%	100-110	0	0%
20-30	135.9	18.3%	110-120	0	0%
30-40	153.5	20.7%	120-130	0	0%
40-50	139.3	18.8%	130-140	0.0	0%
50-60	102.1	13.8%	140-150	0.0	0%
60-70	57.5	7.8%	150-160	0.0	0%
70-80	21.3	2.9%	160-170	0.0	0%
80-90	5.2	0.7%	170-180	0.0	0%

83057, DL6FR9/850/ECO/LED

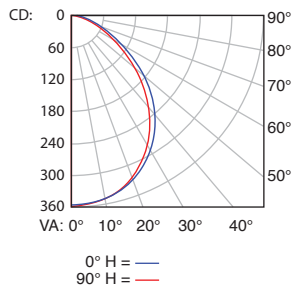

ZONAL LUMEN SUMMARY			
ZONE	LUMENS	% LAMP	% LUMINAIRE
0-30	267.6	34.9%	34.9%
0-40	426.3	55.6%	55.6%
0-60	678.5	88.4%	88.4%
60-90	88.5	11.5%	11.5%
70-100	27.7	3.6%	3.6%
90-120	0.1	0%	0%
0-90	767.0	100%	100%
90-180	0.1	0%	0%
0-180	767.1	100%	100%

Total Luminaire Efficiency = 100.00%

LUMENS PER ZONE

ZONE	LUMENS	% TOTAL	ZONE	LUMENS	% TOTAL
0-10	33.5	4.4%	90-100	0.1	0%
10-20	94.8	12.4%	100-110	0	0%
20-30	139.3	18.2%	110-120	0.0	0%
30-40	158.6	20.7%	120-130	0	0%
40-50	145.1	18.9%	130-140	0.0	0%
50-60	107.1	14.0%	140-150	0.0	0%
60-70	60.9	7.9%	150-160	0.0	0%
70-80	22.1	2.9%	160-170	0.0	0%
80-90	5.5	0.7%	170-180	0.0	0%

ProLED ECO Downlights

Photometrics

83094, DL6FR12/927/ECO/LED

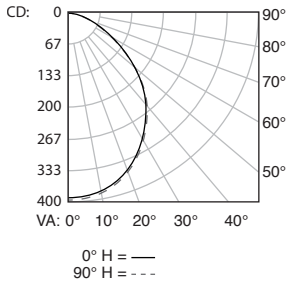

ZONAL LUMEN SUMMARY

ZONE	LUMENS	% LAMP	% LUMINAIRE
0-30	291.5	34.7%	34.7%
0-40	463.9	55.2%	55.2%
0-60	742.2	88.4%	88.4%
60-90	97.5	11.6%	11.6%
70-100	29.8	3.6%	3.6%
90-120	0.0	0%	0%
0-90	839.7	100%	100%
90-180	0.1	0%	0%
0-180	839.7	100%	100%

Total Luminaire Efficiency = 100.00%

LUMENS PER ZONE

ZONE	LUMENS	% TOTAL	ZONE	LUMENS	% TOTAL
0-10	36.7	4.4%	90-100	0.0	0%
10-20	103.4	12.3%	100-110	0.000	0%
20-30	151.4	18.0%	110-120	0.001	0%
30-40	172.3	20.5%	120-130	0.000	0%
40-50	159.1	19.0%	130-140	0.002	0%
50-60	119.2	14.2%	140-150	0.006	0%
60-70	67.7	8.1%	150-160	0.005	0%
70-80	24.0	2.9%	160-170	0.003	0%
80-90	5.8	0.7%	170-180	0.001	0%

83095, DL6FR12/930/ECO/LED

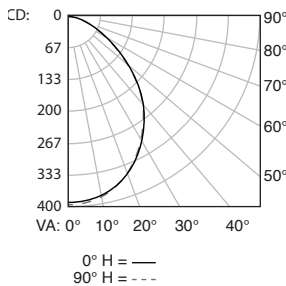

ZONAL LUMEN SUMMARY

ZONE	LUMENS	% LAMP	% LUMINAIRE
0-30	294.2	34.7%	34.7%
0-40	468.6	55.2%	55.2%
0-60	749.3	88.3%	88.3%
60-90	99.5	11.7%	11.7%
70-100	30.7	3.6%	3.6%
90-120	0.0	0%	0%
0-90	848.8	100%	100%
90-180	0.0	0%	0%
0-180	848.8	100%	100%

Total Luminaire Efficiency = 100.00%

LUMENS PER ZONE

ZONE	LUMENS	% TOTAL	ZONE	LUMENS	% TOTAL
0-10	37.0	4.4%	90-100	0.0	0%
10-20	104.3	12.3%	100-110	0.000	0%
20-30	153.0	18.0%	110-120	0.000	0%
30-40	174.3	20.5%	120-130	0.000	0%
40-50	160.6	18.9%	130-140	0.004	0%
50-60	120.2	14.2%	140-150	0.006	0%
60-70	68.8	8.1%	150-160	0.005	0%
70-80	24.6	2.9%	160-170	0.003	0%
80-90	6.1	0.7%	170-180	0.001	0%

83096, DL6FR12/940/ECO/LED

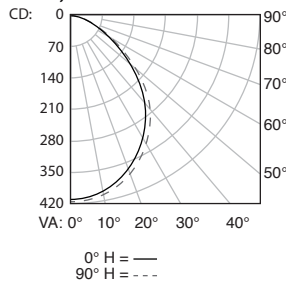

ZONAL LUMEN SUMMARY

ZONE	LUMENS	% LAMP	% LUMINAIRE
0-30	308.6	34.8%	34.8%
0-40	491.4	55.4%	55.4%
0-60	785.2	88.5%	88.5%
60-90	102.2	11.5%	11.5%
70-100	31.0	3.5%	3.5%
90-120	0.005	0%	0%
0-90	887.4	100%	100%
90-180	0.0	0%	0%
0-180	887.4	100%	100%

Total Luminaire Efficiency = 100.00%

LUMENS PER ZONE

ZONE	LUMENS	% TOTAL	ZONE	LUMENS	% TOTAL
0-10	38.8	4.4%	90-100	0.004	0%
10-20	109.4	12.3%	100-110	0.000	0%
20-30	160.4	18.1%	110-120	0.001	0%
30-40	182.8	20.6%	120-130	0.000	0%
40-50	168.3	19.0%	130-140	0.002	0%
50-60	125.5	14.1%	140-150	0.007	0%
60-70	71.2	8.0%	150-160	0.005	0%
70-80	25.0	2.8%	160-170	0.003	0%
80-90	6.1	0.7%	170-180	0.001	0%

83097, DL6FR12/950/ECO/LED

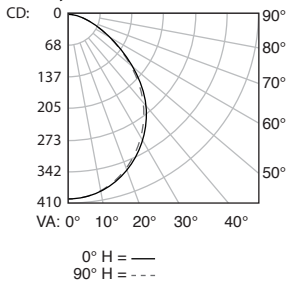

ZONAL LUMEN SUMMARY

ZONE	LUMENS	% LAMP	% LUMINAIRE
0-30	300.0	34.4%	34.4%
0-40	478.1	54.9%	54.9%
0-60	768.1	88.2%	88.2%
60-90	103.1	11.8%	11.8%
70-100	31.5	3.6%	3.6%
90-120	0.0	0%	0%
0-90	871.2	100%	100%
90-180	0.0	0%	0%
0-180	871.2	100%	100%

Total Luminaire Efficiency = 100.00%

LUMENS PER ZONE

ZONE	LUMENS	% TOTAL	ZONE	LUMENS	% TOTAL
0-10	37.7	4.3%	90-100	0.0	0%
10-20	106.4	12.2%	100-110	0.000	0%
20-30	155.9	17.9%	110-120	0.000	0%
30-40	178.1	20.4%	120-130	0.000	0%
40-50	165.3	19.0%	130-140	0.004	0%
50-60	124.8	14.3%	140-150	0.006	0%
60-70	71.6	8.2%	150-160	0.005	0%
70-80	25.2	2.9%	160-170	0.003	0%
80-90	6.2	0.7%	170-180	0.001	0%



ProLED Adjustable Downlights

Applications

Home
Office
Healthcare
Hospitality
Retail
Markets
Commercial
Residential

ProLED 4" and 6" adjustable downlights allow for directional lighting with a striking design



Specifications

- 9 Watt (4") and 12 watt (6") replace up to 65 watt incandescent (80% energy savings)
- Easy rotation and aiming for precise lighting control
- Up to 30° aiming angle, 360° rotation
- 50,000 hour life results in lower maintenance costs over time
- Formed aluminum housing and trim
- Frosted lens for smooth, even and comfortable light distribution
- Rated for indoor use only
- Luminaire is UL listed for damp locations
- RoHS Compliant
- Dimmable to 10%
- 5-year limited warranty

Dimensions

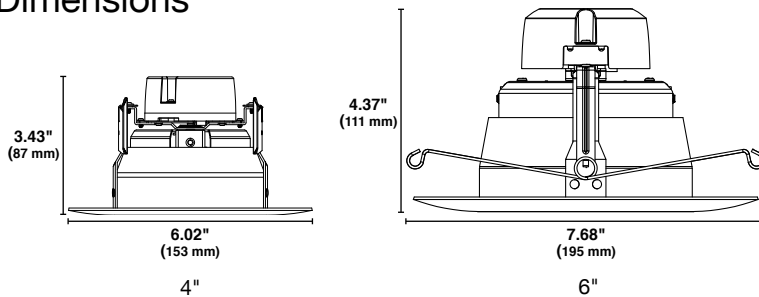

Ordering Information



Watt	Product #	Product Code	Volts	Color Temp.	CRI	Lumens	Useful Life*	Pkg. Qty.	Dimmable	Fixture Size	Equivalent Wattage
9	99966	ADL4FR9/927/LED	120V	2700K	90	700	50,000	1/8	Yes	4"	50W
9	99967	ADL4FR9/930/LED	120V	3000K	90	625	50,000	1/8	Yes	4"	50W
9	99968	ADL4FR9/940/LED	120V	4000K	90	680	50,000	1/8	Yes	4"	50W
9	99969	ADL4FR9/950/LED	120V	5000K	90	730	50,000	1/8	Yes	4"	50W
12	99970	ADL6FR12/927/LED	120V	2700K	90	970	50,000	1/8	Yes	6"	65W
12	99971	ADL6FR12/930/LED	120V	3000K	90	1080	50,000	1/8	Yes	6"	65W
12	99972	ADL6FR12/940/LED	120V	4000K	90	1090	50,000	1/8	Yes	6"	65W
12	99973	ADL6FR12/950/LED	120V	5000K	90	1100	50,000	1/8	Yes	6"	65W

Represents lamps that are ENERGY STAR® certified.

* Useful Life is defined as the point in time at which the LED will maintain at least 70% of its initial lumens. The LED will continue to burn past this point, but at decreased light levels.

Warranty – Commercial / Industrial: This product is warranted for 5 years from the date of purchase.

• May not be compatible with all dimming systems, dimming performance may vary by system, please check the website www.halcolighting.com/ProLEDdim for up-to-date dimmer compatibility information. Use on incompatible systems may shorten lamp life.

ProLED Adjustable Downlights



4"

Friction clips included with 4" version for mounting into 4" recessed housings

6"

Torsion springs are included with the 6" version. They can be mounted into 5" or 6" recessed housings

Housing made of formed aluminum for lasting durability and efficient heat dissipation

Up to 30° aiming angle and 360° Rotation

E26 medium base socket adapter included with both models

Available GU24 socket base adapter sold separately

ProLED Adjustable Downlights

Photometrics

99966, ADL4FR9/827/LED

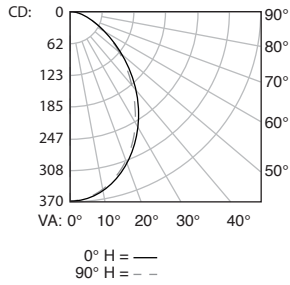

Coefficients of Utilization
Effective Floor Cavity Reflectance 0.20

RC	80	70	50
RW	70 50 30	70 50 30	50 30 20
0	119 119 119	161 161 161	111 111 111
1	110 106 102	071 04 100	100 97 94
2	101 94 88	99 92 87	89 84 80
3	93 84 77	91 83 76	80 74 69
4	86 76 68	84 74 67	72 65 60
5	80 68 60	78 67 60	65 59 53
6	74 62 54	73 61 54	60 53 48
7	69 57 49	68 56 48	55 48 43
8	65 52 44	63 52 44	50 44 39
9	61 48 41	60 48 41	47 40 35
10	57 45 38	56 44 37	43 37 32

ZONAL LUMEN SUMMARY

ZONE	LUMENS	% LAMP	% LUMINAIRE
0-30	260.8	36.8%	36.9%
0-40	400.3	56.5%	56.7%
0-60	612.4	86.5%	86.7%
60-90	94.2	13.3%	13.3%
0-90	706.6	99.8%	100%

99967, ADL4FR9/830/LED

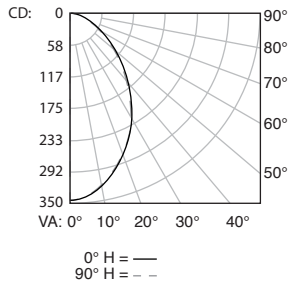

Coefficients of Utilization
Effective Floor Cavity Reflectance 0.20

RC	80	70	50
RW	70 50 30	70 50 30	50 30 20
0	119 119 119	116 116 116	111 111 111
1	111 106 103	108 104 101	100 97 95
2	102 95 89	99 93 88	90 85 81
3	94 85 78	92 83 77	81 75 70
4	87 76 69	85 75 68	73 66 61
5	81 69 61	79 68 61	66 60 54
6	75 63 55	73 62 55	61 54 49
7	70 58 50	69 57 49	56 49 44
8	66 53 45	64 53 45	51 45 40
9	62 49 42	60 49 41	48 41 36
10	58 46 38	57 45 38	44 38 33

ZONAL LUMEN SUMMARY

ZONE	LUMENS	% LAMP	% LUMINAIRE
0-30	238.8	38.3%	38.3%
0-40	363.6	58.2%	58.2%
0-60	546.8	87.6%	87.6%
60-90	77.5	12.4%	12.4%
70-100	28.4	4.5%	4.5%
90-120	0	0%	0%
0-90	624.3	100%	100%
90-180	0	0%	0%
0-180	624.3	100%	100%

99968, ADL4FR9/840/LED

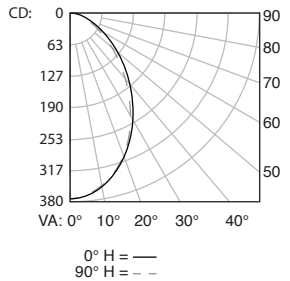

Coefficients of Utilization
Effective Floor Cavity Reflectance 0.20

RC	80	70	50
RW	70 50 30	70 50 30	50 30 20
0	119 119 119	116 116 116	116 100 11
1	111 107 103	100 08 104	101 88 00
2	102 95 89	84 99 93	88 77 90
3	94 85 78	72 92 83	77 67 80
4	87 76 69	63 85 75	68 60 73
5	81 69 61	55 79 68	61 53 66
6	75 63 55	49 73 62	55 48 60
7	70 58 50	44 69 57	49 43 56
8	66 53 45	40 64 53	45 39 51
9	62 49 42	37 60 49	41 36 48
10	58 46 38	34 57 45	38 33 44

ZONAL LUMEN SUMMARY

ZONE	LUMENS	% LAMP	% LUMINAIRE
0-30	260.7	38.2%	38.2%
0-40	397.1	58.1%	58.1%
0-60	598.4	87.6%	87.6%
60-90	84.7	12.4%	12.4%
70-100	30.6	4.5%	4.5%
90-120	0	0%	0%
0-90	683.2	100%	100%
90-180	0	0%	0%
0-180	683.2	100%	100%

99969, ADL4FR9/850/LED

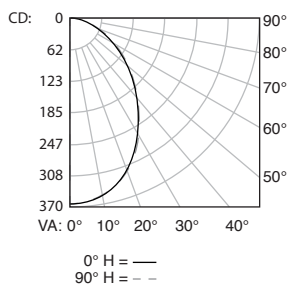

Coefficients of Utilization
Effective Floor Cavity Reflectance 0.20

RC	80	70	50
RW	70 50 30	70 50 30	50 30 20
0	119 119 119	161 161 161	11 111 11
1	110 106 102	071 031 00	99 96 94
2	101 93 87	98 92 86	88 83 79
3	93 83 76	90 82 75	79 73 68
4	86 75 66	83 73 66	71 64 59
5	79 67 59	77 66 58	64 57 52
6	74 61 53	72 60 52	58 51 46
7	69 56 48	67 55 47	54 47 41
8	64 51 43	63 51 43	49 42 38
9	60 47 40	59 47 39	46 39 34
10	57 44 36	55 43 36	43 36 31

ZONAL LUMEN SUMMARY

ZONE	LUMENS	% LAMP	% LUMINAIRE
0-30	257.2	35.2%	35.3%
0-40	396.8	54.3%	54.4%
0-60	619.9	84.9%	85.1%
60-90	108.9	14.9%	14.9%
0-90	728.8	99.8%	100%

ProLED Adjustable Downlights

Photometrics

99970, ADL6FR12/927/LED

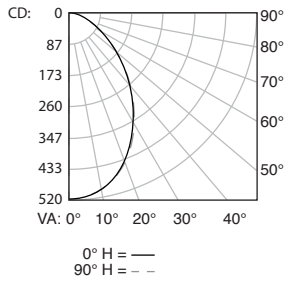

Coefficients of Utilization
Effective Floor Cavity Reflectance 0.20

RC	80			70			50		
RW	70	50	30	70	50	30	50	30	20
0	119	119	119	116	116	116	111	111	111
1	110	106	102	107	104	100	100	97	94
2	102	94	88	99	93	87	89	85	81
3	94	84	77	91	83	76	80	74	70
4	87	76	68	84	75	67	72	66	61
5	80	69	61	78	68	60	66	59	54
6	75	63	55	73	62	54	60	53	48
7	70	57	49	68	57	49	55	48	43
8	65	53	45	64	52	45	51	44	39
9	61	49	41	60	48	41	47	41	36
10	58	45	38	56	45	38	44	37	33

ZONAL LUMEN SUMMARY

ZONE	LUMENS	% LAMP	% LUMINAIRE
0-30	367.2	37.7%	37.8%
0-40	559.2	57.5%	57.6%
0-60	845.0	86.8%	87%
60-90	125.8	12.9%	13%
0-90	970.7	99.8%	100%

99971, ADL6FR12/930/LED

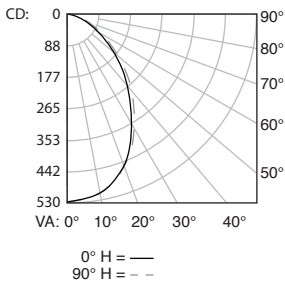

Coefficients of Utilization
Effective Floor Cavity Reflectance 0.20

RC	80			70			50		
RW	70	50	30	70	50	30	50	30	20
0	119	119	119	116	116	116	111	111	111
1	110	106	102	108	104	101	100	97	94
2	102	94	88	99	93	87	89	84	80
3	94	84	77	91	83	76	80	74	69
4	87	76	68	84	74	67	72	66	61
5	80	69	60	78	67	60	65	59	54
6	75	62	54	73	61	54	60	53	48
7	70	57	49	68	56	49	55	48	43
8	65	53	45	64	52	44	51	44	39
9	61	49	41	60	48	41	47	40	35
10	57	45	38	56	45	37	44	37	33

ZONAL LUMEN SUMMARY

ZONE	LUMENS	% LAMP	% LUMINAIRE
0-30	375.4	37%	37%
0-40	575.1	56.7%	56.7%
0-60	879.2	86.7%	86.7%
60-90	134.9	13.3%	13.3%
0-90	1,014.1	100%	100%

99972, ADL6FR12/940/LED

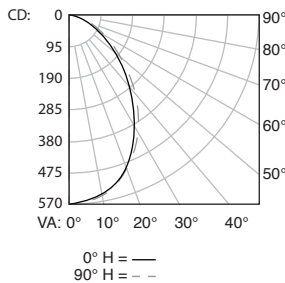

Coefficients of Utilization
Effective Floor Cavity Reflectance 0.20

RC	80			70			50		
RW	70	50	30	70	50	30	50	30	20
0	119	119	119	116	116	116	111	111	111
1	110	106	103	108	104	101	100	97	95
2	102	94	88	99	93	87	89	85	81
3	94	84	77	91	83	76	80	74	69
4	87	76	68	84	75	67	72	66	61
5	80	69	60	78	68	60	66	59	54
6	75	62	54	73	62	54	60	53	48
7	70	57	49	68	56	49	55	48	43
8	65	53	45	64	52	44	51	44	39
9	61	49	41	60	48	41	47	40	36
10	58	45	38	56	45	38	44	37	33

ZONAL LUMEN SUMMARY

ZONE	LUMENS	% LAMP	% LUMINAIRE
0-30	403.5	37.1%	37.1%
0-40	618.1	56.9%	56.9%
0-60	943.2	86.8%	86.8%
60-90	143.3	13.2%	13.2%
70-100	54.4	5%	5%
90-120	0	0%	0%
0-90	1,086.5	100%	100%
90-180	0	0%	0%
0-180	1,086.5	100%	100%

99973, ADL6FR12/950/LED

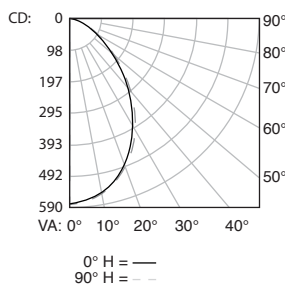

Coefficients of Utilization
Effective Floor Cavity Reflectance 0.20

RC	80			70			50		
RW	70	50	30	70	50	30	50	30	20
0	119	119	119	116	116	116	111	111	111
1	110	106	102	108	104	101	100	97	94
2	102	94	88	99	93	87	89	85	81
3	94	84	77	91	83	76	80	74	70
4	87	76	68	84	75	67	72	66	61
5	80	69	61	78	68	60	66	59	54
6	75	63	54	73	62	54	60	53	48
7	70	57	49	68	56	49	55	48	43
8	65	53	45	64	52	45	51	44	39
9	61	49	41	60	48	41	47	40	36
10	58	45	38	56	45	38	44	37	33

ZONAL LUMEN SUMMARY

ZONE	LUMENS	% LAMP	% LUMINAIRE
0-30	416.6	37.3%	37.4%
0-40	638.7	57.2%	57.4%
0-60	971.0	87%	87.2%
60-90	142.5	12.8%	12.8%
0-90	1,113.5	99.8%	100%

ProLED Commercial Downlight Retrofit

Applications

Office
Lobby
Hospitality
Retail
Conference Room
Markets
Commercial
Residential

LED Commercial Retrofit Downlights combine the ease of installation with energy efficient LED technology



Specifications

- Quick and easy installs with integral junction box
- Replaces up to 200w incandescent for over 80% energy savings
- 4", 6" And 8" options mount to downlight frames, drywall or ceiling tiles
- Downlight comes affixed with a standard junction box
- J-Box can be wired directly to the power source or fed to downlight J-box with supplied 24" flexible conduit
- Comes with 24" flexible metal conduit
- Strong spring clips secure housing to downlight housings, drywall and ceiling tiles
- 50,000 hour life results in lower maintenance costs over time
- ETL approved for damp locations
- Dimmable to 10% (120V only)
- Acceptable for use in Non-IC housings
- 5-year limited warranty

Dimensions

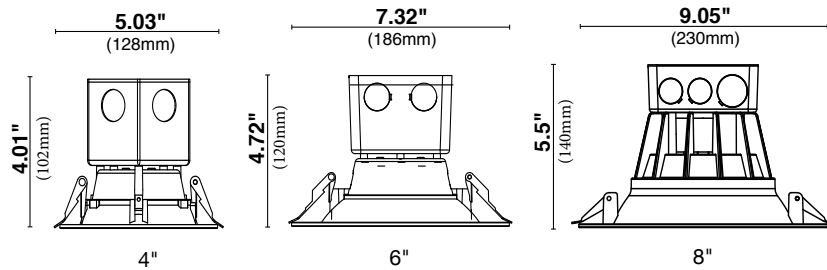

Ordering Information



Watt	Product #	Product Code	Volts	Color Temp.	CRI	Lumens	Useful Life*	Pkg. Qty.	Dimmable	Fixture Size	Equivalent Wattage
10	99610	CDL4FR10/927/RTJB/LED	120-277V	2700K	90	700	50,000	1/12	Yes	4"	65W
10	99611	CDL4FR10/930/RTJB/LED	120-277V	3000K	90	700	50,000	1/12	Yes	4"	65W
10	99612	CDL4FR10/940/RTJB/LED	120-277V	4000K	90	700	50,000	1/12	Yes	4"	65W
10	99613	CDL4FR10/950/RTJB/LED	120-277V	5000K	90	700	50,000	1/12	Yes	4"	65W
15	99614	CDL6FR15/927/RTJB/LED	120-277V	2700K	90	1000	50,000	1/12	Yes	6"	120W
15	99615	CDL6FR15/930/RTJB/LED	120-277V	3000K	90	1000	50,000	1/12	Yes	6"	120W
15	99616	CDL6FR15/940/RTJB/LED	120-277V	4000K	90	1000	50,000	1/12	Yes	6"	120W
15	99617	CDL6FR15/950/RTJB/LED	120-277V	5000K	90	1000	50,000	1/12	Yes	6"	120W
30	99618	CDL8FR30/927/RTJB/LED	120-277V	2700K	90	2000	50,000	1/6	Yes	8"	200W
30	99619	CDL8FR30/930/RTJB/LED	120-277V	3000K	90	2000	50,000	1/6	Yes	8"	200W
30	99620	CDL8FR30/940/RTJB/LED	120-277V	4000K	90	2000	50,000	1/6	Yes	8"	200W
30	99621	CDL8FR30/950/RTJB/LED	120-277V	5000K	90	2000	50,000	1/6	Yes	8"	200W

NEW ITEM

Represents lamps that are ENERGY STAR® certified.

* Useful Life is defined as the point in time at which the LED will maintain at least 70% of its initial lumens. The LED will continue to burn past this point, but at decreased light levels.

Warranty – Commercial / Industrial: This product is warranted for 5 years from the date of purchase.

Warning: Dimmable for 120V only.

Note: May not be compatible with all electronic transformers.

ProLED Commercial Downlight Retrofit

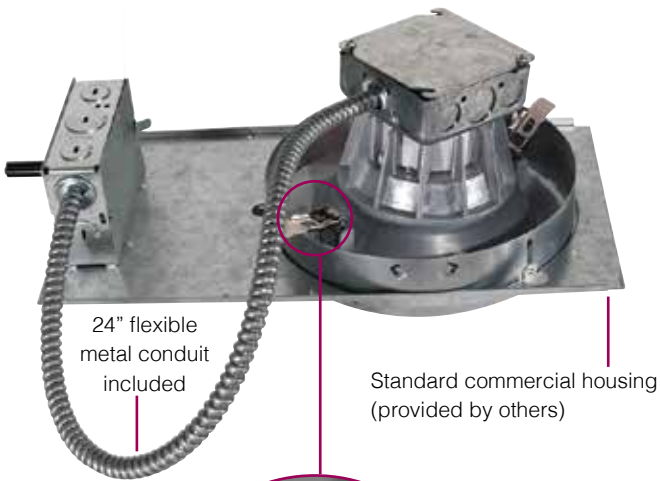

24" flexible metal conduit included

Standard commercial housing (provided by others)

Standard junction box is integrated to downlight for quick and easy retrofit installations



Reinforced spring clips allow for easy install and a secure fit to commercial recessed housings or directly to sheetrock and ceiling tiles

ProLED Commercial Downlight Retrofit

Photometrics

99610, CDL4FR10/927/RTJB/LED

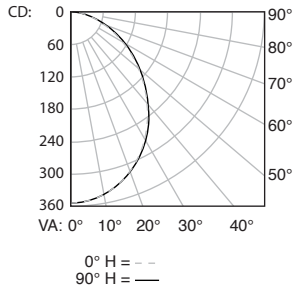

LUMENS PER ZONE

ZONE	LUMENS	% TOTAL	ZONE	LUMENS	% TOTAL
0-10	33.4	4.1%	90-100	0.2	0%
10-20	93.6	11.5%	100-110	0.1	0%
20-30	136.5	16.8%	110-120	0.1	0%
30-40	156.0	19.2%	120-130	0.1	0%
40-50	150.6	18.5%	130-140	0.2	0%
50-60	121.9	15.0%	140-150	0.2	0%
60-70	77.8	9.6%	150-160	0.3	0%
70-80	34.8	4.3%	160-170	0.3	0%
80-90	6.7	0.8%	170-180	0.1	0%

ZONAL LUMEN SUMMARY

ZONE	LUMENS	% LAMP	% LUMINAIRE
0-30	263.4	32.3%	32.4%
0-40	419.4	51.5%	51.6%
0-60	691.9	85%	85.1%
60-90	119.4	14.7%	14.7%
70-100	41.7	5.1%	5.1%
90-120	0.4	0.1%	0.1%
0-90	811.3	99.6%	99.8%
90-180	1.7	0.2%	0.2%
0-180	813.0	99.8%	100%

99611, CDL4FR10/930/RTJB/LED

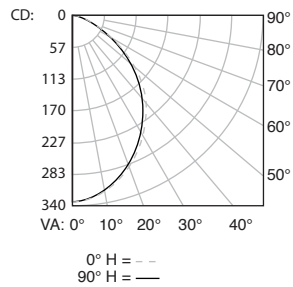

LUMENS PER ZONE

ZONE	LUMENS	% TOTAL	ZONE	LUMENS	% TOTAL
0-10	37.6	4.9%	90-100	0.000	0%
10-20	103.9	13.6%	100-110	0.000	0%
20-30	147.5	19.4%	110-120	0.000	0%
30-40	161.8	21.2%	120-130	0.000	0%
40-50	145.4	19.1%	130-140	0.000	0%
50-60	103.5	13.6%	140-150	0.000	0%
60-70	51.1	6.7%	150-160	0.000	0%
70-80	10.8	1.4%	160-170	0.000	0%
80-90	0.2	0.0%	170-180	0.000	0%

ZONAL LUMEN SUMMARY

ZONE	LUMENS	% LAMP	% LUMINAIRE
0-30	289.0	38.1%	37.9%
0-40	450.8	59.4%	59.2%
0-60	699.7	92.2%	91.8%
60-90	62.1	8.2%	8.2%
70-100	11.0	1.5%	1.4%
90-120	0.000	0%	0%
0-90	761.8	100.4%	100%
90-180	0.000	0%	0%
0-180	761.8	100.4%	100%

99612, CDL4FR10/940/RTJB/LED

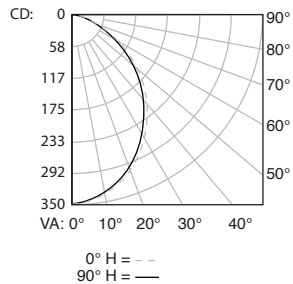

LUMENS PER ZONE

ZONE	LUMENS	% TOTAL	ZONE	LUMENS	% TOTAL
0-10	38.8	4.9%	90-100	0.000	0%
10-20	107.3	13.6%	100-110	0.000	0%
20-30	152.3	19.4%	110-120	0.000	0%
30-40	167.1	21.2%	120-130	0.000	0%
40-50	150.2	19.1%	130-140	0.000	0%
50-60	106.9	13.6%	140-150	0.000	0%
60-70	52.8	6.7%	150-160	0.000	0%
70-80	11.1	1.4%	160-170	0.000	0%
80-90	0.2	0.0%	170-180	0.000	0%

ZONAL LUMEN SUMMARY

ZONE	LUMENS	% LAMP	% LUMINAIRE
0-30	298.4	38.1%	37.9%
0-40	465.4	59.4%	59.2%
0-60	722.4	92.2%	91.8%
60-90	64.1	8.2%	8.2%
70-100	11.4	1.5%	1.4%
90-120	0.000	0%	0%
0-90	786.6	100.4%	100%
90-180	0.000	0%	0%
0-180	786.6	100.4%	100%

99613, CDL4FR10/950/RTJB/LED

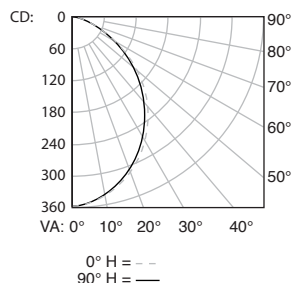

LUMENS PER ZONE

ZONE	LUMENS	% TOTAL	ZONE	LUMENS	% TOTAL
0-10	39.8	4.9%	90-100	0.000	0%
10-20	110.2	13.6%	100-110	0.000	0%
20-30	156.4	19.4%	110-120	0.000	0%
30-40	171.6	21.2%	120-130	0.000	0%
40-50	154.2	19.1%	130-140	0.000	0%
50-60	109.7	13.6%	140-150	0.000	0%
60-70	54.2	6.7%	150-160	0.000	0%
70-80	11.4	1.4%	160-170	0.000	0%
80-90	0.2	0.0%	170-180	0.000	0%

ZONAL LUMEN SUMMARY

ZONE	LUMENS	% LAMP	% LUMINAIRE
0-30	306.4	38.1%	37.9%
0-40	477.9	59.4%	59.2%
0-60	741.9	92.2%	91.8%
60-90	65.8	8.2%	8.2%
70-100	11.7	1.5%	1.4%
90-120	0.000	0%	0%
0-90	807.7	100.4%	100%
90-180	0.000	0%	0%
0-180	807.7	100.4%	100%

ProLED Commercial Downlight Retrofit

Photometrics

99614, CDL6FR15/927/RTJB/LED

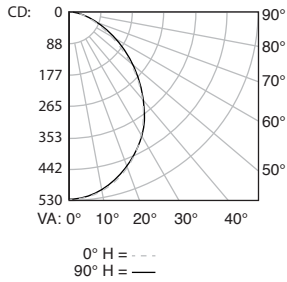

LUMENS PER ZONE

ZONE	LUMENS	% TOTAL	ZONE	LUMENS	% TOTAL
0-10	49.5	4.3%	90-100	0.000	0%
10-20	138.1	12.1%	100-110	0.004	0%
20-30	200.2	17.5%	110-120	0.1	0%
30-40	227.1	19.9%	120-130	0.1	0%
40-50	215.7	18.9%	130-140	0.3	0%
50-60	170.3	14.9%	140-150	0.6	0%
60-70	98.9	8.6%	150-160	0.8	0.1%
70-80	36.1	3.2%	160-170	0.7	0.1%
80-90	5.2	0.5%	170-180	0.3	0%

ZONAL LUMEN SUMMARY

ZONE	LUMENS	% LAMP	% LUMINAIRE
0-30	387.7	33.9%	33.9%
0-40	614.8	53.7%	53.7%
0-60	1,000.9	87.5%	87.5%
60-90	140.2	12.3%	12.3%
70-100	41.4	3.6%	3.6%
90-120	0.1	0%	0%
0-90	1,141.2	99.7%	99.7%
90-180	3.0	0.3%	0.3%
0-180	1,144.1	100%	100%

99615, CDL6FR15/930/RTJB/LED

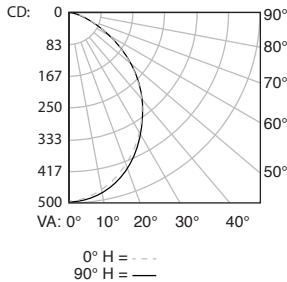

LUMENS PER ZONE

ZONE	LUMENS	% TOTAL	ZONE	LUMENS	% TOTAL
0-10	58.6	5.7%	90-100	0.000	0%
10-20	157.9	15.4%	100-110	0.000	0%
20-30	215.0	21.0%	110-120	0.000	0%
30-40	225.3	22.0%	120-130	0.000	0%
40-50	183.9	17.9%	130-140	0.000	0%
50-60	112.5	11.0%	140-150	0.000	0%
60-70	48.8	4.8%	150-160	0.000	0%
70-80	18.2	1.8%	160-170	0.000	0%
80-90	5.4	0.5%	170-180	0.000	0%

ZONAL LUMEN SUMMARY

ZONE	LUMENS	% LAMP	% LUMINAIRE
0-30	431.6	42.1%	42.1%
0-40	656.9	64.1%	64%
0-60	953.2	93%	92.9%
60-90	72.4	7.1%	7.1%
0-90	1,025.6	100%	100%

99616, CDL6FR15/940/RTJB/LED

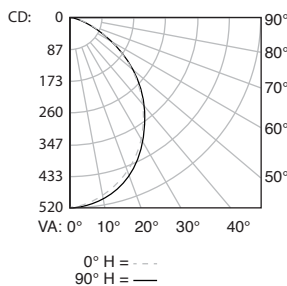

LUMENS PER ZONE

ZONE	LUMENS	% TOTAL	ZONE	LUMENS	% TOTAL
0-10	61.1	5.7%	90-100	0.000	0%
10-20	164.7	15.4%	100-110	0.000	0%
20-30	224.2	21.0%	110-120	0.000	0%
30-40	235.0	22.0%	120-130	0.000	0%
40-50	191.8	17.9%	130-140	0.000	0%
50-60	117.3	11.0%	140-150	0.000	0%
60-70	50.9	4.8%	150-160	0.000	0%
70-80	19.0	1.8%	160-170	0.000	0%
80-90	5.6	0.5%	170-180	0.000	0%

ZONAL LUMEN SUMMARY

ZONE	LUMENS	% LAMP	% LUMINAIRE
0-30	450.1	42.1%	42.1%
0-40	685.1	64.1%	64%
0-60	994.2	93%	92.9%
60-90	75.5	7.1%	7.1%
0-90	1,069.8	100%	100%

99617, CDL6FR15/950/RTJB/LED

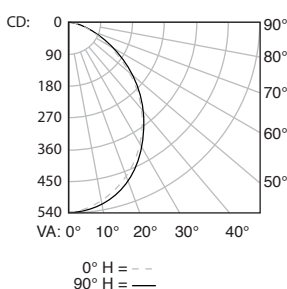

LUMENS PER ZONE

ZONE	LUMENS	% TOTAL	ZONE	LUMENS	% TOTAL
0-10	63.7	5.7%	90-100	0.000	0%
10-20	171.7	15.4%	100-110	0.000	0%
20-30	233.7	21.0%	110-120	0.000	0%
30-40	244.9	22.0%	120-130	0.000	0%
40-50	199.9	17.9%	130-140	0.000	0%
50-60	122.2	11.0%	140-150	0.000	0%
60-70	53.1	4.8%	150-160	0.000	0%
70-80	19.8	1.8%	160-170	0.000	0%
80-90	5.8	0.5%	170-180	0.000	0%

ZONAL LUMEN SUMMARY

ZONE	LUMENS	% LAMP	% LUMINAIRE
0-30	469.1	42.1%	42.1%
0-40	713.9	64.1%	64%
0-60	1,036.1	93%	92.9%
60-90	78.7	7.1%	7.1%
0-90	1,114.8	100%	100%

ProLED Commercial Downlight Retrofit

Photometrics

99618, CDL8FR30/927/RTJB/LED

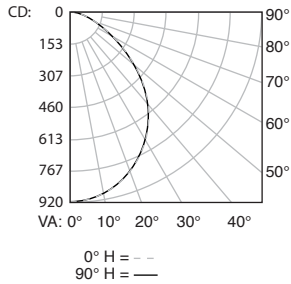

LUMENS PER ZONE

ZONE	LUMENS	% TOTAL	ZONE	LUMENS	% TOTAL
0-10	86.0	4.3%	90-100	0.3	0%
10-20	243.3	12.1%	100-110	0.4	0%
20-30	357.3	17.8%	110-120	0.5	0%
30-40	409.4	20.4%	120-130	0.6	0%
40-50	386.0	19.2%	130-140	0.6	0%
50-60	287.4	14.3%	140-150	1.0	0%
60-70	163.4	8.1%	150-160	1.4	0.1%
70-80	60.5	3.0%	160-170	1.3	0.1%
80-90	11.9	0.6%	170-180	0.5	0%

ZONAL LUMEN SUMMARY

ZONE	LUMENS	% LAMP	% LUMINAIRE
0-30	686.6	34.1%	34.1%
0-40	1,096.1	54.5%	54.5%
0-60	1,769.5	87.9%	88%
60-90	235.8	11.7%	11.7%
70-100	72.8	3.6%	3.6%
90-120	1.2	0.1%	0.1%
0-90	2,005.3	99.7%	99.7%
90-180	6.6	0.3%	0.3%
0-180	2,011.9	100%	100%

99619, CDL8FR30/930/RTJB/LED

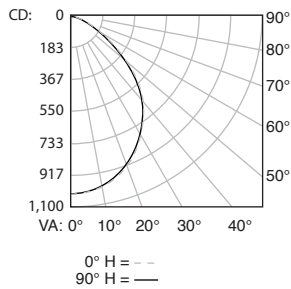

LUMENS PER ZONE

ZONE	LUMENS	% TOTAL	ZONE	LUMENS	% TOTAL
0-10	86.3	4.2%	90-100	0.000	0%
10-20	244.2	11.9%	100-110	0.000	0%
20-30	360.1	17.6%	110-120	0.000	0%
30-40	413.6	20.2%	120-130	0.000	0%
40-50	387.8	18.9%	130-140	0.000	0%
50-60	282.4	13.8%	140-150	0.000	0%
60-70	154.4	7.5%	150-160	0.000	0%
70-80	74.1	3.6%	160-170	0.000	0%
80-90	49.0	2.4%	170-180	0.000	0%

ZONAL LUMEN SUMMARY

ZONE	LUMENS	% LAMP	% LUMINAIRE
0-30	690.6	33.7%	33.7%
0-40	1,104.2	53.9%	53.8%
0-60	1,774.5	86.6%	86.5%
60-90	277.5	13.5%	13.5%
0-90	2,052.0	100.2%	100%

99620, CDL8FR30/940/RTJB/LED

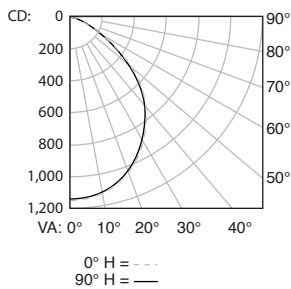

LUMENS PER ZONE

ZONE	LUMENS	% TOTAL	ZONE	LUMENS	% TOTAL
0-10	96.3	4.2%	90-100	0.000	0%
10-20	272.4	11.9%	100-110	0.000	0%
20-30	401.8	17.6%	110-120	0.000	0%
30-40	461.4	20.2%	120-130	0.000	0%
40-50	432.6	18.9%	130-140	0.000	0%
50-60	315.1	13.8%	140-150	0.000	0%
60-70	172.3	7.5%	150-160	0.000	0%
70-80	82.6	3.6%	160-170	0.000	0%
80-90	54.7	2.4%	170-180	0.000	0%

ZONAL LUMEN SUMMARY

ZONE	LUMENS	% LAMP	% LUMINAIRE
0-30	770.4	33.7%	33.7%
0-40	1,231.8	53.9%	53.8%
0-60	1,979.4	86.6%	86.5%
60-90	309.6	13.5%	13.5%
0-90	2,289.0	100.2%	100%

99621, CDL8FR30/950/RTJB/LED

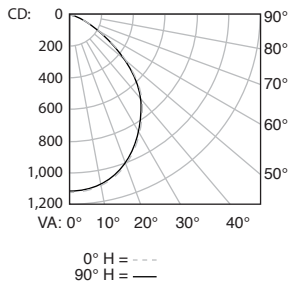

LUMENS PER ZONE

ZONE	LUMENS	% TOTAL	ZONE	LUMENS	% TOTAL
0-10	94.2	4.2%	90-100	0.000	0%
10-20	266.6	11.9%	100-110	0.000	0%
20-30	393.2	17.6%	110-120	0.000	0%
30-40	451.6	20.2%	120-130	0.000	0%
40-50	423.5	18.9%	130-140	0.000	0%
50-60	308.4	13.8%	140-150	0.000	0%
60-70	168.6	7.5%	150-160	0.000	0%
70-80	80.9	3.6%	160-170	0.000	0%
80-90	53.5	2.4%	170-180	0.000	0%

ZONAL LUMEN SUMMARY

ZONE	LUMENS	% LAMP	% LUMINAIRE
0-30	754.1	33.7%	33.7%
0-40	1,205.7	53.9%	53.8%
0-60	1,937.5	86.6%	86.5%
60-90	303.0	13.5%	13.5%
0-90	2,240.6	100.2%	100%

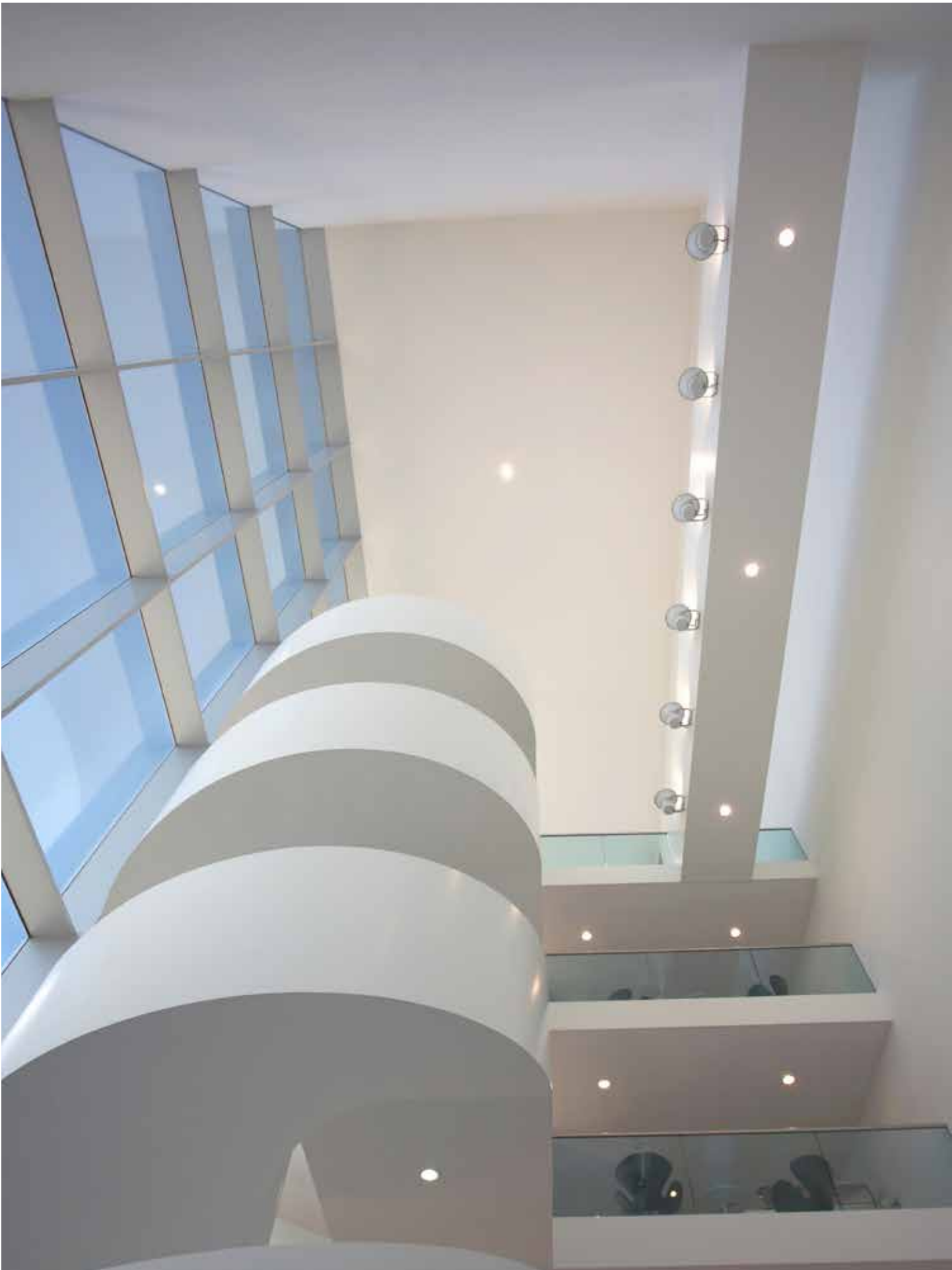

ProLED Linear LED High Bay Series

Applications

Warehouses
Distribution Centers
Industrial facilities
Gymnasiums
Retail
Grocery Stores
Markets
Commercial
Industrial

High performance Linear LED High Bays are energy efficient, long lasting replacements for traditional HID and fluorescent industrial applications

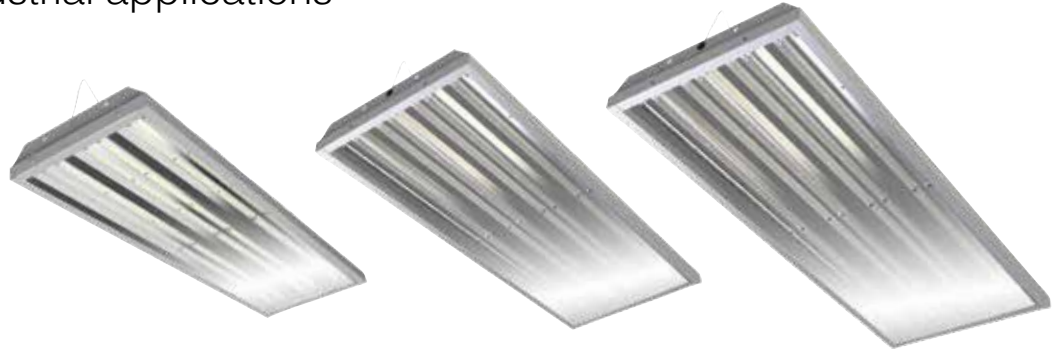

The LHB160 is a 160 watt solution that is great for commercial and industrial applications

The LHB200 and LHB250 are 200 watt and 250 watt solutions that are great for commercial and industrial applications with increased mounting requirements.

Specifications

- Wide and narrow optic options
- 4000K color temperature
- 0-10V dimming
- ETL listed for damp locations
- 50,000 hour life
- 5-year limited warranty
- Instant-on
- 16,800 lumens
- 105 lumens per watt
- Formed steel housing with polyester powder coat finish
- Clear Polycarbonate lens included
- V-Mount hooks included

Specifications

- Wide and narrow optic options
- 4000K color temperature
- 0-10V dimming
- ETL listed for damp locations
- 50,000 hour life
- 5-year limited warranty
- Instant-on
- 21,000 lumens (200W), 26,500 (250W)
- 105 lumens per watt
- Formed steel housing with polyester powder coat finish
- Clear Polycarbonate lens included
- V-Mount hooks included

Dimensions

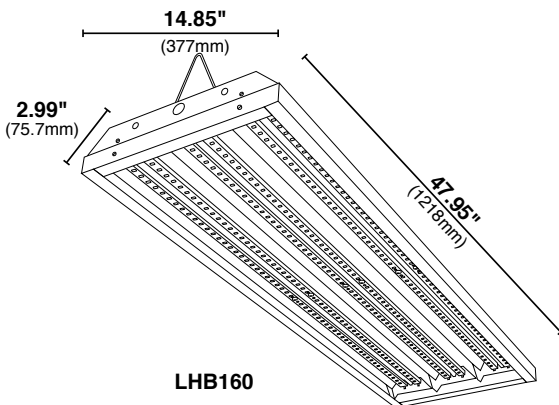

Dimensions

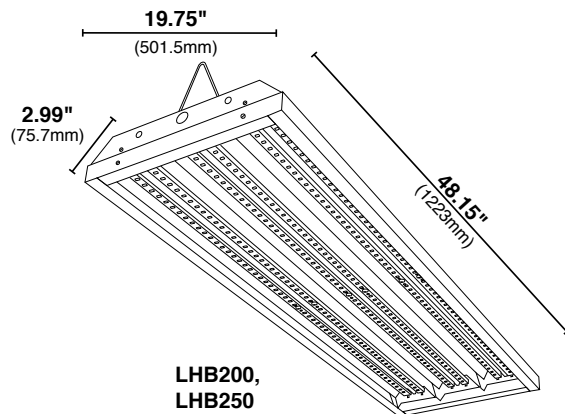

ProLED Linear LED High Bay Series



Ordering Information



Series	Watt option	CRI	Color Temperature	Voltage	Optic Option	Cord Length Option	Cord Volt Option**	Motion Control Option
LHB	160 = 160W 200 = 200W 250 = 250W	8 = 80	40 = 4000K	UNV = 120-277V	N = Narrow W = Wide	C06 = 6 Feet C12 = 12 Feet	12V = 120V 20V = 208V 24V = 240V 27V = 277V	MC = 0-10V Sensor

Use the nomenclature on the left to create product code. Description is on the right. All columns are required except cord length, cord volt and motion control.

Example

LHB 160 8 40 UNV N C06 12V MC

* Useful Life is defined as the point in time at which the lamp will maintain at least 70% of its initial lumens. The lamp will continue to burn past this point, but at decreased light levels.

Warranty Commercial/Industrial: This product is warranted for 5 years from the date purchase.

** Cord voltage designates included NEMA plug configuration.

May not be compatible with all dimmable systems, dimming performance may vary by system, please check the website www.halcolighting.com for up-to-date dimmer compatibility information. Use on incompatible systems may shorten lamp life.

*** Check the latest update at www.DesignLights.org for listed product catalog numbers. All versions may not be listed.

Narrow Optic

Ideal for Aisles

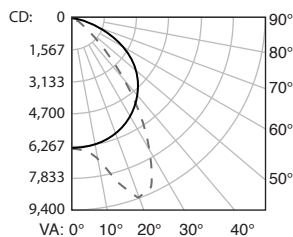

0° H = —
90° H = - -

Wide Optic

Ideal for general purpose lighting

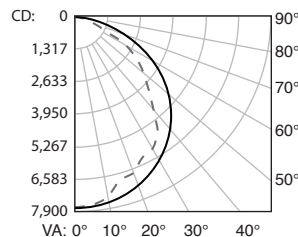

0° H = —
90° H = - -

ProLED Linear LED High Bay Series

Lamp Comparison Table

Traditional HID High Bay	System Watts	Replacement LED	Energy Savings
175W HID	210W	160W	24%
250W HID	289W	200W	31%
400W HID	458W	250W	45%

Traditional Linear Fluorescent	Delivered Lumens	Replacement LED	Increased Performance
4-lamp (T8)	10,100	160W	66%
6-lamp (T8)	15,535	200W	35%
8-Lamp (T8)	20,613	250W	29%

Traditional Linear Fluorescent	Delivered Lumens	Replacement LED	Increased Performance
4-Lamp (T5HO)	16,684	200W	1%
6-Lamp (T5HO)	19,393	250W	8%

Illumination at a Distance

Luminaire	Mounting Height (feet)	Delivered Footcandles	Luminaire (T8 Equivalent)	Mounting Height (feet)	Delivered Footcandles	Luminaire (T5HO Equivalent)	Mounting Height (feet)	Delivered Footcandles	Luminaire (HID Equivalent)	Mounting Height (feet)	Delivered Footcandles
LHB160/840/UNV/W	12'	53.79 fc	4-Lamp (T8)	12'	22.97 fc	-	-	-	175W	12'	15.65 fc
	16'	30.25 fc		16'	12.92 fc					16'	8.80 fc
	20'	19.36 fc		20'	8.27 fc					20'	5.63 fc
LHB200/840/UNV/W	12'	68.80 fc	6-Lamp (T8)	12'	32.72 fc	4-Lamp (T5HO)	12'	64.49 fc	250W	12'	31.35 fc
	16'	38.70 fc		16'	18.41 fc		16'	36.28 fc		16'	17.64 fc
	20'	24.77 fc		20'	11.78 fc		20'	23.22 fc		20'	11.29 fc
LHB250/840/UNV/W	12'	83.49 fc	8-Lamp (T8)	12'	46.54 fc	6-Lamp (T5HO)	12'	58.60 fc	400W	12'	62.49 fc
	16'	46.96 fc		16'	26.18 fc		16'	32.96 fc		16'	35.15 fc
	20'	30.06 fc		20'	16.76 fc		20'	21.10 fc		20'	22.50 fc

Base Product Information



Watt	Product #	Product Code	Volts	Color Temp.	CRI	Lumen Output	Useful Life*	Dimmable	Size	Equivalent Replacement
160W	99974	LHB160/840/UNV/N	120-277V	4000K	80	16,800	50,000	Yes	47.95"l x 14.85"w x 2.99"h	4-lamp (T8)
160W	99975	LHB160/840/UNV/W	120-277V	4000K	80	16,800	50,000	Yes	47.95"l x 14.85"w x 2.99"h	4-lamp (T8)
200W	99978	LHB200/840/UNV/N	120-277V	4000K	80	21,000	50,000	Yes	48.15"l x 19.75"w x 2.99"h	4-lamp (T5HO)/6-LAMP (T8)
200W	99979	LHB200/840/UNV/W	120-277V	4000K	80	21,000	50,000	Yes	48.15"l x 19.75"w x 2.99"h	4-lamp (T5HO)/6-LAMP (T8)
250W	99982	LHB250/840/UNV/N	120-277V	4000K	80	26,500	50,000	Yes	48.15"l x 19.75"w x 2.99"h	6-lamp (T5HO)/8-LAMP (T8)
250W	99983	LHB250/840/UNV/W	120-277V	4000K	80	26,500	50,000	Yes	48.15"l x 19.75"w x 2.99"h	6-lamp (T5HO)/8-LAMP (T8)

Warranty Commercial/Industrial: This product is warranted for 5 years from the date purchase.

May not be compatible with all dimmable systems, dimming performance may vary by system, please check the website www.halcolighting.com for up-to-date dimmer compatibility information. Use on incompatible systems may shorten lamp life.

*** Check the latest update at www.DesignLights.org for listed product catalog numbers. All versions may not be listed.

ProLED Linear LED High Bay Series

Accessories



Wire Guard



Motion Control Sensor Includes High and Low Mount Lens.

Replacement Parts



Clear Polycarbonate Lens

Motion Control Sensor Detection*

High mount lens installed (>15' mounting heights)

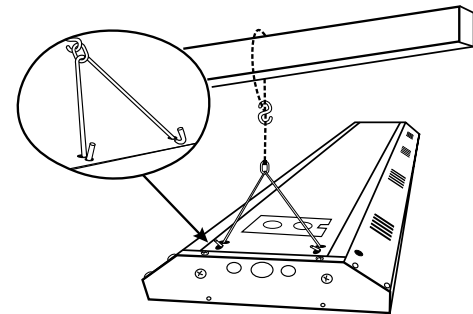
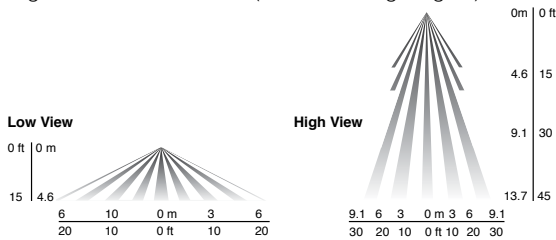

V-Hook Mounting Assembly

Low mount lens installed (<15' mounting heights)

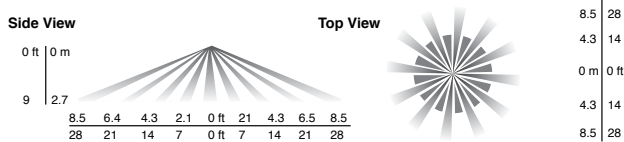

* The high mount lens comes installed on the motion sensor. The low mount sensor lens is included in the box.

Accessories and Replacement Parts Ordering Information

Product #	Product Code	Description	Weight
99986	LHB/MC	(0-10V) Motion Control Sensor	0.25 lb
99987	LHB/WG1	WG1=Wire Guard for LHB1	4.85 lb
99988	LHB/WG2	WG2=Wire Guard for LHB2	6.31 lb
99997	LHB/PC1	Polycarbonate Clear Lens for LHB1	2.43 lb
99998	LHB/PC2	Polycarbonate Clear Lens for LHB2	3.31 lb
99999	LHB/VMA	V Hook Mounting Assembly	0.42 lb

* Useful Life is defined as the point in time at which the lamp will maintain at least 70% of its initial lumens. The lamp will continue to burn past this point, but at decreased light levels. Warranty Commercial/Industrial: This product is warranted for 5 years from the date purchase. May not be compatible with all dimmable systems, dimming performance may vary by system, please check the website www.halcolighting.com for up-to-date dimmer compatibility information. Use on incompatible systems may shorten lamp life.

ProLED Linear LED High Bay Series

Photometrics

99974, LHB160/840/UNV/N

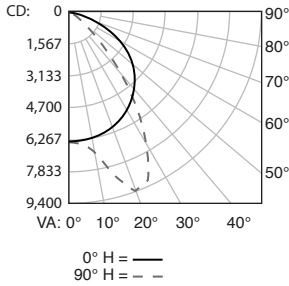

LUMENS PER ZONE

ZONE	LUMENS	% TOTAL	ZONE	LUMENS	% TOTAL
0-10	615.5	3.5%	90-100	6.5	0%
10-20	2,046.6	11.8%	100-110	5.2	0%
20-30	3,632.9	20.9%	110-120	5.5	0%
30-40	4,127.6	23.8%	120-130	6.8	0%
40-50	3,447.8	19.9%	130-140	9.3	0.1%
50-60	2,146.3	12.4%	140-150	13.6	0.1%
60-70	953.0	5.5%	150-160	15.6	0.1%
70-80	264.9	1.5%	160-170	13.3	0.1%
80-90	42.4	0.2%	170-180	5.6	0%

ZONAL LUMEN SUMMARY

ZONE	LUMENS	% LAMP	% LUMINAIRE
0-30	6,295.1	36.2%	36.3%
0-40	10,422.6	60%	60%
0-60	16,016.7	92.2%	92.3%
60-90	1,260.2	7.3%	7.3%
70-100	313.7	1.8%	1.8%
90-120	17.2	0.1%	0.1%
0-90	17,277.0	99.4%	99.5%
90-180	81.4	0.5%	0.5%
0-180	17,358.3	99.9%	100%

99975, LHB160/840/UNV/W

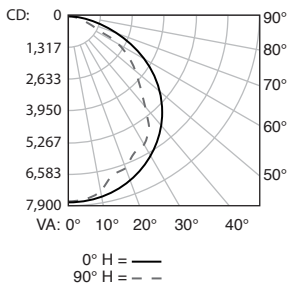

LUMENS PER ZONE

ZONE	LUMENS	% TOTAL	ZONE	LUMENS	% TOTAL
0-10	733.1	3.8%	90-100	12.0	0.1%
10-20	2,053.9	10.8%	100-110	8.7	0%
20-30	3,064.3	16.1%	110-120	8.1	0%
30-40	3,695.7	19.4%	120-130	8.6	0%
40-50	3,640.9	19.1%	130-140	10.9	0.1%
50-60	3,071.5	16.1%	140-150	15.5	0.1%
60-70	1,893.0	9.9%	150-160	18.0	0.1%
70-80	691.6	3.6%	160-170	14.5	0.1%
80-90	109.0	0.6%	170-180	5.7	0%

ZONAL LUMEN SUMMARY

ZONE	LUMENS	% LAMP	% LUMINAIRE
0-30	5,851.3	30.7%	30.7%
0-40	9,547.0	50%	50.1%
0-60	16,259.4	85.2%	85.3%
60-90	2,693.5	14.1%	14.1%
70-100	812.5	4.3%	4.3%
90-120	28.8	0.2%	0.2%
0-90	18,952.9	99.3%	99.5%
90-180	102.0	0.5%	0.5%
0-180	19,054.9	99.8%	100%

99978, LHB200/840/UNV/N

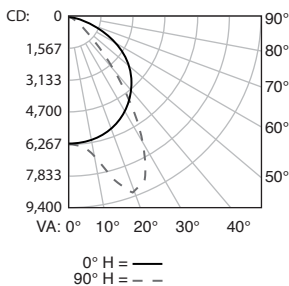

LUMENS PER ZONE

ZONE	LUMENS	% TOTAL	ZONE	LUMENS	% TOTAL
0-10	832.6	3.6%	90-100	8.9	0%
10-20	2,769.1	12.0%	100-110	7.2	0%
20-30	4,880.6	21.1%	110-120	7.7	0%
30-40	5,515.4	23.8%	120-130	9.3	0%
40-50	4,559.0	19.7%	130-140	13.2	0.1%
50-60	2,839.3	12.3%	140-150	18.7	0.1%
60-70	1,261.7	5.4%	150-160	21.4	0.1%
70-80	340.5	1.5%	160-170	18.0	0.1%
80-90	54.0	0.2%	170-180	7.4	0%

ZONAL LUMEN SUMMARY

ZONE	LUMENS	% LAMP	% LUMINAIRE
0-30	8,482.3	36.6%	36.6%
0-40	13,997.7	60.4%	60.4%
0-60	21,395.9	92.2%	92.4%
60-90	1,656.2	7.1%	7.1%
70-100	403.3	1.7%	1.7%
90-120	23.8	0.1%	0.1%
0-90	23,052.1	99.4%	99.5%
90-180	111.8	0.5%	0.5%
0-180	23,163.9	99.9%	100%

ProLED Linear LED High Bay Series

Photometrics

99979, LHB200/840/UNV/W

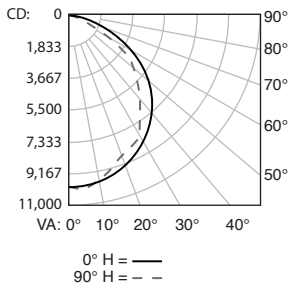

LUMENS PER ZONE

ZONE	LUMENS	% TOTAL	ZONE	LUMENS	% TOTAL
0-10	927.5	3.8%	90-100	14.7	0.1%
10-20	2,621.7	10.8%	100-110	10.7	0%
20-30	3,917.9	16.1%	110-120	9.7	0%
30-40	4,692.2	19.3%	120-130	10.2	0%
40-50	4,657.4	19.2%	130-140	12.9	0.1%
50-60	3,949.5	16.3%	140-150	18.3	0.1%
60-70	2,391.2	9.8%	150-160	21.0	0.1%
70-80	860.5	3.5%	160-170	16.8	0.1%
80-90	141.2	0.6%	170-180	6.5	0%

ZONAL LUMEN SUMMARY

ZONE	LUMENS	% LAMP	% LUMINAIRE
0-30	7,467.0	30.7%	30.8%
0-40	12,159.2	50%	50.1%
0-60	20,766.2	85.4%	85.5%
60-90	3,393.0	14%	14%
70-100	1,016.4	4.2%	4.2%
90-120	35.1	0.1%	0.1%
0-90	24,159.2	99.4%	99.5%
90-180	120.6	0.5%	0.5%
0-180	24,279.8	99.8%	100%

99982, LHB250/840/UNV/N

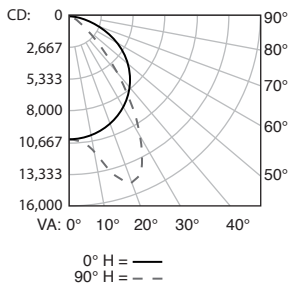

LUMENS PER ZONE

ZONE	LUMENS	% TOTAL	ZONE	LUMENS	% TOTAL
0-10	995.5	3.6%	90-100	10.0	0%
10-20	3,291.4	11.9%	100-110	8.6	0%
20-30	5,781.4	21.0%	110-120	9.1	0%
30-40	6,547.4	23.8%	120-130	11.1	0%
40-50	5,459.1	19.8%	130-140	15.7	0.1%
50-60	3,377.0	12.3%	140-150	22.3	0.1%
60-70	1,497.8	5.4%	150-160	25.5	0.1%
70-80	402.5	1.5%	160-170	21.4	0.1%
80-90	63.0	0.2%	170-180	8.8	0%

ZONAL LUMEN SUMMARY

ZONE	LUMENS	% LAMP	% LUMINAIRE
0-30	10,068.3	36.5%	36.5%
0-40	16,615.7	60.2%	60.3%
0-60	25,451.8	92.3%	92.4%
60-90	1,963.3	7.1%	7.1%
70-100	475.5	1.7%	1.7%
90-120	27.8	0.1%	0.1%
0-90	27,415.1	99.4%	99.5%
90-180	132.6	0.5%	0.5%
0-180	27,547.7	99.9%	100%

99983, LHB250/840/UNV/W

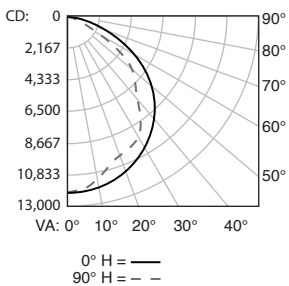

LUMENS PER ZONE

ZONE	LUMENS	% TOTAL	ZONE	LUMENS	% TOTAL
0-10	1,137.8	3.9%	90-100	18.1	0.1%
10-20	3,174.4	10.7%	100-110	13.1	0%
20-30	4,729.3	16.0%	110-120	11.9	0%
30-40	5,690.1	19.3%	120-130	12.5	0%
40-50	5,653.0	19.1%	130-140	15.5	0.1%
50-60	4,793.8	16.2%	140-150	21.7	0.1%
60-70	2,947.9	10.0%	150-160	24.8	0.1%
70-80	1,090.6	3.7%	160-170	19.5	0.1%
80-90	173.7	0.6%	170-180	7.5	0%

ZONAL LUMEN SUMMARY

ZONE	LUMENS	% LAMP	% LUMINAIRE
0-30	9,041.5	30.6%	30.6%
0-40	14,731.7	49.8%	49.9%
0-60	25,178.5	85.1%	85.2%
60-90	4,212.2	14.2%	14.3%
70-100	1,282.3	4.3%	4.3%
90-120	43.1	0.1%	0.1%
0-90	29,390.7	99.4%	99.5%
90-180	144.5	0.5%	0.5%
0-180	29,535.2	99.8%	100%

ProLED Round LED High Bay Series

Applications

Warehouses
Distribution Centers
Industrial facilities
Gymnasiums
Retail
Grocery Stores
Markets
Commercial
Industrial

High performance Round LED High Bays are energy efficient, long lasting replacements for traditional HID and fluorescent industrial applications



The RHB150 is a 150 watt solution that is great for warehouse and industrial applications

The RHB200 is a 200 watt solution that is great for warehouse and industrial applications with increased mounting requirements

Specifications

- Die-cast aluminum body and driver housing for maximum thermal performance and durability
- Unique easy-access door and removeable mounting plate facilitate quick and safe mounting of luminaire
- Durable steel mounting box finished in a polyester powder coating
- UL listed for wet locations
- 4000K color temperature
- 0-10V dimming
- 50,000 hour life
- 5-Year limited warranty
- Control options available
- - 20,250 lumens
- - 3/4" NPT hook available
- - Wide optics



Specifications

- Die-cast aluminum body and driver housing for maximum thermal performance and durability
- Durable steel mounting box finished in a polyester powder coating
- Unique easy-access door and removeable mounting plate facilitate quick and safe mounting of luminaire
- UL listed for wet locations
- 4000K color temperature
- 0-10V dimming
- 50,000 hour life
- 5-Year limited warranty
- Control options available
- - 27,000 lumens
- - 3/4" NPT hook available
- - Wide optics



Dimensions

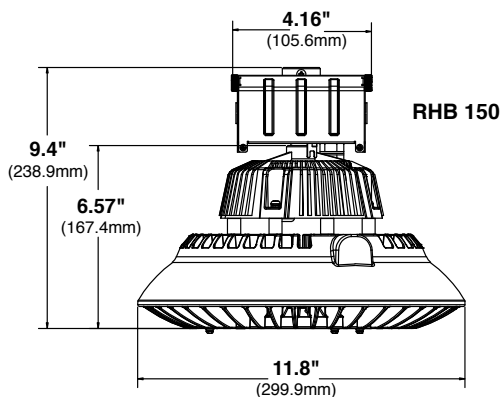

Dimensions

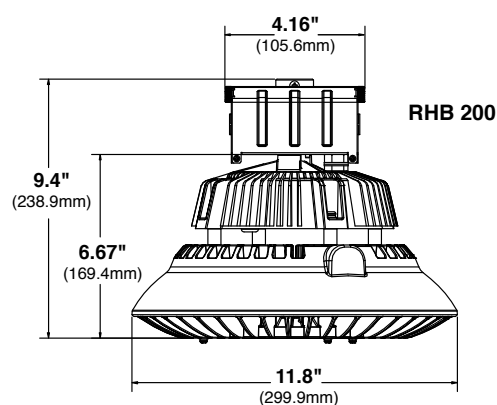

ProLED Round LED High Bay Series



Ordering Information

Series	Watt option	CRI	Color Temperature	Voltage	Optic Option	Cord Length Option	Cord Volt Option**	Motion Control Option
RHB	150 = 150W 200 = 200W	8 = 80	40 = 4000K	UNV = 120-277V	W = Wide	C06 = 6 Feet C12 = 12 Feet	12V = 120V 20V = 208V 24V = 240V 27V = 277V	MC = 0-10V Sensor

Use the nomenclature on the left to create product code. Description is on the right. All columns are required except cord length, cord volt and motion control.

Example

RHB 150 8 40 UNV N C06 12V MC

Ordering information.

* Useful Life is defined as the point in time at which the lamp will maintain at least 70% of its initial lumens. The lamp will continue to burn past this point, but at decreased light levels.

Warranty Commercial/Industrial: This product is warranted for 5 years from the date purchase.

** Cord voltage designates included NEMA plug configuration.

May not be compatible with all dimmable systems, dimming performance may vary by system, please check the website www.halcolighting.com for up-to-date dimmer compatibility information. Use on incompatible systems may shorten lamp life.

*** Check the latest update at www.DesignLights.org for listed product catalog numbers. All versions may not be listed.

Photometrics

RHB150/840/UNV/W 10120

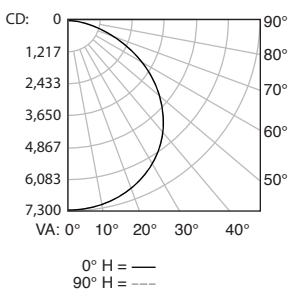

RHB200/840/UNV/W 10121

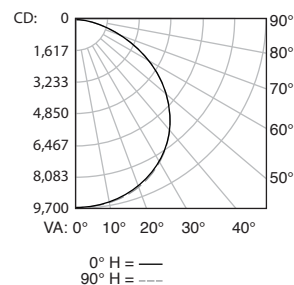

Easy-Access Door

ProLED Round LED High Bay Series



Lamp Comparison Table

Round LED High Bay	System Watts	Lumens	LPW
RHB150/840/UNV/W	150W	20250	135
RHB200/840/UNV/W	200W	27000	135
Traditional Round HID High Bay	System Watts	Replacement LED	Energy Savings
250W HID	289W	150W	66%
400W HID	458W	200W	56%

Illumination at a Distance

Luminaire	Mounting Height (feet)	Center Beam Footcandles	Luminaire (HID Equivalent)	Mounting Height (feet)	Delivered Footcandles	Center Beam Footcandles
RHB150/840/UNV/W	12'	50.43 fc	250W	12'	22.97 fc	31.35 fc
	16'	28.37 fc		16'	12.92 fc	17.64 fc
	20'	18.16 fc		20'	8.27 fc	11.29 fc
RHB200/840/UNV/W	12'	66.78 fc	400W	12'	32.72 fc	62.49 fc
	16'	37.56 fc		16'	18.41 fc	35.15 fc
	20'	24.04 fc		20'	11.78 fc	22.50 fc

ProLED Round LED High Bay Series

Accessories



60° Degree Aluminum Reflector



70° Degree Polycarbonate Reflector



Motion Control Sensor



3/4" NPT Hook (Zinc Material)



90° Degree Aluminum Reflector

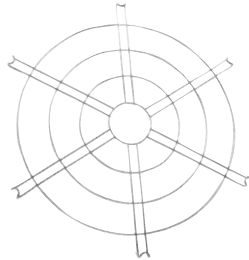

60° Degree Wireguard for Aluminum Reflector

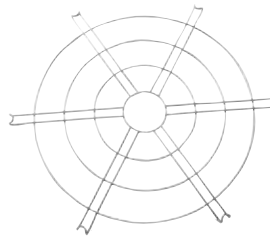

90° Degree Wireguard for Aluminum Reflector

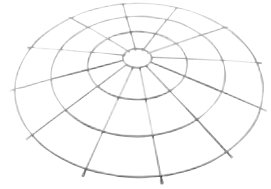

Wireguard for Polycarbonate Reflector

Accessories Ordering Information

Product #	Product Code	Description	Weight
10122	RHB/AL60D	Round LED High Bay 60° Degree Aluminum Reflector	1.14 lb
10123	RHB/AL90D	Round LED High Bay 90° Degree Aluminum Reflector	1.14 lb
10124	RHB/AY70D	Round LED High Bay 70° Degree Polycarbonate Reflector	2.31 lb
10125	RHB/WG/AL60D	Round LED High Bay 60° Degree Wireguard for Aluminum Reflectors	1.10 lb
10126	RHB/WG/AL90D	Round LED High Bay 90° Degree Wireguard for Aluminum Reflectors	1.10 lb
10127	RHB/WG/AY	Round LED High Bay Wireguard for Polycarbonate Reflector	0.60 lb
10128	RHB/H	3/4" NPT Hook (Zinc Material)	0.40 lb
10129	RBH/MC	Motion Control Sensor	0.05 lb

* Useful Life is defined as the point in time at which the lamp will maintain at least 70% of its initial lumens. The lamp will continue to burn past this point, but at decreased light levels.
 Warranty Commercial/Industrial: This product is warranted for 5 years from the date purchase.
 May not be compatible with all dimmable systems, dimming performance may vary by system, please check the website www.halcolighting.com for up-to-date dimmer compatibility information. Use on incompatible systems may shorten lamp life.

ProLED Round LED High Bay Series

Photometrics

RHB150_840_UNV_W 10120

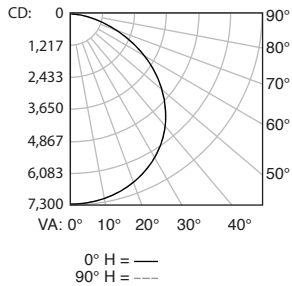

ZONAL LUMEN SUMMARY

ZONE	LUMENS	% LAMP	% LUMINAIRE
0-30	5,732.5	28.3%	28.3%
0-40	9,465.9	46.7%	46.7%
0-60	16,819.6	82.9%	82.9%
60-90	3,377.4	16.7%	16.7%
70-100	1,024.0	5%	5%
90-120	20.5	0.1%	0.1%
0-90	20,197.0	99.6%	99.6%
90-180	83.5	0.4%	0.4%
0-180	20,280.4	100%	100%

LUMENS PER ZONE

ZONE	LUMENS	% TOTAL	ZONE	LUMENS	% TOTAL
0-10	689.2	3.4%	90-100	3.5	0%
10-20	1,989.8	9.8%	100-110	6.7	0%
20-30	3,053.4	15.1%	110-120	10.4	0.1%
30-40	3,733.5	18.4%	120-130	13.3	0.1%
40-50	3,890.4	19.2%	130-140	14.6	0.1%
50-60	3,463.2	17.1%	140-150	13.7	0.1%
60-70	2,356.8	11.6%	150-160	11.3	0.1%
70-80	924.3	4.6%	160-170	7.4	0%
80-90	96.3	0.5%	170-180	2.6	0%

RHB150_840_UNV_W WITH 60 DEG ALUMINUM REFLECTOR

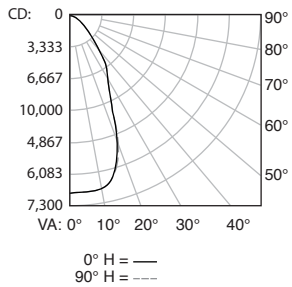

ZONAL LUMEN SUMMARY

ZONE	LUMENS	% LAMP	% LUMINAIRE
0-30	11,413.0	62.1%	62.1%
0-40	15,360.7	83.5%	83.6%
0-60	18,267.7	99.3%	99.4%
60-90	44.2	0.2%	0.2%
70-100	16.9	0.1%	0.1%
90-120	5.1	0%	0%
0-90	18,312.0	99.6%	99.6%
90-180	72.2	0.4%	0.4%
0-180	18,384.2	100%	100%

LUMENS PER ZONE

ZONE	LUMENS	% TOTAL	ZONE	LUMENS	% TOTAL
0-10	1,798.3	9.8%	90-100	1.0	0%
10-20	4,799.6	26.1%	100-110	1.0	0%
20-30	4,815.1	26.2%	110-120	3.1	0%
30-40	3,947.7	21.5%	120-130	6.8	0%
40-50	2,409.4	13.1%	130-140	11.3	0.1%
50-60	497.7	2.7%	140-150	15.2	0.1%
60-70	28.4	0.2%	150-160	16.3	0.1%
70-80	12.5	0.1%	160-170	12.6	0.1%
80-90	3.3	0.0%	170-180	4.9	0%

RHB150_840_UNV_W WITH 70 DEG POLYCARBONATE REFLECTOR

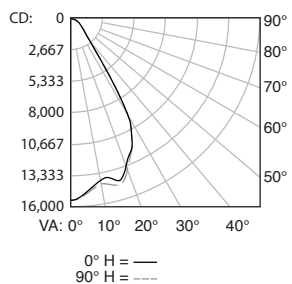

ZONAL LUMEN SUMMARY

ZONE	LUMENS	% LAMP	% LUMINAIRE
0-30	10,992.4	59%	59%
0-40	14,392.5	77.2%	77.2%
0-60	16,777.9	90%	90%
60-90	1,269.7	6.8%	6.8%
70-100	849.8	4.6%	4.6%
90-120	372.9	2%	2%
0-90	18,047.6	96.8%	96.8%
90-180	587.4	3.2%	3.2%
0-180	18,635.0	100%	100%

LUMENS PER ZONE

ZONE	LUMENS	% TOTAL	ZONE	LUMENS	% TOTAL
0-10	1,400.1	7.5%	90-100	185.4	1%
10-20	4,065.3	21.8%	100-110	123.6	0.7%
20-30	5,526.9	29.7%	110-120	63.9	0.3%
30-40	3,400.2	18.2%	120-130	48.3	0.3%
40-50	1,376.2	7.4%	130-140	45.9	0.2%
50-60	1,009.2	5.4%	140-150	44.3	0.2%
60-70	605.3	3.2%	150-160	38.7	0.2%
70-80	373.1	2.0%	160-170	27.4	0.1%
80-90	291.3	1.6%	170-180	9.9	0.1%

RHB150_840_UNV_W WITH 90 DEG ALUMINUM REFLECTOR

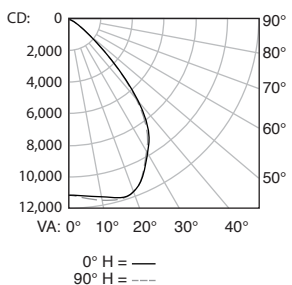

ZONAL LUMEN SUMMARY

ZONE	LUMENS	% LAMP	% LUMINAIRE
0-30	9,356.5	50%	50%
0-40	14,604.8	78.1%	78.1%
0-60	18,529.7	99.1%	99.1%
60-90	95.1	0.5%	0.5%
70-100	32.3	0.2%	0.2%
90-120	6.8	0%	0%
0-90	18,624.8	99.6%	99.6%
90-180	73.8	0.4%	0.4%
0-180	18,698.6	100%	100%

LUMENS PER ZONE

ZONE	LUMENS	% TOTAL	ZONE	LUMENS	% TOTAL
0-10	1,083.0	5.8%	90-100	1.5	0%
10-20	3,320.0	17.8%	100-110	1.5	0%
20-30	4,953.4	26.5%	110-120	3.8	0%
30-40	5,248.3	28.1%	120-130	8.5	0%
40-50	3,228.7	17.3%	130-140	13.5	0.1%
50-60	696.3	3.7%	140-150	15.9	0.1%
60-70	64.2	0.3%	150-160	14.8	0.1%
70-80	24.2	0.1%	160-170	10.4	0.1%
80-90	6.6	0.0%	170-180	3.9	0%

ProLED Round LED High Bay Series

Photometrics

RHB200_840_UNV_W 10121

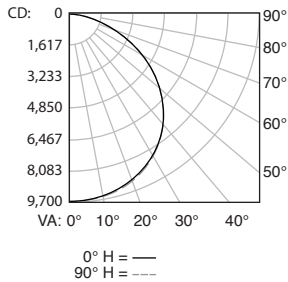

ZONAL LUMEN SUMMARY

ZONE	LUMENS	% LAMP	% LUMINAIRE
0-30	7,610.8	28.3%	28.3%
0-40	12,563.1	46.7%	46.7%
0-60	22,303.9	83%	83%
60-90	4,468.7	16.6%	16.6%
70-100	1,350.4	5%	5%
90-120	26.5	0.1%	0.1%
0-90	26,772.6	99.6%	99.6%
90-180	107.7	0.4%	0.4%
0-180	26,880.3	100%	100%

LUMENS PER ZONE

ZONE	LUMENS	% TOTAL	ZONE	LUMENS	% TOTAL
0-10	914.8	3.4%	90-100	4.2	0%
10-20	2,642.2	9.8%	100-110	8.6	0%
20-30	4,053.8	15.1%	110-120	13.6	0.1%
30-40	4,952.2	18.4%	120-130	17.3	0.1%
40-50	5,154.2	19.2%	130-140	18.9	0.1%
50-60	4,586.7	17.1%	140-150	17.7	0.1%
60-70	3,122.6	11.6%	150-160	14.4	0.1%
70-80	1,223.3	4.6%	160-170	9.5	0%
80-90	122.8	0.5%	170-180	3.4	0%

RHB200_840_UNV_W WITH 60 DEG ALUMINUM REFLECTOR

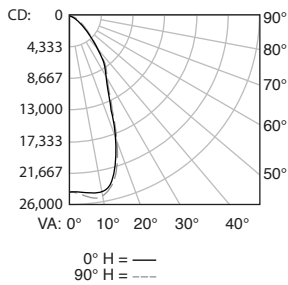

ZONAL LUMEN SUMMARY

ZONE	LUMENS	% LAMP	% LUMINAIRE
0-30	15,021.6	62.1%	62.1%
0-40	20,217.4	83.6%	83.6%
0-60	24,034.6	99.3%	99.4%
60-90	58.1	0.2%	0.2%
70-100	21.9	0.1%	0.1%
90-120	6.4	0%	0%
0-90	24,092.7	99.6%	99.6%
90-180	94.3	0.4%	0.4%
0-180	24,187.0	100%	100%

LUMENS PER ZONE

ZONE	LUMENS	% TOTAL	ZONE	LUMENS	% TOTAL
0-10	2,362.1	9.8%	90-100	1.0	0%
10-20	6,353.9	26.3%	100-110	1.3	0%
20-30	6,305.6	26.1%	110-120	4.1	0%
30-40	5,195.8	21.5%	120-130	8.9	0%
40-50	3,162.8	13.1%	130-140	14.8	0.1%
50-60	654.4	2.7%	140-150	19.9	0.1%
60-70	37.2	0.2%	150-160	21.4	0.1%
70-80	16.6	0.1%	160-170	16.5	0.1%
80-90	4.3	0.0%	170-180	6.4	0%

RHB200_840_UNV_W WITH 70 DEGREE POLYCARBONATE REFLECTOR

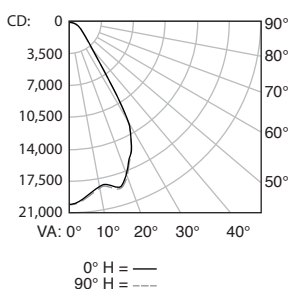

ZONAL LUMEN SUMMARY

ZONE	LUMENS	% LAMP	% LUMINAIRE
0-30	14,347.5	59%	59%
0-40	18,795.3	77.2%	77.3%
0-60	21,886.7	89.9%	90%
60-90	1,654.5	6.8%	6.8%
70-100	1,123.6	4.6%	4.6%
90-120	501.6	2.1%	2.1%
0-90	23,541.2	96.7%	96.8%
90-180	787.0	3.2%	3.2%
0-180	24,328.2	100%	100%

LUMENS PER ZONE

ZONE	LUMENS	% TOTAL	ZONE	LUMENS	% TOTAL
0-10	1,825.2	7.5%	90-100	250.1	1%
10-20	5,307.1	21.8%	100-110	166.1	0.7%
20-30	7,215.3	29.7%	110-120	85.4	0.4%
30-40	4,447.8	18.3%	120-130	64.8	0.3%
40-50	1,782.8	7.3%	130-140	61.7	0.3%
50-60	1,308.6	5.4%	140-150	59.2	0.2%
60-70	781.0	3.2%	150-160	51.0	0.2%
70-80	489.3	2.0%	160-170	35.8	0.1%
80-90	384.2	1.6%	170-180	12.8	0.1%

RHB200_840_UNV_W WITH 90 DEG ALUMINUM REFLECTOR

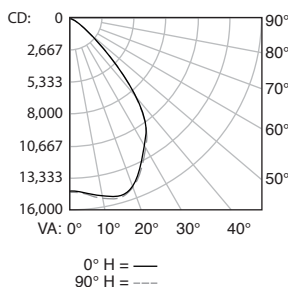

ZONAL LUMEN SUMMARY

ZONE	LUMENS	% LAMP	% LUMINAIRE
0-30	12,195.6	50.2%	50.2%
0-40	19,012.1	78.2%	78.2%
0-60	24,078.0	99.1%	99.1%
60-90	124.6	0.5%	0.5%
70-100	42.2	0.2%	0.2%
90-120	8.1	0%	0%
0-90	24,202.5	99.6%	99.6%
90-180	95.1	0.4%	0.4%
0-180	24,297.6	100%	100%

LUMENS PER ZONE

ZONE	LUMENS	% TOTAL	ZONE	LUMENS	% TOTAL
0-10	1,414.4	5.8%	90-100	1.6	0%
10-20	4,348.1	17.9%	100-110	1.6	0%
20-30	6,433.0	26.5%	110-120	4.9	0%
30-40	6,816.6	28.1%	120-130	11.1	0%
40-50	4,171.1	17.2%	130-140	17.5	0.1%
50-60	894.7	3.7%	140-150	20.6	0.1%
60-70	83.9	0.3%	150-160	19.1	0.1%
70-80	32.1	0.1%	160-170	13.6	0.1%
80-90	8.6	0.0%	170-180	5.1	0%

ProLED Panel Light Series

Applications

Office
Lobby
Hallway
Conference Room
Classroom
Hospitality
Retail
Markets
Commercial
Healthcare

Beautiful illumination in an energy efficient alternative to recessed fluorescent luminaires



Specifications

- Available in 1' x 4', 2' x 2' and 2' x 4' for recessed installations
- Direct backlit design provides a smooth and more uniform light distribution than edge-lit panels
- Rated for wet locations and non-IC applications
- Premium milk white lens
- Remote driver enclosure with multiple knockouts for easy access
- Fast access terminal block for easy thru-wire
- White powder coated steel housing
- 100-277 VAC voltage sensing driver
- Surface mount kit available
- Lightweight
- 0-10V dimming standard
- ETL Listed and tested to UL1598 Luminaire Standard for safety
- 75,000 hour life, up-to 2 times longer than standard T8 Fluorescent
- Available in 3500K, 4000K and 5000K CCT
- 82 CRI for quality and consistent color rendering
- Quiet and flicker-free LED technology
- Emergency battery back up options
- 10-year limited warranty

Ordering Information

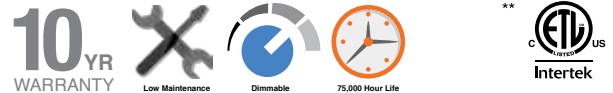

Watt	Product #	Product Code	Volts	Color Temp.	CRI	Lumens	Useful Life*	Pkg. Qty.	Beam Spread	Dimmable	Equivalent Wattage
2' x 2'											
30 Watt	81918	22FPL30/835/LED	100-277V	3500K	82	3000	75,000	1	120°	0-10V	(2) 32W
30 Watt	81900	22FPL30/840/LED	100-277V	4000K	82	3150	75,000	1	120°	0-10V	(2) 32W
30 Watt	81901	22FPL30/850/LED	100-277V	5000K	82	3150	75,000	1	120°	0-10V	(2) 32W
2' x 2' with Emergency Backup (Factory Installed)											
30 Watt	81951	22FPL30/835/EM/LED	100-277V	3500K	82	3000	75,000	1	120°	0-10V	(2) 32W
30 Watt	81952	22FPL30/840/EM/LED	100-277V	4000K	82	3150	75,000	1	120°	0-10V	(2) 32W
30 Watt	81953	22FPL30/850/EM/LED	100-277V	5000K	82	3150	75,000	1	120°	0-10V	(2) 32W
2' x 4'											
45 Watt	81942	24FPL45/835/LED	100-277V	3500K	82	4725	75,000	1	120°	0-10V	(4) 32W
45 Watt	81943	24FPL45/840/LED	100-277V	4000K	82	4950	75,000	1	120°	0-10V	(4) 32W
45 Watt	81944	24FPL45/850/LED	100-277V	5000K	82	4950	75,000	1	120°	0-10V	(4) 32W
2' x 4' with Emergency Backup (Factory Installed)											
45 Watt	81957	24FPL45/835/EM/LED	100-277V	3500K	82	4725	75,000	1	120°	0-10V	(4) 32W
45 Watt	81958	24FPL45/840/EM/LED	100-277V	4000K	82	4950	75,000	1	120°	0-10V	(4) 32W
45 Watt	81959	24FPL45/850/EM/LED	100-277V	5000K	82	4950	75,000	1	120°	0-10V	(4) 32W
1' x 4'											
30 Watt	81917	14FPL30/835/LED	100-277V	3500K	82	3000	75,000	1	120°	0-10V	(2) 32W
30 Watt	81908	14FPL30/840/LED	100-277V	4000K	82	3150	75,000	1	120°	0-10V	(2) 32W
30 Watt	81909	14FPL30/850/LED	100-277V	5000K	82	3150	75,000	1	120°	0-10V	(2) 32W
1' x 4' with Emergency Backup (Factory Installed)											
30 Watt	81954	14FPL30/835/EM/LED	100-277V	3500K	82	3000	75,000	1	120°	0-10V	(2) 32W
30 Watt	81955	14FPL30/840/EM/LED	100-277V	4000K	82	3150	75,000	1	120°	0-10V	(2) 32W
30 Watt	81956	14FPL30/850/EM/LED	100-277V	5000K	82	3150	75,000	1	120°	0-10V	(2) 32W
Emergency Kit (Field Installed)											
	81960	22FPL30/EMKIT									
	81961	24FPL45/EMKIT									
	81962	14FPL30/EMKIT									

* Useful Life is defined as the point in time at which the lamp will maintain at least 70% of its initial lumens. The lamp will continue to operate past this point at decreased light levels.

May not be compatible with all dimming systems, dimming performance may vary by system.

** Check the latest update at www.DesignLights.org for listed product catalog numbers. Not all versions are listed.

ProLED Panel Light Series



Dimensions

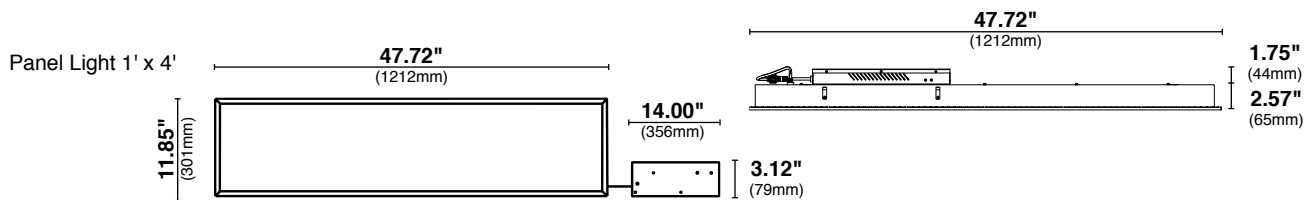
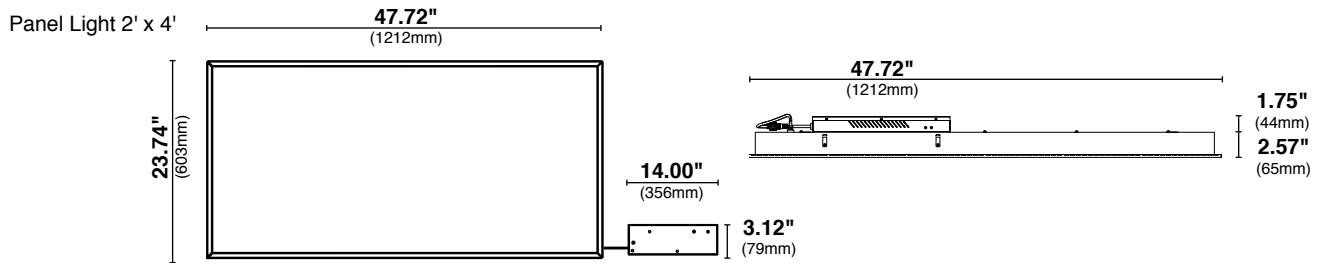
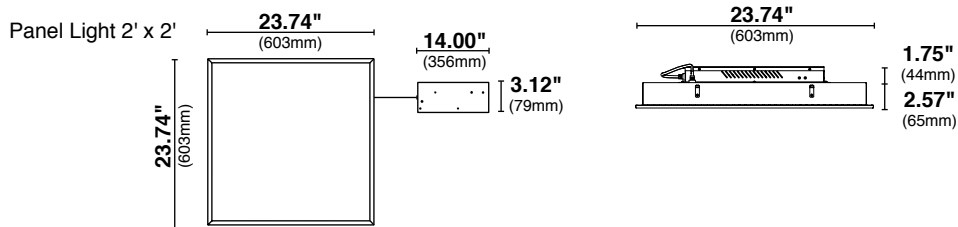

ProLED Panel Light Series

Photometrics

1' x 4'

81917, 14FPL30/835/LED

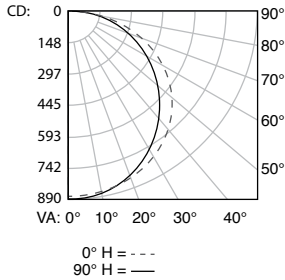

Coefficients of Utilization
Effective Floor Cavity Reflectance 0.20

RC	80			70			50		
RW	70	50	30	50	30	10	50	30	10
0	119	119	119	116	116	116	111	111	111
1	108	103	99	101	97	93	97	93	90
2	98	89	82	87	81	75	84	78	74
3	89	78	70	76	69	62	73	67	61
4	81	69	60	68	59	52	65	58	52
5	75	61	52	60	51	45	58	50	44
6	69	55	46	54	45	39	52	44	39
7	64	50	41	49	40	34	47	40	34
8	59	45	37	45	36	31	43	36	30
9	55	42	33	41	33	27	40	32	27
10	52	38	30	38	30	25	37	30	25

Zonal Lumen Summary

Zone	Lumens	% Lamp	% Fixt
0-30	699.20	25.10	25.10
0-40	1162.64	41.80	41.80
0-60	2126.76	76.50	76.50
0-80	2716.66	97.70	97.70
0-90	2777.87	99.90	99.90

Total Luminaire Efficiency = 100.00%

81908, 14FPL30/840/LED

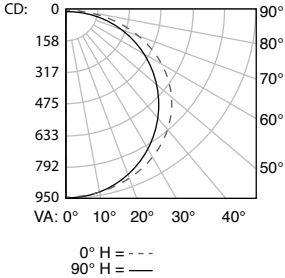

Coefficients of Utilization
Effective Floor Cavity Reflectance 0.20

RC	80			70			50		
RW	70	50	30	50	30	10	50	30	10
0	119	119	119	116	116	116	111	111	111
1	108	103	99	101	97	93	97	93	90
2	98	89	82	87	81	75	84	78	74
3	89	78	70	76	69	62	73	67	61
4	81	69	60	68	59	52	65	58	52
5	75	61	52	60	51	45	58	50	44
6	69	55	46	54	45	39	52	44	39
7	64	50	41	49	40	34	47	40	34
8	59	45	37	45	36	31	43	36	30
9	55	42	33	41	33	27	40	32	27
10	52	38	30	38	30	25	37	30	25

Zonal Lumen Summary

Zone	Lumens	% Lamp	% Fixt
0-30	748.27	25.10	25.10
0-40	1244.17	41.80	41.80
0-60	2275.78	76.50	76.50
0-80	2972.35	97.70	97.70
0-90	2882.88	96.90	96.90

Total Luminaire Efficiency = 100.00%

81909, 14FPL30/850/LED

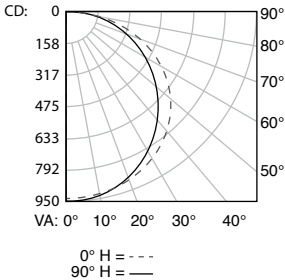

Coefficients of Utilization
Effective Floor Cavity Reflectance 0.20

RC	80			70			50		
RW	70	50	30	50	30	10	50	30	10
0	119	119	119	116	116	116	111	111	111
1	108	103	99	101	97	93	97	93	90
2	98	89	82	87	81	75	84	78	74
3	89	78	70	76	69	62	73	67	61
4	81	69	60	67	59	52	65	58	52
5	75	61	52	60	51	45	58	50	44
6	69	55	46	54	45	39	52	44	39
7	64	50	41	49	40	34	47	40	34
8	59	45	37	45	36	31	43	35	30
9	55	42	33	41	33	27	40	32	27
10	52	38	30	38	30	25	37	30	25

Zonal Lumen Summary

Zone	Lumens	% Lamp	% Fixt
0-30	746.49	25.10	25.10
0-40	1241.40	41.80	41.80
0-60	2271.76	76.40	76.40
0-80	2902.80	97.70	97.70
0-90	2968.92	99.90	99.90

Total Luminaire Efficiency = 100.00%

2' x 2'

81918, 22FPL30/835/LED

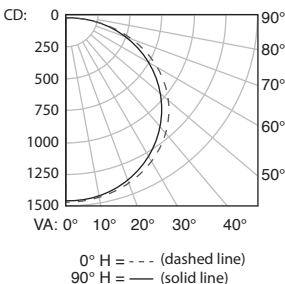

Coefficients of Utilization
Effective Floor Cavity Reflectance 0.20

RC	80			70			50		
RW	70	50	30	50	30	10	50	30	10
0	119	119	119	116	116	116	111	111	111
1	108	104	99	101	97	93	97	94	91
2	98	90	83	88	82	76	84	79	74
3	89	79	70	77	69	63	74	67	62
4	82	70	61	68	60	53	66	58	53
5	75	62	53	61	52	46	59	51	45
6	69	56	46	55	46	40	53	45	39
7	64	50	41	50	41	35	48	40	35
8	59	45	37	45	37	31	44	36	31
9	55	42	33	42	34	28	40	33	28
10	52	38	30	38	31	25	37	30	25

Zonal Lumen Summary

Zone	Lumens	% Lamp	% Fixt
0-30	752.60	26.10	26.10
0-40	1243.17	43.10	43.10
0-60	2239.16	77.60	77.60
0-80	2826.56	97.90	97.90
0-90	2882.97	99.90	99.90

Total Luminaire Efficiency = 100.00%

ProLED Panel Light Series

Photometrics

2' x 2'

81900, 22FPL30/840/LED

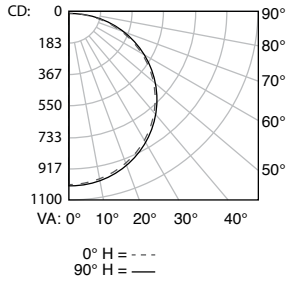

Coefficients of Utilization
Effective Floor Cavity Reflectance 0.20

RC	80			70			50		
RW	70	50	30	50	30	10	50	30	10
0	119	119	119	116	116	116	111	111	111
1	108	104	99	101	97	94	97	94	91
2	98	89	82	88	82	76	84	79	74
3	89	79	70	77	69	63	74	67	62
4	82	70	61	68	60	53	66	58	53
5	75	62	53	61	52	46	59	51	45
6	69	56	47	55	46	40	53	45	40
7	64	50	42	50	41	35	48	40	35
8	60	46	37	45	37	31	44	36	31
9	56	42	34	42	34	28	40	33	28
10	52	39	31	38	31	25	37	30	25

Zonal Lumen Summary

Zone	Lumens	% Lamp	% Fixt
0-30	792.10	26.10	26.10
0-40	1308.36	43.10	43.10
0-60	2356.13	77.60	77.60
0-80	2973.78	97.90	97.90
0-90	3032.92	99.90	99.90

Total Luminaire Efficiency = 100.00%

81901, 22FPL30/850/LED

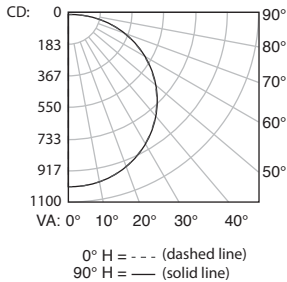

Coefficients of Utilization
Effective Floor Cavity Reflectance 0.20

RC	80			70			50		
RW	70	50	30	50	30	10	50	30	10
0	119	119	119	116	116	116	111	111	111
1	108	104	99	101	97	94	97	94	91
2	98	90	83	88	82	76	84	79	74
3	89	79	70	77	69	63	74	67	62
4	82	70	61	68	60	53	66	58	53
5	75	62	53	61	52	46	59	51	45
6	69	56	47	55	46	40	53	45	40
7	64	50	42	50	41	35	48	40	35
8	60	46	37	45	37	31	44	36	31
9	56	42	34	42	34	28	40	33	28
10	52	39	31	38	31	25	37	30	25

Zonal Lumen Summary

Zone	Lumens	% Lamp	% Fixt
0-30	792.77	26.10	26.10
0-40	1309.41	43.10	43.10
0-60	2358.03	77.60	77.60
0-80	2939.88	96.80	96.80
0-90	3035.44	99.90	99.90

Total Luminaire Efficiency = 100.00%

2' x 4'

81942, 24FPL45/835/LED

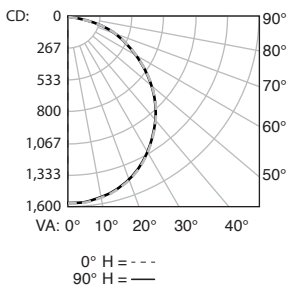

Coefficients of Utilization-Zonal Cavity Method

Effective Floor Cavity Reflectance: 20

RC	80				70				50			
	RW	70	50	30	0	70	50	30	0	50	30	20
0	1.19	1.19	1.19	1.19	1.19	1.16	1.16	1.16	.99	1.11	1.11	1.11
1	1.08	1.04	.99	.96	1.06	1.01	.97	.84	.97	.94	.91	
2	.99	.90	.84	.78	.96	.88	.82	.71	.85	.79	.75	
3	.90	.79	.71	.65	.87	.78	.70	.60	.75	.68	.63	
4	.82	.70	.61	.55	.80	.69	.61	.52	.66	.59	.53	
5	.76	.63	.54	.47	.73	.62	.53	.45	.59	.52	.46	
6	.70	.56	.47	.41	.68	.55	.47	.39	.54	.46	.40	
7	.65	.51	.42	.36	.63	.50	.42	.35	.49	.41	.36	
8	.60	.47	.38	.32	.59	.46	.38	.31	.45	.37	.32	
9	.56	.43	.35	.29	.55	.42	.34	.28	.41	.34	.29	
10	.53	.40	.32	.26	.51	.39	.31	.26	.38	.31	.26	

Zonal Lumen Summary

ZONE	LUMENS	% LAMP	% LUMINAIRE
0-30	1,220.6	27.3%	27.3%
0-40	1,994.3	44.5%	44.6%
0-60	3,515.7	78.5%	78.6%
60-90	934.3	20.9%	20.9%
70-100	392.4	8.8%	8.8%
90-120	9.5	0.2%	0.2%
0-90	4,450.0	99.4%	99.5%
90-180	23.5	0.5%	0.5%
0-180	4,473.5	99.9%	100%

Total Luminaire Efficiency = 100.00%

ProLED Panel Light Series

Photometrics

2' x 4' with Emergency Backup

81943, 24FPL45/840/LED

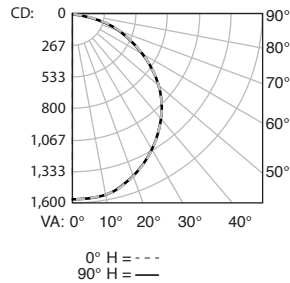

Coefficients of Utilization-Zonal Cavity Method
Effective Floor Cavity Reflectance: 20

RC	80				70				50			
RW	70	50	30	0	70	50	30	0	50	30	20	
0	1.19	1.19	1.19	1.19	1.16	1.16	1.16	1.00	1.11	1.11	1.11	
1	1.09	1.04	1.00	.96	1.06	1.02	.98	.84	.97	.94	.91	
2	.99	.90	.84	.78	.96	.89	.82	.71	.85	.80	.75	
3	.90	.79	.71	.65	.87	.78	.70	.60	.75	.68	.63	
4	.82	.70	.62	.55	.80	.69	.61	.52	.66	.59	.54	
5	.76	.63	.54	.47	.74	.62	.53	.45	.59	.52	.46	
6	.70	.57	.48	.41	.68	.56	.47	.40	.54	.46	.41	
7	.65	.51	.42	.36	.63	.50	.42	.35	.49	.41	.36	
8	.60	.47	.38	.32	.59	.46	.38	.31	.45	.37	.32	
9	.56	.43	.35	.29	.55	.42	.34	.28	.41	.34	.29	
10	.53	.40	.32	.26	.52	.39	.31	.26	.38	.31	.26	

Zonal Lumen Summary

ZONE	LUMENS	% LAMP	% LUMINAIRE
0-30	1,232	27.4	27.4%
0-40	2,012	44.7	44.8%
0-60	3,547	78.8	78.9%
60-90	932	20.7	20.7%
70-100	386	8.6	8.6%
90-120	6	0.1	0.1%
0-90	4,479	99.59	9.6%
90-180	16	0.4	0.4%
0-180	4,495	99.9	100%

Total Luminaire Efficiency = 100.00%

81944, 24FPL45/850/LED

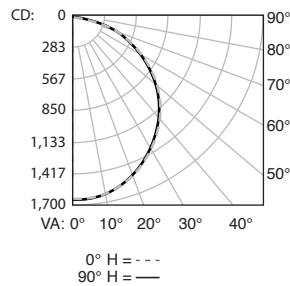

Coefficients of Utilization-Zonal Cavity Method
Effective Floor Cavity Reflectance: 20

RC	80				70				50			
RW	70	50	30	0	70	50	30	0	50	30	20	
0	1.19	1.19	1.19	1.19	1.16	1.16	1.16	1.00	1.11	1.11	1.11	
1	1.09	1.04	1.00	.96	1.06	1.01	.98	.84	.97	.94	.91	
2	.99	.90	.84	.78	.96	.88	.82	.71	.85	.80	.75	
3	.90	.79	.71	.65	.87	.78	.70	.60	.75	.68	.63	
4	.82	.70	.61	.55	.80	.69	.61	.52	.66	.59	.54	
5	.76	.63	.54	.47	.74	.62	.53	.45	.59	.52	.46	
6	.70	.57	.48	.41	.68	.56	.47	.40	.54	.46	.41	
7	.65	.51	.42	.36	.63	.50	.42	.35	.49	.41	.36	
8	.60	.47	.38	.32	.59	.46	.38	.31	.45	.37	.32	
9	.56	.43	.35	.29	.55	.42	.34	.28	.41	.34	.29	
10	.53	.40	.32	.26	.51	.39	.31	.26	.38	.31	.26	

Zonal Lumen Summary

ZONE	LUMENS	% LAMP	% LUMINAIRE
0-30	1,280.1	27.4%	27.4%
0-40	2,090.8	44.7%	44.7%
0-60	3,683.8	78.7%	78.8%
60-90	973.2	20.8%	20.8%
70-100	406.3	8.7%	8.7%
90-120	7.0	0.1%	0.1%
0-90	4,657.0	99.5%	99.6%
90-180	17.1	0.4%	0.4%
0-180	4,674.1	99.9%	100%

Total Luminaire Efficiency = 100.00%



ProLED Surface Mount Kit

Applications
Classroom
Conference Room
Hallway
Hospitality
Lobby
Office
Retail
Markets
Commercial
Healthcare



SMK22



SMK24

Specifications

- Fully powdercoated white surface mount kit allows ProLED Flat Panel and Volumetric Panels to be installed on the surface of drywall or concrete ceilings
- High quality 22 gauge steel
- 3/4" knockout
- Fits multiple standard ceiling box screw patterns
- Can be used for Volumetric or Flat panel
- Easy to install - simply remove access door and slide luminaire onto support rails inside surface mount kit
- Mounting hardware included

Dimensions

SMK22

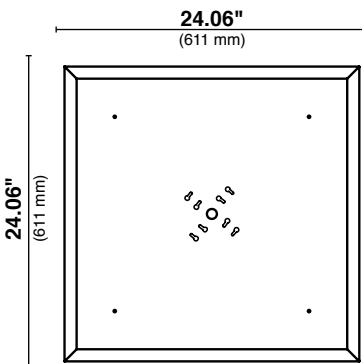

SMK24

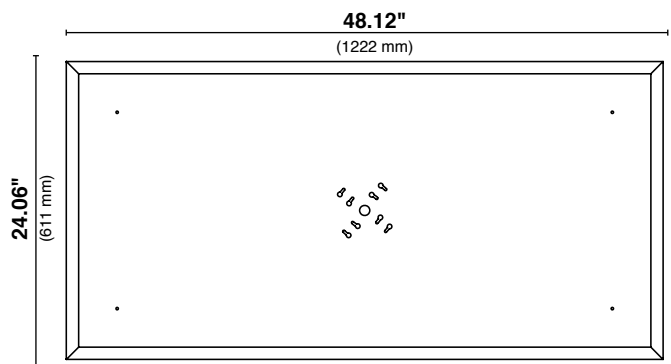

Ordering Information

Product #	Product Code	Description	Color	Dimensions (L" x W" x H")
81105	SMK22	2' x 2' Surface Mount Kit for Flat and Volumetric LED panels	White	24.06" x 24.06" x 4.5"
81106	SMK24	2' x 4' Surface Mount Kit for Flat and Volumetric LED panels	White	48.12" x 24.06" x 4.5"

ProLED Volumetric Panel Light Series

Applications

Classroom
Conference Room
Hallway
Hospitality
Lobby
Office
Retail

Markets

Commercial
Healthcare

Beautiful illumination and architectural appeal in an energy efficient alternative to recessed fluorescent luminaires

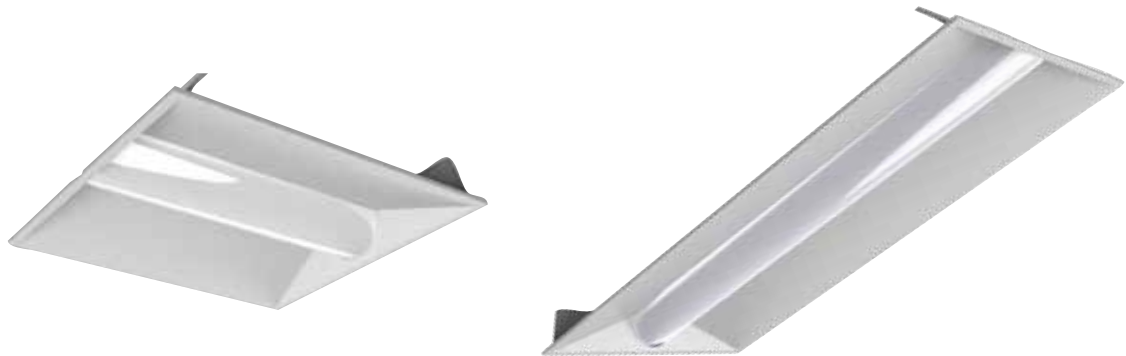

Specifications

- Available in 2' x 2' and 2' x 4' for recessed installations
- Specification grade architectural high-end appearance
- Rated for wet locations and non-IC applications
- Premium milk white lens
- Integrated driver multiple knockouts for easy access
- Fast access terminal block for easy thru-wire
- White powder coated steel housing
- 100-277 VAC voltage sensing driver
- Lightweight
- Emergency battery back up options
- Surface mount kit available
- 0-10V dimming standard
- ETL Listed and tested to UL1598 Luminaire Standard for safety
- 75,000 hour life, up-to 2 times longer than standard T8 Fluorescent
- Available in 3500K, 4000K and 5000K CCT
- 82 CRI for quality and consistent color rendering
- Quiet and flicker-free LED technology
- 10-year limited warranty

Ordering Information



Watt	Product #	Product Code	Volts	Color Temp.	CRI	Lumens	Useful Life*	Pkg. Qty.	Beam Spread	Dimmable	Emergency Backup	Equivalent Wattage
2' x 2'												
35 Watt	81894	22VPL35/835/LED	100-277V	3500K	82	3500	75,000	1	120°	0-10V	-	(2) 32W
35 Watt	81890	22VPL35/840/LED	100-277V	4000K	82	3675	75,000	1	120°	0-10V	-	(2) 32W
35 Watt	81891	22VPL35/850/LED	100-277V	5000K	82	3710	75,000	1	120°	0-10V	-	(2) 32W
2' x 2' with Emergency Backup												
35 Watt	81945	22VPL35/835/EM/LED	100-277V	3500K	82	3500	75,000	1	120°	0-10V	Yes	(2) 32W
35 Watt	81946	22VPL35/840/EM/LED	100-277V	4000K	82	3675	75,000	1	120°	0-10V	Yes	(2) 32W
35 Watt	81947	22VPL35/850/EM/LED	100-277V	5000K	82	3710	75,000	1	120°	0-10V	Yes	(2) 32W
2' x 4'												
42 Watt	81895	24VPL42/835/LED	100-277V	3500K	82	4200	75,000	1	120°	0-10V	-	(4) 32W
42 Watt	81892	24VPL42/840/LED	100-277V	4000K	82	4400	75,000	1	120°	0-10V	-	(4) 32W
42 Watt	81893	24VPL42/850/LED	100-277V	5000K	82	4450	75,000	1	120°	0-10V	-	(4) 32W
2' x 4' with Emergency Backup												
42 Watt	81948	24VPL42/835/EM/LED	100-277V	3500K	82	4200	75,000	1	120°	0-10V	Yes	(4) 32W
42 Watt	81949	24VPL42/840/EM/LED	100-277V	4000K	82	4400	75,000	1	120°	0-10V	Yes	(4) 32W
42 Watt	81950	24VPL42/850/EM/LED	100-277V	5000K	82	4450	75,000	1	120°	0-10V	Yes	(4) 32W

* Useful Life is defined as the point in time at which the lamp will maintain at least 70% of its initial lumens. The lamp will continue to operate past this point at decreased light levels.

May not be compatible with all dimming systems, dimming performance may vary by system.

** Check the latest update at www.DesignLights.org for listed product catalog numbers. Not all versions are listed.

ProLED Volumetric Panel Light Series

Dimensions

Panel Light 2' x 2'

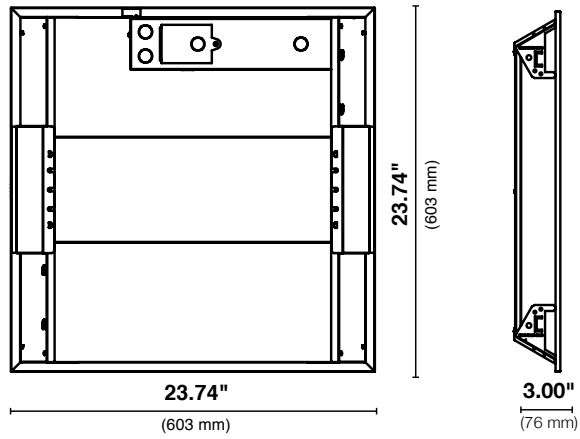

Panel Light 2' x 4'

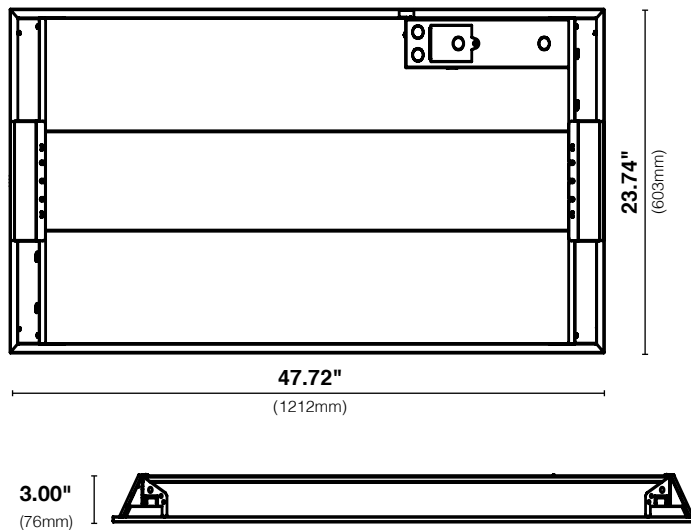

ProLED Volumetric Panel Light Series

Photometrics

2' x 2'

81894, 22VPL35/835/LED

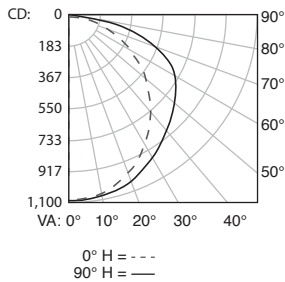

Coefficients of Utilization

Effective Floor Cavity Reflectance 0.20

RC	80			70			50			
RW	70	50	30	70	50	30	10	50	30	20
0	119	119	119	116	116	116	111	111	111	111
1	108	103	98	105	100	96	96	92	89	
2	97	88	81	95	86	80	83	77	72	
3	88	77	68	86	75	67	72	65	60	
4	80	68	59	78	66	58	64	56	50	
5	74	60	51	72	59	50	57	49	43	
6	68	54	45	66	53	44	51	43	38	
7	63	49	40	61	48	40	47	39	33	
8	59	45	36	57	44	36	43	35	30	
9	55	41	32	53	40	32	39	32	27	
10	51	38	30	50	37	29	36	29	24	

Zonal Lumen Summary

Zone	Lumens	% Lamp	% Fixt
0-30	839.1	24.6	24.6
0-40	1,381.4	40.5	40.6
0-60	2,516.0	73.8	73.9
60-90	881.7	25.9	25.9
70-100	401.4	11.8	11.8
90-120	3.4	0.1	0.1
0-90	3,397.7	99.7	99.8
90-180	8.1	0.2	0.2
0-180	3,405.8	99.9	100

Total Luminaire Efficiency = 100.00%

81890, 22VPL35/840/LED

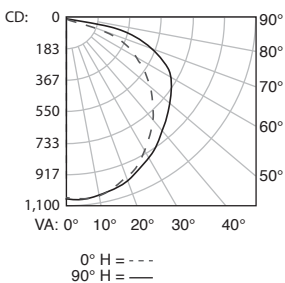

Coefficients of Utilization

Effective Floor Cavity Reflectance 0.20

RC	80			70			50			
RW	70	50	30	70	50	30	10	50	30	20
0	119	119	119	116	116	116	111	111	111	111
1	108	102	98	105	100	96	96	92	89	
2	97	88	81	94	86	80	83	77	72	
3	88	77	68	85	75	67	72	65	59	
4	80	68	58	78	66	58	64	56	50	
5	74	60	51	71	59	50	57	49	43	
6	68	54	45	66	53	44	51	43	37	
7	63	49	40	61	48	39	46	39	33	
8	58	44	36	57	44	35	42	35	29	
9	55	41	32	53	40	32	39	32	26	
10	51	38	29	50	37	29	36	29	24	

Zonal Lumen Summary

Zone	Lumens	% Lamp	% Fixt
0-30	838.0	24.4	24.4
0-40	1,380.6	40.2	40.2
0-60	2,521.0	73.4	73.5
60-90	902.1	26.3	26.3
70-100	417.04	12.1	12.2
90-120	3.4	0.1	0.1
0-90	3,423.1	99.7	99.8
90-180	7.4	0.2	0.2
0-180	3,430.4	99.90	100

Total Luminaire Efficiency = 100.00%

81891, 22VPL35/850/LED

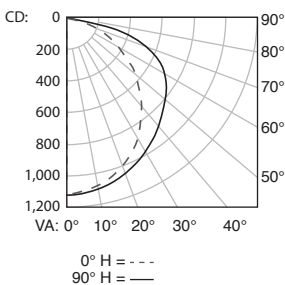

Coefficients of Utilization

Effective Floor Cavity Reflectance 0.20

RC	80			70			50			
RW	70	50	30	70	50	30	10	50	30	20
0	119	119	119	116	116	116	111	111	111	111
1	108	102	98	105	100	96	96	92	89	
2	97	88	81	94	86	80	83	77	72	
3	88	77	68	86	75	67	72	65	60	
4	80	68	59	78	66	58	64	56	50	
5	74	60	51	72	59	50	57	49	43	
6	68	54	45	66	53	44	51	43	38	
7	63	49	40	61	48	40	47	39	33	
8	59	45	36	57	44	36	43	35	30	
9	55	41	32	53	40	32	39	32	27	
10	51	38	30	50	37	29	36	29	24	

Zonal Lumen Summary

Zone	Lumens	% Lamp	% Fixt
0-30	871.6	24.6	24.6
0-40	1,485.3	40.5	40.5
0-60	2,614.2	73.7	73.8
60-90	918.5	25.9	25.9
70-100	419.4	11.8	11.8
90-120	3.9	0.1	0.1
0-90	3,532.7	99.6	99.7
90-180	9.8	0.3	0.3
0-180	3,542.5	99.90	100

2' x 4'

81895, 24VPL42/835/LED

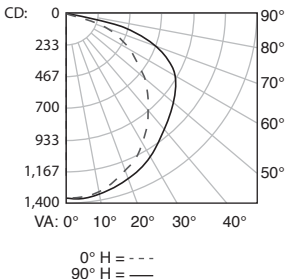

Coefficients of Utilization

Effective Floor Cavity Reflectance 0.20

RC	80			70			50			
RW	70	50	30	70	50	30	10	50	30	20
0	119	119	119	116	116	116	111	111	111	111
1	107	102	98	105	100	96	96	92	89	
2	97	88	81	94	86	79	82	77	72	
3	88	77	68	85	75	67	72	65	59	
4	80	67	58	78	66	57	63	56	50	
5	73	60	50	71	59	50	57	49	43	
6	68	54	44	66	53	44	51	43	37	
7	63	49	40	61	48	39	46	38	33	
8	58	44	35	57	44	35	42	35	29	
9	54	41	32	53	40	32	39	31	26	
10	51	37	29	50	37	29	36	29	24	

Zonal Lumen Summary

Zone	Lumens	% Lamp	% Fixt
0-30	1,053.5	24.1	24.1
0-40	1,737.5	39.7	39.8
0-60	3,187.1	72.9	72.9
60-90	1,164.5	26.6	26.6
70-100	538.1	12.3	12.3
90-120	7.9	0.2	0.2
0-90	4,351.6	99.5	99.6
90-180	17.9	0.4	0.4
0-180	4,369.5	99.9	100

Total Luminaire Efficiency = 100.00%

ProLED Volumetric Panel Light Series

Photometrics

2' x 4'

81892, 24VPL42/840/LED

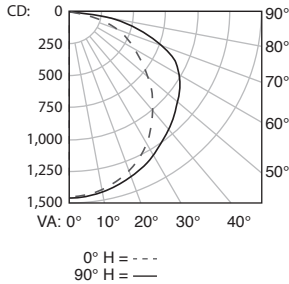

Coefficients of Utilization

Effective Floor Cavity Reflectance 0.20

RC	80			70			50		
RW	70	50	30	70	30	10	50	30	20
0	119	119	119	116	116	116	111	111	111
1	107	102	97	104	100	95	95	92	88
2	97	88	80	94	86	79	82	76	71
3	88	76	68	85	75	66	72	65	59
4	80	67	58	77	66	57	63	55	49
5	73	60	50	71	58	50	56	48	42
6	67	54	44	65	53	44	51	43	37
7	62	48	39	61	48	39	46	38	32
8	58	44	35	56	43	35	42	34	29
9	54	40	33	53	40	32	39	31	26
10	51	37	29	49	37	29	36	28	23

Zonal Lumen Summary

Zone	Lumens	% Lamp	% Fixt
0-30	1,128.1	23.9	23.9
0-40	1,861.2	39.4	39.4
0-60	3,414.6	72.2	72.3
60-90	1,289.5	27.3	27.3
70-100	613.4	13	13
90-120	9.0	0.2	0.2
0-90	4,704.0	99.5	99.6
90-180	20.0	0.4	0.4
0-180	4,724.1	99.9	100

Total Luminaire Efficiency = 100.00%

81893, 24VPL42/850/LED

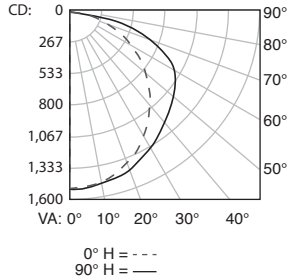

Coefficients of Utilization

Effective Floor Cavity Reflectance 0.20

RC	80			70			50		
RW	70	50	30	50	30	10	50	30	20
0	119	119	119	116	116	116	111	111	111
1	108	102	98	105	100	96	96	92	89
2	97	88	81	94	86	79	82	77	72
3	88	77	68	85	75	67	72	65	59
4	80	67	58	78	66	57	63	56	50
5	73	60	51	71	59	50	57	49	43
6	68	54	44	66	53	44	51	43	37
7	63	49	40	61	48	39	46	38	33
8	58	44	36	57	44	35	42	35	29
9	54	41	32	53	40	32	39	31	26
10	51	37	29	50	37	29	36	29	24

Zonal Lumen Summary

Zone	Lumens	% Lamp	% Fixt
0-30	1,186.9	24.1	24.2
0-40	1,957.5	39.8	39.9
0-60	3,588.7	73	73.1
60-90	1,303.0	26.6	26.5
70-100	598.9	12.2	12.2
90-120	8.1	0.2	0.2
0-90	4,891.7	99.5	99.6
90-180	19.6	0.4	0.4
0-180	4,911.3	99.9	100

Total Luminaire Efficiency = 100.00%



Outdoor Luminaires





LED Wallpack Semi Cutoff Series

Applications
Building Entrances
Gas Stations
Loading Docks
Parking Garages
Pathway Illumination
Schools
Stairways
Tunnels
Markets
Commercial
Industrial

Performance engineered LED technology offers energy efficient alternatives to HID luminaires



Specifications

- Operating temperature range is -40°F (-40°C) to 104°F (40°C)
- Die-cast aluminum housing and hinged lens frame with captive screws
- Textured architectural bronze powder coat finish
- Silicone gaskets protect against rust, corrosion, dirt and insects
- Molded prismatic borosilicate glass
- Mounts directly over a 4" recessed outlet box
- Removable 1/2" threaded plugs with O-rings for conduit access and photocell provision
- Electrical snap-in connectors to simplify wiring and installation
- Voltage sensing 100-277V dimmable driver
- UL Listed for wet locations
- 5-year limited warranty

Dimensions

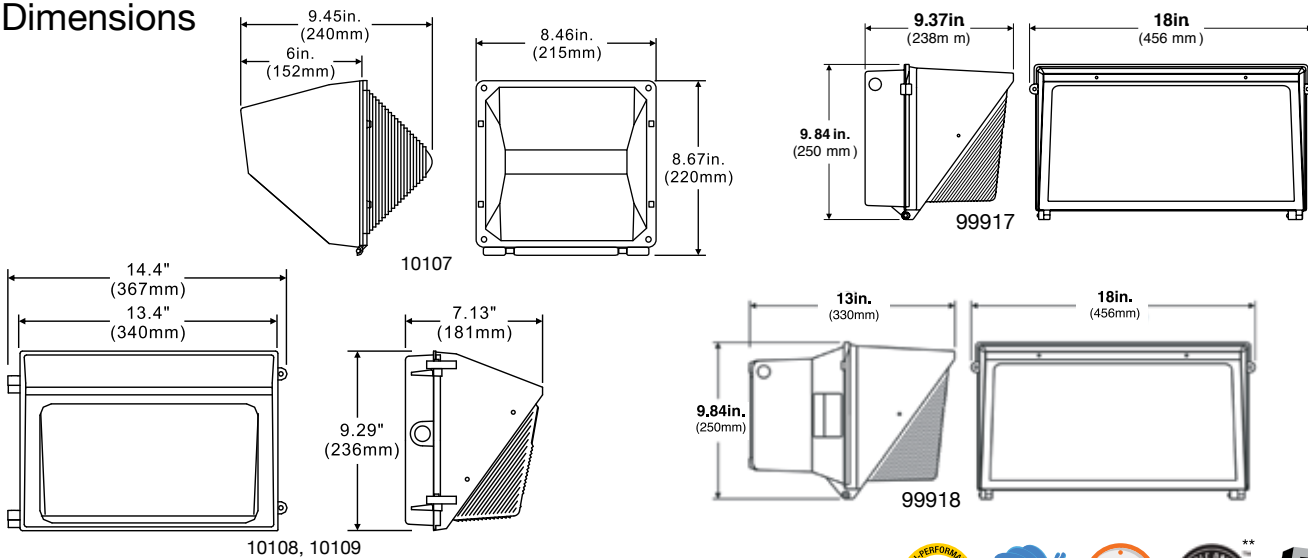

Ordering Information

Watt	Product #	Product Code	Volts	Color Temp.	CRI	Lumens	Useful Life*	Pkg. Qty.	Dimmable	Equivalent Wattage
30	10107	WP1/CL30BZ50/LED	100-277V	5000K	70	3383	50,000	1	0-10V	100W
40	10108	WP2/CL40BZ50/LED	100-277V	5000K	70	4303	50,000	1	0-10V	150W
55	10109	WP2/CL55BZ50/LED	100-277V	5000K	70	5594	50,000	1	0-10V	175W
87	99917	WP4/CL87BZ50/LED	100-277V	5000K	70	9741	50,000	1	0-10V	250W
120	99918	WP4/CL120BZ50/LED	100-277V	5000K	70	15,574	50,000	1	0-10V	400W

NEW ITEM

Accessories include hardware.

Warranty – Commercial / Industrial: This product is warranted for 5 years from the date of purchase.

* Useful Life is defined as the point in time at which the LED will maintain at least 70% of its initial lumens. The LED will continue to operate past this point at decreased light levels.

May not be compatible with all dimming systems, dimming performance may vary by system.

** Check the latest update at www.DesignLights.org for listed product catalog numbers. Not all versions are listed.



LED Wallpack Semi Cutoff Series

Accessories

Product #	Product Code	Description
10110	WG1/WP1	Wire Guard for Wallpack 10107
10111	WG2/WP2	Wire Guard for Wallpacks 10108 & 10109
10112	VG1/WP1	Visor for Wall Pack 10107
10113	VG2/WP2	Visor for Wall Packs 10108 & 10109
10114	PCS/WP	Photocell 120-277V
99817	WG4/WP4	Wireguard for LED Large Wallpack WP4
99818	VG4/WP4	Visor for LED Large Wallpack WP4

Photometrics

**Polar Candela Distribution Plot
10107, WP1/CL30BZ50/LED**

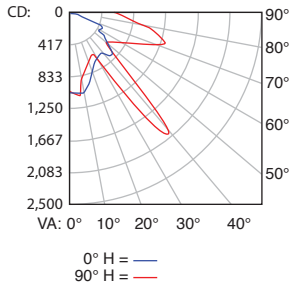

Isofootcandle Plot

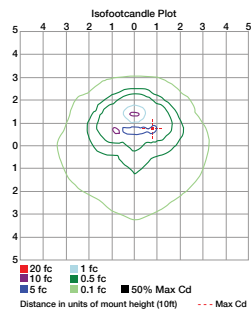

ILLUMINANCE AT A DISTANCE

HEIGHT(FT)	CENTER BEAM FOOTCANDLE	BEAM SPREAD(FT)		FIELD SPREAD(FT)	
		HORIZONTAL	VERTICAL	HORIZONTAL	VERTICAL
4.00	63.91 FC	1.0	1.7	4.5	16.2
8.00	15.98 FC	2.0	3.5	8.9	32.4
12.00	7.10 FC	3.0	5.2	13.4	48.7
16.00	3.99 FC	4.0	6.9	17.8	64.9
20.00	2.56 FC	5.0	8.7	22.3	81.1
		BEAM ANGLE		FIELD ANGLE	
		14.2° 24.5°		58.3° 127.5°	

**Polar Candela Distribution Plot
10108, WP2/CL40BZ50/LE**

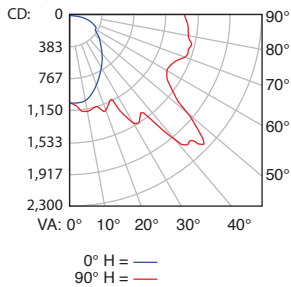

Isofootcandle Plot

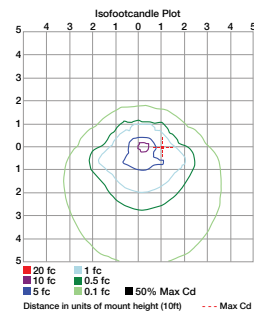

ILLUMINANCE AT A DISTANCE

HEIGHT(FT)	CENTER BEAM FOOTCANDLE	BEAM SPREAD(FT)		FIELD SPREAD(FT)	
		HORIZONTAL	VERTICAL	HORIZONTAL	VERTICAL
4.00	65.47 FC	3.1	8.6	5.9	8.0
8.00	16.37 FC	6.2	17.3	11.8	16.0
12.00	7.27 FC	9.2	25.9	17.7	24.0
16.00	4.09 FC	12.3	34.5	23.5	32.0
20.00	2.62 FC	15.4	43.2	29.4	40.0
		BEAM ANGLE		FIELD ANGLE	
		42.1° 94.4°		72.7° 90.0°	

**Polar Candela Distribution Plot
10109, WP2/CL50BZ50/LED**

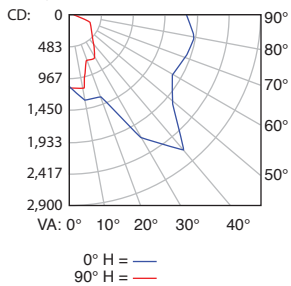

Isofootcandle Plot

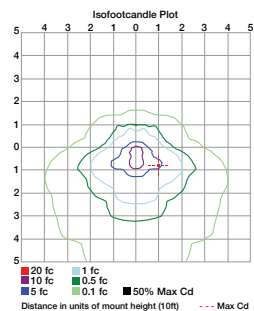

ILLUMINANCE AT A DISTANCE

HEIGHT(FT)	CENTER BEAM FOOTCANDLE	BEAM SPREAD(FT)		FIELD SPREAD(FT)	
		HORIZONTAL	VERTICAL	HORIZONTAL	VERTICAL
4.00	68.26 FC	12.4	5.6	55.2	12.9
8.00	17.06 FC	24.8	11.1	110.4	25.8
12.00	7.58 FC	37.2	16.7	165.5	38.6
16.00	4.27 FC	49.6	22.3	220.7	51.5
20.00	2.73 FC	62.0	27.8	275.9	64.4
		BEAM ANGLE		FIELD ANGLE	
		114.3° 69.7°		163.5° 116.3°	

LED Wallpack Full Cutoff Series

Applications
Building Entrances
Gas Stations
Loading Docks
Parking Garages
Park
Schools
Stairways
Tunnels
Markets
Commercial
Industrial

Long-lasting, low maintenance energy efficient replacements for HID luminaires



Specifications

- Operating temperature range is -40°F (-40°C) to 113°F (45°C)
- Die-cast aluminum housing and hinged lens frame with captive screws
- Textured architectural bronze powdercoat finish
- Silicone gaskets protect against rust, corrosion, dirt and insects
- Clear polycarbonate lens
- Electrical snap-in connectors to simplify wiring and installation
- Voltage sensing 100-277V dimmable driver
- UL listed for wet locations
- Darkness Friendly
- DLC® Qualified
- Dimmable
- 5-year limited warranty

Dimensions

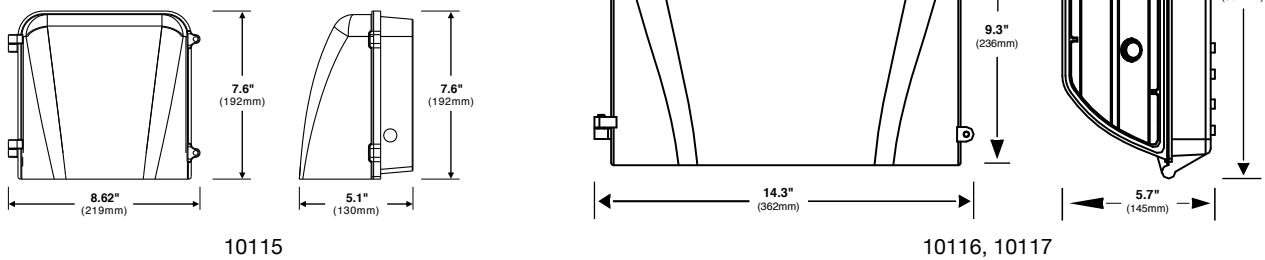

Ordering Information



Watt	Product #	Product Code	Volts	Color Temp.	CRI	Lumens	Useful Life*	Pkg. Qty.	Dimmable	DLC Qualified	Equivalent Wattage
18	10115	WPFC1/CL18BZ50/LED	100-277V	5000K	70	2407	50,000	1/6	0-10V	Yes	100W
35	10116	WPFC2/CL35BZ50/LED	100-277V	5000K	70	5076	50,000	1	0-10V	Yes	150W
50	10117	WPFC2/CL50BZ50/LED	100-277V	5000K	70	6347	50,000	1	0-10V	Yes	175W

* Useful Life is defined as the point in time at which the lamp will maintain at least 70% of its initial lumens. The lamp will continue to burn past this point, but at decreased light levels.
 Warranty – Commercial / Industrial: This product is warranted for 5 years from the date of purchase.
 May not be compatible with all dimming systems, dimming performance may vary by system.
 ** Check the latest update at www.DesignLights.org for listed product catalog numbers. Not all versions are listed.

Accessories

Product #	Product Code	Description
10114	PCS/WP	Photocell 120-277V

LED Wallpack Full Cutoff Series

Photometrics

10115, WPFC1/CL20BZ50/LED

Polar Candela Distribution Plot

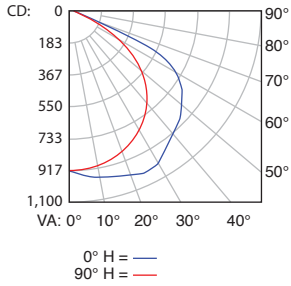

Isofootcandle Plot

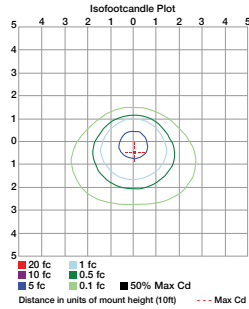

ILLUMINANCE AT A DISTANCE

HEIGHT(FT)	CENTER BEAM FOOTCANDLE	BEAM SPREAD(FT)		FIELD SPREAD(FT)	
		HORIZONTAL	VERTICAL	HORIZONTAL	VERTICAL
2.00	229.67 FC	6.0	4.7	13.7	7.8
4.00	57.42 FC	11.9	9.4	27.4	15.7
6.00	25.52 FC	17.9	14.0	41.2	23.5
8.00	14.35 FC	23.9	18.7	54.9	31.3
10.00	9.19 FC	29.8	23.4	68.6	39.2
		BEAM ANGLE		FIELD ANGLE	
		112.3°	99.0°	147.5°	125.9°

ZONAL LUMEN SUMMARY

ZONE	LUMENS %	LAMP %	LUMINAIRE	LUMENS PER ZONE					
				ZONE LUMENS %	TOTAL	ZONE	LUMENS % TOTAL		
0-30	721.7	30%	30%	0-10	86.9	3.6%	90-100	0.3	0%
0-40	1,184.7	49.2%	49.3%	10-20	250.0	10.4%	100-110	0.5	0%
0-60	2,037.3	84.6%	84.7%	20-30	384.8	16.0%	110-120	0.5	0%
60-90	363.4	15.1%	15.1%	30-40	463.0	19.3%	120-130	0.5	0%
70-100	93.1	3.9%	3.9%	40-50	461.8	19.2%	130-140	0.5	0%
90-120	1.3	0.1%	0.1%	50-60	390.8	16.3%	140-150	0.5	0%
0-90	2,400.7	99.7%	99.8%	60-70	270.6	11.3%	150-160	0.5	0%
90-180	3.6	0.2%	0.2%	70-80	87.5	3.6%	160-170	0.4	0%
0-180	2,404.3	99.9%	100%	80-90	5.3	0.2%	170-180	0.1	0%

10116, WPFC2/CL40BZ50/LED

Polar Candela Distribution Plot

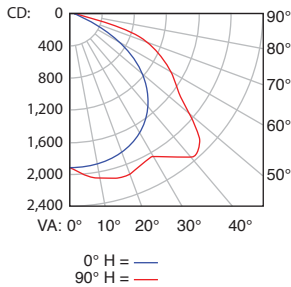

Isofootcandle Plot

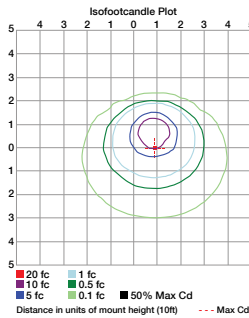

ILLUMINANCE AT A DISTANCE

HEIGHT(FT)	CENTER BEAM FOOTCANDLE	BEAM SPREAD(FT)		FIELD SPREAD(FT)	
		HORIZONTAL	VERTICAL	HORIZONTAL	VERTICAL
2.00	475.35 FC	4.2	5.5	8.0	16.1
4.00	118.84 FC	8.4	11.1	16.1	32.2
6.00	52.82 FC	12.6	16.6	24.1	48.3
8.00	29.71 FC	16.8	22.1	32.2	64.4
10.00	19.01 FC	20.9	27.6	40.2	80.5
		BEAM ANGLE		FIELD ANGLE	
		92.6°	108.2°	127.1°	152.1°

ZONAL LUMEN SUMMARY

ZONE	LUMENS %	LAMP %	LUMINAIRE	LUMENS PER ZONE					
				ZONE LUMENS %	TOTAL	ZONE	LUMENS % TOTAL		
0-30	1,455.8	29.3%	29.3%	0-10	180.6	3.6%	90-100	0.2	0%
0-40	2,437.7	48%	48%	10-20	520.0	10.2%	100-110	0.3	0%
0-60	4,249.8	83.7%	83.7%	20-30	785.3	15.5%	110-120	0.4	0%
60-90	823.2	16.2%	16.2%	30-40	951.8	18.7%	120-130	0.5	0%
70-100	273.1	5.4%	5.4%	40-50	1,000.6	19.7%	130-140	0.7	0%
90-120	0.9	0%	0%	50-60	811.5	16.0%	140-150	0.8	0%
0-90	5,072.9	99.9%	99.9%	60-70	550.3	10.8%	150-160	0.7	0%
90-180	4.2	0.1%	0.1%	70-80	255.8	5.0%	160-170	0.5	0%
0-180	5,077.1	100%	100%	80-90	17.1	0.3%	170-180	0.2	0%

10117, WPFC2/CL55BZ50/LED

Polar Candela Distribution Plot

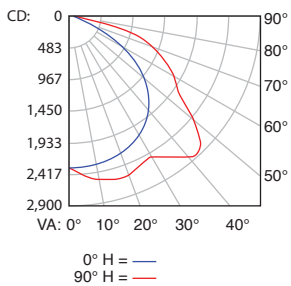

Isofootcandle Plot

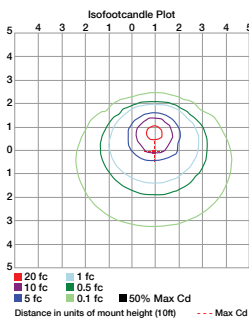

ILLUMINANCE AT A DISTANCE

HEIGHT(FT)	CENTER BEAM FOOTCANDLE	BEAM SPREAD(FT)		FIELD SPREAD(FT)	
		HORIZONTAL	VERTICAL	HORIZONTAL	VERTICAL
2.00	581.24 FC	4.3	5.9	8.3	17.8
4.00	145.31 FC	8.6	11.7	16.5	35.6
6.00	64.58 FC	12.9	17.6	24.8	53.5
8.00	36.33 FC	17.1	23.4	33.1	71.3
10.00	23.25 FC	21.4	29.3	41.4	89.1
		BEAM ANGLE		FIELD ANGLE	
		94.0°	111.3°	128.4°	154.7°

ZONAL LUMEN SUMMARY

ZONE	LUMENS %	LAMP %	LUMINAIRE	LUMENS PER ZONE					
				ZONE LUMENS %	TOTAL	ZONE	LUMENS % TOTAL		
0-30	1,820.6	28.6%	28.6%	0-10	220.9	3.5%	90-100	0.2	0%
0-40	2,989.1	47%	47%	10-20	636.4	10.0%	100-110	0.4	0%
0-60	5,252.0	82.6%	82.6%	20-30	963.4	15.1%	110-120	0.5	0%
60-90	1,101.6	17.3%	17.3%	30-40	1,168.5	18.4%	120-130	0.7	0%
70-100	391.9	6.2%	6.2%	40-50	1,238.6	19.5%	130-140	0.8	0%
90-120	1.1	0%	0%	50-60	1,024.4	16.1%	140-150	1.0	0%
0-90	6,353.6	99.9%	99.9%	60-70	710.0	11.2%	150-160	0.9	0%
90-180	5.3	0.1%	0.1%	70-80	359.1	5.6%	160-170	0.6	0%
0-180	6,358.9	100%	100%	80-90	32.5	0.5%	170-180	0.2	0%

LED Flood Series

Applications

Car Dealerships
Convenience Stores
Common Walkways
Gas Stations
Parking Areas
Schools
Markets
Commercial
Industrial
Residential

Long-lasting, low maintenance, energy efficient replacements for HID luminaires



Specifications

- Operating temperature range is -40°F (-40°C) to 113°F (45°C)
- Die-cast aluminum housing and hinged lens frame with captive screws
- Textured architectural bronze powdercoat finish
- Silicone gaskets protect against rust, corrosion, dirt and insects
- Clear flat glass lens
- Removable 1/2" threaded plugs with O-rings for conduit access and photocell provision
- Electrical snap-in connectors to simplify wiring and installation
- Voltage sensing 100-277V dimmable driver
- CSA Listed for wet locations
- 5-year limited warranty

Dimensions

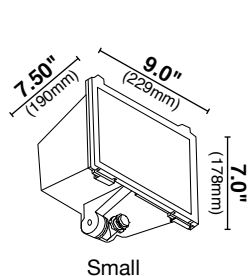

Small

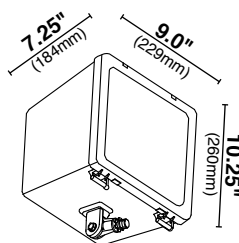

Medium

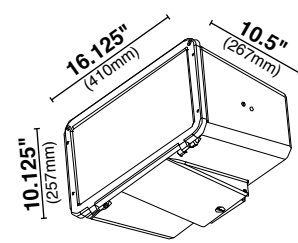

Large



Ordering Information

Watt	Product #	Product Code	Volts	Color Temp.	CRI	Lumens	Useful Life*	Pkg. Qty.	Dimmable	DLC Qualified	Equivalent Wattage
25 Watt	99901	FL1/CL25BZ50/LED	100-277V	5000K	72	2225	50,000	1	0-10V	Yes	100W
41 Watt	99902	FL2/CL41BZ50/LED	100-277V	5000K	73	3468	50,000	1	0-10V	Yes	175W
75 Watt	99903	FL3/CL75BZ50/LED	100-277V	5000K	75	5964	50,000	1	0-10V	Yes	250W

Accessories

Watt	Product #	Product Description	Watt	Product #	Product Description
99803	WG1/FL1	Wire Guard Flood for 99901	99810	SF/FL	Slip Fitter Flood for 99903
99804	WG2/FL2	Wire Guard Flood for 99902	99811	PTF/FL	Post Top Fitter Flood for 99901, 99902
99805	WG3/FL3	Wire Guard Flood for 99903	99812	PTM/FL	Pole Tenon Mount Flood for 99903
99806	GS1/FL1	Glare Shield Flood for 99901	99813	HDGS/FL	Heavy Duty Ground Stake for 99901, 99902
99807	GS2/FL2	Glare Shield Flood for 99902	99815	PCS/120V	Photocell Swivel 110-130V
99808	GS3/FL3	Glare Shield Flood for 99903	99816	PCS/277V	Photocell Swivel 208-277V
99809	LY/FL3	Large Yoke Flood for 99903			

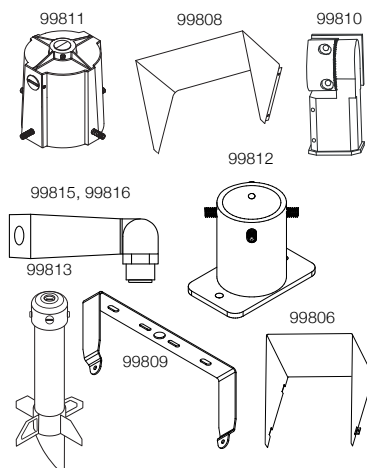

Accessories include hardware.

Warranty - Commercial / Industrial: This product is warranted for 1 year from the date of purchase.

* Useful Life is defined as the point in time at which the LED will maintain at least 70% of its initial lumens. The LED will continue to operate past this point at decreased light levels.

May not be compatible with all dimming systems, dimming performance may vary by system.

** Check the latest update at www.DesignLights.org for listed product catalog numbers. Not all versions are listed.

LED Flood Series

Photometrics

Polar Candela Distribution Plot

99901, FL1/CL25BZ50/LED

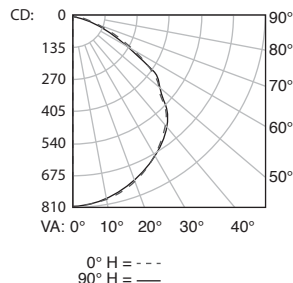

Isofootcandle Plot

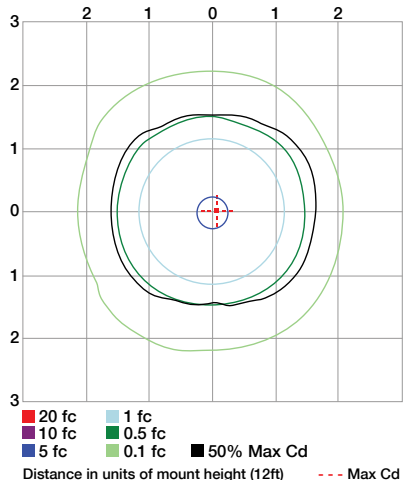

Illuminance at a Distance

Height(ft)	Center Beam Footcandle	Beam Spread(ft)		Field Spread(ft)	
		Horizontal	Vertical	Horizontal	Vertical
2.0	200.3 fc	6.1	6.0	11.4	11.8
4.0	50.1 fc	12.1	12.0	22.8	23.6
6.0	22.3 fc	18.2	18.0	34.2	35.4
8.0	12.5 fc	24.3	24.0	45.6	47.1
10.0	8.0 fc	30.3	29.9	57.0	58.9
12.0	5.6 fc	36.4	35.9	68.3	70.7
		Beam Angle		Field Angle	
		113.2°	112.5°	141.3°	142.5°

Polar Candela Distribution Plot

99902, FL2/CL41BZ50/LED

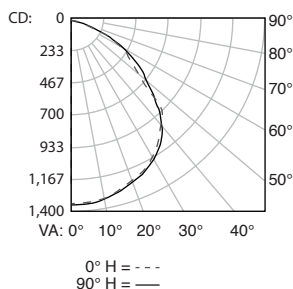

Isofootcandle Plot

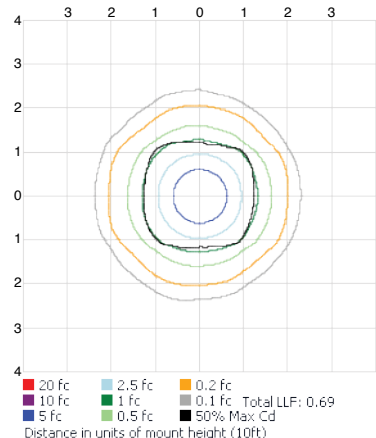

Illuminance at a Distance

Height(ft)	Center Beam Footcandle	Beam Spread(ft)		Field Spread(ft)	
		Horizontal	Vertical	Horizontal	Vertical
1.7	485.43 fc	4.2	4.0	9.3	9.5
3.3	121.36 fc	8.4	8.1	18.7	19.0
5.0	53.94 fc	12.5	12.1	28.0	28.5
6.7	30.34 fc	16.7	16.2	37.4	38.1
8.3	19.42 fc	20.9	20.2	46.7	47.6
10.0	13.48 fc	25.1	24.3	56.1	57.1
		Beam Angle		Field Angle	
		102.8°	101.1°	140.7°	141.4°

Polar Candela Distribution Plot

99903, FL3/CL75BZ50/LED

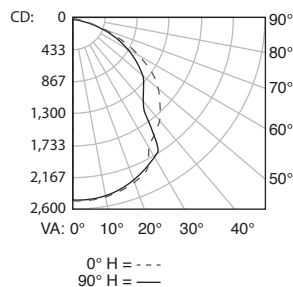

Isofootcandle Plot

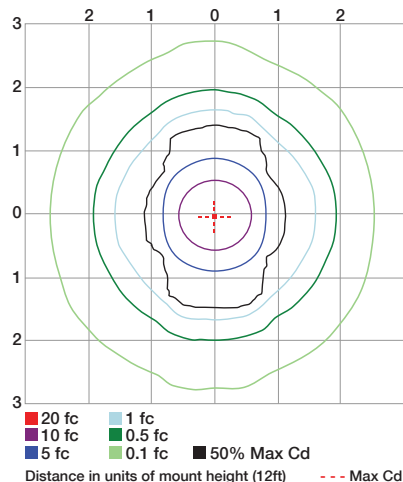

Illuminance at a Distance

Height(ft)	Center Beam Footcandle	Beam Spread(ft)		Field Spread(ft)	
		Horizontal	Vertical	Horizontal	Vertical
2.0	156.1 fc	6.2	5.3	9.1	6.7
4.0	39.0 fc	12.3	10.7	18.3	13.3
6.0	17.3 fc	18.5	16.0	27.4	20.0
8.0	9.8 fc	24.6	21.4	36.5	26.6
10.0	6.2 fc	30.8	26.7	45.7	33.3
12.0	4.3 fc	37.0	32.0	54.8	39.9
		Beam Angle		Field Angle	
		114.0°	106.3°	132.7°	118.0°

LED Compact Flood

Applications

Car Dealerships
Convenience Stores
Common Walkways
Gas Stations
Parking Areas
Schools
Markets
Commercial
Industrial
Residential

Long-lasting, low maintenance, energy efficient replacements for Quartz and HID luminaires



Specifications

- Operating temperature range is -40°F (-40°C) to 113°F (45°C)
- Die-cast aluminum housing and removable lens frame
- Textured architectural bronze powdercoat finish
- Silicone gaskets protect against rust, corrosion, dirt and insects
- Clear flat glass lens
- Multiple mounting options
- Removable 1/2" threaded plugs with O-rings for conduit access and photocell provision
- Electrical snap-in connectors to simplify wiring and installation
- Voltage sensing 100-277V dimmable driver
- CSA Listed for wet locations
- 5-year limited warranty

Dimensions

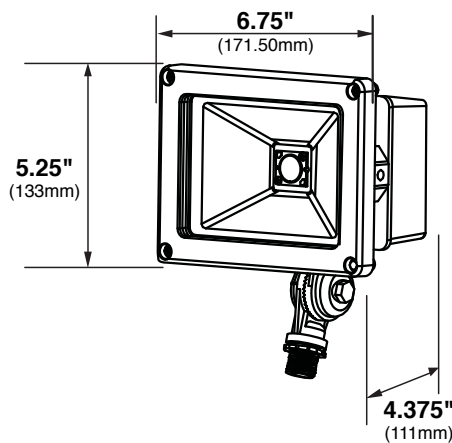

Ordering Information



Watt	Product #	Product Code	Volts	Color Temp.	CRI	Lumens	Useful Life*	Pkg. Qty.	DLC Qualified	Equivalent Wattage
21	99900	FL1C/CL21BZ50/LED	100-277V	5000K	84	1584	50,000	1	Yes	100W

* Useful Life is defined as the point in time at which the lamp will maintain at least 70% of its initial lumens. The lamp will continue to burn past this point, but at decreased light levels.

Warranty – Commercial / Industrial: This product is warranted for 5 years from the date of purchase.

** Check the latest update at www.DesignLights.org for listed product catalog numbers. Not all versions are listed.

LED Compact Flood

Accessories

Product	Product Code	Description
99811	PTF/FL	Post Top Fitter Flood for 99900
99813	HDGS/FL	Heavy Duty Ground Stake for 99900
99815	PCS/120V	Photocell Swivel 110-130V
99816	PCS/277V	Photocell Swivel 208-277V

Accessories

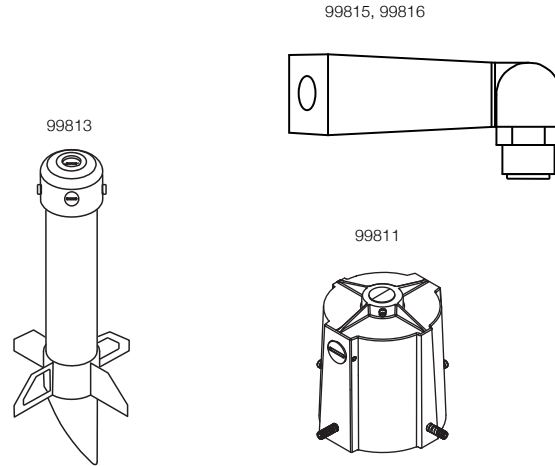

Accessories include hardware.

Warranty – Commercial / Industrial: This product is warranted for 1 year from the date of purchase.

* Useful Life is defined as the point in time at which the LED will maintain at least 70% of its initial lumens. The LED will continue to operate past this point at decreased light levels. May not be compatible with all dimming systems, dimming performance may vary by system.

Photometrics

Polar Candela Distribution Plot

99900, FL1C/CL21BZ50/LED

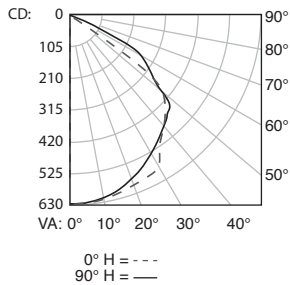

Isofootcandle Plot

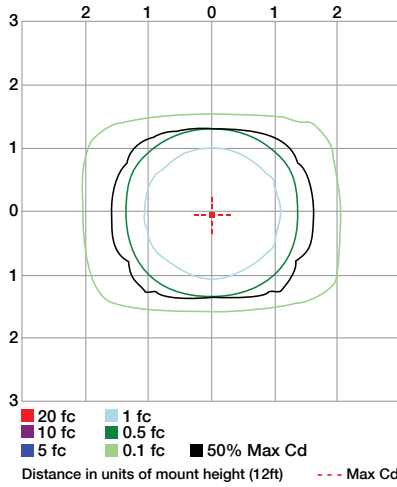

Visual Flood in fc Values

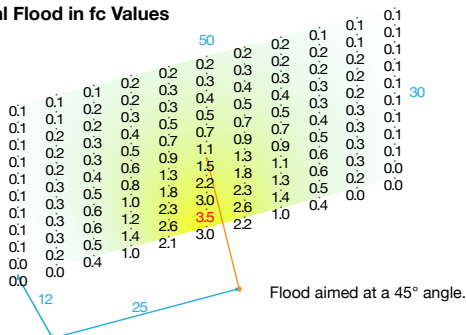

Illuminance at a Distance

Height(ft)	Center Beam Footcandle	Beam Spread(ft)		Field Spread(ft)	
		Horizontal	Vertical	Horizontal	Vertical
2.0	156.1 fc	6.2	5.3	9.1	6.7
4.0	39.0 fc	12.3	10.7	18.3	13.3
8.0	9.8 fc	24.6	21.4	36.5	26.6
10.0	6.2 fc	30.8	26.7	45.7	33.3
12.0	4.3 fc	37.0	32.0	54.8	39.9
		Beam Angle		Field Angle	
		114.0°	106.3°	132.7°	118.0°

LED Low Profile Canopy

Applications

- Car Dealerships
- Canopies
- Gas Stations
- Loading Docks
- Service Areas

Markets

- Commercial
- Industrial

A high power, long-lasting LED canopy with a shallow profile designed for outdoor applications



Specifications

- Operating temperature range; -40°F (-40°C) to 113°F (45°C)
- 3.75" thin design with low glare lens
- Die-cast aluminum housing
- Dark bronze powder coat finish
- Low glare, polycarbonate diffuser
- Optional pendant mounting (3/4" NPT)
- Universal voltage driver, 120-277V
- UL listed for wet locations
- IP65 rated for outdoor use
- Easy to install, hands free wiring
- 5-year limited warranty

Dimensions

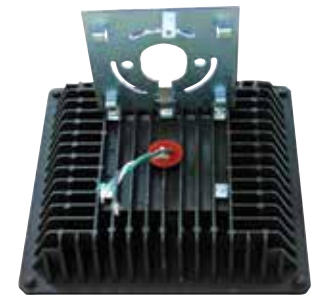
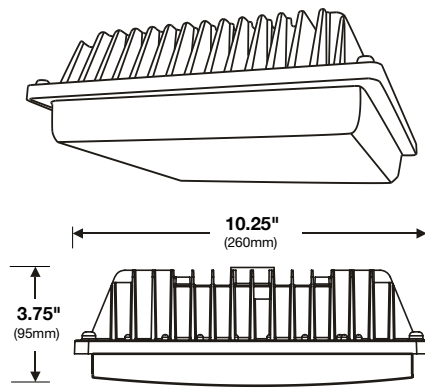
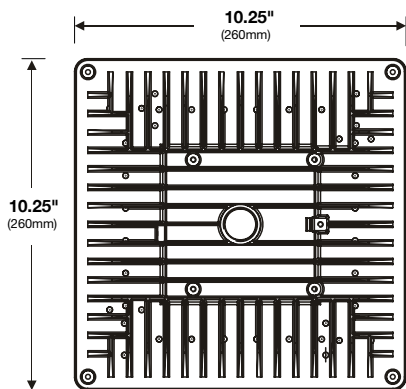

Quick Mount Hands Free Wiring

Ordering Information



Watt	Product #	Product Code	Volts	Color Temp.	CRI	Lumens	Useful Life*	Pkg. Qty.	Fixture Size L x H	Weight	Equivalent Wattage
33	99913	CMS1/CL33BZ50/LED	120-277	5000K	73	2976	50,000	1	10.25" x 3.75"	8.3 lbs. (3.7kg)	70W Metal Halide
58	99914	CMS2/CL58BZ50/LED	120-277	5000K	73	5524	50,000	1	10.25" x 3.75"	8.3 lbs. (3.7kg)	150W Metal Halide

* Useful Life is defined as the point in time at which the lamp will maintain at least 70% of its initial lumens. The lamp will continue to burn past this point, but at decreased light levels.

** Check the latest update at www.DesignLights.org for listed product catalog numbers. Not all versions are listed.

Warranty – Commercial / Industrial: This product is warranted for 5 years from the date of purchase.

IP65 rated – this lamp is rated for use outdoors where exposed directly to water from rain or irrigation. The lamp is not submersible, not for this type of enclosed fixture.

LED Low Profile Canopy

Photometrics

Polar Candela Distribution Plot

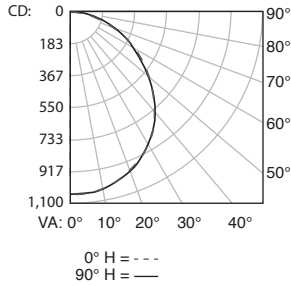

Isofootcandle Plot

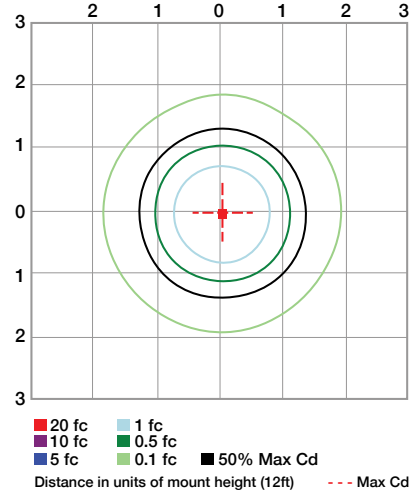

Illuminance at a Distance

Height(ft)	Center Beam Footcandle	Beam Spread(ft)		Field Spread(ft)	
		Horizontal	Vertical	Horizontal	Vertical
8.0	16.4 fc	21.1	21.1	121.2	126.7
12.0	7.3 fc	31.6	31.6	181.8	190.1
16.0	4.1 fc	42.1	42.1	242.4	253.5
20.0	2.6 fc	52.6	52.6	303.0	316.9
		Beam Angle		Field Angle	
		105.6°	105.5°	165.0°	165.6°

Polar Candela Distribution Plot

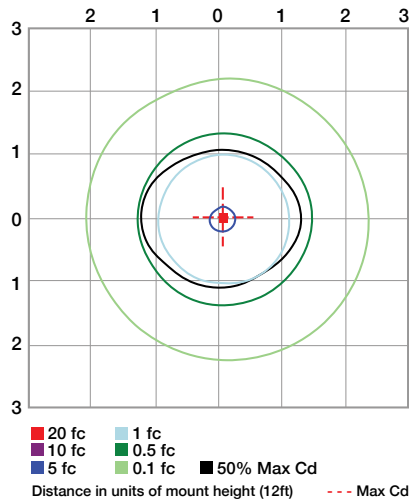
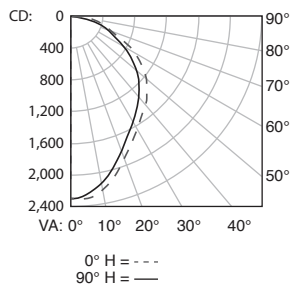

Illuminance at a Distance

Height(ft)	Center Beam Footcandle	Beam Spread(ft)		Field Spread(ft)	
		Horizontal	Vertical	Horizontal	Vertical
8.0	36.1 FC	17.1	16.9	92.4	91.8
12.0	16.0 FC	25.6	25.3	138.7	137.6
16.0	9.0 FC	34.2	33.8	184.9	183.5
20.0	5.8 FC	42.7	42.2	231.1	229.4
		Beam Angle		Field Angle	
		93.7°	93.1°	160.4°	160.2°

LED Large Canopy

Applications

Car Dealerships
Convenience Stores
Common Walkways
Gas Stations
Parking Areas
Schools
Markets
Commercial
Industrial
Residential

Long-lasting, low maintenance, energy efficient replacements for HID luminaires



Specifications

- Operating temperature range is -40°F (-40°C) to 113°F (45°C)
- Die-cast aluminum housing and hinged lens frame with captive screws
- Textured architectural bronze powdercoat finish
- Silicone gaskets protect against rust, corrosion, dirt and insects
- Vandal proof clear polycarbonate prismatic lens with captive screws
- Mounts directly over a 4" recessed outlet box
- Removable 1/2" threaded plugs with O-rings for conduit access and photocell provision
- Electrical snap-in connectors to simplify wiring and installation
- Voltage sensing 100-277V dimmable driver
- CSA Listed for wet locations
- 5-year limited warranty

Dimensions

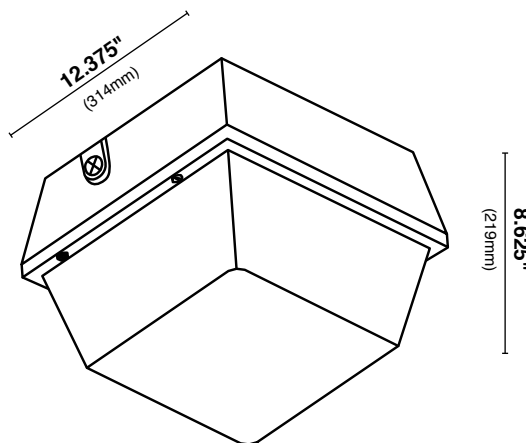

Ordering Information

Watt	Product #	Product Code	Volts	Color Temp.	CRI	Lumens	Useful Life*	Pkg. Qty.	Dimmable	Equivalent Wattage
53	99906	CM2/CL53BZ50/LED	100-277V	5000K	85	4735	50,000	1	0-10V	175W



* Useful Life is defined as the point in time at which the LED will maintain at least 70% of its initial lumens. The LED will continue to operate past this point at decreased light levels. May not be compatible with all dimming systems, dimming performance may vary by system.

LED Large Canopy



Photometrics

Polar Candela Distribution Plot
99906, CM2/CL53BZ50/LED

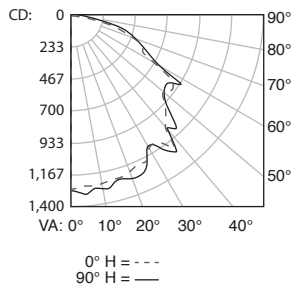

Isofootcandle Plot

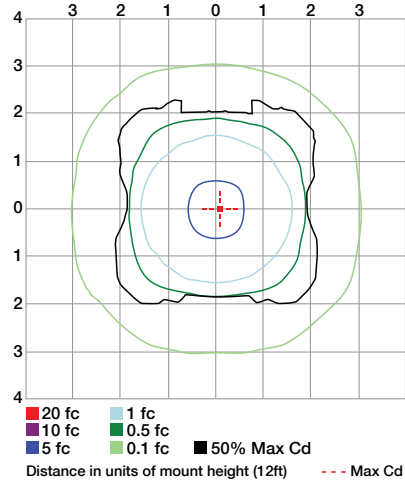

Illuminance at a Distance

Height(ft)	Center Beam	Beam Spread(ft)		Field Spread(ft)	
	Footcandle	Horizontal	Vertical	Horizontal	Vertical
2.0	319.7 fc	7.6	7.6	44.8	45.3
4.0	79.9 fc	15.2	15.2	89.6	90.5
8.0	35.5 fc	22.9	22.9	134.5	135.8
16.0	20.0 fc	30.5	30.5	179.3	181.1
32.0	12.8 fc	38.1	38.1	224.1	226.3
64.0	8.9 fc	45.7	45.7	268.9	271.6
		Beam Angle		Field Angle	
		124.6°	124.6°	169.8°	169.9°

LED Dusk to Dawn Series

Applications

- Security Lighting
- Yards
- Parking Lots
- Roadways

Markets

- Commercial
- Industrial
- Residential

A high performance, low maintenance LED luminaire designed for harsh outdoor environments



Specifications

- Operating temperature range; -40°F (-40°C) to 113°F (45°C)
- Die-cast aluminum housing
- Gray powder coat finish
- High impact polycarbonate lens
- NEMA approved photocell to automatically switch on/off
- 21" Aluminum arm extension for wall/pole mounting
- Universal voltage driver, 120-277V
- UL listed for wet locations
- IP65 rated for outdoor use
- Available in pole and wall mount designs (not for ceiling mount)
- 5-year limited warranty

Dimensions

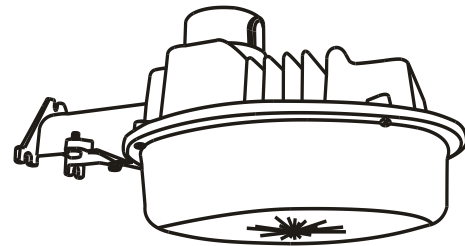
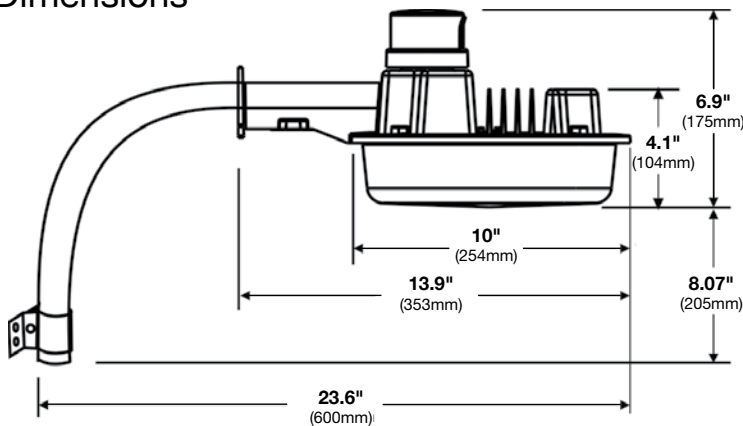

Ordering Information



Watt	Product #	Product Code	Volts	Color Temp.	CRI	Lumens	Useful Life*	Pkg. Qty.	Fixture Size L x W x H	Weight	Equivalent Wattage
41	99915	DD1/CL41GY50/LED	120-277	5000K	75	3194	50,000	1	13.9" x 10" x 6.9"	6.2 lbs. (2.8kg)	100W HID
58	99916	DD2/CL58GY50/LED	120-277	5000K	75	5542	50,000	1	13.9" x 10" x 6.9"	6.2 lbs. (2.8kg)	175W HID

* Useful Life is defined as the point in time at which the lamp will maintain at least 70% of its initial lumens. The lamp will continue to burn past this point, but at decreased light levels.

** Check the latest update at www.DesignLights.org for listed product catalog numbers. Not all versions are listed.

Warranty – Commercial / Industrial: This product is warranted for 5 years from the date of purchase.

IP65 rated – this lamp is rated for use outdoors where exposed directly to water from rain or irrigation. The lamp is not submersible, not for this type of enclosed fixture.

LED Dusk to Dawn Series

Photometrics

Polar Candela Distribution Plot

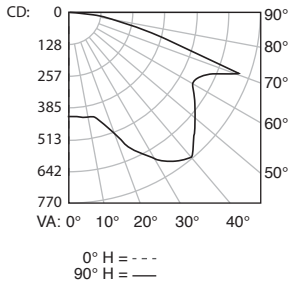

Isofootcandle Plot

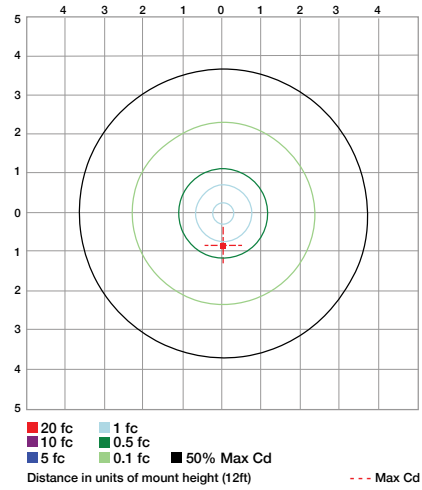

Illuminance at a Distance

Height(ft)	Center Beam	Beam Spread(ft)		Field Spread(ft)	
	Footcandle	Horizontal	Vertical	Horizontal	Vertical
8.0	6.5 fc	59.0	44.0	166.7	127.3
12.0	2.9 fc	88.4	66.0	250.1	190.9
16.0	1.6 fc	117.9	88.5	333.4	254.6
20.0	1.0 fc	147.4	110.0	416.8	318.2
		Beam Angle		Field Angle	
		149.6°	140.0°	169.0°	165.7°

Polar Candela Distribution Plot

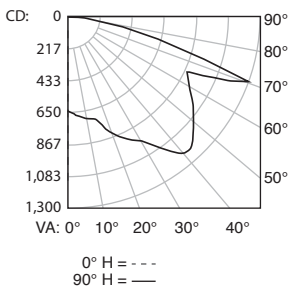

Isofootcandle Plot

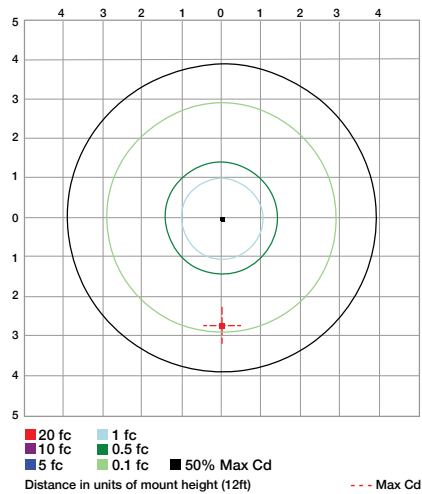

Illuminance at a Distance

Height(ft)	Center Beam	Beam Spread(ft)		Field Spread(ft)	
	Footcandle	Horizontal	Vertical	Horizontal	Vertical
8.0	10.0 FC	12.4	15.2	182.5	61.8
12.0	4.5 FC	18.6	22.8	273.7	92.8
16.0	2.5 FC	24.8	30.4	364.9	123.7
20.0	1.6 FC	31.0	38.1	456.1	154.6
		Beam Angle		Field Angle	
		75.6°	87.1°	170.0°	151.0°

LED Vaportight Series

Applications

Ideal to use where Dust, Dirt, Humidity and Moisture are Present.

Markets

Commercial
Industrial

Long-lasting, low maintenance, energy efficient replacement for Incandescent and HID luminaires



Specifications

- Operating temperature range is -40°F (-40°C) to 113°F (45°C)
- Die-cast aluminum housing with screw-on guard
- Repaintable textured gray powdercoat finish
- Silicone gaskets protect against rust, corrosion, dirt and insects
- Clear glass globe
- Removable 1/2" threaded plugs with O-rings for conduit access and photocell provision
- Weatherproof box with removable threaded 3/4" plugs and O-rings for 3/4" conduit access
- Electrical snap-in connectors to simplify wiring and installation
- Voltage sensing 100-277V dimmable driver
- CSA Listed for wet locations
- 5-year limited warranty

Dimensions

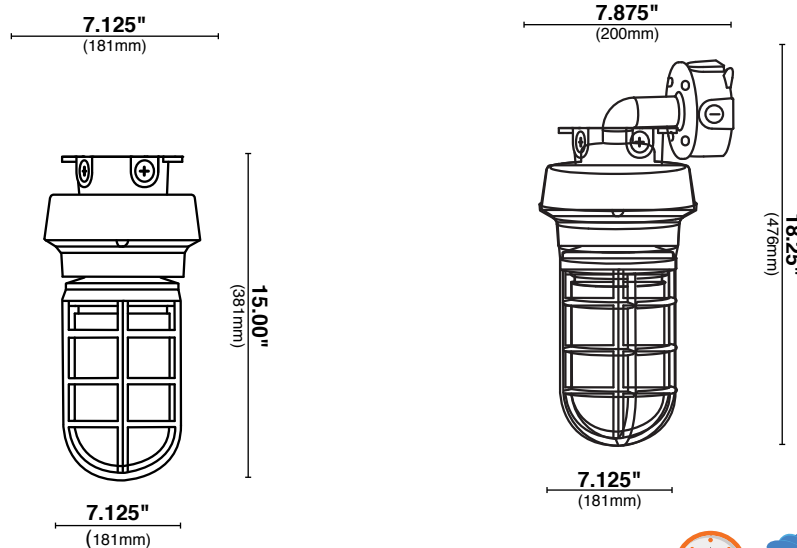

Ordering Information



Watt	Product #	Product Code	Volts	Color Temp.	CRI	Lumens	Useful Life*	Pkg. Qty.	Dimmable	Equivalent Wattage
13	99904	VT1/CL13GRY50/CM/LED	100-277V	5000K	80+	911	50,000	1	0-10V	70W HID
13	99905	VT1/CL13GRY50/MM/LED	100-277V	5000K	80+	911	50,000	1	0-10V	70W HID

* Useful Life is defined as the point in time at which the lamp will maintain at least 70% of its initial lumens. The lamp will continue to burn past this point, but at decreased light levels.
Warranty – Commercial / Industrial: This product is warranted for 5 years from the date of purchase.
IP65 rated – this lamp is rated for use outdoors where exposed directly to water from rain or irrigation. The lamp is not submersible, not for this type of enclosed fixture.

LED Vaportight Series

Photometrics

Polar Candela Distribution Plots

99904, BT1/CL13GRY50/CM/LED

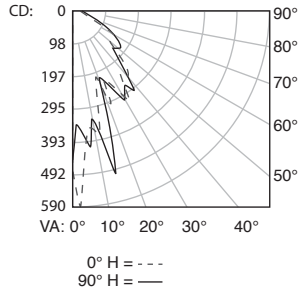

99905, BT1/CL13GRY50/WM/LED

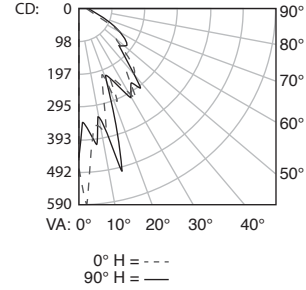

Isofootcandle Plot

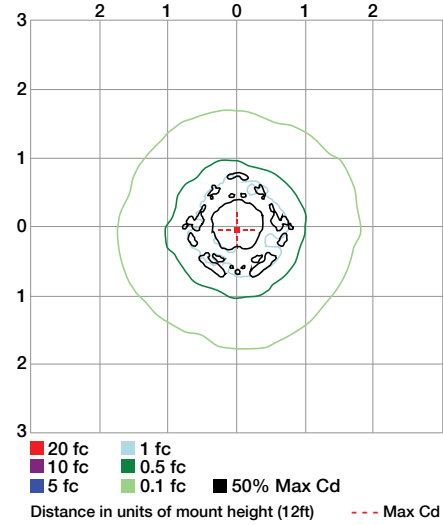
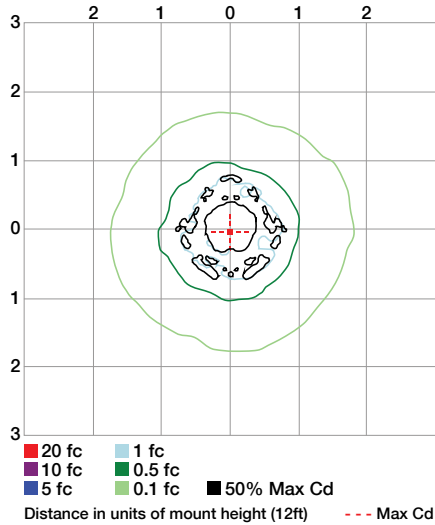

Illuminance at a Distance

Height(ft)	Center Beam	Beam Spread(ft)		Field Spread(ft)	
	Footcandle	Horizontal	Vertical	Horizontal	Vertical
2.0	115.3 fc	1.2	1.3	11.2	11.9
4.0	28.8 fc	2.4	2.7	22.3	23.8
8.0	12.8 fc	3.6	4.0	33.5	35.7
10.0	7.2 fc	4.8	5.3	44.7	47.5
12.0	4.6 fc	6.0	6.7	55.9	59.4
12.0	3.2 fc	7.2	8.0	67.0	71.3
		Beam Angle		Field Angle	
		33.4°	36.9°	140.6°	142.8°

Illuminance at a Distance

Height(ft)	Center Beam	Beam Spread(ft)		Field Spread(ft)	
	Footcandle	Horizontal	Vertical	Horizontal	Vertical
2.0	115.3 fc	1.2	1.3	11.2	11.9
4.0	28.8 fc	2.4	2.7	22.3	23.8
8.0	12.8 fc	3.6	4.0	33.5	35.7
10.0	7.2 fc	4.8	5.3	44.7	47.5
12.0	4.6 fc	6.0	6.7	55.9	59.4
12.0	3.2 fc	7.2	8.0	67.0	71.3
		Beam Angle		Field Angle	
		33.4°	36.9°	140.6°	142.8°

DecoStrand

Applications
Restaurants
Cafes
Exterior Retail Areas
Parks
Home Patios
Markets
Residential
Commercial

Create a distinctive and unique look to your indoor/outdoor space with DecoStrand accent lighting. With the variety of reflectors and available lighting options, DecoStrand is certain to make an impactful impression in any setting.



Reflector sold separately

Commercial DecoStrand® Lighting

Specifications

- 52' cable length with 25, 4" medium base (E26) socket drops
- Heavy duty 14 AWG SJTW molded silicone resin cable for maximum durability, indoors and out
- Fully grounded, three-conductor wire provides peace of mind safety
- Three conductor socket on one end allows for system expansion and continual run capabilities
- Available reflectors (sold separately) create uniquely styled appearance
- DecoStrand features one of the industry's broadest offering of LED, Incandescent and Specialty lamp options with the Halco Lighting family of dependable lamps
- 2-year limited warranty

Dimensions

- Cord Length: 52 ft. (15.8 m)
- Number of Sockets: 25
- Socket Spacing: 2 ft. (0.6 m)
- Socket Drop Length: 4 in. (0.1 m)

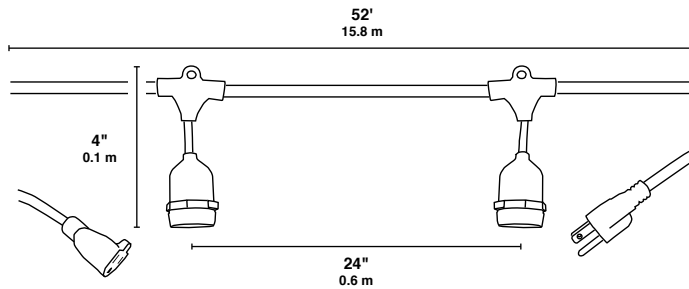

Electrical

- Voltage: 120V Only
- 15A Capacity Circuit Typical
- Maximum Lamp Wattage: 50 Watts
- 3 – Prong grounded plug
- 3 – Prong grounded receptacle

Ordering Information

Product #	Product Code	Description	Weight	Pkg. Qty.
99962	DSL/52254M/3G-BK	Decorative strand lighting 52ft long 25 E26 sockets 4in drops 3 wire grounded	8.55 lbs	1/1



Warranty – Commercial / Industrial: This product is warranted for 2 years from the date of purchase.

DecoStrand



Residential DecoStrand® Lighting

Specifications

- 26' cable length with 12, 4" medium base (E26) socket drops
- SPT 16 AWG 2-wire cable with 8A fuse
- Two conductor socket on one end allows for system expansion and continual run capabilities
- (12) E26 medium bases with 25W maximum per base
- Available reflectors (sold separately) creates uniquely styled appearance
- DecoStrand features one of the industry's broadest offering of LED, Incandescent and Specialty lamp options with the Halco Lighting family of dependable lamps
- 2-year limited warranty

Dimensions

- Cord Length: 26 ft. (7.9 m)
- Number of Sockets: 12
- Socket Spacing: 2 ft. (0.6 m)
- Socket Drop Length: 4 in. (0.1 m)

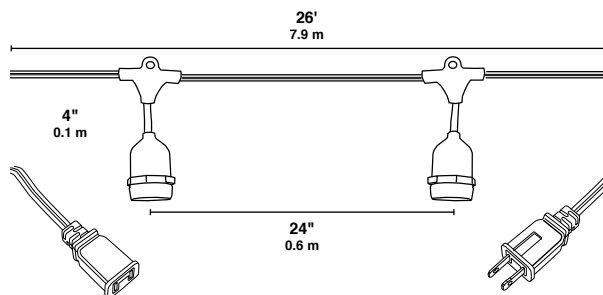

Electrical

- Voltage: 120V Only
- 15A Capacity Circuit Typical
- Maximum Lamp Wattage: 25 Watts
- 2 – Prong plug with 8A fuse
- 2 – Prong receptacle

Ordering Information



Product #	Product Code	Description	Weight	Pkg. Qty.
99603	DSL/26124M/2G-BK	Decorative Strand Lighting 26ft long, (12) E26 sockets, 4in drops, 2-wire with 8A fuse	2.5 lbs	1/1

NEW ITEM
Warranty – Commercial / Industrial: This product is warranted for 2 years from the date of purchase.

Commercial DecoStrand® Lighting

Lamp Wattage Range	Total System Watts	Total # of DecoStrands per Circuit*
40-50 Watts	1000 - 1250	1
17-25 Watts	425 - 625	2
13-16 Watts	325 - 400	3
11-12 Watts	275 - 300	4
9-10 Watts	225 - 250	5
8 Watts	200	6
7 Watts	175	7
6 Watts	150	8
5 Watts	125	9
4 Watts	100	10

*Circuit capacity based on typical 15 Amps system. Larger circuit sizes may be able to accommodate more Decostrand strings. Consult an Electrical Engineer for complete circuit load confirmation.



Residential DecoStrand® Lighting

Lamp Wattage Range	Total System Watts	Total # of DecoStrands per Circuit*
13-25 Watts	156-300	1
9-12 Watts	108-144	2
7-8 Watts	84-96	3
6 Watts	72	4
5 Watts	60	5
4 Watts	48	6
3 Watts	36	8

*Circuit capacity based on typical 15 Amps system. Larger circuit sizes may be able to accommodate more Decostrand strings. Consult an Electrical Engineer for complete circuit load confirmation.



DecoStrand

DecoStrand® Reflectors:

- Decorative reflector for use on DecoStrand decorative string lighting systems
- Adds a unique and charming appearance for a variety of environments
- Formed steel or aluminum in a variety of attractive designs
- Available in natural, copper, antique brass, textured black and textured bronze finishes
- Easily mounts to the DecoStrand socket, without tools, in seconds



Natural



Copper



Antique Brass



4" Textured Bronze



7.5" Textured Bronze



4" Textured Black



7.5" Textured Black







Ordering Information





Product #	Product Code	Description	Weight	Pkg. Qty.
99963	DSL/FSTR-NF	Decorative Strand Steel Reflector Natural Finish	0.20	1/25
☼ 99604	DSL/FSTR-CU	Decorative Strand Steel Reflector Copper Finish	0.20	1/25
☼ 99605	DSL/FSTR-AB	Decorative Strand Steel Reflector Antique Brass Finish	0.20	1/25
☼ 99606	DSL/PSH040-TZ	4" Straight Hat DecoStrand Reflector Textured Bronze Finish	0.05	1/12
☼ 99607	DSL/PSH040-TB	4" Straight Hat DecoStrand Reflector Textured Black Finish	0.05	1/12
☼ 99608	DSL/PSH075-TZ	7.5" Straight Hat DecoStrand Reflector Textured Bronze Finish	0.15	1/12
☼ 99609	DSL/PSH075-TB	7.5" Straight Hat DecoStrand Reflector Textured Black Finish	0.15	1/12

☼ NEW ITEM

Warranty – Commercial / Industrial: This product is warranted for 2 years from the date of purchase.

Recommended Lamps

Product #	Product Code	Watts	Color Temp.
80522* 	S14CL1C/827/LED	1.4	2700K
20006 	ST18ANT40	40	2500K
9051 	S14CL11	11	-
20002 	A21ANT40	40	2500K

Product #	Product Code	Watts	Color Temp.
81140* 	S14AMB2ANT/822/LED 2	2	2200K
81139* 	S14CL2ANT/827/LED 2	2	2700K
81132** 	ST19AMB5ANT/722/LED5	5	2200K
81129** 	A19AMB4ANT/722/LED 4.5	4.5	2200K

* Wet location listed.

** Damp location listed.

For the complete ProLED offering of lamps see HalcoLighting.com

U.S. Department of Energy estimates LEDs offer the potential for cutting general lighting energy use nearly in half by 2030.

ENERGY STAR®

Halco is a proud ENERGY STAR® partner. ENERGY STAR® is a voluntary program by the U.S. Environmental Protection Agency that aims to educate and increase awareness of energy saving and environmentally friendly products. Halco boasts a portfolio of ENERGY STAR® qualified products, specifically in our ProLED and ProLume Compact Fluorescent product offerings.



The Design Lights Consortium®

The Design Lights Consortium (DLC) is intended to accelerate energy efficiency in the building sector through public policy, program strategies and education. The DLC promotes quality, performance and energy commercial sector lighting solutions. Halco ProLED luminaires and T8 Linear lamps are on the DLC Qualified Product List.



LED Lighting Facts®

Halco is a participating partner of the U.S. Department of Energy (DOE) LED Lighting Facts® program, which assures that the performance of LED lighting products is accurately represented. The program helps manage the adoption of the new technology by mandating the use of a label that verifies the product has been tested according to industry standard procedures and that those results are accurately presented. The DOE LED Lighting Facts® label identifies light output, wattage, efficacy, correlated color temperature (CCT) and color rendering index (CRI).



Halco also complies with Federal Trade Commission (FTC) Lighting Facts labeling regulations of medium base screw lamps. Similar to the DOE program, the FTC program establishes consistency among manufacturers so that consumers can easily identify LED product specifications. The FTC label requires lumen output, estimated annual energy cost, life expectancy, color temperature, wattage and mercury content, if applicable.



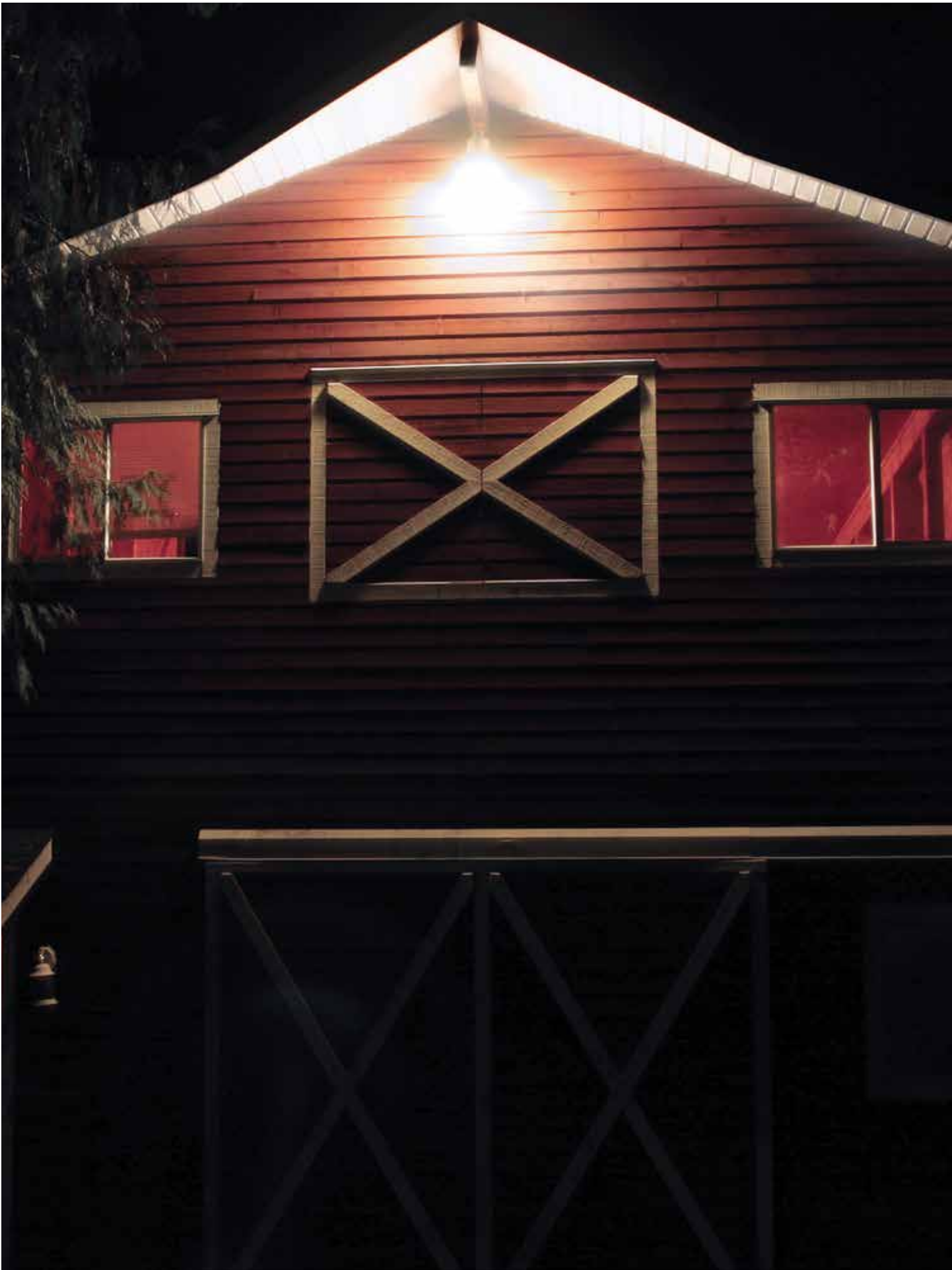

ProLED[®]
ProLume[®]
HaloXen[®]
PRISM[®]
CoverShield[®]
sollos[®]
LANDSCAPE LIGHTING

Halco[®]
LIGHTING TECHNOLOGIES

800.677.3334
FAX: 800.880.0822
www.halcolighting.com

Atlanta
2940 Pacific Drive
Norcross, GA 30071

Houston
6323 Brookhill Drive
Houston, TX 77087

Cleveland
3501 Croton Avenue
Cleveland, OH 44115

Los Angeles
1513 Hataway Drive
Santa Fe Springs, CA 90670

Carlstadt
600 Gotham Parkway, Unit 2
Carlstadt, NJ 07072

Phoenix
6607 W. Boston Street, Suite 1
Chandler, AZ 85226



Halco
LIGHTING TECHNOLOGIES



ProLED

LED LAMP CATALOG

Volume 2.1

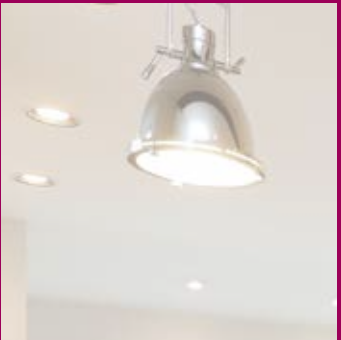

Table of Contents

PL Direct Series	10
PL Bypass Series	11
PL Hybrid Series	12
Linear Direct T8 Series	14
Linear Bypass T8 Series	15
Ubend Direct Series	17
T5 Direct Replacement Series	18
HID Retrofit Series	20
HID High Bay Retrofit Series	21
Universal Voltage PAR38 Lamps	22
Prime Select PAR38	23-24
Prime Select PAR30 Lamps	25-26
Prime Select PAR20 Lamps	27
Choice PAR Lamps	28-29
ECO PAR Lamps	30
PAR16/MR16/MR11 Lamps	32
BR40 Lamps	33
BR30 Lamps	34
R20 Lamps	35
Omnidirectional A-Shape Series	36
ECO A19 Series	37
A19 GU24 Series	38
JA-8 A-Shape and Reflector Series	39
Filament LED Series	40-41
Decorative Chandelier Lamps	42
B11 Chandelier Lamps	43
Globe Lamp	44
PAR36/AR111 Indoor Lamps	45
C7/C9 Lamps	46
Sign Lamps	47
MR16 Lamps	48-49
MR16 GU10 Lamps	49
Black MR16 Lamps	51
MR11 Lamps	52
Outdoor PAR36 Lamps	53
IP Rated LED JC Series	54
Traditional LED JC Series	55-56
Omnidirectional IP65 JC Lamps	56
Elevator Lamps	57



About Halco Lighting Technologies

Established in 1974, Halco Lighting Technologies is a leader in lamp, luminaire and ballast solutions. We are dedicated to providing you with the latest in energy efficient technologies; illustrated by our ProLED luminaires and full offering of ProLED lamps. Halco's luminaire offering features indoor recessed solutions such as ProLED Panel, Volumetric Panel and Downlight Retrofit Series luminaires. Our broad selection of long life, energy efficient ProLED lamps is available in popular shapes with an array of color temperatures and beam spreads. Halco is your single source for LED lamps for replacement and retrofit applications.

Service

We measure our success by one standard - your satisfaction. Halco carries deep inventory of a broad SKU offering to assure we have what you need when you need it. With strategically located warehouses in Atlanta, Carlstadt, Cleveland, Houston, Los Angeles and Phoenix, orders placed by 2:00 PM local warehouse time ship the same day. Will-call and courier service is also available for your convenience.

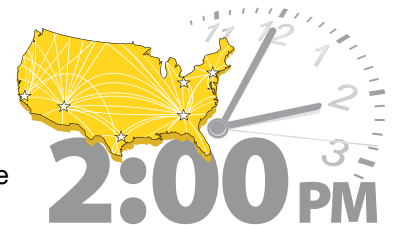

Quality

Our in-house lighting laboratory allows us to perform a variety of testing services including photometric, light output, color metrics and electrical measurements, including IES LM-79 testing. This product testing facility operates under a quality management system and ensures continuous quality control and outstanding product performance.



Halco's Quality Assurance policy ensures we deliver on our commitment to your satisfaction. If our product does not perform according to specifications, rest assured we'll provide a replacement or credit.



Performance

ProLED luminaires and lamps are backed by a warranty you can rely on. Prime Select PAR lamps are backed by a 7-Year Limited Warranty. ECO Select PAR, Luminaires, Reflector, A-Shape, G25, Decorative, MR, PAR36 and IP65 Rated JC lamps are backed by a 5-Year Limited Warranty. ProLED 912, C7/C9 and traditional JC lamps are backed by a 2-Year Limited Warranty.

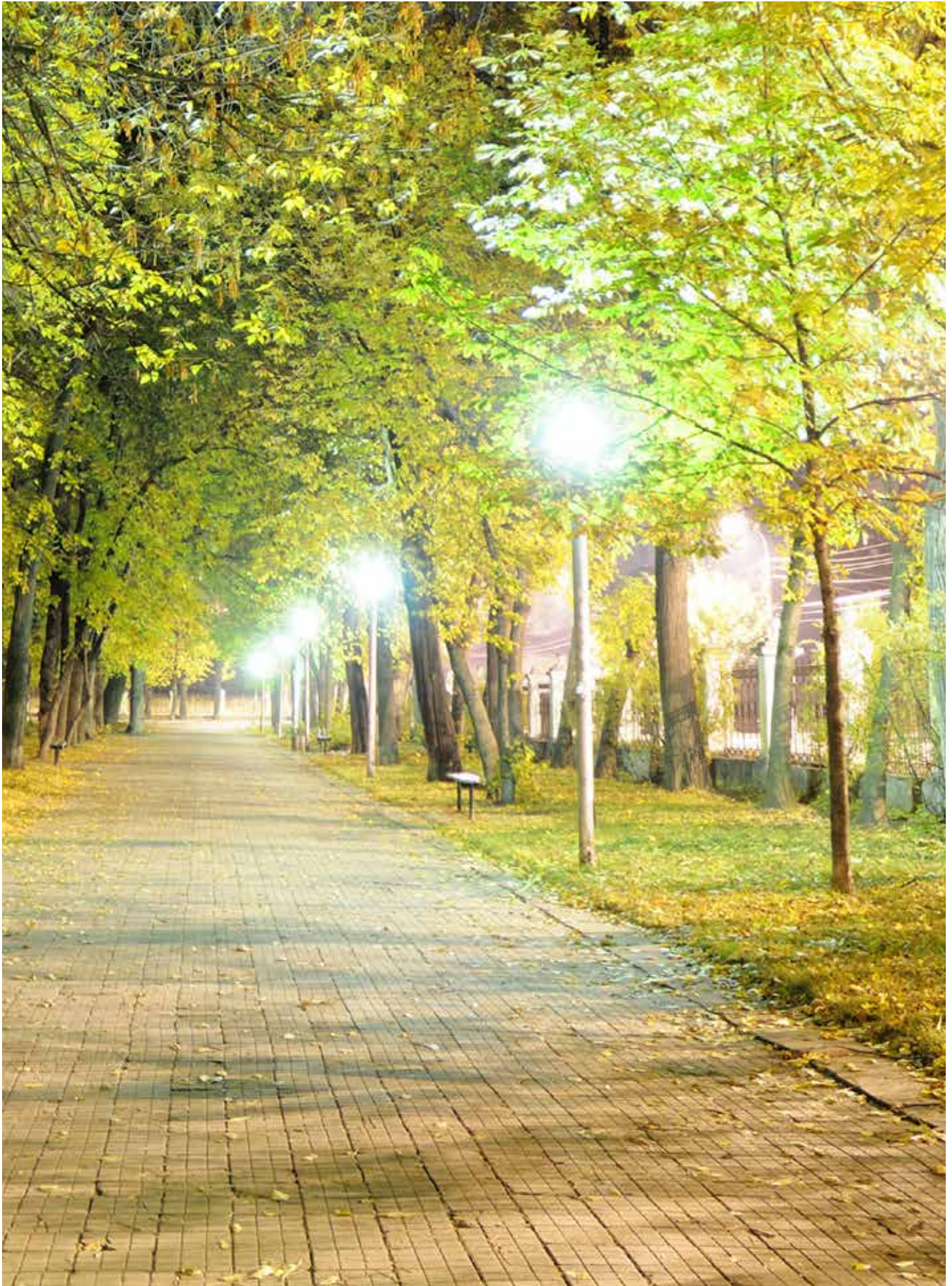

U.S. Department of Energy estimates LEDs offer the potential for cutting general lighting energy use nearly in half by 2030.

ENERGY STAR®

Halco is a proud ENERGY STAR® partner. ENERGY STAR® is a voluntary program by the U.S. Environmental Protection Agency that aims to educate and increase awareness of energy saving and environmentally friendly products. Halco boasts a portfolio of ENERGY STAR® qualified products, specifically in our ProLED and ProLume Compact Fluorescent product offerings.



The Design Lights Consortium®

The Design Lights Consortium (DLC) is intended to accelerate energy efficiency in the building sector through public policy, program strategies and education. The DLC promotes quality, performance and energy commercial sector lighting solutions. Halco ProLED luminaires and T8 Linear lamps are on the DLC Qualified Product List.



LED Lighting Facts®

Halco is a participating partner of the U.S. Department of Energy (DOE) LED Lighting Facts® program, which assures that the performance of LED lighting products is accurately represented. The program helps manage the adoption of the new technology by mandating the use of a label that verifies the product has been tested according to industry standard procedures and that those results are accurately presented. The DOE LED Lighting Facts® label identifies light output, wattage, efficacy, correlated color temperature (CCT) and color rendering index (CRI).



Halco also complies with Federal Trade Commission (FTC) Lighting Facts labeling regulations of medium base screw lamps. Similar to the DOE program, the FTC program establishes consistency among manufacturers so that consumers can easily identify LED product specifications. The FTC label requires lumen output, estimated annual energy cost, life expectancy, color temperature, wattage and mercury content, if applicable.

Lighting Facts/Datos de Iluminación	
Per Bulb/Per Bombilla	
Brightness/Brillo	830 lumens/lúmenes
Estimated Yearly Energy Cost/ Costo Estimado Anual de Energía	\$1.20
Based on 3 hrs/day, 11¢/kWh. Cost depends on rates and use. / Basado en 3 hrs/día, 11¢/kWh. Costo depende de la tarifa y el uso.	
Life/Duración	22.8 years/años
Based on 3 hrs/day / Basado en 3 hrs/día	
Light Appearance/Apariencia de Iluminación	Warm/Cálida Cool/Fría
3000K	
Energy Used/Usó de Energía	10 watts/watios



Halco's ProLED lamps feature an unrivaled combination of efficiency, long life and light quality, providing the best overall performance in LED technology.

ProLED Advantage

ProLED products utilize the highest quality components, including LEDs, precision manufactured optics, optimally engineered drivers and special heat sinks for superior thermal management.



Optics designed for precise beam control providing smooth illumination virtually identical to traditional sources



Achieve consistent lamp-to-lamp color through rigorous adherence to design and manufacturing specifications



Utilize a phosphor that creates a rich R-9 value to enhance reds and skin tones and produce high CRI values

Dimmable down to 5% of rated light output for flicker-free, reliable performance*

Optimal thermal management through the use of an engineered heat sink housing and quality componentry

*Visit www.halcolighting.com/ProLEDdim for a comprehensive Dimmer Compatibility List.

Why Choose ProLED

Using LED retrofit or replacement lamps reduces total cost of ownership of the lighting system without sacrificing performance. ProLED lamps have a longer rated life than traditional sources while consuming less energy. ProLED lamps also produce the same quality of illumination as traditional light sources making them a popular choice for an easy lighting upgrade.

ProLED Payback

Advances in technology have allowed LED lamps to provide equivalent light output while consuming a fraction of the energy. To calculate energy savings of a lighting upgrade compare the wattage, the measure of energy consumed in order to power the lamp. The lower the wattage the greater the energy savings. For example, a 8.5W ProLED BR30 lamp will provide light output equivalent to a 65W Halogen reflector lamp and save as much as 86% in energy.

Operating Details		
	Electricity Cost	\$0.11 kWh
	Annual Operating Hours	3650
Energy Analysis	Existing	Retrofit
Wattage Per Lamp	65W	8.5W
Annual Energy Costs	\$26	\$3.41
Annual Energy Savings		86%

Think Lumens

When evaluating energy efficient lamp options refer to the lamp's light output, which is measured in lumens. Lamps with relatively equivalent lumens and center beam candle power (CBCP) will provide similar illumination in the application. ProLED lamps are extremely efficient light sources. Efficacy is measured in lumens per watt (LPW). ProLED lamps feature high LPW versus Halogen and Incandescent lamps.

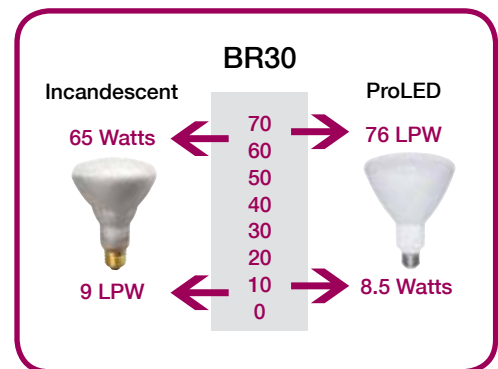

Maintenance Free Operation

The life of a lamp impacts maintenance and relamping costs. The longer the life the fewer times the lamps need to be replaced, the fewer lamps that need to be purchased and the less time spent replacing lamps. Over the 40,000 hour useful life of (1) ProLED BR30 lamp, an Incandescent lamp (3,000 hr life) would need to be replaced 14 times!





How to Read Ordering Information

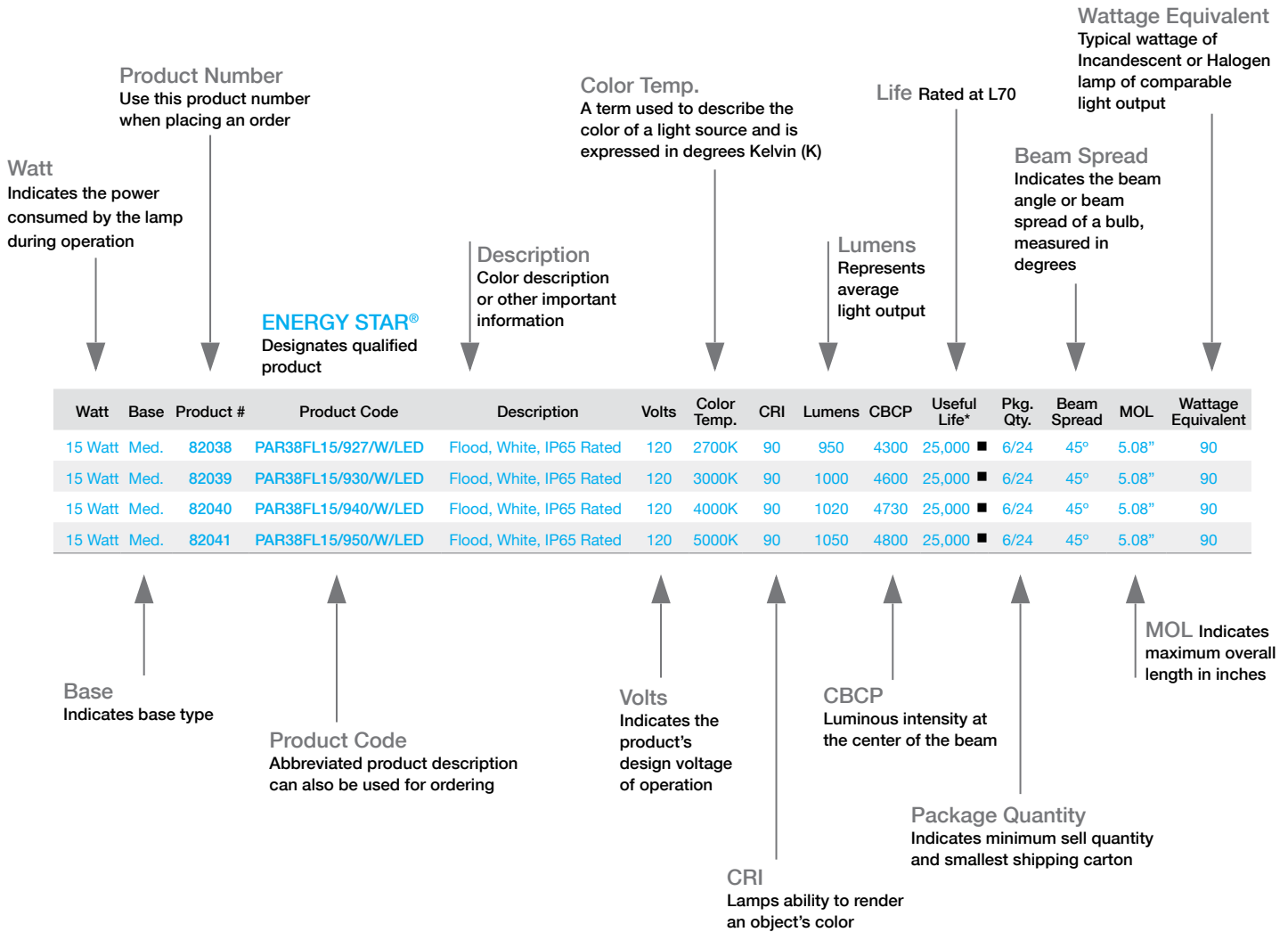



ProLED PL Direct Series

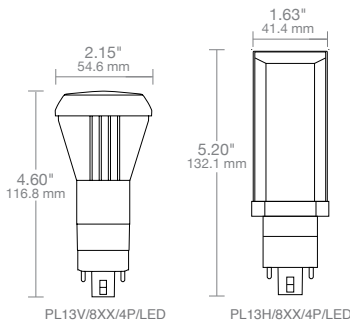

Specifications

- Dedicated horizontal and vertical orientation versions (horizontal features rotatable socket alignment)
- Lasts 5 times longer than CFL
- Electronic CFL ballast compatible
- 50,000 hour life resulting in lower maintenance costs over time
- Horizontal lamp base rotates for proper orientation in luminaire
- Works with existing 26W, 32W and 42W electronic CFL ballasts
- Mercury-free for safer operation and disposal
- RoHS Compliant
- Fits G24q and GX24q Sockets (26, 32, and 42W CFL)
- Instant-On
- Dimmable when used with a compatible dimming ballast (0-10V)
- -20C (-4F) to 45C (113F) operating temperatures
- UL classified 1598C Retrofit Kit

Markets & Applications

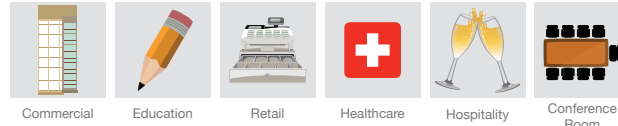

Ordering Information



Watt	Base	Product #	Product Code	Color Temp.	CRI	Lumens	Useful Life*	Pkg. Qty.	MOL	Wattage Equivalent
VERTICAL										
13 Watt	G24q/GX24q	81110	PL13V/827/4P/LED	2700K	82	1000	50,000	1/10	4.60"	26
13 Watt	G24q/GX24q	81111	PL13V/830/4P/LED	3000K	82	1000	50,000	1/10	4.60"	26
13 Watt	G24q/GX24q	81112	PL13V/835/4P/LED	3500K	82	1000	50,000	1/10	4.60"	26
13 Watt	G24q/GX24q	81113	PL13V/841/4P/LED	4100K	82	1000	50,000	1/10	4.60"	26
13 Watt	G24q/GX24q	81114	PL13V/850/4P/LED	5000K	82	1000	50,000	1/10	4.60"	26
HORIZONTAL										
13 Watt	G24q/GX24q	81115	PL13H/827/4P/LED	2700K	82	1000	50,000	1/10	5.20"	26
13 Watt	G24q/GX24q	81116	PL13H/830/4P/LED	3000K	82	1000	50,000	1/10	5.20"	26
13 Watt	G24q/GX24q	81117	PL13H/835/4P/LED	3500K	82	1000	50,000	1/10	5.20"	26
13 Watt	G24q/GX24q	81118	PL13H/841/4P/LED	4100K	82	1000	50,000	1/10	5.20"	26
13 Watt	G24q/GX24q	81119	PL13H/850/4P/LED	5000K	82	1000	50,000	1/10	5.20"	26

* Useful Life is defined as the point in time at which the LED will maintain at least 70% of its initial lumens. The LED will continue to operate past this point at decreased light levels. May not be compatible with all dimming systems, dimming performance may vary by system, please visit www.halcolighting.com/ProLEDdim for dimmer compatibility information.

Savings Comparison

Total Lifetime Costs

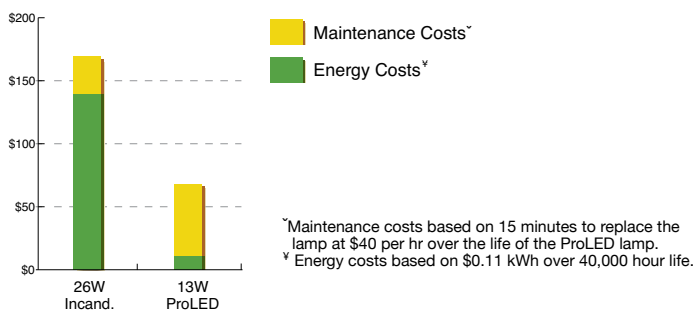

ProLED PL Bypass Series

Specifications

- Dedicated horizontal and vertical orientation versions (horizontal features rotatable socket alignment)
- Lasts 5 times longer than CFL
- Replaces 26W CFL
- 50,000 hour life resulting in lower maintenance costs over time
- Mercury-free for safer operation and disposal
- RoHS Compliant
- Fits G24q, GX24q Sockets (4 pin and 2 pin sockets), G24d, and GA24d
- Instant-On
- Non-Dimmable
- UL Classified 1598C Retrofit Kit
- Rated for ICAT fixtures
- 5-Year Limited Warranty

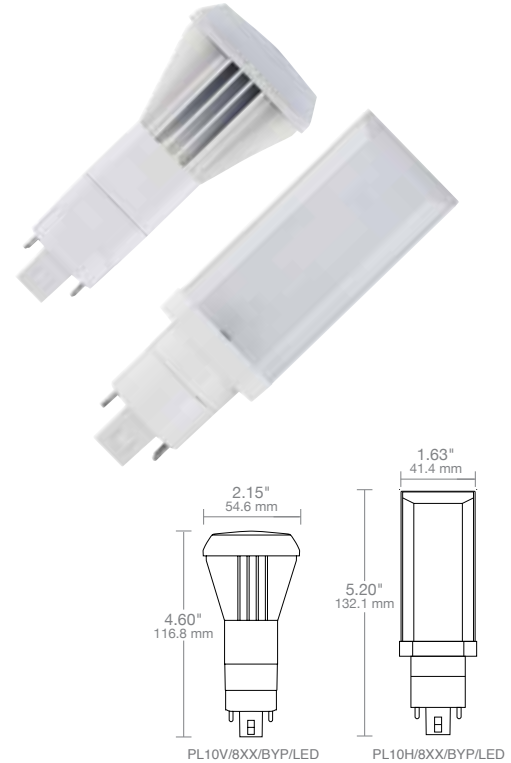

Markets & Applications

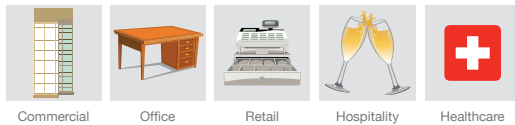

Ordering Information



Watt	Base	Product #	Product Code	Color Temp.	CRI	Lumens	Useful Life*	Pkg. Qty.	MOL	Wattage Equivalent
VERTICAL										
10 Watt	G24q/GX24q/G24d/GX24d	81141	PL10V/835/BYP/LED	3500K	82	1000	50,000	50	4.60"	26
10 Watt	G24q/GX24q/G24d/GX24d	81142	PL10V/841/BYP/LED	4100K	82	1000	50,000	50	4.60"	26
10 Watt	G24q/GX24q/G24d/GX24d	81143	PL10V/850/BYP/LED	5000K	82	1000	50,000	50	4.60"	26
HORIZONTAL										
10 Watt	G24q/GX24q/G24d/GX24d	81144	PL10H/835/BYP/LED	3500K	82	1000	50,000	50	5.20"	26
10 Watt	G24q/GX24q/G24d/GX24d	81145	PL10H/841/BYP/LED	4100K	82	1000	50,000	50	5.20"	26
10 Watt	G24q/GX24q/G24d/GX24d	81146	PL10H/850/BYP/LED	5000K	82	1000	50,000	50	5.20"	26

* Useful Life is defined as the point in time at which the LED will maintain at least 70% of its initial lumens. The LED will continue to operate past this point at decreased light levels. May not be compatible with all dimming systems, dimming performance may vary by system, please visit www.halcolighting.com/ProLEDdim for dimmer compatibility information.

Savings Comparison

Total Lifetime Costs

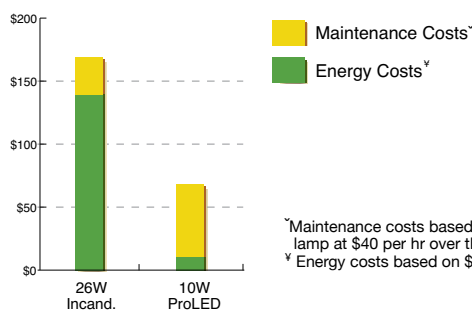

* Maintenance costs based on 15 minutes to replace the lamp at \$40 per hr over the life of the ProLED lamp.
 y Energy costs based on \$0.11 kWh over 40,000 hour life.

ProLED PL Hybrid Series

NEW!

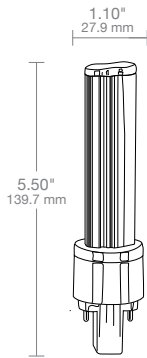

Specifications

- Works with or without magnetic ballasts (line voltage to the socket)
- Dedicated horizontal and vertical orientation versions (horizontal features rotatable socket alignment)
- Lasts 5 times longer than CFL
- 50,000 hour life resulting in lower maintenance costs over time
- Horizontal lamp base rotates for proper orientation in luminaire
- Mercury-free for safer operation and disposal
- RoHS Compliant
- Fits GX23 Sockets
- Instant-On
- -20C (-4F) to 45C (113F) operating temperatures
- Replaces 13W CFL
- ETL Listed

Markets & Applications

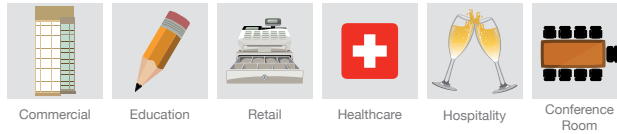

Ordering Information



Watt	Base	Product #	Product Code	Color Temp.	CRI	Lumens	Useful Life*	Pkg. Qty.	MOL	Wattage Equivalent
6 Watt	GX23	81159	PL6H/827/HYB/LED	2700K	82	520	50,000	1/10	5.50"	13
6 Watt	GX23	81160	PL6H/830/HYB/LED	3000K	82	520	50,000	1/10	5.50"	13
6 Watt	GX23	81161	PL6H/835/HYB/LED	3500K	82	520	50,000	1/10	5.50"	13
6 Watt	GX23	81162	PL6H/840/HYB/LED	4000K	82	520	50,000	1/10	5.50"	13
6 Watt	GX23	81163	PL6H/850/HYB/LED	5000K	82	520	50,000	1/10	5.50"	13

* Useful Life is defined as the point in time at which the LED will maintain at least 70% of its initial lumens. The LED will continue to operate past this point at decreased light levels. May not be compatible with all dimming systems, dimming performance may vary by system, please visit www.halcolighting.com/ProLEDDim for dimmer compatibility information.

Savings Comparison

Total Lifetime Costs

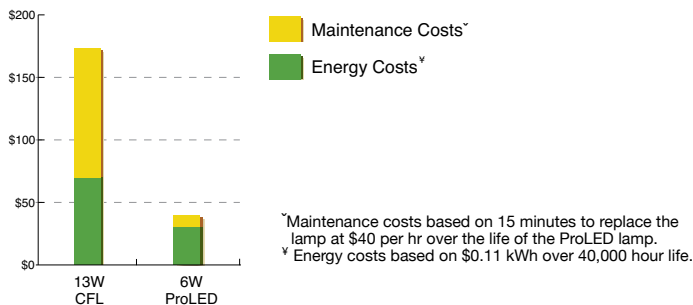



ProLED Linear Direct T8 Series



DIRECT
BALLAST
COMPATIBLE

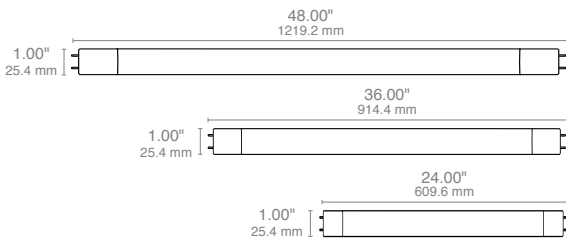

Specifications

- 2 Foot, 3 Foot, 4 Foot options
- No rewiring of existing luminaire necessary
- Operates on instant start and programmed start ballasts
- Up to 156 Lumens Per Watt versus T8 Fluorescent's 90 LPW
- -4°F(-20°C) to 122°F(50°C) operating temperature range
- Instant-on, no flicker
- Frosted glass design
- UL Listed
- 50,000 hour rated life, up-to 2 times the life of standard Fluorescent
- Available in 3500K, 4000K and 5000K CCT
- Conforms to requirements of NSF/ANSI standard 2-food equipment
- Acceptable for use in damp locations and enclosed luminaires
- 82 CRI
- Mercury-free for safer operation
- RoHS Compliant
- 5-Year Limited Warranty

Markets & Applications

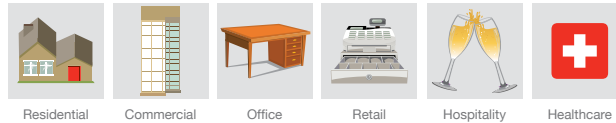

Ordering Information



Lamp Wattage	System Wattage [§]	Base	Product #	Product Code	Color Temp.	CRI	Lumens	Useful Life*	Pkg. Qty.	Beam Spread	MOL	THD	DLC [®] Qualified	Wattage Equivalent
8 Watt	10 Watt	G13	84068	T824FR8/835/DIR2/LED	3500K	82	1250	50,000	1/25	270°	24"	<20%	Yes	17
8 Watt	10 Watt	G13	84069	T824FR8/840/DIR2/LED	4000K	82	1250	50,000	1/25	270°	24"	<20%	Yes	17
8 Watt	10 Watt	G13	84070	T824FR8/850/DIR2/LED	5000K	82	1250	50,000	1/25	270°	24"	<20%	Yes	17
11 Watt	13 Watt	G13	83071	T836FR11/835/DIR/LED	3500K	82	1400	50,000	1/25	270°	36"	<20%	No	25
11 Watt	13 Watt	G13	83072	T836FR11/840/DIR/LED	4000K	82	1450	50,000	1/25	270°	36"	<20%	No	25
11 Watt	13 Watt	G13	83073	T836FR11/850/DIR/LED	5000K	82	1450	50,000	1/25	270°	36"	<20%	No	25
11.5 Watt	14.5 Watt	G13	81880	T8FR11/835/DIR2/LED	3500K	82	1800	50,000	1/25	270°	48"	<20%	Yes	32
11.5 Watt	14.5 Watt	G13	81881	T8FR11/840/DIR2/LED	4000K	82	1800	50,000	1/25	270°	48"	<20%	Yes	32
11.5 Watt	14.5 Watt	G13	81882	T8FR11/850/DIR2/LED	5000K	82	1800	50,000	1/25	270°	48"	<20%	Yes	32

* Useful Life is defined as the point in time at which the lamp will maintain at least 70% of its initial lumens. The lamp will continue to burn past this point but at decreased light levels. Must be operated with an ambient luminaire temperature between -4°F(-20°C) and 122°F(50°C).

§ Specifications are based on use with normal ballast factor ballasts (0.88).

Please check the DLC qualified products List <https://www.designlights.org/qpl> for all qualified Halco products.

Savings Comparison

Total Lifetime Costs

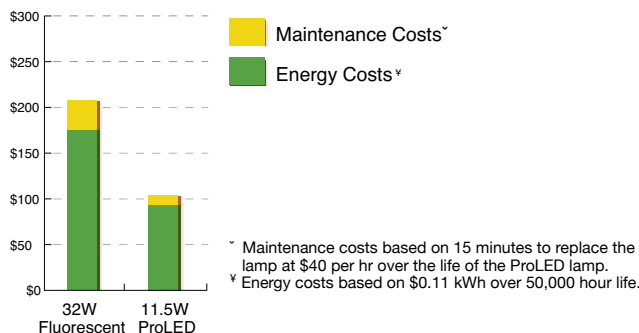

ProLED Linear Bypass T8 Series

Specifications

- 48" T8 LED Tube with bi-pin base
- Single-end powered, operates on 120V - 277V line voltage range
- Reliable and efficient way to retrofit existing Linear Fluorescent luminaires with simple rewiring
- No external ballast or driver required
- Up-to 120 lumens per watt
- -4°F(-20°C) to 122°F(50°C) operating temperature range
- Instant-on, no flicker
- Frosted glass design
- UL Classified 1598C Retrofit Kit
- 50,000 hour rated life, up-to 2 times the life of standard Fluorescent
- Available in 3500K, 4000K and 5000K CCT
- Acceptable for use in damp locations and enclosed luminaires
- Conforms to requirements of NSF/ANSI standard 2-food equipment
- 82 CRI
- Mercury-free for safer operation
- RoHS Compliant
- 5-Year Limited Warranty



Markets & Applications

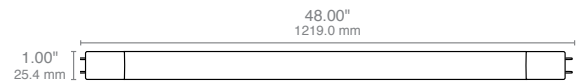

Ordering Information



Watt	Base	Product #	Product Code	Volts	Color Temp.	CRI	Lumens	Useful Life*	Pkg. Qty.	Beam Spread	MOL	THD	DLC® Qualified	Wattage Equivalent
15 Watt	G13	81883	T8FR15/835/BYP2/LED	120-277	3500K	82	1800	50,000	1/25	270°	48"	<20%	Yes	32
15 Watt	G13	81884	T8FR15/840/BYP2/LED	120-277	4000K	82	1800	50,000	1/25	270°	48"	<20%	Yes	32
15 Watt	G13	81885	T8FR15/850/BYP2/LED	120-277	5000K	82	1800	50,000	1/25	270°	48"	<20%	Yes	32

* Useful Life is defined as the point in time at which the lamp will maintain at least 70% of its initial lumens. The lamp will continue to burn past this point at decreased light levels. Must be operated with an ambient luminaire temperature between -4°F(-20°C) and 122°F(50°C). Please check the DLC qualified products List <https://www.designlights.org/qpl> for all qualified Halco products.

Warning

Halco ProLED® Linear Bypass T8 will not operate on a linear fluorescent ballast or with shunted lampholders. Please re-wire the luminaire as shown in the installation instructions included with the product and ensure non-shunted lampholders are installed in the luminaire before installing this product.

Savings Comparison

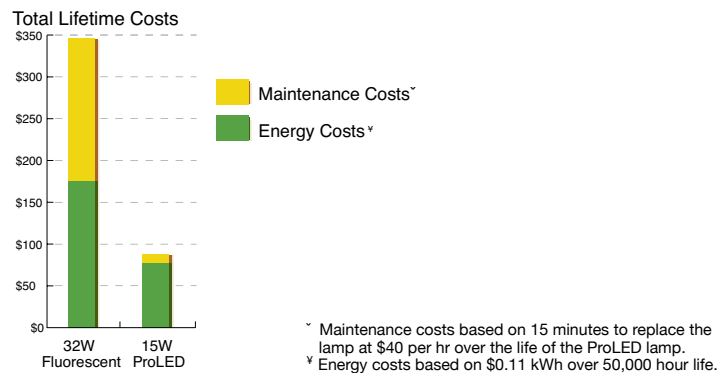



ProLED Ubend Direct Series

Specifications

- 6" and 1-5/8" options
- No re-wiring necessary
- Dimmable when used on dimming ballasts
- Instant on - no flicker
- Operates on instant start, programmed start and dimming ballasts
- 50,000 hour life resulting in lower maintenance costs over time
- Suitable for use in totally enclosed luminaires
- UL listed for damp locations
- 5-Year Limited Warranty



DIRECT
BALLAST
COMPATIBLE

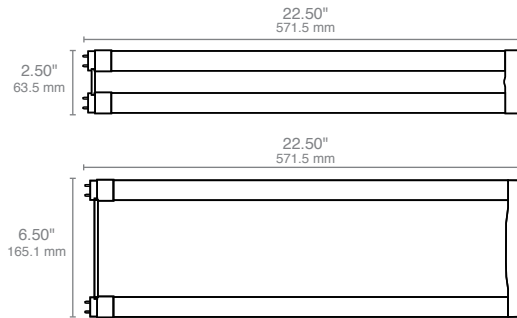

Markets & Applications

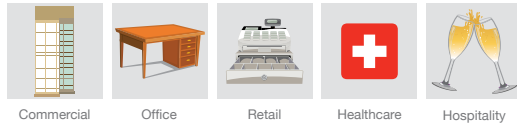

Ordering Information



Lamp Wattage	System Wattage [§]	Base	Product #	Product Code	Color Temp.	CRI	Lumens	Useful Life*	Pkg. Qty.	Beam Spread	MOD	MOL	THD	Wattage Equivalent
12 Watt	14 Watt	G13	83074	T8U6FR12/835/DIR/LED	3500K	82	1700	50,000	1/12	270°	6.5"	22.5"	<20%	32
12 Watt	14 Watt	G13	83075	T8U6FR12/840/DIR/LED	4000K	82	1800	50,000	1/12	270°	6.5"	22.5"	<20%	32
12 Watt	14 Watt	G13	83076	T8U6FR12/850/DIR/LED	5000K	82	1800	50,000	1/12	270°	6.5"	22.5"	<20%	32
12 Watt	14 Watt	G13	83077	T8U2FR12/835/DIR/LED	3500K	82	1700	50,000	1/12	270°	2.5"	22.5"	<20%	31
12 Watt	14 Watt	G13	83078	T8U2FR12/840/DIR/LED	4000K	82	1800	50,000	1/12	270°	2.5"	22.5"	<20%	31
12 Watt	14 Watt	G13	83079	T8U2FR12/850/DIR/LED	5000K	82	1800	50,000	1/12	270°	2.5"	22.5"	<20%	31

* Useful Life is defined as the point in time at which the lamp will maintain at least 70% of its initial lumens. The lamp will continue to burn past this point at decreased light levels. Must be operated with an ambient luminaire temperature between 32°F(0°C) and 113°F(45°C).

§ Specifications are based on use with normal ballast factor ballasts (0.88). For LBF and HBF ballast performance, see the ProLED® Linear Direct T8 Specifications Sheet.

ProLED T5 Direct Replacement Series



DIRECT
BALLAST
COMPATIBLE

Specifications

- Compatible with most program start electronic T5HO ballasts
- No re-wiring necessary
- Instant on - no flicker
- UL Listed for damp locations
- 50,000 hour life resulting in lower maintenance costs over time
- No Mercury
- Replaces F54T5/HO
- RoHS Compliant
- Suitable for use in totally enclosed luminaires
- 5-Year Limited Warranty

Markets & Applications

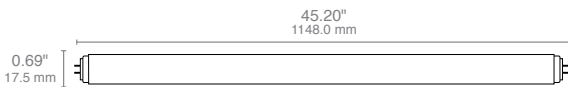
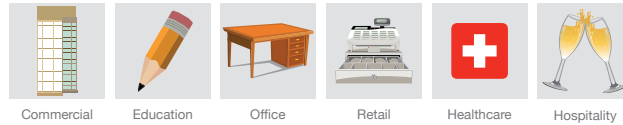

Ordering Information



Lamp Wattage	System Wattage [§]	Base	Product #	Product Code	Color Temp.	CRI	Lumens	Useful Life*	Pkg. Qty.	Beam Spread	MOL	DLC [®] Qualified	Wattage Equivalent
25 Watt	28 Watt	Mini bi-pin	84080	T5FR25/840/DIR2/HO/LED	4000K	82	3500	50,000	1/25	270°	45.2"	Yes	54
25 Watt	28 Watt	Mini bi-pin	84081	T5FR25/850/DIR2/HO/LED	5000K	82	3500	50,000	1/25	270°	45.2"	Yes	54

* Useful Life is defined as the point in time at which the lamp will maintain at least 70% of its initial lumens. The lamp will continue to burn past this point but at decreased light levels. Must be operated with an ambient luminaire temperature between 32°F(0°C) and 113°F(45°C).

§ Specifications are based on use with normal ballast factor ballasts (0.88). For LBF and HBF ballast performance, see the ProLED® Linear Direct T5 Specifications Sheet. Please check the DLC qualified products List <https://www.designlights.org/qpl> for all qualified Halco products.

Savings Comparison

Total Lifetime Costs

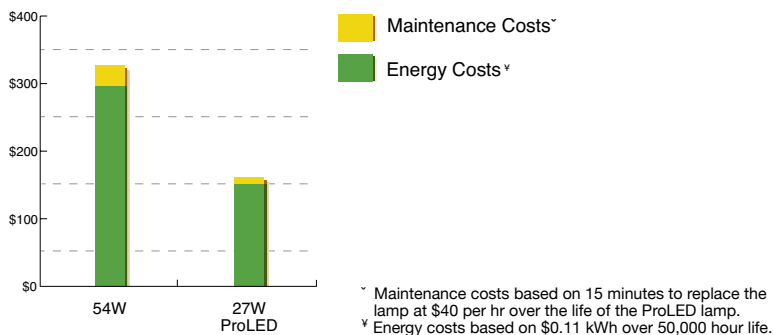



ProLED HID Retrofit Series

NEW!



Specifications

- Acceptable for enclosed luminaires
- Replacement for HID or Incandescent post top applications
- -4°F (-20°C) to 140°F (60°C) operating temperature range
- 120-277V input range (ballast must be bypassed)
- 50,000 hour life
- Available in 4000K and 5000K CCT
- 82 CRI for quality and consistent color rendering
- UL Listed for damp locations
- RoHS Compliant
- 5-Year Limited Warranty
- UL Classified 1598C Retrofit Kit
- Integral 4kV Surge Protection

Markets & Applications



Ordering Information

Watt	Base	Product #	Product Code	Description	Volts	Color Temp.	CRI	Lumens	Useful Life*	Pkg. Qty.	MOL	Wattage Equivalent	DLC® Qualified
15 Watt	E26	84002	HID15/840/MV2/LED	Omnidirectional	120-277	4000K	82	1875	50,000	1/16	5.74"	70	-
15 Watt	E26	84003	HID15/850/MV2/LED	Omnidirectional	120-277	5000K	82	1950	50,000	1/16	5.74"	70	-
27 Watt	E26	84020	HID27/840/MV2/LED	Omnidirectional	120-277	4000K	82	3645	50,000	1/16	7.95"	100	-
27 Watt	E26	84022	HID27/850/MV2/LED	Omnidirectional	120-277	5000K	82	3645	50,000	1/16	7.95"	100	-
27 Watt	EX39	84021	HID27/840/MV2/EX39/LED	Omnidirectional	120-277	4000K	82	3645	50,000	1/16	8.58"	100	Yes
27 Watt	EX39	84023	HID27/850/MV2/EX39/LED	Omnidirectional	120-277	5000K	82	3645	50,000	1/16	8.58"	100	Yes
36 Watt	E26	84004	HID36/840/MV2/LED	Omnidirectional	120-277	4000K	82	4680	50,000	1/16	8.98"	150	-
36 Watt	E26	84005	HID36/850/MV2/LED	Omnidirectional	120-277	5000K	82	4860	50,000	1/16	8.98"	150	-
36 Watt	EX39	84006	HID36/840/MV2/EX39/LED	Omnidirectional	120-277	4000K	82	4680	50,000	1/16	9.6"	150	Yes
36 Watt	EX39	84007	HID36/850/MV2/EX39/LED	Omnidirectional	120-277	5000K	82	4860	50,000	1/16	9.6"	150	Yes
45 Watt	E26	84008	HID45/840/MV2/LED	Omnidirectional	120-277	4000K	82	5850	50,000	1/16	10.2"	175	-
45 Watt	E26	84009	HID45/850/MV2/LED	Omnidirectional	120-277	5000K	82	6075	50,000	1/16	10.2"	175	-
45 Watt	EX39	84010	HID45/840/MV2/EX39/LED	Omnidirectional	120-277	4000K	82	5850	50,000	1/16	10.79"	175	Yes
45 Watt	EX39	84011	HID45/850/MV2/EX39/LED	Omnidirectional	120-277	5000K	82	6075	50,000	1/16	10.79"	175	Yes
54 Watt	E26	84012	HID54/840/MV2/LED	Omnidirectional	120-277	4000K	82	7020	50,000	1/16	10.2"	250	-
54 Watt	E26	84013	HID54/850/MV2/LED	Omnidirectional	120-277	5000K	82	7290	50,000	1/16	10.2"	250	-
54 Watt	EX39	84014	HID54/840/MV2/EX39/LED	Omnidirectional	120-277	4000K	82	7020	50,000	1/16	10.79"	250	Yes
54 Watt	EX39	84015	HID54/850/MV2/EX39/LED	Omnidirectional	120-277	5000K	82	7290	50,000	1/16	10.79"	250	Yes

* Useful Life is defined as the point in time at which the lamp will maintain at least 70% of its initial lumens. The lamp will continue to operate past this point at decreased light levels. May not be compatible with all dimming systems, dimming performance may vary by system, please visit www.halcolighting.com/ProLEDdim for dimmer compatibility information. Use on incompatible systems may shorten lamp life.

Please check the DLC qualified products List <https://www.designlights.org/qpl> for all qualified Halco products.

Savings Comparison

Total Lifetime Costs

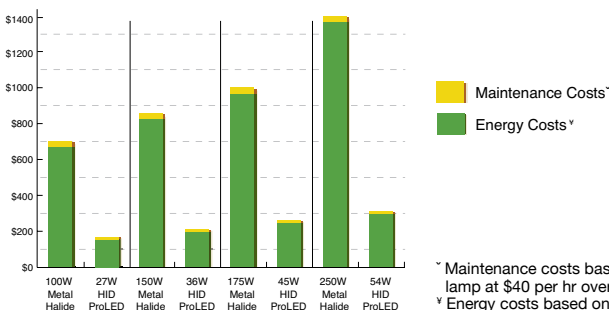

† Maintenance costs based on 15 minutes to replace the lamp at \$40 per hr over the life of the ProLED lamp.
* Energy costs based on \$0.11 kWh over 40,000 hour life.

ProLED HID High Bay Retrofit Series

NEW!

Specifications

- Requires simple re-wiring to bypass ballast and maximize efficiency
- 50,000 hour useful life minimizes maintenance costs over time
- Unique directional design replaces 400W metal halide lamps while delivering maximum energy savings
- UL listed for damp locations
- UL classified 1598C Retrofit Kit for high bay luminaires (allows the system to maintain UL compliance)
- EX39 base can be used in either EX39 or E39 sockets
- Integral 4kV surge protection
- 120-277V input voltage range
- RoHS Compliant
- 5-Year Limited Warranty

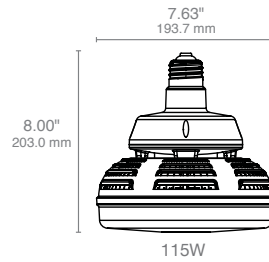

Markets & Applications

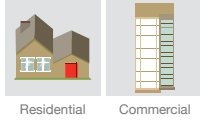

Ordering Information



Watt [§]	Base	Product #	Product Code	Volts	Color Temp.	CRI	Lumens	Useful Life*	Pkg. Qty.	MOL	Wattage Equivalent	DLC® Qualified
115 Watt	EX39	84100	HID115/840/MV2/EX39/LED	120-277	4000K	70	14375	50,000	1/8	8.00"	400	Yes
115 Watt	EX39	84101	HID115/850/MV2/EX39/LED	120-277	5000K	70	14950	50,000	1/8	8.00"	400	Yes

* Useful Life is defined as the point in time at which the lamp will maintain at least 70% of its initial lumens. The lamp will continue to operate past this point at decreased light levels. May not be compatible with all dimming systems, dimming performance may vary by system, please visit www.halcolighting.com/ProLEDdim for dimmer compatibility information. Use on incompatible systems may shorten lamp life. Please check the DLC qualified products List <https://www.designlights.org/qpl> for all qualified Halco products.
[§] Specifications are based on use with normal ballast factor ballasts (0.88).

Savings Comparison

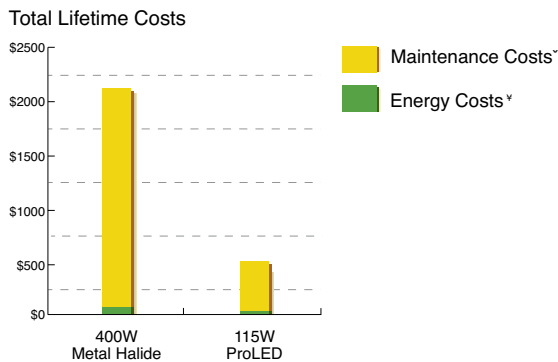

* Maintenance costs based on 15 minutes to replace the lamp at \$40 per hr over the life of the ProLED lamp.
[†] Energy costs based on \$0.11 kWh over 40,000 hour life.

Photometrics

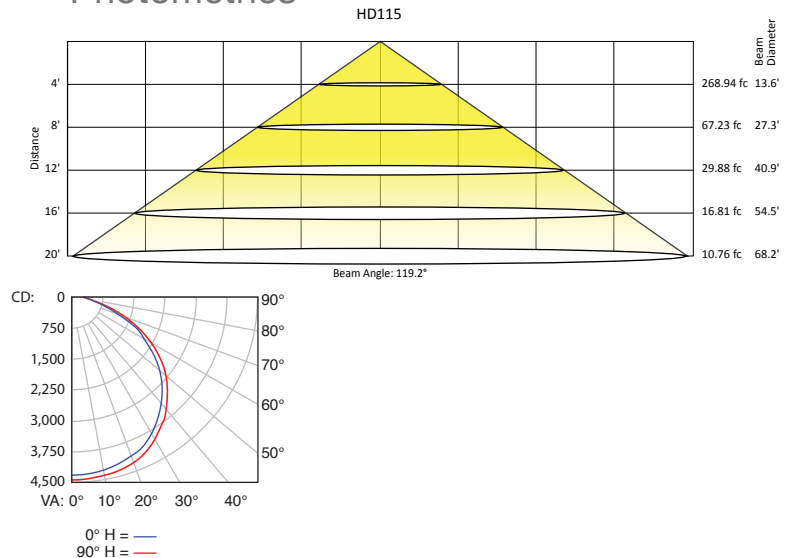

ProLED Universal Voltage PAR38

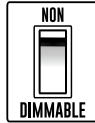

Specifications

- 120-277V range
- UL Listed for wet locations
- Available in 4000K and 5000K CCT
- 90 CRI for quality and consistent color rendering
- No Mercury or UV/IR emissions
- Non-dimmable
- RoHS Compliant
- 7-Year Limited Warranty

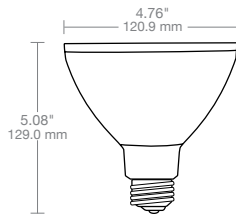

Markets & Applications

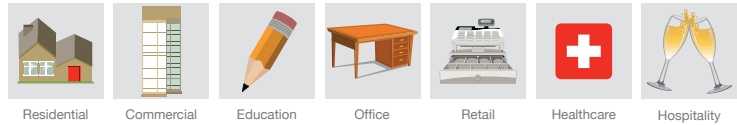

Ordering Information



Watt	Base	Product #	Product Code	Description	Volts	Color Temp.	CRI	Lumens	CBCP	Useful Life*	Pkg. Qty.	Beam Spread	MOL	Wattage Equivalent
PAR38														
17 Watt	Med.	82061	PAR38FL17/940/W/MV/LED	Flood, White ✕	120-277	4000K	90	1200	2590	40,000	6/24	40°	5.08"	120
17 Watt	Med.	82062	PAR38FL17/950/W/MV/LED	Flood, White ✕	120-277	5000K	90	1200	2630	40,000	6/24	40°	5.08"	120

* Useful Life is defined as the point in time at which the lamp will maintain at least 70% of its initial lumens. The lamp will continue to burn past this point at decreased light levels. Acceptable for use in sealed metal landscape luminaires when protected from the elements.
 ✕ Non-dimmable
 Represents lamps that are ENERGY STAR® certified.

Savings Comparison

Total Lifetime Costs

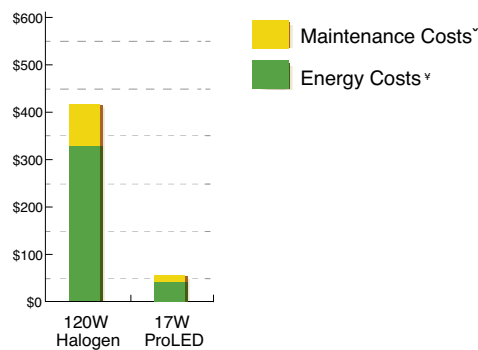

~ Maintenance costs based on 15 minutes to replace the lamp at \$40 per hr over the life of the ProLED lamp.
 ¥ Energy costs based on \$0.11 kWh over 40,000 hour life.



ProLED Prime Select PAR38

Specifications

- Acceptable for use in ICAT rated luminaires
- Available in white and black finishes
- UL Listed for wet locations
- Dimmable to 5% for design flexibility
- Available in 2700K, 3000K, 4000K and 5000K CCT
- 90 CRI provides superior quality and color accuracy
- No Mercury or UV/IR emissions
- RoHS Compliant
- 7-Year Limited Warranty

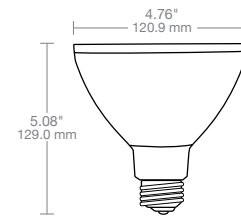

Markets & Applications



Ordering Information



Watt	Base	Product #	Product Code	Description	Volts	Color Temp.	CRI	Lumens	CBCP	Useful Life*	Pkg. Qty.	Beam Spread	MOL	Wattage Equivalent
PAR38														
15 Watt	Med.	82038	PAR38FL15/927/W/LED	Flood, White	120	2700K	90	950	2250	40,000	6/24	40°	5.08"	90
15 Watt	Med.	82039	PAR38FL15/930/W/LED	Flood, White	120	3000K	90	1000	2300	40,000	6/24	40°	5.08"	90
15 Watt	Med.	82040	PAR38FL15/940/W/LED	Flood, White	120	4000K	90	1020	2340	40,000	6/24	40°	5.08"	90
15 Watt	Med.	82041	PAR38FL15/950/W/LED	Flood, White	120	5000K	90	1050	2380	40,000	6/24	40°	5.08"	90
15 Watt	Med.	82042	PAR38NFL15/927/W/LED	Narrow Flood, White	120	2700K	90	950	4560	40,000	6/24	25°	5.08"	90
15 Watt	Med.	82043	PAR38NFL15/930/W/LED	Narrow Flood, White	120	3000K	90	1000	4620	40,000	6/24	25°	5.08"	90
17 Watt	Med.	82046	PAR38FL17/927/W/LED	Flood, White	120	2700K	90	1150	2500	40,000	6/24	40°	5.08"	120
17 Watt	Med.	82047	PAR38FL17/927/B/LED	Flood, Black	120	2700K	90	1150	2500	40,000	6/24	40°	5.08"	120
17 Watt	Med.	82048	PAR38FL17/930/W/LED	Flood, White	120	3000K	90	1200	2550	40,000	6/24	40°	5.08"	120
17 Watt	Med.	82049	PAR38FL17/930/B/LED	Flood, Black	120	3000K	90	1200	2550	40,000	6/24	40°	5.08"	120
17 Watt	Med.	82050	PAR38FL17/940/W/LED	Flood, White	120	4000K	90	1220	2590	40,000	6/24	40°	5.08"	120
17 Watt	Med.	82051	PAR38FL17/940/B/LED	Flood, Black	120	4000K	90	1220	2590	40,000	6/24	40°	5.08"	120
17 Watt	Med.	82052	PAR38FL17/950/W/LED	Flood, White	120	5000K	90	1250	2630	40,000	6/24	40°	5.08"	120
17 Watt	Med.	82053	PAR38NFL17/927/W/LED	Narrow Flood, White	120	2700K	90	1150	5900	40,000	6/24	25°	5.08"	120
17 Watt	Med.	82054	PAR38NFL17/927/B/LED	Narrow Flood, Black	120	2700K	90	1150	5900	40,000	6/24	25°	5.08"	120
17 Watt	Med.	82055	PAR38NFL17/930/W/LED	Narrow Flood, White	120	3000K	90	1200	5960	40,000	6/24	25°	5.08"	120
17 Watt	Med.	82056	PAR38NFL17/930/B/LED	Narrow Flood, Black	120	3000K	90	1200	5960	40,000	6/24	25°	5.08"	120
17 Watt	Med.	82057	PAR38NFL17/940/W/LED	Narrow Flood, White	120	4000K	90	1220	6010	40,000	6/24	25°	5.08"	120
17 Watt	Med.	82059	PAR38NFL17/950/W/LED	Narrow Flood, White	120	5000K	90	1250	6050	40,000	6/24	25°	5.08"	120

* Useful Life is defined as the point in time at which the lamp will maintain at least 70% of its initial lumens. The lamp will continue to burn past this point at decreased light levels. May not be compatible with all dimming systems, dimming performance may vary by system, please visit www.halcolighting.com/ProLEDdim for dimmer compatibility information. Use on incompatible systems may shorten lamp life. Acceptable for use in sealed metal landscape luminaires when protected from the elements. Represents lamps that are ENERGY STAR® certified.

ProLED Prime Select PAR38



Savings Comparison

Total Lifetime Costs

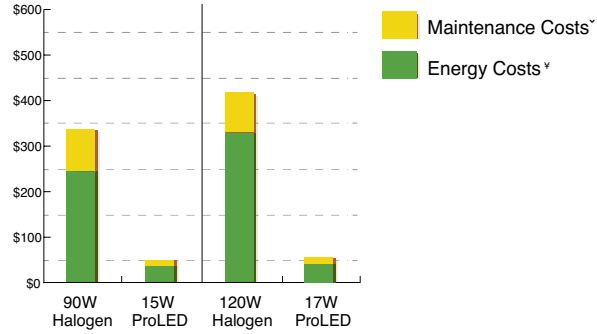

x Maintenance costs based on 15 minutes to replace the lamp at \$40 per hr over the life of the ProLED lamp.
 y Energy costs based on \$0.11 kWh over 40,000 hour life.

Photometrics

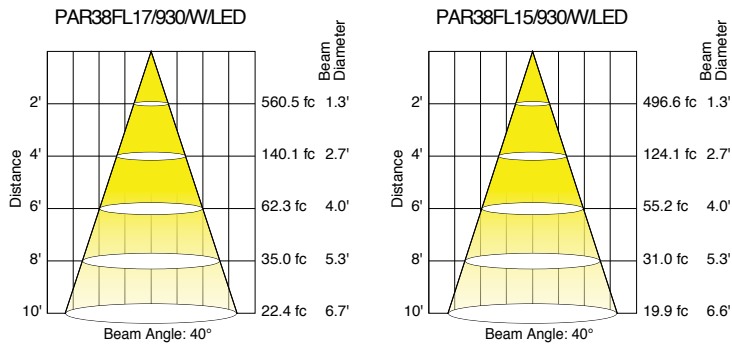



ProLED Prime Select PAR30

Specifications

- PAR30S and PAR30L with smooth sided, lightweight construction
- Acceptable for use in ICAT rated luminaires
- Available in white and black finishes
- UL Listed for wet locations
- Dimmable to 5% for design flexibility
- Available in 2700K, 3000K, 4000K and 5000K
- 90 CRI provides superior quality and color accuracy
- Narrow Flood and Flood beam angles available
- No Mercury or UV/IR emissions
- RoHS Compliant
- 7-Year Limited Warranty

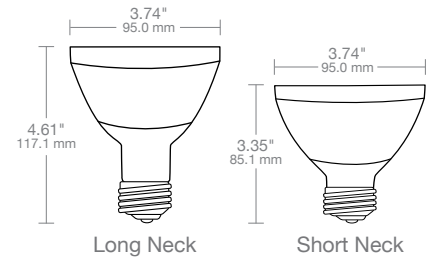

Markets & Applications

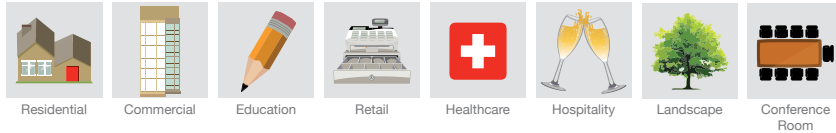

Ordering Information



Watt	Base Product #	Product Code	Description	Volts	Color Temp.	CRI	Lumens	CBCP	Useful Life*	Pkg. Qty.	Beam Spread	MOL	Wattage Equivalent	
PAR30														
10 Watt	Med.	82012	PAR30FL10L/927/W/LED	Flood, White	120	2700K	90	750	1560	40,000	6/24	40°	4.61"	75
10 Watt	Med.	82013	PAR30FL10L/927/B/LED	Flood, Black	120	2700K	90	750	1560	40,000	6/24	40°	4.61"	75
10 Watt	Med.	82014	PAR30FL10L/930/W/LED	Flood, White	120	3000K	90	800	1600	40,000	6/24	40°	4.61"	75
10 Watt	Med.	82015	PAR30FL10L/930/B/LED	Flood, Black	120	3000K	90	800	1600	40,000	6/24	40°	4.61"	75
10 Watt	Med.	82016	PAR30FL10L/940/W/LED	Flood, White	120	4000K	90	820	1630	40,000	6/24	40°	4.61"	75
10 Watt	Med.	82017	PAR30FL10L/940/B/LED	Flood, Black	120	4000K	90	820	1630	40,000	6/24	40°	4.61"	75
10 Watt	Med.	82018	PAR30FL10L/950/W/LED	Flood, White	120	5000K	90	850	1670	40,000	6/24	40°	4.61"	75
10 Watt	Med.	82019	PAR30NFL10L/927/W/LED	Narrow Flood, White	120	2700K	90	750	3540	40,000	6/24	25°	4.61"	75
10 Watt	Med.	82020	PAR30NFL10L/927/B/LED	Narrow Flood, Black	120	2700K	90	750	3540	40,000	6/24	25°	4.61"	75
10 Watt	Med.	82021	PAR30NFL10L/930/W/LED	Narrow Flood, White	120	3000K	90	800	3600	40,000	6/24	25°	4.61"	75
10 Watt	Med.	82024	PAR30NFL10L/950/W/LED	Narrow Flood, White	120	5000K	90	850	3670	40,000	6/24	25°	4.61"	75
PAR30SN														
10 Watt	Med.	82025	PAR30FL10S/927/W/LED	Flood, White	120	2700K	90	750	1590	40,000	6/24	40°	3.35"	75
10 Watt	Med.	82026	PAR30FL10S/927/B/LED	Flood, Black	120	2700K	90	750	1590	40,000	6/24	40°	3.35"	75
10 Watt	Med.	82027	PAR30FL10S/930/W/LED	Flood, White	120	3000K	90	800	1640	40,000	6/24	40°	3.35"	75
10 Watt	Med.	82028	PAR30FL10S/930/B/LED	Flood, Black	120	3000K	90	800	1640	40,000	6/24	40°	3.35"	75
10 Watt	Med.	82029	PAR30FL10S/940/W/LED	Flood, White	120	4000K	90	820	1680	40,000	6/24	40°	3.35"	75
10 Watt	Med.	82030	PAR30FL10S/940/B/LED	Flood, Black	120	4000K	90	820	1680	40,000	6/24	40°	3.35"	75
10 Watt	Med.	82031	PAR30FL10S/950/W/LED	Flood, White	120	5000K	90	850	1720	40,000	6/24	40°	3.35"	75
10 Watt	Med.	82032	PAR30NFL10S/927/W/LED	Narrow Flood, White	120	2700K	90	750	3700	40,000	6/24	25°	3.35"	75
10 Watt	Med.	82033	PAR30NFL10S/927/B/LED	Narrow Flood, Black	120	2700K	90	750	3700	40,000	6/24	25°	3.35"	75
10 Watt	Med.	82034	PAR30NFL10S/930/W/LED	Narrow Flood, White	120	3000K	90	800	3760	40,000	6/24	25°	3.35"	75
10 Watt	Med.	82035	PAR30NFL10S/930/B/LED	Narrow Flood, Black	120	3000K	90	800	3760	40,000	6/24	25°	3.35"	75
10 Watt	Med.	82036	PAR30NFL10S/940/W/LED	Narrow Flood, White	120	4000K	90	900	3820	40,000	6/24	25°	3.35"	75

* Useful Life is defined as the point in time at which the lamp will maintain at least 70% of its initial lumens. The lamp will continue to burn past this point at decreased light levels. May not be compatible with all dimming systems, dimming performance may vary by system, please visit www.halcolighting.com/ProLEDDim for dimmer compatibility information. Use on incompatible systems may shorten lamp life. Represents lamps that are ENERGY STAR® certified.

ProLED Prime Select PAR30



Savings Comparison

Total Lifetime Costs

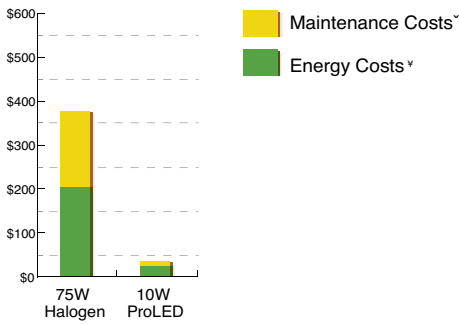

† Maintenance costs based on 15 minutes to replace the lamp at \$40 per hr over the life of the ProLED lamp.

* Energy costs based on \$0.11 kWh over 40,000 hour life.

Photometrics

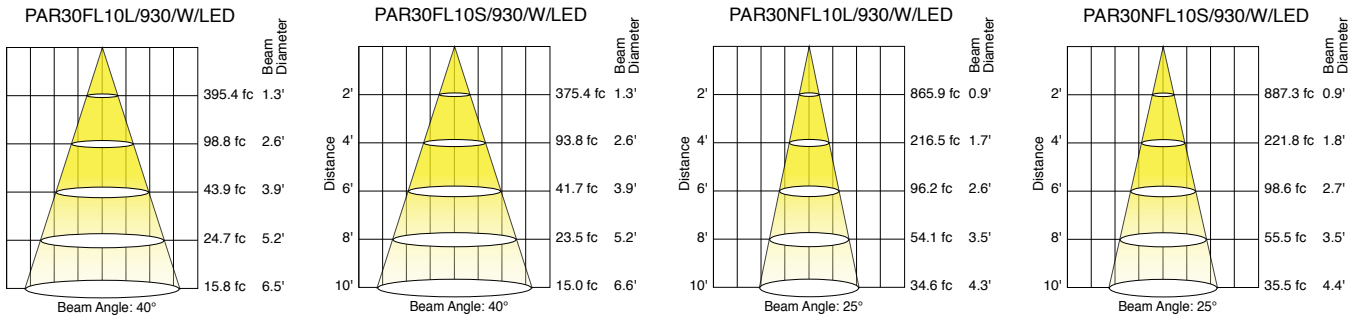

ProLED PAR30 Series IP65 rated long and short neck lamps are ideal for retail applications. Compared to Incandescent and Halogen, ProLED lamps generate less heat and emit no ultraviolet or infrared rays eliminating fading concerns. ProLED PAR30 lamps' labor saving long life - up-to 40,000 hours - reduces maintenance costs *keeping the store open for business.*



ProLED Prime Select PAR20

Specifications

- PAR20 with smooth sided, lightweight construction
- Acceptable for use in ICAT rated luminaires
- Available in white and black finishes
- UL Listed for wet locations
- Dimmable to 5% for design flexibility
- Available in 2700K, 3000K, 4000K and 5000K
- 90 CRI provides superior quality and color accuracy
- Narrow Flood and Flood beam angles available
- No Mercury or UV/IR emissions
- RoHS Compliant
- 7-Year Limited Warranty

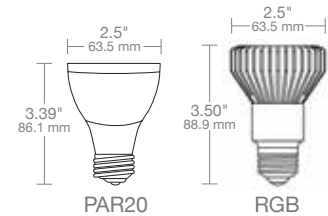

Markets & Applications

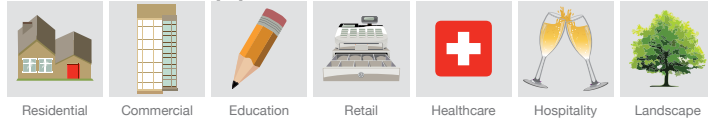

Ordering Information



Watt	Base	Product #	Product Code	Description	Volts	Color Temp.	CRI	Lumens	CBCP	Useful Life*	Pkg. Qty.	Beam Spread	MOL	Wattage Equivalent
PAR20														
7 Watt	Med.	82000	PAR20NFL7/927/W/LED	Narrow Flood, White	120	2700K	90	460	1500	40,000	6/24	25°	3.39"	50
7 Watt	Med.	82001	PAR20NFL7/930/W/LED	Narrow Flood, White	120	3000K	90	470	1540	40,000	6/24	25°	3.39"	50
7 Watt	Med.	82003	PAR20NFL7/930/B/LED	Narrow Flood, Black	120	3000K	90	470	1540	40,000	6/24	25°	3.39"	50
7 Watt	Med.	82004	PAR20NFL7/940/W/LED	Narrow Flood, White	120	4000K	90	500	1590	40,000	6/24	25°	3.39"	50
7 Watt	Med.	82005	PAR20NFL7/950/W/LED	Narrow Flood, White	120	5000K	90	525	1630	40,000	6/24	25°	3.39"	50
7 Watt	Med.	82006	PAR20FL7/927/W/LED	Flood, White	120	2700K	90	460	920	40,000	6/24	40°	3.39"	50
7 Watt	Med.	82007	PAR20FL7/927/B/LED	Flood, Black	120	2700K	90	460	920	40,000	6/24	40°	3.39"	50
7 Watt	Med.	82008	PAR20FL7/930/W/LED	Flood, White	120	3000K	90	470	970	40,000	6/24	40°	3.39"	50
7 Watt	Med.	82009	PAR20FL7/930/B/LED	Flood, Black	120	3000K	90	470	970	40,000	6/24	40°	3.39"	50
7 Watt	Med.	82010	PAR20FL7/940/W/LED	Flood, White	120	4000K	90	500	1020	40,000	6/24	40°	3.39"	50
7 Watt	Med.	82011	PAR20FL7/940/B/LED	Flood, Black	120	4000K	90	500	1020	40,000	6/24	40°	3.39"	50
7 Watt	Med.	82060	PAR20FL7/950/W/LED	Flood, White	120	5000K	90	525	1050	40,000	6/24	40°	3.39"	50
8 Watt	Med.	80638	PAR20/8RGB/NFL/LED	Narrow Flood Color Changing Red, Green, Blue ✕	120	-	-	-	-	40,000	1/6	25°	3.50"	-
		80649	RGB/REMOTE	Remote Control for Color Changing Lamp										

* Useful Life is defined as the point in time at which the lamp will maintain at least 70% of its initial lumens. The lamp will continue to burn past this point at decreased light levels.
 • May not be compatible with all dimming systems, dimming performance may vary by system, please visit www.halcolighting.com/ProLEDdim for dimmer compatibility information.
 Use on incompatible systems may shorten lamp life.
 Represents lamps that are ENERGY STAR® certified.
 ✕ Non-dimmable

Savings Comparison

Total Lifetime Costs

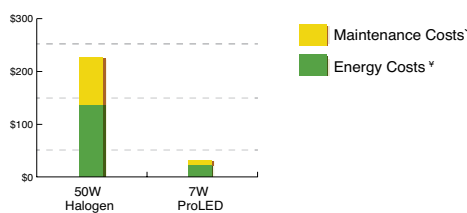

* Maintenance costs based on 15 minutes to replace the lamp at \$40 per hr over the life of the ProLED lamp.
 † Energy costs based on \$0.11 kWh over 40,000 hour life.

Photometrics

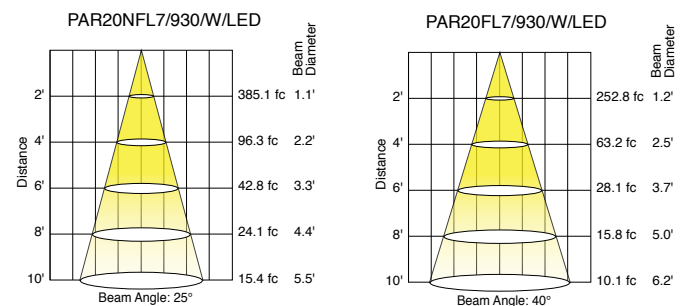

ProLED Choice PAR Series



High
CRI

Specifications

- Acceptable for use in ICAT rated luminaires
- 90+ CRI provides superior color accuracy and quality in the most demanding applications
- Black and white housing options for seamless integration in any indoor application
- R9>50 for richer reds and exceptional color rendering
- Excellent beam control with 25° and 40° options
- Dimmable to 5%
- Damp location rated
- 25,000 Hour Life

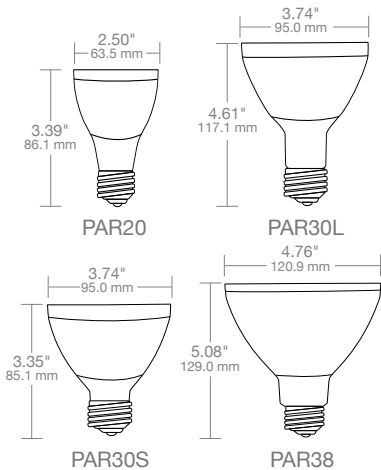

Markets & Applications

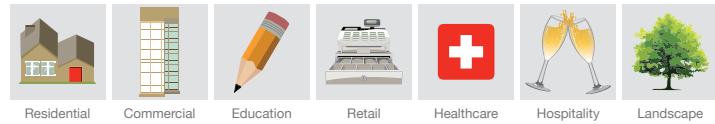

Ordering Information



Watt	Base	Product #	Product Code	Description	Volts	Color Temp.	CRI	Lumens	CBCP	Useful Life*	Pkg. Qty.	Beam Spread	MOL	Wattage Equivalent
PAR20														
7 Watt	Med.	83042	PAR20NFL7/927/WH/LED	Narrow Flood, White	120	2700K	90	500	1334	25,000	6/24	25°	3.39"	50
7 Watt	Med.	83043	PAR20NFL7/930/WH/LED	Narrow Flood, White	120	3000K	90	500	1427	25,000	6/24	25°	3.39"	50
7 Watt	Med.	83044	PAR20NFL7/930/BH/LED	Narrow Flood, Black	120	3000K	90	500	1427	25,000	6/24	25°	3.39"	50
7 Watt	Med.	83045	PAR20NFL7/940/WH/LED	Narrow Flood, White	120	4000K	90	500	1444	25,000	6/24	25°	3.39"	50
7 Watt	Med.	83046	PAR20NFL7/950/WH/LED	Narrow Flood, White	120	5000K	90	500	1377	25,000	6/24	25°	3.39"	50
7 Watt	Med.	83047	PAR20FL7/927/WH/LED	Flood, White	120	2700K	90	500	843	25,000	6/24	40°	3.39"	50
7 Watt	Med.	83048	PAR20FL7/927/BH/LED	Flood, Black	120	2700K	90	500	843	25,000	6/24	40°	3.39"	50
7 Watt	Med.	83049	PAR20FL7/930/WH/LED	Flood, White	120	3000K	90	500	836	25,000	6/24	40°	3.39"	50
7 Watt	Med.	83050	PAR20FL7/930/BH/LED	Flood, Black	120	3000K	90	500	836	25,000	6/24	40°	3.39"	50
7 Watt	Med.	83051	PAR20FL7/940/WH/LED	Flood, White	120	4000K	90	500	865	25,000	6/24	40°	3.39"	50
7 Watt	Med.	83052	PAR20FL7/940/BH/LED	Flood, Black	120	4000K	90	500	865	25,000	6/24	40°	3.39"	50
7 Watt	Med.	83053	PAR20FL7/950/WH/LED	Flood, White	120	5000K	90	500	848	25,000	6/24	40°	3.39"	50
PAR30 Long Neck														
11 Watt	Med.	83000	PAR30FL11L/927/WH/LED	Flood, White	120	2700K	90	800	1468	25,000	6/24	40°	4.61"	75
11 Watt	Med.	83001	PAR30FL11L/927/BH/LED	Flood, Black	120	2700K	90	800	1468	25,000	6/24	40°	4.61"	75
11 Watt	Med.	83002	PAR30FL11L/930/WH/LED	Flood, White	120	3000K	90	800	1438	25,000	6/24	40°	4.61"	75
11 Watt	Med.	83003	PAR30FL11L/930/BH/LED	Flood, Black	120	3000K	90	800	1438	25,000	6/24	40°	4.61"	75
11 Watt	Med.	83004	PAR30FL11L/940/WH/LED	Flood, White	120	4000K	90	800	1491	25,000	6/24	40°	4.61"	75
11 Watt	Med.	83005	PAR30FL11L/940/BH/LED	Flood, Black	120	4000K	90	800	1491	25,000	6/24	40°	4.61"	75
11 Watt	Med.	83006	PAR30FL11L/950/WH/LED	Flood, White	120	5000K	90	800	1492	25,000	6/24	40°	4.61"	75
11 Watt	Med.	83007	PAR30NFL11L/927/WH/LED	Narrow Flood, White	120	2700K	90	800	3066	25,000	6/24	25°	4.61"	75
11 Watt	Med.	83009	PAR30NFL11L/930/WH/LED	Narrow Flood, White	120	3000K	90	800	2912	25,000	6/24	25°	4.61"	75
11 Watt	Med.	83010	PAR30NFL11L/950/WH/LED	Narrow Flood, White	120	5000K	90	800	3286	25,000	6/24	25°	4.61"	75

Ordering information continued on next page.



ProLED Choice PAR Series

Ordering Information Continued



Watt	Base	Product #	Product Code	Description	Volts	Color Temp.	CRI	Lumens	CBCP	Useful Life*	Pkg. Qty.	Beam Spread	MOL	Wattage Equivalent
PAR30 Short Neck														
11 Watt	Med.	83011	PAR30FL11S/927/WH/LED	Flood, White	120	2700K	90	800	1416	25,000	6/24	40°	3.35"	75
11 Watt	Med.	83012	PAR30FL11S/927/BH/LED	Flood, Black	120	2700K	90	800	1416	25,000	6/24	40°	3.35"	75
11 Watt	Med.	83013	PAR30FL11S/930/WH/LED	Flood, White	120	3000K	90	800	1499	25,000	6/24	40°	3.35"	75
11 Watt	Med.	83014	PAR30FL11S/930/BH/LED	Flood, Black	120	3000K	90	800	1499	25,000	6/24	40°	3.35"	75
11 Watt	Med.	83015	PAR30FL11S/940/WH/LED	Flood, White	120	4000K	90	800	1565	25,000	6/24	40°	3.35"	75
11 Watt	Med.	83016	PAR30FL11S/940/BH/LED	Flood, Black	120	4000K	90	800	1565	25,000	6/24	40°	3.35"	75
11 Watt	Med.	83017	PAR30FL11S/950/WH/LED	Flood, White	120	5000K	90	800	1544	25,000	6/24	40°	3.35"	75
11 Watt	Med.	83018	PAR30NFL11S/927/WH/LED	Narrow Flood, White	120	2700K	90	800	2936	25,000	6/24	25°	3.35"	75
11 Watt	Med.	83020	PAR30NFL11S/930/WH/LED	Narrow Flood, White	120	3000K	90	800	2992	25,000	6/24	25°	3.35"	75
11 Watt	Med.	83021	PAR30NFL11S/930/BH/LED	Narrow Flood, Black	120	3000K	90	800	2992	25,000	6/24	25°	3.35"	75
11 Watt	Med.	83022	PAR30NFL11S/940/WH/LED	Narrow Flood, White	120	4000K	90	800	3254	25,000	6/24	25°	3.35"	75
PAR38														
15 Watt	Med.	83036	PAR38FL15/927/WH/LED	Flood, White	120	2700K	90	1050	1908	25,000	6/24	40°	5.08"	100
15 Watt	Med.	83037	PAR38FL15/930/WH/LED	Flood, White	120	3000K	90	1050	1804	25,000	6/24	40°	5.08"	100
15 Watt	Med.	83038	PAR38FL15/940/WH/LED	Flood, White	120	4000K	90	1050	2050	25,000	6/24	40°	5.08"	100
15 Watt	Med.	83039	PAR38FL15/950/WH/LED	Flood, White	120	5000K	90	1050	1970	25,000	6/24	40°	5.08"	100
17 Watt	Med.	83023	PAR38FL17/927/WH/LED	Flood, White	120	2700K	90	1200	1939	25,000	6/24	40°	5.08"	100
17 Watt	Med.	83024	PAR38FL17/927/BH/LED	Flood, Black	120	2700K	90	1200	1939	25,000	6/24	40°	5.08"	100
17 Watt	Med.	83025	PAR38FL17/930/WH/LED	Flood, White	120	3000K	90	1200	1956	25,000	6/24	40°	5.08"	100
17 Watt	Med.	83026	PAR38FL17/930/BH/LED	Flood, Black	120	3000K	90	1200	1956	25,000	6/24	40°	5.08"	100
17 Watt	Med.	83027	PAR38FL17/940/WH/LED	Flood, White	120	4000K	90	1200	1950	25,000	6/24	40°	5.08"	100
17 Watt	Med.	83028	PAR38FL17/940/BH/LED	Flood, Black	120	4000K	90	1200	1950	25,000	6/24	40°	5.08"	100
17 Watt	Med.	83029	PAR38FL17/950/WH/LED	Flood, White	120	5000K	90	1200	2017	25,000	6/24	40°	5.08"	100
17 Watt	Med.	83030	PAR38NFL17/927/WH/LED	Narrow Flood, White	120	2700K	90	1200	4551	25,000	6/24	25°	5.08"	100
17 Watt	Med.	83031	PAR38NFL17/927/BH/LED	Narrow Flood, Black	120	2700K	90	1200	4551	25,000	6/24	25°	5.08"	100
17 Watt	Med.	83032	PAR38NFL17/930/WH/LED	Narrow Flood, White	120	3000K	90	1200	4469	25,000	6/24	25°	5.08"	100
17 Watt	Med.	83034	PAR38NFL17/940/WH/LED	Narrow Flood, White	120	4000K	90	1200	4721	25,000	6/24	25°	5.08"	100
17 Watt	Med.	83035	PAR38NFL17/950/WH/LED	Narrow Flood, White	120	5000K	90	1200	4921	25,000	6/24	25°	5.08"	100

* Useful Life is defined as the point in time at which the lamp will maintain at least 70% of its initial lumens. The lamp will continue to burn past this point at decreased light levels.

For details on ProLED PAR16, see ProLED Commercial MR16/PAR16 Series Sell Sheet.

Represents lamps that are ENERGY STAR® certified.

Not for use in enclosed fixtures.

May not be compatible with all dimmable systems, dimming performance may vary by system, please check the website www.halcolighting.com for up-to-date dimmer compatibility information.

Use on incompatible systems may shorten lamp life.

ENERGY STAR® mandates that all directional lamps may only be listed at 25,000 hour life with 3,000 hour actual life test data, 6,000 hour LM80 data and in-situ temperature measurements.

Upon completion of full lifetime testing.

ProLED ENERGY STAR® listed lamps will be listed at their full lifetime.

ProLED ECO PAR Series



Specifications

- UL listed for wet locations – allows for indoor or outdoor flexibility
- Acceptable for use in ICAT rated luminaires
- Dimmable to 10%
- Prismatic glass lens and silver housing offers traditional halogen PAR look and feel
- Superior efficacy - up to 80 lumens per watt
- 82 CRI for quality and consistent color rendering
- 5-Year Limited Warranty

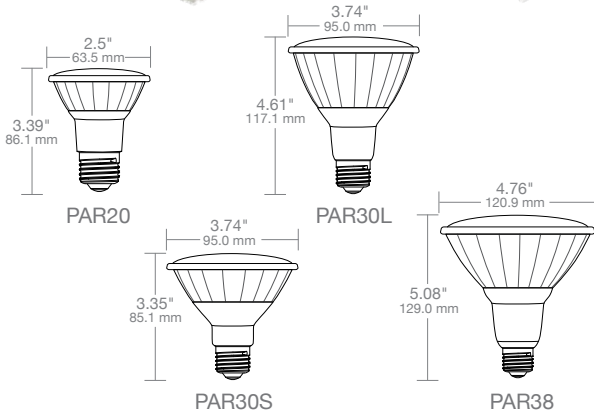

Markets & Applications

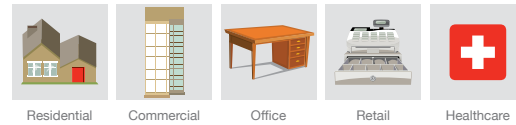

Ordering Information

Watt	Base	Product #	Product Code	Description	Volts	Color Temp.	CRI	Lumens	CBCP	Useful Life*	Pkg. Qty.	Beam Spread	MOL	Wattage Equivalent
PAR20														
7 Watt	Med.	80963	PAR20FL7/827/ECO/LED	Flood	120	2700K	82	500	600	25,000	1/6	40°	3.39"	50
7 Watt	Med.	80964	PAR20FL7/830/ECO/LED	Flood	120	3000K	82	500	600	25,000	1/6	40°	3.39"	50
PAR30														
10 Watt	Med.	80958	PAR30FL10L/827/ECO/LED	Flood	120	2700K	82	800	1120	25,000	1/6	40°	4.61"	50
10 Watt	Med.	80959	PAR30FL10L/830/ECO/LED	Flood	120	3000K	82	800	1120	25,000	1/6	40°	4.61"	50
10 Watt	Med.	80960	PAR30FL10L/840/ECO/LED	Flood	120	4000K	82	800	1120	25,000	1/6	40°	4.61"	50
PAR30SN														
10 Watt	Med.	80961	PAR30FL10S/827/ECO/LED	Flood	120	2700K	82	800	960	25,000	1/6	40°	3.35"	45
10 Watt	Med.	80962	PAR30FL10S/830/ECO/LED	Flood	120	3000K	82	800	960	25,000	1/6	40°	3.35"	45
PAR38														
15 Watt	Med.	80953	PAR38FL15/827/ECO/LED	Flood	120	2700K	82	1200	1800	25,000	1/6	40°	5.08"	90
15 Watt	Med.	80954	PAR38FL15/830/ECO/LED	Flood	120	3000K	82	1200	1800	25,000	1/6	40°	5.08"	90
15 Watt	Med.	80955	PAR38FL15/840/ECO/LED	Flood	120	4000K	82	1200	1800	25,000	1/6	40°	5.08"	90
15 Watt	Med.	80956	PAR38FL15/850/ECO/LED	Flood	120	5000K	82	1200	1800	25,000	1/6	40°	5.08"	90
15 Watt	Med.	80957	PAR38NFL15/830/ECO/LED	Narrow Flood	120	3000K	82	1200	3600	25,000	1/6	25°	5.08"	90

* Useful Life is defined as the point in time at which the lamp will maintain at least 70% of its initial lumens. The lamp will continue to burn past this point at decreased light levels. May not be compatible with all dimming systems, dimming performance may vary by system, please visit www.halcolighting.com/ProLEDdim for dimmer compatibility information. Use on incompatible systems may shorten lamp life. Represents lamps that are ENERGY STAR® certified.

Savings Comparison

Total Lifetime Costs

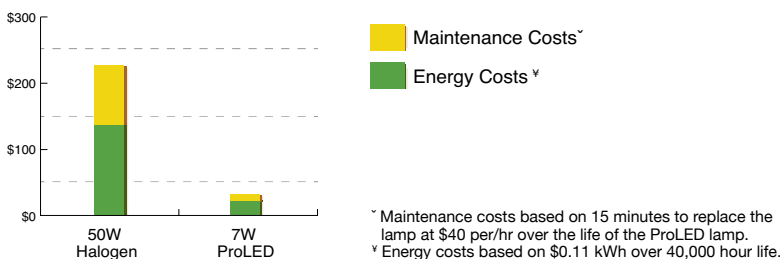



ProLED PAR16/MR16/MR11

NEW!



Specifications

- Up-to 83% energy savings - 6W PAR16 versus 35W Halogen
- UL Listed for damp locations
- Dimmable to 5% for design flexibility
- 40,000 hour life, 16 times longer than traditional lamps
- Available in 2700K, 3000K, 4000K and 5000K CCT
- Up-to 82 CRI for quality and consistent color rendering
- Flood or Narrow Flood beam spreads
- No Mercury or UV/IR emissions
- RoHS Compliant
- 5-Year Limited Warranty

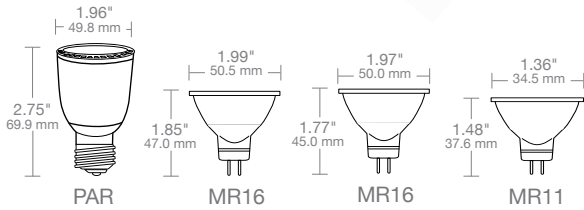

Markets & Applications

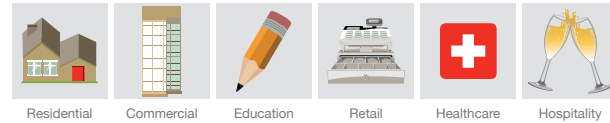

Ordering Information



Watt	Base	Product #	Product Code	Description	Dimmable	Volts	Color Temp.	CRI	Lumens	CBCP	Useful Life*	Pkg. Qty.	Beam Spread	MOL	Wattage Equivalent
MR11															
3 Watt	GU4	80996	MR11NFL3/827/LED	Narrow Flood	No	12	2700K	82	210	700	25,000	1/10	20°	1.48"	20
3 Watt	GU4	80997	MR11NFL3/830/LED	Narrow Flood	No	12	3000K	82	210	700	25,000	1/10	20°	1.48"	20
3 Watt	GU4	80998	MR11NFL3/840/LED	Narrow Flood	No	12	4000K	82	210	700	25,000	1/10	20°	1.48"	20
3 Watt	GU4	80999	MR11NFL3/850/LED	Narrow Flood	No	12	5000K	82	210	700	25,000	1/10	20°	1.48"	20
MR16															
4.5 Watt	GU5.3	80534	MR16FL4/827/LED2	Flood	Yes	12	2700K	82	360	730	25,000	1/10	40°	1.77"	35
4.5 Watt	GU5.3	80535	MR16FL4/830/LED2	Flood	Yes	12	3000K	82	370	750	25,000	1/10	40°	1.77"	35
4.5 Watt	GU5.3	80536	MR16FL4/850/LED2	Flood	Yes	12	5000K	82	400	810	25,000	1/10	40°	1.77"	35
6.5 Watt	GU5.3	80537	MR16FL6/827/LED2	Flood	Yes	12	3000K	82	500	1100	25,000	1/10	40°	1.77"	50
6.5 Watt	GU5.3	80540	MR16NFL6/830/LED2	Narrow Flood	Yes	12	3000K	82	520	2420	25,000	1/10	20°	1.77"	50
7 Watt	GU5.3	81124	MR16FL7/830/LED	Flood	Yes	12	3000K	82	520	780	25,000	1/10	40°	1.85"	50
PAR16															
6 Watt	Med.	81038	PAR16FL6/827/W/LED	Flood ∞	Yes	120	2700K	82	370	780	25,000	6/24	40°	2.75"	35
6 Watt	Med.	81127	PAR16FL6/830/W/LED	Flood ∞	Yes	120	3000K	82	380	780	25,000	6/24	40°	2.75"	35
6 Watt	Med.	81040	PAR16FL6/840/W/LED	Flood ∞	Yes	120	4000K	82	400	780	40,000	6/24	40°	2.75"	35
6 Watt	Med.	81041	PAR16FL6/850/W/LED	Flood ∞	Yes	120	5000K	82	415	780	40,000	6/24	40°	2.75"	35

* Useful Life is defined as the point in time at which the lamp will maintain at least 70% of its initial lumens. The lamp will continue to operate past this point at decreased light levels. May not be compatible with all dimming systems, dimming performance may vary by system, please visit www.halcolighting.com/ProLEDdim for dimmer compatibility information. Use on incompatible systems may shorten lamp life.
 ∞ Acceptable for use in sealed metal landscape luminaires when protected from the elements.
 Represents lamps that are ENERGY STAR® certified.

Savings Comparison

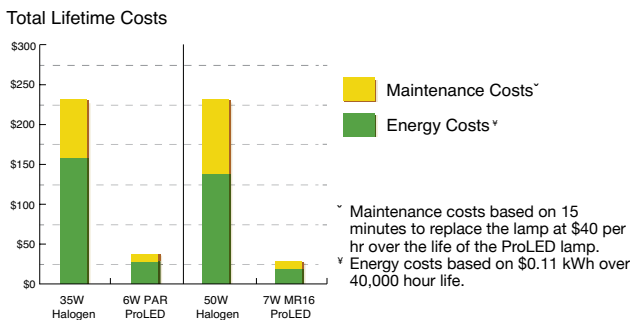

Photometrics

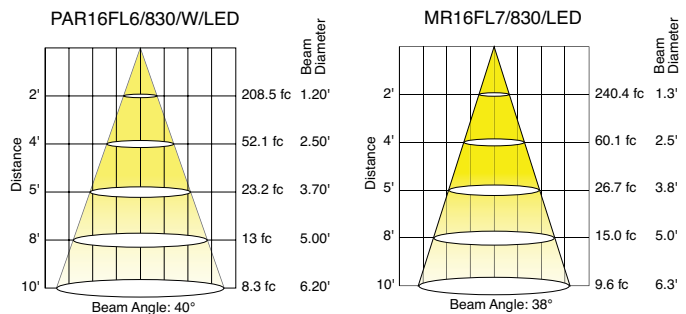

Specifications

- BR40 with Medium E26 base
- Acceptable for ICAT rated luminaires
- UL Listed for damp locations
- Dimmable to 5% for design flexibility
- Up-to 40,000 hour life
- Available in 2700K, 3000K, 4000K and 5000K CCT
- 82 CRI for quality and consistent color rendering
- Flood beam spread
- No Mercury or UV/IR emissions
- RoHS Compliant
- 5-Year Limited Warranty



Markets & Applications

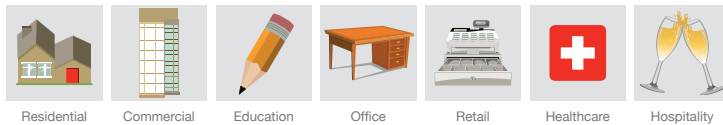

Ordering Information



Watt	Base	Product #	Product Code	Description	Volts	Color Temp.	CRI	Lumens	Useful Life*	Pkg. Qty.	MOL	Wattage Equivalent
11.5	Med.	80981	BR40FL11/827/LED	Reflector	120	2700K	82	940	25,000	1/6	6.46"	75
11.5	Med.	80980	BR40FL11/830/LED	Reflector	120	3000K	82	970	25,000	1/6	6.46"	75
16.5 Watt	Med.	80983	BR40FL16/827/LED	Reflector	120	2700K	82	1200	25,000	1/6	6.46"	85
16.5 Watt	Med.	80982	BR40FL16/830/LED	Reflector	120	3000K	82	1230	25,000	1/6	6.46"	85
16.5 Watt	Med.	80984	BR40FL16/840/LED	Reflector	120	4000K	82	1280	25,000	1/6	6.46"	85
16.5 Watt	Med.	80985	BR40FL16/850/LED	Reflector	120	5000K	82	1320	25,000	1/6	6.46"	85

* Useful Life is defined as the point in time at which the lamp will maintain at least 70% of its initial lumens. The lamp will continue to burn past this point at decreased light levels. May not be compatible with all dimming systems, dimming performance may vary by system, please visit www.halcolighting.com/ProLEDDim for dimmer compatibility information. Use on incompatible systems may shorten lamp life. Represents lamps that are ENERGY STAR® certified.

Savings Comparison

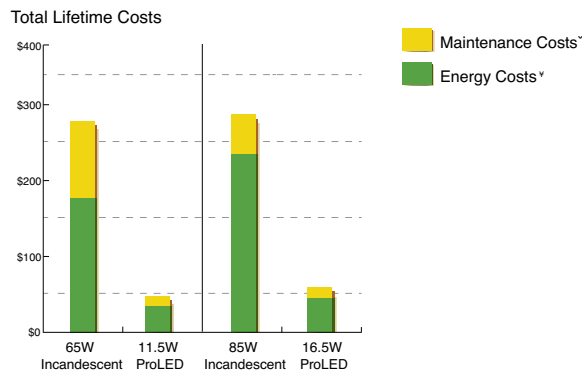

* Maintenance costs based on 15 minutes to replace the lamp at \$40 per/hr over the life of the ProLED lamp.
 † Energy costs based on \$0.11 kWh over 40,000 hour life.

ProLED BR30

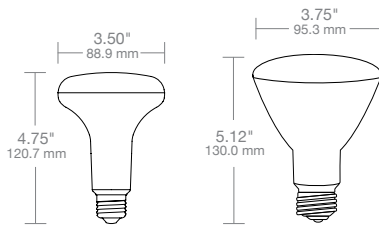

Specifications

- BR30 with Medium E26 base
- Acceptable for ICAT rated luminaires
- 6 Pack option available
- UL Listed for damp locations
- Dimmable to 5% for design flexibility
- Up-to 25,000 hour life
- Available in 2700K, 3000K, 4000K, 5000K CCT and Pink
- 82 CRI for quality and consistent color rendering
- Flood beam spread
- No Mercury or UV/IR emissions
- RoHS Compliant
- 5-Year Limited Warranty on 25,000 hour lamps
- 3-Year Limited Warranty on 15,000 hour lamps

Markets & Applications

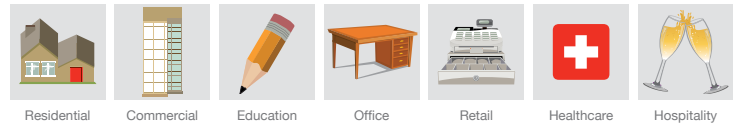

Ordering Information



Watt	Base	Product #	Product Code	Volts	Color Temp.	CRI	Lumens	Useful Life*	Pkg. Qty.	MOL	Wattage Equivalent
8 Watt	Med.	80990	BR30FL8/827/ECO/LED	120	2700K	82	650	25,000	1/6	5.12"	65
8 Watt	Med.	80991	BR30FL8/830/ECOLED	120	3000K	82	670	25,000	1/6	5.12"	65
8 Watt	Med.	80988	BR30FL8/PNK/LED	120	Pink	82	-	25,000	1/6	5.12"	65
9.5 Watt	Med.	80976	BR30FL10/827/LED	120	2700K	82	750	25,000	1/6	5.12"	65
9.5 Watt	Med.	80977	BR30FL10/830/LED	120	3000K	82	770	25,000	1/6	5.12"	65
9.5 Watt	Med.	80978	BR30FL10/840/LED	120	4000K	82	800	25,000	1/6	5.12"	65
9.5 Watt	Med.	80979	BR30FL10/850/LED	120	5000K	82	830	25,000	1/6	5.12"	65
9.5 Watt [§]	Med.	82068	BR30FL9/830/ECO/LED/6PK	120	3000K	82	650	15,000	6/24	4.75"	65

* Useful Life is defined as the point in time at which the lamp will maintain at least 70% of its initial lumens. The lamp will continue to burn past this point at decreased light levels. May not be compatible with all dimming systems, dimming performance may vary by system, please visit www.halcolighting.com/ProLEDdim for dimmer compatibility information. Use on incompatible systems may shorten lamp life.

Represents lamps that are ENERGY STAR[®] certified.

[§] 3-Year limited warranty.

Savings Comparison

Total Lifetime Costs

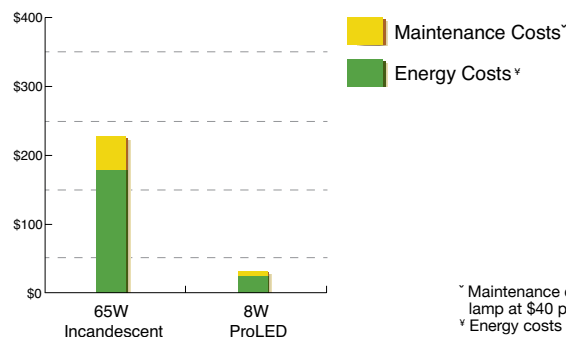

[~] Maintenance costs based on 15 minutes to replace the lamp at \$40 per/hr over the life of the ProLED lamp.
[‡] Energy costs based on \$0.11 kWh over 40,000 hour life.



NEW!

Specifications

- R20 with Medium E26 base
- Acceptable for ICAT rated luminaires
- UL Listed for damp locations
- Dimmable to 5% for design flexibility
- Up-to 40,000 hour life
- Available in 2700K, 3000K, 4000K and 5000K CCT
- 82 CRI for quality and consistent color rendering
- Flood beam spread
- No Mercury or UV/IR emissions
- RoHS Compliant
- 5-Year Limited Warranty

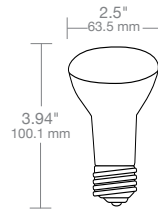

Markets & Applications



Ordering Information



Watt	Base	Product #	Product Code	Description	Volts	Color Temp.	CRI	Lumens	Useful Life*	Pkg. Qty.	MOL	Wattage Equivalent
6.5 Watt	Med.	80989	R20FL6/827/LED	Reflector	120	2700K	82	525	25,000	1/6	3.94"	50
6.5 Watt	Med.	80986	R20FL6/830/LED	Reflector	120	3000K	82	540	25,000	1/6	3.94"	50
6.5 Watt	Med.	81164	R20FL6/840/LED	Reflector	120	4000K	82	525	25,000	1/6	3.94"	50
6.5 Watt	Med.	80987	R20FL6/850/LED	Reflector	120	5000K	82	580	25,000	1/6	3.94"	50

* Useful Life is defined as the point in time at which the lamp will maintain at least 70% of its initial lumens. The lamp will continue to burn past this point at decreased light levels. May not be compatible with all dimming systems, dimming performance may vary by system, please visit www.halcolighting.com/ProLEDDim for dimmer compatibility information. Use on incompatible systems may shorten lamp life. Represents lamps that are ENERGY STAR® certified.

Savings Comparison

Total Lifetime Costs

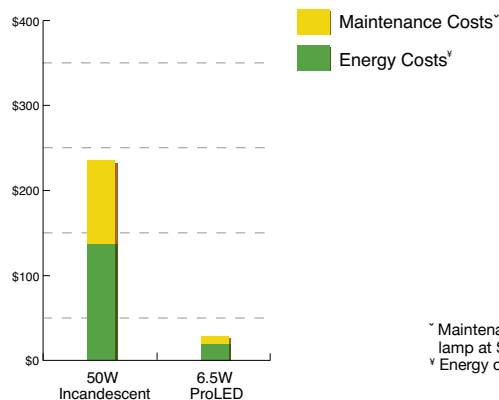

[~] Maintenance costs based on 15 minutes to replace the lamp at \$40 per/hr over the life of the ProLED lamp.
^v Energy costs based on \$0.11 kWh over 40,000 hour life.

ProLED Omnidirectional A-Shape Series

NEW!



Specifications

- Omnidirectional Optical Design Provides 230° Light Distribution
- UL Listed for damp locations and enclosed luminaires
- Dimmable to 10% for design flexibility
- Available in 2700K, 3000K, 4000K and 5000K CCT
- 82 CRI for quality and consistent color rendering
- No Mercury or UV/IR emissions
- RoHS Compliant
- 3-Year Limited Warranty

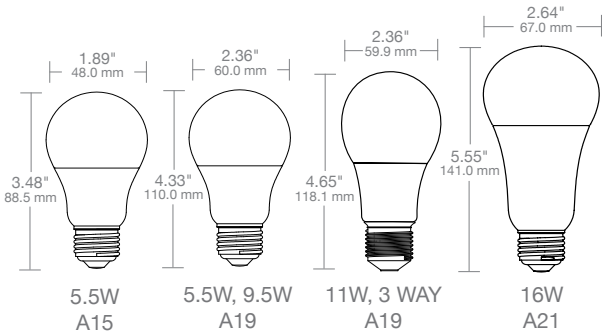

Markets & Applications



Ordering Information



Watt	Base	Product #	Product Code	Volts	Color Temp.	CRI	Lumens	Useful Life*	Pkg. Qty.	MOL	Wattage Equivalent
5.5W	Medium	80196	A15FR5/827/OMNI2/LED	120	2700K	82	450	25,000	1/6	3.484"	40
5.5W	Medium	80197	A15FR5/830/OMNI2/LED	120	3000K	82	450	25,000	1/6	3.484"	40
5.5W	Medium	80198	A15FR5/840/OMNI2/LED	120	4000K	82	450	25,000	1/6	3.484"	40
5.5W	Medium	80199	A15FR5/850/OMNI2/LED	120	5000K	82	450	25,000	1/6	3.484"	40
5.5W	Medium	81153	A19FR5/827/OMNI2/LED	120	2700K	82	450	15,000	1/6	4.53"	40
5.5W	Medium	81154	A19FR5/830/OMNI2/LED	120	3000K	82	470	15,000	1/6	4.53"	40
9.5W	Medium	81155	A19FR9/827/OMNI2/LED	120	2700K	82	800	15,000	1/6	4.53"	60
9.5W	Medium	81156	A19FR9/830/OMNI2/LED	120	3000K	82	830	15,000	1/6	4.53"	60
9.5W	Medium	81157	A19FR9/840/OMNI2/LED	120	4000K	82	860	15,000	1/6	4.53"	60
9.5W	Medium	81158	A19FR9/850/OMNI2/LED	120	5000K	82	900	15,000	1/6	4.53"	60
11W	Medium	81147	A19FR11/827/OMNI2/LED	120	2700K	82	1100	15,000	1/6	4.65"	75
11W	Medium	81148	A19FR11/830/OMNI2/LED	120	3000K	82	1140	15,000	1/6	4.65"	75
16W	Medium	81151	A21FR16/827/OMNI2/LED	120	2700K	82	1600	15,000	1/6	5.28"	100
16W	Medium	81149	A21FR16/830/OMNI2/LED	120	3000K	82	1650	15,000	1/6	5.28"	100
16W	Medium	81150	A21FR16/840/OMNI2/LED	120	4000K	82	1720	15,000	1/6	5.28"	100
16W	Medium	81152	A21FR16/850/OMNI2/LED	120	5000K	82	1800	15,000	1/6	5.28"	100
4.2/8.5/13.5W	Medium	83090	A19FR5/9/14/827/3-WAY/LED	120	2700K	82	450/800/1500	15,000	1/6	4.64"	40/60/100
4.2/8.5/13.5W	Medium	83091	A19FR5/9/14/830/3-WAY/LED	120	3000K	82	450/800/1500	15,000	1/6	4.64"	40/60/100
4.2/8.5/13.5W	Medium	83092	A19FR5/9/14/840/3-WAY/LED	120	4000K	82	480/880/1550	15,000	1/6	4.64"	40/60/100
4.2/8.5/13.5W	Medium	83093	A19FR5/9/14/850/3-WAY/LED	120	5000K	82	480/880/1550	15,000	1/6	4.64"	40/60/100

* Useful Life is defined as the point in time at which the lamp will maintain at least 70% of its initial lumens. The lamp will continue to burn past this point at decreased light levels. May not be compatible with all dimming systems, dimming performance may vary by system, please visit www.halcolighting.com/ProLEDdim for dimmer compatibility information. Use on incompatible systems may shorten lamp life.

Represents lamps that are ENERGY STAR® certified.

15,000 hour useful life rating is based on a maximum ambient temperature of 45°C. Exceeding this ambient temperature rating may result in reduced life.

* Not rated for enclosed luminaires.



ProLED ECO A19 Series



Specifications

- A19 A-Shape with Medium base
- 15,000 hour life
- Available in 2700K, 3000K & 5000K CCT
- 82 CRI for quality and consistent color rendering
- UL listed for damp locations and enclosed luminaires
- No Mercury or UV/IR emissions
- RoHS Compliant
- Non-Dimmable
- 3-Year Limited Warranty

Markets & Applications

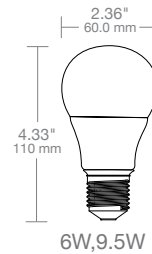
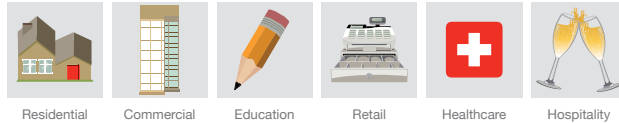

Ordering Information



Watt	Base	Product #	Product Code	Volts	Color Temp.	CRI	Lumens	Useful Life*	Pkg. Qty.	MOL	Wattage Equivalent	ENERGY STAR®
6 Watt	E26	80971	A19FR6/827/ECO/LED	120	2700K	82	450	15,000	1/6	4.33"	40	Yes
6 Watt	E26	80972	A19FR6/830/ECO/LED	120	3000K	82	470	15,000	1/6	4.33"	40	Yes
9.5 Watt	E26	80973	A19FR9/827/ECO/LED	120	2700K	82	800	15,000	1/6	4.33"	60	Yes
9.5 Watt	E26	80974	A19FR9/830/ECO/LED	120	3000K	82	830	15,000	1/6	4.33"	60	Yes
9.5 Watt	E26	80975	A19FR9/850/ECO/LED	120	5000K	82	900	15,000	1/6	4.33"	60	Yes

* Useful Life is defined as the point in time at which the lamp will maintain at least 70% of its initial lumens. The lamp will continue to burn past this point at decreased light levels. May not be compatible with all dimming systems, dimming performance may vary by system, please visit www.halcolighting.com/ProLEDdim for dimmer compatibility information. Use on incompatible systems may shorten lamp life. Represents lamps that are ENERGY STAR® certified.

Savings Comparison

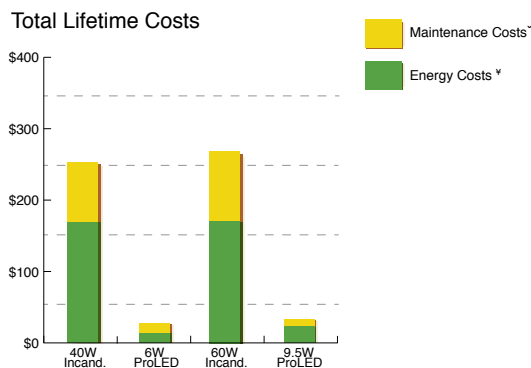

~ Maintenance costs based on 15 minutes to replace the lamp at \$40 per/hr over the life of the ProLED lamp.
 ¥ Energy costs based on \$0.11 kWh over 25,000 hour life.

ProLED A19 GU24 Series

NEW!

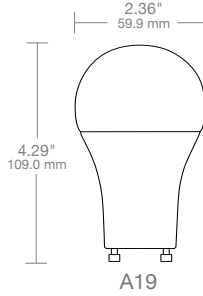

Specifications

- UL Listed for damp locations and enclosed luminaires
- Available in 2700K, 3000K, 4000K and 5000K CCT
- 82 CRI for quality and consistent color rendering
- No Mercury or UV/IR emissions
- Non-Dimmable
- RoHS Compliant
- 3-Year Limited Warranty

Markets & Applications

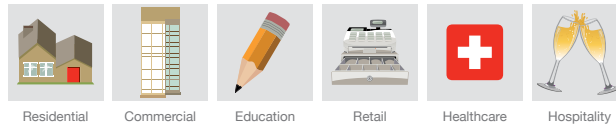

Ordering Information



Watt	Base	Product #	Product Code	Volts	Color Temp.	CRI	Lumens	Useful Life*	Pkg. Qty.	MOL	Wattage Equivalent	CFL Wattage Equivalent
9 Watt	GU24	83080	A19FR9/827/OMNI/GU24/LED	120	2700K	82	800	15,000	1/6	4.29"	60	13
9 Watt	GU24	83081	A19FR9/830/OMNI/GU24/LED	120	3000K	82	800	15,000	1/6	4.29"	60	13
9 Watt	GU24	83082	A19FR9/840/OMNI/GU24/LED	120	4000K	82	800	15,000	1/6	4.29"	60	13
9 Watt	GU24	83083	A19FR9/850/OMNI/GU24/LED	120	5000K	82	800	15,000	1/6	4.29"	60	13
11 Watt	GU24	83084	A19FR11/827/OMNI/GU24/LED	120	2700K	82	1100	15,000	1/6	4.29"	75	18
11 Watt	GU24	83085	A19FR11/830/OMNI/GU24/LED	120	3000K	82	1100	15,000	1/6	4.29"	75	18
11 Watt	GU24	83086	A19FR11/840/OMNI/GU24/LED	120	4000K	82	1100	15,000	1/6	4.29"	75	18
14.5 Watt	GU24	83087	A19FR14/827/OMNI/GU24/LED	120	2700K	82	1600	15,000	1/6	4.29"	100	23
14.5 Watt	GU24	83088	A19FR14/830/OMNI/GU24/LED	120	3000K	82	1600	15,000	1/6	4.29"	100	23
14.5 Watt	GU24	83089	A19FR14/840/OMNI/GU24/LED	120	4000K	82	1600	15,000	1/6	4.29"	100	23

* Useful Life is defined as the point in time at which the lamp will maintain at least 70% of its initial lumens. The lamp will continue to burn past this point at decreased light levels. May not be compatible with all dimming systems, dimming performance may vary by system, please visit www.halcolighting.com/ProLEDdim for dimmer compatibility information. Use on incompatible systems may shorten lamp life.

Represents lamps that are ENERGY STAR® certified.

15,000 hour useful life rating is based on a maximum ambient temperature of 45°C. Exceeding this ambient temperature rating may result in reduced life.

Savings Comparison

Total Lifetime Costs

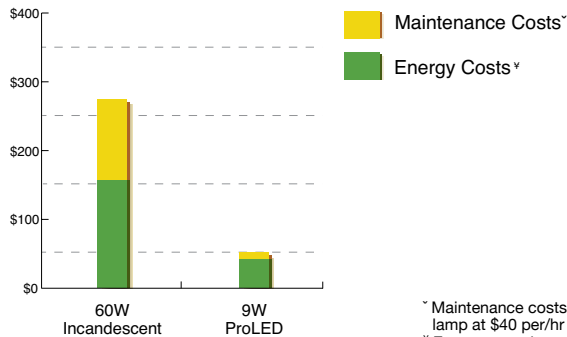

* Maintenance costs based on 15 minutes to replace the lamp at \$40 per/hr over the life of the ProLED lamp.

y Energy costs based on \$0.11 kWh over 25,000 hour life.

ProLED JA-8 A-Shape and Reflector Series

NEW!

Specifications

- UL Listed for Damp Location & Enclosed Fixtures
- Title 24 compliant/JA-8 2016
- Available in 2700K, 3000K CCT
- Dimmable to 5% for design flexibility
- 220° degree beam angle (A19) creates uniform distribution of light
- UL rated for damp locations
- Rated for enclosed fixtures
- 5-Year Limited Warranty



JA-8 2016E

Markets & Applications

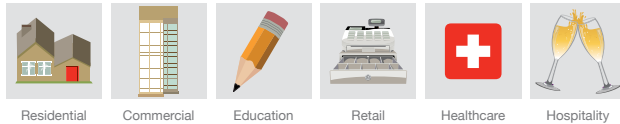

Residential

Commercial

Education

Retail

Healthcare

Hospitality

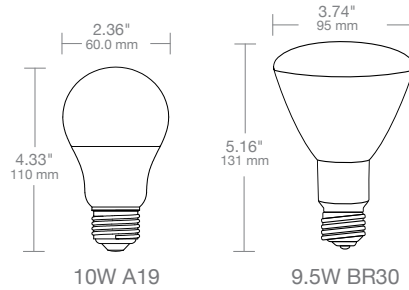

Ordering Information



Watt	Base	Product #	Product Code	Volts	Color Temp.	CRI	Lumens	Useful Life*	Pkg. Qty.	MOL	Wattage Equivalent
10 Watt	E26	80192	A19FR10/927/OMNI2/LED	120	2700K	90	800	25,000	1/6	4.33"	60
10 Watt	E26	80193	A19FR10/930/OMNI2/LED	120	3000K	90	800	25,000	1/6	4.33"	60
9.5 Watt	E26	80194	BR30FL9/927/LED	120	2700K	90	650	25,000	1/6	5.16"	65
9.5 Watt	E26	80195	BR30FL9/930/LED	120	3000K	90	650	25,000	1/6	5.16"	65

* Useful Life is defined as the point in time at which the lamp will maintain at least 70% of its initial lumens. The lamp will continue to burn past this point at decreased light levels. May not be compatible with all dimming systems, dimming performance may vary by system, please visit www.halcolighting.com/ProLEDdim for dimmer compatibility information. Use on incompatible systems may shorten lamp life. Represents lamps that are ENERGY STAR® certified. 25,000 hour useful life rating is based on a maximum ambient temperature of 45°C. Exceeding this ambient temperature rating may result in reduced life.

Savings Comparison

Total Lifetime Costs

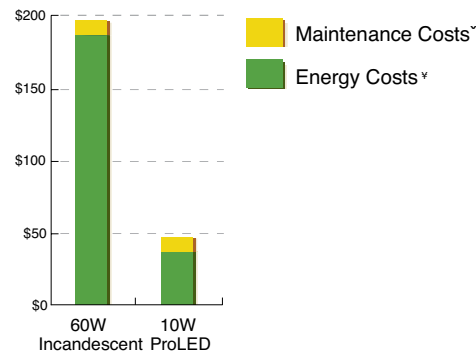

* Maintenance costs based on 15 minutes to replace the lamp at \$40 per/hr over the life of the ProLED lamp.
 * Energy costs based on \$0.11 kWh over 25,000 hour life.

ProLED Filament LED Series

NEW!

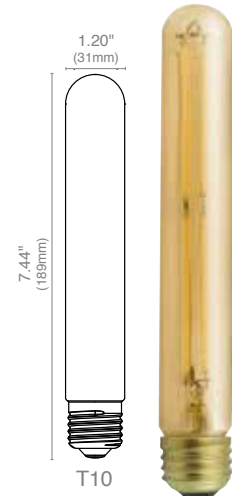

Specifications

- 2200K and 2700K color temperature options
- Designed for indoor and outdoor use
- Clear and amber glass options
- ENERGY STAR Certified options
- Dimmable to 10%
- E12 and E26 base options
- 25,000 and 15,000 hour life options
- 3-Year Warranty
- Perfect for use in DecoStrand™ from Halco
- UL Listed for damp locations

Markets & Applications



Residential

Office

Retail

Hospitality

ProLED Filament LED Series

NEW!

3 YR
WARRANTY



Ordering Information

Watt	Base	Product #	Product Code	Description	Dimmable	Volts	Color Temp.	CRI	Lumens	Useful Life*	Pkg. Qty.	MOL	Wattage Equivalent
B10													
4 Watt	E12	81130	B10CL4ANT/827/LED	Clear Filament	Yes	120	2700K	82	330	25,000 ■	24/96	3.72"	40
4 Watt	E26	81134	B10CL4ANT/827/E26/LED	Clear Filament	Yes	120	2700K	82	350	15,000	24/96	3.78"	40
4 Watt	E12	81135	B10AMB4ANT/722/LED	Amber Filament	Yes	120	2200K	75	240	15,000	24/96	3.72"	40
CA10													
4 Watt	E12	81136	CA10AMB4ANT/722/LED	Amber Filament	Yes	120	2200K	75	350	15,000	24/96	4.09"	40
4 Watt	E12	81137	CA10CL4ANT/827/LED	Clear Filament	Yes	120	2700K	82	450	15,000	24/96	4.13"	40
4 Watt	E12	81138	CA10CL4ANT/827/E26/LED	Clear Filament	Yes	120	2700K	82	450	15,000	24/96	3.78"	40
A19													
4.5 Watt	E26	81128	A19CL4ANT/827/LED	Clear Filament	Yes	120	2700K	82	450	15,000	6/24	4.13"	40
4.5 Watt	E26	81129	A19AMB4ANT/722/LED	Amber Filament	Yes	120	2200K	75	380	15,000	6/24	4.13"	40
S14													
2 Watt	E26	81139**	S14CL2ANT/827/LED	Clear Filament	No	120	2700K	82	200	15,000	25/100	3.46"	25
2 Watt	E26	81140**	S14AMB2ANT/822/LED	Amber Filament	No	120	2200K	82	160	15,000	25/100	3.46"	25
2 Watt	E26	82139**	S14CL2ANT/827/LED2	Clear Filament	Yes	120	2700K	82	200	15,000	25/100	3.46"	25
2 Watt	E26	82140**	S14AMB2ANT/822/LED2	Amber Filament	Yes	120	2200K	82	160	15,000	25/100	3.46"	25
G25													
4.5 Watt	E26	81131	G25CL4ANT/827/LED	Clear Filament	Yes	120	2700K	82	450	15,000	6/24	4.60"	40
ST19													
5 Watt	E26	81132	ST19AMB5ANT/722/LED	Clear Filament	Yes	120	2200K	75	300	15,000	6/24	5.79"	40
T10													
5 Watt	E26	81133	T10AMB5ANT/722/LED	Amber Filament	Yes	120	2200K	75	450	15,000	24/48	7.44"	40

* Useful Life is defined as the point in time at which the lamp will maintain at least 70% of its initial lumens. The lamp will continue to burn past this point at decreased light levels. May not be compatible with all dimming systems, dimming performance may vary by system, please visit www.halcolighting.com/ProLEDdim for dimmer compatibility information. Use on incompatible systems may shorten lamp life.

■ Represents lamps that are ENERGY STAR® certified.

■ ENERGY STAR® mandates that lamps may only be listed at 25,000 hour life with 3,000 hour actual life test data, 6,000 hour LM80 data and in-situ temperature measurements. Upon completion of full lifetime testing, ProLED ENERGY STAR® listed lamps will be listed at their full lifetime.

** Wet location listed.



ProLED Decorative Chandelier

Specifications

- B10 Torpedo and C10 Flame tip options
- Dimmable to 5% for design flexibility
- UL Listed for wet locations
- Available in 2400K and 2700K CCT
- 72 and 82 CRI options
- Up-to 25,000 hour life, 16 times longer than traditional lamps
- Unique "Heat-to-Base" technology
- Omnidirectional distribution
- No Mercury or UV/IR emissions
- RoHS Compliant
- 5-Year Limited Warranty

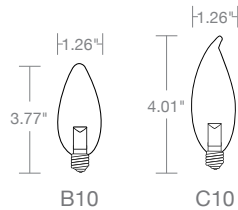

Markets & Applications

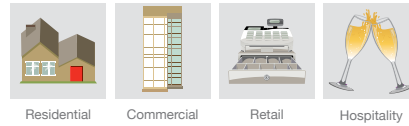

Ordering Information



Watt	Base	Product #	Product Code	Description	Volts	Color Temp.	CRI	Lumens	Useful Life*	Pkg. Qty.	MOL
1 Watt	Cand.	80172	B10CL1/827/LED	Clear Torpedo	120	2700K	82	25	25,000	1/25	3.77"
1 Watt	Cand.	80173	B10CL1/724/LED	Clear Torpedo	120	2400K	72	20	25,000	1/25	3.77"
1 Watt	Cand.	80174	CA10CL1/827/LED	Clear Flame Tip	120	2700K	82	25	25,000	1/25	4.01"
1 Watt	Cand.	80175	CA10CL1/724/LED	Clear Flame Tip	120	2400K	72	20	25,000	1/25	4.01"

* Useful Life is defined as the point in time at which the lamp will maintain at least 70% of its initial lumens. The lamp will continue to burn past this point at decreased light levels. Not for use in enclosed luminaires.

ProLED B11 Chandelier

NEW!

Specifications

- Up-to 87% energy savings
- Cream, Chrome and Brass base options (3W)
- Dimmable to 5% for design flexibility (3W and 4.5W)
- Up-to 25,000 hour life, 16 times longer than traditional lamps
- Available in 2700K and 3000K CCT
- 82 CRI for quality and consistent color rendering
- Omnidirectional distribution
- No Mercury or UV/IR emissions
- RoHS Compliant
- 5-Year Limited Warranty



Markets & Applications

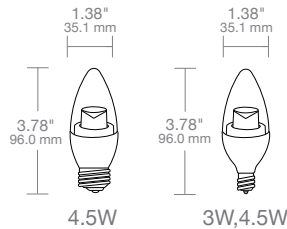
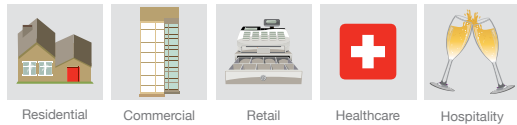

Ordering Information



Watt	Base	Product #	Product Code	Description	Volts	Color Temp.	CRI	Lumens	Useful Life*	Pkg. Qty.	MOL	Wattage Equivalent
3 Watt	Cand.	80094	B11CL3/827/LED	Cream Finish	120	2700K	82	180	25,000	1/10	3.78"	25
3 Watt	Cand.	80789	B11CL3/827/BR/LED	Brass Finish	120	2700K	82	180	25,000	1/10	3.78"	25
3 Watt	Cand.	80790	B11CL3/827/CHR/LED	Chrome Finish	120	2700K	82	180	25,000	1/10	3.78"	25
3 Watt	Cand.	80185	B11CL3/830/LED	Cream Finish	120	3000K	82	180	25,000	1/10	3.78"	25
4.5 Watt	Cand.	80820	B11CL5/827/LED	Cream Finish	120	2700K	82	300	25,000	1/10	3.78"	40
4.5 Watt	Med.	80168	B11CL5/827/E26/LED	Cream Finish	120	2700K	82	300	25,000	1/10	3.78"	40
4.5 Watt	Med.	80183	B11CL5/830/E26/LED	Cream Finish	120	3000K	82	300	25,000	1/10	3.78"	40
4.5 Watt	Cand.	80184	B11CL5/830/LED	Cream Finish	120	3000K	82	300	25,000	1/10	3.78"	40

* Useful Life is defined as the point in time at which the lamp will maintain at least 70% of its initial lumens. The lamp will continue to burn past this point at decreased light levels. May not be compatible with all dimming systems, dimming performance may vary by system, please visit www.halcolighting.com/ProLEDDim for dimmer compatibility information. Use on incompatible systems may shorten lamp life. Represents lamps that are ENERGY STAR® certified.

Savings Comparison

Total Lifetime Costs

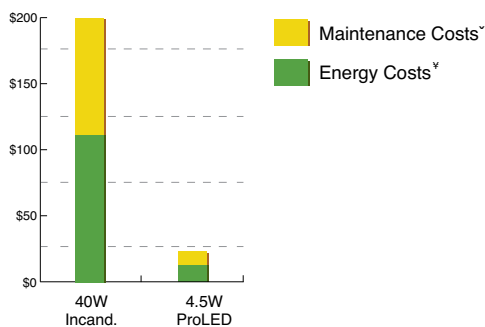

† Maintenance costs based on 15 minutes to replace the lamp at \$40 per/hr over the life of the ProLED lamp.
 * Energy costs based on \$0.11 kWh over 40,000 hour life.

ProLED Globe

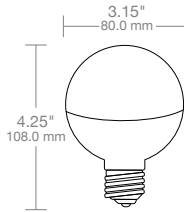

Specifications

- Up-to 80% energy savings - 8W Globe versus 40W Incandescent
- UL Listed for damp locations
- Dimmable to 5% for design flexibility
- 25,000 hour life, 18 times longer than traditional lamps
- Available in 3000K CCT
- 82 CRI for quality and consistent color rendering
- Omnidirectional distribution
- No Mercury or UV/IR emissions
- RoHS Compliant
- 5-Year Limited Warranty

Markets & Applications

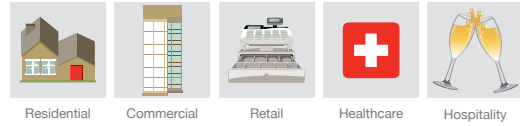

Ordering Information



Watt	Base	Product #	Product Code	Volts	Color Temp.	CRI	Lumens	Useful Life*	Pkg. Qty.	MOL	Wattage Equivalent
6 Watt	Med.	80180	G25FR6/830/LED	120	3000K	82	470	25,000	1/6	4.25"	40

* Useful Life is defined as the point in time at which the lamp will maintain at least 70% of its initial lumens. The lamp will continue to burn past this point at decreased light levels.. Use on incompatible systems may shorten lamp life. Represents lamps that are ENERGY STAR® certified.

Savings Comparison

Total Lifetime Costs

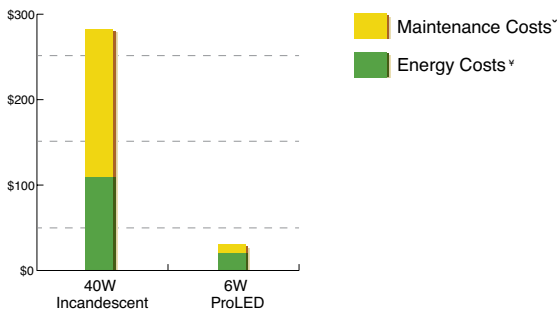

[‡] Maintenance costs based on 15 minutes to replace the lamp at \$40 per/hr over the life of the ProLED lamp.
[†] Energy costs based on \$0.11 kWh over 28,000 hour life.

ProLED PAR36/AR111 Indoor

Specifications

- High power LED for maximum efficiency
- Up-to 73% energy savings - 11.5W PAR36 versus 50W Halogen
- Multi-purpose base for slip-on or screw terminal connections
- 12V input voltage
- 40,000 hour life, 14 times longer than traditional lamps
- Available in 2700K CCT
- 82 CRI for quality and consistent color rendering
- Flood beam spread
- No Mercury or UV/IR emissions
- RoHS Compliant
- 5-Year Limited Warranty



Markets & Applications



Commercial Education Retail Healthcare Hospitality

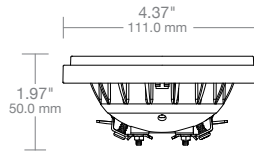

Ordering Information



Watt	Base	Product #	Product Code	Description	Volts	Color Temp.	CRI	Lumens	CBCP	Useful Life*	Pkg. Qty.	Beam Spread	MOL	Wattage Equivalent
11.5 Watt	MP Term	81097	PAR36FL11/827/LED	Flood ✕	12	2700K	82	870	2000	40,000	1/6	32°	1.97"	50
17 Watt	MP Term	80863	PAR36FL17/827/LED	Flood ✕	12	2700K	82	1000	2300	40,000	1/6	32°	1.97"	75

* Useful Life is defined as the point in time at which the lamp will maintain at least 70% of its initial lumens. The lamp will continue to burn past this point at decreased light levels. Not for use in enclosed luminaires. May not be compatible with all electronic transformers. Rated for indoor use only.
✕ Non-dimmable

Savings Comparison

Total Lifetime Costs

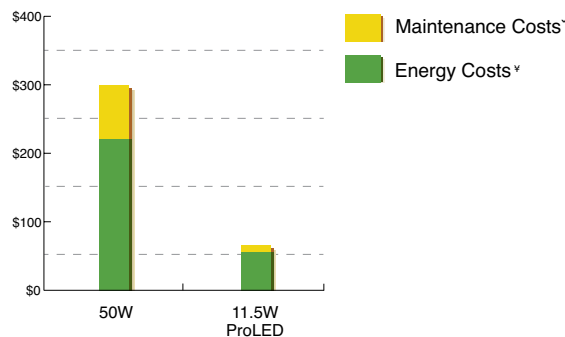

† Maintenance costs based on 15 minutes to replace the lamp at \$40 per/hr over the life of the ProLED lamp.
* Energy costs based on \$0.11 kWh over 40,000 hour life.

ProLED C7/C9

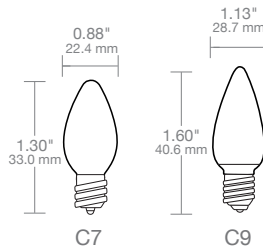

Specifications

- Up-to 86% energy savings - 0.96W C7 or C9 lamp versus 7W Incandescent
- IP65 Rated for outdoor use
- 60,000 hour life, 20 times longer than traditional lamps
- Faceted or Smooth (C7)
- Available in 2700K and 6000K CCT, Blue, Green, Red or Yellow
- Omnidirectional distribution
- No Mercury or UV/IR emissions
- RoHS Compliant
- 2-Year Limited Warranty

Markets & Applications



Ordering Information



Watt	Base	Product #	Product Code	Description	Volts	Useful Life*	Pkg. Qty.	MOL
0.96	Cand.	80510	C7NW/FC/LED	6000K Faceted	120	60,000	10/200	1.30"
0.96	Cand.	80516	C7WW/FC/LED	2700K Faceted	120	60,000	10/200	1.30"
0.96	Cand.	80508	C7BLU/FC/LED	Blue Faceted	120	60,000	10/200	1.30"
0.96	Cand.	80509	C7GRN/FC/LED	Green Faceted	120	60,000	10/200	1.30"
0.96	Cand.	80506	C7RED/FC/LED	Red Faceted	120	60,000	10/200	1.30"
0.96	Cand.	80507	C7YEL/FC/LED	Yellow Faceted	120	60,000	10/200	1.30"
0.96	Int.	80515	C9CL/FC/LED	Clear Faceted	120	60,000	10/200	1.60"
0.96	Int.	80513	C9BLU/FC/LED	Blue Faceted	120	60,000	10/200	1.60"
0.96	Int.	80514	C9GRN/FC/LED	Green Faceted	120	60,000	10/200	1.60"
0.96	Int.	80511	C9RED/FC/LED	Red Faceted	120	60,000	10/200	1.60"
0.96	Int.	80512	C9YEL/FC/LED	Yellow Faceted	120	60,000	10/200	1.60"

* Useful Life is defined as the point in time at which the lamp will maintain at least 70% of its initial lumens. The lamp will continue to burn past this point at decreased light levels.

Savings Comparison

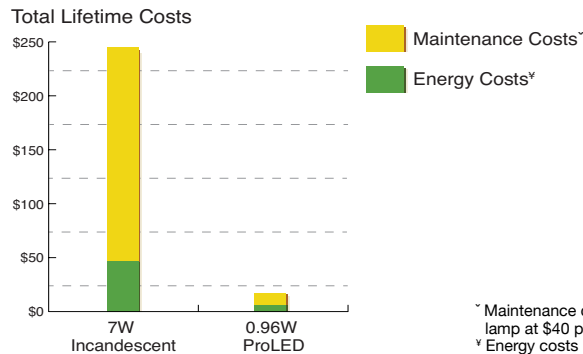

* Maintenance costs based on 15 minutes to replace the lamp at \$40 per/hr over the life of the ProLED lamp.
 † Energy costs based on \$0.11 kWh over 60,000 hour life.

ProLED Sign Lamp Series

Specifications

- S11 Shape with Medium E26 and E17 base
- S14 with Medium E26 base
- UL Listed for wet locations and IP65 Rated
- Dimmable
- 40,000 hour useful life
- S11 Shape available in Clear and White options
- S14 Shape available in Red, Blue, Green, Yellow, Orange, White and Clear 2700K options
- Designed for rapidly flashing sign applications
- Unique "Heat-to-Base" design
- No Mercury or UV/IR emissions
- RoHS Compliant
- 5-Year Limited Warranty



Markets & Applications

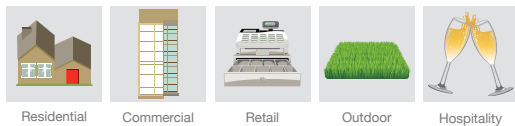

Residential

Commercial

Retail

Outdoor

Hospitality

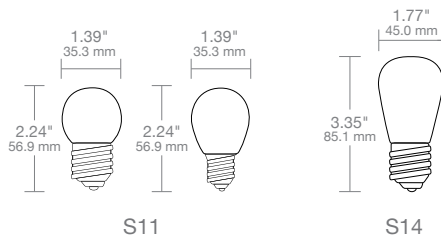

S11

S14

Ordering Information



Watt	Base	Product #	Product Code	Description	Volts	Color Temp.	CRI	Lumens	Useful Life*	Pkg. Qty.	MOL
1.2 Watt	Int.	80525	S11CL1C/827/INT/LED	Clear, IP65 Rated	120	2700K	82	35	40,000	1/25	2.24"
1.2 Watt	Med.	80524	S11CL1C/827/LED	Clear, IP65 Rated	120	2700K	82	35	40,000	1/25	2.24"
1.2 Watt	Med.	80526	S11WH1C/LED	White, IP65 Rated	120	-	-	35	40,000	1/25	2.24"
1.4 Watt	Med.	80517	S14RED1C/LED	Red, IP65 Rated	120	-	-	-	40,000	1/25	3.35"
1.4 Watt	Med.	80518	S14BLU1C/LED	Blue, IP65 Rated	120	-	-	-	40,000	1/25	3.35"
1.4 Watt	Med.	80519	S14GRN1C/LED	Green, IP65 Rated	120	-	-	-	40,000	1/25	3.35"
1.4 Watt	Med.	80520	S14YEL1C/LED	Yellow, IP65 Rated	120	-	-	-	40,000	1/25	3.35"
1.4 Watt	Med.	80521	S14WH1C/LED	White, IP65 Rated	120	-	-	-	40,000	1/25	3.35"
1.4 Watt	Med.	80523	S14ORG1C/LED	Orange, IP65 Rated	120	-	-	-	40,000	1/25	3.35"
1.4 Watt	Med.	80522	S14CL1C/827/LED	Clear, IP65 Rated	120	2700K	82	35	40,000	1/25	3.35"

* Useful Life is defined as the point in time at which the lamp will maintain at least 70% of its initial lumens. The lamp will continue to burn past this point at decreased light levels. Not for use in enclosed luminaires.

ProLED MR16



Specifications

- MR16 with GU5.3 and GU10 base options
- UL Listed for damp locations and enclosed luminaires
- 10-18V (10W, 20W and 50W equivalents)
- 10-15V (35W equivalent)
- Dimmable to 5% for design flexibility
- Available in 2700K, 3000K and 5000K in Flood beam angles
- Available in 2700K and 3000K in Narrow Flood and Wide Flood beam angles
- 82 CRI for quality and consistent color rendering
- No Mercury or UV/IR emissions
- RoHS Compliant
- 5-Year Limited Warranty

Savings Comparison

Total Lifetime Costs

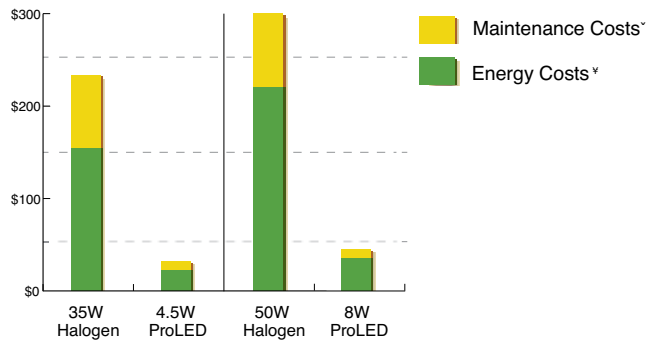

* Maintenance costs based on 15 minutes to replace the lamp at \$40 per/hr over the life of the ProLED lamp.
 * Energy costs based on \$0.11 kWh over 40,000 hour life.

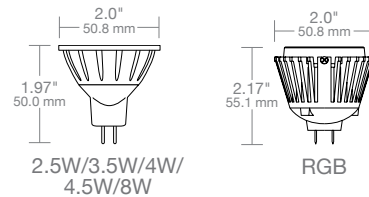

Markets & Applications



Ordering Information



Watt	Base	Product #	Product Code	Description	Volts	Color Temp.	CRI	Lumens	CBCP	Useful Life*	Pkg. Qty.	Beam Spread	MOL	Wattage Equivalent
2.5 Watt	GU5.3	81055	MR16NFL10/827/LED	Narrow Flood ∞	10-18	2700K	82	200	800	40,000	1/10	20°	1.97"	10
2.5 Watt	GU5.3	81079	MR16NFL10/830/LED	Narrow Flood ∞	10-18	3000K	82	210	830	40,000	1/10	20°	1.97"	10
2.5 Watt	GU5.3	81056	MR16FL10/827/LED	Flood ∞	10-18	2700K	82	200	300	40,000	1/10	40°	1.97"	10
2.5 Watt	GU5.3	81077	MR16FL10/830/LED	Flood ∞	10-18	3000K	82	210	320	40,000	1/10	40°	1.97"	10
2.5 Watt	GU5.3	81058	MR16FL10/850/LED	Flood ∞	10-18	5000K	82	230	350	40,000	1/10	40°	1.97"	10
2.5 Watt	GU5.3	81057	MR16WFL10/827/LED	Wide Flood ∞	10-18	2700K	82	200	200	40,000	1/10	60°	1.97"	10
2.5 Watt	GU5.3	81080	MR16WFL10/830/LED	Wide Flood ∞	10-18	3000K	82	210	220	40,000	1/10	60°	1.97"	10
4 Watt	GU5.3	81059	MR16BBF/827/LED	Narrow Flood ∞	10-18	2700K	82	270	900	40,000	1/10	20°	1.97"	20
4 Watt	GU5.3	81081	MR16BBF/830/LED	Narrow Flood ∞	10-18	3000K	82	280	1100	40,000	1/10	20°	1.97"	20
4 Watt	GU5.3	81060	MR16BAB/827/LED	Flood ∞	10-18	2700K	82	270	440	40,000	1/10	40°	1.97"	20
4 Watt	GU5.3	81062	MR16BAB/830/LED	Flood ∞	10-18	3000K	82	280	500	40,000	1/10	40°	1.97"	20
4 Watt	GU5.3	81063	MR16BAB/850/LED	Flood ∞	10-18	5000K	82	310	530	40,000	1/10	40°	1.97"	20
4 Watt	GU5.3	81061	MR16WFL20/827/LED	Wide Flood ∞	10-18	2700K	82	270	210	40,000	1/10	60°	1.97"	20
4 Watt	GU5.3	81082	MR16WFL20/830/LED	Wide Flood ∞	10-18	3000K	82	280	230	40,000	1/10	60°	1.97"	20
4 Watt	GU5.3	80728	MR16/5RGB/FL/LED	Flood Color Changing Red, Green, Blue ∞	10-18	-	-	-	-	40,000	1/10	31°	2.17"	-
		80649	RGB/REMOTE	Remote Control for Color Changing Lamps										

Ordering Information Continued

Watt	Base	Product #	Product Code	Description	Volts	Color Temp.	CRI	Lumens	CBCP	Useful Life*	Pkg. Qty.	Beam Spread	MOL	Wattage Equivalent
4.5 Watt	GU5.3	81064	MR16FRA/827/LED	Narrow Flood ∞∞	10-15	2700K	82	380	1700	40,000	1/10	20°	1.97"	35
4.5 Watt	GU5.3	81083	MR16FRA/830/LED	Narrow Flood ∞∞	10-15	3000K	82	390	1800	40,000	1/10	20°	1.97"	35
4.5 Watt	GU5.3	81065	MR16FMW/827/LED	Flood ∞∞	10-15	2700K	82	380	600	40,000	1/10	40°	1.97"	35
4.5 Watt	GU5.3	81067	MR16FMW/830/LED	Flood ∞∞	10-15	3000K	82	390	650	40,000	1/10	40°	1.97"	35
4.5 Watt	GU5.3	81068	MR16FMW/850/LED	Flood ∞∞	10-15	5000K	82	430	700	40,000	1/10	40°	1.97"	35
4.5 Watt	GU5.3	81066	MR16WFL35/827/LED	Wide Flood ∞∞	10-15	2700K	82	380	300	40,000	1/10	60°	1.97"	35
4.5 Watt	GU5.3	81084	MR16WFL35/830/LED	Wide Flood ∞∞	10-15	3000K	82	390	320	40,000	1/10	60°	1.97"	35
8 Watt	GU5.3	81069	MR16EXZ/827/LED	Narrow Flood ∞∞	10-18	2700K	82	590	2700	40,000	1/10	20°	1.97"	50
8 Watt	GU5.3	81085	MR16EXZ/830/LED	Narrow Flood ∞∞	10-18	3000K	82	600	2800	40,000	1/10	20°	1.97"	50
8 Watt	GU5.3	81070	MR16EXN/827/LED	Flood ∞∞	10-18	2700K	82	590	1100	40,000	1/10	40°	1.97"	50
8 Watt	GU5.3	81072	MR16EXN/830/LED	Flood ∞∞	10-18	3000K	82	600	1200	40,000	1/10	40°	1.97"	50
8 Watt	GU5.3	81073	MR16EXN/850/LED	Flood ∞∞	10-18	5000K	82	660	1400	40,000	1/10	40°	1.97"	50
8 Watt	GU5.3	81071	MR16FNV/827/LED	Wide Flood ∞∞	10-18	2700K	82	590	500	40,000	1/10	60°	1.97"	50
8 Watt	GU5.3	81086	MR16FNV/830/LED	Wide Flood ∞∞	10-18	3000K	82	600	520	40,000	1/10	60°	1.97"	50

* Useful Life is defined as the point in time at which the lamp will maintain at least 70% of its initial lumens. The lamp will continue to burn past this point at decreased light levels.
 ♦ May not be compatible with all dimming systems, dimming performance may vary by system, please visit www.halcolighting.com/ProLEDdim for dimmer compatibility information. Use on incompatible systems may shorten lamp life.
 ∞ Acceptable for use in sealed metal landscape luminaires when protected from the elements.
 Represents lamps that are ENERGY STAR® certified.

ProLED MR16 GU10

Specifications

- Halogen-style lens for familiar look and feel
- 25,000 hour life resulting in lower maintenance costs over time
- 120V input voltage
- 6.5W lamps are 76 lumens per watt
- 82 CRI for quality and consistent color rendering
- Dimmable to 5%
- 5-Year Limited Warranty

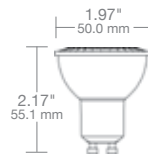

Markets & Applications

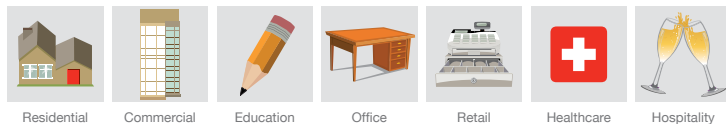

Ordering Information

Watt	Base	Product #	Product Code	Volts	Color Temp.	CRI	Lumens	CBCP	Useful Life*	Pkg. Qty.	Beam Spread	MOL	Wattage Equivalent
4.5 Watt	GU10	80887	MR16FL4/830/GU10/LED	120	3000K	82	370	525	25,000	1/10	40°	2.17"	35
4.5 Watt	GU10	80529	MR16FL4/827/GU10/LED	120	3000K	82	360	525	25,000	1/10	40°	2.70"	35
4.5 Watt	GU10	80531	MR16FL4/840/GU10/LED	120	3000K	82	360	525	25,000	1/10	40°	2.70"	35
4.5 Watt	GU10	80533	MR16FL4/850/GU10/LED	120	3000K	82	360	525	25,000	1/10	40°	2.70"	35
6.5 Watt	GU10	80888	MR16FL6/830/GU10/LED	120	3000K	82	520	730	25,000	1/10	40°	2.17"	50
6.5 Watt	GU10	80528	MR16FL6/827/GU10/LED	120	3000K	82	500	730	25,000	1/10	40°	2.17"	50
6.5 Watt	GU10	80530	MR16FL6/840/GU10/LED	120	3000K	82	500	730	25,000	1/10	40°	2.17"	50
6.5 Watt	GU10	80532	MR16FL6/850/GU10/LED	120	3000K	82	500	730	25,000	1/10	40°	2.17"	50

* Useful Life is defined as the point in time at which the lamp will maintain at least 70% of its initial lumens. The lamp will continue to burn past this point at decreased light levels. Use on incompatible systems may shorten lamp life.
 Represents lamps that are ENERGY STAR® certified.
 ■ ENERGY STAR® mandates that all directional lamps may only be listed at 25,000 hour life with 3,000 hour actual life test data, 6,000 hour LM80 data and in-situ temperature measurements. Upon completion of full lifetime testing, ProLED ENERGY STAR® listed lamps will be listed at their full lifetime.





ProLED Black MR16

Specifications

- Three distributions for application flexibility
- Environmentally friendly
- Long-Lasting for low maintenance
- 30,000+ hour life results in lower maintenance costs over time
- Improved efficiency of ProLED® MR16 series by lowering wattage consumption and increasing light output
- 82 CRI for quality and consistent color rendering
- RoHS Compliant
- 3-Year Limited Warranty



Markets & Applications



Landscape

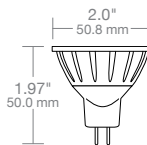

Ordering Information



Watt	Base	Product #	Product Code	Description	Volts	Color Temp.	CRI	Lumens	CBCP	Useful Life*	Pkg. Qty.	Beam Spread	MOL	Wattage Equivalent
3.5 Watt	GU5.3	81103	MR16NFL4/827/LED	Narrow Flood •	10-15	2700K	82	250	860	30,000	1/10	20°	1.97"	20
3.5 Watt	GU5.3	81098	MR16FL4/827/LED	Flood •	10-15	2700K	82	250	410	30,000	1/10	40°	1.97"	20
3.5 Watt	GU5.3	81099	MR16WFL4/827/LED	Wide Flood •	10-15	2700K	82	250	200	30,000	1/10	60°	1.97"	20

* Useful Life is defined as the point in time at which the lamp will maintain at least 70% of its initial lumens. The lamp will continue to burn past this point at decreased light levels.
 • May not be compatible with all dimming systems, dimming performance may vary by system, please visit www.halcolighting.com/ProLEDdim for dimmer compatibility information. Use on incompatible systems may shorten lamp life.
 Acceptable for use in sealed metal landscape luminaires when protected from the elements.

Savings Comparison

Total Lifetime Costs

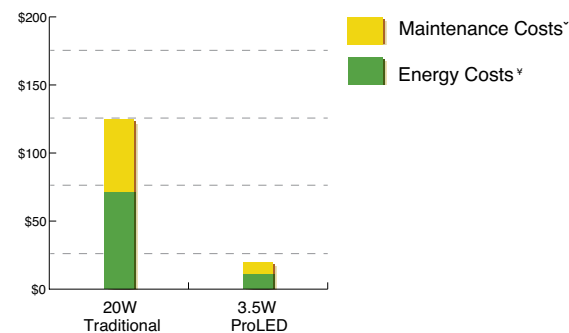

[‡] Maintenance costs based on 15 minutes to replace the lamp at \$40 per/hr over the life of the ProLED lamp.
[†] Energy costs based on \$0.11 kWh over 40,000 hour life.

ProLED MR11

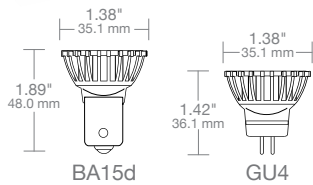

Specifications

- High power LED
- Damp location rated
- 10-18V options
- Dimmable to 5% for design flexibility
- 40,000 hour life
- Available in 2700K and 5000K CCT
- Up-to 82 CRI for quality and consistent color rendering
- Flood or Narrow Flood beam spreads
- UL Listed options
- No Mercury or UV/IR emissions
- RoHS Compliant
- 5-Year Limited Warranty

Markets & Applications

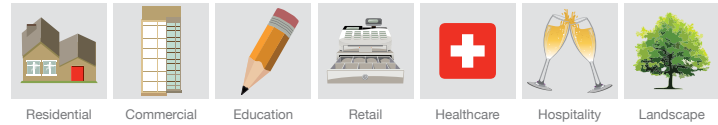

Ordering Information



Watt	Base	Product #	Product Code	Description	Volts	Color Temp.	CRI	Lumens	CBCP	Useful Life*	Pkg. Qty.	Beam Spread	MOL	Wattage Equivalent
3 Watt	GU4	81093	MR11FTD/827/LED	Flood	10-18	2700K	82	230	420	40,000	1/10	30°	1.42"	20
3 Watt	BA15d	81094	MR11FTD/827/BA15D/LED	Flood	10-18	2700K	82	230	420	40,000	1/10	30°	1.50"	20
3 Watt	GU4	81095	MR11FTD/850/LED	Flood	10-18	5000K	82	250	500	40,000	1/10	30°	1.42"	20
3 Watt	GU4	81096	MR11FTC/827/LED	Narrow Flood	10-15	2700K	82	230	600	40,000	1/10	22°	1.42"	20

* Useful Life is defined as the point in time at which the lamp will maintain at least 70% of its initial lumens. The lamp will continue to burn past this point at decreased light levels. May not be compatible with all dimming systems, dimming performance may vary by system, please visit www.halcolighting.com/ProLEDdim for dimmer compatibility information. Use on incompatible systems may shorten lamp life. Acceptable for use in sealed metal landscape luminaires when protected from the elements. May not be compatible with all electronic transformers. Magnetic transformers are recommended for dimming applications. Not for use in enclosed luminaires. Lamps should be tested in the application for compatibility prior to full installations on circuits using such devices.

Savings Comparison

Total Lifetime Costs

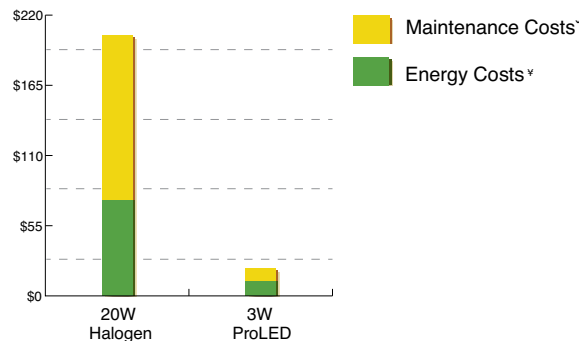

* Maintenance costs based on 15 minutes to replace the lamp at \$40 per/hr over the of the ProLED lamp.
 * Energy costs based on \$0.11 kWh over 60,000 hour life.

Photometrics

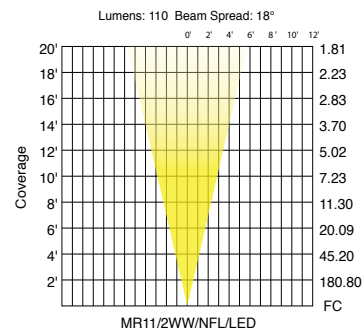
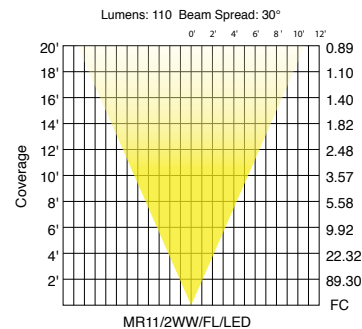

ProLED Outdoor PAR36

Specifications

- IP67 rated for waterproof installations
- Energy savings up-to 81% - 6.5W PAR36 versus 35W Halogen¹
- Multi-purpose base for slip-on or screw terminal connections
- 10-15V input voltage range
- 40,000 hour life, up-to 12 times longer than traditional sources
- Available in 2700K CCT
- 82 CRI for quality and consistent color rendering
- 32° beam spread available for light control
- No Mercury or UV/IR emissions
- RoHS Compliant
- 5-Year Limited Warranty



Markets & Applications

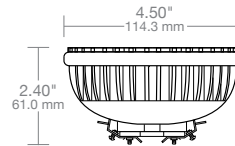
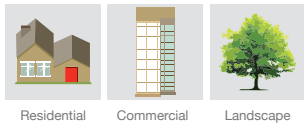

Ordering Information



Watt	Base	Product #	Product Code	Description	Volts	Color Temp.	CRI	Lumens	CBCP	Useful Life*	Pkg. Qty.	Beam Spread	MOL	Wattage Equivalent
4.5 Watt	MP Term	81074	PAR36WFL4/827/IP67/LED	Wide Flood	10-15	2700K	82	300	700	40,000	1/6	32°	2.40"	20
6.5 Watt	MP Term	81075	PAR36WFL6/827/IP67/LED	Wide Flood	10-15	2700K	82	450	1100	40,000	1/6	32°	2.40"	35
12.5 Watt	MP Term	81076	PAR36WFL12/827/IP67/LED	Wide Flood	10-15	2700K	82	800	2000	40,000	1/6	32°	2.40"	50

¹ Energy savings based on \$0.11 kWh over 40,000 hour life.

* Useful Life is defined as the point in time at which the lamp will maintain at least 70% of its initial lumens. The lamp will continue to burn past this point at decreased light levels. Not for use in enclosed luminaires.

May not be compatible with all electronic transformers.

Rated for outdoor use only.

Savings Comparison

Total Lifetime Costs

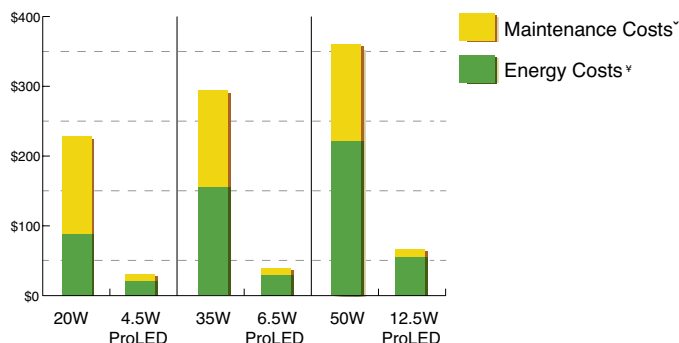

[‡] Maintenance costs based on 15 minutes to replace the lamp at \$40 per/hr over the life of the ProLED lamp.

[†] Energy costs based on \$0.11 kWh over 40,000 hour life.

IP Rated LED JC Series

Specifications

- Directional light output maximizes control and distribution
- Wide variety of base types and body shapes for application versatility
- High power and SMD LED options
- Up-to 88% energy savings - 2.5W JC versus 20W Halogen
- IP65 Rated for high performance and versatility
- 10-18V input voltage range
- Up-to 40,000 hour life, 20 times longer than traditional lamps
- Available in 2700K, 3000K CCT
- 82 CRI for quality and consistent color rendering
- No Mercury or UV/IR emissions
- RoHS Compliant
- 5-Year Limited Warranty on IP65 Rated lamps

Savings Comparison

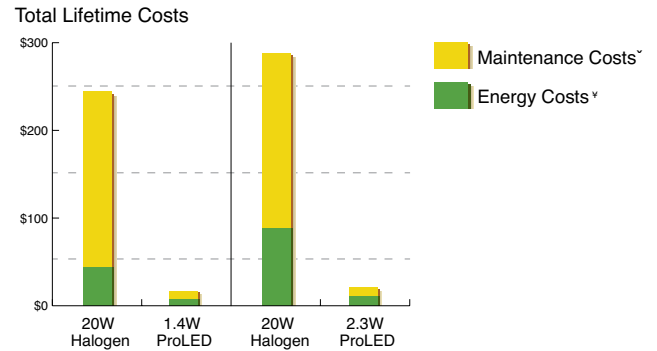

[†] Maintenance costs based on 15 minutes to replace the lamp at \$40 per/hr over the life of the ProLED lamp.
[‡] Energy costs based on \$0.11 kWh over 40,000 hour life.

Markets & Applications



Ordering Information



Watt	Base	Product #	Product Code	Description	Volts	Color Temp.	CRI	Lumens	Useful Life*	Pkg. Qty.	MOL	Wattage Equivalent
JC2S												
1.4 Watt	G4	81091	JC2S/827/LED2	IP65 Rated	10-15	2700K	82	140	40,000	1/10	0.98"	20
1.4 Watt	G4	81092	JC2S/830/LED2	IP65 Rated	10-15	3000K	82	150	40,000	1/10	0.98"	20
JC2												
2.3 Watt	G4	81109	JC2/827/LED2	Omnidirectional, IP65 Rated	10-15	2700K	82	250	40,000	1/10	1.57"	20
2.3 Watt	G4	81108	JC20/2WW/LED2	Omnidirectional, IP65 Rated	10-15	3000K	82	250	40,000	1/10	1.57"	20
JC10												
1.5 Watt	BA15s	80810	JC10/1WW/BA15S/LED2	IP65 Rated	10-18	3000K	82	100	40,000	1/10	1.93"	10
JC20												
2.3 Watt	BA15s	81100	JC20/2WW/BA15S/LED2	IP65 Rated	10-15	3000K	82	250	40,000	1/10	2.00"	20
1.2 Watt	Wedge	81102	912/1WW/LED2	"	10-15	3000K	82	120	40,000	1/10	1.51"	10
2.3 Watt	Wedge	81101	3155/2WW/LED2	"	10-15	3000K	82	250	40,000	1/10	1.67"	20

* Useful Life is defined as the point in time at which the lamp will maintain at least 70% of its initial lumens. The lamp will continue to burn past this point at decreased light levels. May not be compatible with all electronic transformers. Not for use in enclosed luminaires. Suitable for use in sealed metal landscape luminaires; standard JC lamps require protection from elements. IP65 rated lamps are rated for use outdoors where exposed directly to water from rain or irrigation. The lamp is not submersible nor for use in enclosed luminaires. Suitable for use in sealed metal landscape luminaires.

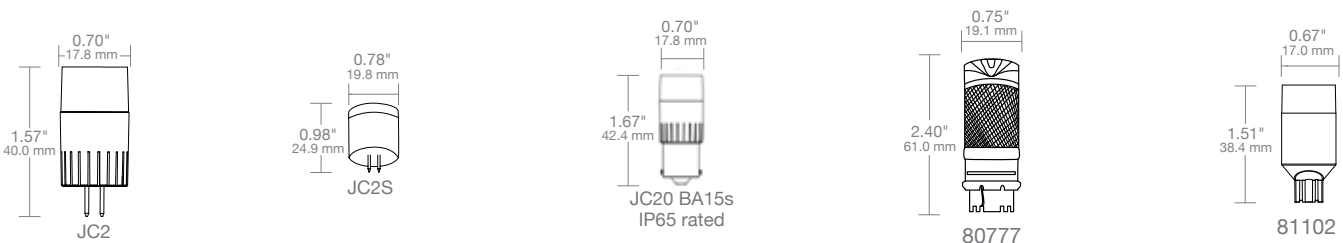

Traditional LED JC Series

NEW!

Specifications

- New white body construction with improved LED chip technology
- Omnidirectional distribution for smooth, even light
- Available in 2700K, 3000K and 5000K CCT
- Wide variety of wattages and base types for maximum application versatility
- 82 CRI for quality and consistent color rendering
- Amber, Blue, Green or Red color options
- No Mercury or UV/IR emissions
- RoHS Compliant
- 3-Year Limited Warranty

Markets & Applications



Savings Comparison

Total Lifetime Costs

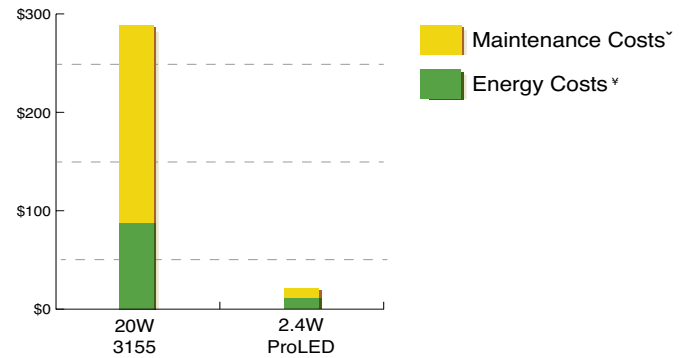

* Maintenance costs based on 15 minutes to replace the lamp at \$40 per/hr over the life of the ProLED lamp.
 † Energy costs based on \$0.11 kWh over 40,000 hour life.



Watt	Base	Product #	Product Code	Description	Volts	Color Temp.	CRI	Lumens	Useful Life*	Pkg. Qty.	MOL	Wattage Equivalent
Mini Wedge												
1 Watt	Wedge	80791	912/1WW/LED	Omnidirectional	10-18	3000K	82	75	20,000	1/50	1.18"	10
JC10												
1.5 Watt	BA15s	80692	JC10/1WW/BA15S/LED	Omnidirectional	10-24	3000K	82	150	30,000	1/40	1.70"	10
1.5 Watt	G4	80693	JC10/1WW/LED	Omnidirectional	10-24	3000K	82	150	30,000	1/10	1.21"	10
JC20												
1.8 Watt	G4	80782	JC20/2AMB/LED	Omnidirectional Amber	10-24	-	-	-	30,000	1/40	1.81"	-
1.8 Watt	G4	80780	JC20/2BLU/LED	Omnidirectional Blue	10-24	-	-	-	30,000	1/40	1.81"	-
1.8 Watt	G4	80779	JC20/2GRN/LED	Omnidirectional Green	10-24	-	-	-	30,000	1/40	1.81"	-
1.8 Watt	G4	80781	JC20/2RED/LED	Omnidirectional Red	10-24	-	-	-	30,000	1/40	1.81"	-
2.4 Watt	BA15s	80691	JC20/2WW/BA15S/LED	Omnidirectional	10-24	3000K	82	250	30,000	1/40	2.01"	20
2.4 Watt	G4	80833	JC2/827/LED	Omnidirectional	10-24	2700K	82	240	30,000	1/10	1.81"	20
2.4 Watt	G4	80690	JC20/2WW/LED	Omnidirectional	10-24	3000K	82	250	30,000	1/40	1.81"	20
2.4 Watt	G4	80815	JC20/2NW/LED	Omnidirectional	10-24	5000K	82	260	30,000	1/10	1.81"	20
JC35												
4.5 Watt	GY6.35	80830	JC35/4WW/LED	Omnidirectional	10-18	3000K	82	450	30,000	1/30	1.71"	35
JC50												
5.5 Watt	GY6.35	81997	JC50/5WW/LED	Omnidirectional	10-18	3000K	82	550	30,000	1/30	1.71"	50

* Useful Life is defined as the point in time at which the lamp will maintain at least 70% of its initial lumens. The lamp will continue to burn past this point at decreased light levels. May not be compatible with all electronic transformers.
 Not for use in enclosed luminaires. Suitable for use in sealed metal landscape luminaires; standard JC lamps require protection from elements.
 IP65 rated lamps are rated for use outdoors where exposed directly to water from rain or irrigation. The lamp is not submersible nor for use in enclosed luminaires. Suitable for use in sealed metal landscape luminaires.

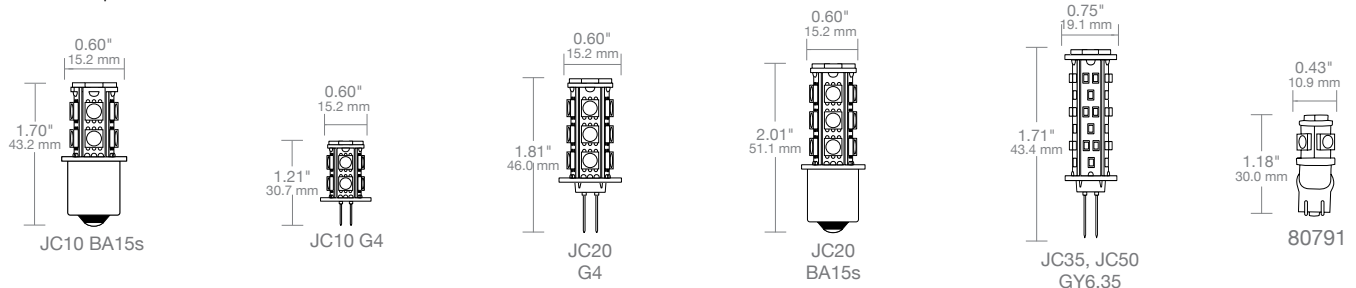

Traditional LED JC Series

Ordering Information continued

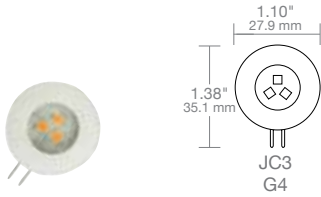

Watt	Base	Product #	Product Code	Description	Volts	Color Temp.	CRI	Lumens	Useful Life*	Pkg. Qty.	MOL	Wattage Equivalent
JC3												
3.3 Watt	G4	81078	JC3VWFL/827/LED	100° Very Wide Flood	12	2700K	82	200	25,000	1/10	1.38"	20

* Useful Life is defined as the point in time at which the lamp will maintain at least 70% of its initial lumens. The lamp will continue to burn past this point at decreased light levels. May not be compatible with all electronic transformers.

Not for use in enclosed luminaires. Suitable for use in sealed metal landscape luminaires; standard JC lamps require protection from elements.

IP65 rated lamps are rated for use outdoors where exposed directly to water from rain or irrigation. The lamp is not submersible nor for use in enclosed luminaires. Suitable for use in sealed metal landscape luminaires.

Omnidirectional IP65 JC Lamps

Specifications

- Omnidirectional for Smooth, Even Light Distribution
- Silicone shell allows for smooth even illumination while adding a durable level of protection to the LEDs
- 15,000 hour life results in lower maintenance costs over time
- IP65 Rated for use where exposed directly to water from rain or irrigation
- 10-15V input range
- Universal operating position, fits most landscape fixtures
- RoHS Compliant



NEW!

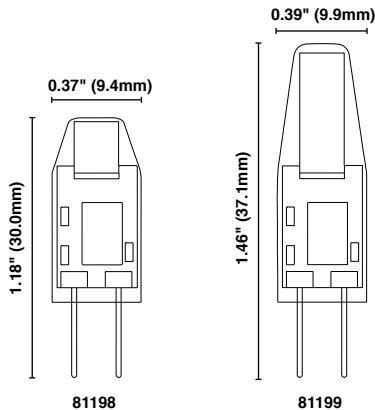

Markets & Applications

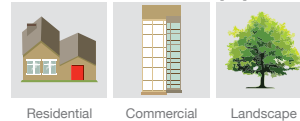

Residential

Commercial

Landscape

Ordering Information

Watt	Base	Product #	Product Code	Description	Volts	Color Temp.	CRI	Lumens	Useful Life*	Pkg. Qty.	Diameter	MOL	Wattage Equivalent
1.2	G4	81198	JC1/830/OMNI/IP65/LED	IP65 Rated	10-15	3000	82	110	15,000	1/10	0.37"	1.18"	10
1.6	G4	81199	JC2/830/OMNI/IP65/LED	IP65 Rated	10-15	3000	82	180	15,000	1/10	0.39"	1.46"	20

* Useful Life is defined as the point in time at which the lamp will maintain at least 70% of its initial lumens. The lamp will continue to burn past this point, but at decreased light levels.

Warranty - Commercial / Industrial: This product is warranted for 2 years from the date of purchase. Not for use on dimmers, timing devices, photo sensors or occupancy sensors. Suitable for use in sealed metal landscape fixtures.

ProLED Elevator Lamp

Specifications

- High power LED for maximum efficiency
- Up-to 87% energy savings - 2.6W GBF versus 20W Incandescent
- 10-18V input voltage range
- 40,000 hour life, 20 times longer than traditional lamps
- Available in 2700K CCT
- 82 CRI for quality and consistent color rendering
- No Mercury or UV/IR emissions
- RoHS Compliant
- 5-Year Limited Warranty



Markets & Applications

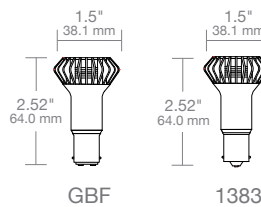

Ordering Information



Watt	Base	Product #	Product Code	Volts	Color Temp.	CRI	CBCP	Lumens	Useful Life*	Pkg. Qty.	MOL	Wattage Equivalent
2.6 Watt	BA15d	80756	GBF/3WW/LED	10-18	2700K	82	410	145	40,000	1/10	2.52"	20
2.6 Watt	BA15s	80701	1383/3WW/LED	10-18	2700K	82	410	145	40,000	1/10	2.52"	20

* Useful Life is defined as the point in time at which the lamp will maintain at least 70% of its initial lumens. The lamp will continue to burn past this point at decreased light levels.

Savings Comparison

Total Lifetime Costs

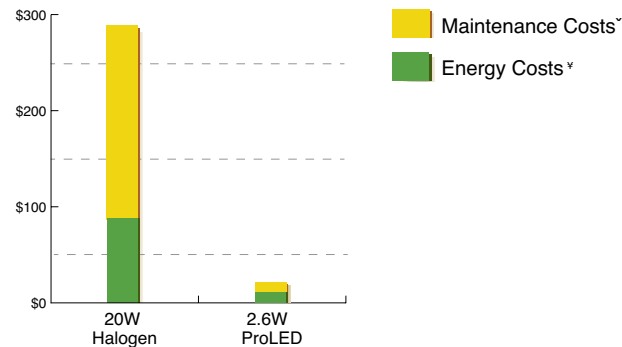

* Maintenance costs based on 15 minutes to replace the lamp at \$40 per/hr over the life of the ProLED lamp.

* Energy costs based on \$0.11 kWh over 40,000 hour life.



Transformer and Dimmer Compatibility in Commercial and Residential Installations

While LED lamps allow for greater energy savings and longer life, they can be challenging when used in existing applications and luminaires. Compatibility with transformers and dimmers are the most common issues faced in replacement and retrofit applications. There are 3 main transformer types, each with their own advantages and disadvantages when considering an LED retrofit.

Although ProLED lamps are designed to perform well with most available transformers in these categories, ensuring transformer compatibility is crucial to the proper performance and lifetime of ProLED lamps.

Positive	Negative
Magnetic Transformers and LED Lighting	
<ul style="list-style-type: none"> – Provide a known 60Hz AC power to the LED, which is often accommodated in the design of many LED products – Robust, reliable and available in many different wattages – Relatively inexpensive, comparatively for higher wattages 	<ul style="list-style-type: none"> – Provide AC rather than DC current – Minimum load rating to provide the expected voltage, which can be difficult due to the efficient nature of LEDs – Translate voltage instability from incoming power to output power – Less efficient at power conversion in comparison to electronic transformers – Larger and heavier than the electronic equivalent
Electronic AC Transformers and LED Lighting	
<ul style="list-style-type: none"> – Can be designed in a very small package and are often integrated into a luminaire – More efficient than a magnetic transformer – At low wattages, they can have a cost advantage due to less material – Less likely to translate voltage instability from incoming power to output power 	<ul style="list-style-type: none"> – Operates at high frequencies which can interfere with or damage LED products – Minimum load rating that can be triggered by the low draw of LED lamps, causing the transformer to think there is a failed lamp and either not working or causing flickering – Less tolerant of heat than magnetic transformers. Must be designed to be dimmed
Electronic DC Transformers and LED Lighting	
<ul style="list-style-type: none"> – Ideal power supply for most LED products, as almost all LED chips are designed as DC only – Provides a very stable power source, often allowing LED products to perform better – Smaller and lighter than magnetic transformers – Provides less voltage drop on long wiring runs – Do not translate voltage instability from incoming power to output power 	<ul style="list-style-type: none"> – DC transformers are less common in existing applications – Often more expensive than the equivalent electronic AC transformer – Usually larger than electronic AC transformer – Must be designed to be dimmed for dimming applications

For a list of transformers compatible with the ProLED MR16 Series, visit the ProLED Compatibility section at <http://www.halcolighting.com/download>.

The ProLED offering features a wide variety of dimmable lamps and when used with compatible dimmers common challenges can be avoided. For a comprehensive list of line voltage ProLED and compatible dimmers, visit <http://www.halcolighting.com/pdf/ProLEDdim.pdf>.

Common Issue	Dimmable ProLED Lamps on Compatible Dimmers
Reduced dimming range	Operate down to 5% of rated lumen output
Lights dropping out	Smooth flicker-free dimming through the lamps dimming range
Lights not turning on	Illuminate at a dimmed light output
Lights turning off unexpectedly	Withstand voltage fluctuations for consistent performance



Selecting a Transformer for Low Voltage LED Landscape Lighting

True power consumed is measured in watts. It is what customers are charged for on their utility bill. A lamp's true power (wattage) is listed on the lamp's packaging. When an LED is powered, the lamp's driver converts alternating current (AC) to direct current (DC), which consumes reactive and harmonic power on top of the true power that is required to produce light. The utility must generate additional energy above and beyond the lamp's true power in order to operate the lamp.

The total amount of power that must be generated by the utility is measured in volt amperes (VA) and is referred to as apparent power. Power factor - the ratio of true power to apparent power - is the measure of how efficiently electrical power is consumed. Dividing a lamp's wattage by the lamp's power factor results in the VA drawn on the line - $\text{Wattage/Power Factor} = \text{Volt-Amperes}$.

Halogen and Incandescent lamps have a power factor of one, which means that the lamp uses 100% of the input power to produce light and heat. Consequently, filament lamps' wattage and VA are equivalent. For example, a 20W MR16 BAB draws 20VA from the line. For LED installations, apparent power (VA) must be taken into consideration, because transformer size is actually based on apparent power (VA), not true power (W). To specify the correct transformer size, the system's total load must be calculated to ensure that the total volt-ampere draw does not exceed the transformer's rating.

The ProLED installation example below shows system load (total VA), true power consumed (W) and annual energy cost calculations.

1. Calculate Load of LED System		Lamp VA	x	# Lamps	= Total Luminaire Load
Well Light with 6.5W ProLED PAR36		10.9		8	= 87
Modern Bullet with 4.5W ProLED MR16		5		4	= 20
Total System Load					107
2. Select Transformer for the LED System Load					
3. Calculate LED Energy Consumption		Lamp Wattage	x	# Lamps	= Power Consumption
Well Light with 6.5W ProLED PAR36		6.5		8	= 52
Modern Bullet with 4.5W ProLED MR16		4.5		4	= 18
Total System Power Consumption					70
4. Calculate the LED System's Annual Energy Cost					
Consumption	x	Utility Cost ¹	x	Annual Operating Hours ² /1000	= Annual Energy Cost
70W		\$0.115 kWh		2190 hrs	= \$17.63

¹ Utility cost based on national average per U.S. Energy Information Administration - <http://www.eia.gov/electricity/data.cfm#summary> at the time of printing.

² Annual operating hours based on 6 hours/day and 365 days/year.

ProLED[®]
ProLume[®]
HaloXen[®]
PRISM[®]
CoverShield[®]
sollos[®]
LANDSCAPE LIGHTING

Halco[®]
LIGHTING TECHNOLOGIES

800.677.3334
FAX: 800.880.0822
www.halcolighting.com

Atlanta
2940 Pacific Drive
Norcross, GA 30071

Houston
6319 Brookhill Drive
Houston, TX 77087

Cleveland
3501 Croton Avenue
Cleveland, OH 44115

Los Angeles
10513 Hataway Drive
Santa Fe Springs, CA 90670

Carlstadt
600 Gotham Parkway, Unit 2
Carlstadt, NJ 07072

Phoenix
6607 W. Boston Street, Suite 1
Chandler, AZ 85226

sollos®

LANDSCAPE LIGHTING
A Halco Lighting Technologies Company



THE ART OF OUTDOOR ILLUMINATION



Table of Contents



Page 5



Page 17



Page 28



Page 31



Page 33



Page 35



Page 36



Page 40



Page 44

2	The Art of Outdoor Illumination
2	Why Choose Sollos?
3	Sollos & Halco ProLED Advantage
7	Up & Accent Lights
16	Lamp Guide
17	Path Lights
25	Lamp Guide
28	Ledge Lights
30	In-Ground & Well Lights
34	Step Lights
36	Deck Lights
38	Hanging Lights
40	Lamp Guide
42	DecoStrand Lights
46	Commercial Transformers
47	Integrated Transformers
48	Accessories
49	ProLED Volt-Ampere Guide
50	Warranty

The Art of Outdoor Illumination

Sollos Landscape Lighting offers a complete line of fixtures and finishes that enhance gardens, landscapes and outdoor settings. Surroundings are enriched by the subtle curves and organic feel of natural metal and architectural aluminum finishes. Dynamic fixture functionality provides safety, security and quality illumination.

Superior thermal management allows Sollos fixtures to operate both halogen and LED lamp technologies. Sollos fixtures powered by energy efficient Halco ProLED lamps provide consistent, reliable light output.

Sollos Landscape Lighting combines aesthetic styling and ProLED power for today's landscapes.



Why Choose Sollos?

Sollos Landscape Lighting was born out of an unmet need in the marketplace for a line of architectural fixtures designed to operate retrofit LED lamps. As a Halco Lighting Technologies Company, Sollos leveraged Halco's lamp expertise to be the first to market with a full line of landscape lighting fixtures designed to operate with both traditional and advanced technology retrofit lamps. The Sollos design methodology centers around form, function and efficiency.

Sollos & Halco ProLED Advantage

When powered by ProLED lamps, Sollos fixtures provide sustainable, high performance and quality LED illumination.

Powered by ProLED

ProLED lamps are constructed with LED chips, integrated drivers and transformers. ProLED lamps utilize a special heat sink to safely drive the components and achieve a long lifespan.

The input voltage range of ProLED lamps eliminate voltage drop, which is a common hurdle with traditional lamp technologies. ProLED lamps perform to specification at every input voltage within their voltage range.

For applications that normally require that the lamp is protected from the elements, Halco offers ingress protection (IP) rated ProLED lamps.

Rigorous adherence to design and manufacturing specifications ensures consistent lamp-to-lamp color, light output and beam spreads. ProLED lamps are available in a variety of color temperatures and color-changing red-green-blue (RGB).

LM-79 and IES files are available for all ProLED lamps upon request.



Strongest Lamp Warranty

20
Year
Warranty

When installed in a Sollos fixture in recommended conditions and packaging warnings are followed, ProLED MR16 and IP65-rated JC lamps are backed by a 20-year limited warranty, the strongest lamp warranty in the industry. When installed in other fixtures, these lamps are backed by a 5-year Limited Warranty. ProLED 912 lamps and non-IP65-rated JC lamps are backed by a 2-year Limited Warranty.

Think Lumens!

Efficient lighting technologies such as LED lamps produce comparable light output while consuming considerably less energy than traditional light sources. When evaluating replacement lamps, refer to lamps' light output, which is measured in lumens, rather than wattage. Lamps with relatively equivalent lumens and CBCP will provide similar illumination. So think lumens for light output and use lamp wattage to determine energy savings.



Up & Accent Lights



Contemporary, Straight & Modern Bullet

Mix and Match Bullet Light Ordering

Sollos Bullet Lights are supplied with an 8" ground stake. To order with lamp, please provide the lamp part number (indicated below) with the fixture order code from the following pages.

1 Select the Fixture:



Contemporary
Bullet



Straight
Bullet



Modern
Bullet

2 Select the Finish:

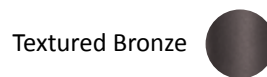
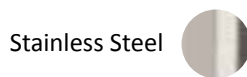
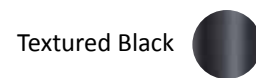
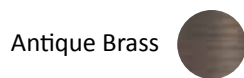

3 Select the Light Output Equivalent:



MR16FL4/827/LED



MR16BAB/827/LED



MR16NFL10/827/LED



MR16WFL10/827/LED

For the complete ProLED offering of lamps see page 16.

Up & Accent Lights

Contemporary Bullet

Contemporary design with minimal footprint to deliver superior illumination for accenting landscape features. Cast Brass or Aluminum housing for additional architectural appeal with Antique Brass, Textured Black, and Textured Bronze finishes for diverse settings.



BCB065-AB

Antique Brass



Textured Black



Textured Bronze



BCB065

Housing	Cast Brass or Architectural Aluminum
Lens	Clear Tempered Glass
Stem/Knuckle	Cast Brass or Architectural Aluminum
Wiring	3 ft. 18-2 Lead Wire
Lamp	MR16 (50W Max)
Mounting Accessory	8" Ground Stake Included

Order Codes

Antique Brass	BCB065-AB
Textured Black	BCB065-TB
Textured Bronze	BCB065-TZ

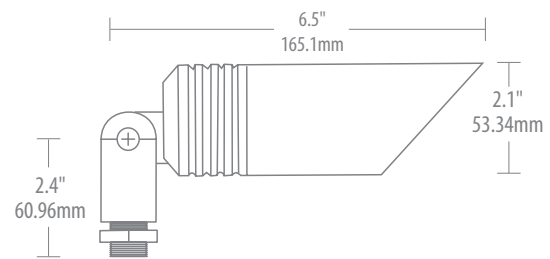

Recommended Lamps



Part Number	81055	81059	81064	81069
Product Code	MR16NFL10/827/LED	MR16BBF/827/LED	MR16FRA/827/LED	MR16EXZ/827/LED
Watts	2.5	4	4.5	8
Color Temp	2700k	2700k	2700k	2700k
Replacement Watt	10	20	35	50

For the complete ProLED offering of lamps see page 16.

Up & Accent Lights

Straight Bullet

Slender design with minimal footprint to deliver superior illumination for accenting landscape features. Cast Brass, Natural Copper, or Stainless Steel housing for additional architectural appeal with Antique Brass, Copper, and Stainless Steel finishes for diverse settings.

BSB067

Housing	Cast Brass, Natural Copper or Stainless Steel
Lens	Clear Tempered Glass
Stem/Knuckle	Cast Brass
Wiring	3 ft. 18-2 Lead Wire
Lamp	MR16 (50W Max)
Mounting Accessory	8" Ground Stake Included

Order Codes

Antique Brass	BSB067-AB
Copper	BSB067-CU
Stainless Steel	BSB067-SS



BSB067-AB

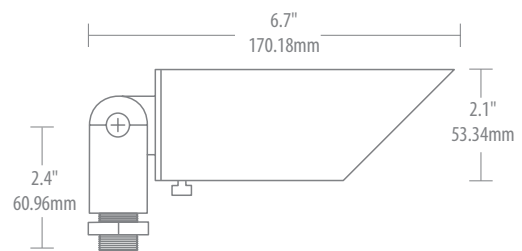

Recommended Lamps



Part Number	81056	81060	81065	81070
Product Code	MR16FL10/827/LED	MR16BAB/827/LED	MR16FMW/827/LED	MR16EXN/827/LED
Watts	2.5	4	4.5	8
Color Temp	2700k	2700k	2700k	2700k
Replacement Watt	10	20	35	50

For the complete ProLED offering of lamps see page 16.

Up & Accent Lights

Modern Bullet

Modern design with minimal footprint to deliver superior illumination for accenting landscape features. Aluminum housing for additional architectural appeal with Textured Black and Textured Bronze finishes for diverse settings.



BMB062-TB

Textured Black



Textured Bronze



BMB062

Housing	Architectural Aluminum
Lens	Clear Tempered Glass
Stem/Knuckle	Architectural Aluminum
Wiring	3 ft. 18-2 Lead Wire
Lamp	MR16 (50W Max)
Mounting Accessory	8" Ground Stake Included

Order Codes

Textured Black	BMB062-TB
Textured Bronze	BMB062-TZ

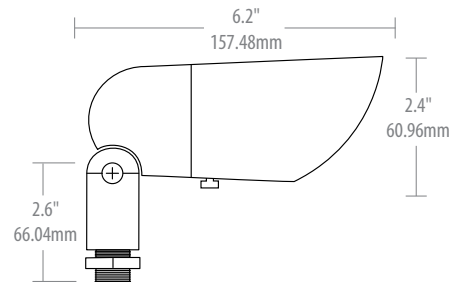

Recommended Lamps



Part Number	81079	81081	81083	81085
Product Code	MR16NFL10/830/LED	MR16BBF/830/LED	MR16FRA/830/LED	MR16EXZ/830/LED
Watts	2.5	4	4.5	8
Color Temp	3000k	3000k	3000k	3000k
Replacement Watt	10	20	35	50

For the complete ProLED offering of lamps see page 16.

Up & Accent Lights

Straight Bullet

Modern design with minimal footprint to deliver superior illumination for accenting landscape features. Aluminum housing for additional architectural appeal with Textured Black and Textured Bronze finishes for diverse settings.

BSB060

Housing	Architectural Aluminum
Lens	Clear Tempered Glass
Stem/Knuckle	Architectural Aluminum
Wiring	3 ft. 18-2 Lead Wire
Lamp	MR16 (50W Max)
Mounting Accessory	8" Ground Stake Included

Order Codes

Textured Black	BSB060-TB
Textured Bronze	BSB060-TZ

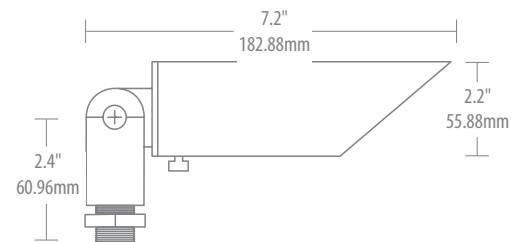

Recommended Lamps



Part Number	81077	81062	81067	81072
Product Code	MR16FL10/830/LED	MR16BAB/830/LED	MR16FMW/830/LED	MR16EXN/830/LED
Watts	2.5	4	4.5	8
Color Temp	3000k	3000k	3000k	3000k
Replacement Watt	10	20	35	50

For the complete ProLED offering of lamps see page 16.

Up & Accent Lights

Straight Bullet

Modern design with minimal footprint to deliver superior illumination for accenting landscape features. Aluminum housing for additional architectural appeal with Textured Black and Textured Bronze finishes for diverse settings.



BSB062-TB

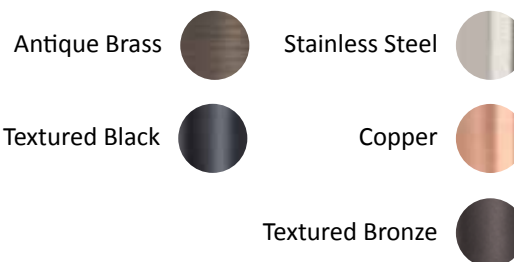

BSB062

Housing	Architectural Aluminum, Cast Brass, Natural Copper or Stainless Steel
Lens	Clear Tempered Glass
Stem/Knuckle	Architectural Aluminum or Cast Brass
Wiring	3 ft. 18-2 Lead Wire
Lamp	MR16 (35W Max)
Mounting Accessory	8" Ground Stake Included

Order Codes

Antique Brass	BSB062-AB
Copper	BSB062-CU
Stainless Steel	BSB062-SS
Textured Black	BSB062-TB
Textured Bronze	BSB062-TZ

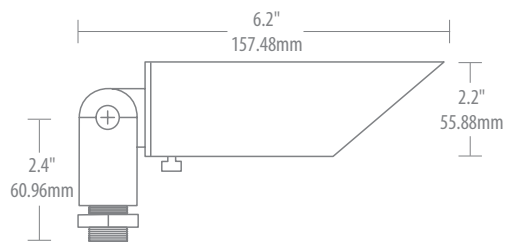

Recommended Lamps



Part Number	81057	81061	81066	81071
Product Code	MR16WFL10/827/LED	MR16WFL20/827/LED	MR16WFL35/827/LED	MR16FNV/827/LED
Watts	2.5	4	4.5	8
Color Temp	2700k	2700k	2700k	2700k
Replacement Watt	10	20	35	50

For the complete ProLED offering of lamps see page 16.

Up & Accent Lights

Straight Bullet

Sleek design with minimal footprint to deliver superior illumination for accenting landscape features. Cast Brass or Natural Copper housing for additional architectural appeal with Antique Brass, Brass, and Copper finishes for diverse settings.



BSB054-CU

Antique Brass



Copper



BSB054

Housing	Cast Brass or Natural Copper
Lens	Clear Tempered Glass
Stem/Knuckle	Cast Brass
Wiring	3 ft. 18-2 Lead Wire
Lamp	MR11 (35W Max)
Mounting Accessory	8" Ground Stake Included

Order Codes

Antique Brass	BSB054-AB
Copper	BSB054-CU

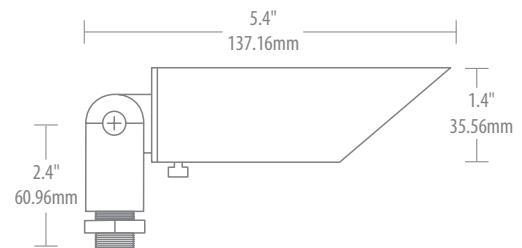

Recommended Lamps



Part Number	81093	81095	81096
Product Code	MR11FTD/827/LED	MR11FTD/850/LED	MR11FTC/827/LED
Watts	3	3	3
Color Temp	2700k	5000k	2700k
Replacement Watt	20	20	20

For the complete ProLED offering of lamps see page 16.

Up & Accent Lights

Flood Light

Contemporary design with a highly efficient reflector to deliver superior illumination for accenting landscape features. Aluminum or Cast brass housing for additional architectural appeal with Antique Brass, Textured Black, and Textured Bronze finishes for diverse settings.



FRF058-AB

Housing	Cast Brass or Architectural Aluminum
Lens	Clear Tempered Glass
Stem/Knuckle	Cast Brass or Architectural Aluminum
Wiring	3 ft. 18-2 Lead Wire
Lamp	T4 Bi-Pin (50W Max)
Mounting Accessory	8" Ground Stake Included

Order Codes

Antique Brass	FRF058-AB
Textured Black	FRF058-TB
Textured Bronze	FRF058-TZ

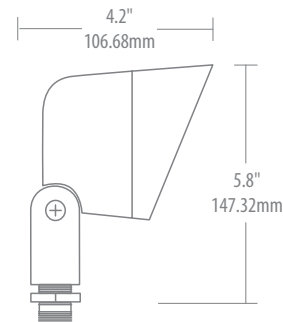
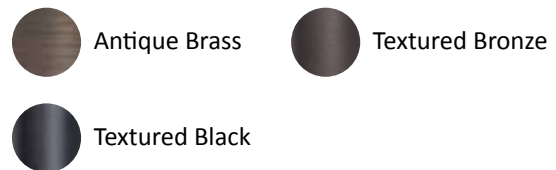

Recommended Lamps



Part Number	81997	80830	80690	80693
Product Code	JC50/5WW/LED	JC35/4WW/LED	JC20/2WW/LED	JC10/1WW/LED
Watts	5.5	4.5	2.4	1.5
Color Temp	3000k	3000k	3000k	3000k
Replacement Watt	50	35	20	10

For the complete ProLED offering of lamps see page 16.

Lamp Guide

Style	Size	Item #	Product Code	Finish	LED Lamp Product Code	
 Contemporary Bullet	6.5"	995502	BCB065-AB	Antique Brass	 MR16NFL10/827/LED - 81055 MR16NFL10/830/LED - 81079 MR16FL10/827/LED - 81056 MR16FL10/830/LED - 81077 MR16FL10/850/LED - 81058 MR16WFL10/827/LED - 81057 MR16WFL10/830/LED - 81080 MR16NFL4/827/LED - 81103 MR16FL4/827/LED - 81098 MR16WFL4/827/LED - 81099 MR16BBF/827/LED - 81059 MR16BBF/830/LED - 81081 MR16BAB/827/LED - 81060 MR16BAB/830/LED - 81062 MR16BAB/850/LED - 81063 MR16WFL20/827/LED - 81061 MR16WFL20/830/LED - 81082 MR16FRA/827/LED - 81064 MR16FRA/830/LED - 81083 MR16FMW/827/LED - 81065 MR16FMW/830/LED - 81067 MR16FMW/850/LED - 81068 MR16WFL35/827/LED - 81066 MR16WFL35/830/LED - 81084 MR16EXZ/827/LED - 81069 MR16EXZ/830/LED - 81085 MR16EXN/827/LED - 81070 MR16EXN/830/LED - 81072 MR16EXN/850/LED - 81073 MR16FNV/827/LED - 81071 MR16FNV/830/LED - 81086 MR16/5RGB/FL/LED - 80728	
		995506	BCB065-TB	Textured Black		
		995314	BCB065-TZ	Textured Bronze		
 Modern Bullet	6.2"	995100	BMB062-TB	Textured Black		
		995104	BMB062-TZ	Textured Bronze		
 Straight Bullet	6.7"	995532	BSB067-AB	Antique Brass		
		995534	BSB067-CU	Copper		
		995536	BSB067-SS	Stainless Steel		
	7.2"	995300	BSB060-TB	Textured Black		
		995304	BSB060-TZ	Textured Bronze		
	6.2"	995310	BSB062-TB	Textured Black		
		995314	BSB062-TZ	Textured Bronze		
 Straight Bullet	5.4"	995362	BSB054-AB	Antique Brass		 MR11FTD/827/LED - 81093 MR11FTD/850/LED - 81095 MR11FTC/827/LED - 81096
		995364	BSB054-CU	Copper		
 Flood Light	4.2"	995406	FRF058-AB	Antique Brass		 JC10/1WW/LED - 80693 JC2/827/LED - 80833 JC20/2WW/LED - 80690 JC20/2NW/LED - 80815 JC35/4WW/LED - 80830 JC50/5WW/LED - 81997
		923006	FRF058-TB	Textured Black		
		923008	FRF058-TZ	Textured Bronze		

Path Lights

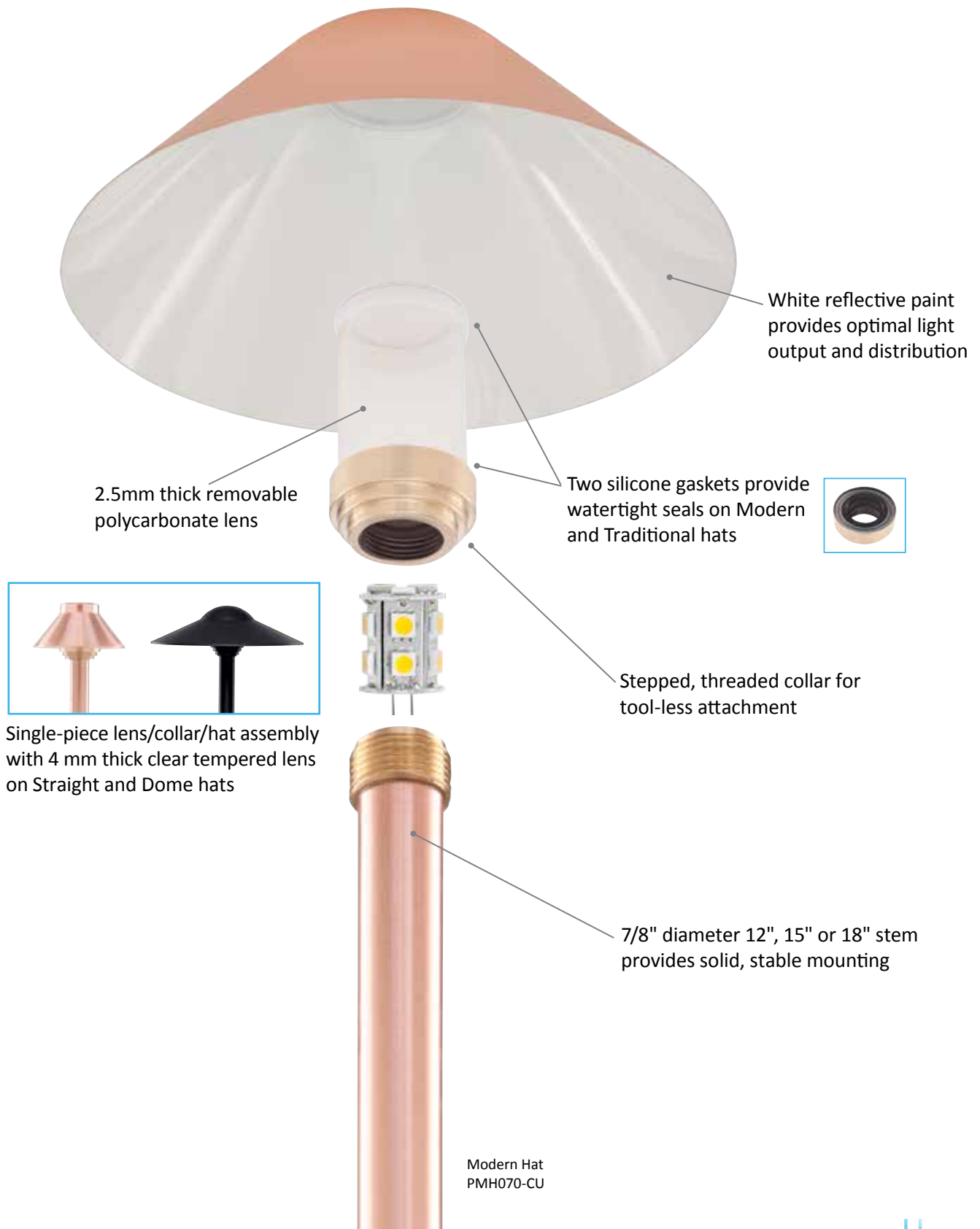

Modern, Traditional, Straight & Dome Hats

Mix and Match Path Light Ordering

Sollos Path Light kits include a hat, stem, 8" ground stake, and lamp. All Sollos Path Lights are supplied with a Halco JC20 halogen lamp unless another lamp model is specified.

1 Select the Hat:



Traditional Hat



Straight Hat



Dome Hat



Mushroom
(Stem Included)

2 Select the Stem Height:

12"

15"

18"

3 Select the Finish:



Antique Brass



Copper



Textured Black



Stainless Steel



Textured Bronze

4 Select the Light Output Equivalent:



JC1/830/OMNI/IP65/LED



JC2/830/OMNI/IP65/LED



JC10/1WW/LED



JC20/2WW/LED



JC2/827/LED2



JC2S/830/LED2

Example: To order an Antique Brass 5.5" Traditional Hat with 15" Stem and Halco ProLED JC20/2WW/LED Lamp, the order code would be **PTH055-AB-15-JC20/2WW/LED**

Path Lights

Traditional Hat

Traditional design that delivers safe and uniform illumination for your outdoor pathways. Brass, Natural Copper, or Stainless Steel housings for additional architectural appeal.



- Copper 
- Stainless Steel 

PTH075-AB-15

Recommended Lamps

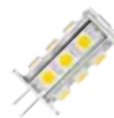
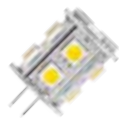

Part Number	80693	80690	80833	81198
Product Code	JC10/1WW/LED	JC20/2WW/LED	JC2/827/LED	JC1/830/OMNI/IP65/LED
Watts	1.5	2.4	2.4	1.6
Color Temp	3000k	3000k	2700k	3000
Replacement Watt	10	20	20	20

For the complete ProLED offering of lamps see pages 25-27.

Dimensions

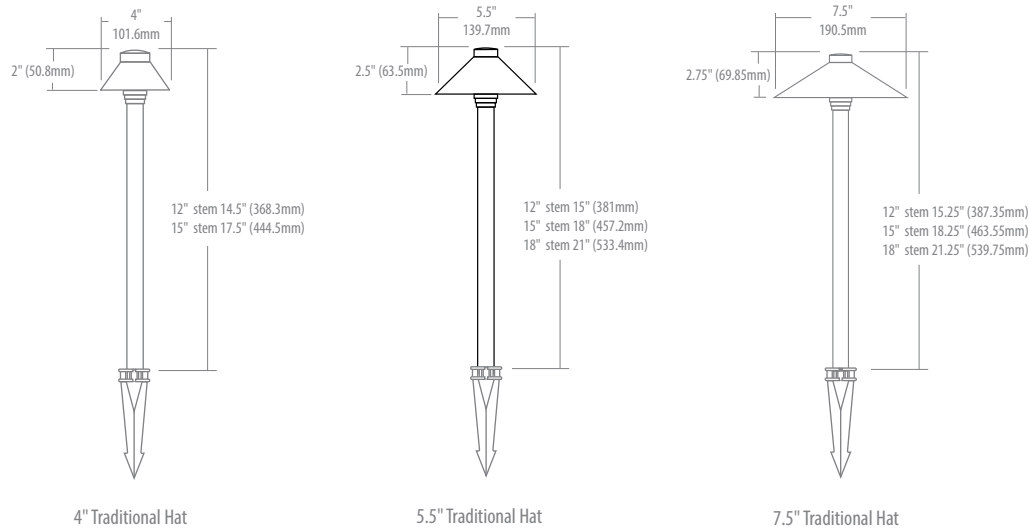

PTH

Housing	Natural Copper, Antique Brass or Stainless Steel
Lens	Clear Polycarbonate with Dual Silicone Gaskets
Collar	Brass
Stem Options	12", 15" and 18"
Wiring	3 ft. 18-2 Lead Wire
Lamp	T3 Bi-Pin (20W Max)
Mounting Accessory	8" Ground Stake Included

Order Codes 4" Diameter 5.5" Diameter 7.5" Diameter

12" Stem			
Antique Brass	PTH040-AB-12	PTH055-AB-12	PTH075-AB-12
Stainless Steel	PTH040-SS-12	PTH055-SS-12	
Natural Copper	PTH040-CU-12	PTH055-CU-12	
15" Stem			
Antique Brass	PTH040-AB-15	PTH055-AB-15	PTH075-AB-15
Stainless Steel		PTH055-SS-15	PTH075-SS-15
Natural Copper	PTH040-CU-15	PTH055-CU-15	PTH075-CU-15
18" Stem			
Antique Brass		PTH055-AB-18	PTH075-AB-18
Stainless Steel		PTH055-SS-18	PTH075-SS-18
Natural Copper		PTH055-CU-18	PTH075-CU-18

Example: To order a Antique Brass 5.5" Traditional Hat with 12" Stem and Halco ProLED JC20/2WW/LED Lamp, the order code would be PTH055-AB-12-JC20/2WW/LED

Path Lights

Straight Hat

Traditional design that delivers safe and uniform illumination for your outdoor pathways. Textured Black or Bronze housings for additional architectural appeal.



Textured Black



Textured Bronze



PSH040-TB-18

Recommended Lamps



Part Number	81091	81092	81198	81198
Product Code	JC2S/827/LED2	JC2S/830/LED2	JC1/830/OMNI/IP65/LED	JC1/830/OMNI/IP65/LED
Watts	1.4	1.4	1.6	1.6
Color Temp	2700k	3000k	3000	3000
Replacement Watt	20	20	20	20

For the complete ProLED offering of lamps see pages 25-27.

Dimensions

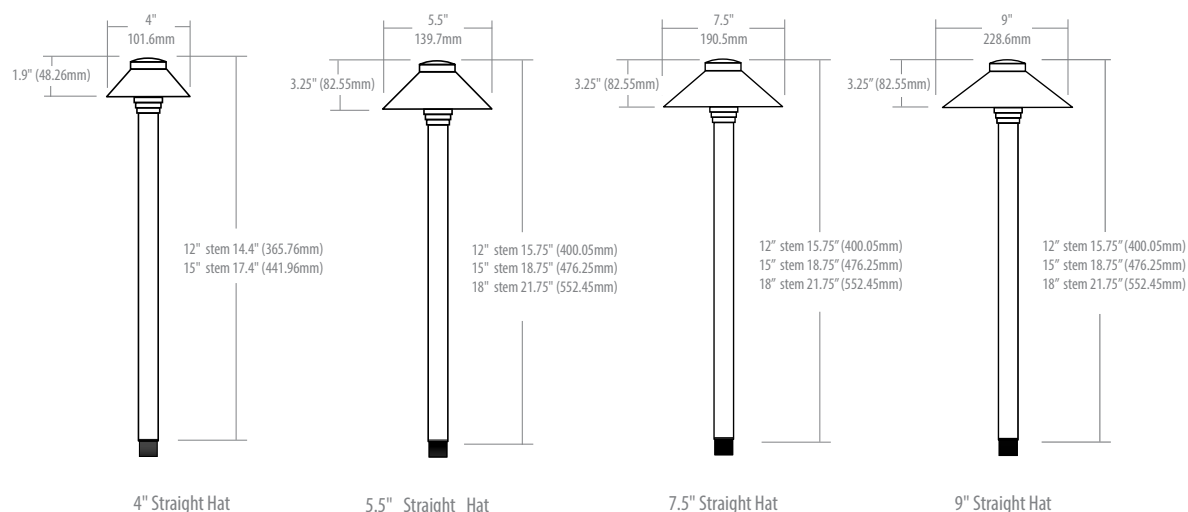

PSH

Housing	Architectural Aluminum
Lens	Clear Tempered Glass
Collar	Architectural Aluminum
Stem Options	12", 15" and 18"
Wiring	3 ft. 18-2 Lead Wire
Lamp	T3 Bi-Pin (20W Max)
Mounting Accessory	8" Ground Stake Included

Order Codes	4" Diameter	5.5" Diameter	7.5" Diameter	9" Diameter
12" Stem				
Textured Bronze	PSH040-TZ-12	PSH055-TZ-12	PSH075-TZ-12	PSH090-TZ-12
Textured Black	PSH040-TB-12	PSH055-TB-12	PSH075-TB-12	PSH090-TB-12
15" Stem				
Textured Bronze	PSH040-TZ-15	PSH055-TZ-15	PSH075-TZ-15	PSH090-TZ-15
Textured Black	PSH040-TB-15	PSH055-TB-1	PSH075-TB-15	PSH090-TB-15
18" Stem				
Textured Bronze		PSH055-TZ-18	PSH075-TZ-18	PSH090-TZ-18
Textured Black		PSH055-TB-18	PSH075-TB-18	PSH090-TB-18

Example: To order a Textured Black 9" Straight Hat with 15" Stem and Halco ProLED JC20/2WW/LED Lamp, the order code would be **PSH090-TB-15-JC20/2WW/LED**

Path Lights

Dome Hat

Architectural design that delivers safe and uniform illumination for your outdoor pathways. Textured Black or Bronze housings for additional architectural appeal.



Textured Black



Textured Bronze



Housing	Architectural Aluminum
Lens	Clear Tempered Glass
Collar	Architectural Aluminum
Stem Options	12", 15" and 18"
Wiring	3 ft. 18-2 Lead Wire
Lamp	T3 Bi-Pin (20W Max)
Mounting Accessory	8" Ground Stake Included

Order Codes

12" Stem	
Textured Black	PDO083-TB-12
Textured Bronze	PDO083-TZ-12
15" Stem	
Textured Black	PDO083-TB-15
Textured Bronze	PDO083-TZ-15
18" Stem	
Textured Black	PDO083-TB-18
Textured Bronze	PDO083-TZ-18

PDO083-TZ-15

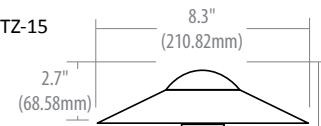

With 12" stem 15.25" (387.35mm)
 With 15" stem 18.25" (463.55mm)
 With 18" stem 21.25" (539.75mm)

Example: To order a Textured Bronze 8.3" Dome Hat with 18" Stem and Halco ProLED JC20/2WW/LED Lamp, the order code would be **PDO083-TZ-18-JC20/2WW/LED**

Recommended Lamps

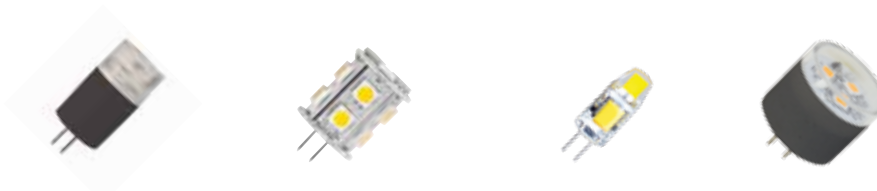

Part Number	81108	80693	81198	81091
Product Code	JC20/2WW/LED2	JC10/1WW/LED	JC1/830/OMNI/IP65/LED	JC2S/827/LED2
Watts	2.3	1.5	1.6	1.4
Color Temp	3000k	3000k	3000	2700k
Replacement Watt	20	10	20	20

For the complete ProLED offering of lamps see pages 25-27.

Path Lights

Mushroom Hat

Architectural design that delivers safe and uniform illumination for your outdoor pathways. Textured Black or Bronze housings for additional architectural appeal.



PMU050-TB-15

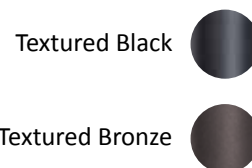

PMU

Housing	Architectural Aluminum
Lens	Clear Tempered Glass with Dual Silicone Gaskets
Stem Options	15" Included
Wiring	3 ft. 18-2 Lead Wire
Lamp	T3 Bi-Pin (20W Max)
Mounting Accessory	8" Ground Stake Included

Order Codes

15" Stem	
Textured Black	PMU050-TB-15
Textured Bronze	PMU050-TZ-15

Example: To order a Textured Black 5" Mushroom with Halco ProLED JC20/2WW/LED Lamp, the order code would be **PMU050-TB-15-JC20/2WW/LED**

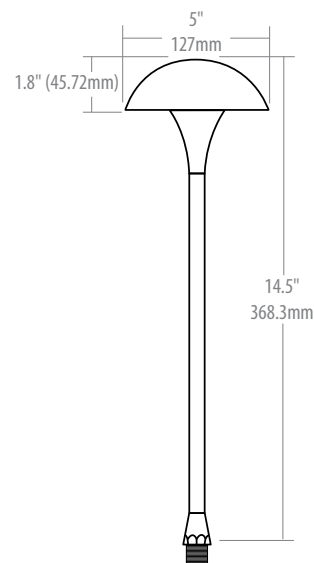









Recommended Lamps

















Part Number	80693	80690	81091	81198
Product Code	JC10/1WW/LED	JC20/2WW/LED	JC2S/827/LED2	JC1/830/OMNI/IP65/LED
Watts	1.5	2.4	1.4	1.6
Color Temp	3000k	3000k	2700k	3000
Replacement Watt	10	20	20	20

For the complete ProLED offering of lamps see pages 25-27.







































Lamp Guide

Style	Size	Item #	Product Code	Finish	LED Lamp Product Code
 <p>Traditional Hat</p>	4"	915400	PTH040-AB-12	Antique Brass	
		915402	PTH040-CU-12	Copper	
	4"	915403	PTH040-AB-15	Antique Brass	
		915405	PTH040-CU-15	Copper	
	5.5"	915454	PTH055-AB-12	Antique Brass	
		915456	PTH055-CU-12	Copper	 JC10/1WW/LED - 80693
		915563	PTH055-SS-12	Stainless Steel	 JC2/827/LED - 80833 JC20/2WW/LED - 80690 JC20/2NW/LED - 80815
	5.5"	915457	PTH055-AB-15	Antique Brass	
		915459	PTH055-CU-15	Copper	 JC35/4WW/LED - 80830 JC2S/827/LED2 - 81091
		915564	PTH055-SS-15	Stainless Steel	 JC2S/830/LED2 - 81092 JC2/827/LED2 - 81109
	5.5"	915460	PTH055-AB-18	Antique Brass	
		915462	PTH055-CU-18	Copper	 JC20/2WW/LED2 - 81108 JC1/830/OMNI/IP65/LED - 81198 JC2/830/OMNI/IP65/LED - 81199
		915565	PTH055-SS-18	Stainless Steel	 JC50/5WW/LED - 81997
	7.5"	915508	PTH075-AB-12	Antique Brass	
		915510	PTH075-CU-12	Copper	
	7.5"	915511	PTH075-AB-15	Antique Brass	
		915513	PTH075-CU-15	Copper	
		915566	PTH075-SS-15	Stainless Steel	
	7.5"	915514	PTH075-AB-18	Antique Brass	
		915516	PTH075-CU-18	Copper	
		915567	PTH075-SS-18	Stainless Steel	

Lamp Guide

Style	Size	Item #	Product Code	Finish	LED Lamp Product Code
 <p>Straight Hat</p>	4"	913021	PSH040-TB-12	Textured Black	
		913023	PSH040-TZ-12	Textured Bronze	
	4"	913028	PSH040-TB-15	Textured Black	
		913030	PSH040-TZ-15	Textured Bronze	
	5.5"	910021	PSH055-TB-12	Textured Black	
		910023	PSH055-TZ-12	Textured Bronze	
	5.5"	910028	PSH055-TB-15	Textured Black	 JC10/1WW/LED - 80693  JC2/827/LED - 80833
		910030	PSH055-TZ-15	Textured Bronze	 JC20/2WW/LED - 80690  JC20/2NW/LED - 80815
	5.5"	910035	PSH055-TB-18	Textured Black	 JC35/4WW/LED - 80830  JC1/830/IP65/LED - 81104
		910037	PSH055-TZ-18	Textured Bronze	 JC2/830/IP65/LED - 81107  JC2S/827/LED2 - 81091  JC2S/830/LED2 - 81092
	7.5"	911021	PSH075-TB-12	Textured Black	 JC2/827/LED2 - 81109  JC20/2WW/LED2 - 81108
		911023	PSH075-TZ-12	Textured Bronze	 JC1/830/OMNI/IP65/LED - 81198  JC2/830/OMNI/IP65/LED - 81199
	7.5"	911028	PSH075-TB-15	Textured Black	 JC50/5WW/LED - 81997
		911030	PSH075-TZ-15	Textured Bronze	
	7.5"	911035	PSH075-TB-18	Textured Black	
		911037	PSH075-TZ-18	Textured Bronze	
	9"	914021	PSH090-TB-12	Textured Black	
		914023	PSH090-TZ-12	Textured Bronze	
	9"	914028	PSH090-TB-15	Textured Black	
		914030	PSH090-TZ-15	Textured Bronze	
9"	914035	PSH090-TB-18	Textured Black		
	914037	PSH090-TZ-18	Textured Bronze		

Lamp Guide

Style	Size	Item #	Product Code	Finish	LED Lamp Product Code	
 <p>Dome Hat</p>	8.3"	915021	PDO083-TB-12	Textured Black	 JC10/1WW/LED - 80693  JC2/827/LED - 80833	
		915023	PDO083-TZ-12	Textured Bronze	 JC20/2WW/LED - 80690  JC20/2NW/LED - 80815  JC35/4WW/LED - 80830  JC1/830/IP65/LED - 81104  JC2/830/IP65/LED - 81107	
	8.3"	915028	PDO083-TB-15	Textured Black	 JC2S/830/LED2 - 81092  JC2S/827/LED2 - 81091  JC2/827/LED2 - 81109  JC20/2WW/LED2 - 81108	
		915030	PDO083-TZ-15	Textured Bronze	 JC1/830/OMNI/IP65/LED - 81198  JC2/830/OMNI/IP65/LED - 81199  JC50/5WW/LED - 81997	
	8.3"	915035	PDO083-TB-18	Textured Black	 JC20/2WW/LED2 - 81108  JC1/830/OMNI/IP65/LED - 81198  JC2/830/OMNI/IP65/LED - 81199  JC50/5WW/LED - 81997	
		915037	PDO083-TZ-18	Textured Bronze	 JC20/2WW/LED2 - 81108  JC1/830/OMNI/IP65/LED - 81198  JC2/830/OMNI/IP65/LED - 81199  JC50/5WW/LED - 81997	
	 <p>Mushroom</p>	5"	912003	PMU050-TB-15	Textured Black	 JC10/1WW/LED - 80693  JC2/827/LED - 80833  JC20/2WW/LED - 80690  JC20/2NW/LED - 80815  JC35/4WW/LED - 80830  JC1/830/IP65/LED - 81104  JC2/830/IP65/LED - 81107
			912005	PMU050-TZ-15	Textured Bronze	 JC2S/830/LED2 - 81092  JC2S/827/LED2 - 81091  JC2/827/LED2 - 81109  JC20/2WW/LED2 - 81108  JC1/830/OMNI/IP65/LED - 81198  JC2/830/OMNI/IP65/LED - 81199  JC50/5WW/LED - 81197

Ledge Lights

Low profile design that delivers uniform illumination to accentuate key hardscape features. Textured Black and Textured Bronze housings for additional architectural appeal.

LLA055

Housing	Architectural Aluminum
Lens	Shock and Heat-Resistant Frosted Tempered Glass
Wiring	10 ft. (3 m) 18-2 lead-wire
Lamp	0.6 Watt, 2700K LED

Order Codes

Textured Black	LLA055/827/TB
Textured Bronze	LLA055/827/TZ
Light Module	LLA055/827



LLA055/827/TB



LLA055/827
Replaceable Light Module

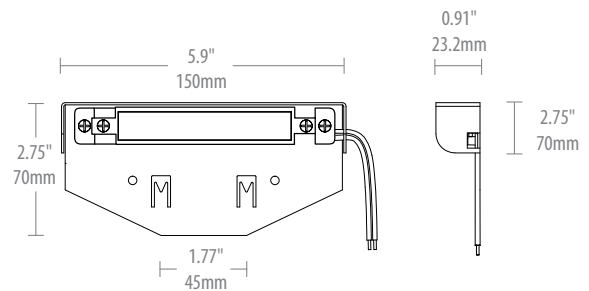
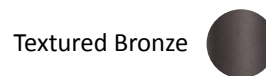
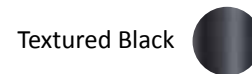



In-Ground Lights

Rock Guard

Durable construction to deliver high performance illumination for desired up light needs. Antique Brass, Composite Black, and Stainless Steel covers for additional architectural appeal.



IGG049-SS

IGG049

Housing	Single-Piece Compression Molded Polyester Composite
Lens	Shock and Heat-Resistant Clear Tempered Glass
Cover	Brass, Composite or Stainless Steel
Aiming	Adjustable Lamp Bracket Provides +/- 15° of Tilt
Wiring	3 ft. 18-2 Lead Wire
Lamp	MR16 (50W Max)

Order Codes

Antique Brass	IGG049-AB
Composite Black	IGG049-CB
Stainless Steel	IGG049-SS

Antique Brass



Composite Black



Stainless Steel

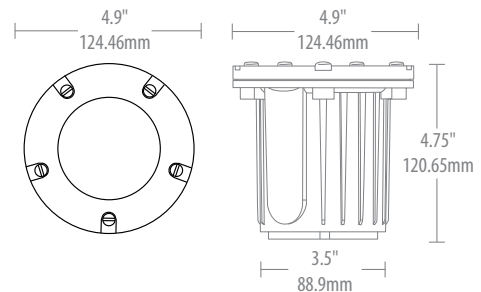

Recommended Lamps



Part Number	81056	81060	81065	81070
Product Code	MR16FL10/827/LED	MR16BAB/827/LED	MR16FMW/827/LED	MR16EXN/827/LED
Watts	2.5	4	4.5	8
Color Temp	2700k	2700k	2700k	2700k
Replacement Watt	10	20	35	50

For the complete ProLED offering of lamps see pages 40-41.

In-Ground Lights

Trim Ring

Durable construction to deliver high performance illumination for desired up light needs. Antique Brass, Composite Black, and Stainless Steel covers for additional architectural appeal.



IGT049-AB

IGT049

Housing	Single-Piece Compression Molded Polyester Composite
Lens	Shock and Heat-Resistant Clear Tempered Glass
Cover	Composite or Stainless Steel
Aiming	Adjustable Lamp Bracket Provides +/- 15° of Tilt
Wiring	3 ft. 18-2 Lead Wire
Lamp	MR16 (50W Max)

Antique Brass



Composite Black



Stainless Steel



Order Codes

Antique Brass	IGT049-AB
Composite Black	IGT049-CB
Stainless Steel	IGT049-SS

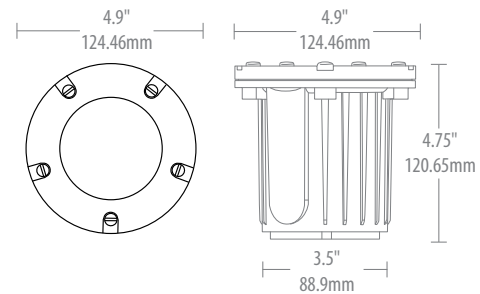

Recommended Lamps



Part Number	81058	81062	81067	81072
Product Code	MR16FL10/850/LED	MR16BAB/830/LED	MR16FMW/830/LED	MR16EXN/830/LED
Watts	2.5	4	4.5	8
Color Temp	5000k	3000k	3000k	3000k
Replacement Watt	10	20	35	50

For the complete ProLED offering of lamps see pages 40-41.

In-Ground Lights

Well Light

Durable construction to deliver high performance illumination for desired up light needs. Composite Black housing to blend with surroundings.



WPO055-CB

WPO055

Housing	Composite Black ABS
Lamp Holder	Adjustable Height and Angle
Aiming	360° Lamp Rotation
Wiring	3 ft. 18-2 Lead Wire with Slip-on Connectors
Lamp	PAR36 (50W Max)

Order Codes

Well Light	WPO055-CB
Replacement Bracket	WPO055-BRACKET

Composite Black

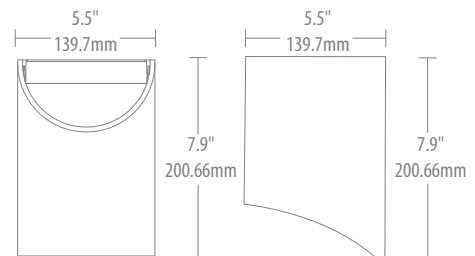

Recommended Lamps



Part Number	81074	81075	81076
Product Code	PAR36WFL4/827/IP67/LED	PAR36WFL6/827/IP67/LED	PAR36WFL12/827/IP67/LED
Watts	4.5	6.5	12.5
Color Temp	2700k	2700k	2700k
Replacement Watt	20	35	50

For the complete ProLED offering of lamps see pages 40-41.



Step Lights

with Trim Faceplate

Low profile design that delivers uniform illumination to accentuate key hardscape features. Copper, Stainless Steel, Textured Black, and Textured Bronze faceplates for additional architectural appeal.



SBT048-TZ

SBT048

Housing	Die Cast Aluminum with Adjustable Mounting Brackets
Faceplate	Copper, Stainless Steel, or Architectural Grade Aluminum
Faceplate Mounting	Adjustable Nylon Mounts Correct Undesired Tilt
Lens	Shock and Heat-Resistant Frosted Tempered Glass
Aiming	Adjustable Socket for Proper Lamp Centering
Wiring	3 ft. 18/2 Lead Wire
Lamp	T3 Bi-Pin (20W Max)

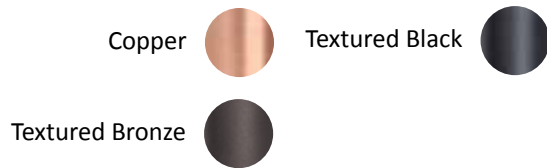

Order Codes

Copper	SBT048-CU
Textured Black	SBT048-TB
Textured Bronze	SBT048-TZ

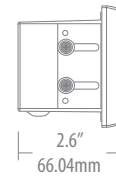
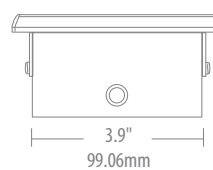
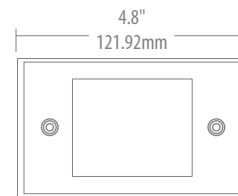

Recommended Lamps

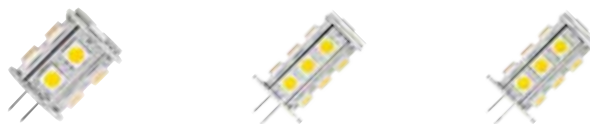

Part Number	80693	80833	80690
Product Code	JC10/1WW/LED	JC2/827/LED	JC20/2WW/LED
Watts	1.5	2.4	2.4
Color Temp	3000k	2700k	3000k
Replacement Watt	10	20	20

For the complete ProLED offering of lamps see pages 40-41.

Step Lights

with Louver Faceplate

Low profile design that delivers uniform illumination to accentuate key hardscape features. Textured Black, and Textured Bronze faceplates for additional architectural appeal.



SBL048-TZ

SBL048

Housing	Die Cast Aluminum with Adjustable Mounting Brackets
Faceplate	Architectural Grade or Aluminum
Faceplate Mounting	Adjustable Nylon Mounts Correct Undesired Tilt
Lens	Shock and Heat-Resistant Frosted Tempered Glass
Aiming	Adjustable Socket for Proper Lamp Centering
Wiring	3 ft. 18-2 Lead Wire
Lamp	T3 Bi-Pin (20W Max)

Textured Black 

Textured Bronze 

Order Codes

Textured Black	SBL048-TB
Textured Bronze	SBL048-TZ

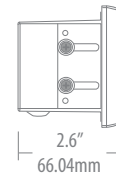
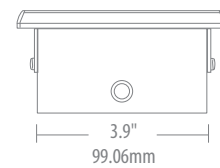
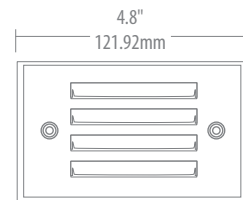

Recommended Lamps

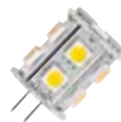

Part Number	81091	80693	80815
Product Code	JC2S/827/LED2	JC10/1WW?LED	JC20/2NW/LED
Watts	1.4	1.5	2.4
Color Temp	2700k	3000k	5000k
Replacement Watt	20	10	20

For the complete ProLED offering of lamps see pages 40-41.

Deck Lights

Post Lights

Traditional design that delivers uniform illumination to accentuate key hardscape features. Antique Brass, Textured Black, and Textured Bronze faceplates for additional architectural appeal.



DPL033-AB

DPL033

Housing	Die Cast Aluminum or Brass
Lens	Shock and Heat-Resistant Frosted Tempered Glass
Mounting	Surface Mounting Plate
Wiring	3 ft. 18-2 Lead Wire
Lamp	T3 Bi-Pin (10W Max Brass; 20W Max Aluminum)

Order Codes

Antique Brass	DPL033-AB
Textured Black	DPL033-TB
Textured Bronze	DPL033-TZ

Antique Brass



Textured Black



Textured Bronze

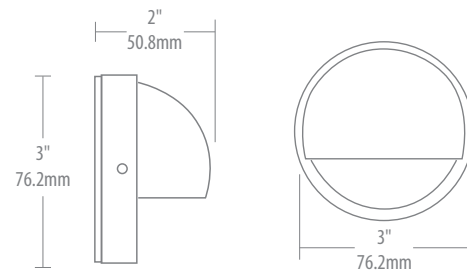

Recommended Lamps



Part Number	80693	80690	80833	81091
Product Code	JC10/1WW/LED	JC20/2WW/LED	JC2/827/LED	JC2S/827/LED2
Watts	1.5	2.4	2.4	1.4
Color Temp	3000k	3000k	2700k	2700k
Replacement Watt	10	20	20	20

For the complete ProLED offering of lamps see pages 40-41.

Deck Lights

Under-Step Lights

Low profile design that delivers uniform illumination to accentuate key hardscape features. Antique Brass, Copper, and Stainless Steel faceplates for additional architectural appeal.



DUS120-CU



DUS060-CU

DUS060/DUS120

Housing	Die Cast Aluminum
Cover	Antique Brass, Natural Copper or Stainless Steel
Lens	Shock and Heat-Resistant Frosted Tempered Glass
Mounting	Optional Stainless Steel Mounting Plate for Hardscape Installations
Wiring	3 ft. 18-2 Lead Wire
Lamp	912 Wedge (20W Max) - DUS120 Operates Two Lamps

Order Codes

	6" Length	12" Length
Antique Brass	DUS060-AB	
Copper	DUS060-CU	DUS120-CU
Stainless Steel	DUS060-SS	
Mounting Plate	MP06	MP12

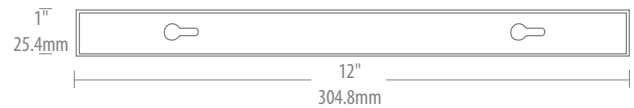

12" Deck Under-Step Light

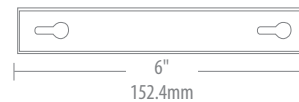

6" Deck Under-Step Light

Recommended Lamps



Part Number	80791	81102
Product Code	912/1WW/LED	912/1WW/LED2
Watts	1	1.2
Color Temp	3000k	3000k
Replacement Watt	10	10

For the complete ProLED offering of lamps see pages 40-41.

Hanging Lights

Pendant Lights

Traditional design that delivers uniform illumination to accentuate key hardscape features. Antique Brass, Brass, and Copper housings for additional architectural appeal.



HLS043-CU

HLS043

Housing	Cast Brass or Natural Copper
Lens	Clear Tempered Glass
Base	Cast Brass
Wiring	3 ft. 18-2 Lead Wire
Lamp	MR16 (35W Max)
Mounting Accessory	6 ft. Stainless Steel Hanger Included

Order Codes

Antique Brass	HLS043-AB
Copper	HLS043-CU

Antique Brass



Copper

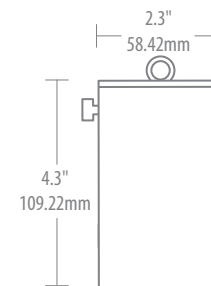

Recommended Lamps









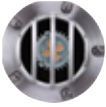

Part Number	81057	81061	81066	81071
Product Code	MR16WFL10/827/LED	MR16WFL20/827/LED	MR16WFL35/827/LED	MR16FNV/827/LED
Watts	2.5	4	4.5	8
Color Temp	2700k	2700k	2700k	2700k
Replacement Watt	10	20	35	50





For the complete ProLED offering of lamps see pages 40-41.



Lamp Guide

Style	Size	Item #	Product Code	Finish	LED Lamp Product Code
 <p>In-Ground w/Rock Guard</p>		996232	IGG049-AB	Antique Brass	
		996200	IGG049-CB	Composite Black	
		996234	IGG049-SS	Stainless Steel	
 <p>In-Ground w/Trim Ring</p>		996132	IGT049-AB	Antique Brass	
		996100	IGT049-CB	Composite Black	
		996134	IGT049-SS	Stainless Steel	
 <p>Hanging Light</p>		997402	HLS043-AB	Antique Brass	
		997404	HLS043-CU	Copper	
 <p>Well Light</p>		996300	WPO055-CB	Composite Black	

Lamp Guide

Style	Size	Item #	Product Code	Finish	LED Lamp Product Code
 Step Light with Trim		942006	SBT048-CU	Copper	 JC10/1WW/LED - 80693 JC2/827/LED - 80833 JC20/2WW/LED - 80690 JC20/2NW/LED - 80815 JC35/4WW/LED - 80830 JC1/830/IP65/LED - 81104 JC2/830/IP65/LED - 81107 JC2S/827/LED2 - 81091 JC2S/830/LED2 - 81092 JC2/827/LED2 - 81109 JC20/2WW/LED2 - 81108
		942004	SPT048-TB	Textured Black	
		942033	SPT048-TZ	Textured Bronze	
	942507	SBL048-SS	Stainless Steel		
	942504	SBL048-TB	Textured Black		
	942533	SBL048-TZ	Textured Bronze		
 Deck Post Light		997104	DPL033-AB	Antique Brass	
		940002	DPL033-TB	Textured Black	
		940003	DPL033-TZ	Textured Bronze	
 Deck Under-Step	6"	941002	DUS060-AB	Antique Brass	
		941000	DUS060-CU	Copper	
		941001	DUS060-SS	Stainless Steel	
	12"	941012	DUS120-CU	Copper	

DecoStrand™

Commercial Outdoor String Lights

Decorative accent strand lighting for indoor/outdoor use that accepts multiple lamp options including LED, incandescent, and specialty color.

DSL/52254M/3G-BK

Overall Length	52 ft.
Number of Sockets	25
Socket Type	Medium Base
Drop Distance	4 in.
Voltage	120V Only
Circuit	15A Capacity Circuit Typical
Maximum Lamp Wattage	50 Watts
Plug	3 — Prong Grounded Plug
Receptacle	3 — Prong Grounded Receptable
Wiring	52 ft. 14-3 Wire Grounded
Lamp	Lamps Sold Separately

Order Codes

Strand Lighting	DSL/52254M/3G-BK
-----------------	------------------

Lamp Wattage Range	Total System Watts	Total # of DecoStrands per Circuit*
40-50 Watts	1000 - 1250	1
17-25 Watts	425 - 625	2
13-16 Watts	325 - 400	3
11-12 Watts	275 - 300	4
9-10 Watts	225 - 250	5
8 Watts	200	6
7 Watts	175	7
6 Watts	150	8
5 Watts	125	9
4 Watts	100	10

*Circuit capacity based on typical 15 Amps system. Larger circuit sizes may be able to accommodate more Decostrand strings. Consult an Electrical Engineer for complete circuit load confirmation.

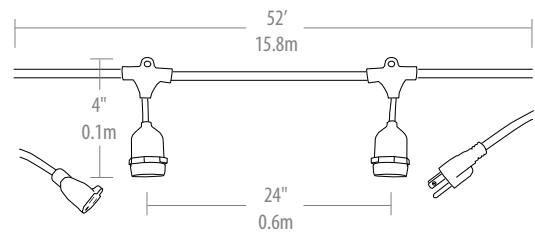

DecoStrand™

Residential Outdoor String Lights

Decorative accent strand lighting for indoor/outdoor use that accepts multiple lamp options including LED, incandescent, and specialty color.

DSL/26124M/2G-BK

Overall Length	26 ft.
Number of Sockets	12
Socket Type	Medium Base
Drop Distance	4 in.
Voltage	120V Only
Circuit	15A
Maximum Lamp Wattage	25 Watts
Plug	2 — Prong Plug with 8A Fuses
Receptable	2 — Prong Receptable
Wiring	26 ft. 16-2 Wire
Lamp	Lamps Sold Separately

Order Codes

Strand Lighting	DSL/26124M/2G-BK
-----------------	------------------

Lamp Wattage Range	Total System Watts	Total # of DecoStrands per Circuit*
13-25 Watts	156-300	1
9-12 Watts	108-144	2
7-8 Watts	84-96	3
6 Watts	72	4
5 Watts	60	5
4 Watts	48	6
3 Watts	36	8

*Circuit capacity based on typical 15 Amps system. Larger circuit sizes may be able to accommodate more Decostrand strings. Consult an Electrical Engineer for complete circuit load confirmation.

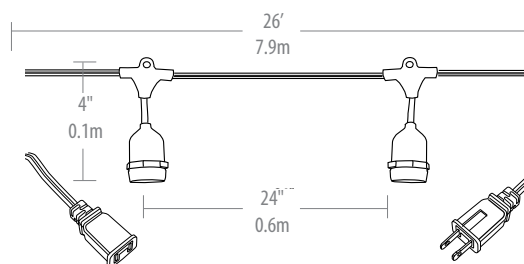

DecoStrand®

DecoStrand® Reflectors



Natural



Copper



Antique Brass

Part Number	99963	99604	99605
Product Code	DSL/FSTR-NF	DSL/FSTR-CU	DSL/FSTR-AB
Product Description	Natural Finish	Copper Finish	Antique Brass Finish

For the complete ProLED offering of lamps see pages 40-41.



4" Textured Bronze



7.5" Textured Bronze



4" Textured Black



7.5" Textured Black

Part Number	99606	99607	99608	99609
Product Code	DSL/PSH040-TZ	DSL/PSH040-TB	DSL/PSH075-TZ	DSL/PSH075-TB
Product Description	4" Straight Hat Textured Bronze Finish	4" Straight Hat Textured Black Finish	7.5" Straight Hat Textured Bronze Finish	7.5" Straight Hat Textured Black Finish

For the complete ProLED offering of lamps see pages 45.

Recommended Lamps



Part Number	81139**	81140*	81129**	81132**
Product Code	S14CL2ANT/827/LED	S14AMB2ANT/822/LED	A19AMB4ANT/722/LED	T19AMB5ANT/722/LED
Watts	2	2	4.5	5
Color Temp	2700K	2200K	2200K	2200K

For the complete ProLED offering of lamps see HalcoLighting.com

* Wet location listed.

** Damp location listed.

For the complete ProLED offering of lamps see HalcoLighting.com



Part Number	80522*	20006	9051	20002
Product Code	S14CL1C/827/LED	ST18ANT40	S14CL11	A21ANT40
Watts	1.4	40	11	40
Color Temp	2700k	2500k		2500k

For the complete ProLED offering of lamps see HalcoLighting.com

* Wet location listed.

** Damp location listed.

For the complete ProLED offering of lamps see HalcoLighting.com



Commercial Transformers

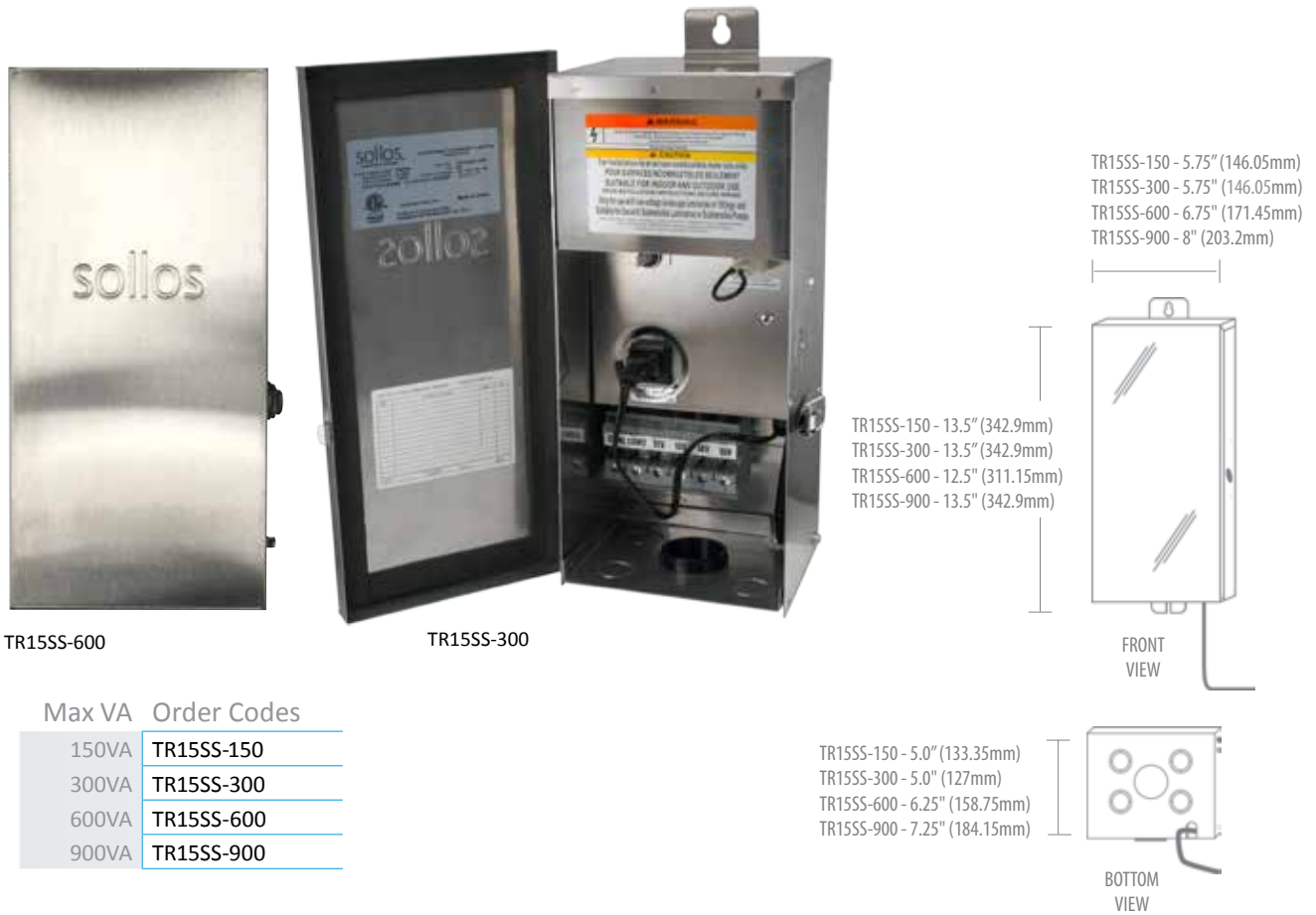

- Corrosion-resistant stainless steel
- Lockable, hinged door
- Bottom panel contains 1½" conduit inlet and (4) ¾" knockouts for low voltage exit
- Input voltage: 120V
- Output voltage taps: 12/13/14/15V
- In-line primary overload protection prevents system damage with auto thermal shut-off
- UL 1838 listed
- In-line secondary magnetic breaker prevents short circuit protection with reset
- Mounting brackets are located on top and bottom of the console
- Plug-in ready
- 6-foot, grounded, water-resistant, heavy gauge power cord
- Approved for use with submersion luminaires
- Limited lifetime warranty

Integrated Transformers



TR15SS-INT-300

Max VA	Voltage Taps	Order Codes
100VA	12V	TR12PC-INT-100
120VA	12V	TR12SS-INT-120
200VA	12V	TR12SS-INT-200
300VA	12V, 13V, 14V, 15V	TR15SS-INT-300



TR12PC-INT-100

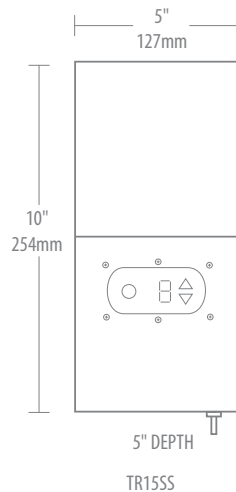

TR12SS-INT-120
TR12SS-INT-200

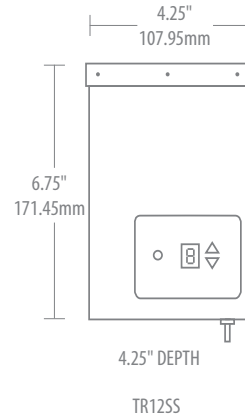
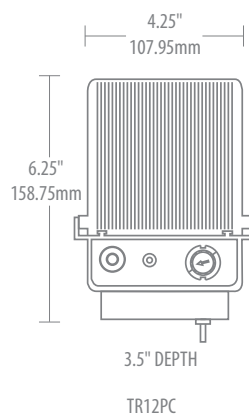

- Corrosion-resistant stainless steel finish (TR12SS)
- Black polycarbonate finish (TR12PC)
- Integral photocell and timer allow light fixtures to operate manually, automatically or on a timer
- Automatic operation turns lights on at dusk and off at dawn
- TR12PC Timer turns lights on at dusk and turns them off 4 hours, 6 hours or 8 hours after dusk
- UL 1838 Listed
- TR12SS Timer turns lights on at dusk and turns them off 1 to 9 hours after dusk
- Resettable circuit breaker prevents overloads and short circuits
- Plug-in ready with 6-foot, grounded, water-resistant, heavy gauge power cord
- Limited 2-year warranty

Accessories

Simple, elegant designs in Antique Brass, Brass, Copper and Stainless Steel natural metals and Textured Black and Textured Bronze powdercoat aluminum finishes complement & enhance landscape settings



TMA

Analog Timer

24-hour clock
3 on/off settings per day



TMDA

Digital
Astronomic Timer

Build-in daylight saving time function
Auto adjusts to sunrise/sunset for dusk/dawn settings



DMT027

Deck Mount

2.7"
Antique Brass (AB)
Textured Black (TB)
Textured Bronze (TZ)



RSR12
RSR18

Risers

12" and 18"
Antique Brass (AB)
Textured Black (TB)
Textured Bronze (TZ)



GS08-NS

Ground Stake

8" Black ABS
No Slot cutout for wires



GS08

Ground Stake

8" Black ABS



PCS

Photocell

6" Lead

ProLED® Volt-Ampere Guide

Selecting a Transformer for LED Lighting Installations

Halco ProLED lamps are more efficient and have significantly longer life compared to traditional light sources while providing high quality light. Unlike halogen and incandescent lamps, which produce light by heating a filament, light from LED lamps is produced by the energy that results from forcing electrons through a semiconductor material.

True power consumed is measured in watts and is what customers are charged for on their utility bill. A lamp's true power (wattage) is listed on the lamp's packaging. When an LED is powered, the lamp's driver converts alternating current (AC) to direct current (DC), which consumes reactive and harmonic power on top of the true power that is required to produce light. The utility must generate additional energy above and beyond the lamp's true power in order to operate the lamp. The total amount of power that must be generated by the utility is measured in volt-amperes (VA) and is referred to as apparent power. Power factor - the ratio of true power to apparent power - is the measure of how efficiently electrical power is consumed. Dividing a lamp's wattage by the lamp's power factor results in the VA drawn on the line:

Wattage/Power Factor = Volt-Amperes

Halogen and incandescent lamps have a power factor of one, which means that the lamp uses 100% of the input power to produce light and heat. Consequently, filament lamps' wattage and VA are equivalent. For example, a 20W MR16 BAB draws 20VA from the line.

For LED installations, apparent power (VA) must be taken into consideration because transformer size is actually based on apparent power (VA), not true power (W). To specify the correct transformer size, the system's total load must be calculated to ensure that the total volt-ampere draw does not exceed the transformer's rating.

The LED installation example below shows system load (total VA), true power consumed (W) and annual energy cost calculations.

1. Calculate Load of LED System

	Lamp VA	x # Lamps	= Total Fixture Load
Well Light with 10W ProLED PAR36	12.0	8	= 96.0
Modern Bullet with 4.5W ProLED MR16	5.5	4	= 22
Total System Load			118

2. Select the Applicable Transformer for the LED System Load

- TR12PC-INT-100
 TR12SS-INT-200
 TR15SS-300
 TR15SS-900
 TR12SS-INT-120
 TR15SS-INT-300
 TR15SS-600

3. Calculate LED Energy Consumption

	Lamp Wattage	x # Lamps	= Power Consumption
Well Light with 10W ProLED PAR36	10	8	= 80
Modern Bullet with 4.5W ProLED MR16	4.5	4	= 18
Total System Power Consumption			98

4. Calculate the LED System's Annual Energy Cost

Consumption	x Utility Cost ¹	x Annual Operating Hours ² /1000	= Annual Energy Cost
98W	\$0.115 kWh	2190 hrs	= \$24.68

¹Utility Cost based on national average per U.S. Energy Information Administration <http://www.eia.gov/electricity/data.cfm#summary> at the time of printing.

²Annual Operating Hours based on 6 hours/day and 365 days/year.



Strongest Lamp Warranty

20
Year
Warranty

When installed in a Sollos fixture in recommended conditions and packaging warnings are followed, ProLED MR16 and IP65-rated JC lamps are backed by a 20-year limited warranty, the strongest lamp warranty in the industry. When installed in other fixtures, these lamps are backed by a 5-year Limited Warranty. ProLED 912 lamps and non-IP65-rated JC lamps are backed by a 2-year Limited Warranty.

Think Lumens!

Efficient lighting technologies such as LED and compact fluorescent lamps produce comparable light output while consuming considerably less energy than traditional light sources. When evaluating replacement lamps, refer to lamps' light output, which is measured in lumens, rather than wattage. Lamps with relatively equivalent lumens and CBCP will provide similar illumination. So think lumens for light output and use lamp wattage to determine energy savings.

Warranty

Sollos Landscape Lighting (hereinafter called "Sollos"), 2940 Pacific Drive, Norcross, GA 30071, warrants to the original purchaser that Sollos fixtures will be free from defects in materials and or workmanship for five years from the date of purchase except as indicated below:

<u>Category</u>	<u>Warranty</u>
Integrated transformers	2 Years
Commercial grade transformers	Lifetime
Antique Brass fixtures	Lifetime
Copper fixtures	15 Years
Stainless Steel fixtures	Lifetime
Composite fixtures	10 Years

EXPLICIT OPERATING CONDITIONS:

All products must be installed according to Sollos Installation Instructions and ProLED lamps must be operated in recommended conditions. This warranty is issued to the original purchaser and is non-transferable.

Should any product fail to meet the warranty specified above, Sollos, at its option, shall correct any defect by repair or replacement. This warranty is conditioned upon proper storage, installation, use and maintenance. Remedy is expressly limited to repair or replacement only.

This warranty is not applicable to any product subjected to abnormal stresses and operating conditions.

Sollos reserves the right to examine all products prior to the determination of warranty status. All products must be retained for warranty claims. The warranty period starts on the date of original purchase.

NO IMPLIED STATUTORY WARRANTY OF MERCHANTABILITY OR FITNESS FOR A PARTICULAR PURPOSE SHALL APPLY BEYOND THE AFOREMENTIONED WARRANTY PERIOD.

The foregoing warranty is exclusive of all other statutory, written or oral warranties, and no other warranties of any kind, statutory or otherwise, are given or herein expressed. The warranty sets forth Sollos' responsibilities regarding the products and claimant's exclusive remedy.

LIMITATION OF LIABILITY

Sollos will not under any circumstances, whether as a result of breach of contract, breach of warranty, tort, strict liability or otherwise, be liable for consequential, incidental, special or exemplary damages including, but not limited to, loss of profits or revenues, loss of use of product or any other goods or associated equipment or damage to any associated equipment, cost of capital, cost of substitute products, facilities of service, down time cost, or claims of claimant's customers. Sollos' liability on any claim of any kind for any loss or damages arising out of, resulting from or concerning any aspect of this agreement from the products or services furnished hereunder shall not exceed the price of the specific product or lamps which gives rise to the claim.

Some states do not allow the exclusion or limitation of damages or the length of time for an implied warranty. Therefore, the limitations or exclusions of consequential or incidental damages and implied warranties may not apply to certain claimants. This warranty gives the claimant specific legal rights. The claimant may also have other rights, which vary from state to state.

sollos®

LANDSCAPE LIGHTING
A Halco Lighting Technologies Company



Sollos Landscape Lighting
2940 Pacific Drive Norcross GA 30071
P.O. Box 1368 Norcross GA 30091-1368
Toll Free 888-976-5567 | Fax 888-576-5567
solloslighting.com

ProLume[®]

LINEAR FLUORESCENT



15



ProLume®

Advanced technologies and environmental focus have changed the face of Linear Fluorescent lighting. From ultra thin and efficient to specialized applications, Halco has your lighting needs covered with a broad offering of reliable ProLume Fluorescent lamps and ballasts.

Halco
LIGHTING TECHNOLOGIES
ProLume Eco-Shield (Hg-Free)
F32T8/841/ECO/XL

Halco ProLume Electronic Ballast
Non-dimmable, Instant Start
Indoor/Outdoor Use
Complies with FCC Part 15 Class B, FCC Part 18, and Consumer Product Commission (CPC) 115
For US, see Shop List on P. 567 for ES
Halco Lighting Technologies | Norcross, GA
Technical Sales/Support: 800.677.6534
www.halcolighting.com



Pro+

ProPLUS ProLume System Warranty

- T8 & T5HO BALLAST - 60 MONTHS
- T8XL LAMP - 60 MONTHS
- T8 LAMP - 36 MONTHS
- T5HO LAMP - 36 MONTHS

Halco's Linear Fluorescent lamps are engineered to provide optimum performance when operated with a ProLume ballast. Halco stands behind the quality of ProLume lamps and ballasts increasing coverage on lamps. Now that's a Plus!

To receive the full benefits of Halco's ProPLUS ProLume System Warranty, please register your project at warranty@halcolighting.com. For more information on Halco's ProPLUS ProLume System Warranty see page 31.

Fluorescent Lighting Systems

Fluorescent Lighting Systems

Fluorescent lighting systems are a combination of lamps and one or more ballasts. A Fluorescent lamp is available in different widths with different bases as well as varied light output and wattage options. Fluorescent ballasts deliver the proper voltage to start lamps and regulate the electric current flowing through the lamp after start-up or ignition then compensate for variations in line voltage.



Halco | ProLume Electronic Ballast
Performance Ballast a semi-conductor

HIGH POWER FACTOR - INSTANT START
 Sound Rated "A", Class P, Type 1 Outdoor, No PCBs, OCV 600V
 Inherent terminal protection / Protection thermique intergrée
 Install in accordance with National Electrical Code
 Complies with FCC 47 CFR Part 18. Non Consumer
 Type HL, Min Start Temp 0°F, 60°F for ES
 PNM00172

Halco Lighting Technologies | Norcross, GA
 Technical Information: (800) 677-3334
 www.halcolighting.com



EP432IS/L/MV/HE		
LOW BALLAST FACTOR		
120-277V	50-60Hz	0.92 - 0.98 AMP
LAMP TYPE		
(H) F2058	(H) F2078-ES	(H) F1178
(L) F3078	(L) F2078-ES	(L) F4078
(H) F2078	(H) F2078	(L) F2078
(L) F2078	(L) F2078	

CAUTION: Disconnect power to ballast and fixture before installing or servicing.

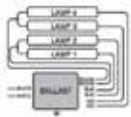

BALLAST MUST BE GROUND
 Install lamp within 3/4" of grounded metal
 Cap Off 1 Blue Wire for 3 Lamp Application

Types of Fluorescent Lamps

Fluorescent lamps get their name from the fluorescent powders called phosphors, that are used to coat the inside surface of the tube. The cathodes located at the end of the tubes are heated by electricity. They release electrons that collide with other gases in the lamp to produce visual light. This process is repeated in different sizes and types of Fluorescent lamps. Standard lamp sizes include T8, T12 and T5.

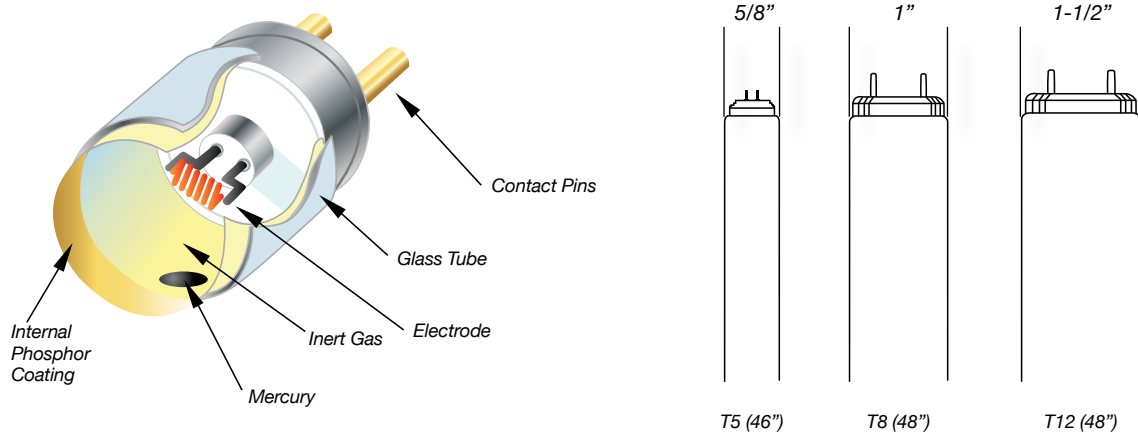

Types of Fluorescent Ballasts

Ballasts are available in different types and operate one or more lamps. Most common types of ballasts are Electronic and Magnetic.

Electronic ballasts are the most popular of Fluorescent ballasts because of their increased efficiency – by operating at a high frequency – and improved performance. Electronic ballasts are available with different starting types which affect overall lamp operation.

- Instant Start are ideal for applications that have long burn hours and minimal on-off switching.
- Rapid Start continue to heat the lamp's electrodes after the lamp has started, which allows for frequent on-off switching with no measurable loss in lamp life.
- Programmed Start are ideal for applications using occupancy sensors.
All T5 and T5HO ballasts are programmed start type ballasts.

Ballasts have a measurement called Ballast Factor, which is the ability of the ballast to produce light from the lamps it is powering. The higher the ballast factor the more energy consumed powering the lamps. Likewise, the lower the ballast factor the less energy consumed. When deciding the correct Fluorescent lamp and ballast system, be sure to look at all of the factors.

Magnetic ballasts, while phased out by the Energy Policy Act of 2005, have recently reemerged. The new legislatively compliant versions are ideal replacements for ballasts in fixtures that operate T12 lamps or when replacing with High CRI T12 lamps and ballasts as part of regular maintenance.

ProLume Lamps

As one of the most efficient and long lasting lighting systems, Linear Fluorescent lamps and ballasts are also the most commonly installed systems. Whether you have T12, T8 or T5 system, ProLume has a solution.

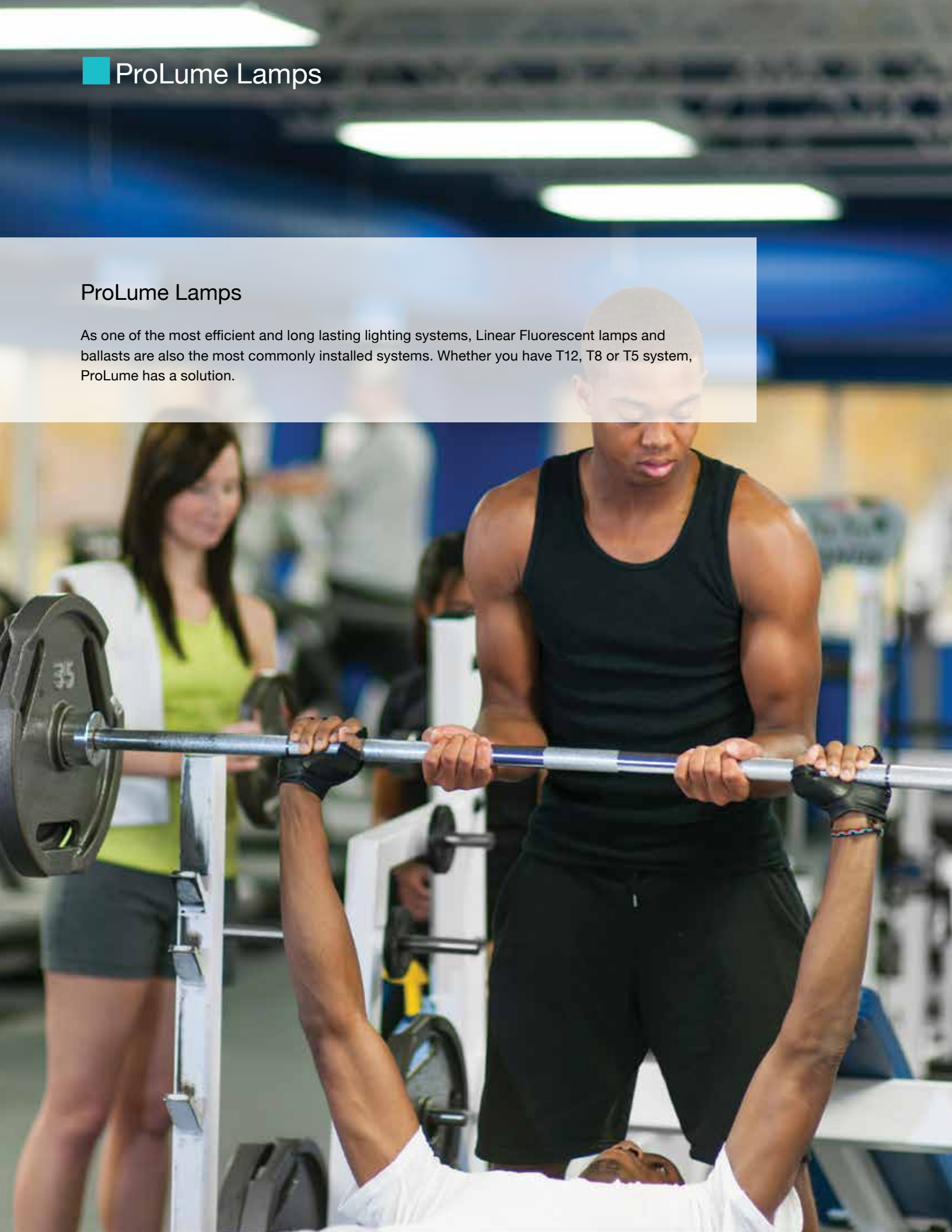

ProLume T8

ProLume T8 lamps are the most popular of all Linear Fluorescent lamps, providing high light quality (86 CRI) and available in the full range of color temperatures with an average rated life of 24,000 hours.

ProLume Reduced Wattage & Energy Saver

ProLume Reduced Wattage & Energy Saver (ES) T8 lamps replace standard 32W T8 lamps without compromise. These ProLume lamps feature performance-enhancing tri-phosphor coating that improves both light quality (CRI) and lamp efficiency.

ProLume High Lumen (HL)

ProLume HL T8 lamps offer 10% more light output while consuming the same wattage as standard T8 lamps. High Lumen lamps are available in 3500K, 4100K and 5000K with a commercial life up-to 30,000 hours.

ProLume Extended Life (XL)

ProLume XL T8 lamps (28W Energy Saver and 32W) surpass the lifetime of an LED lamp while maintaining the performance and value of a Linear Fluorescent lamp. ProLume Extended Life T8 lamps are the optimal solution for installations requiring life up-to 60,000 hours.

ProLume High CRI F40T12

ProLume High CRI F40T12 lamps are a smart retrofit T12 solution, as they are not affected by Department of Energy (DoE) efficiency requirements and are available with high 90 CRI and in 4100K, 5000K and 6500K color temperatures.

ProLume T5 & T5HO

ProLume T5 and T5HO lamps feature a compact tube uniform surface brightness for optimal light output. Coupled with an improved tri-phosphor coating which provides superior color rendering (up to-86 CRI), ProLume T5 and T5HO lamps are a super-efficient light source. T5 lamps operate at higher peak temperatures (95°F vs. 77°F for T8 and T12 lamps) making them ideal for warehouse high bay applications. T5 lamps are available in standard and Reduced Wattages in 3000K (standard only), 3500K, 4100K and 5000K.

CoverShield®

CoverShield shatter-resistant lamps have a skin-tight coating that restricts glass shards, mercury and phosphors within the lamp's envelope in the event of rupture. Halco T5 CoverShield lamps are coated with the highest rated PFA, allowing it to withstand heat up-to 600°F. All Halco CoverShield linear lamps meet NSF, CFIA, USDA, FDA and OSHA regulations.

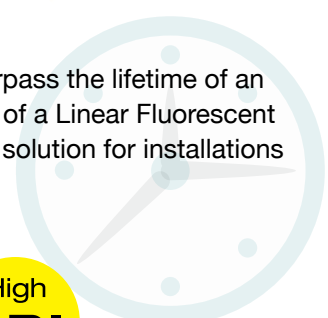
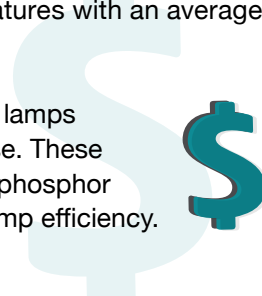



ProLume Lamps

ProLume Lamps

ProLume's broad Fluorescent lamp selection satisfies your need for energy savings, more or less light levels and even reducing lamp maintenance. ProLume lamps comply with environmental and legislative requirements to deliver the highest quality and reliable performance.



Eco-Shield®

ProLume lamps carry the Eco-Shield mark. The U.S. Environmental Protection Agency's (EPA) Toxic Characteristic Leaching Procedure (TCLP) test determines the potential for the mercury contained within a Fluorescent lamp to seep into groundwater when it is disposed in a landfill. All ProLume Eco-Shield Low-Mercury Fluorescent lamps have been analyzed using the TCLP test and satisfy the requirements for non-hazardous products and in most states, require no unique method of disposal. Look for the shield logo for ProLume TCLP compliant lamps.



General Service Fluorescent Lamp Rule Marking

In 2009, the U.S. Department of Energy (DoE) issued updated minimum lumens per watt standards for four foot and eight foot Fluorescent lamps. All ProLume T5 and T5HO lamps passed the minimum efficiency standards. T12 lamps with 87 CRI or greater, including ProLume High CRI F40T12 lamps, are exempt from the minimum efficiency standards. ProLume 800 series T8, F28T8 Energy Saver, F25T8ES Energy Saver, and F32T8 High Lumen lamps pass DoE requirements while offering higher quality, more efficient light and are intelligent replacements for lamps that fail to meet efficiency standards. ProLume Eco-Shield Fluorescent lamps are ideal for U.S. Green Building Council's Leadership in Energy & Environmental Design (LEED) due to their low mercury content.

Utility Rebate Eligibility

Some ProLume lamps qualify for savings through additional utility rebates. ProLume lamps are engineered to meet the requirements of most utility rebate programs. Many utilities use the Consortium for Energy Efficiency® (CEE) Qualified list to develop their utility rebate programs. Look for CEE Listed ProLume T8 lamps including Reduced Wattage, High Performance (HL) and Extended Life (XL) as well as Halco High Performance and Reduced Wattage Ballasts to take advantage of available rebate monies. Check your local utility programs for other opportunities to save on your energy bill. Energy efficient ProLume lamps help qualify for custom rebate programs by lowering your overall energy consumption.



ProLume Ballasts

ProLume Ballasts

As the engine of the lamp and ballast system, ProLume Fluorescent ballasts pair with ProLume lamps for an uncompromising lighting solution.



ProLume ballasts are available with low (L), normal and high (H) ballast factors. When coupled with Energy Saver and High Lumen ProLume lamps, the system can be customized to the application. ProLume ballasts standard sizes are ideal replacements when looking to increase light output or reduce energy savings without installing new lighting fixtures.



32W T8 SYSTEMS

	Standard	Low	High Efficiency
Ballast Code	EP332IS/MV/HE	EP332IS/L/MV/HE	EP332IS/H/M/HE
Ballast Factor	0.88	0.78	1.18
Number of Lamps	3	3	3
Lumen Output	3050	3050	3050
Total Lumen Output	8052	7137	10797
Change in Light Output	-	-11%	+34%
Input Power (@120V)	84	76	108
Annual Energy Cost	\$33.26	\$30.10	\$42.77
Annual Energy Change	-	-\$3.17	+\$9.50

ProFormance

Halco's exclusive ProLume ProFormance® Electronic ballasts, identifiable by an “EP” in the product code prefix, feature high power factor, less than 10% THD and are available in both Multi-Volt and dedicated voltage models. They are renowned for versatility, efficiency and minimal power loss. ProFormance ballasts operate most Fluorescent lamp types including T5, T5HO, T8, T12 and T12HO and are available in instant start, rapid start and programmed start.

All ProLume Electronic ballasts are certified by Underwriters Laboratories® (UL) for use in the United States and are certified by either UL or Canadian Standards Association® (CSA) for use in Canada and backed by a 5-Year Warranty.

ProLume ballasts are Restriction of Hazardous Substances (RoHS) compliant and do NOT include any of the banned substances such as mercury. RoHS compliant ballasts are deemed less harmful to the environment, reduce landfill waste and decrease occupational hazards during manufacturing and recycling.



When ProLume CEE Qualified T8 lamps are installed with ProLume ballasts, they offer additional energy savings and superior performance.

Lamp Ordering Information

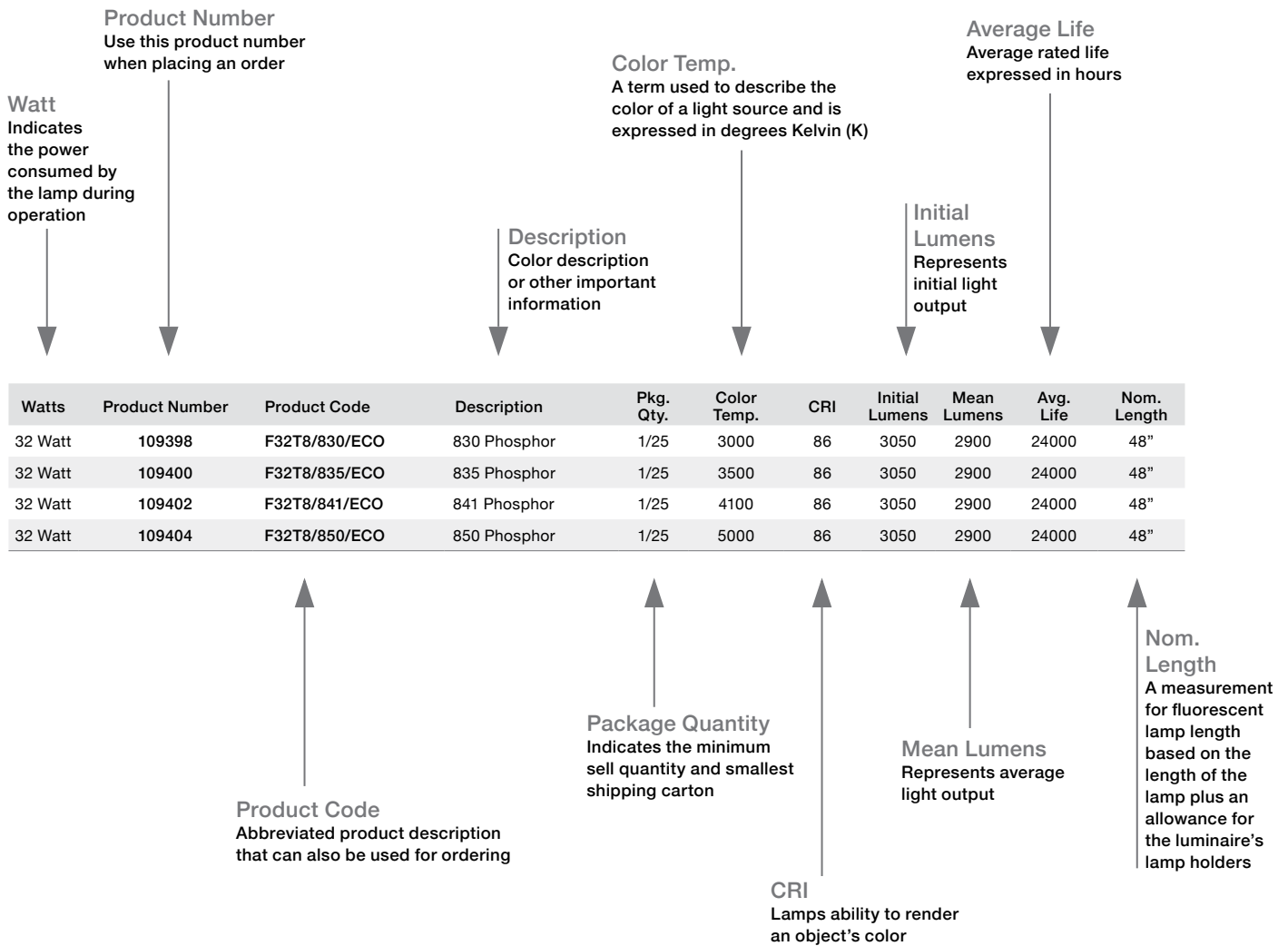

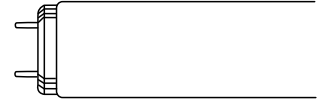

Ordering Information

F32T8



Watts	Product Number	Product Code	Description	Pkg. Qty.	Color Temp.	CRI	Initial Lumens	Mean Lumens	Avg. Life	Nom. Length
32 Watt	109398	F32T8/830/ECO*	830 Phosphor	1/25	3000	86	3050	2900	24000	48"
32 Watt	109400	F32T8/835/ECO*	835 Phosphor	1/25	3500	86	3050	2900	24000	48"
32 Watt	109402	F32T8/841/ECO*	841 Phosphor	1/25	4100	86	3050	2900	24000	48"
32 Watt	109404	F32T8/850/ECO*	850 Phosphor	1/25	5000	86	3050	2900	24000	48"
32 Watt	109428	F32T8/865/ECO	865 Phosphor	1/25	6500	86	3050	2900	24000	48"

F32T8 ballasts can be found on pg.19-20
*CEE Listed Lamp

F32T8 CoverShield®

Watts	Product Number	Product Code	Description	Pkg. Qty.	Color Temp.	CRI	Initial Lumens	Mean Lumens	Avg. Life	Nom. Length
32 Watt	90094	F32T8/835/ECO/CS	835 Phosphor, CoverShield®	1/25	3500	86	3050	2900	24000	48"
32 Watt	90095	F32T8/841/ECO/CS	841 Phosphor, CoverShield®	1/25	4100	86	3050	2900	24000	48"
32 Watt	90096	F32T8/850/ECO/CS	850 Phosphor, CoverShield®	1/25	5000	86	3050	2900	24000	48"

F32T8 ballasts can be found on pg. 19-20

F32T8HL High Lumen



Watts	Product Number	Product Code	Description	Pkg. Qty.	Color Temp.	CRI	Initial Lumens	Mean Lumens	Avg. Life	Nom. Length
32 Watt	35176	F32T8/835/ECO/HL*	835 Phosphor, High Lumen	1/25	3500	86	3150	3000	24000	48"
32 Watt	35177	F32T8/841/ECO/HL*	841 Phosphor, High Lumen	1/25	4100	86	3150	3000	24000	48"
32 Watt	35178	F32T8/850/ECO/HL*	850 Phosphor, High Lumen	1/25	5000	86	3150	3000	24000	48"

F32T8 ballasts can be found on pg. 19-20
*CEE Listed Lamp

F32T8XL Extended Life



Watts	Product Number	Product Code	Pkg. Qty.	Color Temp.	CRI	Initial Lumens	Mean Lumens	Nom. Length	Instant Start		Programmed Start	
									3 Hrs Start	12 Hrs Start	3 Hrs Start	12 Hrs Start
32 Watt	35159	F32T8/835/ECO/XL*	1/25	3500	86	2950	2800	48"	36000	40000	55000	60000
32 Watt	35160	F32T8/841/ECO/XL*	1/25	4100	86	2950	2800	48"	36000	40000	55000	60000
32 Watt	35161	F32T8/850/ECO/XL*	1/25	5000	86	2950	2800	48"	36000	40000	55000	60000

F32T8 ballasts can be found on pg. 19-20
*CEE Listed Lamp

F28T8XL Extended Life



Watts	Product Number	Product Code	Pkg. Qty.	Color Temp.	CRI	Initial Lumens	Mean Lumens	Nom. Length	Instant Start		Programmed Start	
									3 Hrs Start	12 Hrs Start	3 Hrs Start	12 Hrs Start
28 Watt	35181	F28T8/835/ECO/XL*	1/25	3500	86	2700	2550	48"	36000	40000	55000	60000
28 Watt	35182	F28T8/841/ECO/XL*	1/25	4100	86	2700	2550	48"	36000	40000	55000	60000
28 Watt	35183	F28T8/850/ECO/XL*	1/25	5000	86	2700	2550	48"	36000	40000	55000	60000

F28T8 ballasts can be found on pg. 21-22
*CEE Listed Lamp

ProLume T8 Lamps

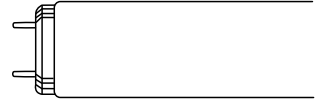

Ordering Information

F28T8 Reduced Wattage



Watts	Product Number	Product Code	Description	Pkg. Qty.	Color Temp.	CRI	Initial Lumens	Mean Lumens	Avg. Life	Nom. Length
28 Watt	35175	F28T8/830/ECO*	830 Phosphor, Reduced Wattage	1/25	3000	86	2800	2660	24000	48"
28 Watt	109364	F28T8/835/ECO*	835 Phosphor, Reduced Wattage	1/25	3500	86	2800	2660	24000	48"
28 Watt	109366	F28T8/841/ECO*	841 Phosphor, Reduced Wattage	1/25	4100	86	2800	2660	24000	48"
28 Watt	109368	F28T8/850/ECO*	850 Phosphor, Reduced Wattage	1/25	5000	86	2800	2660	24000	48"

F28T8 ballasts can be found on pg. 21-22
 *CEE Listed Lamp

F25T8 Energy Saver



Watts	Product Number	Product Code	Description	Pkg. Qty.	Color Temp.	CRI	Initial Lumens	Mean Lumens	Avg. Life	Nom. Length
25 Watt	35162	F25T8ES/830/ECO*	830 Phosphor, Energy Saver	1/25	3000	86	2500	2380	24000	48"
25 Watt	35172	F25T8ES/835/ECO*	835 Phosphor, Energy Saver	1/25	3500	86	2500	2380	24000	48"
25 Watt	35173	F25T8ES/841/ECO*	841 Phosphor, Energy Saver	1/25	4100	86	2500	2380	24000	48"
25 Watt	35174	F25T8ES/850/ECO*	850 Phosphor, Energy Saver	1/25	5000	86	2500	2380	24000	48"

F25T8ES ballasts can be found on pg. 23
 *CEE Listed Lamp

F25T8



Watts	Product Number	Product Code	Description	Pkg. Qty.	Color Temp.	CRI	Initial Lumens	Mean Lumens	Avg. Life	Nom. Length
25 Watt	109340	F25T8/730/ECO	730 Phosphor	1/25	3000	78	2150	2050	24000	36"
25 Watt	109342	F25T8/735/ECO	735 Phosphor	1/25	3500	78	2150	2050	24000	36"
25 Watt	109344	F25T8/741/ECO	741 Phosphor	1/25	4100	78	2150	2050	24000	36"
25 Watt	109346	F25T8/750/ECO	750 Phosphor	1/25	5000	78	2150	2050	24000	36"
25 Watt	109806	F25T8/830/ECO	830 Phosphor	1/25	3000	86	2250	2140	24000	36"
25 Watt	109808	F25T8/835/ECO	835 Phosphor	1/25	3500	86	2250	2140	24000	36"
25 Watt	109810	F25T8/841/ECO	841 Phosphor	1/25	4100	86	2250	2140	24000	36"

F25T8 ballasts can be found on pg. 24

F17T8



Watts	Product Number	Product Code	Description	Pkg. Qty.	Color Temp.	CRI	Initial Lumens	Mean Lumens	Avg. Life	Nom. Length
17 Watt	109320	F17T8/730/ECO	730 Phosphor	1/25	3000	78	1350	1280	24000	24"
17 Watt	109322	F17T8/735/ECO	735 Phosphor	1/25	3500	78	1350	1280	24000	24"
17 Watt	109324	F17T8/741/ECO	741 Phosphor	1/25	4100	78	1350	1280	24000	24"
17 Watt	109326	F17T8/750/ECO	750 Phosphor	1/25	5000	78	1350	1280	24000	24"
17 Watt	35170	F17T8/830/ECO	830 Phosphor	1/25	3000	86	1400	1300	24000	24"
17 Watt	109802	F17T8/835/ECO	835 Phosphor	1/25	3500	86	1400	1300	24000	24"
17 Watt	109804	F17T8/841/ECO	841 Phosphor	1/25	4100	86	1400	1300	24000	24"
17 Watt	35180	F17T8/850/ECO	850 Phosphor	1/25	5000	86	1400	1300	24000	24"

F17T8 ballasts can be found on pg. 25-26

ProLume U-Bend Lamps

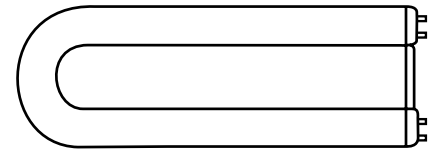

Ordering Information

T8 U-Bend Lamps

Watts	Product Number	Product Code	Description	Pkg. Qty.	Color Temp.	CRI	Initial Lumens	Mean Lumens	Avg. Life	Nom. Length
28 Watt	35307	FB28/835/6/ECO/IC*	835 Phosphor 6"	20	3500	86	2650	2450	24000	22.6"
28 Watt	35321	FB28/841/6/ECO*	841 Phosphor 6"	20	4100	86	2650	2450	24000	22.6"
31 Watt	30301	FB31/830/ECO	830 Phosphor 1-5/8"	12	3000	86	2750	2600	24000	22.6"
31 Watt	30302	FB31/835/ECO	835 Phosphor 1-5/8"	12	3500	86	2750	2600	24000	22.6"
31 Watt	30303	FB31/841/ECO	841 Phosphor 1-5/8"	12	4100	86	2750	2600	24000	22.6"
31 Watt	30304	FB31/850/ECO	850 Phosphor 1-5/8"	12	5000	86	2750	2600	24000	22.6"
32 Watt	109812	FB32/830/6/ECO	830 Phosphor 6"	20	3000	86	2900	2750	24000	22.6"
32 Watt	109814	FB32/835/6/ECO	835 Phosphor 6"	20	3500	86	2900	2750	24000	22.6"
32 Watt	109816	FB32/841/6/ECO	841 Phosphor 6"	20	4100	86	2900	2750	24000	22.6"
32 Watt	109818	FB32/850/6/ECO	850 Phosphor 6"	20	5000	86	2900	2750	24000	22.6"

*CEE Listed Lamp

ProLume T12 Lamps



Ordering Information

F40T12

Watts	Product Number	Product Code	Description	Pkg. Qty.	Color Temp.	CRI	Initial Lumens	Mean Lumens	Avg. Life	Nom. Length
40 Watt	35200	F40CWX/ECO	941 Cool White Deluxe	30	4100	90	2500	2300	24000	48"
40 Watt	35201	F40/950/ECO	950 Natural White Deluxe	30	5000	90	2250	2050	24000	48"
40 Watt	35202	F40DX/ECO	965 Daylight Deluxe	30	6500	90	2200	2000	24000	48"

F40T12 ballasts can be found on pg. 26

ProLume T5 Lamps

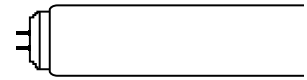

Ordering Information

F28T5



Watts	Product Number	Product Code	Description	Pkg. Qty.	Color Temp.	CRI	Initial Lumens	Mean Lumens	Avg. Life	Nom. Length
28 Watt	35041	F28T5/830/ECO/IC	830 Phosphor	1/25	3000	86	2900	2750	24000	46"
28 Watt	35042	F28T5/835/ECO/IC	835 Phosphor	1/25	3500	86	2900	2750	24000	46"
28 Watt	35043	F28T5/841/ECO/IC	841 Phosphor	1/25	4100	86	2900	2750	24000	46"
28 Watt	35044	F28T5/850/ECO/IC	850 Phosphor	1/25	5000	86	2900	2750	24000	46"

F28T5 ballasts can be found on pg. 27

F21T5



Watts	Product Number	Product Code	Description	Pkg. Qty.	Color Temp.	CRI	Initial Lumens	Mean Lumens	Avg. Life	Nom. Length
21 Watt	30125	F21T5/830/ECO/IC	830 Phosphor	1/25	3000	86	2100	1990	24000	34"
21 Watt	30126	F21T5/835/ECO/IC	835 Phosphor	1/25	3500	86	2100	1990	24000	34"
21 Watt	30127	F21T5/841/ECO/IC	841 Phosphor	1/25	4100	86	2100	1990	24000	34"

F21T5 ballasts can be found on pg. 27

F14T5



Watts	Product Number	Product Code	Description	Pkg. Qty.	Color Temp.	CRI	Initial Lumens	Mean Lumens	Avg. Life	Nom. Length
14 Watt	30117	F14T5/830/ECO/IC	830 Phosphor	1/25	3000	86	1350	1270	24000	22"
14 Watt	30118	F14T5/835/ECO/IC	835 Phosphor	1/25	3500	86	1350	1270	24000	22"
14 Watt	30119	F14T5/841/ECO/IC	841 Phosphor	1/25	4100	86	1350	1270	24000	22"

F14T5 ballasts can be found on pg. 27



Ordering Information

F54T5HO



Watts	Product Number	Product Code	Description	Pkg. Qty.	Color Temp.	CRI	Initial Lumens	Mean Lumens	Avg. Life	Nom. Length
54 Watt	35081	F54T5/830/HO/ECO/IC	830 Phosphor High Output	1/25	3000	86	5000	4850	24000	46"
54 Watt	35082	F54T5/835/HO/ECO/IC	835 Phosphor High Output	1/25	3500	86	5000	4850	24000	46"
54 Watt	35083	F54T5/841/HO/ECO/IC	841 Phosphor High Output	1/25	4100	86	5000	4850	24000	46"
54 Watt	35084	F54T5/850/HO/ECO/IC	850 Phosphor High Output	1/25	5000	86	5000	4850	24000	46"
54 Watt	35086	F54T5/865/HO/ECO/IC	865 Phosphor High Output	1/25	6500	86	5000	4850	24000	46"

F54T5HO ballasts can be found on pg. 28

F49T5HO



Watts	Product Number	Product Code	Description	Pkg. Qty.	Color Temp.	CRI	Initial Lumens	Mean Lumens	Avg. Life	Nom. Length
49 Watt	35085	F49T5/830/HO/ECO	835 Phosphor High Output, Energy Saver	1/25	3500	86	4900	4700	24000	46"
49 Watt	35088	F49T5/841/HO/ECO	841 Phosphor High Output, Energy Saver	1/25	4100	86	4900	4700	24000	46"
49 Watt	35089	F49T5/850/HO/ECO	850 Phosphor High Output, Energy Saver	1/25	5000	86	4900	4700	24000	46"

F49T5HO ballasts can be found on pg. 28

F39T5HO



Watts	Product Number	Product Code	Description	Pkg. Qty.	Color Temp.	CRI	Initial Lumens	Mean Lumens	Avg. Life	Nom. Length
39 Watt	35061	F39T5/835/HO/ECO/IC	835 Phosphor High Output	1/25	3500	86	3500	3320	24000	34"
39 Watt	35062	F39T5/841/HO/ECO/IC	841 Phosphor High Output, Energy Saver	1/25	4100	86	3500	3320	24000	34"

F39T5HO ballasts can be found on pg. 29

F24T5HO



Watts	Product Number	Product Code	Description	Pkg. Qty.	Color Temp.	CRI	Initial Lumens	Mean Lumens	Avg. Life	Nom. Length
24 Watt	30134	F24T5/835/HO/ECO/IC	835 Phosphor High Output	1/25	3500	86	2000	1900	20000	22"
24 Watt	30135	F24T5/841/HO/ECO/IC	841 Phosphor High Output	1/25	4100	86	2000	1900	20000	22"

F24T5HO ballasts can be found on pg. 29

Ballast Ordering Information

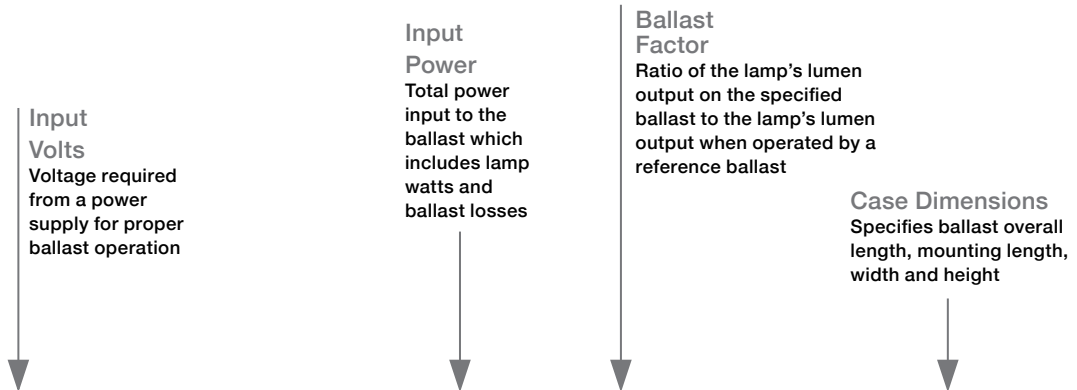

Lamp Type			Input Volts	Product Number	Product Code	Line Current (Amps)	Input Power (Watts)	Power Factor	Ballast Factor	THD %	Min. Start Temp.	Case Dimensions			
Qty.	Watts	Start Type										Length	Mounting	Width	Height
1	28	IS	120	50115	EP232IS/H/MV/HE	0.33	39	0.98	1.38	<10	60°F	9.50"	8.90"	1.30"	1.10"
1	28	IS	277	50115	EP232IS/H/MV/HE	0.15	39	0.97	1.38	<15	60°F	9.50"	8.90"	1.30"	1.10"
1	28	IS	120	50119	EP232IS/L/MV/HE	0.22	26	0.98	0.93	<10	60°F	9.50"	8.90"	1.30"	1.10"
1	28	IS	277	50119	EP232IS/L/MV/HE	0.10	24	0.85	0.93	<20	60°F	9.50"	8.90"	1.30"	1.10"



Lamp Type
Indicates the type of lamp that the ballast will operate

Product Number
Use this product number when placing an order

Product Code
Abbreviated product description can also be used for ordering

Line Current
The current that results when the line voltage is applied to a load

Power Factor
Watts to volt amps ratio, which measures efficiency of a ballast's power usage

THD%
Indicates percentage of Total Harmonic Distortion

Min. Start Temp.
References minimum ambient temperature that the ballast will reliably start a lamp

Ordering Information



F32T8

Qty.	Lamp Type		Input Volts	Product Number	Product Code	Line Current (Amps)	Input Power (Watts)	Power Factor	Ballast Factor	THD %	Min. Start Temp	Case Dimensions			
	Watts	Start Type										Length	Mounting	Width	Height
1	32	IS	120	50118	E232IS/120/R/MC	0.55	34	0.52	1.03	<155	0°F	9.50"	8.90"	1.30"	1.10"
1	32	IS	120	50176	EP232IS/120/MC	0.34	38	0.94	1.01	<32	0°F	9.50"	8.90"	1.30"	1.00"
1	32	IS	120	50115	EP232IS/H/MV/HE	0.37	45	0.98	1.38	<10	0°F	9.50"	8.90"	1.30"	1.10"
1	32	IS	277	50115	EP232IS/H/MV/HE	0.17	45	0.97	1.38	<15	0°F	9.50"	8.90"	1.30"	1.10"
1	32	IS	120	50119	EP232IS/L/MV/HE	0.26	31	0.98	0.93	<10	0°F	9.50"	8.90"	1.30"	1.10"
1	32	IS	277	50119	EP232IS/L/MV/HE	0.12	30	0.95	0.93	<15	0°F	9.50"	8.90"	1.30"	1.10"
1	32	IS	120	50123	EP232IS/MV/HE	0.29	35	0.98	1.08	<10	0°F	9.50"	8.90"	1.30"	1.10"
1	32	IS	277	50123	EP232IS/MV/HE	0.13	34	0.97	1.08	<15	0°F	9.50"	8.90"	1.30"	1.10"
1	32	PS	120	50180	EP232PS/MV/HE	0.31	37	0.98	0.99	<10	0°F	9.50"	8.90"	1.38"	1.18"
1	32	PS	277	50180	EP232PS/MV/HE	0.14	37	0.93	0.99	<10	0°F	9.50"	8.90"	1.38"	1.18"
1	32	PS	120	50178	EP232PS/L/MV/HE	0.28	33	0.99	0.86	<10	0°F	9.50"	8.90"	1.38"	1.18"
1	32	PS	277	50178	EP232PS/L/MV/HE	0.12	33	0.98	0.86	<10	0°F	9.50"	8.90"	1.38"	1.18"
2	32	IS	120	50118	E232IS/120/R/MC	0.80	54	0.56	0.85	<130	0°F	9.50"	8.90"	1.30"	1.10"
2	32	IS	120	50176	EP232IS/120/MC	0.49	59	0.97	0.87	<30	0°F	9.50"	8.90"	1.30"	1.00"
2	32	IS	120	50115	EP232IS/H/MV/HE	0.62	74	0.98	1.18	<10	0°F	9.50"	8.90"	1.30"	1.10"
2	32	IS	277	50115	EP232IS/H/MV/HE	0.27	73	0.98	1.18	<10	0°F	9.50"	8.90"	1.30"	1.10"
2	32	IS	120	50119	EP232IS/L/MV/HE	0.40	49	0.98	0.78	<10	0°F	9.50"	8.90"	1.30"	1.10"
2	32	IS	277	50119	EP232IS/L/MV/HE	0.18	48	0.97	0.78	<15	0°F	9.50"	8.90"	1.30"	1.10"
2	32	IS	120	50123	EP232IS/MV/HE	0.46	56	0.98	0.89	<10	0°F	9.50"	8.90"	1.30"	1.10"
2	32	IS	277	50123	EP232IS/MV/HE	0.20	55	0.97	0.89	<10	0°F	9.50"	8.90"	1.30"	1.10"
2	32	PS	120	50180	EP232PS/MV/HE	0.50	60	0.99	0.88	<10	0°F	9.50"	8.90"	1.38"	1.18"
2	32	PS	277	50180	EP232PS/MV/HE	0.22	60	0.98	0.88	<10	0°F	9.50"	8.90"	1.38"	1.18"
2	32	PS	120	50178	EP232PS/L/MV/HE	0.44	52	0.99	0.77	<10	0°F	9.50"	8.90"	1.38"	1.18"
2	32	PS	277	50178	EP232PS/L/MV/HE	0.19	52	0.98	0.77	<10	0°F	9.50"	8.90"	1.38"	1.18"
2	32	IS	120	50121	EP332IS/H/MV/HE	0.69	81	0.98	1.27	<10	0°F	9.50"	8.90"	1.30"	1.10"
2	32	IS	277	50121	EP332IS/H/MV/HE	0.30	80	0.98	1.27	<10	0°F	9.50"	8.90"	1.30"	1.10"
2	32	IS	120	50168	EP332IS/L/MV/HE	0.49	58	0.98	0.92	<10	0°F	9.50"	8.90"	1.30"	1.10"
2	32	IS	277	50168	EP332IS/L/MV/HE	0.21	57	0.95	0.92	<15	0°F	9.50"	8.90"	1.30"	1.10"
2	32	IS	120	50170	EP332IS/MV/HE	0.53	63	0.98	0.99	<10	0°F	9.50"	8.90"	1.30"	1.10"
2	32	IS	277	50170	EP332IS/MV/HE	0.24	63	0.97	0.99	<15	0°F	9.50"	8.90"	1.30"	1.10"

Ordering Information



F32T8 continued

Lamp Type			Input Volts	Product Number	Product Code	Line Current (Amps)	Input Power (Watts)	Power Factor	Ballast Factor	THD %	Min. Start Temp	Case Dimensions			
Qty.	Watts	Start Type										Length	Mounting	Width	Height
3	32	IS	120	50158	E432IS/R/120/MC	1.35	86	0.50	0.90	<170	0°F	9.50"	8.90"	1.30"	1.10"
3	32	IS	120	50121	EP332IS/H/MV/HE	0.91	108	0.98	1.18	<10	0°F	9.50"	8.90"	1.30"	1.10"
3	32	IS	277	50121	EP332IS/H/MV/HE	0.39	106	0.98	1.18	<10	0°F	9.50"	8.90"	1.30"	1.10"
3	32	IS	120	50168	EP332IS/L/MV/HE	0.64	76	0.98	0.78	<10	0°F	9.50"	8.90"	1.30"	1.10"
3	32	IS	277	50168	EP332IS/L/MV/HE	0.27	74	0.98	0.78	<10	0°F	9.50"	8.90"	1.30"	1.10"
3	32	IS	120	50170	EP332IS/MV/HE	0.71	84	0.98	0.88	<10	0°F	9.50"	8.90"	1.30"	1.10"
3	32	IS	277	50170	EP332IS/MV/HE	0.31	83	0.98	0.88	<10	0°F	9.50"	8.90"	1.30"	1.10"
3	32	IS	120	50124	EP432IS/120/MC	0.79	94	0.98	1.00	<20	0°F	9.50"	8.90"	1.30"	1.10"
3	32	IS	120	50172	EP432IS/L/MV/HE	0.68	81	0.98	0.82	<10	0°F	9.50"	8.90"	1.30"	1.10"
3	32	IS	277	50172	EP432IS/L/MV/HE	0.29	80	0.98	0.82	<10	0°F	9.50"	8.90"	1.30"	1.10"
3	32	IS	120	50174	EP432IS/MV/HE	0.77	92	0.98	0.96	<10	0°F	9.50"	8.90"	1.30"	1.10"
3	32	IS	277	50174	EP432IS/MV/HE	0.34	89	0.98	0.96	<10	0°F	9.50"	8.90"	1.30"	1.10"
3	32	PS	120	50184	EP432PS/MV/HE	0.79	95	0.99	0.92	<10	0°F	9.50"	8.90"	1.65"	1.18"
3	32	PS	277	50184	EP432PS/MV/HE	0.35	95	0.98	0.93	<10	0°F	9.50"	8.90"	1.65"	1.18"
4	32	IS	120	50158	E432IS/120/R/MC	1.62	103	0.50	0.82	<165	0°F	9.50"	8.90"	1.30"	1.10"
4	32	IS	120	50124	EP432IS/120/MC	0.93	110	0.98	0.88	<20	0°F	9.50"	8.90"	1.30"	1.10"
4	32	IS	120	50172	EP432IS/L/MV/HE	0.82	98	0.98	0.77	<10	0°F	9.50"	8.90"	1.30"	1.10"
4	32	IS	277	50172	EP432IS/L/MV/HE	0.35	96	0.98	0.77	<10	0°F	9.50"	8.90"	1.30"	1.10"
4	32	IS	120	50174	EP432IS/MV/HE	0.93	112	0.99	0.88	<10	0°F	9.50"	8.90"	1.30"	1.10"
4	32	IS	277	50174	EP432IS/MV/HE	0.40	109	0.99	0.88	<10	0°F	9.50"	8.90"	1.30"	1.10"
4	32	PS	120	50184	EP432PS/MV/HE	0.95	114	0.99	0.86	<10	0°F	9.50"	8.90"	1.65"	1.18"
4	32	PS	277	50184	EP432PS/MV/HE	0.42	114	0.98	0.86	<10	0°F	9.50"	8.90"	1.65"	1.18"

Ordering Information

F28T8



Lamp Type			Input Volts	Product Number	Product Code	Line Current (Amps)	Input Power (Watts)	Power Factor	Ballast Factor	THD %	Min. Start Temp	Case Dimensions			
Qty.	Watts	Start Type										Length	Mounting	Width	Height
1	28	IS	120	50115	EP232IS/H/MV/HE	0.33	39	0.98	1.38	<10	60°F	9.50"	8.90"	1.30"	1.10"
1	28	IS	277	50115	EP232IS/H/MV/HE	0.15	39	0.97	1.38	<15	60°F	9.50"	8.90"	1.30"	1.10"
1	28	IS	120	50119	EP232IS/L/MV/HE	0.22	26	0.98	0.93	<10	60°F	9.50"	8.90"	1.30"	1.10"
1	28	IS	277	50119	EP232IS/L/MV/HE	0.10	24	0.85	0.93	<20	60°F	9.50"	8.90"	1.30"	1.10"
1	28	IS	120	50123	EP232IS/MV/HE	0.25	30	0.98	1.08	<10	60°F	9.50"	8.90"	1.30"	1.10"
1	28	IS	277	50123	EP232IS/MV/HE	0.11	29	0.97	1.08	<15	60°F	9.50"	8.90"	1.30"	1.10"
1	28	PS	120	50178	EP232PS/L/MV/HE	0.25	30	0.99	0.86	<10	60°F	9.50"	8.90"	1.38"	1.18"
1	28	PS	277	50178	EP232PS/L/MV/HE	0.11	30	0.97	0.86	<12	60°F	9.50"	8.90"	1.38"	1.18"
2	28	IS	120	50115	EP232IS/H/MV/HE	0.54	64	0.98	1.18	<10	60°F	9.50"	8.90"	1.30"	1.10"
2	28	IS	277	50115	EP232IS/H/MV/HE	0.24	63	0.98	1.18	<15	60°F	9.50"	8.90"	1.30"	1.10"
2	28	IS	120	50119	EP232IS/L/MV/HE	0.35	41	0.98	0.78	<10	60°F	9.50"	8.90"	1.30"	1.10"
2	28	IS	277	50119	EP232IS/L/MV/HE	0.15	41	0.97	0.78	<15	60°F	9.50"	8.90"	1.30"	1.10"
2	28	IS	120	50123	EP232IS/MV/HE	0.41	49	0.98	0.89	<10	60°F	9.50"	8.90"	1.30"	1.10"
2	28	IS	277	50123	EP232IS/MV/HE	0.18	47	0.97	0.89	<15	60°F	9.50"	8.90"	1.30"	1.10"
2	28	PS	120	50180	EP232PS/MV/HE	0.45	54	0.99	0.90	<10	60°F	9.50"	8.90"	1.38"	1.18"
2	28	PS	277	50180	EP232PS/MV/HE	0.20	54	0.98	0.90	<10	60°F	9.50"	8.90"	1.38"	1.18"
2	28	PS	120	50178	EP232PS/L/MV/HE	0.39	46	0.99	0.75	<10	60°F	9.50"	8.90"	1.38"	1.18"
2	28	PS	277	50178	EP232PS/L/MV/HE	0.17	47	0.98	0.75	<10	60°F	9.50"	8.90"	1.38"	1.18"
2	28	IS	120	50121	EP332IS/H/MV/HE	0.59	70	0.98	1.27	<10	60°F	9.50"	8.90"	1.30"	1.10"
2	28	IS	277	50121	EP332IS/H/MV/HE	0.26	69	0.97	1.27	<15	60°F	9.50"	8.90"	1.30"	1.10"
2	28	IS	120	50168	EP332IS/L/MV/HE	0.42	49	0.98	0.92	<10	60°F	9.50"	8.90"	1.30"	1.10"
2	28	IS	277	50168	EP332IS/L/MV/HE	0.19	48	0.95	0.92	<15	60°F	9.50"	8.90"	1.30"	1.10"
2	28	IS	120	50170	EP332IS/MV/HE	0.45	54	0.98	0.99	<10	60°F	9.50"	8.90"	1.30"	1.10"
2	28	IS	277	50170	EP332IS/MV/HE	0.20	53	0.97	0.99	<15	60°F	9.50"	8.90"	1.30"	1.10"

Ordering Information

F28T8 continued



Lamp Type			Input Volts	Product Number	Product Code	Line Current (Amps)	Input Power (Watts)	Power Factor	Ballast Factor	THD %	Min. Start Temp	Case Dimensions			
Qty.	Watts	Start Type										Length	Mounting	Width	Height
3	28	IS	120	50121	EP332IS/H/MV/HE	0.78	93	0.98	1.18	<10	60°F	9.50"	8.90"	1.30"	1.10"
3	28	IS	277	50121	EP332IS/H/MV/HE	0.34	92	0.98	1.18	<10	60°F	9.50"	8.90"	1.30"	1.10"
3	28	IS	120	50168	EP332IS/L/MV/HE	0.55	64	0.98	0.81	<10	60°F	9.50"	8.90"	1.30"	1.10"
3	28	IS	277	50168	EP332IS/L/MV/HE	0.24	63	0.95	0.81	<15	60°F	9.50"	8.90"	1.30"	1.10"
3	28	IS	120	50170	EP332IS/MV/HE	0.60	72	0.98	0.88	<10	60°F	9.50"	8.90"	1.30"	1.10"
3	28	IS	277	50170	EP332IS/MV/HE	0.26	70	0.98	0.88	<15	60°F	9.50"	8.90"	1.30"	1.10"
3	28	IS	120	50172	EP432IS/L/MV/HE	0.59	70	0.98	0.82	<10	60°F	9.50"	8.90"	1.30"	1.10"
3	28	IS	277	50172	EP432IS/L/MV/HE	0.26	70	0.97	0.82	<10	60°F	9.50"	8.90"	1.30"	1.10"
3	28	IS	120	50174	EP432IS/MV/HE	0.65	77	0.96	0.98	<10	60°F	9.50"	8.90"	1.30"	1.10"
3	28	IS	277	50174	EP432IS/MV/HE	0.29	77	0.96	0.98	<10	60°F	9.50"	8.90"	1.30"	1.10"
3	28	PS	120	50184	EP432PS/MV/HE	0.70	83	0.99	0.92	<10	60°F	9.50"	8.90"	1.65"	1.18"
3	28	PS	277	50184	EP432PS/MV/HE	0.31	83	0.97	0.93	<12	60°F	9.50"	8.90"	1.65"	1.18"
4	28	IS	120	50172	EP432IS/L/MV/HE	0.71	84	0.98	0.77	<10	60°F	9.50"	8.90"	1.30"	1.10"
4	28	IS	277	50172	EP432IS/L/MV/HE	0.31	84	0.98	0.77	<10	60°F	9.50"	8.90"	1.30"	1.10"
4	28	IS	120	50174	EP432IS/MV/HE	0.79	94	0.98	0.88	<10	60°F	9.50"	8.90"	1.30"	1.10"
4	28	IS	277	50174	EP432IS/MV/HE	0.35	94	0.98	0.88	<10	60°F	9.50"	8.90"	1.30"	1.10"
4	28	PS	120	50184	EP432PS/MV/HE	0.84	100	0.99	0.85	<10	60°F	9.50"	8.90"	1.65"	1.18"
4	28	PS	277	50184	EP432PS/MV/HE	0.37	100	0.98	0.86	<10	60°F	9.50"	8.90"	1.65"	1.18"

Ordering Information

F25T8/ES (F32T8 25W)



Qty.	Lamp Type		Input Volts	Product Number	Product Code	Line Current (Amps)	Input Power (Watts)	Power Factor	Ballast Factor	THD %	Min. Start Temp	Case Dimensions			
	Watts	Start Type										Length	Mounting	Width	Height
1	25	IS	120	50119	EP232IS/L/MV/HE	0.21	25	0.98	0.93	<10	60°F	9.50"	8.90"	1.30"	1.10"
1	25	IS	277	50119	EP232IS/L/MV/HE	0.10	23	0.80	0.93	<20	60°F	9.50"	8.90"	1.30"	1.10"
1	25	IS	120	50123	EP232IS/MV/HE	0.24	29	0.98	1.08	<10	60°F	9.50"	8.90"	1.30"	1.10"
1	25	IS	277	50123	EP232IS/MV/HE	0.11	29	0.97	1.08	<15	60°F	9.50"	8.90"	1.30"	1.10"
1	25	PS	120	50180	EP232PS/MV/HE	0.27	33	0.99	1.05	<10	60°F	9.50"	8.90"	1.38"	1.18"
1	25	PS	277	50180	EP232PS/MV/HE	0.12	33	0.95	1.05	<12	60°F	9.50"	8.90"	1.38"	1.18"
1	25	PS	120	50178	EP232PS/L/MV/HE	0.24	28	0.99	0.92	<10	60°F	9.50"	8.90"	1.38"	1.18"
1	25	PS	277	50178	EP232PS/L/MV/HE	0.11	29	0.97	0.92	<12	60°F	9.50"	8.90"	1.38"	1.18"
2	25	IS	120	50119	EP232IS/L/MV/HE	0.31	37	0.98	0.79	<10	60°F	9.50"	8.90"	1.30"	1.10"
2	25	IS	277	50119	EP232IS/L/MV/HE	0.13	35	0.95	0.79	<15	60°F	9.50"	8.90"	1.30"	1.10"
2	25	IS	120	50123	EP232IS/MV/HE	0.39	46	0.98	0.89	<10	60°F	9.50"	8.90"	1.30"	1.10"
2	25	IS	277	50123	EP232IS/MV/HE	0.17	45	0.97	0.89	<15	60°F	9.50"	8.90"	1.30"	1.10"
2	25	PS	120	50178	EP232PS/L/MV/HE	0.37	44	0.99	0.79	<10	60°F	9.50"	8.90"	1.38"	1.18"
2	25	PS	277	50178	EP232PS/L/MV/HE	0.16	44	0.98	0.79	<10	60°F	9.50"	8.90"	1.38"	1.18"
2	25	PS	120	50180	EP232PS/MV/HE	0.42	50	0.99	0.92	<10	60°F	9.50"	8.90"	1.38"	1.18"
2	25	PS	277	50180	EP232PS/MV/HE	0.19	50	0.97	0.92	<10	60°F	9.50"	8.90"	1.38"	1.18"
2	25	IS	120	50168	EP332IS/L/MV/HE	0.41	48	0.98	0.95	<10	60°F	9.50"	8.90"	1.30"	1.10"
2	25	IS	277	50168	EP332IS/L/MV/HE	0.18	47	0.95	0.92	<15	60°F	9.50"	8.90"	1.30"	1.10"
2	25	IS	120	50170	EP332IS/MV/HE	0.43	51	0.98	1.00	<10	60°F	9.50"	8.90"	1.30"	1.10"
2	25	IS	277	50170	EP332IS/MV/HE	0.19	51	0.97	1.00	<15	60°F	9.50"	8.90"	1.30"	1.10"
3	25	IS	120	50168	EP332IS/L/MV/HE	0.53	63	0.98	0.85	<10	60°F	9.50"	8.90"	1.30"	1.10"
3	25	IS	277	50168	EP332IS/L/MV/HE	0.23	61	0.95	0.85	<15	60°F	9.50"	8.90"	1.30"	1.10"
3	25	IS	120	50170	EP332IS/MV/HE	0.56	68	0.98	0.90	<10	60°F	9.50"	8.90"	1.30"	1.10"
3	25	IS	277	50170	EP332IS/MV/HE	0.25	68	0.97	0.90	<15	60°F	9.50"	8.90"	1.30"	1.10"
3	25	IS	120	50172	EP432IS/L/MV/HE	0.57	68	0.98	0.84	<10	60°F	9.50"	8.90"	1.30"	1.18"
3	25	IS	277	50172	EP432IS/L/MV/HE	0.25	68	0.95	0.84	<15	60°F	9.50"	8.90"	1.30"	1.18"
3	25	IS	120	50174	EP432IS/MV/HE	0.62	74	0.98	0.96	<10	60°F	9.50"	8.90"	1.30"	1.18"
3	25	IS	277	50174	EP432IS/MV/HE	0.27	73	0.98	0.96	<10	60°F	9.50"	8.90"	1.30"	1.18"
3	25	PS	120	50184	EP432PS/MV/HE	0.64	76	0.99	0.94	<10	60°F	9.50"	8.90"	1.65"	1.18"
3	25	PS	277	50184	EP432PS/MV/HE	0.28	76	0.98	0.94	<10	60°F	9.50"	8.90"	1.65"	1.18"
3	25	PS	120	50182	EP432PS/L/MV/HE	0.56	67	0.99	0.81	<10	60°F	9.50"	8.90"	1.65"	1.18"
3	25	PS	277	50182	EP432PS/L/MV/HE	0.25	68	0.98	0.82	<10	60°F	9.50"	8.90"	1.65"	1.18"
4	25	IS	120	50172	EP432IS/L/MV/HE	0.69	82	0.98	0.78	<10	60°F	9.50"	8.90"	1.65"	1.18"
4	25	IS	277	50172	EP432IS/L/MV/HE	0.30	81	0.98	0.78	<10	60°F	9.50"	8.90"	1.65"	1.18"
4	25	IS	120	50174	EP432IS/MV/HE	0.74	88	0.98	0.88	<10	60°F	9.50"	8.90"	1.65"	1.18"
4	25	IS	277	50174	EP432IS/MV/HE	0.32	88	0.98	0.88	<10	60°F	9.50"	8.90"	1.65"	1.18"
4	25	PS	120	50184	EP432PS/MV/HE	0.77	93	0.99	0.89	<10	60°F	9.50"	8.90"	1.65"	1.18"
4	25	PS	277	50184	EP432PS/MV/HE	0.34	93	0.98	0.89	<10	60°F	9.50"	8.90"	1.65"	1.18"
4	25	PS	120	50182	EP432PS/L/MV/HE	0.67	80	0.99	0.75	<10	60°F	9.50"	8.90"	1.65"	1.18"
4	25	PS	277	50182	EP432PS/L/MV/HE	0.30	81	0.98	0.75	<10	60°F	9.50"	8.90"	1.65"	1.18"

Ordering Information



F25T8

Lamp Type			Input Volts	Product Number	Product Code	Line Current (Amps)	Input Power (Watts)	Power Factor	Ballast Factor	THD %	Min. Start Temp	Case Dimensions			
Qty.	Watts	Start Type										Length	Mounting	Width	Height
1	25	IS	120	50118	E232IS/120/R/MC	0.46	27	0.50	1.01	<170	0°F	9.50"	8.90"	1.30"	1.10"
1	25	IS	120	50115	EP232IS/H/MV/HE	0.28	33	0.98	1.40	<10	0°F	9.50"	8.90"	1.30"	1.10"
1	25	IS	277	50115	EP232IS/H/MV/HE	0.13	33	0.96	1.40	<15	0°F	9.50"	8.90"	1.30"	1.10"
1	25	IS	120	50119	EP232IS/L/MV/HE	0.20	24	0.98	0.95	<10	0°F	9.50"	8.90"	1.30"	1.10"
1	25	IS	277	50119	EP232IS/L/MV/HE	0.09	22	0.80	0.95	<20	0°F	9.50"	8.90"	1.30"	1.10"
1	25	IS	120	50123	EP232IS/MV/HE	0.23	26	0.98	1.08	<10	0°F	9.50"	8.90"	1.30"	1.10"
1	25	IS	277	50123	EP232IS/MV/HE	0.10	26	0.96	1.08	<15	0°F	9.50"	8.90"	1.30"	1.10"
1	25	PS	120	50178	EP232PS/L/MV/HE	0.23	27	0.99	0.88	<10	0°F	9.50"	8.90"	1.38"	1.18"
1	25	PS	277	50178	EP232PS/L/MV/HE	0.10	28	0.97	0.88	<12	0°F	9.50"	8.90"	1.38"	1.18"
2	25	IS	120	50118	E232IS/120/R/MC	0.65	43	0.54	0.84	<140	0°F	9.50"	8.90"	1.30"	1.10"
2	25	IS	120	50176	EP232IS/120/MC	0.41	47	0.96	0.85	<30	0°F	9.50"	8.90"	1.30"	1.00"
2	25	IS	120	50115	EP232IS/H/MV/ME	0.45	54	0.98	1.20	<10	0°F	9.50"	8.90"	1.30"	1.10"
2	25	IS	277	50115	EP232IS/H/MV/ME	0.20	54	0.97	1.20	<15	0°F	9.50"	8.90"	1.30"	1.10"
2	25	IS	120	50119	EP232IS/L/MV/HE	0.31	37	0.98	0.79	<10	0°F	9.50"	8.90"	1.30"	1.10"
2	25	IS	277	50119	EP232IS/L/MV/HE	0.13	35	0.95	0.79	<15	0°F	9.50"	8.90"	1.30"	1.10"
2	25	IS	120	50123	EP232IS/MV/HE	0.36	42	0.98	0.89	<10	0°F	9.50"	8.90"	1.30"	1.10"
2	25	IS	277	50123	EP232IS/MV/HE	0.16	41	0.98	0.89	<15	0°F	9.50"	8.90"	1.30"	1.10"
2	25	PS	120	50180	EP232PS/MV/HE	0.40	47	0.99	0.83	<10	0°F	9.50"	8.90"	1.38"	1.18"
2	25	PS	277	50180	EP232PS/MV/HE	0.18	47	0.95	0.88	<10	0°F	9.50"	8.90"	1.30"	1.10"
2	25	PS	120	50178	EP232PS/L/MV/HE	0.35	41	0.99	0.74	<10	0°F	9.50"	8.90"	1.38"	1.18"
2	25	PS	277	50178	EP232PS/L/MV/HE	0.15	41	0.98	0.74	<10	0°F	9.50"	8.90"	1.30"	1.10"
2	25	IS	120	50121	EP332IS/H/MV/HE	0.55	65	0.98	1.28	<10	0°F	9.50"	8.90"	1.38"	1.18"
2	25	IS	277	50121	EP332IS/H/MV/HE	0.25	65	0.97	1.28	<15	0°F	9.50"	8.90"	1.30"	1.10"
2	25	IS	120	50170	EP332IS/MV/HE	0.42	50	0.98	1.00	<10	0°F	9.50"	8.90"	1.38"	1.18"
2	25	IS	277	50170	EP332IS/MV/HE	0.18	50	0.96	1.00	<15	0°F	9.50"	8.90"	1.30"	1.10"

Ordering Information

F17T8



Lamp Type			Input Volts	Product Number	Product Code	Line Current (Amps)	Input Power (Watts)	Power Factor	Ballast Factor	THD %	Min. Start Temp	Case Dimensions			
Qty.	Watts	Start Type										Length	Mounting	Width	Height
1	17	IS	120	50118	E232IS/120/R/MC	0.35	20	0.45	1.05	<150	0°F	9.50"	8.90"	1.30"	1.10"
1	17	IS	120	50115	EP232IS/H/MV/HE	0.22	25	0.95	1.42	<10	0°F	9.50"	8.90"	1.30"	1.10"
1	17	IS	277	50115	EP232IS/H/MV/HE	0.11	25	0.95	1.42	<15	0°F	9.50"	8.90"	1.30"	1.10"
1	17	IS	120	50119	EP232IS/L/MV/HE	0.14	17	0.98	0.96	<10	0°F	9.50"	8.90"	1.30"	1.10"
1	17	IS	277	50119	EP232IS/L/MV/HE	0.08	16	0.80	0.96	<20	0°F	9.50"	8.90"	1.30"	1.10"
1	17	IS	120	50123	EP232IS/MV/HE	0.16	21	0.98	1.10	<10	0°F	9.50"	8.90"	1.30"	1.10"
1	17	IS	277	50123	EP232IS/MV/HE	0.09	21	0.95	1.10	<15	0°F	9.50"	8.90"	1.30"	1.10"
1	17	PS	120	50180	EP232PS/MV/HE	0.20	23	0.98	1.03	<10	0°F	9.50"	8.90"	1.38"	1.18"
1	17	PS	277	50180	EP232PS/MV/HE	0.09	24	0.93	1.03	<12	0°F	9.50"	8.90"	1.38"	1.18"
1	17	PS	120	50178	EP232PS/L/MV/HE	0.28	33	0.99	0.86	<10	0°F	9.50"	8.90"	1.38"	1.18"
1	17	PS	277	50178	EP232PS/L/MV/HE	0.12	33	0.98	0.86	<10	0°F	9.50"	8.90"	1.38"	1.18"
2	17	RS	120	50110	E220RS/120	0.54	36	0.58	1.00	<130	0°F	6.46"	6.00"	1.37"	1.00"
2	17	IS	120	50118	E232IS/120/R/MC	0.52	31	0.52	0.86	<160	0°F	9.50"	8.90"	1.30"	1.00"
2	17	IS	120	50176	EP232IS/120/MC	0.31	33	0.90	0.86	<35	0°F	9.50"	8.90"	1.30"	1.00"
2	17	IS	120	50115	EP232IS/H/MV/HE	0.33	39	0.98	1.23	<10	0°F	9.50"	8.90"	1.30"	1.10"
2	17	IS	277	50115	EP232IS/H/MV/HE	0.15	39	0.96	1.23	<10	0°F	9.50"	8.90"	1.30"	1.10"
2	17	IS	120	50119	EP232IS/L/MV/HE	0.21	25	0.98	0.80	<10	0°F	9.50"	8.90"	1.30"	1.10"
2	17	IS	277	50119	EP232IS/L/MV/HE	0.09	23	0.85	0.80	<20	0°F	9.50"	8.90"	1.30"	1.10"
2	17	IS	120	50123	EP232IS/MV/HE	0.25	28	0.98	0.91	<10	0°F	9.50"	8.90"	1.30"	1.10"
2	17	IS	277	50123	EP232IS/MV/HE	0.11	28	0.97	0.91	<15	0°F	9.50"	8.90"	1.30"	1.10"
2	17	PS	120	50180	EP232PS/MV/HE	0.30	34	0.98	0.90	<10	0°F	9.50"	8.90"	1.38"	1.18"
2	17	PS	277	50180	EP232PS/MV/HE	0.13	35	0.96	0.90	<10	0°F	9.50"	8.90"	1.38"	1.18"
2	17	PS	120	50178	EP232PS/L/MV/HE	0.44	52	0.99	0.77	<10	0°F	9.50"	8.90"	1.38"	1.18"
2	17	PS	277	50178	EP232PS/L/MV/HE	0.19	52	0.98	0.77	<10	0°F	9.50"	8.90"	1.38"	1.18"

ProLume T8 Ballasts

Ordering Information

F17T8 continued



Lamp Type			Input Volts	Product Number	Product Code	Line Current (Amps)	Input Power (Watts)	Power Factor	Ballast Factor	THD %	Min. Start Temp	Case Dimensions			
Qty.	Watts	Start Type										Length	Mounting	Width	Height
3	17	IS	120	50121	EP332IS/H/MV/HE	0.49	58	0.99	1.23	<10	0°F	9.50"	8.90"	1.30"	1.10"
3	17	IS	277	50121	EP332IS/H/MV/HE	0.22	57	0.96	1.23	<10	0°F	9.50"	8.90"	1.30"	1.10"
3	17	IS	120	50168	EP332IS/L/MV/HE	0.37	43	0.98	0.86	<10	0°F	9.50"	8.90"	1.30"	1.10"
3	17	IS	277	50168	EP332IS/L/MV/HE	0.16	43	0.95	0.86	<15	0°F	9.50"	8.90"	1.30"	1.10"
3	17	IS	120	50170	EP332IS/MV/HE	0.38	45	0.98	0.92	<10	0°F	9.50"	8.90"	1.30"	1.10"
3	17	IS	277	50170	EP332IS/MV/HE	0.17	45	0.96	0.92	<15	0°F	9.50"	8.90"	1.30"	1.10"
3	17	PS	120	50184	EP432PS/MV/HE	0.45	53	0.98	0.94	<10	0°F	9.50"	8.90"	1.65"	1.18"
3	17	PS	277	50184	EP432PS/MV/HE	0.21	53	0.95	0.94	<15	0°F	9.50"	8.90"	1.65"	1.18"
3	17	PS	120	50182	EP432PS/L/MV/HE	0.40	48	0.99	0.81	<10	0°F	9.50"	8.90"	1.65"	1.18"
3	17	PS	277	50182	EP432PS/L/MV/HE	0.18	49	0.96	0.82	<12	0°F	9.50"	8.90"	1.65"	1.18"
4	17	IS	120	50158	E432IS/120/R/MC	0.97	67	0.50	0.95	<175	0°F	9.50"	8.90"	1.30"	1.10"
4	17	IS	120	50124	EP432IS/120/MC	0.51	61	0.98	0.96	<20	0°F	9.50"	8.90"	1.30"	1.10"
4	17	IS	120	50172	EP432IS/L/MV/HE	0.46	54	0.98	0.79	<10	0°F	9.50"	8.90"	1.30"	1.18"
4	17	IS	277	50172	EP432IS/L/MV/HE	0.19	52	0.98	0.79	<10	0°F	9.50"	8.90"	1.30"	1.18"
4	17	IS	120	50174	EP432IS/MV/HE	0.49	59	0.98	0.93	<10	0°F	9.50"	8.90"	1.30"	1.10"
4	17	IS	277	50174	EP432IS/MV/HE	0.22	58	0.98	0.93	<10	0°F	9.50"	8.90"	1.30"	1.10"
4	17	PS	120	50184	EP432PS/MV/HE	0.52	63	0.98	0.87	<10	0°F	9.50"	8.90"	1.65"	1.18"
4	17	PS	277	50184	EP432PS/MV/HE	0.24	63	0.97	0.89	<12	0°F	9.50"	8.90"	1.65"	1.18"
4	17	PS	120	50182	EP432PS/L/MV/HE	0.46	55	0.99	0.73	<10	0°F	9.50"	8.90"	1.65"	1.18"
4	17	PS	277	50182	EP432PS/L/MV/HE	0.21	56	0.97	0.74	<12	0°F	9.50"	8.90"	1.65"	1.18"

ProLume T12 Ballasts

Ordering Information

F40T12



Lamp Type			Input Volts	Product Number	Product Code	Line Current (Amps)	Input Power (Watts)	Power Factor	Ballast Factor	THD %	Min. Start Temp	Case Dimensions			
Qty.	Watts	Start Type										Length	Mounting	Width	Height
2	40	RS	120	52118	EP240RS/MV/MC	0.62	68	0.98	0.83	<150	32°F	9.50"	8.90"	1.30"	1.00"
2	40	RS	277	52118	EP240RS/MV/MC	0.26	66	0.98	0.83	<150	32°F	9.50"	8.90"	1.30"	1.00"

F34T12



Lamp Type			Input Volts	Product Number	Product Code	Line Current (Amps)	Input Power (Watts)	Power Factor	Ballast Factor	THD %	Min. Start Temp	Case Dimensions			
Qty.	Watts	Start Type										Length	Mounting	Width	Height
2	34	RS	120	52118	EP240RS/MV/MC	0.55	60	0.98	0.83	<155	32°F	9.50"	8.90"	1.30"	1.00"
2	34	RS	277	52118	EP240RS/MV/MC	0.23	59	0.98	0.83	<155	32°F	9.50"	8.90"	1.30"	1.00"

Ordering Information

F28T5



Lamp Type			Input Volts	Product Number	Product Code	Line Current (Amps)	Input Power (Watts)	Power Factor	Ballast Factor	THD %	Min. Start Temp	Case Dimensions			
Qty.	Watts	Start Type										Length	Mounting	Width	Height
1	28	PS	120	52112	EP228PS/MV/MC	0.29	31	0.98	1.05	<10	0°F	9.50"	8.90"	1.30"	1.00"
1	28	PS	277	52112	EP228PS/MV/MC	0.12	31	0.98	1.05	<10	0°F	9.50"	8.90"	1.30"	1.00"
2	28	PS	120	52112	EP228PS/MV/MC	0.53	62	0.98	1.00	<10	0°F	9.50"	8.90"	1.30"	1.00"
2	28	PS	277	52112	EP228PS/MV/MC	0.23	61	0.98	1.00	<10	0°F	9.50"	8.90"	1.30"	1.10"

F21T5



Lamp Type			Input Volts	Product Number	Product Code	Line Current (Amps)	Input Power (Watts)	Power Factor	Ballast Factor	THD %	Min. Start Temp	Case Dimensions			
Qty.	Watts	Start Type										Length	Mounting	Width	Height
1	21	PS	120	52112	EP228PS/MV/MC	0.22	25	0.98	1.06	<10	0°F	9.50"	8.90"	1.30"	1.00"
1	21	PS	277	52112	EP228PS/MV/MC	0.10	25	0.98	1.06	<10	0°F	9.50"	8.90"	1.30"	1.00"
2	21	PS	120	52112	EP228PS/MV/MC	0.39	49	0.98	1.02	<10	0°F	9.50"	8.90"	1.30"	1.00"
2	21	PS	277	52112	EP228PS/MV/MC	0.17	49	0.98	1.02	<10	0°F	9.50"	8.90"	1.30"	1.10"

F14T5



Lamp Type			Input Volts	Product Number	Product Code	Line Current (Amps)	Input Power (Watts)	Power Factor	Ballast Factor	THD %	Min. Start Temp	Case Dimensions			
Qty.	Watts	Start Type										Length	Mounting	Width	Height
1	14	PS	120	52112	EP228PS/MV/MC	0.14	17	0.98	1.07	<10	0°F	9.50"	8.90"	1.30"	1.00"
1	14	PS	277	52112	EP228PS/MV/MC	0.07	17	0.98	1.07	<10	0°F	9.50"	8.90"	1.30"	1.00"
2	14	PS	120	52112	EP228PS/MV/MC	0.28	33	0.98	1.04	<10	0°F	9.50"	8.90"	1.30"	1.00"
2	14	PS	277	52112	EP228PS/MV/MC	0.13	33	0.98	1.04	<10	0°F	9.50"	8.90"	1.30"	1.00"

Ordering Information



F54T5HO

Lamp Type			Input Volts	Product Number	Product Code	Line Current (Amps)	Input Power (Watts)	Power Factor	Ballast Factor	THD %	Min. Start Temp	Case Dimensions			
Qty.	Watts	Start Type										Length	Mounting	Width	Height
1	54	PS	120	50140	E154HO/RS/120	0.75	51	0.50	0.95	<140	0°F	9.10"	8.75"	0.95"	0.95"
1	54	PS	120	50144	EP254HO/PS/MV	0.51	61	0.98	1.02	<10	0°F	16.90"	16.00"	1.20"	1.00"
1	54	PS	277	50144	EP254HO/PS/MV	0.23	61	0.98	1.02	<10	0°F	16.90"	16.00"	1.20"	1.00"
1	54	PS	120	52114	EP254HO/PS/MV/MC	0.52	62	0.98	1.03	<10	0°F	9.50"	8.90"	1.30"	1.00"
1	54	PS	277	52114	EP254HO/PS/MV/MC	0.23	62	0.90	1.03	<20	0°F	9.50"	8.90"	1.30"	1.00"
2	54	PS	120	52114	EP254HO/PS/MV/MC	1.00	120	0.98	1.00	<10	0°F	9.50"	8.90"	1.30"	1.00"
2	54	PS	277	52114	EP254HO/PS/MV/MC	0.43	117	0.97	1.00	<10	0°F	9.50"	8.90"	1.30"	1.00"
2	54	PS	120	50144	EP254HO/PS/MV	0.98	117	0.98	1.00	<10	0°F	16.90"	16.00"	1.20"	1.00"
2	54	PS	277	50144	EP254HO/PS/MV	0.42	117	0.98	1.00	<10	0°F	16.90"	16.00"	1.20"	1.00"
2	54	PS	120	50186	EP454HO/PS/MV	1.00	120	0.98	1.00	<10	-20°F	16.75"	16.30"	1.80"	1.20"
2	54	PS	277	50186	EP454HO/PS/MV	0.43	117	0.98	1.00	<10	-20°F	16.75"	16.30"	1.80"	1.20"
3	54	PS	120	50186	EP454HO/PS/MV	1.50	176	0.98	1.03	<10	-20°F	16.75"	16.30"	1.80"	1.20"
3	54	PS	277	50186	EP454HO/PS/MV	0.65	173	0.92	1.03	<10	-20°F	16.75"	16.30"	1.80"	1.20"
4	54	PS	120	50186	EP454HO/PS/MV	2.00	231	0.98	1.00	<10	-20°F	16.75"	16.30"	1.80"	1.20"
4	54	PS	277	50186	EP454HO/PS/MV	0.86	228	0.98	1.00	<10	-20°F	16.75"	16.30"	1.80"	1.20"



F49T5HO

Lamp Type			Input Volts	Product Number	Product Code	Line Current (Amps)	Input Power (Watts)	Power Factor	Ballast Factor	THD %	Min. Start Temp	Case Dimensions			
Qty.	Watts	Start Type										Length	Mounting	Width	Height
1	49	PS	120	50144	EP254HO/PS/MV	0.50	59	0.99	1.00	<10	0°F	16.90"	16.00"	1.20"	1.00"
1	49	PS	277	50144	EP254HO/PS/MV	0.22	57	0.92	1.00	<10	0°F	16.90"	16.00"	1.20"	1.00"
1	49	PS	120	52114	EP254HO/PS/MV/MC	0.44	53	0.99	0.90	<10	0°F	9.50"	8.90"	1.30"	1.00"
1	49	PS	277	52114	EP254HO/PS/MV/MC	0.21	58	0.90	1.04	<10	0°F	9.50"	8.90"	1.30"	1.00"
2	49	PS	120	50144	EP254HO/PS/MV	0.94	112	0.99	0.96	<10	0°F	16.90"	16.00"	1.20"	1.00"
2	49	PS	277	50144	EP254HO/PS/MV	0.41	111	0.98	0.96	<10	0°F	16.90"	16.00"	1.20"	1.00"
2	49	PS	120	52114	EP254HO/PS/MV/MC	0.88	106	0.98	0.99	<10	0°F	9.50"	8.90"	1.30"	1.00"
2	49	PS	277	52114	EP254HO/PS/MV/MC	0.38	105	0.97	0.98	<10	0°F	9.50"	8.90"	1.30"	1.00"
2	49	PS	120	50186	EP454HO/PS/MV	0.88	106	0.98	0.97	<10	-20°F	16.90"	16.30"	1.80"	1.20"
2	49	PS	277	50186	EP454HO/PS/MV	0.39	104	0.96	0.97	<10	-20°F	16.90"	16.30"	1.80"	1.20"
3	49	PS	120	50186	EP454HO/PS/MV	1.34	162	0.98	0.97	<10	-20°F	16.90"	16.30"	1.80"	1.20"
3	49	PS	277	50186	EP454HO/PS/MV	0.61	159	0.93	0.97	<10	-20°F	16.90"	16.30"	1.80"	1.20"
4	49	PS	120	50186	EP454HO/PS/MV	1.78	214	0.98	0.97	<10	-20°F	16.90"	16.30"	1.80"	1.20"
4	49	PS	277	50186	EP454HO/PS/MV	0.78	209	0.96	0.97	<10	-20°F	16.90"	16.30"	1.80"	1.20"

Ordering Information

F39T5HO



Lamp Type			Input Volts	Product Number	Product Code	Line Current (Amps)	Input Power (Watts)	Power Factor	Ballast Factor	THD %	Min. Start Temp	Case Dimensions			
Qty.	Watts	Start Type										Length	Mounting	Width	Height
1	39	PS	120	50142	EP239HO/PS/MV	0.40	48	0.98	1.15	<12	0°F	16.90"	16.00"	1.20"	1.00"
1	39	PS	277	50142	EP239HO/PS/MV	0.18	48	0.98	1.15	<12	0°F	16.90"	16.00"	1.20"	1.00"
2	39	PS	120	50142	EP239HO/PS/MV	0.78	94	0.98	1.12	<10	0°F	16.90"	16.00"	1.20"	1.00"
2	39	PS	277	50142	EP239HO/PS/MV	0.34	94	0.98	1.12	<10	0°F	16.90"	16.00"	1.20"	1.00"

F24T5HO



Lamp Type			Input Volts	Product Number	Product Code	Line Current (Amps)	Input Power (Watts)	Power Factor	Ballast Factor	THD %	Min. Start Temp	Case Dimensions			
Qty.	Watts	Start Type										Length	Mounting	Width	Height
1	24	PS	120	50142	EP239HO/PS/MV	0.24	29	0.98	1.10	<12	0°F	16.90"	16.00"	1.20"	1.00"
1	24	PS	277	50142	EP239HO/PS/MV	0.12	29	0.98	1.12	<12	0°F	16.90"	16.00"	1.20"	1.00"
2	24	PS	120	50142	EP239HO/PS/MV	0.44	52	0.98	1.00	<12	0°F	16.90"	16.00"	1.20"	1.00"
2	24	PS	277	50142	EP239HO/PS/MV	0.20	52	0.98	1.00	<12	0°F	16.90"	16.00"	1.20"	1.00"

LAMP AND BALLAST LIMITED WARRANTY

Halco Lighting Technologies (hereinafter called “Halco”), 2940 Pacific Drive, Norcross, GA 30071, warrants to the purchaser that Halco lamps will be free from defect in material and or workmanship from the date of installation for the following time periods:

Lamp Category	Warranty	Ballast Category	Warranty
Self-Ballasted Compact Fluorescent:	2 Years	Electronic Fluorescent:	5 Years
Plug-In Fluorescent:	1 Year	ProFormance Fluorescent:	5 Years
High Power LED:	5 Years	ProFormance Electronic Compact Fluorescent:	5 Years
SMD, C7 and C9 LED:	2 Years	Electronic Residential:	5 Years
Linear Fluorescent, non-pre-heat 14 watts or greater:	2 Years	Electromagnetic Compact Fluorescent:	3 Years
ProLume Linear Fluorescent, non-pre-heat > 14 watts operated on a ProLume Ballast:	3 Years	Electronic Sign:	3 Years
		Electronic HID:	3 Years
All other lamps are covered under our <i>Quality Assurance</i> noted below.		Core & Coil HID:	2 Years

LAMP EXPLICIT OPERATING CONDITIONS:

Self Ballasted and Plug-In Compact Fluorescent Lamps: Based on maximum of 10 hours use per day. Should any product fail to meet the warranty specified above, Halco, at its option, shall correct any defect by issuing a credit for the product or providing a free replacement lamp. This warranty is conditioned upon proper storage, installation, use and maintenance. Remedy is expressly limited to credit or replacement only.

This warranty is not applicable to any lamp, which is not installed and operated in accordance with the current edition of the National Electric Code (NEC), the Standards for Safety of Underwriters Laboratories®, Inc. (UL), the Standards for the American National Standards Institute (ANSI) and with Halco instructions and guidelines for the lamp. This warranty is not applicable to any lamp subjected to abnormal stresses and operating conditions. Use of occupancy sensors, dimmers or programmable systems with some lamp types may void the warranty.

Halco reserves the right to examine all lamps prior to the determination of warranty status. All lamps must be retained for warranty claims. The warranty period starts on the date of installation. If the date of installation cannot be determined or is unknown, the warranty period will start with the date of the original purchase from Halco.

BALLAST EXPLICIT OPERATING CONDITIONS:

Should any product not meet the warranty specified above, Halco, at its option, shall correct any defect, by either repairing any defective part or parts or by replacing any defective part or parts or by making available a new replacement ballast. This warranty is conditioned upon proper storage, installation, use and maintenance.

This warranty is not applicable to any ballast, which is not installed and operated in accordance with the current edition of the National Electric Code (NEC), the Standards for Safety of Underwriters Laboratories®, Inc. (UL), the Standards for the American National Standards Institute (ANSI), and with Halco instructions and guidelines for the ballast. This warranty is not applicable to any ballast subjected to abnormal stresses and operating conditions.

WARRANTY EXCLUSION CLAUSE FOR PRODUCTS EXPORTED:

This warranty shall be void for products that are exported outside the U.S. and its territories. The distributor, private labeler or OEM assumes all responsibility imposed by statute, regulation or law on product sold into those markets.

NO IMPLIED STATUTORY WARRANTY OF MERCHANTABILITY OR FITNESS FOR A PARTICULAR PURPOSE SHALL APPLY BEYOND THE AFOREMENTIONED WARRANTY PERIOD. The foregoing warranty is exclusive of all other statutory, written or oral warranties, and no other warranties of any kind, statutory or otherwise, are given or herein expressed. The warranty sets forth Halco’s responsibilities regarding the ballast and claimant’s exclusive remedy.

Ballast Warranty claims are to be made in accordance with Halco’s published Warranty Service Program, made available upon request.

LIMITATION OF LIABILITY. Halco will not under any circumstances, whether as a result of breach of contract, breach of warranty, tort, strict liability or otherwise, be liable for consequential, incidental, special or exemplary damages including, but not limited to, loss of profits or revenues, loss of use of ballast or any other goods or associated equipment or damage to any associated equipment, cost of capital, cost of substitute products, facilities of service, down time cost, or claims of claimant’s customers. Halco’s liability on any claim of any kind for any loss or damages arising out of, resulting from or concerning any aspect of this agreement from the products or services furnished hereunder shall not exceed the price of the specific ballast or ballasts which gives rise to the claim.

Per the Halco Warranty Service Program, Halco will provide a maximum labor allowance of ten dollars (\$10.00) per ballast for Electronic Ballasts only.

Some states do not allow the exclusion or limitation of damages or the length of time for an implied warranty. Therefore, the limitations or exclusions of consequential or incidental damages and implied warranties may not apply to certain claimants. This warranty gives the claimant specific legal rights. The claimant may also have other rights, which vary from state to state.



ProPLUS SYSTEM WARRANTY

When ProLume ballasts and the ProLume lamps listed below are installed together as a system, Halco Lighting Technologies (“Halco”) warrants to the purchaser that its Linear Fluorescent lamps and ballasts will be free from defects in material and workmanship from the date of installation for the following time period:

Ballast	Lamp	Ballast Warranty	Lamp Warranty
ProLume T8	ProLume F17T8	60 Months	36 Months
ProLume T8	ProLume F25T8	60 Months	36 Months
ProLume T8	ProLume F25T8/ES	60 Months	36 Months
ProLume T8	ProLume F28T8	60 Months	36 Months
ProLume T8	ProLume F28T8/XL	60 Months	60 Months
ProLume T8	ProLume F32T8	60 Months	36 Months
ProLume T8	ProLume F32T8/XL	60 Months	60 Months
ProLume T8	ProLume F32T8/HL	60 Months	36 Months
ProLume T5HO	ProLume F49T5/HO	60 Months	36 Months
ProLume T5HO	ProLume F54T5/HO	60 Months	36 Months

TERMS AND CONDITIONS:

If a lamp or ballast fails to operate within the specified period of time, Halco, at its option, will replace or repair the defective product. This limited warranty only applies when a ProLume ballast is properly wired and installed together with ProLume lamps as a system. This warranty is not applicable to any lamp or ballast that is not installed and operated in accordance with:

- The current edition of the National Electric Code (NEC)
- The Standards for Safety of Underwriter Laboratories®, Inc. (UL)
- The Standards of the American National Standards Institute (ANSI)
- The specific instructions and recommendations provided by Halco for the installation of the products

This warranty is also not applicable to any system, lamp and ballast, subjected to abnormal stresses and operating conditions including, but not limited to, excessive temperatures, excessive operating hours or switching cycles, improper lamp and ballast installations, or dirty or cracked sockets. Halco lamp warranty periods apply to lamps that are operated a maximum of 10 hours per day. Halco lamp warranty periods apply to lamps on burning cycles of 3 hours or more per start when installed with an instant start ballast and 15 minutes or more per start when installed with a programmed start ballast. If the lamps are installed in an occupancy sensor application, they must be installed with ProLume Programmed Start Ballasts. Halco ballast warranty period applies to a system that is properly wired and installed in an environment where the case temperature does not exceed 70°C and the ambient temperature does not exceed 40°C. Lamps and ballasts that have been subjected to abnormal stresses such as frequently-switched applications, high temperatures or under/over voltage as not included under this warranty.

Halco reserves the right to examine failed lamps and/or ballasts to determine the cause of failure, patterns of usage and applicability of warranty. The warranty period starts on the date of installation. If the date of installation cannot be determined or is unknown, the warranty period will start with the date of the original purchase from Halco. To be eligible for this warranty, the system must be registered with Halco within thirty (30) days from the date of installation. Purchaser must use Halco Warranty Registration online form, complete the form in accordance with its instructions and receive an acknowledgement of the installation from Halco.

NO STATUTORY WARRANTY OF MERCHANTABILITY OR FITNESS FOR A PARTICULAR PURPOSE IS MADE OR IS TO BE IMPLIED. The foregoing warranty is exclusive of all other statutory, written or oral warranties, and no other warranties of any kind, statutory or otherwise, are given or herein expressed. Purchaser’s sole remedy and Halco’s exclusive responsibility shall be only those set forth herein.

WARRANTY CLAIM:

To make a warranty claim, the purchaser must notify their Halco representative within thirty days of failure. This warranty extends only to the purchaser of the lamps and ballasts. Halco honors valid warranty claims made by the purchaser resulting from warranty claims made by the purchaser’s customers and indirect customers. The purchaser or customer must retain failed product for examination by Halco. Failure to follow these procedures will void this warranty.

LIMITATION OF LIABILITY. Halco will not under any circumstances whether as a result of breach of contract, breach of warranty, tort, strict liability or otherwise be liable for consequential, incidental, special or exemplary damages, including but not limited to, loss of profits or revenues, loss of use of the lamp/ballast system or any other goods or associated equipment or damage to any associated equipment, cost of capital, cost of substitute products, facility of services, down time cost, or claims of claimant’s customers. Halco’s liability on any claim of any kind for any loss or damage arising out of, resulting from or concerning any aspect of this warranty or from the product or services furnished hereunder shall not exceed the price of the specific lamp or ballast which gives rise to the claim. Halco will provide a maximum labor allowance of ten dollars (\$10.00) per ballast for Electronic Ballasts only.

Questions about this warranty:

Contact Halco Lighting or your local Halco Representative at 800.677.3334 or email warranty@halcolighting.com.



where there's **light**, there's halco®
800.677.3334 FAX: 800.880.0822
www.halcolighting.com

Atlanta
2940 Pacific Drive
Norcross, GA 30071

Houston
6323 Brookhill Drive
Houston, TX 77087

Cleveland
3501 Croton Avenue
Cleveland, OH 44115

Los Angeles
14300 Alondra Boulevard
La Mirada, CA 90638

Carlstadt
600 Gotham Parkway, Unit 2
Carlstadt, NJ 07072

Phoenix
6607 W. Boston Street, Suite 1
Chandler, AZ 85226

ProLume®
ProLED®
HaloXen®
PRISM®
CoverShield®
sollos®
LANDSCAPE LIGHTING
A Halco Lighting Technologies Company



SERVICE

VALUE

INTEGRITY

QUALITY

Lamps
Luminaires
Ballasts

About Us

Halco Lighting Technologies is a leader of lamp, ballast and luminaire solutions for commercial, industrial, residential and specialty lighting applications. Established in 1974, Halco is headquartered near Atlanta, Georgia. We have additional distribution centers in Arizona, New Jersey, Ohio, Texas and Southern California that allow us to deliver products to 95% of the country next day when shipped common carrier.

Halco Lighting Technologies offers one of the most comprehensive product lines in the industry. It includes our brands ProLED[®], ProLume[®], HaloXen[®], Prism[®] and Covershield[®]. Our manufacturing expertise is put to the test, in our state-of-the-art in house laboratory.

In addition to superior quality products, Halco contributes to the vibrant and responsible lighting industry issues, including legislation, environmental impact, energy efficiency and process standards. Halco utilizes the latest standards from UL, ETL, Energy Star, Title 24 and DLC when planning and producing our products.

Halco focuses on providing excellent customer service and takes pride in being easy to do business with. Our Customer Care and Sales Teams are available to provide product information and assisting our customers with any needs they may have. We also have a comprehensive website that provides many useful tools that include product specs, compatibility information and installation diagrams.

Every product we sell is backed by our Quality Assurance Guarantee. Our warranty information can be found on our website at halcolighting.com. In addition, we have an in house Product Development team that is a happy to assist customers with technical support and, more importantly, opportunities.

In closing, Halco would like to be your choice for lighting products. We appreciate the opportunity to do business with you.

Kindest regards,

Kim Cook
President and CEO







ProLED.

ProLume.

HaloXen.

PRISM

CoverShield

sollos
LANDSCAPE LIGHTING

Halco
LIGHTING TECHNOLOGIES®

Atlanta
2940 Pacific Drive
Norcross, GA 30071

Houston
6323 Brookhill Drive
Houston, TX 77087

Cleveland
3501 Croton Ave
Cleveland, OH 44115

Los Angeles
10513 Hataway Drive
La Mirada, CA 90638

Carlstadt
600 Gotham Parkway, Unit 2
Carlstadt, NJ 07072

Phoenix
6607 W. Boston St. Suite 1
Chandler, AZ 85226

800.677.3334
FAX: 800.880.0822
www.halcolighting.com