

Contents

| | |
|--|-------|
| Introduction | 5-2 |
| Catalogue Numbering System | 5-3 |
| Reference Guides | 5-5 |
| Panelboard Mounting Circuit Breakers | |
| BL | 5-13 |
| GFCI, AFCI | 5-15 |
| BQ 125A Frame, Switching Neutral, DIN Rail | 5-16 |
| BQD, BQD6 | 5-18 |
| QJ 225A Frame | 5-19 |
| CQD 100A Frame | 5-20 |
| Sentron Thermal Mag and Electronic Circuit Breakers | |
| ED 125A Frame and Internal Accessories | 5-21 |
| FD 250A Frame and Internal Accessories | 5-24 |
| JD/SJD 400A Frame and Internal Accessories | 5-27 |
| LD/SLD 600A Frame and Internal Accessories | 5-31 |
| LMD 800A Frame and Internal Accessories | 5-35 |
| MD/SMD 800A Frame and Internal Accessories | 5-38 |
| ND/SND 1200A Frame and Internal Accessories | 5-42 |
| PD/SPD 1600A Frame and Internal Accessories | 5-46 |
| RD 2000A Frame and Internal Accessories | 5-49 |
| Magnetic Trip Only—ETI Motor Circuit Protector | 5-50 |
| Adjustable Instantaneous Magnetic Trip Settings | 5-53 |
| Molded Case Switch—Circuit Disconnect | 5-56 |
| Sensitrip III Digital Solid State Sentron Series | 5-57 |
| WL Power Circuit Breakers - Insulated Case | 5-59 |
| Electronic and Communications Accessories | 5-63 |
| Pressure and Compression Connectors | 5-64 |
| Breaker Modifications | 5-67 |
| Internal Accessories - Feature Combinations | 5-68 |
| External Accessories | 5-69 |
| General Technical | |
| Enclosed Circuit Breakers | 5-75 |
| Series Rated Combination Guide | 5-83 |
| Unusual Operating Conditions | 5-93 |
| Typical Specifications | 5-95 |
| Superseded Circuit Breakers | 5-96 |
| VL Thermal Mag and Electronic Circuit Breakers | |
| VL Reference Guide | 5-99 |
| NGG 125A Frame and Accessories | 5-101 |
| EG 125A Frame and Internal Accessories | 5-103 |
| VL Trip Unit Overview | 5-105 |
| DG 150A Frame and Internal Accessories | 5-107 |
| FG 250A Frame and Internal Accessories | 5-111 |
| JG 400A Frame and Internal Accessories | 5-115 |
| LG 600A Frame and Internal Accessories | 5-119 |
| MG 800A Frame and Internal Accessories | 5-123 |
| NG 150A Frame and Internal Accessories | 5-127 |
| PG 150A Frame and Internal Accessories | 5-131 |
| Molded Case Switch | 5-134 |
| Motor Circuit Protectors | 5-135 |
| 600 Volt DC Circuit Breakers | 5-136 |
| External Accessories | 5-137 |
| Accessory Locations | 5-152 |
| Technical Data | 5-153 |
| Unusual Operating Conditions | 5-155 |

Molded Case Circuit Breakers

Introduction

OEM Circuit Breakers

Siemens introduces the modular and flexible design of Siemens VL molded case circuit breakers (MCCB) for OEM applications. This family of MCCB's allow the OEM customer the flexibility of last minute changes, with a minimum level of stock due to product modularity. The VL family of MCCB's also offer the widest range of field installable accessories in the industry, including lay contact for alarms such as Ground Fault Warning and a latching alarm relay contact for trip indication.



Interruption Ratings (UL/CSA)

| | |
|---|-----------------------|
| N | 35kA @ 480Vac Voltage |
| H | 65kA @ 480Vac |
| L | 100kA @ 480Vac |

Ratings 30-1600A

| | |
|---------|--------------|
| Voltage | 600Vac |
| | 690Vac (IEC) |

Standards UL, CSA, NOM, IEC, CE Marked

Ordering

In the FD through RD frames, you may order molded case circuit breakers three basic ways:

1. As separately ordered frames, trip units and lugs
2. As frame, trip unit and lugs ordered as one catalogue number and shipped unassembled or assembled
3. As frame and trip unit shipped assembled and with the trip unit made non-removable, in compliance with UL 489 requirements that to be reverse fed the circuit breaker must **not** have an interchangeable trip unit.

These two options are described in the following:

Components Ordered Separately

To get the components for a 3 pole, 400 Amp standard interrupting circuit breaker, you would order the frame (JD63F400), the trip unit (JD63T400) and six lugs (TA2J6500). This option is normally useful only if you stock and use large volumes of product and wish to reduce your inventory cost. You may stock, for example, a smaller number of frames (JD63F400) and a variety of trip units (JD63T300, JD63T350, etc.) and assemble breakers as you need them.

Frame, Trip Unit and Lugs Ordered Together

If you order the catalogue number JD63B400, you will receive a frame, a trip unit and 6 lugs in separate packages. By suffixing this number with "L" (e.g. JD63B400L), you will receive frame, trip unit and lugs assembled in one container. Pursuant to UL 489, a product ordered thus will have the markings "LINE" and "LOAD"; and may not be "reverse fed" (with power flowing from the "OFF" end of the breaker toward the "ON" end).

Non-Interchangeable Trip Breakers

If you place an "X" after the frame size designator (e.g. JXD63B400), you will receive a frame and trip unit assembled, with the trip unit made non-removable. If you suffix an "L" to this catalogue number (e.g. JXD63B400L), you will receive the breaker, non-removable trip unit and lugs assembled. Unless you anticipate a specific need to change the breaker's ampere rating in the future, this is the preferred ordering method, as the products are assembled to Siemens' specifications in our factories. These breakers are suitable for use reverse fed according to UL 489, since the trip unit is not removable.

The smaller frames (QJ, ED and below) do not have removable trip units, and consequently are shipped only as assembled products. To add lugs, see the ordering instructions on each product's catalogue page.

Connecting Breakers for DC Application

Most Siemens thermal magnetic trip MCCBs are applicable on direct current (dc) systems. Generally, for 250 V dc systems a two pole breaker is used, with one pole on each leg of the supply circuit. For three pole breakers applied on 500 V dc systems, it is important to connect the power supply "zig-zag" through the breaker as shown in the figure below. This assures that the Voltage between phases on the breaker terminals is uniformly distributed.

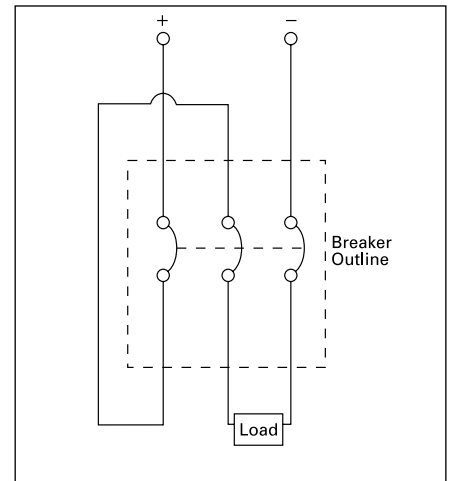

500V DC Wiring Configuration

Molded Case Circuit Breakers

Catalogue Numbering System

Reference

If used on 250A frame and above means non-interchangeable trip breaker with factory assembled frame and trip. Solid state trip and current limiting (S or C in first character) are non-interchangeable only, and the "X" is omitted.

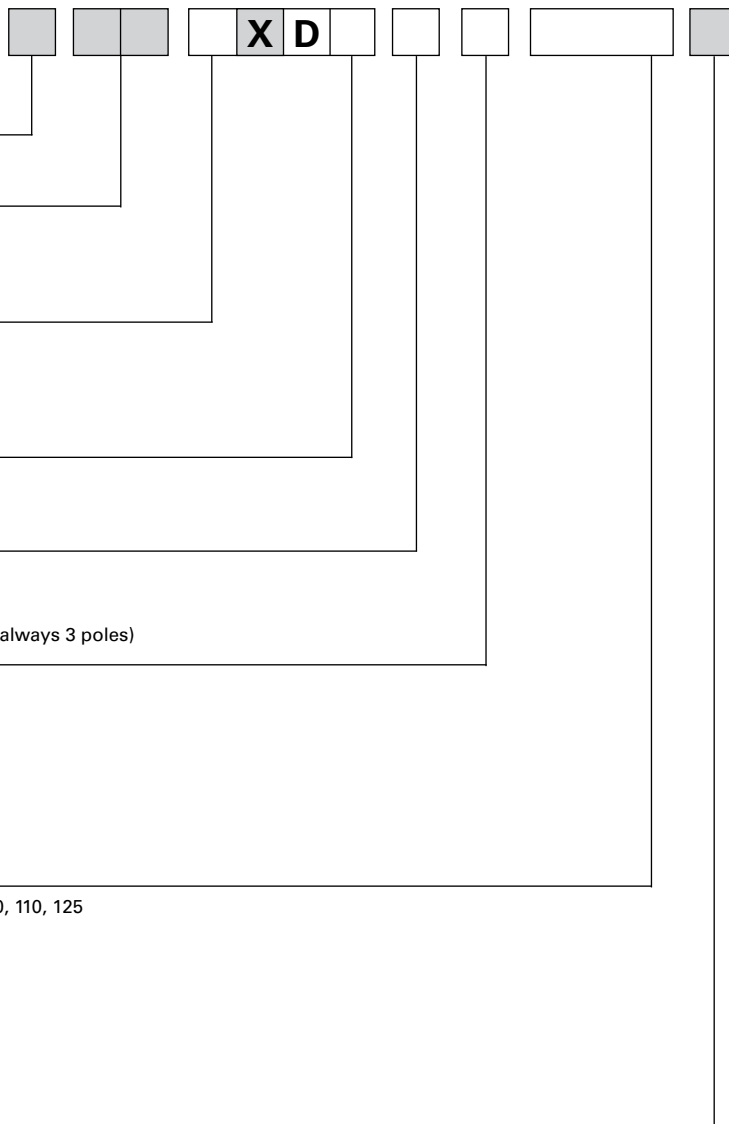

Trip Unit Type

- Omitted — Thermal-Magnetic
- S — Sensitrip® Electronic Trip

Sentron Series Type/Interrupting Range

- Omitted — Standard Rating
- H — High IC Rating
- HH — Extra High IC Rating
- C — Highest IC Rating and Current Limiting

Frame Identifier

- E — Type ED
- F — Type FD
- J — Type JD
- L — Type LD
- LM — Type LMD
- M — Type MD
- N — Type ND
- P — Type PD
- R — Type RD

Maximum Voltage

- 2 — 240 Vac
- 4 — 480 Vac
- 6 — 600 Vac

Number of Poles

- 1
- 2
- 3
- 9 used to indicate the max. functions for an electronic trip circuit breaker (always 3 poles)

(Specific Application Type)

- B — Standard 40°C Breaker
- M — Calibrated for 50°C Application
- F — Frame Only
- T — 40°C Trip Unit Only
- W — 50°C Trip Unit Only
- S — Molded Case Switch
- L — Low Instantaneous Range ETI Breaker
- A — Standard Range ETI Breaker
- H — High Instantaneous Range ETI Breaker

Maximum Continuous Current Rating

- ED Frame — 015, 020, 025, 030, 035, 040, 045, 050, 060, 070, 080, 090, 100, 110, 125
- FD Frame — 070, 080, 090, 100, 110, 125, 150, 175, 200, 225, 250
- JD Frame — 200, 225, 250, 300, 350, 400
- LD Frame — 250, 300, 350, 400, 450, 500, 600
- LMD Frame — 500, 600, 700, 800
- MD Frame — 500, 600, 700, 800
- ND Frame — 900, 100 (1000A), 120 (1200A)
- PD Frame — 120 (1200A), 140 (1400A), 160 (1600A)
- RD Frame — 160 (1600A), 180 (1800A), 200 (2000A)
- TD Frame — 2000, 2500, 3200

Suffix

- L — where applicable indicates a breaker shipped with line/loads lugs installed
- A — used with a switch to show automatic self protection
- Y — 400 Hertz
- H — 100% rated

NOTE:

- Position omitted if not used.

Applicable Standards

- UL489 — Molded Case Circuit Breakers and Circuit Breaker Enclosures.
- UL486A — Wire Connectors and Solderless Lugs for use with copper wire
- UL486B — Wire Connectors and

Note:

- (A) Molded case circuit breakers are designed and tested in accordance to applicable portions of UL489 and CSA22.2 No 5 and meet application requirements of the National Electric Code. Unless marked otherwise, circuit breakers are 80% duty rated.

Solderless Lugs for use with aluminum wire

UL943 — Ground Fault Interrupters (for personnel protectors)

UL1087 — Molded Case Switches

UL50 — Cabinets and Boxes

- (B) Molded case circuit breakers are to be connected with 60 or 75°C wire for circuit breakers having a rated ampacity of 125 amperes or less. Circuit breakers having a rated ampacity greater than 125 amperes shall only be cabled with 75°C cable unless otherwise indicated on the circuit breaker label. Exceptions to this rule are outlined in the article 110-14 C(1)(2) of the 2002 National Electric Code and Canadian Electrical Code.

UL869 — Service Equipment

NEMA AB-1 — Molded Case Circuit Breakers and Molded Case Switches

CSA-C22.2 No. 5, C22.2 No. 14

VL Molded Case Circuit Breakers

Catalogue Numbering System

Selection/Application

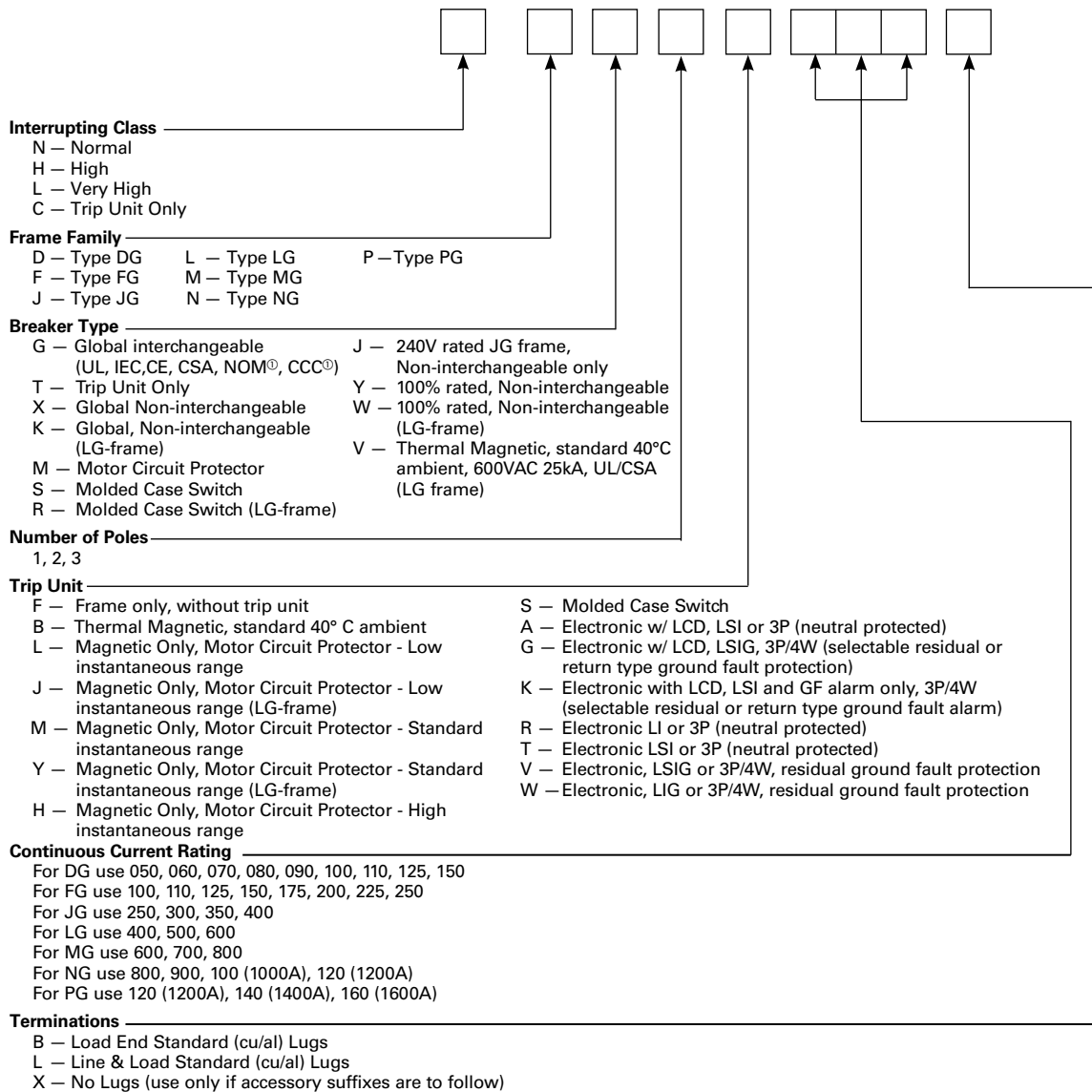

LCD = Liquid Crystal Display
 LS = Long Delay & Short Delay trip functions
 LSI = Long Delay, Short Delay, & Instantaneous trip functions
 LSIG = Long Delay, Short Delay, Instantaneous, & Ground Fault trip functions
 GF = Ground Fault
 3P = 3-pole
 4W = 4-wire

MOLDED CASE
CIRCUIT BREAKERS
5

Molded Case Circuit Breakers

Reference Guide

Selection/Application

Thermal-Magnetic Trip Breakers

| | | | Loadcentre Breakers | | Panelboard Breakers | | | | | | | |
|-----------------------------|----------------------------------|--|---------------------|---------------------|---------------------|---------------------|---------------------|------------------------|---------------------|---------|---------|---------|
| | | | QT | Q | BL | BLH | HBL | BQD, BQD6 ^① | NGB | NEB | HEB | |
| Page | | | 4-11 | 4-11 | 5-13 | 5-13 | 5-13 | 5-16 | 5-101 | 5-103 | 5-103 | |
| Ratings | AC | Poles | 1, 2 | 1, 2, 3 | 1,2,3 | 1,2,3 | 1,2,3 | 1,2,3 | 1,2,3 | 1,2,3 | 1,2,3 | 1,2,3 |
| | | Amperes, Continuous | 15-40 | 10-200 ^② | 15-125 ^③ | 15-125 ^③ | 15-125 ^③ | 15-100 ^④ | 15-125 | 15-125 | 15-125 | 15-125 |
| | | Volts (60 Hertz) | 1 Pole | 120/240 | 120/240 | 120/240 | 120/240 | 120/240 | 277 | 347 | 347 | 347 |
| | | | 2 Pole | — | 240 | 240 | 240 | 240 | 480/277 | 600/347 | 600/347 | 600/347 |
| | | CSA/UL Interrupting Rating - Symmetrical RMS Amperes | 120V | 10,000 | 10,000 | 10,000 | 22,000 | 65,000 | 65,000 | — | — | — |
| | | | 240V | 10,000 | 10,000 | 10,000 | 22,000 | 65,000 | 65,000 | 100,000 | 85,000 | 100,000 |
| | | | 277V | — | — | — | — | — | 14,000 | — | — | — |
| | | | 347V | — | — | — | — | — | 10,000 ^⑤ | — | — | — |
| | | | 480/277V | — | — | — | — | — | 14,000 | 25,000 | — | — |
| | | | 480V | — | — | — | — | — | — | — | 35,000 | 65,000 |
| 600/347V | — | | — | — | — | — | 10,000 ^⑤ | 14,000 | — | — | | |
| DC | 125/250 V DC Interrupting Rating | 2-Pole | — | — | — | — | 14,000 | 14,000 | 35,000 | 42,000 | | |
| | | 3-Pole | — | — | — | — | — | — | 35,000 | 42,000 | | |
| Dimensions in Inches | Height | 15-50A | — | 2.90 | 3.56 | 3.56 | 3.75 | 4.50 | 5.00 | 5.50 | 5.50 | |
| | | 15-40A | 3.12 | — | — | — | — | — | — | — | — | |
| | | 50-125A | — | 2.90 | 3.75 | 3.75 | 3.75 | 4.50 | 5.00 | 5.50 | 5.50 | |
| | Width | 1-Pole | 1.00 | 1.00 | 1.00 | 1.00 | 1.00 | 1.00 | 1.00 | 1.00 | 1.00 | |
| | | 2-Pole | 2.00 | 2.00 | 2.00 | 2.00 | 2.00 | 2.00 | 2.00 | 2.00 | 2.00 | |
| Depth | 3-Pole | — | 3.00 | 3.00 | 3.00 | 3.00 | 3.00 | 3.00 | 3.00 | 3.00 | | |
| Overcurrent Devices | Thermal and Fixed magnetic Trip | | ✓ | ✓ | ✓ | ✓ | ✓ | ✓ | ✓ | ✓ | ✓ | |
| | Molded Case Switch | | — | — | — | — | — | — | — | ✓ | ✓ | |
| Accessories & Modifications | Undervoltage Trip | | — | — | — | — | — | — | — | ✓ | ✓ | |
| | Shunt Trip | | — | — | ✓ | ✓ | ✓ | ✓ | ✓ | ✓ | ✓ | |
| | Auxiliary Switch | | — | — | ✓ | ✓ | ✓ | ✓ | ✓ | ✓ | ✓ | |
| | Alarm Switch | | — | — | — | — | — | ✓ | ✓ | ✓ | ✓ | |
| Individual Enclosures | Type 1 - Indoor | | ✓ | ✓ | — | — | — | — | — | — | — | |
| | Type 3R - Outdoor | | ✓ | ✓ | — | — | — | — | — | — | — | |

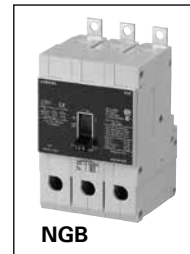

For inches / millimeters conversion, multiply inches by 25.4.

- ① BQD6 CSA certified 10,000A @ 600Y/347V 15-70A only.
- ② Single pole breakers available in ratings 15-70A only, 125A available as a 2-pole only.
- ③ 80A, 125A, 150A and 200A available as a 2-pole only, 90A and 100A available as a 2 and 3 pole only.
- ④ BQD6 breaker available in ratings 15-70A only, BQD available up to 100A

Molded Case Circuit Breakers

Reference Guide

Selection/Application

Thermal-Magnetic Trip Breakers

| Page | | | General Purpose Breakers | | | | | | | | |
|------------------------------------|--|---------------------|--------------------------|---------|----------------|----------------|----------------|----------------|--------|---------------------|--------|
| | | | BQ | BQH | HBQ | QJ2 | QJH2 | QJ2-H | HQJ2 | CQD | |
| 5-16 | | | 5-16 | 5-16 | 5-16 | 5-19 | 5-19 | 5-19 | 5-19 | 5-20 | |
| Ratings | AC | Poles | 1, 2, 3 | 1, 2, 3 | 1, 2, 3 | 2, 3 | 2, 3 | 2, 3 | 3 | 1, 2, 3 | |
| | | Amperes, Continuous | 1-Pole | 15-70 | 15-70 | 15-70 | — | — | — | — | 15-100 |
| | | | 2-Pole | 15-125 | 15-125 | 15-125 | 60-225 | 60-225 | 60-225 | — | 15-100 |
| | | | 3-Pole | 15-100 | 15-100 | 15-100 | | | | 100-225 | 15-100 |
| | | Volts (60 Hertz) | 1-Pole | 120/240 | 120/240 | 120/240 | — | — | — | — | 277 |
| | | | 2-Pole | | | | — | — | — | — | — |
| | 3-Pole | | 240 | 240 | 240 | 240 | 240 | 240 | 240 | 480/277 | |
| | CSA/UL Interrupting Rating — Symmetrical RMS Amperes | 120V | 10,000 | 22,000 | 65,000 | — | — | — | — | 65,000 | |
| | | 240V | 10,000 | 22,000 | 65,000 | 10,000 | 22,000 | 42,000 | 65,000 | 65,000 | |
| | | 480/277V | — | — | — | — | — | — | — | 14,000 | |
| | | 600/347V | — | — | — | — | — | — | — | 10,000 ^① | |
| | DC | Volts — 2-Pole | — | — | — | — | — | — | — | 250 | |
| Interrupting Rating — DC Amperes | | — | — | — | — | — | — | — | 14,000 | | |
| Dimensions in inches | Height | 15-50A | 3.75 | 3.75 | 4.00 | — | — | — | — | 4.50 | |
| | | 55-125A | 4.00 | 4.00 | 4.00 | — | — | — | — | 4.50 | |
| | | 60-225A | — | — | — | 7.00 | 7.00 | 7.00 | 7.00 | — | |
| | Width | 1-Pole | 1.00 | 1.00 | 1.00 | — | — | — | — | 1.00 | |
| | | 2-Pole | 2.00 | 2.00 | 2.00 | 3.00 | 3.00 | 3.00 | — | 2.00 | |
| | | 3-Pole | 3.00 | 3.00 | 3.00 | 4.50 | 4.50 | 4.50 | 4.50 | 3.00 | |
| Depth | | 2.37 | 2.37 | 2.37 | 2.34 | 2.34 | 2.53 | 2.53 | 2.87 | | |
| Overcurrent Devices | Thermal and Fixed Magnetic Trip | ✓ | ✓ | ✓ | ✓ | ✓ | ✓ | ✓ | ✓ | | |
| | Molded Case Switch | ✓ | — | — | ✓ | — | — | — | — | | |
| Accessories & Modifications | Undervoltage Trip | — | — | — | — | — | — | — | ✓ | | |
| | Shunt Trip | ✓ | ✓ | ✓ | ✓ ^① | ✓ ^① | ✓ ^① | ✓ ^① | ✓ | | |
| | Auxiliary Switch | ✓ | ✓ | ✓ | ✓ ^① | ✓ ^① | ✓ ^① | ✓ ^① | ✓ | | |
| | Alarm Switch | — | — | — | ✓ | ✓ | — | — | ✓ | | |
| | Mechanical Interlock | — | — | — | ✓ | ✓ | ✓ | ✓ | — | | |
| | Fungus Proofing (ref. page 5-67) | ✓ | ✓ | ✓ | ✓ | ✓ | ✓ | ✓ | ✓ | | |
| Individual Enclosures ^② | Type 1 — Indoor Surface | ✓ | ✓ | ✓ | ✓ | ✓ | ✓ | ✓ | — | | |
| | Type 1 — Indoor, Flush | ✓ | ✓ | ✓ | ✓ | ✓ | ✓ | ✓ | — | | |
| | Type 3R — Outdoor-Rainproof | ✓ | ✓ | ✓ | ✓ | ✓ | ✓ | ✓ | — | | |

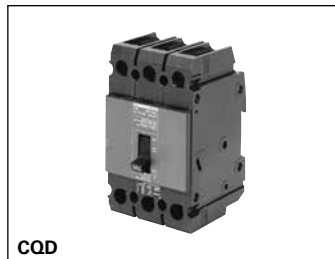
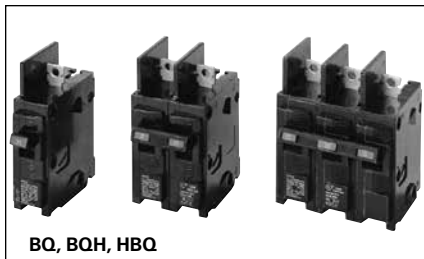

For inches / millimeters conversion, see Application Data section.

① 3-pole breakers only (factory installed only).

② Type CQD6—CSA only.

③ Enclosed breakers are factory assembled.

Molded Case Circuit Breakers

Reference Guide

Selection/Application

Thermal-Magnetic Trip Breakers

| Page | | General Purpose Breakers | | | | | | | | | | | |
|------------------------------------|--|--------------------------|----------|-----------------------|---------------------|--------|---------------------|-------------|----------------------|---------|---------|---------|---|
| | | ED2 | ED4 | ED6 | HED4 | CED6 | FD6A, FXD6A | HFD6, HFXD6 | HHFD6, HHFXD6 | CFD6 | | | |
| Ratings | | 5-21 | 5-21 | 5-21 | 5-22 | 5-22 | 5-24 | 5-25 | 5-25 | 5-25 | | | |
| AC | Poles | 1, 2, 3 | 1, 2, 3 | 1 ^① , 2, 3 | 1, 2, 3 | 2, 3 | 2, 3 | 2, 3 | 2, 3 | 2, 3 | | | |
| | Amperes, Continuous | 15-100 | 15-125 | 15-125 | 15-125 | 15-125 | 70-250 | 70-250 | 70-250 | 70-250 | | | |
| | Volts 50/60HZ | 1-Pole | 120 | 277 | 347 | 277 | — | — | — | — | — | | |
| | | 2-Pole | 240 | 480 | 600 | 480 | 600 | 600 | 600 | 600 | 600 | | |
| | | 3-Pole | — | — | — | — | — | — | — | — | — | | |
| | Interrupting Rating Symmetrical RMS Amperes | CSA / UL | 120V | 10,000 | — | — | — | — | — | — | — | | |
| | | | 240V | 10,000 | 65,000 | 65,000 | 100,000 | 200,000 | 65,000 | 100,000 | 200,000 | | |
| | | | 277V | — | 22,000 ^② | — | 65,000 ^② | — | — | — | — | — | |
| | | | 347V | — | — | 30,000 | — | — | — | — | — | — | |
| | | | 480V | — | 18,000 | 25,000 | 42,000 | 200,000 | 35,000 | 65,000 | 100,000 | 200,000 | |
| | | | 600V | — | — | 18,000 | — | 100,000 | 22,000 | 25,000 | 25,000 | 100,000 | |
| | | IEC 947-2 50/60HZ | 220/240V | lcu | — | — | 65,000 | — | 200,000 ^③ | 65,000 | 100,000 | 200,000 | — |
| | | | | lcs | — | — | 17,000 | — | — | 33,000 | 50,000 | 100,000 | — |
| | | | 380/415V | lcu | — | — | 35,000 | — | 200,000 ^③ | 35,000 | 65,000 | 100,000 | — |
| | | | | lcs | — | — | 9,000 | — | — | 18,000 | 33,000 | 50,000 | — |
| 500V | | | lcu | — | — | 18,000 | — | — | 20,000 | 42,000 | 65,000 | — | |
| | | | lcs | — | — | 5,000 | — | — | 10,000 | 21,000 | 33,000 | — | |
| DC | 2-Pole, 250V DC Interrupting Ratings | 5,000 | 30,000 | 30,000 | 30,000 | 30,000 | 30,000 | 30,000 | — | 30,000 | | | |
| | 3-Pole, 500V DC Interrupting Ratings ^④ | — | — | 18,000 | — | 50,000 | 18,000 | 25,000 | — | 50,000 | | | |
| Dimensions in inches | Height | 6.34 | 6.34 | 6.34 | 6.34 | 9.26 | 9.50 | 9.50 | 11.00 | 14.12 | | | |
| | Width | 1-Pole | 1.00 | 1.00 | 1.00 | 1.00 | — | — | — | — | — | | |
| | | 2-Pole | 2.00 | 2.00 | 2.00 | 2.00 | 2.00 | 4.50 | 4.50 | 4.50 | 4.50 | | |
| | | 3-Pole | 3.00 | 3.00 | 3.00 | 3.00 | 3.00 | 4.50 | 4.50 | 4.50 | 4.50 | | |
| Depth | 4.00 | 4.00 | 4.00 | 4.00 | 4.00 | 4.00 | 4.00 | 4.00 | 4.00 | 4.00 | | | |
| Overcurrent Devices | Thermal and Fixed Magnetic Trip | ✓ | ✓ | ✓ | ✓ | ✓ | — | — | — | — | | | |
| | Thermal and Adjustable Magnetic Trip | — | — | — | — | — | ✓ | ✓ | ✓ | ✓ | | | |
| | Adjustable Magnetic Trip Only Motor Circuit Protector | — | — | ✓ | — | ✓ | ✓ | — | — | ✓ | | | |
| | Molded Case Switch | ✓ | ✓ | ✓ | — | ✓ | ✓ | — | — | ✓ | | | |
| Accessories & Modifications | Undervoltage Trip | ✓ | ✓ | ✓ | ✓ | ✓ | ✓ | ✓ | ✓ | ✓ | | | |
| | Shunt Trip | ✓ | ✓ | ✓ | ✓ | ✓ | ✓ | ✓ | ✓ | ✓ | | | |
| | Auxiliary Switch | ✓ | ✓ | ✓ | ✓ | ✓ | ✓ | ✓ | ✓ | ✓ | | | |
| | Alarm Switch | ✓ | ✓ | ✓ | ✓ | ✓ | ✓ | ✓ | ✓ | ✓ | | | |
| | Mechanical Interlock | — | — | — | — | — | ✓ | ✓ | ✓ | ✓ | | | |
| | Rear Connection Studs | ✓ | ✓ | ✓ | ✓ | ✓ | ✓ | ✓ | ✓ | ✓ | | | |
| | Electric Motor Operator | ✓ | ✓ | ✓ | ✓ | ✓ | ✓ | ✓ | ✓ | ✓ | | | |
| | Plug-In Mounting Assembly | ✓ | ✓ | ✓ | ✓ | ✓ | ✓ | ✓ | ✓ | ✓ | | | |
| Fungus Proofing (ref. page 5-67) | ✓ | ✓ | ✓ | ✓ | ✓ | ✓ | ✓ | ✓ | ✓ | | | | |
| Individual Enclosures ^⑤ | Type 1 — Indoor Surface | ✓ | ✓ | ✓ | ✓ | ✓ | ✓ | ✓ | ✓ | ✓ | | | |
| | Type 1 — Indoor, Flush | ✓ | ✓ | ✓ | ✓ | ✓ | — | ✓ | — | ✓ | | | |
| | Type 3R — Outdoor-Rainproof | ✓ | ✓ | ✓ | ✓ | ✓ | ✓ | ✓ | ✓ | ✓ | | | |
| | Type 5, 12 — Lint, Fine Dust, Oils, Coolants | ✓ | ✓ | ✓ | ✓ | ✓ | ✓ | ✓ | ✓ | ✓ | | | |
| | Type 12K — Semi-Dusttight | ✓ | ✓ | ✓ | ✓ | ✓ | ✓ | ✓ | ✓ | ✓ | | | |

For inches / millimeters conversion, see Application Data section.

① 1-pole only.

② 40-100A: 25,000 AIR at 277V AC.

③ For DC UPS system application.

④ Single pole ED6 (15-30A) 30kA, (35-100A) 18 kA. CSA Only.

⑤ Enclosed breakers are factory assembled.

Molded Case Circuit Breakers

Reference Guide

Selection/Application

Thermal-Magnetic Trip Breakers

| Page | | General Purpose Breakers | | | | | | | | | | | | |
|------------------------------------|--|---|----------------------|--------------------|---|---------|--------------|----------------|-----------------|---------|---------|---------|---------|---------|
| | | JXD2-A | JD6-A, JXD6-A | HJD6-A, HJXD6-A | HHJD6-A, HHJXD6-A | CJD6 | LD6, LXD6 | HLD6, HLXD6 | HHL6, HHLXD6 | CLD6 | | | | |
| Ratings | | Poles | 2, 3 | 2, 3 | 2, 3 | 2, 3 | 2, 3 | 2, 3 | 2, 3 | 2, 3 | 2, 3 | 2, 3 | 2, 3 | 2, 3 |
| | | Amperes, Continuous | 200-400 | 200-400 | 200-400 | 200-400 | 200-400 | 450-600 | 250-600 | 250-600 | 450-600 | 250-600 | 250-600 | 450-600 |
| | | Volts 50/60HZ | 2-Pole | 240 | 600 | 600 | 600 | 600 | 600 | 600 | 600 | 600 | 600 | 600 |
| | | | 3-Pole | 240 | 600 | 600 | 600 | 600 | 600 | 600 | 600 | 600 | 600 | 600 |
| | | Interrupting Rating Symmetrical RMS Amperes | CSA / UL | 240V | 65,000 | 65,000 | 100,000 | 200,000 | 200,000 | 65,000 | 100,000 | 200,000 | 200,000 | 200,000 |
| | | | | 480V | — | 35,000 | 65,000 | 100,000 | 150,000 | 35,000 | 65,000 | 100,000 | 150,000 | 150,000 |
| | | | | 600V | — | 25,000 | 35,000 | 50,000 | 100,000 | 25,000 | 35,000 | 50,000 | 100,000 | 100,000 |
| | | | IEC 947-2 50/60HZ | 220/240V | lcu | — | 65,000 | 100,000 | — | 65,000 | 100,000 | 200,000 | — | — |
| | | | | | lcs | — | 33,000 | 50,000 | 100,000 | — | 33,000 | 50,000 | 100,000 | — |
| | | | 500V | 380/415V | lcu | — | 40,000 | 65,000 | — | 40,000 | 65,000 | 100,000 | — | — |
| | | | | | lcs | — | 20,000 | 33,000 | 50,000 | — | 20,000 | 33,000 | 50,000 | — |
| | | | DC | | 2-Pole 250V DC Interrupting Ratings | 30,000 | 30,000 | 30,000 | — | 30,000 | 30,000 | 30,000 | — | 30,000 |
| | | | | | 3-Pole, 500V DC Interrupting Ratings ^① | — | 25,000 | 35,000 | — | 50,000 | 25,000 | 35,000 | — | 50,000 |
| Dimensions in inches | | | Height | | 11.00 | 11.00 | 11.00 | 11.00 | 17.86 | 11.00 | 11.00 | 11.00 | 11.00 | 17.86 |
| | | Width | 2-Pole | 7.50 | 7.50 | 7.50 | 7.50 | 7.50 | 7.50 | 7.50 | 7.50 | 7.50 | 7.50 | |
| | | | 3-Pole | 7.50 | 7.50 | 7.50 | 7.50 | 7.50 | 7.50 | 7.50 | 7.50 | 7.50 | 7.50 | |
| | | Depth | | 4.00 | 4.00 | 4.00 | 4.00 | 4.00 | 4.00 | 4.00 | 4.00 | 4.00 | 4.00 | |
| Overcurrent Devices | | Thermal and Adjustable Magnetic Trip | | ✓ | ✓ | ✓ | ✓ | ✓ | ✓ | ✓ | ✓ | ✓ | ✓ | |
| | | Adjustable Magnetic Trip Only | | — | — | — | — | ✓ | ✓ | — | — | — | ✓ | |
| | | Motor Circuit Protector | | — | — | — | — | ✓ | ✓ | — | — | — | ✓ | |
| | | Molded Case Switch | | ✓ | ✓ | — | — | ✓ | ✓ | — | — | — | ✓ | |
| Accessories & Modifications | | Undervoltage Trip | | ✓ | ✓ | ✓ | ✓ | ✓ | ✓ | ✓ | ✓ | ✓ | ✓ | |
| | | Shunt Trip | | ✓ | ✓ | ✓ | ✓ | ✓ | ✓ | ✓ | ✓ | ✓ | ✓ | |
| | | Auxiliary Switch | | ✓ | ✓ | ✓ | ✓ | ✓ | ✓ | ✓ | ✓ | ✓ | ✓ | |
| | | Alarm Switch | | ✓ | ✓ | ✓ | ✓ | ✓ | ✓ | ✓ | ✓ | ✓ | ✓ | |
| | | Mechanical Interlock | | ✓ | ✓ | ✓ | ✓ | ✓ | ✓ | ✓ | ✓ | ✓ | ✓ | |
| | | Rear Connection Studs | | ✓ | ✓ | ✓ | ✓ | ✓ | ✓ | ✓ | ✓ | ✓ | ✓ | |
| | | Electric Motor Operator | | ✓ | ✓ | ✓ | ✓ | ✓ | ✓ | ✓ | ✓ | ✓ | ✓ | |
| | | Plug-In Mounting Assembly | | ✓ | ✓ | ✓ | ✓ | ✓ | ✓ | ✓ | ✓ | ✓ | ✓ | |
| | | Fungus Proofing (ref. page 5-67) | | ✓ | ✓ | ✓ | ✓ | ✓ | ✓ | ✓ | ✓ | ✓ | ✓ | |
| Individual Enclosures ^② | | Type 1 — Indoor Surface | | ✓ | ✓ | ✓ | ✓ | ✓ | ✓ | ✓ | ✓ | ✓ | ✓ | |
| | | Type 1 — Indoor, Flush | | — | — | — | — | — | ✓ | — | — | — | — | |
| | | Type 3R — Outdoor-Rainproof | | ✓ | ✓ | ✓ | ✓ | — | ✓ | ✓ | ✓ | — | — | |
| | | Type 5, 12 — Lint, Fine Dust, Oils, Coolants | | ✓ | ✓ | ✓ | ✓ | ✓ | ✓ | ✓ | ✓ | ✓ | ✓ | |
| | | Type 12K — Semi-Dusttight | | — | ✓ | ✓ | ✓ | — | ✓ | ✓ | ✓ | — | — | |

For inches / millimeters conversion, see Application Data section.

① For DC UPS application.

② Enclosed breakers are factory assembled.

Molded Case Circuit Breakers

Reference Guide

Selection/Application

Thermal-Magnetic Trip Breakers

| | | | General Purpose Breakers | | | | | | | | | | |
|---|--|---|--------------------------|----------------------|--------------|----------------|---------|--------------|----------------|----------|---------|---------|---------|
| | | | LMD6, LMXD6 | HLMD6, HLMXD6 | MD6, MXD6 | HMD6, HMXD6 | CMD6 | ND6, NXD6 | HND6, HNXD6 | CND6 | | | |
| Page | | | 5-35 | 5-36 | 5-38 | 5-39 | 5-39 | 5-42 | 5-43 | 5-43 | | | |
| Ratings | AC | Poles | 2, 3 | 2, 3 | 2, 3 | 2, 3 | 3 | 2, 3 | 2, 3 | 3 | | | |
| | | Amperes, Continuous | 500-800 | 500-800 | 500-800 | 500-800 | 400-800 | 800-1200 | 800-1200 | 800-1200 | | | |
| | | Volts 50/60 HZ | 2-Pole | 600 | 600 | 600 | 600 | 600 | 600 | 600 | 600 | | |
| | | | 3-Pole | | | | | | | | | | |
| | | Interrupting Rating Symmetrical RMS Amperes | CSA / UL | 240V | 65,000 | 100,000 | 65,000 | 100,000 | 200,000 | 65,000 | 100,000 | 200,000 | |
| | | | | 480V | 50,000 | 65,000 | 50,000 | 65,000 | 100,000 | 50,000 | 65,000 | 100,000 | |
| | | | | 600V | 25,000 | 25,000 | 25,000 | 50,000 | 65,000 | 25,000 | 50,000 | 65,000 | |
| | | | | IEC 947-2 50/60HZ | 220/240V | lcu | 65,000 | 100,000 | 65,000 | 100,000 | 200,000 | 65,000 | 100,000 |
| | | | lcs | | | 33,000 | 50,000 | 33,000 | 50,000 | 100,000 | 33,000 | 50,000 | 100,000 |
| | | | 380/415V | | lcu | 40,000 | 65,000 | 40,000 | 65,000 | 100,000 | 40,000 | 65,000 | 100,000 |
| | | | | | lcs | 20,000 | 33,000 | 20,000 | 33,000 | 50,000 | 20,000 | 33,000 | 50,000 |
| | | | 500V | lcu | 30,000 | 42,000 | 30,000 | 42,000 | 65,000 | 30,000 | 42,000 | 65,000 | |
| | | lcs | | 15,000 | 21,000 | 15,000 | 21,000 | 33,000 | 15,000 | 21,000 | 33,000 | | |
| | DC | 2-Pole 250V DC Interrupting Ratings | | 30,000 | 30,000 | 30,000 | 30,000 | 30,000 | 30,000 | 30,000 | 30,000 | | |
| 3-Pole, 500V DC Interrupting Ratings ^① | | 25,000 | 50,000 | 25,000 | 50,000 | 50,000 | 25,000 | 50,000 | 50,000 | | | | |
| Dimensions in inches | Height | | 16.00 | 16.00 | 16.00 | 16.00 | 16.00 | 16.00 | 16.00 | 16.00 | | | |
| | Width | 2-Pole | 7.50 | 7.50 | 9.00 | 9.00 | — | 9.00 | 9.00 | — | | | |
| | | 3-Pole | | | | | 9.00 | | | 9.00 | | | |
| Depth | | 4.59 | 4.59 | 6.19 | 6.19 | 6.19 | 6.19 | 6.19 | 6.19 | | | | |
| Overcurrent Devices | Thermal and Fixed Magnetic Trip | | — | — | — | — | — | — | — | — | | | |
| | Thermal and Adjustable Magnetic Trip | | ✓ | ✓ | ✓ | ✓ | ✓ | ✓ | ✓ | ✓ | | | |
| | Adjustable Magnetic Trip Only Motor Circuit Protector | | ✓ | — | ✓ | — | ✓ | — | — | — | | | |
| | Molded Case Switch | | ✓ | ✓ | ✓ | — | ✓ | ✓ | — | ✓ | | | |
| Accessories & Modifications | Undervoltage Trip | | ✓ | ✓ | ✓ | ✓ | ✓ | ✓ | ✓ | ✓ | | | |
| | Shunt Trip | | ✓ | ✓ | ✓ | ✓ | ✓ | ✓ | ✓ | ✓ | | | |
| | Auxiliary Switch | | ✓ | ✓ | ✓ | ✓ | ✓ | ✓ | ✓ | ✓ | | | |
| | Alarm Switch | | ✓ | ✓ | ✓ | ✓ | ✓ | ✓ | ✓ | ✓ | | | |
| | Mechanical Interlock | | ✓ | ✓ | ✓ | ✓ | ✓ | ✓ | ✓ | ✓ | | | |
| | Rear Connection Studs | | ✓ | ✓ | ✓ | ✓ | ✓ | ✓ | ✓ | ✓ | | | |
| | Electric Motor Operator | | ✓ | — | ✓ | ✓ | ✓ | ✓ | ✓ | ✓ | | | |
| | Plug-In Mounting Assembly | | — | ✓ | ✓ | ✓ | ✓ | — | ✓ | ✓ | | | |
| | Fungus Proofing (ref. page 5-67) | | ✓ | ✓ | ✓ | ✓ | ✓ | ✓ | ✓ | ✓ | | | |
| Individual Enclosures^② | Type 1 — Indoor Surface | | — | — | ✓ | ✓ | ✓ | ✓ | ✓ | ✓ | | | |
| | Type 1 — Indoor, Flush | | — | — | — | — | — | — | — | — | | | |
| | Type 3R — Outdoor-Rainproof | | — | — | ✓ | ✓ | ✓ | ✓ | — | ✓ | | | |
| | Type 5, 12 — Lint, Fine Dust, Oils, Coolants | | — | — | ✓ | ✓ | ✓ | ✓ | ✓ | ✓ | | | |
| | Type 12K — Semi-Dusttight | | — | — | ✓ | ✓ | — | ✓ | ✓ | — | | | |

For inches / millimeters conversion, see Application Data section.

① For DC UPS application.

② Enclosed breakers are factory assembled.

Molded Case Circuit Breakers

Reference Guide

Selection/Application

Thermal-Magnetic Trip Breakers

| Page | | | | General Purpose Breakers | | | | | | |
|--------------------------------|---|---|----------------------|---|---|-------------------|---|---|---------|---------|
| | | | | PD6 ^② , PXD6 ^② | HPD6 ^② , HPXD6 ^② | CPD6 ^② | RD6 ^② , RXD6 ^② | HRD6 ^② , HRXD6 ^② | | |
| Ratings | AC | Poles | | 3 | 3 | 3 | 3 | 3 | | |
| | | Amperes, Continuous | | 1200-1600 | 1200-1600 | 1200-1600 | 1600-2000 | 1600-2000 | | |
| | | Volts 50/60 HZ | | 3-Pole | 600 | 600 | 600 | 600 | 600 | |
| | | Interrupting Rating Symmetrical RMS Amperes | CSA / UL | 240V | 65,000 | 100,000 | 200,000 | 65,000 | 100,000 | |
| | | | | 480V | 50,000 | 65,000 | 100,000 | 50,000 | 65,000 | |
| | | | | 600V | 25,000 | 50,000 | 65,000 | 25,000 | 50,000 | |
| | | | IEC 947-2 50/60HZ | 220/240V | lcu | 65,000 | 100,000 | 200,000 | 65,000 | 100,000 |
| | | | | | lcs | 33,000 | 50,000 | 100,000 | 33,000 | 50,000 |
| | | | | 380/415V | lcu | 40,000 | 65,000 | 100,000 | 40,000 | 65,000 |
| | | lcs | 10,000 | | 17,000 | 25,000 | 10,000 | 17,000 | | |
| | 500V | lcu | 30,000 | 42,000 | 65,000 | 30,000 | 42,000 | | | |
| | | lcs | 8,000 | 21,000 | 17,000 | 8,000 | 21,000 | | | |
| | DC | 2-Pole 250V DC Interrupting Ratings | | 30,000 | 30,000 | 30,000 | 30,000 | 30,000 | | |
| | | 3-Pole, 500V DC Interrupting Ratings ^③ | | 25,000 | 50,000 | 50,000 | 25,000 | 50,000 | | |
| Dimensions in inches | Circuit breakers require Connect-all mounting block. Dimensions shown are for circuit breaker only. | | Height | 16.00 | 16.00 | 16.00 | 16.00 | 16.00 | | |
| | | | Width | 9.00 | 9.00 | 9.00 | 9.00 | 9.00 | | |
| | | | Depth | 6.19 | 6.19 | 6.19 | 6.19 | 6.19 | | |
| Overcurrent Devices | Thermal and Adjustable Magnetic Trip | | ✓ | ✓ | ✓ | ✓ | ✓ | | | |
| | Molded Case Switch | | ✓ | — | — | ✓ | — | | | |
| Accessories & Modifications | Undervoltage Trip | | ✓ | ✓ | ✓ | ✓ | ✓ | | | |
| | Shunt Trip | | ✓ | ✓ | ✓ | ✓ | ✓ | | | |
| | Auxiliary Switch | | ✓ | ✓ | ✓ | ✓ | ✓ | | | |
| | Alarm Switch | | ✓ | ✓ | ✓ | ✓ | ✓ | | | |
| | Mechanical Interlock | | ✓ | ✓ | ✓ | ✓ | ✓ | | | |
| | Electric Motor Operator | | ✓ | ✓ | ✓ | ✓ | ✓ | | | |
| | Fungus Proofing (ref. page 5-67) | | ✓ | ✓ | ✓ | ✓ | ✓ | | | |
| | Mounting Block (required) | | ✓ | ✓ | ✓ | ✓ | ✓ | | | |
| Individual Enclosures | Type 1 — Indoor Surface | | — | — | — | — | — | | | |
| | Type 1 — Indoor, Flush | | — | — | — | — | — | | | |
| | Type 3R — Outdoor-Rainproof | | — | — | — | — | — | | | |
| | Type 5, 12 — Lint, Fine Dust, Oils, Coolants | | — | — | — | — | — | | | |
| | Type 12K — Semi-Dusttight | | — | — | — | — | — | | | |

For inches / millimeters conversion, see Application Data section.

① For DC UPS application.

② Requires Connect-all mounting assembly. Dimensions shown are for circuit breaker only.

Molded Case Circuit Breakers

Reference Guide

Selection/Application

Electronic Trip Breakers

| Page | | | | Solid State Trip Circuit Breakers | | | | | | | | | | |
|------------------------------------|-------------------------|--|--|--|---------|---------|---------|---------|---------|---------|---------|---------|---------|---|
| | | | | SJD6 | SHJD6 | SCJD6 | SLD6 | SHLD6 | SCLD6 | SMD6 | SHMD6 | SCMD6 | | |
| Ratings | | | | 5-29 | 5-29 | 5-29 | 5-33 | 5-33 | 5-33 | 5-40 | 5-40 | 5-40 | | |
| AC | Poles | | | 3 | 3 | 3 | 3 | 3 | 3 | 3 | 3 | 3 | | |
| | Amperes, Continuous | | | 200-400 | 200-400 | 200-400 | 300-600 | 300-600 | 300-600 | 600-800 | 600-800 | 600-800 | | |
| | Volts 50/60 HZ | | | 3-Pole | 600 | 600 | 600 | 600 | 600 | 600 | 600 | 600 | | |
| | Interrupting Rating | | | 240V | 65,000 | 100,000 | 200,000 | 65,000 | 100,000 | 200,000 | 65,000 | 100,000 | 200,000 | |
| | Symmetrical RMS Amperes | | | 480V | 35,000 | 65,000 | 150,000 | 35,000 | 65,000 | 150,000 | 50,000 | 65,000 | 100,000 | |
| CSA / UL | | | | 600V | 25,000 | 35,000 | 100,000 | 25,000 | 35,000 | 100,000 | 25,000 | 50,000 | 65,000 | |
| Dimensions in inches | | | | Height | 11.00 | 11.00 | 17.86 | 11.0 | 11.00 | 17.86 | 10.00 | 16.00 | 16.00 | |
| Width | | | | 3-Pole | 7.50 | 7.50 | 7.50 | 7.50 | 7.50 | 7.50 | 9.00 | 9.00 | 9.00 | |
| Depth | | | | | 4.00 | 4.00 | 4.00 | 4.00 | 4.00 | 4.00 | 6.19 | 6.19 | 6.19 | |
| Overcurrent Devices | | | | Solid State Trip | ✓ | ✓ | ✓ | ✓ | ✓ | ✓ | ✓ | ✓ | ✓ | |
| Accessories & Modifications | | | | Undervoltage Trip | ✓ | ✓ | ✓ | ✓ | — | ✓ | ✓ | ✓ | ✓ | |
| | | | | Shunt Trip | ✓ | ✓ | ✓ | ✓ | ✓ | ✓ | ✓ | ✓ | ✓ | ✓ |
| | | | | Auxiliary Switch | ✓ | ✓ | ✓ | ✓ | ✓ | ✓ | ✓ | ✓ | ✓ | ✓ |
| | | | | Alarm Switch | ✓ | ✓ | ✓ | ✓ | ✓ | ✓ | ✓ | ✓ | ✓ | ✓ |
| | | | | Mechanical Interlock | — | — | — | — | — | — | — | — | — | — |
| | | | | Rear Connection Studs | ✓ | ✓ | ✓ | ✓ | ✓ | ✓ | ✓ | ✓ | ✓ | ✓ |
| | | | | Electric Motor Operator | ✓ | ✓ | ✓ | ✓ | ✓ | ✓ | ✓ | ✓ | ✓ | ✓ |
| | | | | Plug-In Mounting Assembly | ✓ | ✓ | ✓ | ✓ | ✓ | ✓ | ✓ | ✓ | ✓ | ✓ |
| Individual Enclosures ^① | | | | Fungus Proofing (ref. page 5-67) | ✓ | ✓ | ✓ | ✓ | ✓ | ✓ | ✓ | ✓ | | |
| | | | | Type 1 — Indoor Surface | ✓ | ✓ | — | ✓ | ✓ | — | ✓ | ✓ | ✓ | |
| | | | | Type 1 — Indoor, Flush | — | — | — | — | — | — | — | — | — | |
| | | | | Type 3R — Outdoor-Rainproof | ✓ | ✓ | — | ✓ | ✓ | — | ✓ | ✓ | ✓ | |
| | | | | Type 5, 12 — Lint, Fine Dust, Oils, Coolants | ✓ | ✓ | ✓ | ✓ | ✓ | ✓ | ✓ | ✓ | ✓ | |
| | | | | Type 12K — Semi-Dusttight | ✓ | ✓ | — | ✓ | ✓ | — | — | | | |

For inches / millimeters conversion, see Application Data section.

① Enclosed breakers are factory assembled.

Molded Case Circuit Breakers

Reference Guide

Selection/Application

Electronic Trip Breakers

| | | | | Solid State Trip Circuit Breakers | | | | | | |
|--|--|---|---------------------|-----------------------------------|-------------|-------------|-------------------|--------------------|---------|---|
| | | | | SND6 | SHND6 | SCND6 | SPD6 ^① | SHPD6 ^① | | |
| Page | | | | 5-44 | 5-44 | 5-44 | 5-47 | 5-47 | | |
| Ratings | AC | Poles | | 3 | 3 | 3 | 3 | 3 | | |
| | | Amperes, Continuous | | 800-1200 | 800-1200 | 800-1200 | 1200-1600 | 1200-1600 | | |
| | | Volts 50/60HZ | | 3-Pole | 600 | 600 | 600 | 600 | 600 | |
| | | Interrupting Rating Symmetrical RMS Amperes | CSA / UL | 240V | 65,000 | 100,000 | 200,000 | 65,000 | 100,000 | |
| | | | | 480V | 50,000 | 65,000 | 100,000 | 50,000 | 65,000 | |
| | | | | 600V | 25,000 | 50,000 | 65,000 | 25,000 | 50,000 | |
| | | | EC 947-2 50/60HZ | 380/415V | lcu | — | — | — | — | — |
| | | | | | lcs | — | — | — | — | — |
| | | | | 690V | lcu | — | — | — | — | — |
| | | | | lcs | — | — | — | — | — | |
| Dimensions - Inches | Height | | 16.00 | 16.00 | 16.00 | 16.00 | 16.00 | | | |
| | Width | | 9.00 | 9.00 | 9.00 | 9.00 | 9.00 | | | |
| | Depth | | 6.19 | 6.19 | 6.19 | 6.19 | 6.19 | | | |
| Overcurrent Devices | Solid State Trip | | ✓ | ✓ | ✓ | ✓ | ✓ | | | |
| Accessories & Modifications | Undervoltage Trip | | ✓ | ✓ | ✓ | ✓ | ✓ | | | |
| | Shunt Trip | | ✓ | ✓ | ✓ | ✓ | ✓ | | | |
| | Auxiliary Switch | | ✓ | ✓ | ✓ | ✓ | ✓ | | | |
| | Alarm Switch | | ✓ | ✓ | ✓ | ✓ | ✓ | | | |
| | Mechanical Interlock | | ✓ | ✓ | ✓ | ✓ | — | | | |
| | Rear Connection Studs | | ✓ | ✓ | ✓ | — | ✓ | | | |
| | Electric Motor Operator | | ✓ | ✓ | ✓ | ✓ | — | | | |
| | Plug-In Mounting Assembly | | — | — | ✓ | — | ✓ | | | |
| | Stored Energy Mechanism | | — | — | — | — | — | | | |
| | Drawout Construction | | — | — | — | — | — | | | |
| | Fungus Proofing (ref. page 5-67) | | ✓ | ✓ | ✓ | ✓ | ✓ | | | |
| Individual Enclosures^② | Type 1 — Indoor Surface | | ✓ | ✓ | ✓ | — | — | | | |
| | Type 1 — Indoor, Flush | | — | — | — | — | — | | | |
| | Type 3R — Outdoor-Rainproof | | ✓ | — | ✓ | — | — | | | |
| | Type 5, 12 — Lint, Fine Dust, Oils, Coolants | | ✓ | ✓ | ✓ | — | — | | | |
| | Type 12K — Semi-Dusttight | | ✓ | ✓ | — | — | — | | | |

For inches / millimeters conversion, see Application Data section.

① Requires connect-all mounting block assembly. Dimensions shown are for circuit breaker.

② Enclosed breakers are factory assembled.

Molded Case Circuit Breakers

Panelboard Mounting Circuit Breakers

Selection/Application

Type **BL**–Low Tab Bolt-on (10,000A IR)^④

Non-Interchangeable Trip

| Continuous Current Rating @ 40°C | 1-Pole ^② | 2-Pole ^③ | 2-Pole ^{③③} | 3-Pole ^③ |
|----------------------------------|---------------------|-------------------------|----------------------|---------------------|
| | 120/240V AC | 120/240V AC Common Trip | 240V AC Common Trip | 240V AC Common Trip |
| | Catalogue Number | Catalogue Number | Catalogue Number | Catalogue Number |
| 15 | B115 | B215 | B215R | B315 |
| 20 | B120 | B220 | B220R | B320 |
| 25 | B125 | B225 | B225R | B325 |
| 30 | B130 | B230 | B230R | B330 |
| 35 | B135 | B235 | B235R■ | B335 |
| 40 | B140 | B240 | B240R■ | B340 |
| 45 | B145■ | B245 | B245R■ | B345 |
| 50 | B150 | B250 | B250R | B350 |
| 55 | B155 | B255 | — | B355 |
| 60 | B160 | B260 | B260R | B360 |
| 70 | B170 | B270 | B270R■ | B370 |
| 80 | — | B280 | B280R■ | B380 |
| 90 | — | B290 | B290R■ | B390 |
| 100 | — | B2100 | B2100R■ | B3100 |
| 110 | — | B2110■ | — | — |
| 125 | — | B2125 | — | — |

Type **BLH**–Low Tab Bolt-on (22,000A IR)^④

| Continuous Current Rating @ 40°C | 1-Pole | 2-Pole | 3-Pole |
|----------------------------------|--------------------|-------------------------|---------------------|
| | 120/240V AC | 120/240V AC Common Trip | 240V AC Common Trip |
| | Catalogue Number | Catalogue Number | Catalogue Number |
| 15 | B115H ^① | B215H | B315H |
| 20 | B120H ^① | B220H | B320H |
| 25 | B125H | B225H■ | B325H |
| 30 | B130H | B230H | B330H |
| 35 | B135H■ | B235H■ | B335H■ |
| 40 | B140H | B240H | B340H |
| 45 | B145H■ | B245H■ | B345H■ |
| 50 | B150H | B250H | B350H |
| 55 | B155H | B255H■ | B355H |
| 60 | B160H■ | B260H | B360H |
| 70 | B170H■ | B270H■ | B370H |
| 80 | — | B280H■ | B380H■ |
| 90 | — | B290H■ | B390H■ |
| 100 | — | B2100H | B3100H |
| 110 | — | B2110H■ | — |
| 125 | — | B2125H | — |

Type **HBL**–Low Tab Bolt-on (65,000A IR)^④

| | | | |
|-----|---------------------|----------|---------|
| 15 | B115HH ^① | B215HH | B315HH |
| 20 | B120HH ^① | B220HH | B320HH |
| 25 | B125HH■ | B225HH■ | B325HH■ |
| 30 | B130HH | B230HH | B330HH |
| 35 | B135HH■ | B235HH■ | B335HH■ |
| 40 | B140HH | B240HH | B340HH |
| 45 | B145HH■ | B245HH■ | B345HH■ |
| 50 | B150HH | B250HH | B350HH |
| 55 | B155HH■ | B255HH | B355HH |
| 60 | B160HH■ | B260HH | B360HH |
| 70 | B170HH■ | B270HH■ | B370HH |
| 80 | — | B280HH■ | B380HH |
| 90 | — | B290HH■ | B390HH |
| 100 | — | B2100HH | B3100HH |
| 110 | — | B2100HH■ | — |
| 125 | — | B2125HH■ | — |

Types **BL/BLH/HBL**

Internal Accessories (Factory installed only; require one additional pole width)

| Control Voltage | | Shunt Trip | Auxiliary Switches |
|-----------------|----|------------|--------------------|
| AC | DC | | 1A and 1B contacts |
| | | Suffix | Suffix |
| 120V | — | ...00S01■ | ...01■ |
| 24V | — | ...00S07■ | ...01■ |

■ Built to order. Allow 3–4 weeks for delivery.
 ① CSA Certified / UL Listed for frequent switching applications (SWD). 120V AC fluorescent lighting.
 ② Shipped 12 per sleeve.

③ CSA Certified / UL Listed for 3 phase 240V grounded B at 10,000 KA IR.
 ④ HACR rated.
 ⑤ Shipped 6 per sleeve.
 ⑥ Shipped 5 per sleeve.

Modifications - page 5-67
 External Accessories - page 5-69

Molded Case Circuit Breakers

Panelboard Mounting Circuit Breakers

Selection

Ordering Instructions

- All BL circuit breakers are supplied with load side connectors.
- All standard circuit breakers are calibrated for 40° C maximum ambient application.

Shipping Weights - BL, BLH, HBL

| Number of Poles | Number Per Carton / Master | Shipping Weight (lbs.) Master |
|-----------------|----------------------------|-------------------------------|
| 1 (15-70A) | 12/48 | 15.3 |
| 2 (15-50A) | 6/24 | 15.3 |
| 2 (55-70A) | 6/24 | 19.4 |
| 2 (80-125A) | 6/24 | 24.9 |
| 3 (15-100A) | 4/16 | 20.1 |

Pressure Wire Connectors (Load side terminal factory installed only)

| Type | Circuit Breaker Ampere Rating | Cables Per Lug | Wire Range |
|--------------|-------------------------------|----------------|--------------------|
| BL, BLH, HBL | 15-20 | 1 | #14 - #10 AWG Cu |
| | | 1 | #12 - #10 AWG Al |
| | 25-35 | 1 | #14 - #6 AWG Cu |
| | | 1 | #12 - #6 AWG Al |
| | 40-50 | 1 | #8 - #6 AWG Cu |
| | | 1 | #8 - #4 AWG Al |
| | 55-70 | 1 | #8 - #4 AWG Cu |
| | | 1 | #8 - #2 AWG Al |
| | 80-100 | 1 | #4 - #1/0 AWG Cu |
| | | 1 | #2 - #1/0 AWG Al |
| | 110-125 | 1 | #2 - #1/0 AWG Cu |
| | | 1 | #1/0 - #2/0 AWG Al |

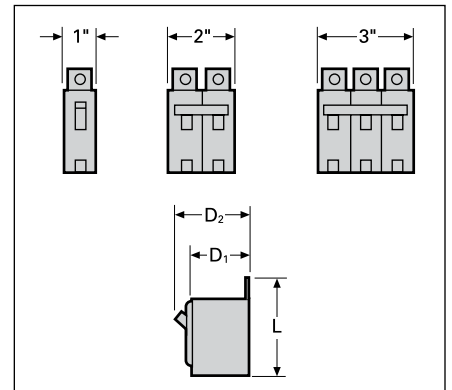

| Breaker Type | Amperes | Dimensions (inches) | | |
|--------------|---------|--------------------------------|-------------------------------|----|
| | | L | D1 | D2 |
| BL, BLH | 15-50 | 3 ⁵ / ₁₆ | 2 ³ / ₄ | 3 |
| BL, BLH | 60-125 | 3 ³ / ₄ | 2 ³ / ₄ | 3 |
| HBL | 15-125 | 3 ³ / ₄ | 2 ³ / ₄ | 3 |

For inches / millimeters conversion, multiply inches by 25.4.

Accessories page 5-69

Molded Case Circuit Breakers

Special Application Panelboard Mounting Breakers

Selection

Ground-Fault Circuit Interrupters (GFCI)Ⓞ

Provides Class A (5mA) ground fault protection. Intended for personal protection. De-energizes the circuit for all ungrounded conductors of the circuit.

| Breaker Type | Ampere Rating | Catalogue Number | Interrupting Ratings (kA) (RMS Symmetrical Amperes) | |
|----------------------------------|---------------|------------------|--|---------|
| | | | Volts AC | |
| | | | 120 | 120/240 |
| BLF 1-Pole Bolt-On | 15 | BF115 | 10 | — |
| | 20 | BF120 | 10 | — |
| | 25 | BF125■ | 10 | — |
| | 30 | BF130 | 10 | — |
| BLF 2-Pole Bolt-On | 15 | BF215 | — | 10 |
| | 20 | BF220 | — | 10 |
| | 30 | BF230 | — | 10 |
| | 40 | BF240■ | — | 10 |
| | 50 | BF250■ | — | 10 |
| | 60 | BF260■ | — | 10 |
| BLHF 1-Pole Bolt-On | 15 | BF115H | 22 | — |
| | 20 | BF120H | 22 | — |
| | 30 | BF130H■ | 22 | — |
| BLHF 2-Pole Bolt-On | 15 | BF215H | — | 22 |
| | 20 | BF220H | — | 22 |
| | 30 | BF230H | — | 22 |
| | 40 | BF240H■ | — | 22 |
| | 50 | BF250H■ | — | 22 |
| | 60 | BF260H■ | — | 22 |

Ground-Fault Equipment Protection (30mA)Ⓞ

Provides protection of equipment from damaging line-to-ground faults currents. De-energizes the circuit for all ungrounded conductors of the circuit.

| | | | | |
|----------------------------------|----|---------|----|----|
| BLE 1-Pole Bolt-On | 15 | BE115■ | 10 | — |
| | 20 | BE120 | 10 | — |
| | 30 | BE130 | 10 | — |
| BLE 2-Pole Bolt-On | 15 | BE215■ | — | 10 |
| | 20 | BE220 | — | 10 |
| | 30 | BE230 | — | 10 |
| | 40 | BE240■ | — | 10 |
| | 50 | BE250■ | — | 10 |
| | 60 | BE260■ | — | 10 |
| BLEH 1-Pole Bolt-On | 20 | BE120H■ | 22 | — |
| | 30 | BE130H■ | 22 | — |
| BLEH 2-Pole Bolt-On | 15 | BE215H■ | — | 22 |
| | 20 | BE220H■ | — | 22 |
| | 30 | BE230H■ | — | 22 |
| | 40 | BE240H■ | — | 22 |
| | 50 | BE250H■ | — | 22 |
| | 60 | BE260H■ | — | 22 |

Branch-Feeder Arc-Fault Circuit Interrupters (AFCI)

AFCI's detect arcing faults (an unintentional arcing condition in a circuit) that standard circuit breakers are unable to detect. The device is intended to mitigate the effects of arcing faults by functioning to de-energize the circuit when an arc-fault is detected. Branch-feeder AFCI detects line-to-ground and line-to-neutral arcs.

| | | | | |
|-----------------------|----|---------|----|---|
| BAF 1-Pole | 15 | B115AF | 10 | — |
| | 20 | B120AF | 10 | — |
| BAFH 1-Pole | 15 | B115AFH | 22 | — |
| | 20 | B120AFH | 22 | — |

Switching NeutralsⓄ

| | | | | |
|------------------------------------|----|--------|----|----|
| BG 2 Wire Common Trip | 15 | BG215■ | 10 | — |
| | 20 | BG220■ | 10 | — |
| | 30 | BG230■ | 10 | — |
| BG 3 Wire Common Trip | 15 | BG315■ | — | 10 |
| | 20 | BG320■ | — | 10 |
| | 30 | BG330■ | — | 10 |

■ Built to order. Allow 2–3 weeks for delivery.
Ⓞ HACR rated.

Wiring Diagrams

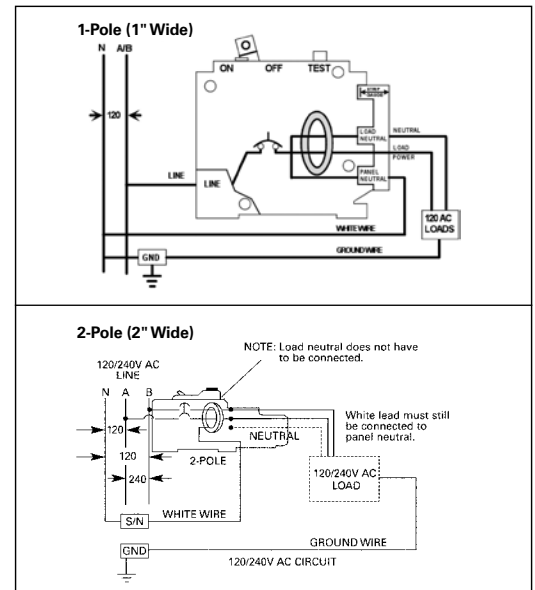

5
MOLDED CASE
CIRCUIT BREAKERS

Molded Case Circuit Breakers

BQ 125A Frame

Selection

Ordering Instructions

- All BQ circuit breakers are supplied with load side lugs. All standard circuit breakers are calibrated for 40°C maximum ambient application.

BQ 125A Frame — BQ (10,000A IR)^②

Non-Interchangeable Trip

| Continuous Current Rating @ 40°C | 1-Pole | 2-Pole | 2-Pole | 3-Pole |
|----------------------------------|------------------------|-------------------------|----------------------------------|---------------------|
| | 120/240V AC | 120/240V AC Common Trip | 240V AC Common Trip ^⑤ | 240V AC Common Trip |
| | Catalogue Number | Catalogue Number | Catalogue Number | Catalogue Number |
| 15 | BQ1B015 ^{①②} | BQ2B015 | BQ2H015 | BQ3B015 |
| 20 | BQ1B020 ^{①②} | BQ2B020 | BQ2H020■ | BQ3B020 |
| 25 | BQ1B025 ^② | BQ2B025 | — | BQ3B025■ |
| 30 | BQ1B030 ^② | BQ2B030 | BQ2H030■ | BQ3B030 |
| 35 | BQ1B035 ^② ■ | BQ2B035 | — | BQ3B035 |
| 40 | BQ1B040 ^② | BQ2B040 | BQ2H040■ | BQ3B040 |
| 45 | BQ1B045 ^② ■ | BQ2B045■ | — | BQ3B045■ |
| 50 | BQ1B050 ^② | BQ2B050 | BQ2H050■ | BQ3B050 |
| 55 | BQ1B055 ^② ■ | — | — | — |
| 60 | BQ1B060 ^② ■ | BQ2B060 | BQ2H060■ | BQ3B060 |
| 70 | BQ1B070■ | BQ2B070 | BQ2H070■ | BQ3B070 |
| 80 | — | BQ2B080 | — | BQ3B080 |
| 90 | — | BQ2B090 | BQ2H090■ | BQ3B090 |
| 100 | — | BQ2B100 | BQ2H100 | BQ3H100 |
| 110 | — | BQ2B110 | — | — |
| 125 | — | BQ2B125 | — | — |

BQH (22,000A IR)^②

| Continuous Current Rating @ 40°C | 1-Pole | 2-Pole | 3-Pole |
|----------------------------------|-----------------------|-------------------------|---------------------|
| | 120/240V AC | 120/240V AC Common Trip | 240V AC Common Trip |
| | Catalogue Number | Catalogue Number | Catalogue Number |
| 15 | BQ1B015H ^① | BQ2B015H | BQ3B015H |
| 20 | BQ1B020H | BQ2B020H | BQ3B020H |
| 25 | BQ1B025H■ | BQ2B025H■ | BQ3B025H■ |
| 30 | BQ1B030H | BQ2B030H | BQ3B030H |
| 35 | BQ1B035H■ | BQ2B035H■ | BQ3B035H |
| 40 | BQ1B040H | BQ2B040H | BQ3B040H |
| 45 | BQ1B045H■ | BQ2B045H■ | BQ3B045H |
| 50 | BQ1B050H■ | BQ2B050H | BQ3B050H |
| 55 | BQ1B055H■ | — | — |
| 60 | BQ1B060H■ | BQ2B060H | BQ3B060H |
| 70 | BQ1B070H■ | BQ2B070H■ | BQ3B070H |
| 80 | — | BQ2B080H■ | BQ3B080H■ |
| 90 | — | BQ2B090H■ | BQ3B090H■ |
| 100 | — | BQ2B100H | BQ3B100H |
| 110 | — | BQ2B110H | — |
| 125 | — | BQ2B125H | — |

HBQ (65,000A IR)^②

| | | | |
|-----|----------------------|----------|----------|
| 15 | HB1B015 ^① | HB2B015■ | HB3B015■ |
| 20 | HB1B020 ^① | HB2B020 | HB3B020 |
| 25 | HB1B025 | HB2B025 | HB3B025 |
| 30 | HB1B030 | HB2B030 | HB3B030 |
| 35 | HB1B035 | HB2B035 | HB3B035 |
| 40 | HB1B040 | HB2B040 | HB3B040 |
| 45 | HB1B045 | HB2B045 | HB3B045 |
| 50 | HB1B050■ | HB2B050■ | HB3B050 |
| 60 | HB1B060 | HB2B060■ | HB3B060 |
| 70 | HB1B070 | HB2B070■ | HB3B070■ |
| 80 | — | HB2B080 | HB3B080■ |
| 90 | — | HB2B090■ | HB3B090■ |
| 100 | — | HB2B100 | HB3B100 |
| 110 | — | HB2B110■ | — |
| 125 | — | HB2B125 | — |

BQ/BQH/HBQ Internal Accessories (Factory installed only)

| Control Voltage | | Shunt Trip | Auxiliary Switches |
|-----------------|----|------------|--------------------|
| AC | DC | | 1A and 1B |
| 120V | — | Suffix | Suffix |
| 120V | — | ...00S01 | ...A01■ |
| 24V | — | ...00S07 | |

■ Built to order. Allow 3–4 weeks for delivery.

①CSA Certified / UL Listed for frequent switching applications (SWD). 120V AC fluorescent lighting.

②HRCAR rated.

⑤UL Listed for use on 3 phase grounded "B" systems - 10,000 for this application.

Accessories pages 5-69
Modifications page 5-67

Molded Case Circuit Breakers

DIN Rail Mounted Circuit Breakers

Selection

Type BQXD — BQ Breaker with DIN Rail Mounting - UL Listed only

| Continuous Current Rating | 1-Pole | 2-Pole | Interrupting Ratings (KA) (RMS Symmetrical Amperes) |
|---------------------------|------------------|------------------|--|
| | Catalogue Number | Catalogue Number | Volts AC |
| | | | 120/240 |
| 15 | BQ1B015QLD | BQ2B015QLD | 10 |
| 20 | BQ1B020QLD | BQ2B020QLD | |
| 25 | BQ1B025QLD | BQ2B025QLD | |
| 30 | BQ1B030QLD | BQ2B030QLD | |
| 35 | BQ1B035QLD | BQ2B035QLD | |
| 40 | BQ1B040QLD | BQ2B040QLD | |
| 45 | BQ1B045QLD | BQ2B045QLD | |
| 50 | BQ1B050QLD | BQ2B050QLD | |
| 60 | BQ1B060QLD | BQ2B060QLD | |

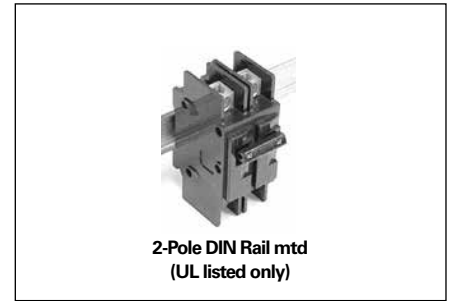

Finger Safe Terminal Shield

Protects against accidental contact with lugs—1 per lug. Fits line and load end.

| Catalogue Number | Qty |
|------------------|------|
| BQFS2 | 2 |
| BQFS1K | 1000 |

Shipping Weights

| Number of Poles | Number Per Carton / Master | Shipping Weight (lbs.) Master |
|------------------------------|----------------------------|-------------------------------|
| BQ | | |
| 1 (15–50A) | 6/72 | 23 |
| 1 (55–70A) | 6/66 | 23 |
| 1 (15–70A, 22 and 65K A IR) | 6/66 | 23 |
| 2 (15–50A) | 3/36 | 24 |
| 2 (60–125A) | 3/33 | 23 |
| 2 (15–100A, 22 and 65K A IR) | 3/33 | 24 |
| 2 (15–100A, 240V) | 3/33 | 23 |
| 3 (15–100A) | 2/22 | 23 |
| BQH and HBQ | | |
| 1 | 6/66 | 23 |
| 2 | 3/33 | 24 |
| 3 | 2/22 | 24 |

| Enclosures | |
|------------|-------------------------------|
| Type | Catalogue Number [Ⓢ] |
| 1 | EB3100S ^{Ⓢ⑦} |
| 3R | WB3100 |

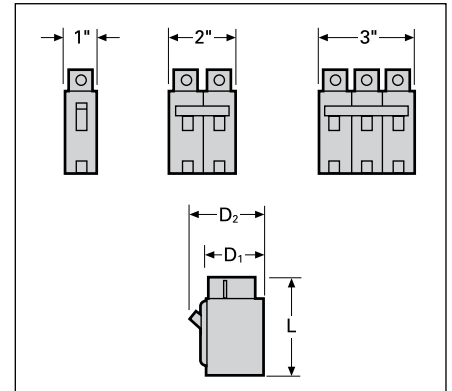

| Breaker Type | Amperes | Dimensions (inches) | | |
|--------------|---------|---------------------|----|----|
| | | L | D1 | D2 |
| BQ, BQH | 15–50 | 3¾ | 2¾ | 3 |
| BQ, BQH | 55–125 | 4 | 2¾ | 3 |
| HBQ | 15–125 | 4 | 2¾ | 3 |
| BQXD | 15–60 | 4½ | 2¾ | 3 |

Lugs For Use with BQ, BQH, HBQ[Ⓢ]

| Circuit Breaker Amp. Rtg. | Cables Per Lug | Lug Wire Range AWG | Catalogue Number |
|---------------------------|----------------|----------------------------|--|
| Line Side | | | |
| 15–40 | 1 1 | #14–#6 Cu #12–#6 Al | TC1Q1 ^{Ⓢ②③} |
| 50–100 | 1 1 | #8–#1 Cu #6–#1/0 Al | TA1Q1 [Ⓢ] |
| Load Side | | | |
| 15–20 | 1 1 | #14–#10 Cu #14–#10 Al | Connectors are Supplied with Circuit Breaker |
| 25–35 | 1 1 | #14–#6 Cu #14–#6 Al | |
| 40–50 | 1 1 | #8–#6 Cu #8–#4 Al | |
| 55–70 | 1 1 | #8–#4 Cu #8–#2 Al | |
| 80–100 | 1 1 | #4–#1/0 Cu #2–#1/0 Al | |
| 110–125 | 1 1 | #2–#1/0 Cu #1/0–#2/0 Cu | |

For inches / millimeters conversion, multiply inches by 25.4.

■ Built to order. Allow 3–4 weeks for delivery.

Ⓢ Terminals are CSA Certified / UL Listed for 60°/75°C conductors.

Ⓢ Connector has steel construction.

Ⓢ Surface mounted indoor. If flush mounting is required, replace suffix “S” in catalogue number with suffix “F”.

Ⓢ Discount Schedule B.

Ⓢ Does not include circuit breaker. Order circuit breaker separately.

Ⓢ Neutral included in enclosure.

Ⓢ Enclosure will not accept circuit breakers with shunt trips or auxiliary switches installed.

Ⓢ Package of 6 connectors.

Ⓢ BQXD uses TA1Q1 or TC1Q1 lugs on both line and load ends.

Accessories pages 5-68

Molded Case Circuit Breakers

BQD 100A Frame Panelboard Mounting Circuit Breakers

Selection

BQD⁴

| Continuous Current Rating @ 40°C | 1-Pole | 2-Pole ^⑤ | 3-Pole ^⑥ |
|----------------------------------|----------------------|--------------------------|---------------------|
| | 277V AC–125V DC | 480Y/277V AC–125/250V DC | 480Y/277V AC |
| | Catalogue Number | Catalogue Number | Catalogue Number |
| 15 | BQD115 ^{①②} | BQD215 ^⑤ | BQD315 ^⑥ |
| 20 | BQD120 ^{①②} | BQD220 ^⑤ | BQD320 ^⑥ |
| 25 | BQD125 ^{①②} | BQD225 ^⑤ | BQD325 ^⑥ |
| 30 | BQD130 ^② | BQD230 ^⑤ | BQD330 ^⑥ |
| 35 | BQD135 | BQD235 ^⑤ | BQD335 ^⑥ |
| 40 | BQD140 | BQD240 ^⑤ | BQD340 ^⑥ |
| 45 | BQD145■ | BQD245 ^⑤ | BQD345 ^⑥ |
| 50 | BQD150 | BQD250 ^⑤ | BQD350 ^⑥ |
| 60 | BQD160 | BQD260 | BQD360 |
| 70 | BQD170■ | BQD270 | BQD370 |
| 80 | BQD180■ | BQD280 | BQD380 |
| 90 | BQD190 | BQD290 | BQD390 |
| 100 | BQD1100■ | BQD2100 | BQD3100 |

BQD6

| Continuous Current Rating @ 40°C | 1-Pole | 2-Pole ^⑤ | 3-Pole ^⑥ |
|----------------------------------|------------------|---------------------|---------------------|
| | 347V AC | 600/347V AC | 600/347V AC |
| | Catalogue Number | Catalogue Number | Catalogue Number |
| 15 | BQD6115 | BQD6215 | BQD6315 |
| 20 | BQD6120 | BQD6220 | BQD6320 |
| 25 | BQD6125■ | BQD6225■ | BQD6325■ |
| 30 | BQD6130 | BQD6230 | BQD6330 |
| 35 | BQD6135■ | BQD6235■ | BQD6335■ |
| 40 | BQD6140 | BQD6240 | BQD6340 |
| 45 | BQD6145■ | BQD6245■ | BQD6345■ |
| 50 | BQD6150 | BQD6250 | BQD6350 |
| 60 | BQD6160 | BQD6260 | BQD6360 |
| 70 | BQD6170 | BQD6270 | BQD6370 |

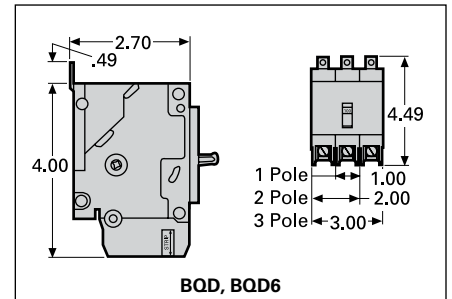

Shipping Weights

| Number of Poles | Number per Carton | Shipping Weight (lbs.) (ea.) |
|-----------------|-------------------|------------------------------|
| 1 | 1/12/48 | .6 |
| 2 | 1/6/24 | 1.2 |
| 3 | 1/4/16 | 2.0 |

Lugs For 60/70°C Wire

| BQD – Load End Only | |
|---------------------|------------------------------------|
| 15–40 | #14 - #6 AWG Cu or #12 - #6 AWG Al |
| 45–100 | #8 - #1 AWG Cu or #6 - #1/0 AWG Al |

Alarm and Auxiliary Switch Combination

| Catalogue Number |
|------------------|
| BQDA1BA |

Interrupting Ratings

| Breaker Type | Number of Poles | RMS Symmetrical Amperes (kA) | | | | | | | |
|----------------|-----------------|------------------------------|-----|-----|---------|-----|---------|----------|-----|
| | | Volts AC | | | | | | Volts DC | |
| | | 120 | 240 | 277 | 480/277 | 347 | 600/347 | 125 | 250 |
| BQD (CSA & UL) | 1 | 65 | — | 14 | — | — | — | 14 | — |
| | 2 | — | 65 | — | 14 | — | — | — | 14 |
| | 3 | — | 65 | — | 14 | — | — | — | — |
| BQD6 (CSA) | 1 | 65 | — | — | — | 10 | — | 14 | — |
| | 2 | — | 65 | — | — | — | 10 | — | 14 |
| | 3 | — | 65 | — | — | — | 10 | — | — |

BQD Internal Accessories

| Control Voltage | | Shunt Trip | Shunt Trip and Auxiliary Switch Combinations | | | | | | |
|-----------------|------|------------------|--|--|--|--|--|--|--|
| V AC | V DC | Catalogue Number | Catalogue Number | | | | | | |
| 120 | — | BQDST120 | BQDST120AAS▲ | | | | | | |
| 240 | — | BQDST240▲ | BQDST240AAS▲ | | | | | | |
| 277 | — | BQDST277▲ | BQDST277AAS▲ | | | | | | |
| 480 | — | BQDST480▲ | BQDST480AAS▲ | | | | | | |
| 600 | — | BQDST600▲ | BQDST600AAS▲ | | | | | | |
| — | 12 | BQDST12▲ | BQDST12DAS▲ | | | | | | |
| — | 24 | BQDST24▲ | BQDST24DAS▲ | | | | | | |
| — | 48 | BQDST48▲ | BQDST48DAS▲ | | | | | | |
| — | 125 | BQDST125▲ | BQDST125DAS▲ | | | | | | |

| Maximum Voltage | | Auxiliary Switch | Alarm Switch |
|-----------------|-----|------------------|------------------|
| AC | DC | Catalogue Number | Catalogue Number |
| 240 | 125 | BQDA1▲ | BQDBA▲ |
| 240 | 125 | BQDA2▲ | — |

For inches / millimeters conversion, multiply inches by 25.4.
■ Built to order. Allow 2–3 weeks for delivery.

▲ Built to order. Allow 6–8 weeks for delivery.
① SWD rated for switching 277V AC fluorescent lighting.
② HID rated at 277V AC.

③ Not suitable for 3 phase delta 480V and 600V applications.
④ HACR rated.
⑤ HID rated at 480Y/277V AC.

Accessories pages 5-69

Molded Case Circuit Breakers

QJ 225A Frame

Type QJ2^②

| Continuous Current Rating @ 40°C | 2-Pole | 3-Pole |
|----------------------------------|------------------|------------------|
| | 240V AC | 240V AC |
| | Catalogue Number | Catalogue Number |
| 60 | QJ22B060 | QJ23B060 |
| 70 | QJ22B070 | QJ23B070 |
| 80 | QJ22B080 | QJ23B080 |
| 90 | QJ22B090 | QJ23B090 |
| 100 | QJ22B100 | QJ23B100 |
| 110 | QJ22B110 | QJ23B110 |
| 125 | QJ22B125 | QJ23B125 |
| 150 | QJ22B150 | QJ23B150 |
| 175 | QJ22B175 | QJ23B175 |
| 200 | QJ22B200 | QJ23B200 |
| 225 | QJ22B225 | QJ23B225 |

Type QJH2^②

| | | |
|-----|-----------|-----------|
| 60 | QJH22B060 | QJH23B060 |
| 70 | QJH22B070 | QJH23B070 |
| 80 | QJH22B080 | QJH23B080 |
| 90 | QJH22B090 | QJH23B090 |
| 100 | QJH22B100 | QJH23B100 |
| 110 | QJH22B110 | QJH23B110 |
| 125 | QJH22B125 | QJH23B125 |
| 150 | QJH22B150 | QJH23B150 |
| 175 | QJH22B175 | QJH23B175 |
| 200 | QJH22B200 | QJH23B200 |
| 225 | QJH22B225 | QJH23B225 |

Type QJ2H^②

| | | |
|-----|-----------|-----------|
| 60 | QJ22B060H | QJ23B060H |
| 70 | QJ22B070H | QJ23B070H |
| 80 | QJ22B080H | QJ23B080H |
| 90 | QJ22B090H | QJ23B090H |
| 100 | QJ22B100H | QJ23B100H |
| 110 | QJ22B110H | QJ23B110H |
| 125 | QJ22B125H | QJ23B125H |
| 150 | QJ22B150H | QJ23B150H |
| 175 | QJ22B175H | QJ23B175H |
| 200 | QJ22B200H | QJ23B200H |
| 225 | QJ22B225H | QJ23B225H |

Type HQJ2^④

| | | |
|-----|---|------------|
| 100 | — | HQJ23B100H |
| 110 | — | HQJ23B110H |
| 125 | — | HQJ23B125H |
| 150 | — | HQJ23B150H |
| 175 | — | HQJ23B175H |
| 200 | — | HQJ23B200H |
| 225 | — | HQJ23B225H |

QJ2

Internal Accessories (Factory installed only) 3-pole only^③.

Add suffix to catalogue number.

| Control Voltage | | Shunt Trip Suffix | Auxiliary Switches | | Shunt Trip and 1A and 1B Auxiliary Switch Suffix |
|-----------------|----|-------------------|--------------------|------------------|--|
| AC | DC | | 1A and 1B Suffix | 2A and 2B Suffix | |
| 120/240 | — | 00S01 | A01 | A02 | 01S01 |
| — | 24 | 00S07 | A01 | A02 | 01S07 |
| — | 25 | 00S11 | A01 | A02 | 01S11 |

① See Note: A page 5-64.
 Note: QJ Breakers are UL Listed for reverse feed applications.
 ② HACR rated.

③ Internal accessories are **not available** on 2-pole QJ breakers.

④ HQJ2 is 65kAIC @ 240VAC and 100kAIC @ 208VAC.

Selection/Dimensions

Ordering Information

Load side TA1Q300 lugs are mounted and included when circuit breaker is ordered. For line and load lugs (TA1Q300) installed at no additional charge, add suffix "L" to catalogue number.

50°C Calibration - See page 5-67.

400HZ. - See page 5-67.

Shipping Weights

| QJ2, QJH2, QJ2H, HQJ2H | | |
|------------------------|-------------------|------------------------|
| Number of Poles | Number per Carton | Shipping Weight (lbs.) |
| 2 | 10 | 30 |
| 3 | 10 | 41 |

Lugs For 75°C Wire^①

| Catalogue Number | Lug Body | Lug Wire Range |
|------------------|----------|--|
| TA1Q300 | Al | (1) #6–300 kcmil Cu (1) #4–300 kcmil Al |
| TC1Q250 | Cu | (1) #6–250 kcmil Cu |

UL 489 Interrupting Ratings

| Breaker Type | AIR @ 240V AC |
|--------------|---------------|
| QJ2 | 10,000 |
| QJH2 | 22,000 |
| QJ2H | 42,000 |
| HQJ2H | 65,000 |

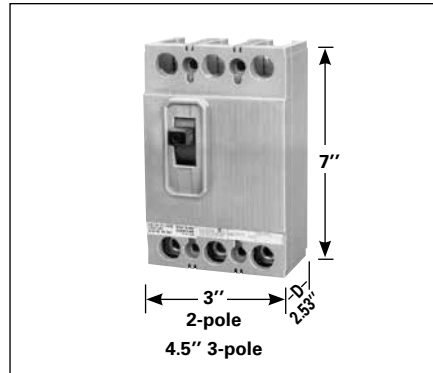

Molded Case Circuit Breakers

CQD 100A Frame

Selection

Type CQD (Cable In - Cable Out) DIN Rail Mount^④

| Continuous Current Rating @ 40°C | 1-Pole | 2-Pole | 3-Pole |
|----------------------------------|----------------------|-----------------------------|------------------|
| | 277V AC 125V DC | 480Y/277V AC 125/250V DC | 480Y/277V AC |
| | Catalogue Number | Catalogue Number | Catalogue Number |
| 15 | CQD115 ^{②③} | CQD215 | CQD315 |
| 20 | CQD120 ^{②③} | CQD220 | CQD320 |
| 25 | CQD125 ^② | CQD225 | CQD325 |
| 30 | CQD130 ^② | CQD230 | CQD330 |
| 35 | CQD135 | CQD235 | CQD335 |
| 40 | CQD140 | CQD240 | CQD340 |
| 45 | CQD145 | CQD245 | CQD345 |
| 50 | CQD150 | CQD250 | CQD350 |
| 60 | CQD160 | CQD260 | CQD360 |
| 70 | CQD170 | CQD270 | CQD370 |
| 80 | CQD180 | CQD280 | CQD380 |
| 90 | CQD190 | CQD290 | CQD390 |
| 100 | CQD1100 | CQD2100 | CQD3100 |

Shipping Weights

| Number of Poles | Number per Carton | Shipping Weight lbs. (kg) |
|-----------------|-------------------|---------------------------|
| 1 | 1 | 0.5 (0) |
| 2 | 1 | 1.0 (0) |
| 3 | 1 | 1.5 (1) |

Lugs For 60/75°C Wire

| Amps | Wire Size |
|--------|--------------------------------|
| 15-40 | #14-#6 AWG Cu #12-#6 AWG Al |
| 45-100 | #8-#1 AWG Cu #6-#1/0 AWG Al |

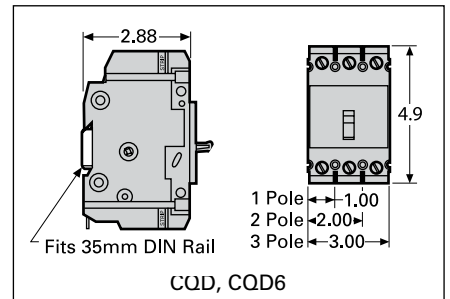

Type CQD6 (Cable In - Cable Out) CSA Certified (not UL)

| Continuous Current Rating @ 40°C | 1-Pole | 2-Pole | 3-Pole |
|----------------------------------|----------------------|-----------------------------|------------------|
| | 347V AC 125V DC | 600Y/347V AC 125/250V DC | 600Y/347V AC |
| | Catalogue Number | Catalogue Number | Catalogue Number |
| 15 | — | CQD6215 | CQD6315 |
| 20 | CQD6120 ^② | CQD6220 | CQD6320 |
| 25 | CQD6125 ^② | CQD6225 | CQD6325 |
| 30 | CQD6130 ^② | CQD6230 | CQD6330 |
| 35 | CQD6135 | CQD6235 | CQD6335 |
| 40 | CQD6140 | CQD6240 | CQD6340 |
| 45 | CQD6145 | CQD6245 | CQD6345 |
| 50 | CQD6150 | CQD6250 | CQD6350 |
| 60 | CQD6160 | CQD6260 | CQD6360 |
| 70 | CQD6170 | CQD6270 | — |

Interrupting Ratings

| Breaker Type | Number of Poles | RMS Symmetrical Amperes (KA) | | | | | |
|--------------|-----------------|------------------------------|-----|---------|---------|----------|-----|
| | | Volts AC (50/60 Hz) | | | | Volts DC | |
| | | 120 | 240 | 480/277 | 600/347 | 125 | 250 |
| CQD (UL) | 1 | 65 | — | 14 | — | 14 | — |
| | 2 | — | 65 | 14 | — | — | 14 |
| | 3 | — | 65 | 14 | — | — | — |
| CQD6 (CSA) | 1 | 65 | — | — | 14 | 14 | — |
| | 2 | — | 65 | — | 14 | — | 14 |
| | 3 | — | 65 | — | 14 | — | — |

Shunt Trip and Auxiliary Switch Combinations

| Shunt Trip Voltage | | CQD, CQD6, NGG Catalogue Number |
|--------------------|-----|---------------------------------|
| AC | DC | |
| 120 | — | CQDST120AAS▲ |
| 240 | — | CQDST240AAS▲ |
| 277 | — | CQDST277AAS▲ |
| 480 | — | CQDST480AAS▲ |
| 600 | — | CQDST600AAS▲ |
| — | 12 | CQDST12DAS▲ |
| — | 24 | CQDST24DAS▲ |
| — | 48 | CQDST48DAS▲ |
| — | 125 | CQDST125DAS▲ |

Shunt Trip

| Control Voltage | | CQD, CQD6, NGG Catalogue Number |
|-----------------|------|---------------------------------|
| V AC | V DC | |
| 120 | — | CQDST120 |
| 240 | — | CQDST240▲ |
| 277 | — | CQDST277▲ |
| 480 | — | CQDST480▲ |
| 600 | — | CQDST600 |
| — | 12 | CQDST12 |
| — | 24 | CQDST24 |
| — | 48 | CQDST48 |
| — | 125 | CQDST125 |

Auxiliary Switch

| Maximum Voltage | | Number of Contacts | CQD, CQD6, NGG Catalogue Number |
|-----------------|-----|--------------------|---------------------------------|
| AC | DC | | |
| 240 | 125 | 1A-1B | CQDA1 |
| 240 | 125 | 2A-2B | CQDA2 |

Alarm Switch

| Maximum Voltage | | CQD, CQD6, NGG Catalogue Number |
|-----------------|-----|---------------------------------|
| AC | DC | |
| 240 | 125 | CQDBA |

For inches / millimeters conversion, see Application Data section.

- ②SWD rated.
- ③HID rated.
- ④HACR rated.

Alarm and Auxiliary Switch Combinations

| For Breaker | Catalogue Number |
|----------------|------------------|
| CQD, CQD6, NGG | CQDA1BA▲ |

Accessories page 5-68

Molded Case Circuit Breakers

ED 125A Frame Sentron Series

Selection

Ordering Instructions

- All ED Frame Sentron circuit breakers are supplied with load side lugs. If line side lugs are required, add "L" suffix to catalogue number. Consult Siemens sales office for any additional charge.
- 50°C Calibration, 400HZ - see page 5-67. All ED frame circuit breakers may be reverse connected.

Type ED2[®]

| Continuous Current Rating @ 40°C | 1-Pole | | 2-Pole | | 3-Pole |
|----------------------------------|-----------------------|---------|------------------|--------------------|------------------|
| | 120V AC | 125V DC | 240V AC | 125V DC 250V DC | 240V AC |
| | Catalogue Number | | Catalogue Number | | Catalogue Number |
| 15 | ED21B015 [®] | | — | | ED23B015 |
| 20 | ED21B020 [®] | | ED22B020 | | ED23B020 |
| 25 | ED21B025 | | ED22B025 | | ED23B025 |
| 30 | ED21B030 | | ED22B030 | | ED23B030 |
| 35 | ED21B035 | | ED22B035 | | ED23B035 |
| 40 | ED21B040 | | ED22B040 | | ED23B040 |
| 45 | ED21B045 | | ED22B045 | | ED23B045 |
| 50 | ED21B050 | | ED22B050 | | ED23B050 |
| 60 | ED21B060 | | ED22B060 | | ED23B060 |
| 70 | ED21B070 | | ED22B070 | | ED23B070 |
| 80 | ED21B080 | | ED22B080 | | ED23B080 |
| 90 | ED21B090 | | ED22B090 | | ED23B090 |
| 100 | ED21B100 | | ED22B100 | | ED23B100 |

Type ED4[®]

| Continuous Current Rating @ 40°C | 1-Pole | | 2-Pole | | 3-Pole |
|----------------------------------|-----------------------|---------|------------------|---------|------------------|
| | 120V AC | 125V DC | 480V AC | 250V DC | 480V AC |
| | Catalogue Number | | Catalogue Number | | Catalogue Number |
| 15 | ED41B015 [®] | | — | | ED43B015 |
| 20 | ED41B020 [®] | | ED42B020 | | ED43B020 |
| 25 | ED41B025 | | ED42B025 | | ED43B025 |
| 30 | ED41B030 | | ED42B030 | | ED43B030 |
| 35 | ED41B035 | | ED42B035 | | ED43B035 |
| 40 | ED41B040 | | ED42B040 | | ED43B040 |
| 45 | ED41B045 | | ED42B045 | | ED43B045 |
| 50 | ED41B050 | | ED42B050 | | ED43B050 |
| 60 | ED41B060 | | ED42B060 | | ED43B060 |
| 70 | ED41B070 | | ED42B070 | | ED43B070 |
| 80 | ED41B080 | | ED42B080 | | ED43B080 |
| 90 | ED41B090 | | ED42B090 | | ED43B090 |
| 100 | ED41B100 | | ED42B100 | | ED43B100 |
| 110 | — | | ED42B110 | | ED43B110 |
| 125 | — | | ED42B125 | | ED43B125 |

Type ED6[®]

| Continuous Current Rating @ 40°C | 1-Pole [®] | | 2-Pole | | 3-Pole |
|----------------------------------|---------------------|---------|------------------|---------|------------------|
| | 347V AC | 250V DC | 600V AC | 250V DC | 600V AC |
| | Catalogue Number | | Catalogue Number | | Catalogue Number |
| 15 | ED61B015 | | — | | ED63B015 |
| 20 | ED61B020 | | ED62B020 | | ED63B020 |
| 25 | ED61B025 | | ED62B025 | | ED63B025 |
| 30 | ED61B030 | | ED62B030 | | ED63B030 |
| 35 | ED61B035 | | ED62B035 | | ED63B035 |
| 40 | ED61B040 | | ED62B040 | | ED63B040 |
| 45 | ED61B045 | | ED62B045 | | ED63B045 |
| 50 | ED61B050 | | ED62B050 | | ED63B050 |
| 60 | ED61B060 | | — | | ED63B060 |
| 70 | ED61B070 | | — | | ED63B070 |
| 80 | ED61B080 | | — | | ED63B080 |
| 90 | ED61B090 | | — | | ED63B090 |
| 100 | ED61B100 | | — | | ED63B100 |
| 110 | — | | — | | ED63B110 |
| 125 | — | | — | | ED63B125 |

Note: ED frame circuit breakers qualified to UL 489 Supplement SB "Naval" — See page 5-67 for additional information

®CSA Certified only (Not UL)

®For CED types and all 110–125 ampere ED frames.

®See Note: A, page 5-64.

®SWD rated.

®HACR rated.

Shipping Weights

| Number of Poles | Number per Carton | Shipping Weight (lbs.) |
|---------------------|-------------------|------------------------|
| ED2, ED4, ED6, HED4 | | |
| 1 | 30 | 38 |
| 2 | 10 | 25 |
| 3 | 10 | 38 |
| CED6 | | |
| 2 | 5 | 20 |
| 3 | 5 | 30 |

Lugs

| Ampere Rating | No. of Poles | Catalogue Number | Wire Range |
|-------------------------|--------------|----------------------------------|--------------------------|
| Aluminum Body Lugs | | | |
| All 15–25A | 1, 2, 3 | Line/Load SA1E025 | #14–#10 Cu #12–#10 Al |
| All 30–100A | 1, 2, 3 | Line Side LN1E100 | #10–1/0 Cu/Al |
| ED2, 4, CED6 30–60A | 1 | Load Side LD1E060 | #10–#4 Cu/Al |
| ED2, 4, CED6 70–100A | 1 | Load Side LD1E100 | #6–#1/0 Cu/Al |
| ED2, 4, 6, HED4 30–100A | 2, 3 | Load Side LN1E100 | #10–1/0 Cu/Al |
| All 110, 125A | 2, 3 | Line/Load TA1E6125 | #3–3/0 Cu #1–2/0 Al |
| Copper Body Lugs | | | |
| All 30–125A only | 1, 2, 3 | Line/Load TC1ED6150 [®] | #10–1/0 Cu |
| Compression Lugs | | | |
| All ED, CED | | CCE125 | 2/0 |

5 MOLDED CASE CIRCUIT BREAKERS

Modifications page 5-67
Accessories page 5-68

Molded Case Circuit Breakers

ED 125A Frame Sentron Series

Selection

Type HED4[®]

Black Label

| Continuous Current Rating @ 40°C | 1-Pole | | 2-Pole | | 3-Pole |
|----------------------------------|------------------------|---------|------------------|---------|------------------|
| | 277V AC | 125V DC | 480V AC | 250V DC | 480V AC |
| | Catalogue Number | | Catalogue Number | | Catalogue Number |
| 15 | HED41B015 ^① | | HED42B015 | | HED43B015 |
| 20 | HED41B020 ^① | | HED42B020 | | HED43B020 |
| 25 | HED41B025 | | HED42B025 | | HED43B025 |
| 30 | HED41B030 | | HED42B030 | | HED43B030 |
| 35 | HED41B035 | | HED42B035 | | HED43B035 |
| 40 | HED41B040 | | HED42B040 | | HED43B040 |
| 45 | HED41B045 | | HED42B045 | | HED43B045 |
| 50 | HED41B050 | | HED42B050 | | HED43B050 |
| 60 | HED41B060 | | HED42B060 | | HED43B060 |
| 70 | HED41B070 | | HED42B070 | | HED43B070 |
| 80 | HED41B080 | | HED42B080 | | HED43B080 |
| 90 | HED41B090 | | HED42B090 | | HED43B090 |
| 100 | HED41B100 | | HED42B100 | | HED43B100 |
| 110 | — | | HED42B110 | | HED43B110 |
| 125 | — | | HED42B125 | | HED43B125 |

FIGURE 1 - ED, HED, HHED

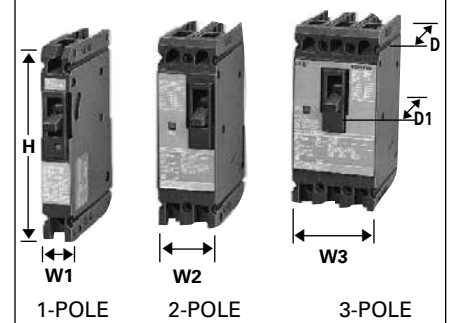
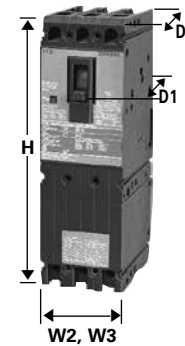

FIGURE 2 - CED (3-Pole shown)



Fuseless Current Limiting

Type CED6

Red Label

| Continuous Current Rating @ 40°C | 2-Pole | | 3-Pole |
|----------------------------------|------------------|--|-------------------------------|
| | 600V AC, 250V DC | | 600V AC, 500V DC ^② |
| | Catalogue Number | | Catalogue Number |
| 15 | — | | CED63B015 |
| 20 | CED62B020 | | CED63B020 |
| 25 | — | | — |
| 30 | CED62B030 | | CED63B030 |
| 35 | — | | — |
| 40 | CED62B040 | | CED63B040 |
| 45 | — | | — |
| 50 | CED62B050 | | CED63B050 |
| 60 | CED62B060 | | CED63B060 |
| 70 | CED62B070 | | CED63B070 |
| 80 | CED62B080 | | CED63B080 |
| 90 | CED62B090 | | CED63B090 |
| 100 | CED62B100 | | CED63B100 |
| 110 | — | | CED63B110 |
| 125 | CED62B125 | | CED63B125 |

Dimensions (in inches)

| Breaker Type | W1 | W2 | W3 | H | D | D1 |
|---|----|----|----|------|------|------|
| Figure 1 ED2, ED4, ED6, HED4, ED6 ETI | 1 | 2 | 3 | 6.35 | 3.92 | 4.56 |
| Figure 2 CED6, CED6 ETI | — | 2 | 3 | 9.58 | 3.92 | 4.56 |

Interrupting Ratings

| Breaker Type | CSA C22.2 No.5-02 / UL 489 AIR (File #E10848) | | | | | | | | | IEC 947-2 | | | | | |
|----------------------------|---|-----|-----|-----------------|-----|-----|----------|----------|------------------|-----------|-----|---------|-----|-----|-----|
| | RMS Symmetrical Amperes (KA) | | | | | | | | | | | | | | |
| | Volts AC | | | | | | Volts DC | | | 220/240 | | 380/415 | | 500 | |
| | 120 | 240 | 277 | 347 | 480 | 600 | 125 | 250 | 500 ^③ | Icu | Ics | Icu | Ics | Icu | Ics |
| ED2 (1-P) | 10 | — | — | — | — | — | 5 | — | — | — | — | — | — | — | — |
| ED2 (2, 3-P) | — | 10 | — | — | — | — | — | 5 (2-P) | — | — | — | — | — | — | — |
| ED4 (1-P) | 65 | — | 22 | — | — | — | 30 | — | — | — | — | — | — | — | — |
| ED4 (2, 3-P) | — | 65 | — | — | 18 | — | — | 30 (2-P) | — | — | — | — | — | — | — |
| ED6 (1-P) | — | — | — | 30 ^④ | — | — | — | — | — | — | — | — | — | — | — |
| ED6 (2, 3-P) | — | 65 | — | — | 25 | 18 | — | 30 (2-P) | 18 (3-P) | 65 | 17 | 35 | 9 | 18 | 5 |
| HED4 (1-P) (15-30A) | 100 | — | 65 | — | — | — | 30 | — | — | — | — | — | — | — | — |
| HED4 (1-P) (35-100A) | 100 | — | 25 | — | — | — | 30 | — | — | — | — | — | — | — | — |
| HED4 (2, 3-P) ^⑤ | — | 100 | — | — | 42 | — | — | 30 (2-P) | — | — | — | — | — | — | — |
| CED6 (2, 3-P) | — | 200 | — | — | 200 | 100 | — | 30 (2-P) | 50 (3-P) | — | — | — | — | — | — |

①SWD rated.

②When wired as shown on page 5-2, this circuit breaker is CSA Certified / UL listed and rated for use on 500V DC ungrounded UPS systems.

③HED4 type circuit breakers meet the CSA / UL criteria for "current limiting" at 240V AC.

④ED6-ETI, CED6-ETI, see page 5-50 for ordering information.

⑤Single Pole 15-30A 30KA @ 347V non-ul.
35-100A 18KA @ 347V non-ul.

⑥HACR rated.

Molded Case Circuit Breakers

Accessories

Selection

Accessories for:

ED 125A Frame



Combinations

Available only when ordered together.

Only one module can be added to a breaker. Additional accessories, which always attach to the left pole, cannot be added to the combination later. Adds 1 inch pole space.

Equipment Ground Sensing

A field addable kit containing 30mA or 5 mA ground fault accessory module, current transformer with 24 inch leads, and current transformer mounting equipment. Current transformer to mount in gutter of lighting panel or any control panel. **Accessory module operates from separate 120V control power source.**

Both 30MA and 5MA devices are equipment protection devices only. **Do not use for personnel protection.**



Shunt Trip Combinations

| Control Voltage | | 1 Shunt Trip | 1 Shunt Trip and 1 Auxiliary Switch | 1 Shunt Trip 1 Auxiliary Switch and 1 Alarm Switch | 1 Shunt Trip and 1 Alarm Switch | 1 Shunt Trip and 2 Auxiliary Switches |
|-----------------|-----|------------------|-------------------------------------|--|---------------------------------|---------------------------------------|
| AC | DC | Catalogue Number | Catalogue Number | Catalogue Number | Catalogue Number | Catalogue Number |
| 24 | — | S17ED60 | — | — | — | — |
| 48 | — | S18ED60 | — | — | — | — |
| 120 | — | S01ED60 | S01ED62A | S01ED62AB | S01ED62B | S01ED62AA |
| 208 | — | — | S02ED62A | S02ED62AB | S02ED62B | S02ED62AA |
| 240 | — | S03ED60 | S03ED62A | S03ED62AB | S03ED62B | S03ED62AA |
| 277 | — | S15ED60 | S15ED64A | S15ED64AB | S15ED64B | — |
| 480 | — | S04ED60 | S04ED64A | S04ED64AB | S04ED64B | — |
| — | 12 | S16ED60 | S16ED62A | — | — | — |
| — | 24 | S07ED60 | S07ED62A | S07ED62AB | S07ED62B | S07ED62AA |
| — | 48 | S09ED60 | S09ED62A | S09ED62AB | S09ED62B | S09ED62AA |
| — | 125 | S11ED60 | S11ED62A | S11ED62AB | S11ED62B | S11ED62AA |
| — | 250 | S13ED60 | S13ED62A | S13ED62AB | S13ED62B | S13ED62AA |

Undervoltage Trip Combinations

| Control Voltage | | 1 Undervoltage Trip | 1 Undervoltage Trip and 1 Auxiliary Switch | 1 Undervoltage Trip and 1 Auxiliary Switch and 1 Alarm Switch | 1 Undervoltage Trip and 1 Alarm Switch | 1 Undervoltage Trip and 2 Auxiliary Switches |
|-----------------|-----|---------------------|--|---|--|--|
| AC | DC | Catalogue Number | Catalogue Number | Catalogue Number | Catalogue Number | Catalogue Number |
| 120 | — | U01ED60 | U01ED62A | U01ED62AB | U01ED62B | U01ED62AA |
| 208 | — | U02ED60 | U02ED62A | U02ED62AB | U02ED62B | U02ED62AA |
| 240 | — | U03ED60 | U03ED62A | U03ED62AB | U03ED62B | U03ED62AA |
| 277 | — | U16ED60 | U16ED64A | U16ED64AB | U16ED64B | — |
| 480 | — | U06ED60 | U06ED64A | U06ED64AB | U06ED64B | — |
| 600 | — | U08ED60 | — | — | — | — |
| — | 24 | U13ED60 | U13ED62A | U13ED62AB | U13ED62B | U13ED62AA |
| — | 48 | U14ED60 | U14ED62A | U14ED62AB | U14ED62B | U14ED62AA |
| — | 125 | U10ED60 | U10ED62A | U10ED62AB | U10ED62B | U10ED62AA |
| — | 250 | U12ED60 | U12ED62A | — | — | U12ED62AA |

Auxiliary and Alarm Switch Combinations

| Maximum Voltage | | 1 Auxiliary Switch* | 1 Alarm Switch | Alarm Switch and 1 Auxiliary Switch | 2 Auxiliary Switches | 1 Alarm Switch and 2 Auxiliary Switches |
|-----------------|-----|---|------------------|-------------------------------------|----------------------|---|
| AC | DC | Catalogue Number | Catalogue Number | Catalogue Number | Catalogue Number | Catalogue Number |
| 240 | 250 | A01ED62 | B00ED62 | A01ED62B | A02ED62 | A02ED62B |
| 480 | — | A01ED64 | B00ED64 | A01ED64B | — | — |
| — | 12 | A01EDLV* Gold Plated Contacts — for PLC use | | | | |

Alarm Switch Only

| Maximum Voltage | | 1 Alarm Switch |
|-----------------|-----|------------------|
| AC | DC | Catalogue Number |
| 240 | 250 | B00ED62 |
| 480 | — | B00ED64 |

Ground Fault Sensing Relay Kit — Equipment Protection Only

| For Use With Breaker Frame | Number of Poles | Description | Catalogue Number | |
|----------------------------|-----------------|---|------------------|------------|
| | | | 30mA | 5mA |
| ED2, ED4, ED6, HED4, CED6 | 1, 2, 3 | Basic Kit | GF01ED60 | GF01ED65 |
| | | Basic Kit with Normally Open Bell Alarm | GF01ED60B0 | GF01ED65B0 |
| | | Basic Kit with Normally Closed Bell Alarm | GF01ED60BC | GF01ED65BC |

Molded Case Circuit Breakers

FD 250A Frame Sentron Series

Selection

Type FXD6-A^{①②}

Blue Label

| Non-Interchangeable Trip (Assembled Circuit Breaker – Without Lugs) | | |
|---|---------------------|-------------------------|
| Continuous Current Rating @ 40°C | 2-Pole ^② | |
| | Catalogue Number | 3-Pole Catalogue Number |
| 70 | FXD62B070 | FXD63B070 |
| 80 | FXD62B080 | FXD63B080 |
| 90 | FXD62B090 | FXD63B090 |
| 100 | FXD62B100 | FXD63B100 |
| 110 | FXD62B110 | FXD63B110 |
| 125 | FXD62B125 | FXD63B125 |
| 150 | FXD62B150 | FXD63B150 |
| 175 | FXD62B175 | FXD63B175 |
| 200 | FXD62B200 | FXD63B200 |
| 225 | FXD62B225 | FXD63B225 |
| 250 | FXD62B250 | FXD63B250 |

Type FD6-A^②

Blue Label

| Interchangeable Trip | | | |
|----------------------------------|--|------------------|------------------|
| Continuous Current Rating @ 40°C | Complete Breaker Unassembled with Lugs | Frame Only | Trip Unit Only |
| | Catalogue Number | Catalogue Number | Catalogue Number |
| 70 | FD62B070 | FD62F250 | FD62T070 |
| 80 | FD62B080 | | FD62T080 |
| 90 | FD62B090 | | FD62T090 |
| 100 | FD62B100 | | FD62T100 |
| 110 | FD62B110 | | FD62T110 |
| 125 | FD62B125 | | FD62T125 |
| 150 | FD62B150 | | FD62T150 |
| 175 | FD62B175 | | FD62T175 |
| 200 | FD62B200 | | FD62T200 |
| 225 | FD62B225 | | FD62T225 |
| 250 | FD62B250 | | FD62T250 |

2-Pole 600V AC, 250V DC^②

| | | | |
|-----|----------|----------|----------|
| 70 | FD62B070 | FD62F250 | FD62T070 |
| 80 | FD62B080 | | FD62T080 |
| 90 | FD62B090 | | FD62T090 |
| 100 | FD62B100 | | FD62T100 |
| 110 | FD62B110 | | FD62T110 |
| 125 | FD62B125 | | FD62T125 |
| 150 | FD62B150 | | FD62T150 |
| 175 | FD62B175 | | FD62T175 |
| 200 | FD62B200 | | FD62T200 |
| 225 | FD62B225 | | FD62T225 |
| 250 | FD62B250 | | FD62T250 |

3-Pole 600V AC, 500V DC^③

| | | | |
|-----|----------|----------|----------|
| 70 | FD63B070 | FD63F250 | FD63T070 |
| 80 | FD63B080 | | FD63T080 |
| 90 | FD63B090 | | FD63T090 |
| 100 | FD63B100 | | FD63T100 |
| 110 | FD63B110 | | FD63T110 |
| 125 | FD63B125 | | FD63T125 |
| 150 | FD63B150 | | FD63T150 |
| 175 | FD63B175 | | FD63T175 |
| 200 | FD63B200 | | FD63T200 |
| 225 | FD63B225 | | FD63T225 |
| 250 | FD63B250 | | FD63T250 |

Interrupting Ratings

| Breaker Type | RMS Symmetrical Amperes (KA) | | | | | | | | | | |
|--|--------------------------------|-----|-----|----------|------------------|--------------------|-----|---------|-----|-----|-----|
| | CSA / UL 489 AIR (File E10848) | | | | | IEC 947-2 | | | | | |
| | Volts AC (50/60Hz) | | | Volts DC | | Volts AC (50/60Hz) | | | | | |
| | 240 | 480 | 600 | 250 | 500 ^④ | 220/240 | | 380/415 | | 500 | |
| | | | | | | lcu | lcs | lcu | lcs | lcu | lcs |
| FXD6-A, FD6-A | 65 | 35 | 22 | 30 (2-P) | 18 (3-P) | 65 | 33 | 35 | 9 | 20 | 10 |
| HFXD6 ^⑤ , HFD6 ^⑤ | 100 | 65 | 25 | 30 (2-P) | 25 (3-P) | 100 | 50 | 65 | 33 | 42 | 21 |
| HHFD6 ^⑤ , HHFXD6 ^⑤ | 200 | 100 | 25 | — | — | 200 | 100 | 100 | 50 | 65 | 33 |
| CFD6 | 200 | 200 | 100 | 50 (2-P) | 50 (3-P) | — | — | — | — | — | — |

Instantaneous Adjustment Trip Range

| Breaker Ampere Rating | Nominal Instantaneous Values | | | | | | | |
|-----------------------|------------------------------|------|------|------|------|------|------|-------------------|
| | Low ^⑥ | 2 | 3 | 4 | 5 | 6 | 7 | High ^⑥ |
| 70-90 | 600 | 640 | 690 | 730 | 770 | 810 | 850 | 900 |
| 100-110 | 700 | 770 | 840 | 920 | 990 | 1060 | 1140 | 1200 |
| 125-150 | 800 | 900 | 1000 | 1100 | 1200 | 1300 | 1400 | 1500 |
| 175-200 | 900 | 1060 | 1210 | 1370 | 1520 | 1780 | 1930 | 2000 |
| 225-250 | 1100 | 1300 | 1500 | 1700 | 1900 | 2100 | 2300 | 2500 |

Note: FD frame qualified to UL489 supplement SB "NAVAL"
See page 5-67 for additional information.

Ordering Information

Complete Breaker Unassembled with Lugs

Prices of FD6, HFD6, and HHFD6 breakers includes frame, trip and both line and load lugs (TA1FD350A). When ordered by these catalogue numbers, the customer will receive the frame, trip, and lugs separately packaged. For applications requiring different lugs, order individual items as needed.

Complete Breaker Assembled without Lugs

Prices of FXD6, HFXD6, HHFXD6, and CFD6 includes frame with non-interchangeable trip unit installed only. Order required lugs separately. For line and load lugs (TA1FD350A) installed, add suffix "L" to catalogue number (add 2 times list price of lugs for each pole).

50°C Applications see page 5-67.

400 Hz Applications see page 5-67.

Lugs For 75°C Wire^⑦

| Catalogue Number | Wire Range |
|------------------|-------------------|
| TA1FD350A | #6 – 350 kcmil Cu |
| TC1FD350 | #4 – 350 kcmil Al |
| | #6 – 350 kcmil Cu |
| Compression Lug | |
| CCF250 | 350 kcmil Cu/Al |

① Type FXD6-A circuit breakers are UL Listed for reverse fed applications.

② 2-pole units are 3-pole width.

③ When wired as shown on page 5-2, this circuit breaker is CSA Certified / UL listed and rated for use on 500V DC ungrounded UPS systems only.

④ See Note A, page 5-64.

⑤ HFD6 and HHFD6 type circuit breakers meet the UL criteria for "current limiting" at 240 and 480V AC.

⑥ HACR rated.

⑦ +/- 20% Tolerance.

Modifications page 5-67
Accessories page 5-68

Molded Case Circuit Breakers

FD 250A Frame Sentron Series

Selection/Dimensions

Type HFD6^③, Type HFXD6^{③④⑤⑥}

Black Label

| Interchangeable Trip | | | |
|----------------------------------|--|------------------|------------------|
| Continuous Current Rating @ 40°C | Complete Breaker Unassembled with Lugs | Frame Only | Trip Unit Only |
| | Catalogue Number | Catalogue Number | Catalogue Number |

2-Pole 600V AC, 250V DC (3 Pole Width)

| Continuous Current Rating @ 40°C | Complete Breaker Unassembled with Lugs | Frame Only | Trip Unit Only |
|----------------------------------|--|------------|----------------|
| 70 | HFD62B070 | HFD62F250 | FD62T070 |
| 80 | HFD62B080 | | FD62T080 |
| 90 | HFD62B090 | | FD62T090 |
| 100 | HFD62B100 | | FD62T100 |
| 110 | HFD62B110 | | FD62T110 |
| 125 | HFD62B125 | | FD62T125 |
| 150 | HFD62B150 | | FD62T150 |
| 175 | HFD62B175 | | FD62T175 |
| 200 | HFD62B200 | | FD62T200 |
| 225 | HFD62B225 | | FD62T225 |
| 250 | HFD62B250 | | FD62T250 |

3-Pole 600V AC, 500V DC^①

| Continuous Current Rating @ 40°C | Complete Breaker Unassembled with Lugs | Frame Only | Trip Unit Only |
|----------------------------------|--|------------|----------------|
| 70 | HFD63B070 | HFD63F250 | FD63T070 |
| 80 | HFD63B080 | | FD63T080 |
| 90 | HFD63B090 | | FD63T090 |
| 100 | HFD63B100 | | FD63T100 |
| 110 | HFD63B110 | | FD63T110 |
| 125 | HFD63B125 | | FD63T125 |
| 150 | HFD63B150 | | FD63T150 |
| 175 | HFD63B175 | | FD63T175 |
| 200 | HFD63B200 | | FD63T200 |
| 225 | HFD63B225 | | FD63T225 |
| 250 | HFD63B250 | | FD63T250 |

Type HHFD^④, HHFXD6^{②③④⑥}

3-Pole 600V AC, Extra High Interrupting

| Continuous Current Rating @ 40°C | Complete Breaker Unassembled with Lugs | Frame Only | Trip Unit Only |
|----------------------------------|--|------------|----------------|
| 70 | HHFD63B070 | HHFD63F250 | FD63T070 |
| 80 | HHFD63B080 | | FD63T080 |
| 90 | HHFD63B090 | | FD63T090 |
| 100 | HHFD63B100 | | FD63T100 |
| 110 | HHFD63B110 | | FD63T110 |
| 125 | HHFD63B125 | | FD63T125 |
| 150 | HHFD63B150 | | FD63T150 |
| 175 | HHFD63B175 | | FD63T175 |
| 200 | HHFD63B200 | | FD63T200 |
| 225 | HHFD63B225 | | FD63T225 |
| 250 | HHFD63B250 | | FD63T250 |

Type CFD6^{③⑥}

Fuseless Current Limiting

Red Label

| Non-Interchangeable Trip (Assembled Circuit Breaker Without Lugs) | |
|---|------------------|
| Continuous Current Rating @ 40°C | 3-Pole |
| | 600V AC/500V DC |
| | Catalogue Number |
| 70 | CFD63B070 |
| 80 | CFD63B080 |
| 90 | CFD63B090 |
| 100 | CFD63B100 |
| 110 | CFD63B110 |
| 125 | CFD63B125 |
| 150 | CFD63B150 |
| 175 | CFD63B175 |
| 200 | CFD63B200 |
| 225 | CFD63B225 |
| 250 | CFD63B250 |

① When wired as shown on page 5-2, this circuit breaker is CSA Certified / UL listed and rated for use on 500V DC ungrounded UPS systems.

② For non-interchangeable trip 3-pole HFD6 type circuit breaker, change prefix identifier from HFD6 to HFXD6. Price equals frame and trip prices combined, e.g. price of HFXD63B250 equals price of HFD63F250 plus price of FD63T250. Order lugs separately.

③ Type HFXD6, HHFXD6, CFD6 are UL Listed for reverse feed applications.

④ Type HFXD6, HFD6, HHFD6, HHFXD6 meet the CSA Certified / UL criteria for "Current Limiting" at 240 VAC and 480V AC.

⑤ FXD6, ETI, CFD6, ETI — See page 5-50 for ordering information.

⑥ HACR rated.

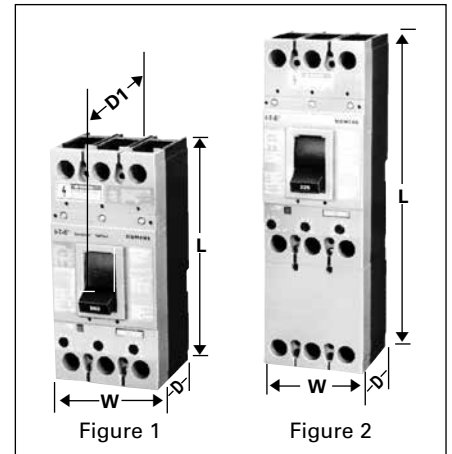

Dimensions (in inches)

| Breaker Type | W | L | D | D1 (to handle) |
|---|------|-------|---|----------------|
| Figure 1 FXD6-A, FD6-A, HFD6, HFXD6, HHFD6, FD6-ETI ^⑤ | 4.50 | 9.50 | 4 | 5.25 |
| Figure 2 CFD6, CFD6-ETI ^⑤ | 4.50 | 14.25 | 4 | 5.25 |

Shipping Weights

| Number of Poles | Number per Carton | Shipping Weight (lbs.) |
|---|-------------------|------------------------|
| FD6-A, HFD6, HHFD6, FXD6-A Assembled Circuit Breaker (less connectors) | | |
| 2 | 1 | 8.6 |
| 3 | 1 | 10 |
| FD6-A, HFD6, HHFD6 Frame Only | | |
| 2 | 1 | 7.5 |
| 3 | 1 | 8.7 |
| FD6 Trip Unit Only | | |
| 2 | 1 | 1.1 |
| 3 | 1 | 1.3 |
| CFD6 Assembled Circuit Breaker (less terminals) | | |
| 2 | 1 | 31 |
| 3 | 1 | 34 |

Molded Case Circuit Breakers

Internal Accessories

Selection

Accessories:
FD 250A Frame



Shunt Trip Combinations

| Control Voltage | | 1 Shunt Trip |
|-----------------|-----|------------------|
| AC | DC | Catalogue Number |
| 24 | — | S17FD60 |
| 120 | — | S01FD60 |
| 240 | — | S03FD60 |
| 277 | — | S15FD60 |
| 480 | — | S04FD60 |
| 600 | — | S06FD60 |
| — | 12 | S16FD60 |
| — | 24 | S07FD60 |
| — | 48 | S09FD60 |
| — | 125 | S11FD60 |
| — | 250 | S13FD60 |

Undervoltage Trip Combinations

| Control Voltage | | 1 Undervoltage Trip | 1 Undervoltage Trip and 1 Auxiliary Switch |
|-----------------|-----|---------------------|--|
| AC | DC | Catalogue Number | Catalogue Number |
| 120 | — | U01FD60 | W01FD64 |
| 208 | — | U02FD60 | W02FD64 |
| 240 | — | U03FD60 | W03FD64 |
| 277 | — | U16FD60 | W16FD64 |
| 480 | — | U06FD60 | W06FD64 |
| 600 | — | U08FD60 | W08FD64 |
| — | 24 | U13FD60 | W13FD64 |
| — | 48 | U14FD60 | W14FD64 |
| — | 125 | U10FD60 | W10FD64 |
| — | 250 | U12FD60 | W12FD64 |

Auxiliary Switch Combinations

| Voltage | | 1 Auxiliary Switch | 2 Auxiliary Switches |
|---------|----|--------------------|------------------------------------|
| AC | DC | Catalogue Number | Catalogue Number |
| 240 | — | A01FD62 | A02FD62 |
| 480 | — | A01FD64 | A02FD64 |
| — | 12 | A01FDLV | Gold Plated Contacts - for PLC use |

Alarm Switch Combinations

| Maximum Voltage | | 1 Alarm Switch | 1 Alarm Switch and 1 Auxiliary Switch |
|-----------------|-----|------------------|---------------------------------------|
| AC | DC | Catalogue Number | Catalogue Number |
| 480 | 250 | B00FD64 | C01FD64 |

©Auxiliary switch application is for 480V AC maximum.
Note: Old F-frame accessories cannot be used in new Sentron line. Likewise, new FD-frame accessories cannot be used on old F-frame circuit breakers.

Molded Case Circuit Breakers

JD 400A Frame Sentron Series

Selection

Type JXD2-A^⑤

240V AC, 2-pole 250V DC only

Blue Label

| Non-Interchangeable Trip (Assembled Circuit Breaker without Lugs) | | | |
|---|-----------------------|-----------|------------------|
| Continuous Current Rating @ 40°C | 2-Pole (3 Pole Width) | | 3-Pole |
| | Catalogue Number | | Catalogue Number |
| 200 | JXD22B200 | JXD23B200 | |
| 225 | JXD22B225 | JXD23B225 | |
| 250 | JXD22B250 | JXD23B250 | |
| 300 | JXD22B300 | JXD23B300 | |
| 350 | JXD22B350 | JXD23B350 | |
| 400 | JXD22B400 | JXD23B400 | |

Type JXD6-A^{①⑤}

600V AC, 2-pole 250V DC, 3-pole 500V DC

Blue Label

| Non-Interchangeable Trip (Assembled Circuit Breaker without Lugs) | | | |
|---|-----------------------|-----------|------------------|
| Continuous Current Rating @ 40°C | 2-Pole (3 Pole Width) | | 3-Pole |
| | Catalogue Number | | Catalogue Number |
| 200 | JXD62B200 | JXD63B200 | |
| 225 | JXD62B225 | JXD63B225 | |
| 250 | JXD62B250 | JXD63B250 | |
| 300 | JXD62B300 | JXD63B300 | |
| 350 | JXD62B350 | JXD63B350 | |
| 400 | JXD62B400 | JXD63B400 | |

Type JD6-A^⑥

Blue Label

| Interchangeable Trip | | | |
|----------------------------------|--|------------------|------------------|
| Continuous Current Rating @ 40°C | Complete Breaker Unassembled with Lugs | Frame Only | Trip Unit Only |
| | Catalogue Number | Catalogue Number | Catalogue Number |
| 200 | JD62B200 | JD62F400 | JD62T200 |
| 225 | JD62B225 | | JD62T225 |
| 250 | JD62B250 | | JD62T250 |
| 300 | JD62B300 | | JD62T300 |
| 350 | JD62B350 | | JD62T350 |
| 400 | JD62B400 | | JD62T400 |

2-Pole 600V AC, 250V DC (3 Pole Width)

| Continuous Current Rating @ 40°C | Catalogue Number | Frame Only | Trip Unit Only |
|----------------------------------|------------------|------------|------------------|
| | | | Catalogue Number |
| 200 | JD62B200 | JD62F400 | JD62T200 |
| 225 | JD62B225 | | JD62T225 |
| 250 | JD62B250 | | JD62T250 |
| 300 | JD62B300 | | JD62T300 |
| 350 | JD62B350 | | JD62T350 |
| 400 | JD62B400 | | JD62T400 |

3-Pole 600V AC, 500V DC^②

| Continuous Current Rating @ 40°C | Catalogue Number | Frame Only | Trip Unit Only |
|----------------------------------|------------------|------------|------------------|
| | | | Catalogue Number |
| 200 | JD63B200 | JD63F400 | JD63T200 |
| 225 | JD63B225 | | JD63T225 |
| 250 | JD63B250 | | JD63T250 |
| 300 | JD63B300 | | JD63T300 |
| 350 | JD63B350 | | JD63T350 |
| 400 | JD63B400 | | JD63T400 |

Interrupting Ratings

| Breaker Type | RMS Symmetrical Amperes (KA) | | | | | | | | | | |
|------------------------------|---|-----|-----|----------|------------------|--------------------|-----|---------|-----|-----|----|
| | CSA 22.2 No.5-02 / UL 489 AIR (File E10848) | | | | | IEC 947-2 | | | | | |
| | Volts AC (50/60Hz) | | | Volts DC | | Volts AC (50/60Hz) | | | | | |
| | 240 | 480 | 600 | 250 | 500 ^③ | 220/240 | | 380/415 | | 500 | |
| | Icu | Ics | Icu | Ics | Icu | Ics | Icu | Ics | Icu | Ics | |
| JXD2-2 | 65 | — | — | 30 (2-P) | — | — | — | — | — | — | |
| JXD6-2, JD6-A | 65 | 35 | 25 | 30 (2-P) | 25 (3-P) | 65 | 33 | 40 | 20 | 30 | 15 |
| HJD6-A, HJXD6-A | 100 | 65 | 35 | 30 (2-P) | 35 (3-P) | 100 | 50 | 65 | 33 | 42 | 21 |
| HHJD6-A, HHJXD6 ^④ | 200 | 100 | 50 | — | — | 200 | 100 | 100 | 50 | 65 | 33 |
| CJD6 | 200 | 150 | 100 | 50 (2-P) | 50 (3-P) | — | — | — | — | — | — |

Instantaneous Adjustment Trip Range

| Breaker Ampere Rating | Nominal Instantaneous Values | | | | | | | |
|-----------------------|------------------------------|------|------|------|------|------|------|-------------------|
| | Low ^⑥ | 2 | 3 | 4 | 5 | 6 | 7 | High ^⑥ |
| 200-300 | 1250 | 1430 | 1610 | 1790 | 1960 | 2140 | 2320 | 2500 |
| 350-400 | 2000 | 2290 | 2570 | 2860 | 3140 | 3430 | 3710 | 4000 |

① Type JXD2 and JXD6 circuit breakers are UL Listed for reverse feed applications.

② When wired as shown on page 5-2, this circuit breaker is CSA Certified / UL listed and rated for use on 500V DC ungrounded UPS systems only.

③ See Note: A, page 5-64.

④ HHJD6 type circuit breakers meet the CSA / UL criteria for "current limiting" at 240 and 480V AC.

⑤ HACR rated.

⑥ +/- 20% Tolerance.

Note: JD frame qualified to UL489 supplement B "NAVAL." See page 5-67 for additional information.

Ordering Information

Complete Breaker Unassembled with Lugs

Prices of JD6, HJD6, and HHJD6 breakers include frame, trip and both line and load lugs (TA2J6500). When ordered by these catalogue numbers, the customer will receive the frame, trip, and lugs separately packaged. For applications requiring different lugs, order individual items as needed.

Complete Breaker Assembled without Lugs

Prices of JXD6, HJXD6, HHJXD6, and CJD6 include frame with non-interchangeable trip unit installed only. Order required lugs separately. For line and load lugs (TA2J6500) installed, add suffix "L" to catalogue number (add 2 times list price of lugs for each pole).

100% Rated

Types JXD6 and HJXD6 breakers are available with 100% ratings. To order add suffix "H" to catalogue number, and 10% to list price.

100% rated JD breakers require the use of 90°C Cu cable and lugs TC1J6600 or TC2J6500.

50°C Applications see page 5-67.

400Hz Applications see page 5-67.

Lugs For 75°C Wire^③

| Catalogue Number | Cables per Lug | Wire Range |
|------------------|----------------|--|
| TA2J6500 | 1, 2 | #3/0-500 kcmil Cu #4/0-500 kcmil Al |
| TA1L6750 | 1 | 500-750 kcmil Al 500-600 kcmil Cu |
| TC1J6600 | 1 | #3/0-600 kcmil Cu |
| TC2J6500 | 1, 2 | #3/0-500 kcmil Cu |
| Compression Lug | | |
| CCL600 | 1 | 500 kcmil Cu/Al |

Modifications page 5-67
Accessories page 5-68

Molded Case Circuit Breakers

JD 400A Frame Sentron Series

Selection

Type HJD6-A, HJXD6-A^{②④⑥}

Black Label

| Interchangeable Trip | | | |
|----------------------------------|--|------------------|------------------|
| Continuous Current Rating @ 40°C | Complete Breaker Unassembled with Lugs | Frame Only | Trip Unit Only |
| | Catalogue Number | Catalogue Number | Catalogue Number |

2-Pole 600V AC, 250V DC (3 Pole Width)

| Continuous Current Rating @ 40°C | Catalogue Number | Catalogue Number | Catalogue Number |
|----------------------------------|------------------|------------------|------------------|
| 200 | HJD62B200 | HJD62F400 | JD62T200 |
| 225 | HJD62B225 | | JD62T225 |
| 250 | HJD62B250 | | JD62T250 |
| 300 | HJD62B300 | | JD62T300 |
| 350 | HJD62B350 | | JD62T350 |
| 400 | HJD62B400 | | JD62T400 |

3-Pole 600V AC, 500V DC^{①②⑤}

| Continuous Current Rating @ 40°C | Catalogue Number | Catalogue Number | Catalogue Number |
|----------------------------------|------------------|------------------|------------------|
| 200 | HJD63B200 | HJD63F400 | JD63T200 |
| 225 | HJD63B225 | | JD63T225 |
| 250 | HJD63B250 | | JD63T250 |
| 300 | HJD63B300 | | JD63T300 |
| 350 | HJD63B350 | | JD63T350 |
| 400 | HJD63B400 | | JD63T400 |

Type HHJD6, HHJXD6-A^{②④⑥}

2-Pole 600V AC (3 Pole Width)

Black Label

| Continuous Current Rating @ 40°C | Catalogue Number | Catalogue Number | Catalogue Number |
|----------------------------------|------------------|------------------|------------------|
| 200 | HHJD62B200 | HHJD62F400 | JD62T200 |
| 225 | HHJD62B225 | | JD62T225 |
| 250 | HHJD62B250 | | JD62T250 |
| 300 | HHJD62B300 | | JD62T300 |
| 350 | HHJD62B350 | | JD62T350 |
| 400 | HHJD62B400 | | JD62T400 |

| Continuous Current Rating @ 40°C | Catalogue Number | Catalogue Number | Catalogue Number |
|----------------------------------|------------------|------------------|------------------|
| 200 | HHJD63B200 | HHJD63F400 | JD63T200 |
| 225 | HHJD63B225 | | JD63T225 |
| 250 | HHJD63B250 | | JD63T250 |
| 300 | HHJD63B300 | | JD63T300 |
| 350 | HHJD63B350 | | JD63T350 |
| 400 | HHJD63B400 | | JD63T400 |

Type CJD6^⑥

Fuseless Current Limiting

Red Label

| Non-Interchangeable Trip (Assembled Circuit Breakers Without Lugs) | | |
|--|--|------------------|
| Continuous Current Rating @ 40°C | 2-Pole | 3-Pole |
| | 600V AC/250V DC | 600V AC/500V DC |
| | | Catalogue Number |
| 200 | For 2-pole application use outside poles of 3-pole circuit breaker | CJD63B200 |
| 225 | | CJD63B225 |
| 250 | | CJD63B250 |
| 300 | | CJD63B300 |
| 350 | | CJD63B350 |
| 400 | | CJD63B400 |

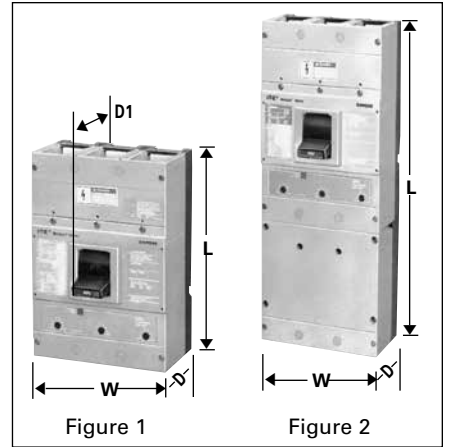

Dimensions (in inches)

| Breaker Type | W | L | D | To Handle D1 |
|---|-----|-------|---|--------------|
| Figure 1 JXD2-A, JXD6-A, JD6-A HJD6-A, HJXD6-A, HHJD6, HJD6, HJXD6, HHJXD6, JXD6-ETI ^③ | 7.5 | 11 | 4 | 5.44 |
| Figure 2 CJD6, CJD6-ETI ^③ | 7.5 | 17.86 | 4 | 5.44 |

Shipping Weights

| Number of Poles | Number per Carton | Shipping Weight (lbs.) |
|--|-------------------|------------------------|
| JXD2, JXD6, JD6, HJD6, HHJD6 Assembled Breaker (less terminals) | | |
| 2 | 1 | 17.5 |
| 3 | 1 | 19.5 |
| JD6, HJD6, HHJD6 Frame Only | | |
| 2 | 1 | 14 |
| 3 | 1 | 15.5 |
| JD6 Trip Unit Only | | |
| 2 | 1 | 3.5 |
| 3 | 1 | 4 |
| CJD6 Complete Assembled Breaker (less terminals) | | |
| 2 | 1 | 29.5 |
| 3 | 1 | 31.5 |

For inches / millimeters conversion, see Application Data section.

2-pole units available in 3-pole construction.

① When wired as shown on page 5-2, this circuit breaker is CSA Certified / UL listed and rated for use on 500V DC ungrounded UPS systems only.

② For non-interchangeable 3-pole HJD6 or HHJD6 type circuit breaker change the prefix identifier to HJXD6 or HHJXD6. Order lugs separately.

③ JXD6-ETI, CJD6-ETI see page 5-50 for ordering information.

④ Type HJXD6, HHJXD6 Circuit Breakers are CSA Certified / UL listed for reverse fed applications.

⑤ CE applies to non-interchangeable type HJXD only.

⑥ HACR rated.

Molded Case Circuit Breakers

SJD 400A Frame Digital Solid State Sentron Sensitrip III Series

Selection

Type SJD6-A

Blue Label

| 3-Pole, 600V AC | |
|------------------|--------------------|
| Catalogue Number | Max Current Rating |
| SJD69200 | 200 |
| SJD69300 | 300 |
| SJD69400 | 400 |
| SJD69200G | 200 |
| SJD69300G | 300 |
| SJD69400G | 400 |
| SJD69200NT | 200 |
| SJD69300NT | 300 |
| SJD69400NT | 400 |
| SJD69200NGT | 200 |
| SJD69300NGT | 300 |
| SJD69400NGT | 400 |

Type SHJD6-A

Black Label

| 3-Pole, 600V AC | |
|------------------|--------------------|
| Catalogue Number | Max Current Rating |
| SHJD69200 | 200 |
| SHJD69300 | 300 |
| SHJD69400 | 400 |
| SHJD69200G | 200 |
| SHJD69300G | 300 |
| SHJD69400G | 400 |
| SHJD69200NT | 200 |
| SHJD69300NT | 300 |
| SHJD69400NT | 400 |
| SHJD69200NGT | 200 |
| SHJD69300NGT | 300 |
| SHJD69400NGT | 400 |

Current Limiting

Type SCJD6-A

Red Label

| 3-Pole, 600V AC | |
|------------------|--------------------|
| Catalogue Number | Max Current Rating |
| SCJD69200 | 200 |
| SCJD69300 | 300 |
| SCJD69400 | 400 |
| SCJD69200G | 200 |
| SCJD69300G | 300 |
| SCJD69400G | 400 |
| SCJD69200NT | 200 |
| SCJD69300NT | 300 |
| SCJD69400NT | 400 |
| SCJD69200NGT | 200 |
| SCJD69300NGT | 300 |
| SCJD69400NGT | 400 |

Ordering Information

Pricing information for all Digital Sentron Series SJD frames is for complete breaker only – price required lugs as separate items – lugs are suitable for 75° C wire.

SJD6 and SCJD6 are acceptable for reverse connection application.

SHJD6 are not acceptable for reverse connection application.

Shipping Weights

| Breaker Type | Number per Carton | Shipping Weight (lbs) |
|--------------|-------------------|-----------------------|
| SJD6-A | 1 | 20 |
| SHJD6-A | 1 | 20 |
| SCJD6-A | 1 | 33 |

SJD 400A Frame – 100% Rated[®]

Type SJD6-A

Blue Label

| 3-Pole, 600V AC | |
|------------------|--------------------|
| Catalogue Number | Max Current Rating |
| SJD69200H | 200 |
| SJD69300H | 300 |
| SJD69400H | 400 |
| SJD69200GH | 200 |
| SJD69300GH | 300 |
| SJD69400GH | 400 |
| SJD69200NTH | 200 |
| SJD69300NTH | 300 |
| SJD69400NTH | 400 |
| SJD69200NGTH | 200 |
| SJD69300NGTH | 300 |
| SJD69400NGTH | 400 |

Type SHJD6-A

Black Label

| 3-Pole, 600V AC | |
|------------------|--------------------|
| Catalogue Number | Max Current Rating |
| SHJD69200H | 200 |
| SHJD69300H | 300 |
| SHJD69400H | 400 |
| SHJD69200GH | 200 |
| SHJD69300GH | 300 |
| SHJD69400GH | 400 |
| SHJD69200NTH | 200 |
| SHJD69300NTH | 300 |
| SHJD69400NTH | 400 |
| SHJD69200NGTH | 200 |
| SHJD69300NGTH | 300 |
| SHJD69400NGTH | 400 |

Lugs for 75° C Wire^①

| Catalogue Number | No of Cables per Connector | Wire Range |
|------------------------|----------------------------|--|
| TA2J6500 | 2 | #3/0-500 kcmil Cu #4/0-500 kcmil Al |
| TA1L6750 | 1 | 500-750 kcmil Al 500-600 kcmil Cu |
| TC1J6600 | 1 | #3/0-600 kcmil Cu |
| TC2J6500 | 2 | #3/0-500 kcmil Cu |
| TA2J630 | 2 | #4-#3/0-Cu/Al |
| Compression Lug | | |
| CCL600 | (1 pc.) | #1/0-500 kcmil Cu/Al |

Neutral Transformers

| Ampere Rating | Catalogue Number |
|---------------|------------------|
| 200 | N02SJD |
| 300 | N03SJD |
| 400 | N04SJD |

Trip Unit Adjustable Functions

| Suffix Letter Code | Trip Type | Cont Current Setting | Long Time Delay | Instantaneous Setting | Short Time Pick Up | Short Time Delay | Short Time Pick Up | Ground Fault Pick Up | Ground Fault Delay |
|--------------------|-----------|----------------------|-----------------|-----------------------|--------------------|------------------|--------------------|----------------------|--------------------|
| None | LI | ✓ | ✓ | ✓ | – | – | – | – | – |
| G | LIG | ✓ | ✓ | ✓ | – | – | – | ✓ | ✓ |
| NT | LSI | ✓ | ✓ | ✓ | ✓ | ✓ | ✓ | – | – |
| NGT | LSIG | ✓ | ✓ | ✓ | ✓ | ✓ | ✓ | ✓ | ✓ |

Interrupting Ratings

| Breaker Type | RMS Symmetrical kA UL 489 (File E10848) | | |
|--------------|---|---------|---------|
| | 240V AC | 480V AC | 600V AC |
| SJD6-A | 65 | 35 | 25 |
| SHJD6-A | 100 | 65 | 35 |
| SCJD6-A | 200 | 150 | 100 |

Note: "G" suffix in catalogue number denotes circuit breaker for 3 phase, 3 wire systems.
For 3 phase, 4 wire, order correct 4th wire (neutral) transformer as separate and additional item.

①For additional information, see **Note: A**, page 5-64.
②Refer to the NEC for proper application of 100% rated devices.

Accessories page 5-68

Molded Case Circuit Breakers

Internal Accessories

Selection

Accessories for:

JD 400A Frame
LD 600A Frame
LMD 800A Frame
SJD 400A Frame
SLD 600A Frame



Sensitrip Ammeter



The Ammeter Display Units plug into the Sensitrip Trip Unit and displays the phase current flowing in the SADU breaker. They are powered by the breaker's CT's with replaceable battery back-up for maintaining trip and max logs.

The SADU reads currents, current imbalance, current demand, and trip status.

Ammeter Mounting Kit

The Ammeter may also be panel or door mounted using the SADURMK18 remote mounting kit.

Shunt Trip Combinations

| Control Voltage | | 1 Shunt Trip | 1 Shunt Trip and 1 Auxiliary Switch |
|-----------------|-----|------------------|-------------------------------------|
| AC | DC | Catalogue Number | Catalogue Number |
| 24 | — | S17JLD6 | — |
| 48 | — | S18JLD6 | — |
| 120 | — | S01JLD6 | S01JLD62A |
| 240 | — | S03JLD6 | S03JLD62A |
| 277 | — | S15JLD6 | S15JLD64A |
| 480 | — | S04JLD6 | — |
| — | 12 | S16JLD6 | S16JLD62A |
| — | 24 | S07JLD6 | S07JLD62A |
| — | 48 | S09JLD6 | S09JLD62A |
| — | 125 | S11JLD6 | S11JLD62A |
| — | 250 | S13JLD6 | S13JLD62A |

Undervoltage Trip Combinations

| Control Voltage | | 1 Undervoltage Trip | 1 Undervoltage Trip and 1 Auxiliary Switch | 1 Undervoltage Trip and 2 Auxiliary Switches |
|-----------------|-----|---------------------|--|--|
| AC | DC | Catalogue Number | Catalogue Number | Catalogue Number |
| 120 | — | U01JLD6 | U01JLD62A | U01JLD62AA |
| 208 | — | U02JLD6 | U02JLD62A | U02JLD62AA |
| 240 | — | U03JLD6 | U03JLD62A | U03JLD62AA |
| 480 | — | U06JLD6 | U06JLD64A | U06JLD64AA |
| — | 24 | U13JLD6 | U13JLD62A | U13JLD62AA |
| — | 48 | U14JLD6 | U14JLD62A | U14JLD62AA |
| — | 125 | U10JLD6 | U10JLD62A | U10JLD62AA |
| — | 250 | U12JLD6 | U12JLD62A | U12JLD62AA |

Auxiliary Switch Combinations

| Maximum Voltage | | 1 Form C | 2 Form C |
|-----------------|-----|------------------|------------------|
| AC | DC | Catalogue Number | Catalogue Number |
| 480 | 250 | A01JLD64 | A02JLD64 |
| — | 12 | A01JLDLV | A02JLDLV |

Alarm Switch Combinations

| Maximum Voltage | | 1 Alarm Switch | 1 Alarm Switch and 1 Auxiliary Switch | 1 Alarm Switch and 2 Auxiliary Switches |
|-----------------|-----|------------------|---------------------------------------|---|
| AC | DC | Catalogue Number | Catalogue Number | Catalogue Number |
| 480 | 250 | B01JLD64 | A01JLD64B | A02JLD64B |

Plug-in Ammeter Display Units

| Breaker Type | Description | Catalogue Number |
|--------------|---------------------|------------------|
| SJD, SLD | Display Unit | SADU |
| | Remote Mounting Kit | SADURMK18 |

Note: Accessory modules can only be added to right side pole of solid state SJD and SLD frame circuit breakers. All accessories on this page are useable on superseded JD2, JJ6, JL6, HJ6, SJL, LJ6, LL6, HL6 and SLL circuit breakers.

No accessories can be added if mechanical interlock is used.

Molded Case Circuit Breakers

LD 600A Frame Sentron Series

Selection

Type LXD6-A^{①④}

Blue Label

| Non-Interchangeable Trip (Assembled Circuit Breaker without Lugs) | | | | |
|---|-----------------------|---------|------------------|---------|
| Continuous Current Rating @ 40°C | 2-Pole (3 Pole Width) | | 3-Pole | |
| | 600V AC | 250V DC | 600V AC | 500V DC |
| | Catalogue Number | | Catalogue Number | |
| 450 | LXD62B450 | | LXD63B450 | |
| 500 | LXD62B500 | | LXD63B500 | |
| 600 | LXD62B600 | | LXD63B600 | |

Type LD6-A^④

Blue Label

| Interchangeable Trip | | | |
|----------------------------------|-------------------------------------|------------------|------------------|
| Continuous Current Rating @ 40°C | Complete Breaker Unassembled w/Lugs | Frame Only | Trip Unit Only |
| | Catalogue Number | Catalogue Number | Catalogue Number |

2-Pole 600V AC, 250V DC (3 Pole Width)

| Continuous Current Rating @ 40°C | Catalogue Number | Frame Only Catalogue Number | Trip Unit Only Catalogue Number |
|----------------------------------|------------------|-----------------------------|---------------------------------|
| 250 | LD62B250 | LD62F600 | JD62T250 |
| 300 | LD62B300 | | JD62T300 |
| 350 | LD62B350 | | JD62T350 |
| 400 | LD62B400 | | JD62T400 |
| 450 | LD62B450 | | LD62T450 |
| 500 | LD62B500 | | LD62T500 |
| 600 | LD62B600 | | LD62T600 |

3-Pole 600V AC, 500V DC^②

| Continuous Current Rating @ 40°C | Catalogue Number | Frame Only Catalogue Number | Trip Unit Only Catalogue Number |
|----------------------------------|------------------|-----------------------------|---------------------------------|
| 250 | LD63B250 | LD63F600 | JD63T250 |
| 300 | LD63B300 | | JD63T300 |
| 350 | LD63B350 | | JD63T350 |
| 400 | LD63B400 | | JD63T400 |
| 450 | LD63B450 | | LD63T450 |
| 500 | LD63B500 | | LD63T500 |
| 600 | LD63B600 | | LD63T600 |

Interrupting Ratings

| Breaker Type | RMS Symmetrical Amperes (KA) | | | | | | | | | | |
|--------------|--------------------------------|-----|-----|----------|------------------|--------------------|-------|---------|-------|-------|-------|
| | CSA / UL 489 AIR (File E10848) | | | | | IEC 947-2 | | | | | |
| | Volts AC (50/60Hz) | | | Volts DC | | Volts AC (50/60Hz) | | | | | |
| | 240 | 480 | 600 | 250 | 500 ^③ | 220/240 | | 380/415 | | 500 | |
| | | | | | | (lcu) | (lcs) | (lcu) | (lcs) | (lcu) | (lcs) |
| LXD6, LD6 | 65 | 35 | 25 | 30 (2-P) | 25 (3-P) | 65 | 33 | 40 | 20 | 30 | 15 |
| HLD6, HLXD6 | 100 | 65 | 35 | 30 (2-P) | 35 (3-P) | 100 | 50 | 65 | 33 | 42 | 21 |
| HHL6, HHLXD6 | 200 | 100 | 50 | — | — | 200 | 100 | 100 | 50 | 65 | 33 |
| CLD6 | 200 | 150 | 100 | 30 (2-P) | 50 (3-P) | — | — | — | — | — | — |

Instantaneous Adjustment Trip Range

| Breaker Ampere Rating | Nominal Instantaneous Values | | | | | | | |
|-----------------------|------------------------------|------|------|------|------|------|------|-------------------|
| | Low ^⑤ | 2 | 3 | 4 | 5 | 6 | 7 | High ^⑤ |
| 250-300 | 1250 | 1430 | 1610 | 1790 | 1960 | 2140 | 2320 | 2500 |
| 350-450 | 2000 | 2290 | 2570 | 2860 | 3140 | 3430 | 3710 | 4000 |
| 500-600 | 3000 | 3430 | 3800 | 4290 | 4710 | 5140 | 5570 | 6000 |

① Type LXD6A circuit breakers are CSA Certified / UL Listed for reverse

fed applications.

② When wired as shown on page 5-2, this circuit breaker is UL listed and rated for use on 500V DC ungrounded UPS systems only.

③ See Note A, page 5-64.

④ HACR rated.

⑤ +/- 20% Tolerance

Note: LD frame qualified to UL489 supplement SB "NAVAL" See page 5-67 for additional information.

Modifications page 5-67
Accessories page 5-68

Ordering Information

Complete Breaker Unassembled with Lugs

Prices of LD6, HLD6, and HHL6 breakers include frame, trip, and both line and load lugs (TA2J6500). When ordered by these catalogue numbers, the customer will receive the frame, trip and lugs separately packaged. For applications requiring different lugs, order individual items as needed.

Complete Breaker Assembled without Lugs

Prices of LXD6, HLXD6, HHLXD6, and CLD6 include frame with non-interchangeable trip unit installed only. Order required lugs separately. For line and load lugs (TA2J6500) installed, add suffix "L" to catalogue number (add 2 times list price of lugs for each pole).

100% Rated (3-pole only)

Types, LXD6 and HLXD6 breakers are available with 100% ratings. To order add suffix "H" to catalogue number, and 10% to list price. 100% rated LD breakers require the use of 90°C Cu cable and lugs TC1J6600 or TC2J6500.

50°C Applications see page 5-67.

400Hz Applications see page 5-67.

Shipping Weights

| Number of Poles | Number per Carton | Shipping Weight (lbs.) |
|---|-------------------|------------------------|
| LXD6, LD6, HLD6, HHL6 Assembled Breaker (less terminals) | | |
| 2 | 1 | 17.5 |
| 3 | 1 | 19.5 |
| LD6, HLD6, HHL6 Frame Only | | |
| 2 | 1 | 14 |
| 3 | 1 | 15.5 |
| LD6, HHL6 Trip Unit Only | | |
| 2 | 1 | 3.5 |
| 3 | 1 | 4 |
| CLD6 Complete Assembled Breaker (less terminals) | | |
| 2 | 1 | 29.5 |
| 3 | 1 | 31.5 |

Lugs For 75°C Wire^③

| Catalogue Number | Cables per Lug | Wire Range |
|------------------------|----------------|--|
| TA2J6500 | 1, 2 2 | #3/0 500 kcmil Cu #4/0 500 kcmil Al |
| TC2J6500 | 2 | #3/0-500 kcmil Cu |
| TA1L6750 | 1 1 | 500-750 kcmil Al 500-600 kcmil Cu |
| TC1J6600 | 1 | #3/0-600 kcmil Cu |
| Compression Lug | | |
| CCL600 | 1 | 500 kcmil Cu/Al |

Molded Case Circuit Breakers

LD 600A Frame Sentron Series

Selection

Type HLD6-A, HLXD6^{②③④}

Black Label

| Interchangeable Trip | | | |
|----------------------------------|-------------------------------------|------------------|------------------|
| Continuous Current Rating @ 40°C | Complete Breaker Unassembled w/Lugs | Frame Only | Trip Unit Only |
| | Catalogue Number | Catalogue Number | Catalogue Number |

2-Pole 600V AC, 250V DC (3 Pole Width)

| Continuous Current Rating @ 40°C | Catalogue Number | Catalogue Number | Catalogue Number |
|----------------------------------|------------------|------------------|------------------|
| 250 | HLD62B250 | HLD62F600 | JD62T250 |
| 300 | HLD62B300 | | JD62T300 |
| 350 | HLD62B350 | | JD62T350 |
| 400 | HLD62B400 | | JD62T400 |
| 450 | HLD62B450 | | LD62T450 |
| 500 | HLD62B500 | | LD62T500 |
| 600 | HLD62B600 | | LD62T600 |

3-Pole 600V AC, 500V DC^{①⑤}

| Continuous Current Rating @ 40°C | Catalogue Number | Catalogue Number | Catalogue Number |
|----------------------------------|------------------|------------------|------------------|
| 250 | HLD63B250 | HLD63F600 | JD63T250 |
| 300 | HLD63B300 | | JD63T300 |
| 350 | HLD63B350 | | JD63T350 |
| 400 | HLD63B400 | | JD63T400 |
| 450 | HLD63B450 | | LD63T450 |
| 500 | HLD63B500 | | LD63T500 |
| 600 | HLD63B600 | | LD63T600 |

Type HHL6, HHLXD6^{②⑤⑥}

2-Pole 600V AC (3 Pole Width)

Black Label

| Continuous Current Rating @ 40°C | Catalogue Number | Catalogue Number | Catalogue Number |
|----------------------------------|------------------|------------------|------------------|
| 250 | HHL62B250 | HHL62F600 | JD62T250 |
| 300 | HHL62B300 | | JD62T300 |
| 350 | HHL62B350 | | JD62T350 |
| 400 | HHL62B400 | | JD62T400 |
| 450 | HHL62B450 | | HHL62T450 |
| 500 | HHL62B500 | | HHL62T500 |
| 600 | HHL62B600 | | HHL62T600 |

3-Pole 600V AC

| Continuous Current Rating @ 40°C | Catalogue Number | Catalogue Number | Catalogue Number |
|----------------------------------|------------------|------------------|------------------|
| 250 | HHL63B250 | HHL63F600 | JD63T250 |
| 300 | HHL63B300 | | JD63T300 |
| 350 | HHL63B350 | | JD63T350 |
| 400 | HHL63B400 | | JD63T400 |
| 450 | HHL63B450 | | HHL63T450 |
| 500 | HHL63B500 | | HHL63T500 |
| 600 | HHL63B600 | | HHL63T600 |

Type CLD6^⑥

Fuseless Current Limiting

Red Label

| Non-Interchangeable Trip (Assembled Circuit Breaker) | | |
|--|--|------------------|
| Continuous Current Rating @ 40°C | 2-Pole | 3-Pole |
| | 600V AC/250V DC | 600V AC/500V DC |
| | | Catalogue Number |
| 450 | For 2-pole application use outside poles of 3-pole circuit breaker | CLD63B450 |
| 500 | | CLD63B500 |
| 600 | | CLD63B600 |

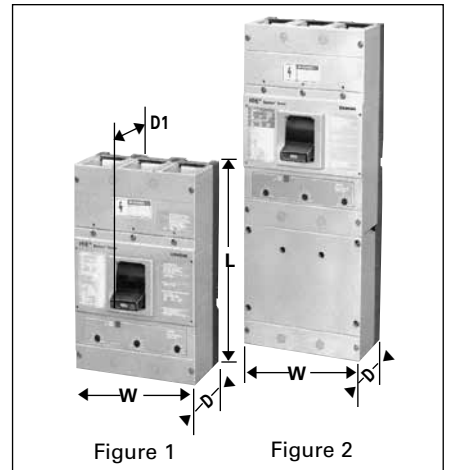

Figure 1

Figure 2

Dimensions (in inches)

| Breaker Type | W | L | D | To Handle D1 |
|---|-----|-------|---|--------------|
| Figure 1 LXD6-A, LD6-A HLD6-A HHL6, HHLXD6, LXD6-ETI ^⑥ | 7.5 | 11 | 4 | 5.44 |
| Figure 2 CLD6, CLD6-ETI ^⑥ | 7.5 | 17.86 | 4 | 5.44 |

For inches / millimeters conversion, see Application Data section

① When wired as shown on page 5-2, this circuit breaker is CSA Certified / UL listed and rated for use on 500V DC ungrounded UPS systems only.

② For complete assembled 3 pole HLD6 or HHL6 type circuit breaker change the prefix identifier HLD6 or HHL6 to HLXD6 or HHLXD6. Price is sum of frame and trip units prices, e.g. price of HLXD63B400 is the price of HLD63F600 plus the price of LD63T600. Order the terminal connectors separately.

③ Type HLXD6, HHLXD6 Circuit Breakers are CSA Certified / UL Listed for reverse feed applications.

④ LXD6-ETI, CLD6-ETI see page 5-50 for ordering information.

⑤ CE Applies to non-interchangeable type HLXD only.

⑥ HACR rated.

Molded Case Circuit Breakers

SLD 600A Frame Digital Solid State Sentron Sensitrip III Series

Selection

Type SLD6-A

Blue Label

| 3-Pole, 600V AC | |
|------------------|--------------------|
| Catalogue Number | Max Current Rating |
| SLD69300 | 300 |
| SLD69400 | 400 |
| SLD69500 | 500 |
| SLD69600 | 600 |
| SLD69300G | 300 |
| SLD69400G | 400 |
| SLD69500G | 500 |
| SLD69600G | 600 |
| SLD69300NT | 300 |
| SLD69400NT | 400 |
| SLD69500NT | 500 |
| SLD69600NT | 600 |
| SLD69300NGT | 300 |
| SLD69400NGT | 400 |
| SLD69500NGT | 500 |
| SLD69600NGT | 600 |

Type SHLD6-A

Black Label

| 3-Pole, 600V AC | |
|------------------|--------------------|
| Catalogue Number | Max Current Rating |
| SHLD69300 | 300 |
| SHLD69400 | 400 |
| SHLD69500 | 500 |
| SHLD69600 | 600 |
| SHLD69300G | 300 |
| SHLD69400G | 400 |
| SHLD69500G | 500 |
| SHLD69600G | 600 |
| SHLD69300NT | 300 |
| SHLD69400NT | 400 |
| SHLD69500NT | 500 |
| SHLD69600NT | 600 |
| SHLD69300NGT | 300 |
| SHLD69400NGT | 400 |
| SHLD69500NGT | 500 |
| SHLD69600NGT | 600 |

Current Limiting

Type SCLD6-A

Red Label

| 3-Pole, 600V AC | |
|------------------|--------------------|
| Catalogue Number | Max Current Rating |
| SCLD69300 | 300 |
| SCLD69400 | 400 |
| SCLD69500 | 500 |
| SCLD69600 | 600 |
| SCLD69300G | 300 |
| SCLD69400G | 400 |
| SCLD69500G | 500 |
| SCLD69600G | 600 |
| SCLD69300NT | 300 |
| SCLD69400NT | 400 |
| SCLD69500NT | 500 |
| SCLD69600NT | 600 |
| SCLD69300NGT | 300 |
| SCLD69400NGT | 400 |
| SCLD69500NGT | 500 |
| SCLD69600NGT | 600 |



SJD6, SLD6

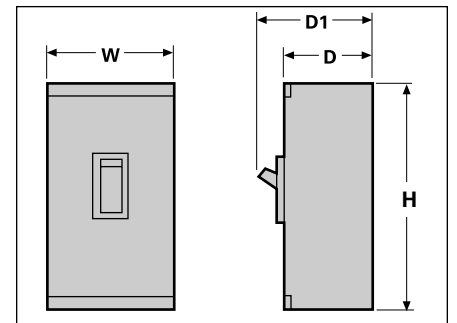

SJD6, SHJD6, SLD6, SHLD6

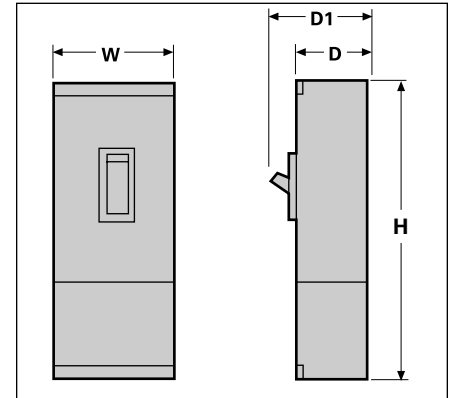

SCJD6, SCLD6

Dimensions (Inches)

| Breaker Type | W | H | D | D1 |
|---|-----|-------|---|------|
| SJD6(A), SHJD6(A) SLD6(A), SHLD6(A) SLD6, SHLD6 | 7.5 | 11 | 4 | 5.44 |
| SCJD6 SCLD6 | 7.5 | 17.86 | 4 | 5.44 |

Trip Unit Adjustable Functions

| Suffix Letter Code | Trip Type | Cont Current Setting | Long Time Delay | Instantaneous Setting | Short Time Pick Up | Short Time Delay | Short Time I _t Pick Up | Ground Fault Pick Up | Ground Fault Delay |
|--------------------|-----------|----------------------|-----------------|-----------------------|--------------------|------------------|-----------------------------------|----------------------|--------------------|
| None | LI | ✓ | ✓ | ✓ | — | — | — | — | — |
| G | LIG | ✓ | ✓ | ✓ | — | — | — | ✓ | ✓ |
| NT | LSI | ✓ | ✓ | ✓ | ✓ | ✓ | ✓ | — | — |
| NGT | LSIG | ✓ | ✓ | ✓ | ✓ | ✓ | ✓ | ✓ | ✓ |

Interrupting Ratings

| Breaker Type | RMS Symmetrical kA UL 489 (File E10848) | | |
|--------------|---|---------|---------|
| | 240V AC | 480V AC | 600V AC |
| SLD6-A | 65 | 35 | 25 |
| SHLD6-A | 100 | 65 | 35 |
| SCLD6-A | 200 | 150 | 100 |

Ordering Information

Pricing information for all Digital Sentron Series SLD frames is for complete breaker only – price required lugs as separate items – lugs are suitable for 75° C wire.

SLD6 and SCLD6 are suitable for reverse connection application.
SHLD6 are not suitable for reverse connection application.

Neutral Transformers

| Ampere Rating | Catalogue Number |
|---------------|------------------|
| 300 | N03SJD |
| 400 | N04SJD |
| 500 | N05SLD |
| 600 | N06SLD |

Note: "G" suffix in catalogue number denotes circuit breaker for 3 phase, 3 wire circuits.
For 3 phase, 4 wire, order correct 4th wire (neutral) transformer as separate and additional item.

For ordering information and terminal connectors, neutral transformers, see page 5-33.
100% Rated – Not available in SLD6 Frame.

Molded Case Circuit Breakers

Internal Accessories

Selection

Accessories for:

JD 400A Frame
LD 600A Frame
LMD 800A Frame
SJD 400A Frame
SLD 600A Frame



Sensitrip Ammeter



The Ammeter Display Units plug into the Sensitrip Trip Unit and displays the phrase current flowing in the SADU breaker. They are powered by the breaker's CT's with replaceable battery back-up for maintaining trip and max logs.

The SADU reads currents, current imbalance, current demand, and trip status.

Ammeter Mounting Kit

The Ammeter may also be panel or door mounted using the SADURMK18 remote mounting kit.

Shunt Trip Combinations

| Control Voltage | | 1 Shunt Trip | 1 Shunt Trip and 1 Auxiliary Switch |
|-----------------|-----|------------------|-------------------------------------|
| AC | DC | Catalogue Number | Catalogue Number |
| 24 | — | S17JLD6 | — |
| 48 | — | S18JLD6 | — |
| 120 | — | S01JLD6 | S01JLD62A |
| 240 | — | S03JLD6 | S03JLD62A |
| 277 | — | S15JLD6 | S15JLD64A |
| 480 | — | S04JLD6 | — |
| — | 12 | S16JLD6 | S16JLD62A |
| — | 24 | S07JLD6 | S07JLD62A |
| — | 48 | S09JLD6 | S09JLD62A |
| — | 125 | S11JLD6 | S11JLD62A |
| — | 250 | S13JLD6 | S13JLD62A |

Undervoltage Trip Combinations

| Control Voltage | | 1 Undervoltage Trip | 1 Undervoltage Trip and 1 Auxiliary Switch | 1 Undervoltage Trip and 2 Auxiliary Switches |
|-----------------|-----|---------------------|--|--|
| AC | DC | Catalogue Number | Catalogue Number | Catalogue Number |
| 120 | — | U01JLD6 | U01JLD62A | U01JLD62AA |
| 208 | — | U02JLD6 | U02JLD62A | U02JLD62AA |
| 240 | — | U03JLD6 | U03JLD62A | U03JLD62AA |
| 277 | — | U16JLD6 | U16JLD64A | U16JLD62AA |
| 480 | — | U06JLD6 | U06JLD64A | U06JLD64AA |
| 600 | — | U08JLD6 | — | — |
| — | 24 | U13JLD6 | U13JLD62A | U13JLD62AA |
| — | 48 | U14JLD6 | U14JLD62A | U14JLD62AA |
| — | 125 | U10JLD6 | U10JLD62A | U10JLD62AA |
| — | 250 | U12JLD6 | U12JLD62A | U12JLD62AA |

Auxiliary Switch Combinations

| Maximum Voltage | | 1 Form C | 2 Form C |
|-----------------|-----|------------------|------------------|
| AC | DC | Catalogue Number | Catalogue Number |
| 480 | 250 | A01JLD64 | A02JLD64 |
| — | 12 | A01JLDLV | A02JLDLV |

Alarm Switch Combinations

| Maximum Voltage | | 1 Alarm Switch | 1 Alarm Switch and 1 Auxiliary Switch | 1 Alarm Switch and 2 Auxiliary Switches |
|-----------------|-----|------------------|---------------------------------------|---|
| AC | DC | Catalogue Number | Catalogue Number | Catalogue Number |
| 480 | 250 | B01JLD64 | A01JLD64B | A02JLD64B |

Plug-in Ammeter Display Units

| Breaker Type | Description | Catalogue Number |
|--------------|---------------------|------------------|
| SJD, SLD | Display Unit | SADU |
| | Remote Mounting Kit | SADURMK18 |

Note: Accessory modules can only be added to right side pole of solid state SJD and SLD frame circuit breakers. All accessories on this page are useable on superseded JD2, JJ6, JL6, HJ6, SJL, LJ6, LL6, HL6 and SLL circuit breakers.

No accessories can be added if mechanical interlock is used.

Molded Case Circuit Breakers

LMD 800A Frame Sentron Series

Selection

Type LMXD6^{①⑤}

Blue Label

| Non-Interchangeable Trip (Assembled Circuit Breaker without Lugs) | | |
|---|-----------------------|------------------|
| Continuous Current Rating @ 40°C | 2-Pole (3 Pole Width) | 3-Pole |
| | Catalogue Number | Catalogue Number |
| 500 | — | LMXD63B500 |
| 600 | LMXD62B600 | LMXD63B600 |
| 700 | LMXD62B700 | LMXD63B700 |
| 800 | LMXD62B800 | LMXD63B800 |

Type LMD6^⑤

Blue Label

| Interchangeable Trip | | | |
|----------------------------------|-------------------------------------|------------------|------------------|
| Continuous Current Rating @ 40°C | Complete Breaker Unassembled w/Lugs | Frame Only | Trip Unit Only |
| | Catalogue Number | Catalogue Number | Catalogue Number |

2-Pole 600V AC, 250V DC (3 Pole Width)

| | | | |
|-----|-----------|-----------|-----------|
| 500 | LMD62B500 | LMD62F800 | LMD62T500 |
| 600 | LMD62B600 | | LMD62T600 |
| 700 | LMD62B700 | | LMD62T700 |
| 800 | LMD62B800 | | LMD62T800 |

3-Pole 600V AC, 500V DC^⑤

| | | | |
|-----|-----------|-----------|-----------|
| 500 | LMD63B500 | LMD63F800 | LMD63T500 |
| 600 | LMD63B600 | | LMD63T600 |
| 700 | LMD63B700 | | LMD63T700 |
| 800 | LMD63B800 | | LMD63T800 |

Instantaneous Adjustment Trip Range

| Ampere Rating | Nominal Instantaneous Values | | | | | | | |
|---------------|------------------------------|------|------|------|------|------|------|-------------------|
| | Low ^⑥ | 2 | 3 | 4 | 5 | 6 | 7 | High ^⑥ |
| 500-600 | 3000 | 3430 | 3860 | 4290 | 4710 | 5140 | 5570 | 6000 |
| 700-800 | 3200 | 3500 | 3700 | 4200 | 4700 | 6400 | 7300 | 8000 |

Ordering Information

Complete Breaker Unassembled with Lugs

Prices of LMD6 and HLMD6 breakers include frame, trip, and both line and load lugs (TA3K500). These catalogue numbers include the frame, trip and lugs separately packaged. For applications requiring different lugs, order individual items as needed.

Complete Breaker Assembled without Lugs

Prices of LMXD6 and HLMXD6 include frame with non-interchangeable trip unit installed only. Order required lugs separately. For line and load lugs (TA3K500) installed, add suffix "L" to catalogue number (add 2 times list price of lugs for each pole).

50°C Applications see page 5-67.

400Hz Applications see page 5-67.

Shipping Weights

| Number of Poles | Number per Carton | Shipping Weight (lbs.) |
|---|-------------------|------------------------|
| LMD6, HLMD6, LMXD6, HLMXD6 Complete Breaker (less terminals) | | |
| 2 | 1 | 53 |
| 3 | 1 | 61.5 |
| LMD6, HLMD6 Frame Only | | |
| 2 | 1 | 42.25 |
| 3 | 1 | 46 |
| LMD6, HLMD6 Trip Unit Only | | |
| 2 | 1 | 4.5 |
| 3 | 1 | 6.5 |

Lugs^④ for 75°C Wire

| Catalogue Number | Cables per Lug | Wire Range |
|------------------|----------------|----------------------|
| TA2K500 | 1, 2 | #1-500 kcmil Cu/Al |
| TA3K500 | 1-3 | #1/0-500 kcmil Cu/Al |
| TA2N750 | 1, 2 | 500-750 kcmil Cu/Al |

① LMXD6 circuit breakers are CSA Certified / UL Listed for reverse connected applications.

② Use 6 lugs for 3-pole, use 4 connectors for 2-pole.

③ When wired as shown on page 5-2, this circuit breaker is CSA Certified / UL listed and rated for use on 500UDC ungrounded UPS systems only.

④ See **Note: A**, page 5-64.

⑤ HACR rated.

⑥ +/- 20% Tolerance

Modifications page 5-67
Accessories page 5-68

Molded Case Circuit Breakers

LMD 800A Frame Sentron Series

Selection/Dimensions

Type HLMXD6^{①②}

Black Label

| Non-Interchangeable Trip (Assembled Circuit Breaker without Lugs) | | |
|---|---|-------------------------|
| Continuous Current Rating @ 40°C | 2-Pole 600V AC/ 250V DC | 3-Pole 600V AC/ 500V DC |
| | Catalogue Number | |
| 500 | For 2-Pole application use outside poles of 3-Pole circuit breaker. | HLMXD63B500 |
| 600 | | HLMXD63B600 |
| 700 | | HLMXD63B700 |
| 800 | | HLMXD63B800 |



Type HLMD6^④

Black Label

| Interchangeable Trip | | | |
|---|------------------------------|------------------|------------------|
| Continuous Current Rating @ 40°C | Complete Breaker Unassembled | Frame Only | Trip Unit Only |
| | Catalogue Number | Catalogue Number | Catalogue Number |
| 2-Pole 600V AC, 250V DC (3 Pole Width) | | | |
| 500 | HLMD62B500 | HLMD62F800 | LMD62T500 |
| 600 | HLMD62B600 | | LMD62T600 |
| 700 | HLMD62B700 | | LMD62T700 |
| 800 | HLMD62B800 | | LMD62T800 |

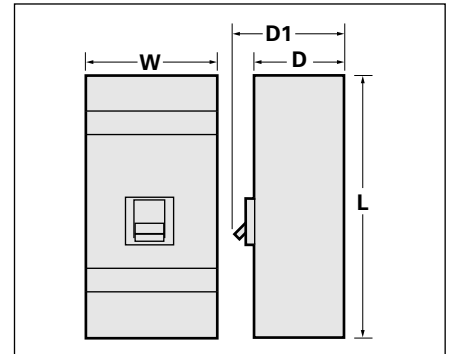

Dimensions (in inches)

| Breaker Type | W | L | D | D1 |
|---|-----|----|-----|------|
| LMD6, LMXD6, HLMD6, HLMXD6 LMXD6-ETI ^③ | 7.5 | 16 | 4.5 | 5.93 |

3-Pole 600V AC, 500V DC^⑤

| | | | |
|-----|------------|------------|-----------|
| 500 | HLMD63B500 | HLMD63F800 | LMD63T500 |
| 600 | HLMD63B600 | | LMD63T600 |
| 700 | HLMD63B700 | | LMD63T700 |
| 800 | HLMD63B800 | | LMD63T800 |

Interrupting Ratings

| Breaker Type | UL 489A IR | | | | | IEC 947-2 | | | | | |
|---------------|------------------------------|-----|-----|----------|------------------|--------------------|-------|---------|-------|-------|-------|
| | RMS Symmetrical Amperes (KA) | | | | | Volts AC (50/60HZ) | | | | | |
| | Volts AC | | | Volts DC | | 220/240 | | 380/415 | | 500 | |
| | 240 | 480 | 600 | 250 | 500 ^⑥ | (Icu) | (Ics) | (Icu) | (Ics) | (Icu) | (Ics) |
| LMD6, LMXD6 | 65 | 50 | 25 | 30 (2-P) | 25 (3-P) | 65 | 33 | 40 | 20 | 30 | 15 |
| HLMD6, HLMXD6 | 100 | 65 | 50 | 30 (2-P) | 50 (3-P) | 100 | 50 | 65 | 33 | 42 | 21 |

For inches / millimeters conversion, see Application Data section.

① HLMXD6 circuit breakers are UL Listed for reverse connection applications.

② LMXD6-ETI, see page 5-50 for catalogue information.

③ When wired as shown on page 5-2, this circuit breaker is UL listed and rated for use on 500VDC ungrounded UPS systems only.

④ HACR rated.

Molded Case Circuit Breakers

Internal Accessories

Selection

Accessories for:

JD 400A Frame
LD 600A Frame
LMD 800A Frame
SJD 400A Frame
SLD 600A Frame



Sensitrip Ammeter



The Ammeter Display Units plug into the Sensitrip Trip Unit and displays the phrase current flowing in the SADU breaker. They are powered by the breaker's CT's with replaceable battery back-up for maintaining trip and max logs.

The SADU reads currents, current imbalance, current demand, and trip status.

Ammeter Mounting Kit

The Ammeter may also be panel or door mounted using the SADURMK18 remote mounting kit.

Note: Accessory modules can only be added to right side pole of solid state SJD and SLD frame circuit breakers. All accessories on this page are useable on superseded JD2, JJ6, JL6, HJ6, SJL, LJ6, LL6, HL6 and SLL circuit breakers.

No accessories can be added if mechanical interlock is used.

Shunt Trip Combinations

| Control Voltage | | 1 Shunt Trip | 1 Shunt Trip and 1 Auxiliary Switch |
|-----------------|-----|------------------|-------------------------------------|
| AC | DC | Catalogue Number | Catalogue Number |
| 24 | — | S17JLD6 | — |
| 48 | — | S18JLD6 | — |
| 120 | — | S01JLD6 | S01JLD62A |
| 240 | — | S03JLD6 | S03JLD62A |
| 277 | — | S15JLD6 | S15JLD64A |
| 480 | — | S04JLD6 | — |
| — | 12 | S16JLD6 | S16JLD62A |
| — | 24 | S07JLD6 | S07JLD62A |
| — | 48 | S09JLD6 | S09JLD62A |
| — | 125 | S11JLD6 | S11JLD62A |
| — | 250 | S13JLD6 | S13JLD62A |

Undervoltage Trip Combinations

| Control Voltage | | 1 Undervoltage Trip | 1 Undervoltage Trip and 1 Auxiliary Switch | 1 Undervoltage Trip and 2 Auxiliary Switches |
|-----------------|-----|---------------------|--|--|
| AC | DC | Catalogue Number | Catalogue Number | Catalogue Number |
| 120 | — | U01JLD6 | U01JLD62A | U01JLD62AA |
| 208 | — | U02JLD6 | U02JLD62A | U02JLD62AA |
| 240 | — | U03JLD6 | U03JLD62A | U03JLD62AA |
| 277 | — | U16JLD6 | U16JLD64A | U16JLD62AA |
| 480 | — | U06JLD6 | U06JLD64A | U06JLD64AA |
| 600 | — | U08JLD6 | — | — |
| — | 24 | U13JLD6 | U13JLD62A | U13JLD62AA |
| — | 48 | U14JLD6 | U14JLD62A | U14JLD62AA |
| — | 125 | U10JLD6 | U10JLD62A | U10JLD62AA |
| — | 250 | U12JLD6 | U12JLD62A | U12JLD62AA |

Auxiliary Switch Combinations

| Maximum Voltage | | 1 Form C* | 2 Form C |
|-----------------|-----|------------------|------------------|
| AC | DC | Catalogue Number | Catalogue Number |
| 480 | 250 | A01JLD64 | A02JLD64 |
| — | 12 | A01JLDLV | A02JLDLV |

Alarm Switch Combinations

| Maximum Voltage | | 1 Alarm Switch | 1 Alarm Switch and 1 Auxiliary Switch | 1 Alarm Switch and 2 Auxiliary Switches |
|-----------------|-----|------------------|---------------------------------------|---|
| AC | DC | Catalogue Number | Catalogue Number | Catalogue Number |
| 480 | 250 | B01JLD64 | A01JLD64B | A02JLD64B |

Plug-in Ammeter Display Units

| Breaker Type | Description | Catalogue Number |
|--------------|---------------------|------------------|
| SJD, SLD | Display Unit | SADU |
| | Remote Mounting Kit | SADURMK18 |

5
MOLDED CASE
CIRCUIT BREAKERS

Molded Case Circuit Breakers

MD 800A Frame Sentron Series

Selection

Type MXD6^{①⑦}

Blue Label

| Non-Interchangeable Trip (Assembled Circuit Breaker Without Lugs) | | |
|---|---------------------|------------------|
| Continuous Current Rating @ 40°C | 2-Pole ^② | |
| | Catalogue Number | Catalogue Number |
| 600 | MXD62B600 | MXD63B600 |
| 700 | MXD62B700 | MXD63B700 |
| 800 | MXD62B800 | MXD63B800 |

Type MD6^⑦

Blue Label

| Interchangeable Trip | | | |
|-----------------------------------|--|------------------|------------------|
| Continuous Current Setting @ 40°C | Complete Breaker Unassembled with Lugs | Frame Only | Trip Unit Only |
| | Catalogue Number | Catalogue Number | Catalogue Number |
| 500 | MD62B500 | MD62F800 | MD62T500 |
| 600 | MD62B600 | | MD62T600 |
| 700 | MD62B700 | | MD62T700 |
| 800 | MD62B800 | | MD62T800 |

2-Pole 600V AC, 250V DC^②

| | | | |
|-----|----------|----------|----------|
| 500 | MD62B500 | MD62F800 | MD62T500 |
| 600 | MD62B600 | | MD62T600 |
| 700 | MD62B700 | | MD62T700 |
| 800 | MD62B800 | | MD62T800 |

3-Pole 600V AC, 500V DC^④

| | | | |
|-----|----------|----------|----------|
| 500 | MD63B500 | MD63F800 | MD63T500 |
| 600 | MD63B600 | | MD63T600 |
| 700 | MD63B700 | | MD63T700 |
| 800 | MD63B800 | | MD63T800 |

Lugs^⑤

| Catalogue Number | Cables Per Lug | Lugs Per Kit | Wire Range |
|------------------------|----------------|--------------|---------------------|
| TA2K500 | 1-2 | 1 | #1-500 kcmil Cu/Al |
| TA3K500 | 1-3 | 1 | 1/0-500 kcmil Cu/Al |
| TC2K500 | 1-2 | 1 | #1-500 kcmil Cu |
| TC3K350 | 1-3 | 1 | #1-350 kcmil Cu |
| Kits | | | |
| 2TA2N8750 3TA2N8750 | 1-2 | 2 3 | 600-750 kcmil Cu/Al |
| 2TA3N8750 3TA3N8750 | 1-3 | 2 3 | 500-750 kcmil Cu/Al |
| 2TA4N8500 3TA4N8500 | 1-4 | 2 3 | 250-500 kcmil Cu/Al |
| 2TA4P8500 3TA4P8500 | 1-4 | 2 3 | 250-500 kcmil Cu/Al |

Instantaneous Adjustment Trip Range

| Ampere Rating | Nominal Instantaneous Values | | | | | | | |
|---------------|------------------------------|------|------|------|------|------|------|-------------------|
| | Low ^⑧ | 2 | 3 | 4 | 5 | 6 | 7 | High ^⑧ |
| 500-600 | 3000 | 3430 | 3860 | 4280 | 4710 | 5140 | 5570 | 6000 |
| 700-800 | 4000 | 4570 | 5140 | 5710 | 6280 | 6850 | 7420 | 8000 |

①MXD6 circuit breakers are CSA Certified / UL Listed for reverse connection applications.

②2-pole units available in 3-pole width only.

③Use 6 connectors for 3-pole, use 4 connectors for 2-pole.

④ When wired as shown on page 5-2, this circuit breaker is CSA Certified / UL listed and rated for use on 500V DC ungrounded UPS systems.

⑤ See Note: A, page 5-64.

⑥80% rated breakers with the CE mark will also be marked in the 100% rated version.

⑦ HACR rated.

⑧ +/- 20% Tolerance.

Note: MD frame qualified to UL489 supplement B "NAVAL"
See page 5-67 for additional information.

Ordering Information

Complete Breaker Unassembled with Lugs

Pricing information for MD6 and HMD6 breakers includes frame, trip, and both line and load lugs (TA3K500). When ordered by these catalogue numbers, the customer will receive the frame, trip and lugs separately packaged. For applications requiring different lugs, order individual items as needed.

Complete Breaker Assembled without Lugs

Prices of MXD6, HMXD6 and CMD6 include frame with non-interchangeable trip units installed only. Order required lugs separately. For line and load lugs (TA3K500) installed, add suffix "L" to catalogue number (add 2 times list price of lugs for each pole).

100% Rated^⑥

Types MXD6, HMXD6 and CMD6 breakers are available with 100% ratings. To order add suffix "H" to catalogue number, and 10% to list price. 100% rated MD breakers require the use of 90°C Cu cable and lugs 2TA4P8500 or 2TA2N8750 for 2-pole; 3TA4P8500 or 3TA2N8750 for 3-pole.

50°C Applications see page 5-67.

400Hz Applications see page 5-67.

Shipping Weights

| Number of Poles | Number per Carton | Shipping Weight (lbs.) |
|--|-------------------|------------------------|
| MD6, HMD6, HMXD6, CMD6 Complete Breaker Assembled (less lugs) | | |
| 2 | 1 | 53 |
| 3 | 1 | 61.5 |
| MD6, HMD6 Frame Only | | |
| 2 | 1 | 42.25 |
| 3 | 1 | 46 |
| MD6, HMD6 Trip Unit Only | | |
| 2 | 1 | 4.5 |
| 3 | 1 | 6.5 |

Modifications page 5-67
Accessories page 5-68

Molded Case Circuit Breakers

MD 800A Frame Sentron Series

Type HMXD6^{①③}

Black Label

| Non-Interchangeable Trip (Assembled Circuit Breaker Without Lugs) | | | |
|---|--|--|---------------------------|
| Continuous Current Rating @ 40°C | 2-Pole 600V AC 250V DC | | 3-Pole 600V AC 500V DC |
| | | | Catalogue Number |
| 600 | For 2-pole application use outside poles of 3-pole circuit breaker | | HMXD63B600 |
| 700 | | | HMXD63B700 |
| 800 | | | HMXD63B800 |

Type HMD6^⑤

Black Label

| Interchangeable Trip | | | |
|----------------------------------|--|------------------|------------------|
| Continuous Current Rating @ 40°C | Complete Breaker Unassembled with Lugs | Frame Only | Trip Unit Only |
| | Catalogue Number | Catalogue Number | Catalogue Number |
| 500 | HMD62B500 | HMD62F800 | MD62T500 |
| 600 | HMD62B600 | | MD62T600 |
| 700 | HMD62B700 | | MD62T700 |
| 800 | HMD62B800 | | MD62T800 |

2-Pole 600V AC, 250V DC^②

| | | | |
|-----|-----------|-----------|----------|
| 500 | HMD62B500 | HMD62F800 | MD62T500 |
| 600 | HMD62B600 | | MD62T600 |
| 700 | HMD62B700 | | MD62T700 |
| 800 | HMD62B800 | | MD62T800 |

3-Pole 600V AC, 500V DC^④

| | | | |
|-----|-----------|-----------|----------|
| 500 | HMD63B500 | HMD63F800 | MD63T500 |
| 600 | HMD63B600 | | MD63T600 |
| 700 | HMD63B700 | | MD63T700 |
| 800 | HMD63B800 | | MD63T800 |

Type CMD6^⑤

Fuseless Current Limiting

Red Label

| Non-Interchangeable Trip (Assembled Circuit Breaker Without Lugs) | | | |
|---|--|--|---------------------------|
| Continuous Current Rating @ 40°C | 2-Pole 600V AC/250V DC | | 3-Pole 600V AC/500V DC |
| | | | Catalogue Number |
| 500 | For 2-pole application use outside poles of 3-pole circuit breaker | | CMD63B500 |
| 600 | | | CMD63B600 |
| 700 | | | CMD63B700 |
| 800 | | | CMD63B800 |

Interrupting Ratings

| Breaker Type | UL 489 AIR – File E10848 | | | | | | IEC 947-2 AIR | | | | | |
|--------------|------------------------------|-----|-----|----------|------------------|-------|--------------------|-------|---------|-------|-------|--|
| | RMS Symmetrical Amperes (KA) | | | | | | Volts AC (50/60HZ) | | | | | |
| | Volts AC | | | Volts DC | | | 220/240 | | 380/415 | | 500 | |
| | 240 | 480 | 600 | 250 | 500 ^⑤ | (Icu) | (Ics) | (Icu) | (Ics) | (Icu) | (Ics) | |
| MD6, MXD6 | 65 | 50 | 25 | 30 (2-P) | 25 (3-P) | 65 | 33 | 40 | 20 | 30 | 15 | |
| HMD6, HMXD6 | 100 | 65 | 50 | 30 (2-P) | 50 (3-P) | 100 | 50 | 65 | 33 | 42 | 21 | |
| CMD6 | 200 | 100 | 65 | 30 (2-P) | 50 (3-P) | 200 | 100 | 100 | 50 | 65 | 33 | |

Selection/Dimensions

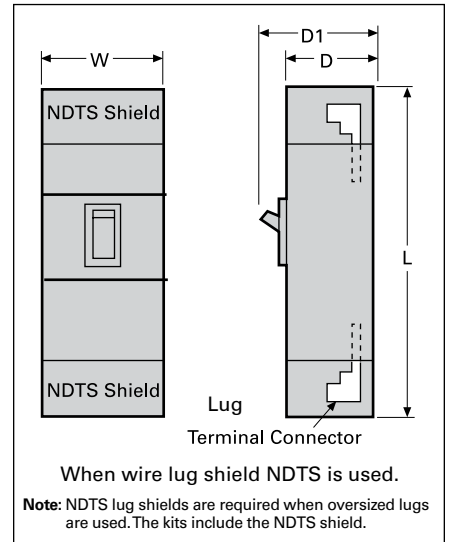

Dimensions (in inches)

| Breaker Type | W | L | D | (To Handle) D1 |
|--|---|----|---|----------------|
| MD6, MXD6, HMD6, HMXD6, CMD6, MXD6-ETI, CMD6-ETI | 9 | 16 | 6 | 8.25 |
| with lug shields | 9 | 24 | 6 | 8.25 |

For inches / millimeters conversion, see Application Data section.

①HMXD6 circuit breakers are CSA Certified / UL listed for reverse connection applications.

②2-pole units available in 3-pole width only.

③MXD6-ETI, CMD6-ETI see page 5-50 for catalogue information.

④When wired as shown on page 5-2, this circuit breaker is CSA Certified / UL listed and rated for use on 500V DC ungrounded UPS systems only.

⑤HACR rated.

Molded Case Circuit Breakers

SMD 800A Frame Digital Solid State Sentron Sensitrip III Series

Selection

Type SMD6

Blue Label

| 3-Pole, 600V AC | |
|------------------|--------------------|
| Catalogue Number | Max Current Rating |
| SMD69600A | 600 |
| SMD69700A | 700 |
| SMD69800A | 800 |
| SMD69600AG | 600 |
| SMD69700AG | 700 |
| SMD69800AG | 800 |
| SMD69600ANT | 600 |
| SMD69700ANT | 700 |
| SMD69800ANT | 800 |
| SMD69600ANGT | 600 |
| SMD69700ANGT | 700 |
| SMD69800ANGT | 800 |

Type SHMD6

Black Label

| 3-Pole, 600V AC | |
|------------------|--------------------|
| Catalogue Number | Max Current Rating |
| SHMD69600A | 600 |
| SHMD69700A | 700 |
| SHMD69800A | 800 |
| SHMD69600AG | 600 |
| SHMD69700AG | 700 |
| SHMD69800AG | 800 |
| SHMD69600ANT | 600 |
| SHMD69700ANT | 700 |
| SHMD69800ANT | 800 |
| SHMD69600ANGT | 600 |
| SHMD69700ANGT | 700 |
| SHMD69800ANGT | 800 |

Current Limiting

Type SCMD6-A

Red Label

| 3-Pole, 600V AC | |
|------------------|--------------------|
| Catalogue Number | Max Current Rating |
| SCMD69600A | 600 |
| SCMD69700A | 700 |
| SCMD69800A | 800 |
| SCMD69600AG | 600 |
| SCMD69700AG | 700 |
| SCMD69800AG | 800 |
| SCMD69600ANT | 600 |
| SCMD69700ANT | 700 |
| SCMD69800ANT | 800 |
| SCMD69600ANGT | 600 |
| SCMD69700ANGT | 700 |
| SCMD69800ANGT | 800 |

Ordering Information

Pricing information for all Digital Sentron Series MD and ND frames is for complete breaker only. Price requires lugs or lug kits as separate items. Lugs are suitable for 75°C wire or as noted. Connector wire ranges and cavities are established in conjunction with Table 6.1.4.2.1 of UL 489 standards. Choose actual connector for circuit breakers based on customer requirements.

Recommended Terminal Connectors

| Breaker Frame | Ampere Rating | Connector or Connector Kit |
|---------------|----------------|----------------------------|
| MD | 500–600 | TA2K500 |
| MD | 700–800 | TA3K500 |
| ND | 800 | TA3K500 |
| ND | 900–1200 (kit) | 3TA4N8500 |

Types SMD6, SHMD6, SMD6, SHMD6 are acceptable for reverse connection applications.

Shipping Weights

| Breaker Type | Number per Carton | Shipping Weight (lbs) |
|--------------|-------------------|-----------------------|
| All types | 1 | 61.5 |

Lugs for 75°C Wire^②

| Catalogue Number | Cables per Lug | Wire Range |
|------------------|----------------|--------------------|
| TA2K500 | 2 | #1-500 kcmil Cu/Al |
| TA3K500 | 3 | #1-500 kcmil Cu/Al |
| TC2K500 | 2 | #1-500 kcmil Cu |
| TC3K350 | 3 | #1-350 kcmil Cu |

Kits (3 lugs/kit)

| | | |
|-----------|---|---------------------|
| 3TA4N8500 | 4 | 250–500 kcmil Cu/Al |
| 3TA4P8500 | 4 | 250–500 kcmil Cu/Al |
| 3TA2N8750 | 2 | 500–750 kcmil Cu/Al |
| 3TA3N8750 | 3 | 500–750 kcmil Cu/Al |

Each kit contains the following:
 3TA4P8500—3 connectors plus 1 NDTs end barrier
 3TA3N8750—3 connectors plus 1 NDTs end barrier
 3TA2N8750—3 connectors plus 1 NDTs end barrier

Neutral Transformers

| Ampere Rating | Catalogue Number |
|---------------|------------------|
| 600 | N06SMDA |
| 700 | N07SMDA |
| 800 | N08SMDA |

SMD 800A Frame – 100% Rated^①

Type SMD6

Blue Label

| 3-Pole, 600V AC | |
|------------------|--------------------|
| Catalogue Number | Max Current Rating |
| SMD69600AH | 600 |
| SMD69700AH | 700 |
| SMD69800AH | 800 |
| SMD69600AGH | 600 |
| SMD69700AGH | 700 |
| SMD69800AGH | 800 |
| SMD69600ANTH | 600 |
| SMD69700ANTH | 700 |
| SMD69800ANTH | 800 |
| SMD69600ANGTH | 600 |
| SMD69700ANGTH | 700 |
| SMD69800ANGTH | 800 |

Type SHMD6

Black Label

| 3-Pole, 600V AC | |
|------------------|--------------------|
| Catalogue Number | Max Current Rating |
| SHMD69600AH | 600 |
| SHMD69700AH | 700 |
| SHMD69800AH | 800 |
| SHMD69600AGH | 600 |
| SHMD69700AGH | 700 |
| SHMD69800AGH | 800 |
| SHMD69600ANTH | 600 |
| SHMD69700ANTH | 700 |
| SHMD69800ANTH | 800 |
| SHMD69600ANGTH | 600 |
| SHMD69700ANGTH | 700 |
| SHMD69800ANGTH | 800 |

Current Limiting

Type SCMD6-A

Red Label

| 3-Pole, 600V AC | |
|------------------|--------------------|
| Catalogue Number | Max Current Rating |
| SCMD69600AH | 600 |
| SCMD69700AH | 700 |
| SCMD69800AH | 800 |
| SCMD69600AGH | 600 |
| SCMD69700AGH | 700 |
| SCMD69800AGH | 800 |
| SCMD69600ANTH | 600 |
| SCMD69700ANTH | 700 |
| SCMD69800ANTH | 800 |
| SCMD69600ANGTH | 600 |
| SCMD69700ANGTH | 700 |
| SCMD69800ANGTH | 800 |

Trip Unit Adjustable Functions

| Suffix Letter Code | Trip Type | Cont Current Setting | Long Time Delay | Instantaneous Setting | Short Time Pick Up | Short Time Delay | Ground Fault Pick Up | Ground Fault Delay |
|--------------------|-----------|----------------------|-----------------|-----------------------|--------------------|------------------|----------------------|--------------------|
| A | LI | ✓ | ✓ | ✓ | — | — | — | — |
| AG | LIG | ✓ | ✓ | ✓ | — | — | ✓ | ✓ |
| ANT | LSI | ✓ | ✓ | ✓ | ✓ | ✓ | — | — |
| ANGT | LSIG | ✓ | ✓ | ✓ | ✓ | ✓ | ✓ | ✓ |

Interrupting Ratings

| Breaker Type | RMS Symmetrical kA UL 489 (File E10848) | | |
|--------------|---|---------|---------|
| | 240V AC | 480V AC | 600V AC |
| SMD6 | 65 | 50 | 25 |
| SHMD6 | 100 | 65 | 50 |
| SCMD6 | 200 | 100 | 65 |

Note: "G" suffix in catalogue number denotes circuit breaker for 3-phase, 3-wire circuits.
 For 3-phase, 4-wire, order correct 4th wire (neutral) transformer as separate and additional item.

- ① Use 2-3TA4P8500 for 3-pole. These kits are rated for 90°C wire. 90°C Cu cable must be used, and sized per 75°C ampacity.
- ② For additional information, see Note: A, page 5-64.
- ③ SMD6, SHMD6 and SCMD6 circuit breakers are UL Listed for reverse connection applications.

Accessories page 5-68

Molded Case Circuit Breakers

Internal Accessories

Selection

Accessories for:

MD/SMD 800A Frame
ND/SND 1200A Frame
PD/SPD 1600A Frame
RD 2000A Frame



Accessory modules can mount in either left hand or right hand poles of all circuit breakers, including solid state. Exception: when mechanical interlock is used accessories cannot be mounted in left pole.

Sensitrip Ammeter



The Ammeter Display Units plug into the Sensitrip Trip Unit and displays the phase current flowing in the SADU breaker. They are powered by the breaker's CT's with replaceable battery back-up for maintaining trip and max logs.

The SADU reads currents, current imbalance, current demand, and trip status.

Ammeter Mounting Kit

The Ammeter may also be panel or door mounted using the SADURMK18 remote mounting kit.

Shunt Trip Combinations

| Control Voltage | | 1 Shunt Trip | 1 Shunt Trip and 1 Auxiliary Switch |
|-----------------|-----|------------------|-------------------------------------|
| AC | DC | Catalogue Number | Catalogue Number |
| 120 | — | S01MN6 | S01MN64A |
| 208 | — | S02MN6 | S02MN64A |
| 240 | — | S03MN6 | S03MN64A |
| 277 | — | S15MN6 | S15MN64A |
| 480 | — | S04MN6 | S04MN64A |
| 600 | — | S06MN6 | — |
| — | 12 | S16MN6 | S16MN64A |
| — | 24 | S07MN6 | S07MN64A |
| — | 48 | S09MN6 | — |
| — | 125 | S11MN6 | S11MN64A |
| — | 250 | S13MN6 | S13MN64A |

Undervoltage Trip Combinations

| Control Voltage | | 1 Undervoltage Trip | 1 Undervoltage Trip and 1 Auxiliary Switch | 1 Undervoltage Trip and 2 Auxiliary Switches |
|-----------------|-----|---------------------|--|--|
| AC | DC | Catalogue Number | Catalogue Number | Catalogue Number |
| 120 | — | U01MN6 | U01MN64A | U01MN64AA |
| 208 | — | U02MN6 | U02MN64A | U02MN64AA |
| 240 | — | U03MN6 | U03MN64A | U03MN64AA |
| 277 | — | U15MN6 | U15MN64A | U15MN64AA |
| 480 | — | U04MN6 | U04MN64A | U04MN64AA |
| 600 | — | U06MN6 | — | — |
| — | 24 | U07MN6 | U07MN64A | U07MN64AA |
| — | 48 | U09MN6 | U09MN64A | U09MN64AA |
| — | 125 | U11MN6 | U11MN64A | U11MN64AA |
| — | 250 | U13MN6 | U13MN64A | U13MN64AA |

Auxiliary Switch Combinations

| Maximum Voltage | | 1 Form C | 2 Form C |
|-----------------|-----|------------------|------------------|
| AC | DC | Catalogue Number | Catalogue Number |
| 480 | 250 | A01MN64 | A02MN64 |
| — | 12 | A01MNDLV | A02MNDLV |

Alarm Switch Combinations

| Maximum Voltage | | 1 Alarm Switch | 1 Alarm Switch and 1 Auxiliary Switch | 1 Alarm Switch and 2 Auxiliary Switches |
|-----------------|-----|------------------|---------------------------------------|---|
| AC | DC | Catalogue Number | Catalogue Number | Catalogue Number |
| 480 | 250 | B00MN64 | A01MN64B | A02MN64B |

Plug-in Ammeter Display Units

| Breaker Type | Description | Catalogue Number |
|---------------|---------------------|------------------|
| SMD, SND, SPD | Display Unit | SADU |
| | Remote Mounting Kit | SADURMK18 |

5
MOLDED CASE
CIRCUIT BREAKERS

Molded Case Circuit Breakers

ND 1200A Frame Sentron Series

Selection

Type NXD6^①

Blue Label

| Non-Interchangeable Trip (Assembled Circuit Breaker Without Lugs) | | |
|---|---------------------------|---------------------------|
| Continuous Current Rating @ 40°C | 2-Pole 600V AC 250V DC | 3-Pole 600V AC 500V DC |
| | Catalogue Number | Catalogue Number |
| 900 | NXD62B900 | NXD63B900 |
| 1000 | NXD62B100 | NXD63B100 |
| 1200 | NXD62B120 | NXD63B120 |

Type ND6^②

Blue Label

| Interchangeable Trip | | | |
|----------------------------------|--|------------------|------------------|
| Continuous Current Rating @ 40°C | Complete Breaker Unassembled with Lugs | Frame Only | Trip Unit Only |
| | Catalogue Number | Catalogue Number | Catalogue Number |

2-Pole 600V AC, 250V DC^②

| Continuous Current Rating @ 40°C | Catalogue Number | Catalogue Number | Catalogue Number |
|----------------------------------|------------------|------------------|------------------|
| 800 | ND62B800 | ND62F120 | MD62T800 |
| 900 | ND62B900 | | ND62T900 |
| 1000 | ND62B100 | | ND62T100 |
| 1200 | ND62B120 | | ND62T120 |

3-Pole 600V AC, 500V DC^⑤

| Continuous Current Rating @ 40°C | Catalogue Number | Catalogue Number | Catalogue Number |
|----------------------------------|------------------|------------------|------------------|
| 800 | ND63B800 | ND63F120 | MD63T800 |
| 900 | ND63B900 | | ND63T900 |
| 1000 | ND63B100 | | ND63T100 |
| 1200 | ND63B120 | | ND63T120 |

Interrupting Ratings

| Breaker Type | RMS Symmetrical Amperes (KA) | | | | | | | | | | |
|--------------|------------------------------|-----|-----|----------|------------------|--------------------|-------|---------|-------|-------|-------|
| | CSA / UL 489 A IR | | | | | IEC 947-2 | | | | | |
| | Volts AC | | | Volts DC | | Volts AC (50/60HZ) | | | | | |
| | 240 | 480 | 600 | 250 | 500 ^③ | 220/240 | | 380/415 | | 500 | |
| | | | | | | (lcu) | (lcs) | (lcu) | (lcs) | (lcu) | (lcs) |
| ND6, NXD6 | 65 | 50 | 25 | 30 (2-P) | 25 (3-P) | 65 | 33 | 40 | 20 | — | — |
| HND6, HNXD6 | 100 | 65 | 50 | 30 (2-P) | 50 (3-P) | 100 | 50 | 65 | 33 | — | — |
| CND6 | 200 | 100 | 65 | — | 50 (3-P) | — | — | — | — | — | — |

Instantaneous Adjustment Trip Range

| Breaker Ampere Rating | Nominal Instantaneous Values | | | | | | | |
|-----------------------|------------------------------|------|------|------|------|------|------|-------------------|
| | Low ^④ | 2 | 3 | 4 | 5 | 6 | 7 | High ^④ |
| 800 | 4000 | 4570 | 5140 | 5710 | 6280 | 6850 | 7420 | 8000 |
| 900-1200 | 5000 | 5715 | 6430 | 7145 | 7860 | 8575 | 9290 | 10000 |

① NXD6 circuit breakers are UL listed for reverse connection applications.

② 2-pole units available in 3-pole width only.

③ When wired as shown on page 5-2, this circuit breaker is CSA Certified / UL listed and rated for use on 500VDC ungrounded UPS systems only.

④ Use 6 connectors for 3-pole, use 4 connectors for 2-pole.

⑤ Use 2 – 3TA4P8500 kits for 3-pole, or 2 – 2TA4P8500 kits for 2-pole. Rated for 90°C cable. Use for 100% rated breakers.

⑥ Use 2 – 3TA4N8500 for 3-pole or 2 – 2TA4N8500 for 2-pole. Rated for 75°C cable.

⑦ See **Note: A**, page 5-64.

⑧ 80% rated breakers with the CE mark will also be marked in the 100% rated version.

⑨ HACR rated.

⑩ +/- 20% Tolerance.

Note: ND frame qualified to UL489 supplement B "NAVAL" See page 5-67 for additional information.

Ordering Information

Complete Breaker Unassembled with Lugs

Prices of ND6 and HND6 breakers include frame, trip, and both line and load lugs (3TA4N8500). These catalogue numbers are the frame, trip and lugs separately packaged. For applications requiring different lugs, order individual items as needed.

Complete Breaker Assembled without Lugs

Prices of NXD6, HNXD6, and CND6 include frame with non-interchangeable trip units installed only. Order required terminal connectors separately. For line and load lugs (3TA4N8500) installed, add suffix "L" to catalogue number (add 2 times list price of lug kit).

100% Rated^⑧

Types NXD6, HNXD6 and CND6 breakers are available with 100% ratings. To order, suffix "H" to catalogue number, and add 10% to list price. 100% rated ND breakers require 90°C Cu cable and lug kit 3TA4P8500 or 3TA3N8750.

50°C Applications see page 5-67.

400Hz Applications see page 5-67.

Lugs^⑦

| Catalogue Number | Cables per Lug | Wire Range |
|--|----------------|---------------------|
| TA2K500 | 2 | #1-500 kcmil Cu/Al |
| TA3K500 | 3 | #1-500 kcmil Cu/Al |
| TC2K500 | 2 | #1-500 kcmil Cu |
| TC3K350 | 3 | #1-350 kcmil Cu |
| Kits (2 Kits required per breaker) | | |
| 2TA4P8500 ^⑤ 3TA4P8500 ^⑤ | 4 | 250-500 kcmil Cu/Al |
| 2TA4N8500 ^⑥ 3TA4N8500 ^⑥ | 4 | 250-500 kcmil Cu/Al |
| 2TA2N8750 3TA2N8750 | 2 | 500-750 kcmil Cu/Al |
| 2TA3N8750 3TA3N8750 | 3 | 500-750 kcmil Cu/Al |

Modifications page 5-67
Accessories page 5-68

Molded Case Circuit Breakers

ND 1200A Frame Sentron Series

Type HNXD6^{①④}

Black Label

| Non-Interchangeable Trip (Assembled Circuit Breaker Without Lugs) | | |
|---|--|---------------------------|
| Continuous Current Rating @ 40°C | 2-Pole 600V AC 250V DC | 3-Pole 600V AC 500V DC |
| | Catalogue Number | |
| 900 | For 2-pole application use outside poles of 3-pole circuit breaker | HNXD63B900 |
| 1000 | | HNXD63B100 |
| 1200 | | HNXD63B120 |

Type HND6^④

Black Label

| Interchangeable Trip | | | |
|----------------------------------|--|------------------|------------------|
| Continuous Current Rating @ 40°C | Complete Breaker Unassembled with Lugs | Frame Only | Trip Unit Only |
| | Catalogue Number | Catalogue Number | Catalogue Number |
| 800 | For 2-pole application use outside poles of 3-pole circuit breaker | HND63F120 | MD63T800 |
| 900 | | | ND63T900 |
| 1000 | | | ND63T100 |
| 1200 | | | ND63T120 |

2-Pole 600V AC, 250V DC^②

| | |
|------|--|
| 800 | For 2-pole application use outside poles of 3-pole circuit breaker |
| 900 | |
| 1000 | |
| 1200 | |

3-Pole 600V AC, 500V DC^⑤

| | | | |
|------|-----------|-----------|----------|
| 800 | HND63B800 | HND63F120 | MD63T800 |
| 900 | HND63B900 | | ND63T900 |
| 1000 | HND63B100 | | ND63T100 |
| 1200 | HND63B120 | | ND63T120 |

Type CND6^{①③}

Fuseless Current Limiting

Red Label

| Non-Interchangeable Trip (Assembled Circuit Breaker) | | |
|--|---|-----------|
| Continuous Current Rating @ 40°C | 2-Pole | 3-Pole |
| | Catalogue Number | |
| 900 | For 2-pole application, use outside poles of 3-pole circuit breaker | CND63B900 |
| 1000 | | CND63B100 |
| 1200 | | CND63B120 |

Shipping Weights

| Number of Poles | Number per Carton | Shipping Weight (lbs.) |
|--|-------------------|------------------------|
| ND6, HND6, NXD6, HNXD6, CND6 Assembled Breaker (less terminals) | | |
| 2 | 1 | 53 |
| 3 | 1 | 61.5 |
| ND6, HND6 Frame Only | | |
| 2 | 1 | 42.25 |
| 3 | 1 | 46 |
| ND6, HND6 Trip Unit Only | | |
| 2 | 1 | 4.5 |
| 3 | 1 | 6.5 |

For inches / millimeters conversion, see Application Data section.

① HNXD6 and CND6 circuit breakers are CSA Certified / UL Listed for reverse connection applications.
② 2-pole units available in 3-pole width only.

③ When wired as shown on page 5-2, this circuit breaker is UL listed and rated for use on 500V DC ungrounded UPS systems only.

④ HACR rated.

Selection/Dimensions

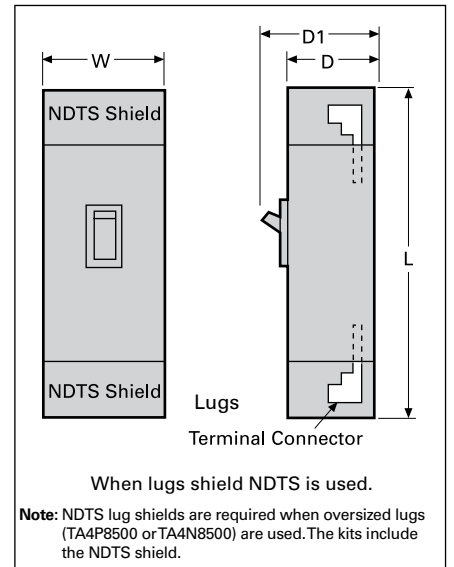

5
MOLDED CASE
CIRCUIT BREAKERS

Dimensions (in inches)

| Breaker Type | W | L | D | D1 |
|------------------------------|---|----|---|------|
| ND6, NXD6, HND6, HNXD6, CND6 | 9 | 16 | 6 | 8.25 |
| with NDTs lug shield | 9 | 29 | 6 | 8.25 |

Molded Case Circuit Breakers

SND 1200A Frame Digital Solid State Sentron Sensitrip III Series^②

Selection

Type SND6

Blue Label

| 3-Pole, 600V AC | |
|------------------|--------------------|
| Catalogue Number | Max Current Rating |
| SND69800A | 800 |
| SND69100A | 1000 |
| SND69120A | 1200 |
| SND69800AG | 800 |
| SND69100AG | 1000 |
| SND69120AG | 1200 |
| SND69800ANT | 800 |
| SND69100ANT | 1000 |
| SND69120ANT | 1200 |
| SND69800ANGT | 800 |
| SND69100ANGT | 1000 |
| SND69120ANGT | 1200 |

Type SHND6

Black Label

| 3-Pole, 600V AC | |
|------------------|--------------------|
| Catalogue Number | Max Current Rating |
| SHND69800A | 800 |
| SHND69100A | 1000 |
| SHND69120A | 1200 |
| SHND69800AG | 800 |
| SHND69100AG | 1000 |
| SHND69120AG | 1200 |
| SHND69800ANT | 800 |
| SHND69100ANT | 1000 |
| SHND69120ANT | 1200 |
| SHND69800ANGT | 800 |
| SHND69100ANGT | 1000 |
| SHND69120ANGT | 1200 |

Current Limiting

Type SCND6-A

Red Label

| 3-Pole, 600V AC | |
|------------------|--------------------|
| Catalogue Number | Max Current Rating |
| SCND69800A | 800 |
| SCND69100A | 1000 |
| SCND69120A | 1200 |
| SCND69800AG | 800 |
| SCND69100AG | 1000 |
| SCND69120AG | 1200 |
| SCND69800ANT | 800 |
| SCND69100ANT | 1000 |
| SCND69120ANT | 1200 |
| SCND69800ANGT | 800 |
| SCND69100ANGT | 1000 |
| SCND69120ANGT | 1200 |



SND 1200A Frame – 100% Rated^①

Type SND6

Blue Label

| 3-Pole, 600V AC | |
|------------------|--------------------|
| Catalogue Number | Max Current Rating |
| SND69800AH | 800 |
| SND69100AH | 1000 |
| SND69120AH | 1200 |
| SND69800AGH | 800 |
| SND69100AGH | 1000 |
| SND69120AGH | 1200 |
| SND69800ANTH | 800 |
| SND69100ANTH | 1000 |
| SND69120ANTH | 1200 |
| SND69800ANGTH | 800 |
| SND69100ANGTH | 1000 |
| SND69120ANGTH | 1200 |

Type SHND6

Black Label

| 3-Pole, 600V AC | |
|------------------|--------------------|
| Catalogue Number | Max Current Rating |
| SHND69800AH | 800 |
| SHND69100AH | 1000 |
| SHND69120AH | 1200 |
| SHND69800AGH | 800 |
| SHND69100AGH | 1000 |
| SHND69120AGH | 1200 |
| SHND69800ANTH | 800 |
| SHND69100ANTH | 1000 |
| SHND69120ANTH | 1200 |
| SHND69800ANGTH | 800 |
| SHND69100ANGTH | 1000 |
| SHND69120ANGTH | 1200 |

Current Limiting

Type SCND6-A

Red Label

| 3-Pole, 600V AC | |
|------------------|--------------------|
| Catalogue Number | Max Current Rating |
| SCND69800AH | 800 |
| SCND69100AH | 1000 |
| SCND69120AH | 1200 |
| SCND69800AGH | 800 |
| SCND69100AGH | 1000 |
| SCND69120AGH | 1200 |
| SCND69800ANTH | 800 |
| SCND69100ANTH | 1000 |
| SCND69120ANTH | 1200 |
| SCND69800ANGTH | 800 |
| SCND69100ANGTH | 1000 |
| SCND69120ANGTH | 1200 |

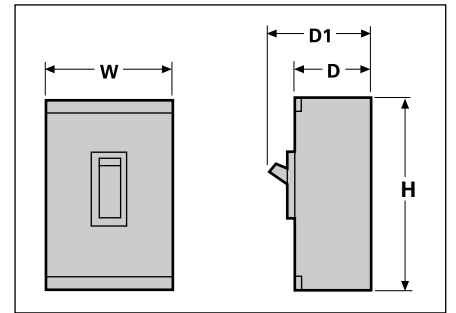

SMD6, SHMD6, SCMD6, SND6, SHND6, SCND6

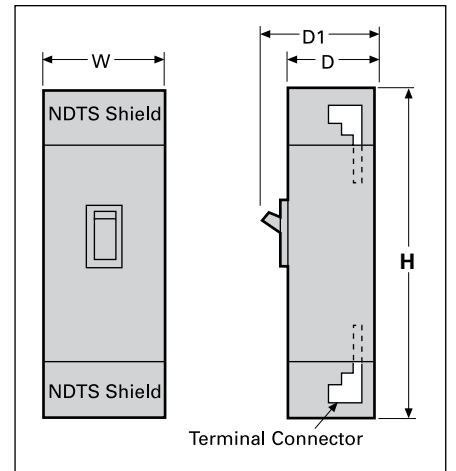

When wire connector shield NDTs is used.

Trip Unit Adjustable Functions

| Suffix Letter Code | Trip Type | Cont Current Setting | Long Time Delay | Instantaneous Setting | Short Time Pick Up | Short Time Delay | Short Time I _t Pick Up | Ground Fault Pick Up | Ground Fault Delay |
|--------------------|-----------|----------------------|-----------------|-----------------------|--------------------|------------------|-----------------------------------|----------------------|--------------------|
| A | LI | ✓ | ✓ | ✓ | — | — | — | — | — |
| AG | LIG | ✓ | ✓ | ✓ | — | — | — | ✓ | ✓ |
| ANT | LSI | ✓ | ✓ | ✓ | ✓ | ✓ | ✓ | — | — |
| ANGT | LSIG | ✓ | ✓ | ✓ | ✓ | ✓ | ✓ | ✓ | ✓ |

Neutral Transformers

| Ampere Rating | Catalogue Number |
|---------------|------------------|
| 800 | N08SMDA |
| 1000 | N10SNDA |
| 1200 | N12SNDA |

Dimensions (in Inches)

| Breaker Type | W | H | D | D1 |
|--|---|----|---|------|
| SMD6, SHMD6, SCMD6 SND6, SHND6, SCND6 | 9 | 16 | 6 | 8.25 |
| With NDTs shields | 9 | 24 | 6 | 8.25 |

For inches / millimeters conversion, see Application Data section.

For ordering information and terminal connectors, see page 5-64.

Note: "G" suffix in catalogue number denotes circuit breaker for 3-phase, 3-wire circuits.
For 3-phase, 4-wire, order correct 4th wire (neutral) transformer as separate and additional item.

① Use 2-3TA4P8500 for 3-pole. These kits are rated for 90°C wire. 90°C Cu only cable must be used, and sized per 75°C ampacity.

② SND6, SHND6 and SCND6 circuit breakers are UL Listed for reverse connection applications.

Molded Case Circuit Breakers

Internal Accessories

Selection

Accessories for:

MD/SMD 800A Frame
ND/SND 1200A Frame
PD/SPD 1600A Frame
RD 2000A Frame



Accessory modules can mount in either left hand or right hand poles of all circuit breakers, including solid state. Exception: when mechanical interlock is used accessories cannot be mounted in left pole.

Sensitrip Ammeter



The Ammeter Display Units plug into the Sensitrip Trip Unit and displays the phase current flowing in the breaker. They are powered by the breaker's CT's with replaceable battery back-up for maintaining trip and max logs.

The SADU reads currents, current imbalance, current demand, and trip status.

Ammeter Mounting Kit

The Ammeter may also be panel or door mounted using the SADURMK18 remote mounting kit.

Shunt Trip Combinations

| Control Voltage | | 1 Shunt Trip | 1 Shunt Trip and 1 Auxiliary Switch |
|-----------------|-----|------------------|-------------------------------------|
| AC | DC | Catalogue Number | Catalogue Number |
| 120 | — | S01MN6 | S01MN64A |
| 208 | — | S02MN6 | S02MN64A |
| 240 | — | S03MN6 | S03MN64A |
| 277 | — | S15MN6 | S15MN64A |
| 480 | — | S04MN6 | S04MN64A |
| 600 | — | S06MN6 | — |
| — | 12 | S16MN6 | S16MN64A |
| — | 24 | S07MN6 | S07MN64A |
| — | 48 | S09MN6 | — |
| — | 125 | S11MN6 | S11MN64A |
| — | 250 | S13MN6 | S13MN64A |

Undervoltage Trip Combinations

| Control Voltage | | 1 Undervoltage Trip | 1 Undervoltage Trip and 1 Auxiliary Switch | 1 Undervoltage Trip and 2 Auxiliary Switches |
|-----------------|-----|---------------------|--|--|
| AC | DC | Catalogue Number | Catalogue Number | Catalogue Number |
| 120 | — | U01MN6 | U01MN64A | U01MN64AA |
| 208 | — | U02MN6 | U02MN64A | U02MN64AA |
| 240 | — | U03MN6 | U03MN64A | U03MN64AA |
| 277 | — | U15MN6 | U15MN64A | U15MN64AA |
| 480 | — | U04MN6 | U04MN64A | U04MN64AA |
| 600 | — | U06MN6 | — | — |
| — | 24 | U07MN6 | U07MN64A | U07MN64AA |
| — | 48 | U09MN6 | U09MN64A | U09MN64AA |
| — | 125 | U11MN6 | U11MN64A | U11MN64AA |
| — | 250 | U13MN6 | U13MN64A | U13MN64AA |

Auxiliary Switch Combinations

| Maximum Voltage | | 1 Form C | 2 Form C |
|-----------------|-----|------------------|------------------|
| AC | DC | Catalogue Number | Catalogue Number |
| 480 | 250 | A01MN64 | A02MN64 |
| — | 12 | A01MNDLV | A02MNDLV |

Alarm Switch Combinations

| Maximum Voltage | | 1 Alarm Switch | 1 Alarm Switch and 1 Auxiliary Switch | 1 Alarm Switch and 2 Auxiliary Switches |
|-----------------|-----|------------------|---------------------------------------|---|
| AC | DC | Catalogue Number | Catalogue Number | Catalogue Number |
| 480 | 250 | B00MN64 | A01MN64B | A02MN64B |

Plug-in Ammeter Display Units

| Breaker Type | Description | Catalogue Number |
|---------------|---------------------|------------------|
| SMD, SND, SPD | Display Unit | SADU |
| | Remote Mounting Kit | SADURMK18 |

5
MOLDED CASE
CIRCUIT BREAKERS

Molded Case Circuit Breakers

PD 1600A Frame Sentron Series

Selection

Type PXD6² Non-Interchangeable Trip⁵

3-Pole 600V AC, 250-500V DC¹

Blue Label

| Continuous Current Rating @ 40°C | Complete Breaker Assembled (Frame/Trip Unit Only) | Mounting Assembly | Lugs (6 required) |
|----------------------------------|---|-------------------|-------------------|
| | Catalogue Number | Catalogue Number | Catalogue Number |
| 1200 | PXD63B120 | MB9301 | TA5P600 |
| 1400 | PXD63B140 | -or- | |
| 1600 | PXD63B160 | MBR9302 | |

Type PD6 Interchangeable Trip⁵

3-Pole 600V AC, 250-500V DC¹

Blue Label

| Continuous Current Rating @ 40°C | Complete Breaker Unassembled | Frame Only | Trip Unit Only | Mounting Assembly | Lugs (6 required) |
|----------------------------------|------------------------------|------------------|------------------|-------------------|-------------------|
| | Catalogue Number | Catalogue Number | Catalogue Number | Catalogue Number | Catalogue Number |
| 1200 | PD63B120 | PD63F160 | PD63T120 | MB9301 | TA5P600 |
| 1400 | PD63B140 | | PD63T140 | -or- | |
| 1600 | PD63B160 | | PD63T160 | MBR9302 | |

Type HPXD6² Non-Interchangeable Trip⁵

3-Pole 600V AC, 250-500V DC¹

Blue Label

| Continuous Current Rating @ 40°C | Complete Breaker Assembled (Frame/Trip Unit Only) |
|----------------------------------|---|
| | Catalogue Number |
| 1200 | HPXD63B120 |
| 1400 | HPXD63B140 |
| 1600 | HPXD63B160 |

Type HPD6 Interchangeable Trip⁵

3-Pole 600V AC, 250-500V DC¹

Black Label

| Continuous Current Rating @ 40°C | Complete Breaker Unassembled | Frame Only | Trip Unit Only | Mounting Assembly | Lugs (6 required) |
|----------------------------------|------------------------------|------------------|------------------|-------------------|-------------------|
| | Catalogue Number | Catalogue Number | Catalogue Number | Catalogue Number | Catalogue Number |
| 1200 | HPD63B120 | HPD63F160 | PD63T120 | MB9301 | TA5P600 |
| 1400 | HPD63B140 | | PD63T140 | -or- | |
| 1600 | HPD63B160 | | PD63T160 | MBR9302 | |

Type CPD6 Non-Interchangeable Trip⁵

Fuseless Current Limiting
3-Pole 600V AC, 250-500V DC¹

Red Label

| Continuous Current Rating @ 40°C | Complete Breaker Assembled (Frame/Trip Unit Only) |
|----------------------------------|---|
| | Catalogue Number |
| 1200 | CPD63B120 |
| 1400 | CPD63B140 |
| 1600 | CPD63B160 |

Mounting Bases for PD & RD

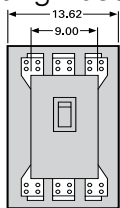

MB9301

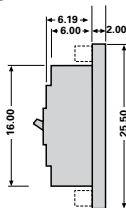

MB9301



MB9301

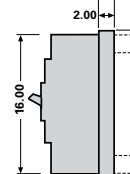

MBR9302

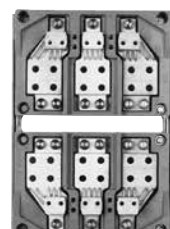

MBR9302

① Use two outside poles of a 3-pole circuit breaker for 250V
② When wired as shown on page 5-2, this circuit breaker is CSA Certified / UL listed and rated for use on 500V DC ungrounded UPS systems only.

③ PXD6, HPXD6 and CPD6 type circuit breakers are UL Listed for reverse feed applications.
④ For additional information See **Note: A**, page 5-64.
⑤ HACR rated.

Note: PD frame qualified to UL489 supplement B "NAVAL" See page 5-67 for additional information.

Ordering Instructions

Complete Breaker Unassembled with Lugs

Prices of PD6, HPD6, RD6, and HRD6 type breakers include frame, trip, mounting base (MB9301), and both line and load lugs (PD Frame – TA5P600, RD Frame – TC5R600). When ordered by these catalogue numbers, the customer will receive the frame, trip, mounting assembly and lugs separately packaged. For applications requiring different mounting base or lugs, order individual items as needed.

Complete Breaker Assembled without Lugs

Prices of PXD6, HPXD6, RXD6, HRXD6 and CPD6 type breakers include frame with non-interchangeable trip unit installed only. Order required mounting base and lugs separately.

100% Rated (3-Pole only)

Types PXD6, HPXD6 breakers are available with 100% ratings. To order add suffix "H" to catalogue number, and 10% to list price. 100% PD breakers require 90° C cable sized at 75° C ampacity and TC5R600 lugs. RD 2000A Frames not available with 100% ratings.

50°C Applications see page 5-67.

400HZ Applications see page 5-67.

Lugs (6 required per breaker)⁴

| Catalogue Number | No of Cables per Connector | Wire Range |
|------------------|----------------------------|-----------------------|
| TA5P600 | 1-5 | 300-600 kcmil Cu/Al |
| TC5R600 | 1-5 | 300-600 kcmil Cu only |
| TA4P750 | 1-4 | 500-750 kcmil Cu/Al |
| TA6R600 | 1-6 | 300-600 kcmil Cu/Al |

Interrupting Ratings

| Breaker Type | UL 489 A IR | | | | |
|--------------|--------------------|-----|-----|-----------------------|---------|
| | RMS Symmetrical KA | | | | |
| | Volts AC | | | Volts DC ^① | |
| | 240 | 480 | 600 | 250 | 500 |
| PD6, PXD6 | 65 | 50 | 25 | 30 (2P) | 25 (3P) |
| HPD6, HPXD6 | 100 | 65 | 50 | 30 (2P) | 50 (3P) |
| CPD6 | 200 | 100 | 65 | 30 (2P) | 50 (3P) |

Molded Case Circuit Breakers

SPD 1600A Frame Digital Solid State Sentron Sensitrip III Series

Selection/Dimensions

Ordering Information

Pricing information for all Digital Sentron Series PD frame unit is for breaker only. Price required mounting block assembly and necessary terminal connectors as separate items.

SPD6 and SHPD6 are acceptable for reverse connection applications.

Type SPD6

Blue Label

| 3-Pole, 600V AC | |
|------------------|--------------------|
| Catalogue Number | Max Current Rating |
| SPD69140 | 1400 |
| SPD69160 | 1600 |
| SPD69140G | 1400 |
| SPD69160G | 1600 |
| SPD69140NT | 1400 |
| SPD69160NT | 1600 |
| SPD69140NGT | 1400 |
| SPD69160NGT | 1600 |

Type SHPD6

Black Label

| 3-Pole, 600V AC | |
|------------------|--------------------|
| Catalogue Number | Max Current Rating |
| SHPD69140 | 1400 |
| SHPD69160 | 1600 |
| SHPD69140G | 1400 |
| SHPD69160G | 1600 |
| SHPD69140NT | 1400 |
| SHPD69160NT | 1600 |
| SHPD69140NGT | 1400 |
| SHPD69160NGT | 1600 |



Lugs^①

| Catalogue Number | No. of Cables per Connector | Wire Range |
|------------------|-----------------------------|-----------------------|
| TA5P600 | 1-5 pcs. | 300-600 kcmil Cu/Al |
| TC5R600 | 1-5 pcs. | 300-600 kcmil Cu Only |
| TA6R600 | 1-5 pcs. | 300-600 kcmil Cu/Al |

Neutral Transformers

| Ampere Rating | Catalogue Number |
|---------------|------------------|
| 1400 | N14SPD |
| 1600 | N16SPD |

Mounting Block (Required)^②

| Catalogue Number |
|------------------|
| MB9301 |
| MBR9302 |

| Suffix Letter Code | Trip Type | Cont Current Setting | Long Time Delay | Instantaneous Setting | Short Time Pick Up | Short Time Delay | Short Time Pick Up | Ground Fault Pick Up | Ground Fault Delay |
|--------------------|-----------|----------------------|-----------------|-----------------------|--------------------|------------------|--------------------|----------------------|--------------------|
| None | LI | ✓ | ✓ | ✓ | — | — | — | — | — |
| G | LIG | ✓ | ✓ | ✓ | — | — | — | ✓ | ✓ |
| NT | LSI | ✓ | ✓ | ✓ | ✓ | ✓ | ✓ | — | — |
| NGT | LSIG | ✓ | ✓ | ✓ | ✓ | ✓ | ✓ | ✓ | ✓ |

Interrupting Ratings

| Breaker Type | RMS Symmetrical kA CSA / UL 489 | | |
|--------------|---------------------------------|---------|---------|
| | 240V AC | 480V AC | 600V AC |
| SPD6 | 65 | 50 | 25 |
| SHPD6 | 100 | 65 | 50 |

All PD, RD Frames:

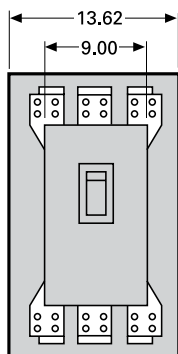

MB9301 (shown)
MBR9302

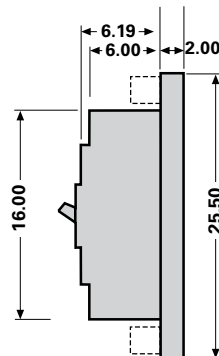

MBR9301



MB9301

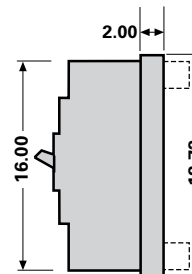

MBR9302

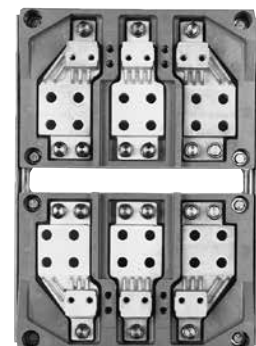

MBR9302

For inches / millimeters conversion, see Application Data section.

① For additional information, see Note: A, page 5-64.

② The PD frame circuit breaker requires the use of a connect-all mounting assembly to allow for placing into service.

Note: "G" suffix in catalogue number denotes circuit breaker for 3 phase, 3 wire circuits.

For 3 phase, 4 wire, order correct 4th wire (neutral) transformer as separate and additional item.

Molded Case Circuit Breakers

Internal Accessories

Selection/Dimensions

Accessories for:

MD/SMD 800A Frame
ND/SND 1200A Frame
PD/SPD 1600A Frame
RD 2000A Frame



Accessory modules can mount in either left hand or right hand poles of all circuit breakers, including solid state. Exception: when mechanical interlock is used accessories cannot be mounted in left pole.

Sensitrip Ammeter



The Ammeter Display Units plug into the Sensitrip Trip Unit and displays the phase current flowing in the breaker. They are powered by the breaker's CT's with replaceable battery back-up for maintaining trip and max logs.

The SADU reads currents, current imbalance, current demand, and trip status.

Ammeter Mounting Kit

The Ammeter may also be panel or door mounted using the SADURMK18 remote mounting kit.

Shunt Trip Combinations

| Control Voltage | | 1 Shunt Trip | 1 Shunt Trip and 1 Auxiliary Switch |
|-----------------|-----|------------------|-------------------------------------|
| AC | DC | Catalogue Number | Catalogue Number |
| 120 | — | S01MN6 | S01MN64A |
| 208 | — | S02MN6 | S02MN64A |
| 240 | — | S03MN6 | S03MN64A |
| 277 | — | S15MN6 | S15MN64A |
| 480 | — | S04MN6 | S04MN64A |
| 600 | — | S06MN6 | — |
| — | 12 | S16MN6 | S16MN64A |
| — | 24 | S07MN6 | S07MN64A |
| — | 48 | S09MN6 | — |
| — | 125 | S11MN6 | S11MN64A |
| — | 250 | S13MN6 | S13MN64A |

Undervoltage Trip Combinations

| Control Voltage | | 1 Undervoltage Trip | 1 Undervoltage Trip and 1 Auxiliary Switch | 1 Undervoltage Trip and 2 Auxiliary Switches |
|-----------------|-----|---------------------|--|--|
| AC | DC | Catalogue Number | Catalogue Number | Catalogue Number |
| 120 | — | U01MN6 | U01MN64A | U01MN64AA |
| 208 | — | U02MN6 | U02MN64A | U02MN64AA |
| 240 | — | U03MN6 | U03MN64A | U03MN64AA |
| 277 | — | U15MN6 | U15MN64A | U15MN64AA |
| 480 | — | U04MN6 | U04MN64A | U04MN64AA |
| 600 | — | U06MN6 | — | — |
| — | 24 | U07MN6 | U07MN64A | U07MN64AA |
| — | 48 | U09MN6 | U09MN64A | U09MN64AA |
| — | 125 | U11MN6 | U11MN64A | U11MN64AA |
| — | 250 | U13MN6 | U13MN64A | U13MN64AA |

Auxiliary Switch Combinations

| Maximum Voltage | | 1 Form C* | 2 Form C |
|-----------------|-----|------------------|------------------|
| AC | DC | Catalogue Number | Catalogue Number |
| 480 | 250 | A01MN64 | A02MN64 |
| — | 12 | A01MNDLV | A02MNDLV |

Alarm Switch Combinations

| Maximum Voltage | | 1 Alarm Switch | 1 Alarm Switch and 1 Auxiliary Switch | 1 Alarm Switch and 2 Auxiliary Switches |
|-----------------|-----|------------------|---------------------------------------|---|
| AC | DC | Catalogue Number | Catalogue Number | Catalogue Number |
| 480 | 250 | B00MN64 | A01MN64B | A02MN64B |

Plug-in Ammeter Display Units

| Breaker Type | Description | Catalogue Number |
|---------------|---------------------|------------------|
| SMD, SND, SPD | Display Unit | SADU |
| | Remote Mounting Kit | SADURMK18 |

Molded Case Circuit Breakers

RD 2000A Frame Sentron Series

Selection

Type RXD6^④

3-Pole 600V AC, 250-500V DC^①

Blue Label

| Non-Interchangeable Trip (Assembled Circuit Breaker Only Without Lugs) | | | |
|--|---|------------------------------------|-------------------|
| Continuous Current Rating @ 40°C | Complete Breaker Assembled (Frame/Trip Unit Only) | | Lugs (6 required) |
| | Catalogue Number | | Catalogue Number |
| 1600 | RXD63B160 | | TC5R600 |
| 1800 | RXD63B180 | | |
| 2000 | RXD63B200 | | |
| | | Mounting Assembly Catalogue Number | |
| | | MB9301 | |
| | | -or- | |
| | | MBR9302 | |

Type RD6^④

3-Pole 600V AC, 250-500V DC^①

Blue Label

| Interchangeable Trip (Unassembled Circuit Breaker with Lugs) | | | | | |
|--|------------------------------|-----------------------------|------------------|-------------------|-------------------|
| Continuous Current Rating @ 40°C | Complete Breaker Unassembled | | Trip Unit Only | Mounting Assembly | Lugs (6 required) |
| | Catalogue Number | | Catalogue Number | Catalogue Number | Catalogue Number |
| 1600 | RD63B160 | | RD63T160 | MB9301 | TC5R600 |
| 1800 | RD63B180 | | RD63T180 | -or- | |
| 2000 | RD63B200 | | RD63T200 | MBR9302 | |
| | | Frame Only Catalogue Number | | | |
| | | RD63F200 | | | |

Type HRXD6^④

| Continuous Current Rating @ 40°C | Complete Breaker Assembled (Frame/Trip Unit Only) | |
|----------------------------------|---|--|
| | Catalogue Number | |
| 1600 | HRXD63B160 | |
| 1800 | HRXD63B180 | |
| 2000 | HRXD63B200 | |

Type HRD6^④

Black Label

| Continuous Current Rating @ 40°C | Complete Breaker Unassembled | | Trip Unit Only | Mounting Assembly | Lugs (6 required) |
|----------------------------------|------------------------------|-----------------------------|------------------|-------------------|-------------------|
| | Catalogue Number | | Catalogue Number | Catalogue Number | Catalogue Number |
| 1600 | HRD63B160 | | RD63T160 | MB9301 | TC5R600 |
| 1800 | HRD63B180 | | RD63T180 | -or- | |
| 2000 | HRD63B200 | | RD63T200 | MBR9302 | |
| | | Frame Only Catalogue Number | | | |
| | | HRD63F200 | | | |

Interrupting Ratings

| Breaker Type | UL 489 A IR | | | | | |
|--------------|--------------------|-----|-----|-----------------------|---------|--|
| | RMS Symmetrical KA | | | | | |
| | Volts AC | | | Volts DC ^① | | |
| | 240 | 480 | 600 | 250 | 500 | |
| RD6, RXD6 | 65 | 50 | 25 | 30 (2P) | 25 (3P) | |
| HRD6, HRXD6 | 100 | 65 | 50 | 30 (2P) | 50 (3P) | |

Instantaneous Adjustment Trip Range (PD / RD Frames)

| Breaker Ampere Rating | Nominal Instantaneous Values | | | | | | | |
|-----------------------|------------------------------|------|------|------|------|------|------|---------------------|
| | ±25% Tolerance Low | 2 | 3 | 4 | 5 | 6 | 7 | ±20% Tolerance High |
| | | | | | | | | |
| 1200-2000 | 5000 | 5715 | 6430 | 7145 | 7860 | 8575 | 9790 | 10,000 |

① Use two outside poles of a 3-pole circuit breaker for 250V DC applications.

② When wired as shown on page 5-2, this circuit breaker is CSA Certified / UL listed and rated for use on 500V DC ungrounded UPS systems only.

③ RXD6 and HRXD6 type circuit breakers are CSA Certified / UL Listed for reverse feed applications. ④ HACR rated.

⑤ For additional information See Note: A, page 5-64. Note: RD frame qualified to UL489 supplement B "NAVAL". See page 5-67 for additional information.

⑥ For required mounting base (MB9301 or MBR9302) see page 5-49.



Mounting Block^⑥

| Catalogue Number | Connection Points |
|------------------|-------------------|
| MB9301 | Front |
| MBR9302 | Rear |

Shipping Weights

| Number of Poles | Number per Carton | Shipping Weight (lbs.) |
|--|-------------------|------------------------|
| PXD6, HPXD6, RXD6, HRXD6, CPD6 Assembled Breakers | | |
| 3 | 1 | 61.5 |
| PD6, HPD6, RD6, HRD6 Frame Only | | |
| 3 | 1 | 55.0 |
| PD6, RD6 Trip Unit Only | | |
| 3 | 1 | 6.5 |
| Mounting Assembly | | |
| MB9301 | 1 | 53.0 |
| MBR9302 | 1 | 50.9 |

Lugs (6 required per breaker)^⑥

| Catalogue Number | No of Cables per Connector | Wire Range |
|------------------|----------------------------|-----------------------|
| TA5P600 | 1-5 | 300-600 kcmil Cu/Al |
| TC5R600 | 1-5 | 300-600 kcmil Cu only |
| TA6R600 | 1-6 | 300-600 kcmil Cu/Al |

5 MOLDED CASE CIRCUIT BREAKERS

Molded Case Circuit Breakers

Magnetic Trip Only — ETI Motor Circuit Protector

Selection

| Breaker Type | Ampere Rating | Instantaneous Trip Range ^② | | Complete Circuit Breaker Without Lugs | |
|--|---------------|---------------------------------------|----------------------|---------------------------------------|-------------------------|
| | | Minimum ^③ | Maximum ^③ | Catalogue Number 2-Pole | Catalogue Number 3-Pole |
| ED6-A 600V AC 250V DC | 1 | 2.6 | 9 | — | ED63A001 |
| | 2 | 7 | 22 | — | ED63A002 |
| | 3 | 10 | 35 | — | ED63A003 |
| | 5 | 16 | 54 | — | ED63A005 |
| | 10 | 30 | 100 | — | ED63A010 |
| | 25 | 55 | 180 | — | ED63A025 |
| | 30 | 80 | 270 | — | ED63A030 |
| | 40 | 115 | 375 | — | ED63A040 |
| | 50 | 180 | 600 | — | ED63A050 |
| | 100 | 315 | 1000 | — | ED63A100 |
| | 125 | 500 | 1250 | — | ED63A125 |
| | SHIPPING: | | | | |
| CED6-A 600V AC 250V DC | 1 | 2.6 | 9 | — | CED63A001 |
| | 2 | 7 | 22 | — | CED63A002 |
| | 3 | 10 | 35 | — | CED63A003 |
| | 5 | 16 | 54 | — | CED63A005 |
| | 10 | 30 | 100 | — | CED63A010 |
| | 25 | 55 | 180 | — | CED63A025 |
| | 30 | 80 | 270 | — | CED63A030 |
| | 40 | 115 | 375 | — | CED63A040 |
| | 50 | 180 | 600 | — | CED63A050 |
| | 100 | 315 | 1000 | — | CED63A100 |
| | 125 | 500 | 1250 | — | CED63A125 |
| | SHIPPING: | | | | |
| FXD6 ^④ 600V AC 250V DC | 150 | 400 | 800 | — | FXD63L150 |
| | 150 | 800 | 1500 | — | FXD63A150 |
| | 150 | 1100 | 2500 | — | FXD63H150 |
| | 250 | 1100 | 2500 | — | FXD63A250 |
| SHIPPING: | | | | | 9 lbs. each |
| CFD6 ^④ 600V AC 250V DC | 150 | 400 | 800 | — | CFD63L150 |
| | 150 | 800 | 1500 | — | CFD63A150 |
| | 150 | 1100 | 2500 | — | CFD63H150 |
| | 250 | 1100 | 2500 | — | CFD63A250 |
| SHIPPING: | | | | | 12 lbs. each |
| JXD6(A) ^① 600V AC 250V DC | 400 | 1250 | 2500 | — | JXD63L400 |
| | 400 | 2000 | 4000 | JXD62H400 | JXD63H400 |
| SHIPPING: | | | | | 16 lbs. each |
| CJD6 ^① 600V AC 250V DC | 400 | 1250 | 2500 | CJD62L400 | CJD63L400 |
| | 400 | 2000 | 4000 | CJD62H400 | CJD63H400 |
| SHIPPING: | | | | | 29.5 lbs. each |
| LXD6(A) ^① 600V AC 250V DC | 600 | 2000 | 4000 | LXD62L600 | LXD63L600 |
| | 600 | 3000 | 6000 | — | LXD63H600 |
| SHIPPING: | | | | | 16 lbs. each |
| CLD6 ^① 600V AC 250V DC | 600 | 2000 | 4000 | CLD62L600 | CLD63L600 |
| | 600 | 3000 | 6000 | CLD62H600 | CLD63H600 |
| SHIPPING: | | | | | 31.5 lbs. each |
| LMXD6 ^④ 600V AC 250V DC | 800 | 2800 | 6000 | — | LMXD63L800 |
| | 800 | 3200 | 8000 | — | LMXD63A800 |
| SHIPPING: | | | | | 35 lbs. each |
| MXD6 ^④ 600V AC 250V DC | 800 | 3000 | 6000 | — | MXD63L800 |
| | 800 | 4000 | 8000 | — | MXD63A800 |
| | 800 | 5000 | 10000 | — | MXD63H800 |
| SHIPPING: | | | | | 33 lbs. each |
| CMD6 ^④ 600V AC 250V DC | 800 | 3000 | 6000 | — | CMD63L800 |
| | 800 | 4000 | 8000 | — | CMD63A800 |
| | 800 | 5000 | 10000 | — | CMD63H800 |
| SHIPPING: | | | | | 80 lbs. each |

Important Information

ETI interrupting ratings are determined through combination tests with properly sized overload relays and contactors.

Connectors included when ordering by circuit breaker catalogue number for ED6 and CED6 ETI's. Order ETI circuit breaker and lugs (2 per pole) separately for the FXD6, CFD6, MXD6, CMD6, JXD6, CJD6, LXD6 and CLD6 ETI's.

Lug Information page 5-64
Accessories page 5-68
Application data page 5-51

① 2-pole available in 3-pole width only.

② When applied on DC Circuits — Trip levels will increase approximately +15 to 20%.

③ Tolerance -20%/+30% for lowest setting. All other set-

tings are -20%/+20%.

④ For 2-pole application use outside poles of 3-pole circuit breaker.

Molded Case Circuit Breakers

Motor Circuits

Application

General

Protection of Motor Circuits

Molded case circuit breakers are used in motor circuits as a disconnecting means and for short-circuit protection. They should be used in conjunction with motor-running, over-current-protection devices, and should permit the motor to start without nuisance tripping from motor-inrush current. The circuit breaker should have a continuous-current rating of not less than 115% of the motor full-load current.

The recommended motor circuit protectors (Siemens ETI instantaneous only circuit breakers) listed have

continuous-current ratings of at least 115% of motor full-load currents. The trip-setting positions are approximately 11 times motor full-load currents. The suggested trip settings may have to be adjusted upward to no higher than 1300% of full-load current for non-design E type motors, and no greater than 1700% of full load current for design B & E energy efficient motors, to allow for motor start-up due to inrush currents.

Breaker Mounted Immediately Ahead of Motor Starter

Siemens ETI motor circuit protectors are recommended for use in combination motor starters to provide selective short-circuit protection for the motor branch

circuit. The adjustable instantaneous-trip feature of the Siemens ETI motor circuit protector provides for a trip setting slightly above the peak motor-inrush current. With this setting, no delay is introduced in opening the circuit when a fault occurs. This circuit breaker has no time-delay trip element. Therefore it must be used in conjunction with, and immediately ahead of, the motor-running overcurrent protective device.

Important: The information below does not apply to all motor applications: it is recommended that the user refer to the National Electrical Code (NEC) for specific needs.

Table 1 (When Breaker is Mounted Immediately Ahead of Motor Starter)

3 Phase Induction Type Motors (Siemens ETI motor circuit protectors for branch circuit use with alternating-current combination, full voltage motor starters).

| Motor Full Load Amperes | Catalogue Number | ETI Trip Setting | | Motor Full Load Amperes | Catalogue Number | ETI Trip Setting | | Motor Full Load Amperes | Catalogue Number | ETI Trip Setting | |
|-------------------------|-----------------------|------------------|---------|-------------------------|------------------------|------------------------|-----------------|-------------------------|------------------------|------------------------|------------------------|
| | | Adjustment | Amperes | | | Adjustment | Amperes | | | Adjustment | Amperes |
| .20 – .33 | ED63A001 CED63A001 | Low | 2.6 | 38.46 – 55.37 | ED63A125 CED63A125 | Low | 500 | 231.00 – 264.00 | LXD63H600 CLD63H600 | Low | 3000 |
| .34 – .45 | | 2 | 4.5 | 55.38 – 70.75 | | 2 | 720 | 264.00 – 292.00 | | 2 | 3430 |
| .46 – .56 | | 3 | 6 | 70.76 – 84.60 | | 3 | 920 | 330.00 – 362.00 | | 4 | 4290 |
| .57 – .68 | | 4 | 7.5 | 84.61 – 96.14 | | 4 | 1100 | 395.00 – 428.00 | | 6 | 5140 |
| .69 – .81 | | High | 9 | 96.15 – 113.60 | | High | 1250 | 428.99 – 462.00 | | 7 | 5570 |
| | | | | | | | 462.00 – 490.00 | High | | 6000 | |
| .53 – .83 | ED63A002 CED63A002 | Low | 7 | 30.76 – 35.37 | FXD63L150 CFD63L150 | Low | 400 | 215.00 – 238.00 | | LMXD63L800 | Low |
| .84 – 1.14 | | 2 | 11 | 35.38 – 39.99 | | 2 | 460 | 238.00 – 261.00 | 2 | | 3100 |
| 1.15 – 1.45 | | 3 | 15 | 44.51 – 49.23 | | 4 | 580 | 261.00 – 284.00 | 3 | | 3400 |
| 1.46 – 1.69 | | 4 | 19 | 53.84 – 58.45 | | 6 | 700 | 308.00 – 369.00 | 5 | | 4000 |
| 1.69 – 2.00 | | High | 22 | 58.46 – 63.06 | | 7 | 760 | 369.00 – 423.00 | 6 | | 4800 |
| | | | | | | | | 423.00 – 462.00 | 7 | | 5500 |
| | | | | | | | | 462.00 – 490.00 | High | | 6000 |
| .76 – 1.29 | ED63A003 CED63A003 | Low | 10 | 61.53 – 69.22 | FXD63A150 CFD63A150 | Low | 800 | 246.00 – 269.00 | LMXD63A800 | Low | 3200 |
| 1.30 – 1.75 | | 2 | 17 | 69.23 – 76.91 | | 2 | 900 | 269.00 – 284.00 | | 2 | 3500 |
| 1.76 – 2.29 | | 3 | 23 | 84.61 – 92.29 | | 4 | 1100 | 284.00 – 323.00 | | 3 | 3700 |
| 2.30 – 2.68 | | 4 | 30 | 100.00 – 108.00 | | 6 | 1300 | 362.00 – 492.00 | | 5 | 4700 |
| 2.69 – 3.18 | | High | 35 | 108.00 – 115.00 | | 7 | 1400 | 492.00 – 562.00 | | 6 | 6400 |
| | | | | | | | | 562.00 – 616.00 | | 7 | 7300 |
| | | | | | | | | 616.00 – 660.00 | | High | 8000 |
| 1.23 – 1.99 | ED63A005 CED63A005 | Low | 16 | 131.00 – 146.00 | FXD63A250 CFD63A250 | Low | 1100 | 231.00 – 264.00 | MXD63L800 CMD63L800 | Low | 3000 |
| 2.00 – 2.75 | | 2 | 26 | 146.00 – 162.00 | | 2 | 1300 | 264.00 – 292.00 | | 2 | 3430 |
| 2.76 – 3.52 | | 3 | 36 | 162.00 – 177.00 | | 4 | 1700 | 292.00 – 330.00 | | 3 | 3800 |
| 3.53 – 4.14 | | 4 | 46 | 177.00 – 192.00 | | 6 | 2100 | 362.00 – 395.00 | | 5 | 4710 |
| 4.15 – 4.90 | | High | 54 | 192.00 – 227.00 | | 7 | 2300 | 428.00 – 462.00 | | 7 | 5570 |
| | | | | | | | | 462.00 – 490.00 | | High | 6000 |
| 2.30 – 3.83 | ED63A010 CED63A010 | Low | 30 | 95.00 – 110.00 | | JXD63L400 CJD63L400 | Low | 1250 | | 308.00 – 352.00 | MXD63A800 CMD63A800 |
| 3.84 – 5.37 | | 2 | 50 | 110.00 – 124.00 | 2 | | 1430 | 352.00 – 442.00 | 2 | 4570 | |
| 5.38 – 6.52 | | 3 | 70 | 138.00 – 151.00 | 4 | | 1790 | 442.00 – 447.00 | 3 | 5740 | |
| 6.53 – 7.68 | | 4 | 85 | 165.00 – 178.00 | 6 | | 2140 | 483.00 – 527.00 | 5 | 6280 | |
| 7.69 – 9.10 | | High | 100 | 178.00 – 192.00 | 7 | | 2320 | 571.00 – 616.00 | 7 | 7240 | |
| | | | | | | | | 616.00 – 660.00 | High | 8000 | |
| 4.23 – 6.91 | ED63A025 CED63A025 | Low | 55 | 154.00 – 176.00 | JXD63H400 CJD63H400 | | Low | 2000 | 385.00 – 440.00 | MXD63H800 CMD63H800 | |
| 6.92 – 9.61 | | 2 | 90 | 176.00 – 198.00 | | 2 | 2290 | 495.00 – 550.00 | 3 | | 6430 |
| 9.62 – 11.91 | | 3 | 125 | 220.00 – 242.00 | | 4 | 2860 | 605.00 – 660.00 | 5 | | 7860 |
| 11.92 – 13.83 | | 4 | 155 | 264.00 – 285.00 | | 6 | 3430 | 660.00 – 695.00 | 6 | | 8575 |
| 13.84 – 16.40 | | High | 180 | 285.00 – 308.00 | | 7 | 3710 | | | | |
| | | | | | | | | | | | |
| 6.15 – 10.37 | ED63A030 CED63A030 | Low | 80 | 155.00 – 176.00 | | LXD63L600 CLD63L600 | Low | 2000 | | | |
| 10.38 – 14.22 | | 2 | 135 | 176.00 – 198.00 | 2 | | 2290 | | | | |
| 14.23 – 18.06 | | 3 | 185 | 220.00 – 242.00 | 4 | | 2860 | | | | |
| 18.07 – 20.75 | | 4 | 235 | 264.00 – 285.00 | 6 | | 3430 | | | | |
| 20.76 – 24.50 | | High | 270 | 285.00 – 308.00 | 7 | | 3710 | | | | |
| | | | | | | | | | | | |
| 8.84 – 14.22 | ED63A040 CED63A040 | Low | 115 | 155.00 – 176.00 | LXD63L600 CLD63L600 | | Low | 2000 | | | |
| 14.23 – 19.60 | | 2 | 185 | 176.00 – 198.00 | | 2 | 2290 | | | | |
| 19.61 – 24.99 | | 3 | 255 | 220.00 – 242.00 | | 4 | 2860 | | | | |
| 25.00 – 28.83 | | 4 | 325 | 264.00 – 285.00 | | 6 | 3430 | | | | |
| 28.84 – 34.00 | | High | 375 | 285.00 – 308.00 | | 7 | 3710 | | | | |
| | | | | | | | | | | | |
| 13.84 – 23.06 | ED63A050 CED63A050 | Low | 180 | 155.00 – 176.00 | | LXD63L600 CLD63L600 | Low | 2000 | | | |
| 23.07 – 31.52 | | 2 | 300 | 176.00 – 198.00 | 2 | | 2290 | | | | |
| 31.53 – 39.99 | | 3 | 410 | 220.00 – 242.00 | 4 | | 2860 | | | | |
| 40.00 – 46.14 | | 4 | 520 | 264.00 – 285.00 | 6 | | 3430 | | | | |
| 46.15 – 54.50 | | High | 600 | 285.00 – 308.00 | 7 | | 3710 | | | | |
| | | | | | | | | | | | |
| 24.23 – 41.52 | ED63A100 CED63A100 | Low | 315 | 155.00 – 176.00 | LXD63L600 CLD63L600 | | Low | 2000 | | | |
| 41.53 – 56.91 | | 2 | 540 | 176.00 – 198.00 | | 2 | 2290 | | | | |
| 56.92 – 68.45 | | 3 | 740 | 220.00 – 242.00 | | 4 | 2860 | | | | |
| 68.46 – 76.91 | | 4 | 890 | 264.00 – 285.00 | | 6 | 3430 | | | | |
| 76.92 – 90.90 | | High | 1000 | 285.00 – 308.00 | | 7 | 3710 | | | | |
| | | | | | | | | | | | |

Note: Lowest instantaneous settings have a -20%/+30% tolerance and all other settings have a -20%/+20% tolerance.

Molded Case Circuit Breakers

Motor Circuits

Application

Breaker Mounted at a Distance From Motor Starter

ET thermal-magnetic circuit breakers conform to the National Electrical Code (2002) table 430-52 requirements for motor branch and feeder circuit protection when properly applied in conjunction with motor-running overcurrent protective devices. The

recommended circuit-breaker ratings in Table 2 provide adequate time delay for starting the majority of three-phase induction motors.

To determine the ampere ratings of the ET breaker to protect a motor feeder, add the rating of the ET breaker used to protect the largest motor branch circuit in the group to the full-load currents of

the remaining motors in the group.

Interrupt Ratings

For normal commercial purposes, available fault current can conveniently be obtained in the Interrupting Selector Tables.

Table 2 (When Breaker is Mounted at a Distance From Motor Starter)

3 Phase Induction Type Motors (EQ and ET circuit breakers (thermal-magnetic trip) for branch breaker use with alternating-current combination motor starters).

| Motor Horsepower Rating | 200 and 208V Motors | | | 230V Motors | | | 460V Motors | | | 575V Motors | | |
|-------------------------|--|--------------------------|---------------|--|--------------------------|---------------|---|--|-------------------|--|----------------------------------|-------------------|
| | 240V Circuit Breaker Data ^① | | | 240V Circuit Breaker Data ^① | | | 480V Circuit Breaker Data ^① | | | 600V Circuit Breaker Data ^① | | |
| | Breaker Type | Catalogue Number | Ampere Rating | Breaker Type | Catalogue Number | Ampere Rating | Breaker Type | Catalogue Number | Ampere Rating | Breaker Type | Catalogue Number | Ampere Rating |
| 1/2 | BQ [Ⓞ] | BQ3B015 | 15 | BQ [Ⓞ] | BQ3B015 | 15 | ED4 | ED43B015 | 15 | ED6 | ED63B015 | 15 |
| 3/4 | | BQ3B015 | 15 | | BQ3B015 | 15 | | ED43B015 | 15 | | ED63B015 | 15 |
| 1 | | BQ3B015 | 15 | | BQ3B015 | 15 | | ED43B015 | 15 | | ED63B015 | 15 |
| 1 1/2 | | BQ3B015 | 15 | | BQ3B015 | 15 | | ED43B015 | 15 | | ED63B015 | 15 |
| 2 | | BQ3B020 | 20 | | BQ3B015 | 15 | | ED43B015 | 15 | | ED63B015 | 15 |
| 3 | | BQ3B030 | 30 | | BQ3B020 | 20 | | ED43B015 | 15 | | ED63B015 | 15 |
| 5 | BQ [Ⓞ] | BQ3B040 | 40 | BQ [Ⓞ] | BQ3B030 | 30 | ED4 | ED43B015 | 15 | ED6 | ED63B015 | 15 |
| 7 1/2 | | BQ3B060 | 60 | | BQ3B050 | 50 | | ED43B030 | 30 | | ED63B020 | 20 |
| 10 | | BQ3B070 | 70 | | BQ3B070 | 70 | | ED43B030 | 30 | | ED63B030 | 30 |
| 15 | | BQ3B100 | 100 | | BQ3B090 | 90 | | ED43B040 | 40 | | ED63B035 | 35 |
| 20 | | | | | BQ3B100 | 100 | | ED43B050 | 50 | | ED63B050 | 50 |
| 25 | FXD6 | FXD63B125 | 125 | FXD6 | FXD63B125 | 125 | FXD6 | FXD63B090 | 90 | FXD6 | FXD63B060 | 60 |
| 30 | | FXD63B150 | 150 | | FXD63B150 | 150 | | FXD63B100 | 100 | | FXD63B070 | 70 |
| 40 | | FXD63B175 | 175 | | FXD63B175 | 175 | | FXD63B125 | 125 | | FXD63B090 | 90 |
| 50 | | FXD63B200 | 200 | | FXD63B200 | 200 | | FXD63B150 | 150 | | FXD63B100 | 100 |
| | | FXD63B225 | 225 | | | | | | | | | |
| 60 | JXD2 | JXD23B300 | 300 | — | — | — | FXD6, FD6 | FXD63B150 | 150 | FXD6 | FXD63B100 | 100 |
| 75 | JXD2 | JXD23B400 | 400 | JXD2 | JXD23B350 | 350 | FXD6, FD6 | FXD63B200 | 200 | FXD6, FD6 | FXD63B125 | 125 |
| 100 | JXD2 | JXD23B400 | 400 | JXD2 | JXD23B400 | 400 | FD6 [Ⓞ] JD6 [Ⓞ] | FD63B250 JD63B250 | 250 250 | FXD6, FD6 | FD63B175 | 175 |
| 125 | LD6 [Ⓞ] or LMD6 | LD63B600 LMD63B600 | 600 | LD6 [Ⓞ] or LMD6 | LD63B500 or LMD63B500 | 500 | JD6 [Ⓞ] | JD63B300 | 300 | FXD6, FD6 OR JD6 [Ⓞ] | FXD63B200 JD63B200 | 200 200 |
| 150 | LD6 [Ⓞ] or LMD6 | LD63B600 or LMD63B600 | 600 | LMD6 | LD63B600 or LMD63B600 | 600 | JD6 [Ⓞ] | JD63B300 | 300 | FXD6 or JD6 [Ⓞ] | FXD63B225 JD63B225 | 225 225 |
| 200 | LMD6 | LMD63B800 | 800 | LMD6 | LMD63B800 | 800 | JD6 [Ⓞ] JD6 [Ⓞ] LD6 [Ⓞ] or LMD6 | JD63B350 JD63B400 LD63B600 or LMD63B600 | 350 400 600 | JD6 [Ⓞ] JD6 [Ⓞ] JD6 [Ⓞ] | JD63B300 JD63B400 JD63B400 | 300 400 400 |
| 250 | — | — | — | — | — | — | — | — | — | — | — | — |
| 300 | — | — | — | — | — | — | — | — | — | — | — | — |
| 350 | — | — | — | — | — | — | LMD6 | LMD63B700 | 700 | LD6 [Ⓞ] or LMD6 | LD63B500 or LMD63B500 | 500 |
| 400 | — | — | — | — | — | — | LMD6 | LMD63B800 | 800 | LD6 [Ⓞ] or LMD6 | LD63B600 or LMD63B600 | 600 |
| 500 | — | — | — | — | — | — | — | — | — | LMD6 | LMD63B800 | 800 |

①The selection of breakers for this table is in accordance with Article 430, 2002 National Electric Code. The Canadian electrical code should also be referred to for rating information. Recommended circuit breakers are for full voltage starting, special consideration is necessary for reduced voltage starting.

②For panelboard applications, substitute the BL breaker for the BQ, ED2 circuit breakers may also be used.

③For non-interchangeable trip applications, substitute the FXD6 for the FD6, the JXD6 for the JD6, or the LXD6 for the LD6.

Molded Case Circuit Breakers

Adjustable Instantaneous Magnetic Trip Settings

Application

| Breaker Type | Maximum Continuous Amperes | Nominal AC Adjustable Trip Range | | | | | | | | ETI Motor Circuit Protector Catalogue Number | | Thermal Magnetic Catalogue Number | | |
|--------------|----------------------------|----------------------------------|------|------|------|------|------|------|------|--|---|-----------------------------------|------------|--|
| | | Low | 2 | 3 | 4 | 5 | 6 | 7 | High | 3-Pole | | 2-Pole | 3-Pole | |
| JXD2(A) | 200 | 1250 | 1430 | 1610 | 1790 | 1960 | 2140 | 2320 | 2500 | — | — | JXD22B200 | JXD23B200 | |
| | 225 | 1250 | 1430 | 1610 | 1790 | 1960 | 2140 | 2320 | 2500 | — | — | JXD22B225 | JXD23B225 | |
| | 250 | 1250 | 1430 | 1610 | 1790 | 1960 | 2140 | 2320 | 2500 | — | — | JXD22B250 | JXD23B250 | |
| | 300 | 1250 | 1430 | 1610 | 1790 | 1960 | 2140 | 2320 | 2500 | — | — | JXD22B300 | JXD23B300 | |
| | 350 | 2000 | 2290 | 2570 | 2860 | 3140 | 3430 | 3710 | 4000 | — | — | JXD22B350 | JXD23B350 | |
| | 400 | 2000 | 2290 | 2570 | 2860 | 3140 | 3430 | 3710 | 4000 | — | — | JXD22B400 | JXD23B400 | |
| JXD6(A) | 200 | 1250 | 1430 | 1610 | 1790 | 1960 | 2140 | 2320 | 2500 | — | — | JXD62B200 | JXD63B200 | |
| | 225 | 1250 | 1430 | 1610 | 1790 | 1960 | 2140 | 2320 | 2500 | — | — | JXD62B225 | JXD63B225 | |
| | 250 | 1250 | 1430 | 1610 | 1790 | 1960 | 2140 | 2320 | 2500 | — | — | JXD62B250 | JXD63B250 | |
| | 300 | 1250 | 1430 | 1610 | 1790 | 1960 | 2140 | 2320 | 2500 | — | — | JXD62B300 | JXD63B300 | |
| | 350 | 2000 | 2290 | 2570 | 2860 | 3140 | 3430 | 3710 | 4000 | — | — | JXD62B350 | JXD23B350 | |
| | 400 | 2000 | 2290 | 2570 | 2860 | 3140 | 3430 | 3710 | 4000 | — | — | JXD62B400 | JXD23B400 | |
| JD6(A) | 200 | 1250 | 1430 | 1610 | 1790 | 1960 | 2140 | 2320 | 2500 | — | — | JD62B200 | JD63B200 | |
| | 225 | 1250 | 1430 | 1610 | 1790 | 1960 | 2140 | 2320 | 2500 | — | — | JD62B225 | JD63B225 | |
| | 250 | 1250 | 1430 | 1610 | 1790 | 1960 | 2140 | 2320 | 2500 | — | — | JD62B250 | JD63B250 | |
| | 300 | 1250 | 1430 | 1610 | 1790 | 1960 | 2140 | 2320 | 2500 | — | — | JD62B300 | JD63B300 | |
| | 350 | 2000 | 2290 | 2570 | 2860 | 3140 | 3430 | 3710 | 4000 | — | — | JD62B350 | JD63B350 | |
| | 400 | 2000 | 2290 | 2570 | 2860 | 3140 | 3430 | 3710 | 4000 | — | — | JD62B400 | JD63B400 | |
| HJD6(A) | 200 | 1250 | 1430 | 1610 | 1790 | 1960 | 2140 | 2320 | 2500 | — | — | HJD62B200 | HJD63B200 | |
| | 225 | 1250 | 1430 | 1610 | 1790 | 1960 | 2140 | 2320 | 2500 | — | — | HJD62B225 | HJD63B225 | |
| | 250 | 1250 | 1430 | 1610 | 1790 | 1960 | 2140 | 2320 | 2500 | — | — | HJD62B250 | HJD63H250 | |
| | 300 | 1250 | 1430 | 1610 | 1790 | 1960 | 2140 | 2320 | 2500 | — | — | HJD62B300 | HJD63B300 | |
| | 350 | 2000 | 2290 | 2570 | 2860 | 3140 | 3430 | 3710 | 4000 | — | — | HJD62B350 | HJD63B350 | |
| | 400 | 2000 | 2290 | 2570 | 2860 | 3140 | 3430 | 3710 | 4000 | — | — | HJD62H400 | HJD63B400 | |
| HHJD6 | 200 | 1250 | 1430 | 1610 | 1790 | 1960 | 2140 | 2320 | 2500 | — | — | HHJD62B200 | HHJD63B200 | |
| | 225 | 1250 | 1430 | 1610 | 1790 | 1960 | 2140 | 2320 | 2500 | — | — | HHJD62B225 | HHJD63B225 | |
| | 250 | 1250 | 1430 | 1610 | 1790 | 1960 | 2140 | 2320 | 2500 | — | — | HHJD62B250 | HHJD63B250 | |
| | 300 | 1250 | 1430 | 1610 | 1790 | 1960 | 2140 | 2320 | 2500 | — | — | HHJD62B300 | HHJD63B300 | |
| | 350 | 2000 | 2290 | 2570 | 2860 | 3140 | 3430 | 3710 | 4000 | — | — | HHJD62B350 | HHJD63B350 | |
| | 400 | 2000 | 2290 | 2570 | 2860 | 3140 | 3430 | 3710 | 4000 | — | — | HHJD62B400 | HHJD63B400 | |
| CJD6 | 200 | 1250 | 1430 | 1610 | 1790 | 1960 | 2140 | 2320 | 2500 | — | — | — | CJD63B200 | |
| | 225 | 1250 | 1430 | 1610 | 1790 | 1960 | 2140 | 2320 | 2500 | — | — | — | CJD63B225 | |
| | 250 | 1250 | 1430 | 1610 | 1790 | 1960 | 2140 | 2320 | 2500 | — | — | — | CJD63B250 | |
| | 300 | 1250 | 1430 | 1610 | 1790 | 1960 | 2140 | 2320 | 2500 | — | — | — | CJD63B300 | |
| | 350 | 2000 | 2290 | 2570 | 2860 | 3140 | 3430 | 3710 | 4000 | — | — | — | CJD63B350 | |
| | 400 | 2000 | 2290 | 2570 | 2860 | 3140 | 3430 | 3710 | 4000 | — | — | CJD63H400 | CHD63B400 | |
| LXD6(A) | 450 | 3000 | 3430 | 3860 | 4290 | 4710 | 5140 | 5570 | 6000 | — | — | LXD62B450 | LXD63B450 | |
| | 500 | 3000 | 3430 | 3860 | 4290 | 4710 | 5140 | 5570 | 6000 | — | — | LXD62B500 | LXD63B500 | |
| | 600 | 3000 | 3430 | 3860 | 4290 | 4710 | 5140 | 5570 | 6000 | — | — | LXD62B600 | LXD63B600 | |
| LD6(A) | 250 | 1250 | 1430 | 1610 | 1790 | 1960 | 2140 | 2320 | 2500 | — | — | LD62B250 | LD63B250 | |
| | 300 | 1250 | 1430 | 1610 | 1790 | 1960 | 2140 | 2320 | 2500 | — | — | LD62B300 | LD63B300 | |
| | 350 | 2000 | 2290 | 2570 | 2860 | 3140 | 3430 | 3710 | 4000 | — | — | LD62B350 | LD63B350 | |
| | 400 | 2000 | 2290 | 2570 | 2860 | 3140 | 3430 | 3710 | 4000 | — | — | LD62B400 | LD63B400 | |
| | 450 | 2000 | 2290 | 2570 | 2860 | 3140 | 3430 | 3710 | 4000 | — | — | LD62B450 | LD63B450 | |
| | 500 | 3000 | 3430 | 3860 | 4290 | 4710 | 5140 | 5570 | 6000 | — | — | LD62B500 | LD63B500 | |
| | 600 | 2000 | 2290 | 2570 | 2860 | 3140 | 3430 | 3710 | 4000 | — | — | — | — | |
| | 600 | 3000 | 3430 | 3860 | 4290 | 4710 | 5140 | 5570 | 6000 | — | — | LXD63L600 | LD63B600 | |
| HLD6(A) | 250 | 1250 | 1430 | 1610 | 1790 | 1960 | 2140 | 2320 | 2500 | — | — | HLD62B250 | HLD63B250 | |
| | 300 | 1250 | 1430 | 1610 | 1790 | 1960 | 2140 | 2320 | 2500 | — | — | HLD62B300 | HLD63B300 | |
| | 350 | 2000 | 2290 | 2570 | 2860 | 3140 | 3430 | 3710 | 4000 | — | — | HLD62B350 | HLD63B350 | |
| | 400 | 2000 | 2290 | 2570 | 2860 | 3140 | 3430 | 3710 | 4000 | — | — | HLD62B400 | HLD63B400 | |
| | 450 | 2000 | 2290 | 2570 | 2860 | 3140 | 3430 | 3710 | 4000 | — | — | HLD62B450 | HLD63B450 | |
| | 500 | 3000 | 3430 | 3860 | 4290 | 4710 | 5140 | 5570 | 6000 | — | — | HLD62B500 | HLD63B500 | |
| HHLD6 | 250 | 1250 | 1430 | 1610 | 1790 | 1960 | 2140 | 2320 | 2500 | — | — | HHLD62B250 | HHLD63B250 | |
| | 300 | 1250 | 1430 | 1610 | 1790 | 1960 | 2140 | 2320 | 2500 | — | — | HHLD62B300 | HHLD63B300 | |
| | 350 | 2000 | 2290 | 2570 | 2860 | 3140 | 3430 | 3710 | 4000 | — | — | HHLD62B350 | HHLD63B350 | |
| | 400 | 2000 | 2290 | 2570 | 2860 | 3140 | 3430 | 3710 | 4000 | — | — | HHLD62B400 | HHLD63B400 | |
| | 450 | 2000 | 2290 | 2570 | 2860 | 3140 | 3430 | 3710 | 4000 | — | — | HHLD62B450 | HHLD63B450 | |
| | 500 | 3000 | 3430 | 3860 | 4290 | 4710 | 5140 | 5570 | 6000 | — | — | HHLD62B500 | HHLD63B500 | |
| CLD6 | 250 | 1250 | 1430 | 1610 | 1790 | 1960 | 2140 | 2320 | 2500 | — | — | — | CLD63B250 | |
| | 300 | 1250 | 1430 | 1610 | 1790 | 1960 | 2140 | 2320 | 2500 | — | — | — | CLD63B300 | |
| | 350 | 2000 | 2290 | 2570 | 2860 | 3140 | 3430 | 3710 | 4000 | — | — | — | CLD63B350 | |
| | 400 | 2000 | 2290 | 2570 | 2860 | 3140 | 3430 | 3710 | 4000 | — | — | — | CLD63B400 | |
| | 450 | 2000 | 2290 | 2570 | 2860 | 3140 | 3430 | 3710 | 4000 | — | — | — | CLD63B450 | |
| | 500 | 3000 | 3430 | 3860 | 4290 | 4710 | 5140 | 5570 | 6000 | — | — | — | CLD63B500 | |
| LMXD6 | 500 | 3000 | 3430 | 3860 | 4290 | 4710 | 5140 | 5570 | 6000 | — | — | — | LMXD63B500 | |
| | 600 | 3000 | 3430 | 3860 | 4290 | 4710 | 5140 | 5570 | 6000 | — | — | LMXD62B600 | LMXD63B600 | |
| | 700 | 3200 | 3500 | 3700 | 4200 | 4700 | 6400 | 7300 | 8000 | — | — | LMXD62B700 | LMXD63B700 | |
| | 800 | 2800 | 3100 | 3400 | 3700 | 4000 | 4800 | 5500 | 6000 | — | — | — | — | |
| | 800 | 3200 | 3500 | 3700 | 4200 | 4700 | 6400 | 7300 | 8000 | — | — | LMXD62B800 | LMXD63B800 | |
| LMD6 | 500 | 3000 | 3430 | 3860 | 4290 | 4710 | 5140 | 5570 | 6000 | — | — | LMD62B500 | LMD63B500 | |
| | 600 | 3000 | 3430 | 3860 | 4290 | 4710 | 5140 | 5570 | 6000 | — | — | LMD62B600 | LMD63B600 | |
| | 700 | 3200 | 3500 | 3700 | 4200 | 4700 | 6400 | 7300 | 8000 | — | — | LMD62B700 | LMD63B700 | |
| | 800 | 3200 | 3500 | 3700 | 4200 | 4700 | 6400 | 7300 | 8000 | — | — | LMD62B800 | LMD63B800 | |

Molded Case Circuit Breakers

Adjustable Instantaneous Magnetic Trip Settings

Application

| Breaker Type | Maximum Continuous Amperes | Nominal AC Adjustable Trip Range | | | | | | | | ETI Motor Circuit Protector Catalogue Number | Thermal Magnetic Catalogue Number | | |
|--------------|----------------------------|----------------------------------|------|------|------|------|------|------|-------|--|-----------------------------------|-------------|-----------|
| | | Low | 2 | 3 | 4 | 5 | 6 | 7 | High | 3-Pole | 2-Pole | 3-Pole | |
| HLMXD6 | 500 | 3000 | 3430 | 3860 | 4290 | 4710 | 5140 | 5570 | 6000 | — | — | HLMXD63B500 | |
| | 600 | 3000 | 3430 | 3860 | 4290 | 4710 | 5140 | 5570 | 6000 | — | — | HLMXD63B600 | |
| | 700 | 3200 | 3500 | 3700 | 4200 | 4700 | 6400 | 7300 | 8000 | — | — | HLMXD63B700 | |
| | 800 | 3200 | 3500 | 3700 | 4200 | 4700 | 6400 | 7300 | 8000 | — | — | HLMXD63B800 | |
| HLMD6 | 500 | 3000 | 3430 | 3860 | 4290 | 4710 | 5140 | 5570 | 6000 | — | HLMD62B500 | HLMD63B500 | |
| | 600 | 3000 | 3430 | 3860 | 4290 | 4710 | 5140 | 5570 | 6000 | — | HLMD62B600 | HLMD63B600 | |
| | 700 | 3200 | 3500 | 3700 | 4200 | 4700 | 6400 | 7300 | 8000 | — | HLMD62B700 | HLMD63B700 | |
| | 800 | 3200 | 3500 | 3700 | 4200 | 4700 | 6400 | 7300 | 8000 | — | HLMD62B800 | HLMD63B800 | |
| MD6 | 500 | 3000 | 3430 | 3860 | 4290 | 4710 | 5140 | 5570 | 6000 | — | MD62B500 | MD63B500 | |
| | 600 | 3000 | 3430 | 3860 | 4290 | 4710 | 5140 | 5570 | 6000 | — | MD62B600 | MD63B600 | |
| | 700 | 4000 | 4570 | 5140 | 5710 | 6280 | 6850 | 7420 | 8000 | — | MD62B700 | MD63B700 | |
| | 800 | 3000 | 3430 | 3860 | 4280 | 4710 | 5140 | 5570 | 6000 | MXD63L800 | — | — | |
| | 800 | 4000 | 4570 | 5140 | 5710 | 6280 | 6850 | 7420 | 8000 | MXD63A800 | MD62B800 | MD63B800 | |
| | 800 | 5000 | 5715 | 6430 | 7145 | 7860 | 8575 | 9290 | 10000 | MXD63H800 | — | — | |
| MXD6 | 500 | 3000 | 3430 | 3860 | 4280 | 4710 | 5140 | 5570 | 6000 | — | MXD62B500 | MXD63B500 | |
| | 600 | 3000 | 3430 | 3860 | 4280 | 4710 | 5140 | 5570 | 6000 | — | MXD62B600 | MXD63B600 | |
| | 700 | 4000 | 4570 | 5140 | 5710 | 6280 | 6850 | 7420 | 8000 | — | MXD62B700 | MXD63B700 | |
| | 800 | 3000 | 3430 | 3860 | 4280 | 4710 | 5140 | 5570 | 6000 | MXD63L800 | — | — | |
| | 800 | 4000 | 4570 | 5140 | 5710 | 6280 | 6850 | 7420 | 8000 | MXD63A800 | MXD62B800 | MXD63B800 | |
| | 800 | 5000 | 5715 | 6430 | 7145 | 7860 | 8575 | 9290 | 10000 | MXD63H800 | — | — | |
| HMD6 | 500 | 3000 | 3430 | 3860 | 4280 | 4710 | 5140 | 5570 | 6000 | — | HMD62B500 | HMD63B500 | |
| | 600 | 3000 | 3430 | 3860 | 4280 | 4710 | 5140 | 5570 | 6000 | — | HMD62B600 | HMD63B600 | |
| | 700 | 4000 | 4570 | 5140 | 5710 | 6280 | 6850 | 7420 | 8000 | — | HMD62B700 | HMD63B700 | |
| | 800 | 4000 | 4570 | 5140 | 5710 | 6280 | 6850 | 7420 | 8000 | — | HMD62B800 | HMD63B800 | |
| HMXD6 | 500 | 3000 | 3430 | 3860 | 4280 | 4710 | 5140 | 5570 | 6000 | — | — | HMXD63B500 | |
| | 600 | 3000 | 3430 | 3860 | 4280 | 4710 | 5140 | 5570 | 6000 | — | — | HMXD63B600 | |
| | 700 | 4000 | 4570 | 5140 | 5710 | 6280 | 6850 | 7420 | 8000 | — | — | HMXD63B700 | |
| | 800 | 4000 | 4570 | 5140 | 5710 | 6280 | 6850 | 7420 | 8000 | — | — | HMXD63B800 | |
| CMD6 | 400 | 3000 | 3430 | 3860 | 4280 | 4710 | 5140 | 5570 | 6000 | — | — | CMD63B400 | |
| | 500 | 3000 | 3430 | 3860 | 4280 | 4710 | 5140 | 5570 | 6000 | — | — | CMD63B500 | |
| | 600 | 3000 | 3430 | 3860 | 4280 | 4710 | 5140 | 5570 | 6000 | — | — | CMD63B600 | |
| | 700 | 4000 | 4570 | 5140 | 5710 | 6280 | 6850 | 7420 | 8000 | — | — | CMD63B700 | |
| | 800 | 3000 | 3430 | 3860 | 4280 | 4710 | 5140 | 5570 | 6000 | CMD63L800 | — | — | |
| | 800 | 4000 | 4570 | 5140 | 5710 | 6280 | 6850 | 7420 | 8000 | CMD63A800 | — | CMD63B800 | |
| ND6 | 800 | 4000 | 4570 | 5140 | 5710 | 6280 | 6850 | 7420 | 8000 | — | ND62B800 | ND63B800 | |
| | 900 | 5000 | 5715 | 6430 | 7145 | 7860 | 8575 | 9290 | 10000 | — | ND62B900 | ND63B900 | |
| | 1000 | 5000 | 5715 | 6430 | 7145 | 7860 | 8575 | 9290 | 10000 | — | ND62B100 | ND63B100 | |
| | 1200 | 5000 | 5715 | 6430 | 7145 | 7860 | 8575 | 9290 | 10000 | — | ND62B120 | ND63B120 | |
| | NXD6 | 900 | 5000 | 5715 | 6430 | 7145 | 7860 | 8575 | 9290 | 10000 | — | NXD62B900 | NXD63B900 |
| | | 1000 | 5000 | 5715 | 6430 | 7145 | 7860 | 8575 | 9290 | 10000 | — | NXD62B100 | NXD63B100 |
| 1200 | | 5000 | 5715 | 6430 | 7145 | 7860 | 8575 | 9290 | 10000 | — | NXD62B120 | NXD63B120 | |
| HND6 | 800 | 4000 | 4570 | 5140 | 5710 | 6280 | 6850 | 7420 | 8000 | — | HND62B800 | HND63B800 | |
| | 900 | 5000 | 5715 | 6430 | 7145 | 7860 | 8575 | 9290 | 10000 | — | HND62B900 | HND63B900 | |
| | 1000 | 5000 | 5715 | 6430 | 7145 | 7860 | 8575 | 9290 | 10000 | — | HND62B100 | HND63B100 | |
| | 1200 | 5000 | 5715 | 6430 | 7145 | 7860 | 8575 | 9290 | 10000 | — | HND62B120 | HND63B120 | |
| HNXD6 | 900 | 5000 | 5715 | 6430 | 7145 | 7860 | 8575 | 9290 | 10000 | — | — | HNXD63B900 | |
| | 1000 | 5000 | 5715 | 6430 | 7145 | 7860 | 8575 | 9290 | 10000 | — | — | HNXD63B100 | |
| | 1200 | 5000 | 5715 | 6430 | 7145 | 7860 | 8575 | 9290 | 10000 | — | — | HNXD63B120 | |
| CND6 | 800 | 4000 | 4570 | 5140 | 5710 | 6280 | 6850 | 7420 | 8000 | — | — | CND63B800 | |
| | 900 | 5000 | 5715 | 6430 | 7145 | 7860 | 8575 | 9290 | 10000 | — | — | CND63B900 | |
| | 1000 | 5000 | 5715 | 6430 | 7145 | 7860 | 8575 | 9290 | 10000 | — | — | CND63B100 | |
| | 1200 | 5000 | 5715 | 6430 | 7145 | 7860 | 8575 | 9290 | 10000 | — | — | CND63B120 | |
| PD6 | 1200 | 5000 | 5715 | 6430 | 7145 | 7860 | 8575 | 9290 | 10000 | — | — | PD63B120 | |
| | 1400 | 5000 | 5715 | 6430 | 7145 | 7860 | 8575 | 9290 | 10000 | — | — | PD63B140 | |
| | 1600 | 5000 | 5715 | 6430 | 7145 | 7860 | 8575 | 9290 | 10000 | — | — | PD63B160 | |
| PXD6 | 1200 | 5000 | 5715 | 6430 | 7145 | 7860 | 8575 | 9290 | 10000 | — | — | PXD63B120 | |
| | 1400 | 5000 | 5715 | 6430 | 7145 | 7860 | 8575 | 9290 | 10000 | — | — | PXD63B140 | |
| | 1600 | 5000 | 5715 | 6430 | 7145 | 7860 | 8575 | 9290 | 10000 | — | — | PXD63B160 | |
| HPD6 | 1200 | 5000 | 5715 | 6430 | 7145 | 7860 | 8575 | 9290 | 10000 | — | — | HPD63B120 | |
| | 1400 | 5000 | 5715 | 6430 | 7145 | 7860 | 8575 | 9290 | 10000 | — | — | HPD63B140 | |
| | 1600 | 5000 | 5715 | 6430 | 7145 | 7860 | 8575 | 9290 | 10000 | — | — | HPD63B160 | |
| HPXD6 | 1200 | 5000 | 5715 | 6430 | 7145 | 7860 | 8575 | 9290 | 10000 | — | — | HPXD63B120 | |
| | 1400 | 5000 | 5715 | 6430 | 7145 | 7860 | 8575 | 9290 | 10000 | — | — | HPXD63B140 | |
| | 1600 | 5000 | 5715 | 6430 | 7145 | 7860 | 8575 | 9290 | 10000 | — | — | HPXD63B160 | |
| CPD6 | 1200 | 5000 | 5715 | 6430 | 7145 | 7860 | 8575 | 9290 | 10000 | — | — | CPD63B120 | |
| | 1400 | 5000 | 5715 | 6430 | 7145 | 7860 | 8575 | 9290 | 10000 | — | — | CPD63B140 | |
| | 1600 | 5000 | 5715 | 6430 | 7145 | 7860 | 8575 | 9290 | 10000 | — | — | CPD63B160 | |
| RD6 | 1800 | 5000 | 5715 | 6430 | 7145 | 7860 | 8575 | 9290 | 10000 | — | — | RD63B180 | |
| | 2000 | 5000 | 5715 | 6430 | 7145 | 7860 | 8575 | 9290 | 10000 | — | — | RD63B200 | |
| RXD6 | 1800 | 5000 | 5715 | 6430 | 7145 | 7860 | 8575 | 9290 | 10000 | — | — | RXD63B180 | |
| | 2000 | 5000 | 5715 | 6430 | 7145 | 7860 | 8575 | 9290 | 10000 | — | — | RXD63B200 | |
| HRD6 | 1800 | 5000 | 5715 | 6430 | 7145 | 7860 | 8575 | 9290 | 10000 | — | — | HRD63B180 | |
| | 2000 | 5000 | 5715 | 6430 | 7145 | 7860 | 8575 | 9290 | 10000 | — | — | HRD63B200 | |

Molded Case Circuit Breakers

Molded Case Switch — Circuit Disconnect

Selection

| Maximum Frame Amp Rating | 2-Pole | 3-Pole | Self-Protective Instantaneous Override $\pm 20\%$ ③ |
|--------------------------|------------------|------------------|---|
| | Catalogue Number | Catalogue Number | |
| 100 | BQ2S060 | BQ3S060 | 1000 |
| | BQ2S100 | BQ3S100 | 1000 |
| 125 | ED22S100A | ED23S100A | 1000 |
| | ED42S100A | ED43S100A | 1000 |
| | ED42S125A | ED43S125A | 1000 |
| | ED62S100A | ED63S100A | 1000 |
| | — | ED63S125A | 1000 |
| | CED62S100A | CED63S100A | 1000 |
| | CED62S125A | CED63S125A | 1000 |
| 225 | QJ22S225A | QJ23S225A | 2000 |
| 250 | FXD62S250A | FXD63S250A | 3200 |
| | HFXD62S250A | HFXD63S250A | 3200 |
| | ① | CFD63S250A | 3200 |
| 400 | JXD22S400A | JXD23S400A | 6000 |
| | — | JXD63S400A | 6000 |
| | — | HJXD63S400A | 6000 |
| | ① | CJD63S400A | 6000 |
| 600 | — | LXD63S600A | 6000 |
| | — | HLXD63S600A | 6000 |
| | ① | CLD63S600A | 6000 |
| 800 | — | LMXD63S800A | 8000 |
| | — | MXD63S800A | 8000 |
| | ① | CMD63S800A | 8000 |
| 1200 | — | NXD63S120A | 10000 |
| | ① | CND63S120A | 10000 |
| 1600 | ① | PXD63S160A ③ | 10000 |
| 2000 | ① | RXD63S200A ③ | 10000 |

Ordering Information

Order by catalogue number. Switches include frame and self protective trip unit only. Order lugs separately from page 5-64.

① For 2-pole application use outside poles of 3-pole circuit breaker.

② For additional lugs see page 5-64.

③ Molded case switches up to R frame contain a self protecting instantaneous element, which may open circuit above their override set point.

④ Requires mounting block MB9301 or MBR9302.

Lugs pages 5-64
Accessories page 5-68

Molded Case Circuit Breakers

Digital Solid State Sentron Sensitrip III Series

Technical

The Sentron Sensitrip III circuit breaker is a true RMS current sensing device. Digital microprocessor circuitry within the electronic trip unit provides more precise control over the circuit breaker functions. This control allows circuit coordination flexibility not available with thermal magnetic circuit breakers.

Functions available in Sentron Sensitrip circuit breakers.

| Catalogue Number (Description + Suffix) | Trip Type | Cont Current Setting | Long Time Delay | Instantaneous Setting | Short Time Pick Up | Short Time Delay | Short Time It Pick Up | Ground Fault Pick Up | Ground Fault Delay |
|---|-----------|----------------------|-----------------|-----------------------|--------------------|------------------|-----------------------|----------------------|--------------------|
| Basic Unit + (A) | LI | ✓ | ✓ | ✓ | — | — | — | — | — |
| Basic Unit + (A)G | LIG | ✓ | ✓ | ✓ | — | — | — | ✓ | ✓ |
| Basic Unit + (A)NT | LSI | ✓ | ✓ | ✓ | ✓ | ✓ | ✓ | — | — |
| Basic Unit + (A)NGT | LSIG | ✓ | ✓ | ✓ | ✓ | ✓ | ✓ | ✓ | ✓ |

Letter "A" is used for MD and ND Solid State frame types only.

Typical Trip Unit Labeling and Adjustment Positions for the Sentron Sensitrip Circuit Breaker.

SMD6, SHMD6, SCMD6, SND6, SHND6, SCND6, SPD6, SHPD6

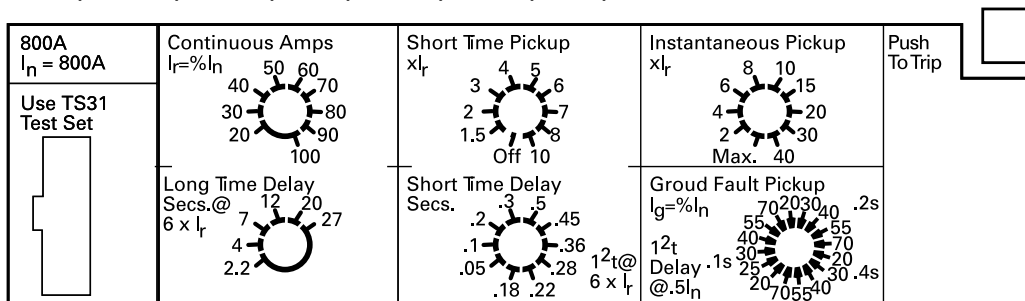

SJD6, SHJD6, SCJD6, SCD6, SHLD6, SCLD6

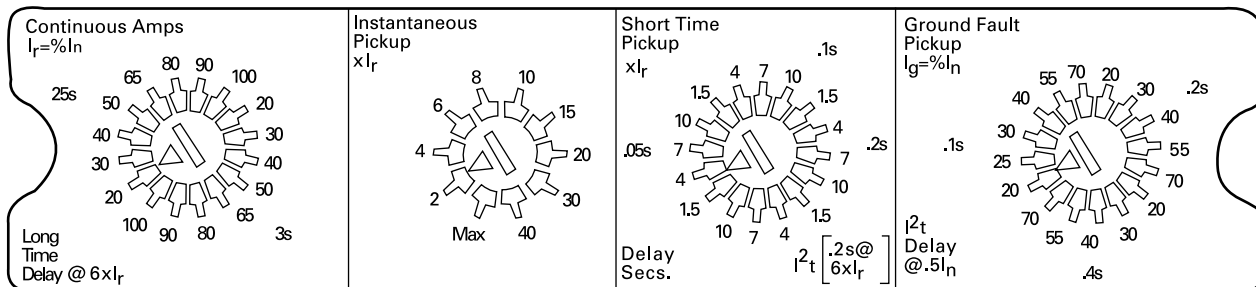

I_n = Maximum circuit breaker ampere rating.

I_r = Current Rating — a function of continuous ampere adjustment setting expressed in % of I_n .

I_g = Ground Fault Pickup — a function of adjustment setting expressed in % of I_n .

Molded Case Circuit Breakers

Digital Solid State Sentron Sensitrip III Series

Technical

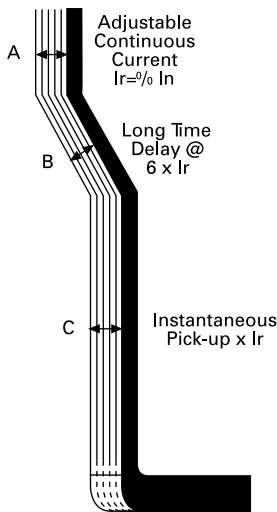

A. Adjustable "Continuous Amps" Rating Switch
All Sensitrip III solid state molded case circuit breakers have an adjustable ampere rating switch. Adjustments made to this switch change the continuous current rating of the breaker from 20% to 100% of its maximum trip unit rating depending on the circuit breaker frame.

B. Adjustable "Long Time Delay" Switch
All Sensitrip III circuit breakers have an adjustable long time delay switch to allow for selection of long time delays of fixed time intervals at six times the setting of the adjustable "continuous amps" rating switch.

C. Adjustable "Instantaneous Pick-Up" Switch
Sensitrip III circuit breakers with an adjustable instantaneous trip switch allow selection of a tripping point from related to the adjusted circuit breaker Rating (I_n).

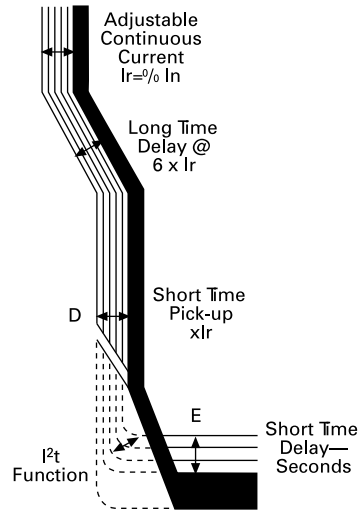

D. Adjustable "Short Time Pick-Up" Switch (Optional)
Sensitrip III circuit breakers with an adjustable short time pick-up switch allow for selection of short time pick-up in a range from 1.5 to 10 times the setting of the maximum current rating.

E. Adjustable "Short Time Delay" Switch (Optional)
Sensitrip III circuit breakers with an adjustable short time pick-up switch also contain a switch for adjustment in time delay. The adjustable short time delay switch allows for either of two modes of short time delays. One range of settings enables the breaker to be set for fixed time delays and the other range of settings enables the breaker to be set for short time delays based on I²t curves.

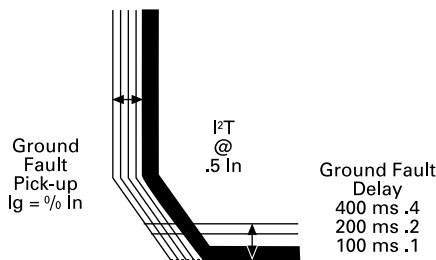

Adjustable "Ground Fault Pick-Up" Switch
Sensitrip III circuit breakers containing the optional equipment ground fault protection cover the ground fault pick-up range of 20% to 70% of the circuit breaker frame rating. The ground fault pick-up settings also allow for one of three time delays based on I²t curves.
For 3-phase, 4-wire systems, an external neutral transformer is required with an ampere rating equal to the trip unit ampere rating.

5
MOLDED CASE
CIRCUIT BREAKERS

- I_n = Maximum circuit breaker ampere rating.
- I_r = Current Rating — a function of adjustment setting expressed in % of I_n.
- I_g = Ground Fault Pick-up — a function of adjustment setting expressed in % of I_n.

Examples of Adjustment Settings

Catalogue Number SMD69800A

| I _n = 800 | Continuous Current Setting | Long Time Delay Setting | Instantaneous Setting |
|---|--|--|---|
| I _n = 800 amperes Results | 30 240 amperes I _r = 30% of 800 | 12 12 seconds trip at 6 x 240 amps = 1440. | 8 1920 amperes 8 x I _r = 8 x 240 |

Catalogue Number SMD69800ANGT

| I _n | I _r Setting | Long Time Delay | Short Time Pick-Up Off | Instantaneous Setting | Short Time Pick-Up On | Short Time Delay | I ² T Set | Ground Fault Pick-Up | Ground Fault Delay |
|------------------------|------------------------|-----------------|------------------------|----------------------------|---------------------------|------------------|------------------------|----------------------|--------------------|
| 800 amperes Results | 70 560 | 20 20 sec. | — — | 10 I _r 5600A | 8 I _r 4480A | .5 .5 secs | .28 .28 sec @ 4480A | 40 320A | .2 .2 sec |
| ① | ② | ③ | ④ | ⑤ | ⑥ | ⑦ | ⑧ | ⑨ | ⑩ |

- ① I_n = 800 amperes.
- ② I_r = 560 amperes (70% of 800).
- ③ Delay = 20 seconds at 3360 amps (6 x I_r).
Breaker will trip in 20 seconds with 3360 amperes.
- ④ Short Time Pick-Up Off — Instantaneous can be used.
- ⑤ Instantaneous set at 10 x I_r = 10 x 560 = 5600 amperes.
- ⑥ Short Time Pick-Up On — Set at 8 x I_r = 8 x 560 = 4480 amperes.
- ⑦ Short Time Delay = .5 seconds. (Definite Time)
Note: ⑦ & ⑩ are mutually exclusive.
- ⑧ It switch on .28 seconds @ 6 x 560 = 3360 amperes. (Inverse time)
- ⑨ Ground Fault Pick-Up set at 40 = 40% of I_n = 320 amperes. (Definite Time)
- ⑩ Ground Fault Delay set at .2 seconds. Breaker will trip in 200 milliseconds with a 400 ampere ground fault.

WL Power Circuit Breakers

3-pole, up to 5000A

General

Breaker Description

The ever-increasing use of plant and energy management systems has intensified the demand for circuit breakers supporting multiple open protocols to monitor and control the flow of energy in the power system. The extensive and modular WL family of circuit breakers and accessories provides this for applications from 200A to 5000A.

Applications

WL breakers can be applied as main, tie, feeder or distribution breakers in low-voltage electrical power systems.

Versions

- Frame ratings: 800A to 5000A
- 3 physical frame sizes
- Rated nominal operating voltage up to 600VAC
- Seven interrupting classes from 50kA to 200kA at 480V
- Circuit breaker or non-automatic switch
- WL Circuit Breakers are delivered as complete assembled breakers or individual frames, guide frames, and accessories

Installation Types

Fixed-mounted or Draw-out version.

Standards

- WL ANSI / UL 1066 Circuit Breakers will satisfy: C37.13, C37.16, C37.17, C37.50, NEMA SG3
- WL UL 489 Circuit Breakers will satisfy: UL 489
- WL Circuit Breakers are suitable for use in UL 1558 LV Switchgear and UL 891 LV Switchboards

Conditions of Application

WL Circuit Breakers are designed to meet standard Industrial and Commercial application requirements.

Uniform Dimensions

WL Circuit Breaker dimensions differ only in the device width, which varies by frame size. With the exception of the 200kA ANSI Frame Size II which has an additional 5" in depth to accommodate integral fuses and the UL489 Frame Size I which measures only 15" in height to allow six-high stacking in switchboards.

Minimal Space Requirements

The WL design is extremely compact without sacrificing performance and does not use energy-wasting heat sinks.

Trip Units

The electronic, micro processor-based trip unit is auxiliary voltage-independent for all protective functions and enables adaptation to the different protection requirements of distribution systems, motors, transformers and generators.

Non-Automatic Switch

A special version of the circuit breaker is used as a non-automatic switch. The non-automatic switch is constructed without a trip unit and has no protective function. A possible application is for use as a tie in systems with parallel feeds.

Main Bus Connectors

Breakers are equipped with standard vertical main bus connections. Horizontal bus connections are available as an option in Frame Size 1 and 2 up to 2000A.

Communication Capability

MODBUS or PROFIBUS communications transmit the acquired and metered data, such as current values, breaker status, trip log, etc. to a central monitoring computer. When the optional metering function is installed, the WL acquires data useful for power management and can contribute to a significant savings in energy costs. A new, internal circuit breaker bus enables the expansion of breaker functionality through the integration of many secondary functions which were previously separate, including:

- Control of analog displays
- Options for testing the communication setup
- Display of breaker status and reason for trip
- Input modules for reading other external signals and transmitting these signals via PROFIBUS or MODBUS communication
- A selection of output modules to provide contact closures based on events or measured-value setpoints. It is not only possible to monitor the breaker remotely, it is also possible to open and close the breaker as well as setting parameters remotely

Operating Mechanisms

Circuit breakers can be optionally delivered with different operating mechanisms, including:

- Manual operating mechanism with mechanical closing (standard)

- Manual operating mechanism with mechanical and electrically interlocked closing
- Motorized operating mechanism with mechanical and electrically interlocked closing. Operating mechanisms with electrically interlocked closing are suitable for synchronizing tasks

Auxiliary Contacts

Auxiliary switches can be added according to the type of installation. They are easily mounted via front, top mounted terminal blocks.

Modularity

Common guide frames for the draw-out version make them completely interchangeable between the UL 489 and ANSI / UL 1066 rated circuit breakers. Components, such as auxiliary releases, motorized operating mechanisms, trip units, current sensors, auxiliary signal switches, automatic reset devices or interlocks can be used to modify or retrofit any circuit breaker to meet changing requirements. The main contacts can be replaced to extend the life of the circuit breaker and feature integrated contact wear indicators.

Electronic Trip Unit Modularity

Modularity is the outstanding feature of the new WL Circuit Breakers. The trip units themselves can be retrofitted with special LCDs, ground fault modules, rating plugs and communication modules. 100% Rated Circuit Breaker WL circuit breakers are designed for continuous operation at 100% of their current rating without the need for external heat sinks.

Conditions of Application

WL Circuit Breakers are designed to meet standard Industrial and Commercial application requirements.



WL Power Circuit Breakers

Communication Information

General

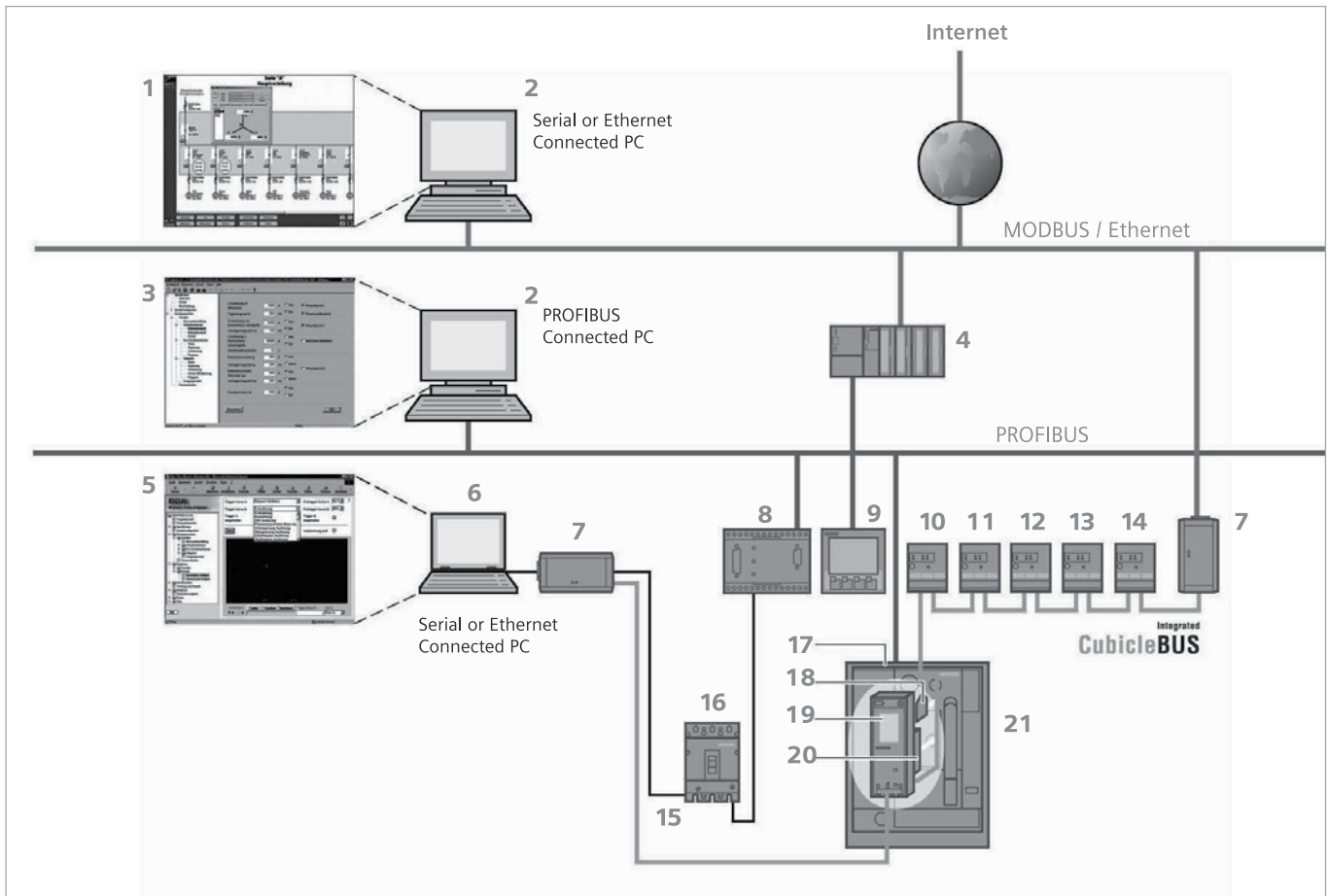

5
MOLDED CASE
CIRCUIT BREAKERS

A spectrum of power distribution communication

- | | |
|--|--|
| 1 WinPM.Net software | 12 Analog output module |
| 2 Server or desktop PC | 13 Digital output module |
| 3 Switch ES power software | 14 Relay output module |
| 4 PLC | 15 VL CubicleBus network |
| 5 BDA web server | 16 VL feeder breaker |
| 6 Portable PC | 17 Input power and communication terminals |
| 7 Breaker data adapter (BDA) | 18 Breaker status sensor (BSS) |
| 8 COM10 PROFIBUS module or COM11 MODBUS module | 19 Trip unit display |
| 9 Power metering device | 20 Metering function |
| 10 Zone selective interlock | 21 WL power breaker |
| 11 Digital input module | |

WL Power Circuit Breakers

Electronic Trip Units

General



Trip Unit Functions

| Basic Protective Functions | | ETU745 | ETU748 | ETU776 |
|---|---|--------|--------|--------|
| Long-time overcurrent protection | L | ● | ● | ● |
| Short-time delayed overcurrent protection | S | ● | ● | ● |
| Instantaneous overcurrent protection | I | ● | ● | ● |
| Neutral conductor protection | N | ● | ● | ● |
| Ground fault protection | G | ○ | ○ | ○ |
| Additional Functions | | | | |
| Selectable neutral protection | | ● | ● | ● |
| Defeatable short-time protection | | ● | — | ● |
| Defeatable instantaneous protection | | ● | — | ● |
| Selectable thermal memory | | ● | ● | ● |
| Zone selective interlocking | | ● | ● | ● |
| Selectable I2t or fixed short-time delay | | ● | ● | ● |
| Adjustable instantaneous pick-up | | ● | — | ● |
| Selectable I2t or I4t long-time delay | | ● | ● | ● |
| Adjustable short-time delay and pick-up | | ● | ● | ● |
| Selectable and adjustable neutral protection | | ● | ● | ● |
| Dual protective setting capability | | — | — | ● |
| Dynamic arc-flash sentry | | — | — | ● |
| Extended instantaneous protection | | ● | ● | ● |
| Parameterization and Displays | | | | |
| Parameterization by rotary switches (10 steps) | | ● | ● | — |
| Parameterization by communication (absolute values) | | — | ● | ● |
| Parameterization by menu/keypad (absolute values) | | — | — | ● |
| Remote parameterization of the basic functions | | — | — | ● |
| Remote parameterization of the additional functions | | — | — | ● |
| Alphanumeric LCD | | ○ | ○ | — |
| Graphical LCD | | — | — | ● |
| Metering Function | | | | |
| Metering function | | ○ | ○ | ○ |
| Metering function Plus | | ○ | ○ | ○ |
| Communication | | | | |
| CubicleBUS | | ● | ● | ● |
| Communication via PROFIBUS-DP | | ○ | ○ | ○ |
| Communication via the MODBUS | | ○ | ○ | ○ |
| Communication via the Ethernet (BDA) | | ○ | ○ | ○ |

● Standard — Not available ○ Optional

5
MOLDED CASE
CIRCUIT BREAKERS

WL Power Circuit Breakers

3-Pole, up to 5000A

General

Rating Plug

It is no longer necessary to replace the current transformer to change the rated current of the breaker. Instead, you simply replace the rating plug which is easily accessible on the front of the trip unit. The circuit breaker is set to the new rated current quickly and is already correctly labeled.

Long Time Overcurrent Protection with Switchable I2t/I4t Characteristics

The long time overcurrent protection in the ETU745, ETU755 and ETU776 trip units can be switched between an I2t and I4t characteristic to improve coordination between upstream circuit breakers and fuses.

Front Panel

The front panel is designed so that it can be accessed through a cutout in the door, which means that all controls and displays are accessible even when the cubicle door is closed. The front panels of all Frame Size II and Frame Size III circuit breakers are identical, and allow for two different through-door access designs: Trip unit and front panel controls or front panel controls only. The degree of protection of the front panel is IP 20.

Environmental Protection

The plastics used are halogen-free and recyclable.

Safety and Reliability

In order to help protect the electrical distribution system and circuit breaker against unauthorized breaker operations, a wide range of locking devices can be

installed or retrofit, including:

- Lockable drawout version to protect against unauthorized removal (standard)
- High degree of protection through Plexiglas cover
- Mechanical reclosing lockout after long-time, short-time or instantaneous trip (optional)
- Devices with trip unit ETU745 or higher are equipped with temperature sensors on the BSS and COM15/COM16 (standard)
- Lock provision for locking the breaker in the OPEN position
- Lockable covers for the CLOSE button
- Lockable racking handle prevents moving the breaker
- Lockable charging handle prevents charging the springs

Standard Version Features

WL Circuit Breakers have the following standard equipment:

- Mechanical CLOSE and mechanical OPEN push buttons
- Manual operating mechanism with mechanical closing
- Contact position indicator
- Front panel ready-to-close indicator
- Spring charge indicator

- Rear vertical main contacts
- Main contact replacement flag
- Auxiliary plug system with bare wire pressure screw terminals. Delivery includes all auxiliary plugs necessary for both factory installed and future field installed accessories
- Mechanical trip indicator of the overcurrent release system
- Automatic reset after trip
- The front panel cannot be removed if the circuit breaker closed
- Laminated main contact fingers as part of the breaker contact strip on the drawout circuit breaker
- Breaker position display in the operator's panel
- Captive crank handle for racking out the breaker
- Guide frame with guide rails for easy handling of draw-out version
- Breaker cannot be moved in the CLOSED state
- Rated current coding between the guide frame and the breaker
- Suitable for reverse feed applications
- The breaker is always equipped with the required number of secondary disconnect blocks

Exclusive Features

Generator/Utility Protection Sets

24/7/365 power availability is critical for some systems. On-site generation capability is growing more and more common in many systems. All of the WL digital electronic trip units allow the system designer to precisely tailor trip settings for the most demanding requirements. However, the 776 trip unit allows one set of trip settings for a fully loaded utility feed and with a simple contact closure, the trip unit toggles to a second trip set tailored to provide optimal generator protection. The wide range of settings allows the WL to provide protection for a minimal generator capacity for only essential loads, through full backup for an entire facility. This dual utility/generator protection capability in a single circuit breaker allows the system designer unparalleled, cost effective, flexibility.

Dynamic Arc-Flash Sentry

A unique feature of the WL trip unit allows the system designer to achieve lower levels of arc flash energy and delayed tripping for selective trip coordination purposes.

Dynamic Arc-Flash Sentry (DAS) employs the unique dual protective setting capability of the 776 trip unit, coupled with the ability to easily toggle to a lower arc flash parameter set. A normal operation parameter set can be optimized for selective trip coordination, while the second set is optimized for lower arc flash energy levels. The dynamic action comes from the ability to switch from the normal operation set to the arc flash limiting set based on the presence of personnel as they approach the flash protection boundary. A wide variety of switching methods may be used based on the needs of a particular facility. The capabilities range from fully automatic switching using appropriate occupancy sensors to manual switching via a key operation.

Extended Instantaneous Protection

Extended Instantaneous protection (EIP), another unique feature of the WL trip unit, allows the system designer to achieve full selective trip coordination up to the short-time rating of the frame while also allowing application of the breaker up to the interrupting rating of the frame. The typical power circuit

breaker with an 'LS' trip unit, or when the instantaneous function is switched off on an 'LSI' trip unit, can only be applied up to its short-time rating, commonly 85kA or less. For application on systems with levels of available fault current above the short-time rating, the typical 'LS' power circuit breaker cannot be applied or must employ an instantaneous override. This instantaneous override is set at as much as 20% below the short-time rating and can seriously compromise selective trip coordination with downstream breakers.

The WL, equipped with EIP, overcomes these limitations by providing full withstand capability, and full coordination, with a minus 0% short-time band tolerance up to 85kA on frame Size II and 100kA on Size III. Above fault currents of 20% higher than the full short-time rating, the WL breaker is self-protecting, and the EIP function will trip the breaker instantly to protect the frame and the system from these extremely high currents, as high as 150kA on frame Size III. One added benefit is that arc flash energy is greatly reduced in this high current region due to the instantaneous trip response that EIP provides.

Molded Case Circuit Breakers

Electronic and Communications Accessories

Selection

Electronic & Display Devices

Trip Unit Test Set

| Type | Catalogue Number |
|--|------------------|
| Portable | TS31 |
| Spare TS-31 Test Set Interconnecting Cable | TS31CABLE |

The TS-31 test set is used to test the operation of the fault protection functions of the circuit breaker's trip unit, including long-time, short-time, instantaneous, and ground fault by means of secondary current injections.

Sensitrip Ammeter Display Unit

| Breaker Type | Catalogue Number |
|----------------|------------------|
| SJD, SLD, SMD, | SADU |
| SND, SPD | SADURMK18 |

The Sensitrip Ammeter Display Unit (SADU) provides real-time metering for all Sentron-Sensitrip III Molded Case Circuit Breakers. The unit plugs directly onto the front of the trip unit and provides displays for individual phase currents flowing through the breaker. Additional features include Average, Demand, Ground and Unbalance Current displays, along with impending Trip Status. Current Metering Logs, and a unique diagnostic Trip Log that records the date, time and type of fault for the previous five breaker trips. The device is UL and CSA certified.

The optional panel mount accessory (SADURMK18) allows easy device mounting external from the circuit breaker, in panelboard and switchboard spaces or gutters, with the flexibility of interior panel exterior panel, or wall mounting capability.

The 2 x 16 alphanumeric LCD display provides easy viewing of data, such as viewing all three phase currents simultaneously.

Plug-in Mounting

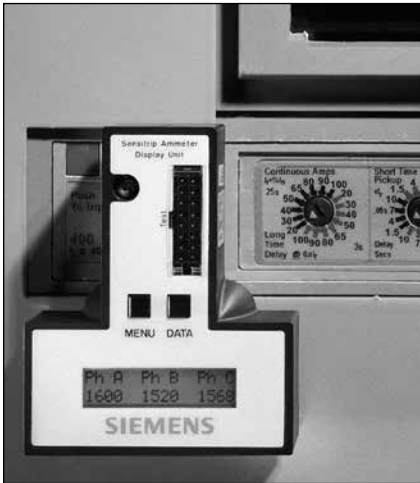

SADU Ammeter Display Unit



- Direct plug-in or Panel Mounting*
- Trip Unit Powered & Battery back-up
- 2 x 16 LCD Alphanumeric Display*
- Ammeter Display Functions
 - RMS Phase Currents
 - Average Current*
 - Current Demand*
 - Ground Current
 - Current Unbalance (%)*
- Breaker Status
 - Normal
 - Impending Trip*
- Time Stamped Trip Log (last 5)
 - Time & Date*
 - Trip Cause: LT, ST, GF, SC
- Max Log (with date & time)
 - Max Phase Current*
 - Max Average Current*
 - Max Ground Current*
 - Max Unbalance Current*
 - Max Current Demand*

* Unique Features

Lug information

Mechanical Lug

Selection

| For Use With Type(s) | Circuit Breaker Ampere Rating | Cables Per Lug | Lug Wire Range | Catalogue Number |
|--|-------------------------------|----------------|------------------------------------|---|
| BO, BQH, BQHF, BQE, BQF, BL, BLH, HBL, HBQ Switching Neutrals BG BLG | Line Side | | | |
| | 15–40 | 1 | #14–#6 AWG Cu #12–#6 AWG Al | TC1Q1 ^{①②} (Pkg. of 6) |
| | 50–100 | 1 | #8–#1 AWG Cu #6–#1/0 AWG Al | TA1Q1 ^② (Pkg. of 6) |
| | Load Side | | | |
| | 15–20 | 1 | #14–#10 AWG Cu #12–#10 AWG Al | Lugs are integral to Circuit Breaker |
| | 25–35 | 1 | #14–#6 AWG Cu #12–#6 AWG Al | |
| | 40–50 | 1 | #8–#6 AWG Cu #8–#4 AWG Al | |
| | 55–70 | 1 | #8–#4 AWG Cu #8–#2 AWG Al | |
| | 80–100 | 1 | #4–#1/0 AWG Cu #2–#1/0 AWG Al | |
| | 110–125 | 1 | #2–#1/0 AWG Cu #1/0–#2/0 AWG Al | |
| Line Side (CQD, CQD6) & Load Side | | | | |
| BQD, CQD BQD6, CQD6 | 15–40 | 1 | #14–#6 AWG Cu #12–#6 AWG Al | Integral |
| | 45–100 | 1 | #8–#1 AWG Cu #6–#1/0 AWG Al | Integral |
| NGG | 15–40 | 1 | #14–#6 AWG Cu #12–#6 AWG Al | TC1Q1 (pkg. of 6) |
| | 50–100 | 1 | #8–#1 AWG Cu #6–#1/0 AWG Al | TA1Q1 (pkg. of 6) |
| | 110–125 | 1 | #6–#1/0 AWG Cu #4–#2/0 AWG Al | 3TA1GG20 (pkg. of 3) |
| | 15–125 | — | NUT KEEPER PLATE | TNKG3 ^③ (Pkg. of 3) |

Note:

(A) Molded case circuit breakers having a rated ampacity of 125 amperes or less are to be connected with 60 or 75°C wire. Circuit breakers having a rated ampacity greater than 125 amperes shall only be cabled with 75°C cable unless otherwise indicated on the circuit breaker label. Exceptions to this rule are outlined in the 2002 National Electrical Code and table 6.1.4.2.1 per CSA C22.2 No5.02 standard.

(B) Connector wire ranges and cavities are established in conjunction with Table 6.1.4.2.1 of UL 489 standards.

- ① Lug is steel.
- ② Sold in package of six.
- ③ Use on load side only.
- ④ One nut keeper plate is required with each lug on the NGG breaker.

Lug Information

Aluminum Body Lugs for Copper or Aluminum Wire

Selection

| For Use With Type(s) | Circuit Breaker Ampere Rating | Cables Per Lug | Lug Wire Range | Catalogue Number |
|---|-------------------------------|----------------|--|---|
| QJ2, QJH2 QJ2H, HQJ2H | 60–225 | 1 | #6 AWG–300 kcmil (Cu) #4 AWG–300 kcmil (Al) | TA1Q300 (pkg of 3) |
| All 2, 3 pole ED2, ED4, ED6, ED6 ETI, HED4, | 15–25 | 1 | #14–#10 AWG (Cu) #12–#10 AWG (Al) | SA1E025 |
| | 30–100 | 1 | #10–#1/0 (Cu or Al) | LN1E100 |
| | 110–125 | 1 | #3-3/0 (Cu) #1-2/0 (Al) | TA1E6125 |
| CED6 All 1 pole ED, HED | 30–60 | 1 | #10–4 (Cu or Al) | LD1E060 (Load Side) |
| | 70–100 | 1 | #4–#1/0 (Cu or Al) | LD1E100 (Load Side) |
| FXD6-A, FD6-A, HFD6, CFD6 HHFD6 | 70–250 | 1 | #6 AWG–350 kcmil (Cu) #4 AWG–350 kcmil (Al) | TA1FD350A |
| SJD6(A), SHJD6(A) SCJD6 | 65-200 | 1–2 | #4 AWG–310 kcmil (Cu or Al) | TA2J630 |
| JXD2(A), JXD6(A), JD6(A), SJD6(A), HJD6(A), HHJXD6, HHJD6, SHJD6(A), CJD6, SCJD6 | 200–400 | 1–2 | 3/0–500 kcmil (Cu) 4/0–500 kcmil (Al) | TA2J6500 |
| LXD6(A), LD6(A), SLD6(A), HLD6(A), HHLXD6, HHL6, SHLD6(A), CLD6, SCLD6 | 250–600 | 1–2 | 3/0–500 kcmil (Cu) 4/0–500 kcmil (Al) | TA2J6500 |
| LMD6 ^① , LMXD6 ^① , HLM6 ^① , HLMXD6 ^① , MD6, MXD6, SMD6, HMD6, HMXD6, SHMD6, CMD6, SCMD6 | 500–600 | 1–2 | #1–500 kcmil (Cu or Al) | TA2K500 |
| | | 1–3 | 1/0–500 kcmil (Cu or Al) | TA3K500 |
| ND6, NXD6, SND6, HND6, HNXD6, SHND6, CND6, SCND6 | 800–1200 | 1–4 | 250–500 kcmil (Cu or Al) | 2TA4P8500 ^{②③} 3TA4P8500 ^④ |
| | | | 250–500 kcmil (Cu or Al) | 2TA4N8500 ^② 3TA4N8500 ^④ |
| PD6, HPD6, CPD6 PXD6, HPXD6, SPD6, SHPD6 | 1200–1600 | 1–5 | 300–600 kcmil (Cu or Al) | TA5P600 |
| PD6, PXD6, HPD6, HPXD6, SPD6, SHPD6, RD6, RXD6, HRD6, HRXD6 | 1200–2000 | 1–6 | 300–600 kcmil (Cu or Al) | TA6R600 |

① Use TA2K500 or TA3K500 only.
 ② Contains 2 connectors plus 1 NDTs end barrier.
 ③ Contains 3 connectors plus 1 NDTs end barrier.

Lug information

Optional Mechanical Lugs

Selection

| For Use With Type | Circuit Breaker Ampere Rating | Cables Per Lug | Lug Material | Lug Wire Range | Qty per Cat. # | Catalogue Number |
|--|-------------------------------|----------------|--------------|--|----------------|--|
| QJ2, QJH2, QJ2H, HQJ2H | 60–225 | 1 | Cu | #6 AWG–250 kcmil (Cu) | 1 | TC1Q250 |
| ED, HED 2&3 pole | 2–3 pole 30-125 | 1 | Cu | #10–#1/0 (Cu) | 1 | TC1ED6150 |
| HFD6, HHFD6, CFD6, F(X)D6-A | 70–250 | 1 | Cu | #6 AWG–350 kcmil (Cu) | 1 | TC1FD350 |
| J(X)D2(A), J(X)D6(A), HJD6(A), HHJD6, SHJD6(A), L(X)D6(A), HHL6, SCD6, HLD6(A), SHLD6(A), CJD6, CLD6, SCJD6, SCLD6 | 200–600 | 1 1–2 | Cu | 3/0–600 kcmil (Cu) 3/0–500 kcmil (Cu) | 1 1 | TC1J6600 [Ⓢ] TC2J6500 [Ⓢ] |
| | 250–600 | 1 1 | Al | 500–750 kcmil (Al) 500–600 kcmil (Cu) | 1 | TA1L6750 |
| SMD6, M(X)D6, HM(X)D6, HMD6, CMD6, SCMD6, SND6, N(X)D6, HN(X)D6, SHND6, CND6, SCND6 | 500–600 | 1–2 | Cu | #1 AWG–500 kcmil (Cu) | 1 | TC2K500 |
| | 700–800 | 1–3 | Cu | #1 AWG–350 kcmil (Cu) | 1 | TC3K350 |
| | | 1–2 | Al | 500–750 kcmil (Cu) 500–750 kcmil (Al) | 2 3 | 2TA2N8750 3TA2N8750 |
| | 800–1200 | 1–3 | Al | 500–750 kcmil (Cu) 500–750 kcmil (Al) | 2 3 | 2TA3N8750 3TA3N8750 |
| R(X)D6, HR(X)D6 | 1600–2000 | 1–5 | Cu | 300–600 kcmil (Cu) | 1 | TC5R600 |
| P(X)D6, HP(X)D6, CPD6, SPD6, SHPD6 | 1200–1600 | 1–4 | Al | 600–750 kcmil (Cu/Al) | 1 | TA4P750 |

Compression Lugs

| For Circuit Breaker Types | Ampere Rating | Poles | Lugs Per Kit | Lug Wire Size | Catalogue Number |
|--|---------------|---------|--------------|-----------------|------------------|
| Lugs (contains indicated number of lugs and necessary hardware per kit) | | | | | |
| ED2, ED4, ED6, HED4, CED4 | 15–125 | 1, 2, 3 | 1 | #2/0 AWG Cu/AL | CCE125 |
| QJ2, QJH2, QJ2-H | 125–225 | 2, 3 | 1 | 350 kcmil Cu/AL | CCQ225 |
| F(X)D6-A, HF(X)D6, HHF(X)D6, CFD6 | 125–250 | 2, 3 | 1 | 350 kcmil | CCF250 |
| JXD2-A, J(X)D6-A, HJ(X)D6-A, HHJ(X)D6-A, CJD6, SJD6-A, SHJD6-A, SCJD6, L(X)D6-A, HL(X)D6-A, CLD6, SLD6-A, SHLD6-A, SCLD6 | 200–600 | 2, 3 | 1 | 500 kcmil | CCL600 |
| Kits (contain lugs and hardware for complete line or load end of 2 or 3 pole breaker) | | | | | |
| M(X)D6, HM(X)D6, CMD6, SMD6, SHMD6, SCMD6 | 500–800 | 2 | 6 | 500 kcmil | CCM800K2 |
| | | 3 | 9 | | CCM800K3 |
| N(X)D6, HN(X)D6, CND6, SND6, SHND6, SCND6 | 900–1200 | 2 | 8 | 500 kcmil | CCN1200K2 |
| | | 3 | 12 | | CCN1200K3 |

Distribution Lugs[Ⓢ]

| For Circuit Breaker Types | Ampere Rating | Poles | Lugs Per kit | Wires Per Lug | Lug Wire Size | Catalogue Number |
|--|---------------|-------|--------------|---------------|---------------------------------|------------------|
| NGG | 15-125 | 1,2,3 | 1 | 6 | #6-#4 AL #14-#4 Cu | TA6GG04 |
| NEG, HEG | 15-125 | 1,2,3 | 3 | 3 | #14-#2 AWG Cu | 3TA3EG02 |
| NEG, HEG | 15-125 | 1,2,3 | 3 | 6 | #14-#6 AWG Cu | 3TA6EG06 |
| ED2, ED4, ED6, HED4, HHED6, CED6 | 15-125 | 1,2,3 | 1 | 6 | #14-#4 AWG Cu #6-#4 AWG Al | TA6ED06 |
| F(X)D6-A, HF(X)D6, HHF(X)D6, CFD6 | 70-250 | 2,3 | 1 | 6 | #14-#4 AWG Cu #6-#4 AWG Al | TA6FD04 |
| JXD2-A, J(X)D6-A, HJ(X)D6-A, HHJ(X)D6-A, CJD6-A, SJD6, SHJD6-A, SCJD6, L(X)D6-A, HL(X)D6-A, CLD6-A, SLD6-A, SHLD6-A, SCLD6 | 200-600 | 2,3 | 1 | 6 | #14-2/0 AWG Cu #6-2/0 AWG Al | TA6JD20 |

[Ⓢ]Used for 100% rated JD/LD frame circuit breakers.

[Ⓢ] Special purpose wire connectors, not for general use.

Molded Case Circuit Breakers

Modifications

Selection/ General

A variety of internal and external accessories, as well as modifications, are available to adapt Siemens circuit breakers to special installation requirements. UL listed internal accessories for 100 through 2000A circuit breakers are field-addable.

Internal accessories fine tune an electrical distribution system, allowing control of the circuit breakers to meet special application requirements. For example, emergency situations may dictate tripping critically placed circuit breakers quickly. Shunt trips accomplish this conveniently and efficiently. Or, when voltage drops are a concern, undervoltage trips automatically open the circuit breaker at a predetermined voltage level.

A wide range of external operating and mounting accessories is also available. For example, face, shallow, and back mounting plates are ideal for tailoring BQ circuit breakers to OEM applications. A complete line of operating handles and handle-blocking devices meet switchboard, enclosure and safety needs. Plug-in mounting assemblies, which simplify switchboard mounting of circuit breakers and permit breaker removal without disconnecting bus or cable connections, are available.

UL 489 Supplement SB Naval Use Breakers

Breakers tested to UL 489 Supplement SB are qualified for use on non combat and auxiliary naval vessels.

Siemens' molded case breakers from the ED frame through the 2000 Amp SB frame can be labeled "Naval" in compliance with Supplement SB.

Supplement SB testing comprises two sets of vibration tests. The first is to find mechanical resonances in the product and to subject the breaker to extreme testing at each resonant frequency. The second is a swept frequency test, in which the frequency of excitation is changed in intervals of 1Hz, and held at each frequency for five minutes. The excitation frequencies run from 4 to 33Hz, and the test is conducted in each of the three orthogonal axes of the breaker.

During these tests, the breaker must not trip from the closed position, nor may the contacts touch from the open position. Calibration and insulation resistance are also verified during the test.

For detailed information, refer to UL 489, Supplement SB.

Modifications^①

50°C Ambient Calibration — Not UL listed and not available for solid state, 100% rated breakers or 400HZ calibrated breakers.

For BL Type Circuit Breakers

— Add suffix 'M' to catalogue number (Example: B120M)

For BQ, QJ2, and ED Frame Circuit Breakers

— Replace 'B' in catalogue number with 'M' (Example: BQ3M060, QJ23M200, ED63M060)

For FD, JD, LD, LMD, MD, ND, PD, and RD Frame Circuit Breakers

Non-Interchangeable Trip (3-pole only)

— Replace 'B' in catalogue number with 'M' (Example: FXD63M225, JXD63M400)

Interchangeable Trip (trip unit only, 3-pole only)

— Replace 'T' in catalogue number with 'W' (Example: FD63W200, JD63W400)

400 HZ Calibration

UL Listed (5KA IR)

For BQ, BL, and QJ Type Circuit Breakers (200A max.)

— Add suffix 'Y' to catalogue number

Not UL Listed

For all other Circuit Breakers — Add suffix 'Y' to catalogue number

Fungus Proofing — In accordance with MIL-T-152.

All BQD, CQD, NGG, ED, FD, JD, LD, LMD, MD, ND, PD, and RD, Frame Circuit Breakers are inherently fungus resistant and do not require special treatment.

Fungus proofing in accordance with MIL-T-152

For BL, and BQ Type Circuit Breakers

— Order must be placed directly with the factory by the sales office.

For all other Circuit Breaker Types

— Order must be placed directly with the factory by the sales office.

Certificate of Compliance

Certificate of compliance testing must be performed on the actual device being shipped. The certificate cannot be provided after initial shipment. Order for devices with COC requirement must be placed directly with the factory by the sales office.

Ordering Information^①

For "NAVAL" label, order must be placed directly with the factory by Siemens Sales Office.

| Types | UL File |
|--|-----------------------|
| ED2, ED4, ED6, HED4 | E10848, Vol 4, Sec 11 |
| CED6 | E10848, Vol 4, Sec 13 |
| FD6, FXD6, HFD6, HFXD6 | E10848, Vol 4, Sec 17 |
| CFD6 | E10848, Vol 4, Sec 18 |
| JXD2, JD6, JXD6, LXD6, LD6, HJD6, HJXD6, HLD6, HLXD6 | E10848, Vol 4, Sec 8 |
| HHJD6, HHJXD6, HHLD6, HHLXD6 | E10848, Vol 4, Sec 20 |
| CJD6, CLD6 | E10848, Vol 4, Sec 14 |
| MD6, MXD6, HMD6, HMXD6, CMD6, ND6, NXD6, HND6, HNXD6, CND6 | E10848, Vol 4, Sec 15 |
| PD6, PXD6, HPD6, HPXD6, CPD6, RD6, RXD6, HRD6, HRXD6 | E10848, Vol 4, Sec 19 |

① Consult sales office for pricing.

Molded Case Circuit Breakers

Internal Accessories

Selection/General

Feature Combinations

The available feature combinations are shown in the chart below. For applications requiring combinations of features not listed in this chart, consult the sales office for availability.

| Breakers | Modules/ Breaker | Avail. On Breaker Poles | ST | ST/ AUX | ST/ ALSW | ST/ AUX/ ALSW | UVT | UVT/ AUX | UVT/ ALSW | UVT/ ST/ ALSW | AUX | AUX/ ALSW | ALSW | Elect. Bell Alarm | Ground fault | Grd fault w/Bell |
|---|---------------------|-------------------------------|----|------------|-------------|---------------------|-----|-------------|--------------|---------------------|------|--------------|------|-------------------------|-----------------|---------------------|
| QP, BQ, BL ^① | 1 | 1, 2, 3 | 1 | — | — | — | — | — | — | — | 1, 2 | — | — | — | — | — |
| BQD, CQD, NGG | 1 | 2, 3 | 1 | 1/1 | — | — | — | — | — | — | 1, 2 | 1/1 | 1 | — | — | — |
| QJ ^② | 1 | 3 | 1 | 1/1 | — | — | — | — | — | — | 2 | — | — | — | — | — |
| All ED, EF | 1 | 1, 2, 3 | 1 | 1/1 | 1/1 | 1/1/1 | 1 | 1/1, 1/2 | 1/1 | 1/1/1 | 1, 2 | 1/1, 2/1 | 1 | — | 1 | 1 |
| All FD, FF | 2 | 2, 3 | 1 | — | — | — | 1 | 1 | — | — | 1, 2 | 1/1 | 1 | — | — | — |
| All JD, LD, LMD ^② | 2 | 2,3 | 1 | 1 | — | — | 1 | 1/1, 1/2 | — | — | 1, 2 | — | 1, 2 | — | — | — |
| SJD6, SHJD6, SCJD6, SLD6, SHLD6, SCLD6 ^③ | 1 | 3 | 1 | 1 | — | — | 1 | 1/1, 1/2 | — | — | 1, 2 | — | 1, 2 | — | — | — |
| All MD, ND, PD, RD Including Electronic trip ^③ | 2 | 2,3 | 1 | 1/1 | — | — | 1 | 1/1, 1/2 | — | — | 1, 2 | 1/1, 2/1 | 1, 2 | — | — | — |

Shunt Trip (ST)

One or all critical circuit breakers may be tripped from a distant control point by use of a shunt trip device. A shunt trip operates through an auxiliary switch contact; when the breaker opens, current is not maintained on the shunt trip coil.

Undervoltage Trip (UVT)

When voltage drops to a value below 35% of the nominal coil rating, the undervoltage trip device automatically opens the breaker. The operation is instantaneous, and the circuit breaker cannot be reclosed

until the voltage returns to 85% of line voltage. The undervoltage trip, which is continuously energized, must be energized before the circuit breaker can be closed.

Auxiliary Switch (AUX)

For applications requiring remote "on" or "off" indication (or electrical interlocking), auxiliary switches are available. Each switch comprises an "A" (open when circuit breaker is open) and a "B" (closed when circuit breaker is open) contact with a common connection. (Form C)

Alarm Switch (ALSW)

The alarm switch contact is closed when the circuit breaker is opened automatically by an overload, short circuit, shunt trip or undervoltage trip. The alarm switch contact is open when the circuit breaker is reset.



① Factory assembled only

② If mechanical interlock is installed, no accessory module can be installed in the right pocket.

③ If mechanical interlock is installed, no accessory module can be installed.

④ If mechanical interlock is installed, no accessory module can be installed in the left pocket.

Molded Case Circuit Breakers

External Accessories

Selection

Handle Ties

Provide simultaneous switching of 2 adjacent handles. Do not provide common trip.

| For Use With Breaker Frame(s) | Catalogue Number | Standard Package | Wt Lb/Std Pkg |
|-------------------------------------|------------------|------------------|---------------|
| BQ, BQH, HBQ, B6, BLH, HBL (2 Pole) | QTH3 | 50 | 1/4 |

Padlocking Devices

For locking breaker in "OFF" position.

| | | | |
|----------------------------------|---------------|----|-----|
| BQXD, BQ, BQH, HBQ, BL, BLH, HBL | ECQLD3 | 10 | 1/4 |
| One pole BL, BLF, BE, BAF | ECPLD1 | 3 | 1/4 |
| Two-pole BL, BLF and BE | ECPLD2 | 3 | 1/4 |
| All QJ | HL9419 | 10 | 1/4 |
| All BQD, CQD | BQDPLD | 1 | 1/8 |
| All ED | ED2HPL | 1 | 1/4 |
| All FD | FD6PL1 | 1 | 1/4 |
| All JD, LD, LMD | JD6HPL | 1 | 1/4 |
| All MD, ND, PD, RD | MN6PLD | 1 | 1/4 |

Filler Plates

| | | | |
|----------------------------|---------------|---|-----|
| BQ, BQH, HBQ, BL, BLH, HBL | QF3-UL | 1 | 1/4 |
|----------------------------|---------------|---|-----|

Handle Blocking Devices

For holding breaker in "ON" or "OFF" position. Not a lockout/tagout device.

| | | | |
|----------------------------------|---------------|----|-----|
| BL, BLH, HBL, BQXD, BQ, BQH, HBQ | ECQL1 | 25 | 1/4 |
| QJ2, QJH2, QJ2H, HQJ2H | QJHS1 | 25 | 1 |
| All BQD, CQD, NGG | BQDHBD | 1 | 1/4 |
| All ED | E2HBL | 1 | 1/4 |
| All FD | FD6HB1 | 1 | 1/2 |
| All JD, LD, LMD | JD6HBL | 1 | 1/2 |
| All MD, ND, PD, RD | MN6BL | 1 | 1/2 |

Handle Extensions

For replacement. One extension shipped with breaker.

| | | | |
|--------------------|-------------|---|---|
| All MD, ND, PD, RD | EX11 | 1 | 2 |
|--------------------|-------------|---|---|

Replacement Terminal Cover

| | | | |
|-----|--------------|----|-----|
| NGG | RTCG3 | 10 | 1/4 |
|-----|--------------|----|-----|

©Sold only in standard package quantities.

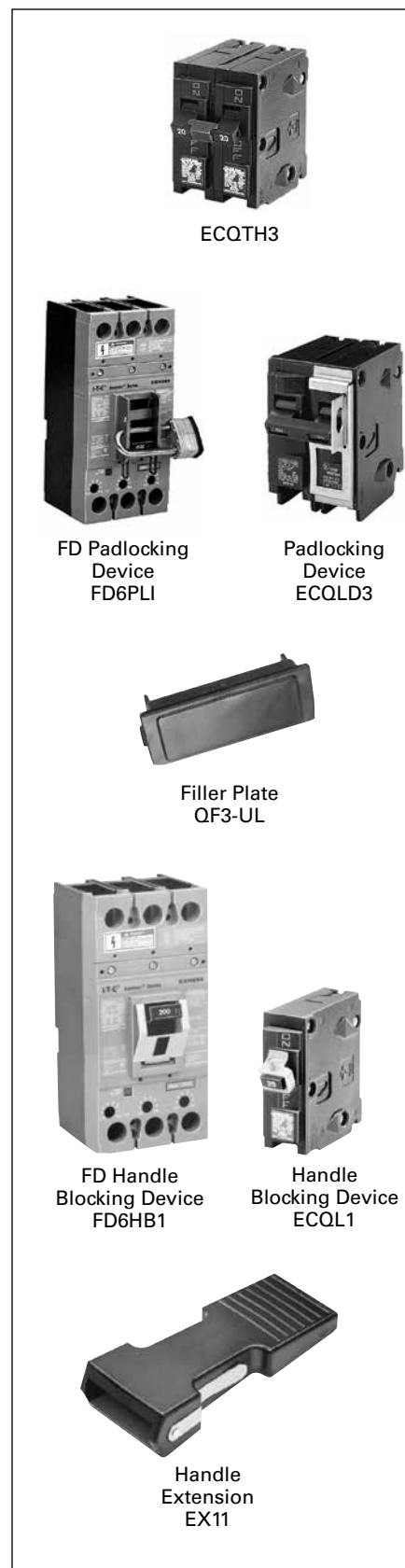

5
MOLDED CASE
CIRCUIT BREAKERS

Molded Case Circuit Breakers

External Accessories

Selection

Mounting Clips

| For Use With Breaker Frame(s) | Number of Poles | Catalogue Number | Standard Package | Wt Lb Std Pkg |
|-------------------------------|-----------------|------------------|------------------|---------------|
| BQ, BQH | 1 | MB120 | 20 ^② | 1/4 |

Face Mounting Plates

| | | | | |
|---------------|---|---------|-----------------|------------------|
| BQ, BQH, BQXD | 1 | FP9508 | 10 ^② | 1/2 |
| | 2 | FP9555 | 10 ^② | 1 |
| | 3 | FP9556 | 10 ^② | 1 ^{1/2} |
| CQD, CQD6 | 1 | CQDFMB1 | 1 | 1/4 |
| | 2 | CQDFMB2 | 1 | 1/4 |
| | 3 | CQDFMB3 | 1 | 1/4 |
| BQ-GFCI | 1 | FP9558 | 10 ^② | 1 |
| NGG | 1 | FMPG1 | 1 | 1/4 |
| | 2 | FMPG2 | 1 | 1/4 |
| | 3 | FMPG3 | 1 | 1/4 |

Shallow Mounting Brackets

| | | | | |
|---------|-----|------|------------------|------------------|
| BQ, BQH | 1-6 | SMB6 | 30 ^{②③} | 1 ^{1/4} |
|---------|-----|------|------------------|------------------|

Back Mounting Plates

| | | | | |
|---------------------|---|-------|-----------------|-----|
| BQ, BQH, BQXD | 2 | BR2 | 10 ^② | 1/4 |
| | 3 | BR3 | 10 ^② | 1/4 |
| | 4 | BR4 | 10 ^② | 1/4 |
| ED2, ED4, ED6, HED4 | 1 | E2BMB | 1 | 1/4 |

Mounting Screw Kits

| | | | |
|-------------------------------|----------------------|------------------|------------------|
| CQD, CQD6 | CQDSMK ^① | 1 | 1 ^{1/4} |
| All ED (CED6 requires 2 kits) | MSE6 ^① | 1 | 1/4 |
| | MSE6100 ^② | 100 ^② | 1 |
| NNG | MSKG2 | 1 | 1/4 |
| All QJ | MSQJ ^① | 1 | 1 |
| All FD (CFD6 requires 2 kits) | MSF6 ^① | 1 | 1/4 |
| | MSF650 ^③ | 50 ^② | 1 |
| All JD, LD | MSJ6 ^① | 1 | 1/4 |
| All LMD | MSLMD | 1 | 1/4 |
| All MD, ND, | MSMN | 1 | 1/4 |
| All PD, RD | MSPR6 | 1 | 2 |

"MI" Mechanical Interlocks

| For Use With Breaker Type(s) | Panel ^① Mounted | Plug-in Mounted | Standard Package | Wt Lb Std Pkg |
|------------------------------|----------------------------|---------------------|----------------------------|---------------|
| BQ | — | ECQML12 | 10 ^② | 1/4 |
| All QJ | CSO | — | 1 | 1 |
| All FD | MI5444 | MI5444 | Complete with two breakers | — |
| All JD, LD | MI5413 ^⑤ | — | 1 | 1 |
| All LMD | MI5406 ^⑤ | — | 1 | 1 |
| All MD | MI5404 ^⑤ | — | 1 | 3 |
| All ND | MI5404 ^⑤ | — | 1 | 3 |
| All PD, RD | MI5405 ^⑤ | MI5405 ^⑤ | — | — |
| STD | STDMIF32 | — | — | — |

Note: CSO = Consult Sales Office

① Kit consists of 4 screws and washers.

② Consists of 1 screw and washers (order 100).

③ Consists of 1 screw and washers (order 50).

④ With mechanical interlock in place, no accessory can be installed into circuit breaker right pole.

⑤ Addition of the mechanical interlock will prevent accessory installation in the left pole.

⑥ Sold only in standard package quantities. Multiply List

⑦ Price Each times package quantity for full price.

MB120

Face Mounting Plates
FP9558 FP9508 FP9555 FP9556

SMB6 (6 shown) **QML12**

Back Mounting Plate BR2

Mounting Screw Kit MSE6

Mechanical Interlock MI5444

⑧ Each package contains 5 strips of 6 each. Each strip can be broken at perforations for 1, 2 or 3-pole use.

⑨ Mechanical interlock is not designed for use within Siemens panelboards.

Molded Case Circuit Breakers

External Accessories

Selection

Rotary Door Mounted Operating Handles^⑤ Types 1, 3, 3R, 12, 4 4X

| For Use With Breaker Frames | Complete Mechanism | | Handle Only | Breaker Operator | Shaft Only | |
|-----------------------------|--------------------|----------------|--------------------|---------------------|-----------------|-------------------------------|
| | Standard Depth | Variable Depth | | | Length (inches) | Catalogue Number |
| EG | RHVE64X | RHVE124X | — | — | — | — |
| ED ^① | CRHOESD | CRHOEVD | CRHOH ^② | RHOEBO | 2 | RHOSSD |
| FD | CRHOFSD | CRHOFVD | | RHOFBO | 12 | RHOSVD |
| JD, LD | CRHOJSD | CRHOJVD | | RHOJBO | 16 | RHOSXD |
| LMD | CRHOLMSD | CRHOLMVD | | RHOLMBO | | |
| MD, ND PD, RD | RHONSD | RHONVD | RHOH | RHONBO ^③ | 3 12 24 | RHONSSD RHONSVD RHONSXD |

For 3 or 3R, order shaft and breaker operator as shown, and handle RHOH. For 4 & 4X, order handle RHOH4.

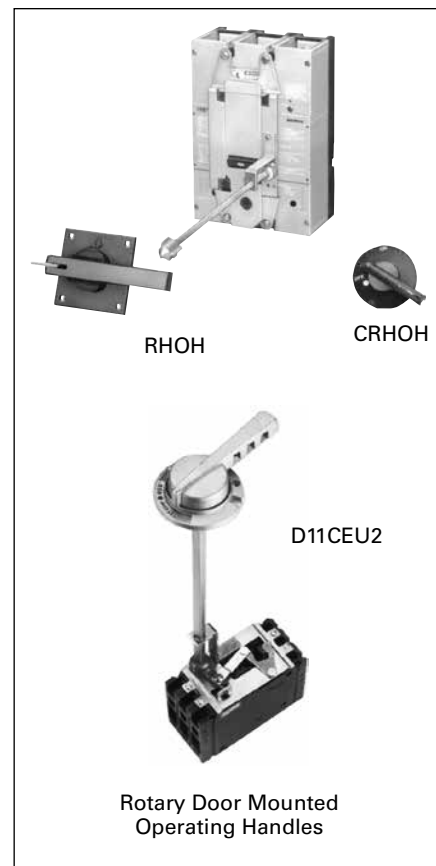

Rotary Door Mounted Operating Handles Types 1 & 12

| For Use With Breaker Frames | Standard Depth | Variable Depth | Handle and Shaft | Breaker Operator |
|-----------------------------|------------------|------------------|------------------|------------------|
| | Catalogue Number | Catalogue Number | | |
| CQD, NGG | — | RHOCQVD | RHOH62 | CQDOP |
| ED | D11CEU1 | D11CEU2 | — | — |
| FD | D11CFU1 | D11CFU2 | — | — |
| JD, LD, LMD | — | D11CJU2 | — | — |

Through Door Mounted Operating Handles Types 1 & 12

| For Use With Breaker Frames | Standard Depth | Variable Depth |
|-----------------------------|------------------|------------------|
| | Catalogue Number | Catalogue Number |
| CQD, NGG | FMHOS | — |
| QJ | OH9498 | VH9499 |
| ED | E2RH1 | E2RHV9 |
| FD | F6RH1 | F6RHV9 |

Door Latch Kits

| Type | Catalogue Number Right Hand | Catalogue Number Left Hand |
|---------------|-----------------------------|----------------------------|
| 2 point latch | DKR2 | DKL2 |
| 3 point latch | DKR3 | DKL3 |

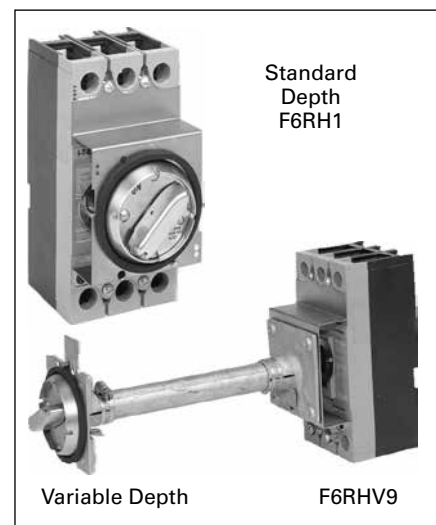

5
MOLDED CASE
CIRCUIT BREAKERS

① For use on 3-pole ED frame only.
② Meets the requirements of NFPA 79, section 5.3.3.1 for locking external operator disconnecting devices.

③ For 3 or 3R, order shaft and breaker operator as shown, and handle RHOH. For 4 & 4X, order handle **RHOH4**.
④ For extended shaft support order catalogue number **RHONSB2**.

⑤ Consult Siemens Sales Office for NFPA-79 Compliance.

Molded Case Circuit Breakers

External Accessories

Max-Flex™, Flange Mounted Variable Depth Operators^③

| Frames | NEMA Type | Complete Kit Catalogue Number | Handle Only Catalogue Number | Breaker Operator Catalogue Number | 36" Cable Catalogue Number |
|-------------------------------|--------------|-------------------------------|------------------------------|-----------------------------------|----------------------------|
| NGG | 1, 3 (R), 12 | MFKG3R3 | MFHM3R | MFMG | MFCF036 |
| | 4 (x) | MFKG4X3 | MFHM4X | | |
| ED | 1, 3 (R), 12 | FHOE036 ^① | FHOH | FHOEBO ^① | FHOEC036 |
| | 4 (x) | — | FHOH4 | | |
| FD | 1, 3 (R), 12 | FHOF036 | FHOH | FHOFBO | FHOF036 |
| | 4 (x) | — | FHOH4 | | |
| JD, LD, SJD, SLD | 1, 3 (R), 12 | FHOJ036 | FHOH | FHOJBO | FHOJC036 |
| | 4 (x) | — | FHOH4 | | |
| LMD | 1, 3 (R), 12 | FHOLM036 | FHOH | FHOLMBO | FHOJC036 |
| | 4 (x) | — | FHOH4 | | |
| MD, ND, PD, RD, SMD, SND, SPD | 1, 3 (R), 12 | FHON048 | FHOHN | FHONBO | FHONC048 ^② |
| | 4 (x) | — | FHOHN4 | | |

Max-Flex™ handles are available with solid black handles instead of the customary "red for on" flange handle. These are preferred for use in IEC markets, where red handles have specific meaning. Order components separately, appending the letter "i" to the catalogue number (e.g. FHOHI).

Selection

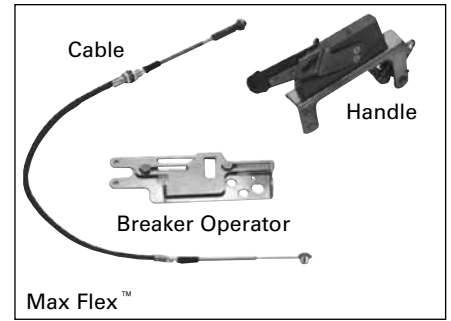

Alternate Length Cable Only

| | ED | FD | JD/LD/LMD | MD/ND/PD/RD |
|--------|------------------|------------------|------------------|------------------|
| Inches | Catalogue Number | Catalogue Number | Catalogue Number | Catalogue Number |
| 48 | FHOEC048 | FHOF048 | FHOJC048 | FHONC048 |
| 60 | FHOEC060 | FHOF060 | FHOJC060 | FHONC060 |
| 72 | FHOEC072 | FHOF072 | FHOJC072 | FHONC072 |
| 84 | FHOEC084 | FHOF084 | FHOJC084 | FHONC084 |
| 96 | FHOEC096 | FHOF096 | FHOJC096 | FHONC096 |
| 120 | FHOEC120 | FHOF120 | FHOJC120 | FHONC120 |
| 144 | FHOEC144 | FHOF144 | FHOJC144 | FHONC144 |

Handle Auxiliary Switch

For use with Max-Flex and Rotary Door operators (FHOH and RHOH). 1 NO and 1 NC contact (Form C).

| For Use With | Catalogue Number |
|---|------------------|
| ED, FD, JD, LD, LMD, ND, PD, RD, SD, Max Flex | HAS1 |

Fixed Depth Flange Mounting

| Frames | Minimum Enclosure Depth | NEMA Type | Left Hand Mount | Right Hand Mount |
|--------|-------------------------|-----------|------------------|------------------|
| | | | Catalogue Number | Catalogue Number |
| ED | 6.44 | 1, 3R, 12 | FDLBEL | FDLBER |
| | | 4, 4X | FDLBEL4 | FDLBER4 |
| FD | 6.44 | 1, 3R, 12 | FDLFL | FDLFR |
| | | 4, 4X | FDLFL4 | FDLFR4 |

Max-Flex™ handles are available with solid black handles instead of the customary "Red for On" flange handle. These are preferred for use in IEC markets, where red handles have specific meaning. Order components separately, appending the letter "i" to the catalogue number (e.g. FHOHI).



①For 1- or 2-pole breaker order FHOED036 complete kit or FHOEDBO breaker operator only.

②48 inch cable is standard length for M through R frame Max-Flex operators.

③Meets requirements of NFPA 79, section 5.3.3.1 for locking external operator disconnecting devices

Molded Case Circuit Breakers

External Accessories

Selection

Telemand® Motor Operator

| Breaker Frame | AC Voltage | Hinged to Open Down |
|---------------|------------|---------------------|
| ED except CED | 120 | MOE6120 |
| | 240 | MOE6240 |

ED motor operator opens downward.

| Breaker Frame | DC Voltage | Hinged to Open Right | AC Voltage | Hinged to Open Right |
|----------------|------------|----------------------|------------|----------------------|
| FD | 24 | MOF6024DC | 120 | MOF6120 |
| | 48 | MOF6048DC | 240 | MOF6240 |
| | 125 | MOF6125DC | — | — |
| JD, LD | 24 | MOJ6024DC | 120 | MOJ6120 |
| | 48 | MOJ6048DC | 240 | MOJ6240 |
| | 125 | MOJ6125DC | — | — |
| LMD | 24 | MOLMD6024DC | 120 | MOLMD6120 |
| | 48 | MOLMD6048DC | 240 | MOLMD6240 |
| | 125 | MOLMD6125DC | — | — |
| MD, ND, PD, RD | — | — | 120 | MOMN6120 |
| | — | — | 240 | MOMN6240 |

To order FD through RD motor operators with Left side hinges, add "L" to catalogue number (e.g. MOF6120L).

Dimensions

| Frame | A | B | C | D | E | F |
|----------------|-------|------|------|------|-------|-------|
| ED | 7.04 | 4.31 | — | 4.31 | 13.84 | 8.84 |
| FD | 9.50 | 4.55 | 1.60 | 6.84 | 9.70 | 7.58 |
| JD, LD, LMD | 11.00 | 7.50 | 0.79 | 8.34 | 9.85 | 7.74 |
| MD, ND, PD, RD | 16.00 | 9.00 | — | 9.83 | 13.13 | 10.13 |

Operating Currents

| Catalogue Number | On | | | Off | | | Reset (Amps) |
|------------------|----------------|----------------|-------------|----------------|----------------|-------------|--------------|
| | In-Rush (Amps) | Running (Amps) | Time (msec) | In-Rush (Amps) | Running (Amps) | Time (msec) | |
| MOE6120 | 10.25 | 2.3 | 550 | 10.0 | 2.3 | 400 | 2.3 |
| MOE6240 | 5.2 | 1.1 | 500 | 5.0 | 1.0 | 330 | 1.1 |
| MOF6120/L | 10.0 | 5.5 | 200 | 10.0 | 5.5 | 175 | 5.5 |
| MOF6240/L | 4.7 | 2.5 | 200 | 4.7 | 2.5 | 185 | 2.5 |
| MOLMD6120/L | 15.2 | 6.0 | 210 | 15.2 | 6.0 | 185 | 6.0 |
| MOJ6120/L | 15.2 | 6.0 | 210 | 15.2 | 6.0 | 185 | 6.0 |
| MOJ6240/L | 5.0 | 2.5 | 217 | 5.0 | 2.5 | 185 | 2.5 |
| MOMN6120/L | 22.7 | 13.9 | 240 | 22.7 | 13.9 | 210 | 13.9 |
| MOMN6240/L | 12.6 | 4.6 | 260 | 12.6 | 4.6 | 230 | 12.6 |



FD, JD, LD, LMD, MD, ND, PD, RD Frames

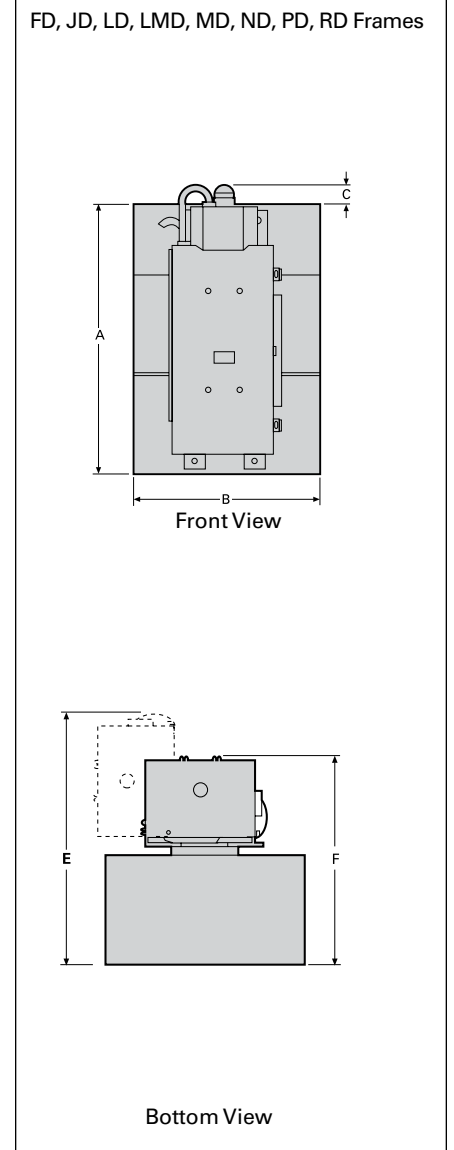

For inches / millimeters conversion, see Application Data section.

Molded Case Circuit Breakers

External Accessories

Plug-In Mounting Assemblies, Including Base and Tulip Assemblies

Selection/Dimensions

| For Use With Breaker Frames | Poles | Line Side | Load Side | Steel Switchboard Mounting Plate ^① Catalogue Number |
|-----------------------------|-------|-------------------------------|-------------------------------|--|
| | | Catalogue Number ^② | Catalogue Number ^② | |
| All ED except CED | 2 | PC2637▲ | PC2638▲ | PL2616 |
| | 3 | PC2657 | PC2658 | |
| CED | 2 | PC2637▲ | PC2638▲ | PL2617 |
| | 3 | PC2657 | PC2658 | |
| All FD except CFD | 2 | PC4753▲ | PC4753▲ | PL4762 |
| | 3 | PC4754 | PC4754 | |
| CFD | 2 | PC4753▲ | PC4753▲ | PL4763 |
| | 3 | PC4754 | PC4754 | |
| All JD except CJD | 2 | PC5777▲ | PC5777▲ | PL5796 |
| | 3 | PC5778 | PC5778 | |
| Kit CJD, SCJD | 3 | PCCJD | PCCJD | PL5797 |
| All LD except CLD | 2 | PC5660▲ | PC5660▲ | PL5696 |
| | 3 | PC5661 | PC5661 | |
| Kit CLD, SCLD | 3 | PCCLD | PCCLD | PL5797 |
| All MD | 2 | PC5662▲ | PC5662▲ | PL9698 |
| | 3 | PC5663 | PC5663 | |
| All ND | 2 | PC5664 ^③ ▲ | PC5664 ^③ ▲ | PL9699 |
| | 3 | PC5666 ^③ | PC5666 ^③ | |

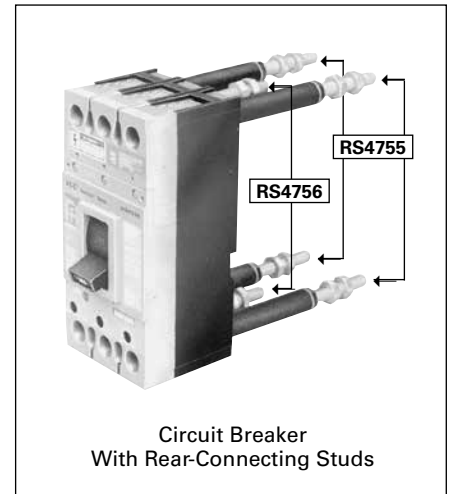
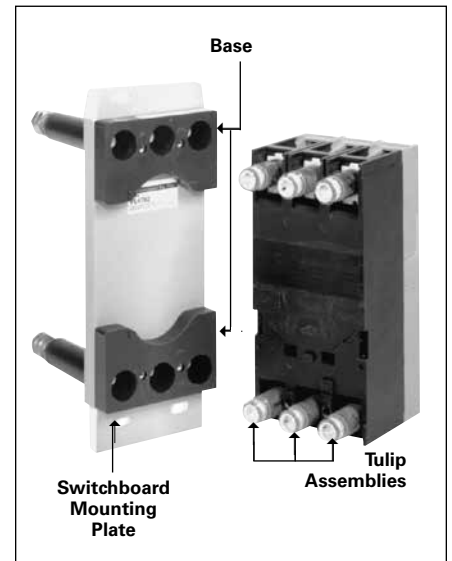

5 Tulip Assemblies Separately

| For Frame | 2 Pole | 3 Pole |
|-----------|------------------|------------------|
| | Catalogue Number | Catalogue Number |
| ED | TCE2▲ | TCE3▲ |
| FD | TCF2▲ | TCF3▲ |
| JD | TCJ2▲ | TCJ3▲ |
| LD | TCL2▲ | TCL3▲ |
| MD | TCM2▲ | TCM3▲ |
| ND | TCN2▲ | TCN3▲ |

Rear-Connecting Studs

| For Use With Breaker Frames | Ampere Rating | Description | Extension Behind Breaker (inches) | Line Side | Load Side |
|-----------------------------|--------------------------|-------------------|-----------------------------------|-----------------------|-----------------------|
| | | | | Catalogue Number | Catalogue Number |
| All ED | 100 | Line Side (Short) | 2.38 | RS2643 ^④ ▲ | — |
| | 100 | Load Side (Short) | 2.38 | — | RS2644 ^④ ▲ |
| | 100 | Line Side (Long) | 4.88 | RS2641 ^④ ▲ | — |
| | 100 | Load Side (Long) | 4.88 | — | RS2642 ^④ ▲ |
| All FD | 250 | Short | 3.12 | RS4756 ^④ ▲ | RS4756 ^④ ▲ |
| | 250 | Long | 7.06 | RS4755 ^④ ▲ | RS4755 ^④ ▲ |
| All JD | 400 | Short | 5.85 | RS5774▲ | RS5774▲ |
| | 400 | Long | 11.20 | RS5773▲ | RS5773▲ |
| All LD | 600 | Short | 5.85 | RS5784▲ | RS5784▲ |
| | 600 | Long | 11.20 | RS5783▲ | RS5783▲ |
| CJD, SCJD CLD, SCLD | Add required shield kit. | | | — | CLRSJL3 |
| LM(X)D6, HLM(X)D6 | 800 | Short | 5.85 | RS5788▲ | RS5788▲ |
| | | Long | 11.20 | RS5787▲ | RS5787▲ |
| All MD, ND | 1200 | Short | 5.50 | RS5786▲ | RS5786▲ |
| | | Long | 8.00 | RS5785▲ | RS5785▲ |

▲ Built to order. Allow 7–9 weeks for delivery.

① Furnished at no extra charge when ordered with plug-in mounting assembly.

② Each piece catalogue number consists of (1) mounting block assembly and required tulip assemblies (2) for 2-pole, (3) for 3-pole

③ For vertical bus mounting — for horizontal, substitute PC5665 for PC5664 and PC5667 for PC5666.

④ Price includes one current stud, insulating tube, stud nuts and terminal shields, when required.

⑤ For proper electrical clearance, studs must alternate between short and long stud lengths on circuit breaker poles (e.g. SLSLSL or LSLSL).

Enclosed Circuit Breakers

Enclosures

General



Type 1 — A general indoor, sheet-steel enclosure for use in normal atmospheres.

Type 3R — An outdoor, sheet-steel enclosure providing protection against driving rain, sleet or snow. Listed as service entrance equipment.

Types 12 — A special-industry, sheet-steel enclosure for use in atmospheres containing particles of lint, dust, dirt, sawdust and other foreign matter.

5

MOLDED CASE
CIRCUIT BREAKERS

Enclosed Circuit Breakers

Enclosed Breaker Nomenclature

General

| | | | | | | | | | | |
|-------------------------------------|---|-------|--|----|---|-----|-----|-------|-----|----|
| Sample Part Numbers: | E | 3R | QJ | 2 | 2 | B | 60 | H | A | — |
| | I | II | III | IV | V | VI* | VII | VIII* | IX* | X* |
| | E | 12 | JXD | 6 | 3 | B* | 200 | H | — | — |
| | I | II | III | IV | V | VI* | VII | VIII* | IX* | X* |
| | E | 1S | SHJD | 6 | 9 | — | 400 | NGTH | A | N |
| | I | II | III | IV | V | VI* | VII | VIII* | IX* | X* |
| I | Basemodel Start with E | | | | | | | | | |
| Placeholder Position Options | | | | | | | | | | |
| II | May be replaced by 1S, 1F, 12, 3R or 4X | | | | | | | | | |
| III | May be replaced by BQ, BQH, HBQ | | | | | | | | | |
| | May be replaced by QJ, QJH, QH | | | | | | | | | |
| | May be replaced by ED, HED, HHED, CED | | | | | | | | | |
| | May be replaced by FD, FXD HFXD, HFD, HHFD, HHFXD, CFD | | | | | | | | | |
| | May be replaced by JD, JXD, HJD, HJXD, HHJD, HHJXD. CJD | | | | | | | | | |
| | May be replaced by FD, FXD JD, JXD, SJD, SHJD, SCJD | | | | | | | | | |
| | May be replaced by LD, LXD, HLD, HLXD. HHL, HHLCD, CLD, SLD, SHLD, SCLD | | | | | | | | | |
| | May be replaced by MD, MXD, HMD, HMXD, CMD, SMD, SHMD, SCMD | | | | | | | | | |
| | May be replaced by ND, NXD, HND, HNXD, CND, SND, SHND, SCND | | | | | | | | | |
| IV | May be replaced by 2, 4, 6 | | | | | | | | | |
| V | May be replaced by 2, 3, 9 | | | | | | | | | |
| VI* | May be replaced by B, M, S, L, A, H, * If option not present omitted | | | | | | | | | |
| VII | May be replaced by : | | | | | | | | | |
| | QJ | Frame | 060,070,080, 090,100, 110, 125, 150, 175, 200, 225 | | | | | | | |
| | ED | | 015, 020, 025, 030, 040, 045, 050, 060, 070, 080, 090, 100, 110, 125 | | | | | | | |
| | FD | | 070, 080, 090, 100, 110, 125, 150, 175, 200, 225, 250 | | | | | | | |
| | JD | | 200, 225, 250, 300, 350, 400 | | | | | | | |
| | LD | | 300, 400, 450, 500, 600 | | | | | | | |
| | MD | | 600, 700, 800 | | | | | | | |
| | ND | | 900, 1000, 1200 | | | | | | | |
| VIII* | May be replaced by A, AG, ANT, ANG, AH, AGH, ANTH, G, GH, NT, NTH, NGT, NGTH, if option+ not present position omitted | | | | | | | | | |
| IX* | A: Consist of breaker internal accessories and Neutral Sensor, + If option not present position omitted | | | | | | | | | |
| X* | N: Suitable for service entrance,+ If option not present position omitted | | | | | | | | | |

The enclosed breakers are factory assembled. Each enclosed breakers assembly includes the selected type of enclosures, circuit breakers, standard lugs, and optional Neutral* assembly and accessories.

*except BQ, QJ and ED enclosures.

Enclosed Circuit Breakers

Enclosures — Type 1

Selection/Dimensions

Dimensions

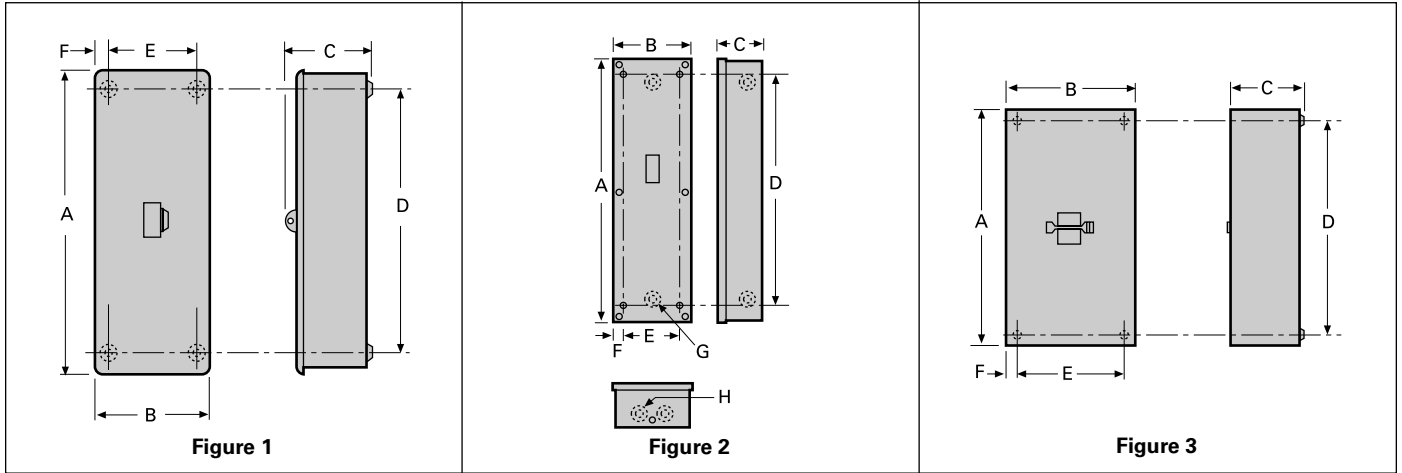

Type 1

| Fig. No. | Breaker Type | Number of Poles | Maximum Current Rating | Catalogue [®] Number | Weight Lb./Ship. Package | Dimensions (inches) | | | | | | K.O. Dimensions | |
|--|--|-------------------|------------------------|-------------------------------|--------------------------|---------------------|---------------------|-------------------|---------------------|-------------------|--------------------|------------------------------|---|
| | | | | | | A | B | C | D | E | F | G | H |
| 1 | BQ, BQH, HBQ | 3 | 100 | EB3100S ^{①③⑦} | 32 | 17 ^{1/8} | 7 ^{1/8} | 4 ^{3/4} | 14 ^{1/16} | 1 ^{5/16} | 1 ^{5/16} | — | — |
| 2 | ED2, ED4, ED6, HED4, HED6 | 3 | | E2N1S ^② | 8 | 16 ^{23/32} | 7 ^{1/2} | 5 ^{1/16} | 13 ^{45/64} | 5 ^{1/4} | 1 | 7/8, 11/8, 13/8, 13/4, 2 | |
| | ED4, ED6, HED4, HED6, CED6 | | 125 | CED6N1S ^{②⑥} | 14 | 21 ^{15/32} | 7 ^{19/32} | 5 ^{7/64} | 18 ^{1/4} | | | | |
| 3 | FXD6, FD6, FXD6-A, FD6-A, HFD6, HFXD6, HHFD6, CFD6 | 2-3 | 250 | F6N1S ^③ | 33 | 381 ^{3/32} | 11 ^{15/32} | 5 ^{1/16} | 33 | 8 | 13 ^{3/64} | 11/8, 13/8, 13/4, 2, 21/2, 3 | |
| | JXD2(A), JD6(A), JXD6(A), HJD6(A), HJXD6(A), HHJD6, HHJXD6, SJD6(A), SHJD6(A), SXD6H | 400 | J6N1 ^③ | 120 | 40 ^{13/64} | 22 ^{27/64} | 10 ^{45/64} | 18 ^{1/4} | 2 ^{5/64} | — | | | |
| | LD6(A), LXD6(A), HLD6(A), HLXD6(A), HHL6, HHLXD6, SLD6(A), SHLD6(A), SCJD6, SCLD6, LXD6H | 600 | LD6N1 ^③ | (L6N1) ^③ | 101 | | | | | 46 | — | | |
| MD6, MXD6, SMD6, HMD6, HMXD6, SHMD6, ND6, NXD6, SND6, HND6, HNXD6, SHND6, CMD6, SCMD6, CND6, SCND6 | 1200 | MND6 ^③ | 132 | 60 | 10 | 55 ^{7/8} | — | | | | | | |

5
MOLDED CASE
CIRCUIT BREAKERS

For inches / millimeters conversion, see Application Data section.

- ① Surface mounted, indoor. If flush mounting is required, replace suffix "S" in catalogue number with suffix "F". Also, if outdoor model required, use prefix "W" instead of "E".
- ② Does not include circuit breaker. Order circuit breaker separately.
- ③ Neutral not included. Order as separate item from table on next page.
- ④ Neutral included in enclosure.

- ⑤ Surface mounted, indoor. If outdoor model is required, use prefix "W" instead of "E". Not available in flush ("F") model.
- ⑥ Use for 110-125 ampere ED4, ED6, HED4 or HED6 circuit breakers.
- ⑦ Will not accept breaker with shunt trip.
- ⑧ Will not accept 2-pole GFCI or breaker with shunt trip.
- ⑨ Items cannot be ordered separately. See configuration.

Built to order. Consult sales office for factory lead time and prices.

Enclosed Circuit Breakers

Enclosures — Type 1

Selection/Dimensions

Dimensions

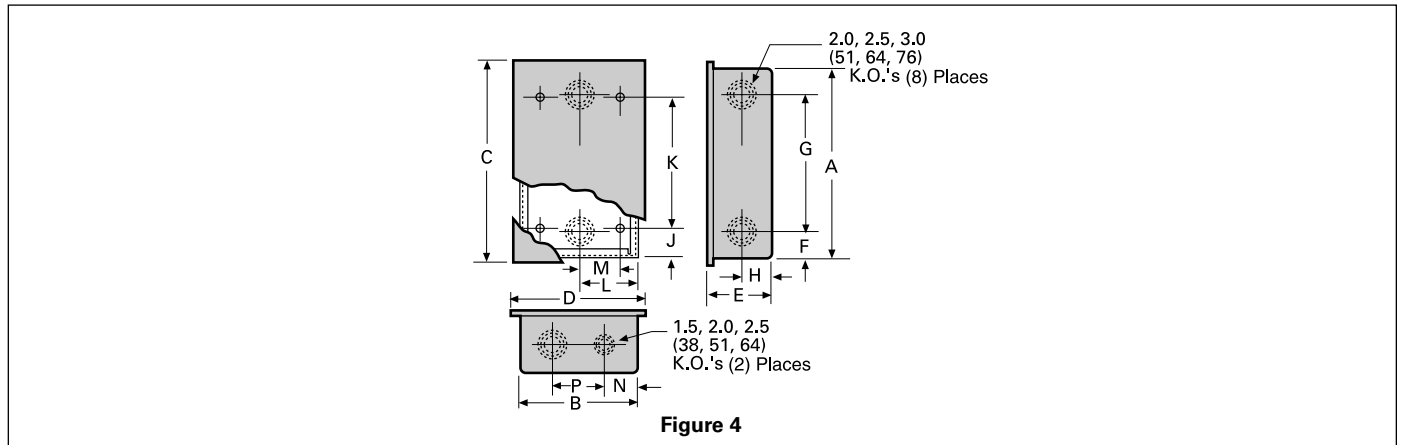

Figure 4

| Fig. No. | Breaker Type | Number of Poles | Maximum Current Rating | Catalogue ^③ Number | Weight Lb./Ship. Package | Dimensions (inches) | | | | | | | | | | | | |
|----------|---------------------------|-----------------|------------------------|-------------------------------|--------------------------|---------------------|-------------------|-------------------------|--|------------------|--------------------|-------------------|------------------|---|----|-------------------|------------------|------------------|
| | | | | | | A | B | C | D | E | F | G | H | J | K | L | M | N |
| 4 | QJ2, QJH2, QH2-H, QJ, QJH | 2-3 | 225 | EB3225S EB3225F | 15 | 27 | 10 ^{1/8} | 27 28 ^{1/8} | 10 ^{1/8} 11 ^{1/4} | 5 ^{1/4} | 21 ^{3/16} | 21 ^{3/8} | 2 ^{3/8} | 3 | 20 | 5 ^{1/16} | 2 ^{3/4} | 4 ^{1/2} |

5
MOLDED CASE
CIRCUIT BREAKERS

Neutrals

| Enclosure Catalogue Number | Neutral Catalogue Number | Neutral Cable Capacity and Wire Range |
|----------------------------|--------------------------|---|
| E2N1(S)(F) CED6N1(S)(F) | W53045 ^② | (1 pc.) #14-2 Cu/Al Grd. Lug (1 pc.) #14-8 Cu/Al |
| F6N1(S)(F) | N250 (NFD) | (1 pc.) #6-350 kcmil Grd. Lug (1 pc.) #14-2/0 Cu/Al |
| J6N1 | W60992 (NJD) | (1 pc.) #1/0-750 kcmil Cu/Al or (2 pcs.) #1/0-300 kcmil Cu/Al Grd. Lug (1 pc.) #6-250 kcmil Cu/Al |
| LD6N1 | W60993 (NLD) | (2 pcs.) #1/0-600 kcmil Grd. Lug (1 pc.) #6-250 kcmil Cu/Al |
| MND61 | W63623 (NMND) | (8 pcs.) 250 kcmil-500 kcmil Cu/Al Grd. Lug (1 pc.) #6-300 kcmil Cu/Al |

For inches / millimeters conversion, see Application Data section.

- ① Does not include circuit breaker. Order circuit breaker separately.
- ② Neutral included in enclosure.
- ③ Items cannot be ordered separately. See configuration.

Built to order. Consult sales office for factory lead time and prices.

Enclosed Circuit Breakers

Enclosures — Type 3R

Selection/Dimensions

Dimensions

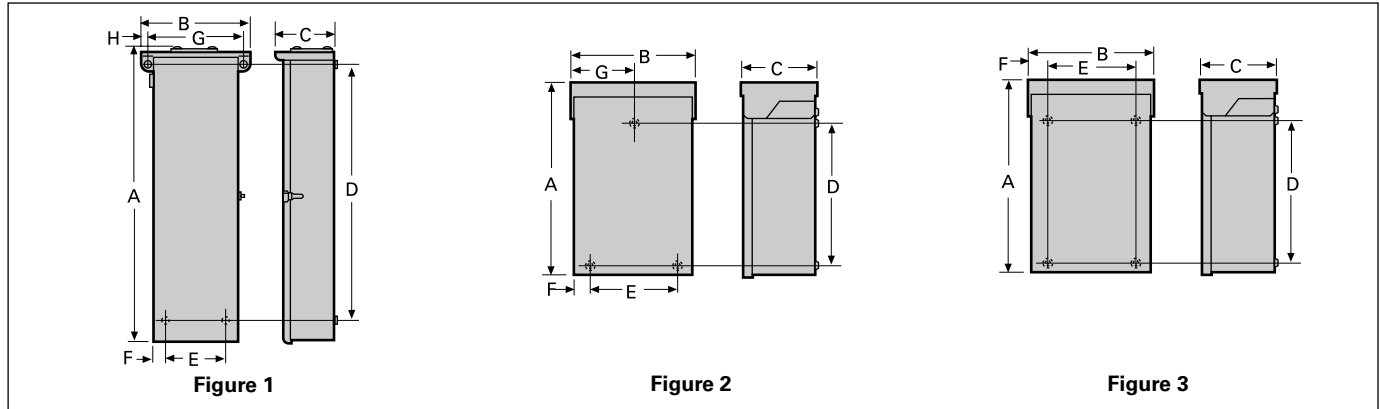

Type 3R

| Fig. No. | Breaker Type | Number of Poles | Maximum Current Rating | Catalogue [®] Number | Weight Lb./Ship. Package | Dimensions (inches) | | | | | | | | |
|----------|--|-----------------|------------------------|--|--------------------------|---|--------------------|---------------------|--|-------------------|--------------------|--------------------|--------------------|---------------------|
| | | | | | | A | B | C | D | E | F | G | H | |
| 2 | BQ, BQH, HBQ | 3 | 50 100 | WB3100 ^② | 9 | 17 ^{1/8} | 7 ^{3/8} | 4 ^{5/16} | 14 ^{1/8} | 4 ^{1/2} | 1 ^{1/8} | 3 ^{11/16} | — | |
| 5 | ED2, ED4, ED6, HED4, HED6 CED6 | 2-3 | 100 125 | E2N3R [®] CED6N3R [®] | 12 16 | 17 ^{9/16} 22 ^{21/64} | 7 ^{1/4} | 5 ^{1/4} | 12 ^{39/64} 17 ^{3/8} | 5 ^{1/4} | 1 | 3 | — | |
| 1 | FXD6, FD6, FXD6-A, FD6-A, HFD6, HFXD6, HHFD6, CFD6 | | 250 | F6N3R [®] | 45 | 38 ^{1/8} | 14 ^{1/16} | 7 ^{3/4} | 33 ^{9/32} | 8 | 13 ^{1/16} | 13 ^{1/2} | 13 ^{1/16} | |
| | JXD2(A), JD6(A), JXD6(A), HJD6(A), HJXD6(A), HHJD6, HHJXD6, SJD6(A), SHJD6(A), SXD6H | | 400 | J6N3R [®] | 126 | 40 ^{63/64} | 26 ^{3/4} | 11 ^{23/32} | 40 ^{3/4} | 18 ^{1/4} | 2 ^{1/8} | 24 ^{1/2} | 1 ^{1/8} | |
| | LD6(A), LXD6(A), LXD6H, HLD6(A), HLXD6(A), HHL6(A), CLD6, SCJD6(A), SLD6(A), SHLD6(A) | | 600 | LD6N3R [®] | 127 | 45 ^{63/64} | | | | | | | | |
| | MD6, MXD6, SMD6, HMD6, HMXD6, SHMD6, ND6, NXD6, SND6, HND6, HNXD6, SHND6, CMD6, SCMD6, CND6, SCND6 | | 1200 | MND63 [®] | 210 | 61 ^{9/64} | | | | | | | | 57 ^{17/32} |

5
MOLDED CASE
CIRCUIT BREAKERS

For inches / millimeters conversion, see Application Data section.

① Does not include circuit breaker.

Order circuit breaker separately.

② Neutral not included. Order as separate item from table on next page.

③ Neutral included in enclosure.

④ Will not accept breaker with shunt trip.

⑤ Items cannot be ordered separately. See configuration.

Enclosed Circuit Breakers

Enclosures — Type 3R

Selection/Dimensions

Dimensions

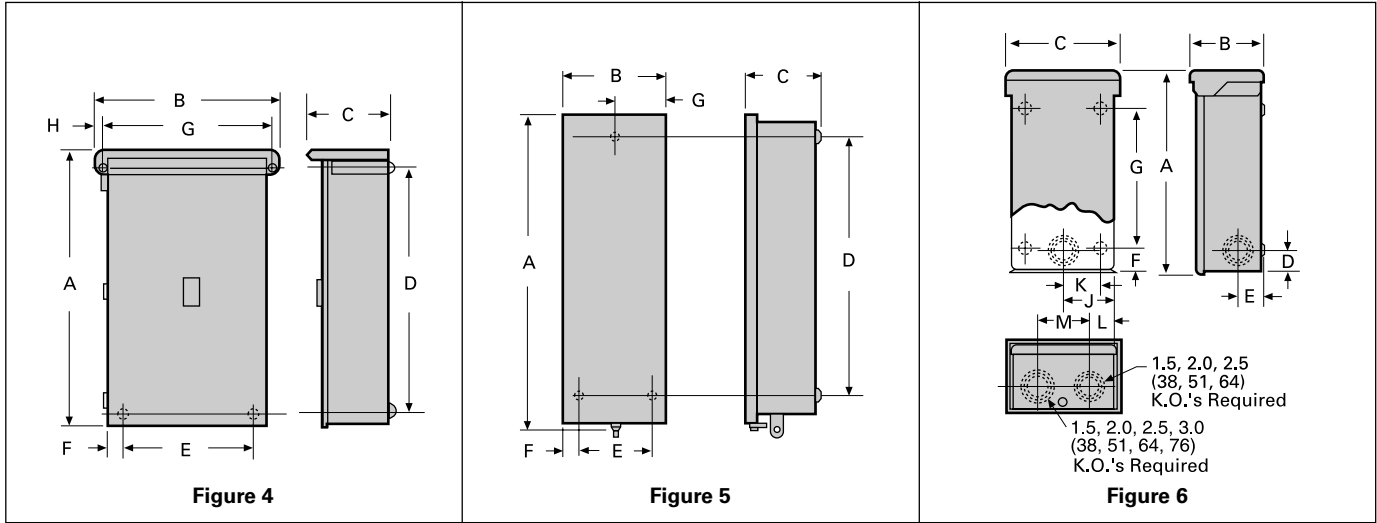

| Fig. No. | Breaker Type | Number of Poles | Maximum Current Rating | Catalogue [®] Number | Weight Lb./Ship. Package | Dimensions (inches) | | | | | | | | | | |
|----------|---------------------------|-----------------|------------------------|-------------------------------|--------------------------|---------------------|-----------------------|---|------------------|---|------------------|----|------------------|--------------------------------------|------------------|-----------------------|
| | | | | | | A | B | C | D | E | F | G | H | J | K | L |
| 6 | QJ2, QJH2, QJ2-H, QJ, QJH | 2 3 | 225 | WB2225 WB3225 | 17 | 27 | 5 5 ^{5/8} | 7 ^{11/16} 10 ^{3/8} | 2 ^{1/4} | 2 | 2 ^{7/8} | 20 | 4 ^{1/8} | 3 ^{5/8} 5 ^{1/8} | 2 ^{3/4} | — 4 ^{1/2} |

Neutrals

| Enclosure Catalogue Number | Neutral Catalogue Number | Neutral Cable Capacity and Wire Range |
|----------------------------|--------------------------|---|
| E2N3R [Ⓢ] | W53045 [Ⓢ] | (1 pc.) #14–2 Cu/Al Grd. Lug (1 pc.) #14–8 Cu/Al |
| CED6N3R [Ⓢ] | | |
| F6N3R [Ⓢ] | N250 | (1 pc.) #6–350 kcmil Grd. Lug (1 pc.) #14–2/0 Cu/Al |
| JD6N3R [Ⓢ] | W60992 | (1 pc.) #1/0–750 kcmil Cu/Al or (2 pcs.) #1/0–300 kcmil Cu/Al Grd. Lug (1 pc.) #6–250 kcmil Cu/Al |
| LD6N3R [Ⓢ] | W60993 | (2 pcs.) #1/0–600 kcmil Grd. Lug (1 pc.) #6–250 kcmil Cu/Al |
| MND63 [Ⓢ] | W63623 | (8 pcs.) 250 kcmil–500 kcmil Cu/Al Grd. Lug (1 pc.) #6–300 kcmil Cu/Al |

Hubs — see page 5-82

For inches / millimeters conversion, see Application Data section.

- Ⓢ Does not include circuit breaker. Order circuit breaker separately.
- Ⓢ Neutral not included. Order as separate item from table on next page.

- Ⓢ Neutral included in enclosure.
- Ⓢ Use CED enclosure for all ED-frame 110-125 ampere units.
- Ⓢ Items cannot be ordered separately. See configuration.

Enclosed Circuit Breakers

Enclosures — Type 12

Selection/Dimensions

| Fig. No. | Breaker Type | Number of Poles | Maximum Current Rating | Catalogue Number | Weight Lb./Ship. Package | Dimensions (inches) | | | | | |
|--|---|----------------------------|------------------------|--|--------------------------|---------------------|---------------------|-------------------|----|---------------------|-------|
| | | | | | | A | B | C | D | E | F |
| 2 | ED2, ED4, ED6, HED4, HED6 | 2-3 | 100 | E2N12 ^③ | 12 | 18 ^{5/8} | 8 ^{11/32} | 7 ^{1/16} | 18 | 6 ^{1/16} | 1/2 |
| 5 | CED6 | | 125 | CE6N12 ^③ | 16 | 22 ^{5/8} | | | 22 | | 5/8 |
| 1 | FXD6, FD6, FXD6-A, FD6-A, HFD6, CFD6 | | 250 | F6N12 ^② | 40 | 38 ^{19/32} | 14 ^{29/64} | 8 ^{1/8} | 34 | 13 | 22/32 |
| | JXD2(A), JD6(A), JXD6(A), HJD6(A), HJXD6(A), HHJD6, HHJXD6, SJD6(A), SHJD6(A) | | 400 | J6N12 ^② | 104 | 40 | 25 ^{5/64} | 11 ^{7/8} | 36 | 25 ^{35/64} | — |
| | LD6(A), LXD6(A), HLD6(A), HLXD6(A), HHL6, HHLXD6, SLD6(A), SHLD6(A), CJD6, CLD6, SCJD6(A), SCLD6(A) | | 600 | LD6N12 ^② (L6N12) | | | | | 45 | | 41 |
| MD6, MXD6, SMD6, HMD6, HMXD6, SHMD6, ND6, NXD6, SND6, HND6, HNXD6, SHND6, CMD6, SCMD6, CND6, SCND6 | 1200 | MND612 ^② | 220 | 60 | 37 ^{3/8} | 10 | 5/8 | 3 | 2 | | |

Dimensions

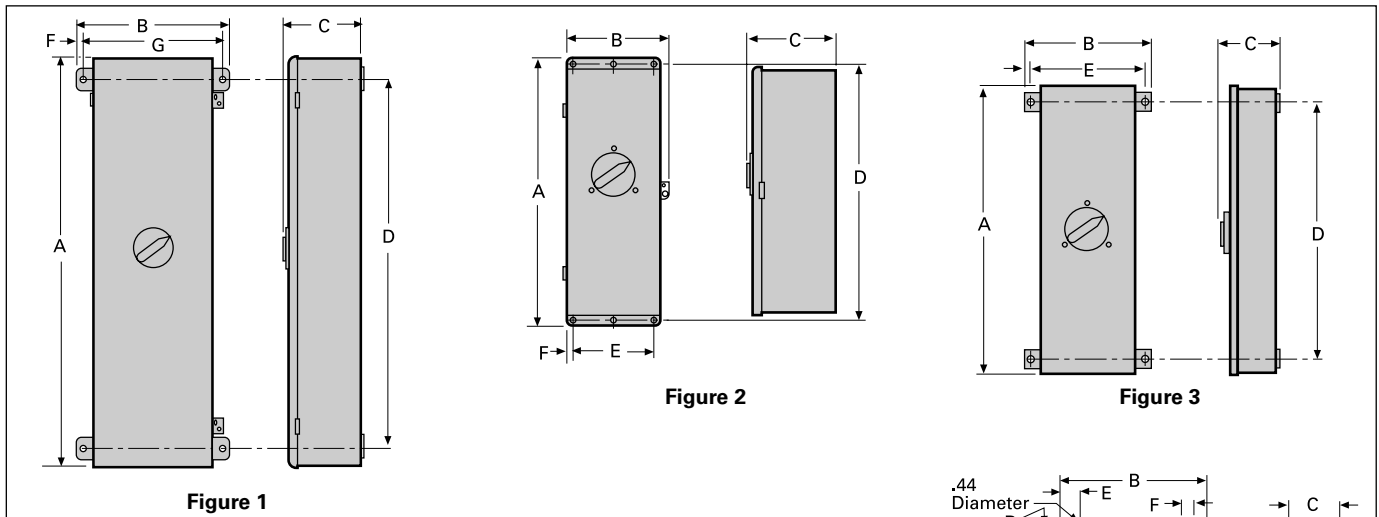

Neutrals

| Enclosure Catalogue Number | Neutral Catalogue Number | Neutral Cable Capacity and Wire Range |
|----------------------------|----------------------------|---|
| E2N12 ^③ | W53045 ^③ | (1 pc.) #14-2 Cu/Al |
| CE6N12 ^④ | | (1 pc.) #14-2 Cu/Al |
| F6N12 ^② | N250 ^② | (1 pc.) #6-350 kcmil Grd. Lug (1 pc.) #14-2/0 Cu/Al |
| J6N12 ^② | W60992 ^② | (1 pc.) #1/0-750 kcmil Cu/Al or (2 pcs.) #1/0-300 kcmil Cu/Al Grd. Lug (1 pc.) #6-250 kcmil Cu/Al |
| L6N12 ^② | W60993 ^② | (2 pcs.) #1/0-600 kcmil Grd. Lug (1 pc.) #6-250 kcmil Cu/Al |
| MND612 ^② | W63623 ^② | (8 pcs.) 250 kcmil-500 kcmil Cu/Al Grd. Lug (1 pc.) #6-300 kcmil Cu/Al |

For inches / millimeters conversion, see Application Data section.

- ① Does not include circuit breaker. Order circuit breaker separately.
- ② Neutral not included. Order as separate item.

- ③ Neutral included in enclosure.
- ④ Use CED enclosure for all ED-frame 110-125 ampere units.
- ⑤ Items cannot be ordered separately. See configuration.

Enclosed Circuit Breakers

Selection/Dimensions

Knockouts & Wire Bending Space

| Breaker Type | Conduit Range Per Knockout Outside Dimensions (inches) | Types 1, 12 | | | | Type 3R | | | Maximum Cable Sizes Recommended (Cu/Al) for Type 1, 3R, 4, 4X, 12 & 12K Enclosures ^{③④} | |
|---|---|--|--------|--------|--------|---------|--------|--------|--|------------------------------------|
| | | Number of Knockouts Per Panel (type 12 have no KO's) | | | | | | | | |
| | | Top | Bottom | Side | Back | Bottom | Side | Back | | Maximum Hub Size (inches) Type 3R |
| BQ, BQH, HBQ 70-100A | 3/4, 1, 1 1/4 | 1 | 1 | 2 | 2 | 8 | 1 | 3 | 2 | ② |
| QJ | 1 1/2, 2, 2 1/2, 3 | 2 | 2 | 2 | 2 | 2 | 1 | 1 | 2 1/2 | ② |
| ED2, ED4, ED6, HED4 | 7/8, 1 1/8, 1 3/8, 1 3/4, 2 | 2 | 2 | 2 | 2 | 2 | 1 | 1 | 2 | ② |
| CED6 | 7/8, 1 1/8, 1 3/8, 1 3/4, 2 7/8, 1 1/8, 1 3/8, 1 3/4, 2, 2 1/2 | — 2 | — 2 | — 2 | — 2 | 2 — | — 1 | — 1 | 2 | (CFD6 only 300 kcmil) ^③ |
| FXD6, FD6, FXD6-A, FD6-A, HFD6, CFD6 | 1 1/8, 1 3/8, 1 3/4, 2, 2 1/2, 3 | 1 1 | 1 1 | 2 — | 2 — | 1 1 | 1 — | — — | 4 | ② |
| JXD2(A), JXD6(A), JD6(A), HJD6(A), HJXD6(A), HHJD6, HHJXD6, SJD6(A), SHJD6(A) | 1 1/2, 2, 2 1/2, 3, 3 1/2, 4 | 1 | 1 | 2 | 4 | — | — | — | 4 | (2) 500 kcmil |
| LXD6(A), LD6(A), HLXD6(A), HLD6(A), HHLXD6, HHLXD6, SLD6(A), SHLD6(A) | 1 1/2, 2, 2 1/2, 3, 3 1/2, 4 | 1 | 1 | 2 | 4 | — | — | — | 4 | (2) 500 kcmil |
| MD6, SMD6, HMD6, ND6, SND6, HND6 | — | — | — | — | — | — | — | — | 4 | (3) 600 kcmil or (4) 500 kcmil |

Hubs (Type 3R)

| Breaker Type | Conduit Size (inches) | Catalogue Number |
|---|-------------------------------|---|
| BQ, BQH, HBQ, ED2, ED4, ED6, HED4, HED6, CED6 | 3/4 1 1/4 1 1/2 2 | ECHR075 ECHR100 ECHR125 ECHR150 ECHR200 |
| QJ2, QJH2, QJ2-H | 1 1/4 1 1/2 2 2 1/2 | ECHS125 ECHS150 ECHS200 ECHS250 |
| FXD6-A, FD6-A, HFD6, HFXD6, CFD6, JXD2(A), JD6(A), JXD6(A), HJD6(A), HJXD6(A), LD6(A), LXD6(A), HLD6(A), HLXD6(A) | 2 1/2 3 3 1/2 4 | ECHV250 ECHV300 ECHV350 ECHV400 |



For inches / millimeters conversion, see Application Data section.

- ① 17 1/8" high enclosure provides sufficient wire bending space for all available CB lugs.
- ② Sufficient wire bending space is provided for all available mechanical type CB lugs.

- ③ The use of cables larger than those listed below may violate NEC & CSA wire bending space requirements.
- ④ The use of compression type connectors will violate NEC and CSA wire bending space requirements.

Molded Case Circuit Breakers

Series Rated Combination Guide

General

Introduction

The short circuit protection devices of most common electrical distribution systems have interrupting ratings higher than the respective available fault current. These are known as **Fully Rated Systems**. Fully rated protection devices are essential for main or upstream but not essential for branch or downstream devices if the main and branch devices have been tested and approved as series rated. In instances of a short circuit in a series rated combination, on the load side of the downstream device, the fully rated upstream device will assist in clearing the fault.

Short circuit devices with higher interrupting ratings are generally more costly than lower rated devices. Installing Series Rated systems can be economical without compromising system reliability or safety.

Definition of a Series Rated System

Series rated systems (Fig.1) have at least two tested and certified series connection devices. In the event of a short circuit, on the load side of the lower interrupting rated downstream device, both devices will operate simultaneously to clear the fault.

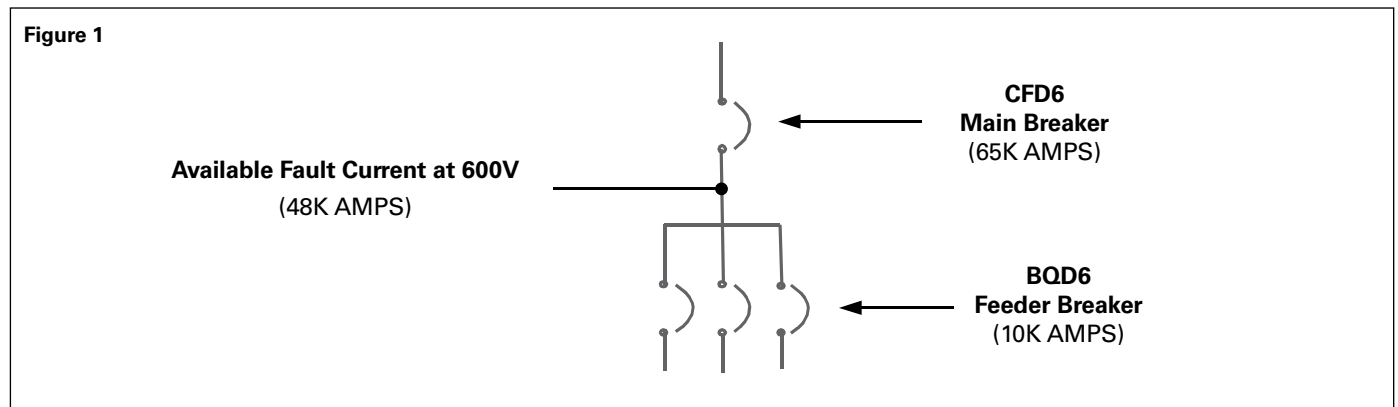

Definition of a Fully Rated System

Fully rated systems (Fig.2) have protection devices tested to withstand the fault current available at their respective applied location.

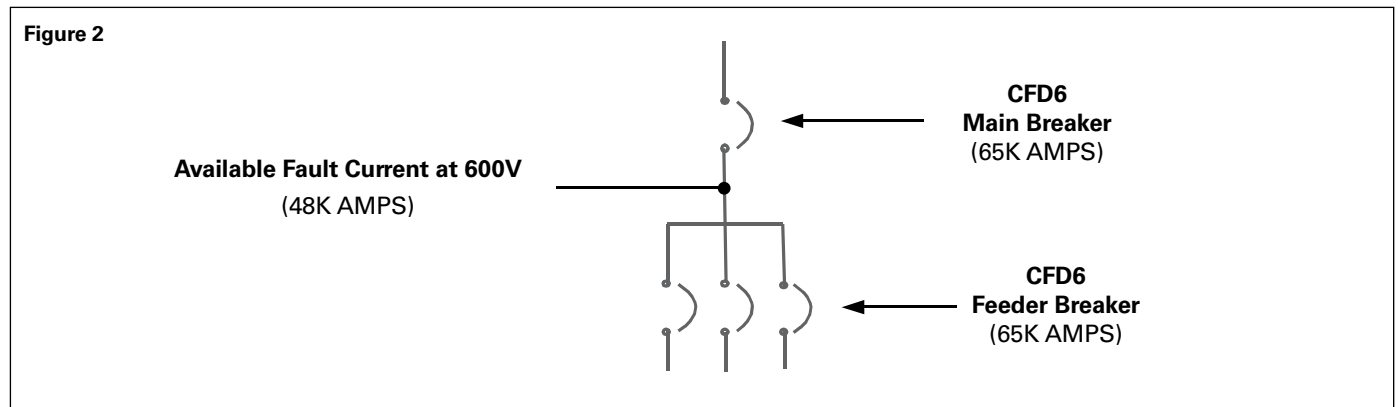

Standards Guiding Series Rated Combinations

Canadian standards governing testing of **SERIES RATED** combinations are: CSA C22.2 No. 29-M1989, C22.2 No. 5-M1989, C22.2 No. 31-M89. The Canadian Electrical Code rules are covered under section 14-012, *Ratings of Protective and Control Equipment* and 14-014, *Series rated combinations*.

Labeling of equipment containing Series Rated protective devices

A Series Rated system requires appropriate caution labeling indicating that approved series tested devices are the only acceptable replacement.

Molded Case Circuit Breakers

Series Rated Combination Guide

General

Reading the Series Rated combination tables

Identify the application voltage.

Identify the available short circuit current at the point where the breaker is to be applied.

Identify the ampere rating and number of poles for both the upstream and downstream breakers.

Example:

The application voltage is 208V, 3phase, the available short circuit current is 19,000 Amps. The Main breaker is 200A rated and the Branch breaker is 3 Pole, 100A rated.

From the tables select the voltage greater than and closest to the application voltage. (240)

From the IC column select the current rating greater than and closest to the application short circuit current.

From the Main Breaker column select the type based on the required ampere rating and number of poles.

(QJH2, 200A, 3P) The Maximum current tested for this type of breaker is 225A.

From the Branch Breaker column select the type based on the required ampere rating and number of poles. In some cases more than one option may be available. (QP, BQ, BL)

| IC/CI KA | Main Breaker / Disjoncteur principal | | Branch Breaker / Disjoncteur de branchement | | | Max Voltage (AC/CA) | | |
|----------|--------------------------------------|------------------|---|----------|---------|---------------------|------------|--------|
| | Type | Ams (Poles) | Type | # PolesA | mps | | | |
| 22 | QJH2 | 60 - 225 (2 & 3) | QP, BQ, BL | 11 | 5 - 70 | 120/240 | | |
| | | | | 21 | 5 - 125 | 240 | | |
| | | | | 36 | 0 - 100 | 240 | | |
| | | | QPF, BQF BLF, QE, BE, BLE | | | | 15 - 30 | 20 |
| | | | QT | | | 1, 2 | 15, 20, 40 | 20/240 |

This information is of a general nature and is intended for reference purposes only. Although every effort to ensure correctness of the material, Siemens Canada Limited cannot assume any responsibility for actions taken on the basis of the content herein.

Diagram for the above example:

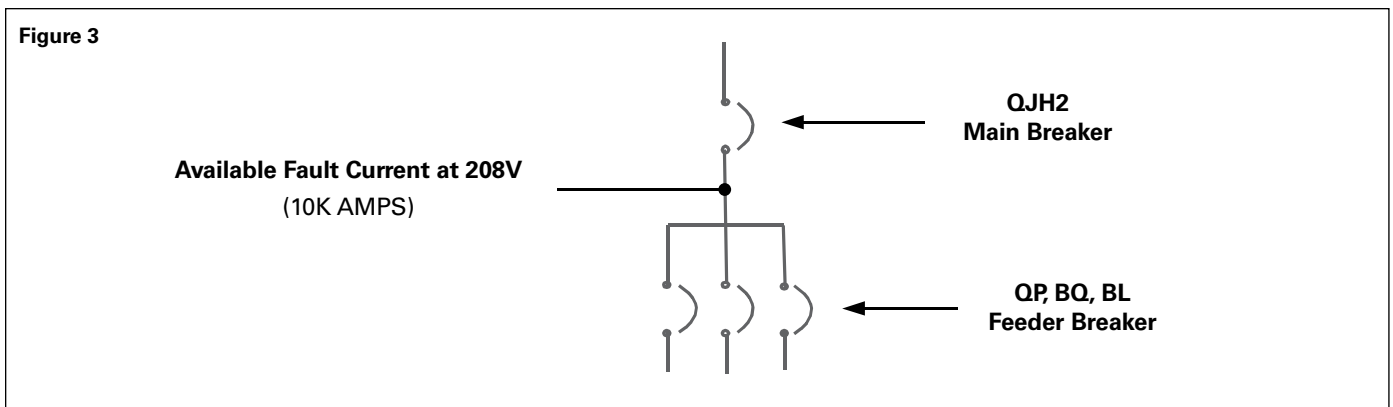

Molded Case Circuit Breakers

Series Rated Combination Guide

General

| IC/CI KA | Main Breaker | | Branch Breaker | | | Max Voltage (AC/CA) |
|----------|-----------------------|-----------------------------------|---|---------|------------|---------------------|
| | Type | Ams (Poles) | Type | # Poles | Amps | |
| 22 | QPH, BQH, BLH | 15-70 (1), 15-125 (2), 15-100 (3) | QP, BQ, BL | 1 | 15 - 70 | 120/240 |
| | | | | 2 | 15 - 125 | 120/240 |
| | | | | 3 | 15-100 | 240 |
| | | | QE, BLE, QPF, BLF | 1 | 15 - 60 | 120/240 |
| | | | QE, BLE, QPF, BQF, BLF | 2 | 15 - 30 | 120 |
| | | | QT | 1, 2 | 15, 20, 40 | 120/240 |
| 22 | QPPH | 125 - 225 (2) | QP, BQ, BL | 1 | 15 - 70 | 120/240 |
| | | | | 2 | 15 - 125 | 120/240 |
| | | | QE, BLE, BE, QPF, BQF, BLF | 1 | 15 - 30 | 120 |
| | | | QE, BLE, BE, QPF, BLF | 2 | 15 - 60 | 120/240 |
| | | | QPP | 2 | 125 - 200 | 120/240 |
| | | | QT | 1, 2 | 15, 20, 40 | 120/240 |
| 22 | QJH2 | 60 - 225 (2 & 3) | QP, BQ, BL | 1 | 15 - 70 | 120/240 |
| | | | | 2 | 15 - 125 | 240 |
| | | | | 3 | 60 - 100 | 240 |
| | | | QPF, BQF BLF, QE, BE, BLE | 1 | 15 - 30 | 120 |
| | | | QT | 1, 2 | 15, 20, 40 | 120/240 |
| | | | | 1 | 15 - 70 | 120/240 |
| 42 | QJ2H | 60 - 225 (2 & 3) | QP, BQ, BL | 2 | 15 - 125 | 120/240 |
| | | | | 3 | 60 - 100 | 240 |
| | | | | 1 | 15 - 70 | 120/240 |
| | | | QPH, BQH, BLH | 2 | 15 - 125 | 120/240 |
| | | | | 3 | 15 - 100 | 240 |
| | | | QE, BLE, BE, QPF, BLF | 2 | 15 - 60 | 120/240 |
| | | | QJH2 | 2, 3 | 60 - 225 | 240 |
| | | | | 1 | 15 - 70 | 120/240 |
| | | | | 2 | 15 - 100 | 120/240 |
| | | | | 3 | 15 - 100 | 240 |
| 65 | HQP, HBQ, HBL | 15-70 (1), 15-125 (2), 15-100 (3) | QP, BQ, BL, QPH, BQH, BLH | 1 | 15 - 70 | 120/240 |
| | | | | 2 | 15 - 100 | 120/240 |
| | | | | 3 | 15 - 100 | 240 |
| | | | QPF, BQF, BLF, BE, QPHF, BQHF, BLHF, QEH, BLEH, QE, BLE | 1 | 15 - 30 | 120 |
| | | | QEH, BLEH, QE, QPHF, BLHF, BLE, QPF, BLF | 2 | 15 - 60 | 120/240 |
| | | | QT | 1, 2 | 15 - 40 | 120/240 |
| 65 | HQPP | 125 - 225 (2) | QP, BQ, BL, QPH, BQH, BLH | 1 | 15 - 70 | 120/240 |
| | | | | 2 | 15 - 125 | 120/240 |
| | | | QPF, BQF, BLF, QPHF, BQHF, BLHF, QEH, BLEH, QE, BLE, BE | 1 | 15 - 30 | 120 |
| | | | QEH, BLEH, QE, QPHF, BLHF, BLE, QPF, BLF | 2 | 15 - 60 | 120/240 |
| | | | QT | 1, 2 | 15 - 40 | 120 |
| | | | QPPH, QPP | 2 | 125 - 200 | 120/240 |
| 65 | ED4, ED6 | 15 - 100 (1), 15 - 125 (2 & 3) | QP, BQ, BL, QPH, BQH, BLH | 1 | 15 - 70 | 120 |
| | | | | 2 | 15 - 125 | 120/240 |
| | | | | 3 | 15 - 100 | 240 |
| | | | QPHF, BQHF, BLHF, QPF, BQF, BLF, QE, QEH, BLEH, BE, BLE | 1 | 15 - 30 | 120 |
| | | | QEH, BLEH, QE, QPHF, BLHF, BLE, QPF, BLF | 2 | 15 - 60 | 120/240 |
| | | | ED2 | 1, 2, 3 | 15 - 100 | 120/240 |
| 65 | FD6-A, FXD6-A | 70 - 250 (2 & 3) | QP, BQ, BL, QPH, BQH, BLH | 1, 2 | 15 - 40 | 120/240 |
| | | | | 1 | 15 - 70 | 120/240 |
| | | | | 2 | 15 - 125 | 120/240 |
| | | | | 3 | 15 - 100 | 240 |
| | | | QJ2H, QJ2, QJH2 | 2, 3 | 60 - 225 | 240 |
| | | | QPPH | 2 | 125 - 225 | 120/240 |
| 65 | JXD2-A, JD6-A, JXD6-A | 200 - 400 (2 & 3) | QPH, BQH, BLH | 1 | 15 - 70 | 120/240 |
| | | | | 2 | 15 - 125 | 120/240 |
| | | | | 3 | 15 - 100 | 240 |
| | | | QJ2H, QJH2 | 2, 3 | 60 - 225 | 240 |
| 65 | LD6-A | 200 - 600 (2 & 3) | QPH, BQH, BLH | 1 | 15 - 70 | 120/240 |
| | | | | 2 | 15 - 125 | 120/240 |
| | | | | 3 | 15 - 100 | 240 |
| | | | QJ2H, QJH2 | 2, 3 | 60 - 225 | 240 |
| 65 | LXD6-A | 450 - 600 (2 & 3) | QPH, BQH, BLH | 1 | 15 - 70 | 120/240 |
| | | | | 2 | 15 - 125 | 120/240 |
| | | | | 3 | 15 - 100 | 240 |
| | | | QJ2H, QJH2 | 2, 3 | 60 - 225 | 240 |

Molded Case Circuit Breakers

Series Rated Combination Guide

General

| IC/CI KA | Main Breaker | | Branch Breaker | | | Max Voltage (AC/CA) | |
|--|--|--------------------|--|-------------------------------|-------------------|--|---------|
| | Type | Ams (Poles) | Type | # Poles | Amps | | |
| 65 | HJD6-A, HJXD6-A, HLD6-A, HLXD6-A, HMD6, HMXD6, HND6, HNXD6, HPD6, HPXD6, HRD6, HRXD6 | 200 - 2000 (2 & 3) | QPH | 1 | 15 - 70 | 120/240 | |
| | | | | 2 | 15 - 125 | 120/240 | |
| | | | | 3 | 15 - 100 | 240 | |
| 65 | SJD6-A, SLD6-A, SMD6, SND6, SPD6 | 200 - 1600 (2 & 3) | QPH, BQH, BLH | 1 | 15 - 70 | 120/240 | |
| | | | | 2 | 15 - 125 | 120/240 | |
| | | | | 3 | 15 - 100 | 240 | |
| | MD6, MXD6, ND6, NXD6, PD6, PXD6, RD6, RXD6 | 500 - 2000 (2 & 3) | QPH, BQH, BLH | 1 | 15 - 70 | 120/240 | |
| | | | | 2 | 15 - 125 | 120/240 | |
| | | | | 3 | 15 - 100 | 240 | |
| 100 | HED4 | 15 - 100 (1) | ED2, ED4 | 1 | 15 - 100 | 120 | |
| 100 | HED4, HED6 | 15 - 125 (2 & 3) | QP, BQ, BL, QPH, BQH, BLH, HQP, HBO, HBL | 1 | 15 - 70 | 120 | |
| | | | | 2 | 15 - 125 | 120/240 | |
| | | | | 3 | 15 - 100 | 240 | |
| | | | QE, BLEH, QE, BE, QPHF, BQHF, BLHF, QPF, BLF, BQF, BLE | 1 | 15 - 30 | 120 | |
| | | | | 2 | 15 - 60 | 120/240 | |
| | | | | 1, 2, 3 | 15 - 100 | 120/240 | |
| | | | ED2 | 1, 2, 3 | 15 - 100 | 120/240 | |
| | | | ED4 | 1 | 15 - 100 | 120 | |
| | | | ED4, ED6 | 2, 3 | 15 - 125 | 240 | |
| QT | 1, 2 | 15 - 40 | 120/240 | | | | |
| 100 | HED4 | 15 - 100 (1) | ED2, ED4 | 1 | 15 - 100 | 120 | |
| 100 | HOPPH | 125 - 225 (2) | QP, BQ, BL, QPH, BQH, BLH, HQP, HBO, HBL | 1 | 15 - 70 | 120/240 | |
| | | | | 2 | 15 - 125 | 120/240 | |
| | | | HQPP, QPPH, QPP | 2 | 125 - 225 | 120/240 | |
| | | | QE, BLEH, QE, BE, QPHF, BQHF, BLHF, QPF, BQF, BLF, BLE | 1 | 15 - 30 | 120 | |
| | | | QT | 1, 2 | 15 - 40 | 120/240 | |
| | | | 100 | HQJ2H | 60 - 225 (2 & 3) | QP, BQ, BL | 1 |
| 35 - 70 | 120/240 | | | | | | |
| 2 | 15 - 25 | 120/240 | | | | | |
| 35 - 125 | 120/240 | | | | | | |
| 3 | 15 - 100 | 240 | | | | | |
| QPH, BQH, BLH, HQP, HBO, HBL | 1 | 15 - 70 | | | | 120/240 | |
| | 2 | 15 - 125 | | | | 120/240 | |
| | 3 | 15 - 100 | | | | 240 | |
| QE, BLEH, QE, BE, QPHF, BQHF, BLHF, QPF, BQF, BLF, BLE | 1 | 15 - 30 | | | | 120 | |
| QE, BLEH, QPHF, BLHF, QE, BLE, QPF, BLF | 2 | 15 - 60 | | | | 120/240 | |
| QT | 1 | 15 - 50 | | | | 120/240 | |
| 100 | HFD6, HFXD6 | 70 - 250 (2 & 3) | | | | QP, BQ, BL, QPH, BQH, BLH, HQP, HBO, HBL | 1 |
| | | | 2 | 15 - 125 | 120/240 | | |
| | | | 3 | 15 - 100 | 240 | | |
| | | | QE, BE, BLE, QPHF, BQHF, BLHF, QPF, BQF, BLF, QE, BLEH | 1 | 15 - 30 | 120 | |
| | | | QPF, BLF, QE, BLE, QPHF, BLHF, QE, BLEH | 2 | 15 - 60 | 120 | |
| | | | ED4 | 1 | 15 - 100 | 120 | |
| | | | ED4, ED6 | 2, 3 | 15 - 125 | 240 | |
| | | | FD6-A, FXD6-A | 2, 3 | 70 - 250 | 240 | |
| | | | QJ2, QJH2, QJ2H | 2, 3 | 60 - 225 | 240 | |
| | | | HQPP, QPPH, QPP | 2 | 125 - 225 | 120/240 | |
| | | | QT | 1, 2 | 15 - 30 | 120/240 | |
| | | | 100 | HJD6-A, HJXD6-A, SHJD6-A | 200 - 400 (2 & 3) | ED4 | 1 |
| ED4, ED6 | 2, 3 | 15 - 125 | | | | | 120/240 |
| FD6-A, FXD6-A | 2, 3 | 70 - 250 | | | | | 120/240 |
| JD6-A, JXD6-A, JXD2-A, SJD6-A | 2, 3 | 200 - 400 | | | | | 120/240 |
| 100 | HLD6-A | 200 - 600 (2 & 3) | ED4 | 1 | 15 - 100 | 120 | |
| | | | | ED4, ED6 | 2, 3 | 15 - 125 | 240 |
| | | | | FD6-A, FXD6-A | 2, 3 | 70 - 250 | 240 |
| | | | | JD6-A, JXD6-A, JXD2-A, SJD6-A | 2, 3 | 200 - 400 | 240 |

Molded Case Circuit Breakers

Series Rated Combination Guide

General

| IC/CI KA | Main Breaker | | Branch Breaker | | | Max Voltage (AC/CA) |
|----------|-------------------|--------------------|-------------------------------|---------|-------------|---------------------|
| | Type | Ams (Poles) | Type | # Poles | Amps | |
| 100 | HLD6-A | 200 - 600 (2 & 3) | LD6-A | 2, 3 | 200 - 600 | 240 |
| | | | LXD6-A | 2, 3 | 450 - 600 | 240 |
| | | | SLD6-A | 3 | 300 - 600 | 240 |
| 100 | HLXD6-A | 450 - 600 (2 & 3) | ED4 | 1 | 15 - 100 | 120 |
| | | | ED4, ED6 | 2, 3 | 15 - 125 | 240 |
| | | | FD6-A, FXD6-A | 2, 3 | 70 - 250 | 240 |
| | | | JD6-A, JXD6-A, JXD2-A, SJD6-A | 2, 3 | 200 - 400 | 240 |
| | | | LD6-A | 2, 3 | 200 - 600 | 240 |
| | | | LXD6-A | 2, 3 | 450 - 600 | 240 |
| | | | SLD6-A | 3 | 300 - 600 | 240 |
| 100 | SHLD6-A | 300 - 600 (3) | ED4 | 1 | 15 - 100 | 120 |
| | | | ED4, ED6 | 2, 3 | 15 - 125 | 240 |
| | | | FD6-A, FXD6-A | 2, 3 | 70 - 250 | 240 |
| | | | JD6-A, JXD6-A, JXD2-A, SJD6-A | 2, 3 | 200 - 400 | 240 |
| | | | LD6-A | 2, 3 | 200 - 600 | 240 |
| | | | LXD6-A | 2, 3 | 450 - 600 | 240 |
| | | | SLD6-A | 3 | 300 - 600 | 240 |
| 100 | HMD6, HMXD6 | 500 - 800 (2 & 3) | ED4 | 1 | 15 - 100 | 120 |
| | | | ED4, ED6 | 2, 3 | 15 - 125 | 240 |
| | | | FD6-A, FXD6-A | 2, 3 | 70 - 250 | 240 |
| | | | JD6-A, JXD6-A, JXD2-A, SJD6-A | 2, 3 | 200 - 400 | 240 |
| | | | LD6-A | 2, 3 | 200 - 600 | 240 |
| | | | LXD6-A | 2, 3 | 450 - 600 | 240 |
| | | | SLD6-A | 3 | 300 - 600 | 240 |
| | | | MD6, MXD6, SMD6 | 2, 3 | 500 - 800 | 240 |
| | | | | | | |
| 100 | SHMD6 | 500 - 800 (3) | ED4 | 1 | 15 - 100 | 120 |
| | | | ED4, ED6 | 2, 3 | 15 - 125 | 240 |
| | | | FD6-A, FXD6-A | 2, 3 | 70 - 250 | 240 |
| | | | JD6-A, JXD6-A, JXD2-A, SJD6-A | 2, 3 | 200 - 400 | 240 |
| | | | LD6-A | 2, 3 | 200 - 600 | 240 |
| | | | LXD6-A | 2, 3 | 450 - 600 | 240 |
| | | | SLD6-A | 3 | 300 - 600 | 240 |
| | | | MD6, MXD6, SMD6 | 2, 3 | 500 - 800 | 240 |
| | | | | | | |
| 100 | HND6, HNXD6 | 500 - 1200 (2 & 3) | FD6-A, FXD6-A | 2, 3 | 70 - 250 | 240 |
| | | | JD6-A, JXD6-A, JXD2-A, SJD6-A | 2, 3 | 200 - 400 | 240 |
| | | | LD6-A | 2, 3 | 200 - 600 | 240 |
| | | | LXD6-A | 2, 3 | 450 - 600 | 240 |
| | | | SLD6-A | 3 | 300 - 600 | 240 |
| | | | MD6, MXD6, SMD6 | 2, 3 | 500 - 600 | 240 |
| | | | ND6, NXD6, SND6 | 2, 3 | 500 - 1200 | 240 |
| 100 | SHND6 | 500 - 1200 (2 & 3) | ED4 | 1 | 15 - 100 | 120 |
| | | | ED4, ED6 | 2, 3 | 15 - 125 | 240 |
| | | | FD6-A, FXD6-A | 2, 3 | 70 - 250 | 240 |
| | | | JD6-A, JXD6-A, JXD2-A, SJD6-A | 2, 3 | 200 - 400 | 240 |
| | | | LD6-A | 2, 3 | 200 - 600 | 240 |
| | | | LXD6-A | 2, 3 | 450 - 600 | 240 |
| | | | SLD6-A | 3 | 300 - 600 | 240 |
| | | | MD6, MXD6, SMD6 | 2, 3 | 500 - 600 | 240 |
| | | | ND6, NXD6, SND6 | 2, 3 | 500 - 1200 | 240 |
| | | | | | | |
| 100 | HPD6, HPXD6, SHPD | 1200 - 1600 (3) | ED4 | 1 | 15 - 100 | 120 |
| | | | ED4, ED6 | 2, 3 | 15 - 125 | 240 |
| | | | FD6-A, FXD6-A | 2, 3 | 70 - 250 | 240 |
| | | | JD6-A, JXD6-A, JXD2-A, SJD6-A | 2, 3 | 200 - 400 | 240 |
| | | | LD6-A | 2, 3 | 200 - 600 | 240 |
| | | | LXD6-A | 2, 3 | 450 - 600 | 240 |
| | | | SLD6-A | 3 | 300 - 600 | 240 |
| | | | MD6, MXD6, SMD6 | 2, 3 | 500 - 800 | 240 |
| 100 | HPD6, HPXD6, SHPD | 1200 - 1600 (3) | ND6, NXD6, SND6 | 2, 3 | 500 - 1200 | 240 |
| | | | PD6, PXD6, SPD6 | 2, 3 | 1200 - 1600 | 240 |

5
MOLDED CASE
CIRCUIT BREAKERS

Molded Case Circuit Breakers

Series Rated Combination Guide

General

| IC/CI KA | Main Breaker | | Branch Breaker | | | Max Voltage (AC/CA) |
|-----------|--------------|--------------------|---|------------------------------|-------------------|----------------------------|
| | Type | Ams (Poles) | Type | # Poles | Amps | |
| 100 | HRD6, HRXD6 | 1600 - 2000 (3) | ED4 | 1 | 15 - 100 | 120 |
| | | | ED4, ED6 | 2, 3 | 15 - 125 | 240 |
| | | | FD6-A, FXD6-A | 2, 3 | 70 - 250 | 240 |
| | | | JD6-A, JXD6-A, JXD2-A, SJD6-A | 2, 3 | 200 - 400 | 240 |
| | | | LD6-A | 2, 3 | 200 - 600 | 240 |
| | | | LXD6-A | 2, 3 | 450 - 600 | 240 |
| | | | SLD6-A | 3 | 300 - 600 | 240 |
| | | | MD6, MXD6, SMD6 | 2, 3 | 500 - 800 | 240 |
| | | | ND6, NXD6, SND6 | 2, 3 | 500 - 1200 | 240 |
| | | | PD6, PXD6, SPD6 | 2, 3 | 1200 - 1600 | 240 |
| RD6, RXD6 | 2, 3 | 1600 - 2000 | 240 | | | |
| 200 | CED6 | 15 - 125 (2 & 3) | QP, BQ, BL, QPH, BOH, BLH, HQP, HBO, HBL | 1 | 15 - 70 | 120/240 |
| | | | | 2 | 15 - 125 | 120/240 |
| | | | | 3 | 15 - 100 | 240 |
| | | | QPHF, BQHF, BLHF, QPF, BQF, BLF, QEH, QE, BE, BLEH | 1 | 15 - 30 | 120 |
| | | | QEH, BLEH, QPHF, BLHF, QPF, BLF, QE, BLE | 2 | 15 - 60 | 120/240 |
| | | | ED4, HED4 | 1 | 15 - 100 | 120 |
| | | | ED4, ED6, HED4, HED6 | 2, 3 | 15 - 125 | 240 |
| | | | QT | 1, 2 | 15 - 40 | 120/240 |
| | | | QP, BQ, BL, QPH, BOH, BLH, HQP, HBO, HBL | 1 | 15 - 70 | 120/240 |
| | | | | 2 | 15 - 125 | 120/240 |
| | 3 | 15 - 100 | 240 | | | |
| 200 | CFD6 | 70 - 250 (2 & 3) | QPHF, BQHF, BLHF, QE, BE, BLE, QPF, BQF, BLF, QEH, BLEH | 1 | 15 - 30 | 120 |
| | | | QPHF, BLHF, QE, BLE, QPF, BLF, QEH, BLEH | 2 | 15 - 60 | 120/240 |
| | | | ED2 | 1, 2, 3 | 15 - 100 | 120/240 |
| | | | HED4, ED4 | 1 | 15 - 100 | 120 |
| | | | ED4, ED6, HED4, HED6 | 2, 3 | 15 - 125 | 240 |
| | | | FD6-A, FXD6-A, HFD6, HFXD6 | 2, 3 | 70 - 250 | 240 |
| | | | QJ2H, QJH2, QJ2 | 2, 3 | 60 - 225 | 240 |
| | | | QPPH, QPP | 2 | 125 - 225 | 120/240 |
| | | | QT | 1, 2 | 15 - 40 | 120/240 |
| | | | 200 | HHJD6, HHJXD6, HHLD6, HHLXD6 | 200 - 600 (2 & 3) | FD6-A, FXD6-A, HFD6, HFXD6 |
| | | | | | | |
| 200 | CJD6 | 200 - 400 (2 & 3) | QPH, BOH, BLH, HQP, HBO, HBL | 2 | 100 - 125 | 120/240 |
| | | | | 3 | 100 | 240 |
| | | | ED4, ED6 | 2, 3 | 15 - 125 | 240 |
| | | | FD6-A, FXD6-A, HFD6, HFXD6 | 2, 3 | 70 - 250 | 240 |
| | | | JXD2-A, JD6-A, JXD6-A, HJD6-A, HJXD6-A | 2, 3 | 200 - 400 | 240 |
| QT | 1, 2 | 15 - 30 | 120/240 | | | |
| 200 | CLD6 | 450 - 600 (2 & 3) | QPH, BOH, BLH, HQP, HBO, HBL | 2 | 100 - 125 | 120/240 |
| | | | | 3 | 100 | 240 |
| | | | ED4, ED6 | 2, 3 | 15 - 25 | 120/240 |
| | | | FD6-A, FXD6-A, HFD6, HFXD6 | 2, 3 | 70 - 250 | 240 |
| | | | JXD2-A, JD6-A, JXD6-A, HJD6-A, HJXD6-A | 2, 3 | 200 - 400 | 240 |
| | | | LD6-A, HLD6-A | 2, 3 | 200 - 600 | 240 |
| | | | LXD6-A, HJXD6-A | 2, 3 | 450 - 600 | 240 |
| QT | 1, 2 | 15 - 30 | 120/240 | | | |
| 200 | CMD6 | 500 - 800 (2 & 3) | ED4, ED6, HED4, HED6 | 2, 3 | 15 - 125 | 240 |
| | | | FD6-A, FXD6-A, HFD6, HFXD6 | 2, 3 | 70 - 250 | 240 |
| | | | JXD2-A, JD6-A, JXD6-A, HJD6-A, HJXD6-A | 2, 3 | 200 - 400 | 240 |
| | | | LD6-A, HLD6-A | 2, 3 | 200 - 600 | 240 |
| | | | LXD6-A, HLXD6-A | 2, 3 | 450 - 600 | 240 |
| | | | MD6, MXD6, HMD6, HMXD6 | 2, 3 | 500 - 800 | 240 |
| 200 | SCMD6 | 500 - 800 (3) | MD6, MXD6, HMD6, HMXD6 | 2, 3 | 500 - 800 | 240 |
| 200 | CND6 | 900 - 1200 (2 & 3) | ED4, ED6, HED4, HED6 | 2, 3 | 15 - 125 | 240 |
| | | | FD6-A, FXD6-A, HFD6, HFXD6 | 2, 3 | 70 - 250 | 240 |
| | | | JXD2-A, JD6-A, JXD6-A, HJD6-A, HJXD6-A | 2, 3 | 200 - 400 | 240 |
| 200 | CND6 | 900 - 1200 (2 & 3) | LD6-A, HLD6-A | 2, 3 | 200 - 600 | 240 |
| | | | LXD6-A, HLXD6-A | 2, 3 | 450 - 600 | 240 |
| | | | MD6, MXD6, HMD6, HMXD6 | 2, 3 | 500 - 800 | 240 |
| | | | ND6, NXD6, SND6, HND6, HNXD6 | 2, 3 | 500 - 1200 | 240 |

Molded Case Circuit Breakers

Series Rated Combination Guide

General

| IC/CI KA | Main Breaker | | Branch Breaker | | | Max Voltage (AC/CA) |
|------------------|--------------|----------------------|--|---------|-------------|---------------------|
| | Type | Ams (Poles) | Type | # Poles | Amps | |
| 200 | SCND6 | 900 - 1200 (3) | MD6, HMD6, HMXD6, MXD6, SHMD6, SMD6 | 2, 3 | 500 - 800 | 240 |
| | | | ND6, HND6, SHND6, NXD6, HNXD6, SND6 | 2, 3 | 500 - 1200 | 240 |
| 200 | CPD6 | 1200 - 1600 (3) | FD6-A, FXD6-A, HFD6, HFXD6 | 2, 3 | 70 - 250 | 240 |
| | | | JXD2-A, JD6-A, JXD6-A, HJD6-A, HJXD6-A | 2, 3 | 200 - 400 | 240 |
| | | | LD6-A, HLD6-A | 2, 3 | 200 - 600 | 240 |
| | | | LXD6-A, HLXD6-A | 2, 3 | 450 - 600 | 240 |
| | | | MD6, MXD6, HMD6, HMXD6 | 2, 3 | 500 - 800 | 240 |
| | | | ND6, NXD6, SND6, HND6, HNXD6 | 2, 3 | 500 - 1200 | 240 |
| 65 | J, R | 15 - 600 (1, 2, 3) | QPH, BQH, BLH | 1 | 15-70 | 120/240 |
| | | | | 2 | 15-125 | 120/240 |
| | | | | 3 | 15 - 100 | 240 |
| 65 | T | 15 - 1200 (1, 2, 3) | QPH, BQH, BLH | 1 | 15-70 | 120/240 |
| | | | | 2 | 15-125 | 120/240 |
| | | | | 3 | 15 - 100 | 240 |
| 65 | L | 601 - 6000 (1, 2, 3) | QPH, BQH, BLH | 1 | 15-70 | 120/240 |
| | | | | 2 | 15-125 | 120/240 |
| | | | | 3 | 15 - 100 | 240 |
| 100 | T (300 V) | 15-200 (1, 2, 3) | QP, BQ, BL | 1, 2, 3 | 15 - 125 | 120/240 |
| | | | HQP, HBQ, HBL, QPH, BQH, BLH | 3 | 15 - 100 | 240 |
| | | | QPF, BOF, BLF, QE, BE, BLE, QEH, BLEH, BLHF, QPHF, BQHF, | 1 | 15 - 30 | 120 |
| | | | QEH, BLEH, QE, QPHF, BLHF, BLE, QPF, BLF | 2 | 15 - 60 | 120/240 |
| | | | QT | 1, 2 | 15 - 50 | 120/240 |
| | | 15 - 600 (1, 2, 3) | QPH, BQH, BLH, HQP, HBQ, HBL | 1, 2 | 15 - 125 | 120/240 |
| 100 | J, R | 15 - 600 (2, 3) | ED4, HED4 | 1 | 15 - 100 | 120 |
| | | | ED4, ED6, HED4, HED6 | 2, 3 | 15 - 125 | 240 |
| | | 70 - 600 (2, 3) | FD6-A, FXD6-A | 2, 3 | 70 - 250 | 240 |
| | | 200 - 600 (2, 3) | JD6-A, JXD6-A, JXD2-A, SJD6-A | 2, 3 | 200 - 400 | 240 |
| | | | LD6-A | 2, 3 | 200 - 600 | 240 |
| | | 300 - 600 (3) | SLD6-A | 3 | 300 - 600 | 240 |
| 450 - 600 (2, 3) | LXD6-A | 2, 3 | 450 - 600 | 240 | | |
| 100 | T | 15 - 1200 (2, 3) | ED4, HED4 | 1 | 15 - 100 | 120/240 |
| | | | ED4, ED6, HED4, HED6 | 2, 3 | 15 - 125 | 240 |
| | | 70 - 1200 (2, 3) | FXD6-A, FD6-A | 2, 3 | 70 - 250 | 240 |
| | | 450 - 1200 (2, 3) | LXD6-A | 2, 3 | 450 - 600 | 240 |
| | | 200 - 1200 (2, 3) | JD6-A, JXD6-A, JXD2-A, SJD6-A | 2, 3 | 200 - 400 | 240 |
| | | | LD6-A | 2, 3 | 200 - 600 | 240 |
| 300 - 1200 (3) | SLD6-A | 3 | 300 - 600 | 240 | | |
| 100 | L | 601 - 6000 (2, 3) | ED4, HED4 | 1 | 15 - 100 | 120/240 |
| | | | ED4, ED6, HED4, HED6 | 2, 3 | 15 - 125 | 240 |
| | | | FD6-A, FXD6-A | 2, 3 | 70 - 250 | 240 |
| | | | JD6-A, JXD6-A, JXD2-A, SJD6-A | 2, 3 | 200 - 400 | 240 |
| | | | LD6-A | 2, 3 | 200 - 600 | 240 |
| | | | LXD6-A | 2, 3 | 450 - 600 | 240 |
| | | | SLD6-A | 3 | 300 - 600 | 240 |
| | | | SMD6 | 3 | 500 - 800 | 240 |
| | | | SND6 | 3 | 500 - 1200 | 240 |
| | | | PD6, PXD6, SPD6 | 3 | 1200 - 1600 | 240 |
| | | | RD6, RXD6 | 3 | 1600 - 2000 | 240 |
| 200 | R | 125 - 200 (2, 3) | QJH2, QJ2H, QJ2 | 2, 3 | 125 - 200 | 240 |
| 200 | T, J | 125 - 600 (2, 3) | QJH2, QJ2H | 2, 3 | 125 - 225 | 240 |
| | | 125 - 400 (2, 3) | QJ2 | 2, 3 | 125 - 225 | 240 |
| 200 | J, R | 70 - 600 (2, 3) | HFD6, HFXD6 | 2, 3 | 70 - 250 | 240 |
| 200 | T | 70 - 1200 (2, 3) | HFD6, HFXD6 | 2, 3 | 70 - 250 | 240 |

5
MOLDED CASE
CIRCUIT BREAKERS

Molded Case Circuit Breakers

Series Rated Combination Guide

General

| IC/CI KA | Main Breaker | | Branch Breaker | | | Max Voltage (AC/CA) |
|-----------------------|-----------------------|-------------------|------------------------|-----------|-----------------|---------------------|
| | Type | Ams (Poles) | Type | # Poles | Amps | |
| 200 | L | 601 - 6000 (2, 3) | HFD6, HFXD6 | 2, 3 | 70 - 250 | 240 |
| | | | MD6, MXD6, HMD6, HMXD6 | 2, 3 | 500 - 800 | 240 |
| | | | ND6, NXD6, HND6, HNXD6 | 2, 3 | 500 - 1200 | 240 |
| 30 | HED6 | 15 - 125 (2 & 3) | BQD, CQD | 1, 2, 3 | 15 - 100 | 277 |
| | | | ED4 | 1 | 15 - 100 | 277 |
| | | | ED4, ED6 | 2, 3 | 15 - 125 | 480 |
| 35 | JD6, JXD6 | 200-400 (2 & 3) | ED4 | 2,3 | 15-100 | 277 |
| | LD6 | 200-600 (2 & 3) | | | | 277 |
| | LXD6 | 450-600 (2 & 3) | | | | 277 |
| 42 | HED4 | 15 - 125 (2 & 3) | BQD, CQD | 1, 2, 3 | 15,100 | 277 |
| | | | ED4 | 1 | 15 - 100 | 480 |
| | | | ED4, ED6 | 2, 3 | 15 - 125 | 480 |
| 50 | HJD6-A, HJXD6-A | 200-400 (2 & 3) | HED4 | 2, 3 | 15 - 50 | 480 |
| 50 | HLD6-A, HLXD6-A | 200-600 (2 & 3) | | | | |
| 50 | MD6, MXD6 | 500-800 (2 & 3) | FD6-A, FXD6-A | 2, 3 | 70 - 250 | 480 |
| | | | JD6-A, JXD6-A, SJD6-A | 2, 3 | 200 - 400 | 480 |
| | | | LD6-A | 2, 3 | 200 - 600 | 480 |
| | | | LXD6-A | 2, 3 | 450 - 600 | 480 |
| | | | SLD6-A | 3 | 400 - 600 | 480 |
| 50 | ND6, NXD6 | 500-1200 (2 & 3) | FD6-A, FXD6-A | 2, 3 | 70 - 250 | 480 |
| | | | JD6-A, JXD6-A, | 2, 3 | 200 - 400 | 480 |
| | | | LD6-A | 2, 3 | 200 - 600 | 480 |
| | | | LXD6-A | 2, 3 | 450 - 600 | 480 |
| | | | SJD6-A | 3 | 200 - 400 | 480 |
| | | | SLD6-A | 3 | 400 - 600 | 480 |
| 50 | SMD6 | 500 - 800 (3) | JD6-A, JXD6-A | 2, 3 | 200 - 400 | 480 |
| | | | LD6-A | 2, 3 | 200 - 600 | 480 |
| | | | LXD6-A | 2, 3 | 450 - 600 | 480 |
| | | | SJD6-A | 3 | 200 - 400 | 480 |
| | | | SLD6-A | 3 | 400 - 600 | 480 |
| | | | 50 | SND6 | 500 - 1200 (3) | JD6-A, JXD6-A |
| LD6-A | 2, 3 | 200 - 600 | | | | 480 |
| LXD6-A | 2, 3 | 450 - 600 | | | | 480 |
| SJD6-A | 3 | 200 - 400 | | | | 480 |
| SLD6-A | 3 | 400 - 600 | | | | 480 |
| 50 | SPD6 | 1200 - 1600 (3) | | | | JD6-A, JXD6-A |
| | | | LD6-A | 2, 3 | 200 - 600 | 480 |
| | | | LXD6-A | 2, 3 | 450 - 600 | 480 |
| | | | SJD6-A | 3 | 200 - 400 | 480 |
| | | | SLD6-A | 3 | 400 - 600 | 480 |
| | | | 50 | PD6, PXD6 | 1400 - 1600 (3) | FD6-A, FXD6-A |
| 1200 - 1600 (3) | JD6-A, JXD6-A, SJD6-A | 2, 3 | | | 200 - 400 | 480 |
| | LD6-A | 2, 3 | | | 200 - 600 | 480 |
| | LXD6-A | 2, 3 | | | 450 - 600 | 480 |
| | SJD6-A | 3 | | | 200 - 400 | 480 |
| | SLD6-A | 3 | | | 400 - 600 | 480 |
| | 50 | RD6, RXD6 | | | 1800 - 2000 (3) | FD6-A, FXD6-A |
| JD6-A, JXD6-A, SJD6-A | | | 2, 3 | 200 - 400 | | 480 |
| LD6-A | | | 2, 3 | 200 - 600 | | 480 |
| LXD6-A | | | 2, 3 | 450 - 600 | | 480 |
| SJD6-A | | | 3 | 200 - 400 | | 480 |
| SLD6-A | | | 3 | 400 - 600 | | 480 |
| 65 | HFD6, HFXD6 | 70 - 250 (2 & 3) | BQD, CQD | 1, 2, 3 | 15 - 100 | 480 |
| | | | ED4, HED4 | 1 | 15 - 100 | 277 |
| 65 | HJD6-A, HJXD6-A | 200 - 400 (2 & 3) | ED4, ED6, HED4, HED6 | 2, 3 | 15 - 125 | 480 |
| | | | HED4, ED4 | 1 | 15 - 100 | 480 |
| | | | FD6-A, FXD6-A | 2, 3 | 70 - 250 | 480 |
| | | | JD6-A, JXD6-A | 2, 3 | 200 - 400 | 480 |

Molded Case Circuit Breakers

Series Rated Combination Guide

General

| IC/CI KA | Main Breaker | | Branch Breaker | | | Max Voltage (AC/CA) |
|----------|-----------------------------|--------------------|--------------------------------|-----------------|----------------------------|---------------------|
| | Type | Ams (Poles) | Type | # Poles | Amps | |
| 65 | HLD6-A | 200 - 600 (2 & 3) | ED4, HED4 | 1 | 15 - 100 | 277 |
| | | | FD6-A, FXD6-A | 2, 3 | 70 - 250 | 480 |
| | | | JD6-A, JXD6-A | 2, 3 | 200 - 400 | 480 |
| | | | LD6-A | 2, 3 | 200 - 600 | 480 |
| | | | LXD6-A | 2, 3 | 450 - 600 | 480 |
| 65 | HLXD6-A | 450 - 600 (2 & 3) | ED4, HED4 | 1 | 15 - 100 | 277 |
| | | | FD6-A, FXD6-A | 2, 3 | 70 - 250 | 480 |
| | | | JD6-A, JXD6-A | 2, 3 | 200 - 400 | 480 |
| | | | LD6-A | 2, 3 | 200 - 600 | 480 |
| | | | LXD6-A | 2, 3 | 450 - 600 | 480 |
| 65 | HMD6, HMXD6 | 500 - 800 (2 & 3) | FD6-A, FXD6-A | 2, 3 | 70 - 250 | 480 |
| | | | JD6-A, JXD6-A | 2, 3 | 200 - 400 | 480 |
| | | | LD6-A | 2, 3 | 200 - 600 | 480 |
| | | | LXD6-A | 2, 3 | 450 - 600 | 480 |
| 65 | HND6, HNXD6 | 500 - 1200 (2 & 3) | FD6-A, FXD6-A | 2, 3 | 70 - 250 | 480 |
| | | | JD6-A, JXD6-A | 2, 3 | 200 - 400 | 480 |
| | | | LD6-A | 2, 3 | 200 - 600 | 480 |
| | | | LXD6-A | 2, 3 | 450 - 600 | 480 |
| | | | MD6, MXD6, SMD6 | 2, 3 | 500 - 800 | 480 |
| 65 | HRD6, HRXD6 | 1800 - 2000 (3) | FD6-A, FXD6-A | 2, 3 | 70 - 250 | 480 |
| | | | JD6-A, JXD6-A | 2, 3 | 200 - 400 | 480 |
| | | | LD6-A | 2, 3 | 200 - 600 | 480 |
| | | | LXD6-A | 2, 3 | 450-600 | 480 |
| 100 | HHJXD6, HHJD6, HHL6, HHLXD6 | 200 - 600 (2 & 3) | ED4, ED6, HED4, HED6 | 1 | 15 - 100 | 277 |
| | | | FD6-A, FXD6-A, HFD6, HFXD6 | 2, 3 | 70 - 250 | 480 |
| 100 | CMD6 | 500 - 800 (3) | FD6-A, FXD6-A, HFD6, HFXD6 | 2, 3 | 70 - 250 | 480 |
| | | | JD6-A, HJD6-A, JXD6-A, HJXD6-A | 2, 3 | 200 - 400 | 480 |
| | | | LD6-A, HLD6-A | 2, 3 | 200 - 600 | 480 |
| | | | LXD6-A, HLXD6-A | 2, 3 | 450 - 600 | 480 |
| | | | MD6, MXD6, HMD6, HMXD6 | 2, 3 | 500 - 800 | 480 |
| 100 | SCMD | 500 - 800 (3) | HFXD6 | 2, 3 | 70 - 250 | 480 |
| 100 | SCND6 | 900 - 1200 (3) | HFD6, HFXD6 | 2, 3 | 70 - 250 | 480 |
| 100 | CND6 | 1200 (3) | FD6-A, FXD6-A, HFD6, HFXD6 | 2, 3 | 70 - 250 | 480 |
| | | | JD6-A, JXD6-A, HJD6-A, HJXD6-A | 2, 3 | 200 - 400 | 480 |
| | | | LD6-A, HLD6-A | 2, 3 | 200 - 600 | 480 |
| | | | LXD6-A, HLXD6-A | 2, 3 | 450 - 600 | 480 |
| | | | MD6, MXD6, HMD6, HMXD6 | 2, 3 | 500 - 800 | 480 |
| | | | ND6, NXD6, HND6, HNXD6 | 2, 3 | 500 - 1200 | 480 |
| | | | CPD6 | 1200 - 1600 (3) | FD6-A, FXD6-A, HFD6, HFXD6 | 2, 3 |
| 150 | CJD6 | 200 - 400 (2 & 3) | ED4 | 1 | 15 - 100 | 277 |
| | | | HFD6, HFXD6 | 2, 3 | 70 - 250 | 480 |
| | | | JD6-A, JXD6-A, HJD6-A, HJXD6-A | 2, 3 | 200 - 400 | 480 |
| 150 | CLD6 | 450 - 600 (2 & 3) | ED4 | 1 | 15 - 100 | 277 |
| | | | HFD6, HFXD6 | 2, 3 | 70 - 250 | 480 |
| | | | JD6-A, HJD6-A, JXD6-A, HJXD6-A | 2, 3 | 200 - 400 | 480 |
| | | | LD6-A, HLD6-A | 2, 3 | 200 - 600 | 480 |
| | | | LXD6-A, HLXD6-A | 2, 3 | 450 - 600 | 480 |
| 200 | CED6 | 15 - 125 (2 & 3) | BQD, CQD | 1 | 15 - 100 | 480 |
| | | | | 2, 3 | 20 - 30 | 480 |
| | | | ED4, HED4 | 1 | 15 - 100 | 277 |
| | | | ED4, ED6, HED4, HED6 | 2, 3 | 15 - 125 | 480 |
| 200 | CFD6 | 70 - 250 (2 & 3) | BQD, CQD | 1 | 15 - 100 | 480 |
| | | | | 2, 3 | 20 - 30 | 480 |
| | | | ED4, ED6 | 2, 3 | 15 - 50 | 480 |
| | | | ED4, HED4 | 1 | 15 - 100 | 277 |
| | | | HED4, HED6 | 2, 3 | 15 - 125 | 480 |
| | | | FD6-A, FXD6-A, HFD6, HFXD6 | 2, 3 | 70 - 250 | 480 |
| 50 | J | 60 - 400 (1, 2, 3) | ED4 | 1 | 60 - 100 | 277 |
| | | 15 - 400 (2, 3) | ED4 | 2, 3 | 15 - 100 | 480 |
| 100 | J | 15 - 400 (1, 2, 3) | ED4 | 1 | 15 - 50 | 277 |
| 100 | T, J | 70 - 600 (2, 3) | FD6-A, FXD6-A | 2, 3 | 70 - 250 | 480 |
| 100 | J, R | 70 - 600 (2, 3) | HFD6, HFXD6 | 2, 3 | 70 - 250 | 480 |

5
MOLDED CASE
CIRCUIT BREAKERS

Molded Case Circuit Breakers

Series Rated Combination Guide

General

| IC/CI KA | Main Breaker | | Branch Breaker | | | Max Voltage (AC/CA) |
|----------|------------------------------|--|--------------------------------|---------|-------------|---------------------|
| | Type | Ams (Poles) | Type | # Poles | Amps | |
| 100 | T, J, R | 200 - 600 (2, 3) | JD6-A, JXD6-A, HJD6-A, HJXD6-A | 2, 3 | 200 - 400 | 480 |
| | | | LD6-A, HLD6-A, HLXD6-A | 2, 3 | 200 - 600 | 480 |
| 100 | T | 70 - 1200 (2, 3) | LXD6-A, | 2, 3 | 450 - 600 | 480 |
| | | | HFD6, HFXD6 | 2, 3 | 70 - 250 | 480 |
| 100 | T, L | 601 - 1200 (2, 3) | JD6-A, JXD6-A, HJD6-A, HJXD6-A | 2, 3 | 200 - 400 | 480 |
| | | | LD6-A, HLD6-A | 2, 3 | 200 - 600 | 480 |
| | | | LXD6-A, HLXD6-A | 2, 3 | 450 - 600 | 480 |
| 100 | L | 601 - 6000 (2, 3) | HFD6, HFXD6 | 2, 3 | 70 - 250 | 480 |
| | | | MD6, MXD6, HMD6, HMXD6 | 2, 3 | 500 - 800 | 480 |
| | | | ND6, NXD6, HND6, HNXD6 | 2, 3 | 500 - 1200 | 480 |
| | | | PD6, HPD6, HPXD6 | 3 | 1200 - 1600 | 480 |
| 200 | R | 15 - 100 (1, 2, 3) | BQD, CQD | 1 | 15 - 100 | 480 |
| | | | | 2, 3 | 20 - 30 | 480 |
| | T, J | 15 - 200 (1, 2, 3) | BQD, CQD | 1 | 15 - 100 | 480 |
| | | | | 2,3 | 20 - 30 | 480 |
| 18 | ED6, HED6 | 15 -125 (1, 2, 3) | BQD6,CQD6 | 1 | 15 - 70 | 347 |
| | ED6, HED6 | 15 -125 (2, 3) | BQD6,CQD6 | 2, 3 | 15 - 70 | 347/600 |
| 25 | HFD6 | 70 - 250 (2, 3) | BQD6, CQD6 | 1 | 15 - 70 | 347 |
| | | | BQD6, CQD6, ED6, HED6 | 2, 3 | 15 - 70 | 347/600 |
| | | | ED6, HED6 | 2, 3 | 15 - 125 | 347/600 |
| 35 | HJD6, HJXD6 | 200 - 400 (2, 3) | HFD6 | 2, 3 | 70 - 250 | 347/600 |
| | HLD6, HLXD6 | 450 - 600 (2, 3) | | | | |
| 50 | HMD6, HMXD6 HND6 HNXD6 | 500 - 800 (2, 3) 500 - 1200 (2, 3) 900 - 1200 (2, 3) | HFD6 | 2, 3 | 70 | 600 |
| | | | JD6, JXD6 | | 200 - 400 | 600 |
| | | | HJD6, HJXD6 | | 200 - 400 | 600 |
| | | | LD6, HLD6 | | 200 - 600 | 600 |
| | | | LXD6, HLXD6 | | 450 - 600 | 600 |
| 65 | CFD6 | 70 - 250 (2, 3) | BQD6,CQD6 | 2, 3 | 15 - 70 | 347/600 |
| | | | ED6, HED6 | | 15 - 125 | 600 |
| 65 | CMD6 CND6 CPD6 | 500 - 800 (2, 3) 900 - 1200 (2,3) 1200 - 1600 (2,3) | HFD6 | 2, 3 | 70 | 600 |
| | | | JD6, JXD6 | | 200 - 400 | 600 |
| | | | HJD6, HJXD6 | | 200 - 400 | 600 |
| | | | LD6, HLD6 | | 200 - 600 | 600 |
| | | | LXD6, HLXD6 | | 450 - 600 | 600 |
| 65 | HPD6, HPXD6 | 1200 - 1600 (2, 3) | HFD6 | 2, 3 | 70 | 600 |
| | | | JD6, JXD6 | | 200 - 400 | 600 |
| | | | HJD6, HJXD6 | | 200 - 400 | 600 |
| | | | LD6, HLD6 | | 200 - 600 | 600 |
| | | | LXD6, HLXD6 | | 450 - 600 | 600 |
| 100 | CED6 | 15 - 125 (2, 3) | BQD6,CQD6 | 1 | 15 - 70 | 347 |
| | | | | 2 | 15 - 70 | 347/600 |
| | | | | 3 | 15 - 70 | 347/600 |
| 100 | CFD6 | 70 -250 (2, 3) | ED6, HED6 | 2, 3 | 15 - 125 | 600 |
| | | | BQD6,CQD6 | 1 | 15 - 70 | 347 |
| | | | ED6, HED6 | 2, 3 | 15 - 125 | 600 |
| 100 | J,R,T | 200 - 600 (2, 3) | HFD6 | 2, 3 | 70 - 250 | 600 |
| | | | JD6, JXD6 | | 200 - 400 | 600 |
| | | | HJD6, HJXD6 | | 200 - 600 | 600 |
| | | | LD6, HLD6 | | 200 - 600 | 600 |
| 100 | J,R,T | 200 - 600 (2, 3) | LXD6, HLXD6 | 2, 3 | 450 - 600 | 600 |
| | | | | | | |

Molded Case Circuit Breakers

Unusual Operating Conditions

Reference

Note: The information provided on this and the next page is intended for reference and recommendation only. Because several variables can act on a circuit breaker's performance at the same time, the data below is based less on controlled testing, than on experience and engineering judgment. Contact Siemens for further information on special conditions and treatment.

High Ambient Temperatures

Because thermal-magnetic trip breakers are temperature sensitive and calibrated for a specific ambient of 40° C (104° F) (average enclosure temperature), a higher ambient will cause the breaker to trip at lower current than its nameplate rating, in other words, causing the breaker to "derate" (see Table 1). Similarly, the current carrying capacity of a circuit conductor is based upon a certain ambient temperature, a higher ambient will reduce its current carrying capacity, causing it to "derate." Thus, with a fluctuating temperature, a thermal-magnetic breaker will derate nearly parallel with its connected circuit conductors and maintain close circuit protection. If the application temperature exceeds 40° C (104° F) and is known, either a breaker specially calibrated for the higher ambient or one oversized according to Table 1 may be selected. In a case such as this, the circuit conductors should be oversized as well. Siemens Sensitrip® III and Type SB Encased Systems Breakers are insensitive to temperature changes. However, they do include circuitry to protect the components from abnormally high temperatures.

Moisture – Corrosion

For atmospheres having high moisture content and / or where fungus growth is prevalent, a special preventive treatment may be required.

Where the air is heavily laden with corrosive elements, breakers made with special corrosion-resistant finishes may be required.

Altitude

Reduced air density at altitudes greater than 6600 ft. (2000 meters) affects the ability of a molded case circuit breaker to transfer heat and interrupt faults. Therefore, circuit breakers applied at these altitudes should have interrupting, insulation and continuous currents derated as indicated in Figure 1.

Table 1 – Temperature Derating Data for Thermal-Magnetic Breakers

| Reference Ampere Rating at 40° C (104° F) | Ampere Rating at: | | | Siemens Breaker Frames |
|---|-------------------|----------------|----------------|------------------------|
| | 25° C (77° F) | 50° C (122° F) | 60° C (140° F) | |
| 15 | 17 | 13 | 11 | ED |
| 20 | 22 | 18 | 16 | |
| 25 | 28 | 23 | 21 | |
| 30 | 33 | 28 | 26 | |
| 35 | 39 | 30 | 25 | |
| 40 | 44 | 37 | 34 | |
| 50 | 55 | 46 | 42 | |
| 60 | 66 | 56 | 52 | |
| 70 | 77 | 65 | 60 | |
| 90 | 99 | 84 | 78 | |
| 100 | 110 | 94 | 87 | |
| 125 | 137 | 114 | 100 | |
| 150 | 165 | 136 | 120 | |
| 175 | 192 | 159 | 140 | |
| 200 | 220 | 182 | 160 | |
| 225 | 247 | 205 | 180 | |
| 250 | 275 | 235 | 220 | |
| 300 | 330 | 276 | 252 | |
| 350 | 385 | 325 | 301 | |
| 400 | 440 | 372 | 340 | |
| 500 | 550 | 468 | 435 | |
| 600 | 660 | 564 | 525 | |
| 700 | 770 | 658 | 613 | |
| 800 | 880 | 754 | 704 | |
| 900 | 990 | 828 | 749 | |
| 1000 | 1100 | 900 | 825 | |
| 1200 | 1320 | 1090 | 1000 | |
| 1400 | 1540 | 1304 | 1148 | |
| 1600 | 1760 | 1500 | 1320 | |
| 1800 | 1980 | 1690 | 1485 | |
| 2000 | 2200 | 1880 | 1650 | |
| | | | | QJ |
| | | | | FD |
| | | | | JD |
| | | | | LD |
| | | | | MD |
| | | | | ND |
| | | | | PD |
| | | | | RD |

5
MOLDED CASE
CIRCUIT BREAKERS

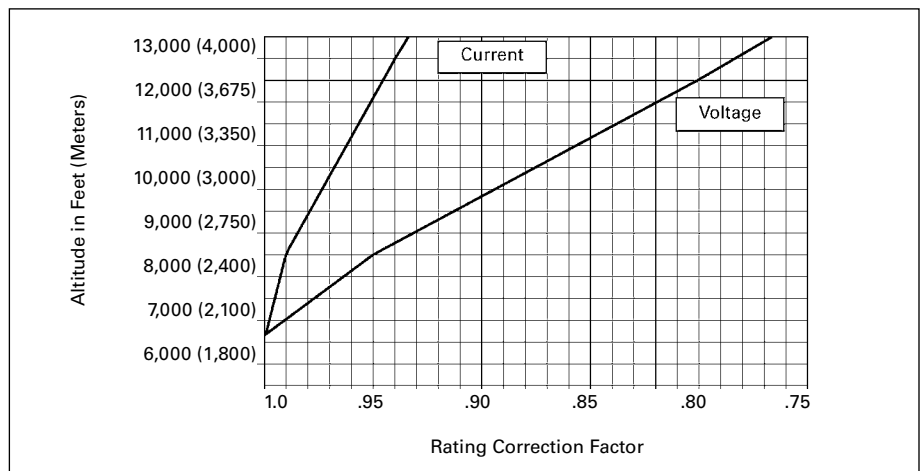

Figure 1 – Altitude Adjustment

Molded Case Circuit Breakers

Unusual Operating Conditions

Reference

400 Hz Systems^①

Siemens molded case circuit breakers can be applied for overcurrent protection on 400Hz systems, commonly used to power computer installations, aircraft, military and other specialty equipment. Below are basic guidelines.

Circuit Breaker Derating Required

This table lists the maximum continuous current carrying capacity for Siemens breakers at 400Hz. Due to the increased resistance of the copper sections resulting from the skin effect produced by eddy currents at these frequencies, circuit breakers in many cases require derating. The thermal derating on these devices is based upon 100%, three-phase application in open air in a maximum of 40° C (104° F) with 48 in. (1219 mm) of the specified cable or bus at the line and load side. Additional derating of not less than 20% will be required if the circuit breaker is to be utilized in an enclosure. Further derating may be required if the enclosure

ambient temperature exceeds 40° C (104° F).

Cable and Bus Sizing

The cable and bus sizes to be utilized at 400Hz are not based on standard National Electric Codes tables for 60Hz application. Larger cross sections are necessary at 400Hz. All bus bars specified are based upon mounting the bars in the vertical plane to allow maximum air flow. All bus bars are spaced at a minimum of 0.25 in. (6mm) apart. Mounting of bus bars in the horizontal plane will necessitate additional drafting. Edgewise orientation of the bus may change the maximum ratings indicated. If additional information is required for other connections of cable or bus, contact Siemens for information.

Application Recommendations

It is recommended that temperatures be measured on the line and load terminals or T-connectors of the center pole. These

are usually the hottest terminals with a balanced load. A maximum temperature of 75° C (35° C over a maximum ambient of 40° C) would verify the particular application. Temperature profiles taken on these breakers can be correlated to ensure that the hottest points within the breaker are within the required temperature limits.

Factory Configuration

When required, molded case circuit breakers may be factory calibrated for 400Hz application. These breakers are specially labeled for 400Hz usage and their nameplate current rating will include the necessary derating factor. The highest "Maximum Continuous Amperes" rating at 400Hz, found in the table below approximates the highest specially calibrated 400Hz nameplate ampere rating available for a given frame size. Contact Siemens for ordering information on other breakers applied in 400Hz systems.

400Hz Breakers

| Siemens Breaker Type | Maximum Continuous Ampere Rating At 40° C (104° F) ^② | | | 75° C (167° F) Copper Cable per Pole | |
|---|---|-----------------------|-------------------------|--------------------------------------|-----------|
| | 60HZ | | 400HZ | No of Pieces | Wire Size |
| | Open Air | Open Air ^③ | Enclosed After Derating | | |
| ED2, ED4, ED6, HED4, CED6 | 15 | 15 | 12 | 1 | #14 |
| | 20 | 20 | 16 | 1 | #12 |
| | 25 | 25 | 20 | 1 | #10 |
| | 30 | 30 | 24 | 1 | #10 |
| | 35 | 35 | 28 | 1 | #10 |
| | 40 | 40 | 32 | 1 | #8 |
| | 45 | 43 | 34 | 1 | #8 |
| | 50 | 48 | 38 | 1 | #8 |
| | 60 | 57 | 46 | 1 | #6 |
| | 70 | 67 | 54 | 1 | #4 |
| | 80 | 76 | 61 | 1 | #4 |
| | 90 | 86 | 69 | 1 | #3 |
| FD6, FXD6, HFD6, HFXD6, CFD6 | 70 | 63 | 50 | 1 | #4 |
| | 80 | 72 | 58 | 1 | #4 |
| | 90 | 80 | 64 | 1 | #3 |
| | 100 | 90 | 72 | 1 | #3 |
| | 110 | 95 | 75 | 1 | #2 |
| | 125 | 105 | 84 | 1 | #1 |
| | 150 | 125 | 100 | 1 | #1/0 |
| | 175 | 140 | 112 | 1 | #2/0 |
| | 200 | 160 | 128 | 1 | #3/0 |
| | 225 | 180 | 144 | 1 | #4/0 |
| | 250 | 200 | 160 | 1 | 250 kcmil |
| | 200 | 170 | 136 | 1 | #3/0 |
| JXD2, JD6, JXD6, HJD6, HJXD6, HHJD6, HHJXD6, CJD6 | 225 | 190 | 152 | 1 | #4/0 |
| | 250 | 210 | 168 | 1 | 250 kcmil |
| | 300 | 240 | 192 | 1 | 350 kcmil |
| | 350 | 260 | 208 | 1 | 500 kcmil |
| | 400 | 300 | 240 | 2 | #3/0 |
| | JD6, JXD6, HJD6, HJXD6 100% Rated | 200 | 170 | 170 | 2 |
| 225 | | 190 | 190 | 2 | #4/0 |
| 250 | | 210 | 210 | 1 | 250 kcmil |
| 300 | | 240 | 240 | 1 | 350 kcmil |
| 350 | | 260 | 260 | 1 | 500 kcmil |
| 400 | | 300 | 300 | 2 | #3/0 |

| Siemens Breaker Type | Maximum Continuous Ampere Rating At 40° C (104° F) ^② | | | 75° C (167° F) Copper Cable per Pole | |
|--|---|-----------------------|-------------------------|--------------------------------------|-----------|
| | 60HZ | | 400/415HZ | No of Pieces | Wire Size |
| | Open Air | Open Air ^③ | Enclosed After Derating | | |
| LD6, LXD6, HLD6, HLXD6, HHLXD6, HHLXD6, CLD6 | 250 | 210 | 168 | 1 | 250 kcmil |
| | 300 | 240 | 192 | 1 | 350 kcmil |
| | 350 | 260 | 208 | 1 | 500 kcmil |
| | 400 | 300 | 240 | 2 | #3/0 |
| | 450 | 340 | 272 | 2 | #4/0 |
| | 500 | 375 | 300 | 2 | 250 kcmil |
| | 600 | 420 | 336 | 2 | 350 kcmil |
| | 250 | 210 | 210 | 1 | 250 kcmil |
| LD6, LXD6, HLD6, HLXD6, 100% Rated | 300 | 240 | 240 | 1 | 350 kcmil |
| | 350 | 260 | 260 | 1 | 500 kcmil |
| | 400 | 300 | 300 | 2 | #3/0 |
| | 450 | 340 | 340 | 2 | #4/0 |
| | 500 | 375 | 375 | 2 | 250 kcmil |
| | 600 | 420 | 420 | 2 | 350 kcmil |
| | 500 | 400 | 320 | 2 | 250 kcmil |
| | 600 | 430 | 360 | 2 | 350 kcmil |
| MD6, MXD6, HMD6, HMXD6, CMD6 | 700 | 500 | 400 | 3 | 250 kcmil |
| | 800 | 560 | 448 | 3 | 300 kcmil |
| | 500 | 400 | 400 | 2 | 250 kcmil |
| | 600 | 430 | 430 | 2 | 350 kcmil |
| MD6, MXD6, HMD6, HMXD6, CMD6 100% Rated | 700 | 500 | 500 | 3 | 250 kcmil |
| | 800 | 560 | 560 | 3 | 300 kcmil |
| | 800 | 560 | 448 | 3 | 300 kcmil |
| | 900 | 600 | 480 | 3 | 350 kcmil |
| ND6, NXD6, HND6, HNXD6, CND6 | 1000 | 650 | 520 | 3 | 400 kcmil |
| | 1200 | 780 | 624 | 4 | 350 kcmil |
| | 900 | 600 | 600 | 3 | 350 kcmil |
| | 1000 | 650 | 650 | 3 | 400 kcmil |
| PD6, PXD6, HPD6, HFXD6, CPD6, 100% Rated | 1200 | 780 | 780 | 4 | 350 kcmil |
| | 1200 | 780 | 624 | 4 | 400 kcmil |
| | 1400 | 850 | 680 | 4 | 500 kcmil |
| | 1600 | 960 | 768 | 5 | 500 kcmil |
| PD6, PXD6, HPD6, HFXD6, CPD6 | 1200 | 780 | 780 | 4 | 400 kcmil |
| | 1400 | 850 | 850 | 4 | 500 kcmil |
| | 1600 | 960 | 960 | 5 | 500 kcmil |
| | 1600 | 960 | 768 | 5 | 500 kcmil |
| RD6, RXD6, HRD6, HFXD6 80% Rated | 1800 | 1080 | 864 | 5 | 500 kcmil |
| | 2000 | 1200 | 960 | 6 | 500 kcmil |

^①The information provided on this page is intended for reference and recommendation only. Because several variables can act on a circuit breaker's performance at the same time, the data above is based less on

controlled testing, than on experience and engineering judgment. Contact Siemens for further information on special conditions and treatment.

^②Additional derating may be required if the ambient temperature is greater than 40° C (104° F).

^③Calculated after derating to compensate for the heating of the copper conductor, caused by the skin effect generated by eddy currents produced at 400/415Hz.

Molded Case Circuit Breakers

Typical Specifications

Reference

General Specifications

Molded case circuit breakers shall provide circuit overcurrent protection with inverse time and instantaneous tripping characteristics and shall be Siemens Sentron, Sensitrip or approved equal.

All circuit breakers shall be CSA Certified and conform to applicable requirements of NEMA Standard Publication No. AB1.

All circuit breakers shall have a quick-make, quick-break over center toggle type mechanism and the handle mechanism shall be trip free to prevent holding contacts closed against a short circuit or sustained overload. All circuit breaker handles shall assume a position between "ON" and "OFF" when tripped automatically. Multi-pole circuit breakers shall be common-trip such that an overload or short circuit on any one pole will result in all poles opening simultaneously. Arc extinction is to be accomplished by magnetic arc chutes. All ratings are to be clearly visible. When reverse feed is indicated on the drawings, in accordance with CSA, circuit breakers with sealed trip units shall be supplied.

Thermal Magnetic Specifications

Unless otherwise noted on the drawings, all Circuit breakers 2000 Ampere and below shall have thermal-magnetic trip units, with inverse time-current characteristics. Automatic operation of these circuit breakers shall be obtained by means of thermal-magnetic tripping devices located in each pole providing inverse time delay and instantaneous circuit protection. Circuit breakers shall be ambient compensating in that, as the ambient temperature increases over 40°C, the circuit breaker automatically derates itself so as to better protect its associated conductor. Thermal magnetic breakers from 250 to 2000A frames shall have thermal interchangeable trip units, with instantaneous magnetic trip settings that are adjustable and accessible from the front of all circuit breakers on frame sizes 250 Amperes and above. Where indicated, provide circuit breakers CSA Certified for application at 100% of their continuous ampere rating in their intended enclosure.

Motor Circuit Protectors

Where indicated on the drawings and in the combination motor starter/motor control center schedule, furnish instantaneous magnetic trip only circuit breakers for motor short circuit protection. The magnetic trips shall be adjustable and accessible from the front of all circuit breakers frames. The continuous current rating shall be between 1 and 800 Amperes as indicated on the drawing.

The interrupting rating of the circuit breakers shall be as indicated in the specifications, and shown on the drawing or single line diagram. The interrupting rating of the circuit breakers shall be at least equal to the available short circuit current at the line terminals of the circuit breaker and correspond to the CSA Certified integrated short circuit current rating specified.

Internal Accessories

Provide shunt trips, bell alarms, and auxiliary switches as shown on the contract drawings. Gold plated auxiliary switches shall be supplied for PLC connection. Internal accessories for all breakers shall be CSA Certified for field installation and modification.

Connection Accessories

Unless otherwise noted, Mechanical lugs shall be provided with all Molded Case Breakers. Where indicated on the drawings, compression lugs shall be provided on 1200 Ampere frame and below circuit breakers. All compression lugs shall be supplied by the Circuit Breaker Manufacturer. Where indicated on the drawings, CSA Certified plug-in or rear connectors shall be supplied.

Solid State Sensing Specifications

As indicated on the drawings, circuit breaker frames 400 Ampere through 3200-Ampere shall have microprocessor-based RMS sensing trip units, with the capability to measure through to the 21st harmonic. Automatic operation of all circuit breaker frames 400A and larger shall be obtained by means of solid state tripping elements providing inverse time delay and (instantaneous) and/or (short-time delay) circuit protection. Continuous current ratings shall be adjustable from 20% to 100% of the trip unit rating, without the need for a rating plug. Long-time delay and instantaneous trip shall be adjustable. The optional short-time trip function shall have adjustable pick-up settings, three fixed times, and I_t ramp. Circuit breaker frames 400A and larger, and where indicated on the drawings, shall be 100% equipment rated.

Integral Ground Fault Option

Main and feeder circuit breakers, as indicated on the drawings, shall be provided with integral ground fault protection. Ground fault pick-up shall be adjustable from 20% to 70% of the circuit breakers maximum continuous current rating. Ground fault time delay shall be adjustable with three 1_t ramps.

Metering Option

When indicated on the drawings, solid state trip breakers shall be furnished with a plug-in or panel mounted metering device. This device shall simultaneously display all three phase currents, as well as average current, ground current, and phase unbalance. In addition it shall display breaker status, a max log, and a trip log. The trip log will retain and display date, time and type of trip (overload, short circuit or ground fault) for the most recent 5 trip events.

Current Limiting Specifications

Where indicated on the drawings, Siemens current limiting circuit breakers are to be furnished. Current limiting circuit breakers shall limit the let-through I_t to a value less than the I_t of one-half cycle wave of the symmetrical prospective current without any fusible elements when operating within its current range.

Series Connected Combination Specifications

Where protective devices are applied in series combination, such that the prospective available fault current exceeds the interrupting rating (AIR) of the downstream protective devices, such combinations shall be CSA Certified combinations. All electrical equipment using these CSA Certified circuit breaker combinations shall be clearly marked.

Molded Case Circuit Breakers

Superseded Breakers

Reference

| Sentron Series | Note | Superseded | Note | Superseded |
|--|--------------------------------------|--|---------------------------------|---|
| CED62B015-CED62B125 CED62S100A CED63A001-CED63A125 CED63B015-CED63B125 CED63S100A - - | ① ① ① ① ① ① ② | CLE62B015-CLE62B100 CLE62S100 CLE63A001-CLE63A125 CLE63B015-CLE63B100 CLE63S100 HHED62B015-HHED62B125 HHED63B015-HHED63B125 | ③ ③ ④ ④ ① ① | CE2B015-CE2B100 CE2S100 - CE3B015-CEB100 CE3S100 HED62B015-HED62B125 HED63B015-HED63B125 |
| CFD62A150, CFD62L150, CFD62A250 CFD62B070-CFD62B250 CFD62S250A CFD63A150, CFD63L150, CFD63A250 CFD63B070-CFD63B250 CFD63S250A | ① ① ① ① ① ① | CLF62A150, CLF62A250 CLF62B070-CLF62B240 CLF62S250 CLF63A150, CLF63A250 CLF63B070-CLF63B250 CLF63S250 | ③ ③ | - CJ2B125-CJ2B250 - - CJ3B125-CJ3B250 |
| CJD62B200-CJD62B400 CJD62H400, CJD62L400 CJD62S400A CJD63B200-CJD63B400 CJD63H400, CJD63L400 CJD63S400A | ① ① ① ① ① ① | CLJ62B100-CLJ62B400 CLJ62L400, CLJ62H400 CLJ62S400 CLJ63B200-CLJ63B400 CLJ63L400, CLJ63H400 CLJ63S400 | ④ ④ ④ ④ | CJ2B300-CJ2B400 - CJ2S400 CJ3B300-CJ3B400 - CJ3S400 |
| CPD63B120-CPD63B160 | ① | CP3B120-CP3B160 | | - |
| ED21B015-ED21B100 ED22B015-ED22B100 ED22S100A ED23B015-ED23B100 ED23S100A | ① ① ① ① ① | E21B015-E21B100 E22B015-E22B100 E22S100A E23B015-E23B100 E23S100A | ② ② ② ② ② | EE1B015-EE1B100 EE2B015-EE2B100 EE2S100 EE3B015-EE3B100 EE3S100 |
| ED41B015-ED41B100 ED42B015-ED42B125 ED42S100A ED43B015-ED43B125 ED43S100A | ① ① ① ① ① | E41B015-E41B100 E42B015-E42B100 E42S100 E43B015-E43B100 E43S100 | ② ② ② ② ② | EH1B015-EH1B100 EH2B015-ED2B125 EH2S100 EH3B015-EH3B100 EH3S100 |
| ED61B015-ED61B100 ED62B015-ED62B125 ED62S100A ED63A001-ED63A125 ED63B015-ED63B125 ED63S100A CED62B015-CED62B125 CED62B015-CED62B125 | ① ① ① ① ① ① ① ① | E61B015-E61B100 E62B015-E62B100 E62S100A E63A001-E63A125 E63B015-E63B100 E63S100A HHED62B015-HHED62B125 HHED63B015-HHED63B125 | ② ② ② ② ② ② ② | EF1B015-EF1B020 EF2B015-EF2B100 EF2S100 EF3A003, EF3J050, EF3L050-EF3A100, EF3H1 EF3B015-EF3B100 EF3S100 HED62B015-HED62B125 HED63B015-HED63B125 |
| FD62B070-FD62B250 FD63B070-FD63B250 | ①,② ①,② | F62B070, F62B250 F63B070-F63B250 | | - - |
| FXD62A150, FXD62L150, FXD62A250 FXD62B070-FXD62B250 FXD62S250A FXD63A150, FXD63L150, FXD63A250 FXD63B070-FXD63B250 FXD63S250A | ① ①,② ① ① ①,② ① | FJ62A150, FJ62L150-FJ62A250 FJ62B070-FJ62B250 FJ62S250 FJ63A150, FJ63L150-FJ63A250 FJ63B070-FJ63B250 FJ63S250 | ② ② ② ② ② ② | - FJ2B070-FJ2B225 FJ2S225 FJ3A225 FJ3B070-FJ3B225 FJ3S225 |
| HED41B015-HED41B100 HED42B015-HED42B125 HED43B015-HED43B125 | ① ① ① | HE41B015-HE41B100 HE42B015-HE42B100 HE43B015-HE43B100 | | - - - |
| - CED62B015-CED62B125 CED63B015-CED63B125 | ② ② ② | HED61B015-HED61B100 HED62B015-HED62B125 HED63B015-HED63B125 | ② ② | HE61B015-HE61B100 HE62B015-HE62B110 or (HE2B015-HE2B100) HE63B015-HE63B100 or (HE3B015-HE3B100) |
| HFD62B070-HFD62B250 HFD63B070-HFD63B250 | ① ① | HF62B070-HF62B250 HF63B070-HF63B250 | | - - |
| CED62B015-CED62B125 CED63B015-CED63B125 | ① ① | HHED62B015-HHED62B125 HHED63B015-HHED63B125 | | HED62B015-HED62B125 HED63B015-HED63B125 |
| HJD63B200-HJD63B400 | ① | HJ63B200-HJ63B400 | ② | HJ3B125-HJ3B400 |
| HLD63B250-HLD63B600 | ① | HL63B450-HL63B600 | ② | HL3B450-HL3B600 |
| HMD63B500-HMD63B800 | ② | HN3B500-HN3B800 | | - |
| HND63B100-HND63B120 | ② | HK3B100-HK3B120 | | - |
| HPD63B120-HPD63B160 | ② | HP3B120-HP3B160 | | - |
| HRD63B160-HRD63B200 | ② | HR3B160-HR3B200 | | - |

① Mechanically and electrically interchangeable.

② Electrically interchangeable only, refer to sales office for further details.

③ Electrically interchangeable only if the system interrupting capacity is less than or equal to:
200 kA at 240V AC
200 kA at 480V AC
100 kA at 600V AC

④ Electrically interchangeable only if the system interrupting capacity is less than or equal to:
200 kA at 240V AC
150 kA at 480V AC
100 kA at 600V AC

⑤ Refer to local sales office for replacement information.

⑥ Effective 1994 — The FD6 and FXD6 types have been replaced by FD6-A and FXD6-A type thermal / magnetic circuit breakers — mechanically and electrically interchangeable with the exception that FXD6-A and FD6-A have 22kA at 600V AC ratings versus 18kA at 600V AC for types FXD6 and FD6.

Molded Case Circuit Breakers

Superseded Breakers

General

| Sentron Series | Note | Superseded | Note | Superseded |
|--|----------------------------|--|-----------------------|--|
| JD62B200-JD62B400 JD63B200-JD63B400 | ① ① | JLB200-JL62B400 JL63B200-JL63B400 | ② ② | JL2B070-JL2B400 JL3B0L0-JL3B400 |
| JXD22B200-JXD22B400 JXD22S400A JXD23B200-JXD23B400 JXD23S400A | ① ① ① ① | JD22B200-JD22B400 JD22S400 JD23B200-JD23B400 JD23S400 | ② ② ② ② | JD2B250-JD2B400 JD2S400 JD3B250-JD3B400 JD3S400 |
| JXD62B200-JXD62B400 JXD62H400, JXD62L400 JXD62S400A JXD63B200-JXD63B400 JXD63H400, JXD63L400 JXD63S400A | ① ① ① ① ① ① | JJ62B200-JJ62B400 JL62L400, JL62H400 JJ62S400A JJ63B200-JJ63B400 JL63A400, JL63H400, JL63L400 JJ63S400A | ② ② ② ② ② | JJ2B250-JJ2B400 JL2L400-JL2H400 - JJ3B200-JJ3B400 JL3H400, JL3L400, JL3A225 - |
| LD62B250-LD62B500 LD62B250-LD63B600 | ① ① | LL63B250-LL62B600 LL63B250-LL63B600 | ② ② | LL2B450-LL2B600 LL3B450-LL3B600 |
| LXD62B450-LXD62B600 LXD62J600, LXD62L600 LXD62S600A LXD63B450-LXD63B600 LXD64H600, LXD63L600 LXD63S600A | ① ① ① ① ① ① | LJ62B450-LJ62B600 LL2H600, LL2U600, LL2X600 LJ62S600 LJ63B450-LJ63B600 LL63H600, LL63L600 LJ63S600A | ② ② | - - - - LL3A450, LL3H600 LL3S600 |
| MD62B500-MD62B800 MD63B500-MD63B800 | ② ② | KM2B500-KM2B800 KM3B500-KM3B800 | - - | - - |
| MXD62A800, MXD62H800, MXD62L800 MXD62S800A MXD63A800, MXD63H800, MXD63L800 MXD63S800A | ② ② ② ② | KM2A800, KM2H800, KM2L800 KM2S800 KM3A600, KM3H800, KM3L800 KM3S800 | - - - - | - - - - |
| ND63B100-ND63B900 NXD63A120A | ② ② | KP3B100-KP3B900 KP3S120 | - - | - - |
| PD63B120-PD63B160 PXD63S160A | ② ② | HP3B120-HP3B160 HP3S160 | - - | - - |
| RD63B160-RD63B200 | ② | HR3B160-HR3B200 | - | - |
| QJ22B060-QJ22B225 QJ22B060H-QJ22B225H QJ22S225 QJ23B060-QJ23B225 QJ23B060H-QJ23B225H | ① ① ① ① ① | QJ2B125-QJ2B225 - QJS225 QJ3B125-QJ3B225 - | - - - - - | - - - - - |
| QJH22B060-QJH22B225 QJH23B060-QJH23B225 QJH23S225 | ① ① ① | QJ2H125-QJ2B225 QJ3H125-QJ3H225 QJ3S225 | - - - | - - - |
| RD63B160-RD63B200 RXD63S200A | ② ② | HR3B160-HR3B200 HR3S200 | - - | - - |
| SHJD69200-SHJD69400 SHJD69200G-SHJD69400G SHJD69200NGT-SHJD69400NGT SHJD69200NT-SHJD69400NT | ① ① ① ① | SHJ63B200-SHJ63B400G SHJ63B200G-SHJ63B400G SHJ63N200G-SHJ63N400G SHJ63N200-SHJ63N400 | - - - - | - - - - |
| SHLD69300-SHLD69600 SHLD69300G-SHLD69600G SHLD69300NGT-SHLD69600NG SHLD69300NT-SHLD69600NT | ① ① ① ① | SHL63B300-SHL63B600 SHL63B300G-SHL63B600G SHL63N300G-SHL63N600G SHL63N300-SHL63N600 | - - - - | - - - - |
| SHND69100A-SHND69120A SHND69100AG-SHND69120AG | ① ① | SHND69100-SHND69800 SHND69100G-SHND69800G | ② ② | SHKF3B100-SHKF3B800 SHKF3B100G-SHKF3B800G |
| SHPD69120-SHPD69160 SHPD69120G-SHPD69160G | ② ② | SHPF3B120-SHPF3B160 SHPF3B120G-SHPF3B160G | - - | - - |

① Mechanically and electrically interchangeable.

② Electrically interchangeable only, refer to sales office for further details.

③ Electrically interchangeable only if the system interrupting capacity is less than or equal to:
200 kA at 240V AC
200 kA at 480V AC
100 kA at 600V AC

④ Electrically interchangeable only if the system interrupting capacity is less than or equal to:
200 kA at 240V AC
150 kA at 480V AC
100 kA at 600V AC

⑤ Refer to local sales office for replacement information.

Molded Case Circuit Breakers

Superseded Breakers

General

| New Sentron Series | Note | Superseded | Note | Superseded |
|--|------------------|---|------------------|--|
| SHND69100NGT-SHND69800NGT SHND69100NT-SHND69800NT | ① ② | SHKF3N100G-SHKF3N800G SHKF3N100-SHKF3N800 | ② ② | SHK3N100G-SHK3N600G SHK3N100-SHK3N600 |
| SHPF3B120-SHPF3B160 SHPF3B120G-SHPF3B160G SHPF3N120-SHPF3N160 SHPF3N120G-SHPF3N160G | ② ② ② ② | SHP3B120-SHP3B800 SHP3B120G-SHP3B800G SHP3N120-SHP3N800 SHP3N120G-SHP3N800G | | — — — — |
| SJD69200-SJ369400 SJD69200G-SJD69400G SJD69200NGT-SJD69400NGT SJD69200NT-SJD69400NT | ① ① ① ① | SJL63B200-SJL63B400 SJL63B200G-SJL63B400G SJL63N200G-SJL63N400G SJL63N200-SJL63N400 | | — — — — |
| SLD69300-SLD69600 SLD69300G-SLD69600G SLD69300NGT-SLD69600NGT SLD69300NT-SLD69600NT | ① ① ① ① | SLL63B300-SLL63B600 SLL63B300G-SLL63B600G SLL63N300G-SLL63N600G SLL63N300-SLL63N600 | | — — — — |
| SMD69600A-SMD69800A SMD69600AG-SMD69800AG SMD69600ANGT-SMD69800ANGT SMD69600ANT-SMD69800ANT | ① ① ① ① | SMD69600-SMD69800 SMD69600G-SMD69800G SMD69600NGT-SMD69800NGT SMD69600NT-SMD69800NT | ② ② ② ② | SKMF3B600-SKMF3B800 SKMF3B600G-SKMF3B800G SKMF3N600G-SKMF3N800G SKMF3N600-SKMF3N800 |
| SND69800A-SND69120A SND69800AG-SND69120AG SND69800ANGT-SND69120ANGT SND69800ANT-SND69120ANT | ① ① ① ① | SND69100-SND69800 SND69100G-SND69800G SND69100NGT-SND69800NGT SND69100NT-SND69800NT | ② ② ② ② | SKPF3B100-SKPF3B600 SKPF3B100G-SKPF3B600G SKPF3N100G-SKPF3N600G SKPF3N100-SKPF3N600 |
| SPD69120-SPD69160 SPD69120G-SPD69160G SPD69120NGT-SPD69160NGT SPD69120NT-SPD69160NT | ② ② ② ② | SHPF3B120-SHPF3B160 SHPF3B120G-SHPF3B160G SHPF3N120-SHPF3N160G SHPF3N120G-SHPF3N160G | | — — — — |
| — | ⑥ | BQCC1B015-BQC1B030 | | — |
| — | ⑥ | CC1B015-CC1B030 | | — |
| — | ⑥ | CC2B015-CC2B030 | | — |
| — | ⑥ | CC3B015-CC3B030 | | — |
| — | ⑥ | EF2A003, EF2H050, EF2L050, EF2A100, EF2H150, EF2L150 | | — — |
| — | ⑥ | EH1B015-EH1B100 | | — |
| — | ⑥ | EH2B015-EH2B100 | | — |
| — | ⑥ | EH3B015-EH3B100 | | — |
| — | ⑥ | HE2A003, HE2H050, HE2L050-HE2A100 HE3A003, HE3H050, HE3L050-HE3A100 HE3B015-HE3B100 | | — — — |

5
MOLDED CASE
CIRCUIT BREAKERS

- ① Mechanically and electrically interchangeable.
- ② Electrically interchangeable only, refer to sales office for further details.
- ③ Electrically interchangeable only if the system interrupting capacity is less than or equal to:
200 kA at 240V AC
200 kA at 480V AC
100 kA at 600V AC

- ④ Electrically interchangeable only if the system interrupting capacity is less than or equal to:
200 kA at 240V AC
150 kA at 480V AC
100 kA at 600V AC
- ⑤ These units are for replacement purposes only. Consult sales office for availability.

- ⑥ These units are no longer manufactured, and no replacement is available.

Siemens VL Circuit Breakers

Reference Guide

Selection/Application

| Page | | 5-101 | 5-103 | 5-107 | 5-111 | 5-115 | | |
|-------------------------------|--|----------------------------------|------------------|----------------|--------------------|----------------------|----------------------|----------------------|
| Breaker Frame Family | | GB/GG | EB/EG | DG | FG | JG | | |
| | Continuous Amps | 15-125A | 15-125A | 30-150A | 40-250A | 70-400A | | |
| | Poles | 1, 2, 3 | 1, 2, 3, 4 | 2, 3, 4 | 2, 3, 4 | 2, 3, 4 | | |
| | Max. Volts AC | 600Y/347V | 600Y/347V | 600V | 600V | 600V | | |
| Breaker Type | | NGG | NEG HEG | NDG HDG LDG | NFG HFG LFG | NJG HJG LJG | | |
| Ratings | Interrupting Class | | N | N H | N H L | N H L | N H L | |
| | Interrupting Rating RMS Symmetrical Amperes AC 50/60Hz | UL | 240Vac | 65 | 85 100 | 65 100 200 | 65 100 200 | 65 100 200 |
| | | | 480Vac | 25 (480Y/277) | 35 65 | 35 65 100 | 35 65 100 | 35 65 100 |
| | | | 600Vac | 14 (600Y/347) | 22 25 | 18 20 25 | 18 20 25 | 25 25 25 |
| | DC Interrupting Ratings (UL)® | I _{CS} /I _{CU} | 220/240Vac | 65/33 | 85/43 100/50 | 65/65 100/75 200/150 | 65/65 100/75 200/150 | 65/65 100/75 200/150 |
| | | | 380/415Vac | 25/12.5 | 40/30 70/35 | 40/40 70/70 100/75 | 40/40 70/70 100/75 | 45/45 70/70 100/75 |
| | | | 690Vac | — | — — | 12/6 12/6 12/6 | 12/6 12/6 12/6 | 12/6 15/8 15/8 |
| | DC Interrupting Ratings (UL)® | I _{CS} /I _{CU} | 250Vdc (2-Pole) | 14 | 35 42 | 30 30 30 | 30 30 30 | 30 30 30 |
| | | | 500Vdc (3-Pole) | — | — — | 18 18 18 | 18 18 30 | 25 35 35 |
| | | | 600Vdc (3-Pole) | — | — — | # # # | # # # | # # # |
| Dimensions in Inches | 1-Pole | | 5.1H x 1W x 2.8D | 5.5H x 1W x 3D | — | | | — |
| | 2-Pole | | 5.1H x 2W x 2.8D | 5.5H x 2W x 3D | 6.9H x 4.1W x 3.4D | | | 11H x 5.5W x 4.2D |
| | 3-Pole | | 5.1H x 3W x 2.8D | 5.5H x 3W x 3D | 6.9H x 4.1W x 3.4D | | | 11H x 5.5W x 4.2D |
| | 4-Pole | | — | 5.5H x 4W x 3D | 6.9H x 5.5W x 3.4D | | | 11H x 7.2W x 4.2D |
| Trip Unit Information | Thermal-Magnetic | | ◆ | ◆ | ◆ | ◆ | ◆ | |
| | Electronic | | | | ◆ | ◆ | ◆ | |
| | Electronic with LCD | | | | ◆ | ◆ | ◆ | |
| | Interchangeable Trip Unit | | | | ◆ | ◆ | ◆ | |
| | Reverse Feed (w/Non-Interchangeable Trip) | | ◆ | ◆ | ◆ | ◆ | ◆ | |
| | Communications Capability* | | | | ◆ | ◆ | ◆ | |
| Specific Application Breakers | Molded Case Switch | | | ◆ | ◆ | ◆ | ◆ | |
| | Motor Circuit Protector | | | ◆ | ◆ | ◆ | ◆ | |
| | 100% Rated | | | | | ◆ | ◆ | |
| | 50°C Calibrated ^A | | | ◆ | ◆ | ◆ | ◆ | |
| Accessories & Modifications | Auxiliary Switch | | ◆ | ◆ | ◆ | ◆ | ◆ | |
| | Alarm Switch | | ◆ | ◆ | ◆ | ◆ | ◆ | |
| | Shunt Trip | | ◆ | ◆ | ◆ | ◆ | ◆ | |
| | Undervoltage Release | | | ◆ | ◆ | ◆ | ◆ | |
| | Mechanical Interlocks | | | ◆ | ◆ | ◆ | ◆ | |
| | Electric Motor or Stored Energy Operator | | | ◆ | ◆ | ◆ | ◆ | |
| | Rear Connecting Studs | | | ◆ | ◆ | ◆ | ◆ | |
| | Plug-In Mounting Assy. w/Trip Interlock | | | ◆ | ◆ | ◆ | ◆ | |
| | Draw-Out Assembly | | | | ◆ | ◆ | ◆ | |
| | Handle Mechanism Options | | ◆ | ◆ | ◆ | ◆ | ◆ | |
| Fungus Proofing | | | ◆ | | | | | |
| Enclosures ^① | NEMA 1 – Indoor, Surface Mount | | | | | | | |
| | NEMA 1 – Indoor, Flush Mount | | | | | | | |
| | NEMA 3R – Outdoor, Rain Proof | | | | | | | |
| | NEMA 4, 4X – Stainless Steel | | | | | | | |
| | NEMA 7, 9 – Hazardous Locations | | | | | | | |
| NEMA 12 – Dust | | | | | | | | |
| | Terminal Shields | | ◆ | | ◆ | ◆ | ◆ | |
| | Distribution Lugs | | ◆ | ◆ | ◆ | ◆ | ◆ | |
| | Ground Sensor (Neutral Transformer) | | | ◆ | ◆ | ◆ | ◆ | |

① 500Vdc nominal, 600Vdc max. for ungrounded DC UPS systems.
 ② DC Interrupting Ratings are not applicable to electronic circuit breakers.
 * - Communications available via a COM 10 module using Profibus protocol.
 # - Consult Siemens for these applications.
 GG and EG are not VL family breakers and do not share common VL accessories.
 A - Consult Siemens for availability.

Siemens VL Circuit Breakers

Reference Guide

Selection/Application

| Page | | 5-119 | | | 5-123 | | | 5-128 | | | 5-131 | | | | |
|--|---|--------------------|----------------------------------|------------|-------------------|---------|--------|------------------|---------|--------|-----------|---------|--------|--------|---------|
| Breaker Frame Family | | LG | | | MG | | | NG | | | PG | | | | |
| Continuous Amps | | 150–600A | | | 200–800A | | | 300–1200A | | | 400–1600A | | | | |
| Poles | | 2, 3 | | | 2, 3, 4 | | | 2, 3, 4 | | | 3, 4 | | | | |
| Max. Volts AC | | 600V | | | 600V | | | 600V | | | 600V | | | | |
| Breaker Type | | NLG | HLG | LLG | NMG | HMG | LMG | NNG | HNG | LNG | NPG | HPG | LPG | | |
| Ratings | | Interrupting Class | | | N | H | L | N | H | L | N | H | L | | |
| Ratings | Interrupting Class | 240Vac | 65 | 100 | 200 | 65 | 100 | 200 | 65 | 100 | 200 | 65 | 100 | 200 | |
| | | 480Vac | 35 | 65 | 100 | 35 | 65 | 100 | 35 | 65 | 100 | 35 | 65 | 100 | |
| | | 600Vac | 25 | 25 | 25 | 25 | 35 | 50 | 25 | 35 | 65 | 25 | 35 | 65 | |
| | Symmetrical Rating RMS Amperes AC 50/60Hz | UL | 220/240Vac | 65/65 | 100/75 | 200/150 | 65/65 | 100/75 | 200/150 | 65/65 | 100/75 | 200/150 | 65/65 | 100/75 | 200/150 |
| | | | I _{cs} /I _{cu} | 380/415Vac | 45/45 | 70/70 | 100/75 | 50/50 | 70/70 | 100/75 | 50/25 | 70/35 | 100/50 | 50/25 | 70/35 |
| | 690Vac | 12/6 | | 15/8 | 15/8 | 20/10 | 30/15 | 35/17 | 20/10 | 30/15 | 35/15 | 20/10 | 30/15 | 35/15 | |
| | DC Interrupting Ratings (UL) ^③ | DC | 250Vdc (2-Pole) | 30 | 30 | 30 | 22 | 25 | 42 | 22 | 25 | 42 | 22 | 25 | 42 |
| 500Vdc (3-Pole) | | | 25 | 35 | 35 | 35 | 50 | 65 | 35 | 50 | 65 | 35 | 50 | 65 | |
| 600Vdc (3-Pole) | | | # | # | # | # | # | # | # | # | # | # | # | # | |
| 750Vdc (4-Pole) | | | # | # | # | # | # | # | # | # | # | # | # | # | |
| Dimensions in Inches | 1-Pole | — | | | — | | | — | | | — | | | | |
| | 2-Pole | 11H x 5.5W x 4.2D | | | 16H x 7.5W x 4.7D | | | 16H x 9W x 6.2D | | | — | | | | |
| | 3-Pole | 11H x 5.5W x 4.2D | | | 16H x 7.5W x 4.7D | | | 16H x 9W x 6.2D | | | — | | | | |
| | 4-Pole | — | | | 16H x 10W x 4.7D | | | 16H x 12W x 6.2D | | | — | | | | |
| Trip Unit Information | Thermal-Magnetic | ◆ | ◆ | ◆ | ◆ | ◆ | ◆ | ◆ | ◆ | ◆ | ◆ | ◆ | ◆ | | |
| | Electronic | ◆ | ◆ | ◆ | ◆ | ◆ | ◆ | ◆ | ◆ | ◆ | ◆ | ◆ | ◆ | | |
| | Electronic with LCD | ◆ | ◆ | ◆ | ◆ | ◆ | ◆ | ◆ | ◆ | ◆ | ◆ | ◆ | ◆ | | |
| | Interchangeable Trip Unit | ◆ | ◆ | ◆ | ◆ | ◆ | ◆ | ◆ | ◆ | ◆ | ◆ | ◆ | ◆ | | |
| | Reverse Feed (w/Non-Interchangeable Trip) | ◆ | ◆ | ◆ | ◆ | ◆ | ◆ | ◆ | ◆ | ◆ | ◆ | ◆ | ◆ | | |
| | Communications Capability ^① | ◆ | ◆ | ◆ | ◆ | ◆ | ◆ | ◆ | ◆ | ◆ | ◆ | ◆ | ◆ | | |
| Specific Application Breakers | Molded Case Switch | ◆ | ◆ | ◆ | ◆ | ◆ | ◆ | ◆ | ◆ | ◆ | ◆ | ◆ | ◆ | | |
| | Motor Circuit Protector | ◆ | ◆ | ◆ | ◆ | ◆ | ◆ | ◆ | ◆ | ◆ | ◆ | ◆ | ◆ | | |
| | 100% Rated | ◆ | ◆ | ◆ | ◆ | ◆ | ◆ | ◆ | ◆ | ◆ | ◆ | ◆ | ◆ | | |
| 50°C Calibrated ^A | ◆ | ◆ | ◆ | ◆ | ◆ | ◆ | ◆ | ◆ | ◆ | ◆ | ◆ | ◆ | | | |
| Accessories & Modifications | Auxiliary Switch | ◆ | ◆ | ◆ | ◆ | ◆ | ◆ | ◆ | ◆ | ◆ | ◆ | ◆ | ◆ | | |
| | Alarm Switch | ◆ | ◆ | ◆ | ◆ | ◆ | ◆ | ◆ | ◆ | ◆ | ◆ | ◆ | ◆ | | |
| | Shunt Trip | ◆ | ◆ | ◆ | ◆ | ◆ | ◆ | ◆ | ◆ | ◆ | ◆ | ◆ | ◆ | | |
| | Undervoltage Release | ◆ | ◆ | ◆ | ◆ | ◆ | ◆ | ◆ | ◆ | ◆ | ◆ | ◆ | ◆ | | |
| | Mechanical Interlocks | ◆ | ◆ | ◆ | ◆ | ◆ | ◆ | ◆ | ◆ | ◆ | ◆ | ◆ | ◆ | | |
| | Electric Motor or Stored Energy Operator | ◆ | ◆ | ◆ | ◆ | ◆ | ◆ | ◆ | ◆ | ◆ | ◆ | ◆ | ◆ | | |
| | Rear Connecting Studs | ◆ | ◆ | ◆ | ◆ | ◆ | ◆ | ◆ | ◆ | ◆ | ◆ | ◆ | ◆ | | |
| | Plug-In Mounting Assy. w/Trip Interlock | ◆ | ◆ | ◆ | ◆ | ◆ | ◆ | ◆ | ◆ | ◆ | ◆ | ◆ | ◆ | | |
| | Draw-Out Assembly | ◆ | ◆ | ◆ | ◆ | ◆ | ◆ | ◆ | ◆ | ◆ | ◆ | ◆ | ◆ | | |
| | Handle Mechanism Options | ◆ | ◆ | ◆ | ◆ | ◆ | ◆ | ◆ | ◆ | ◆ | ◆ | ◆ | ◆ | | |
| Fungus Proofing | ◆ | ◆ | ◆ | ◆ | ◆ | ◆ | ◆ | ◆ | ◆ | ◆ | ◆ | ◆ | | | |
| Enclosures ^① | NEMA 1 – Indoor, Surface Mount | ◆ | ◆ | ◆ | ◆ | ◆ | ◆ | ◆ | ◆ | ◆ | ◆ | ◆ | ◆ | | |
| | NEMA 1 – Indoor, Flush Mount | ◆ | ◆ | ◆ | ◆ | ◆ | ◆ | ◆ | ◆ | ◆ | ◆ | ◆ | ◆ | | |
| | NEMA 3R – Outdoor, Rain Proof | ◆ | ◆ | ◆ | ◆ | ◆ | ◆ | ◆ | ◆ | ◆ | ◆ | ◆ | ◆ | | |
| | NEMA 4, 4X – Stainless Steel | ◆ | ◆ | ◆ | ◆ | ◆ | ◆ | ◆ | ◆ | ◆ | ◆ | ◆ | ◆ | | |
| | NEMA 7, 9 – Hazardous Locations | ◆ | ◆ | ◆ | ◆ | ◆ | ◆ | ◆ | ◆ | ◆ | ◆ | ◆ | ◆ | | |
| NEMA 12 – Lint, Fine Dust, Oils, Coolant | ◆ | ◆ | ◆ | ◆ | ◆ | ◆ | ◆ | ◆ | ◆ | ◆ | ◆ | ◆ | | | |
| Terminal Shields | Terminal Shields | ◆ | ◆ | ◆ | ◆ | ◆ | ◆ | ◆ | ◆ | ◆ | ◆ | ◆ | ◆ | | |
| | Distribution Lugs | ◆ | ◆ | ◆ | ◆ | ◆ | ◆ | ◆ | ◆ | ◆ | ◆ | ◆ | ◆ | | |
| | Ground Sensor (Neutral Transformer) | ◆ | ◆ | ◆ | ◆ | ◆ | ◆ | ◆ | ◆ | ◆ | ◆ | ◆ | ◆ | | |

① Communications available via COMPRO or COMMOD modules using Profibus or Modbus protocol.

② 500Vdc nominal, 600Vdc max. for ungrounded DC UPS systems.

③ DC Interrupting Ratings are not applicable to electronic circuit breakers.

- Consult Siemens for these applications.

A - Consult Siemens for availability.

Molded Case Circuit Breakers

NGB/NGG Frame

Selection

NGB (Panelboard Mount) NGG (Cable In - Cable Out)

| Continuous Ampere Rating @ 40C | 1-Pole | | 2-Pole | | 3-Pole | |
|--------------------------------|------------------------|---------------------------------------|------------------------|---------------------------------------|------------------------|---------------------------------------|
| | Catalogue Number | | Catalogue Number | | Catalogue Number | |
| | Panelboard Mount | General Purpose Breakers ^① | Panelboard Mount | General Purpose Breakers ^① | Panelboard Mount | General Purpose Breakers ^① |
| 15 | NGB1B015B ^② | NGG1B015L ^② | NGB2B015B ^② | NGG2B015L ^② | NGB3B015B ^② | NGG3B015L ^② |
| 20 | NGB1B020B ^② | NGG1B020L ^② | NGB2B020B ^② | NGG2B020L ^② | NGB3B020B ^② | NGG3B020L ^② |
| 25 | NGB1B025B ^② | NGG1B015L ^② | NGB2B025B ^② | NGG2B015L ^② | NGB3B025B ^② | NGG3B015L ^② |
| 30 | NGB1B030B ^② | NGG1B030L ^② | NGB2B030B ^② | NGG2B030L ^② | NGB3B030B ^② | NGG3B030L ^② |
| 35 | NGB1B035B ^② | NGG1B035L ^② | NGB2B035B ^② | NGG2B035L ^② | NGB3B035B ^② | NGG3B035L ^② |
| 40 | NGB1B040B ^② | NGG1B040L ^② | NGB2B040B ^② | NGG2B040L ^② | NGB3B040B ^② | NGG3B040L ^② |
| 45 | NGB1B045B ^② | NGG1B045L ^② | NGB2B045B ^② | NGG2B045L ^② | NGB3B045B ^② | NGG3B045L ^② |
| 50 | NGB1B050B ^② | NGG1B050L ^② | NGB2B050B ^② | NGG2B050L ^② | NGB3B050B ^② | NGG3B050L ^② |
| 60 | NGB1B060B | NGG1B060L | NGB2B060B | NGG2B060L | NGB3B060B | NGG3B060L |
| 70 | NGB1B070B | NGG1B070L | NGB2B070B | NGG2B070L | NGB3B070B | NGG3B070L |
| 80 | NGB1B080B | NGG1B080L | NGB2B080B | NGG2B080L | NGB3B080B | NGG3B080L |
| 90 | NGB1B090B | NGG1B090L | NGB2B090B | NGG2B090L | NGB3B090B | NGG3B090L |
| 100 | NGB1B100B | NGG1B100L | NGB2B100B | NGG2B100L | NGB3B100B | NGG3B100L |
| 110 | NGB1B110B | NGG1B110L | NGB2B110B | NGG2B110L | NGB3B110B | NGG3B110L |
| 125 | NGB1B125B | NGG1B125L | NGB2B125B | NGG2B125L | NGB3B125B | NGG3B125L |

Line and load lugs are included as standard. If only load side lugs are needed, change "L" suffix to "B" HACR rated.

NGG Suitable for screws or DIN rail mounting.

Shipping Weights

| Number of Poles | Number per Carton | Shipping Weight lbs. (kg) | |
|-----------------|-------------------|---------------------------|------------|
| | | NGB | NGG |
| 1 | 1 | 0.9 (0.4) | .75 (0.34) |
| 2 | 1 | 1.9 (0.9) | 1.3 (0.59) |
| 3 | 1 | 2.9 (1.2) | 2.0 (0.98) |

Lugs For 60/75°C Wire

| Ampere Rating | Wire Size | Catalogue Number | |
|---------------|--|-----------------------|---------------------------------|
| | | NGB | NGG |
| 15-30A | #14-#6 AWG Cu #12-#6 AWG Al | Integral with breaker | TC1Q1 (qty.1) 3TC1Q1 (qty.3) |
| 35-125A | #8-1/0 AWG Cu #8-2/0 AWG Cu | Integral with breaker | 3TC1GG20 (qty.3) |
| 15-125A | Nut Keeper plate w/screw (for crimp) terminals) | N/A | TNKG3 (qty.3) |

Interrupting Ratings

| Breaker Type | Number of Poles | CSA / UL 489 AIR | | | | | | IEC 947-2 | | | | | | |
|--------------|-----------------|------------------------------|-----|-----|-----|-----|---------|--------------------|-----------------|---------|------|----------|------|-------------|
| | | RMS Symmetrical Amperes (KA) | | | | | | Volts AC (50/60Hz) | | | | | | |
| | | Volts AC(50/60Hz) | | | | | | 220/240 | | 380/415 | | Volts DC | | |
| | 1 | 120 | 240 | 277 | 347 | 480 | 600/347 | 125 | 250 | Icu | Ics | Icu | Ics | 125/250V DC |
| NGB/NGG | 1 | 65 | — | 25 | 14 | — | — | 14 | — | 25 | 12.5 | — | — | — |
| | 2, 3 | — | 65 | — | — | 25 | 14 | — | 14 ^③ | 65 | 12.5 | 25 | 12.5 | — |

For inches / millimeters conversion, see Application Data section.

① SWD rated.

② HID Rated at 15-50A 1 Pole @ 347V; 2&3 pole @ 347V.

③ 125/250V DC rating applies to 2-Pole NGG only.

④ General Purpose Breakers also carry CE marks.

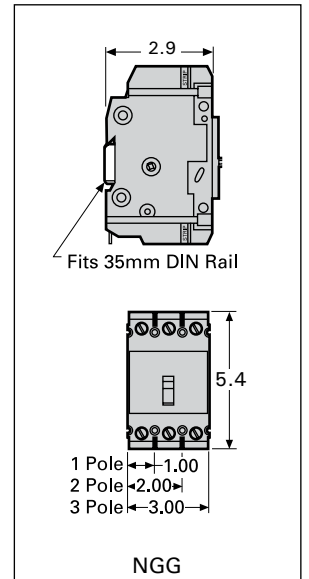

5
MOLDED CASE
CIRCUIT BREAKERS

Molded Case Circuit Breakers

Internal Accessories for NGG and NGB 125A Frame

Selection

Shunt Trip

| Control Voltage | | CQD, CQD6, NGG, NGB Catalogue Number |
|-----------------|------|---|
| V AC | V DC | |
| 120 | — | CQDST120 |
| 240 | — | CQDST240▲ |
| 277 | — | CQDST277▲ |
| 480 | — | CQDST480▲ |
| 600 | — | CQDST600 |
| — | 12 | CQDST12 |
| — | 24 | CQDST24 |
| — | 48 | CQDST48 |
| — | 125 | CQDST125 |

Auxiliary Switch

| Maximum Voltage | | Number of Contacts | CQD, CQD6, NGG, NGB Catalogue Number |
|-----------------|-----|--------------------|---|
| AC | DC | | |
| 240 | 125 | 1A-1B | CQDA1 |
| 240 | 125 | 2A-2B | CQDA2 |

Alarm Switch

| Maximum Voltage | | CQD, CQD6, NGG, NGB Catalogue Number |
|-----------------|-----|---|
| AC | DC | |
| 240 | 125 | CQDBA |

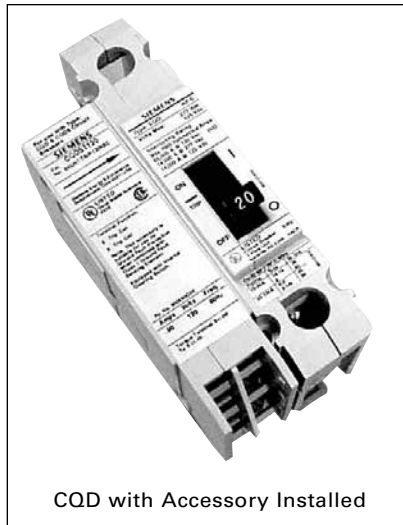

CQD with Accessory Installed

Shunt Trip and Auxiliary Switch Combinations

| Shunt Trip Voltage | | CQD, CQD6, NGG, NGB Catalogue Number |
|--------------------|-----|---|
| AC | DC | |
| 24 | | CQDST24AAS▲ |
| 120 | | CQDST120AAS▲ |
| 240 | | CQDST240AAS▲ |
| 277 | | CQDST277AAS▲ |
| 480 | | CQDST480AAS▲ |
| 600 | | CQDST600AAS▲ |
| | 12 | CQDST12DAS▲ |
| | 24 | CQDST24DAS▲ |
| | 48 | CQDST48DAS▲ |
| | 125 | CQDST125DAS▲ |

Alarm and Auxiliary Switch Combinations

| For Breaker | Catalogue Number |
|---------------------|------------------|
| CQD, CQD6, NGG, NGB | CQDA1BA▲ |

Padlocking Devices

For locking breaker in "OFF" position.

| | |
|-----|------|
| NGG | HPLG |
|-----|------|

Handle Blocking Devices

| | |
|----------|--------|
| NGG, NGB | BQDHBD |
|----------|--------|

Terminal Shields

| | |
|-----|--------|
| NGG | TSSG3A |
|-----|--------|

▲ Built to order. Allow 6-8 weeks for delivery.

Molded Case Circuit Breakers

EG 125A Frame

Selection/Dimensions

Type NEB (Panelboard Mount), NEG (Cable In - Cable Out)

| Continuous Ampere Rating @ 40C | 1-Pole | | 2-Pole | | 3-Pole | | 4-Pole |
|--------------------------------|------------------------|---------------------------------------|------------------|---------------------------------------|------------------|---------------------------------------|---------------------------------------|
| | Catalogue Number | | Catalogue Number | | Catalogue Number | | Catalogue Number |
| | Panelboard Mount | General Purpose Breakers ^⑤ | Panelboard Mount | General Purpose Breakers ^⑤ | Panelboard Mount | General Purpose Breakers ^⑤ | General Purpose Breakers ^⑤ |
| 15 | NEB1B015B ^① | NEG1B015L ^{②③} | NEB2B015B | NEG2B015L ^② | NEB3B015B | NEG3B015L ^② | NEG4B015L |
| 20 | NEB1B020B ^① | NEG1B020L ^{②③} | NEB2B020B | NEG2B020L ^② | NEB3B020B | NEG3B020L ^② | NEG4B020L |
| 25 | NEB1B025B | NEG1B015L ^② | NEB2B025B | NEG2B015L ^② | NEB3B025B | NEG3B015L ^② | NEG4B015L |
| 30 | NEB1B030B | NEG1B030L ^② | NEB2B030B | NEG2B030L ^② | NEB3B030B | NEG3B030L ^② | NEG4B030L |
| 35 | NEB1B035B | NEG1B035L ^② | NEB2B035B | NEG2B035L ^② | NEB3B035B | NEG3B035L ^② | NEG4B035L |
| 40 | NEB1B040B | NEG1B040L ^② | NEB2B040B | NEG2B040L ^② | NEB3B040B | NEG3B040L ^② | NEG4B040L |
| 45 | NEB1B045B | NEG1B045L ^② | NEB2B045B | NEG2B045L ^② | NEB3B045B | NEG3B045L ^② | NEG4B045L |
| 50 | NEB1B050B | NEG1B050L ^② | NEB2B050B | NEG2B050L ^② | NEB3B050B | NEG3B050L ^② | NEG4B050L |
| 60 | NEB1B060B | NEG1B060L ^② | NEB2B060B | NEG2B060L ^② | NEB3B060B | NEG3B060L ^② | NEG4B060L |
| 70 | NEB1B070B | NEG1B070L ^② | NEB2B070B | NEG2B070L ^② | NEB3B070B | NEG3B070L ^② | NEG4B070L |
| 80 | NEB1B080B | NEG1B080L ^② | NEB2B080B | NEG2B080L ^② | NEB3B080B | NEG3B080L ^② | NEG4B080L |
| 90 | NEB1B090B | NEG1B090L ^② | NEB2B090B | NEG2B090L ^② | NEB3B090B | NEG3B090L ^② | NEG4B090L |
| 100 | NEB1B100B | NEG1B100L ^② | NEB2B100B | NEG2B100L ^② | NEB3B100B | NEG3B100L ^② | NEG4B100L |
| 110 | NEB1B110B | NEG1B110L ^② | NEB2B110B | NEG2B110L ^② | NEB3B110B | NEG3B110L ^② | NEG4B110L |
| 125 | NEB1B125B | NEG1B125L ^② | NEB2B125B | NEG2B125L ^② | NEB3B125B | NEG3B125L ^② | NEG4B125L |

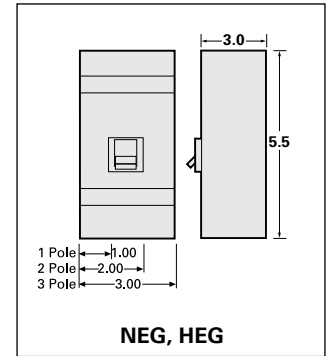

Type HEB (Panelboard Mount), HEG (Cable In - Cable Out)

| | | | | | | | |
|-----|------------------------|-------------------------|-----------|------------------------|-----------|------------------------|------------------------|
| 15 | HEB1B015B ^① | HEG1B015L ^{②③} | HEB2B015B | HEG2B015L ^② | HEB3B015B | HEG3B015L ^② | HEG4B015L ^② |
| 20 | HEB1B020B ^① | HEG1B020L ^{②③} | HEB2B020B | HEG2B020L ^② | HEB3B020B | HEG3B020L ^② | HEG4B020L ^② |
| 25 | HEB1B025B | HEG1B015L ^② | HEB2B025B | HEG2B015L ^② | HEB3B025B | HEG3B015L ^② | HEG4B015L ^② |
| 30 | HEB1B030B | HEG1B030L ^② | HEB2B030B | HEG2B030L ^② | HEB3B030B | HEG3B030L ^② | HEG4B030L ^② |
| 35 | HEB1B035B | HEG1B035L ^② | HEB2B035B | HEG2B035L ^② | HEB3B035B | HEG3B035L ^② | HEG4B035L ^② |
| 40 | HEB1B040B | HEG1B040L ^② | HEB2B040B | HEG2B040L ^② | HEB3B040B | HEG3B040L ^② | HEG4B040L ^② |
| 45 | HEB1B045B | HEG1B045L ^② | HEB2B045B | HEG2B045L ^② | HEB3B045B | HEG3B045L ^② | HEG4B045L ^② |
| 50 | HEB1B050B | HEG1B050L ^② | HEB2B050B | HEG2B050L ^② | HEB3B050B | HEG3B050L ^② | HEG4B050L ^② |
| 60 | HEB1B060B | HEG1B060L ^② | HEB2B060B | HEG2B060L ^② | HEB3B060B | HEG3B060L ^② | HEG4B060L ^② |
| 70 | HEB1B070B | HEG1B070L ^② | HEB2B070B | HEG2B070L ^② | HEB3B070B | HEG3B070L ^② | HEG4B070L ^② |
| 80 | HEB1B080B | HEG1B080L ^② | HEB2B080B | HEG2B080L ^② | HEB3B080B | HEG3B080L ^② | HEG4B080L ^② |
| 90 | HEB1B090B | HEG1B090L ^② | HEB2B090B | HEG2B090L ^② | HEB3B090B | HEG3B090L ^② | HEG4B090L ^② |
| 100 | HEB1B100B | HEG1B100L ^② | HEB2B100B | HEG2B100L ^② | HEB3B100B | HEG3B100L ^② | HEG4B100L ^② |
| 110 | HEB1B110B | HEG1B110L ^② | HEB2B110B | HEG2B110L ^② | HEB3B110B | HEG3B110L ^② | HEG4B110L ^② |
| 125 | HEB1B125B | HEG1B125L ^② | HEB2B125B | HEG2B125L ^② | HEB3B125B | HEG3B125L ^② | HEG4B125L ^② |

| No. of Poles | No. per Carton | Shipping Weight lbs. (kg) | |
|--------------|----------------|---------------------------|-----------|
| | | NEB/HEB | NEG/HEG |
| 1 | 1 | 1.4 (0.7) | 1.1 (0.5) |
| 2 | 1 | 2.4 (1.1) | 2.0 (0.9) |
| 3 | 1 | 3.7 (1.7) | 3.1 (1.4) |
| 4 | 1 | N/A | 3.9 (1.8) |

HEG Line and load lugs are included as standard. HACR rated. Suitable for screw mounting.

EG 125A Frame Molded Case Switch - (Magnetic Trip Only)

| Continuous Ampere Rating | Catalogue Number |
|--------------------------|------------------|
| 3-Pole | |
| 100 | HES3S100L |
| 125 | HES3S125L |
| 160 | HES3S160L |
| 4-Pole | |
| 125 | HES4S125L |

EG 125A Frame 3-Pole Motor Circuit Protector

| Continuous Ampere Rating | Catalogue Number |
|--------------------------|------------------|
| 3 | HEM3M003L |
| 7 | HEM3M007L |
| 15 | HEM3M015L |
| 30 | HEM3M030L |
| 50 | HEM3M050L |
| 70 | HEM3M070L |
| 100 | HEM3M100L |
| 125 | HEM3M125L |

Lugs For 60/75°C Wire

| Ampere Rating | Wire Size | Catalogue Number | |
|---------------|--|------------------|---------------------------------|
| | | NEB-HEB | NEG-HEG |
| 15-100A | #14-1/0 | 3TA1EG10 (qty.3) | N/A |
| 60-125A | #6-2/0 | 3TA1EG30 (qty.3) | N/A |
| 15-125A | #14-3/0 AWG Cu (steel lugs) | N/A | 3TW1EG30 (qty.3) |
| 15-125A4 | #14-1/0 AWG Cu #14-1/0 AWG Al | N/A | 3TA1EG10 (qty.3) |
| 15-125A4 | #6-3/0 AWG Cu #6-3/0 AWG Al | N/A | 3TA1EG30 (qty.3) |
| 15-125A | Nut Keeper plate w/screw (for crimp) terminals | N/A | TNKE3(3-Pole) TNKE4 (4-Pole) |

Interrupting Ratings

| Breaker Type | Number of Poles | UL 489 AIR | | | | | IEC 60947-2 | | | | | | | |
|--------------|-----------------|------------------------------|-----|-----|-----|-----------------|--------------------|---------|---------|-----|---------|-----|----------|---------|
| | | RMS Symmetrical Amperes (KA) | | | | | Volts AC (50/60Hz) | | | | | | | |
| | | Volts AC(50/60Hz) | | | | | Volts DC | | 220/240 | | 380/415 | | Volts DC | |
| | | 240 | 277 | 347 | 480 | 600/347 | 125 | 125/250 | Icu | Ics | Icu | Ics | 125 | 125/250 |
| NEB/NEG | 1 | 85 | 35 | 22 | — | — | 35 | — | 85 | 43 | — | — | 35 | — |
| | 2, 3, 4 | 85 | — | — | 35 | 22 ^⑥ | — | 35 | 85 | 43 | 40 | 20 | — | 35 |
| HEB/HEG | 1 | 100 | 65 | 25 | — | — | 42 | — | 100 | 50 | — | — | 42 | — |
| | 2, 3, 4 | 100 | — | — | 65 | 25 ^⑥ | — | 42 | 100 | 50 | 70 | 35 | — | 42 |

For inches / millimeters conversion, see Application Data section.

① SWD rated.
② HID rated 347V.

③ Applies to 3 & 4-pole breakers only.
④ Optional lugs for NEG and HEG breakers.

⑤ General Purpose Breakers also carry CE marks

Molded Case Circuit Breakers

Internal Accessories for NEG and HEG 125A Frame

Selection

Shunt Trip

| Control Voltage | | NEG, HEG, NEB, HEB Catalogue Number |
|-----------------|-------|--|
| V AC | V DC | |
| 110-240 | 125 | STREB240 |
| 380-600 | — | STREB600 |
| 24-60 | 24-60 | STREB60D |

Auxiliary Switch

| Maximum Voltage | | Number of Contacts | NEG, HEG, NEB, HEB Catalogue Number |
|-----------------|-----|--------------------|--|
| AC | DC | | |
| 240 | 125 | 1A-1B | ASKE2 |
| 240 | 125 | 2A-2B | ASKE3 |

Alarm Switch

| Maximum Voltage | | Number of Contacts | NEG, HEG, NEB, HEB Catalogue Number |
|-----------------|-----|--------------------|--|
| AC | DC | | |
| 240 | 125 | 1A-1B | ASKE1 |
| 240 | 125 | 2A-2B | ASKE5 |

Undervoltage Trip

| Control Voltage | | NEG, HEG, NEB, HEB Catalogue Number |
|-----------------|-----|--|
| AC | DC | |
| 24 | | UVREB24A |
| 60 | | UVREM60▲ |
| 120 | | UVREN120 |
| 240 | | UVRER240 |
| 480 | | UVREU480▲ |
| 600 | | UVREV600▲ |
| | 24 | UVREB24D |
| | 48 | UVREC48D▲ |
| | 125 | UVRED125D▲ |
| | 250 | UVREE250D▲ |

Alarm and Auxiliary Switch Combinations

| For Breaker | Catalogue Number |
|-------------|------------------|
| NEG, HEG | ASKE6 |

Locks and Interlocks

| Description | Quantity per Kit | Accessory Kit Catalogue Number |
|--|------------------|--------------------------------|
| Handle Blocking Device | 1 | HBDE |
| Handle Padlocking Device, 3-pole only (allows padlocking the handle in the OFF or ON position) | 1 | HPLE |

Miscellaneous Accessories

| Breaker Amp Rating (A) | Description | Catalogue Number |
|------------------------|---------------------------------|------------------|
| | Mounting Screw Kit, 1-pole | MSKE1 |
| | Mounting Screw Kit, 2-pole | MSKE2 |
| | Mounting Screw Kit, 3 or 4-pole | MSKE4 |
| | DIN Rail Adapter, 3 or 4-pole | DRAE3 |

Handle Operators

| Description | NEMA Type | Catalogue Number |
|--|---------------|------------------|
| Rotary Handle Operator (black handle, breaker mounted) | 1 | RHFESD |
| Rotary Handle Operator with Door Interlock (black handle, breaker mounted) | 1 | RHFESDL |
| Rotary Handle Operator (red handle, breaker mounted) | 1 | RHFESDEM |
| Variable Depth Rotary Operator Kit (black handle, 6 inch shaft) | 1, 12, 3R, 4X | RHVE64X |
| Variable Depth Rotary Operator Kit (black handle, 12 inch shaft) | 1, 12, 3R, 4X | RHVE124X |
| Variable Depth Rotary Operator Kit (black handle, 24 inch shaft) | 1, 12, 3R, 4X | RHVE244X |
| Variable Depth Rotary Operator Kit (red handle, 6 inch shaft) | 1, 12, 3R, 4X | RHVEEM64X |
| Variable Depth Rotary Operator Kit (red handle, 12 inch shaft) | 1, 12, 3R, 4X | RHVEEM124X |
| Variable Depth Rotary Operator Kit (red handle, 24 inch shaft) | 1, 12, 3R, 4X | RHVEEM244X |
| Flex Operator Kit (Flange Mounted Variable Depth, 24 in. cable) | 1, 12 | MFKE2 |
| Flex Operator Kit (Flange Mounted Variable Depth, 36 in. cable) | 1, 12 | MFKE3 |
| Flex Operator Kit (Flange Mounted Variable Depth, 48 in. cable) | 1, 12 | MFKE4 |
| Flex Operator Kit (Flange Mounted Variable Depth, 60 in. cable) | 1, 12 | MFKE5 |
| Flex Operator Kit (Flange Mounted Variable Depth, 72 in. cable) | 1, 12 | MFKE6 |
| Flex Operator Kit (Flange Mounted Variable Depth, 84 in. cable) | 1, 12 | MFKE7 |
| Flex Operator Kit (Flange Mounted Variable Depth, 96 in. cable) | 1, 12 | MFKE8 |
| Flex Operator Kit (Flange Mounted Variable Depth, 108 in. cable) | 1, 12 | MFKE9 |
| Flex Operator Kit (Flange Mounted Variable Depth, 120 in. cable) | 1, 12 | MFKE10 |
| Flex Operator Kit (Flange Mounted Variable Depth, 24 in. cable) | 4X | MFKE4X2 |
| Flex Operator Kit (Flange Mounted Variable Depth, 36 in. cable) | 4X | MFKE4X3 |
| Flex Operator Kit (Flange Mounted Variable Depth, 48 in. cable) | 4X | MFKE4X4 |
| Flex Operator Kit (Flange Mounted Variable Depth, 60 in. cable) | 4X | MFKE4X5 |
| Flex Operator Kit (Flange Mounted Variable Depth, 72 in. cable) | 4X | MFKE4X6 |
| Flex Operator Kit (Flange Mounted Variable Depth, 84 in. cable) | 4X | MFKE4X7 |
| Flex Operator Kit (Flange Mounted Variable Depth, 96 in. cable) | 4X | MFKE4X8 |
| Flex Operator Kit (Flange Mounted Variable Depth, 108 in. cable) | 4X | MFKE4X9 |
| Flex Operator Kit (Flange Mounted Variable Depth, 120 in. cable) | 4X | MFKE4X10 |

All operators are for use on 3-pole and 4-pole breakers.

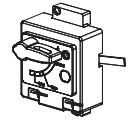

RHFESDEM

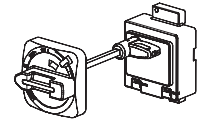

RHVE64X

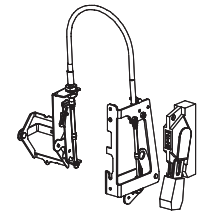

Flex Operator Kit

VL Circuit Breakers

Trip Unit Overview

Selection

The interchangeability of the VL circuit breaker trip units allow for easy conversion from any of 3 types of protection. They are thermal-magnetic, electronic, or electronic with a built-in LCD display. The thermal-magnetic trip unit features an adjustable magnetic trip setting. The electronic trip units are microprocessor based true RMS sensing devices and are available with a variety of adjustable trip settings, configurations, and infor-

mation menus. With precise control over the circuit breaker functions and access to system status, diagnostics, and information, these trip units allow for unsurpassed flexibility in circuit coordination.

An example of coordination is the out of the box Ground Fault function on the Model 555 trip units. The pick-up and time delay settings are set at the

factory for each frame and do not overlap with the settings on the other frames. Therefore, when VL breakers are used together in a system the GF protection is automatically coordinated. The user also has the ability to program a custom coordination scheme with adjustable settings on both the 555 and 586 trip units.

| Trip Unit Functions | VL Trip Units | | | | | | | |
|--------------------------------------|------------------|---------------|----------------|----------------|-----------------|-------------------------|--------------------------|--|
| | Model 525 | Model 555 | | | | Model 586 | | |
| | Thermal-magnetic | Electronic LI | Electronic LIG | Electronic LSI | Electronic LSIG | Electronic with LCD LSI | Electronic with LCD LSIG | Electronic with LCD LSI + G alarm only |
| Continuous Current Setting (I_r) | Fixed | ◆ | ◆ | ◆ | ◆ | ◆ | ◆ | ◆ |
| Long Time Delay (t_r) | □ | ◆ | ◆ | ◆ | ◆ | ◆ | ◆ | ◆ |
| Instantaneous Function | ● | ● | ● | ● | ● | (ON/OFF) | (ON/OFF) | (ON/OFF) |
| Instantaneous Pickup (I_i) | ◆ | ◆ | ◆ | ◆ | ◆ | ◆ | ◆ | ◆ |
| Short Time Function | □ | □ | □ | ● | ● | (ON/OFF) | (ON/OFF) | (ON/OFF) |
| Short Time Pick-up (I_{sd}) | □ | □ | □ | ◆ | ◆ | ◆ | ◆ | ◆ |
| Short Time Delay (t_{sd}) | □ | □ | □ | ◆ | ◆ | ◆ | ◆ | ◆ |
| Ground Fault Pick-up (I_g) | □ | □ | ◆ | □ | ◆ | □ | ◆ | □ |
| Ground Fault Delay (t_g) | □ | □ | ◆ | □ | ◆ | □ | ◆ | □ |
| Ground Fault Alarm Pick-up | □ | □ | □ | □ | □ | □ | ◆ | ◆ |
| Ground Fault Alarm Delay | □ | □ | □ | □ | □ | □ | ◆ | ◆ |
| Alarm & Status Indicator | □ | ● | ● | ● | ● | ● | ● | ● |
| Built-in Display (LCD) | □ | □ | □ | □ | □ | ● | ● | ● |
| Pre-Trip Alarm ^① | □ | ● | ● | ● | ● | ● | ● | ● |
| Last Trip Information ^① | □ | ● | ● | ● | ● | ● | ● | ● |
| Zone Selective ^① | □ | ● | ● | ● | ● | ● | ● | ● |
| Communications ^① | □ | ● | ● | ● | ● | ● | ● | ● |

◆ Adjustable setting
 ● This feature is included
 □ Feature is not included.
 ① Requires a COMPRO20 or COMMOD21 module in a communication system.

Continuous Amps Rating (I_r)

This setting is the continuous current that the breaker will carry without tripping. It can be set up to 100% of the trip unit's nominal rating (I_n).

Long Time Delay (t_r)

Sometimes referred to as the "overload" position, this function controls the breaker's "pause-in-tripping" time. It allows low level, temporary inrush currents such as those encountered when starting a motor to pass without tripping. The time delay begins when the current reaches $6 \times I_r$.

Instantaneous Pick-up (I_i)

This function sets the breaker to trip instantaneously during high fault conditions. This function may be turned off on Model 586 trip units.

Short Time Pick-Up (I_{sd})

This function controls the level of fault current the breaker will carry for a short time without tripping, thus allowing downstream devices to clear short circuits ahead of up-stream protection. It may be defeated (turned-off) on Model 586 trip units.

Short Time Delay (t_{sd})

This controls the interval of time the breaker will remain closed against a fault (at the Short Time Pick-up current level) without tripping. The time delay may be set at fixed points or at short time intervals based on I^2t curves. This function is used with the Short Time Pick-up to achieve selectivity and better system coordination.

Ground Fault Pick-Up (I_g)

This setting controls the level of ground fault current that will cause the breaker to trip. Model 555 Electronic Trip Units act on the residual current to sense ground current. The Model 586 Electronic Trip Unit is programmable and allows the user to select either the residual current method or direct detection (via a separate current transformer) to detect ground current.

Ground Fault Time Delay (t_g)

This controls the interval of time the breaker will remain closed after a ground fault is detected (at the Ground Fault Pick-up current level) without tripping.

5
MOLDED CASE
CIRCUIT BREAKERS

VL Circuit Breakers

General Information

Selection

Thermal-Magnetic trip units, Model 525, combine the inverse time element design for low level overloads, and instantaneous magnetic action for short circuit protection. The standard unit has preset overload protection and an adjustable instantaneous trip setting, with 6 set points. Thermal-Magnetic trip units are available throughout the VL family, from 30 to 1600A.

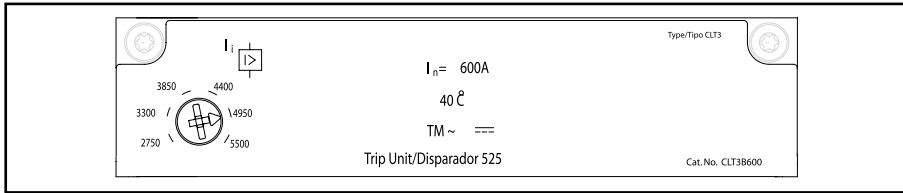

Electronic Trip Units

Electronic trip units are available through the VL family, from 60A (which can be set as low as 30A) up through 1600A. They are also available in four trip configurations (LI, LIG, LSI, LSIG) and features can include a built-in LCD display.

microprocessor is in operating and another indicates an overload condition. For ease-of-use and to insure proper coordination, the set points for the continuous current are shown on the face of these trip units in amps.

On the Model 555 Electronic Trip Unit a flashing LED confirms that the

On the Model 586, the LCD version, the current in each phase is continuously shown on the display. Unlike many

displays, no secondary or auxiliary voltage is required as long as the breaker is energized and a minimal load current is present. These trip units can also indicate the "last trip" status (date, time, amps) when they're connected to a PC via one of our communications modules. Without being connected via a communication module, the last trip status can be viewed on Model 586 trip units (no time stamp).

5
MOLDED CASE
CIRCUIT BREAKERS

Typical Trip Unit Labeling and Adjustment Positions

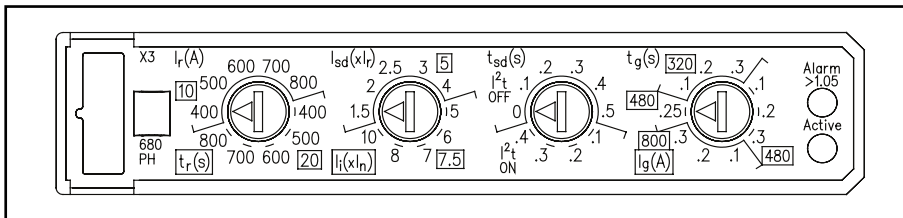

Model 555 Electronic Trip Unit with LSIG trip functions

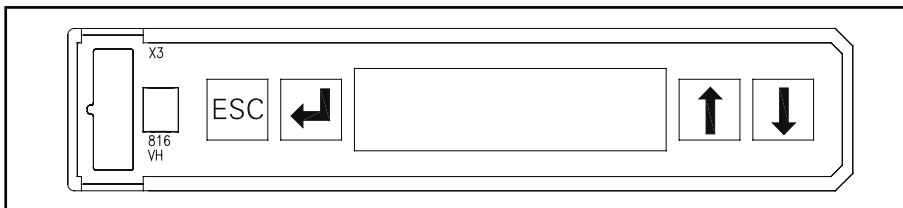

Model 586 Electronic Trip Unit has an LCD display

VL Circuit Breakers

DG 150A Frame, VL Series

Selection

Ordering Information

Complete Assembled Breaker

A complete factory assembled DG breaker includes the frame, trip unit, and standard line and load connectors, all factory installed and shipped as a complete breaker. Assembled breakers are only available with standard connectors.

For any other configuration, order the frame, trip unit, and terminals as separate items.

For DC applications, use thermal magnetic trip unit only.

For reverse feed applications, select non-interchangeable trip breakers only. For non-interchangeable trip breakers, change the third digit of the catalogue number to "X" for standard breakers.

For special applications, refer to page 5-155.

Mounting hardware is included with each frame or complete breaker.

For 100% rated breakers with a non-interchangeable trip unit, change the 3rd character of the catalogue number to "Y". Available in electronic and electronic with LCD only.

HACR rated.



Interrupting Ratings

| Breaker Type | RMS Symmetrical Amperes (KA) | | | | | | | | | | |
|--------------|------------------------------|-----|-----|----------|-----------------|---------------------|-----------------|-----------------|-----------------|-----------------|---|
| | UL 489 | | | | | IEC 60947-2 | | | | | |
| | Volts AC (50/60 Hz) | | | Volts DC | | Volts AC (50/60 Hz) | | | | | |
| | 240 | 480 | 600 | 250 | 500 | 220/240 | | 380/415 | | 690 | |
| | | | | | I _{co} | I _{cs} | I _{co} | I _{cs} | I _{co} | I _{cs} | |
| NDGA | 65 | 35 | 18 | 30 | 18 | 65 | 65 | 40 | 40 | 12 | 6 |
| HDGA | 100 | 65 | 20 | 30 | 18 | 100 | 75 | 70 | 70 | 12 | 6 |
| LDGA | 200 | 100 | 25 | 30 | 18 | 200 | 150 | 100 | 75 | 12 | 6 |

Connectors for 75°C Wire

| Construction | Ampere Rating | Wire Range | No. of cables per connector | Catalogue Number |
|-------------------|---------------|-----------------------|-----------------------------|------------------------|
| Steel | 30-150 | #8-1/0 Cu | 1 | 3TW1DG20 ^② |
| Aluminum | 30-150 | #6-3/0 Al/Cu | 1 | 3TA1DG30 ^{①②} |
| Copper | 30-150 | #6-3/0 Cu | 1 | 3TC1DG30 ^{②④} |
| Distribution Lugs | | | | |
| | 30-150 | #14-#2 Cu (3pcs. Max) | 3 | 3TA3DG02 ^② |
| | 30-150 | #14-#4 Cu | 6 | 3TA6DG04 ^② |
| Compression Lugs | | | | |
| | 30-150 | #14-2/0 kcmil Al/Cu | - | 2CLD20 ^③ |
| | 30-150 | #14-2/0 kcmil Al/Cu | - | 3CLD20 ^② |

① Standard connector supplied with complete breakers.

② Kit consists of 3 terminal connectors.

③ 2 Lugs for 2-pole breakers.

④ Required for 100% rated DG breakers. Requires 90°C cable sized at 75°C ampacity

DG Thermal-Magnetic, Instantaneous Trip Adjustment Range

| Trip Unit Continuous Amp Rating (I _c) | Instantaneous Overcurrent Setting (I _i) | |
|---|---|------|
| | Min. | Max. |
| 50 | 450 | 700 |
| 60 | 450 | 700 |
| 70 | 450 | 700 |
| 80 | 450 | 800 |
| 90 | 500 | 1000 |
| 100 | 500 | 1000 |
| 110 | 550 | 1100 |
| 125 | 625 | 1250 |
| 150 | 800 | 1600 |

Note: Each breaker has 6 trip settings in this range.

Dimensions - Inches (mm)

| Number of Poles | Width | Length | Depth | To Handle D1 |
|-----------------|-----------|-----------|----------|--------------|
| 2, 3 | 4.1 (105) | 6.9 (175) | 3.4 (81) | 4.2(107) |

Approx. Shipping Weight, lbs. (kg)

| Poles | Frame | Trip Unit | | Complete Breaker |
|-------|-----------|--------------|------------|------------------|
| | | Thermal-Mag. | Electronic | |
| 2, 3 | 3.7 (1.7) | 2.2 (1.0) | 2.6 (1.2) | 5.9 (2.7) |

5 MOLDED CASE CIRCUIT BREAKERS

External Accessories page 5-137

VL Circuit Breakers

DG 150A Thermal-Magnetic Trip Unit

Selection

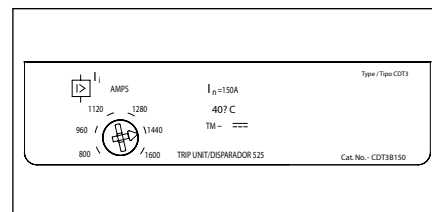

Model 525 Trip Unit

DG 150A Frame 2-Pole with Thermal-Magnetic Trip Unit

| Continuous Ampere Rating | N-Interrupting Class | H-Interrupting Class | L-Interrupting Class | Catalogue Number |
|--|----------------------|----------------------|----------------------|------------------|
| | Catalogue Number | Catalogue Number | Catalogue Number | |
| | FRAME ONLY | | | |
| | NDG2F150 | HDG2F150 | LDG2F150 | |
| COMPLETE FACTORY ASSEMBLED CIRCUIT BREAKER | | | | TRIP UNIT ONLY |
| 50 | NDG2B050L | HDG2B050L | LDG2B050L | CDT2B050 |
| 60 | NDG2B060L | HDG2B060L | LDG2B060L | CDT2B060 |
| 70 | NDG2B070L | HDG2B070L | LDG2B070L | CDT2B070 |
| 80 | NDG2B080L | HDG2B080L | LDG2B080L | CDT2B080 |
| 90 | NDG2B090L | HDG2B090L | LDG2B090L | CDT2B090 |
| 100 | NDG2B100L | HDG2B100L | LDG2B100L | CDT2B100 |
| 110 | NDG2B110L | HDG2B110L | LDG2B110L | CDT2B110 |
| 125 | NDG2B125L | HDG2B125L | LDG2B125L | CDT2B125 |
| 150 | NDG2B150L | HDG2B150L | LDG2B150L | CDT2B150 |

DG 150A Frame 3-Pole with Thermal-Magnetic Trip Unit

| Continuous Ampere Rating | N-Interrupting Class | H-Interrupting Class | L-Interrupting Class | Catalogue Number |
|--|----------------------|----------------------|----------------------|------------------|
| | Catalogue Number | Catalogue Number | Catalogue Number | |
| | FRAME ONLY | | | |
| | NDG3F150 | HDG3F150 | LDG3F150 | |
| COMPLETE FACTORY ASSEMBLED CIRCUIT BREAKER | | | | TRIP UNIT ONLY |
| 50 | NDG3B050L | HDG3B050L | LDG3B050L | CDT3B050 |
| 60 | NDG3B060L | HDG3B060L | LDG3B060L | CDT3B060 |
| 70 | NDG3B070L | HDG3B070L | LDG3B070L | CDT3B070 |
| 80 | NDG3B080L | HDG3B080L | LDG3B080L | CDT3B080 |
| 90 | NDG3B090L | HDG3B090L | LDG3B090L | CDT3B090 |
| 100 | NDG3B100L | HDG3B100L | LDG3B100L | CDT3B100 |
| 110 | NDG3B110L | HDG3B110L | LDG3B110L | CDT3B110 |
| 125 | NDG3B125L | HDG3B125L | LDG3B125L | CDT3B125 |
| 150 | NDG3B150L | HDG3B150L | LDG3B150L | CDT3B150 |

VL Circuit Breakers

DG 150A Electronic 3-Knob & LCD Trip Units

Selection

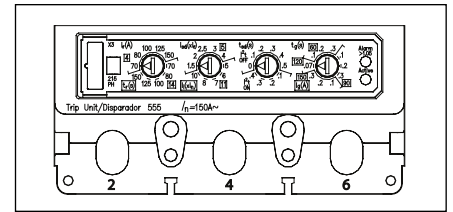
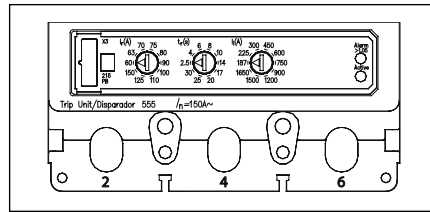

Model 555 Trip Units

DG 150A Frame 3-Pole Electronic Trip Unit^①

| Continuous Ampere Rating | N-Interrupting Class | H-Interrupting Class | L-Interrupting Class | Catalogue Number |
|--|----------------------|----------------------|----------------------|------------------|
| | Catalogue Number | Catalogue Number | Catalogue Number | |
| | FRAME ONLY | | | |
| | NDG3F150 | HDG3F150 | LDG3F150 | |
| COMPLETE FACTORY ASSEMBLED CIRCUIT BREAKER | | | | TRIP UNIT ONLY |
| ELECTRONIC LI TRIP | | | | |
| 60 | NDG3R060L | HDG3R060L | LDG3R060L | CDT3R060 |
| 100 | NDG3R100L | HDG3R100L | LDG3R100L | CDT3R100 |
| 150 | NDG3R150L | HDG3R150L | LDG3R150L | CDT3R150 |
| ELECTRONIC LSI TRIP | | | | |
| 60 | NDG3T060L | HDG3T060L | LDG3T060L | CDT3T060 |
| 100 | NDG3T100L | HDG3T100L | LDG3T100L | CDT3T100 |
| 150 | NDG3T150L | HDG3T150L | LDG3T150L | CDT3T150 |
| ELECTRONIC LSIG TRIP | | | | |
| 60 | NDG3V060L | HDG3V060L | LDG3V060L | CDT3V060 |
| 100 | NDG3V100L | HDG3V100L | LDG3V100L | CDT3V100 |
| 150 | NDG3V150L | HDG3V150L | LDG3V150L | CDT3V150 |
| ELECTRONIC LIG TRIP | | | | |
| 60 | NDG3W060L | HDG3W060L | LDG3W060L | CDT3W060 |
| 100 | NDG3W100L | HDG3W100L | LDG3W100L | CDT3W100 |
| 150 | NDG3W150L | HDG3W150L | LDG3W150L | CDT3W150 |

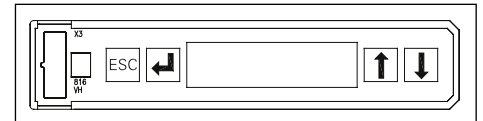

Model 586 Trip Unit

DG 150A Frame 3-Pole Electronic LCD Trip Unit^①

| Continuous Ampere Rating | N-Interrupting Class | H-Interrupting Class | L-Interrupting Class | Catalogue Number |
|--|----------------------|----------------------|----------------------|------------------|
| | Catalogue Number | Catalogue Number | Catalogue Number | |
| | FRAME ONLY | | | |
| | NDG3F150 | HDG3F150 | LDG3F150 | |
| COMPLETE FACTORY ASSEMBLED CIRCUIT BREAKER | | | | TRIP UNIT ONLY |
| LCD ELECTRONIC LSI TRIP | | | | |
| 60 | NDG3A060L | HDG3A060L | LDG3A060L | CDT3A060 |
| 100 | NDG3A100L | HDG3A100L | LDG3A100L | CDT3A100 |
| 150 | NDG3A150L | HDG3A150L | LDG3A150L | CDT3A150 |
| LCD ELECTRONIC LSIG TRIP | | | | |
| 60 | NDG3G060L | HDG3G060L | LDG3G060L | CDT3G060 |
| 100 | NDG3G100L | HDG3G100L | LDG3G100L | CDT3G100 |
| 150 | NDG3G150L | HDG3G150L | LDG3G150L | CDT3G150 |
| LCD ELECTRONIC LSI + GF ALARM ONLY | | | | |
| 60 | NDG3K060L | HDG3K060L | LDG3K060L | CDT3K060 |
| 100 | NDG3K100L | HDG3K100L | LDG3K100L | CDT3K100 |
| 150 | NDG3K150L | HDG3K150L | LDG3K150L | CDT3K150 |

^① Due to the location of the magnetic tripping solenoid, the left accessory pocket is not available for accessories.

5 MOLDED CASE CIRCUIT BREAKERS

VL Circuit Breakers

Internal Accessories for DG 150A and FG 250A Frames

Selection

Auxiliary Switch and Alarm Switch Combination Kits

| Description | Mounting Pocket ^① | Catalogue Number |
|--|------------------------------|------------------|
| 1 Alarm Switch 1A/B ^② Bases AMBL2 & AMBL3 | Left, Right ^② | ASKL1 |
| 2 Aux. Switches 1A + 1B Bases AMBL1 | Left, Right | ASKL2 |
| 2 Aux. + 1 Alarm Switch 1A + 1B, 1A/B ^② Bases AMBL2 & AMBL3 | Left, Right ^② | ASKL3 |

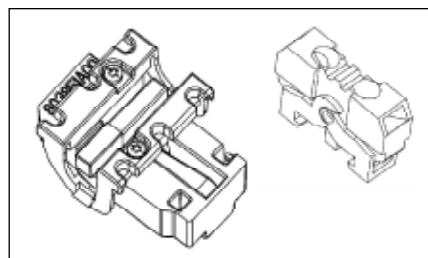

Auxiliary/Alarm Switch Mounting Base Only

| Description | Mounting Pocket | Catalogue Number |
|----------------------------|-------------------|------------------|
| Up to 3 Auxiliary Switches | Left, Right | AMBL1 |
| 2 Aux. + 1 Alarm Switch | Left Pocket Only | AMBL2 |
| 2 Aux. + 1 Alarm Switch | Right Pocket Only | AMBL3 |

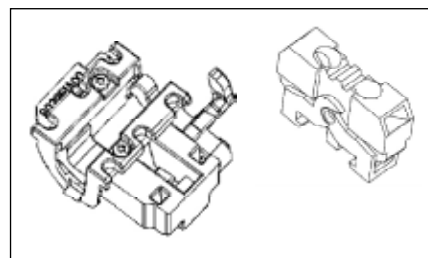

Auxiliary/Alarm Switch Only

Common to DG - PG Frames

| Description | Catalogue Number |
|--------------------------------|------------------|
| 1 Normally Open Contact (1A) | ASWPA |
| 1 Normally Closed Contact (1B) | ASWPB |

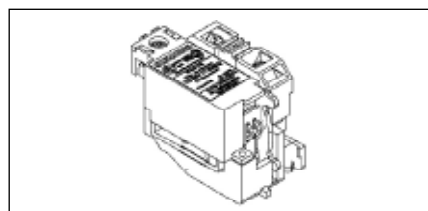

Shunt Trips

| Description | Mounting Pocket | Catalogue Number |
|-------------|-------------------|------------------|
| 24 VDC | Right Pocket Only | STRLB24DC |
| 48-60 VDC | | STRLC60DC |
| 110-127 VDC | | STRLD125DC |
| 220-250 VDC | | STRLE250DC |
| 48-60 VAC | | STRLM60 |
| 110-127 VAC | | STRLN120 |
| 208-277 VAC | | STRLS277 |
| 380-600 VAC | | STRLV600 |

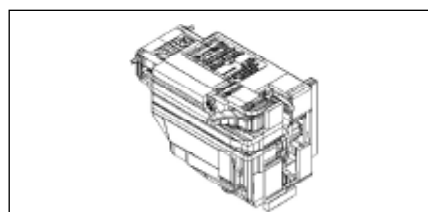

Undervoltage Release

| Description | Mounting Pocket | Catalogue Number |
|-------------|-------------------|------------------|
| 12 VDC | Right Pocket Only | UVRLA12DC |
| 24 VDC | | UVRLB24DC |
| 48 VDC | | UVRLC48DC |
| 60 VDC | | UVRLG60DC |
| 110-127 VDC | | UVRLD125DC |
| 220-250 VDC | | UVRLE250DC |
| 24 VAC | | UVRL24 |
| 110-127 VAC | | UVRLN120 |
| 220-240 VAC | | UVRLR240 |
| 208 VAC | | UVRLP208 |
| 277 VAC | | UVRLS277 |
| 380-415 VAC | | UVRLT415 |
| 440-480 VAC | | UVRLU480 |

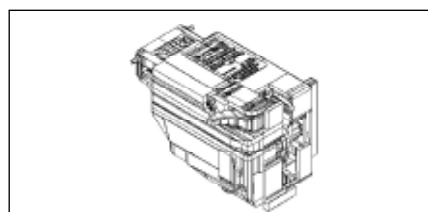

'A' refers to a normally open contact (open when the breaker contacts are open).

'B' refers to a normally closed contact (closed when the breaker contacts are open).

① Refer to the "Accessory Locations" chart for guidelines and limitations about which pockets may be used for accessory combinations.

② These kits include two bases, one for mounting switches in the left pocket and another for mounting in the right.

③ Includes 1A and 1B contact for alarm purposes, only one of which may be installed at any time.

VL Circuit Breakers

FG 250A Frame, VL Series

Selection/Dimensions

Ordering Information

Complete Assembled Breaker

A complete factory assembled FG breaker includes the frame, trip unit, and standard line and load connectors, all factory installed and shipped as a complete breaker. Assembled breakers are available only with standard connectors.

For any other configuration, order the frame, trip unit, and terminals as separate items.

For DC applications, use thermal magnetic trip unit only.

For reverse feed applications, select non-interchangeable trip breakers only. For non-interchangeable trip breakers, change the third digit of the catalogue number to "X" for standard breakers.

For special applications, refer to page 5-155.

Mounting hardware is included with each frame or complete breaker. HACR rated.



Dimensions - Inches (mm)

| Number of Poles | Width | Length | Depth | To Handle D1 |
|-----------------|-----------|-----------|----------|--------------|
| 2, 3 | 4.1 (105) | 6.9 (175) | 3.4 (81) | 4.2 (107) |

Shipping Weight, lbs. (kg)

| Poles | Frame | Trip Unit | | Complete Breaker |
|-------|-----------|--------------|------------|------------------|
| | | Thermal-Mag. | Electronic | |
| 2, 3 | 4.0 (1.8) | 2.2 (1.0) | 2.6 (1.2) | 6.2 (2.8) |

Interrupting Ratings

| Interrupting Class | Breaker Type | RMS Symmetrical Amperes (KA) | | | | | | | | | | |
|--------------------|--------------|------------------------------|-----|-----|----------|-----|---------------------|---------|-----|-----------------|-----------------|---|
| | | UL 489 | | | | | IEC 60947-2 | | | | | |
| | | Volts AC (50/60 Hz) | | | Volts DC | | Volts AC (50/60 Hz) | | | 690 | | |
| | | 240 | 480 | 600 | 250 | 500 | 220/240 | 380/415 | 690 | I _{cs} | I _{cs} | |
| N | NFGA | 65 | 35 | 18 | 30 | 18 | 65 | 65 | 40 | 40 | 12 | 6 |
| H | HFGA | 100 | 65 | 20 | 30 | 25 | 100 | 75 | 70 | 70 | 12 | 6 |
| L | LFGA | 200 | 100 | 25 | 30 | 30 | 200 | 150 | 100 | 75 | 12 | 6 |

Connectors for 75°C Wire

| Construction | Ampere Rating | Wire Range | No. of cables per connector | Catalogue Number |
|-------------------|---------------|--------------------|-----------------------------|--------------------------|
| Steel | 50-250 | #4-350 kcmil Cu | 1 | 3TW1FG350 ^② |
| Aluminum | 50-250 | #4-350 kcmil Al/Cu | 1 | 3TAW1FG350 ^{①②} |
| Copper | 50-250 | #4-350 kcmil Cu | 1 | 3TCW1FG350 ^② |
| Distribution Lugs | | | | |
| | 50-250 | #14-2/0 Cu | 3 | 3TA3FG20 ^② |
| | 50-250 | #14-#4 Cu | 6 | 3TA6FG04 ^② |
| Compression Lugs | | | | |
| | 50-250 | #4-350 Al/Cu | 1 | 3CLF350 ^② |

① Standard connector supplied with complete breakers.

② Kit consists of 3 terminal connectors.

FG Thermal-Magnetic, Instantaneous Trip Adjustment Range

| Trip Unit Continuous Amp Rating (I _n) | Instantaneous Overcurrent Setting (I) | |
|---|---------------------------------------|------|
| | Min. | Max. |
| 100 | 625 | 1250 |
| 110 | 800 | 1600 |
| 125 | 800 | 1600 |
| 150 | 800 | 1600 |
| 175 | 1000 | 2000 |
| 200 | 1000 | 2000 |
| 225 | 1250 | 2500 |
| 250 | 1250 | 2500 |

Note: Each breaker has 6 trip settings in this range.

5
MOLDED CASE
CIRCUIT BREAKERS

External Accessories page 5-137

VL Circuit Breakers

FG 250A Thermal-Magnetic Trip Unit

Selection

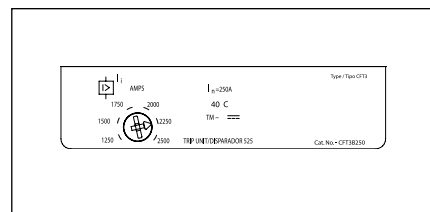

Model 525 Trip Unit

FG 250A Frame 2-Pole with Thermal-Magnetic Trip Unit

| Continuous Ampere Rating | N-Interrupting Class | H-Interrupting Class | L-Interrupting Class | Catalogue Number |
|-----------------------------|--|----------------------|----------------------|------------------|
| | Catalogue Number | Catalogue Number | Catalogue Number | |
| | FRAME ONLY | | | |
| | NFG2F250 | HFG2F250 | LFG2F250 | |
| | COMPLETE FACTORY ASSEMBLED CIRCUIT BREAKER | | | |
| | TRIP UNIT ONLY | | | |
| 100 | NFG2B100L | HFG2B100L | LFG2B100L | CFT2B100 |
| 110 | NFG2B110L | HFG2B110L | LFG2B110L | CFT2B110 |
| 125 | NFG2B125L | HFG2B125L | LFG2B125L | CFT2B125 |
| 150 | NFG2B150L | HFG2B150L | LFG2B150L | CFT2B150 |
| 175 | NFG2B175L | HFG2B175L | LFG2B175L | CFT2B175 |
| 200 | NFG2B200L | HFG2B200L | LFG2B200L | CFT2B200 |
| 225 | NFG2B225L | HFG2B225L | LFG2B225L | CFT2B225 |
| 250 | NFG2B250L | HFG2B250L | LFG2B250L | CFT2B250 |

5
MOLDED CASE
CIRCUIT BREAKERS

FG 250A Frame 3-Pole with Thermal-Magnetic Trip Unit

| Continuous Ampere Rating | N-Interrupting Class | H-Interrupting Class | L-Interrupting Class | Catalogue Number |
|-----------------------------|--|----------------------|----------------------|------------------|
| | Catalogue Number | Catalogue Number | Catalogue Number | |
| | FRAME ONLY | | | |
| | NFG3F250 | HFG3F250 | LFG3F250 | |
| | COMPLETE FACTORY ASSEMBLED CIRCUIT BREAKER | | | |
| | TRIP UNIT ONLY | | | |
| 100 | NFG3B100L | HFG3B100L | LFG3B100L | CFT3B100 |
| 110 | NFG3B110L | HFG3B110L | LFG3B110L | CFT3B110 |
| 125 | NFG3B125L | HFG3B125L | LFG3B125L | CFT3B125 |
| 150 | NFG3B150L | HFG3B150L | LFG3B150L | CFT3B150 |
| 175 | NFG3B175L | HFG3B175L | LFG3B175L | CFT3B175 |
| 200 | NFG3B200L | HFG3B200L | LFG3B200L | CFT3B200 |
| 225 | NFG3B225L | HFG3B225L | LFG3B225L | CFT3B225 |
| 250 | NFG3B250L | HFG3B250L | LFG3B250L | CFT3B250 |

VL Circuit Breakers

FG 250A Electronic 3-Knob & LCD Trip Units

Selection

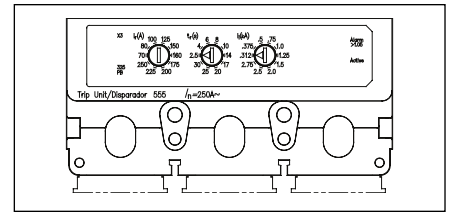
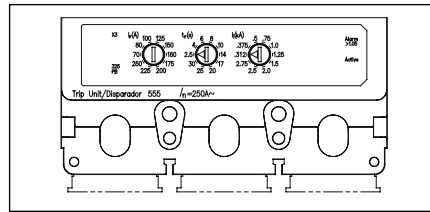

Model 555 Trip Units

FG 250A Frame 3-Pole Electronic Trip Unit^①

| Continuous Ampere Rating | N-Interrupting Class | H-Interrupting Class | L-Interrupting Class | Catalogue Number |
|--|----------------------|----------------------|----------------------|------------------|
| | Catalogue Number | Catalogue Number | Catalogue Number | |
| | FRAME ONLY | | | |
| | NFG3F250 | HFG3F250 | LFG3F250 | |
| COMPLETE FACTORY ASSEMBLED CIRCUIT BREAKER | | | | TRIP UNIT ONLY |
| ELECTRONIC LI TRIP | | | | |
| 100 | NFG3R100L | HFG3R100L | LFG3R100L | CFT3R100 |
| 150 | NFG3R150L | HFG3R150L | LFG3R150L | CFT3R150 |
| 250 | NFG3R250L | HFG3R250L | LFG3R250L | CFT3R250 |
| ELECTRONIC LSI TRIP | | | | |
| 100 | NFG3T100L | HFG3T100L | LFG3T100L | CFT3T100 |
| 150 | NFG3T150L | HFG3T150L | LFG3T150L | CFT3T150 |
| 250 | NFG3T250L | HFG3T250L | LFG3T250L | CFT3T250 |
| ELECTRONIC LSIG TRIP | | | | |
| 100 | NFG3V100L | HFG3V100L | LFG3V100L | CFT3V100 |
| 150 | NFG3V150L | HFG3V150L | LFG3V150L | CFT3V150 |
| 250 | NFG3V250L | HFG3V250L | LFG3V250L | CFT3V250 |
| ELECTRONIC LIG TRIP | | | | |
| 100 | NFG3W100L | HFG3W100L | LFG3W100L | CFT3W100 |
| 150 | NFG3W150L | HFG3W150L | LFG3W150L | CFT3W150 |
| 250 | NFG3W250L | HFG3W250L | LFG3W250L | CFT3W250 |

5
MOLDED CASE
CIRCUIT BREAKERS

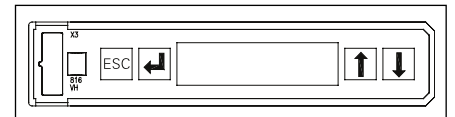

Model 586 Trip Unit

FG 250A Frame 3-Pole Electronic LCD Trip Unit^①

| Continuous Ampere Rating | N-Interrupting Class | H-Interrupting Class | L-Interrupting Class | Catalogue Number |
|--|----------------------|----------------------|----------------------|------------------|
| | Catalogue Number | Catalogue Number | Catalogue Number | |
| | FRAME ONLY | | | |
| | NFG3F250 | HFG3F250 | LFG3F250 | |
| COMPLETE FACTORY ASSEMBLED CIRCUIT BREAKER | | | | TRIP UNIT ONLY |
| LCD ELECTRONIC LSI TRIP | | | | |
| 100 | NFG3A100L | HFG3A100L | LFG3A100L | CFT3A100 |
| 150 | NFG3A150L | HFG3A150L | LFG3A150L | CFT3A150 |
| 250 | NFG3A250L | HFG3A250L | LFG3A250L | CFT3A250 |
| LCD ELECTRONIC LSIG TRIP | | | | |
| 100 | NFG3G100L | HFG3G100L | LFG3G100L | CFT3G100 |
| 150 | NFG3G150L | HFG3G150L | LFG3G150L | CFT3G150 |
| 250 | NFG3G250L | HFG3G250L | LFG3G250L | CFT3G250 |
| LCD ELECTRONIC LSI TRIP + GF ALARM ONLY | | | | |
| 100 | NFG3K100L | HFG3K100L | LFG3K100L | CFT3K100 |
| 150 | NFG3K150L | HFG3K150L | LFG3K150L | CFT3K150 |
| 250 | NFG3K250L | HFG3K250L | LFG3K250L | CFT3K250 |

① Due to the location of the magnetic tripping solenoid, the left accessory pocket is not available for accessories.

VL Circuit Breakers

Internal Accessories for DG 150A and FG 250A Frames

Selection

Auxiliary Switch and Alarm Switch Combination Kits

| Description | Mounting Pocket ^① | Catalogue Number |
|--|------------------------------|------------------|
| 1 Alarm Switch 1A/B ^③ Bases AMBL2 & AMBL3 | Left, Right ^② | ASKL1 |
| 2 Aux. Switches 1A + 1B Bases AMBL1 | Left, Right | ASKL2 |
| 2 Aux. + 1 Alarm Switches 1A + 1B, 1A/B ^③ Bases AMBL2 & AMBL3 | Left, Right ^② | ASKL3 |

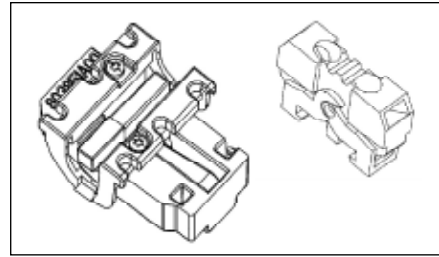

Auxiliary/Alarm Switch Mounting Base Only

| Description | Mounting Pocket | Catalogue Number |
|----------------------------|-------------------|------------------|
| Up to 3 Auxiliary Switches | Left, Right | AMBL1 |
| 2 Aux. + 1 Alarm Switch | Left Pocket Only | AMBL2 |
| 2 Aux. + 1 Alarm Switch | Right Pocket Only | AMBL3 |

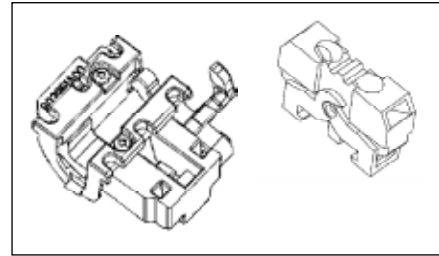

Auxiliary/Alarm Switch Only

Common to DG - PG Frames

| Description | Catalogue Number |
|--------------------------------|------------------|
| 1 Normally Open Contact (1A) | ASWPA |
| 1 Normally Closed Contact (1B) | ASWPB |

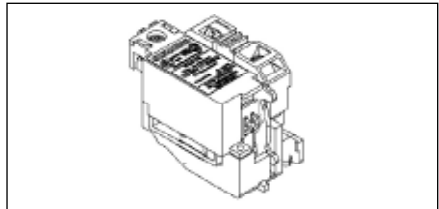

Shunt Trips

| Description | Mounting Pocket | Catalogue Number |
|-------------|-------------------|------------------|
| 24 VDC | Right Pocket Only | STRLB24DC |
| 48-60 VDC | | STRLC60DC |
| 110-127 VDC | | STRLD125DC |
| 220-250 VDC | | STRLE250DC |
| 48-60 VAC | | STRLM60 |
| 110-127 VAC | | STRLN120 |
| 208-277 VAC | | STRLS277 |
| 380-600 VAC | | STRLV600 |

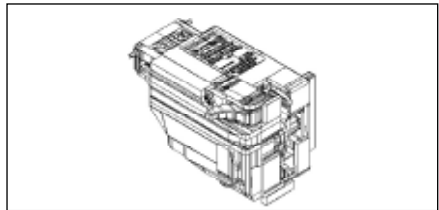

Undervoltage Release

| Description | Mounting Pocket | Catalogue Number |
|-------------|-------------------|------------------|
| 12 VDC | Right Pocket Only | UVRLA12DC |
| 24 VDC | | UVRLB24DC |
| 48 VDC | | UVRLC48DC |
| 60 VDC | | UVRLG60DC |
| 110-127 VDC | | UVRLD125DC |
| 220-250 VDC | | UVRLE250DC |
| 24 VAC | | UVRL24 |
| 110-127 VAC | | UVRLN120 |
| 220-240 VAC | | UVRLR240 |
| 208 VAC | | UVRLP208 |
| 277 VAC | | UVRLS277 |
| 380-415 VAC | | UVRLT415 |
| 440-480 VAC | | UVRLU480 |

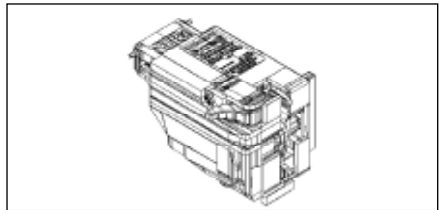

① Refer to the "Accessory Locations" chart for guidelines and limitations about which pockets may be used for accessory combinations.
 ② These kits include two bases, one for mounting switches in the left pocket and another for mounting in the right.
 ③ Includes 1A and 1B contact for alarm purposes, only one of which may be installed at any time.
 'A' refers to a normally open contact (open when the breaker contacts are open).
 'B' refers to a normally closed contact (closed when the breaker contacts are open).

External Accessories page 5-137

VL Circuit Breakers

JG 400A Frame, VL Series

Selection/Dimensions

| Ordering Information | |
|--|--|
| Complete Assembled Breaker | |
| A complete factory assembled JG breaker includes the frame, trip unit, and standard line and load connectors, all factory installed and shipped as a complete breaker. Assembled breakers are available only with standard connectors. | |
| For any other configuration, order the frame, trip unit, and terminals as separate items. | |
| For DC applications, use thermal magnetic trip unit only. | |
| For reverse feed applications, select non-interchangeable trip breakers only. | |
| For non-interchangeable trip breakers, change the third digit of the catalogue number to "X" for standard breakers. | |
| For 100% rated breakers with a non-interchangeable trip unit, change the 3 rd character of the catalogue number to "Y". | |
| For special applications, refer to page 5-155. | |
| Mounting hardware is included with each frame or complete breaker. | |
| HACR rated. | |



Dimensions - Inches (mm)

| Number of Poles | Width | Length | Depth | To Handle D1 |
|-----------------|-----------|----------|-----------|--------------|
| 2, 3 | 5.5 (139) | 11 (279) | 4.2 (102) | 5.4 (138) |

Interrupting Ratings

| Interrupting Class | Breaker Type | RMS Symmetrical Amperes (KA) | | | | | | | | | | |
|--------------------|--------------|------------------------------|-----|-----|----------|-----------------|---------------------|-----------------|-----------------|-----------------|-----------------|---|
| | | UL 489 AIR (File E10848) | | | | | IEC 60947-2 | | | | | |
| | | Volts AC (50/60 Hz) | | | Volts DC | | Volts AC (50/60 Hz) | | | | | |
| | | 240 | 480 | 600 | 250 | 500 | 220/240 | | 380/415 | | 690 | |
| | | | | | | I _{av} | I _{cs} | I _{av} | I _{cs} | I _{av} | I _{cs} | |
| N | NJGA | 65 | 35 | 25 | 30 | 25 | 65 | 65 | 45 | 45 | 12 | 6 |
| H | HJGA | 100 | 65 | 25 | 30 | 35 | 100 | 75 | 70 | 70 | 15 | 8 |
| L | LJGA | 200 | 100 | 25 | 30 | 35 | 200 | 150 | 100 | 75 | 15 | 8 |

Shipping Weight, lbs. (kg)

| Poles | Frame | Trip Unit | | Complete Breaker |
|-------|-----------|--------------|------------|------------------|
| | | Thermal-Mag. | Electronic | |
| 2, 3 | 9.3 (4.2) | 4.0 (1.8) | 4.0 (1.8) | 12.6 (5.7) |

Connectors for 75°C Wire

| Construction | Ampere Rating | Wire Range | No. of cables per connector | Catalogue Number |
|-------------------|---------------|---------------------|-----------------------------|-------------------------|
| Steel | 70-400 | 1/0-600 kcmil Cu | 1 | 3TW1JG600 ^② |
| Aluminum | 70-400 | 3/0-250 kcmil Al/Cu | 2 | 3TA2JG250 ^{①②} |
| Aluminum | 70-400 | 250-750 kcmil Al | 1 | 3TA1JG750 ^② |
| Aluminum | 70-400 | 3/0-600 kcmil Cu | 1 | 3TA1JG750 ^② |
| Copper | 70-400 | 3/0-750 kcmil Cu | 1 | TC1JG750 ^③ |
| Copper | 70-400 | 3/0-250 kcmil Cu | 2 | TC2JG250 ^③ |
| Distribution Lugs | | | | |
| | 70-400 | #14-4 Cu | 12 | 3TA12JG04 ^② |
| | 70-400 | #14-2/0 Cu | 6 | 3TA6JG20 ^② |
| Compression Lugs | | | | |
| | 70-400 | #6-350 kcmil | — | 3CLJ350 ^② |
| | 70-400 | 250-600 kcmil | — | 3CLJ600 ^② |
| | 70-400 | 250-750 kcmil | — | 3CLJ750 ^② |

① Standard construction supplied for each breaker.

② Kit consists of 3 terminal connectors.

③ Required for 100% rated JG breakers. Requires 90°C cable sized at 75°C ampacity.

JG Thermal-Magnetic, Instantaneous Trip Adjustment Range

| Trip Unit Continuous Amp Rating (I _c) | Instantaneous Overcurrent Setting (I) | |
|---|---------------------------------------|------|
| | Min. | Max. |
| 250 | 1250 | 2500 |
| 300 | 1500 | 3000 |
| 350 | 1750 | 3500 |
| 400 | 2000 | 4000 |

Note: Each breaker has 6 trip settings in this range.

5 MOLDED CASE CIRCUIT BREAKERS

External Accessories page 5-137

VL Circuit Breakers

JG 400A Thermal-Magnetic Trip Unit

Selection

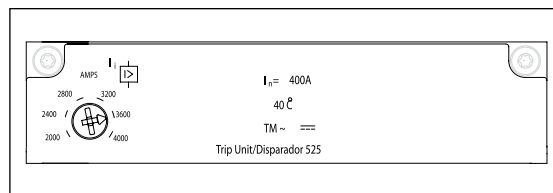

Model 525 Trip Unit

JG 400A Frame 2-Pole with Thermal-Magnetic Trip Unit

| Continuous Ampere Rating | N-Interrupting Class | H-Interrupting Class | L-Interrupting Class | Catalogue Number |
|-----------------------------|--|----------------------|----------------------|------------------|
| | Catalogue Number | Catalogue Number | Catalogue Number | |
| | FRAME ONLY | | | |
| | NJG2F400 | HJG2F400 | LJG2F400 | |
| | COMPLETE FACTORY ASSEMBLED CIRCUIT BREAKER | | | TRIP UNIT ONLY |
| 250 | NJG2B250L | HJG2B250L | LJG2B250L | CJT2B250 |
| 300 | NJG2B300L | HJG2B300L | LJG2B300L | CJT2B300 |
| 350 | NJG2B350L | HJG2B350L | LJG2B350L | CJT2B350 |
| 400 | NJG2B400L | HJG2B400L | LJG2B400L | CJT2B400 |

JG 400A Frame 3-Pole with Thermal-Magnetic Trip Unit

| Continuous Ampere Rating | N-Interrupting Class | H-Interrupting Class | L-Interrupting Class | Catalogue Number |
|-----------------------------|--|----------------------|----------------------|------------------|
| | Catalogue Number | Catalogue Number | Catalogue Number | |
| | FRAME ONLY | | | |
| | NJG3F400 | HJG3F400 | LJG3F400 | |
| | COMPLETE FACTORY ASSEMBLED CIRCUIT BREAKER | | | TRIP UNIT ONLY |
| 250 | NJG3B250L | HJG3B250L | LJG3B250L | CJT3B250 |
| 300 | NJG3B300L | HJG3B300L | LJG3B300L | CJT3B300 |
| 350 | NJG3B350L | HJG3B350L | LJG3B350L | CJT3B350 |
| 400 | NJG3B400L | HJG3B400L | LJG3B400L | CJT3B400 |

5
MOLDED CASE
CIRCUIT BREAKERS

JJ 400A Frame 240V max., 2-pole with Thermal-Magnetic Non-Interchangeable Trip Unit^①

| Continuous Ampere Rating | N-Interrupting Class |
|-----------------------------|----------------------|
| | Catalogue Number |
| | COMPLETE BREAKER |
| 250 | NJJ2B250 |
| 300 | NJJ2B300 |
| 350 | NJJ2B350 |
| 400 | NJJ2B400 |

JJ 400A Frame 240V max., 3-pole with Thermal-Magnetic Non-Interchangeable Trip Unit^①

| Continuous Ampere Rating | N-Interrupting Class |
|-----------------------------|----------------------|
| | Catalogue Number |
| | COMPLETE BREAKER |
| 250 | NJJ3B250 |
| 300 | NJJ3B300 |
| 350 | NJJ3B350 |
| 400 | NJJ3B400 |

^① Terminal connectors must be ordered separately.
Breaker Type NJJA.

VL Circuit Breakers

JG 400A Electronic 3-Knob & LCD Trip Units

Selection

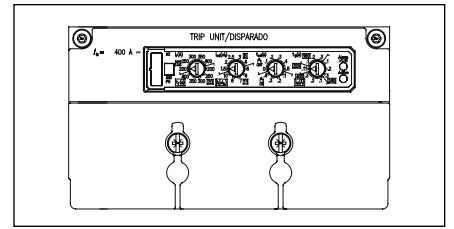
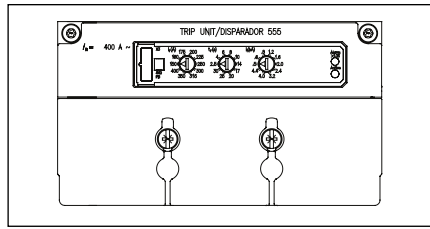

Model 555 Trip Units

JG 400A Frame 3-Pole Electronic Trip Unit

| Continuous Ampere Rating | N-Interrupting Class | H-Interrupting Class | L-Interrupting Class | Catalogue Number |
|--|----------------------|----------------------|----------------------|------------------|
| | Catalogue Number | Catalogue Number | Catalogue Number | |
| | FRAME ONLY | | | |
| | NJG3F400 | HJG3F400 | LJG3F400 | |
| COMPLETE FACTORY ASSEMBLED CIRCUIT BREAKER | | | | TRIP UNIT ONLY |
| ELECTRONIC LI TRIP | | | | |
| 250 | NJG3R250L | HJG3R250L | LJG3R250L | CJT3R250 |
| 400 | NJG3R400L | HJG3R400L | LJG3R400L | CJT3R400 |
| ELECTRONIC LSI TRIP | | | | |
| 250 | NJG3T250L | HJG3T250L | LJG3T250L | CJT3T250 |
| 400 | NJG3T400L | HJG3T400L | LJG3T400L | CJT3T400 |
| ELECTRONIC LSIG TRIP | | | | |
| 250 | NJG3V250L | HJG3V250L | LJG3V250L | CJT3V250 |
| 400 | NJG3V400L | HJG3V400L | LJG3V400L | CJT3V400 |
| ELECTRONIC LIG TRIP | | | | |
| 250 | NJG3W250L | HJG3W250L | LJG3W250L | CJT3W250 |
| 400 | NJG3W400L | HJG3W400L | LJG3W400L | CJT3W400 |

5
MOLDED CASE
CIRCUIT BREAKERS

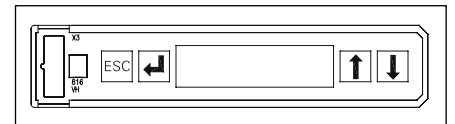

Model 586 Trip Unit

JG 400A Frame 3-Pole Electronic LCD Trip Unit

| Continuous Ampere Rating | N-Interrupting Class | H-Interrupting Class | L-Interrupting Class | Catalogue Number |
|--|----------------------|----------------------|----------------------|------------------|
| | Catalogue Number | Catalogue Number | Catalogue Number | |
| | FRAME ONLY | | | |
| | NJG3F400 | HJG3F400 | LJG3F400 | |
| COMPLETE FACTORY ASSEMBLED CIRCUIT BREAKER | | | | TRIP UNIT ONLY |
| LCD ELECTRONIC LSI TRIP | | | | |
| 250 | NJG3A250L | HJG3A250L | LJG3A250L | CJT3A250 |
| 400 | NJG3A400L | HJG3A400L | LJG3A400L | CJT3A400 |
| LCD ELECTRONIC LSIG TRIP | | | | |
| 250 | NJG3G250L | HJG3G250L | LJG3G250L | CJT3G250 |
| 400 | NJG3G400L | HJG3G400L | LJG3G400L | CJT3G400 |
| LCD ELECTRONIC LSI TRIP + GF ALARM ONLY | | | | |
| 250 | NJG3K250L | HJG3K250L | LJG3K250L | CJT3K250 |
| 400 | NJG3K400L | HJG3K400L | LJG3K400L | CJT3K400 |

VL Circuit Breakers

Internal Accessories for JG 400A and LG 600A Frames

Selection

Auxiliary Switch and Alarm Switch Combination Kits

| Description | Mounting Pocket ^① | Catalogue Number |
|--|------------------------------|------------------|
| 1 Alarm Switch 1A/B ^② Bases AMBL2 & AMBL3 | Left, Right ^② | ASKL1 |
| 2 Aux. Switches 1A + 1B Bases AMBL1 | Left, Right | ASKL2 |
| 2 Aux. + 1 Alarm Switches 1A + 1B, 1A/B ^② Bases AMBL2 & AMBL3 | Left, Right ^② | ASKL3 |

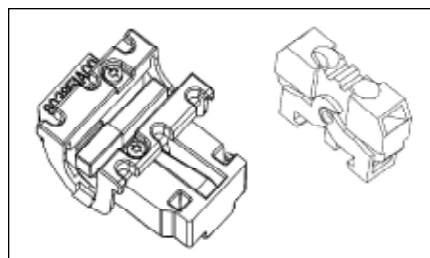

Auxiliary/Alarm Switch Mounting Base Only

| Description | Mounting Pocket | Catalogue Number |
|----------------------------|-------------------|------------------|
| Up to 3 Auxiliary Switches | Left, Right | AMBL1 |
| 2 Aux. + 1 Alarm Switch | Left Pocket Only | AMBL2 |
| 2 Aux. + 1 Alarm Switch | Right Pocket Only | AMBL3 |

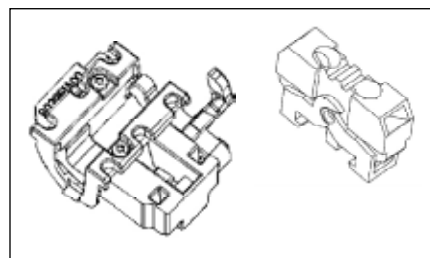

Auxiliary/Alarm Switch Only

Common to DG - PG Frames

| Description | Catalogue Number |
|--------------------------------|------------------|
| 1 Normally Open Contact (1A) | ASWPA |
| 1 Normally Closed Contact (1B) | ASWPB |

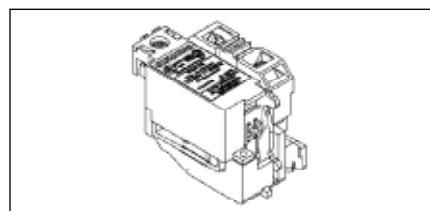

Shunt Trips

| Description | Mounting Pocket | Catalogue Number |
|-------------|-------------------|------------------|
| 24 VDC | Right Pocket Only | STRLB24DC |
| 48-60 VDC | | STRLC60DC |
| 110-127 VDC | | STRLD125DC |
| 220-250 VDC | | STRLE250DC |
| 48-60 VAC | | STRLM60 |
| 110-127 VAC | | STRLN120 |
| 208-277 VAC | | STRLS277 |
| 380-600 VAC | | STRLV600 |

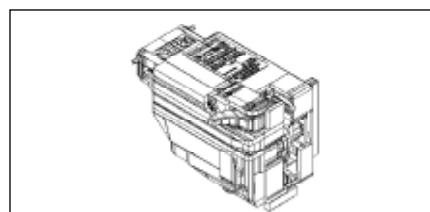

Undervoltage Release

| Description | Mounting Pocket | Catalogue Number |
|-------------|-------------------|------------------|
| 12 VDC | Right Pocket Only | UVRLA12DC |
| 24 VDC | | UVRLB24DC |
| 48 VDC | | UVRLC48DC |
| 60 VDC | | UVRLG60DC |
| 110-127 VDC | | UVRLD125DC |
| 220-250 VDC | | UVRLE250DC |
| 24 VAC | | UVRLL24 |
| 110-127 VAC | | UVRLN120 |
| 220-240 VAC | | UVRLR240 |
| 208 VAC | | UVRLP208 |
| 277 VAC | | UVRLS277 |
| 380-415 VAC | | UVRLT415 |
| 440-480 VAC | | UVRLU480 |

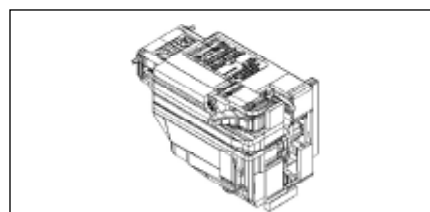

① Refer to the "Accessory Locations" chart for guidelines and limitations about which pockets may be used for accessory combinations.

② Includes 1A and 1B contact for alarm purposes, only one of which may be installed at any time.

'A' refers to a normally open contact (open when the breaker contacts are open).

'B' refers to a normally closed contact (closed when the breaker contacts are open).

VL Circuit Breakers

LG 600A Frame, VL Series

Selection/Dimensions

Ordering Information

Complete Assembled Breaker

A complete factory assembled LG breaker includes the frame, trip unit, and standard line and load lugs, all factory installed and shipped as a complete breaker. Assembled breakers are available only with standard connectors.

For DC applications, use thermal magnetic trip unit only.

Breakers are suitable for reverse feed applications.

For special applications, refer to page 5-155.

Mounting hardware is included with each breaker.

For 100% rated breakers, change the 3rd character of the catalogue number to "W". Available on 400/500 Amp only.

HACR rated.



Interrupting Ratings

| Interrupting Class | Breaker Type | RMS Symmetrical Amperes (KA) | | | | | | | | | | |
|--------------------|--------------|------------------------------|-----|-----|-----------------|-----------------|---------------------|-----------------|-----------------|-----------------|-----|---|
| | | UL 489 | | | | | IEC 60947-2 | | | | | |
| | | Volts AC (50/60 Hz) | | | Volts DC | | Volts AC (50/60 Hz) | | | | | |
| | | 240 | 480 | 600 | 250 | 500 | 220/240 | | 380/415 | | 690 | |
| | | | | | I _{cu} | I _{cs} | I _{cu} | I _{cs} | I _{cu} | I _{cs} | | |
| N | NLGB | 65 | 35 | 18 | 30 | 25 | 65 | 65 | 45 | 45 | 12 | 6 |
| H | HLGB | 100 | 65 | 18 | 30 | 35 | 100 | 75 | 70 | 70 | 15 | 8 |
| L | LLGB | 200 | 100 | 18 | 30 | 35 | 200 | 150 | 100 | 75 | 15 | 8 |

Connectors for 75°C Wire

| Construction | Ampere Rating | Wire Range | No. of cables per connector | Catalogue Number ^② |
|------------------|---------------|----------------------|-----------------------------|-------------------------------|
| Aluminum | 150-600 | #2/0-600 kcmil Al/Cu | 2 (load side) | 3TA2LG600LD ^① |
| Aluminum | 150-600 | #2/0-600 kcmil Al/Cu | 2 (line side) | 3TA2LG600LN ^① |
| Copper | 150-600 | #2/0-600 kcmil Cu | 2 (load side) | 3TC2LG600LD ^④ |
| Copper | 150-600 | #2/0-600 kcmil Cu | 2 (line side) | 3TC2LG600LN ^④ |
| Compression Lugs | | | | |
| | 150-600 | #6-350 kcmil Al/Cu | — | 6CLL350 ^③ |
| | 150-600 | 250-750 kcmil Al/Cu | — | 3CLL750 ^② |
| | 150-600 | 250-600 kcmil Al/Cu | — | 6CLL600 ^③ |

① Standard construction supplied for each breaker.

② Kit consists of 3 terminal connectors.

③ Kit consists of 6 lugs for Line or Load end.

④ Required for 100% rated LG breakers. Requires 90°C cable sized at 75°C ampacity.

LG Thermal-Magnetic, Instantaneous Trip Adjustment Range

| Trip Unit Continuous Amp Rating (I _c) | Instantaneous Overcurrent Setting (I) | |
|---|---------------------------------------|------|
| | Min. | Max. |
| 400 | 2000 | 4000 |
| 500 | 2500 | 5000 |
| 600 | 2750 | 5500 |

Note: Each breaker has 6 trip settings.

Dimensions - Inches (mm)

| Number of Poles | Width | Length | Depth | To Handle D1 |
|-----------------|-----------|--------------|-----------|--------------|
| 2, 3 | 5.5 (139) | 11 (279) | 4.2 (102) | 5.4 (138) |
| Ext. Shield | | 13.6 (345.5) | | |

Shipping Weight, lbs. (kg)

| Poles | Frame | Trip Unit | | Complete Breaker |
|-------|------------|--------------|------------|------------------|
| | | Thermal-Mag. | Electronic | |
| 2, 3 | 17.4 (7.9) | 3.5 (1.6) | 4.2 (1.9) | 20.9 (9.5) |

5
MOLDED CASE
CIRCUIT BREAKERS

External Accessories page 5-137

VL Circuit Breakers

LG 600A Thermal-Magnetic Trip Unit

Selection

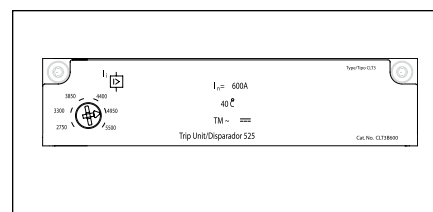

Model 525 Trip Unit

LG 600A Frame 2-Pole with Thermal-Magnetic Trip Unit

| Continuous Ampere Rating | N-Interrupting Class | H-Interrupting Class | L-Interrupting Class |
|-----------------------------|--|----------------------|----------------------|
| | Catalogue Number | Catalogue Number | Catalogue Number |
| | COMPLETE FACTORY ASSEMBLED CIRCUIT BREAKER | | |
| 400 | NLK2B400L | HLK2B400L | LLK2B400L |
| 500 | NLK2B500L | HLK2B500L | LLK2B500L |
| 600 | NLK2B600L | HLK2B600L | LLK2B600L |

LG 600A Frame 3-Pole with Thermal-Magnetic Trip Unit

| Continuous Ampere Rating | N-Interrupting Class | H-Interrupting Class | L-Interrupting Class |
|-----------------------------|--|----------------------|----------------------|
| | Catalogue Number | Catalogue Number | Catalogue Number |
| | COMPLETE FACTORY ASSEMBLED CIRCUIT BREAKER | | |
| 400 | NLK3B400L | HLK3B400L | LLK3B400L |
| 500 | NLK3B500L | HLK3B500L | LLK3B500L |
| 600 | NLK3B600L | HLK3B600L | LLK3B600L |

① For 100% rated 400A or 500A versions, change the third character of the catalogue number to "Z".
② Please consult Siemens sales office for availability.

VL Circuit Breakers

LG 600A Electronic 3-Knob & LCD Trip Units

Selection

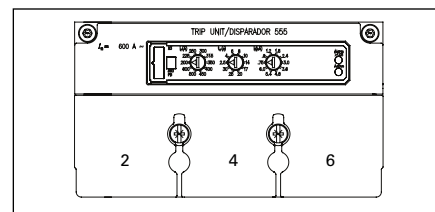

Model 555 Trip Unit

LG 600A Frame 3-Pole Electronic Trip Unit

| Continuous Ampere Rating | N-Interrupting Class | H-Interrupting Class | L-Interrupting Class |
|---|----------------------|----------------------|----------------------|
| | Catalogue Number | Catalogue Number | Catalogue Number |
| COMPLETE FACTORY ASSEMBLED CIRCUIT BREAKER | | | |
| ELECTRONIC LI TRIP | | | |
| 400 | NLK3R400L | HLK3R400L | LLK3R400L |
| 600 | NLK3R600L | HLK3R600L | LLK3R600L |
| ELECTRONIC LSI TRIP | | | |
| 400 | NLK3T400L | HLK3T400L | LLK3T400L |
| 600 | NLK3T600L | HLK3T600L | LLK3T600L |
| ELECTRONIC LSIG TRIP | | | |
| 400 | NLK3V400L | HLK3V400L | LLK3V400L |
| 600 | NLK3V600L | HLK3V600L | LLK3V600L |
| ELECTRONIC LIG TRIP | | | |
| 400 | NLK3W400L | HLK3W400L | LLK3W400L |
| 600 | NLK3W600L | HLK3W600L | LLK3W600L |

5
MOLDED CASE
CIRCUIT BREAKERS

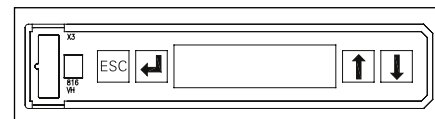

Model 586 Trip Unit

LG 600A Frame 3-Pole Electronic LCD Trip Unit

| Continuous Ampere Rating | N-Interrupting Class | H-Interrupting Class | L-Interrupting Class |
|---|----------------------|----------------------|----------------------|
| | Catalogue Number | Catalogue Number | Catalogue Number |
| COMPLETE FACTORY ASSEMBLED CIRCUIT BREAKER | | | |
| ELECTRONIC LSI TRIP | | | |
| 400 | NLK3A400L | HLK3A400L | LLK3A400L |
| 600 | NLK3A600L | HLK3A600L | LLK3A600L |
| ELECTRONIC LSIG TRIP | | | |
| 400 | NLK3G400L | HLK3G400L | LLK3G400L |
| 600 | NLK3G600L | HLK3G600L | LLK3G600L |
| ELECTRONIC LSIG TRIP + GFG ALARM ONLY | | | |
| 400 | NLK3K400L | HLK3K400L | LLK3K400L |
| 600 | NLK3K600L | HLK3K600L | LLK3K600L |

VL Circuit Breakers

Internal Accessories for JG 400A and LG 600A Frames

Selection

Auxiliary Switch and Alarm Switch Combination Kits

| Description | Mounting Pocket ^① | Catalogue Number |
|--|------------------------------|------------------|
| 1 Alarm Switch 1A/B ^② Bases AMBL2 & AMBL3 | Left, Right ^② | ASKL1 |
| 2 Aux. Switches 1A + 1B Bases AMBL1 | Left, Right | ASKL2 |
| 2 Aux. + 1 Alarm Switches 1A + 1B, 1A/B ^② Bases AMBL2 & AMBL3 | Left, Right ^② | ASKL3 |

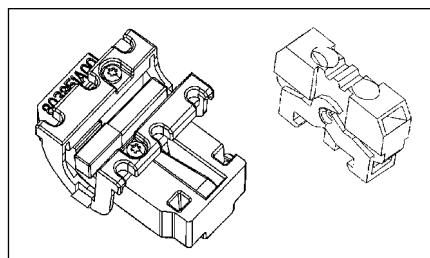

Auxiliary/Alarm Switch Mounting Base Only

| Description | Mounting Pocket | Catalogue Number |
|----------------------------|-------------------|------------------|
| Up to 3 Auxiliary Switches | Left, Right | AMBL1 |
| 2 Aux. + 1 Alarm Switch | Left Pocket Only | AMBL2 |
| 2 Aux. + 1 Alarm Switch | Right Pocket Only | AMBL3 |

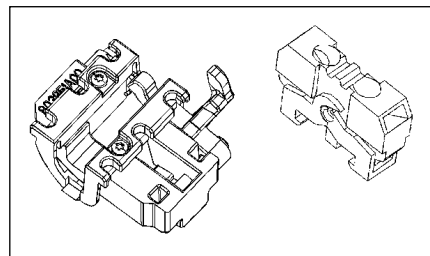

Auxiliary/Alarm Switch Only

Common to DG - PG Frames

| Description | Catalogue Number |
|--------------------------------|------------------|
| 1 Normally Open Contact (1A) | ASWPA |
| 1 Normally Closed Contact (1B) | ASWPB |

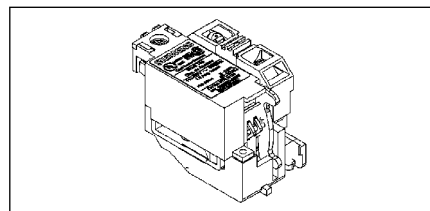

Shunt Trips

| Description | Mounting Pocket | Catalogue Number |
|-------------|-------------------|------------------|
| 24 VDC | Right Pocket Only | STRLB24DC |
| 48-60 VDC | | STRLC60DC |
| 110-127 VDC | | STRLD125DC |
| 220-250 VDC | | STRLE250DC |
| 48-60 VAC | | STRLM60 |
| 110-127 VAC | | STRLN120 |
| 208-277 VAC | | STRLS277 |
| 380-600 VAC | | STRLV600 |

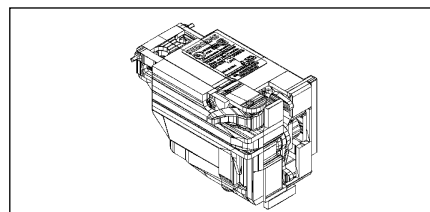

Undervoltage Release

| Description | Mounting Pocket | Catalogue Number |
|-------------|-------------------|------------------|
| 12 VDC | Right Pocket Only | UVRLA12DC |
| 24 VDC | | UVRLB24DC |
| 48 VDC | | UVRLC48DC |
| 60 VDC | | UVRLG60DC |
| 110-127 VDC | | UVRLD125DC |
| 220-250 VDC | | UVRLE250DC |
| 24 VAC | | UVRL24 |
| 110-127 VAC | | UVRLN120 |
| 220-240 VAC | | UVRLR240 |
| 208 VAC | | UVRLP208 |
| 277 VAC | | UVRLS277 |
| 380-415 VAC | | UVRLT415 |
| 440-480 VAC | | UVRLU480 |

^① Refer to the "Accessory Locations" chart for guidelines and limitations about which pockets may be used for accessory combinations.

^② Includes 1A and 1B contact for alarm purposes, only one of which may be installed at any time.

'A' refers to a normally open contact (open when the breaker contacts are open).

'B' refers to a normally closed contact (closed when the breaker contacts are open).

External Accessories page 5-137

VL Circuit Breakers

MG 800A Frame, VL Series

Selection/Dimensions

Ordering Information

Complete Assembled Breaker

A complete factory assembled MG breaker includes the frame, trip unit, and standard line and load lugs, all factory installed and shipped as a complete breaker. Assembled breakers are available only with standard connectors.

For any other configuration, order the frame, trip unit, and terminals as separate items.

For DC applications, use thermal magnetic trip unit only.

For reverse feed applications, select non-interchangeable trip breakers only. For non-interchangeable trip breakers, change the third digit of the catalogue number to "X" for standard breakers.

For 100% rated breakers with a non-interchangeable trip unit, change the 3rd character of the catalogue number to "Y".

For special applications, refer to page 5-155.

Mounting hardware is included with each frame or complete breaker.
HACR rated.



Dimensions - Inches (mm)

| Number of Poles | Width | Length | Depth | To Handle D1 |
|-----------------|-----------|----------|-----------|--------------|
| 2, 3 | 7.5 (190) | 16 (406) | 4.7 (119) | 5.9 (151) |

Interrupting Ratings

| Interrupting Class | Breaker Type | RMS Symmetrical Amperes (KA) | | | | | | | | | | |
|--------------------|--------------|------------------------------|-----|-----|----------|-----------------|---------------------|-----------------|-----------------|-----------------|-----------------|----|
| | | UL 489 | | | | | IEC 60947-2 | | | | | |
| | | Volts AC (50/60 Hz) | | | Volts DC | | Volts AC (50/60 Hz) | | | | | |
| | | 240 | 480 | 600 | 250 | 500 | 220/240 | | 380/415 | | 690 | |
| | | | | | | I _{cu} | I _{cs} | I _{cu} | I _{cs} | I _{cu} | I _{cs} | |
| N | NMG | 65 | 35 | 25 | 22 | 35 | 65 | 65 | 50 | 50 | 20 | 10 |
| H | HMG | 100 | 65 | 35 | 25 | 50 | 100 | 75 | 70 | 70 | 30 | 15 |
| L | LMG | 200 | 100 | 50 | 42 | 65 | 200 | 150 | 100 | 75 | 35 | 17 |

Shipping Weight, lbs. (kg)

| Poles | Frame | Trip Unit | Complete Breaker |
|-------|-------------|-----------|------------------|
| 2, 3 | 31.3 (14.2) | 4.0 (1.8) | 35.3 (16.0) |

Connectors for 75°C Wire

| Construction | Ampere Rating | Wire Range | No. of cables per connector | Catalogue Number |
|--------------|---------------|---------------------|-----------------------------|-------------------------|
| Aluminum | 200-800A | 1/0-500 kcmil Al/Cu | 3 | 3TA3MG500 ^{①②} |
| Aluminum | 200-800A | 500-750 kcmil Al/Cu | 2 | 3TA2MG750 ^② |
| Copper | 200-800A | 1/0-500 kcmil Cu | 3 | TC3MG500 ^{③⑤} |
| Aluminum | 200-800A | #2-600 kcmil Al/Cu | 3 | 3TA3MG600 ^{②④} |

① Standard connector supplied with complete breakers.

② Kit consists of 3 terminal connectors.

③ Consists of one terminal.

④ Includes extended terminal cover.

⑤ Required for 100% rated MG breakers. Requires 90°C cable sized at 75°C ampacity.

MG Thermal-Magnetic, Instantaneous Trip Adjustment Range

| Trip Unit Continuous Amp Rating (I _n) | Instantaneous Overcurrent Setting (I) | |
|---|---------------------------------------|------|
| | Min. | Max. |
| 600 | 3000 | 6000 |
| 700 | 3250 | 6500 |
| 800 | 3250 | 6500 |

Note: Each breaker has 6 trip settings.

5 MOLDED CASE CIRCUIT BREAKERS

External Accessories page 5-137

VL Circuit Breakers

MG 800A Thermal-Magnetic Trip Unit

Selection

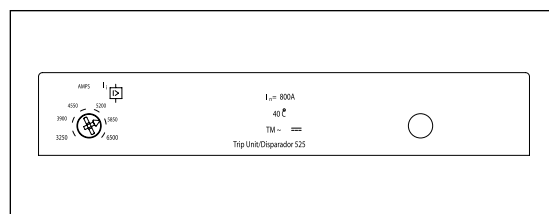

Model 525 Trip Unit

MG 800A Frame 2-Pole with Thermal-Magnetic Trip Unit

| Continuous Ampere Rating | N-Interrupting Class | H-Interrupting Class | L-Interrupting Class | |
|-----------------------------|--|----------------------|----------------------|------------------|
| | Catalogue Number | Catalogue Number | Catalogue Number | Catalogue Number |
| | FRAME ONLY | | | TRIP UNIT ONLY |
| | NMG2F800 | HMG2F800 | LMG2F800 | |
| | COMPLETE FACTORY ASSEMBLED CIRCUIT BREAKER | | | |
| 600 | NMG2B600L | HMG2B600L | LMG2B600L | CMT2B600 |
| 700 | NMG2B700L | HMG2B700L | LMG2B700L | CMT2B700 |
| 800 | NMG2B800L | HMG2B800L | LMG2B800L | CMT2B800 |

MG 800A Frame 3-Pole with Thermal-Magnetic Trip Unit

| Continuous Ampere Rating | N-Interrupting Class | H-Interrupting Class | L-Interrupting Class | |
|-----------------------------|--|----------------------|----------------------|------------------|
| | Catalogue Number | Catalogue Number | Catalogue Number | Catalogue Number |
| | FRAME ONLY | | | TRIP UNIT ONLY |
| | NMG3F800 | HMG3F800 | LMG3F800 | |
| | COMPLETE FACTORY ASSEMBLED CIRCUIT BREAKER | | | |
| 600 | NMG3B600L | HMG3B600L | LMG3B600L | CMT3B600 |
| 700 | NMG3B700L | HMG3B700L | LMG3B700L | CMT3B700 |
| 800 | NMG3B800L | HMG3B800L | LMG3B800L | CMT3B800 |

VL Circuit Breakers

MG 800A Electronic 3-Knob & LCD Trip Units

Selection

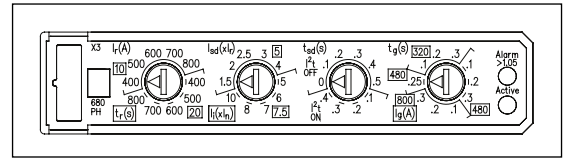
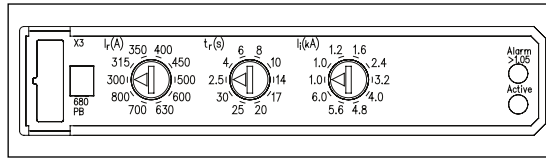

Model 555 Trip Units

MG 800A Frame 3-Pole Electronic Trip Unit

| Continuous Ampere Rating | N-Interrupting Class | H-Interrupting Class | L-Interrupting Class | Catalogue Number |
|--|------------------------|------------------------|------------------------|----------------------|
| | Catalogue Number | Catalogue Number | Catalogue Number | |
| | FRAME ONLY | | | |
| | NMG3F800 | HMG3F800 | LMG3F800 | |
| COMPLETE FACTORY ASSEMBLED CIRCUIT BREAKER | | | | TRIP UNIT ONLY |
| ELECTRONIC LI TRIP | | | | |
| 600 800 | NMG3R600L NMG3R800L | HMG3R600L HMG3R800L | LMG3R600L LMG3R800L | CMT3R600 CMT3R800 |
| ELECTRONIC LSI TRIP | | | | |
| 600 800 | NMG3T600L NMG3T800L | HMG3T600L HMG3T800L | LMG3T600L LMG3T800L | CMT3T600 CMT3T800 |
| ELECTRONIC LSIG TRIP | | | | |
| 600 800 | NMG3V600L NMG3V800L | HMG3V600L HMG3V800L | LMG3V600L LMG3V800L | CMT3V600 CMT3V800 |
| ELECTRONIC LIG TRIP | | | | |
| 600 800 | NMG3W600L NMG3W800L | HMG3W600L HMG3W800L | LMG3W600L LMG3W800L | CMT3W600 CMT3W800 |

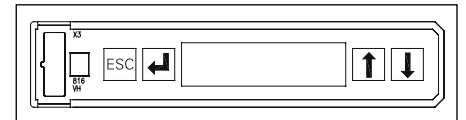

Model 586 Trip Unit

MG 800A Frame 3-Pole Electronic LCD Trip Unit

| Continuous Ampere Rating | N-Interrupting Class | H-Interrupting Class | L-Interrupting Class | Catalogue Number |
|--|------------------------|------------------------|------------------------|----------------------|
| | Catalogue Number | Catalogue Number | Catalogue Number | |
| | FRAME ONLY | | | |
| | NMG3F800 | HMG3F800 | LMG3F800 | |
| COMPLETE FACTORY ASSEMBLED CIRCUIT BREAKER | | | | TRIP UNIT ONLY |
| LCD ELECTRONIC LSI TRIP | | | | |
| 600 800 | NMG3A600L NMG3A800L | HMG3A600L HMG3A800L | LMG3A600L LMG3A800L | CMT3A600 CMT3A800 |
| LCD ELECTRONIC LSIG TRIP | | | | |
| 600 800 | NMG3G600L NMG3G800L | HMG3G600L HMG3G800L | LMG3G600L LMG3G800L | CMT3G600 CMT3G800 |
| LCD ELECTRONIC LSI TRIP + GF ALARM ONLY | | | | |
| 600 800 | NMG3K600L NMG3K800L | HMG3K600L HMG3K800L | LMG3K600L LMG3K800L | CMT3K600 CMT3K800 |

5 MOLDED CASE CIRCUIT BREAKERS

VL Circuit Breakers

Internal Accessories for MG 800A, NG 1200A and PG 1600A Frames

Selection

Auxiliary Switch and Alarm Switch Combination Kits

| Description | Mounting Pocket ^① | Catalogue Number |
|---|------------------------------|------------------|
| 2 Aux. + 2 Alarm Switches 2A + 2B Bases AMBP2 | Left Pocket Only | ASKP3 |
| 4 Aux. Switches 2A + 2B Bases AMBP1 | Left, Right | ASKP4 |

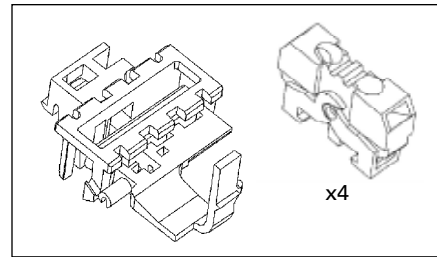

Auxiliary/Alarm Switch Mounting Base Only

| Description | Mounting Pocket | Catalogue Number |
|----------------------------|------------------|------------------|
| Up to 4 Auxiliary Switches | Left, Right | AMBP1 |
| 2 Aux. + 2 Alarm Switches | Left Pocket Only | AMBP2 |

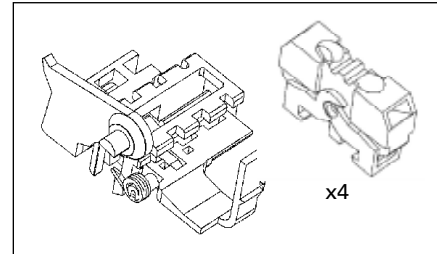

Auxiliary/Alarm Switch Only

Common to DG - PG Frames

| Description | Catalogue Number |
|--------------------------------|------------------|
| 1 Normally Open Contact (1A) | ASWPA |
| 1 Normally Closed Contact (1B) | ASWPB |

Shunt Trips

| Description | Mounting Pocket | Catalogue Number |
|-------------|-------------------|-------------------|
| 24 VDC | Right Pocket Only | STRPB24DC |
| 48-60 VDC | | STRPC60DC |
| 110-127 VDC | | STRPD125DC |
| 220-250 VDC | | STRPE250DC |
| 48-60 VAC | | STRPM60 |
| 110-127 VAC | | STRPN120 |
| 208-277 VAC | | STRPS277 |
| 380-600 VAC | | STRPV600 |

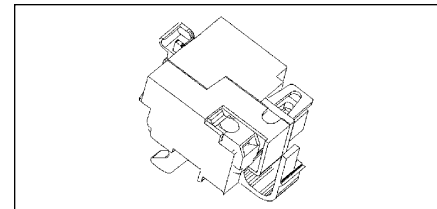

Undervoltage Release

| Description | Mounting Pocket | Catalogue Number |
|-------------|-------------------|-------------------|
| 12 VDC | Right Pocket Only | UVRPA12DC |
| 24 VDC | | UVRPB24DC |
| 48 VDC | | UVRPC48DC |
| 60 VDC | | UVRPG60DC |
| 110-127 VDC | | UVRPD125DC |
| 220-250 VDC | | UVRPE250DC |
| 110-127 VAC | | UVRPN120 |
| 220-240 VAC | | UVRPR240 |
| 208 VAC | | UVRPP208 |
| 277 VAC | | UVRPS277 |
| 380-415 VAC | | UVRPT415 |
| 440-480 VAC | | UVRPU480 |

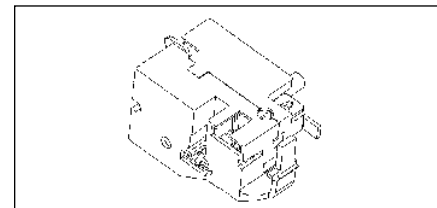

^① Refer to the "Accessory Locations" chart for guidelines and limitations about which pockets may be used for accessory combinations.

'A' refers to a normally open contact (open when the breaker contacts are open).

'B' refers to a normally closed contact (closed when the breaker contacts are open).

VL Circuit Breakers

NG 1200A Frame, VL Series

Selection/Dimensions

Ordering Information

Complete Assembled Breaker with Lugs

A complete factory assembled NG breaker includes the frame, trip unit, and standard line and load lugs, all factory installed and shipped as a complete breaker. Assembled breakers are available only with standard connectors.

For any other configuration, order the frame, trip unit, and terminals as separate items.

For DC applications, use thermal magnetic trip unit only.

For reverse feed applications, select non-interchangeable trip breakers only. For non-interchangeable trip breakers, change the third digit of the catalogue number to "X" for standard breakers.

For 100% rated breakers with a non-interchangeable trip unit, change the 3rd character of the catalogue number to "Y".

For special applications, refer to page 5-155.

Mounting hardware is included with each frame or complete breaker.

A Toggle Handle Extension is included with each frame or complete breaker.

HACR rated.



Dimensions - Inches (mm)

| Number of Poles | W | L | D | To Handle D1 |
|-----------------|---------|----------|---------|--------------|
| 2, 3 | 9 (229) | 16 (406) | 6 (152) | 8.1 (207) |

Shipping Weight, lbs. (kg)

| Poles | Frame | Trip Unit | Complete Breaker |
|-------|-------------|-----------|------------------|
| 2, 3 | 46.3 (21.0) | 8.8 (4.0) | 55.1 (25.0) |

Interrupting Ratings

| Interrupting Class | Breaker Type | RMS Symmetrical Amperes (KA) | | | | | | | | | | |
|--------------------|--------------|------------------------------|-----|-----|----------|-----------------|---------------------|-----------------|-----------------|-----------------|-----------------|----|
| | | CSA/UL 489 | | | | | IEC 60947-2 | | | | | |
| | | Volts AC (50/60 Hz) | | | Volts DC | | Volts AC (50/60 Hz) | | | | | |
| | | 240 | 480 | 600 | 250 | 500 | 220/240 | | 380/415 | | 690 | |
| | | | | | | I _{co} | I _{cs} | I _{co} | I _{cs} | I _{co} | I _{cs} | |
| N | NNG | 65 | 35 | 25 | 22 | 35 | 65 | 35 | 50 | 25 | 20 | 10 |
| H | HNG | 100 | 65 | 35 | 25 | 50 | 100 | 50 | 70 | 35 | 30 | 15 |
| L | LNG | 200 | 100 | 65 | 42 | 65 | 200 | 100 | 100 | 50 | 35 | 17 |

Connectors for 75°C Wire

| Construction | Ampere Rating | Wire Range | No. of cables per connector | Catalogue Number |
|------------------|---------------|---------------------|-----------------------------|--------------------------|
| Aluminum | 300-1200A | 1/0-500 kcmil Al/Cu | 4 | 3TA4NG500 ^{③④} |
| Aluminum | 300-1200A | 500-750 kcmil Al/Cu | 3 | 3TA3NG750 ^④ |
| Copper | 300-1200A | 1/0-500 kcmil Cu | 4 | 3TC4NG500 ^{②④} |
| Aluminum | 300-1200A | 1/0-500 kcmil Al/Cu | 4 | 3TA4NG500H ^{②④} |
| Compression Lugs | | | | |
| | 300-1200A | 1/0-500 kcmil Al/Cu | — | 12CLN500 ^① |

① Total of 12 connectors (4 per phase Line or Load).

② For 100% rated NG breakers. Requires 90°C cable sized at 75°C ampacity.

③ Standard connector provided with complete breakers.

④ Kit consists of 3 terminal connectors.

NG Thermal-Magnetic, Instantaneous Trip Adjustment Range

| Trip Unit Continuous Amp Rating (I _c) | Instantaneous Overcurrent Setting (I) | |
|---|---------------------------------------|-------|
| | Min. | Max. |
| 800 | 4000 | 8000 |
| 900 | 5000 | 10000 |
| 1000 | 5000 | 10000 |
| 1200 | 7000 | 12000 |

Note: Each breaker has 6 trip settings.

5
MOLDED CASE
CIRCUIT BREAKERS

External Accessories page 5-137

VL Circuit Breakers

NG 1200A Thermal-Magnetic Trip Unit

Selection

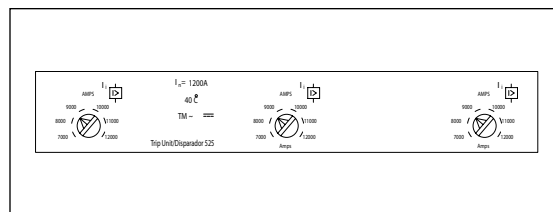

Model 525 Trip Unit

NG 1200A Frame 2-Pole with Thermal-Magnetic Trip Unit

| Continuous Ampere Rating | N-Interrupting Class | H-Interrupting Class | L-Interrupting Class | Catalogue Number |
|--|----------------------|----------------------|----------------------|------------------|
| | Catalogue Number | Catalogue Number | Catalogue Number | |
| | FRAME ONLY | | | |
| | NNG2F120 | HNG2F120 | LNG2F120 | |
| COMPLETE FACTORY ASSEMBLED CIRCUIT BREAKER | | | | TRIP UNIT ONLY |
| 800 | NNG2B800L | HNG2B800L | LNG2B800L | CNT2B800 |
| 900 | NNG2B900L | HNG2B900L | LNG2B900L | CNT2B900 |
| 1000 | NNG2B100L | HNG2B100L | LNG2B100L | CNT2B100 |
| 1200 | NNG2B120L | HNG2B120L | LNG2B120L | CNT2B120 |

NG 1200A Frame 3-Pole with Thermal-Magnetic Trip Unit

| Continuous Ampere Rating | N-Interrupting Class | H-Interrupting Class | L-Interrupting Class | Catalogue Number |
|--|----------------------|----------------------|----------------------|------------------|
| | Catalogue Number | Catalogue Number | Catalogue Number | |
| | FRAME ONLY | | | |
| | NNG3F120 | HNG3F120 | LNG3F120 | |
| COMPLETE FACTORY ASSEMBLED CIRCUIT BREAKER | | | | TRIP UNIT ONLY |
| 800 | NNG3B800L | HNG3B800L | LNG3B800L | CNT3B800 |
| 900 | NNG3B900L | HNG3B900L | LNG3B900L | CNT3B900 |
| 1000 | NNG3B100L | HNG3B100L | LNG3B100L | CNT3B100 |
| 1200 | NNG3B120L | HNG3B120L | LNG3B120L | CNT3B120 |

VL Circuit Breakers

NG 1200A Electronic 3-Knob & LCD Trip Units

Selection

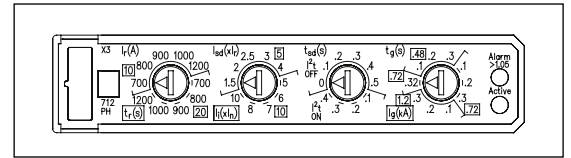
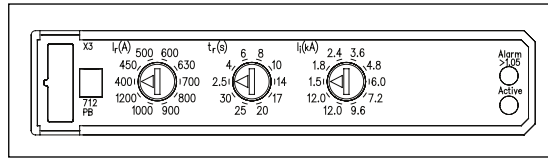

Model 555 Trip Units

NG 1200A Frame 3-Pole Electronic Trip Unit

| Continuous Ampere Rating | N-Interrupting Class | H-Interrupting Class | L-Interrupting Class | Catalogue Number |
|--|----------------------|----------------------|----------------------|------------------|
| | Catalogue Number | Catalogue Number | Catalogue Number | |
| | FRAME ONLY | | | |
| | NNG3F120 | HNG3F120 | LNG3F120 | |
| COMPLETE FACTORY ASSEMBLED CIRCUIT BREAKER | | | | TRIP UNIT ONLY |
| ELECTRONIC LI TRIP | | | | |
| 800 | NNG3R800L | HNG3R800L | LNG3R800L | CNT3R800 |
| 1000 | NNG3R100L | HNG3R100L | LNG3R100L | CNT3R100 |
| 1200 | NNG3R120L | HNG3R120L | LNG3R120L | CNT3R120 |
| ELECTRONIC LSI TRIP | | | | |
| 800 | NNG3T800L | HNG3T800L | LNG3T800L | CNT3T800 |
| 1000 | NNG3T100L | HNG3T100L | LNG3T100L | CNT3T100 |
| 1200 | NNG3T120L | HNG3T120L | LNG3T120L | CNT3T120 |
| ELECTRONIC LSIG TRIP | | | | |
| 800 | NNG3V800L | HNG3V800L | LNG3V800L | CNT3V800 |
| 1000 | NNG3V100L | HNG3V100L | LNG3V100L | CNT3V100 |
| 1200 | NNG3V120L | HNG3V120L | LNG3V120L | CNT3V120 |
| ELECTRONIC LIG TRIP | | | | |
| 800 | NNG3W800L | HNG3W800L | LNG3W800L | CNT3W800 |
| 1000 | NNG3W100L | HNG3W100L | LNG3W100L | CNT3W100 |
| 1200 | NNG3W120L | HNG3W120L | LNG3W120L | CNT3W120 |

5 MOLDED CASE CIRCUIT BREAKERS

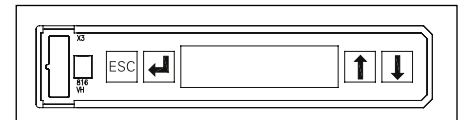

Model 586 Trip Unit

NG 1200A Frame 3-Pole Electronic LCD Trip Unit

| Continuous Ampere Rating | N-Interrupting Class | H-Interrupting Class | L-Interrupting Class | Catalogue Number |
|---|----------------------|----------------------|----------------------|------------------|
| | Catalogue Number | Catalogue Number | Catalogue Number | |
| | FRAME ONLY | | | |
| | NNG3F120 | HNG3F120 | LNG3F120 | |
| COMPLETE FACTORY ASSEMBLED CIRCUIT BREAKER | | | | TRIP UNIT ONLY |
| LCD ELECTRONIC LSI TRIP | | | | |
| 800 | NNG3A800L | HNG3A800L | LNG3A800L | CNT3A800 |
| 1000 | NNG3A100L | HNG3A100L | LNG3A100L | CNT3A100 |
| 1200 | NNG3A120L | HNG3A120L | LNG3A120L | CNT3A120 |
| LCD ELECTRONIC LSIG TRIP | | | | |
| 800 | NNG3G800L | HNG3G800L | LNG3G800L | CNT3G800 |
| 1000 | NNG3G100L | HNG3G100L | LNG3G100L | CNT3G100 |
| 1200 | NNG3G120L | HNG3G120L | LNG3G120L | CNT3G120 |
| LCD ELECTRONIC LSIG TRIP + GF ALARM ONLY | | | | |
| 800 | NNG3K800L | HNG3K800L | LNG3K800L | CNT3K800 |
| 1000 | NNG3K100L | HNG3K100L | LNG3K100L | CNT3K100 |
| 1200 | NNG3K120L | HNG3K120L | LNG3K120L | CNT3K120 |

VL Circuit Breakers

Internal Accessories for MG 800A, NG 1200A, and PG 1600A Frames

Selection

Auxiliary Switch and Alarm Switch Combination Kits

| Description | Mounting Pocket [Ⓢ] | Catalogue Number |
|--|------------------------------|------------------|
| 2 Aux. + 2 Alarm Switches 2A + 2B Base AMBP2 | Left Pocket Only | ASKP3 |
| 4 Aux. Switches 2A + 2B Base AMBP1 | Left, Right | ASKP4 |

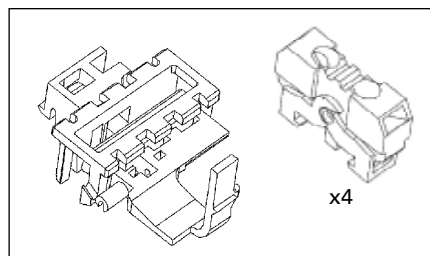

Auxiliary/Alarm Switch Mounting Base Only

| Description | Mounting Pocket [Ⓢ] | Catalogue Number |
|---|---------------------------------|------------------------------|
| Up to 4 Auxiliary Switches 2 Aux. + 2 Alarm Switches | Left, Right Left Pocket Only | AMBP1 AMBP2 |

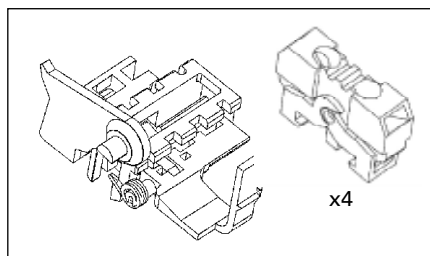

Auxiliary/Alarm Switch Only

Common to DG-PG Frames

| Description | Catalogue Number |
|--------------------------------|------------------|
| 1 Normally Open Contact (1A) | ASWPA |
| 1 Normally Closed Contact (1B) | ASWPB |

Shunt Trips

| Description | Mounting Pocket | Catalogue Number |
|-------------|-------------------|-------------------|
| 24 VDC | Right Pocket Only | STRPB24DC |
| 48-60 VDC | | STRPC60DC |
| 110-127 VDC | | STRPD125DC |
| 220-250 VDC | | STRPE250DC |
| 48-60 VAC | | STRPM60 |
| 110-127 VAC | | STRPN120 |
| 208-277 VAC | | STRPS277 |
| 380-600 VAC | | STRPV600 |

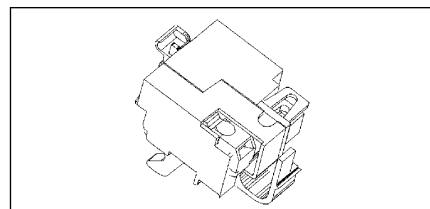

Undervoltage Release

| Description | Mounting Pocket | Catalogue Number |
|-------------|-------------------|-------------------|
| 12 VDC | Right Pocket Only | UVRPA12DC |
| 24 VDC | | UVRPB24DC |
| 48 VDC | | UVRPC48DC |
| 60 VDC | | UVRPG60DC |
| 110-127 VDC | | UVRPD125DC |
| 220-250 VDC | | UVRPE250DC |
| 110-127 VAC | | UVRPN120 |
| 220-240 VAC | | UVRPR240 |
| 208 VAC | | UVRPP208 |
| 277 VAC | | UVRPS277 |
| 380-415 VAC | | UVRPT415 |
| 440-480 VAC | | UVRPU480 |

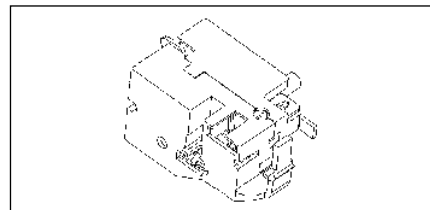

Ⓢ Refer to the "Accessory Locations" chart for guidelines and limitations about which pockets may be used for accessory combinations.
 'A' refers to a normally open contact (open when the breaker contacts are open).
 'B' refers to a normally closed contact (closed when the breaker contacts are open).

VL Circuit Breakers

PG 1600A Frame, VL Series & Thermal-Magnetic Trip Unit

Selection/Dimensions

Ordering Information

A complete factory assembled PG breaker includes the frame and trip unit only. The connectors must be ordered as separate items.

PG thermal-magnetic breakers sold as non-interchangeable only.

For any other configuration, order the frame, trip unit, and connectors as separate items.

Connectors require a Breaker Lug Mounting Assembly or Breaker Mounting Base and must be ordered as a separate item.

For DC applications, use Thermal magnetic trip unit only.

For reverse feed applications select non-interchangeable trip breakers only. Change the third digit of the catalogue number to "X" for non-interchangeable trip breakers.

For 100% rated breakers with a non-interchangeable trip unit, change the 3rd character of the catalogue number to "Y".

For special applications, refer to page 5-155.

Mounting hardware is included with each frame or complete breaker.

A Toggle Handle Extension is included with each frame or complete breaker.



Dimensions - Inches (mm)

| Number of Poles | W | L | D | To Handle D1 |
|-----------------|---------|----------|---------|--------------|
| 2, 3 | 9 (229) | 16 (406) | 6 (152) | 8.1 (207) |

Shipping Weight, lbs. (kg)

| Poles | Frame | Trip Unit | Complete Breaker |
|-------|-------------|-----------|------------------|
| 2, 3 | 60.2 (27.3) | 8.8 (4.0) | 69.0 (31.3) |

PG Thermal-Magnetic, Instantaneous Trip Adjustment Range

| Trip Unit Continuous Amp Rating (I _n) | Instantaneous Overcurrent Setting (I) | |
|---|---------------------------------------|-------|
| | Min. | Max. |
| 1200 | 7000 | 12000 |
| 1400 | 7000 | 12000 |
| 1600 | 7000 | 12000 |

Note: Each breaker has 6 trip settings in this range.

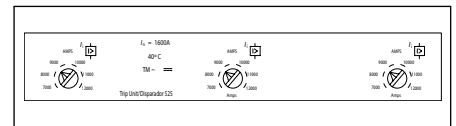

Model 525 Trip Unit

Interrupting Ratings

| Interrupting Class | Breaker Type | RMS Symmetrical Amperes (KA) | | | | | | | | | | |
|--------------------|--------------|------------------------------|-----|-----|----------|-----|---------------------|-----|---------|----|-----|----|
| | | CSA/UL 489 | | | | | IEC 60947-2 | | | | | |
| | | Volts AC (50/60 Hz) | | | Volts DC | | Volts AC (50/60 Hz) | | | | | |
| | | 240 | 480 | 600 | 250 | 500 | 220/240 | | 380/415 | | 690 | |
| N | NPG | 65 | 35 | 25 | 22 | 35 | 65 | 35 | 50 | 25 | 20 | 10 |
| H | HPG | 100 | 65 | 35 | 25 | 50 | 100 | 50 | 70 | 35 | 30 | 15 |
| L | LPG | 200 | 100 | 65 | 42 | 65 | 200 | 100 | 100 | 50 | 35 | 17 |

Connectors for 75°C Wire

| Construction | Ampere Rating | Wire Range | No. of cables per phase | Catalogue Number |
|--------------|---------------|---------------------|-------------------------|--------------------------|
| Aluminum | 1200-1600A | 1/0-750 kcmil Al/Cu | 6 | 3TA6PG750 ^{①②③} |
| Aluminum | 1200-1600A | 300-600 kcmil | 5 | TA5P600 ^{②④} |
| Aluminum | 1200-1600A | 600-750 kcmil | 4 | TA4P750 ^{②④} |
| Aluminum | 1200-1600A | 300-600 kcmil | 6 | TA6R600 ^{②④} |
| Copper | 1200-1600A | 300-600 kcmil | 5 | TC5R600 ^{②④⑤} |

① Requires Lug Mounting Assembly LMAP1600.

② Requires Breaker Mounting Base MBPG1600 Kit or MBPG1601.

③ Consists of 3 connectors.

④ Consists of 1 connector.

⑤ For 100% rated PG breakers. Requires 90°C cable sized at 75°C ampacity.

Mounting Arrangement

| Description | Catalogue Number |
|---------------------------------------|------------------|
| Lug Mounting Assembly | LMAP1600 |
| Breaker Mounting Base (Front Connect) | MBPG1600 |
| Breaker Mounting Base (Rear Connect) | MBPG1601 |

PG 1600A Frame 3-Pole with Thermal-Magnetic Trip Unit

| Continuous Ampere Rating | N-Interrupting Class | H-Interrupting Class | L-Interrupting Class |
|--------------------------|--|----------------------|----------------------|
| | Catalogue Number | Catalogue Number | Catalogue Number |
| | COMPLETE FACTORY ASSEMBLED CIRCUIT BREAKER | | |
| 1200 | NPX3B120 | HPX3B120 | LPX3B120 |
| 1400 | NPX3B140 | HPX3B140 | LPX3B140 |
| 1600 | NPX3B160 | HPX3B160 | LPX3B160 |

External Accessories page 5-137

VL Circuit Breakers

PG 1600A Electronic 3-Knob & LCD Trip Units

Selection

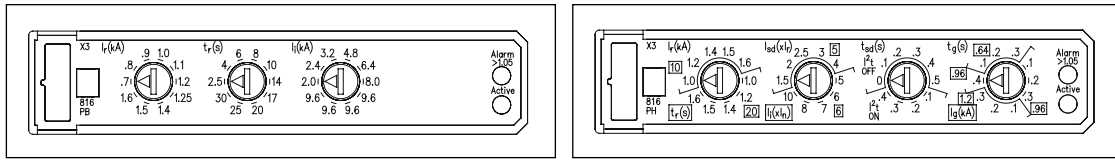

Model 555 Trip Unit

PG 1600A Frame 3-Pole Electronic Trip Unit

| Continuous Ampere Rating | N-Interrupting Class | H-Interrupting Class | L-Interrupting Class | Catalogue Number |
|--|----------------------|----------------------|----------------------|------------------|
| | Catalogue Number | Catalogue Number | Catalogue Number | |
| | FRAME ONLY | | | |
| | NPG3F160 | HPG3F160 | LPG3F160 | |
| COMPLETE FACTORY ASSEMBLED CIRCUIT BREAKER | | | | TRIP UNIT ONLY |
| ELECTRONIC LI TRIP | | | | |
| 1200 | NPG3R120 | HPG3R120 | LPG3R120 | CPT3R120 |
| 1600 | NPG3R160 | HPG3R160 | LPG3R160 | CPT3R160 |
| ELECTRONIC LSI TRIP | | | | |
| 1200 | NPG3T120 | HPG3T120 | LPG3T120 | CPT3T120 |
| 1600 | NPG3T160 | HPG3T160 | LPG3T160 | CPT3T160 |
| ELECTRONIC LSIG TRIP | | | | |
| 1200 | NPG3V120 | HPG3V120 | LPG3V120 | CPT3V120 |
| 1600 | NPG3V160 | HPG3V160 | LPG3V160 | CPT3V160 |
| ELECTRONIC LIG TRIP | | | | |
| 1200 | NPG3W120 | HPG3W120 | LPG3W120 | CPT3W120 |
| 1600 | NPG3W160 | HPG3W160 | LPG3W160 | CPT3W160 |

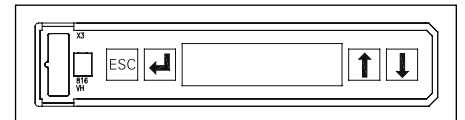

Model 586 Trip Unit

PG 1600A Frame 3-Pole Electronic LCD Trip Unit

| Continuous Ampere Rating | N-Interrupting Class | H-Interrupting Class | L-Interrupting Class | Catalogue Number |
|---|----------------------|----------------------|----------------------|------------------|
| | Catalogue Number | Catalogue Number | Catalogue Number | |
| | FRAME ONLY | | | |
| | NPG3F160 | HPG3F160 | LPG3F160 | |
| COMPLETE FACTORY ASSEMBLED CIRCUIT BREAKER | | | | TRIP UNIT ONLY |
| LCD ELECTRONIC LSI TRIP | | | | |
| 1200 | NPG3A120 | HPG3A120 | LPG3A120 | CPT3A120 |
| 1600 | NPG3A160 | HPG3A160 | LPG3A160 | CPT3A160 |
| LCD ELECTRONIC LSIG TRIP | | | | |
| 1200 | NPG3G120 | HPG3G120 | LPG3G120 | CPT3G120 |
| 1600 | NPG3G160 | HPG3G160 | LPG3G160 | CPT3G160 |
| LCD ELECTRONIC LSIG TRIP + GF ALARM ONLY | | | | |
| 1200 | NPG3K120 | HPG3K120 | LPG3K120 | CPT3K120 |
| 1600 | NPG3K160 | HPG3K160 | LPG3K160 | CPT3K160 |

VL Circuit Breakers

Internal Accessories for MG 800A, NG 1200A, and PG 1600A Frames

Selection

Auxiliary Switch and Alarm Switch Combination Kits

| Description | Mounting Pocket ^① | Catalogue Number |
|--|------------------------------|------------------|
| 2 Aux. + 2 Alarm Switches 2A + 2B Base AMBP2 | Left Pocket Only | ASKP3 |
| 4 Aux. Switches 2A + 2B Base AMBP1 | Left, Right | ASKP4 |

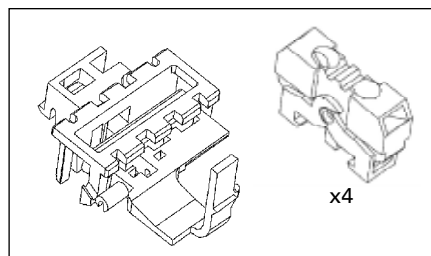

Auxiliary/Alarm Switch Mounting Base Only

| Description | Mounting Pocket ^① | Catalogue Number |
|---|---------------------------------|------------------------------|
| Up to 4 Auxiliary Switches 2 Aux. + 2 Alarm Switches | Left, Right Left Pocket Only | AMBP1 AMBP2 |

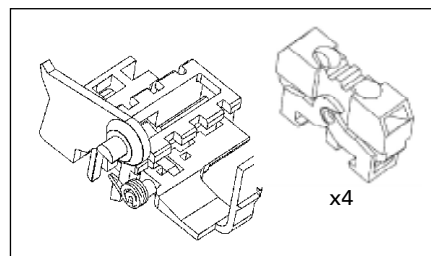

Auxiliary/Alarm Switch Only

Common to DG-PG Frames

| Description | Catalogue Number |
|--------------------------------|------------------|
| 1 Normally Open Contact (1A) | ASWPA |
| 1 Normally Closed Contact (1B) | ASWPB |

Shunt Trips

| Description | Mounting Pocket | Catalogue Number |
|-------------|-------------------|-------------------|
| 24 VDC | Right Pocket Only | STRPB24DC |
| 48-60 VDC | | STRPC60DC |
| 110-127 VDC | | STRPD125DC |
| 220-250 VDC | | STRPE250DC |
| 48-60 VAC | | STRPM60 |
| 110-127 VAC | | STRPN120 |
| 208-277 VAC | | STRPS277 |
| 380-600 VAC | | STRPV600 |

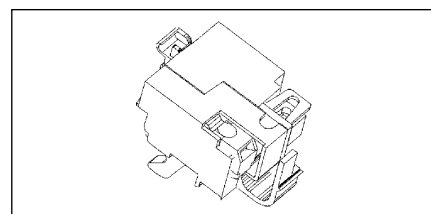

Undervoltage Release

| Description | Mounting Pocket | Catalogue Number |
|-------------|-------------------|-------------------|
| 12 VDC | Right Pocket Only | UVRPA12DC |
| 24 VDC | | UVRPB24DC |
| 48 VDC | | UVRPC48DC |
| 60 VDC | | UVRPG60DC |
| 110-127 VDC | | UVRPD125DC |
| 220-250 VDC | | UVRPE250DC |
| 110-127 VAC | | UVRPN120 |
| 220-240 VAC | | UVRPR240 |
| 208 VAC | | UVRPP208 |
| 277 VAC | | UVRPS277 |
| 380-415 VAC | | UVRPT415 |
| 440-480 VAC | | UVRPU480 |

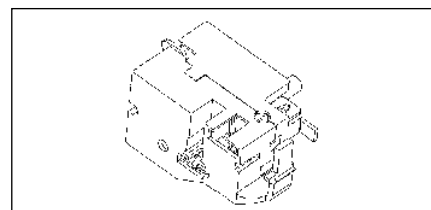

① Refer to the "Accessory Locations" chart for guidelines and limitations about which pockets may be used for accessory combinations.
 'A' refers to a normally open contact (open when the breaker contacts are open).
 'B' refers to a normally closed contact (closed when the breaker contacts are open).

Molded Case Circuit Breakers

Molded Case Switch

Selection

General

Typically a molded case switch is used when a compact load-break switch is needed for disconnect purposes. The VL line of molded case switches from Siemens is made of the same materials and components as the VL circuit breakers but do not provide overcurrent protection. Each molded case

switch has a fixed instantaneous self-protecting trip element which may open the switch under high fault conditions.

Application Note

Overcurrent protection must be provided by an appropriate overcurrent protective device located upstream

from the molded case switch. Also, the short-circuit current rating of the switch is limited to the interrupting rating of the upstream protective device or the ratings in the table below, **whichever is less.**

Ordering Information

Each type VL molded case switch accepts the same terminals and accessories as the equivalent VL circuit breakers.

All type VL molded case switches are suitable for reverse feed applications.

Mounting hardware and standard line and load terminals are included on ratings through 250A. For 400 – 1600A ratings, order the lugs separately.

All ratings are UL listed and CSA certified.

Molded Case Switch

| Maximum Ampere Rating / Frame | 2-Pole | 3-Pole | Short-Circuit Current Rating ^① | | | Self Protective Instantaneous Override |
|-------------------------------|------------------|------------------|---|------|------|--|
| | Catalogue Number | Catalogue Number | 240V | 480V | 600V | |
| 150A / DG | HDS2S150L | HDS3S150L | 100k | 65k | 20k | 2,500A |
| 250A / FG | HFS2S250L | HFS3S250L | 100k | 65k | 20k | 3,500A |
| 400A / JG | HJS2S400 | HJS3S400 | 100k | 65k | 25k | 4,400A |
| 600A / LG | HLR2S600 | HLR3S600 | 100k | 65k | 18k | 5,500A |
| 800A / MG | HMS2S800 | HMS3S800 | 100k | 65k | 35k | 6,500A |
| 1200A / NG | HNS2S120 | HNS3S120 | 100k | 65k | 35k | 12,000A |
| 1600A / PG | - | HPS3S160 | 100k | 65k | 35k | 14,000A |

| Maximum Ampere Rating / Frame | 3-Pole | Short-Circuit Current Rating ^① | | | Self Protective Instantaneous Override |
|-------------------------------|------------------|---|------|------|--|
| | Catalogue Number | 240V | 480V | 600V | |
| 250A / FG | LFS3S250L | 200k | 100k | 25k | 3,500A |
| 400A / JG | LJS3S400 | 200k | 100k | 25k | 4,400A |
| 600A / LG | LLR3S600 | 200k | 100k | 18k | 5,500A |
| 800A / MG | LMS3S800 | 200k | 100k | 65k | 6,500A |
| 1200A / NG | LNS3S120 | 200k | 100k | 65k | 12,000A |
| 1600A / PG | LPS3S160 | 200k | 100k | 65k | 14,000A |

^①The Short-Circuit Current Rating is the maximum available current of the circuit where the switch is used, when protected by an appropriate overcurrent protective device.

Molded Case Circuit Breakers

Motor Circuit Protectors

Selection

General

Protection of Motor Circuits

Molded case circuit breakers are used in motor circuits as a disconnecting means and for short-circuit protection. They should be used in conjunction with motor-running, over-current protection devices, and should permit the motor to start without nuisance tripping from motor-inrush current. The circuit breaker should have a continuous current rating of not less than 115% of the motor full-load current.

The recommended motor circuit protectors listed have continuous-current ratings of at least 115% of motor full-load currents. The trip setting positions are approximately 11 times motor full-load current. The suggested trip settings may need to be adjusted upward to no higher than 1300% of full-load current for non-design E type motors, and no greater than 1700% of full-load current for design E motors, to allow for motor startup due to in-rush current.

Breaker Mounted Immediately Ahead of Motor Starter

Siemens motor circuit protectors are recommended for use in combination motor starters to provide selective short-circuit protection for the motor branch circuit. The adjustable instantaneous trip feature of the Siemens motor circuit protector provides for a trip setting slightly above the peak motor in-rush current. With this setting, no delay is introduced in opening the circuit when a fault occurs. This circuit breaker has no time-delay trip element. Therefore it must be used in conjunction with, and immediately ahead of, the motor-running overcurrent protection device.

Important: The information below does not apply to all motor applications: it is recommended that the user refer to the National Electrical Code (NEC) for specific needs.

Table 1 (When Breaker is Mounted Immediately Ahead of Motor Starter)

3-Phase Induction Type Motors (Siemens motor circuit protectors for branch circuit use with alternating-current combination, full voltage motor starters)

| Motor Full Load Amperes | Trip Setting (A) | Catalogue Number ^① |
|-------------------------|------------------|-------------------------------|
| 35-50 | 450 | HDM3L150L |
| 42-60 | 540 | |
| 48-70 | 630 | |
| 55-80 | 720 | |
| 62-90 | 810 | |
| 69-100 | 900 | |
| 58-83 | 750 | HDM3M150L |
| 69-100 | 900 | |
| 81-117 | 1050 | |
| 92-133 | 1200 | |
| 104-150 | 1350 | |
| 115-150 ^② | 1500 | |
| 96-139 | 1250 | HDM3H150L |
| 115-150 ^② | 1500 | |
| 135-150 ^② | 1750 | |
| 135-150 ^② | 2000 | |
| 135-150 ^② | 2250 | |
| 135-150 ^② | 2500 | |
| 46-67 | 600 | HFM3L250L |
| 55-80 | 720 | |
| 65-93 | 840 | |
| 74-107 | 960 | |
| 83-120 | 1080 | |
| 92-133 | 1200 | |
| 77-111 | 1000 | HFM3M250L |
| 92-133 | 1200 | |
| 108-156 | 1400 | |
| 123-178 | 1600 | |
| 138-200 | 1800 | |
| 154-222 | 2000 | |
| 135-194 | 1750 | HFM3H250L |
| 162-210 | 2100 | |
| 188-220 | 2450 | |
| 215-241 | 2800 | |
| 242-250 ^② | 3150 | |
| 242-250 ^② | 3500 | |

① Motor circuit protectors rated 150A and 250A are supplied with line and load lugs installed. If lugs are required on 400A to 1200A motor circuit breakers, order required lugs separately.

| Motor Full Load Amperes | Trip Setting (A) | Catalogue Number ^① |
|-------------------------|------------------|-------------------------------|
| 96-139 | 1250 | HJM3L400 |
| 115-167 | 1500 | |
| 135-194 | 1750 | |
| 154-222 | 2000 | |
| 173-250 | 2250 | |
| 192-278 | 2500 | |
| 154-222 | 2000 | HJM3M400 |
| 185-267 | 2400 | |
| 215-311 | 2800 | |
| 246-356 | 3200 | |
| 277-400 | 3600 | |
| 308-400 ^② | 4000 | |
| 154-222 | 2000 | HLM3J600 |
| 185-267 | 2400 | |
| 215-311 | 2800 | |
| 246-356 | 3200 | |
| 277-400 | 3600 | |
| 308-444 | 4000 | |
| 212-306 | 2750 | HLM3Y600 |
| 254-367 | 3300 | |
| 296-428 | 3850 | |
| 338-489 | 4400 | |
| 381-550 | 4950 | |
| 423-600 | 5500 | |
| 250-361 | 3250 | HMM3M800 |
| 292-422 | 3800 | |
| 335-483 | 4350 | |
| 385-556 | 5000 | |
| 442-638 | 5740 | |
| 500-722 | 6500 | |
| 385-556 | 5000 | HNM3M120 |
| 462-667 | 6000 | |
| 538-778 | 7000 | |
| 615-889 | 8000 | |
| 692-1000 | 9000 | |
| 769-1111 | 10,000 | |

② These settings are provided for starting currents greater than 11X but not to exceed 17X. Full Load Amps (FLA) not to exceed ampere rating of MCP.

Molded Case Circuit Breakers

600 Volt DC Circuit Breakers

Selection

General

Siemens cUL Listed non-interchangeable trip DC Thermal/magnetic Molded Case Circuit Breakers shown below are for use in grounded & ungrounded general DC circuits and ungrounded battery supply circuits of UPS systems. These breakers are rated at 600Vdc closed circuit and feature rated interruption levels from 42,000 to 65,000 amperes as indicated in

the table. This family of circuit breakers is rated from 50 to 1600 Amperes.

Types HDGD through HPGD circuit breakers are provided with an adjustable magnetic over-current function located on the face of the circuit breaker. Contact Siemens for specific magnetic over-current values.

To properly use these cUL Listed circuit breakers at 600Vdc and the indicated

interruption level, it is necessary to connect the terminals of the 3 pole circuit breaker in a series configuration as shown in the diagram below.

Types HDGD through HPGD use the same internal and external accessories as the standard DG through PG frames and associated types. Consult the individual frame section for accessory information.

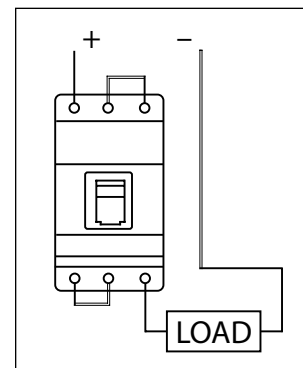

| Frame | Type | Continuous Ampere Rating | Catalogue Number (3-pole) ^① | Short-Circuit Current Rating 600VDC ^② |
|-----------------|------|--------------------------|--|--|
| DG | HDGD | 50 | HDC3B050 | 42K |
| | | 60 | HDC3B060 | 42K |
| | | 70 | HDC3B070 | 42K |
| | | 80 | HDC3B080 | 42K |
| | | 90 | HDC3B090 | 42K |
| | | 100 | HDC3B100 | 42K |
| | | 110 | HDC3B110 | 42K |
| | | 125 | HDC3B125 | 42K |
| FG | HFGD | 150 | HDC3B150 | 42K |
| | | 100 | HFC3B100 | 42K |
| | | 150 | HFC3B150 | 42K |
| JG | HJGD | 250 | HFC3B250 | 42K |
| | | 250 | HJC3B250 | 65K |
| | | 300 | HJC3B300 | 65K |
| | | 350 | HJC3B350 | 65K |
| LG | HLGD | 400 | HJC3B400 | 65K |
| | | 400 | HLC3B400 | 65K |
| | | 600 | HLC3B600 | 65K |
| MG | HMGD | 600 | HMC3B600 | 65K |
| | | 700 | HMC3B700 | 65K |
| | | 800 | HMC3B800 | 65K |
| NG | HNGD | 800 | HNC3B800 | 65K |
| | | 900 | HNC3B900 | 65K |
| | | 1000 | HNC3B1000 | 65K |
| | | 1200 | HNC3B1200 | 65K |
| PG ^③ | HPGD | 1200 | HPC3B1200 | 65K |
| | | 1400 | HPC3B1400 | 65K |
| | | 1600 | HPC3B1600 | 65K |

^① Terminal connectors must be ordered separately; see page 5-146

^② Standard VL breakers DG - PG feature DC ratings up to 500V for ungrounded UPS applications. Consult the individual frame section for more information.

^③ UL only.

Modularity To Support All Your Application Needs Modules and More: VL Circuit Breakers with Optional Accessories

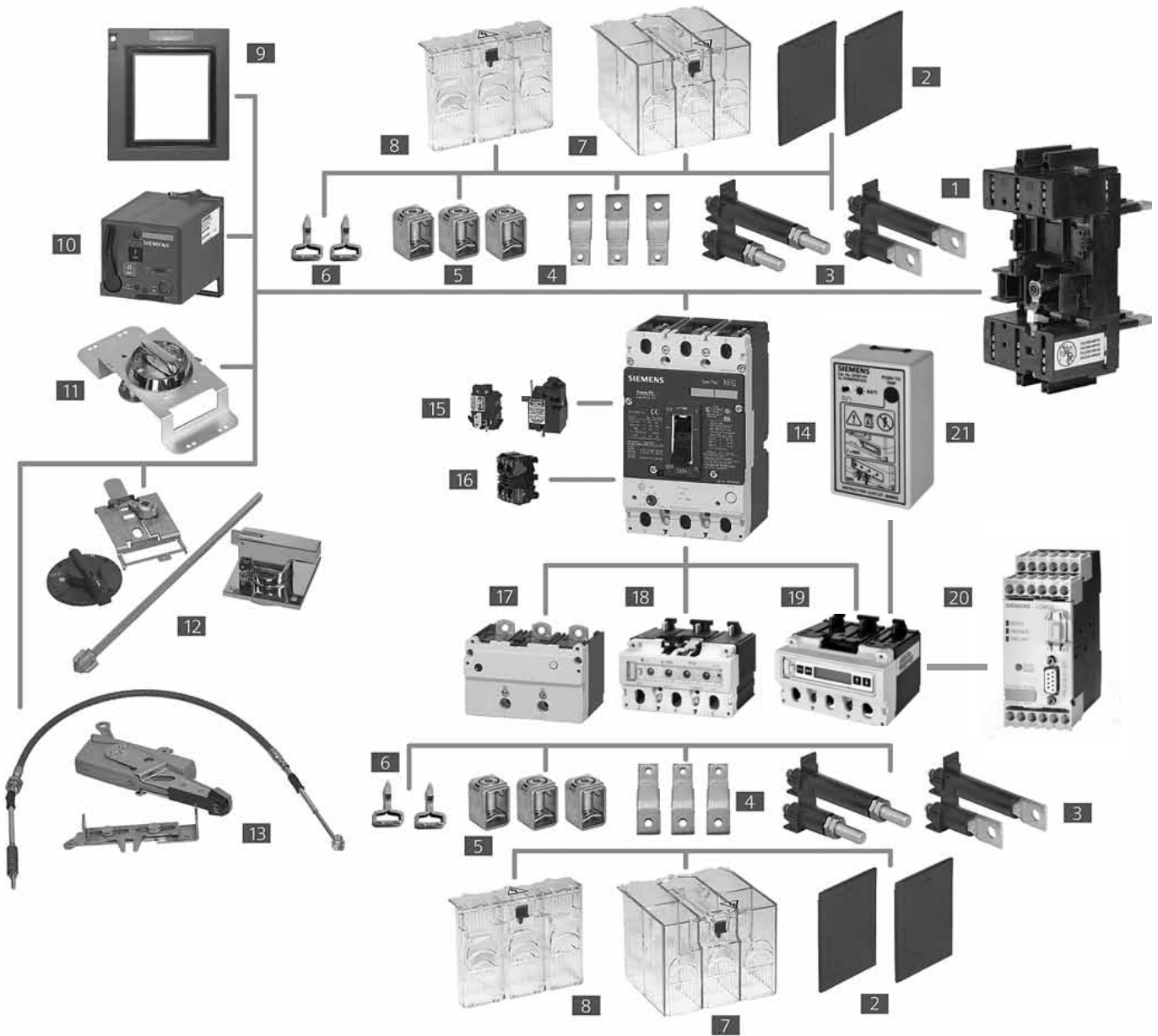

5
MOLDED CASE
CIRCUIT BREAKERS

- 1 Base for Plug-In or Draw-Out
- 2 Interphase Barriers
- 3 Rear Terminals – Flat and Round
- 4 Bus Extensions
- 5 Terminal Connectors
- 6 Plug-In Terminal Blades
- 7 Extended Terminal Shield
- 8 Standard Terminal Shield

- 9 Cover Frame for Door Cutout
- 10 Stored Energy Operator
- 11 Rotary Handle Operator
- 12 Variable Depth Rotary Operator
- 13 Max Flex Operator
- 14 Circuit Breaker
- 15 Shunt Trip or Undervoltage Releases
- 16 Auxiliary/Alarm Switches

- 17 Thermal Magnetic Trip Unit (525)
- 18 Electronic Trip Unit (555)
- 19 Elec. Trip Unit with LCD (586)
- 20 Communication Module with ZSI
- 21 Electronic Trip Unit Tester and LCB Power Supply

VL External Accessories

Operating Mechanisms

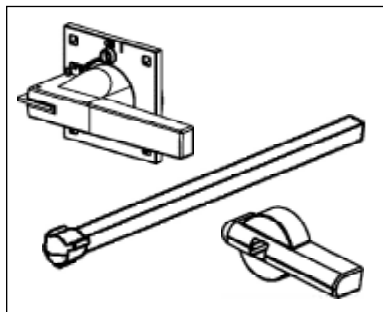
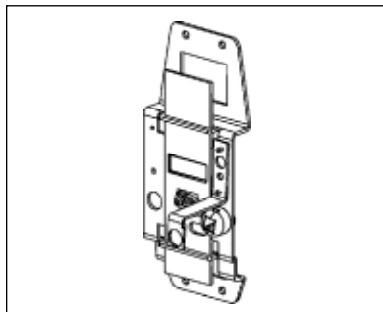
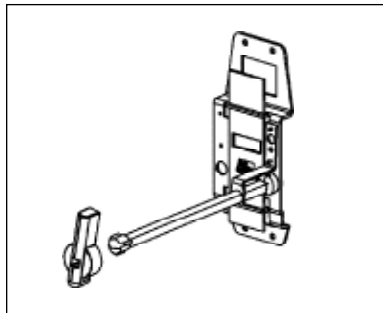
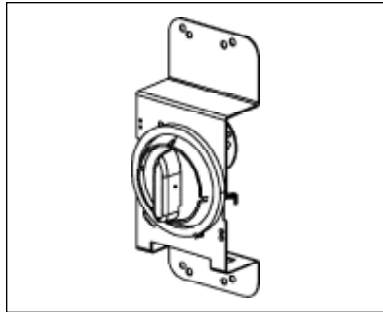

Ⓞ During manual operation, Early Break auxiliary switch contacts open before the breaker opens.

| Description | For DG to FG Frame 150 to 250 A | For JG to LG Frame 400 A to 600 A |
|---|---|---|
| | Catalogue Number | Catalogue Number |
| Through-Door Rotary Handle Operator Kit Fixed depth and the handle is mounted directly on the circuit breaker. Lockable knob (for up to 3 padlocks). NEMA 1, 12 Red Handle Version with red knob, yellow indicator plate NEMA 1, 12 | RHFF | RHFL |
| Door-Mounted Rotary Handle Operator Kit Variable depth, door mounted handle. Includes knob with masking frame, indicator plate, detachable door coupling, 12" shaft, and breaker mounted rotary operator. Lockable knob (for up to 3 padlocks). NEMA 1, 12 | RHFFEM | RHFLEM |
| Auxiliary Switch Kits For Direct or Extended Rotary Handle Operators (RHF and RHV). Form C, Early Break type2 Aux. Switch Kit [Ⓞ] Includes 1 switch with 5' wire For Door-Mounted Operator For Through-Door Operator Includes 2 switches with 5' wire For Door-Mounted Operator For Through-Door Operator | — RHSFA1F — RHSFA2F | RHSLA1 RHSLA1F RHSLA2 RHSLA2F |
| Door-Mounted Rotary Operator Mechanism Breaker mechanism only | RHVFBM | RHVLBM |
| Door-Mounted Rotary Handle Only Standard version NEMA 1, 12 NEMA 3R NEMA 4X Red Handle version | RHVM12H RHVM3RH RHVM4XH RHVMEMH | RHVM12H RHVM3RH RHVM4XH RHVMEMH |
| NFPA-79 Handle Kit Intermediate handle for NFPA-79 compliance with door-mounted rotary operator | RHVF79H | RHVM79H |
| Extension Shaft Only, for Door Mounted Operator 2 inches (50.8mm) 3 inches (76.2mm) 12 inches (304.8 mm) 16 inches (406.4 mm) 24 inches (609.6mm) w/ support bracket | RHVMS02 — RHVMS12 RHVMS16 RHVMS24 | RHVMS02 — RHVMS12 RHVMS16 RHVMS24 |

| Description | For MG Frame 800 A | For NG to PG Frame 1200 to 1600 A |
|--|---|---|
| | Catalogue Number | Catalogue Number |
| Through-Door Rotary Handle Operator Kit Fixed depth, breaker mounted. For direct fitting to the circuit breaker. Lockable with up to 3 padlocks. NEMA 1, 12 Red Handle Version with red knob, yellow indicator plate NEMA 1, 12 | RHFM — | — — |
| Door-Mounted Rotary Handle Operator Kit Variable depth, door mounted handle. Includes knob with masking frame, indicator plate, detachable door coupling, 12" shaft, and breaker mounted rotary operator. Lockable knob (for up to 3 padlocks). NEMA 1, 12 | RHVM12 — | — — |
| Auxiliary Switch Kits For Direct or Extended Rotary Handle Operators (RHF and RHV). Early Break type 2 Aux. Switch Kit Includes 1 switch with 5' wire For Door-Mounted Operator For Through-Door Operator Includes 2 switches with 5' wire For Door-Mounted Operator For Through-Door Operator | RHSMA1 — RHSMA2 — | RHSPA1 — RHSPA2 — |
| Door-Mounted Rotary Operator Mechanism Breaker mechanism only | RHVMBM | RHVPBM |
| Door-Mounted Rotary Handle Only Standard version NEMA 1, 12 NEMA 3R NEMA 4X Red Handle version | RHVM12H RHVM3RH RHVM4XH RHVMEH | RHVP12H RHVP3RH RHVP4XH RHVPEH |
| NFPA-79 Handle Kit Intermediate handle for NFPA-79 compliance with door-mounted rotary operator | RHVM79H | RHVP79H |
| Extension Shaft Only, for Door Mounted Operator 2 inches (50.8mm) 3 inches (76.2mm) 12 inches (304.8 mm) 16 inches (406.4 mm) 24 inches (609.6mm) w/ support bracket | RHVMS02 — RHVMS12 RHVMS16 RHVMS24 | — RHVPS03 RHVPS12 — RHVPS24 |

VL External Accessories

Operating Mechanisms

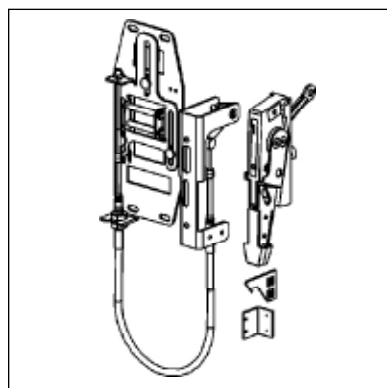
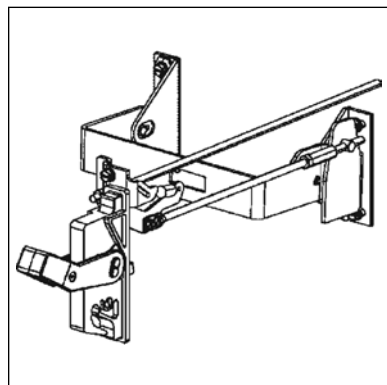

| Description | For DG and FG Frame 150 to 250 A | For JG and LG Frame 400 to 600 A |
|--|--|--|
| | Catalogue Number | Catalogue Number |
| Variable Depth Flange Mounted Operator Kit Adjustable from 8" to 16" Complete kit, includes handle and variable depth operator. NEMA 1, 3R, 12 NEMA 4X IEC Black Handle NEMA 1, 3R, 12 NEMA 4X | FHVF3R FHVF4X FHVF3RB FHVF4XB | FHVL3R FHVL4X FHVL3RB FHVL4XB |
| Max-Flex™, Variable Depth Flange Mounted Operator Kit Complete kit, includes plastic handle, breaker operator, and cable. NEMA 1, 3R, 12 For DG and FG operators, the cable is 36", all others are 48" May be right- or left-hand mounted | MFKF3R | MFKL3R |
| Handle Only, for Max-Flex™ Variable Depth NEMA 1, 3R, 12 Plastic NEMA 1, 3R, 12 Steel - epoxy coated NEMA 4, 4X Steel - chrome plated Solid color (all gray) Plastic [Ⓞ] NEMA 1, 3R, 12 Solid color (black handle) Steel epoxy coated [Ⓞ] NEMA 1, 3R, 12 | MFHM3R MFHM3RS MFHM4X MFHM3RB MFHM3RSB | MFHM3R MFHM3RS MFHM4X MFHM3RB MFHM3RSB |
| Breaker Operator Mechanism Only, for Max-Flex™ | MFMF | MFML |
| Cable Only, for Max-Flex™ Variable Depth 36" 48" 60" 72" 84" 96" 120" 144" | MFCF036 MFCF048 MFCF060 MFCF072 MFCF084 MFCF096 MFCF120 MFCF144 | MFCM036 MFCM048 MFCM060 MFCM072 MFCM084 MFCM096 MFCM120 MFCM144 |
| Handle Auxiliary Switch Form C (1NO - 1NC), early break [Ⓞ] 1 Aux. switch 2 Aux. switch | MFSFA1 MFSFA2 | MFSLA1 MFSLA2 |

Ⓞ Max-Flex™ handles are available with solid gray or black handles instead of the customary "Red for On" flange handle.

The black handle is preferred for IEC markets, where red handles have a specific meaning.

Ⓞ During manual operation, Early Break aux. contacts open before the breaker opens.

| Description | For MG Frame 800 A | For NG Frame 1200 A | For PG Frame 1600 A |
|---|-----------------------|------------------------|------------------------|
| | Catalogue Number | Catalogue Number | Catalogue Number |
| Variable Depth Flange Mounted Operator Kit Adjustable from 8" to 16" Complete kit, includes handle and variable depth operator. | | | |
| NEMA 1, 3R, 12 | — | — | |
| NEMA 4X | — | — | |
| IEC Black Handle NEMA 1, 3R, 12 NEMA 4X | — | — | |
| Max-Flex™, Variable Depth Flange Mounted Operator Kit Complete kit, includes plastic handle, breaker operator, and cable. NEMA 1, 3R, 12 For DG and FG operators, the cable is 36", all others are 48" May be right- or left-hand mounted | MFKM3R | MFKP3RS | MFKP3RS |
| Handle Only, for Max-Flex™ Variable Depth | | | |
| NEMA 1, 3R, 12 Plastic | MFHM3R | — | — |
| NEMA 1, 3R, 12 Steel - epoxy coated | MFHM3RS | MFHP3RS | MFHP3RS |
| NEMA 4, 4X Steel - chrome plated | MFHM4X | MFHP4X | MFHP4X |
| Solid color (all gray) Plastic [Ⓞ] | | | |
| NEMA 1, 3R, 12 | MFHM3RB | — | — |
| Solid color (black handle) Steel epoxy coated [Ⓞ] | | | |
| NEMA 1, 3R, 12 | MFHM3RSB | MFHP3RSB | MFHP3RSB |
| Breaker Operator Mechanism Only, for Max-Flex™ | MFMM | MFMP | MFMP |
| Cable Only, for Max-Flex™ Variable Depth | | | |
| 36" | MFCM036 | — | — |
| 48" | MFCM048 | MFCP048 | MFCP048 |
| 60" | MFCM060 | MFCP060 | MFCP060 |
| 72" | MFCM072 | MFCP072 | MFCP072 |
| 84" | MFCM084 | MFCP084 | MFCP084 |
| 96" | MFCM096 | MFCP096 | MFCP096 |
| 120" | MFCM120 | MFCP120 | MFCP120 |
| 144" | MFCM144 | MFCP144 | MFCP144 |
| Handle Auxiliary Switch Form C (1NO - 1NC), early break [Ⓞ] | | | |
| 1 Aux. switch | MFSPA1 | MFSPA1 | MFSPA1 |
| 2 Aux. switch | MFSPA2 | MFSPA2 | MFSPA2 |

Ⓞ Max-Flex™ handles are available with solid gray or black handles instead of the customary "Red for On" flange handle.

The black handle is preferred for IEC markets, where red handles have a specific meaning.

Ⓞ During manual operation, Early Break aux. contacts open before the breaker opens.

VL External Accessories

Operating Mechanisms

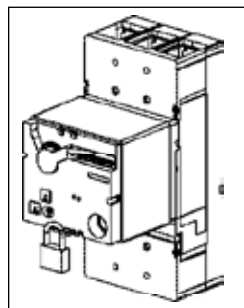

| Description | For DG to FG Frame 150 to 250 A | |
|---|------------------------------------|--|
| | Catalogue Number | |
| Stored Energy and Motor Operators Lockable with up to 3 padlocks. | | |
| AC Voltage DC Voltage | Stored Energy Type | |
| — 24 | SEAFB | |
| 42-48 42-48 | SEAFM | |
| 60 60 | SEAFY | |
| 110-127 110-127 | SEAFN | |
| 220-250 220-250 | SEAFR | |
| Cylinder Locks for Field Installation | CLKF | |

Plug-In and Draw-Out Bases

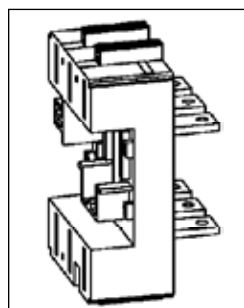

| Description | For DG Frame 150 A | For FG Frame 250 A |
|---|-----------------------|-----------------------|
| | Catalogue Number | Catalogue Number |
| Plug-in Mounting Base Assembly Includes base, terminal blade kit, sec. terminal block assembly, base trip interlock, and mounting hardware. | | |
| Rear Connected 3-pole | PCBDRC3 | PCBFRC3 |
| Front Connected 3-pole | PCBDFC3 | PCBFFC3 |
| Draw-out Assembly Includes base, position indicator switch, socket, base trip interlock, crank handle, connectors, and necessary shields. | | |
| Rear Connected 3-pole | DCADRC3 | DCAFRC3 |
| Front Connected 3-pole (Draw-out assembly includes side plates and all hardware) | DCADFC3 | DCAFFC3 |
| Hex Wrench for racking draw-out assembly and position indicator | DCHP | DCHP |
| Position Indicator Switch Form "C" switch to indicate breaker engaged/de-engaged position.Ⓢ | DCIP | DCIP |
| Secondary Terminal Block Assy. Accessory connections for plug-in or draw-out breakers. Pre-wired plug and block with 8 terminal points.Ⓢ | PCTF83 | PCTF83 |
| Plug-In Spare Breaker Kit Set of 6 terminal blades, 2 terminal shield, & 1 trip interlock | PCXD3 | PCXF3 |
| Draw-out Spare Breaker Kit Set of 6 terminal blades, & 1 trip interlock | DCXD3 | DCXF3 |
| Spare Breaker Trip Interlock | PCXFT | PCXFT |

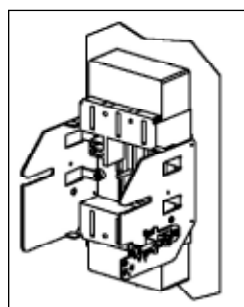
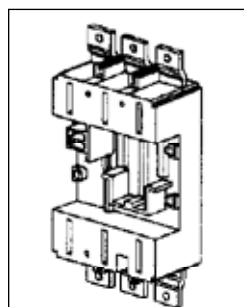

Ⓢ Up to 2 position indicator switches may be mounted per plug-in or draw-out base.

Ⓢ Up to 2 plugs per breaker (16 terminal points) may be mounted on DG, and FG breakers. Up to 3 plugs per breaker (24 terminal points) may be mounted on JG, LG, MG, NG, and PG breakers.

| For JG to LG Frame 400 to 600 A | For MG Frame 800 A | For NG to PG Frame 1200 to 1600 A |
|---|---|--|
| Catalogue Number | Catalogue Number | Catalogue Number |
| Stored Energy Type SEALB SEALM SEALY SEALN SEALR CLKP | Stored Energy Type SEAMB SEAMM SEAMY SEAMN SEAMR CLKP | Motor Operator Type MTRPB MTRPM MTRPY MTRPN MTRPR CLKP |

| For JG Frame 400 A | For LG Frame 600 A | For MG Frame 800 A | For NG Frame 1200 A | For PG Frame 1600 A |
|-----------------------|-----------------------|-----------------------|------------------------|------------------------|
| Catalogue Number | Catalogue Number | Catalogue Number | Catalogue Number | Catalogue Number |
| PCBJRC3 PCBJFC3 | PCBLRC3 PCBLFC3 | PCBMRC3 — | PCBNRC3 — | — — |
| DCAJRC3 DCAJFC3 | DCALRC3 DCALFC3 | DCAMRC3 DCAMFC3 | DCANRC3 DCANFC3 | — — |
| DCHP | DCHP | DCHP | DCHP | — |
| DCIP | DCIP | DCIP | DCIP | — |
| PCTL83 | PCTL83 | PCTM83 | PCTN83 | — |
| PCXJ3 | PCXL3 | PCXM3 | PCXN3 | — |
| DCXJ3 | DCXL3 | DCXM3 | DCXN3 | — |
| PCXLT | PCXLT | PCXMT | PCXPT | — |

External Accessories

Connections

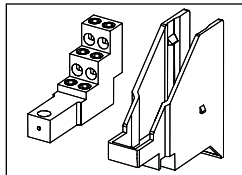
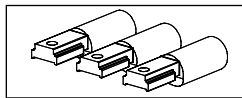
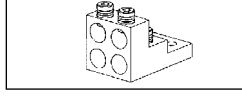
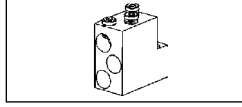
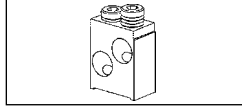
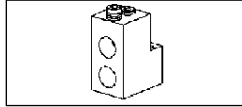
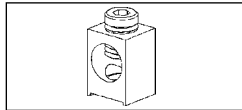
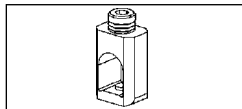
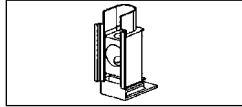
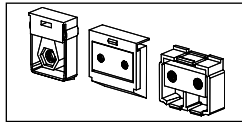

Note: pictures provide graphical representations only.

| Description | For DG Frame 150 A | For FG Frame 250 A |
|--|--|---|
| | Catalogue Number | Catalogue Number |
| Nut Keeper Plates For ring/tongue terminal or bus bar connections. (For metric threads on other than the JG or LG frame, change "TNK" to "TMK") 1 Nut Keeper Plate Kit of 3 | TNKD TNKD3 | TNKF TNKF3 |
| Mechanical Lugs <i>Steel Wrap Around Body (Cu Wire Only)</i> Cable Size; (cables per phase) Single Lug Kit of 3 | #8-1/0; 1-hole TW1DG20 3TW1DG20 | #4-350 kcmil; 1-hole TW1FG350 3TW1FG350 |
| <i>Aluminum Body (Al or Cu Wire)</i> Cable Size; (cables per phase) Single Lug Kit of 2 Kit of 3 Cable Size; (cables per phase) Single Lug Kit of 2 Kit of 3 Cable Size; (cables per phase) Single Lug Kit of 3 | #6-3/0; 1-hole TA1DG30 — 3TA1DG30 — — — — — | #4-350 kcmil; 1-hole TAW1FG350 — 3TAW1FG350 — — — — |
| <i>Copper Body (Cu Wire Only)</i> Cable Size; (cables per phase) Single Lug Kit of 2 Kit of 3 Cable Size; (cables per phase) Single Lug | #6-3/0; 1-hole TC1DG30 [Ⓢ] — 3TC1DG30 [Ⓢ] — — | #4-350 kcmil; 1-hole TCW1FG350 [Ⓢ] — 3TCW1FG350 [Ⓢ] — — |
| Compression Lugs Cable Size; (cables per phase) Kit of 2 Kit of 3 Cable Size; (cables per phase) Kit of 2 Kit of 3 Cable Size; (cables per phase) Kit of 3 | #14-2/0; 1-cable 2CLD20 3CLD20 — — — | #4-350 kcmil; 1-cable — 3CLF350 — — — |
| Distribution Lugs (Cu Wire Only) Cable Size; (cables per phase) Single Lug Kit of 3 Cable Size; (cables per phase) Single Lug Kit of 3 | #14-#2; 3-hole TA3DG02 3TA3DG02 #14-#4; 6-hole TA6DG04 3TA6DG04 | #14-#1; 2-hole and #14-2/0; 1-hole TA3FG20 3TA3FG20 #14-#4; 6-hole TA6FG04 3TA6FG04 |
| Control Wire Terminals Control Wire Terminal (Single) Control Wire Terminal (Kit of 3) | — — | — — |

Ⓢ Required for 100% rated breakers. Requires 90°C cable sized at 75°C ampacity.

| For JG Frame 400 A | For LG Frame 600 A | For MG Frame 800 A | For NG Frame 1200 A | For PG Frame 1600 A |
|--|---|--|--|--------------------------------------|
| Catalogue Number | Catalogue Number | Catalogue Number | Catalogue Number | Catalogue Number |
| FBCJ3 ^① — | FBCL3 ^① — | FBCM3 ^① — | SSBP SSBPH | SSBP SSBPH |
| RTLJSR RTLJLR SRTJR3 RTLJSF RTLJLF SRTJF3 — — | — — — — — — RTLLSF SRTL3F3 | — — — — — — RTLMSF SRTMF3 | — — — — — — RTLNSF SRTNF3 | — — — — — — — — |
| TSSL3 TSLL3 | TSSL3 ^② TSLL3 ^② | TSSM3 TSLM3 | TSSP3 TSLP3 | TSSP3 TSLP3 |
| IPBM | IPBM | IPBM | IPBP | IPBP |
| — | — | — | — | LMAP1600 ^③ |
| — — | — — | — — | — — | MBPG1600 MBPG1601 |







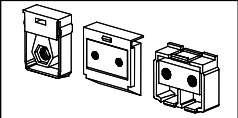
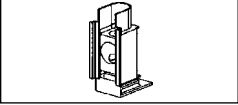
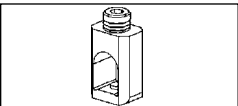

① Consult Siemens for availability.

② Not for use with standard AI terminals. Use Standard Shield for rear connection and Extended Shield for bus - bar connection.

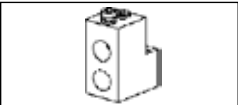
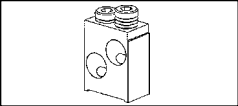
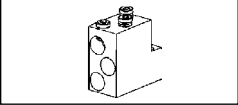
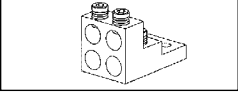
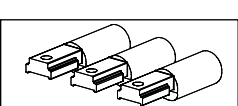
③ Kit includes connection for one side of breaker only. Order quantity 2 if connecting line and load side.

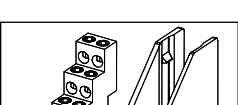
VL External Accessories

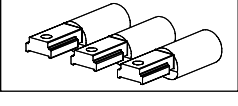
Connections

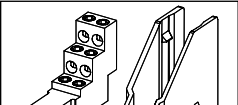
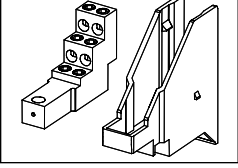
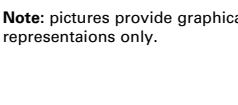
| | | For DG Frame 150 A | For FG Frame 250 A |
|---|--|--|--|
| | Description | Catalogue Number | Catalogue Number |
|  | Nut Keeper Plates For ring/tongue terminal or bus bar connections. (For metric threads on other than the JG or LG frame, change "TNK" to "TMK") 1 Nut Keeper Plate Kit of 3 | TNKD TNKD3 | TNKF TNKF3 |
|  | | | |
|  | Mechanical Lugs <i>Steel Wrap Around Body (Cu Wire Only)</i> Cable Size; (cables per phase) Single Lug Kit of 3 | #8-1/0; 1-hole TW1DG20 3TW1DG20 | #4-350 kcmil; 1-hole TW1FG350 3TW1FG350 |
|  | <i>Aluminum Body (Al or Cu Wire)</i> Cable Size; (cables per phase) Single Lug Kit of 2 | #6-3/0; 1-hole TA1DG30 — | #4-350 kcmil; 1-hole TAW1FG350 — |
|  | Kit of 3 | 3TA1DG30 | 3TAW1FG350 |
|  | Cable Size; (cables per phase) | — | — |
|  | Single Lug Kit of 2 Kit of 3 | — — — | — — — |
|  | Cable Size; (cables per phase) Single Lug | — — | — — |
|  | Kit of 3 | — | — |
|  | <i>Copper Body (Cu Wire Only)</i> Cable Size; (cables per phase) Single Lug Kit of 2 | #6-3/0; 1-hole TC1DG30 [Ⓞ] — | #4-350 kcmil; 1-hole TCW1FG350 [Ⓞ] — |
|  | Kit of 3 | 3TC1DG30 [Ⓞ] | 3TCW1FG350 [Ⓞ] |
|  | Cable Size; (cables per phase) Single Lug | — — | — — |
|  | Compression Lugs Cable Size; (cables per phase) Kit of 2 Kit of 3 | #14-2/0; 1-cable 2CLD20 3CLD20 | #4-350 kcmil; 1-cable — 3CLF350 |
|  | Cable Size; (cables per phase) Kit of 2 Kit of 3 | — — | — — |
|  | Cable Size; (cables per phase) Kit of 3 | — — | — — |
|  | Distribution Lugs (Cu Wire Only) Cable Size; (cables per phase) Single Lug Kit of 3 | #14-#2; 3-hole TA3DG02 3TA3DG02 | #14-#1; 2-hole and #14-2/0; 1-hole TA3FG20 3TA3FG20 |
|  | Cable Size; (cables per phase) Single Lug Kit of 3 | #14-#4; 6-hole TA6DG04 3TA6DG04 | #14-#4; 6-hole TA6FG04 3TA6FG04 |
| | Control Wire Terminals Control Wire Terminal (Single) Control Wire Terminal (Kit of 3) | — — | — — |

Note: pictures provide graphical representations only.

Ⓞ Required for 100% rated breakers. Requires 90°C cable sized at 75°C ampacity.

| For JG Frame 400 A | For LG Frame 600 A | For MG Frame 800 A | For NG Frame 1200 A | For PG Frame 1600 A |
|--|---|--|--|--|
| Catalogue Number | Catalogue Number | Catalogue Number | Catalogue Number | Catalogue Number |
| TMKJ TMKJ3 <i>metric only</i> | TNKL TNKL3 | TNKM TNKM3 | TNKP TNKP3 | TNKP TNKP3 |
| 1/0-600 kcmil; 1-hole TW1JG600 3TW1JG600 | — — — | — — — | — — — | — — — |
| 3/0-250 kcmil; 2-hole TA2JG250 — 3TA2JG250 AL: 250-750 kcmil CU: 3/0-600 kcmil; 1-hole TA1JG750 — 3TA1JG750 — — — | #2-600 kcmil; 2-hole — — 3TA2LG600LD ^① 3TA2LG600LN ^② AL: 250-750 kcmil CU: 3/0-600 kcmil; 1-hole TA1JG750 (400A max) — 3TA1JG750 (400A max) — — — | 1/0-500 kcmil, 3-hole TA3MG500 3TA3MG500 500 -750 kcmil; 2-hole TA2MG750 — 3TA2MG750 #2-600 kcmil; 3-hole — 3TA3MG600 ^④ | 1/0-500 kcmil; 4-hole — 2TA4NG500 3TA4NG500 3TA4NG500H ^⑤ 500 -750 kcmil; 3-hole — 2TA3NG750 3TA3NG750 — | 1/0-750 kcmil; 6-hole — — 3TA6PG750 ^⑥ 600-750 kcmil; 4-hole TA4P750 ^⑥ — 300-600 kcmil; 5; 6-hole TA5P600 ^⑥ TA6R600 ^⑥ — |
| 3/0-250 kcmil; 2-hole TC2JG250 ^③ — — 3/0-750 kcmil; 1-hole TC1JG750 ^③ | #2-600 kcmil; 2-hole — — 3TC2LG600LD ^{①③} 3TC2LG600LN ^{②③} — — | 1/0-500 kcmil; 3-hole TC3MG500 ^③ — — — — | 1/0-500 kcmil; 4-hole — — 3TC4NG500 ^③ — — | — — — — 300-600 kcmil; 5-hole TC5R600 ^{③⑥} |
| #6-350 kcmil; 1-cable — 3CLJ350 250-600 kcmil; 1-cable 3CLJ600 — 250-750 kcmil; 1-cable 3CLJG750 — | #6-350 kcmil; 2-cable — 6CLL350 (kit of 6) 250-750 kcmil; 1-cable 3CLL750 — 250-600 kcmil; 2-cable 6CLL600 (kit of 6) — | — — — — — — | 1/0-500 kcmil; 4-cable — 12CLN500 (kit of 12) — — — — — | — — — — — — |
| #14-#4; 12-hole TA12JG04 3TA12JG04 #14-2/0; 6-hole TA6JG20 3TA6JG20 | — — — — — | — — — — — | — — — — — | — — — — — |
| TA2JG250PT — | — 3TA2LG600LNPT | TA3MG500PT — | — 3TA4NG500PT | — — |

All lug kits include the nut keepers.

① Mounted on Load Side Only.

② Mounted on Line Side Only.

③ Required for 100% rated breakers. Requires 90°C cable

sized at 75°C ampacity.

④ Requires extended modified shield.

⑤ Used only with LMAP1600 mounting base.

⑥ Used only with MBPG1600 or MBPG1601 mounting base.

VL External Accessories

General

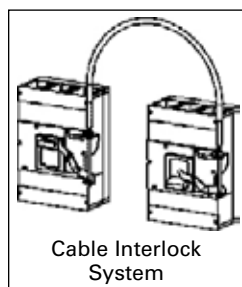
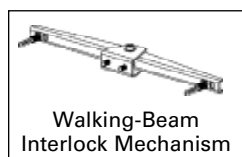
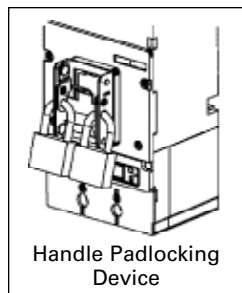

| Description | For DG Frame 150 A | For FG Frame 250 A |
|--|----------------------------|----------------------------|
| | Catalogue Number | Catalogue Number |
| Handle Padlocking Device To padlock breaker toggle in the "OFF" position. Accepts up to 3 padlocks with 5–8 mm shackles. | HPLF | HPLF |
| Handle Blocking Device For holding the handle in the "ON" position. Not a lockout/tagout device. | HBDF | HBDF |
| Walking-Beam Interlock Mechanism Provides mechanical interlocking between two adjacent circuit breakers. Fixed mounted breakers Note: Both breakers must be of the same frame size. | WBMFFM | WBMFFM |
| Cable Interlock Mechanism Provides mechanical interlocking between 2 circuit-breakers - includes operator mechanism for one circuit breaker only. Combination with the next larger or smaller frame size is possible. | CBTF | CBTF |
| Interlock Cable Cable only, to connect 2 circuit breakers. Cable length 18 in. .46m (recommended up to 250A) Cable length 36 in. .91m (recommended from 400–800A) Cable length 54 in. 1.37m (recommended from 1200–1600A) | CBCF18 CBCM36 CBCP54 | CBCF18 CBCM36 CBCP54 |
| Mounting Screw Kit Includes the necessary hardware to mount a circuit breaker to the user's prepared surface Kit with 2 screws (SAE thread) Kit with 4 screws (SAE thread) | MSKF2 MSKF4 | MSKF2 MSKF4 |
| Trip Adjustment Sealing Cover Includes a trip unit cover to prevent tampering or adjustment of trip settings. Seal not included. Thermal-Magnetic Trip Units | TSCFTM | TSCFTM |

| For JG Frame 400 A | For LG Frame 600 A | For MG Frame 800 A | For NG Frame 1200 A | For PG Frame 1600 A |
|-----------------------|-----------------------|-----------------------|------------------------|------------------------|
| Catalogue Number | Catalogue Number | Catalogue Number | Catalogue Number | Catalogue Number |
| HPLL | HPLL | HPLM | HPLP | HPLP |
| HBDL | HBDL | HBDM | HBDP | HBDP |
| WBMLFM | WBMLFM | WBMMFM | WBMPFM | WBMPFM |
| CBTL | CBTL | CBTM | CBTP | CBTP |
| — CBCM36 CBCP54 | — CBCM36 CBCP54 | — CBCM36 CBCP54 | — — CBCP54 | — — CBCP54 |
| — MSKL4 | — MSKL4 | — MSKM4 | — MSKP4 | — MSKP4 |
| TSLTM | TSLTM | TSCMTM | — | — |

VL External Accessories

Ground Sensors & Electronic Accessories

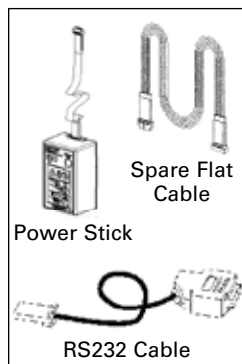
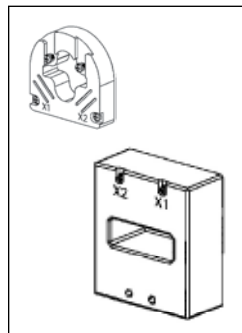

| Description | For DG Frame 150 A | For FG Frame 250 A |
|---|--|--|
| | Catalogue Number | Catalogue Number |
| Neutral Current Transformer (Ground Sensor, N-pole) Neutral = 35/60A Neutral = 100A Neutral = 150A Neutral = 250A Neutral = 400A Neutral = 600A Neutral = 800A Neutral = 1000/1200A Neutral = 1600A | NGSD060 NGSF100 NGSF150 — — — — — — — | — NGSF100 NGSF150 NGSJ250 — — — — — — |
| Communications & Electronics Power Stick - Hand held, battery operated power supply for LCD trip units. (Requires two -9V batteries) For programming and trip testing only. | EPSP18V | EPSP18V |
| Com20 Profibus Communications Module with ZSI for electronic trip units (order cable separately) | COMPRO20 | COMPRO020 |
| Com21 Modbus Communications Module with ZSI for electronic trip units (order cable separately) | COMM0D21 | COMM0D21 |
| Cable for COM20/21 and power supply.....5ft. (1.5m) | COMKIT13 | COMKIT13 |
| Cable for COM20/21, 3.0m (9.8ft). | COMKIT6 | COMKIT6 |
| Spare flat cable for Test Kits | COMPCA | COMPCA |
| Addressing Plug - Assigns a field bus address without a PC by plugging into Com20/21 | 3UF79100AA00 | 3UF79100AA000 |

Door Cutouts & Extensions

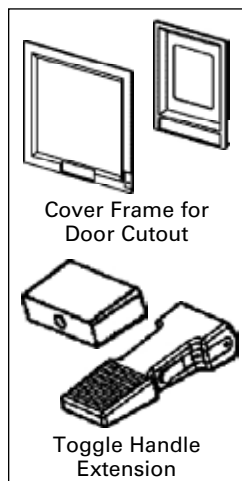

| | | |
|---|----------|----------|
| Cover Frame for Door Cutout For fixed or plug-in mounted circuit breakers. (IP30) 2-Pole & 3-Pole | BZLF3 | BZLF3 |
| For breakers with stored energy operator. (IP40) | BZLFRHSE | BZLFRHSE |
| Circuit-breaker draw-out mounted and toggle handle operated. Kit includes cover frame (bezel) and escutcheon as needed. (IP40) (not for use with rotary handle or stored energy operator) | BZLFBDC | BZLFBDC |
| Toggle Handle Extension For spare or replacement. (One is included with each NG - PG frame.) | — | — |

| For JG Frame 400 A | For LG Frame 600 A | For MG Frame 800 A | For NG Frame 1200 A | For PG Frame 1600 A |
|---|--|--|---|---|
| Catalogue Number | Catalogue Number | Catalogue Number | Catalogue Number | Catalogue Number |
| — — — NGSJ250 NGSL400 — — — — | — — — — NGSL400 NGSM600 — — — — | — — — — — NGSM600 NGSN800 — — — | — — — — — — NGSN800 NGSP120 — | — — — — — — — NGSP120 NGSP160 |
| EPSP18V | EPSP18V | EPSP18V | EPSP18V | EPSP18V |
| COMPRO20 | COMPRO20 | COMPRO20 | COMPRO20 | COMPRO20 |
| COMMOD21 | COMMOD21 | COMMOD21 | COMMOD21 | COMMOD21 |
| COMKIT4 | COMKIT4 | COMKIT5 | COMKIT5 | COMKIT5 |
| COMKIT7 | COMKIT7 | COMKIT8 | COMKIT8 | COMKIT8 |
| COMPCA | COMPCA | COMPCA | COMPCA | COMPCA |
| 3UF79100AA000 | 3UF79100AA000 | 3UF79100AA000 | 3UF79100AA000 | 3UF79100AA000 |
| BZLL3 | BZLL3 | BZLM3 | BZLP3 | BZLP3 |
| BZLLRHSE | BZLLRHSE | BZLMRHSE | BZLPRHSE | BZLPRHSE |
| BZLLBDC | BZLLBDC | BZLMBDC | BZLPBDC | BZLPBDC |
| THEL | THEL | THEM | THEP | THEP |

VL Molded Case Circuit Breakers

Accessory Locations

Selection

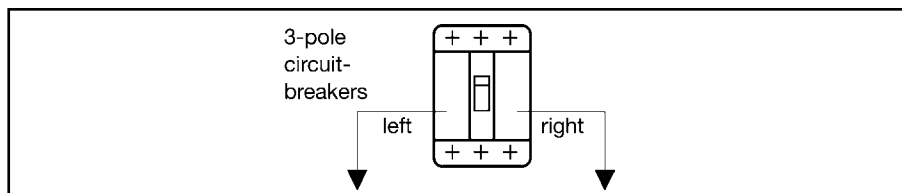

Locations of Internally Mounted Accessories

| Frame Family | Left Pocket | Right Pocket |
|--|---|---|
| DG*, FG*, JG, LG 150 to 600A | Up to 3 Auxiliary Switches | Shunt Trip or UVR or up to 3 Auxiliary Switches or up to 2 Auxiliary Switches + 1 Alarm Switch |
| | Up to 2 Auxiliary Switches + 1 Alarm Switch | Shunt Trip or UVR or up to 3 Auxiliary Switches or up to 2 Auxiliary Switches + 1 Alarm Switch |
| MG, NG, PG 800 to 1600A | Up to 4 Auxiliary Switches | Shunt Trip or UVR or up to 4 Auxiliary Switches |
| | Up to 2 Auxiliary Switches + 2 Alarm Switches | Shunt Trip or UVR or up to 4 Auxiliary Switches |

* Except DG and FG breakers with Electronic Trip Units. Due to the location of the Magnetic Latch, the Left Pocket is not available for accessories.

Accessory Information

- Aux. Switch is an Auxiliary Switch, 1A or 1B contact
- Alarm Switch has 1A or 1B contact
- UVR is an Undervoltage Release
- The standard location for factory mounted Auxiliary and Alarm Switches is the Left Pocket

Accessory Maximums

DG, FG, JG, LG Maximum Accessories:

- Maximum of six (6) switches total
- DG, FG Maximum of two (2) Alarm Switches, one each in the Left and Right Pockets. JG, LG Max. of 1 Alarm, Left only

MG, NG, PG Maximum Accessories:

- Maximum of eight (8) switches total
- Maximum of two (2) Alarm Switches, Left Pocket only

VL Technical Data

| | | DG | FG | JG | LG | MG | NG | PG |
|--------------------------------------|------|------------|------------|------------|------------|------------|------------|------------|
| Max rated continuous current | | 150 | 250 | 400 | 600 | 800 | 1200 | 1600 |
| Rated operational voltage | | | | | | | | |
| NEMA | V AC | 600 | 600 | 600 | 600 | 600 | 600 | 600 |
| IEC | V AC | 690 | 690 | 690 | 690 | 690 | 690 | 690 |
| Rated impulse withstand voltage | | | | | | | | |
| Main conducting paths | kV | 8 | 8 | 8 | 8 | 8 | 8 | 8 |
| Auxiliary circuits | kV | 4 | 4 | 4 | 4 | 4 | 4 | 4 |
| Ambient temperature range | °C | -25 to +75 | -25 to +75 | -25 to +75 | -25 to +75 | -25 to +75 | -25 to +75 | -25 to +75 |
| High ambient derating (thermal-mag.) | 50°C | 93% | 93% | 93% | 93% | 95% | 95% | 95% |
| | 60°C | 86% | 86% | 86% | 86% | 86% | 86% | 80% |
| | 70°C | 80% | 80% | 80% | 80% | 80% | 80% | 74% |
| Operating cycles | | 20,000 | 20,000 | 20,000 | 10,000 | 5,000 | 3,000 | 3,000 |
| Max switching rate (per hour) | | 120 | 120 | 120 | 60 | 60 | 30 | 30 |
| Power loss (at max. rated current) | | | | | | | | |
| Thermal-magnetic | W | 15 – 48 | 32 – 80 | 60 – 175 | 85 – 230 | 170 – 250 | 150 – 220 | 200 – 260 |
| Electronic trip unit | W | 40 | 60 | 90 | 160 | 250 | 210 | 260 |
| IEC ① | | | | | | | | |
| Time constant t = 10 ms | | | | | | | | |
| 1 current path | | | | | | | | |
| 2 current paths | | | | | | | | |
| 3 current paths | | | | | | | | |
| in series | | | | | | | | |
| Up to 250V DC | | — | — | — | — | — | — | — |
| 440V DC | | | | | | | | |
| 600V DC | | | | | | | | |
| NEMA | | | | | | | | |
| Time constant t = 8 ms | | | | | | | | |
| 2 poles switching | | | | | | | | |
| 1 current path | | | | | | | | |
| 250V DC max.② | | 30 | 30 | 30 | 30 | 42 | 42 | 42 |
| 3 poles switching | | | | | | | | |
| 2 current paths in series | | | | | | | | |
| 500V DC max.② | | 18 | 25 | 35 | 35 | 65 | 65 | 65 |
| Accessories | | | | | | | | |
| Auxiliary/Alarm switch | | | | | | | | |
| Current rating (1 or 2 switches) | | 10 | 10 | 10 | 10 | 10 | 10 | 10 |
| Current rating (3 or 4 same switch) | A | 5 | 5 | 5 | 5 | 5 | 5 | 5 |
| Shunt trip | | | | | | | | |
| Pick-up voltage | V | 0.7 – 1.1 | 0.7 – 1.1 | 0.7 – 1.1 | 0.7 – 1.1 | 0.7 – 1.1 | 0.7 – 1.1 | 0.7 – 1.1 |
| Power consumption (short-time) at: | | | | | | | | |
| 48 – 60 V AC | VA | 158 – 200 | 158 – 200 | 158 – 200 | 158 – 200 | 380 – 480 | 380 – 480 | 380 – 480 |
| 110 – 127 V AC | VA | 136 – 158 | 136 – 158 | 136 – 158 | 136 – 158 | 302 – 353 | 302 – 353 | 302 – 353 |
| 208 – 277 V AC | VA | 274 – 350 | 274 – 350 | 274 – 350 | 274 – 350 | 330 – 439 | 330 – 439 | 330 – 439 |
| 380 – 600 V AC | VA | 158 – 237 | 158 – 237 | 158 – 237 | 158 – 237 | 243 – 384 | 243 – 384 | 243 – 384 |
| 24 V DC | W | 110 | 110 | 110 | 110 | 360 | 360 | 360 |
| 48 – 60 V DC | W | 110 – 172 | 110 – 172 | 110 – 172 | 110 – 172 | 512 – 820 | 512 – 820 | 512 – 820 |
| 110 – 127 V DC | W | 220 – 254 | 220 – 254 | 220 – 254 | 220 – 254 | 302 – 353 | 302 – 353 | 302 – 353 |
| 220 – 250 V DC | W | 97 – 110 | 97 – 110 | 97 – 110 | 97 – 110 | 348 – 397 | 348 – 397 | 348 – 397 |
| Max. operating time | ms | 50 | 50 | 50 | 50 | 50 | 50 | 50 |

① Consult Siemens for short circuit values.

② Review individual frame and type values.

VL Technical Data

| Undervoltage trip | | DG | FG | JG | LG | MG | NG | PG |
|---|------|-----------|-----------|-----------|-----------|-----------|-----------|-----------|
| Drop voltage (percentage) | V | 35% – 70% | 35% – 70% | 35% – 70% | 35% – 70% | 35% – 70% | 35% – 70% | 35% – 70% |
| Pick-up voltage (percentage) | V | 70% – 85% | 70% – 85% | 70% – 85% | 70% – 85% | 70% – 85% | 70% – 85% | 70% – 85% |
| Power consumption (continuous) at: | | | | | | | | |
| 110 – 127 V AC | VA | 1.5 | 1.5 | 1.5 | 1.5 | 1.1 | 1.1 | 1.1 |
| 220 – 250 V AC | VA | 1.5 | 1.5 | 1.5 | 1.5 | 2.1 | 2.1 | 2.1 |
| 208 V AC | VA | 1.8 | 1.8 | 1.8 | 1.8 | 2.2 | 2.2 | 2.2 |
| 277 V AC | VA | 2.1 | 2.1 | 2.1 | 2.1 | 1.6 | 1.6 | 1.6 |
| 380 – 415 V AC | VA | 1.6 | 1.6 | 1.6 | 1.6 | 2.0 | 2.0 | 2.0 |
| 440 – 480 V AC | VA | 1.8 | 1.8 | 1.8 | 1.8 | 2.3 | 2.3 | 2.3 |
| 500 – 525 V AC | VA | 2.5 | 2.5 | 2.5 | 2.5 | 2.9 | 2.9 | 2.9 |
| Max. opening time | ms | 50 | 50 | 50 | 50 | 50 | 50 | 50 |
| Motorized operating mechanism | | | | | | | | |
| Motor with stored energy mechanism (synchronizable) | | X | X | X | X | X | — | — |
| Motor Operator | | | | | | — | X | X |
| Max. switching rate (per hour) | | 120 | 120 | 120 | 60 | 60 | 30 | 30 |
| Command duration | ms | 20 – 50 | 20 – 50 | 20 – 50 | 20 – 50 | 20 – 50 | 50 | 50 |
| Closing time | ms | <100 | <100 | <100 | <100 | <100 | <5,000 | <5,000 |
| Charging time | s | <5 | <5 | <5 | <5 | <5 | <5 | <5 |
| Break time | s | <5 | <5 | <5 | <5 | <5 | <5 | <5 |
| Power consumption | VA/W | <100 | <100 | <100 | <100 | <250 | <250 | <250 |
| Control voltages 24 V DC | | | | | | | | |
| 42 – 48 V AC / DC | | | | | | | | |
| 60 V AC / DC | | | | | | | | |
| 110 - 127 V AC/ DC | | | | | | | | |
| 220 - 250 V AC/ DC | | | | | | | | |
| Operating range: 85 – 110% of rated control voltage | | | | | | | | |

Technical Data

Unusual Operating Conditions

Reference

Note: The information provided on this and the next page is intended for reference and recommendation only. Because several variables can act on a circuit breaker's performance at the same time, the data below is based less on controlled testing, than on experience and engineering judgment. Contact Siemens for further information on special conditions and treatment.

High Ambient Temperatures

Because thermal-magnetic trip breakers are temperature sensitive and calibrated for a specific ambient of 40° C (104° F) (average enclosure temperature), a higher ambient will cause the breaker to trip at lower current than its nameplate rating, in other words, causing the breaker to "derate" (see Table 1). Similarly, the current carrying capacity of a circuit conductor is based upon a certain ambient temperature, a higher ambient will reduce its current carrying capacity, causing it to "derate." Thus, with a fluctuating temperature, a thermal-magnetic breaker will derate nearly parallel with its connected circuit conductors and maintain close circuit protection. If the application temperature exceeds 40° C (104° F) and is known, either a breaker specially calibrated for the higher ambient or one oversized according to Table 1 may be selected. In a case such as this, the circuit conductors should be oversized as well.

Siemens Electronic Trip Unit Breakers are insensitive to temperature changes. However, they do include circuitry to protect the components from abnormally high temperatures.

Altitude

Reduced air density at altitudes greater than 6600 ft. (2000 meters) affects the ability of a molded case circuit breaker to transfer heat and interrupt faults. Therefore, circuit breakers applied at these altitudes should have interrupting, insulation and continuous currents derated as indicated in Figure 1.

Table 1 – Temperature derating date for thermal-magnetic breakers

| Reference Ampere Rating at 40° C (104° F) | Ampere Rating at: | | | Siemens Breaker Frames |
|---|-------------------|----------------|----------------|------------------------|
| | 25° C (77° F) | 50° C (122° F) | 60° C (140° F) | |
| 50 | 55 | 46 | 42 | DG |
| 60 | 66 | 56 | 52 | |
| 70 | 77 | 65 | 60 | |
| 90 | 99 | 84 | 78 | |
| 100 | 110 | 94 | 87 | |
| 125 | 137 | 114 | 100 | |
| 150 | 165 | 136 | 120 | |
| 175 | 192 | 159 | 140 | |
| 200 | 220 | 182 | 160 | |
| 225 | 247 | 205 | 180 | |
| 250 | 275 | 235 | 220 | |
| 300 | 330 | 276 | 252 | |
| 350 | 385 | 325 | 301 | |
| 400 | 440 | 372 | 340 | |
| 500 | 550 | 468 | 435 | |
| 600 | 660 | 564 | 525 | |
| 700 | 770 | 658 | 613 | |
| 800 | 880 | 754 | 704 | |
| 900 | 990 | 828 | 749 | |
| 1000 | 1100 | 900 | 825 | |
| 1200 | 1320 | 1090 | 1000 | |
| 1400 | 1540 | 1304 | 1148 | |
| 1600 | 1760 | 1500 | 1320 | |
| | | | | FG |
| | | | | JG |
| | | | | LG |
| | | | | MG |
| | | | | NG |
| | | | | PG |

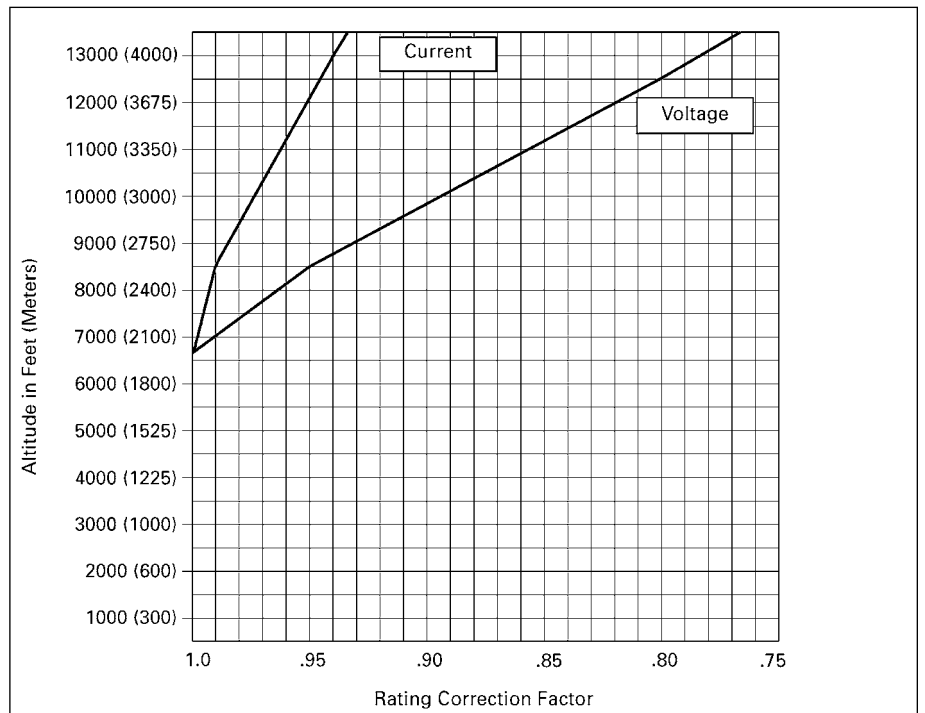

Figure 1 – Altitude adjustment

Technical Data

Unusual Operating Conditions

Reference

Unusual Operating Conditions 400 Hz Systems

Circuit Breaker Derating Required

This table lists the maximum continuous current carrying capacity for Siemens breakers at 400Hz. Due to the increased resistance of the copper sections resulting from the skin effect produced by eddy currents at these frequencies, circuit breakers in many cases require derating. The thermal derating on these devices is based upon 100%, three phase application in open air in a maximum of 40°C (104° F) with 48 in. (1219 mm) of the specified cable or bus at the line and load side. Additional derating of not less than 20% will be required if the circuit breaker is to be utilized in an enclosure. Further derating may be required if the enclosure ambient temperature exceeds 40°C(104° F).

Cable and Bus Sizing

The cable and bus sizes to be utilized at 400Hz are not based on standard National Electric Codes tables for 60Hz application. Larger cross sections are necessary at 400Hz. All bus bars specified are based upon mounting the bars in the vertical plane to allow maximum air flow. All bus bars are spaced at a minimum of 0.25 in. (6 mm) apart. Mounting of bus bars in the horizontal plane will necessitate additional drafting. Edgewise orientation of the bus may change the maximum ratings indicated. If additional information is required for other connections of cable or bus, contact Siemens for information.

Application Recommendations

It is recommended that temperatures be measured on the line and load terminals or T-connectors of the center pole. These are usually the hottest terminals with a balanced load. A maximum temperature of 75°C (35°C over a maximum ambient of 40°C) would verify the particular application. Temperature profiles taken on these breakers can be correlated to ensure that the hottest points within the breaker are within the required temperature limits.

Interrupting Rating

Circuit breakers used in 400 Hz systems are limited to a 5000 A interrupting rating. If higher ratings are required, consult Siemens.

| Breaker type | Maximum continuous ampere rating at 40°C (104°F)® | | | 75°C (167F) Copper cable per pole | |
|---------------|---|-----------|-------------------------|-----------------------------------|-----------|
| | 60HZ | | 400HZ | No of pieces | Wire size |
| | Open air | Open air® | Enclosed after derating | | |
| DG | 50 | 48 | 38 | 1 | #8 |
| | 60 | 57 | 46 | 1 | #6 |
| | 70 | 63 | 50 | 1 | #4 |
| | 80 | 72 | 58 | 1 | #4 |
| | 90 | 80 | 64 | 1 | #3 |
| | 100 | 90 | 72 | 1 | #3 |
| | 110 | 95 | 75 | 1 | #2 |
| | 125 | 105 | 84 | 1 | #1 |
| FG | 150 | 125 | 100 | 1 | #1/0 |
| | 100 | 90 | 72 | 1 | #3 |
| | 110 | 95 | 75 | 1 | #2 |
| | 125 | 105 | 84 | 1 | #1 |
| | 150 | 125 | 100 | 1 | #1/0 |
| | 175 | 140 | 112 | 1 | #2/0 |
| | 200 | 160 | 128 | 1 | #3/0 |
| | 225 | 180 | 144 | 1 | #4/0 |
| JG | 250 | 200 | 160 | 1 | 250 kcmil |
| | 250 | 210 | 168 | 1 | 250 kcmil |
| | 300 | 240 | 192 | 1 | 350 kcmil |
| | 350 | 260 | 208 | 1 | 500 kcmil |
| JG 100% Rated | 400 | 300 | 240 | 2 | #2/0 |
| | 250 | 210 | 210 | 1 | 250 kcmil |
| | 300 | 240 | 240 | 1 | 350 kcmil |
| | 350 | 260 | 260 | 1 | 500 kcmil |
| LG | 400 | 300 | 300 | 2 | #3/0 |
| | 400 | 300 | 240 | 2 | #3/0 |
| | 500 | 375 | 300 | 2 | 250 kcmil |
| | 600 | 420 | 336 | 2 | 350 kcmil |

| Breaker type | Maximum continuous ampere rating at 40°C (104°F)® | | | 75°C (167F) Copper cable per pole | |
|---------------|---|-----------|-------------------------|-----------------------------------|-----------|
| | 60HZ | | 400HZ | No of pieces | Wire size |
| | Open air | Open air® | Enclosed after derating | | |
| LG | 400 | 300 | 240 | 2 | #3/0 |
| | 500 | 375 | 300 | 2 | 250 kcmil |
| | 600 | 420 | 336 | 2 | 350 kcmil |
| MG | 600 | 430 | 360 | 2 | 350 kcmil |
| | 700 | 500 | 400 | 3 | 250 kcmil |
| | 800 | 560 | 448 | 3 | 300 kcmil |
| MG 100% Rated | 600 | 430 | 430 | 2 | 350 kcmil |
| | 700 | 500 | 500 | 3 | 250 kcmil |
| NG | 800 | 560 | 560 | 3 | 300 kcmil |
| | 800 | 560 | 448 | 3 | 300 kcmil |
| | 900 | 600 | 480 | 3 | 350 kcmil |
| | 1000 | 650 | 520 | 3 | 400 kcmil |
| NG 100% Rated | 1200 | 780 | 624 | 4 | 350 kcmil |
| | 900 | 600 | 600 | 3 | 350 kcmil |
| | 1000 | 650 | 650 | 3 | 400 kcmil |
| PG | 1200 | 780 | 780 | 4 | 350 kcmil |
| | 1200 | 780 | 624 | 4 | 400 kcmil |
| | 1400 | 850 | 680 | 4 | 500 kcmil |
| PG 100% Rated | 1600 | 960 | 768 | 5 | 500 kcmil |
| | 1200 | 780 | 780 | 4 | 400 kcmil |
| PG 100% Rated | 1400 | 850 | 850 | 4 | 500 kcmil |
| | 1600 | 960 | 960 | 5 | 500 kcmil |

® The information provided on this page is intended for reference and recommendation only. Because several variables can act on a circuit breaker's performance at the same time, the data above is based less on controlled testing, than on experience and engineering

judgment. Contact Siemens for further information on special conditions and treatment.
® Additional derating may be required if the ambient temperature is greater than 40°C (104°F).

® Calculated after derating to compensate for the heating of the copper conductor, caused by the skin effect generated by eddy currents produced at 400/415HZ.