

2016  
LG Lighting  
Catalog  
1st Edition



# 2016 LG Lighting Catalog

## 1st Edition

### CONTENTS

LG Electronics : A History of Innovation

The LG Lighting Difference

---

Performance Troffer

Simple Choice Troffer

Performance High Bay (IP65)

Simple Choice High Bay

Commercial Retrofit Downlight

Tube (T8)

Retrofit Board & Driver Kit

Smart Multi Sensor

Wireless Scheduling Switch

---

LG Wireless Control

LG SENSOR CONNECT

Commercial Term and Conditions

# LG Electronics : A History of Innovation



Since 1947, LG Electronics has enjoyed a legacy of innovation, developing exceptional products that meet customers' needs while exceeding their expectations. Now, LG has brought that expertise to LED lighting, offering designers, property owners and contractors versatile retrofit options while assuring significant energy savings and fast payback with long-term return on investment.

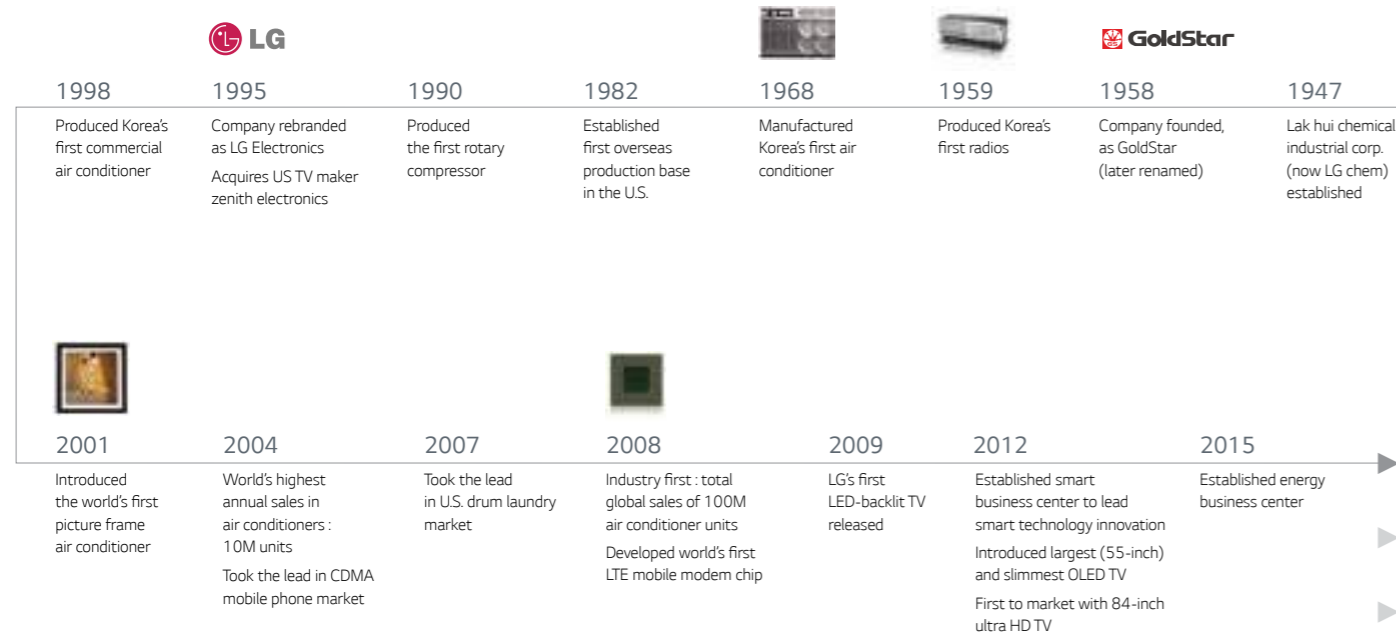

## LG Lighting

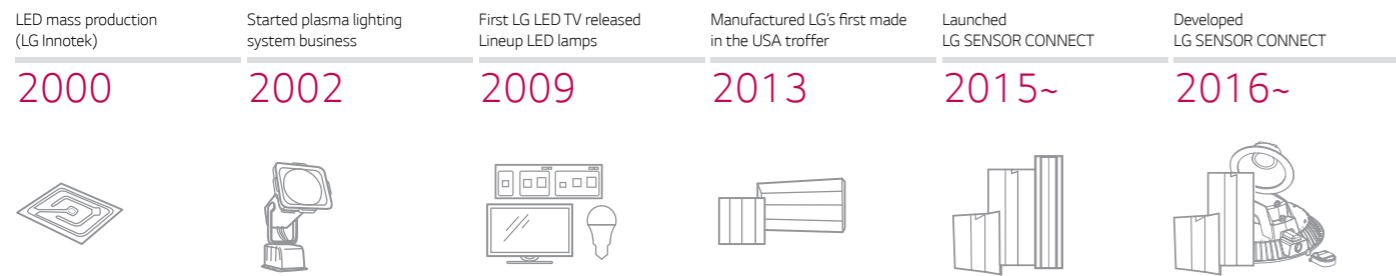

# The LG Lighting Difference

LG is focused on driving profitability and payback in your retrofit project. That means increasing the return on investment with the highest efficacy troffers listed on the DLC. That efficiency pays back both in terms of reduced energy consumption and improved incentive eligibility. Improving payback is also about reducing first install costs by making installation easier. LG is also focused on protect your project budget and timeline by delivering products that meet rigorous quality controls using a vertically integrated supply chain.

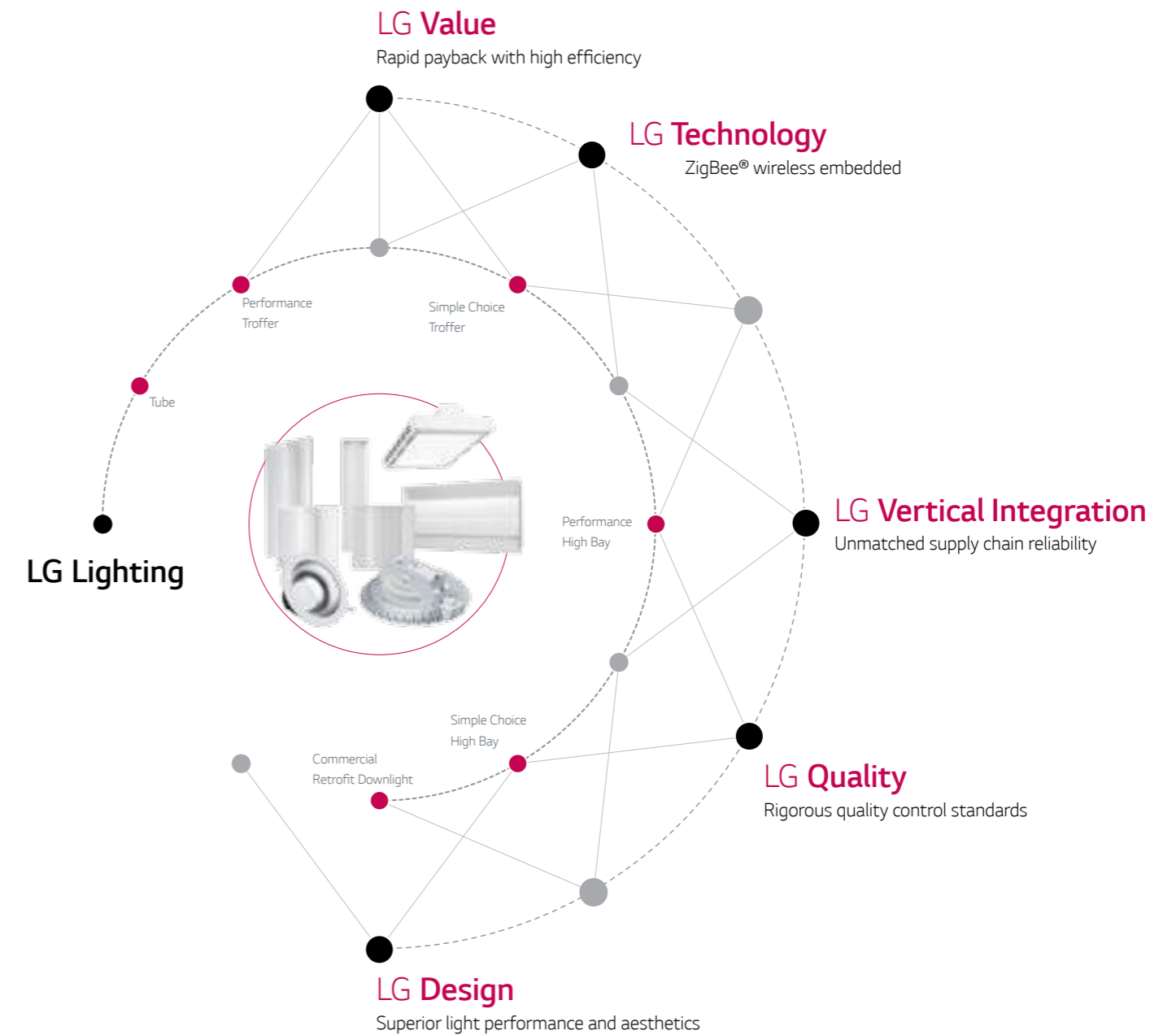

# Performance Troffer with sensor connect option

## Features

- Available in T-Bar lay-in, retrofit and emergency backup types
- Retrofit versions can be installed in 5–7 minutes, retaining the backframe of the existing luminaire
- High system efficacy up to 133 lm/W
- Diffuser with large luminous area provides soft light and visual comfort
- Standard 0-10 V dimming
- Wireless lighting control ready (ZigBee®)
- Integral emergency backup fixtures available
- Lumen maintenance of L85 at 50,000 hours
- 5-year warranty
- Made in USA



## Product details

### Quick upgrade solution (retrofit fixture)

Retrofit fixtures can be installed simply in 5-7 minutes, using mounting brackets that attach to the existing housing. This retrofit solution saves on labor costs while delivering the aesthetics and light performance of a brand new LED fixture.



### Occupancy sensing & daylight harvesting

- No re-circuiting or mounting for sensors
- Wireless control
- Pre-programmed optimal values



## Dimension

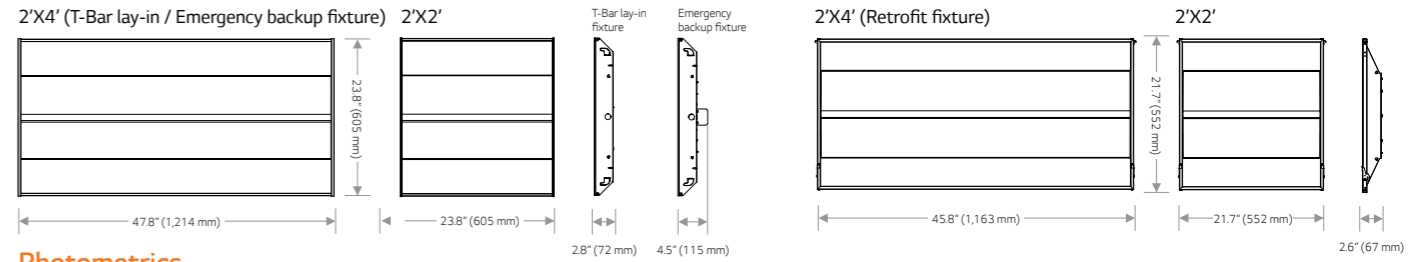

## Photometrics

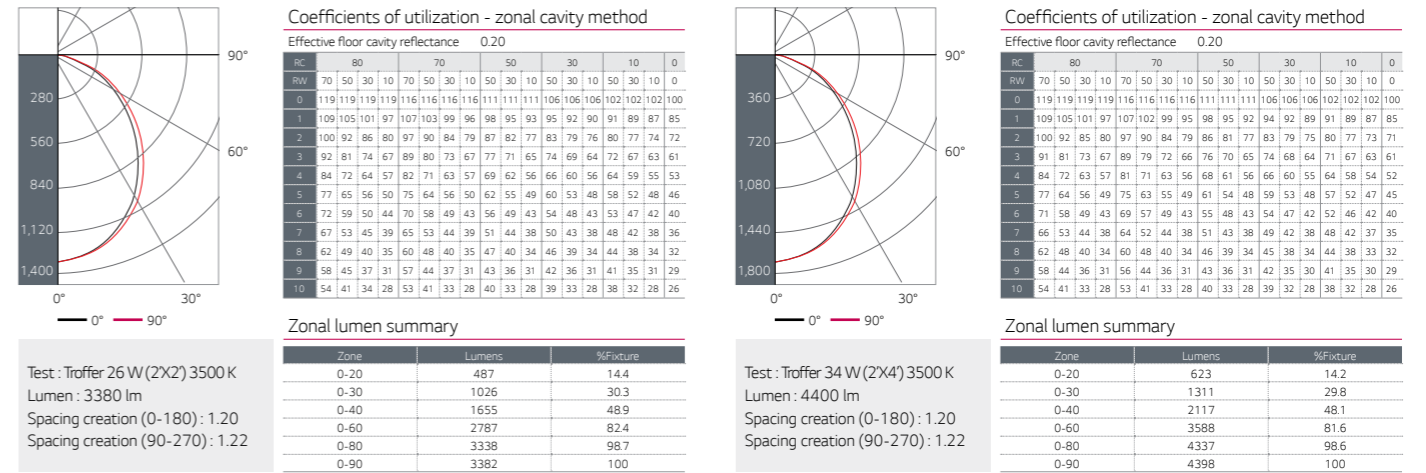

## Specifications & Ordering Information

Product type	Model code (US order code)	Input power W	Delivered light output		Efficacy lm/W	CCT K	Beam angle °	CRI	Input voltage Vac	Power factor	Operating temperature °F (°C)	Dimensions inch (mm)	Optical unit	Weight lb (kg)	Controls
			lm	lm/W											
T-Bar lay-in fixture	FRR626D2H0A.BUAAWAA (LGE-2X4RT-26-35-3400-TB)	26	3380	130	3500	105	82	120 - 277	≥0.9	-4 - 122 (-20 - 50)	23.8X47.8X2.8 (605X1,214X7.2)	Frost (PMMA)	16.5 (7.5)	0-10 V (ZigBee ready)	
	FRR626D3H0A.BUAAWAA (LGE-2X4RT-26-40-3400-TB)	26	3400	131	4000							Clear (PMMA)	9.0 (4.1)		
	FRR634D2H0B.BUAAWAA (LGE-2X4RT-34-35-4400-TB)	34	4400	129	3500							Frost (PMMA)	14.6 (6.6)		
	FRR634D3H0B.BUAAWAA (LGE-2X4RT-34-40-4500-TB)	34	4500	132	4000							White (PMMA)	7.5 (3.4)		
	FRR648D2H0A.BUAAWAA (LGE-2X4RT-48-35-5800-TB)	48	5550	116	3500							Frost (PMMA)	19.2 (8.7)		
	FRR648D3H0A.BUAAWAA (LGE-2X4RT-48-40-6000-TB)	48	5750	120	4000							White (PMMA)	12.3 (5.6)		
	FRS618D2H0A.BUAAWAA (LGE-2X2RT-18-35-2350-TB)	18	2350	131	3500							Frost (PMMA)	14.6 (6.6)		
	FRS618D3H0A.BUAAWAA (LGE-2X2RT-18-40-2400-TB)	18	2400	133	4000							White (PMMA)	7.5 (3.4)		
	FRS632D2H0A.BUAAWAA (LGE-2X2RT-32-35-3400-TB)	32	3200	100	3500							Frost (PMMA)	15.0 (6.8)		
	FRS632D3H0A.BUAAWAA (LGE-2X2RT-32-40-3400-TB)	32	3250	102	4000							White (PMMA)	7.9 (3.6)		
Retrofit fixture	FRR626D2HRA.BUAAWBB (LGE-2X4RT-26-35-3400-R(W))	26	3380	130	3500	105	82	120 - 277	≥0.9	-4 - 122 (-20 - 50)	21.7X45.8X2.6 (552X1,163X6.7)	Frost (PMMA)	14.6 (6.6)	0-10 V (ZigBee ready)	
	FRR634D3HRB.BUAAWBB (LGE-2X4RT-34-40-4500-R(W))	34	4400	129	3500							White (PMMA)	7.5 (3.4)		
	FRS618D2HRA.BUAAWBB (LGE-2X2RT-18-35-2350-R(W))	18	2350	131	3500							Frost (PMMA)	14.6 (6.6)		
	FRS618D3HRA.BUAAWBB (LGE-2X2RT-18-40-2400-R(W))	18	2400	133	4000							White (PMMA)	7.5 (3.4)		
	FRS632D2HRA.BUAAWBB (LGE-2X2RT-32-35-3400-R(W))	32	3200	100	3500							Frost (PMMA)	15.0 (6.8)		
	FRS632D3HRA.BUAAWBB (LGE-2X2RT-32-40-3400-R(W))	32	3250	102	4000							White (PMMA)	7.9 (3.6)		
Emergency backup fixture	FRR641D2H5B.BUAAWAA (LGE-2X4RT-41-35-4400-EM)	41	4400	107	3500	105	82	120 - 277	≥0.9	-4 - 122 (-20 - 50)	23.8X47.8X4.5 (605X1,214X11.5)	Frost (PMMA)	19.2 (8.7)	0-10 V (ZigBee ready)	
	FRR641D3H5B.BUAAWAA (LGE-2X4RT-41-40-4500-EM)	41	4500	110	4000							White (PMMA)	12.3 (5.6)		
	FRS639D2H5A.BUAAWAA (LGE-2X2RT-39-35-3300-EM)	39	3300	85	3500							Frost (PMMA)	14.6 (6.6)		
Retrofit fixture ('16 May)	FRS639D3H5A.BUAAWAA (LGE-2X2RT-39-40-3350-EM)	39	3350	86	4000	105	82	120 - 277	≥0.9	-4 - 122 (-20 - 50)	21.7X45.8X2.6 (552X1,163X6.7)	Frost (PMMA)	14.6 (6.6)	0-10 V (ZigBee ready)	
	FRR634D2HRD.BUAAWBB (LGE-2X4RT-34-35-4400-R2(W))	34	4400	130	3500							White (PMMA)	7.5 (3.4)		
	FRR634D3HRD.BUAAWBB (LGE-2X4RT-34-40-4500-R2(W))	34	4500	133	4000							Frost (PMMA)	15.0 (6.8)		
	FRS626D2HRB.BUAAWBB (LGE-2X2RT-26-35-3400-R(W))	26	3380	130	3500							White (PMMA)	7.9 (3.6)		
Retrofit fixture with Sensor ('16 May)	FRR634D2HRC.BUAAWBB (LGE-2X4RT-34-35-4400-R(W)-SN)	34	4400	130	3500	105	82	120 - 277	≥0.9	-4 - 122 (-20 - 50)	21.7X45.8X2.6 (552X1,163X6.7)	Frost (PMMA)	15.0 (6.8)	ZigBee	
	FRR634D3HRC.BUAAWBB (LGE-2X4RT-34-40-4500-R(W)-SN)	34	4500	133	4000							White (PMMA)	7.9 (3.6)		
	FRS626D2HRC.BUAAWBB (LGE-2X2RT-26-35-3400-R(W)-SN)	26	3380	130	3500							Frost (PMMA)	15.0 (6.8)		
FRS626D3HRC.BUAAWBB (LGE-2X2RT-26-40-3400-R(W)-SN)	26	3400	130	4000	White (PMMA)	7.9 (3.6)									

⊙ Emergency initial lumens : 1400 lm ⊙ Emergency operating time : 90 minutes + ⊙ When utilizing integral ZigBee wireless controls, the optional 0-10 V dimming is deactivated

- Motion sensor specification
  - Mounting height : Max. 11.5 ft
  - Dimming level adjustment : 0%, 30%, 100%
  - Delay time adjustment : 0.5~20 min.
  - Sensor coverage : (1.6 X h) X (2.0 X h) m<sup>2</sup> @ height(h)

## Compliance

### T-Bar lay-in fixture

- cULus Listed to UL 1598, suitable for damp location use
- DesignLights Consortium qualified products
- Based on photometric testing consistent with IES LM-79

### Retrofit fixture

- cULus Listed to UL 1598C, suitable for damp location use
- DesignLights Consortium qualified products
- Based on photometric testing consistent with IES LM-79

### Emergency backup fixture

- cULus listed to UL 924, suitable for damp location use
- Suitable for operation in ambient not exceeding 104 °F
- DesignLights Consortium qualified products
- Based on photometric testing consistent with IES LM-79



# Simple Choice Troffer with sensor connect option

## Features

- System efficacy up to 132 lm/W
- Standard 0-10 V dimming
- Wireless lighting control ready (ZigBee®)
- Sensor-embedded(occupancy sensing & daylight harvesting) models are available for additional energy savings
- Lumen maintenance of L78 at 50,000 hours
- 5-year warranty



## Product details

### Occupancy sensing & daylight harvesting

- No re-circuiting or mounting for sensors
- Wireless control
- Pre-programmed optimal values



### Rugged housing

The rugged housing does not easily get distorted when handled and the matt finish prevents fingerprints.

### Soft light

When looking directly at the luminaire, the light is soft with low glare.



## Dimension

• Simple choice / SENSOR CONNECT

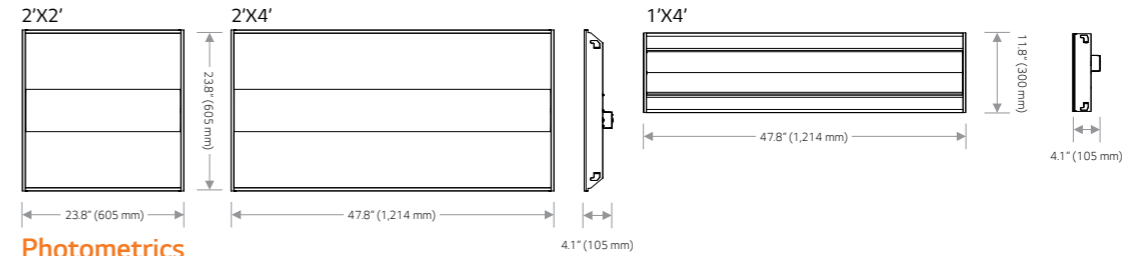

## Photometrics

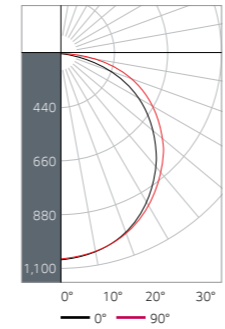

Test : Troffer 25W (2'X2') 3500K  
Lumen : 3200 lm  
Spacing creation (0-180) : 1.26  
Spacing creation (90-270) : 1.28

### Coefficients of utilization - zonal cavity method

Effective floor cavity reflectance		0.20											
RC	80	70	50	30	10	0	80	70	50	30	10	0	
RW	70	50	30	10	0	0	110	119	119	119	116	116	116
1	108	103	99	95	106	101	97	93	87	93	90	87	89
2	98	89	82	76	95	87	81	75	84	78	74	81	76
3	89	78	70	63	87	77	69	62	73	67	61	71	65
4	81	69	60	53	79	68	59	53	65	58	52	63	56
5	75	61	52	45	73	60	52	45	58	50	45	56	49
6	69	55	46	39	67	54	46	39	52	45	39	51	44
7	64	50	41	35	62	49	41	35	48	40	34	46	39
8	59	46	37	31	58	45	37	31	43	36	31	42	35
9	55	42	33	28	54	41	33	28	40	33	27	39	32
10	52	38	30	25	51	38	30	25	37	30	25	36	29

### Zonal lumen summary

Zone	Lumens	%Fixture
0-20	386	12.1
0-30	822	25.7
0-40	1351	42.2
0-60	2437	76.1
0-80	3135	97.9
0-90	3202	100

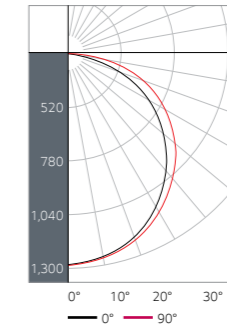

Test : Troffer 31W (2'X4') 3500K  
Lumen : 4000 lm  
Spacing creation (0-180) : 1.26  
Spacing creation (90-270) : 1.28

### Coefficients of utilization - zonal cavity method

Effective floor cavity reflectance		0.20										
RC	80	70	50	30	10	0	80	70	50	30	10	0
RW	70	50	30	10	0	0	110	119	119	116	116	116
1	108	103	98	94	105	101	96	93	86	93	90	87
2	98	89	82	76	95	87	80	75	83	78	73	80
3	89	78	69	62	86	76	68	62	73	66	61	70
4	81	68	59	52	79	67	59	52	65	57	51	62
5	74	61	52	45	72	60	51	45	58	50	44	56
6	69	55	46	39	67	54	45	39	52	44	38	50
7	63	50	41	34	62	49	40	34	47	39	34	46
8	59	45	36	30	57	44	36	30	43	36	30	41
9	55	41	33	27	54	41	33	27	40	32	27	39
10	52	38	30	25	51	38	30	25	37	29	25	36

### Zonal lumen summary

Zone	Lumens	%Fixture
0-20	474	11.8
0-30	1009	25.2
0-40	1661	41.5
0-60	3009	75.2
0-80	3906	97.6
0-90	4003	100

## Specifications & Ordering Information

Product type	Model code (US order code)	Input power		Delivered light output		Efficacy	CCT	Beam angle	CRI	Input voltage	Power factor	Operating temperature	Dimensions	Optical unit	Weight	Controls							
		W	lm	lm/W	K																		
Simple choice	F4035TB1131.BUAAWAA (LGE-1X4SI-40-35-4000-TB)	40	4000	100	3500	120	82	120 - 277	≥0.9	-4 - 104 (-20 - 40)	11.8X47.8X4.14 (300X1,214X105)	White (PC)	7.9 (3.6)	0-10 V (ZigBee ready)									
	F4040TB1131.BUAAWAA (LGE-1X4SI-40-40-4000-TB)	40	4000	100	4000																		
	F3035TB1111.BUAAWAA (LGE-2X4SI-31-35-4000-TB)	31	4050	130	3500																		
	F3040TB1111.BUAAWAA (LGE-2X4SI-31-40-4000-TB)	31	4100	132	4000																		
	FRR640D2H0A.BUAAWAA (LGE-2X4SI-40-35-4000-TB)	40	4000	100	3500																		
	FRR640D3H0A.BUAAWAA (LGE-2X4SI-40-40-4000-TB)	40	4000	100	4000																		
	F2435TB1111.BUAAWAA (LGE-2X2SI-25-35-3200-TB)	25	3250	130	3500																		
	F2440TB1111.BUAAWAA (LGE-2X2SI-25-40-3200-TB)	25	3270	130	4000																		
	FRS632D2H0B.BUAAWAA (LGE-2X2SI-32-35-3200-TB)	32	3200	100	3500																		
	FRS632D3H0B.BUAAWAA (LGE-2X2SI-32-40-3200-TB)	32	3200	100	4000																		
	F4035TB1S31.BUAAWAA (LGE-1X4SC-40-35-4000-TB)	40	4000	100	3500										120	82	120 - 277	≥0.9	-4 - 104 (-20 - 40)	11.8X47.8X4.14 (300X1,214X105)	White (PC)	8.4 (3.8)	ZigBee
	F4040TB1S31.BUAAWAA (LGE-1X4SC-40-40-4000-TB)	40	4000	100	4000																		
F3035TB1S11.BUAAWAA (LGE-2X4SC-31-35-4000-TB)	31	4050	130	3500																			
F3040TB1S11.BUAAWAA (LGE-2X4SC-31-40-4000-TB)	31	4100	132	4000																			
FRR640D2H0C.BUAAWAA (LGE-2X4SC-40-35-4000-TB)	40	4000	100	3500																			
FRR640D3H0C.BUAAWAA (LGE-2X4SC-40-40-4000-TB)	40	4000	100	4000																			
F2435TB1S41.BUAAWAA (LGE-2X2SC-25-35-3200-TB)	25	3250	130	3500																			
F2440TB1S41.BUAAWAA (LGE-2X2SC-25-40-3200-TB)	25	3270	130	4000																			
FRS632D2H0C.BUAAWAA (LGE-2X2SC-32-35-3200-TB)	32	3200	100	3500																			
FRS632D3H0C.BUAAWAA (LGE-2X2SC-32-40-3200-TB)	32	3200	100	4000																			

© When utilizing integral ZigBee wireless controls, the optional 0-10 V dimming is deactivated

- Motion sensor specification
  - Mounting height : Max. 11.5 ft
  - Delay time adjustment : 0.5-20 min.
  - Dimming level adjustment : 0%, 30%, 100%
  - Sensor coverage : (1.6 X h) X (2.0 X h) m<sup>2</sup> @ height(h)

## Compliance

- cULus Listed to UL 1598, suitable for damp location use (2'x4' / 2'x2')
- cETLus Listed to UL 1598, suitable for damp location use (1'x4')
- DesignLights Consortium qualified products
- Based on photometric testing consistent with IES LM-79



# Performance High-Bay (IP65)

## Features

- Easy installation with 9.0 lbs light weight and various mounting option
- Wide selection for control options
- Maximized energy saving by IP65 Multi Sensor (option)
- IP65, suitable for damp location use
- High efficacy up to 108 lm/W
- Long lifetime with outstanding durability
- Fast heat transfer with pure aluminum and dual layer structure
- Tempered glass & frost PET sheet



## Product details

Various mounting options

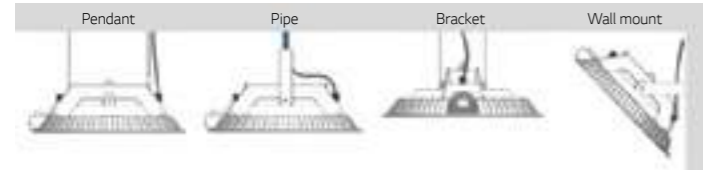

Highly efficient cooling system

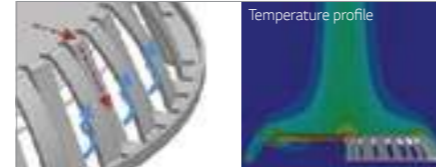

Light weight



9.0lb (4.1 kg)

IP65 rating



Various control solutions

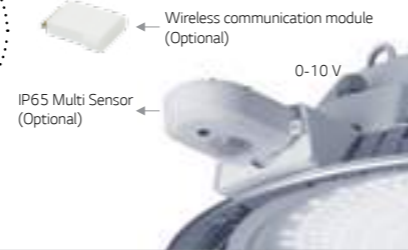

## Dimension

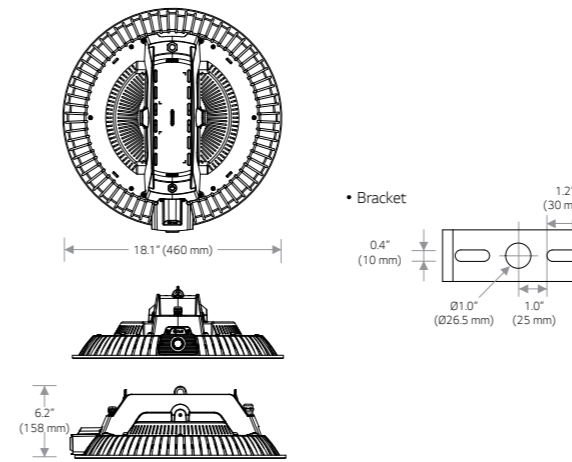

## Photometrics

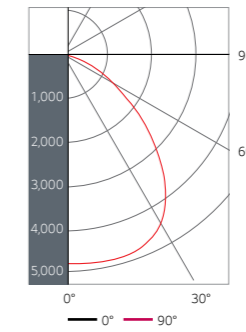

Test: 115 W, 90D, 4000 K  
Lumen: 11900 lm  
Spacing creation (0-180): 1.37  
Spacing creation (90-270): 1.37

Coefficients of utilization - zonal cavity method

Effective floor cavity reflectance		0.20		0.50		0.80		1.00	
RC	80	30	10	50	30	10	50	30	10
0	119	119	119	111	111	111	106	106	106
1	111	107	103	100	100	98	95	94	92
2	102	95	89	84	84	81	78	73	69
3	94	85	77	72	72	68	64	58	53
4	87	76	68	62	62	57	52	46	41
5	80	68	60	54	54	49	44	38	33
6	74	62	54	48	48	43	38	32	27
7	69	57	48	43	43	38	32	26	21
8	64	52	44	38	38	33	27	21	16
9	60	48	40	35	35	30	24	18	13
10	57	44	37	31	31	26	20	14	9

Zonal lumen summary

Zone	Lumens	%Fixture
0-20	1852	15.6
0-30	4064	34.2
0-40	6684	56.2
0-60	10612	89.2
0-80	11848	99.6
0-90	11901	100

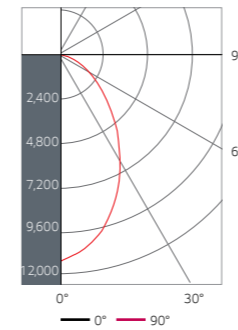

Test: 180 W, 65 D, 4000 K  
Lumen: 19500 lm  
Spacing creation (0-180): 1.00  
Spacing creation (90-270): 1.00

Coefficients of utilization - zonal cavity method

Effective floor cavity reflectance		0.20		0.50		0.80		1.00	
RC	80	30	10	50	30	10	50	30	10
0	119	119	119	116	111	111	106	106	106
1	111	107	103	98	100	97	95	94	92
2	102	95	89	83	90	85	81	80	78
3	94	85	78	72	81	75	71	73	69
4	87	77	69	63	73	67	62	61	58
5	81	70	62	56	67	60	55	54	51
6	76	64	56	50	61	54	49	48	45
7	71	58	51	45	56	49	44	43	40
8	66	54	46	41	52	45	41	40	37
9	62	50	42	37	48	42	37	36	33
10	59	47	39	34	45	39	34	33	30

Zonal lumen summary

Zone	Lumens	%Fixture
0-20	3896	20.5
0-30	7587	39.9
0-40	11227	59.1
0-60	16599	87.4
0-80	18847	99.2
0-90	18998	100

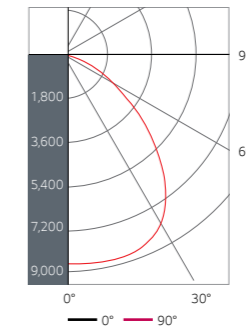

Test: 180 W, 90 D, 4000 K  
Lumen: 19000 lm  
Spacing creation (0-180): 1.32  
Spacing creation (90-270): 1.32

Coefficients of utilization - zonal cavity method

Effective floor cavity reflectance		0.20		0.50		0.80		1.00	
RC	80	30	10	50	30	10	50	30	10
0	119	119	119	111	111	111	106	106	106
1	111	107	104	101	98	96	97	95	93
2	103	96	90	86	91	87	83	84	81
3	95	86	79	74	82	77	72	79	75
4	88	78	70	65	74	68	63	72	67
5	82	71	63	57	68	61	56	66	60
6	76	64	56	51	62	55	50	60	54
7	71	59	51	46	57	50	45	55	49
8	66	54	47	41	52	46	41	51	45
9	62	50	43	37	48	42	37	47	41
10	59	46	39	34	45	39	34	44	38

Zonal lumen summary

Zone	Lumens	%Fixture
0-20	3383	17.8
0-30	7382	38.8
0-40	11783	62
0-60	17291	91
0-80	18924	99.6
0-90	19002	100

## Accessory



- Simply set-up with LG SENSOR CONNECT System or plug-and-play
- Occupancy & daylight sensor
- IP65
- Wide sensor detection area

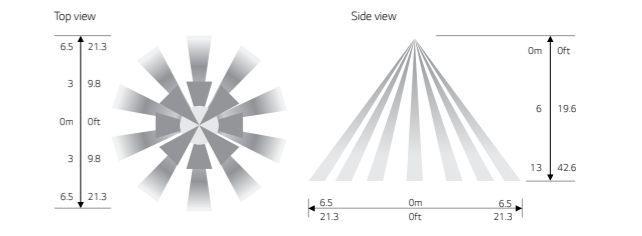

## Specifications & Ordering Information

Product Type	Model code (US order code)	Input power	Luminous flux	Efficacy	CCT	IP	Beam Angle	CRI	Input Voltage	Input Frequency	Power factor	Operating Temp	Dimension	Optical unit	Weight	Life span	Control	
		W	lm	lm/W	K		°	-	V	Hz	-	°F (°C)	inch (mm)	-	lb (kg)	hrs		
Performance High Bay	H1240P901SB.ALWB000 (LGE-HB-115-40-11900-90D)	115	11900	103	4000		90					-22-122 (-30-50)	Ø18.1X6.2 (Ø460X158)	Dual (Tempered glass + Frost PET sheet)	9.0 (4.1)			
	H1250P901SB.ALWB000 (LGE-HB-115-50-12200-90D)	115	12200	106	5000		90											
	H1840P551SB.ALWB000 (LGE-HB-180-40-19000-65D)	180	19000	106	4000	65, Damp	65	83	120-277	50/60	≥0.9				9.5 (4.3)	50,000 (L85)	0-10 V, (ZigBee ready)	
	H1850P551SB.ALWB000 (LGE-HB-180-50-19500-65D)	180	19500	108	5000		65											
	H1840P901SB.ALWB000 (LGE-HB-180-40-19000-90D)	180	19000	106	4000		90											
	H1850P901SB.ALWB000 (LGE-HB-180-50-19500-90D)	180	19500	108	5000		90											
Product Type	Model code	Input power	Input Voltage	Input Frequency	Mounting Height	Dimension	Weight	Operating Temp	IP	Control								
IP65 Multi Sensor	9SDA81VDA.ALWB000	0.3	Vdc	MHz	ft (m)	inch (mm)	oz (g)	°F (°C)										
Bracket	MAZ64943201.ALWB000					6.4X5.1X1.8 (165X130X45)												

## Compliance

- cULus listed to UL 1598, suitable for damp location use
- DesignLights Consortium qualified products
- Based on photometric testing consistent with IES LM-79
- Suitable for operation in ambient not exceeding 122 °F



# Simple Choice High-Bay

## Features

- System efficacy up to 104 lm/W
- Precision optics – medium and wide distribution
- Steel housing, powder-coating
- Provides two carabiners for easy connection
- Wireless lighting control ready (ZigBee®)
- Plug-and-play motion sensor
- Ambient operating temperature -22 °F ~104 °F
- 230 W : L85 at 50,000 hours, 120 W : L76 at 50,000 hours



## Product details

### Easy installation

Factory included carabiners mount the fixture easily to a chain



### Light weight

Light weight ensure easy handling and installation



### Motion sensor

- Easy plug-and-play motion sensor
- Adjustable time delay and dimming level

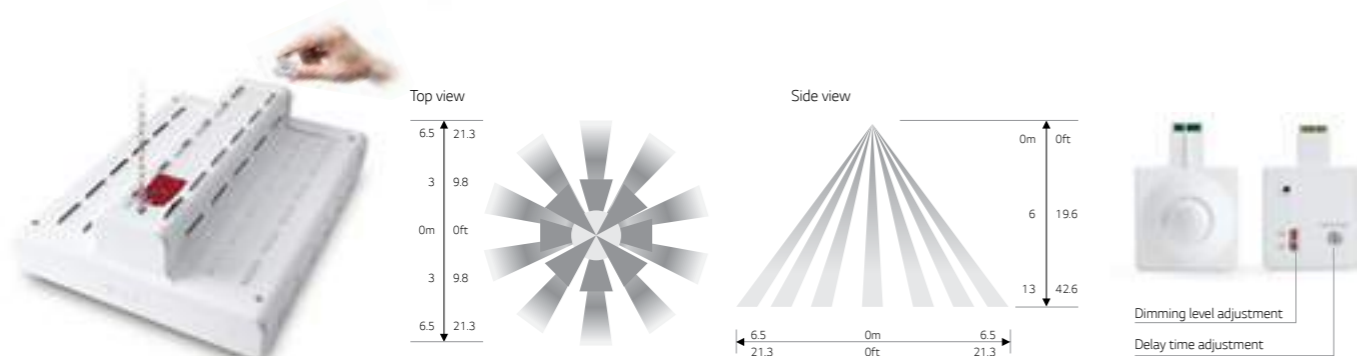

## Dimension

120 W

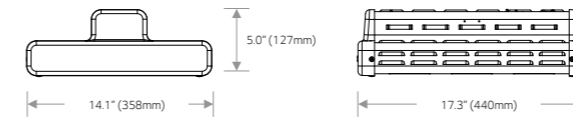

230 W

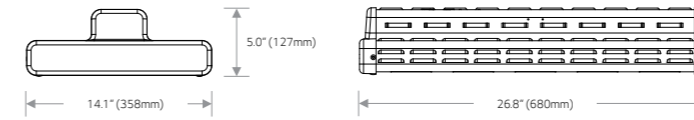

## Photometrics

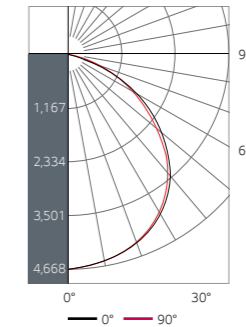

Test : 120 W, 120°, 4000 K  
Lumen : 12000 lm  
Spacing creation (0-180) : 1.28  
Spacing creation (90-270) : 1.26

### Coefficients of utilization - zonal cavity method

RC	Effective floor cavity reflectance										
	80		50		30		10		0		
0	119	119	119	119	111	111	111	111	106	106	106
1	110	106	102	98	99	96	94	95	93	91	91
2	101	93	87	82	88	83	79	85	81	77	77
3	92	82	75	69	78	72	67	75	70	66	66
4	85	73	65	59	70	63	58	67	62	57	57
5	78	66	57	51	63	56	50	61	55	50	50
6	72	59	51	45	57	50	44	55	49	44	44
7	67	54	46	40	52	44	39	50	44	39	39
8	62	49	41	35	47	40	35	46	40	35	35
9	58	45	37	32	44	37	32	43	36	32	32
10	55	42	34	29	40	33	29	39	33	29	29

### Zonal lumen summary

Zone	Lumens	%Fixture
0-20	1713	14.3
0-30	3656	30.5
0-40	6003	50.0
0-60	10286	85.7
0-80	11906	99.2
0-90	12000	100.0

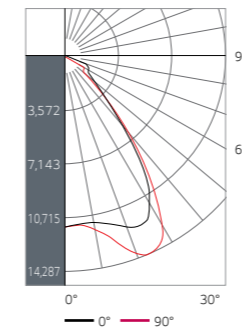

### Coefficients of utilization - zonal cavity method

RC	Effective floor cavity reflectance									
	80		50		30		10		0	
0	119	119	119	119	111	111	111	106	106	106
1	111	108	104	101	101	99	96	97	95	94
2	103	97	91	87	92	87	84	88	85	82
3	96	87	81	75	83	78	74	80	76	72
4	89	79	72	66	76	70	65	74	68	64
5	83	72	65	59	69	63	58	67	62	58
6	78	66	59	53	64	57	53	62	56	52
7	73	61	53	48	59	52	48	57	52	47
8	68	56	49	44	54	48	43	53	47	43
9	64	52	45	40	51	44	40	50	44	40
10	60	49	41	37	47	41	36	46	40	36

### Zonal lumen summary

Zone	Lumens	%Fixture
0-20	4516	18.8
0-30	10606	44.2
0-40	1678	69.5
0-60	21616	90.1
0-80	23929	99.7
0-90	24000	100.0

Test : 230 W, 85°, 4000 K  
Lumen : 24000 lm  
Spacing creation (0-180) : 1.34  
Spacing creation (90-270) : 1.40

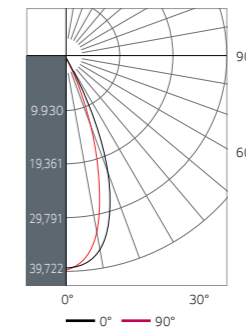

Test : 230 W, 50°, 4000 K  
Lumen : 24000 lm  
Spacing creation (0-180) : 0.72  
Spacing creation (90-270) : 0.60

### Coefficients of utilization - zonal cavity method

RC	Effective floor cavity reflectance									
	80		50		30		10		0	
0	119	119	119	119	111	111	111	106	106	106
1	113	106	107	104	103	101	99	100	98	96
2	107	101	97	93	96	93	90	93	90	88
3	101	94	89	84	90	86	82	87	84	81
4	96	88	82	77	84	80	76	82	78	75
5	91	83	77	72	80	75	71	78	74	70
6	87	78	72	67	76	71	67	74	70	66
7	83	74	68	64	72	67	63	71	66	63
8	80	70	64	60	69	63	60	68	63	60
9	76	67	61	57	66	60	57	65	60	57
10	73	64	58	55	63	58	54	62	57	54

### Zonal lumen summary

Zone	Lumens	%Fixture
0-20	12037	50.2
0-30	17864	74.4
0-40	19762	82.3
0-60	21942	91.4
0-80	23943	99.8
0-90	24008	100.0

## Specifications & Ordering Information

Product Type	Model code (US order code)	Input power W	Delivered light output lm	Efficacy lm/W	CCT K	IP	UGR	Beam Angle °	CRI	Input Voltage	Power factor	Operating temperature °F (°C)	Dimension inch (mm)	Optical unit	Weight lb (kg)	Life span hrs	Control
Simple Choice High-Bay	H1240PA2N0AACWB000 (LGE-HB-120-40-12000)	120	12000	100	4000	-	-	28 120	-	Vac	-	-	17.3X14.1X5.0 (440X358X127)	-	9.9 (4.5)	-	-
	H1257PA2N0AACWB000 (LGE-HB-120-57-12000)	120	12000	100	5700	20	-	28 120	83	120 - 277	≥0.9	-22 - 104 (-30 - 40)	17.3X14.1X5.0 (440X358X127)	Tempered glass	9.9 (4.5)	50000	0-10 V (ZigBee ready)
	H2440P50N0AACWB000 (LGE-HB-230-40-24000-50D)	230	24000	104	4000	-	-	25 50	-	200 - 277	≥0.9	-22 - 104 (-30 - 40)	26.8X14.1X5.0 (680X358X127)	-	20.9 (9.5)	-	-
	H2440P85N0AACWB000 (LGE-HB-230-40-24000-85D)	230	24000	104	4000	-	-	25 85	-	200 - 277	≥0.9	-22 - 104 (-30 - 40)	26.8X14.1X5.0 (680X358X127)	-	20.9 (9.5)	-	-

Product Type	Model code (US order code)	Input power W	Input Voltage Vdc	Frequency MHz	Dimension inch (mm)	Mounting Height ft	Dimming level adjustment %	Delay time adjustment min.	Operating Temp °F (°C)	Communication type
Motion Sensor	9SD751TVDAALWB000 (LGE-HB-DSZ)	0.17	3.3	2,405 - 2,480	3.0X2.1X1.0 (75X54X25)	Max. 42.6	0/30,100	0.5 - 20	-4 - 122 (-20 - 50)	ZigBee

## Compliance

- cULus listed to UL 1598, suitable for damp location use
- DesignLights Consortium qualified products
- Based on photometric testing consistent with IES LM-79
- Suitable for operation in ambient not exceeding 104 °F



# Commercial Retrofit Downlight

## Features

- High efficacy of 90 lm/W
- Aluminum reflector & trim
- Mounts into existing recessed frame
- Easy disconnect for easy installation
- Wireless lighting control ready (ZigBee®)
- Enabled Smart Multi Sensor
- Lumen maintenance of L85 at 50,000 hours



## Product details

### Wireless Dimming (Optional)

(Only for wireless ready) Remove the dongle cover on the driver then insert the LG wireless module connected to LG Multi Sensor. LG LED Downlight is compatible with the Daintree ControlScope™ system.

- \* When using wireless dimming function, 0-10 V dimming will not be served.
- \* 0-10 V dimming should be removed.

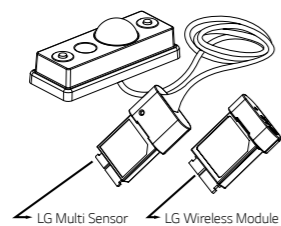
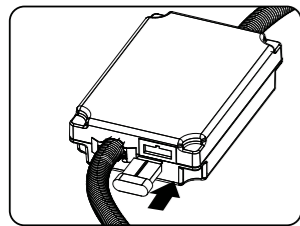

## Dimension

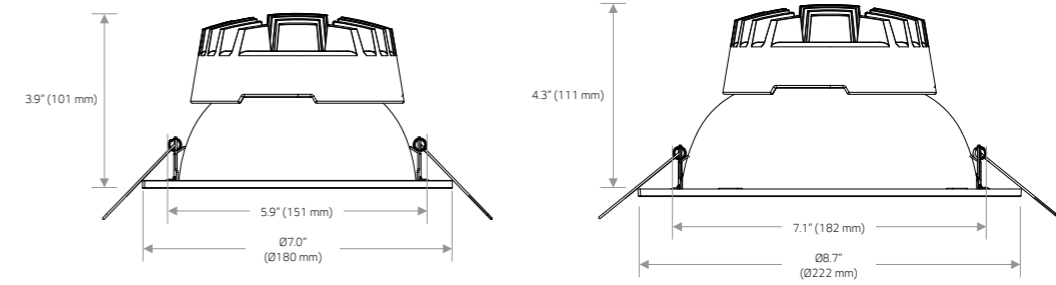

## Photometrics

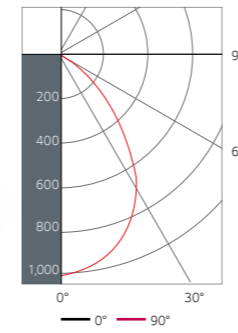

### Coefficients of utilization - zonal cavity method

Effective floor cavity reflectance 0.20

RC	70	80	10	70	50	30	10	50	30	10
0	119	119	119	116	116	116	111	111	111	111
1	113	109	106	104	110	107	105	102	103	101
2	106	100	95	91	103	98	94	90	95	91
3	99	91	85	81	97	90	84	80	87	83
4	93	84	77	72	91	83	76	72	80	75
5	87	77	70	65	85	76	70	65	74	68
6	81	71	64	59	80	70	63	59	68	63
7	77	66	59	54	75	65	58	53	63	57
8	72	61	54	49	71	60	54	49	59	53
9	68	57	50	45	67	56	49	45	55	49
10	64	53	46	42	63	52	46	42	51	46

### Zonal lumen summary

Zone	Lumens	%Fixture
0-20	354	24.4
0-30	723	49.8
0-40	1098	75.6
0-60	1425	98.1
0-80	1450	99.8
0-90	1452	100

Test : 16 W, 4000 K  
Lumen : 1450 lm  
Spacing creation (0-180) : 1.08  
Spacing creation (90-270) : 1.10

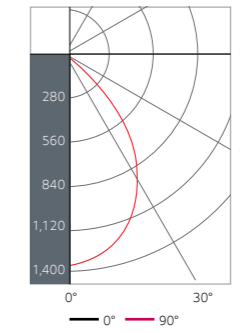

### Coefficients of utilization - zonal cavity method

Effective floor cavity reflectance 0.20

RC	70	80	10	70	50	30	10	50	30	10
0	119	119	119	117	117	117	111	111	111	111
1	113	109	107	104	110	107	105	102	103	101
2	106	100	95	91	103	98	94	90	95	91
3	99	91	86	81	97	90	85	80	87	83
4	93	84	77	72	91	83	76	72	80	75
5	87	77	70	65	85	76	69	65	74	68
6	81	71	64	59	80	70	63	58	68	63
7	76	65	58	53	75	65	58	53	63	57
8	72	61	54	49	70	60	53	49	59	53
9	68	56	49	45	66	56	49	45	55	49
10	64	53	46	42	63	52	46	42	51	46

### Zonal lumen summary

Zone	Lumens	%Fixture
0-20	480	24
0-30	978	48.8
0-40	1494	74.6
0-60	1983	98.9
0-80	2001	99.9
0-90	2004	100

Test : 22 W, 4000 K  
Lumen : 2000 lm  
Spacing creation (0-180) : 1.10  
Spacing creation (90-270) : 1.10

## Specifications & Ordering Information

Product Type	Size	Model Code (US order code)	Input Power	Luminous flux	Efficacy	CCT	CRI	Beam Angle	Input Voltage	Input Frequency	Power Factor	Dimension	Weight	Optical Unit	Operating Temp.	Life span	Control
			W	lm	lm/W	K		°				V			Hz		
Commercial Retrofit Downlight	6inch	D1635RH8161ACWB000 (LGE-DW-16-35-1450)	16	1450	90	3500	80	80	120-277	50-60	≥0.9	Ø7.1x4.0 (Ø180x101)	1.87 (0.85)	White(PC)	-4 - 104 (-20 - 40)	50,000 (L85)	0-10 V (ZigBee ready)
		D1640RH8161ACWB000 (LGE-DW-16-40-1450)	16	1450	90	4000											
	8inch	D2235RH7181ACWB000 (LGE-DW-22-35-2000)	22	2000	90	3500											
		D2240RH7181ACWB000 (LGE-DW-22-40-2000)	22	2000	90	4000						Ø8.7x4.4 (Ø222x111)	2.02 (0.92)				



## Compliance

- cETLus Listed and Classified to UL 1598 and 1598c, suitable for damp location use
- Satisfied ENERGY STAR program requirements for Luminaires
- IC-rated for direct contact with insulation
- Based on photometric testing consistent with IES LM-79





# Tube (T8) 2-Lamps & 1-Driver System

## Features

- Tube with a dedicated remote driver
- Better reliability and longer lifespan than LED tubes with internal drivers
- System efficacy up to 111 lm/W
- Wide beam angle 180° (the angle light reaches is 270°)
- Standard 0-10 V dimming
- Wireless lighting control ready (ZigBee®)
- Lumen maintenance of L85 at 50,000 hours
- 5-year warranty



## Dimension

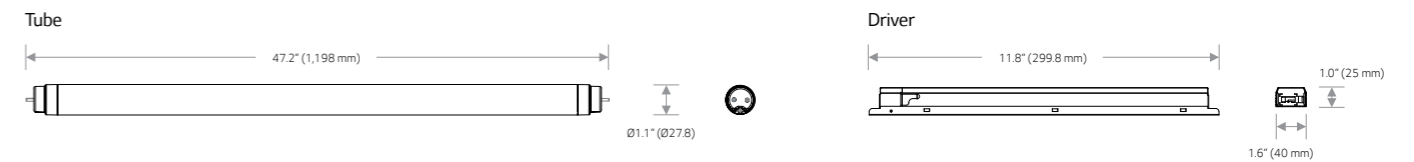

## Photometrics

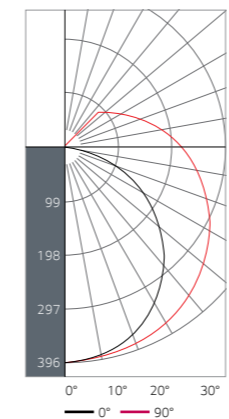

### Coefficients of utilization - zonal cavity method

RC	Effective floor cavity reflectance									
	80		50		30		10		0	
RW	70	50	30	10	50	30	10	50	30	10
0	111	111	111	111	97	97	97	88	88	88
1	98	92	87	83	80	77	73	70	68	68
2	88	79	72	65	69	63	58	63	58	54
3	80	69	60	53	60	53	48	54	49	44
4	73	60	51	44	53	46	40	48	42	37
5	67	53	44	37	47	40	34	43	37	32
6	61	48	39	32	42	35	30	38	32	28
7	57	43	34	28	38	31	26	35	29	24
8	53	39	31	25	35	28	23	32	26	22
9	49	36	28	22	32	25	20	29	24	19
10	46	33	25	20	29	23	18	27	21	17

Test : 18 W, 4000 K (1 lamp)  
 Lumen : 1900 lm  
 Spacing creation (0-180) : 1.26  
 Spacing creation (90-270) : 1.42

### Zonal lumen summary

Zone	Lumens	%Lamp
0-20	146	7.7
0-30	315	16.6
0-40	526	27.7
0-60	994	52.3
0-80	1379	72.6
0-90	1512	79.6
10-90	1474	77.6
20-40	380	20.0
20-50	614	32.3
40-70	678	35.7
60-80	386	20.3
70-80	175	9.2
80-90	133	7.0
90-110	200	10.5
90-120	272	14.3
90-130	323	17.0
90-150	344	18.1
90-180	388	20.4
110-180	186	9.8
0-180	1900	100.0

## Specifications & Ordering Information

Product type	Model code (US order code)	Input power W	Delivered light output lm	Efficacy lm/W	CCT K	Beam Angle °	CRI	Input Voltage Vac	Power factor	Operating temperature °F (°C)	Dimension inch (mm)	Weight lb (kg)

Product type	Model code (US order code)	Control	Dimension inch (mm)
Driver	TC3622HC.BUAAWAA (LGE-TUBE-DRIVER-2TUBE)	0-10 V (ZigBee ready)	11.8X1.6X1.0 (299.8X40X25)

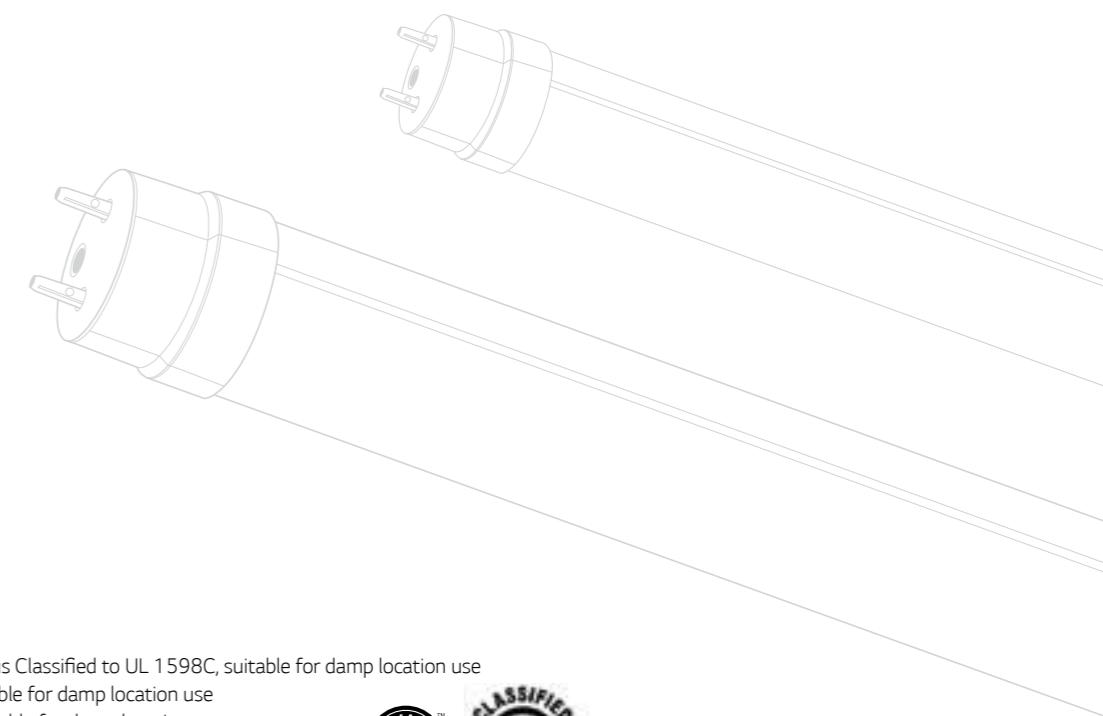

## Compliance

- LED retrofit luminaire conversion kit : cULus Classified to UL 1598C, suitable for damp location use
- Tube : cULus recognized to UL 1993, suitable for damp location use
- Driver : cULus recognized to UL 8750, suitable for damp location use
- DesignLights Consortium qualified products
- Based on photometric testing consistent with IES LM-79



# Retrofit Board & Driver Kit

## Features

- Simple retrofit solution for typical 2' or 4' troffers
- Efficacy up to 130 lm/W (light source level)
- Standard 0-10 V dimming
- Wireless lighting control ready (ZigBee®)
- Lumen maintenance of L85 at 50,000 hours
- 5-year warranty



## Product details

### Easy installation

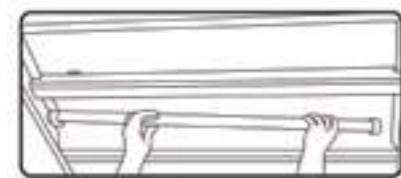

Remove lens frame and existing fluorescent tubes and ballast

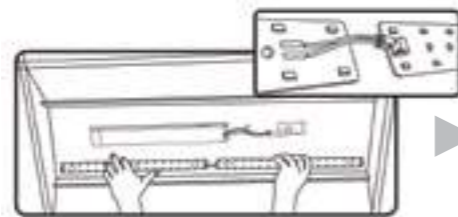

Install LED boards and driver

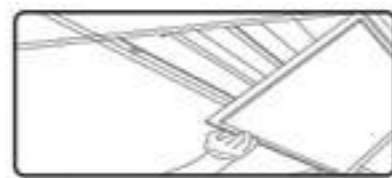

Re-install lens frame, turn power back on

### Kit includes

- 2 LED boards for 2'X2'; 4 LED boards for 2'X4'
- Driver
- Driver screw
- Mounting tape on the back that allows the installer to ensure alignment during screw-in installation
- UL1598C certification label
- Installation manual

## Dimension

Board  
2'X4'

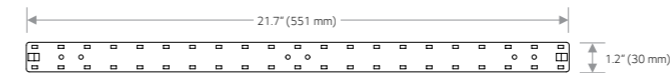

2'X2'

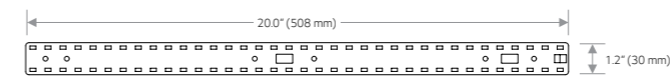

Driver

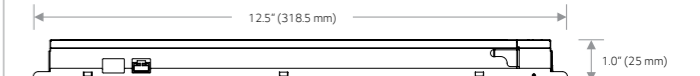
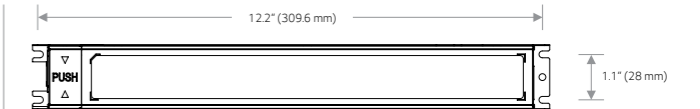

## Photometrics

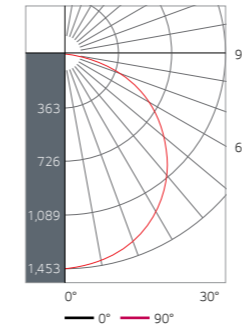

### Coefficients of utilization - zonal cavity method

RC	Effective floor cavity reflectance					0.20				
	70	50	30	10	50	30	10	50	30	10
0	119	119	119	119	111	111	111	106	106	106
1	109	104	100	96	97	94	91	93	91	88
2	99	90	84	78	85	80	75	82	77	73
3	90	79	71	64	75	68	63	72	66	62
4	82	70	61	54	66	59	53	64	58	53
5	75	62	53	47	59	52	46	57	51	45
6	70	56	47	41	53	46	40	52	45	40
7	65	51	42	36	48	41	35	47	40	35
8	60	46	38	32	44	37	32	43	36	31
9	56	43	34	29	41	33	28	40	33	28
10	53	39	31	26	38	31	26	37	30	26

### Zonal lumen summary

Zone	Lumens	%Fixture
0-20	534	12.5
0-30	1140	26.6
0-40	1880	43.9
0-60	3370	78.7
0-80	4208	98.3
0-90	4280	100.0

Test: 2'X4'; 34 W, 3500 K  
Lumen: 4280 lm  
Spacing creation (0-180): 1.28  
Spacing creation (90-270): 1.28

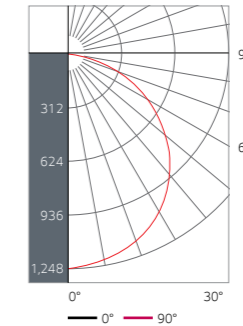

### Coefficients of utilization - zonal cavity method

RC	Effective floor cavity reflectance					0.20				
	70	50	30	10	50	30	10	50	30	10
0	119	119	119	119	111	111	111	106	106	106
1	109	104	100	96	97	94	91	93	91	88
2	99	90	84	78	85	80	75	82	77	73
3	90	79	71	64	75	68	63	72	66	62
4	82	70	61	54	66	59	53	64	58	53
5	76	63	53	47	59	52	46	57	51	45
6	70	56	47	41	53	46	40	52	45	40
7	65	51	42	36	49	41	35	47	40	35
8	60	46	38	32	44	37	32	43	36	31
9	56	43	34	29	41	34	28	40	33	28
10	53	39	31	26	38	31	26	37	30	26

### Zonal lumen summary

Zone	Lumens	%Fixture
0-20	458	12.5
0-30	977	26.7
0-40	1612	44.0
0-60	2887	78.9
0-80	3601	98.4
0-90	3660	100.0

Test: 2'X2'; 29 W, 3500 K  
Lumen: 3660 lm  
Spacing creation (0-180): 1.28  
Spacing creation (90-270): 1.28

## Specifications & Ordering Information

Product type	Model code (US order code)	Input power	Delivered light output	Efficacy	CCT	UGR	Beam Angle	CRI	Input Voltage	Power factor	Operating temperature	Dimension	Weight	Controls
		W	lm	lm/W	K							inch (mm)	lb (kg)	
Retrofit Board & Driver kit	FRR634D1HZZ.BJAAWAA (LGE-4BDK-34-30-4200)	34	4240	125	3000							Board (X4EA) 21.7X1.2 (551X30) Driver 12.5X1.1X1.0 (319X28X25)	1.4 (0.6)	0-10 V (ZigBee ready)
	FRR634D2HZZ.BJAAWAA (LGE-4BDK-34-35-4300)	34	4280	126	3500									
	FRR634D3HZZ.BJAAWAA (LGE-4BDK-34-40-4400)	34	4420	130	4000									
	FRR629D2HZZ.BJAAWAA (LGE-4BDK-29-35-3700)	29	3660	126	3500	≤19	117	82	120 - 277	≥0.9	-4 - 122 (-20 - 50)			
	FRR629D3HZZ.BJAAWAA (LGE-4BDK-29-40-3800)	29	3770	130	4000									
	FRS629D2HZZ.BJAAWAA (LGE-2BDK-29-35-3700)	29	3660	126	3500							Board (X2EA) 20.0X1.9 (508X30) Driver 12.5X1.1X1.0 (319X28X25)	1.1 (0.5)	
FRS629D3HZZ.BJAAWAA (LGE-2BDK-29-40-3800)	29	3770	130	4000										

## Compliance

- Retrofit board: cULus classified to UL 1598C, suitable for damp location use
- Driver: cULus recognized to UL 8750, suitable for damp location use
- DesignLights Consortium qualified products
- Based on photometric testing consistent with IES LM-79





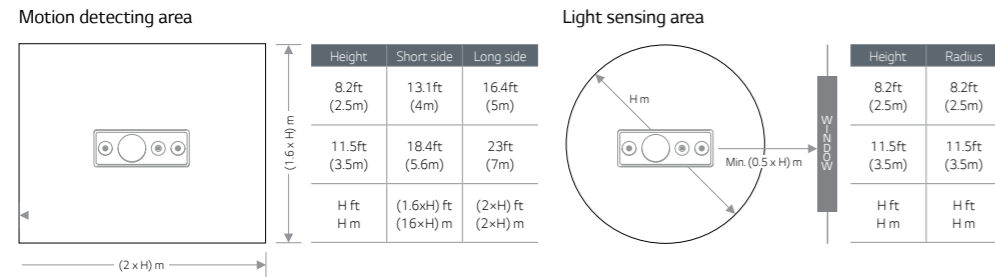

# Smart Multi Sensor

## Features

- Maximized energy saving with daylight harvesting and motion detecting
  - Automatically maintain illumination through daylight harvesting
  - Occupancy detection automatic on/off/dimming
- Useable to max. 11.5ft (3.5m) high ceiling
- Individual or Group control

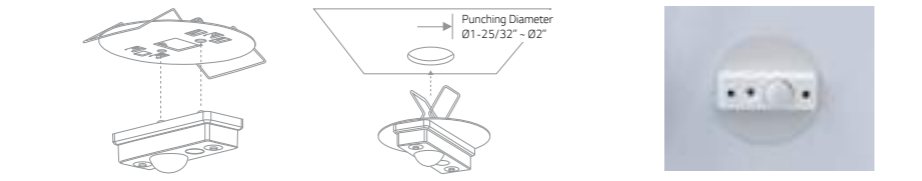

## Clip options >

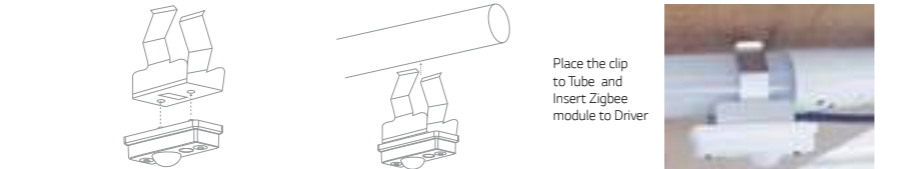
Application	Accessory	Installation
Performance Troffer	 <Plate Clip>	 <p>Put the cable through two holes of clip and assemble the multi sensor</p> <p>Insert Zigbee module to LED Driver</p> <p>Assemble inner cover of Troffer</p> <p>Fix the clip to optic cover and assemble the optic cover to Troffer</p>
Downlight		 <p>Punching Diameter Ø1-25/32" - Ø2"</p>
Tube		 <p>Place the clip to Tube and Insert Zigbee module to Driver</p>

## Specifications & Ordering Information

Product Type	Model Code	Input Power	Input Voltage	Input Frequency	Mounting Height	Dimension	Weight	Operating Temp.	IP	Control
		W	Vdc	MHz	ft (m)	inch (mm)	oz (g)	°F (°C)		
Smart Multi-sensor	9SD131VVDAALWB000	0.2	3.3	2,405 -2,480	Max 11.5 (3.5)	Sensor : 0.8X2.0X0.7 (20X50X17) Dongle : 0.9X1.1X0.3 (22X28.7X7.7) Cable : Ø0.16X31.5 (Ø4.0X800)	0.4 (10)	-4 - 122 (-20 - 50)	20	ZigBee
Clip for Performance Troffer	BKTRR015122.BUAAWAA					1.61X0.63X0.35 (41X16X9)	0.11 (3.1)			
Clip for Downlight	BKTCE015123.BUAAWAA					2.68X2.28X0.35 (68X58X9)	0.44 (12.6)			
Clip for Tube	BKTTU015121.BUAAWAA					1.26X1.06X1.34 (32X27X34)	0.11 (3.1)			

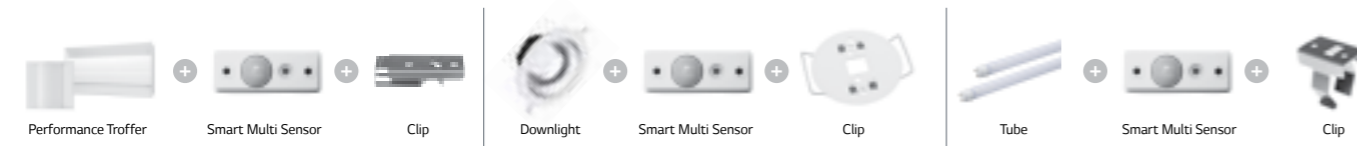

# Wireless Scheduling Switch

## Features

- Energy saving with automatic scheduling
- Minimize labor cost with easy installation
  - ZigBee® wireless communication
  - AAA alkaline battery type (easy replacement)
- Real time clock & back-up battery embedded for durability of scheduling
- 0.49 inch (1.25cm) slim & sleek design
- Zone control : On/Off/Dimming
  - Touch : On (Auto sensing off) / Hold : Dim up
  - Touch : Off / Hold : Dim down



## Dimension

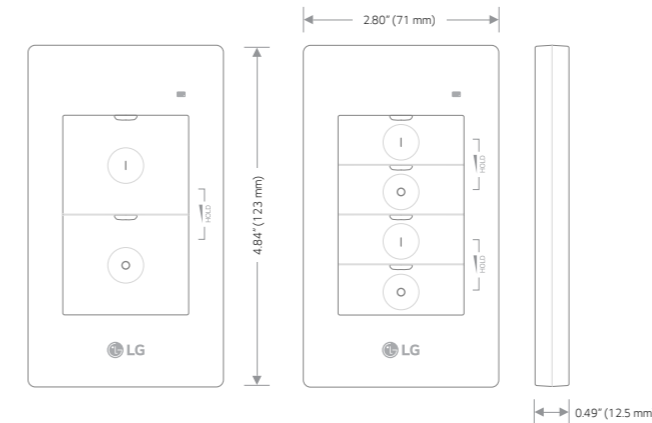

## Specifications & Ordering Information

Product Type	Model Code	Input Frequency	Mounting Height	Dimension	Weight	Operating Temp.	IP	Control
		MHz	ft (m)	inch (mm)	oz (g)	°F (°C)		
Wireless Scheduling Switch	1-Zone (2buttons)	2,405 -2,480	Max. 98.4(30)	4.84X2.80X0.49 (123X71X12.5)	2.0 (58) (Without Battery)	-4 - 122 (-20 - 50)	20	ZigBee
	2-Zone (4buttons)							

# LG Wireless Control

## Benefits of wireless lighting control

Although lighting control solutions have been proven to significantly reduce lighting energy consumption, many parts of commercial building market have been hesitant due to cost, complexity and applicability. However, new wireless technologies are eliminating these concerns, while expanding the lighting control capabilities.

### Removing the wires

A new generation of lighting control systems is reducing cost and eliminating complexity concerns by removing the dedicated control wiring.

### Flexibility

Instead of placing controls where wiring permits, building owners are free to place controls where they are needed to improve building performance. As the needs of a space change, changes can be made at any point, or new devices and control strategies added, simply by reprogramming.

### Scalability

Once a wireless network is established, that network can grow to cover an ever-expanding area at a low additional cost. Additional sensors, switches and lights require minimal labor and disruption, and utilize the same wireless control system without the need to add a new control infrastructure.

## Lighting control strategy

Lighting control manages and automates the delivery of the correct amount of light, where you want it, when you want it. Lights can automatically turn on/off or dim at set times or under set conditions, and users can have control over their own lighting levels to provide optimal working conditions. A lighting control solution automates and simplifies cost- and energy-saving strategies such as belows.

### Scheduling

Turn on/off and dim lights at specified times during the day—for example, automatically turn lights on at the start of business hours, and off after workers leave at night.

### Occupancy sensors

Detect when a room is occupied, to automatically turn lights on when someone enters and off (or dim) shortly after they leave.

### Daylight harvesting

Use photosensors to detect levels of natural lighting, and automatically dim lights when sunlight is streaming into windows. This reduces energy use and provides consistent lighting levels.

### Demand response

Utility companies frequently offer their customers incentives to encourage them to reduce energy consumption, especially at times of peak usage or when retail energy prices are high. Lighting control solutions can automatically respond to these events and reduce energy consumed by lighting to pre-set levels.

## LG Lighting with ZigBee® wireless capability

LG Lighting is designed as a wireless-embedded system, which users can control wirelessly by simply inserting a compact communication dongle into the driver. By adopting ZigBee®, an open wireless protocol, the system not only works seamlessly with devices that use the same protocol, but also integrates with the control systems of solution providers like DaintreeNetworks.

### Easy installation & scalability



### Total control system with DaintreeNetworks

LG Electronics adopts ZigBee®, an open wireless protocol, so that the system not only works seamlessly with devices that use the same protocol, but also integrates with the control systems of solution providers like DaintreeNetworks.

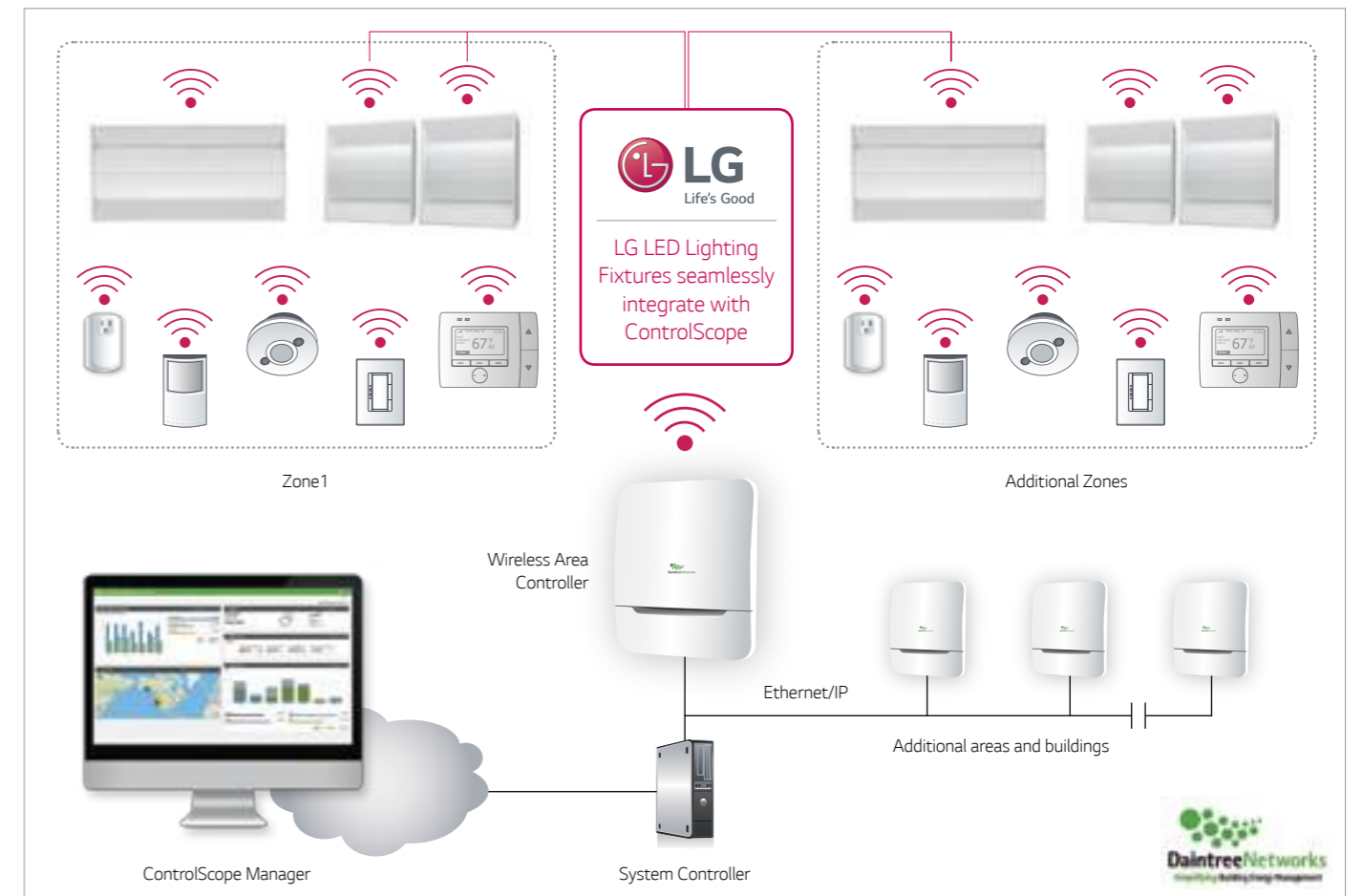

# LG SENSOR CONNECT

## Benefits of LG SENSOR CONNECT

The LG SENSOR CONNECT system from LG Electronics meets the needs of small and medium-sized buildings that require a wireless lighting control solution but are constrained by cost. ZigBee® wireless mesh control platform & sensors (occupancy sensing, daylight harvesting) embedded into luminaires, touting the exact same integration benefits with wireless lighting control solutions.

### LG solves your problems



Specifiers

- Simple stand-alone system



Installers (facility managers)

- No re-circuiting or new control wiring
- Easy installation & maintenance



Building owners

- Saving installation & energy costs
- Provide optimum lighting control

### A new generation of much simpler lighting control system

#### Easy Installation

- Tool-less installation
- Simple set-up for the installer
- Flexible layout

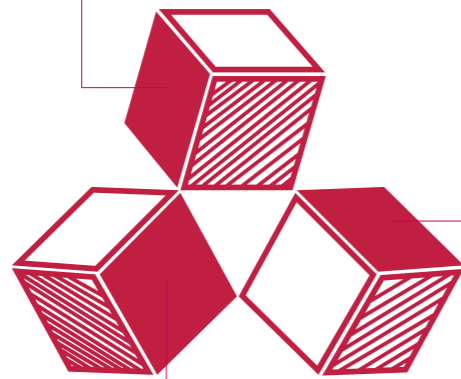

#### Excellent Savings

- Occupancy and daylight sensing
- Automatic schedule control
- App reports real-time energy savings

#### Intuitive Operation

- Easy and convenient for the end user
- Manual or automatic on/off/dimming
- Automated sensor control
- Remote monitoring & management

### Simple yet powerful commissioning App

For office

For industry



### How LG SENSOR CONNECT system works for open-plan office

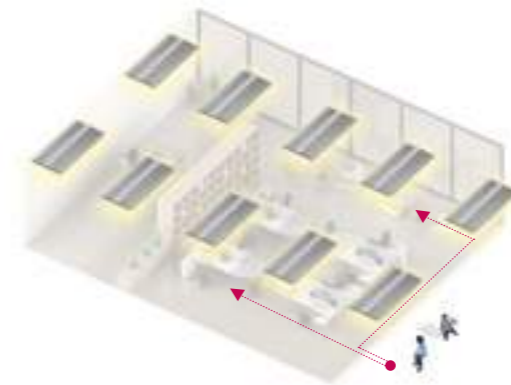

01 The entire lighting group brighten to a background level when the first occupant is detected.



02 As each occupant arrives at their desk space, the luminaires in the immediate area brighten to the task level while the remaining luminaires stay at a background level. In the meantime, automatic daylight harvesting occurs throughout the day.



03 When occupants leave their desk space, the luminaires in the immediate area dim to the background level.

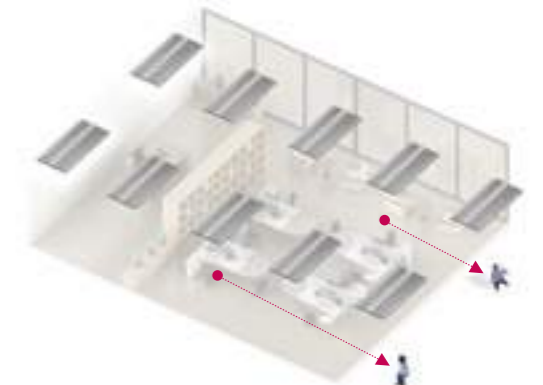

04 The luminaires will turn off when no occupancy is detected from the entire lighting group.

# Commercial Term and Conditions

## Terms

- Credit accounts : Invoice payments are required to be paid in Net Thirty (30) Days.
- Cash account : 100% balance of payment due before shipping.
- 1.5% monthly service charge can be imposed on all accounts past due in excess of thirty (30) days on the unpaid balance, except where prohibited by law.
- Customer may be held responsible for any fees arising from third party collection efforts.

## Orders

- The minimum order charge for LGE LED Lighting lamps, fixtures, or control is \$100.00
- Orders will be accepted by facsimile or electronic means only (E.D.I. preferably).
- Hold for Release (HFR) orders will only be accepted with an approximate release date, and are subject to applicable price increases.

## Cancellations

- Orders cannot be cancelled without prior written LGE consent.
- All cancellation requests must be submitted in writing to LGE and may be subject to restocking fees.

## Return policy

- All product or order return requests must be submitted in writing to LGE.
  - Return requests without prior written LGE authorization will not be accepted.
  - All returns must be marked with the LGE RMA number or LGE reserves the right to refuse return.
- All returns are subject to a possible restocking fee, with that fee being a maximum of 30% of the order.
- Freight on returns will not be credited. Collect return shipments will not be accepted.
- LGE has the right to repair or replace any warranty item. LGE has the right to substitute any warranty item not on the current price / product list.
- Returns of new, uninstalled merchandise must be requested within 90 days of invoice date.
- LGE will not accept returns of installed products, or items older than 90 days past invoice date.
- Returned merchandise must be in original LGE packaging and deemed suitable for resale by LGE.
  - All returns to be inspected by LGE.
  - Damaged products will be credited less repair costs or at salvage value.

## Freight

- The following prepaid freight terms apply to orders shipped from LG Electronics U.S.A., Inc. warehouses.
- For LG LED Lighting order of \$5,000 or greater, customer will receive LG pre-paid freight services.
- Special freight handling , including international deliveries, must be submitted in writing to LGE.
  - All special freight charges (including overnight airfare) will be billed to the customer requesting the special freight handling.
- All shipments are subject to availability.
- Requests to ship partials must be submitted in writing and freight will be charged per each shipment.
- All next day air shipments must be submitted in writing and received before 12 PM Eastern Time.
- All freight claims for damaged or lost-in-transit material must be made directly to the carrier.

## Point of contact

- For more information, please contact LG Electronics order management at (201)816-2000
- Please visit [www.lglightingus.com](http://www.lglightingus.com)

## Product selection guide

### Performance Troffer

Product type	Model code (US order code)	Input power	Delivered light output	Efficacy	CCT	Beam angle	CRI	Input voltage	Power factor	Operating temperature	Dimensions	Optical unit	Weight	Controls							
		W	lm	lm/W	K	°	-	Vac	-	°F (°C)	inch (mm)	-	lb (kg)	-							
T-Bar lay-in fixture	FRR626D2HOA.BUAAWAA (LGE-2X4RT-26-35-3400-TB)	26	3380	130	3500	105	82	120 - 277	≥0.9	-4 - 122 (-20 - 50)	23.8X47.8X2.8 (605X1,214X72)	Frost (PMMA)	16.5 (7.5)	0-10 V (ZigBee ready)							
	FRR626D3HOA.BUAAWAA (LGE-2X4RT-26-40-3400-TB)	26	3400	131	4000																
	FRR634D2HOB.BUAAWAA (LGE-2X4RT-34-35-4400-TB)	34	4400	129	3500																
	FRR634D3HOB.BUAAWAA (LGE-2X4RT-34-40-4500-TB)	34	4500	132	4000																
	FRR648D2HOA.BUAAWAA (LGE-2X4RT-48-35-5800-TB)	48	5550	116	3500																
	FRR648D3HOA.BUAAWAA (LGE-2X4RT-48-40-6000-TB)	48	5750	120	4000																
	FRS618D2HOA.BUAAWAA (LGE-2X2RT-18-35-2350-TB)	18	2350	131	3500						115										
	FRS618D3HOA.BUAAWAA (LGE-2X2RT-18-40-2400-TB)	18	2400	133	4000																
	FRS632D2HOA.BUAAWAA (LGE-2X2RT-32-35-3400-TB)	32	3200	100	3500																
	FRS632D3HOA.BUAAWAA (LGE-2X2RT-32-40-3400-TB)	32	3250	102	4000																
	FRR626D2HRA.BUAAWBB (LGE-2X4RT-26-35-3400-R(W))	26	3380	130	3500																
	FRR626D3HRA.BUAAWBB (LGE-2X4RT-26-40-3400-R(W))	26	3400	131	4000																
Retrofit fixture	FRR634D2HRB.BUAAWBB (LGE-2X4RT-34-35-4400-R(W))	34	4400	129	3500	105	82	120 - 277	≥0.9	-4 - 122 (-20 - 50)	21.7X45.8X2.6 (552X1,163X67)	Frost (PMMA)	14.6 (6.6)	0-10 V (ZigBee ready)							
	FRR634D3HRB.BUAAWBB (LGE-2X4RT-34-40-4500-R(W))	34	4500	132	4000																
	FRS618D2HRA.BUAAWBB (LGE-2X2RT-18-35-2350-R(W))	18	2350	131	3500																
	FRS618D3HRA.BUAAWBB (LGE-2X2RT-18-40-2400-R(W))	18	2400	133	4000																
	FRS632D2HRA.BUAAWBB (LGE-2X2RT-32-35-3400-R(W))	32	3200	100	3500																
	FRS632D3HRA.BUAAWBB (LGE-2X2RT-32-40-3400-R(W))	32	3250	102	4000																
	Emergency backup fixture	FRR641D2H5B.BUAAWAA (LGE-2X4RT-41-35-4400-EM)	41	4400	107						3500	105	82		120 - 277	≥0.9	-4 - 122 (-20 - 50)	23.8X47.8X4.5 (605X1,214X115)	Frost (PMMA)	19.2 (8.7)	0-10 V (ZigBee ready)
		FRR641D3H5B.BUAAWAA (LGE-2X4RT-41-40-4500-EM)	41	4500	110						4000										
		FRS639D2H5A.BUAAWAA (LGE-2X2RT-39-35-3300-EM)	39	3300	85						3500										
		FRS639D3H5A.BUAAWAA (LGE-2X2RT-39-40-3350-EM)	39	3350	86						4000										
		FRR634D2HRD.BUAAWBB (LGE-2X4RT-34-35-4400-R2(W))	34	4400	130						3500							115			
		FRR634D3HRD.BUAAWBB (LGE-2X4RT-34-40-4500-R2(W))	34	4500	133						4000										
FRS626D2HRB.BUAAWBB (LGE-2X2RT-26-35-3400-R(W))	26	3380	130	3500																	
Retrofit fixture ('16. May)	FRS626D3HRB.BUAAWBB (LGE-2X2RT-26-40-3400-R(W))	26	3400	130	4000	105	82	120 - 277	≥0.9	-4 - 122 (-20 - 50)	21.7X21.7X2.6 (552X552X67)	Frost (PMMA)	7.5 (3.4)	0-10 V (ZigBee ready)							
	FRR634D2HRC.BUAAWBB (LGE-2X4RT-34-35-4400-R(W)-SN)	34	4400	130	3500																
	FRR634D3HRC.BUAAWBB (LGE-2X4RT-34-40-4500-R(W)-SN)	34	4500	133	4000																
	FRS626D2HRC.BUAAWBB (LGE-2X2RT-26-35-3400-R(W)-SN)	26	3380	130	3500																
	FRS626D3HRC.BUAAWBB (LGE-2X2RT-26-40-3400-R(W)-SN)	26	3400	130	4000																
	Retrofit fixture with Sensor ('16. May)	FRR634D2HRC.BUAAWBB (LGE-2X4RT-34-35-4400-R(W)-SN)	34	4400	130						3500	105	82		120 - 277	≥0.9	-4 - 122 (-20 - 50)	21.7X45.8X2.6 (552X1,163X67)	Frost (PMMA)	15.0 (6.8)	ZigBee
FRR634D3HRC.BUAAWBB (LGE-2X4RT-34-40-4500-R(W)-SN)		34	4500	133	4000																
FRS626D2HRC.BUAAWBB (LGE-2X2RT-26-35-3400-R(W)-SN)		26	3380	130	3500																
FRS626D3HRC.BUAAWBB (LGE-2X2RT-26-40-3400-R(W)-SN)		26	3400	130	4000																
Simple Choice		F4035TB1131.BUAAWAA (LGE-1X4SI-40-35-4000-TB)	40	4000	100	3500	120	82	120 - 277	≥0.9	-4 - 104 (-20 - 40)			11.8X47.8X4.14 (300X1,214X105)				White (PC)	7.9 (3.6)	0-10 V (ZigBee ready)	
		F4040TB1131.BUAAWAA (LGE-1X4SI-40-40-4000-TB)	40	4000	100	4000															
	F3035TB1111.BUAAWAA (LGE-2X4SI-31-35-4000-TB)	31	4050	130	3500																
	F3040TB1111.BUAAWAA (LGE-2X4SI-31-40-4000-TB)	31	4100	132	4000																
	FRR640D2HOA.BUAAWAA (LGE-2X4SI-40-35-4000-TB)	40	4000	100	3500																
	FRR640D3HOA.BUAAWAA (LGE-2X4SI-40-40-4000-TB)	40	4000	100	4000																
	F2435TB1111.BUAAWAA (LGE-2X2SI-25-35-3200-TB)	25	3250	130	3500	23.8X47.8X4.1 (605X1,214X105)															
	F2440TB1111.BUAAWAA (LGE-2X2SI-25-40-3200-TB)	25	3270	130	4000																
	FRS632D2HOB.BUAAWAA (LGE-2X2SI-32-35-3200-TB)	32	3200	100	3500																
	FRS632D3HOB.BUAAWAA (LGE-2X2SI-32-40-3200-TB)	32	3200	100	4000																
	F4035TB1S31.BUAAWAA (LGE-1X4SC-40-35-4000-TB)	40	4000	100	3500							23.8X23.8X4.1 (605X605X105)									
	F4040TB1S31.BUAAWAA (LGE-1X4SC-40-40-4000-TB)	40	4000	100	4000																
F3035TB1S11.BUAAWAA (LGE-2X4SC-31-35-4000-TB)	31	4050	130	3500																	
F3040TB1S11.BUAAWAA (LGE-2X4SC-31-40-4000-TB)	31	4100	132	4000																	
FRR640D2HOC.BUAAWAA (LGE-2X4SC-40-35-4000-TB)	40	4000	100	3500																	
FRR640D3HOC.BUAAWAA (LGE-2X4SC-40-40-4000-TB)	40	4000	100	4000																	
SENSOR CONNECT	F2435TB1S41.BUAAWAA (LGE-2X2SC-25-35-3200-TB)	25	3250	130	3500	120	82	120 - 277	≥0.9	-4 - 104 (-20 - 40)	23.8X47.8X4.1 (605X1,214X105)	White (PC)	8.4 (3.8)	ZigBee							
	F2440TB1S41.BUAAWAA (LGE-2X2SC-25-40-3200-TB)	25	3270	130	4000																
	FRS632D2HOC.BUAAWAA (LGE-2X2SC-32-35-3200-TB)	32	3200	100	3500																
	FRS632D3HOC.BUAAWAA (LGE-2X2SC-32-40-3200-TB)	32	3200	100	4000																
	F2435TB1S41.BUAAWAA (LGE-2X2SC-25-35-3200-TB)	25	3250	130	3500						23.8X23.8X4.1 (605X605X105)										
	F2440TB1S41.BUAAWAA (LGE-2X2SC-25-40-3200-TB)	25	3270	130	4000																
FRS632D2HOC.BUAAWAA (LGE-2X2SC-32-35-3200-TB)	32	3200	100	3500																	

### Simple Choice Troffer

Product type	Model code (US order code)	Input power	Delivered light output	Efficacy	CCT	Beam angle	CRI	Input voltage	Power factor	Operating temperature	Dimensions	Optical unit	Weight	Controls
		W	lm	lm/W	K	°	-	Vac	-	°F (°C)	inch (mm)	-	lb (kg)	-
Simple Choice	F4035TB1131.BUAAWAA (LGE-1X4SI-40-35-4000-TB)	40	4000	100	3500	120	82	120 - 277	≥0.9	-4 - 104 (-20 - 40)	11.8X47.8X4.14 (300X1,214X105)	White (PC)	7.9 (3.6)	0-10 V (ZigBee ready)
	F4040TB1131.BUAAWAA (LGE-1X4SI-40-40-4000-TB)	40	4000	100	4000									
	F3035TB1111.BUAAWAA (LGE-2X4SI-31-35-4000-TB)	31	4050	130	3500									
	F3040TB1111.BUAAWAA (LGE-2X4SI-31-40-4000-TB)	31	4100	132	4000									
	FRR640D2HOA.BUAAWAA (LGE-2X4SI-40-35-4000-TB)	40	4000	100	3500									
	FRR640D3HOA.BUAAWAA (LGE-2X4SI-40-40-4000-TB)	40	4000	100	4000									
	F2435TB1111.BUAAWAA (LGE-2X2SI-25-35-3200-TB)	25	3250	130	3500						23.8X47.8X4.1 (605X1,214X105)			
	F2440TB1111.BUAAWAA (LGE-2X2SI-25-40-3200-TB)	25	3270	130	4000									
	FRS632D2HOB.BUAAWAA (LGE-2X2SI-32-35-3200-TB)	32	3200	100	3500									
	FRS632D3HOB.BUAAWAA (LGE-2X2SI-32-40-3200-TB)	32	3200	100	4000									
	F4035TB1S31.BUAAWAA (LGE-1X4SC-40-35-4000-TB)	40	4000	100	3500							23.8X23.8X4.1 (605X605X105)		
	F4040TB1S31.BUAAWAA (LGE-1X4SC-40-40-4000-TB)	40	4000	100	4000									
F3035TB1S11.BUAAWAA (LGE-2X4SC-31-35-4000-TB)	31	4050	130	3500										
F3040TB1S11.BUAAWAA (LGE-2X4SC-31-40-4000-TB)	31	4100	132	4000										
FRR640D2HOC.BUAAWAA (LGE-2X4SC-40-35-4000-TB)	40	4000	100	3500										
FRR640D3HOC.BUAAWAA (LGE-2X4SC-40-40-4000-TB)	40	4000	100	4000										
SENSOR CONNECT	F2435TB1S41.BUAAWAA (LGE-2X2SC-25-35-3200-TB)	25	3250	130	3500	120	82	120 - 277	≥0.9	-4 - 104 (-20 - 40)	23.8X47.8X4.1 (605X1,214X105)	White (PC)	8.4 (3.8)	ZigBee
	F2440TB1S41.BUAAWAA (LGE-2X2SC-25-40-3200-TB)	25	3270	130	4000									
	FRS632D2HOC.BUAAWAA (LGE-2X2SC-32-35-3200-TB)	32	3200	100	3500									
	FRS632D3HOC.BUAAWAA (LGE-2X2SC-32-40-3200-TB)	32	3200	100	4000									
	F2435TB1S41.BUAAWAA (LGE-2X2SC-25-35-3200-TB)	25	3250	130	3500						23.8X23.8X4.1 (605X605X105)			
	F2440TB1S41.BUAAWAA (LGE-2X2SC-25-40-3200-TB)	25	3270	130	4000									
FRS632D2HOC.BUAAWAA (LGE-2X2SC-32-35-3200-TB)	32	3200	100	3500										



**LG Electronics, U.S.A.**

920 Sylvan Avenue

Englewood Cliffs, NJ 07632

[www.LGLightingUS.com](http://www.LGLightingUS.com)

© 2016 LG Electronics U.S.A., Inc., Englewood Cliffs, NJ. All rights reserved.  
LG Life's Good is a registered trademark of LG Corporation.  
Specifications are subject to change without prior notice.