



**LED QUICK
REFERENCE
GUIDE
MARCH, 2017**

We are pleased to present the latest edition of our Lamp Specification Guide. Many new lamps and accessories have been added, and each section is color-coded and arranged to make finding the right product easy.

Brilliance

Satco is committed to providing unsurpassed quality, service and product assortment. Many of our product categories are supported by merchandising systems, displays and a selection of attention-getting point of purchase materials. These efforts, along with our strategic locations, make Satco the preferred choice in light sources and electrical related products.

Six convenient locations

WASHINGTON

4710 116th St. S.W.
Mukilteo, Washington 98275
800-437-2826
(425) 789-3300 FAX: (425) 789-3310

NEW YORK CORPORATE OFFICES

110 Heartland Blvd.
Brentwood, N.Y. 11717
800-437-2826
(631) 243-2022 FAX: (631) 243-2027

CALIFORNIA

31288 San Benito St.
Hayward, California 94544
800-437-2826
(510) 487-4822 FAX: (510) 487-8955

TEXAS

2000 Valwood Parkway
Farmers Branch, Texas 75234
800-437-2826
(972) 247-2437 FAX: (972) 247-5408

FLORIDA

900 N.W. 159th Drive
Miami, Florida 33169
800-437-2826
(305) 624-2044 FAX: (305) 623-0286

PUERTO RICO

Bldg 3, Compeche St. 22
Julio N. Matos Industrial Park
Carolina, PR 00984
800-437-2826
(787) 757-3510 Fax: (787) 757-3540

Contents

About Satco	2-5
Retail Support	6-9
LED Filament Lamps	10-11
Omni-Directional LED A19 Lamps	12-15
Omni-Directional LED A21 Lamps	15
Omni-Directional 3-Way & Colored A19 LED Lamps	16
Omni-Directional A15 & Decorative LED Lamps	17
LED Reflector Lamps	18-19
LED PAR Lamps	20-23
LED PAR 16 & MR11 Lamps	24
LED MR16 & Elevator Lamps	25
LED Specialty Lamps	26-27
LED Recessed Downlight Retrofits	28-33
LED Direct Wire Edge-Lit Downlights	34-35
LED Direct Wire Downlights	36-37
LED Commercial Recessed Downlight Retrofits	38-39
LED 12V Recessed Downlight Retrofits	40
LED High Lumen Lamps	41-48
LED Specialty Lamps	49
LED/CFL Lamps	50-51
LED T8 Lamps	52-57
LED T5 Lamps	57

At Satco, our business isn't about us. It's about you and your business.

Satco and our Nuvo® and Hygrade™ brands have grown to be industry leaders by offering you the widest selection of lamps, fixtures and lighting components.

The most innovative technology.

The highest standards of quality and efficiency. And a reputation for service earned one customer at a time for almost 50 years.

Satco. Setting the standards.

With a vast catalog of products built to the highest quality standards, massive inventories, a highly automated nationwide distribution network, and a growing investment in research and development, few lighting manufacturers can match Satco's depth of industry experience.

The widest selection.

Satco keeps homes across North America lit through the thousands of retail outlets we supply with replacements lamps and consumer lighting accessories.

The residential and commercial building trades rely on Satco's comprehensive line of fixtures, track and outdoor lighting and lamps, which are widely available through electrical distributors across the country.

Lighting fixture manufacturers turn to Satco Logistics for on-time shipping of thousands of component parts in orders of any size, including lamps, ballasts, sockets, switches, cords, canopies and glassware of every description.



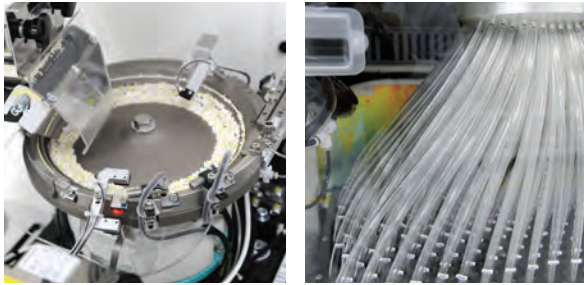

The most innovative technology.

Over the years, Satco's robust R&D programs have moved lighting technology forward with patented innovations that have been widely adopted throughout the industry that includes breaking new ground in the design and manufacture of high-efficiency LED lamps.



The highest quality and efficiency.

Every Satco product is designed, manufactured and tested to meet or exceed the highest industry standards for quality and performance. And we offer hundreds of products that have earned ENERGY STAR® certification. In fact, we were selected ENERGY STAR® Partner of the Year in 2009.



Over a million square feet of warehouse space.

The Satco brand has stood for quality, innovation and value in lighting products since 1966. From a 3,000 square foot warehouse in Elmont, NY, to more than 1.2 million square feet of U.S. Distribution space today. To be certain you'll have the parts you need where you need them, Satco maintains enormous amounts of inventories at our major distribution and sales centers in New York, Miami, Dallas, San Francisco, Seattle and San Juan, Puerto Rico, and at Satco Express stocking locations in Canton MA, Cincinnati OH, Charlotte NC, Chicago IL, Cleveland OH, La Mirada CA, Lavergne TN, Ridgeland MS and Syracuse NY.

Satco. An innovative family of brands.

LED lamps that only experience can deliver.

With one of the industry's largest R&D programs behind it, Satco is producing LED replacement lamps that meet all of the newest efficiency standards – and exceed user expectations for light output, color temperature, beam pattern, diffusion, and overall reliability.



Hygrade. The leader in commercial lighting.

Hygrade has been a trusted name in commercial and industrial lighting for more than a century. From fluorescent and compact fluorescent lamps to high intensity discharge bulbs of every description, Hygrade offers a variety of cost effective, energy efficient products for virtually any commercial application.



Nuvo. Inspired designs. Enlightened engineering.

Nuvo Lighting was launched in 2005 with more than 1,500 new lighting fixtures – one of the largest catalogs of any manufacturer – and our product line has continued to grow every year since. Today offering more than 3,000 chandeliers, pendants and sconces in designs that range from classic to contemporary, from elegant to understated and from simple to stylish.



As an ongoing effort on behalf of Satco Products, Inc. to remain dedicated to the improvement of our products, we reserve the right to change specifications. The information contained in this specification guide is subject to change without notice. We cannot be responsible for typographical errors.



Energy Efficient Lamps and Fixtures Counter Card
Item # SA1458



Energy Efficient Lamps Counter Card
Item # SA1207



Paint Department Counter Card
Item # SA1456

Counter cards

Place these informative cards in other busy departments to remind customers about their lighting needs.

At Satco we don't just bring great products and great value to market. We help our products sell! We offer powerful in-store selling tools to help make the lighting center a focal point and profit center.

Educate customers and increase sales!

Satco hanging signs and gondola headers clearly call-out the lighting center while shelf strips and aisle flags indicate lamp technologies to help customers find exactly what they're looking for. And the shelf strips correspond to the attractive, informative Satco packaging! Our educational gondola headers educate consumers about all the current lighting technologies, the energy efficiency of each and what energy savings they can expect from each.

Counter cards, hanging signs, shelf-talkers and gondola aisle flags all help customers find the exact replacement lamp they need.

Let Satco help you increase your lighting sales dramatically! For information and how to order, please contact your Satco sales representative.

Logo banners

Measuring 5' x 2', Satco logo banners can be strategically placed, indoors or out, to direct customers to the lighting aisle or simply make customers aware you carry Satco lighting products.



Satco Brand Logo Banner
Item # SA1296

HID	HID	HID	SA1265/1
LED	LED	LED	SA1265/2
CFL	CFL	CFL	SA1265/3
HALOGEN	HALOGEN	HALOGEN	SA1265/4
INCANDESCENT	INCANDESCENT	INCANDESCENT	SA1265/5

Lighting Technology Gondola Shelf Strips

(Can be ordered separately)
Each strip measures 12" long
Item # SA1265

Packaging

Satco retail packaging is informative and attractive, creating an easy to navigate presentation for your customers. Coupled with consistent branding, lamp technology types are clearly indicated and all government regulations are adhered to for lumen output, wattage and cost to operate. Satco packaging makes choosing the right lamp easy.

Gondola shelf technology strips

Indicate what technologies are on what shelves. Grouping products by their technology has been shown to help customers find the products they want easily.

Shelf talkers

Are an important silent salesman, explaining a sale or calling attention to a new product.



Energy Efficient Shelf Talker
Item # SA1205

RETAIL SUPPORT

SATCO LIGHTING CENTER
www.satco.com

- LED • Fluorescent Tubes
- Compact Fluorescent Lamps
- Decorative • Incandescent
- Halogen • Specialty Bulbs
- High Intensity Discharge

Generic Lighting Center Gondola Header
Item # SA1098

Header mounting hardware available

Reduce utility bills with energy saving Satco lamps.

Standard CFL Spirals BR/PAR CFL Lamps Ditto® LED Reflector Lamps Specialty LED Lamps LED A19 LED PAR Lamps

Energy Efficient Gondola Header
Item # SA1206

Header mounting hardware available

LED Lighting Center

LED Retrofits LED Reflectors LED Specialty Lamps LED MR16 LED A19 LED PAR Lamps LED 4' Lamps SA200-619

LED Gondola Header
Item # SA2006

Header mounting hardware available

Gondola headers

Clearly call out your lighting center, and our educational versions help explain new vs. old lighting technologies and the savings your customers can expect from them. Customers making more informed decisions will be pleased with their purchase and remember the help they received in your store.

Product photos

Satco offers our entire library of product photos for use in your flyers and advertising. Our high-quality product and packaging images will show customers exactly what you're offering.

Aisle flags

Help define what's on each section of shelving for easy product location.



Lighting Technology Aisle Violator Tags
Item # SA1292
Mounting hardware available



SA1292/1 SA1292/2 SA1292/3 SA1292/4 SA1292/5 SA1292/6

Lamp Technology Wattage Comparison www.satco.com

INCANDESCENT - Life: 1,000 Hours			HALOGEN - Life: 1,000 Hours - GOOD			CFL - Life: 10,000 Hours - BETTER			LED - Life: 25,000+ Hours - BEST		
Standard Wattage	Lumens/Brightness	Cost to Operate/Yr*	Wattage	Lumens/Brightness	Cost to Operate/Yr*	Wattage	Lumens/Brightness	Cost to Operate/Yr*	Wattage	Lumens/Brightness	Cost to Operate/Yr*
25W = 200	\$3.01					5W = 280	\$0.84		3W = 180	\$0.36	
40W [†] = 450	\$4.82		29W = 410	\$3.49		9W = 550	\$1.08		8W = 450	\$0.96	
60W [†] = 800	\$7.23		43W = 750	\$5.18		13W = 900	\$1.57		10W = 800	\$1.20	
75W [†] = 1,100	\$9.03		53W = 1,050	\$6.38		18W = 1,200	\$2.17		13W = 1,100	\$1.57	
100W [†] = 1,600	\$12.05		72W = 1,490	\$8.67		23W = 1,600	\$2.77		17W = 1,600	\$2.05	

* Discontinued technology
† Estimated yearly energy cost is based on 3 hrs/day, 0.11¢ kWh. Cost depends on rates and use.

SA1285/1
Lamp Comparison Guide





Lamp Savings Comparison - per lamp, per year* www.satco.com

INCANDESCENT Standard Wattage	Savings for Halogen Life = 1,000 Hours	Savings for CFL Life = 10,000 Hours	Savings for LED Life = 25,000 Hours	SAVE MORE
25W =		\$2.17	\$2.65	Long life = Less replacement lamps
40W =	\$1.33	\$3.74	\$3.86	
60W =	\$2.05	\$5.66	\$6.03	
75W =	\$2.65	\$6.86	\$7.46	
100W =	\$3.38	\$9.28	\$10.00	

* Estimated yearly energy cost is based on 3 hrs/day, 0.11¢ kWh. Cost depends on rates and use.

SA1285/2
Lamp Savings Comparison

Lamp Feature Comparison www.satco.com

 <p>INCANDESCENT</p> <ul style="list-style-type: none"> • Good light quality • Low initial cost • Dimmable • Shortest life • Least Efficient 	 <p>HALOGEN</p> <ul style="list-style-type: none"> • Great light quality • Dimmable • Energy savings: GOOD 	 <p>CFL (COMPACT FLUORESCENT)</p> <ul style="list-style-type: none"> • Big jump in energy savings • Instant on • Long bulb life, recyclable • Energy savings: BETTER 	 <p>LED (LIGHT EMITTING DIODE)</p> <ul style="list-style-type: none"> • Most energy efficient • Immediate full brightness • Dimmable • Costs the least to operate • Longest bulb life available • Energy savings: BEST
---	--	---	---

SA1285/3
Lamp Features Comparison

Long Life = Less Replacements www.satco.com

1 CFL lasts as long as 10 Incandescents 1 LED lasts as long as 25 Incandescents



A 13W CFL costs \$1.57 per year to operate in energy costs vs. a 60W incandescent that costs \$7.23 per year.*



An 8W LED costs \$0.96 per year to operate in energy costs vs. a 60W incandescent that costs \$7.23 per year.*

* Estimated yearly energy cost is based on 3 hrs/day, 0.11¢ kWh. Cost depends on rates and use.

SA1285/4
Long Life = Less Replacements



SA1285/5
Lumens: The new way to shop for light

Choosing Color Temperature www.satco.com

Lighting sets the mood in your room.

COLOR TEMPERATURE SCALE			
Soft White	Bright White	Natural Light	
2700K	3000K	3500K	4100K 5000K 7500K
Warm 2700K is inviting, warm, friendly and relaxing. • Homes • Restaurants	Neutral 3000K is inviting, comfortable and relaxing. • Homes • Showrooms • Reception • Offices	Cool 4100K is efficient, clean and organized. • Offices • Hospitals • Conference rooms	Daylight 5000K is exacting, refreshing, bright and alert. • Galleries • Jewelry displays



Warm



Neutral



Cool



Daylight

SA1285/6
Choosing Color Temperature

Lamp Comparison Gondola Headers

SET: 6

(Can be ordered separately)

Item # SA1285

Header mounting hardware available

LED FILAMENT LAMPS

LED filament lamps

Applications / Features

- LED with a traditional incandescent look and feel
- Omni-directional light source
- Dimmable
- Replaces up to 60 watt lamps
- Long life—15,000 hours
- Damp location
- Approved for totally enclosed fixtures
- cUL listed
- 3 Year warranty



LED Filament Lamps



Item Number	Lamp Description	W	Bulb Type	Base	V	Finish	CCT	Lm	CRI	M.O.L. (Inches)	Life/Hrs.	UPC	Pack
S9560	4.5A15/CL/LED/E26/27K/120V	4.5	A15	E26	120	Clear	2700K	450	80	3 3/8	15K	045923095603	24/6
S9561†	4.5A19/CL/LED/E26/27K/120V	4.5	A19	E26	120	Clear	2700K	450	80	4 1/8	15K	045923095610	24/6
S9562†	6.5A19/CL/LED/E26/27K/120V	6.5	A19	E26	120	Clear	2700K	800	80	4 1/8	15K	045923095627	24/6
S9824†	4.5A19/SW/LED/E26/27K/120V	4.5	A19	E26	120	Soft White	2700K	400	80	4 1/8	15K	045923098246	24/6
S9825†	6.5A19/SW/LED/E26/27K/120V	6.5	A19	E26	120	Soft White	2700K	720	80	4 1/8	15K	045923098253	24/6
S9826	6.5A19/SLV/LED/E26/27K/120V	6.5	A19	E26	120	Silver Crown	2700K	650	80	4 1/8	15K	045923098260	24/6
S9563†*	4.5G25/CL/LED/E26/27K/120V	4.5	G25	E26	120	Clear	2700K	550	80	4 3/8	25K	045923095634	24/6
S9564†	6.5G25/CL/LED/E26/27K/120V	6.5	G25	E26	120	Clear	2700K	810	80	4 3/8	15K	045923095641	24/6
S9827†	4.5G25/SW/LED/E26/27K/120V	4.5	G25	E26	120	Soft white	2700K	430	80	4 3/8	15K	045923098277	24/6
S9828	4.5G25/SLV/LED/E26/27K/120V	4.5	G25	E26	120	Silver Crown	2700K	430	80	4 3/8	15K	045923098284	24/6
S9567†*	2.5W ETC/LED/27K/120V	2.5	C11	E26	120	Clear	2700K	250	80	3 1/2	15K	045923095672	24/6
S9568†*	2.5W CTC/LED/27K/120V	2.5	C11	E12	120	Clear	2700K	250	80	4 5/16	15K	045923095689	24/6
S9569†*	4.5W ETC/LED/27K/120V	4.5	C11	E26	120	Clear	2700K	450	80	3 1/2	15K	045923095696	24/6
S9570†*	4.5W CTC/LED/27K/120V	4.5	C11	E12	120	Clear	2700K	450	80	4 5/16	15K	045923095702	24/6
S9571†	2.5W EFC/LED/27K/120V	2.5	CA11	E26	120	Clear	2700K	250	80	4 5/16	15K	045923095719	24/6
S9572†	2.5W CFC/LED/27K/120V	2.5	CA11	E12	120	Clear	2700K	250	80	5	15K	045923095726	24/6
S9573†	4.5W EFC/LED/27K/120V	4.5	CA11	E26	120	Clear	2700K	450	80	4 5/16	15K	045923095733	24/6
S9574†	4.5W CFC/LED/27K/120V	4.5	CA11	E12	120	Clear	2700K	450	80	5	15K	045923095740	24/6
S9866†	3.5CTC/LED/CL/50K/120V	3.5	C11	E12	120	Clear	5000K	350	80	4 5/16	15K	045923098666	24/6
S9867†	3.5CFC/LED/CL/50K/120V	3.5	CA11	E12	120	Clear	5000K	350	80	5	15K	045923098673	24/6
S9868†	3.5CTF/LED/FR/27K/120V	3.5	C11	E12	120	Frosted	2700K	350	80	4 5/16	15K	045923098680	24/6
S9869†	3.5CFF/LED/FR/27K/120V	3.5	CA11	E12	120	Frosted	2700K	350	80	5	15K	045923098697	24/6

(cont'd on page 11)

LED FILAMENT LAMPS

LED Filament Lamps (cont'd)



Item Number	Lamp Description	W	Bulb Type	Base	V	Finish	CCT	Lm	CRI	M.O.L. (Inches)	Life/Hrs.	UPC	Pack
S9920†	2.5W CTC/LED/CL/27K/120V	2.5	C11	E12	120	Clear	2700K	200	80	3 7/8	15K	045923099205	24/6
S9921†	2.5W CFC/LED/CL/27K/120V	2.5	CA11	E12	120	Clear	2700K	200	80	4 1/16	15K	045923099212	24/6
S9922†	3.5W CTC/LED/CL/27K/120V	3.5	C11	E12	120	Clear	2700K	350	80	3 7/8	15K	045923099229	24/6
S9923†	3.5W CFC/LED/CL/27K/120V	3.5	CA11	E12	120	Clear	2700K	350	80	4 1/16	15K	045923099236	24/6
S9870†	2.5G16.5/LED/CL/27K/120V	2.5	G16 1/2	E12	120	Clear	2700K	200	80	3 3/16	15K	045923098703	24/6
S9871†	3.5G16.5/LED/CL/27K/120V	3.5	G16 1/2	E12	120	Clear	2700K	350	80	3 3/16	15K	045923098710	24/6
S9565†	4.5G40/CL/LED/E26/27K/120V	4.5	G40	E26	120	Clear	2700K	450	80	6 1/2	15K	045923095658	24/6
S9566†	6.5G40/CL/LED/E26/27K/120V	6.5	G40	E26	120	Clear	2700K	800	80	6 1/2	15K	045923095665	24/6
S9575†	4.5BT15/CL/LED/E26/27K/120V	4.5	BT15	E26	120	Clear	2700K	450	80	4 1/8	15K	045923095757	24/6
S9576†	6.5BT15/CL/LED/E26/27K/120V	6.5	BT15	E26	120	Clear	2700K	800	80	4 1/8	15K	045923095764	24/6
S9581†	6.5ST19/CL/LED/E26/27K/120V	6.5	ST19	E26	120	Clear	2700K	810	80	5 1/2	15K	045923095818	24/6
S9582†	6.5T9/CL/LED/E26/27K/120V	6.5	T9	E26	120	Clear	2700K	800	80	12	15K	045923095825	24/6
S9580†	4.5T10/LED/E26/27K/120V	4.5	T10	E26	120	Clear	2700K	430	80	5	15K	045923095801	24/6
S9872†	2.5T6/LED/CL/27K/E12/120V	2.5	T6	E12	120	Clear	2700K	200	80	3 3/16	15K	045923098727	24/6

Vintage style LED filament lamps

Applications / Features

- LED with a traditional vintage look and feel
- Amber finish
- Omni-directional light source
- Dimmable
- 2200 & 2300K - warm tone color temperature
- Replaces up to 60 watt lamps
- Long life—15,000 hours
- Damp location
- Approved for totally enclosed fixtures
- cUL listed
- 3 Year warranty



Vintage Style LED Filament Lamps



Item Number	Lamp Description	W	Bulb Type	Base	V	Finish	CCT	Lm	CRI	M.O.L. (Inches)	Life/Hrs.	UPC	Pack
S9577	2.5ST19/AMB/LED/E26/23K/120V	2.5	ST19	E26	120	Amber	2300K	220	80	5 3/8	15K	045923095771	24/6
S9578	4.5ST19/AMB/LED/E26/23K/120V	4.5	ST19	E26	120	Amber	2300K	400	80	5 3/8	15K	045923095788	24/6
S9579	6.5ST19/AMB/LED/E26/23K/120V	6.5	ST19	E26	120	Amber	2300K	650	80	5 3/8	15K	045923095795	24/6
S9585	4.5ST19/AMB/LED/E26/22K/120V	4.5	ST19	E26	120	Amber	2200K	380	80	5 1/2	15K	045923095856	24/6
S9583	4.5A19/AMB/LED/E26/22K/120V	4.5	A19	E26	120	Amber	2200K	380	80	4 1/8	15K	045923095832	24/6
S9584	4.5G25/AMB/LED/E26/22K/120V	4.5	G25	E26	120	Amber	2200K	380	80	4 3/8	15K	045923095849	24/6
S9588	6.5T9/AMB/LED/E26/22K/120V	6.5	T9	E26	120	Amber	2200K	620	80	12	15K	045923095887	24/6
S9873	2T6/AMB/LED/E12/22K/120V	2	T6	E12	120	Amber	2200K	150	80	3 3/16	15K	045923098734	24/6
S9986	3.5CTA/AMB/LED/22K/120V	3.5	C11	E12	120	Amber	2200K	300	80	4 3/16	15K	045923099861	24/6
S9987	3.5CFA/AMB/LED/22K/120V	3.5	CA11	E12	120	Amber	2200K	300	80	5	15K	045923099878	24/6

OMNI-DIRECTIONAL LED A19 LAMPS

40 & 60W replacement omni-directional LED A19 lamps

Direct replacements for 40 Watt & 60 Watt incandescent lamps

Applications / Features

- Indoor residential and commercial lighting
- Direct replacement for 40–60 Watt incandescent lamps, uses only 5–9.5 Watts
- Innovative design—smooth heat sink design to resemble traditional incandescent lamp
- Dimmable
- 2700K, 3000K, 3500K, 4000K and 5000K options
- Damp location
- Long life—25,000 hours
- Approved for totally enclosed fixtures
- No UV or IR radiation
- 3 Year warranty

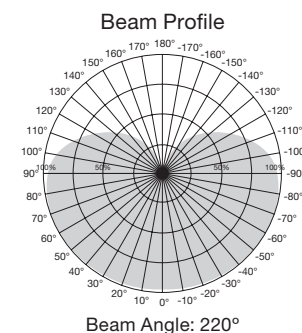

Omni-Directional A19 LED Lamps



Item Number	Lamp Description	W	V	CRI	CCT	Lm	Bm	M.O.L. (Inches)	Life/Hrs.	UPC	Pack
S9830*	5A19/OMNI/220/LED/27K	5	120	80	2700K	450	220°	4 3/16	25K	045923098307	24/6
S9831*	5A19/OMNI/220/LED/30K	5	120	80	3000K	450	220°	4 3/16	25K	045923098314	24/6
S9832*	5A19/OMNI/220/LED/35K	5	120	80	3500K	450	220°	4 3/16	25K	045923098321	24/6
S9833*	5A19/OMNI/220/LED/40K	5	120	80	4000K	450	220°	4 3/16	25K	045923098338	24/6
S9834*	5A19/OMNI/220/LED/50K	5	120	80	5000K	450	220°	4 3/16	25K	045923098345	24/6
S9835*	9.5A19/OMNI/220/LED/27K	9.5	120	80	2700K	800	220°	4 3/16	25K	045923098352	24/6
S9836*	9.5A19/OMNI/220/LED/30K	9.5	120	80	3000K	800	220°	4 3/16	25K	045923098369	24/6
S9837*	9.5A19/OMNI/220/LED/35K	9.5	120	80	3500K	800	220°	4 3/16	25K	045923098376	24/6
S9838*	9.5A19/OMNI/220/LED/40K	9.5	120	80	4000K	800	220°	4 3/16	25K	045923098383	24/6
S9839*	9.5A19/OMNI/220/LED/50K	9.5	120	80	5000K	800	220°	4 3/16	25K	045923098390	24/6
S9840*	9.5A19/OMNI/220/LED/27K/GU24	9.5	120	80	2700K	800	220°	4 3/16	25K	045923098406	24/6
S9841*	9.5A19/OMNI/220/LED/35K/GU24	9.5	120	80	3500K	800	220°	4 3/16	25K	045923098413	24/6
S9842*	9.5A19/OMNI/220/LED/40K/GU24	9.5	120	80	4000K	800	220°	4 3/16	25K	045923098420	24/6
90 CRI											
S9612*	10.5A19/OMNI/LED/27K/90CRI	10.5	120	90	2700K	800	300°	4 5/8	25K	045923096129	24/6
S9613*	10.5A19/OMNI/LED/27K/90CRI/GU24	10.5	120	90	2700K	800	300°	4 1/2	25K	045923096136	24/6
S9617*	10.5A19/OMNI/LED/30K/90CRI	10.5	120	90	3000K	830	300°	4 5/8	25K	045923096174	24/6

OMNI-DIRECTIONAL LED A19 LAMPS

40 & 60W replacement omni-directional LED A19 lamps

Direct replacements for 40 Watt & 60 Watt incandescent lamps

Applications / Features

- Direct replacement for 40–60 Watt incandescent lamps uses only 6–9.5 Watts
- Direct replacement for 9 & 13 Watt screw-in CFLs
- Indoor residential and commercial lighting
- Damp location
- Approved for totally enclosed fixtures
- 3 Year warranty

Non-Dimmable

Omni-Directional LED A19 Lamps

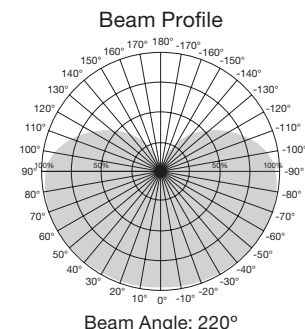

Item Number	Lamp Description	W	V	CRI	CCT	Lm	Bm	M.O.L. (Inches)	Life/Hrs.	UPC	Pack
S9590*	6A19/LED/2700K/120V	6	120	80	2700K	480	220°	4 5/16	15K	045923095900	24/6
S9591*	6A19/LED/3000K/120V	6	120	80	3000K	480	220°	4 5/16	15K	045923095917	24/6
S9592*	6A19/LED/5000K/120V	6	120	80	5000K	480	220°	4 5/16	15K	045923095924	24/6
S9593*	9.5A19/LED/2700K/120V	9.5	120	80	2700K	800	220°	4 5/16	15K	045923095931	24/6
S9594*	9.5A19/LED/3000K/120V	9.5	120	80	3000K	800	220°	4 5/16	15K	045923095948	24/6
S9595*	9.5A19/LED/5000K/120V	9.5	120	80	5000K	800	220°	4 5/16	15K	045923095955	24/6

60W replacement omni-directional LED A19 display pack

Direct replacements for 60 Watt incandescent lamps

Applications / Features

- 60W replacement uses only 9.5 Watts
- Indoor residential and commercial lighting
- Warm white 2700K
- Dimmable
- Damp location
- Approved for totally enclosed fixtures
- 3 Year warranty



9.5 Watt Omni 240° LED A19 Display Packs

Item Number	Lamp Description	W	V	CRI	CCT	Lm	Bm	M.O.L. (Inches)	Life/Hrs.	UPC	Pack/Master
S9629*	9.5A19/LED/2700K/800L/120V/D	9.5	120	80	2700K	800	240°	4 3/8	25K	045923096297	72

Must be ordered in full cases only.

MULTI & OMNI-DIRECTIONAL LED A19 MULTI-PACKS & LAMPS

60W replacement multi-directional LED A19 4-packs

Direct replacements for 60 Watt incandescent lamps

Applications / Features

- 60W replacement uses only 9 Watts
- Indoor residential and commercial lighting
- Direct replacement for 13 Watt screw-in CFLs
- Innovative design—smooth heat sink design to resemble traditional incandescent lamp
- 2700K, 3000K and 5000K options
- Damp location
- Approved for totally enclosed fixtures
- 3 Year warranty

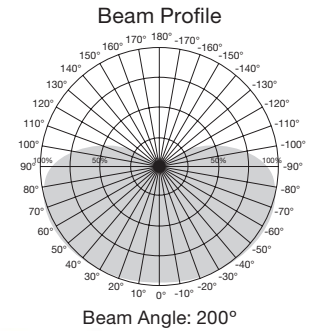

Non-dimmable

Multi-Directional LED A19 4-packs



Item Number	Lamp Description	W	V	CRI	CCT	Lm	Bm	M.O.L. (Inches)	Life/Hrs.	UPC	Pack/Master
S9596	9A19/LED/2700K/120V/4PK	9	120	80	2700K	800	200°	4 3/16	10K	045923095962	12-4pks
S9589	9A19/LED/3000K/120V/4PK	9	120	80	3000K	800	200°	4 3/16	10K	045923095894	12-4pks
S9597	9A19/LED/5000K/120V/4PK	9	120	80	5000K	800	200°	4 3/16	10K	045923095979	12-4pks

Must be ordered in full cases only.

75W replacement omni-directional LED lamps

Direct replacement for 75 Watt incandescent lamps

Applications / Features

- Indoor residential and commercial lighting
- Direct replacement for 75 Watt incandescent lamps uses only 11.5 Watts
- Dimmable
- Damp Location
- Approved for totally enclosed fixtures
- 3 Year warranty

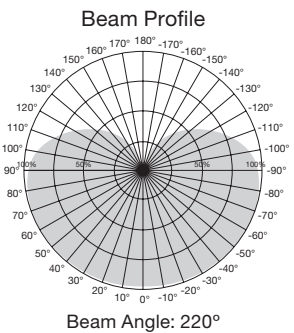

Omni-Directional LED Lamps



Item Number	Lamp Description	W	V	CRI	CCT	Lm	Bm	M.O.L. (Inches)	Life/Hrs.	UPC	Pack
S9810*	11.5A19/LED/2700K/1100L/120V/D	11.5	120	80	2700K	1100	220°	4 5/8	25K	045923098109	24/6
S9811*	11.5A19/LED/3000K/1140L/120V/D	11.5	120	80	3000K	1100	220°	4 5/8	25K	045923098116	24/6
S9812*	11.5A19/LED/4000K/1190L/120V/D	11.5	120	80	4000K	1100	220°	4 5/8	25K	045923098123	24/6
S9813*	11.5A19/LED/5000K/1230L/120V/D	11.5	120	80	5000K	1100	220°	4 5/8	25K	045923098130	24/6
S9814*	11.5A19/LED/2700K/1100L/120V/D/GU24	11.5	120	80	2700K	1100	220°	4 1/2	25K	045923098147	24/6

OMNI-DIRECTIONAL LED A19 & A21 LAMPS

100W replacement omni-directional LED lamps

Direct replacement for
100 Watt incandescent lamps

Applications / Features

- Indoor residential and commercial lighting
- Direct replacement for 100 Watt incandescent lamps uses only 15.5 Watts
- Dimmable
- Damp location
- Long life—25,000 hours
- Approved for totally enclosed fixtures
- 3 Year warranty

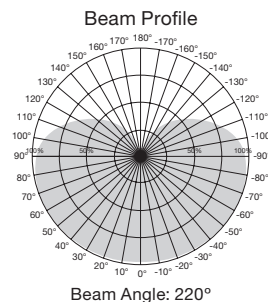

Omni-Directional LED Lamps

Item Number	Lamp Description	W	V	CRI	CCT	Lm	Bm	M.O.L. (Inches)	Life/Hrs.	UPC	Pack
S9815*	15.5A21/LED/2700K/1600L/120V/D	15.5	120	80	2700K	1600	220°	5 9/16	25K	045923098154	24/6
S9816*	15.5A21/LED/3000K/1650L/120V/D	15.5	120	80	3000K	1600	220°	5 9/16	25K	045923098161	24/6
S9817*	15.5A21/LED/4000K/1720L/120V/D	15.5	120	80	4000K	1600	220°	5 9/16	25K	045923098178	24/6
S9818*	15.5A21/LED/5000K/1800L/120V/D	15.5	120	80	5000K	1600	220°	5 9/16	25K	045923098185	24/6
S9819*	15.5A21/LED/2700K/1600L/120V/D/GU24	15.5	120	80	2700K	1600	220°	5 7/16	25K	045923098192	24/6

75 & 100W replacement LED 4 packs

Direct replacement for 75 Watt
& 100 Watt incandescent lamps

Applications / Features

- Indoor residential and commercial lighting
- Convenient 4 packs
- Direct replacement for 75–100 Watt incandescent lamps uses only 11–15 Watts
- Innovative design—smooth heat sink design to resemble traditional incandescent lamp
- 240° Omni-directional
- 2700K and 5000K options
- Damp location
- Long life—15,000 hours
- Approved for totally enclosed fixtures
- 3 Year warranty



S9800, S9801

S9802, S9803

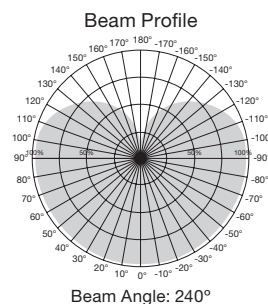

Non-Dimmable

Omni-Directional LED Lamps

Item Number	Lamp Description	W	V	CRI	CCT	Lm	Bm	M.O.L. (Inches)	Life/Hrs.	UPC	Pack (4-pks)
S9800	11A19/LED/2700K/120V/4PK	11	120	80	2700K	1100	240°	4 3/16	15K	045923098000	12/4
S9801	11A19/LED/5000K/120V/4PK	11	120	80	5000K	1100	240°	4 3/16	15K	045923098017	12/4
S9802	15A21/LED/2700K/120V/4PK	15	120	80	2700K	1500	240°	5 1/4	15K	045923098024	12/4
S9803	15A21/LED/5000K/120V/4PK	15	120	80	5000K	1500	240°	5 1/4	15K	045923098031	12/4

OMNI-DIRECTIONAL 3-WAY & COLORED A19 LED LAMPS

Omni-directional 3-way LED lamps Direct replacement for 30/70/100W 3-way incandescent lamps

Applications / Features

- Indoor residential and commercial lighting
- Direct replacement for 30/70/100W 3-Way incandescent lamps uses only 3/9/12W
- 220° Omni-directional
- 2700K, 3000K, 4000K and 5000K options
- Damp location rated
- Long life—25,000 hours
- Approved for totally enclosed fixtures
- 3 year warranty

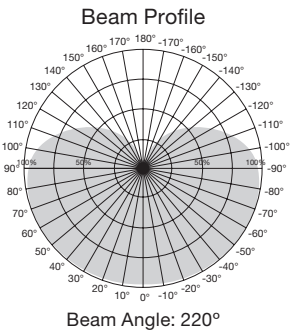

Omni-Directional 3-Way LED Lamps

Item Number	Lamp Description	W	V	CRI	CCT	Lumens	Bm	M.O.L. (Inches)	Life/Hrs.	UPC	Pack
S9316*	3/9/12A19/3WAY LED/2700K/120V	3/9/12	120	80	2700K	280/950/1200	220°	4 5/8	25K	045923093166	24/6
S9317*	3/9/12A19/3WAY LED/3000K/120V	3/9/12	120	80	3000K	280/950/1200	220°	4 5/8	25K	045923093173	24/6
S9318	3/9/12A19/3WAY LED/4000K/120V	3/9/12	120	80	4000K	280/950/1200	220°	4 5/8	25K	045923093180	24/6
S9319	3/9/12A19/3WAY LED/5000K/120V	3/9/12	120	80	5000K	280/950/1200	220°	4 5/8	25K	045923093197	24/6

* ENERGY STAR certified pending

LED A19 colors

Applications / Features

- Indoor residential and commercial lighting
- Party bulbs
- Display lighting
- Accent lighting
- Direct replacement for 25 Watt incandescent lamps, uses only 2 Watts
- Damp location
- Long life—15,000 hours
- Approved for totally enclosed fixtures
- 3 year warranty

Colors for a reason

- Blue—in support of law enforcement / Autism awareness
- Green—in support of veterans
- Yellow—bug lights

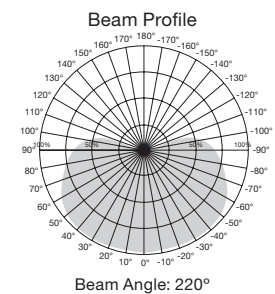

Colored Multi-Directional LED Lamps

Item Number	Lamp Description	W	V	CCT	Lm	Bm	M.O.L. (Inches)	Life/Hrs.	UPC	Pack
S9642	2A19/LED/RED/120V	2	120	Red	200	220°	4 3/16	15K	045923096426	24/6
S9643	2A19/LED/GREEN/120V	2	120	Green	200	220°	4 3/16	15K	045923096433	24/6
S9644	2A19/LED/BLUE/120V	2	120	Blue	200	220°	4 3/16	15K	045923096440	24/6
S9645	2A19/LED/YELLOW/120V	2	120	Yellow	200	220°	4 3/16	15K	045923096457	24/6

40W replacement omni-directional LED lamps

Direct replacement for 40 Watt A15 incandescent lamps

Applications / Features

- Indoor residential and commercial lighting
- Direct replacement for 40 Watt A15 incandescent lamps uses only 5.5 Watts
- Dimmable
- 230° Omni-directional
- 2700K, 3000K, 4000K and 5000K options
- Damp location rated
- Long life—25,000 hours
- Approved for totally enclosed fixtures
- 3 year warranty

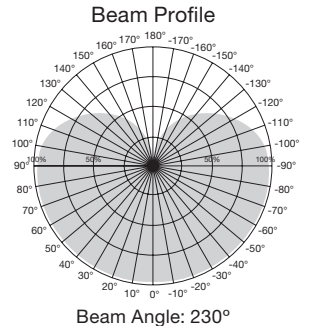

Omni-Directional LED Lamps

Item Number	Lamp Description	W	V	CRI	CCT	Lm	Bm	M.O.L. (Inches)	Life/Hrs.	UPC	Pack
S9030*	5.5A15/LED/2700K/120V	5.5	120	80	2700K	450	230°	3 7/16	25K	045923090301	24/6
S9031*	5.5A15/LED/3000K/120V	5.5	120	80	3000K	450	230°	3 7/16	25K	045923090318	24/6
S9032	5.5A15/LED/4000K/120V	5.5	120	80	4000K	450	230°	3 7/16	25K	045923090325	24/6
S9033	5.5A15/LED/5000K/120V	5.5	120	80	5000K	450	230°	3 7/16	25K	045923090332	24/6

* ENERGY STAR certified pending

Decorative LED lamps

Applications / Features

- 25W candle replacement uses only 2.8 Watts
- 40W candle replacement uses only 4.5 Watts
- Accent lighting
- Pendant lighting
- Dimmable
- Damp location
- Approved for totally enclosed fixtures
- 3 Year warranty



Candle Beam Profile

Globe Beam Profile

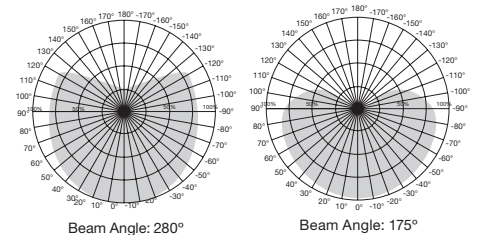

Decorative LED Lamps

Item Number	Lamp Description	W	V	CRI	CCT	Lm	Bm	M.O.L. (Inches)	Life/Hrs.	UPC	Pack
S8950†	2.8CTC/LED/3000K/E12/120V	2.8	120	80	3000K	165	280°	3 3/4	25K	045923089503	12/1
S8951†*	4.5CTC/LED/2700K/E12/120V	4.5	120	80	2700K	300	280°	3 3/4	25K	045923089510	12/1
S8952†*	4.5CTC/LED/3000K/E12/120V	4.5	120	80	3000K	300	280°	3 3/4	25K	045923089527	12/1
S8953†*	4.5ETC/LED/3000K/E26/120V	4.5	120	80	3000K	300	280°	3 3/4	25K	045923089534	12/1
90 CRI											
S9618	5CTC/LED/2700K/E12/120V	5	120	90	2700K	325	280°	3 3/4	25K	045923096181	12/1
S9200*	6G25/LED/2700K/E26	6	120	80	2700K	450	175°	4 1/4	25K	045923090523	24/6
S9201*	6G25/LED/3000K/E26	6	120	80	3000K	450	175°	4 1/4	25K	045923090530	24/6
S9202	6G25/LED/4000K/E26	6	120	80	4000K	450	175°	4 1/4	25K	045923090691	24/6
S9203	6G25/LED/5000K/E26	6	120	80	5000K	450	175°	4 1/4	25K	045923092039	24/6
90 CRI											
S9619	6G25/LED/2700K/90/E26	6	120	90	2700K	390	175°	4 1/4	25K	045923096198	24/6

LED REFLECTOR LAMPS

Satco 6.5W R20 LED reflectors 80 & 90 CRI

Applications / Features

- 50R20 replacement uses only 6.5 Watts
- Indoor residential and commercial lighting
- Dimmable
- Damp location
- 3 Year warranty



Beam Profile

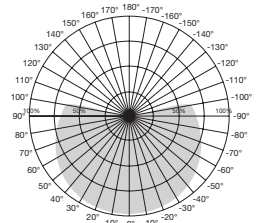

Beam Angle: 107°



6.5W R20 LED Reflectors

Item Number	Lamp Description	W	V	CRI	CCT	Lm	Bulb Type	M.O.L. (Inches)	Life/ Hrs.	UPC	Pack
S9630*	6.5R20/LED/2700K/525L/120V	6.5	120	80	2700K	525	R20	3 15/16	25K	045923096303	24/6
S9631*	6.5R20/LED/3000K/540L/120V	6.5	120	80	3000K	525	R20	3 15/16	25K	045923096310	24/6
S9632*	6.5R20/LED/4000K/560L/120V	6.5	120	80	4000K	525	R20	3 15/16	25K	045923096327	24/6
S9633*	6.5R20/LED/5000K/580L/120V	6.5	120	80	5000K	525	R20	3 15/16	25K	045923096334	24/6
90 CRI											
S9614*	6.5R20/LED/2700K/450L/90CRI	6.5	120	90	2700K	450	R20	3 15/16	25K	045923096143	24/6

Satco 9.5W BR30 LED reflectors 80 & 90 CRI

Applications / Features

- 65BR30 replacement uses only 9.5 Watts
- Indoor residential and commercial lighting
- Display lighting
- New one piece, lighter weight design
- Dimmable
- Damp location
- 3 Year warranty



Beam Profile

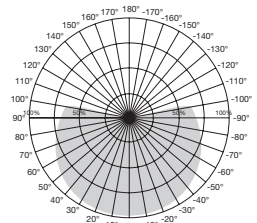

Beam Angle: 105°



9.5W BR30 LED Reflectors

Item Number	Lamp Description	W	V	CRI	CCT	Lm	Bulb Type	M.O.L. (Inches)	Life/ Hrs.	UPC	Pack
S9620*	9.5BR30/LED/2700K/750L/120V/D	9.5	120	80	2700K	750	BR30	5 3/16	25K	045923096204	12/6
S9621*	9.5BR30/LED/3000K/800L/120V/D	9.5	120	80	3000K	750	BR30	5 3/16	25K	045923096211	12/6
S9622*	9.5BR30/LED/4000K/830L/120V/D	9.5	120	80	4000K	750	BR30	5 3/16	25K	045923096228	12/6
S9623*	9.5BR30/LED/5000K/860L/120V/D	9.5	120	80	5000K	750	BR30	5 3/16	25K	045923096235	12/6
S9624*	9.5BR30/LED/2700K/GU24/750L/120V	9.5	120	80	2700K	750	BR30	4 15/16	25K	045923096242	12/6
S9627	9.5BR30/LED/3000K/GU24/750L/120V	9.5	120	80	3000K	750	BR30	4 15/16	25K	045923096273	12/6
90 CRI											
S9625*	9.5BR30/LED/2700K/650L/120V/D	9.5	120	90	2700K	650	BR30	5 3/16	25K	045923096259	12/6
S9626*	9.5BR30/LED/2700K/GU24/650L/120V	9.5	120	90	2700K	650	BR30	4 15/16	25K	045923096266	12/6

LED REFLECTOR LAMPS

Satco LED 10W BR30 Ditto

Applications / Features

- 65W BR30 replacement uses only 10 Watts
- Indoor residential and commercial lighting
- 65W replacement
- 2700K
- Dimmable
- Damp location
- 3 Year warranty



10W BR30 LED Reflector Display Packs



Item Number	Lamp Description	W	V	CRI	CCT	Lm	M.O.L. (Inches)	Life/Hrs.	UPC	Pack/Master
S9628*	10BR30/LED/2700K/700L/120V/D	10	120	80	2700K	700	5 7/16	25K	045923096280	48

Must be ordered in full cases only.

Satco 11.5W & 16.5W BR40 LED reflectors 80 & 90 CRI

Applications / Features

- 65W BR40 replacement uses only 11.5 Watts
- 85W BR40 replacement uses only 16.5 Watts
- Indoor residential and commercial lighting
- Dimmable
- Damp location
- 3 Year warranty

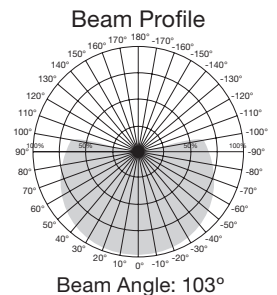

11.5W & 16.5W BR40 LED Reflectors



Item Number	Lamp Description	W	V	CRI	CCT	Lm	Bulb Type	M.O.L. (Inches)	Life/Hrs.	UPC	Pack
S9634*	11.5BR40/LED/2700K/940L/120V	11.5	120	80	2700K	940	BR40	6 7/16	25K	045923096341	12/6
S9635*	11.5BR40/LED/3000K/970L/120V	11.5	120	80	3000K	940	BR40	6 7/16	25K	045923096358	12/6
S9636*	11.5BR40/LED/4000K/1000L/120V	11.5	120	80	4000K	940	BR40	6 7/16	25K	045923096365	12/6
S9637*	11.5BR40/LED/5000K/1050L/120V	11.5	120	80	5000K	940	BR40	6 7/16	25K	045923096372	12/6
S9638*	16.5BR40/LED/2700K/1200L/120V	16.5	120	80	2700K	1200	BR40	6 7/16	25K	045923096389	12/6
S9639*	16.5BR40/LED/3000K/1230L/120V	16.5	120	80	3000K	1200	BR40	6 7/16	25K	045923096396	12/6
S9640*	16.5BR40/LED/4000K/1280L/120V	16.5	120	80	4000K	1200	BR40	6 7/16	25K	045923096402	12/6
S9641*	16.5BR40/LED/5000K/1320L/120V	16.5	120	80	5000K	1200	BR40	6 7/16	25K	045923096419	12/6
90 CRI											
S9615*	16.5BR40/LED/2700K/1075L/90CRI	16.5	120	90	2700K	1075	BR40	3 7/16	25K	045923096150	12/6

LED PAR LAMPS

Familiar appearance.
High efficiency.
Direct replacements.

Introducing Satco LED PAR Lamps.
LED efficiency, indoors or out.

Satco LED PAR lamps have the familiar look of the Halogen PAR lamps they replace, but deliver the high efficiency that only LEDs can. With the silvered reflector, traditional lens pattern, and exact dimensions of older Halogen PARs, Satco LED PARs represent an exact replacement. The only difference will be the greatly reduced energy and maintenance costs!

7W LED PAR20 lamps

Applications / Features

- 50W PAR20 replacement uses only 7 Watts
- Down lighting
- Track lighting
- Dimmable
- IP65 Listed - indoor/outdoor
- Approved for totally enclosed fixtures
- 3 Year warranty

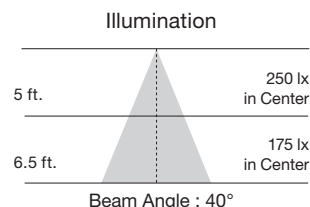
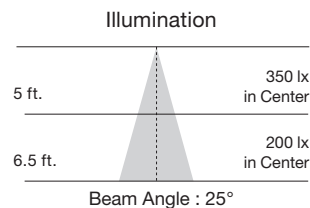

LED PAR Lamps

Item Number	Lamp Description	W	V	CRI	CCT	Color Temp.	Lm	Bm	M.O.L. (Inches)	Life/Hrs.	UPC	Pack
LED PAR20 - Replaces 50W												
S9400*	7PAR20/LED/25/2700K/120V/SP	7	120	80	2700K	Warm White	525	25°	3 1/16	25K	045923094002	24/6
S9401*	7PAR20/LED/25/3000K/120V/SP	7	120	80	3000K	Soft White	525	25°	3 1/16	25K	045923094019	24/6
S9402*	7PAR20/LED/25/3500K/120V/SP	7	120	80	3500K	Neutral White	525	25°	3 1/16	25K	045923094026	24/6
S9403*	7PAR20/LED/25/4000K/120V/SP	7	120	80	4000K	Cool White	525	25°	3 1/16	25K	045923094033	24/6
S9404*	7PAR20/LED/25/5000K/120V/SP	7	120	80	5000K	Natural Light	525	25°	3 1/16	25K	045923094040	24/6
S9405*	7PAR20/LED/40/2700K/120V/FL	7	120	80	2700K	Warm White	525	40°	3 1/16	25K	045923094057	24/6
S9406*	7PAR20/LED/40/3000K/120V/FL	7	120	80	3000K	Soft White	525	40°	3 1/16	25K	045923094064	24/6
S9407*	7PAR20/LED/40/3500K/120V/FL	7	120	80	3500K	Neutral White	525	40°	3 1/16	25K	045923094071	24/6
S9408*	7PAR20/LED/40/4000K/120V/FL	7	120	80	4000K	Cool White	525	40°	3 1/16	25K	045923094088	24/6
S9409*	7PAR20/LED/40/5000K/120V/FL	7	120	80	5000K	Natural Light	525	40°	3 1/16	25K	045923094095	24/6
90 CRI												
S9485*	7PAR20/LED/40/2700K/90CRI	7	120	90	2700K	Warm White	470	40°	3	25K	045923094859	24/6

LED PAR LAMPS

13W LED PAR30 short neck lamps

Applications / Features

- 50W PAR30 short neck replacement uses only 13 Watts
- Down lighting
- Track lighting
- Dimmable
- IP65 Listed - indoor/outdoor
- Approved for totally enclosed fixtures
- 3 Year warranty

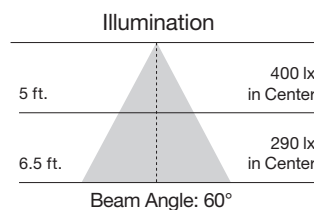
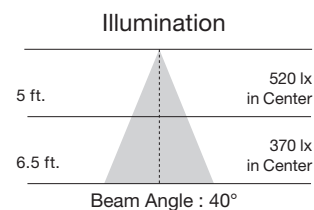
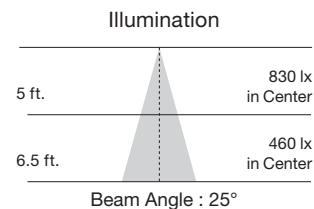

LED PAR Lamps



Item Number	Lamp Description	W	V	CRI	CCT	Color Temp.	Lm	Bm	M.O.L. (Inches)	Life/ Hrs.	UPC	Pack
LED PAR30 Short Neck - Replaces 50W												
S9410*	13PAR30/SN/LED/25/2700K/120V/SP	13	120	80	2700K	Warm White	1000	25°	3 5/8	25K	045923094101	12/6
S9411*	13PAR30/SN/LED/25/3000K/120V/SP	13	120	80	3000K	Soft White	1000	25°	3 5/8	25K	045923094118	12/6
S9412*	13PAR30/SN/LED/25/3500K/120V/SP	13	120	80	3500K	Neutral White	1000	25°	3 5/8	25K	045923094125	12/6
S9413*	13PAR30/SN/LED/25/4000K/120V/SP	13	120	80	4000K	Cool White	1000	25°	3 5/8	25K	045923094132	12/6
S9414*	13PAR30/SN/LED/25/5000K/120V/SP	13	120	80	5000K	Natural Light	1000	25°	3 5/8	25K	045923094149	12/6
S9415*	13PAR30/SN/LED/40/2700K/120V/FL	13	120	80	2700K	Warm White	1000	40°	3 5/8	25K	045923094156	12/6
S9416*	13PAR30/SN/LED/40/3000K/120V/FL	13	120	80	3000K	Soft White	1000	40°	3 5/8	25K	045923094163	12/6
S9417*	13PAR30/SN/LED/40/3500K/120V/FL	13	120	80	3500K	Neutral White	1000	40°	3 5/8	25K	045923094170	12/6
S9418*	13PAR30/SN/LED/40/4000K/120V/FL	13	120	80	4000K	Cool White	1000	40°	3 5/8	25K	045923094187	12/6
S9419*	13PAR30/SN/LED/40/5000K/120V/FL	13	120	80	5000K	Natural Light	1000	40°	3 5/8	25K	045923094194	12/6
S9420*	13PAR30/SN/LED/60/2700K/120V/WFL	13	120	80	2700K	Warm White	1000	60°	3 5/8	25K	045923094200	12/6
S9421*	13PAR30/SN/LED/60/3000K/120V/WFL	13	120	80	3000K	Soft White	1000	60°	3 5/8	25K	045923094217	12/6
S9422*	13PAR30/SN/LED/60/3500K/120V/WFL	13	120	80	3500K	Neutral White	1000	60°	3 5/8	25K	045923094224	12/6
S9423*	13PAR30/SN/LED/60/4000K/120V/WFL	13	120	80	4000K	Cool White	1000	60°	3 5/8	25K	045923094231	12/6
S9424*	13PAR30/SN/LED/60/5000K/120V/WFL	13	120	80	5000K	Natural Light	1000	60°	3 5/8	25K	045923094248	12/6
90 CRI												
S9486*	13PAR30/SN/LED/40/2700K/90CRI	13	120	90	2700K	Warm White	820	40°	3 5/8	25K	045923094866	12/6

LED PAR LAMPS

13W LED PAR30 long neck lamps

Applications / Features

- 75W PAR30 long neck replacement uses only 13 Watts
- Down lighting
- Track lighting
- Dimmable
- IP65 Listed - indoor/outdoor
- Approved for totally enclosed fixtures
- 3 Year warranty

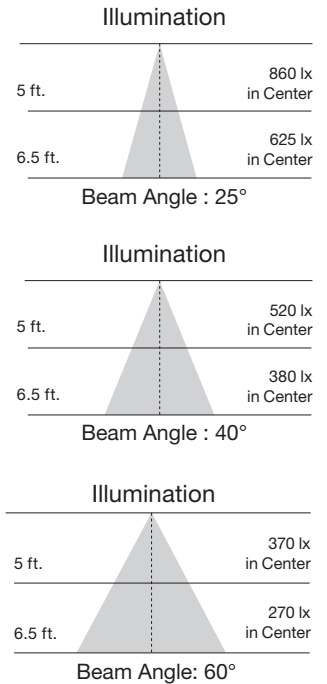

LED PAR Lamps



Item Number	Lamp Description	W	V	CRI	CCT	Color Temp.	Lm	Bm	M.O.L. (Inches)	Life/Hrs.	UPC	Pack
LED PAR30 Long Neck - Replaces 75W												
S9425*	13PAR30/LN/LED/25/2700K/120V/SP	13	120	80	2700K	Warm White	1000	25°	4 1/16	25K	045923094255	12/6
S9426*	13PAR30/LN/LED/25/3000K/120V/SP	13	120	80	3000K	Soft White	1000	25°	4 1/16	25K	045923094262	12/6
S9427*	13PAR30/LN/LED/25/3500K/120V/SP	13	120	80	3500K	Neutral White	1000	25°	4 1/16	25K	045923094279	12/6
S9428*	13PAR30/LN/LED/25/4000K/120V/SP	13	120	80	4000K	Cool White	1000	25°	4 1/16	25K	045923094286	12/6
S9429*	13PAR30/LN/LED/25/5000K/120V/SP	13	120	80	5000K	Natural Light	1000	25°	4 1/16	25K	045923094293	12/6
S9430*	13PAR30/LN/LED/40/2700K/120V/FL	13	120	80	2700K	Warm White	1000	40°	4 1/16	25K	045923094309	12/6
S9431*	13PAR30/LN/LED/40/3000K/120V/FL	13	120	80	3000K	Soft White	1000	40°	4 1/16	25K	045923094316	12/6
S9432*	13PAR30/LN/LED/40/3500K/120V/FL	13	120	80	3500K	Neutral White	1000	40°	4 1/16	25K	045923094323	12/6
S9433*	13PAR30/LN/LED/40/4000K/120V/FL	13	120	80	4000K	Cool White	1000	40°	4 1/16	25K	045923094330	12/6
S9434*	13PAR30/LN/LED/40/5000K/120V/FL	13	120	80	5000K	Natural Light	1000	40°	4 1/16	25K	045923094347	12/6
S9435*	13PAR30/LN/LED/60/2700K/120V/WFL	13	120	80	2700K	Warm White	1000	60°	4 1/16	25K	045923094354	12/6
S9436*	13PAR30/LN/LED/60/3000K/120V/WFL	13	120	80	3000K	Soft White	1000	60°	4 1/16	25K	045923094361	12/6
S9437*	13PAR30/LN/LED/60/3500K/120V/WFL	13	120	80	3500K	Neutral White	1000	60°	4 1/16	25K	045923094378	12/6
S9438*	13PAR30/LN/LED/60/4000K/120V/WFL	13	120	80	4000K	Cool White	1000	60°	4 1/16	25K	045923094385	12/6
S9439*	13PAR30/LN/LED/60/5000K/120V/WFL	13	120	80	5000K	Natural Light	1000	60°	4 1/16	25K	045923094392	12/6
90 CRI												
S9487*	13PAR30/LN/LED/40/2700K/90CRI	13	120	90	2700K	Warm White	820	40°	4 19/32	25K	045923094873	12/6

LED PAR LAMPS

15 & 18W LED PAR38 lamps

Applications / Features

- 90 & 100W PAR38 replacement uses only 15-18 Watts
- Down lighting
- Track lighting
- Dimmable
- IP65 Listed - indoor/outdoor
- Approved for totally enclosed fixtures
- 3 Year warranty



S9480 S9481 S9482 S9483 S9484

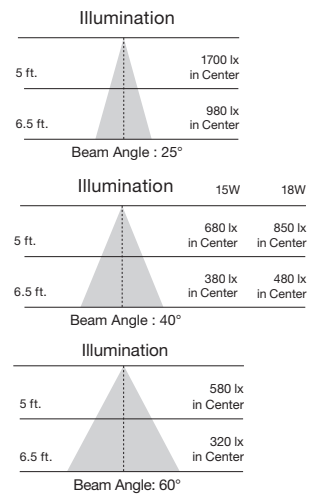

LED PAR Lamps

Item Number	Lamp Description	W	V	CRI	CCT	Color Temp.	Lm	Bm	M.O.L. (Inches)	Life/Hrs.	UPC	Pack
LED PAR38 - Replaces 90W												
S9440*	15PAR38/LED/25'/2700K/120V/SP	15	120	80	2700K	Warm White	1200	25°	5 3/16	25K	045923094408	12/6
S9441*	15PAR38/LED/25'/3000K/120V/SP	15	120	80	3000K	Soft White	1200	25°	5 3/16	25K	045923094415	12/6
S9442*	15PAR38/LED/25'/3500K/120V/SP	15	120	80	3500K	Neutral White	1200	25°	5 3/16	25K	045923094422	12/6
S9443*	15PAR38/LED/25'/4000K/120V/SP	15	120	80	4000K	Cool White	1200	25°	5 3/16	25K	045923094439	12/6
S9444*	15PAR38/LED/25'/5000K/120V/SP	15	120	80	5000K	Natural Light	1200	25°	5 3/16	25K	045923094446	12/6
S9445*	15PAR38/LED/40'/2700K/120V/FL	15	120	80	2700K	Warm White	1200	40°	5 3/16	25K	045923094453	12/6
S9446*	15PAR38/LED/40'/3000K/120V/FL	15	120	80	3000K	Soft White	1200	40°	5 3/16	25K	045923094460	12/6
S9447*	15PAR38/LED/40'/3500K/120V/FL	15	120	80	3500K	Neutral White	1200	40°	5 3/16	25K	045923094477	12/6
S9448*	15PAR38/LED/40'/4000K/120V/FL	15	120	80	4000K	Cool White	1200	40°	5 3/16	25K	045923094484	12/6
S9449*	15PAR38/LED/40'/5000K/120V/FL	15	120	80	5000K	Natural Light	1200	40°	5 3/16	25K	045923094491	12/6
S9450*	15PAR38/LED/60'/2700K/120V/WFL	15	120	80	2700K	Warm White	1200	60°	5 3/16	25K	045923094507	12/6
S9451*	15PAR38/LED/60'/3000K/120V/WFL	15	120	80	3000K	Soft White	1200	60°	5 3/16	25K	045923094514	12/6
S9452*	15PAR38/LED/60'/3500K/120V/WFL	15	120	80	3500K	Neutral White	1200	60°	5 3/16	25K	045923094521	12/6
S9453*	15PAR38/LED/60'/4000K/120V/WFL	15	120	80	4000K	Cool White	1200	60°	5 3/16	25K	045923094538	12/6
S9454*	15PAR38/LED/60'/5000K/120V/WFL	15	120	80	5000K	Natural Light	1200	60°	5 3/16	25K	045923094545	12/6
90 CRI												
S9488*	15PAR38/LED/40'/2700K/90CRI	15	120	90	2700K	Warm White	1000	40°	5 3/16	25K	045923094880	12/6
LED PAR38 - Replaces 100W												
S9455*	18PAR38/LED/40'/3000K/120V/FL	18	120	80	3000K	Soft White	1400	40°	5 3/16	25K	045923094552	12/6
S9456*	18PAR38/LED/40'/4000K/120V/FL	18	120	80	4000K	Cool White	1400	40°	5 3/16	25K	045923094569	12/6
LED PAR38 - Non-Dimmable 2 Pack - Replaces 90W												
S9457*	15PAR38/LED/60'/3000K/120V/2PK	15	120	80	3000K	Soft White	1150	60°	5 3/16	25K	045923094576	8-2pks
LED PAR38 - Colors												
S9480	15PAR38/LED/40'/RED/120V	15	120	—	—	Red	—	40°	5 3/16	25K	045923094804	12/6
S9481	15PAR38/LED/40'/GREEN/120V	15	120	—	—	Green	—	40°	5 3/16	25K	045923094811	12/6
S9482	15PAR38/LED/40'/BLUE/120V	15	120	—	—	Blue	—	40°	5 3/16	25K	045923094828	12/6
S9483	15PAR38/LED/40'/AMBER/120V	15	120	—	—	Amber	—	40°	5 3/16	25K	045923094835	12/6
S9484	15PAR38/LED/40'/YELLOW/120V	15	120	—	—	Yellow	—	40°	5 3/16	25K	045923094842	12/6

LED PAR 16 & MR11 LAMPS

LED PAR16 4.5 & 6.5W lamps

Applications / Features

- 45 & 60W Halogen PAR16 lamp replacement uses only 4.5-6.5 Watts
- Indoor residential and commercial lighting
- Down lighting
- Accent lighting
- Pendant lighting
- Dimmable
- Damp location
- Approved for totally enclosed fixtures
- 3 Year warranty

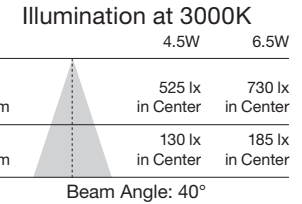
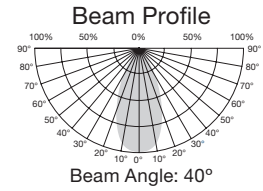

LED PAR16 Lamps

Item Number	Lamp Description	W	V	CRI	CCT	Lm	Bm	M.O.L. (Inches)	Life/Hrs.	UPC	Pack
S9386	4.5PAR16/LED/40°/3000K/120V	4.5	120	80	3000K	370	40°	2 7/8	25K	045923093869	12/1
S9387	4.5PAR16/LED/40°/5000K/120V	4.5	120	80	5000K	370	40°	2 7/8	25K	045923093876	12/1
S9388	6.5PAR16/LED/40°/3000K/120V	6.5	120	80	3000K	520	40°	2 7/8	25K	045923093883	12/1
S9389	6.5PAR16/LED/40°/5000K/120V	6.5	120	80	5000K	520	40°	2 7/8	25K	045923093890	12/1

3W, 12V LED MR11 lamps with GU4 base

Applications / Features

- Indoor residential and commercial lighting
- Down lighting
- Accent lighting
- Pendant lighting
- Non-dimmable
- Damp location
- Approved for totally enclosed fixtures
- 3 Year warranty

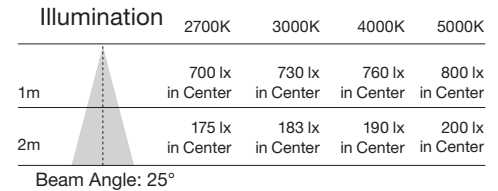
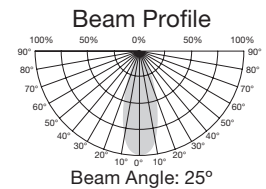

3W, 12V LED MR11 Lamps With GU4 Base

Item Number	Lamp Description	W	V	CRI	CCT	Lm	Bm	M.O.L. (Inches)	Life/Hrs.	UPC	Pack
S9280	3MR11/LED/25°/2700K/12V	3	12	80	2700K	210	25°	1 1/2	25K	045923092800	12/1
S9281	3MR11/LED/25°/3000K/12V	3	12	80	3000K	220	25°	1 1/2	25K	045923092817	12/1
S9282	3MR11/LED/25°/4000K/12V	3	12	80	4000K	230	25°	1 1/2	25K	045923092824	12/1
S9283	3MR11/LED/25°/5000K/12V	3	12	80	5000K	240	25°	1 1/2	25K	045923092831	12/1

LED MR16 & ELEVATOR LAMPS

MR16 LED lamps

Applications / Features

- Down lighting
- Accent lighting
- Pendant lighting
- Dimmable
- 3 Year warranty



S9380, S9381, S9382, S9383, S9384, S9385



S9490, S9491, S9492, S9493, S9494, S9495, S9496, S9497, S9498, S9499, S9616

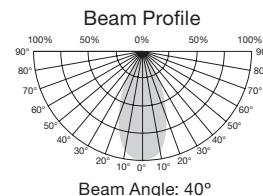
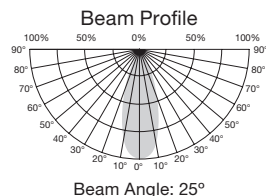

MR16 LED Lamps

Item Number	Lamp Description	W	V	CRI	CCT	Lm	Bm	M.O.L. (Inches)	Life/ Hrs.	UPC	Pack
S9380†*	4.5MR16/LED/40°/30K/120V/GU10	4.5	120	80	3000K	370	40°	2 3/16	25K	045923093807	12/1
S9381†	4.5MR16/LED/40°/50K/120V/GU10	4.5	120	80	5000K	370	40°	2 3/16	25K	045923093814	12/1
S9382†	6.5MR16/LED/40°/27K/120V/GU10	6.5	120	80	2700K	500	40°	2 3/16	25K	045923093821	12/1
S9383†*	6.5MR16/LED/40°/30K/120V/GU10	6.5	120	80	3000K	500	40°	2 3/16	25K	045923093838	12/1
S9384†	6.5MR16/LED/40°/40K/120V/GU10	6.5	120	80	4000K	500	40°	2 3/16	25K	045923093845	12/1
S9385†*	6.5MR16/LED/40°/50K/120V/GU10	6.5	120	80	5000K	500	40°	2 3/16	25K	045923093852	12/1
S9490†*	6.5MR16/LED/25°/27K/12V	6.5	12	80	2700K	500	25°	1 3/4	25K	045923094903	12/1
S9491†*	6.5MR16/LED/25°/30K/12V	6.5	12	80	3000K	500	25°	1 3/4	25K	045923094910	12/1
S9492†	6.5MR16/LED/25°/35K/12V	6.5	12	80	3500K	500	25°	1 3/4	25K	045923094927	12/1
S9493†	6.5MR16/LED/25°/40K/12V	6.5	12	80	4000K	500	25°	1 3/4	25K	045923094934	12/1
S9494†	6.5MR16/LED/25°/50K/12V	6.5	12	80	5000K	500	25°	1 3/4	25K	045923094941	12/1
S9495†*	6.5MR16/LED/40°/27K/12V	6.5	12	80	2700K	500	40°	1 3/4	25K	045923094958	12/1
S9496†*	6.5MR16/LED/40°/30K/12V	6.5	12	80	3000K	500	40°	1 3/4	25K	045923094965	12/1
S9497†*	6.5MR16/LED/40°/35K/12V	6.5	12	80	3500K	500	40°	1 3/4	25K	045923094972	12/1
S9498†*	6.5MR16/LED/40°/40K/12V	6.5	12	80	4000K	500	40°	1 3/4	25K	045923094989	12/1
S9499†*	6.5MR16/LED/40°/50K/12V	6.5	12	80	5000K	500	40°	1 3/4	25K	045923094996	12/1
S9616†*	6.5MR16/LED/40°/30K/12V/90CRI	6.5	12	90	3000K	450	40°	1 3/4	25K	045923094965	12/1

All 12V MR16 lamps are compatible with electronic and magnetic transformers
Visit www.satco.com for compatibility information.

LED elevator lamps

Applications / Features

- Elevator lighting
- Display lighting
- Non dimmable
- 3 Year warranty

Not for use with dimmers.

Recommended for use with magnetic transformers.
Compatibility with electronic transformers minimum load requirement must be verified.



S9005

S9004

LED Elevator Lamps

Item Number	Lamp Description	W	V	CRI	CCT	Lm	Bm	M.O.L. (Inches)	Life/ Hrs.	UPC	Pack
S9005	2W/GBF/LED/12V/BA15D	2	12	80	3000K	120	40°	1 3/4	30K	045923090059	48/12
S9004	3W/1383/LED/12V/BA15S	3	12	80	3000K	120	40°	2 1/2	30K	045923090042	48/12

Indoor use only. Not for use in totally enclosed fixtures.

LED replacements for Halogen G4, G9 and BA15S lamps

Applications / Features

- Solid state LED lighting
- High efficacy
- Long life—15,000 hours
- Omni-directional light
- G9 Dimmable and non-dimmable
- Damp location
- G4, BA15S
- 3 Year warranty



S9226, S9227,
S9228, S9229



S9220,
S9221



S9222,
S9223



S9224,
S9225

LED Replacements for Halogen G4, G9 and BA15S Lamps



Item Number	Lamp Description	W	V	Base	CRI	CCT	Lm	M.O.L. (Inches)	Life/Hrs.	UPC	Pack
G4 Bi-Pin											
S9220	LED/2.3W/JC/G4/3000K	2.3	12	G4	80	3000K	180	1 3/4	15K	045923092206	50/1
S9221	LED/2.3W/JC/G4/5000K	2.3	12	G4	80	5000K	180	1 3/4	15K	045923092213	50/1
BA15S											
S9222	LED/2.3W/BA15S/3000K	2.3	12	BA15S	80	3000K	180	2	15K	045923092220	50/1
S9223	LED/2.3W/BA15S/5000K	2.3	12	BA15S	80	5000K	180	2	15K	045923092237	50/1
G9											
S9224*	LED/3.0W/G9/220L/3000K/DIM	3	120	G9	80	3000K	220	2 1/8	15K	045923092244	50/1
S9225*	LED/3.0W/G9/220L/5000K/DIM	3	120	G9	80	5000K	220	2 1/8	15K	045923092251	50/1
S9226	LED/5.0W/G9/450L/3000K	5	120	G9	80	3000K	450	2 1/8	15K	045923092268	20/1
S9227	LED/5.0W/G9/450L/5000K	5	120	G9	80	5000K	450	2 1/8	15K	045923092275	20/1
S9228*	LED/5.0W/G9/360L/3000K/DIM	5	120	G9	80	3000K	350	2 1/8	15K	045923092282	20/1
S9229*	LED/5.0W/G9/360L/5000K/DIM	5	120	G9	80	5000K	350	2 1/8	15K	045923092299	20/1

Silicon LED replacements for Halogen G4, G6.35, G9, GU5.3, MR11 and MR16 lamps

Applications / Features

- Solid state LED lighting
- High efficacy
- Long life—25,000 hours
- Omni-directional light
- Damp location
- Dimmable
- 3 Year warranty



S9542,
S9543



S9544,
S9545



S9546,
S9547,



S9548,
S9549



S9550,
S9551



S9552,
S9553

Silicon LED Replacements for Halogen G4, G6.35, G9, MR11 and MR16 Lamps



Item Number	Lamp Description	W	V	Base	CRI	CCT	Lm	M.O.L. (Inches)	Life/Hrs.	UPC	Pack
G4 Bi-Pin											
S9542	LED/1.6W/JC/G4/12V/3000K/200L/360°D	1.6	12	G4	80	3000K	200	1 7/16	25K	045923095429	20/200
S9543	LED/1.6W/JC/G4/12V/5000K/200L/360°D	1.6	12	G4	80	5000K	200	1 7/16	25K	045923095436	20/200
G6.35											
S9544	LED/3W/JC/G6.35/12V/3000K/300L/360°D	3	12	G6.35	80	3000K	300	1 5/8	25K	045923095443	20/200
S9545	LED/3W/JC/G6.35/12V/5000K/300L/360°D	3	12	G6.35	80	5000K	300	1 5/8	25K	045923095450	20/200
G9											
S9546	LED/1.6W/JCD/G9/120V/3000K/D	1.6	120	G9	80	3000K	200	1 7/8	25K	045923095467	20/200
S9547	LED/1.6W/JCD/G9/120V/5000K/D	1.6	120	G9	80	5000K	200	1 7/8	25K	045923095474	20/200
S9548	LED/4W/JCD/G9/120V/3000K/D	4	120	G9	80	3000K	480	2 7/16	25K	045923095481	20/200
S9549	LED/4W/JCD/G9/120V/5000K/D	4	120	G9	80	5000K	480	2 7/16	25K	045923095498	20/200
MR11											
S9550	LED/1.6MR11/40°/3000K/12V/D	1.6	12	G4	80	3000K	330	1 1/2	25K	045923095504	20/200
S9551	LED/1.6MR11/40°/5000K/12V/D	1.6	12	G4	80	5000K	330	1 1/2	25K	045923095511	20/200
MR16											
S9552	LED/3MR16/40°/3000K/12V/D	3	12	GU5.3	80	3000K	330	2	25K	045923095528	20/200
S9553	LED/3MR16/40°/5000K/12V/D	3	12	GU5.3	80	5000K	330	2	25K	045923095535	20/200

LED RECESSED DOWNLIGHT RETROFITS

4" LED recessed downlight retrofits

Applications / Features

- Residential
- Office
- Retail
- Hospitality
- Solid state LED lighting
- Direct replacement for reflector lamps
- Dimmable
- Long life—50,000 hours
- High efficiency/Environmentally friendly
- No UV or IR radiation
- 5 Year warranty
- c-UL-us damp location listed - Gimbal
- c-UL-us wet location listed - Baffle
- ENERGY STAR® certified*

E26 Adapter included 

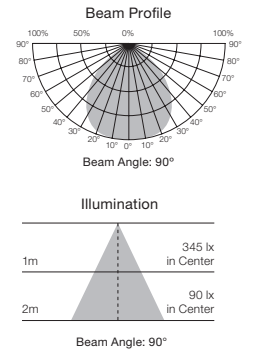
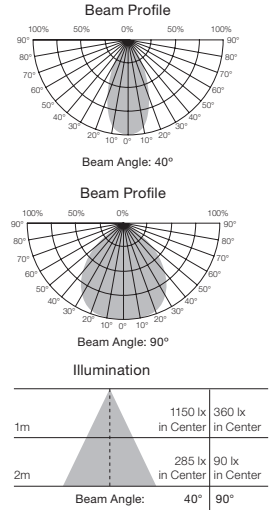
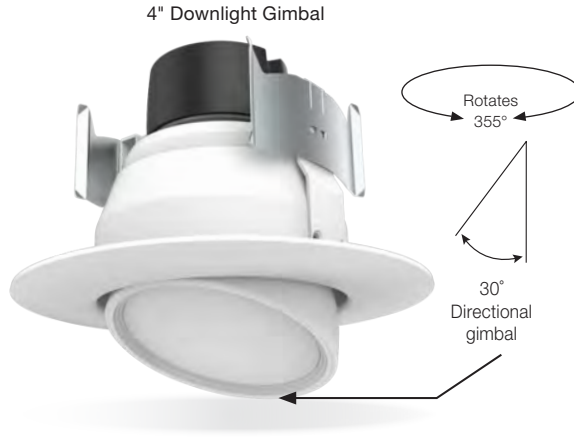

4" LED Recessed Downlight Retrofits



Item Number	Lamp Description	W	V	CRI	CCT	Lm	Bm	M.O.L. (Inches)	Life/Hrs.	UPC	Pack
S9460*	9WLED/RDL/4"/27K/DIM/120V	9	120	90	2700K	600	90°	2 7/8	50K	045923094606	16/1
S9461*	9WLED/RDL/4"/30K/DIM/120V	9	120	90	3000K	600	90°	2 7/8	50K	045923094613	16/1
S9462*	9WLED/RDL/4"/40K/DIM/120V	9	120	90	4000K	600	90°	2 7/8	50K	045923094620	16/1
S9478*	9WLED/RDL/4"/50K/DIM/120V	9	120	90	5000K	630	90°	2 7/8	50K	045923094781	16/1
4" LED Gimbal Retrofits											
S9463*	9WLED/DIR/4"/40°/27K/120V	9	120	90	2700K	600	40°	3 5/16	50K	045923094637	8/1
S9464*	9WLED/DIR/4"/40°/30K/120V	9	120	90	3000K	600	40°	3 5/16	50K	045923094644	8/1
S9465*	9WLED/DIR/4"/40°/40K/120V	9	120	90	4000K	630	40°	3 5/16	50K	045923094651	8/1
S9466*	9WLED/DIR/4"/90°/27K/120V	9	120	90	2700K	600	90°	3 5/16	50K	045923094668	8/1
S9467*	9WLED/DIR/4"/90°/30K/120V	9	120	90	3000K	600	90°	3 5/16	50K	045923094675	8/1
S9468*	9WLED/DIR/4"/90°/40K/120V	9	120	90	4000K	630	90°	3 5/16	50K	045923094682	8/1

GU10 base sold separately, item number: S9000

LED RECESSED DOWNLIGHT RETROFITS

5", 6" LED recessed downlight retrofits

Applications / Features

- Residential
- Office
- Retail
- Hospitality
- Solid state LED lighting
- Direct replacement for reflector lamps
- Dimmable
- Long life—50,000 hours
- High efficiency/Environmentally friendly
- Innovative design
- No UV or IR radiation
- 5 Year warranty
- c-UL-us damp location listed - Gimbal
- c-UL-us wet location listed - Baffle
- ENERGY STAR® certified*

E26 Adapter included

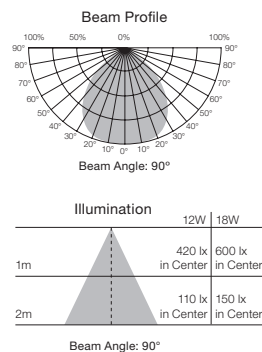
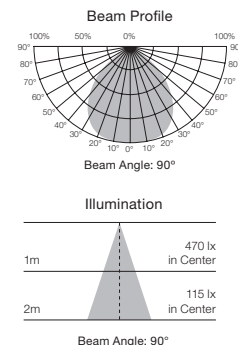

5 5/8" LED Recessed Downlight Retrofits



Gimbal

Baffle

Item Number	Lamp Description	W	V	CRI	CCT	Lm	Bm	M.O.L. (Inches)	Life/Hrs.	UPC	Pack
S9469*	12WLED/RDL/5"-6"/27K/120V	12	120	90	2700K	800	90°	3 7/16	50K	045923094699	8/1
S9470*	12WLED/RDL/5"-6"/30K/120V	12	120	90	3000K	800	90°	3 7/16	50K	045923094705	8/1
S9471*	12WLED/RDL/5"-6"/40K/120V	12	120	90	4000K	840	90°	3 7/16	50K	045923094712	8/1
S9479*	12WLED/RDL/5"-6"/50K/120V	12	120	90	5000K	840	90°	3 7/16	50K	045923094798	8/1
S9475*	18WLED/RDL/5"-6"/27K/120V	18	120	90	2700K	1200	90°	3 7/16	50K	045923094750	8/1
S9476*	18WLED/RDL/5"-6"/30K/120V	18	120	90	3000K	1200	90°	3 7/16	50K	045923094767	8/1
S9477*	18WLED/RDL/5"-6"/40K/120V	18	120	90	4000K	1260	90°	3 7/16	50K	045923094774	8/1
5 5/8" LED Gimbal Retrofits											
S9472*	12WLED/DIR/5"-6"/27K/120V	12	120	90	2700K	800	90°	4 1/4	50K	045923094729	8/1
S9473*	12WLED/DIR/5"-6"/30K/120V	12	120	90	3000K	800	90°	4 1/4	50K	045923094736	8/1
S9474*	12WLED/DIR/5"-6"/40K/120V	12	120	90	4000K	840	90°	4 1/4	50K	045923094743	8/1

GU24 base sold separately, item number: S8999

LED RECESSED DOWNLIGHT RETROFITS

5"/6" LED recessed downlight retrofits

Applications / Features

- Residential
- Office
- Retail
- Hospitality
- Solid state LED lighting
- Direct replacement for reflector lamps
- Dimmable**
- Long life—35,000 hours
- High efficiency/environmentally friendly
- c-UL-us classified
- Wet location
- 5 year warranty***
- ENERGY STAR® certified*

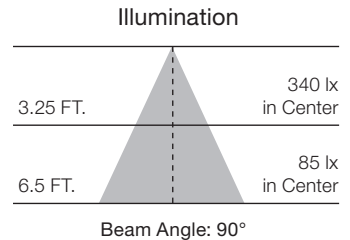

E26 Adapter included 

5"/6" LED Recessed Downlight Retrofits



Item Number	Lamp Description	W	V	CRI	CCT	Lm	Bm	M.O.L. (Inches)	Life/Hrs.	UPC	Pack
S9312*	9WLED/RDL/5-6/27K/120V	9	120	80	2700K	650	90°	3 1/4	35K	045923093128	12/1
S9313*	9WLED/RDL/5-6/30K/120V	9	120	80	3000K	650	90°	3 1/4	35K	045923093135	12/1
S9314*	9WLED/RDL/5-6/40K/120V	9	120	80	4000K	650	90°	3 1/4	35K	045923093142	12/1
S9315*	9WLED/RDL/5-6/50K/120V	9	120	80	5000K	650	90°	3 1/4	35K	045923093159	12/1

**Consult Satco or visit www.satco.com for an up to date dimmer compatibility list.

***See separate warranty for complete terms and conditions.

Quick Trim™ 4", 5/6" LED recessed downlight retrofit 2-packs

Innovative design—
adjustable neck makes
installation into any
recessed can easy

Applications / Features

- Residential
- Office
- Retail
- Hospitality
- Direct replacement for reflector lamps
- Dimmable**
- Long life—25,000 hours
- Damp location listed
- 5 year warranty***
- ENERGY STAR® certified*

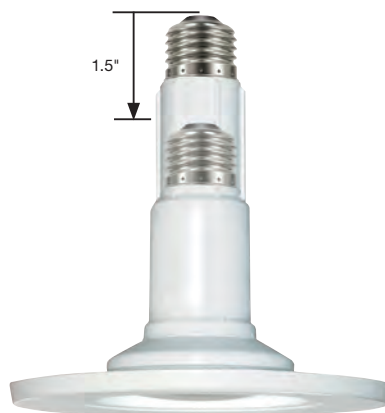
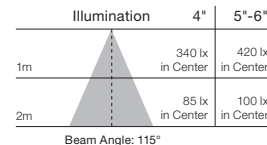
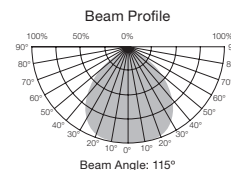

Extends to reach the socket.
Retracts to meet the surface.



Screw lamp into
existing socket.



Push into the fixture
until the trim is flush
against surface.

LED Recessed Downlight Retrofit 2-Packs



Item Number	Lamp Description	W	V	CRI	CCT	Lm	Bm	M.O.L. (Inches)	Life/Hrs.	UPC	Pack
S9598*	8.5WLED/4"TRIM/27K/120V/2PK	8.5	120	80	2700K	510	115°	3.8-5.4"	25K	045923095986	12-2pks
S9599*	12WLED/5-6"TRIM/27K/120V/2PK	12	120	80	2700K	800	110°	4.5-6.3"	25K	045923095993	12-2pks

**Consult Satco or visit www.satco.com for an up to date dimmer compatibility list.

***See separate warranty for complete terms and conditions.

LED RECESSED DOWNLIGHT RETROFITS

4" LED square trim recessed downlight retrofits

Applications / Features

- Residential
- Office
- Retail
- Hospitality
- 45 Watt replacement uses only 10 Watts
- Direct replacement for reflector lamps
- Dimmable**
- Long life—50,000 hours
- Durable die-cast finish
- c-UL-us classified
- Wet location
- 5 year warranty
- ENERGY STAR® certified*

E26 Adapter included



GU10 Adapter sold separately

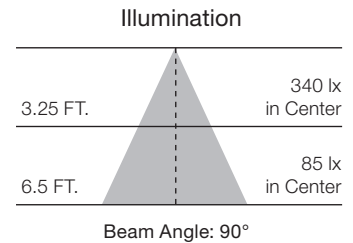

4" LED Square Trim Recessed Downlight Retrofits



Item Number	Lamp Description	W	V	CRI	CCT	Lm	Bm	M.O.L. (Inches)	Life/Hrs.	UPC	Pack
S9756*	10WLED/4/SQ/27K/120V	10	120	90	2700K	600	90°	4	50K	045923097560	24/1
S9757*	10WLED/4/SQ/30K/120V	10	120	90	3000K	600	90°	4	50K	045923097577	24/1
S9758*	10WLED/4/SQ/40K/120V	10	120	90	4000K	600	90°	4	50K	045923097584	24/1
S9759*	10WLED/4/SQ/50K/120V	10	120	90	5000K	600	90°	4	50K	045923097591	24/1

**Consult Satco or visit www.satco.com for an up to date dimmer compatibility list.

5"/6" LED square trim recessed downlight retrofits

Applications / Features

- Residential
- Office
- Retail
- Hospitality
- Up to 85 Watt replacement uses only 16 Watts
- Direct replacement for reflector lamps
- Dimmable**
- Long life—50,000 hours
- Durable die-cast finish
- c-UL-us classified
- Wet location
- 5 year warranty
- ENERGY STAR® certified*

E26 Adapter included



GU24 Adapter sold separately

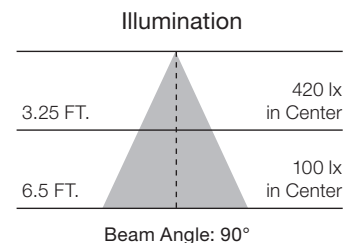

5"/6" LED Square Trim Recessed Downlight Retrofits



Item Number	Lamp Description	W	V	CRI	CCT	Lm	Bm	M.O.L. (Inches)	Life/Hrs.	UPC	Pack
S9770*	16WLED/5-6/SQ/27K/120V	16	120	90	2700K	1000	90°	5-6	50K	045923097706	12/1
S9771*	16WLED/5-6/SQ/30K/120V	16	120	90	3000K	1000	90°	5-6	50K	045923097713	12/1
S9772*	16WLED/5-6/SQ/40K/120V	16	120	90	4000K	1000	90°	5-6	50K	045923097720	12/1
S9773*	16WLED/5-6/SQ/50K/120V	16	120	90	5000K	1000	90°	5-6	50K	045923097737	12/1

**Consult Satco or visit www.satco.com for an up to date dimmer compatibility list.

LED DIRECT WIRE EDGE-LIT DOWNLIGHTS



4" LED direct wire edge-lit downlights

Applications / Features

- Residential
- Office
- Retail
- Hospitality
- Drop ceilings
- Remodeling
- Direct replacement for 45 Watt reflector lamps uses only 8.5 Watts
- Edge lit technology
- Slim design
- Integrated j-box for direct wire installation saves time and materials
- Dimmable*
- Long life—40,000 hours
- c-UL-us classified
- Damp location
- 5 year warranty**

Highlights

- Easy install spring clips
- IC rated
- Low profile
- No recessed can required

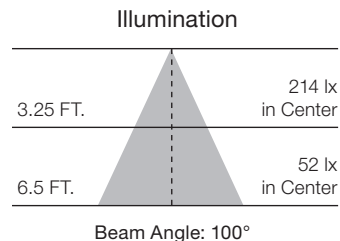

4" LED Direct Wire Edge-Lit Downlights



Item Number	Lamp Description	W	V	CRI	CCT	Lm	Bm	M.O.L. (Inches)	Life/Hrs.	UPC	Pack
S9055	8.5WLED/DW/EL/4/27K/120V	8.5	120	83	2700K	500	100°	1 3/4	40K	045923090554	12/1
S9056	8.5WLED/DW/EL/4/30K/120V	8.5	120	83	3000K	500	100°	1 3/4	40K	045923090561	12/1
S9057	8.5WLED/DW/EL/4/40K/120V	8.5	120	83	4000K	500	100°	1 3/4	40K	045923090578	12/1

*Consult Satco or visit www.satco.com for an up to date dimmer compatibility list.

**See separate warranty for complete terms and conditions.

LED DIRECT WIRE EDGE-LIT DOWNLIGHTS

5 5/8" LED direct wire edge-lit downlights

Applications / Features

- Residential
- Office
- Retail
- Hospitality
- Drop ceilings
- Remodeling
- Direct replacement for 65 Watt reflector lamps uses only 11.6 Watts
- Edge lit technology
- Slim design
- Integrated j-box for direct wire installation saves time and materials
- Dimmable*
- Long life—40,000 hours
- c-UL-us classified
- Damp location
- 5 year warranty**

Highlights

- Easy install spring clips
- IC rated
- Low profile
- No recessed can required

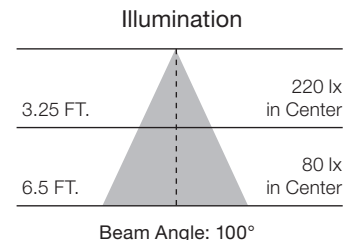

5 5/8" LED Direct Wire Edge-Lit Downlights



Item Number	Lamp Description	W	V	CRI	CCT	Lm	Bm	M.O.L. (Inches)	Life/Hrs.	UPC	Pack
S9061	11.6WLED/DW/EL/5-6/27K/120V	11.6	120	83	2700K	800	100°	1 3/4	40K	045923090615	12/1
S9062	11.6WLED/DW/EL/5-6/30K/120V	11.6	120	83	3000K	800	100°	1 3/4	40K	045923090622	12/1
S9063	11.6WLED/DW/EL/5-6/40K/120V	11.6	120	83	4000K	800	100°	1 3/4	40K	045923090639	12/1

*Consult Satco or visit www.satco.com for an up to date dimmer compatibility list.

**See separate warranty for complete terms and conditions.

LED DIRECT WIRE DOWNLIGHTS



4" LED direct wire downlights

Applications / Features

- Residential
- Office
- Retail
- Hospitality
- Drop ceilings
- Remodeling
- Direct replacement for 45 Watt reflector lamps uses only 7 Watts
- Integrated j-box for direct wire installation saves time and materials
- Dimmable**
- Long life—40,000 hours
- c-UL-us classified
- Wet location
- 5 year warranty***
- ENERGY STAR® certified*

Highlights

- Easy install spring clips
- IC rated
- Low profile
- No recessed can required

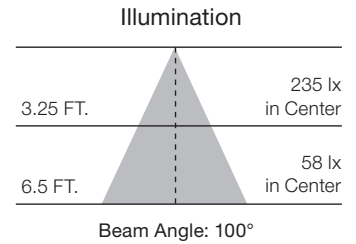

4" LED Direct Wire Downlights



Item Number	Lamp Description	W	V	CRI	CCT	Lm	Bm	M.O.L. (Inches)	Life/Hrs.	UPC	Pack
S9011*	7WLED/DW/RDL/4/27K/120V	7	120	83	2700K	550	100°	3 ¼	40K	045923090110	12/1
S9012*	7WLED/DW/RDL/4/30K/120V	7	120	83	3000K	550	100°	3 ¼	40K	045923090127	12/1
S9013*	7WLED/DW/RDL/4/40K/120V	7	120	83	4000K	550	100°	3 ¼	40K	045923090134	12/1

**Consult Satco or visit www.satco.com for an up to date dimmer compatibility list.

***See separate warranty for complete terms and conditions.

LED DIRECT WIRE DOWNLIGHTS

5"/6" LED direct wire downlights

Applications / Features

- Residential
- Office
- Retail
- Hospitality
- Drop ceilings
- Remodeling
- Direct replacement for 65 Watt reflector lamps uses only 9 Watts
- Integrated j-box for direct wire installation saves time and materials
- Dimmable**
- Long life—40,000 hours
- c-UL-us classified
- Wet location
- 5 year warranty***
- ENERGY STAR® certified*

Highlights

- Easy install spring clips
- IC rated
- Low profile
- No recessed can required

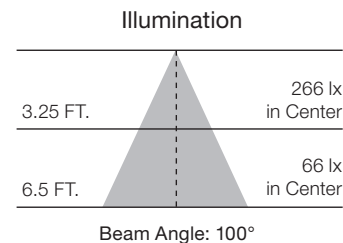

5"/6" LED Direct Wire Downlights



Item Number	Lamp Description	W	V	CRI	CCT	Lm	Bm	M.O.L. (Inches)	Life/Hrs.	UPC	Pack
S9026*	9WLED/DW/RDL/5-6/27K/120V	9	120	83	2700K	700	100°	3 5/8	40K	045923090264	12/1
S9027*	9WLED/DW/RDL/5-6/30K/120V	9	120	83	3000K	700	100°	3 5/8	40K	045923090271	12/1
S9028*	9WLED/DW/RDL/5-6/40K/120V	9	120	83	4000K	700	100°	3 5/8	40K	045923090288	12/1

**Consult Satco or visit www.satco.com for an up to date dimmer compatibility list.

***See separate warranty for complete terms and conditions.

LED RECESSED DOWNLIGHT RETROFITS

6" Commercial LED recessed downlight retrofits

Applications / Features

- Office
- Retail
- Hospitality
- Manufacturing
- Replace up to 2 x 18W CFLs per fixture
- External driver for simple retrofitting
- Quick connect feature for easy installation
- 120-277 range voltage circuit
- 0-10V dimming
- 90CRI
- Wet location
- c-UL-us Classified
- ENERGY STAR certified*
- 5 Year warranty



Installs into existing frame-in kit.

Set of 3 retaining clips included.



6" Commercial LED Recessed Downlight Retrofits



Item Number	Lamp Description	W	V	CRI	CCT	Lm	Bm	M.O.L. (Inches)	Life/Hrs.	UPC	Pack/Master
S9794*	20WLED/CDL/6/30K/120-277V	20	120-277	90	3000K	1500	40°	6	50K	045923097942	8/1
S9795*	30WLED/CDL/6/30K/120-277V	30	120-277	90	3000K	2000	40°	6	50K	045923097959	8/1

*ENERGY STAR pending April 2017

8" Commercial LED recessed downlight retrofits

Applications / Features

- Office
- Retail
- Hospitality
- Manufacturing
- Replace up to 2 x 26W CFLs per fixture
- External driver for simple retrofitting
- Quick connect feature for easy installation
- 120-277 range voltage circuit
- 0-10V dimming
- 90CRI
- Wet location
- c-UL-us Classified
- ENERGY STAR certified*
- 5 Year warranty



Installs into existing frame-in kit.

Set of 3 retaining clips included.



8" Commercial LED Recessed Downlight Retrofits



Item Number	Lamp Description	W	V	CRI	CCT	Lm	Bm	M.O.L. (Inches)	Life/Hrs.	UPC	Pack/Master
S9796*	20WLED/CDL/8/30K/120-277V	20	120-277	90	3000K	1500	40°	8	50K	045923097966	4/1
S9797*	30WLED/CDL/8/30K/120-277V	30	120-277	90	3000K	2000	40°	8	50K	045923097973	4/1

*ENERGY STAR pending April 2017

LED RECESSED DOWNLIGHT RETROFITS



S9128
3" Baffle

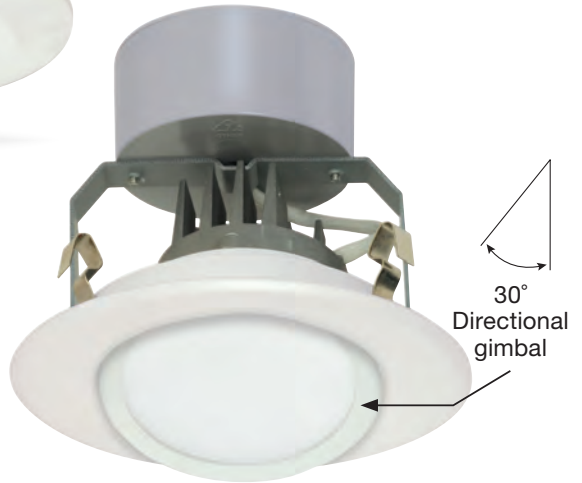

S9129
4" Gimbal



S9130
4" Baffle



12V LED recessed downlight retrofits

Applications / Features

- Residential
- Office
- Retail
- Hospitality
- Dimmable
- Damp location listed - Gimbal
- Wet location listed - Baffle
- Works with magnetic and electronic 12V transformers
- 5 Year warranty

Bi-Pin Adapter included



LED Recessed Downlight Retrofits 12V

Item Number	Lamp Description	W	V	Base	CRI	CCT	Lm	Bm	M.O.L. (Inches)	Life/Hrs.	UPC	Pack
S9128	7WLED/RDL/3BFL/12V	7	12	GU5.3	90	3000K	400	90°	3	35K	045923091285	12/1
S9129	7WLED/RDL/4GBL/12V	7	12	GU5.3	90	3000K	430	90°	4	35K	045923091292	12/1
S9130	8WLED/RDL/4BFL/12V	8	12	GU5.3	90	3000K	460	90°	3 5/8	35K	045923091308	12/1

Hi-Pro LED lamps

High lumen,
omni-directional lamps
for industrial and
commercial applications

Applications / Features

- Replaces HID, CFL, and Incandescent
- Direct wire range voltage 100-277V
- Approved for totally enclosed fixtures
- IP65 rated
- 3 CCT options
- Base up, base down or horizontal operation
- 5 Year limited warranty



High Lumen Industrial/Commercial LED Lamps



Item Number	Lamp Description	Replaces INC/CFL/HID	W	V	Base Type	CCT	Lm	M.O.L. (Inches)	Life/Hrs.	UPC	Pack
S9670	18W/LED/HID/2700K/100-277V	120/32/70	18	100-277	E26	2700K	2200	6 7/8	50K	045923096709	48
S9390	18W/LED/HID/5000K/100-277V	120/32/70	18	100-277	E26	5000K	2400	6 7/8	50K	045923093906	48
S9678	18W/LED/HID/AMBER/100-277V	—	18	100-277	E26	Amber	—	6 7/8	50K	045923096785	48
S9671	22W/LED/HID/2700K/100-277V	150/40/100	22	100-277	E26	2700K	2680	7 1/16	50K	045923096716	48
S9391	22W/LED/HID/5000K/100-277V	150/40/100	22	100-277	E26	5000K	2950	7 1/16	50K	045923093913	48
S9672	36W/LED/HID/2700K/100-277V	200/55/150	36	100-277	E26	2700K	4390	9 1/4	50K	045923096723	12
S9392	36W/LED/HID/5000K/100-277V	200/55/150	36	100-277	E26	5000K	4800	9 1/4	50K	045923093920	12
S9673*	45W/LED/HID/4000K/120-277V	300/65/175	45	100-277	EX39	4000K	5850	10 3/4	50K	045923096730	12
S9393*	45W/LED/HID/5000K/100-277V	300/65/175	45	100-277	EX39	5000K	6000	10 3/4	50K	045923093937	12
S9674*	54W/LED/HID/4000K/120-277V	300/85/250	54	100-277	EX39	4000K	7020	10 3/4	50K	045923096747	12
S9394*	54W/LED/HID/5000K/100-277V	300/85/250	54	100-277	EX39	5000K	7200	10 3/4	50K	045923093944	12
S9675*	80W/LED/HID/4000K/120-277V	400/100/320	80	100-277	EX39	4000K	10400	9 1/4	50K	045923096754	4
S9395*	80W/LED/HID/5000K/100-277V	400/100/320	80	100-277	EX39	5000K	10640	9 1/4	50K	045923093951	4
S9676*	100W/LED/HID/4000K/100-277V	500/150/400	100	100-277	EX39	4000K	13000	9 5/8	50K	045923096761	4
S9396*	100W/LED/HID/5000K/100-277V	500/150/400	100	100-277	EX39	5000K	13300	9 5/8	50K	045923093968	4
S9677*	120W/LED/HID/4000K/100-277V	750/200/600	120	100-277	EX39	4000K	15600	10 3/8	50K	045923096778	4
S9397*	120W/LED/HID/5000K/100-277V	750/200/600	120	100-277	EX39	5000K	16000	10 3/8	50K	045923093975	4

Accessories

92-406	Mog to Med Socket Reducer	045923924064
80-929	Hard Wire Surge Protector	045923809293

HIGH LUMEN LED LAMPS

Hi-Pro low voltage LED lamps

Low voltage, high lumen, omni-directional lamps for industrial and commercial applications

Applications / Features

- Replaces HID, CFL, and Incandescent
- Direct wire range voltage 12-24V
- Approved for totally enclosed fixtures
- IP64 rated
- 5000K
- Base up, base down or horizontal operation
- 5 Year limited warranty



S9753



S9754



S9755

High Lumen Industrial/Commercial LED Lamps



Item Number	Lamp Description	Replaces INC/HID	W	V	Base Type	CCT	Lm	M.O.L. (Inches)	Life/ Hrs.	UPC	Pack
S9753	10W/LED/HID/5000K/12V-24V E26	90/30	10	12-24	E26	5000K	1200	5 13/16	50K	045923097539	48
S9754	14W/LED/HID/5000K/12V-24V E26	150/50	14	12-24	E26	5000K	1680	6 3/16	50K	045923097546	48
S9755	18W/LED/HID/5000K/12V-24V E26	200/70	18	12-24	E26	5000K	2160	7	50K	045923097553	48

Hi-Pro LED wall pack lamp series

High lumen, directional lamps for industrial and commercial fixture applications

Applications / Features

- For use in wall pack, canopy, shoe box, or cobra head fixtures
- Replaces HID
- Approved for totally enclosed fixtures
- Direct wire range voltage 100-277V
- IP64, higher efficiency, improved heat dissipation
- 20/30/40 Watt options replaces 100/150/175 Watt HID
- 2 CCT options
- 180° beam/adjustable base (E26/E39)
- Horizontal operation
- 5 Year limited warranty



S8924, S8925



S8904, S8905

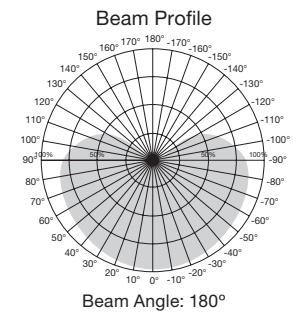

High Lumen Industrial/Commercial LED Lamps



Item Number	Lamp Description	W	V	Replaces	Base Type	CCT	Lm	Bm	M.O.L. (Inches)	Life/Hrs.	UPC	Pack
S8904	20W/LED/HID/WP/3K/E26/100-277V	20	100-277	100W	E26	3000K	2700	180°	7 1/8	50K	045923089046	12
S8905	20W/LED/HID/WP/5K/E26/100-277V	20	100-277	100W	E26	5000K	2700	180°	7 1/8	50K	045923089053	12
S8906	30W/LED/HID/WP/3K/E26/100-277V	30	100-277	150W	E26	3000K	4050	180°	8 1/8	50K	045923089060	12
S8907	30W/LED/HID/WP/5K/E26/100-277V	30	100-277	150W	E26	5000K	4050	180°	8 1/8	50K	045923089077	12
S8908*	30W/LED/HID/WP/3K/E39/100-277V	30	100-277	150W	E39	3000K	4050	180°	8 1/16	50K	045923089084	12
S8909*	30W/LED/HID/WP/5K/E39/100-277V	30	100-277	150W	E39	5000K	4050	180°	8 1/16	50K	045923089091	12
S8924	40W/LED/HID/WP/3K/E26/100-277V	40	100-277	175W	E26	3000K	5400	180°	9 7/8	50K	045923089244	12
S8925	40W/LED/HID/WP/5K/E26/100-277V	40	100-277	175W	E26	5000K	5400	180°	9 7/8	50K	045923089251	12
S8926*	40W/LED/HID/WP/3K/E39/100-277V	40	100-277	175W	E39	3000K	5400	180°	10 5/8	50K	045923089268	12
S8927*	40W/LED/HID/WP/5K/E39/100-277V	40	100-277	175W	E39	5000K	5400	180°	10 5/8	50K	045923089275	12

HIGH LUMEN LED LAMPS

Hi-Pro LED shoe box lamp series

High lumen, directional lamps for industrial and commercial fixture applications

Applications / Features

- For use in shoe box fixtures
- 80/110 Watt options (10,000/14,000 lm) replaces 250/400 Watt HID
- Replaces HID
- Approved for totally enclosed fixtures
- Damp location
- Direct wire range voltage 100-277V
- Higher efficiency, improved heat dissipation
- 2 CCT options
- Expandable 180° beam design w/adjustable base (E39)
- Horizontal operation
- 5 Year limited warranty

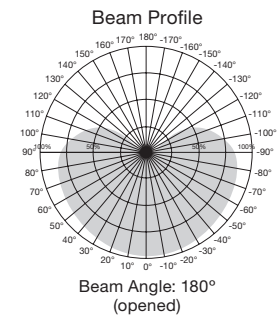
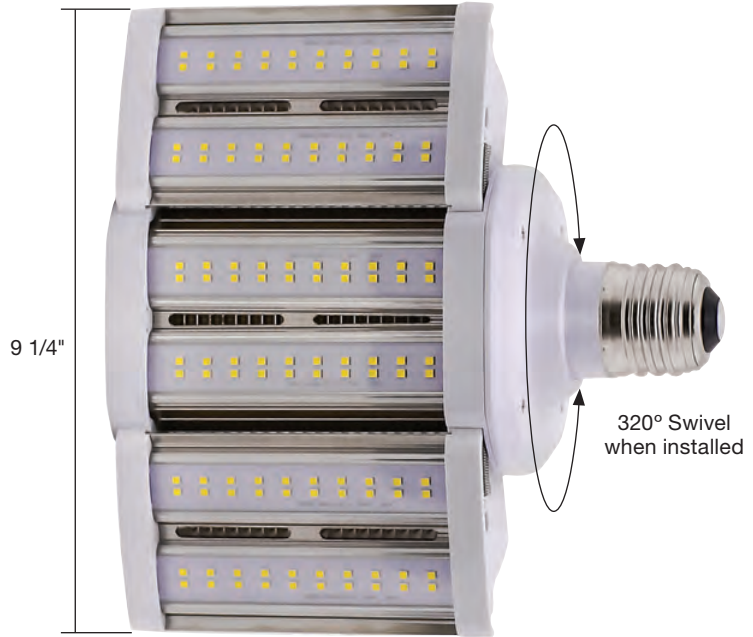

High Lumen Industrial/Commercial LED Lamps



Item Number	Lamp Description	W	V	Rpl.	Base Type	CCT	Lm	Bm	M.O.L. (Inches)	Life/Hrs.	UPC	Pack
S8931	80W/LED/HID/SB/3K/E39/100-277V	80	100-277	250W	E39	3000K	10000	180°	8 1/4"	50K	045923089312	4
S8932	80W/LED/HID/SB/5K/E39/100-277V	80	100-277	250W	E39	5000K	10000	180°	8 1/4"	50K	045923089329	4
S8937	110W/LED/HID/SB/3K/E39/100-277V	110	100-277	400W	E39	3000K	14000	180°	11 1/8"	50K	045923089374	4
S8938	110W/LED/HID/SB/5K/E39/100-277V	110	100-277	400W	E39	5000K	14000	180°	11 1/8"	50K	045923089381	4

Hi-Pro LED temporary hi-bay caged lamp series

High lumen, omni-directional lamps for industrial and commercial work areas

Applications / Features

- For use in any commercial work area
- 60/80 Watt options (7200/9600 lm)
- Includes 3' power cord/plug and hook for easy installation
- Replaces HID, CFL, and Incandescent
- Direct wire 120V
- Approved for totally enclosed fixtures
- IP64, higher efficiency, improved heat dissipation
- 360° Omni-directional light
- 5 Year limited warranty

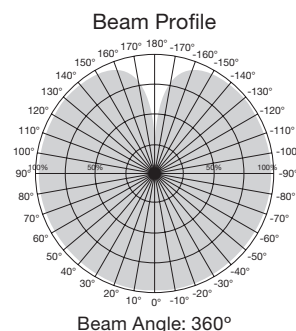

High Lumen Industrial/Commercial LED Lamps



Item Number	Lamp Description	W	V	Rpl.	Base Type	CCT	Lm	Bm	M.O.L. (Inches)	Life/Hrs.	UPC	Pack
S8939	60W/LED/HID/TEMP/5000K/120V	60	120	200W	Hook/Plug	5000K	7200	360°	13 ½	50K	045923089398	4
S8940	80W/LED/HID/TEMP/5000K/120V	80	120	250W	Hook/Plug	5000K	9600	360°	13 ½	50K	045923089404	4

HIGH LUMEN LED LAMPS

Hi-Pro multi-beam LED lamps

High lumen, adjustable, multi-directional lamps for industrial and commercial applications

Applications / Features

- Replaces HID, CFL, and incandescent
- Direct wire range voltage 100-277V
- Approved for totally enclosed fixtures
- Hi bay, low bay and post top
- 2700K or 5000K
- Light panels lock into place creating 3 separate beam angle options
- IP65 rated
- 5 Year limited warranty



360° Beam



270° Beam



180° Beam

High Lumen Multi-beam Industrial/Commercial LED Lamps



Item Number	Lamp Description	Replaces Inc/CFL/HID	W	V	Base Type	CCT	Lm	CRI	M.O.L. (Inches)	Life/Hrs.	UPC	Pack/Mstr.
S9768	30W/LED/HID/MB/2700K/100-277V	200/55/150	30	120-277	E26	2700K	3660	83	6 3/8	50K	045923097683	24
S9750	30W/LED/HID/MB/5000K/100-277V	200/55/150	30	100-277	E26	5000K	3900	83	6 3/8	50K	045923097508	24
S9798*	40W/LED/HID/MB/2700K/100-277V	300/65/175	40	120-277	EX39	2700K	4880	83	7 7/8	50K	045923097980	12
S9751*	40W/LED/HID/MB/5000K/100-277V	300/65/175	40	100-277	EX39	5000K	5200	83	7 7/8	50K	045923097515	12
S9799*	60W/LED/HID/MB/2700K/100-277V	500/85/250	60	120-277	EX39	2700K	7320	83	8 1/6	50K	045923097997	12
S9752*	60W/LED/HID/MB/5000K/100-277V	500/85/250	60	100-277	EX39	5000K	7800	83	8 1/6	50K	045923097522	12
S9769	75W/LED/HID/MB/5000K/100-277V	750/105/400	75	100-277	EX39	5000K	9800	80+	8 5/8	50K	045923097690	12

Accessories

92-406	Mog to Med Socket Reducer for S9750										045923924064	
80-929	Hard Wire Surge Protector										045923809293	

PATENT PENDING

HIGH LUMEN LED LAMPS

Hi-Pro LED high bay/low bay lamps

High lumen, LED lamps for industrial and commercial applications

Applications / Features

- Replaces HID, CFL, and Incandescent
- 120° beam angle
- Long neck option fits more fixtures
- Direct wire range voltage 100-277V
- Light weight
- Advanced passive heat dissipation
- Long life—25,000 hours
- 5 Year limited warranty

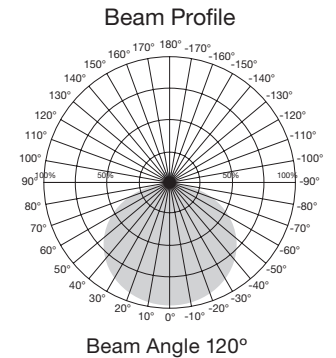

High Lumen Industrial/Commercial LED Lamps

Item Number	Lamp Description	Replaces INC/CFL/HID	W	V	Base Type	CRI	CCT	Lm	Bm	M.O.L. (Inches)	Life/Hrs.	UPC	Pack/Master
S9766	62W/LED/HID-HB/5000K/100-277V	500/150/250	62	100-277	E39	80+	5000K	5700	120°	9 1/8	25K	045923097669	6
S9767	80W/LED/HID-HB/5000K/100-277V	750/200/400	80	100-277	E39	80+	5000K	7600	120°	10 13/16	25K	045923097676	4

Accessories												
80-929	HARD WIRE SURGE PROTECTOR											045923809293

Hi-Pro LED post top lamps

Applications / Features

- For use in any post top fixture to provide light out and down only
- Direct wire (ballast by-pass) 100-277V / E26
- Approved for enclosed fixtures
- 5 Year limited warranty

Available March 2017

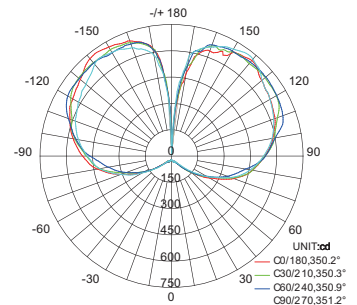

High Lumen LED Lamps

Item Number	Lamp Description	W	V	Base Type	CRI	CCT	Lm	M.O.L. (Inches)	Life/Hrs.	UPC	Pack/Master
S9779	40W/LED/HID/PT/3000K/100-277V	40	100-277	E26	80+	3000K	4400	5 1/2	50K	045923097799	12



HIGH LUMEN LED LAMPS

Hi-Pro LED PAR30 lamps

High lumen, PAR lamps for industrial and commercial applications

Applications / Features

- Replaces Halogen and ceramic metal Halide lamps
- Saves over 80% on energy costs
- Direct wire range voltage 100-277V
- High efficiency—100LPW
- 3000 and 4000K options
- Base up, base down or horizontal operation
- Long life—50,000 hours
- 5 Year limited warranty



S9764, S9765

S9762, S9763

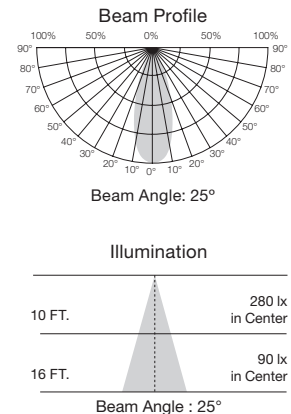

High Lumen PAR30 Industrial/Commercial LED Lamps

Item Number	Lamp Description	W	V	CRI	CCT	Lm	Bm	M.O.L. (Inches)	Life/Hrs.	UPC	Pack/Master
S9762	12W/LED/PAR30/SN/3K/100-277V	12	100-277	83	3000K	1200	25°	3 1/2	50K	045923097621	24/6
S9763	12W/LED/PAR30/SN/4K/100-277V	12	100-277	83	4000K	1200	25°	3 1/2	50K	045923097638	24/6
S9764	12W/LED/PAR30/LN/3K/100-277V	12	100-277	83	3000K	1200	25°	4 5/16	50K	045923097645	24/6
S9765	12W/LED/PAR30/LN/4K/100-277V	12	100-277	83	4000K	1200	25°	4 5/16	50K	045923097652	24/6

Accessories

80-929 HARD WIRE SURGE PROTECTOR

045923809293

Hi-Pro LED PAR38 lamps

High lumen, PAR lamps for industrial and commercial applications

Applications / Features

- Replaces Halogen and ceramic metal Halide lamps
- Saves over 80% on energy costs
- Direct wire range voltage 100-277V
- High efficiency—over 100LPW
- 3000 and 4000K options
- Base up, base down or horizontal operation
- Long life—50,000 hours
- 5 Year limited warranty

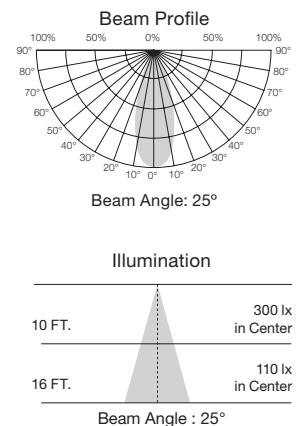

High Lumen PAR38 Industrial/Commercial LED Lamps

Item Number	Lamp Description	W	V	CRI	CCT	Lm	Bm	M.O.L. (Inches)	Life/Hrs.	UPC	Pack/Master
S9760	18W/LED/PAR38/3000K/100-277V	18	100-277	83	3000K	1950	25°	5 1/6	50K	045923097607	12/6
S9761	18W/LED/PAR38/4000K/100-277V	18	100-277	83	4000K	2000	25°	5 1/6	50K	045923097614	12/6

Accessories

80-929 HARD WIRE SURGE PROTECTOR

045923809293

Carded specialty LED lamps

Applications / Features

- Sign bulbs
- Indicator
- Nightlights
- Decorative lamps
- Non-dimmable
- Direct replacements for incandescent & specialty lamps
- LED replacements use 80% less energy
- Wet location
- Long life—25,000 hours
- 3 Year warranty



Carded Specialty LED Lamps

Item Number	Lamp Description	W	Base	V	Finish	CCT	Lm	M.O.L. (Inches)	Life/Hrs.	UPC	Pack
S9150	1.4W A15/CL/LED/120V/CD	1.4	Med.	120	Clear	2700K	36	3 15/16	25K	045923091506	12/1
S9151	1.4W A15/FR/LED/120V/CD	1.4	Med.	120	Frost	2700K	45	3 15/16	25K	045923091513	12/1
S9152	1W CTC/LED/120V/CD	1.0	Cand.	120	Clear	2700K	25	3 9/16	25K	045923091520	12/1
S9153	1W CFC/LED/120V/CD	1.0	Cand.	120	Clear	2700K	25	3 7/8	25K	045923091537	12/1
S9154	1.4W ETC/LED/120V/CD	1.4	Med.	120	Clear	2700K	36	3 13/16	25K	045923091544	12/1
S9155	1W CTD/LED/CRYSTAL/120V/CD	1.0	Cand.	120	Clear	2700K	25	3 9/16	25K	045923091551	12/1
S9156	0.5W C7/CL/LED/120V/CD	0.5	Cand.	120	Clear	2700K	14	2 1/16	25K	045923091568	12/1
S9157	0.5W C7/WH/LED/120V/CD	0.5	Cand.	120	White	2700K	14	2 1/16	25K	045923091575	12/1
S9158	1.4W G16.5/CL/LED/120V/CD	1.4	Med.	120	Clear	2700K	36	2 3/4	25K	045923091582	12/1
S9159	1.4W G16.5/WH/LED/120V/CD	1.4	Med.	120	White	2700K	45	2 13/16	25K	045923091599	12/1
S9160	1.2W S11/CL/LED/120V/CD	1.2	Med.	120	Clear	2700K	32	2 5/16	25K	045923091605	12/1
S9161	1.2W S11/WH/LED/120V/CD	1.2	Med.	120	White	2700K	40	2 5/16	25K	045923091612	12/1
S9162	1.2W S11/BL/LED/120V/CD	1.2	Med.	120	Blue	—	—	2 5/16	25K	045923091629	12/1
S9163	1.2W S11/GR/LED/120V/CD	1.2	Med.	120	Green	—	—	2 5/16	25K	045923091636	12/1
S9164	1.2W S11/OR/LED/120V/CD	1.2	Med.	120	Orange	—	—	2 5/16	25K	045923091643	12/1
S9165	1.2W S11/RED/LED/120V/CD	1.2	Med.	120	Red	—	—	2 5/16	25K	045923091650	12/1
S9166	1.2W S11/Y/LED/120V/CD	1.2	Med.	120	Yellow	—	—	2 5/16	25K	045923091667	12/1
S9167	1.0W S11/CL/LED/E17/120V/CD	1.0	Inter.	120	Clear	2700K	28	2 5/16	25K	045923091674	12/1
S9168	1.0W S11/WH/LED/E17/120V/CD	1.0	Inter.	120	White	2700K	35	2 5/16	25K	045923091681	12/1
S9169	1.4W S14/Y/LED/120V/CD	1.4	Med.	120	Yellow	—	—	3 5/16	25K	045923091698	12/1
S9170	1.4W S14/RED/LED/120V/CD	1.4	Med.	120	Red	—	—	3 5/16	25K	045923091704	12/1
S9171	1.4W S14/GR/LED/120V/CD	1.4	Med.	120	Green	—	—	3 5/16	25K	045923091711	12/1
S9172	1.4W S14/BL/LED/120V/CD	1.4	Med.	120	Blue	—	—	3 5/16	25K	045923091728	12/1
S9173	1.4W S14/OR/LED/120V/CD	1.4	Med.	120	Orange	—	—	3 5/16	25K	045923091735	12/1
S9174	1.4W S14/CL/LED/120V/CD	1.4	Med.	120	Clear	2700K	36	3 5/16	25K	045923091742	12/1
S9175	1.4W S14/FR/LED/120V/CD	1.4	Med.	120	Frost	2700K	45	3 5/16	25K	045923091759	12/1
S9176	0.8W T6/FR/LED/120V/CD	0.8	Cand.	120	Frost	2700K	25	2 1/16	25K	045923091766	12/1
S9177	0.8W T6/CL/LED/120V/CD	0.8	Cand.	120	Clear	2700K	20	2 1/16	25K	045923091773	12/1



LED/CFL LAMPS

LED/CFL direct replacement lamps

4-pin (electronic ballasts)

2-pin (magnetic ballasts)

Applications / Features

- UL Classified
 - 4-pin 26, 32, 42 Watt direct replacement
 - 2-pin 26 Watt direct replacement
- 4-pin lamps fit G24q-3 & GX24q-3 and GX24q-4 sockets
- 2-pin lamps fit G24d-3 & GX24d-3 sockets
- No re-wiring needed
- Instant on to full brightness / no flickering
- Vertical and horizontal options
- Up to 70% energy saving
- Long life—50,000 hours
- 5 year warranty



S9858, S9859, S9860, S9861



S9862, S9863, S9864, S9865

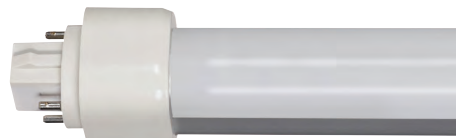

S9850, S9851, S9852, S9853

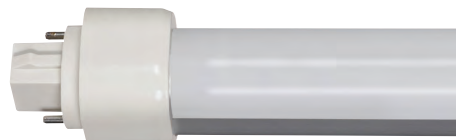

S9854, S9855, S9856, S9857

LED/CFL Replacement Lamps



Item Number	Lamp Description	W	Base Type	CCT	CRI	M.O.L. (Inches)	Lm	Life/Hrs.	UPC	Pack/Master
4 Pin Horizontal										
S9850*	9WPLH/LED/830/DR/4P	9	G24Q	3000K	82	6 5/8	850	50K	045923098505	50/10
S9851*	9WPLH/LED/835/DR/4P	9	G24Q	3500K	82	6 5/8	850	50K	045923098512	50/10
S9852*	9WPLH/LED/840/DR/4P	9	G24Q	4000K	82	6 5/8	900	50K	045923098529	50/10
S9853*	9WPLH/LED/850/DR/4P	9	G24Q	5000K	82	6 5/8	900	50K	045923098536	50/10
2 Pin Horizontal										
S9854	9WPLH/LED/830/DR/2P	9	G24D	3000K	82	6 5/8	850	50K	045923098543	50/10
S9855	9WPLH/LED/835/DR/2P	9	G24D	3500K	82	6 5/8	850	50K	045923098550	50/10
S9856	9WPLH/LED/840/DR/2P	9	G24D	4000K	82	6 5/8	900	50K	045923098567	50/10
S9857	9WPLH/LED/850/DR/2P	9	G24D	5000K	82	6 5/8	900	50K	045923098574	50/10
4 Pin Vertical										
S9858*	9WPLV/LED/830/DR/4P	9	G24Q	3000K	82	4 11/16	850	50K	045923098581	50/10
S9859*	9WPLV/LED/835/DR/4P	9	G24Q	3500K	82	4 11/16	850	50K	045923098598	50/10
S9860*	9WPLV/LED/840/DR/4P	9	G24Q	4000K	82	4 11/16	900	50K	045923098604	50/10
S9861*	9WPLV/LED/850/DR/4P	9	G24Q	5000K	82	4 11/16	900	50K	045923098611	50/10
2 Pin Vertical										
S9862	9WPLV/LED/830/DR/2P	9	G24D	3000K	82	4 11/16	850	50K	045923098628	50/10
S9863	9WPLV/LED/835/DR/2P	9	G24D	3500K	82	4 11/16	850	50K	045923098635	50/10
S9864	9WPLV/LED/840/DR/2P	9	G24D	4000K	82	4 11/16	900	50K	045923098642	50/10
S9865	9WPLV/LED/850/DR/2P	9	G24D	5000K	82	4 11/16	900	50K	045923098659	50/10

*With compatible dimming ballasts for 4-pin lamps, ballast dependent. Visit www.satco.com

LED/CFL replacement lamps

Direct replacement for 4-pin* CFL's with electronic ballasts

Applications/ Features

- UL Classified 26 Watt direct replacement
- Works on 18, 26, 32, and 42 watt CFL ballasts*
- No re-wiring needed
- Instant on to full brightness / no flickering
- Vertical and horizontal options
- Up to 70% energy savings
- Long life—50,000 hours
- 3 Year warranty
- Dimmable**

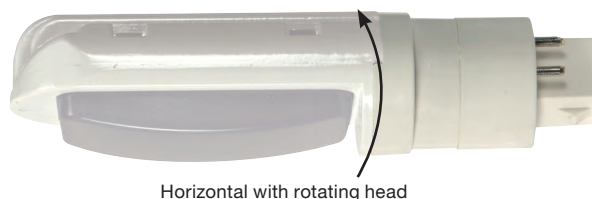

LED/CFL Replacement Lamps



Item Number	Lamp Description	W	V	Base Type	CCT	CRI	M.O.L. (Inches)	Lm	Life/ Hrs.	UPC	Pack
S9300	13W/V/LED/CFL/827/4P	13	120-277	G24Q	2700K	80	3 5/8	900	50K	045923093005	50/10
S9301	13W/V/LED/CFL/835/4P	13	120-277	G24Q	3500K	80	3 5/8	900	50K	045923093012	50/10
S9302	13W/V/LED/CFL/840/4P	13	120-277	G24Q	4000K	80	3 5/8	925	50K	045923093029	50/10
S9303	13W/V/LED/CFL/850/4P	13	120-277	G24Q	5000K	80	3 5/8	950	50K	045923093036	50/10
S9304	13W/VL/LED/CFL/827/4P (Long)	13	120-277	G24Q	2700K	80	4 5/8	900	50K	045923093043	50/10
S9305	13W/VL/LED/CFL/835/4P (Long)	13	120-277	G24Q	3500K	80	4 5/8	900	50K	045923093050	50/10
S9306	13W/VL/LED/CFL/840/4P (Long)	13	120-277	G24Q	4000K	80	4 5/8	925	50K	045923093067	50/10
S9307	13W/VL/LED/CFL/850/4P (Long)	13	120-277	G24Q	5000K	80	4 5/8	950	50K	045923093074	50/10
S9308	13W/H/LED/CFL/827/4P	13	120-277	G24Q	2700K	80	5 1/4	900	50K	045923093081	50/10
S9309	13W/H/LED/CFL/835/4P	13	120-277	G24Q	3500K	80	5 1/4	900	50K	045923093098	50/10
S9310	13W/H/LED/CFL/840/4P	13	120-277	G24Q	4000K	80	5 1/4	925	50K	045923093104	50/10
S9311	13W/H/LED/CFL/850/4P	13	120-277	G24Q	5000K	80	5 1/4	950	50K	045923093111	50/10

*Fits G24q-2,3,4 sockets

**With compatible dimming ballasts. Visit www.satco.com for updated list.

Satco 4-pin 23W LED/CFL replacement lamps

Direct replacement for
4-pin 40W PL-L
with electronic ballast

Applications/ Features

- UL Classified 40 Watt replacement
- Ballast dependent*
- Voltage: 120-277 (electronic ballast)
- No re-wiring needed
- Instant on to full brightness/no flickering
- c-UL-us classified
- Long life—50,000 hours
- 3 Year warranty



Satco 4-Pin 23W LED/CFL Replacement Lamps



Item Number	Lamp Description	W	CRI	V	Base Type	CCT	Lm	M.O.L. (Inches)	Life/Hrs.	UPC	Pack
S9730	23PLL/LED/835/DR	23	82	120-277	2G11	3500K	2600	22.5	50K	045923097300	10
S9731	23PLL/LED/840/DR	23	82	120-277	2G11	4000K	2800	22.5	50K	045923097317	10

*May not be compatible with all ballasts. Visit www.satco.com for an approved list.

LED T8 LAMPS

Satco 2', 3' & 6" U-bend LED T8 lamps

Direct replacement for linear or U-bend T8 fluorescent lamps in existing fixtures with instant or rapid start ballasts. **No rewiring required****

Applications / Features

- Over 40% energy savings vs. standard T8 systems
- All glass tube
- Direct replacement solution allows the fixture to maintain the Original UL and CSA Compliance
- Compatible with emergency ballasts (2' & 3')***
- Long life—50,000 hours
- 2 ft. - DLC listed*
- NSF certified
- c-UL-us listed
- Damp location
- 5 Year warranty



LED T8 Fluorescent 2', 3' & 6" U-Bend Replacement Lamps

Item Number	Lamp Description	W	CRI	Base Type	Bm	CCT	Lm	M.O.L. (Inches)	Life/Hrs.	UPC	Pack
2' LED T8											
S9946*	8T8/LED/24-830/DR	8	82	Med Bi-Pin	210°	3000K	1200	24	50K	045923099465	10
S9947*	8T8/LED/24-835/DR	8	82	Med Bi-Pin	210°	3500K	1200	24	50K	045923099472	10
S9948*	8T8/LED/24-840/DR	8	82	Med Bi-Pin	210°	4000K	1250	24	50K	045923099489	10
S9949*	8T8/LED/24-850/DR	8	82	Med Bi-Pin	210°	5000K	1250	24	50K	045923099496	10
3' LED T8											
S9990	10.5T8/LED/36-830/DR	10.5	82	Med Bi-Pin	210°	3000K	1400	36	50K	045923099908	10
S9991	10.5T8/LED/36-835/DR	10.5	82	Med Bi-Pin	210°	3500K	1400	36	50K	045923099915	10
S9992	10.5T8/LED/36-840/DR	10.5	82	Med Bi-Pin	210°	4000K	1450	36	50K	045923099922	10
S9993	10.5T8/LED/36-850/DR	10.5	82	Med Bi-Pin	210°	5000K	1450	36	50K	045923099939	10
U-Bend 6" LED T8											
S9294	12T8U6/LED/22.5-830/DR	12	82	Med Bi-Pin	230°	3000K	1800	22.5	50K	045923092947	12
S9295	12T8U6/LED/22.5-835/DR	12	82	Med Bi-Pin	230°	3500K	1800	22.5	50K	045923092954	12
S9296	12T8U6/LED/22.5-840/DR	12	82	Med Bi-Pin	230°	4000K	1800	22.5	50K	045923092961	12
S9297	12T8U6/LED/22.5-850/DR	12	82	Med Bi-Pin	230°	5000K	1800	22.5	50K	045923092978	12

**May not be compatible with all ballasts. Visit www.satco.com for an approved list.

***2' & 3' May not be compatible with all rapid start, dimmable, and emergency ballasts. Visit www.satco.com for an approved list.

LED T8 LAMPS

Satco 11.5W, 4' LED T8 lamps

Direct replacement for linear fluorescent T8 lamps in existing fixtures with instant or rapid start ballasts. No rewiring required**

Applications/ Features

- Over 40% energy savings vs standard 4' T8 systems
- All glass tube
- Direct replacement solution allows the fixture to maintain the Original UL and CSA Compliance
- Long life—50,000 hours
- Compatible with emergency ballasts**
- Damp location
- c-UL-us listed
- DLC listed*
- 5 Year warranty



LED Fluorescent Replacement Lamps

Item Number	Lamp Description	W	CRI	Base Type	Bm	CCT	Lm	M.O.L. (Inches)	Life/Hrs.	UPC	Pack
S9934*	11.5T8/LED/48-830/DR	11.5	82	Med Bi-Pin	210°	3000K	1700	48	50K	045923099342	10
S9935*	11.5T8/LED/48-835/DR	11.5	82	Med Bi-Pin	210°	3500K	1700	48	50K	045923097355	10
S9936*	11.5T8/LED/48-840/DR	11.5	82	Med Bi-Pin	210°	4000K	1800	48	50K	045923099366	10
S9937*	11.5T8/LED/48-850/DR	11.5	82	Med Bi-Pin	210°	5000K	1800	48	50K	045923099373	10

**May not be compatible with all instant start, rapid start, and emergency ballasts. Visit www.satco.com for an approved list.

Satco 11.5W, 4' LED T8 lamps

Direct replacement for linear fluorescent T8 lamps in existing fixtures with instant or rapid start ballasts. No rewiring required**

Applications/ Features

- Over 40% energy savings vs standard 4' T8 systems
- All glass tube
- Direct replacement solution allows the fixture to maintain the Original UL and CSA Compliance
- Long life—50,000 hours
- Compatible with emergency & dimming ballasts**
- Damp location
- c-UL-us listed
- DLC listed*
- 5 Year warranty



LED Fluorescent Replacement Lamps

Item Number	Lamp Description	W	CRI	Base Type	Bm	CCT	Lm	M.O.L. (Inches)	Life/Hrs.	UPC	Pack
S9938*	11.5T8/LED/48-830/DR/DM	11.5	82	Med Bi-Pin	210°	3000K	1700	48	50K	045923099380	10
S9939*	11.5T8/LED/48-835/DR/DM	11.5	82	Med Bi-Pin	210°	3500K	1700	48	50K	045923099397	10
S9940*	11.5T8/LED/48-840/DR/DM	11.5	82	Med Bi-Pin	210°	4000K	1800	48	50K	045923099403	10
S9941*	11.5T8/LED/48-850/DR/DM	11.5	82	Med Bi-Pin	210°	5000K	1800	48	50K	045923099410	10

**May not be compatible with all instant start, rapid start, dimmable, and emergency ballasts. Visit www.satco.com for an approved list.

LED T8 LAMPS

Satco 15W, 4' LED T8 lamps

Direct replacement for linear fluorescent T8 lamps in existing fixtures with instant or rapid start ballasts. No rewiring required**

Applications/ Features

- Over 40% energy savings vs standard 4' T8 systems
- All glass tube
- Direct replacement solution allows the fixture to maintain the Original UL and CSA Compliance
- Long life—50,000 hours
- Compatible with emergency ballasts**
- Damp location
- DLC listed*
- 5 Year warranty



LED Fluorescent Replacement Lamps

Item Number	Lamp Description	W	CRI	Base Type	Bm	CCT	Lm	M.O.L. (Inches)	Life/Hrs.	UPC	Pack
S9975*	15T8/LED/48-830/DR	15	80	Med Bi-Pin	210°	3000K	2100	48	50K	045923099755	10
S9976*	15T8/LED/48-835/DR	15	80	Med Bi-Pin	210°	3500K	2100	48	50K	045923099762	10
S9977*	15T8/LED/48-840/DR	15	80	Med Bi-Pin	210°	4000K	2200	48	50K	045923099779	10
S9978*	15T8/LED/48-850/DR	15	80	Med Bi-Pin	210°	5000K	2200	48	50K	045923099786	10

**May not be compatible with all instant start, rapid start, and emergency ballasts. Visit www.satco.com for an approved list.

Satco By-pass 15W LED T8 lamps

Direct wire replacement for linear fluorescent T8 lamps in existing fixtures. Single ended wiring/non-shunted sockets.

Applications/ Features

- No ballast or external driver required
- Direct wire 120-277V line voltage**
- All glass tube
- Single ended wiring/non-shunted sockets
- Long life—50,000 hours
- Damp location
- c-UL-us classified
- DLC listed*
- 5 Year warranty



LED Fluorescent Replacement Lamps

Item Number	Lamp Description	W	CRI	Base Type	Bm	CCT	Lm	M.O.L. (Inches)	Life/Hrs.	UPC	Pack
S9720*	15T8/LED/48-830/BP	15	82	Med Bi-Pin	230°	3000K	1700	48	50K	045923097201	10
S9721*	15T8/LED/48-835/BP	15	82	Med Bi-Pin	230°	3500K	1700	48	50K	045923097218	10
S9722*	15T8/LED/48-840/BP	15	82	Med Bi-Pin	230°	4000K	1800	48	50K	045923097225	10
S9723*	15T8/LED/48-850/BP	15	82	Med Bi-Pin	230°	5000K	1800	48	50K	045923097232	10

**Install only in non-shunted lampholders

LED T8 LAMPS

14W Linear LED ballast by-pass T8 series

Double ended wiring

Applications/ Features

- Works with existing sockets—shunted or non-shunted
- Reduces labor costs for installation
- Built-in shock resistant circuit (not hot until both ends are installed)
- No ballast or external driver required
- Direct wire 120-277V line voltage
- All glass tube
- Long life—50,000 hours
- Damp location
- c-UL-us classified
- DLC listed*
- 5 Year warranty



LED Fluorescent Replacement Lamps

Item Number	Lamp Description	W	CRI	Base Type	Bm	CCT	Lm	M.O.L. (Inches)	Life/Hrs.	UPC	Pack
S9913*	14T8/LED/48-830/BP	14	82	Med Bi-Pin	210°	3000K	1800	48	50K	045923099137	10
S9914*	14T8/LED/48-835/BP	14	82	Med Bi-Pin	210°	3500K	1800	48	50K	045923099144	10
S9915*	14T8/LED/48-840/BP	14	82	Med Bi-Pin	210°	4000K	1800	48	50K	045923099151	10
S9916*	14T8/LED/48-850/BP	14	82	Med Bi-Pin	210°	5000K	1800	48	50K	045923099168	10

Satco 33W, 8' LED T8 lamps

Direct replacement for linear fluorescent T8 lamps in existing fixtures with electronic instant start ballasts. No rewiring required**

Applications/ Features

- Over 40% energy savings vs standard 8' T8 systems
- All glass tube
- Direct replacement solution allows the fixture to maintain the Original UL and CSA Compliance
- Long life—50,000 hours
- Instant on to full brightness/no flickering
- Damp location
- NSF certified*
- 5 Year warranty



LED Fluorescent Replacement Lamps

Item Number	Lamp Description	W	CRI	Base Type	Bm	CCT	Lm	M.O.L. (Inches)	Life/Hrs.	UPC	Pack
S9700*	33T8/LED/96-840/DR	33	82	Single Pin	230°	4000K	4400	96	50K	045923097003	10
S9701*	33T8/LED/96-850/DR	33	82	Single Pin	230°	5000K	4400	96	50K	045923097010	10

**May not be compatible with all instant start ballasts. Visit www.satco.com for an approved list.

43W Linear LED ballast by-pass T8 series

Applications/ Features

- Double ended wiring
- Shatterproof coated
- Over 40% energy savings vs standard 8' T8 systems
- All glass tube
- Long life—50,000 hours
- Instant on to full brightness/no flickering
- Damp location
- NSF certified*
- c-UL-us classified
- 5 Year warranty



LED Fluorescent Replacement Lamps

Item Number	Lamp Description	W	CRI	Base Type	Bm	CCT	Lm	M.O.L. (Inches)	Life/ Hrs.	UPC	Pack
S9917*	43T8/LED/96-835/BP	43	82	Single Pin	210°	3500K	5500	96	50K	045923099175	10
S9918*	43T8/LED/96-840/BP	43	82	Single Pin	210°	4000K	5500	96	50K	045923099182	10
S9919*	43T8/LED/96-850/BP	43	82	Single Pin	210°	5000K	5500	96	50K	045923099199	10

Satco 25W, 4' LED T5 lamps

Direct replacement for linear fluorescent F54T5 lamps in existing fixtures with electronic ballasts. No rewiring required**

Applications/ Features

- Over 50% energy savings vs standard 4' T5 systems
- All glass tube
- Direct replacement solution allows the fixture to maintain the Original UL and CSA Compliance
- Long life—50,000 hours
- Compatible with emergency ballasts**
- Damp location
- NSF certified†
- c-UL-us listed
- DLC listed*
- 5 Year warranty



LED T5 Fluorescent Replacement Lamps

Item Number	Lamp Description	W	CRI	Base Type	Bm	CCT	Lm	M.O.L. [†] (Nominal)	Life/ Hrs.	UPC	Pack
S9912†*	25T5/LED/46-835/DR	25	82	Mini Bi-Pin	185°	3500K	3500	48 (46)	50K	045923097126	10
S9910†*	25T5/LED/46-840/DR	25	82	Mini Bi-Pin	185°	4000K	3500	48 (46)	50K	045923097102	10
S9911†*	25T5/LED/46-850/DR	25	82	Mini Bi-Pin	185°	5000K	3500	48 (46)	50K	045923097119	10

**May not be compatible with all rapid start and emergency ballasts. Visit www.satco.com for an approved list.

Discover all that Satco has to offer...



SA1039, Satco Lamp Specification Guide
SA1700, Satco Lighting Components Guide



SA1696, Satco Blink LED Fixtures
SA1710, Satco Freedom Architectural LED Downlights & Retrofits



Nuvo Lighting complete binder set contains:
NU4010, The Decorative Book
NU4020, The Outdoor Book
NU4030, The Basics Book



National Toll-Free:
800-43-SATCO
(800-437-2826)
www.satco.com

Copyright © 2017
Satco Products, Inc
All Rights Reserved.
3/17 SA1297-7



Distribution Centers:

FLORIDA
900 N.W. 159th Dr.
Miami, FL 33169
PH 305-624-2044
FX 305-623-0286

CALIFORNIA
31288 San Benito St.
Hayward, CA 94544
PH 510-487-4822
FX 510-487-8955

WASHINGTON
4710 116th St. S.W.
Mukilteo, WA 98275
PH 425-789-3300
FX 425-789-3310

TEXAS
2000 Valwood Pkwy.
Farmers Branch, TX
75234
PH 972-247-2437
FX 972-247-5408

PUERTO RICO
Campeche St. 23
Julio N. Matos
Industrial Park,
Carolina, PR 00984
PH 787-757-3510
FX 787-757-3540

**Corporate Offices and
Distribution Center:**

NEW YORK
110 Heartland Blvd.
Brentwood, NY 11717
PH 631-243-2022
FX 631-243-2027