

Safety and Disconnect Switches

Industrial Controls Product Catalog 2017

contents

Heavy Duty Enclosed Safety Switches

Features and Benefits	18/2
240V Selection	18/3
600V Selection	18/4 - 18/5
Switches with Viewing Window	18/6
4-Pole and 6-Pole Switches	18/7
Interlocked Receptacle Switches	18/8
Type VBII Non-Metallic & 316 Grade Stainless Steel	18/9
Enclosed Solar Photovoltaic (PV) Switches	18/10
Accessories	18/11 - 18/13
Rotary Disconnect Switches in Non-Metallic Enclosures	18/14 - 18/15

Open Disconnect Switches

Compact Non-Fusible — Rotary and Toggle (LBR)	18/16
Compact Non-Fusible — Rotary and Toggle (3LD)	18/17 - 18/19
Type VBII (30-600A) with Flange Mounted Operating Handle	18/20
Type VBII Switch, Handle and Linkage Kit Selection	18/21
Accessories Type VBII	18/22 - 18/24
Type MCS (30-200A) — Switches, Fuse and No Fuse Kits	18/25 - 18/26
Type CFS Compact Fusible Switches	18/27 - 18/30

Heavy Duty Safety Switch Standards and Ratings

Standards

- UL98 approved per file #E4776
- Suitable for use as service entrance equipment (where applicable)
- Meets NEMA standard KS-1-1990 for Type HD switches
- Seismic qualification – all switches have been tested and comply with the 2007 California Building Code CBC (Zone 4)

Ratings

- 30-1200A, 240V and 600V AC and DC
- 2, 3, 4 and 6 pole fusible and non-fusible
- All HD safety switches are both HP and load break rated
- Enclosures are available to meet NEMA 1, 3R, 12 & 4/4X requirements

Safety Switch AIC Ratings When Protected by Fuses

- 30-600A – 10,000 AIC with Class H fuses
- 30-600A – 200,000 AIC with Class R, J or T fuses
- 800 & 1200A – 200,000 AIC with Class L or T fuse

Fuse Provisions supplied in fusible switches

- 30 & 60A 240V – Class H standard, Class R with kit
- 100-600A 240V – Class H standard, Class J by moving load base, Class R with kit
- 30-600A 600V - Class H standard, Class J by moving load base, Class R with kit
- 100 & 200A - Class T with kit
- 400 & 600A - Class H standard, Class J & T by moving load base, Class R with kit
- 800A – Class L standard, Class T by moving load base
- 1200A – Class L standard, Class T with kit (240V max)

Non-Fusible Safety Switch AIC Ratings When Protected by a Circuit Breaker^{①②}

Breaker Frame	Non-Fused Switch	UL Listed Short Circuit Current Rating
NEG, NGB, ED4	30 DT (240V)	18 kA Thru 240 VAC
NEB, NEG, NGG, NGB, ED4	60-100A GD & DT (240V)	18 kA Thru 240 VAC
NEB, NEG, NGG, NGB, ED4	30-100A HD & DT (600V)	18 kA Thru 480 VAC
ED6	30-100A HD & DT (600V)	18 kA Thru 600 VAC
FD6-A, JD6-A	200A HD & DT (600V)	18 kA Thru 600 VAC
JD6-A, LD6-A	400A GD & DT (240V)	18 kA Thru 240 VAC
JD6-A, LD6-A	400A HD & DT (600V)	18 kA Thru 600 VAC
LD6-A	600A GD & DT (240V)	25kA Thru 240 VAC
LD6-A	600A HD & DT (600V)	25kA Thru 600 VAC
NNG	1200A HD & DT (600V)	25 kA Thru 600 VAC

① All switches above are rated at 10 KA when protected by any UL Listed CB
 ② Circuit breaker trip rating must not exceed switch ampere rating

Heavy Duty Safety Switches

Features

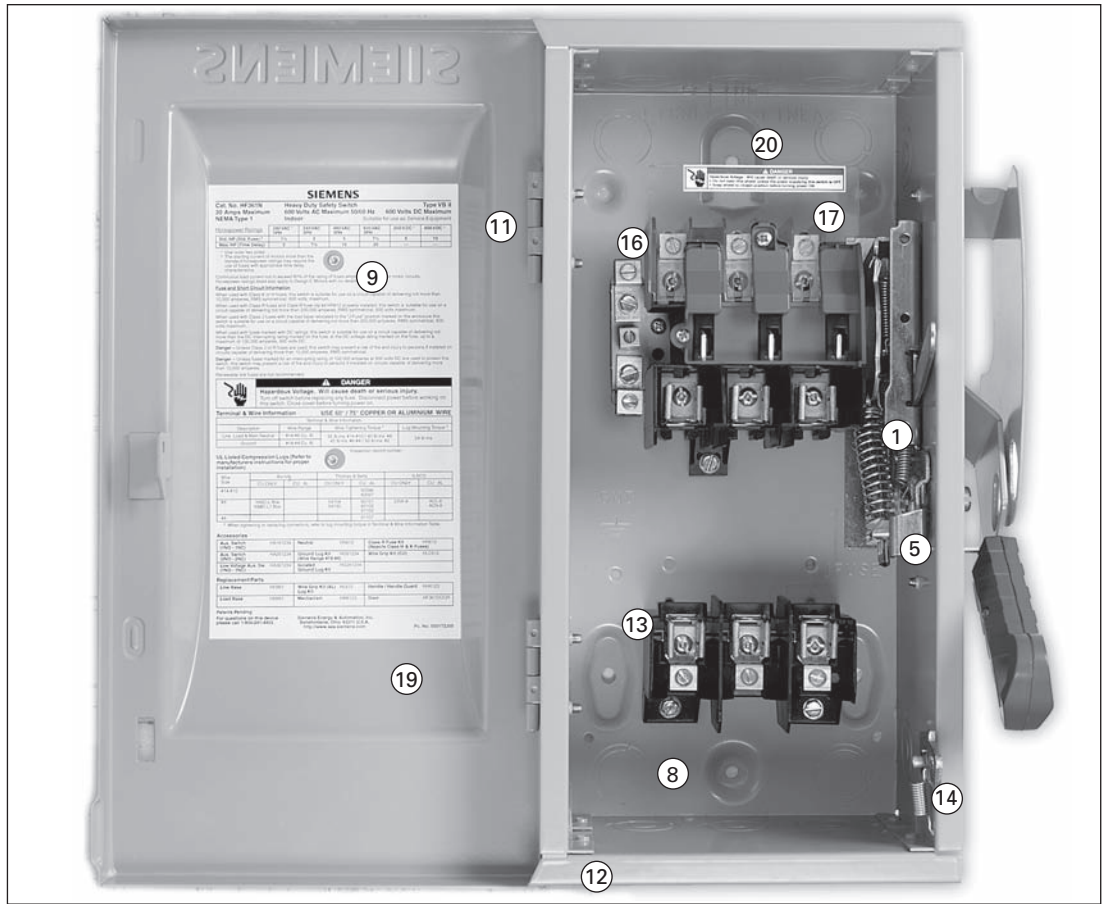
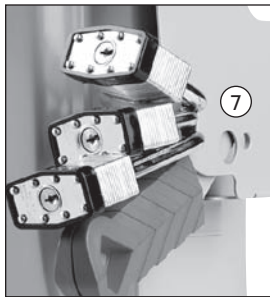
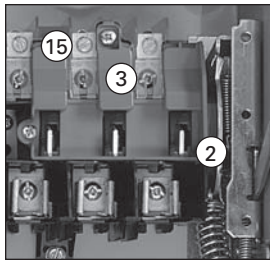

1. Quick-make, quick-break operating mechanism that ensures positive operation.
2. Visible blade, double-break switching action.
3. Arc chutes dissipate heat and prolong switch life.
4. Highly visible red handle grip. Designed for hook stick operation.
5. Defeatable dual cover interlock.
6. Center punch provided for field drilling to allow ON padlocking.
7. Handle can be padlocked in the OFF position with up to (3) padlocks with 5/16" hasps.
8. Generous top, bottom and side gutters that meet or exceed NEC wire-bending space requirements.
9. Informative door labeling which includes replacement parts list.
10. Tangential knockouts through 600A for easy conduit lineup.
11. Side-hinged door that opens past 180 degrees for easier wiring.
12. Unique enclosure design increases rigidity and prevents cuts and scrapes to conductors and installer's hands.
13. Spring reinforced fuse clips that assure reliable contact for cool operation.
14. Door latch securely holds door closed and allows cover padlocking.
15. Front removable mechanical lugs that are suitable for CU/Al 60 or 75° C conductors.
16. Lugs are field convertible to copper body and to a wide variety of compression connectors.
17. Hinged clear line terminal shield with probe holes for inspecting or testing line side terminals.
18. Embossed aluminum nameplate on Heavy Duty Switches provides highly visible ON/OFF indication.
19. Drawn cover for increased rigidity and resistance to abuse.
20. Top key hole and bottom mounting holes provide easy 2 or 3 point mounting.

Heavy Duty Safety Switches

Selection



System	Ampere Rating	Indoor — Type 1		Outdoor — Type 3R		Horsepower Rating ^①					
		Catalog Number	Ship Wt. (lbs.) Std. Pkg	Catalog Number	Ship Wt. (lbs.) Std. Pkg	240V AC				250 Volt DC	
						1-Phase, 2-Wire	2-Phase, 4-Wire	3-Phase, 3-Wire			
Std.	Max.	Std.	Max.	Std.	Max.	Std.	Max.	Std.			

240 Volt Fusible^⑤

2-Pole, 2-Fuse, and Solid Neutral^③ (Also used for 2-Pole, 2-Wire Applications) 240 Volt AC/250 Volt DC

Ampere Rating	Indoor Type 1 Catalog Number	Indoor Type 1 Ship Wt. (lbs.) Std. Pkg	Outdoor Type 3R Catalog Number	Outdoor Type 3R Ship Wt. (lbs.) Std. Pkg	1-Phase, 2-Wire Std.	1-Phase, 2-Wire Max.	2-Phase, 4-Wire Std.	2-Phase, 4-Wire Max.	3-Phase, 3-Wire Std.	3-Phase, 3-Wire Max.	250 Volt DC Std.
30	HF221N	12	HF221NR	13	1½	3	—	—	3	7½	5
60	HF222N	18	HF222NR	19	3	10	—	—	7½	15	10
100	HF223N	23	HF223NR	24	7½	15	—	—	15	30	20
200	HF224N	47	HF224NR	48	15	—	—	—	25	60	40
400	HF225NA	91.1	HF225NRA	91.1	15	—	—	—	50	125	50
600	HF226NA	95.6	HF226NRA	95.6	15	—	—	—	75	200	50
800	HF227N	365	HF227NR	365	—	—	—	—	100	250	50
1200	HF228N■	385	HF228NR■	385	—	—	—	—	100	250	50

3-Pole, 3-Fuse, and Solid Neutral (Also used for 3-Pole, 3-Wire Applications) 240 Volt AC/250 Volt DC

Ampere Rating	Indoor Type 1 Catalog Number	Indoor Type 1 Ship Wt. (lbs.) Std. Pkg	Outdoor Type 3R Catalog Number	Outdoor Type 3R Ship Wt. (lbs.) Std. Pkg	1-Phase, 2-Wire Std.	1-Phase, 2-Wire Max.	2-Phase, 4-Wire Std.	2-Phase, 4-Wire Max.	3-Phase, 3-Wire Std.	3-Phase, 3-Wire Max.	250 Volt DC Std.
30	HF321N	14	HF321NR	15	1½	3	—	—	3	7½	5
60	HF322N	19	HF322NR	20	3	10	—	—	7½	15	10
100	HF323N	25	HF323NR	26	7½	15	—	—	15	30	20
200	HF324N	49	HF324NR	50	15	—	—	—	25	60	40
400	HF325NA	94.6	HF325NRA	94.6	15	—	—	—	50	125	50
600	HF326NA	99.6	HF326NRA	99.6	15	—	—	—	75	200	50
800	HF327N	375	HF327NR	375	—	—	—	—	100	250	50
1200	HF328N	395	HF328NR	388	—	—	—	—	100	250	50

240 Volt Fusible^⑤

2-Pole, 2-Fuse^④ 240 Volt AC/250 Volt DC

Ampere Rating	Type 4/4X Stainless ^②		Type 12 Industrial ^⑥		1-Phase, 2-Wire Std.	1-Phase, 2-Wire Max.	2-Phase, 4-Wire Std.	2-Phase, 4-Wire Max.	3-Phase, 3-Wire Std.	3-Phase, 3-Wire Max.	250 Volt DC Std.
	Catalog Number	Ship Wt. (lbs.) Std. Pkg	Catalog Number	Ship Wt. (lbs.) Std. Pkg							
30	HF221S	13	HF221J	13	1½	3	—	—	3	7½	5
60	HF222S	19	HF222J	19	3	10	—	—	7½	15	10
100	HF223S	24	HF223J	24	7½	15	—	—	15	30	20
200	HF224S	48	HF224J	48	15	—	—	—	25	60	40

3-Pole, 3-Fuse^④ (Also used for 2-Pole, 2-Wire Applications in 400–800A Ratings) 240 Volt AC/250 Volt DC

Ampere Rating	Indoor Type 1 Catalog Number	Indoor Type 1 Ship Wt. (lbs.) Std. Pkg	Outdoor Type 3R Catalog Number	Outdoor Type 3R Ship Wt. (lbs.) Std. Pkg	1-Phase, 2-Wire Std.	1-Phase, 2-Wire Max.	2-Phase, 4-Wire Std.	2-Phase, 4-Wire Max.	3-Phase, 3-Wire Std.	3-Phase, 3-Wire Max.	250 Volt DC Std.
30	HF321S	14	HF321J	14	1½	3	—	—	3	7½	—
60	HF322S	20	HF322J	20	3	10	—	—	7½	15	10
100	HF323S	25	HF323J	25	7½	15	—	—	15	30	20
200	HF324S	49	HF324J	49	15	—	—	—	25	60	40
400	HF325SA	93	HF325JA	93	15	—	—	—	50	125	50
400	HF325SSA	93	—	—	15	—	—	—	50	125	50
600	HF326SA	98	HF326JA	98	15	—	—	—	75	200	50
600	HF326SSA	98	—	—	15	—	—	—	75	200	50
800	HF327S■	370	HF327J■	365	—	—	—	—	100	250	50

■ Built to order. Allow 3-5 weeks for delivery.

① Height reduced switch (45.25 rather than 56 inches in height) for use with 500MCM or smaller conductors.

② Dual horsepower ratings: Std.- applies when non-time delay fuses are installed. Max.- applies when time-delay fuses are installed.

③ These switches are UL-listed for application on grounded B-phase systems and are suitable for 3-phase motor applications.

④ When a neutral is required use a field installed neutral kit.

⑤ Suitable for use as service entrance equipment.

⑥ Also rated Type 3S/3R.

⑦ 304 grade stainless steel. For switches with enclosures constructed from 316 grade stainless steel, see page 18/9.

Heavy Duty Safety Switches

Selection



System	Ampere Rating	Indoor — Type 1		Outdoor — Type 3R		Horsepower Rating [Ⓞ]								250 Volt DC	600 Volt DC
		Catalog Number	Ship Wt. (lbs.) Std. Pkg	Catalog Number	Ship Wt. (lbs.) Std. Pkg	480V AC		600V AC							
						1-Phase, 2-Wire	3-Phase, 3-Wire	1-Phase, 2-Wire	3-Phase, 3-Wire	Std.	Max.	Std.	Max.		

600 Volt Fusible[Ⓞ]

2-Pole, 2-Fuse[Ⓞ]

Ampere Rating	Catalog Number	Ship Wt. (lbs.) Std. Pkg	Catalog Number	Ship Wt. (lbs.) Std. Pkg	480 Volt AC/600 Volt AC/600 Volt DC									
					1-Phase, 2-Wire	3-Phase, 3-Wire	1-Phase, 2-Wire	3-Phase, 3-Wire	Std.	Max.	Std.	Max.		
30	HF261	15	HF261R	15	3	7½	—	—	3	10	—	—	5	15
60	HF262	20	HF262R	20	5	20	—	—	10	25	—	—	10	30
100	HF263	26	HF263R	27	10	30	—	—	15	40	—	—	20	50

3-Pole, 3-Fuse

Ampere Rating	Catalog Number	Ship Wt. (lbs.) Std. Pkg	Catalog Number	Ship Wt. (lbs.) Std. Pkg	480 Volt AC/600 Volt AC/250 Volt DC [Ⓢ]									
					1-Phase, 2-Wire	3-Phase, 3-Wire	1-Phase, 2-Wire	3-Phase, 3-Wire	Std.	Max.	Std.	Max.		
30	HF361	14	HF361R	15	3	7½	5	15	3	10	7½	20	5	—
30	HF361L [Ⓢ]	19	HF361RL [Ⓢ]	20	3	7½	5	15	3	10	7½	20	5	—
60	HF362	19	HF362R	20	5	20	15	30	10	25	15	50	10	30 [Ⓢ]
60	—	—	HF362RL [Ⓢ]	25	5	20	15	30	10	25	15	50	10	30 [Ⓢ]
100	HF363	24	HF363R	25	5	20	25	60	15	40	30	75	20	50 [Ⓢ]
200	HF364	48	HF364R	49	25	50	50	125	30	50	60	150	40	50
400	HF365A [Ⓢ]	93	HF365RA [Ⓢ]	157	—	—	100	250	—	—	125	350	50	—
600	HF366A [Ⓢ]	98	HF366RA [Ⓢ]	161	—	—	150	400	—	—	200	500	50	—
800	HF367	365	HF367R	365	—	—	200	500	—	—	250	500	50	—
1200	HF368	383	HF368R	385	—	—	200	500	—	—	250	500	50	—

3-Pole, 3-Fuse and Solid Neutral

Ampere Rating	Catalog Number	Ship Wt. (lbs.) Std. Pkg	Catalog Number	Ship Wt. (lbs.) Std. Pkg	480 Volt AC/600 Volt AC/250 Volt DC [Ⓢ]									
					1-Phase, 2-Wire	3-Phase, 3-Wire	1-Phase, 2-Wire	3-Phase, 3-Wire	Std.	Max.	Std.	Max.		
30	HF361N	14	HF361NR	15	3	7½	5	15	3	10	7½	20	5	—
60	HF362N	19	HF362NR	20	5	20	15	30	10	25	15	50	10	30 [Ⓢ]
100	HF363N	25	HF363NR	26	10	30	25	60	15	40	30	75	20	50 [Ⓢ]
200	HF364N	49	HF364NR	50	25	50	50	125	30	50	60	150	40	50
400	HF365NA	94.6	HF365NRA	94.6	—	—	100	250	—	—	125	350	50	—
600	HF366NA	99.6	HF366NRA	99.6	—	—	150	400	—	—	200	500	50	—
800	HF367N	375	HF367NR	375	—	—	250	500	—	—	250	500	50	—
1200	HF368N	395	HF368NR	388	—	—	250	500	—	—	250	500	50	—

600 Volt Fusible[Ⓞ] (For 2-Pole Applications use outside poles of 3-Pole Switches)

2-Pole, 2-Fuse[Ⓞ]

Ampere Rating	Type 4/4X Stainless [Ⓞ]		Type 12 Industrial [Ⓞ]		480 Volt AC/600 Volt AC/600 Volt DC									
	Catalog Number	Ship Wt. (lbs.) Std. Pkg	Catalog Number	Ship Wt. (lbs.) Std. Pkg	1-Phase, 2-Wire	3-Phase, 3-Wire	1-Phase, 2-Wire	3-Phase, 3-Wire	Std.	Max.	Std.	Max.		
30	HF261S	15	HF261J■	15	3	7½	—	—	3	10	—	—	5	15
60	HF262S	20	HF262J■	20	5	20	—	—	10	25	—	—	10	30
100	HF263S■	27	HF263J■	27	10	30	—	—	15	40	—	—	20	50

3-Pole, 3-Fuse

Ampere Rating	Catalog Number	Ship Wt. (lbs.) Std. Pkg	Catalog Number	Ship Wt. (lbs.) Std. Pkg	480 Volt AC/600 Volt AC/250 Volt DC [Ⓢ]									
					1-Phase, 2-Wire	3-Phase, 3-Wire	1-Phase, 2-Wire	3-Phase, 3-Wire	Std.	Max.	Std.	Max.		
30	HF361S	13	HF361J	14	—	—	5	15	—	—	7½	20	5	—
60	HF362S	20	HF362J	20	—	—	15	30	—	—	15	50	10	30 [Ⓢ]
100	HF363S	25	HF363J	25	—	—	25	60	—	—	30	75	20	50 [Ⓢ]
200	HF364S	49	HF364J	49	—	—	50	125	—	—	60	150	40	50
400	HF365SA [Ⓢ]	93	HF365JA [Ⓢ]	93	—	—	100	250	—	—	125	350	50	—
400	HF365SSA	93	—	—	—	—	100	250	—	—	125	350	50	—
600	HF366SA [Ⓢ]	98	HF366JA [Ⓢ]	98	—	—	150	400	—	—	200	500	50	—
600	HF366SSA	98	—	—	—	—	150	400	—	—	200	500	50	—
800	HF367S	370	HF367J■	365	—	—	200	500	—	—	250	500	50	—
1200	HF368S■	388	HF368J■	388	—	—	250	500	—	—	250	500	50	—

■ Built to order. Allow 3-5 weeks for delivery.
 Ⓢ 60-600A 3-Pole switches are also rated 600V DC.
 Ⓞ Height reduced switch (45.25 rather than 56 inches in height) for use with 500MCM or smaller conductors.
 Ⓢ Use 3-Pole switch for 200A applications.
 Ⓢ Dual horsepower ratings: Std.- applies when non-time delay fuses are installed. Max.- applies when time-delay fuses are installed.
 Ⓢ Suitable for use as service entrance equipment except on 1200 Amp solidly grounded wye systems per NEC 230.95.
 Ⓢ Also rated Type 3S/3R.
 Ⓢ Indicates oversized enclosure (30A switch with 60A lugs in a 60A enclosure or 60A switch with 100A lugs in a 100A enclosure).
 Ⓢ 600V DC & 600V DC horsepower rating shown requires (2) poles to be connected in series.
 Ⓢ 304 grade stainless steel. For switches with enclosures constructed from 316 grade stainless steel, see page 18/9.

Heavy Duty Safety Switches

Selection



System	Ampere Rating	Indoor — Type 1		Outdoor — Type 3R		Horsepower Rating							
		Catalog Number	Ship Wt. (lbs.)	Catalog Number	Ship Wt. (lbs.)	240 Volt		480 Volt		600 Volt		250V DC	600V DC
						1-Phase	3-Phase	1-Phase	3-Phase	1-Phase	3-Phase		

600 Volt Non-Fusible^④

2-Pole ^③						480 Volt AC / 600 Volt AC / 600 Volt DC							
	30	HNF261	12	HNF261R	13	—	—	7½	—	10	—	5	15
	60	HNF262	19	HNF262R	20	—	—	20	—	25	—	10	30
	100	HNF263	24	HNF263R	25	—	—	30	—	40	—	20	50

3-Pole 480 Volt AC / 600 Volt AC / 250 Volt DC

	30	HNF361	12	HNF361R	13	5	10	7½	20	10	30	5	—
	30	—	—	HNF361RL ^⑥	19	5	10	7½	20	10	30	5	—
	60	HNF362H ^②	11	HNF362RH ^②	11	10	20	20	50	20	40	10	—
	60	HNF362 ^①	18	HNF362R ^①	19	10	20	20	50	25	60	10	30 ^②
	60	—	—	HNF362RL ^⑥	24	10	20	20	50	25	60	10	30 ^②
	100	HNF363 ^①	23	HNF363R ^①	24	15	40	30	75	40	100	20	50 ^②
	200	HNF364 ^①	46	HNF364R ^①	47	15	60	50	125	50	150	40	50
	400	HNF365A ^①	75	HNF365RA ^①	75	15	125	50	250	50	350	50	—
	600	HNF366A ^①	77	HNF366RA ^①	77	15	200	50	400	50	500	50	—
	800	HNF367	295	HNF367R	295	15	250	50	500	50	500	50	—
1200	HNF368	305	HNF368R	307	15	250	50	500	50	500	50	—	

600 Volt Non-Fusible^④

2-Pole ^③						480 Volt AC / 600 Volt AC / 600 Volt DC							
	Ampere Rating	Type 4 / 4X Stainless ^⑥		Type 12 Industrial ^⑤		240V	480V	600V	250V DC	600V DC	250V DC	600V DC	
		Cat. No.	Ship Wt.	Cat. No.	Ship Wt.								
30	HNF261S	13	HNF261J	13	—	—	7½	—	10	—	5	15	
60	HNF262S	20	HNF262J	20	—	—	20	—	25	—	10	30	
100	HNF263S■	25	HNF263J■	25	—	—	30	—	40	—	20	50	

3-Pole 480 Volt AC / 600 Volt AC / 250 Volt DC

	30	HNF361S	13	HNF361J	13	5	10	7½	20	10	30	5	—
	60	HNF362SH ^②	15	HNF362JH ^②	14	10	20	20	50	20	40	10	—
	60	HNF362S ^①	19	HNF362J ^①	19	10	20	20	50	25	60	10	30 ^②
	100	HNF363S ^①	24	HNF363J ^①	24	15	40	30	75	40	100	20	50 ^②
	200	HNF364S ^①	47	HNF364J ^①	47	15	60	50	125	50	150	40	50
	400	HNF365SA ^①	75	HNF365JA ^①	75	15	125	50	250	50	350	50	—
	400	HNF365SSA	75	—	—	15	125	50	250	50	350	50	—
	600	HNF366SA ^①	77	HNF366JA ^①	77	15	200	50	400	50	500	50	—
	600	HNF366SSA	77	—	—	15	200	50	400	50	500	50	—
	800	HNF367S	295	HNF367J■	295	15	250	50	500	50	500	50	—
1200	HNF368S■	310	HNF368J■	310	15	250	50	500	50	500	50	—	

■ Built to order. Allow 3-5 weeks for delivery.

① 60-600A 3-Pole switches are also rated 600V DC.

② Compact switch (11.1"H, 6.6"W box less cover and handle).

Short circuit withstand rating—100,000 RMS sym. amps.

③ Use 3-Pole switch for 200A application.

④ Suitable for use as service entrance equipment except for 1200 when used on a 480 or 600V grounded wye system.

⑤ Also rated type 3S / 3R.

⑥ Indicates oversized enclosure (30A switch in a 60A enclosure or a 60A switch in a 100A enclosure).

⑦ 600V DC and 600V DC horsepower rating shown requires (2) poles to be connected in series.

⑧ 304 grade stainless steel. For switches with enclosures constructed from 316 grade stainless steel, see page 18/9.

Heavy Duty Safety Switches

Type 3R, 4/4X, & 12 with Viewing Window

Description







30–600A, 3-pole 600V max. in fusible and non-fusible versions in Type 4/4X stainless steel and Type 12 enclosures.

All allow viewing of visible blade position. 30–200A also allow viewing of indicating type fuses.

Features

- Rugged installer-friendly enclosure design features a gasket flange with continuously welded seams
- Tool-free cover latches
- Two, three and four point mounting
- Metal handle with large insulating grip features a positive stop in both ON and OFF position
- Ground lugs provided as standard
- Type 12 enclosures are fabricated from galvanized steel and are also rated for 3R/3S outdoor applications
- Type 4X stainless steel switches (30–200A) are provided with stainless steel interior parts
- The widest range of accessories available including 200% neutrals, gold plated PLC auxiliary contacts and isolated ground kits



System	Ampere Rating	Catalog Number	Ship Wt. (lbs.)	Maximum Horsepower Rating ^②					
				240V AC		480V AC	600V AC	250V DC	600V DC
				1-Phase, 2-Wire	3-Phase, 3-Wire	3-Phase, 3-Wire	3-Phase, 3-Wire	—	—
3-Pole, 3-Wire Fusible, Type 3R^④				600 Volt AC / 250 Volt DC^①					
	30 60	HF361RW HF362RW	17 22	3 10	7½ 15	15 30	20 50	5 10	— 30 ^⑤
3-Pole, 3-Wire Non-Fusible, Type 3R^④				600 Volt AC / 250 Volt DC^①					
	30 60	HNF361RW HNF362RW	14 21	3 10	10 20	20 50	30 60	5 10	— 30 ^⑤
3-Pole, 3-Wire Fusible, Type 12^{③④}				600 Volt AC / 250 Volt DC^①					
	30 60 100 200 400 600	HF361JW HF362JW HF363JW HF364JW HF365JWA HF366JWA	17 22 26 53 93 98	3 10 15 — — —	7½ 15 30 60 125 200	15 30 60 125 250 400	20 50 75 150 350 500	5 10 20 40 50 50	— 30 ^⑤ 50 ^⑤ 50 — —
3-Pole, 3-Wire Non-Fusible, Type 12^{③④}				600 Volt AC / 250 Volt DC^①					
	30 60 100 200 400	HNF361JW HNF362JW HNF363JW HNF364JW HNF365JWA	14 21 25 51 75	3 10 15 15 15	10 20 40 60 125	20 50 75 125 250	30 60 100 150 350	5 10 20 40 50	— 30 ^⑤ 50 ^⑤ 50 —
3-Pole, 3-Wire Fusible, Type 4X Stainless Steel^{④⑥}				600 Volt AC / 250 Volt DC^①					
	30 60 100 200 400 400	HF361SW HF362SW HF363SW HF364SW HF365SWA HF365SSWA	17 23 28 55 75 75	3 10 15 — 15 15	7½ 15 30 60 125 125	15 30 60 125 250 250	20 50 75 150 350 350	5 10 20 40 50 50	— 30 ^⑤ 50 ^⑤ 50 — —
3-Pole, 3-Wire Non-Fusible, Type 4X Stainless Steel^{④⑥}				600 Volt AC / 250 Volt DC^①					
	30 60 100 200 400 400	HNF361SW HNF362SW HNF363SW HNF364SW HNF365SWA HNF365SSWA	15 23 27 54 75 75	3 10 15 15 15 15	10 20 40 60 125 125	20 50 75 125 250 250	30 60 100 150 350 350	5 10 20 40 50 50	— 30 ^⑤ 50 ^⑤ 50 — —

① 200A switches are also rated 600V DC.

② Maximum HP ratings listed apply only when time delay fuses are used.

③ Also rated 3S/3R for outdoor use.

④ All switches are suitable for use as service entrance equipment. Use outside poles of 3-pole switch for 2-pole application.

⑤ 600V DC and 600V DC horsepower rating shown requires (2) poles to be connected in series.

⑥ 304 grade stainless steel. For switches with enclosures constructed from 316 grade stainless steel, see page 18/9.

Heavy Duty Safety Switches

Type VBII 4 & 6 Pole – Heavy Duty Safety Switches

Application

4 & 6-pole Switches are commonly used as a disconnecting means for two-speed, two-winding motors. Fused switches provide both over current and short circuit protection. Non-fusible switches normally provide a local disconnection means for two-speed motors which are remote from their motor controller. 4-pole switches are also used in 3-phase, 4-wire circuits when a switching neutral is required. All 4 & 6-pole switches are service entrance rated.

Description

4 & 6-pole switches are available in 30-200A ratings and in both fusible and non-fusible versions. 4-pole switches are supplied with either Type 1 or Type 12/3R enclosures. 6-pole switches are available with either Type 12/3R or Type 4X stainless steel enclosures.

Standards

- UL & CUL listed under file #E4776
- Meets UL98 for enclosed switches
- 4 & 6-Pole switches are suitable for use as service entrance
- Meets NEMA Standard KS-1 for enclosed switches
- Meets NEC wire bending space requirements

Features

- Visible blade, double break switching action
- Highly visible ON/OFF indication
- Defeatable dual cover interlock
- Padlock option in OFF position
- All copper current carrying parts^①
- Tangenital knockouts (Type 1, 4-pole switches)



HNF662J

4-Pole Type VBII Switches^{①②}

System	Amp Rating	Indoor Type 1		Type 12/3R Industrial ^③		Horsepower Ratings ^③								
		Catalog Number	Ship Wt. (lbs.)	Catalog Number	Ship Wt. (lbs.)	240V, 2Ø, 4W		240V 3Ø		480V, 3Ø		600V, 3Ø		250V DC
						Std.	Max.	Std.	Max.	Std.	Max.	Std.	Max.	

Fusible 600 Volt AC, 250 Volt DC — 4-Pole, 4 Fuse^④

	30	HF461	36	HF461J	36	3	10	3	7½	5	15	7½	20	5
	60	HF462	40	HF462J	40	7½	20	7½	15	15	30	15	50	10
	100	HF463	43	HF463J	43	15	30	15	30	25	60	30	75	20
	200	HF464	88	HF464J	88	25	50	25	60	50	125	60	150	40

Non-fusible 600 Volt AC, 250 Volt DC — 4-Pole

	30	HNF461	32	HNF461J	32	—	10	—	10	—	20	—	30	5
	60	HNF462	34	HNF462J	34	—	20	—	20	—	50	—	60	10
	100	HNF463	36	HNF463J	36	—	30	—	40	—	75	—	100	20
	200	HNF464	78	HNF464J	78	—	50	—	60	—	125	—	150	4

6-Pole Type VBII Switches^{①②⑤}

System	Amp Rating	Type 12/3R Industrial		Type 4X Stainless Steel		Horsepower Ratings ^③							
		Catalog Number	Ship Wt. (lbs.)	Catalog Number	Ship Wt. (lbs.)	240V 3Ø		480V, 3Ø		600V, 3Ø		250V DC	
						Std.	Max.	Std.	Max.	Std.	Max.		

Fusible 600 Volt AC, 250 Volt DC — 6-Pole, 6 Fuse^④

	30	HF661J	37	HF661S	37	3	7½	5	15	7½	20	5
	60	HF662J	41	HF662S	41	7½	15	15	30	15	50	10
	100	HF663J	44	HF663S	44	15	30	25	60	30	75	20
	200	HF664J	90	HF664S	90	25	60	50	125	60	150	40

Non-fusible 600 Volt AC, 250 Volt DC — 6-Pole

	30	HNF661J	33	HNF661S	33	—	10	—	20	—	30	5
	60	HNF662J	35	HNF662S	35	—	20	—	50	—	60	10
	100	HNF663J	37	HNF663S	37	—	40	—	75	—	100	20
	200	HNF664J	80	HNF664S	80	—	60	—	125	—	150	40

■ Built to order. Allow 3-5 weeks for delivery.

① Lugs are aluminum alloy as standard. Optional copper body lugs are available.

② All 4 & 6-pole VBII switches are suitable for use as service equipment when a neutral is installed or equipment ground kit is properly connected.

③ Dual horsepower ratings: Std. – applies when non-time-delay fuses are installed. Max. – applies when time delay fuses are installed.

④ Fusible switches accept Class H Fuses as the standard. Class R & J fuses can also be installed and increase the rating from 10,000 to 200,000 AIC. For

Class J, the load base is moved upward. For Class R fuses, rejection kits are required.

⑤ Supplied with factory installed ground lugs.

Heavy Duty Safety Switches

Special Application Switches / Interlocked Receptacle Switches

Application

Receptacle Safety Switches provide cord connection protection of heavy-duty portable equipment (welders, infrared ovens, batch feeders, portable conveyors, assembly line fixtures and tools, refrigerator trucks, etc.) under load or fault conditions.

Standards

All receptacle switches are UL listed under file #E4776. Those with a viewing window are also CSA certified under file #1079316.

Description^{①②}

Type 12 and 4/4X Receptacle Safety Switches are available with 3-phase, 4-wire grounded type Crouse-Hinds Arkite™ 2 or Pyle-National receptacle, pre-wired and mounted with interlock linkage to the switch mechanism. Insertion or removal of the plug is prevented by the interlock linkage while the switch is in the "ON" position. Receptacle prevents operation of switch if incorrect plug is inserted.



HF362JCH

Crouse-Hinds Interlocked Receptacle Switches

Ampere Rating ^③	Type 12 ^⑤	Type 4/4X ^⑥	Shipping Wt. (lbs.) Std. Pkg.	Accepts Crouse-Hinds Arkite [®] Plug Catalog Number
	Catalog Number	Catalog Number		

240V Fusible, 3-Pole, 3-Wire

30	HF321JCH	HF321SCH▲	23	APJ3485 & NPJ3485
60	HF322JCH	HF322SCH▲	30	APJ6485 & NPJ6485
100	HF323JCH	HF323SCH▲	36	APJ10487 & NPJ10487

600V Fusible, 3-Pole, 3-Wire

30	HF361JCH	HF361SCH	24	APJ3485 & NPJ3485
60	HF362JCH	HF362SCH	30	APJ6485 & NPJ6485
100	HF363JCH	HF363SCH▲	36	APJ10487 & NPJ10487

600V Non-Fusible, 3-Pole, 3-Wire

30	HNF361JCH▲	HNF361SCH▲	22	APJ3485 & NPJ3485
60	HNF362JCH	HNF362SCH	29	APJ6485 & NPJ6485
100	HNF363JCH▲	HNF363SCH▲	35	APJ10487 & NPJ10487

600V Fusible, 3-Pole, 3-Wire with Viewing Window

30	HF361JCHW▲	HF361SCHW▲	24	APJ3485 & NPJ3485
60	HF362JCHW	HF362SCHW	30	APJ6485 & NPJ6485
100	HF363JCHW▲	HF363SCHW▲	36	APJ10487 & NPJ10487

600V Non-Fusible, 3-Pole, 3-Wire with Viewing Window

30	HNF361JCHW▲	HNF361SCHW▲	22	APJ3485 & NPJ3485
60	HNF362JCHW	HNF362SCHW▲	29	APJ6485 & NPJ6485
100	HNF363JCHW▲	HNF363SCHW▲	35	APJ10487 & NPJ10487

Pyle-National Interlocked Receptacle Switches 3-Poles Fusible and Non-Fusible

Ampere Rating		Voltage Rating	Type 12 Catalog Number ^⑤	Type 12 Stainless Steel Catalog Number ^⑥	Shipping Wt. (lbs.) Std. Pkg.	Accepts Pyle-National QuelArc™ ^{②③} Plugs Plug Catalog Number
Switch	Receptacle					
30	30	600 (F)	HF361JPN▲	HF361SPN▲	23	JPD-83046
		600 (N-F)	HNF361JPN	HNF361SPN	21	
60	60	240 (F)	HF322JPN▲	—	28	JPD-116046
		600 (F)	HF362JPN▲	HF362SPN▲	28	
		600 (N-F)	HNF362JPN	HNF362SPN	27	

▲ Built to order. Allow 6–8 weeks for delivery.

⑤ Arkite™ is a registered trademark of the Crouse-Hinds Company. Plugs are not sold or supplied by Siemens.

⑥ Indicates plug with maximum diameter cable bushing.

⑥ QuelArc™ is a registered trademark of the Pyle-National Company.

② Ampere rating of both switch and receptacle.

③ Also rated Type 3R/3S.

④ Enclosure is constructed of Type 304 stainless steel.

Heavy Duty Safety Switches

Special Application Safety Switches / Type VBII Non-Metallic & 316 Grade Stainless Steel

Application

Siemens Non-metallic and 316 grade stainless steel switches provide a superior level of corrosion resistance to assure trouble free performance in the most severe conditions. 316 grade stainless steel provides increased corrosion resistance when compared to 304 grade, especially in atmospheres containing a high level of chlorine commonly encountered in marine and waste management applications. Our non-metallic enclosures are constructed from fiberglass reinforced polyester and are extremely resistant to a wide range

of corrosive atmospheres. They allow a wide range of operating temperatures and their insulating properties virtually eliminate problems caused by internal condensation.

Description

30-200A, 600V Max, fusible and non-fusible switches are available in both non-metallic and 316 grade stainless steel versions. All are supplied with factory installed ground bars as standard. Viewing windows are also available in the stainless offering.



Type 4/4X Non-Metallic

Ampere Rating	Catalog Number	Ship Weight Std. pkg. (lbs.)	Horsepower Rating—3-Phase						250 Volts DC	600 Volts DC
			240 Volt AC		480 Volt AC		600 Volt AC			
			Std.	Max.	Std.	Max.	Std.	Max.		
3-Pole, 4-Wire, 240 Volt Fusible, Type 4X^⑤										
30	HF321NX	21	3	7½	—	—	—	—	5	—
60	HF322NX▲	22	7½	15	—	—	—	—	10	—
3-Pole, 4-Wire, 600 Volt AC Fusible, Type 4X^{②③⑤}										
30	HF361NX	21	3	7½	5	15	7½	20	5	15 ^④
60	HF362NX	22	7½	15	15	30	15	50	10	30 ^④
100	HF363NX▲ ^①	39	15	30	25	60	30	75	20	50 ^④
200	HF364NX▲ ^①	83	25	60	50	125	60	150	40	50
3-Pole, 3-Wire, 600 AC Volt Non-Fusible,^① Type 4X^{②③}										
30	HNF361X	20	—	7½	—	20	—	30	5	15 ^④
60	HNF362X	20	—	15	—	50	—	60	10	30 ^④
100	HNF363X▲	38	—	30	—	75	—	100	20	50 ^④
200	HNF364X▲	81	—	60	—	125	—	150	40	50

Type 4/4X 316 Grade Stainless Steel

Ampere Rating	Standard Catalog Number	With Viewing Window Catalog Number	Ship Weight (lbs.)	Horsepower Rating—3-Phase						250 Volts DC	600 Volts DC
				240 Volt AC		480 Volt AC		600 Volt AC			
				Std.	Max.	Std.	Max.	Std.	Max.		
240V AC, 250V DC Fusible 3-Pole, 3-Wire											
30	HF321SS▲	—	15	3	7½	—	—	—	—	5	—
60	HF322SS▲	—	19	7½	15	—	—	—	—	10	—
100	HF323SS▲	—	27	15	30	—	—	—	—	20	—
200	HF324SS▲	—	48	25	60	—	—	—	—	40	—
600V AC, 250V DC Fusible 3-Pole, 3-Wire^③											
30	HF361SS	HF361SSW	17	3	7½	5	15	7½	20	5	—
60	HF362SS	HF362SSW▲	21	7½	15	10	30	15	50	10	30 ^④
100	HF363SS	HF363SSW▲	28	15	30	25	60	30	75	20	50 ^④
200	HF364SS	HF364SSW▲	54	25	60	50	125	60	150	40	50
600V AC, 250 V DC Non-Fusible 3-Pole, 3-Wire^{①③}											
30	HNF361SS	HNF361SSW	15	—	10	—	20	—	30	5	—
60	HNF362SS	HNF362SSW▲	21	—	20	—	50	—	60	10	30 ^④
100	HNF363SS	HNF363SSW▲	26	—	40	—	75	—	100	20	50 ^④
200	HNF364SS	HNF364SSW▲	51	—	60	—	125	—	150	40	50

▲ Built to order. Allow 6-8 weeks for delivery.

① Also used for 240 volt applications.

② Add "L" to end of catalog number for switches less line & load lugs with mounting hardware for crimp type or copper body lugs.

③ 200A switches are also rated 600V DC max.

④ 600V DC voltage and horsepower rating shown requires (2) poles to be connected in series.

⑤ Supplied with factory installed neutral.

Heavy Duty Safety Switches

Enclosed Solar Photovoltaic (PV) Switches

Application

Solar disconnect switches are designed to be used in the DC portion of photovoltaic power generation circuits. They incorporate powerful magnets within the switch line base which work in combination with a double break switching action to quickly dissipate the very hot arc that is generated when a 600V DC circuit is opened under load. These circuits are defined by article 690 of the NEC which requires the grounded conductor to be at ground potential at all times and therefore cannot be switched.

Description

30-200A switches are available in both Type 1 and 3R enclosures and in both fusible and non-fusible versions. They are provided with an additional door mounted warning label as required by the NEC and are supplied with a factory installed equipment ground bar. They are built to UL98 requirements but are UL listed in file number E335018 as UL1741 photovoltaic disconnect switches. They are 3 pole switches that are approved to switch 3 separate 600V DC circuits (one per pole). The design incorporates

many of the standard VBII switch features including a rolled out enclosure front flange, a large metal operating handle, oversized line and load lugs and large wire gutters. 1000VDC photovoltaic switches are UL98B listed for solar applications and comply with article 690 of the NEC. The new 400-600Amp switches are also UL98B listed at 600VDC and come in NEMA Type 3R.

Solar Photovoltaic Enclosed Disconnect Switches

Ampere Rating	Indoor – Type 1		Outdoor – Type 3R		Rated Isc Per NEC Article 690
	Catalog Number	Ship Wt* Std. Pkg.	Catalog Number	Ship Wt* Std. Pkg.	
Negative Ground 3 Pole 3 Wire Fusible 600Volt DC					
30	HF361PV	14	HF361RPV	15	19.2 A
60	HF362PV	20	HF362RPV	21	38.4 A
100	HF363PV▲	25	HF363RPV	26	64.0 A
200	HF364PV▲	49	HF364RPV	50	128.0 A
Negative Ground 3 Pole 3 Wire Non-Fusible 600Volt DC					
30	HNF361PV	12	HNF361RPV	13	24.0 A
60	HNF362PV	19	HNF362RPV	20	48.0 A
100	HNF363PV▲	24	HNF363RPV	25	80.0 A
200	HNF364PV▲	47	HNF364RPV	48	160.0 A
NEW Positive and Negative Ground, 1 Pole, Fusible 1000 Volt DC					
200	HF1104NPV▲	52	HF1104NRPV▲	53	128.0A
NEW Positive and Negative Ground, 1 Pole, Non-Fusible 1000 Volt DC					
200	HNF1104NPV▲	50	HNF1104NRPV▲	51	160.0A
Positive Ground 3 Pole 3 Wire Fusible 600Volt DC					
30	HF361PVPG	14	HF361RPVPG	15	19.2 A
60	HF362PVPG▲	20	HF362RPVPG	21	38.4 A
100	HF363PVPG▲	25	HF363RPVPG▲	26	64.0 A
200	HF364PVPG▲	49	HF364RPVPG▲	50	128.0 A
Positive Ground 3 Pole 3 Wire Non-Fusible 600Volt DC					
30	HNF361PVPG	12	HNF361RPVPG	13	24.0 A
60	HNF362PVPG▲	19	HNF362RPVPG	20	48.0 A
100	HNF363PVPG▲	24	HNF363RPVPG▲	25	80.0 A
200	HNF364PVPG▲	47	HNF364RPVPG▲	48	160.0 A
NEW Positive and Negative Ground, 2 Wire, 600Volt DC, Type 3R					
Amperage Rating	No. Poles	Fuse Type	Catalog Number	Ship Wt* Std. Pkg	Rated Isc Per NEC Article 690
400A	1	Fusible	HF165NRPV▲	165	256A
400A	1	Non-fusible	HNF165NRPV▲	127	256A
400A	2	Fusible	HF265NRPV▲	325	256A
400A	2	Non-fusible	HNF265NRPV▲	315	256A
600A	1	Fusible	HF166NRPV▲	167	384A
600A	1	Non-fusible	HNF166NRPV▲	129	384A
600A	2	Fusible	HF266NRPV▲	327	384A
600A	2	Non-fusible	HNF266NRPV▲	315	384A

▲ Built to order. Allow 6-8 weeks for delivery.

* In pounds (lbs)

Note: All disconnects are rated at 10,000 AIC per UL requirements when used with or protected by Class K, J or R fuses rated at 600VDC.



HF361PV



HNF361RPV



HF362RPV

Heavy Duty Safety Switches

Accessories



HR612

Class R Fuse Clip Kits

All General Duty and Heavy Duty Switches are field convertible to accept Class R Fuse Clip Kits. The kits prevent the installation of Class H and K fuses (one kit required per 3-pole switch).

Class R Fuse Clip Kits

Catalog Number	Description
GSRK321	30A, 240V Kit (GD only)
HR21	30A, 240V Kit (HD only)
HR612	30A, 600V Kit/60A, 240V Kit
HR62	60A, 600V Kit
HR63	100A Kit
HR64	200A Kit
HR65A	400A Kit
HR66A	600A Kit

Class J Fusing

All 30-600A, 600V and 100-600A, 240V fusible Heavy Duty Switches are field convertible to accept Class J fuses by moving the load base to a pre-drilled J fuse position. All 100-600A, 240V fusible General Duty switches can also be field converted to accept Class J fuses.

Class J Fuse Kits

Catalog Number	Description
HJ66A	600A, 240V/600V Kit

Internal Shield Kits (for fusible switches)

Kits provide a clear plastic inner door to prevent accidental contact with live parts. Test probe holes are provided and fuses can be replaced without removal of kit.

NEW Internal Shield Kits ^②

Switch Ampere Rating	Kit Catalog Number
30A HD	HSK61SSW
60A HD	HSK62SSW
100A HD	HSK63SSW
200A HD	HSK64SSW

▲ Built to order. Allow 6-8 weeks for delivery.

① One kit per pole required.



HT63

Class T Fuse Adapter Kits

All 100-600A, General Duty and 100-200Amp and 1200Amp Heavy Duty Switches are field convertible to accept Class T fuses. 800A switches are field convertible to accept Class T fuses by moving the load base to a pre-drilled T fuse position.

Class T Fuse Adapter Kits^①

Catalog Number	Description
HT23	100A, 240V Kit
HT63	100A, 600V Kit
HT24	200A, 240V Kit
HT64▲	200A, 600V Kit
HT25A	400A, 240V Kit
HT65A	400A, 600V Kit
HT26A	600A, 240V Kit
HT66A	600A, 600V Kit
TFAK82	1200A, 240V Kit



HN612

Neutral Kits

Standard Neutral Kits can be field installed in General and Heavy Duty Switches.

Neutral Kits

Switch Ampere Rating	Kit Catalog Number
30 GD	W410190
30 HD, 60 GD	HN612
60, 100 HD, 100 GD	HN623
200	HN64
400 & 600	HN656A
800 & 1200	HN678

② Not designed for use in Non-metallic 4X safety switches. Not designed for use with Auxiliary Contacts.



HN264

200% Neutral Kits

UL listed 200% Neutrals are available on 100-600A Heavy Duty Switches. They are typically used with non-linear transformers or where increased neutral ampacity/lug capacity is required.

200% Neutral Kits

Switch Ampere Rating	Kit Catalog Number	Wire Range Line & Load Lugs (Cu/Al)
100	HN263	(2) #14-1/0 AWG
200	HN264	(2) #6 AWG-300 Kcmil
400	HN656A	(2) 1/0 AWG-600 Kcmil (2) #6 AWG-300 Kcmil
600	HN678A	(2) 1/0 AWG-600 Kcmil (2) #6 AWG-300 Kcmil

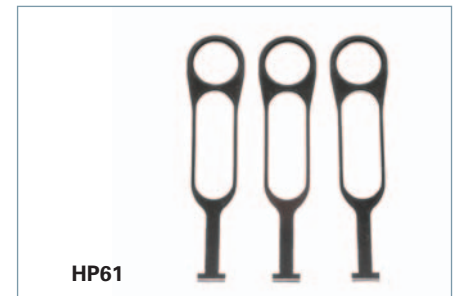

HP61

Fuse Puller Kits

Fuse Puller Kits are field installable in 30-100A Type VBII Heavy Duty Switches (one kit required per 3-pole switch).

Fuse Puller Kits

Switch Ampere Rating	Fuse Puller Kit Catalog Number
30	HP61
60	HP62▲
100	HP63▲

Heavy Duty Safety Switches

Accessories



HA261234



HA261234



HLC612

HG261234

Auxiliary Contacts

Auxiliary Contacts are available only for Heavy Duty Switches. The auxiliary contacts are available in 1 normally open and 1 normally closed or 2 normally open and 2 normally closed configurations. Siemens offers a PLC Auxiliary Switch (30-200A) that has very low resistance for low voltage and current typical in PLC circuits. All auxiliary contacts make after and break before main switch contacts.

Auxiliary Contacts

Switch Ampere	Aux. Switch Catalog Number	Kit Ampere Rating			Horsepower Rating	
		125V AC Max.	250V AC Max.	28V DC Max.	125V AC Max.	250V AC Max.
30-600	HA161234	10	10	7	1/2	3/4
800-1200	HA165678	10	10	—	1/2	3/4

With 1 NO & 1 NC Isolated Contacts

30-600	HA161234	10	10	7	1/2	3/4
800-1200	HA165678	10	10	—	1/2	3/4

With 2 NO & 2 NC Isolated Contacts

30-600	HA261234	10	10	7	1/2	3/4
800-1200	HA265678	10	10	7	1/2	3/4

Low Current PLC Type with 1 NO & 1 NC Gold Plated Contacts

30-600	HA361234	10	10	7	1/2	3/4
800-1200	HA365678	10	10	—	1/2	3/4

Copper Lug Kits

Heavy duty switches are UL approved to accept field installed copper lug kits.

Copper Lug Kits

Switch Ampere Rating	Copper Lug Catalog Number	Description
30-60	HLC612	(9) Lugs/Kit #14-4 AWG Cu
100	HLC63▲	(9) Lugs/Kit #14-1/0 AWG Cu
200	HLC64▲	(9) Lugs/Kit #6 AWG-300 Kcmil Cu
400-600	HCU656A■	(1) Lugs/Kit #1/0 AWG-600 Kcmil Cu
800-1200	HLC65678	(1) Lugs/Kit #1/0 AWG-600 Kcmil Cu

▲ Built to order. Allow 6-8 weeks for delivery.

■ Purchase field replacement kit along with lugs.

NEW Quick Connects

They provide two point control power take-off capability and are normally used on two poles on the line side when it is required to have control power available when the switch is in the OFF position. They provide a mounting provision for standard ¼" quick connect terminal. Installed in the line or load side. 30A VBII switches have lugs UL listed to accept (2) wires per pole as standard so a 30A kit is not required.

Quick Connects

Catalog Number	Description
HCO62	60A 2 wire quick connect kit
HCO63	100A 2 wire quick connect kit
HCO64	200A 2 wire quick connect kit

Isolated Ground Kits

Isolated Ground Kits are available on 30-600A Heavy Duty Switches. They are normally used on circuits with a high content of computer or other electronic loading which require a ground which is isolated from the building ground and neutral circuits. The kit includes both isolated and grounded terminals as listed below.

Isolated Ground Kits

Switch Ampere Rating	Catalog Number	Number of Terminals		Wire Range Per Terminal (Cu/Al)
		Isolated	Grounded	
30-200	HG261234	2	2	#14-4 AWG
400-600	HG2656A	4	4	2/0-14 AWG 2/0-6 AWG

Equipment Ground Kits

Equipment Ground Lug Kits are available for all General and Heavy Duty Switches. They are field installable in Type 1 and Type 3R Switches and are factory installed as standard in Type 4 / 4X and Type 12 and also in all VBII 4&6-pole Switches.

Equipment Ground Kits

Switch Ampere Rating	Catalog Number	Number of Terminals	Wire Range Per Terminal (Cu/Al)
30A GD	GSGK60	2	#14-8 AWG
60-200 GD	HG61234	2	#14-4 AWG
30-200 HD	HG61234	2	#14-4 AWG
400 & 600	HG656A	4	2/0-6 AWG
800-1200	HG678	8	#6 AWG-250 Kcmil

Heavy Duty Safety Switches

Hub and Lug Data

Interchangeable Hubs

Conduit hubs are available for Type 3R, 12 and 4 / 4X applications. 30-200A Type 3R Switches are provided with a conduit hub provision and a removable hub plate on their top rainshed.

Conduit Size (inches)	Catalog Number	Used On
-----------------------	----------------	---------

Type 3R^①

Cover	Catalog Number	Used On
3/4	ECHA000	30A GD Only
1	ECHA075	
1 1/4	ECHA100	
1 1/4	ECHA125	
3/4	ECHS000	60–200A GD 30–200A HD
1	ECHS075	
1	ECHS100	
1 1/4	ECHS125	
1 1/2	ECHS150	
2	ECHS200	
2 1/2	ECHS250	
2 1/2	ECHV250	
3	ECHV300	400–1200A
3 1/2	ECHV350	
4	ECHV400	

Type 4/4X^②

Cover	Catalog Number	Used On
3/4	SSH075	30–200A
1	SSH100	
1 1/4	SSH125	
1 1/2	SSH150	
2	SSH200	
2 1/2	SSH250	400–600A
3	SSH300	
3 1/2	SSH350	
4	SSH400	

Note: 30 thru 200A. Type 3R Switches have removable hub plates on rainshed. 400A and larger Type 3R Switches have no provisions for mounting hubs. Drill or punch hole in the field to accommodate hub size desired.

Field Replacement Kits and Neutral Barrier Kits

All Heavy Duty Switches are field convertible for (Crimp) type lugs. When compression lugs are required for 30-100A switches, a neutral barrier kit is required for 1-Phase, 3W or 3-Phase, 4W applications. When compression lugs are required on 400-1200A switches, lug mounting kits are required.

Field Replacement Kits and Neutral Barrier Kits

Switch Ampere Rating	Catalog Number	Kit Description
30	HCL612	Neutral Barrier Kit
60 & 100	HCL623	Neutral Barrier Kit
400	HCM65A	240V/600V Fusible Kit
400	HNCM65A	240/600V Non-Fusible Kit
600	HCM66A	240V/600V Fusible Kit
600	HNCM66A	240V/600V Non-Fusible Kit
800 & 1200 ^③	HCL65678	1 Pole, Compression Lug Mounting Kit

Lugs

30 & 60A Switches are suitable for use with 60° or 75°C wire. 100–1200A are suitable for use with 75°C rated wire.

Multiple Padlock Accessory

A tamper-proof device to provide for multiple padlocking to meet OSHA or plant requirements. Accepts up to 6 1/4" padlocks. Catalog number **SL0420**. Standard Carton-12.



SSH125

ECHV300

ECHS200

SL0420

■ Built to order. Allow 3-4 weeks for delivery.

- ① Hubs suitable for 3R Switches.
- ② Also suitable for Type 12 applications.
- ③ Neutral Barrier kits are required on 30-100A switches only and only with 1-Phase / 3W or 3-Phase / 4W loads. Compression Lugs mounting kits are required on 400-1200A switches only.
- ④ Provides mounting for a single line or load lug.
- ⑤ Provides mounting for (2) compression lugs per phase on line or load.
- ⑥ Line base lugs (only) are UL approved to accept #14-6 CU/Al cable.
- ⑦ Max. wire size for height reduced switches is 500 kcmil (Cu/Al).
- ⑧ All but 60A GD & Compact HD NF switches are also UL approved for #2 Cu/Al conductors.
- ⑨ All 200A Heavy Duty Switches have a wire range & wire bending space for (1) #6-300 Kcmil (Cu/Al).
- ⑩ Also for 30A oversized heavy duty switches.
- ⑪ Also for 60A oversized heavy duty switches.

Wire Ranges (Line, Load and Standard Neutral)

Switch Ampere Rating	Wire Range with Wire Bending Space Per NEC Requirements	Lug Wire Range
30GD	#14-8 AWG (Cu/Al) ^⑥	#14-6 AWG (Cu/Al)
30HD	#14-6 AWG (Cu/Al)	#14-2 AWG (Cu/Al)
60 ^{⑧⑩}	#14-3 AWG (Cu/Al)	#14-2 AWG (Cu/Al)
100 ^⑩	#14-1/0 AWG (Cu/Al)	#14-1/0 AWG (Cu/Al)
200 ^⑨	#6 AWG-250 Kcmil (Cu/Al)	#6 AWG-300 Kcmil (Cu/Al)
400 ^⑦	(1) 1/0 AWG-600 Kcmil (Cu/Al) (2) 1/0 AWG-500 Kcmil (Cu/Al)	(2) 1/0 AWG-600 Kcmil (Cu/Al)
600 ^⑦	(1) 1/0 AWG-600 Kcmil (Cu/Al) (2) 1/0 AWG-500 Kcmil (Cu/Al)	(2) 1/0 AWG-600 Kcmil (Cu/Al)
800	(3) 1/0 AWG-750 Kcmil (Cu/Al) Line Load (4) 1/0 AWG-750 Kcmil (Cu/Al) neutral	(3) 1/0 AWG-750 Kcmil (Cu/Al) Line Load (4) 1/0 AWG-750 Kcmil (Cu/Al) neutral
1200	(4) 3/0 AWG-750 Kcmil (Cu/Al) Line Load (4) 1/0 AWG-750 Kcmil (Cu/Al) neutral	(4) 1/0 AWG-750 Kcmil (Cu/Al) Line Load (4) 1/0 AWG-750 Kcmil (Cu/Al) neutral

Enclosed Switches

Rotary Disconnect Switches in Non-Metallic Enclosures

Description

16–125A non-fusible switches are available in fiberglass reinforced polycarbonate enclosures which are UL approved as Type 12 & 4X and for either indoor or outdoor use. All are horsepower and load break rated. All are panel mounted and are either supplied with factory installed aux. contacts or will accept contact kits. All are compact in size while providing ample wiring space for copper line & load conductors.



Siemens Enclosed Rotary Disconnect Switches

- 16–125A, Non-Fusible
- 600VAC max. rated
- Available in both Type 12 and 4X non-metallic enclosures
- Both screw and hinged cover designs available
- Listed and marked “suitable for use as motor disconnect” per NEC Section 430-109
- Screw cover switches are UL listed under File No. E47705 and are CSA certified under File No. 203576
- IEC 60947-3 rated and CE marked (enclosures are IP65 rated)
- HP rated
- Hinged door switches are UL listed for multiple line and load conductors per phase in 30–100A ratings. They are UL & CUL listed under File No. E191706
- Rotary handles are available in black, red, and yellow and in pistol grip designs
- 16–63A screw cover switches have factory installed ground bars. All hinge cover switches accept ground lug kits
- Screw cover switches are provided with knockouts
- Padlockable in OFF position with up to (3) padlocks

Ampere Rating	Catalog Number		Shipping Weight ^①	Horsepower Ratings			
	3 Pole, 3 Wire	3 Pole, 3 Wire with (1) NO & (1) NC Aux. Contact ^{⑧⑨}		240V AC		480V AC	600V AC
				1 Phase	3 Phase	3 Phase	3 Phase

Non-Fusible, Type 1, 4X & 12K^② with Screw Cover and Black Rotary Handle 600V AC Max.^⑤

16	3LD2064-0TB51-0US2	3LD2064-1GP51-0US2	1	1½	3	7½	10
25	3LD2164-0TB51-0US2	3LD2164-1GP51-0US2	1	3	7½	10	15
30	3LD2264-0TB51-0US2	3LD2264-1GP51-0US2	1	3	7½	15	20
30	—	3LD2264-1TS51-0US2 ^{⑥▲}	1	3	7½	15	20
30	—	3LD2264-2TW51-0US2 ^{⑦▲}	1	3	7½	15	20
63	3LD2565-0TB51-0US2	3LD2565-1GP51-0US2▲	3	10	15	40	50
100	3LD2766-0TB51-0US2	3LD2766-1GP51-0US2▲	6	—	30	60	75
125	3LD2866-0TB51-0US2	3LD2866-1GP51-0US2▲	6	—	40	75	100

Non-Fusible, Type 1, 4X & 12K^② with Screw Cover and Red and Yellow Rotary Handle 600V AC Max.^⑤

16	3LD2064-0TB53-0US2	3LD2064-1GP53-0US2	1	1½	3	7½	10
25	3LD2164-0TB53-0US2	3LD2164-1GP53-0US2	1	3	7½	10	15
30	3LD2264-0TB53-0US2	3LD2264-1GP53-0US2	1	3	7½	15	20
30	—	3LD2264-1TS53-0US2 ^{⑥▲}	1	3	7½	15	20
30	—	3LD2264-2TW53-0US2 ^{⑦▲}	1	3	7½	15	20
63	3LD2565-0TB53-0US2	3LD2565-1GP53-0US2▲	3	10	15	40	50
100	3LD2766-0TB53-0US2▲	3LD2766-1GP53-0US2▲	6	—	30	60	75
125	3LD2866-0TB53-0US2▲	3LD2866-1GP53-0US2▲	6	—	40	75	100

▲ Built to order. Allow 6–8 weeks for delivery.

① Carton quantity of (1). Shipping weight in pounds (lbs.).

② Approved for indoor/outdoor use. No cover interlock provided.

③ 30 and 60A switches are also rated 600V AC.

④ Also rated as Type 12 and UL approved for both indoor and outdoor use. Defeatable cover interlock provided.

⑤ Screw cover enclosures are constructed from Makrolon 9425.

⑥ Hinged cover enclosures are constructed from fiberglass reinforced polycarbonate.

⑦ Switch is supplied with (2) NO and no NC aux. contacts.

⑧ Switch is supplied with (4) NO and no NC aux. contacts. Ground bar is not provided or available.

⑨ Aux. contacts break about 3 Ms before and make about 3 Ms after main switch contacts.

⑩ 6P, 25A, switch with 1 NO & 1 NC aux. contacts and a black operating handle is also available. Order catalog number 3LD2165-4VD51 (Discount Code: Pilot Devices).

Enclosed Switches

Rotary Disconnect Switches

Enclosed Disconnect Switch Dimensions (Inches)*

Catalog Number	Ampere Rating	Fig. No.	Dimensions			
			A	B	C	D
3LD2064-	16	1	5.52 ^④	3.94	3.19	4.57
3LD2164-	25		5.52 ^④	3.94	3.19	4.57
3LD2264-	30		5.52 ^④	3.94	3.19	4.57
3LD2565-	63		6.93 ^⑤	5.75	4.10	5.87
3LD2766-	100		11.90	8.35	5.36	7.13
3LD2866-	125		11.90	8.35	5.36	7.13

Note: 3LD2 Type switches only have top and bottom end KOs as follows:
 16-30A - 1/2" & 3/4", 63A - 3/4" & 1", 100 & 25A - 1" & 1 1/4"

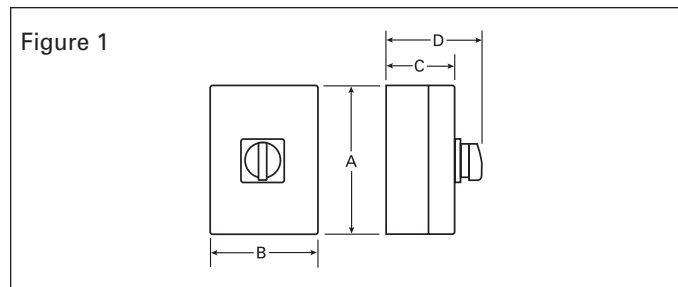

UL and CUL Short Circuit Withstand Ratings

Ampere Rating	Short Circuit Withstand Rating and Fuse Class				
	With Line Side Fusing			With Load Side Fusing ^①	
	5 kA at 600V Max	10 kA at 600V Max	18 kA at 480V Max	5 kA at 480V Max	18 kA at 480V Max
16	RK5 (50A Max)	—	—	—	—
25 & 30	RK5 (80A Max)	—	—	—	—
63	RK5 (175A Max)	—	—	—	—
100 & 125	—	RK5 (200A Max)	—	—	—

3LD2 Type Switches^②

16	RK5 (50A Max)	—	—	—	—
25 & 30	RK5 (80A Max)	—	—	—	—
63	RK5 (175A Max)	—	—	—	—
100 & 125	—	RK5 (200A Max)	—	—	—

HNF Type Switches

30	—	H, K & RK5 (100A Max)	J, T & CC (100A Max)	H, K & RK5 (30A Max)	Ferraz Shawmut A50P or lower let-through semiconductor fuses (60A Max)
60	—	H, K & RK5 (150A Max)		H, K & RK5 (60A Max)	Ferraz Shawmut A50P or lower let-through semiconductor fuses (100A Max)
100	⑥	⑥			

① For use as supplemental protection on the load side of the branch circuit over current protective device.
 ② Ground lug kit has two lugs for #14-4 Cu/Al wire.
 ③ Factory installed ground lugs supplied as follows: 16-30A #14-10 Cu, 63A #14-8 Cu. Ground lug not provided and is not available on catalog numbers 3LD2264-2TW51-0US2 and 3LD2264-2TW53-0US2.
 ④ 6.38 inches high including mounting feet.
 ⑤ 7.85 inches high including mounting feet.
 ⑥ 60 & 100A HNF switches are rated 10kA at 480V max. with line side Class H, K & RK5 150A max. fuses.
 ⑦ Wire range (1) #14-2 AWG 60/75 °C Cu only.
 ⑧ 16-63A 3LD switches are also rated 5kA at 600VAC max when protected by a 3RV type MSP of the same or lesser ampere rating.

*For inches / millimeters conversion, multiply inches by 25.4.

Wire ranges 60/75°C Cu Only

3LD2 Type Switches^③

16 Amps	(1) #18-10 AWG
25-30 Amps	(1) #14-10 AWG
63 Amps	(1) #14-6 AWG
100-125 Amps	(1) #12-1 AWG

HNF Type Switches

30 Amps	(1) #14-#10 AWG Solid (1) #14-#4 AWG Stranded Up to (4) #12 AWG Solid Up to (3) #12 AWG Stranded Up to (6) #14 AWG Stranded Up to (4) #14 AWG Stranded with (1) #10 AWG Stranded
60 & 100 Amps	(1) #14-#10 AWG Solid (1) #14-#1 AWG Stranded (2) #6 AWG Stranded Up to (3) #8 AWG Stranded Up to (6) #10 AWG Stranded Up to (6) #12 AWG Solid

Figure 2

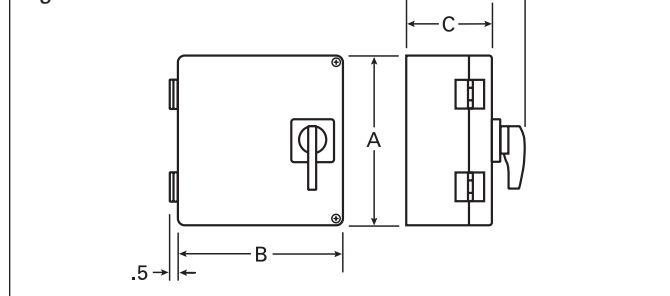

IEC Fuse and Withstand Ratings

Ampere Rating	gG Fuse Size	Short Circuit Rating
---------------	--------------	----------------------

3LD2 Screw Cover Switches

16	20A	5k Arms
25	25A	10k Arms
32	50A	10k Arms
63	63A	15k Arms
100	100A	20k Arms
125	125A	20k Arms

HNF Hinged Cover Switches

30	63A	10k Arms
60	100A	10k Arms
100	100A	10k Arms

Accessories

Switch Ampere Rating	Catalog Number	Description
----------------------	----------------	-------------

3LD2 Type Switches^③

16-30A	3LD9220-2C	Neutral Kit
63A	3LD9250-2CA	Neutral Kit
100-125A	3LD9280-2C	Neutral Kit

HNF Type Switches

30-100A	GSGK60	Ground Lug Kit ^②
30A	LBRA1	Auxiliary Contact Kit (1 NO-1 NC)
60-100A	LBRA2	Auxiliary Contact Kit (1 NO-1 NC)
30-100A	HF63CX ^⑦	Neutral Kit

Disconnect Switches

Compact Non-Fusible — Rotary and Toggle

Features

- 16–250 Ampere, to 100 hp, 480V & 600V
- Rotary and Toggle actuation models
- LBR Type switches are padlockable in the OFF position and are UL & CUL listed under File No. E191706 as manual motor controllers per UL Standard UL508
- 3LD2 Type switches are padlockable in the OFF position and are UL listed under File No. E47705 per UL508 and are CSA certified under File No. 203576
- Base, DIN-rail and door mounting
- Multiple conductor, distribution terminal type rating LBR & LBT Type (40A -100A only)
- IEC 947-1 rated, CE marked
- Listed and marked “suitable as motor disconnect” per NEC Section 430-109

Application

Siemens Load Break Switches are listed as manual motor controllers and are suitable as motor disconnects. They are load break rated and act as enclosure disconnects when short circuit protection is provided upstream of the switch. If upstream over current protection is not provided, use a Siemens fusible Type VBII, CFS or MCS Disconnect Switch.

Ordering Information

Door Mounted Switches (Rotary Type Only) — Order either complete “3LD2” assemblies or individual “LBR” components as follows:

Complete Assemblies include switch, handle, and shaft. Certain 25 and 32A assemblies are also available with factory installed neutral blocks and/or aux. contacts. These accessories can also be ordered as field installed kits.

Individual Components are ordered as follows:

25A — LBR3025D switch + LBRH3 or 4 handle.

40–100A — LBR switch + LBRH3 or 4 handle + LBRD1.

Notes: (LBR Type switches only)

1. Aux contacts are available as field installed kits on 25A units only.
2. Lugs on 25A units face to the rear and lugs on 40–100A units face toward the front.

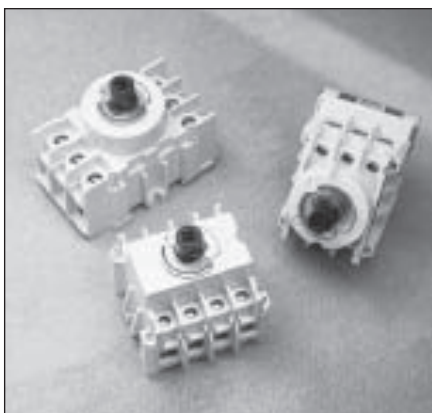

Type LBR Rotary Switches

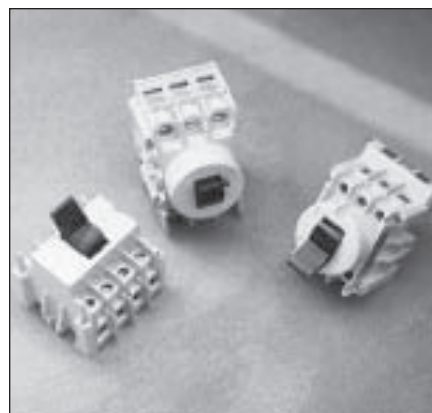

Type LBT Toggle Switches



3LD2254-0TK51

Base/DIN Rail Mounted Switches (Rotary or Toggle Type) — Order individual components as follows:

Toggle — Order the LBT switch required and a toggle switch cover plate if needed.

Rotary, Base Mounted with Door Mounted Handle — Order “LBR” switch + door mounted handle + shaft + any accessories.

Rotary, Base Mounted with Direct Mounted Handle — Order “LBR” switch + direct mounted handle.

Short Circuit Withstand Ratings

Switch Rating & Type	Max. Line Side Fuse Rating
----------------------	----------------------------

5kA with Line Side Class H, K, or RK5 Fuses

25 & 32A 3LD2	80A Max. at 600V AC Max.
63A 3LD2	175A Max. at 600V AC Max.

10kA with Line Side Class H, K, or RK5 Fuses^②

25A LBR	30A Max. at 480V AC Max.
40A, 4P LBR & LBT	60A Max. at 480V AC Max.
40 & 60A, 3P LBR & LBT	100A Max. at 480V AC Max.
80 & 100A LBR & LBT	150A Max. at 480V AC Max.

18kA with Line Side Class J, T, or CC Fuses

40–100A, 3P LBR & LBT	100A Max. at 480V AC Max.
-----------------------	---------------------------

Note: 3LD2 switches are also rated 5kA at 600V AC Max. when protected by a 3RV motor starter with a FLA rating equal to or less than the switch ampere rating.

Door Mounted Complete Assemblies (Operator, Shaft, & Switch) 600V AC Max.^②

Shaft Mounted	4 Hole Mounted	Number of Poles	Ampere Rating	AC Horsepower Ratings				
				120V 1Ø	240V 1Ø 3Ø		480V 3Ø	600V 3Ø
—	3LD2003-1TP53 ^③	3	16	½	1½	3	7½	10
3LD2154-0TK 3LD2154-1TP 3LD2154-1TL 3LD2154-2EP	3LD2103-0TK 3LD2103-1TP 3LD2103-1TL 3LD2103-2EP	3 3 ^① 3 + N 3 + N ^①	25	2	3	7½	10	15
3LD2254-0TK 3LD2254-1TL	3LD2203-0TK 3LD2203-1TL	3 3 + N	32	2	3	10	20	20
3LD2555-0TK	3LD2504-0TK	3	63	—	10	15	40	50
—	3LD2704-0TK	3	100	—	—	30	60	75
—	3LD2804-0TK	3	125	—	—	40	75	100

① Includes auxiliary contacts (1 NO and 1 NC).

② Handles are IP65 rated and are also UL listed for Type 1, 4X and 12 applications.

③ Add 51 for a black handle or 53 for a red & yellow handle to the end of the catalog number.

④ 100-250A 3LD2 switches are rated 10kA when protected by 200A Max. Class RK5 fuses.

Disconnect Switches

Compact Non-Fusible — Rotary and Toggle

3LD Type Base Mounted Complete Assemblies
(Operator, Shaft, & Switch) 600V AC Max.②

Handle mounting②			Number of Poles	Ampere Rating	AC Horsepower Ratings				
Shaft (center hole)	4 Hole (no defeat)	4 Hole (with defeat)			120V	240V	480V	600V	
Catalog Number	Catalog Number	Catalog Number			10	10	30	30	30
—	3LD2013-0TK5_	3LD2017-0TK1 3LD2017-1TL1	3 3 + N	16	½	1½	3	7½	10
3LD2144-0TK5 3LD2144-1TL5	3LD2113-0TK5 3LD2113-1TL5	—	3 3 + N	25	2	3	7½	10	15
3LD2244-0TK5 3LD2244-1TL53	3LD2213-0TK5 3LD2213-1TL53	3LD2217-0TK1 3LD2217-1TL1	3 3 + N	32	2	3	10	20	20
3LD2545-0TK5 —	3LD2514-0TK5 —	3LD2517-0TK1 3LD2517-1TL1	3 3 + N	63	3	10	15	40	50
—	3LD2714-0TK5	—	3	100	—	—	30	60	75
—	3LD2814-0TK5	—	3	125	—	—	40	75	100
—	3LD2318-0TK1	—	3	160	—	—	40	75	75
—	3LD2418-0TK1	—	3	250	—	—	50	100	75



Base Mount

3LD2217-0TK13

Accessories for Front Mounted 3LD2 Switches

Catalog Number	Description	Switches Used With
3LD9200-5B③ 3LD9200-5BF③	1 NO, 1 NC Aux. Contact 1 NO, 1 NC Aux. with Gold Plated Contacts	25-125A 25-125A
3LD9220-2B 3LD9250-2BA 3LD9280-2B	Neutral/Ground Terminal Neutral/Ground Terminal Neutral/Ground Terminal	25 & 32A 63A 100 & 125A
3LD9220-0B 3LD9250-0BA 3LD9280-0B	4th Pole (leading ON, lagging OFF) 4th Pole (leading ON, lagging OFF) 4th Pole (leading ON, lagging OFF)	25 & 32A 63A 100 & 125A
3LD9224-1B① 3LD9284-1B① 3LD9224-3B① 3LD9284-3B①	Black Handle (4 hole mtg.) Black Handle (4 hole mtg.) Red/Yellow Handle (4 hole mtg.) Red/Yellow Handle (4 hole mtg.)	25 & 32A 63-125A 25 & 32A 63-125A
3LD9224-1D① 3LD9284-1D① 3LD9224-3D① 3LD9284-3D①	Black Handle (shaft mtg.)④ Black Handle (shaft mtg.)④ Red/Yellow Handle (shaft mtg.)④ Red/Yellow Handle (shaft mtg.)④	25 & 32A 63-125A 25 & 32A 63-125A
3LD9221-2A① 3LD9221-0A① 3LD9251-0A①	Terminal Cover 1P (Pack of 4) Terminal Cover 3P (Pack of 4) Terminal Cover 3P (Pack of 4)	25 & 32A 25 & 32A 63A



3LD9220-2C

Accessories for Base Mounted 3LD2 Switches

3LD9200-5C③ 3LD9200-5CF③	1 NO, 1 NC Aux. Contact 1 NO, 1 NC Aux. with Gold Plated Contacts	25-250A 25-250A
3LD9220-2C 3LD9250-2CA 3LD9280-2C 3LD9240-2C	Neutral/Ground Terminal Neutral/Ground Terminal Neutral/Ground Terminal Neutral/Ground Terminal	25 & 32A 63A 100 & 125A 160 & 250A
3LD9220-0C 3LD9250-0CA 3LD9280-0C 3LD9240-0C	4th Pole (leading ON, lagging OFF) 4th Pole (leading ON, lagging OFF) 4th Pole (leading ON, lagging OFF) 4th Pole (leading ON, lagging OFF)	25 & 32A 63A 100 & 125A 160 & 250A
3LD9224-1B① 3LD9284-1B① 3LD9224-3B① 3LD9284-3B①	Black Handle (4 hole mtg. no defeat) Black Handle (4 hole mtg. no defeat) Red/Yellow Handle (4 hole mtg. no defeat) Red/Yellow Handle (4 hole mtg. no defeat)	25 & 32A 63-125A 25 & 32A 63-125A
3LD9224-1D① 3LD9284-1D① 3LD9224-3D① 3LD9284-3D①	Black Handle (shaft mtg.) Black Handle (shaft mtg.) Red/Yellow Handle (shaft mtg.) Red/Yellow Handle (shaft mtg.)	25 & 32A 63-125A 25 & 32A 63-125A
3LD9221-2A① 3LD9221-0A① 3LD9251-0A①	Terminal Cover 1P (Pack of 4) Terminal Cover 3P (Pack of 4) Terminal Cover 3P (Pack of 4)	25 & 32A 25 & 32A 63A

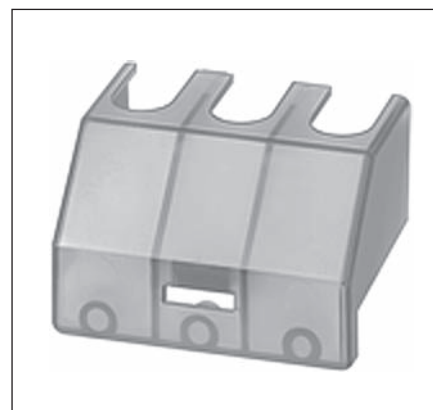

3LD9251-0A

Note: 3LD2 shaft lengths allow the following maximum enclosure depths from the switch mounting surface to the outside of the cover:

16-32A, 15.25"
63-125A, 15.75"
160 & 250A, 23.70"

① Handles and line side terminal covers are supplied as standard with 3LD2 switches.

② Add suffix 1 for a black or 3 for a red & yellow handle to the catalog number (except 3LD2244-1TL53 & 3LD2213-1TL53). Handles are IP65 rated and are also listed by UL for Type 1, 4X and 12 applications.

③ Aux. contacts break about 30 Ms before and make about 3 Ms after main switch contacts.

Ratings 10A at 120V AC
6A at 240V AC
1.4A at 480V AC

④ Can be used as replacement handles on enclosed 3LD2 switches.

⑤ Base mounted switches with direct mount handles are also available (3LD2330-0TK1_⑤ rated 160A and 3LD2430-0TK1_⑤ rated 250).

Disconnect Switches

Compact Non-Fusible — Rotary and Toggle

Individual Components and Assemblies

Recommended for Basemount. For Door mounting only, use LBRD1.^⑥

Rotary and Toggle Switches

Catalog Number	Switch Type	No. of Poles	Ampere Rating	Max AC Volt	AC Horsepower Ratings					
					115V		240V		480V	600V
					1Ø	3Ø	1Ø	3Ø	3Ø	3Ø
LBR3040 ^②	Rotary	3	40	600	2	3	7½	20	25	
LBR3060 ^②	Rotary	3	60	480	2	5	10	25	—	
LBR3080 ^②	Rotary	3	80	600	3	10	20	40	50	
LBR3100 ^②	Rotary	3	100	480	5	15	25	50	—	
LBR4040	Rotary	4	40	480	2	3	7½	20	—	
LBT3040	Toggle	3	40	600	2	3	7½	20	25	
LBT3060	Toggle	3	60	480	2	5	10	25	—	
LBT3080	Toggle	3	80	600	3	10	20	40	50	
LBT3100	Toggle	3	100	480	5	15	25	50	—	
LBT4040	Toggle	4	40	480	2	3	7½	20	—	

Standard and Heavy Duty Rotary Switch Door Handles

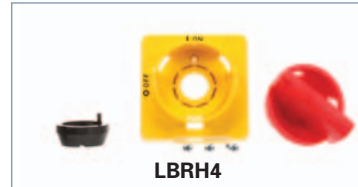
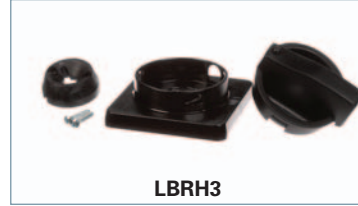

LBR Type Handles

Catalog Number	Used on Rotary Switches	NEMA Type	Mounting	Marking	Color	Cover Interlock Supplied	Padlockable
Standard Duty							
LBRH2 ^②	All	1	Door	ON/OFF	Black	No	No
LBRH3 ^②	All	1, 3R, 12, 4X	Door	O/I, ON/OFF	Black	Yes ^①	Yes
LBRH4 ^②	All	1, 3R, 12, 4X	Door	O/I, ON/OFF	Red/Yel	Yes ^①	Yes
LBRH9 ^②	All (Pistol Grip Type)	1, 3R, 12, 4X	Door	O/I, ON/OFF	Black	Yes	Yes
LBRH10 ^②	All (Pistol Grip Type)	1, 3R, 12, 4X	Door	O/I, ON/OFF	Red/Yel	Yes	Yes
LBRH5	25 Amps	1	Direct Mount	O/I	Black	—	Yes
LBRH6	3-Pole, 40-60 Amps	1	Direct Mount	O/I	Black	—	Yes
LBRH7	3-Pole, 80-100 Amps	1	Direct Mount	O/I	Black	—	Yes
LBRH8	4-Pole, 40-60 Amps	1	Direct Mount	O/I	Black	—	Yes
Heavy Duty							
CFSH10B12	All	1, 3R, 12	Door	O/I, ON/OFF	Black	Yes	Yes
CFSH10R12	All	1, 3R, 12	Door	O/I, ON/OFF	Red/Yel	Yes	Yes

LBR Type Rotary Shafts

Catalog No	Length In. (mm)
For Standard Duty Handles	
LBR5040	1.57 (40)
LBR5050	1.97 (50)
LBR5055	2.17 (55)
LBR5080	3.15 (80)
LBR5120	4.72 (120)
LBR5180	7.09 (180)
LBR5305	12.00 (305)
For Heavy Duty Handles	
CFSS5200H	7.9 (200)
CFSS5400H	15.7 (400)

Rotary Shafts



LBR Type Handles



Rotary and Toggle Switches



Auxiliary Switch Kits

Used on Rotary Switch	Catalog Number	Contact Arrangement
LBR3040, LBR3060	LBRA1 ^{③④}	1 NO/1 NC with common point
LBR3080, LBR3100	LBRA2 ^{③④}	1 NO/1 NC with common point

LBR Type Rotary Switch Door Mounting Kit (For use with LBRH3 & LBRH4 only)

Used on Rotary Switch	Catalog Number
40-100 Amps	LBRD1 ^⑥

LBR/LBT Neutral Kit^⑤

Used with Catalog Number	Catalog Number
All	HF63CX



LBR Type Toggle Switch Cover Plate

Used on Toggle Switches	Catalog Number
LBT3040, LBT3060 LBT3080, LBT3100 LBT4040	LBTCP1 LBTCP2 LBTCP3

① No cover interlock defeat mechanism provided. To eliminate cover interlock, order additional catalog number LBRDC1.

② LBRH2 is IP54 rated. All others are IP65.

③ Ratings

15.1A resistive at 250V AC max.
.5A at 125V DC
.25A at 250V DC
.5 HP at 250V AC max.

④ Auxiliary switch contacts break about 30 Ms before and make about 3 Ms after main switch contacts.

⑤ Lug wire ranges:

HF63CX—(1) #14-2 AWG 60/75°C Cu only

⑥ Only door mountable and for use with LBRH3 & 4 handles only.

⑦ For door mounting of 40–100A LBR switches use door mounting kit LBRD1 & LBRH3 or 4 handle.

⑧ LBRD1 does not require shaft.

Disconnect Switches

Compact Non-Fusible — Rotary and Toggle

Dimension Drawings and Wire Ranges

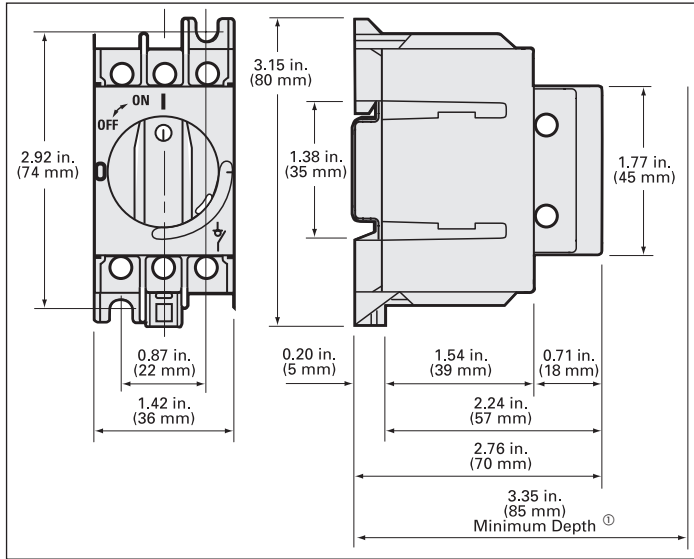

LBR 3025

Wire Ranges 60/75°C Cu only

25 Amps LBR	(1) #14 - #10 AWG Solid (1) #14 - #8 AWG Stranded
40 & 60 Amps LBR & LBT	(1) #14 - #10 AWG Solid (1) #14 - #4 AWG Stranded UP to (4) #12 AWG Solid Up to (3) #12 AWG Stranded Up to (6) #14 AWG Stranded Up to (4) #14 AWG Stranded with (1) #10 AWG Stranded
80 & 100 Amps LBR & LBT	(1) #14 - #10 AWG Solid (1) #14 - #1 AWG Stranded (2) #6 AWG Stranded Up to (3) #8 AWG Stranded Up to (6) #10 AWG Stranded Up to (6) #12 AWG Solid
16A, 3LD20 25A, 3LD21 32A, 3LD22 63A, 3LD25 100, 125A, 3LD2 160, 250A, 3LD2	(1) #18-10 AWG (1) #14-8 AWG (1) #14-8 AWG (1) #14-6 AWG (1) #12-1 AWG (1) #1-400 MCM

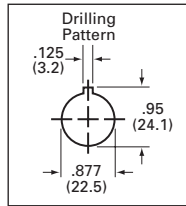

Shaft Mounted 3LD2 Handle Cutout (4-hole pattern)

Dimension J Minimum Depth^①

Switch	Dimension J
LBR 40-100A	3.35 (85)
3LD2 25 & 32A Front Shaft Mounted	3.07 (78)
3LD2 63 Front Shaft Mounted	3.35 (85)
3LD2 16-32A Front 4-hole Mounted	2.13 (54)
3LD2 63A Front 4-hole Mounted	2.48 (63)
3LD2 100 & 125A Front 4-hole Mounted	2.56 (65)
3LD2 25 & 32A Base w/shaft Mtg. Handle	6.46 (164)
3LD2 63A Base w/shaft Mtg. Handle	6.77 (172)
3LD2 16-32A Base w/4-hole Mtg. Handle	5.59 (142)
3LD2 63A Base w/4-hole Mtg. Handle	5.99 (152)
3LD2 100-250A Base w/4-hole Mtg. Handle	6.07 (154)

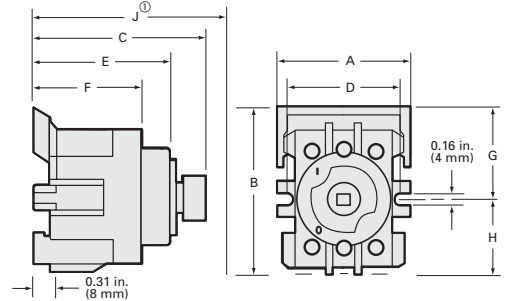

LBR 40-100 Amps & 3LD2 16-250A

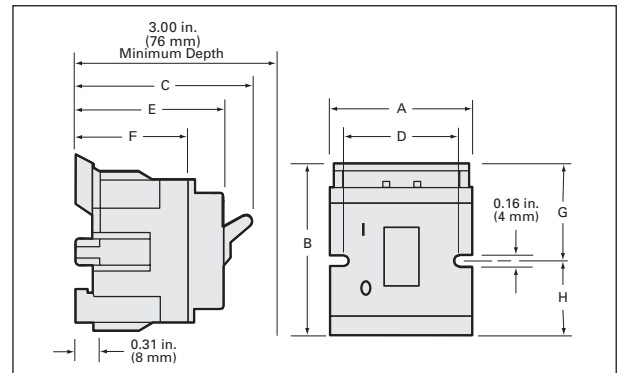

LBT Toggle — 40-100 Amps

Switch Type	Switch Catalog Number	Dimensions Inches (mm)							
		A	B	C	D	E	F	G	H
Rotary	LBR3040	2.00 (51)	2.72 (69)	2.72 (69)	1.78 (45)	2.16 (55)	1.67 (42)	1.50 (38)	1.22 (31)
Rotary	LBR3060	2.00 (51)	2.72 (69)	2.72 (69)	1.78 (45)	2.16 (55)	1.67 (42)	1.50 (38)	1.22 (31)
Rotary	LBR3080	2.09 (53)	3.32 (84)	2.92 (74)	1.97 (50)	2.29 (58)	1.69 (42)	1.66 (42)	1.66 (42)
Rotary	LBR3100	2.09 (53)	3.32 (84)	2.92 (74)	1.97 (50)	2.29 (58)	1.69 (42)	1.66 (42)	1.66 (42)
Rotary	LBR4040	2.42 (61)	2.72 (69)	2.72 (69)	2.28 (58)	2.16 (55)	1.67 (42)	1.50 (38)	1.22 (31)
Rotary Front Mtg.	3LD20 ^②	1.89 (48)	1.97 (50)	1.97 (50)	—	—	—	—	—
Rotary Front Mtg.	3LD21 & 2 ^②	1.81 (46)	2.17 (55)	1.97 (50)	—	—	—	—	—
Rotary Front Mtg.	3LD25 ^②	2.36 (60)	2.52 (64)	2.32 (59)	—	—	—	—	—
Rotary Front Mtg.	3LD27 & 8 ^②	2.40 (61)	3.27 (83)	2.40 (61)	—	—	—	—	—
Rotary Base Mtg.	3LD20 ^②	1.89 (48)	1.97 (50)	2.29 (58)	—	—	—	—	—
Rotary Base Mtg.	3LD21 & 2 ^②	1.81 (46)	2.17 (55)	2.29 (58)	—	—	—	—	—
Rotary Base Mtg.	3LD25 ^②	2.36 (60)	2.52 (64)	2.68 (68)	—	—	—	—	—
Rotary Base Mtg.	3LD27 & 8 ^②	2.80 (71)	3.27 (83)	2.76 (70)	—	—	—	—	—
Rotary Base Mtg.	3LD23 & 4	4.41 (112)	5.83 (148)	4.10 (104)	—	—	—	—	—
Toggle	LBT3040	2.00 (51)	2.72 (69)	2.75 (70)	1.78 (45)	2.16 (55)	1.67 (42)	1.50 (38)	1.22 (31)
Toggle	LBT3060	2.00 (51)	2.72 (69)	2.75 (70)	1.78 (45)	2.16 (55)	1.67 (42)	1.50 (38)	1.22 (31)
Toggle	LBT3080	2.09 (53)	3.32 (84)	2.90 (74)	1.97 (50)	2.29 (58)	1.69 (42)	1.66 (42)	1.66 (42)
Toggle	LBT3100	2.09 (53)	3.32 (84)	2.90 (74)	1.97 (50)	2.29 (58)	1.69 (42)	1.66 (42)	1.66 (42)
Toggle	LBT4040	2.42 (61)	2.72 (69)	2.75 (70)	2.28 (58)	2.16 (55)	1.67 (42)	1.50 (38)	1.22 (31)

① Depth from outside of cover to back of switch.

② Handle front plate dimensions:
3LD 16-32A—2.64 inches square
3LD 63-125—3.55 inches square

Disconnect Switches

Type VBII (30-600A) with Flange Mounted Operating Handle

Features

- 30-600A, 600VAC and DC ratings
- 240 & 600V AC switches are UL Recognized under file number E121152, Vol. 3 and CSA certified under file number 154852
- 600V DC Photovoltaic switches are UL Recognized under file number E335018, Vol. 3 and are rated to switch 3 separate 600V DC circuits
- Visible blade quick make and break switching action
- Panel and Flange mounted assemblies facilitate installation
- Panel mounted switches are variable depth
- Short circuit rating of 10,000 AIC with class H fuse, and of 200,000 AIC with class R or J fuses. PV switches are rated 10,000 AIC at 600V DC with 600V DC rated class K, J or R fuses.
- Flange mounted handles rated as Type 1, 3R & 12 or 4X are padlockable in the off position with up to (3) padlocks with 5/16 hasps
- Meets UL98 requirements and suitable for both main and branch circuit applications
- A complete line of aux contacts are available
- Load break and horsepower rated
- Defeatable cover interlock standard with all handles
- Meets NFPA79 requirements
- Seismic qualified — complies with the 2010 California Building Code (CBC) — and with the International Building Code (IBC) — Compliance Level SDS = 1.85 g



VBFS361, VBLK1 & VBH1



VBFS363F



VBNFS365, VBLK4 & VBH2

Ordering Information

1. Determine the ratings required (amps, volts, HP, Fusible, NF), the mounting needed (Panel or Flange), and select the appropriate switch.
2. For panel mounted switches with a rigid operating shaft (30-600A), order panel mounted switch, flange mounted operating handle & rigid linkage kit based on depth required.
3. For panel mounted switches with a Max-Flex operator, order panel mounted switch, Max-Flex Handle & Adapter Kit and drive cable.
4. Select accessories if required.

Disconnect Switches

Type VBII Switch, Handle and Linkage Kit Selection

Switches—for Standard 600V Max AC or DC Applications

Switch Ampere Rating	Max. AC Voltage Rating	Catalog Number	Horsepower Rating, Switches and 3-Phase ^④						600 Volts DC (max) ^⑤
			240 Volts AC		480 Volts AC		600 Volts AC		
			Standard	Max.	Standard	Max.	Standard	Max.	
Fusible Panel Mounted Variable Depth Switches - 3-Pole^⑥									
30	240	VBFS321	3	7 1/2	—	—	—	—	— ^①
60	240	VBFS322	7 1/2	15	—	—	—	—	— ^②
30	600	VBFS361	—	—	5	15	7 1/2	20	15 ^③
60	600	VBFS362	—	—	15	30	15	50	30 ^③
100	600	VBFS363	—	—	25	60	30	75	50 ^③
200	600	VBFS364	—	—	50	125	60	150	50
400	600	VBFS365	—	—	100	250	125	350	— ^⑨
600	600	VBFS366	—	—	150	400	200	500	— ^⑨
Non-fusible Panel Mounted Variable Depth Switches - 3-Pole^⑥									
30	600	VBNS361	—	10	—	20	—	30	15 ^③
60	600	VBNS362	—	20	—	50	—	60	30 ^③
100	600	VBNS363	—	40	—	75	—	100	50 ^③
200	600	VBNS364	—	60	—	125	—	150	50
400	600	VBNS365	—	125	—	250	—	300	— ^⑨
600	600	VBNS366	—	200	—	400	—	500	— ^⑨
Fusible Flange Mounted Switches - 3-Pole^⑥									
30	240	VBFS321F	3	7 1/2	—	—	—	—	— ^①
60	240	VBFS322F	7 1/2	15	—	—	—	—	— ^②
30	600	VBFS361F	—	—	5	15	7 1/2	20	15 ^③
60	600	VBFS362F	—	—	15	30	15	50	30 ^③
100	600	VBFS363F	—	—	50	60	30	75	50 ^③
200	600	VBFS364F	—	—	100	125	60	150	50
Non-fusible Flange Mounted Switches - 3-Pole^⑥									
30	600	VBNS361F	—	10	—	20	—	30	15 ^③
60	600	VBNS362F	—	20	—	50	—	60	30 ^③
100	600	VBNS363F	—	40	—	75	—	100	50 ^③
200	600	VBNS364F	—	60	—	125	—	150	50

Note: Fusible switches include fuse provisions for Class H Fuses. The load base can be moved to pre-drilled holes for Class J Fuses on all 600V switches. If Class R Fuses are required, add a Class R Fuse Clip Kit.

Switches—for Photovoltaic Applications, 600VDC Max.^⑦

(for use in negative ground systems only)

Switch Ampere Rating	Catalog Number	Rated Isc per NEC Article 690
Fusible Panel Mounted Variable Depth Switches—3 Pole^⑧		
30	VBFS361PV	19.2A
60	VBFS362PV	38.4A
100	VBFS363PV	64.0A
Non-Fusible Panel Mounted Variable Depth Switches—3 Pole^⑧		
30	VBNS361PV	24.0A
60	VBNS362PV	48.0A
100	VBNS363PV	80.0A
Fusible Flange Mounted Variable Depth Switches—3 Pole (Includes Type 1, 3R and 12 Rated Operating Handle)^⑧		
30	VBFS361FPV	19.2A
60	VBFS362FPV	38.4A
100	VBFS363FPV	64.0A
Non-Fusible Flange Mounted Variable Depth Switches—3 Pole (Includes Type 1, 3R and 12 Rated Operating Handle)^⑧		
30	VBNS361FPV	24.0A
60	VBNS362FPV	48.0A
100	VBNS363FPV	80.0A

① Rated 5 HP at 250V DC.

② Rated 10 HP at 250V DC.

③ 600V DC & 600V DC horsepower rating shown requires (2) poles to be connected in series.

④ Std. - applies when non-time delay fuses are used.
Max. - applies when time delay fuses are used.

⑤ Includes line base, load base, operating mechanism and line and load lugs.

Order operating handle and linkage kits from tables on pages 18/21 or 18/22.

⑥ Includes line base, load base, operating mechanism line and load lugs plastic operating handle and required linkage.

⑦ All photovoltaic switches are rated to be used with 3 separate 600V DC circuits.

⑧ Fusible switches accept Class K or R fuses as standard and Class J fuses by relocating the load base.

⑨ Rated 250V DC max and 50HP at 250V DC.

Cable Kit

For use with 30-200A panel mounted switches and Max-Flex handle and adapter kit.

Catalog Number	Description
FHOEC036	36" long drive cable
FHOEC048	48" long drive cable

Max-Flex™ Handle and Adapter Kit

(Type 1, 12, 3R & 4X) Use with 30-200A panel mounted switches and cable kit.

Catalog Number	Operating Handle Description
Plastic Handles	
VBHM1	30-200A Type 1, 3R, 12 and 4X
Metal Handles	
VBH112	30-200A Type 1, 3R and 12
VBH14	30-200A Type 4X

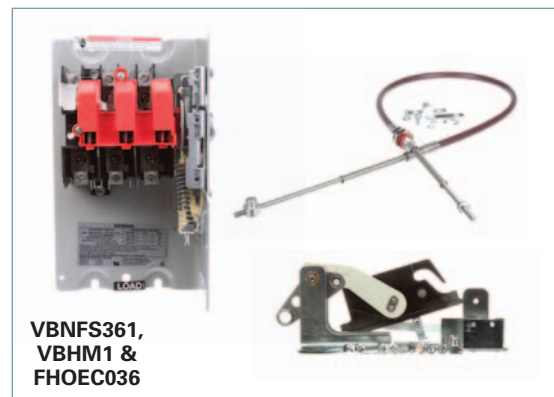

Disconnect Switches

Accessories Type VBII

Flange Mounted Operating Handles

For use with Panel Mounted Switches. Plastic handle is included with Flange Mounted Switches as standard.

Catalog Number	Operating Handle Description
Plastic Handles	
VBH1	30-200A Type 1, 3R & 12
VBH14X	30-200A Type 4X
Metal Handles	
VBH112	30-200A Type 1, 3R & 12
VBH14	30-200A Type 4X
VBH2	400A Type 1 & 12
VBH2R	400 & 600A Type 1, 3R & 12
VBH24X	400 & 600A Type 4X



HR612

Class R Fuse Clip Kits

These kits prevent the installation of Class H and K fuses (one kit required per switch).

Class R Fuse Clip Kits

Catalog Number	Description
HR21	30A, 240V Kit (HD only)
HR612	30A, 600V Kit/60A, 240V Kit
HR62	60A, 600V Kit
HR63	100A Kit
HR64	200A Kit
HR656	400A/600A Kit

Internal Door Latch Kits

For use with enclosures with door mounted latching bar. Required when a flange mounted switch is mounted in a Hoffmann or Rittal enclosure provided with an AB cutout.

Catalog Number	Description
DKR2	2 point (for use with enclosures less than 40" high)
DKR3	3 point (for use with enclosures 40" or larger in height)

Rigid Linkage Kits

For use with Panel Mounted Switches. Not required for Flange Mounted Switches.

Catalog Number	Switch Ampere Rating	Enclosure Depth ^①	
		Min	Max.
VBLK1	30-200	6.94 ^②	6.94 ^②
VBLK2	30-200	6.94 ^②	19.0
VBLK3	400 & 600	9.00	8.75
VBLK4	400 & 600	9.00	19.0



HT63

Class T Fuse Adapter Kits

100-600A fusible switches are field convertible to accept Class T fuses. 400-600A switches are field convertible to accept Class T fuses by moving the load base to a pre-drilled T fuse position.

Class T Fuse Adapter Kits^③

Catalog Number	Description
HT23	100A, 240V Kit
HT63	100A, 600V Kit
HT24	200A, 240V Kit
HT64▲	200A, 600V Kit

Class J Fuse Provisions

All 30-600A, 600V fusible switches are field convertible to accept Class J fuses by moving the load base to a pre-drilled J fuse position.

Window Kits (Type 1, 12, 3R and 4x)

Allows viewing of visible blades and of indicating fuses through 200A.

Catalog Number	Description
VBWK1	30A Window Kit
VBWK2	60 & 100A Window Kit
VBWK3	200-600A Window Kit

NEW Quick Connects

They provide two point control power take-off capability and are normally used on two poles on the line side when it is required to have control power available when the switch is in the OFF position. They provide a mounting provision for standard 1/4" quick connect terminal. Installed in the line or load side. 30A VBII switches have lugs UL listed to accept (2) wires per pole as standard so a 30A kit is not required.

Catalog Number	Description
HCO62	60A 2 wire quick connect kit
HCO63	100A 2 wire quick connect kit
HCO64	200A 2 wire quick connect kit



HN612

Neutral Kits^④

Standard Neutral Kits can be field installed in 30-100A switches.

Neutral Kits

Switch Ampere Rating	Kit Catalog Number
30A 600V, 60A 240V	HN612
60A, 600V & 100A	HN623

200% Neutral Kits^④

UL listed 200% Neutrals are available on 60 & 100A switches. They are typically used with non-linear transformers or where increased neutral ampacity/lug capacity is required.

200% Neutral Kits

Switch Ampere Rating	Kit Catalog Number	Wire Range Line & Load Lugs (Cu/Al)
60 & 100A	HN263	(2) #14-1/0 AWG

▲ Built to order. Allow 6-8 weeks for delivery.

① Dimensions (min. & max.) from enclosure mounting pan to outside surface of enclosure handle mounting flange.

② 7.12 for 200A switches.

③ One kit per pole required.

④ UL approved (not CSA certified).

Disconnect Switches

Type VBII Accessories



HA161234



HA261234

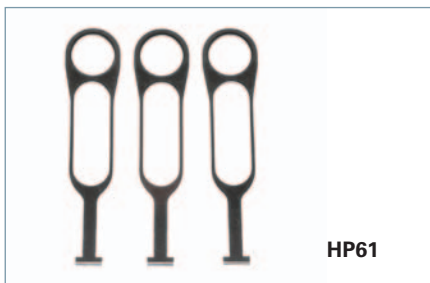

HP61



HLC612



HSK61

▲ Built to order. Allow 6-8 weeks for delivery.

Auxiliary Contacts

The auxiliary contacts are available in 1 normally open and 1 normally closed or 2 normally open and 2 normally closed configurations. Siemens offers a PLC Auxiliary Switch (30-200A) that has very low resistance for low voltage and current typical in PLC circuits. All auxiliary contacts make after and break before main switch contacts.

Switch Ampere Rating	Aux. Switch Catalog Number	Kit Ampere Rating			Kit Horsepower Rating		
		125V AC Max.	250V AC Max.	28V DC Max.	125V AC Max.	250V AC Max.	28V DC Max.

With 1 NO & 1 NC Isolated Contacts

30-200	HA161234	10	10	—	1/2	3/4	—
400-600	HA165678	10	10	—	1/2	3/4	—

With 2 NO & 2 NC Isolated Contacts

30-200	HA261234	10	10	7	1/2	3/4	—
400-600	HA265678	10	10	7	1/2	3/4	—

Low Current PLC Type with 1 NO & 1 NC Gold Plated Contacts

30-200	HA361234	10	10	—	1/2	3/4	—
400-600	HA365678	10	10	—	1/2	3/4	—

Fuse Puller Kits

Fuse Puller Kits are field installable in 30-100A Type VBII Heavy Duty Switches (one kit required per 3-pole switch).

Switch Ampere Rating	Fuse Puller Kit Catalog Number
30	HP61
60	HP62▲
100	HP63▲

Copper Lug Kits

All switches are UL approved to accept field installed copper lug kits.

Switch Ampere Rating	Copper Lug Catalog Number	Description
30-60	HLC612	(9) Lugs/Kit #14-4 AWG Cu
100	HLC63▲	(9) Lugs/Kit #14-1/0 AWG Cu
200	HLC64▲	(9) Lugs/Kit #6 AWG-300 Kcmil Cu
400-600A	HLC65678	(1) Lugs/Kit #1/0 AWG-600 Kcmil Cu

Equipment Ground Kits

Equipment Ground Lug Kits are available for all switches.

Switch Ampere Rating	Catalog Number	Number of Terminals	Wire Range Per Terminal (Cu/Al)
30-200	HG61234	2	#14-4 AWG
400 & 600	HG656	4	#6 AWG-250 Kcmil

NEW Internal Shield Kits (for fusible switches)

Kits provide a "skirt" that encloses the VBII switch and also a clear plastic inner door to prevent accidental contact with live parts. Test probe holes are provided and fuses can be replaced without removal of kit.

Switch Ampere Rating	Shield Kit Catalog Number
30A	HSK61
60-100A	HSK623
200A	HSK64

Disconnect Switches

Type VBII Lug Wire Ranges & Dimensions

Lugs

30 & 60A switches are suitable for use with 60° or 75°C wire. 100–600A switches are suitable for use with 75°C rated wire. All switches are supplied with factory installed line and load lugs.

Wire Ranges (Line, Load and Standard Neutral)

Switch Ampere Rating	UL Approved Wire Range	Lug Wire Range
30	#14-6 AWG (Cu/Al)	#14-2 AWG (Cu/Al)
60	#14-2 AWG (Cu/Al)	#14-2 AWG (Cu/Al)
100	#14-1/0 AWG (Cu/Al)	#14-1/0 AWG (Cu/Al)
200	#6 AWG-300 Kcmil (Cu/Al)	#6 AWG-300 Kcmil (Cu/Al)
400	1/0 AWG-750 Kcmil (Cu/Al) or (2) 1/0 AWG-250 Kcmil (Cu/Al)	(1) 1/0 AWG-750 Kcmil (Cu/Al) or (2) 1/0 AWG-250 Kcmil (Cu/Al)
600	(2) 1/0 AWG-750 Kcmil (Cu/Al) or (4) 1/0 -250 Kcmil (Cu/Al)	(2) 1/0 AWG-750 Kcmil (Cu/Al) or (4) 1/0 AWG-250 Kcmil (Cu/Al)

Approximate Dimensions

Mounting bracket shown with handle installed is supplied with Flange Mounted Switches only. All Panel Mounted Switches have a "L" shaped mounting pan with a line base, load base (if fusible) and mechanism installed.

Catalog Number	Dimensions				
	A	B	C [Ⓞ]	D (min)	D (max)
Fusible, Panel Mounted					
VBFS321	11.88	N/A	7.47	6.94	19
VBFS322	13.12	N/A	8.50	6.94	19
VBFS361, PV	11.88	N/A	7.47	6.94	19
VBFS362, PV	13.12	N/A	8.50	6.94	19
VBFS363, PV	13.12	N/A	8.50	6.94	19
VBFS364	17	N/A	12.33	7.12	19
VBFS365	26.25	N/A	16.50	8.63	19
VBFS366	26.25	N/A	16.50	8.63	19
Non-fusible, Panel Mounted					
VBNFS361, PV	9.79	N/A	7.47	6.94	19
VBNFS362, PV	9.79	N/A	8.50	6.94	19
VBNFS363, PV	9.79	N/A	8.50	6.94	19
VBNFS364	10.77	N/A	12.33	7.12	19
VBNFS365	13	N/A	16.50	8.63	19
VBNFS366	13	N/A <td 16.50	8.63	19	
Fusible, Flange Mounted					
VBFS321F	11.88	14.08	7.47	7.27	N/A
VBFS322F	13.12	15.83	8.85	7.27	N/A
VBFS361F, PV	11.88	14.08	7.47	7.27	N/A
VBFS362F, PV	13.12	15.83	8.85	7.27	N/A
VBFS363F, PV	13.12	15.83	8.85	7.27	N/A
VBFS364F	17	18.20	12.68	7.57	N/A
Non-fusible, Flange Mounted					
VBNFS361F, PV	9.79	11.78	7.47	7.27	N/A
VBNFS362F, PV	9.79	11.78	8.85	7.27	N/A
VBNFS363F, PV	9.79	11.78	8.85	7.27	N/A
VBNFS364F	10.77	11.97	12.68	7.57	N/A

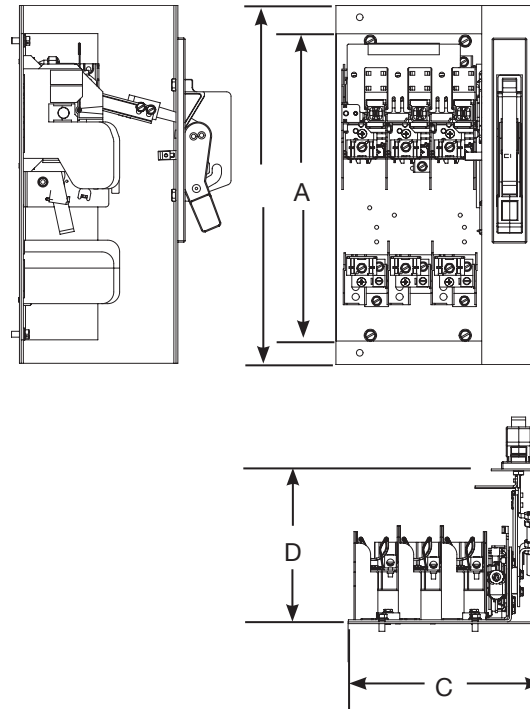

[Ⓞ] Dimension C for panel mounted switches indicates the minimum width from the left hand edge of the switch mounting pan to the right hand inside surface of the enclosure.

Disconnect Switches

Type MCS (30-200A) — Switches, Fuse and No Fuse Kits

Features

- 30, 60, 100 and 200 Ampere Switches
- UL Recognized (file # E121152 vol. 1 & 2) and CSA Certified
- Simple Mounting — with an integral switch and over center mechanism
- Horsepower & load break rated
- Compact Size
- Visible Blade Contacts
- Rugged Construction — with a short circuit current rating of 10,000 amps with Class H or 200,000 amps at 600V maximum AC, when fused with Class R or Class J fuses
- Available with three operator handle options, allowing flexible placement of switch
- Field Installable Auxiliary Contacts
- Flexible Fuse Class Configurations
- Flange mounted handles meet NFPA79 requirements

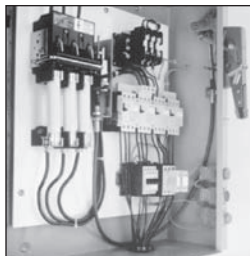

Type MCS Disconnect Switch with Max-Flex™ handle operator

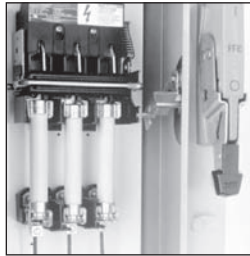

Type MCS Disconnect Switch with fixed-depth, flange-mounted handle

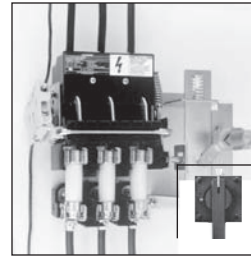

Type MCS Disconnect Switch with rotary handle

Ordering Information

1. Select the basic switch size you need (30, 60, 100 or 200 ampere).
2. Check the switch selected against the maximum horsepower rating required for our application. "L" or "R" suffix on switch catalog numbers denotes left or right-handed mechanism drive.
3. Choose either fuse or no fuse kit from chart below.
4. Check "Minimum Dimensions" on page 18/26 for installation space requirements.
5. Select from the list of handle operators, the type which best suits your application. Handle operators can be selected from the next page.

Basic Switches

Switch Ampere Rating	Maximum Voltage Rating	Catalog Number Right Hand	Catalog Number Left Hand	Maximum Horsepower Rating, 3 Phase ^④						250 Volts DC (max) ^④
				240 Volts AC		480 Volts AC		600 Volts AC		
				Standard Fuse	Time Delay Fuse	Standard Fuse	Time Delay Fuse	Standard Fuse	Time Delay Fuse	
30	600	MCS603R	MCS603L	3	7½	5	15	7½	20	5
60	600	MCS606R	MCS606L	7½	15	15	30	15	50	10
100	600	MCS610R	MCS610L▲	15	30	25	60	30	75	20
200	600	MCS620R	MCS620L▲	25	60	50	125	60	150	40

Fuse And No Fuse Kits (Includes load base plus line and load fuse clips)^①

Basic Switch Ampere Rating	Switch Catalog Number	Kit Description	No Fuse Kits		For Class H	For Class J	For Class R	Lug Wire Size
			Standard	Cu Only ^②	Catalog Number ^①	Catalog Number ^①	Catalog Number ^①	
			Catalog Number	Catalog Number				
30	MCS603R or MCS603L	No Fuse	TMK606	—	—	—	—	#14 to #4 AWG Cu/Al
		30A, 250V	—	—	FCK203▲	—	FCRK203	
		30A, 600V	—	—	FCK206	FCJK603	FCRK206	
		60A, 250V	—	—	FCK206	—	FCRK206	
60	MCS606R or MCS606L	60A, 600V	—	—	FCK606	FCJK606	FCRK606	#14 to #4 AWG Cu/Al
		No Fuse	TMK606	—	—	—	—	
		60A, 250V	—	—	FCK206	—	FCRK206	
		60A, 600V	—	—	FCK606	FCJK606	FCRK606	
100	MCS610R or MCS610L	100A, 250V	—	—	OFCK661▲	OFCK661▲	③	#14 to #2/0 AWG Cu/Al
		100A, 600V	—	—	OFCK661▲	OFCK661▲	③	
		200A, 250V	—	—	OFCK661▲	OFCK661▲	③	
		200A, 600V	—	—	OFCK661▲	OFCK661▲	③	
200	MCS620R or MCS620L	No Fuse	TMK620	TMK620C▲	—	—	—	#6 to 300 kcmil Cu/Al
		200A, 250V	—	—	FCK620	FCJK620	③	
		200A, 600V	—	—	FCK620	FCJK620	③	
		200A, 600V	—	—	FCK620	FCJK620	③	

▲ Built to order. Allow 6-8 weeks for delivery.

① For "copper only" connectors, order as follows:

Fusible—order standard switch, standard fuse kit and copper only no fuse kit.

Non-Fusible—order standard switch and copper only no fuse kit.

② Includes both line and load lugs.

③ For Class R fuses order Class H kit from this table and the Class R conversion kit from the next page.

④ HP ratings for time delay fuses and for 250V DC also apply to Non-fusible switches.

Disconnect Switches

Type MCS (30-200A)

Auxiliary Switch Kits

Switch Catalog Number	Contact Arrangement	
	1 NO/1 NC Catalog Number	2 NO/2 NC Catalog Number
MCS603R	MCSAKR136	MCSAKR236
MCS603L	MCSAKL136	MCSAKL236▲
MCS606R	MCSAKR136	MCSAKR236
MCS606L	MCSAKL136	MCSAKL236▲
MCS610R	MCSAK116	MCSAK216
MCS610L	MCSAK116	MCSAK216
MCS620R	MCSAK126	MCSAK226
MCS620L	MCSAK126	MCSAK226

Class R Fuse Conversion Kits

Fuse Clip Rating	Catalog Number
100A, 600V	SSRK33
200A, 600V	SSRK34

Fuse Ejector Kits

Switch Catalog Number	Fuse Ejector Kit Catalog Number
MCS610	FE100▲
MCS620	FE200▲

Handle Operators

Fixed Depth, Flange Mounted, Types 1, 3, 3R, 12^{①⑥}

Switch Catalog Number	Complete Handle Mechanism Catalog Number	Handle Only Catalog Number	Switch Operator Only Catalog Number
MCS603R	FDFS06R	FDH10	FDS06R
MCS603L	FDFS06L	FDH10	FDS06L
MCS606R	FDFS06R	FDH10	FDS06R
MCS606L	FDFS06L	FDH10	FDS06L
MCS610R	FDFS06R	FDH10	FDS06R
MCS610L	FDFS06L	FDH10	FDS06L
MCS620R	FDFS20R	FDH20	FDS20R
MCS620L	FDFS20L	FDH20	FDS20L

Variable Depth, Flange Mounted Max-Flex™, Types 1, 3, 3R, 12^②

Switch Catalog Number	Complete Handle Mechanism Catalog Number	Handle Only Catalog Number	Switch Operator Only Catalog Number	Cable Only ^③ Catalog Number
MCS603R	FHOS06036R	FHOHS	FHOS06R	FHOEC036
MCS603L	FHOS06036L	FHOHS	FHOS06L	FHOEC036
MCS606R	FHOS06036R	FHOHS	FHOS06R	FHOEC036
MCS606L	FHOS06036L	FHOHS	FHOS06L	FHOEC036
MCS610R	FHOS06036R	FHOHS	FHOS06R	FHOEC036
MCS610L	FHOS06036L	FHOHS	FHOS06L	FHOEC036
MCS620R	FHOS20036R	FHOHS	FHOS20R	FHOJC036
MCS620L	FHOS20036L	FHOHS	FHOS20L	FHOJC036

Variable Depth Rotary, Through-The-Door-Mounted, Types 1, 12^{④⑤}

Variable Depth				Shaft Only Variable Depth
MCS603R	CRHOS06VD	CRHOH	RHOS06	RHOSVD
MCS606R	CRHOS06VD	CRHOH	RHOS06	RHOSVD
MCS610R	CRHOS06VD	CRHOH	RHOS06	RHOSVD
MCS620R	CRHOS20VD	RHOH	RHOS20	RHOSVD

MCS Disconnect Switch Panel Space Requirements

Panel Space Requirements

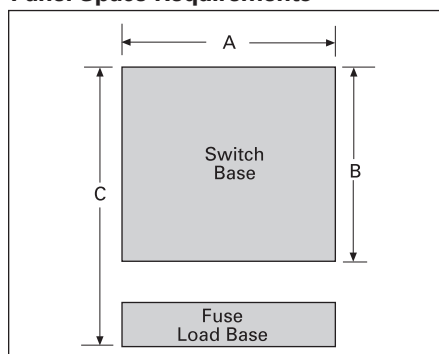

Minimum Dimensions (inches*)

Switch Catalog Number	Size	"A"	"B"	"C"	Fuse Class
MCS603	30A/240V	6.13	5.52	8.11	H, K, R
	30A/600V	6.13	5.52	10.11	H, K, R
	30A/600V	6.13	5.52	8.48	J
MCS606	60A/240V	6.13	5.52	7.86	H, K, R
	60A/600V	6.13	5.52	10.38	H, K, R
	60A/600V	6.13	5.52	8.35	J
MCS610	100A/240V	7.38	7.59	11.85	H, K, R
	100A/600V	7.38	7.59	13.85	H, K, R
	100A/600V	7.38	7.59	10.6	J
MCS620	200A/240V	9.17	9.00	14.7	H, K, R
	200A/600V	9.17	9.00	17.2	H, K, R
	200A/600V	9.17	9.00	13.32	J

"A" – Dimension is measured from each cross bail pin.

"B" – Dimension is measured from line side barrier to load side barrier.

"C" – Dimension is measured from line side terminal of switch to load side terminal of fuse load base.

▲ Built to order. Allow 6–8 weeks for delivery.

①For Type 4 and 4X applications, order handle only
Catalog Number
100A - FDH104 200A - FDH204

②For Type 4 and 4X applications, order handle only
Catalog Number FHOHS4

③Standard cable length is 36 inches. Alternate lengths are available as follows:

Length	Amps	Cat. No.
48"	30–100	FHOEC048
60"	30–100	FHOEC060
48"	200	FHOJC048
60"	200	FHOJC060

④For Type 4 and 4X applications, order handle only
Catalog Number RHOH4

⑤For Type 3 and 3R applications, order handle only
Catalog Number RHOH

⑥Min. enclosure depth from mounting pan to handle mounting surfaces: 30-100A 6.44 Inches
200A 10.93 Inches

*For millimeters multiply inches by 25.4.

Disconnect Switches

Type CFS Compact Fusible Switches

Features

- 30 - 800A ratings
- UL Listed under file #E121152 & CSA Certified under file #222227
- Door mounted rotary handles with defeatable cover interlock
- Meets UL requirements for both main and branch circuit applications
- Compact size
- 100kA with Class CC fuses or up to 200kA with Class J fuses
- Load break and horsepower rated
- Quick make and break operation
- All handles are padlockable with up to (3) padlocks with 5/16" hasps in the OFF position
- Catalog number **CFS361C5**, **CFS361J5** and **CNFS361** can be DIN-rail mounted and can be either front or side operated with standard rotary handles.
- All CFS part numbers ending in N can be either front or side operated with standard rotary handles.
- Handles are available in Type 1, 3R, 4/4X & 12 ratings
- NFPA 79 field installed kits are available
- 30-400A, 200kA switches are provided with quick connect terminal provisions for voltage sensing or for 10A max. control circuits
- Fusible switches, 3-pole 600V AC Max. 30-100A & 600-800A switches are also rated 250V DC Max when poles are field connected in series.



Ordering information

1. Select the panel mounted switch required based on Ampere, HP and AIC requirements. Switches with a right hand mechanism are standard, 30-100A switches with a left hand mechanism are available.
2. Select handle based on environmental rating required.
3. Select operating shaft (200 or 400mm in length). For enclosure depths of 9.0" or less from panel mounting surface to inside of door use 200mm long shafts. For deeper enclosures use 400mm long shafts. 30A 100kA switches can be used in 10" deep enclosures (panel to inside of door) with 200mm shaft and CFSH5N handles.

Note: Be sure to check shaft and handle compatibility with the switch selected by using information provided in the selection tables.

4. Line & load lugs are provided as standard on 30-100A switches. Terminal kits are available for 200-800A switches if needed.

5. Auxiliary contact are available if needed as follows.
 - A. 30A switch CFS361C5 and non-fusible 30A switch CNFS361 will accept up to (4) aux contacts
 - B. 30A switch CFS361J5 will accept up to (2) aux contacts without an aux contact holder. If more than (2) aux contacts are required order aux contacts PLUS aux contact holder kit CFSAuxH1. All other switches will accept up to (4) aux contacts.
6. If non-fusible switch is required order a shorting bar for 60-600A switches or catalog number CNFS361 for 30A.
7. 30-100A switches are designed to prevent inadvertent contact with live parts and shields are not required. 200 & 400A switches are not supplied with terminal shields. They are available as field installed kits for both line and load terminals. 400-800A switches are supplied as standard with line shields and terminal shroud kits are available for the load side.

Disconnect Switches

Type CFS Compact Fusible Switches

Fusible switches, 3-pole 600V AC Max. 30-100A & 600-800A switches are also rated 250V DC Max when poles are field connected in series^⑤

Switch ampere rating	Catalog number	Fuse provisions provided	Max horsepower ratings				AC short circuit rating
			240V 3Ø AC	480V 3Ø AC	600V 3Ø AC	250V DC	

Standard – with right hand mounted mechanism

30 ^①	CFS361C5	Class CC	7.5	15	20	5 ^③	100kA
30 ^①	CFS361J5	Class J	7.5	15	20	5 ^③	100kA
30 ^①	CFS361JN	Class J	7.5	15	20	5 ^③	200kA
30 ^①	CNFS361 ^②	None	7.5	15	20	5 ^③	65kA
60 ^①	CFS362JN1	Class J	15	30	50	10 ^③	100kA
60 ^①	CFS362JN	Class J	15	30	50	10 ^③	200kA
100 ^①	CFS363JN		30	60	75	20 ^③	
200 ^②	CFS364JN ^④		60	125	150	–	
400 ^②	CFS365JN ^④		125	250	350	–	
600 ^②	CFS366J ^④		200	400	500	–	
800 ^②	CFS367L ^④	Class L	200	400	500	–	200kA

Optional – with left hand mounted mechanism^⑤

30 ^①	CFS361JLN	Class J	7.5	15	20	5 ^③	200kA
60 ^①	CFS362JLN		15	30	50	10 ^③	
100 ^①	CFS363JLN		30	60	75	20 ^③	

Operating shafts for 30-400A switches^⑤

Catalog number	Shaft length in. (mm)	Switch & handle compatibility
CFSS5200N	7.9 (200)	5mm x 5mm for use with CFS361C5, CFS361J5 & CNFS361 switches & with "CFSS5" handles only
CFSS5400N	15.7 (400)	
CFSS5200HN	7.9 (200)	5mm x 5mm for use with all "CFSS10" handles & with CFS361C5, CFS361J5 & CNFS361 switches only
CFSS5400HN	15.7 (400)	
CFSS10200HN	7.9 (200)	10mm x 10mm for use with all "CFSS10" handles & with all 30-400A switches except CFS361C5, CFS361J5 & CNFS361
CFSS10400HN	15.7 (400)	

Compact rotary operating handles – door mounted (for use with CFS361C5, CFS361J5 & CNFS361 switches only)^⑥

Catalog number	Color	UL Type	Operating shaft compatibility
CFSH5B12N	Blue & Black	1, 3R & 12	CFSS5200N or CFSS5400N
CFSH5R12N	Yellow & Red		
CFSH5B4N	Blue & Black	1, 3R, 12 & 4/4X	
CFSH5R4N	Yellow & Red		

Rotary operating handles - door mounted (for use with CFSS5200HN, CFSS5400HN, CFSS10200HN & CFSS10400HN)

Catalog number	Color	Description
----------------	-------	-------------

Type 1, 3R & 12^⑦

CFSH10B12N	Blue & Black	Heavy duty pistol grip (2.75" long) for use with 30A switches & CFS362JN1)
CFSH10R12N	Yellow & Red	
CFSH10BL12N	Blue & Black	Heavy duty pistol grip (4.92" long for 30-400A switches)
CFSH10RL12N	Yellow & Red	

Type 1, 3R, 4/4X & 12^⑦

CFSH10B4N	Blue & Black	Heavy duty pistol grip (2.75" long) for use with 30A switches & CFS362JN1)
CFSH10R4N	Yellow & Red	
CFSH10BL4N	Blue & Black	Heavy duty pistol grip (4.92" long for 30-400A switches)
CFSH10RL4N	Yellow & Red	

① Line and load lugs included.

② Line and load lugs are not included.

Order from table on next page if required.

③ DC HP rating shown requires (3) poles to be connected in series.

④ CFS364JN & CFS365JN can be rotated 180° for left hand operation as standard.

⑤ Catalog numbers CFS361C5, CFS361J5 & CNFS361 accept 5mm x 5mm operating shafts. All other 30-400A switches accept 10mm x 10mm operating shafts.



CFS361J5



CFSS5400N



CFSH5B12N

⑥ Compact pistol grip design (2.75" long) with defeatable cover interlock. Cover can be opened when handle is padlocked in the OFF position.

⑦ Defeatable cover interlock provided. Cover cannot be opened when handle is padlocked in the OFF position.

⑧ Catalog number CNFS361 is a non-fusible switch.

⑨ 4 pole 600 & 800A switches, CFS466J & CFS467L are also available.

⑩ CFS366J and CFS367L are rated 250 & 600V DC when (2) poles are connected in series.

⑪ CNFS361 is rated 65kA when protected by Class J or CC 30A max. fuses.

Disconnect Switches

Type CFS Compact Fusible Switches

600 & 800A rotary operating handles - door mounted
(8.27" long)^②

Catalog number	Color	UL Type
CFSH12BL12	Blue & Black	1, 3R & 12
CFSH12RL12	Yellow & Red	1, 3R & 12
CFSH12BL4	Blue & Black	1, 3R, 12 & 4/4X
CFSH12RL4	Yellow & Red	1, 3R, 12 & 4/4X

600 & 800A operating shafts (cross section 12 x 12 mm)

Catalog number	Shaft length in. (mm)	Enclosure depth (switch mounting surface to door OD)
CFSS12200H	12.59 (320)	10.43 – 16.68 in.
CFSS12400H	15.75 (400)	10.43 – 19.84 in.

Type CFS fusible switch accessories

Catalog number	Description
----------------	-------------

Terminals^①

CFSL200	200A lug kit (6 lugs per kit) (1)#6-3/0
CFSL400N	400A lug kit (6 lugs per kit) (1)#2-600kcmil (for CFS365JN only)
CFSL400	600-800A lug kit (6 lugs per kit) (2)#2-600kcmil

Shorting bars (no fuse kits)

CFSSB60	60A shorting bar kit (3 links per kit)
CFSSB100	100A shorting bar kit (3 links per kit)
CFSSB200	200A shorting bar kit (3 links per kit)
CFSSB400	400A shorting bar kit (3 links per kit)
CFSSB680	600 & 800A shorting bar kit (1 link per kit)

Auxiliary contacts (NEMA ratings AC A600 DC N600)

CFSAUXH1 ^②	Aux contact holder (CFS361J5, CFS361C5 & CNFS361)
CFSAUX1NO	Aux contact 1 NO (30-800A Sws)
CFSAUX1NC	Aux contact 1 NC (30-800A Sws)
CFS11AUX	1NO, 1NC aux contact kit (side mount for 200kA switches)
CFS22AUX	2NO, 2NC aux contact kit (side mount for 200kA switches)

Terminal shrouds (line or load)

CFSTS200N ^③	200A shroud kit (line or load 3-pole kit)
CFSTS400N ^③	400A shroud kit (line or load 3-pole kit for CFS365JN only)
CFSTS680 ^③	600/800A 3-pole shroud kit
CFSTS6804 ^③	600/800A 4-pole shroud kit

30A compact switch kits

CFSPK	Shaft padlocking kit for 30A compact switch when door is open ^④
CFSH5CDM	Direct mount handle kit for CFS361C5 & CNFS361
CFSH5JDM	Direct mount handle kit for CFS361J5

NFPA 79 kits

(if auxiliary contacts are needed, see table on page 7)

Kits provide an operating shaft suitable for use with all heavy duty handles (not for use with CFSH5 handles). Kits also provide an internal operating handle and an internal OFF padlocking provision.

CFSNFPA1 ^⑤	For use with CFS361C5, CFS361J5 & CNFS361
CFSNFPA2N ^⑤	For use with CFS361JN, CFS361CN, CFS362JN1, CFS362JN, CFS363JN & CFS364JN
CFSNFPA3N ^⑤	For use with CFS365JN only

^① Supplied as standard on 30-100A switches

^② CFS361C5 and CNFS361 will accept (4) aux contacts without an aux contact holder. CFS361J5 will accept (2) aux contacts without an aux contact holder.

^③ Supplied as standard on all but 30A, 65kA & 100kA compact switches.

^④ 12.6 in. (320 mm) long operating shaft included

^⑤ 12.7 in. (323 mm) long operating shaft included

^⑥ Line side terminal shrouds supplied with switch



CFSL200 & 400



CFSAUX1NC



CFSSB100 - CFSSB400

^⑦ Defeatable cover interlock included. Cover cannot be opened when the handle is padlocked in the OFF position.

^⑧ Neither line or load terminal shrouds are supplied as standard with new style 200 & 400A switches.

Disconnect Switches

Type CFS Compact Fusible Switches

UL & CSA technical characteristics and panel space requirements

Catalog number	Amps	Fuse Class	AC short circuit rating	Electrical endurance	Mechanical endurance	Panel space requirements - in. (mm)		
						Height	Width	Depth ^①
CFS361C5	30	CC	100kA	6000	10000	4.56 (116)	3.78 (96)	6.00 (152)
CFS361J5	30	J	100kA	6000	10000	4.56 (116)	4.15 (105)	6.00 (152)
CFS361JN	30	J	200kA	6000	10000	5.35 (136)	5.89 (150)	6.00 (152)
CFS361JLN	30	J	200kA	6000	10000	5.35 (136)	5.89 (150)	6.00 (152)
CNFS361	30	None	65kA ^②	6000	10000	4.56 (116)	3.78 (96)	6.00 (152)
CFS362JN1	60	J	100kA	6000	10000	5.35 (136)	5.89 (150)	6.00 (152)
CFS362JN	60	J	200kA	6000	10000	7.32 (186)	5.89 (150)	6.00 (152)
CFS362JLN	60	J	200kA	6000	10000	7.32 (186)	5.89 (150)	6.00 (152)
CFS363JN	100	J	200kA	6000	10000	7.32 (186)	5.89 (150)	6.00 (152)
CFS363JLN	100	J	200kA	6000	10000	7.32 (186)	5.89 (150)	6.00 (152)
CFS364JN	200	J	200kA	6000	8000	11.46 (291)	7.72 (196)	6.00 (152)
CFS365JN	400	J	200kA	1000	6000	15.35 (390)	10.19 (259)	8.00 (203)
CFS366J	600	J	200kA	1000	5000	11.81 (300)	14.33 (364)	11 (280)
CFS466J	600	J	200kA	1000	5000	11.81 (300)	18.03 (458)	11 (280)
CFS367L	800	L	200kA	500	3500	11.81 (300)	14.33 (364)	11 (280)
CFS467L	800	L	200kA	500	3500	11.81 (300)	18.03 (458)	11 (280)

Wire ranges line & load lugs

Switch	Amperage Rating	UL approved wire size (75° C)
CFS361J5	30	(1)#14-10
CFS361C5	30	(1)#14-10
CNFS361	30	(1)#14-10
CFS361JN	30	(1)#14-6
CFS362JN1	60	(1)#14-6
CFS362JN	60	(1)#12-1
CFS363JN	100	(1)#12-1
CFS364JN	200	(1)#3/0
CFS365JN	400	(1)600MCM
CFS366J	600	(2)350 MCM
CFS367L	800	(2)600 MCM

Auxiliary contact capability when an NFPA79 kit is used

Switch	NFPA79 kit	Aux contacts that can be installed
CNFS361	CFSNFPA1	(2) Total, CFS AUX1NO or CFS AUX1NC
CFS361C5		
CFS361J5	CFSNFPA2N	(2) Total, CFS AUX1NO or (1) CFS AUX1NC
CFS361JN		
CFS362JN1		
CFS362JN		
CFS363JN		
CFS364JN	CFSNFPA3N	(2) Total, CFS AUX1NO or CFS AUX1NC ^③
CFS365JN		

① Minimum dimensions from mounting surface to inside of cover. Dimensions shown can be decreased if aux contacts are not required.

② CNFS361 is rated 65kA when protected by 30A max. Class J or CC fuses.

③ For additional auxiliary contacts use side mounted CFS11AUX or CFS22AUX.