

Fasteners

RUFFIN-16

B-LINE
SERIES

Ruff-IN[®] pre-fab systems

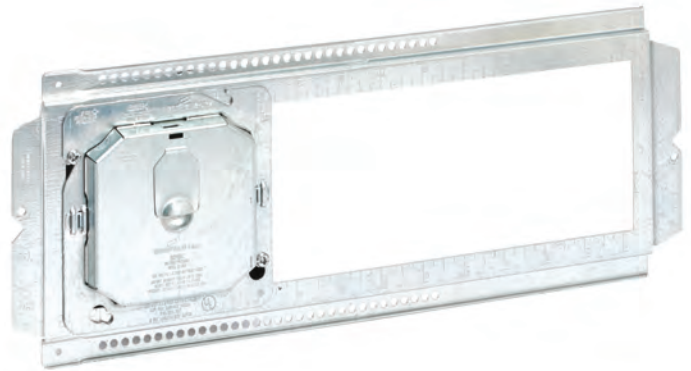

EATON

Powering Business Worldwide



Energizing a world that demands more.

Discover today's Eaton.

Powering business worldwide

As a global power management company, we help customers worldwide manage the power needed for buildings, aircraft, trucks, cars, machinery and businesses.

Eaton's innovative technologies help customers manage electrical, hydraulic and mechanical power more reliably, efficiently, safely and sustainably.



EATON

Powering Business Worldwide



We deliver:

- **Electrical solutions** that use less energy, improve power reliability and make the places we live and work safer and more comfortable
- **Hydraulic and electrical solutions** that enable machines to deliver more productivity without wasting power
- **Aerospace solutions** that make aircraft lighter, safer and less costly to operate, and help airports operate more efficiently
- **Vehicle drivetrain and powertrain solutions** that deliver more power to cars, trucks and buses, while reducing fuel consumption and emissions

We provide integrated solutions that help make energy, in all its forms, more practical and accessible.

With 2014 sales of \$22.6 billion, Eaton has approximately 100,000 employees around the world and sells products in more than 175 countries.



Eaton's electrical business

Eaton is a global leader with expertise in:

- Power distribution and circuit protection
- Backup power protection
- Solutions for harsh and hazardous environments
- Lighting and security
- Structural solutions and wiring devices
- Control and automation
- Engineering services

Eaton is positioned through its global solutions to answer today's most critical electrical power management challenges. With 100 years of electrical experience behind us, we're energized by the challenge of powering up a world that demands twice as much energy as today. We're anticipating needs, engineering products and creating solutions to energize our markets today and in the future.

We are dedicated to ensuring that reliable, efficient and safe power is available when it's needed most.

Eaton.com

Ruff-IN™ Table of Contents

Table of Contents	1
Ruff-IN Products	
Brackets & Support Pictorial	2
Telescoping Brackets	3
Box Mounting Clip	3
Floor Mount Box Supports	4
Double Sided Box Support Bracket	5
Single Sided Box Support Bracket	5
Double Sided Support Bracket	6
Box Support Brackets	7
Multiple Box Mounting Brackets	8
Open Box Support Mounting Brackets	8
Uni-Mount Box Supports	9
Heavy Duty Electrical Box Hanger	9
Box Mounting Bracket Accessories	10
Floor Mounted Box Support	10
Rapid Ring™ Products	11 - 12
Basic Prefab Assemblies Pictorial	13
Basic Ruff-IN Information	14
BB216TSC Series Products	15 - 16
BB816 Series Products	17 - 18
BB716 Series Products	19 - 20
BB70 Series Products	21 - 22
Ruff-IN Accessories Pictorial	23
Adjustable Plaster Rings	24
Firestop Pads	25
Metal Protector Plates	26
Conduit Quick Caps & Spacers	27
Concrete Box Clamps	28
Cable Supports	29 - 30
Index	31

Brackets & Supports



Telescoping Brackets (page 3)

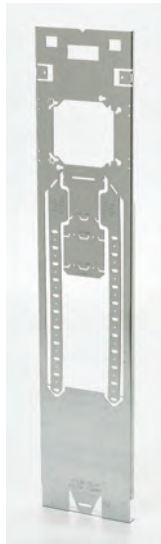

Floor Mount Box Supports (page 4)



Double Sided Box Support Brackets (page 5)

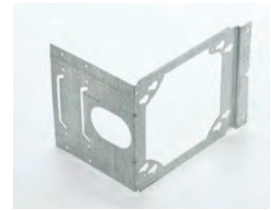

Single Sided Box Support Brackets (page 5)



Box Mounting Clips (page 3)

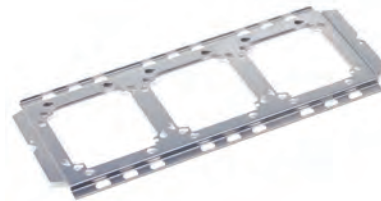

Multiple Box Mounting Brackets (page 8)

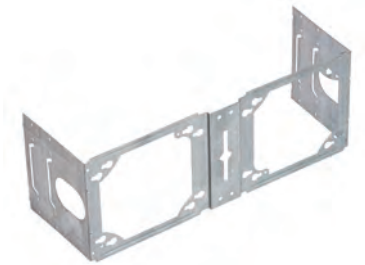

Double Sided Support Brackets (page 6)



Uni-Mount Box Supports (page 9)



Open Box Mounting Brackets (page 8)

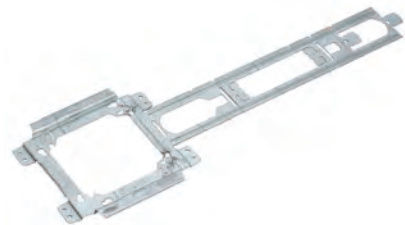

Box Support Brackets (page 7)



Box Mounting Bracket Accessories (page 10)



Heavy Duty Electrical Box Hanger (page 9)



Rapid Ring™ Products (pages 11 & 12)



Floor Mounted Box Support (page 10)

Telescoping Brackets

BB2-16T

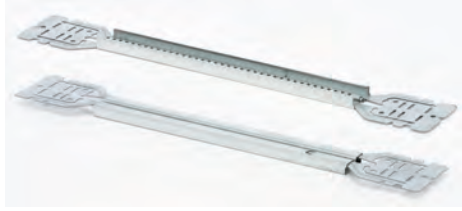

Features

- Completely adjustable, fits a range of stud spacing
- Mounts 1¹/₂" , 2¹/₈" , 2¹/₂" , and 2¹³/₁₆" deep boxes
- Increased rigidity through center groove design
- Only two screws required to mount 1¹/₂" and 2¹/₈" box depths
- Pre-punched screw holes provide for easy box installation
- Bar is marked with a scale for stud spacing
- Finish: Pre-galvanized

BB2-24T



UPC/Part Number	Catalog Number	Stud Spacing	Box Qty.
799038 63001	BB2-16T	11" to 18"	50
799038 63002	BB2-24T	15 ¹ / ₂ " to 26"	50

Patent Pending

Box Mounting Clip



Features

- Allows for pre-fabrication of the electrical box prior to installing the box onto the bracket
- Tool-less, simply installs by snapping onto the bracket and requires no hardware to secure



Shown mounted on box

UPC/Part Number	Catalog Number	Description	Box Qty
799038 63003	BB2TSC	Box Mounting Clip	100

Notes: Read safety/installation instruction sheet in packages before use.

Features

- BBF floorstand provides the most rigid support in the industry
- Far-side support accomodates 6", 5 1/2", 3 5/8", and 2 1/2" stud depths
- Fold-out tab built-in to attach floor stand to stud if desired
- Integral "wings" provide rigid support when floorstand is mounted between studs
- Optional cable containment clip securely attaches to floorstand without hardware
- Patented Marty Mouse ears enable boxes to be secured with or without the plaster rings
- Finish: Pre-galvanized



Floor Mount Box Supports

UPC/Part Number	Catalog Number	Box Center Height	Box Qty
782051 52944	BBF15	15" Floorstand	25
782051 52945	BBF18	18" Floorstand	25
782051 52946	BBF24	24" Floorstand	25
782051 52947	BBFC	Cable Containment Clip	25
782051 52948	BBF15C	15" Floorstand with Cable Containment Clip	25
782051 52949	BBF18C	18" Floorstand with Cable Containment Clip	25
782051 52950	BBF24C	24" Floorstand with Cable Containment Clip	25

Patent # 5595362
#7956285B2

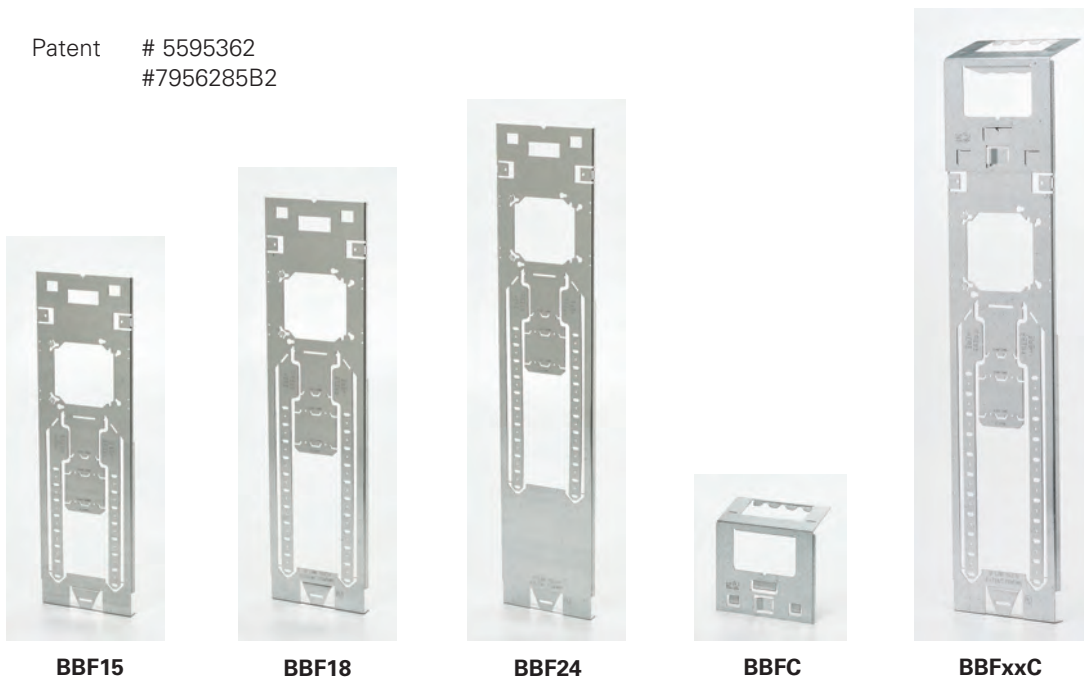

Notes: Read safety/installation instruction sheet in packages before use.

Double Sided Box Support Bracket

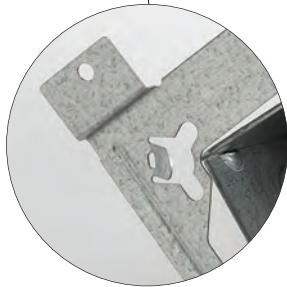

Features

- Double sided box support designed for Pre-Fab installations. Unit can be installed on either side of stud without repositioning box or devices
- Patented Marty-Mouse ears feature an innovative keyhole pattern to secure outlet box to bracket with or without plaster ring
- Marty-Mouse ears simplify wiring of pre-fab units. Plaster ring can be removed for full access to box contents while box remains in place
- Wider box opening accommodates one or two gang adjustable plaster rings (B1AJ & B2AJ - see pg. 24)
- Enhanced far-side support stands up during drywall installation and outperforms competitor brackets
- Finish: Pre-galvanized



UPC/Part Number	Catalog Number	Stud Size	Box Qty
781011 38645	BB73	3 1/2" & 2 1/2"	50
781011 38717	BB74	4", 3 1/2" & 2 1/2"	50
781011 38759	BB76	6", 5 1/2", 3 1/2", 2 1/2"	25

Patent # 5595362

Single Sided Box Support Brackets

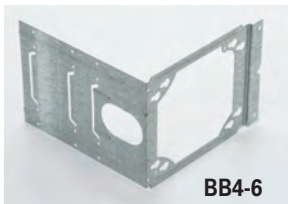
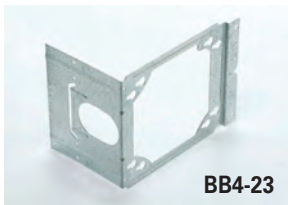

Features

- Improved far-side support prevents box movement in wall cavity
- Adjustable far-side supports designed to reduce labor
- Brackets may be piggy-backed in series
- Not recommended for pre-installed wiring devices
See BB70 (page 7) for an improved Pre-Fab assembly solution



UPC/Part Number	Catalog Number	Stud Size	Box Qty
781011 18190	BB4-23	3 1/2" & 2 1/2"	100
781011 18200	BB4-4	4", 3 1/2" & 2 1/2"	100
781011 18202	BB4-6	6", 5 1/2", 3 1/2", 2 1/2"	100

Notes: Read safety/installation instruction sheet in packages before use.

Double Sided Support Brackets

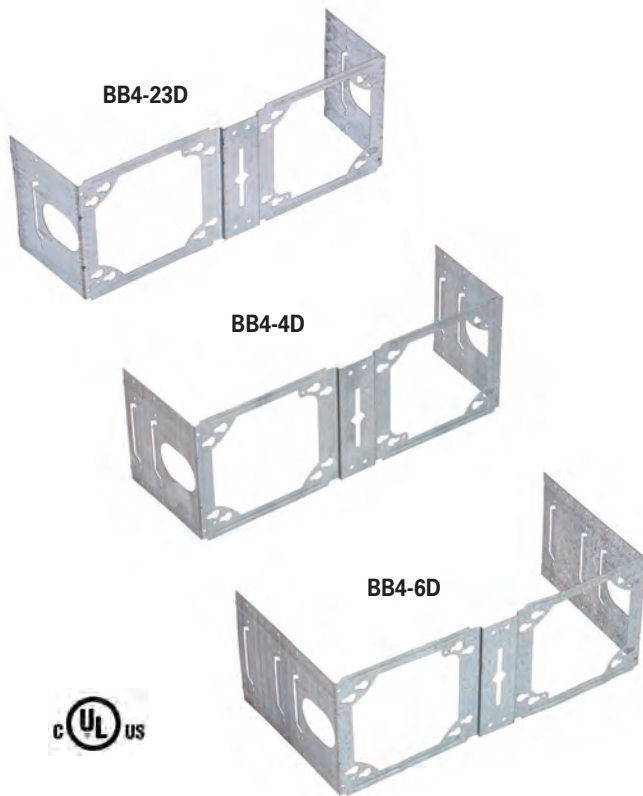

Features

- Improved far-side support prevents box movement in wall cavity
- Adjustable far-side supports designed to reduce labor
- Ruff-IN assemblies available with box, plaster ring and ground wire

UPC/Part Number	Catalog Number	Stud Size	Box Qty
799038 48375	BB4-23D	3 1/2" & 2 1/2"	50
799038 48376	BB4-4D	4", 3 1/2" & 2 1/2"	50
799038 48377	BB4-6D	6", 5 1/2", 3 1/2", 2 1/2"	50

Notes: Read safety/installation instruction sheet in packages before use.

Box Support Brackets

BB70

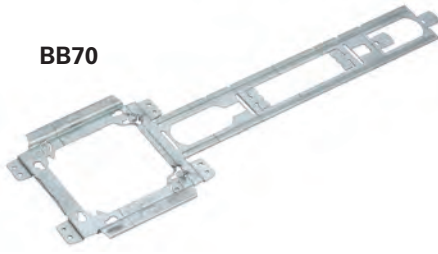

*BB70E
(Sold separately,
must be used
with BB70)

Features

- Interlocking wrap-around design provides extra rigidity
- Compatible with 1-gang and 2-gang Rapid Ring™ and adjustable plaster rings (see pages 11 & 12)
- Adjustable for varying stud depths (2½" to 6")
- Integral mounting tabs for attaching plaster rings
- Multiple brackets may be ganged together
- Available factory assembled as part of the Ruff-IN™ pre-fab line with box, mud ring, and ground wire
- Finish: Pre galvanized
- Patent Pending



UPC/Part Number	Catalog Number	Metal Stud Size	Box Qty
799038 56399	BB70	2½" - 4"	50
799038 56400	BB70E*	5½" - 6"	50

Can be used with BBFS-18 (floor stand)
See page 10.

Bent For Various Depths

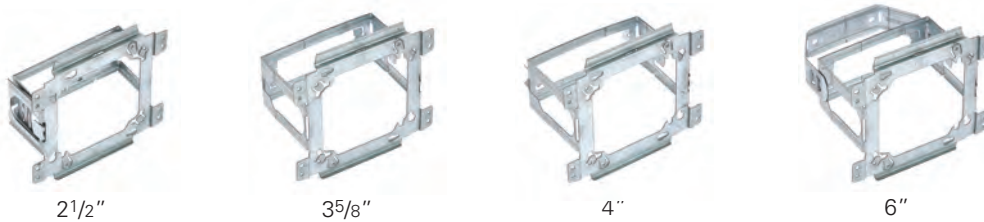

For 5½" depth, snap the BB70E into the next notch on the bracket side

Bending Bracket For 3½" Depth

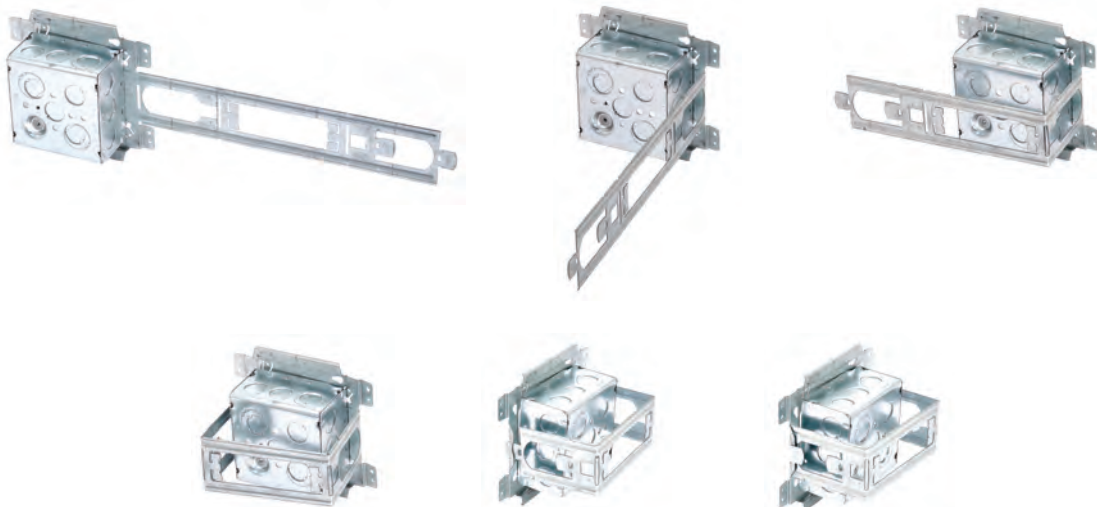

Notes: Read safety/installation instruction sheet in packages before use.

Multiple Box Mounting Brackets

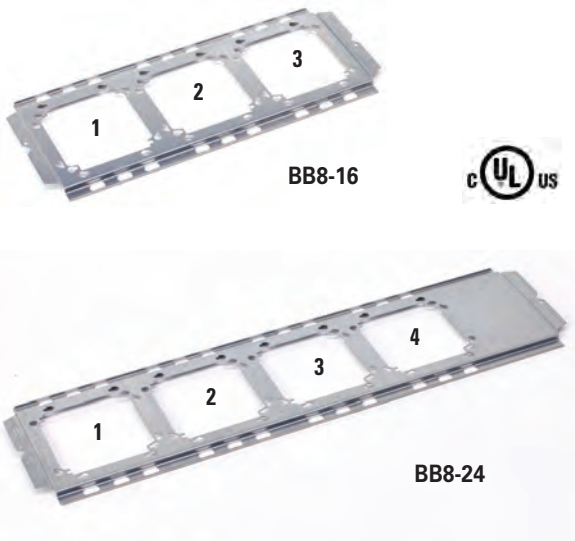

Features

- Increased strength and rigidity help withstand the stress of drywall installation
- Supports most US & Canadian boxes and plaster rings 4" SQ. and 4^{11/16}" SQ
- Compatible with 1-gang and 2-gang Rapid Ring™ and adjustable plaster rings (see pages 11 & 12)
- Available factory assembled as part of the Ruff-IN™ pre-fab line with box(es), mud ring(s), and ground wire(s)
- Finish: Pre-galvanized
- Patent Pending

UPC/Part Number	Catalog Number	Stud Size	Box Qty
781011 02898	BB8-16	16"	25
781011 02900	BB8-24	24"	25

Open Box Support Mounting Brackets

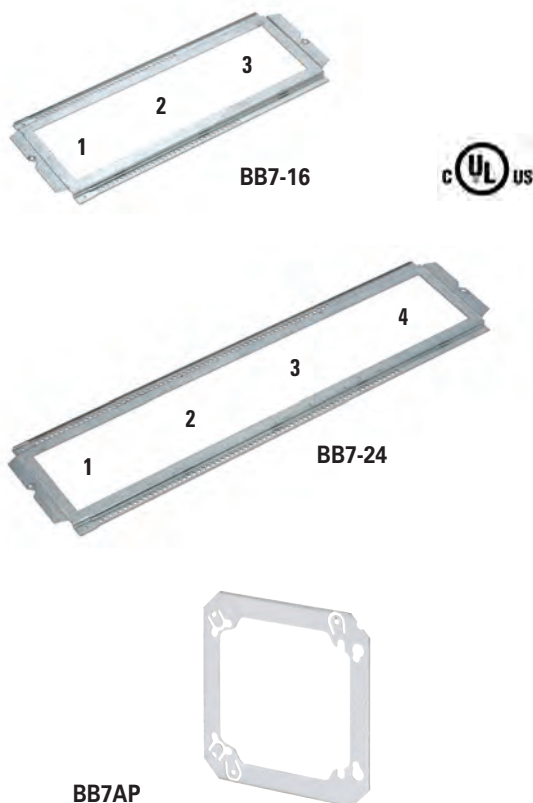

Features

- Open box support allows for adjustability of box position between studs
- Supports most US and Canadian boxes and/or plaster rings 4" SQ., 4^{11/16}" SQ., 5" SQ., and multi-gang boxes
- Fits up to 1^{1/2}" wide studs 16" to 24" on center
- Compatible with Rapid Ring™ & adjustable plaster rings (see pages 11 & 12)
- Field cut to adjust to non-standard stud spacings
- Stamped markings at 1/4", 1/2", and 1" increments to allow the installer to easily locate the desired box position
- Available factory assembled as part of the Ruff-IN pre-fab line with box(es), mud ring(s), and ground wire(s)
- BB7AP alignment plate centers and secures box to the bracket, allows for easy adjustment of box location
- Finish: Pre-galvanized
- Patent Pending

UPC/Part Number	Catalog Number	Stud Size	Box Qty
781011 45325	BB7-16	16"	25
781011 45328	BB7-24	24"	25
799038 59494	BB7AP		100

Notes: Read safety/installation instruction sheet in packages before use.

Uni-Mount™ Box Supports



Features

- Uni-Mount provides a secure box support and features a built-in plaster ring
- Rigid bracket design eliminates the need for far-side support
- Guide tabs ensure alignment on studs
- Ruff-In assemblies available with box, plaster ring and ground wire
- Fire stop pad can be pre-installed in boxes if desired
- Not recommended for pre-installed wiring devices
See BB70 on page 7 for an improved Pre-Fab assembly solution

UPC/Part Number	Catalog Number	Plaster Ring	Box Qty
782051 22768	BB40-08	1/2" raise	50
782051 22771	BB40-10	5/8" raise	50
782051 22772	BB40-12	3/4" raise	50
782051 22773	BB45-08	1/2" raise	50
782051 22774	BB45-10	5/8" raise	50
782051 22775	BB45-12	3/4" raise	50

Heavy Duty Electrical Box Hanger



Features

- Supports octagonal or square boxes on 24" span
- Bendable ends mount 1 1/2" or 2 1/8" deep boxes without tools
- Self-centering feature positions box on center
- Includes BA50C4T Box Mounting Clip
- Ultimate Static Load Capacity: 50 Lbs. (without dedicated dropwire)
- Static Load Capacity: 70 Lbs. (with dedicated dropwire)
35 Lbs. Canada
- Finish: Pre-galvanized

UPC/Part Number	Catalog Number	Description	Box Qty
781011 96490	BA50	Box Hanger	25
781011 96491	BA50D	Box Hanger for Box with 1 1/2" Extension	25
782051 18460	BA50A	Adjustable Box Hanger for T-Bar	10

Notes: Read safety/installation instruction sheet in packages before use.

Box Mounting Bracket Accessories



BBFS-18

Features

- BBFS-18 floor stand ensures consistent box height and eliminates need to measure for proper install height
- Can be used with BB7, and BB8 brackets (see page 8)
- Finish: Pre-galvanized

UPC/Part Number	Catalog Number	Description	Box Qty.
79903851597	BBFS-18	Floor Stand	25

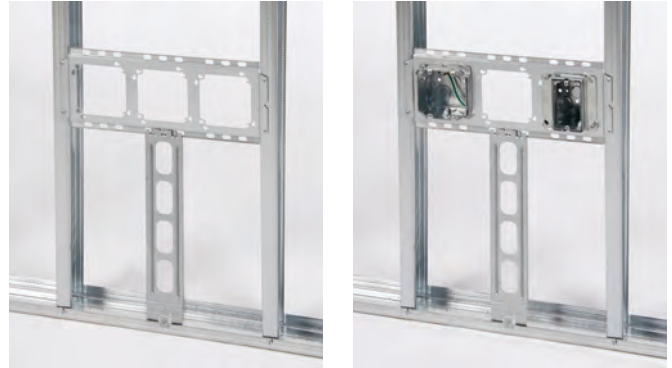

BBFS-18 Installed (Can be used with BB7 or BB8 brackets)

Floor Mounted Box Support

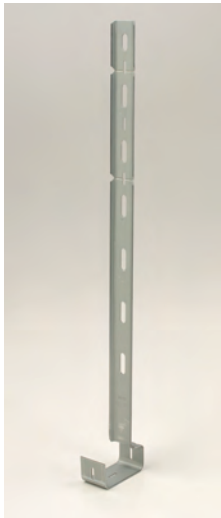

Features

- See BBF Series (see page 4) for a better solution.
- Provides support for electrical box from floor track or concrete forms.
- 18" length with break-away feature for 12" or 16" box mounting.
- Finish: Pre-galvanized.

UPC/Part Number	Catalog Number	Description	Box Qty.
78101103623	BB-18	Floor Mounted Box Support	50

Notes: Read safety/installation instruction sheet in packages before use.

Rapid Ring™ Products



Features

- Self-adjusting to various wall thickness and types of tile
- Easy off/quick release protective plate
- Works with wall thickness up to 2"
- Completely tool-free trim-out phase
- Manufactured in the USA with union-made assemblies
- Fits most standard boxes and B-Line series brackets
- One-source supplier for full line of 1-gang to 4-gang product offerings
- Easy to route around raised surface on the protective plate
- UL Listed

Box Plate (Includes Protective Plate)



B1RRP4C shown



B3RRP



B3RRPC



B2RRP4C shown



B4RRP



B4RRPC

UPC/Part Number	Catalog Number	Use With	Box Qty
782051 68758	B1RRP4C	1-Gang - 4" Square Electrical Box ¹	25
782051 68760	B1RRP5C	1-Gang - 4 ¹¹ / ₁₆ " Square Electrical Box ¹	25
782051 68759	B2RRP4C	2-Gang - 4" Square Electrical Box ¹	25
782051 68761	B2RRP5C	2-Gang - 4 ¹¹ / ₁₆ " Square Electrical Box ¹	25
782051 68762	B3RRPC	3-Gang - Electrical Box ^{1, 2}	10
782051 68763	B4RRPC	4-Gang - Electrical Box ^{1, 3}	10

Covered by and/or use under one or more of the following U.S. patents: 8,575,484, 8,658,894

¹ Minimum electrical box depth is 2¹/₈"

² Keyhole knockouts allow use on 2-gang electrical box

³ Keyhole knockouts allow use on 3-gang electrical box

Notes: Read safety/installation instruction sheet in packages before use.

Rapid Ring™ Sleeve



B1RRR



B2RRR



B3RRR



B4RRR



UPC/Part Number	Catalog Number	Use With	Box Qty
782051 68741	B1RRR	1-Gang - 4" & 4 ¹¹ / ₁₆ " Square Electrical Box ^{1, 4, 5}	25
782051 68742	B2RRR	2-Gang - 4" & 4 ¹¹ / ₁₆ " Square Electrical Box ^{1, 4, 5}	25
782051 68743	B3RRR	3-Gang - Electrical Box ^{1, 4, 5}	10
782051 68744	B4RRR	4-Gang - Electrical Box ^{1, 4, 5}	10

Covered by and/or use under one or more of the following U.S. patents: 8,575,484, 8,658,894

¹ Minimum electrical box depth is 2¹/₈"

⁴ Wall thickness range: 1/2" minimum to 1¹/₄" maximum

⁵ Stop plates included with sleeve

Rapid Ring™ Sleeve Extender



B1RRE



B2RRE



B3RRE



B4RRE



UPC/Part Number	Catalog Number	Use With	Box Qty
782051 68745	B1RRE	B1RRR Sleeve ⁶	25
782051 68746	B2RRE	B2RRR Sleeve ⁶	25
782051 68747	B3RRE	B3RRR Sleeve ⁶	10
782051 68748	B4RRE	B4RRR Sleeve ⁶	10

Covered by and/or use under one or more of the following U.S. patents: 8,575,484, 8,658,894

⁶ Sleeve extender is an optional accessory to extend maximum wall thickness range to 2" (order separately, mounting hardware includes)

Notes: Read safety/installation instruction sheet in packages before use.

Basic Prefab Assemblies



BB2TSC Series (pages 15 & 16)

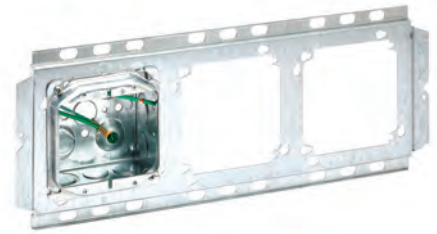
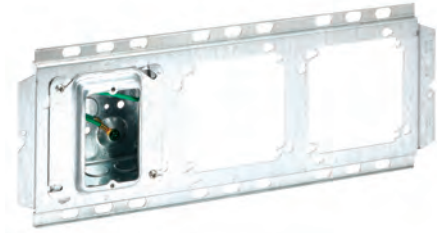

BB816 Series (pages 17 & 18)

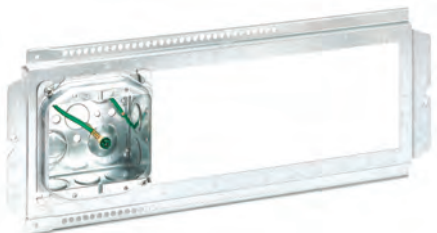

BB716 Series (pages 19 & 20)



BB70 Series (pages 21 & 22)

Notes: Read safety/installation instruction sheet in packages before use.

Basic Ruff-IN™

"I own a pre-fab shop, and I need high-quality, innovative components that will keep me versatile for my customers' projects."

Whether you run your own pre-fab shop or simply want maximum project control, Basic Ruff-IN can provide a profitable pre-fab solution that perfectly suits your operation. Keep control of your project, keep your crew working and garner the cost- and time-saving benefits of pre-fab with Basic Ruff-IN assemblies.



Advantages

- Innovative, versatile designs that minimize the number of SKUs required to stock
- Many tool-less installation products
- Union-made assemblies, manufactured in the USA
- UL Listed assemblies

Offerings

- Brackets
- Boxes
- Mud rings
- Ground wire

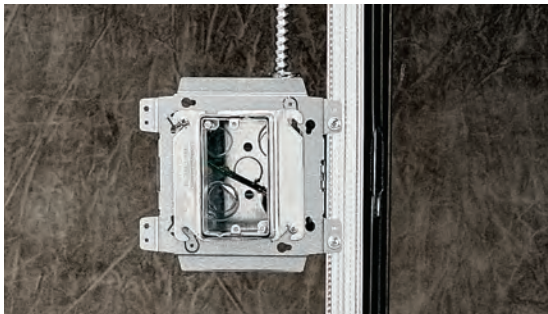

Box Support Bracket

Interlocking wrap around design provides extra rigidity.



Telescoping Box Mounting Bracket

The industry's first fully adjustable support bracket.

Experience the competitive edge of Ruff-IN pre-fab assemblies. Speak with one of our consultants or visit www.cooperblin.com/ruff-in to download our Ruff-IN catalog.

Notes: Read safety/installation instruction sheet in packages before use.

BB2TSC Series

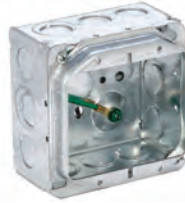







Back of box assembly



Features

- Box assembly comes with box mounting clip attached.
- BB2TSC boxes can be field mounted, in the proper location, to telescoping brackets by snapping the box mounting clip (on the back of the box assembly) over the installed bracket..
- Telescoping brackets can be purchased separately (see page 3).

Assembly Part Number & Components

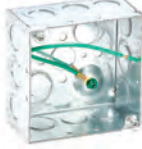
Assembly	Plaster Ring Type	Mounting Clip	Box Type
BB2TSC-1104DA 	1 Gang $\frac{5}{8}$ " Plaster Ring 	Box Mounting Clip 	4" Square $\frac{2}{8}$ " Deep Box Stranded Ground 
BB2TSC-1204DA 	1 Gang $\frac{1}{4}$ " Plaster Ring 	Box Mounting Clip 	4" Square $\frac{2}{8}$ " Deep Box Stranded Ground 

Notes: Read safety/installation instruction sheet in packages before use.

BB2TSC Series - cont.

Assembly Part Number & Components - cont.

Assembly	Plaster Ring Type	Mounting Clip	Box Type
BB2TSC-1AJ4DA 	1 Gang Adjustable Plaster Ring 	Box Mounting Clip 	4" Square 2 1/8" Deep Box Stranded Ground 
BB2TSC-1RR4DA 	1 Gang Rapid Ring 	Box Mounting Clip 	4" Square 2 1/8" Deep Box Stranded Ground 
BB2TSC-2104DA 	2 Gang 5/8" Plaster Ring 	Box Mounting Clip 	4" Square 2 1/8" Deep Box Stranded Ground 
BB2TSC-2204DA 	2 Gang 1 1/4" Plaster Ring 	Box Mounting Clip 	4" Square 2 1/8" Deep Box Stranded Ground 
BB2TSC-2AJ4DA 	2 Gang Adjustable Plaster Ring 	Box Mounting Clip 	4" Square 2 1/8" Deep Box Stranded Ground 
BB2TSC-2RR5DA 	2 Gang Rapid Ring 	Box Mounting Clip 	4 11/16" Square 2 1/8" Deep Box Stranded Ground 

Basic Prefab Assemblies

Notes: Read safety/installation instruction sheet in packages before use.

BB816 Series

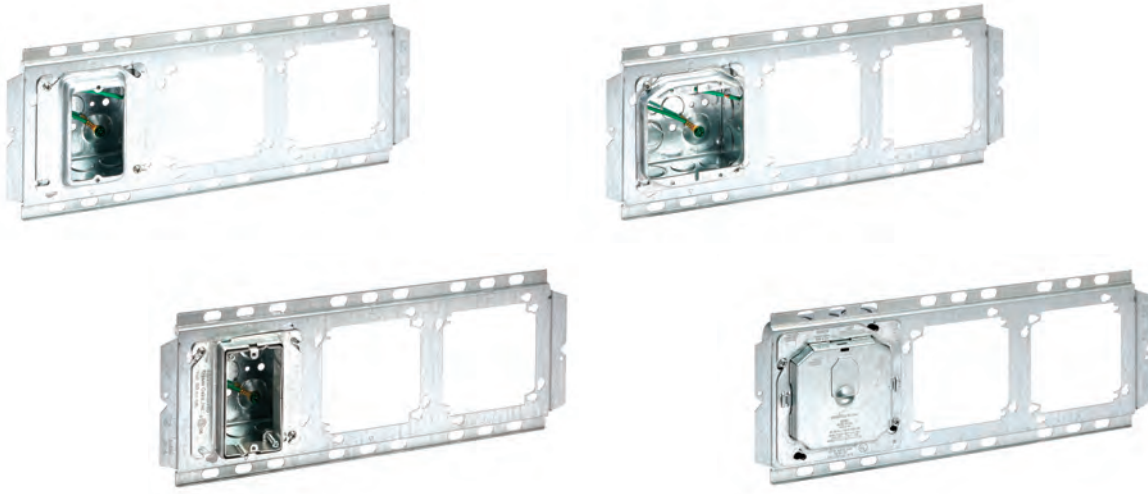









Features

- Increased strength and rigidity help withstand the stress of stress of drywall installation.
- Assemblies shipped with box installed on left side of bracket, as shown below, unless otherwise specified.

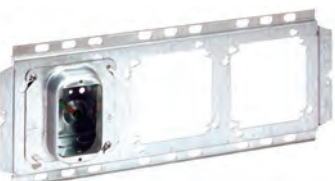











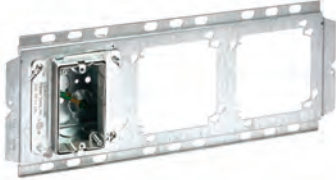

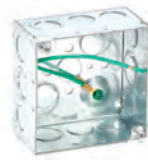
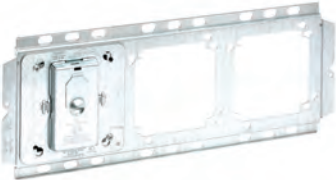



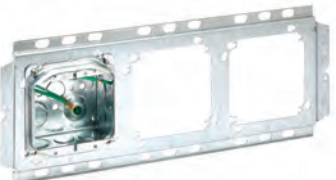



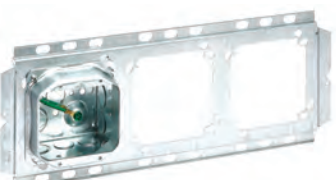

Assembly Part Number & Components

Assembly	Plaster Ring Type	Bracket	Box Type
BB816-104DA-1-X-X 	1 Gang 5/8" Plaster Ring 	16" 3-Hole Position Bracket 	4" Square 2 1/8" Deep Box Stranded Ground 
BB816-204DA-1-X-X 	1 Gang 1 1/4" Plaster Ring 	16" 3-Hole Position Bracket 	4" Square 2 1/8" Deep Box Stranded Ground 

Notes: Read safety/installation instruction sheet in packages before use.

BB816 Series - cont.

Assembly Part Number & Components - cont.

Assembly	Plaster Ring Type	Bracket	Box Type
BB816-AJ4DA-1-X-X 	1 Gang Adjustable Plaster Ring 	16" 3-Hole Position Bracket 	4" Square 2 1/8" Deep Box Stranded Ground 
BB816-RR4DA-1-X-X 	1 Gang Rapid Ring 	16" 3-Hole Position Bracket 	4" Square 2 1/8" Deep Box Stranded Ground 
BB816-104DA-2-X-X 	2 Gang 5/8" Plaster Ring 	16" 3-Hole Position Bracket 	4" Square 2 1/8" Deep Box Stranded Ground 
BB816-204DA-2-X-X 	2 Gang 1 1/4" Plaster Ring 	16" 3-Hole Position Bracket 	4" Square 2 1/8" Deep Box Stranded Ground 
BB816-AJ4DA-2-X-X 	2 Gang Adjustable Plaster Ring 	16" 3-Hole Position Bracket 	4" Square 2 1/8" Deep Box Stranded Ground 
BB816-RR5DA-2-X-X 	2 Gang Rapid Ring 	16" 3-Hole Position Bracket 	4 1/16" Square 2 1/8" Deep Box Stranded Ground 

Notes: Read safety/installation instruction sheet in packages before use.

BB716 Series













Features

- Increased strength and rigidity help withstand the stress of drywall installation.
- Assemblies shipped with box installed on left side of bracket, as shown below, unless otherwise specified.
- Assemblies include BB7AP alignment plate for easy adjustment of box location.



















Assembly Part Number & Components

Assembly	Plaster Ring Type	Bracket	Alignment Plate	Box Type
BB716-104DA-1-X-X 	1 Gang 5/8" Plaster Ring 	16" Open Box Mounting Bracket 	BB7AP 	4" Square 2 1/8" Deep Box Stranded Ground 
BB716-204DA-1-X-X 	1 Gang 1 1/4" Plaster Ring 	16" Open Box Mounting Bracket 	BB7AP 	4" Square 2 1/8" Deep Box Stranded Ground 

Notes: Read safety/installation instruction sheet in packages before use.

BB716 Series - cont.

Assembly Part Number & Components - cont.

Assembly	Plaster Ring Type	Bracket	Alignment Plate	Box Type
BB716-AJ4DA-1-X-X 	1 Gang Adjustable Plaster Ring 	16" Open Box Mounting Bracket 	BB7AP 	4" Square 2 1/8" Deep Box Stranded Ground 
BB716-RR4DA-1-X-X 	1 Gang Rapid Ring 	16" Open Box Mounting Bracket 	BB7AP 	4" Square 2 1/8" Deep Box Stranded Ground 
BB716-104DA-2-X-X 	2 Gang 5/8" Plaster Ring 	16" Open Box Mounting Bracket 	BB7AP 	4" Square 2 1/8" Deep Box Stranded Ground 
BB716-204DA-2-X-X 	2 Gang 1 1/4" Plaster Ring 	16" Open Box Mounting Bracket 	BB7AP 	4" Square 2 1/8" Deep Box Stranded Ground 
BB716-AJ4DA-2-X-X 	2 Gang Adjustable Plaster Ring 	16" Open Box Mounting Bracket 	BB7AP 	4" Square 2 1/8" Deep Box Stranded Ground 
BB716-RR5DA-2-X-X 	2 Gang Rapid Ring 	16" Open Box Mounting Bracket 	BB7AP 	4 11/16" Square 2 1/8" Deep Box Stranded Ground 

Notes: Read safety/installation instruction sheet in packages before use.

BB70 Series

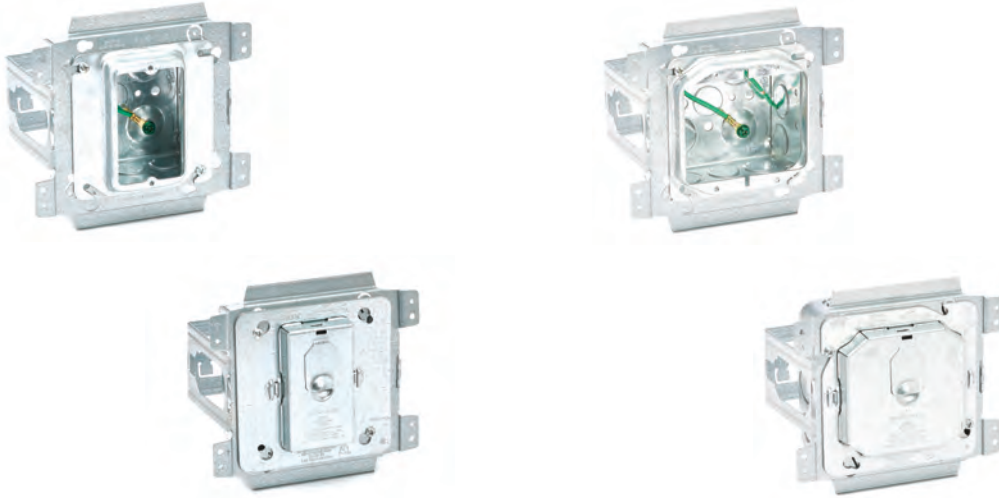







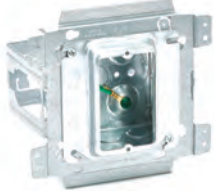

Features

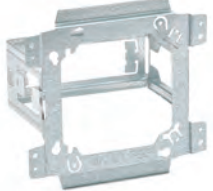
- Interlocking wrap-around design provides extra rigidity.
- Bracket pre-assembled at 3⁵/₈" , back tabs can be folded out for 4" , purchase BB70E as add on for 5¹/₂" and 6" stud spacing options.
- Multiple brackets may be ganged together.



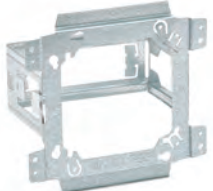















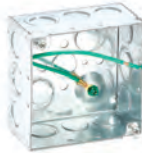



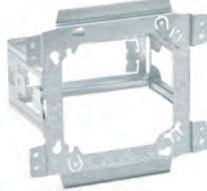

Assembly Part Number & Components

Assembly	Plaster Ring Type	Bracket	Box Type
BB70-358-1104DA 	1 Gang 5/8" Plaster Ring 	Stud Mount Bracket - 3 ⁵ / ₈ " Stud Depth 	4" Square 2 ¹ / ₈ " Deep Box Stranded Ground 
BB70-358-1204DA 	1 Gang 1 ¹ / ₄ " Plaster Ring 	Stud Mount Bracket - 3 ⁵ / ₈ " Stud Depth 	4" Square 2 ¹ / ₈ " Deep Box Stranded Ground 

Notes: Read safety/installation instruction sheet in packages before use.

BB70 Series - cont.

Assembly Part Number & Components - cont.

Assembly	Plaster Ring Type	Bracket	Box Type
BB70-358-1AJ4DA 	1 Gang Adjustable Plaster Ring 	Stud Mount Bracket - 3 ⁵ / ₈ " Stud Depth 	4" Square 2 ¹ / ₈ " Deep Box Stranded Ground 
BB70-358-1RR4DA 	1 Gang Rapid Ring 	Stud Mount Bracket - 3 ⁵ / ₈ " Stud Depth 	4" Square 2 ¹ / ₈ " Deep Box Stranded Ground 
BB70-358-2104DA 	2 Gang 5 ⁸ / ₁₆ " Plaster Ring 	Stud Mount Bracket - 3 ⁵ / ₈ " Stud Depth 	4" Square 2 ¹ / ₈ " Deep Box Stranded Ground 
BB70-358-2204DA 	2 Gang 1 ¹ / ₄ " Plaster Ring 	Stud Mount Bracket - 3 ⁵ / ₈ " Stud Depth 	4" Square 2 ¹ / ₈ " Deep Box Stranded Ground 
BB70-358-2AJ4DA 	2 Gang Adjustable Plaster Ring 	Stud Mount Bracket - 3 ⁵ / ₈ " Stud Depth 	4" Square 2 ¹ / ₈ " Deep Box Stranded Ground 
BB70-358-2RR5DA 	2 Gang Rapid Ring 	Stud Mount Bracket - 3 ⁵ / ₈ " Stud Depth 	4 ¹ / ₁₆ " Square 2 ¹ / ₈ " Deep Box Stranded Ground 

Notes: Read safety/installation instruction sheet in packages before use.

Accessories



Adjustable Plaster Rings (page 24)

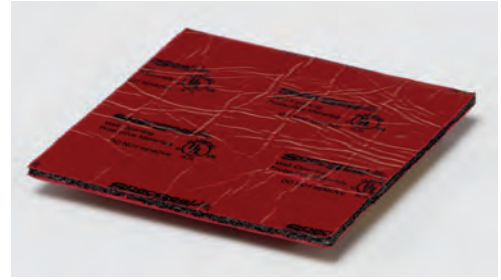

Firestop Pads (page 25)



Metal Protector Plates (page 26)



Conduit Quick Caps & Spacers (page 27)



Concrete Box Clamp (page 28)



Cable Supports (page 29 & 30)

Notes: Read safety/installation instruction sheet in packages before use.

Adjustable Plaster Rings

Features

- Adjustable plaster ring can be used with 4" square, 2 1/8" deep boxes and fits a range of drywall thicknesses
- Plaster ring can be adjusted after sheet rock, mud, or tile is installed without removing the wiring devices
- Helps reduce labor and requirements for multiple products of varying wall thicknesses



UPC/Part Number	Catalog Number	Description	Depth	Box Qty.
782051 49200	B1AJ	One Device Adjustable Ring	3/4" - 1 1/2"	25
782051 49201	B2AJ	Two Device Adjustable Ring	5/8" - 1 1/2"	25
782051 53426	B3AJ	Three Device Adjustable Ring	3/4" - 1 1/2"	25
782051 53427	BRAJ	Round Device Adjustable Ring	3/4" - 1 1/2"	25

Notes: Read safety/installation instruction sheet in packages before use.

Firestop Pads

Features

- SpecSeal®† Power Shield electrical box inserts are used to protect an electrical box and maintain fire-resistance ratings of wall assemblies when the horizontal separation between metallic boxes on opposite sides of the wall is less than 24"
- The intumescent insert is designed to install inside the box, directly against the back wall
- SpecSeal®† Power Shield expands a minimum of 24 times its original size, when exposed to high temperatures or flames, to quickly seal off the passage of fire and smoke
- Simple to install. SpecSeal®† Power Shields are sized to fit typical outlet boxes and feature an adhesive strip on the back of the pad to ensure adhesion to the back of the electrical box. Installs quickly with no mess/residue
- The low profile design maximizes the area inside the electrical box
- Water resistant - no soluble or hygroscopic ingredients

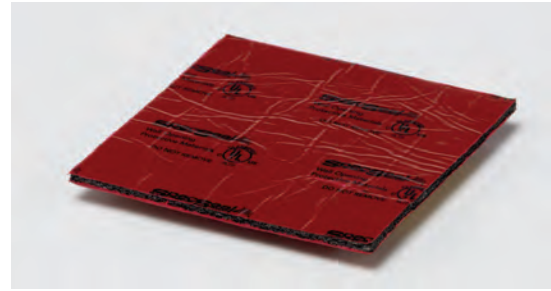

UPC/Part Number	Catalog Number	Size & Description	Box Qty.
782051 49195	EP44	3 ³ / ₄ " x 3 ³ / ₄ " x 1/8" for 4" Square Box	20
782051 49196	EP45	4 ¹ / ₂ " x 4 ¹ / ₂ " x 1/8" for 4 ¹¹ / ₁₆ " Square Box	20

Properties	Electrical Box Inserts
Color:	Red
Weight:	EP44 - 0.08 lbs. (0.036 kg) EP45 - 0.10 lbs. (0.045 kg)
Volume:	EP44 - 1.75 cu in. (28.8 cu cm.) EP45 - 2.50 cu in. (41.0 cu cm.)
Expansion Begins:	350°F (177°C)
Expansion Range:	350°F to >1000°F (177°C - 537°C)
Volume Expansion:	16 to 24X (free expansion)
In Service Temperature:	<130°F (54°C)
Oven Aging:	No Change (60°C)*
Humidity Exposure:	No Change (60°C, 98% R.H.)*
Shelf Life:	No Limit
STC Rating:	64

* Evaluation of physical properties and total expansion.

† SpecSeal® is a registered trademark of Specified Technologies Inc.

Notes: Read safety/installation instruction sheet in packages before use.

Metal Protector Plates

BPS1



BPS2



BPR1



Features

- Protects box contents from drywall mud, paint and debris
- Protector plates provided with all wiring device assemblies
- Can be installed on plaster rings with or without pre-installed wiring devices.
- Protects pre-installed wiring devices from damage during drywall installation
- Improved design transmits force of drywall installation to the plaster ring - not the wiring device
- Domed plate for toggle switches allows for clearance between the plate and switch, and eliminates scratching of the devices
- Two protector plates are required for two device plaster rings

BPR2



UPC/Part Number	Catalog Number	Devices	Plaster Ring Style	Box Qty.
782051 49197	BPR1	Receptacles, GFCI, Decorator, None	One Device	50
782051 38937	BPS1	Toggle Switches	One Device	50
782051 49199	BPR2	Receptacles, GFCI, Decorator, None	Two Device	50
782051 38938	BPS2	Toggle Switches	Two Device	50

Notes: Read safety/installation instruction sheet in packages before use.

Conduit Quick Caps & Spacers

Features

- Quick caps and spacers help eliminate the time consuming method of duct taping conduit stubs
- Quick spacers are designed to separate and secure conduit during concrete pours
- Quick anchor spacers are designed to separate and secure conduit with rod anchor hole during concrete pours
- Quick caps maintain spacing and help keep conduit free from dirt and debris
- Quick caps and spacers properly space conduit for any 4" square box
- New EMT sizes now available



BCS-AS



Accessories



BCS & BES
Conduit
Spacers



BCS-C &
BES-C
Conduit Caps

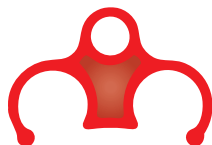

BCS-AS
Anchor
Spacers

UPC/Part Number	Catalog Number	Conduit Size	Box Qty.
782051 22356	BCS-8	1/2" Rigid Conduit	50
782051 40057	BES-8	1/2" EMT Conduit	50
782051 22357	BCS-12	3/4" Rigid Conduit	50
782051 40058	BES-12	3/4" EMT Conduit	50
782051 22358	BCS-16	1" Rigid Conduit	50
782051 40059	BES-16	1" EMT Conduit	50
782051 22359	BCS-8C	1/2" Rigid Conduit	50
782051 40060	BES-8C	1/2" EMT Conduit	50
782051 22361	BCS-12C	3/4" Rigid Conduit	50
782051 40061	BES-12C	3/4" EMT Conduit	50
782051 22362	BCS-16C	1" Rigid Conduit	50
782051 40062	BES-16C	1" EMT Conduit	50
799038 55808	BCS-12AS	3/4" Rigid Conduit	50
799038 55809	BCS-16AS	1" Rigid Conduit	25

Patent #5896892

Notes: Read safety/installation instruction sheet in packages before use.

Concrete Box Clamp



Features

- Secures electrical boxes in concrete block
- Quickly installs with no tools required
- Works for single or double gang boxes
- Completely re-usable
- Able to be used with flush mount rings or penetrating rings when block wall will be covered

UPC/Part Number	Catalog Number	Description	Box Qty.
79903863423	BB-4SCBC	Concrete Box Clamp	25



Notes: Read safety/installation instruction sheet in packages before use.

Cable Support



Features

- Can be push mounted to stud for positioning
- Stiffening ribs and more material for rigid design
- Zip tie locking tab allows trouble-free securing of cables
- Attaches to stud using only one screw
- Allows cables to be positioned a minimum of 1 1/4" from face of stud as required by NEC Article 300.4(D)

UPC/Part Number	Catalog Number	Description	Box Qty.
79903843761	BRC6M	Cable Support	100

Note: Canadian applications are limited to wood studs only.

Cable Type	Size	Cable Capacity
Non-Metallic Cable (NM)	14/2, 14/3, 12/2, 12/3, 10/2, 10/3, 8/2 with ground	8
	8/3, 6/2 with ground	6
Metal Clad Cable (MC)	14/2, 14/3, 14/4, 12/2, 12/3, 12/4, 10/2 with ground	6
	10/3, 10/4 with ground	5
Armored Cable (AC)	14/2, 14/3, 14/4, 12/2, 12/3, 12/4, 10/2 with ground	6
	10/3, 10/4 with ground	5
Flexible Cable (BX)	5/16"	6
	3/8"	5



Push support onto stud



Support stays mounted to stud while securely attached with one screw



Insert cables to be secured

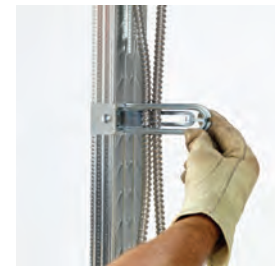

Once cables are inserted, wrap zip-tie around the end of the support to secure the cables

Notes: Read safety/installation instruction sheet in packages before use.

Cable Support



Features

- For use on wood or metal stud
- Allows cables to be positioned a minimum of 1¹/₄" from face of stud as required by NEC Article 300.4(D)

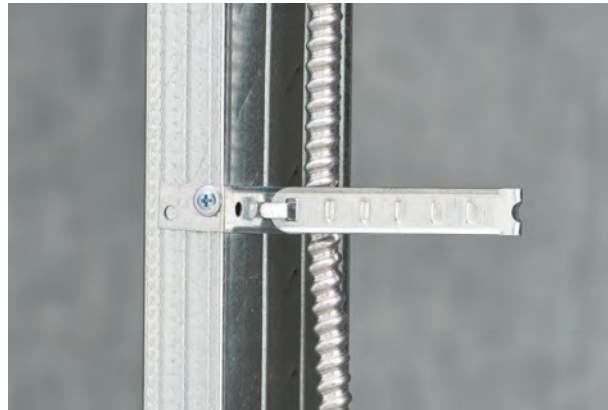

UPC/Part Number	Catalog Number	Description	Box Qty.
79903862843	BRCJ	Cable Support	100

Surface	Cable Type	Size	Cable Capacity
Wood	Non-Metallic	14/2, 12/2, 10/2, 14-3, 12-3, 10-3 w/ground	Max 6
	Non-Metallic	8/2, 6/2 w/ground	Max 4
Metal Stud	Metal Clad (MC)	14/2, 12-2, 10-2, 14-3, 12-3, 10-3, 14-4, 12-4, 10-4 w/ground	Max 4
Furring Strip & Hat Channel	Armored Cable (AC)	12-2, 10-2, 8-2, 14-3, 12-3, 10-3, 14-4, 12-4, 10-4 w/ground	Max 4
Furring Strip & Hat Channel	Flexible Conduit (BX)	5/16" & 3/8"	Max 4
Metal Stud (Canada only)	Non-Metallic Sheathed Cable	14-2, 12-2, 10-2, 14-3, 12-3, 10-3 w/ground	Max 4

Notes: Read safety/installation instruction sheet in packages before use.

Ruff-IN™ Products - Index

Part No.	Page #	Part No.	Page #	Part No.	Page #
B1AJ	24	BB45-10	9	BCS-16	27
B1RRE	12	BB45-12	9	BCS-16AS	27
B1RRP4C	11	BB70	7	BCS-16C	27
B1RRP5C	11	BB70E	7	BES-8	27
B1RRR	12	BB70-358-1AJ4DA	21 - 22	BES-8C	27
B2AJ	24	BB70-358-1RR4DA	21 - 22	BES-12	27
B2RRE	12	BB70-358-1104DA	21 - 22	BES-12C	27
B2RRP4C	11	BB70-358-1204DA	21 - 22	BES-16	27
B2RRP5C	11	BB70-358-2AJ4DA	21 - 22	BES-16C	27
B2RRR	12	BB70-358-2RR5DA	21 - 22	BPR1	26
B3AJ	24	BB70-358-2104DA	21 - 22	BPR2	26
B3RRE	12	BB70-358-2204DA	21 - 22	BPS1	26
B3RRPC	11	BB73	5	BPS2	26
B3RRR	12	BB74	5	BRAJ	24
B4RRE	12	BB76	5	BRC6M	29
B4RRPC	11	BB2-16T	3	BRCJ	30
B4RRR	12	BB2-24T	3	EP44	25
BA50	9	BB716-104DA-1-X-X	19 - 20	EP45	25
BA50A	9	BB716-204DA-1-X-X	19 - 20		
BA50D	9	BB716-AJ4DA-1-X-X	19 - 20		
BB2TSC	3	BB716-RR4DA-1-X-X	19 - 20		
BB2TSC-1AJ4DA	15 - 16	BB716-104DA-2-X-X	19 - 20		
BB2TSC-1RR4DA	15 - 16	BB716-204DA-2-X-X	19 - 20		
BB2TSC-1104DA	15 - 16	BB716-AJ4DA-2-X-X	19 - 20		
BB2TSC-1204DA	15 - 16	BB716-RR5DA-2-X-X	19 - 20		
BB2TSC-2AJ4DA	15 - 16	BB816-104DA-1-X-X	17 - 18		
BB2TSC-2RR5DA	15 - 16	BB816-204DA-1-X-X	17 - 18		
BB2TSC-2104DA	15 - 16	BB816-AJ4DA-1-X-X	17 - 18		
BB2TSC-2204DA	15 - 16	BB816-RR4DA-1-X-X	17 - 18		
BB4-4	5	BB816-104DA-2-X-X	17 - 18		
BB4-4D	6	BB816-204DA-2-X-X	17 - 18		
BB4-6	5	BB816-AJ4DA-2-X-X	17 - 18		
BB4-6D	6	BB816-RR5DA-2-X-X	17 - 18		
BB4-23	5	BBF15	4		
BB4-23D	6	BBF15C	4		
BB-4SCBC	28	BBF18	4		
BB7-16	8	BBF18C	4		
BB7-24	8	BBF24	4		
BB7AP	8	BBF24C	4		
BB8-16	8	BBFC	4		
BB8-24	8	BBFS-18	10		
BB-18	10	BCS-8	27		
BB40-08	9	BCS-8C	27		
BB40-10	9	BCS-12	27		
BB40-12	9	BCS-12AS	27		
BB45-08	9	BCS-12C	27		

NOTICE

Eaton reserves the right to change the specifications, materials, equipment, prices or the availability of products at any time without prior notice. While every effort has been made to assure the accuracy of information contained in this catalog at the time of publication, we are not responsible for inaccuracies resulting from undetected errors or omissions.

U.S. Customer Service Center is staffed Monday through Friday
from 7 a.m. to 5:00 p.m. Central Standard Time.
For more information, visit www.eaton.com/b-lineseries.

Eaton
509 West Monroe Street
Highland, IL 62249
United States
Phone: (800) 851-7415
www.cooperblines.com/contactus

Eaton
5925 McLaughlin Road
Mississauga, ON L5R 1B8
Canada
Phone: (800) 569-3660
www.cooperblines.com/contactca

Eaton
1000 Eaton Boulevard
Cleveland, OH 44122
United States
Eaton.com

B-Line Division
509 West Monroe Street
Highland, IL 62249
Phone: 800-851-7415
Fax: 618-654-1917
www.bline.com

© 2016 Eaton
All Rights Reserved
Printed in USA
Publication No. CA306001EN
January 2016 1M (RUFFIN-16)

Eaton is a registered trademark
All other trademarks are property
of their respective owners.

Follow us on social media to get the
latest product and support information.

