



SINCE 1945

KEYSTONE

ENGINEERED LIGHTING SOLUTIONS
LIGHTING PRODUCTS SPECIFICATION GUIDE





LIGHTING PRODUCTS SPECIFICATION GUIDE



3 GENERATIONS OF FAMILY OWNERSHIP

Left: Ira Greenberg, CEO | Center: Marvin Spielman, Founder | Right: Fred Greenberg, President and CFO

Since our founding more than 70 years ago by a veteran returning home from World War II, Keystone has grown into North America's leading independently owned driver, ballast, and lighting manufacturer.

We serve the largest lighting fixture manufacturers in North America as well as thousands of local, regional, and national wholesale distributors.

Now in our third generation of family ownership, we are proud of our manufacturing heritage and our unique ability to meet the changing needs of our OEM and distributor customers. Since 1945, our dedication to product innovation and exceptional service has earned our customers' trust. No wonder so many of our customers have been loyal to us since day one!

HERE FOR YOU



CELEBRATING 70 YEARS

ONE
STOP
SHOP

Keystone is your one stop shop for all your lighting needs: LED solutions, LED tubes and lamps, ballasts and retrofit kits.



100%
SATISFACTION
GUARANTEED

Customer satisfaction is our top priority. Our phones are always answered by an educated, caring team member. Should you need it, our products are backed with an industry-leading warranty.

Proudly standing behind more than
100 MILLION
KEYSTONE BALLASTS
AND DRIVERS in use today.

TABLE OF CONTENTS



QUICK REFERENCE GUIDE

- 2 Quick Ship Program
- 2 100% Quality Control Process
- 3 Quick Reference Guide

LINEAR LED TUBES

- 10 DirectDrive T8 Linear Replacements
- 12 SmartDrive T8 Linear Replacements
- 14 SmartDrive T5/T5HO Linear Replacements
- 14 SmartDrive T8 U-Bend Replacements
- 15 ComboDrive T8 Linear Replacements
- 16 Accessories for Linear Retrofits

COMPACT LED LAMPS

- 18 SmartDrive 4-Pin Replacements
- 20 DirectDrive 2-Pin and 4-Pin Replacements

HID REPLACEMENT LED LAMPS

- 24 DirectDrive
- 26 SmartDrive

LED DRIVERS

- 28 LED Driver Selection
- 29 Constant Voltage
- 31 SAM Qualified Products
- 32 Constant Current
- 49 Programmable Drivers
- 50 Dimmer Compatibility List

LED MODULES

- 52 Linear Series
- 54 Circular Series
- 55 Square and Rectangular Series
- 56 OEM LED Systems

FUTURE FIT LED KITS

- 58 Linear LED Module and Driver Kits
- 59 Linear Troffer Pan LED Kits
- 60 Circular LED Kits
- 61 Rectangular LED Kits
- 62 Sconce LED Kits

SMART SAFE LED EMERGENCY BACK-UP

- 64 LED Emergency Back-Up
- 66 Constant Wattage Output Curves

EMERGENCY BALLASTS

- 68 Linear Fluorescent
- 69 Compact Fluorescent
- 70 Lamp Compatibility Charts

FLUORESCENT LAMPS

- 72 T12 Linear
- 72 T8 Linear
- 73 T5 Linear
- 74 T9 Circular

FLUORESCENT BALLASTS

- 76 T12
- 78 T12HO
- 79 T8
- 87 T8 Lamps Over 48"
- 89 T5
- 91 T5HO
- 92 Compact Fluorescent
- 96 PLL
- 98 Circline
- 100 2D

SIGN BALLASTS

- 102 SmartWire
- 104 Parallel Wire
- 105 Wiring Diagrams

HID BALLASTS

- 108 Pulse Start Metal Halide
- 110 Metal Halide
- 112 High Pressure Sodium
- 114 Wiring Diagrams
- 118 Case Styles
- 119 F-Can
- 120 Accessories
- 122 HID Kits

124 LOW VOLTAGE TRANSFORMERS

126 STEP DOWN TRANSFORMERS

SENSORS

- 128 High Bay Occupancy Sensors
- 128 Wet Location Occupancy Sensors
- 129 Photocells
- 130 Benefits of Sensing

REFERENCES

- 131 Explanation of Approvals
- 132 Cross Reference Guide
- 136 Ordering Information
- 137 Catalog Number Designations
- 141 Obsolete Product Guide
- 142 Warranty Information
- 144 Index

QUICK SHIP PROGRAM

Keystone's got you covered from Florida to Oregon and everywhere in between.



Time is money when it comes to servicing your customers. That's why we pledge to ship most items the very same day you place your order. In fact, most orders are **DELIVERED NEXT DAY** thanks to Keystone's strategically located, nationwide fulfillment centers.

Our network of **22 FULFILLMENT CENTERS** across the country enables industry-leading service with next day delivery to most points in the United States. **Need it even faster?** Same day pickup is available. **Have questions?** Our personal customer service will get you the answers you need right away.



Headquarters: Philadelphia, PA

Additional Fulfillment Center Locations:

Atlanta, GA	Los Angeles, CA
Boston, MA	Louisville, KY
Charlotte, NC	Memphis, TN
Chicago, IL	Minneapolis, MN
Cincinnati, OH	Nashville, TN
Dallas, TX	New Orleans, LA
Denver, CO	Phoenix, AZ
Detroit, MI	Portland, OR
Fort Lauderdale, FL	San Francisco, CA
Houston, TX	Syracuse, NY
Kansas City, MO	

100% QUALITY CONTROL PROCESS



Step 1: Incoming Parts Inspection

100% of all component parts are inspected upon receipt.



Step 4: Hi-Pot Testing

After the circuit board is mounted inside the casing, every unit undergoes a hi-pot test which checks for abnormalities in operating voltage and current.

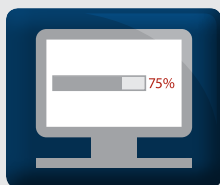

Step 2: In-Circuit Testing

After all components are populated on the printed circuit board, every ballast is tested for circuit integrity using computer aided testing protocols.

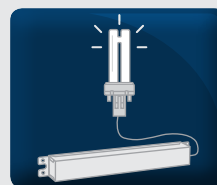

Step 5: Burn-In Testing

Once each ballast is sealed and all assembly is complete, each unit is connected to the proper lamps and powered at full load for at least one hour, thus eliminating virtually any manufacturing or component defects.



Step 3: Functional Testing

Subsequently, every unit is connected to a computerized functional testing apparatus that confirms all electrical input and output characteristics measure within specified tolerances.



Quality Guaranteed

From newly received components to finished ballasts, we make sure that testing is 100% completed at each step of our quality control process so that the products reaching our customers are free of virtually any type of defects.

QUICK REFERENCE GUIDE

SmartDrive (PLUG & PLAY) T8 LED LAMPS										
Construction	Catalog Number	Nominal Length	CRI	Beam Angle	Bare Lamp Wattage	Nominal Lumens	Initial Lumens			Bare Lamp Efficacy
							.78 BF	.88 BF	1.18 BF	
Shatterproof Coated Glass	KT-LED9T8-24GC-8xx-S	2'	>80	220°	9W	1150	945	1080	1370	128 lm/W
	KT-LED11T8-36GC-8xx-S	3'	>80	220°	11W	1450	1210	1400	1780	132 lm/W
	KT-LED12T8-48GC-8xx-S	4'	>80	220°	12W	1800	1470	1710	2090	150 lm/W
	KT-LED14T8-48GC-8xx-S	4'	>80	220°	14W	1800	1620	1870	2490	129 lm/W
	KT-LED17T8-48GC-8xx-S	4'	>80	220°	17W	2200	1930	2200	2800	129 lm/W
Plastic/Aluminum	KT-LED18T8-48P-8xx-S	4'	>80	120°	18W	2000	1800	2000	2700	111 lm/W

SmartDrive (PLUG & PLAY) T5 AND T5HO LED LAMPS					
Construction	Catalog Number	Nominal Length	CRI	Beam Angle	Bare Lamp Wattage
Shatterproof Coated Glass	KT-LED13T5HE-48GC-8xx-S	4'	>80	240°	13W
	KT-LED27T5HO-48GC-8xx-S	4'	>80	240°	27W

SmartDrive (PLUG & PLAY) U-BEND LED LAMPS									
Construction	Catalog Number	Nominal Length	Bare Lamp Wattage	Nominal Lumens	Initial Lumens			Beam Angle	Bare Lamp Efficacy
					.78 BF	.88 BF	1.18 BF		
Shatterproof Coated Glass	KT-LED17T8-U6GC-8xx-S	6" U-Bend	17W	2200	1930	2200	2800	220°	129 lm/W

DirectDrive (BALLAST BYPASS) T8 LED LAMPS									
Construction	Catalog Number	Nominal Length	Input Voltage	CRI	Lamp Wattage	Lumens	Beam Angle	Efficacy	Meets DLC
Shatterproof Coated Glass	KT-LED7T8-18GC-8xx-D	18"	120-277V	>80	7W	700	240°	100 lm/W	N/A
	KT-LED9T8-24GC-8xx-D	2'	120-277V	>80	9W	900	240°	100 lm/W	Yes
	KT-LED12T8-36GC-8xx-D	3'	120-277V	>80	12W	1200	240°	100 lm/W	N/A
	KT-LED15T8-48GC-8xx-D	4'	120-277V	>80	15W	1700	240°	113 lm/W	Yes
	KT-LED18T8-48GC-8xx-D	4'	120-277V	>80	18W	1800	240°	100 lm/W	Yes
	KT-LED18T8-48GC-8xx-D-FDIM	4'	120V	>80	18W	1800	240°	100 lm/W	Yes
Plastic/Aluminum	KT-LED18T8-48P-8xx-D	4'	120-277V	>80	18W	1800	120°	100 lm/W	Yes
	KT-LED36T8-96P-8xx-D	8'	120-277V	>80	36W	3800	120°	106 lm/W	N/A

DirectDrive (BALLAST BYPASS) U-BEND LED LAMPS									
Construction	Catalog Number	Nominal Length	Input Voltage	CRI	Lamp Wattage	Lumens	Beam Angle	Efficacy	Meets DLC
Shatterproof Coated Glass	KT-LED18T8-U6GC-8xx-D	6" U-Bend	120-277V	>80	18W	2100	220°	116 lm/W	N/A

*"8xx" in the part number denotes several color temperatures available

The constant current LED drivers listed in this quick reference are available in any output current configuration within the stated current range.

FEATURES: • FCC Class B Rating for EMI • Over Current, Short Circuit, and Open Circuit Protection

CONSTANT CURRENT LED DRIVERS					
Wattage Family	Output Current Range	Catalog Number	Input Voltage	Power Factor	Dimming
10W	300mA	KTLD-10-1-300-FDIM-AF1	120V	>0.9	Phase Control
	300-380mA	KTLD-10-1N-xxx-F3	120V	>0.5	N/A
	350mA	KTLD-10-1N-350-AF3	120V	>0.5	N/A
	300-700mA	KTLD-10-1P-xxx-LDIM-F5	120V	>0.7	Local
	380mA	KTLD-10-1P-380-LDIM-AF1	120V	>0.7	Local
12W	350-700mA	KTLD-12-1-xxx-FDIM-AF1	120V	>0.9	Phase Control
	220-700mA	KTLD-12-1-xxx-FDIM-F5	120V	>0.9	Phase Control
	400mA	KTLD-12-1P-400-LDIM-F5	120V	>0.7	Local
14W	600mA	KTLD-14-1N-600-AF1	120V	>0.5	N/A
	260-800mA	KTLD-14-1-xxx-FDIM-AF1	120V	>0.9	Phase Control
	350-700mA	KTLD-14-UV-xxx-AF1	120-277V	>0.9	N/A
	260-700mA	KTLD-14-UV-xxx-VDIM-L7	120-277V	>0.9	0-10V

**"xxx" in the part number is a placeholder for the output current value. For example, KTLD-12-1-350-FDIM-AF1 has an output current of 350mA.

Specifications subject to change without notice. For complete product specifications, visit www.keystonetech.com

QUICK REFERENCE GUIDE

CONSTANT CURRENT LED DRIVERS (continued)					
Wattage Family	Output Current Range	Catalog Number	Input Voltage	Power Factor	Dimming
16W	290-1400mA	KTLD-16-1-xxx-FDIM-AK1	120V	>0.9	Phase Control
	300-1100mA	KTLD-16-1-xxx-FDIM-AQ1	120V	>0.9	Phase Control
	290-1400mA	KTLD-16-UV-xxx-AK1	120-277V	>0.9	N/A
	290-1400mA	KTLD-16-UV-xxx-VDIM-AK1	120-277V	>0.9	0-10V
	300-900mA	KTLD-16-UV-xxx-VDIM-AQ1	120-277V	>0.9	0-10V
20W	600mA	KTLD-20-1N-600-AQ1	120V	>0.5	N/A
22W	350-1100mA	KTLD-22-UV-xxx-VDIM-L7	120-277V	>0.9	0-10V
	700mA	KTLD-22-1-700-AK1	120V	>0.9	N/A
	220-1200mA	KTLD-22-1-xxx-FDIM-AK1	120V	>0.9	Phase Control
	350-1600mA	KTLD-22-UV-xxx-AK1	120-277V	>0.9	N/A
23W	830mA	KTLD-23-UV-830-VDIM-L7	120-277V	>0.9	0-10V
25W	600-1380mA	KTLD-25-1-xxx-FDIM-AF4	120V	>0.9	Phase Control
	700-1000mA	KTLD-25-1-xxx-FDIM-AF4	120V	>0.9	Phase Control
	300-1200mA	KTLD-25-1-xxx-FDIM-AQ1	120V	>0.9	Phase Control
	700-1100mA	KTLD-25-1-xxx-FDIM-L9	120V	>0.9	Phase Control
	700mA	KTLD-25-1P-700-VDIM-L9	120V	>0.7	0-10V
	350-1050mA	KTLD-25-UV-xxx-VDIM-AF6	120-277V	>0.9	0-10V
	300-1400mA	KTLD-25-UV-xxx-VDIM-AK1	120-277V	>0.9	0-10V
	350-1400mA	KTLD-25-UV-xxx-VDIM-AQ1	120-277V	>0.9	0-10V
700-1400mA	KTLD-25-UV-xxx-VDIM-L9	120-277V	>0.9	0-10V	
36W	1000-1200mA	KTLD-36-1-xxx-L9	120V	>0.9	N/A
	1000-2000mA	KTLD-36-1-xxx-FDIM-AF6	120V	>0.9	Phase Control
	650-2000mA	KTLD-36-1-xxx-FDIM-AK2	120V	>0.9	Phase Control
	1000-1200mA	KTLD-36-1-xxx-FDIM-L9	120V	>0.9	Phase Control
	640-1500mA	KTLD-36-UV-xxx-AF6	120-277V	>0.9	N/A
	660-1500mA	KTLD-36-UV-xxx-L2	120-277V	>0.9	N/A
	1000mA	KTLD-36-UV-1000-L9	120-277V	>0.9	N/A
	640-1500mA	KTLD-36-UV-xxx-VDIM-AF6	120-277V	>0.9	0-10V
	600-1500mA	KTLD-36-UV-xxx-VDIM-L2	120-277V	>0.9	0-10V
	640-2000mA	KTLD-36-UV-xxx-VDIM-L9	120-277V	>0.9	0-10V
40W	970-2200mA	KTLD-40-UV-xxx-L2	120-277V	>0.9	N/A
	740-1670mA	KTLD-40-UV-xxx-W1	120-277V	>0.9	N/A
	350-2000mA	KTLD-40-UV-xxx-VDIM-AT1	120-277V	>0.9	0-10V
	970-2200mA	KTLD-40-UV-xxx-VDIM-L2	120-277V	>0.9	0-10V
	1100mA	KTLD-40-UV-1100-VDIM-L9	120-277V	>0.9	0-10V
	740-1670mA	KTLD-40-UV-xxx-VDIM-W1	120-277V	>0.9	0-10V
50W	500-2100mA	KTLD-50-UV-xxx-AR2	120-277V	>0.9	N/A
	1200-1400mA	KTLD-50-UV-xxx-L9	120-277V	>0.9	N/A
	920-1400mA	KTLD-50-UV-xxx-W2	120-277V	>0.9	N/A
	920-2500mA	KTLD-50-3-xxx-VDIM-W2	347V	>0.9	0-10V
	500-2100mA	KTLD-50-UV-xxx-VDIM-AR2	120-277V	>0.9	0-10V
	1200-1400mA	KTLD-50-UV-xxx-VDIM-L9	120-277V	>0.9	0-10V
	920-1400mA	KTLD-50-UV-xxx-VDIM-W2	120-277V	>0.9	0-10V
	450-1100mA (2 Channel)	KTLD-50-UV-2xxx-VDIM-L5	120-277V	>0.9	0-10V
230-600mA (4 Channel)	KTLD-50-UV-4xxx-VDIM-L5	120-277V	>0.9	0-10V	
60W	600-2500mA	KTLD-60-UV-xxx-W2	120-277V	>0.9	N/A
	1750mA	KTLD-60-UV-xxx-VDIM-AR1	120-277V	>0.9	0-10V
	600-2500mA	KTLD-60-UV-xxx-VDIM-W2	120-277V	>0.9	0-10V
72W	660-1000mA (2 Channel)	KTLD-72-UV-2xxx-VDIM-L5	120-277V	>0.9	0-10V
	290-900mA (4 Channel)	KTLD-72-UV-4xxx-VDIM-L5	120-277V	>0.9	0-10V
75W	1400mA	KTLD-75-UV-xxx-L5	120-277V	>0.9	N/A
80W	1320-1870mA	KTLD-80-UV-xxx-VDIM-W3	120-277V	>0.9	0-10V

*"xxx" in the part number is a placeholder for the output current value. For example, KTLD-12-1-350-FDIM-AF1 has an output current of 350mA.

Specifications subject to change without notice. For complete product specifications, visit www.keystonetech.com

QUICK REFERENCE GUIDE

CONSTANT CURRENT LED DRIVERS (continued)

Wattage Family	Output Current Range	Catalog Number	Input Voltage	Power Factor	Dimming
100W	500-3200mA	KTLD-100-UV-xxx-67-AP4	120-277V	>0.9	N/A
	530-3200mA	KTLD-100-UV-xxx-L5	120-277V	>0.9	N/A
	530-3200mA	KTLD-100-UV-xxx-VDIM-67-AP4	120-277V	>0.9	0-10V
	500-3200mA	KTLD-100-UV-xxx-VDIM-L5	120-277V	>0.9	0-10V
	1580-2240mA	KTLD-100-UV-xxx-VDIM-W3	120-277V	>0.9	0-10V
	460-1000mA (4 Channel)	KTLD-100-UV-4xxx-VDIM-L18	120-277V	>0.9	0-10V
150W	530-2500mA	KTLD-150-UV-xxx-AU1	120-277V	>0.9	N/A
150W	530-1600mA	KTLD-150-UV-xxx-67-AP3	120-277V	>0.9	N/A
	530-2500mA	KTLD-150-UV-xxx-VDIM-AU1	120-277V	>0.9	0-10V
	530-2500mA	KTLD-150-UV-xxx-VDIM-67-AP3	120-277V	>0.9	0-10V
200W	700-1400mA	KTLD-200-UV-xxx-67-AP5	120-277V	>0.9	N/A
	700-1400mA	KTLD-200-UV-xxx-VDIM-67-AP5	120-277V	>0.9	0-10V
400W	2000mA	KTLD-400-UV-2000-67-AP7	120-277V	>0.9	0-10V

*"xxx" in the part number is a placeholder for the output current value. For example, KTLD-12-1-350-FDIM-AFI has an output current of 350mA.

CONSTANT VOLTAGE LED DRIVERS

Family	Keystone Part Number	Input Voltage	Output Voltage	Max. Output Power	Case Style
24W	KTLD-24-UV-12V-AK1	120-277V	12Vdc	24W	AK1
	KTLD-24-UV-24V-AK1	120-277V	24Vdc	24W	AK1
60W	KTLD-60-1-12V	120V	12Vdc	60W	L5
	KTLD-60-1-24V	120V	24Vdc	60W	L5
	KTLD-60-1N-12V-L2	120V	12Vdc	60W	L2
	KTLD-60-UV-12V	120-277V	12Vdc	60W	L5
	KTLD-60-UV-24V	120-277V	24Vdc	60W	L5
	KTLD-60-UV-24V-67-AP4	120-277V	24Vdc	60W	AP4
	KTLD-60-UV-24V	120-277V	24Vdc	60W	L5
100W	KTLD-100-UV-24V	120-277V	24Vdc	100W	L5
120W	KTLD-120-UV-12V-L10	120-277V	24Vdc	120W	L10

ELECTRONIC BALLASTS

Category	Primary Lamp Type	No. of Lamps	Input Volts	Catalog Number	Description
T12	F20T12	1	120V	KTEB-120-1-TP	F20T12, Normal Power Factor
				KTEB-120-1-TP-EMI	F20T12, FCC Class B, Normal Power Factor
	F40T12	1	120V	KTEB-220-1-TP-EMI	F20T12, FCC Class B, Normal Power Factor
				KTEB-140-1-TP-EMI	F40T12, FCC Class B, Normal Power Factor
		2	120V	KTEB-240-1-TP-PIC	F40T12, F40T12ES, and F34T12, High Power Factor
				120-277V	KTEB-240-UV-TP-PIC
	F96T12	1 or 2	120V	KTEB-275-1-TP-PIC-SL	F96T12 and F96T12ES
				120-277V	KTEB-275-UV-TP-PIC
		1 or 2	120-277V	KTEB-275-UV-TP-PIC-SL	F48/72/96 T12
	F96T12HO	1 or 2	120V	KTEB-2110-1-TP-PIC	F96T12HO and F96T12HOES
120-277V				KTEB-2110-UV-TP-PIC	F96T12HO and F96T12HOES
T8 Instant Start High Efficiency	F32T8	2	120-277V	KTEB-232-UV-IS-N-P	F17/25/32 T8, Standard Output
				KTEB-232-UV-IS-L-P	F17/25/32 T8, Reduced Output
				KTEB-232-UV-IS-H-P	F17/25/32 T8, High Output
		3	120-277V	KTEB-332-UV-IS-N-P	F17/25/32 T8, Standard Output
				KTEB-332-UV-IS-L-P	F17/25/32 T8, Reduced Output
				KTEB-332-UV-IS-H-P	F17/25/32 T8, High Output
	4	120V	KTEB-432-1-IS-N-P	F17/25/32 T8, Standard Output	
			120-277V	KTEB-432-UV-IS-N-P	F17/25/32 T8, Standard Output
4	120-277V	KTEB-432-UV-IS-L-P	F17/25/32 T8, Reduced Output		
		KTEB-432-UV-IS-H-P	F17/25/32 T8, High Output		

Specifications subject to change without notice. For complete product specifications, visit www.keystonetech.com

QUICK REFERENCE GUIDE

ELECTRONIC BALLASTS (continued)					
Category	Primary Lamp Type	No. of Lamps	Input Volts	Catalog Number	Description
T8 Program Start High Efficiency	F32T8	1	120-277V	KTEB-132-UV-PS-N-P	F17/25/32 T8, Standard Output
				KTEB-232-UV-PS-N-P	F17/25/32 T8, Standard Output
		2	120-277V	KTEB-232-UV-PS-L-P	F17/25/32 T8, Reduced Output
				KTEB-232-UV-PS-H-P	F17/25/32 T8, High Output
		3	120-277V	KTEB-332-UV-PS-N-P	F17/25/32 T8, Standard Output
				KTEB-332-UV-PS-L-P	F17/25/32 T8, Reduced Output
		4	120-277V	KTEB-332-UV-PS-H-P	F17/25/32 T8, High Output
				KTEB-432-UV-PS-N-P	F17/25/32 T8, Standard Output
KTEB-432-UV-PS-L-P	F17/25/32 T8, Reduced Output				
T8 Instant Start Standard	F32T8	2	120V	KTEB-232-1-IS-N	F17/25/32 T8
	F59T8	2	120-277V	KTEB-259-UV-IS-N	F96T8
	F96T8H0	2	120-277V	KTEB-286H0-UV-IS-N	F96T8H0
T8 Residential	F32T8	1	120V	KTEB-132-1-TP-EMI	F17/25/32 T8, Normal Power Factor
		2	120V	KTEB-232RIS-1-TP-SL	F17/25/32 T8, Normal Power Factor
		4	120V	KTEB-432RIS-1-TP-SL	F17/25/32 T8, Normal Power Factor
T5H0 Program Start	F24T5H0	2	120-277V	KTEB-224H0-UV-PS-SL	F24T5H0, 90°C Rated, 9" Case
	F39T5H0	2	120-277V	KTEB-239H0-UV-PS-SL	F39T5H0, 90°C Rated, 9" Case
	F54T5H0	2	120-277V	KTEB-254H0-UV-PS-SL	F54T5H0, 90°C Rated, 9" Case
				KTEB-254H0-UV-PS	F54T5H0, 90°C Rated, 16" Case
	4	120-277V	KTEB-454H0-UV-PS	F54T5H0, 90°C Rated, 16" Case	
T5	F8T5	1	120V	KTEB-108-1-TP-FC	F8T5 for Undercabinet
	F13T5	2	120V	KTEB-213-1-TP-SL-MB	F13T5 for Undercabinet with Mounting Bracket
	F14T5	1	120V	KTEB-114-1-TP-FC	F13/14T5 for Undercabinet
	F28T5	2	120-277V	KTEB-228HE-UV-PS-SL	F14/21/28 T5 Program Start, 9" Case
				KTEB-228HE-UV-PS	F14/21/28 T5 Program Start, 90°C Rated
F35T5	1	120V	KTEB-135HE-1-TP	F35T5HE Electronic Ballast	
Commercial Grade CFL	13W CFL	1 or 2	120-277V	KTEB-213-UV-PS-DW	13W 4-Pin CFL, Program Start, 90°C Rated
				KTEB-213-UV-RS-DW	13W 4-Pin CFL, Rapid Start
				KTEB-213-UV-RS-DW-KIT	13W 4-Pin CFL, Kit Includes Wires and Stud Plate
	18W CFL	1 or 2	120-277V	KTEB-218-UV-PS-DW	18W 4-Pin CFL, Program Start, 90°C Rated
				KTEB-218-UV-RS-DW	18W 4-Pin CFL, Rapid Start
				KTEB-218-UV-RS-DW-KIT	18W 4-Pin CFL, Kit Includes Wires and Stud Plate
	26W CFL	1 or 2	120-277V	KTEB-226-UV-PS-DW	26W, 1x 32W or 40W 4-Pin CFL, Program Start, 90°C Rated
				KTEB-226-UV-RS-DW	26W, 1x 32W or 40W 4-Pin CFL, Rapid Start
				KTEB-226-UV-RS-DW-KIT	26W, 1x 32W or 40W 4-Pin CFL, Kit Includes Wires and Stud Plate
	42W CFL	1 or 2	120-277V	KTEB-242-UV-PS-DW	32W or 42W 4-Pin CFL, Program Start, 90°C Rated
				KTEB-242-UV-RS-DW	32W or 42W 4-Pin CFL, Rapid Start
				KTEB-242-UV-RS-DW-KIT	32W or 42W 4-Pin CFL, Kit Includes Wires and Stud Plate
Residential Grade CFL	13W CFL	1	120V	KTEB-113-1-TP-xx*	13W 4-Pin CFL
		2	120V	KTEB-213-1-TP-xx*	13W 4-Pin CFL
	18W CFL	1	120V	KTEB-118-1-TP-xx*	18W 4-Pin CFL
		2	120V	KTEB-218-1-TP-xx*	18W 4-Pin CFL
	26W CFL	1	120V	KTEB-126-1-TP-xx*	26W 4-Pin CFL
		2	120V	KTEB-226-1-TP-xx*	26W 4-Pin CFL
	42W CFL	1	120V	KTEB-142T-1-TP-xx*	42W 4-Pin CFL
2-Pin CFL Magnetic	13W 2-Pin	1	120V	CC1322MTP	13W-22W, 2-Pin CFL
	9W 2-Pin	1	120V	CC579TP	5W, 7W, & 9W, 2-Pin CFL
Circline	FC22T9	1	120V	KTEB-1C22-1-TP-WS	22W, 3.5" Case, with Sockets
	FC32T9 & FC40T9	1	120V	KTEB-140-1-TP-EMI-WS	32W or 40W, with Sockets
	FC22T9 & FC32T9	2	120V	KTEB-2C72-1-TP-WS	22W & 32W or 32 & 40W, with Sockets
	FC32T9 & FC40T9	2	120V	KTEB-2C72-1-TP-WS	22W & 32W or 32 & 40W, with Sockets
Circline Magnetic	FC8T9	1	120V	SS22WSTP	22W Circline, Small Case, Self-Start

*"xx" in the part number denotes several case styles available

Specifications subject to change without notice. For complete product specifications, visit www.keystonetech.com

QUICK REFERENCE GUIDE

HID kits include a core and coil ballast, a capacitor and ignitor (if required), and mounting hardware.

HID					
Category	Lamp Wattage	No. of Taps	Input Volts	Catalog Number	ANSI Code
Metal Halide	50W	Quad	120/208/240/277V	MH-50X-Q-KIT*	M110
	70W	Quad	120/208/240/277V	MH-70X-Q-KIT*	M98
	100W	Quad	120/208/240/277V	MH-100X-Q-KIT*	M90
	150W	Quad	120/208/240/277V	MH-150X-Q-KIT*	M102
	175W	Quad	120/208/240/277V	MH-175A-Q-KIT	M57
		5-Tap	120/208/240/277/480V	MH-175A-P-KIT	M57
	250W	Quad	120/208/240/277V	MH-250A-Q-KIT	M58
		5-Tap	120/208/240/277/480V	MH-250A-P-KIT	M58
		Single	480V	MH-250A-480-KIT	M58
	400W	Quad	120/208/240/277V	MH-400A-Q-KIT	M59
		5-Tap	120/208/240/277/480V	MH-400A-P-KIT	M59
		Single	480V	MH-400A-480-KIT	M59
	1000W	Quad	120/208/240/277V	MH-1000A-Q-KIT	M47
		5-Tap	120/208/240/277/480V	MH-1000A-P-KIT	M47
		Single	480V	MH-1000A-480-KIT	M47
1500W	Quad	120/208/240/277V	MH-1500A-Q-KIT	M48	
	5-Tap	120/208/240/277/480V	MH-1500A-P-KIT	M48	
Pulse Start Metal Halide	175W	Quad	120/208/240/277V	MPS-175A-Q-KIT	M137
		5-Tap	120/208/240/277/480V	MPS-175A-P-KIT	M137
	200W	Quad	120/208/240/277V	MPS-200A-Q-KIT	M136
		5-Tap	120/208/240/277/480V	MPS-200A-P-KIT	M136
	250W	Quad	120/208/240/277V	MPS-250A-Q-KIT	M138
		5-Tap	120/208/240/277/480V	MPS-250A-P-KIT	M138
	320W	Quad	120/208/240/277V	MPS-320A-Q-KIT	M132
		5-Tap	120/208/240/277/480V	MPS-320A-P-KIT	M132
	350W	Quad	120/208/240/277V	MPS-350A-Q-KIT	M131
		5-Tap	120/208/240/277/480V	MPS-350A-P-KIT	M131
	400W	Quad	120/208/240/277V	MPS-400A-Q-KIT	M135
		5-Tap	120/208/240/277/480V	MPS-400A-P-KIT	M135
		Single	480V	MPS-400A-480-KIT	M135
	450W	Quad	120/208/240/277V	MPS-450A-Q-KIT	M144
		5-Tap	120/208/240/277/480V	MPS-450A-P-KIT	M144
750W	Quad	120/208/240/277V	MPS-750A-Q-KIT	M149	
	5-Tap	120/208/240/277/480V	MPS-750A-P-KIT	M149	
1000W	Quad	120/208/240/277V	MPS-1000A-Q-KIT	M141	
High Pressure Sodium	35W	Single	120V	HPS-35R-1-KIT	S76
	50W	Single	120V	HPS-50R-1-KIT	S68
	70W	Single	120V	HPS-70R-1-KIT	S62
		Quad	120/208/240/277V	HPS-70X-Q-KIT	S62
	100W	Single	120V	HPS-100R-1-KIT	S54
		Quad	120/208/240/277V	HPS-100X-Q-KIT	S54
	150W	Single	120V	HPS-150R-1-KIT	S55
		Quad	120/208/240/277V	HPS-150X-Q-KIT	S55
	250W	Quad	120/208/240/277V	HPS-250A-Q-KIT	S50
		5-Tap	120/208/240/277/480V	HPS-250A-P-KIT	S50
	400W	Quad	120/208/240/277V	HPS-400A-Q-KIT	S51
		5-Tap	120/208/240/277/480V	HPS-400A-P-KIT	S51
		Single	480V	HPS-400A-480-KIT	S51
	600W	Quad	120/208/240/277V	HPS-600A-Q-KIT	S106
	1000W	Quad	120/208/240/277V	HPS-1000A-Q-KIT	S52
5-Tap		120/208/240/277/480V	HPS-1000A-P-KIT	S52	

*operates both pulse and probe start metal halide lamps

QUICK REFERENCE GUIDE

HID (continued)

Category	Lamp Wattage	No. of Taps	Input Volts	Catalog Number	ANSI Code
F-Can	50W	Dual	120/277V	MH-50X-D-FCAN	M110
	70W	Dual	120/277V	MH-70X-D-FCAN	M98
	100W	Dual	120/277V	MH-100X-D-FCAN	M90
	150W	Dual	120/277V	MH-150X-D-FCAN	M102
	175W	Dual	120/277V	MH-175A-D-FCAN	M57/H39
	250W	Dual	120/277V	MH-250A-D-FCAN	M58/H37
	400W	Dual	120/277V	MH-400A-D-FCAN	M59

SIGN BALLASTS

Category	Wiring	Input Volts	No. of Lamps	Combined T12HO Lamp Length	Combined T8HO Lamp Length	Catalog Number
SMARTWIRE™	Series	120V	1	2'-8'	2'-8'	KTSB-E-0208-11-1-S
			1 or 2	4'-16'	4'-12'	KTSB-E-0416-12-1-S
			2 or 3	8'-24'	8'-18'	KTSB-E-0824-23-1-S
			2, 3, or 4	8'-32'	8'-24'	KTSB-E-0832-24-1-S
			4, 5, or 6	26'-48'	18'-36'	KTSB-E-2448-46-1-S
PARALLEL WIRE	Parallel	120-277V	1 or 2	2'-16'	4'-12'	KTSB-E-0216-12-UV /A
			1, 2, 3, or 4	4'-32'	6'-24'	KTSB-E-0432-14-UV /A
				10'-40'	8'-32'	KTSB-E-1040-14-UV /A
				8'-48'	16'-36'	KTSB-E-0848-46-UV /A

EMERGENCY BALLASTS

Category	Primary Lamp Types	Catalog Number	Input Volts	Light Output	Illumination Time
Linear	T8, T12	KT-EMRG-500	120/277V	500 Lumens	90 Minutes
		KT-EMRG-500-SL	120/277V	500 Lumens	90 Minutes
		KT-EMRG-700-SL	120/277V	700 Lumens	90 Minutes
		KT-EMRG-1400-SL	120/277V	1400 Lumens	90 Minutes
	T5, T5HO	KT-EMRG-500-T5	120/277V	500 Lumens	90 Minutes
		KT-EMRG-800-T5	120/277V	800 Lumens	90 Minutes
Compact Fluorescent	2-Pin CFL	KT-EMRG-1300-T5	120/277V	1300 Lumens	90 Minutes
		KT-EMRG-650-CFL2	120/277V	650 Lumens	90 Minutes
	4-Pin CFL	KT-EMRG-750-CFL4	120/277V	750 Lumens	90 Minutes

Specifications subject to change without notice. For complete product specifications, visit www.keystonetech.com

LINEAR LED TUBES

SECTION CONTENTS

DirectDrive T8 Linear Replacements: 10

SmartDrive T8 Linear Replacements: 12

SmartDrive T5/T5HO Linear Replacements: 14

SmartDrive T8 U-Bend Replacements: 14

ComboDrive T8 Linear Replacements: 15

Accessories for Linear Retrofits: 16



Now is the time to upgrade from fluorescent lamps to LED tubes. All Keystone LED tubes are powered with integral Keystone drivers and are available in 3 unique varieties: SmartDrive (plug & play with existing ballast), DirectDrive (connect directly to line voltage) and ComboDrive (plug & play or line voltage). All are backed by our extensive warranty, so you can buy with confidence.



Learn more about upgrading to LED tubes. Scan this QR code or visit keystonetech.com and watch our 2 minute video.



LINEAR LED TUBES

T8 LINEAR REPLACEMENTS



DirectDrive LED tubes eliminate the need for an external driver or ballast. For new construction installations, simply connect the 120-277V line voltage directly to the sockets. For retrofit installations, bypass the existing ballast by cutting the wires and connecting the 120-277V line voltage directly to the sockets. No ballast or driver is required.



PRODUCT FEATURES

- Integral Keystone Driver
- Plastic/Aluminum Operating Temperature: -20°C/-4°F to 55°C/131°F
- Glass and Shatterproof Operating Temperature: -20°C/-4°F to 45°C/113°F
- Environmentally Friendly: No Mercury Used
- Frosted Lens Eliminates Pixelation
- Suitable for Use in Dry and Damp Locations



DirectDrive LED tubes will last for 16 years* or more, which means significant savings on maintenance. Keystone LED tubes practically eliminate the need for future relamping.

**Based on 12 hours/day, 5 days/week usage.*

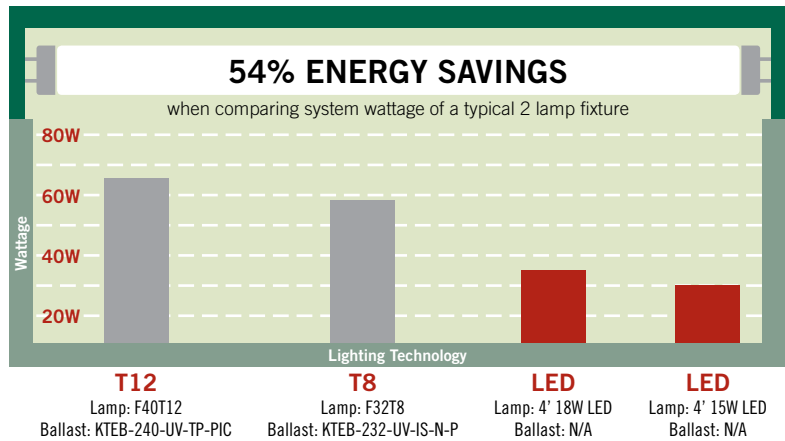
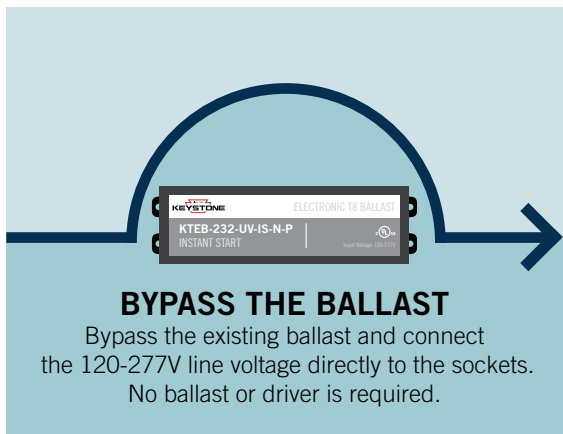

LIGHT DISTRIBUTION

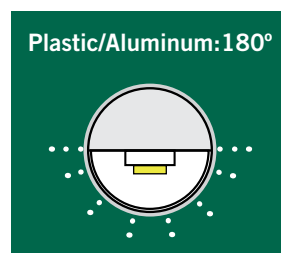
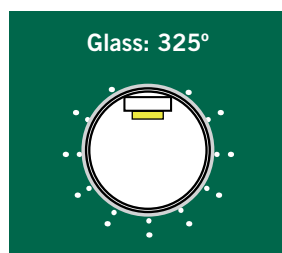
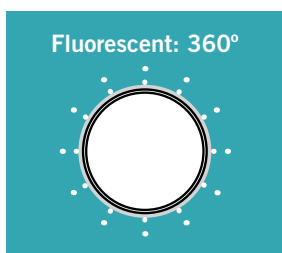

Typical Non-Shunted Lampholder

Connect wires directly to these terminals

CAUTION: Use only non-shunted lampholders.

Do not use existing shunted lampholders (found in all fixtures using instant start ballasts) when wiring for line voltage. Remove existing shunted lampholders and replace them with non-shunted lampholders. Make new connections directly to terminals as indicated. Keystone can provide any style replacement lampholders. Call us at 800-464-2680.

Specifications subject to change without notice. For complete product specifications, visit www.keystonetech.com

LINEAR LED TUBES

T8 LINEAR REPLACEMENTS



ELECTRICAL SPECIFICATIONS

T8



DirectDrive Shatterproof Glass
T8 Lamps are ETL Sanitation Listed.

Catalog Number	Color	Nominal Length	Input Voltage	CRI	Lamp Wattage	Lumens	Beam Angle	Light Spread	Efficacy	Meets DLC
SHATTERPROOF COATED GLASS CONSTRUCTION										
Also available in glass construction and/or 3000K color temperature upon request.										
KT-LED7T8-18GC-840-D	4000K	18"	120-277V	>80	7W	750	240°	325°	107 lm/W	N/A
KT-LED7T8-18GC-850-D	5000K	18"	120-277V	>80	7W	800	240°	325°	114 lm/W	N/A
KT-LED7T8-18GC-865-D	6500K	18"	120-277V	>80	7W	800	240°	325°	114 lm/W	N/A
KT-LED9T8-24GC-835-D	3500K	2'	120-277V	>80	9W	900	240°	325°	100 lm/W	Yes
KT-LED9T8-24GC-840-D	4000K	2'	120-277V	>80	9W	950	240°	325°	106 lm/W	Yes
KT-LED9T8-24GC-850-D	5000K	2'	120-277V	>80	9W	1000	240°	325°	111 lm/W	Yes
KT-LED9T8-24GC-865-D	6500K	2'	120-277V	>80	9W	1000	240°	325°	111 lm/W	Yes
KT-LED12T8-36GC-835-D	3500K	3'	120-277V	>80	12W	1200	240°	325°	100 lm/W	N/A
KT-LED12T8-36GC-840-D	4000K	3'	120-277V	>80	12W	1250	240°	325°	104 lm/W	N/A
KT-LED12T8-36GC-850-D	5000K	3'	120-277V	>80	12W	1300	240°	325°	108 lm/W	N/A
KT-LED12T8-36GC-865-D	6500K	3'	120-277V	>80	12W	1300	240°	325°	108 lm/W	N/A
KT-LED12.5T8-48GC-835-D	3500K	4'	120-277V	>83	12.5W	1700	240°	325°	129 lm/W	Yes
KT-LED12.5T8-48GC-840-D	4000K	4'	120-277V	>83	12.5W	1750	240°	325°	132 lm/W	Yes
KT-LED12.5T8-48GC-850-D	5000K	4'	120-277V	>83	12.5W	1850	240°	325°	139 lm/W	Yes
KT-LED15T8-48GC-835-D	3500K	4'	120-277V	>80	15W	1750	240°	325°	113 lm/W	Yes
KT-LED15T8-48GC-840-D	4000K	4'	120-277V	>80	15W	1800	240°	325°	120 lm/W	Yes
KT-LED15T8-48GC-850-D	5000K	4'	120-277V	>80	15W	1900	240°	325°	126 lm/W	Yes
KT-LED15T8-48GC-865-D	6500K	4'	120-277V	>80	15W	1900	240°	325°	126 lm/W	N/A
KT-LED18T8-48GC-835-D	3500K	4'	120-277V	>80	18W	1800	240°	325°	106 lm/W	Yes
KT-LED18T8-48GC-840-D	4000K	4'	120-277V	>80	18W	1900	240°	325°	106 lm/W	Yes
KT-LED18T8-48GC-850-D	5000K	4'	120-277V	>80	18W	2000	240°	325°	111 lm/W	Yes
KT-LED18T8-48GC-865-D	6500K	4'	120-277V	>80	18W	2000	240°	325°	111 lm/W	N/A
KT-LED18T8-48GC-835-D-FDIM*	3500K	4'	120-277V	>80	18W	1800	240°	325°	100 lm/W	Yes
KT-LED18T8-48GC-840-D-FDIM*	4000K	4'	120V	>80	18W	1850	240°	325°	103 lm/W	Yes
KT-LED18T8-48GC-850-D-FDIM*	5000K	4'	120V	>80	18W	1900	240°	325°	106 lm/W	Yes
KT-LED22T8-48GC-835-D	3500K	4'	120-277V	>83	22W	2450	240°	325°	111 lm/W	Yes
KT-LED22T8-48GC-840-D	4000K	4'	120-277V	>83	22W	2500	240°	325°	113 lm/W	Yes
KT-LED22T8-48GC-850-D	5000K	4'	120-277V	>83	22W	2600	240°	325°	11 lm/W	Yes
PLASTIC/ALUMINUM CONSTRUCTION										
KT-LED18T8-48P-830-D	3000K	4'	120-277V	>80	18W	1800	120°	180°	100 lm/W	Yes
KT-LED18T8-48P-840-D	4000K	4'	120-277V	>80	18W	1900	120°	180°	106 lm/W	Yes
KT-LED18T8-48P-850-D	5000K	4'	120-277V	>80	18W	2000	120°	180°	111 lm/W	Yes
KT-LED36T8-96P-840-D	4000K	8'	120-277V	>80	36W	3800	120°	180°	106 lm/W	N/A
KT-LED36T8-96P-850-D	5000K	8'	120-277V	>80	36W	4000	120°	180°	111 lm/W	N/A
KT-LED54T8-96P-850-D	5000K	8'	120-277V	>80	54W	5900	120°	180°	110 lm/W	N/A
KT-LED54T8-96P-865-D	6500K	8'	120-277V	>80	54W	5900	120°	180°	110 lm/W	N/A

*TRIAC dimmable

U-BEND



DirectDrive
U-Bend Lamps
are NSF Listed.

Catalog Number	Color	Nominal Length	Input Voltage	CRI	Lamp Wattage	Lumens	Beam Angle	Light Spread	Efficacy	Meets DLC
SHATTERPROOF COATED GLASS CONSTRUCTION										
Also available in glass construction and/or 3000K color temperature upon request.										
KT-LED18T8-U6GC-835-D	3500K	6" U-Bend	120-277V	>80	18W	2100	220°	325°	116 lm/W	N/A
KT-LED18T8-U6GC-840-D	4000K	6" U-Bend	120-277V	>80	18W	2150	220°	325°	119 lm/W	N/A
KT-LED18T8-U6GC-850-D	5000K	6" U-Bend	120-277V	>80	18W	2200	220°	325°	122 lm/W	N/A

Specifications subject to change without notice. For complete product specifications, visit www.keystonetech.com

LINEAR LED TUBES

T8 LINEAR REPLACEMENTS



It's as easy as changing a light bulb. Simply remove the existing fluorescent lamps and replace with Keystone SmartDrive LED tubes. No special instructions, no tools. The LED tubes run on the existing instant or program start electronic ballast. Energy efficiency in an instant.



PRODUCT FEATURES

- Plastic/Aluminum Operating Temperature: -20°C/-4°F to 55°C/131°F
- Glass and Shatterproof Operating Temperature: -20°C/-4°F to 45°C/113°F
- Environmentally Friendly: No Mercury Used
- Frosted Lens Eliminates Pixelation

BALLAST COMPATIBLE

Before installing, confirm ballast compatibility at SmartDriveLED.com

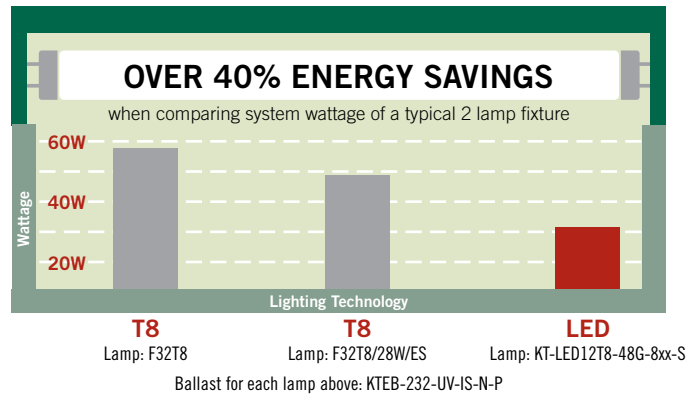

Use SmartDrive LED tubes with our occupancy sensors on fixtures with instant start ballasts for even greater energy savings.

LIGHT DISTRIBUTION

Material	Light Distribution
Fluorescent	360°
Glass	325°
Plastic/Aluminum	180°

Specifications subject to change without notice. For complete product specifications, visit www.keystonetech.com

LINEAR LED TUBES

T8 LINEAR REPLACEMENTS



ELECTRICAL SPECIFICATIONS

Catalog Number	Color	Nominal Length	Bare Lamp Wattage	Nominal Lumens	System Wattage			Initial Lumens			Beam Angle	Light Spread	Bare Lamp Efficacy
					.78 BF	.88 BF	1.18 BF	.78 BF	.88 BF	1.18 BF			
SHATTERPROOF COATED GLASS CONSTRUCTION											Also available in glass construction upon request.		
KT-LED9T8-24GC-830-S	3000K	2'	9W	1150	10.2W	11.8W	15.2W	945	1080	1370	220°	325°	128 lm/W
KT-LED9T8-24GC-840-S	4000K	2'	9W	1150	10.2W	11.8W	15.2W	1020	1170	1490	220°	325°	128 lm/W
KT-LED9T8-24GC-850-S	5000K	2'	9W	1150	10.2W	11.8W	15.2W	1040	1200	1520	220°	325°	128 lm/W
KT-LED11T8-36GC-830-S	3000K	3'	11W	1450	11.7W	13.7W	17.8W	1210	1400	1780	220°	325°	132 lm/W
KT-LED11T8-36GC-840-S	4000K	3'	11W	1450	11.7W	13.7W	17.8W	1305	1500	1900	220°	325°	132 lm/W
KT-LED11T8-36GC-850-S	5000K	3'	11W	1450	11.7W	13.7W	17.8W	1130	1530	1940	220°	325°	132 lm/W
KT-LED12T8-48GC-830-S	3000K	4'	12W	1800	12.6W	14.9W	19.4W	1470	1710	2090	220°	325°	150 lm/W
KT-LED12T8-48GC-835-S	3500K	4'	12W	1800	12.6W	14.9W	19.4W	1475	1720	2130	220°	325°	150 lm/W
KT-LED12T8-48GC-840-S	4000K	4'	12W	1800	12.6W	14.9W	19.4W	1480	1730	2160	220°	325°	150 lm/W
KT-LED12T8-48GC-850-S	5000K	4'	12W	1800	12.6W	14.9W	19.4W	1530	1800	2290	220°	325°	150 lm/W
KT-LED14T8-48GC-830-S	3000K	4'	14W	1800	14.2W	16.4W	22.1W	1620	1870	2490	220°	325°	129 lm/W
KT-LED14T8-48GC-835-S	3500K	4'	14W	1800	14.2W	16.4W	22.1W	1640	1900	2520	220°	325°	129 lm/W
KT-LED14T8-48GC-840-S	4000K	4'	14W	1800	14.2W	16.4W	22.1W	1670	1940	2560	220°	325°	129 lm/W
KT-LED14T8-48GC-850-S	5000K	4'	14W	1800	14.2W	16.4W	22.1W	1720	2000	2620	220°	325°	129 lm/W
KT-LED17T8-48GC-830-S	3000K	4'	17W	2200	17.2W	20.2W	27.8W	1930	2200	2800	220°	325°	129 lm/W
KT-LED17T8-48GC-835-S	3500K	4'	17W	2200	17.2W	20.2W	27.8W	1940	2230	2830	220°	325°	129 lm/W
KT-LED17T8-48GC-840-S	4000K	4'	17W	2200	17.2W	20.2W	27.8W	1990	2300	2930	220°	325°	129 lm/W
KT-LED17T8-48GC-850-S	5000K	4'	17W	2200	17.2W	20.2W	27.8W	2050	2370	3080	220°	325°	129 lm/W
PLASTIC/ALUMINUM CONSTRUCTION													
KT-LED18T8-48P-830-S	3000K	4'	18W	2000	21.0W	23.0W	32.0W	1800	2000	2700	120°	180°	111 lm/W
KT-LED18T8-48P-840-S	4000K	4'	18W	2000	21.0W	23.0W	32.0W	1900	2050	2850	120°	180°	111 lm/W
KT-LED18T8-48P-850-S	5000K	4'	18W	2000	21.0W	23.0W	32.0W	2000	2200	3000	120°	180°	111 lm/W

*3' lamps are not included on the DLC Qualified Products List

For all Keystone SmartDrive linear LED lamps, input voltage is ballast dependent and CRI >80.

RECOMMENDED 0-10V DIMMING DRIVER, COMPATIBLE WITH SmartDrive T8 TUBES (Sold Separately)

Catalog Number	No. of Lamps	Input Volts	Line Current	Min. Power Factor	Output Current	Dimming Method
14-17W T8 LED Tubes						
KTLD-2LEDT8-UV-IS-VDIM	1-2	120-277V	0.40-0.06A	0.9	190-210mA	0-10V

Note: All SmartDrive System Wattage and Initial Lumens listed are nominal values. Actual values may vary depending on electronic ballast used.

LINEAR LED TUBES

T5HO AND T8 U-BEND REPLACEMENTS



SmartDrive Shatterproof Coated Glass
T5HO Lamps are ETL Sanitation Listed.

ELECTRICAL SPECIFICATIONS

T5 AND T5HO

Catalog Number	Color	Nominal Length	Bare Lamp Wattage	System Wattage	Initial Lumens	Nominal Bare Lamp Efficacy	Nominal System Efficacy	Power Factor	Max. THD	Beam Angle	Light Spread
SHATTERPROOF COATED GLASS CONSTRUCTION											
KT-LED13T5HE-48GC-835-S*	3500K	4'	13W	18W	1650	127 lm/W	92 lm/W	>0.9	20%	240°	325°
KT-LED13T5HE-48GC-840-S*	4000K	4'	13W	18W	1700	130 lm/W	94 lm/W	>0.9	20%	240°	325°
KT-LED13T5HE-48GC-850-S*	5000K	4'	13W	18W	1800	138 lm/W	100 lm/W	>0.9	20%	240°	325°
KT-LED27T5HO-48GC-830-S	3000K	4'	27W	30W	3100	114 lm/W	103 lm/W	>0.9	20%	240°	325°
KT-LED27T5HO-48GC-835-S	3500K	4'	27W	30W	3150	116 lm/W	105 lm/W	>0.9	20%	240°	325°
KT-LED27T5HO-48GC-840-S	4000K	4'	27W	30W	3200	118 lm/W	106 lm/W	>0.9	20%	240°	325°
KT-LED27T5HO-48GC-850-S	5000K	4'	27W	30W	3400	125 lm/W	113 lm/W	>0.9	20%	240°	325°

*Not included on DLC Qualified Products List

For all Keystone SmartDrive linear LED lamps, input voltage is ballast dependent and CRI >80.



SmartDrive
U-Bend Lamps
are NSF Listed.

ELECTRICAL SPECIFICATIONS

U-BEND

Catalog Number	Color	Nominal Length	Bare Lamp Wattage	Nominal Lumens	System Wattage			Initial Lumens			Beam Angle	Light Spread	Bare Lamp Efficacy
					.78 BF	.88 BF	1.18 BF	.78 BF	.88 BF	1.18 BF			
SHATTERPROOF COATED GLASS CONSTRUCTION													
KT-LED17T8-U6GC-830-S*	3000K	6" U-Bend	17W	2200	17.7W	20.2W	26.7W	1930	2200	2800	220°	325°	129 lm/W
KT-LED17T8-U6GC-835-S*	3500K	6" U-Bend	17W	2200	17.7W	20.2W	26.7W	1940	2230	2830	220°	325°	129 lm/W
KT-LED17T8-U6GC-840-S*	4000K	6" U-Bend	17W	2200	17.7W	20.2W	26.7W	1990	2300	2930	220°	325°	129 lm/W
KT-LED17T8-U6GC-850-S*	5000K	6" U-Bend	17W	2200	17.7W	20.2W	26.7W	2050	2370	3080	220°	325°	129 lm/W

*Not included on DLC Qualified Products List

For all Keystone SmartDrive U-Bend LED lamps, input voltage is ballast dependent and CRI >80.

Note: All SmartDrive System Wattage and Initial Lumens listed are nominal values. Actual values may vary depending on electronic ballast used.

Specifications subject to change without notice. For complete product specifications, visit www.keystonetech.com

LINEAR LED TUBES

T8 LINEAR REPLACEMENTS

COMBODRIVE LED

PLUG & PLAY OR LINE VOLTAGE COMPATIBLE

ComboDrive offers maximum flexibility. Plug and play for ballast-compatible operation or remove the ballast and connect line voltage directly to the lamp sockets for bypass operation.



PRODUCT FEATURES

- Runs on Existing Instant Start T8 Electronic Ballast or 120-277V Line Voltage
- Operating Temperature: -20°C/-4°F to 45°C/113°F
- Instant Startup
- Environmentally Friendly: No Mercury Used
- Frosted Lens Eliminates Pixelation

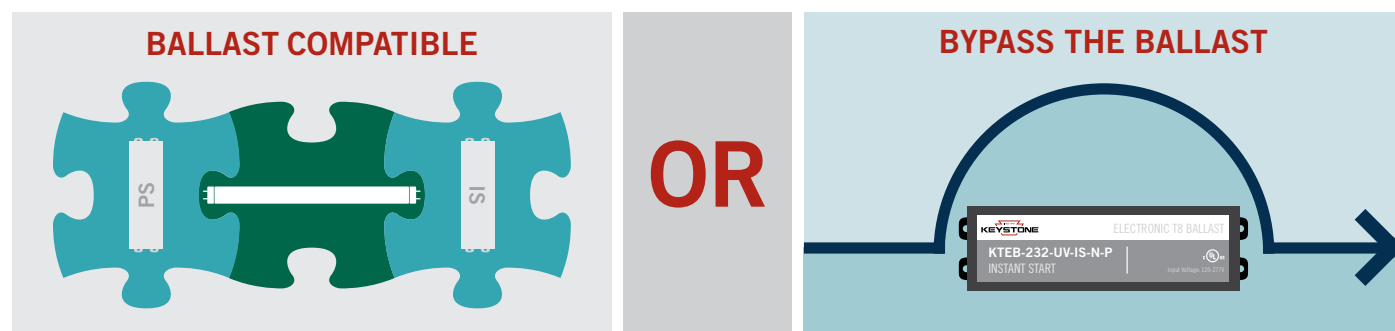

REDUCED INVENTORY

50,000 HOUR LIFETIME

INSTALLS IN SECONDS

FOOD SAFETY RATED

Our Shatterproof Coated Glass Lamps are

Typical Non-Shunted Lampholder
Connect wires directly to these terminals

FOR ComboDrive BALLAST BYPASS (LINE VOLTAGE) APPLICATION ONLY
CAUTION: Use only non-shunted lampholders.

Do not use existing shunted lampholders (found in all fixtures using instant start ballasts) when wiring for line voltage. Remove existing shunted lampholders and replace them with non-shunted lampholders. Make new connections directly to terminals as indicated. Keystone can provide any style replacement lampholders. Call us at 800-464-2680.

ELECTRICAL SPECIFICATIONS

Catalog Number	Color	Nominal Length	Lamp Wattage	Lumens	Beam Angle	Instant Start Ballast Compatible Application						Line Voltage Application		
						System Wattage			Initial Lumens			Input Voltage	Lamp Wattage	Initial Lumens
						.78 BF	.88 BF	1.18 BF	.78 BF	.88 BF	1.18 BF			
SHATTERPROOF COATED GLASS CONSTRUCTION												3000K color temperature available upon request.		
KT-LED9T8-24GC-835-X	3500K	2'	9W	1100	220°	11.2W	11.5W	12.1W	1110	1110	1110	120-277V	9W	1110
KT-LED9T8-24GC-840-X	4000K	2'	9W	1150	220°	11.2W	11.5W	12.1W	1170	1170	1170	120-277V	9W	1170
KT-LED9T8-24GC-850-X	5000K	2'	9W	1150	220°	11.2W	11.5W	12.1W	1190	1190	1190	120-277V	9W	1190
KT-LED15T8-48GC-835-X	3500K	4'	15W	1800	220°	16.2W	17.4W	18.5W	1670	1780	1920	120-277V	15W	1750
KT-LED15T8-48GC-840-X	4000K	4'	15W	1800	220°	16.2W	17.4W	18.5W	1710	1840	1980	120-277V	15W	1800
KT-LED15T8-48GC-850-X	5000K	4'	15W	1800	220°	16.2W	17.4W	18.5W	1730	1860	2010	120-277V	15W	1830

For all Keystone ComboDrive linear LED lamps, input voltage is ballast dependent.

LINEAR LED TUBES

ACCESSORIES FOR LINEAR RETROFITS

From pre-wired harnesses to tek screws, Keystone has what you need to get the job done.

Catalog Number	Description
DirectDrive WIRING HARNESSES	
KT-SOCKET-T8-U-T-2-W	2-Lamp Wiring Harness for LED Tubes; Includes (2) Pre-Wired Tall, Non-Shunted Sockets with Power Quick Disconnect
KT-SOCKET-T8-U-T-3-W	3-Lamp Wiring Harness for LED Tubes; Includes (3) Pre-Wired Tall, Non-Shunted Sockets with Power Quick Disconnect
KT-SOCKET-T8-U-T-4-W	4-Lamp Wiring Harness for LED Tubes; Includes (4) Pre-Wired Tall, Non-Shunted Sockets with Power Quick Disconnect
KT-SOCKET-T8-U-T-6-W	6-Lamp Wiring Harness for LED Tubes; Includes (4) Pre-Wired Tall, Non-Shunted Sockets with Power Quick Disconnect
KT-SOCKET-T8-U-S-2-W	2-Lamp Wiring Harness for LED Tubes; Includes (2) Pre-Wired Standard, Non-Shunted Sockets with Power Quick Disconnect
KT-SOCKET-T8-U-S-3-W	3-Lamp Wiring Harness for LED Tubes; Includes (3) Pre-Wired Standard, Non-Shunted Sockets with Power Quick Disconnect
KT-SOCKET-T8-U-S-4-W	4-Lamp Wiring Harness for LED Tubes; Includes (4) Pre-Wired Standard, Non-Shunted Sockets with Power Quick Disconnect
KT-SOCKET-T8-U-S-6-W	6-Lamp Wiring Harness for LED Tubes; Includes (4) Pre-Wired Standard, Non-Shunted Sockets with Power Quick Disconnect
KT-WH-FA8-2L	Wiring Harness for Single Pin 8' DirectDrive LED Tubes; No Sockets Included

DirectDrive Wiring Harness with Power Quick Disconnect



DirectDrive Wiring Diagram

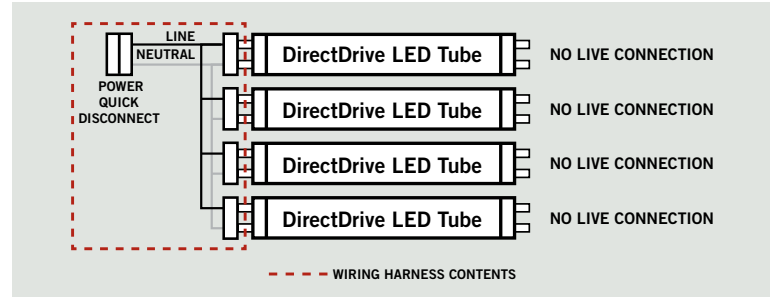

Catalog Number	Description
4' LED TUBE READY KIT	
KT-RKIT-SP-W-4-C4-2LED	2-Lamp 4' LED Tube Ready Kit. Pre-wired 4.25" Ballast Cover Kit for DirectDrive LED Tubes; Includes (1) 4' Ballast Cover, (1) Wiring Harness, (2) Additional Sockets, and 4 Tek Screws
8' STRIP READY KIT	
KT-RKIT-SP-W-82-C4-4LED	4-Lamp 8' Strip LED Tube Ready Kit. Pre-Wired 4.25" Ballast Cover Kit for DirectDrive LED Tubes; Includes (2) 4' Ballast Covers, (1) Wiring Harness, (4) Sockets and (8) Tek Screws
BALLAST COVERS AND STRIP REFLECTORS	
KT-RKIT-SC-C4	4' White Ballast Cover Only, Approximately 4.25"
KT-RKIT-SR8-W	4' White (91%) Reflector, 8" Width
KT-RKIT-SR8-S	4' Specular Aluminum (87%) Reflector, 8" Width
KT-RKIT-SR8-M	4' Enhanced Aluminum (95%) Reflector, 8" Width
BRACKETS	
KT-RKIT-S-BR-1	One-Piece Break-Apart Adjustable Bracket for 1-Lamp 4' or 8' Strip Fixture
KT-RKIT-T-BR-2	One-Piece Break-Apart Adjustable Bracket for 2-Lamp 4' or 8' Strip Fixture
KT-RKIT-T-BR-3	One-Piece Break-Apart Adjustable Bracket for 3-Lamp 4' or 8' Strip Fixture
KT-RKIT-T-BR-4	One-Piece Break-Apart Adjustable Bracket for 4-Lamp 4' or 8' Strip Fixture
SOCKETS	
KT-SOCKET-T8-U-T	Non-Shunted Tall T8 Socket with Push-Through with Nub, Approximately 30mm
KT-SOCKET-T8-U-S	Non-Shunted Short T8 Socket with Push-Through with Nub, Approximately 23mm
MISCELLANEOUS	
KT-RKIT-QD	Power Quick Disconnect
KT-RKIT-TEK	Tek Screws

Break-Apart Adjustable Bracket

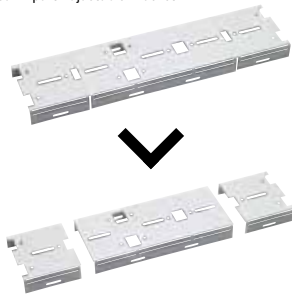

Reflector and Ballast Cover



Power Quick Disconnect



Non-Shunted Socket



Troffer Brackets

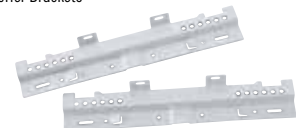

Specifications subject to change without notice. For complete product specifications, visit www.keystonetech.com

COMPACT LED LAMPS

SECTION CONTENTS

SmartDrive 4-Pin Replacements: 18

DirectDrive 2-Pin and 4-Pin Replacements: 20



LED lighting has expanded beyond linear tubes and now includes compact LED lamp options for recessed and downlight applications. All Keystone LED lamps are powered with integral Keystone drivers and are available in 2 unique varieties: SmartDrive (plug and play with existing ballast), DirectDrive (connect directly to line voltage). Both varieties are backed by our extensive warranty, so you can buy with confidence.

COMPACT LED LAMPS

4-PIN, 26W/32W/42W CFL REPLACEMENTS



Making the switch to LED is no longer just for linear lamps. SmartDrive plug and play compact LED lamps are energy efficient, long-lasting replacements for downlight applications that previously used 4-pin compact fluorescent lamps.



PRODUCT FEATURES

- Replacement for Conventional CFL 26W/32W/42W G24q Lamps
- Plug and Play: Directly Compatible with Most Existing CFL Ballasts
- Operating Temperature: -20°C/-4°F to 45°C/113°F
- Instant Startup
- Environmentally Friendly: No Mercury Used
- Frosted Lens Eliminates Pixelation
- Dimmable (Depending on Ballast)

11W LED COMPARISON	> 26W CFL 10% more lumens
= 32W CFL same lumens	< 42W CFL 10% less lumens

**INSTALLS
IN SECONDS**

No tools required.

**50,000 HOUR
LIFETIME**

BALLAST COMPATIBLE

Before installing, confirm ballast compatibility at SmartDriveLED.com

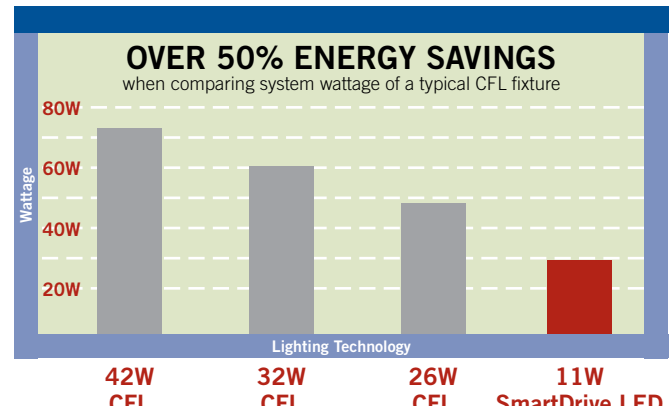

Ballast for each lamp above: KTEB-242-UV-RS-DW

LIGHT DISTRIBUTION

CFL Lamp 	SmartDrive LED Horizontal Lamp 	SmartDrive LED Vertical Lamp
---------------------	---	---

LASTS 4x LONGER
than CFL Lamps

Specifications subject to change without notice. For complete product specifications, visit www.keystonetech.com

COMPACT LED LAMPS

4-PIN, 26W/32W/42W CFL REPLACEMENTS



ELECTRICAL SPECIFICATIONS

Catalog Number	Color	Base	Orientation	CRI	Lamp Wattage	System Wattage	Lumens	Application
KT-LED114P-H-827-S	2700K	G24q	Horizontal	>80	11W	12.5W	1000	
KT-LED114P-H-830-S	3000K	G24q	Horizontal	>80	11W	12.5W	1000	
KT-LED114P-H-835-S	3500K	G24q	Horizontal	>80	11W	12.5W	1000	
KT-LED114P-H-840-S	4000K	G24q	Horizontal	>80	11W	12.5W	1050	
KT-LED114P-H-850-S	5000K	G24q	Horizontal	>80	11W	12.5W	1050	
KT-LED114P-V-827-S	2700K	G24q	Vertical	>80	11W	12.5W	1000	
KT-LED114P-V-830-S	3000K	G24q	Vertical	>80	11W	12.5W	1000	
KT-LED114P-V-835-S	3500K	G24q	Vertical	>80	11W	12.5W	1000	
KT-LED114P-V-840-S	4000K	G24q	Vertical	>80	11W	12.5W	1050	
KT-LED114P-V-850-S	5000K	G24q	Vertical	>80	11W	12.5W	1050	
KT-LED114P-EV-827-S	2700K	G24q	Extended Vertical	>80	11W	12.5W	1000	
KT-LED114P-EV-830-S	3000K	G24q	Extended Vertical	>80	11W	12.5W	1000	
KT-LED114P-EV-835-S	3500K	G24q	Extended Vertical	>80	11W	12.5W	1000	
KT-LED114P-EV-840-S	4000K	G24q	Extended Vertical	>80	11W	12.5W	1050	
KT-LED114P-EV-850-S	5000K	G24q	Extended Vertical	>80	11W	12.5W	1050	

Input voltage for all Keystone SmartDrive compact LED lamps is ballast dependent.

COMPACT LED LAMPS

2-PIN, 18-26W CFL REPLACEMENTS



Keystone's DirectDrive compact lamps eliminate the need for an external driver or ballast. For new construction installations, simply connect the 120-277V line voltage directly to the sockets. For retrofit installations, bypass the existing ballast by cutting the wires and connecting the 120-277V line voltage directly to the sockets. No ballast or driver is required.



PRODUCT FEATURES

- Replacement for 18/26W CFL Lamps with a 2-Pin (G24d) or 4-Pin (G24q) Base Type
- Operating Temperature: -20°C/-4°F to 45°C/113°F
- Environmentally Friendly: No Mercury Used
- Frosted Lens Eliminates Pixelation
- Suitable for Use in Dry and Damp Locations

BYPASS THE BALLAST
This lamp will fit into 2-pin (G24d) and 4-pin (G24q) lampholders for direct wire 120-277V applications.

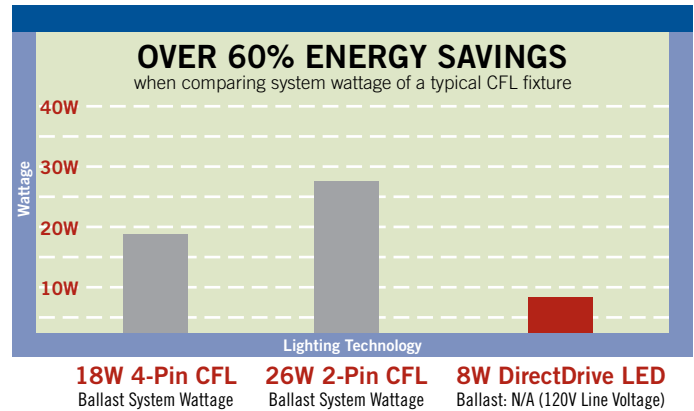

Connect 120-277V line voltage directly to the sockets and never think about the power source again.

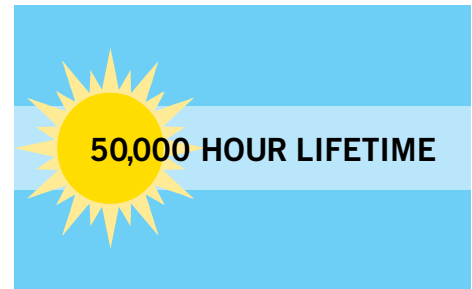

LIGHT DISTRIBUTION



Specifications subject to change without notice. For complete product specifications, visit www.keystonetech.com

COMPACT LED LAMPS

2-PIN, 18-26W CFL REPLACEMENTS



ELECTRICAL SPECIFICATIONS

Catalog Number	Color	Base	Input Voltage	Orientation	CRI	Lamp Wattage	Lumens	Application
KT-LED82P-H-827-D	2700K	G24d	120-277V	Horizontal	>80	8W	900	
KT-LED82P-H-830-D	3000K	G24d	120-277V	Horizontal	>80	8W	900	
KT-LED82P-H-835-D	3500K	G24d	120-277V	Horizontal	>80	8W	900	
KT-LED82P-H-840-D	4000K	G24d	120-277V	Horizontal	>80	8W	950	
KT-LED82P-H-850-D	5000K	G24d	120-277V	Horizontal	>80	8W	950	
KT-LED82P-V-827-D	2700K	G24d	120-277V	Vertical	>80	8W	900	
KT-LED82P-V-830-D	3000K	G24d	120-277V	Vertical	>80	8W	900	
KT-LED82P-V-835-D	3500K	G24d	120-277V	Vertical	>80	8W	900	
KT-LED82P-V-840-D	4000K	G24d	120-277V	Vertical	>80	8W	950	
KT-LED82P-V-850-D	5000K	G24d	120-277V	Vertical	>80	8W	950	
KT-LED82P-EV-827-D	2700K	G24d	120-277V	Extended Vertical	>80	8W	900	
KT-LED82P-EV-830-D	3000K	G24d	120-277V	Extended Vertical	>80	8W	900	
KT-LED82P-EV-835-D	3500K	G24d	120-277V	Extended Vertical	>80	8W	900	
KT-LED82P-EV-840-D	4000K	G24d	120-277V	Extended Vertical	>80	8W	950	
KT-LED82P-EV-850-D	5000K	G24d	120-277V	Extended Vertical	>80	8W	950	

WIRING DIAGRAMS

BYPASS MAGNETIC BALLAST WITH 1 LAMP

BEFORE

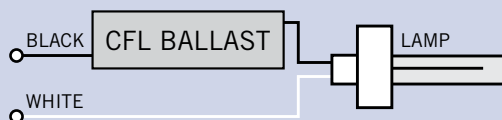

AFTER

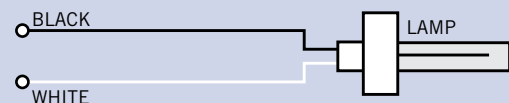

BYPASS ELECTRONIC BALLAST WITH 1 LAMP

BEFORE

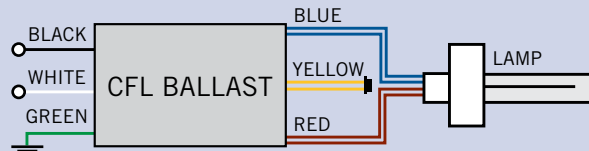

AFTER

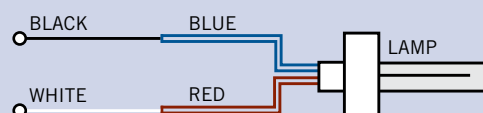

BYPASS MAGNETIC BALLAST WITH 2 LAMPS

BEFORE

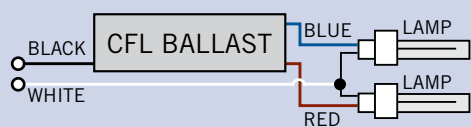

AFTER

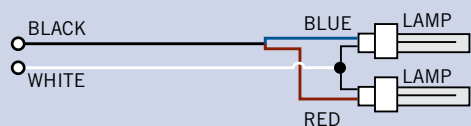

BYPASS ELECTRONIC BALLAST WITH 2 LAMPS

BEFORE

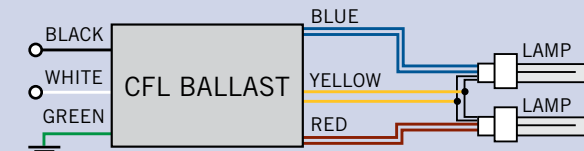

AFTER

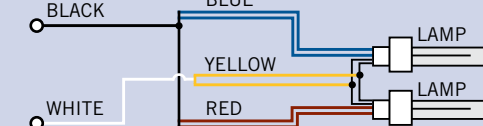

Specifications subject to change without notice. For complete product specifications, visit www.keystonetech.com

Keystone Technologies, LLC | North Wales, PA 19454 | Phone (800) 464-2680 | keystonetech.com

COMPACT LED LAMPS

2-PIN, 13W CFL REPLACEMENTS



PRODUCT FEATURES

- Replacement for 13W CFL Lamps with a 2-Pin (GX23) Base Type
- Operating Temperature: -20°C/-4°F to 45°C/113°F
- Environmentally Friendly: No Mercury Used
- Frosted Lens Eliminates Pixelation
- Suitable for Use in Dry and Damp Locations

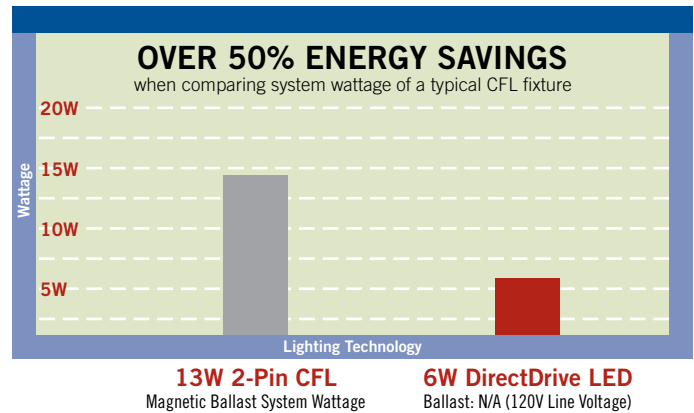
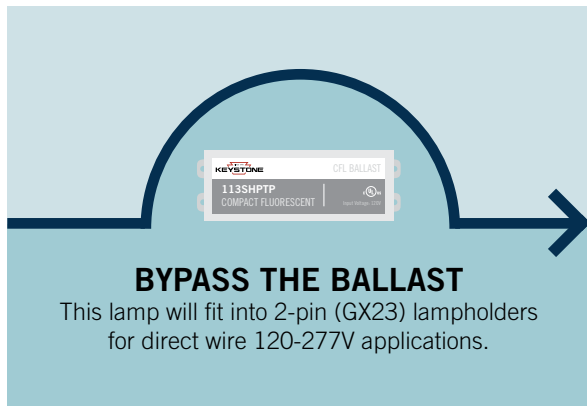

ELECTRICAL SPECIFICATIONS

Catalog Number	Color	Base	Orientation	Input Voltage	CRI	Lamp Wattage	Lumens
PLASTIC/ALUMINUM CONSTRUCTION; REPLACES 13W CFL LAMP							
KT-LED62P-H-827-D	2700K	GX23	Horizontal	120-277V	>80	6W	500
KT-LED62P-H-830-D	3000K	GX23	Horizontal	120-277V	>80	6W	500
KT-LED62P-H-835-D	3500K	GX23	Horizontal	120-277V	>80	6W	500
KT-LED62P-H-840-D	4000K	GX23	Horizontal	120-277V	>80	6W	550
KT-LED62P-H-850-D	5000K	GX23	Horizontal	120-277V	>80	6W	550

Specifications subject to change without notice. For complete product specifications, visit www.keystonetech.com

HID REPLACEMENT LED LAMPS

SECTION CONTENTS

DirectDrive: 24

SmartDrive: 26



LED technology continues to expand, and we now offer HID Replacement LED lamps. Designed for both indoor and outdoor use, these replacement lamps are a simple retrofit for a variety of applications including street lights, post lights, high bays, and security lighting. All Keystone HID Replacement LED lamps are powered with integral Keystone drivers and are available in both SmartDrive (plug and play with existing ballast) and DirectDrive (connect directly to line voltage). All of our LED lamps are backed by our extensive warranty, so you can buy with confidence.

HID REPLACEMENT LED LAMPS



Keystone DirectDrive HID Replacement LED lamps are the ideal way to upgrade existing HID fixtures to the latest in LED technology. Simply bypass the existing ballast by cutting the wires and connecting the 120-277V line voltage directly to the sockets. No ballast or external driver is required.



PRODUCT FEATURES

- Integral Keystone Driver
- High Wattage Lamps Include Safety Tether to Add Additional Security for Install
- Operating Temperature: -29°C/-20°F to 60°C/140°F
- Environmentally Friendly: No Mercury Used
- Suitable for Use in Dry, Damp and Wet Locations
- Up to 70% Energy Savings Over Existing HID Applications
- Integrated Heat Sink Quickly Dissipates Heat and Guides Any Water Intrusion Out of the Lamp
- SmartCool Technology on 54W, 80W, and 100W Lamps Prevents Overheating in High Temperature Applications
- High Wattage Lamps Include Safety Tether for Additional Installation Security



With SmartCool technology, a thermal sensor in the lamp activates during extreme high temperature conditions. Power to the lamp is reduced by up to 20% to cool the lamp and maintain lamp life. Once the sensor reaches an acceptable temperature, the lamp gradually returns to full light output. Included in 54W, 80W and 100W DirectDrive HID LED lamps.

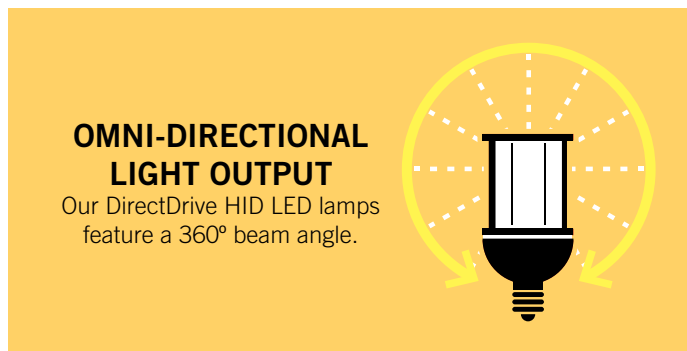
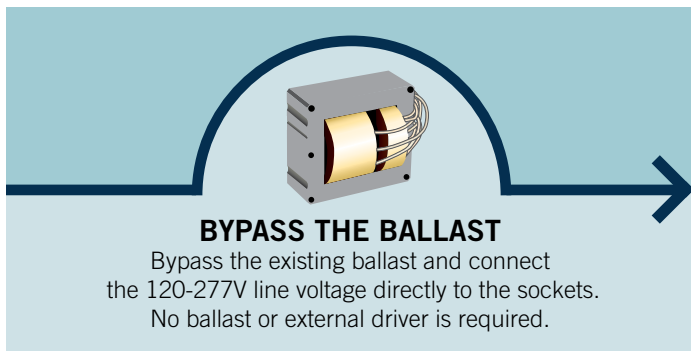
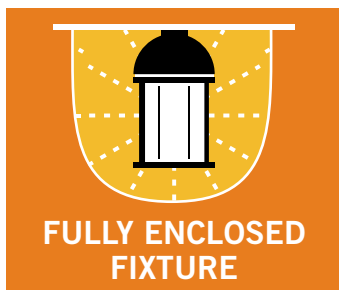

Note: Failure to remove the ballast will result in product damage and void the product warranty.

Specifications subject to change without notice. For complete product specifications, visit www.keystonetech.com

HID REPLACEMENT LED LAMPS



ELECTRICAL SPECIFICATIONS

LOW WATTAGE

Catalog Number	Rated Lamp Wattage	Metal Halide Equivalent Wattage	Input Voltage	Base Type	Lumens	Color Temp	CRI	IP Rating	Efficacy	DLC QPL
KT-LED20HID-E26-830-D	20W	50-70W	120-277V	Medium E26	2080	4000K	>85	IP64	104 lm/W	N/A
KT-LED20HID-E26-840-D	20W	50-70W	120-277V	Medium E26	2100	4000K	>85	IP64	105 lm/W	N/A
KT-LED20HID-E26-850-D	20W	50-70W	120-277V	Medium E26	2130	5000K	>85	IP64	107 lm/W	N/A

MID WATTAGE

Catalog Number	Rated Lamp Wattage	Metal Halide Equivalent Wattage	Input Voltage	Base Type	Lumens	Color Temp	CRI	IP Rating	Efficacy	DLC QPL
KT-LED27HID-E26-830-D	27W	100W	120-277V	Medium E26	3750	4000K	>85	IP64	139 lm/W	N/A
KT-LED27HID-E26-840-D	27W	100W	120-277V	Medium E26	3780	4000K	>85	IP64	140 lm/W	N/A
KT-LED27HID-E26-850-D	27W	100W	120-277V	Medium E26	3830	5000K	>85	IP64	142 lm/W	N/A
KT-LED36HID-E26-830-D	36W	150W	120-277V	Medium E26	5000	4000K	>85	IP64	139 lm/W	N/A
KT-LED36HID-E26-840-D	36W	150W	120-277V	Medium E26	5040	4000K	>85	IP64	140 lm/W	N/A
KT-LED36HID-E26-850-D	36W	150W	120-277V	Medium E26	5100	5000K	>85	IP64	142 lm/W	N/A
KT-LED45HID-E26-830-D	45W	175W	120-277V	Mogul EX39	6250	4000K	>85	IP64	139 lm/W	N/A
KT-LED45HID-E26-840-D	45W	175W	120-277V	Medium E26	6300	4000K	>85	IP64	140 lm/W	N/A
KT-LED45HID-E26-850-D	45W	175W	120-277V	Medium E26	6350	5000K	>85	IP64	141 lm/W	N/A
KT-LED45HID-EX39-830-D	45W	175W	120-277V	Mogul EX39	6250	4000K	>85	IP64	139 lm/W	No
KT-LED45HID-EX39-840-D	45W	175W	120-277V	Mogul EX39	6300	4000K	>85	IP64	140 lm/W	Yes
KT-LED45HID-EX39-850-D	45W	175W	120-277V	Mogul EX39	6350	5000K	>85	IP64	141 lm/W	Yes
KT-LED54HID-EX39-830-D	54W	250W	120-277V	Mogul EX39	7460	4000K	>85	IP64	138 lm/W	Yes
KT-LED54HID-EX39-840-D	54W	250W	120-277V	Mogul EX39	7560	4000K	>85	IP64	140 lm/W	Yes
KT-LED54HID-EX39-850-D	54W	250W	120-277V	Mogul EX39	7660	5000K	>85	IP64	142 lm/W	Yes

Note: 27W and 36W lamps are available with an EX39 base as a special order item.

HIGH WATTAGE

Catalog Number	Rated Lamp Wattage	Metal Halide Equivalent Wattage	Input Voltage	Base Type	Lumens	Color Temp	CRI	IP Rating	Efficacy	DLC QPL
KT-LED80HID-EX39-840-D	80W	320W	120-277V	Mogul EX39	11,200	4000K	>85	IP64	140 lm/W	Yes
KT-LED80HID-EX39-850-D	80W	320W	120-277V	Mogul EX39	11,300	5000K	>85	IP64	141 lm/W	Yes
KT-LED100HID-EX39-840-D	100W	400W	120-277V	Mogul EX39	14,000	4000K	>85	IP64	140 lm/W	Yes
KT-LED100HID-EX39-850-D	100W	400W	120-277V	Mogul EX39	14,100	5000K	>85	IP64	141 lm/W	Yes

ACCESSORIES (Sold Separately)

Catalog Number	Description
SURGE PROTECTOR	
KTSP-10KV	External Surge Protector; 120-277V Input Voltage; Max. Peak Current: 10KV; IP65 Rated
STEP DOWN TRANSFORMERS	
KTAT-250-480-277	Step Down Transformer; 480V Input; 277V Output; Max. Load: 250VA
KTAT-70-480-277	Step Down Transformer; 480V Input; 277V Output; Max. Load: 70VA
ADAPTER	
KT-ADAPTER-E39-E26	Socket Base Adapter Allowing an E26 Base Lamp to be Used in E39 Socket

Specifications subject to change without notice. For complete product specifications, visit www.keystonetech.com

HID REPLACEMENT LED LAMPS



Keystone SmartDrive HID LED lamps are energy efficient, long-lasting replacements for open or enclosed HID downlight fixtures. Simply replace the existing fluorescent lamp with Keystone Smart Drive LED lamp. No changes to the existing fluorescent ballast wiring needed.



PRODUCT FEATURES

- **Compatible with Most Magnetic HID Ballasts**
(Check Compatibility Prior to Installation)
- **Plug and Play Installation: No Wiring Required**
- Includes Safety Tether to Add Additional Security for Install
- Environmentally Friendly: No Mercury Used
- Instant Startup
- Frosted Lens Eliminates Glare
- Operating Temperature: -30°C to 30°C-35°C (Fixture Dependent)
- Suitable for Dry and Damp Locations
- Lower Wattage Draw Can Extend Lifetime of HID Ballast
- CRI > 80

5

5 YEAR SYSTEM WARRANTY FOR LAMP AND BALLAST KITS

Keystone offers the best system warranty in the industry. When installing Keystone SmartDrive HID LED replacement lamps with Keystone ballasts, we extend the ballast warranty by 3 years. You benefit from a 5 year total system warranty.

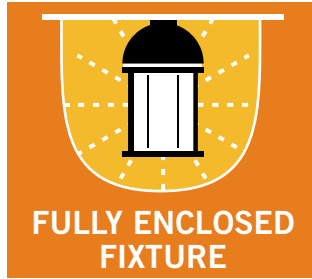
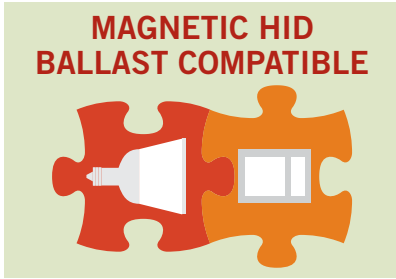

ELECTRICAL SPECIFICATIONS

LAMP AND BALLAST KITS

400W METAL HALIDE REPLACEMENT

Catalog Number	Included Ballast Kit	Color Temp.	Lamp Wattage	Base Type	Orientation	Input Voltage	Driven by 400W (M59) Ballast	
							Lumens	System Wattage
KT-LED130HID-V-EX39-840-S-PKIT	MH-400A-P-KIT	4000K	130W	EX39	Vertical	Ballast Dependent	12,700	166W
KT-LED130HID-V-EX39-850-S-PKIT		5000K					13,000	166W

175W METAL HALIDE REPLACEMENT

Catalog Number	Included Ballast Kit	Color Temp.	Lamp Wattage	Base Type	Orientation	Input Voltage	Driven by 175W (M57) Ballast	
							Lumens	System Wattage
KT-LED48HID-V-E26-840-S-PKIT	MH-175A-P-KIT	4000K	48W	E26	Vertical	Ballast Dependent	5,400	79W
KT-LED48HID-V-E26-850-S-PKIT		5000K					5,600	79W

LAMPS

400W METAL HALIDE REPLACEMENT

Catalog Number	Supported Ballast Types	Color Temp.	Lamp Wattage	Base Type	Orientation	Input Voltage	Driven by 400W (M59) Ballast		Driven by 320W (M154) Ballast	
							Lumens	System Wattage*	Lumens	System Wattage*
KT-LED130HID-V-EX39-840-S	400W (M59, M135/M155), 320W (M132/M154)	4000K	130W	EX39	Vertical	Ballast Dependent	12,700	166W	10,800	138W
KT-LED130HID-V-EX39-850-S		5000K					13,000	166W	11,000	138W

175W METAL HALIDE REPLACEMENT

Catalog Number	Supported Ballast Types	Color Temp.	Lamp Wattage	Base Type	Orientation	Input Voltage	Driven by 175W (M57) Ballast	
							Lumens	System Wattage*
KT-LED48HID-V-E26-840-S	175W (M57, M137/M152)	4000K	48W	E26	Vertical	Ballast Dependent	5,400	79W
KT-LED48HID-V-E26-850-S		5000K					5,600	79W

* typical values; actual values will vary based on ballast used

Specifications subject to change without notice. For complete product specifications, visit www.keystonetech.com

LED DRIVERS

SECTION CONTENTS

LED Driver Selection: 28

Constant Voltage: 29

SAM Qualified Products: 31

Constant Current: 32

Programmable Drivers: 49

Dimmer Compatibility List: 50



An LED fixture is only as good as its driver. Depend on Keystone's 70 year legacy of building world-class lighting power electronics for superior reliability and performance.

Keystone's extensive portfolio of LED drivers features a wide variety of driver technologies including programmable, dimmable, and IP rated drivers as well as cost-conscious dedicated driver products for specific fixture applications.

We have millions of drivers in use today and millions of dollars in LED driver inventory for immediate shipment. Turn to Keystone for your next LED project.

BASIC FACTORS TO CONSIDER WHEN SELECTING AN LED DRIVER

Constant Current vs. Constant Voltage LED Drivers

Keystone offers both constant current and constant voltage LED drivers. We provide LED fixture and sign manufacturers options and flexibility in order to optimize their LED systems for various applications and environments.

CONSTANT CURRENT DRIVERS

These drivers are required when the driver is used to power the LED load directly. With constant current drivers, the output current is fixed by the driver, while the output voltage varies depending on the LED load. The more LEDs the driver is powering, the greater the output voltage will be, up to a maximum as allowed by the driver specifications. In order to correctly select a constant current driver, you need to know the following:

The RECOMMENDED DRIVE CURRENT required by the LED module.

The drive current of the LED module(s) should match the **RATED OUTPUT CURRENT** of the driver. For example, one 380mA LED module requires one 380mA driver and two 350mA LED modules connected in series require a 700mA driver.

The MAXIMUM FORWARD VOLTAGE of all LEDs in the module.*

The maximum forward voltage required of the LED module must not exceed the **MAXIMUM OUTPUT VOLTAGE** of the driver.

CONSTANT VOLTAGE DRIVERS

These drivers are required when another LED current controlling device, such as a built in resistor or regulating driver is already connected directly to the LED load. With constant voltage drivers, the output voltage remains fixed (typically at 12Vdc or 24Vdc) at any current level, up to a maximum allowable current, as dictated by the maximum output power of the driver. In order to correctly select a constant voltage driver, you need to know the following:

The CONSTANT INPUT VOLTAGE required by the LED module.

The constant input voltage required by the LED module must match the **CONSTANT OUTPUT VOLTAGE** of the driver.

The MAXIMUM POWER required by the LED modules in the system.**

The total power consumption of the LED modules in the system must not exceed the **MAX OUTPUT POWER** of the LED driver.

* Maximum forward voltage should be specified by the LED module manufacturer. If not, calculate by taking the maximum forward voltage rating as indicated by the LED manufacturer and multiply by the total number of LEDs in the module.

** Calculate by taking the rated power consumption of the LED module as specified by the manufacturer and multiply by total number of modules in the system.

Dimming Requirements

Keystone offers a wide range of dimmable Constant Current LED drivers, compatible with 3 different types of dimming technologies:

- **Phase Control Dimming (FDIM)**
- **0-10V Analog Dimming (VDIM)**
- **Local Dimming (LDIM)**

For additional information on dimming methods and dimmer compatibility, please see page 50.

Form Factor Requirements

Because of the variety of applications that employ LED technology, there are often size constraints that LED drivers must meet. Keystone has a large selection of LED driver case styles available to fit virtually every application. See pages 30 and 48 for more information on case dimensions.

We make LED easy. From simple explanations to special design requests, call us today for any LED questions. All LED drivers can be modified to accommodate specific requirements.

ELECTRICAL SPECIFICATIONS

FEATURES: • FCC Class B rating for EMI • Over Current, Short Circuit, and Open Circuit Protection • Class 2 Output Except for the Following, which are Class 1 Output: KTLD-80-UV-12V, KTLD-100-UV-12V, KTLD-100-UV-12V-67-AP2, KTLD-100-UV-12V-67-AP3, KTLD-150-UV-24V-67-AP3

Wattage Family	Catalog Number	OUTPUT CHARACTERISTICS				INPUT CHARACTERISTICS			FEATURES	
		Output Voltage	Max Power	Current		Input Voltage	Input Power	Power Factor	Efficiency*	Case Style
				Min Current	Max Current					
10W	KTLD-10-1N-12V-F3	12Vdc	10W	0A	0.83A	120Vac	13W	>0.50	77%	F3
	KTLD-10-1N-24V-F3	24Vdc	10W	0A	0.42A	120Vac	13W	>0.50	77%	F3
24W	KTLD-24-1-12V-AK1	12Vdc	24W	0A	2.00A	120Vac	32W	>0.90	75%	AK1
	KTLD-24-1-24V-AK1	24Vdc	24W	0A	1.00A	120Vac	32W	>0.90	75%	AK1
	KTLD-24-UV-12V-AK1	12Vdc	24W	0A	2.00A	120~277Vac	32W	>0.90	75%	AK1
	KTLD-24-UV-24V-AK1	24Vdc	24W	0A	1.00A	120~277Vac	32W	>0.90	75%	AK1
60W	KTLD-60-1-12V	12Vdc	60W	0A	5.00A	120Vac	73W	>0.90	82%	L5
	KTLD-60-1N-12V-L2	12Vdc	60W	0A	5.00A	120Vac	71W	>0.50	85%	L2
	KTLD-60-1-24V	24Vdc	60W	0A	2.50A	120Vac	69W	>0.90	87%	L5
	KTLD-60-1-24V-W2	24Vdc	60W	0A	2.50A	120Vac	69W	>0.90	87%	W2
	KTLD-60-1N-24V-L2	24Vdc	60W	0A	2.50A	120Vac	71W	>0.50	85%	L2
	KTLD-60-UV-12V	12Vdc	60W	0A	5.00A	120~277Vac	71W	>0.90	85%	L5
	KTLD-60-UV-12V-67-AP4	12Vdc	60W	0A	5.00A	120~277Vac	70W	>0.90	86%	AP4
	KTLD-60-UV-12V-AO1	12Vdc	60W	0A	5.00A	120~277Vac	70W	>0.90	85%	AO1
	KTLD-60-UV-12V-VDIM-L5	12Vdc	60W	0A	5.00A	120~277Vac	75W	>0.90	80%	L5
	KTLD-60-UV-12V-W2	12Vdc	60W	0A	5.00A	120~277Vac	71W	>0.90	85%	W2
	KTLD-60-UV-24V	24Vdc	60W	0A	2.50A	120~277Vac	70W	>0.90	85%	L5
	KTLD-60-UV-24V-67-AP4	24Vdc	60W	0A	2.50A	120~277Vac	70W	>0.90	86%	AP4
	KTLD-60-UV-24V-AO1	24Vdc	60W	0A	2.50A	120~277Vac	70W	>0.90	86%	AO1
	KTLD-60-UV-24V-W2	24Vdc	60W	0A	2.50A	120~277Vac	70W	>0.90	86%	W2
80W	KTLD-80-1-12V	12Vdc	80W	0A	6.60A	120Vac	93W	>0.90	86%	L5
	KTLD-80-1-24V	24Vdc	80W	0A	3.30A	120Vac	92W	>0.90	87%	L5
	KTLD-80-UV-12V	12Vdc	80W	0A	6.70A	120~277Vac	93W	>0.90	86%	L5
	KTLD-80-UV-12V-67-AP4	12Vdc	80W	0A	6.70A	120~277Vac	93W	>0.90	86%	AP4
	KTLD-80-UV-24V	24Vdc	80W	0A	3.30A	120~277Vac	93W	>0.90	86%	L5
	KTLD-80-UV-24V-67-AP4	24Vdc	80W	0A	3.30A	120~277Vac	93W	>0.90	86%	AP4
100W	KTLD-100-UV-12V	12Vdc	96W	0A	8.00A	120~277Vac	114W	>0.90	84%	L5
	KTLD-100-UV-12V-67-AP4	12Vdc	96W	0A	8.00A	120~277Vac	114W	>0.90	84%	AP4
	KTLD-100-UV-24V	24Vdc	96W	0A	4.00A	120~277Vac	110W	>0.90	87%	L5
	KTLD-100-UV-24V-AO2	24Vdc	96W	0A	4.00A	120~277Vac	112W	>0.90	86%	AO2
	KTLD-100-UV-24V-67-AP4	24Vdc	96W	0A	4.00A	120~277Vac	110W	>0.90	87%	AP4
120W	KTLD-120-UV-12V-L10	12Vdc	120W	0A	5.00A	120~277Vac	142W	>0.9	84%	L10
150W	KTLD-150-UV-12V-AU1	12Vdc	150W	0A	12.50A	120~277Vac	165W	>0.90	90%	AU1
	KTLD-150-UV-24V-AU1	24Vdc	150W	0A	6.25A	120~277Vac	165W	>0.90	90%	AU1

* Nominal efficiency. Actual efficiency may vary slightly due to manufacturing tolerances and application.

IP (Ingress Protection) Case Rating

IP67 Cases, designated by -67 in the catalog number, are dust-tight and protected from temporary water immersion (30 minutes at a depth of 1 meter).

There are several Keystone case types that can be upgraded to a higher IP rating upon request. Please consult Keystone for details.

LED DRIVERS

CONSTANT VOLTAGE

CASE STYLES

All LED drivers can be modified to accommodate specific requirements.

Contact Keystone to discuss custom and semi-custom LED driver solutions.

CASE AK

Material: Steel

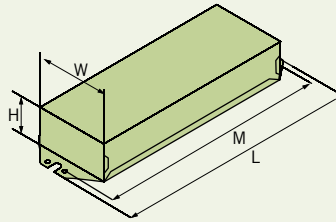

Case Style	Mounting	Length	Width	Height
AK1	4.29"	4.80"	1.58"	0.96"

CASE AO

Material: Steel

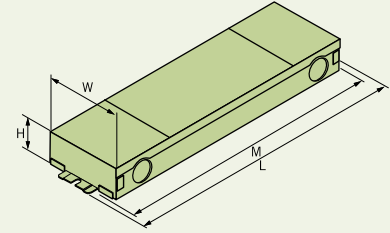

Case Style	Mounting	Length	Width	Height
A01	9.05"	9.49"	3.00"	1.30"
A02	11.02"	11.46"	3.00"	1.30"

CASE AP

Material: Aluminum
Case Rating: IP67

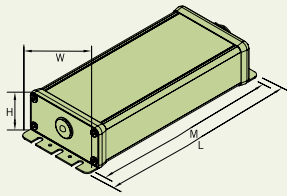

Case Style	Mounting	Length	Width	Height
AP4	8.65"	9.26"	1.90"	1.50"

CASE AU

Material: Aluminum

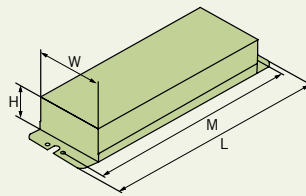

Case Style	Mounting	Length	Width	Height
AU1	8.90"	9.45"	1.80"	1.37"

CASE F

Material: Aluminum

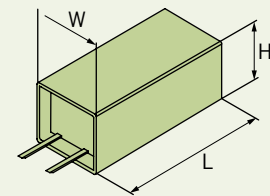

Case Style	Mounting	Length	Width	Height
F3	N/A	2.68"	1.30"	0.79"

CASE L

Material: Steel

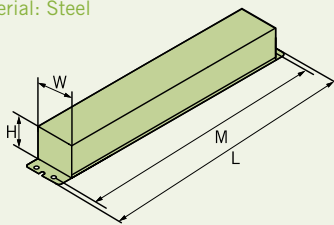

Case Style	Mounting	Length	Width	Height
L2	6.00"	6.46"	1.89"	1.15"
L5	8.90"	9.50"	1.70"	1.18"
L10	16.35"	16.73"	1.70"	1.18"

CASE W

Material: Steel

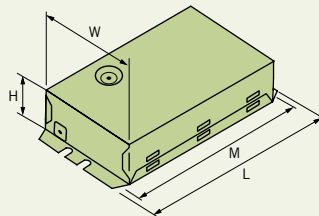

Case Style	Mounting	Length	Width	Height
W2	4.63"	5.00"	3.00"	1.38"

SAM

Sign Component Manual (SAM) - SAM is a directory governed by UL that lists all components that have been tested and certified under the UL standard for electric signs. It is updated quarterly and contains all of the components associated with the manufacturing of electric signs, including LED power supplies. For more information, visit www.ul.com.

Keystone has several LED drivers that meet the qualifications for SAM approval. Use the charts below to see which of our products are SAM Qualified or currently pending approval.

UL Sign Component Manual Qualified Products

Catalog Number	Catalog Number	Catalog Number
KTLD-10-1N-12V-F3	KTLD-60-1-24V-W2	KTLD-80-1-24V
KTLD-10-1N-24V-F3	KTLD-60-UV-12V	KTLD-80-UV-24V*
KTLD-12-1-350-FDIM-AF1	KTLD-60-UV-12V-67-AP4	KTLD-100-UV-12V
KTLD-24-UV-12V-AK1	KTLD-60-UV-12V-VDIM-L5	KTLD-100-UV-24V
KTLD-24-1-12V-AK1	KTLD-60-UV-12V-W2	KTLD-120-UV-12V-L10
KTLD-24-1-24V-AK1	KTLD-60-UV-24V	KTLD-150-UV-24V-AU1
KTLD-24-UV-24V-AK1	KTLD-60-UV-24V-67-AP4	<i>*Approval Pending</i>
KTLD-60-1-12V	KTLD-60-UV-24V-W2	
KTLD-60-1-24V	KTLD-80-1-12V	



LED DRIVERS

CONSTANT CURRENT

➤ The constant current drivers listed in this catalog are available in any output current configuration within the stated current range. ➤

*"xxx" in the part number is a placeholder for the output current value. For example, KTLD-12-1-350-FDIM-AF1 has an output current of 350mA.

ELECTRICAL SPECIFICATIONS

FEATURES: FCC Class B rating for EMI • Over Current, Short Circuit, and Open Circuit Protection

Wattage Family	Output Current Range	Catalog Number	Input Voltage	Power Factor	Dimming	Typical Output Current	Output Voltage	Efficiency	Case Style
10W	300mA	KTLD-10-1-300-FDIM-AF1	120V	>0.9	Phase Control	300mA	5-33Vdc	74%	AF1
	300-380mA	KTLD-10-1N-xxx-F3	120V	>0.5	N/A	300mA	6-33Vdc	77%	F3
						330mA	9-30Vdc	77%	
						350mA	7.5-30Vdc	77%	
						380mA	6.5-28Vdc	77%	
	350mA	KTLD-10-1N-350-AF3	120V	>0.5	N/A	350mA	7.5-30Vdc	77%	AF3
	300-700mA	KTLD-10-1P-xxx-LDIM-F5	120V	>0.7	Local	300mA	6-33Vdc	77%	F5
						400mA	6-25Vdc	77%	
						500mA	6-20Vdc	77%	
						600mA	6-17Vdc	77%	
700mA						6-14Vdc	77%		
380mA	KTLD-10-1P-380-LDIM-AF1	120V	>0.7	Local	380mA	13-27Vdc	77%	AF1	
12W	350-700mA	KTLD-12-1-xxx-FDIM-AF1	120V	>0.9	Phase Control	350mA	6-32Vdc	75%	AF1
						380mA	5-32Vdc	75%	
						500mA	5-24Vdc	77%	
						600mA	5-20Vdc	77%	
						700mA	5-17Vdc	77%	
	220-700mA	KTLD-12-1-xxx-FDIM-F5	120V	>0.9	Phase Control	220mA	27-54Vdc	75%	F5
						300mA	20-40Vdc	75%	
						350mA	17-34Vdc	75%	
						400mA	15-30Vdc	75%	
						500mA	12-24Vdc	77%	
						600mA	10-20Vdc	77%	
						700mA	8-17Vdc	77%	
	400mA	KTLD-12-1P-400-LDIM-F5	120V	>0.7	Local	400mA	5-30Vdc	77%	F5
14W	600mA	KTLD-14-1N-600-AF1	120V	>0.5	N/A	600mA	10-23Vdc	80%	AF1
	260-800mA	KTLD-14-1-xxx-FDIM-AF1	120V	>0.9	Phase Control	260mA	18-54Vdc	77%	AF1
						300mA	16-47Vdc	77%	
						350mA	10-40Vdc	77%	
						400mA	12-35Vdc	77%	
						500mA	10-28Vdc	77%	
						600mA	10-40Vdc	77%	
						700mA	7-20Vdc	77%	
						800mA	6-18Vdc	77%	
	350-700mA	KTLD-14-UV-xxx-AF1	120-277V	>0.9	N/A	350mA	15-40Vdc	80%	AF1
						700mA	10-20Vdc	80%	
	260-700mA	KTLD-14-UV-xxx-VDIM-L7	120-277V	>0.9	0-10V	260mA	27-54Vdc	82%	L7
						300mA	23-47Vdc	82%	
						350mA	20-40Vdc	82%	
400mA						18-35Vdc	82%		
450mA						15-30Vdc	82%		
500mA						14-28Vdc	82%		
600mA						12-24Vdc	82%		
700mA						12-20Vdc	82%		

Specifications subject to change without notice. For complete product specifications, visit www.keystonetech.com

ELECTRICAL SPECIFICATIONS

Wattage Family	Output Current Range	Catalog Number	Input Voltage	Power Factor	Dimming	Typical Output Current	Output Voltage	Efficiency	Case Style
16W	290-1400mA	KTLD-16-1-xxx-FDIM-AK1	120V	>0.9	Phase Control	290mA	18-54Vdc	80%	AK1
						300mA	17-53Vdc	80%	
						400mA	13-40Vdc	80%	
						500mA	10-32Vdc	80%	
						600mA	9-27Vdc	80%	
						700mA	8-23Vdc	80%	
						800mA	7-20Vdc	80%	
						900mA	6-18Vdc	80%	
						1000mA	6-16Vdc	80%	
						1100mA	6-15Vdc	80%	
						1200mA	6-13Vdc	80%	
						1300mA	6-12Vdc	80%	
						1400mA	6-11Vdc	80%	
	300-1100mA	KTLD-16-1-xxx-FDIM-AQ1	120V	>0.9	Phase Control	300mA	17-53Vdc	80%	AQ1
						350mA	15-46Vdc	80%	
						400mA	13-40Vdc	80%	
						500mA	10-32Vdc	80%	
						600mA	9-27Vdc	80%	
						700mA	7-23Vdc	80%	
						800mA	7-20Vdc	80%	
						900mA	6-18Vdc	80%	
						1000mA	6-16Vdc	80%	
	290-1400mA	KTLD-16-UV-xxx-AK1	120-277V	>0.9	N/A	290mA	18-54Vdc	83%	AK1
						400mA	13-40Vdc	83%	
						500mA	10-32Vdc	83%	
						600mA	10-27Vdc	83%	
						700mA	9-23Vdc	83%	
						800mA	7-20Vdc	83%	
						900mA	6-18Vdc	83%	
						1000mA	6-16Vdc	82%	
						1100mA	6-14Vdc	82%	
						1200mA	6-13Vdc	82%	
						1300mA	6-12Vdc	82%	
						1400mA	6-12Vdc	82%	
						290-1400mA	KTLD-16-UV-xxx-VDIM-AK1	120-277V	
	400mA	20-40Vdc	81%						
	500mA	16-32Vdc	81%						
	600mA	14-27Vdc	81%						
	700mA	12-23Vdc	81%						
	800mA	10-20Vdc	81%						
900mA	9-18Vdc	81%							
1000mA	8-16Vdc	81%							
1100mA	7-14Vdc	81%							
1200mA	7-13Vdc	81%							
1300mA	6-12Vdc	81%							
1400mA	6-12Vdc	81%							

Specifications subject to change without notice. For complete product specifications, visit www.keystonetech.com

LED DRIVERS

CONSTANT CURRENT

ELECTRICAL SPECIFICATIONS

Wattage Family	Output Current Range	Catalog Number	Input Voltage	Power Factor	Dimming	Typical Output Current	Output Voltage	Efficiency	Case Style
16W	300-900mA	KTLD-16-UV-xxx-VDIM-AQ1	120-277V	>0.9	0-10V	300mA	17-53Vdc	80%	AQ1
						350mA	15-46Vdc	80%	
						400mA	13-40Vdc	80%	
						500mA	10-32Vdc	80%	
						600mA	9-27Vdc	80%	
						700mA	8-23Vdc	80%	
						800mA	8-20Vdc	80%	
						900mA	8-18Vdc	80%	
20W	600mA	KTLD-20-1N-600-AQ1	120V	>0.5	N/A	600mA	10-34Vdc	81%	AQ1
22W	350-1100mA	KTLD-22-UV-xxx-VDIM-L7	120-277V	>0.9	0-10V	350mA	32-63Vdc	81%	L7
						400mA	28-55Vdc	81%	
						500mA	22-44Vdc	81%	
						600mA	18-36Vdc	81%	
						700mA	16-32Vdc	81%	
						800mA	14-28Vdc	81%	
						900mA	12-24Vdc	81%	
						1000mA	12-22Vdc	81%	
	1100mA	12-20Vdc	81%						
	700mA	KTLD-22-1-700-AK1	120V	>0.9	N/A	700mA	10-32Vdc	81%	AK1
	220-1200mA	KTLD-22-1-xxx-FDIM-AK1	120V	>0.9	Phase Control	220mA	33-100Vdc	81%	AK1
						300mA	24-73Vdc	81%	
						400mA	18-54Vdc	81%	
						500mA	10-40Vdc	81%	
						600mA	10-36Vdc	81%	
						700mA	10-32Vdc	81%	
						800mA	10-28Vdc	81%	
						900mA	6-24Vdc	81%	
						1000mA	6-24Vdc	81%	
						1100mA	6-20Vdc	81%	
1200mA						6-20Vdc	81%		
350-1600mA						KTLD-22-UV-xxx-AK1	120-277V	>0.9	
	400mA	18-55Vdc	81%						
	500mA	14-44Vdc	81%						
	600mA	12-36Vdc	81%						
	700mA	10-32Vdc	81%						
	800mA	9-28Vdc	81%						
	900mA	8-24Vdc	81%						
	1000mA	8-22Vdc	81%						
	1100mA	7-20Vdc	81%						
	1200mA	7-18Vdc	81%						
	1300mA	7-17Vdc	81%						
	1400mA	7-16Vdc	81%						
1500mA	7-15Vdc	81%							
1540mA	7-14Vdc	81%							
1600mA	7-14Vdc	81%							
23W	830mA	KTLD-23-UV-830-VDIM-L7	120-277V	>0.9	0-10V	830mA	14-28Vdc	84%	L7

Specifications subject to change without notice. For complete product specifications, visit www.keystonetech.com

ELECTRICAL SPECIFICATIONS

Wattage Family	Output Current Range	Catalog Number	Input Voltage	Power Factor	Dimming	Typical Output Current	Output Voltage	Efficiency	Case Style
25W	600-1380mA	KTLD-25-1-xxx-FDIM-AF4	120V	>0.9	Phase Control	600mA	21-41Vdc	82%	AF4
						700mA	18-36Vdc	82%	
						800mA	16-32Vdc	82%	
						900mA	14-28Vdc	82%	
						1000mA	12-25Vdc	82%	
						1100mA	11-23Vdc	81%	
						1200mA	10-21Vdc	81%	
						1380mA	9-18Vdc	81%	
	700-1000mA	KTLD-25-1-xxx-FDIM-AF4	120V	>0.9	Phase Control	700mA	18-36Vdc	82%	AF4
						1000mA	13-25Vdc	82%	
	300-1200mA	KTLD-25-1-xxx-FDIM-AQ1	120V	>0.9	Phase Control	300mA	28-84Vdc	80%	AQ1
						350mA	24-72Vdc	80%	
						400mA	21-63Vdc	80%	
						500mA	17-50Vdc	80%	
						600mA	14-42Vdc	80%	
						700mA	12-36Vdc	80%	
						800mA	10-32Vdc	80%	
						900mA	9-28Vdc	80%	
						1000mA	8-25Vdc	80%	
						1100mA	7-23Vdc	80%	
	700-1100mA	KTLD-25-1-xxx-FDIM-L9	120V	>0.9	Phase Control	700mA	24-72Vdc	80%	L9
						800mA	21-63Vdc	80%	
						900mA	17-50Vdc	80%	
						1000mA	14-42Vdc	80%	
	700mA	KTLD-25-1P-700-VDIM-L9	120V	>0.7	0-10V	700mA	12-36Vdc	80%	L9
						700mA	12-36Vdc	80%	
						700mA	12-36Vdc	80%	
						700mA	12-36Vdc	80%	
350-1050mA	KTLD-25-UV-xxx-VDIM-AF6	120-277V	>0.9	0-10V	350mA	36-72Vdc	85%	AF6	
					400mA	31-63Vdc	85%		
					500mA	25-50Vdc	85%		
					600mA	21-42Vdc	85%		
					700mA	18-36Vdc	85%		
					800mA	16-32Vdc	85%		
					900mA	14-28Vdc	85%		
					1000mA	12-25Vdc	85%		
300-1400mA	KTLD-25-UV-xxx-VDIM-AK1 <i>(continued on next page)</i>	120-277V	>0.9	0-10V	300mA	42-84Vdc	80%	AK1	
					400mA	31-63Vdc	81%		
					500mA	25-50Vdc	81%		
					600mA	21-42Vdc	81%		
					700mA	18-36Vdc	81%		
					800mA	16-32Vdc	81%		
					900mA	14-28Vdc	81%		
					1000mA	12-25Vdc	81%		

Specifications subject to change without notice. For complete product specifications, visit www.keystonetech.com

LED DRIVERS

CONSTANT CURRENT

ELECTRICAL SPECIFICATIONS

Wattage Family	Output Current Range	Catalog Number	Input Voltage	Power Factor	Dimming	Typical Output Current	Output Voltage	Efficiency	Case Style
25W	300-1400mA	KTLD-25-UV-xxx-VDIM-AK1 <i>(continued from previous page)</i>	120-277V	>0.9	0-10V	1100mA	12-23Vdc	81%	AK1
						1200mA	12-21Vdc	81%	
						1300mA	12-19Vdc	81%	
						1400mA	12-18Vdc	81%	
	350-1400mA	KTLD-25-UV-xxx-VDIM-AQ1	120-277V	>0.9	0-10V	350mA	24-72Vdc	81%	AQ1
						400mA	21-63Vdc	81%	
						500mA	17-50Vdc	81%	
						600mA	14-42Vdc	81%	
						700mA	12-36Vdc	81%	
						800mA	10-32Vdc	81%	
						900mA	9-28Vdc	81%	
						1000mA	8-25Vdc	81%	
	700-1400mA	KTLD-25-UV-xxx-VDIM-L9	120-277V	>0.9	0-10V	1100mA	8-23Vdc	80%	L9
						1200mA	8-21Vdc	80%	
						1400mA	8-18Vdc	80%	
						700mA	18-36Vdc	80%	
						800mA	16-32Vdc	80%	
						900mA	14-28Vdc	80%	
1000mA						12-25Vdc	80%		
1100mA						12-23Vdc	80%		
36W	1000-1200mA	KTLD-36-1-xxx-L9	120V	>0.9	N/A	1000mA	18-36Vdc	80%	L9
						1100mA	17-33Vdc	80%	
						1200mA	15-30Vdc	80%	
	1000-2000mA	KTLD-36-1-xxx-FDIM-AF6	120V	>0.9	Phase Control	1000mA	12-36Vdc	83%	AF6
						1100mA	10-33Vdc	83%	
						1200mA	10-30Vdc	83%	
						1300mA	10-28Vdc	82%	
						1400mA	10-26Vdc	82%	
						1500mA	10-24Vdc	82%	
						1600mA	10-22.5Vdc	82%	
						1700mA	10-21Vdc	81%	
						1800mA	10-20Vdc	81%	
						1900mA	10-19Vdc	81%	
	2000mA	10-16Vdc	81%						
	650-2000mA	KTLD-36-1-xxx-FDIM-AK2	120V	>0.9	Phase Control	650mA	19-55Vdc	83%	AK2
						1000mA	18-36Vdc	83%	
						2000mA	9-18Vdc	83%	
	1000-1200mA	KTLD-36-1-xxx-FDIM-L9	120V	>0.9	Phase Control	1000mA	12-36Vdc	82%	L9
1100mA						11-33Vdc	82%		
1200mA						10-30Vdc	82%		
640-1500mA	KTLD-36-UV-xxx-AF6 <i>(continued on next page)</i>	120-277V	>0.9	N/A	640mA	28-56Vdc	85%	AF6	
					700mA	26-51Vdc	85%		
					800mA	23-45Vdc	85%		
					900mA	20-40Vdc	85%		
						1000mA	18-36Vdc	85%	

Specifications subject to change without notice. For complete product specifications, visit www.keystonetech.com

ELECTRICAL SPECIFICATIONS

Wattage Family	Output Current Range	Catalog Number	Input Voltage	Power Factor	Dimming	Typical Output Current	Output Voltage	Efficiency	Case Style
36W	640-1500mA	KTLD-36-UV-xxx-AF6 <i>(continued from previous page)</i>	120-277V	>0.9	N/A	1100mA	17-33Vdc	85%	AF6
						1200mA	16-30Vdc	85%	
						1300mA	14-28Vdc	85%	
						1400mA	13-26Vdc	85%	
						1500mA	12-24Vdc	85%	
	660-1500mA	KTLD-36-UV-xxx-L2	120-277V	>0.9	N/A	660mA	27-54Vdc	82%	L2
						700mA	26-51Vdc	82%	
						800mA	23-45Vdc	82%	
						900mA	18-36Vdc	82%	
						1000mA	18-36Vdc	82%	
						1100mA	16-33Vdc	82%	
						1200mA	15-30Vdc	82%	
						1300mA	14-28Vdc	82%	
						1400mA	13-26Vdc	82%	
	1500mA	12-24Vdc	82%						
	1000mA	KTLD-36-UV-1000-L9	120-277V	>0.9	N/A	1000mA	18-36Vdc	82%	L9
	640-1500mA	KTLD-36-UV-xxx-VDIM-AF6	120-277V	>0.9	0-10V	640mA	28-56Vdc	85%	AF6
						700mA	26-51Vdc	85%	
						800mA	23-45Vdc	85%	
						900mA	20-40Vdc	85%	
						1000mA	18-36Vdc	85%	
						1100mA	17-33Vdc	85%	
						1200mA	16-30Vdc	85%	
						1300mA	14-28Vdc	85%	
						1400mA	13-26Vdc	85%	
						1500mA	12-24Vdc	85%	
	600-1500mA	KTLD-36-UV-xxx-VDIM-L2	120-277V	>0.9	0-10V	600mA	30-60Vdc	81%	L2
						660mA	27-54Vdc	81%	
						700mA	26-51Vdc	81%	
						800mA	23-45Vdc	81%	
						900mA	18-36Vdc	81%	
						1000mA	18-36Vdc	81%	
						1100mA	16-33Vdc	81%	
						1200mA	15-30Vdc	81%	
						1300mA	14-28Vdc	81%	
						1400mA	13-26Vdc	81%	
	1500mA	12-24Vdc	80%						
	640-2000mA	KTLD-36-UV-xxx-VDIM-L9 <i>(continued on next page)</i>	120-277V	>0.9	0-10V	640mA	28-56Vdc	82%	L9
						700mA	26-51Vdc	82%	
						800mA	23-45Vdc	82%	
900mA						20-40Vdc	82%		
1000mA						18-36Vdc	82%		
1100mA						17-33Vdc	82%		
1200mA						15-30Vdc	82%		
1300mA						14-28Vdc	82%		
1400mA						13-26Vdc	82%		
1500mA						12-24Vdc	82%		

Specifications subject to change without notice. For complete product specifications, visit www.keystonetech.com

LED DRIVERS

CONSTANT CURRENT

ELECTRICAL SPECIFICATIONS

Wattage Family	Output Current Range	Catalog Number	Input Voltage	Power Factor	Dimming	Typical Output Current	Output Voltage	Efficiency	Case Style
36W	640-2000mA	KTLD-36-UV-xxx-VDIM-L9 <i>(continued from previous page)</i>	120-277V	>0.9	0-10V	1600mA	12-22.5Vdc	82%	L9
						1700mA	12-21Vdc	82%	
						1800mA	12-20Vdc	82%	
						1900mA	12-19Vdc	82%	
						2000mA	12-18Vdc	82%	
40W	970-2200mA	KTLD-40-UV-xxx-L2	120-277V	>0.9	N/A	970mA	20-41Vdc	82%	L2
						1000mA	20-40Vdc	82%	
						1100mA	18-36Vdc	82%	
						1200mA	17-33Vdc	82%	
						1300mA	15-31Vdc	82%	
						1400mA	14-29Vdc	82%	
						1500mA	13-27Vdc	82%	
						1600mA	13-25Vdc	82%	
						1700mA	12-24Vdc	82%	
						1800mA	11-22Vdc	82%	
						1900mA	11-21Vdc	82%	
						2000mA	10-20Vdc	82%	
						2100mA	10-19Vdc	82%	
						2200mA	9-18Vdc	82%	
	740-1670mA	KTLD-40-UV-xxx-W1	120-277V	>0.9	N/A	740mA	27-54Vdc	82%	W1
						800mA	25-50Vdc	82%	
						900mA	22-44Vdc	82%	
						1000mA	20-40Vdc	82%	
						1100mA	18-36Vdc	82%	
						1200mA	17-33Vdc	82%	
						1300mA	17-31Vdc	82%	
						1400mA	14-29Vdc	82%	
						1500mA	13-27Vdc	82%	
						1670mA	12-24Vdc	82%	
	350-2000mA	KTLD-40-UV-xxx-VDIM-AT1	120-277V	>0.9	0-10V	350mA	38-126Vdc	87%	AT1
						400mA	33-100Vdc	87%	
						500mA	27-80Vdc	86%	
						600mA	22-67Vdc	86%	
						700mA	19-57Vdc	86%	
						800mA	17-50Vdc	86%	
						900mA	15-44Vdc	86%	
						1000mA	13-40Vdc	85%	
						1100mA	12-36Vdc	85%	
1200mA						12-33Vdc	85%		
1300mA						12-31Vdc	85%		
1400mA						12-29Vdc	85%		
1500mA						12-27Vdc	85%		
1600mA						12-25Vdc	85%		
1700mA						12-24Vdc	85%		
1800mA						12-22Vdc	85%		
1900mA						12-21Vdc	85%		
2000mA						12-20Vdc	84%		

Specifications subject to change without notice. For complete product specifications, visit www.keystonetech.com

LED DRIVERS

CONSTANT CURRENT

ELECTRICAL SPECIFICATIONS

Wattage Family	Output Current Range	Catalog Number	Input Voltage	Power Factor	Dimming	Typical Output Current	Output Voltage	Efficiency	Case Style
40W	970-2200mA	KTLD-40-UV-xxx-VDIM-L2	120-277V	>0.9	0-10V	970mA	20-41Vdc	82%	L2
						1000mA	20-40Vdc	82%	
						1100mA	18-36Vdc	82%	
						1200mA	17-33Vdc	82%	
						1300mA	15-31Vdc	82%	
						1400mA	14-29Vdc	82%	
						1500mA	13-27Vdc	82%	
						1600mA	13-25Vdc	82%	
						1700mA	12-24Vdc	82%	
						1800mA	11-22Vdc	82%	
						1900mA	11-21Vdc	82%	
						2000mA	10-20Vdc	82%	
						2100mA	10-19Vdc	82%	
	2200mA	9-18Vdc	82%						
	1100mA	KTLD-40-UV-1100-VDIM-L9	120-277V	>0.9	0-10V	1100mA	18-36Vdc	82%	L9
40W	740-1670mA	KTLD-40-UV-xxx-VDIM-W1	120-277V	>0.9	0-10V	740mA	27-54Vdc	82%	W1
						800mA	25-50Vdc	82%	
						900mA	22-44Vdc	82%	
						1000mA	20-40Vdc	82%	
						1100mA	18-36Vdc	82%	
						1200mA	17-33Vdc	82%	
						1300mA	17-31Vdc	82%	
						1400mA	14-29Vdc	82%	
						1500mA	13-27Vdc	82%	
						1600mA	13-25Vdc	82%	
						1670mA	12-24Vdc	82%	
50W	500-2100mA	KTLD-50-UV-xxx-AR2	120-277V	>0.9	N/A	500mA	50-100Vdc	83%	AR2
						600mA	42-83Vdc	83%	
						700mA	36-72Vdc	83%	
						800mA	31-63Vdc	83%	
						900mA	28-56Vdc	83%	
						1000mA	25-50Vdc	83%	
						1100mA	23-45Vdc	83%	
						1200mA	21-42Vdc	83%	
						1300mA	19-38Vdc	83%	
						1400mA	18-36Vdc	83%	
						1500mA	17-33Vdc	83%	
						1600mA	16-31Vdc	83%	
						1700mA	15-29Vdc	83%	
						1800mA	14-28Vdc	83%	
						1900mA	13-26Vdc	83%	
						2000mA	13-25Vdc	83%	
						2100mA	12-24Vdc	83%	
						1200-1400mA	KTLD-50-UV-xxx-L9	120-277V	
						1400mA	18-36Vdc	84%	

Specifications subject to change without notice. For complete product specifications, visit www.keystonetech.com

LED DRIVERS

CONSTANT CURRENT

ELECTRICAL SPECIFICATIONS

Wattage Family	Output Current Range	Catalog Number	Input Voltage	Power Factor	Dimming	Typical Output Current	Output Voltage	Efficiency	Case Style
50W	920-1400mA	KTLD-50-UV-xxx-W2	120-277V	>0.9	N/A	920mA	27-54Vdc	84%	W2
						1000mA	25-50Vdc	84%	
						1100mA	23-45Vdc	84%	
						1200mA	21-42Vdc	84%	
						1300mA	19-38Vdc	84%	
						1400mA	18-36Vdc	84%	
	920-2500mA	KTLD-50-3-xxx-VDIM-W2	347V	>0.9	0-10V	920mA	27-54Vdc	84%	W2
						1000mA	25-50Vdc	84%	
						1100mA	23-45Vdc	84%	
						1200mA	21-42Vdc	84%	
						1300mA	19-38Vdc	84%	
						1400mA	18-36Vdc	84%	
						1500mA	17-33Vdc	84%	
						1600mA	16-31Vdc	84%	
						1700mA	15-29Vdc	84%	
						1800mA	14-28Vdc	84%	
						1900mA	13-26Vdc	84%	
						2000mA	13-25Vdc	84%	
						2100mA	12-24Vdc	84%	
						2200mA	12-23Vdc	84%	
	500-2100mA	KTLD-50-UV-xxx-VDIM-AR2	120-277V	>0.9	0-10V	500mA	50-100Vdc	83%	AR2
						600mA	42-83Vdc	83%	
						700mA	36-72Vdc	83%	
						800mA	31-63Vdc	83%	
						900mA	28-56Vdc	83%	
						1000mA	25-50Vdc	83%	
						1100mA	23-45Vdc	83%	
						1200mA	21-42Vdc	83%	
						1300mA	19-38Vdc	83%	
						1400mA	18-36Vdc	83%	
						1500mA	17-33Vdc	83%	
						1600mA	16-31Vdc	83%	
						1700mA	15-29Vdc	83%	
						1800mA	14-28Vdc	83%	
	1200-1400mA	KTLD-50-UV-xxx-VDIM-L9	120-277V	>0.9	0-10V	1200mA	21-42Vdc	84%	L9
						1400mA	18-36Vdc	84%	
920mA						27-54Vdc	84%		
920-1400mA	KTLD-50-UV-xxx-VDIM-W2	120-277V	>0.9	0-10V	1000mA	25-50Vdc	84%	W2	
					1100mA	23-45Vdc	84%		
					1200mA	21-42Vdc	84%		
					1300mA	19-38Vdc	84%		
					1400mA	18-36Vdc	84%		

Specifications subject to change without notice. For complete product specifications, visit www.keystonetech.com

ELECTRICAL SPECIFICATIONS

Wattage Family	Output Current Range	Catalog Number	Input Voltage	Power Factor	Dimming	Typical Output Current	Output Voltage	Efficiency	Case Style
50W	450-1100mA (2 Channel)	KTLD-50-UV-2xxxx-VDIM-L5	120-277V	>0.9	0-10V	450mA	27-54Vdc	82%	L5
						500mA	25-50Vdc	82%	
						600mA	21-42Vdc	82%	
						700mA	18-36Vdc	82%	
						800mA	16-31Vdc	82%	
						900mA	14-28Vdc	82%	
						1000mA	12-24Vdc	82%	
	230-600mA (4 Channel)	KTLD-50-UV-4xxxx-VDIM-L5	120-277V	>0.9	0-10V	1100mA	12-23Vdc	82%	L5
						230mA	27-54Vdc	82%	
						300mA	21-42Vdc	82%	
						350mA	18-36Vdc	82%	
						400mA	16-31Vdc	82%	
						500mA	12-25Vdc	82%	
						600mA	12-20Vdc	82%	
60W	600-2500mA	KTLD-60-UV-xxx-W2	120-277V	>0.9	N/A	600mA	50-100Vdc	84%	W2
						700mA	43-86Vdc	84%	
						800mA	38-75Vdc	84%	
						900mA	33-67Vdc	84%	
						930mA	29-59Vdc	84%	
						1000mA	30-60Vdc	83%	
						1100mA	27-55Vdc	83%	
						1200mA	25-50Vdc	83%	
						1300mA	23-46Vdc	83%	
						1400mA	21-43Vdc	83%	
						1500mA	20-40Vdc	83%	
						1600mA	18-37Vdc	83%	
						1700mA	18-35Vdc	83%	
						1800mA	17-33Vdc	83%	
						1900mA	16-32Vdc	83%	
						2000mA	15-30Vdc	83%	
						2100mA	14-29Vdc	83%	
						2200mA	14-27Vdc	83%	
						2300mA	13-26Vdc	83%	
						2400mA	12-25Vdc	83%	
	2500mA	12-24Vdc	83%						
	1750mA	KTLD-60-UV-xxx-VDIM-AR1	120-277V	>0.9	0-10V	1750mA	10-34Vdc	84%	AR1
						600mA	50-100Vdc	84%	
	600-2500mA	KTLD-60-UV-xxx-VDIM-W2 <i>(continued on next page)</i>	120-277V	>0.9	0-10V	700mA	43-86Vdc	84%	W2
						800mA	38-75Vdc	84%	
						900mA	33-67Vdc	84%	
						930mA	29-59Vdc	84%	
						1000mA	30-60Vdc	83%	
1100mA						27-55Vdc	83%		
1200mA						25-50Vdc	83%		
1300mA						23-46Vdc	83%		
1400mA						21-43Vdc	83%		
1500mA						20-40Vdc	83%		

Specifications subject to change without notice. For complete product specifications, visit www.keystonetech.com

LED DRIVERS

CONSTANT CURRENT

ELECTRICAL SPECIFICATIONS

Wattage Family	Output Current Range	Catalog Number	Input Voltage	Power Factor	Dimming	Typical Output Current	Output Voltage	Efficiency	Case Style	
60W	600-2500mA	KTLD-60-UV-xxx-VDIM-W2 <i>(continued from previous page)</i>	120-277V	>0.9	0-10V	1600mA	18-37Vdc	83%	W2	
						1700mA	18-35Vdc	83%		
						1800mA	17-33Vdc	83%		
						1900mA	16-32Vdc	83%		
						2000mA	15-30Vdc	83%		
						2100mA	14-29Vdc	83%		
						2200mA	14-27Vdc	83%		
						2300mA	13-26Vdc	83%		
						2400mA	12-25Vdc	83%		
						2500mA	12-24Vdc	83%		
72W	660-1000mA (2 Channel)	KTLD-72-UV-2xxxx-VDIM-L5	120-277V	>0.9	0-10V	660mA	27-54Vdc	82%	L5	
						700mA	26-51Vdc	82%		
						800mA	23-45Vdc	82%		
						900mA	20-40Vdc	82%		
						1000mA	18-36Vdc	82%		
	290-900mA (4 Channel)	KTLD-72-UV-4xxxx-VDIM-L5	120-277V	>0.9	0-10V	290mA	31-62Vdc	82%	L5	
						300mA	30-60Vdc	82%		
						400mA	23-45Vdc	82%		
						500mA	18-36Vdc	82%		
						600mA	15-30Vdc	82%		
						700mA	13-26Vdc	82%		
						750mA	12-24Vdc	82%		
						800mA	12-23Vdc	82%		
						900mA	12-20Vdc	82%		
	75W	1400mA	KTLD-75-UV-xxx-L5	120-277V	>0.9	N/A	1400mA	27-54Vdc	86%	L5
			KTLD-75-UV-xxx-VDIM-L5	120-277V	>0.9	0-10V	1400mA	27-54Vdc	86%	
	80W	1320-1870mA	KTLD-80-UV-xxx-VDIM-W3	120-277V	>0.9	0-10V	1320mA	29-58Vdc	87%	W3
							1400mA	28-56Vdc	87%	
1500mA							26-52Vdc	87%		
1600mA							24-49Vdc	87%		
1700mA							23-46Vdc	87%		
1800mA							21-42Vdc	87%		
1870mA							21-41Vdc	87%		
100W	500-3200mA	KTLD-100-UV-xxx-67-AP4 <i>(continued on next page)</i>	120-277V	>0.9	N/A	500mA	94-189Vdc	86%	AP4	
						600mA	83-167Vdc	86%		
						700mA	72-143Vdc	86%		
						800mA	63-125Vdc	86%		
						900mA	56-111Vdc	86%		
						1000mA	50-100Vdc	86%		
						1100mA	45-91Vdc	86%		
						1200mA	43-83Vdc	86%		
						1300mA	38-77Vdc	86%		
						1400mA	36-71Vdc	86%		
						1500mA	33-67Vdc	86%		
						1600mA	31-63Vdc	86%		

Specifications subject to change without notice. For complete product specifications, visit www.keystonetech.com

ELECTRICAL SPECIFICATIONS

Wattage Family	Output Current Range	Catalog Number	Input Voltage	Power Factor	Dimming	Typical Output Current	Output Voltage	Efficiency	Case Style
100W	500-3200mA	KTLD-100-UV-xxx-67-AP4 <i>(continued from previous page)</i>	120-277V	>0.9	N/A	1700mA	29-59Vdc	86%	AP4
						1800mA	28-56Vdc	86%	
						1900mA	26-53Vdc	86%	
						2000mA	25-50Vdc	86%	
						2100mA	24-48Vdc	86%	
						2200mA	23-45Vdc	86%	
						2300mA	22-43Vdc	86%	
						2400mA	21-42Vdc	86%	
						2500mA	20-40Vdc	86%	
						2600mA	19-38Vdc	86%	
						2700mA	18-37Vdc	86%	
						2800mA	17-35Vdc	86%	
						2900mA	17-34Vdc	86%	
						3000mA	17-33Vdc	86%	
						3100mA	16-32Vdc	86%	
	3200mA	16-31Vdc	86%						
	530-3200mA	KTLD-100-UV-xxx-L5	120-277V	>0.9	N/A	530mA	94-189Vdc	90%	L5
						600mA	83-167Vdc	90%	
						700mA	72-143Vdc	90%	
						800mA	63-125Vdc	90%	
						900mA	56-111Vdc	90%	
						1000mA	50-100Vdc	90%	
						1100mA	45-91Vdc	89%	
						1200mA	43-83Vdc	89%	
						1300mA	38-77Vdc	89%	
						1400mA	36-71Vdc	89%	
						1500mA	33-67Vdc	89%	
						1600mA	31-63Vdc	89%	
						1700mA	29-59Vdc	89%	
						1800mA	28-56Vdc	89%	
						1900mA	26-53Vdc	89%	
						2000mA	25-50Vdc	86%	
2100mA						24-48Vdc	86%		
2200mA	23-45Vdc	86%							
2300mA	22-43Vdc	86%							
2400mA	21-42Vdc	86%							
2500mA	20-40Vdc	86%							
2600mA	19-36Vdc	89%							
2700mA	18-37Vdc	88%							
2800mA	17-35Vdc	88%							
2900mA	17-34Vdc	88%							
3000mA	17-33Vdc	88%							
3100mA	16-32Vdc	88%							
3200mA	16-31Vdc	88%							

Specifications subject to change without notice. For complete product specifications, visit www.keystonetech.com

LED DRIVERS

CONSTANT CURRENT

ELECTRICAL SPECIFICATIONS

Wattage Family	Output Current Range	Catalog Number	Input Voltage	Power Factor	Dimming	Typical Output Current	Output Voltage	Efficiency	Case Style
100W	530-3200mA	KTLD-100-UV-xxx-VDIM-67-AP4	120-277V	>0.9	0-10V	530mA	94-189Vdc	86%	AP4
						600mA	83-167Vdc	86%	
						700mA	72-143Vdc	86%	
						800mA	63-125Vdc	86%	
						900mA	56-111Vdc	86%	
						1000mA	50-100Vdc	86%	
						1100mA	45-91Vdc	86%	
						1200mA	43-83Vdc	86%	
						1300mA	38-77Vdc	86%	
						1400mA	36-71Vdc	86%	
						1500mA	33-67Vdc	86%	
						1600mA	31-63Vdc	86%	
						1700mA	29-59Vdc	86%	
						1800mA	28-56Vdc	86%	
						1900mA	26-53Vdc	86%	
						2000mA	25-50Vdc	86%	
						2100mA	24-48Vdc	86%	
						2200mA	23-45Vdc	86%	
						2300mA	22-43Vdc	86%	
						2400mA	21-42Vdc	86%	
	2500mA	20-40Vdc	86%						
	2600mA	19-36Vdc	89%						
	2700mA	18-37Vdc	88%						
	2800mA	17-35Vdc	88%						
	2900mA	17-34Vdc	88%						
	3000mA	17-33Vdc	88%						
	3100mA	16-32Vdc	88%						
	3200mA	16-31Vdc	88%						
	500-3200mA	KTLD-100-UV-xxx-VDIM-L5 <i>(continued on next page)</i>	120-277V	>0.9	0-10V	500mA	94-189Vdc	86%	L5
						600mA	83-167Vdc	86%	
						700mA	72-143Vdc	86%	
						800mA	63-125Vdc	86%	
900mA						56-111Vdc	86%		
1000mA						50-100Vdc	86%		
1100mA						45-91Vdc	86%		
1200mA						43-83Vdc	86%		
1300mA						38-77Vdc	86%		
1400mA						36-71Vdc	86%		
1500mA						33-67Vdc	86%		
1600mA						31-63Vdc	86%		
1700mA	29-59Vdc	86%							
1800mA	28-56Vdc	86%							
1900mA	26-53Vdc	86%							
2000mA	25-50Vdc	86%							
2100mA	24-48Vdc	86%							
2200mA	23-45Vdc	86%							
2300mA	22-43Vdc	86%							
2400mA	21-42Vdc	86%							

Specifications subject to change without notice. For complete product specifications, visit www.keystonetech.com

LED DRIVERS

CONSTANT CURRENT

ELECTRICAL SPECIFICATIONS

Wattage Family	Output Current Range	Catalog Number	Input Voltage	Power Factor	Dimming	Typical Output Current	Output Voltage	Efficiency	Case Style
100W	500-3200mA	KTLD-100-UV-xxx-VDIM-L5 <i>(continued from previous page)</i>	120-277V	>0.9	0-10V	2500mA	20-40Vdc	86%	L5
						2600mA	19-38Vdc	86%	
						2700mA	18-37Vdc	86%	
						2800mA	17-35Vdc	86%	
						2900mA	17-34Vdc	86%	
						3000mA	17-33Vdc	86%	
						3100mA	16-32Vdc	86%	
						3200mA	16-31Vdc	86%	
	1580-2240mA	KTLD-100-UV-xxx-VDIM-W3	120-277V	>0.9	0-10V	1580mA	29-58Vdc	87%	W3
						1600mA	29-58Vdc	87%	
						1700mA	28-55Vdc	87%	
						1800mA	26-52Vdc	87%	
						1900mA	25-49Vdc	87%	
						2000mA	24-47Vdc	87%	
						2100mA	22-45Vdc	87%	
						2200mA	21-43Vdc	87%	
	460-1000mA (4 Channel)	KTLD-100-UV-4xxxx-VDIM-L18	120-277V	>0.9	0-10V	2240mA	21-41Vdc	87%	L18
						460mA	27-54Vdc	82%	
						500mA	25-50Vdc	82%	
						600mA	21-42Vdc	82%	
						700mA	18-36Vdc	82%	
						800mA	16-31Vdc	82%	
						900mA	14-28Vdc	82%	
						1000mA	12-25Vdc	82%	
150W	530-2500mA	KTLD-150-UV-xxx-AU1	120-277V	>0.9	N/A	530mA	141-283Vdc	87%	AU1
						600mA	125-250Vdc	87%	
						700mA	107-214Vdc	87%	
						800mA	94-188Vdc	87%	
						900mA	83-167Vdc	87%	
						1000mA	75-150Vdc	87%	
						1100mA	68-136Vdc	87%	
						1200mA	63-125Vdc	87%	
						1300mA	58-115Vdc	87%	
						1400mA	54-107Vdc	87%	
						1500mA	50-100Vdc	87%	
						1600mA	47-94Vdc	87%	
						1700mA	44-88Vdc	87%	
						1800mA	42-83Vdc	87%	
						1900mA	39-79Vdc	87%	
						2000mA	38-75Vdc	87%	
						2100mA	36-71Vdc	87%	
						2200mA	34-68Vdc	87%	
2300mA	33-65Vdc	87%							
2400mA	31-63Vdc	87%							
2500mA	30-60Vdc	87%							

Specifications subject to change without notice. For complete product specifications, visit www.keystonetech.com

LED DRIVERS

CONSTANT CURRENT

ELECTRICAL SPECIFICATIONS

Wattage Family	Output Current Range	Catalog Number	Input Voltage	Power Factor	Dimming	Typical Output Current	Output Voltage	Efficiency	Case Style
150W	530-1600mA	KTLD-150-UV-xxx-67-AP3	120-277V	>0.9	N/A	530mA	141-283Vdc	92%	AP3
						600mA	125-250Vdc	92%	
						700mA	107-214Vdc	92%	
						800mA	94-188Vdc	92%	
						900mA	83-167Vdc	92%	
						1000mA	75-150Vdc	92%	
						1100mA	68-136Vdc	92%	
						1200mA	63-125Vdc	92%	
						1300mA	58-115Vdc	92%	
						1400mA	54-107Vdc	92%	
						1500mA	50-100Vdc	92%	
						1600mA	47-94Vdc	91%	
	530-2500mA	KTLD-150-UV-xxx-VDIM-AU1	120-277V	>0.9	0-10V	530mA	141-283Vdc	87%	AU1
						600mA	125-250Vdc	87%	
						700mA	107-214Vdc	87%	
						800mA	94-188Vdc	87%	
						900mA	83-167Vdc	87%	
						1000mA	75-150Vdc	87%	
						1100mA	68-136Vdc	87%	
						1200mA	63-125Vdc	87%	
						1300mA	58-115Vdc	87%	
						1400mA	54-107Vdc	87%	
						1500mA	50-100Vdc	87%	
						1600mA	47-94Vdc	87%	
						1700mA	44-88Vdc	87%	
						1800mA	42-83Vdc	87%	
						1900mA	39-79Vdc	87%	
						2000mA	38-75Vdc	87%	
						2100mA	36-71Vdc	87%	
						2200mA	34-68Vdc	87%	
						2300mA	33-65Vdc	87%	
						2400mA	31-63Vdc	87%	
	2500mA	30-60Vdc	87%						
	530-2500mA	KTLD-150-UV-xxx-VDIM-67-AP3 <i>(continued on next page)</i>	120-277V	>0.9	0-10V	530mA	141-283Vdc	92%	AP3
						600mA	125-250Vdc	92%	
						700mA	107-214Vdc	92%	
800mA						94-188Vdc	92%		
900mA						83-167Vdc	92%		
1000mA						75-150Vdc	92%		
1100mA						68-136Vdc	92%		
1200mA						63-125Vdc	92%		
1300mA						58-115Vdc	92%		
1400mA						54-107Vdc	92%		
1500mA						50-100Vdc	92%		
1600mA						47-94Vdc	91%		

Specifications subject to change without notice. For complete product specifications, visit www.keystonetech.com

ELECTRICAL SPECIFICATIONS

Wattage Family	Output Current Range	Catalog Number	Input Voltage	Power Factor	Dimming	Typical Output Current	Output Voltage	Efficiency	Case Style
150W	530-2500mA	KTLD-150-UV-xxx-VDIM-67-AP3 <i>(continued from previous page)</i>	120-277V	>0.9	0-10V	1700mA	44-88Vdc	91%	AP3
						1800mA	42-83Vdc	91%	
						1900mA	39-79Vdc	91%	
						2000mA	38-75Vdc	91%	
						2100mA	36-71Vdc	91%	
						2200mA	34-68Vdc	91%	
						2300mA	33-65Vdc	91%	
						2400mA	31-63Vdc	91%	
						2500mA	30-60Vdc	91%	
200W	700-1400mA	KTLD-200-UV-xxx-67-AP5	120-277V	>0.9	N/A	700mA	143-286Vdc	91%	AP5
						800mA	125-250Vdc	91%	
						900mA	111-222Vdc	91%	
						1000mA	100-200Vdc	91%	
						1100mA	91-182Vdc	91%	
						1200mA	83-167Vdc	91%	
						1300mA	77-154Vdc	91%	
						1400mA	71-143Vdc	91%	
	700-1400mA	KTLD-200-UV-xxx-VDIM-67-AP5	120-277V	>0.9	0-10V	700mA	143-286Vdc	91%	AP5
						800mA	125-250Vdc	91%	
						900mA	111-222Vdc	91%	
						1000mA	100-200Vdc	91%	
						1100mA	91-182Vdc	91%	
						1200mA	83-167Vdc	91%	
						1300mA	77-154Vdc	91%	
						1400mA	71-143Vdc	91%	
						400W	2000mA	KTLD-400-UV-2000-67-AP7	

LED DRIVERS

CONSTANT CURRENT

CASE STYLES

All LED drivers can be modified to accommodate specific requirements.

Contact Keystone to discuss custom and semi-custom LED driver solutions.

CASE AF

Material: Plastic

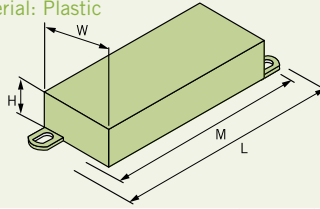

Case Style	Mounting	Length	Width	Height
AF1	4.57"	4.86"	1.30"	0.79"
AF3	3.02"	3.32"	1.30"	0.79"
AF4	5.20"	5.49"	1.30"	0.79"
AF6	6.61"	6.93"	1.33"	0.83"

CASE AK

Material: Steel

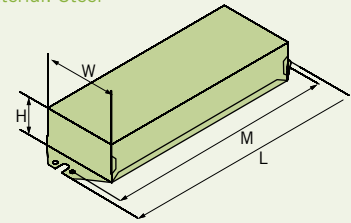

Case Style	Mounting	Length	Width	Height
AK1	4.29"	4.80"	1.58"	0.96"
AK2	7.01"	7.68"	1.42"	0.83"

CASE AP

Material: Aluminum
Case Rating: IP67

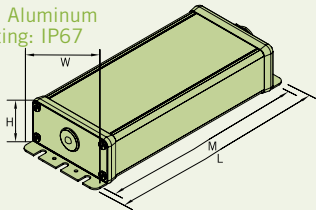

Case Style	Mounting	Length	Width	Height
AP3	8.33"	8.94"	2.68"	1.52"
AP4	8.65"	9.26"	1.90"	1.50"
AP5	9.17"	9.78"	2.68"	1.52"
AP7	11.52"	11.82"	3.53"	1.73"

CASE AQ

Material: Plastic

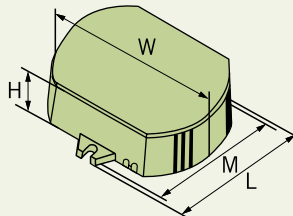

Case Style	Mounting	Length	Width	Height
AQ1	2.76"	3.07"	3.15"	1.00"

CASE AR

Material: Plastic

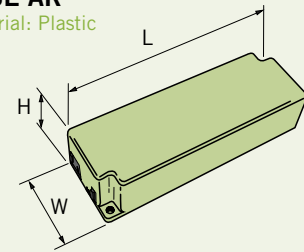

Case Style	Mounting	Length	Width	Height
AR1	6.07"	6.48"	1.67"	1.26"
AR2	5.00"	5.54"	1.86"	1.26"

CASE AT

Material: Plastic

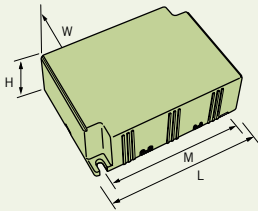

Case Style	Mounting	Length	Width	Height
AT1	3.34"	3.76"	2.81"	1.26"

CASE AU

Material: Aluminum

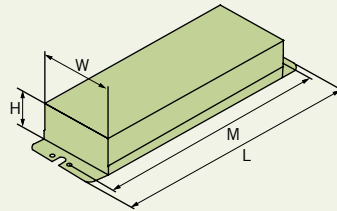

Case Style	Mounting	Length	Width	Height
AU1	8.90"	9.45"	1.80"	1.37"

CASE F

Material: Aluminum

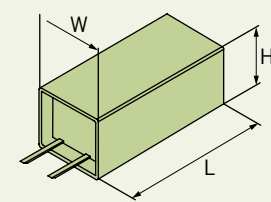

Case Style	Mounting	Length	Width	Height
F3	N/A	2.68"	1.30"	0.79"
F5	N/A	3.15"	1.30"	0.79"

CASE L

Material: Steel

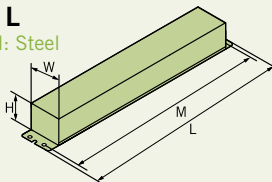

Case Style	Mounting	Length	Width	Height
L2	6.00"	6.46"	1.89"	1.15"
L5	8.90"	9.50"	1.70"	1.18"
L7	6.00"	6.46"	1.37"	1.00"
L9	8.90"	9.57"	1.13"	1.07"
L18	10.97"	11.46"	1.70"	1.15"
L20	8.86"	9.45"	1.63"	1.20"

CASE W

Material: Steel

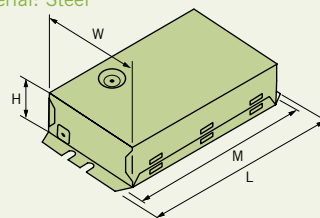

Case Style	Mounting	Length	Width	Height
W1	4.63"	5.00"	2.40"	1.00"
W2	4.63"	5.00"	3.00"	1.38"
W3	6.73"	7.11"	3.08"	1.34"

Specifications subject to change without notice. For complete product specifications, visit www.keystonetech.com

SPEEDDIAL

PROGRAMMABLE DRIVERS

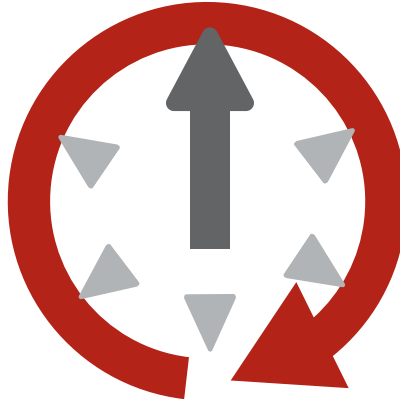

NO COMPUTERS. NO MISTAKES. NO HASSLES.

Introducing the easiest programmable LED Driver on the market. With just the simple twist of Keystone's unique SpeedDial, the LED driver is programmed to your desired output current in less than a second. Reduce inventory SKUs, increase productivity, gain performance flexibility... all with Keystone's proprietary SpeedDial LED drivers.

FEATURES AND BENEFITS

- **Slim Form Factor** - Ideal for narrow channels and slender fixtures.
- **Incredibly Fast Programmability** - Just twist the SpeedDial with a standard screwdriver to the desired setting. The SpeedDial clicks right into place.
- **Many Output Current Options** - Utilize a single SKU for several output current settings. One driver covers all of the desired settings.
- **High Efficiency** - Keystone's expertise in LED driver design targets maximum efficiencies at all current settings.
- **0-10V Dimming** - Uncompromised dimming performance for any 0-10V dimming system.

ELECTRICAL SPECIFICATIONS

Catalog Number	INPUT CHARACTERISTICS				OUTPUT CHARACTERISTICS			FEATURES	
	Input Voltage	Input Power	Power Factor	Max. Current	Max. Output Power	Rated Output Current	Output Voltage	Efficiency	Case Style
KTLD-44-UV-SD700-1200-VDIM-L20	120-277Vac	52W	>0.9	0.48A @ 120V 0.22A @ 277V	44W	700, 800, 900, 1000, 1100, or 1200 mA	18~36Vdc	84% (at 1200mA)	L20



Ask about custom solutions! We can develop our SpeedDial product to specific current settings.

LED DRIVERS

DIMMER COMPATIBILITY LIST

Phase Control Dimming

Designated by **FDIM** in Catalog Number.

Phase control dimming (also called TRIAC, forward phase/leading edge, or reverse phase/trailing edge dimming) is a common dimming technology used in residential and commercial applications. Phase control dimmers work by effectively “cutting-off” a portion of the wave on each power cycle (the front half of the waveform for forward phase and the back half of the waveform for reverse phase). Cutting off the waveform causes an imperceptible flicker at each cycle, which the human eye perceives as dimmed light output. Phase control dimmers are commonly wall-mounted and control several fixtures up to a combined 800VA at 120V.

TRIAC (Leading Edge):

MANUFACTURER	MODEL
Lutron	Diva DV-600P
	SkyLark S-600P
	Ariadni AY-600P
	Ariadni TG-603P
	Maestro MA-600 (Digital)
	Diva CFL/LED DVCL-153P
	Satin Colors DVSC-600P-SW
Leviton	6641
	IllumaTech IPI06-1LX
	ToggleTouch TGI06-1LW (Digital)

Reverse (Trailing Edge):

MANUFACTURER	MODEL
Lutron	MAELV-600BL (Digital)
	DVELV-300P
	SkyLark SELV-300P

Consult dimmer manufacturer for dimmer specifications.

0-10V (Analog Dimming)

Designated by **VDIM** in Catalog Number.

All major brand 0-10V dimmers are acceptable for use with Keystone 0-10V drivers. Please note that the 0-10V regulated voltage (dimming setting) at a particular position may be different for each dimmer, even among the same brand and model. Dimming performance may vary because of this phenomenon. Consult factory for verification.

Local Dimming

Designated by **LDIM** in Catalog Number.

Local dimming refers to using a locally installed potentiometer, or simple resistor to control the light output of the lighting fixture. The user can manually adjust the potentiometer (and light output) by mechanically moving a rotary or sliding switch. These dimmers are typically installed directly into the lighting fixture for a simple user control. Torchieres, table lamps, and undercabinet/task lighting often employ local dimming technology.



Specifications subject to change without notice. For complete product specifications, visit www.keystonetech.com

LED MODULES

SECTION CONTENTS

Linear Series: 52

Circular Series: 54

Square and Rectangular Series: 55

OEM LED Systems: 56



Keystone offers a wide variety of LED system solutions. We manufacture systems with pre-selected drivers for maximum efficiency as well as systems with multiple driver options based on light output, efficiency, and form factor requirements. We can also tailor any system to fit your specific project needs.

Looking for an LED system that's not listed here? We can design your system and have samples available in as little as 3 weeks. Just let us know what you are looking for and we will develop the perfect LED system to meet your requirements.



LED MODULES

LINEAR SERIES

ELECTRICAL SPECIFICATIONS

Catalog Number	Nominal Lumens	Max. Drive Current	Forward Voltage	Max. Module Power	Dimensions
1600SL Series LED Module					1,600 lm/ft, Narrow Footprint
KTLM-450-L5-8xx-30A	1600	450mA	31Vdc	14.0W	L5 (10.75" x 0.70")
KTLM-900-L2-8xx-60A	3200	900mA	31Vdc	28.0W	L2 (21.50" x 0.70")
KTLM-1800-L6-8xx-120A	6400	1800mA	31Vdc	55.8W	L6 (43.10" x 0.70")
1100SL Series LED Module					1,100 lm/ft, Narrow Footprint
KTLM-300-L5-8xx-22A	1100	300mA	34Vdc	10.3W	L5 (10.75" x 0.70")
KTLM-600-L2-8xx-44A	2200	600mA	34Vdc	20.5W	L2 (21.50" x 0.70")
KTLM-1500-L6-8xx-90A	4400	1500mA	28Vdc	42.0W	L6 (43.10" x 0.70")
900SL Series LED Module					900 lm/ft, Narrow Footprint
KTLM-300-L7-8xx-10A	500	300mA	15Vdc	4.5W	L7 (5.375" x 0.70")
KTLM-300-L5-8xx-18A	900	300mA	28Vdc	8.5W	L5 (10.75" x 0.70")
KTLM-600-L2-8xx-36A	1800	600mA	28Vdc	16.6W	L2 (21.50" x 0.70")
KTLM-1200-L6-8xx-72A	3600	1200mA	28Vdc	33.6W	L6 (43.10" x 0.70")
650SL Series LED Module					650 lm/ft, Narrow Footprint
KTLM-300-L5-8xx-14A	650	300mA	21.5Vdc	6.4W	L5 (10.75" x 0.70")
KTLM-600-L2-8xx-28A	1300	600mA	21.5Vdc	13.0W	L2 (21.50" x 0.70")
KTLM-1200-L6-8xx-56A	2600	1200mA	21.5Vdc	25.8W	L6 (43.10" x 0.70")
Future Fit Series LED Module					Optimized for Keystone LED Kits
KTLM-1050-L6-8xx-63A	3300	1050mA	28Vdc	29.4W	L6 (43.10" x 0.70")
KTLM-1050-L6-8xx-77A	4000	1050mA	34Vdc	35.7W	L6 (43.10" x 0.70")
KTLM-1050-L2-8xx-63A	3300	1050mA	28Vdc	29.4W	L2 (21.50" x 0.70")

COLOR TEMPERATURE OPTIONS

Designed For Multiple Applications & Light Output Levels

Color temperature options, noted in the chart above by an "xx" in the part number, are as follows:

Catalog Number Designation	Color Temperature
30	3000K
35	3500K
40	4000K
50	5000K

PHYSICAL SPECIFICATIONS

LEDs shown on modules below are for placement only.

L2

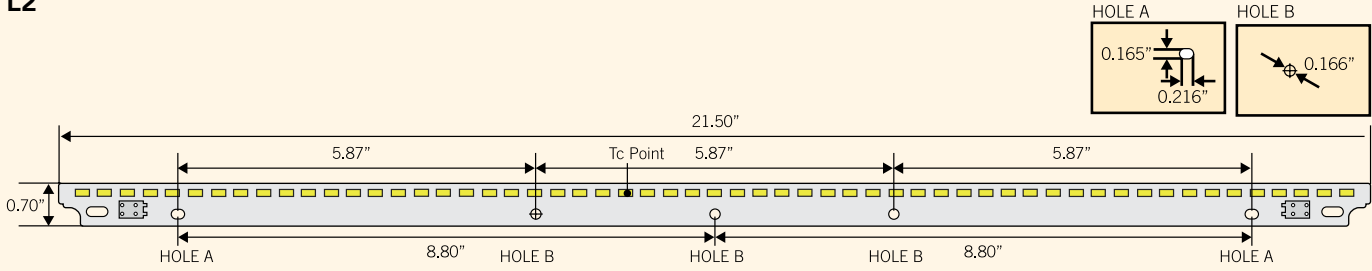

Length	21.50"	Width	0.70"
---------------	--------	--------------	-------

L5

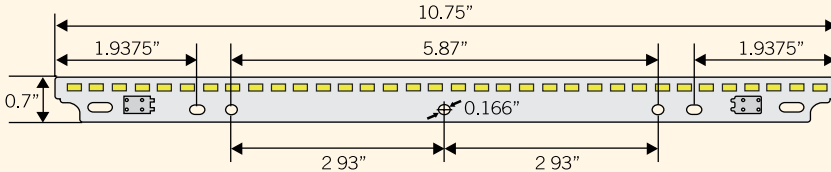

Length	10.75"	Width	0.70"
---------------	--------	--------------	-------

L6

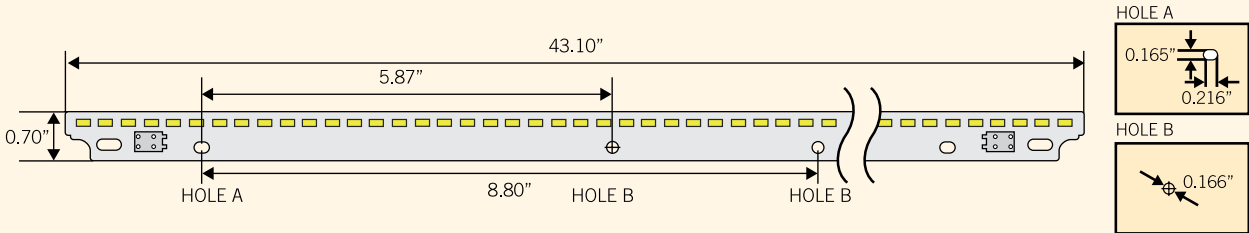

Length	43.10"	Width	0.70"
---------------	--------	--------------	-------

L7

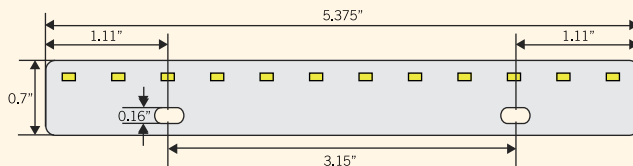

Length	5.375"	Width	0.70"
---------------	--------	--------------	-------

Specifications subject to change without notice. For complete product specifications, visit www.keystonetech.com

LED MODULES

CIRCULAR SERIES

ELECTRICAL SPECIFICATIONS

Catalog Number	Nominal Lumens	Max. Drive Current	Forward Voltage	Max. Module Power	Dimensions
Circular Series LED Module					
KTLM-600-C1-8xx-28A	1300	600mA	21Vdc	12.6W	C1
Future Fit Series LED Module Optimized for Keystone LED Kits					
KTLM-900-C2-840-48A	2600	900mA	25Vdc	22.5W	C2 (A)
KTLM-900-C2-840-60A	3200	900mA	31Vdc	27.9W	C2 (B)

COLOR TEMPERATURE OPTIONS

Designed For Multiple Applications & Light Output Levels

Color temperature options, noted in the chart above by an "xx" in the part number, are as follows:

Catalog Number Designation	Color Temperature
30	3000K
35	3500K
40	4000K
50	5000K

PHYSICAL SPECIFICATIONS

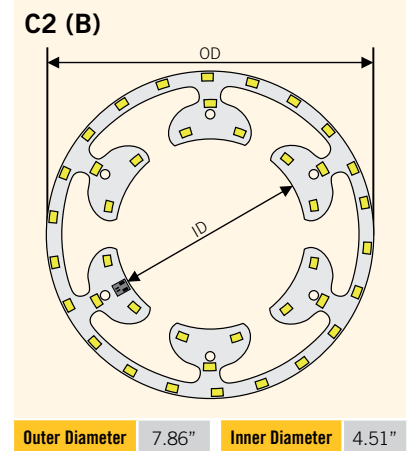
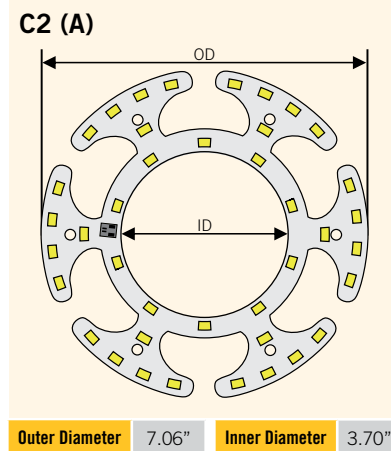
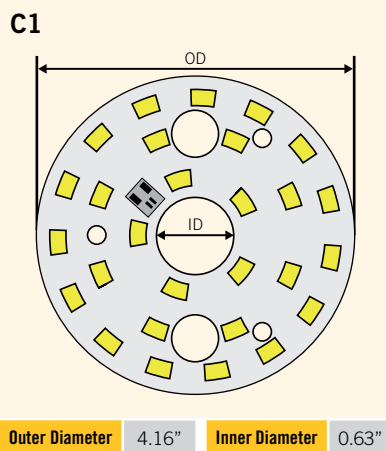

Specifications subject to change without notice. For complete product specifications, visit www.keystonetech.com

LED MODULES

SQUARE AND RECTANGULAR SERIES

ELECTRICAL SPECIFICATIONS

Catalog Number	Nominal Lumens	Max. Drive Current	Forward Voltage	Max. Module Power	Dimensions
Square Series LED Module					
KTLM-350-SQ1-8xx-21A	875	350mA	21Vdc	7.4W	SQ1
KTLM-350-SQ1-8xx-9A	360	350mA	9Vdc	3.1W	SQ1
KTLM-400-SQ2-8xx-6A	700	400mA	20Vdc	7.9W	SQ2
Future Fit Series LED Module			Optimized for Keystone LED Kits		
KTLM-1050-R1-840-14A	700	1050mA	6Vdc	6.5W	R1
KTLM-1050-R1-840-28A	1300	1050mA	12.5Vdc	13W	R1
KTLM-450-R2-8xx-24A	1300	450mA	25Vdc	11.2W	R2
KTLM-450-R2-8xx-15A	800	450mA	15.5Vdc	7W	R2

COLOR TEMPERATURE OPTIONS

Designed For Multiple Applications & Light Output Levels

Color temperature options, noted in the chart above by an "xx" in the part number, are as follows:

Catalog Number Designation	Color Temperature
30	3000K
35	3500K
40	4000K
50	5000K

PHYSICAL SPECIFICATIONS

LEDs shown on modules below are for placement only.

R1

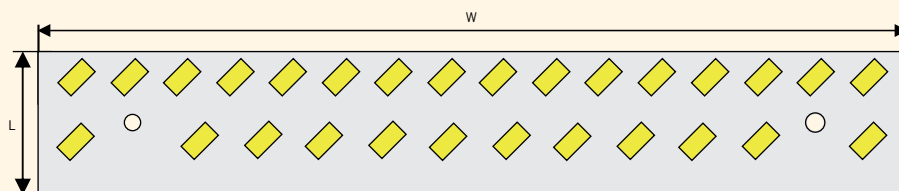

Length 0.63" Width 5.50"

R2

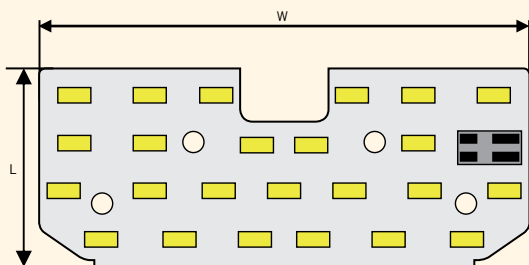

Length 1.68" Width 4.31"

SQ1

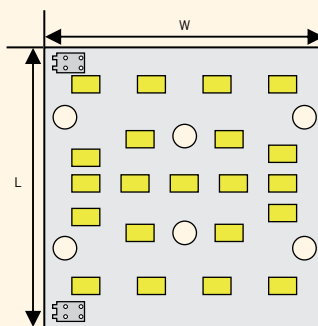

Length 1.875" Width 1.875"

SQ2

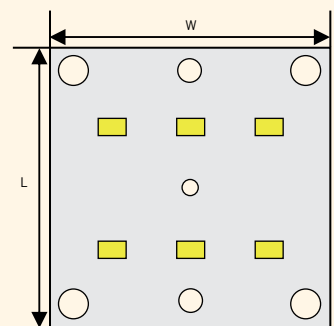

Length 2.36" Width 2.36"

Specifications subject to change without notice. For complete product specifications, visit www.keystonetech.com

Keystone Technologies, LLC | North Wales, PA 19454 | Phone (800) 464-2680 | keystonetech.com

OEM LED SYSTEMS

KEYSTONE TURNKEY LED PROGRAM FOR FIXTURE OEMs

Save Money. Save Time. Instead of submitting each fixture for UL and DLC approval and paying the associated fees, the Keystone Turnkey LED Program allows the fixture assembler to “alternate list” against the pre-tested, pre-approved fixture designs. This co-op program between Keystone and A.L.P. substantially reduces the cost to bring new fixtures to market while dramatically speeding up the UL and DLC approval process. **Available to fixture manufacturers only.**

FIXTURE OPTIONS

SteelCraft Metal Work from A.L.P.		Keystone Components	
Fixture Family	Luminaire Type	LED Driver Cat. No.	LED Module Cat. No.
ELC, ELL, ELP, ELV or RDIDB	2x2 Recessed Troffer	(1) KTLD-40-UV-1100-VDIM-L9	(2) KTLM-900-L2-8xx-60A
	2x4 Recessed Troffer	(1) KTLD-72-UV-2x1000-VDIM-L5	(4) KTLM-900-L2-8xx-60A (2) KTLM-1500-L6-8xx-90A

HOW TO ORDER:

1 Contact Keystone to enroll in the Turnkey Fixture LED Program.

2 Purchase one of the following Steel Craft metal packages from A.L.P.



ELC Troffer



ELL Troffer



ELP Troffer



ELV Troffer



RDIDB Troffer



3 Purchase a UL and DLC QPL Listed LED driver and board system from Keystone.



Keystone Drivers



Keystone Modules



4 Assemble at your facility and customize to your unique requirements.



Call us today to learn how to get started with this ground-breaking opportunity for fixture manufacturers.

Keystone offers a remarkable 10 year warranty on the electronic components (driver and board) used in this system.*

Terms and Conditions: 1. **Hours of Operation:** Cannot exceed 12 hrs/day, 7 days a week. 2. **Ambient Temperature:** Used in climate controlled environment where ambient temperature does not exceed 77°F (25°C) during operational hours. 3. **Driver Temperature:** Driver case temperature at tC point does not exceed 158°F (70°C) during operation.

**Metal work is covered under a separate 5 year warranty from A.L.P.*

Specifications subject to change without notice. For complete product specifications, visit www.keystonetech.com

SECTION CONTENTS

Linear LED Module and Driver Kits: 58

Linear Troffer Pan LED Kits: 59

Circular LED Kits: 60

Rectangular LED Kits: 61

Sconce LED Kits: 62



Keystone's innovative Future Fit LED kits are the ideal solution to convert legacy fluorescent fixtures into energy-efficient LED systems.

Keystone pre-packages the appropriate Keystone drivers, modules and mounting accessories which means that the LED retrofit can be installed quickly and easily either in the field or at the point of fixture manufacture.

We did all the safety testing and performance verification, so upgrading to LED is as easy as zip-screwing in these clever Future Fit LED kits, only from Keystone.

LINEAR LED MODULE AND DRIVER KITS

2x4, 4000 LUMEN LINEAR LED MODULE AND DRIVER KIT

Dimming Type: 0-10V

KIT CONTENTS:

(1) Driver: KTLD-40-UV-1100-VDIM-L9

(2) Modules: KTLM-1050-L6-8xx-63A

Mounting Hardware and Accessories

Color Temp	Input Voltage	LED Retrofit Kit Catalog Number	No. of Modules	System Drive Current	Drive Current per Module	System Lumens	Module Power	Module Efficacy	Driver Efficiency	System Power	System Efficacy
3500K	120-277V	KT-RKIT-24-4000-835-VDIM	2	1100mA	550mA	3820	30W	129 lm/W	82%	36W	106 lm/W
4000K	120-277V	KT-RKIT-24-4000-840-VDIM	2	1100mA	550mA	3860	30W	130 lm/W	82%	36W	107 lm/W
5000K	120-277V	KT-RKIT-24-4000-840-VDIM	2	1100mA	550mA	4000	30W	135 lm/W	82%	36W	111 lm/W

2x4, 5000 LUMEN LINEAR LED MODULE AND DRIVER KIT

Dimming Type: 0-10V

KIT CONTENTS:

(1) Driver: KTLD-40-UV-1100-VDIM-L9

(2) Modules: KTLM-1050-L6-8xx-77A

Mounting Hardware and Accessories

Color Temp	Input Voltage	LED Retrofit Kit Catalog Number	No. of Modules	System Drive Current	Drive Current per Module	System Lumens	Module Power	Module Efficacy	Driver Efficiency	System Power	System Efficacy
3500K	120-277V	KT-RKIT-24-5000-835-VDIM	2	1100mA	550mA	4680	36W	130 lm/W	82%	44W	107 lm/W
4000K	120-277V	KT-RKIT-24-5000-840-VDIM	2	1100mA	550mA	4800	36W	133 lm/W	82%	44W	109 lm/W
5000K	120-277V	KT-RKIT-24-5000-850-VDIM	2	1100mA	550mA	5000	36W	138 lm/W	82%	44W	113 lm/W

2x2, 4000 LUMEN LINEAR LED MODULE AND DRIVER KIT

Dimming Type: 0-10V

KIT CONTENTS:

(1) Driver: KTLD-40-UV-1100-VDIM-L9

(2) Modules: KTLM-1050-L2-8xx-63A

Mounting Hardware and Accessories

Color Temp	Input Voltage	LED Retrofit Kit Catalog Number	No. of Modules	System Drive Current	Drive Current per Module	System Lumens	Module Power	Module Efficacy	Driver Efficiency	System Power	System Efficacy
3500K	120-277V	KT-RKIT-22-4000-835-VDIM	2	1100mA	550mA	3820	30W	129 lm/W	82%	36W	106 lm/W
4000K	120-277V	KT-RKIT-22-4000-840-VDIM	2	1100mA	550mA	3860	30W	130 lm/W	82%	36W	107 lm/W
5000K	120-277V	KT-RKIT-22-4000-850-VDIM	2	1100mA	550mA	4000	30W	135 lm/W	82%	36W	111 lm/W

TYPICAL INSTALLATION APPLICATION



Specifications subject to change without notice. For complete product specifications, visit www.keystonetech.com

2x2, 4000 LUMEN PRE-MOUNTED LINEAR TROFFER PAN

Dimming Type: 0-10V

KIT CONTENTS:

(1) Driver: KTLD-40-UV-1100-VDIM-L9

(2) Modules: KTLM-1050-L6-8xx-63A

(1) Metal Pan

Mounting Hardware and Accessories

Color Temp	Input Voltage	LED Retrofit Kit Catalog Number	No. of Modules	System Drive Current	Drive Current per Module	System Lumens	Module Power	Module Efficacy	Driver Efficiency	System Power	System Efficacy
3500K	120-277V	KT-RKIT-TP-22-4000-835-VDIM	2	1100mA	550mA	3820	30W	129 lm/W	82%	36W	106 lm/W
4000K	120-277V	KT-RKIT-TP-22-4000-840-VDIM	2	1100mA	550mA	3860	30W	130 lm/W	82%	36W	107 lm/W
5000K	120-277V	KT-RKIT-TP-22-4000-850-VDIM	2	1100mA	550mA	4000	30W	135 lm/W	82%	36W	111 lm/W

2x4, 4000 LUMEN LINEAR PRE-MOUNTED LINEAR TROFFER PAN

Dimming Type: 0-10V

KIT CONTENTS:

(1) Driver: KTLD-40-UV-1100-VDIM-L9

(2) Modules: KTLM-1050-L6-8xx-77A

(1) Metal Pan

Mounting Hardware and Accessories

Color Temp	Input Voltage	LED Retrofit Kit Catalog Number	No. of Modules	System Drive Current	Drive Current per Module	System Lumens	Module Power	Module Efficacy	Driver Efficiency	System Power	System Efficacy
3500K	120-277V	KT-RKIT-TP-24-4000-835-VDIM	2	1100mA	550mA	4680	36W	130 lm/W	82%	44W	107 lm/W
4000K	120-277V	KT-RKIT-TP-24-4000-840-VDIM	2	1100mA	550mA	4800	36W	133 lm/W	82%	44W	109 lm/W
5000K	120-277V	KT-RKIT-TP-24-4000-850-VDIM	2	1100mA	550mA	5000	36W	138 lm/W	82%	44W	113 lm/W

2x4, 5000 LUMEN LINEAR PRE-MOUNTED LINEAR TROFFER PAN

Dimming Type: 0-10V

KIT CONTENTS:

(1) Driver: KTLD-40-UV-1100-VDIM-L9

(2) Modules: KTLM-1050-L2-8xx-63A

(1) Metal Pan

Mounting Hardware and Accessories

Color Temp	Input Voltage	LED Retrofit Kit Catalog Number	No. of Modules	System Drive Current	Drive Current per Module	System Lumens	Module Power	Module Efficacy	Driver Efficiency	System Power	System Efficacy
3500K	120-277V	KT-RKIT-TP-24-5000-835-VDIM	2	1100mA	550mA	3820	30W	129 lm/W	82%	36W	106 lm/W
4000K	120-277V	KT-RKIT-TP-24-5000-850-VDIM	2	1100mA	550mA	3860	30W	130 lm/W	82%	36W	107 lm/W
5000K	120-277V	KT-RKIT-TP-24-5000-840-VDIM	2	1100mA	550mA	4000	30W	135 lm/W	82%	36W	111 lm/W

OPTIONAL ACCESSORIES (Sold Separately)

Catalog Number	Description
KT-RKIT-MAG-KIT	(2) High Strength Magnets to Aid in the Installation of the Future Fit Troffer Pan; Re-Usable

TYPICAL INSTALLATION APPLICATION



CIRCULAR LED KITS

8", 1600 LUMEN CIRCULAR

Dimming Type: Phase Control

KIT CONTENTS:

(1) Driver: KTLD-20-1-560-FDIM-AQ7

(1) Module: KTLM-900-C2-8xx-48A

(1) Metal Pan

Mounting Hardware and Accessories

Color Temp	Input Voltage	LED Retrofit Kit Catalog Number	No. of Modules	System Drive Current	Drive Current per Module	System Lumens	Module Power	Module Efficacy	Driver Efficiency	System Power	System Efficacy
3000K	120V	KT-RKIT-CP-8-1600-830-FDIM	1	560mA	560mA	1700	13W	130 lm/W	80%	16.2W	105 lm/W
4000K	120V	KT-RKIT-CP-8-1600-840-FDIM	1	560mA	560mA	1750	13W	135 lm/W	80%	16.2W	108 lm/W
5000K	120V	KT-RKIT-CP-8-1600-850-FDIM	1	560mA	560mA	1800	13W	138 lm/W	80%	16.2W	111 lm/W

Dimming Type: 0-10V

KIT CONTENTS:

(1) Driver: KTLD-20-UV-560-VDIM-AQ7

(1) Module: KTLM-900-C2-8xx-48A

(1) Metal Pan

Mounting Hardware and Accessories

Color Temp	Input Voltage	LED Retrofit Kit Catalog Number	No. of Modules	System Drive Current	Drive Current per Module	System Lumens	Module Power	Module Efficacy	Driver Efficiency	System Power	System Efficacy
3000K	120-277V	KT-RKIT-CP-8-1600-830-VDIM	1	560mA	560mA	1700	13W	130 lm/W	80%	16.2W	105 lm/W
4000K	120-277V	KT-RKIT-CP-8-1600-840-VDIM	1	560mA	560mA	1750	13W	135 lm/W	80%	16.2W	108 lm/W
5000K	120-277V	KT-RKIT-CP-8-1600-850-VDIM	1	560mA	560mA	1800	13W	138 lm/W	80%	16.2W	111 lm/W

8", 2200 LUMEN CIRCULAR

Dimming Type: Phase Control

KIT CONTENTS:

(1) Driver: KTLD-20-1-560-FDIM-AQ7

(1) Module: KTLM-900-C2-8xx-60A

(1) Metal Pan

Mounting Hardware and Accessories

Color Temp	Input Voltage	LED Retrofit Kit Catalog Number	No. of Modules	System Drive Current	Drive Current per Module	System Lumens	Module Power	Module Efficacy	Driver Efficiency	System Power	System Efficacy
3000K	120V	KT-RKIT-CP-8-2200-830-FDIM	1	560mA	560mA	2110	16.3W	129 lm/W	80%	20.4W	103 lm/W
4000K	120V	KT-RKIT-CP-8-2200-840-FDIM	1	560mA	560mA	2180	16.3W	134 lm/W	80%	20.4W	107 lm/W
5000K	120V	KT-RKIT-CP-8-2200-850-FDIM	1	560mA	560mA	2240	16.3W	137 lm/W	80%	20.4W	109 lm/W

Dimming Type: 0-10V

KIT CONTENTS:

(1) Driver: KTLD-20-UV-560-VDIM-AQ7

(1) Module: KTLM-900-C2-8xx-60A

(1) Metal Pan

Mounting Hardware and Accessories

Color Temp	Input Voltage	LED Retrofit Kit Catalog Number	No. of Modules	System Drive Current	Drive Current per Module	System Lumens	Module Power	Module Efficacy	Driver Efficiency	System Power	System Efficacy
3000K	120-277V	KT-RKIT-CP-8-2200-830-VDIM	1	560mA	560mA	2110	16.3W	129 lm/W	80%	20.4W	103 lm/W
4000K	120-277V	KT-RKIT-CP-8-2200-840-VDIM	1	560mA	560mA	2180	16.3W	134 lm/W	80%	20.4W	107 lm/W
5000K	120-277V	KT-RKIT-CP-8-2200-850-VDIM	1	560mA	560mA	2240	16.3W	137 lm/W	80%	20.4W	109 lm/W

TYPICAL INSTALLATION APPLICATION



3"x6", 800 LUMEN RECTANGULAR

Wiring: Series

Dimming Type: N/A

KIT CONTENTS:

(1) **Driver:** KTLD-14-1P-560-AF5

(2) **Modules:** KTLM-1050-R1-840-14A

(1) **Metal Pan**

Mounting Hardware and Accessories

Color Temp	Input Voltage	LED Retrofit Kit Catalog Number	No. of Modules	System Drive Current	Drive Current per Module	Lumens per Module	System Lumens	Module Power	Module Efficacy	Driver Efficiency	System Power	System Efficacy
3000K	120V	KT-RKIT-RP-6-800-830	2	560mA	560mA	415	830	7W	118 lm/W	82%	8.5W	97 lm/W
4000K	120V	KT-RKIT-RP-6-800-840	2	560mA	560mA	425	850	7W	121 lm/W	82%	8.5W	100 lm/W
5000K	120V	KT-RKIT-RP-6-800-850	2	560mA	560mA	435	870	7W	124 lm/W	82%	8.5W	102 lm/W

3"x6", 1600 LUMEN RECTANGULAR

Wiring: Series

Dimming Type: N/A

KIT CONTENTS:

(1) **Driver:** KTLD-14-1P-560-AF5

(2) **Modules:** KTLM-1050-R1-840-28A

(1) **Metal Pan**

Mounting Hardware and Accessories

Color Temp	Input Voltage	LED Retrofit Kit Catalog Number	No. of Modules	System Drive Current	Drive Current per Module	Lumens per Module	System Lumens	Module Power	Module Efficacy	Driver Efficiency	System Power	System Efficacy
3000K	120V	KT-RKIT-RP-6-1600-830	2	560mA	560mA	775	1550	14W	110 lm/W	82%	17W	91 lm/W
4000K	120V	KT-RKIT-RP-6-1600-840	2	560mA	560mA	800	1600	14W	114 lm/W	82%	17W	94 lm/W
5000K	120V	KT-RKIT-RP-6-1600-850	2	560mA	560mA	825	1650	14W	118 lm/W	82%	17W	97 lm/W

TYPICAL INSTALLATION APPLICATION

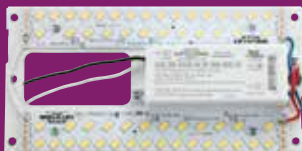

SCONCE LED KITS

8", 1100 LUMEN WALL SCONCE

Dimming Type: Phase Control

KIT CONTENTS:

(1) **Driver:** KTLD-10-1-350-FDIM-AF5

(1) **Module:** KTLM-450-R2-8xx-24A

(1) **Metal Pan**

Mounting Hardware and Accessories

Color Temp	Input Voltage	LED Retrofit Kit Catalog Number	No. of Modules	System Drive Current	Drive Current per Module	Lumens per Module	System Lumens	Module Power	Module Efficacy	Driver Efficiency	System Power	System Efficacy
3000K	120V	KT-RKIT-HCP-8-1100-830-FDIM	1	350mA	350mA	1115	1115	8.5W	131 lm/W	80%	10.6W	105 lm/W
4000K	120V	KT-RKIT-HCP-8-1100-840-FDIM	1	350mA	350mA	1150	1150	8.5W	135 lm/W	80%	10.6W	108 lm/W
5000K	120V	KT-RKIT-HCP-8-1100-850-FDIM	1	350mA	350mA	1180	1180	8.5W	138 lm/W	80%	10.6W	111 lm/W

8", 700 LUMEN WALL SCONCE

Dimming Type: Phase Control

KIT CONTENTS:

(1) **Driver:** KTLD-10-1-350-FDIM-AF5

(1) **Module:** KTLM-450-R2-8xx-15A

(1) **Metal Pan**

Mounting Hardware and Accessories

Color Temp	Input Voltage	LED Retrofit Kit Catalog Number	No. of Modules	System Drive Current	Drive Current per Module	Lumens per Module	System Lumens	Module Power	Module Efficacy	Driver Efficiency	System Power	System Efficacy
3000K	120V	KT-RKIT-HCP-8-700-830-FDIM	1	350mA	350mA	680	680	5.5W	123 lm/W	80%	6.9W	98 lm/W
4000K	120V	KT-RKIT-HCP-8-700-840-FDIM	1	350mA	350mA	700	700	5.5W	127 lm/W	80%	6.9W	101 lm/W
5000K	120V	KT-RKIT-HCP-8-700-850-FDIM	1	350mA	350mA	720	720	5.5W	130 lm/W	80%	6.9W	104 lm/W

TYPICAL INSTALLATION APPLICATION



Specifications subject to change without notice. For complete product specifications, visit www.keystonetech.com

SMART//SAFE

LED EMERGENCY BACK-UP

SECTION CONTENTS

LED Emergency Back-Up: 64

Constant Wattage Output Curves: 66



Keystone's line of LED emergency back-up solutions utilize state-of-the-art power electronics and high performance batteries, delivering exceptional reliability in the event of power failure.

Our products adjust to the unique requirements of each fixture, guaranteeing target lumen levels are achieved. With both low-lumen and high-lumen products available, Keystone has the solution to match any LED emergency back-up requirement.

Keystone's intelligent constant wattage technology responds every time it's needed, in virtually any type of LED fixture.
 This new technology detects the LED load in the light fixture and adjusts the output accordingly. Available in 500 or 1200 lumens.

FEATURES AND BENEFITS

- Adds Emergency Lighting Capability to Almost Any Existing LED or Fluorescent Fixture
- Battery is Separate from the Driver
- Battery Pack Has a Metal Shroud So It Can Be Mounted Remotely from the Fixture
- Remote Mounting Means No Interference with the Sleek Design of LED Architectural Fixtures
- 2-in-1 LED Test Switch and Indicator Light Provides Instant Reassurance That the System is Working
- UL 924 Listed
- Reliable Operation with 90 Minute Duration
- Low or High Wattage Option

2 OPTIONS AVAILABLE

STANDARD LED EMERGENCY BACK-UP

For LED Fixtures

Includes Driver and Battery

The LED emergency back-up enables emergency lighting solutions to be incorporated into a variety of new and existing LED fixtures. Simply install the emergency back-up solution into the fixture, tying into both the existing AC driver and LED module(s).



LED EMERGENCY BACK-UP KIT

Multiple Fixture Options

Includes Driver, Battery, and LED Module

The LED emergency back-up kit enables emergency lighting solutions to be incorporated into a variety of lighting fixtures including direct-wire LED tube fixtures, fluorescent fixtures and LED fixtures.



ELECTRICAL SPECIFICATIONS

LED EMERGENCY BACK-UP KITS

Catalog Number	INPUT CHARACTERISTICS			OUTPUT CHARACTERISTICS			LED Module Included
	Input Voltage	Power Factor	Max. Current	Max. Output Power	Rated Output Current	Output Voltage	
KT-EMRG-LED-5-500-K1	120-277Vac	≥0.5	0.03A @ 120V	5W	400mA-100mA	12~41Vdc	Yes
KT-EMRG-LED-12-1200-K1	120-277Vac	≥0.5	0.07A @ 120V	12W	1000mA-200mA	12~41Vdc	Yes

STANDARD LED EMERGENCY BACK-UP

Catalog Number	INPUT CHARACTERISTICS			OUTPUT CHARACTERISTICS			LED Module Included
	Input Voltage	Power Factor	Max. Current	Max. Output Power	Rated Output Current	Output Voltage	
KT-EMRG-LED-5-500	120-277Vac	≥0.5	0.03A @ 120V	5W	400mA-100mA	12~41Vdc	No
KT-EMRG-LED-12-1200	120-277Vac	≥0.5	0.07A @ 120V	12W	1000mA-200mA	12~41Vdc	No

Specifications subject to change without notice. For complete product specifications, visit www.keystonetech.com

CASE STYLE

CASE L

Material: Steel

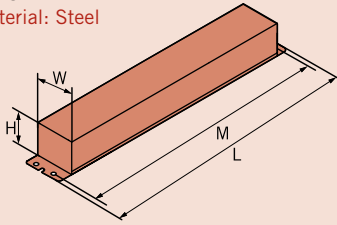

BATTERY STYLES

BATTERY

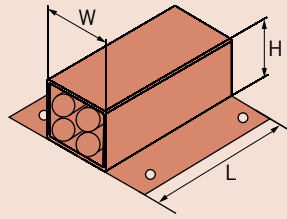

Case Style	Mounting	Length	Width	Height
L7	6.00"	6.46"	1.32"	1.00"

Case Style	Length	Width	Height
B5	7.20"	1.90"	0.90"
B12	9.45"	2.23"	1.02"

WIRING DIAGRAMS

STANDARD WIRING DIAGRAM

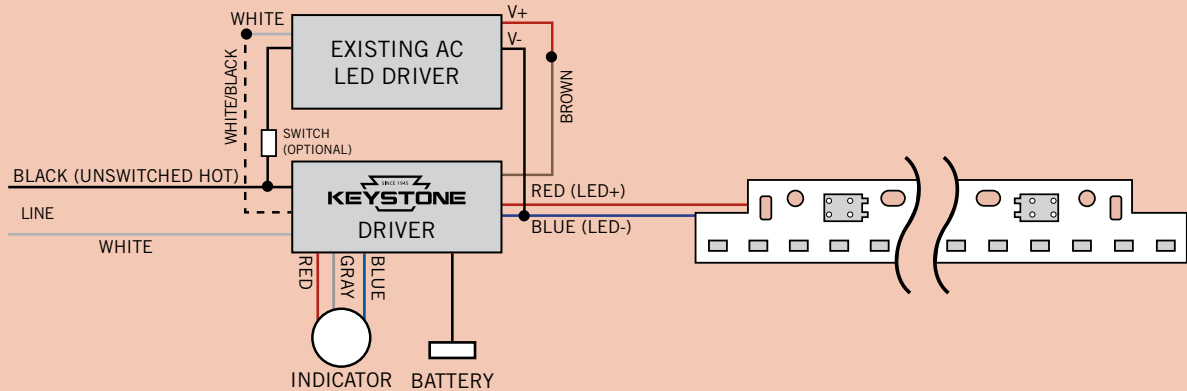

KIT WIRING DIAGRAM WITH EXISTING POWER SUPPLY

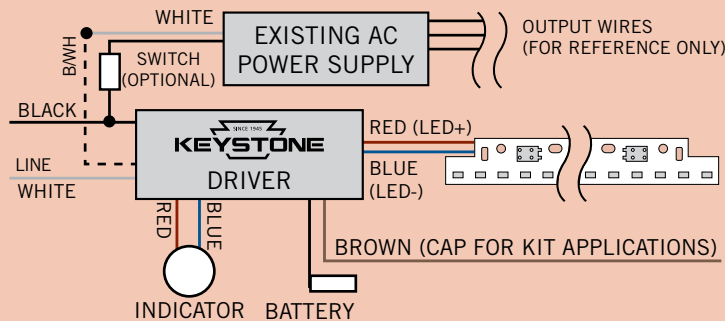

KIT WIRING DIAGRAM WITH DIRECT DRIVE LED TUBE FIXTURE

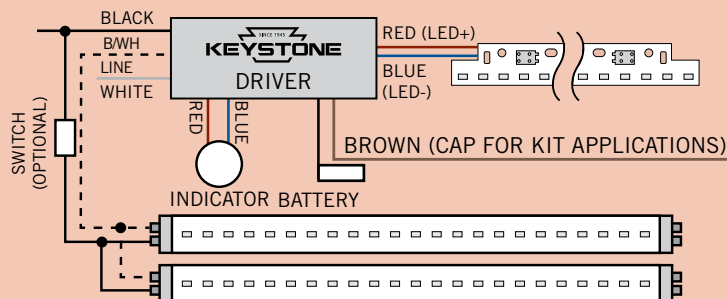

5 WATT OUTPUT CURVE

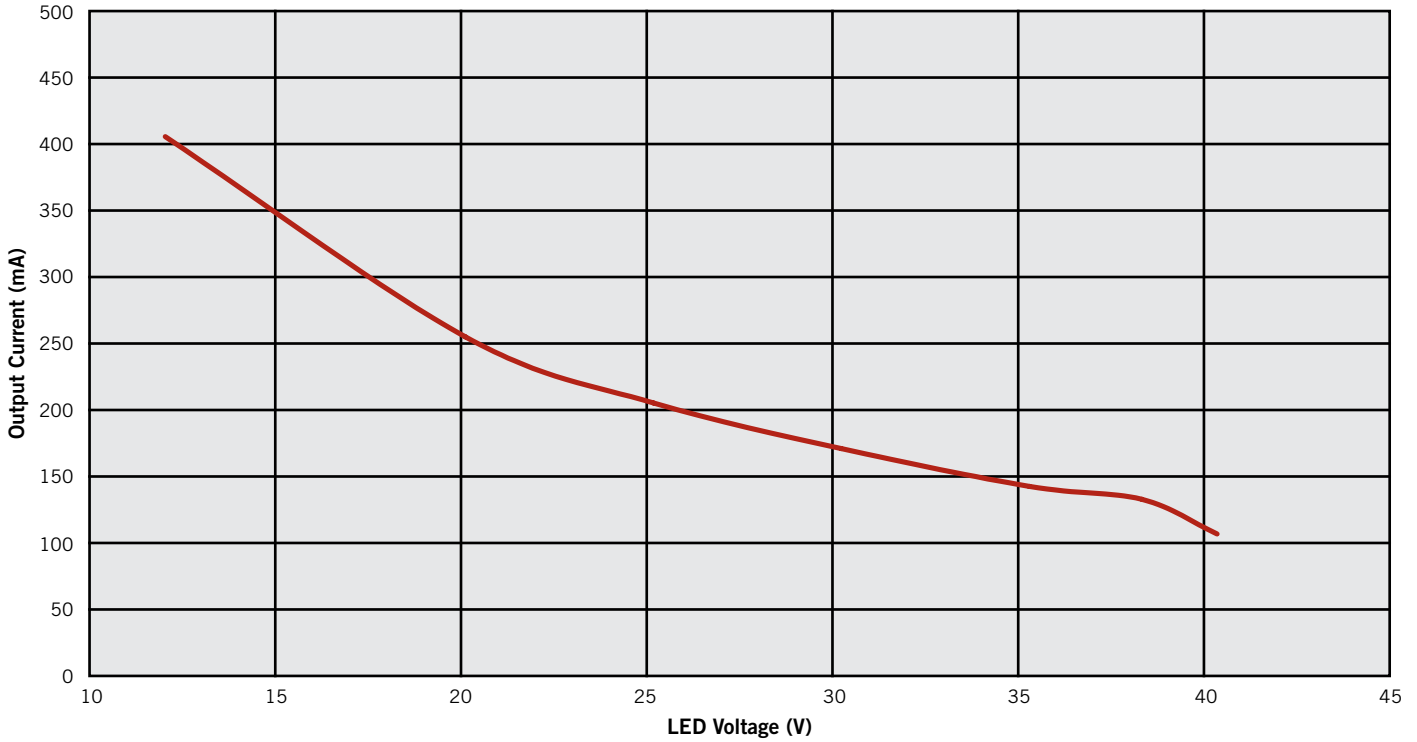

12 WATT OUTPUT CURVE

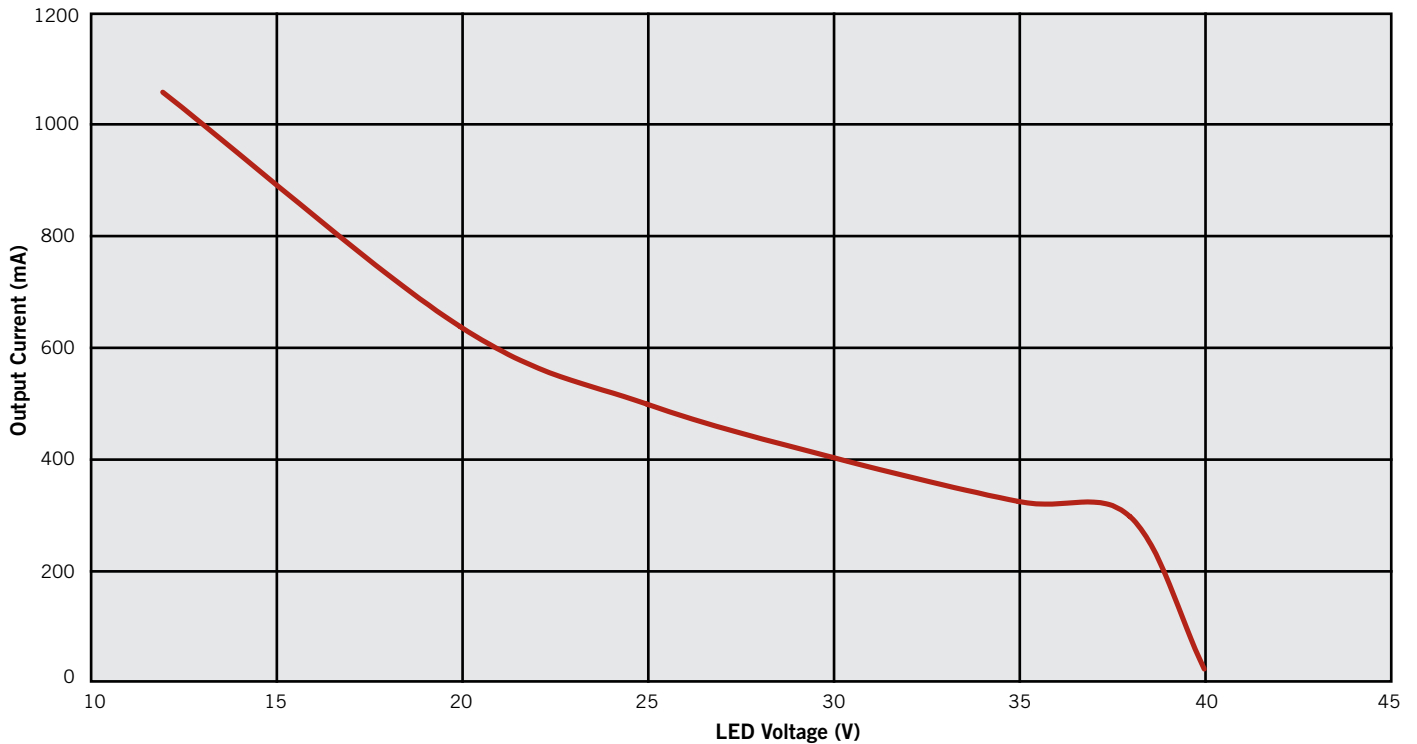

EMERGENCY BALLASTS

SECTION CONTENTS

Linear Fluorescent: 68

Compact Fluorescent: 69

Lamp Compatibility Charts: 70

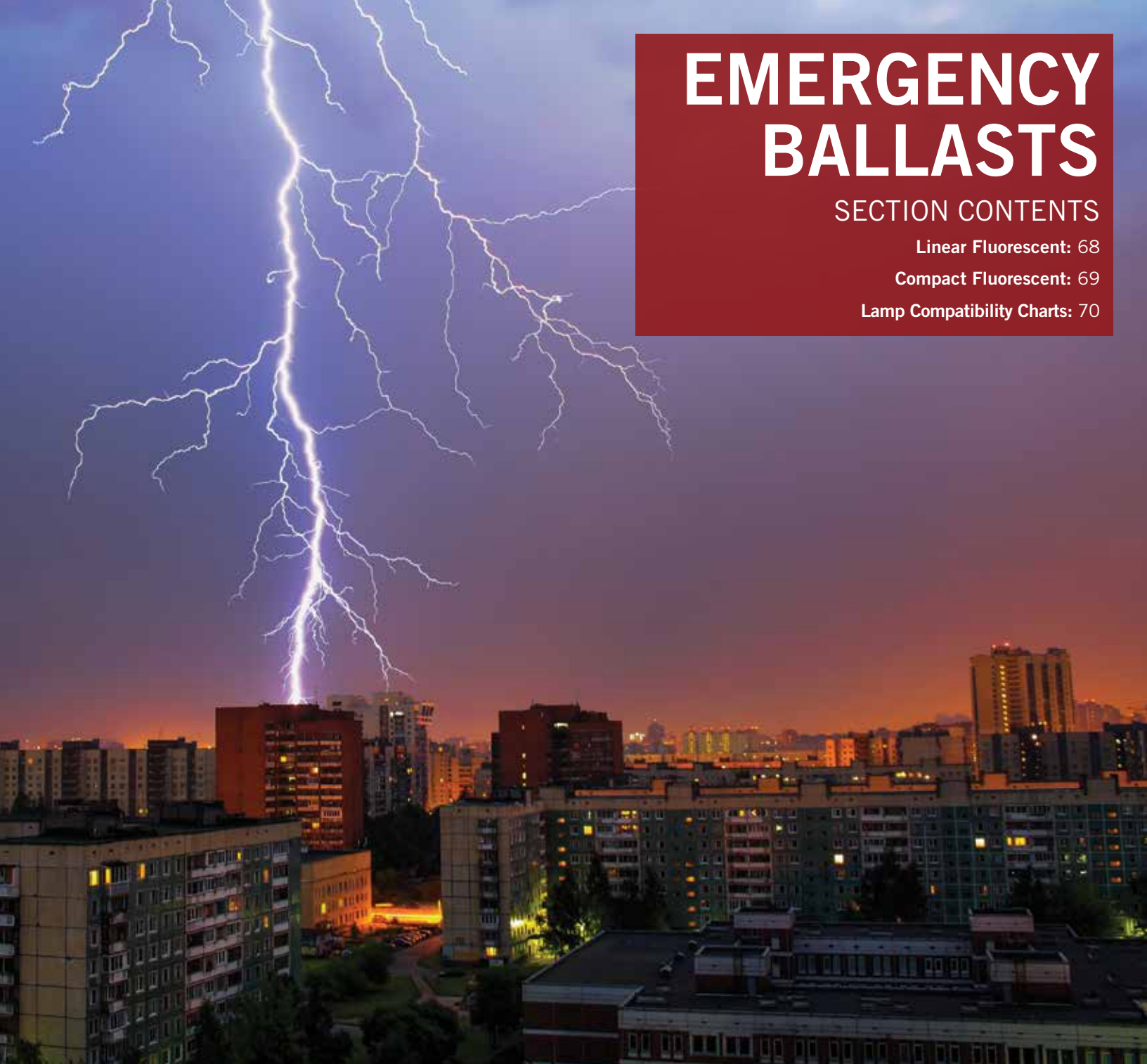

Emergency situations require superior dependability. When the power fails, trust only Keystone's emergency ballasts to keep the area safely lit. Keystone's emergency ballasts allow your job site to stay ahead of building code requirements, while letting you rest assured that the lights won't go out. Count on Keystone when it matters most.

Each Keystone emergency ballast comes packaged with a test switch that includes an LED indicator light for simplified use in factory or retrofit installations.

EMERGENCY BALLASTS

LINEAR



ELECTRICAL SPECIFICATIONS

No. of Lamps in Fixture	Catalog Number	Input Volts	Light Output	Illumination Time	Battery	Case Style
T8 & T12 Linear						
1-4	KT-EMRG-500	120/277V, 60Hz	500 lm	90 Minutes	NiCd	D14
	KT-EMRG-500-SL	120/277V, 60Hz	500 lm	90 Minutes	NiCd	L24
	KT-EMRG-700	120/277V, 60Hz	700 lm	90 Minutes	NiCd	D15
	KT-EMRG-700-SL	120/277V, 60Hz	700 lm	90 Minutes	NiCd	L25
	KT-EMRG-1400	120/277V, 60Hz	1400 lm	90 Minutes	NiCd	D16
	KT-EMRG-1400-SL	120/277V, 60Hz	1400 lm	90 Minutes	NiCd	L26
T5 Linear						
1-4	KT-EMRG-500-T5	120/277V, 60Hz	500 lm	90 Minutes	NiCd	H1
	KT-EMRG-800-T5	120/277V, 60Hz	800 lm	90 Minutes	NiCd	H2
	KT-EMRG-1300-T5	120/277V, 60Hz	1300 lm	90 Minutes	NiCd	H3

CASE STYLES

CASE D

Material: Steel

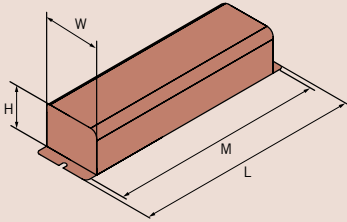

Case Style	Length	Width	Height
D14	9.50"	2.40"	1.50"
D15	9.50"	2.40"	1.50"
D16	13.40"	2.40"	1.50"

CASE H

Material: Steel

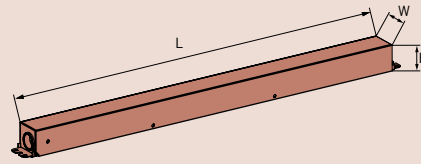

Case Style	Length	Width	Height
H1	14.25"	1.28"	1.21"
H2	17.60"	1.28"	1.19"
H3	21.50"	1.28"	1.19"

CASE L

Material: Steel

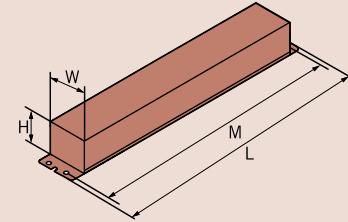

Case Style	Length	Width	Height
L24	10.00"	2.10"	1.19"
L25	13.40"	2.31"	1.30"
L26	14.25"	2.10"	1.19"

Specifications subject to change without notice. For complete product specifications, visit www.keystonetech.com

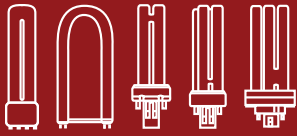

EMERGENCY BALLASTS

COMPACT

ELECTRICAL SPECIFICATIONS

No. of Lamps in Fixture	Catalog Number	Input Volts	Light Output	Illumination Time	Battery	Case Style
1-4	KT-EMRG-650-CFL2	120/277, 60Hz	650 lm	90 Minutes	NiCd	DD1
	KT-EMRG-750-CFL4	120/277, 60Hz	750 lm	90 Minutes	NiCd	DD1

CASE STYLE

CASE DD

Material: Steel

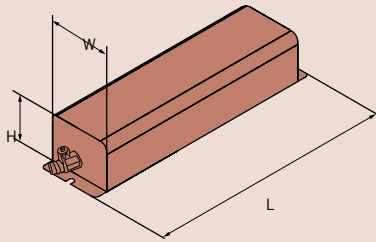

Case Style	Length	Width	Height
DD1	9.50"	2.40"	1.50"

EMERGENCY BALLASTS

LAMP COMPATIBILITY CHARTS

Keystone's line of emergency ballasts may be used with many lamp types and fixture applications. Refer to the lamp compatibility charts below to easily identify which Keystone emergency ballast is right for your application.

ALL LAMPS LISTED BELOW HAVE AN OPERATION TIME OF 90 MINUTES.

Lamp Type	T5		T5HO		T8		T8HO	T10	
Number of Lamps Operated	1	2	1	2	1	2	1	1	2

Light Output	Catalog Number	T5		T5HO		T8		T8HO	T10	
650 Lumens	KT-EMRG-650-CFL2									
750 Lumens	KT-EMRG-750-CFL4					17-40W			17-40W	
500 Lumens	KT-EMRG-500 /B	21-28W		24W		25-32W				
700 Lumens	KT-EMRG-700					17-110W	17-40W		17-40W	17-40W
1400 Lumens	KT-EMRG-1400 /B	14-35W	14-28W	24-54W	24W-54W	17-59W	17-40W	44W, 86W		
500 Lumens	KT-EMRG-500-SL /B	21-28W		24W		25-40W				
700 Lumens	KT-EMRG-700-SL	8-28W		39W		17-40W			17-40W	
1400 Lumens	KT-EMRG-1400-SL /B	14-28W	14-21W	39W, 54W		17-25W, 32-40W, 59W	17-25W, 32-40W	86W		
500 Lumens	KT-EMRG-500-T5	8-28W				17-32W				
800 Lumens	KT-EMRG-800-T5	8-28W		39W, 54W		17-40W			17-40W	
1300 Lumens	KT-EMRG-1300-T5	14-35W	14-21W	24-54W		17-40W	17-28W			

Lamp Type	T12		T12HO	T8 U-Bend		T12 U-Bend		4-Pin CFL	
Number of Lamps Operated	1	2	1	1	2	1	2	1	2

Light Output	Catalog Number	T12		T12HO	T8 U-Bend		T12 U-Bend		4-Pin CFL	
650 Lumens	KT-EMRG-650-CFL2									
750 Lumens	KT-EMRG-750-CFL4	17-40W			32W, 40W		34W, 40W		13-42W	13-39W
500 Lumens	KT-EMRG-500 /B	25-34W			32W		34W			
700 Lumens	KT-EMRG-700	17-110W	17-40W		32W, 40W	32W, 40W	34W, 40W	34W, 40W	13-42W	13-39W
1400 Lumens	KT-EMRG-1400 /B	20-75W	20-25W, 34-40W	95-215W	32W	32W	34W, 40W	34W, 40W	13-57W	13-42W
500 Lumens	KT-EMRG-500-SL /B	30-40W			32W		34W, 40W			
700 Lumens	KT-EMRG-700-SL	17-40W			32W, 40W		34W, 40W		13-39W	
1400 Lumens	KT-EMRG-1400-SL /B	20-85W	20-40W	95-215W	32W	32W	34W, 40W	34W, 40W	13-18W, 26-57W	13-18W, 26-32W
500 Lumens	KT-EMRG-500-T5								13-26W	
800 Lumens	KT-EMRG-800-T5	17-40W							13-26W	
1300 Lumens	KT-EMRG-1300-T5	20W, 30-40W			32W		34W, 40W			

Lamp Type	4-Pin Long CFL Twin Tube		4-Pin GR10q		2-Pin	T9 Circline		T5 Circline		LED T8
Number of Lamps Operated	1	2	1	2	1	1	2	1	2	1

Light Output	Catalog Number	4-Pin Long CFL Twin Tube		4-Pin GR10q		2-Pin	T9 Circline		T5 Circline		LED T8
650 Lumens	KT-EMRG-650-CFL2					13-26W					
750 Lumens	KT-EMRG-750-CFL4	18-40W	18-36W				20W				
500 Lumens	KT-EMRG-500 /B	36W					20-32W	22W			
700 Lumens	KT-EMRG-700	18-50W	18-36W				20-40W	20-40W			
1400 Lumens	KT-EMRG-1400 /B	18-55W	18-50W	10-55W	10-38W		20-40W	20-40W	22-55W	22-40W	
500 Lumens	KT-EMRG-500-SL /B	36-40W		38W			32-40W		40-55W		
700 Lumens	KT-EMRG-700-SL	18-50W					20-40W				
1400 Lumens	KT-EMRG-1400-SL /B	18-55W	18-36W				32-40W	32-40W	22-40W	22-40W	
500 Lumens	KT-EMRG-500-T5										
800 Lumens	KT-EMRG-800-T5	18-50W					20-40W				
1300 Lumens	KT-EMRG-1300-T5	36-55W		28-38W	28W		20-40W	20W	22-55W		12-17W*

*tested and approved for use with Keystone SmartDrive T8 lamps

Specifications subject to change without notice. For complete product specifications, visit www.keystonetech.com

FLUORESCENT LAMPS

SECTION CONTENTS

T12 Linear: 72

T8 Linear: 72

T5 Linear: 73

T9 Circular: 74



With long life and exceptional reliability, our energy efficient fluorescent lamps provide the same high quality you have come to expect from Keystone. Our eco-friendly fluorescent lamps have a high CRI, lumen maintenance of up to 94% and are TCLP compliant. When installing Keystone fluorescent lamps and ballasts together, you experience the industry's best warranty program and a lighting system that is guaranteed to perform. By pairing a Keystone lamp with a Keystone ballast, customers are eligible for a 36-month Keystone Fluorescent System Warranty. The Keystone Fluorescent System Warranty extends the standard 24-month warranty included with our lamps by an additional 12 months. In the event that you need to utilize our warranty, we'll work with you to make it easy and hassle-free.



LIGHTING COLOR GUIDE

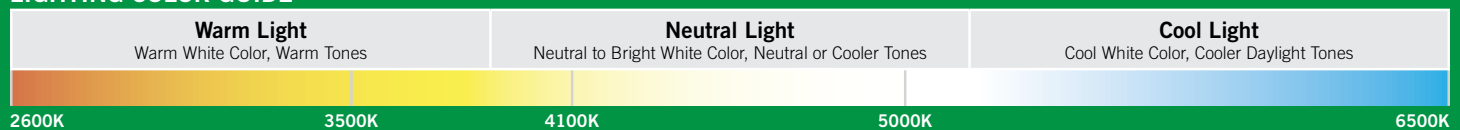

FLUORESCENT LAMPS

LINEAR

ELECTRICAL SPECIFICATIONS

T12 Linear



Nominal Wattage	Nominal Length	Catalog Number	Case Quantity	Color Temperature	CRI	Initial Lumens ¹	Mean Lumens ²	Rated Average Life ³		Lumen Maintenance
								3-hr/Start	12-hr/Start	
2012 DOE Compliant Linear T12 Lamps (Medium Bi-Pin, G13 Base)										
40W	48"	KTL-F40T12-841-CWX	30	4100K	89	2500	2250	24,000 Hours	30,000 Hours	90%

¹ Approximate initial lumens. Lumen output based upon performance after 100 hours of operating life. Measurements obtained during operation using a reference ballast under standard laboratory conditions at 25°C.

² Approximate mean lumens. Lumen output based upon performance at 40% of the lamp's rated average life. Measurements obtained during operation using a reference ballast under standard laboratory conditions at 25°C.

³ When operated on a rapid start ballast.

T8 Linear



Nominal Wattage	Nominal Length	Catalog Number	Case Quantity	Color Temperature	CRI	Initial Lumens ¹	Mean Lumens ²	Rated Average Life ³		Lumen Maintenance	CEE Qualified
								3-hr/Start	12-hr/Start		
High Performance Linear T8 Lamps (Medium Bi-Pin, G13 Base)											
17W	24"	KTL-F17T8-835-HP	25	3500K	85	1380	1300	30,000 Hours	36,000 Hours	94%	N/A
17W	24"	KTL-F17T8-841-HP	25	4100K	85	1380	1300	30,000 Hours	36,000 Hours	94%	N/A
17W	24"	KTL-F17T8-850-HP	25	5000K	85	1280	1205	30,000 Hours	36,000 Hours	94%	N/A
25W	36"	KTL-F25T8-835-HP	25	3500K	85	2275	2140	30,000 Hours	36,000 Hours	94%	N/A
25W	36"	KTL-F25T8-841-HP	25	4100K	85	2275	2140	30,000 Hours	36,000 Hours	94%	N/A
25W	36"	KTL-F25T8-850-HP	25	5000K	85	2175	2045	30,000 Hours	36,000 Hours	94%	N/A
25W	48"	KTL-F25T8ES-835-HP	25	3500K	85	2500	2350	30,000 Hours	36,000 Hours	94%	N/A
25W	48"	KTL-F25T8ES-841-HP	25	4100K	85	2500	2350	30,000 Hours	36,000 Hours	94%	N/A
25W	48"	KTL-F25T8ES-850-HP	25	5000K	85	2450	2300	30,000 Hours	36,000 Hours	94%	N/A
28W	48"	KTL-F28T8ES-835-HP	25	3500K	85	2725	2560	30,000 Hours	36,000 Hours	94%	Yes
28W	48"	KTL-F28T8ES-841-HP	25	4100K	85	2725	2560	30,000 Hours	36,000 Hours	94%	Yes
28W	48"	KTL-F28T8ES-850-HP	25	5000K	85	2700	2530	30,000 Hours	36,000 Hours	94%	Yes
32W	48"	KTL-F32T8-835-HP	25	3500K	85	3100	2915	30,000 Hours	36,000 Hours	94%	Yes
32W	48"	KTL-F32T8-841-HP	25	4100K	85	3100	2915	30,000 Hours	36,000 Hours	94%	Yes
32W	48"	KTL-F32T8-850-HP	25	5000K	85	3000	2820	30,000 Hours	36,000 Hours	94%	Yes
32W	48"	KTL-F32T8-865-HP	25	6500K	85	2985	2810	30,000 Hours	36,000 Hours	94%	Yes
32W	48"	KTL-F32T8-835-XHP	25	3500K	85	3200	3010	30,000 Hours	36,000 Hours	94%	Yes
32W	48"	KTL-F32T8-841-XHP	25	4100K	85	3200	3010	30,000 Hours	36,000 Hours	94%	Yes
32W	48"	KTL-F32T8-850-XHP	25	5000K	85	3100	2915	30,000 Hours	36,000 Hours	94%	Yes
32W	48"	KTL-F32T8-835-XL	25	3500K	85	3100	2915	42,000 Hours	48,000 Hours	94%	Yes
32W	48"	KTL-F32T8-841-XL	25	4100K	85	3100	2915	42,000 Hours	48,000 Hours	94%	Yes
32W	48"	KTL-F32T8-850-XL	25	5000K	85	3000	2820	42,000 Hours	48,000 Hours	94%	Yes

¹ Approximate initial lumens. Lumen output based upon performance after 100 hours of operating life. Measurements obtained during operation using a reference ballast under standard laboratory conditions at 25°C.

² Approximate mean lumens. Lumen output based upon performance at 40% of the lamp's rated average life. Measurements obtained during operation using a reference ballast under standard laboratory conditions at 25°C.

³ When operated on a rapid/program start ballast. Rated average life when operated on an instant start ballast: 24,000 hours at 3-hour/start and 30,000 hours at 12-hour/start.

FLUORESCENT LAMPS

LINEAR

ELECTRICAL SPECIFICATIONS

T5 Linear



Nominal Wattage	Nominal Length	Catalog Number	Case Quantity	Color Temperature	CRI	Initial Lumens ¹	Mean Lumens ²	Rated Average Life ³		Lumen Maintenance
								3-hr/Start	12-hr/Start	
High Efficiency Linear T5 Lamps (Miniature Bi-Pin, G5 Base)										
14W	24"	KTL-F14T5-835-HE	25	3500K	85	1350	1265	24,000 Hours	30,000 Hours	94%
14W	24"	KTL-F14T5-841-HE	25	4100K	85	1350	1265	24,000 Hours	30,000 Hours	94%
14W	24"	KTL-F14T5-850-HE	25	5000K	85	1250	1170	24,000 Hours	30,000 Hours	94%
21W	36"	KTL-F21T5-835-HE	25	3500K	85	2200	2060	24,000 Hours	30,000 Hours	94%
21W	36"	KTL-F21T5-841-HE	25	4100K	85	2200	2060	24,000 Hours	30,000 Hours	94%
21W	36"	KTL-F21T5-850-HE	25	5000K	85	2100	1970	24,000 Hours	30,000 Hours	94%
28W	48"	KTL-F28T5-835-HE	25	3500K	85	2900	2725	24,000 Hours	30,000 Hours	94%
28W	48"	KTL-F28T5-841-HE	25	4100K	85	2900	2725	24,000 Hours	30,000 Hours	94%
28W	48"	KTL-F28T5-850-HE	25	5000K	85	2750	2580	24,000 Hours	30,000 Hours	94%
High Output Linear T5 Lamps (Miniature Bi-Pin, G5 Base)										
49W	48"	KTL-F49T5-835-HO	25	3500K	85	4900	4600	24,000 Hours	30,000 Hours	94%
49W	48"	KTL-F49T5-841-HO	25	4100K	85	4900	4600	24,000 Hours	30,000 Hours	94%
49W	48"	KTL-F49T5-850-HO	25	5000K	85	4800	4500	24,000 Hours	30,000 Hours	94%
54W	48"	KTL-F54T5-835-HO	25	3500K	85	5000	4700	24,000 Hours	30,000 Hours	94%
54W	48"	KTL-F54T5-841-HO	25	4100K	85	5000	4700	24,000 Hours	30,000 Hours	94%
54W	48"	KTL-F54T5-850-HO	25	5000K	85	4850	4560	24,000 Hours	30,000 Hours	94%
54W	48"	KTL-F54T5-865-HO	25	6500K	85	4800	4515	24,000 Hours	30,000 Hours	94%

¹ Approximate initial lumens. Lumen output based upon performance after 100 hours of operating life. Measurements obtained during operation using a reference ballast under standard laboratory conditions at 35°C.

² Approximate mean lumens. Lumen output based upon performance at 40% of the lamp's rated average life. Measurements obtained during operation using a reference ballast under standard laboratory conditions at 35°C.

³ When operated on a program start ballast.

PHYSICAL SPECIFICATIONS

LINEAR LAMP DIMENSIONS

Lamp Type	A (Base to Base)		B (Base to End of Opposite Pin)		C (End of Pin to End of Pin)		D (Bulb Diameter)	
	Min.	Max.	Min.	Max.	Min.	Max.	Min.	Max.
48" Nominal T5	N/A	45.24"	45.42"	45.51"	N/A	45.79"	0.61"	0.63"
24" Nominal T8	N/A	23.57"	23.40"	23.50"	23.67"	23.78"	1.00"	1.04"
36" Nominal T8	N/A	35.22"	35.40"	35.50"	35.67"	35.78"	1.00"	1.04"
48" Nominal T8	N/A	47.22"	47.40"	47.50"	47.67"	47.78"	1.00"	1.04"
48" Nominal T12	N/A	47.22"	47.40"	47.50"	47.67"	47.78"	1.40"	1.59"

BASE TYPES

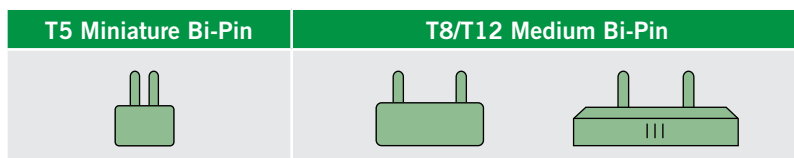

Specifications subject to change without notice. For complete product specifications, visit www.keystonetech.com

FLUORESCENT LAMPS

CIRCULAR

ELECTRICAL SPECIFICATIONS



T9 Circular

Nominal Wattage	Diameter	Catalog Number	Case Quantity	Color Temperature	CRI	Initial Lumens ¹	Mean Lumens ²	Rated Average Life ³ (3-hr/Start)	Lumen Maintenance
Circular T9 Lamps (4-Pin, G10q Base)									
22W	8"	KTL-FC8T9-CW	12	4100K	60	1120	920	10,000 Hours	82%
22W	8"	KTL-FC8T9-DL	12	6500K	76	980	805	10,000 Hours	82%
32W	12"	KTL-FC12T9-CW	12	4100K	60	1930	1582	10,000 Hours	82%
32W	12"	KTL-FC12T9-DL	12	6500K	76	1675	1373	10,000 Hours	82%
40W	16"	KTL-FC16T9-CW	12	4100K	60	2950	2420	10,000 Hours	82%
40W	16"	KTL-FC16T9-DL	12	6500K	76	2450	2010	10,000 Hours	82%

¹ Approximate initial lumens. Lumen output based upon performance after 100 hours of operating life. Measurements obtained during operation using a reference ballast under standard laboratory conditions at 25°C.

² Approximate mean lumens. Lumen output based upon performance at 40% of the lamp's rated average life. Measurements obtained during operation using a reference ballast under standard laboratory conditions at 25°C.

³ When operated on a rapid start ballast.

PHYSICAL SPECIFICATIONS

CIRCULAR LAMP DIMENSIONS

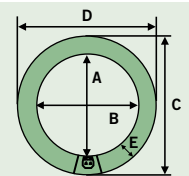

Lamp Type	A (Inner Diameter 1)		B (Inner Diameter 2)		C, D (Outer Diameter)		E (Bulb Diameter)	
	Min.	Max.	Min.	Max.	Min.	Max.	Min.	Max.
8" Nominal T9	5.87"	6.06"	5.83"	6.02"	8.09"	8.29"	1.10"	1.18"
12" Nominal T9	9.44"	9.65"	9.35"	9.55"	11.63"	11.83"	1.10"	1.18"
16" Nominal T9	13.44"	13.68"	13.33"	13.60"	15.61"	15.86"	1.10"	1.18"

BASE TYPES

T9 4-Pin

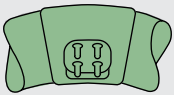



FLUORESCENT BALLASTS

SECTION CONTENTS

T12:	76
T12HO:	78
T8:	79
T8 Lamps Over 48”:	87
T5:	89
T5HO:	91
Compact Fluorescent:	92
PLL:	96
Circline:	98
2D:	100



Keystone's extensive portfolio of electronic ballasts covers all fluorescent lighting applications, including commercial, industrial, and residential type lighting fixtures. Known for dependability and energy efficiency, every Keystone electronic ballast is "burned in" at the factory to ensure both exceptional performance and superior reliability.

Smaller Case Sizes

Keystone's latest electronic ballast designs employ the smallest case styles on the market today. Smaller cases enable fixture manufacturers to design sleeker, more streamlined fixtures.

FLUORESCENT BALLASTS

T12



ELECTRICAL SPECIFICATIONS

No. of Lamps	Input Power	Catalog Number	Input Volts	Starting Method	Line Current	Min. Power Factor	Max. THD	Ballast Factor	Min. Start Temperature	Max. Case Temperature	Case Style
F14T12											
1	16W	CC1322MTP*	120V	Preheat	0.33A	0.40	15%	0.80	0°C/32°F	90°C/194°F	B2
	15W	KTEB-120-1-TP	120V	Rapid	0.24A	0.50	150%	1.00	-18°C/0°F	75°C/167°F	X1
		KTEB-120-1-TP-EMI	120V	Rapid	0.24A	0.50	150%	1.00	-18°C/0°F	75°C/167°F	L7
2	27W	KTEB-220-1-TP-EMI	120V	Rapid	0.42A	0.50	150%	0.85	-18°C/0°F	75°C/167°F	L7
F15T12											
1	17W	CC1322MTP*	120V	Preheat	0.32A	0.45	15%	0.85	0°C/32°F	90°C/194°F	B2
	14W	KTEB-125-1-TP-FC	120V	Rapid	0.21A	0.52	160%	0.82	-18°C/0°F	75°C/167°F	V2
		KTEB-132-1-TP-FC	120V	Rapid	0.21A	0.52	160%	0.82	-18°C/0°F	75°C/167°F	V2
	17W	KTEB-120-1-TP	120V	Rapid	0.26A	0.50	150%	1.00	-18°C/0°F	75°C/167°F	X1
KTEB-120-1-TP-EMI		120V	Rapid	0.26A	0.50	150%	1.00	-18°C/0°F	75°C/167°F	L7	
2	36W	KTEB-220-1-TP-EMI	120V	Rapid	0.52A	0.50	150%	1.02	-18°C/0°F	75°C/167°F	L7
F20T12											
1	17W	CC1322MTP*	120V	Preheat	0.24A	0.60	15%	0.65	0°C/32°F	90°C/194°F	B2
	18W	KTEB-120-1-TP	120V	Rapid	0.27A	0.50	150%	0.90	-18°C/0°F	75°C/167°F	X1
		KTEB-120-1-TP-EMI	120V	Rapid	0.27A	0.50	150%	0.90	-18°C/0°F	75°C/167°F	L7
	17W	KTEB-125-1-TP-FC	120V	Rapid	0.26A	0.52	160%	0.90	-18°C/0°F	75°C/167°F	V2
		KTEB-132-1-TP-FC	120V	Rapid	0.26A	0.52	160%	0.90	-18°C/0°F	75°C/167°F	V2
2	36W	KTEB-220-1-TP-EMI	120V	Rapid	0.52A	0.50	150%	0.87	-18°C/0°F	75°C/167°F	L7
F30T12											
1	21W	KTEB-125-1-TP-FC	120V	Rapid	0.29A	0.52	160%	0.66	-18°C/0°F	75°C/167°F	V2
		KTEB-132-1-TP-FC	120V	Rapid	0.29A	0.50	160%	0.66	-18°C/0°F	75°C/167°F	V2
2	47W	KTEB-240-1-TP	120V	Rapid	0.73A	0.55	150%	0.85	-18°C/0°F	75°C/167°F	L1
	58W	KTEB-240-1-TP-PIC	120V	Rapid	0.49A	0.99	10%	0.88	-18°C/0°F	75°C/167°F	L6
		KTEB-240-UV-TP-PIC	120-277V	Rapid	0.49A-0.22A	0.99	10%	0.88	-18°C/0°F	75°C/167°F	L6
F34T12											
1	24W	KTEB-125-1-TP-FC	120V	Rapid	0.34A	0.52	160%	0.70	-18°C/0°F	75°C/167°F	V2
		KTEB-132-1-TP-FC	120V	Rapid	0.34A	0.52	160%	0.70	-18°C/0°F	75°C/167°F	V2
F40T12											
1	25W	KTEB-125-1-TP-FC	120V	Rapid	0.34A	0.56	160%	0.65	-18°C/0°F	75°C/167°F	V2
		KTEB-132-1-TP-FC	120V	Rapid	0.34A	0.56	160%	0.65	-18°C/0°F	75°C/167°F	V2
2	36W	KTEB-140-1-TP-EMI	120V	Rapid	0.53A	0.50	150%	0.88	-18°C/0°F	75°C/167°F	L7
	58W	KTEB-240-1-TP	120V	Rapid	0.87A	0.50	150%	0.75	-18°C/0°F	75°C/167°F	L1
	74W	KTEB-240-1-TP-PIC	120V	Rapid	0.62A	0.99	10%	0.88	-18°C/0°F	75°C/167°F	L6
		KTEB-240-UV-TP-PIC	120V	Rapid	0.62-0.27A	0.99	10%	0.88	-18°C/0°F	75°C/167°F	L6
F40T12 (34W ENERGY SAVER)											
1	30W	KTEB-140-1-TP-EMI	120V	Rapid	0.45A	0.50	150%	0.88	-18°C/0°F	75°C/167°F	L7
2	48W	KTEB-240-1-TP	120V	Rapid	0.76A	0.50	150%	0.73	-18°C/0°F	75°C/167°F	L1
	63W	KTEB-240-1-TP-PIC	120V	Rapid	0.53A	0.99	10%	0.85	-18°C/0°F	75°C/167°F	L6
	74W	KTEB-240-UV-TP-PIC	120-277V	Rapid	0.62A-0.27A	0.98	10%	0.88	-18°C/0°F	75°C/167°F	L6
F48T12 (40W)											
2	64W	KTEB-275-1-TP-PIC-SL	120V	Instant	0.68A	0.99	12%	0.92	-18°C/0°F	75°C/167°F	L3
		KTEB-275-UV-TP-PIC	120-277V	Instant	0.68-0.30A	0.99	12%	0.92	-18°C/0°F	75°C/167°F	AA1
		KTEB-275-UV-TP-PIC-SL	120-277V	Instant	0.68-0.30A	0.99	12%	0.92	-18°C/0°F	75°C/167°F	L3
F48T12 (30W ENERGY SAVER)											
2	64W	KTEB-275-1-TP-PIC-SL	120V	Instant	0.60A	0.98	12%	0.92	16°C/60°F	75°C/167°F	L3
		KTEB-275-UV-TP-PIC	120-277V	Instant	0.60-0.26A	0.95	12%	0.92	16°C/60°F	75°C/167°F	AA1
		KTEB-275-UV-TP-PIC-SL	120-277V	Instant	0.60-0.26A	0.95	12%	0.92	16°C/60°F	75°C/167°F	L3

*electromagnetic ballast

Specifications subject to change without notice. For complete product specifications, visit www.keystonetech.com



FLUORESCENT BALLASTS

T12

ELECTRICAL SPECIFICATIONS

No. of Lamps	Input Power	Catalog Number	Input Volts	Starting Method	Line Current	Min. Power Factor	Max. THD	Ballast Factor	Min. Start Temperature	Max. Case Temperature	Case Style
F72T12											
1	67W	KTEB-275-1-TP-PIC-SL	120V	Instant	0.60A	0.98	12%	1.05	-18°C/0°F	75°C/167°F	L3
		KTEB-275-UV-TP-PIC	120-277V	Instant	0.60-0.26A	0.95	12%	1.05	-18°C/0°F	75°C/167°F	AA1
		KTEB-275-UV-TP-PIC-SL	120-277V	Instant	0.60-0.26A	0.95	12%	1.05	-18°C/0°F	75°C/167°F	L3
2	107W	KTEB-275-1-TP-PIC-SL	120V	Instant	0.92A	0.98	12%	0.95	-18°C/0°F	75°C/167°F	L3
		KTEB-275-UV-TP-PIC	120-277V	Instant	0.92-0.40A	0.95	12%	0.95	-18°C/0°F	75°C/167°F	AA1
		KTEB-275-UV-TP-PIC-SL	120-277V	Instant	0.92-0.40A	0.95	12%	0.95	-18°C/0°F	75°C/167°F	L3
F96T12											
1	83W	KTEB-275-1-TP-PIC-SL	120V	Instant	0.69A	0.98	12%	1.05	-18°C/0°F	75°C/167°F	L3
		KTEB-275-UV-TP-PIC	120-277V	Instant	0.31-0.69A	0.98	12%	1.05	-18°C/0°F	75°C/167°F	AA1
		KTEB-275-UV-TP-PIC-SL	120-277V	Instant	0.31-0.69A	0.98	12%	1.05	-18°C/0°F	75°C/167°F	L3
2	133W	KTEB-275-1-TP-PIC-SL	120V	Instant	1.15A	0.98	12%	0.86	-18°C/0°F	75°C/167°F	L3
		KTEB-275-UV-TP-PIC	120-277V	Instant	1.15-0.49A	0.98	12%	0.86	-18°C/0°F	75°C/167°F	AA1
		KTEB-275-UV-TP-PIC-SL	120-277V	Instant	1.15-0.49A	0.98	12%	0.86	-18°C/0°F	75°C/167°F	L3
F96T12 (60W ENERGY SAVER)											
1	71W	KTEB-275-1-TP-PIC-SL	120V	Instant	0.60A	0.98	12%	1.12	16°C/60°F	75°C/167°F	L3
	72W	KTEB-275-UV-TP-PIC	120-277V	Instant	0.27-0.60A	0.98	12%	1.12	16°C/60°F	75°C/167°F	AA1
		KTEB-275-UV-TP-PIC-SL	120-277V	Instant	0.27-0.60A	0.98	12%	1.12	16°C/60°F	75°C/167°F	L3
2	115W	KTEB-275-1-TP-PIC-SL	120V	Instant	0.97A	0.98	12%	0.95	16°C/60°F	75°C/167°F	L3
		KTEB-275-UV-TP-PIC	120-277V	Instant	0.97-0.42A	0.98	12%	0.95	16°C/60°F	75°C/167°F	AA1
		KTEB-275-UV-TP-PIC-SL	120-277V	Instant	0.97-0.42A	0.98	12%	0.95	16°C/60°F	75°C/167°F	L3

CASE STYLES

CASE AA

Material: Steel

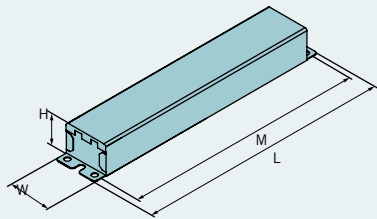

Case Style	Mounting	Length	Width	Height
AA1	11.00"	11.80"	2.15"	1.61"

CASE B

Material: Steel

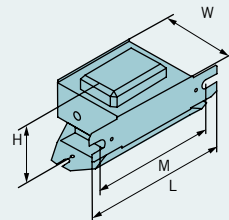

Case Style	Mounting	Length	Width	Height
B2	2.50"	3.15"	1.14"	1.77"

CASE L

Material: Steel

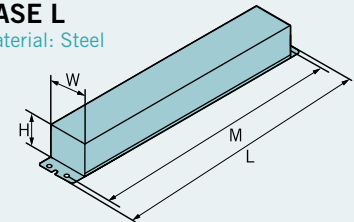

Case Style	Mounting	Length	Width	Height
L1	6.00"	6.46"	1.89"	1.00"
L3	8.90"	9.45"	1.80"	1.37"
L6	8.90"	9.50"	1.38"	1.18"
L7	6.00"	6.46"	1.37"	1.00"

CASE V

Material: Steel

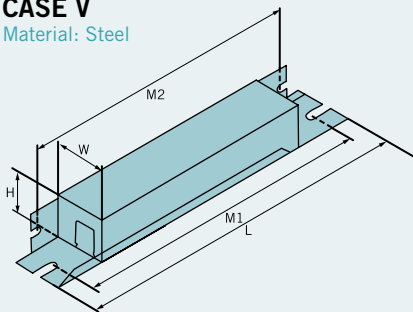

Case Style	M1	M2	Length	Width	Height
V2	5.63"	5.90"	6.46"	0.92"	0.75"

CASE X

Material: Plastic

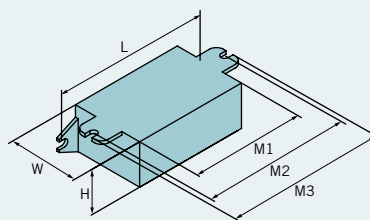

Case Style	Mounting	Length	Width	Height
X1	2.80"	3.07"	1.16"	1.00"

Specifications subject to change without notice. For complete product specifications, visit www.keystonetech.com

FLUORESCENT BALLASTS

T12HO



ELECTRICAL SPECIFICATIONS

No. of Lamps	Input Power	Catalog Number	Input Volts	Starting Method	Line Current	Min. Power Factor	Max. THD	Ballast Factor	Min. Start Temperature	Max. Case Temperature	Case Style
F24T12HO											
1	35W	KTEB-260HO-UV-PS-SL	120-277V	Program	0.27-0.12A	0.85	10%	1.03	-30°C/-22°F	90°C/194°F	L35
2		KTEB-260HO-UV-PS-SL	120-277V	Program	0.50-0.22A	0.95	10%	1.00	-30°C/-22°F	90°C/194°F	L35
F36T12HO											
1	45W	KTEB-260HO-UV-PS-SL	120-277V	Program	0.40-0.18A	0.90	10%	1.03	-30°C/-22°F	90°C/194°F	L35
2		KTEB-260HO-UV-PS-SL	120-277V	Program	0.75-0.32A	0.98	10%	1.00	-30°C/-22°F	90°C/194°F	L35
F48T12HO											
1	62W	KTEB-260HO-UV-PS-SL	120-277V	Program	0.53-0.23A	0.95	10%	1.00	-30°C/-22°F	90°C/194°F	L35
2	104W	KTEB-2110-1-TP-PIC	120V	Rapid	0.88A	0.98	10%	0.90	-29°C/-20°F	75°C/167°F	AA1
		KTEB-2110-UV-TP-PIC	120-277V	Rapid	0.88-0.38A	0.95	20%	0.90	-29°C/-20°F	75°C/167°F	AA1
	60W	KTEB-2110-UV-TP-PIC-SL	120-277V	Program	0.80-0.34A	0.97	10%	0.83	-29°C/-20°F	90°C/194°F	D11
	120W	KTEB-260HO-UV-PS-SL	120-277V	Program	1.02-0.43A	0.98	10%	1.00	-30°C/-22°F	90°C/194°F	L35
F48T12HO (55W ENERGY SAVER)											
1	55W	KTEB-260HO-UV-PS-SL	120-277V	Program	0.47-0.20A	0.95	10%	0.93	16°C/60°F	90°C/194°F	L35
2	105W	KTEB-260HO-UV-PS-SL	120-277V	Program	0.89-0.38A	0.98	10%	0.93	16°C/60°F	90°C/194°F	L35
F60T12HO											
1	79W	KTEB-260HO-UV-PS-SL	120-277V	Program	0.66-0.29A	0.95	10%	1.22	-30°C/-22°F	90°C/194°F	L35
2	132W	KTEB-2110-1-TP-PIC	120V	Rapid	1.10A	0.98	10%	0.90	-29°C/-20°F	75°C/167°F	AA1
		KTEB-2110-UV-TP-PIC	120-277V	Rapid	1.10-0.48A	0.95	20%	0.90	-29°C/-20°F	75°C/167°F	AA1
	75W	KTEB-2110-UV-TP-PIC-SL	120-277V	Program	0.98-0.42A	0.97	10%	0.82	-29°C/-20°F	90°C/194°F	D11
F72T12HO											
2	154W	KTEB-2110-1-TP-PIC	120V	Rapid	1.30A	0.98	10%	0.90	-29°C/-20°F	75°C/167°F	AA1
		KTEB-2110-UV-TP-PIC	120-277V	Rapid	1.30-0.56A	0.95	20%	0.90	-29°C/-20°F	75°C/167°F	AA1
	85W	KTEB-2110-UV-TP-PIC-SL	120-277V	Program	1.17-0.50A	0.97	10%	0.85	-29°C/-20°F	90°C/194°F	D11
F96T12HO											
1	104W	KTEB-2110-1-TP-PIC	120V	Rapid	0.88A	0.98	10%	0.92	-29°C/-20°F	75°C/167°F	AA1
		KTEB-2110-UV-TP-PIC	120-277V	Rapid	0.88-0.38A	0.95	20%	0.92	-29°C/-20°F	75°C/167°F	AA1
	110W	KTEB-2110-UV-TP-PIC-SL	120-277V	Program	0.80-0.37A	0.90	15%	0.91	-29°C/-20°F	90°C/194°F	D11
	120W	KTEB-260HO-UV-PS-SL	120-277V	Program	1.02-0.43A	0.98	10%	1.00	16°C/60°F	90°C/194°F	L35
2	196W	KTEB-2110-1-TP-PIC	120V	Rapid	1.65A	0.98	10%	0.90	-29°C/-20°F	75°C/167°F	AA1
		KTEB-2110-UV-TP-PIC	120-277V	Rapid	1.65-0.72A	0.95	20%	0.90	-29°C/-20°F	75°C/167°F	AA1
	110W	KTEB-2110-UV-TP-PIC-SL	120-277V	Program	1.54-0.66A	0.97	10%	0.88	-29°C/-20°F	90°C/194°F	D11
F96T12HO (95W ENERGY SAVER)											
1	95W	KTEB-2110-UV-TP-PIC-SL	120-277V	Program	0.60-0.32A	0.90	15%	0.91	-18°C/0°F	90°C/194°F	D11
	102W	KTEB-260HO-UV-PS-SL	120-277V	Program	0.86-0.37A	0.98	10%	1.00	-30°C/-22°F	90°C/194°F	L35
2	164W	KTEB-2110-1-TP-PIC	120V	Rapid	1.38A	0.98	10%	0.90	16°C/60°F	75°C/167°F	AA1
		KTEB-2110-UV-TP-PIC	120-277V	Rapid	1.38-0.60A	0.95	20%	0.90	16°C/60°F	75°C/167°F	AA1
	95W	KTEB-2110-UV-TP-PIC-SL	120-277V	Program	1.28-0.74A	0.97	10%	0.88	-18°C/0°F	90°C/194°F	D11

CASE STYLES

CASE AA

Material: Steel

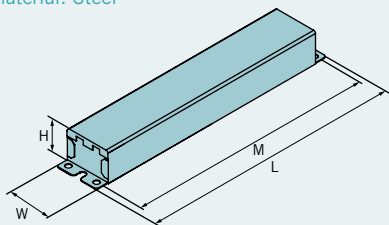

Case Style	Mounting	Length	Width	Height
AA1	11.00"	11.80"	2.15"	1.61"

CASE L

Material: Steel

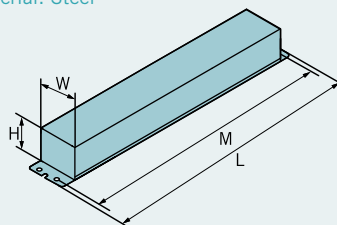

Case Style	Mounting	Length	Width	Height
L35	8.90"	9.50"	2.30"	1.50"

CASE D

Material: Steel

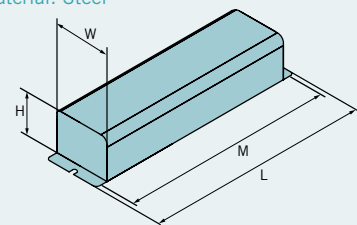

Case Style	Mounting	Length	Width	Height
D11	8.84"	9.50"	2.36"	1.69"

Specifications subject to change without notice. For complete product specifications, visit www.keystonetech.com



FLUORESCENT BALLASTS

T8

ELECTRICAL SPECIFICATIONS

No. of Lamps	Input Power	Catalog Number	Input Volts	Starting Method	Line Current	Min. Power Factor	Max. THD	Ballast Factor	Min. Start Temperature	Max. Case Temperature	Case Style
F13T8											
1	16W	KTEB-126-1-TP	120V	Rapid	0.27A	0.50	160%	1.10	-18°C/0°F	75°C/167°F	S1
		KTEB-126-1-TP-LC	120V	Rapid	0.27A	0.50	160%	1.10	-18°C/0°F	75°C/167°F	L2
F14T8											
1	16W	CC1322MTP*	120V	Preheat	0.33A	0.40	15%	0.80	0°C/32°F	90°C/194°F	B2
	15W	KTEB-120-1-TP	120V	Rapid	0.24A	0.50	150%	1.10	-18°C/0°F	75°C/167°F	X1
		KTEB-120-1-TP-EMI	120V	Rapid	0.24A	0.50	150%	1.10	-18°C/0°F	75°C/167°F	L7
2	27W	KTEB-220-1-TP-EMI	120V	Rapid	0.42A	0.50	150%	0.85	-18°C/0°F	75°C/167°F	L7
F15T8											
1	17W	CC1322MTP*	120V	Preheat	0.27A	0.50	15%	0.82	0°C/32°F	90°C/194°F	B2
		KTEB-120-1-TP	120V	Rapid	0.26A	0.50	150%	1.10	-18°C/0°F	75°C/167°F	X1
		KTEB-120-1-TP-EMI	120V	Rapid	0.26A	0.50	150%	1.10	-18°C/0°F	75°C/167°F	L7
	16W	KTEB-125-1-TP-FC	120V	Rapid	0.27A	0.48	160%	1.00	-18°C/0°F	75°C/167°F	V2
	17W	KTEB-126-1-TP	120V	Rapid	0.27A	0.50	150%	1.00	-18°C/0°F	75°C/167°F	S1
		KTEB-126-1-TP-LC	120V	Rapid	0.27A	0.50	150%	1.00	-18°C/0°F	75°C/167°F	L2
		KTEB-132-1-TP-EMI	120V	Rapid	0.27A	0.50	150%	1.10	-18°C/0°F	75°C/167°F	L7
	16W	KTEB-132-1-TP-FC	120V	Rapid	0.27A	0.48	160%	1.00	-18°C/0°F	75°C/167°F	V2
	17W	KTEB-232-1-IS-N	120V	Instant	0.15A	0.96	10%	0.91	-18°C/0°F	75°C/167°F	L9
	20W	KTEB-232RIS-1-TP-SL	120V	Instant	0.32A	0.52	150%	0.90	-18°C/0°F	75°C/167°F	N3
2	32W	KTEB-220-1-TP-EMI	120V	Rapid	0.48A	0.50	150%	1.00	-18°C/0°F	75°C/167°F	L7
	25W	KTEB-232-1-IS-N	120V	Instant	0.21A	0.97	10%	0.77	-18°C/0°F	75°C/167°F	L9
	28W	KTEB-232RIS-1-TP-SL	120V	Instant	0.43A	0.50	160%	0.80	-18°C/0°F	75°C/167°F	N3
	29W	KTEB-2C72-1-TP	120V	Rapid	0.45A	0.50	160%	0.80	-18°C/0°F	75°C/167°F	L1
F17T8											
1	19W	KTEB-120-1-TP	120V	Rapid	0.29A	0.50	150%	1.15	-18°C/0°F	75°C/167°F	X1
		KTEB-120-1-TP-EMI	120V	Rapid	0.29A	0.50	150%	1.15	-18°C/0°F	75°C/167°F	L7
	18W	KTEB-125-1-TP-FC	120V	Rapid	0.29A	0.50	160%	1.00	-18°C/0°F	75°C/167°F	V2
	20W	KTEB-126-1-TP	120V	Rapid	0.31A	0.50	150%	1.00	-18°C/0°F	75°C/167°F	S1
		KTEB-126-1-TP-LC	120V	Rapid	0.31A	0.50	150%	1.00	-18°C/0°F	75°C/167°F	L2
		KTEB-132-1-TP-EMI	120V	Rapid	0.31A	0.50	150%	1.15	-18°C/0°F	75°C/167°F	L7
	18W	KTEB-132-1-TP-FC	120V	Rapid	0.29A	0.50	160%	1.00	-18°C/0°F	75°C/167°F	V2
	20W	KTEB-132-UV-PS-N-P	120-277V	Program	0.17-0.08A	0.95	10%	0.88	-18°C/0°F	75°C/167°F	L30
	21W	KTEB-132-UV-TP-SL	120-277V	Rapid	0.18-0.08A	0.96	12%	1.00	-18°C/0°F	75°C/167°F	L34
	22W	KTEB-232-1-IS-N	120V	Instant	0.19A	0.97	10%	1.18	-18°C/0°F	75°C/167°F	L9
	20W	KTEB-232-3-IS-N	347V	Instant	0.07A	0.90	15%	1.07	-18°C/0°F	90°C/194°F	L5
	25W	KTEB-232RIS-1-TP-SL	120V	Instant	0.39A	0.54	150%	1.10	-18°C/0°F	75°C/167°F	N3
	28W	KTEB-232-UV-IS-H-P	120-277V	Instant	0.26-0.13A	0.92	15%	1.38	-18°C/0°F	75°C/167°F	L4
	18W	KTEB-232-UV-IS-L-P	120-277V	Instant	0.15-0.07A	0.95	12%	1.05	-18°C/0°F	75°C/167°F	L4
	21W	KTEB-232-UV-IS-N-P	120-277V	Instant	0.17-0.08A	0.95	15%	1.25	-18°C/0°F	75°C/167°F	L4
	30W	KTEB-232-UV-PS-H-P	120-277V	Program	0.25-0.12A	0.93	15%	1.44	-18°C/0°F	75°C/167°F	L5
	21W	KTEB-232-UV-PS-L-P	120-277V	Program	0.17-0.08A	0.95	15%	0.84	-18°C/0°F	75°C/167°F	L4
	24W	KTEB-232-UV-PS-N-P	120-277V	Program	0.38-0.17A	0.97	12%	0.99	-18°C/0°F	75°C/167°F	L4

*electromagnetic ballast

Specifications subject to change without notice. For complete product specifications, visit www.keystonetech.com

Keystone Technologies, LLC | North Wales, PA 19454 | Phone (800) 464-2680 | [keystonetech.com](http://www.keystonetech.com)

FLUORESCENT BALLASTS

T8



ELECTRICAL SPECIFICATIONS

No. of Lamps	Input Power	Catalog Number	Input Volts	Starting Method	Line Current	Min. Power Factor	Max. THD	Ballast Factor	Min. Start Temperature	Max. Case Temperature	Case Style
F17T8 (continued)											
2	37W	KTEB-220-1-TP-EMI	120V	Rapid	0.54A	0.50	150%	1.02	-18°C/0°F	75°C/167°F	L7
	34W	KTEB-232-1-IS-N	120V	Instant	0.28A	0.98	10%	0.88	-18°C/0°F	75°C/167°F	L9
	32W	KTEB-232-3-IS-N	347V	Instant	0.09A	0.90	10%	0.91	-18°C/0°F	90°C/194°F	L5
	34W	KTEB-232RIS-1-TP-SL	120V	Instant	0.50A	0.54	150%	0.93	-18°C/0°F	75°C/167°F	N3
	32W	KTEB-232SIS-1-TP	120V	Instant	0.52A	0.50	150%	0.95	-18°C/0°F	75°C/167°F	L9
	41W	KTEB-232-UV-IS-H-P	120-277V	Instant	0.38-0.18A	0.95	15%	1.18	-18°C/0°F	75°C/167°F	L4
	25W	KTEB-232-UV-IS-L-P	120-277V	Instant	0.21-0.10A	0.95	12%	0.80	-18°C/0°F	75°C/167°F	L4
	30W	KTEB-232-UV-IS-N-P	120-277V	Instant	0.24-0.12A	0.95	12%	0.90	-18°C/0°F	75°C/167°F	L4
	28-65W	KTEB-232-UV-PS-CDIM*	120-277V	Program	0.52-0.12A	0.90	20%	0.85	10°C/50°F	65°C/149°F	U4
	44W	KTEB-232-UV-PS-H-P	120-277V	Program	0.37-0.16A	0.96	12%	1.18	-18°C/0°F	75°C/167°F	L5
	31W	KTEB-232-UV-PS-L-P	120-277V	Program	0.25-0.12A	0.97	12%	0.77	-18°C/0°F	75°C/167°F	L4
	35W	KTEB-232-UV-PS-N-P	120-277V	Program	0.30-0.13A	0.96	10%	0.88	-18°C/0°F	75°C/167°F	L4
	28-65W	KTEB-232-UV-PS-VDIM**	120-277V	Program	0.52-0.12A	0.90	20%	0.85	10°C/50°F	65°C/149°F	U4
	36W	KTEB-2C72-1-TP	120V	Rapid	0.60A	0.50	160%	0.95	-18°C/0°F	75°C/167°F	L1
	46W	KTEB-332-UV-IS-H-P	120-277V	Instant	0.41-0.19A	0.95	15%	1.20	-18°C/0°F	75°C/167°F	L4
	35W	KTEB-332-UV-IS-L-P	120-277V	Instant	0.28-0.14A	0.92	15%	0.94	-18°C/0°F	75°C/167°F	L4
	38W	KTEB-332-UV-IS-N-P	120-277V	Instant	0.31-0.14A	0.93	15%	1.01	-18°C/0°F	75°C/167°F	L4
	49W	KTEB-332-UV-PS-H-P	120-277V	Program	0.40-0.19A	0.95	15%	1.30	-18°C/0°F	75°C/167°F	L5
36W	KTEB-332-UV-PS-L-P	120-277V	Program	0.30-0.14A	0.95	15%	0.84	-18°C/0°F	75°C/167°F	L5	
41W	KTEB-332-UV-PS-N-P	120-277V	Program	0.33-0.15A	0.95	10%	0.98	-18°C/0°F	75°C/167°F	L5	
3	60W	KTEB-332-UV-IS-H-P	120-277V	Instant	0.54-0.24A	0.97	12%	1.19	-18°C/0°F	75°C/167°F	L4
	42W	KTEB-332-UV-IS-L-P	120-277V	Instant	0.35-0.15A	0.95	12%	0.82	-18°C/0°F	75°C/167°F	L4
	46W	KTEB-332-UV-IS-N-P	120-277V	Instant	0.39-0.17A	0.97	10%	0.92	-18°C/0°F	75°C/167°F	L4
	62W	KTEB-332-UV-PS-H-P	120-277V	Program	0.52-0.23A	0.96	12%	1.18	-18°C/0°F	75°C/167°F	L5
	45W	KTEB-332-UV-PS-L-P	120-277V	Program	0.37-0.17A	0.96	12%	0.77	-18°C/0°F	75°C/167°F	L5
	51W	KTEB-332-UV-PS-N-P	120-277V	Program	0.42-0.19A	0.97	10%	0.90	-18°C/0°F	75°C/167°F	L5
	50W	KTEB-432-3-IS-N	347V	Instant	0.15A	0.90	12%	0.98	-18°C/0°F	90°C/194°F	L5
	60W	KTEB-432RIS-1-TP-SL	120V	Instant	0.96A	0.50	140%	0.88	-18°C/0°F	75°C/167°F	L11
	66W	KTEB-432-UV-IS-H-P	120-277V	Instant	0.52-0.24A	0.95	10%	0.27	-18°C/0°F	75°C/167°F	L5
	47W	KTEB-432-UV-IS-L-P	120-277V	Instant	0.39-0.17A	0.95	15%	0.90	-18°C/0°F	75°C/167°F	L4
	51W	KTEB-432-UV-IS-N-P	120-277V	Instant	0.43-0.18A	0.95	15%	0.99	-18°C/0°F	75°C/167°F	L4
	49W	KTEB-432-UV-PS-L-P	120-277V	Program	0.40-0.18A	0.96	12%	0.82	-18°C/0°F	75°C/167°F	L5
53W	KTEB-432-UV-PS-N-P	120-277V	Program	0.45-0.21A	0.95	10%	0.94	-18°C/0°F	75°C/167°F	L5	
4	60W	KTEB-432RIS-1-TP-SL	120V	Instant	0.96A	0.50	140%	0.88	-18°C/0°F	75°C/167°F	L11
	60W	KTEB-432-3-IS-N	347V	Instant	0.19A	0.90	10%	0.89	-18°C/0°F	90°C/194°F	L5
	79W	KTEB-432-UV-IS-H-P	120-277V	Instant	0.63-0.29A	0.97	10%	1.20	-18°C/0°F	75°C/167°F	L5
	53W	KTEB-432-UV-IS-L-P	120-277V	Instant	0.44-0.20A	0.98	10%	0.79	-18°C/0°F	75°C/167°F	L4
	59W	KTEB-432-UV-IS-N-P	120-277V	Instant	0.49-0.22A	0.97	10%	0.90	-18°C/0°F	75°C/167°F	L4
	56W	KTEB-432-UV-PS-L-P	120-277V	Program	0.46-0.21A	0.97	12%	0.74	-18°C/0°F	75°C/167°F	L5
	63W	KTEB-432-UV-PS-N-P	120-277V	Program	0.52-0.24A	0.97	10%	0.90	-18°C/0°F	75°C/167°F	L5
F18T8											
1	18W	KTEB-120-1-TP	120V	Rapid	0.27A	0.50	150%	0.95	-18°C/0°F	75°C/167°F	X1
		KTEB-120-1-TP-EMI	120V	Rapid	0.27A	0.50	150%	0.95	-18°C/0°F	75°C/167°F	L7
		KTEB-126-1-TP	120V	Rapid	0.28A	0.50	160%	0.95	-18°C/0°F	75°C/167°F	S1
		KTEB-126-1-TP-LC	120V	Rapid	0.28A	0.50	160%	0.95	-18°C/0°F	75°C/167°F	L2
2	34W	KTEB-220-1-TP-EMI	120V	Rapid	0.50A	0.50	150%	0.92	-18°C/0°F	75°C/167°F	L7

* 0-10V or phase control dimming **0-10V dimming

Specifications subject to change without notice. For complete product specifications, visit www.keystonetech.com

FLUORESCENT BALLASTS

T8

ELECTRICAL SPECIFICATIONS

No. of Lamps	Input Power	Catalog Number	Input Volts	Starting Method	Line Current	Min. Power Factor	Max. THD	Ballast Factor	Min. Start Temperature	Max. Case Temperature	Case Style	
F25T8												
1	21W	KTEB-125-1-TP-FC	120V	Rapid	0.35A	0.50	160%	0.85	-18°C/0°F	75°C/167°F	V2	
	28W	KTEB-126-1-TP	120V	Rapid	0.41A	0.50	130%	0.95	-18°C/0°F	75°C/167°F	S1	
		KTEB-126-1-TP-LC	120V	Rapid	0.41A	0.50	130%	0.95	-18°C/0°F	75°C/167°F	L2	
	28W	KTEB-132-1-TP-EMI	120V	Rapid	0.41A	0.50	130%	1.05	-18°C/0°F	75°C/167°F	L7	
	21W	KTEB-132-1-TP-FC	120V	Rapid	0.35A	0.50	160%	0.85	-18°C/0°F	75°C/167°F	V2	
	9-27W	KTEB-132-UV-PS-N-P-SDIM3	120-277V	Program	0.22-0.04A	0.90	15%	0.92	10°C/50°F	75°C/167°F	L5	
	27W	KTEB-132-UV-PS-N-P	120-277V	Program	0.22-0.10A	0.96	10%	0.88	-18°C/0°F	75°C/167°F	L30	
	29W	KTEB-232-1-IS-N	120V	Instant	0.25A	0.98	10%	1.10	-18°C/0°F	75°C/167°F	L9	
	28W	KTEB-232-3-IS-N	347V	Instant	0.08A	0.90	10%	1.05	-18°C/0°F	90°C/194°F	L5	
	27W	KTEB-232RIS-1-TP-SL	120V	Instant	0.45A	0.50	150%	0.95	-18°C/0°F	75°C/167°F	N3	
	38W	KTEB-232-UV-IS-H-P	120-277V	Instant	0.35-0.16A	0.94	15%	1.38	-18°C/0°F	75°C/167°F	L4	
	23W	KTEB-232-UV-IS-L-P	120-277V	Instant	0.19-0.09A	0.97	12%	0.92	-18°C/0°F	75°C/167°F	L4	
	27W	KTEB-232-UV-IS-N-P	120-277V	Instant	0.23-0.10A	0.97	12%	1.10	-18°C/0°F	75°C/167°F	L4	
	38W	KTEB-232-UV-PS-H-P	120-277V	Program	0.32-0.14A	0.95	15%	1.33	-18°C/0°F	75°C/167°F	L5	
	28W	KTEB-232-UV-PS-L-P	120-277V	Program	0.23-0.10A	0.97	12%	0.88	-18°C/0°F	75°C/167°F	L4	
	32W	KTEB-232-UV-PS-N-P	120-277V	Program	0.26-0.12A	0.95	12%	0.99	-18°C/0°F	75°C/167°F	L4	
	2	46W	KTEB-232-1-IS-N	120V	Instant	0.39A	0.99	10%	0.88	-18°C/0°F	75°C/167°F	L9
		43W	KTEB-232-3-IS-N	347V	Instant	0.13A	0.90	10%	0.89	-18°C/0°F	90°C/194°F	L5
		47W	KTEB-232RIS-1-TP-SL	120V	Instant	0.65A	0.59	150%	0.90	-18°C/0°F	75°C/167°F	N3
		42W	KTEB-232SIS-1-TP	120V	Instant	0.65A	0.50	150%	0.85	-18°C/0°F	75°C/167°F	L9
28-65W		KTEB-232-UV-PS-CDIM*	120-277V	Program	0.52-0.12A	0.90	20%	0.95	10°C/50°F	65°C/149°F	U4	
61W		KTEB-232-UV-IS-H-P	120-277V	Instant	0.51-0.22A	0.97	10%	1.18	-18°C/0°F	75°C/167°F	L4	
37W		KTEB-232-UV-IS-L-P	120-277V	Instant	0.30-0.14A	0.97	10%	0.79	-18°C/0°F	75°C/167°F	L4	
44W		KTEB-232-UV-IS-N-P	120-277V	Instant	0.36-0.16A	0.97	10%	0.88	-18°C/0°F	75°C/167°F	L4	
60W		KTEB-232-UV-PS-H-P	120-277V	Program	0.50-0.22A	0.97	12%	1.15	-18°C/0°F	75°C/167°F	L5	
41W		KTEB-232-UV-PS-L-P	120-277V	Program	0.35-0.15A	0.98	10%	0.74	-18°C/0°F	75°C/167°F	L4	
47W		KTEB-232-UV-PS-N-P	120-277V	Program	0.40-0.18A	0.95	10%	0.86	-18°C/0°F	75°C/167°F	L4	
28-65W		KTEB-232-UV-PS-VDIM**	120-277V	Program	0.52-0.12A	0.90	20%	0.95	10°C/50°F	65°C/149°F	U4	
52W		KTEB-240-1-TP	120V	Rapid	0.81A	0.50	150%	1.05	-18°C/0°F	75°C/167°F	L1	
48W		KTEB-2C72-1-TP	120V	Rapid	0.72A	0.50	150%	0.95	-18°C/0°F	75°C/167°F	L1	
64W		KTEB-332-UV-IS-H-P	120-277V	Instant	0.57-0.24A	0.97	12%	1.25	-18°C/0°F	75°C/167°F	L4	
47W		KTEB-332-UV-IS-L-P	120-277V	Instant	0.39-0.18A	0.96	12%	0.88	-18°C/0°F	75°C/167°F	L4	
54W		KTEB-332-UV-IS-N-P	120-277V	Instant	0.45-0.20A	0.96	12%	1.01	-18°C/0°F	75°C/167°F	L4	
68W		KTEB-332-UV-PS-H-P	120-277V	Program	0.57-0.25A	0.97	12%	1.33	-18°C/0°F	75°C/167°F	L5	
50W		KTEB-332-UV-PS-L-P	120-277V	Program	0.40-0.18A	0.97	12%	0.88	-18°C/0°F	75°C/167°F	L5	
54W		KTEB-332-UV-PS-N-P	120-277V	Program	0.44-0.20A	0.97	10%	0.95	-18°C/0°F	75°C/167°F	L5	
3	83W	KTEB-332-UV-IS-H-P	120-277V	Instant	0.69-0.30A	0.98	10%	1.16	-18°C/0°F	75°C/167°F	L4	
	58W	KTEB-332-UV-IS-L-P	120-277V	Instant	0.48-0.21A	0.98	10%	0.77	-18°C/0°F	75°C/167°F	L4	
	66W	KTEB-332-UV-IS-N-P	120-277V	Instant	0.56-0.24A	0.97	10%	0.87	-18°C/0°F	75°C/167°F	L4	
	87W	KTEB-332-UV-PS-H-P	120-277V	Program	0.73-0.32A	0.98	10%	1.15	-18°C/0°F	75°C/167°F	L5	
	62W	KTEB-332-UV-PS-L-P	120-277V	Program	0.51-0.23A	0.98	10%	0.74	-18°C/0°F	75°C/167°F	L5	
	69W	KTEB-332-UV-PS-N-P	120-277V	Program	0.58-0.26A	0.98	10%	0.88	-18°C/0°F	75°C/167°F	L5	
	63W	KTEB-432RIS-1-TP-SL	120V	Instant	1.04A	0.50	130%	0.84	-18°C/0°F	75°C/167°F	L11	
	70W	KTEB-432-3-IS-N	347V	Instant	0.21A	0.90	10%	0.96	-18°C/0°F	90°C/194°F	L5	
	89W	KTEB-432-UV-IS-H-P	120-277V	Instant	0.75-0.32A	0.97	10%	1.26	-18°C/0°F	75°C/167°F	L4	
	63W	KTEB-432-UV-IS-L-P	120-277V	Instant	0.53-0.23A	0.97	12%	0.82	-18°C/0°F	75°C/167°F	L4	
	70W	KTEB-432-UV-IS-N-P	120-277V	Instant	0.58-0.25A	0.97	12%	0.91	-18°C/0°F	75°C/167°F	L4	
	66W	KTEB-432-UV-PS-L-P	120-277V	Program	0.55-0.24A	0.98	10%	0.80	-18°C/0°F	75°C/167°F	L5	
74W	KTEB-432-UV-PS-N-P	120-277V	Program	0.62-0.28A	0.97	10%	0.90	-18°C/0°F	75°C/167°F	L5		

* 0-10V or phase control dimming **0-10V dimming

Specifications subject to change without notice. For complete product specifications, visit www.keystonetech.com

Keystone Technologies, LLC | North Wales, PA 19454 | Phone (800) 464-2680 | [keystonetech.com](http://www.keystonetech.com)

FLUORESCENT BALLASTS

T8



ELECTRICAL SPECIFICATIONS

No. of Lamps	Input Power	Catalog Number	Input Volts	Starting Method	Line Current	Min. Power Factor	Max. THD	Ballast Factor	Min. Start Temperature	Max. Case Temperature	Case Style
F25T8 (continued)											
4	77W	KTEB-432RIS-1-TP-SL	120V	Instant	1.22A	0.50	130%	0.80	-18°C/0°F	75°C/167°F	L11
	85W	KTEB-432-3-IS-N	347V	Instant	0.26A	0.90	10%	0.88	-18°C/0°F	90°C/194°F	L5
	109W	KTEB-432-UV-IS-H-P	120-277V	Instant	0.92-0.40A	0.98	10%	1.19	-18°C/0°F	75°C/167°F	L4
	78W	KTEB-432-UV-IS-L-P	120-277V	Instant	0.65-0.28A	0.98	10%	0.78	-18°C/0°F	75°C/167°F	L4
	87W	KTEB-432-UV-IS-N-P	120-277V	Instant	0.72-0.31A	0.98	10%	0.89	-18°C/0°F	75°C/167°F	L4
	78W	KTEB-432-UV-PS-L-P	120-277V	Program	0.65-0.29A	0.98	10%	0.73	-18°C/0°F	75°C/167°F	L5
	88W	KTEB-432-UV-PS-N-P	120-277V	Program	0.74-0.33A	0.98	10%	0.87	-18°C/0°F	75°C/167°F	L5
F32T8 (25W)											
1	27W	KTEB-132-UV-PS-N-P	120-277V	Program	0.23-0.10A	0.96	10%	0.88	-18°C/0°F	75°C/167°F	L30
	32W	KTEB-232-1-IS-N	120V	Instant	0.26A	0.99	10%	1.06	-18°C/0°F	75°C/167°F	L9
	28W	KTEB-232-3-IS-N	347V	Instant	0.08A	0.90	10%	1.05	-18°C/0°F	90°C/194°F	L5
	38W	KTEB-232-UV-IS-H-P	120-277V	Instant	0.36-0.16A	0.95	15%	1.38	-18°C/0°F	75°C/167°F	L4
	25W	KTEB-232-UV-IS-L-P	120-277V	Instant	0.20-0.10A	0.97	12%	0.95	-18°C/0°F	75°C/167°F	L4
	27W	KTEB-232-UV-IS-N-P	120-277V	Instant	0.23-0.10A	0.98	10%	1.05	-18°C/0°F	75°C/167°F	L4
	41W	KTEB-232-UV-PS-H-P	120-277V	Program	0.34-0.16A	0.95	12%	1.46	-18°C/0°F	75°C/167°F	L5
	29W	KTEB-232-UV-PS-L-P	120-277V	Program	0.24-0.11A	0.97	12%	0.86	-18°C/0°F	75°C/167°F	L4
	33W	KTEB-232-UV-PS-N-P	120-277V	Program	0.27-0.12A	0.95	12%	1.05	-18°C/0°F	75°C/167°F	L4
2	49W	KTEB-232-1-IS-N	120V	Instant	0.41A	0.99	10%	0.87	-18°C/0°F	75°C/167°F	L9
	43W	KTEB-232-3-IS-N	347V	Instant	0.13A	0.90	10%	0.89	-18°C/0°F	90°C/194°F	L5
	39W	KTEB-232-UV-IS-H-P	120-277V	Instant	0.56-0.25A	0.97	12%	1.18	-18°C/0°F	75°C/167°F	L4
		KTEB-232-UV-IS-L-P	120-277V	Instant	0.32-0.15A	0.98	10%	0.77	-18°C/0°F	75°C/167°F	L4
	44W	KTEB-232-UV-IS-N-P	120-277V	Instant	0.37-0.16A	0.99	10%	0.87	-18°C/0°F	75°C/167°F	L4
	64W	KTEB-232-UV-PS-H-P	120-277V	Program	0.54-0.24A	0.98	10%	1.24	-18°C/0°F	75°C/167°F	L5
	44W	KTEB-232-UV-PS-L-P	120-277V	Program	0.37-0.16A	0.98	10%	0.79	-18°C/0°F	75°C/167°F	L4
	50W	KTEB-232-UV-PS-N-P	120-277V	Program	0.42-0.19A	0.97	10%	0.88	-18°C/0°F	75°C/167°F	L4
	66W	KTEB-332-UV-IS-H-P	120-277V	Instant	0.61-0.27A	0.98	10%	1.28	-18°C/0°F	75°C/167°F	L4
	47W	KTEB-332-UV-IS-L-P	120-277V	Instant	0.39-0.18A	0.96	12%	0.88	-18°C/0°F	75°C/167°F	L4
	56W	KTEB-332-UV-IS-N-P	120-277V	Instant	0.45-0.20A	0.96	12%	1.01	-18°C/0°F	75°C/167°F	L4
	69W	KTEB-332-UV-PS-H-P	120-277V	Program	0.58-0.26A	0.97	12%	1.37	-18°C/0°F	75°C/167°F	L5
	50W	KTEB-332-UV-PS-L-P	120-277V	Program	0.40-0.18A	0.97	12%	0.88	-18°C/0°F	75°C/167°F	L5
	56W	KTEB-332-UV-PS-N-P	120-277V	Program	0.46-0.21A	0.98	10%	0.97	-18°C/0°F	75°C/167°F	L5
	3	87W	KTEB-332-UV-IS-H-P	120-277V	Instant	0.80-0.35A	0.98	10%	1.18	-18°C/0°F	75°C/167°F
60W		KTEB-332-UV-IS-L-P	120-277V	Instant	0.49-0.22A	0.97	12%	0.78	-18°C/0°F	75°C/167°F	L4
72W		KTEB-332-UV-IS-N-P	120-277V	Instant	0.59-0.26A	0.97	12%	0.94	-18°C/0°F	75°C/167°F	L4
89W		KTEB-332-UV-PS-H-P	120-277V	Program	0.75-0.33A	0.98	10%	1.19	-18°C/0°F	75°C/167°F	L5
65W		KTEB-332-UV-PS-L-P	120-277V	Program	0.53-0.24A	0.98	10%	0.79	-18°C/0°F	75°C/167°F	L5
73W		KTEB-332-UV-PS-N-P	120-277V	Program	0.60-0.27A	0.98	10%	0.90	-18°C/0°F	75°C/167°F	L5
70W		KTEB-432-3-IS-N	347V	Instant	0.21A	0.90	10%	0.96	-18°C/0°F	90°C/194°F	L5
93W		KTEB-432-UV-IS-H-P	120-277V	Instant	0.77-0.34A	0.98	10%	1.24	-18°C/0°F	75°C/167°F	L4
69W		KTEB-432-UV-IS-L-P	120-277V	Instant	0.56-0.25A	0.97	12%	0.88	-18°C/0°F	75°C/167°F	L4
77W		KTEB-432-UV-IS-N-P	120-277V	Instant	0.64-0.28A	0.97	12%	1.01	-18°C/0°F	75°C/167°F	L4
68W		KTEB-432-UV-PS-L-P	120-277V	Program	0.56-0.25A	0.98	10%	0.82	-18°C/0°F	75°C/167°F	L5
21W		KTEB-432-UV-PS-N-P	120-277V	Program	0.64-0.28A	0.98	10%	0.93	-18°C/0°F	75°C/167°F	L5
4	85W	KTEB-432-3-IS-N	347V	Instant	0.26A	0.90	10%	0.88	-18°C/0°F	90°C/194°F	L5
	109W	KTEB-432-UV-IS-H-P	120-277V	Instant	0.91-0.40A	0.98	10%	1.19	-18°C/0°F	75°C/167°F	L4
	83W	KTEB-432-UV-IS-L-P	120-277V	Instant	0.68-0.30A	0.98	10%	0.80	-18°C/0°F	75°C/167°F	L4
	94W	KTEB-432-UV-IS-N-P	120-277V	Instant	0.78-0.34A	0.98	10%	0.93	-18°C/0°F	75°C/167°F	L4
	81W	KTEB-432-UV-PS-L-P	120-277V	Program	0.67-0.30A	0.98	10%	0.76	-18°C/0°F	75°C/167°F	L5
	24W	KTEB-432-UV-PS-N-P	120-277V	Program	0.77-0.34A	0.98	10%	0.90	-18°C/0°F	75°C/167°F	L5

Specifications subject to change without notice. For complete product specifications, visit www.keystonetech.com



FLUORESCENT BALLASTS

T8

ELECTRICAL SPECIFICATIONS

No. of Lamps	Input Power	Catalog Number	Input Volts	Starting Method	Line Current	Min. Power Factor	Max. THD	Ballast Factor	Min. Start Temperature	Max. Case Temperature	Case Style
F32T8 (28W)											
1	29W	KTEB-132-UV-PS-N-P	120-277V	Program	0.24-0.11A	0.97	10%	0.88	-18°C/0°F	75°C/167°F	L30
	28W	KTEB-232-1-IS-N	120V	Instant	0.28A	0.99	10%	1.01	-18°C/0°F	75°C/167°F	L9
	32W	KTEB-232-3-IS-N	347V	Instant	0.09A	0.90	10%	1.04	-18°C/0°F	90°C/194°F	L5
	40W	KTEB-232-UV-IS-H-P	120-277V	Instant	0.38-0.17A	0.95	15%	1.38	-18°C/0°F	75°C/167°F	L4
	27W	KTEB-232-UV-IS-L-P	120-277V	Instant	0.22-0.10A	0.97	10%	0.95	-18°C/0°F	75°C/167°F	L4
	29W	KTEB-232-UV-IS-N-P	120-277V	Instant	0.25-0.11A	0.98	10%	1.10	-18°C/0°F	75°C/167°F	L4
	43W	KTEB-232-UV-PS-H-P	120-277V	Program	0.36-0.16A	0.96	12%	1.39	-18°C/0°F	75°C/167°F	L5
	30W	KTEB-232-UV-PS-L-P	120-277V	Program	0.25-0.11A	0.97	12%	0.86	-18°C/0°F	75°C/167°F	L4
	35W	KTEB-232-UV-PS-N-P	120-277V	Program	0.29-0.13A	0.96	10%	1.04	-18°C/0°F	75°C/167°F	L4
2	53W	KTEB-232-1-IS-N	120V	Instant	0.44A	0.99	10%	0.84	-18°C/0°F	75°C/167°F	L9
	48W	KTEB-232-3-IS-N	347V	Instant	0.14A	0.90	10%	0.88	-18°C/0°F	90°C/194°F	L5
	64W	KTEB-232-UV-IS-H-P	120-277V	Instant	0.53-0.23A	0.97	10%	1.18	-18°C/0°F	75°C/167°F	L4
	43W	KTEB-232-UV-IS-L-P	120-277V	Instant	0.36-0.15A	0.99	10%	0.77	-18°C/0°F	75°C/167°F	L4
	49W	KTEB-232-UV-IS-N-P	120-277V	Instant	0.40-0.18A	0.97	10%	0.87	-18°C/0°F	75°C/167°F	L4
	68W	KTEB-232-UV-PS-H-P	120-277V	Program	0.57-0.25A	0.98	10%	1.18	-18°C/0°F	75°C/167°F	L5
	47W	KTEB-232-UV-PS-L-P	120-277V	Program	0.39-0.17A	0.98	10%	0.75	-18°C/0°F	75°C/167°F	L4
	54W	KTEB-232-UV-PS-N-P	120-277V	Program	0.45-0.20A	0.98	10%	0.88	-18°C/0°F	75°C/167°F	L4
	71W	KTEB-332-UV-IS-H-P	120-277V	Instant	0.65-0.28A	0.98	10%	1.28	-18°C/0°F	75°C/167°F	L4
	52W	KTEB-332-UV-IS-L-P	120-277V	Instant	0.43-0.20A	0.96	12%	0.89	-18°C/0°F	75°C/167°F	L4
	58W	KTEB-332-UV-IS-N-P	120-277V	Instant	0.48-0.21A	0.96	12%	0.99	-18°C/0°F	75°C/167°F	L4
	76W	KTEB-332-UV-PS-H-P	120-277V	Program	0.64-0.28A	0.97	12%	1.34	-18°C/0°F	75°C/167°F	L5
	55W	KTEB-332-UV-PS-L-P	120-277V	Program	0.45-0.20A	0.97	12%	0.86	-18°C/0°F	75°C/167°F	L5
	61W	KTEB-332-UV-PS-N-P	120-277V	Program	0.52-0.23A	0.97	10%	1.00	-18°C/0°F	75°C/167°F	L5
	3	95W	KTEB-332-UV-IS-H-P	120-277V	Instant	0.86-0.38A	0.98	10%	1.18	-18°C/0°F	75°C/167°F
52W		KTEB-332-UV-IS-L-P	120-277V	Instant	0.56-0.26A	0.96	12%	0.89	-18°C/0°F	75°C/167°F	L4
58W		KTEB-332-UV-IS-N-P	120-277V	Instant	0.48-0.21A	0.96	12%	0.99	-18°C/0°F	75°C/167°F	L4
99W		KTEB-332-UV-PS-H-P	120-277V	Program	0.83-0.36A	0.98	10%	1.18	-18°C/0°F	75°C/167°F	L5
69W		KTEB-332-UV-PS-L-P	120-277V	Program	0.57-0.25A	0.98	10%	0.75	-18°C/0°F	75°C/167°F	L5
79W		KTEB-332-UV-PS-N-P	120-277V	Program	0.65-0.29A	0.98	10%	0.88	-18°C/0°F	75°C/167°F	L5
78W		KTEB-432-3-IS-N	347V	Instant	0.23A	0.90	10%	0.96	-18°C/0°F	90°C/194°F	L5
98W		KTEB-432-UV-IS-H-P	120-277V	Instant	0.80-0.36A	0.98	10%	1.24	-18°C/0°F	75°C/167°F	L4
74W		KTEB-432-UV-IS-L-P	120-277V	Instant	0.57-0.27A	0.97	12%	0.78	-18°C/0°F	75°C/167°F	L4
84W		KTEB-432-UV-IS-N-P	120-277V	Instant	0.69-0.30A	0.97	12%	0.98	-18°C/0°F	75°C/167°F	L4
4	95W	KTEB-432-3-IS-N	347V	Instant	0.28A	0.90	10%	0.88	-18°C/0°F	90°C/194°F	L5
	116W	KTEB-432-UV-IS-H-P	120-277V	Instant	0.98-0.42A	0.98	10%	1.18	-18°C/0°F	75°C/167°F	L4
	85W	KTEB-432-UV-IS-L-P	120-277V	Instant	0.70-0.31A	0.98	10%	0.77	-18°C/0°F	75°C/167°F	L4
	97W	KTEB-432-UV-IS-N-P	120-277V	Instant	0.77-0.33A	0.98	10%	0.87	-18°C/0°F	75°C/167°F	L4
	88W	KTEB-432-UV-PS-L-P	120-277V	Program	0.73-0.32A	0.98	10%	0.75	-18°C/0°F	75°C/167°F	L5
	100W	KTEB-432-UV-PS-N-P	120-277V	Program	0.84-0.37A	0.98	10%	0.87	-18°C/0°F	75°C/167°F	L5
	F32T8 (30W)										
1	30W	KTEB-132-UV-PS-N-P	120-277V	Program	0.25-0.12A	0.97	10%	0.88	-18°C/0°F	75°C/167°F	L6
	35W	KTEB-232-1-IS-N	120V	Instant	0.29A	0.99	10%	1.01	-18°C/0°F	75°C/167°F	L9
	34W	KTEB-232-3-IS-N	347V	Instant	0.09A	0.90	10%	1.04	-18°C/0°F	90°C/194°F	L5
	43W	KTEB-232-UV-IS-H-P	120-277V	Instant	0.40-0.18A	0.95	15%	1.38	-18°C/0°F	75°C/167°F	L4
	28W	KTEB-232-UV-IS-L-P	120-277V	Instant	0.24-0.11A	0.97	10%	0.92	-18°C/0°F	75°C/167°F	L4
	32W	KTEB-232-UV-IS-N-P	120-277V	Instant	0.27-0.12A	0.98	12%	1.05	-18°C/0°F	75°C/167°F	L4
	45W	KTEB-232-UV-PS-H-P	120-277V	Program	0.38-0.17A	0.96	12%	1.37	-18°C/0°F	75°C/167°F	L5
	31W	KTEB-232-UV-PS-L-P	120-277V	Program	0.26-0.12A	0.97	12%	0.84	-18°C/0°F	75°C/167°F	L4
	36W	KTEB-232-UV-PS-N-P	120-277V	Program	0.30-0.14A	0.96	10%	1.00	-18°C/0°F	75°C/167°F	L4

Specifications subject to change without notice. For complete product specifications, visit www.keystonetech.com

FLUORESCENT BALLASTS

T8



ELECTRICAL SPECIFICATIONS

No. of Lamps	Input Power	Catalog Number	Input Volts	Starting Method	Line Current	Min. Power Factor	Max. THD	Ballast Factor	Min. Start Temperature	Max. Case Temperature	Case Style
F32T8 (30W) (continued)											
2	55W	KTEB-232-1-IS-N	120V	Instant	0.46A	0.99	10%	0.88	-18°C/0°F	75°C/167°F	L9
	52W	KTEB-232-3-IS-N	347V	Instant	0.15A	0.90	10%	0.88	-18°C/0°F	90°C/194°F	L5
	70W	KTEB-232-UV-IS-H-P	120-277V	Instant	0.59-0.25A	0.97	10%	1.18	-18°C/0°F	75°C/167°F	L4
	46W	KTEB-232-UV-IS-L-P	120-277V	Instant	0.38-0.17A	0.97	10%	0.77	-18°C/0°F	75°C/167°F	L4
	52W	KTEB-232-UV-IS-N-P	120-277V	Instant	0.42-0.19A	0.97	10%	0.87	-18°C/0°F	75°C/167°F	L4
	72W	KTEB-232-UV-PS-H-P	120-277V	Program	0.60-0.26A	0.98	10%	1.18	-18°C/0°F	75°C/167°F	L5
	48W	KTEB-232-UV-PS-L-P	120-277V	Program	0.41-0.18A	0.98	10%	0.75	-18°C/0°F	75°C/167°F	L4
	56W	KTEB-232-UV-PS-N-P	120-277V	Program	0.47-0.21A	0.98	10%	0.88	-18°C/0°F	75°C/167°F	L4
	78W	KTEB-332-UV-IS-H-P	120-277V	Instant	0.66-0.29A	0.98	10%	1.28	-18°C/0°F	75°C/167°F	L4
	54W	KTEB-332-UV-IS-L-P	120-277V	Instant	0.45-0.20A	0.96	12%	0.88	-18°C/0°F	75°C/167°F	L4
	60W	KTEB-332-UV-IS-N-P	120-277V	Instant	0.50-0.22A	0.97	12%	0.98	-18°C/0°F	75°C/167°F	L4
	80W	KTEB-332-UV-PS-H-P	120-277V	Program	0.67-0.30A	0.97	12%	1.33	-18°C/0°F	75°C/167°F	L5
	56W	KTEB-332-UV-PS-L-P	120-277V	Program	0.47-0.21A	0.97	12%	0.84	-18°C/0°F	75°C/167°F	L5
	63W	KTEB-332-UV-PS-N-P	120-277V	Program	0.52-0.23A	0.97	10%	0.95	-18°C/0°F	75°C/167°F	L5
3	104W	KTEB-332-UV-IS-H-P	120-277V	Instant	0.86-0.37A	0.98	10%	1.18	-18°C/0°F	75°C/167°F	L4
	70W	KTEB-332-UV-IS-L-P	120-277V	Instant	0.58-0.25A	0.98	10%	0.77	-18°C/0°F	75°C/167°F	L4
	79W	KTEB-332-UV-IS-N-P	120-277V	Instant	0.65-0.28A	0.98	10%	0.87	-18°C/0°F	75°C/167°F	L4
	104W	KTEB-332-UV-PS-H-P	120-277V	Program	0.88-0.38A	0.98	10%	1.18	-18°C/0°F	75°C/167°F	L5
	73W	KTEB-332-UV-PS-L-P	120-277V	Program	0.60-0.27A	0.98	10%	0.75	-18°C/0°F	75°C/167°F	L5
	82W	KTEB-332-UV-PS-N-P	120-277V	Program	0.68-0.30A	0.98	10%	0.88	-18°C/0°F	75°C/167°F	L5
	85W	KTEB-432-1-IS-N-P	120V	Instant	0.71A	0.99	10%	0.93	-18°C/0°F	75°C/167°F	L6
	85W	KTEB-432-3-IS-N	347V	Instant	0.25A	0.90	10%	0.96	-18°C/0°F	90°C/194°F	L5
	105W	KTEB-432-UV-IS-H-P	120-277V	Instant	0.88-0.37A	0.98	10%	1.24	-18°C/0°F	75°C/167°F	L4
	75W	KTEB-432-UV-IS-L-P	120-277V	Instant	0.63-0.27A	0.97	12%	0.81	-18°C/0°F	75°C/167°F	L4
	85W	KTEB-432-UV-IS-N-P	120-277V	Instant	0.71-0.31A	0.97	12%	0.93	-18°C/0°F	75°C/167°F	L4
	76W	KTEB-432-UV-PS-L-P	120-277V	Program	0.63-0.28A	0.98	10%	0.79	-18°C/0°F	75°C/167°F	L5
	86W	KTEB-432-UV-PS-N-P	120-277V	Program	0.72-0.32A	0.98	10%	0.88	-18°C/0°F	75°C/167°F	L5
	4	105W	KTEB-432-1-IS-N-P	120V	Instant	0.88A	0.99	10%	0.86	-18°C/0°F	75°C/167°F
102W		KTEB-432-3-IS-N	347V	Instant	0.30A	0.90	10%	0.86	-18°C/0°F	90°C/194°F	L5
120W		KTEB-432-UV-IS-H-P	120-277V	Instant	1.01-0.44A	0.98	10%	1.18	-18°C/0°F	75°C/167°F	L4
91W		KTEB-432-UV-IS-L-P	120-277V	Instant	0.75-0.32A	0.98	10%	0.77	-18°C/0°F	75°C/167°F	L4
103W		KTEB-432-UV-IS-N-P	120-277V	Instant	0.85-0.36A	0.98	10%	0.87	-18°C/0°F	75°C/167°F	L4
91W		KTEB-432-UV-PS-L-P	120-277V	Program	0.77-0.34A	0.98	10%	0.72	-18°C/0°F	75°C/167°F	L5
104W		KTEB-432-UV-PS-N-P	120-277V	Program	0.87-0.38A	0.98	10%	0.86	-18°C/0°F	75°C/167°F	L5
F32T8 (32W)											
1	35W	KTEB-126-1-TP	120V	Rapid	0.51A	0.50	130%	1.10	-18°C/0°F	75°C/167°F	S1
		KTEB-126-1-TP-LC	120V	Rapid	0.51A	0.50	130%	1.10	-18°C/0°F	75°C/167°F	L2
	32W	KTEB-132-1-TP-EMI	120V	Rapid	0.48A	0.50	130%	0.95	-18°C/0°F	75°C/167°F	L7
	26W	KTEB-132-1-TP-FC	120V	Rapid	0.40A	0.52	160%	0.85	-18°C/0°F	75°C/167°F	V2
	11-36W	KTEB-132-UV-PS-N-P-SDIM3	120-277V	Program	0.30-0.05A	0.90	15%	1.00	10°C/50°F	75°C/167°F	L5
	31W	KTEB-132-UV-PS-N-P	120-277V	Program	0.27-0.12A	0.98	10%	0.88	-18°C/0°F	75°C/167°F	L6
	36W	KTEB-232-1-IS-N	120V	Instant	0.30A	0.98	10%	1.10	-18°C/0°F	75°C/167°F	L9
	36W	KTEB-232-3-IS-N	347V	Instant	0.11A	0.90	10%	1.04	-18°C/0°F	90°C/194°F	L5
	37W	KTEB-232RIS-1-TP-SL	120V	Instant	0.55A	0.50	150%	1.00	-18°C/0°F	75°C/167°F	N3
	47W	KTEB-232-UV-IS-H-P	120-277V	Instant	0.42-0.19A	0.96	12%	1.38	-18°C/0°F	75°C/167°F	L4
	30W	KTEB-232-UV-IS-L-P	120-277V	Instant	0.25-0.11A	0.98	10%	0.95	-18°C/0°F	75°C/167°F	L4
	33W	KTEB-232-UV-IS-N-P	120-277V	Instant	0.28-0.12A	0.98	10%	1.05	-18°C/0°F	75°C/167°F	L4
	50W	KTEB-232-UV-PS-H-P	120-277V	Program	0.42-0.19A	0.97	12%	1.42	-18°C/0°F	75°C/167°F	L5
	33W	KTEB-232-UV-PS-L-P	120-277V	Program	0.28-0.12A	0.98	10%	0.86	-18°C/0°F	75°C/167°F	L4
37W	KTEB-232-UV-PS-N-P	120-277V	Program	0.31-0.14A	0.93	10%	1.05	-18°C/0°F	75°C/167°F	L4	

Specifications subject to change without notice. For complete product specifications, visit www.keystonetech.com

FLUORESCENT BALLASTS

T8

ELECTRICAL SPECIFICATIONS

No. of Lamps	Input Power	Catalog Number	Input Volts	Starting Method	Line Current	Min. Power Factor	Max. THD	Ballast Factor	Min. Start Temperature	Max. Case Temperature	Case Style
F32T8 (32W) (continued)											
2	59W	KTEB-232-1-IS-N	120V	Instant	0.50A	0.99	10%	0.88	-18°C/0°F	75°C/167°F	L9
	56W	KTEB-232-3-IS-N	347V	Instant	0.16A	0.90	10%	0.88	-18°C/0°F	90°C/194°F	L5
	57W	KTEB-232RIS-1-TP-SL	120V	Instant	0.78A	0.60	150%	0.88	-18°C/0°F	75°C/167°F	N3
	53W	KTEB-232SIS-1-TP	120V	Instant	0.80A	0.50	150%	0.83	-18°C/0°F	75°C/167°F	L9
	74W	KTEB-232-UV-IS-H-P	120-277V	Instant	0.62-0.26A	0.99	10%	1.18	-18°C/0°F	75°C/167°F	L4
	48W	KTEB-232-UV-IS-L-P	120-277V	Instant	0.40-0.17A	0.98	10%	0.77	-18°C/0°F	75°C/167°F	L4
	55W	KTEB-232-UV-IS-N-P	120-277V	Instant	0.45-0.20A	0.99	10%	0.87	-18°C/0°F	75°C/167°F	L4
	28-65W	KTEB-232-UV-PS-CDIM*	120-277V	Program	0.52-0.12A	0.90	20%	1.00	10°C/50°F	65°C/149°F	U4
	78W	KTEB-232-UV-PS-H-P	120-277V	Program	0.65-0.29A	0.98	10%	1.18	-18°C/0°F	75°C/167°F	L5
	52W	KTEB-232-UV-PS-L-P	120-277V	Program	0.44-0.19A	0.98	10%	0.77	-18°C/0°F	75°C/167°F	L4
	60W	KTEB-232-UV-PS-N-P	120-277V	Program	0.50-0.22A	0.98	10%	0.88	-18°C/0°F	75°C/167°F	L4
	28-65W	KTEB-232-UV-PS-VDIM**	120-277V	Program	0.52-0.12A	0.90	20%	1.00	10°C/50°F	65°C/149°F	U4
	68W	KTEB-240-1-TP	120V	Rapid	1.00A	0.50	150%	1.05	-18°C/0°F	75°C/167°F	L1
	62W	KTEB-2C72-1-TP	120V	Rapid	0.89A	0.50	130%	0.97	-18°C/0°F	75°C/167°F	L1
	83W	KTEB-332-UV-IS-H-P	120-277V	Instant	0.71-0.32A	0.98	10%	1.27	-18°C/0°F	75°C/167°F	L4
	58W	KTEB-332-UV-IS-L-P	120-277V	Instant	0.50-0.22A	0.97	12%	0.89	-18°C/0°F	75°C/167°F	L4
	64W	KTEB-332-UV-IS-N-P	120-277V	Instant	0.53-0.23A	0.97	12%	0.99	-18°C/0°F	75°C/167°F	L4
	88W	KTEB-332-UV-PS-H-P	120-277V	Program	0.73-0.32A	0.98	10%	1.35	-18°C/0°F	75°C/167°F	L5
58W	KTEB-332-UV-PS-L-P	120-277V	Program	0.49-0.21A	0.98	10%	0.86	-18°C/0°F	75°C/167°F	L5	
69W	KTEB-332-UV-PS-N-P	120-277V	Program	0.57-0.25A	0.98	10%	0.98	-18°C/0°F	75°C/167°F	L5	
3	104W	KTEB-332-UV-IS-H-P	120-277V	Instant	0.86-0.37A	0.98	10%	1.18	-18°C/0°F	75°C/167°F	L4
	70W	KTEB-332-UV-IS-L-P	120-277V	Instant	0.58-0.25A	0.98	10%	0.77	-18°C/0°F	75°C/167°F	L4
	79W	KTEB-332-UV-IS-N-P	120-277V	Instant	0.65-0.28A	0.98	10%	0.87	-18°C/0°F	75°C/167°F	L4
	114W	KTEB-332-UV-PS-H-P	120-277V	Program	0.96-0.14A	0.98	10%	1.18	-18°C/0°F	75°C/167°F	L5
	79W	KTEB-332-UV-PS-L-P	120-277V	Program	0.65-0.29A	0.98	10%	0.77	-18°C/0°F	75°C/167°F	L5
	88W	KTEB-332-UV-PS-N-P	120-277V	Program	0.73-0.32A	0.98	10%	0.88	-18°C/0°F	75°C/167°F	L5
	83W	KTEB-432RIS-1-TP-SL	120V	Instant	1.29A	0.50	130%	0.87	-18°C/0°F	75°C/167°F	L11
	89W	KTEB-432-3-IS-N	347V	Instant	0.26A	0.90	10%	0.96	-18°C/0°F	90°C/194°F	L5
	120W	KTEB-432-UV-IS-H-P	120-277V	Instant	1.01-0.44A	0.98	10%	1.24	-18°C/0°F	75°C/167°F	L4
	81W	KTEB-432-UV-IS-L-P	120-277V	Instant	0.68-0.28A	0.97	10%	0.86	-18°C/0°F	75°C/167°F	L4
	89W	KTEB-432-UV-IS-N-P	120-277V	Instant	0.74-0.32A	0.98	10%	0.94	-18°C/0°F	75°C/167°F	L4
	78W	KTEB-432-UV-PS-L-P	120-277V	Program	0.66-0.29A	0.98	10%	0.79	-18°C/0°F	75°C/167°F	L5
95W	KTEB-432-UV-PS-N-P	120-277V	Program	0.79-0.35A	0.98	10%	0.94	-18°C/0°F	75°C/167°F	L5	
4	99W	KTEB-432RIS-1-TP-SL	120V	Instant	1.47A	0.50	120%	0.80	-18°C/0°F	75°C/167°F	L11
	108W	KTEB-432-3-IS-N	347V	Instant	0.32A	0.90	10%	0.88	-18°C/0°F	90°C/194°F	L5
	145W	KTEB-432-UV-IS-H-P	120-277V	Instant	1.24-0.53A	0.98	10%	1.18	-18°C/0°F	75°C/167°F	L4
	97W	KTEB-432-UV-IS-L-P	120-277V	Instant	0.80-0.34A	0.98	10%	0.77	-18°C/0°F	75°C/167°F	L4
	109W	KTEB-432-UV-IS-N-P	120-277V	Instant	0.91-0.38A	0.99	10%	0.87	-18°C/0°F	75°C/167°F	L4
	97W	KTEB-432-UV-PS-L-P	120-277V	Program	0.82-0.35A	0.99	10%	0.74	-18°C/0°F	75°C/167°F	L5
	114W	KTEB-432-UV-PS-N-P	120-277V	Program	0.95-0.42A	0.98	10%	0.87	-18°C/0°F	75°C/167°F	L5

* 0-10V or phase control dimming **0-10V dimming

Specifications subject to change without notice. For complete product specifications, visit www.keystonetech.com

Keystone Technologies, LLC | North Wales, PA 19454 | Phone (800) 464-2680 | keystonetech.com

FLUORESCENT BALLASTS

T8

CASE STYLES

CASE B

Material: Steel

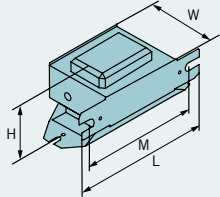

Case Style	Mounting	Length	Width	Height
B2	2.50"	3.15"	1.14"	1.77"

CASE L

Material: Steel

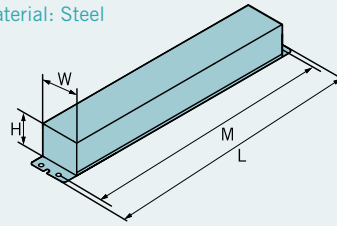

Case Style	Mounting	Length	Width	Height
L1	6.00"	6.46"	1.89"	1.00"
L2	6.00"	6.46"	1.89"	1.15"
L4	9.00"	9.50"	1.30"	1.18"
L5	8.90"	9.50"	1.70"	1.18"
L7	6.00"	6.46"	1.37"	1.00"
L9	8.90"	9.57"	1.13"	1.07"
L11	8.90"	9.50"	1.30"	1.10"
L30	8.90"	9.50"	1.30"	1.10"
L34	8.90"	9.45"	1.15"	1.26"

CASE N

Material: Steel

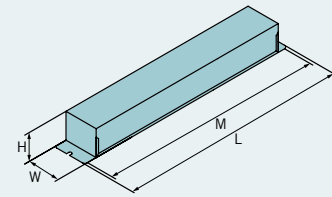

Case Style	Mounting	Length	Width	Height
N3	9.00"	9.60"	1.16"	0.88"

CASE S

Material: Plastic

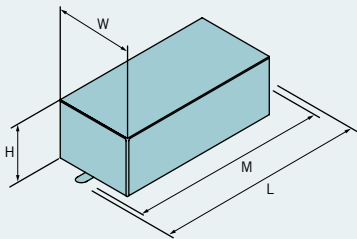

Case Style	Mounting	Length	Width	Height
S1	2.88"	3.45"	1.81"	1.21"

CASE U

Material: Steel

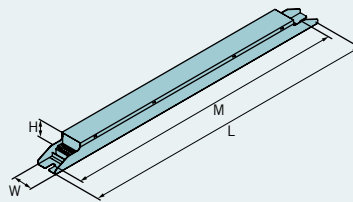

Case Style	Mounting	Length	Width	Height
U4	16.02"	16.89"	1.20"	1.00"

CASE V

Material: Steel

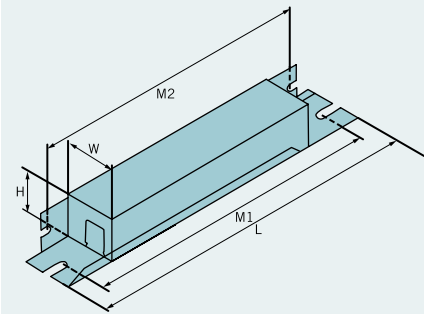

Case Style	M1	M2	Length	Width	Height
V2	5.63"	5.90"	6.46"	0.92"	0.75"

CASE X

Material: Plastic

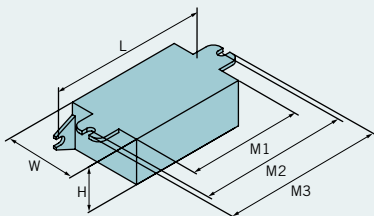

Case Style	Mounting	Length	Width	Height
X1	2.80"	3.07"	1.16"	1.00"

Specifications subject to change without notice. For complete product specifications, visit www.keystonetech.com



FLUORESCENT BALLASTS

T8 LAMPS OVER 48"

ELECTRICAL SPECIFICATIONS

No. of Lamps	Input Power	Catalog Number	Input Volts	Starting Method	Line Current	Min. Power Factor	Max. THD	Ballast Factor	Min. Start Temperature	Max. Case Temperature	Case Style
F40T8											
1	43W	KTEB-232-1-IS-N	120V	Instant	0.37A	0.98	10%	1.00	-18°C/0°F	75°C/167°F	L9
	45W	KTEB-232-3-IS-N	347V	Instant	0.13A	0.90	10%	1.00	-18°C/0°F	90°C/194°F	L5
	42W	KTEB-232RIS-1-TP-SL	120V	Instant	0.60A	0.57	150%	1.00	-18°C/0°F	75°C/167°F	N3
	50W	KTEB-232-UV-IS-H-P	120-277V	Instant	0.43-0.19A	0.99	10%	1.20	-18°C/0°F	75°C/167°F	L4
	35W	KTEB-232-UV-IS-L-P	120-277V	Instant	0.30-0.13A	0.98	10%	0.85	-18°C/0°F	75°C/167°F	L4
	39W	KTEB-232-UV-IS-N-P	120-277V	Instant	0.33-0.15A	0.99	10%	0.95	-18°C/0°F	75°C/167°F	L4
	58W	KTEB-232-UV-PS-H-P	120-277V	Program	0.49-0.22A	0.97	12%	1.35	-18°C/0°F	75°C/167°F	L5
	39W	KTEB-232-UV-PS-L-P	120-277V	Program	0.32-0.14A	0.98	10%	0.82	-18°C/0°F	75°C/167°F	L4
	45W	KTEB-232-UV-PS-N-P	120-277V	Program	0.38-0.17A	0.97	10%	0.99	-18°C/0°F	75°C/167°F	L4
2	101W	KTEB-332-UV-IS-H-P	120-277V	Instant	0.84-0.36A	0.99	10%	1.25	-18°C/0°F	75°C/167°F	L4
	68W	KTEB-332-UV-IS-L-P	120-277V	Instant	0.57-0.27A	0.98	10%	0.89	-18°C/0°F	75°C/167°F	L4
	77W	KTEB-332-UV-IS-N-P	120-277V	Instant	0.64-0.27A	0.98	10%	1.00	-18°C/0°F	75°C/167°F	L4
	104W	KTEB-332-UV-PS-H-P	120-277V	Program	0.88-0.38A	0.98	10%	1.18	-18°C/0°F	75°C/167°F	L5
	74W	KTEB-332-UV-PS-L-P	120-277V	Program	0.61-0.27A	0.98	10%	0.82	-18°C/0°F	75°C/167°F	L5
	81W	KTEB-332-UV-PS-N-P	120-277V	Program	0.67-0.30A	0.98	10%	0.95	-18°C/0°F	75°C/167°F	L5
3	108W	KTEB-432-3-IS-N	347V	Instant	0.31A	0.90	10%	0.97	-18°C/0°F	90°C/194°F	L5
	143W	KTEB-432-UV-IS-H-P	120-277V	Instant	1.22-0.51A	0.98	10%	1.25	-18°C/0°F	75°C/167°F	L4
	97W	KTEB-432-UV-IS-L-P	120-277V	Instant	0.81-0.35A	0.98	10%	0.90	-18°C/0°F	75°C/167°F	L4
	111W	KTEB-432-UV-IS-N-P	120-277V	Instant	0.93-0.39A	0.99	10%	0.95	-18°C/0°F	75°C/167°F	L4
	99W	KTEB-432-UV-PS-L-P	120-277V	Program	0.83-0.36A	0.99	10%	0.79	-18°C/0°F	75°C/167°F	L5
	111W	KTEB-432-UV-PS-N-P	120-277V	Program	0.93-0.41A	0.98	10%	0.88	-18°C/0°F	75°C/167°F	L5
F48T8HO (44W)											
1	51W	KTEB-286HO-UV-IS-N	120-277V	Instant	0.42-0.20A	0.93	15%	0.93	-18°C/0°F	75°C/167°F	D11
		KTEB-286HO-UV-PS-N	120-277V	Program	0.43-0.20A	0.93	15%	0.87	-18°C/0°F	75°C/167°F	D11
2	80W	KTEB-286HO-UV-IS-N	120-277V	Instant	0.66-0.30A	0.97	12%	0.88	-18°C/0°F	75°C/167°F	D11
	77W	KTEB-286HO-UV-PS-N	120-277V	Program	0.65-0.29A	0.95	15%	0.75	-18°C/0°F	75°C/167°F	L33
F60T8HO (56W)											
1	55W	KTEB-286HO-UV-IS-N	120-277V	Instant	0.44-0.22A	0.90	15%	0.91	-18°C/0°F	75°C/167°F	D11
	63W	KTEB-286HO-UV-PS-N	120-277V	Program	0.53-0.24A	0.90	15%	0.90	-18°C/0°F	75°C/167°F	L33
2	84W	KTEB-286HO-UV-IS-N	120-277V	Instant	0.71-0.32A	0.95	15%	0.85	-18°C/0°F	75°C/167°F	D11
	97W	KTEB-286HO-UV-PS-N	120-277V	Program	0.82-0.36A	0.98	12%	0.76	-18°C/0°F	75°C/167°F	L33
F58T8											
1	58W	KTEB-270-UV-PS-N /C1	120-277V	Program	0.55-0.26A	0.90	10%	1.17	-30°C/-20°F	94°C/194°F	L36
2		KTEB-270-UV-PS-N /C1	120-277V	Program	1.08-0.47A	0.96	10%	1.07	-30°C/-20°F	94°C/194°F	L36
F70T8											
1	70W	KTEB-270-UV-PS-N /C1	120-277V	Program	0.62-0.28A	0.92	10%	1.08	-30°C/-20°F	94°C/194°F	L36
2		KTEB-270-UV-PS-N /C1	120-277V	Program	1.16-0.50A	0.96	10%	0.95	-30°C/-20°F	94°C/194°F	L36
F72T8											
1	52W	KTEB-259-UV-IS-N	120-277V	Instant	0.43-0.19A	0.97	12%	1.05	-18°C/0°F	75°C/167°F	L11
2	80W	KTEB-259-UV-IS-N	120-277V	Instant	0.67-0.29A	0.99	10%	0.88	-18°C/0°F	75°C/167°F	L11

Specifications subject to change without notice. For complete product specifications, visit www.keystonetech.com

FLUORESCENT BALLASTS

T8 LAMPS OVER 48"



ELECTRICAL SPECIFICATIONS

No. of Lamps	Input Power	Catalog Number	Input Volts	Starting Method	Line Current	Min. Power Factor	Max. THD	Ballast Factor	Min. Start Temperature	Max. Case Temperature	Case Style
F72T8HO (66W)											
1	71W	KTEB-286HO-UV-IS-N	120-277V	Instant	0.60-0.27A	0.94	15%	0.94	-18°C/0°F	75°C/167°F	D11
		KTEB-286HO-UV-PS-N	120-277V	Program	0.60-0.27A	0.98	15%	0.77	-18°C/0°F	75°C/167°F	L33
2	114W	KTEB-286HO-UV-IS-N	120-277V	Instant	0.96-0.39A	0.97	12%	0.86	-18°C/0°F	75°C/167°F	D11
		KTEB-286HO-UV-PS-N	120-277V	Program	0.96-0.42A	0.96	12%	0.91	-18°C/0°F	75°C/167°F	L33
F96T8											
1	70W	KTEB-259-UV-IS-N	120-277V	Instant	0.58-0.26A	0.99	10%	1.05	-18°C/0°F	75°C/167°F	L11
2	112W	KTEB-259-UV-IS-N	120-277V	Instant	0.94-0.41A	0.99	10%	0.88	-18°C/0°F	75°C/167°F	L11
F96T8HO (86W)											
1	89W	KTEB-286HO-UV-IS-N	120-277V	Instant	0.75-0.33A	0.97	10%	0.95	-18°C/0°F	75°C/167°F	D11
	93W	KTEB-286HO-UV-PS-N	120-277V	Program	0.78-0.35A	0.98	15%	0.91	-18°C/0°F	75°C/167°F	D11
2	146W	KTEB-286HO-UV-IS-N	120-277V	Instant	1.22-0.54A	0.98	10%	0.85	-18°C/0°F	75°C/167°F	D11
	152W	KTEB-286HO-UV-PS-N	120-277V	Program	1.28-0.56A	0.96	10%	0.80	-18°C/0°F	75°C/167°F	D11

CASE STYLES

CASE D

Material: Steel

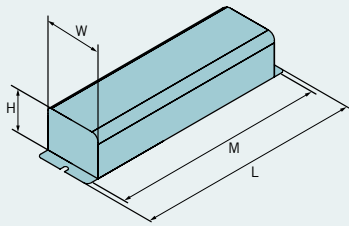

Case Style	Mounting	Length	Width	Height
D11	8.84"	9.50"	2.36"	1.69"

CASE L

Material: Steel

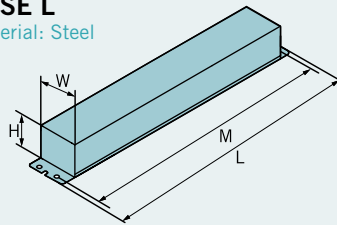

Case Style	Mounting	Length	Width	Height
L4	9.00"	9.50"	1.30"	1.18"
L5	8.90"	9.50"	1.70"	1.15"
L6	8.90"	9.50"	1.38"	1.18"
L9	8.90"	9.57"	1.13"	1.07"
L11	8.90"	9.50"	1.30"	1.10"
L33	11.14"	11.75"	1.70"	1.18"
L36	9.25"	9.75"	1.56"	1.10"

CASE N

Material: Steel

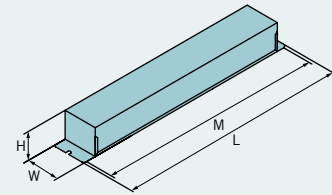

Case Style	Mounting	Length	Width	Height
N3	9.00"	9.60"	1.16"	0.88"

Specifications subject to change without notice. For complete product specifications, visit www.keystonetech.com

FLUORESCENT BALLASTS

T5

ELECTRICAL SPECIFICATIONS

No. of Lamps	Input Power	Catalog Number	Input Volts	Starting Method	Line Current	Min. Power Factor	Max. THD	Ballast Factor	Min. Start Temperature	Max. Case Temperature	Case Style
F4T5											
1	6W	KTEB-108-1-TP-FC	120V	Rapid	0.10A	0.50	160%	1.05	-18°C/0°F	75°C/167°F	V1
		KTEB-108-1-TP-FC-PH	120V	Rapid	0.10A	0.50	160%	1.05	-18°C/0°F	75°C/167°F	V1
2	8W	KTEB-108-1-TP-FC	120V	Rapid	0.12A	0.50	160%	1.00	-18°C/0°F	75°C/167°F	V1
		KTEB-108-1-TP-FC-PH	120V	Rapid	0.12A	0.50	160%	1.00	-18°C/0°F	75°C/167°F	V1
F6T5											
1	8W	KTEB-108-1-TP-FC	120V	Rapid	0.12A	0.50	160%	1.00	-18°C/0°F	75°C/167°F	V1
		KTEB-108-1-TP-FC-PH	120V	Rapid	0.12A	0.50	160%	1.00	-18°C/0°F	75°C/167°F	V1
2	14W	KTEB-114-1-TP-FC	120V	Rapid	0.23A	0.50	150%	1.00	-18°C/0°F	75°C/167°F	V1
		KTEB-114-1-TP-FC-PH	120V	Rapid	0.23A	0.50	150%	1.00	-18°C/0°F	75°C/167°F	V1
F8T5											
1	8.5W	KTEB-108-1-TP-FC	120V	Rapid	0.13A	0.50	130%	1.00	-18°C/0°F	75°C/167°F	V1
		KTEB-108-1-TP-FC-PH	120V	Rapid	0.13A	0.50	130%	1.00	-18°C/0°F	75°C/167°F	V1
2	10W	KTEB-113-1-TP-SL-MB	120V	Rapid	0.17A	0.50	150%	1.10	-18°C/0°F	75°C/167°F	P2
		KTEB-114-1-TP-FC	120V	Rapid	0.25A	0.50	150%	0.95	-18°C/0°F	75°C/167°F	V1
	16W	KTEB-114-1-TP-FC	120V	Rapid	0.25A	0.50	150%	0.95	-18°C/0°F	75°C/167°F	V1
		KTEB-114-1-TP-FC-PH	120V	Rapid	0.25A	0.50	150%	0.95	-18°C/0°F	75°C/167°F	V1
17W	KTEB-208-1-TP-SL-MB	120V	Rapid	0.28A	0.50	150%	0.95	-18°C/0°F	75°C/167°F	P1	
F13T5											
1	16.5W	KTEB-113-1-TP-EMIA	120V	Rapid	0.25A	0.55	150%	1.00	-18°C/0°F	75°C/167°F	X1
	25W	KTEB-113-1-TP-SL-MB	120V	Rapid	0.25A	0.50	150%	0.95	-18°C/0°F	75°C/167°F	P2
	14W	KTEB-114-1-TP-FC	120V	Rapid	0.22A	0.50	150%	0.95	-18°C/0°F	75°C/167°F	V1
KTEB-114-1-TP-FC-PH		120V	Rapid	0.22A	0.50	150%	0.95	-18°C/0°F	75°C/167°F	V1	
2	28W	KTEB-213-1-TP-SL-MB	120V	Rapid	0.43A	0.50	150%	0.95	-18°C/0°F	75°C/167°F	P1
F14T5											
1	15W	KTEB-114-1-TP-FC	120V	Rapid	0.23A	0.50	150%	0.95	-18°C/0°F	75°C/167°F	V1
		KTEB-114-1-TP-FC-PH	120V	Rapid	0.23A	0.50	150%	0.95	-18°C/0°F	75°C/167°F	V1
	21W	KTEB-128HE-1-RS	120V	Rapid	0.18A	0.90	10%	1.20	-18°C/0°F	75°C/167°F	N3
		KTEB-228HE-UV-PS-SL	120-277V	Program	0.16-0.08A	0.92	15%	1.12	-18°C/0°F	70°C/158°F	L30
19W	KTEB-228HE-UV-PS	120-277V	Program	0.16-0.07A	0.90	20%	1.07	-18°C/0°F	90°C/194°F	U4	
	KTEB-235HE-UV-PS	120-277V	Program	0.16-0.07A	0.90	20%	1.07	-18°C/0°F	90°C/194°F	U4	
2	31W	KTEB-128-1-TP-FC	120V	Rapid	0.45A	0.57	150%	0.95	-18°C/0°F	75°C/167°F	V1
		KTEB-128-1-TP-FC-PH	120V	Rapid	0.45A	0.57	150%	0.95	-18°C/0°F	75°C/167°F	V1
	30W	KTEB-221PS-1-TP	120V	Program	0.44A	0.50	130%	0.95	-18°C/0°F	75°C/167°F	L7
		KTEB-228-1-TP-PH-SL	120V	Preheat	0.44A	0.50	130%	0.95	-18°C/0°F	75°C/167°F	N1
	34W	KTEB-228HE-UV-PS-SL	120-277V	Program	0.28-0.13A	0.96	12%	1.04	-18°C/0°F	70°C/158°F	L30
		KTEB-228HE-UV-PS	120-277V	Program	0.29-0.13A	0.98	10%	1.06	-18°C/0°F	90°C/194°F	U4
37W	KTEB-235HE-UV-PS	120-277V	Program	0.29-0.13A	0.98	10%	1.06	-18°C/0°F	90°C/194°F	U4	
F21T5											
1	21W	KTEB-114-1-TP-FC	120V	Rapid	0.30A	0.50	150%	0.80	-18°C/0°F	75°C/167°F	V1
		KTEB-114-1-TP-FC-PH	120V	Rapid	0.30A	0.50	150%	0.80	-18°C/0°F	75°C/167°F	V1
	27W	KTEB-128HE-1-RS	120V	Rapid	0.22A	0.90	10%	1.05	-18°C/0°F	75°C/167°F	N3
	24W	KTEB-128-1-TP-FC	120V	Rapid	0.34A	0.50	150%	1.00	-18°C/0°F	75°C/167°F	V1
	25.5W	KTEB-128-1-TP-FC-PH	120V	Rapid	0.38A	0.56	150%	1.00	-18°C/0°F	75°C/167°F	V1
	28W	KTEB-135HE-1-RS	120V	Rapid	0.23A	0.90	10%	1.05	-18°C/0°F	75°C/167°F	N3
		KTEB-135HE-1-TP	120V	Rapid	0.34A	0.50	150%	1.00	-18°C/0°F	75°C/167°F	N1
	22W	KTEB-135HE-1-TP-PH	120V	Rapid	0.34A	0.50	150%	1.00	-18°C/0°F	75°C/167°F	N1
		KTEB-228HE-UV-PS-SL	120-277V	Program	0.22-0.10A	0.95	12%	1.06	-18°C/0°F	70°C/158°F	L30
	26W	KTEB-228HE-UV-PS	120-277V	Program	0.21-0.10A	0.95	15%	1.03	-18°C/0°F	90°C/194°F	U4
56W	KTEB-235HE-UV-PS	120-277V	Program	0.21-0.10A	0.95	15%	1.03	-18°C/0°F	90°C/194°F	U4	
2	41W	KTEB-221PS-1-TP	120V	Program	0.60A	0.50	130%	0.90	-18°C/0°F	75°C/167°F	L7
		KTEB-228-1-TP-PH-SL	120V	Preheat	0.60A	0.50	130%	0.90	-18°C/0°F	75°C/167°F	N1
	51W	KTEB-228HE-UV-PS-SL	120-277V	Program	0.42-0.19A	0.98	10%	1.04	-18°C/0°F	70°C/158°F	L30
		KTEB-228HE-UV-PS	120-277V	Program	0.40-0.17A	0.98	10%	1.02	-18°C/0°F	90°C/194°F	U4
48W	KTEB-235HE-UV-PS	120-277V	Program	0.40-0.17A	0.98	10%	1.02	-18°C/0°F	90°C/194°F	U4	

Specifications subject to change without notice. For complete product specifications, visit www.keystonetech.com

FLUORESCENT BALLASTS

T5



ELECTRICAL SPECIFICATIONS

No. of Lamps	Input Power	Catalog Number	Input Volts	Starting Method	Line Current	Min. Power Factor	Max. THD	Ballast Factor	Min. Start Temperature	Max. Case Temperature	Case Style
F28T5											
1	30W	KTEB-128-1-TP-FC	120V	Rapid	0.42A	0.50	130%	0.95	-18°C/0°F	75°C/167°F	V1
	31W	KTEB-128-1-TP-FC-PH	120V	Rapid	0.45A	0.57	150%	0.90	-18°C/0°F	75°C/167°F	V1
	32W	KTEB-128HE-1-RS	120V	Rapid	0.27A	0.90	10%	0.95	-18°C/0°F	75°C/167°F	N3
	34W	KTEB-135HE-1-RS	120V	Rapid	0.29A	0.90	10%	0.92	-18°C/0°F	75°C/167°F	N3
	28W	KTEB-135HE-1-TP	120V	Rapid	0.41A	0.50	130%	0.92	-18°C/0°F	75°C/167°F	N1
		KTEB-135HE-1-TP-PH	120V	Rapid	0.41A	0.50	130%	0.92	-18°C/0°F	75°C/167°F	N1
	33W	KTEB-228HE-UV-PS-SL	120-277V	Program	0.28-0.13A	0.95	12%	1.04	-18°C/0°F	70°C/158°F	L30
		KTEB-228HE-UV-PS	120-277V	Program	0.28-0.12A	0.98	10%	1.04	-18°C/0°F	90°C/194°F	U4
		KTEB-235HE-UV-PS	120-277V	Program	0.28-0.12A	0.98	10%	1.04	-18°C/0°F	90°C/194°F	U4
2	50W	KTEB-221PS-1-TP	120V	Program	0.70A	0.50	130%	0.80	-18°C/0°F	75°C/167°F	L7
		KTEB-228-1-TP-PH-SL	120V	Preheat	0.70A	0.50	130%	0.80	-18°C/0°F	75°C/167°F	N1
	67W	KTEB-228HE-UV-PS-SL	120-277V	Program	0.56-0.24A	0.98	10%	1.05	-18°C/0°F	70°C/158°F	L30
	64W	KTEB-228HE-UV-PS	120-277V	Program	0.55-0.23A	0.98	10%	1.03	-18°C/0°F	90°C/194°F	U4
		KTEB-235HE-UV-PS	120-277V	Program	0.55-0.23A	0.98	10%	1.03	-18°C/0°F	90°C/194°F	U4
F35T5											
1	38W	KTEB-135HE-1-RS	120V	Rapid	0.34A	0.90	10%	0.89	-18°C/0°F	75°C/167°F	N3
	34W	KTEB-135HE-1-TP	120V	Rapid	0.48A	0.50	130%	0.88	-18°C/0°F	75°C/167°F	N1
		KTEB-135HE-1-TP-PH	120V	Rapid	0.48A	0.50	130%	0.88	-18°C/0°F	75°C/167°F	N1
		KTEB-235HE-UV-PS	120-277V	Program	0.34-0.15A	0.98	10%	1.00	-18°C/0°F	90°C/194°F	U4
	41W	KTEB-228HE-UV-PS-SL	120-277V	Program	0.34-0.15A	0.96	10%	1.00	-18°C/0°F	70°C/158°F	L30
		KTEB-228HE-UV-PS	120-277V	Program	0.34-0.15A	0.97	12%	1.04	-18°C/0°F	90°C/194°F	U4
2	80W	KTEB-235HE-UV-PS	120-277V	Program	0.67-0.28A	0.98	10%	1.00	-18°C/0°F	90°C/194°F	U4

CASE STYLES

CASE L

Material: Steel

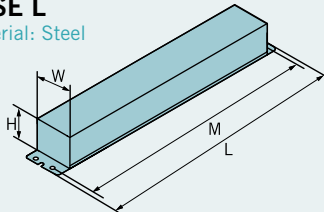

Case Style	Mounting	Length	Width	Height
L7	6.00"	6.46"	1.37"	1.00"
L19	17.92"	18.44"	1.31"	1.03"
L30	8.90"	9.50"	1.30"	1.00"

CASE N

Material: Steel

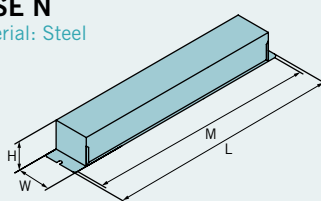

Case Style	Mounting	Length	Width	Height
N1	8.75"	9.00"	0.95"	0.95"
N3	9.00"	9.50"	1.18"	0.88"

CASE P

Material: Steel

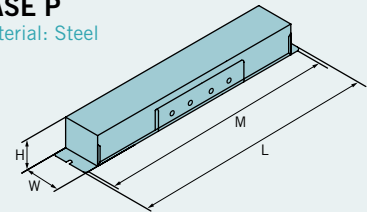

Case Style	Mounting	Length	Width	Height
P1	8.75"	9.00"	0.95"	0.95"
P2	7.25"	7.50"	0.95"	0.95"

CASE U

Material: Steel

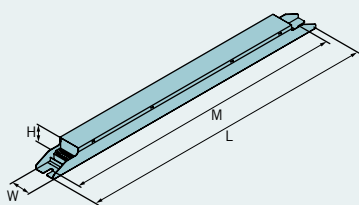

Case Style	Mounting	Length	Width	Height
U4	16.02"	16.89"	1.20"	1.00"

CASE V

Material: Steel

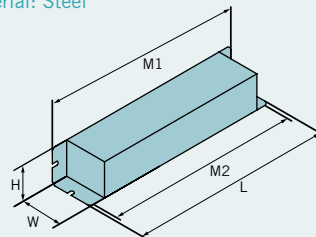

Case Style	Mounting	Length	Width	Height
V1	5.60"	5.90"	0.91"	0.76"

CASE X

Material: Plastic

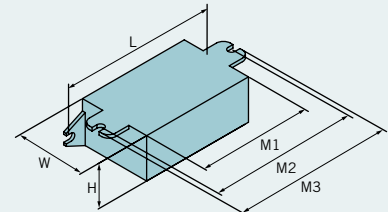

Case Style	Mounting	Length	Width	Height
X1	2.80"	3.07"	1.16"	1.00"

Specifications subject to change without notice. For complete product specifications, visit www.keystonetech.com

FLUORESCENT BALLASTS

T5HO

ELECTRICAL SPECIFICATIONS

No. of Lamps	Input Power	Catalog Number	Input Volts	Starting Method	Line Current	Min. Power Factor	Max. THD	Ballast Factor	Min. Start Temperature	Max. Case Temperature	Case Style
F24T5HO											
1	28W	KTEB-139HO-1-TP	120V	Rapid	0.41A	0.50	130%	1.00	-18°C/0°F	75°C/167°F	N1
	27W	KTEB-224HO-UV-PS-SL	120-277V	Program	0.23-0.10A	0.98	10%	1.02	-18°C/0°F	90°C/194°F	L30
	28W	KTEB-224HO-UV-PS	120-277V	Program	0.23-0.11A	0.95	12%	0.96	-18°C/0°F	90°C/194°F	U4
	30W	KTEB-239HO-UV-PS-SL	120-277V	Program	0.25-0.12A	0.95	15%	1.10	-18°C/0°F	90°C/194°F	L30
	29W	KTEB-239HO-UV-PS	120-277V	Program	0.24-0.12A	0.92	12%	1.10	-18°C/0°F	90°C/194°F	U4
2	52W	KTEB-224HO-UV-PS-SL	120-277V	Program	0.44-0.19A	0.98	10%	1.00	-18°C/0°F	90°C/194°F	L30
	50W	KTEB-224HO-UV-PS	120-277V	Program	0.42-0.19A	0.98	12%	0.90	-18°C/0°F	90°C/194°F	U4
	59W	KTEB-239HO-UV-PS-SL	120-277V	Program	0.22-0.50A	0.98	10%	1.08	-18°C/0°F	90°C/194°F	L30
	52W	KTEB-239HO-UV-PS	120-277V	Program	0.44-0.20A	0.97	12%	1.00	-18°C/0°F	90°C/194°F	U4
F39T5HO											
1	35W	KTEB-139HO-1-TP	120V	Rapid	0.49A	0.50	130%	0.90	-18°C/0°F	75°C/167°F	N1
	39W	KTEB-224HO-UV-PS-SL	120-277V	Program	0.33-0.15A	0.97	10%	0.90	-18°C/0°F	90°C/194°F	L30
		KTEB-224HO-UV-PS	120-277V	Program	0.33-0.15A	0.97	12%	0.90	-18°C/0°F	90°C/194°F	U4
	47W	KTEB-239HO-UV-PS-SL	120-277V	Program	0.39-0.18A	0.97	12%	1.06	-18°C/0°F	90°C/194°F	L30
	48W	KTEB-239HO-UV-PS	120-277V	Program	0.40-0.18A	0.96	12%	1.15	-18°C/0°F	90°C/194°F	U4
2	90W	KTEB-239HO-UV-PS-SL	120-277V	Program	0.78-0.34A	0.99	10%	1.00	-18°C/0°F	90°C/194°F	L30
	94W	KTEB-239HO-UV-PS	120-277V	Program	0.78-0.34A	0.98	10%	1.12	-18°C/0°F	90°C/194°F	U4
F54T5HO											
1	51W	KTEB-154HO-1-TP	120V	Rapid	0.74A	0.50	130%	0.95	-18°C/0°F	75°C/167°F	N1
	61W	KTEB-254HO-UV-PS-SL	120-277V	Program	0.51-0.23A	0.98	10%	1.02	-18°C/0°F	90°C/194°F	L5
		KTEB-254HO-UV-PS	120-277V	Program	0.51-0.23A	0.98	10%	1.02	-18°C/0°F	90°C/194°F	U4
	63W	KTEB-454HO-UV-PS	120-277V	Program	0.52-0.25A	0.91	20%	1.02	-18°C/0°F	90°C/194°F	L10
2	117W	KTEB-254HO-UV-PS-SL	120-277V	Program	0.98-0.42A	0.98	10%	1.00	-18°C/0°F	90°C/194°F	L5
	117W	KTEB-254HO-UV-PS	120-277V	Program	0.98-0.42A	0.98	10%	1.00	-18°C/0°F	90°C/194°F	U4
	116W	KTEB-454HO-UV-PS	120-277V	Program	0.98-0.44A	0.97	15%	1.00	-18°C/0°F	90°C/194°F	L10
3	170W	KTEB-454HO-UV-PS	120-277V	Program	1.42-0.62A	0.98	15%	1.02	-18°C/0°F	90°C/194°F	L10
4	220W	KTEB-454HO-UV-PS	120-277V	Program	1.85-0.79A	0.99	10%	1.00	-18°C/0°F	90°C/194°F	L10

CASE STYLES

CASE L

Material: Steel

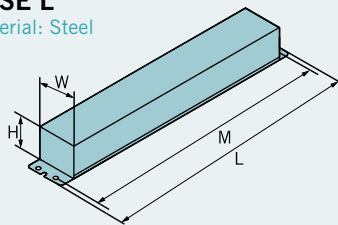

Case Style	Mounting	Length	Width	Height
L5	8.90"	9.50"	1.70"	1.18"
L10	16.09"	16.70"	1.70"	1.18"
L30	8.90"	9.50"	1.30"	1.00"

CASE N

Material: Steel

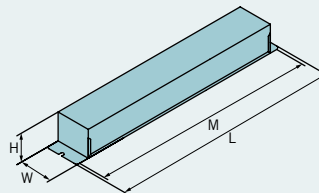

Case Style	Mounting	Length	Width	Height
N1	8.75"	9.00"	0.95"	0.95"

CASE U

Material: Steel

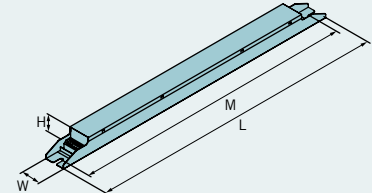

Case Style	Mounting	Length	Width	Height
U4	16.02"	16.89"	1.20"	1.00"

Specifications subject to change without notice. For complete product specifications, visit www.keystonetech.com

Keystone Technologies, LLC | North Wales, PA 19454 | Phone (800) 464-2680 | keystonetech.com

FLUORESCENT BALLASTS

COMPACT FLUORESCENT



ELECTRICAL SPECIFICATIONS

No. of Lamps	Input Power	Catalog Number	Input Volts	Starting Method	Line Current	Min. Power Factor	Max. THD	Ballast Factor	Min. Start Temperature	Max. Case Temperature	Case Style
CFT7W/2G7											
1	7.5W	KTEB-108-1-TP-FC	120V	Rapid	0.12A	0.50	150%	1.05	-18°C/0°F	75°C/167°F	V1
		KTEB-108-1-TP-FC-PH	120V	Rapid	0.12A	0.50	150%	1.05	-18°C/0°F	75°C/167°F	V1
CFT7W/G23											
1	9W	CC579TP*	120V	Preheat	0.15A	0.50	15%	0.87	0°C/32°F	90°C/194°F	B1
CFT9W/2G7											
1	8.5W	KTEB-108-1-TP-FC	120V	Rapid	0.13A	0.50	150%	1.00	-18°C/0°F	75°C/167°F	V1
		KTEB-108-1-TP-FC-PH	120V	Rapid	0.13A	0.50	150%	1.00	-18°C/0°F	75°C/167°F	V1
CFT9W/G23											
1	9W	CC579TP*	120V	Preheat	0.15A	0.50	15%	0.75	0°C/32°F	90°C/194°F	B1
CFQ13W/G24q											
1	14W	KTEB-113-1-TP	120V	Rapid	0.22A	0.50	150%	0.90	-18°C/0°F	75°C/167°F	C6
		KTEB-113-1-TP-PN	120V	Rapid	0.22A	0.50	150%	0.90	-18°C/0°F	75°C/167°F	S1
		KTEB-113-1-TP-SC	120V	Rapid	0.22A	0.50	150%	0.90	-18°C/0°F	90°C/194°F	L8
		KTEB-113-1-TP-SC-RJ	120V	Rapid	0.22A	0.50	150%	0.90	-18°C/0°F	90°C/194°F	L8
		KTEB-113-1-TP-SC-RJS	120V	Rapid	0.22A	0.50	150%	0.90	-18°C/0°F	90°C/194°F	L8
		KTEB-113-1-TP-SCS	120V	Rapid	0.22A	0.50	150%	0.90	-18°C/0°F	90°C/194°F	L8
		KTEB-114-1-TP-FC	120V	Rapid	0.22A	0.50	150%	0.90	-18°C/0°F	75°C/167°F	V1
		KTEB-114-1-TP-FC-PH	120V	Rapid	0.22A	0.50	150%	0.90	-18°C/0°F	75°C/167°F	V1
	18W	KTEB-213-UV-RS-DW KTEB-213-UV-RS-DW-KIT	120-277V	Rapid	0.15-0.07A	0.96	10%	1.10	-18°C/0°F	75°C/167°F	W1
	17W	KTEB-213-UV-PS-DW	120-277V	Program	0.14-0.07A	0.95	12%	1.05	-18°C/0°F	90°C/194°F	W1
2	28W	KTEB-213-1-TP	120V	Rapid	0.43A	0.50	150%	0.95	-18°C/0°F	75°C/167°F	C6
		KTEB-213-1-TP-DW	120V	Rapid	0.43A	0.50	150%	0.95	-18°C/0°F	75°C/167°F	W1
		KTEB-213-1-TP-SC	120V	Rapid	0.43A	0.50	150%	0.95	-18°C/0°F	75°C/167°F	L8
		KTEB-213-1-TP-SC-RJ	120V	Rapid	0.43A	0.50	150%	0.95	-18°C/0°F	90°C/194°F	L8
		KTEB-213-1-TP-SC-RJS	120V	Rapid	0.43A	0.50	150%	0.95	-18°C/0°F	90°C/194°F	L8
		KTEB-213-1-TP-SCS	120V	Rapid	0.43A	0.50	150%	0.95	-18°C/0°F	90°C/194°F	L8
	32W	KTEB-213-UV-RS-DW KTEB-213-UV-RS-DW-KIT	120-277V	Rapid	0.27-0.12A	0.99	10%	1.05	-18°C/0°F	75°C/167°F	W1
	30W	KTEB-213-UV-PS-DW	120-277V	Program	0.26-0.12A	0.98	10%	1.00	-18°C/0°F	90°C/194°F	W1
CFT13W/2GX7											
1	16W	KTEB-113-1-TP-EMIA	120V	Rapid	0.24A	0.54	150%	1.00	-18°C/0°F	75°C/167°F	X1
CFTR13W/GX24q											
1	18W	KTEB-213-UV-RS-DW KTEB-213-UV-RS-DW-KIT	120-277V	Rapid	0.15-0.07A	0.96	10%	1.10	-18°C/0°F	75°C/167°F	W1
	17W	KTEB-213-UV-PS-DW	120-277V	Program	0.14-0.07A	0.95	12%	1.05	-18°C/0°F	90°C/194°F	W1
2	28W	KTEB-213-1-TP-DW	120V	Rapid	0.43A	0.50	150%	0.95	-18°C/0°F	75°C/167°F	W1
		KTEB-213-1-TP-SC	120V	Rapid	0.43A	0.50	150%	0.95	-18°C/0°F	75°C/167°F	L8
		KTEB-213-1-TP-SC-RJ	120V	Rapid	0.43A	0.50	150%	0.95	-18°C/0°F	90°C/194°F	L8
		KTEB-213-1-TP-SC-RJS	120V	Rapid	0.43A	0.50	150%	0.95	-18°C/0°F	90°C/194°F	L8
		KTEB-213-1-TP-SCS	120V	Rapid	0.43A	0.50	150%	0.95	-18°C/0°F	90°C/194°F	L8
		32W	KTEB-213-UV-RS-DW KTEB-213-UV-RS-DW-KIT	120-277V	Rapid	0.27-0.12A	0.99	10%	1.05	-18°C/0°F	75°C/167°F
	30W	KTEB-213-UV-PS-DW	120-277V	Program	0.26-0.12A	0.98	10%	1.00	-18°C/0°F	90°C/194°F	W1
	CFQ13W/GX23 OR CFT13W/GX23										
1	16W	CC1322MTP*	120V	Preheat	0.30A	0.45	15%	0.93	0°C/32°F	90°C/194°F	B2
	15W	113SHPTP*	120V	Preheat	0.13A	0.90	10%	0.88	0°C/32°F	90°C/194°F	C7

*electromagnetic ballast

Specifications subject to change without notice. For complete product specifications, visit www.keystonetech.com



FLUORESCENT BALLASTS

COMPACT FLUORESCENT

ELECTRICAL SPECIFICATIONS

No. of Lamps	Input Power	Catalog Number	Input Volts	Starting Method	Line Current	Min. Power Factor	Max. THD	Ballast Factor	Min. Start Temperature	Max. Case Temperature	Case Style
CFQ18W/G24q											
1	18W	KTEB-118-1-TP-SC	120V	Rapid	0.28A	0.50	150%	1.00	-18°C/0°F	90°C/194°F	L8
		KTEB-118-1-TP-SC-RJ	120V	Rapid	0.28A	0.50	150%	1.00	-18°C/0°F	90°C/194°F	L8
		KTEB-118-1-TP-SC-RJS	120V	Rapid	0.28A	0.50	150%	1.00	-18°C/0°F	90°C/194°F	L8
		KTEB-118-1-TP-SCS	120V	Rapid	0.28A	0.50	150%	1.00	-18°C/0°F	90°C/194°F	L8
	20W	KTEB-1C22-1-TP	120V	Rapid	0.33A	0.50	150%	1.00	-18°C/0°F	75°C/167°F	S1
	24W	KTEB-218-UV-RS-DW KTEB-218-UV-RS-DW-KIT	120-277V	Rapid	0.21-0.10A	0.95	12%	1.20	-18°C/0°F	75°C/167°F	W1
	20W	KTEB-218-UV-PS-DW	120-277V	Program	0.17-0.08A	0.95	12%	1.00	-18°C/0°F	90°C/194°F	W1
2	36W	KTEB-218-1-TP	120V	Rapid	0.59A	0.50	150%	1.00	-18°C/0°F	75°C/167°F	C6
		KTEB-218-1-TP-SC	120V	Rapid	0.59A	0.50	150%	1.00	-18°C/0°F	90°C/194°F	L8
		KTEB-218-1-TP-SC-RJ	120V	Rapid	0.59A	0.50	150%	1.00	-18°C/0°F	90°C/194°F	L8
		KTEB-218-1-TP-SC-RJS	120V	Rapid	0.59A	0.50	150%	1.00	-18°C/0°F	90°C/194°F	L8
		KTEB-218-1-TP-SCS	120V	Rapid	0.59A	0.50	150%	1.00	-18°C/0°F	90°C/194°F	L8
	40W	KTEB-218-UV-RS-DW KTEB-218-UV-RS-DW-KIT	120-277V	Rapid	0.36-0.16A	0.99	10%	1.10	-18°C/0°F	75°C/167°F	W1
	36W	KTEB-218-UV-PS-DW	120-277V	Program	0.30-0.13A	0.98	10%	0.95	-18°C/0°F	90°C/194°F	W1
	CFTR18W/GX24q										
1	24W	KTEB-218-UV-RS-DW KTEB-218-UV-RS-DW-KIT	120-277V	Rapid	0.21-0.10A	0.95	12%	1.20	-18°C/0°F	75°C/167°F	W1
	20W	KTEB-218-UV-PS-DW	120-277V	Program	0.17-0.08A	0.95	12%	1.00	-18°C/0°F	90°C/194°F	W1
2	36W	KTEB-218-1-TP-DW	120V	Rapid	0.59A	0.50	150%	1.00	-18°C/0°F	75°C/167°F	W1
		KTEB-218-1-TP-SC	120V	Rapid	0.59A	0.50	150%	1.00	-18°C/0°F	90°C/194°F	L8
		KTEB-218-1-TP-SC-RJ	120V	Rapid	0.59A	0.50	150%	1.00	-18°C/0°F	90°C/194°F	L8
		KTEB-218-1-TP-SC-RJS	120V	Rapid	0.59A	0.50	150%	1.00	-18°C/0°F	90°C/194°F	L8
		KTEB-218-1-TP-SCS	120V	Rapid	0.59A	0.50	150%	1.00	-18°C/0°F	90°C/194°F	L8
	42W	KTEB-218-UV-RS-DW KTEB-218-UV-RS-DW-KIT	120-277V	Rapid	0.36-0.16A	0.99	10%	1.10	-18°C/0°F	75°C/167°F	W1
	36W	KTEB-218-UV-PS-DW	120-277V	Program	0.30-0.13A	0.98	10%	0.95	-18°C/0°F	90°C/194°F	W1
CFQ26W/G24q											
1	24W	KTEB-126-1-TP	120V	Rapid	0.40A	0.50	150%	0.90	-18°C/0°F	75°C/167°F	S1
		KTEB-126-1-TP-LC	120V	Rapid	0.40A	0.50	150%	0.90	-18°C/0°F	75°C/167°F	L2
		KTEB-126-1-TP-SC	120V	Rapid	0.40A	0.50	150%	0.90	-18°C/0°F	90°C/194°F	L8
		KTEB-126-1-TP-SC-RJ	120V	Rapid	0.40A	0.50	150%	0.90	-18°C/0°F	90°C/194°F	L8
		KTEB-126-1-TP-SC-RJS	120V	Rapid	0.40A	0.50	150%	0.90	-18°C/0°F	90°C/194°F	L8
		KTEB-126-1-TP-SCS	120V	Rapid	0.40A	0.50	150%	0.90	-18°C/0°F	90°C/194°F	L8
	28W	KTEB-142T-1-TP-SC	120V	Rapid	0.43A	0.50	150%	1.05	-18°C/0°F	90°C/194°F	L8
		KTEB-142T-1-TP-SC-RJ	120V	Rapid	0.43A	0.50	150%	1.05	-18°C/0°F	90°C/194°F	L8
		KTEB-142T-1-TP-SC-RJS	120V	Rapid	0.43A	0.50	150%	1.05	-18°C/0°F	90°C/194°F	L8
		KTEB-142T-1-TP-SCS	120V	Rapid	0.43A	0.50	150%	1.05	-18°C/0°F	90°C/194°F	L8
	30W	KTEB-218-UV-RS-DW KTEB-218-UV-RS-DW-KIT	120-277V	Rapid	0.26-0.11A	0.98	10%	1.05	-18°C/0°F	75°C/167°F	W1
	33W	KTEB-226-UV-RS-DW KTEB-226-UV-RS-DW-KIT	120-277V	Rapid	0.27-0.12A	0.96	12%	1.20	-18°C/0°F	75°C/167°F	W1
	27W	KTEB-226-UV-PS-DW	120-277V	Program	0.23-0.10A	0.95	10%	0.95	-18°C/0°F	90°C/194°F	W1
	32W	KTEB-242-UV-RS-DW KTEB-242-UV-RS-DW-KIT	120-277V	Rapid	0.27-0.13A	0.95	10%	1.00	-18°C/0°F	75°C/167°F	W2
KTEB-242-UV-PS-DW		120-277V	Program	0.27-0.13A	0.95	10%	1.00	-18°C/0°F	90°C/194°F	W2	

Specifications subject to change without notice. For complete product specifications, visit www.keystonetech.com

FLUORESCENT BALLASTS

COMPACT FLUORESCENT



ELECTRICAL SPECIFICATIONS

No. of Lamps	Input Power	Catalog Number	Input Volts	Starting Method	Line Current	Min Power Factor	Max. THD	Ballast Factor	Min. Start Temperature	Max. Case Temperature	Case Style
CFQ26W/G24q											
2	50W	KTEB-226-1-TP	120V	Rapid	0.80A	0.50	150%	1.00	-18°C/0°F	75°C/167°F	C6
	51W	KTEB-226-1-TP-DW	120V	Rapid	0.80A	0.50	150%	1.00	-18°C/0°F	75°C/167°F	W1
	50W	KTEB-226-1-TP-SC	120V	Rapid	0.80A	0.50	150%	1.00	-18°C/0°F	90°C/194°F	L8
		KTEB-226-1-TP-SC-RJ	120V	Rapid	0.80A	0.50	150%	1.00	-18°C/0°F	90°C/194°F	L8
		KTEB-226-1-TP-SC-RJS	120V	Rapid	0.80A	0.50	150%	1.00	-18°C/0°F	90°C/194°F	L8
		KTEB-226-1-TP-SCS	120V	Rapid	0.80A	0.50	150%	1.00	-18°C/0°F	90°C/194°F	L8
	58W	KTEB-226-UV-RS-DW KTEB-226-UV-RS-DW-KIT	120-277V	Rapid	0.49-0.21A	0.99	10%	1.00	-18°C/0°F	75°C/167°F	W1
	51W	KTEB-226-UV-PS-DW	120-277V	Program	0.42-0.18A	0.98	10%	0.95	-18°C/0°F	90°C/194°F	W1
	43W	KTEB-240-1-TP	120V	Rapid	0.69A	0.50	150%	0.85	-18°C/0°F	75°C/167°F	L1
	54W	KTEB-242-UV-RS-DW KTEB-242-UV-RS-DW-KIT	120-277V	Rapid	0.45-0.21A	0.97	10%	0.90	-18°C/0°F	75°C/167°F	W2
KTEB-242-UV-PS-DW		120-277V	Program	0.45-0.21A	0.97	10%	0.90	-18°C/0°F	90°C/194°F	W2	
CFTR26W/G24Xq											
1	26W	KTEB-142T-1-TP-SC	120V	Rapid	0.40A	0.50	150%	1.00	-18°C/0°F	90°C/194°F	L8
		KTEB-142T-1-TP-SC-RJ	120V	Rapid	0.40A	0.50	150%	1.00	-18°C/0°F	90°C/194°F	L8
		KTEB-142T-1-TP-SC-RJS	120V	Rapid	0.40A	0.50	150%	1.00	-18°C/0°F	90°C/194°F	L8
		KTEB-142T-1-TP-SCS	120V	Rapid	0.40A	0.50	150%	1.00	-18°C/0°F	90°C/194°F	L8
	30W	KTEB-226-UV-RS-DW KTEB-226-UV-RS-DW-KIT	120-277V	Rapid	0.26-0.11A	0.96	12%	1.05	-18°C/0°F	75°C/167°F	W1
		24W	KTEB-226-UV-PS-DW	120-277V	Program	0.20-0.09A	0.95	10%	0.90	-18°C/0°F	90°C/194°F
	32W	KTEB-242-UV-RS-DW KTEB-242-UV-RS-DW-KIT	120-277V	Rapid	0.27-0.13A	0.95	10%	1.00	-18°C/0°F	75°C/167°F	W2
		KTEB-242-UV-PS-DW	120-277V	Program	0.27-0.13A	0.95	10%	1.00	-18°C/0°F	90°C/194°F	W2
2	51W	KTEB-226-1-TP-DW	120V	Rapid	0.80A	0.50	150%	1.00	-18°C/0°F	75°C/167°F	W1
		KTEB-226-1-TP-SC	120V	Rapid	0.80A	0.50	150%	1.00	-18°C/0°F	90°C/194°F	L8
		KTEB-226-1-TP-SC-RJ	120V	Rapid	0.80A	0.50	150%	1.00	-18°C/0°F	90°C/194°F	L8
		KTEB-226-1-TP-SC-RJS	120V	Rapid	0.80A	0.50	150%	1.00	-18°C/0°F	90°C/194°F	L8
		KTEB-226-1-TP-SCS	120V	Rapid	0.80A	0.50	150%	1.00	-18°C/0°F	90°C/194°F	L8
	54W	KTEB-226-UV-RS-DW KTEB-226-UV-RS-DW-KIT	120-277V	Rapid	0.46-0.20A	0.98	10%	0.95	-18°C/0°F	75°C/167°F	W1
	48W	KTEB-226-UV-PS-DW	120-277V	Program	0.40-0.18A	0.98	10%	0.90	-18°C/0°F	90°C/194°F	W1
	56W	KTEB-242-UV-RS-DW KTEB-242-UV-RS-DW-KIT	120-277V	Rapid	0.48-0.21A	0.97	10%	1.00	-18°C/0°F	75°C/167°F	W2
	54W	KTEB-242-UV-PS-DW	120-277V	Program	0.45-0.21A	0.97	10%	0.90	-18°C/0°F	90°C/194°F	W2
	CFTR32W/GX24q										
1	33W	KTEB-142T-1-TP-SC	120V	Rapid	0.50A	0.50	130%	0.95	-18°C/0°F	90°C/194°F	L8
		KTEB-142T-1-TP-SC-RJ	120V	Rapid	0.50A	0.50	130%	0.95	-18°C/0°F	90°C/194°F	L8
		KTEB-142T-1-TP-SC-RJS	120V	Rapid	0.50A	0.50	130%	0.95	-18°C/0°F	90°C/194°F	L8
		KTEB-142T-1-TP-SCS	120V	Rapid	0.50A	0.50	130%	0.95	-18°C/0°F	90°C/194°F	L8
	41W	KTEB-226-UV-RS-DW KTEB-226-UV-RS-DW-KIT	120-277V	Rapid	0.35-0.15A	0.98	10%	1.10	-18°C/0°F	75°C/167°F	W1
	36W	KTEB-226-UV-PS-DW	120-277V	Program	0.30-0.13A	0.98	10%	1.00	-18°C/0°F	90°C/194°F	W1
	42W	KTEB-242-UV-RS-DW KTEB-242-UV-RS-DW-KIT	120-277V	Rapid	0.35-0.13A	0.96	10%	0.96	-18°C/0°F	75°C/167°F	W2
		KTEB-242-UV-PS-DW	120-277V	Program	0.35-0.13A	0.96	10%	0.96	-18°C/0°F	90°C/194°F	W2
CFTR32W/GX24q											
2	61W	KTEB-240-1-TP	120V	Rapid	0.91A	0.50	150%	0.89	-18°C/0°F	75°C/167°F	L1
	69W	KTEB-242-UV-RS-DW KTEB-242-UV-RS-DW-KIT	120-277V	Rapid	0.56-0.23A	0.96	10%	0.90	-18°C/0°F	75°C/167°F	W2
		KTEB-242-UV-PS-DW	120-277V	Program	0.56-0.25A	0.96	10%	0.90	-18°C/0°F	90°C/194°F	W2

Specifications subject to change without notice. For complete product specifications, visit www.keystonetech.com



FLUORESCENT BALLASTS

COMPACT FLUORESCENT

ELECTRICAL SPECIFICATIONS

No. of Lamps	Input Power	Catalog Number	Input Volts	Starting Method	Line Current	Min. Power Factor	Max. THD	Ballast Factor	Min. Start Temperature	Max. Case Temperature	Case Style
CFTR42W/GX24q											
1	37W	KTEB-142T-1-TP-SC	120V	Rapid	0.54A	0.50	120%	0.80	-18°C/0°F	90°C/194°F	L8
		KTEB-142T-1-TP-SC-RJ	120V	Rapid	0.54A	0.50	120%	0.80	-18°C/0°F	90°C/194°F	L8
		KTEB-142T-1-TP-SC-RJS	120V	Rapid	0.54A	0.50	120%	0.80	-18°C/0°F	90°C/194°F	L8
		KTEB-142T-1-TP-SCS	120V	Rapid	0.54A	0.50	120%	0.80	-18°C/0°F	90°C/194°F	W2
2	84W	KTEB-242-UV-RS-DW	120-277V	Rapid	0.70-0.30A	0.98	10%	0.90	-18°C/0°F	75°C/167°F	W2
		KTEB-242-UV-RS-DW-KIT	120-277V	Rapid	0.70-0.30A	0.98	10%	0.90	-18°C/0°F	75°C/167°F	W2
		KTEB-242-UV-PS-DW	120-277V	Program	0.70-0.30A	0.98	10%	0.90	-18°C/0°F	90°C/194°F	W2

CASE STYLES

CASE B

Material: Steel

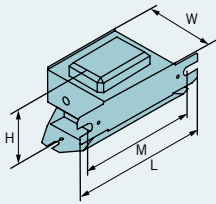

Case Style	Mounting	Length	Width	Height
B1	2.50"	2.75"	1.50"	1.20"
B2	2.50"	3.15"	1.14"	1.77"

CASE C

Material: Steel

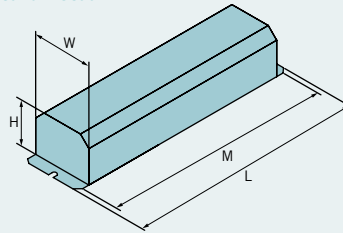

Case Style	Mounting	Length	Width	Height
C6	6.00"	6.46"	1.89"	0.98"
C7	2.75"	3.10"	1.89"	1.43"

CASE L

Material: Steel

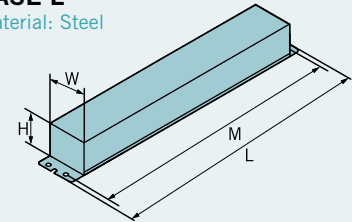

Case Style	Mounting	Length	Width	Height
L1	6.00"	6.46"	1.89"	1.00"
L2	6.00"	6.46"	1.89"	1.15"
L8	3.60"	4.00"	1.87"	1.18"

CASE S

Material: Plastic

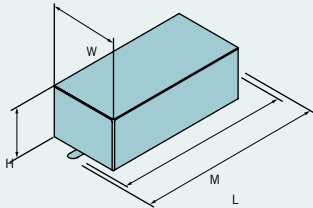

Case Style	Mounting	Length	Width	Height
S1	2.88"	3.45"	1.81"	1.21"

CASE V

Material: Steel

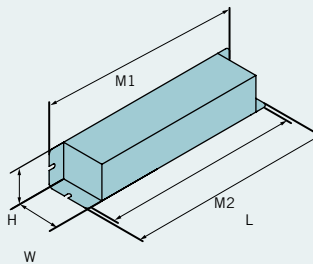

Case Style	Mounting	Length	Width	Height
V1	5.60"	5.90"	0.91"	0.76"

CASE W*

Material: Steel

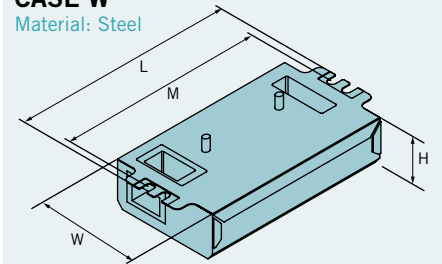

Case Style	Mounting	Length	Width	Height
W1	4.63"	5.00"	2.40"	1.00"
W2	4.63"	5.00"	3.00"	1.38"

* Available with and without studs.

CASE X

Material: Plastic

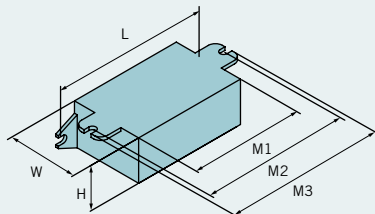

Case Style	Mounting	Length	Width	Height
X1	2.80"	3.07"	1.16"	1.00"

Specifications subject to change without notice. For complete product specifications, visit www.keystonetech.com

Keystone Technologies, LLC | North Wales, PA 19454 | Phone (800) 464-2680 | keystonetech.com

FLUORESCENT BALLASTS

PLL



ELECTRICAL SPECIFICATIONS

No. of Lamps	Input Power	Catalog Number	Input Volts	Starting Method	Line Current	Min. Power Factor	Max. THD	Ballast Factor	Min. Start Temperature	Max. Case Temperature	Case Style
FT24W/2G11											
1	28W	KTEB-139HO-1-TP	120V	Rapid	0.43A	0.50	150%	1.00	-18°C/0°F	75°C/167°F	N1
	27W	KTEB-224HO-UV-PS-SL	120-277V	Program	0.23-0.10A	0.98	10%	1.02	-18°C/0°F	90°C/194°F	L30
	26W	KTEB-224HO-UV-PS	120-277V	Program	0.10-0.22A	0.95	12%	0.95	-18°C/0°F	90°C/194°F	U4
	30W	KTEB-239HO-UV-PS-SL	120-277V	Program	0.25-0.12A	0.95	15%	1.09	-18°C/0°F	90°C/194°F	L30
2	52W	KTEB-224HO-UV-PS-SL	120-277V	Program	0.44-0.19A	0.98	10%	1.00	-18°C/0°F	90°C/194°F	L30
	50W	KTEB-224HO-UV-PS	120-277V	Program	0.18-0.42A	0.98	12%	0.90	-18°C/0°F	90°C/194°F	U4
	46W	KTEB-226-UV-PS-DW	120-277V	Program	0.38-0.17A	0.98	10%	0.87	-18°C/0°F	90°C/194°F	W1
	55W	KTEB-239HO-UV-PS-SL	120-277V	Program	0.45-0.20A	0.98	10%	0.99	-18°C/0°F	90°C/194°F	L30
	54W	KTEB-242-UV-PS-DW	120-277V	Program	0.45-0.20A	0.98	10%	1.00	-18°C/0°F	90°C/194°F	W2
FT36W/2G11											
1	33W	KTEB-139HO-1-TP	120V	Rapid	0.48A	0.50	150%	0.90	-18°C/0°F	75°C/167°F	N1
	34W	KTEB-224HO-UV-PS-SL	120-277V	Program	0.29-0.13A	0.98	10%	0.90	-18°C/0°F	90°C/194°F	L30
	40W	KTEB-224HO-UV-PS	120-277V	Program	0.33-0.15A	0.95	12%	1.00	-18°C/0°F	90°C/194°F	U4
	38W	KTEB-239HO-UV-PS-SL	120-277V	Program	0.32-0.14A	0.99	10%	0.92	-18°C/0°F	90°C/194°F	L30
	37W	KTEB-242-UV-PS-DW	120-277V	Program	0.31-0.14A	0.95	12%	0.88	-18°C/0°F	90°C/194°F	W2
	42W	KTEB-454HO-UV-PS	120-277V	Program	0.35-0.18A	0.85	20%	1.10	-18°C/0°F	90°C/194°F	L10
2	72W	KTEB-239HO-UV-PS-SL	120-277V	Program	0.60-0.26A	0.98	10%	0.87	-18°C/0°F	90°C/194°F	L30
	74W	KTEB-239HO-UV-PS	120-277V	Program	0.62-0.27A	0.98	10%	0.95	-18°C/0°F	90°C/194°F	U4
	66W	KTEB-242-UV-PS-DW	120-277V	Program	0.55-0.24A	0.98	10%	0.80	-18°C/0°F	90°C/194°F	W2
	80W	KTEB-454HO-UV-PS	120-277V	Program	0.66-0.31A	0.94	15%	1.10	-18°C/0°F	90°C/194°F	L10
3	122W	KTEB-454HO-UV-PS	120-277V	Program	1.03-0.46A	0.97	15%	1.10	-18°C/0°F	90°C/194°F	L10
4	160W	KTEB-454HO-UV-PS	120-277V	Program	1.35-0.59A	0.99	10%	1.10	-18°C/0°F	90°C/194°F	L10
FT40W/2G11RS											
1	38W	KTEB-139HO-1-TP	120V	Rapid	0.55A	0.50	150%	0.90	-18°C/0°F	75°C/167°F	N1
	39W	KTEB-142T-1-TP-SC	120V	Rapid	0.56A	0.50	120%	0.85	-18°C/0°F	90°C/194°F	L8
	47W	KTEB-224HO-UV-PS-SL	120-277V	Program	0.40-0.17A	0.98	10%	1.00	-18°C/0°F	90°C/194°F	L30
	50W	KTEB-239HO-UV-PS-SL	120-277V	Program	0.42-0.19A	0.97	12%	1.09	-18°C/0°F	90°C/194°F	L30
	45W	KTEB-242-UV-PS-DW	120-277V	Program	0.37-0.17A	0.96	10%	1.00	-18°C/0°F	90°C/194°F	W2
2	82W	KTEB-242-UV-PS-DW	120-277V	Program	0.69-0.30A	0.98	10%	0.95	-18°C/0°F	90°C/194°F	W2
FT50W/2G11RS											
1	48W	KTEB-154HO-1-TP	120V	Rapid	0.73A	0.50	150%	0.90	-18°C/0°F	75°C/167°F	N1
	57W	KTEB-254HO-UV-PS-SL	120-277V	Program	0.49-0.22A	0.92	12%	1.00	-18°C/0°F	90°C/194°F	L5
		KTEB-254HO-UV-PS	120-277V	Program	0.49-0.22A	0.92	12%	1.00	-18°C/0°F	90°C/194°F	U4
	53W	KTEB-454HO-UV-PS	120-277V	Program	0.90-0.38A	0.90	20%	0.87	-18°C/0°F	90°C/194°F	L10
2	115W	KTEB-254HO-UV-PS-SL	120-277V	Program	0.98-0.43A	0.98	10%	1.00	-18°C/0°F	90°C/194°F	L5
		KTEB-254HO-UV-PS	120-277V	Program	0.98-0.43A	0.98	10%	1.00	-18°C/0°F	90°C/194°F	U4
	102W	KTEB-454HO-UV-PS	120-277V	Program	0.45-0.25A	0.96	15%	0.85	-18°C/0°F	90°C/194°F	L10
3	153W	KTEB-454HO-UV-PS	120-277V	Program	1.28-0.56A	0.98	15%	0.87	-18°C/0°F	90°C/194°F	L10
4	202W	KTEB-454HO-UV-PS	120-277V	Program	1.70-0.77A	0.99	10%	0.85	-18°C/0°F	90°C/194°F	L10

Specifications subject to change without notice. For complete product specifications, visit www.kestonetech.com



FLUORESCENT BALLASTS

PLL

ELECTRICAL SPECIFICATIONS

No. of Lamps	Input Power	Catalog Number	Input Volts	Starting Method	Line Current	Min. Power Factor	Max. THD	Ballast Factor	Min. Start Temperature	Max. Case Temperature	Case Style
FT55W/2G11RS											
1	48W	KTEB-154HO-1-TP	120V	Rapid	0.73A	0.50	150%	0.85	-18°C/0°F	75°C/167°F	N1
	55W	KTEB-254HO-UV-PS-SL	120-277V	Program	0.46-0.21A	0.92	12%	0.86	-18°C/0°F	90°C/194°F	L5
		KTEB-254HO-UV-PS	120-277V	Program	0.46-0.21A	0.92	12%	0.86	-18°C/0°F	90°C/194°F	U4
2	106W	KTEB-254HO-UV-PS-SL	120-277V	Program	0.98-0.38A	0.99	10%	0.85	-18°C/0°F	90°C/194°F	L5
		KTEB-254HO-UV-PS	120-277V	Program	0.98-0.38A	0.99	10%	0.85	-18°C/0°F	90°C/194°F	U4
	102W	KTEB-454HO-UV-PS	120-277V	Program	0.85-0.39A	0.96	15%	0.85	-18°C/0°F	90°C/194°F	L10
3	153W	KTEB-454HO-UV-PS	120-277V	Program	1.28-0.56A	0.98	15%	0.87	-18°C/0°F	90°C/194°F	L10
4	202W	KTEB-454HO-UV-PS	120-277V	Program	1.70-0.77A	0.99	10%	0.85	-18°C/0°F	90°C/194°F	L10

CASE STYLES

CASE L

Material: Steel

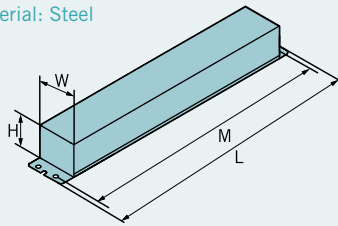

Case Style	Mounting	Length	Width	Height
L5	8.90"	9.50"	1.70"	1.18"
L8	3.60"	4.00"	1.87"	1.18"
L10	16.09"	16.70"	1.70"	1.18"
L30	8.90"	9.50"	1.30"	1.00"

CASE N

Material: Steel

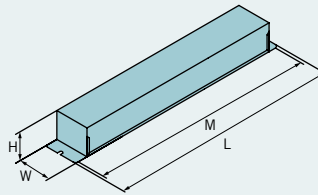

Case Style	Mounting	Length	Width	Height
N1	8.75"	9.00"	0.95"	0.95"

CASE U

Material: Steel

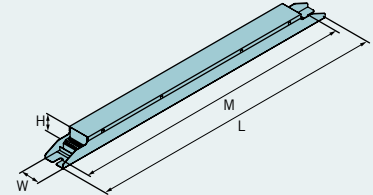

Case Style	Mounting	Length	Width	Height
U4	16.02"	16.89"	1.20"	1.00"

CASE W*

Material: Steel

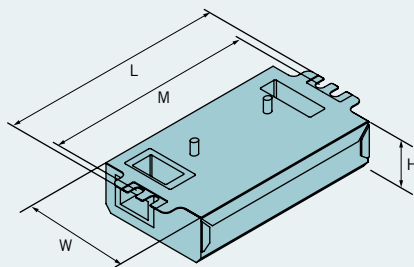

Case Style	Mounting	Length	Width	Height
W1	4.63"	5.00"	2.40"	1.00"
W2	4.63"	5.00"	3.00"	1.38"

* Available with and without studs.

Specifications subject to change without notice. For complete product specifications, visit www.keystonetech.com

Keystone Technologies, LLC | North Wales, PA 19454 | Phone (800) 464-2680 | keystonetech.com

FLUORESCENT BALLASTS

CIRCLINE



ELECTRICAL SPECIFICATIONS

No. of Lamps	Input Power	Catalog Number	Input Volts	Starting Method	Line Current	Min. Power Factor	Max. THD	Ballast Factor	Min. Start Temperature	Max. Case Temperature	Case Style
FC6T9 (20W)											
1	21W	SS22WSTP*	120V	Preheat	0.35A	0.50	20%	0.79	0°C/32°F	90°C/194°F	C7
FC8T9 (22W)											
1	21W	KTEB-1C22-1-TP-WS	120V	Rapid	0.33A	0.50	150%	0.90	-18°C/0°F	75°C/167°F	S1
	19W	SS22WSTP*	120V	Preheat	0.29A	0.50	15%	0.79	0°C/32°F	90°C/194°F	C7
FC12T9 (32W)											
1	29W	KTEB-140-1-TP-EMI-WS	120V	Rapid	0.42A	0.57	150%	0.92	-18°C/0°F	75°C/167°F	L7
	37W	KTEB-1C3032-1-TP-WS	120V	Rapid	0.55A	0.50	150%	1.00	-18°C/0°F	75°C/167°F	S1
FC8T9 & FC12T9											
2	48W	KTEB-2C54PS-1-TP-WS	120V	Program	0.68A	0.50	130%	0.85	-18°C/0°F	75°C/167°F	L1
	40W	KTEB-2C72-1-TP-WS	120V	Rapid	0.60A	0.50	150%	0.76	-18°C/0°F	75°C/167°F	L1
FC16T9 (40W)											
1	43W	KTEB-1382D-1-TP-WS	120V	Rapid	0.63A	0.50	130%	0.95	-18°C/0°F	75°C/167°F	S1
	38W	KTEB-140-1-TP-EMI-WS	120V	Rapid	0.53A	0.58	150%	0.95	-18°C/0°F	75°C/167°F	L7
	42W	KTEB-226-UV-RS-DW KTEB-226-UV-RS-DW-KIT	120-277V	Rapid	0.36-0.16A	0.97	10%	1.00	-18°C/0°F	75°C/167°F	W1
FC12T9 & FC16T9											
2	50W	KTEB-2C72-1-TP-WS	120V	Rapid	0.75A	0.50	150%	0.70	-18°C/0°F	75°C/167°F	L1
FC9T5 (22W)											
1	22W	KTEB-126-1-TP	120V	Rapid	0.34A	0.50	150%	1.00	-18°C/0°F	75°C/167°F	S1
		KTEB-126-1-TP-LC	120V	Rapid	0.34A	0.50	150%	1.00	-18°C/0°F	75°C/167°F	L2
	27W	KTEB-224HO-UV-PS-SL	120-277V	Program	0.23-0.10A	0.98	10%	1.02	-18°C/0°F	90°C/194°F	L30
	33W	KTEB-239HO-UV-PS-SL	120-277V	Program	0.28-0.13A	0.95	12%	1.31	-18°C/0°F	90°C/194°F	L30
	31W	KTEB-242-UV-PS-DW	120-277V	Program	0.27-0.13A	0.93	15%	1.20	-18°C/0°F	90°C/194°F	W2
2	52W	KTEB-224HO-UV-PS-SL	120-277V	Program	0.44-0.19A	0.98	10%	1.00	-18°C/0°F	90°C/194°F	L30
	63W	KTEB-239HO-UV-PS-SL	120-277V	Program	0.53-0.23A	0.98	10%	1.25	-18°C/0°F	90°C/194°F	L30
	59W	KTEB-242-UV-PS-DW	120-277V	Program	0.49-0.22A	0.97	10%	1.10	-18°C/0°F	90°C/194°F	W2
FCL-30 (30W)											
1	32W	KTEB-1C3032-1-TP-WS	120V	Rapid	0.50A	0.50	150%	0.95	-18°C/0°F	75°C/167°F	L1
FC12T5 (40W)											
1	41W	KTEB-1382D-1-TP-WS	120V	Rapid	0.62A	0.50	150%	0.95	-18°C/0°F	75°C/167°F	S1
	40W	KTEB-224HO-UV-PS-SL	120-277V	Program	0.34-0.15A	0.98	10%	0.84	-18°C/0°F	90°C/194°F	L30
	45W	KTEB-242-UV-PS-DW	120-277V	Program	0.37-0.17A	0.96	10%	1.00	-18°C/0°F	90°C/194°F	W2
2	82W	KTEB-242-UV-PS-DW	120-277V	Program	0.69-0.30A	0.97	10%	0.95	-18°C/0°F	90°C/194°F	W2
FC9T5 & FC12T5											
2	68W	KTEB-239HO-UV-PS-SL	120-277V	Program	0.57-0.25A	0.98	10%	0.96	-18°C/0°F	90°C/194°F	L30
	67W	KTEB-242-UV-PS-DW	120-277V	Program	0.55-0.25A	0.98	10%	0.90	-18°C/0°F	90°C/194°F	W2

*electromagnetic ballast

Specifications subject to change without notice. For complete product specifications, visit www.keystonetech.com



FLUORESCENT BALLASTS

CIRCLINE

CASE STYLES

CASE C

Material: Steel

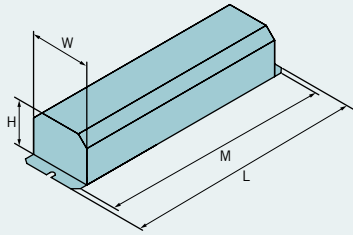

Case Style	Mounting	Length	Width	Height
C7	2.75"	3.10"	1.89"	1.43"

CASE L

Material: Steel

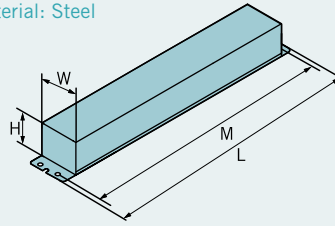

Case Style	Mounting	Length	Width	Height
L1	6.00"	6.46"	1.89"	1.00"
L2	6.00"	6.46"	1.89"	1.15"
L7	6.00"	6.46"	1.37"	1.00"
L30	8.90"	9.50"	1.30"	1.10"

CASE S

Material: Plastic

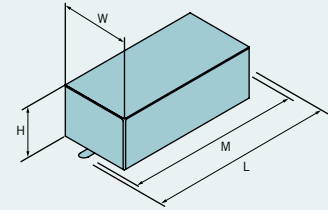

Case Style	Mounting	Length	Width	Height
S1	2.88"	3.45"	1.81"	1.21"

CASE W*

Material: Steel

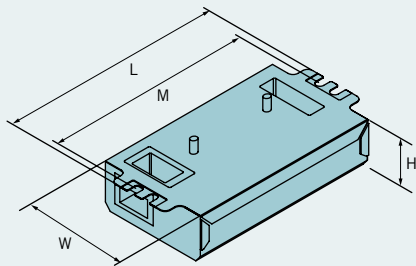

Case Style	Mounting	Length	Width	Height
W1	4.63"	5.00"	2.40"	1.00"
W2	4.63"	5.00"	3.00"	1.38"

* Available with and without studs.

FLUORESCENT BALLASTS

2D



ELECTRICAL SPECIFICATIONS

No. of Lamps	Input Power	Catalog Number	Input Volts	Starting Method	Line Current	Min. Power Factor	Max. THD	Ballast Factor	Min. Start Temperature	Max. Case Temperature	Case Style
CFS21W/GR10q											
1	18W	KTEB-118-1-TP-SC	120V	Rapid	0.28A	0.50	150%	0.80	-18°C/0°F	90°C/194°F	L8
	19W	KTEB-1C22-1-TP	120V	Rapid	0.30A	0.50	150%	0.85	-18°C/0°F	75°C/167°F	S1
		KTEB-1C22-1-TP-LC	120V	Rapid	0.30A	0.50	150%	0.85	-18°C/0°F	75°C/167°F	L1
	20W	KTEB-218-UV-PS-DW	120-277V	Program	0.17-0.07A	0.95	10%	0.85	-18°C/0°F	90°C/194°F	W1
CFS28W/GR10q											
1	28W	KTEB-126-1-TP	120V	Rapid	0.40A	0.50	130%	0.90	-18°C/0°F	75°C/167°F	S1
	30W	KTEB-142T-1-TP-SC	120V	Rapid	0.45A	0.50	130%	0.95	-18°C/0°F	90°C/194°F	L8
		KTEB-226-UV-PS-DW	120-277V	Program	0.25-0.11A	0.97	10%	0.95	-18°C/0°F	90°C/194°F	W1
	34W	KTEB-242-UV-PS-DW	120-277V	Program	0.29-0.14A	0.93	15%	1.00	-18°C/0°F	90°C/194°F	W2
CFS38W/GR10q											
1	40W	KTEB-1382D-1-TP	120V	Rapid	0.60A	0.50	150%	0.95	-18°C/0°F	75°C/167°F	S1

CASE STYLES

CASE L

Material: Steel

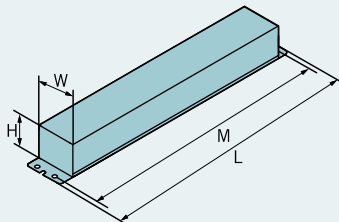

Case Style	Mounting	Length	Width	Height
L1	6.00"	6.46"	1.89"	1.00"
L8	3.60"	4.00"	1.87"	1.18"

CASE S

Material: Plastic

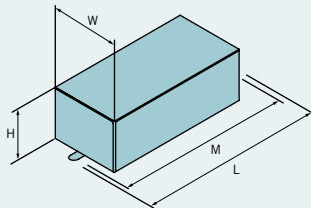

Case Style	Mounting	Length	Width	Height
S1	2.88"	3.45"	1.81"	1.21"

CASE W*

Material: Steel

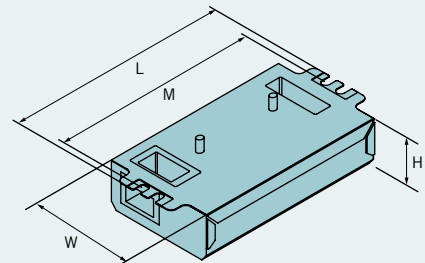

Case Style	Mounting	Length	Width	Height
W1	4.63"	5.00"	2.40"	1.00"
W2	4.63"	5.00"	3.00"	1.38"

* Available with and without studs.

SIGN BALLASTS

SECTION CONTENTS

SMARTWIRE: 102

PARALLEL WIRE: 104

Wiring Diagrams: 105



Keystone's line of sign ballasts makes commercial sign maintenance simple. Our SmartWire electronic sign ballasts wire exactly the same as legacy magnetic ballasts, so upgrading from magnetic to electronic in an existing sign is effortless. Keystone's sign ballasts cover virtually all sign applications, ensuring you'll always have the right ballast for the job. With Keystone's quality and dependability, you can count on your installation to last, maintenance-free, for years to come.

The US Federal Government has prohibited the manufacture of magnetic sign ballasts.

THE KEYSTONE SOLUTION:

SMARTWIRE™

ELECTRONIC SIGN BALLASTS

AWARD WINNING FEATURES



• **SMARTWIRE Technology:** Wires exactly the same as traditional magnetic ballasts for seamless compatibility and installation.

- **Lightweight:** Using solid-state technology, SmartWire electronic sign ballasts weigh *up to 50% less* than heavy magnetic ballasts, making transporting and handling significantly easier.
- **2014 DOE Compliant:** All SmartWire electronic sign ballasts exceed the energy efficiency levels mandated by the DOE and are at least 10% more energy efficient than traditional magnetic sign ballasts.
- **Versatile:** Just 5 SmartWire ballasts operate both T8HO and T12HO lamps, reducing inventory without sacrificing application options.

Additional Features: Series Wiring • Minimum Starting Temperature of -30°C/-20°F • 120V Input • 4 Year Warranty



See how easy it is to install SmartWire sign ballasts. Scan this QR code or visit keystonetech.com and watch our 90 second video.

Specifications subject to change without notice. For complete product specifications, visit www.keystonetech.com

SIGN BALLASTS

SMARTWIRE
ELECTRONIC SIGN BALLASTS

Total T8HO Lamp Footage Permitted (in Feet)

Lamps Per Ballast	Total T8HO Lamp Footage Permitted (in Feet)																							
	2	4	6	8	10	12	14	16	18	20	22	24	26	28	30	32	34	36	38	40	42	44	46	48
1	KTSB-E-0208-11-1-S																							
1-2	KTSB-E-0416-12-1-S																							
2-3	KTSB-E-0824-23-1-S																							
2-4	KTSB-E-0832-24-1-S																							
4-6	KTSB-E-244 8-46-1-S																							

Total T12HO Lamp Footage Permitted (in Feet)

Lamps Per Ballast	Total T12HO Lamp Footage Permitted (in Feet)																							
	2	4	6	8	10	12	14	16	18	20	22	24	26	28	30	32	34	36	38	40	42	44	46	48
1	KTSB-E-0208-11-1-S																							
1-2	KTSB-E-0416-12-1-S																							
2-3	KTSB-E-0824-23-1-S																							
2-4	KTSB-E-0832-24-1-S																							
4-6	KTSB-E-2448-46-1-S																							

ELECTRICAL SPECIFICATIONS

Catalog Number	Wiring	No. of Fluorescent Lamps	Input Line Current	Lamp Footage		Min. Start Temp.	Input Voltage	Open Circuit Voltage	Thermal Protection	High Power Factor	Wiring Diagram	Case Style
				Min.	Max.							
T8HO												
KTSB-E-0208-11-1-S	Series	(1) F96T8HO/86W	1.00A	2'	8'	-30°C	120V	1000V	Yes	>0.98	F1-17	L27
	Series	(1) F72T8HO/65W	0.75A	2'	8'	-20°F	50/60Hz					
KTSB-E-0416-12-1-S	Series	(2) F72T8HO/65W	1.45A	4'	12'	-30°C	120V	1000V	Yes	>0.98	F1-18, F2-1	L28
	Series	(1) F96T8HO/86W	1.05A	4'	12'	-20°F	50/60Hz					
KTSB-E-0824-23-1-S	Series	(3) F72T8HO/65W	2.15A	8'	18'	-30°C	120V	993V	Yes	>0.98	F2-26, F3-10	L32
	Series	(2) F96T8HO/86W	1.90A	8'	18'	-20°F	50/60Hz					
KTSB-E-0832-24-1-S	Series	(4) F72T8HO/65W	2.55A	8'	24'	-30°C	120V	1000V	Yes	>0.98	F2-27, F3-11, F4-8	L29
	Series	(2) F96T8HO/86W	2.20A	8'	24'	-20°F	50/60Hz					
KTSB-E-2448-46-1-S	Series	(6) F72T8HO/65W	4.10A	18'	36'	-30°C	120V	1000V	Yes	>0.98	F4-9, F5-2, F6-3	L31
	Series	(4) F96T8HO/86W	3.80A	18'	36'	-20°F	50/60Hz					
T12HO												
KTSB-E-0208-11-1-S	Series	(1) F96T12HO/110W	0.85A	2'	8'	-30°C	120V	1000V	Yes	>0.98	F1-17	L27
	Series	(1) F24T12HO/37W	0.32A	2'	8'	-20°F	50/60Hz					
KTSB-E-0416-12-1-S	Series	(2) F96T12HO/110W	1.60A	4'	16'	-30°C	120V	1000V	Yes	>0.98	F1-18, F2-1	L28
	Series	(1) F120T12HO/135W	1.10A	4'	16'	-20°F	50/60Hz					
KTSB-E-0824-23-1-S	Series	(3) F96T12HO/110W	2.20A	8'	24'	-30°C	120V	993V	Yes	>0.98	F2-26, F3-10	L32
	Series	(2) F120T12HO/135W	2.00A	8'	24'	-20°F	50/60Hz					
KTSB-E-0832-24-1-S	Series	(2) F96T12HO/110W	1.65A	8'	24'	-30°C	120V	1000V	Yes	>0.98	F2-27, F3-11, F4-8	L29
	Series	(4) F96T12HO/110W	3.20A	8'	32'	-20°F	50/60Hz					
KTSB-E-2448-46-1-S	Series	(3) F96T12HO/110W	2.30A	8'	32'	-30°C	120V	1000V	Yes	>0.98	F2-27, F3-11, F4-8	L29
	Series	(2) F120T12HO/135W	2.30A	8'	32'	-20°F	50/60Hz					
KTSB-E-2448-46-1-S	Series	(2) F96T12HO/110W	1.75A	8'	32'	-30°C	120V	1000V	Yes	>0.98	F2-27, F3-11, F4-8	L29
	Series	(6) F96T12HO/110W	4.15A	24'	48'	-30°C	120V	1000V	Yes	>0.90	F3-12, F4-9, F5-2, F6-3	L31
	Series	(4) F120T12HO/135W	3.96A	24'	48'	-20°F	50/60Hz					
	Series	(5) F96T12HO/110W	3.65A	24'	48'							
	Series	(4) F96T12HO/110W	3.20A	24'	48'							
Series	(3) F120T12HO/135W	2.64A	24'	48'								

CASE STYLES

CASE L

Material: Steel

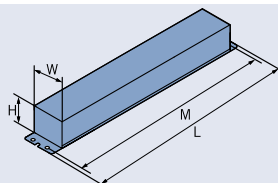

Case Style	Mounting	Length	Width	Height
L27	8.84"	9.47"	2.35"	1.69"
L28	11.21"	11.77"	2.15"	1.62"
L29	13.81"	14.44"	3.20"	2.73"
L31	15.62"	16.25"	3.20"	2.15"
L32	11.07"	11.73"	3.09"	1.83"

Specifications subject to change without notice. For complete product specifications, visit www.keystonetech.com

Keystone Technologies, LLC | North Wales, PA 19454 | Phone (800) 464-2680 | keystonetech.com

SIGN BALLASTS

PARALLEL WIRE
ELECTRONIC SIGN BALLASTS

Total T8HO Lamp Footage Permitted (in Feet)

Lamps Per Ballast	Total T8HO Lamp Footage Permitted (in Feet)																																			
	2	4	6	8	10	12	14	16	18	20	22	24	26	28	30	32	34	36	38	40	42	44	46	48												
1-2	KTSB-E-0216-12-UV																																			
1-4	KTSB-E-0432-14-UV																																			
4-6	KTSB-E-0848-46-UV																																			

Total T12HO Lamp Footage Permitted (in Feet)

Lamps Per Ballast	Total T12HO Lamp Footage Permitted (in Feet)																							
	2	4	6	8	10	12	14	16	18	20	22	24	26	28	30	32	34	36	38	40	42	44	46	48
1-2	KTSB-E-0216-12-UV																							
1-4	KTSB-E-0432-14-UV																							
4-6	KTSB-E-0848-46-UV																							

ELECTRICAL SPECIFICATIONS

No. of Lamps	Lamp Footage		Input Voltage	Catalog Number	Wiring	Cycles	Max. Input Power	Max. Input Current	Open Circuit Voltage	Min. Start Temperature	Wiring Diagram(s)	Case Style
	Min.	Max.										
T8HO												
1-2	4'	12'	120-277V	KTSB-E-0216-12-UV /A	Parallel	50/60Hz	122W	1.10A	800V	-20°F	F2-17	L14
1-4	4'	24'	120-277V	KTSB-E-0432-14-UV /A	Parallel	50/60Hz	244W	2.20A	800V	-20°F	F1-19, F2-28, F3-15, F4-11	L15
	8'	32'	120-277V	KTSB-E-1040-14-UV /A	Parallel	50/60Hz	330W	2.80A	1000V	-20°F	F1-19, F2-28, F3-14, F4-11	L16
4-6	16'	36'	120-277V	KTSB-E-0848-46-UV /A	Parallel	50/60Hz	370W	3.20A	860V	-20°F	F4-12, F5-3, F6-4	L16
T12HO												
1-2	2'	16'	120-277V	KTSB-E-0216-12-UV /A	Parallel	50/60Hz	132W	1.20A	800V	-20°F	F2-17	L14
1-4	4'	32'	120-277V	KTSB-E-0432-14-UV /A	Parallel	50/60Hz	267W	2.40A	800V	-20°F	F1-19, F2-28, F3-15, F4-11	L15
	10'	40'	120-277V	KTSB-E-1040-14-UV /A	Parallel	50/60Hz	352W	3.00A	1000V	-20°F	F1-19, F2-28, F3-14, F4-11	L16
4-6	8'	48'	120-277V	KTSB-E-0848-46-UV /A	Parallel	50/60Hz	410W	3.50A	860V	-20°F	F4-12, F5-3, F6-4	L16

CASE STYLES

CASE L

Material: Steel

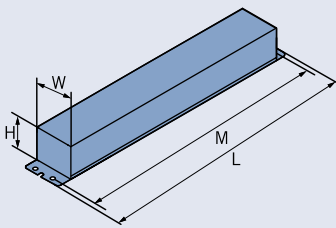

Case Style	Mounting	Length	Width	Height
L14	8.90"	9.50"	2.36"	1.70"
L15	11.00"	11.65"	3.15"	1.85"
L16	13.75"	14.45"	3.23"	2.20"

Specifications subject to change without notice. For complete product specifications, visit www.keystonetech.com

SIGN BALLASTS

WIRING DIAGRAMS

WIRING DIAGRAMS

F1-17

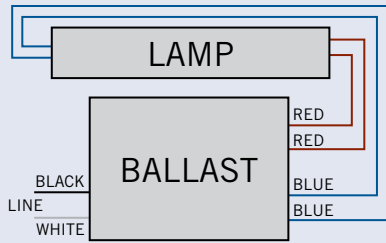

F1-18

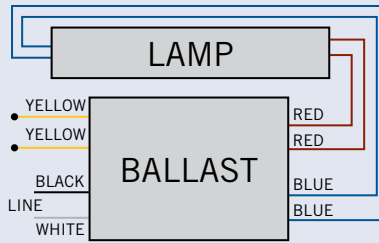

F1-19

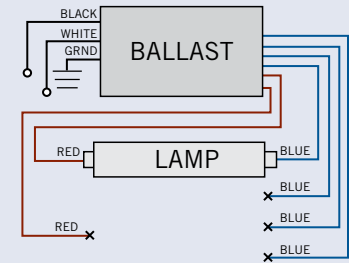

1 LAMP OPERATION
INDIVIDUALLY CAP RED AND BLUE LEADS;
INSULATE UNUSED WIRE

F2-1

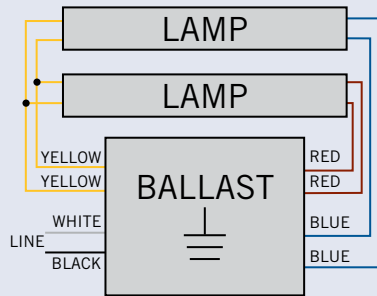

F2-17

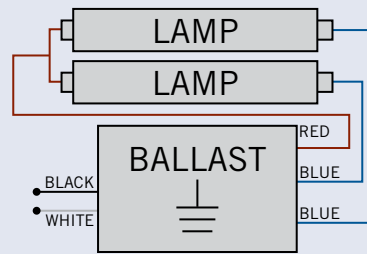

FOR 1 LAMP OPERATION,
INDIVIDUALLY CAP 1 BLUE LEAD

F2-26

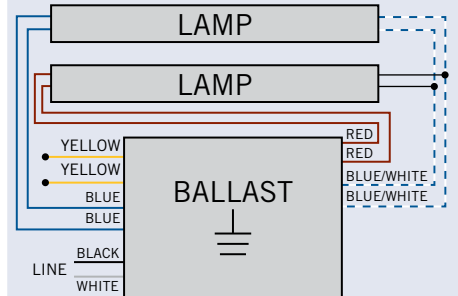

F2-27

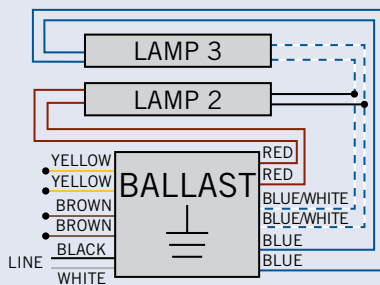

F2-28

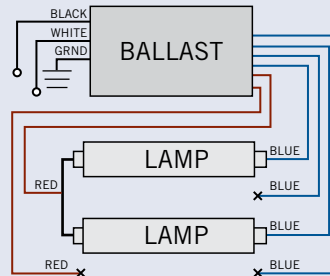

2 LAMP OPERATION
INDIVIDUALLY CAP RED AND BLUE LEADS;
INSULATE UNUSED WIRE

F3-10

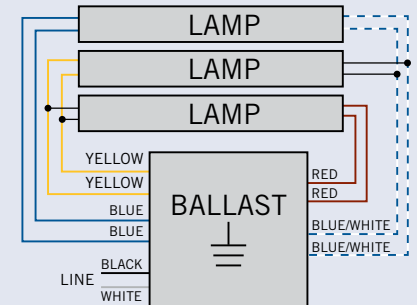

F3-11

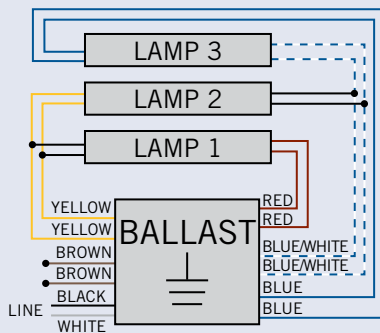

F3-12

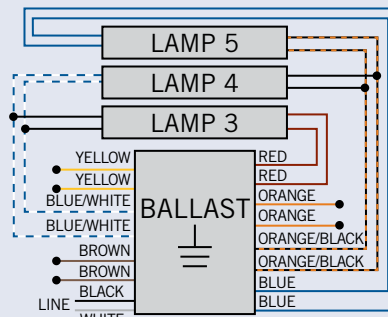

3 LAMP OPERATION,
INDIVIDUALLY CAP UNUSED LEADS

F3-14

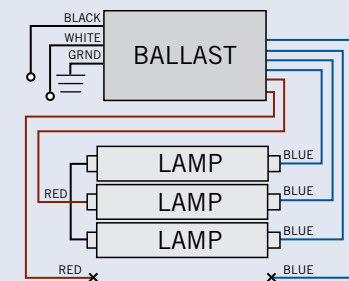

3 LAMP OPERATION
INDIVIDUALLY CAP RED AND BLUE LEADS;
INSULATE UNUSED WIRE

SIGN BALLASTS

WIRING DIAGRAMS

WIRING DIAGRAMS (CONTINUED)

F3-15

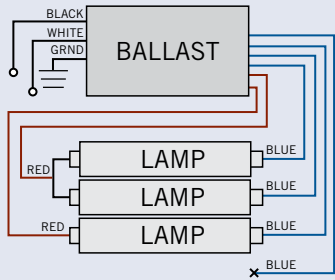

3 LAMP OPERATION
INDIVIDUALLY CAP BLUE LEADS;
INSULATE UNUSED WIRE

F4-8

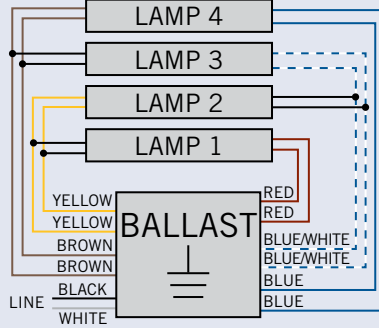

F4-9

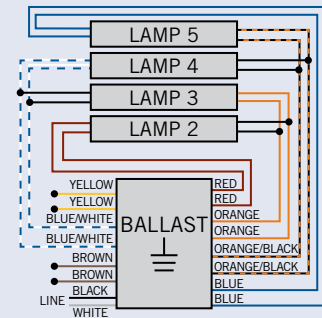

F4-11

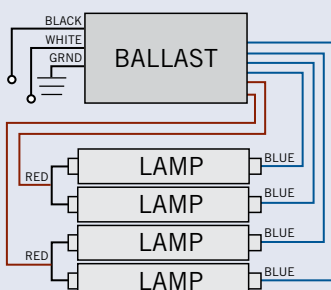

4 LAMP OPERATION

F4-12

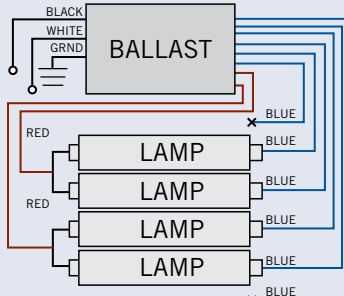

4 LAMP OPERATION INDIVIDUALLY CAP BLUE LEADS;
INSULATE UNUSED WIRE

F5-2

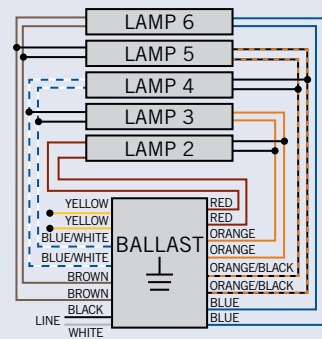

F5-3

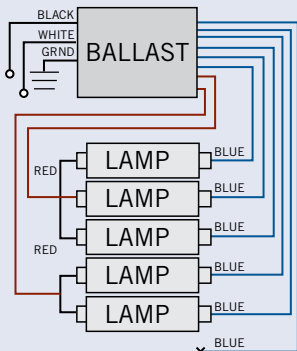

5 LAMP OPERATION
INDIVIDUALLY CAP BLUE LEADS;
INSULATE UNUSED WIRE

F6-3

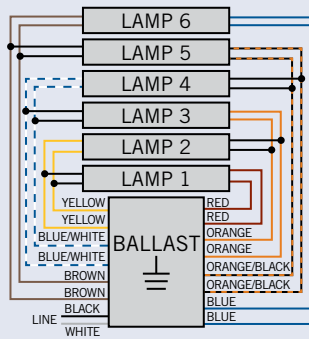

F6-4

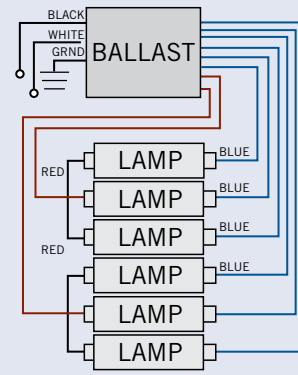

6 LAMP OPERATION

HID BALLASTS

SECTION CONTENTS

Pulse Start Metal Halide: 108

Metal Halide: 110

High Pressure Sodium: 112

Wiring Diagrams: 114

Case Styles: 118

F-Can: 119

Accessories: 120

HID Kits: 122

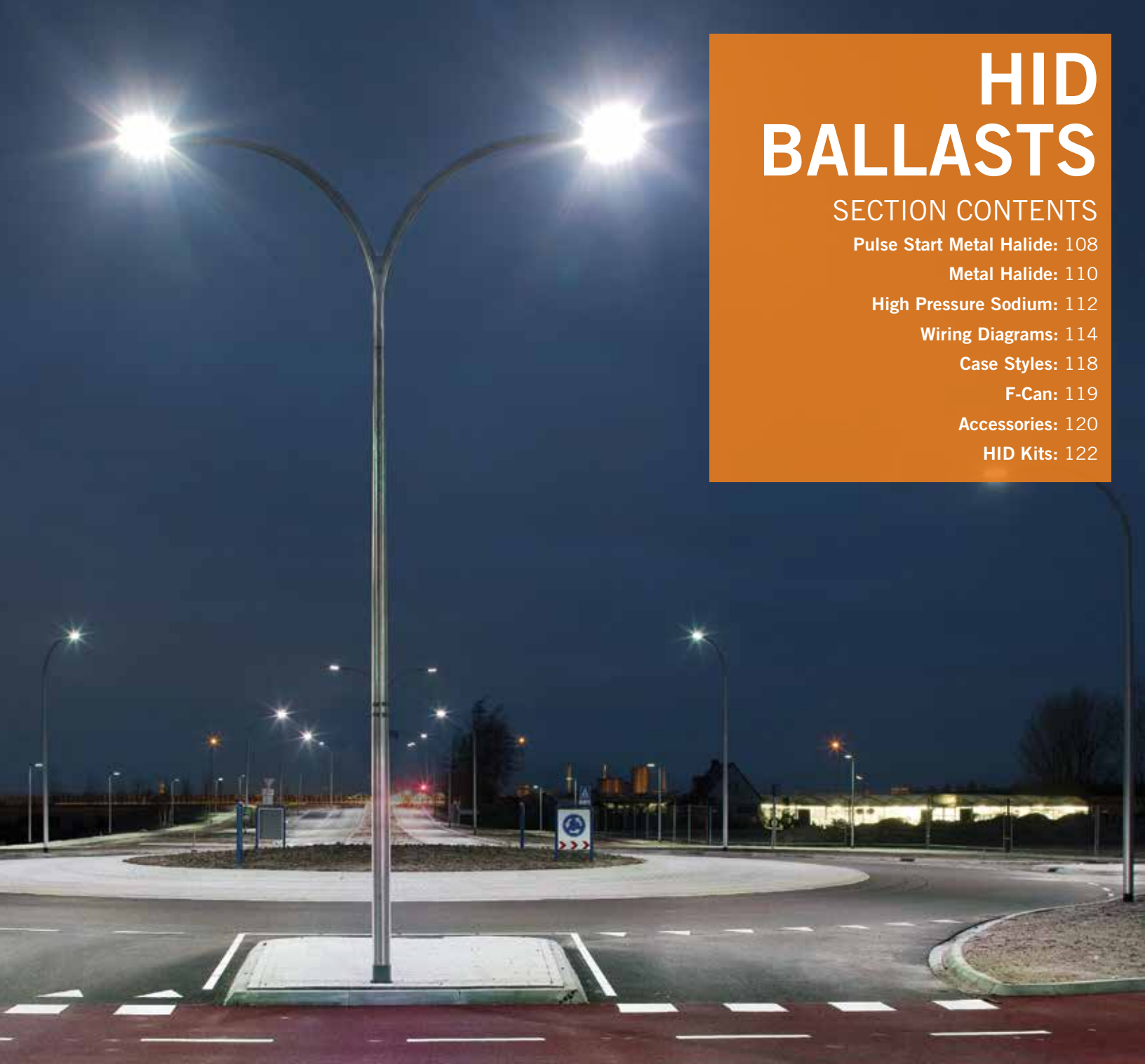

Known for dependability and superior efficiency, Keystone's high intensity discharge (HID) ballasts are perfectly suited for even the most demanding HID lighting applications. Keystone utilizes quality control processes and sophisticated manufacturing to guarantee solid performance in the field. Demand the most durable and energy efficient HID ballasts on the market. Demand Keystone.

HID BALLASTS

PULSE START METAL HALIDE



ELECTRICAL SPECIFICATIONS

Input Voltage	No. of Taps	Catalog Number	Circuit Type	Input Watts	Input Current	Coil Material		Wiring Diagram	Case Style	E
						Primary	Secondary			
175 Watt M137/M152 Pulse Start Metal Halide Lamp						Capacitor: Dry Type, 370 Volts, 11 Microfarad; Ignitor: XG-04				
480V	Single	MPS-175A-4-HP	CWA	198W	0.43A	Copper	Copper	H9A	A49	●
120/480V	Dual	MPS-175A-D4-HP	CWA	198W	1.75/0.43A	Copper	Copper	H9B	A50	●
120/277/347V	Tri	MPS-175A-T3-HP	CWA	198W	1.75/0.75/0.60A	Copper	Copper	H9C	A52	●
120/208/240/277V	Quad	MPS-175A-Q-HP MPS-175A-Q-KIT	CWA	198W	1.75/1.00/0.86/0.75A	Copper	Copper	H3	A48	●
120/208/240/277/480V	5-Tap	MPS-175A-P-HP MPS-175A-P-KIT	CWA	198W	1.75/1.00/0.86/0.75/0.43A	Copper	Copper	H9	A51	●
200 Watt M136 Pulse Start Metal Halide Lamp						Capacitor: Dry Type, 330 Volts, 15 Microfarad; Ignitor: XG-04				
480V	Single	MPS-200A-4-HP	CWA	227W	0.50A	Copper	Copper	H9A	A49	●
120/480V	Dual	MPS-200A-D4-HP	CWA	227W	2.00/0.50A	Copper	Copper	H9B	A49	●
120/277/347V	Tri	MPS-200A-T3-HP	CWA	227W	2.00/0.86/0.69A	Copper	Copper	H9C	A49	●
120/208/240/277V	Quad	MPS-200A-Q-HP MPS-200A-Q-KIT	CWA	227W	2.00/1.15/1.00/0.86A	Copper	Copper	H3	A49	●
120/208/240/277/480V	5-Tap	MPS-200A-P-HP MPS-200A-P-KIT	CWA	227W	2.00/1.15/1.00/0.86/0.50A	Copper	Copper	H9	A49	●
250 Watt M138/M153 Pulse Start Metal Halide Lamp						Capacitor: Dry Type, 400 Volts, 17 Microfarad; Ignitor: XG-04				
480V	Single	MPS-250A-4-HP	CWA	284W	0.62A	Copper	Copper	H9A	A50	●
120/480V	Dual	MPS-250A-D4-HP	CWA	284W	2.50/0.62A	Copper	Copper	H9B	A50	●
120/277/347V	Tri	MPS-250A-T3-HP	CWA	284W	2.50/1.10/0.86A	Copper	Copper	H9C	A50	●
120/208/240/277V	Quad	MPS-250A-Q-HP MPS-250A-Q-KIT	CWA	284W	2.50/1.44/1.25/1.10A	Copper	Copper	H3	A50	●
120/208/240/277/480V	5-Tap	MPS-250A-P-HP MPS-250A-P-KIT	CWA	284W	2.50/1.44/1.25/1.10/0.62A	Copper	Copper	H9	A50	●
320 Watt M132 Pulse Start Metal Halide Lamp						Capacitor: Dry Type, 345 Volts, 21 Microfarad; Ignitor: XG-04				
120V	Single	MPS-320A-1-HP	CWA	363W	3.20A	Copper	Copper	H3B	A51	●
480V	Single	MPS-320A-4-CA	CWA	363W	0.80A	Copper	Aluminum	H9A	A51	●
120/277V	Dual	MPS-320A-D-HP	CWA	363W	3.20/1.38A	Copper	Copper	H3A	A51	●
120/480V	Dual	MPS-320A-D4-CA	CWA	363W	3.20/0.80A	Copper	Aluminum	H9B	A51	●
120/277/347V	Tri	MPS-320A-T3-CA	CWA	363W	3.20/1.38/1.10A	Copper	Aluminum	H9C	A51	●
120/208/240/277V	Quad	MPS-320A-Q-HP	CWA	363W	3.20/1.84/1.60/1.38A	Copper	Copper	H3	A51	●
		MPS-320A-Q-CA MPS-320A-Q-KIT	CWA	363W	3.20/1.84/1.60/1.38A	Copper	Aluminum	H3	A51	●
120/208/240/277/480V	5-Tap	MPS-320A-P-CA MPS-320A-P-KIT	CWA	363W	3.20/1.84/1.60/1.38/0.80A	Copper	Aluminum	H9	A51	●
350 Watt M131 Pulse Start Metal Halide Lamp						Capacitor: Dry Type, 360 Volts, 22.5 Microfarad; Ignitor: XG-04				
120V	Single	MPS-350A-1-HP	CWA	397W	3.50A	Copper	Copper	H3B	A52	●
480V	Single	MPS-350A-4-CA	CWA	397W	0.87A	Copper	Aluminum	H9A	A52	●
120/277V	Dual	MPS-350A-D-HP	CWA	397W	3.50/1.50A	Copper	Copper	H3A	A52	●
120/480V	Dual	MPS-350A-D4-CA	CWA	397W	3.50/0.87A	Copper	Aluminum	H9B	A52	●
120/277/347V	Tri	MPS-350A-T3-CA	CWA	397W	3.50/1.50/1.20A	Copper	Aluminum	H9C	A52	●
120/208/240/277V	Quad	MPS-350A-Q-HP	CWA	397W	3.50/2.00/1.75/1.50A	Copper	Copper	H3	A52	●
		MPS-350A-Q-CA MPS-350A-Q-KIT	CWA	397W	3.50/2.00/1.75/1.50A	Copper	Aluminum	H3	A52	●
120/208/240/277/480V	5-Tap	MPS-350A-P-CA MPS-350A-P-KIT	CWA	397W	3.50/2.00/1.75/1.50/0.87A	Copper	Aluminum	H9	A52	●

Specifications subject to change without notice. For complete product specifications, visit www.keystonetech.com



HID BALLASTS

PULSE START METAL HALIDE

ELECTRICAL SPECIFICATIONS

Input Volts	No. of Taps	Catalog Number	Circuit Type	Input Watts	Input Current	Coil Material		Wiring Diagram	Case Style	E
						Primary	Secondary			
400 Watt M155 Pulse Start Metal Halide Lamp						Capacitor: Dry Type, 330 Volts, 26 Microfarad; Ignitor: XG-04				
480V	Single	MPS-400A-4-CA MPS-400A-480-KIT	CWA	454W	1.00A	Copper	Aluminum	H9A	A53	●
120/480V	Dual	MPS-400A-D4-CA	CWA	454W	4.00/1.00A	Copper	Aluminum	H9B	A53	●
120/277/347V	Tri	MPS-400A-T3-CA	CWA	454W	4.00/1.73/1.38A	Copper	Aluminum	H9C	A53	●
120/208/240/277V	Quad	MPS-400A-Q-CA MPS-400A-Q-KIT	CWA	454W	4.00/2.30/1.90/1.73A	Copper	Aluminum	H3	A53	●
120/208/240/277/480V	5-Tap	MPS-400A-P-CA MPS-400A-P-KIT	CWA	454W	4.00/2.30/1.90/1.73/1.00A	Copper	Aluminum	H9	A53	●
450 Watt M144 Pulse Start Metal Halide Lamp						Capacitor: Dry Type, 400 Volts, 26.5 Microfarad; Ignitor: XG-04				
480V	Single	MPS-450A-4-HP	CWA	511W	1.12A	Copper	Copper	H9A	A54	●
120/480V	Dual	MPS-450A-D4-HP	CWA	511W	4.50/1.12A	Copper	Copper	H9B	A54	●
120/277/347V	Tri	MPS-450A-T3-HP	CWA	511W	4.50/1.95/1.55A	Copper	Copper	H9C	A54	●
120/208/240/277V	Quad	MPS-450A-Q-AA MPS-450A-Q-KIT	CWA	511W	4.50/2.60/2.24/1.95A	Aluminum	Aluminum	H3	A54	
120/208/240/277/480V	5-Tap	MPS-450A-P-HP MPS-450A-P-KIT	CWA	511W	4.50/2.60/2.24/1.95/1.12A	Copper	Copper	H9	A54	●
750 Watt M149 Pulse Start Metal Halide Lamp						Capacitor Specs: Oil Type, 400 Volts, 28 Microfarad; Ignitor: XG-03A				
480V	Single	MPS-750A-4-CA	CWA	810W	1.75A	Copper	Aluminum	H9A	A56	
120/208/240/277V	Quad	MPS-750A-Q-CA MPS-750A-Q-KIT	CWA	810W	6.90/4.00/3.50/3.00A	Copper	Aluminum	H3	A56	
120/208/240/277/480V	5-Tap	MPS-750A-P-CA MPS-750A-P-KIT	CWA	810W	6.90/4.00/3.50/3.00/1.75A	Copper	Aluminum	H9	A56	
875 Watt M166 Pulse Start Metal Halide Lamp						Capacitor Specs: Oil Type, 480 Volts, 21 Microfarad; Ignitor: XG-05				
480V	Single	MPS-875A-4-CA	CWA	924W	2.10A	Copper	Aluminum	H9A	A56	
120/208/240/277V	Quad	MPS-875A-Q-CA	CWA	924W	8.10/4.70/4.10/3.50A	Copper	Aluminum	H3	A56	
120/208/240/277/480V	5-Tap	MPS-875A-P-CA	CWA	924W	8.10/4.70/4.10/3.50/2.10A	Copper	Aluminum	H9	A56	
1000 Watt M141 Pulse Start Metal Halide Lamp						Capacitor Specs: Oil Type, 480 Volts, 24 Microfarad; Ignitor: XG-03				
480V	Single	MPS-1000A-4-CA	CWA	1037W	2.20A	Copper	Aluminum	H9A	A56	
120/208/240/277V	Quad	MPS-1000A-Q-CA MPS-1000A-Q-KIT	CWA	1037W	8.90/5.10/4.50/3.90A	Copper	Aluminum	H3	A56	
120/208/240/277/480V	5-Tap	MPS-1000A-P-CA	CWA	1037W	8.90/5.10/4.50/3.90/2.20A	Copper	Aluminum	H9	A56	

Specifications subject to change without notice. For complete product specifications, visit www.keystonetech.com

HID BALLASTS

METAL HALIDE



ELECTRICAL SPECIFICATIONS

Input Voltage	No. of Taps	Catalog Number	Circuit Type	Input Watts	Input Current	Coil Material		Wiring Diagram	Case Style
						Primary	Secondary		
50 Watt M110 Metal Halide Lamp						Capacitor: Dry Type, 280 Volts, 6 Microfarad; Ignitor: XG-04			
120V	Single	MH-50X-1	HX-NPF HX-HPF (with Cap.)	67W	1.70A 0.64A	Copper	Copper	H4A	A7
277V	Single	MH-50R-2	R-NPF R-HPF (with Cap.)	60W	0.63A 0.24A	Copper	Copper	H1A	R6
120/277V	Dual	MH-50X-D	HX-NPF HX-HPF (with Cap.)	67W	1.70/0.70A 0.64/0.28A	Copper	Copper	H4	A7
120/208/240/277V	Quad	MH-50X-Q-AA MH-50X-Q-KIT	HX-NPF HX-HPF (with Cap.)	67W	1.70/0.98/0.85/0.70A 0.64/0.37/0.32/0.28A	Aluminum	Aluminum	H4B	A7
70 Watt M98 Metal Halide Lamp						Capacitor: Dry Type, 280 Volts, 8 Microfarad; Ignitor: XG-04			
120V	Single	MH-70X-1	HX-NPF HX-HPF (with Cap.)	91W	2.50A 0.83A	Copper	Copper	H4A	A8
277V	Single	MH-70R-2	R-NPF R-HPF (with Cap.)	80W	0.90A 0.31A	Copper	Copper	H1A	R4
120/277V	Dual	MH-70X-D	HX-NPF HX-HPF (with Cap.)	91W	2.50/1.10A 0.83/0.38A	Copper	Copper	H4	A8
120/208/240/277V	Quad	MH-70X-Q-CA MH-70X-Q-KIT	HX-NPF HX-HPF (with Cap.)	91W	2.50/1.46/1.26/1.10A 0.83/0.49/0.42/0.38A	Copper	Aluminum	H4B	A8
100 Watt M90 Metal Halide Lamp						Capacitor: Dry Type, 280 Volts, 12 Microfarad; Ignitor: XG-04			
120V	Single	MH-100X-1	HX-NPF HX-HPF (with Cap.)	125W	3.10A 1.10A	Copper	Copper	H4A	A10
277V	Single	MH-100R-2	R-NPF R-HPF (with Cap.)	118W	1.30A 0.47A	Copper	Copper	H1A	R7
120/277V	Dual	MH-100X-D	HX-NPF HX-HPF (with Cap.)	125W	3.10/1.40A 1.10/0.48A	Copper	Copper	H4	A10
120/208/240/277V	Quad	MH-100X-Q-CA MH-100X-Q-KIT	HX-NPF HX-HPF (with Cap.)	125W	3.10/1.90/1.63/1.40A 1.10/0.65/0.58/0.48A	Copper	Aluminum	H4B	A10
150 Watt M102 Metal Halide Lamp						Capacitor: Dry Type, 280 Volts, 16 Microfarad; Ignitor: XG-04			
120V	Single	MH-150X-1	HX-NPF HX-HPF (with Cap.)	186W	3.40A 1.59A	Copper	Copper	H4A	A12
277V	Single	MH-150R-2	R-NPF R-HPF (with Cap.)	176W	1.85A 0.71A	Copper	Copper	H1A	R8
120/277V	Dual	MH-150X-D	HX-NPF HX-HPF (with Cap.)	186W	3.40/1.90A 1.59/0.67A	Copper	Copper	H4	A12
120/208/240/277V	Quad	MH-150X-Q-CA MH-150X-Q-KIT	HX-NPF HX-HPF (with Cap.)	186W	3.40/2.60/2.00/1.90A 1.59/0.97/0.81/0.67A	Copper	Aluminum	H4B	A12
175 Watt M57/H39 Metal Halide Lamp						Capacitor: Dry Type, 400 Volts, 10 Microfarad; Ignitor: N/A			
120V	Single	MH-175A-1-HP	CWA	205W	1.90A	Copper	Copper	H2B	A1
120/277V	Dual	MH-175A-D-HP	CWA	205W	1.90/0.80A	Copper	Copper	H2A	A1
120/277/347V	Tri	MH-175A-T3-HP	CWA	205W	1.90/0.80/0.70A	Copper	Copper	H8B	A26
120/208/240/277V	Quad	MH-175A-Q-HP	CWA	205W	1.90/1.10/0.95/0.80A	Copper	Copper	H2	A1
		MH-175A-Q-AA MH-175A-Q-AA-KIT	CWA	205W	1.90/1.10/0.95/0.80A	Aluminum	Aluminum	H2	A34
		MH-175A-Q-CA MH-175A-Q-KIT	CWA	205W	1.90/1.10/0.95/0.80/0.70A	Copper	Aluminum	H2	A34
120/208/240/277/480	5-Tap	MH-175A-P-HP	CWA	205W	1.90/1.10/0.95/0.80/0.48A	Copper	Copper	H8	A41
		MH-175A-P-CA MH-175A-P-KIT	CWA	205W	1.90/1.10/0.95/0.80/0.48A	Copper	Aluminum	H8	A42

Specifications subject to change without notice. For complete product specifications, visit www.keystonetech.com



HID BALLASTS

METAL HALIDE

ELECTRICAL SPECIFICATIONS

Input Voltage	No. of Taps	Catalog Number	Circuit Type	Input Watts	Input Current	Coil Material		Wiring Diagram	Case Style
						Primary	Secondary		
250 Watt M58/H37 Metal Halide Lamp						Capacitor: Dry Type, 400 Volts, 15 Microfarad; Ignitor: N/A			
120V	Single	MH-250A-1-HP	CWA	292W	2.50A	Copper	Copper	H2B	A15
480V	Single	MH-250A-4-CA MH-250A-480-KIT	CWA	290W	0.63A	Copper	Aluminum	H8A	A60
120/277V	Dual	MH-250A-D-HP	CWA	292W	2.50/1.10A	Copper	Copper	H2A	A15
120/277/347V	Tri	MH-250A-T3-HP	CWA	292W	2.50/1.10/0.90A	Copper	Copper	H8B	A27
120/208/240/277V	Quad	MH-250A-Q-HP	CWA	292W	2.50/1.50/1.30/1.10A	Copper	Copper	H2	A15
		MH-250A-Q-AA MH-250A-Q-AA-KIT	CWA	292W	2.50/1.50/1.30/1.10A	Aluminum	Aluminum	H2	A39
		MH-250A-Q-CA MH-250A-Q-KIT	CWA	292W	2.50/1.50/1.30/1.10A	Copper	Aluminum	H2	A39
120/208/240/277/480V	5-Tap	MH-250A-P-HP	CWA	292W	2.50/1.50/1.30/1.10 /0.60A	Copper	Copper	H8	A28
		MH-250A-P-CA MH-250A-P-KIT	CWA	292W	2.50/1.50/1.30/1.10 /0.60A	Copper	Aluminum	H8	A43
400 Watt M59/H33 Metal Halide Lamp						Capacitor: Dry Type, 400 Volts, 24 Microfarad; Ignitor: N/A			
120V	Single	MH-400A-1-HP	CWA	450W	4.20A	Copper	Copper	H2B	A16
480V	Single	MH-400A-4-HP MH-400A-480-KIT	CWA	450W	1.10A	Copper	Copper	H8A	A31
120/277V	Dual	MH-400A-D-HP	CWA	450W	4.20/1.80A	Copper	Copper	H2A	A16
120/277/347V	Tri	MH-400A-T3-HP	CWA	450W	4.20/1.80/1.45A	Copper	Copper	H8B	A29
120/208/240/277V	Quad	MH-400A-Q-HP	CWA	450W	4.20/2.44/2.10/1.80A	Copper	Copper	H2	A16
		MH-400A-Q-AA MH-400A-Q-AA-KIT	CWA	450W	4.20/2.44/2.10/1.80A	Aluminum	Aluminum	H2	A40
		MH-400A-Q-CA MH-400A-Q-KIT	CWA	450W	4.20/2.44/2.10/1.80A	Copper	Aluminum	H2	A44
120/208/240/277/480V	5-Tap	MH-400A-P-HP	CWA	450W	4.20/2.44/2.10/1.80/1.10A	Copper	Copper	H8	A30
		MH-400A-P-CA MH-400A-P-KIT	CWA	450W	4.20/2.44/2.10/1.80/1.10A	Copper	Aluminum	H8	A44
1000 Watt M47/H36 Metal Halide Lamp						Capacitor: Oil Type, 480 Volts, 24 Microfarad; Ignitor: N/A			
120V	Single	MH-1000A-1-HP	CWA	1070W	9.00A	Copper	Copper	H2B	A5
480V	Single	MH-1000A-4-CA MH-1000A-480-KIT	CWA	1080W	2.30A	Copper	Aluminum	H8A	A61
120/277V	Dual	MH-1000A-D-HP	CWA	1070W	9.00/4.00A	Copper	Copper	H2A	A5
120/277/347V	Tri	MH-1000A-T3-HP	CWA	1070W	9.00/4.00/3.20A	Copper	Copper	H8B	A32
120/208/240/277V	Quad	MH-1000A-Q-HP	CWA	1070W	9.00/5.20/4.50/4.00A	Copper	Copper	H2	A5
		MH-1000A-Q-CA MH-1000A-Q-KIT	CWA	1070W	9.00/5.20/4.50/4.00A	Copper	Aluminum	H2	A5
		MH-1000A-Q-AA MH-1000A-Q-AA-KIT	CWA	1070W	9.00/5.20/4.50/4.00A	Aluminum	Aluminum	H2	A57
120/208/240/277/480V	5-Tap	MH-1000A-P-HP	CWA	1070W	9.00/5.20/4.50/4.00/2.30A	Copper	Copper	H8	A33
		MH-1000A-P-CA MH-1000A-P-KIT	CWA	1070W	9.00/5.20/4.50/4.00/2.31A	Copper	Aluminum	H8	A45
1500 Watt M48 Metal Halide Lamp						Capacitor: Oil Type, 525 Volts, 32 Microfarad; Ignitor: N/A			
480V	Single	MH-1500A-4-HP	CWA	1587W	3.50A	Copper	Copper	H8A	A58
120/208/240/277V	Quad	MH-1500A-Q-CA	CWA	1596W	13.90/7.80/6.90/6.00A	Copper	Aluminum	H2	A58
		MH-1500A-Q-HP MH-1500A-Q-KIT	CWA	1595W	13.90/7.80/6.90/6.00A	Copper	Copper	H2	A58
120/208/240/277/480V	5-Tap	MH-1500A-P-CA	CWA	1610W	13.90/7.80/6.90/6.00/3.50A	Copper	Aluminum	H8	A59
		MH-1500A-P-HP MH-1500A-P-KIT	CWA	1610W	13.60/7.73/6.75/ 5.92/3.44A	Copper	Copper	H8	A62

Specifications subject to change without notice. For complete product specifications, visit www.keystonetech.com

HID BALLASTS

HIGH PRESSURE SODIUM



ELECTRICAL SPECIFICATIONS

Input Voltage	No. of Taps	Catalog Number	Circuit Type	Input Watts	Input Current	Coil Material		Wiring Diagram	Case Style
						Primary	Secondary		
35 Watt S76 High Pressure Sodium Lamp					Capacitor: Dry Type, 120 Volts, 14 Microfarad; Ignitor: XG-01				
120V	Single	HPS-35R-1 HPS-35R-1-KIT	R-NPF R-HPF (with Cap.)	42W	0.85A 0.38A	Copper	Copper	H1	R1
50 Watt S68 High Pressure Sodium Lamp					Capacitor: Dry Type, 280 Volts, 5 Microfarad; Ignitor: XG-01				
120V	Single	HPS-50R-1 HPS-50R-1-KIT	R-NPF	60W	1.20A	Copper	Copper	H1	R2
			R-HPF (with Cap.)		0.55A				
		HPS-50X-1	HX-NPF	67W	1.48A	Copper	Copper	H4A	A6
			HX-HPF (with Cap.)		0.60A				
120/277V	Dual	HPS-50X-D	HX-NPF HX-HPF (with Cap.)	67W	1.48/0.64A 0.60/0.26A	Copper	Copper	H4	A6
70 Watt S62 High Pressure Sodium Lamp					Capacitor: Dry Type, 280 Volts, 7 Microfarad; Ignitor: XG-01				
120V	Single	HPS-70R-1 HPS-70R-1-KIT	R-NPF	81W	1.69A	Copper	Copper	H1	R3
			R-HPF (with Cap.)		0.73A				
		HPS-70X-1	HX-NPF	93W	1.96A	Copper	Copper	H4D	A9
			HX-HPF (with Cap.)		0.82A				
120/277V	Dual	HPS-70X-D	HX-NPF HX-HPF (with Cap.)	93W	1.96/0.85A 0.82/0.35A	Copper	Copper	H4C	A9
120/208/240/277V	Quad	HPS-70X-Q-CA HPS-70X-Q-KIT	HX-NPF HX-HPF (with Cap.)	93W	1.96/1.13/0.98/0.85A 0.82/0.47/0.41/0.35A	Copper	Aluminum	H4B	A9
100 Watt S54 High Pressure Sodium Lamp					Capacitor: Dry Type, 280 Volts, 10 Microfarad; Ignitor: XG-01				
120V	Single	HPS-100R-1 HPS-100R-1-KIT	R-NPF	110W	2.30A	Copper	Copper	H1	R4
			R-HPF (with Cap.)		1.00A				
		HPS-100X-1	HX-NPF	130W	2.40A	Copper	Copper	H4D	A11
			HX-HPF (with Cap.)		1.16A				
120/277V	Dual	HPS-100X-D	HX-NPF HX-HPF (with Cap.)	130W	2.40/1.10A 1.16/0.50A	Copper	Copper	H4C	A11
120/208/240/277V	Quad	HPS-100X-Q-AC HPS-100X-Q-KIT	HX-NPF HX-HPF (with Cap.)	130W	2.40/1.40/1.30/1.10A 1.16/0.68/0.58/0.50A	Aluminum	Copper	H4B	A11
150 Watt S55 High Pressure Sodium Lamp					Capacitor: Dry Type, 280 Volts, 14 Microfarad; Ignitor: XG-01				
120V	Single	HPS-150R-1 HPS-150R-1-KIT	R-NPF	170W	3.40A	Copper	Copper	H1	R5
			R-HPF (with Cap.)		1.55A				
		HPS-150X-1	HX-NPF	188W	3.70A	Copper	Copper	H4D	A13
			HX-HPF (with Cap.)		1.68A				
120/277V	Dual	HPS-150X-D	HX-NPF HX-HPF (with Cap.)	188W	3.70/1.62A 1.68/0.73A	Copper	Copper	H4C	A13
120/208/240/277V	Quad	HPS-150X-Q-AC HPS-150X-Q-KIT	HX-NPF HX-HPF (with Cap.)	188W	3.70/2.15/1.87/1.62A 1.68/0.97/0.84/0.73A	Aluminum	Copper	H4B	A13
200 Watt S66 High Pressure Sodium Lamp					Capacitor: Dry Type, 300 Volts, 28 Microfarad; Ignitor: XG-02				
120V	Single	HPS-200A-1-HP	CWA	245W	2.15A	Copper	Copper	H3B	A14
120/277V	Dual	HPS-200A-D-HP	CWA	245W	2.15/0.93A	Copper	Copper	H3A	A14
120/208/240/277V	Quad	HPS-200A-Q-HP	CWA	245W	2.15/1.25/1.05/0.93A	Copper	Copper	H3	A14

Specifications subject to change without notice. For complete product specifications, visit www.keystonetech.com



HID BALLASTS

HIGH PRESSURE SODIUM

ELECTRICAL SPECIFICATIONS

Input Voltage	No. of Taps	Catalog Number	Circuit Type	Input Watts	Input Current	Coil Material		Wiring Diagram	Case Style
						Primary	Secondary		
250 Watt S50 High Pressure Sodium Lamp						Capacitor: Dry Type, 280 Volts, 35 Microfarad; Ignitor: XG-02			
120V	Single	HPS-250A-1-HP	CWA	290W	2.50A	Copper	Copper	H3B	A2
120/277V	Dual	HPS-250A-D-HP	CWA	290W	2.50/1.10A	Copper	Copper	H3A	A2
120/277/347V	Tri	HPS-250A-T3-HP	CWA	290W	2.50/1.10/0.90A	Copper	Copper	H9C	A18
120/208/240/277V	Quad	HPS-250A-Q-HP	CWA	290W	2.50/1.50/1.30/1.10A	Copper	Copper	H3	A2
		HPS-250A-Q-CA HPS-250A-Q-KIT	CWA	290W	2.53/1.50/1.30/1.10A	Copper	Aluminum	H3	A2
120/208/240/277/480V	5-Tap	HPS-250A-P-CA HPS-250A-P-KIT	CWA	290W	2.50/1.50/1.30/1.10/0.70A	Copper	Aluminum	H9	A19
400 Watt S51 High Pressure Sodium Lamp						Capacitor: Dry Type, 300 Volts, 55 Microfarad; Ignitor: XG-02			
120V	Single	HPS-400A-1-HP	CWA	465W	4.00A	Copper	Copper	H3B	A3
480V	Single	HPS-400A-4-CA HPS-400A-480-KIT	CWA	465W	1.10A	Copper	Aluminum	H9A	A22
120/277V	Dual	HPS-400A-D-HP	CWA	465W	4.00/1.70A	Copper	Copper	H3A	A3
120/277/347V	Tri	HPS-400A-T3-HP	CWA	465W	4.00/1.70/1.30A	Copper	Copper	H9C	A20
120/208/240/277V	Quad	HPS-400A-Q-CA HPS-400A-Q-KIT	CWA	465W	4.00/2.40/2.10/1.70A	Copper	Aluminum	H3	A3
120/208/240/277/480V	5-Tap	HPS-400A-P-CA HPS-400A-P-KIT	CWA	465W	4.00/2.40/2.10/1.70/1.10A	Copper	Aluminum	H9	A21
600 Watt S106 High Pressure Sodium Lamp						Capacitor: Oil Type, 280 Volts, 64 Microfarad; Ignitor: XG-06			
120/208/240/277V	Quad	HPS-600A-Q-HP HPS-600A-Q-KIT	CWA	670W	5.50/3.25/2.85/2.30A	Copper	Copper	H3	A23
1000 Watt S52 High Pressure Sodium Lamp						Capacitor: Oil Type, 525 Volts, 26 Microfarad; Ignitor: XG-03			
120V	Single	HPS-1000A-1-HP	CWA	1100W	9.50A	Copper	Copper	H3B	A4
120/277V	Dual	HPS-1000A-D-HP	CWA	1100W	9.50/4.00A	Copper	Copper	H3A	A4
120/277/347V	Tri	HPS-1000A-T3-HP	CWA	1100W	9.50/4.00/3.30A	Copper	Copper	H9C	A24
120/208/240/277V	Quad	HPS-1000A-Q-CA HPS-1000A-Q-KIT	CWA	1100W	9.50/5.20/4.50/4.00A	Copper	Aluminum	H3	A4
120/208/240/277/480V	5-Tap	HPS-1000A-P-CA HPS-1000A-P-KIT	CWA	1100W	9.50/5.20/4.50/4.00/2.30A	Copper	Aluminum	H9	A25

Specifications subject to change without notice. For complete product specifications, visit www.keystonetech.com

HID BALLASTS

WIRING DIAGRAMS

H1 WITH CAPACITOR

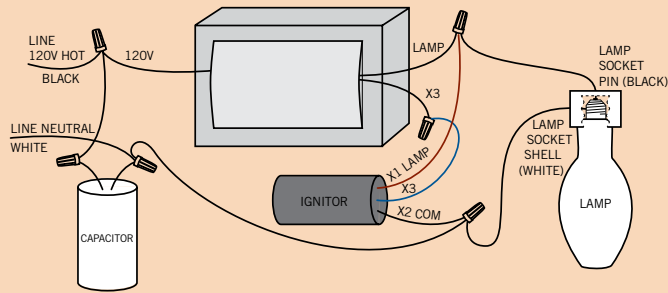

H1 WITHOUT CAPACITOR

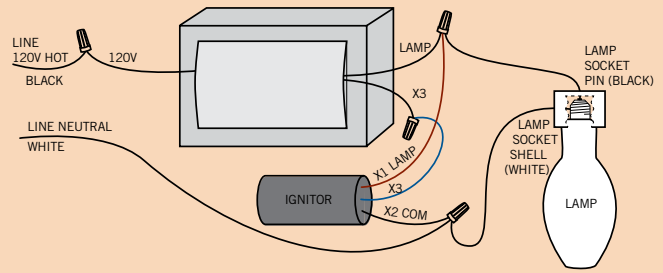

H1A WITH CAPACITOR

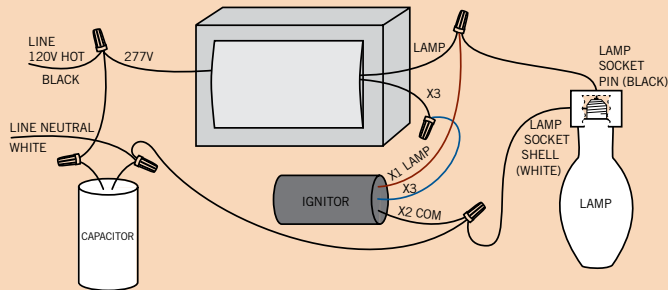

H1A WITHOUT CAPACITOR

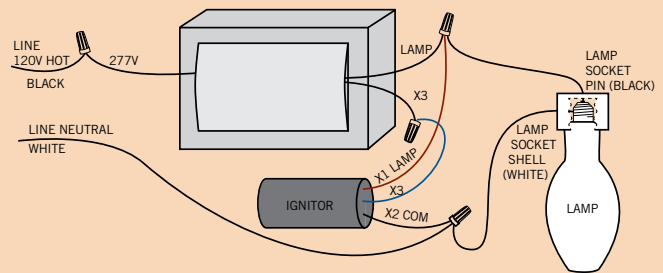

H2

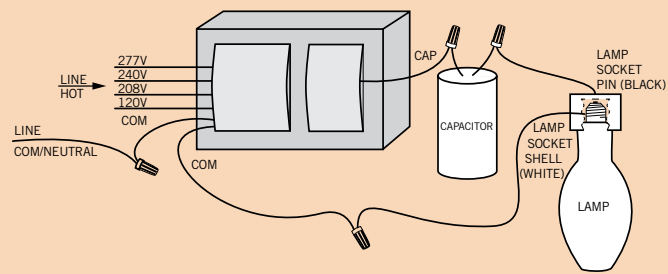

H2A

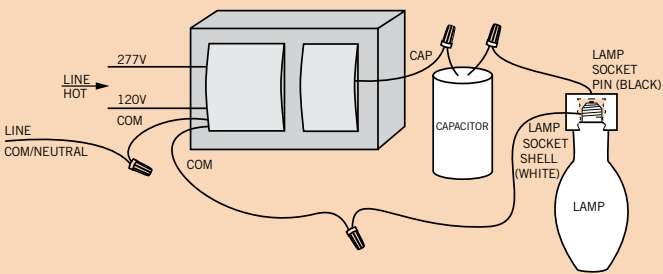

H2B

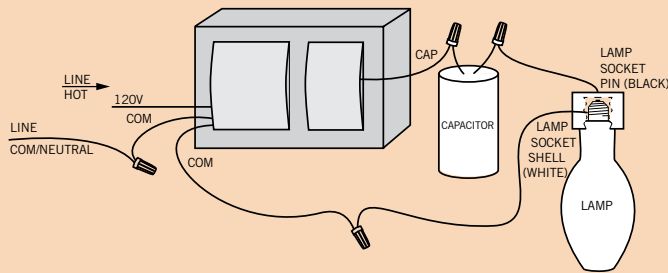

H3

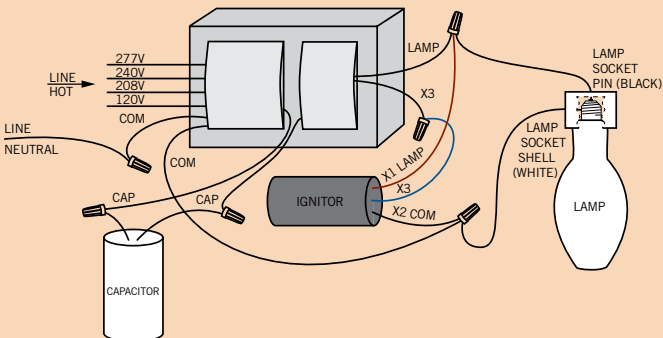

Specifications subject to change without notice. For complete product specifications, visit www.keystonetech.com

HID BALLASTS WIRING DIAGRAMS

H3A

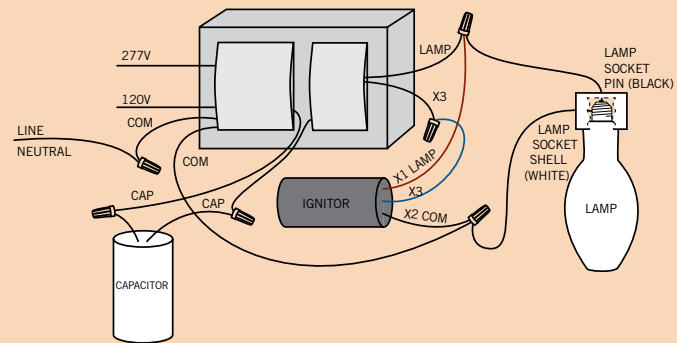

H3B

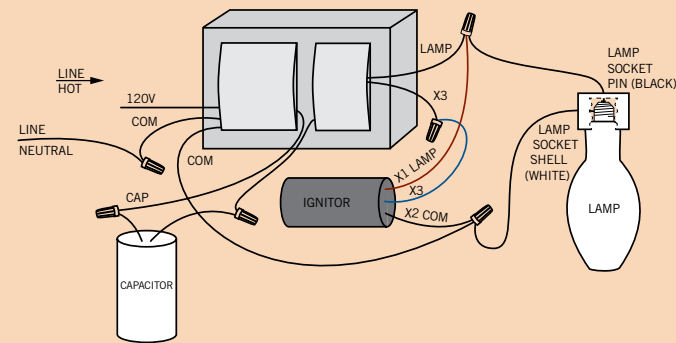

H4 WITH CAPACITOR

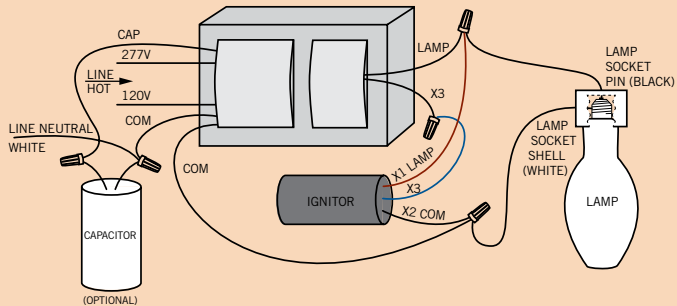

H4 WITHOUT CAPACITOR

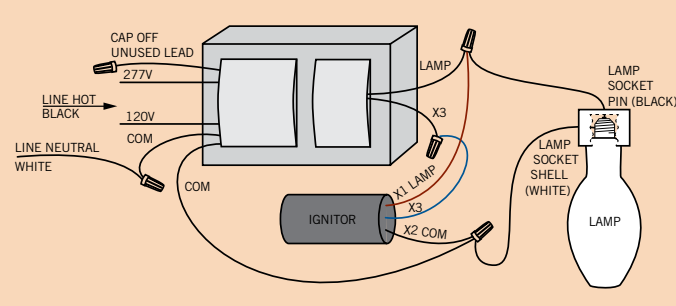

H4A WITH CAPACITOR

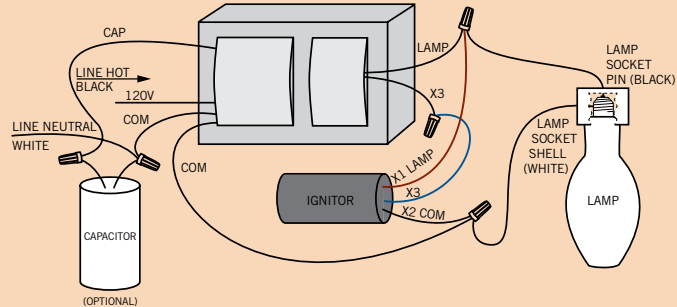

H4A WITHOUT CAPACITOR

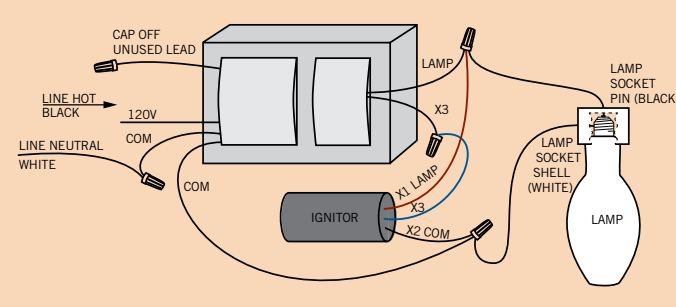

H4B WITH CAPACITOR

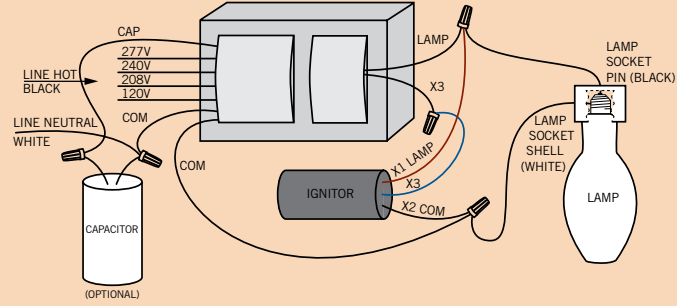

H4B WITHOUT CAPACITOR

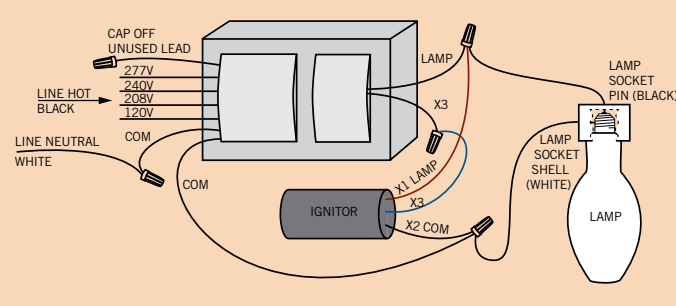

HID BALLASTS WIRING DIAGRAMS

H4C WITH CAPACITOR

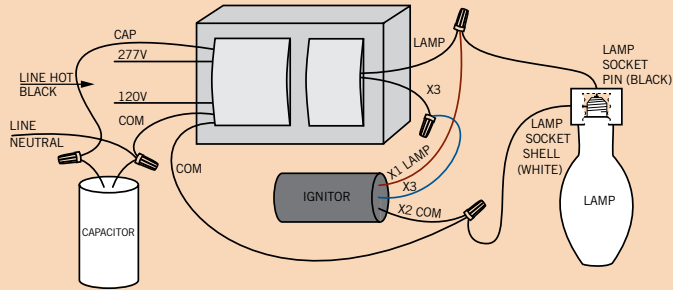

H4C WITHOUT CAPACITOR

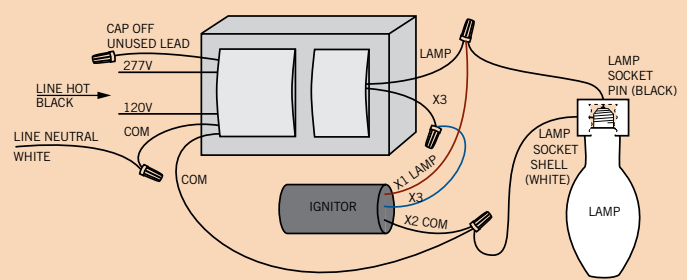

H4D WITH CAPACITOR

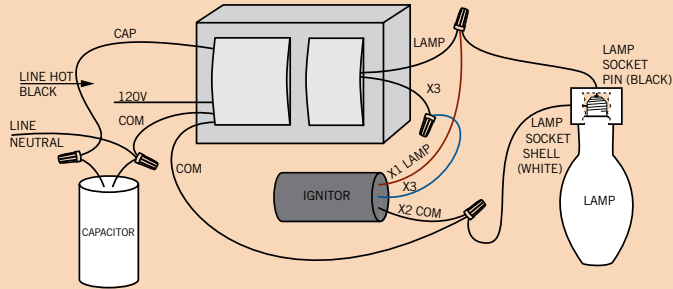

H4D WITHOUT CAPACITOR

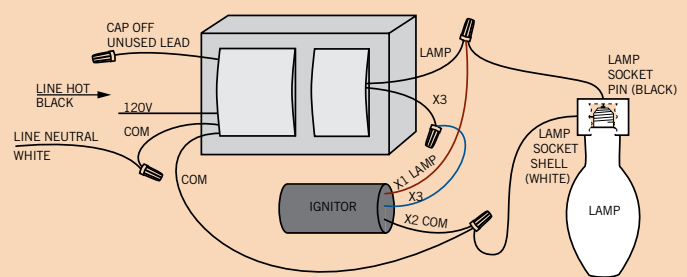

H8

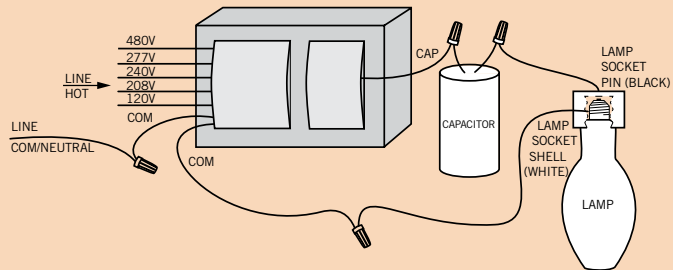

H8A

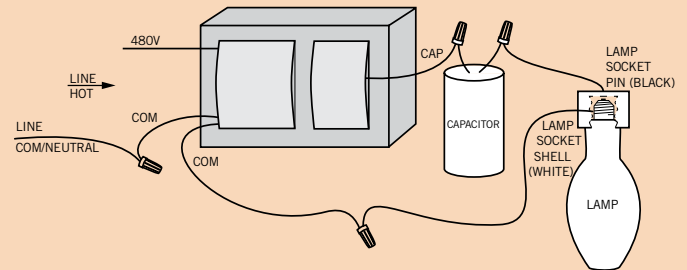

H8B

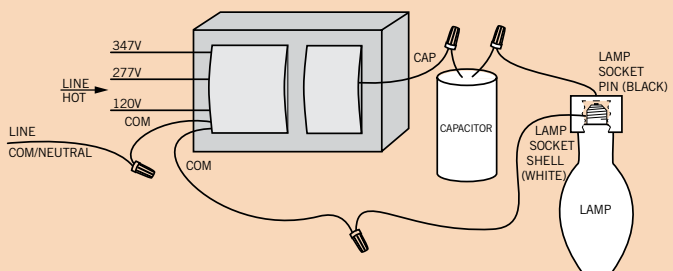

H9

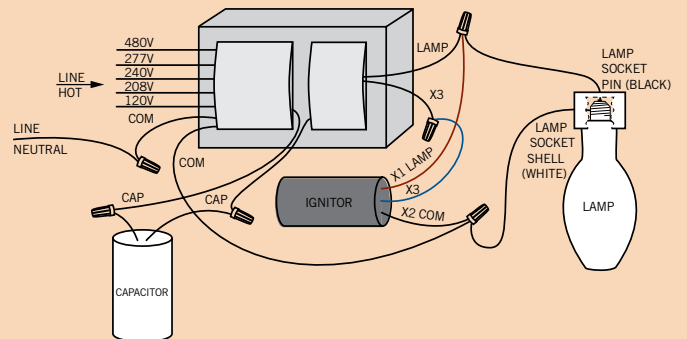

Specifications subject to change without notice. For complete product specifications, visit www.keystonetech.com

HID BALLASTS WIRING DIAGRAMS

H9A

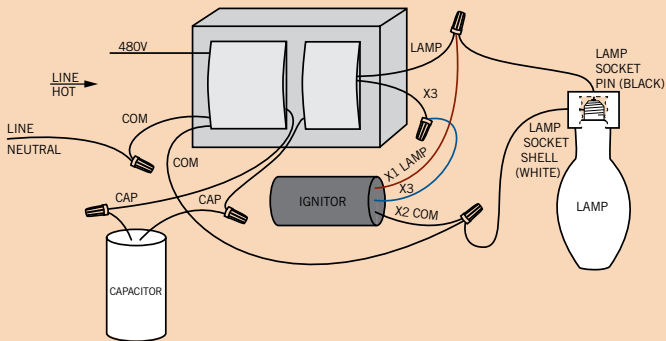

H9B

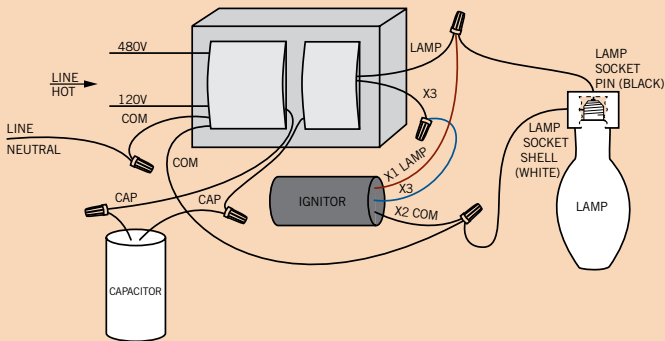

H9C

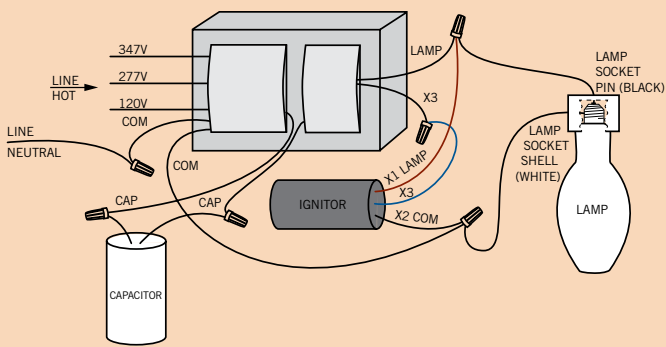

Wiring diagram concepts courtesy of Rob Godwin.

HID BALLASTS

CASE STYLES

CASE A

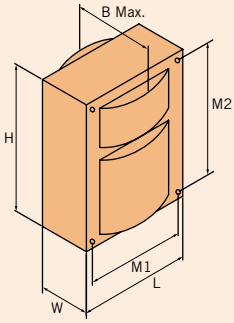

Case Style	M1	M2	Length	Width	Height	B Max	Case Style	M1	M2	Length	Width	Height	B Max
A1	2.44"	3.50"	2.80"	2.42"	3.94"	3.86"	A29	3.87"	4.38"	4.30"	2.17"	4.80"	4.02"
A2	3.87"	4.38"	4.30"	1.81"	4.80"	3.43"	A30	3.87"	4.38"	4.30"	2.17"	4.80"	4.02"
A3	3.87"	4.38"	4.30"	2.31"	4.80"	4.14"	A31	3.87"	4.38"	4.30"	2.37"	4.80"	4.14"
A4	3.87"	5.37"	4.30"	3.74"	6.02"	5.99"	A32	3.87"	5.37"	4.30"	2.84"	6.02"	4.92"
A5	3.87"	5.37"	4.30"	2.84"	6.02"	6.30"	A33	3.87"	5.37"	4.30"	2.88"	6.02"	5.32"
A6	2.44"	3.50"	2.80"	1.02"	3.94"	1.02"	A34	2.45"	3.50"	2.83"	2.48"	3.94"	3.70"
A7	2.44"	3.50"	2.80"	1.04"	3.94"	1.04"	A39	3.87"	4.38"	4.30"	1.65"	4.80"	3.62"
A8	2.44"	3.50"	2.80"	2.46"	3.94"	2.91"	A40	3.87"	4.38"	4.30"	2.30"	4.80"	4.33"
A9	2.44"	3.50"	2.80"	1.54"	3.94"	2.91"	A41	2.44"	3.50"	2.80"	2.48"	3.94"	4.20"
A10	2.44"	3.50"	2.80"	1.58"	3.94"	2.95"	A42	2.44"	3.50"	2.80"	2.42"	3.94"	4.02"
A11	2.44"	3.50"	2.80"	1.99"	3.94"	3.35"	A43	3.87"	4.38"	4.30"	1.65"	4.80"	3.62"
A12	2.44"	3.50"	2.80"	2.28"	3.94"	3.70"	A44	3.87"	4.38"	4.30"	2.30"	4.80"	4.53"
A13	2.44"	3.50"	2.80"	2.58"	3.94"	3.86"	A45	3.87"	5.37"	4.30"	3.46"	6.02"	5.71"
A14	3.87"	4.38"	4.30"	1.20"	4.80"	2.72"	A48	2.44"	3.50"	2.81"	3.07"	3.94"	4.92"
A15	3.87"	4.38"	4.30"	1.52"	4.80"	3.15"	A49	2.44"	3.50"	2.81"	2.89"	3.94"	4.72"
A16	3.87"	4.38"	4.30"	2.03"	4.80"	3.70"	A50	3.88"	4.38"	4.25"	1.52"	4.75"	4.13"
A18	3.87"	4.38"	4.30"	1.97"	4.80"	3.78"	A51	3.88"	4.38"	4.25"	1.81"	4.75"	4.33"
A19	3.87"	4.38"	4.30"	1.97"	4.80"	4.14"	A52	3.88"	4.38"	4.25"	1.93"	4.75"	4.45"
A20	3.87"	4.38"	4.30"	2.35"	4.80"	4.14"	A53	3.88"	4.38"	4.25"	2.11"	4.75"	4.72"
A21	3.87"	4.38"	4.30"	2.35"	4.80"	4.25"	A54	3.88"	4.38"	4.25"	2.30"	4.75"	4.92"
A22	3.87"	4.38"	4.30"	2.62"	4.80"	4.25"	A56	3.88"	5.38"	4.25"	2.81"	6.00"	5.51"
A23	3.87"	5.37"	4.30"	3.15"	6.02"	5.44"	A57	3.88"	5.38"	4.25"	3.46"	6.00"	5.92"
A24	3.87"	5.37"	4.30"	3.90"	6.02"	6.03"	A58	3.88"	5.38"	4.25"	4.72"	6.00"	7.28"
A25	3.87"	5.37"	4.30"	3.74"	6.02"	6.18"	A59	3.88"	5.38"	4.25"	4.72"	6.00"	7.48"
A26	2.44"	3.50"	2.80"	2.42"	3.94"	3.74"	A60	3.87"	4.38"	4.25"	1.65"	4.75"	3.75"
A27	3.87"	4.38"	4.30"	1.70"	4.80"	3.31"	A61	3.87"	5.37"	4.25"	3.46"	6.00"	5.70"
A28	3.87"	4.38"	4.30"	1.65"	4.80"	3.31"	A62	3.87"	5.37"	4.25"	4.13"	6.00"	6.69"

CASE R

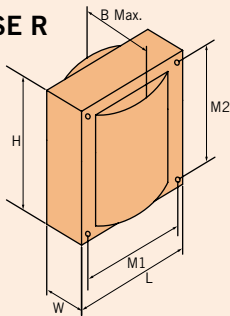

Case Style	M1	M2	Length	Width	Height	B Max
R1	2.19"	1.79"	2.64"	0.61"	2.25"	1.58"
R2	2.19"	1.79"	2.64"	0.83"	2.25"	1.81"
R3	2.19"	1.79"	2.64"	1.30"	2.25"	2.25"
R4	2.19"	1.79"	2.64"	1.54"	2.25"	2.72"
R5	2.19"	1.79"	2.64"	2.09"	2.25"	3.35"
R6	2.19"	1.79"	2.64"	1.14"	2.25"	2.29"
R7	2.19"	1.79"	2.64"	1.61"	2.25"	2.80"
R8	2.19"	1.79"	2.64"	2.54"	2.25"	3.78"

Specifications subject to change without notice. For complete product specifications, visit www.keystonetech.com



HID BALLASTS

F-CAN

Keystone's Metal Halide F-Can ballasts are ideal for recessed downlighting applications, particularly in demanding environments where both long life and high performance are essential.

ELECTRICAL SPECIFICATIONS

Lamp Type	Input Voltage	No. of Taps	Catalog Number	Circuit Type	Input Watts	Input Current	UL Bench Top Rise	Wiring Diagram	Case Style
Metal Halide F-Can									
50W (M110)	120/277V	Dual	MH-50X-D-FCAN	HX-HPF	67/65W	0.59/0.25A	A/A	FC1-1	D11
70W (M98)	120/277V	Dual	MH-70X-D-FCAN	HX-HPF	82/79W	0.70/0.30A	A/A	FC1-1	D11
100W (M90)	120/277V	Dual	MH-100X-D-FCAN	HX-HPF	122W	1.07/0.47A	A/A	FC1-1	D11
150W (M102)	120/277V	Dual	MH-150X-D-FCAN	HX-HPF	184/186W	1.61/0.71A	A/A	FC1-1	D11
175W (M57/H39)	120/277V	Dual	MH-175A-D-FCAN	CWA	202/205W	1.85/0.82A	A/A	FC1-1	D11
250W (M58/H37)	120/277V	Dual	MH-250A-D-FCAN	CWA	314/312W	2.69/1.16A	A/A	FC1-1	D13
400W (M59/H33)	120/277V	Dual	MH-400A-D-FCAN	CWA	445/446W	3.93/1.70A	A/A	FC1-1	D12

CASE STYLES

CASE D

Material: Steel

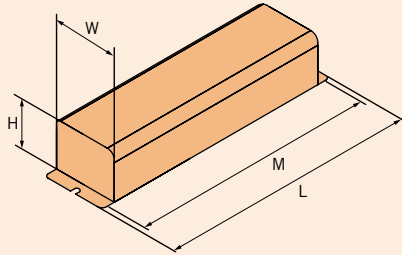

Case Style	Mounting	Length	Width	Height
D11	11.40"	11.80"	3.23"	2.75"
D12	18.63"	19.19"	3.23"	2.75"
D13	16.10"	16.60"	3.23"	2.75"

Specifications subject to change without notice. For complete product specifications, visit www.keystonetech.com

Keystone Technologies, LLC | North Wales, PA 19454 | Phone (800) 464-2680 | keystonetech.com

HID BALLASTS

ACCESSORIES

ELECTRICAL SPECIFICATIONS

Catalog Number	Lamp Type	Wattage	Microfarad	Voltage	Type	Case Style
Capacitors						
CAP-50MH	Metal Halide	50W	6 μ F	280V	Dry Film	CAP1-11
CAP-70HPS	High Pressure Sodium	70W	7 μ F	280V	Dry Film	CAP1-8
CAP-70MH	Metal Halide	70W	8 μ F	280V	Dry Film	CAP1-2
CAP-100HPS	High Pressure Sodium	100W	10 μ F	280V	Dry Film	CAP1-2
CAP-100MH	Metal Halide	100W	12 μ F	280V	Dry Film	CAP1-3
CAP-150HPS	High Pressure Sodium	150W	14 μ F	280V	Dry Film	CAP1-1
CAP-150MH	Metal Halide	150W	16 μ F	280V	Dry Film	CAP1-1
CAP-175MH	Metal Halide	175W	10 μ F	400V	Dry Film	CAP1-1
CAP-175MPS	Pulse Start Metal Halide	175W	11 μ F	370V	Dry Film	CAP1-1
CAP-200MPS	Pulse Start Metal Halide	200W	15 μ F	330V	Dry Film	CAP1-6
CAP-250HPS	High Pressure Sodium	250W	35 μ F	280V	Dry Film	CAP1-10
CAP-250MH	Metal Halide	250W	15 μ F	400V	Dry Film	CAP1-6
CAP-250MPS	Pulse Start Metal Halide	250W	17 μ F	400V	Dry Film	CAP1-7
CAP-320MPS	Pulse Start Metal Halide	320W	21 μ F	345V	Dry Film	CAP1-7
CAP-350MPS	Pulse Start Metal Halide	350W	22.5 μ F	360V	Dry Film	CAP1-7
CAP-400HPS	High Pressure Sodium	400W	55 μ F	300V	Dry Film	CAP1-5
CAP-400MH	Metal Halide	400W	24 μ F	400V	Dry Film	CAP1-4
CAP-400MPS	Pulse Start Metal Halide	400W	26 μ F	330V	Dry Film	CAP1-7
CAP-450MPS	Pulse Start Metal Halide	450W	26.5 μ F	400V	Dry Film	CAP1-9
CAP-750MPS	Pulse Start Metal Halide	750W	28 μ F	400V	Oil Filled	CAP2-2
CAP-1000HPS	High Pressure Sodium	1000W	26 μ F	525V	Oil Filled	CAP2-1
CAP-1000MH	Metal Halide	1000W	24 μ F	480V	Oil Filled	CAP2-1
CAP-1000MPS	Pulse Start Metal Halide	1000W	24 μ F	480V	Oil Filled	CAP2-1
CAP-1500MH	Metal Halide	1500W	32 μ F	525V	Oil Filled	CAP2-2

CASE STYLES

CASE CAP1

Type: Dry Film
Case Material: Plastic

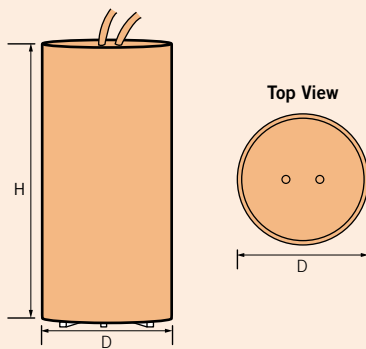

Case Style	Diameter	Height
CAP1-1	1.38"	3.07"
CAP1-2	1.18"	2.68"
CAP1-3	1.18"	3.07"
CAP1-4	1.77"	3.15"
CAP1-5	1.77"	5.24"
CAP1-6	1.57"	2.68"
CAP1-7	1.57"	3.66"
CAP1-8	1.02"	2.68"
CAP1-9	1.57"	5.24"
CAP1-10	1.57"	3.07"
CAP1-11	0.79"	2.68"

CASE CAP2

Type: Oil Filled
Case Material: Metal

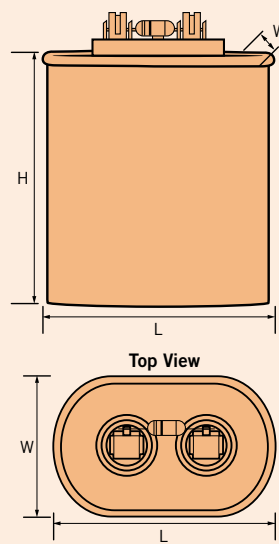

Case Style	Length	Width	Height
CAP2-1	2.91"	1.91"	3.91"
CAP2-2	3.66"	1.97"	3.91"

Specifications subject to change without notice. For complete product specifications, visit www.keystonetech.com

ELECTRICAL SPECIFICATIONS

Catalog Number	Lamp Type	Wattage	Circuit Type	Case Style
Ignitors				
IGN-XG-01	High Pressure Sodium	35-150W	Reactor, HX	IGN1
IGN-XG-02	High Pressure Sodium	250-400W	CWA	IGN1
IGN-XG-03	High Pressure Sodium	1000W	CWA	IGN1
IGN-XG-03A	Pulse Start Metal Halide	750W	CWA	IGN1
IGN-XG-04	Probe and Pulse Start Metal Halide	50-450W	HX, CWA	IGN1
IGN-XG-06	High Pressure Sodium	600W	CWA	IGN1

CASE STYLES

CASE IGN

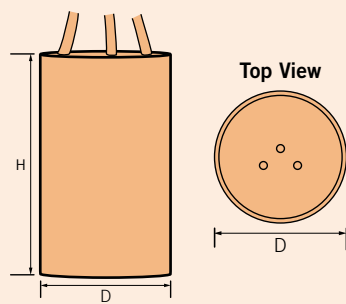

Case Style	Diameter	Height
IGN1	1.38"	2.33"

HID BALLASTS

HID KITS

All Keystone HID kits include a core and coil ballast, a capacitor and ignitor (if required), mounting hardware, and a pictorial installation guide.



Many Keystone HID ballasts are available in contractor-friendly kits. Featuring a multi-tap ballast, pre-wired at the factory with the appropriate capacitor and ignitor, Keystone's HID kits make for a hassle-free *and* error-free installation.

HID KIT CATALOG NUMBER	HID KIT CONTENTS				
	Ballast	Capacitor	Ignitor	Mounting Brackets	Mounting Hardware
MPS-175A-Q-KIT	✓	✓	✓	✓	✓
MPS-175A-P-KIT	✓	✓	✓	✓	✓
MPS-200A-Q-KIT	✓	✓	✓	✓	✓
MPS-200A-P-KIT	✓	✓	✓	✓	✓
MPS-250A-Q-KIT	✓	✓	✓	✓	✓
MPS-250A-P-KIT	✓	✓	✓	✓	✓
MPS-320A-Q-KIT	✓	✓	✓	✓	✓
MPS-320A-P-KIT	✓	✓	✓	✓	✓
MPS-350A-Q-KIT	✓	✓	✓	✓	✓
MPS-350A-P-KIT	✓	✓	✓	✓	✓
MPS-400A-480-KIT	✓	✓	✓	✓	✓
MPS-400A-Q-KIT	✓	✓	✓	✓	✓
MPS-400A-P-KIT	✓	✓	✓	✓	✓
MPS-450A-Q-KIT	✓	✓	✓	✓	✓
MPS-450A-P-KIT	✓	✓	✓	✓	✓
MPS-750A-P-KIT	✓	✓	✓	✓	✓
MPS-750A-Q-KIT	✓	✓	✓	✓	✓
MPS-1000A-Q-KIT	✓	✓	✓	✓	✓
MH-50X-Q-KIT	✓	✓	✓	✓	✓
MH-70X-Q-KIT	✓	✓	✓	✓	✓
MH-100X-Q-KIT	✓	✓	✓	✓	✓
MH-150X-Q-KIT	✓	✓	✓	✓	✓
MH-175A-Q-KIT	✓	✓	N/A	✓	✓
MH-175A-Q-AA-KIT	✓	✓	N/A	✓	✓
MH-175A-P-KIT	✓	✓	N/A	✓	✓
MH-250A-480-KIT	✓	✓	N/A	✓	✓
MH-250A-Q-KIT	✓	✓	N/A	✓	✓
MH-250A-Q-AA-KIT	✓	✓	N/A	✓	✓
MH-250A-P-KIT	✓	✓	N/A	✓	✓
MH-400A-480-KIT	✓	✓	N/A	✓	✓
MH-400A-Q-KIT	✓	✓	N/A	✓	✓
MH-400A-Q-AA-KIT	✓	✓	N/A	✓	✓
MH-400A-P-KIT	✓	✓	N/A	✓	✓
MH-1000A-480-KIT	✓	✓	N/A	✓	✓
MH-1000A-Q-KIT	✓	✓	N/A	✓	✓
MH-1000A-Q-AA-KIT	✓	✓	N/A	✓	✓
MH-1000A-P-KIT	✓	✓	N/A	✓	✓
MH-1500A-Q-KIT	✓	✓	N/A	✓	✓
MH-1500A-P-KIT	✓	✓	N/A	✓	✓

HID KIT CATALOG NUMBER	HID KIT CONTENTS				
	Ballast	Capacitor	Ignitor	Mounting Brackets	Mounting Hardware
HPS-35R-1-KIT	✓	N/A	✓	✓	✓
HPS-50R-1-KIT	✓	N/A	✓	✓	✓
HPS-70R-1-KIT	✓	N/A	✓	✓	✓
HPS-70X-Q-KIT	✓	✓	✓	✓	✓
HPS-100R-1-KIT	✓	N/A	✓	✓	✓
HPS-100X-Q-KIT	✓	✓	✓	✓	✓
HPS-150R-1-KIT	✓	N/A	✓	✓	✓
HPS-150X-Q-KIT	✓	✓	✓	✓	✓
HPS-250A-Q-KIT	✓	✓	✓	✓	✓
HPS-250A-P-KIT	✓	✓	✓	✓	✓
HPS-400A-480-KIT	✓	✓	✓	✓	✓
HPS-400A-Q-KIT	✓	✓	✓	✓	✓
HPS-400A-P-KIT	✓	✓	✓	✓	✓
HPS-600A-Q-KIT	✓	✓	✓	✓	✓
HPS-1000A-Q-KIT	✓	✓	✓	✓	✓
HPS-1000A-P-KIT	✓	✓	✓	✓	✓



Specifications subject to change without notice. For complete product specifications, visit www.keystonetech.com

LOW VOLTAGE TRANSFORMERS



Keystone's portfolio of durable low voltage halogen and xenon transformers are ideally suited for track, task, and recessed lighting applications. Chosen by the leading designers and architectural fixture manufacturers for reliability and performance, all Keystone low voltage transformers are 100% factory tested to ensure superior performance in the field. Available in a variety of common and specialty configurations, we are sure to have the right transformer for your low voltage lighting system.

LOW VOLTAGE TRANSFORMERS



ELECTRICAL SPECIFICATIONS

Max. Input Power	Input Volts	Catalog Number	Input Current	Output Volts	Dimmable	Case Style	Remarks
12V Halogen							
60W	120V	KTET-60-1-WC-F	0.50A	11V	No	O1	With Cord and Fuse
		KTET-60-1-SCP-DIM-AL	0.50A	12V	Yes	F4	Class 2, Short Circuit Protected, Aluminum Case
75W	120V	KTET-75-1-SCP-EMI	0.63A	11V	No	F3	Short Circuit Protected, EMI Filter
		KTET-75-1-SCP-DIM-RJS	0.62A	11V	Yes	Z1	With Rear Mount Studs and Leads for J-Box Application
	277V	KTET-75-2-SCP-RJS	0.26A	11V	No	Z1	With Rear Mount Studs and Leads for J-Box Application
150W	120V	KTET-150-1-SCP-DIM	1.27A	11.4V	Yes	AB1	Short Circuit Protected, Aluminum Case

CASE STYLES

CASE AB

Material: Aluminum

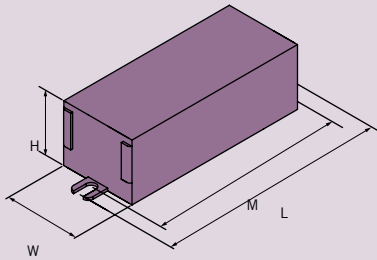

Case Style	Mounting	Length	Width	Height
AB1	3.62"	4.11"	1.38"	1.10"

CASE F

Material: Aluminum

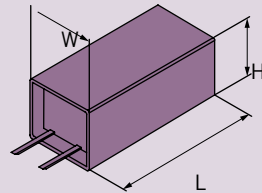

Case Style	Mounting	Length	Width	Height
F3	N/A	2.68"	1.30"	0.79"
F4	N/A	2.09"	1.30"	0.79"

CASE O

Material: Plastic

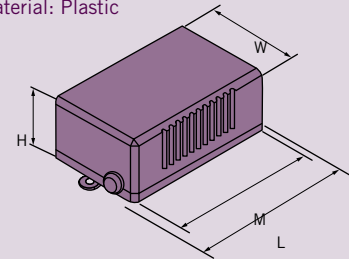

Case Style	Mounting	Length	Width	Height
O1	2.80"	3.15"	1.50"	1.06"

CASE Z

Material: Steel

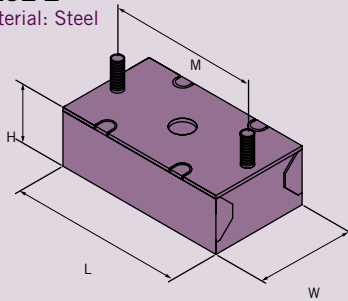

Case Style	Mounting	Length	Width	Height
Z1	2.00"	2.48"	1.38"	0.83"

Specifications subject to change without notice. For complete product specifications, visit www.keystonetech.com

STEP DOWN TRANSFORMERS



Keystone's step down transformers are ideal for powering down from a 480 volt or 347 volt system to a 277 volt system, rated up to 375 watts. Utilizing a precision wound core and coil integrated design, these auto-transformers provide a safe and reliable solution for effective power conversion to use standard 277 volt or multi-voltage lighting ballasts.

STEP DOWN TRANSFORMERS

ELECTRICAL SPECIFICATIONS

Catalog Number	INPUT CHARACTERISTICS			OUTPUT CHARACTERISTICS			Case Style
	Input Voltage	Input Current at Max. Load	Input Current at No Load	Output Voltage	Max. Load	Max Output Current	
KTAT-30-347-277	374V	0.11A	0.05A	277V	30VA	0.13A	AK6
KTAT-30-347-277-RJS	374V	0.11A	0.05A	277V	30VA	0.13A	AK6
KTAT-70-347-277	374V	0.23A	0.07A	277V	70VA	0.27A	AK6
KTAT-70-347-277-RJS	374V	0.23A	0.07A	277V	70VA	0.27A	AK6
KTAT-70-480-277	480V	0.16A	0.06A	277V	70VA	0.25A	AK6
	347V	0.22A	0.08A	277V	70VA	0.25A	
KTAT-70-480-277-RJS	480V	0.16A	0.06A	277V	70VA	0.25A	AK6
	347V	0.22A	0.08A	277V	70VA	0.25A	
KTAT-250-480-277 /A	480V	0.55A	0.13A	277V	250VA	0.90A	L20
	347V	0.57A	0.11A	200V	180VA	0.90A	
KTAT-375-480-277 /A	480V	0.86A	0.21A	277V	375VA	1.35A	L21
	347V	0.86A	0.11A	200V	270VA	1.35A	

CASE STYLES

CASE AK*

Material: Steel

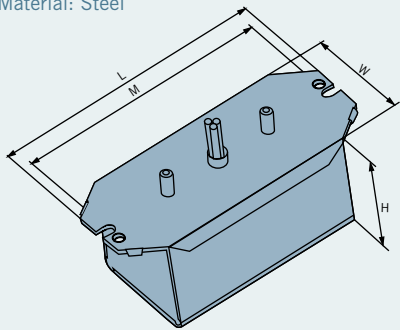

Case Style	Mounting	Length	Width	Height
AK6	2.00"	4.76"	2.15"	1.61"

* Available with and without studs.

CASE L

Material: Steel

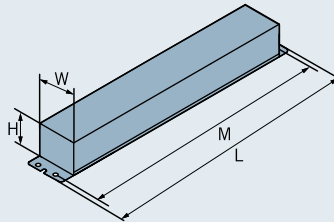

Case Style	Mounting	Length	Width	Height
L20	8.86"	9.45"	1.63"	1.20"
L21	11.10"	11.70"	1.63"	1.20"

Specifications subject to change without notice. For complete product specifications, visit www.keystonetech.com

SENSORS

SECTION CONTENTS

High Bay Occupancy Sensors: 128

Wet Location Occupancy Sensors: 128

Photocells: 129

Benefits of Sensoring: 130



Sensors are the smart solution for minimizing energy consumption and maximizing lighting system life. Utilizing state-of-the-art electronics and optics, Keystone's line of occupancy and daylight sensors provides a cost-effective solution for dramatically improving your return on investment by intelligently signalling when to turn the lights on and off. After installing Keystone sensors, customers commonly save up to 80% on electricity usage and extend the system life over two years.

SENSORS

OCCUPANCY SENSORS

ELECTRICAL SPECIFICATIONS

Standard High Bay Occupancy Sensors

Catalog Number	Frequency	Maximum Load Rating	Power Consumption	Case Style
HBE-PIR-120/277/347	50/60Hz	800VA @ 120VAC 1200VA @ 277VAC 1500VA @ 347VAC	0.2W @ 120VAC 1.0W @ 277VAC 2.0W @ 347VAC	OS1

Accessories for Standard High Bay Occupancy Sensors (Sold Separately)

Catalog Number	Description
HBE-EXBT	Extender Bracket for High Bay Motion Sensor; Lowers Sensor for Optimum Field of View
HBE-LENS-AISLE	Interchangeable Lens - Aisle Way Fresnel Pattern
HBE-LENS-360	Interchangeable Lens - 360° View Fresnel Pattern

Wet Location Occupancy Sensors

Catalog Number	Frequency	Maximum Load Rating	Power Consumption	Case Style
HBE-PIR-120-277-IP65	50/60Hz	800VA @ 120VAC 1200VA @ 208/240/277VAC	0.07W @ 120VAC 0.39W @ 277VAC	OS2
HBE-PIR-347/480-IP65	50/60Hz	1500VA @ 347VAC 2000VA @ 480VAC	0.19W @ 347VAC 0.37W @ 480VAC	OS2

FEATURES

- Passive Infrared (PIR) Sensing Technology
- Ideal for Fluorescent or LED High Bay Fixtures in Warehouses, Manufacturing Facilities, and Other High Ceiling Applications
- LED Indicator
- No Minimum Load Requirements
- Simple Adjustable Controls for Time Delay and Day Lighting Control
- Interchangeable Lenses including Aisle Pattern View
- Low Bay Lens Included with Wet Location Sensor Only
- Embedded Relay (No External Box Required)

PERFORMANCE

- Mounting Height: Up to 40' Maximum
- Adjustable for a Variety of Time Delay and Ambient Daylight Conditions
- Operating Temperature Range: 14°F-160°F for Standard High Bay Sensors; -4°F-160°F for Wet Location Sensors
- Storage Temperature Range: 14°F-160°F for Standard High Bay Sensors; -4°F-160°F for Wet Location Sensors

CASE STYLES

CASE OS1

Material: Plastic

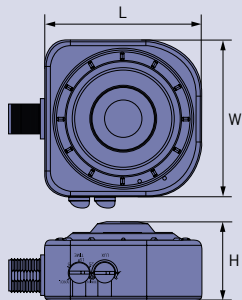

Case Style	Length	Width	Height
OS1	3.60"	3.60"	1.80"

CASE OS2

Material: Plastic

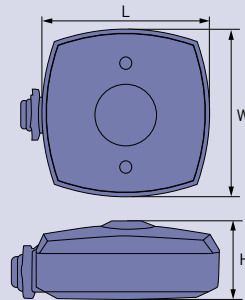

Case Style	Length	Width	Height
OS2	4.13"	4.13"	1.89"

Specifications subject to change without notice. For complete product specifications, visit www.keystonetech.com

ELECTRICAL SPECIFICATIONS

Catalog Number	Input Voltage	Input Frequency	Maximum Input Power	Maximum Input Current	Maximum Ambient Temperature	Case Style
KTPS-45-1	120V	50/60Hz	45VA	0.375A	149°F/65°C	PS1
KTPS-80-1	120V	50/60Hz	80VA	0.67A	149°F/65°C	PS1

FEATURES

- Photocell Sensors Utilize an Industry-Leading Compact Design to Enable Installation into Small Enclosures and Fixtures
- Available in Low Power (45VA) and High Power (80VA) Versions to Cover Many Applications
- Designed to Power Fluorescent, Incandescent, and LED Loads

CASE STYLE

CASE PS

Material: Plastic

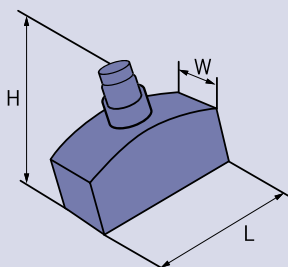

Case Style	Length	Width	Height	Diameter
PS1	1.61"	0.75"	1.40"	0.374"

SENSORS

BENEFITS OF SENSORING

Occupancy sensors and photocells are devices that turn lights (and other equipment) on or off as a result of presence or absence of people in a specific area. There are many types of occupancy sensors and technologies in the market today for a variety of applications. It is a fact that incorporating occupancy sensors and/or photocells results in significant cost and energy savings. They are relatively inexpensive to install, and other benefits are noted below:



Energy and Money Savings

An occupancy sensor or photocell essentially only turns on the lights when needed or scheduled. When a fixture is not needed or scheduled to be used and it is turned off by a sensor or photocell, the amount of energy saved throughout a 24 hour period of time can be significant. This energy savings leads to a reduction in electric bills.

Percentage Reduction in On-Time for Lights in a Given Area

AREA TYPE	PERCENT REDUCTION
Warehouse	75%
Locker Room	65%
Large Work Room/Office	55%
Restroom	50%
File Room	45%
Small Work Room	40%
Corridor	25%
Small Office	22%

Chart information provided by www.dot.gov.

Utility Rebates

Many states and municipalities offer incentives to incorporate energy-consumption controls in retrofit projects and new construction. To find out if rebates are available in your area, you can visit the DOE's Database of State Incentives for Renewables and Efficiency online at www.dsireusa.org. You can also visit our website at www.keystonetech.com for more information.

Convenience

Adding a sensor to any lighting system also adds a level of convenience for the people who utilize the areas in range of the lighting system. In the case of an office area that is not occupied at all times, it is convenient to know that the lights in the area will automatically turn on when needed and, more importantly, turn off when the area is no longer occupied. This guards against lights accidentally being left on, wasting both energy and money. This is especially beneficial in warehouse and some manufacturing applications where lights are often left on at all times regardless of whether or not an area is occupied.

Security

Photocells are an obvious choice in certain applications where security and safety are an issue. They automatically turn lights on when ambient light (sunlight) diminishes and off when the ambient light returns. Therefore, areas that would normally be shrouded in darkness after dusk automatically become well-lit until sunrise. Occupancy sensors are also a beneficial security measure because if a dark area becomes occupied, the light will automatically turn on. It quickly becomes evident that the area is occupied and the well-lit area is now safer for security personnel to investigate.



Specifications subject to change without notice. For complete product specifications, visit www.keystonetech.com

REFERENCES

SECTION CONTENTS

Cross Reference Guide: 132

Ordering Information: 136

Catalog Number Designations: 137

Obsolete Product Guide: 141

Warranty Information: 142

Index: 144

EXPLANATION OF APPROVALS

Items that meet the following ratings are noted throughout this catalog.



CEE Qualified - The Consortium for Energy Efficiency (CEE) is the premiere agency for recognizing the most efficient electrical products. Lighting ballasts qualified by CEE are recognized as the most energy efficient products and automatically qualify for utility rebate programs throughout the United States. For more information visit www.cee1.org.



Circle E - This mark indicates that the ballast meets or exceeds the requirements of the Energy Independence and Security Act of 2009.



DLC (Design Lights Consortium) - A collaboration of utility companies and regional energy efficiency organizations dedicated to promoting the development of quality, high efficiency LED products for use in commercial settings. Having products on the DLC Qualified Products List is a requirement for many utility company rebate programs for LED lighting products.



2014 DOE Compliant - As of November 14th, 2014 the Department of Energy (DOE) implemented new and amended energy conservation standards for fluorescent lamp ballasts. All ballasts (defined within the scope of the standards) made or imported into the United States on or after November 14th, 2014 must meet the minimum requirements of the new standards.



ETL Sanitation Listed - This mark indicates that equipment is fit for use in the production of food intended for human consumption, or that equipment is fit for use in an environment where food intended for human consumption is produced.



NSF International - An independent, non-profit, non-governmental organization committed to the global development of public health and safety standards. NSF Listed products meet food protection and sanitation requirements for the materials, design, fabrication, construction, and performance of food handling and processing equipment.



RoHS (Removal of Hazardous Substances) Compliant - This means that the ballast complies with environmentally-friendly standards set for acceptable levels of cadmium, hexavalent chromium, lead, PBB, PBDE, and mercury.



Sign Component Manual (SAM) - A directory governed by UL that lists all components that have been tested and certified under the UL standard for electric signs. It is updated quarterly and contains all of the components associated with the manufacturing of electric signs, including LED power supplies. For more information, visit www.ul.com.



UL Classified - The Underwriters Laboratories, Inc. mark signifies that a product meets a specific set of safety requirements related to a given product type. This UL Classified mark is used often on LED retrofit kit products.



UL Listed - This mark indicates that the product meets the safety standards set forth by Underwriters Laboratories, Inc. All Keystone products meet the highest level of UL approval.



UL Recognized Component - This mark indicates that the product meets UL standards to be installed into another device, system, or product.

REFERENCES

CROSS REFERENCE GUIDE

LED DRIVERS

Keystone Part Number	Description	ULT/Magnetek Part Number	Advance Part Number	Meanwell Part Number
60W CONSTANT VOLTAGE				
KTLD-60-UV-12V	60W, 120-277V Input, 12V Output	D12V60UNV-A	LEDINTA0012V50F0	N/A
KTLD-60-UV-12V-67-AP4	60W, 120-277V Input, 12V Output, IP67 Rated	D12V60UNV-Q	N/A	CEN-60-12
100W CONSTANT VOLTAGE				
KTLD-100-UV-24V	100W, 120-277V Input, 24V Output	D24V100UNV-A	LEDINTA0024V41F0	N/A

FLUORESCENT BALLASTS

Keystone Part Number	Description	ULT/Magnetek Part Number	Advance Part Number	GE Part Number	Sylvania Part Number
T12					
KTEB-240-1-TP-PIC	(2) F40T12, 120V	B240R120HP	RELB-2S40-N	GE-240-RS-120	QTP2X40T12/120/RSNSC
KTEB-240-UV-TP-PIC	(2) F40T12, 120-277V	N/A	ICN-2S40-N	GE-240-RS-MV-N	QTP2x40T12/UNV/RS/SC
KTEB-260HO-UV-PS-SL	(2) F48T12HO, 120-277V	B259SRUNVHP	ICN2S110-SC	N/A	N/A
KTEB-275-1-TP-PIC-SL	(2) F96T12, 120V	B260I120MA	REL-2P60-S-A	N/A	QT2X96/120 IS (Larger Case)
KTEB-275-UV-TP-PIC	(2) F96T12, 120-277V	B260IUNVHP	ICN-2P60-SC	GE-260-IS-MV-N	QTP2x96/T12/UNV/IS
KTEB-2110-1-TP-PIC	(2) F96T12HO, 120V	B295SR120HP	N/A	N/A	QT2X96/120HO
KTEB-2110-UV-TP-PIC	(2) F96T12HO, 120-277V	B295SRUNVHP	ICN-2S110-SC	GE-296-HO-MV-N	QTP2X96T12HO/UNV RS
KTEB-140-1-TP-EMI	(1) F40T12, 120V	B140R120HP	RELB-1S40-SC	GE140RS120-DIY	N/A
T8					
KTEB-232-UV-IS-N-P	(2) F17/25/32T8, 120-277V, Standard Output	B232IUNVHE-A	IOP-2P32-SC	GE232MAX-N/ULTRA	QHE2X32T8/UNVISN-SC
KTEB-332-UV-IS-N-P	(3) F17/25/32 T8, 120-277V, Standard Output	B332IUNVHE-A	IOP-3P32-SC	GE332MAX-N/ULTRA	QHE3X32T8/UNVISN-SC
KTEB-432-UV-IS-N-P	(4) F17/25/32T8, 120-277V, Standard Output	B432IUNVHE-A	IOP-4P32-SC	GE432MAX-N/ULTRA	QHE4X32T8/UNVISN-SC
KTEB-232-UV-IS-L-P	(2) F17/25/32T8, 120-277V, Reduced Output	B232IUNVEL-A	IOP-2P32-LW-SC	GE232MAX-L/ULTRA	QHE2X32T8/UNVISL-SC
KTEB-332-UV-IS-L-P	(3) F17/25/32T8, 120-277V, Reduced Output	B332IUNVEL-A	IOP-3P32-LW-SC	GE332MAX-L/ULTRA	QHE3X32T8/UNVISL-SC
KTEB-432-UV-IS-L-P	(4) F17/25/32T8, 120-277V, Reduced Output	B432IUNVEL-A	IOP-4P32-LW-SC	GE432MAX-L/ULTRA	QHE4X32T8/UNVISL-SC
KTEB-232-UV-IS-H-P	(2) F17/25/32T8, 120-277V, High Output	B232IUNVHEH-A	IOP-2P32-HL-SC	GE232MAX-H/ULTRA	QHE2X32T8/UNVISH-SC
KTEB-332-UV-IS-H-P	(3) F17/25/32T8, 120-277V, High Output	B332IUNVHEH-A	IOP-3P32-HL-90C-SC	GE332MAX-H/ULTRA	QHE3X32T8/UNVISH-SC
KTEB-132-UV-PS-N-P	(1) F17/25/32T8, 120-277V, Standard Output	B132PUNVHE-A	IOP-1S32-SC	GE132-MVPS-N	QTP 1x32T8/UNV PSN-TC
KTEB-232-UV-PS-N-P	(2) F17/25/32T8, 120-277V, Standard Output	B232PUNVHE-A	IOP-2S32-SC	GE232-MVPS-N	QTP 2x32T8/UNV PSN-TC
KTEB-332-UV-PS-N-P	(3) F17/25/32T8, 120-277V, Standard Output	B332PUNVHE-A	IOP-3S32-SC	GE332-MVPS-N	QTP 3x32T8/UNV PSN-SC
KTEB-432-UV-PS-N-P	(4) F17/25/32T8, 120-277V, Standard Output	B432PUNVHE-A	IOP-4S32-SC	GE432-MVPS-N	QTP 4x32T8/UNV PSN-SC
KTEB-232-UV-PS-L-P	(2) F17/25/32T8, 120-277V, Reduced Output	B232PUNVEL-A	IOP-2S32-LW-SC	GE-232-MVPS-L	QTP 2X32T8/UNV PSX-TC
KTEB-332-UV-PS-L-P	(3) F17/25/32T8, 120-277V, Reduced Output	B332PUNVEL-A	IOP-3S32-LW-SC	GE-332-MVPS-L	QTP 3X32T8/UNV PSX-TC
KTEB-432-UV-PS-L-P	(4) F17/25/32T8, 120-277V, Reduced Output	B432PUNVEL-A	IOP-4S32-LW-SC	GE-432-MVPS-L	QTP 4X32T8/UNV PSX-TC
KTEB-232-UV-PS-H-P	(2) F17/25/32T8, 120-277V, High Output	N/A	N/A	GE-232-MVPS-H	QHE 2X32T8/UNVPSH-HT
KTEB-332-UV-PS-H-P	(3) F17/25/32T8, 120-277V, High Output	N/A	N/A	GE-332-MVPS-H	QHE 3X32T8/UNVPSH-HT
KTEB-232-1-IS-N	(2) F17/25/32T8, 120V	B232I120RH-A	REL-2P32-SC	GE-232-120-N	QT 2x32/120 IS-SC
KTEB-432-1-IS-N-P	(4) F17/25/32T8, 120V	B432I120RH-A	REL-4P32-SC	GE-432-120-N	QT 4X32/120 IS
KTEB-259-UV-IS-N	(2) F96T8, 120-277V	B259IUNVHP-A	IOP-2P59-SC	GE-259MAX-N/ULTRA	QTP 2X59T8/UNV ISN-SC
KTEB-259-1-IS-N	(2) F96T8, 120V	B259I120RH	REL-2P59-SC	GE-259-120-N	QTP2X59T8/120ISN-A
T8HO					
KTEB-286HO-UV-PS-N	(2) F96T8HO, 120-277V, Program Start	N/A	ICN-2S86	N/A	QHE2x86T8HO/UNVPSN-HT
KTEB-286HO-UV-IS-N	(2) F96T8HO, 120-277V, Instant Start	B286I20RH or B268I277RH	ICN-2S86 (Program Start Only)	GE-286-HO-MV-N	N/A

Specifications subject to change without notice. For complete product specifications, visit www.kestonetech.com

REFERENCES

CROSS REFERENCE GUIDE

FLUORESCENT BALLASTS (continued)

Keystone Part Number	Description	ULT/Magnetek Part Number	Advance Part Number	GE Part Number	Sylvania Part Number
T5HO					
KTEB-224HO-UV-PS-SL	(2) F24T5HO, 120-277V, Program Start, 9" Case	B224PUNV-C (16.7" Case)	ICN-2S24 (16.7" Case)	B224PUNV-COG1C (Different Case Size)	QTP2X39-24T5HO/UNV PSN (16.7" Case)
KTEB-239HO-UV-PS-SL	(2) F39T5HO, 120-277V, Program Start, 9" Case	B239PUNV-D (16.7" Case)	ICN-2S39 (16.7" Case)	B239PUNV-DOG1C (Different Case Size)	QTP2X39-24T5HO/UNV PSN (16.7" Case)
KTEB-254HO-UV-PS	(2) F54T5HO, 120-277V, Program Start	B254PUNV-D	ICN-2S54-90C	GE254MVPS90-F (Different Case Size)	QTP2X54T5HO/UNV PSN
KTEB-254HO-UV-PS-SL	(2) F54T5HO, 120-277V, Program Start, 9" Case	N/A	ICN-2S54-90C-SC	N/A	N/A
KTEB-454HO-UV-PS	(4) F54T5HO, 120-277V, Program Start	B454PUNV-E	ICN-4S54-90C-2LS-G	GE454MVPS90-E	QTP4X54T5HO/UNV PSN
T5					
KTEB-228HE-UV-PS	(2) F14/21/28T5, Program Start, 120-277V	B228PUNV	ICN-2S28	GE-228-MV-PS-A (Different Case Size)	QTP2X28T5/UNV
COMPACT FLUORESCENT					
KTEB-213-UV-RS-DW	(1 or 2) 13W 4-Pin CFL, No Studs, No Leads	C213UNV BE/BES/ME	ICF-2S13-M1-BS	GEC213-MVPS-SE	QTP1/2x13CF/UNV
KTEB-213-UV-RS-DW-KIT	(1 or 2) 13W 4-Pin CFL, Kit Includes Leads/Stud Plate	C213UNV BE/BES/ME	ICF-2S13-H1-LDK	GEC213-MVPS-3W	QTP1/2x13CF/UNV (BS/TS) (No Leads)
KTEB-218-UV-RS-DW	(1 or 2) 18W 4-Pin CFL, No Studs, No Leads	C218UNV BE/BES/ME	ICF-2S18-M1-BS	GEC218-MVPS-SE	QTP1/2X18CF/UNV
KTEB-218-UV-RS-DW-KIT	(1 or 2) 18W 4-Pin CFL, Kit Includes Leads/Stud Plate	C218UNV BE/BES/ME	ICF-2S18-H1-LDK	GEC218-MVPS-3W	QTP1/2X18CF/UNV (BS/TS) (No Leads)
KTEB-226-UV-RS-DW	(1 or 2) 26W 4-Pin CFL, No Studs, No Leads	C2642UNV BE/BES/ME	ICF-2S26-M1-BS	GEC226-MVPS-SE	QTP2x26CF/UNV
KTEB-226-UV-RS-DW-KIT	(1 or 2) 26W 4-Pin CFL, Kit Includes Leads/Stud Plate	C2642UNV BE/BES/ME	ICF-2S26-H1-LDK	GE226-MVPS-3W	QTP2x26CF/UNV (BM/PM/TM) (No Leads)
KTEB-242-UV-RS-DW	(1 or 2) 42W 4-Pin CFL, No Studs, No Leads	C242UNV BE/BES/ME	ICF-2S42-M2-BS	GEC242-MVPS-SE	QTP2x26/32/42CF/UNV
KTEB-242-UV-RS-DW-KIT	(1 or 2) 42W 4-Pin CFL, Kit Includes Leads/Stud Plate	C242UNV BE/BES/ME	ICF-2S42-M2-LDK	GEC242-MVPS-3W	QTP2x26/32/42CF/UNV (BM/PM/TM) (No Leads)

HID

Keystone Part Number	Description	ULT/Magnetek Part Number	Advance Part Number	GE Part Number	Sylvania Part Number
HIGH PRESSURE SODIUM KITS					
HPS-35R-1-KIT	35W (S76), 120V	S35120RCEM000K	71A7707-001D	N/A	LU35/120R-INT (No Kit)
HPS-50R-1-KIT	50W (S68), 120V	S50120RCEM000K	71A7807-001D	N/A	LU50/120R-INT (No Kit)
HPS-70R-1-KIT	70W (S62), 120V	S70120RCEM000K	71A7907-001D	N/A	LU70/120R-INT (No Kit)
HPS-70X-Q-KIT	70W (S62), Quad Tap	S70MLTLC3M-500K	71A7971-001D	GES70MLTLC3D-5	LU70/MULTI-KIT
HPS-100R-1-KIT	100W (S54), 120V	S100120RCEM000K	71A8007-001D	N/A	LU100/120R-INT (No Kit)
HPS-100X-Q-KIT	100W (S54), Quad Tap	S100MLTLC3M-500K	71A8071-001D	GES100MLTLC3D-5	LU100/MULTI-KIT
HPS-150R-1-KIT	150W (S55), 120V	S150120RCEM000K	71A8107-001D	N/A	LU150/120R-INT (No Kit)
HPS-150X-Q-KIT	150W (S55), Quad Tap	S150MLTAC4M-500K	71A8172-001D	GES150MLTLC3D-5	LU150/MULTI-KIT
HPS-250A-Q-KIT	250W (S50), Quad Tap	S250MLTAC4M-500K	71A8271-001D	GES250MLTAC4-5	LU250/MULTI-KIT
HPS-250A-P-KIT	250W (S50), 5-Tap	S250ML5AC4M-500K	71A8251-001D	GES250ML5AC4-5	LU250/SUPER5-KIT
HPS-400A-Q-KIT	400W (S51), Quad Tap	S400MLTAC5M-500K	71A8473-001D	GES400MLTAC4-5	LU400/MULTI-KIT
HPS-400A-P-KIT	400W (S51), 5-Tap	S400ML5AC5M-500K	71A8453-001D	GES400ML5AC4-5	LU400/SUPER5-KIT
HPS-400A-480-KIT	400W (S51), 480V	S400480AC4M	71A8443-001D	GES40048TAC4-5	LU400/480-KIT
HPS-600A-Q-KIT	600W (S106), Quad Tap	71A85E5-500D	S600MLTAC5M500K	N/A	N/A
HPS-1000A-Q-KIT	1000W (S52), Quad Tap	S1000MLTAC5M	71A8773-001D	GES1000MLTAC5-5	LU1000/MULTI-KIT
HPS-1000A-P-KIT	1000W (S52), 5-Tap	S1000ML5AC5M	71A8753-001D	GES1000ML5AC5-5	LU1000/SUPER5-KIT

Specifications subject to change without notice. For complete product specifications, visit www.keystonetech.com

REFERENCES

CROSS REFERENCE GUIDE

HID (continued)

Keystone Part Number	Description	ULT/Magnetek Part Number	Advance Part Number	GE Part Number	Sylvania Part Number
METAL HALIDE KITS					
MH-50X-Q-KIT	50W (M110), Quad Tap	M50MLTLC3M	71A5191-001D	GEM50MLTLC3D-5	M50/MULTI-KIT
MH-70X-Q-KIT	70W (M98), Quad Tap	M70MLTLC3M-500K	71A5292-001D	GEM70MLTLC3D-5	M70/MULTI-KIT
MH-100X-Q-KIT	100W (M90), Quad Tap	M100MLTLC3M-500K	71A5390-001D	GEM100MLTLC3D-5	M100/MULTI-KIT
MH-150X-Q-KIT	150W (M102), Quad Tap	M150MLTLC3M	71A5492-001D	GEM150MLTLC3D-5	M150/MULTI-KIT
MH-175A-Q-KIT	175W (M57), Quad Tap	M175MLTAC3M-500K	71A5570-001D	GEM175MLTAC3-5	M175/MULTI-KIT
MH-175A-P-KIT	175W (M57), 5-Tap	M175ML5AC3M-500K	N/A	GEM175ML5AC3-5	M175/SUPER5-KIT
MH-250A-Q-KIT	250W (M58), Quad Tap	M250MLTAC3M-500k	71A5771-001D	GEM250MLTAC3-5	M250/MULTI-KIT
MH-250A-P-KIT	250W (M58), 5-Tap	M250ML5AC3M-500K	71A5750-001D	GEM250ML5AC3-5	M250/SUPER5-KIT
MH-250A-480-KIT	250W (M58), 480V	N/A	71A5741-001D	N/A	M250/480-KIT
MH-400A-Q-KIT	400W (M59), Quad Tap	M400MLTAC4M-500K	71A6071-001D	GEM400MLTAA4-5	M400/MULTI-KIT
MH-400A-P-KIT	400W (M59), 5-Tap	M400ML5AC4M-500K	71A6051-001D	GEM400ML5AA4-5	M400/SUPER5-KIT
MH-400A-480-KIT	400W (M59), 480V	M400480AC4M	71A6041-001D	GEM40048TAC4-5	M400/480-KIT
MH-1000A-Q-KIT	1000W (M47), Quad Tap	M1000MLTAC5M-500K	71A6572-001D	GEM1000MLTAC5-5	M1000/MULTI-KIT
MH-1000A-P-KIT	1000W (M47), 5-Tap	M1000ML5AC5M-500K	71A6552-001	GEM1000ML5AC5-5	M1000/SUPER5-KIT
MH-1000A-480-KIT	1000W (M47), 480V	M1000480AC5M	71A6542-001	GEM100048TAC5-5	M1000/480-KIT
MH-1500A-Q-KIT	1500W (M48), Quad Tap	M1500MLTAC5M-500K	71A6772-001	GEM1500MLTAC5-5	M1500/MULTI-KIT
PULSE START METAL HALIDE KITS					
MPS-175A-Q-KIT	175W (M137), Quad Tap, 88% Efficiency	P175MLTAC3M500K	71A5593-001D	GEP175MLTAC3-5	M175/MULTI-PS-KIT
MPS-175A-P-KIT	175W (M137), 5-Tap, 88% Efficiency	P175ML5AC3M	N/A	N/A	N/A
MPS-200A-Q-KIT	200W (M136), Quad Tap, 88% Efficiency	P200MLTAC3M500K	71A5692-001D	N/A	M200/MULTI-PS-KIT
MPS-200A-P-KIT	200W (M136), 5-Tap, 88% Efficiency	P200ML5AC3M	N/A	N/A	N/A
MPS-250A-Q-KIT	250W (M138), Quad Tap, 88% Efficiency	P250MLTAC4M500K	71A5792-001D	GEP250MLTAC4-5	M250/MULTI-PS-KIT
MPS-250A-P-KIT	250W (M138), 5-Tap, 88% Efficiency	P250ML5AC4M-500K	71A5752-001D	N/A	M250/SUPER5-PS-KIT
MPS-320A-Q-KIT	320W (M132), Quad Tap, 88% Efficiency	P320MLTAC4M-500K	71A5892-001D	GEP320MLTAC4-5	M320/MULTI-PS-KIT
MPS-320A-P-KIT	320W (M132), 5-Tap, 88% Efficiency	P320ML5AC4M-500K	71A5852-001D	N/A	N/A
MPS-350A-Q-KIT	350W (M131), Quad Tap, 88% Efficiency	P350MLTAC4M500K	71A5993-001D	GEP350MLTAC4-5	M350/MULTI-PS-KIT
MPS-350A-P-KIT	350W (M131), 5-Tap, 88% Efficiency	P350ML5AC4M	71A5953-001D	N/A	N/A
MPS-400A-Q-KIT	400W (M135), Quad Tap, 88% Efficiency	P400MLTAC4M500K	71A6092-001D	GEP400MLTAC4-5	M400/MULTI-PS-KIT
MPS-400A-P-KIT	400W (M135), 5-Tap, 88% Efficiency	P400ML5AC4M-500K	71A6052-001D	N/A	M400/SUPER5-PS-KIT
MPS-400A-480-KIT	400W (M135) 480V, 88% Efficiency	P40048TAC4M	71A6042-001D	GEP40048TAC4-5	M400/480-PS-KIT
MPS-450A-Q-KIT	450W (M144), Quad Tap, 88% Efficiency	P450MLTAC4M500K	71A6393-001D	N/A	M450/MULTI-PS-KIT
MPS-450A-P-KIT	450W (M144), 5-Tap, 88% Efficiency	P450ML5AC4M	N/A	N/A	N/A
MPS-750A-Q-KIT	750W (M149), Quad Tap	P750MLTAC5M500K	71A6490-001D	GEP750MLTAC5-5	M750/MULTI-PS-KIT
MPS-750A-P-KIT	750W (M149), 5-Tap	P750ML5AC5M	71A6452-001D	N/A	N/A
MPS-1000A-Q-KIT	1000W (M141), Quad Tap	P1000MLTAC5M500K	71A6593-001D	GEP1000MLTAC5-5	M1000/MULTI-PS-KIT
F-CAN					
MH-70X-D-FCAN	70W (M98) Metal Halide, Dual Tap	11210506CTC	72C5282-NP-001	11210506CTC000C	M70/120/277/F-CAN
MH-100X-D-FCAN	100W (M90) Metal Halide, Dual Tap	11210239CTC	72C5381-NP-001	11210239CTC000I	M100/120/277/F-CAN
MH-150X-D-FCAN	150W (M102) Metal Halide, Dual Tap	11210242CTC	72C5482-NP-001	N/A	M150-PS/120/277/F-CAN
MH-175A-D-FCAN	175W (M57) Metal Halide, Dual Tap	1110245SCTC	72C5581-NP-001	1110245SCTC000I	M175/120/277/F-CAN
MH-250A-D-FCAN	250W (M58/H37) Metal Halide, Dual Tap	72C5782NP001	1110246CTC	1110246CTC000C	M250/120/277/F-CAN
MH-400A-D-FCAN	400W (M59) Metal Halide, Dual Tap	1110247SCTC	72C6082-NP-001	111247SCTC000I	M400/120/277/F-CAN

Specifications subject to change without notice. For complete product specifications, visit www.keystonetech.com

SIGN BALLASTS

Keystone Part Number	Description	ULT/Magnetek Part Number	Advance Part Number	GE Part Number	Sylvania Part Number
PARALLEL WIRE ELECTRONIC SIGN BALLASTS					
KTSB-E-0216-12-UV /A	1-2 Lamp, T8HO 4-12', T12HO 2-16'	ASB-0412-12-E	ESB216-12	N/A	N/A
KTSB-E-0432-14-UV /A	1-4 Lamp, T8HO 4-24', T12HO 4-32'	ASB-1232-24-E	ESB432-14	N/A	ESB-13-0424-TP
KTSB-E-1040-14-UV /A	1-4 Lamp, T8HO 8-32', T12HO 10-40'	N/A	ESB1040-14	N/A	ESB-14-1040-TP
KTSB-E-0848-46-UV /A	4-6 Lamp, T8HO 16-36', T12HO 8-48'	ASB-2048-46-E	ESB848-46	N/A	N/A
SMARTWIRE ELECTRONIC SIGN BALLASTS					
KTSB-E-0208-11-1-S	1 T8HO or T12HO Lamp, Combined Length of 2-8'	N/A	N/A	N/A	N/A
KTSB-E-0416-12-1-S	1-2 T8HO Lamps, 4-12'/1-2 T12HO Lamps, 4-16'	N/A	N/A	N/A	N/A
KTSB-E-0824-23-1-S	2-3 T8HO Lamps, 8-18'/2-3 T12HO Lamps, 8-24'	N/A	N/A	N/A	N/A
KTSB-E-0832-24-1-S	2 or 4 T8HO Lamps, 8-24'/2-4 T12HO Lamps, 8-32'	N/A	N/A	N/A	N/A
KTSB-E-2448-46-1-S	4 or 6 T8HO Lamps, 18-36'/4-6 T12HO Lamps, 24-48'	N/A	N/A	N/A	N/A

EMERGENCY BALLASTS

Keystone Part Number	Iota Part Number	Remarks	Bodine Part Number	Remarks
KT-EMRG-650-CFL2	I-13-EM-A and I-26-EM-A	IOTA models are more lamp specific; Keystone model has a single LED switch	B463	Keystone model has a single LED switch
KT-EMRG-750-CFL4	I-42-EM-A	IOTA model has AC-output and time-delay features; Keystone model has a single LED switch	B94CG	Bodine model includes time-delay feature; Keystone model includes a single LED switch
KT-EMRG-500	I-32	IOTA model is low profile and includes time-delay feature	B100	Bodine model includes time delay feature; Keystone model includes a single LED switch
KT-EMRG-700	I-48	IOTA model includes time-delay feature and single LED switch	B60	Bodine model includes time-delay feature
KT-EMRG-1400	I-320	IOTA model is low profile and includes time-delay feature	B50	Bodine model includes time-delay feature; Keystone model includes a single LED switch
KT-EMRG-500-T5	ISL-28	Keystone model includes AC-output feature	LP400 or LP500	LP400 is 0.4" wider than Keystone model with a separate switch and LED indicator; LP500 is 4.1" longer than Keystone model and can be used in sealed and gasketed fixtures; Keystone model has AC-output feature
KT-EMRG-800-T5	ISL-54	Keystone model includes AC-output feature	LP550	Bodine model is 1" longer and can be used in sealed and gasketed fixtures; Keystone model has AC-output feature
KT-EMRG-1300-T5	ISL-540	Keystone model includes AC-output feature	LP600	Bodine model can be used in sealed and gasketed fixtures; Keystone model has AC-output feature
KT-EMRG-500-SL	I-32	Keystone model is 0.5" longer and includes AC-output feature	B100LP	Bodine model is almost 7" longer and little thinner, can be used with sealed and gasketed fixtures; Keystone model includes AC-output feature
KT-EMRG-700-SL	N/A	None	B60LP	Bodine model is 3" longer and a little thinner, can be used with sealed and gasketed fixtures; Keystone model includes AC-output feature
KT-EMRG-1400-SL	I-320	Keystone model includes AC-ouput feature, is 1.25" longer, and a little thinner in comparison to IOTA's model	B50LP	Bodine model is approx. 7" longer and a little thinner, can be used with sealed and gasketed fixtures; Keystone model includes AC-output feature

MAGNETIC FLUORESCENT BALLASTS

Keystone Part Number	Description	ULT/Magnetek Part Number	Advance Part Number	GE Part Number	Sylvania Part Number
CC1322MTP	13-22 Watt, 2-Pin Compact Fluorescent	200-H2P	LO-13-22-TP	GEM1CF13PH120	N/A
113SHPTP	(1) 13 Watt, 2-Pin Compact Fluorescent, High Power Factor	4112P	H-1B13-TP-W	N/A	N/A
CC579TP	5, 7, 9 Watt, 2-Pin Compact Fluorescent	4105F2P	LPL-5-9-TP	N/A	N/A
SS22WSTP	22W Circline, Small Case, Self Start	200-C-S-P	N/A	N/A	N/A

Product specifications are subject to change without notice. Keystone Technologies, LLC does not warrant or guarantee the accuracy of this cross reference guide. **Please contact Keystone Technologies for help with proper ballast selection.**

REFERENCES

ORDERING INFORMATION

Keystone packages products in a variety of styles so that customers can benefit from the most suitable packaging for their needs:

BULK PACK

Products are shipped nested together for maximum loading onto the pallet. All lead wires are organized so each ballast or driver can be pulled quickly from the pallet. This packaging style is typically requested by fixture manufacturers.

TO ORDER: Add “BP” to the end of the catalog number to order Bulk Pack. Example: KTEB-232-UV-IS-N-P-BP

CARTON PACK

Products are packed in economic quantities to fit into a UPS shippable carton. This packaging style is typically used for fixture manufacturers or direct shipments to job sites.

TO ORDER: Add “CP” to the end of the catalog number to order Carton Pack. Example: KTEB-232-UV-IS-N-P-CP

DISTRIBUTOR PACK

Products are individually shrink wrapped and packed in quantities most suitable for distributor stocking requirements. Each box is clearly labeled with all relevant information for easy identification in distributor warehouses. This packaging style is only available to authorized Keystone distributors.

TO ORDER: Add “DP” to the end of the catalog number to order Distributor Pack. Example: KTEB-232-UV-IS-N-P-DP

HID KIT

HID ballast kits include a ballast, capacitor (if required), ignitor (if required), mounting brackets, bolts, and instruction sheet. The ballast, capacitor, and ignitor are pre-wired at the factory to facilitate a quicker and error-free installation. This packaging style is ideal for fixture manufacturers and distributors and is preferred by contractors because all necessary items are contained within the kit.

TO ORDER: Add “KIT” to the end of HID catalog numbers. Example: MH-100X-Q-KIT

COMPACT FLUORESCENT KIT

Compact fluorescent (CFL) kits include a commercial grade, multi-voltage electronic ballast, universal mounting plate, color-coded wires, and a convenient wire extraction tool. These CFL kits are preferred by distributors and contractors because each CFL kit offers the ability to change out any equally rated CFL ballast, regardless of wiring and mounting configurations.

TO ORDER: Add “KIT” to the end of compact fluorescent catalog numbers. Example: KTEB-226-UV-RS-KIT

CUSTOM ORDERS

As a national leader in LED driver and ballast innovation, Keystone Technologies offers a competitive advantage with over 70 years of experience in the design and implementation of new solutions to meet your lighting needs. If your specifications exceed what is offered in this catalog, Keystone has the capabilities to be your partner in designing and building custom products to meet your requirements.

Please do not hesitate to contact us with any questions regarding custom LED driver or ballast solutions or accessories for any HID, compact fluorescent, linear lamp ballast, low voltage transformer, or LED driver. E-mail info@keystonetech.com or call (800) 464-2680.

LINEAR LED TUBES

KT-LED17T8-48GC-830-S

1 2 3 4 5 6 7 8 9

- 1 Keystone Technologies
- 2 LED Lamp
- 3 Wattage
- 4 Lamp Type
- 5 Nominal Length (Inches)
- 6 Material: GC = Shatterproof Coated Glass, G = Glass, P = Plastic/Aluminum
- 7 CRI: 8 = 800 Series
- 8 CCT: 30 = 3000K, 40 = 4000K, 50 = 5000K, 65 = 6500K
- 9 Lamp Series: S = SmartDrive, D = DirectDrive, X = ComboDrive

COMPACT LED LAMPS

KT-LED-114P-H-827-S

1 2 3 4 5 6 7 8

- 1 Keystone Technologies
- 2 LED Lamp
- 3 Wattage
- 4 Lamp Type: 2P = 2-Pin, 4P = 4-Pin
- 5 Orientation: H = Horizontal, V = Vertical, EV = Extended Vertical
- 6 CRI: 8 = 800 Series
- 7 CCT: 27 = 2700K, 30 = 3000K, 35 = 3500K, 40 = 4000K, 50 = 5000K
- 8 Lamp Series: S = SmartDrive, D = DirectDrive, X = ComboDrive

HID REPLACEMENT LED LAMPS

KT-LED-130HID-V-EX39-840-S

1 2 3 4 5 6 7 8 9

- 1 Keystone Technologies
- 2 LED Lamp
- 3 Lamp Wattage
- 4 Lamp Type
- 5 Orientation: V = Vertical
- 6 Base Type
- 7 CRI: 8 = 800 Series
- 8 CCT: 40 = 4000K, 50 = 5000K
- 9 Lamp Series: S = SmartDrive, D = DirectDrive

LED MODULES

KTLM-900-L2-830-60A

1 2 3 4 5 6 7

- 1 Keystone Technologies LED Module
- 2 Recommended Current (mA)
- 3 Form Factor
- 4 CRI: 8 = 800 Series
- 5 CCT: 30 = 3000K, 35 = 3500K, 40 = 4000K, 50 = 5000K
- 6 Number of LEDs
- 7 Beam Angle: A = 120°

REFERENCES

CATALOG NUMBER DESIGNATIONS

LED DRIVERS

Constant Current

KTLD-12-1-700-FDIM-F5

1 2 3 4 5 6

- 1 Keystone Technologies LED Driver
- 2 Maximum Power (W)
- 3 Input Voltage: 1 = 120V, UV = 120-277V
- 4 Rated Output Current (mA)
- 5 Dimming Type: FDIM = Phase Control, VDIM = 0-10V, LDIM = Local
- 6 Case Style

Constant Voltage

KTLD-60-UV-24V-W2

1 2 3 4 5

- 1 Keystone Technologies LED Driver
- 2 Maximum Power (W)
- 3 Input Voltage: 1 = 120V, UV = 120-277V
- 4 Rated Constant Output Voltage (Vdc)
- 5 Case Style

LED RETROFIT KITS

Linear

KT-RKIT-24-4000-835-VDIM

1 2 3 4 5 6 7

- 1 Keystone Technologies
- 2 Retrofit Kit
- 3 Application: 24 = 2'x4' Indoor Troffer, 22 = 2'x2' Indoor Troffer
- 4 Nominal Lumens
- 5 CRI: 8 = 800 Series
- 6 CCT: 35 = 3500K, 40 = 4000K, 50 = 5000K
- 7 Dimming Type: VDIM = 0-10V

Circular, Rectangular, and Sconce

KT-RKIT-CP-8-1600-840-FDIM

1 2 3 4 5 6 7 8

- 1 Keystone Technologies
- 2 Retrofit Kit
- 3 Pan Type: CP = Circular Pan, RP = Rectangular Pan, HCP = Half Circle Pan (for Sconces), TP = Troffer Pan
- 4 Nominal Size: 8 = 8" Circular, 6 = 3"x6" Rectangular, 8 = 8" Half Circle Width, 24 = 2'x4' Troffer, 22 = 2'x2' Troffer
- 5 Nominal Lumens
- 6 CRI: 8 = 800 Series
- 7 CCT: 30 = 3000K, 40 = 4000K, 50 = 5000K
- 8 Dimming Type: FDIM = Phase Control (Not Applicable for Rectangular or Troffer Kits), VDIM = 0-10V (Troffer Kits Only)

SMART SAFE LED EMERGENCY BACK-UP

KT-EMRG-LED-5-500-K1

1 2 3 4 5 6

- 1 Keystone Technologies
- 2 Emergency Back-Up
- 3 LED Driver
- 4 Wattage Family
- 5 Nominal Lumen Output
- 6 Kit Version with Module (When Applicable)

Specifications subject to change without notice. For complete product specifications, visit www.kestonetech.com

EMERGENCY BALLASTS

KT-EMRG-500-T5

1 2 3 4

- 1 Keystone Technologies
- 2 Emergency Ballast
- 3 Initial Light Output (Lumens)
- 4 Lamp Type

FLUORESCENT LAMPS

KTL-F28T5-835-HE

1 2 3 4 5

- 1 Keystone Technologies Lamp
- 2 Lamp Type
- 3 CRI: 8 = 800 Series
- 4 CCT: 35 = 3500K, 41 = 4100K, 50 = 5000K, 65 = 6500K
- 5 Lamp Performance: HE = High Efficiency, HO = High Output, HP = High Performance, XL = Extended Life, XHP = Extra High Performance, CWX = 2012 DOE Compliant

FLUORESCENT BALLASTS

Electronic

KTEB-232-UV-IS-N-P

1 2 3 4 5 6 7

- 1 Keystone Technologies Electronic Ballast
- 2 Number of Lamps
- 3 Wattage
- 4 Input Volts: 1 = 120V, UV = 120-277V
- 5 Starting Method: IS = Instant Start, PS = Program Start
- 6 Ballast Factor: N = Normal, H = High, L = Low
- 7 Premium Series

Compact Fluorescent

KTEB-226-UV-PS-DW

1 2 3 4 5 6

- 1 Keystone Technologies Electronic Ballast
- 2 Number of Lamps
- 3 Wattage
- 4 Input Volts: UV = 120-277V
- 5 Starting Method: PS = Program Start, RS = Rapid Start
- 6 Case Configuration: DW = Dual Wire, DWS = Dual Wire with Studs, RJS = Rear Junction with Studs, LS = Leads from Side of Ballast

SIGN BALLASTS

PARALLEL WIRE Electronic

KTSB-E-0216-12-UV

1 2 3 4 5 6 7

- 1 Keystone Technologies Sign Ballast
- 2 Electronic
- 3 Minimum Total T12HO Lamp Length
- 4 Maximum Total T12HO Lamp Length
- 5 Minimum Number of Lamps
- 6 Maximum Number of Lamps
- 7 Input Voltage: UV = 120-277V

SMARTWIRE Electronic

KTSB-E-0208-11-1-S

1 2 3 4 5 6 7 8

- 1 Keystone Technologies Sign Ballast
- 2 Electronic
- 3 Minimum Total T12HO Lamp Length
- 4 Maximum Total T12HO Lamp Length
- 5 Minimum Number of Lamps
- 6 Maximum Number of Lamps
- 7 Input Voltage: 1 = 120V
- 8 SmartWire (Series Wired)

REFERENCES

CATALOG NUMBER DESIGNATIONS

HID BALLASTS

HID Ballasts

MH-400A-P-CA

1 2 3 4 5

- 1 Lamp Type:** MH = Metal Halide, MPS = Pulse Start Metal Halide, HPS = High Pressure Sodium
- 2 Wattage**
- 3 Circuit Type:** A = Constant Wattage Autotransformer, X = High Reactance, R = Reactor
- 4 Number of Taps:** 1 = 120V, 480 = 480V, D = 120/277, Q = 120/208/240/277V, P = 120/208/240/277/480V
- 5 Winding Type:** HP = Copper Primary, Copper Secondary, CA = Copper Primary, Aluminum Secondary, AA = Aluminum Primary, Aluminum Secondary

HID Kits

MH-400A-P-KIT

1 2 3 4 5

- 1 Lamp Type:** MH = Metal Halide, MPS = Pulse Start Metal Halide, HPS = High Pressure Sodium
- 2 Wattage**
- 3 Circuit Type:** A = Constant Wattage Autotransformer, HX = High Reactance, R = Reactor
- 4 Number of Taps:** 1 = 120V, 480 = 480V, D = 120/277, Q = 120/208/240/277V, P = 120/208/240/277/480V
- 5 Kit:** Pre-Wired Ballast Kit

LOW VOLTAGE TRANSFORMERS

KTET-75-1-SCP-DIM-HV-AL

1 2 3 4

- 1 Keystone Technologies Electronic Transformer**
- 2 Maximum Input Power**
- 3 Input Voltage:** 1 = 120V, 2 = 277V
- 4 Options:** SCP = Short Circuit Protection, DIM = Dimmable, HV = Higher Voltage, AL = Aluminum Case, WC = With Cord, F = With Fuse, EMI = EMI Filter, RJS = Rear Mount Studs and Leads for J-Box Application

STEP DOWN TRANSFORMERS

KTAT-250-480-277

1 2 3 4

- 1 Keystone Technologies Step Down Transformer**
- 2 Maximum Load (VA)**
- 3 Input Volts**
- 4 Output Volts**

SENSORS

Occupancy and Wet Location 140Sensors

HBE-PIR-120-277-IP65

1 2 3 4

- 1 Hi Bay Occupancy Sensor, External Mount**
- 2 Passive Infrared Sensing Technology**
- 3 Input Voltage Options:** 120/277/347 (Occupancy Sensor Only), 120-277 (Wet Location Sensor Only), 347/480 (Wet Location Sensor Only)
- 4 IP 65 Rated (Wet Location Sensor Only)**

Photocells

KTPS-45-1

1 2 3

- 1 Keystone Technologies Photocell Sensor**
- 2 Maximum Input Power (VA)**
- 3 Input Voltage:** 1 = 120V

Specifications subject to change without notice. For complete product specifications, visit www.keystonetech.com

REFERENCES

OBSOLETE PRODUCT GUIDE

CATALOG NUMBER OF OBSOLETE ITEM	REPLACED WITH	KEY DIFFERENCES
113ATP	No Replacement	N/A
120TP	KTEB-120-1-TP-EMI	Electronic, Same Mounting and Wiring
122TPWS	KTEB-1C22-1-TP-WS	Electronic, Smaller Footprint
140TP	KTEB-140-1-TP-EMI	Electronic, Same Mounting and Wiring
140TPWS	KTEB-140-1-TP-EMI-WS	Electronic, Same Mounting and Wiring
154TPWS	KTEB-2C72-1-TP-WS	Electronic, Same Mounting and Wiring
172TPWS	KTEB-2C72-1-TP-WS	Electronic, Same Mounting and Wiring
213TPES	No Replacement	N/A
220TP	KTEB-220-1-TP-EMI	Electronic, Same Mounting and Wiring
234TPH	KTEB-240-1-TP-PIC	Electronic, Same Mounting and Wiring
240TPES	No Replacement	N/A
296TPH	KTEB-275-1-TP-PIC-SL	Electronic, 120V, 9" Case
240TPH277	KTEB-240-UV-TP-PIC	Electronic 120-277V, Same Mounting
240TPH	KTEB-240-1-TP-PIC	Electronic, Same Mounting and Wiring
240TPLW	KTEB-240-1-TP-PIC	Electronic, Same Mounting and Wiring
296HOTPH277	KTEB-2110-UV-TP-PIC	Electronic 120-277V, Same Mounting
296HOTPH	KTEB-2110-UV-TP-PIC	Electronic 120-277V, Same Mounting
296TPH277	KTEB-275-UV-TP-PIC	Electronic 120-277V, Same Mounting
IL-xx* Series	No Replacement	N/A
KTEB-132LBF-UV-TP-PIC	No Replacement	N/A
KTEB-1C22-1-TP-WS-LC	KTEB-1C22-1-TP-WS	New Unit has a Smaller Case
KTEB-1C3032-1-TP-WS-LC	KTEB-140-1-TP-EMI-WS	New Unit Operates More Lamp Combinations
KTEB-213-UV-TP-PSD	KTEB-213-UV-PS-DW	None
KTEB-218-UV-TP-PSD	KTEB-218-UV-PS-DW	None
KTEB-226-UV-TP-PSD	KTEB-226-UV-PS-DW	None
KTEB-232LBF-1-TP-PIC-SL	KTEB-232-1-IS-N	None
KTEB-232LBF-UV-TP-PIC	KTEB-232-UV-IS-N-P	New Unit has Improved Energy Efficiency
KTEB-232LBF-UV-TP-PIC-SL	KTEB-232-UV-IS-N-P	New Unit has Improved Energy Efficiency
KTEB-232RIS-1-TP	KTEB-232RIS-1-TP-SL	New Model is Slightly Narrower
KTEB-260-1-TP-PIC	KTEB-275-1-TP-PIC-SL	New Unit Operates a Wider Range of Lamps
KTEB-332LBF-1-TP-PIC	KTEB-332-UV-IS-N-P	New Unit has Improved Energy Efficiency
KTEB-332LBF-UV-TP-PIC	KTEB-332-UV-IS-N-P	New Unit has Improved Energy Efficiency
KTEB-432LBF-1-TP	KTEB-432-UV-IS-N-P	None
KTEB-432LBF-UV-TP-PIC	KTEB-432-UV-IS-N-P	New Unit has Improved Energy Efficiency
KTLD-30-UV-0A80-VDIM-SC	25W & 36W LED Drivers	Larger Wattage Range
KTLD-32-1-0A80-FDIM	36W LED Drivers	Larger Wattage Range
KTLD-60-UV-1214V/A	KTLD-60-UV-12V	None
KTSB-0412-12-1-TP	No Replacement	N/A
KTSB-0620-24-1-TP	No Replacement	N/A
KTSB-1224-24-1-TP	No Replacement	N/A
KTSB-1240-46-1-TP	No Replacement	N/A
KTSB-2040-24-1-TP	No Replacement	N/A
KTSB-2448-46-1-TP	No Replacement	N/A
RL40P	KTEB-140-1-TP-EMI	Electronic, Same Mounting and Wiring
RSL40P	KTEB-140-1-TP-EMI	Electronic, Same Mounting and Wiring
TR20P	KTEB-120-1-TP-EMI	Electronic, Same Mounting and Wiring
KTEB-132-UV-IS-N-P	KTEB-232-UV-IS-N-P	Cap Leads for 1 Lamp Application
KTEB-132-UV-IS-L-P	KTEB-232-UV-IS-L-P	Cap Leads for 1 Lamp Application
KTEB-132-UV-IS-H-P	KTEB-232-UV-IS-H-P	Cap Leads for 1 Lamp Application
KTEB-454HO-UV-PS-SL	KTEB-454HO-UV-PS	Different Case Size
KTEB-428HE-UV-PS	No Replacement	N/A

* "xx" denotes several case styles available.

Specifications subject to change without notice. For complete product specifications, visit www.keystonetech.com

Keystone Technologies, LLC | North Wales, PA 19454 | Phone (800) 464-2680 | [keystonetech.com](http://www.keystonetech.com)

REFERENCES

WARRANTY INFORMATION

STATEMENT OF WARRANTY: Ballasts, LED Drivers, Transformers, Sensors

Keystone Technologies, LLC., P.O. Box 246, Ambler, PA 19002, (215) 283-2600 (hereinafter called “Keystone Technologies”) warrants to the purchaser of its lighting power supplies, transformers, drivers, and sensors (hereinafter called “lighting components”) to be free of defects in material and workmanship for the specified warranty periods indicated in this catalog starting from the date of manufacture indicated on lighting component.

Product Category	Warranty Period
LED Drivers	5 Years
LED Modules	5 Years
T5, T5HO, T8, Circline, and CFL Electronic Ballasts	5 Years
Residential Grade (T8, CFL, T5) Ballasts and T12 Electronic Ballasts	3 Years
Magnetic Ballasts	2 Years
Electronic Sign Ballasts (Parallel and SmartWire)	4 Years
Magnetic Sign Ballasts	3 Years
HIDs	2 Years
Emergency Ballasts	5 Years
Low Voltage Transformers	3 Years
480V Step Down Transformers	5 Years
Occupancy Sensors	5 Years

If it appears within the specified warranty period that any Keystone Technologies lighting component does not meet the warranty specified above, Keystone Technologies, at its option, will replace or repair the defective lighting component.

This warranty is not applicable if the lighting component is not installed in accordance with the National Electric Code, the Standards for Safety of Underwriters Laboratories, Inc., Standards for the American National Standards Institute, or the Canadian Standards Association. This warranty is also not applicable if the lighting component is not installed according to Keystone Technologies instructions or recommendations or if the product has been exposed to abnormal operating conditions including excessive temperatures.

If a customer must make a warranty claim, please contact Keystone Technologies for appropriate shipping instructions.

Upon return and evaluation of merchandise Keystone Technologies will determine applicability of warranty. If the product is found to be defective under this warranty, Keystone Technologies will provide replacement lighting component(s) as necessary. A maximum of US \$10.00 may be applied to each defective lighting component to apply to labor charges at the sole discretion of Keystone Technologies.

NO IMPLIED STATUTORY WARRANTY OF MERCHANTABILITY OR FITNESS FOR A PARTICULAR PURPOSE SHALL APPLY BEYOND THE AFOREMENTIONED WARRANTY PERIOD. The foregoing warranty is exclusive of all other statutory, written or oral warranties, and no other warranties of any kind, statutory or otherwise, are given or herein expressed.

LIMITATION OF LIABILITY. Keystone Technologies will not under any circumstances whether as a result of breach of contract, breach of warranty, tort, strict liability or otherwise be liable for consequential, incidental, special or exemplary damages including, but not limited to: loss of profits or revenues, loss of use of ballast or any other goods or associated equipment to damage to any associated equipment, cost of capital, cost of substitute products, facilities of services, down time cost, or claims of claimant's customers.

KEYSTONE LAMP LIMITED WARRANTY

Keystone Technologies, LLC., P.O. Box 246, Ambler, PA 19002, (215) 283-2600 (hereinafter called “Keystone Technologies”) offers both a **Keystone Standard Fluorescent Lamp Warranty** and an enhanced **Keystone Fluorescent System Warranty**. Keystone Technologies also offers a **Keystone Standard LED Lamp Warranty**. Keystone Technologies warrants that the lamps listed below will be free of defects in material and workmanship and comply with their respective published specifications, from the date of installation, for the time periods outlined below and subject to the terms and conditions herein.

FLUORESCENT LAMPS

These warranties apply only to lamps that are operated a maximum of 4,000 hours per year, on burning cycles of (3) hours or more per start for instant and rapid start ballasts, and (15) minutes or more per start for program start ballasts. Occupancy sensor application only allowed in conjunction with program start ballasts (15 minute/start minimum.) If lamps fail to operate for the warranty period, Keystone will, at its sole discretion, provide a free replacement lamp (but no labor allowance) or issue a credit for future purchase.

REFERENCES

WARRANTY INFORMATION

Lamp Type	Keystone Standard Lamp Warranty Period ^{1,2}	Keystone Fluorescent System Warranty Period (Lamp Only) ^{2,3,4}
T8 High Performance Series	2 Years	3 Years
T8 Extra High Performance Series	2 Years	3 Years
T8 Extended Life Series	3 Years	4 Years
T5 High Efficiency Series	2 Years	3 Years
T5 High Output Series	2 Years	3 Years
T12 CWX Series	2 Years	3 Years
T9 Circline Series	2 Years	3 Years

¹ Lamps must be operated on ANSI compatible ballast.

² Lamps and ballast must be installed in accordance with manufacturer's instructions; operated within the electrical values shown on the ballast label; operated in lighting equipment designed and approved for the application; and used in environmental conditions (temperature, humidity and air movement) within the normal specified operating range of the system.

³ Lamps must be operated on compatible electronic ballast manufactured by Keystone Technologies, as defined by ballast specifications.

⁴ For ballast portion of Keystone Fluorescent System Warranty, Keystone Technologies warrants its ballasts as provided in Keystone Technologies current published Statement of Warranty, hereby made part of this warranty.

LED LAMPS

This warranty applies only to lamps that are operated a maximum of 8,760 hours/year (equal to 24 hours/day, 365 days/year). If lamps fail to operate for the warranty period, Keystone will, at its sole discretion, provide a free replacement lamp (but no labor allowance) or issue a credit for future purchase. Lamp warranty does not apply to vapor-tight fixture applications, unless explicitly stated in a warranty supplement letter from Keystone Technologies.

Lamp Type	Keystone Standard LED Lamp Warranty Period ^{1,2}
DirectDrive Series	5 Years
SmartDrive Series	5 Years ³
ComboDrive Series	5 Years

¹ SmartDrive and ComboDrive lamps must be operated on ANSI-compatible ballasts.

² Lamps must be installed in accordance with manufacturer's instructions; operated within the electrical values shown on the ballast label; operated in lighting equipment designed and approved for the application; and used in environmental conditions (temperature, humidity and air movement) within the normal specified operating range of the system.

³ When used in conjunction with a ballast that has a ballast factor greater than or equal to 1.00, warranty period is 48 months. For ballast factors less than 1.00, warranty period is 60 months.

ELIGIBILITY

In order to be eligible for the warranty, lamp installations should be registered with Keystone Technologies within 30 days of the completion date. If registration is not completed, Keystone Technologies reserves the right to request more information as needed to address warranty claims. Contact your Keystone sales representative or visit <http://keystonetech.com/lamp-warranty-and-registration> to find the Keystone Lamp Registration Form. Registration forms can be submitted to lampregistration@keystonetech.com, faxed to 888-966-0556, or mailed to Keystone Technologies, Attn: Lamp Registration, PO Box 246, Ambler, PA 19002. Registration will be acknowledged via email with a registration number to be referenced for all warranty claims.

TO MAKE A WARRANTY CLAIM

Retain the failed products and notify Keystone Technologies or authorized Keystone sales representative within 30 days of the failure. Please have installation registration number available for reference. At the sole discretion of Keystone Technologies the user/customer may be required to return the failed product for analysis. Failure to follow this request shall void the warranty.

TERMS AND CONDITIONS

- Keystone Technologies reserves the right to examine all failed lamps and/or ballasts and reserves the right to be the sole judge as to whether any lamps and/or ballasts are defective and covered under warranty.
- Replacement of Keystone Technologies lamps with lamps from another manufacturer will void the Keystone Standard Lamp Warranty and the lamp portion of the Keystone Fluorescent System Warranty.
- Replacement of Keystone Technologies electronic ballast with a ballast from any other manufacturer will void the entire Keystone Fluorescent System Warranty.
- The Keystone Standard Lamp Warranty and Keystone Fluorescent System Warranty shall be the sole remedy of the Customer and the sole liability of Keystone Technologies to the Customer. NO IMPLIED STATUTORY WARRANTY OF MERCHANTABILITY OR FITNESS FOR A PARTICULAR PURPOSE IS MADE OR IS TO BE IMPLIED. Keystone Technologies will not under any circumstances whether as a result of breach of contract, breach of warranty, tort, strict liability or otherwise be liable for consequential, incidental, special or exemplary damages including, but not limited to, loss of profits or revenues, loss of use of ballasts or any other goods or associated equipment to damage to any associated equipment, cost of capital, cost of substitute products, facilities or service, down time cost, or claims of claimant's customers.
- Subject to change without notice.

REFERENCES

INDEX

CATALOG NUMBER	PAGE(S)
113SHPTP	92, 135
CAP-1000HPS	120
CAP-1000MH	120
CAP-1000MPS	120
CAP-100HPS	120
CAP-100MH	120
CAP-1500MH	120
CAP-150HPS	120
CAP-150MH	120
CAP-175MH	120
CAP-175MPS	120
CAP-200MPS	120
CAP-250HPS	120
CAP-250MH	120
CAP-250MPS	120
CAP-320MPS	120
CAP-350MPS	120
CAP-400HPS	120
CAP-400MH	120
CAP-400MPS	120
CAP-450MPS	120
CAP-50MH	120
CAP-70HPS	120
CAP-70MH	120
CAP-750MPS	120
CC1322MTP	6, 76, 79, 92, 135
CC579TP	6, 92, 135
HBE-EXBT	128
HBE-LENS-360	128
HBE-LENS-AISLE	128
HBE-PIR-120-277-IP65	128
HBE-PIR-120/277/347	128
HBE-PIR-347/480-IP65	128
HPS-1000A-1-HP	113
HPS-1000A-D-HP	113
HPS-1000A-P-CA	113
HPS-1000A-P-KIT	7, 113, 122, 133
HPS-1000A-Q-CA	113
HPS-1000A-Q-KIT	7, 113, 122, 133
HPS-1000A-T3-HP	113
HPS-100R-1	112
HPS-100R-1-KIT	7, 112, 122, 133
HPS-100X-1	112
HPS-100X-D	112
HPS-100X-Q-AC	112
HPS-100X-Q-KIT	7, 112, 122, 133
HPS-150R-1	112
HPS-150R-1-KIT	7, 112, 122, 133
HPS-150X-1	112
HPS-150X-D	112
HPS-150X-Q-AC	112
HPS-150X-Q-KIT	7, 112, 122, 133
HPS-200A-1-HP	112
HPS-200A-D-HP	112
HPS-200A-Q-HP	112
HPS-250A-1-HP	113
HPS-250A-D-HP	113
HPS-250A-P-CA	113
HPS-250A-P-KIT	7, 113, 122, 133
HPS-250A-Q-CA	113
HPS-250A-Q-HP	113
HPS-250A-Q-KIT	7, 113, 122, 133
HPS-250A-T3-HP	113

CATALOG NUMBER	PAGE(S)
HPS-35R-1	112
HPS-35R-1-KIT	7, 112, 122, 133
HPS-400A-1-HP	113
HPS-400A-4-CA	113
HPS-400A-480-KIT	7, 113, 122, 133
HPS-400A-D-HP	113
HPS-400A-P-CA	113
HPS-400A-P-KIT	7, 113, 122, 133
HPS-400A-Q-CA	113
HPS-400A-Q-KIT	7, 113, 122, 133
HPS-400A-T3-HP	113
HPS-50R-1	112
HPS-50R-1-KIT	7, 113, 122, 133
HPS-50X-1	112
HPS-50X-D	112
HPS-600A-Q-HP	113
HPS-600A-Q-KIT	7, 113, 122, 133
HPS-70R-1	112
HPS-70R-1-KIT	7, 112, 122, 133
HPS-70X-1	112
HPS-70X-D	112
HPS-70X-Q-CA	112
HPS-70X-Q-KIT	7, 112, 122, 133
IGN-XG-01	121
IGN-XG-02	121
IGN-XG-03	121
IGN-XG-03A	121
IGN-XG-04	121
IGN-XG-06	121
KT-EMRG-1300-T5	8, 68, 70, 135
KT-EMRG-1400	68, 70, 135
KT-EMRG-1400-SL	8, 68, 70, 135
KT-EMRG-500	8, 68, 70, 135
KT-EMRG-500-SL	8, 68, 70, 135
KT-EMRG-500-T5	8, 68, 70, 135
KT-EMRG-650-CFL2	8, 69, 70, 135
KT-EMRG-700	68, 70, 135
KT-EMRG-700-SL	8, 68, 70, 135
KT-EMRG-750-CFL4	8, 69, 70, 135
KT-EMRG-800-T5	8, 68, 70, 135
KT-EMRG-LED-12-1200	64
KT-EMRG-LED-5-500	64
KT-LED114P-EV-827-S	19
KT-LED114P-EV-830-S	19
KT-LED114P-EV-835-S	19
KT-LED114P-EV-840-S	19
KT-LED114P-EV-850-S	19
KT-LED114P-H-827-S	19
KT-LED114P-H-830-S	19
KT-LED114P-H-835-S	19
KT-LED114P-H-840-S	19
KT-LED114P-H-850-S	19
KT-LED114P-V-827-S	19
KT-LED114P-V-830-S	19
KT-LED114P-V-835-S	19
KT-LED114P-V-840-S	19
KT-LED114P-V-850-S	19
KT-LED11T8-36GC-830-S	3, 13
KT-LED11T8-36GC-840-S	3, 13
KT-LED11T8-36GC-850-S	3, 13
KT-LED12.5T8-48GC-835-D	3, 11
KT-LED12.5T8-48GC-840-D	3, 11

CATALOG NUMBER	PAGE(S)
KT-LED12.5T8-48GC-850-D	3, 11
KT-LED12T8-36GC-835-D	3, 11
KT-LED12T8-36GC-840-D	3, 11
KT-LED12T8-36GC-850-D	3, 11
KT-LED12T8-36GC-865-D	3, 11
KT-LED12T8-48GC-830-S	3, 13
KT-LED12T8-48GC-835-S	3, 13
KT-LED12T8-48GC-840-S	3, 13
KT-LED12T8-48GC-850-S	3, 13
KT-LED13T5HE-48GC-835-S	14
KT-LED13T5HE-48GC-840-S	14
KT-LED13T5HE-48GC-850-S	14
KT-LED14T8-48GC-830-S	3, 13
KT-LED14T8-48GC-835-S	3, 13
KT-LED14T8-48GC-840-S	3, 13
KT-LED14T8-48GC-850-S	3, 13
KT-LED15T8-48GC-835-D	3, 11
KT-LED15T8-48GC-835-X	15
KT-LED15T8-48GC-840-D	3, 11
KT-LED15T8-48GC-840-X	15
KT-LED15T8-48GC-850-D	3, 11
KT-LED15T8-48GC-850-X	15
KT-LED15T8-48GC-865-D	3, 11
KT-LED178T8-U6GC-835-D	11
KT-LED178T8-U6GC-840-D	11
KT-LED178T8-U6GC-850-D	11
KT-LED17T8-48GC-830-S	3, 13
KT-LED17T8-48GC-835-S	3, 13
KT-LED17T8-48GC-840-S	3, 13
KT-LED17T8-48GC-850-S	3, 13
KT-LED17T8-48GC-830-S	14
KT-LED17T8-U6GC-835-S	14
KT-LED17T8-U6GC-840-S	14
KT-LED17T8-U6GC-850-S	14
KT-LED18T8-48GC-835-D	3, 11
KT-LED18T8-48GC-835-D-FDIM	3, 11
KT-LED18T8-48GC-840-D	3, 11
KT-LED18T8-48GC-840-D-FDIM	3, 11
KT-LED18T8-48GC-850-D	3, 11
KT-LED18T8-48GC-850-D-FDIM	3, 11
KT-LED18T8-48GC-865-D	3, 11
KT-LED18T8-48P-830-D	3, 11
KT-LED18T8-48P-830-S	3, 13
KT-LED18T8-48P-840-D	11
KT-LED18T8-48P-840-S	3, 13
KT-LED18T8-48P-850-D	11
KT-LED18T8-48P-850-S	3, 13
KT-LED20HID-E26-840-D	25
KT-LED20HID-E26-850-D	25
KT-LED22T8-48GC-835-D	11
KT-LED22T8-48GC-840-D	11
KT-LED22T8-48GC-850-D	11
KT-LED27HID-E26-840-D	25
KT-LED27HID-E26-850-D	25
KT-LED27T5HO-48GC-830-S	3, 14
KT-LED27T5HO-48GC-835-S	3, 14
KT-LED27T5HO-48GC-840-S	3, 14
KT-LED27T5HO-48GC-850-S	3, 14
KT-LED36HID-E26-840-D	25
KT-LED36HID-E26-850-D	25
KT-LED36T8-96P-840-D	11
KT-LED36T8-96P-850-D	11
KT-LED45HID-E26-840-D	25

Specifications subject to change without notice. For complete product specifications, visit www.keystonetech.com

REFERENCES

INDEX

CATALOG NUMBER	PAGE(S)
KT-LED45HID-E26-850-D	25
KT-LED45HID-EX39-840-D	25
KT-LED45HID-EX39-850-D	25
KT-LED-48HID-V-E26-8xx-S	26
KT-LED-48HID-V-E26-8xx-S-PKIT	26
KT-LED54HID-EX39-840-D	25
KT-LED54HID-EX39-850-D	25
KT-LED62P-H-827-D	22
KT-LED62P-H-830-D	22
KT-LED62P-H-835-D	22
KT-LED62P-H-840-D	22
KT-LED62P-H-850-D	22
KT-LED7T8-18GC-840-D	3, 11
KT-LED7T8-18GC-850-D	3, 11
KT-LED7T8-18GC-865-D	3, 11
KT-LED80HID-EX39-840-D	25
KT-LED80HID-EX39-850-D	25
KT-LED100HID-EX39-840-D	25
KT-LED100HID-EX39-850-D	25
KT-LED-130HID-V-EX39-8xx-S	26
KT-LED-130HID-V-EX39-8xx-S-PKIT	26
KT-LED82P-EV-827-D	21
KT-LED82P-EV-830-D	21
KT-LED82P-EV-835-D	21
KT-LED82P-EV-840-D	21
KT-LED82P-EV-850-D	21
KT-LED82P-H-827-D	21
KT-LED82P-H-830-D	21
KT-LED82P-H-835-D	21
KT-LED82P-H-840-D	21
KT-LED82P-H-850-D	21
KT-LED82P-V-827-D	21
KT-LED82P-V-830-D	21
KT-LED82P-V-835-D	21
KT-LED82P-V-840-D	21
KT-LED82P-V-850-D	21
KT-LED9T8-24GC-830-S	3, 13
KT-LED9T8-24GC-835-D	3, 11
KT-LED9T8-24GC-835-X	15
KT-LED9T8-24GC-840-D	3, 11
KT-LED9T8-24GC-840-S	3, 13
KT-LED9T8-24GC-840-X	15
KT-LED9T8-24GC-850-D	3, 11
KT-LED9T8-24GC-850-S	3, 13
KT-LED9T8-24GC-850-X	15
KT-LED9T8-24GC-865-D	3, 11
KT-RKIT-22-4000-835-VDIM	58
KT-RKIT-22-4000-840-VDIM	58
KT-RKIT-22-4000-850-VDIM	58
KT-RKIT-24-4000-835-VDIM	58
KT-RKIT-24-4000-840-VDIM	58
KT-RKIT-24-4000-840-VDIM	58
KT-RKIT-24-5000-835-VDIM	58
KT-RKIT-24-5000-840-VDIM	58
KT-RKIT-24-5000-850-VDIM	58
KT-RKIT-CP-8-1600-830-FDIM	60
KT-RKIT-CP-8-1600-840-VDIM	60
KT-RKIT-CP-8-1600-850-VDIM	60
KT-RKIT-CP-8-2200-830-FDIM	60
KT-RKIT-CP-8-2200-840-FDIM	60
KT-RKIT-CP-8-2200-850-FDIM	60
KT-RKIT-HCP-8-1100-830-FDIM	62

CATALOG NUMBER	PAGE(S)
KT-RKIT-HCP-8-1100-840-FDIM	62
KT-RKIT-HCP-8-1100-850-FDIM	62
KT-RKIT-HCP-8-700-830-FDIM	62
KT-RKIT-HCP-8-700-840-FDIM	62
KT-RKIT-HCP-8-700-850-FDIM	62
KT-RKIT-MAG-KIT	59
KT-RKIT-QD	16
KT-RKIT-RP-6-1600-830	61
KT-RKIT-RP-6-1600-840	61
KT-RKIT-RP-6-1600-850	61
KT-RKIT-RP-6-800-830	61
KT-RKIT-RP-6-800-840	61
KT-RKIT-RP-6-800-850	61
KT-RKIT-S-BR-1	16
KT-RKIT-SC-C4	16
KT-RKIT-SP-W-4-C4-2LED	16
KT-RKIT-SP-W-82-C4-4LED	16
KT-RKIT-SR8-M	16
KT-RKIT-SR8-S	16
KT-RKIT-SR8-W	16
KT-RKIT-T-BR-2	16
KT-RKIT-T-BR-3	16
KT-RKIT-T-BR-4	16
KT-RKIT-TEK	16
KT-RKIT-TP-22-4000-835-VDIM	59
KT-RKIT-TP-22-4000-840-VDIM	59
KT-RKIT-TP-22-4000-850-VDIM	59
KT-RKIT-TP-24-4000-835-VDIM	59
KT-RKIT-TP-24-4000-840-VDIM	59
KT-RKIT-TP-24-4000-850-VDIM	59
KT-RKIT-TP-24-5000-835-VDIM	59
KT-RKIT-TP-24-5000-840-VDIM	59
KT-RKIT-TP-24-5000-850-VDIM	59
KT-SOCKET-T8-U-S	16
KT-SOCKET-T8-U-S-2-W	16
KT-SOCKET-T8-U-S-3-W	16
KT-SOCKET-T8-U-S-4-W	16
KT-SOCKET-T8-U-T	16
KT-SOCKET-T8-U-T-2-W	16
KT-SOCKET-T8-U-T-3-W	16
KT-SOCKET-T8-U-T-4-W	16
KTAT-250-480-277	25
KTAT-250-480-277 /A	126
KTAT-30-347-277	126
KTAT-30-347-277-RJS	126
KTAT-375-480-277 /A	126
KTAT-70-347-277	126
KTAT-70-347-277-RJS	126
KTAT-70-480-277	25, 126
KTAT-70-480-277-RJS	126
KTEB-108-1-TP-FC	6, 89, 92
KTEB-108-1-TP-FC-PH	89, 92
KTEB-113-1-TP	6, 92
KTEB-113-1-TP-EMIA	6, 89, 92
KTEB-113-1-TP-PN	6, 92
KTEB-113-1-TP-SC	6, 92
KTEB-113-1-TP-SC-RJ	6, 92
KTEB-113-1-TP-SC-RJS	6, 92
KTEB-113-1-TP-SCS	6, 92
KTEB-113-1-TP-SL-MB	6, 89
KTEB-114-1-TP-FC	6, 89, 92
KTEB-114-1-TP-FC-PH	89, 92
KTEB-118-1-TP-SC	93, 100

CATALOG NUMBER	PAGE(S)
KTEB-118-1-TP-SC-RJ	6, 93
KTEB-118-1-TP-SC-RJS	6, 93
KTEB-118-1-TP-SCS	6, 93
KTEB-120-1-TP	5, 76, 79, 80
KTEB-120-1-TP-EMI	5, 76, 79, 80
KTEB-120-1-TP-EMI	141
KTEB-125-1-TP-FC	76, 79, 81
KTEB-126-1-TP	6, 79, 80, 81, 84, 93, 98, 100
KTEB-126-1-TP-LC	79, 80, 81, 84, 93, 98
KTEB-126-1-TP-SC	6, 93
KTEB-126-1-TP-SC-RJ	6, 93
KTEB-126-1-TP-SC-RJS	6, 93
KTEB-126-1-TP-SCS	6, 93
KTEB-128-1-TP-FC	89, 90
KTEB-128-1-TP-FC-PH	89, 90
KTEB-128HE-1-RS	89, 90
KTEB-132-1-TP-EMI	6, 79, 80, 81, 84
KTEB-132-1-TP-FC	76, 79, 81, 84
KTEB-132-UV-PS-N-P	6, 79, 81, 82, 83, 84, 132
KTEB-132-UV-PS-N-P-SDIM3	81, 84
KTEB-132-UV-TP-SL	79
KTEB-135HE-1-RS	89, 90
KTEB-135HE-1-TP	6, 89, 90
KTEB-135HE-1-TP-PH	89, 90
KTEB-1382D-1-TP	100
KTEB-1382D-1-TP-WS	98
KTEB-139HO-1-TP	91, 96
KTEB-140-1-TP-EMI	5, 76, 132, 141
KTEB-140-1-TP-EMI-WS	6, 98, 141
KTEB-142T-1-TP-SC	6, 93, 94, 95, 96, 100
KTEB-142T-1-TP-SC-RJ	6, 93, 94, 95
KTEB-142T-1-TP-SC-RJS	6, 93, 94, 95
KTEB-142T-1-TP-SCS	6, 93, 94, 95
KTEB-154HO-1-TP	91, 96, 97
KTEB-1C22-1-TP	93, 100
KTEB-1C22-1-TP-LC	100
KTEB-1C22-1-TP-WS	6, 98, 141
KTEB-1C3032-1-TP-WS	98
KTEB-208-1-TP-SL-MB	89
KTEB-2110-1-TP-PIC	5, 78, 132
KTEB-2110-UV-TP-PIC	5, 78, 132, 141
KTEB-2110-UV-TP-PIC-SL	78
KTEB-213-1-TP	6, 92
KTEB-213-1-TP-DW	6, 92
KTEB-213-1-TP-SC	6, 92
KTEB-213-1-TP-SC-RJ	6, 92
KTEB-213-1-TP-SC-RJS	6, 92
KTEB-213-1-TP-SCS	6, 92
KTEB-213-1-TP-SL-MB	6, 89
KTEB-213-UV-PS-DW	6, 92, 141
KTEB-213-UV-RS-DW	6, 92, 133
KTEB-213-UV-RS-DW-KIT	6, 92, 133
KTEB-218-1-TP	6, 93
KTEB-218-1-TP-DW	6, 93
KTEB-218-1-TP-SC	6, 93
KTEB-218-1-TP-SC-RJ	6, 93
KTEB-218-1-TP-SC-RJS	6, 93
KTEB-218-1-TP-SCS	6, 93
KTEB-218-UV-PS-DW	6, 93, 100, 141
KTEB-218-UV-RS-DW	6, 93, 133
KTEB-218-UV-RS-DW-KIT	6, 93, 133

Specifications subject to change without notice. For complete product specifications, visit www.keystonetech.com

REFERENCES

INDEX

CATALOG NUMBER	PAGE(S)
KTEB-220-1-TP-EMI	5, 76, 79, 80, 141
KTEB-221PS-1-TP	89, 90
KTEB-224HO-UV-PS	91, 96
KTEB-224HO-UV-PS-SL	6, 91, 96, 98, 133
KTEB-226-1-TP	6, 94
KTEB-226-1-TP-DW	6, 94
KTEB-226-1-TP-SC	6, 94
KTEB-226-1-TP-SC-RJ	6, 94
KTEB-226-1-TP-SC-RJS	6, 94
KTEB-226-1-TP-SCS	6, 94
KTEB-226-UV-PS-DW	6, 93, 94, 96, 100, 141
KTEB-226-UV-RS-DW	6, 93, 94, 98, 133
KTEB-226-UV-RS-DW-KIT	6, 93, 94, 98, 133
KTEB-228-1-TP-PH-SL	89, 90
KTEB-228HE-UV-PS	6, 89, 90, 133
KTEB-228HE-UV-PS-SL	6, 89, 90
KTEB-232-1-IS-N	6, 79, 80, 81, 82, 83, 84, 85, 87, 132, 141
KTEB-232-3-IS-N	79, 80, 81, 82, 83, 84, 85, 87
KTEB-232-UV-IS-H-P	5, 79, 80, 81, 82, 83, 84, 85, 87, 132, 141
KTEB-232-UV-IS-L-P	5, 79, 80, 81, 82, 83, 84, 85, 87, 132, 141
KTEB-232-UV-IS-N-P	5, 79, 80, 81, 82, 83, 84, 85, 87, 132, 141
KTEB-232-UV-PS-CDIM	80, 81, 85
KTEB-232-UV-PS-H-P	6, 79, 80, 81, 82, 83, 84, 85, 87, 132
KTEB-232-UV-PS-L-P	6, 79, 80, 81, 82, 83, 84, 85, 87, 132
KTEB-232-UV-PS-N-P	6, 79, 80, 81, 82, 83, 84, 85, 87, 132
KTEB-232-UV-PS-VDIM	80, 81, 85
KTEB-232RIS-1-TP-SL	6, 79, 80, 81, 84, 85, 87, 141
KTEB-232SIS-1-TP	80, 81, 85
KTEB-235HE-UV-PS	89, 90
KTEB-239HO-UV-PS	91, 96
KTEB-239HO-UV-PS	96
KTEB-239HO-UV-PS-SL	91, 96, 98, 133
KTEB-240-1-TP	76, 81, 85, 94
KTEB-240-1-TP-PIC	5, 76, 132, 141
KTEB-240-UV-TP-PIC	5, 76, 132, 141
KTEB-242-UV-PS-DW	6, 93, 94, 95, 96, 98, 100
KTEB-242-UV-RS-DW	6, 93, 94, 95, 133
KTEB-242-UV-RS-DW-KIT	6, 93, 94, 95, 133
KTEB-254HO-UV-PS	6, 91, 96, 97, 133
KTEB-254HO-UV-PS-SL	6, 91, 96, 97, 133
KTEB-259-1-IS-N	132
KTEB-259-UV-IS-N	6, 87, 88, 132
KTEB-260HO-UV-PS-SL	78, 132
KTEB-270-UV-PS-N /C1	87
KTEB-275-1-TP-PIC-SL	5, 76, 77, 132, 141
KTEB-275-UV-TP-PIC	5, 76, 77, 132, 141
KTEB-275-UV-TP-PIC-SL	5, 76, 77
KTEB-286HO-UV-IS-N	6, 87, 88, 132
KTEB-286HO-UV-PS-N	87, 88, 132
KTEB-2C54PS-1-TP-WS	98
KTEB-2C72-1-TP	79, 80, 81, 85
KTEB-2C72-1-TP-WS	6, 98, 141
KTEB-332-UV-IS-H-P	5, 80, 81, 82, 83, 84, 85, 87, 132
KTEB-332-UV-IS-L-P	5, 80, 81, 82, 83, 84, 85, 87, 132

CATALOG NUMBER	PAGE(S)
KTEB-332-UV-IS-N-P	5, 80, 81, 82, 83, 84, 85, 87, 132, 141
KTEB-332-UV-PS-H-P	6, 80, 81, 82, 83, 84, 85, 87, 132
KTEB-332-UV-PS-L-P	6, 80, 81, 82, 83, 84, 85, 87, 132
KTEB-332-UV-PS-N-P	6, 80, 81, 82, 83, 84, 85, 87, 132
KTEB-432-1-IS-N-P	5, 84, 132
KTEB-432-3-IS-N	80, 82, 83, 84, 85, 87
KTEB-432-UV-IS-H-P	5, 80, 81, 82, 83, 84, 85, 87
KTEB-432-UV-IS-L-P	5, 80, 81, 82, 83, 84, 85, 87, 132
KTEB-432-UV-IS-N-P	5, 80, 81, 82, 83, 84, 85, 87, 132, 141
KTEB-432-UV-PS-L-P	6, 80, 81, 82, 83, 84, 85, 87, 132
KTEB-432-UV-PS-N-P	6, 80, 81, 82, 83, 84, 85, 87, 132
KTEB-432RIS-1-TP-SL	6, 80, 81, 82, 85
KTEB-454HO-UV-PS	6, 91, 96, 97, 133, 141
KTEB-150-1-SCP-DIM	124
KTEB-60-1-SCP-DIM-AL	124
KTEB-60-1-WC-F	124
KTEB-75-1-SCP-DIM-HV-AL	124
KTEB-75-1-SCP-DIM-RJS	124
KTEB-75-1-SCP-EMI	124
KTEB-75-2-SCP-RJS	124
KTL-F14T5-835-HE	73
KTL-F14T5-841-HE	73
KTL-F14T5-850-HE	73
KTL-F17T8-835-HP	72
KTL-F17T8-841-HP	72
KTL-F17T8-850-HP	72
KTL-F21T5-835-HE	73
KTL-F21T5-841-HE	73
KTL-F21T5-850-HE	73
KTL-F25T8-835-HP	72
KTL-F25T8-841-HP	72
KTL-F25T8-850-HP	72
KTL-F25T8ES-835-HP	72
KTL-F25T8ES-841-HP	72
KTL-F25T8ES-850-HP	72
KTL-F28T5-835-HE	73
KTL-F28T5-841-HE	73
KTL-F28T5-850-HE	73
KTL-F28T8ES-835-HP	72
KTL-F28T8ES-841-HP	72
KTL-F28T8ES-850-HP	72
KTL-F32T8-835-HP	72
KTL-F32T8-835-XHP	72
KTL-F32T8-835-XL	72
KTL-F32T8-841-HP	72
KTL-F32T8-841-XHP	72
KTL-F32T8-841-XL	72
KTL-F32T8-850-HP	72
KTL-F32T8-850-XHP	72
KTL-F32T8-850-XL	72
KTL-F32T8-865-HP	72
KTL-F40T12-841-CWX	72
KTL-F49T5-835-HO	73
KTL-F49T5-841-HO	73
KTL-F49T5-850-HO	73
KTL-F54T5-835-HO	73

CATALOG NUMBER	PAGE(S)
KTL-F54T5-841-HO	73
KTL-F54T5-850-HO	73
KTL-F54T5-865-HO	73
KTL-FC12T9-CW	74
KTL-FC12T9-DL	74
KTL-FC16T9-CW	74
KTL-FC16T9-DL	74
KTL-FC8T9-CW	74
KTL-FC8T9-DL	74
KTLD-10-1-12V-F3	29
KTLD-10-1-300-FDIM-AF1	3
KTLD-10-1-300-FDIM-AF1	32
KTLD-10-1-350-FDIM-AF5	62
KTLD-10-1-350-FDIM-AF5	62
KTLD-10-1N-12V-F3	5, 29, 31
KTLD-10-1N-24V-F3	5, 29, 31
KTLD-10-1N-350-AF3	3, 32
KTLD-10-1N-xxx-F3	3, 32
KTLD-10-1P-380-LDIM-AF1	3, 32
KTLD-10-1P-xxx-LDIM-F5	3, 32
KTLD-100-UV-12V	5, 29, 31
KTLD-100-UV-12V-67-AP2	5, 29
KTLD-100-UV-12V-67-AP3	5, 29
KTLD-100-UV-24V	5, 29, 31, 132
KTLD-100-UV-24V-67-AP2	5, 29
KTLD-100-UV-24V-AO2	5, 29
KTLD-100-UV-4xxx-VDIM-L18	4, 45
KTLD-100-UV-xxx-67-AP4	4, 43
KTLD-100-UV-xxx-L5	4, 42, 43
KTLD-100-UV-xxx-VDIM-67-AP4	4, 44
KTLD-100-UV-xxx-VDIM-L5	4, 44, 45
KTLD-100-UV-xxx-VDIM-W3	4, 45
KTLD-12-1-350-FDIM-AF1	31
KTLD-12-1-xxx-FDIM-AF1	3, 32
KTLD-12-1-xxx-FDIM-F5	3, 32
KTLD-12-1P-400-LDIM-F5	3, 32
KTLD-120-UV-12V-L10	29, 31
KTLD-14-1-xxx-FDIM-AF1	3, 32
KTLD-14-1N-600-AF1	3, 32
KTLD-14-1P-560-AF5	61
KTLD-14-UV-xxx-AF1	3, 32
KTLD-14-UV-xxx-VDIM-L7	3, 32
KTLD-150-UV-24V-67-AP3	5, 29, 31
KTLD-150-UV-24V-AU1	29, 31
KTLD-150-UV-xxx-67-AP3	4, 46
KTLD-150-UV-xxx-AU1	4, 45
KTLD-150-UV-xxx-VDIM-67-AP3	4, 46, 47
KTLD-150-UV-xxx-VDIM-AU1	4, 46
KTLD-16-1-xxx-FDIM-AK1	3, 33
KTLD-16-1-xxx-FDIM-AQ1	3, 33
KTLD-16-UV-xxx-AK1	3, 33
KTLD-16-UV-xxx-VDIM-AK1	3, 33
KTLD-16-UV-xxx-VDIM-AQ1	3, 34
KTLD-20-1-560-FDIM-AQ7	60
KTLD-20-1N-600-AQ1	3, 34
KTLD-20-UV-560-VDIM-AQ7	60
KTLD-200-UV-xxx-67-AP5	4, 47
KTLD-200-UV-xxx-VDIM-67-AP5	4, 47
KTLD-22-1-700-AK1	3, 34
KTLD-22-1-xxx-FDIM-AK1	3, 34
KTLD-22-UV-xxx-AK1	3, 34
KTLD-22-UV-xxx-VDIM-L7	3, 34
KTLD-23-UV-830-VDIM-L7	3, 34

Specifications subject to change without notice. For complete product specifications, visit www.keystonetech.com

REFERENCES INDEX

CATALOG NUMBER	PAGE(S)
KTLD-24-1-12V-AK1	5, 29, 31
KTLD-24-1-24V-AK1	5, 29, 31
KTLD-24-UV-12V-AK1	5, 29, 31
KTLD-24-UV-24V-AK1	5, 29, 31
KTLD-25-1-xxx-FDIM-AF4	35
KTLD-25-1-xxx-FDIM-AQ1	4, 35
KTLD-25-1-xxx-FDIM-L9	4, 35
KTLD-25-1P-700-VDIM-L9	4, 35
KTLD-25-UV-xxx-VDIM-AF6	35
KTLD-25-UV-xxx-VDIM-AK1	4, 35, 36
KTLD-25-UV-xxx-VDIM-AQ1	4, 36
KTLD-25-UV-xxx-VDIM-L9	4, 36
KTLD-2LEDT8-UV-IS-VDIM	13
KTLD-36-1-xxx-FDIM-AF6	36
KTLD-36-1-xxx-FDIM-AK2	36
KTLD-36-1-xxx-FDIM-L9	4, 36
KTLD-36-1-xxx-L9	4, 36
KTLD-36-1-xxx-VDIM-L9	4
KTLD-36-UV-1000-L9	4, 37
KTLD-36-UV-xxx-AF6	36, 37
KTLD-36-UV-xxx-L2	4, 37
KTLD-36-UV-xxx-VDIM-AF6	37
KTLD-36-UV-xxx-VDIM-L2	4, 37
KTLD-36-UV-xxx-VDIM-L9	4, 37, 38
KTLD-40-UV-1000-VDIM-L2	4
KTLD-40-UV-1100-L2	4
KTLD-40-UV-1100-VDIM-L2	4
KTLD-40-UV-1100-VDIM-L9	39, 56, 58, 59
KTLD-40-UV-xxx-L2	38
KTLD-40-UV-xxx-VDIM-AT1	4, 38
KTLD-40-UV-xxx-VDIM-L2	39
KTLD-40-UV-xxx-VDIM-W1	4, 39
KTLD-40-UV-xxx-W1	4, 38
KTLD-400-UV-2000-67-AP7	4, 47
KTLD-44-UV-SD700-1200-VDIM-L20	49
KTLD-50-3-xxx-VDIM-W2	40
KTLD-50-UV-1400-L9	4
KTLD-50-UV-1450-VDIM-AR1	4
KTLD-50-UV-2xxxx-VDIM-L5	4, 41
KTLD-50-UV-4xxxx-VDIM-L5	4, 41
KTLD-50-UV-xxx-AR2	4, 39
KTLD-50-UV-xxx-L9	39
KTLD-50-UV-xxx-VDIM-AR2	4, 40
KTLD-50-UV-xxx-VDIM-L9	4, 40
KTLD-50-UV-xxx-VDIM-W2	4, 40
KTLD-50-UV-xxx-W2	4, 40
KTLD-60-1-12V	5, 29, 31
KTLD-60-1-12V-67-AP4	29
KTLD-60-1-24V	5, 29, 31
KTLD-60-1-24V-W2	5, 29, 31
KTLD-60-UV-12V	5, 29, 31, 132, 141
KTLD-60-UV-12V-67-AP1	29
KTLD-60-UV-12V-67-AP4	5, 29, 31, 132
KTLD-60-UV-12V-VDIM-L5	31
KTLD-60-UV-12V-W2	5, 29, 31
KTLD-60-UV-14V	29
KTLD-60-UV-14V-W2	29
KTLD-60-UV-1750-AR1	4
KTLD-60-UV-1750-VDIM-AR1	4
KTLD-60-UV-24V	5, 29, 31
KTLD-60-UV-24V-67-AP1	29
KTLD-60-UV-24V-67-AP4	5, 29, 31

CATALOG NUMBER	PAGE(S)
KTLD-60-UV-24V-A01	29
KTLD-60-UV-24V-W2	5, 29, 31
KTLD-60-UV-xxx-VDIM-AR1	41
KTLD-60-UV-xxx-VDIM-W2	4, 41, 42
KTLD-60-UV-xxx-VDIM-W2 /A	4
KTLD-60-UV-xxx-W2	4, 41
KTLD-60-UV-xxx-W2 /A	4
KTLD-7-1P-xxx-LDIM-F5	3
KTLD-72-UV-2x1000-VDIM-L5	56
KTLD-72-UV-2xxxx-VDIM-L5	4, 42
KTLD-72-UV-4xxxx-VDIM-L5	4, 42
KTLD-75-UV-1450-L5	4
KTLD-75-UV-1450-VDIM-L5	4
KTLD-75-UV-xxx-L5	42
KTLD-75-UV-xxx-VDIM-L5	42
KTLD-80-1-12V	31
KTLD-80-1-24V	5, 29, 31
KTLD-80-UV-12V	29
KTLD-80-UV-24V	5, 29, 31
KTLD-80-UV-24V-67-AP2	29
KTLD-80-UV-xxx-VDIM-W3	4, 42
KTLM-1050-L2-835-63A	52
KTLM-1050-L2-8xx-63A	58, 59
KTLM-1050-L6-8xx-63A	52, 58, 59
KTLM-1050-L6-8xx-77A	52, 58, 59
KTLM-1050-R1-840-14A	55, 61
KTLM-1050-R1-840-28A	55, 61
KTLM-1200-L6-8xx-56A	52
KTLM-1200-L6-8xx-72A	52
KTLM-1500-L6-8xx-90A	52, 56
KTLM-1800-L6-8xx-120A	52
KTLM-300-L3-8xx-14A	52
KTLM-300-L3-8xx-18A	52
KTLM-300-L3-8xx-22A	52
KTLM-300-L5-8xx-14A	52
KTLM-300-L5-8xx-18A	52
KTLM-300-L5-8xx-22A	52
KTLM-300-L7-8xx-10A	52
KTLM-350-SQ1-8xx-21A	55
KTLM-350-SQ1-8xx-9A	55
KTLM-400-SQ2-8xx-6A	55
KTLM-450-L5-8xx-30A	52
KTLM-450-R2-8xx-15A	55, 62
KTLM-450-R2-8xx-24A	55, 62
KTLM-600-C1-8xx-28A	54
KTLM-600-L2-8xx-44A	52
KTLM-600-L4-8xx-44A	52
KTLM-900-C2-840-60A	54
KTLM-900-C2-8xx-48A	60
KTLM-900-C2-8xx-60A	60
KTLM-900-L2-8xx-60A	52, 56
KTPS-45-1	129
KTPS-80-1	129
KTSB-E-0208-11-1-S	8, 103, 135
KTSB-E-0216-12-UV /A	8, 104, 135
KTSB-E-0416-12-1-S	8, 103, 135
KTSB-E-0432-14-UV /A	8, 104, 135
KTSB-E-0824-23-1-S	8, 103, 135
KTSB-E-0832-24-1-S	8, 103, 135
KTSB-E-0848-46-UV /A	8, 104, 135
KTSB-E-1040-14-UV /A	8, 104, 135
KTSB-E-2448-46-1-S	8, 103, 135
KTSP-10KV	25

CATALOG NUMBER	PAGE(S)
MH-1000A-1-HP	111
MH-1000A-4-CA	111
MH-1000A-480-KIT	7, 111, 122, 134
MH-1000A-D-HP	111
MH-1000A-P-CA	111
MH-1000A-P-HP	111
MH-1000A-P-KIT	7, 111, 122, 134
MH-1000A-Q-AA	111
MH-1000A-Q-AA-KIT	111, 122
MH-1000A-Q-CA	111
MH-1000A-Q-HP	111
MH-1000A-Q-KIT	7, 111, 122, 134
MH-1000A-T3-HP	111
MH-100R-2	110
MH-100X-1	110
MH-100X-D	110
MH-100X-D-FCAN	8, 119, 134
MH-100X-Q-CA	110
MH-100X-Q-KIT	7, 110, 122, 134
MH-1500A-4-HP	111
MH-1500A-P-CA	111
MH-1500A-P-HP	111
MH-1500A-P-KIT	7, 111, 122
MH-1500A-Q-CA	111
MH-1500A-Q-HP	111
MH-1500A-Q-KIT	7, 111, 122, 134
MH-150R-2	110
MH-150X-1	110
MH-150X-D	110
MH-150X-D-FCAN	8, 119, 134
MH-150X-Q-CA	110
MH-150X-Q-KIT	7, 110, 122, 134
MH-175A-1-HP	110
MH-175A-D-FCAN	8, 119, 134
MH-175A-D-HP	110
MH-175A-P-CA	110
MH-175A-P-HP	110
MH-175A-P-KIT	7, 26, 110, 122, 134
MH-175A-Q-AA	110
MH-175A-Q-AA-KIT	110, 122
MH-175A-Q-CA	110
MH-175A-Q-HP	110
MH-175A-Q-KIT	7, 110, 122, 134
MH-175A-T3-HP	110
MH-250A-1-HP	111
MH-250A-4-CA	111
MH-250A-480-KIT	7, 111, 122, 134
MH-250A-D-FCAN	8, 119, 134
MH-250A-D-HP	111
MH-250A-P-CA	111
MH-250A-P-HP	111
MH-250A-P-KIT	7, 111, 122, 134
MH-250A-Q-AA	111
MH-250A-Q-AA-KIT	111, 122
MH-250A-Q-CA	111
MH-250A-Q-HP	111
MH-250A-Q-KIT	7, 111, 122, 134
MH-250A-T3-HP	111
MH-400A-1-HP	111
MH-400A-4-HP	111
MH-400A-480-KIT	7, 111, 122, 134
MH-400A-D-FCAN	8, 119, 134
MH-400A-D-HP	111

Specifications subject to change without notice. For complete product specifications, visit www.keystonetech.com

REFERENCES

INDEX

CATALOG NUMBER	PAGE(S)	CATALOG NUMBER	PAGE(S)	CATALOG NUMBER	PAGE(S)
MH-400A-P-CA	111	MPS-200A-4-HP	108	MPS-350A-Q-KIT	7, 108, 122, 134
MH-400A-P-HP	111	MPS-200A-D4-HP	108	MPS-350A-T3-CA	108
MH-400A-P-KIT	7, 26, 111, 122, 134	MPS-200A-P-HP	108	MPS-400A-4-CA	109
MH-400A-Q-AA	111	MPS-200A-P-KIT	7, 108, 122, 134	MPS-400A-480-KIT	7, 109, 122, 134
MH-400A-Q-AA-KIT	111, 122	MPS-200A-Q-HP	108	MPS-400A-D4-CA	109
MH-400A-Q-CA	111	MPS-200A-Q-KIT	7, 108, 122, 134	MPS-400A-P-CA	109
MH-400A-Q-HP	111	MPS-200A-T3-HP	108	MPS-400A-P-KIT	7, 109, 122, 134
MH-400A-Q-KIT	7, 111, 122, 134	MPS-250A-4-HP	108	MPS-400A-Q-CA	109
MH-400A-T3-HP	111	MPS-250A-D4-HP	108	MPS-400A-Q-KIT	7, 109, 122, 134
MH-50R-2	110	MPS-250A-P-HP	108	MPS-400A-T3-CA	109
MH-50X-1	110	MPS-250A-P-KIT	7, 108, 122, 134	MPS-450A-4-HP	109
MH-50X-D	110	MPS-250A-Q-HP	108	MPS-450A-D4-HP	109
MH-50X-D-FCAN	8, 119	MPS-250A-Q-KIT	7, 108, 122, 134	MPS-450A-P-HP	109
MH-50X-Q-AA	110	MPS-250A-T3-HP	108	MPS-450A-P-KIT	7, 109, 122, 134
MH-50X-Q-KIT	7, 110, 122, 134	MPS-320A-1-HP	108	MPS-450A-Q-AA	109
MH-70R-2	110	MPS-320A-4-CA	108	MPS-450A-Q-KIT	7, 109, 122, 134
MH-70X-1	110	MPS-320A-D-HP	108	MPS-450A-T3-HP	109
MH-70X-D	110	MPS-320A-D4-CA	108	MPS-750A-4-CA	109
MH-70X-D-FCAN	8, 119, 134	MPS-320A-P-CA	108	MPS-750A-P-CA	109
MH-70X-Q-CA	110	MPS-320A-P-KIT	7, 108, 122, 134	MPS-750A-P-KIT	7, 109, 122, 134
MH-70X-Q-KIT	7, 110, 122, 134	MPS-320A-Q-CA	108	MPS-750A-Q-CA	109
MPS-1000A-4-CA	109	MPS-320A-Q-HP	108	MPS-750A-Q-KIT	7, 109, 122, 134
MPS-1000A-P-CA	109	MPS-320A-Q-KIT	7, 108, 122, 134	MPS-875A-4-CA	109
MPS-1000A-Q-CA	109	MPS-320A-T3-CA	108	MPS-875A-P-CA	109
MPS-1000A-Q-KIT	7, 109, 122, 134	MPS-350A-1-HP	108	MPS-875A-Q-CA	109
MPS-175A-4-HP	108	MPS-350A-4-CA	108	SS22WSTP	6, 98, 135
MPS-175A-D4-HP	108	MPS-350A-D-HP	108		
MPS-175A-P-HP	108	MPS-350A-D4-CA	108		
MPS-175A-P-KIT	7, 108, 122, 134	MPS-350A-P-CA	108		
MPS-175A-Q-HP	108	MPS-350A-P-KIT	7, 108, 122, 134		
MPS-175A-Q-KIT	7, 108, 122, 134	MPS-350A-Q-CA	108		
MPS-175A-T3-HP	108	MPS-350A-Q-HP	108		

TERMS AND CONDITIONS OF SALE

Payment Terms: Net 30 days with approved credit, unless otherwise agreed to in writing prior to sale.

Standard Pricing: Keystone Technologies will furnish a price list for all products available for purchase. All new orders will apply the most current price list available. Updated price lists are always available through our online portal or by contacting Keystone Technologies. Prices are subject to change without notice. Keystone Technologies will make all price updates available as soon as they occur.

Job Pricing: Customers may request special job pricing by contacting Keystone Technologies or the authorized sales representative. Job pricing quotes are valid for 30 days, unless specified otherwise at time of quotation.

Minimum Billing: Minimum billing on all orders is \$100.00 in merchandise. Freight and taxes are not included. Orders less than \$100.00 are subject to a \$10.00 processing fee.

Order Quantity: Keystone Technologies reserves the right to ship in full carton quantity. Please refer to our list of product packaging and minimum order information for all carton quantities and minimum order requirements.

Freight Allowance: Keystone Technologies will prepay freight based on the prevailing freight policy stated on the customer price list at the time of order. Freight charges will be added to the invoice on shipments less than the prevailing freight policy at the time of order.

Express Freight: Keystone Technologies will ship all orders using standard ground shipping methods. If the customer requests an express shipping method, Keystone Technologies will ship only if the customer's express freight account number is provided at the time of order. Keystone Technologies assumes no responsibility regarding the carriers shipping delivery schedules.

Freight Routing: Keystone Technologies reserves the right to determine the routing of freight on all orders. Keystone Technologies will make every effort to ship orders complete, however, Keystone Technologies reserves the right to split shipments as necessary to ensure faster delivery.

Transportation Claims: All product is shipped in new condition with title of the merchandise passing to the buyer upon delivery to the carrier. The buyer has the responsibility to inspect the goods upon delivery. Any claim for shortage or damage must be noted on the freight bill of lading and filed promptly with the carrier. In the event of concealed damage, the carrier should be notified immediately. Hold all damaged goods with the packaging material intact until an inspection is completed. Although Keystone Technologies' responsibility for shipments ends with the delivery to the carrier, Keystone will make every effort to assist the buyer in rectifying the claim.

Returned Goods: No merchandise may be returned without prior authorization from Keystone Technologies. Keystone Technologies will issue a returned goods authorization, which must be accompanied on any returned shipments. The returned goods authorization is valid for 30 days. Material must be returned freight prepaid. Upon inspection and acceptance of the returned material, Keystone Technologies will issue a merchandise credit. Restocking fees may apply.

Specifications subject to change without notice. For complete product specifications, visit www.keystonetech.com

LIGHT

Lighting is our legacy. It's all we've done since 1945, relentlessly developing energy efficient lighting solutions for the industry's most discerning customers. From incumbent fluorescent lighting systems through the latest LED technologies, Keystone is singularly focused on being your one-stop-shop for quality lighting products.

MADE

With more than 100 Million Keystone ballasts and LED drivers in use today, thousands of installers, architects and engineers depend on Keystone for lighting products that are manufactured to last. We factory test 100% of every production run, so you know that when you install a Keystone product, it's made to perform.

EASY

What makes us different? We fundamentally believe that we are here to make buying and using lighting products easy. From easy-to-read installation guides to exceptionally fast quote response time and the most convenient fulfillment centers in the industry, our primary goal is to make lighting refreshingly easy.



Contact us today to experience **Light Made Easy**, only by Keystone.



Keystone Technologies • 1390 Welsh Road, North Wales, PA 19454 • Phone (800) 464-2680
Fax (888) 966-0556 • www.keystonetech.com

WAREHOUSE LOCATIONS: Atlanta, GA • Boston, MA • Charlotte, NC • Chicago, IL • Cincinnati, OH • Dallas, TX • Denver, CO • Detroit, MI
Fort Lauderdale, FL • Houston, TX • Kansas City, MO • Los Angeles, CA • Louisville, KY • Memphis, TN • Minneapolis, MN • Nashville, TN
New Orleans, LA • Philadelphia, PA • Phoenix, AZ • Portland, OR • San Francisco, CA • Syracuse, NY





LIGHTING PRODUCTS

QUICK REFERENCE GUIDE



3 GENERATIONS OF FAMILY OWNERSHIP

Left: Ira Greenberg, CEO | **Center:** Marvin Spielman, Founder | **Right:** Fred Greenberg, President and CFO

Since our founding more than 70 years ago by a veteran returning home from World War II, Keystone has grown into North America's leading independently owned driver, ballast, and lighting manufacturer.

We serve the largest lighting fixture manufacturers in North America as well as thousands of local, regional, and national wholesale distributors.

Now in our third generation of family ownership, we are proud of our manufacturing heritage and our unique ability to meet the changing needs of our OEM and distributor customers. Since 1945, our dedication to product innovation and exceptional service has earned our customers' trust. No wonder why many of our customers have been loyal to us since day one!

HERE FOR YOU



CELEBRATING 70 YEARS

ONE
STOP
SHOP

Keystone is the one stop shop for all your lighting needs: LED solutions, LED tubes and lamps, ballasts and retrofit kits.



100%
SATISFACTION
GUARANTEED

Customer satisfaction is our top priority. Our phones are always answered by an educated, caring team member. Should you need it, our products are backed with an industry-leading warranty.

Proudly standing behind more than
100 MILLION
KEYSTONE BALLASTS
AND DRIVERS in use today.

TABLE OF CONTENTS



REFERENCES

- 2 Quick Ship Program
- 2 100% Quality Control Process

LINEAR LED TUBES

- 3 SmartDrive
- 4 DirectDrive
- 4 ComboDrive

COMPACT LED LAMPS

- 5 SmartDrive
- 5 DirectDrive

HID REPLACEMENT LED LAMPS

- 6 DirectDrive
- 7 SmartDrive

LED DRIVERS

- 8 Constant Current
- 9 Constant Voltage
- 9 Programmable Drivers

FUTURE FIT LED KITS

- 10 Linear Module and Driver Kits
- 11 Linear Troffer Pans
- 12 Circular
- 13 Rectangular
- 14 Sconce

RETROFIT KITS

- 15 Linear Retrofit Kits
- 16 Accessories

EMERGENCY BACK-UP SOLUTIONS

- 17 Smart Safe LED Emergency Back-Up
- 18 Linear Fluorescent
- 18 Compact Fluorescent

FLUORESCENT LAMPS

- 19 T12 Linear
- 19 T8 Linear
- 19 T5 Linear
- 19 T9 Circular

FLUORESCENT BALLASTS

- 20 T12
- 20 T8 Instant Start
- 20 T8 Program Start
- 21 T5
- 21 T5HO
- 21 Compact Fluorescent
- 21 Circline

SIGN BALLASTS

- 22 Smart Wire
- 23 Parallel Wire

HID BALLASTS

- 24 Metal Halide
- 24 F-Can Metal Halide
- 25 Pulse Start Metal Halide
- 26 High Pressure Sodium

TRANSFORMERS

- 27 12V Halogen Transformers
- 27 Step Down Transformers

SENSORS

- 28 High Bay Occupancy Sensors
- 28 Wet Location Occupancy Sensors
- 28 Photocells

QUICK SHIP PROGRAM

Keystone's got you covered from Florida to Oregon and everywhere in between.



Time is money when it comes to servicing your customers. That's why we pledge to ship most items the very same day you place your order. In fact, most orders are **DELIVERED NEXT DAY** thanks to Keystone's strategically located, nationwide fulfillment centers.

Our network of **22 FULFILLMENT CENTERS** across the country enables industry-leading service with next day delivery to most points in the United States. **Need it even faster?** Same day pickup is available. **Have questions?** Our personal customer service will get you the answers you need right away.



Headquarters: Philadelphia, PA

Additional Fulfillment Center Locations:

Atlanta, GA	Los Angeles, CA
Boston, MA	Louisville, KY
Charlotte, NC	Memphis, TN
Chicago, IL	Minneapolis, MN
Cincinnati, OH	Nashville, TN
Dallas, TX	New Orleans, LA
Denver, CO	Phoenix, AZ
Detroit, MI	Portland, OR
Fort Lauderdale, FL	San Francisco, CA
Houston, TX	Syracuse, NY
Kansas City, MO	

100% QUALITY CONTROL PROCESS



Step 1: Incoming Parts Inspection
100% of all component parts are inspected upon receipt.



Step 4: Hi-Pot Testing
After the circuit board is mounted inside the casing, every unit undergoes a hi-pot test which checks for abnormalities in operating voltage and current.

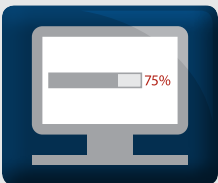

Step 2: In-Circuit Testing
After all components are populated on the printed circuit board, every ballast is tested for circuit integrity using computer aided testing protocols.

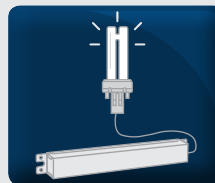

Step 5: Burn-In Testing
Once each ballast is sealed and all assembly is complete, each unit is connected to the proper lamps and powered at full load for at least one hour, thus eliminating virtually any manufacturing or component defects.



Step 3: Functional Testing
Subsequently, every unit is connected to a computerized functional testing apparatus that confirms all electrical input and output characteristics measure within specified tolerances.



Quality Guaranteed
From newly received components to finished ballasts, we make sure that testing is 100% completed at each step of our quality control process so that the products reaching our customers are free of virtually any type of defects.



LINEAR LED LAMPS



SMARTDRIVE LED

PLUG & PLAY WITH BALLAST



SmartDrive Shatterproof Coated Glass T8 Lamps are NSF Listed.

T8

Catalog Number	Nominal Length	Bare Lamp Wattage	Nominal Lumens	Bare Lamp Efficacy	System Wattage			Initial Lumens			Beam Angle	Light Spread
					.78 BF	.88 BF	1.18 BF	.78 BF	.88 BF	1.18 BF		
SHATTERPROOF COATED GLASS CONSTRUCTION												
Also available in uncoated glass construction upon request.												
KT-LED9T8-24GC-8xx-S	2'	9W	1150	128 lm/W	10.2W	11.8W	15.2W	945	1080	1370	220°	325°
KT-LED11T8-36GC-8xx-S*	3'	11W	1450	132 lm/W	11.7W	13.7W	17.8W	1210	1400	1780	220°	325°
KT-LED12T8-48GC-8xx-S	4'	12W	1800	150 lm/W	12.6W	14.9W	19.4W	1470	1710	2090	220°	325°
KT-LED14T8-48GC-8xx-S	4'	14W	1800	129 lm/W	14.2W	16.4W	22.1W	1620	1870	2490	220°	325°
KT-LED17T8-48GC-8xx-S	4'	17W	2200	129 lm/W	17.2W	20.2W	27.8W	1930	2200	2800	220°	325°
PLASTIC/ALUMINUM CONSTRUCTION												
KT-LED18T8-48P-8xx-S	4'	18W	2000	111 lm/W	21.0W	23.0W	32.0W	1800	2000	2700	120°	180°

*3' lamps are not included on the DLC Qualified Products List



SmartDrive Shatterproof Coated Glass T5HO Lamps are ETL Sanitation Listed.

T5 AND T5HO

Catalog Number	Nominal Length	Bare Lamp Wattage	Initial Lumens	Bare Lamp Efficacy	System Wattage	Beam Angle	Light Spread
SHATTERPROOF COATED GLASS CONSTRUCTION							
KT-LED13T5HE-48GC-8xx-S*	4'	13W	1800	130 lm/W	17W	240°	325°
KT-LED27T5HO-48GC-8xx-S	4'	27W	3400	126 lm/W	30W	240°	325°

*Not included on the DLC Qualified Products List

U-BEND



SmartDrive U-Bend Lamps are NSF Listed.

Catalog Number	Nominal Length	Bare Lamp Wattage	Nominal Lumens	Bare Lamp Efficacy	System Wattage			Initial Lumens			Beam Angle	Light Spread
					.78 BF	.88 BF	1.18 BF	.78 BF	.88 BF	1.18 BF		
SHATTERPROOF COATED GLASS CONSTRUCTION												
KT-LED17T8-U6GC-8xx-S*	6" U-Bend	17W	2200	129 lm/W	17.7W	20.2W	26.7W	1930	2200	2800	220°	325°

*U-bend lamps are not included on the DLC Qualified Products List

*8xx denotes several color temperatures available:

830	800 Series, 3000K	835	800 Series, 3500K	840	800 Series, 4000K	850	800 Series, 5000K
------------	-------------------	------------	-------------------	------------	-------------------	------------	-------------------

For all Keystone SmartDrive linear LED lamps, input voltage is ballast dependent and CRI >80.

OPTIONAL 0-10V DIMMING DRIVER FOR SmartDrive T8 TUBES (Sold Separately)

Catalog Number	No. of Lamps	Input Volts	Line Current	Min. Power Factor	Output Current	Dimming Method
14-17W T8 LED Tubes						
KTLD-2LEDT8-UV-IS-VDIM	1-2	120-277V	0.40-0.06A	0.9	190-210mA	0-10V

LINEAR LED LAMPS



DIRECT DRIVE LED[®]

T8 LINE VOLTAGE T8 TUBES



Direct Drive Shatterproof Glass T8 Lamps are ETL Sanitation Listed.

Catalog Number	Nominal Length	Input Voltage	CRI	Lamp Wattage	Lumens	Beam Angle	Light Spread	Efficacy	Meets DLC
SHATTERPROOF COATED GLASS CONSTRUCTION									
KT-LED7T8-18GC-8xx-D	18"	120-277V	>80	7W	800	240°	325°	114 lm/W	N/A
KT-LED9T8-24GC-8xx-D	2'	120-277V	>80	9W	1000	240°	325°	111 lm/W	Yes
KT-LED12T8-36GC-8xx-D	3'	120-277V	>80	12W	1300	240°	325°	108 lm/W	N/A
KT-LED12.5T8-48GC-8xx-D	4'	120-277V	>83	12.5W	1850	240°	325°	148 lm/W	Yes
KT-LED15T8-48GC-8xx-D	4'	120-277V	>80	15W	1900	240°	325°	127 lm/W	Yes
KT-LED18T8-48GC-8xx-D	4'	120-277V	>80	18W	2000	240°	325°	111 lm/W	Yes
KT-LED18T8-48GC-8xx-D-FDIM*	4'	120V	>80	18W	2000	240°	325°	111 lm/W	Yes
KT-LED22T8-48GC-8xx-D	4'	120-277V	>83	22W	2600	240°	325°	118 lm/W	Yes
PLASTIC/ALUMINUM CONSTRUCTION									
KT-LED18T8-48P-8xx-D	4'	120-277V	>80	18W	2000	120°	180°	111 lm/W	Yes
KT-LED36T8-96P-8xx-D	8'	120-277V	>80	36W	4000	120°	180°	111 lm/W	N/A
KT-LED54T8-96P-8xx-D	8'	120-277V	>80	54W	5900	120°	180°	110 lm/W	N/A

*TRIAC dimmable

HiCRI T8



Catalog Number	Nominal Length	Input Voltage	CRI	Lamp Wattage	Lumens	Beam Angle	Light Spread	Efficacy	Meets DLC
SHATTERPROOF COATED GLASS CONSTRUCTION									
KT-LED15T8-48GC-940-D	4'	120-277V	>90	15W	1625	240°	325°	108 lm/W	N/A
KT-LED15T8-48GC-950-D	4'	120-277V	>90	15W	1675	240°	325°	112 lm/W	N/A

U-Bend



Catalog Number	Nominal Length	Input Voltage	CRI	Lamp Wattage	Lumens	Beam Angle	Light Spread	Efficacy	Meets DLC
SHATTERPROOF COATED GLASS CONSTRUCTION									
KT-LED18T8-U6GC-8xx-D	6" U-Bend	120-277V	>80	18W	2150	220°	325°	119 lm/W	N/A

COMBODRIVE LED[®]

PLUG & PLAY OR LINE VOLTAGE COMPATIBLE



Catalog Number	Nominal Length	Lamp Wattage	Lumens	Beam Angle	Instant Start Ballast Compatible Application						Line Voltage Application		
					System Wattage			Initial Lumens			Input Voltage	Lamp Wattage	Initial Lumens
					.78 BF	.88 BF	1.18 BF	.78 BF	.88 BF	1.18 BF			
SHATTERPROOF COATED GLASS CONSTRUCTION													
KT-LED9T8-24GC-8xx-X	2'	9W	1150	220°	11.2W	11.5W	12.1W	1100	1170	1210	120-277V	9W	1170
KT-LED15T8-48GC-8xx-X	4'	15W	1800	220°	16.2W	17.4W	18.5W	1620	1750	1880	120-277V	15W	1710

For all Keystone ComboDrive linear LED lamps, input voltage is ballast dependent.

*8xx denotes several color temperatures available. ComboDrive not available in 865.

830	800 Series, 3000K	835	800 Series, 3500K	840	800 Series, 4000K	850	800 Series, 5000K	865	800 Series, 6500K, Not DLC Listed
------------	-------------------	------------	-------------------	------------	-------------------	------------	-------------------	------------	-----------------------------------

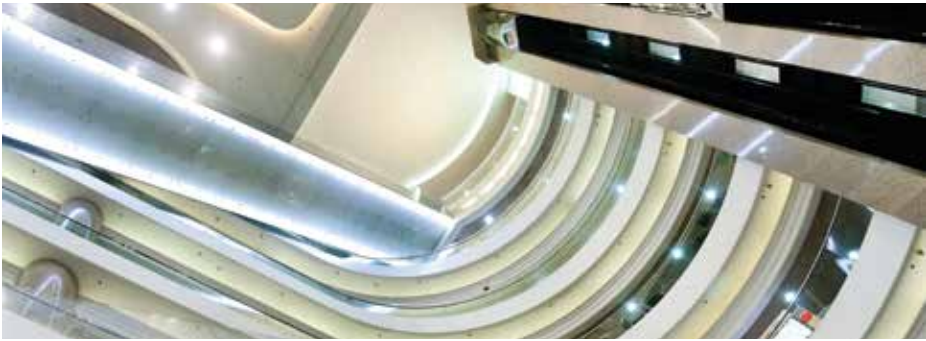

SMARTDRIVE LED

PLUG & PLAY WITH CFL BALLASTS



Catalog Number	Input Voltage	Base	Orientation	CRI	Lamp Wattage	System Wattage	Lumens
4-PIN 26W, 32W, OR 42W CFL LAMP REPLACEMENT							
KT-LED114P-H-8xx-S	Ballast Dependent	G24q	Horizontal	>80	11W	13W	1000
KT-LED114P-V-8xx-S	Ballast Dependent	G24q	Vertical	>80	11W	13W	1000
KT-LED114P-EV-8xx-S	Ballast Dependent	G24q	Extended Vertical	>80	11W	13W	1000

DIRECTDRIVE LED

CONNECT TO LINE VOLTAGE



Catalog Number	Input Voltage	Base	Orientation	CRI	Lamp Wattage	Lumens	Rated Average Life
2-PIN 13W CFL LAMP REPLACEMENT							
KT-LED62P-H-8xx-D	120-277V	GX23	Horizontal	>80	6W	500	50,000 Hours
2-PIN 26W, 32W, OR 42W CFL LAMP REPLACEMENT							
KT-LED82P-H-8xx-D	120-277V	G24d	Horizontal	≥83	8W	900	50,000 Hours
KT-LED82P-V-8xx-D	120-277V	G24d	Vertical	≥83	8W	900	50,000 Hours
KT-LED82P-EV-8xx-D	120-277V	G24d	Extended Vertical	≥83	8W	900	50,000 Hours

*8xx denotes several color temperatures available:

827	800 Series, 2700K	830	800 Series, 3000K	835	800 Series, 3500K	840	800 Series, 4000K	850	800 Series, 5000K
------------	-------------------	------------	-------------------	------------	-------------------	------------	-------------------	------------	-------------------

HID REPLACEMENT LED LAMPS



BYPASS THE BALLAST

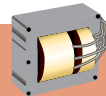

Bypass the existing ballast and connect the 120-277V line voltage directly to the sockets. No ballast or external driver is required.

50,000 HOUR LIFETIME



With SmartCool technology, a thermal sensor in the lamp activates during extreme high temperature conditions. Power to the lamp is reduced by up to 20% to cool the lamp and maintain lamp life. Once the sensor reaches an acceptable temperature, the lamp gradually returns to full light output. Included in 54W, 80W and 100W DirectDrive HID LED lamps.

LOW WATTAGE

Catalog Number	Rated Lamp Wattage	Metal Halide Equivalent Wattage	Input Voltage	Base Type	Lumens	CRI	IP Rating	Efficacy	DLC QPL
KT-LED15HID-E26-8xx-D	15W	50W	120-277V	Medium E26	2000	>83	IP64	133 lm/W	N/A
KT-LED19HID-E26-8xx-D	19W	75W	120-277V	Medium E26	2400	>83	IP64	126 lm/W	N/A
KT-LED20HID-E26-8xx-D	20W	50-70W	120-277V	Medium E26	2130	>83	IP64	107 lm/W	N/A

MID WATTAGE

Catalog Number	Rated Lamp Wattage	Metal Halide Equivalent Wattage	Input Voltage	Base Type	Lumens	CRI	IP Rating	Efficacy	DLC QPL
KT-LED27HID-E26-8xx-D	27W	100W	120-277V	Medium E26	3830	>83	IP64	142 lm/W	N/A
KT-LED36HID-E26-8xx-D	36W	150W	120-277V	Medium E26	5100	>83	IP64	142 lm/W	N/A
KT-LED45HID-E26-8xx-D	45W	175W	120-277V	Medium E26	6350	>83	IP64	141 lm/W	N/A
KT-LED45HID-EX39-8xx-D	45W	175W	120-277V	Mogul EX39	6350	>83	IP64	141 lm/W	Yes*
KT-LED54HID-EX39-8xx-D	54W	250W	120-277V	Mogul EX39	7660	>83	IP64	142 lm/W	Yes

*For 4000K and 5000K color temperatures only

HIGH WATTAGE

Catalog Number	Rated Lamp Wattage	Metal Halide Equivalent Wattage	Input Voltage	Base Type	Lumens	CRI	IP Rating	Efficacy	DLC QPL
KT-LED80HID-EX39-8xx-D	80W	320W	120-277V	Mogul EX39	11,300	>83	IP64	141 lm/W	N/A
KT-LED100HID-EX39-8xx-D	100W	400W	120-277V	Mogul EX39	14,100	>83	IP64	141 lm/W	N/A

*8xx denotes several color temperatures available. 830 color temperature available for low and mid wattage lamps only.

830	800 Series, 3000K	840	800 Series, 4000K	850	800 Series, 5000K
------------	-------------------	------------	-------------------	------------	-------------------

ACCESSORIES (Sold Separately)

Catalog Number	Description
KTSP-10KV	External Surge Protector; Input Voltage 120-277V; Max. Peak Current: 10KV; IP65 Rated
KT-ADAPTER-E39-E26	Socket Base Adapter Allowing an E26 Base Lamp to be Used in E39 Socket



RoHS Compliant

5 YEAR WARRANTY

HID REPLACEMENT LED LAMPS



MAGNETIC HID BALLAST COMPATIBLE

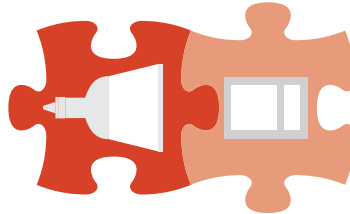

LAMP AND BALLAST KITS

400W METAL HALIDE REPLACEMENT

Driven by 400W (M59) Ballast

Catalog Number	Included Ballast Kit	Lamp Wattage	Base Type	Orientation	Input Voltage	Lumens	System Wattage
KT-LED-130HID-V-EX39-8xx-S-PKIT	MH-400A-P-KIT	130W	EX39	Vertical	Ballast Dependent	13,000	166W

175W METAL HALIDE REPLACEMENT

Driven by 175W (M57) Ballast

Catalog Number	Included Ballast Kit	Lamp Wattage	Base Type	Orientation	Input Voltage	Lumens	System Wattage
KT-LED-48HID-V-E26-8xx-S-PKIT	MH-175A-P-KIT	48W	E26	Vertical	Ballast Dependent	5,600	79W

5 YEAR SYSTEM WARRANTY FOR LAMP AND BALLAST KITS

Keystone offers the best system warranty in the industry. When installing Keystone SmartDrive HID LED replacement lamps with Keystone ballasts, we extend the ballast warranty by 3 years. You benefit from a 5 year total system warranty.

LAMPS

400W METAL HALIDE REPLACEMENT

Driven by 400W (M59) Ballast

Driven by 320W (M154) Ballast

Catalog Number	Supported Ballast Types	Lamp Wattage	Base Type	Orientation	Input Voltage	Lumens	System Wattage	Lumens	System Wattage
KT-LED-130HID-V-EX39-8xx-S	400W (M59, M135), 320W (M154, M155)	130W	EX39	Vertical	Ballast Dependent	13,000	166W	11,000	138W

175W METAL HALIDE REPLACEMENT

Driven by 175W (M57) Ballast

Catalog Number	Supported Ballast Types	Lamp Wattage	Base Type	Orientation	Input Voltage	Lumens	System Wattage
KT-LED-48HID-V-E26-8xx-S	175W (M57, M137, M152)	48W	E26	Vertical	Ballast Dependent	5,600	79W

* 8xx denotes several color temperatures available:

840	800 Series, 4000K	850	800 Series, 5000K
-----	-------------------	-----	-------------------



CONSTANT CURRENT

Wattage Family	Catalog Number	Rated Output Current	Output Voltage	Output Power	Input Voltage	Dimming
10W	KTLD-10-1N-350-F3	350mA	7.5-30Vdc	10W	120Vac	N/A
	KTLD-10-1N-300-F3	300mA	6-33Vdc	10W	120Vac	N/A
	KTLD-10-1N-380-F3	380mA	6.5-28Vdc	10W	120Vac	N/A
	KTLD-10-1P-380-LDIM-AF1	380mA	13-27Vdc	10W	120Vac	Local
12W	KTLD-12-1-350-FDIM-F5	350mA	17-34Vdc	12W	120Vac	Phase Control
	KTLD-12-1-500-FDIM-F5	500mA	12-24Vdc	12W	120Vac	Phase Control
	KTLD-12-1-700-FDIM-F5	700mA	8-17Vdc	12W	120Vac	Phase Control
	KTLD-12-1-350-FDIM-AF1	350mA	6-32Vdc	12W	120Vac	Phase Control
	KTLD-12-1-380-FDIM-AF1	380mA	5-32Vdc	12W	120Vac	Phase Control
	KTLD-12-1-700-FDIM-AF1	700mA	5-17Vdc	12W	120Vac	Phase Control
14W	KTLD-14-1-350-FDIM-AF1	350mA	10-40Vdc	14W	120Vac	Phase Control
22W	KTLD-22-1-350-FDIM-AK1	350mA	21-63Vdc	22W	120Vac	Phase Control
	KTLD-22-1-700-FDIM-AK1	700mA	10-32Vdc	22W	120Vac	Phase Control
	KTLD-22-UV-500-VDIM-L7	500mA	22-44Vdc	22W	120-277Vac	0-10V
	KTLD-22-UV-600-VDIM-L7	600mA	18-36Vdc	22W	120-277Vac	0-10V
	KTLD-22-UV-700-AK1	700mA	10-32Vdc	22W	120-277Vac	N/A
23W	KTLD-23-UV-830-VDIM-L7	830mA	14-28Vdc	23W	120-277Vac	0-10V
25W	KTLD-25-UV-700-VDIM-L9	700mA	18-36Vdc	25W	120-277Vac	0-10V
36W	KTLD-36-UV-900-VDIM-L2	900mA	18-36Vdc	36W	120-277Vac	0-10V
	KTLD-36-UV-1500-VDIM-L2	1500mA	12-24Vdc	36W	120-277Vac	0-10V
40W	KTLD-40-UV-1100-VDIM-L2	1100mA	18-36Vdc	40W	120-277Vac	0-10V
	KTLD-40-UV-1100-VDIM-L9	1100mA	18-36Vdc	40W	120-277Vac	0-10V
50W	KTLD-50-UV-2X500-VDIM-L5	2x 500mA (Dual Channel)	25-50Vdc	50W	120-277Vac	0-10V
	KTLD-50-UV-2X700-VDIM-L5	2x 700mA (Dual Channel)	18-36Vdc	50W	120-277Vac	0-10V
60W	KTLD-60-UV-1600-VDIM-W2	1600mA	18-37.5Vdc	60W	120-277Vac	0-10V
72W	KTLD-72-UV-2X1000-VDIM-L5	2x 1000mA (Dual Channel)	18-36Vdc	72W	120-277Vac	0-10V
75W	KTLD-75-UV-1450-VDIM-L5	1450mA	27-51Vdc	75W	120-277Vac	0-10V
100W	KTLD-100-UV-1750-VDIM-L5	1750mA	29-57Vdc	100W	120-277Vac	0-10V
	KTLD-100-UV-4X500-VDIM-L18	4x 500mA (4 Channel)	25-50Vdc	100W	120-277Vac	0-10V

We make LED easy. From simple explanations to special design requests, call us today for any LED questions. For a complete listing of our LED drivers, contact Keystone or visit our website at KeystoneTech.com.

CONSTANT VOLTAGE

Wattage Family	Catalog Number	Rated Output Voltage	Max. Power	Max. Current	Input Voltage	SAM Qualified*
10W	KTLD-10-1N-12V-F3	12Vdc	10W	0.83A	120Vac	Yes
24W	KTLD-24-1-12V-AK1	12Vdc	24W	2.00A	120Vac	Yes
	KTLD-24-1-24V-AK1	24Vdc	24W	1.00A	120Vac	Yes
	KTLD-24-UV-12V-AK1	12Vdc	24W	2.00A	120-277Vac	Yes
	KTLD-24-UV-24V-AK1	24Vdc	24W	1.00A	120-277Vac	N/A
60W	KTLD-60-1-12V	12Vdc	60W	5.00A	120Vac	Yes
	KTLD-60-1N-12V-L2	12Vdc	60W	5.00A	120Vac	Yes
	KTLD-60-1-24V	24Vdc	60W	2.50A	120Vac	Yes
	KTLD-60-UV-12V	12Vdc	60W	5.00A	120-277Vac	Yes
	KTLD-60-UV-12V-67-AP4	12Vdc	60W	5.00A	120-277Vac	Yes
	KTLD-60-UV-12V-VDIM-L5	12Vdc	60W	5.00A	120-277Vac	Yes
	KTLD-60-UV-24V	24Vdc	60W	2.50A	120-277Vac	Yes
80W	KTLD-80-1-12V	12Vdc	80W	6.60A	120Vac	Yes
	KTLD-80-1-24V	24Vdc	80W	3.30A	120Vac	Yes
	KTLD-80-UV-12V	12Vdc	80W	6.70A	120-277Vac	N/A
	KTLD-80-UV-24V	24Vdc	80W	3.30A	120-277Vac	N/A
100W	KTLD-100-UV-12V	12Vdc	100W	8.00A	120-277Vac	Yes
	KTLD-100-UV-24V	24Vdc	100W	4.00A	120-277Vac	Yes
	KTLD-100-UV-24V-67-AP4	24Vdc	100W	4.00A	120-277Vac	N/A
120W	KTLD-120-UV-12V-L10	12Vdc	120W (2x60W Channels)	5.00A	120-277Vac	Yes

*Sign Component Manual (SAM) - SAM is a directory governed by UL that lists all components that have been tested and certified under the UL standard for electric signs. It is updated quarterly and contains all of the components associated with the manufacturing of electric signs, including LED power supplies. For more information, visit www.ul.com.

SPEED DIAL PROGRAMMABLE CONSTANT CURRENT LED DRIVER

SPEEDDIAL
PROGRAMMABLE DRIVERS

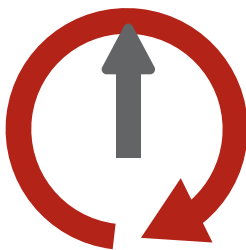

NO COMPUTERS. NO MISTAKES. NO HASSLES.

Introducing the easiest programmable constant current LED driver on the market. With just the simple twist of Keystone's unique SpeedDial, the LED driver is programmed to your desired output current in less than a second. Reduce inventory SKUs, increase productivity, gain performance flexibility... all with Keystone's proprietary SpeedDial LED drivers.

FEATURES AND BENEFITS

- **Slim Form Factor** - Ideal for narrow channels and slender fixtures.
- **Incredibly Easy Adjustability** - Just twist the SpeedDial with a standard screwdriver to the desired setting. The SpeedDial clicks right into place.
- **Reduced Inventory** - Utilize a single SKU for several output current settings.
- **High Efficiency** - Keystone's expertise in LED driver design targets maximum efficiencies at all current settings.
- **0-10V Dimming** - Uncompromised dimming performance for any 0-10V dimming system.

Catalog Number	INPUT CHARACTERISTICS				OUTPUT CHARACTERISTICS			FEATURES
	Input Voltage	Input Power	Power Factor	Max. Current	Max. Output Power	Rated Output Current	Output Voltage	Efficiency
KTLD-44-UV-SD700-1200-VDIM-L20	120-277Vac	52W	>0.9	0.48A @ 120V 0.22A @ 277V	44W	700, 800, 900, 1000, 1100, or 1200 mA	18-36Vdc	84% (at 1200mA)





Each Kit includes (1) 0-10V Dimmable LED Driver, (2) LED Modules, Mounting Hardware, and Accessories.

2x2, 4000 LUMEN LINEAR LED MODULE AND DRIVER KIT

Color Temp	Input Voltage	LED Retrofit Kit Catalog Number	No. of Modules	Total System Drive Current	Drive Current per Module	Total System Lumens	Total Module Power	Module Efficacy	Driver Efficiency	Total System Power	Total System Efficacy
3500K	120-277V	KT-RKIT-22-4000-835-VDIM	2	1100mA	550mA	3820	30W	129 lm/W	82%	36W	106 lm/W
4000K	120-277V	KT-RKIT-22-4000-840-VDIM	2	1100mA	550mA	3860	30W	130 lm/W	82%	36W	107 lm/W
5000K	120-277V	KT-RKIT-22-4000-850-VDIM	2	1100mA	550mA	4000	30W	135 lm/W	82%	36W	111 lm/W

2x4, 4000 LUMEN LINEAR LED MODULE AND DRIVER KIT

Color Temp	Input Voltage	LED Retrofit Kit Catalog Number	No. of Modules	Total System Drive Current	Drive Current per Module	Total System Lumens	Total Module Power	Module Efficacy	Driver Efficiency	Total System Power	Total System Efficacy
3500K	120-277V	KT-RKIT-24-4000-835-VDIM	2	1100mA	550mA	3820	30W	129 lm/W	82%	36W	106 lm/W
4000K	120-277V	KT-RKIT-24-4000-840-VDIM	2	1100mA	550mA	3860	30W	130 lm/W	82%	36W	107 lm/W
5000K	120-277V	KT-RKIT-24-4000-850-VDIM	2	1100mA	550mA	4000	30W	135 lm/W	82%	36W	111 lm/W

2x4, 5000 LUMEN LINEAR LED MODULE AND DRIVER KIT

Color Temp	Input Voltage	LED Retrofit Kit Catalog Number	No. of Modules	Total System Drive Current	Drive Current per Module	Total System Lumens	Total Module Power	Module Efficacy	Driver Efficiency	Total System Power	Total System Efficacy
3500K	120-277V	KT-RKIT-24-5000-835-VDIM	2	1100mA	550mA	4680	36W	130 lm/W	82%	44W	107 lm/W
4000K	120-277V	KT-RKIT-24-5000-840-VDIM	2	1100mA	550mA	4800	36W	133 lm/W	82%	44W	109 lm/W
5000K	120-277V	KT-RKIT-24-5000-850-VDIM	2	1100mA	550mA	5000	36W	138 lm/W	82%	44W	113 lm/W

TYPICAL INSTALLATION APPLICATION

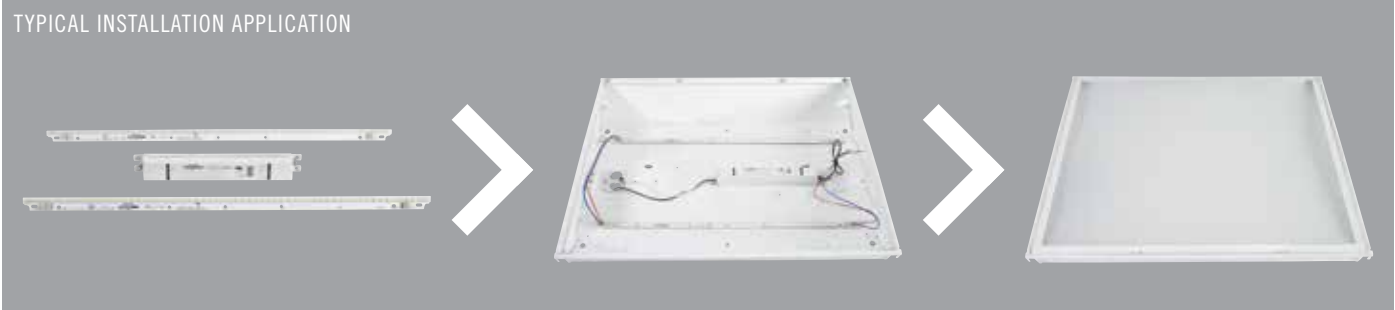



RoHS Compliant

10 YEAR WARRANTY

FUTURE FIT
LED KITS

LINEAR TROFFER PAN LED KITS

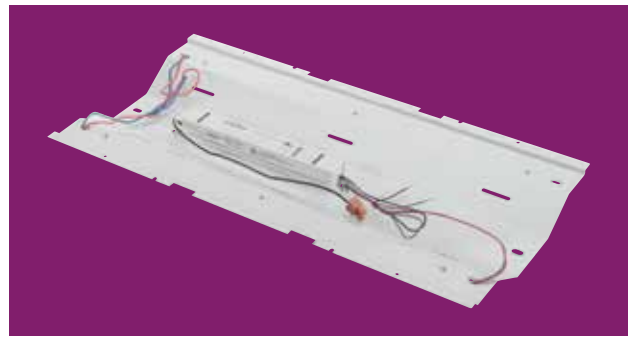

Each Pre-Assembled Kit includes (1) 0-10V Dimmable LED Driver, (2) LED Modules, (1) Metal Pan, Mounting Hardware, and Accessories.

2x2, 4000 LUMEN PRE-MOUNTED LINEAR TROFFER PAN

Color Temp	Input Voltage	LED Retrofit Kit Catalog Number	No. of Modules	Total System Drive Current	Drive Current per Module	Total System Lumens	Total Module Power	Module Efficacy	Driver Efficiency	Total System Power	Total System Efficacy
3500K	120-277V	KT-RKIT-TP-22-4000-835-VDIM	2	1100mA	550mA	3820	30W	129 lm/W	82%	36W	106 lm/W
4000K	120-277V	KT-RKIT-TP-22-4000-840-VDIM	2	1100mA	550mA	3860	30W	130 lm/W	82%	36W	107 lm/W
5000K	120-277V	KT-RKIT-TP-22-4000-850-VDIM	2	1100mA	550mA	4000	30W	135 lm/W	82%	36W	111 lm/W

2x4, 4000 LUMEN PRE-MOUNTED LINEAR TROFFER PAN

Color Temp	Input Voltage	LED Retrofit Kit Catalog Number	No. of Modules	Total System Drive Current	Drive Current per Module	Total System Lumens	Total Module Power	Module Efficacy	Driver Efficiency	Total System Power	Total System Efficacy
3500K	120-277V	KT-RKIT-TP-24-4000-835-VDIM	2	1100mA	550mA	4680	36W	130 lm/W	82%	44W	107 lm/W
4000K	120-277V	KT-RKIT-TP-24-4000-840-VDIM	2	1100mA	550mA	4800	36W	133 lm/W	82%	44W	109 lm/W
5000K	120-277V	KT-RKIT-TP-24-4000-850-VDIM	2	1100mA	550mA	5000	36W	138 lm/W	82%	44W	113 lm/W

2x4, 5000 LUMEN PRE-MOUNTED LINEAR TROFFER PAN

Color Temp	Input Voltage	LED Retrofit Kit Catalog Number	No. of Modules	Total System Drive Current	Drive Current per Module	Total System Lumens	Total Module Power	Module Efficacy	Driver Efficiency	Total System Power	Total System Efficacy
3500K	120-277V	KT-RKIT-TP-24-5000-835-VDIM	2	1100mA	550mA	3820	30W	129 lm/W	82%	36W	106 lm/W
4000K	120-277V	KT-RKIT-TP-24-5000-840-VDIM	2	1100mA	550mA	3860	30W	130 lm/W	82%	36W	107 lm/W
5000K	120-277V	KT-RKIT-TP-24-5000-850-VDIM	2	1100mA	550mA	4000	30W	135 lm/W	82%	36W	111 lm/W

OPTIONAL ACCESSORIES

Catalog Number	Description
KT-RKIT-MAG-KIT	(2) Reusable High-Strength Magnets to Aid in the Installation of the Future Fit Troffer Pan

TYPICAL INSTALLATION APPLICATION



CIRCULAR LED KITS



Each Pre-Assembled Kit includes (1) Dimmable LED Driver, (1) LED Module, (1) Metal Pan, Mounting Hardware, and Accessories.

8", 1600 LUMEN CIRCULAR (Phase Control Dimming)

Color Temp	Input Voltage	LED Retrofit Kit Catalog Number	No. of Modules	Total System Drive Current	Drive Current per Module	Total System Lumens	Total Module Power	Module Efficacy	Driver Efficiency	Total System Power	Total System Efficacy
3000K	120V	KT-RKIT-CP-8-1600-830-FDIM	1	560mA	560mA	1700	13W	130 lm/W	80%	16.2W	105 lm/W
4000K	120V	KT-RKIT-CP-8-1600-840-FDIM	1	560mA	560mA	1750	13W	135 lm/W	80%	16.2W	108 lm/W
5000K	120V	KT-RKIT-CP-8-1600-850-FDIM	1	560mA	560mA	1800	13W	138 lm/W	80%	16.2W	111 lm/W

8", 1600 LUMEN CIRCULAR (0-10V Dimming)

Color Temp	Input Voltage	LED Retrofit Kit Catalog Number	No. of Modules	Total System Drive Current	Drive Current per Module	Total System Lumens	Total Module Power	Module Efficacy	Driver Efficiency	Total System Power	Total System Efficacy
3000K	120-277V	KT-RKIT-CP-8-1600-830-VDIM	1	560mA	560mA	1700	13W	130 lm/W	80%	16.2W	105 lm/W
4000K	120-277V	KT-RKIT-CP-8-1600-840-VDIM	1	560mA	560mA	1750	13W	135 lm/W	80%	16.2W	108 lm/W
5000K	120-277V	KT-RKIT-CP-8-1600-850-VDIM	1	560mA	560mA	1800	13W	138 lm/W	80%	16.2W	111 lm/W

8", 2200 LUMEN CIRCULAR (Phase Control Dimming)

Color Temp	Input Voltage	LED Retrofit Kit Catalog Number	No. of Modules	Total System Drive Current	Drive Current per Module	Total System Lumens	Total Module Power	Module Efficacy	Driver Efficiency	Total System Power	Total System Efficacy
3000K	120V	KT-RKIT-CP-8-2200-830-FDIM	1	560mA	560mA	2110	16.3W	129 lm/W	80%	20.4W	103 lm/W
4000K	120V	KT-RKIT-CP-8-2200-840-FDIM	1	560mA	560mA	2180	16.3W	134 lm/W	80%	20.4W	107 lm/W
5000K	120V	KT-RKIT-CP-8-2200-850-FDIM	1	560mA	560mA	2240	16.3W	137 lm/W	80%	20.4W	109 lm/W

8", 2200 LUMEN CIRCULAR (0-10V Dimming)

Color Temp	Input Voltage	LED Retrofit Kit Catalog Number	No. of Modules	Total System Drive Current	Drive Current per Module	Total System Lumens	Total Module Power	Module Efficacy	Driver Efficiency	Total System Power	Total System Efficacy
3000K	120-277V	KT-RKIT-CP-8-2200-830-VDIM	1	560mA	560mA	2110	16.3W	129 lm/W	80%	20.4W	103 lm/W
4000K	120-277V	KT-RKIT-CP-8-2200-840-VDIM	1	560mA	560mA	2180	16.3W	134 lm/W	80%	20.4W	107 lm/W
5000K	120-277V	KT-RKIT-CP-8-2200-850-VDIM	1	560mA	560mA	2240	16.3W	137 lm/W	80%	20.4W	109 lm/W

TYPICAL INSTALLATION APPLICATION





Each Pre-Assembled Kit includes (1) LED Driver, (2) LED Modules, (1) Metal Pan, Mounting Hardware, and Accessories.

3"x6", 800 LUMEN RECTANGULAR

Color Temp	Input Voltage	LED Retrofit Kit Catalog Number	No. of Modules	Total System Drive Current	Drive Current per Module	Total Lumens per Module	Total System Lumens	Total Module Power	Module Efficacy	Driver Efficiency	Total System Power	Total System Efficacy
3000K	120V	KT-RKIT-RP-6-800-830	2	560mA	560mA	415	830	7W	118 lm/W	82%	8.5W	97 lm/W
4000K	120V	KT-RKIT-RP-6-800-840	2	560mA	560mA	425	850	7W	121 lm/W	82%	8.5W	100 lm/W
5000K	120V	KT-RKIT-RP-6-800-850	2	560mA	560mA	435	870	7W	124 lm/W	82%	8.5W	102 lm/W

3"x6", 1600 LUMEN RECTANGULAR

Color Temp	Input Voltage	LED Retrofit Kit Catalog Number	No. of Modules	Total System Drive Current	Drive Current per Module	Total Lumens per Module	Total System Lumens	Total Module Power	Module Efficacy	Driver Efficiency	Total System Power	Total System Efficacy
3000K	120V	KT-RKIT-RP-6-1600-830	2	560mA	560mA	775	1550	14W	110 lm/W	82%	17W	91 lm/W
4000K	120V	KT-RKIT-RP-6-1600-840	2	560mA	560mA	800	1600	14W	114 lm/W	82%	17W	94 lm/W
5000K	120V	KT-RKIT-RP-6-1600-850	2	560mA	560mA	825	1650	14W	118 lm/W	82%	17W	97 lm/W

TYPICAL INSTALLATION APPLICATION



SCONCE LED KITS



Each Pre-Assembled Kit includes (1) Phase Control Dimmable LED Driver, (1) LED Module, (1) Metal Pan, Mounting Hardware, and Accessories.

8", 650 LUMEN WALL SCONCE (Phase Control Dimming)

Color Temp	Input Voltage	LED Retrofit Kit Catalog Number	No. of Modules	Total System Drive Current	Drive Current per Module	Total Lumens per Module	Total System Lumens	Total Module Power	Module Efficacy	Driver Efficiency	Total System Power	Total System Efficacy
3000K	120V	KT-RKIT-HCP-8-650-830-FDIM	1	350mA	350mA	680	680	5.5W	123 lm/W	80%	6.9W	98 lm/W
4000K	120V	KT-RKIT-HCP-8-650-840-FDIM	1	350mA	350mA	700	700	5.5W	127 lm/W	80%	6.9W	101 lm/W
5000K	120V	KT-RKIT-HCP-8-650-850-FDIM	1	350mA	350mA	720	720	5.5W	130 lm/W	80%	6.9W	104 lm/W

8", 1150 LUMEN WALL SCONCE (Phase Control Dimming)

Color Temp	Input Voltage	LED Retrofit Kit Catalog Number	No. of Modules	Total System Drive Current	Drive Current per Module	Total Lumens per Module	Total System Lumens	Total Module Power	Module Efficacy	Driver Efficiency	Total System Power	Total System Efficacy
3000K	120V	KT-RKIT-HCP-8-1150-830-FDIM	1	350mA	350mA	1115	1115	8.5W	131 lm/W	80%	10.6W	105 lm/W
4000K	120V	KT-RKIT-HCP-8-1150-840-FDIM	1	350mA	350mA	1150	1150	8.5W	135 lm/W	80%	10.6W	108 lm/W
5000K	120V	KT-RKIT-HCP-8-1150-850-FDIM	1	350mA	350mA	1180	1180	8.5W	138 lm/W	80%	10.6W	111 lm/W



LINEAR RETROFIT KITS



PRE-WIRED & PRE-MOUNTED 4' AND 8' T8 READY KITS

Keystone's T8 Ready Kits are pre-wired units that include everything you need to upgrade your lighting system, making installation quick and simple. Built of lightweight aluminum, our pre-assembled retrofit kits will dramatically reduce labor and maintenance costs when installed. It is designed to fit channels up to 4.25" wide, but custom widths are also available.

8' READY KITS

8' kit components shown.



Each Kit Contains: Ballast Channel Cover with Pre-Mounted Ballast (if Applicable) and Pre-Wired Sockets, Ballast Cover, and Tek Screws

STRIP READY KITS

Catalog Number	Description
4' Strip Ready Kits	
KT-RKIT-SP-W-4-C4-2LED	2-Lamp 4' Strip LED Tube Ready Kit. Pre-Wired 4.25" Ballast Cover Kit for DirectDrive LED Tubes; Includes (1) 4' Ballast Cover, (1) Wiring Harness, (2) Additional Sockets and (4) Tek Screws
KT-RKIT-SP-W-4-C4-232I-N-W	2-Lamp 4' Strip Ready Kit. Pre-Wired 4.25" Ballast Cover Kit for SmartDrive LED Tubes or Fluorescent Lamps; Includes (1) Pre-Wired Ballast with Sockets, (1) 4' Ballast Covers, and (4) Tek Screws
8' Strip Ready Kits	
KT-RKIT-SP-W-82-C4-4LED	4-Lamp 8' Strip LED Tube Ready Kit. Pre-Wired 4.25" Ballast Cover Kit for DirectDrive LED Tubes; Includes (2) 4' Ballast Covers, (1) Wiring Harness, (4) Additional Sockets and (8) Tek Screws
KT-RKIT-SP-W-82-C4-432I-N-W	4-Lamp 8' Strip Ready Kit. Pre-Wired 4.25" Ballast Cover Kit for SmartDrive LED Tubes or Fluorescent Lamps; Includes (1) Pre-Wired Ballast with Sockets, (2) 4' Ballast Covers, and (8) Tek Screws

Consult Keystone for other custom options, such as alternate ballast types and additional reflectors.

INSTALLATION DIAGRAMS

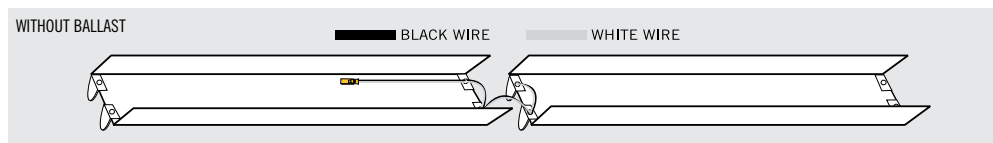
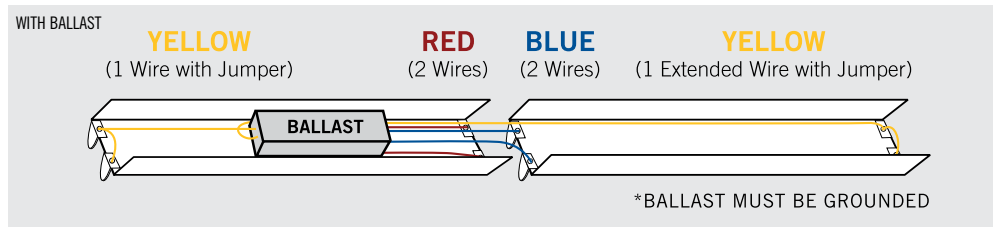

ACCESSORIES FOR LINEAR RETROFITS

From pre-wired harnesses to tek screws, Keystone has what you need to get the job done.

Catalog Number	Description
DirectDrive WIRING HARNESSES	
KT-SOCKET-T8-U-T-2-W	2-Lamp Wiring Harness for LED Tubes; Includes (2) Pre-Wired Tall, Non-Shunted Sockets with Power Quick Disconnect
KT-SOCKET-T8-U-T-3-W	3-Lamp Wiring Harness for LED Tubes; Includes (3) Pre-Wired Tall, Non-Shunted Sockets with Power Quick Disconnect
KT-SOCKET-T8-U-T-4-W	4-Lamp Wiring Harness for LED Tubes; Includes (4) Pre-Wired Tall, Non-Shunted Sockets with Power Quick Disconnect
KT-SOCKET-T8-U-T-6-W	6-Lamp Wiring Harness for LED Tubes; Includes (6) Pre-Wired Tall, Non-Shunted Sockets with Power Quick Disconnect
KT-SOCKET-T8-U-S-2-W	2-Lamp Wiring Harness for LED Tubes; Includes (2) Pre-Wired Standard, Non-Shunted Sockets with Power Quick Disconnect
KT-SOCKET-T8-U-S-3-W	3-Lamp Wiring Harness for LED Tubes; Includes (3) Pre-Wired Standard, Non-Shunted Sockets with Power Quick Disconnect
KT-SOCKET-T8-U-S-4-W	4-Lamp Wiring Harness for LED Tubes; Includes (4) Pre-Wired Standard, Non-Shunted Sockets with Power Quick Disconnect
KT-WH-FA8-2L	Wiring Harness for Single Pin 8' Direct Drive LED Tubes

DirectDrive Wiring Harness with Power Quick Disconnect



DirectDrive Wiring Diagram

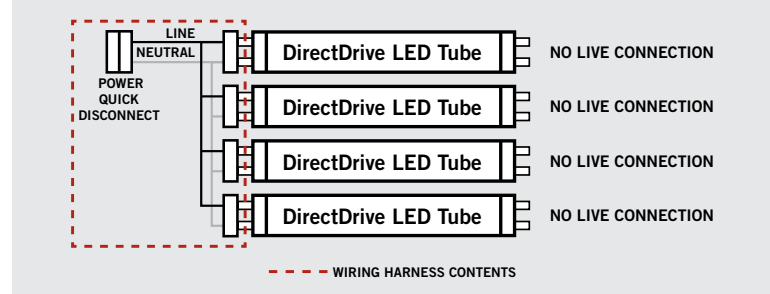

Catalog Number	Description
BALLAST COVERS AND STRIP REFLECTORS	
KT-RKIT-SC-C4	4' White Ballast Cover Only, Approximately 4.25"
KT-RKIT-SR8-W	4' White (91%) Reflector, 8" Width
KT-RKIT-SR8-S	4' Specular Aluminum (87%) Reflector, 8" Width
KT-RKIT-SR8-M	4' Enhanced Aluminum (95%) Reflector, 8" Width
BRACKETS	
KT-RKIT-S-BR-1	One-Piece Break-Apart Adjustable Bracket for 1-Lamp 4' or 8' Strip Fixture
KT-RKIT-T-BR-2	Socket Bar for 2-Lamp Troffers
KT-RKIT-T-BR-3	Socket Bar for 3-Lamp Troffers
KT-RKIT-T-BR-4	Socket Bar for 4-Lamp Troffers
SOCKETS	
KT-SOCKET-RDC-PE	Recessed Double Contact Socket with Plunger End for HO Lamps
KT-SOCKET-RDC-SE	Recessed Double Contact Socket with Stationary End for HO Lamps
KT-SOCKET-SL-PE	Single Pin Slimline Socket with Plunger End
KT-SOCKET-SL-SE	Single Pin Slimline Socket with Stationary End
KT-SOCKET-T8-U-T	Non-Shunted Tall T8 Socket with Push-Through with Nub, Approximately 30mm
KT-SOCKET-T8-U-S	Non-Shunted Standard T8 Socket with Push-Through with Nub, Approximately 23mm
MISCELLANEOUS	
KT-RKIT-QD	Power Quick Disconnect
KT-RKIT-TEK	Tek Screws

Break-Apart Adjustable Bracket

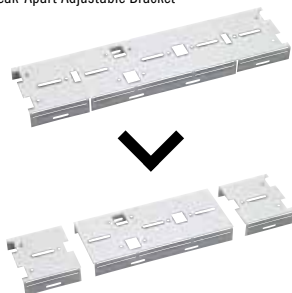

Reflector and Ballast Cover



Power Quick Disconnect



Non-Shunted Socket



Troffer Brackets

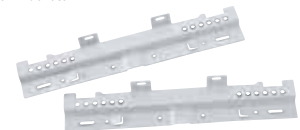



EMERGENCY BACK-UP SOLUTIONS

LED EMERGENCY BACK-UP



SMART//SAFE

LED EMERGENCY BACK-UP

2 OPTIONS AVAILABLE

LED EMERGENCY BACK-UP KIT

Multiple Fixture Options

Includes Driver, Battery, and LED Module

The LED emergency back-up kit enables emergency lighting solutions to be incorporated into a variety of lighting fixtures including direct-wire LED tube fixtures, fluorescent fixtures and LED fixtures.



STANDARD LED EMERGENCY BACK-UP

For LED Fixtures

Includes Driver and Battery

The LED emergency back-up enables emergency lighting solutions to be incorporated into a variety of new and existing LED fixtures. Simply install the emergency back-up solution into the fixture, tying into both the existing AC driver and LED module(s).



LED EMERGENCY BACK-UP KITS

Catalog Number	INPUT CHARACTERISTICS			OUTPUT CHARACTERISTICS			LED Module Included
	Input Voltage	Power Factor	Max. Current	Max. Output Power	Rated Output Current	Output Voltage	
KT-EMRG-LED-5-500-K1	120-277Vac	≥0.5	0.03A @ 120V	5W	400mA-100mA	12-41Vdc	Yes
KT-EMRG-LED-12-1200-K1	120-277Vac	≥0.5	0.07A @ 120V	12W	1000mA-200mA	12-41Vdc	Yes

STANDARD LED EMERGENCY BACK-UP

Catalog Number	INPUT CHARACTERISTICS			OUTPUT CHARACTERISTICS			LED Module Included
	Input Voltage	Power Factor	Max. Current	Max. Output Power	Rated Output Current	Output Voltage	
KT-EMRG-LED-5-500	120-277Vac	≥0.5	0.03A @ 120V	5W	400mA-100mA	12-41Vdc	No
KT-EMRG-LED-12-1200	120-277Vac	≥0.5	0.07A @ 120V	12W	1000mA-200mA	12-41Vdc	No

EMERGENCY BACK-UP SOLUTIONS

FLUORESCENT EMERGENCY BALLASTS



RoHS
Compliant

5 YEAR
WARRANTY



LINEAR FLUORESCENT EMERGENCY BALLASTS

No. of Lamps in Fixture	Catalog Number	Input Voltage	Light Output	Illumination Time	Battery	Warranty
T8 & T12 Linear						
1-4	KT-EMRG-500	120/277V, 60 Hz	500 Lumens	90 Minutes	NiCd	5 Years
	KT-EMRG-700	120/277V, 60 Hz	700 Lumens	90 Minutes	NiCd	5 Years
	KT-EMRG-1400	120/277V, 60 Hz	1400 Lumens	90 Minutes	NiCd	5 Years
T8 & T12 Linear Slim Can						
1-4	KT-EMRG-500-SL	120/277V, 60 Hz	500 Lumens	90 Minutes	NiCd	5 Years
	KT-EMRG-700-SL	120/277V, 60 Hz	700 Lumens	90 Minutes	NiCd	5 Years
	KT-EMRG-1400-SL	120/277V, 60 Hz	1400 Lumens	90 Minutes	NiCd	5 Years
T5 Linear						
1-4	KT-EMRG-500-T5	120/277V, 60 Hz	500 Lumens	90 Minutes	NiCd	5 Years
	KT-EMRG-800-T5	120/277V, 60 Hz	800 Lumens	90 Minutes	NiCd	5 Years
	KT-EMRG-1300-T5*	120/277V, 60 Hz	1300 Lumens	90 Minutes	NiCd	5 Years

*Compatible for use with Keystone 12W, 14W, or 17W SmartDrive LED Tubes

COMPACT FLUORESCENT EMERGENCY BALLASTS

No. of Lamps in Fixture	Catalog Number	Lamp Type	Input Voltage	Light Output	Illumination Time	Battery	Warranty
1-4	KT-EMRG-650-CFL2	2-Pin CFL	120/277V, 60Hz	650 Lumens	90 Minutes	NiCd	5 Years
	KT-EMRG-750-CFL4	4-Pin CFL	120/277V, 60Hz	750 Lumens	90 Minutes	NiCd	5 Years



T8 LINEAR

Nominal Wattage	Nominal Length	Catalog Number	Case Quantity	CRI	Initial Lumens	Mean Lumens	Rated Average Life		Lumen Maintenance	CEE Qualified
							3-hr/Start	12-hr/Start		
High Performance Linear T8 Lamps (Medium Bi-Pin, G13 Base)										
17W	24"	KTL-F17T8-8xx-HP	25	85	1380	1300	30,000 Hours	36,000 Hours	94%	N/A
25W	36"	KTL-F25T8-8xx-HP	25	85	2275	2140	30,000 Hours	36,000 Hours	94%	N/A
25W	48"	KTL-F25T8ES-8xx-HP	25	85	2500	2350	30,000 Hours	36,000 Hours	94%	N/A
28W	48"	KTL-F28T8ES-8xx-HP	25	85	2725	2560	30,000 Hours	36,000 Hours	94%	Yes
32W	48"	KTL-F32T8-8xx-HP	25	85	3100	2915	30,000 Hours	36,000 Hours	94%	Yes
32W	48"	KTL-F32T8-8xx-XHP	25	85	3200	3010	30,000 Hours	36,000 Hours	94%	Yes
32W	48"	KTL-F32T8-8xx-XL	25	85	3100	2915	42,000 Hours	48,000 Hours	94%	Yes

T5 LINEAR

Nominal Wattage	Nominal Length	Catalog Number	Case Quantity	CRI	Initial Lumens	Mean Lumens	Rated Average Life		Lumen Maintenance
							3-hr/Start	12-hr/Start	
High Efficiency Linear T5 Lamps (Miniature Bi-Pin, G5 Base)									
14W	24"	KTL-F14T5-8xx-HE	25	85	1350	1265	24,000 Hours	30,000 Hours	94%
21W	36"	KTL-F21T5-8xx-HE	25	85	2200	2060	24,000 Hours	30,000 Hours	94%
28W	48"	KTL-F28T5-8xx-HE	25	85	2900	2725	24,000 Hours	30,000 Hours	94%
High Output Linear T5 Lamps (Miniature Bi-Pin, G5 Base)									
49W	48"	KTL-F49T5-8xx-HO	25	85	4900	4600	24,000 Hours	30,000 Hours	94%
54W	48"	KTL-F54T5-8xx-HO	25	85	5000	4700	24,000 Hours	30,000 Hours	94%

T12 LINEAR

Nominal Wattage	Nominal Length	Catalog Number	Case Quantity	Color Temperature	CRI	Initial Lumens	Mean Lumens	Rated Average Life		Lumen Maintenance
								3-hr/Start	12-hr/Start	
2012 DOE Compliant Linear T12 Lamps (Medium Bi-Pin, G13 Base)										
40W	48"	KTL-F40T12-841-CWX	30	4100K	89	2500	2250	24,000 Hours	30,000 Hours	90%

T9 CIRCULAR

Nominal Wattage	Diameter	Catalog Number	Case Quantity	Color Temperature	CRI	Initial Lumens	Mean Lumens	Rated Average Life (3-hr/Start)	Lumen Maintenance
Circular T9 Lamps (4-Pin, G10q Base)									
22W	8"	KTL-FC8T9-CW	12	4100K	60	1120	920	10,000 Hours	82%
22W	8"	KTL-FC8T9-DL	12	6500K	76	980	805	10,000 Hours	82%
32W	12"	KTL-FC12T9-CW	12	4100K	60	1930	1582	10,000 Hours	82%
32W	12"	KTL-FC12T9-DL	12	6500K	76	1675	1373	10,000 Hours	82%
40W	16"	KTL-FC16T9-CW	12	4100K	60	2950	2420	10,000 Hours	82%
40W	16"	KTL-FC16T9-DL	12	6500K	76	2450	2010	10,000 Hours	82%

*8xx denotes several color temperatures available:

835	800 Series, 3500K	841	800 Series, 4100K	850	800 Series, 5000K	865	800 Series, 6500K
------------	-------------------	------------	-------------------	------------	-------------------	------------	-------------------

FLUORESCENT BALLASTS



T12

Primary Lamp Type	No. of Lamps	Input Voltage	Catalog Number	Warranty	Description
F20T12	1	120V	KTEB-120-1-TP-EMI	3 Years	1 Lite F20T12, FCC Class B, Normal Power Factor
	2	120V	KTEB-220-1-TP-EMI	3 Years	2 Lite F20T12, FCC Class B, Normal Power Factor
F40T12	1	120V	KTEB-140-1-TP-EMI	3 Years	1 Lite F40T12, FCC Class B, Normal Power Factor
	2	120V	KTEB-240-1-TP-PIC	3 Years	2 Lite F40T12, F40T12ES, and F34T12 High Power Factor
		120-277V	KTEB-240-UV-TP-PIC	3 Years	2 Lite F40T12, F40T12ES, and F34T12 High Power Factor
F96T12	2	120V	KTEB-275-1-TP-PIC-SL	3 Years	1 or 2 Lite F96T12 and F96T12ES, 9" Case
		120-277V	KTEB-275-UV-TP-PIC	3 Years	1 or 2 Lite F96T12 and F96T12ES
			KTEB-275-UV-TP-PIC-SL	3 Years	1 or 2 Lite F96T12 and F96T12ES, 9" Case
F96T12HO	2	120V	KTEB-2110-1-TP-PIC	3 Years	1 or 2 Lite F96T12HO and F96T12HOES
		120-277V	KTEB-2110-UV-TP-PIC	3 Years	1 or 2 Lite F96T12HO and F96T12HOES

T8 INSTANT START

Primary Lamp Type	No. of Lamps	Input Voltage	Catalog Number	Warranty	Light Output	Description
F17T8 F25T8 F32T8*	2	120-277V	KTEB-232-UV-IS-L-P	5 Years	Low	1 or 2 Lite F17/25/32 T8, Reduced Output
			KTEB-232-UV-IS-N-P	5 Years	Normal	1 or 2 Lite F17/25/32 T8, Standard Output
			KTEB-232-UV-IS-H-P	5 Years	High	1 or 2 Lite F17/25/32 T8, High Output
			347V	KTEB-232-3-IS-N-P	5 Years	Normal
	3	120-277V	KTEB-332-UV-IS-L-P	5 Years	Low	2 or 3 Lite F17/25/32 T8, Reduced Output
			KTEB-332-UV-IS-N-P	5 Years	Normal	2 or 3 Lite F17/25/32 T8, Standard Output
			KTEB-332-UV-IS-H-P	5 Years	High	2 or 3 Lite F17/25/32 T8, High Output
	4	120-277V	KTEB-432-UV-IS-L-P	5 Years	Low	3 or 4 Lite F17/25/32 T8, Reduced Output
			KTEB-432-UV-IS-N-P	5 Years	Normal	3 or 4 Lite F17/25/32 T8, Standard Output
			KTEB-432-UV-IS-H-P	5 Years	High	3 or 4 Lite F17/25/32 T8, High Output
		347V	KTEB-432-3-IS-N-P	5 Years	High	3 or 4 Lite F17/25/32/40 T8, High Output
F96T8	2	120-277V	KTEB-259-UV-IS-N	5 Years	Normal	1 or 2 Lite F96T8, Standard Output
F96T8HO	2	120-277V	KTEB-286HO-UV-IS-N	5 Years	Normal	1 or 2 Lite F96T8HO, Standard Output

*F32T8 lamps including F32T8 (25W), F32T8 (28W), F32T8 (30W) and F32T8 (32W)

T8 PROGRAM START

Primary Lamp Type	No. of Lamps	Input Voltage	Catalog Number	Warranty	Light Output	Description
F17T8 F25T8 F32T8*	1	120-277V	KTEB-132-UV-PS-N-P	5 Years	Normal	1 Lite F17/25/32 T8, Standard Output
	2	120-277V	KTEB-232-UV-PS-VDIM	5 Years	Normal	2 Lite F17/25/32 T8, 0-10V Dimming
			KTEB-232-UV-PS-L-P	5 Years	Low	1 or 2 Lite 17/25/32 T8, Reduced Output
			KTEB-232-UV-PS-N-P	5 Years	Normal	1 or 2 Lite F17/25/32 T8, Standard Output
			KTEB-232-UV-PS-H-P	5 Years	High	1 or 2 Lite F17/25/32 T8, High Output
	3	120-277V	KTEB-332-UV-PS-L-P	5 Years	Low	2 or 3 Lite F17/25/32 T8, Reduced Output
			KTEB-332-UV-PS-N-P	5 Years	Normal	2 or 3 Lite F17/25/32 T8, Standard Output
			KTEB-332-UV-PS-H-P	5 Years	High	2 or 3 Lite F17/25/32 T8, High Output
	4	120-277V	KTEB-432-UV-PS-L-P	5 Years	Low	3 or 4 Lite F17/25/32 T8, Reduced Output
			KTEB-432-UV-PS-N-P	5 Years	Normal	3 or 4 Lite F17/25/32 T8, Standard Output
F58T8, F70T8	2	120-277V	KTEB-270-UV-PS-N /C1	5 Years	Normal	1 or 2 Lite F58/70 T8, Freezer Ballast with Molex Connectors
F96T8HO	2	120-277V	KTEB-286HO-UV-PS-N	5 Years	Normal	1 or 2 Lite F96T8HO, Standard Output

*F32T8 lamps including F32T8 (25W), F32T8 (28W), F32T8 (30W) and F32T8 (32W) except KTEB-232-UV-PS-VDIM



T5

Primary Lamp Type	No. of Lamps	Input Voltage	Catalog Number	Warranty	Description
F14T5, F21T5, F28T5	1 or 2	120-277V	KTEB-228HE-UV-PS	5 Years	1 or 2 Lite F14/21/28 T5 Program Start, 90°C Rated
			KTEB-228HE-UV-PS-SL	5 Years	1 or 2 Lite F14/21/28 T5 Program Start, 90°C Rated, 9" Case

T5HO

Primary Lamp Type	No. of Lamps	Input Voltage	Catalog Number	Warranty	Description
F24T5HO	1 or 2	120-277V	KTEB-224HO-UV-PS	5 Years	1 or 2 Lite F24T5HO Program Start, 90°C Rated
			KTEB-224HO-UV-PS-SL	5 Years	1 or 2 Lite F24T5HO Program Start, 90°C Rated, 9" Case
			KTEB-239HO-UV-PS	5 Years	1 or 2 Lite F24T5HO or F39T5HO Program Start, 90°C Rated
			KTEB-239HO-UV-PS-SL	5 Years	1 or 2 Lite F24T5HO or F39T5HO Program Start, 90°C Rated, 9" Case
F39T5HO	1 or 2	120-277V	KTEB-239HO-UV-PS	5 Years	1 or 2 Lite F24T5HO or F39T5HO Program Start, 90°C Rated
			KTEB-239HO-UV-PS-SL	5 Years	1 or 2 Lite F24T5HO or F39T5HO Program Start, 90°C Rated, 9" Case
F54T5HO	1 or 2	120-277V	KTEB-254HO-UV-PS	5 Years	1 or 2 Lite F54T5HO Program Start, 90°C Rated
			KTEB-254HO-UV-PS-SL	5 Years	1 or 2 Lite F54T5HO Program Start, 90°C Rated, 9" Case
	3 or 4	120-277V	KTEB-454HO-UV-PS	5 Years	3 or 4 Lite F54T5HO Program Start, 90°C Rated

COMPACT FLUORESCENT

Primary Lamp Type	No. of Lamps	Input Voltage	Catalog Number	Warranty	Description
9W CFL	1	120V	CC579TP	3 Years	5, 7, 9W, 2-Pin CFL, Magnetic
13W CFL	1	120V	CC1322TP	3 Years	13W, 2-Pin CFL, Magnetic
			113SHPTP	3 Years	1 Lite 13W 2-Pin CFL, High Power Factor, Magnetic
	1 or 2	120-277V	KTEB-213-UV-PS-DW	5 Years	1 or 2 Lite 13W 4-Pin CFL, Program Start
18W CFL	1 or 2	120-277V	KTEB-213-UV-RS-DW	5 Years	1 or 2 Lite 13W 4-Pin CFL, Rapid Start
			KTEB-213-UV-RS-DW-KIT	5 Years	1 or 2 Lite 13W 4-Pin CFL, Kit includes Wires/Stud Plate
			KTEB-218-UV-PS-DW	5 Years	1 or 2 Lite 18W 4-Pin CFL, Program Start
26W CFL	1 or 2	120-277V	KTEB-218-UV-RS-DW	5 Years	1 or 2 Lite 18W 4-Pin CFL, Rapid Start
			KTEB-218-UV-RS-DW-KIT	5 Years	1 or 2 Lite 18W 4-Pin CFL, Kit includes Wires/Stud Plate
			KTEB-226-UV-PS-DW	5 Years	1 or 2 Lite 26W 4-Pin CFL, Program Start
42W CFL	1 or 2	120-277V	KTEB-226-UV-RS-DW	5 Years	1 or 2 Lite 26W 4-Pin CFL, Rapid Start
			KTEB-226-UV-RS-DW-KIT	5 Years	1 or 2 Lite 26W 4-Pin CFL, Kit includes Wires/Stud Plate
			KTEB-242-UV-PS-DW	5 Years	1 or 2 Lite 42W 4-Pin CFL, Program Start
			KTEB-242-UV-RS-DW	5 Years	1 or 2 Lite 42W 4-Pin CFL, Rapid Start
			KTEB-242-UV-RS-DW-KIT	5 Years	1 or 2 Lite 42W 4-Pin CFL, Kit includes Wires/Stud Plate

CIRCLINE

Primary Lamp Type	No. of Lamps	Input Voltage	Catalog Number	Warranty	Description
FC8T9	1	120V	SS22WSTP	3 Years	22W Circline, Small Case, Self-Start, Magnetic with Sockets
FC22T9	1	120V	KTEB-1C22-1-TP-WS	3 Years	1 Lite 22W, Small Case, with Sockets
FC32T9 or FC40T9	1	120V	KTEB-140-1-TP-EMI-WS	3 Years	1 Lite 32 or 40W, with Sockets
	1	120V	KTEB-140-1-TP-EMI-WS	3 Years	1 Lite 32 or 40W, with Sockets
FC22T9 & FC32T9 or FC32T9 & FC40T9	2	120V	KTEB-2C72-1-TP-WS	3 Years	2 Lite 22W & 32W or 32 & 40W, with Sockets

SIGN BALLASTS



SMARTWIRE™ ELECTRONIC SIGN BALLASTS

• **SMARTWIRE Technology:** Wires exactly the same as traditional magnetic ballasts for seamless compatibility and installation.

• **Lightweight:** Using solid-state technology, SmartWire electronic sign ballasts weigh **up to 50% less** than heavy magnetic ballasts, making transporting and handling significantly easier.

• **2014 DOE Compliant:** All SmartWire electronic sign ballasts exceed the energy efficiency levels mandated by the DOE and are at least 10% more energy efficient than traditional magnetic sign ballasts.

• **Versatile:** Just 5 SmartWire ballasts operate both T8HO and T12HO lamps, reducing inventory without sacrificing application options.

Additional Features: Series Wiring • Minimum Starting Temperature of -30°C/-20°F • 120V Input

Total T8HO Lamp Footage Permitted (in Feet)

	2	4	6	8	10	12	14	16	18	20	22	24	26	28	30	32	34	36	38	40	42	44	46	48						
1	KTSB-E-0208-11-1-S																													
1-2	KTSB-E-0416-12-1-S																													
2-3	KTSB-E-0824-23-1-S																													
2-4	KTSB-E-0832-24-1-S																													
4-6	KTSB-E-2448-46-1-S																													

Total T12HO Lamp Footage Permitted (in Feet)

	2	4	6	8	10	12	14	16	18	20	22	24	26	28	30	32	34	36	38	40	42	44	46	48						
1	KTSB-E-0208-11-1-S																													
1-2	KTSB-E-0416-12-1-S																													
2-3	KTSB-E-0824-23-1-S																													
2-4	KTSB-E-0832-24-1-S																													
4-6	KTSB-E-2448-46-1-S																													

Input Voltage	No. of Lamps	Combined Lamp Length	Catalog Number	Description
T12HO				
120V	1	2-8 Feet	KTSB-E-0208-11-1-S	1 T12HO Lamp with Combined Length of 2-8 Feet
	1-2	4-16 Feet	KTSB-E-0416-12-1-S	1-2 T12HO Lamps with Combined Length of 4-16 Feet
	2-3	8-24 Feet	KTSB-E-0824-23-1-S	2-3 T12HO Lamps with Combined Length of 8-24 Feet
	2-4	8-32 Feet	KTSB-E-0832-24-1-S	2-4 T12HO Lamps with Combined Length of 8-32 Feet
	4-6	24-48 Feet	KTSB-E-2448-46-1-S	4-6 T12HO Lamps with Combined Length of 24-48 Feet
T8HO				
120V	1	2-8 Feet	KTSB-E-0208-11-1-S	1 T8HO Lamp with Combined Length of 2-8 Feet
	1-2	4-12 Feet	KTSB-E-0416-12-1-S	1-2 T8HO Lamps, with Combined Length of 4-12 Feet
	2-3	8-18 Feet	KTSB-E-0824-23-1-S	2-3 T8HO Lamps with Combined Length of 8-18 Feet
	2-4	8-24 Feet	KTSB-E-0832-24-1-S	2 or 4 T8HO Lamps with Combined Length of 8-24 Feet
	4-6	18-36 Feet	KTSB-E-2448-46-1-S	4 or 6 T8HO Lamps with Combined Length of 18-36 Feet



PARALLELWIRE

ELECTRONIC SIGN BALLASTS

Total T8HO Lamp Footage Permitted (in Feet)

		2	4	6	8	10	12	14	16	18	20	22	24	26	28	30	32	34	36	38	40	42	44	46	48	
Lamps Per Ballast	1-2	KTSB-E-0216-12-UV																								
	1-4	KTSB-E-0432-14-UV																								
		KTSB-E-1040-14-UV																								
	4-6	KTSB-E-0848-46-UV																								

Total T12HO Lamp Footage Permitted (in Feet)

		2	4	6	8	10	12	14	16	18	20	22	24	26	28	30	32	34	36	38	40	42	44	46	48	
Lamps Per Ballast	1-2	KTSB-E-0216-12-UV																								
	1-4	KTSB-E-0432-14-UV																								
		KTSB-E-1040-14-UV																								
	4-6	KTSB-E-0848-46-UV																								

Input Voltage	No. of Lamps	Combined Lamp Length	Catalog Number	Description
T12HO				
120-277	1-2	2-16 Feet	KTSB-E-0216-12-UV	1-2 T12HO Lamps with Combined Length of 2-16 feet*
	1-4	4-32 Feet	KTSB-E-0432-14-UV	1-4 T12HO Lamps with Combined Length of 4-32 feet*
		10-40 Feet	KTSB-E-1040-14-UV	1-4 T12HO Lamps with Combined Length of 10-40 feet
	4-6	8-48 Feet	KTSB-E-0848-46-UV	4-6 T12HO Lamps with Combined Length of 8-48 feet*
T8HO				
120-277	1-2	4-12 Feet	KTSB-E-0216-12-UV	1-2 T8HO Lamps with Combined Length of 4-12 feet*
	1-4	4-24 Feet	KTSB-E-0432-14-UV	1-4 T8HO Lamps with Combined Length of 4-24 feet*
		8-32 Feet	KTSB-E-1040-14-UV	1-4 T8HO Lamps with Combined Length of 8-32 feet*
	4-6	16-36 Feet	KTSB-E-0848-46-UV	4-6 T8HO Lamps with Combined Length of 16-36 feet*

*For use only with lamps 8' and shorter



METAL HALIDE BALLAST KITS

Lamp Wattage	No. of Taps	Input Voltage	Catalog Number	Description
50W	Quad	120/208/240/277V	MH-50X-Q-KIT	50W (M110) Metal Halide Ballast Kit
70W	Quad	120/208/240/277V	MH-70X-Q-KIT	70W (M98) Metal Halide Ballast Kit
100W	Quad	120/208/240/277V	MH-100X-Q-KIT	100W (M90) Metal Halide Ballast Kit
150W	Quad	120/208/240/277V	MH-150X-Q-KIT	150W (M102) Metal Halide Ballast Kit
175W	Quad	120/208/240/277V	MH-175A-Q-KIT	175W (M57) Metal Halide Ballast Kit
	5-Tap	120/208/240/277/480V	MH-175A-P-KIT	175W (M57) Metal Halide Ballast Kit
250W	Single	480V	MH-250A-480-KIT	250W (M58) Metal Halide Ballast Kit
	Quad	120/208/240/277V	MH-250A-Q-KIT	250W (M58) Metal Halide Ballast Kit
	5-Tap	120/208/240/277/480V	MH-250A-P-KIT	250W (M58) Metal Halide Ballast Kit
400W	Single	480V	MH-400A-480-KIT	400W (M59) Metal Halide Ballast Kit
	Quad	120/208/240/277V	MH-400A-Q-KIT	400W (M59) Metal Halide Ballast Kit
	5-Tap	120/208/240/277/480V	MH-400A-P-KIT	400W (M59) Metal Halide Ballast Kit
1000W	Single	480V	MH-1000A-480-KIT	1000W (M47) Metal Halide Ballast Kit
	Quad	120/208/240/277V	MH-1000A-Q-KIT	1000W (M47) Metal Halide Ballast Kit
	5-Tap	120/208/240/277/480V	MH-1000A-P-KIT	1000W (M47) Metal Halide Ballast Kit
1500W	Quad	120/208/240/277V	MH-1500A-Q-KIT	1500W (M48) Metal Halide Ballast Kit
	5-Tap	120/208/240/277/480V	MH-1500A-P-KIT	1500W (M48) Metal Halide Ballast Kit

Each kit includes the ballast pre-wired to a properly rated capacitor and ignitor (if required), mounting hardware, and pictorial installation guide.

IGNITORS

0.04 in	Lamp Type	Wattage	Type
IGN-XG-04	Probe Start Metal Halide	50-150W	HX

CAPACITORS

Catalog Number	Lamp Type	Wattage	Microfarad	Voltage	Type
CAP-50MH	Metal Halide	50W	6 μ F	280V	Dry Film
CAP-70MH	Metal Halide	70W	8 μ F	280V	Dry Film
CAP-100MH	Metal Halide	100W	12 μ F	280V	Dry Film
CAP-150MH	Metal Halide	150W	16 μ F	280V	Dry Film
CAP-175MH	Metal Halide	175W	10 μ F	400V	Dry Film
CAP-250MH	Metal Halide	250W	15 μ F	400V	Dry Film
CAP-400MH	Metal Halide	400W	24 μ F	400V	Dry Film
CAP-1000MH	Metal Halide	1000W	24 μ F	480V	Oil Filled
CAP-1500MH	Metal Halide	1500W	32 μ F	525V	Oil Filled

METAL HALIDE F-CAN BALLASTS

Lamp Wattage	No. of Taps	Input Voltage	Catalog Number	Description
50W	Dual	120/277V	MH-50X-D-FCAN	50W (M110) Metal Halide F-Can
70W	Dual	120/277V	MH-70X-D-FCAN	70W (M98) Metal Halide F-Can
100W	Dual	120/277V	MH-100X-D-FCAN	100W (M90) Metal Halide F-Can
150W	Dual	120/277V	MH-150X-D-FCAN	150W (M102) Metal Halide F-Can
175W	Dual	120/277V	MH-175A-D-FCAN	175W (M57) Metal Halide F-Can
250W	Dual	120/277V	MH-250A-D-FCAN	250W (M58/H37) Metal Halide F-Can
400W	Dual	120/277V	MH-400A-D-FCAN	400W (M59) Metal Halide F-Can



RoHS
Compliant

2 YEAR
WARRANTY

HID

PULSE START METAL HALIDE



PULSE START METAL HALIDE BALLAST KITS

Lamp Wattage	No. of Taps	Input Voltage	Catalog Number	Description
50W	Quad	120/208/240/277V	MH-50X-Q-KIT	50W (M110) Metal Halide Ballast Kit
70W	Quad	120/208/240/277V	MH-70X-Q-KIT	70W (M98) Metal Halide Ballast Kit
100W	Quad	120/208/240/277V	MH-100X-Q-KIT	100W (M90) Metal Halide Ballast Kit
150W	Quad	120/208/240/277V	MH-150X-Q-KIT	150W (M102) Metal Halide Ballast Kit
175W	Quad	120/208/240/277V	MPS-175A-Q-KIT	175W Pulse Start (M137) Metal Halide Ballast Kit, EISA Compliant
	5 Tap	120/208/240/277/480V	MPS-175A-P-KIT	175W Pulse Start (M137) Metal Halide Ballast Kit, EISA Compliant
200W	5 Tap	120/208/240/277/480V	MPS-200A-P-KIT	200W Pulse Start (M136) Metal Halide Ballast Kit, EISA Compliant
250W	Quad	120/208/240/277V	MPS-250A-Q-KIT	250W Pulse Start (M138) Metal Halide Ballast Kit, EISA Compliant
	5 Tap	120/208/240/277/480V	MPS-250A-P-KIT	250W Pulse Start (M138) Metal Halide Ballast Kit, EISA Compliant
320W	Quad	120/208/240/277V	MPS-320A-Q-KIT	320W Pulse Start (M132) Metal Halide Ballast Kit, EISA Compliant
	5 Tap	120/208/240/277/480V	MPS-320A-P-KIT	320W Pulse Start (M132) Metal Halide Ballast Kit, EISA Compliant
350W	Quad	120/208/240/277V	MPS-350A-Q-KIT	350W Pulse Start (M131) Metal Halide Ballast Kit, EISA Compliant
	5 Tap	120/208/240/277/480V	MPS-350A-P-KIT	350W Pulse Start (M131) Metal Halide Ballast Kit, EISA Compliant
400W	Single	480V	MPS-400A-480-KIT	400W Pulse Start (M135) Metal Halide Ballast Kit, EISA Compliant
	Quad	120/208/240/277V	MPS-400A-Q-KIT	400W Pulse Start (M135) Metal Halide Ballast Kit, EISA Compliant
	5 Tap	120/208/240/277/480V	MPS-400A-P-KIT	400W Pulse Start (M135) Metal Halide Ballast Kit, EISA Compliant
450W	Quad	120/208/240/277V	MPS-450A-Q-KIT	450W Pulse Start (M144) Metal Halide Ballast Kit, EISA Compliant
	5 Tap	120/208/240/277/480V	MPS-450A-P-KIT	450W Pulse Start (M144) Metal Halide Ballast Kit, EISA Compliant
750W	Quad	120/208/240/277V	MPS-750A-Q-KIT	750W Pulse Start (M149) Metal Halide Ballast Kit
	5 Tap	120/208/240/277/480V	MPS-750A-P-KIT	750W Pulse Start (M149) Metal Halide Ballast Kit
1000W	Quad	120/208/240/277V	MPS-1000A-Q-KIT	1000W Pulse Start (M141) Metal Halide Ballast Kit
	5 Tap	120/208/240/277/480V	MPS-1000A-P-KIT	1000W Pulse Start (M141) Metal Halide Ballast Kit

Each kit includes the ballast pre-wired to a properly rated capacitor and ignitor (if required), mounting hardware, and pictorial installation guide.

IGNITORS

Catalog Number	Lamp Type	Wattage	Type
IGN-XG-03	Pulse Start Metal Halide	1000W	CWA
IGN-XG-03/A	Pulse Start Metal Halide	750W	CWA
IGN-XG-04	Pulse Start Metal Halide	50-450W	HX

CAPACITORS

Catalog Number	Lamp Type	Wattage	Microfarad	Voltage	Type
CAP-70MH	Metal Halide	70W	8 μ F	280V	Dry Film
CAP-100MH	Metal Halide	100W	12 μ F	280V	Dry Film
CAP-150MH	Metal Halide	150W	16 μ F	280V	Dry Film
CAP-175MPS	Pulse Start Metal Halide	175W	11 μ F	400V	Dry Film
CAP-200MPS	Pulse Start Metal Halide	200W	15 μ F	330V	Dry Film
CAP-250MPS	Pulse Start Metal Halide	250W	17 μ F	400V	Dry Film
CAP-320MPS	Pulse Start Metal Halide	320W	21 μ F	345V	Dry Film
CAP-350MPS	Pulse Start Metal Halide	350W	22.5 μ F	345V	Dry Film
CAP-400MPS	Pulse Start Metal Halide	400W	26 μ F	330V	Dry Film
CAP-450MPS	Pulse Start Metal Halide	450W	26.5 μ F	400V	Dry Film
CAP-750MPS	Pulse Start Metal Halide	750W	28 μ F	400V	Oil Filled
CAP-1000MPS	Pulse Start Metal Halide	1000W	24 μ F	480V	Oil Filled



HIGH PRESSURE SODIUM BALLAST KITS

Lamp Wattage	No. of Taps	Input Voltage	Catalog Number	Description
35W	Single	120V	HPS-35R-1-KIT	35W (S76) High Pressure Sodium Ballast Kit
50W	Single	120V	HPS-50R-1-KIT	50W (S68) High Pressure Sodium Ballast Kit
70W	Single	120V	HPS-70R-1-KIT	70W (S62) High Pressure Sodium Ballast Kit
	Quad	120/208/240/277V	HPS-70X-Q-KIT	70W (S62) High Pressure Sodium Ballast Kit
100W	Single	120V	HPS-100R-1-KIT	100W (S54) High Pressure Sodium Ballast Kit
	Quad	120/208/240/277V	HPS-100X-Q-KIT	100W (S54) High Pressure Sodium Ballast Kit
150W	Single	120V	HPS-150R-1-KIT	150W (S55) High Pressure Sodium Ballast Kit
	Quad	120/208/240/277V	HPS-150X-Q-KIT	150W (S55) High Pressure Sodium Ballast Kit
250W	Quad	120/208/240/277V	HPS-250A-Q-KIT	250W (S50) High Pressure Sodium Ballast Kit
	5-Tap	120/208/240/277/480V	HPS-250A-P-KIT	250W (S50) High Pressure Sodium Ballast Kit
400W	Single	480V	HPS-400A-480-KIT	400W (S51) High Pressure Sodium Ballast Kit
	Quad	120/208/240/277V	HPS-400A-Q-KIT	400W (S51) High Pressure Sodium Ballast Kit
	5-Tap	120/208/240/277/480V	HPS-400A-P-KIT	400W (S51) High Pressure Sodium Ballast Kit
600W	Quad	120/208/240/277V	HPS-600A-Q-KIT	600W (S106) High Pressure Sodium Ballast Kit
1000W	Quad	120/208/240/277V	HPS-1000A-Q-KIT	1000W (S52) High Pressure Sodium Ballast Kit
	5-Tap	120/208/240/277/480V	HPS-1000A-P-KIT	1000W (S52) High Pressure Sodium Ballast Kit

Each kit includes the ballast pre-wired to a properly rated capacitor and ignitor (if required), mounting hardware, and pictorial installation guide.

IGNITORS

Catalog Number	Lamp Type	Wattage	Type
IGN-XG-01	High Pressure Sodium	35-150W	Reactor, HX
IGN-XG-02	High Pressure Sodium	250-400W	CWA
IGN-XG-03	High Pressure Sodium	1000W	CWA
IGN-XG-06	High Pressure Sodium	600W	CWA

CAPACITORS

Catalog Number	Lamp Type	Wattage	Microfarad	Voltage	Type
CAP-70HPS	High Pressure Sodium	70W	7 μ F	280V	Dry Film
CAP-100HPS	High Pressure Sodium	100W	10 μ F	280V	Dry Film
CAP-150HPS	High Pressure Sodium	150W	14 μ F	280V	Dry Film
CAP-250HPS	High Pressure Sodium	250W	35 μ F	240V	Dry Film
CAP-400HPS	High Pressure Sodium	400W	55 μ F	300V	Dry Film
CAP-1000HPS	High Pressure Sodium	1000W	26 μ F	525V	Oil Filled



12V HALOGEN TRANSFORMERS



Max. Input Power	Input Voltage	Catalog Number	Input Current	Output Voltage	Dimmable	Remarks
60W	120V	KTET-60-1-WC-F	0.50A	11V	No	With Cord and Fuse
		KTET-60-1-SCP-DIM-AL	0.50A	12V	Yes	Class 2, Short Circuit Protected, Aluminum Case
75W	120V	KTET-75-1-SCP-EMI	0.63A	11V	No	Short Circuit Protected, EMI Filter
		KTET-75-1-SCP-DIM-RJS	0.62A	11V	Yes	With Rear Mount Studs and Leads for J-Box Application
		KTET-75-1-SCP-DIM-HV-AL	0.59A	12V	Yes	With Aluminum Case, Side Leads
	277V	KTET-75-2-SCP-RJS	0.26A	11V	No	With Rear Mount Studs and Leads for J-Box Application
150W	120V	KTET-150-1-SCP-DIM	1.27A	11.4V	Yes	Short Circuit Protected, Aluminum Case

STEP DOWN TRANSFORMERS



Catalog Number	INPUT CHARACTERISTICS			OUTPUT CHARACTERISTICS		
	Input Voltage	Input Current at Max. Load	Input Current at No Load	Output Voltage	Max. Load	Max Output Current
KTAT-375-480-277 /A	480V	0.86A	0.21A	277V	375VA	1.35A
	347V	0.86A	0.11A	200V	270VA	1.35A
KTAT-250-480-277 /A	480V	0.57A	0.16A	277V	250VA	0.90A
	347V	0.57A	0.11A	200V	180VA	0.90A
KTAT-70-347-277	347V	0.23A	0.07A	277V	70VA	0.27A
KTAT-70-347-277-RJS	347V	0.23A	0.07A	277V	70VA	0.27A
KTAT-70-480-277	480V	0.16A	0.06A	277V	70VA	0.25A
	347V	0.22A	0.08A	277V	70VA	0.25A
KTAT-70-480-277-RJS	480V	0.16A	0.06A	277V	70VA	0.25A
	347V	0.22A	0.08A	277V	70VA	0.25A
KTAT-30-347-277	347V	0.11A	0.05A	277V	30VA	0.13A
KTAT-30-347-277-RJS	347V	0.11A	0.05A	277V	30VA	0.13A



STANDARD HIGH BAY OCCUPANCY SENSORS

Catalog Number	Frequency	Maximum Load Rating	Power Consumption
HBE-PIR-120/277/347	50/60Hz	800VA @ 120VAC	0.2W @ 120VAC
		1200VA @ 277VAC	1.0W @ 277VAC
		1500VA @ 347VAC	2.0W @ 347VAC

ACCESSORIES FOR STANDARD HIGH BAY OCCUPANCY SENSORS (Sold Separately)

Catalog Number	Description
HBE-EXBT	Extender Bracket for High Bay Motion Sensor; Lowers Sensor for Optimum Field of View
HBE-LENS-AISLE	Interchangeable Lens - Aisle Way Fresnel Pattern
HBE-LENS-360	Interchangeable Lens - 360° View Fresnel Pattern

WET LOCATION OCCUPANCY SENSORS

Catalog Number	Frequency	Maximum Load Rating	Power Consumption	Features
HBE-PIR-120-277-IP65	50/60Hz	800VA @ 120VAC	0.07W @ 120VAC	IP65 Rated
		1200VA @ 208/240/277VAC	0.39W @ 277VAC	
HBE-PIR-347/480-IP65	50/60Hz	1500VA @ 347VAC	0.19W @ 347VAC	IP65 Rated
		2000VA @ 480VAC	0.37W @ 480VAC	

FEATURES

- Passive Infrared (PIR) Sensing Technology
- Ideal for Fluorescent or LED High Bay Fixtures in Warehouses, Manufacturing Facilities, and Other High Ceiling Applications
- LED Indicator
- No Minimum Load Requirements
- Simple Adjustable Controls for Time Delay and Day Lighting Control
- Interchangeable Lenses including Aisle Pattern View
- Low Bay Lens Included with Wet Location Sensor Only
- Embedded Relay (No External Box Required)

PERFORMANCE

- Mounting Height: Up to 40' Maximum
- Adjustable for a Variety of Time Delay and Ambient Daylight Conditions
- Operating Temperature Range: 14°F-160°F for Standard High Bay Sensors; -4°F-160°F for Wet Location Sensors
- Storage Temperature Range: 14°F-160°F for Standard High Bay Sensors; -4°F-160°F for Wet Location Sensors

PHOTOCELLS

Catalog Number	Input Voltage	Input Frequency	Maximum Input Power	Maximum Input Current	Max. Ambient Temperature
KTPS-45-1	120V	50/60Hz	45VA	1.00A	149°F/65°C
KTPS-80-1	120V	50/60Hz	80VA	0.67A	149°F/65°C

FEATURES

- Photocell Sensors utilize an industry-leading compact design to enable installation into small enclosures and fixtures.
- Available in low (45W) and high (80W) power versions to cover many applications.
- Designed to power fluorescent, incandescent, and LED loads.

LIGHT

Lighting is our legacy. It's all we've done since 1945, relentlessly developing energy efficient lighting solutions for the industry's most discerning customers. From incumbent fluorescent lighting systems through the latest LED technologies, Keystone is singularly focused on being your one-stop-shop for quality lighting products.

MADE

With more than 100 Million Keystone ballasts and LED drivers in use today, thousands of installers, architects, and engineers depend on Keystone for lighting products that are manufactured to last. We factory test 100% of every production run, so you know that when you install a Keystone product, it's made to perform.

EASY

What makes us different? We fundamentally believe that we are here to make buying and using lighting products easy. From easy-to-read installation guides to exceptionally fast quote response time and the most convenient fulfillment centers in the industry, our primary goal is to make lighting refreshingly easy.



Contact us today to experience **Light Made Easy**, only by Keystone.



Keystone Technologies • 1390 Welsh Road, North Wales, PA 19454 • Phone (800) 464-2680
Fax (888) 966-0556 • www.keystonetech.com

WAREHOUSE LOCATIONS: Atlanta, GA • Boston, MA • Charlotte, NC • Chicago, IL • Cincinnati, OH • Dallas, TX • Denver, CO • Detroit, MI
Fort Lauderdale, FL • Houston, TX • Kansas City, MO • Los Angeles, CA • Louisville, KY • Memphis, TN • Minneapolis, MN • Nashville, TN
New Orleans, LA • Philadelphia, PA • Phoenix, AZ • Portland, OR • San Francisco, CA • Syracuse, NY



LED PRODUCT GUIDE

TABLE OF CONTENTS

1 FUTURE FIT LED KITS: Linear, Circular, Rectangular, Sconce

5 SMART SAFE LED EMERGENCY BACK-UP

7 LED DRIVERS: Constant Current, Programmable Drivers, Constant Voltage, SAM Qualified LED Drivers, Dimmer Compatibility List

25 LED MODULES: Linear, Circular, Square and Rectangular, OEM LED Systems

30 LINEAR LED TUBES: SmartDrive, DirectDrive, ComboDrive

32 COMPACT LED LAMPS: SmartDrive, DirectDrive, ComboDrive



3 GENERATIONS OF FAMILY OWNERSHIP

Left: Marvin Spielman, Founder | **Center:** Fred Greenberg, President and CFO | **Right:** Ira Greenberg, CEO

Since our founding more than 65 years ago by a veteran returning home from World War II, Keystone has grown into North America's leading independently owned driver, ballast, and lighting manufacturer.

We serve the largest lighting fixture manufacturers in North America as well as thousands of local, regional, and national wholesale distributors.

Now in our third generation of family ownership, we are proud of our manufacturing heritage and our unique ability to meet the changing needs of our OEM and distributor customers. Since 1945, our dedication to product innovation and exceptional service has earned our customers' trust. No wonder why many of our customers have been loyal to us since day one!

HERE FOR YOU
SINCE
1945
CELEBRATING 70 YEARS

ONE
STOP
SHOP

Keystone is the one stop shop for all your lighting needs: LED solutions, LED tubes and lamps, ballasts and retrofit kits.



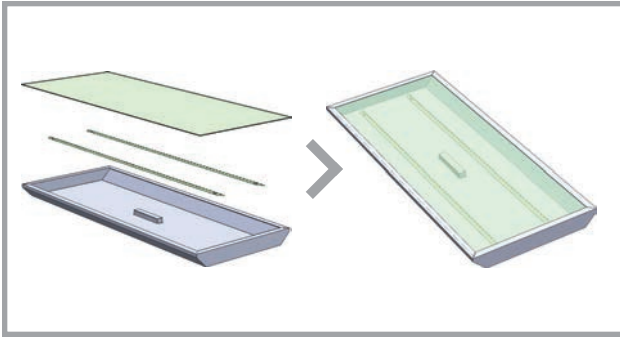

Each Pre-Assembled Kit includes (1) 0-10V Dimmable LED Driver, (2) LED Modules, Mounting Hardware, and Accessories.

2x4, 4000 LUMEN LINEAR

Color Temp	Input Voltage	LED Retrofit Kit Catalog Number	No. of Modules	Total System Drive Current	Drive Current per Module	Total System Lumens	Total Module Power	Module Efficacy	Driver Efficiency	Total System Power	Total System Efficacy
3500K	120-277V	KT-RKIT-24-4000-835-VDIM	2	1100mA	550mA	3820	30W	129 lm/W	82%	36W	106 lm/W
4000K	120-277V	KT-RKIT-24-4000-840-VDIM	2	1100mA	550mA	3860	30W	130 lm/W	82%	36W	107 lm/W
5000K	120-277V	KT-RKIT-24-4000-850-VDIM	2	1100mA	550mA	4000	30W	135 lm/W	82%	36W	111 lm/W

2x4, 5000 LUMEN LINEAR

Color Temp	Input Voltage	LED Retrofit Kit Catalog Number	No. of Modules	Total System Drive Current	Drive Current per Module	Total System Lumens	Total Module Power	Module Efficacy	Driver Efficiency	Total System Power	Total System Efficacy
3500K	120-277V	KT-RKIT-24-5000-835-VDIM	2	1100mA	550mA	4680	36W	130 lm/W	82%	44W	107 lm/W
4000K	120-277V	KT-RKIT-24-5000-840-VDIM	2	1100mA	550mA	4800	36W	133 lm/W	82%	44W	109 lm/W
5000K	120-277V	KT-RKIT-24-5000-850-VDIM	2	1100mA	550mA	5000	36W	138 lm/W	82%	44W	113 lm/W

2x2, 4000 LUMEN LINEAR

Color Temp	Input Voltage	LED Retrofit Kit Catalog Number	No. of Modules	Total System Drive Current	Drive Current per Module	Total System Lumens	Total Module Power	Module Efficacy	Driver Efficiency	Total System Power	Total System Efficacy
3500K	120-277V	KT-RKIT-22-4000-835-VDIM	2	1100mA	550mA	3820	30W	129 lm/W	82%	36W	106 lm/W
4000K	120-277V	KT-RKIT-22-4000-840-VDIM	2	1100mA	550mA	3860	30W	130 lm/W	82%	36W	107 lm/W
5000K	120-277V	KT-RKIT-22-4000-850-VDIM	2	1100mA	550mA	4000	30W	135 lm/W	82%	36W	111 lm/W

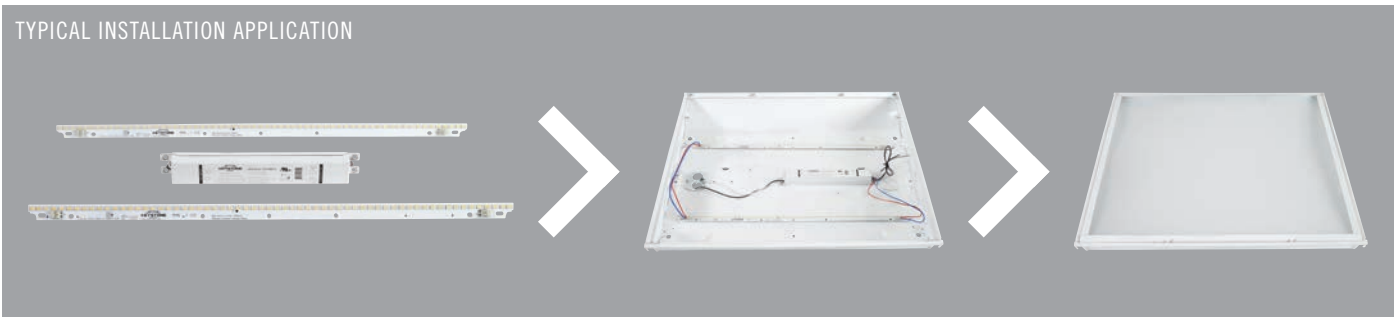

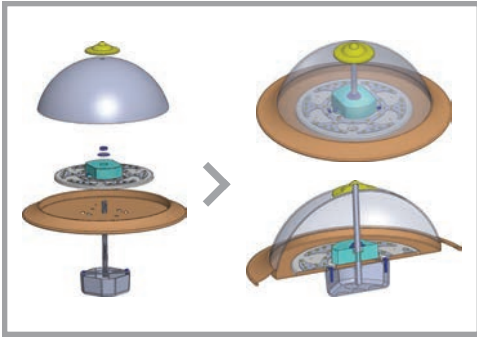

Each Pre-Assembled Kit includes (1) Dimmable LED Driver, (1) LED Module, (1) Metal Pan, Mounting Hardware, and Accessories.

8", 1600 LUMEN CIRCULAR (PHASE CONTROL DIMMING)

Color Temp	Input Voltage	LED Retrofit Kit Catalog Number	No. of Modules	Total System Drive Current	Drive Current per Module	Total System Lumens	Total Module Power	Module Efficacy	Driver Efficiency	Total System Power	Total System Efficacy
3000K	120V	KT-RKIT-CP-8-1600-830-FDIM	1	560mA	560mA	1700	13W	130 lm/W	80%	16.2W	105 lm/W
4000K	120V	KT-RKIT-CP-8-1600-840-FDIM	1	560mA	560mA	1750	13W	135 lm/W	80%	16.2W	108 lm/W
5000K	120V	KT-RKIT-CP-8-1600-850-FDIM	1	560mA	560mA	1800	13W	138 lm/W	80%	16.2W	111 lm/W

8", 1600 LUMEN CIRCULAR (0-10V DIMMING)

Color Temp	Input Voltage	LED Retrofit Kit Catalog Number	No. of Modules	Total System Drive Current	Drive Current per Module	Total System Lumens	Total Module Power	Module Efficacy	Driver Efficiency	Total System Power	Total System Efficacy
3000K	120-277V	KT-RKIT-CP-8-1600-830-VDIM	1	560mA	560mA	1700	13W	130 lm/W	80%	16.2W	105 lm/W
4000K	120-277V	KT-RKIT-CP-8-1600-840-VDIM	1	560mA	560mA	1750	13W	135 lm/W	80%	16.2W	108 lm/W
5000K	120-277V	KT-RKIT-CP-8-1600-850-VDIM	1	560mA	560mA	1800	13W	138 lm/W	80%	16.2W	111 lm/W

8", 2200 LUMEN CIRCULAR (PHASE CONTROL DIMMING)

Color Temp	Input Voltage	LED Retrofit Kit Catalog Number	No. of Modules	Total System Drive Current	Drive Current per Module	Total System Lumens	Total Module Power	Module Efficacy	Driver Efficiency	Total System Power	Total System Efficacy
3000K	120V	KT-RKIT-CP-8-2200-830-FDIM	1	560mA	560mA	2110	16.3W	129 lm/W	80%	20.4W	103 lm/W
4000K	120V	KT-RKIT-CP-8-2200-840-FDIM	1	560mA	560mA	2180	16.3W	134 lm/W	80%	20.4W	107 lm/W
5000K	120V	KT-RKIT-CP-8-2200-850-FDIM	1	560mA	560mA	2240	16.3W	137 lm/W	80%	20.4W	109 lm/W

8", 2200 LUMEN CIRCULAR (0-10V DIMMING)

Color Temp	Input Voltage	LED Retrofit Kit Catalog Number	No. of Modules	Total System Drive Current	Drive Current per Module	Total System Lumens	Total Module Power	Module Efficacy	Driver Efficiency	Total System Power	Total System Efficacy
3000K	120-277V	KT-RKIT-CP-8-2200-830-VDIM	1	560mA	560mA	2110	16.3W	129 lm/W	80%	20.4W	103 lm/W
4000K	120-277V	KT-RKIT-CP-8-2200-840-VDIM	1	560mA	560mA	2180	16.3W	134 lm/W	80%	20.4W	107 lm/W
5000K	120-277V	KT-RKIT-CP-8-2200-850-VDIM	1	560mA	560mA	2240	16.3W	137 lm/W	80%	20.4W	109 lm/W



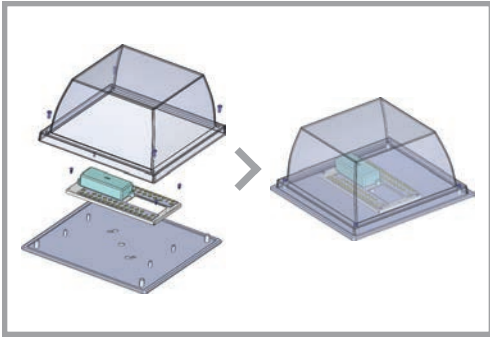

Each Pre-Assembled Kit includes (1) LED Driver, (2) LED Module, (1) Metal Pan, Mounting Hardware, and Accessories.

3"x6", 800 LUMEN RECTANGULAR

Color Temp	Input Voltage	LED Retrofit Kit Catalog Number	No. of Modules	Total System Drive Current	Drive Current per Module	Total Lumens per Module	Total System Lumens	Total Module Power	Module Efficacy	Driver Efficiency	Total System Power	Total System Efficacy
3000K	120V	KT-RKIT-RP-6-800-830	2	560mA	560mA	415	830	7W	118 lm/W	82%	8.5W	97 lm/W
4000K	120V	KT-RKIT-RP-6-800-840	2	560mA	560mA	425	850	7W	121 lm/W	82%	8.5W	100 lm/W
5000K	120V	KT-RKIT-RP-6-800-850	2	560mA	560mA	435	870	7W	124 lm/W	82%	8.5W	102 lm/W

3"x6", 1600 LUMEN RECTANGULAR

Color Temp	Input Voltage	LED Retrofit Kit Catalog Number	No. of Modules	Total System Drive Current	Drive Current per Module	Total Lumens per Module	Total System Lumens	Total Module Power	Module Efficacy	Driver Efficiency	Total System Power	Total System Efficacy
3000K	120V	KT-RKIT-RP-6-1600-830	2	560mA	560mA	775	1550	14W	110 lm/W	82%	17W	91 lm/W
4000K	120V	KT-RKIT-RP-6-1600-840	2	560mA	560mA	800	1600	14W	114 lm/W	82%	17W	94 lm/W
5000K	120V	KT-RKIT-RP-6-1600-850	2	560mA	560mA	825	1650	14W	118 lm/W	82%	17W	97 lm/W

TYPICAL INSTALLATION APPLICATION

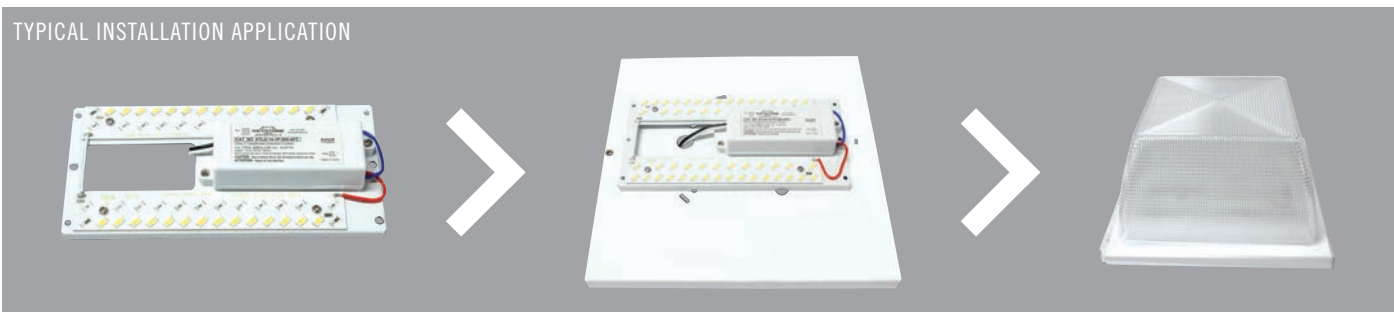

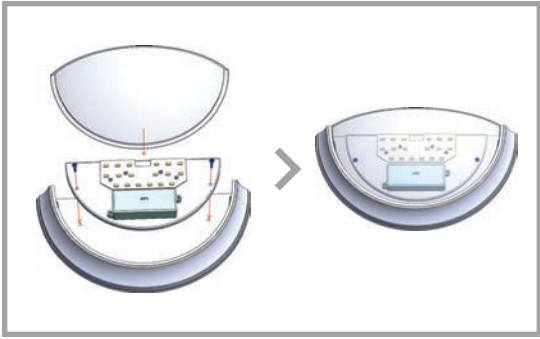

Each Pre-Assembled Kit includes (1) Phase Control Dimmable LED Driver, (1) LED Module, (1) Metal Pan, Mounting Hardware, and Accessories.

8", 1100 LUMEN WALL SCONCE

Color Temp	Input Voltage	LED Retrofit Kit Catalog Number	No. of Modules	Total System Drive Current	Drive Current per Module	Total Lumens per Module	Total System Lumens	Total Module Power	Module Efficacy	Driver Efficiency	Total System Power	Total System Efficacy
3000K	120V	KT-RKIT-HCP-8-1150-830-FDIM	1	350mA	350mA	1115	1115	8.5W	131 lm/W	80%	10.6W	105 lm/W
4000K	120V	KT-RKIT-HCP-8-1150-840-FDIM	1	350mA	350mA	1150	1150	8.5W	135 lm/W	80%	10.6W	108 lm/W
5000K	120V	KT-RKIT-HCP-8-1150-850-FDIM	1	350mA	350mA	1180	1180	8.5W	138 lm/W	80%	10.6W	111 lm/W

8", 700 LUMEN WALL SCONCE

Color Temp	Input Voltage	LED Retrofit Kit Catalog Number	No. of Modules	Total System Drive Current	Drive Current per Module	Total Lumens per Module	Total System Lumens	Total Module Power	Module Efficacy	Driver Efficiency	Total System Power	Total System Efficacy
3000K	120V	KT-RKIT-HCP-8-650-830-FDIM	1	350mA	350mA	680	680	5.5W	123 lm/W	80%	6.9W	98 lm/W
4000K	120V	KT-RKIT-HCP-8-650-840-FDIM	1	350mA	350mA	700	700	5.5W	127 lm/W	80%	6.9W	101 lm/W
5000K	120V	KT-RKIT-HCP-8-650-850-FDIM	1	350mA	350mA	720	720	5.5W	130 lm/W	80%	6.9W	104 lm/W

TYPICAL INSTALLATION APPLICATION





2 OPTIONS AVAILABLE

LED EMERGENCY BACK-UP KIT

Multiple Fixture Options

Includes Driver, Battery, and LED Module

The LED emergency back-up kit enables emergency lighting solutions to be incorporated into a variety of lighting fixtures including direct-wire LED tube fixtures, fluorescent fixtures and LED fixtures.



STANDARD LED EMERGENCY BACK-UP

For LED Fixtures

Includes Driver and Battery

The LED emergency back-up enables emergency lighting solutions to be incorporated into a variety of new and existing LED fixtures. Simply install the emergency back-up solution into the fixture, tying into both the existing AC driver and LED module(s).



LED EMERGENCY BACK-UP KITS

Catalog Number	INPUT CHARACTERISTICS			OUTPUT CHARACTERISTICS			LED Module Included
	Input Voltage	Power Factor	Max. Current	Max. Output Power	Rated Output Current	Output Voltage	
KT-EMRG-LED-5-500-K1	120-277Vac	≥0.5	0.03A @ 120V	5W	400mA-100mA	12-41Vdc	Yes
KT-EMRG-LED-12-1200-K1	120-277Vac	≥0.5	0.07A @ 120V	12W	1000mA-200mA	12-41Vdc	Yes

STANDARD LED EMERGENCY BACK-UP

Catalog Number	INPUT CHARACTERISTICS			OUTPUT CHARACTERISTICS			LED Module Included
	Input Voltage	Power Factor	Max. Current	Max. Output Power	Rated Output Current	Output Voltage	
KT-EMRG-LED-5-500	120-277Vac	≥0.5	0.03A @ 120V	5W	400mA-100mA	12-41Vdc	No
KT-EMRG-LED-12-1200	120-277Vac	≥0.5	0.07A @ 120V	12W	1000mA-200mA	12-41Vdc	No

CASE STYLE

CASE L

Material: Steel

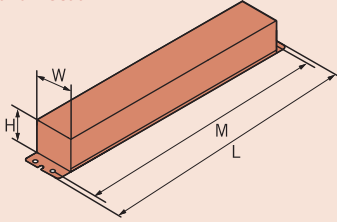

Case Style	Mounting	Length	Width	Height
L7	6.00"	6.46"	1.32"	1.00"

BATTERY STYLES

BATTERY

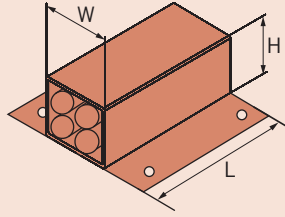

Case Style	Length	Width	Height
B5	7.20"	1.90"	0.90"
B12	9.45"	2.23"	1.02"

WIRING DIAGRAMS

STANDARD WIRING DIAGRAM

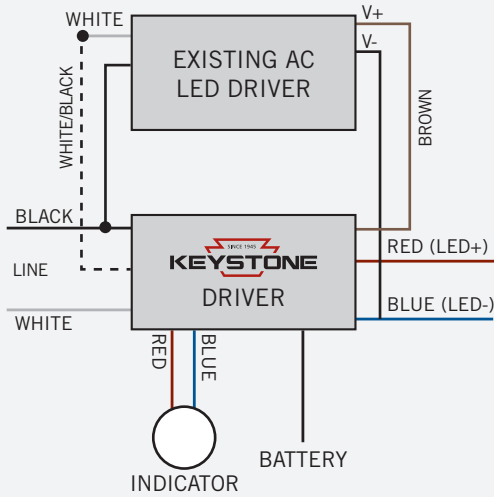

KIT WIRING DIAGRAM WITH EXISTING LED MODULE(S)

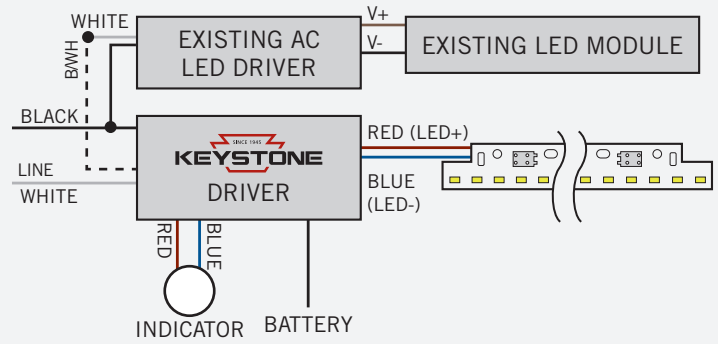

KIT WIRING DIAGRAM WITH DIRECT DRIVE TUBE FIXTURE

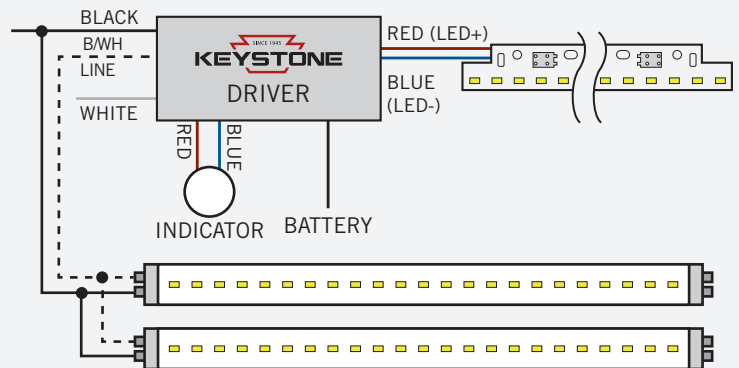



➤ The constant current drivers listed in this catalog are available in any output current configuration within the stated current range. ➤

ELECTRICAL SPECIFICATIONS

FEATURES: FCC Class B rating for EMI • Over Current, Short Circuit, and Open Circuit Protection

Wattage Family	Output Current Range	Catalog Number	Input Voltage	Power Factor	Dimming	Typical Output Current	Output Voltage	Efficiency	Case Style
10W	300-700mA	KTLD-10-1P-xxx-LDIM-F5	120V	>0.7	Local	300mA	6-33Vdc	77%	F5
						400mA	6-25Vdc	77%	
						500mA	6-20Vdc	77%	
						600mA	6-17Vdc	77%	
						700mA	6-14Vdc	77%	
	380mA	KTLD-10-1P-380-LDIM-AF1	120V	>0.7	Local	380mA	13-27Vdc	77%	AF1
						300mA	5-33Vdc	74%	
	300-380mA	KTLD-10-1N-xxx-F3	120V	>0.5	N/A	300mA	6-33Vdc	77%	F3
						330mA	9-30Vdc	77%	
						350mA	7.5-30Vdc	77%	
380mA	6.5-28Vdc	77%	AF3						
350mA	KTLD-10-1N-350-AF3	120V		>0.5	N/A	350mA	7.5-30Vdc	77%	
12W	350-700mA	KTLD-12-1-xxx-FDIM-AF1	120V	>0.9	Phase Control	350mA	6-32Vdc	75%	AF1
						380mA	5-32Vdc	75%	
						500mA	5-24Vdc	77%	
						600mA	5-20Vdc	77%	
						700mA	5-17Vdc	77%	
	400mA	KTLD-12-1P-400-LDIM-F5	120V	>0.7	Local	400mA	5-30Vdc	77%	F5
	220-700mA	KTLD-12-1-xxx-FDIM-F5	120V	>0.9	Phase Control	220mA	27-54Vdc	75%	F5
						300mA	20-40Vdc	75%	
						350mA	17-34Vdc	75%	
						400mA	15-30Vdc	75%	
500mA						12-24Vdc	77%		
600mA						10-20Vdc	77%		
700mA						8-17Vdc	77%		
14W	600mA	KTLD-14-1N-600-AF1	120V	>0.5	N/A	600mA	10-23Vdc	80%	AF1
	260-800mA	KTLD-14-1-xxx-FDIM-AF1	120V	>0.9	Phase Control	260mA	18-54Vdc	77%	AF1
						300mA	16-47Vdc	77%	
						350mA	10-40Vdc	77%	
						400mA	12-35Vdc	77%	
						500mA	10-28Vdc	77%	
						600mA	10-40Vdc	77%	
						700mA	7-20Vdc	77%	
						800mA	6-18Vdc	77%	

ELECTRICAL SPECIFICATIONS

Wattage Family	Output Current Range	Catalog Number	Input Voltage	Power Factor	Dimming	Typical Output Current	Output Voltage	Efficiency	Case Style						
14W	350-700mA	KTLD-14-UV-xxx-AF1	120-277V	>0.9	N/A	350mA	15-40Vdc	80%	AF1						
						700mA	10-20Vdc	80%							
	260-700mA	KTLD-14-UV-xxx-VDIM-L7	120-277V	>0.9	0-10V	260mA	27-54Vdc	82%	L7						
						300mA	23-47Vdc	82%							
						350mA	20-40Vdc	82%							
						400mA	18-35Vdc	82%							
						450mA	15-30Vdc	82%							
						500mA	14-28Vdc	82%							
						600mA	12-24Vdc	82%							
						700mA	12-20Vdc	82%							
16W	300-1100mA	KTLD-16-1-xxx-FDIM-AQ1	120V	>0.9	Phase Control	300mA	17-53Vdc	80%	AQ1						
						350mA	15-46Vdc	80%							
						400mA	13-40Vdc	80%							
						500mA	10-32Vdc	80%							
						600mA	9-27Vdc	80%							
						700mA	7-23Vdc	80%							
						800mA	7-20Vdc	80%							
						900mA	6-18Vdc	80%							
						1000mA	6-16Vdc	80%							
						1100mA	6-15Vdc	80%							
	300-900mA	KTLD-16-UV-xxx-VDIM-AQ1	120-277V	>0.9	0-10V	300mA	17-53Vdc	80%	AQ1						
						350mA	15-46Vdc	80%							
						400mA	13-40Vdc	80%							
						500mA	10-32Vdc	80%							
						600mA	9-27Vdc	80%							
						700mA	8-23Vdc	80%							
						800mA	8-20Vdc	80%							
						900mA	8-18Vdc	80%							
						290-1400mA	KTLD-16-1-xxx-FDIM-AK1	120V		>0.9	Phase Control	290mA	18-54Vdc	80%	AK1
												300mA	17-53Vdc	80%	
	400mA	13-40Vdc	80%												
	500mA	10-32Vdc	80%												
	600mA	9-27Vdc	80%												
	700mA	8-23Vdc	80%												
	800mA	7-20Vdc	80%												
	900mA	6-18Vdc	80%												
	1000mA	6-16Vdc	80%												
	1100mA	6-15Vdc	80%												
	290-1400mA	KTLD-16-UV-xxx-AK1	120-277V	>0.9	N/A	290mA	18-54Vdc	83%	AK1						
						400mA	13-40Vdc	83%							
500mA						10-32Vdc	83%								
600mA						10-27Vdc	83%								
700mA						9-23Vdc	83%								
800mA						7-20Vdc	83%								
900mA						6-18Vdc	83%								
1000mA						6-16Vdc	82%								
1100mA						6-14Vdc	82%								
1200mA						6-13Vdc	82%								
1300mA	6-12Vdc	82%													
1400mA	6-12Vdc	82%													

ELECTRICAL SPECIFICATIONS

Wattage Family	Output Current Range	Catalog Number	Input Voltage	Power Factor	Dimming	Typical Output Current	Output Voltage	Efficiency	Case Style						
16W	290-1400mA	KTLD-16-UV-xxx-VDIM-AK1	120-277V	>0.9	0-10V	290mA	27-54Vdc	81%	AK1						
						400mA	20-40Vdc	81%							
						500mA	16-32Vdc	81%							
						600mA	14-27Vdc	81%							
						700mA	12-23Vdc	81%							
						800mA	10-20Vdc	81%							
						900mA	9-18Vdc	81%							
						1000mA	8-16Vdc	81%							
						1100mA	7-14Vdc	81%							
						1200mA	7-13Vdc	81%							
						1300mA	6-12Vdc	81%							
1400mA	6-12Vdc	81%													
20W	600mA	KTLD-20-1N-600-AQ1	120V	>0.5	N/A	600mA	10-34Vdc	81%	AQ1						
22W	350-1100mA	KTLD-22-UV-xxx-VDIM-L7	120-277V	>0.9	0-10V	350mA	32-63Vdc	81%	L7						
						400mA	28-55Vdc	81%							
						500mA	22-44Vdc	81%							
						600mA	18-36Vdc	81%							
						700mA	16-32Vdc	81%							
						800mA	14-28Vdc	81%							
						900mA	12-24Vdc	81%							
						1000mA	12-22Vdc	81%							
						1100mA	12-20Vdc	81%							
						830mA	KTLD-23-UV-830-VDIM-L7	120-277V		>0.9	0-10V	830mA	14-28Vdc	84%	L7
25W	300-1200mA	KTLD-25-1-xxx-FDIM-AQ1	120V	>0.9	Phase Control	300mA	28-84Vdc	80%	AQ1						
						350mA	24-72Vdc	80%							
						400mA	21-63Vdc	80%							
						500mA	17-50Vdc	80%							
						600mA	14-42Vdc	80%							
						700mA	12-36Vdc	80%							
						800mA	10-32Vdc	80%							
						900mA	9-28Vdc	80%							
						1000mA	8-25Vdc	80%							
						1100mA	7-23Vdc	80%							
						1200mA	7-21Vdc	80%							
						350-1400mA	KTLD-25-UV-xxx-VDIM-AQ1	120-277V		>0.9	0-10V	350mA	24-72Vdc	81%	AQ1
	400mA	21-63Vdc	81%												
	500mA	17-50Vdc	81%												
	600mA	14-42Vdc	81%												
	700mA	12-36Vdc	81%												
	800mA	10-32Vdc	81%												
	900mA	9-28Vdc	81%												
	1000mA	8-25Vdc	81%												
	1100mA	8-23Vdc	80%												
	1200mA	8-21Vdc	80%												
	1400mA	8-18Vdc	80%												
	300-1400mA	KTLD-25-UV-xxx-VDIM-AK1	120-277V	>0.9	0-10V				300mA			42-84Vdc	80%	AK1	
									400mA			31-63Vdc	81%		
									500mA			25-50Vdc	81%		
						600mA	21-42Vdc	81%							
						700mA	18-36Vdc	81%							
						800mA	16-32Vdc	81%							
900mA						14-28Vdc	81%								
1000mA						12-25Vdc	81%								
1100mA						12-23Vdc	81%								
1200mA						12-21Vdc	81%								
1300mA	12-19Vdc	81%													
1400mA	12-18Vdc	81%													
700mA	KTLD-25-1P-700-VDIM-L9	120V	>0.7	0-10V	700mA	12-36Vdc	80%	L9							

ELECTRICAL SPECIFICATIONS

Wattage Family	Output Current Range	Catalog Number	Input Voltage	Power Factor	Dimming	Typical Output Current	Output Voltage	Efficiency	Case Style
25W	700-1100mA	KTLD-25-1-xxx-FDIM-L9	120V	>0.9	Phase Control	700mA	24-72Vdc	80%	L9
						800mA	21-63Vdc	80%	
						900mA	17-50Vdc	80%	
						1000mA	14-42Vdc	80%	
						1100mA	12-36Vdc	80%	
	700-1400mA	KTLD-25-UV-xxx-VDIM-L9	120-277V	>0.9	0-10V	700mA	18-36Vdc	80%	L9
						800mA	16-32Vdc	80%	
						900mA	14-28Vdc	80%	
						1000mA	12-25Vdc	80%	
						1100mA	12-23Vdc	80%	
						1200mA	12-21Vdc	80%	
						1300mA	12-19Vdc	80%	
	700-1000mA	KTLD-25-1-xxx-FDIM-AF4	120V	>0.9	Phase Control	700mA	18-36Vdc	82%	AF4
						1000mA	13-25Vdc	82%	
36W	660-1500mA	KTLD-36-UV-xxx-L2	120-277V	>0.9	N/A	660mA	27-54Vdc	82%	L2
						700mA	26-51Vdc	82%	
						800mA	23-45Vdc	82%	
						900mA	18-36Vdc	82%	
						1000mA	18-36Vdc	82%	
						1100mA	16-33Vdc	82%	
						1200mA	15-30Vdc	82%	
						1300mA	14-28Vdc	82%	
						1400mA	13-26Vdc	82%	
						1500mA	12-24Vdc	82%	
	600-1500mA	KTLD-36-UV-xxx-VDIM-L2	120-277V	>0.9	0-10V	600mA	30-60Vdc	81%	L2
						660mA	27-54Vdc	81%	
						700mA	26-51Vdc	81%	
						800mA	23-45Vdc	81%	
						900mA	18-36Vdc	81%	
						1000mA	18-36Vdc	81%	
						1100mA	16-33Vdc	81%	
						1200mA	15-30Vdc	81%	
						1300mA	14-28Vdc	81%	
						1400mA	13-26Vdc	81%	
	1000-1200mA	KTLD-36-1-xxx-L9	120V	>0.9	N/A	1000mA	18-36Vdc	80%	L9
						1100mA	17-33Vdc	80%	
						1200mA	15-30Vdc	80%	
	1000-1200mA	KTLD-36-1-xxx-FDIM-L9	120V	>0.9	Phase Control	1000mA	12-36Vdc	82%	L9
						1100mA	11-33Vdc	82%	
						1200mA	10-30Vdc	82%	
	640-2000mA	KTLD-36-UV-1000-L9	120-277V	>0.9	N/A	1000mA	18-36Vdc	82%	L9
						640mA	28-56Vdc	82%	
						700mA	26-51Vdc	82%	
						800mA	23-45Vdc	82%	
900mA						20-40Vdc	82%		
1000mA						18-36Vdc	82%		
1100mA						17-33Vdc	82%		
1200mA						15-30Vdc	82%		
1300mA						14-28Vdc	82%		
1400mA						13-26Vdc	82%		
1500mA						12-24Vdc	82%		
1600mA						12-22.5Vdc	82%		
1700mA						12-21Vdc	82%		
1800mA						12-20Vdc	82%		
1900mA						12-19Vdc	82%		
2000mA						12-18Vdc	82%		

ELECTRICAL SPECIFICATIONS

Wattage Family	Output Current Range	Catalog Number	Input Voltage	Power Factor	Dimming	Typical Output Current	Output Voltage	Efficiency	Case Style
40W	350-2000mA	KTLD-40-UV-xxx-VDIM-AT1	120-277V	>0.9	0-10V	350mA	38-126Vdc	87%	AT1
						400mA	33-100Vdc	87%	
						500mA	27-80Vdc	86%	
						600mA	22-67Vdc	86%	
						700mA	19-57Vdc	86%	
						800mA	17-50Vdc	86%	
						900mA	15-44Vdc	86%	
						1000mA	13-40Vdc	85%	
						1100mA	12-36Vdc	85%	
						1200mA	12-33Vdc	85%	
						1300mA	12-31Vdc	85%	
						1400mA	12-29Vdc	85%	
						1500mA	12-27Vdc	85%	
						1600mA	12-25Vdc	85%	
						1700mA	12-24Vdc	85%	
						1800mA	12-22Vdc	85%	
						1900mA	12-21Vdc	85%	
						2000mA	12-20Vdc	84%	
	970-2200mA	KTLD-40-UV-xxx-L2	120-277V	>0.9	N/A	970mA	20-41Vdc	82%	L2
						1000mA	20-40Vdc	82%	
						1100mA	18-36Vdc	82%	
						1200mA	17-33Vdc	82%	
						1300mA	15-31Vdc	82%	
						1400mA	14-29Vdc	82%	
						1500mA	13-27Vdc	82%	
						1600mA	13-25Vdc	82%	
						1700mA	12-24Vdc	82%	
						1800mA	11-22Vdc	82%	
						1900mA	11-21Vdc	82%	
						2000mA	10-20Vdc	82%	
						2100mA	10-19Vdc	82%	
						2200mA	9-18Vdc	82%	
	970-2200mA	KTLD-40-UV-xxx-VDIM-L2	120-277V	>0.9	0-10V	970mA	20-41Vdc	82%	L2
						1000mA	20-40Vdc	82%	
						1100mA	18-36Vdc	82%	
						1200mA	17-33Vdc	82%	
						1300mA	15-31Vdc	82%	
						1400mA	14-29Vdc	82%	
						1500mA	13-27Vdc	82%	
						1600mA	13-25Vdc	82%	
						1700mA	12-24Vdc	82%	
						1800mA	11-22Vdc	82%	
1900mA						11-21Vdc	82%		
2000mA						10-20Vdc	82%		
2100mA						10-19Vdc	82%		
2200mA						9-18Vdc	82%		
1100mA	KTLD-40-UV-1100-VDIM-L9	120-277V	>0.9	0-10V	1100mA	18-36Vdc	82%	L9	
740-1670mA	KTLD-40-UV-xxx-W1	120-277V	>0.9	N/A	740mA	27-54Vdc	82%	W2	
					800mA	25-50Vdc	82%		
					900mA	22-44Vdc	82%		
					1000mA	20-40Vdc	82%		
					1100mA	18-36Vdc	82%		
					1200mA	17-33Vdc	82%		
					1300mA	17-31Vdc	82%		
					1400mA	14-29Vdc	82%		
					1500mA	13-27Vdc	82%		
					1600mA	13-25Vdc	82%		
					1670mA	12-24Vdc	82%		
					1670mA	12-24Vdc	82%		

ELECTRICAL SPECIFICATIONS

Wattage Family	Output Current Range	Catalog Number	Input Voltage	Power Factor	Dimming	Typical Output Current	Output Voltage	Efficiency	Case Style
40W	740-1670mA	KTLD-40-UV-xxx-VDIM-W1	120-277V	>0.9	0-10V	740mA	27-54Vdc	82%	W2
						800mA	25-50Vdc	82%	
						900mA	22-44Vdc	82%	
						1000mA	20-40Vdc	82%	
						1100mA	18-36Vdc	82%	
						1200mA	17-33Vdc	82%	
						1300mA	17-31Vdc	82%	
						1400mA	14-29Vdc	82%	
						1500mA	13-27Vdc	82%	
						1600mA	13-25Vdc	82%	
						1670mA	12-24Vdc	82%	
50W	920-1400mA	KTLD-50-UV-xxx-W2	120-277V	>0.9	N/A	920mA	27-54Vdc	84%	W2
						1000mA	25-50Vdc	84%	
						1100mA	23-45Vdc	84%	
						1200mA	21-42Vdc	84%	
						1300mA	19-38Vdc	84%	
						1400mA	18-36Vdc	84%	
	920-1400mA	KTLD-50-UV-xxx-VDIM-W2	120-277V	>0.9	0-10V	920mA	27-54Vdc	84%	W2
						1000mA	25-50Vdc	84%	
						1100mA	23-45Vdc	84%	
						1200mA	21-42Vdc	84%	
						1300mA	19-38Vdc	84%	
						1400mA	18-36Vdc	84%	
	920-2500mA	KTLD-50-3-xxx-VDIM-W2	347V	>0.9	0-10V	920mA	27-54Vdc	84%	W2
						1000mA	25-50Vdc	84%	
						1100mA	23-45Vdc	84%	
						1200mA	21-42Vdc	84%	
						1300mA	19-38Vdc	84%	
						1400mA	18-36Vdc	84%	
						1500mA	17-33Vdc	84%	
						1600mA	16-31Vdc	84%	
						1700mA	15-29Vdc	84%	
						1800mA	14-28Vdc	84%	
						1900mA	13-26Vdc	84%	
						2000mA	13-25Vdc	84%	
						2100mA	12-24Vdc	84%	
						2200mA	12-23Vdc	84%	
						2300mA	12-22Vdc	84%	
	2400mA	12-21Vdc	84%						
	2500mA	12-20Vdc	84%						
	500-2100mA	KTLD-50-UV-xxx-AR2	120-277V	>0.9	N/A	500mA	50-100Vdc	83%	AR2
						600mA	42-83Vdc	83%	
						700mA	36-72Vdc	83%	
						800mA	31-63Vdc	83%	
900mA						28-56Vdc	83%		
1000mA						25-50Vdc	83%		
1100mA						23-45Vdc	83%		
1200mA						21-42Vdc	83%		
1300mA						19-38Vdc	83%		
1400mA						18-36Vdc	83%		
1500mA						17-33Vdc	83%		
1600mA						16-31Vdc	83%		
1700mA						15-29Vdc	83%		
1800mA						14-28Vdc	83%		
1900mA						13-26Vdc	83%		
2000mA						13-25Vdc	83%		
2100mA						12-24Vdc	83%		

ELECTRICAL SPECIFICATIONS

Wattage Family	Output Current Range	Catalog Number	Input Voltage	Power Factor	Dimming	Typical Output Current	Output Voltage	Efficiency	Case Style					
50W	500-2100mA	KTLD-50-UV-xxx-VDIM-AR2	120-277V	>0.9	0-10V	500mA	50-100Vdc	83%	AR2					
						600mA	42-83Vdc	83%						
						700mA	36-72Vdc	83%						
						800mA	31-63Vdc	83%						
						900mA	28-56Vdc	83%						
						1000mA	25-50Vdc	83%						
						1100mA	23-45Vdc	83%						
						1200mA	21-42Vdc	83%						
						1300mA	19-38Vdc	83%						
						1400mA	18-36Vdc	83%						
						1500mA	17-33Vdc	83%						
						1600mA	16-31Vdc	83%						
						1700mA	15-29Vdc	83%						
						1800mA	14-28Vdc	83%						
	1900mA	13-26Vdc	83%											
	2000mA	13-25Vdc	83%											
	2100mA	12-24Vdc	83%											
	1200-1400mA	KTLD-50-UV-xxx-VDIM-L9	120-277V	>0.9	0-10V	1200mA	21-42Vdc	84%	L9					
						1400mA	18-36Vdc	84%						
		KTLD-50-UV-xxx-L9	120-277V	>0.9	N/A	1200mA	21-42Vdc	84%	L9					
						1400mA	18-36Vdc	84%						
450-1100mA (2 Channel)		KTLD-50-UV-2xxxx-VDIM-L5	120-277V	>0.9	0-10V	450mA	27-54Vdc	82%	L5					
						500mA	25-50Vdc	82%						
	600mA					21-42Vdc	82%							
	700mA					18-36Vdc	82%							
	800mA					16-31Vdc	82%							
	900mA					14-28Vdc	82%							
	1000mA					12-24Vdc	82%							
	1100mA					12-23Vdc	82%							
	230-600mA (4 Channel)					KTLD-50-UV-4xxxx-VDIM-L5	120-277V	>0.9		0-10V	230mA	27-54Vdc	82%	L5
											300mA	21-42Vdc	82%	
											350mA	18-36Vdc	82%	
											400mA	16-31Vdc	82%	
											500mA	12-25Vdc	82%	
											600mA	12-20Vdc	82%	
60W	600-2500mA	KTLD-60-UV-xxx-W2	120-277V	>0.9	N/A	600mA	50-100Vdc	84%	W2					
						700mA	43-86Vdc	84%						
						800mA	38-75Vdc	84%						
						900mA	33-67Vdc	84%						
						930mA	29-59Vdc	84%						
						1000mA	30-60Vdc	83%						
						1100mA	27-55Vdc	83%						
						1200mA	25-50Vdc	83%						
						1300mA	23-46Vdc	83%						
						1400mA	21-43Vdc	83%						
						1500mA	20-40Vdc	83%						
						1600mA	18-37Vdc	83%						
						1700mA	18-35Vdc	83%						
						1800mA	17-33Vdc	83%						
						1900mA	16-32Vdc	83%						
						2000mA	15-30Vdc	83%						
						2100mA	14-29Vdc	83%						
						2200mA	14-27Vdc	83%						
						2300mA	13-26Vdc	83%						
2400mA	12-25Vdc	83%												
2500mA	12-24Vdc	83%												

ELECTRICAL SPECIFICATIONS

Wattage Family	Output Current Range	Catalog Number	Input Voltage	Power Factor	Dimming	Typical Output Current	Output Voltage	Efficiency	Case Style	
60W	600-2500mA	KTLD-60-UV-xxx-VDIM-W2	120-277V	>0.9	0-10V	600mA	50-100Vdc	84%	W2	
						700mA	43-86Vdc	84%		
						800mA	38-75Vdc	84%		
						900mA	33-67Vdc	84%		
						930mA	29-59Vdc	84%		
						1000mA	30-60Vdc	83%		
						1100mA	27-55Vdc	83%		
						1200mA	25-50Vdc	83%		
						1300mA	23-46Vdc	83%		
						1400mA	21-43Vdc	83%		
						1500mA	20-40Vdc	83%		
						1600mA	18-37Vdc	83%		
						1700mA	18-35Vdc	83%		
						1800mA	17-33Vdc	83%		
						1900mA	16-32Vdc	83%		
						2000mA	15-30Vdc	83%		
						2100mA	14-29Vdc	83%		
						2200mA	14-27Vdc	83%		
						2300mA	13-26Vdc	83%		
						2400mA	12-25Vdc	83%		
2500mA	12-24Vdc	83%								
	1750mA	KTLD-60-UV-xxx-VDIM-AR1	120-277V	>0.9	0-10V	1750mA	10-34Vdc	84%	AR1	
72W	660-1000mA (2 Channel)	KTLD-72-UV-2xxxx-VDIM-L5	120-277V	>0.9	0-10V	660mA	27-54Vdc	82%	L5	
						700mA	26-51Vdc	82%		
						800mA	23-45Vdc	82%		
						900mA	20-40Vdc	82%		
						1000mA	18-36Vdc	82%		
		290-900mA (4 Channel)	KTLD-72-UV-4xxxx-VDIM-L5	120-277V	>0.9	0-10V	290mA	31-62Vdc	82%	L5
							300mA	30-60Vdc	82%	
							400mA	23-45Vdc	82%	
							500mA	18-36Vdc	82%	
							600mA	15-30Vdc	82%	
							700mA	13-26Vdc	82%	
							750mA	12-24Vdc	82%	
							800mA	12-23Vdc	82%	
							900mA	12-20Vdc	82%	
	75W	1400mA	KTLD-75-UV-xxx-L5	120-277V	>0.9	N/A	1400mA	27-54Vdc	86%	L5
			KTLD-75-UV-xxx-VDIM-L5	120-277V	>0.9	0-10V	1400mA	27-54Vdc	86%	
	80W	1320-1870mA	KTLD-80-UV-xxx-VDIM-W3	120-277V	>0.9	0-10V	1320mA	29-58Vdc	87%	W3
							1400mA	28-56Vdc	87%	
1500mA							26-52Vdc	87%		
1600mA							24-49Vdc	87%		
1700mA							23-46Vdc	87%		
1800mA							21-42Vdc	87%		
1870mA							21-41Vdc	87%		

ELECTRICAL SPECIFICATIONS

Wattage Family	Output Current Range	Catalog Number	Input Voltage	Power Factor	Dimming	Typical Output Current	Output Voltage	Efficiency	Case Style
100W	1580-2240mA	KTLD-100-UV-xxx-VDIM-W3	120-277V	>0.9	0-10V	1580mA	29-58Vdc	87%	W3
						1600mA	29-58Vdc	87%	
						1700mA	28-55Vdc	87%	
						1800mA	26-52Vdc	87%	
						1900mA	25-49Vdc	87%	
						2000mA	24-47Vdc	87%	
						2100mA	22-45Vdc	87%	
						2200mA	21-43Vdc	87%	
						2240mA	21-41Vdc	87%	
	530-2500mA	KTLD-100-UV-xxx-67-AP4	120-277V	>0.9	N/A	530mA	94-189Vdc	86%	W3
						600mA	83-167Vdc	86%	
						700mA	72-143Vdc	86%	
						800mA	63-125Vdc	86%	
						900mA	56-111Vdc	86%	
						1000mA	50-100Vdc	86%	
						1100mA	45-91Vdc	86%	
						1200mA	43-83Vdc	86%	
						1300mA	38-77Vdc	86%	
						1400mA	36-71Vdc	86%	
						1500mA	33-67Vdc	86%	
						1600mA	31-63Vdc	86%	
						1700mA	29-59Vdc	86%	
						1800mA	28-56Vdc	86%	
						1900mA	26-53Vdc	86%	
						2000mA	25-50Vdc	86%	
						530-2500mA	KTLD-100-UV-xxx-VDIM-67-AP4	120-277V	
	600mA	83-167Vdc	86%						
	700mA	72-143Vdc	86%						
	800mA	63-125Vdc	86%						
	900mA	56-111Vdc	86%						
1000mA	50-100Vdc	86%							
1100mA	45-91Vdc	86%							
1200mA	43-83Vdc	86%							
1300mA	38-77Vdc	86%							
1400mA	36-71Vdc	86%							
1500mA	33-67Vdc	86%							
1600mA	31-63Vdc	86%							
1700mA	29-59Vdc	86%							
1800mA	28-56Vdc	86%							
1900mA	26-53Vdc	86%							
2000mA	25-50Vdc	86%							
2100mA	24-48Vdc	86%							
2200mA	23-45Vdc	86%							
2300mA	22-43Vdc	86%							
2400mA	21-42Vdc	86%							
2500mA	20-40Vdc	86%							

ELECTRICAL SPECIFICATIONS

Wattage Family	Output Current Range	Catalog Number	Input Voltage	Power Factor	Dimming	Typical Output Current	Output Voltage	Efficiency	Case Style	
100W	500-3200mA	KTLD-100-UV-xxx-L5	120-277V	>0.9	N/A	500mA	94-189Vdc	86%	L5	
						600mA	83-167Vdc	86%		
						700mA	72-143Vdc	86%		
						800mA	63-125Vdc	86%		
						900mA	56-111Vdc	86%		
						1000mA	50-100Vdc	86%		
						1100mA	45-91Vdc	86%		
						1200mA	43-83Vdc	86%		
						1300mA	38-77Vdc	86%		
						1400mA	36-71Vdc	86%		
						1500mA	33-67Vdc	86%		
						1600mA	31-63Vdc	86%		
						1700mA	29-59Vdc	86%		
						1800mA	28-56Vdc	86%		
						1900mA	26-53Vdc	86%		
						2000mA	25-50Vdc	86%		
						2100mA	24-48Vdc	86%		
						2200mA	23-45Vdc	86%		
						2300mA	22-43Vdc	86%		
						2400mA	21-42Vdc	86%		
	2500mA	20-40Vdc	86%							
	2600mA	19-38Vdc	86%							
	2700mA	18-37Vdc	86%							
	2800mA	17-35Vdc	86%							
	2900mA	17-34Vdc	86%							
	3000mA	17-33Vdc	86%							
	3100mA	16-32Vdc	86%							
	3200mA	16-31Vdc	86%							
	100W	500-3200mA	KTLD-100-UV-xxx-VDIM-L5	120-277V	>0.9	0-10V	500mA	94-189Vdc	86%	L5
							600mA	83-167Vdc	86%	
							700mA	72-143Vdc	86%	
							800mA	63-125Vdc	86%	
							900mA	56-111Vdc	86%	
							1000mA	50-100Vdc	86%	
1100mA							45-91Vdc	86%		
1200mA							43-83Vdc	86%		
1300mA							38-77Vdc	86%		
1400mA							36-71Vdc	86%		
1500mA							33-67Vdc	86%		
1600mA							31-63Vdc	86%		
1700mA							29-59Vdc	86%		
1800mA							28-56Vdc	86%		
1900mA							26-53Vdc	86%		
2000mA							25-50Vdc	86%		
2100mA							24-48Vdc	86%		
2200mA							23-45Vdc	86%		
2300mA							22-43Vdc	86%		
2400mA							21-42Vdc	86%		
2500mA	20-40Vdc	86%								
2600mA	19-38Vdc	86%								
2700mA	18-37Vdc	86%								
2800mA	17-35Vdc	86%								
2900mA	17-34Vdc	86%								
3000mA	17-33Vdc	86%								
3100mA	16-32Vdc	86%								
3200mA	16-31Vdc	86%								

ELECTRICAL SPECIFICATIONS

Wattage Family	Output Current Range	Catalog Number	Input Voltage	Power Factor	Dimming	Typical Output Current	Output Voltage	Efficiency	Case Style	
100W	460-1000mA (4 Channel)	KTLD-100-UV-4xxxx-VDIM-L18	120-277V	>0.9	0-10V	460mA	27-54Vdc	82%	L18	
						500mA	25-50Vdc	82%		
						600mA	21-42Vdc	82%		
						700mA	18-36Vdc	82%		
						800mA	16-31Vdc	82%		
						900mA	14-28Vdc	82%		
						1000mA	12-25Vdc	82%		
150W	530-1400mA	KTLD-150-UV-xxx-67-AP3	120-277V	>0.9	N/A	530mA	141-283Vdc	87%	AP3	
						600mA	125-250Vdc	87%		
						700mA	107-214Vdc	87%		
						800mA	94-188Vdc	87%		
						900mA	83-167Vdc	87%		
						1000mA	75-150Vdc	87%		
						1100mA	68-136Vdc	87%		
						1200mA	63-125Vdc	87%		
						1300mA	58-115Vdc	87%		
						1400mA	54-107Vdc	87%		
	530-1400mA	KTLD-150-UV-xxx-VDIM-67-AP3	120-277V	>0.9	0-10V	N/A	530mA	141-283Vdc	87%	AP3
							600mA	125-250Vdc	87%	
							700mA	107-214Vdc	87%	
							800mA	94-188Vdc	87%	
							900mA	83-167Vdc	87%	
							1000mA	75-150Vdc	87%	
							1100mA	68-136Vdc	87%	
							1200mA	63-125Vdc	87%	
							1300mA	58-115Vdc	87%	
							1400mA	54-107Vdc	87%	
	530-2500mA	KTLD-150-UV-xxx-AU1	120-277V	>0.9	N/A	N/A	530mA	141-283Vdc	87%	AU1
							600mA	125-250Vdc	87%	
							700mA	107-214Vdc	87%	
							800mA	94-188Vdc	87%	
							900mA	83-167Vdc	87%	
							1000mA	75-150Vdc	87%	
							1100mA	68-136Vdc	87%	
							1200mA	63-125Vdc	87%	
1300mA							58-115Vdc	87%		
1400mA							54-107Vdc	87%		
1500mA							50-100Vdc	87%		
1600mA							47-94Vdc	87%		
1700mA							44-88Vdc	87%		
1800mA							42-83Vdc	87%		
1900mA							39-79Vdc	87%		
2000mA							38-75Vdc	87%		
2100mA							36-71Vdc	87%		
2200mA							34-68Vdc	87%		
2300mA	33-65Vdc	87%								
2400mA	31-63Vdc	87%								
2500mA	30-60Vdc	87%								

ELECTRICAL SPECIFICATIONS

Wattage Family	Output Current Range	Catalog Number	Input Voltage	Power Factor	Dimming	Typical Output Current	Output Voltage	Efficiency	Case Style							
150W	530-2500mA	KTLD-150-UV-xxx-VDIM-AU1	120-277V	>0.9	0-10V	530mA	141-283Vdc	87%	AU1							
						600mA	125-250Vdc	87%								
						700mA	107-214Vdc	87%								
						800mA	94-188Vdc	87%								
						900mA	83-167Vdc	87%								
						1000mA	75-150Vdc	87%								
						1100mA	68-136Vdc	87%								
						1200mA	63-125Vdc	87%								
						1300mA	58-115Vdc	87%								
						1400mA	54-107Vdc	87%								
						1500mA	50-100Vdc	87%								
						1600mA	47-94Vdc	87%								
						1700mA	44-88Vdc	87%								
						1800mA	42-83Vdc	87%								
						1900mA	39-79Vdc	87%								
						2000mA	38-75Vdc	87%								
						200W	700-1400mA	KTLD-200-UV-xxx-67-AP5		120-277V	>0.9	N/A	700mA	143-286Vdc	91%	AP5
													800mA	125-250Vdc	91%	
900mA	111-222Vdc	91%														
1000mA	100-200Vdc	91%														
1100mA	91-182Vdc	91%														
1200mA	83-167Vdc	91%														
1300mA	77-154Vdc	91%														
1400mA	71-143Vdc	91%														
700-1400mA	KTLD-200-UV-xxx-VDIM-67-AP5	120-277V	>0.9	0-10V	700mA		143-286Vdc	91%	AP5							
					800mA		125-250Vdc	91%								
					900mA		111-222Vdc	91%								
					1000mA		100-200Vdc	91%								
					1100mA		91-182Vdc	91%								
					1200mA		83-167Vdc	91%								
					1300mA	77-154Vdc	91%									
1400mA	71-143Vdc	91%														
400W	2000mA	KTLD-400-UV-2000-67-AP7	120-277V	>0.9	0-10V	2000mA	100-200Vdc	92%	AP7							

CASE STYLES

All LED drivers can be modified to accommodate specific requirements.

Contact Keystone to discuss custom and semi-custom LED driver solutions.

CASE AF

Material: Plastic

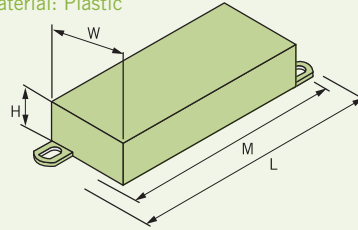

Case Style	Mounting	Length	Width	Height
AF1	4.57"	4.86"	1.30"	0.79"
AF3	3.02"	3.32"	1.30"	0.79"
AF4	5.20"	5.49"	1.30"	0.79"

CASE AK

Material: Steel

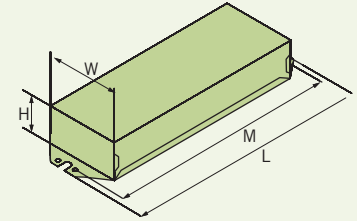

Case Style	Mounting	Length	Width	Height
AK1	4.29"	4.80"	1.58"	0.96"

CASE AP

Material: Aluminum
Case Rating: IP67

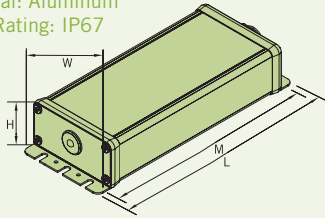

Case Style	Mounting	Length	Width	Height
AP3	8.33"	8.94"	2.68"	1.52"
AP5	9.17"	9.78"	2.68"	1.52"
AP7	11.52"	11.82"	3.53"	1.73"

CASE AQ

Material: Plastic

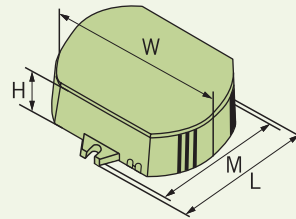

Case Style	Mounting	Length	Width	Height
AQ1	2.76"	3.07"	3.15"	1.00"

CASE AR

Material: Plastic

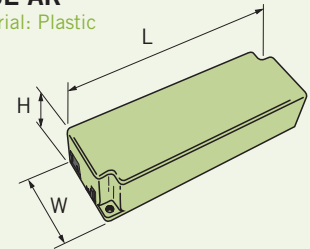

Case Style	Mounting	Length	Width	Height
AR1	6.07"	6.48"	1.67"	1.26"
AR2	5.00"	5.54"	1.86"	1.26"

CASE AT

Material: Plastic

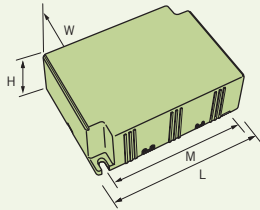

Case Style	Mounting	Length	Width	Height
AT1	3.34"	3.76"	2.81"	1.26"

CASE AU

Material: Aluminum

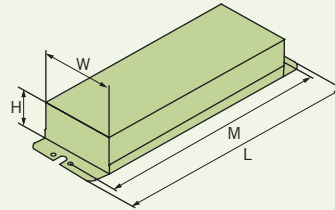

Case Style	Mounting	Length	Width	Height
AU1	8.90"	9.45"	1.80"	1.37"

CASE F

Material: Aluminum

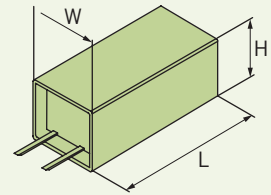

Case Style	Mounting	Length	Width	Height
F3	N/A	2.68"	1.30"	0.79"
F5	N/A	3.15"	1.30"	0.79"

CASE L

Material: Steel

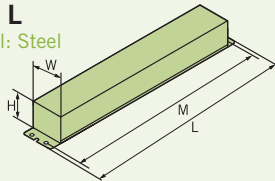

Case Style	Mounting	Length	Width	Height
L2	6.00"	6.46"	1.89"	1.15"
L5	8.90"	9.50"	1.70"	1.18"
L7	6.00"	6.46"	1.37"	1.00"
L9	8.90"	9.57"	1.13"	1.07"
L18	10.97"	11.46"	1.70"	1.15"
L20	8.86"	9.45"	1.63"	1.20"

CASE W

Material: Steel

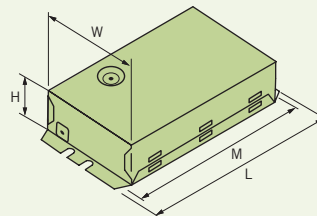

Case Style	Mounting	Length	Width	Height
W2	4.63"	5.00"	3.00"	1.38"
W3	6.73"	7.11"	3.08"	1.34"

SPEEDDIAL

PROGRAMMABLE DRIVERS

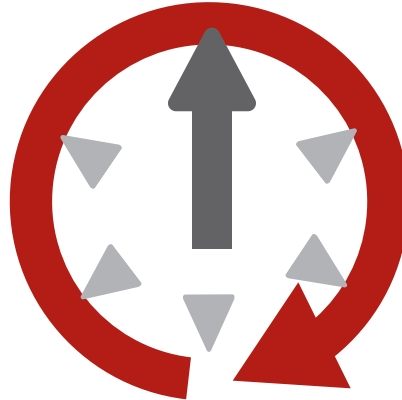

NO COMPUTERS. NO MISTAKES. NO HASSLES.

Introducing the easiest programmable LED Driver on the market. With just the simple twist of Keystone's unique SpeedDial, the LED driver is programmed to your desired output current in less than a second. Reduce inventory SKUs, increase productivity, gain performance flexibility... all with Keystone's proprietary SpeedDial LED drivers.

FEATURES AND BENEFITS

- **Slim Form Factor** - Ideal for narrow channels and slender fixtures.
- **Incredibly Fast Programmability** - Just twist the SpeedDial with a standard screwdriver to the desired setting. The SpeedDial clicks right into place.
- **Many Output Current Options** - Utilize a single SKU for several output current settings. One driver covers all of the desired settings.
- **High Efficiency** - Keystone's expertise in LED driver design targets maximum efficiencies at all current settings.
- **0-10V Dimming** - Uncompromised dimming performance for any 0-10V dimming system.



ELECTRICAL SPECIFICATIONS

Catalog Number	INPUT CHARACTERISTICS				OUTPUT CHARACTERISTICS			FEATURES	
	Input Voltage	Input Power	Power Factor	Max. Current	Max. Output Power	Rated Output Current	Output Voltage	Efficiency	Case Style
KTLD-44-UV-SD700-1200-VDIM-L20	120-277Vac	52W	>0.9	0.48A @ 120V 0.22A @ 277V	44W	700, 800, 900, 1000, 1100, or 1200 mA	18-36Vdc	84% (at 1200mA)	L20

Ask about custom solutions! We can develop our SpeedDial product to specific current settings.

ELECTRICAL SPECIFICATIONS

FEATURES: • FCC Class B rating for EMI • Over Current, Short Circuit, and Open Circuit Protection • Class 2 Output Except for the Following, which are Class 1 Output: KTLD-80-UV-12V, KTLD-100-UV-12V, KTLD-100-UV-12V-67-AP2, KTLD-100-UV-12V-67-AP3, KTLD-150-UV-24V-67-AP3

Wattage Family	Catalog Number	OUTPUT CHARACTERISTICS				INPUT CHARACTERISTICS			FEATURES	
		Output Voltage	Max Power	Current		Input Voltage	Input Power	Power Factor	Efficiency*	Case Style
				Min Current	Max Current					
10W	KTLD-10-1N-12V-F3	12Vdc	10W	0A	0.83A	120Vac	13W	>0.50	77%	F3
	KTLD-10-1-12V-F3	12Vdc	10W	0A	0.83A	120Vac	13W	>0.90	77%	F3
	KTLD-10-1N-24V-F3	24Vdc	10W	0A	0.42A	120Vac	13W	>0.50	77%	F3
24W	KTLD-24-1-12V-AK1	12Vdc	24W	0A	2.00A	120Vac	32W	>0.90	75%	AK1
	KTLD-24-1-24V-AK1	24Vdc	24W	0A	1.00A	120Vac	32W	>0.90	75%	AK1
	KTLD-24-UV-12V-AK1	12Vdc	24W	0A	2.00A	120~277Vac	32W	>0.90	75%	AK1
	KTLD-24-UV-24V-AK1	24Vdc	24W	0A	1.00A	120~277Vac	32W	>0.90	75%	AK1
60W	KTLD-60-1-12V	12Vdc	60W	0A	5.00A	120Vac	73W	>0.90	82%	L5
	KTLD-60-1-12V-67-AP4	12Vdc	60W	0A	5.00A	120Vac	70W	>0.90	86%	AP4
	KTLD-60-1-12V-67-AP4	12Vdc	60W	0A	5.00A	120Vac	70W	>0.90	86%	AP4
	KTLD-60-1-24V	24Vdc	60W	0A	2.50A	120Vac	69W	>0.90	87%	L5
	KTLD-60-1-24V-W2	24Vdc	60W	0A	2.50A	120Vac	69W	>0.90	87%	W2
	KTLD-60-UV-12V	12Vdc	60W	0A	5.00A	120~277Vac	71W	>0.90	85%	L5
	KTLD-60-UV-12V-67-AP1	12Vdc	60W	0A	5.00A	120~277Vac	71W	>0.90	85%	AP1
	KTLD-60-UV-12V-67-AP4	12Vdc	60W	0A	5.00A	120~277Vac	70W	>0.90	86%	AP4
	KTLD-60-UV-12V-W2	12Vdc	60W	0A	5.00A	120~277Vac	71W	>0.90	85%	W2
	KTLD-60-UV-14V	14Vdc	60W	0A	4.30A	120~277Vac	71W	>0.90	85%	L5
	KTLD-60-UV-14V-W2	14Vdc	60W	0A	4.30A	120~277Vac	71W	>0.90	85%	W2
	KTLD-60-UV-24V	24Vdc	60W	0A	2.50A	120~277Vac	70W	>0.90	85%	L5
	KTLD-60-UV-24V-67-AP1	24Vdc	60W	0A	2.50A	120~277Vac	71W	>0.90	85%	AP1
	KTLD-60-UV-24V-A01	24Vdc	60W	0A	2.50A	120~277Vac	70W	>0.90	86%	A01
	KTLD-60-UV-24V-67-AP4	24Vdc	60W	0A	2.50A	120~277Vac	70W	>0.90	86%	AP4
	KTLD-60-UV-24V-W2	24Vdc	60W	0A	2.50A	120~277Vac	70W	>0.90	86%	W2
80W	KTLD-80-UV-12V	12Vdc	80W	0A	6.70A	120~277Vac	93W	>0.90	86%	L5
	KTLD-80-1-24V	24Vdc	80W	0A	3.30A	120Vac	92W	>0.90	87%	L5
	KTLD-80-UV-24V	24Vdc	80W	0A	3.30A	120~277Vac	93W	>0.90	86%	L5
	KTLD-80-UV-24V-67-AP2	24Vdc	80W	0A	3.30A	120~277Vac	93W	>0.90	86%	AP2
100W	KTLD-100-UV-12V	12Vdc	96W	0A	8.00A	120~277Vac	114W	>0.90	84%	L5
	KTLD-100-UV-12V-67-AP2	12Vdc	96W	0A	8.00A	120~277Vac	114W	>0.90	84%	AP2
	KTLD-100-UV-12V-67-AP3	12Vdc	96W	0A	8.00A	120~277Vac	114W	>0.90	84%	AP3
	KTLD-100-UV-24V	24Vdc	96W	0A	4.00A	120~277Vac	110W	>0.90	87%	L5
	KTLD-100-UV-24V-A02	24Vdc	96W	0A	4.00A	120~277Vac	112W	>0.90	86%	A02
	KTLD-100-UV-24V-67-AP2	24Vdc	96W	0A	4.00A	120~277Vac	110W	>0.90	87%	AP2
120W	KTLD-120-UV-12V-L10	12Vdc	120W	0A	5.00A	120~277Vac	142W	>0.9	84%	L10
150W	KTLD-150-UV-24V-AU1	24Vdc	150W	0A	6.25A	120~277Vac	165W	>0.90	90%	AU1
	KTLD-150-UV-24V-67-AP3	24Vdc	150W	0A	6.25A	120~277Vac	169W	>0.90	89%	AP3

* Nominal efficiency. Actual efficiency may vary slightly due to manufacturing tolerances and application.

IP (Ingress Protection) Case Rating

IP67 Cases, designated by -67 in the catalog number, are dust-tight and protected from temporary water immersion (30 minutes at a depth of 1 meter).

There are several Keystone case types that can be upgraded to a higher IP rating upon request. Please consult Keystone for details.

CASE STYLES

All LED drivers can be modified to accommodate specific requirements.

Contact Keystone to discuss custom and semi-custom LED driver solutions.

CASE AK

Material: Steel

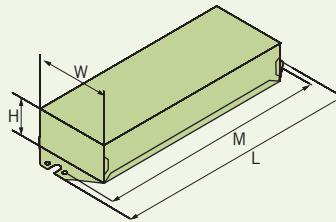

Case Style	Mounting	Length	Width	Height
AK1	4.29"	4.80"	1.58"	0.96"

CASE AO

Material: Steel

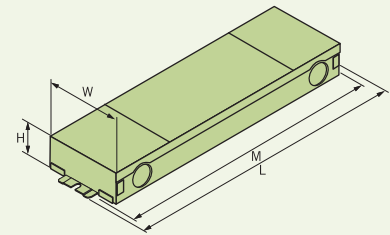

Case Style	Mounting	Length	Width	Height
A01	9.05"	9.49"	3.00"	1.30"
A02	11.02"	11.46"	3.00"	1.30"

CASE AP

Material: Aluminum
Case Rating: IP67

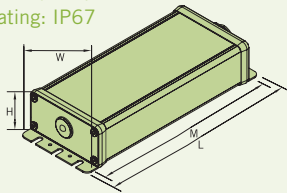

Case Style	Mounting	Length	Width	Height
AP1	7.24"	7.83"	3.20"	1.57"
AP2	7.76"	8.35"	3.20"	1.57"
AP3	8.33"	8.94"	2.68"	1.52"
AP4	8.65"	9.26"	1.90"	1.50"

CASE AU

Material: Aluminum

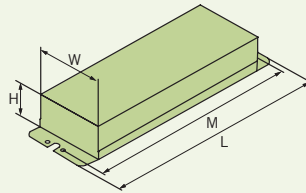

Case Style	Mounting	Length	Width	Height
AU1	8.90"	9.45"	1.80"	1.37"

CASE F

Material: Aluminum

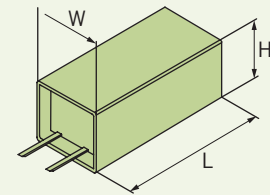

Case Style	Mounting	Length	Width	Height
F3	N/A	2.68"	1.30"	0.79"

CASE L

Material: Steel

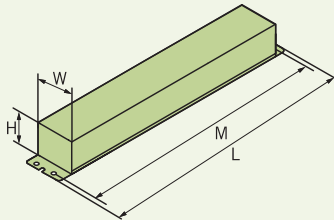

Case Style	Mounting	Length	Width	Height
L5	8.90"	9.50"	1.70"	1.18"
L10	16.35"	16.73"	1.70"	1.18"

CASE W

Material: Steel

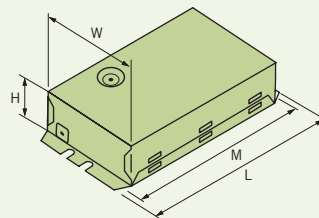

Case Style	Mounting	Length	Width	Height
W2	4.63"	5.00"	3.00"	1.38"

SAM

Sign Component Manual (SAM) - SAM is a directory governed by UL that lists all components that have been tested and certified under the UL standard for electric signs. It is updated quarterly and contains all of the components associated with the manufacturing of electric signs, including LED power supplies. For more information, visit www.ul.com.

Keystone has several LED drivers that meet the qualifications for SAM approval. Use the charts below to see which of our products are SAM Qualified or currently pending approval.

UL Sign Component Manual Qualified Products

Catalog Number	Catalog Number	Catalog Number
KTLD-10-1N-12V-F3	KTLD-60-UV-12V	KTLD-100-UV-12V
KTLD-10-1N-24V-F3	KTLD-60-UV-12V-67-AP4	KTLD-100-UV-24V
KTLD-12-1-350-FDIM-AF1	KTLD-60-UV-12V-VDIM-L5	KTLD-120-UV-12V-L10
KTLD-24-UV-12V-AK1	KTLD-60-UV-12V-W2	KTLD-150-UV-24V-AU1
KTLD-24-1-12V-AK1	KTLD-60-UV-24V	KTLD-150-UV-24V-67-AP3
KTLD-24-1-24V-AK1	KTLD-60-UV-24V-67-AP4	<i>*Approval Pending</i>
KTLD-24-UV-24V-AK1	KTLD-60-UV-24V-W2	
KTLD-60-1-12V	KTLD-80-1-12V	
KTLD-60-1-24V	KTLD-80-1-24V	
KTLD-60-1-24V-W2	KTLD-80-UV-24V*	



LED DRIVERS

DIMMER COMPATIBILITY LIST

Phase Control Dimming

Designated by **FDIM** in Catalog Number.

Phase control dimming (also called TRIAC, forward phase/leading edge, or reverse phase/trailing edge dimming) is a common dimming technology used in residential and commercial applications. Phase control dimmers work by effectively “cutting-off” a portion of the wave on each power cycle (the front half of the waveform for forward phase and the back half of the waveform for reverse phase). Cutting off the waveform causes an imperceptible flicker at each cycle, which the human eye perceives as dimmed light output. Phase control dimmers are commonly wall-mounted and control several fixtures up to a combined 800VA at 120V.

TRIAC (Leading Edge):

MANUFACTURER	MODEL
Lutron	Diva DV-600P
	SkyLark S-600P
	Ariadni AY-600P
	Ariadni TG-603P
	Maestro MA-600 (Digital)
	Diva CFL/LED DVCL-153P
	Satin Colors DVSC-600P-SW
Leviton	6641
	IllumaTech IPI06-1LX
	ToggleTouch TGI06-1LW (Digital)

Reverse (Trailing Edge):

MANUFACTURER	MODEL
Lutron	MAELV-600BL (Digital)
	DVELV-300P
	SkyLark SELV-300P

Consult dimmer manufacturer for dimmer specifications.

0-10V (Analog Dimming)

Designated by **VDIM** in Catalog Number.

All major brand 0-10V dimmers are acceptable for use with Keystone 0-10V drivers. Please note that the 0-10V regulated voltage (dimming setting) at a particular position may be different for each dimmer, even among the same brand and model. Dimming performance may vary because of this phenomenon. Consult factory for verification.

Local Dimming

Designated by **LDIM** in Catalog Number.

Local dimming refers to using a locally installed potentiometer, or simple resistor to control the light output of the lighting fixture. The user can manually adjust the potentiometer (and light output) by mechanically moving a rotary or sliding switch. These dimmers are typically installed directly into the lighting fixture for a simple user control. Torchieres, table lamps, and undercabinet/task lighting often employ local dimming technology.



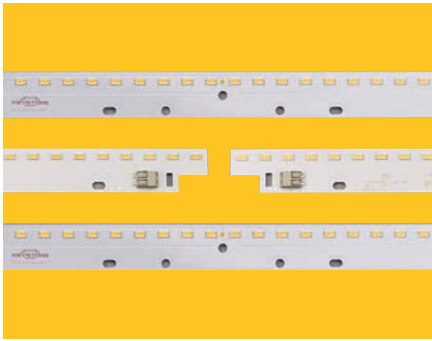

ELECTRICAL SPECIFICATIONS

Catalog Number	Nominal Lumens	Max. Drive Current	Forward Voltage	Max. Module Power	Dimensions
1600SL Series LED Module					1,600 lm/ft, Narrow Footprint
KTLM-450-L5-8xx-30A	1600	450mA	31Vdc	14.0W	L5 (10.75" x 0.70")
KTLM-900-L2-8xx-60A	3200	900mA	31Vdc	28.0W	L2 (21.50" x 0.70")
KTLM-1800-L6-8xx-120A	6400	1800mA	31Vdc	55.8W	L6 (43.10" x 0.70")
1100SL Series LED Module					1,100 lm/ft, Narrow Footprint
KTLM-300-L5-8xx-22A	1100	300mA	34Vdc	10.3W	L5 (10.75" x 0.70")
KTLM-600-L2-8xx-44A	2200	600mA	34Vdc	20.5W	L2 (21.50" x 0.70")
KTLM-1500-L6-8xx-90A	4400	1500mA	28Vdc	42.0W	L6 (43.10" x 0.70")
900SL Series LED Module					900 lm/ft, Narrow Footprint
KTLM-300-L7-8xx-10A	500	300mA	15Vdc	4.5W	L7 (5.375" x 0.70")
KTLM-300-L5-8xx-18A	900	300mA	28Vdc	8.5W	L5 (10.75" x 0.70")
KTLM-600-L2-8xx-36A	1800	600mA	28Vdc	16.6W	L2 (21.50" x 0.70")
KTLM-1200-L6-8xx-72A	3600	1200mA	28Vdc	33.6W	L6 (43.10" x 0.70")
650SL Series LED Module					650 lm/ft, Narrow Footprint
KTLM-300-L5-8xx-14A	650	300mA	21.5Vdc	6.4W	L5 (10.75" x 0.70")
KTLM-600-L2-8xx-28A	1300	600mA	21.5Vdc	13.0W	L2 (21.50" x 0.70")
KTLM-1200-L6-8xx-56A	2600	1200mA	21.5Vdc	25.8W	L6 (43.10" x 0.70")
1100Z Series LED Module					1,100 lm/ft, Compatible with Standard Industry Recognized Mounting
KTLM-300-L3-8xx-22A	1100	300mA	34Vdc	10.3W	L3 (11.00" x 1.00")
KTLM-600-L4-8xx-44A	2200	600mA	34Vdc	20.5W	L4 (22.00" x 1.00")
900Z Series LED Module					900 lm/ft, Compatible with Standard Industry Recognized Mounting
KTLM-300-L3-8xx-18A	900	300mA	28Vdc	8.5W	L3 (11.00" x 1.00")
KTLM-600-L4-8xx-36A	1800	600mA	28Vdc	16.6W	L4 (22.00" x 1.00")
650Z Series LED Module					650 lm/ft, Compatible with Standard Industry Recognized Mounting
KTLM-300-L3-8xx-14A	650	300mA	21.5Vdc	6.4W	L3 (11.00" x 1.00")
KTLM-600-L4-8xx-28A	1300	600mA	21.5Vdc	13.0W	L4 (22.00" x 1.00")
Future Fit Series LED Module					Optimized for Keystone LED Kits
KTLM-1050-L6-8xx-63A	3300	1050mA	28Vdc	29.4W	L6 (43.10" x 0.70")
KTLM-1050-L6-8xx-77A	4000	1050mA	34Vdc	35.7W	L6 (43.10" x 0.70")
KTLM-1050-L2-835-63A	3300	1050mA	28Vdc	29.4W	L2 (21.50" x 0.70")

COLOR TEMPERATURE OPTIONS

Designed For Multiple Applications & Light Output Levels

Color temperature options, noted in the chart above by an "xx" in the part number, are as follows:

Catalog Number Designation	Color Temperature
30	3000K
35	3500K
40	4000K
50	5000K

LED MODULES

LINEAR SERIES

PHYSICAL SPECIFICATIONS

LEDs on modules below are to show placement only.

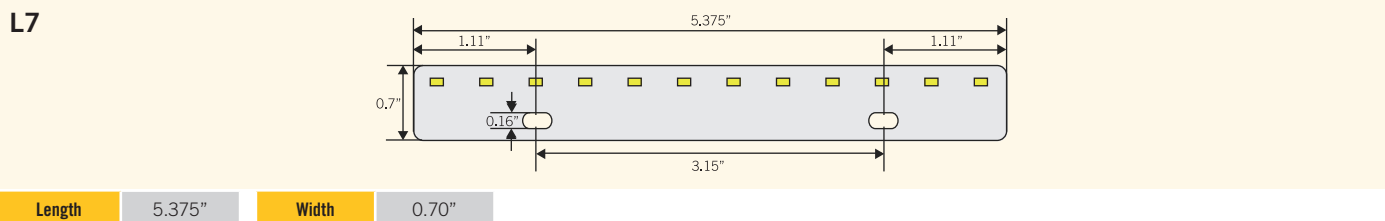
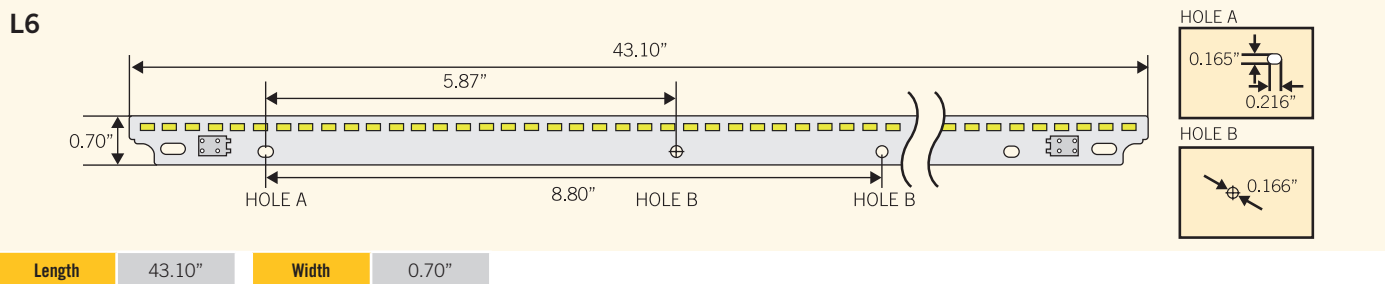
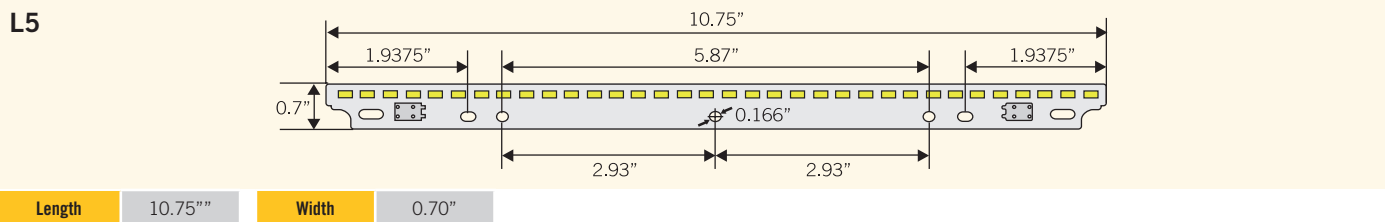
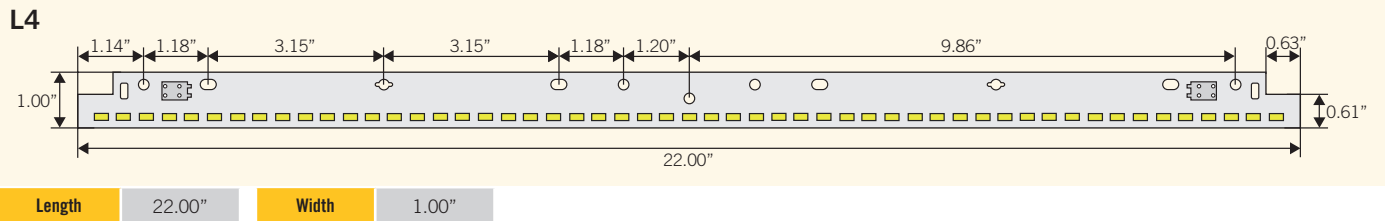
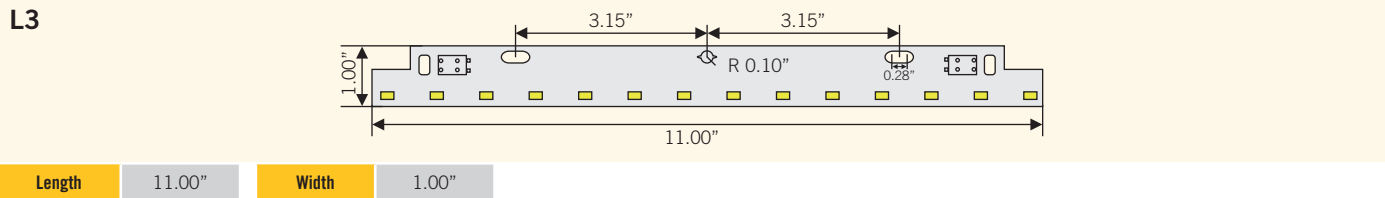
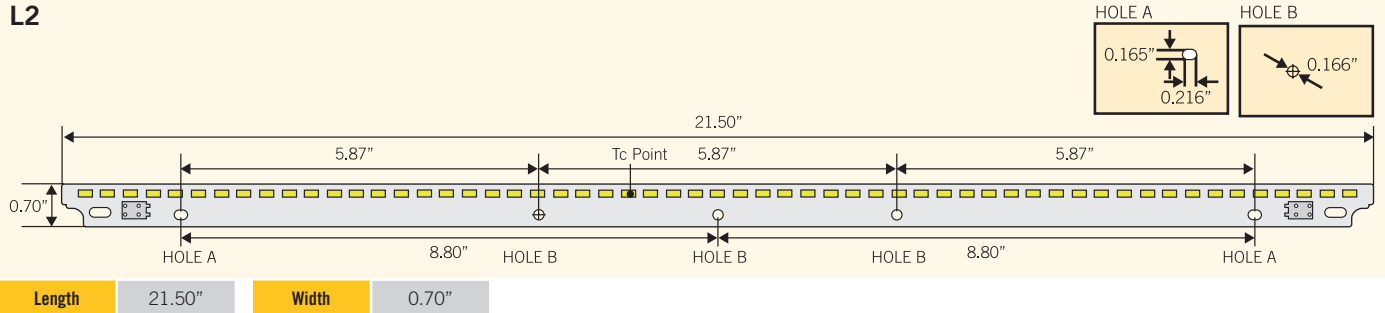

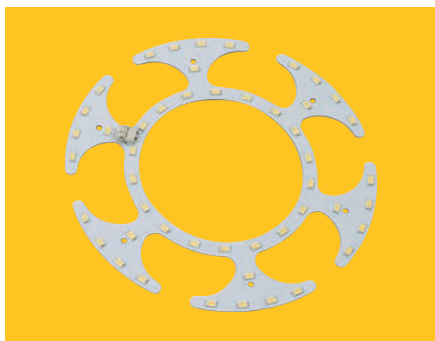

ELECTRICAL SPECIFICATIONS

Catalog Number	Nominal Lumens	Max. Drive Current	Forward Voltage	Max. Module Power	Dimensions
Circular Series LED Module					
KTLM-600-C1-8xx-28A	1300	600mA	21Vdc	12.6W	C1
Future Fit Series LED Module				Optimized for Keystone LED Kits	
KTLM-900-C2-840-48A	2600	900mA	25Vdc	22.5W	C2 (A)
KTLM-900-C2-840-60A	3200	900mA	31Vdc	27.9W	C2 (B)

COLOR TEMPERATURE OPTIONS

Designed For Multiple Applications & Light Output Levels

Color temperature options, noted in the chart above by an "xx" in the part number, are as follows:

Catalog Number Designation	Color Temperature
30	3000K
35	3500K
40	4000K
50	5000K

PHYSICAL SPECIFICATIONS

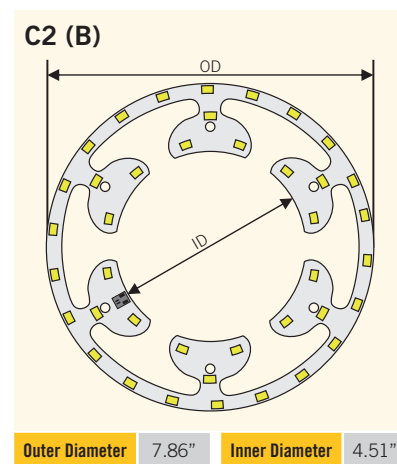
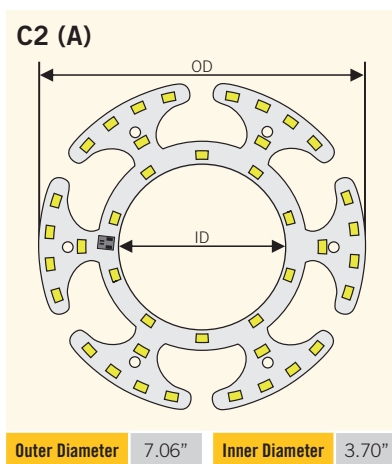
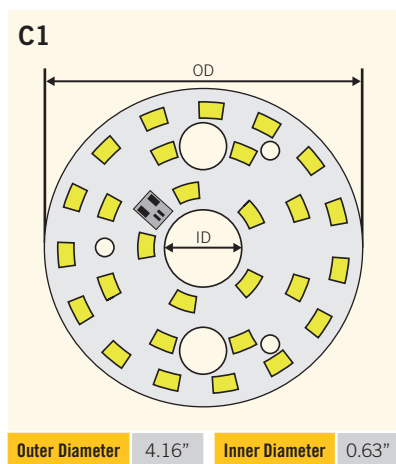

LED MODULES

SQUARE AND RECTANGULAR SERIES



ELECTRICAL SPECIFICATIONS

Catalog Number	Nominal Lumens	Max. Drive Current	Forward Voltage	Max. Module Power	Dimensions
Square Series LED Module					
KTLM-350-SQ1-8xx-21A	875	350mA	21Vdc	7.4W	SQ1
KTLM-350-SQ1-8xx-9A	360	350mA	9Vdc	3.1W	SQ1
KTLM-400-SQ2-8xx-6A	700	400mA	20Vdc	7.9W	SQ2
Future Fit Series LED Module Optimized for Keystone LED Kits					
KTLM-1050-R1-840-14A	700	1050mA	6Vdc	6.5W	R1
KTLM-1050-R1-840-28A	1300	1050mA	12.5Vdc	13W	R1
KTLM-450-R2-8xx-24A	1300	450mA	25Vdc	11.2W	R2
KTLM-450-R2-8xx-15A	800	450mA	15.5Vdc	7W	R2

COLOR TEMPERATURE OPTIONS

Designed For Multiple Applications & Light Output Levels

Color temperature options, noted in the chart above by an "xx" in the part number, are as follows:

Catalog Number Designation	Color Temperature	Catalog Number Designation	Color Temperature
30	3000K	40	4000K
35	3500K	50	5000K

PHYSICAL SPECIFICATIONS

LEDs on module below are to show placement only.

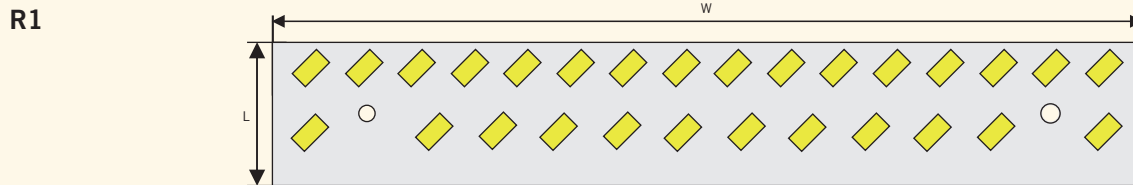

Length 0.63" Width 5.50"

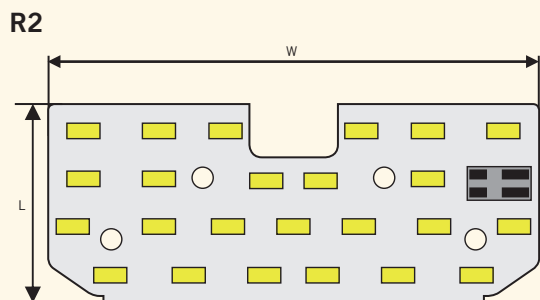

Length 1.68" Width 4.31"

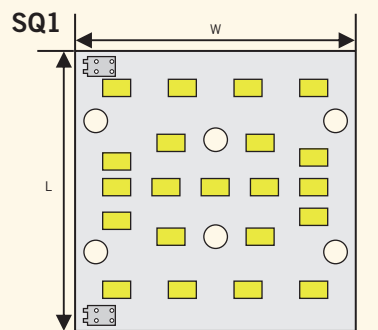

Length 1.875" Width 1.875"

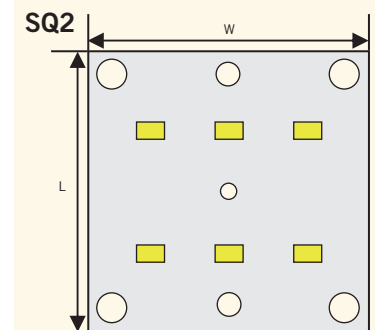

Length 2.36" Width 2.36"

KEYSTONE TURNKEY LED PROGRAM FOR FIXTURE OEMs

Save Money. Save Time. Instead of submitting each fixture for UL and DLC approval and paying the associated fees, the Keystone Turnkey LED Program allows the fixture assembler to “alternate list” against the pre-tested, pre-approved fixture designs. This co-op program between Keystone and A.L.P. substantially reduces the cost to bring new fixtures to market while dramatically speeding up the UL and DLC approval process. **Available to fixture manufacturers only.**

FIXTURE OPTIONS

SteelCraft Metal Work from A.L.P.		Keystone Components	
Fixture Family	Luminaire Type	LED Driver Cat. No.	LED Module Cat. No.
ELC, ELL, ELP, ELV or RDIDB	2x2 Recessed Troffer	(1) KTLD-40-UV-1100-VDIM-L9	(2) KTLM-900-L2-8xx-60A
	2x4 Recessed Troffer	(1) KTLD-72-UV-2x1000-VDIM-L5	(4) KTLM-900-L2-8xx-60A (2) KTLM-1500-L6-8xx-90A

HOW TO ORDER:

1 Contact Keystone to enroll in the Turnkey Fixture LED Program.

2 Purchase one of the following Steel Craft metal packages from A.L.P.



ELC Troffer



ELL Troffer



ELP Troffer



ELV Troffer



RDIDB Troffer



3 Purchase a UL and DLC QPL Listed LED driver and board system from Keystone.



Keystone Drivers



Keystone Modules



4 Assemble at your facility and customize to your unique requirements.



Call us today to learn how to get started with this ground-breaking opportunity for fixture manufacturers.

Keystone offers a remarkable 10 year warranty on the electronic components (driver and board) used in this system.*

Terms and Conditions: 1. **Hours of Operation:** Cannot exceed 12 hrs/day, 7 days a week. 2. **Ambient Temperature:** Used in climate controlled environment where ambient temperature does not exceed 77°F (25°C) during operational hours. 3. **Driver Temperature:** Driver case temperature at tC point does not exceed 158°F (70°C) during operation.

*Metal work is covered under a separate 5 year warranty from A.L.P.

LINEAR LED LAMPS

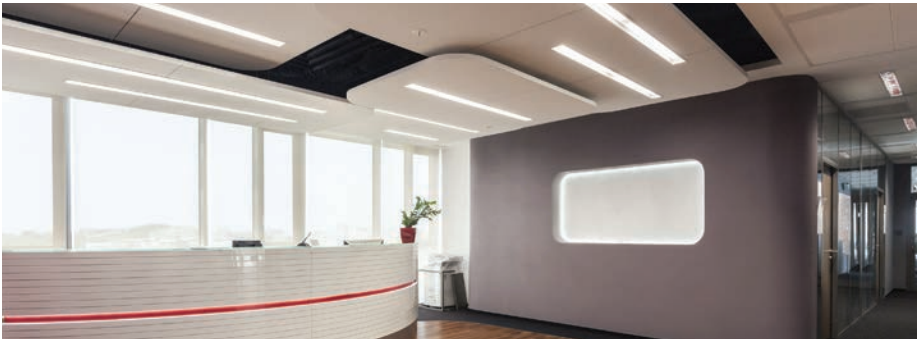

SMARTDRIVE LED[®]

PLUG & PLAY WITH BALLAST

T8



SmartDrive Shatterproof Coated Glass T8 Lamps are NSF Listed.

Catalog Number	Nominal Length	Bare Lamp Wattage	Nominal Lumens	System Wattage			Initial Lumens			Beam Angle	Light Spread	Bare Lamp Efficacy
				.78 BF	.88 BF	1.18 BF	.78 BF	.88 BF	1.18 BF			
SHATTERPROOF COATED GLASS CONSTRUCTION												
KT-LED9T8-24GC-8xx-S	2'	9W	1150	10.2W	11.8W	15.2W	945	1080	1370	220°	325°	128 lm/W
KT-LED11T8-36GC-8xx-S*	3'	11W	1450	11.7W	13.7W	17.8W	1210	1400	1780	220°	325°	132 lm/W
KT-LED12T8-48GC-8xx-S	4'	12W	1800	12.6W	14.9W	19.4W	1470	1710	2090	220°	325°	150 lm/W
KT-LED14T8-48GC-8xx-S	4'	14W	1800	14.2W	16.4W	22.1W	1620	1870	2490	220°	325°	129 lm/W
KT-LED17T8-48GC-8xx-S	4'	17W	2200	17.2W	20.2W	27.8W	1930	2200	2800	220°	325°	129 lm/W
GLASS CONSTRUCTION												
KT-LED9T8-24G-8xx-S	2'	9W	1150W	17.2W	20.2W	27.8W	945	1080	1370	220°	325°	128 lm/W
KT-LED11T8-36G-8xx-S*	3'	11W	1450W	12.6W	14.9W	19.4W	1210	1400	1780	220°	325°	132 lm/W
KT-LED12T8-48G-8xx-S	4'	12W	1800W	14.2W	16.4W	22.1W	1470	1710	2090	220°	325°	150 lm/W
KT-LED14T8-48G-8xx-S	4'	14W	1800W	11.7W	13.7W	17.8W	1620	1870	2490	220°	325°	129 lm/W
KT-LED17T8-48G-8xx-S	4'	17W	2200W	10.2W	11.8W	15.2W	1930	2200	2800	220°	325°	129 lm/W
PLASTIC/ALUMINUM CONSTRUCTION												
KT-LED18T8-48P-8xx-S	4'	18W	2000W	21.0W	23.0W	32.0W	1800	2000	2700	120°	180°	111 lm/W

*3' lamps are not included on the DLC Qualified Products List

T5HO



SmartDrive Shatterproof Coated Glass T5HO Lamps are ETL Sanitation Listed.

Catalog Number	Nominal Length	Bare Lamp Wattage	Initial Lumens	System Wattage	Beam Angle	Light Spread	Bare Lamp Efficacy
SHATTERPROOF COATED GLASS CONSTRUCTION							
KT-LED27T5HO-48GC-8xx-S	4'	27W	3200	30W	240°	325°	111 lm/W

U-BEND



SmartDrive U-Bend Lamps are NSF Listed.

Catalog Number	Nominal Length	Bare Lamp Wattage	Nominal Lumens	System Wattage			Initial Lumens			Beam Angle	Light Spread	Bare Lamp Efficacy
				.78 BF	.88 BF	1.18 BF	.78 BF	.88 BF	1.18 BF			
SHATTERPROOF COATED GLASS CONSTRUCTION												
KT-LED17T8-U6GC-8xx-S*	6" U-Bend	17W	2200	17.7W	20.2W	26.7W	1930	2200	2800	220°	325°	129 lm/W

*U-bend lamps are not included on the DLC Qualified Products List

For all Keystone SmartDrive linear LED lamps, input voltage is ballast dependent and CRI >80.

*8xx denotes several color temperatures available:

830	800 Series, 3000K	835	800 Series, 3500K	840	800 Series, 4000K	850	800 Series, 5000K
------------	-------------------	------------	-------------------	------------	-------------------	------------	-------------------



LINEAR LED LAMPS



DIRECT DRIVE LED[®] LINE VOLTAGE T8 TUBES



Direct Drive Shatterproof Glass T8 Lamps are ETL Sanitation Listed.

Catalog Number	Nominal Length	Input Voltage	CRI	Lamp Wattage	Lumens	Beam Angle	Light Spread	Efficacy	Meets DLC
SHATTERPROOF COATED GLASS CONSTRUCTION									
KT-LED7T8-18GC-8xx-D	18"	120-277V	>80	7W	700	240°	325°	100 lm/W	N/A
KT-LED9T8-24GC-8xx-D	2'	120-277V	>80	9W	900	240°	325°	100 lm/W	Yes
KT-LED12T8-36GC-8xx-D	3'	120-277V	>80	12W	1200	240°	325°	100 lm/W	N/A
KT-LED15T8-48GC-8xx-D	4'	120-277V	>80	15W	1700	240°	325°	113 lm/W	Yes
KT-LED18T8-48GC-8xx-D	4'	120-277V	>80	18W	1800	240°	325°	100 lm/W	Yes
KT-LED18T8-48GC-8xx-D-FDIM*	4'	120V	>80	18W	1800	240°	325°	100 lm/W	Yes
KT-LED22T8-48GC-8xx-D	4'	120-277V	>80	22W	2400	240°	325°	109 lm/W	Yes
GLASS CONSTRUCTION									
KT-LED7T8-18G-8xx-D	18"	120-277V	>80	7W	700	240°	325°	100 lm/W	N/A
KT-LED9T8-24G-8xx-D	2'	120-277V	>80	9W	900	240°	325°	100 lm/W	Yes
KT-LED12T8-36G-8xx-D	3'	120-277V	>80	12W	1200	240°	325°	100 lm/W	N/A
KT-LED18T8-48G-8xx-D	4'	120-277V	>80	18W	1800	240°	325°	100 lm/W	Yes
PLASTIC/ALUMINUM CONSTRUCTION									
KT-LED18T8-48P-8xx-D	4'	120-277V	>80	18W	1800	120°	180°	100 lm/W	Yes

*TRIAC dimmable

*8xx denotes several color temperatures available:

830	800 Series, 3000K	835	800 Series, 3500K	840	800 Series, 4000K	850	800 Series, 5000K	865	800 Series, 6500K, Not DLC Listed
------------	-------------------	------------	-------------------	------------	-------------------	------------	-------------------	------------	-----------------------------------

COMBODRIVE LED[®] PLUG & PLAY OR LINE VOLTAGE COMPATIBLE



Catalog Number	Nominal Length	Lamp Wattage	Lumens	Beam Angle	Instant Start Ballast Compatible Application						Line Voltage Application		
					System Wattage			Initial Lumens			Input Voltage	Lamp Wattage	Initial Lumens
					.78 BF	.88 BF	1.18 BF	.78 BF	.88 BF	1.18 BF			
SHATTERPROOF COATED GLASS CONSTRUCTION													
KT-LED15T8-48GC-8xx-X	4'	15W	1800	220°	16.2W	17.4W	18.5W	1620	1750	1880	120-277V	15W	1710

For all Keystone ComboDrive linear LED lamps, input voltage is ballast dependent.

*8xx denotes several color temperatures available:

830	800 Series, 3000K	835	800 Series, 3500K	840	800 Series, 4000K	850	800 Series, 5000K
------------	-------------------	------------	-------------------	------------	-------------------	------------	-------------------

COMPACT LED LAMPS

RoHS Compliant

5 YEAR WARRANTY

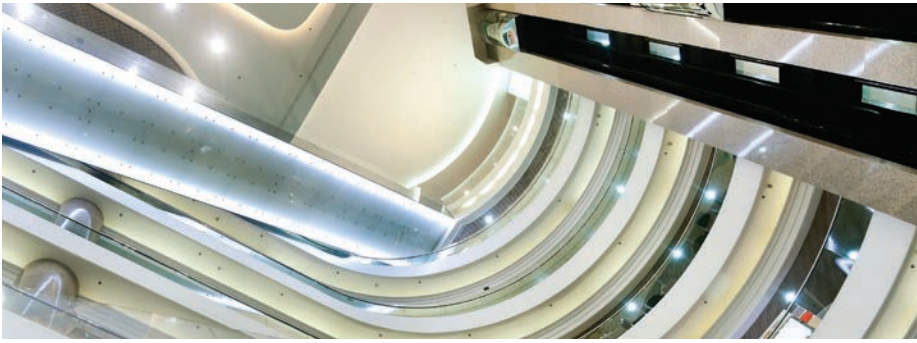

SMARTDRIVE LED

PLUG & PLAY WITH CFL BALLASTS



Catalog Number	Input Voltage	Base	Orientation	CRI	Lamp Wattage	System Wattage	Lumens
PLASTIC/ALUMINUM CONSTRUCTION; REPLACES 4-PIN 26W, 32W, OR 42W CFL LAMP							
KT-LED134P-H-8xx-S	Ballast Dependent	G24q	Horizontal	>80	13W	14W	900
KT-LED-134P-V-8xx-S	Ballast Dependent	G24q	Vertical	>80	13W	14W	900
KT-LED-134P-EV-8xx-S	Ballast Dependent	G24q	Extended Vertical	>80	13W	14W	900
KT-LED114P-H-8xx-S*	Ballast Dependent	G24q	Horizontal	>80	11W	13W	1000
KT-LED114P-V-8xx-S*	Ballast Dependent	G24q	Vertical	>80	11W	13W	1000
KT-LED114P-EV-8xx-S*	Ballast Dependent	G24q	Extended Vertical	>80	11W	13W	1000

*Generation 2

DIRECTDRIVE LED

CONNECT TO LINE VOLTAGE



Catalog Number	Color	Base	Input Voltage	CRI	Lamp Wattage	Lumens	Rated Average Life
PLASTIC/ALUMINUM CONSTRUCTION; REPLACES 2-PIN 13W CFL LAMP							
KT-LED62P-H-8xx-D	2700K	GX23	120-277V	>80	6W	500	50,000 Hours

COMBODRIVE LED

PLUG & PLAY OR LINE VOLTAGE COMPATIBLE



Catalog Number	Input Voltage	Base	Orientation	CRI	Lamp Wattage	System Wattage		Lumens
						With Ballast	Line Voltage	
PLASTIC/ALUMINUM CONSTRUCTION; REPLACES 2-PIN AND 4-PIN 18W OR 26W (WITH REWIRING) CFL LAMP								
KT-LED112P-H-8xx-X	Ballast Dependent or 120-277V	G24d	Horizontal	>80	11W	13W	11W	1000
KT-LED112P-V-8xx-X	Ballast Dependent or 120-277V	G24d	Vertical	>80	11W	13W	11W	1000
KT-LED112P-EV-8xx-X	Ballast Dependent or 120-277V	G24d	Extended Vertical	>80	11W	13W	11W	1000

*8xx denotes several color temperatures available:

827 800 Series, 2700K **830** 800 Series, 3000K **835** 800 Series, 3500K **840** 800 Series, 4000K **850** 800 Series, 5000K

LIGHT

Lighting is our legacy. It's all we've done since 1945, relentlessly developing energy efficient lighting solutions for the industry's most discerning customers. From incumbent fluorescent lighting systems through the latest LED technologies, Keystone is singularly focused on being your one-stop-shop for quality lighting products.

MADE

With more than 100 Million Keystone ballasts and LED drivers in use today, thousands of installers, architects and engineers depend on Keystone for lighting products that are manufactured to last. We factory test 100% of every production run, so you know that when you install a Keystone product, it's made to perform.

EASY

What makes us different? We fundamentally believe that we are here to make buying and using lighting products easy. From easy-to-read installation guides to exceptionally fast quote response time and the most convenient fulfillment centers in the industry, our primary goal is to make lighting refreshingly easy.



Contact us today to experience **Light Made Easy**, only by Keystone.



Keystone Technologies • 1390 Welsh Road, North Wales, PA 19454 • Phone (800) 464-2680
Fax (888) 966-0556 • www.KeystoneLEDsolutions.com

WAREHOUSE LOCATIONS: Atlanta, GA • Boston, MA • Charlotte, NC • Chicago, IL • Cincinnati, OH • Dallas, TX • Denver, CO • Detroit, MI
Fort Lauderdale, FL • Houston, TX • Kansas City, MO • Los Angeles, CA • Louisville, KY • Memphis, TN • Minneapolis, MN • Nashville, TN
Philadelphia, PA • Phoenix, AZ • Portland, OR • San Francisco, CA • Syracuse, NY