



GREENCREATIVE

LAMPS



2018 LAMPS CATALOG



GREENCREATIVE

GREEN CREATIVE, founded in 2010, is a solid state lighting development and manufacturing company based in Silicon Valley, CA. The company offers a comprehensive line of high-performance LED lighting solutions which has been widely adopted by some of the largest companies in the world.



2016 Top 10
MUST SEE Products



2017
PRODUCT
SPRINT
2017 WINNER



A complete line with national & international distribution

GREEN CREATIVE's full product line of ENERGY STAR, DLC, NSF & JA8 certified indoor retrofit and new construction lighting solutions serves the Retail, Hospitality, Food & Beverage, Office, Education & Industrial sectors through multiple distribution centers and sales networks across the USA.



Bringing you the latest in LED technology

Anchored by strong integrated R&D capabilities and patented technology, GREEN CREATIVE innovation, performance and reliability have been recognized year after year by the Illuminating Engineering Society Progress Report, the LEDs Magazine Sapphire Awards, Edison Report, NAILD and more.



2018 LAMPS TABLE OF CONTENTS

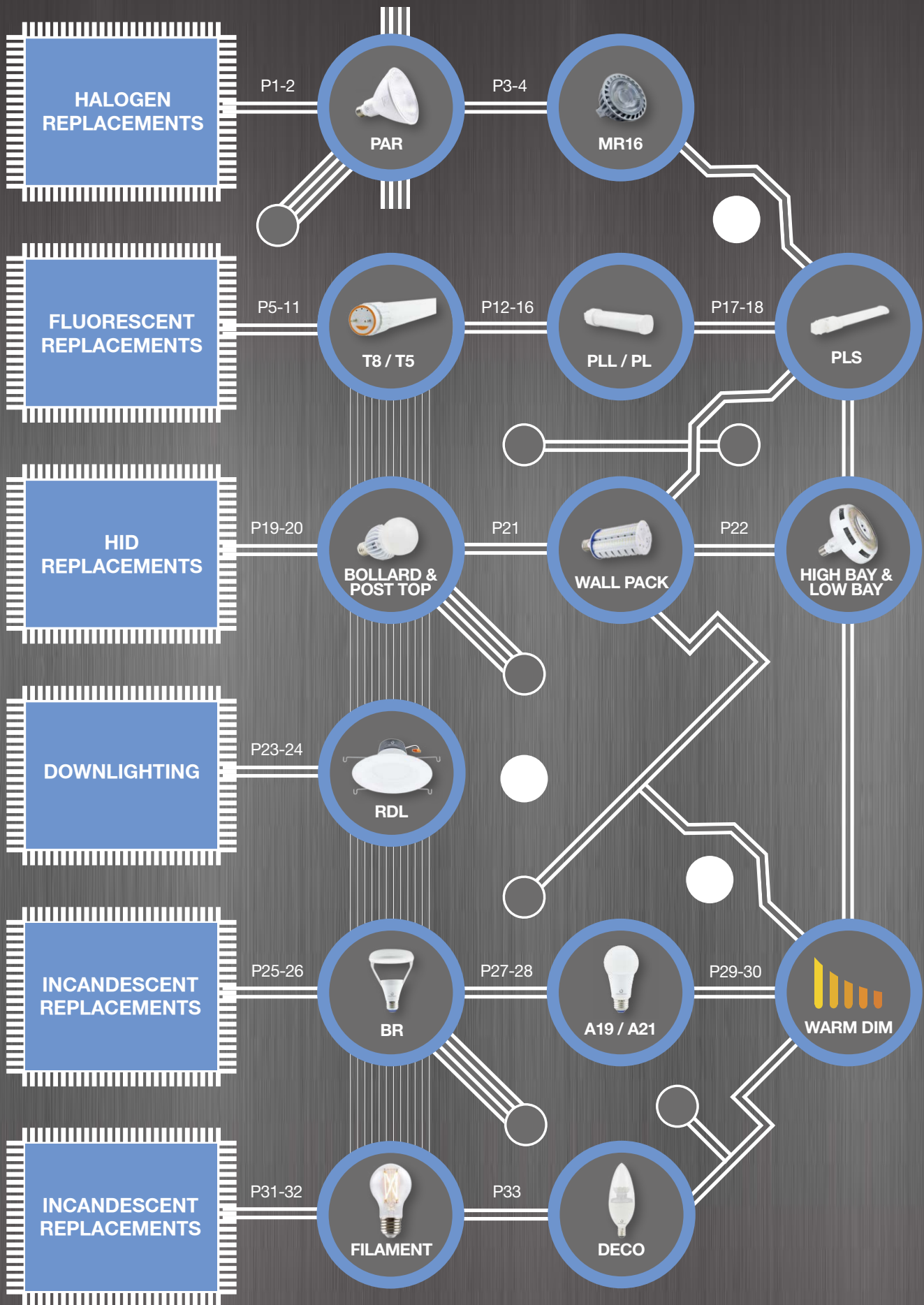

2018 LAMPS FEATURED PRODUCTS



COMING SOON!



P1-2

PAR30 HO

1700lm output
Superior candela & CRI
Enclosed fixture rated

COMING SOON!



P5-11

T8 EXT, T5 EXT & T5 BYP

T8 EXTERNAL driver
T5 HO & HE EXTERNAL driver
T5 HO & HE BYPASS

COMING SOON!



P13-16

PL DIR & BYP 42W EQUIV.

>1800lm output
DIRect - 42W ballast compatible
BYPass - 120-277V

NEW!



P19

HID LED BOLLARD

Compact form factor
Universal voltage 120-277V
Enclosed fixture rated

NEW!



P21

HID LED WALL PACK

54W, 40W & 20W versions
Universal voltage 120-277V
Enclosed fixture rated

NEW!



P22

HID LED HIGH BAY & LOW BAY

90W, 65W & 35W versions
Universal voltage 120-277V
Visible uplighting

PAR LINE



LIGHTING
for
tomorrow

PAR38 17W



PAR38 17W



Exc. PAR38 & PAR30 HO

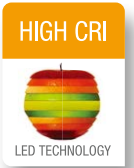

SPECIFICATIONS

| | Model | Product | CCT | Lumens (lm) | Equiv. | LPW | Beam Angle | CBCP (cd) | CRI (typ.) | Dim | Life (hrs) | Voltage | Encl. | |
|-------------------------|------------------------|---------|-------|-------------|--------|-----|------------|-----------|------------|--------|------------|----------|-------|---|
| | 17PAR38DIM/927SP15 | 58149 | 2700K | 1150 | 120W | 68 | 15° | 12,200 | 90 | Yes | 50,000 | 120V | Yes | ✓ |
| | 17PAR38DIM/927NF25 | 58150 | 2700K | 1400 | 120W | 82 | 25° | 7300 | 90 | Yes | 50,000 | 120V | Yes | ✓ |
| | 17PAR38DIM/927FL40 | 58151 | 2700K | 1400 | 120W | 82 | 40° | 3100 | 90 | Yes | 50,000 | 120V | Yes | ✓ |
| | 17PAR38DIM/930SP15 | 58152 | 3000K | 1200 | 120W | 71 | 15° | 12,500 | 90 | Yes | 50,000 | 120V | Yes | ✓ |
| | 17PAR38DIM/930NF25 | 58153 | 3000K | 1430 | 120W | 84 | 25° | 7500 | 90 | Yes | 50,000 | 120V | Yes | ✓ |
| | 17PAR38DIM/930FL40 | 58154 | 3000K | 1430 | 120W | 84 | 40° | 3200 | 90 | Yes | 50,000 | 120V | Yes | ✓ |
| | 17PAR38DIM/940FL40 | 58157 | 4000K | 1450 | 120W | 85 | 40° | 3300 | 90 | Yes | 50,000 | 120V | Yes | ✓ |
| | 17PAR38DIM/930NF25/B • | 97904 | 3000K | 1430 | 120W | 84 | 25° | 7500 | 90 | Yes | 50,000 | 120V | Yes | ✓ |
| | 17PAR38DIM/930FL40/B • | 97905 | 3000K | 1430 | 120W | 84 | 40° | 3200 | 90 | Yes | 50,000 | 120V | Yes | ✓ |
| 17PAR38DIM/930FL40/GU24 | 58172 | 3000K | 1430 | 120W | 84 | 40° | 3200 | 90 | Yes | 50,000 | 120V | Yes | ✓ | |
| | 17PAR38/930FL40/277V | 58163 | 3000K | 1430 | 120W | 84 | 40° | 3200 | 90 | No | 50,000 | 120-277V | Yes | ✓ |
| | 17PAR38/940FL40/277V | 58166 | 4000K | 1450 | 120W | 85 | 40° | 3300 | 90 | No | 50,000 | 120-277V | Yes | ✓ |
| | 13PAR30DIM/927SP15 | 58113 | 2700K | 870 | 75W | 67 | 15° | 7800 | 90 | Yes | 50,000 | 120V | Yes | ✓ |
| | 13PAR30DIM/927NF25 | 58114 | 2700K | 1000 | 90W | 77 | 25° | 4500 | 90 | Yes | 50,000 | 120V | Yes | ✓ |
| | 13PAR30DIM/927FL40 | 58115 | 2700K | 1000 | 90W | 77 | 40° | 2200 | 90 | Yes | 50,000 | 120V | Yes | ✓ |
| | 13PAR30DIM/930SP15 | 58116 | 3000K | 880 | 75W | 68 | 15° | 8000 | 90 | Yes | 50,000 | 120V | Yes | ✓ |
| | 13PAR30DIM/930NF25 | 58117 | 3000K | 1050 | 90W | 81 | 25° | 4700 | 90 | Yes | 50,000 | 120V | Yes | ✓ |
| | 13PAR30DIM/930FL40 | 58118 | 3000K | 1050 | 90W | 81 | 40° | 2300 | 90 | Yes | 50,000 | 120V | Yes | ✓ |
| | 13PAR30DIM/940FL40 | 58121 | 4000K | 1100 | 90W | 85 | 40° | 2500 | 90 | Yes | 50,000 | 120V | Yes | ✓ |
| | 13PAR30DIM/930FL40/B • | 97902 | 3000K | 1050 | 90W | 81 | 40° | 2300 | 90 | Yes | 50,000 | 120V | Yes | ✓ |
| | 13PAR30/930FL40/277V | 58127 | 3000K | 1050 | 90W | 81 | 40° | 2300 | 90 | No | 50,000 | 120-277V | Yes | ✓ |
| | 13PAR30/940FL40/277V | 58130 | 4000K | 1100 | 90W | 85 | 40° | 2500 | 90 | No | 50,000 | 120-277V | Yes | ✓ |

• Black finish

Patented REFINE Optic

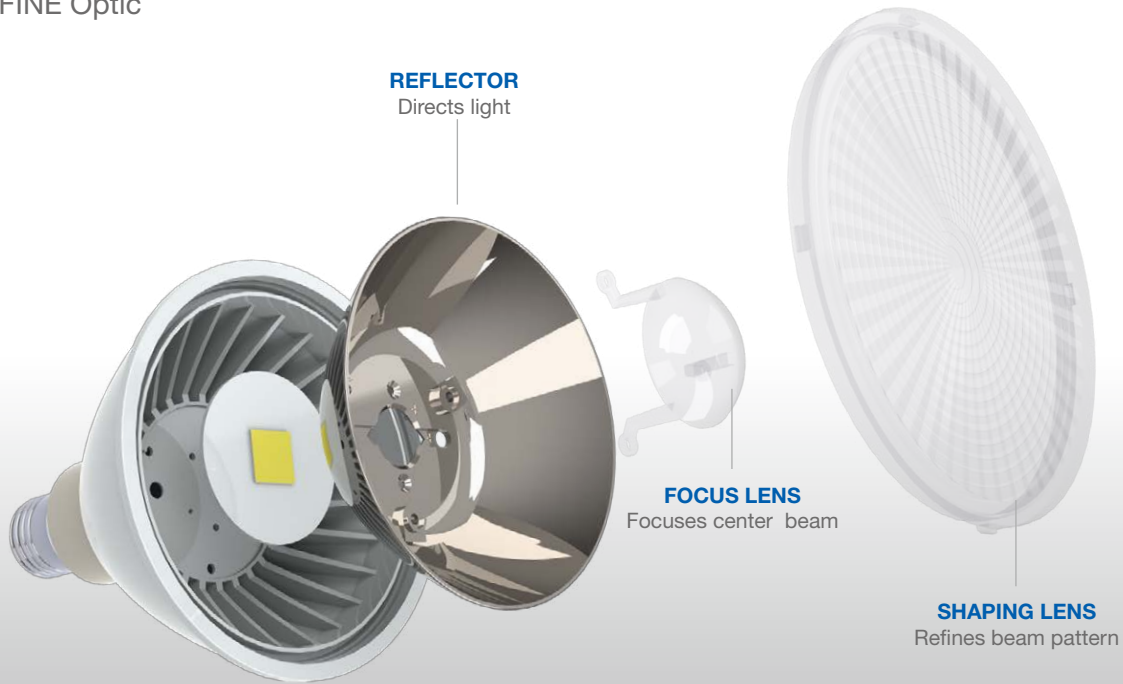

SPECIFICATIONS



| | Model | Product | CCT | Lumens (lm) | Equiv. | LPW | Beam Angle | CBCP (cd) | CRI (typ.) | Dim | Life (hrs) | Voltage | Encl. | |
|--|---|---------|-------|-------------|--------|-----|------------|-----------|------------|-----|------------|----------|-------|-----|
| | 13PAR30SNDIM/927SP15 | 58140 | 2700K | 870 | 75W | 67 | 15° | 7800 | 90 | Yes | 50,000 | 120V | Yes | ✓ |
| | 13PAR30SNDIM/927NF25 | 58141 | 2700K | 1000 | 90W | 77 | 25° | 4500 | 90 | Yes | 50,000 | 120V | Yes | ✓ |
| | 13PAR30SNDIM/927FL40 | 58142 | 2700K | 1000 | 90W | 77 | 40° | 2200 | 90 | Yes | 50,000 | 120V | Yes | ✓ |
| | 13PAR30SNDIM/930SP15 | 58143 | 3000K | 880 | 75W | 68 | 15° | 8000 | 90 | Yes | 50,000 | 120V | Yes | ✓ |
| | 13PAR30SNDIM/930NF25 | 58144 | 3000K | 1050 | 90W | 81 | 25° | 4700 | 90 | Yes | 50,000 | 120V | Yes | ✓ |
| | 13PAR30SNDIM/930FL40 | 58145 | 3000K | 1050 | 90W | 81 | 40° | 2300 | 90 | Yes | 50,000 | 120V | Yes | ✓ |
| | 13PAR30SNDIM/940FL40 | 58148 | 4000K | 1100 | 90W | 85 | 40° | 2500 | 90 | Yes | 50,000 | 120V | Yes | ✓ |
| | 13PAR30SNDIM/930FL40/B • | 97903 | 3000K | 1050 | 90W | 81 | 40° | 2300 | 90 | Yes | 50,000 | 120V | Yes | ✓ |
| | 8PAR20DIM/927SP15 | 58104 | 2700K | 535 | 50W | 67 | 15° | 5300 | 90 | Yes | 50,000 | 120V | Yes | ✓ |
| | 8PAR20DIM/927NF25 | 58105 | 2700K | 535 | 50W | 67 | 25° | 2700 | 90 | Yes | 50,000 | 120V | Yes | ✓ |
| | 8PAR20DIM/927FL40 | 58106 | 2700K | 535 | 50W | 67 | 40° | 1170 | 90 | Yes | 50,000 | 120V | Yes | ✓ |
| | 8PAR20DIM/930SP15 | 58107 | 3000K | 550 | 50W | 69 | 15° | 5400 | 90 | Yes | 50,000 | 120V | Yes | ✓ |
| | 8PAR20DIM/930NF25 | 58108 | 3000K | 550 | 50W | 69 | 25° | 2800 | 90 | Yes | 50,000 | 120V | Yes | ✓ |
| | 8PAR20DIM/930FL40 | 58109 | 3000K | 550 | 50W | 69 | 40° | 1200 | 90 | Yes | 50,000 | 120V | Yes | ✓ |
| | 8PAR20DIM/940FL40 | 58112 | 4000K | 570 | 50W | 71 | 40° | 1250 | 90 | Yes | 50,000 | 120V | Yes | ✓ |
| | 8PAR20DIM/930FL40/B • | 97901 | 3000K | 550 | 50W | 69 | 40° | 1200 | 90 | Yes | 50,000 | 120V | Yes | ✓ |
| | COMING SOON! 19.5PAR30HO/930NF25/277V | 98206 | 3000K | 1700 | 250W | 87 | 25° | 8160 | 90 | No | 50,000 | 120-277V | No | TBC |
| | 19.5PAR30HO/930FL40/277V | 98207 | 3000K | 1700 | 250W | 87 | 40° | 3400 | 90 | No | 50,000 | 120-277V | No | TBC |
| | 19.5PAR30HO/940NF25/277V | 98208 | 4000K | 1700 | 250W | 87 | 25° | 8160 | 90 | No | 50,000 | 120-277V | No | TBC |
| | 19.5PAR30HO/940FL40/277V | 98209 | 4000K | 1700 | 250W | 87 | 40° | 3400 | 90 | No | 50,000 | 120-277V | No | TBC |
| | 19PAR38HO/827NF25/277V | 97769 | 2700K | 1725 | 250W | 91 | 25° | 10,000 | 80 | No | 40,000 | 120-277V | No | ✓ |
| | 19PAR38HO/830NF25/277V | 97772 | 3000K | 1775 | 250W | 93 | 25° | 10,200 | 80 | No | 40,000 | 120-277V | No | ✓ |
| | 19PAR38HO/830FL40/277V | 97773 | 3000K | 1775 | 250W | 93 | 40° | 4300 | 80 | No | 40,000 | 120-277V | No | ✓ |
| | 19PAR38HO/840NF25/277V | 97778 | 4000K | 1850 | 250W | 97 | 25° | 10,400 | 80 | No | 40,000 | 120-277V | No | ✓ |
| | 19PAR38HO/840FL40/277V | 97779 | 4000K | 1850 | 250W | 97 | 40° | 4600 | 80 | No | 40,000 | 120-277V | No | ✓ |

• Black finish

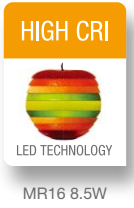
MR16 LINE



SPECIFICATIONS

| | Model | Product | CCT | Lumens (lm) | Equiv. | LPW | Beam Angle | CBCP (cd) | CRI (typ.) | Dim | Life (hrs) | Voltage | Encl. | ES | JA8 |
|---|----------------------|-------------------|-------|-------------|--------|-----|------------|-----------|------------|-----|------------|---------|-------|----------|-----|
|  MR16 8.5W | 8.5MR16DIM/927SP15 | 57975 | 2700K | 550 | 75W | 65 | 15° | 5900 | 92 | Yes | 25,000 | 12V | Yes | ✓ | |
| | 8.5MR16DIM/927NF25 | 57976 | 2700K | 550 | 75W | 65 | 25° | 2900 | 92 | Yes | 25,000 | 12V | Yes | ✓ | |
|  MR16 8.5W | 8.5MR16DIM/927SP15/R | NEW! 98026 | 2700K | 550 | 75W | 65 | 15° | 5900 | 92 | Yes | 25,000 | 12V | Yes | Jul. / ✓ | |
| | 8.5MR16DIM/927NF25/R | 98027 | 2700K | 550 | 75W | 65 | 25° | 2900 | 92 | Yes | 25,000 | 12V | Yes | Jul. / ✓ | |
| | 8.5MR16DIM/927FL35/R | 98028 | 2700K | 550 | 75W | 65 | 35° | 1650 | 92 | Yes | 25,000 | 12V | Yes | Jul. / ✓ | |
| | 8.5MR16DIM/930SP15/R | 98029 | 3000K | 580 | 75W | 68 | 15° | 5950 | 92 | Yes | 25,000 | 12V | Yes | Jul. / ✓ | |
| | 8.5MR16DIM/930NF25/R | 98030 | 3000K | 580 | 75W | 68 | 25° | 2950 | 92 | Yes | 25,000 | 12V | Yes | Jul. / ✓ | |
| | 8.5MR16DIM/930FL35/R | 98031 | 3000K | 580 | 75W | 68 | 35° | 1700 | 92 | Yes | 25,000 | 12V | Yes | Jul. / ✓ | |
|  MR16 6W | 6MR16DIM/827FL35 | 57984 | 2700K | 480 | 50W | 80 | 35° | 1350 | 82 | Yes | 25,000 | 12V | Yes | ✓ | |
| | 6MR16DIM/830FL35 | 57985 | 3000K | 500 | 50W | 83 | 35° | 1400 | 82 | Yes | 25,000 | 12V | Yes | ✓ | |
| | 6MR16DIM/840FL35 | 57986 | 4000K | 520 | 50W | 86 | 35° | 1450 | 82 | Yes | 25,000 | 12V | Yes | ✓ | |

MR16 LINE

True 75W Halogen Replacement

8.5MR16DIM/930SP15/R



| Degree | Candela |
|--------|---------|
| 0 | 5950 |
| 5 | 3837 |
| 15 | 682 |
| 25 | 114 |
| 35 | 16 |
| 45 | 12 |

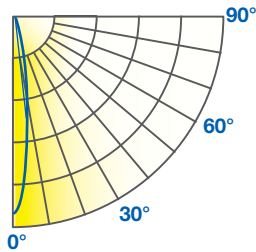

8.5MR16DIM/930NF25/R



| Degree | Candela |
|--------|---------|
| 0 | 2950 |
| 5 | 2623 |
| 15 | 859 |
| 25 | 204 |
| 35 | 67 |
| 45 | 22 |

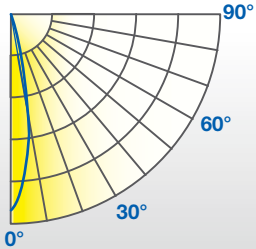

8.5MR16DIM/930FL35/R



| Degree | Candela |
|--------|---------|
| 0 | 1700 |
| 5 | 1649 |
| 15 | 1016 |
| 25 | 257 |
| 35 | 33 |
| 45 | 12 |

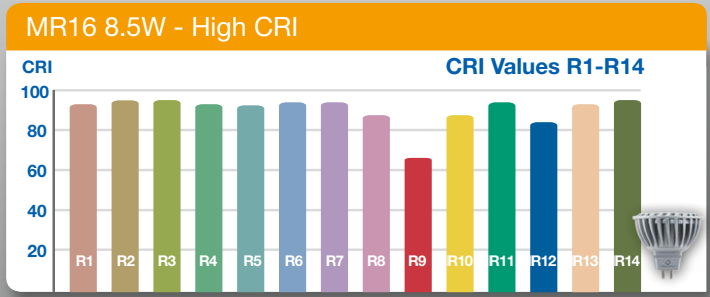
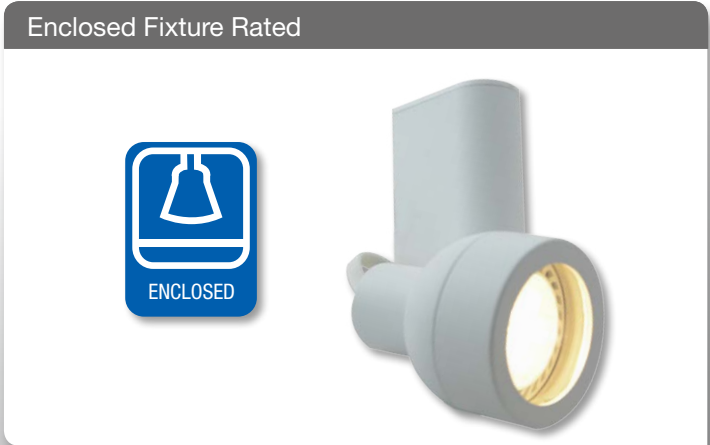
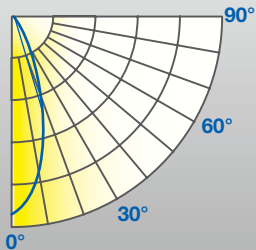

- Most efficient high CRI MR16 75W halogen replacement
- Exceptional color rendering CRI 92
- Richer reds and natural skin tones (R9 65, R13 93)
- Suitable for use in totally enclosed fixtures

SPECIFICATIONS

| Model | Product | CCT | Lumens (lm) | Equiv. | LPW | Beam Angle | CBCP (cd) | CRI (typ.) | Dim | Life (hrs) | Voltage | Encl. | Energy Star |
|-----------------|----------------------|-------|-------------|--------|-----|------------|-----------|------------|-----|------------|---------|-------|-------------|
| MR16 6W | 6MR16DIM/827FL35/35W | 2700K | 425 | 35W | 71 | 35° | 910 | 82 | Yes | 25,000 | 12V | Yes | ✓ |
| | 6MR16DIM/830FL35/35W | 3000K | 450 | 35W | 75 | 35° | 910 | 82 | Yes | 25,000 | 12V | Yes | ✓ |
| GU10 6W | 6GU10DIM/827FL35 | 2700K | 480 | 50W | 80 | 35° | 1000 | 82 | Yes | 25,000 | 120V | Yes | ✓ |
| | 6GU10DIM/830FL35 | 3000K | 500 | 50W | 83 | 35° | 1050 | 82 | Yes | 25,000 | 120V | Yes | ✓ |
| PAR16 6W | 6PAR16DIM/827FL35 | 2700K | 480 | 60W | 80 | 35° | 1000 | 82 | Yes | 25,000 | 120V | Yes | ✓ |
| | 6PAR16DIM/830FL35 | 3000K | 500 | 60W | 83 | 35° | 1050 | 82 | Yes | 25,000 | 120V | Yes | ✓ |
| MR11 3W | 3MR11/827NF30 | 2700K | 200 | 20W | 67 | 30° | 600 | 80 | No | 25,000 | 12V | Yes | N.A. |
| | 3MR11/840NF30 | 4000K | 220 | 20W | 73 | 30° | 620 | 80 | No | 25,000 | 12V | Yes | N.A. |

T8 DIR LINE



Compatible with Electronic Ballasts - Dimmable

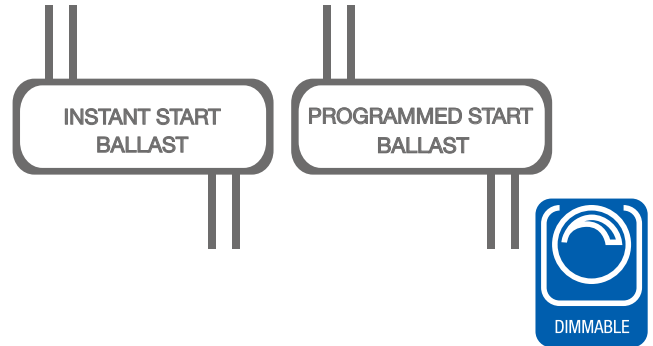







Extra Wide Beam Design - End-to-End Lighting



- ⌚ Easy to install – Plug & play direct
- ⌚ Instant Start & Programmed Start ballast compatible
- ⌚ Suitable for use in totally enclosed fixtures
- ⌚ Glass design – Meets NSF requirements

SPECIFICATIONS

| | Model | Product | CCT | Lumens (lm) | Equiv. | LPW | Beam Angle | CBCP (cd) | CRI (typ.) | Dim | Life (hrs) | Voltage | Encl. |  |
|--|-------------------|---------|-------|-------------|--------|-----|------------|-----------|------------|-----|------------|----------|-------|---|
|  | 13T8/4F/840/DIR | 28403 | 4000K | 2050 | 32W | 158 | 160° | N.A. | 82 | Yes | 50,000 | 120-277V | Yes | ✓ |
| | 13T8/4F/850/DIR | 28404 | 5000K | 2050 | 32W | 158 | 160° | N.A. | 82 | Yes | 50,000 | 120-277V | Yes | ✓ |
|  | 10.5T8/4F/830/DIR | 28397 | 3000K | 1650 | 32W | 157 | 160° | N.A. | 82 | Yes | 50,000 | 120-277V | Yes | ✓ |
| | 10.5T8/4F/835/DIR | 28398 | 3500K | 1650 | 32W | 157 | 160° | N.A. | 82 | Yes | 50,000 | 120-277V | Yes | ✓ |
| | 10.5T8/4F/840/DIR | 28399 | 4000K | 1700 | 32W | 162 | 160° | N.A. | 82 | Yes | 50,000 | 120-277V | Yes | ✓ |
| | 10.5T8/4F/850/DIR | 28400 | 5000K | 1700 | 32W | 162 | 160° | N.A. | 82 | Yes | 50,000 | 120-277V | Yes | ✓ |
|  | 8T8/3F/830/DIR | 97837 | 3000K | 1100 | 25W | 138 | 160° | N.A. | 82 | Yes | 50,000 | 120-277V | Yes | N.A. |
| | 8T8/3F/835/DIR | 97838 | 3500K | 1100 | 25W | 138 | 160° | N.A. | 82 | Yes | 50,000 | 120-277V | Yes | N.A. |
| | 8T8/3F/840/DIR | 97839 | 4000K | 1150 | 25W | 144 | 160° | N.A. | 82 | Yes | 50,000 | 120-277V | Yes | N.A. |
|  | 8T8/2F/830/DIR | 97841 | 3000K | 1300 | 17W | 163 | 160° | N.A. | 82 | Yes | 50,000 | 120-277V | Yes | ✓ |
| | 8T8/2F/835/DIR | 97842 | 3500K | 1300 | 17W | 163 | 160° | N.A. | 82 | Yes | 50,000 | 120-277V | Yes | ✓ |
| | 8T8/2F/840/DIR | 97843 | 4000K | 1300 | 17W | 163 | 160° | N.A. | 82 | Yes | 50,000 | 120-277V | Yes | ✓ |
|  | 16T8U6/830/DIR | 97958 | 3000K | 2200 | 32W | 138 | 140° | N.A. | 82 | Yes | 50,000 | 120-277V | Yes | ✓ |
| | 16T8U6/840/DIR | 97959 | 4000K | 2200 | 32W | 138 | 140° | N.A. | 82 | Yes | 50,000 | 120-277V | Yes | ✓ |
| | 16T8U6/850/DIR | 97960 | 5000K | 2250 | 32W | 141 | 140° | N.A. | 82 | Yes | 50,000 | 120-277V | Yes | ✓ |



EXternal Driver



- Compatible with external drivers only**
- 0-10V dimming**
- Suitable for use in totally enclosed fixtures**
- Glass design – Meets NSF requirements**

For Use with EXternal LED Drivers - Dimmable

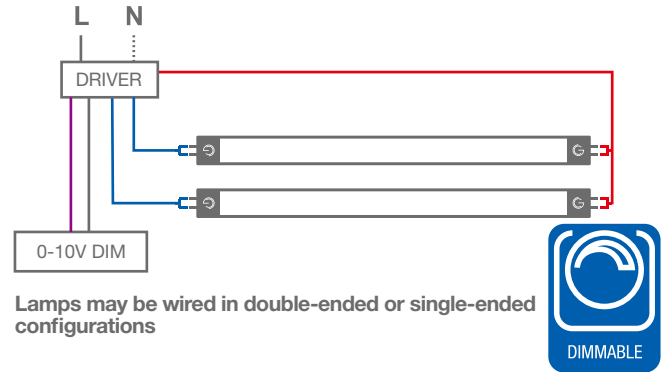

PRELIMINARY SPECIFICATIONS

| Model | Product | CCT | Lumens | Equiv. (lm) | LPW | Beam Angle | CBCP (cd) | CRI (typ.) | Dim | Life (hrs) | Voltage | Encl. | | |
|-------------------------------|---|-------|---|-------------|-----|------------|-----------|------------|-----|------------|---------|----------|-----|------|
| T8 14W 4FT. EXT | COMING SOON! 14T8/4F/840/EXT | 98335 | 4000K | 2050 | 32W | 146 | 160° | N.A. | 82 | Yes | 50,000 | 120-277V | Yes | Aug. |
| | 14T8/4F/850/EXT | 98336 | 5000K | 2050 | 32W | 146 | 160° | N.A. | 82 | Yes | 50,000 | 120-277V | Yes | Aug. |
| T8 11.5W 4FT. EXT | COMING SOON! 11.5T8/4F/830/EXT | 98331 | 3000K | 1600 | 32W | 139 | 160° | N.A. | 82 | Yes | 50,000 | 120-277V | Yes | Aug. |
| | 11.5T8/4F/835/EXT | 98332 | 3500K | 1650 | 32W | 143 | 160° | N.A. | 82 | Yes | 50,000 | 120-277V | Yes | Aug. |
| | 11.5T8/4F/840/EXT | 98333 | 4000K | 1800 | 32W | 157 | 160° | N.A. | 82 | Yes | 50,000 | 120-277V | Yes | Aug. |
| | 11.5T8/4F/850/EXT | 98334 | 5000K | 1800 | 32W | 157 | 160° | N.A. | 82 | Yes | 50,000 | 120-277V | Yes | Aug. |
| T8 10.5W 3FT. EXT | COMING SOON! 10.5T8/3F/830/EXT | 98328 | 3000K | 1450 | 25W | 138 | 160° | N.A. | 82 | Yes | 50,000 | 120-277V | Yes | N.A. |
| | 10.5T8/3F/835/EXT | 98329 | 3500K | 1500 | 25W | 143 | 160° | N.A. | 82 | Yes | 50,000 | 120-277V | Yes | N.A. |
| | 10.5T8/3F/840/EXT | 98330 | 4000K | 1600 | 25W | 152 | 160° | N.A. | 82 | Yes | 50,000 | 120-277V | Yes | N.A. |
| T8 9.5W 2FT. EXT | COMING SOON! 9.5T8/2F/830/EXT | 98325 | 3000K | 1350 | 17W | 142 | 160° | N.A. | 82 | Yes | 50,000 | 120-277V | Yes | N.A. |
| | 9.5T8/2F/835/EXT | 98326 | 3500K | 1400 | 17W | 147 | 160° | N.A. | 82 | Yes | 50,000 | 120-277V | Yes | N.A. |
| | 9.5T8/2F/840/EXT | 98327 | 4000K | 1500 | 17W | 158 | 160° | N.A. | 82 | Yes | 50,000 | 120-277V | Yes | N.A. |
| T8 U-BENT 14.5W EXT | COMING SOON! 14.5T8U6/830/EXT | 98337 | 3000K | 2050 | 32W | 141 | 140° | N.A. | 82 | Yes | 50,000 | 120-277V | Yes | N.A. |
| | 14.5T8U6/840/EXT | 98338 | 4000K | 2200 | 32W | 152 | 140° | N.A. | 82 | Yes | 50,000 | 120-277V | Yes | N.A. |
| | 14.5T8U6/850/EXT | 98339 | 5000K | 2200 | 32W | 152 | 140° | N.A. | 82 | Yes | 50,000 | 120-277V | Yes | N.A. |
| T8/T5 HE DRIVER 4-LAMP | COMING SOON! 15T8T5HEDRIVER/4CH | 98260 | 120-277V with 0-10V Dimming External LED Driver for Use with 3-4 T8/T5 HE Lamps | | | | | | | | | | | |
| T8/T5 HE DRIVER 2-LAMP | COMING SOON! 15T8T5HEDRIVER/2CH | 98259 | 120-277V with 0-10V Dimming External LED Driver for Use with 1-2 T8/T5 HE Lamps | | | | | | | | | | | |

* Note specification data is preliminary and may be subject to change

T8 BYP LINE



T8 17.5W
4FT. BYP



BYPass Installation - Single Ended

~~BALLAST~~

120-277V
UNIVERSAL



UL1598C classification ensures fixture maintains original UL compliance



- Built-in universal voltage driver – Bypass installation
- Wide beam design 310° light emitting area
- Suitable for use in totally enclosed fixtures
- Glass design – Meets NSF requirements

Extra Wide Beam Design - End-to-End Lighting

Lamp Front View



Lamp Back View



SPECIFICATIONS

| | Model | Product | CCT | Lumens (lm) | Equiv. | LPW | Beam Angle | CBCP (cd) | CRI (typ.) | Dim | Life (hrs) | Voltage | Encl. | |
|--|--------------------|-------------------|-------|-------------|--------|-----|------------|-----------|------------|-----|------------|----------|-------|------|
| | 16T8/4F/840/BYP | 28411 | 4000K | 2050 | 32W | 128 | 160° | N.A. | 82 | No | 50,000 | 120-277V | Yes | ✓ |
| | 16T8/4F/850/BYP | 28412 | 5000K | 2050 | 32W | 128 | 160° | N.A. | 82 | No | 50,000 | 120-277V | Yes | ✓ |
| | 13T8/4F/830/BYP | 28405 | 3000K | 1650 | 32W | 123 | 160° | N.A. | 82 | No | 50,000 | 120-277V | Yes | ✓ |
| | 13T8/4F/835/BYP | 28406 | 3500K | 1650 | 32W | 127 | 160° | N.A. | 82 | No | 50,000 | 120-277V | Yes | ✓ |
| | 13T8/4F/840/BYP | 28407 | 4000K | 1700 | 32W | 131 | 160° | N.A. | 82 | No | 50,000 | 120-277V | Yes | ✓ |
| | 13T8/4F/850/BYP | 28408 | 5000K | 1700 | 32W | 131 | 160° | N.A. | 82 | No | 50,000 | 120-277V | Yes | ✓ |
| | 12T8/3F/830/BYP | 97893 | 3000K | 1500 | 25W | 125 | 160° | N.A. | 82 | No | 50,000 | 120-277V | Yes | June |
| | 12T8/3F/835/BYP | 97894 | 3500K | 1500 | 25W | 125 | 160° | N.A. | 82 | No | 50,000 | 120-277V | Yes | June |
| | 12T8/3F/840/BYP | 97895 | 4000K | 1550 | 25W | 129 | 160° | N.A. | 82 | No | 50,000 | 120-277V | Yes | June |
| | 8T8/2F/830/BYP | 28413 | 3000K | 1000 | 17W | 125 | 160° | N.A. | 82 | No | 50,000 | 120-277V | Yes | ✓ |
| | 8T8/2F/835/BYP | 28414 | 3500K | 1050 | 17W | 131 | 160° | N.A. | 82 | No | 50,000 | 120-277V | Yes | ✓ |
| | 8T8/2F/840/BYP | 28415 | 4000K | 1050 | 17W | 131 | 160° | N.A. | 82 | No | 50,000 | 120-277V | Yes | ✓ |
| | 17.5T8/4F/GOLD/BYP | 57840 | N.A. | 1100 | 32W | 63 | 160° | N.A. | 80 | No | 50,000 | 120-277V | Yes | N.A. |
| | 17T8U6/830/BYP | NEW! 98162 | 3000K | 2100 | 32W | 124 | 140° | N.A. | 82 | No | 50,000 | 120-277V | Yes | ✓ |
| | 17T8U6/840/BYP | 98163 | 4000K | 2300 | 32W | 135 | 140° | N.A. | 82 | No | 50,000 | 120-277V | Yes | ✓ |
| | 17T8U6/850/BYP | 98164 | 5000K | 2300 | 32W | 135 | 140° | N.A. | 82 | No | 50,000 | 120-277V | Yes | ✓ |



T8 11.5W
4FT. DEB



BYPass



BYPass Installation - Double Ended

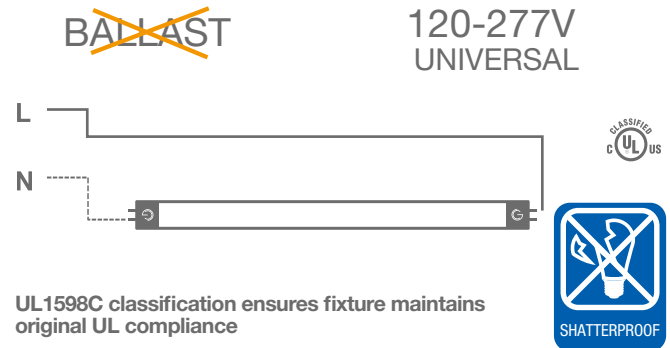

Utilizes Existing Non-Shunted or Shunted Lampholders

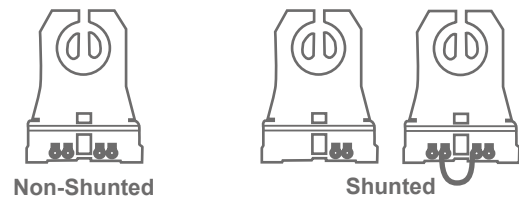

- 🕒 Double-ended bypass installation – Wired at both ends
- 🕒 Utilizes existing lampholders – Non-shunted or shunted
- 🕒 Easy installation – Reduced wiring time
- 🕒 Glass design – Meets NSF requirements

SPECIFICATIONS

| | Model | Product | CCT | Lumens (lm) | Equiv. | LPW | Beam Angle | CBCP (cd) | CRI (typ.) | Dim | Life (hrs) | Voltage | Incl. | |
|--|---------------------|---------|-------|-------------|--------|-----|------------|-----------|------------|-----|------------|----------|-------|------|
| | 14.5T8/4F/840/DEB | 58270 | 4000K | 2100 | 32W | 145 | 160° | N.A. | 82 | No | 50,000 | 120-277V | Yes | ✓ |
| | 14.5T8/4F/850/DEB | 58271 | 5000K | 2100 | 32W | 145 | 160° | N.A. | 82 | No | 50,000 | 120-277V | Yes | ✓ |
| | 11.5T8/4F/830/DEB | 58272 | 3000K | 1650 | 32W | 143 | 160° | N.A. | 82 | No | 50,000 | 120-277V | Yes | ✓ |
| | 11.5T8/4F/835/DEB | 58273 | 3500K | 1650 | 32W | 143 | 160° | N.A. | 82 | No | 50,000 | 120-277V | Yes | ✓ |
| | 11.5T8/4F/840/DEB | 58274 | 4000K | 1700 | 32W | 148 | 160° | N.A. | 82 | No | 50,000 | 120-277V | Yes | ✓ |
| | 11.5T8/4F/850/DEB | 58275 | 5000K | 1700 | 32W | 148 | 160° | N.A. | 82 | No | 50,000 | 120-277V | Yes | ✓ |
| | COMING SOON! | | | | | | | | | | | | | |
| | 12T8/3F/830/DEB | 98340 | 3000K | 1400 | 25W | 117 | 160° | N.A. | 82 | No | 50,000 | 120-277V | Yes | July |
| | 12T8/3F/835/DEB | 98341 | 3500K | 1400 | 25W | 117 | 160° | N.A. | 82 | No | 50,000 | 120-277V | Yes | July |
| | 12T8/3F/840/DEB | 98342 | 4000K | 1450 | 25W | 121 | 160° | N.A. | 82 | No | 50,000 | 120-277V | Yes | July |
| | 8.5T8/2F/830/DEB | 97934 | 3000K | 1050 | 17W | 124 | 160° | N.A. | 82 | No | 50,000 | 120-277V | Yes | ✓ |
| | 8.5T8/2F/835/DEB | 97935 | 3500K | 1050 | 17W | 124 | 160° | N.A. | 82 | No | 50,000 | 120-277V | Yes | ✓ |
| | 8.5T8/2F/840/DEB | 97936 | 4000K | 1100 | 17W | 129 | 160° | N.A. | 82 | No | 50,000 | 120-277V | Yes | ✓ |

T5 DIR LINE



Compatible with Electronic Ballasts - Dimmable

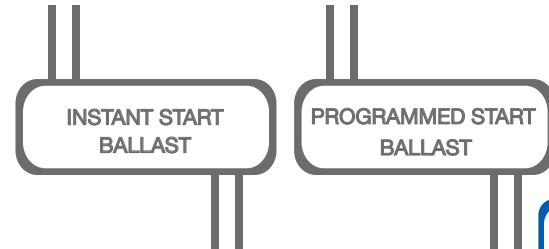

- Easy to install – Plug & play direct
- Instant Start & Programmed Start ballast compatible
- Suitable for use in totally enclosed fixtures
- Dimmable

SPECIFICATIONS

| Model | Product | CCT | Lumens (lm) | Equiv. | LPW | Beam Angle | CBCP (cd) | CRI (typ.) | Dim | Life (hrs) | Voltage | Encl. | | |
|----------------------|---------------------|----------------------|-------------|--------|-----|------------|-----------|------------|-----|------------|---------|----------|-----|------|
| T5 24W HO 4FT. DIR | 24T5HO/4F/830/DIR/R | 97924 | 3000K | 3450 | 54W | 144 | 120° | N.A. | 82 | Yes | 50,000 | 120-277V | Yes | ✓ |
| | 24T5HO/4F/835/DIR/R | 97925 | 3500K | 3450 | 54W | 144 | 120° | N.A. | 82 | Yes | 50,000 | 120-277V | Yes | ✓ |
| | 24T5HO/4F/840/DIR/R | 97926 | 4000K | 3500 | 54W | 146 | 120° | N.A. | 82 | Yes | 50,000 | 120-277V | Yes | ✓ |
| | 24T5HO/4F/850/DIR/R | 97927 | 5000K | 3500 | 54W | 146 | 120° | N.A. | 82 | Yes | 50,000 | 120-277V | Yes | ✓ |
| T5 14.5W HO 3FT. DIR | 14.5T5HO/3F/830/DIR | NEW! 98168 | 3000K | 2050 | 39W | 142 | 120° | N.A. | 82 | Yes | 50,000 | 120-277V | Yes | N.A. |
| | 14.5T5HO/3F/835/DIR | 98169 | 3500K | 2050 | 39W | 142 | 120° | N.A. | 82 | Yes | 50,000 | 120-277V | Yes | N.A. |
| | 14.5T5HO/3F/840/DIR | 98170 | 4000K | 2200 | 39W | 152 | 120° | N.A. | 82 | Yes | 50,000 | 120-277V | Yes | N.A. |
| T5 10.5W HO 2FT. DIR | 10.5T5HO/2F/830/DIR | NEW! 98165 | 3000K | 1500 | 24W | 143 | 120° | N.A. | 82 | Yes | 50,000 | 120-277V | Yes | N.A. |
| | 10.5T5HO/2F/835/DIR | 98166 | 3500K | 1500 | 24W | 143 | 120° | N.A. | 82 | Yes | 50,000 | 120-277V | Yes | N.A. |
| | 10.5T5HO/2F/840/DIR | 98167 | 4000K | 1600 | 24W | 152 | 120° | N.A. | 82 | Yes | 50,000 | 120-277V | Yes | N.A. |
| T5 15W HE 4FT. DIR | 15T5HE/4F/830/DIR/R | 97929 | 3000K | 2200 | 28W | 147 | 120° | N.A. | 82 | Yes | 50,000 | 120-277V | Yes | ✓ |
| | 15T5HE/4F/835/DIR/R | 97930 | 3500K | 2200 | 28W | 147 | 120° | N.A. | 82 | Yes | 50,000 | 120-277V | Yes | ✓ |
| | 15T5HE/4F/840/DIR/R | 97931 | 4000K | 2250 | 28W | 150 | 120° | N.A. | 82 | Yes | 50,000 | 120-277V | Yes | ✓ |
| | 15T5HE/4F/840/DIR/R | 97932 | 5000K | 2250 | 28W | 150 | 120° | N.A. | 82 | Yes | 50,000 | 120-277V | Yes | ✓ |
| T5 12W HE 3FT. DIR | 12T5HE/3F/830/DIR | 57954 | 3000K | 1420 | 21W | 118 | 120° | N.A. | 80 | Yes | 50,000 | 120-277V | Yes | N.A. |
| | 12T5HE/3F/835/DIR | 57955 | 3500K | 1420 | 21W | 118 | 120° | N.A. | 80 | Yes | 50,000 | 120-277V | Yes | N.A. |
| | 12T5HE/3F/840/DIR | 57956 | 4000K | 1500 | 21W | 125 | 120° | N.A. | 80 | Yes | 50,000 | 120-277V | Yes | N.A. |
| T5 8W HE 2FT. DIR | 8T5HE/2F/830/DIR | 57958 | 3000K | 950 | 14W | 119 | 120° | N.A. | 80 | Yes | 50,000 | 120-277V | Yes | N.A. |
| | 8T5HE/2F/835/DIR | 57959 | 3500K | 950 | 14W | 119 | 120° | N.A. | 80 | Yes | 50,000 | 120-277V | Yes | N.A. |
| | 8T5HE/2F/840/DIR | 57960 | 4000K | 1020 | 14W | 128 | 120° | N.A. | 80 | Yes | 50,000 | 120-277V | Yes | N.A. |

* All T5 DIR products conform to the NSF/ANSI 2 standard and may be used in Splash Zones of Food Equipment. These products do not contain glass or any other hazardous materials.



EXternal Driver



- Compatible with external drivers only
- 0-10V dimming
- Suitable for use in totally enclosed fixtures
- Meets NSF requirements

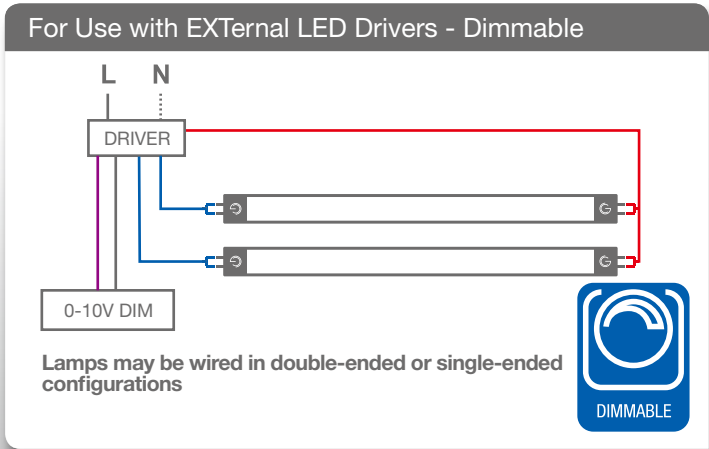

PRELIMINARY SPECIFICATIONS

| Model | Product | CCT | Lumens | Equiv. (lm) | LPW | Beam Angle | CBCP (cd) | CRI (typ.) | Dim | Life (hrs) | Voltage | Encl. | DLC QUALIFIED | |
|-------------------------------|--|-------|---|-------------|-----|------------|-----------|------------|-----|------------|---------|----------|---------------|------|
| T5 22W HO 4FT. EXT | COMING SOON! 22T5HO/4F/830/EXT | 98321 | 3000K | 3200 | 54W | 145 | 120° | N.A. | 82 | Yes | 50,000 | 120-277V | Yes | Aug. |
| | 22T5HO/4F/835/EXT | 98322 | 3500K | 3200 | 54W | 145 | 120° | N.A. | 82 | Yes | 50,000 | 120-277V | Yes | Aug. |
| | 22T5HO/4F/840/EXT | 98323 | 4000K | 3400 | 54W | 155 | 120° | N.A. | 82 | Yes | 50,000 | 120-277V | Yes | Aug. |
| | 22T5HO/4F/850/EXT | 98324 | 5000K | 3400 | 54W | 155 | 120° | N.A. | 82 | Yes | 50,000 | 120-277V | Yes | Aug. |
| T5 13.5W HE 4FT. EXT | COMING SOON! 13.5T5HE/4F/830/EXT | 98312 | 3000K | 1800 | 28W | 133 | 120° | N.A. | 82 | Yes | 50,000 | 120-277V | Yes | Aug. |
| | 13.5T5HE/4F/835/EXT | 98313 | 3500K | 1850 | 28W | 137 | 120° | N.A. | 82 | Yes | 50,000 | 120-277V | Yes | Aug. |
| | 13.5T5HE/4F/840/EXT | 98314 | 4000K | 2000 | 28W | 148 | 120° | N.A. | 82 | Yes | 50,000 | 120-277V | Yes | Aug. |
| T5 11W HE 3FT. EXT | COMING SOON! 11T5HE/3F/830/EXT | 98309 | 3000K | 1350 | 21W | 123 | 120° | N.A. | 82 | Yes | 50,000 | 120-277V | Yes | N.A. |
| | 11T5HE/3F/835/EXT | 98310 | 3500K | 1400 | 21W | 127 | 120° | N.A. | 82 | Yes | 50,000 | 120-277V | Yes | N.A. |
| | 11T5HE/3F/840/EXT | 98311 | 4000K | 1500 | 21W | 136 | 120° | N.A. | 82 | Yes | 50,000 | 120-277V | Yes | N.A. |
| T5 9.5W HE 2FT. EXT | COMING SOON! 9.5T5HE/2F/830/EXT | 98306 | 3000K | 1350 | 14W | 142 | 120° | N.A. | 82 | Yes | 50,000 | 120-277V | Yes | N.A. |
| | 9.5T5HE/2F/835/EXT | 98307 | 3500K | 1400 | 14W | 147 | 120° | N.A. | 82 | Yes | 50,000 | 120-277V | Yes | N.A. |
| | 9.5T5HE/2F/840/EXT | 98308 | 4000K | 1500 | 14W | 158 | 120° | N.A. | 82 | Yes | 50,000 | 120-277V | Yes | N.A. |
| T5 HO DRIVER 4-LAMP | COMING SOON! 24T5HODRIVER/4CH | 98262 | 120-277V with 0-10V Dimming External LED Driver for Use with 3-4 T5 HO Lamps | | | | | | | | | | | |
| T5 HO DRIVER 2-LAMP | COMING SOON! 24T5HODRIVER/2CH | 98261 | 120-277V with 0-10V Dimming External LED Driver for Use with 1-2 T5 HO Lamps | | | | | | | | | | | |
| T8/T5 HE DRIVER 4-LAMP | COMING SOON! 15T8T5HEDRIVER/4CH | 98260 | 120-277V with 0-10V Dimming External LED Driver for Use with 3-4 T8/T5 HE Lamps | | | | | | | | | | | |
| T8/T5 HE DRIVER 2-LAMP | COMING SOON! 15T8T5HEDRIVER/2CH | 98259 | 120-277V with 0-10V Dimming External LED Driver for Use with 1-2 T8/T5 HE Lamps | | | | | | | | | | | |

* Note specification data is preliminary and may be subject to change

T5 BYP LINE



BYPass



BYPass Installation - Single Ended

~~BALLAST~~

120-277V
UNIVERSAL



UL1598C classification ensures fixture maintains original UL compliance

- Ⓞ Built-in universal voltage driver – Bypass installation
- Ⓞ Wide beam design 270° light emitting area
- Ⓞ Suitable for use in totally enclosed fixtures
- Ⓞ Meets NSF requirements

High Output (HO) & High Efficiency (HE) Versions



PRELIMINARY SPECIFICATIONS

| | Model | Product | CCT | Lumens Equiv. | | LPW | Beam Angle | CBCP (cd) | CRI (typ.) | Dim | Life (hrs) | Voltage | Encl. | DLC LISTED | |
|-----------------------------------|---------------------|--------------------|-------|---------------|------|-----|------------|-----------|------------|-----|------------|----------|----------|------------|------|
| <p>T5 25W HO 4FT. BYP</p> | COMING SOON! | | | | | | | | | | | | | | |
| | | 25T5HO/4F/830/BYP | 98302 | 3000K | 3200 | 54W | 128 | 120° | N.A. | 82 | No | 50,000 | 120-277V | Yes | July |
| | | 25T5HO/4F/835/BYP | 98303 | 3500K | 3200 | 54W | 128 | 120° | N.A. | 82 | No | 50,000 | 120-277V | Yes | July |
| | | 25T5HO/4F/840/BYP | 98304 | 4000K | 3200 | 54W | 128 | 120° | N.A. | 82 | No | 50,000 | 120-277V | Yes | July |
| | 25T5HO/4F/850/BYP | 98305 | 5000K | 3200 | 54W | 128 | 120° | N.A. | 82 | No | 50,000 | 120-277V | Yes | July | |
| <p>T5 15W HE 4FT. BYP</p> | COMING SOON! | | | | | | | | | | | | | | |
| | | 15T5HE/4F/830/BYP | 98293 | 3000K | 1850 | 28W | 123 | 120° | N.A. | 82 | No | 50,000 | 120-277V | Yes | July |
| | | 15T5HE/4F/835/BYP | 98294 | 3500K | 1900 | 28W | 128 | 120° | N.A. | 82 | No | 50,000 | 120-277V | Yes | July |
| | 15T5HE/4F/840/BYP | 98295 | 4000K | 2000 | 28W | 133 | 120° | N.A. | 82 | No | 50,000 | 120-277V | Yes | July | |
| <p>T5 12W HE 3FT. BYP</p> | COMING SOON! | | | | | | | | | | | | | | |
| | | 12T5HE/3F/830/BYP | 98290 | 3000K | 1350 | 21W | 113 | 120° | N.A. | 80 | No | 50,000 | 120-277V | Yes | N.A. |
| | | 12T5HE/3F/835/BYP | 98291 | 3500K | 1400 | 21W | 117 | 120° | N.A. | 80 | No | 50,000 | 120-277V | Yes | N.A. |
| | 12T5HE/3F/840/BYP | 98292 | 4000K | 1500 | 21W | 125 | 120° | N.A. | 80 | No | 50,000 | 120-277V | Yes | N.A. | |
| <p>T5 9.5W HE 2FT. BYP</p> | COMING SOON! | | | | | | | | | | | | | | |
| | | 9.5T5HE/2F/830/BYP | 98287 | 3000K | 1100 | 14W | 116 | 120° | N.A. | 80 | No | 50,000 | 120-277V | Yes | N.A. |
| | | 9.5T5HE/2F/835/BYP | 98288 | 3500K | 1150 | 14W | 121 | 120° | N.A. | 80 | No | 50,000 | 120-277V | Yes | N.A. |
| | 9.5T5HE/2F/840/BYP | 98289 | 4000K | 1200 | 14W | 126 | 120° | N.A. | 80 | No | 50,000 | 120-277V | Yes | N.A. | |

* Note specification data is preliminary and may be subject to change



Support Clip Included

Extra Wide Beam Design - Compact Driver Technology



Compatible with Electronic Ballasts - Dimmable



- Easy to install – Plug & play direct**
- Instant Start & Programmed Start ballast compatible**
- Suitable for use in totally enclosed fixtures**
- 0-10V dimming**

SPECIFICATIONS

| | Model | Product | CCT | Lumens (lm) | Equiv. | LPW | Beam Angle | CBCP (cd) | CRI (typ.) | Dim | Life (hrs) | Voltage | Encl. |
|-----------------------------|-----------------|---------|-------|-------------|--------|-----|------------|-----------|------------|-----|------------|----------|-------|
| <p>PLL 17W DIR</p> | 17PLL/830/DIR | 97745 | 3000K | 2000 | 40W | 118 | 120° | N.A. | 80 | Yes | 50,000 | 120-277V | Yes |
| | 17PLL/835/DIR | 97746 | 3500K | 2050 | 40W | 121 | 120° | N.A. | 80 | Yes | 50,000 | 120-277V | Yes |
| | 17PLL/840/DIR | 97747 | 4000K | 2100 | 40W | 124 | 120° | N.A. | 80 | Yes | 50,000 | 120-277V | Yes |
| <p>PLL 14.5W DIR</p> | 14.5PLL/835/DIR | 97750 | 3500K | 1550 | 36W | 107 | 120° | N.A. | 80 | Yes | 50,000 | 120-277V | Yes |

PL DIR LINE



SPECIFICATIONS

| | Model | Product | CCT | Lumens (lm) | Equiv. | LPW | Beam Angle | CBCP (cd) | CRI (typ.) | Dim | Life (hrs) | Voltage | Encl. | |
|---------------------------|--|---------|-------|-------------|--------|-----|------------|-----------|------------|-----|------------|----------|-------|------|
| PL H 14.5W DIR | COMING SOON! 14.5PLH/830/DIR | 98244 | 3000K | 1750 | 42W | 121 | 110° | N.A. | 82 | Yes | 50,000 | 120-277V | No | N.A. |
| | 14.5PLH/835/DIR | 98245 | 3500K | 1800 | 42W | 124 | 110° | N.A. | 82 | Yes | 50,000 | 120-277V | No | N.A. |
| | 14.5PLH/840/DIR | 98246 | 4000K | 1850 | 42W | 128 | 110° | N.A. | 82 | Yes | 50,000 | 120-277V | No | N.A. |
| PL H 8.5W DIR | 8.5PLH/827/DIR | 28366 | 2700K | 870 | 26W | 102 | 110° | N.A. | 82 | Yes | 50,000 | 120-277V | No | ✓ |
| | 8.5PLH/830/DIR | 28367 | 3000K | 950 | 26W | 112 | 110° | N.A. | 82 | Yes | 50,000 | 120-277V | No | ✓ |
| | 8.5PLH/835/DIR | 28368 | 3500K | 950 | 26W | 112 | 110° | N.A. | 82 | Yes | 50,000 | 120-277V | No | ✓ |
| | 8.5PLH/840/DIR | 28369 | 4000K | 1020 | 26W | 120 | 110° | N.A. | 82 | Yes | 50,000 | 120-277V | No | ✓ |
| PL H 10.5W DIR | 10.5PLH/930/DIR | 57903 | 3000K | 890 | 26W | 85 | 110° | N.A. | 90 | Yes | 50,000 | 120-277V | No | N.A. |
| PL H 5.5W DIR | 5.5PLH/827/DIR/R | 57895 | 2700K | 520 | 13-18W | 95 | 110° | N.A. | 82 | Yes | 50,000 | 120-277V | No | N.A. |
| | 5.5PLH/830/DIR/R | 57896 | 3000K | 550 | 13-18W | 100 | 110° | N.A. | 82 | Yes | 50,000 | 120-277V | No | N.A. |
| | 5.5PLH/835/DIR/R | 57897 | 3500K | 550 | 13-18W | 100 | 110° | N.A. | 82 | Yes | 50,000 | 120-277V | No | N.A. |
| | 5.5PLH/840/DIR/R | 57898 | 4000K | 560 | 13-18W | 102 | 110° | N.A. | 82 | Yes | 50,000 | 120-277V | No | N.A. |

PL H & V high output versions replace 42W CFL lamps

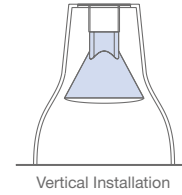
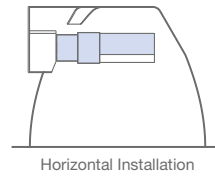

High Performance - Ballast Smart Control

| Ballast Type | Lumens | Bare Lamp |
|--------------|--------|-----------|
| 13W | 600 | 4.5W |
| 18W | 700 | 5.5W |
| 26W | 1020 | 8.5W |

PL H 8.5W DIR

- Plug & play direct – Electronic ballast compatible**
- Compatible with G24q & GX24q installations**
- Patented design**
- 0-10V dimming**

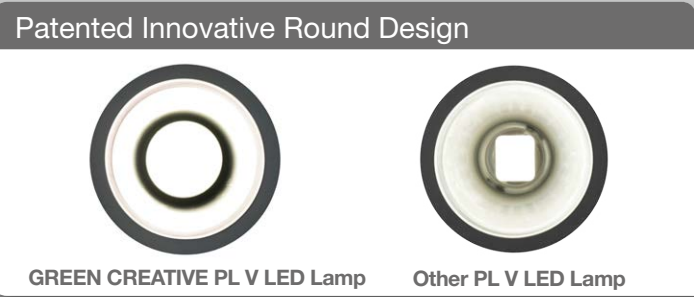







SPECIFICATIONS

| Model | Product | CCT | Lumens (lm) | Equiv. | LPW | Beam Angle | CBCP (cd) | CRI (typ.) | Dim | Life (hrs) | Voltage | Encl. | | |
|--------------------------|--------------------------------------|-------|-------------|--------|--------|------------|-----------|------------|-----|------------|---------|----------|----|------|
| PL V 17W DIR | COMING SOON! 17PLV/830/DIR | 98248 | 3000K | 1900 | 42W | 112 | 110° | N.A. | 82 | Yes | 50,000 | 120-277V | No | July |
| | 17PLV/835/DIR | 98249 | 3500K | 1950 | 42W | 115 | 110° | N.A. | 82 | Yes | 50,000 | 120-277V | No | July |
| | 17PLV/840/DIR | 98250 | 4000K | 2000 | 42W | 118 | 110° | N.A. | 82 | Yes | 50,000 | 120-277V | No | July |
| PL V 9.5W DIR | 9.5PLV/827/DIR | 28374 | 2700K | 950 | 26W | 100 | 120° | N.A. | 82 | Yes | 50,000 | 120-277V | No | ✓ |
| | 9.5PLV/830/DIR | 28375 | 3000K | 1000 | 26W | 105 | 120° | N.A. | 82 | Yes | 50,000 | 120-277V | No | ✓ |
| | 9.5PLV/835/DIR | 28376 | 3500K | 1000 | 26W | 105 | 120° | N.A. | 82 | Yes | 50,000 | 120-277V | No | ✓ |
| | 9.5PLV/840/DIR | 28377 | 4000K | 1020 | 26W | 107 | 120° | N.A. | 82 | Yes | 50,000 | 120-277V | No | ✓ |
| PL V 11W DIR | 11PLV/930/DIR | 57918 | 3000K | 920 | 26W | 84 | 120° | N.A. | 90 | Yes | 50,000 | 120-277V | No | N.A. |
| PL V 6W DIR | 6PLV/827/DIR | 28370 | 2700K | 570 | 13-18W | 95 | 120° | N.A. | 82 | Yes | 50,000 | 120-277V | No | N.A. |
| | 6PLV/830/DIR | 28371 | 3000K | 600 | 13-18W | 100 | 120° | N.A. | 82 | Yes | 50,000 | 120-277V | No | N.A. |
| | 6PLV/835/DIR | 28372 | 3500K | 600 | 13-18W | 100 | 120° | N.A. | 82 | Yes | 50,000 | 120-277V | No | N.A. |
| | 6PLV/840/DIR | 28373 | 4000K | 620 | 13-18W | 103 | 120° | N.A. | 82 | Yes | 50,000 | 120-277V | No | N.A. |

PL BYP LINE



SPECIFICATIONS

| | Model | Product | CCT | Lumens (lm) | Equiv. | LPW | Beam Angle | CBCP (cd) | CRI (typ.) | Dim | Life (hrs) | Voltage | Encl. |  |
|---|--|---------|-------|-------------|--------|-----|------------|-----------|------------|-----|------------|----------|-------|---|
|  PL H 15.5W BYP | COMING SOON! 15.5PLH/830/BYP | 98252 | 3000K | 1750 | 42W | 113 | 110° | N.A. | 82 | No | 50,000 | 120-277V | No | N.A. |
| | 15.5PLH/835/BYP | 98253 | 3500K | 1800 | 42W | 116 | 110° | N.A. | 82 | No | 50,000 | 120-277V | No | N.A. |
| | 15.5PLH/840/BYP | 98254 | 4000K | 1850 | 42W | 119 | 110° | N.A. | 82 | No | 50,000 | 120-277V | No | N.A. |
|  PL H 9.5W BYP | 9.5PLH/827/BYP | 28354 | 2700K | 870 | 26W | 92 | 110° | N.A. | 82 | No | 50,000 | 120-277V | No | N.A. |
| | 9.5PLH/830/BYP | 28355 | 3000K | 920 | 26W | 97 | 110° | N.A. | 82 | No | 50,000 | 120-277V | No | N.A. |
| | 9.5PLH/835/BYP | 28356 | 3500K | 920 | 26W | 97 | 110° | N.A. | 82 | No | 50,000 | 120-277V | No | N.A. |
| | 9.5PLH/840/BYP | 28357 | 4000K | 950 | 26W | 100 | 110° | N.A. | 82 | No | 50,000 | 120-277V | No | N.A. |
|  PL H 6W BYP | 6PLH/835/BYP/R | 57904 | 3500K | 550 | 13-18W | 92 | 110° | N.A. | 82 | No | 50,000 | 120-277V | No | N.A. |
| | 6PLH/840/BYP/R | 57905 | 4000K | 560 | 13-18W | 93 | 110° | N.A. | 82 | No | 50,000 | 120-277V | No | N.A. |
|  PL H 6W BYP E26 | 6PLH/830/BYP/E26 | 57925 | 3000K | 550 | 13W | 92 | 110° | N.A. | 82 | No | 50,000 | 120-277V | No | N.A. |
| | 6PLH/835/BYP/E26 | 57926 | 3500K | 550 | 13W | 92 | 110° | N.A. | 82 | No | 50,000 | 120-277V | No | N.A. |
| | 6PLH/840/BYP/E26 | 57927 | 4000K | 560 | 13W | 93 | 110° | N.A. | 82 | No | 50,000 | 120-277V | No | N.A. |
|  PL H 6W BYP GU24 | 6PLH/830/BYP/GU24/R | 57928 | 3000K | 550 | 13W | 92 | 110° | N.A. | 82 | No | 50,000 | 120-277V | No | N.A. |
| | 6PLH/835/BYP/GU24/R | 57929 | 3500K | 550 | 13W | 92 | 110° | N.A. | 82 | No | 50,000 | 120-277V | No | N.A. |
| | 6PLH/840/BYP/GU24/R | 57930 | 4000K | 560 | 13W | 93 | 110° | N.A. | 82 | No | 50,000 | 120-277V | No | N.A. |

* Note PL H 15.5W BYP operates on line voltage only and is not compatible with magnetic ballasts

PL H & V high output versions replace 42W CFL lamps

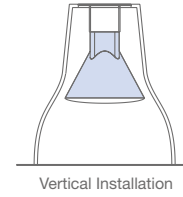
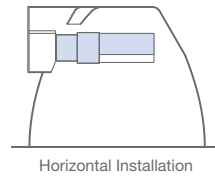

Hybrid Installation

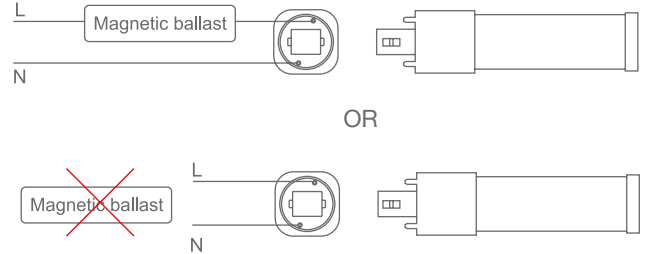

Note PL H 15.5W BYP & PL V 16.5W BYP are not compatible with magnetic ballasts

- Hybrid installation – Mag. ballast or 120-277V line voltage
- Compatible with G24d, GX24d, G24q & GX24q installations
- Patented design
- E26 & GU24 versions available

170° Rotatable Base

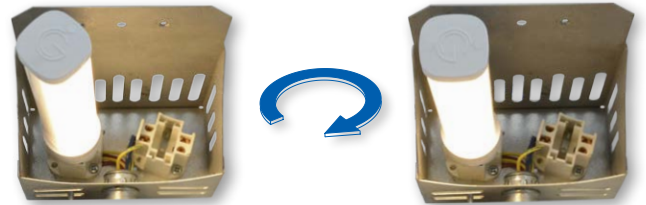

SPECIFICATIONS

| | Model | Product | CCT | Lumens (lm) | Equiv. | LPW | Beam Angle | CBCP (cd) | CRI (typ.) | Dim | Life (hrs) | Voltage | Encl. | |
|--|---------------------|---------|-------|-------------|--------|-----|------------|-----------|------------|-----|------------|----------|-------|------|
| | COMING SOON! | | | | | | | | | | | | | |
| | 16.5PLV/830/BYP | 98256 | 3000K | 1800 | 42W | 109 | 110° | N.A. | 82 | No | 50,000 | 120-277V | No | N.A. |
| | 16.5PLV/835/BYP | 98257 | 3500K | 1850 | 42W | 112 | 110° | N.A. | 82 | No | 50,000 | 120-277V | No | N.A. |
| | 16.5PLV/840/BYP | 98258 | 4000K | 1900 | 42W | 115 | 110° | N.A. | 82 | No | 50,000 | 120-277V | No | N.A. |
| | 10PLV/827/BYP | 28362 | 2700K | 950 | 26W | 95 | 120° | N.A. | 82 | No | 50,000 | 120-277V | No | N.A. |
| | 10PLV/830/BYP | 28363 | 3000K | 1000 | 26W | 100 | 120° | N.A. | 82 | No | 50,000 | 120-277V | No | N.A. |
| | 10PLV/835/BYP | 28364 | 3500K | 1000 | 26W | 100 | 120° | N.A. | 82 | No | 50,000 | 120-277V | No | N.A. |
| | 10PLV/840/BYP | 28365 | 4000K | 1020 | 26W | 102 | 120° | N.A. | 82 | No | 50,000 | 120-277V | No | N.A. |
| | 6.5PLV/835/BYP | 28360 | 3500K | 600 | 13-18W | 92 | 120° | N.A. | 82 | No | 50,000 | 120-277V | No | N.A. |
| | 6.5PLV/840/BYP | 28361 | 4000K | 620 | 13-18W | 95 | 120° | N.A. | 82 | No | 50,000 | 120-277V | No | N.A. |

* Note PL V 16.5W BYP operates on line voltage only and is not compatible with magnetic ballasts

PLS HYB LINE



PLS V 6.5W HYB GX23
PLS 3.5W HYB G23



GX23 (HYBrid) Replaces 13W GX23 (HYBrid) Replaces 13W GX23 (HYBrid) Replaces 13W G23 (HYBrid) Replaces 7-9W

- Hybrid installation - DIRect or BYPass**
- Compatible with magnetic ballasts - DIRect installation**
- Built-in universal voltage driver - BYPass installation**
- Exceptional efficacy**

HYBrid Installation

MAGNETIC BALLAST COMPATIBLE

120-277V UNIVERSAL

This lamp operates on existing magnetic ballasts or on 120-277V line voltage.

PLS V GX23 - Designed for Vertical Applications

GREEN CREATIVE PLS V LED Other PLS LED Lamp

| SPECIFICATIONS | | | | | | | | | | | | | |
|----------------|----------------------|---------|-------|-------------|--------|-----|------------|-----------|------------|-----|------------|----------|-------|
| | Model | Product | CCT | Lumens (lm) | Equiv. | LPW | Beam Angle | CBCP (cd) | CRI (typ.) | Dim | Life (hrs) | Voltage | Encl. |
| | 7PLSV/827/HYB/GX23 | 57931 | 2700K | 550 | 13W | 79 | 120° | N.A. | 82 | No | 50,000 | 120-277V | No |
| | 6.5PLSV/830/HYB/GX23 | 28379 | 3000K | 600 | 13W | 92 | 120° | N.A. | 82 | No | 50,000 | 120-277V | No |
| | 6.5PLSV/835/HYB/GX23 | 28380 | 3500K | 600 | 13W | 92 | 120° | N.A. | 82 | No | 50,000 | 120-277V | No |
| | 6.5PLSV/840/HYB/GX23 | 28381 | 4000K | 620 | 13W | 95 | 120° | N.A. | 82 | No | 50,000 | 120-277V | No |
| | 6PLS/827/HYB/GX23/R | 57962 | 2700K | 520 | 13W | 87 | 120° | N.A. | 82 | No | 50,000 | 120-277V | No |
| | 6PLS/830/HYB/GX23/R | 57963 | 3000K | 550 | 13W | 92 | 120° | N.A. | 82 | No | 50,000 | 120-277V | No |
| | 6PLS/835/HYB/GX23/R | 57964 | 3500K | 550 | 13W | 92 | 120° | N.A. | 82 | No | 50,000 | 120-277V | No |
| | 6PLS/840/HYB/GX23/R | 57965 | 4000K | 560 | 13W | 93 | 120° | N.A. | 82 | No | 50,000 | 120-277V | No |
| | 5.5PLS/827/HYB/GX23 | 57820 | 2700K | 450 | 13W | 82 | 120° | N.A. | 80 | No | 50,000 | 120-277V | Yes |
| | 5.5PLS/830/HYB/GX23 | 57821 | 3000K | 500 | 13W | 91 | 120° | N.A. | 80 | No | 50,000 | 120-277V | Yes |
| | 5.5PLS/835/HYB/GX23 | 57822 | 3500K | 500 | 13W | 91 | 120° | N.A. | 80 | No | 50,000 | 120-277V | Yes |
| | 5.5PLS/840/HYB/GX23 | 57823 | 4000K | 520 | 13W | 95 | 120° | N.A. | 80 | No | 50,000 | 120-277V | Yes |
| | 3.5PLS/827/HYB/G23 | 57812 | 2700K | 280 | 7-9W | 80 | 120° | N.A. | 80 | No | 50,000 | 120-277V | Yes |
| | 3.5PLS/835/HYB/G23 | 57814 | 3500K | 300 | 7-9W | 86 | 120° | N.A. | 80 | No | 50,000 | 120-277V | Yes |



Extra Wide Beam Design - 180° Rotatable Base



Compact Form Factor Fits All Applications



- BYPass installation – Requires bypassing the ballast**
- Suitable for use in totally enclosed fixtures**
- 180° rotatable base**
- Compact form factor fits most fixtures**

SPECIFICATIONS

| Model | Product | CCT | Lumens (lm) | Equiv. | LPW | Beam Angle | CBCP (cd) | CRI (typ.) | Dim | Life (hrs) | Voltage | Encl. | |
|--------------------------|---------------------|-------|-------------|--------|------|------------|-----------|------------|-----|------------|---------|----------|-----|
| PLS 5.5W BYP 2GX7 | 5.5PLS/835/BYP/2GX7 | 57826 | 3500K | 500 | 13W | 91 | 120° | N.A. | 80 | No | 50,000 | 120-277V | Yes |
| PLS 3.5W BYP 2G7 | 3.5PLS/835/BYP/2G7 | 57818 | 3500K | 300 | 7-9W | 86 | 120° | N.A. | 80 | No | 50,000 | 120-277V | Yes |

HID BOLLARD LINE



EX39 Version Available

Designed for Bollard & Post Top Applications



HID Replacements



25W: 70-100W
16.5W: 50-70W
HID
120-277V

- Universal voltage 120-277V – Not compatible with ballasts**
- E26 base – ENERGY STAR® certified**
- EX39 base – DLC® qualified**
- Suitable for use in totally enclosed fixtures**





SPECIFICATIONS

| | Model | Product | CCT | Lumens (lm) | Equiv. | LPW | Beam Angle | CBCP (cd) | CRI (typ.) | Dim | Life (hrs) | Voltage | Encl. | ES | DLC |
|----------------------------------|---------------------|-------------------|--|-------------|-------------|-----|------------|-----------|------------|-----|------------|----------|-------|----|-----|
| HID LED 25W 277V | 25HID/830/277V/EX39 | NEW! 97968 | 3000K | 3200 | 70-100W HID | 128 | 290° | N.A. | 82 | No | 50,000 | 120-277V | Yes | ✓ | ✓ |
| | 25HID/840/277V/EX39 | 97969 | 4000K | 3300 | 70-100W HID | 132 | 290° | N.A. | 82 | No | 50,000 | 120-277V | Yes | ✓ | ✓ |
| | 25HID/850/277V/EX39 | 97970 | 5000K | 3400 | 70-100W HID | 136 | 290° | N.A. | 82 | No | 50,000 | 120-277V | Yes | ✓ | ✓ |
| | 25HID/830/277V/E26 | 97972 | 3000K | 3200 | 70-100W HID | 128 | 290° | N.A. | 82 | No | 50,000 | 120-277V | Yes | ✓ | ✓ |
| | 25HID/840/277V/E26 | 97973 | 4000K | 3300 | 70-100W HID | 132 | 290° | N.A. | 82 | No | 50,000 | 120-277V | Yes | ✓ | ✓ |
| | 25HID/850/277V/E26 | 97974 | 5000K | 3400 | 70-100W HID | 136 | 290° | N.A. | 82 | No | 50,000 | 120-277V | Yes | ✓ | ✓ |
| HID LED 16.5W HO 277V | 16.5A21/830/277V | 58238 | 3000K | 2000 | 50-70W HID | 121 | 330° | N.A. | 82 | No | 40,000 | 120-277V | Yes | ✓ | ✓ |
| | 16.5A21/840/277V | 58239 | 4000K | 2000 | 50-70W HID | 121 | 330° | N.A. | 82 | No | 40,000 | 120-277V | Yes | ✓ | ✓ |
| | 16.5A21/850/277V | 58240 | 5000K | 2050 | 50-70W HID | 124 | 330° | N.A. | 82 | No | 40,000 | 120-277V | Yes | ✓ | ✓ |
| E26 LAMP EXTENDER | E26 EXTENDER | 16325 | E26 Lamp Extender Adds 1.30" (33mm) to Lamp Height | | | | | | | | | | | | |
| 10KV SURGE PROTECTOR | 10SURGE/277V | 97718 | 10kV Surge Protector | | | | | | | | | | | | |

HID POST TOP LINE









E26 Versions Available

-  **Universal voltage 120-277V – Not compatible with ballasts**
-  **Fully omnidirectional beam angle**
-  **Compatible with EX39 & E39 sockets**
-  **Suitable for use in totally enclosed fixtures**

Designed for Post Top Applications



SPECIFICATIONS





| | Model | Product | CCT | Lumens (lm) | Equiv. | LPW | Beam Angle | CBCP (cd) | CRI (typ.) | Dim | Life (hrs) | Voltage | Encl. |  |
|--|------------------------------------|---------|-------|-------------|--------------|-----|------------|-----------|------------|-----|------------|----------|-------|--|
|  HID LED 98W | 98HID/840/277V/EX39 | 58098 | 4000K | 12,250 | 250-400W HID | 125 | 320° | N.A. | 80 | No | 50,000 | 120-277V | Yes | ✓ |
| | 98HID/850/277V/EX39 | 58099 | 5000K | 12,800 | 250-400W HID | 131 | 320° | N.A. | 80 | No | 50,000 | 120-277V | Yes | ✓ |
|  HID LED 80W | 80HID/840/277V/EX39/R | 57948 | 4000K | 9300 | 175-250W HID | 116 | 320° | N.A. | 80 | No | 50,000 | 120-277V | Yes | ✓ |
| | 80HID/850/277V/EX39/R | 57949 | 5000K | 9600 | 175-250W HID | 120 | 320° | N.A. | 80 | No | 50,000 | 120-277V | Yes | ✓ |
|  HID LED 54W | NEW! 54HID/830/277V/EX39 | 98090 | 3000K | 7300 | 175-250W HID | 135 | 320° | N.A. | 82 | No | 50,000 | 120-277V | Yes | July |
| | 54HID/840/277V/EX39 | 98091 | 4000K | 7550 | 175-250W HID | 140 | 320° | N.A. | 82 | No | 50,000 | 120-277V | Yes | July |
| | 54HID/850/277V/EX39 | 98092 | 5000K | 7550 | 175-250W HID | 140 | 320° | N.A. | 82 | No | 50,000 | 120-277V | Yes | July |
|  HID LED 45W | 45HID/830/277V/EX39/R | 57938 | 3000K | 5040 | 100-175W HID | 112 | 320° | N.A. | 80 | No | 50,000 | 120-277V | Yes | ✓ |
| | 45HID/840/277V/EX39/R | 57939 | 4000K | 5350 | 100-175W HID | 119 | 320° | N.A. | 80 | No | 50,000 | 120-277V | Yes | ✓ |
| | 45HID/850/277V/EX39/R | 57940 | 5000K | 5400 | 100-175W HID | 120 | 320° | N.A. | 80 | No | 50,000 | 120-277V | Yes | ✓ |
| | 45HID/840/277V/E26 | 58008 | 4000K | 5350 | 100-175W HID | 119 | 320° | N.A. | 80 | No | 50,000 | 120-277V | Yes | N.A. |
| | 45HID/850/277V/E26 | 57994 | 5000K | 5400 | 100-175W HID | 120 | 320° | N.A. | 80 | No | 50,000 | 120-277V | Yes | N.A. |
|  HID LED 27W | 27HID/830/277V/EX39/R | 57935 | 3000K | 3020 | 70-100W HID | 112 | 320° | N.A. | 80 | No | 50,000 | 120-277V | Yes | ✓ |
| | 27HID/840/277V/E26 | 58006 | 4000K | 3150 | 70-100W HID | 117 | 320° | N.A. | 80 | No | 50,000 | 120-277V | Yes | N.A. |
| | 27HID/850/277V/E26 | 57993 | 5000K | 3200 | 70-100W HID | 118 | 320° | N.A. | 80 | No | 50,000 | 120-277V | Yes | N.A. |

HID WALL PACK LINE

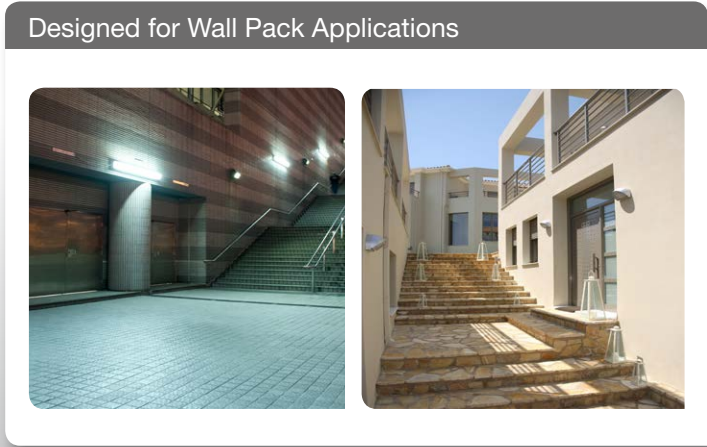





E26 Version Available



-  Universal voltage 120-277V – Not compatible with ballasts
-  Designed for horizontally-mounted wall pack applications
-  Exceptional efficacy >140 LPW
-  Suitable for use in totally enclosed fixtures



SPECIFICATIONS

| | Model | Product | CCT | Lumens (lm) | Equiv. | LPW | Beam Angle | CBCP (cd) | CRI (typ.) | Dim | Life (hrs) | Voltage | Encl. |  |
|--|--------------------------------------|---------|-------|-------------|--------------|-----|------------|-----------|------------|-----|------------|----------|-------|---|
|  HID LED WALL PACK 54W | NEW! 54HIDWP/850/277V/EX39 | 98190 | 5000K | 7800 | 175-250W HID | 144 | 120° | N.A. | 82 | No | 50,000 | 120-277V | Yes | ✓ |
|  HID LED WALL PACK 40W | NEW! 40HIDWP/850/277V/EX39 | 98186 | 5000K | 5800 | 100-175W HID | 145 | 120° | N.A. | 82 | No | 50,000 | 120-277V | Yes | ✓ |
| | 40HIDWP/850/277V/E26 | 98184 | 5000K | 5800 | 100-175W HID | 145 | 120° | N.A. | 82 | No | 50,000 | 120-277V | Yes | N.A. |
|  HID LED WALL PACK 20W | NEW! 20HIDWP/850/277V/E26 | 98180 | 5000K | 2800 | 70-100W HID | 140 | 120° | N.A. | 82 | No | 50,000 | 120-277V | Yes | N.A. |

HID HIGH BAY / LOW BAY LINE



E26 Version Available

-  **Universal voltage 120-277V – Not compatible with ballasts**
-  **Visible uplighting**
-  **Compatible with EX39 & E39 sockets**
-  **Exceptional efficacy >126 LPW**

Designed for High Bay & Low Bay Applications

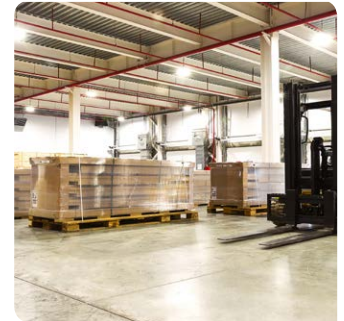





Intentional Uplighting

All High Bay and Low Bay products feature a ring of LEDs mounted around the base to provide visible uplighting for improved aesthetics and comfort



SPECIFICATIONS

| | Model | Product | CCT | Lumens (lm) | Equiv. | LPW | Beam Angle | CBCP (cd) | CRI (typ.) | Dim | Life (hrs) | Voltage | Encl. |  |
|---|---|---------|-------|-------------|--------------|-----|------------|-----------|------------|-----|------------|----------|-------|---|
|  HID LED HIGH BAY 90W | COMING SOON! 90HIDHB/840/BYP/EX39 | 98127 | 4000K | 12,400 | 250-400W HID | 138 | 110° | N.A. | 82 | No | 50,000 | 120-277V | No | ✓ |
| | 90HIDHB/850/BYP/EX39 | 98128 | 5000K | 12,400 | 250-400W HID | 138 | 110° | N.A. | 82 | No | 50,000 | 120-277V | No | ✓ |
|  HID LED HIGH BAY 65W | NEW! 65HIDHB/840/BYP/EX39 | 98124 | 4000K | 8600 | 175-250W HID | 132 | 110° | N.A. | 82 | No | 50,000 | 120-277V | No | ✓ |
| | 65HIDHB/850/BYP/EX39 | 98125 | 5000K | 8600 | 175-250W HID | 132 | 110° | N.A. | 82 | No | 50,000 | 120-277V | No | ✓ |
|  HID LED LOW BAY 35W | NEW! 35HIDLB/840/BYP/EX39 | 98118 | 4000K | 4400 | 100-175W HID | 126 | 110° | N.A. | 82 | No | 50,000 | 120-277V | No | N.A. |
| | 35HIDLB/850/BYP/EX39 | 98119 | 5000K | 4400 | 100-175W HID | 126 | 110° | N.A. | 82 | No | 50,000 | 120-277V | No | N.A. |
| | 35HIDLB/840/BYP/E26 | 98121 | 4000K | 4400 | 100-175W HID | 126 | 110° | N.A. | 82 | No | 50,000 | 120-277V | No | N.A. |
| | 35HIDLB/850/BYP/E26 | 98122 | 5000K | 4400 | 100-175W HID | 126 | 110° | N.A. | 82 | No | 50,000 | 120-277V | No | N.A. |

RESIDENTIAL DOWNLIGHT LINE



DL 5-6" 18W
DL 5-6" 12W
DL 4" 12W

HIGH CRI



DL 5-6" 18W
DL 5-6" 12W
DL 4" 12W



SPECIFICATIONS

| Model | Product | CCT | Lumens (lm) | Equiv. | LPW | Beam Angle | CBCP (cd) | CRI (typ.) | Dim | Life (hrs) | Voltage | Wet | ES | JA8 |
|--|-----------------------------|-------|-------------|--------|------|------------|-----------|------------|-----|------------|---------|------|-----|----------|
|  DL 5-6" 18W | NEW! 18DL6DIM/927 | 97994 | 2700K | 1260 | 100W | 70 | 100° | N.A. | 90 | Yes | 50,000 | 120V | Yes | ✓ / ✓ |
| | 18DL6DIM/930 | 97995 | 3000K | 1260 | 100W | 70 | 100° | N.A. | 90 | Yes | 50,000 | 120V | Yes | ✓ / ✓ |
| | 18DL6DIM/940 | 97996 | 4000K | 1260 | 100W | 70 | 100° | N.A. | 90 | Yes | 50,000 | 120V | Yes | ✓ / ✓ |
|  DL 5-6" 10W | 10DL6DIM/827 | 97756 | 3000K | 700 | 65W | 65 | 100° | N.A. | 80 | Yes | 35,000 | 120V | No | ✓ / N.A. |
| | 10DL6DIM/830 | 97757 | 4000K | 700 | 65W | 65 | 100° | N.A. | 80 | Yes | 35,000 | 120V | No | ✓ / N.A. |

* GU24 connector available

RESIDENTIAL DOWNLIGHT LINE

Adjustable springs to fit 5-6" housings. High CRI versions rated for wet locations.



Easy Installation

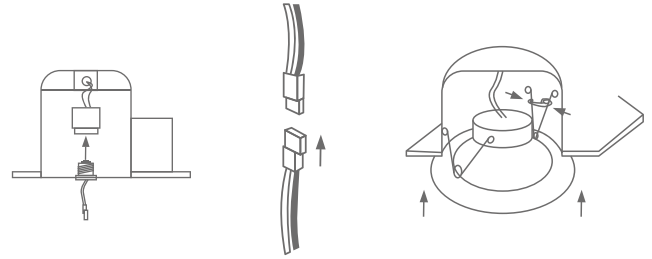

- Compatible with 5-6" and 4" housings**
- Installs in just minutes – No rewiring**
- High output 1260 lumen version**
- High CRI versions rated for wet locations**

DOWNLIGHT 5-6" - High CRI

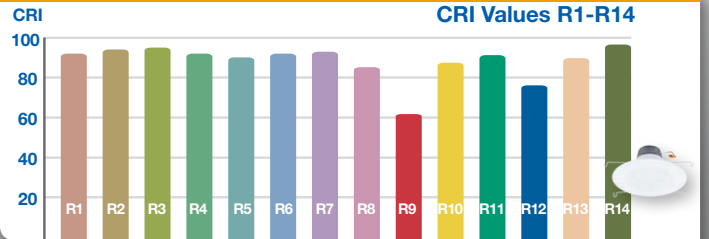

SPECIFICATIONS

| Model | Product | CCT | Lumens (lm) | Equiv. | LPW | Beam Angle | CBCP (cd) | CRI (typ.) | Dim | Life (hrs) | Voltage | Wet | ES |
|-------|--------------|-------|-------------|--------|-----|------------|-----------|------------|-----|------------|---------|-----|-------|
| | 12DL6DIM/927 | 2700K | 720 | 65W | 60 | 100° | N.A. | 90 | Yes | 35,000 | 120V | Yes | ✓ / ✓ |
| | 12DL6DIM/930 | 3000K | 750 | 65W | 63 | 100° | N.A. | 90 | Yes | 35,000 | 120V | Yes | ✓ / ✓ |
| | 12DL4DIM/927 | 2700K | 600 | 50W | 50 | 85° | N.A. | 90 | Yes | 35,000 | 120V | Yes | ✓ / ✓ |
| | 12DL4DIM/930 | 3000K | 650 | 50W | 54 | 85° | N.A. | 90 | Yes | 35,000 | 120V | Yes | ✓ / ✓ |

* GU24 connector available

BR LINE



BR30 8W



BR30 9.5W
BR30 9.5W GU24

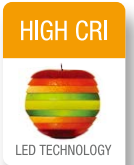

BR30 9.5W
BR30 9.5W GU24



SPECIFICATIONS

| | Model | Product | CCT | Lumens (lm) | Equiv. | LPW | Beam Angle | CBCP (cd) | CRI (typ.) | Dim | Life (hrs) | Voltage | Encl. | |
|--|----------------|---------|-------|-------------|--------|-----|------------|-----------|------------|-----|------------|---------|-------|---|
| | 14BR40DIM/827 | 40636 | 2700K | 1100 | 85W | 79 | 110° | N.A. | 82 | Yes | 25,000 | 120V | Yes | ✓ |
| | 14BR40DIM/830 | 40637 | 3000K | 1140 | 85W | 81 | 110° | N.A. | 82 | Yes | 25,000 | 120V | Yes | ✓ |
| | 9BR40G4DIM/827 | 40627 | 2700K | 700 | 65W | 78 | 110° | N.A. | 82 | Yes | 25,000 | 120V | Yes | ✓ |
| | 8BR30DIM/827 | 40771 | 2700K | 650 | 65W | 81 | 110° | N.A. | 82 | Yes | 25,000 | 120V | Yes | ✓ |
| | 8BR30DIM/830 | 40772 | 3000K | 685 | 65W | 86 | 110° | N.A. | 82 | Yes | 25,000 | 120V | Yes | ✓ |
| | 8BR30DIM/840 | 40773 | 4000K | 710 | 65W | 89 | 110° | N.A. | 82 | Yes | 25,000 | 120V | Yes | ✓ |

High CRI version available in E26 and GU24 bases



- Revolutionary CLOUD design
- 60% lighter due to environmentally friendly construction
- BR30 high CRI & GU24 versions available
- Suitable for use in totally enclosed fixtures

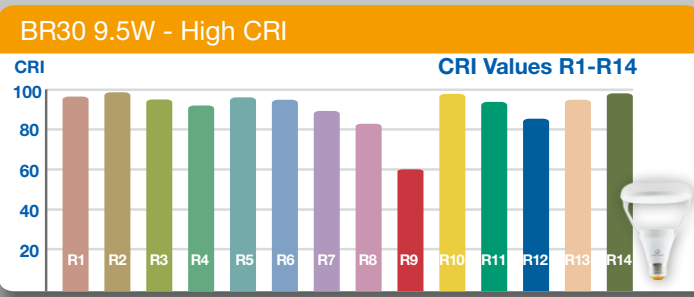

SPECIFICATIONS

| Model | Product | CCT | Lumens (lm) | Equiv. | LPW | Beam Angle | CBCP (cd) | CRI (typ.) | Dim | Life (hrs) | Voltage | Encl. | ES | JAS |
|---------------------------------------|----------------------|-------|-------------|--------|-----|------------|-----------|------------|-----|------------|---------|-------|----------|-----|
| BR30 9.5W 9.5BR30DIM/927 | 58048 | 2700K | 700 | 65W | 74 | 110° | N.A. | 90 | Yes | 25,000 | 120V | Yes | ✓ / N.A. | |
| BR30 9.5W 9.5BR30DIM/927/R | NEW! 98023 | 2700K | 700 | 65W | 74 | 110° | N.A. | 92 | Yes | 25,000 | 120V | Yes | ✓ / ✓ | |
| BR30 9.5W GU24 9.5BR30DIM/927/GU24 | NEW! 98024 | 2700K | 700 | 65W | 74 | 110° | N.A. | 92 | Yes | 25,000 | 120V | Yes | ✓ / ✓ | |
| R20 6.5W 6.5R20G4DIM/827 | 40612 | 2700K | 500 | 45W | 77 | 110° | N.A. | 82 | Yes | 25,000 | 120V | Yes | ✓ / N.A. | |

A19 / A21 LINE



A21 14W
A19 10W



A21 18.5W



A19 9W



A21 18.5W
A19 9W
A19 9W GU24



A21 18.5W
A21 15W
A19 9W
A19 9W GU24





SPECIFICATIONS

| | Model | Product | CCT | Lumens (lm) | Equiv. | LPW | Beam Angle | CBCP (cd) | CRI (typ.) | Dim | Life (hrs) | Voltage | Encl. | |
|-------------------------|-------------------|---------|-------|-------------|--------|-----|------------|-----------|------------|-----|------------|---------|-------|------|
| A21 17W | 17A21G4DIM/827/R | 16179 | 2700K | 1600 | 100W | 94 | 330° | N.A. | 80 | Yes | 25,000 | 120V | Yes | ✓ |
| | 17A21G4DIM/840/R | 16181 | 4000K | 1700 | 100W | 100 | 330° | N.A. | 80 | Yes | 25,000 | 120V | Yes | ✓ |
| A21 14W | 14A21DIM/830 | 97962 | 3000K | 1650 | 100W | 82 | 230° | N.A. | 82 | Yes | 25,000 | 120V | Yes | ✓ |
| A21 17W GU24 | 17A21DIM/827/GU24 | 16332 | 2700K | 1600 | 100W | 94 | 330° | N.A. | 80 | Yes | 25,000 | 120V | Yes | ✓ |
| A19 12W | 12A19G4DIM/827/R | 16175 | 2700K | 1100 | 75W | 92 | 330° | N.A. | 80 | Yes | 25,000 | 120V | Yes | ✓ |
| | 12A19G4DIM/830/R | 16176 | 3000K | 1150 | 75W | 96 | 330° | N.A. | 80 | Yes | 25,000 | 120V | Yes | ✓ |
| A19 10W | 10A19DIM/840 | 97966 | 4000K | 1200 | 75W | 120 | 240° | N.A. | 82 | Yes | 25,000 | 120V | Yes | ✓ |
| A19 9W | 9A19DIM/827 | 97780 | 2700K | 800 | 60W | 89 | 240° | N.A. | 80 | Yes | 25,000 | 120V | Yes | ✓ |
| | 9A19DIM/830 | 97781 | 3000K | 820 | 60W | 91 | 240° | N.A. | 80 | Yes | 25,000 | 120V | Yes | ✓ |
| | 9A19DIM/840 | 97782 | 4000K | 860 | 60W | 96 | 240° | N.A. | 80 | Yes | 25,000 | 120V | Yes | ✓ |
| A19 8W | 9A19G4DIM/824 | 40741 | 2400K | 700 | 60W | 78 | 300° | N.A. | 80 | Yes | 25,000 | 120V | No | N.A. |
| | 8.5A19DIM/827/R | 57856 | 2700K | 800 | 60W | 94 | 240° | N.A. | 80 | Yes | 25,000 | 120V | No | ✓ |
| | 8A19DIM/830 | 98012 | 3000K | 810 | 60W | 101 | 230° | N.A. | 82 | Yes | 25,000 | 120V | No | ✓ |
| | 8A19DIM/840 | 98013 | 4000K | 810 | 60W | 101 | 230° | N.A. | 82 | Yes | 25,000 | 120V | No | ✓ |
| A19 9W GU24 | 9A19DIM/827/GU24 | 97908 | 2700K | 800 | 60W | 89 | 240° | N.A. | 80 | Yes | 25,000 | 120V | Yes | ✓ |
| | 9A19DIM/830/GU24 | 97909 | 3000K | 820 | 60W | 91 | 240° | N.A. | 80 | Yes | 25,000 | 120V | Yes | ✓ |
| | 9A19DIM/840/GU24 | 97910 | 4000K | 860 | 60W | 96 | 240° | N.A. | 80 | Yes | 25,000 | 120V | Yes | ✓ |
| A19 6W | 6A19DIM/827/R | 97731 | 2700K | 450 | 40W | 75 | 240° | N.A. | 80 | Yes | 25,000 | 120V | No | ✓ |
| | 6A19DIM/830 | 97986 | 3000K | 480 | 40W | 80 | 230° | N.A. | 82 | Yes | 25,000 | 120V | No | ✓ |

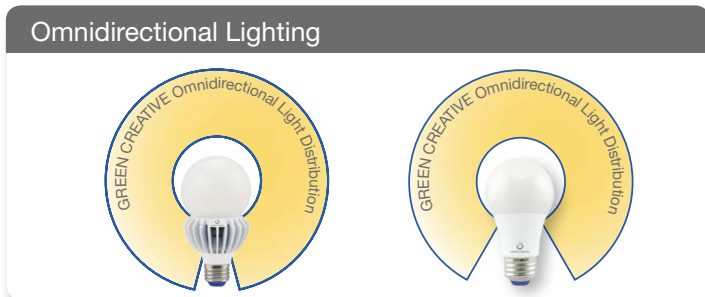



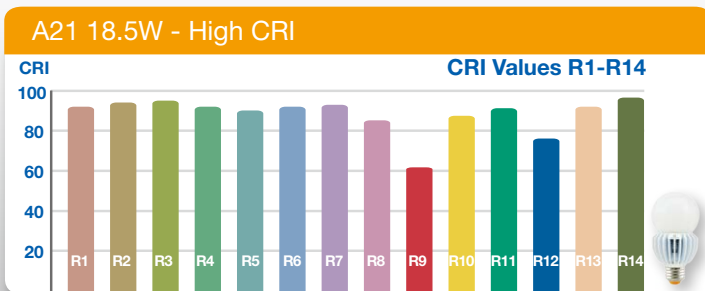

High CRI 100W, 75W, 60W replacements & GU24 versions



-  **Enclosed rated 100W, 75W & 60W replacements**
-  **High CRI 100W, 75W & 60W replacements**
-  **Enclosed rated GU24 100W & 60W replacements**
-  **120-277V universal voltage 60W replacement**



SPECIFICATIONS

| Model | Product | CCT | Lumens (lm) | Equiv. LPW | Beam Angle | CBCP (cd) | CRI (typ.) | Dim | Life (hrs) | Voltage | Encl. | ES | JA8 | |
|--|---|-------------------------|-------------------------|---------------------|--------------------|-------------------|----------------------|----------------------|----------------|----------------|----------------------------|----------------------------------|-------------------|----------------------------------|
|  A21 18.5W | 18.5A21DIM/927 | 16329 | 2700K | 1600 | 100W | 86 | 330° | N.A. | 90 | Yes | 25,000 | 120V | Yes | ✓ / ✓ |
|  A19 3-WAY 4/8/14W | NEW! 14A19/827/3WAY | 98083 | 2700K | 500 1000 1500 | 40W 75W 100W | 125 125 107 | 230° | N.A. | 82 | No | 15,000 | 120V | No | ✓ / N.A. |
|  A21 15W | 15A21DIM/927 | 16326 | 2700K | 1100 | 75W | 73 | 330° | N.A. | 90 | Yes | 25,000 | 120V | Yes | ✓ / N.A. |
|  A19 9W 277V | 9A19/827/277V 9A19/830/277V 9A19/840/277V | 58037 58038 58039 | 2700K 3000K 4000K | 800 820 860 | 60W 60W 60W | 89 91 96 | 240° 240° 240° | N.A. N.A. N.A. | 82 82 82 | No No No | 25,000 25,000 25,000 | 120-277V 120-277V 120-277V | Yes Yes Yes | ✓ / N.A. ✓ / N.A. ✓ / N.A. |
|  A19 9W | 9A19DIM/927 | 28395 | 2700K | 800 | 60W | 89 | 240° | N.A. | 92 | Yes | 30,000 | 120V | Yes | ✓ / ✓ |
|  A19 9W GU24 | 9A19DIM/927/GU24 | 97911 | 2700K | 800 | 60W | 89 | 240° | N.A. | 92 | Yes | 30,000 | 120V | Yes | ✓ / ✓ |



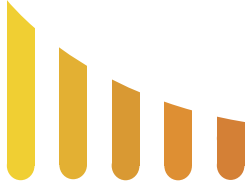



WARM DIM LINE



WARM DIM



SPECIFICATIONS

| | Model | Product | CCT | Lumens Equiv. (lm) | | LPW | Beam Angle | CBCP (cd) | CRI (typ.) | Dim | Life (hrs) | Voltage | Encl. |  |
|--|-------------------|---------|-------------|--------------------|-----|-----|------------|-----------|------------|-----|------------|---------|-------|---|
|  DL 11W WARM DIM | 11DL6DIM/8CCTD | 58100 | 2200K-2700K | 770 | 65W | 70 | 110° | N.A. | 82 | Yes | 40,000 | 120V | N.A. | ✓ |
|  BR40 10.5W WARM DIM | 10.5BR40DIM/8CCTD | 58002 | 2200K-2700K | 735 | 65W | 70 | 110° | N.A. | 82 | Yes | 25,000 | 120V | Yes | ✓ |
|  BR30 9W WARM DIM | 9BR30DIM/8CCTD | 57885 | 2200K-2700K | 650 | 65W | 72 | 110° | N.A. | 80 | Yes | 25,000 | 120V | Yes | ✓ |
|  R20 6.5W WARM DIM | 6.5R20DIM/8CCTD | 58001 | 2200K-2700K | 500 | 45W | 77 | 110° | N.A. | 82 | Yes | 25,000 | 120V | Yes | ✓ |
|  A19 9.5W WARM DIM | 9.5A19DIM/8CCTD | 57884 | 2200K-2700K | 800 | 60W | 84 | 330° | N.A. | 80 | Yes | 25,000 | 120V | Yes | ✓ |
|  B11 5W WARM DIM | 5B11DIM/8CCTD | 57834 | 2200K-2700K | 300 | 40W | 60 | 230° | N.A. | 80 | Yes | 25,000 | 120V | Yes | ✓ |

WARM DIM LINE

All Warm Dim Lamps Feature 2700K-2200K CCT Dimming



Lighting for Any Occasion



2700K-2200K Warm Dim

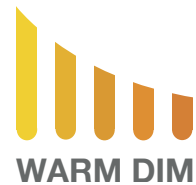

- ☾ Smooth dimming from 2700K-2200K CCT
- ☾ Traditional incandescent style dimming
- ☾ Exceptional efficacy
- ☾ Available in Downlight, BR, A19 & Candle lamps

CREATE THE PERFECT AMBIENCE



+ 2700K

- 2200K







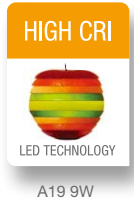



These GREEN CREATIVE lamps feature 2700K-2200K CCT dimming designed to replicate the warm dimming effect of traditional incandescent light sources. As the lamp dims, its CCT gradually warms, helping to create the perfect ambience for all occasions.

FILAMENT LINE







SPECIFICATIONS

| | Model | Product | CCT | Lumens Equiv. (lm) | LPW | Beam Angle | CBCP (cd) | CRI (typ.) | Dim | Life (hrs) | Voltage | Finish |  |
|--|---------------------------|---------------------|-------|--------------------|-----|------------|-----------|------------|-----|------------|---------|--------|---|
|  | 9FA19DIM/827 | | | | | | | | | | | | |
| | | COMING SOON! | | | | | | | | | | | |
| A19 9W | | 98279 | 2700K | 810 | 60W | 90 | 300° | N.A. | 90 | Yes | 15,000 | 120V | Clear ✓ |
|  | 7.5FA19DIM/827 | 98278 | 2700K | 800 | 60W | 107 | 300° | N.A. | 82 | Yes | 15,000 | 120V | Clear ✓ |
| A19 7.5W | | | | | | | | | | | | | |
|  | 4.5FA19DIM/827/R | 57971 | 2700K | 450 | 40W | 100 | 330° | N.A. | 80 | Yes | 15,000 | 120V | Clear ✓ |
| A19 4.5W | | | | | | | | | | | | | |
|  | 5FG40DIM/827 | 57945 | 2700K | 470 | 40W | 94 | 330° | N.A. | 82 | Yes | 15,000 | 120V | Clear ✓ |
| G40 5W | | | | | | | | | | | | | |
|  | 4.5FG25DIM/827 | 57893 | 2700K | 450 | 40W | 100 | 330° | N.A. | 80 | Yes | 15,000 | 120V | Clear ✓ |
| G25 4.5W | | | | | | | | | | | | | |
|  | 3.5FB10DIM/827/R | 58009 | 2700K | 320 | 40W | 91 | 320° | N.A. | 80 | Yes | 15,000 | 120V | Clear ✓ |
| B10 3.5W | | | | | | | | | | | | | |
|  | 3.5FB11DIM/827/E26 | 57888 | 2700K | 320 | 40W | 91 | 320° | N.A. | 80 | Yes | 15,000 | 120V | Clear ✓ |
| B11 3.5W E26 | | | | | | | | | | | | | |

Silver bowl design helps redirect light and minimizes glare









-  Fully omnidirectional beam angle
-  Micro-designed driver - No heatsink required
-  Comfortable warm diffused light
-  Smooth dimming with existing installations

Suitable for All Decorative Applications

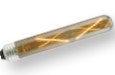





SPECIFICATIONS

| | Model | Product | CCT | Lumens (lm) | Equiv. LPW | Beam Angle | CBCP (cd) | CRI (typ.) | Dim | Life (hrs) | Voltage | Finish |  |
|--|------------------------|---------|-------|-------------|------------|------------|-----------|------------|-----|------------|---------|-------------|---|
|  ST19 5W | 5FST19DIM/824/A | 57892 | 2400K | 380 | 40W 76 | 330° | N.A. | 80 | Yes | 15,000 | 120V | Amber | N.A. |
|  A19 4.5W | 4.5FA19DIM/824/A/R | 57890 | 2400K | 380 | 40W 84 | 330° | N.A. | 80 | Yes | 15,000 | 120V | Amber | N.A. |
|  T10 3.5W | 3.5FT10DIM/822/A | 57946 | 2200K | 250 | 40W 71 | 330° | N.A. | 82 | Yes | 15,000 | 120V | Amber | N.A. |
|  G25 4.5W | 4.5FG25DIM/824/A | 57894 | 2400K | 380 | 40W 84 | 330° | N.A. | 80 | Yes | 15,000 | 120V | Amber | N.A. |
|  BA10 3.5W | 3.5FBA10DIM/824/FT/A/R | 57887 | 2400K | 280 | 40W 80 | 320° | N.A. | 80 | Yes | 15,000 | 120V | Amber | N.A. |
|  A19 7W | 7FA19DIM/827/SB | 97825 | 2700K | 700 | 40W 100 | N.A. | N.A. | 82 | Yes | 15,000 | 120V | Silver Bowl | N.A. |
|  G25 4.5W | 4.5FG25DIM/827/SB | 97826 | 2700K | 400 | 40W 89 | N.A. | N.A. | 82 | Yes | 15,000 | 120V | Silver Bowl | N.A. |

DECORATIVE LINE



-  **60W & 40W incandescent replacements**
-  **Innovative crown lens creates unique sparkling effect**
-  **Available in E12 & E26 bases**
-  **Smooth dimming with existing installations**





Crown Lens - Omnidirectional Lighting

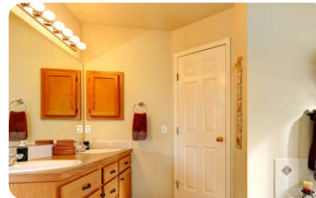

Suitable for All Decorative Applications



SPECIFICATIONS

| Model | Product | CCT | Lumens (lm) | Equiv. | LPW | Beam Angle | CBCP (cd) | CRI (typ.) | Dim | Life (hrs) | Voltage | Encl. |  | |
|--|-------------------|-------|-------------|--------|-----|------------|-----------|------------|-----|------------|---------|-------|---|---|
|  G25 6W | 6G25DIM/827 | 97729 | 2700K | 450 | 40W | 75 | 275° | N.A. | 80 | Yes | 25,000 | 120V | No | ✓ |
|  B11 5.5W E12 & E26 | 5.5B11DIM/827 | 97823 | 2700K | 500 | 60W | 91 | 230° | N.A. | 80 | Yes | 25,000 | 120V | No | ✓ |
| | 5.5B11DIM/827/E26 | 97824 | 2700K | 500 | 60W | 91 | 230° | N.A. | 80 | Yes | 25,000 | 120V | No | ✓ |
|  B11 4.5W E12 & E26 | 4.5B11DIM/827/R | 97817 | 2700K | 300 | 40W | 64 | 230° | N.A. | 80 | Yes | 25,000 | 120V | No | ✓ |
| | 4.5B11DIM/827/E26 | 97818 | 2700K | 300 | 40W | 64 | 230° | N.A. | 80 | Yes | 25,000 | 120V | No | ✓ |



GREEN CREATIVE

1200 Bayhill Drive, Suite 220
San Bruno, CA 94066
Tel / Fax: (866) 774-5433
info@greencreative.com

www.greencreative.com



/ GREENCREATIVELED



/ GClightingLED



/ GREEN CREATIVE



GREENCREATIVE