Ty-Duct® Wiring Duct

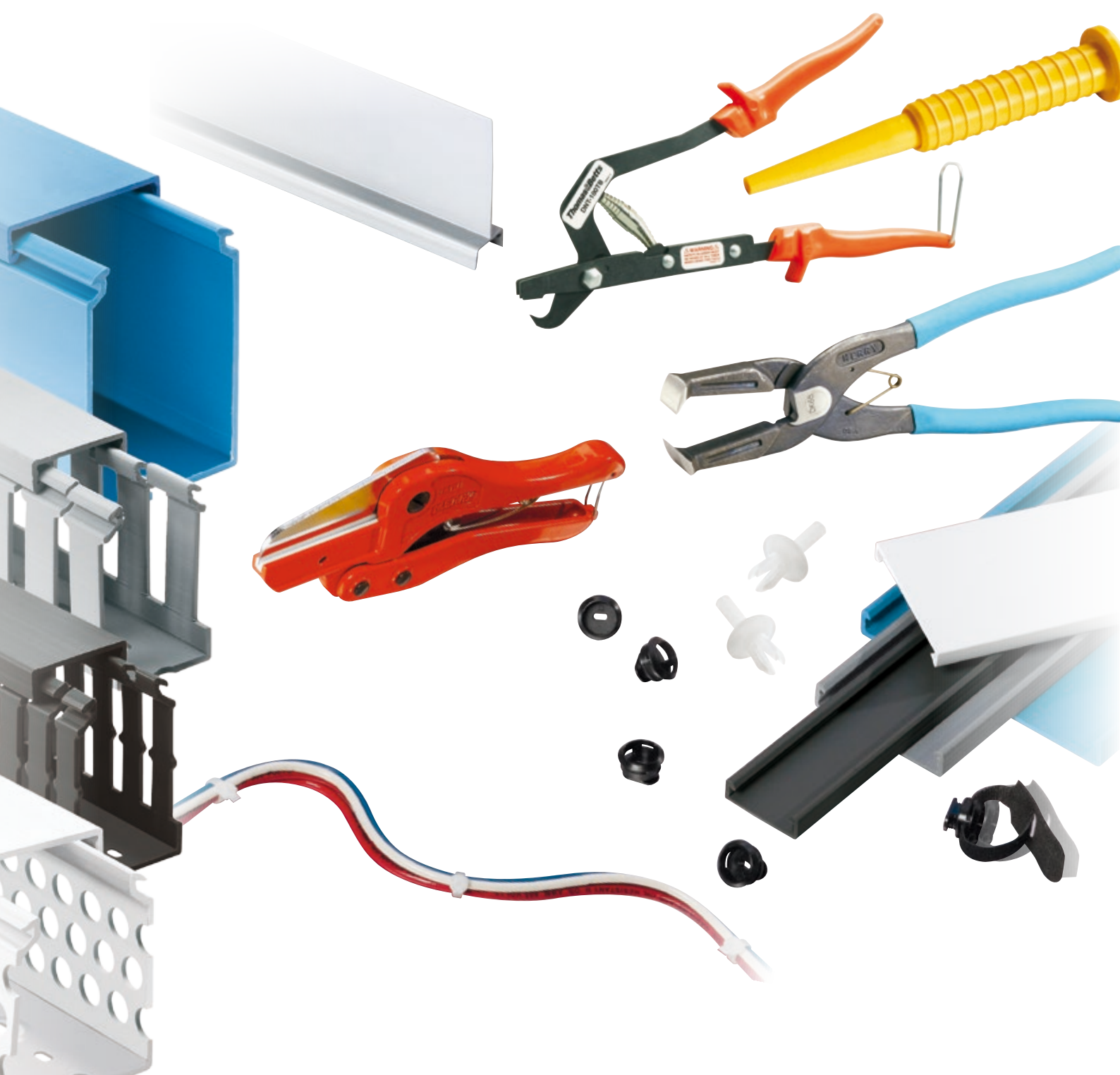

Table of contents

| | | |
|-----------|---|-----------|
| 1. | Overview | 2 |
| 1.1 | Wiring duct styles | 4 |
| 1.2 | How to order | 5 |
| 2. | Product ordering and information | 7 |
| 2.1 | Solid wall wiring duct | 8 |
| 2.2 | Wide slot wiring duct | 10 |
| 2.3 | Narrow slot wiring duct | 12 |
| 2.4 | Round hole wiring duct | 14 |
| 2.5 | Metric wide and narrow slot wiring duct | 16 |
| 2.6 | Flexible metric wiring duct | 19 |
| 2.7 | Halogen-free wide and narrow slot wiring duct | 20 |
| 2.8 | Accessories | 23 |
| 2.9 | Tools | 26 |
| 3. | Appendix | 29 |
| 3.1 | Technical information | 30 |
| 3.2 | Dimensional information | 32 |
| 3.3 | Industry standards and certifications | 39 |
| 3.4 | Catalog number index | 40 |

1. Overview

The versatile configurations you need for routing and concealing wiring

ABB's innovative Ty-Duct products offer a total solution for routing and concealing wiring in control panels. Many different sizes are available to accommodate anything from the smallest wall-mount panel to larger integrated systems. Impressive features are incorporated into all of our wiring duct solutions.

Ty-Duct wiring duct features

- Available in solid, wide slot, narrow slot and round hole versions to meet your capacity and flexibility needs
- Widths from 0.75" to 6" and depths from 1" to 5"
- Optional adhesive back for quick, hassle-free installation
- Complete selection of accessories and tools for installation
- Lead-free construction
- Lightweight halogen-free unit available for wide and narrow slot wiring duct

Ty-Duct wiring duct certifications

- UL® Recognized continuous-use temperature — 140 °F (60 °C)
- UL Flammability — Rating of UL94V-0
- CE compliant for European shipping
- CSA certified
- RoHS compliant

Available in four colors

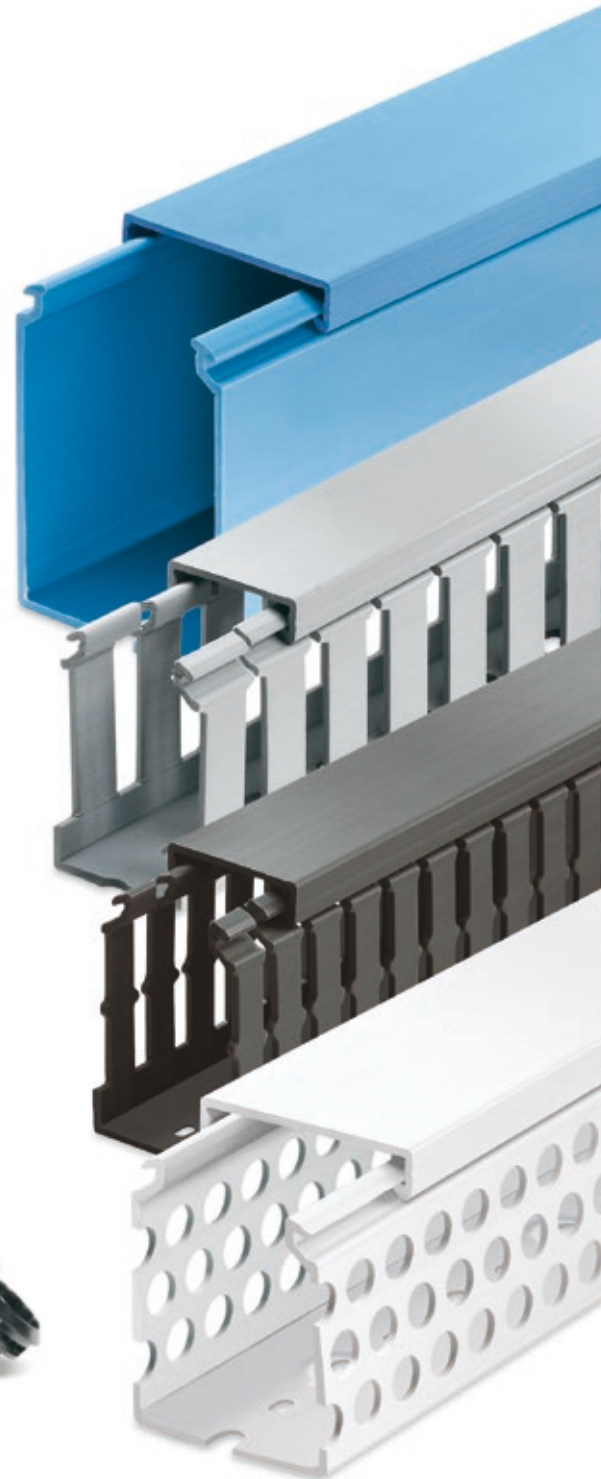
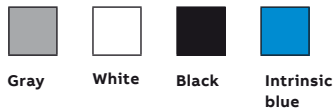

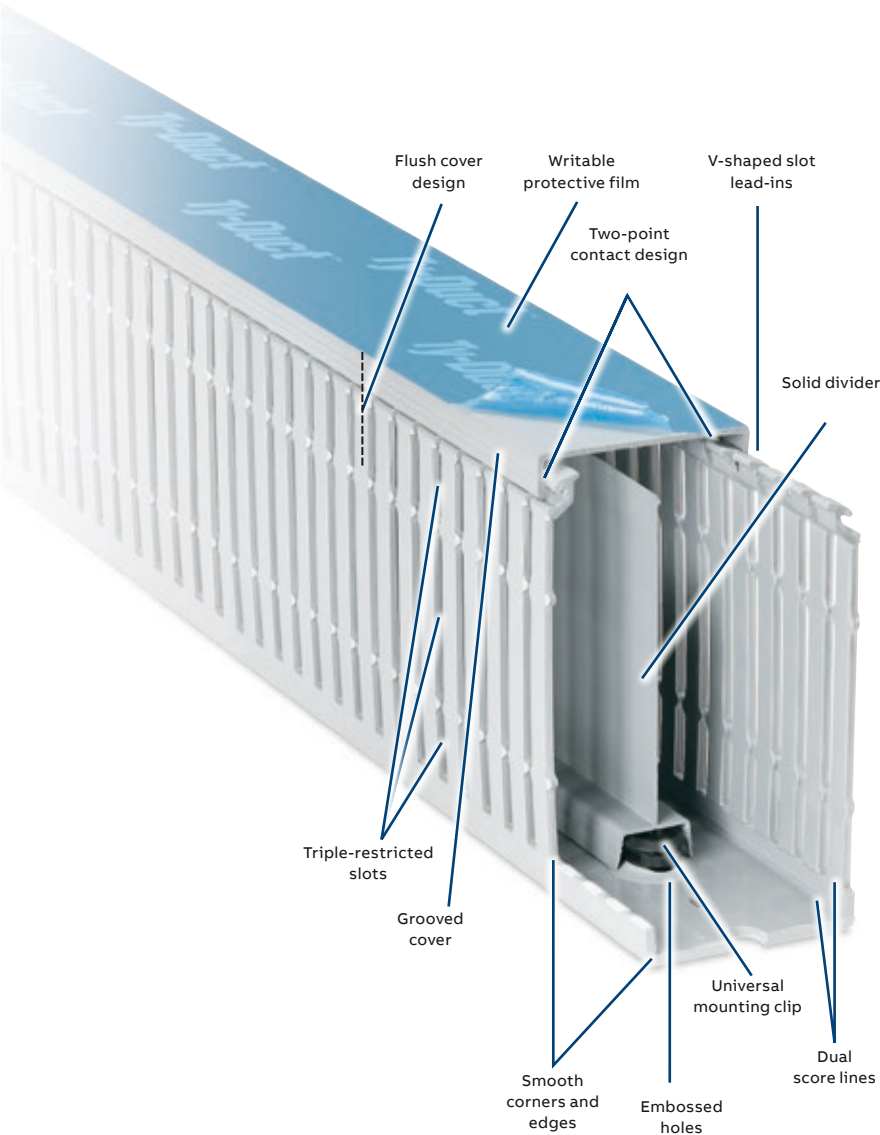

Ty-Duct wiring duct advantages

- Two-point contact design enables the cover to be easily installed in the right place with less force
- Co-extruded cover ensures the cover will stay in place once installed
- Smooth corners and edges protect wires
- Flush cover design enables greater capacity and sits flush with duct side wall
- Triple-restricted slots speed installation while enabling better wire retaining in duct
- Score lines — upper score line allows fingers to be broken out without tools
- V-shaped slot lead-in funnels wires into slot for easier wire insertion
- Universal mounting clip secures into base to perform several tasks:
 - Enables divider to be snapped into base
 - Slots in the universal mounting clip allow cable ties to pass through to hold wire bundles in place
 - Two slot sizes on universal mounting clip accommodate traditional nylon cable ties or hook-and-loop fasteners
- Slotted and solid dividers accommodate various wiring applications
- Grooved cover provides better grip for removal and placement of cover onto base
- Writable protective film on covers protects against job site scratches and scuffs and enables temporary marking or labeling
- Embossed holes enable universal mounting clips to be installed, even after the duct has been riveted to the panel
- PVC construction is excellent for flame retardancy
- North American and DIN standard mounting holes

1.1 Wiring duct styles

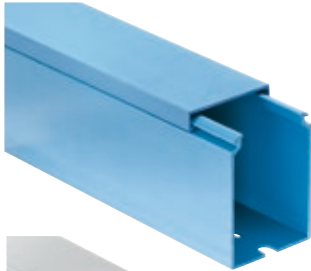

Solid wall wiring duct

- Engineered to restrict wire access for greater security
- Available in improved flush sidewall and cover style for greater wire capacity



Wide slot wiring duct

- Wide fingers and slots increase rigidity and enable easy insertion of bundles
- Halogen-free version available



Narrow slot wiring duct

- Smaller, higher number of fingers for more concise harnessing
- Finger design restricts wire from slipping along the edge — creates two or three levels of wire service



Round hole wiring duct

- Multiple rows of holes retain wire at different heights and positions with or without cover
- Features maximum number of wire holes



Metric wiring duct

- Lead-free thermoplastic duct
- Available in wide and narrow slot styles
- Covers included with all duct orders



Flexible wiring duct

- Ribs alternate and angle slightly inwards to make it easier to insert and extract cables
- No covers so that cables can be constantly monitored
- Possibility of fastening using screws and rivets or bi-adhesive tape which sticks strongly to the steel (pre-mounted)
- Suitable for connecting panels and doors with compass opening mechanisms and in general for applications where cabling is subject to bending and twisting
- Industrial application

1.2 How to order

Ordering the Ty-Duct products you need is as easy as 1, 2, 3.

After selecting the appropriate Ty-Duct solutions for your application, make sure you complete the following checklist.

For Ty-Duct wiring duct and covers:

1. Specify color
2. Indicate if you want the duct without mounting holes
3. Indicate if you want an adhesive-backed duct (not available with halogen-free duct)

[] = space for color identifier:

G = Gray

W = White

B = Black

I = Intrinsic blue



2. To order duct without mounting holes, add suffix NM to catalog number.
Example: TYD75X1WPG6NM is a 0.75" x 1" wide slot gray duct with no mounting holes.

3. To order adhesive-backed duct, add suffix A to Catalog Number. Example: TYD75x15WPB6A is a 0.75" x 1.5" wide slot black duct with adhesive backing. Shelf life for adhesive is 1 year.

| Cat. no. | Description | Nominal width x nominal height | | Cover cat. no. | Duct std. ctn. qty. | Cover std. ctn. qty. | Length (ft.) |
|-----------------|---------------------------|--------------------------------|-------------|----------------|---------------------|----------------------|--------------|
| | | Size (W x H) In. | mm | | | | |
| TYD75X1WPG]6]NM | 0.75 x 1 wide slot duct | 0.94 x 1.09 | 23.9 x 27.7 | TYD75CP[]]6 | 120 | 120 | 6 |
| TYD75X15WPB]6]A | 0.75 x 1.5 Wide slot duct | 0.94 x 1.56 | 23.9 x 39.6 | | 120 | | |
| TYD75X2WRP]6] | 0.75 x 2 wide slot duct | 0.94 x 2.07 | 23.9 x 52.6 | | 120 | | |

Standard carton quantity

SP = Solid
WP = Wide slot
NP = Narrow slot
RP = Round hole

1. Catalog number must be completed by adding suffix G for gray, W for white, I for intrinsic blue, B for black. Example: TYD75x2WPI6 is a 0.75" x 2" wide slot intrinsic blue duct. Cover color must be specified also.

Standard lengths are 6 feet.

For Ty-Duct dividers:



Catalog number must be completed by adding suffix S for solid or W for wide slot.
Example: TY2DSPG6 is a 2" high solid wall gray divider.

| Cat. no. | Description | Length (ft.) | Std. ctn. qty |
|--------------|----------------------|--------------|---------------|
| TY2D[SP][G]6 | 2" High wall divider | 6 | 120 |

Catalog number must be completed by adding suffix G for gray, W for white, I for intrinsic blue, B for black.
Example: TY2DSPG6 is a 2" high solid wall gray divider.

For Ty-Duct corner and joining strips:

Corner strip sample shown below. Joining strips are ordered the same way.

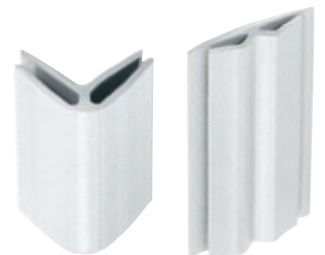

| Cat. no. | Description | Length (ft.) | Std. ctn. qty |
|----------|--------------|--------------|---------------|
| TYCS[G]6 | Corner strip | 6 | 120 |

Catalog number must be completed by adding suffix G for gray, W for white, I for intrinsic blue, B for black.
Example: TYCSG6 is a gray corner strip.

2. Ty-Duct wiring duct

Product ordering and information

| | |
|---|----|
| Solid wall wiring duct | 8 |
| Wide slot wiring duct | 10 |
| Narrow slot wiring duct | 12 |
| Round hole wiring duct | 14 |
| Metric wide and narrow slot wiring duct | 16 |
| Flexible metric wiring duct | 19 |
| Halogen-free wide and narrow slot wiring duct | 20 |
| Accessories | 23 |
| Tools | 26 |

2. Ty-Duct wiring duct

2.1 Solid wall wiring duct

Flame-retardant PVC offers the protection you need.

Solid wall duct — PVC

- Engineered to restrict wire access
- Constructed of flame-retardant PVC
- Improved flush sidewall and cover style for greater wire capacity
- Versatile North American and DIN standard mounting holes enable use of the same duct for multiple applications
- Base score line
- Lead-free construction

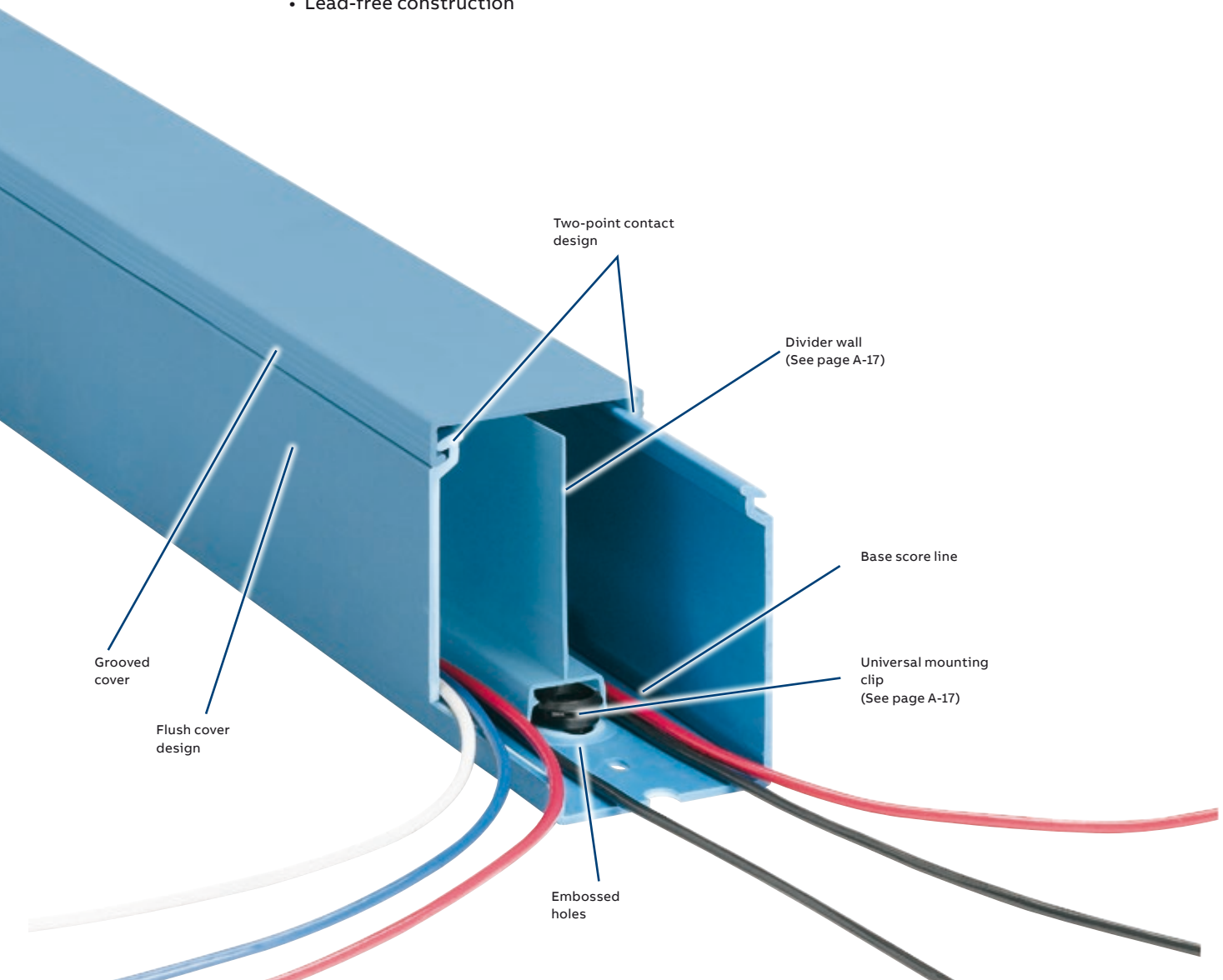

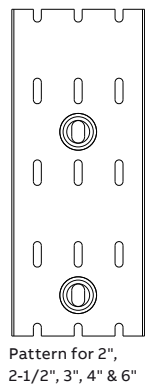
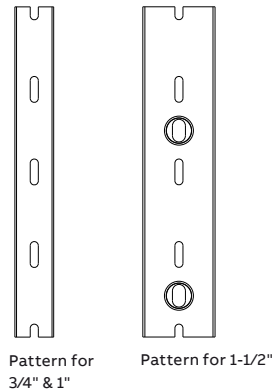
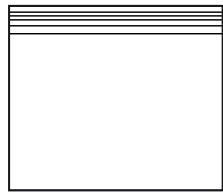
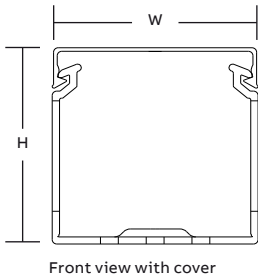

For a complete listing of solid wall dimensional details, see page B-4.



| Cat. no. | Description | Size (W x H) | | Cover cat. no. | Duct std. ctn. qty. | Cover std. ctn. qty. | Length (ft.) |
|----------------|----------------------------|--------------|---------------|----------------|---------------------|----------------------|--------------|
| | | In. | mm | | | | |
| TYD75X1SP[_]6 | 0.75 x 1 Solid wall duct | 0.94 x 1.14 | 23.9 x 27.7 | TYD75CP[_]6 | 120 | 120 | 6 |
| TYD75X15SP[_]6 | 0.75 x 1.5 Solid wall duct | 0.94 x 1.60 | 23.9 x 39.6 | | | | |
| TYD75X2SP[_]6 | 0.75 x 2 Solid wall duct | 0.94 x 2.10 | 23.9 x 52.6 | | | | |
| TYD1X1SP[_]6 | 1 x 1 Solid wall duct | 1.25 x 1.14 | 31.8 x 27.7 | TYD1CP[_]6 | 120 | 120 | 6 |
| TYD1X15SP[_]6 | 1 x 1.5 Solid wall duct | 1.25 x 1.60 | 31.8 x 39.9 | | | | |
| TYD1X2SP[_]6 | 1 x 2 Solid wall duct | 1.25 x 2.10 | 31.8 x 52.8 | | | | |
| TYD1X3SP[_]6 | 1 x 3 Solid wall duct | 1.25 x 3.05 | 31.8 x 77.7 | | | | |
| TYD1X4SP[_]6 | 1 x 4 Solid wall duct | 1.25 x 4.37 | 31.8 x 111.3 | | 60 | | |
| TYD15X1SP[_]6 | 1.5 x 1 Solid wall duct | 1.75 x 1.14 | 44.5 x 27.7 | TYD15CP[_]6 | 120 | 120 | 6 |
| TYD15X15SP[_]6 | 1.5 x 1.5 Solid wall duct | 1.75 x 1.60 | 44.5 x 39.9 | | | | |
| TYD15X2SP[_]6 | 1.5 x 2 Solid wall duct | 1.75 x 2.10 | 44.5 x 52.8 | | | | |
| TYD15X3SP[_]6 | 1.5 x 3 Solid wall duct | 1.75 x 3.05 | 44.5 x 77.7 | | | | |
| TYD15X4SP[_]6 | 1.5 x 4 Solid wall duct | 1.75 x 4.37 | 44.5 x 111.3 | | 60 | | |
| TYD2X1SP[_]6 | 2 x 1 Solid wall duct | 2.25 x 1.24 | 57.2 x 28.4 | TYD2CP[_]6 | 120 | 120 | 6 |
| TYD2X15SP[_]6 | 2 x 1.5 Solid wall duct | 2.25 x 1.70 | 57.2 x 40.4 | | | | |
| TYD2X2SP[_]6 | 2 x 2 Solid wall duct | 2.25 x 2.19 | 57.2 x 53.3 | | | | |
| TYD2X3SP[_]6 | 2 x 3 Solid wall duct | 2.25 x 3.14 | 57.2 x 78.2 | | 60 | | |
| TYD2X4SP[_]6 | 2 x 4 Solid wall duct | 2.25 x 4.46 | 57.2 x 111.8 | | | | |
| TYD2X5SP[_]6 | 2 x 5 Solid wall duct | 2.25 x 5.15 | 57.2 x 129.3 | | | | |
| TYD25X2SP[_]6 | 2.5 x 2 Solid wall duct | 2.75 x 2.19 | 69.9 x 53.6 | TYD25CP[_]6 | 120 | 120 | 6 |
| TYD25X3SP[_]6 | 2.5 x 3 Solid wall duct | 2.75 x 3.14 | 69.9 x 78.2 | | 60 | | |
| TYD25X4SP[_]6 | 2.5 x 4 Solid wall duct | 2.75 x 4.46 | 69.9 x 111.8 | | | | |
| TYD3X1SP[_]6 | 3 x 1 Solid wall duct | 3.25 x 1.24 | 82.6 x 29.0 | TYD3CP[_]6 | 120 | 120 | 6 |
| TYD3X2SP[_]6 | 3 x 2 Solid wall duct | 3.25 x 2.19 | 82.6 x 54.9 | | 60 | | |
| TYD3X3SP[_]6 | 3 x 3 Solid wall duct | 3.25 x 3.14 | 82.6 x 79.8 | | | | |
| TYD3X4SP[_]6 | 3 x 4 Solid wall duct | 3.25 x 4.46 | 82.6 x 113.5 | | | | |
| TYD3X5SP[_]6 | 3 x 5 Solid wall duct | 3.25 x 5.15 | 82.6 x 130.6 | | | | |
| TYD4X15SP[_]6 | 4 x 1.5 Solid wall duct | 4.25 x 1.70 | 108.0 x 42.4 | TYD4CP[_]6 | 60 | 120 | 6 |
| TYD4X2SP[_]6 | 4 x 2 Solid wall duct | 4.25 x 2.19 | 108.0 x 55.1 | | | | |
| TYD4X3SP[_]6 | 4 x 3 Solid wall duct | 4.25 x 3.14 | 108.0 x 80.0 | | | | |
| TYD4X4SP[_]6 | 4 x 4 Solid wall duct | 4.25 x 4.46 | 108.0 x 113.8 | | 30 | | |
| TYD4X5SP[_]6 | 4 x 5 Solid wall duct | 4.25 x 5.15 | 108.0 x 130.8 | | | | |
| TYD6X4SP[_]6 | 6 x 4 Solid wall duct | 6.25 x 4.46 | 158.8 x 114.0 | TYD6CP[_]6 | 30 | 60 | 6 |

= space for color identifier:

- G = Gray
- W = White
- B = Black
- I = Intrinsic blue

- Standard lengths are 6 feet.
- + Catalog number must be completed by adding suffix G for gray, W for white, I for intrinsic blue, B for black.
Example: TYD75X1SPG6 is a 0.75" x 1" solid wall gray duct.
To order duct without mounting holes, add suffix NM to catalog number.
Example: TYD75X1SPGNM6 is a 0.75" x 1" solid wall gray duct with no mounting holes.
To order adhesive-backed duct, add suffix A to catalog number.
Example: TYD75X1SPGA6 is a 0.75" x 1" solid wall gray duct with adhesive backing. Shelf life for adhesive is 1 year.
PVC vinyl duct is UL® Recognized , CSA certified and CE compliant.

2.2 Wide slot wiring duct

Greater sidewall rigidity with increased versatility.

Wide slot wiring duct — PVC

- Wide fingers and slots increase rigidity and enable easier insertion of wiring bundles
- Non-slip cover does not slide easily and resists vibration
- Rounded edges keep hands and wires free of abrasion
- V-shaped slot lead-in enables easier and faster wire installation
- Dual score lines are designed to yield clean breakoffs at the base of the slot and the duct
- Restricted slot design ensures that wires are held with or without the cover inserted
- Cover attaches flush with sidewall for finished look
- Improved flush sidewall and cover style for greater wire capacity
- Versatile North American and DIN standard mounting holes enable use of the same duct for multiple applications
- Constructed of flame-retardant PVC
- Integrated mounting holes — larger sizes include staggered holes for mounting flexibility (see page B-5 for illustration)
- Lead-free construction

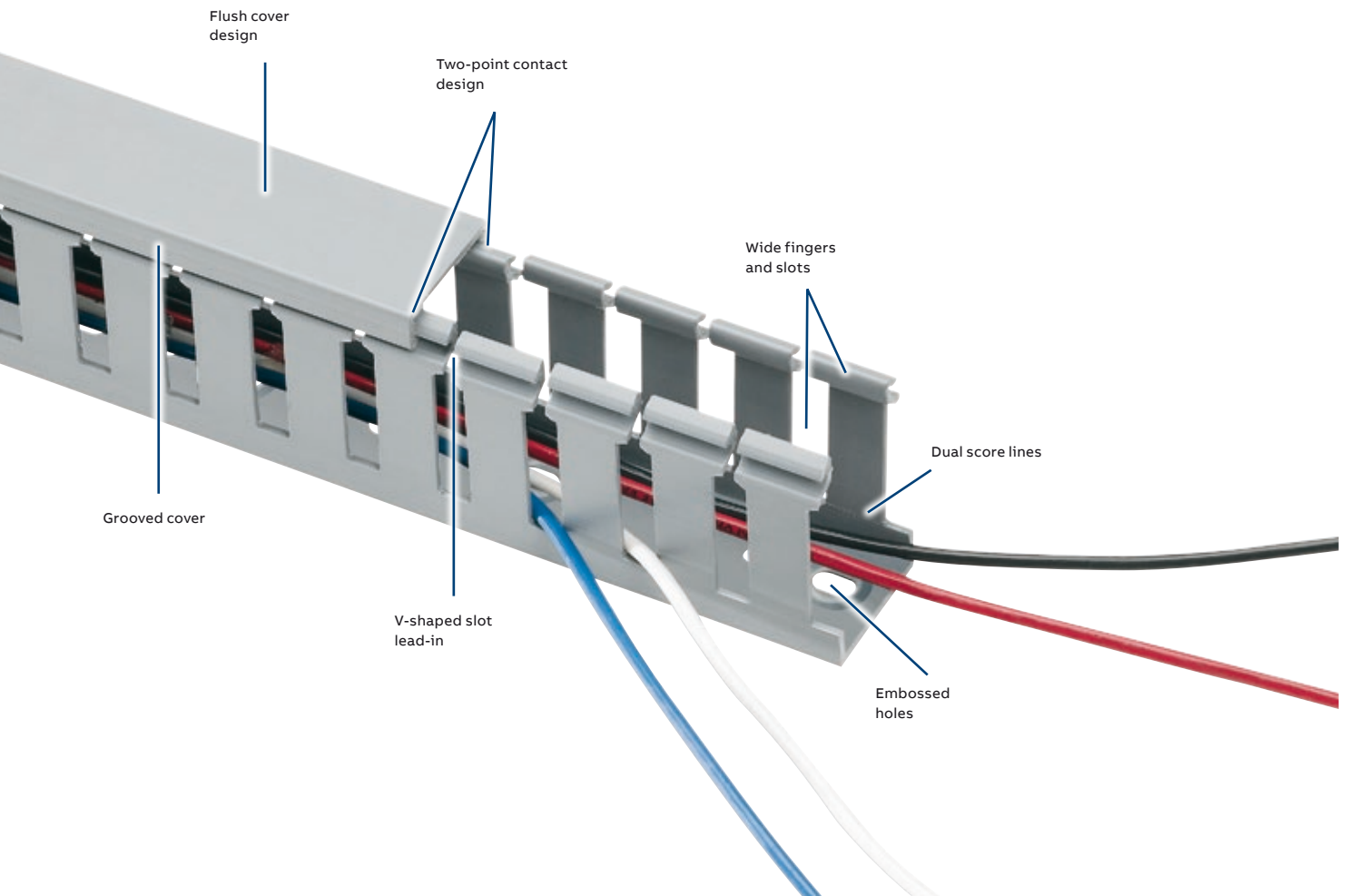

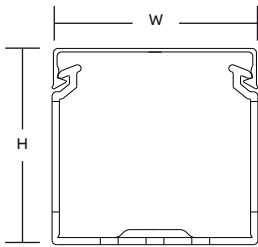

Front view with cover

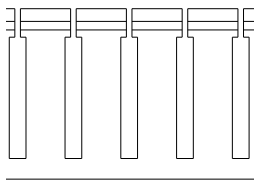

Side view

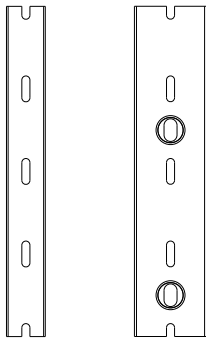

Pattern for 3/4" & 1"

Pattern for 1-1/2"

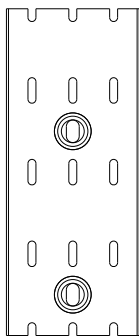

Pattern for 2", 2-1/2", 3", 4" & 6"

For a complete listing of wide slot dimensional details, see page B-5.



| Cat. no. | Description | Size (W x H) | | Cover cat. no. | Duct std. ctn. qty. | Cover std. ctn. qty. | Length (ft.) |
|----------------|---------------------------|--------------|---------------|----------------|---------------------|----------------------|--------------|
| | | In. | mm | | | | |
| TYD75X1WP[_]6 | 0.75 x 1 Wide slot duct | 0.94 x 1.14 | 23.9 x 27.7 | TYD75CP[_]6 | 120 | 120 | 6 |
| TYD75X15WP[_]6 | 0.75 x 1.5 Wide slot duct | 0.94 x 1.60 | 23.9 x 39.6 | | | | |
| TYD75X2WP[_]6 | 0.75 x 2 Wide slot duct | 0.94 x 2.10 | 23.9 x 52.6 | | | | |
| TYD1X1WP[_]6 | 1 x 1 Wide slot duct | 1.25 x 1.14 | 31.8 x 27.7 | TYD1CP[_]6 | 120 | 120 | 6 |
| TYD1X15WP[_]6 | 1 x 1.5 Wide slot duct | 1.25 x 1.60 | 31.8 x 39.9 | | | | |
| TYD1X2WP[_]6 | 1 x 2 Wide slot duct | 1.25 x 2.10 | 31.8 x 52.8 | | | | |
| TYD1X3WP[_]6 | 1 x 3 Wide slot duct | 1.25 x 3.05 | 31.8 x 77.7 | | | | |
| TYD1X4WP[_]6 | 1 x 4 Wide slot duct | 1.25 x 4.37 | 31.8 x 111.3 | | 60 | | |
| TYD15X1WP[_]6 | 1.5 x 1 Wide slot duct | 1.75 x 1.14 | 44.5 x 27.7 | TYD15CP[_]6 | 120 | 120 | 6 |
| TYD15X15WP[_]6 | 1.5 x 1.5 Wide slot duct | 1.75 x 1.60 | 44.5 x 39.9 | | | | |
| TYD15X2WP[_]6 | 1.5 x 2 Wide slot duct | 1.75 x 2.10 | 44.5 x 52.8 | | | | |
| TYD15X3WP[_]6 | 1.5 x 3 Wide slot duct | 1.75 x 3.05 | 44.5 x 77.7 | | | | |
| TYD15X4WP[_]6 | 1.5 x 4 Wide slot duct | 1.75 x 4.37 | 44.5 x 111.3 | | 60 | | |
| TYD2X1WP[_]6 | 2 x 1 Wide slot duct | 2.25 x 1.24 | 57.2 x 28.4 | TYD2CP[_]6 | 120 | 120 | 6 |
| TYD2X15WP[_]6 | 2 x 1.5 Wide slot duct | 2.25 x 1.70 | 57.2 x 40.4 | | | | |
| TYD2X2WP[_]6 | 2 x 2 Wide slot duct | 2.25 x 2.19 | 57.2 x 53.3 | | | | |
| TYD2X3WP[_]6 | 2 x 3 Wide slot duct | 2.25 x 3.14 | 57.2 x 78.2 | | 60 | | |
| TYD2X4WP[_]6 | 2 x 4 Wide slot duct | 2.25 x 4.46 | 57.2 x 111.8 | | | | |
| TYD2X5WP[_]6 | 2 x 5 Wide slot duct | 2.25 x 5.15 | 57.2 x 129.3 | | | | |
| TYD25X2WP[_]6 | 2.5 x 2 Wide slot duct | 2.75 x 2.19 | 69.9 x 53.6 | TYD25CP[_]6 | 120 | 120 | 6 |
| TYD25X3WP[_]6 | 2.5 x 3 Wide slot duct | 2.75 x 3.14 | 69.9 x 78.2 | | 60 | | |
| TYD25X4WP[_]6 | 2.5 x 4 Wide slot duct | 2.75 x 4.46 | 69.9 x 111.8 | | | | |
| TYD3X1WP[_]6 | 3 x 1 Wide slot duct | 3.25 x 1.24 | 82.6 x 29.0 | TYD3CP[_]6 | 120 | 120 | 6 |
| TYD3X2WP[_]6 | 3 x 2 Wide slot duct | 3.25 x 2.19 | 82.6 x 54.9 | | 60 | | |
| TYD3X3WP[_]6 | 3 x 3 Wide slot duct | 3.25 x 3.14 | 82.6 x 79.8 | | | | |
| TYD3X4WP[_]6 | 3 x 4 Wide slot duct | 3.25 x 4.46 | 82.6 x 113.5 | | | | |
| TYD3X5WP[_]6 | 3 x 5 Wide slot duct | 3.25 x 5.15 | 82.6 x 130.6 | | | | |
| TYD4X15WP[_]6 | 4 x 1.5 Wide slot duct | 4.25 x 1.70 | 108.0 x 42.4 | TYD4CP[_]6 | 60 | 120 | 6 |
| TYD4X2WP[_]6 | 4 x 2 Wide slot duct | 4.25 x 2.19 | 108.0 x 55.1 | | | | |
| TYD4X3WP[_]6 | 4 x 3 Wide slot duct | 4.25 x 3.14 | 108.0 x 80.0 | | | | |
| TYD4X4WP[_]6 | 4 x 4 Wide slot duct | 4.25 x 4.46 | 108.0 x 113.8 | | 30 | | |
| TYD4X5WP[_]6 | 4 x 5 Wide slot duct | 4.25 x 5.15 | 108.0 x 130.8 | | | | |
| TYD6X4WP[_]6 | 6 x 4 Wide slot duct | 6.25 x 4.46 | 158.8 x 114.0 | TYD6CP[_]6 | 30 | 60 | 6 |

= space for color identifier:

G = Gray



W = White



B = Black



I = Intrinsic blue



- Standard lengths are 6 feet.
 - + Catalog number must be completed by adding suffix G for gray, W for white, I for intrinsic blue, B for black.
- Example: TYD75X1WPG6 is a 0.75" x 1" wide slot gray duct.
 To order duct without mounting holes, add suffix NM to catalog number.
 Example: TYD75X1WPGNM6 is a 0.75" x 1" wide slot gray duct with no mounting holes.
 To order adhesive-backed duct, add suffix A to Catalog Number.
 Example: TYD75X1WPGA6 is a 0.75" x 1" wide slot gray duct with adhesive backing. Shelf life for adhesive is 1 year.
 PVC vinyl duct is UL® Recognized , CSA certified and CE compliant.

2.3 Narrow slot wiring duct

Designed to fit the spacing of high-density terminal blocks.

Narrow slot wiring duct — PVC

- Higher number of smaller fingers for more concise harnessing
- Non-slip cover does not slide easily and resists vibration
- Rounded edges protect hands and wires
- V-shaped slot lead-in enables easier and faster wire installation
- Restricted slot design makes sure that wires are held with or without the cover inserted
- Cover attaches flush with sidewall for finished look
- Versatile North American and DIN standard mounting holes enable use of the same duct for multiple applications
- Dual score lines are designed to yield clean breakoffs at the base of the slot and the duct
- Finger design restricts wire from slipping along the edge; creates two or three levels of wire service (see page B-6 for illustration)
- Lead-free construction
- Constructed of flame-retardant PVC

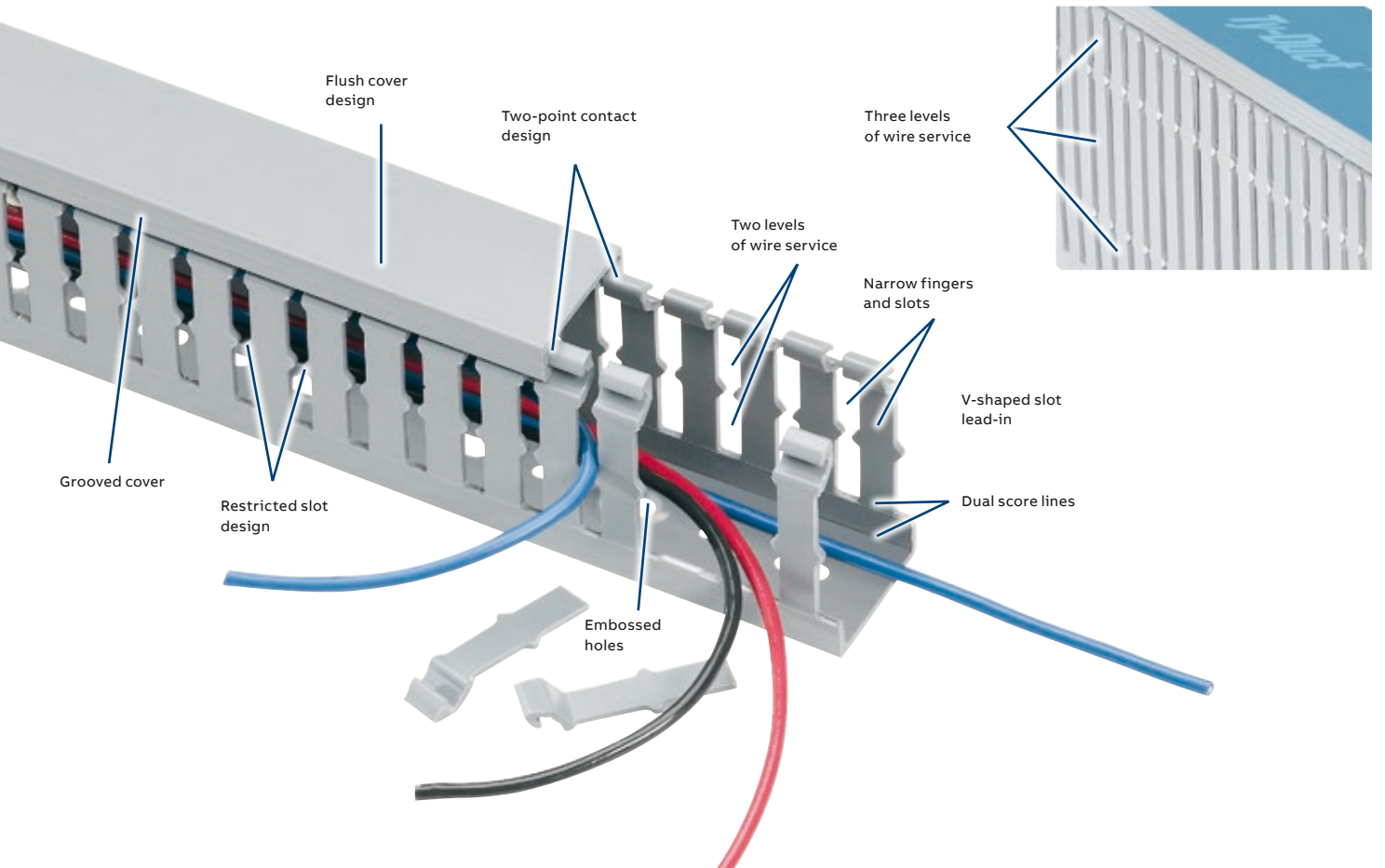

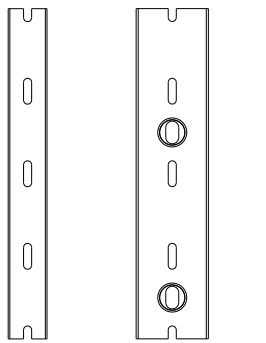
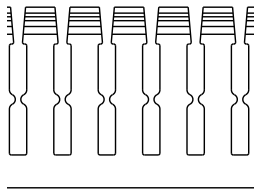
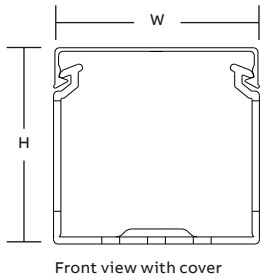

Pattern for 3/4" & 1"

Pattern for 1-1/2"

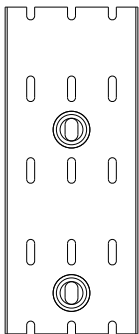

Pattern for 2", 2-1/2", 3", 4" & 6"

For a complete listing of narrow slot dimensional details, see page B-6.



| Cat. no. | Description | Size (W x H) | | Cover cat. no. | Duct std. ctn. qty. | Cover std. ctn. qty. | Length (ft.) |
|----------------|-----------------------------|--------------|---------------|----------------|---------------------|----------------------|--------------|
| | | In. | mm | | | | |
| TYD75X15NP[_]6 | 0.75 x 1.5 Narrow slot duct | 0.94 x 1.60 | 23.9 x 39.6 | TYD75CP[_]6 | 120 | 120 | 6 |
| TYD1X1NP[_]6 | 1 x 1 Narrow slot duct | 1.25 x 1.14 | 31.8 x 27.7 | TYD1CP[_]6 | 120 | 120 | 6 |
| TYD1X15NP[_]6 | 1 x 1.5 Narrow slot duct | 1.25 x 1.60 | 31.8 x 39.9 | | | | |
| TYD1X2NP[_]6 | 1 x 2 Narrow slot duct | 1.25 x 2.10 | 31.8 x 52.8 | | | | |
| TYD1X3NP[_]6 | 1 x 3 Narrow slot duct | 1.25 x 3.05 | 31.8 x 77.7 | | | | |
| TYD1X4NP[_]6 | 1 x 4 Narrow slot duct | 1.25 x 4.37 | 31.8 x 111.3 | | 60 | | |
| TYD15X1NP[_]6 | 1.5 x 1 Narrow slot duct | 1.75 x 1.14 | 44.5 x 27.7 | TYD15CP[_]6 | 120 | 120 | 6 |
| TYD15X15NP[_]6 | 1.5 x 1.5 Narrow slot duct | 1.75 x 1.60 | 44.5 x 39.9 | | | | |
| TYD15X2NP[_]6 | 1.5 x 2 Narrow slot duct | 1.75 x 2.10 | 44.5 x 52.8 | | | | |
| TYD15X3NP[_]6 | 1.5 x 3 Narrow slot duct | 1.75 x 3.05 | 44.5 x 77.7 | | | | |
| TYD15X4NP[_]6 | 1.5 x 4 Narrow slot duct | 1.75 x 4.37 | 44.5 x 111.3 | | 60 | | |
| TYD2X1NP[_]6 | 2 x 1 Narrow slot duct | 2.25 x 1.24 | 57.2 x 28.4 | TYD2CP[_]6 | 120 | 120 | 6 |
| TYD2X15NP[_]6 | 2 x 1.5 Narrow slot duct | 2.25 x 1.70 | 57.2 x 40.4 | | | | |
| TYD2X2NP[_]6 | 2 x 2 Narrow slot duct | 2.25 x 2.19 | 57.2 x 53.3 | | | | |
| TYD2X3NP[_]6 | 2 x 3 Narrow slot duct | 2.25 x 3.14 | 57.2 x 78.2 | | 60 | | |
| TYD2X4NP[_]6 | 2 x 4 Narrow slot duct | 2.25 x 4.46 | 57.2 x 111.8 | | | | |
| TYD2X5NP[_]6 | 2 x 5 Narrow slot duct | 2.25 x 5.15 | 57.2 x 129.3 | | | | |
| TYD25X2NP[_]6 | 2.5 x 2 Narrow slot duct | 2.75 x 2.19 | 69.9 x 53.6 | TYD25CP[_]6 | 120 | 120 | 6 |
| TYD25X3NP[_]6 | 2.5 x 3 Narrow slot duct | 2.75 x 3.14 | 69.9 x 78.2 | | 60 | | |
| TYD25X4NP[_]6 | 2.5 x 4 Narrow slot duct | 2.75 x 4.46 | 69.9 x 111.8 | | | | |
| TYD3X1NP[_]6 | 3 x 1 Narrow slot duct | 3.25 x 1.24 | 82.6 x 29.0 | TYD3CP[_]6 | 120 | 120 | 6 |
| TYD3X2NP[_]6 | 3 x 2 Narrow slot duct | 3.25 x 2.19 | 82.6 x 54.9 | | 60 | | |
| TYD3X3NP[_]6 | 3 x 3 Narrow slot duct | 3.25 x 3.14 | 82.6 x 79.8 | | | | |
| TYD3X4NP[_]6 | 3 x 4 Narrow slot duct | 3.25 x 4.46 | 82.6 x 113.5 | | | | |
| TYD3X5NP[_]6 | 3 x 5 Narrow slot duct | 3.25 x 5.15 | 82.6 x 130.6 | | | | |
| TYD4X2NP[_]6 | 4 x 2 Narrow slot duct | 4.25 x 2.19 | 108.0 x 55.1 | TYD4CP[_]6 | 60 | 120 | 6 |
| TYD4X3NP[_]6 | 4 x 3 Narrow slot duct | 4.25 x 3.14 | 108.0 x 80.0 | | | | |
| TYD4X4NP[_]6 | 4 x 4 Narrow slot duct | 4.25 x 4.46 | 108.0 x 113.8 | | 30 | | |
| TYD4X5NP[_]6 | 4 x 5 Narrow slot duct | 4.25 x 5.15 | 108.0 x 130.8 | | | | |

[] = space for color identifier:

- G = Gray
- W = White
- B = Black
- I = Intrinsic blue

- Standard lengths are 6 feet.
 - + Catalog number must be completed by adding suffix G for gray, W for white, I for intrinsic blue, B for black.
- Example: TYD75X1WPG6 is a 0.75" x 1" wide slot gray duct.
 To order duct without mounting holes, add suffix NM to catalog number.
 Example: TYD75X1WPGNM6 is a 0.75" x 1" wide slot gray duct with no mounting holes.
 To order adhesive-backed duct, add suffix A to Catalog Number.
 Example: TYD75X1WPGA6 is a 0.75" x 1" wide slot gray duct with adhesive backing. Shelf life for adhesive is 1 year.
 PVC vinyl duct is UL® Recognized , CSA certified and CE compliant.

2.4 Round hole wiring duct

Holes retain and support wires at different heights.

Round hole wiring duct — PVC

- Multiple rows of holes retain wire at different heights and positions with or without the cover
- Features maximum number of wire holes
- Greater wall rigidity than open slot duct
- Non-slip cover does not slide easily and resists vibration
- Rounded edges protect hands and wires
- Base score line enables sidewall section to be removed
- Cover attaches flush with sidewall for finished look
- Constructed of flame-retardant PVC
- Integrated mounting holes — larger sizes include staggered holes for mounting flexibility (see page B-7 for illustration)
- Lead-free construction

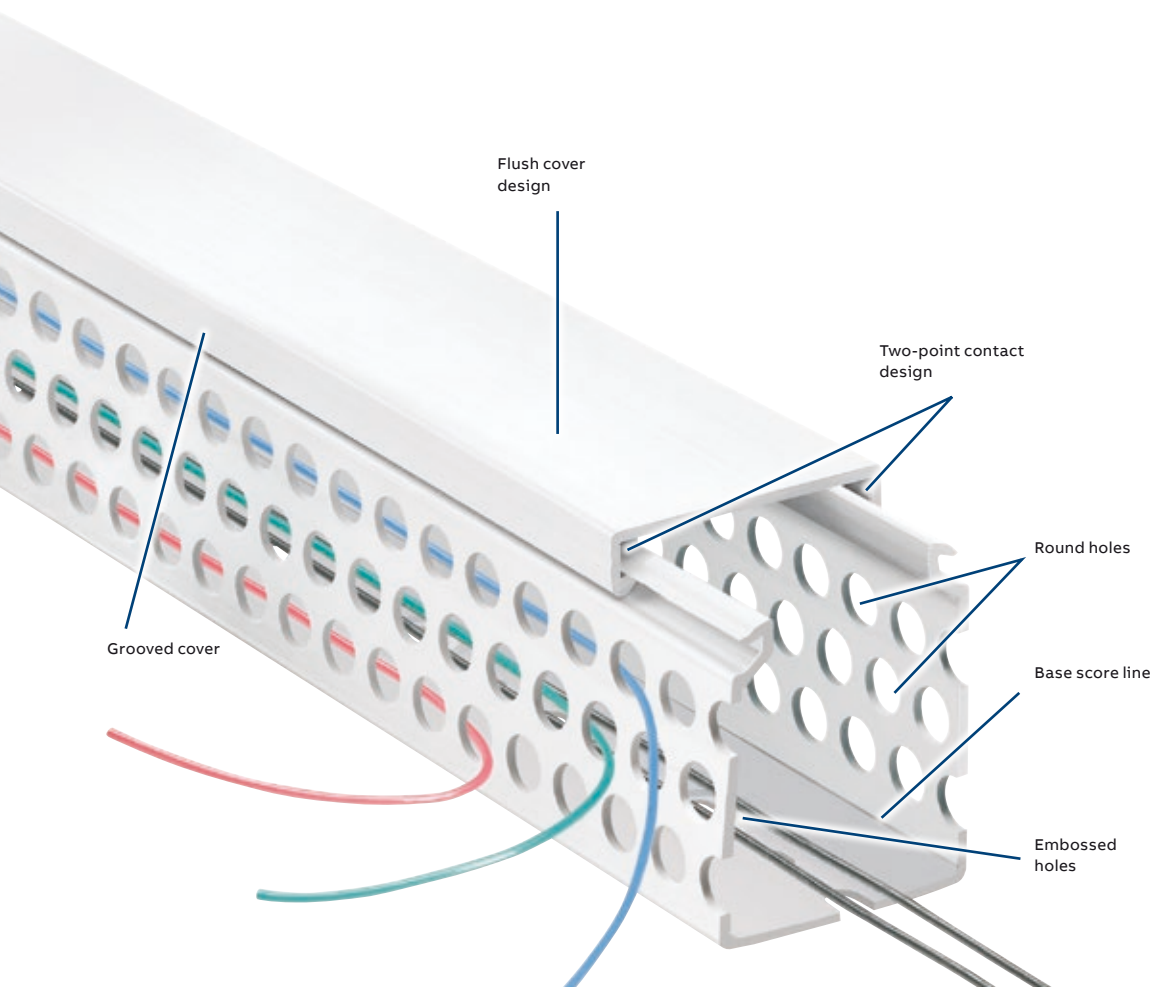

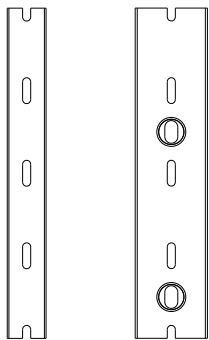
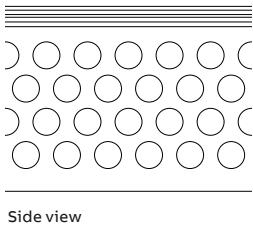
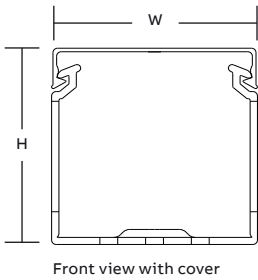

Pattern for 3/4" & 1" Pattern for 1-1/2"

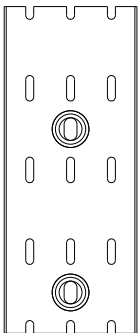

Pattern for 2", 2-1/2", 3", 4" & 6"

For a complete listing of round hole dimensional details, see page B-7.



| Cat. no. | Description | Size (W x H) | | Cover cat. no. | Duct std. ctn. qty. | Cover std. ctn. qty. | Length (ft.) |
|----------------|---------------------------|--------------|---------------|----------------|---------------------|----------------------|--------------|
| | | In. | mm | | | | |
| TYD1X15RP[_]6 | 1 x 1.5 Round hole duct | 1.75 x 1.60 | 44.5 x 39.9 | TYD1CP[_]6 | 120 | 120 | 6 |
| TYD1X2RP[_]6 | 1 x 2 Round hole duct | 1.25 x 2.10 | 31.8 x 52.8 | | | | |
| TYD1X3RP[_]6 | 1 x 3 Round hole duct | 1.25 x 3.05 | 31.8 x 77.7 | | | | |
| TYD1X4RP[_]6 | 1 x 4 Round hole duct | 1.25 x 4.37 | 31.8 x 111.3 | | 60 | | |
| TYD15X15RP[_]6 | 1.5 x 1.5 Round hole duct | 1.75 x 1.60 | 44.5 x 39.9 | TYD15CP[_]6 | 120 | 120 | 6 |
| TYD15X2RP[_]6 | 1.5 x 2 Round hole duct | 1.75 x 2.10 | 44.5 x 52.8 | | | | |
| TYD15X3RP[_]6 | 1.5 x 3 Round hole duct | 1.75 x 3.05 | 44.5 x 77.7 | | | | |
| TYD15X4RP[_]6 | 1.5 x 4 Round hole duct | 1.75 x 4.37 | 44.5 x 111.3 | | 60 | | |
| TYD2X15RP[_]6 | 2 x 1.5 Round hole duct | 2.25 x 1.70 | 57.2 x 40.4 | TYD2CP[_]6 | 120 | 120 | 6 |
| TYD2X2RP[_]6 | 2 x 2 Round hole duct | 2.25 x 2.19 | 57.2 x 53.3 | | | | |
| TYD2X3RP[_]6 | 2 x 3 Round hole duct | 2.25 x 3.14 | 57.2 x 78.2 | | 60 | | |
| TYD2X4RP[_]6 | 2 x 4 Round hole duct | 2.25 x 4.46 | 57.2 x 111.8 | | | | |
| TYD3X2RP[_]6 | 3 x 2 Round hole duct | 3.25 x 2.19 | 82.6 x 54.9 | TYD3CP[_]6 | 60 | 120 | 6 |
| TYD3X3RP[_]6 | 3 x 3 Round hole duct | 3.25 x 3.14 | 82.6 x 79.8 | | | | |
| TYD3X4RP[_]6 | 3 x 4 Round hole duct | 3.25 x 4.46 | 82.6 x 113.5 | | | | |
| TYD4X15RP[_]6 | 4 x 1.5 Round hole duct | 4.25 x 1.70 | 108.0 x 42.4 | TYD4CP[_]6 | 60 | 120 | 6 |
| TYD4X2RP[_]6 | 4 x 2 Round hole duct | 4.25 x 2.19 | 108.0 x 55.1 | | | | |
| TYD4X3RP[_]6 | 4 x 3 Round hole duct | 4.25 x 3.14 | 108.0 x 80.0 | | | | |
| TYD4X4RP[_]6 | 4 x 4 Round hole duct | 4.25 x 4.46 | 108.0 x 113.8 | | 30 | | |

= space for color identifier:

- G = Gray
- W = White
- B = Black
- I = Intrinsic blue

- Standard lengths are 6 feet.
- + Catalog number must be completed by adding suffix G for gray, W for white, I for intrinsic blue, B for black.
- Example: TYD1X15RPG6 is a 1" x 1.5" round hole gray duct.
- To order duct without mounting holes, add suffix NM to catalog number. Example: TYD1X15RPGNM6 is a 1" x 1.5" round hole gray duct with no mounting holes.
- To order adhesive-backed duct, add suffix A to catalog number. Example: TYD1X15RPGA6 is a 1" x 1.5" round hole gray duct with adhesive backing.
- PVC vinyl duct is UL[®] Recognized , CSA certified and CE compliant.

2.5 Metric wide and narrow slot wiring duct

Lead-free thermoplastic ducts

With 8–12 / 4–6 mm slots

- Shock-resistant and self-extinguishing thermoplastic in conformity with UL94V-0 standard, resistant to abnormal heat and fire up to 960 °C (glow-wire test) in conformity with IEC 60695-2-1 standard
- Minimum storage/transport temperature -5 °C
- Minimum installation/use temperature -15 °C
- Maximum use temperature +60 °C
- Standard length 2 meters
- Color RAL 7030 gray
- Conforms to EN 50085-2-3 standard
- Conforms to RoHS directive
- Lead-free
- Certifications: IMQ, UL, CSA, RINA

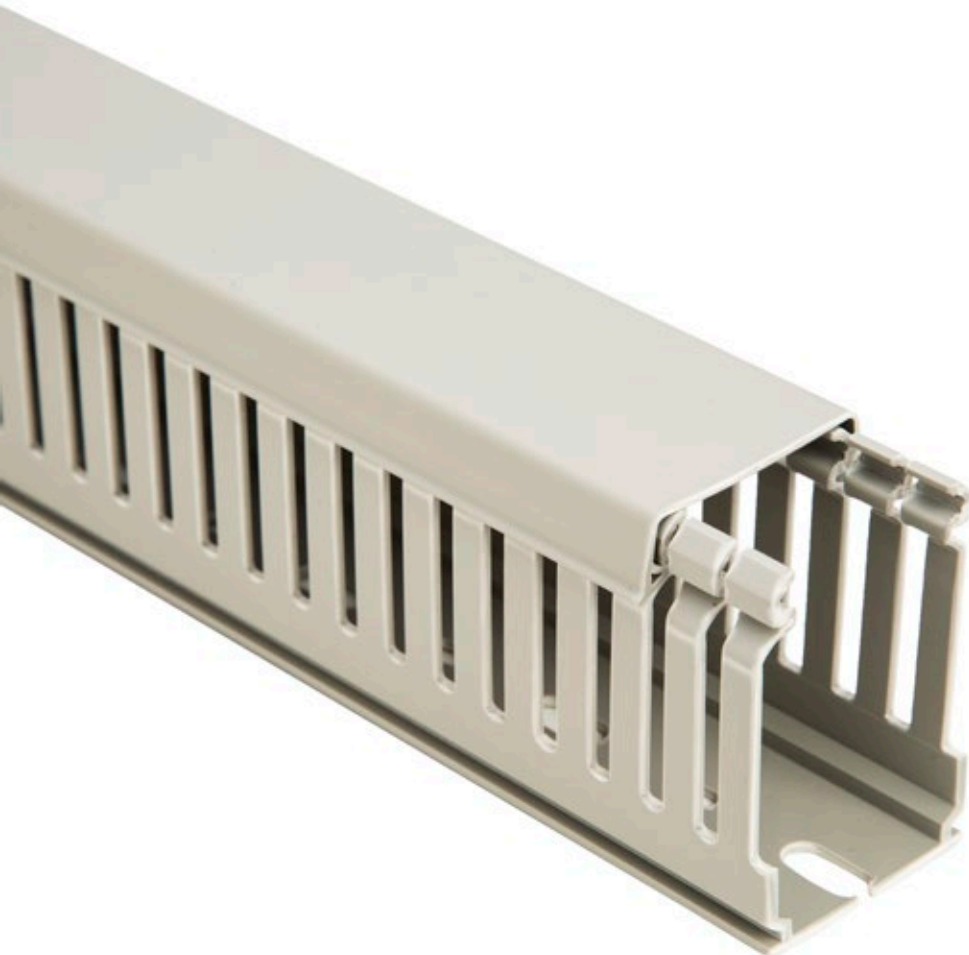

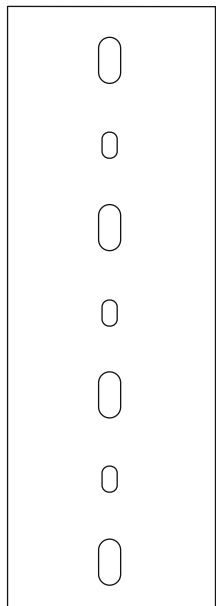
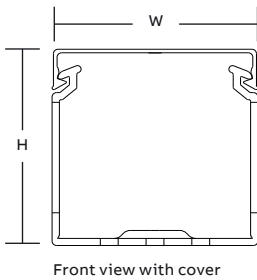

Side view

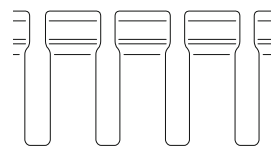

Bottom view

Wide slot wiring duct

| Cat. no. | Description | Size (W x H) | | Cover cat. no.* | Duct std. ctn. qty. (meters) | Length (meters) |
|----------|--|--------------|-----------|-----------------|------------------------------|-----------------|
| | | In. | mm | | | |
| 05019 | 15 x 17 Gray wide finger wiring duct | .59 x .67 | 15 x 17 | 05300 | 46 | 2 |
| 05033 | 25 x 30 Gray wide finger wiring duct | .98 x 1.18 | 25 x 30 | 05302 | 58 | 2 |
| 05035 | 40 x 30 Gray wide finger wiring duct | 1.57 x 1.18 | 40 x 30 | 05304 | 38 | 2 |
| 05037 | 60 x 30 Gray wide finger wiring duct | 2.36 x 1.18 | 60 x 30 | 05306 | 52 | 2 |
| 05043 | 25 x 40 Gray wide finger wiring duct | 0.98 x 1.57 | 25 x 40 | 05302 | 48 | 2 |
| 05045 | 40 x 40 Gray wide finger wiring duct | 1.57 x 1.57 | 40 x 40 | 05304 | 30 | 2 |
| 05047 | 60 x 40 Gray wide finger wiring duct | 2.36 x 1.57 | 60 x 40 | 05306 | 40 | 2 |
| 05049 | 80 x 40 Gray wide finger wiring duct | 3.15 x 1.57 | 80 x 40 | 05308 | 32 | 2 |
| 05051 | 100 x 40 Gray wide finger wiring duct | 3.94 x 1.57 | 100 x 40 | 05310 | 24 | 2 |
| 05053 | 120 x 40 Gray wide finger wiring duct | 4.72 x 1.57 | 120 x 40 | 05312 | 20 | 2 |
| 05063 | 25 x 60 Gray wide finger wiring duct | 0.98 x 2.36 | 25 x 60 | 05302 | 34 | 2 |
| 05065 | 40 x 60 Gray wide finger wiring duct | 1.57 x 2.36 | 40 x 60 | 05304 | 22 | 2 |
| 05067 | 60 x 60 Gray wide finger wiring duct | 2.36 x 2.36 | 60 x 60 | 05306 | 32 | 2 |
| 05069 | 80 x 60 Gray wide finger wiring duct | 3.15 x 2.36 | 80 x 60 | 05308 | 24 | 2 |
| 05071 | 100 x 60 Gray wide finger wiring duct | 3.94 x 2.36 | 100 x 60 | 05310 | 20 | 2 |
| 05073 | 120 x 60 Gray wide finger wiring duct | 4.72 x 2.36 | 120 x 60 | 05312 | 14 | 2 |
| 05083 | 25 x 80 Gray wide finger wiring duct | 0.98 x 3.15 | 25 x 80 | 05302 | 28 | 2 |
| 05085 | 40 x 80 Gray wide finger wiring duct | 1.57 x 3.15 | 40 x 80 | 05304 | 36 | 2 |
| 05087 | 60 x 80 Gray wide finger wiring duct | 2.36 x 3.15 | 60 x 80 | 05306 | 24 | 2 |
| 05089 | 80 x 80 Gray wide finger wiring duct | 3.15 x 3.15 | 80 x 80 | 05308 | 16 | 2 |
| 05091 | 100 x 80 Gray wide finger wiring duct | 3.94 x 3.15 | 100 x 80 | 05310 | 16 | 2 |
| 05093 | 120 x 80 Gray wide finger wiring duct | 4.72 x 3.15 | 120 x 80 | 05312 | 12 | 2 |
| 05094 | 25 x 100 Gray wide finger wiring duct | 0.98 x 3.94 | 25 x 100 | 05302 | 20 | 2 |
| 05095 | 40 x 100 Gray wide finger wiring duct | 1.57 x 3.94 | 40 x 100 | 05304 | 28 | 2 |
| 05096 | 60 x 100 Gray wide finger wiring duct | 2.36 x 3.94 | 60 x 100 | 05306 | 20 | 2 |
| 05097 | 80 x 100 Gray wide finger wiring duct | 3.15 x 3.94 | 80 x 100 | 05308 | 14 | 2 |
| 05098 | 100 x 100 Gray wide finger wiring duct | 3.94 x 3.94 | 100 x 100 | 05310 | 8 | 2 |
| 05099 | 150 x 100 Gray wide finger wiring duct | 5.91 x 3.94 | 150 x 100 | 05314 | 8 | 2 |

*Covers are included with all duct orders.

2.5 Metric wide and narrow slot wiring duct

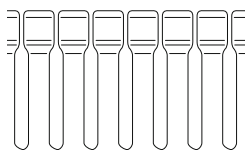
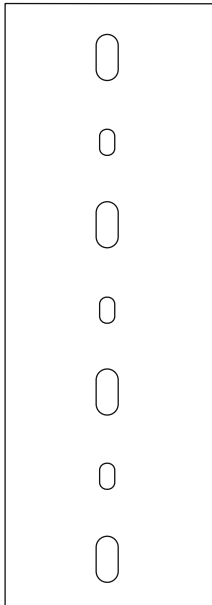
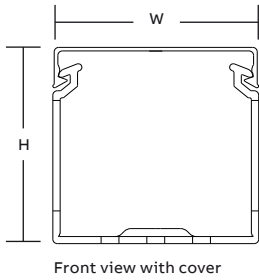

Narrow slot wiring duct

| Cat. no. | Description | Size (W x H) | | Cover cat. no.* | Duct std. ctn. qty. (meters) | Length (meters) |
|----------|--|--------------|-----------|-----------------|------------------------------|-----------------|
| | | In. | mm | | | |
| 05119 | 15 x 17 Gray narrow finger wiring duct | 0.59 x .67 | 15 x 17 | 05300 | 46 | 2 |
| 05133 | 25 x 30 Gray narrow finger wiring duct | 0.98 x 1.18 | 25 x 30 | 05302 | 58 | 2 |
| 05135 | 40 x 30 Gray narrow finger wiring duct | 1.57 x 1.18 | 40 x 30 | 05304 | 38 | 2 |
| 05137 | 60 x 30 Gray narrow finger wiring duct | 2.36 x 1.18 | 60 x 30 | 05306 | 52 | 2 |
| 05143 | 25 x 40 Gray narrow finger wiring duct | 0.98 x 1.57 | 25 x 40 | 05302 | 48 | 2 |
| 05145 | 40 x 40 Gray narrow finger wiring duct | 1.57 x 1.57 | 40 x 40 | 05304 | 30 | 2 |
| 05147 | 60 x 40 Gray narrow finger wiring duct | 2.36 x 1.57 | 60 x 40 | 05306 | 40 | 2 |
| 05149 | 80 x 40 Gray narrow finger wiring duct | 3.15 x 1.57 | 80 x 40 | 05308 | 32 | 2 |
| 05151 | 100 x 40 Gray narrow finger wiring duct | 3.94 x 1.57 | 100 x 40 | 05310 | 24 | 2 |
| 05153 | 120 x 40 Gray narrow finger wiring duct | 4.72 x 1.57 | 120 x 40 | 05312 | 20 | 2 |
| 05163 | 25 x 60 Gray narrow finger wiring duct | 0.98 x 2.36 | 25 x 60 | 05302 | 34 | 2 |
| 05165 | 40 x 60 Gray narrow finger wiring duct | 1.57 x 2.36 | 40 x 60 | 05304 | 22 | 2 |
| 05167 | 60 x 60 Gray narrow finger wiring duct | 2.36 x 2.36 | 60 x 60 | 05306 | 32 | 2 |
| 05169 | 80 x 60 Gray narrow finger wiring duct | 3.15 x 2.36 | 80 x 60 | 05308 | 24 | 2 |
| 05171 | 100 x 60 Gray narrow finger wiring duct | 3.94 x 2.36 | 100 x 60 | 05310 | 20 | 2 |
| 05173 | 120 x 60 Gray narrow finger wiring duct | 4.72 x 2.36 | 120 x 60 | 05312 | 14 | 2 |
| 05183 | 25 x 80 Gray narrow finger wiring duct | 0.98 x 3.15 | 25 x 80 | 05302 | 28 | 2 |
| 05185 | 40 x 80 Gray narrow finger wiring duct | 1.57 x 3.15 | 40 x 80 | 05304 | 36 | 2 |
| 05187 | 60 x 80 Gray narrow finger wiring duct | 2.36 x 3.15 | 60 x 80 | 05306 | 24 | 2 |
| 05189 | 80 x 80 Gray narrow finger wiring duct | 3.15 x 3.15 | 80 x 80 | 05308 | 16 | 2 |
| 05191 | 100 x 80 Gray narrow finger wiring duct | 3.94 x 3.15 | 100 x 80 | 05310 | 16 | 2 |
| 05193 | 120 x 80 Gray narrow finger wiring duct | 4.72 x 3.15 | 120 x 80 | 05312 | 12 | 2 |
| 05194 | 25 x 100 Gray narrow finger wiring duct | 0.98 x 3.94 | 25 x 100 | 05302 | 20 | 2 |
| 05195 | 40 x 100 Gray narrow finger wiring duct | 1.57 x 3.94 | 40 x 100 | 05304 | 28 | 2 |
| 05196 | 60 x 100 Gray narrow finger wiring duct | 2.36 x 3.94 | 60 x 100 | 05306 | 20 | 2 |
| 05197 | 80 x 100 Gray narrow finger wiring duct | 3.15 x 3.94 | 80 x 100 | 05308 | 14 | 2 |
| 05198 | 100 x 100 Gray narrow finger wiring duct | 3.94 x 3.94 | 100 x 100 | 05310 | 8 | 2 |
| 05199 | 150 x 100 Gray narrow finger wiring duct | 5.91 x 3.94 | 150 x 100 | 05314 | 8 | 2 |

*Covers are included with all duct orders.

Replacement covers for wiring duct

| Cat. no. | Description | Size (mm) | Length / pack qty (meters) |
|----------|-------------------------|-----------|----------------------------|
| 05300 | 15mm wiring duct cover | 15 | 2 / 200 |
| 05302 | 25mm wiring duct cover | 25 | 2 / 60 |
| 05304 | 40mm wiring duct cover | 40 | 2 / 40 |
| 05306 | 60mm wiring duct cover | 60 | 2 / 24 |
| 05308 | 80mm wiring duct cover | 80 | 2 / 16 |
| 05310 | 100mm wiring duct cover | 100 | 2 / 48 |
| 05312 | 120mm wiring duct cover | 120 | 2 / 36 |
| 05314 | 150mm wiring duct cover | 150 | 2 / 28 |

2.6 Flexible metric wiring duct

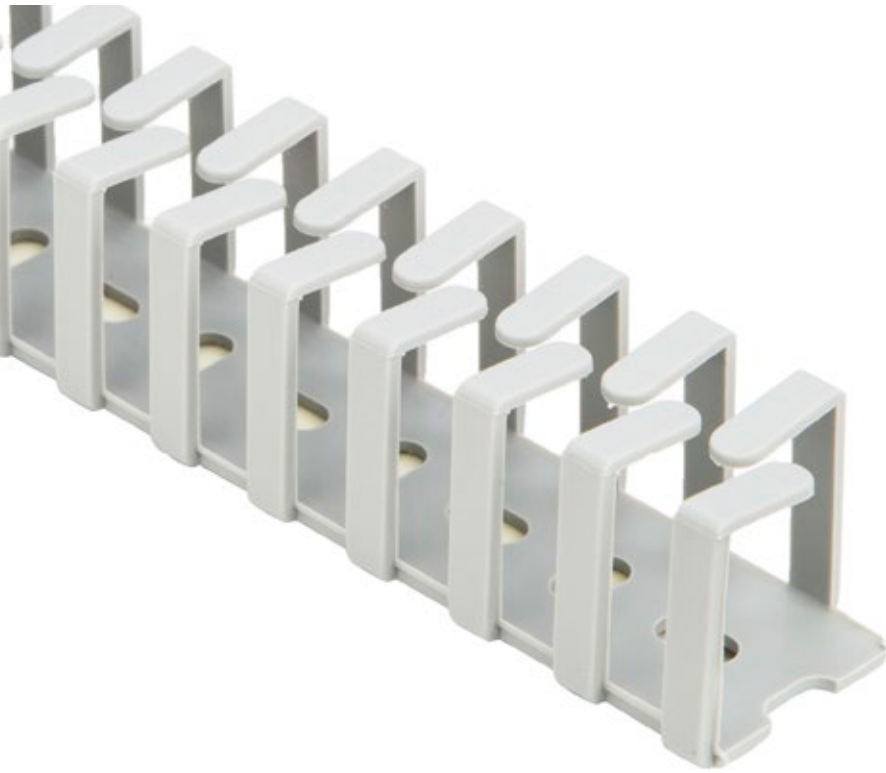

Flexible thermoplastic wiring ducts

Specifications

- Color RAL 7040 gray
- Plastic, insulating, shock-proof, self-extinguishing material
- Resistant to acids, oils and greases
- Standard 500 mm length

Standards

- Material in compliance with UL94V-2 standard and resistant to permanent temperature of 80 °C and peaks up to 110 °C in compliance with IEC 216 standards

Features

- Ribs alternate and angle slightly inwards to make it easier to insert and extract cables
- No covers so that cables can be constantly monitored
- Possibility of fastening using screws and rivets or bi-adhesive tape that sticks strongly to the steel (pre-mounted) — suitable for connecting panels and doors with compass opening mechanisms and in general for applications where cabling is subject to bending and twisting
- Industrial application

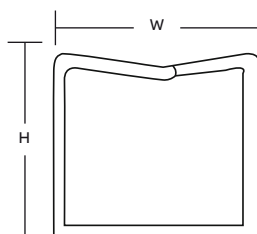

Front view with cover

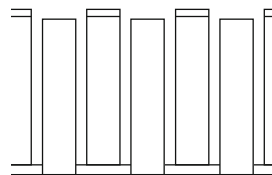

Bottom view

| Cat. no. | Description | Size (W x H) | | Qty. | Length (mm) |
|----------|----------------------------------|--------------|-------------|------|-------------|
| | | In. | mm | | |
| 05400 | 12.5 x 12.5 Flexible wiring duct | 0.5 x 0.5 | 12.5 x 12.5 | 112 | 500 |
| 05405 | 20 x 20 Flexible wiring duct | 0.8 x 0.8 | 20 x 20 | 112 | 500 |
| 05410 | 25 x 25 Flexible wiring duct | 1 x 1 | 25 x 25 | 70 | 500 |
| 05415 | 30 x 30 Flexible wiring duct | 1.2 x 1.2 | 30 x 30 | 50 | 500 |
| 05420 | 40 x 40 Flexible wiring duct | 1.6 x 1.6 | 40 x 40 | 20 | 500 |

2.7 Halogen-free wide and narrow slot wiring duct

Halogen-free thermoplastic ducts

With 8–12 / 4–6 mm slots

- Halogen-free thermoplastic in conformity with VDE 0472 standard Part 815: Br + Cl < 0.2 %, F < 0.1 %
- Toxic smoke index: 25.78 in conformity with NF X70-100 and NF F16-101 standards
- Opacity of smoke*:
Dm 352.2 (2 mm)
V0F4 475.8 (2 mm) in conformity with NF X10-702 standard (NF F16-101 reference)
- Based on the values obtained in the opacity and toxicity tests of smoke, the material belongs to class F2 (in conformity with NF F16-101 standard)
- Insulating, shock-resistant and self-extinguishing thermoplastic in conformity with UL94V-0 standard, resistant to abnormal heat and fire up to 850 °C (glow-wire test) in conformity with IEC 60695-2-1 standard
- Dimensional stability from -40 to +100 °C
- Standard length 2 m
- Color RAL 7035 gray
- Conforms to EN 50085-2-3 standard
- Conforms to RoHS directive
- Certification: UL

* Reduced smoke opacity during the first 4 minutes of a fire facilitates evacuation from areas of risk.

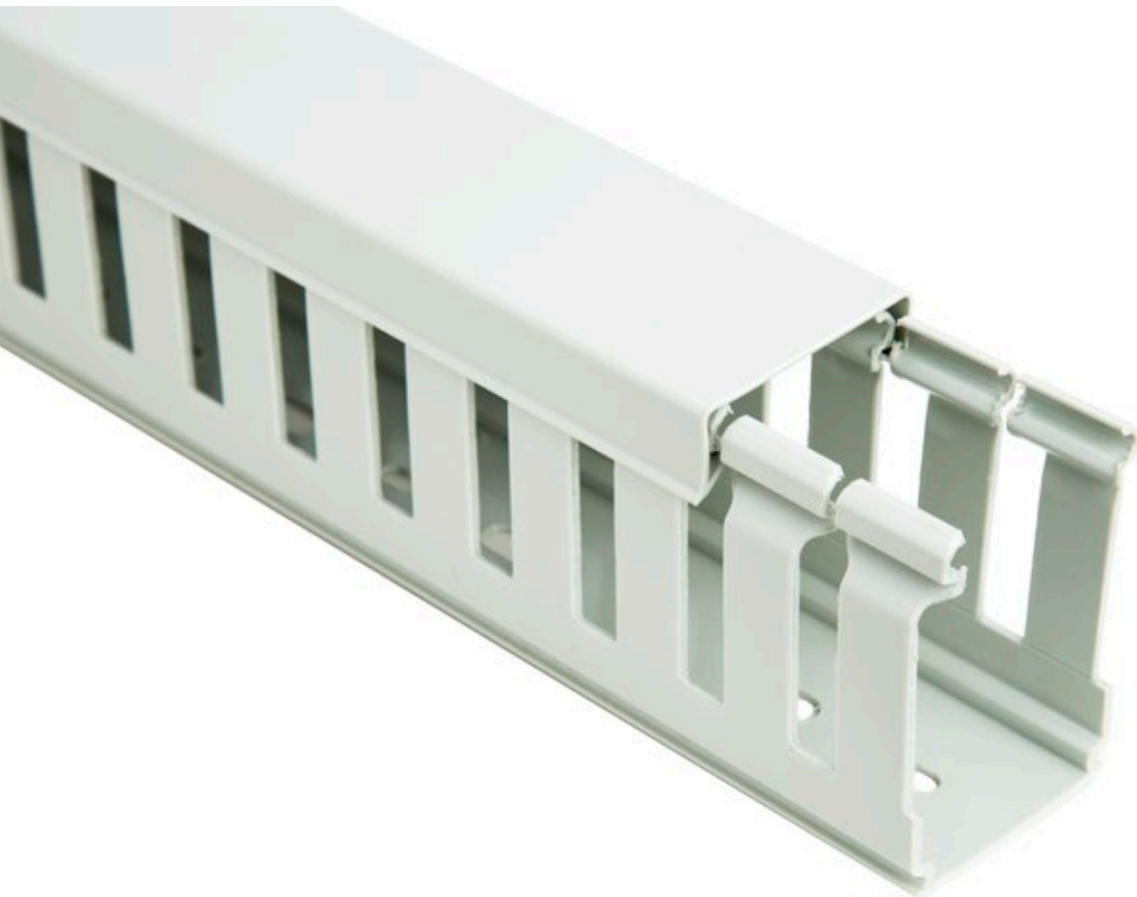

Wide slot wiring duct

| Cat. no. | Description | Size (W x H) | | Cover cat. no.* | Duct std. ctn. qty. (meters) | Length (meters) |
|------------|---|--------------|-----------|--------------------|---------------------------------|--------------------|
| | | In. | mm | | | |
| 1SL9019A00 | 15 x 17 Halogen-free wide finger duct | 0.59 x .67 | 15 x 17 | 1SL5316A00 | 46 | 2 |
| 1SL9033A00 | 25 x 30 Halogen-free wide finger duct | 0.98 x 1.18 | 25 x 30 | 1SL5317A00 | 58 | 2 |
| 1SL9043A00 | 25 x 40 Halogen-free wide finger duct | 0.98 x 1.57 | 25 x 40 | 1SL5317A00 | 48 | 2 |
| 1SL9063A00 | 25 x 60 Halogen-free wide finger duct | 0.98 x 2.36 | 25 x 60 | 1SL5317A00 | 34 | 2 |
| 1SL9083A00 | 25 x 80 Halogen-free wide finger duct | 0.98 x 3.15 | 25 x 80 | 1SL5317A00 | 28 | 2 |
| 1SL9035A00 | 40 x 30 Halogen-free wide finger duct | 1.57 x 1.18 | 40 x 30 | 1SL5318A00 | 40 | 2 |
| 1SL9045A00 | 40 x 40 Halogen-free wide finger duct | 1.57 x 1.57 | 40 x 40 | 1SL5318A00 | 30 | 2 |
| 1SL9065A00 | 40 x 60 Halogen-free wide finger duct | 1.57 x 2.36 | 40 x 60 | 1SL5318A00 | 22 | 2 |
| 1SL9085A00 | 40 x 80 Halogen-free wide finger duct | 1.57 x 3.15 | 40 x 80 | 1SL5318A00 | 36 | 2 |
| 1SL9095A00 | 40 x 100 Halogen-free wide finger duct | 1.57 x 3.94 | 40 x 100 | 1SL5318A00 | 28 | 2 |
| 1SL9037A00 | 60 x 30 Halogen-free wide finger duct | 2.36 x 1.18 | 60 x 30 | 1SL5319A00 | 52 | 2 |
| 1SL9047A00 | 60 x 40 Halogen-free wide finger duct | 2.36 x 1.57 | 60 x 40 | 1SL5319A00 | 40 | 2 |
| 1SL9067A00 | 60 x 60 Halogen-free wide finger duct | 2.36 x 2.36 | 60 x 60 | 1SL5319A00 | 32 | 2 |
| 1SL9087A00 | 60 x 80 Halogen-free wide finger duct | 2.36 x 3.15 | 60 x 80 | 1SL5319A00 | 24 | 2 |
| 1SL9096A00 | 60 x 100 Halogen-free wide finger duct | 2.36 x 3.94 | 60 x 100 | 1SL5319A00 | 20 | 2 |
| 1SL9049A00 | 80 x 40 Halogen-free wide finger duct | 3.15 x 1.57 | 80 x 40 | 1SL5320A00 | 32 | 2 |
| 1SL9069A00 | 80 x 60 Halogen-free wide finger duct | 3.15 x 2.36 | 80 x 60 | 1SL5320A00 | 24 | 2 |
| 1SL9089A00 | 80 x 80 Halogen-free wide finger duct | 3.15 x 3.15 | 80 x 80 | 1SL5320A00 | 16 | 2 |
| 1SL9097A00 | 80 x 100 Halogen-free wide finger duct | 3.15 x 3.94 | 80 x 100 | 1SL5320A00 | 14 | 2 |
| 1SL9051A00 | 100 x 40 Halogen-free wide finger duct | 3.94 x 1.57 | 100 x 40 | 1SL5321A00 | 24 | 2 |
| 1SL9071A00 | 100 x 60 Halogen-free wide finger duct | 3.94 x 2.36 | 100 x 60 | 1SL5321A00 | 20 | 2 |
| 1SL9091A00 | 100 x 80 Halogen-free wide finger duct | 3.94 x 3.15 | 100 x 80 | 1SL5321A00 | 16 | 2 |
| 1SL9098A00 | 100 x 100 Halogen-free wide finger duct | 3.94 x 3.94 | 100 x 100 | 1SL5321A00 | 8 | 2 |
| 1SL9053A00 | 120 x 40 Halogen-free wide finger duct | 4.72 x 1.57 | 120 x 40 | 1SL5322A00 | 20 | 2 |
| 1SL9073A00 | 120 x 60 Halogen-free wide finger duct | 4.72 x 2.36 | 120 x 60 | 1SL5322A00 | 14 | 2 |
| 1SL9093A00 | 120 x 80 Halogen-free wide finger duct | 4.72 x 3.15 | 120 x 80 | 1SL5322A00 | 12 | 2 |

*Covers are included with all duct orders.

2.7 Halogen-free wide and narrow slot wiring duct

Narrow slot wiring duct

| Cat. no. | Description | Size (W x H) | | Cover cat. no.* | Duct std. ctn. qty. (meters) | Length (meters) |
|------------|--|--------------|-------------|-----------------|------------------------------|-----------------|
| | | In. | mm | | | |
| 1SL9119A00 | 15 x 17 Halogen-free narrow finger duct | 15 x 17 | 0.59 x .67 | 1SL5316A00 | 46 | 2 |
| 1SL9133A00 | 25 x 30 Halogen-free narrow finger duct | 25 x 30 | 0.98 x 1.18 | 1SL5317A00 | 58 | 2 |
| 1SL9143A00 | 25 x 40 Halogen-free narrow finger duct | 25 x 40 | 0.98 x 1.57 | 1SL5317A00 | 40 | 2 |
| 1SL9163A00 | 25 x 60 Halogen-free narrow finger duct | 25 x 60 | 0.98 x 2.36 | 1SL5317A00 | 52 | 2 |
| 1SL9183A00 | 25 x 80 Halogen-free narrow finger duct | 25 x 80 | 0.98 x 3.15 | 1SL5317A00 | 48 | 2 |
| 1SL9135A00 | 40 x 30 Halogen-free narrow finger duct | 40 x 30 | 1.57 x 1.18 | 1SL5318A00 | 30 | 2 |
| 1SL9145A00 | 40 x 40 Halogen-free narrow finger duct | 40 x 40 | 1.57 x 1.57 | 1SL5318A00 | 40 | 2 |
| 1SL9165A00 | 40 x 60 Halogen-free narrow finger duct | 40 x 60 | 1.57 x 2.36 | 1SL5318A00 | 32 | 2 |
| 1SL9185A00 | 40 x 80 Halogen-free narrow finger duct | 40 x 80 | 1.57 x 3.15 | 1SL5318A00 | 24 | 2 |
| 1SL9137A00 | 60 x 30 Halogen-free narrow finger duct | 60 x 30 | 2.36 x 1.18 | 1SL5319A00 | 20 | 2 |
| 1SL9147A00 | 60 x 40 Halogen-free narrow finger duct | 60 x 40 | 2.36 x 1.57 | 1SL5319A00 | 34 | 2 |
| 1SL9167A00 | 60 x 60 Halogen-free narrow finger duct | 60 x 60 | 2.36 x 2.36 | 1SL5319A00 | 22 | 2 |
| 1SL9187A00 | 60 x 80 Halogen-free narrow finger duct | 60 x 80 | 2.36 x 3.15 | 1SL5319A00 | 32 | 2 |
| 1SL9149A00 | 80 x 40 Halogen-free narrow finger duct | 80 x 40 | 3.15 x 1.57 | 1SL5320A00 | 24 | 2 |
| 1SL9169A00 | 80 x 60 Halogen-free narrow finger duct | 80 x 60 | 3.15 x 2.36 | 1SL5320A00 | 20 | 2 |
| 1SL9189A00 | 80 x 80 Halogen-free narrow finger duct | 80 x 80 | 3.15 x 3.15 | 1SL5320A00 | 14 | 2 |
| 1SL9151A00 | 100 x 40 Halogen-free narrow finger duct | 100 x 40 | 3.94 x 1.57 | 1SL5321A00 | 28 | 2 |
| 1SL9171A00 | 100 x 60 Halogen-free narrow finger duct | 100 x 60 | 3.94 x 2.36 | 1SL5321A00 | 36 | 2 |
| 1SL9191A00 | 100 x 80 Halogen-free narrow finger duct | 100 x 80 | 3.94 x 3.15 | 1SL5321A00 | 24 | 2 |
| 1SL9153A00 | 120 x 40 Halogen-free narrow finger duct | 120 x 40 | 4.72 x 1.57 | 1SL5322A00 | 16 | 2 |
| 1SL9173A00 | 120 x 60 Halogen-free narrow finger duct | 120 x 60 | 4.72 x 2.36 | 1SL5322A00 | 16 | 2 |
| 1SL9193A00 | 120 x 80 Halogen-free narrow finger duct | 120 x 80 | 4.72 x 3.15 | 1SL5322A00 | 12 | 2 |

*Covers are included with all duct orders.

Replacement covers for halogen-free wiring duct

| Cat. no. | Description | Size (mm) | Length / pack qty (meters) |
|------------|-------------------------|-----------|----------------------------|
| 1SL5316A00 | 15mm wiring duct cover | 15 | 2 / 200 |
| 1SL5317A00 | 25mm wiring duct cover | 25 | 2 / 60 |
| 1SL5318A00 | 40mm wiring duct cover | 40 | 2 / 40 |
| 1SL5319A00 | 60mm wiring duct cover | 60 | 2 / 24 |
| 1SL5320A00 | 80mm wiring duct cover | 80 | 2 / 16 |
| 1SL5321A00 | 100mm wiring duct cover | 100 | 2 / 48 |
| 1SL5322A00 | 120mm wiring duct cover | 120 | 2 / 36 |

2.8 Accessories





Trust ABB for all your wiring accessories

Accessories include:

- Divider walls, enabling multiple channels to be created within a duct channel
- Universal mounting clips that secure channels and wires
- Corner strips that keep corners rigid at tee junctions when used for control panel applications
- Joining strips to unite sections of duct and keep the wall rigid
- Plastic rivets for securing ducts quickly and easily



= space for color identifier:

- G = Gray 
- W = White 
- B = Black 
- I = Intrinsic blue 

Universal mounting clips

One size fits all.

- Added before or after the duct is in place, without additional hardware
- Twists into place — holds securely
- Installs easily using a screwdriver
- Accommodates up to 40 lb. cable ties
- Black polycarbonate construction

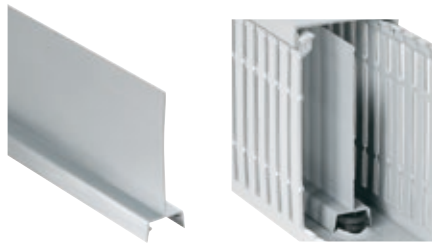

| Cat. no. | Description | Length (ft.) | Std. ctn. qty |
|---------------|------------------------|--------------|---------------|
| TY1D[][]6 | 1" High wall divider | 6 | 120 |
| TY1.5D[][]6 | 1.5" High wall divider | 6 | 120 |
| TY2D[][]6 | 2" High wall divider | 6 | 120 |
| TY3D[][]6 | 3" High wall divider | 6 | 120 |
| TY4D[][]6 | 4" High wall divider | 6 | 120 |
| TY5D[][]6 | 5" High wall divider | 6 | 120 |

+ Catalog number must be completed by adding suffix SP for solid or WP for wide slot.
Example: TY2DSPG6 is a 2" high solid wall gray divider.

Divider wall

Create multiple channels inside wiring ducts.

- Separates high and low voltage to reduce shortages and interference
- Mount inside any Ty-Duct PVC wiring duct using universal mounting clips
- Score lines enable sections to be removed
- Solid and wide slotted style



| Cat. no. | Description | Qty |
|----------|--------------------------|--------|
| UMC | Universal fastener mount | 100 pk |

2.8 Accessories

Corner strips

Install smooth round corners on your wiring duct.

- Constructed of rigid PVC
- One-piece design makes installation a snap
- Works with any Ty-Duct wiring duct
- Select from a variety of sizes



| Cat. no. | Description | Length (ft.) | Std. ctn. qty |
|----------|--------------|--------------|---------------|
| TYCS[_]6 | Corner strip | 6 | 120 |

+ Catalog number must be completed by adding suffix G for gray, W for white, I for intrinsic blue, B for black. Example: TYCSG6 is a gray corner strip.

Joining strips

Join duct sections easily.

- Slides on duct
- Constructed of rigid PVC
- One-piece design makes installation easy
- Works with any Ty-Duct wiring duct



| Cat. no. | Description | Length (ft.) | Std. ctn. qty |
|----------|---------------|--------------|---------------|
| TYJC[_]6 | Joining strip | 6 | 120 |

+ Catalog number must be completed by adding suffix G for gray, W for white, I for intrinsic blue, B for black. Example: TYJCG6 is a gray joining strip.

Plastic rivets

Plastic rivets make mounting ducts easy.

- Fast installation
- Durable and economical
- One size

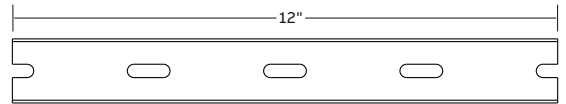

Minimum mounting rivet distance for ducts of 0.75" and 1" wide.

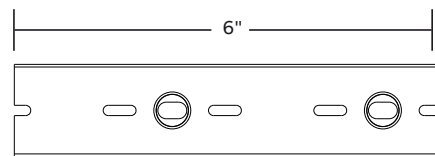

Minimum mounting rivet distance for ducts 1.5" wide.

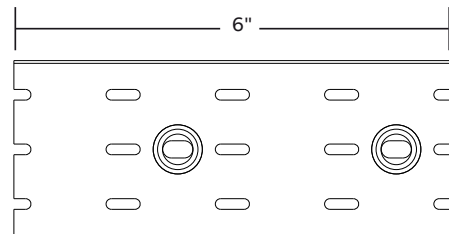

Minimum mounting rivet distance for ducts greater than 1.5" wide. Installed top and bottom.

| Cat. no. | Description | Qty |
|----------|---------------------|--------|
| 08200C | 3/16" Plastic rivet | 100 pk |

Wire retainer

Holds wires in place for faster, easier installation and routing.

- One-size-and-color-fits-all
- Comes in gray and clear plastic to blend with any duct color
- Size is 2.5" L and 0.281" x 0.18" square



| Cat. no. | Description | Qty. |
|----------|----------------------|------|
| TYWRC | Wire retainer, clear | 100 |
| TYWRG | Wire retainer, gray | 100 |

Mounting clips

Ideal for high-temperature environments.

- Speeds duct mounting
- Enables duct removal
- Provides a stand-off between panel and duct to prevent direct heat transfer — ideal for high temperature environments

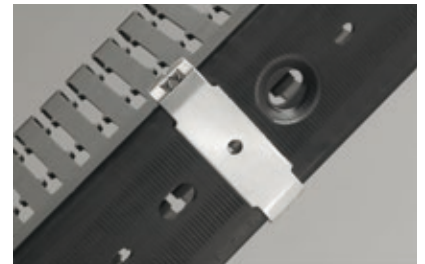

| Cat. no. | Width (in.) | Std. ctn. qty. |
|----------|-------------|----------------|
| TY1MC | 1 | 100 |
| TY15MC | 1.5 | 100 |
| TY2MC | 2 | 100 |
| TY3MC | 3 | 100 |

All are 0.75" D x 0.35" H and made of Type 316 stainless steel.

2.9 Tools

The wiring duct tools you need for every application.

Tools include:

- Duct cutting tools for a clean professional finish
- Finger cutting tools that make modifications simple
- Notching tools for duct sidewalls to facilitate tee and corner junctions
- Benchmount cutting tools for fast, high volume duct cutting
- Rivet installation tools for quick duct mounting



Duct/cover cutting tool

Lightweight and durable.

- All-steel construction
- Sharp cutting surface
- Replaceable blades available
- Improved performance

| Cat. no. | Description |
|----------|-----------------------------|
| CC125 | Handheld duct cutter |
| SX-25TB | Handheld duct cutter — long |

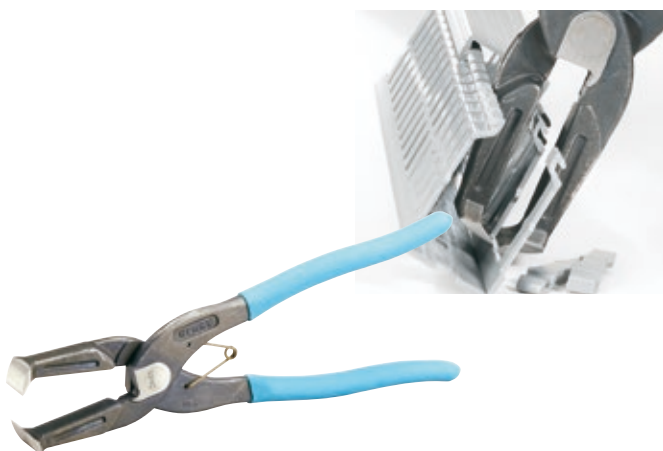

Finger cutting tool

Cut duct fingers easily.

- Rugged die-cast construction with insulated handles for a comfortable, non-slip grip
- Removes duct fingers in tight places
- Works with all slotted wiring duct
- Also cuts round and solid wall duct
- Spring loaded

| Cat. no. | Description |
|----------|--------------------|
| DK-65TB | Duct finger cutter |



Bench-mount cutting tool

For fast, high volume duct cutting.

- Engineered for use with Ty-Duct plastic wiring ducts and covers
- All-steel construction lasts for years
- Adjustable gauge sets the desired length of duct
- Easy-to-read measuring indicator
- Adjustable stop for easy repeated cutting

| Cat. no. | Description |
|----------|-------------------------|
| DC-125TB | Bench-mount duct cutter |

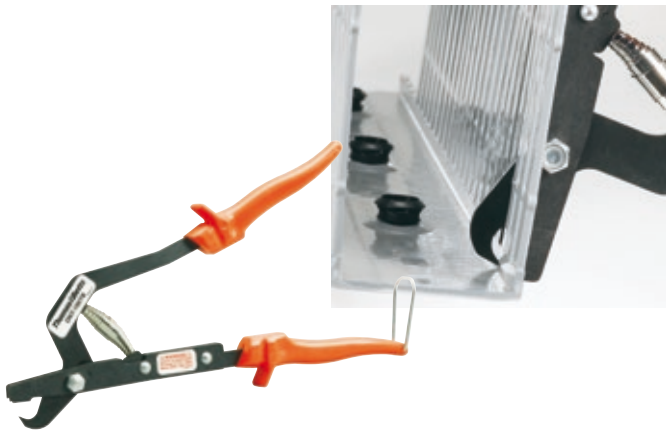

Notching tool

Notch duct sidewalls fast.

- Notches sidewalls to bottom scoreline
- Facilitates tee and corner junctions
- Rugged design
- Easy to use
- Spring loaded

| Cat. no. | Description |
|-----------|--------------------|
| DNT-100TB | Duct notching tool |



Rivet installation tool

Mount ducts quickly.

- Use for setting duct rivets
- Pressure on the tool head secures the rivet in place

For duct rivets, see page A-18.



| Cat. no. | Description |
|----------|--------------------------------------|
| 08205 | 08200 Series rivet installation tool |

For any questions or concerns, please contact the Tool Service Center at 1-800-284-TOOL (8665)



3. Ty-Duct wiring duct

Appendix

| | |
|---------------------------------------|----|
| Technical information | 30 |
| Dimensional information | 32 |
| Industry standards and certifications | 39 |
| Catalog number index | 40 |

3. Ty-Duct wiring duct

3.1 Technical information

Wiring duct — wire fill capacity

NOTE: Wire fill is based on 50% fill of duct area.

| Nominal duct size (inches) | | | Electrical | | | | | | | | | | | Data cable | | | | |
|----------------------------|---|-----------------------------|------------|-------|--------|-------|--------|-------|--------|-------|--------|-------|--------|------------|--------------|-------------|--------|----|
| | | | 8 AWG | | 10 AWG | | 12 AWG | | 14 AWG | | 16 AWG | | 18 AWG | | 22 AWG | | 24 AWG | |
| | | | 0.216 | 0.153 | 0.122 | 0.158 | 0.105 | 0.139 | 0.165 | 0.096 | 0.125 | 0.084 | 0.113 | 0.065 | 0.217 | 0.25 | 0.422 | |
| W | H | Area (inches ²) | THHN | THHN | THHN | MTW | THHN | MTW | MTW | THHN | MTW | THHN | MTW | MTW | Utp/CM CAT5E | Utp/CM CAT6 | Utp/CM | |
| 0.75 | x | 1.00 | 0.750 | 5 | 9 | 14 | 9 | 19 | 11 | 8 | 23 | 14 | 30 | 17 | 51 | 5 | 3 | 1 |
| 0.75 | x | 1.50 | 1.125 | 7 | 14 | 22 | 13 | 29 | 17 | 12 | 35 | 21 | 46 | 25 | 76 | 7 | 5 | 2 |
| 0.75 | x | 2.00 | 1.500 | 9 | 18 | 29 | 17 | 39 | 22 | 16 | 47 | 27 | 61 | 34 | 101 | 9 | 7 | 2 |
| 1.00 | x | 1.00 | 1.000 | 6 | 12 | 19 | 11 | 26 | 15 | 10 | 31 | 18 | 40 | 22 | 68 | 6 | 5 | 2 |
| 1.00 | x | 1.50 | 1.500 | 9 | 18 | 29 | 17 | 39 | 22 | 16 | 47 | 27 | 61 | 34 | 101 | 9 | 7 | 2 |
| 1.00 | x | 2.00 | 2.000 | 12 | 24 | 38 | 23 | 52 | 30 | 21 | 62 | 37 | 81 | 45 | 135 | 12 | 9 | 3 |
| 1.00 | x | 3.00 | 3.000 | 18 | 37 | 58 | 34 | 78 | 44 | 31 | 93 | 55 | 121 | 67 | 203 | 18 | 14 | 5 |
| 1.00 | x | 4.00 | 4.000 | 24 | 49 | 77 | 46 | 104 | 59 | 42 | 124 | 73 | 162 | 90 | 270 | 24 | 18 | 6 |
| 1.50 | x | 1.00 | 1.500 | 9 | 18 | 29 | 17 | 39 | 22 | 16 | 47 | 27 | 61 | 34 | 101 | 9 | 7 | 2 |
| 1.50 | x | 1.50 | 2.250 | 14 | 27 | 43 | 26 | 58 | 33 | 24 | 70 | 41 | 91 | 50 | 152 | 14 | 10 | 4 |
| 1.50 | x | 2.00 | 3.000 | 18 | 37 | 58 | 34 | 78 | 44 | 31 | 93 | 55 | 121 | 67 | 203 | 18 | 14 | 5 |
| 1.50 | x | 3.00 | 4.500 | 27 | 55 | 86 | 52 | 117 | 67 | 47 | 140 | 82 | 182 | 101 | 304 | 27 | 21 | 7 |
| 1.50 | x | 4.00 | 6.000 | 36 | 73 | 115 | 69 | 155 | 89 | 63 | 186 | 110 | 243 | 134 | 406 | 36 | 27 | 10 |
| 2.00 | x | 1.00 | 2.000 | 12 | 24 | 38 | 23 | 52 | 30 | 21 | 62 | 37 | 81 | 45 | 135 | 12 | 9 | 3 |
| 2.00 | x | 1.50 | 3.000 | 18 | 37 | 58 | 34 | 78 | 44 | 31 | 93 | 55 | 121 | 67 | 203 | 18 | 14 | 5 |
| 2.00 | x | 2.00 | 4.000 | 24 | 49 | 77 | 46 | 104 | 59 | 42 | 124 | 73 | 162 | 90 | 270 | 24 | 18 | 6 |
| 2.00 | x | 3.00 | 6.000 | 36 | 73 | 115 | 69 | 155 | 89 | 63 | 186 | 110 | 243 | 134 | 406 | 36 | 27 | 10 |
| 2.00 | x | 4.00 | 8.000 | 48 | 98 | 154 | 92 | 207 | 118 | 84 | 248 | 146 | 324 | 179 | 541 | 49 | 37 | 13 |
| 2.00 | x | 5.00 | 10.000 | 60 | 122 | 192 | 114 | 259 | 148 | 105 | 310 | 183 | 405 | 224 | 676 | 61 | 46 | 16 |
| 2.50 | x | 2.00 | 5.000 | 30 | 61 | 96 | 57 | 130 | 74 | 52 | 155 | 91 | 202 | 112 | 338 | 30 | 23 | 8 |
| 2.50 | x | 3.00 | 7.500 | 45 | 92 | 144 | 86 | 194 | 111 | 79 | 233 | 137 | 304 | 168 | 507 | 46 | 34 | 12 |
| 2.50 | x | 4.00 | 10.000 | 60 | 122 | 192 | 114 | 259 | 148 | 105 | 310 | 183 | 405 | 224 | 676 | 61 | 46 | 16 |
| 3.00 | x | 1.00 | 3.000 | 18 | 37 | 58 | 34 | 78 | 44 | 31 | 93 | 55 | 121 | 67 | 203 | 18 | 14 | 5 |
| 3.00 | x | 2.00 | 6.000 | 36 | 73 | 115 | 69 | 155 | 89 | 63 | 186 | 110 | 243 | 134 | 406 | 36 | 27 | 10 |
| 3.00 | x | 3.00 | 9.000 | 54 | 110 | 173 | 103 | 233 | 133 | 94 | 279 | 165 | 364 | 201 | 609 | 55 | 41 | 14 |
| 3.00 | x | 4.00 | 12.000 | 72 | 146 | 230 | 137 | 311 | 177 | 126 | 372 | 219 | 486 | 269 | 811 | 73 | 55 | 19 |
| 3.00 | x | 5.00 | 15.000 | 90 | 183 | 288 | 172 | 389 | 222 | 157 | 465 | 274 | 607 | 336 | 1014 | 91 | 69 | 24 |
| 4.00 | x | 1.50 | 6.000 | 36 | 73 | 115 | 69 | 155 | 89 | 63 | 186 | 110 | 243 | 134 | 406 | 36 | 27 | 10 |
| 4.00 | x | 2.00 | 8.000 | 48 | 98 | 154 | 92 | 207 | 118 | 84 | 248 | 146 | 324 | 179 | 541 | 49 | 37 | 13 |
| 4.00 | x | 3.00 | 12.000 | 72 | 146 | 230 | 137 | 311 | 177 | 126 | 372 | 219 | 486 | 269 | 811 | 73 | 55 | 19 |
| 4.00 | x | 4.00 | 16.000 | 96 | 195 | 307 | 183 | 415 | 237 | 168 | 496 | 293 | 648 | 358 | 1082 | 97 | 73 | 26 |
| 4.00 | x | 5.00 | 20.000 | 120 | 244 | 384 | 229 | 518 | 296 | 210 | 620 | 366 | 810 | 448 | 1352 | 121 | 91 | 32 |
| 6.00 | x | 4.00 | 24.000 | 144 | 293 | 461 | 275 | 622 | 355 | 252 | 744 | 439 | 972 | 537 | 1623 | 146 | 110 | 39 |

Formula for calculating fill capacity

$$\text{Number of wires} = \frac{\text{Duct W x H}}{1.75 \times (\text{Wire O.D.})^2} / 2$$

Properties of materials used in wiring duct

| Property | Units | ASTM test | PVC | Halogen-free |
|--------------------------------|------------------|-----------|---------|--------------|
| Specific gravity | | D792 | 1.43 | 1.10 |
| IZOD | ft.-lb./in. | D256 | 2 | 5.0 |
| Flexural strength | psi | D790 | 10,900 | 12,800 |
| Flexural modulus | psi | D790 | 382,000 | 360,000 |
| Tensile strength | psi | D638 | 5,500 | 7,800 |
| Compressive strength | psi | D695 | 8,600 | 16,000 |
| Water absorption | 24 hrs.-% | D570 | 0.10 | 0.07 |
| Hardness | Rockwell | D785 | R-111 | R-115 |
| | Duro D | D676 | 78 | |
| Dielectric strength | | D149 | | |
| | 60Hz, 25° C, s/t | | | 400 |
| Dielectric constant | | D150 | | |
| | 60Hz, Dry | | 1.9 | 2.65 |
| | 1MHz, Dry | | | 2.64 |
| Volume resistivity | ohm-cm | D257 | | 1017 |
| Heat deflecting (° F@ 264 psi) | ° F | D648 | 158 | 212 |
| Flammability | | | 94 V-O | 94 V-1 |

The above information is believed reliable. The user should, however, check the applicable specifications to verify values.

Rigid polyvinyl chloride (PVC)

- General-purpose material for indoor applications
- UL[®] flammability rating of V-0
- UL94 recognized for use in temperatures up to 60 °C (140 °F)
- Economical wiring duct material

Halogen-free

With 8-12 / 4-6mm slots

- Halogen-free thermoplastic in conformity with VDE 0472 standard Part 815: Br + Cl < 0.2 %, F < 0.1 %
- Toxic smoke index: 25.78 in conformity with NF X70-100 and NF F16-101 standards
- Opacity of smoke*:
- Dm 352.2 (2mm)
- VOF4 475.8 (2mm) in conformity with NF X10-702 standard (NF F16-101 reference)
- Based on the values obtained in the opacity and toxicity tests of smoke, the material belongs to class F2 (in conformity with NF F16-101 standard)
- Insulating, shock-resistant and self-extinguishing thermoplastic in conformity with UL 94 V0 standard, resistant to abnormal heat and fire up to 850 °C (glow-wire test) in conformity with IEC 60695-2-1 standard
- Dimensional stability from -40 to +100 °C
- Standard length 2m
- Color RAL 7035 gray
- Conforms to EN 50085-2-3 standard
- Conforms to RoHS directive

* Reduced smoke opacity during the first 4 minutes of a fire facilitates evacuation from areas of risk.

3.2 Dimensional information

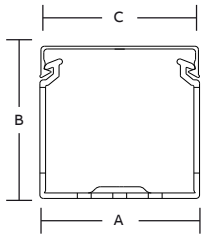

Solid wall PVC wiring duct dimensions

| Trade size | | Dimensions (inches) | | | | | | |
|------------|---|---------------------|------|------|------|------|------|------|
| W | | H | A | B | C | D | E | F |
| 0.75 | x | 1.00 | 0.94 | 1.14 | 0.94 | 1.03 | 0.26 | 0.77 |
| 0.75 | x | 1.50 | 0.94 | 1.60 | 0.94 | 1.50 | 0.27 | 1.23 |
| 0.75 | x | 2.00 | 0.94 | 2.10 | 0.94 | 2.01 | 0.29 | 1.73 |
| 1.00 | x | 1.00 | 1.25 | 1.14 | 1.25 | 1.03 | 0.26 | 0.77 |
| 1.00 | x | 1.50 | 1.25 | 1.60 | 1.25 | 1.50 | 0.27 | 1.23 |
| 1.00 | x | 2.00 | 1.25 | 2.10 | 1.25 | 2.01 | 0.28 | 1.73 |
| 1.00 | x | 3.00 | 1.25 | 3.05 | 1.25 | 2.99 | 0.32 | 2.68 |
| 1.00 | x | 4.00 | 1.25 | 4.37 | 1.25 | 4.32 | 0.32 | 4.00 |
| 1.50 | x | 1.00 | 1.75 | 1.14 | 1.75 | 1.03 | 0.26 | 0.77 |
| 1.50 | x | 1.50 | 1.75 | 1.60 | 1.75 | 1.50 | 0.27 | 1.23 |
| 1.50 | x | 2.00 | 1.75 | 2.10 | 1.75 | 2.01 | 0.29 | 1.73 |
| 1.50 | x | 3.00 | 1.75 | 3.05 | 1.75 | 2.99 | 0.34 | 2.65 |
| 1.50 | x | 4.00 | 1.75 | 4.37 | 1.75 | 4.32 | 0.32 | 4.00 |
| 2.00 | x | 1.00 | 2.25 | 1.24 | 2.25 | 1.05 | 0.28 | 0.77 |
| 2.00 | x | 1.50 | 2.25 | 1.70 | 2.25 | 1.52 | 0.29 | 1.23 |
| 2.00 | x | 2.00 | 2.25 | 2.19 | 2.25 | 2.03 | 0.30 | 1.73 |
| 2.00 | x | 3.00 | 2.25 | 3.14 | 2.25 | 3.00 | 0.33 | 2.68 |
| 2.00 | x | 4.00 | 2.25 | 4.46 | 2.25 | 4.33 | 0.33 | 4.00 |
| 2.00 | x | 5.00 | 2.25 | 5.15 | 2.25 | 5.02 | 0.34 | 4.68 |
| 2.50 | x | 2.00 | 2.75 | 2.19 | 2.75 | 2.03 | 0.30 | 1.73 |
| 2.50 | x | 3.00 | 2.75 | 3.14 | 2.75 | 3.00 | 0.33 | 2.68 |
| 2.50 | x | 4.00 | 2.75 | 4.46 | 2.75 | 4.33 | 0.33 | 4.00 |
| 3.00 | x | 1.00 | 3.25 | 1.24 | 3.25 | 1.06 | 0.29 | 0.77 |
| 3.00 | x | 2.00 | 3.25 | 2.19 | 3.25 | 2.08 | 0.35 | 1.73 |
| 3.00 | x | 3.00 | 3.25 | 3.14 | 3.25 | 3.06 | 0.38 | 2.68 |
| 3.00 | x | 4.00 | 3.25 | 4.46 | 3.25 | 4.39 | 0.39 | 4.00 |
| 3.00 | x | 5.00 | 3.25 | 5.15 | 3.25 | 5.06 | 0.38 | 4.68 |
| 4.00 | x | 1.50 | 4.25 | 1.70 | 4.25 | 1.57 | 0.34 | 1.23 |
| 4.00 | x | 2.00 | 4.25 | 2.19 | 4.25 | 2.08 | 0.35 | 1.73 |
| 4.00 | x | 3.00 | 4.25 | 3.14 | 4.25 | 3.06 | 0.38 | 2.68 |
| 4.00 | x | 4.00 | 4.25 | 4.46 | 4.25 | 4.39 | 0.39 | 4.00 |
| 4.00 | x | 5.00 | 4.25 | 5.15 | 4.25 | 5.06 | 0.38 | 4.68 |
| 6.00 | x | 4.00 | 6.25 | 4.46 | 6.25 | 4.39 | 0.39 | 4.00 |

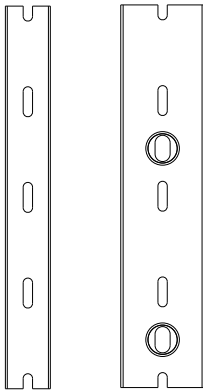
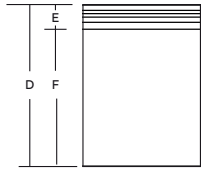

Pattern for 3/4" & 1" Pattern for 1-1/2"

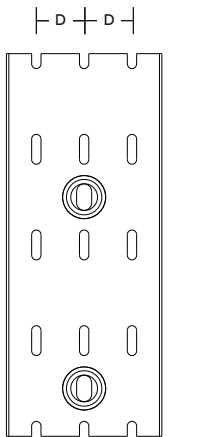

Pattern for 2", 2-1/2", 3", 4" & 6"

Dimensions shown are for reference only. Contact T&B for specific dimensional needs.

| Duct width | D |
|------------|-------|
| 2" | .50" |
| 2.5" | .75" |
| 3" | 1.00" |
| 4" | 1.50" |
| 6" | 2.50" |

Wide slot PVC wiring duct dimensions

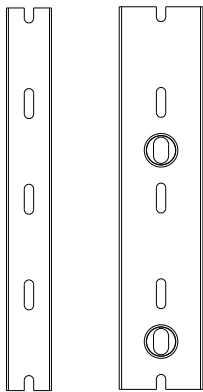
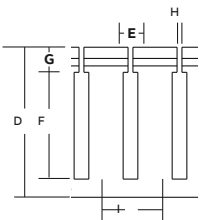
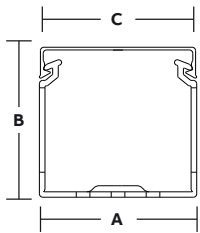

Pattern for 3/4" & 1"

Pattern for 1-1/2"

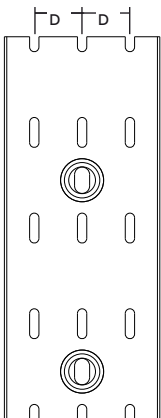

Pattern for 2", 2-1/2", 3", 4" & 6"

| Trade size | | Dimensions (inches) | | | | | | | | | |
|------------|---|---------------------|------|------|------|------|------|------|------|------|------|
| W | H | A | B | C | D | E | F | G | H | I | |
| 0.75 | x | 1.00 | 0.94 | 1.14 | 0.94 | 1.03 | 0.30 | 0.52 | 0.26 | 0.10 | 0.80 |
| 0.75 | x | 1.50 | 0.94 | 1.60 | 0.94 | 1.50 | 0.30 | 0.93 | 0.27 | 0.10 | 0.80 |
| 0.75 | x | 2.00 | 0.94 | 2.10 | 0.94 | 2.01 | 0.30 | 1.36 | 0.29 | 0.10 | 0.80 |
| 1.00 | x | 1.00 | 1.25 | 1.14 | 1.25 | 1.03 | 0.30 | 0.52 | 0.26 | 0.10 | 0.80 |
| 1.00 | x | 1.50 | 1.25 | 1.60 | 1.25 | 1.50 | 0.30 | 0.93 | 0.27 | 0.10 | 0.80 |
| 1.00 | x | 2.00 | 1.25 | 2.10 | 1.25 | 2.01 | 0.30 | 1.36 | 0.28 | 0.10 | 0.80 |
| 1.00 | x | 3.00 | 1.25 | 3.05 | 1.25 | 2.99 | 0.30 | 2.31 | 0.32 | 0.10 | 1.00 |
| 1.00 | x | 4.00 | 1.25 | 4.37 | 1.25 | 4.32 | 0.30 | 3.63 | 0.32 | 0.10 | 1.00 |
| 1.50 | x | 1.00 | 1.75 | 1.14 | 1.75 | 1.03 | 0.30 | 0.52 | 0.26 | 0.10 | 0.80 |
| 1.50 | x | 1.50 | 1.75 | 1.60 | 1.75 | 1.50 | 0.30 | 0.93 | 0.27 | 0.10 | 0.80 |
| 1.50 | x | 2.00 | 1.75 | 2.10 | 1.75 | 2.01 | 0.30 | 1.36 | 0.29 | 0.10 | 0.80 |
| 1.50 | x | 3.00 | 1.75 | 3.05 | 1.75 | 2.99 | 0.30 | 2.28 | 0.34 | 0.10 | 1.00 |
| 1.50 | x | 4.00 | 1.75 | 4.37 | 1.75 | 4.32 | 0.30 | 3.63 | 0.32 | 0.10 | 1.00 |
| 2.00 | x | 1.00 | 2.25 | 1.24 | 2.25 | 1.05 | 0.30 | 0.52 | 0.28 | 0.10 | 0.80 |
| 2.00 | x | 1.50 | 2.25 | 1.70 | 2.25 | 1.52 | 0.30 | 0.93 | 0.29 | 0.10 | 0.80 |
| 2.00 | x | 2.00 | 2.25 | 2.19 | 2.25 | 2.03 | 0.30 | 1.36 | 0.30 | 0.10 | 0.80 |
| 2.00 | x | 3.00 | 2.25 | 3.14 | 2.25 | 3.00 | 0.30 | 2.31 | 0.33 | 0.10 | 1.00 |
| 2.00 | x | 4.00 | 2.25 | 4.46 | 2.25 | 4.33 | 0.30 | 3.63 | 0.33 | 0.10 | 1.00 |
| 2.00 | x | 5.00 | 2.25 | 5.15 | 2.25 | 5.02 | 0.38 | 4.31 | 0.34 | 0.10 | 1.33 |
| 2.50 | x | 2.00 | 2.75 | 2.19 | 2.75 | 2.03 | 0.30 | 1.36 | 0.30 | 0.10 | 0.80 |
| 2.50 | x | 3.00 | 2.75 | 3.14 | 2.75 | 3.00 | 0.30 | 2.31 | 0.33 | 0.10 | 1.00 |
| 2.50 | x | 4.00 | 2.75 | 4.46 | 2.75 | 4.33 | 0.30 | 3.63 | 0.33 | 0.10 | 1.00 |
| 3.00 | x | 1.00 | 3.25 | 1.24 | 3.25 | 1.06 | 0.30 | 0.52 | 0.29 | 0.10 | 0.80 |
| 3.00 | x | 2.00 | 3.25 | 2.19 | 3.25 | 2.08 | 0.30 | 1.36 | 0.35 | 0.10 | 0.80 |
| 3.00 | x | 3.00 | 3.25 | 3.14 | 3.25 | 3.06 | 0.30 | 2.31 | 0.38 | 0.10 | 1.00 |
| 3.00 | x | 4.00 | 3.25 | 4.46 | 3.25 | 4.39 | 0.30 | 3.63 | 0.39 | 0.10 | 1.00 |
| 3.00 | x | 5.00 | 3.25 | 5.15 | 3.25 | 5.06 | 0.38 | 4.31 | 0.38 | 0.10 | 1.33 |
| 4.00 | x | 1.50 | 4.25 | 1.70 | 4.25 | 1.57 | 0.30 | 0.93 | 0.34 | 0.10 | 0.80 |
| 4.00 | x | 2.00 | 4.25 | 2.19 | 4.25 | 2.08 | 0.30 | 1.36 | 0.35 | 0.10 | 0.80 |
| 4.00 | x | 3.00 | 4.25 | 3.14 | 4.25 | 3.06 | 0.30 | 2.31 | 0.38 | 0.10 | 1.00 |
| 4.00 | x | 4.00 | 4.25 | 4.46 | 4.25 | 4.39 | 0.30 | 3.63 | 0.39 | 0.10 | 1.00 |
| 4.00 | x | 5.00 | 4.25 | 5.15 | 4.25 | 5.06 | 0.38 | 4.31 | 0.38 | 0.10 | 1.33 |
| 6.00 | x | 4.00 | 6.25 | 4.46 | 6.25 | 4.39 | 0.30 | 3.63 | 0.39 | 0.10 | 1.00 |

Dimensions shown are for reference only. Contact T&B for specific dimensional needs.

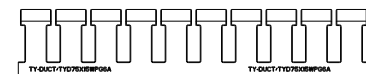

3/4" x 1-1/2"

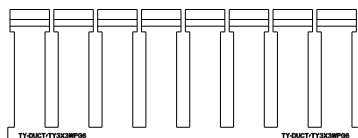

3" x 3"

| Duct width | D |
|------------|-------|
| 2" | .50" |
| 2.5" | .75" |
| 3" | 1.00" |
| 4" | 1.50" |
| 6" | 2.50" |

3.2 Dimensional information

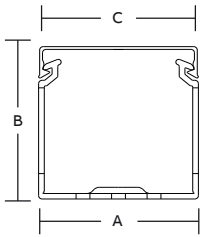

Narrow slot PVC wiring duct dimensions

| Trade size | | Dimensions (inches) | | | | | | | | | |
|------------|---|---------------------|------|------|------|------|------|------|------|------|------|
| W | H | A | B | C | D | E | F | G | H | I | |
| 0.75 | x | 1.50 | 0.94 | 1.60 | 0.94 | 1.50 | 0.20 | 0.93 | 0.27 | 0.10 | 0.50 |
| 1.00 | x | 1.00 | 1.25 | 1.14 | 1.25 | 1.03 | 0.20 | 0.52 | 0.26 | 0.10 | 0.50 |
| 1.00 | x | 1.50 | 1.25 | 1.60 | 1.25 | 1.50 | 0.20 | 0.93 | 0.27 | 0.10 | 0.50 |
| 1.00 | x | 2.00 | 1.25 | 2.10 | 1.25 | 2.01 | 0.20 | 1.36 | 0.28 | 0.10 | 0.50 |
| 1.00 | x | 3.00 | 1.25 | 3.05 | 1.25 | 2.99 | 0.20 | 2.31 | 0.32 | 0.10 | 0.50 |
| 1.00 | x | 4.00 | 1.25 | 4.37 | 1.25 | 4.32 | 0.20 | 3.63 | 0.32 | 0.10 | 0.50 |
| 1.50 | x | 1.00 | 1.75 | 1.14 | 1.75 | 1.03 | 0.20 | 0.52 | 0.26 | 0.10 | 0.50 |
| 1.50 | x | 1.50 | 1.75 | 1.60 | 1.75 | 1.50 | 0.20 | 0.93 | 0.27 | 0.10 | 0.50 |
| 1.50 | x | 2.00 | 1.75 | 2.10 | 1.75 | 2.01 | 0.20 | 1.36 | 0.29 | 0.10 | 0.50 |
| 1.50 | x | 3.00 | 1.75 | 3.05 | 1.75 | 2.99 | 0.20 | 2.28 | 0.34 | 0.10 | 0.50 |
| 1.50 | x | 4.00 | 1.75 | 4.37 | 1.75 | 4.32 | 0.20 | 3.63 | 0.32 | 0.10 | 0.50 |
| 2.00 | x | 1.00 | 2.25 | 1.24 | 2.25 | 1.05 | 0.20 | 0.52 | 0.28 | 0.10 | 0.50 |
| 2.00 | x | 1.50 | 2.25 | 1.70 | 2.25 | 1.52 | 0.20 | 0.93 | 0.29 | 0.10 | 0.50 |
| 2.00 | x | 2.00 | 2.25 | 2.19 | 2.25 | 2.03 | 0.20 | 1.36 | 0.30 | 0.10 | 0.50 |
| 2.00 | x | 3.00 | 2.25 | 3.14 | 2.25 | 3.00 | 0.20 | 2.31 | 0.33 | 0.10 | 0.50 |
| 2.00 | x | 4.00 | 2.25 | 4.46 | 2.25 | 4.33 | 0.20 | 3.63 | 0.33 | 0.10 | 0.50 |
| 2.00 | x | 5.00 | 2.25 | 5.15 | 2.25 | 5.02 | 0.20 | 4.31 | 0.34 | 0.10 | 0.50 |
| 2.50 | x | 2.00 | 2.75 | 2.19 | 2.75 | 2.03 | 0.20 | 1.36 | 0.30 | 0.10 | 0.50 |
| 2.50 | x | 3.00 | 2.75 | 3.14 | 2.75 | 3.00 | 0.20 | 2.31 | 0.33 | 0.10 | 0.50 |
| 2.50 | x | 4.00 | 2.75 | 4.46 | 2.75 | 4.33 | 0.20 | 3.63 | 0.33 | 0.10 | 0.50 |
| 3.00 | x | 1.00 | 3.25 | 1.24 | 3.25 | 1.06 | 0.20 | 0.52 | 0.29 | 0.10 | 0.50 |
| 3.00 | x | 2.00 | 3.25 | 2.19 | 3.25 | 2.08 | 0.20 | 1.36 | 0.35 | 0.10 | 0.50 |
| 3.00 | x | 3.00 | 3.25 | 3.14 | 3.25 | 3.06 | 0.20 | 2.31 | 0.38 | 0.10 | 0.50 |
| 3.00 | x | 4.00 | 3.25 | 4.46 | 3.25 | 4.39 | 0.20 | 3.63 | 0.39 | 0.10 | 0.50 |
| 3.00 | x | 5.00 | 3.25 | 5.15 | 3.25 | 5.06 | 0.20 | 4.31 | 0.38 | 0.10 | 0.50 |
| 4.00 | x | 2.00 | 4.25 | 2.19 | 4.25 | 2.08 | 0.20 | 1.36 | 0.35 | 0.10 | 0.50 |
| 4.00 | x | 3.00 | 4.25 | 3.14 | 4.25 | 3.06 | 0.20 | 2.31 | 0.38 | 0.10 | 0.50 |
| 4.00 | x | 4.00 | 4.25 | 4.46 | 4.25 | 4.39 | 0.20 | 3.63 | 0.39 | 0.10 | 0.50 |
| 4.00 | x | 5.00 | 4.25 | 5.15 | 4.25 | 5.06 | 0.20 | 4.31 | 0.38 | 0.10 | 0.50 |

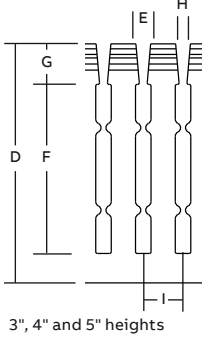
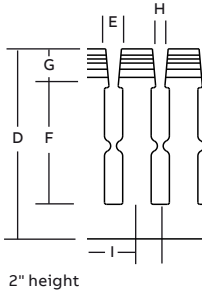
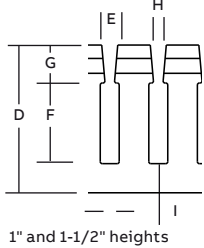

Dimensions shown are for reference only. Contact T&B for specific dimensional needs.

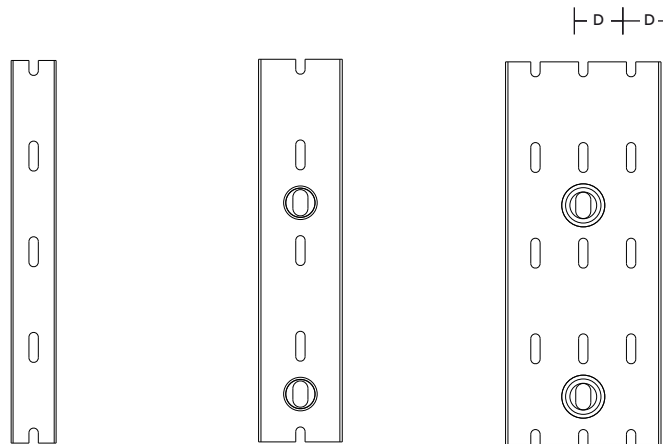

Pattern for 3/4" & 1" Pattern for 1-1/2" Pattern for 2" & 2-1/2", 3" & 4"

| Duct width | D |
|------------|-------|
| 2" | .50" |
| 2.5" | .75" |
| 3" | 1.00" |
| 4" | 1.50" |

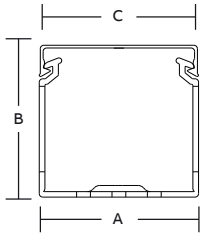

Round hole PVC wiring duct dimensions

| Trade size | | Dimensions (inches) | | | | | | | | Rows of holes |
|------------|---|---------------------|------|------|------|------|------|------|------|---------------|
| W | H | A | B | C | D | E | F | G | | |
| 1.00 | x | 1.50 | 1.25 | 1.60 | 1.25 | 1.50 | 0.27 | 1.23 | 0.67 | 2 |
| 1.00 | x | 2.00 | 1.25 | 2.10 | 1.25 | 2.01 | 0.28 | 1.73 | 0.67 | 2 |
| 1.00 | x | 3.00 | 1.25 | 3.05 | 1.25 | 2.99 | 0.32 | 2.68 | 0.67 | 4 |
| 1.00 | x | 4.00 | 1.25 | 4.37 | 1.25 | 4.32 | 0.32 | 4.00 | 0.67 | 6 |
| 1.50 | x | 1.00 | 1.75 | 1.14 | 1.75 | 1.03 | 0.26 | 0.77 | 0.67 | 2 |
| 1.50 | x | 1.50 | 1.75 | 1.60 | 1.75 | 1.50 | 0.27 | 1.23 | 0.67 | 2 |
| 1.50 | x | 2.00 | 1.75 | 2.10 | 1.75 | 2.01 | 0.29 | 1.73 | 0.67 | 2 |
| 1.50 | x | 3.00 | 1.75 | 3.05 | 1.75 | 2.99 | 0.34 | 2.65 | 0.67 | 4 |
| 1.50 | x | 4.00 | 1.75 | 4.37 | 1.75 | 4.32 | 0.32 | 4.00 | 0.67 | 6 |
| 2.00 | x | 1.50 | 2.25 | 1.70 | 2.25 | 1.52 | 0.29 | 1.23 | 0.67 | 2 |
| 2.00 | x | 2.00 | 2.25 | 2.19 | 2.25 | 2.03 | 0.30 | 1.73 | 0.67 | 2 |
| 2.00 | x | 3.00 | 2.25 | 3.14 | 2.25 | 3.00 | 0.33 | 2.68 | 0.67 | 4 |
| 2.00 | x | 4.00 | 2.25 | 4.46 | 2.25 | 4.33 | 0.33 | 4.00 | 0.67 | 6 |
| 3.00 | x | 2.00 | 3.25 | 2.19 | 3.25 | 2.08 | 0.35 | 1.73 | 0.67 | 2 |
| 3.00 | x | 3.00 | 3.25 | 3.14 | 3.25 | 3.06 | 0.38 | 2.68 | 0.67 | 4 |
| 3.00 | x | 4.00 | 3.25 | 4.46 | 3.25 | 4.39 | 0.39 | 4.00 | 0.67 | 6 |
| 4.00 | x | 1.50 | 4.25 | 1.70 | 4.25 | 1.57 | 0.34 | 1.23 | 0.67 | 2 |
| 4.00 | x | 2.00 | 4.25 | 2.19 | 4.25 | 2.08 | 0.35 | 1.73 | 0.67 | 2 |
| 4.00 | x | 3.00 | 4.25 | 3.14 | 4.25 | 3.06 | 0.38 | 2.68 | 0.67 | 4 |
| 4.00 | x | 4.00 | 4.25 | 4.46 | 4.25 | 4.39 | 0.39 | 4.00 | 0.67 | 6 |

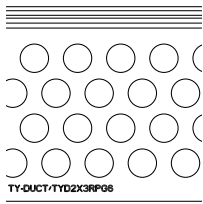
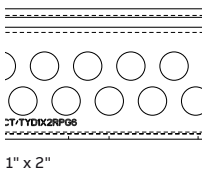
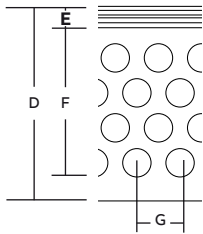

Dimensions shown are for reference only. Contact T&B for specific dimensional needs.

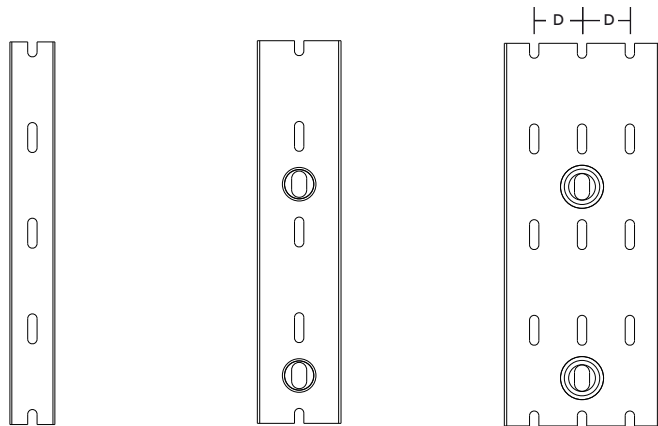

Pattern for 3/4" & 1" Pattern for 1-1/2" Pattern for 2" & 2-1/2", 3" & 4"

| Duct width | D |
|------------|-------|
| 2" | .50" |
| 2.5" | .75" |
| 3" | 1.00" |
| 4" | 1.50" |

3.2 Dimensional information

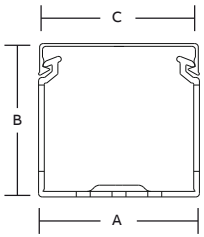

Wide slot halogen-free and metric wiring duct dimensions

| Trade size (mm) | | Dimensions (mm) | | | | | | | | | |
|-----------------|---|-----------------|-----|-----|-------|-------|---|------|------|-----|----|
| W | H | A | B | C | D | E | F | G | H | I | |
| 15 | X | 17 | 15 | 17 | 18.3 | 16.25 | 8 | 9.7 | 3.55 | 5.4 | 20 |
| 25 | X | 30 | 25 | 30 | 28.3 | 28.5 | 8 | 6.5 | 12 | 2 | 20 |
| 40 | X | 30 | 40 | 30 | 43.3 | 28.5 | 8 | 6.5 | 12 | 2 | 20 |
| 60 | X | 30 | 60 | 30 | 63.3 | 28.5 | 8 | 6.5 | 12 | 2 | 20 |
| 25 | X | 40 | 25 | 40 | 28.3 | 38.5 | 8 | 14.5 | 12 | 2 | 20 |
| 40 | X | 40 | 40 | 40 | 43.3 | 38.5 | 8 | 14.5 | 12 | 2 | 20 |
| 60 | X | 40 | 60 | 40 | 63.3 | 38.5 | 8 | 14.5 | 12 | 2 | 20 |
| 80 | X | 40 | 80 | 40 | 83.3 | 38.5 | 8 | 14.5 | 12 | 2 | 20 |
| 100 | X | 40 | 100 | 40 | 103.3 | 38.5 | 8 | 14.5 | 12 | 2 | 20 |
| 120 | X | 40 | 120 | 40 | 123.3 | 38.5 | 8 | 14.5 | 12 | 2 | 20 |
| 25 | X | 60 | 25 | 60 | 28.3 | 58.5 | 8 | 32.5 | 12 | 2 | 20 |
| 40 | X | 60 | 40 | 60 | 43.3 | 58.5 | 8 | 32.5 | 12 | 2 | 20 |
| 60 | X | 60 | 60 | 60 | 63.3 | 58.5 | 8 | 32.5 | 12 | 2 | 20 |
| 80 | X | 60 | 80 | 60 | 83.3 | 58.5 | 8 | 32.5 | 12 | 2 | 20 |
| 100 | X | 60 | 100 | 60 | 103.3 | 58.5 | 8 | 32.5 | 12 | 2 | 20 |
| 120 | X | 60 | 120 | 60 | 123.3 | 58.5 | 8 | 32.5 | 12 | 2 | 20 |
| 25 | X | 80 | 25 | 80 | 28.3 | 78 | 8 | 53 | 12 | 2 | 20 |
| 40 | X | 80 | 40 | 80 | 43.3 | 78 | 8 | 53 | 12 | 2 | 20 |
| 60 | X | 80 | 60 | 80 | 63.3 | 78 | 8 | 53 | 12 | 2 | 20 |
| 80 | X | 80 | 80 | 80 | 83.3 | 78 | 8 | 53 | 12 | 2 | 20 |
| 100 | X | 80 | 100 | 80 | 103.3 | 78 | 8 | 53 | 12 | 2 | 20 |
| 120 | X | 80 | 120 | 80 | 123.3 | 78 | 8 | 53 | 12 | 2 | 20 |
| 40 | X | 100 | 40 | 100 | 43.3 | 98 | 8 | 70 | 12 | 2 | 20 |
| 60 | X | 100 | 60 | 100 | 63.3 | 98 | 8 | 70 | 12 | 2 | 20 |
| 80 | X | 100 | 80 | 100 | 83.3 | 98 | 8 | 70 | 12 | 2 | 20 |
| 100 | X | 100 | 100 | 100 | 103.3 | 98 | 8 | 70 | 12 | 2 | 20 |

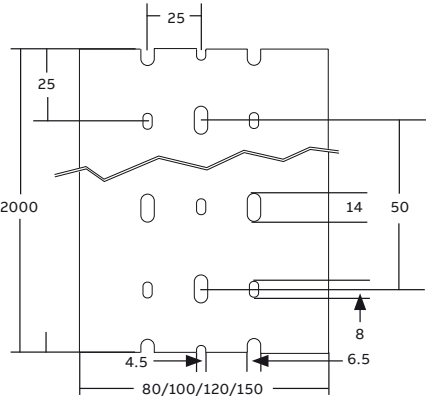
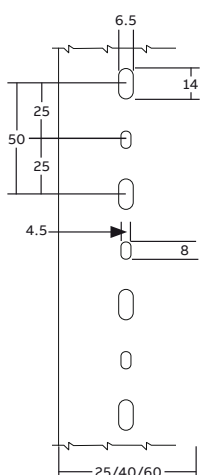
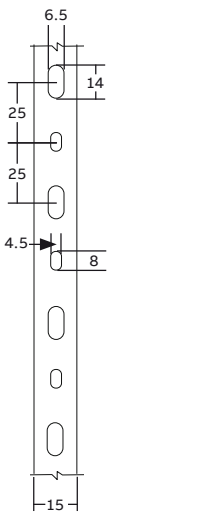
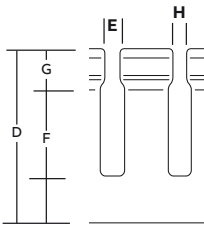

- A = duct width
- B = total height (duct + cover)
- C = overall cover width
- D = duct height
- E = slot width
- F = slot height
- G = cover engagement height
- H = insertion width
- I = slot to slot distance

Narrow slot halogen-free and metric wiring duct dimensions

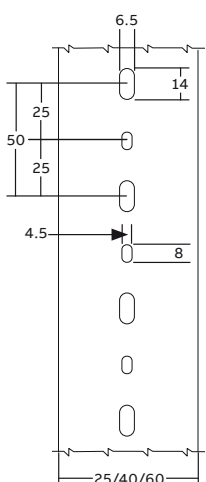
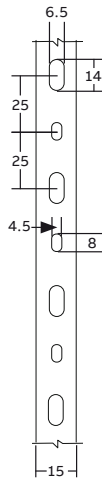
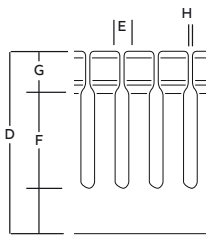
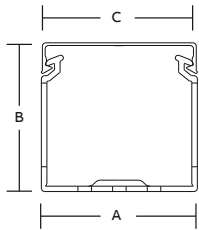

| Trade size (mm) | | Dimensions (mm) | | | | | | | | | |
|-----------------|---|-----------------|-----|----|-------|-------|---|------|------|-----|----|
| W | H | A | B | C | D | E | F | G | H | I | |
| 15 | X | 17 | 15 | 17 | 18.3 | 16.25 | 4 | 9.7 | 3.55 | 1.4 | 10 |
| 25 | X | 30 | 25 | 30 | 28.3 | 28.5 | 4 | 7.3 | 12 | 1.6 | 10 |
| 40 | X | 30 | 40 | 30 | 43.3 | 28.5 | 4 | 7.3 | 12 | 1.6 | 10 |
| 60 | X | 30 | 60 | 30 | 63.3 | 28.5 | 4 | 7.3 | 12 | 1.6 | 10 |
| 25 | X | 40 | 25 | 40 | 28.3 | 38.5 | 4 | 15.3 | 12 | 1.6 | 10 |
| 40 | X | 40 | 40 | 40 | 43.3 | 38.5 | 4 | 15.3 | 12 | 1.6 | 10 |
| 60 | X | 40 | 60 | 40 | 63.3 | 38.5 | 4 | 15.3 | 12 | 1.6 | 10 |
| 80 | X | 40 | 80 | 40 | 83.3 | 38.5 | 4 | 15.3 | 12 | 1.6 | 10 |
| 100 | X | 40 | 100 | 40 | 103.3 | 38.5 | 4 | 15.3 | 12 | 1.6 | 10 |
| 120 | X | 40 | 120 | 40 | 123.3 | 38.5 | 4 | 15.3 | 12 | 1.6 | 10 |
| 25 | X | 60 | 25 | 60 | 28.3 | 58.5 | 4 | 32.5 | 12 | 1.6 | 10 |
| 40 | X | 60 | 40 | 60 | 43.3 | 58.5 | 4 | 32.5 | 12 | 1.6 | 10 |
| 60 | X | 60 | 60 | 60 | 63.3 | 58.5 | 4 | 32.5 | 12 | 1.6 | 10 |
| 80 | X | 60 | 80 | 60 | 83.3 | 58.5 | 4 | 32.5 | 12 | 1.6 | 10 |
| 100 | X | 60 | 100 | 60 | 103.3 | 58.5 | 4 | 32.5 | 12 | 1.6 | 10 |
| 120 | X | 60 | 120 | 60 | 123.3 | 58.5 | 4 | 32.5 | 12 | 1.6 | 10 |
| 25 | X | 80 | 25 | 80 | 28.3 | 78 | 4 | 53 | 12 | 1.6 | 10 |
| 40 | X | 80 | 40 | 80 | 43.3 | 78 | 4 | 53 | 12 | 1.6 | 10 |
| 60 | X | 80 | 60 | 80 | 63.3 | 78 | 4 | 53 | 12 | 1.6 | 10 |
| 80 | X | 80 | 80 | 80 | 83.3 | 78 | 4 | 53 | 12 | 1.6 | 10 |
| 100 | X | 80 | 100 | 80 | 103.3 | 78 | 4 | 53 | 12 | 1.6 | 10 |
| 120 | X | 80 | 120 | 80 | 123.3 | 78 | 4 | 53 | 12 | 1.6 | 10 |

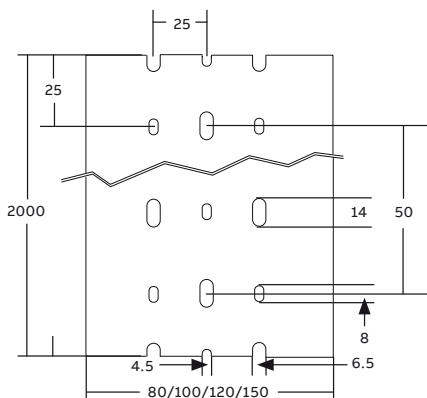

3.2 Dimensional information

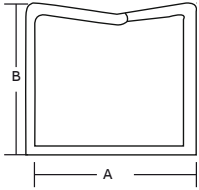

Flexible metric wiring duct dimensions

| Trade size (mm) | | Flexible duct dimensions (mm) | | | | | |
|-----------------|---|-------------------------------|------|-----|------|------|--|
| W | H | A | B | C | D | E | |
| 12.5 | X | 12.5 | 12.5 | 7.5 | 12.5 | 12.5 | |
| 20 | X | 20 | 20 | 7.5 | 20 | 12.5 | |
| 25 | X | 25 | 25 | 7.5 | 25 | 12.5 | |
| 30 | X | 30 | 30 | 7.5 | 30 | 12.5 | |
| 40 | X | 40 | 40 | 7.5 | 40 | 12.5 | |

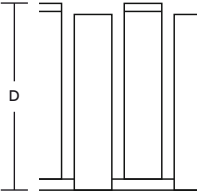

A = duct width
 B = duct height
 C = slot width
 D = slot height
 E = slot to slot distance

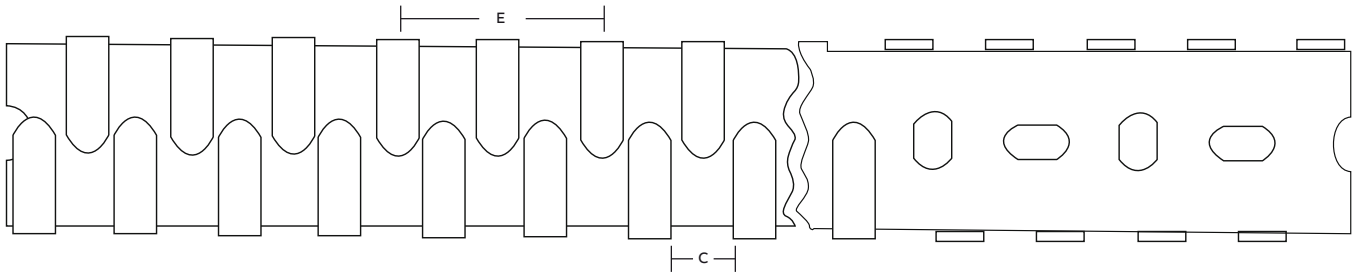

3.3 Industry standards and certifications

Ty-Duct wiring duct meets all of the prominent agency approvals and standards.

Agency approvals:



ABB Ty-Duct wiring duct is UL Recognized for all requirements set forth in UL standard 1565 “Positioning Device.”



The Ty-Duct wiring duct meets all applicable requirements of the Canadian Standard Association as described in CSA C22.2 No. 18.5.



All Ty-Duct wiring duct components comply with the European Directives for CE (Conformite European) Marking.

All materials used in the making of the Ty-Duct wiring duct comply with the European Directives 2002/95/EC (RoHS), 2002/96/EC (WEEE), and 2003/11/EC.

Standards:

UL 508/UL 508A

As required in UL508/UL508A a factory-installed conductor shall be separated from a conductor used in a different circuit when the conductors are not insulated for the maximum voltage of either circuit. The Ty-Duct wiring duct with a divider wall creates the required separation to meet this requirement.

DIN 43 659

This European standard specifies dimensions for slotted trunkings installed in electrical switchgear assemblies.

- The standard defines the following dimensions:
- The mounting hole pattern
- The mounting hole slot dimensions
- The mounting hole pitch and location
- The minimum overall product length

3.4 Catalog number index

| Cat. No | Page | Cat. No | Page | Cat. No | Page |
|---------|------|------------|-----------|-------------------|--------------------|
| 05019 | A-11 | 05199 | A-12 | 1SL9147A00 | A-16 |
| 05033 | A-11 | 05300 | A-11-A-12 | 1SL9149A00 | A-16 |
| 05035 | A-11 | 05302 | A-11-A-12 | 1SL9151A00 | A-16 |
| 05037 | A-11 | 05304 | A-11-A-12 | 1SL9153A00 | A-16 |
| 05043 | A-11 | 05306 | A-11-A-12 | 1SL9163A00 | A-16 |
| 05045 | A-11 | 05308 | A-11-A-12 | 1SL9165A00 | A-16 |
| 05047 | A-11 | 05310 | A-11-A-12 | 1SL9167A00 | A-16 |
| 05049 | A-11 | 05312 | A-11-A-12 | 1SL9169A00 | A-16 |
| 05051 | A-11 | 05314 | A-11-A-12 | 1SL9171A00 | A-16 |
| 05053 | A-11 | 05400 | A-13 | 1SL9173A00 | A-16 |
| 05063 | A-11 | 05405 | A-13 | 1SL9183A00 | A-16 |
| 05065 | A-11 | 05410 | A-13 | 1SL9185A00 | A-16 |
| 05067 | A-11 | 05415 | A-13 | 1SL9187A00 | A-16 |
| 05069 | A-11 | 05420 | A-13 | 1SL9189A00 | A-16 |
| 05071 | A-11 | 08205 | A-21 | 1SL9191A00 | A-16 |
| 05073 | A-11 | 08200C | A-18 | 1SL9193A00 | A-16 |
| 05083 | A-11 | 1SL5316A00 | A-15-A-16 | CC125 | A-20 |
| 05085 | A-11 | 1SL5317A00 | A-15-A-16 | DC-125TB | A-21 |
| 05087 | A-11 | 1SL5318A00 | A-15-A-16 | DK-65TB | A-20 |
| 05089 | A-11 | 1SL5319A00 | A-15-A-16 | DNT-100TB | A-21 |
| 05091 | A-11 | 1SL5320A00 | A-15-A-16 | SX-25TB | A-20 |
| 05093 | A-11 | 1SL5321A00 | A-15-A-16 | TY1.5D[] [] _j6 | A-17 |
| 05094 | A-11 | 1SL5322A00 | A-15-A-16 | TY15MC | A-19 |
| 05095 | A-11 | 1SL9019A00 | A-15 | TY1D[] [] _j6 | A-17 |
| 05096 | A-11 | 1SL9033A00 | A-15 | TY1MC | A-19 |
| 05097 | A-11 | 1SL9035A00 | A-15 | TY2D[] [] _j6 | A-17 |
| 05098 | A-11 | 1SL9037A00 | A-15 | TY2MC | A-19 |
| 05099 | A-11 | 1SL9043A00 | A-15 | TY3D[] [] _j6 | A-17 |
| 05119 | A-12 | 1SL9045A00 | A-15 | TY3MC | A-19 |
| 05133 | A-12 | 1SL9047A00 | A-15 | TY4D[] [] _j6 | A-17 |
| 05135 | A-12 | 1SL9049A00 | A-15 | TY5D[] [] _j6 | A-17 |
| 05137 | A-12 | 1SL9051A00 | A-15 | TYCS[] _j6 | A-18 |
| 05143 | A-12 | 1SL9053A00 | A-15 | TYD15CP[] _j6 | A-3, A-5, A-7, A-9 |
| 05145 | A-12 | 1SL9063A00 | A-15 | TYD15X15NP[] _j6 | A-7 |
| 05147 | A-12 | 1SL9065A00 | A-15 | TYD15X15RP[] _j6 | A-9 |
| 05149 | A-12 | 1SL9067A00 | A-15 | TYD15X15SP[] _j6 | A-3 |
| 05151 | A-12 | 1SL9069A00 | A-15 | TYD15X15WP[] _j6 | A-5 |
| 05153 | A-12 | 1SL9071A00 | A-15 | TYD15X1NPI[] _j6 | A-7 |
| 05163 | A-12 | 1SL9073A00 | A-15 | TYD15X1SP[] _j6 | A-3 |
| 05165 | A-12 | 1SL9083A00 | A-15 | TYD15X1WPI[] _j6 | A-5 |
| 05167 | A-12 | 1SL9085A00 | A-15 | TYD15X2NPI[] _j6 | A-7 |
| 05169 | A-12 | 1SL9087A00 | A-15 | TYD15X2RPI[] _j6 | A-9 |
| 05171 | A-12 | 1SL9089A00 | A-15 | TYD15X2SPI[] _j6 | A-3 |
| 05173 | A-12 | 1SL9091A00 | A-15 | TYD15X2WPI[] _j6 | A-5 |
| 05183 | A-12 | 1SL9093A00 | A-15 | TYD15X3NPI[] _j6 | A-7 |
| 05185 | A-12 | 1SL9095A00 | A-15 | TYD15X3RPI[] _j6 | A-9 |
| 05187 | A-12 | 1SL9096A00 | A-15 | TYD15X3SPI[] _j6 | A-3 |
| 05189 | A-12 | 1SL9097A00 | A-15 | TYD15X3WPI[] _j6 | A-5 |
| 05191 | A-12 | 1SL9098A00 | A-15 | TYD15X4NPI[] _j6 | A-7 |
| 05193 | A-12 | 1SL9119A00 | A-16 | TYD15X4RPI[] _j6 | A-9 |
| 05194 | A-12 | 1SL9133A00 | A-16 | TYD15X4SPI[] _j6 | A-3 |
| 05195 | A-12 | 1SL9135A00 | A-16 | TYD15X4WPI[] _j6 | A-5 |
| 05196 | A-12 | 1SL9137A00 | A-16 | TYD1CP[] _j6 | A-3, A-5, A-7, A-9 |
| 05197 | A-12 | 1SL9143A00 | A-16 | TYD1X15NP[] _j6 | A-7, A-9 |
| 05198 | A-12 | 1SL9145A00 | A-16 | TYD1X15SP[] _j6 | A-3 |

| Cat. No | Page | Cat. No | Page |
|-----------------|--------------------|------------------|--------------------|
| TYD1X15WP[]_j6 | A-5 | TYD3X2SP[]_j6 | A-3 |
| TYD1X1NP[]_j6 | A-7 | TYD3X2WP[]_j6 | A-5 |
| TYD1X1SP[]_j6 | A-3 | TYD3X3NP[]_j6 | A-7 |
| TYD1X1WP[]_j6 | A-5 | TYD3X3RP[]_j6 | A-9 |
| TYD1X2NP[]_j6 | A-7 | TYD3X3SP[]_j6 | A-3 |
| TYD1X2RP[]_j6 | A-9 | TYD3X3WP[]_j6 | A-5 |
| TYD1X2SP[]_j6 | A-3 | TYD3X4NP[]_j6 | A-7 |
| TYD1X2WP[]_j6 | A-5 | TYD3X4RP[]_j6 | A-9 |
| TYD1X3NP[]_j6 | A-7 | TYD3X4SP[]_j6 | A-3 |
| TYD1X3RP[]_j6 | A-9 | TYD3X4WP[]_j6 | A-5 |
| TYD1X3SP[]_j6 | A-3 | TYD3X5NP[]_j6 | A-7 |
| TYD1X3WP[]_j6 | A-5 | TYD3X5SP[]_j6 | A-3 |
| TYD1X4NP[]_j6 | A-7 | TYD3X5WP[]_j6 | A-5 |
| TYD1X4RP[]_j6 | A-9 | TYD4CP[]_j6 | A-3, A-5, A-7, A-9 |
| TYD1X4SP[]_j6 | A-3 | TYD4X15RP[]_j6 | A-9 |
| TYD1X4WP[]_j6 | A-5 | TYD4X15SP[]_j6 | A-3 |
| TYD25CP[]_j6 | A-3, A-5, A-7 | TYD4X15WP[]_j6 | A-5 |
| TYD25X2NP[]_j6 | A-7 | TYD4X2NP[]_j6 | A-7 |
| TYD25X2SP[]_j6 | A-3 | TYD4X2RP[]_j6 | A-9 |
| TYD25X2WP[]_j6 | A-5 | TYD4X2SP[]_j6 | A-3 |
| TYD25X3NP[]_j6 | A-7 | TYD4X2WP[]_j6 | A-5 |
| TYD25X3SP[]_j6 | A-3 | TYD4X3NP[]_j6 | A-7 |
| TYD25X3WP[]_j6 | A-5 | TYD4X3RP[]_j6 | A-9 |
| TYD25X4NP[]_j6 | A-7 | TYD4X3SP[]_j6 | A-3 |
| TYD25X4SP[]_j6 | A-3 | TYD4X3WP[]_j6 | A-5 |
| TYD25X4WP[]_j6 | A-5 | TYD4X4NP[]_j6 | A-7 |
| TYD2CP[]_j6 | A-3, A-5, A-7, A-9 | TYD4X4RP[]_j6 | A-9 |
| TYD2X15NP[]_j6 | A-7 | TYD4X4SP[]_j6 | A-3 |
| TYD2X15RP[]_j6 | A-9 | TYD4X4WP[]_j6 | A-5 |
| TYD2X15SP[]_j6 | A-3 | TYD4X5NP[]_j6 | A-7 |
| TYD2X15WP[]_j6 | A-5 | TYD4X5SP[]_j6 | A-3 |
| TYD2X1NP[]_j6 | A-7 | TYD4X5WP[]_j6 | A-5 |
| TYD2X1SP[]_j6 | A-3 | TYD6CP[]_j6 | A-3, A-5 |
| TYD2X1WP[]_j6 | A-5 | TYD6X4SP[]_j6 | A-3 |
| TYD2X2NP[]_j6 | A-7 | TYD6X4WP[]_j6 | A-5 |
| TYD2X2RP[]_j6 | A-9 | TYD75CP[]_j6 | A-3, A-5, A-7 |
| TYD2X2SP[]_j6 | A-3 | TYD75X15NP[]_j6 | A-7 |
| TYD2X2WP[]_j6 | A-5 | TYD75X15SP[]_j6 | A-3 |
| TYD2X3NP[]_j6 | A-7 | TYD75X15WP[]_j6 | A-5 |
| TYD2X3RP[]_j6 | A-9 | TYD75X1SP[]_j6 | A-3 |
| TYD2X3SP[]_j6 | A-3 | TYD75X1WP[]_j6 | A-5 |
| TYD2X3WP[]_j6 | A-5 | TYD75X2SP[]_j6 | A-3 |
| TYD2X4NP[]_j6 | A-7 | TYD75X2WP[]_j6 | A-5 |
| TYD2X4RP[]_j6 | A-9 | TYJCI[]_j6 | A-18 |
| TYD2X4SP[]_j6 | A-3 | TYWRC | A-19 |
| TYD2X4WP[]_j6 | A-5 | TYWRG | A-19 |
| TYD2X5NP[]_j6 | A-7 | UMC | A-17 |
| TYD2X5SP[]_j6 | A-3 | | |
| TYD2X5WP[]_j6 | A-5 | | |
| TYD3CP[]_j6 | A-3, A-5, A-7, A-9 | | |
| TYD3X1NP[]_j6 | A-7 | | |
| TYD3X1SP[]_j6 | A-3 | | |
| TYD3X1WP[]_j6 | A-5 | | |
| TYD3X2NP[]_j6 | A-7 | | |
| TYD3X2RP[]_j6 | A-9 | | |



ABB Ltd.

8155 T&B Blvd.
Memphis, TN 38125
United States

new.abb.com/low-voltage

