



Industrial Electrical Solutions

Best in Class Electrical Infrastructure Solutions
for Industrial Construction, MRO and OEM

PANDUIT[®]





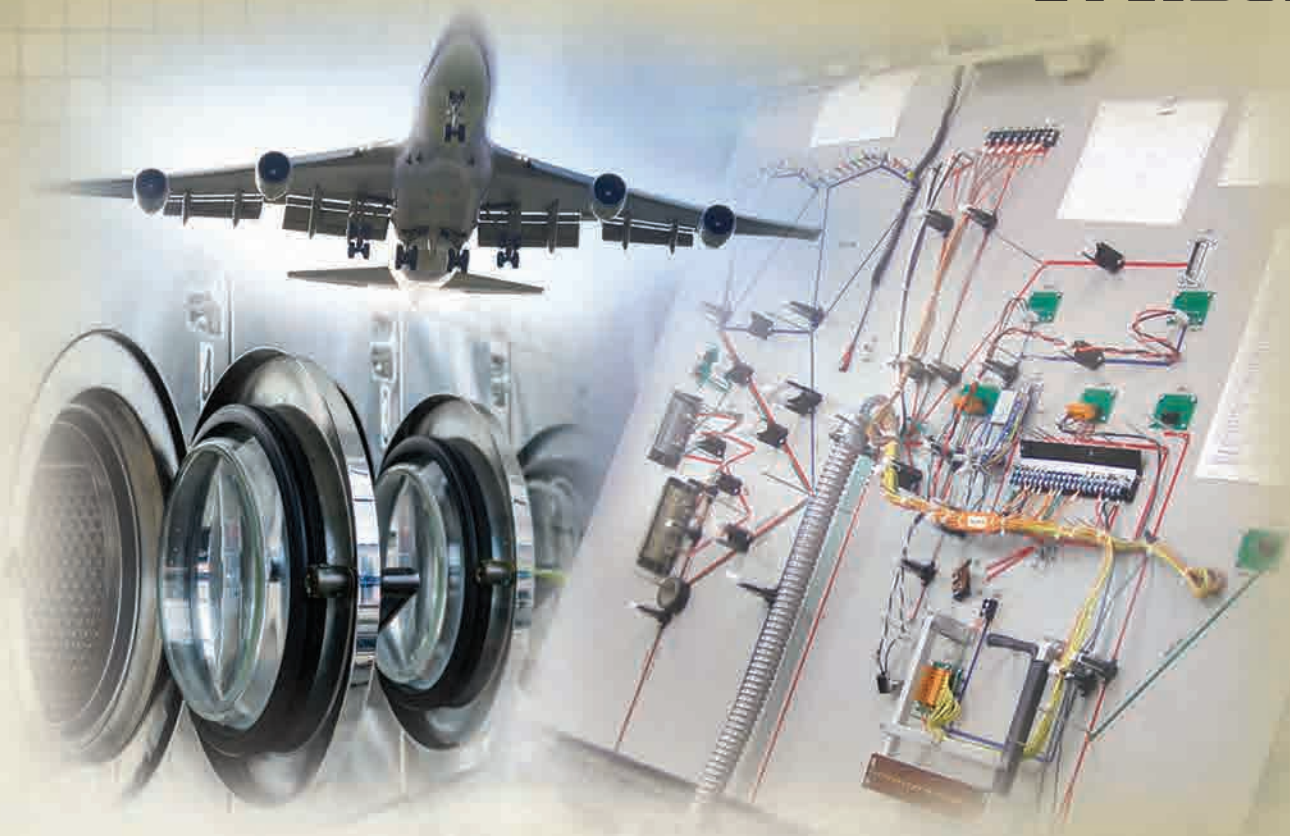

infrastructure for a connected world

PANDUIT®



www.panduit.com

Table of Contents

-  **A. System Overview**
-  **B. Bundle**
 - 1. Cable Ties
 - 2. Cable Accessories
 - 3. Stainless Steel Cable Ties and Accessories
-  **C. Route/Protect**
 - 1. Wiring Duct
 - 2. Abrasion Protection
 - 3. Cable Management
-  **D. Terminate**
 - 1. Terminals
 - 2. Power Connectors
 - 3. Grounding Connectors
-  **E. Identification and Safety Solutions**
 - 1. Labeling Systems
 - 2. Labels
 - 3. Pre-Printed and Write-On Markers
 - 4. Permanent Identification
 - 5. Industrial and Safety Solutions
-  **F. Keystone Cabling Systems**
-  **G. Part Number Index**

**B1.
Cable
Ties**

**B2.
Cable
Accessories**

**B3.
Stainless
Steel Cable
Ties &
Accessories**

**C1.
Wiring
Duct**

**C2.
Abrasion
Protection**

**C3.
Cable
Management**

**D1.
Terminals**

**D2.
Power
Connectors**

**D3.
Grounding
Connectors**

**E1.
Labeling
Systems**

**E2.
Labels**

**E3.
Pre-Printed
&
Write-On
Markers**

**E4.
Permanent
Identification**

**E5.
Industrial
Safety
Solutions**

**F.
Keystone
Cabling
Systems**

**G.
Part
Number
Index**

Notes

System Overview

Panduit® is a world-class provider of engineered, flexible, end-to-end electrical infrastructure solutions that provide businesses with the ability to keep pace with a connected world. Our robust partner ecosystem, global staff, unmatched service and support make Panduit a valuable and trusted partner.



To help assure optimum quality, Panduit products are designed and manufactured to meet applicable environmental, safety, market industry and customer standards including ROHS, UL, CSA, CE, ISO....detailed compliance information is found throughout this catalog.



- **Proven QUALITY performance:** Time and again, customers trust Panduit for reliable cabling and infrastructure products
- **Subject matter EXPERTISE:** Our engineers know the standards and specifications of your industry so you don't have to; the products they develop meet or exceed requirements to ensure you get the best and most reliable results possible
- **Customer-driven INNOVATION:** At Panduit, we research, prototype, test, and develop practical solutions for the real electrical infrastructure problems you face; by choosing Panduit, you get a partner with the available products you need now, and the know-how to solve future challenges before they disrupt your system

- B1. Cable Ties
- B2. Cable Accessories
- B3. Stainless Steel Cable Ties & Accessories
- C1. Wiring Duct
- C2. Abrasion Protection
- C3. Cable Management
- D1. Terminals
- D2. Power Connectors
- D3. Grounding Connectors
- E1. Labeling Systems
- E2. Labels
- E3. Pre-Printed & Write-On Markers
- E4. Permanent Identification
- E5. Industrial Safety Solutions
- F. Keystone Cabling Systems
- G. Part Number Index

B1.
Cable
Ties

Applications and Market Solutions

B2.
Cable
Accessories

Oil and Gas/Chemical

B3.
Stainless
Steel Cable
Ties &
Accessories

The world's appetite for energy grows every day, and oil and gas are still the best options for meeting global demand. Faced with the need to explore in challenging locations, integrate new oil sands and shale capabilities, meet updated safety protocols, and identify new technologies to handle remote environments, energy producers are looking for partners who can help them keep up with changing business conditions and goals.

C1.
Wiring
Duct

C2.
Abrasion
Protection

C3.
Cable
Management

D1.
Terminals

D2.
Power
Connectors

D3.
Grounding
Connectors

Mining and Minerals

E1.
Labeling
Systems

As the global demand on natural resources continues to increase, efficiency and productivity requirements are pushing all mining systems and components to the limit. Site and operator safety are also extremely important as exposure to harsh chemicals, abrasive environments, and extreme temperature conditions are consistently present in this hectic environment.

E2.
Labels

E3.
Pre-Printed
&
Write-On
Markers

E4.
Permanent
Identification

Industrial Water/Wastewater Treatment
Water treatment facilities are critical for maintaining public sanitation and a healthy environment. Whether the facility treats industrial and residential wastewater to remove impurities, or treats fresh water for consumption, these facilities rely on robust solutions for dependable continuous operation within harsh environments.

E5.
Industrial
Safety
Solutions

F.
Keystone
Cabling
Systems

G.
Part
Number
Index

Applications and Market Solutions

Pulp and Paper

From sawmill operations through the manufacturing of the final wood and paper, the pulp, paper and wood industry comprises over 3,500 operational plants worldwide. The pulping process occurs in a harsh environment and is exposed to high cooking temperatures and a variety of chemicals that require high quality of maintenance, repair and operation products to protect people and infrastructure to ultimately eliminate downtime and improve productivity.



Shipbuilding

Shipbuilders focusing on ultimate reliability and safety while facing constant cost containment pressures, are looking into ways to increase productivity, minimize unscheduled maintenance, and extend global availability and lower overhead expenses.



Food and Beverage

Food and beverage manufacturers are faced with countless product safety, quality and manufacturing challenges. Maximizing productivity while reducing downtime requires a robust integrated electrical infrastructure that can deliver optimum productivity, reliability and profitability.



B1.
Cable
Ties

B2.
Cable
Accessories

B3.
Stainless
Steel Cable
Ties &
Accessories

C1.
Wiring
Duct

C2.
Abrasion
Protection

C3.
Cable
Management

D1.
Terminals

D2.
Power
Connectors

D3.
Grounding
Connectors

E1.
Labeling
Systems

E2.
Labels

E3.
Pre-Printed
&
Write-On
Markers

E4.
Permanent
Identification

E5.
Industrial
Safety
Solutions

F.
Keystone
Cabling
Systems

G.
Part
Number
Index

B1.
Cable
Ties

B2.
Cable
Accessories

B3.
Stainless
Steel Cable
Ties &
Accessories

C1.
Wiring
Duct

C2.
Abrasion
Protection

C3.
Cable
Management

D1.
Terminals

D2.
Power
Connectors

D3.
Grounding
Connectors

E1.
Labeling
Systems

E2.
Labels

E3.
Pre-Printed
&
Write-On
Markers

E4.
Permanent
Identification

E5.
Industrial
Safety
Solutions

F.
Keystone
Cabling
Systems

G.
Part
Number
Index

Applications and Market Solutions

Harsh Environments

When vibration, radiation, weathering, corrosion, and temperature extremes are a factor, you need a high quality, reliable, and durable solution. Panduit® provides everything necessary to bundle, route, protect, terminate, and identify electrical and network cable in indoor and outdoor extreme conditions. These innovative solutions meet the needs of the most demanding harsh and industrial environment applications to deliver long life, increased productivity, and improved worker safety.



Transportation

Panduit develops high-quality products to meet the requirements of the transportation market while providing the lowest installed cost. Performance, reliability, efficiency, regulatory approvals and availability are critical issues to success. Panduit solutions are designed to hold up under vibration, shock, and exposure to nature's elements while preventing corrosion, reducing weight, complying with market standards and speeding installation.



Applications and Market Solutions

Wire Harness

Intense global competition and increasing operational expenses are pressuring contract manufacturers and original equipment manufacturers to speed production and control costs without compromising quality, system availability, and reliability. Wire harness solutions from Panduit® offer the broadest range of options for the most demanding requirements and applications. Through innovative product systems and services, we help you increase your productivity, reduce your installation costs, and improve reliability.



Control Cabinet/ Panel Builders

Panel shops, engineering firms, machine builders, and system integrators are dealing with the convergence of high/low voltage and network cabling within control panels. This trend creates challenges in meeting production schedules, controlling costs, while maintaining quality, system availability, and reliability. Control panel solutions from Panduit offer the broadest range of options for the most demanding requirements and applications. Through innovative product systems and services we help you save valuable panel space, mitigate disruptions due to electrical/mechanical noise, enable and future proof your network, and improve reliability.

- B1. Cable Ties
- B2. Cable Accessories
- B3. Stainless Steel Cable Ties & Accessories
- C1. Wiring Duct
- C2. Abrasion Protection
- C3. Cable Management
- D1. Terminals
- D2. Power Connectors
- D3. Grounding Connectors
- E1. Labeling Systems
- E2. Labels
- E3. Pre-Printed & Write-On Markers
- E4. Permanent Identification
- E5. Industrial Safety Solutions
- F. Keystone Cabling Systems
- G. Part Number Index

**B1.
Cable
Ties**

**B2.
Cable
Accessories**

**B3.
Stainless
Steel Cable
Ties &
Accessories**

**C1.
Wiring
Duct**

**C2.
Abrasion
Protection**

**C3.
Cable
Management**

**D1.
Terminals**

**D2.
Power
Connectors**

**D3.
Grounding
Connectors**

**E1.
Labeling
Systems**

**E2.
Labels**

**E3.
Pre-Printed
&
Write-On
Markers**

**E4.
Permanent
Identification**

**E5.
Industrial
Safety
Solutions**

**F.
Keystone
Cabling
Systems**

**G.
Part
Number
Index**

Notes

Cable Ties



Panduit® offers the most complete selection of cable tie styles, sizes, materials and colors to meet our customers' needs. Panduit cable ties bundle, mount, and identify in countless indoor, outdoor, and harsh environment applications. Panduit cable ties, wiring accessories, and installation tools allow our customers to achieve the lowest total installed cost of managing wire and cable.



- Panduit continues to provide innovative new cable tie designs to meet our customers' application challenges
- Panduit cable ties and wiring accessories can be used in a variety of applications and environments, providing the optimal wire management solution
- Panduit offers a large selection of ergonomic cable tie installation tools – all with consistent, and reliable performance

Panduit leads the industry in the breadth and depth of available cable tie designs created from customer feedback on their application requirements. As with all Panduit products, quality in design and production along with customer service excellence are assured.



Cable Tie Selection Chart

Follow this step-by-step process to find the cable ties that best suit your application:

Cable Tie Function

- 1) Select the main function of the cable tie you need:
 Bundle = Standard Cable Ties
 Re-use = Nylon Releasable Ties*
 Identify = Marker and Flag Ties
 Mount = Clamp Ties, Push Mount Ties, and Stud Mount Ties

Material Properties

- 2) Determine the appropriate material for your application:
 Mechanical
 Chemical
 Thermal

Cable Tie Family

- 3) Select the cable tie family that meets your overall needs

	Cable Tie Function	Test Method	Bundle, Re-use, Identify, Mount	Bundle, Re-use, Identify, Mount	Bundle, Re-use, Mount	Bundle, Re-use, Mount	Bundle	Bundle
C1. Wiring Duct	Material		Nylon 6.6	Weather Resistant Nylon 6.6	Impact Modified Weather Resistant Nylon 6.6	Heat Stabilized Nylon 6.6	Heat Stabilized Nylon 6.6	Heat Stabilized Weather Resistant Nylon 6.6
	Color	—	Natural	Black	Black	Black	Natural	Black
	Part Number Suffix (Material Designation)	—	No Suffix	0	0	30	39	300
C2. Abrasion Protection	Tensile @ Yield @ 73°F (psi)	ISO 527	12,000	12,000	9,700	12,000	12,000	12,000
	Water Absorption (24 Hours)	ASTM D570	1.2%	1.2%	1.2%	1.2%	1.2%	1.2%
	Radiation Resistance (Rads)	—	1 x 10 ⁵	1 x 10 ⁵	1 x 10 ⁵	1 x 10 ⁵	1 x 10 ⁵	1 x 10 ⁵
C3. Cable Management	Weathering Life Expectancy (Years)/ UV Resistance	—	1 – 2	7 – 9	7 – 9	4 – 5	1 – 2	7 – 9
	Impact Resistance	—	○	○	●	○	○	○
D1. Terminals	Salts	—	●	●	●	●	●	●
	Hydrocarbons (Gas, Oil, Lubricants)	—	●	●	●	●	●	●
D2. Power Connectors	Chlorinated Hydrocarbons	—	●	●	●	●	●	●
	Acids	—	●	●	●	●	●	●
D3. Grounding Connectors	Bases	—	●	●	●	●	●	●
	Acid Rain	—	●	●	●	●	●	●
E1. Labeling Systems	Continuous Use Temperature Range	UL 746B	-76°F - 185°F -60°C - 85°C	-76°F - 185°F -60°C - 85°C	-76°F - 185°F -60°C - 85°C	-76°F - 239°F -60°C - 115°C	-76°F - 239°F -60°C - 115°C	-76°F - 239°F -60°C - 115°C
	Minimum Installation Temperature	UL 62275	-4°F or +32°F -20°C or 0°C (Note 1)	-4°F or +32°F -20°C or 0°C (Note 1)	-4°F or +32°F -20°C or 0°C (Note 1)	-4°F or +32°F -20°C or 0°C (Note 1)	-4°F or +32°F -20°C or 0°C (Note 1)	-4°F or +32°F -20°C or 0°C (Note 1)
E2. Labels	Flammability Rating	UL 94	V-2	V-2	HB	V-2	V-2	V-2
	Low Smoke	ASTM E662	PASS	PASS	PASS	PASS	PASS	PASS
E3. Pre-Printed & Write-On Markers	Oxygen Index	BS ISO 4589	28	28	—	28	28	28
	Halogen-Free	IEC 60754-2	Yes	Yes	Yes	Yes	Yes	Yes
E4. Permanent Identification	Burning Fume Toxicity	BSS-7239	PASS	PASS	PASS	PASS	PASS	PASS
	Heat Deflection Temperature @ 1.8 Mpa	ASTM D648 ISO 75 -1/-2	158°F 70°C	158°F 70°C	145°F 63°C	158°F 70°C	158°F 70°C	158°F 70°C
	Relative Price	—	Low	Low	Low	Low	Low	Med

Cable Tie Catalog Page	Product Line	Cross Sections					
	Pan-Ty®	✓	SM, M, I, S	LH, H, EH	✓	✓	✓
Super-Grip® (B1.38)	✓	M, I, S, LH	H	✓			
Dome-Top® Barb Ty (B1.43)	✓	M, I, S	LH	✓	✓	✓	
Dura-Ty™ (B1.53)							
Parallel-Entry (B1.56)	✓	M, I, S, HS	LH		✓		
Sta-Strap® (B1. 65)	✓	M, I, S, LH, H		✓			
Specialty Ties (B1.73)	✓		H	✓		✓	

Check mark indicates material availability in that product line.

Cross Sections: SM = Subminiature, M = Miniature, I = Intermediate, S = Standard, HS = Heavy-Standard, LH = Light-Heavy, H = Heavy, EH = Extra-Heavy.

*For information on re-usable Hook and Loop Cable Ties, see page B1.81.

Recommendation Legend	Highest	High	Acceptable	Low	Lowest

Bundle	Bundle, Identify	Bundle	Bundle	Bundle, Re-use	Bundle	Bundle	Bundle	Bundle	Bundle	Bundle
Flame Retardant Nylon 6.6	Flame Retardant Nylon 6.6	Weather Resistant Nylon 12	Polypropylene	Weather Resistant Polypropylene	TEFZEL ■	HALAR ▲	PEEK	Metal Detectable Nylon 6.6	Metal Detectable Polypropylene	Weather Resistant Acetal
Black	Natural Ivory	Black	Green	Black	Aqua Blue	Maroon	Brown	Blue	Blue	Black
60	69	120	109	100	76	702Y	71	86	186	N/A
11,000	11,000	6,700	4,100	4,100	7,500	7,000	15,200	—	—	6,500
1.1%	1.1%	0.3%	0.1%	0.1%	<0.03%	<0.05%	0.5%	1.2%	0.1%	<0.45%
1 x 10 ⁵	1 x 10 ⁵	3.5 x 10 ⁶	1 x 10 ⁶	1 x 10 ⁶	2 x 10 ⁸	2 x 10 ⁸	1 x 10 ⁹	—	1 x 10 ⁶	6 x 10 ⁵
1 – 2	1 – 2	12 – 15	1	7 – 9	>15	>15	—	—	1	>20
								—		
-76°F - 212°F -60°C - 100°C	-76°F - 212°F -60°C - 100°C	-76°F - 194°F -60°C - 90°C	-76°F - 239°F -60°C - 115°C	-76°F - 239°F -60°C - 115°C	-76°F - 338°F -60°C - 170°C	-76°F - 257°F -60°C - 125°C	-76°F - 257°F -60°C - 125°C	-76°F - 500°F -60°C - 260°C	-76°F - 239°F -60°C - 115°C	-76°F - 185°F -60°C - 85°C
-4°F or +32°F -20°C or 0°C (Note 1)	-4°F or +32°F -20°C or 0°C (Note 1)	-4°F or +32°F -20°C or 0°C (Note 1)	-4°F or +32°F -20°C or 0°C (Note 1)	-4°F or +32°F -20°C or 0°C (Note 1)	-4°F or +32°F -20°C or 0°C (Note 1)	-4°F or +32°F -20°C or 0°C (Note 1)	-4°F or +32°F -20°C or 0°C (Note 1)	-4°F or +32°F -20°C or 0°C (Note 1)	-4°F or +32°F -20°C or 0°C (Note 1)	-4°F or +32°F -20°C or 0°C (Note 1)
V-0	V-0	HB	HB	HB	V-0	V-0	V-0	HB	HB	HB
PASS	PASS	—	—	—	—	—	PASS	—	—	PASS
34	34	—	—	—	30	52	35	—	—	—
Yes	Yes	Yes	Yes	Yes	No	No	Yes	Yes	Yes	Yes
PASS	PASS	—	—	—	—	—	—	—	—	—
154°F 68°C	154°F 68°C	122°F 50°C	122°F 50°C	122°F 50°C	—	149°F 65°C	313°F 156°C	145°F 63°C	122°F 50°C	239°F 115°C
Med	Med	Med	Med	Med	High	High	High	Low	Med	Med

✓	✓	✓	✓	✓	✓	✓	✓	✓	✓	✓
	✓									
	✓									✓

Note 1: Check UL file for the specific part number rating

Note 2: Based upon UL RTI for electrical properties

■ TEFZEL is a registered trademark of E.I. du Pont de Nemours and Company ▲ HALAR is a registered trademark of Solvay Solexis

Cable Tie Styles Overview

Pan-Ty® Cable Ties

Pages B1.6 – B1.35

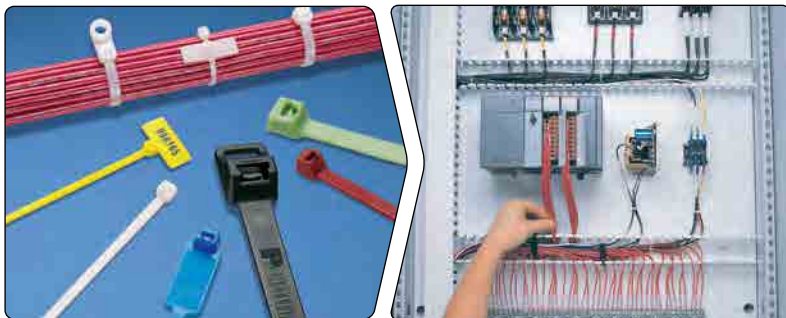

- Designed for use in numerous applications to meet a variety of needs in the OEM, MRO, and construction markets
- Largest selection of styles, materials, and sizes
- One-piece construction for consistent performance and reliability
- Lowest threading force of any one-piece cable tie in the industry

Super-Grip® Cable Ties

Pages B1.36 – B1.40



- Designed for the strength requirements of the MRO and construction markets
- Thin, wide strap body – flexible, conforms to bundles
- Strong – withstands rough installation practices
- Grips wires tightly and resists lateral movement

Dome-Top® Barb Ty Cable Ties

Pages B1.41 – B1.53



- Approved for the demanding MRO and construction requirements as typified in the oil and gas markets
- Stainless steel barb provides consistent performance and reliability
- Infinitely adjustable for tight bundles throughout entire bundle range
- Dome-top head features unique patented design with smooth, round edges

Parallel-Entry Cable Ties

Pages B1.54 – B1.62



- Designed for use in the OEM and transportation markets
- All parallel-entry ties provide a low profile head which avoids snags and reduces overall bundle size
- No protrusion of tie cut-off – protects workers' arms/hands
- Contour-Ty® Cable Ties have outside teeth and smooth, round edges to protect cable jacket – perfect for high vibration applications

Sta-Strap® Cable Ties

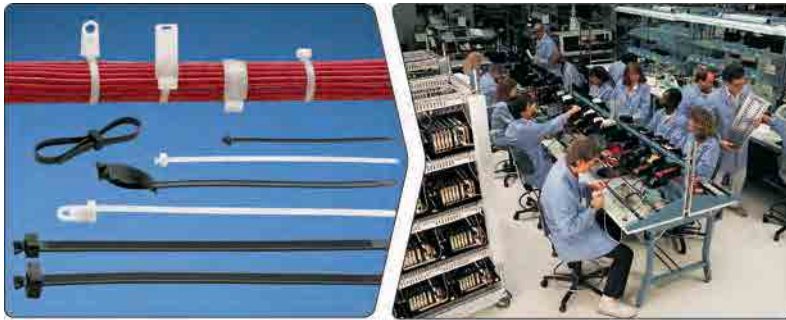

Pages B1.63 – B1.69

- Convenient and easy to use in OEM manual assembly operations
- Exclusive, two-piece design provides lowest threading force in the industry
- Use for normal bundling and through-panel applications
- Releasable prior to final tensioning and cut-off

Network Cable Ties



Pages B1.81 – B1.88

- Ideal for the telecommunications, financial, education, and government markets
- Adjustable, releasable, and re-usable
- No risk of over-tensioning or damaging high performance network cables
- Variety of styles, sizes, and colors

Features and Benefits – Pan-Ty® Cable Ties

One-piece design for consistent performance and reliability.
Available in lengths from 2.8 to 43.3 inches and a variety of styles, materials, and colors for specific applications.

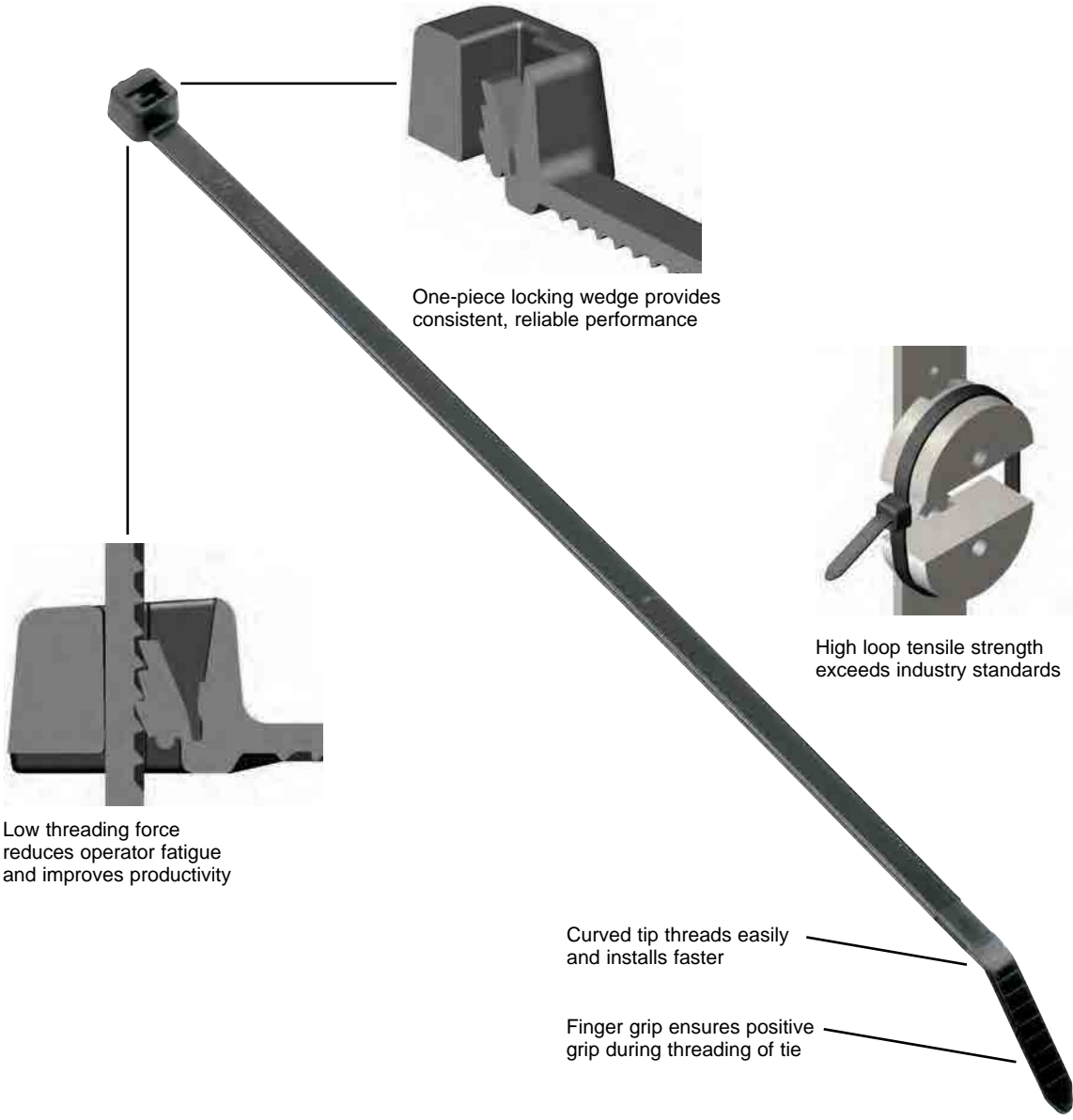

Cable tie tools speed installation and reduce total installed cost.
Visit www.panduit.com/tools.



Cable tie accessories are used to speed and simplify the mounting of wires, cables, and tubing.
See pages B2.1 – B2.26.

Selection Guide – Pan-Ty® Cable Ties



Material, Color (Suffix)	Style/Function	Part Number Prefix	Catalog Page
Nylon 6.6, Natural (No Suffix)	Locking Ties/Bundle	PLT	B1.8, 9
	Releasable Ties/Re-usable	PRT	B1.20
	Clamp Ties/Mount	PLC	B1.24
	Push Mount Ties/Mount	PLWP, PRWP, PLUP, PLP	B1.26, 28, 31
	Marker Ties/Identify	PLF, PLM	B1.32
Weather Resistant Nylon 6.6, Black (0)	Locking Ties/Bundle	PLT	B1.10, 11
	Releasable Ties/Re-usable	PRT	B1.21, 22
	Clamp Ties/Mount	PLC	B1.25
	Push Mount Ties/Mount	PLWP, PRWP, PLUP, PLP	B1.27 – B1.31
	Marker Ties/Identify	PLF, PLM	B1.32
Heat Stabilized Nylon 6.6, Black (30)	Locking Ties/Bundle	PLT	B1.12
	Releasable Ties/Re-usable	PRT	B1.21, 22
	Clamp Ties/Mount	PLC	B1.25
	Push Mount Ties/Mount	PLWP, PRLWP, PRWP, PLUP, PLP	B1.27 – B1.31
Heat Stabilized Weather Resistant Nylon 6.6, Black (300)	Locking Ties/Bundle	PLT	B1.13
Heat Stabilized Nylon 6.6, Natural (39)	Locking Ties/Bundle	PLT	B1.12
Flame Retardant Nylon 6.6, Black (60)	Locking Ties/Bundle	PLT	B1.14
Flame Retardant Nylon 6.6, Ivory (69)	Locking Ties/Bundle	PLT	B1.14
	Marker Ties/Identify	PLF, PLM	B1.32
Weather Resistant Nylon 12, Black (120)	Locking Ties/Bundle	PLT	B1.15
Polypropylene, Green (109)	Locking Ties/Bundle	PLT	B1.15
Weather Resistant Polypropylene, Black (100)	Locking Ties/Bundle	PLT	B1.16
	Releasable Ties/Re-usable	PRT	B1.23
HALAR▲, Maroon (702Y) TEFZEL■, Aqua Blue (76)	Locking Ties/Bundle	PLT	B1.16, 17
PEEK, Translucent Brown (71)	Locking Ties/Bundle	PLT	B1.18
Metal Detectable, Blue (86, 186)	Locking Ties/Bundle	PLT	B1.19

■ TEFZEL is a registered trademark of E.I. du Pont de Nemours and Company

▲ HALAR is a registered trademark of Solvay Solexis

Part Number System for Pan-Ty® Cable Ties

PLT	2	S	—	C	
Type	Size	Cross Section	Screw Hole Size	Package Size	Material/Color
PLT = Locking Tie	Approx. Maximum Bundle Dia. (In.)	SM = Subminiature M = Miniature I = Intermediate S = Standard LH = Light-Heavy H = Heavy EH = Extra-Heavy	(Clamp Ties Only) -S4 = #4 (M2.5) -S6 = #6 (M3) -S8 = #8 (M4) -S10 = #10 (M5) -S25 = 1/4 (M6)	Q = 25 L = 50 C = 100 TL = 250 D = 500 M = 1000 VMR = 2 reels/2500 ea. XMR = 2 reels/5000 ea.	See Page B1.33
PRT = Releasable Tie					
PLC = Locking Clamp					
PLF = Locking Flag					
PLM = Locking Marker					
PLP = Locking Push Mount					
PLWP = Locking Wing Push Mount					
PRLWP = Releasable Ladder Wing Push Mount					
PRWP = Releasable Wing Push Mount					
PLUP = Locking Umbrella Push Mount					



Pan-Ty® Cable Ties – Nylon 6.6

- For indoor use
- Versatile cable ties can be used in countless applications
- One-piece construction for consistent performance and reliability
- Among the lowest threading force of any one-piece cable tie in the industry
- Curved tip is easy to pick up from flat surfaces and allows faster initial threading to speed installation
- A variety of materials and colors available for specific applications
- UL Listed for use in plenum or air handling spaces per NEC except PLT.6SM and PLT5H/6H/8H/13H

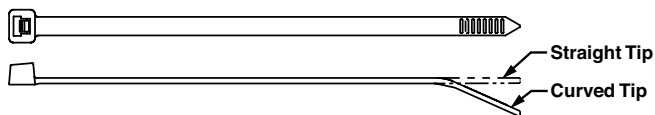

Part Number	Length		Width		Thickness		Max. Bundle Dia.		Min. Loop Tensile Str.		Recommended Installation Tool	Std. Pkg. Qty.	Std. Ctn. Qty.
	In.	mm	In.	mm	In.	mm	In.	mm	Lbs.	N			

Subminiature Cross Section

PLT.6SM-C	2.8	71	0.070	1.8	0.030	0.8	0.60	15	8	36	GTS-E, PTS	100	1000
-----------	-----	----	-------	-----	-------	-----	------	----	---	----	------------	-----	------

Miniature Cross Section – Plenum-Rated

PLT.7M-C	3.1	79	0.090	2.3	0.032	0.8	0.68	17	18	80	GTS-E, GS2B, PTS, PPTS, STS2	100	1000
PLT1M-C	3.9	99	0.098	2.5	0.043	1.1	0.87	22	18	80		100	1000
PLT1.5M-C	5.6	142	0.098	2.5	0.043	1.1	1.25	32	18	80		100	1000
PLT2M-C	8.0	203	0.098	2.5	0.043	1.1	2.00	51	18	80		100	1000

Intermediate Cross Section – Plenum-Rated

PLT1.5I-C	5.6	142	0.142	3.6	0.045	1.1	1.38	35	40	178	GTS-E, GS2B, PTS, PPTS, STS2	100	1000
PLT2I-C	8.0	203	0.142	3.6	0.045	1.1	2.00	51	40	178		100	1000
PLT2.5I-C	9.7	246	0.145	3.7	0.052	1.3	2.50	64	40	178		100	1000
PLT3I-C	11.4	290	0.145	3.7	0.052	1.3	3.00	76	40	178		100	1000
PLT4I-C	14.5	368	0.145	3.7	0.052	1.3	4.00	102	40	178		100	1000

Standard Cross Section – Plenum-Rated NEW! UL TYPE 2S Rated

PLT1S-C	4.8	122	0.190	4.8	0.052	1.3	1.00	25	50	222	GTS-E, GS2B, GTH-E, GS4H, PTS, PPTS, PTH, STS2, STH2	100	1000
PLT1.5S-C	6.2	157	0.190	4.8	0.052	1.3	1.50	38	50	222		100	1000
PLT2S-C	7.4	188	0.190	4.8	0.052	1.3	1.88	48	50	222		100	1000
PLT2.5S-C	9.8	249	0.190	4.8	0.052	1.3	2.50	64	50	222		100	1000
PLT3S-C	11.5	292	0.190	4.8	0.052	1.3	3.00	76	50	222		100	1000
PLT4S-C	14.5	368	0.190	4.8	0.052	1.3	4.00	102	50	222		100	1000
PLT4.5S-C	15.5	394	0.190	4.8	0.052	1.3	4.50	114	50	222		100	1000
PLT5S-C	17.5	445	0.190	4.8	0.052	1.3	5.00	127	50	222		100	500

Light-Heavy Cross Section (Straight Tip) – Plenum-Rated

PLT2H-L	8.1	206	0.300	7.6	0.075	1.9	2.00	51	120	534	GTH-E, GS4H, GS4EH, PTH, STH2, ST3EH	50	500
PLT2.5H-L	9.8	251	0.300	7.6	0.075	1.9	2.50	64	120	534		50	500
PLT3H-L	11.4	290	0.300	7.6	0.075	1.9	3.00	76	120	534		50	500
PLT4H-L	14.5	368	0.300	7.6	0.075	1.9	4.00	102	120	534		50	500
PLT6LH-L	21.9	556	0.300	7.6	0.075	1.9	6.00	152	120	534		50	500
PLT7LH-L	24.7	627	0.300	7.6	0.075	1.9	7.00	178	120	534		50	500
PLT8LH-L	27.6	701	0.300	7.6	0.075	1.9	8.00	203	120	534		50	500
PLT9LH-L*	30.5	775	0.300	7.6	0.075	1.9	9.00	229	120	534		50	500
PLT10LH-L*	34.3	871	0.300	7.6	0.075	1.9	10.31	262	120	534		50	1000

Heavy Cross Section (Straight Tip)

PLT5H-L*	17.7	450	0.350	8.9	0.078	2.0	5.00	127	175	778	GTH-E, GS4H, GS4EH, PTH, STH2, ST3EH	50	500
PLT6H-L*	20.9	530	0.350	8.9	0.078	2.0	6.00	152	175	778		50	500
PLT8H-L*	30.6	779	0.350	8.9	0.078	2.0	9.00	229	175	778		50	500
PLT13H-Q*	43.3	1100	0.350	8.9	0.078	2.0	13.00	330	175	778		25	500

*UL Listed – meets the requirements of UL 181B-C, for securing UL Listed non-metallic air ducts and air connectors.



Pan-Ty® Lashing Ties – Nylon 6.6

- For indoor use
- Typically used for heavy duty applications
- Among the strongest Pan-Ty® Cable Tie available
- Can be used with MCEH mounting clip, see page B1.22
- UL Listed for use in plenum or air handling spaces per NEC

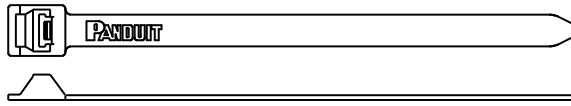

Part Number	Length		Width		Thickness		Max. Bundle Dia.		Min. Loop Tensile Str.		Recommended Installation Tool	Std. Pkg. Qty.	Std. Ctn. Qty.
	In.	mm	In.	mm	In.	mm	In.	mm	Lbs.	N			
Extra-Heavy Cross Section													
PLT2EH-C	9.0	229	0.500	12.7	0.075	1.9	2.00	51	250	1112	GS4EH, ST3EH	100	1000
PLT5EH-Q	20.1	511	0.500	12.7	0.075	1.9	5.00	127	250	1112		25	250
PLT6EH-Q	22.2	564	0.500	12.7	0.075	1.9	6.00	152	250	1112		25	250
PLT8EH-C	28.3	719	0.500	12.7	0.085	2.2	8.00	203	250	1112		100	1000
PLT10EH-C	34.2	869	0.500	12.7	0.085	2.2	10.00	254	250	1112		100	500
PLT12EH-C	40.1	1019	0.500	12.7	0.085	2.2	12.00	305	250	1112		100	500



Pan-Ty® Cable Ties – Weather Resistant Nylon 6.6

- Greater resistance to damage caused by ultraviolet light – indoor or outdoor use
- Versatile cable ties can be used in countless applications
- One-piece construction for consistent performance and reliability
- Among the lowest threading force of any one-piece cable tie in the industry
- Curved tip is easy to pick up from flat surfaces and allows faster initial threading to speed installation

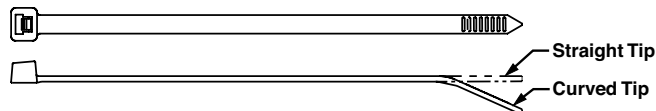
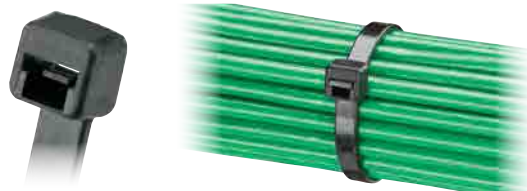

Part Number	Length		Width		Thickness		Max. Bundle Dia.		Min. Loop Tensile Str.		Recommended Installation Tool	Std. Pkg. Qty.	Std. Ctn. Qty.
	In.	mm	In.	mm	In.	mm	In.	mm	Lbs.	N			
Subminiature Cross Section													
PLT.6SM-C0	2.8	71	0.070	1.8	0.030	0.8	0.60	15	8	36	GTS-E, PTS	100	1000
Miniature Cross Section													
PLT.7M-M0	3.1	79	0.090	2.3	0.032	0.8	0.68	17	18	80	GTS-E, GS2B, PTS, PPTS, STS2	1000	50000
PLT1M-C0	3.9	99	0.098	2.5	0.043	1.1	.87	22	18	80		100	1000
PLT1.5M-C0	5.6	142	0.098	2.5	0.043	1.1	1.25	32	18	80		100	1000
PLT2M-C0	8.0	203	0.098	2.5	0.043	1.1	2.00	51	18	80		100	1000
Intermediate Cross Section													
PLT1.5I-C0	5.6	142	0.142	3.6	0.045	1.1	1.38	35	40	178	GTS-E, GS2B, PTS, PPTS, STS2	100	1000
PLT2I-C0	8.0	203	0.142	3.6	0.045	1.1	2.00	51	40	178		100	1000
PLT2.5I-C0	9.7	246	0.145	3.7	0.052	1.3	2.50	64	40	178		100	1000
PLT3I-C0	11.4	290	0.145	3.7	0.052	1.3	3.00	76	40	178		100	1000
PLT4I-C0	14.5	368	0.145	3.7	0.052	1.3	4.00	102	40	178		100	1000
Standard Cross Section													
PLT1S-C0	4.8	122	0.190	4.8	0.052	1.3	1.00	25	50	222	GTS-E, GS2B, GTH-E, GS4H, PTS, PPTS, PTH, STS2, STH2	100	1000
PLT1.5S-C0	6.2	157	0.190	4.8	0.052	1.3	1.50	38	50	222		100	1000
PLT2S-C0	7.4	188	0.190	4.8	0.052	1.3	1.88	48	50	222		100	1000
PLT2.5S-C0	9.8	249	0.190	4.8	0.052	1.3	2.50	64	50	222		100	1000
PLT3S-C0	11.5	292	0.190	4.8	0.052	1.3	3.00	76	50	222		100	1000
PLT4S-C0	14.5	368	0.190	4.8	0.052	1.3	4.00	102	50	222		100	1000
PLT4.5S-C0	15.5	394	0.190	4.8	0.052	1.3	4.50	114	50	222		100	1000
PLT5S-C0	17.5	445	0.190	4.8	0.052	1.3	5.00	127	50	222		100	500
Light-Heavy Cross Section (Straight Tip)													
PLT2H-L0	8.1	206	0.300	7.6	0.075	1.9	2.00	51	120	534	GTH-E, GS4H, GS4EH, PTH, STH2, ST3EH	50	500
PLT2.5H-L0	9.8	251	0.300	7.6	0.075	1.9	2.50	64	120	534		50	500
PLT3H-L0	11.4	290	0.300	7.6	0.075	1.9	3.00	76	120	534		50	500
PLT4H-L0	14.5	368	0.300	7.6	0.075	1.9	4.00	102	120	534		50	500
PLT4H-TL0/147	14.5	368	0.300	7.6	0.075	1.5	4.11	104.5	120	534		250	2500
PLT6LH-L0	21.9	556	0.300	7.6	0.075	1.9	6.00	152	120	534		50	500
PLT7LH-L0	24.7	627	0.300	7.6	0.075	1.9	7.00	178	120	534		50	500
PLT8LH-L0	27.6	701	0.300	7.6	0.075	1.9	8.00	203	120	534		50	500
PLT9LH-L0	30.5	775	0.300	7.6	0.075	1.9	9.00	229	120	534		50	500
Heavy Cross Section (Straight Tip)													
PLT5H-L0	17.7	450	0.350	8.9	0.078	2.0	5.00	127	175	778	GTH-E, GS4H, GS4EH, PTH, STH2, ST3EH	50	500
PLT6H-L0	20.9	530	0.350	8.9	0.078	2.0	6.00	152	175	778		50	500
PLT8H-L0	30.6	779	0.350	8.9	0.078	2.0	9.00	229	175	778		50	500
PLT13H-Q0	43.3	1100	0.350	8.9	0.078	2.0	13.00	330	175	778		25	500

UL Listed or UL Recognized except LH and H cross sections.



Pan-Ty® Lashing Ties – Weather Resistant Nylon 6.6

- Greater resistance to damage caused by ultraviolet light – indoor or outdoor use
- Typically used for heavy duty applications
- Among the strongest Pan-Ty® Cable Tie available
- Can be used with MCEH mounting clip, shown below

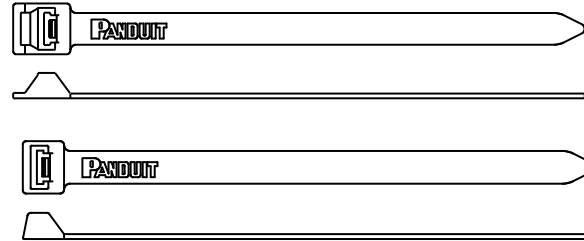

Part Number	Length		Width		Thickness		Max. Bundle Dia.		Min. Loop Tensile Str.		Recommended Installation Tool	Std. Pkg. Qty.	Std. Ctn. Qty.
	In.	mm	In.	mm	In.	mm	In.	mm	Lbs.	N			
Extra-Heavy Cross Section													
PLT2EH-Q0	9.0	229	0.500	12.7	0.075	1.9	2.00	51	250	1112	GS4EH, ST3EH	25	250
PLT5EH-Q0	20.1	511	0.500	12.7	0.075	1.9	5.00	127	250	1112		25	250
PLT6EH-Q0	22.2	564	0.500	12.7	0.075	1.9	6.00	152	250	1112		25	250
PLT8EH-Q0	28.3	719	0.500	12.7	0.085	2.2	8.00	203	250	1112		25	250
PLT10EH-Q0	34.2	869	0.500	12.7	0.085	2.2	10.00	254	250	1112		25	250
PLT12EH-Q0	40.1	1019	0.500	12.7	0.085	2.2	12.00	305	250	1112		25	250
Extra-Heavy Cross Section (No Buckle Design)													
PLT3EH-NB-C0	12.2	310	0.500	12.7	0.075	1.9	3.30	84	250	1112	GS4EH, ST3EH	100	1000
PLT5EH-NB-C0	19.8	503	0.500	12.7	0.075	1.9	5.00	127	250	1112		100	1000
PLT6EH-NB-C0	21.8	554	0.500	12.7	0.075	1.9	6.00	152	250	1112		100	1000

 **Lashing Tie Mounting Clip – Weather Resistant Nylon 6.6**

- Greater resistance to damage caused by ultraviolet light – indoor or outdoor use
- Converts Panduit® lashing ties into clamps
- Easily snaps in place for a secure clamp
- Use with lashing ties shown on pages B1.9, B1.11, B1.20, B1.22 and B1.23

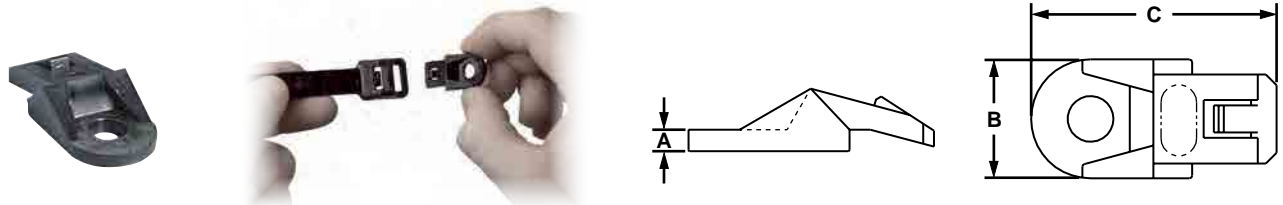

Part Number	Height A		Width B		Length C		Mounting Method	Std. Pkg. Qty.	Std. Ctn. Qty.
	In.	mm	In.	mm	In.	mm			
MCEH-S25-C0	0.13	3.3	0.67	17.0	1.38	35	1/4" (M6) screw (not flathead)	100	1000



Pan-Ty® Cable Ties – Heat Stabilized Nylon 6.6

- For high temperature applications up to 239°F (115°C) – indoor use
- One-piece construction for consistent performance and reliability
- Among the lowest threading force of any one-piece cable tie in the industry
- Curved tip is easy to pick up from flat surfaces and allows faster initial threading to speed installation

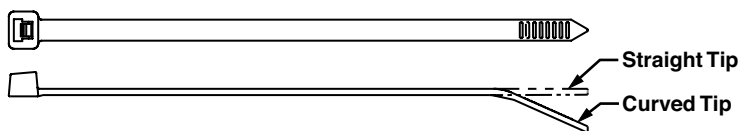

Part Number	Length		Width		Thickness		Max. Bundle Dia.		Min. Loop Tensile Str.		Recommended Installation Tool	Std. Pkg. Qty.	Std. Ctn. Qty.
	In.	mm	In.	mm	In.	mm	In.	mm	Lbs.	N			

Subminiature Cross Section

PLT.6SM-M30	2.8	71	0.070	1.8	0.030	0.8	.60	15	8	36	GTS-E, PTS	1000	50000
-------------	-----	----	-------	-----	-------	-----	-----	----	---	----	------------	------	-------

Miniature Cross Section

PLT.7M-M30	3.1	79	0.090	2.3	0.032	0.8	.68	17	18	80	GTS-E, GS2B, PTS, PPTS, STS2	1000	50000
PLT1M-C30	3.9	99	0.098	2.5	0.043	1.1	.87	22	18	80		100	1000
PLT1.5M-M30	5.6	142	0.098	2.5	0.043	1.1	1.25	32	18	80		1000	50000
PLT2M-M30	8.0	203	0.098	2.5	0.043	1.1	2.00	51	18	80		1000	25000

Intermediate Cross Section

PLT1.5I-C30	5.6	142	0.142	3.6	0.045	1.1	1.38	35	40	178	GTS-E, GS2B, PTS, PPTS, STS2	100	1000
PLT2I-C30	8.0	203	0.142	3.6	0.045	1.1	2.00	51	40	178		100	1000
PLT3I-M30	11.4	290	0.145	3.7	0.052	1.3	3.00	76	40	178		1000	10000
PLT4I-M30	14.5	368	0.145	3.7	0.052	1.3	4.00	102	40	178		1000	10000

Standard Cross Section

PLT1S-M30	4.8	122	0.190	4.8	0.052	1.3	1.00	25	50	222	GTS-E, GS2B, GTH-E, GS4H, PTS, PPTS, PTH, STS2, STH2	1000	10000
PLT1.5S-M30	6.2	157	0.190	4.8	0.052	1.3	1.50	38	50	222		1000	10000
PLT2S-C30	7.4	188	0.190	4.8	0.052	1.3	1.88	48	50	222		100	1000
PLT2S-M39*	7.4	188	0.190	4.8	0.052	1.3	1.88	48	50	222		1000	10000
PLT2.5S-M30	9.8	249	0.190	4.8	0.052	1.3	2.50	64	50	222		1000	10000
PLT3S-C30	11.5	292	0.190	4.8	0.052	1.3	3.00	76	50	222		100	1000
PLT4S-C30	14.5	368	0.190	4.8	0.052	1.3	4.00	102	50	222		100	1000
PLT5S-M30	17.5	445	0.190	4.8	0.052	1.3	5.00	127	50	222		1000	5000

Light-Heavy Cross Section (Straight Tip)

PLT2H-TL30	8.1	206	0.300	7.6	0.075	1.9	2.00	51	120	534	GTH-E, GS4H, GS4EH, PTH, STH2, ST3EH	250	2500
PLT3H-TL30	11.4	290	0.300	7.6	0.075	1.9	3.00	76	120	534		250	2500
PLT4H-TL30	14.5	368	0.300	7.6	0.075	1.9	4.00	102	120	534		250	2500
NEW! PLT4H-TL30/147	14.5	368	0.300	7.6	0.060	1.5	4.11	104.5	120	534		250	2500
PLT7LH-C30	24.7	627	0.300	7.6	0.075	1.9	7.00	178	120	534		100	2000
PLT9LH-C30	30.5	775	0.300	7.6	0.075	1.9	9.00	229	120	534		100	1000

Heavy Cross Section (Straight Tip)

PLT5H-C30	17.7	450	0.350	8.9	0.078	2.0	5.00	127	175	778	GTH-E, GS4H, GS4EH, PTH, STH2, ST3EH	100	2000
PLT6H-C30	20.9	530	0.350	8.9	0.078	2.0	6.00	152	175	778		100	2000
PLT8H-C30	30.6	779	0.350	8.9	0.078	2.0	9.00	229	175	778		100	1500

*Natural heat stabilized material (39).



Pan-Ty® Cable Ties – Heat Stabilized Weather Resistant Nylon 6.6

- Greater resistance to damage caused by ultraviolet light and for high temperature applications up to 239°F (115°C) – indoor or outdoor use
- One-piece construction for consistent performance and reliability
- Among the lowest threading force of any one-piece cable tie in the industry
- Curved tip is easy to pick up from flat surfaces and allows faster initial threading to speed installation

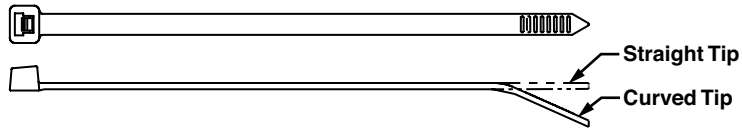

Part Number	Length		Width		Thickness		Max. Bundle Dia.		Min. Loop Tensile Str.		Recommended Installation Tool	Std. Pkg. Qty.	Std. Ctn. Qty.
	In.	mm	In.	mm	In.	mm	In.	mm	Lbs.	N			
Miniature Cross Section													
PLT1M-M300	3.9	99	0.098	2.5	0.035	0.9	0.87	22	18	80	GTS-E, GS2B, PTS, STS2	1000	50000
Intermediate Cross Section													
PLT1.5I-M300	5.6	142	0.142	3.6	0.045	1.1	1.38	35	40	178	GTS-E, GS2B, PTS, PPTS, STS2	1000	25000
PLT2I-M300	8.0	203	0.142	3.6	0.045	1.1	2.00	51	40	178		1000	25000
Standard Cross Section													
PLT1S-M300	4.8	122	0.190	4.8	0.052	1.3	1.00	25	50	222	GTS-E, GS2B, GTH-E, GS4H, PTS, PTH, PPTS, STS2, STH2	1000	10000
PLT2S-M300	7.4	188	0.190	4.8	0.052	1.3	1.88	48	50	222		1000	10000
PLT4S-M300	14.5	368	0.190	4.8	0.052	1.3	4.00	102	50	222		1000	5000
Light-Heavy Cross Section (Straight Tip)													
PLT2H-TL300	8.4	213	0.300	7.6	0.075	1.9	2.00	51	120	534	GTH-E, GS4H, GS4EH, PTH, STH2, ST3EH	250	2500
PLT4H-TL300	14.5	368	0.300	7.6	0.075	1.9	4.00	102	120	534		250	2500



Pan-Ty® Cable Ties – Flame Retardant Nylon 6.6

- Flammability rating of UL 94V-0 – indoor use
- One-piece construction for consistent performance and reliability
- Among the lowest threading force of any one-piece cable tie in the industry
- Curved tip is easy to pick up from flat surfaces and allows faster initial threading to speed installation

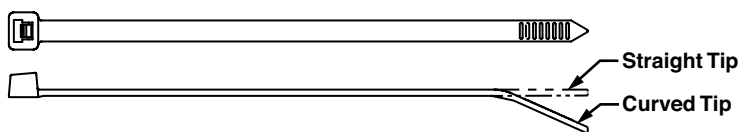

Part Number	Length		Width		Thickness		Max. Bundle Dia.		Min. Loop Tensile Str.		Recommended Installation Tool	Std. Pkg. Qty.	Std. Ctn. Qty.
	In.	mm	In.	mm	In.	mm	In.	mm	Lbs.	N			

Miniature Cross Section

PLT1M-M60*	4.0	102	0.098	2.5	0.043	1.1	0.87	22	18	80	GTS-E, GS2B, PTS, PPTS, STS2	1000	25000
PLT1M-M69	4.0	102	0.098	2.5	0.043	1.1	0.87	22	18	80		1000	25000
PLT2M-M69	8.0	203	0.098	2.5	0.043	1.1	2.00	51	18	80		1000	25000

Intermediate Cross Section

PLT1.5I-M69	5.6	142	0.142	3.6	0.044	1.1	1.38	35	40	178	GTS-E, GS2B, PTS, PPTS, STS2	1000	25000
PLT2I-M69	8.0	203	0.142	3.6	0.044	1.1	2.00	51	40	178		1000	25000

Standard Cross Section

PLT2S-M60*	7.4	188	0.190	4.8	0.052	1.3	1.88	48	50	222	GTS-E, GS2B, GTH-E, GS4H, PTS, PTH, PPTS, STS2, STH2	1000	10000
PLT2S-M69	7.4	188	0.190	4.8	0.052	1.3	1.88	48	50	222		1000	10000
PLT4S-M69	14.5	368	0.190	4.8	0.052	1.3	4.00	102	50	222		1000	5000

Light-Heavy Cross Section (Straight Tip)

PLT4H-TL69	14.6	371	0.300	7.6	0.075	1.9	4.00	102	120	534	GTH-E, GS4H, GS4EH, PTH, STH2, ST3EH	250	2500
------------	------	-----	-------	-----	-------	-----	------	-----	-----	-----	--------------------------------------	-----	------

*Black flame retardant material (60).



Cable Tie Mounts – Flame Retardant Nylon 6.6

- Flammability rating of UL 94V-0 – indoor use
- Unique cradle design provides maximum stability for the cable bundle
- Low profile design keeps bundle close to mounting surface

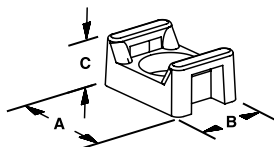

Part Number	Used with Cable Ties*	Length A		Width B		Height C		Counterbore Diameter		Mounting Method	Std. Pkg. Qty.	Std. Ctn. Qty.
		In.	mm	In.	mm	In.	mm	Lbs.	N			
TM1S4-M69	M	0.51	13.0	0.32	8.0	0.23	5.8	0.23	5.7	#4 (M2.5) Screw	1000	5000
TM1S6-M69		0.51	13.0	0.32	8.0	0.23	5.8	0.28	7.0	#6 (M3) Screw	1000	5000
TM2S6-M69	M, I, S	0.63	16.0	0.43	10.8	0.28	7.0	0.29	7.1	#6 (M3) Screw	1000	5000
TM2S8-M69		0.63	16.0	0.43	10.8	0.28	7.0	0.33	8.4	#8 (M4) Screw	1000	5000
TM3S8-C69	M, I, S, LH	0.86	21.9	0.61	15.5	0.37	9.4	0.32	8.1	#8 (M4) Screw	100	500
TM3S10-M69		0.86	21.9	0.61	15.8	0.37	9.4	0.38	9.7	#10 (M5) Screw	1000	5000

*Cable tie cross section sizes: M = Miniature, I = Intermediate, S = Standard and LH = Light-Heavy.

Pan-Ty® Cable Ties – Weather Resistant Nylon 12



- For high moisture, corrosive (zinc chloride and dilute acids), and low temperature indoor or outdoor applications
- Cable tie of choice for making attachments to galvanized surfaces
- One-piece construction for consistent performance and reliability
- Among the lowest threading force of any one-piece cable tie in the industry
- Curved tip is easy to pick up from flat surfaces and allows faster initial threading to speed installation

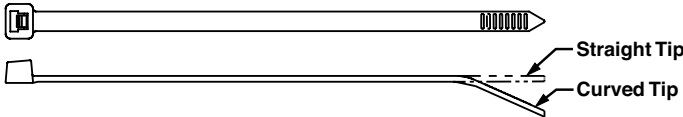

Part Number	Length		Width		Thickness		Max. Bundle Dia.		Min. Loop Tensile Str.		Recommended Installation Tool	Std. Pkg. Qty.	Std. Ctn. Qty.
	In.	mm	In.	mm	In.	mm	In.	mm	Lbs.	N			
Intermediate Cross Section													
PLT1.5I-M120	5.6	142	0.142	3.6	0.045	1.1	1.38	35	25	111	GTS-E, GS2B, PTS, PPTS, STS2	1000	25000
Standard Cross Section													
PLT2S-M120	7.4	188	0.190	4.8	0.052	1.3	1.88	48	40	178	GTS-E, GS2B, GTH-E, GS4H, PTS, PTH, PPTS, STS2, STH2	1000	10000
PLT4S-M120	14.5	368	0.190	4.8	0.052	1.3	4.00	102	40	178		1000	5000
Light-Heavy Cross Section (Straight Tip)													
PLT4H-TL120	14.5	368	0.300	7.6	0.075	1.9	4.00	102	90	400	GTH-E, GTSL, GS4H, GS4EH, PTH, STH2, ST3EH	250	2500
PLT8LH-C120	27.6	701	0.300	7.6	0.075	1.9	8.00	203	90	400		100	2500

Pan-Ty® Cable Ties – Polypropylene – Distinctive Green Color



- For chemical resistance where high loop tensile strength is not required especially in the presence of hydrochloric acid, salts, and bases
- For indoor use
- One-piece construction for consistent performance and reliability
- Among the lowest threading force of any one-piece cable tie in the industry
- Curved tip is easy to pick up from flat surfaces and allows faster initial threading to speed installation

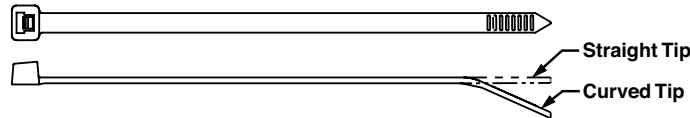

Part Number	Length		Width		Thickness		Max. Bundle Dia.		Min. Loop Tensile Str.		Recommended Installation Tool	Std. Pkg. Qty.	Std. Ctn. Qty.
	In.	mm	In.	mm	In.	mm	In.	mm	Lbs.	N			
Miniature Cross Section													
PLT1M-M109	3.9	99	0.098	2.5	0.043	1.1	0.87	22	11	49	GTS-E, GS2B, PTS, PPTS, STS2	1000	50000
Intermediate Cross Section													
PLT1.5I-M109	5.6	142	0.142	3.6	0.045	1.1	1.38	35	18	80	GTS-E, GS2B, PTS, PPTS, STS2	1000	25000
Standard Cross Section													
PLT2S-M109	7.4	188	0.190	4.8	0.052	1.3	1.88	48	30	133	GTS-E, GS2B, GTH-E, GS4H, PTS, PTH, PPTS, STS2, STH2	1000	10000
PLT3S-M109	11.5	292	0.190	4.8	0.052	1.3	3.00	76	30	133		1000	10000
PLT4S-M109	14.5	368	0.190	4.8	0.052	1.3	4.00	102	30	133		1000	5000
Light-Heavy Cross Section (Straight Tip)													
PLT2H-TL109	8.1	206	0.300	7.6	0.075	1.9	2.00	51	50	222	GTH-E, GS4H, GS4EH, PTH, STH2, ST3EH	250	2500
PLT3H-TL109	11.4	290	0.300	7.6	0.075	1.9	3.00	76	50	222		250	2500
PLT4H-TL109	14.5	368	0.300	7.6	0.075	1.9	4.00	102	50	222		250	2500

Pan-Ty® Cable Ties – Weather Resistant Polypropylene



- For chemical resistance where high loop tensile strength is not required especially in the presence of hydrochloric acid, salts, and bases
- Greater resistance to damage caused by ultraviolet light – indoor or outdoor use
- One-piece construction for consistent performance and reliability
- Among the lowest threading force of any one-piece cable tie in the industry
- Curved tip is easy to pick up from flat surfaces and allows faster initial threading to speed installation

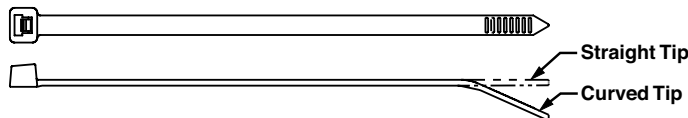

Part Number	Length		Width		Thickness		Max. Bundle Dia.		Min. Loop Tensile Str.		Recommended Installation Tool	Std. Pkg. Qty.	Std. Ctn. Qty.
	In.	mm	In.	mm	In.	mm	In.	mm	Lbs.	N			

Miniature Cross Section

PLT1M-M100	3.9	99	0.098	2.5	0.043	1.1	0.87	22	11	49	GTS-E, GS2B, PTS, PPTS, STS2	1000	50000
------------	-----	----	-------	-----	-------	-----	------	----	----	----	------------------------------	------	-------

Intermediate Cross Section

PLT1.5I-M100	5.6	142	0.142	3.6	0.045	1.1	1.38	35	18	80	GTS-E, GS2B, PTS, PPTS, STS2	1000	25000
--------------	-----	-----	-------	-----	-------	-----	------	----	----	----	------------------------------	------	-------

Standard Cross Section

PLT2S-M100	7.4	188	0.190	4.8	0.052	1.3	1.88	48	30	133	GTS-E, GS2B, GTH-E, GS4H, PTS, PTH, PPTS, STS2, STH2	1000	10000
PLT3S-M100	11.5	292	0.190	4.8	0.052	1.3	3.00	76	30	133		1000	10000
PLT4S-M100	14.5	368	0.190	4.8	0.052	1.3	4.00	102	30	133		1000	5000

Light-Heavy Cross Section (Straight Tip)

PLT2H-TL100	8.1	206	0.300	7.6	0.075	1.9	2.00	51	50	222	GTH-E, GS4H, GS4EH, PTH, STH2, ST3EH	250	2500
PLT3H-TL100	11.4	290	0.300	7.6	0.075	1.9	3.00	76	50	222		250	2500
PLT4H-TL100	14.5	368	0.300	7.6	0.075	1.9	4.00	102	50	222		250	2500



Pan-Ty® Cable Ties – HALAR[▲] – Distinctive Maroon Color

- UL Listed for use in plenum or air handling spaces per NEC, Section 300-22 (C) and (D)
- Low smoke density and excellent flammability rating of UL 94V-0
- Commonly accepted solution for bundling qualified cable without conduit in air handling space applications
- Greater resistance to damage caused by ultraviolet light – indoor or outdoor use
- One-piece construction for consistent performance and reliability
- Among the lowest threading force of any one-piece cable tie in the industry
- Curved tip is easy to pick up from flat surfaces and allows faster initial threading to speed installation
- Provides primary support for a flexible conduit, flexible tubing, or cable in accordance with the relevant national installation code

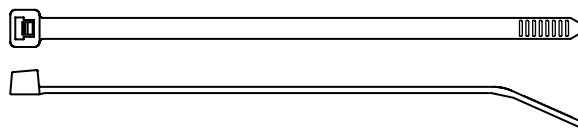

Part Number	Length		Width		Thickness		Max. Bundle Dia.		Min. Loop Tensile Str.		Recommended Installation Tool	Std. Pkg. Qty.	Std. Ctn. Qty.
	In.	mm	In.	mm	In.	mm	In.	mm	Lbs.	N			

Miniature Cross Section — Plenum-Rated

PLT1M-C702Y	4.0	102	0.098	2.5	0.043	1.1	0.87	22	18	80	GTS-E, GS2B, PTS, PPTS, STS2	100	1000
-------------	-----	-----	-------	-----	-------	-----	------	----	----	----	------------------------------	-----	------

Standard Cross Section — Plenum-Rated

PLT2S-C702Y	7.4	188	0.190	4.8	0.055	1.4	1.88	48	50	222	GTS-E, GS2B, GTH-E, GS4H, PTS, PTH, PPTS, STS2, STH2	100	1000
PLT3S-C702Y	11.6	295	0.190	4.8	0.055	1.4	3.00	76	50	222		100	1000

▲HALAR is a registered trademark of Solvay Solexis



Pan-Ty® Cable Ties – TEFZEL® – Distinctive Aqua Blue Color

- Ideal for applications requiring resistance to environmental stresses such as chemical attack, gamma radiation, ultraviolet radiation and extreme high and low temperatures
- Ideal for use in nuclear power facilities and chemical processing plants and meets the requirements of IEEE 383
- Low smoke density and excellent flammability rating of UL 94V-0
- One-piece construction for consistent performance and reliability
- Among the lowest threading force of any one-piece cable tie in the industry
- Curved tip is easy to pick up from flat surfaces and allows faster initial threading to speed installation
- For indoor or outdoor use

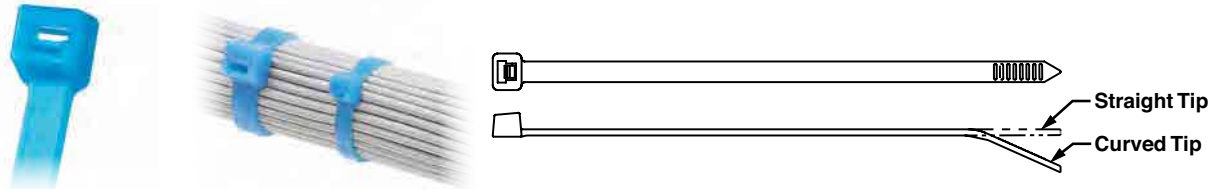

Part Number	Length		Width		Thickness		Max. Bundle Dia.		Min. Loop Tensile Str.		Recommended Installation Tool	Std. Pkg. Qty.	Std. Ctn. Qty.
	In.	mm	In.	mm	In.	mm	In.	mm	Lbs.	N			
Miniature Cross Section													
PLT1M-C76	4.0	102	0.098	2.5	0.043	1.1	.87	22	18	80	GTS-E, GS2B, PTS, PPTS, STS2	100	1000
Intermediate Cross Section													
PLT2I-C76	8.0	203	0.135	3.4	0.045	1.1	2.00	51	30	133	GTS-E, GS2B, PTS, PPTS, STS2	100	1000
Standard Cross Section													
PLT2S-C76	7.4	188	0.190	4.8	0.055	1.4	1.88	48	50	222	GTS-E, GS2B, GTH-E, GS4H, PTS, PTH, PPTS, STS2, STH2	100	1000
PLT3S-C76	11.6	295	0.190	4.8	0.059	1.5	3.00	76	50	222		100	1000
PLT4S-C76	14.6	371	0.190	4.8	0.059	1.5	4.00	102	50	222		100	1000
Light-Heavy Cross Section (Straight Tip)													
PLT3H-L76	11.5	292	0.300	7.6	0.075	1.9	3.00	78	120	534	GTH-E, GS4H, GS4EH, PTH, STH2, ST3EH	50	500
PLT4H-L76	14.6	371	0.300	7.6	0.075	1.9	4.00	102	120	534		50	500

■ TEFZEL is a registered trademark of E. I. du Pont de Nemours and Company.



Cable Tie Mounts – TEFZEL®

- Flammability rating of UL 94V-0 – indoor use
- Unique cradle design provides maximum stability for the cable bundle
- Low profile design keeps bundle close to mounting surface

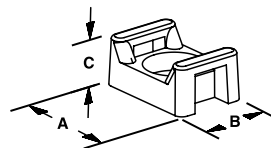

Part Number	Used with Cable Ties*	Length A		Width B		Height C		Counterbore Diameter		Mounting Method	Std. Pkg. Qty.	Std. Ctn. Qty.
		In.	mm	In.	mm	In.	mm	In.	mm			
TM2S8-C76	M, I, S	0.63	16.0	0.43	10.8	0.28	7.0	0.30	7.6	#8 (M4) screw	100	500
TM3S8-C76	S, LH	0.86	21.7	0.62	15.5	0.38	9.5	0.37	9.4	#8 (M4) screw	100	500
TM3S10-C76		0.86	21.7	0.62	15.8	0.38	9.5	0.37	9.4	#10 (M5) screw	100	500

*Cable tie cross section sizes: M = Miniature, I = Intermediate, S = Standard, LH = Light-Heavy.

■ TEFZEL is a registered trademark of E. I. du Pont de Nemours and Company.

Pan-Ty® Cable Ties – PEEK (Polyetheretherketone)

- Ideal for harsh environments where a cable tie material is required to hold up to chemical or radiation exposure
- Non-conductive material that is excellent for high temperature applications up to 500°F (260°C)
- High strength properties over a wide range of temperatures
- Flammability rating of UL 94V-0 with low smoke and toxicity; halogen-free
- PEEK material meets MIL specification MIL-P-46183, and is approved for use by the Department of Defense
- One-piece construction for consistent performance and reliability
- Among the lowest threading force of any one-piece cable tie in the industry

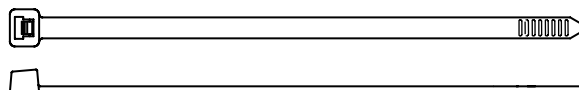
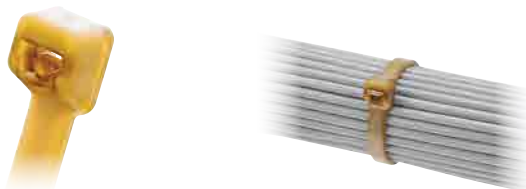

Part Number	Length		Width		Thickness		Max. Bundle Dia.		Min. Loop Tensile Str.		Recommended Installation Tool	Std. Pkg. Qty.	Std. Ctn. Qty.
	In.	mm	In.	mm	In.	mm	In.	mm	Lbs.	N			
Miniature Cross Section													
PLT1M-C71	4.0	102	0.098	2.5	0.048	1.2	0.87	22	35	156	GTS-E, PTS	100	1000
PLT1.5M-C71	5.9	150	0.098	2.5	0.048	1.2	1.38	35	35	156		100	1000
Standard Cross Section													
PLT2S-C71	7.4	188	0.190	4.8	0.055	1.4	1.88	48	050	668	GTS-E, GS2B, GTH-E, GS4H, PTS, PTH, PPTS, STS2, STH2	100	1000

▲HALAR is a registered trademark of Solvay Solexis

Cable Tie Mounts – (Polyetheretherketone)

- Unique cradle design provides maximum stability for cable bundle
- Low profile design keeps bundle close to mounting surface where overhead space is limited

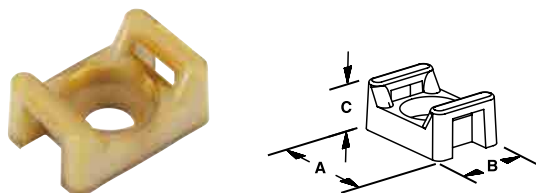

Part Number	Used with Cable Ties*	A Length In. mm	B Width In. mm	C Height In. mm	Counterbore Diameter In. (mm)	Mounting Method	Std. Pkg. Qty.	Std. Ctn. Qty.
TM2S8-C71	Min., Std.	0.636 (16.2)	0.427 (10.8)	0.278 (7.1)	0.335 (8.5)	#8 (M4) screw	100	500

Pan-Ty® Cable Ties – Metal Detectable Nylon 6.6 and Polypropylene

- Metal impregnated material allows identification by metal detectors or x-ray inspection equipment to help meet food, beverage, and pharmaceutical safety standards, to help reduce product contamination, loss, and recall
- Nylon material for general purpose maintenance and repair applications; ideal for use in control panels and overhead cable runs

- Polypropylene material provides excellent chemical resistance for use in processing and packaging areas where aggressive acid and alkaline chemicals are used to clean the equipment
- One-piece construction for consistent performance and reliability
- Among the lowest threading force of any one-piece cable tie in the industry
- Curved tip is easy to pick up from flat surfaces and allows faster initial threading to speed installation

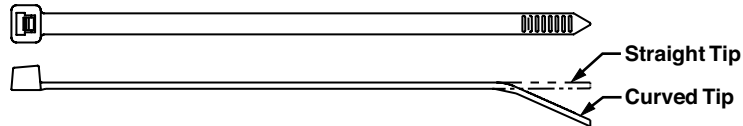

Part Number	Length		Width		Thickness		Max. Bundle Dia.		Min. Loop Tensile Str.		Recommended Installation Tool	Material	Std. Pkg. Qty.	Std. Ctn. Qty.
	In.	mm	In.	mm	In.	mm	In.	mm	Lbs.	N				

Nylon 6.6

Miniature Cross Section

PLT1M-C86	3.9	100	0.098	2.5	0.044	1.1	.87	22	18	80	GTS-E, GS2B, STS2	Nylon 6.6	100	1000
-----------	-----	-----	-------	-----	-------	-----	-----	----	----	----	-------------------	-----------	-----	------

Intermediate Cross Section

PLT2I-C86	8.0	203	0.135	3.4	0.047	1.2	2.00	51	40	178	GTS-E, GS2B, STS2	Nylon 6.6	100	1000
-----------	-----	-----	-------	-----	-------	-----	------	----	----	-----	-------------------	-----------	-----	------

Standard Cross Section

PLT2S-C86	7.3	186	0.190	4.8	0.057	1.4	1.85	47	50	222	GTS-E, GS2B, GTH-E, GS4H, STS2, STH2	Nylon 6.6	100	1000
PLT3S-C86	11.5	291	0.190	4.8	0.057	1.4	3.00	76	50	222		Nylon 6.6	100	1000
PLT4S-C86	14.4	366	0.190	4.8	0.057	1.4	4.00	102	50	222		Nylon 6.6	100	1000

Light-Heavy Cross Section (Straight Tip)

PLT3H-L86	11.1	282	0.300	7.6	0.075	1.9	3.00	76	120	534	GTH-E, GS4H, GS4EH, STH2, ST3EH	Nylon 6.6	50	500
PLT4H-L86	14.4	366	0.300	7.6	0.075	1.9	4.00	102	120	534		Nylon 6.6	50	500

Polypropylene

Miniature Cross Section

PLT1M-C186	3.9	100	0.098	2.5	0.044	1.1	0.87	22	15	67	GTS-E, GS2B, STS2	Polypropylene	100	1000
------------	-----	-----	-------	-----	-------	-----	------	----	----	----	-------------------	---------------	-----	------

Intermediate Cross Section

PLT2I-C186	8.0	203	0.135	3.4	0.047	1.2	2.00	51	24	107	GTS-E, GS2B, STS2	Polypropylene	100	1000
------------	-----	-----	-------	-----	-------	-----	------	----	----	-----	-------------------	---------------	-----	------

Standard Cross Section

PLT2S-C186	7.3	186	0.190	4.8	0.057	1.4	1.85	47	30	133	GTS-E, GS2B, GTH-E, GS4H, STS2, STH2	Polypropylene	100	1000
PLT3S-C186	11.5	291	0.190	4.8	0.057	1.4	3.00	76	30	133		Polypropylene	100	1000
PLT4S-C186	14.4	366	0.190	4.8	0.057	1.4	4.00	102	30	133		Polypropylene	100	1000

Light-Heavy Cross Section (Straight Tip)

PLT3H-L186	11.1	282	0.300	7.6	0.075	1.9	3.00	76	60	267	GTH-E, GS4H, GS4EH, STH2, ST3EH	Polypropylene	50	500
PLT4H-L186	14.4	366	0.300	7.6	0.075	1.9	4.00	102	60	267		Polypropylene	50	500

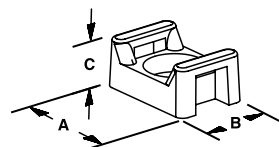

Part Number	Material	Used with Cable Ties*	A Lgth. In. mm	B Width In. mm	C Ht. In. mm	Counterbore Diameter In. (mm)	Mounting Method	Std. Pkg. Qty.	Std. Ctn. Qty.
-------------	----------	-----------------------	----------------	----------------	--------------	-------------------------------	-----------------	----------------	----------------

Cable Tie Mounts

TM2S8-C86	Nylon 6.6	Min., Int., Std.	0.630 (16.0)	0.422 (10.7)	0.275 (7.0)	0.325 (8.3)	#8 (M4) screw	100	500
		Std., Lt. Hvy.	0.867 (22.0)	0.614 (15.6)	0.373 (9.5)	0.325 (8.3)	#8 (M4) screw	100	500
		#10 (M5) screw	100	500					
TM2S8-C186	Polypropylene	Min., Int., Std.	0.630 (16.0)	0.422 (10.7)	0.275 (7.0)	0.325 (8.3)	#8 (M4) screw	100	500
		Std., Lt. Hvy.	0.867 (22.0)	0.614 (15.6)	0.373 (9.5)	0.325 (8.3)	#8 (M4) screw	100	500
		#10 (M5) screw	100	500					

Pan-Ty® Releasable Cable Ties – Nylon 6.6

- For indoor use
- Extended release tab permits easy release and re-use where changes are anticipated during development, production, or servicing in the field
- One-piece construction for consistent performance and reliability
- Curved tip is easy to pick up from flat surfaces and allows faster initial threading to speed installation
- UL Listed for use in plenum or air handling spaces per NEC except PRT2H/3H/4H

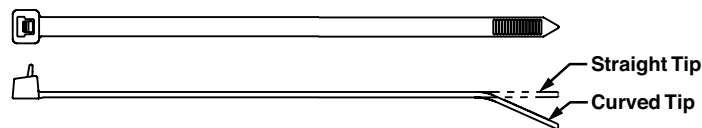
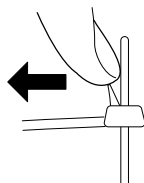

To release, grasp the head of the cable tie, deflect release tab, and pull the cable tie away from the bundle.



Part Number	Length		Width		Thickness		Max. Bundle Dia.		Min. Loop Tensile Str.		Recommended Installation Tool	Std. Pkg. Qty.	Std. Ctn. Qty.
	In.	mm	In.	mm	In.	mm	In.	mm	Lbs.	N			

Standard Cross Section — Plenum-Rated UL Type 2S Rated

PRT1S-C	4.8	122	0.190	4.8	0.052	1.3	1.00	25	50	222	Hand install only	100	1000
PRT1.5S-C	6.3	160	0.190	4.8	0.052	1.3	1.50	38	50	222		100	1000
PRT2S-C	7.4	188	0.190	4.8	0.052	1.3	1.88	48	50	222		100	1000
PRT3S-C	11.5	292	0.190	4.8	0.052	1.3	3.00	76	50	222		100	1000
PRT4S-C	14.5	368	0.190	4.8	0.052	1.3	4.00	102	50	222		100	1000

Light-Heavy Cross Section (Straight Tip)

PRT2H-L	8.4	213	0.300	7.6	0.075	1.9	2.00	51	80	356	Hand install only	50	500
PRT3H-L	11.4	290	0.300	7.6	0.075	1.9	3.00	76	80	356		50	500
PRT4H-L	14.5	368	0.300	7.6	0.075	1.9	4.00	102	80	356		50	500

Pan-Ty® Releasable Lashing Ties – Nylon 6.6

- For indoor use
- Release tab permits easy release and re-use where changes are anticipated during development, production, or servicing in the field
- Typically used for heavy duty applications
- Among the strongest Pan-Ty® Cable Tie available
- Can be used with MCEH mounting clip, see page B1.22

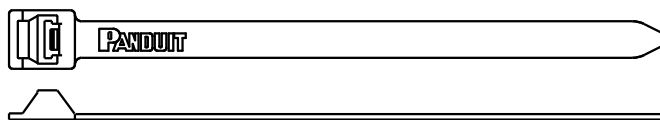

Part Number	Length		Width		Thickness		Max. Bundle Dia.		Min. Loop Tensile Str.		Recommended Installation Tool	Std. Pkg. Qty.	Std. Ctn. Qty.
	In.	mm	In.	mm	In.	mm	In.	mm	Lbs.	N			

Extra-Heavy Cross Section

PRT2EH-C	9.0	229	0.500	12.7	0.075	1.9	2.00	51	250	1112	Hand install only	100	1000
PRT5EH-Q	20.1	511	0.500	12.7	0.075	1.9	5.00	127	250	1112		25	250
PRT6EH-Q	22.2	564	0.500	12.7	0.075	1.9	6.00	152	250	1112		25	250
PRT8EH-C	28.3	719	0.500	12.7	0.085	2.2	8.00	203	250	1112		100	1000
PRT10EH-C	34.2	869	0.500	12.7	0.085	2.2	10.00	254	250	1112		100	500
PRT12EH-C	40.1	1019	0.500	12.7	0.085	2.2	12.00	305	250	1112		50	500



Pan-Ty® Releasable Cable Ties – Weather Resistant and Heat Stabilized Nylon 6.6

- Weather resistant material has greater resistance to damage caused by ultraviolet light – indoor or outdoor use
- Heat stabilized material for high temperature applications up to 239°F (115°C) – indoor use
- Extended release tab permits easy release and re-use where changes are anticipated during development, production, or servicing in the field
- One-piece construction for consistent performance and reliability
- Curved tip is easy to pick up from flat surfaces and allows faster initial threading to speed installation

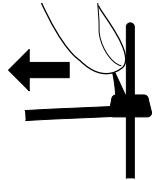

To release, grasp the head of the cable tie, deflect release tab, and pull the cable tie away from the bundle.

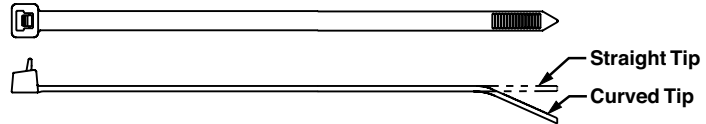

Part Number	Length		Width		Thickness		Max. Bundle Dia.		Min. Loop Tensile Str.		Recommended Installation Tool	Std. Pkg. Qty.	Std. Ctn. Qty.
	In.	mm	In.	mm	In.	mm	In.	mm	Lbs.	N			

Weather Resistant Nylon 6.6 Standard Cross Section

PRT1S-C0	4.8	122	0.190	4.8	0.052	1.3	1.00	25	50	222	Hand install only	100	1000
PRT1.5S-C0	6.3	160	0.190	4.8	0.052	1.3	1.50	38	50	222		100	1000
PRT2S-C0	7.4	188	0.190	4.8	0.052	1.3	1.88	48	50	222		100	1000
PRT3S-C0	11.5	292	0.190	4.8	0.052	1.3	3.00	76	50	222		100	1000
PRT4S-C0	14.5	368	0.190	4.8	0.052	1.3	4.00	102	50	222		100	1000

Light-Heavy Cross Section (Straight Tip)

PRT2H-L0	8.4	213	0.300	7.6	0.075	1.9	2.00	51	80	356	Hand install only	50	500
PRT3H-L0	11.4	290	0.300	7.6	0.075	1.9	3.00	76	80	356		50	500
PRT4H-L0	14.5	368	0.300	7.6	0.075	1.9	4.00	102	80	356		50	500

Heat Stabilized Nylon 6.6

Standard Cross Section

PRT1.5S-M30	6.3	160	0.190	4.8	0.052	1.3	1.50	38	50	222	Hand install only	1000	1000
-------------	-----	-----	-------	-----	-------	-----	------	----	----	-----	-------------------	------	------

Note: UL Listed, UL Recognized, and CSA Certified, except PRT2H/3H/4H.

Pan-Ty® Releasable Lashing Ties – Weather Resistant and Heat Stabilized Nylon 6.6

- Weather resistant material has greater resistance to damage caused by ultraviolet light – indoor or outdoor use
- Heat stabilized material for high temperature applications up to 239°F (115°C) – indoor use
- Release tab permits easy release and re-use where changes are anticipated during development, production, or servicing in the field
- Typically used for heavy duty applications
- Among the strongest Pan-Ty® Cable Tie available
- Can be used with MCEH mounting clip shown below

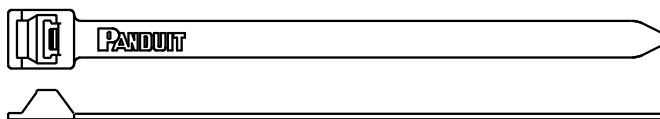

Part Number	Length		Width		Thickness		Max. Bundle Dia.		Min. Loop Tensile Str.		Recommended Installation Tool	Std. Pkg. Qty.	Std. Ctn. Qty.
	In.	mm	In.	mm	In.	mm	In.	mm	Lbs.	N			

Weather Resistant Nylon 6.6

Extra-Heavy Cross Section

PRT2EH-Q0	9.0	229	0.500	12.7	0.075	1.9	2.00	51	250	1112	Hand install only	25	250
PRT5EH-Q0	20.1	511	0.500	12.7	0.075	1.9	5.00	127	250	1112		25	250
PRT6EH-Q0	22.2	564	0.500	12.7	0.075	1.9	6.00	152	250	1112		25	250
PRT8EH-Q0	28.3	719	0.500	12.7	0.085	2.2	8.00	203	250	1112		25	250
PRT10EH-Q0	34.2	869	0.500	12.7	0.085	2.2	10.00	254	250	1112		25	250
PRT12EH-Q0	40.1	1019	0.500	12.7	0.085	2.2	12.00	305	250	1112		25	250

Heat Stabilized Nylon 6.6

Extra-Heavy Cross Section

PRT5EH-C30	20.1	511	0.500	12.7	0.075	1.9	5.00	127	250	1112	Hand install only	100	1000
------------	------	-----	-------	------	-------	-----	------	-----	-----	------	-------------------	-----	------



Lashing Tie Mounting Clip – Weather Resistant Nylon 6.6

- Greater resistance to damage caused by ultraviolet light – indoor or outdoor use
- Converts Panduit® lashing ties into clamps
- Easily snaps in place for a secure clamp
- Use with lashing ties shown on pages B1.9, B1.11, B1.20, B1.22 and B1.23



Part Number	Height A		Width B		Length C		Mounting Method	Std. Pkg. Qty.	Std. Ctn. Qty.
	In.	mm	In.	mm	In.	mm			
MCEH-S25-C0	.13	3.3	.67	17.0	1.38	35	1/4" (M6) screw (not flathead)	100	1000

Pan-Ty® Releasable Lashing Ties – Weather Resistant Polypropylene

- For chemical resistance where high loop tensile strength is not required especially in the presence of hydrochloric acid, salts, and bases
- Greater resistance to damage caused by ultraviolet light – indoor or outdoor use
- Release tab permits easy release and re-use where changes are anticipated during development, production, or servicing in the field
- Typically used for heavy duty applications
- Can be used with MCEH mounting clip, see page B1.22

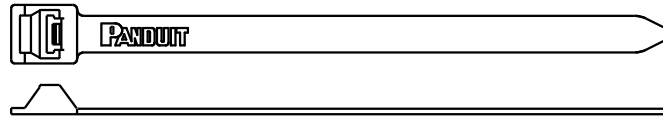

Part Number	Length		Width		Thickness		Max. Bundle Dia.		Min. Loop Tensile Str.		Recommended Installation Tool	Std. Pkg. Qty.	Std. Ctn. Qty.
	In.	mm	In.	mm	In.	mm	In.	mm	Lbs.	N			
Extra-Heavy Cross Section													
PRT2EH-C100	9.0	229	0.500	12.7	0.075	1.9	2.00	51	90	400	Hand install only	100	1000
PRT5EH-C100	20.1	511	0.500	12.7	0.075	1.9	5.00	127	90	400		100	1000
PRT6EH-C100	22.2	564	0.500	12.7	0.075	1.9	6.00	152	90	400		100	1000
PRT8EH-C100	28.3	719	0.500	12.7	0.085	2.2	8.00	203	90	400		100	1000

Pan-Ty® Clamp Ties – Nylon 6.6

- For indoor use
- Used to secure a cable bundle to another surface such as a control panel, communication rack, wall or ceiling
- Design allows for bundling before or after screwing clamp in place
- One-piece construction for consistent performance and reliability
- Curved tip is easy to pick up from flat surfaces and allows faster initial threading to speed installation
- UL Listed for use in plenum or air handling spaces per NEC

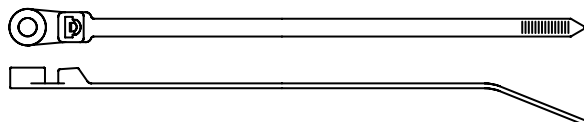

Part Number	Length		Width		Thickness		Nominal Hole Dia.		Screw Size	Metric Screw Size	Max. Bundle Dia.		Min. Loop Tensile Str.		Recommended Installation Tool	Std. Pkg. Qty.	Std. Ctn. Qty.
	In.	mm	In.	mm	In.	mm	In.	mm			In.	mm	Lbs.	N			
Miniature Cross Section — Plenum-Rated																	
PLC1M-S4-C	4.3	109	0.100	2.5	0.045	1.1	0.122	3.1	#4	M2.5	.75	19	18	80	GTS-E, GS2B, PTS, PPTS, STS2	100	1000
Intermediate Cross Section — Plenum-Rated																	
PLC1.5I-S8-C	6.1	155	0.135	3.4	0.045	1.1	0.174	4.4	#8	M4	1.25	32	40	178	GTS-E, GS2B, PTS, PPTS, STS2	100	1000
Standard Cross Section — Plenum-Rated																	
PLC2S-S6-C	7.9	201	0.190	4.8	0.047	1.2	0.148	3.8	#6	M3	1.84	47	50	222	GTS-E, GS2B, GTH-E, GS4H, PTS, PTH, PPTS, STS2, STH2	100	1000
PLC2S-S10-C	7.9	201	0.190	4.8	0.047	1.2	0.200	5.1	#10	M5	1.84	47	50	222		100	1000
PLC3S-S10-C	12.0	305	0.190	4.8	0.047	1.2	0.200	5.1	#10	M5	3.00	76	50	222		100	1000
PLC4S-S10-C	15.0	381	0.190	4.8	0.052	1.3	0.200	5.1	#10	M5	4.00	102	50	222		100	1000
Light-Heavy Cross Section — Plenum-Rated																	
PLC2H-S25-L	9.0	229	0.300	7.6	0.075	1.9	0.260	6.6	1/4	M6	2.00	51	120	534	GTH-E, GS4H, GS4EH, PTH, STH2, ST3EH	50	500
PLC4H-S25-L	15.1	384	0.300	7.6	0.075	1.9	0.260	6.6	1/4	M6	4.00	102	120	534		50	500



Pan-Ty® Clamp Ties – Weather Resistant and Heat Stabilized Nylon 6.6

- Weather resistant material has greater resistance to damage caused by ultraviolet light – indoor or outdoor use
- Heat stabilized material for high temperature applications up to 239°F (115°C) – indoor use
- Used to secure a cable bundle to another surface such as a control panel, communication rack, wall or ceiling
- Design allows for bundling before or after screwing clamp in place
- One-piece construction for consistent performance and reliability
- Curved tip is easy to pick up from flat surfaces and allows faster initial threading to speed installation

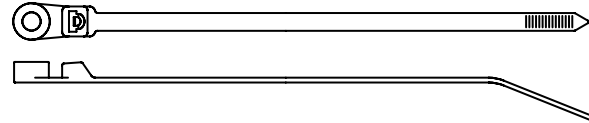

Part Number	Length		Width		Thickness		Nominal Hole Dia.		Screw Size	Metric Screw Size	Max. Bundle Dia.		Min. Loop Tensile Str.		Recommended Installation Tool	Std. Pkg. Qty.	Std. Ctn. Qty.	
	In.	mm	In.	mm	In.	mm	In.	mm			In.	mm	Lbs.	N				
Weather Resistant Nylon 6.6																		
Miniature Cross Section																		
PLC1M-S4-C0	4.3	109	0.100	2.5	0.045	1.1	0.122	3.1	#4	M2.5	.75	19	18	80	GTS-E, GS2B, PTS, PPTS, STS2	100	1000	
Intermediate Cross Section																		
PLC1.5I-S8-C0	6.1	155	0.135	3.4	0.045	1.1	0.174	4.4	#8	M4	1.25	32	40	178	GTS-E, GS2B, PTS, PPTS, STS2	100	1000	
Standard Cross Section																		
PLC2S-S6-C0	7.9	201	0.190	4.8	0.047	1.2	0.148	3.8	#6	M3	1.84	47	50	222	GTS-E, GS2B, GTH-E, GS4H, PTS, PTH, PPTS, STS2, STH2	100	1000	
PLC2S-S10-C0	7.9	201	0.190	4.8	0.047	1.2	0.200	5.1	#10	M5	1.84	47	50	222		100	1000	
PLC3S-S10-C0	12.0	305	0.190	4.8	0.052	1.3	0.200	5.1	#10	M5	3.00	76	50	222		100	1000	
PLC4S-S10-C0	15.0	381	0.190	4.8	0.052	1.3	0.200	5.1	#10	M5	4.00	102	50	222		100	1000	
Light-Heavy Cross Section																		
PLC2H-S25-TL0	9.0	229	0.300	7.6	0.075	1.9	0.260	6.6	1/4	M6	2.00	51	120	534	GTH-E, GS4H, GS4EH, PTH, STH2, ST3EH	250	2500	
PLC4H-S25-L0	15.1	384	0.300	7.6	0.075	1.9	0.260	6.6	1/4	M6	4.00	102	120	534		50	500	
Heat Stabilized Nylon 6.6																		
Miniature Cross Section																		
PLC1M-S4-M30	4.3	109	0.100	2.5	0.045	1.1	0.122	3.1	#4	M2.5	0.75	19	18	80	GTS-E, GS2B, PTS, PPTS, STS2	1000	50000	
Intermediate Cross Section																		
PLC1.5I-S8-M30	6.1	155	0.135	3.4	0.045	1.1	0.174	4.4	#8	M4	1.25	32	40	178	GTS-E, GS2B, PTS, PPTS, STS2	1000	25000	
Standard Cross Section																		
PLC2S-S10-M30	7.9	201	0.190	4.8	0.047	1.2	0.200	5.1	#10	M5	1.84	47	50	222	GTS-E, GS2B, GTH-E, GS4H, PTS, PTH, PPTS, STS2, STH2	1000	10000	
PLC4S-S10-M30	15.0	381	0.190	4.8	0.052	1.3	0.200	5.1	#10	M5	4.00	102	50	222		1000	5000	
Light-Heavy Cross Section																		
PLC2H-S25-TL30	9.0	229	0.300	7.6	0.075	1.9	0.260	6.6	1/4	M6	2.00	51	120	534	GTH-E, GS4H, GS4EH, PTH, STH2, ST3EH	250	2500	
PLC4H-S25-TL30	15.1	384	0.300	7.6	0.075	1.9	0.260	6.6	1/4	M6	4.00	102	120	534		250	2500	

Note: UL Recognized and CSA Certified except PLC2H/4H in Weather Resistant material (0).

Pan-Ty® Wing Push Mount Ties – Nylon 6.6

- For indoor use
- Cable tie, mount, and fastener in a single part
- Used to attach bundles to another surface such as a flat panel
- Anchor is easily pressed into a pre-formed hole and locks in place
- Wings provide constant tension for a stable, secure, and rattle-free installation
- Curved tip is easy to pick up from flat surfaces and allows faster initial threading to speed installation

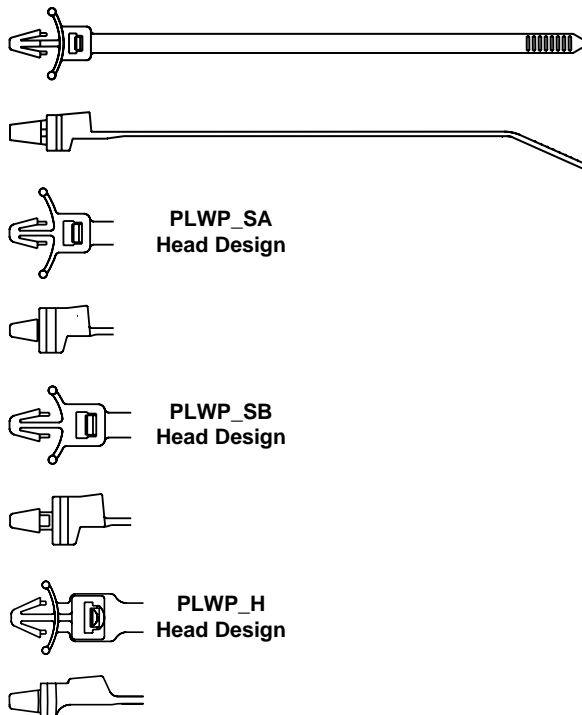

Part Number	Length		Width		Thickness		Nominal Hole Dia.		Max. Panel Thickness		Max. Bundle Dia.		Min. Loop Tensile Str.		Recommended Installation Tool	Std. Pkg. Qty.	Std. Ctn. Qty.	
	In.	mm	In.	mm	In.	mm	In.	mm	In.	mm	In.	mm	Lbs.	N				
Miniature Cross Section																		
PLWP1M-C	4.3	109	0.098	2.5	0.044	1.1	0.187	4.7	0.093	2.4	0.87	22	18	80	GTS-E, GS2B, PTS, PPTS, STS2	100	1000	
Intermediate Cross Section																		
PLWP1.5I-C	6.0	152	0.135	3.4	0.045	1.2	0.187	4.7	0.093	2.4	1.25	32	40	178	GTS-E, GS2B, PTS, PPTS, STS2	100	1000	
Standard Cross Section																		
PLWP1S-C	5.2	132	0.190	4.8	0.052	1.3	0.250	6.4	0.105	2.7	1.00	25	50	222	GTS-E, GS2B, GTH-E, GS4H, PTS, PTH, PPTS, STS2, STH2	100	1000	
PLWP1SA-D	5.1	130	0.190	4.8	0.052	1.3	0.187	4.7	0.093	2.4	1.00	25	50	222		500	5000	
PLWP1SB-D	5.2	132	0.190	4.8	0.052	1.3	0.187	4.7	0.157	4.0	1.00	25	50	222		500	5000	
PLWP1.5S-D	6.8	173	0.190	4.8	0.052	1.3	0.250	6.4	0.105	2.7	1.50	38	50	222		500	5000	
PLWP1.5SA-D	6.7	170	0.190	4.8	0.052	1.3	0.187	4.7	0.093	2.4	1.50	38	50	222		500	5000	
PLWP2S-C	7.8	198	0.190	4.8	0.052	1.3	0.250	6.4	0.105	2.7	1.75	45	50	222		100	1000	
PLWP2SA-D	7.7	196	0.190	4.8	0.052	1.3	0.187	4.7	0.093	2.4	1.75	45	50	222		500	5000	
PLWP2SB-D	7.8	198	0.190	4.8	0.052	1.3	0.187	4.7	0.157	4.0	1.75	45	50	222		500	5000	
Light-Heavy Cross Section																		
PLWP2H-TL	8.9	226	0.300	7.6	0.075	1.9	0.266	6.8	0.105	2.7	2.00	51	120	534	GTH-E, GS4H, GS4EH, PTH, STH2, ST3EH	250	2500	
PLWP3H-TL	12.0	305	0.300	7.6	0.075	1.9	0.266	6.8	0.105	2.7	3.00	76	120	534		250	2500	

Note: UL Recognized and CSA Certified except PLWP2H/3H.



Pan-Ty® Wing Push Mount Ties – Weather Resistant and Heat Stabilized Nylon 6.6

- Weather resistant material has greater resistance to damage caused by ultraviolet light – indoor or outdoor use
- Heat stabilized material for high temperature applications up to 239°F (115°C) – indoor use
- Cable tie, mount, and fastener in a single part
- Used to attach bundles to another surface such as a flat panel
- Anchor is easily pressed into a pre-formed hole and locks in place
- Wings provide constant tension for a stable, secure, and rattle-free installation
- Curved tip is easy to pick up from flat surfaces and allows faster initial threading to speed installation

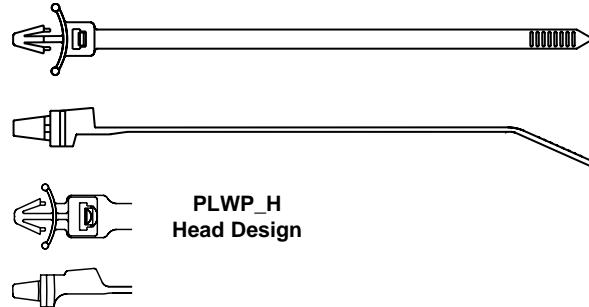

Part Number	Length		Width		Thickness		Nominal Hole Dia.		Max. Panel Thickness		Max. Bundle Dia.		Min. Loop Tensile Str.		Recommended Installation Tool	Std. Pkg. Qty.	Std. Ctn. Qty.
	In.	mm	In.	mm	In.	mm	In.	mm	In.	mm	In.	mm	Lbs.	N			

Weather Resistant Nylon 6.6

Miniature Cross Section

PLWP1M-D0	4.3	109	0.098	2.5	0.044	1.1	0.187	4.7	0.093	2.4	0.87	22	18	80	GTS-E, GS2B, PTS, PPTS, STS2	500	5000
-----------	-----	-----	-------	-----	-------	-----	-------	-----	-------	-----	------	----	----	----	------------------------------	-----	------

Standard Cross Section

PLWP1S-C0	5.2	132	0.190	4.8	0.052	1.3	0.250	6.4	0.105	2.7	1.00	25	50	222	GTS-E, GS2B, GTH-E, GS4H, PTS, PTH, PPTS, STS2, STH2	100	1000
PLWP2S-C0	7.8	198	0.190	4.8	0.052	1.3	0.250	6.4	0.105	2.7	1.75	45	50	222		100	1000

Light-Heavy Cross Section

PLWP2H-TL0	8.9	226	0.300	7.6	0.075	1.9	0.266	6.8	0.105	2.7	2.00	51	120	534	GTH-E, GS4H, GS4EH, PTH, STH2, ST3EH	250	2500
PLWP3H-TL0	12.0	305	0.300	7.6	0.075	1.9	0.266	6.8	0.105	2.7	3.00	76	120	534		250	2500

Heat Stabilized Nylon 6.6

Miniature Cross Section

PLWP1M-D30	4.3	109	0.098	2.5	0.044	1.1	0.187	4.7	0.093	2.4	.87	22	18	80	GTS-E, GS2B, PTS, PPTS, STS2	500	5000
------------	-----	-----	-------	-----	-------	-----	-------	-----	-------	-----	-----	----	----	----	------------------------------	-----	------

Intermediate Cross Section

PLWP1.5I-D30	6.0	152	0.135	3.4	0.045	1.2	0.187	4.7	0.093	2.4	1.25	32	40	178	GTS-E, GS2B, PTS, PPTS, STS2	500	5000
--------------	-----	-----	-------	-----	-------	-----	-------	-----	-------	-----	------	----	----	-----	------------------------------	-----	------

Standard Cross Section

PLWP1S-D30	5.2	132	0.190	4.8	0.052	1.3	0.250	6.4	0.105	2.7	1.00	25	50	222	GTS-E, GS2B, GTH-E, GS4H, PTS, PTH, PPTS, STS2, STH2	500	5000
PLWP1.5S-D30	6.8	173	0.190	4.8	0.052	1.3	0.250	6.4	0.105	2.7	1.50	38	50	222		500	5000
PLWP2S-D30	7.8	198	0.190	4.8	0.052	1.3	0.250	6.4	0.105	2.7	1.75	45	50	222		500	5000

Light-Heavy Cross Section

PLWP2S-D30	8.9	226	0.300	7.6	0.075	1.9	0.266	6.8	0.105	2.7	2.00	51	120	534	GTH-E, GS4H, GS4EH, PTH, STH2, ST3EH	250	2500
------------	-----	-----	-------	-----	-------	-----	-------	-----	-------	-----	------	----	-----	-----	--------------------------------------	-----	------

Note: UL Recognized and CSA Certified except PLWP2H/3H.

Pan-Ty® Releasable Wing Push Mount Ties

- Natural nylon material for indoor use
- Weather resistant material has greater resistance to damage caused by ultraviolet light – indoor or outdoor use
- Heat stabilized material for high temperature applications up to 239°F (115°C) – indoor use
- Cable tie, mount, and fastener in a single part
- Used to attach bundles to another surface such as a flat panel
- Anchor is easily pressed into a pre-formed hole and locks in place
- Wings provide constant tension for a stable, secure, and rattle-free installation
- Extended release tab permits easy release and re-use where changes are anticipated during development, production, or servicing in the field
- Curved tip is easy to pick up from flat surfaces and allows faster initial threading to speed installation



PRWP2S-D



PRWP2S-D0

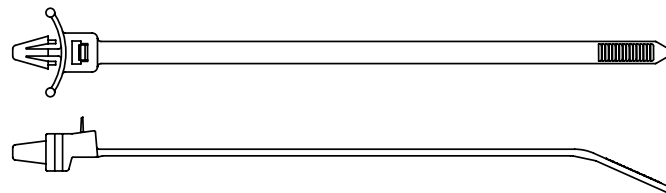

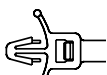
 **PRWP_SA Head Design**

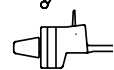

 **PRWP_SB Head Design**

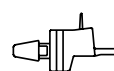

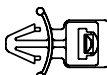
 **PRWP_H Head Design**

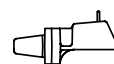

Part Number	Length		Width		Thickness		Nominal Hole Dia.		Max. Panel Thickness		Max. Bundle Dia.		Min. Loop Tensile Str.		Recommended Installation Tool	Std. Pkg. Qty.	Std. Ctn. Qty.
	In.	mm	In.	mm	In.	mm	In.	mm	In.	mm	In.	mm	Lbs.	N			

Nylon 6.6

Standard Cross Section

PRWP1S-C	5.2	132	0.190	4.8	0.052	1.3	0.250	6.4	0.105	2.7	1.00	25	50	222	Hand install only	100	1000
PRWP1SA-D	5.1	130	0.190	4.8	0.052	1.3	0.187	4.7	0.093	2.4	1.00	25	50	222		500	5000
PRWP1SB-D	5.2	132	0.190	4.8	0.052	1.3	0.187	4.7	0.157	4.0	1.00	25	50	222		500	5000
PRWP1.5S-D	6.8	173	0.190	4.8	0.052	1.3	0.250	6.4	0.105	2.7	1.50	38	50	222		500	5000
PRWP2S-D	7.8	198	0.190	4.8	0.052	1.3	0.250	6.4	0.105	2.7	1.75	45	50	222		500	5000

Light-Heavy Cross Section

PRWP2H-TL	8.9	226	0.300	7.6	0.075	1.9	0.266	6.8	0.105	2.7	2.00	51	120	534	Hand install only	250	2500
-----------	-----	-----	-------	-----	-------	-----	-------	-----	-------	-----	------	----	-----	-----	-------------------	-----	------

Weather Resistant Nylon 6.6

Standard Cross Section

PRWP1S-D0	5.2	132	0.190	4.8	0.052	1.3	0.250	6.4	0.105	2.7	1.00	25	50	222	Hand install only	500	5000
PRWP1.5S-D0	6.8	173	0.190	4.8	0.052	1.3	0.250	6.4	0.105	2.7	1.50	38	50	222		500	5000
PRWP2S-D0	7.8	198	0.190	4.8	0.052	1.3	0.250	6.4	0.105	2.7	1.75	45	50	222		500	5000

Heat Stabilized Nylon 6.6

Standard Cross Section

PRWP1.5S-D30	6.8	173	0.190	4.8	0.052	1.3	0.250	6.4	0.105	2.7	1.50	38	50	222	Hand install only	500	5000
--------------	-----	-----	-------	-----	-------	-----	-------	-----	-------	-----	------	----	----	-----	-------------------	-----	------

Note: UL Recognized and CSA Certified except PRWP2H.



Pan-Ty® Center Mounted Wing Push Mount Ties – Heat Stabilized Nylon 6.6

- For high temperature applications up to 239°F (115°C) – indoor use
- Used to center the bundle over the mount on all bundle diameters
- Cable tie, mount, and fastener in a single part
- Anchor is easily pressed into a pre-formed hole and locks in place
- Wings provide constant tension for a stable, secure, and rattle-free installation
- Curved tip is easy to pick up from flat surfaces and allows faster initial threading to speed installation

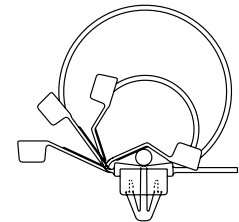
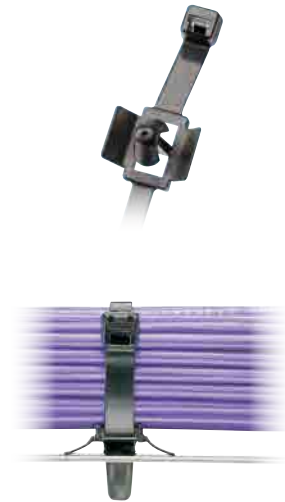

**Bundle diameters
from .12" to 1.97"
(3mm to 50mm)**



PLWP-SC – Designed for normal wire bundles.

PLWP-SD – Designed for corrugated loom tubing. Bump prevents lateral and axial movement.

PLWP-SE – Designed for corrugated loom tubing, see page C2.13. Bump prevents lateral movement.

Part Number	Length		Width		Thickness		Nominal Hole Dia.		Max. Panel Thickness		Max. Bundle Dia.		Min. Loop Tensile Str.		Recommended Installation Tool	Std. Pkg. Qty.	Std. Ctn. Qty.
	In.	mm	In.	mm	In.	mm	In.	mm	In.	mm	In.	mm	Lbs.	N			
Standard Cross Section																	
PLWP30SC-D30	5.8	147	0.190	4.8	0.050	1.3	0.266	6.8	0.118	3.0	1.18	30	50	222	GTS-E, GS2B, GTH-E, GS4H, PTS, PTH, PPTS, STS2, STH2	500	5000
PLWP40SC-D30	7.0	178	0.190	4.8	0.050	1.3	0.266	6.8	0.118	3.0	1.58	40	50	222		500	5000
PLWP40SD-D30	7.0	178	0.190	4.8	0.050	1.3	0.266	6.8	0.118	3.0	1.58	40	50	222		500	5000
PLWP50SC-D30	8.2	208	0.190	4.8	0.050	1.3	0.266	6.8	0.118	3.0	1.97	50	50	222		500	5000
PLWP50SE-D30	8.2	208	0.190	4.8	0.050	1.3	0.266	6.8	0.118	3.0	1.97	50	50	222		500	5000



Pan-Ty® Ladder Style Releasable Wing Push Mount Ties – Heat Stabilized Nylon 6.6

- For high temperature applications up to 239°F (115°C) – indoor use
- Unique releasable ladder design eliminates the need for multiple clamp sizes
- Cable tie, mount, and fastener in a single part
- Used to attach bundles to another surface such as a flat panel
- Anchor is easily pressed into a pre-formed hole and locks in place
- Wings provide constant tension for a stable, secure, and rattle-free installation
- Curved tip is easy to pick up from flat surfaces and allows faster initial threading to speed installation

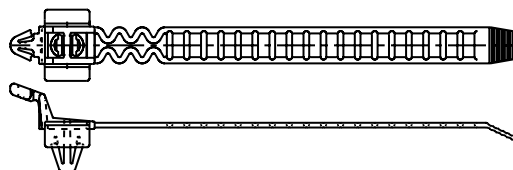
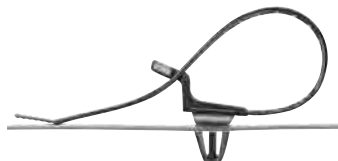

Part Number	Length		Width		Thickness		Nominal Hole Dia.		Max. Panel Thickness		Max. Bundle Dia.		Min. Loop Tensile Str.		Recommended Installation Tool	Std. Pkg. Qty.	Std. Ctn. Qty.	
	In.	mm	In.	mm	In.	mm	In.	mm	In.	mm	In.	mm	Lbs.	N				
Standard Cross Section																		
PRLWP30S-D30	4.7	119	0.380	9.7	0.050	1.3	0.266	6.8	0.118	3.0	1.43	36	35	156	Hand install only	500	5000	
PRLWP50S-D30	7.1	180	0.380	9.7	0.050	1.3	0.266	6.8	0.118	3.0	2.18	55	35	156		500	5000	

Pan-Ty® Umbrella Wing Push Mount Ties – Nylon and Heat Stabilized Nylon 6.6

- Natural nylon material for indoor use
- Heat stabilized material for high temperature applications up to 239°F (115°C) – indoor use
- Quick, secure way to fasten to clearance holes in panel
- Anchor is easily pressed into a pre-formed hole in a light gauge metal or plastic and locks in place
- Umbrella shaped disk provides constant tension for a stable, secure, and rattle-free installation
- Disk forms a dust-tight and semi-liquid tight seal to the panel surface
- PLUP40SE style is for use with corrugated loom tubing, see page C2.13
- Curved tip is easy to pick up from flat surfaces and allows faster initial threading to speed installation

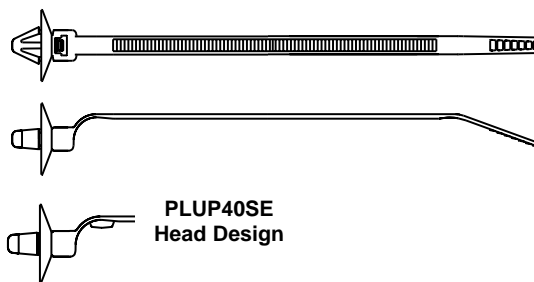

Part Number	Length		Width		Thickness		Nominal Hole Dia.		Max. Panel Thickness		Max. Bundle Dia.		Min. Loop Tensile Str.		Recommended Installation Tool	Std. Pkg. Qty.	Std. Ctn. Qty.	
	In.	mm	In.	mm	In.	mm	In.	mm	In.	mm	In.	mm	Lbs.	N				
Standard Cross Section																		
PLUP40S-D30*	7.0	177	0.190	4.8	0.047	1.2	0.266	6.8	0.050	1.3	1.57	40	50	222	GTS-E, GS2B, GTH-E, GS4H, PTS, PTH, PPTS, STS2, STH2	500	5000	
PLUP40SE-D	7.0	177	0.190	4.8	0.047	1.2	0.266	6.8	0.050	1.3	1.57	40	50	222		500	5000	
PLUP40SE-D30*	7.0	177	0.190	4.8	0.047	1.2	0.266	6.8	0.050	1.3	1.57	40	50	222		500	5000	

*Heat stabilized material (30).

UL[®] US **CSA[®] US** **Pan-Ty® Push Mount Ties**

- Natural nylon material for indoor use
- Weather resistant material has greater resistance to damage caused by ultraviolet light – indoor or outdoor use
- Heat stabilized material for high temperature applications up to 239°F (115°C) – indoor use
- *Wingless* design allows tie to be used in confined spaces
- Cable tie, mount, and fastener in a single part

- Economical push mount ties are used to attach bundles to another surface such as a flat panel
- Anchor is easily pressed into a pre-formed hole and locks in place
- Curved tip is easy to pick up from flat surfaces and allows faster initial threading to speed installation

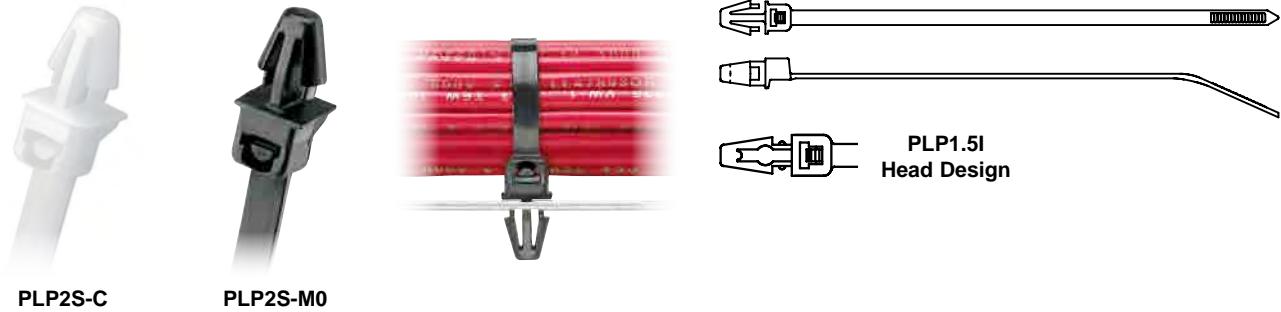

Part Number	Length		Width		Thickness		Nominal Hole Dia.		Max. Panel Thickness		Max. Bundle Dia.		Min. Loop Tensile Str.		Recommended Installation Tool	Std. Pkg. Qty.	Std. Ctn. Qty.	
	In.	mm	In.	mm	In.	mm	In.	mm	In.	mm	In.	mm	Lbs.	N				
Nylon 6.6																		
Intermediate Cross Section																		
PLP1.5I-C	6.1	156	0.135	3.4	0.045	1.1	0.187	4.7	0.093	2.4	1.25	32	40	178	GTS-E, GS2B, PTS, PPTS, STS2	100	1000	
Standard Cross Section																		
PLP1S-M	5.3	135	0.180	4.6	0.050	1.3	0.250	6.4	0.125	3.2	1.00	25	50	222	GTS-E, GS2B, GTH-E, GS4H, PTS, PTH, PPTS, STS2, STH2	1000	10000	
PLP1.5S-M	6.7	170	0.180	4.6	0.050	1.3	0.250	6.4	0.125	3.2	1.50	38	50	222		1000	10000	
PLP2S-C	7.9	200	0.180	4.6	0.050	1.3	0.250	6.4	0.125	3.2	1.75	45	50	222		100	1000	
Weather Resistant Nylon 6.6																		
Intermediate Cross Section																		
PLP1.5I-M0	6.1	156	0.135	3.4	0.045	1.1	0.187	4.7	0.093	2.4	1.25	32	40	178	GTS-E, GS2B, PTS, PPTS, STS2	1000	25000	
Standard Cross Section																		
PLP1S-M0	5.3	135	0.180	4.6	0.050	1.3	0.250	6.4	0.125	3.2	1.00	25	50	222	GTS-E, GS2B, GTH-E, GS4H, PTS, PTH, PPTS, STS2, STH2	1000	10000	
PLP2S-M0	7.9	200	0.180	4.6	0.050	1.3	0.250	6.4	0.125	3.2	1.75	45	50	222		1000	10000	
Heat Stabilized Nylon 6.6																		
Intermediate Cross Section																		
PLP1.5I-M30	6.1	156	0.135	3.4	0.045	1.1	0.187	4.7	0.093	2.4	1.25	32	40	178	GTS-E, GS2B, PTS, PPTS, STS2	1000	25000	
Standard Cross Section																		
PLP1S-M30	5.3	135	0.180	4.6	0.050	1.3	0.250	6.4	0.125	3.2	1.00	25	50	222	GTS-E, GS2B, GTH-E, GS4H, PTS, PTH, PPTS, STS2, STH2	1000	10000	
PLP2S-M30	7.9	200	0.180	4.6	0.050	1.3	0.250	6.4	0.125	3.2	1.75	45	50	222		1000	10000	

Pan-Ty® Marker and Flag Ties

- Natural nylon material for indoor use
- Weather resistant material has greater resistance to damage caused by ultraviolet light – indoor or outdoor use
- Flame retardant material has a flammability rating of UL 94V-0 – for indoor use
- Used to fasten and identify bundles at the same time
- One-piece construction for consistent performance and reliability
- Can be marked with Panduit® marker pens on page B1.49 or computer printable labels
- Custom imprinting with text, symbols, or trademarks available using Panduit Custom Hot Stamping Service, see page B1.89
- Curved tip is easy to pick up from flat surfaces and allows faster initial threading to speed installation

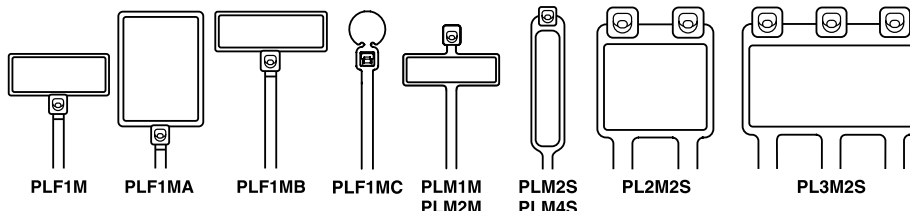

Part Number	Marker Type	Length		Width		Thickness		Marker Write-On Area		Max. Bundle Dia.		Min. Loop Tensile Str.		Recommended Installation Tool	Std. Pkg. Qty.	Std. Ctn. Qty.
		In.	mm	In.	mm	In.	mm	In.	mm	In.	mm	Lbs.	N			
Nylon 6.6																
Miniature Cross Section																
PLF1M-C	Flag	4.3	109	0.098	2.5	0.045	1.1	0.31 x 0.75	7.9 x 19.1	0.87	22	18	80	GTS-E, GS2B, PTS, PPTS, STS2	100	1000
PLF1MA-C	Flag	5.1	130	0.098	2.5	0.045	1.1	0.76 x 1.04	19.1 x 26.4	0.87	22	18	80		100	1000
PLF1MB-C	Flag	4.0	101	0.098	2.5	0.045	1.1	0.31 x 0.92	7.9 x 23.4	0.75	19	18	80		100	1000
PLF1MC-M	Flag	4.3	109	0.098	2.5	0.045	1.1	0.29 x 0.32	7.4 x 8.0	0.87	22	18	80		1000	25000
PLM1M-C	Wrap	3.9	99	0.098	2.5	0.035	0.9	0.26 x 0.95	6.6 x 24.1	0.75	19	18	80		100	1000
PLM2M-C	Wrap	8.0	203	0.098	2.5	0.035	0.9	0.26 x 0.95	6.6 x 24.1	2.00	51	18	80	100	1000	

Standard Cross Section																
PLM2S-C	Wrap	7.4	188	0.185	4.7	0.052	1.3	0.44 x 0.87	11.1 x 22.1	1.75	45	50	222	GTS-E, GS2B, GTH-E, GS4H, PTS, PTH, PPTS, STS2, STH2	100	1000
PLM4S-C	Wrap	14.6	371	0.185	4.7	0.052	1.3	0.44 x 2.00	11.1 x 50.8	4.00	102	50	222		100	1000
PL2M2S-L	Wrap	7.4	188	0.185	4.7	0.052	1.3	0.87 x 1.07	22.1 x 27.2	1.75	45	50	222		50	500
PL3M2S-L	Wrap	7.4	188	0.185	4.7	0.052	1.3	0.87 x 1.79	22.1 x 45.5	1.75	45	50	222		50	500

Weather Resistant Nylon 6.6																
Miniature Cross Section																
PLF1M-C0	Flag	4.3	109	0.098	2.5	0.045	1.1	0.31 x 0.75	7.9 x 19.1	0.87	22	18	80	GTS-E, GS2B, PTS, PPTS, STS2	100	1000
PLF1MA-M0	Flag	5.1	130	0.098	2.5	0.045	1.1	0.76 x 1.04	19.1 x 26.4	0.87	22	18	80		1000	10000
PLM1M-C0	Wrap	3.9	99	0.098	2.5	0.035	0.9	0.26 x 0.95	6.6 x 24.1	0.75	19	18	80		100	1000
PLM2M-M0	Wrap	8.0	203	0.098	2.5	0.035	0.9	0.26 x 0.95	6.6 x 24.1	2.00	51	18	80		1000	25000

Standard Cross Section																
PLM2S-C0	Wrap	7.4	188	0.185	4.7	0.052	1.3	0.44 x 0.87	11.1 x 22.1	1.75	45	50	222	GTS-E, GS2B, GTH-E, GS4H, PTS, PTH, PPTS, STS2, STH2	100	1000
PLM4S-D0	Wrap	14.6	371	0.185	4.7	0.052	1.3	0.44 x 2.00	11.1 x 50.8	4.00	102	50	222		500	5000
PL2M2S-L0	Wrap	7.4	188	0.185	4.7	0.052	1.3	0.87 x 1.07	22.1 x 27.2	1.75	45	50	222		50	500
PL3M2S-D0	Wrap	7.4	188	0.185	4.7	0.052	1.3	0.87 x 1.79	22.1 x 45.5	1.75	45	50	222		500	2500

Flame Retardant Nylon 6.6																
Miniature Cross Section																
PLF1M-M69	Flag	4.3	109	0.098	2.5	0.045	1.1	0.31 x 0.75	7.9 x 19.1	0.87	22	18	80	GTS-E, GS2B, PTS, PPTS, STS2	1000	25000
PLM1M-M69	Wrap	3.9	99	0.098	2.5	0.035	0.9	0.26 x 0.95	6.6 x 24.1	0.75	19	18	80		1000	25000

Pan-Ty® Cable Ties

Material and Color Chart

Material	Color	Panduit Suffix
Nylon 6.6	Natural	✓
Weather Resistant Nylon 6.6	Black	0
Weather Resistant Nylon 6.6 (meets Mil Spec.)	Black	00
Nylon 6.6	Brown	1
Nylon 6.6	Red	2
Nylon 6.6	Orange	3
Nylon 6.6	Yellow	4Y
Nylon 6.6	Green	5
Nylon 6.6	Blue	6
Nylon 6.6	Purple	7
Nylon 6.6	Gray	8
Nylon 6.6	White	10
Nylon 6.6	Telephone Gray	14
Nylon 6.6	Black	20
Heat Stabilized Nylon 6.6	Black	30
Heat Stabilized Nylon 6.6	Natural	39

Material	Color	Panduit Suffix
Nylon 6.6	Fluorescent Orange	53
Nylon 6.6	Fluorescent Yellow	54
Nylon 6.6	Fluorescent Green	55
Nylon 6.6	Fluorescent Pink	59
Flame Retardant Nylon 6.6	Black	60
Flame Retardant Nylon 6.6	Natural (Ivory)	69
PEEK (Polyetheretherketone)	Translucent Brown	71
TEFZEL [■]	Aqua Blue	76
Metal Detectable, Nylon	Blue	86
Metal Detectable, Polypropylene	Blue	186
Weather Resistant Polypropylene	Black	100
Polypropylene	Green	109
Nylon 12	Black	120
Heat Stabilized Weather Resistant Nylon 6.6	Black	300
HALAR [▲]	Maroon	702Y

✓Denotes Panduit® Natural Nylon 6.6 (no suffix)

■TEFZEL is a registered trademark of E.I. du Pont de Nemours and Company

▲HALAR is a registered trademark of Solvay Solexis

Part Number Availability List

Standard Packaging			Bulk Packaging		
Part Number	Natural Nylon 6.6	Material/Color Suffix	Part Number	Natural Nylon 6.6	Material/Color Suffix
PLC1M-S4-C	✓	0	PLC1M-S4-M	✓	0,30
PLC1.5I-S8-C	✓	0	PLC1.5I-S8-M	✓	0,30
PLC2S-S6-C	✓	0	PLC2S-S6-M	✓	0
PLC2S-S10-C	✓	0,14	PLC2S-S10-M	✓	0,20,30
PLC3S-S10-C	✓	0	PLC3S-S10-M	✓	0
PLC4S-S10-C	✓	0	PLC4S-S10-M	✓	0,30
PLC2H-S25-L	✓		PLC2H-S25-TL	✓	0,30
PLC4H-S25-L	✓	0	PLC4H-S25-TL	✓	0,30
PLF1M-C	✓	0	PLF1M-M	✓	0,2,3,4Y,6,10,69
PLF1MA-C	✓	3,4Y	PLF1MA-M	✓	0,2,3,4Y,5,6,10
PLF1MB-C	✓		PLF1MB-M	✓	
			PLF1MC-M		3
PLM1M-C	✓	0	PLM1M-M	✓	0,1,2,3,4Y,5,6,7,8,10,60
PLM2M-C	✓		PLM2M-M	✓	0,4Y,6
PLM2S-C	✓	0,4Y	PLM2S-D	✓	0,2,3,4Y,5,6,8
PLM4S-C	✓		PLM4S-D	✓	0,2,4Y,6

Continues on next page

Pan-Ty® Cable Ties (continued)

Standard Packaging			Bulk Packaging		
Part Number	Natural Nylon 6.6	Material/Color Suffix	Part Number	Natural Nylon 6.6	Material/Color Suffix
PL2M2S-L	✓	0	PL2M2S-D	✓	0,4Y,10
PL3M2S-L	✓		PL3M2S-D	✓	0,4Y
PLP1.5I-C	✓		PLP1.5I-M	✓	0,30
			PLP1S-M	✓	0,30
			PLP1.5S-M	✓	
PLP2S-C	✓		PLP2S-M	✓	0,30
PLT.6SM-C	✓	0	PLT.6SM-M	✓	0,30
PLT.7M-C	✓		PLT.7M-M	✓	0,30
PLT1M-C	✓	0,00,2,3,5,6,7,8,14,30,71,76,86,186,702Y	PLT1M-M	✓	0,00,2,3,5,6,7,8,14,20,30,53,54,55,59,60,69,76,100,109,300,702Y
			PLT1M-XMR	✓	0,00,2,3,5,6,7,8,30
PLT1.5M-C	✓	0	PLT1.5M-M	✓	0,00,1,2,3,4Y,5,6,7,8,10,14,20,30
			PLT1.5M-XMR	✓	0,00,30
PLT2M-C	✓	0	PLT2M-M	✓	0,1,2,3,4Y,5,6,7,8,10,20,30,69
PLT1.5I-C	✓	0,1,2,3,4Y,5,6,7,8,10,20,30	PLT1.5I-M	✓	0,00,1,2,3,4Y,5,6,7,8,10,20,30,69,100,109,120,300
PLT2I-C	✓	0,14,30,76,86,186	PLT2I-M	✓	0,00,1,2,3,4Y,5,6,7,8,10,14,20,30,53,54,55,59,69,76,300
PLT2.5I-C	✓	0	PLT2.5I-M	✓	0,20
PLT3I-C	✓	0,14	PLT3I-M	✓	0,2,3,4Y,5,6,8,10,14,20,30
PLT4I-C	✓	0,14	PLT4I-M	✓	0,2,5,6,14,20,30
PLT1S-C	✓	0	PLT1S-M	✓	0,30,38,300
PLT1.5S-C	✓	0	PLT1.5S-M	✓	0,30
PLT2S-C	✓	0,00,1,2,3,4Y,5,6,7,8,10,20,30,71,76,86,186,702Y	PLT2S-M	✓	0,00,1,2,3,4Y,5,6,7,8,10,20,30,38,39,53,54,55,59,60,69,71,76,100,109,120,300,702Y
			PLT2S-VMR	✓	0,30
PLT2.5S-C	✓	0	PLT2.5S-M	✓	0,30
PLT3S-C	✓	0,00,2,20,30,76,86,186,702Y	PLT3S-M	✓	0,00,1,2,3,4Y,5,6,7,8,10,20,30,53,54,55,59,76,100,109,702Y
PLT4S-C	✓	0,00,2,3,4Y,5,6,8,10,20,30,76,86,186	PLT4S-M	✓	0,00,1,2,3,4Y,5,6,7,8,10,14,20,30,69,76,100,109,120,300
PLT4.5S-C	✓	0	PLT4.5S-M	✓	0
PLT5S-C	✓	0	PLT5S-M	✓	0,2,3,4Y,5,6,8,30
PLT6LH-L	✓	0	PLT6LH-C	✓	0
PLT7LH-L	✓	0	PLT7LH-C	✓	0,30
PLT8LH-L	✓	0	PLT8LH-C	✓	0,120
PLT8LH-Q		0			
PLT9LH-L	✓	0	PLT9LH-C	✓	0,30
PLT10LH-L	✓		PLT10LH-C	✓	
PLT2H-L	✓	0	PLT2H-TL	✓	0,2,4Y,6,30,100,109,300
PLT2.5H-L	✓	0	PLT2.5H-TL	✓	0
PLT3H-L	✓	0,76,86,186	PLT3H-TL	✓	0,30,76,100,109
PLT4H-L	✓	0,00,76,86,186	PLT4H-TL	✓	0,00,1,2,3,4Y,5,6,10,20,30,69,76,100,109,120,300
PLT4H-C	✓	0			
PLT5H-L	✓	0	PLT5H-C	✓	0,30
PLT6H-L	✓	0	PLT6H-C	✓	0,30
PLT8H-L	✓	0	PLT8H-C	✓	0,00,30
PLT13H-Q	✓	0	PLT13H-C	✓	0,3

Continues on next page

Pan-Ty® Cable Ties (continued)

Standard Packaging			Bulk Packaging		
Part Number	Natural Nylon 6.6	Material/Color Suffix	Part Number	Natural Nylon 6.6	Material/Color Suffix
PLT2EH-Q		0	PLT2EH-C	✓	0
			PLT3EH-NB-C		0
PLT5EH-Q	✓	0	PLT5EH-C	✓	0
			PLT5EH-NB-C		0
PLT6EH-Q	✓	0	PLT6EH-C	✓	0
			PLT6EH-NB-C		0
PLT8EH-Q		0	PLT8EH-C	✓	0
PLT10EH-Q		0	PLT10EH-C	✓	0
PLT12EH-Q		0	PLT12EH-C	✓	0
			PLUP40S-D		30
			PLUP40SE-D	✓	30
PLWP1M-C	✓		PLWP1M-D	✓	0,30
PLWP1.5I-C	✓		PLWP1.5I-D	✓	30
PLWP1S-C	✓	0	PLWP1S-D	✓	0,20,30
			PLWP1SA-D	✓	
			PLWP1SB-D	✓	
			PLWP1.5S-D	✓	30
			PLWP1.5SA-D	✓	
PLWP2S-C	✓	0	PLWP2S-D	✓	0,30
			PLWP2SA-D	✓	
			PLWP2SB-D	✓	
			PLWP2H-TL	✓	0,30
			PLWP3H-TL	✓	0
			PLWP30SC-D		30
			PLWP40SC-D		30
			PLWP40SD-D		30
			PLWP50SC-D		30
			PLWP50SE-D		30
			PRLWP30S-D		30
			PRLWP50S-D		30
PRT1S-C	✓	0	PRT1S-M	✓	0
PRT1.5S-C	✓	0	PRT1.5S-M	✓	0,30
PRT2S-C	✓	0	PRT2S-M	✓	0,2,3,4Y,6,7
PRT3S-C	✓	0	PRT3S-M	✓	0
PRT4S-C	✓	0	PRT4S-M	✓	0,2,3,4Y,6
PRT2H-L	✓	0	PRT2H-TL	✓	0
PRT3H-L	✓	0	PRT3H-TL	✓	0
PRT4H-L	✓	0	PRT4H-TL	✓	0
PRT2EH-Q		0	PRT2EH-C	✓	0,100
PRT5EH-Q	✓	0	PRT5EH-C	✓	0,100
PRT6EH-Q	✓	0	PRT6EH-C	✓	0,100
PRT8EH-Q		0	PRT8EH-C	✓	0,100
PRT10EH-Q		0	PRT10EH-C	✓	0
PRT12EH-Q		0	PRT12EH-C	✓	0
PRWP1S-C	✓		PRWP1S-D	✓	0
			PRWP1SA-D	✓	
			PRWP1SB-D	✓	
			PRWP1.5S-D	✓	0,20,30
			PRWP2S-D	✓	0
			PRWP2H-TL	✓	

Features and Benefits – Super-Grip® Cable Ties

One-piece design with a thin, wide strap body for improved flexibility.

Dome shaped head and smooth, round strap body protect the cable insulation

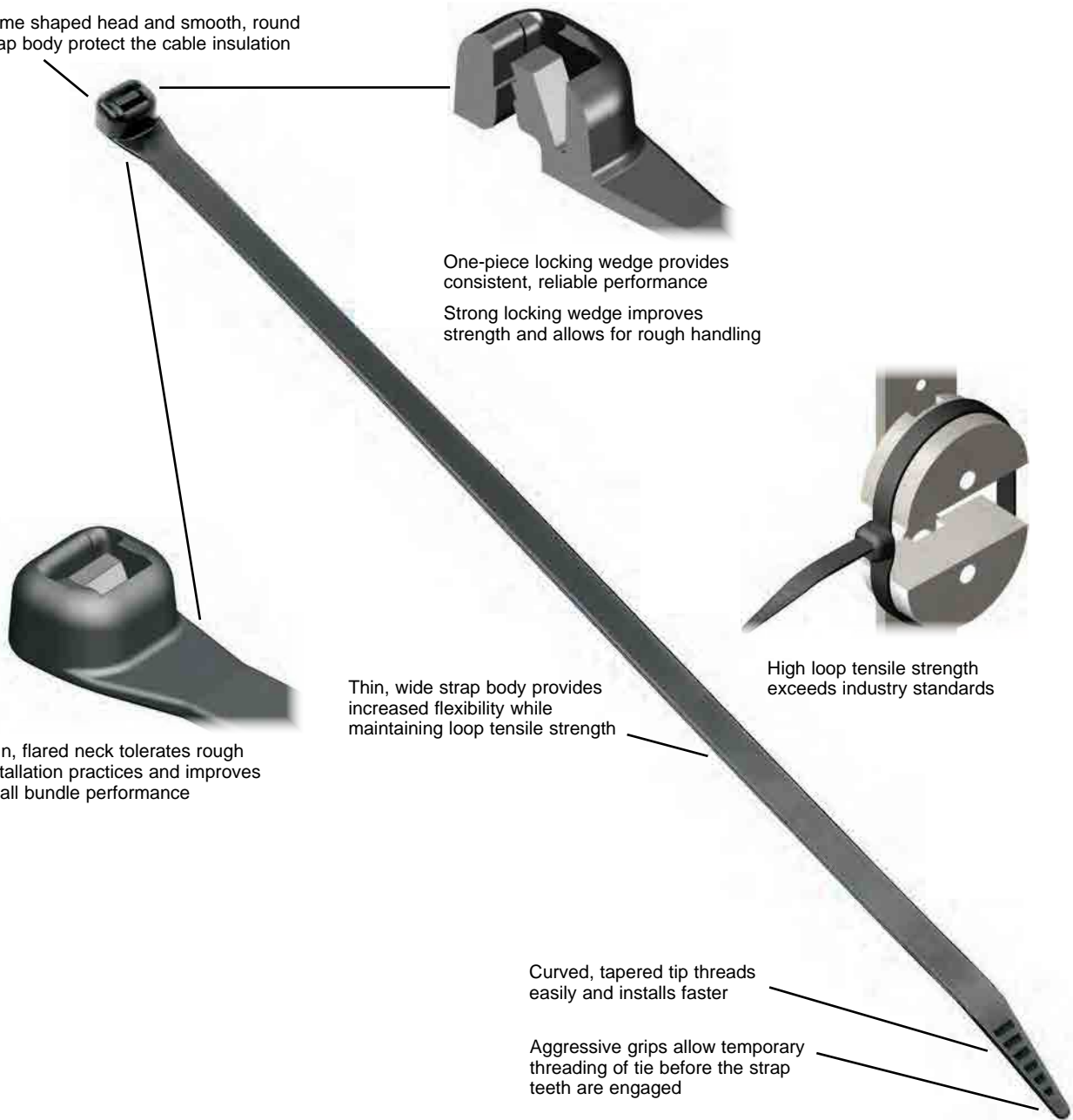

One-piece locking wedge provides consistent, reliable performance
Strong locking wedge improves strength and allows for rough handling

Thin, wide strap body provides increased flexibility while maintaining loop tensile strength

High loop tensile strength exceeds industry standards

Thin, flared neck tolerates rough installation practices and improves small bundle performance

Curved, tapered tip threads easily and installs faster

Aggressive grips allow temporary threading of tie before the strap teeth are engaged



Cable tie tools speed installation and reduce total installed cost.

Visit www.panduit.com/tools.



Cable tie accessories are used to speed and simplify the mounting of wires, cables, and tubing.

See pages B2.6, B2.9, B2.11, B2.19.

Selection Guide – Super-Grip® Cable Ties



Material, Color (Suffix)	Style/Function	Part Number Prefix	Catalog Page
Nylon 6.6, Natural (No Suffix)	Locking Ties/Bundle	SG	B1.38
Weather Resistant Nylon 6.6, Black (0)	Locking Ties/Bundle	SG	B1.39
Heat Stabilized Nylon 6.6, Black (30)	Locking Ties/Bundle	SG	B1.39

■ TEFZEL is a registered trademark of E.I. du Pont de Nemours and Company
 ▲ HALAR is a registered trademark of Solvay Solexis

Part Number System for Super-Grip® Cable Ties

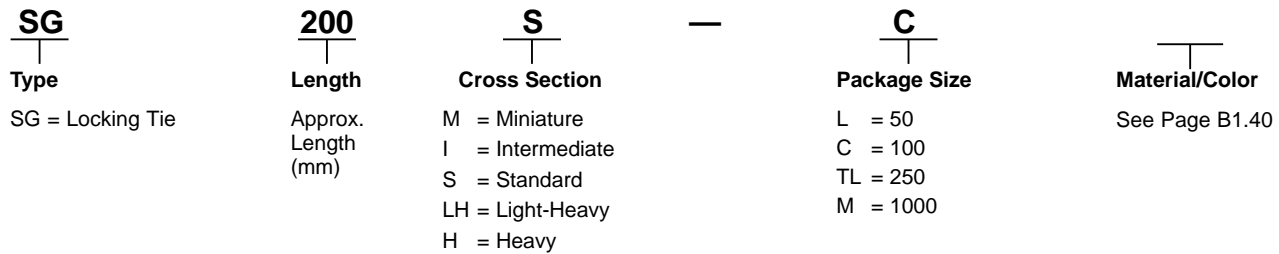

  **Super-Grip® Cable Ties – Nylon 6.6**

- For indoor use
- Designed to grip the bundle tightly to resist lateral movement of the tie once installed
- High strength allows the tie to withstand rough installation practices that occur in MRO and construction environments
- Thin, wide strap body provides flexibility enabling it to conform to bundle while maintaining tensile strength
- Curved tip is easy to pick up from flat surfaces and allows faster initial threading to speed installation
- UL Listed for use in plenum or air handling spaces per NEC
- Complementary mounts available, see pages B2.6, B2.9, B2.11, B2.19

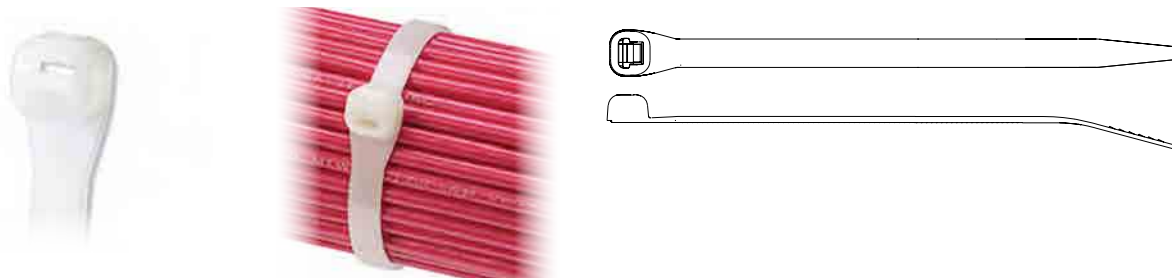

Part Number	Length		Width		Thickness		Max. Bundle Dia.		Min. Loop Tensile Str.		Recommended Installation Tool	Std. Pkg. Qty.	Std. Ctn. Qty.
	In.	mm	In.	mm	In.	mm	In.	mm	Lbs.	N			
Miniature Cross Section – Plenum-Rated													
SG100M-C	4.2	106	0.118	3.0	0.038	1.0	0.90	23	18	80	GTS-E, GS2B, PTS, PPTS, STS2	100	1000
Intermediate Cross Section – Plenum-Rated													
SG150I-C	6.2	157	0.168	4.3	0.040	1.0	1.50	38	40	178	GTS-E, GS2B, PTS, PPTS, STS2	100	1000
Standard Cross Section – Plenum-Rated													
SG200S-C	8.3	211	0.225	5.7	0.046	1.2	2.00	51	50	222	GTS-E, GS2B, GTH-E, GS4H, PTS, PTH, PPTS, STS2, STH2	100	1000
SG250S-C	10.4	264	0.225	5.7	0.050	1.3	2.60	66	75	334		100	1000
SG300S-C	12.4	315	0.225	5.7	0.050	1.3	3.20	81	75	334		100	1000
SG370S-C	15.3	389	0.225	5.7	0.052	1.3	4.20	107	75	334		100	1000
Light-Heavy Cross Section – Plenum-Rated													
SG350LH-L	15.3	389	0.330	8.4	0.064	1.6	4.13	105	120	534	GTH-E, GS4H, GS4EH, PTH, STH2, ST3EH	50	500
Heavy Cross Section – Plenum-Rated													
SG450H-L	18.6	471	0.380	9.7	0.068	1.7	5.20	132	175	778	GTH-E, GS4H, GS4EH, PTH, STH2, ST3EH	50	500

Order number of pieces required, in multiples of Standard Package Quantity.

B2. Cable Accessories

B3. Stainless Steel Cable Ties & Accessories

C1. Wiring Duct

C2. Abrasion Protection

C3. Cable Management

D1. Terminals

D2. Power Connectors

D3. Grounding Connectors

E1. Labeling Systems

E2. Labels

E3. Pre-Printed & Write-On Markers

E4. Permanent Identification

E5. Industrial Safety Solutions

F. Keystone Cabling Systems

G. Part Number Index



Super-Grip® Cable Ties – Weather Resistant and Heat Stabilized Nylon 6.6

- Weather resistant material has greater resistance to damage caused by ultraviolet light – indoor or outdoor use
- Heat stabilized material for high temperature applications up to 239°F (115°C) – indoor use
- Designed to grip the bundle tightly to resist lateral movement of the tie once installed
- High strength allows the tie to withstand rough installation practices that occur in MRO and construction environments
- Thin, wide strap body provides flexibility enabling it to conform to bundle while maintaining tensile strength
- Curved tip is easy to pick up from flat surfaces and allows faster initial threading to speed installation
- Complementary mounts available, see pages B2.6, B2.9, B2.11, B2.19

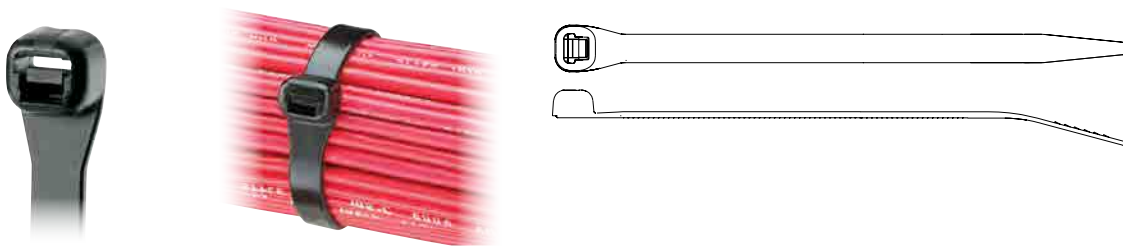

Part Number	Length		Width		Thickness		Max. Bundle Dia.		Min. Loop Tensile Str.		Recommended Installation Tool	Std. Pkg. Qty.	Std. Ctn. Qty.
	In.	mm	In.	mm	In.	mm	In.	mm	Lbs.	N			
Weather Resistant Nylon 6.6													
Miniature Cross Section													
SG100M-C0	4.2	106	0.118	3.0	0.038	1.0	.90	23	18	80	GTS-E, GS2B, PTS, PPTS, STS2	100	1000
Intermediate Cross Section													
SG150I-C0	6.2	157	0.168	4.3	0.040	1.0	1.50	38	40	178	GTS-E, GS2B, PTS, PPTS, STS2	100	1000
Standard Cross Section													
SG200S-C0	8.3	211	0.225	5.7	0.046	1.2	2.00	51	50	222	GTS-E, GS2B, GTH-E, GS4H, PTS, PTH, PPTS, STS2, STH2	100	1000
SG250S-C0	10.4	264	0.225	5.7	0.050	1.3	2.60	66	75	334		100	1000
SG300S-C0	12.4	315	0.225	5.7	0.050	1.3	3.20	81	75	334		100	1000
SG370S-C0	15.3	389	0.225	5.7	0.052	1.3	4.20	107	75	334		100	1000
Light-Heavy Cross Section													
SG350LH-L0	15.3	389	0.330	8.4	0.064	1.6	4.13	105	120	534	GTH-E, GS4H, GS4EH, PTH, STH2, ST3EH	50	500
Heavy Cross Section													
SG450H-L0	18.6	471	0.380	9.7	0.068	1.7	5.20	132	175	778	GTH-E, GS4H, GS4EH, PTH, STH2, ST3EH	50	500
Heat Stabilized Nylon 6.6													
Standard Cross Section													
SG200S-M30	8.3	211	0.225	5.7	0.046	1.2	2.00	51	50	222	GTS-E, GS2B, GTH-E, GS4H, PTS, PTH, PPTS, STS2, STH2	1000	10000
SG300S-M30	12.4	315	0.225	5.7	0.050	1.3	3.20	81	70	311		1000	10000
Light-Heavy Cross Section													
SG350LH-TL30	15.3	389	0.330	8.4	0.064	1.6	4.13	105	120	534	GTH-E, GS4H, GS4EH, PTH, STH2, ST3EH	250	2500

Note: UL Listed and CSA Certified except SG450H-L0 and heat stabilized material (30).

Super-Grip® Cable Ties and Mounts**Material and Color Chart**

Material	Color	Panduit Suffix
Nylon 6.6	Natural	✓
Weather Resistant Nylon 6.6	Black	0
Heat Stabilized Nylon 6.6	Black	30

✓Denotes Panduit® Natural Nylon 6.6 (no suffix).

Part Number Availability List

Standard Packaging			Bulk Packaging		
Part Number	Natural Nylon 6.6	Material/Color Suffix	Part Number	Natural Nylon 6.6	Material/Color Suffix
SG100M-C	✓	0	SG100M-M	✓	0
SG150I-C	✓	0	SG150I-M	✓	0
SG200S-C	✓	0	SG200S-M	✓	0,30
SG250S-C	✓	0			
SG300S-C	✓	0	SG300S-M	✓	0,30
SG370S-C	✓	0	SG370S-M	✓	0
SG350LH-L	✓	0	SG350LH-TL	✓	0,30
SG450H-L	✓	0	SG450H-C	✓	0

Features and Benefits – Dome-Top® Barb Ty Cable Ties

Two-piece design incorporates a stainless steel locking barb in a nylon cable tie.

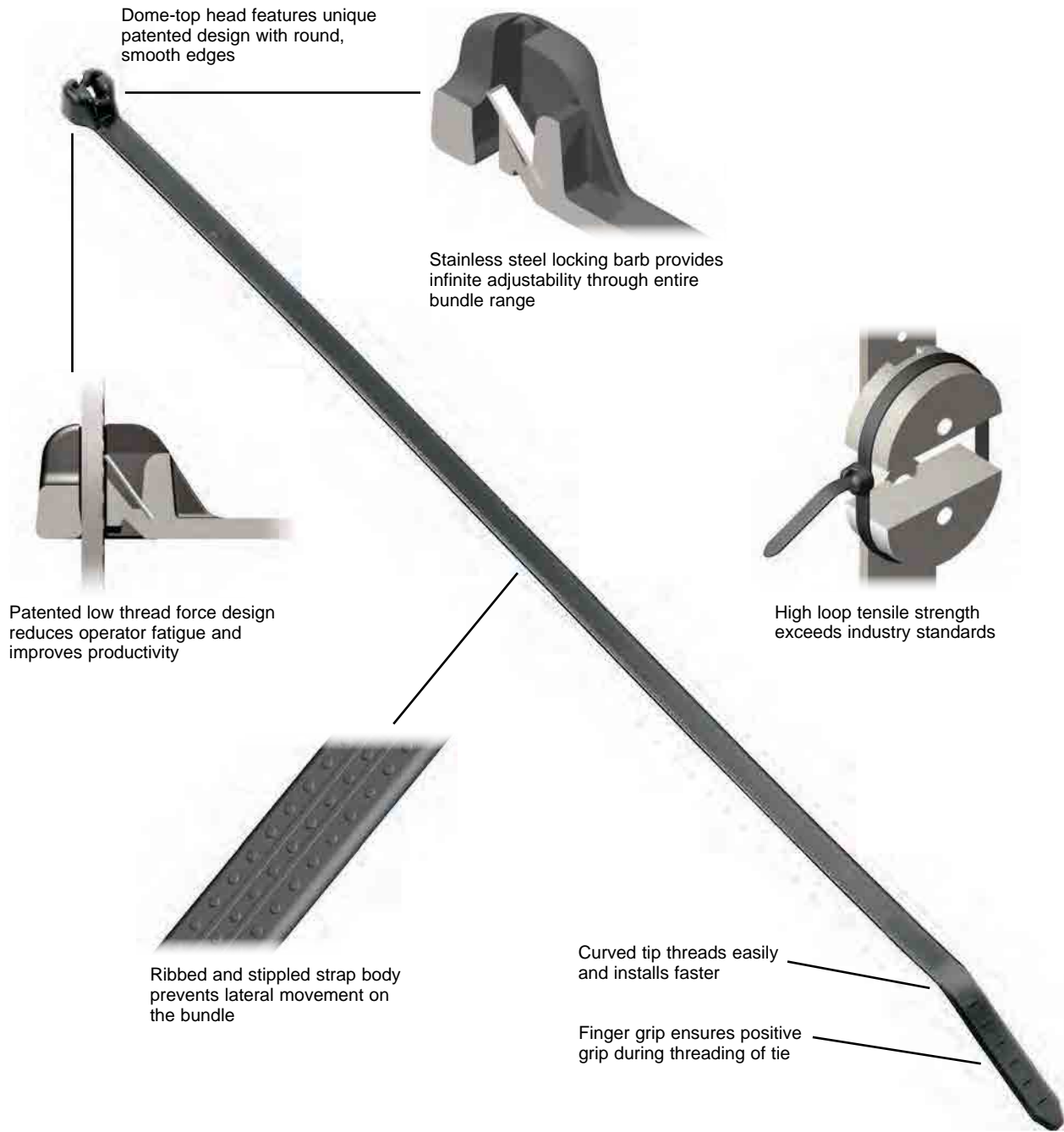

Cable tie tools speed installation and reduce total installed cost. Visit www.panduit.com/tools.



Cable tie accessories are used to speed and simplify the mounting of wires, cables, and tubing. See pages B2.1 – B2.26.

Selection Guide – Dome-Top® Barb Ty and Dura-Ty™ Cable Ties



	Material, Color (Suffix)	Style/Function	Part Number Prefix	Catalog Page
Dome-Top® Barb Ty Cable Ties	Nylon 6.6, Natural (No Suffix)	Locking Ties/Bundle	BT	B1.43
		Clamp Ties/Mount	BC	B1.46
		Push Mount Ties/Mount	BW	B1.48
		Marker Ties/Identify	BF, BM, B2M, B3M, B4M	B1.50
Dome-Top® Barb Ty Cable Ties	Weather Resistant Nylon 6.6, Black (0)	Locking Ties/Bundle	BT	B1.44
		Clamp Ties/Mount	BC	B1.47
		Push Mount Ties/Mount	BW, BP	B1.48, 49
		Marker Ties/Identify	BF, BM, B2M, B3M, B4M	B1.50
Dome-Top® Barb Ty Cable Ties	Heat Stabilized Nylon 6.6, Black (30)	Locking Ties/Bundle	BT	B1.45
		Clamp Ties/Mount	BC	B1.47
Dura-Ty™ Cable Ties, Strapping, and Kits	Heat Stabilized Nylon 6.6, Natural (39)	Locking Ties/Bundle	BT	B1.45
		Weather Resistant Acetal, Black	DT	B1.51

Part Number System for Dome-Top® Barb Ty and Dura-Ty™ Cable Ties

BT	2	S	—	C	—
Type	Size	Cross Section	Screw Hole Size	Package Size	Material/Color
BT = Locking Tie BC = Clamp Tie BF = Flag Tie BM = Marker Tie BP = Push Mount Tie BW = Wing Push Mount Tie DT = Locking Tie	Approx. Maximum Bundle Dia. (In.)	M = Miniature I = Intermediate S = Standard LH = Light-Heavy H = Heavy EH = Extra-Heavy	(Clamp Ties Only) -S4 = #4 (M2.5) -S6 = #6 (M3) -S8 = #8 (M4) -S10 = #10 (M5) -S25 = 1/4 (M6)	Q = 25 L = 50 C = 100 TL = 250 D = 500 M = 1000 LR = 50' Reel	See Page B1.52



Dome-Top® Barb Ty Cable Ties – Nylon 6.6

- For indoor use
- Dome-top head features unique patented design with round, smooth edges
- Stainless steel locking barb provides consistent performance, reliability, and infinite adjustability through entire bundle range
- High strength and low thread force
- A variety of materials and colors are available for specific applications
- Curved tip is easy to pick up from flat surfaces and allows faster initial threading to speed installation
- UL Listed for use in plenum or air handling spaces per NEC

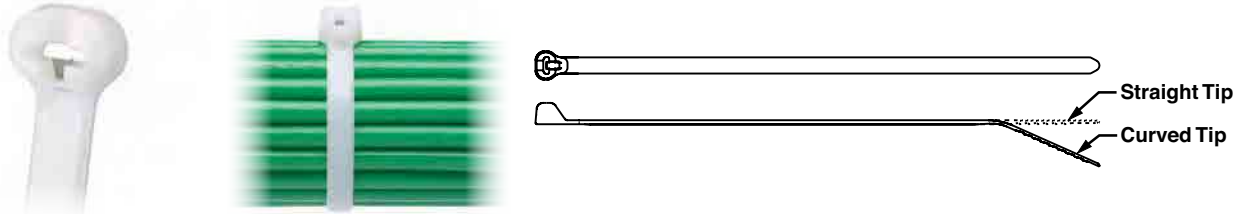

Part Number	Length		Width		Thickness		Max. Bundle Dia.		Min. Loop Tensile Str.		Recommended Installation Tool	Std. Pkg. Qty.	Std. Ctn. Qty.
	In.	mm	In.	mm	In.	mm	In.	mm	Lbs.	N			

Miniature Cross Section – Plenum-Rated													
BT1M-C	4.0	102	0.095	2.4	0.036	.9	.90	23	18	80	GTS-E, GS2B, PTS, PPTS, STS2	100	1000
BT1.5M-C	6.3	160	0.095	2.4	0.046	1.2	1.50	38	18	80		100	1000
BT2M-C	7.9	201	0.095	2.4	0.046	1.2	2.00	51	18	80		100	1000
BT4M-C	14.2	361	0.095	2.4	0.046	1.2	4.00	102	18	80		100	1000

Intermediate Cross Section – Plenum-Rated													
BT1.5I-C	6.1	155	0.141	3.6	0.041	1.0	1.50	38	40	178	GTS-E, GS2B, PTS, PPTS, STS2	100	1000
BT2I-C	8.0	203	0.141	3.6	0.041	1.0	2.00	51	40	178		100	1000
BT3I-C	11.3	287	0.141	3.6	0.049	1.2	3.00	76	40	178		100	1000
BT4I-C	14.3	363	0.141	3.6	0.049	1.2	4.00	102	40	178		100	1000

Standard Cross Section – Plenum-Rated NEW! UL TYPE 2S Rated													
BT2S-C	8.0	203	0.185	4.7	0.045	1.2	2.00	51	50	222	GTS-E, GS2B, GTH-E, GS4H, PTS, PTH, PPTS, STS2, STH2	100	1000
BT3S-C	12.0	305	0.185	4.7	0.052	1.3	3.00	76	50	222		100	1000
BT4S-C	15.1	384	0.185	4.7	0.052	1.3	4.00	102	50	222		100	1000

Light-Heavy Cross Section (Straight Tip) – Plenum-Rated													
BT2LH-L	8.7	221	0.275	7.0	0.065	1.7	2.00	51	120	534	GTH-E, GS4H, GS4EH, PTH, STH2, ST3EH	50	500
BT3LH-L	11.8	300	0.275	7.0	0.065	1.7	3.00	76	120	534		50	500
BT4LH-L	14.9	378	0.275	7.0	0.065	1.7	4.00	102	120	534		50	500
BT5LH-L	18.1	460	0.275	7.0	0.065	1.7	5.00	127	120	534		50	500
BT6LH-L	21.2	538	0.275	7.0	0.065	1.7	6.00	152	120	534		50	500
BT7LH-L	24.4	620	0.275	7.0	0.065	1.7	7.00	178	120	534		50	500
BT8LH-L	27.5	699	0.275	7.0	0.065	1.7	8.00	203	120	534		50	500
BT9LH-L	30.7	780	0.275	7.0	0.065	1.7	9.00	229	120	534		50	500



Dome-Top® Barb Ty Cable Ties – Weather Resistant Nylon 6.6

- Greater resistance to damage caused by ultraviolet light – indoor or outdoor use
- Dome-top head features unique patented design with round, smooth edges
- Stainless steel locking barb provides consistent performance, reliability, and infinite adjustability through entire bundle range
- High strength and low thread force
- Curved tip is easy to pick up from flat surfaces and allows faster initial threading to speed installation

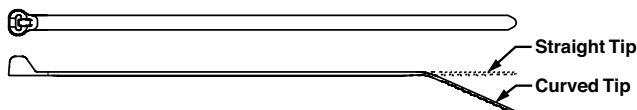

Part Number	Length		Width		Thickness		Max. Bundle Dia.		Min. Loop Tensile Str.		Recommended Installation Tool	Std. Pkg. Qty.	Std. Ctn. Qty.
	In.	mm	In.	mm	In.	mm	In.	mm	Lbs.	N			

Miniature Cross Section

BT1M-C0	4.0	102	0.095	2.4	0.036	.9	.90	23	18	80	GTS-E, GS2B, PTS, PPTS, STS2	100	1000
BT1.5M-C0	6.3	160	0.095	2.4	0.046	1.2	1.50	38	18	80		100	1000
BT2M-C0	7.9	201	0.095	2.4	0.046	1.2	2.00	51	18	80		100	1000
BT4M-C0	14.2	361	0.095	2.4	0.046	1.2	4.00	102	18	80		100	1000

Intermediate Cross Section

BT1.5I-C0	6.1	155	0.141	3.6	0.041	1.0	1.50	38	40	178	GTS-E, GS2B, PTS, PPTS, STS2	100	1000
BT2I-C0	8.0	203	0.141	3.6	0.041	1.0	2.00	51	40	178		100	1000
BT3I-C0	11.3	287	0.141	3.6	0.049	1.2	3.00	76	40	178		100	1000
BT4I-C0	14.3	363	0.141	3.6	0.049	1.2	4.00	102	40	178		100	1000

Standard Cross Section

BT2S-C0	8.0	203	0.185	4.7	0.045	1.2	2.00	51	50	222	GTS-E, GS2B, GTH-E, GS4H, PTS, PTH, PPTS, STS2, STH2	100	1000
BT3S-C0	12.0	305	0.185	4.7	0.052	1.3	3.00	76	50	222		100	1000
BT4S-C0	15.1	384	0.185	4.7	0.052	1.3	4.00	102	50	222		100	1000

Light-Heavy Cross Section (Straight Tip)

BT2LH-L0	8.7	221	0.275	7.0	0.065	1.7	2.00	51	120	534	GTH-E, GS4H, GS4EH, PTH, STH2, ST3EH	50	500
BT3LH-L0	11.8	300	0.275	7.0	0.065	1.7	3.00	76	120	534		50	500
BT4LH-L0	14.9	378	0.275	7.0	0.065	1.7	4.00	102	120	534		50	500
BT5LH-L0	18.1	460	0.275	7.0	0.065	1.7	5.00	127	120	534		50	500
BT6LH-L0	21.2	538	0.275	7.0	0.065	1.7	6.00	152	120	534		50	500
BT7LH-L0	24.4	620	0.275	7.0	0.065	1.7	7.00	178	120	534		50	500
BT8LH-L0	27.5	699	0.275	7.0	0.065	1.7	8.00	203	120	534		50	500
BT9LH-L0	30.7	780	0.275	7.0	0.065	1.7	9.00	229	120	534		50	500

Note: UL Recognized, UL Listed, and CSA Certified, except LH cross section.



Dome-Top® Barb Ty Cable Ties – Heat Stabilized Nylon 6.6

- For high temperature applications up to 239°F (115°C) – indoor use
- Dome-top head features unique patented design with round, smooth edges

- Stainless steel locking barb provides consistent performance, reliability, and infinite adjustability through entire bundle range
- Curved tip is easy to pick up from flat surfaces and allows faster initial threading to speed installation

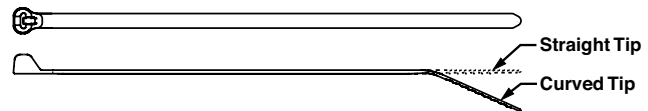

Part Number	Length		Width		Thickness		Max. Bundle Dia.		Min. Loop Tensile Str.		Recommended Installation Tool	Std. Pkg. Qty.	Std. Ctn. Qty.
	In.	mm	In.	mm	In.	mm	In.	mm	Lbs.	N			

**Heat Stabilized Nylon 6.6
Miniature Cross Section**

BT1M-C30	4.0	102	0.095	2.4	0.036	0.9	0.90	23	18	80	GTS-E, GS2B, PTS, PPTS, STS2	100	1000
BT1.5M-M30	6.3	160	0.095	2.4	0.046	1.2	1.50	38	18	80		1000	50000
BT2M-M30	7.9	201	0.095	2.4	0.046	1.2	2.00	51	18	80		1000	25000

Intermediate Cross Section

BT1.5I-M30	6.1	155	0.141	3.6	0.041	1.0	1.50	38	40	178	GTS-E, GS2B, PTS, PPTS, STS2	1000	25000
BT2I-M30	8.0	203	0.141	3.6	0.041	1.0	2.00	51	40	178		1000	25000
BT3I-M30	11.3	287	0.141	3.6	0.049	1.2	3.00	76	40	178		1000	10000

Standard Cross Section

BT2S-M30	8.0	203	0.185	4.7	0.045	1.2	2.00	51	50	222	GTS-E, GS2B, GTH-E, GS4H, PTS, PTH, PPTS, STS2, STH2	1000	10000
BT3S-M30	12.0	305	0.185	4.7	0.052	1.3	3.00	76	50	222		1000	10000
BT4S-M30	15.1	384	0.185	4.7	0.052	1.3	4.00	102	50	222		1000	5000

Light-Heavy Cross Section (Straight Tip)

BT4LH-TL30	14.9	378	0.275	7.0	0.065	1.7	4.00	102	120	534	GTH-E, GS4H, GS4EH, PTH, STH2, ST3EH	250	2500
------------	------	-----	-------	-----	-------	-----	------	-----	-----	-----	--------------------------------------	-----	------

**Heat Stabilized Nylon 6.6
Miniature Cross Section**

BT1M-M39	4.0	102	0.095	2.4	0.036	0.9	0.90	23	18	80	GTS-E, GS2B, PTS, PPTS, STS2	1000	50000
----------	-----	-----	-------	-----	-------	-----	------	----	----	----	------------------------------	------	-------

Intermediate Cross Section

BT1.5I-M39	6.1	155	0.141	3.6	0.041	1.0	1.50	38	40	178	GTS-E, GS2B, PTS, PPTS, STS2	1000	25000
------------	-----	-----	-------	-----	-------	-----	------	----	----	-----	------------------------------	------	-------

Standard Cross Section

BT2S-M39	8.0	203	0.185	4.7	0.045	1.2	2.00	51	50	222	GTS-E, GS2B, GTH-E, GS4H, PTS, PTH, PPTS, STS2, STH2	1000	10000
BT3S-M39	12.0	305	0.185	4.7	0.052	1.3	3.00	76	50	222		1000	10000
BT4S-M39	15.1	384	0.185	4.7	0.052	1.3	4.00	102	50	222		1000	5000

Light-Heavy Cross Section (Straight Tip)

BT4LH-TL39	14.9	378	0.275	7.0	0.065	1.7	4.00	102	120	534	GTH-E, GS4H, GS4EH, PTH, STH2, ST3EH	250	2500
------------	------	-----	-------	-----	-------	-----	------	-----	-----	-----	--------------------------------------	-----	------

Note: UL Listed and CSA Certified except SG450H-L0 and heat stabilized material (30).



Dome-Top® Barb Ty Clamp Ties – Nylon 6.6

- For indoor use
- Used to secure a cable bundle to another surface such as a control panel, communication rack, wall or ceiling
- Design allows for bundling before or after screwing clamp in place
- Stainless steel locking barb provides consistent performance, reliability, and infinite adjustability through entire bundle range
- Curved tip is easy to pick up from flat surfaces and allows faster initial threading to speed installation
- UL Listed for use in plenum or air handling spaces per NEC

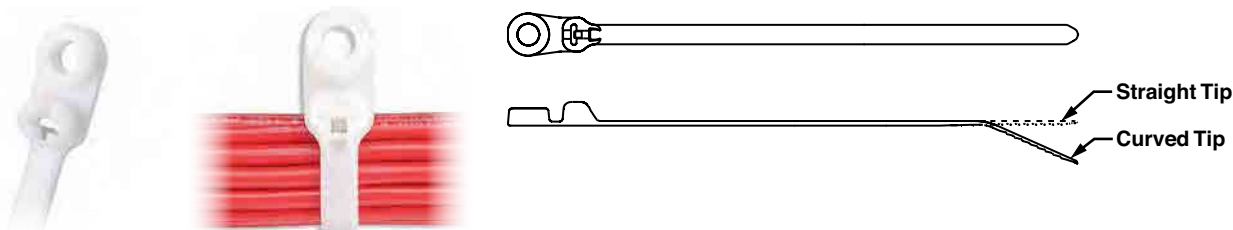

Part Number	Length		Width		Thickness		Nominal Hole Dia.		Screw Size	Metric Screw Size	Max. Bundle Dia.		Min. Loop Tensile Str.		Recommended Installation Tool	Std. Pkg. Qty.	Std. Ctn. Qty.
	In.	mm	In.	mm	In.	mm	In.	mm			In.	mm	Lbs.	N			
Miniature Cross Section — Plenum-Rated																	
BC1M-S4-M	4.6	117	0.095	2.4	0.046	1.2	0.122	3.1	#4	M2.5	0.90	23	18	80	GTS-E, GS2B, PTS, PPTS, STS2	1000	50000
BC2M-S4-M	8.3	211	0.095	2.4	0.046	1.2	0.122	3.1	#4	M2.5	2.00	51	18	80		1000	25000
Intermediate Cross Section — Plenum-Rated																	
BC1.5I-S8-M	6.6	168	0.141	3.6	0.041	1.0	0.174	4.4	#8	M4	1.50	38	40	178	GTS-E, GS2B, PTS, PPTS, STS2	1000	25000
Standard Cross Section — Plenum-Rated																	
BC2S-S10-C	8.5	216	0.185	4.7	0.052	1.3	0.200	5.1	#10	M5	2.00	51	50	222	GTS-E, GS2B, GTH-E, GS4H, PTS, PTH, PPTS, STS2, STH2	100	1000
BC3S-S10-D	12.5	318	0.185	4.7	0.052	1.3	0.200	5.1	#10	M5	3.00	76	50	222		500	5000
BC4S-S10-C	15.6	396	0.185	4.7	0.052	1.3	0.200	5.1	#10	M5	4.00	102	50	222		100	1000
Light-Heavy Cross Section — Plenum-Rated																	
BC4LH-S25-L	15.5	394	0.275	7.0	0.065	1.7	0.260	6.6	1/4	M6	4.00	102	120	534	GTH-E, GS4H, GS4EH, PTH, STH2, ST3EH	50	500



Dome-Top® Barb Ty Clamp Ties – Weather Resistant and Heat Stabilized Nylon 6.6

- Weather Resistant material has greater resistance to damage caused by ultraviolet light – indoor or outdoor use
- Heat stabilized material for high temperature applications up to 239°F (115°C) – indoor use
- Used to secure a cable bundle to another surface such as a control panel, communication rack, wall or ceiling
- Design allows for bundling before or after screwing clamp in place
- Stainless steel locking barb provides consistent performance, reliability, and infinite adjustability through entire bundle range
- Curved tip is easy to pick up from flat surfaces and allows faster initial threading to speed installation

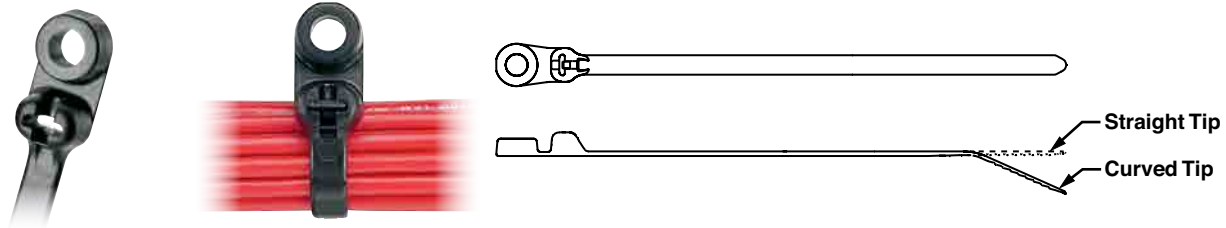

Part Number	Length		Width		Thickness		Nominal Hole Dia.		Screw Size	Metric Screw Size	Max. Bundle Dia.		Min. Loop Tensile Str.		Recommended Installation Tool	Std. Pkg. Qty.	Std. Ctn. Qty.	
	In.	mm	In.	mm	In.	mm	In.	mm			In.	mm	Lbs.	N				
Weather Resistant Nylon 6.6																		
Miniature Cross Section																		
BC1M-S4-M0	4.6	117	0.095	2.4	0.046	1.2	0.122	3.1	#4	M2.5	0.90	23	18	80	GTS-E, GS2B, PTS, PPTS, STS2	1000	50000	
BC2M-S4-M0	8.3	211	0.095	2.4	0.046	1.2	0.122	3.1	#4	M2.5	2.00	51	18	80		1000	25000	
Intermediate Cross Section																		
BC1.5I-S8-M0	6.6	168	0.141	3.6	0.041	1.0	0.174	4.4	#8	M4	1.50	38	40	178	GTS-E, GS2B, PTS, PPTS, STS2	1000	25000	
Standard Cross Section																		
BC2S-S10-C0	8.5	216	0.185	4.7	0.052	1.3	0.200	5.1	#10	M5	2.00	51	50	222	GTS-E, GS2B, GTH-E, GS4H, PTS, PTH, PPTS, STS2, STH2	100	1000	
BC3S-S10-D0	12.5	318	0.185	4.7	0.052	1.3	0.200	5.1	#10	M5	3.00	76	50	222		500	5000	
BC4S-S10-C0	15.6	396	0.185	4.7	0.052	1.3	0.200	5.1	#10	M5	4.00	102	50	222		100	1000	
Light-Heavy Cross Section (Straight Tip)																		
BC4LH-S25-L0	15.5	394	0.275	7.0	0.065	1.7	0.260	6.6	1/4	M6	4.00	102	120	534	GTH-E, GS4H, GS4EH, PTH, STH2, ST3EH	50	500	
Heat Stabilized Nylon 6.6																		
Miniature Cross Section																		
BC4S-S10-D30	15.6	396	0.185	4.7	0.052	1.3	0.200	5.1	#10	M5	4.00	102	50	222	GTS-E, GS2B, GTH-E, GS4H, PTS, PTH, PPTS, STH2, STS2	500	5000	

Note: UL Recognized and CSA Certified except BC4LH-S25-L0.



Dome-Top® Barb Ty Wing Push Mount Ties – Nylon and Weather Resistant Nylon 6.6

- Natural nylon material for indoor use
- Weather resistant material has greater resistance to damage caused by ultraviolet light – indoor or outdoor use
- Combine cable tie, mount, and fastener into a single part
- Used to attach bundles to another surface such as a flat panel
- Anchor is easily pressed into a pre-formed hole and locks in place
- Wings provide constant tension for a stable, secure, and rattle-free installation
- Stainless steel locking barb provides consistent performance, reliability, and infinite adjustability through entire bundle range
- Curved tip is easy to pick up from flat surfaces and allows faster initial threading to speed installation



BW2S-D



BW2S-D0

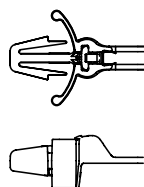
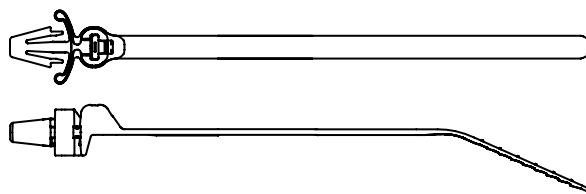

BW2S Head Design



Part Number	Length		Width		Thickness		Nominal Hole Dia.		Max. Panel Thickness		Max. Bundle Dia.		Min. Loop Tensile Str.		Recommended Installation Tool	Std. Pkg. Qty.	Std. Ctn. Qty.	
	In.	mm	In.	mm	In.	mm	In.	mm	In.	mm	In.	mm	Lbs.	N				
Nylon 6.6																		
Intermediate Cross Section																		
BW1.5I-D	6.6	177	0.190	4.8	0.047	1.2	0.266	6.8	0.050	1.3	1.57	40	50	222	GTS-E, GS2B, PTS, PPTS, STS2	500	5000	
Standard Cross Section																		
BW2S-D	8.5	216	0.185	4.7	0.052	1.3	0.250	6.4	0.156	4.0	2.00	51	50	222	GTS-E, GS2B, GTH-E, GS4H, PTS, PTH, PPTS, STS2, STH2	500	5000	
BW3S-D	8.5	216	0.185	4.7	0.052	1.3	0.250	6.4	0.156	4.0	3.00	76	50	222		500	5000	
Weather Resistant Nylon 6.6																		
Standard Cross Section																		
BW2S-D0	8.5	216	0.185	4.7	0.052	1.3	0.250	6.4	0.156	4.0	2.00	51	50	222	GTS-E, GS2B, GTH-E, GS4H, PTS, PTH, PPTS, STS2, STH2	500	5000	
BW3S-D0	8.5	216	0.185	4.7	0.052	1.3	0.250	6.4	0.156	4.0	3.00	76	50	222		500	5000	



Dome-Top® Barb Ty Push Mount Ties – Weather Resistant Nylon 6.6

- Greater resistance to damage caused by ultraviolet light – indoor or outdoor use
- Used to attach bundles to another surface such as a flat panel
- Cable tie, mount, and fastener in a single part
- Anchor is easily pressed into a pre-formed hole and locks in place
- *Wingless* design allows tie to be used in confined spaces
- Stainless steel locking barb provides consistent performance, reliability, and infinite adjustability through entire bundle range
- Curved tip is easy to pick up from flat surfaces and allows faster initial threading to speed installation

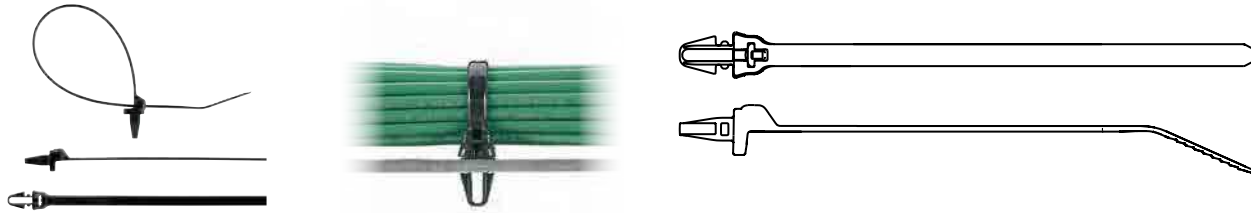

Part Number	Length		Width		Thickness		Nominal Hole Dia.		Max. Panel Thickness		Max. Bundle Dia.		Min. Loop Tensile Str.		Recommended Installation Tool	Std. Pkg. Qty.	Std. Ctn. Qty.	
	In.	mm	In.	mm	In.	mm	In.	mm	In.	mm	In.	mm	Lbs.	N				
Standard Cross Section																		
BP2S-D0	8.5	216	0.185	4.7	0.052	1.3	0.255	6.5	0.125	3.2	2.00	51	50	222	GTS-E, GS2B, GTH-E, GS4H, PTS, PTH, PPTS, STS2, STH2	500	5000	

Permanent Marking Pens

- Fast drying, permanent ink for identification on marker ties (pages B1.32, B1.50, and B1.68), marker plates (page B2.26), or cable marker straps (page B1.76)
- May be used with any label shown in the catalog when a printer is not available



Part Number	Color	Description	Std. Pkg. Qty.	Std. Ctn. Qty.
PX-0	Black	Permanent marking pen – regular tip.	12	144
PX-2	Red	Permanent marking pen – regular tip.	12	144
PX-10	White	Marking pen for black or other dark colored parts – regular tip.	12	300



Dome-Top® Barb Ty Marker and Flag Ties

- Natural nylon material for indoor use
- Weather resistant material has greater resistance to damage caused by ultraviolet light – indoor or outdoor use
- Used to fasten and identify bundles at the same time
- Stainless steel locking barb provides consistent performance, reliability, and infinite adjustability through entire bundle range
- Can be marked with Panduit® marker pens on the previous page or computer printable labels
- Custom imprinting with text, symbols, or trademarks available using Panduit Custom Hot Stamping Service, see page B1.89
- Curved tip is easy to pick up from flat surfaces and allows faster initial threading to speed installation

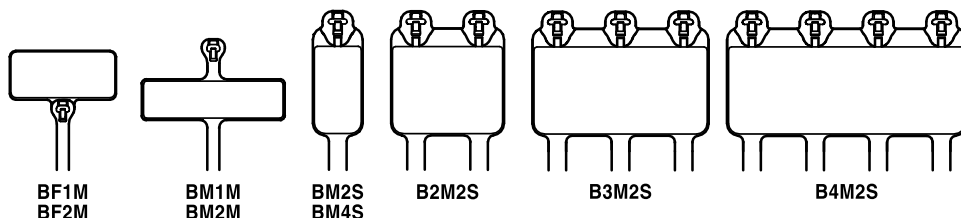

Part Number	Marker Type	Length		Width		Thickness		Marker Write-On Area		Max. Bundle Dia.		Min. Loop Tensile Str.		Recommended Installation Tool	Std. Pkg. Qty.	Std. Ctn. Qty.
		In.	mm	In.	mm	In.	mm	In.	mm	In.	mm	Lbs.	N			

Nylon 6.6

Miniature Cross Section

BF1M-C	Flag	4.6	117	0.095	2.4	0.046	1.2	0.36 x 0.81	9.1 x 20.6	.90	23	18	80	GTS-E, GS2B, PTS, PPTS, STS2	100	1000
BF2M-C	Flag	8.3	211	0.095	2.4	0.046	1.2	0.36 x 0.81	9.1 x 20.6	2.00	51	18	80		100	1000
BM1M-C	Wrap	4.2	107	0.095	2.4	0.046	1.2	0.29 x 1.09	7.4 x 27.7	.90	23	18	80		100	1000
BM2M-C	Wrap	7.9	201	0.095	2.4	0.046	1.2	0.29 x 1.09	7.4 x 27.7	2.00	51	18	80		100	1000

Standard Cross Section

BM2S-C	Wrap	8.0	203	0.185	4.7	0.045	1.2	0.49 x 0.91	12.4 x 23.1	2.00	51	50	222	GTS-E, GS2B, GTH-E, GS4H, PTS, PTH, PPTS, STS2, STH2	100	1000
BM4S-C	Wrap	15.1	384	0.185	4.7	0.052	1.3	0.50 x 2.13	12.7 x 54.1	4.00	102	50	222		100	1000
B2M2S-D	Wrap	8.0	203	0.185	4.7	0.045	1.2	1.15 x 0.91	29.2 x 23.1	2.00	51	50	222		500	2500
B3M2S-TL	Wrap	8.0	203	0.185	4.7	0.045	1.2	1.81 x 0.91	46.0 x 23.1	2.00	51	50	222		250	2500
B4M2S-TL	Wrap	8.0	203	0.185	4.7	0.045	1.2	2.47 x 0.91	62.7 x 23.1	2.00	51	50	222		250	2500

Weather Resistant Nylon 6.6

Miniature Cross Section

BF1M-M0	Flag	4.6	117	0.095	2.4	0.046	1.2	0.36 x 0.81	9.1 x 20.6	.90	23	18	80	GTS-E, GS2B, PTS, PPTS, STS2	1000	25000
BF2M-M0	Flag	8.3	211	0.095	2.4	0.046	1.2	0.36 x 0.81	9.1 x 20.6	2.00	51	18	80		1000	25000
BM1M-M0	Wrap	4.2	107	0.095	2.4	0.046	1.2	0.29 x 1.09	7.4 x 27.7	.90	23	18	80		1000	25000
BM2M-M0	Wrap	7.9	201	0.095	2.4	0.046	1.2	0.29 x 1.09	7.4 x 27.7	2.00	51	18	80		1000	25000

Standard Cross Section

BM2S-D0	Wrap	8.0	203	0.185	4.7	0.045	1.2	0.49 x 0.91	12.4 x 23.1	2.00	51	50	222	GTS-E, GS2B, GTH-E, GS4H, PTS, PTH, PPTS, STS2, STH2	500	10000
BM4S-D0	Wrap	15.1	384	0.185	4.7	0.052	1.3	0.50 x 2.13	12.7 x 54.1	4.00	102	50	222		500	5000
B2M2S-D0	Wrap	8.0	203	0.185	4.7	0.045	1.2	1.15 x 0.91	29.2 x 23.1	2.00	51	50	222		500	2500
B3M2S-TL0	Wrap	8.0	203	0.185	4.7	0.045	1.2	1.81 x 0.91	46.0 x 23.1	2.00	51	50	222		250	2500
B4M2S-TL0	Wrap	8.0	203	0.185	4.7	0.045	1.2	2.47 x 0.91	62.7 x 23.1	2.00	51	50	222		250	2500

Dura-Ty™ Cable Ties – Weather Resistant Acetal – Heavy Cross Section



- Acetal strap and head materials can provide 20 years + life in outdoor applications. Factors such as installation procedures, tooling and environmental conditions can influence the actual life
- Excellent ultraviolet light, chemical, and moisture resistance
- Double stainless steel locking barbs provide consistent and predictable holding values
- Textured strap provides better gripping surface to prevent tie from moving laterally along the length of the bundle for tight, consistent bundles
- Robust head design allows tie to be tightened over a wide range of angles
- Convenient reel dispenser pack allows installer to cut-to-size for customized field applications; recyclable box has through-hole for attaching to belt, plus storage area for bag of heads
- Ideal for securing cables in outdoor messenger strand applications
- May be used with stackable aerial cable spacer on the next page

Part Number	Description	Strap Length		Strap Width		Min. Loop Tenside Str.		Head Height		Head Width		Recommended Installation Tool	Std. Pkg. Qty.	Std. Ctn. Qty.
		In.	mm	In.	mm	In.	mm	In.	mm	Lbs.	N			
Strapping, Heads, and Kit – Allows user to customize strap length														
DTRH-LR0	50' reel of strapping.	50.0	15.2	0.331	8.40	200	890	–	–	–	–	GTH-E, GS4EH, STH2, STHV	1	20
DTHH-Q0	25 cable tie heads.	–	–	–	–	–	–	0.393	9.98	0.557	14.15	–	25	500
DTKH-0	Kit: Strapping (50'), Heads (25)	50.0	15.2	0.331	8.40	200	890	0.393	9.98	0.557	14.15	GTH-E, GS4EH, STH2, STHV	1	20

Dura-Ty™ Cable Ties – Weather Resistant Acetal – Extra-Heavy Cross Section



- Acetal strap and head materials can provide 20 years + life in outdoor applications. Factors such as installation procedures, tooling and environmental conditions can influence the actual life
- Excellent ultraviolet light, chemical, and moisture resistance
- Double stainless steel locking barbs provide consistent and predictable holding values
- Ideal for securing cables in outdoor messenger strand applications
- Meets Telcordia TR-TSY-000789 industry guidelines for lashed cable supports
- Convenient reel dispenser pack allows installer to cut-to-size for customized field applications; recyclable box has through-hole for attaching to belt, plus storage area for bag of heads
- Several pre-cut sizes have lead-in style angled tips on pre-assembled straps for easy installation, even with gloved hands, to speed installation
- May be used with stackable aerial cable spacer on the next page

Formula to determine amount of strapping required:
 Diameter (inches) x 3.14 + 4.5 inches
 Diameter (mm) x 3.14 + 114mm

Part Number	Description	Strap Length		Strap Width		Min. Loop Tenside Str.		Head Height		Head Width		Recommended Installation Tool	Std. Pkg. Qty.	Std. Ctn. Qty.
		In.	mm	In.	mm	In.	mm	In.	mm	Lbs.	N			
DTREH-LR0	50' reel of strapping.	50.0	15.2	0.500	12.70	250	1112	–	–	–	–	GS4EH	1	20
DTHEH-Q0	25 cable tie heads.	–	–	–	–	–	–	0.490	12.45	0.718	18.24	–	25	500
DTKEH-0	Kit: Strapping (50'), Heads (25)	50.0	15.2	0.500	12.70	250	1112	0.490	12.45	0.718	18.24	GS4EH	1	20

Part Number	Length		Width		Thickness		Nominal Hole Dia.		Max. Panel Thickness		Max. Bundle Dia.		Min. Loop Tensile Str.		Recommended Installation Tool	Std. Pkg. Qty.	Std. Ctn. Qty.
	In.	mm	In.	mm	In.	mm	In.	mm	In.	mm	In.	mm	Lbs.	N			
Discrete Lengths – Speed Installation																	
DT4EH-L0	13.5	343	0.500	12.70	0.059	1.50	0.490	12.45	0.718	18.24	3.8	98	250	1112	GS4EH	50	1000
DT8EH-Q0	27.0	686	0.500	12.70	0.059	1.50	0.490	12.45	0.718	18.24	8.0	203	250	1112		25	500
DT14EH-L0	48.0	1219	0.500	12.70	0.059	1.50	0.490	12.45	0.718	18.24	14.0	355	250	1112		50	250
DT15EH-L0	53.0	1346	0.500	12.70	0.059	1.50	0.490	12.45	0.718	18.24	15.0	381	250	1112		50	250
DT28EH-C0	96.0	2438	0.500	12.70	0.059	1.50	0.490	12.45	0.718	18.24	28.0	711	250	1112		100	–
DT44EH-C0	144.0	3658	0.500	12.70	0.059	1.50	0.490	12.45	0.718	18.24	44.0	1117	250	1112	100	–	

Stackable Aerial Cable Spacer – Weather Resistant Polypropylene

- Greater resistance to damage caused by ultraviolet light – indoor or outdoor use
- Each spacer snaps into another to increase spacer heights by 1/2" increments
- Designed for use in parallel or perpendicular applications
- For use with Dura-Ty™ Cable Ties shown on the previous page

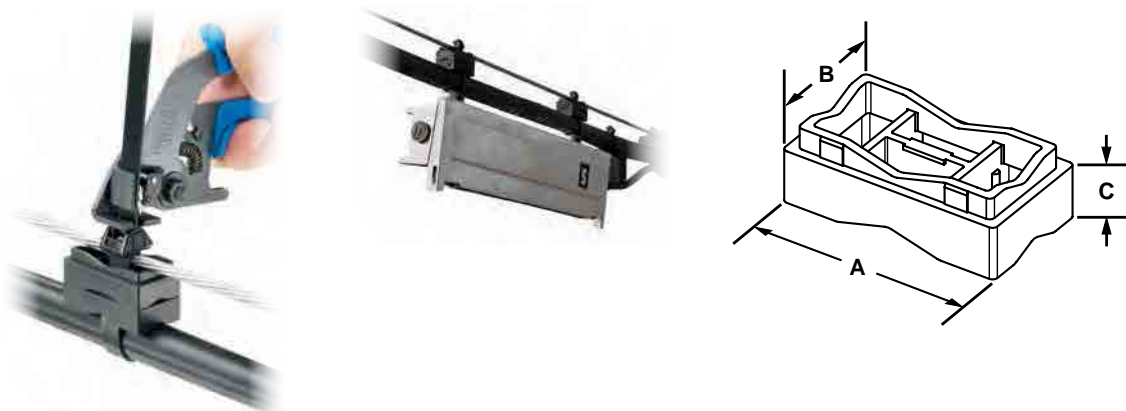

Part Number	Length A		Width B		Height C		Used with Cable Ties*	Std. Pkg. Qty.	Std. Ctn. Qty.
	In.	mm	In.	mm	In.	mm			
SACS50-T100	2.08	52.8	1.16	29.5	0.71	18.0	LH, H, EH	200	2000

*Cable tie cross section sizes: LH = Light-Heavy, H = Heavy, and EH = Extra-Heavy.

Dome-Top® Barb Ty and Dura-Ty™ Cable Ties

Material and Color Chart

Part Number	Color	Panduit Suffix
Nylon 6.6	Natural	✓
Weather Resistant Nylon 6.6	Black	0
Nylon 6.6	Brown	1
Nylon 6.6	Red	2
Nylon 6.6	Orange	3
Nylon 6.6	Yellow	4Y
Nylon 6.6	Green	5
Nylon 6.6	Blue	6
Nylon 6.6	Purple	7

Part Number	Color	Panduit Suffix
Nylon 6.6	Gray	8
Nylon 6.6	White	10
Nylon 6.6	Telephone Gray	14
Nylon 6.6	Black	20
Heat Stabilized Nylon 6.6	Black	30
Heat Stabilized Nylon 6.6	Natural	39
Flame Retardant Nylon 6.6	Natural (Ivory)	69
Weather Resistant Acetal	Black	*

✓Denotes Panduit® Natural Nylon 6.6 (no suffix).

*Denotes Dura-Ty™ Weather Resistant Acetal material (no suffix).

Part Number Availability List

Standard Packaging			Bulk Packaging		
Part Number	Natural Nylon 6.6	Material/Color Suffix	Part Number	Natural Nylon 6.6	Material/Color Suffix
			BC1M-S4-M	✓	0
			BC2M-S4-M	✓	0
			BC1.5I-S8-M	✓	0
BC2S-S10-C	✓	0	BC2S-S10-D	✓	0
			BC3S-S10-D	✓	0
BC4S-S10-C	✓	0	BC4S-S10-D	✓	0,30
BC4LH-S25-L	✓	0	BC4LH-S25-TL	✓	0
BF1M-C	✓		BF1M-M	✓	0
BF2M-C	✓		BF2M-M	✓	0
BM1M-C	✓		BM1M-M	✓	0
BM2M-C	✓		BM2M-M	✓	0
BM2S-C	✓		BM2S-D	✓	0
BM4S-C	✓		BM4S-D	✓	0
			BP2S-D		0
BT1M-C	✓	0,30	BT1M-M	✓	0,1,2,3,4Y,5,6,7,8,10,30,39
			BT1M-XMR	✓	0,30
BT1.5M-C	✓	0	BT1.5M-M	✓	0,30
			BT1.5M-XMR	✓	0,30
BT2M-C	✓	0	BT2M-M	✓	0,2,3,4Y,5,6,8,30
BT4M-C	✓	0	BT4M-M	✓	0
BT1.5I-C	✓	0	BT1.5I-M	✓	0,1,2,3,4Y,5,6,7,8,10,30,39
BT2I-C	✓	0	BT2I-M	✓	0,30
BT3I-C	✓	0	BT3I-M	✓	0,30
BT4I-C	✓	0	BT4I-M	✓	0
BT2S-C	✓	0	BT2S-M	✓	0,1,2,3,4Y,5,6,7,8,10,20,30,39
BT3S-C	✓	0,2	BT3S-M	✓	0,30,39
BT4S-C	✓	0	BT4S-M	✓	0,2,3,4Y,5,6,7,8,10,30,39
BT2LH-L	✓	0	BT2LH-TL	✓	0
BT3LH-L	✓	0	BT3LH-TL	✓	0
BT4LH-L	✓	0	BT4LH-TL	✓	0,30,39
BT5LH-L	✓	0	BT5LH-C	✓	0
BT6LH-L	✓	0	BT6LH-C	✓	0
BT7LH-L	✓	0	BT7LH-C	✓	0
BT8LH-L	✓	0	BT8LH-C	✓	0
BT9LH-L	✓	0	BT9LH-C	✓	0
			BW1.5I-D	✓	
			BW2S-D	✓	0
			BW3S-D	✓	0
			B2M2S-D	✓	0
			B3M2S-TL	✓	0
			B4M2S-TL	✓	0

Dura-Ty™ Cable Ties and Strapping

DTHEH-Q0, DTHH-Q0	*			
DTKEH-0, DTKH-0	*			
DTRH-LR0	*			
DTRH-LR0	*			
DT4EH-L0	*			
DT8EH-Q0	*			
DT14EH-L0	*		DT14EH-C0	*
DT15EH-L0	*			
DT28EH-C0	*			
DT44EH-C0	*			

*Denotes Dura-Ty™ Weather Resistant Acetal material (no suffix).

Features and Benefits – Parallel-Entry Cable Ties

Parallel-entry cable ties limit exposure to sharp edges and protect workers' arms/hands. The ties are designed with a low profile head to avoid snags and reduce overall bundle size.

Contour-Ty® Cable Ties

Fully enclosed head for consistent strength

Fully rounded edges on head and strap

Outside teeth and smooth round edges protect cable jacket – ideal for high vibration applications

Curved tip threads easily and installs faster

Rounded tip and aggressive grip for faster initial threading

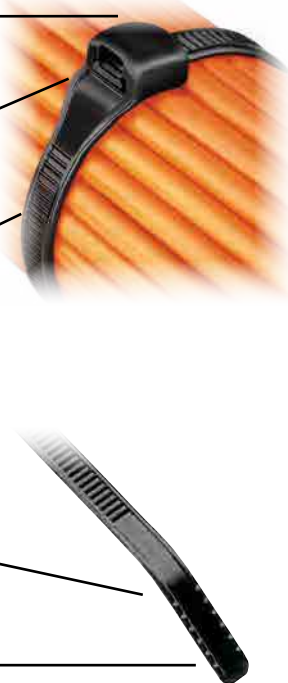

Hyper-V™ Cable Ties

Design provides for an optional threading position that allows releasable, temporary bundling

Fixed and flexible 2-wedge locking design

Tip bending serrations and threading hole facilitate installations in confined spaces

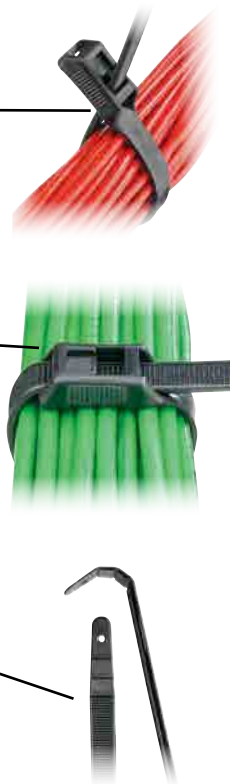

Belt-Ty™ In-Line Cable Ties



"Finger grip" shaped head assures positive grip while threading tie

Parallel-entry limits exposure to sharp edges and protects workers' arms/hands



IN-LINE Cable Ties

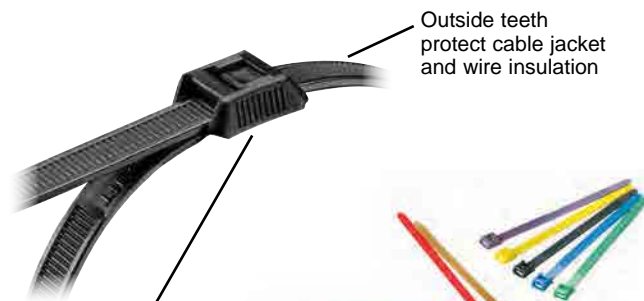

Outside teeth protect cable jacket and wire insulation

"Finger grip" shaped head with serrations assures positive grip while threading tie



Cable tie tools speed installation and reduce total installed cost. Visit www.panduit.com/tools.



Cable tie accessories are used to speed and simplify the mounting of wires, cables, and tubing. See pages B2.1 – B2.26.

Selection Guide – Parallel-Entry Cable Ties



	Material, Color (Suffix)	Style/Function	Part Number Prefix	Catalog Page
Contour-Ty® Cable Ties	Nylon 6.6, Natural (No Suffix)	Locking Ties/Bundle	CBR	B1.56
	Weather Resistant Nylon 6.6, Black (0)	Locking Ties/Bundle	CBR	B1.57
	Heat Stabilized Nylon 6.6, Black (30)	Locking Ties/Bundle	CBR	B1.58
	Heat Stabilized Nylon 6.6, Natural (39)	Locking Ties/Bundle	CBR	B1.58
	Flame Retardant Nylon 6.6, Ivory (69)	Locking Ties/Bundle	CBR	B1.58
Belt-Ty™ In-Line Cable Ties	Nylon 6.6, Natural (No Suffix)	Locking Ties/Bundle	ILT	B1.59
	Weather Resistant Nylon 6.6, Black (0)	Locking Ties/Bundle	ILT	B1.59
Hyper-V™ Cable Ties	Weather Resistant Nylon 6.6, Black (0)	Locking Ties/Bundle	HV	B1.60
IN-LINE Cable Ties	Weather Resistant Nylon 6.6, Black (0 and colors)	Locking Ties/Bundle	IT	B1.61

Part Number System for Contour-Ty® and Belt-Ty™ Cable Ties

CBR	2	S	—	M	
Type	Size	Cross Section		Package Size	Material/Color
CBR = Locking Tie ILT = Locking Tie	Approx. Maximum Bundle Dia. (In.)	M = Miniature I = Intermediate S = Standard HS = Heavy-Standard LH = Light-Heavy		C = 100 TL = 250 D = 500 M = 1000	See Page B1.62

Part Number System for Hyper-V™ and IN-LINE Cable Ties

HV	9	100	—	C	
Type	Width	Size		Package Size	Material/Color
HV = Locking Tie IT = Locking Tie	Approx. Width (mm)	Approx. Maximum Bundle Dia. (mm)		C = 100	See Page B1.62



Contour-Ty® Cable Ties – Nylon 6.6

- For indoor use
- Unique design prevents wire and cable damage
- Low profile head avoids snags and reduces overall bundle size
- Outside teeth and smooth round edges protect cable jacket – ideal for high vibration applications
- Parallel-entry limits exposure to sharp edges and protects workers' arms/hands
- Fully enclosed head for consistent strength
- Curved tip is easy to pick up from flat surfaces and allows faster initial threading to speed installation
- UL Listed for use in plenum or air handling spaces per NEC
- Note: Nylon 6.6 cable ties in natural and colors meet the testing requirements of SAE Aerospace Standard AS23190 and the dimensional requirements of SAE Aerospace Standard AS33671

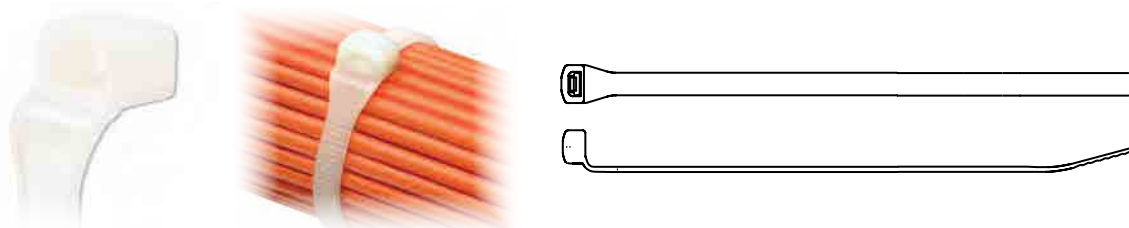

Part Number	Length		Width		Thickness		Max. Bundle Dia.		Min. Loop Tensile Str.		Recommended Installation Tool	Std. Pkg. Qty.	Std. Ctn. Qty.
	In.	mm	In.	mm	In.	mm	In.	mm	Lbs.	N			
Miniature Cross Section – Plenum-Rated													
CBR1M-M	4.1	104	0.098	2.5	0.038	1.0	1.00	25	18	80	GTS-E, GS2B, PTS, PPTS, STS2	1000	50000
CBR1.5M-M	5.6	142	0.098	2.5	0.042	1.1	1.50	38	18	80		1000	50000
CBR2M-M	7.2	183	0.098	2.5	0.042	1.1	2.00	51	18	80		1000	25000
Intermediate Cross Section – Plenum-Rated													
CBR1.5I-M	5.9	150	0.140	3.6	0.040	1.0	1.50	38	40	178	GTS-E, GS2B, PTS, PPTS, STS2	1000	25000
CBR3I-M	10.4	264	0.140	3.6	0.052	1.3	3.00	76	40	178		1000	10000
CBR4I-M	13.6	345	0.140	3.6	0.052	1.3	4.00	102	40	178		1000	10000
Standard Cross Section – Plenum-Rated													
CBR2S-M	7.6	193	0.190	4.8	0.044	1.1	2.00	51	50	222	GTS-E, GS2B, GTH-E, GS4H, PTS, PTH, PPTS, STS2, STH2	1000	10000
CBR3S-M	10.8	274	0.190	4.8	0.052	1.3	3.00	76	50	222		1000	5000
CBR4S-M	14.0	356	0.190	4.8	0.052	1.3	4.00	102	50	222		1000	5000
Heavy-Standard Cross Section – Plenum-Rated													
CBR2HS-D	8.0	203	0.250	6.4	0.058	1.4	2.00	51	85	378	GTH-E, GS4H, GS4EH, PTH, STH2, ST3EH	500	5000
Light-Heavy Cross Section – Plenum-Rated													
CBR4LH-TL	14.6	371	0.300	7.6	0.070	1.8	4.00	102	120	534	GTH-E, GS4H, GS4EH, PTH, STH2, ST3EH	250	2500
CBR6LH-C	20.9	531	0.300	7.6	0.070	1.8	6.00	152	120	534		100	2000



Contour-Ty® Cable Ties – Weather Resistant Nylon 6.6

- Greater resistance to damage caused by ultraviolet light – indoor or outdoor use
- Unique design prevents wire and cable damage
- Low profile head avoids snags and reduces overall bundle size
- Outside teeth and smooth round edges protect cable jacket – ideal for high vibration applications
- Parallel-entry limits exposure to sharp edges and protects workers' arms/hands
- Fully enclosed head for consistent strength
- Curved tip is easy to pick up from flat surfaces and allows faster initial threading to speed installation

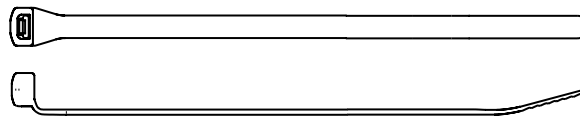

Part Number	Length		Width		Thickness		Max. Bundle Dia.		Min. Loop Tensile Str.		Recommended Installation Tool	Std. Pkg. Qty.	Std. Ctn. Qty.
	In.	mm	In.	mm	In.	mm	In.	mm	Lbs.	N			
Miniature Cross Section													
CBR1M-M0	4.1	104	0.098	2.5	0.038	1.0	1.00	25	18	80	GTS-E, GS2B, PTS, PPTS, STS2	1000	50000
CBR1.5M-M0	5.6	142	0.098	2.5	0.042	1.1	1.50	38	18	80		1000	50000
CBR2M-M0	7.2	183	0.098	2.5	0.042	1.1	2.00	51	18	80		1000	25000
Intermediate Cross Section													
CBR1.5I-M0	5.9	150	0.140	3.6	0.040	1.0	1.50	38	40	178	GTS-E, GS2B, PTS, PPTS, STS2	1000	25000
CBR3I-M0	10.4	264	0.140	3.6	0.052	1.3	3.00	76	40	178		1000	10000
CBR4I-M0	13.6	345	0.140	3.6	0.052	1.3	4.00	102	40	178		1000	10000
Standard Cross Section													
CBR2S-M0	7.6	193	0.190	4.8	0.044	1.1	2.00	51	50	222	GTS-E, GS2B, GTH-E, GS4H, PTS, PTH, PPTS, STS2, STH2	1000	10000
CBR3S-M0	10.8	274	0.190	4.8	0.052	1.3	3.00	76	50	222		1000	5000
CBR4S-M0	14.0	356	0.190	4.8	0.052	1.3	4.00	102	50	222		1000	5000
Heavy-Standard Cross Section													
CBR2HS-D0	8.0	203	0.250	6.4	0.058	1.4	2.00	51	85	378	GTH-E, GS4H, GS4EH, PTH, STH2, ST3EH	500	5000
Light-Heavy Cross Section													
CBR4LH-TL0	14.6	371	0.300	7.6	0.070	1.8	4.00	102	120	534	GTH-E, GS4H, GS4EH, PTH, STH2, ST3EH	250	2500
CBR6LH-C0	20.9	531	0.300	7.6	0.070	1.8	6.00	152	120	534		100	2000

B1.
Cable
Ties

B2.
Cable
Accessories

B3.
Stainless
Steel Cable
Ties &
Accessories

C1.
Wiring
Duct

C2.
Abrasion
Protection

C3.
Cable
Management

D1.
Terminals

D2.
Power
Connectors

D3.
Grounding
Connectors

E1.
Labeling
Systems

E2.
Labels

E3.
Pre-Printed
&
Write-On
Markers

E4.
Permanent
Identification

E5.
Industrial
Safety
Solutions

F.
Keystone
Cabling
Systems

G.
Part
Number
Index



Contour-Ty® Cable Ties – Heat Stabilized and Flame Retardant Nylon 6.6

- Heat stabilized material for high temperature applications up to 239°F (115°C) – indoor use
- Flame retardant material has a flammability rating of UL 94V-0 – indoor use
- Unique design prevents wire and cable damage
- Low profile head avoids snags and reduces overall bundle size
- Outside teeth and smooth round edges protect cable jacket – ideal for high vibration applications
- Parallel-entry limits exposure to sharp edges and protects workers' arms/hands
- Fully enclosed head for consistent strength
- Curved tip is easy to pick up from flat surfaces and allows faster initial threading to speed installation



CBR2S-M30



CBR2S-M39



CBR3S-M69

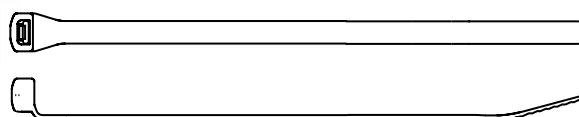

Part Number	Length		Width		Thickness		Max. Bundle Dia.		Min. Loop Tensile Str.		Recommended Installation Tool	Std. Pkg. Qty.	Std. Ctn. Qty.
	In.	mm	In.	mm	In.	mm	In.	mm	Lbs.	N			

Heat Stabilized Nylon 6.6 – Black Miniature Cross Section

CBR1M-M30	4.1	104	0.098	2.5	0.038	1.0	0.90	25	18	80	GTS-E, GS2B, PTS, PPTS, STS2	1000	50000
-----------	-----	-----	-------	-----	-------	-----	------	----	----	----	------------------------------	------	-------

Intermediate Cross Section

CBR1.5I-M30	5.9	150	0.140	3.6	0.040	1.0	1.50	38	40	178	GTS-E, GS2B, PTS, PPTS, STS2	1000	25000
-------------	-----	-----	-------	-----	-------	-----	------	----	----	-----	------------------------------	------	-------

Standard Cross Section

CBR2S-M30	7.6	193	0.190	4.8	0.044	1.1	2.00	51	50	222	GTS-E, GS2B, GTH-E, GS4H, PTS, PTH, PPTS, STS2, STH2	1000	10000
CBR3S-M30	10.8	274	0.190	4.8	0.052	1.3	3.00	76	50	222		1000	5000
CBR4S-M30	14.0	356	0.190	4.8	0.052	1.3	4.00	102	50	222		1000	5000

Light-Heavy Cross Section

CBR4LH-TL30	14.6	371	0.300	7.6	0.070	1.8	4.00	102	120	534	GTH-E, GS4H, GS4EH, PTH, STH2, ST3EH	250	2500
CBR6LH-C30	20.9	531	0.300	7.6	0.070	1.8	6.00	152	120	534		100	2000

Heat Stabilized Nylon 6.6 – Natural Standard Cross Section

CBR2S-M39	7.6	193	0.190	4.8	0.044	1.1	2.00	51	50	222	GTS-E, GS2B, GTH-E, GS4H, PTS, PTH, PPTS, STS2, STH2	1000	10000
-----------	-----	-----	-------	-----	-------	-----	------	----	----	-----	--	------	-------

Heat Stabilized Nylon 6.6 – Natural Ivory Standard Cross Section

CBR3S-M69	10.8	274	0.190	4.8	0.052	1.3	3.00	76	50	222	GTS-E, GS2B, GTH-E, GS4H, PTS, PTH, PPTS, STS2, STH2	1000	5000
-----------	------	-----	-------	-----	-------	-----	------	----	----	-----	--	------	------

Note: UL Recognized, UL Listed, and CSA Certified, except CBR3S-M69.



Belt-Ty™ In-Line Cable Ties – Nylon and Weather Resistant Nylon 6.6

- Natural nylon material for indoor use
- Weather resistant material has greater resistance to damage caused by ultraviolet light – indoor or outdoor use
- Parallel-entry cable tie that threads like a belt (180° entry)
- Low profile head avoids snags and reduces overall bundle size
- Up to 35% lower head height than conventional 90° ties

- Parallel-entry limits exposure to sharp edges and protects workers' arms/hands
- Curved tip is easy to pick up from flat surfaces and allows faster initial threading to speed installation
- Nylon 6.6 cable ties are UL Listed for use in plenum or air handling spaces per NEC



ILT2S-C



ILT2S-C0

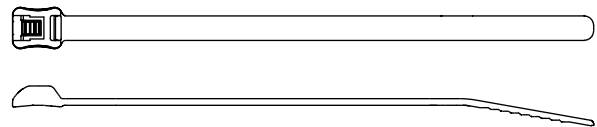

Part Number	Length		Width		Thickness		Max. Bundle Dia.		Min. Loop Tensile Str.		Recommended Installation Tool	Std. Pkg. Qty.	Std. Ctn. Qty.
	In.	mm	In.	mm	In.	mm	In.	mm	Lbs.	N			

Nylon 6.6 – Black

Standard Cross Section – Plenum-Rated

ILT2S-C	8.3	211	0.190	4.8	0.052	1.3	1.88	48	50	222	GTS-E, GS2B, GTH-E, GS4H, PTS, PTH, PPTS, STS2, STH2	100	1000
ILT3S-C	11.5	292	0.190	4.8	0.052	1.3	3.00	76	50	222		100	1000
ILT4S-C	14.7	373	0.190	4.8	0.052	1.3	4.00	102	50	222		100	1000

Light-Heavy Cross Section – Plenum-Rated

ILT4LH-TL	14.8	376	0.300	7.6	0.075	1.9	4.00	102	120	534	GTH-E, GS4H, GS4EH, PTH, STH2, ST3EH	250	2500
ILT6LH-C	21.2	538	0.300	7.6	0.075	1.9	6.00	152	120	534		100	2000

Weather Resistant Nylon 6.6

Standard Cross Section

ILT2S-C0	8.3	211	0.190	4.8	0.052	1.3	1.88	48	50	222	GTS-E, GS2B, GTH-E, GS4H, PTS, PTH, PPTS, STS2, STH2	100	1000
ILT3S-C0	11.5	292	0.190	4.8	0.052	1.3	3.00	76	50	222		100	1000
ILT4S-C0	14.7	373	0.190	4.8	0.052	1.3	4.00	102	50	222		100	1000

Light-Heavy Cross Section

ILT4LH-TL0	14.8	376	0.190	7.6	0.075	1.9	4.00	102	120	534	GTH-E, GS4H, GS4EH, PTH, STH2, ST3EH	250	2500
ILT6LH-C0	21.2	538	0.300	7.6	0.075	1.9	6.00	152	120	534		100	2000

Weather resistant nylon 6.6 cable ties are UL Listed, and CSA Certified except ILT4LH/6LH.

Hyper-V™ In-Line Cable Ties – Weather Resistant Nylon 6.6

- Fixed and flexible two-wedge locking design provides a low threading force
- Teeth on both sides of cable tie body provide additional locking strength and improved flexibility to conform to irregular bundle shapes such as securing cables to cable tray systems
- Releasable head position for temporary bundling of cables prior to final locking; no need to replace ties when adding cables/wires to the bundle
- Teeth on full length of body support a wide range of bundle diameters
- Bending serrations on the tip of the tie allow the tip to be easily formed into an arc, enabling installer to “fish” the tie around the bundle in a confined space
- Threading hole in the tip of the tie allows an installer to hook the tip with a simple device to pull the tie through spaces with limited access
- In-Line tie design for parallel-entry of the tie into head resulting in a lower profile on cable bundles
- Complementary mounts shown below

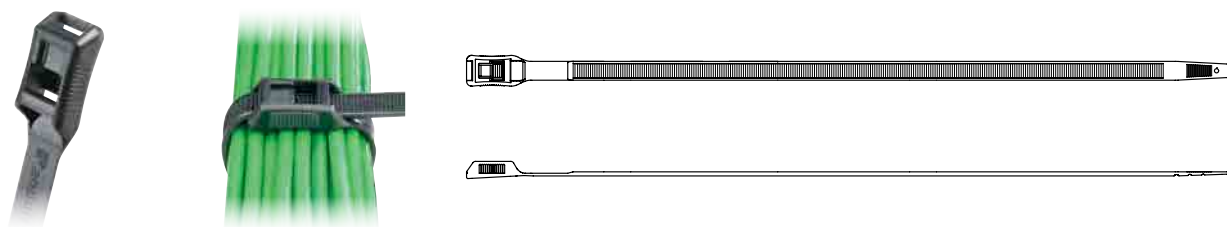

Part Number	Length		Width		Thickness		Max. Bundle Dia.		Min. Loop Tensile Str.		Recommended Installation Tool	Std. Pkg. Qty.	Std. Ctn. Qty.
	In.	mm	In.	mm	In.	mm	In.	mm	Lbs.	N			
HV965-C0	10.4	265	0.350	8.9	0.076	1.9	2.60	65	160	710	GTH-E, GS4H, GS4EH, PTH, STH2, ST3EH, STHV	100	1000
HV9100-C0	14.4	367	0.350	8.9	0.076	1.9	3.90	100	160	710		100	1000
HV9150-C0	20.7	525	0.350	8.9	0.076	1.9	5.90	150	160	710		100	1000
HV9250-C0	33.1	841	0.350	8.9	0.076	1.9	9.80	250	160	710		100	1000

Hyper-V™ Cable Tie Mounts

- Tie mount has retaining tab within window to hold cable tie in position when pre-installed in the mount; low profile design keeps bundle close to mounting surface
- Masonry mounts are used to secure wire, cable, or tubing to masonry surfaces
- For outdoor use



Part Number	Material	Color	Mounting Method	Std. Pkg. Qty.	Std. Ctn. Qty.
Tie Mounts					
HVTM-06-C0	Weather Resistant Nylon 6.6	Black	#12 (M6) screw	100	500
Masonry Mounts					
HVMPM-08-C0	Impact Modified Weather Resistant Nylon 6.6	Black	Fir tree hole mount	100	500

IN-LINE Cable Ties – Weather Resistant Nylon 6.6

- Greater resistance to damage caused by ultraviolet light – indoor or outdoor use
- Parallel-entry cable tie that threads like a belt (180° entry)
- Wide tie body provides high tensile strength
- Up to 50% lower head height than conventional 90° ties
- Parallel-entry limits exposure to sharp edges and protects workers’ arms/hands
- Outside teeth protect cable jacket and wire insulation
- “Finger grip” shaped head with serrations assures positive grip while threading tie
- Install by hand or use Panduit® GTH installation tool
- Flexible – easy to handle and install
- Available in UV weather resistant colors for color coordination and UV stability

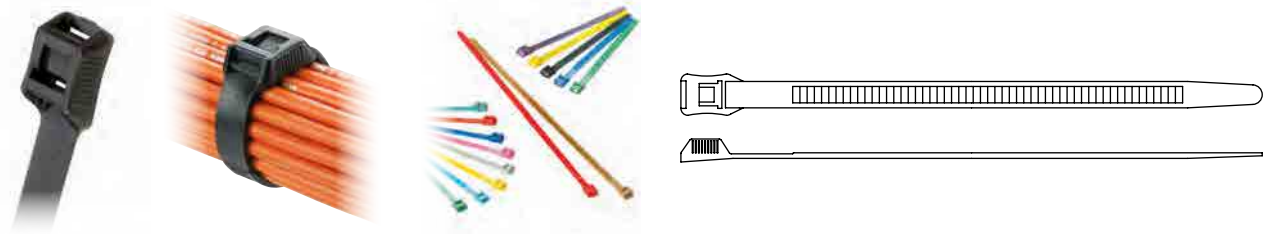

Part Number	Color	Length		Width		Thickness		Max. Bundle Dia.		Min. Loop Tensile Str.		Std. Pkg. Qty.	Std. Ctn. Qty.
		In.	mm	In.	mm	In.	mm	In.	mm	Lbs.	N		
Black Cable Ties													
IT940-C0	UV Black	6.8	173	0.350	8.9	0.065	1.7	1.57	40	124	552	100	1000
IT965-C0	UV Black	10.1	257	0.350	8.9	0.065	1.7	2.56	65	124	552	100	1000
IT9100-C0	UV Black	14.1	358	0.350	8.9	0.065	1.7	3.94	100	124	552	100	1000
IT9115-C0	UV Black	15.3	389	0.350	8.9	0.065	1.7	4.53	115	124	552	100	1000

Colored Cable Ties													
IT9100-CUV2	UV Red	14.1	358	0.350	8.9	0.065	1.7	3.94	100	124	552	100	1000
IT9100-CUV4Y	UV Yellow	14.1	358	0.350	8.9	0.065	1.7	3.94	100	124	552	100	1000
IT9100-CUV6	UV Dark Blue	14.1	358	0.350	8.9	0.065	1.7	3.94	100	124	552	100	1000
IT9100-CUV6A	UV Light Blue	14.1	358	0.350	8.9	0.065	1.7	3.94	100	124	552	100	1000
IT9100-CUV7A	UV Purple	14.1	358	0.350	8.9	0.065	1.7	3.94	100	124	552	100	1000
IT9100-CUV8	UV Gray	14.1	358	0.350	8.9	0.065	1.7	3.94	100	124	552	100	1000
IT9100-CUV16B	UV Magenta	14.1	358	0.350	8.9	0.065	1.7	3.94	100	124	552	100	1000
IT9115-CUV2	UV Red	15.3	389	0.350	8.9	0.065	1.7	4.53	115	124	552	100	1000
IT9115-CUV2A	UV Bright Red	15.3	389	0.350	8.9	0.065	1.7	4.53	115	124	552	100	1000
IT9115-CUV4Y	UV Yellow	15.3	389	0.350	8.9	0.065	1.7	4.53	115	124	552	100	1000
IT9115-CUV4A	UV Butterscotch	15.3	389	0.350	8.9	0.065	1.7	4.53	115	124	552	100	1000
IT9115-CUV5A	UV Green	15.3	389	0.350	8.9	0.065	1.7	4.53	115	124	552	100	1000
IT9115-CUV5B	UV Hunter Green	15.3	389	0.350	8.9	0.065	1.7	4.53	115	124	552	100	1000
IT9115-CUV6	UV Dark Blue	15.3	389	0.350	8.9	0.065	1.7	4.53	115	124	552	100	1000
IT9115-CUV6A	UV Light Blue	15.3	389	0.350	8.9	0.065	1.7	4.53	115	124	552	100	1000
IT9115-CUV6B	UV Cobalt Blue	15.3	389	0.350	8.9	0.065	1.7	4.53	115	124	552	100	1000
IT9115-CUV7A	UV Purple	15.3	389	0.350	8.9	0.065	1.7	4.53	115	124	552	100	1000
IT9115-CUV8	UV Gray	15.3	389	0.350	8.9	0.065	1.7	4.53	115	124	552	100	1000
IT9115-CUV8A	UV Charcoal Gray	15.3	389	0.350	8.9	0.065	1.7	4.53	115	124	552	100	1000
IT9115-CUV11	UV Teal	15.3	389	0.350	8.9	0.065	1.7	4.53	115	124	552	100	1000
IT9115-CUV16B	UV Magenta	15.3	389	0.350	8.9	0.065	1.7	4.53	115	124	552	100	1000
IT9115-CUV18	UV Tan	15.3	389	0.350	8.9	0.065	1.7	4.53	115	124	552	100	1000

Parallel-Entry Cable Ties

Material and Color Chart

Part Number	Color	Panduit Suffix
Nylon 6.6	Natural	✓
Weather Resistant Nylon 6.6	Black	0
Nylon 6.6	Brown	1
Nylon 6.6	Red	2
Nylon 6.6	Orange	3
Nylon 6.6	Yellow	4Y
Nylon 6.6	Green	5
Nylon 6.6	Blue	6
Nylon 6.6	Purple	7
Nylon 6.6	Gray	8
Nylon 6.6	White	10
Heat Stabilized Nylon 6.6	Black	30
Heat Stabilized Nylon 6.6	Natural	39
Flame Retardant Nylon 6.6	Natural (Ivory)	69

✓Denotes Panduit® Natural Nylon 6.6 (no suffix).

Part Number	Color	Panduit Suffix
Nylon 6.6	Ultraviolet Red	UV2
Nylon 6.6	Ultraviolet Bright Red	UV2A
Nylon 6.6	Ultraviolet Yellow	UV4Y
Nylon 6.6	Ultraviolet Butterscotch	UV4A
Nylon 6.6	Ultraviolet Green	UV5A
Nylon 6.6	Ultraviolet Hunter Green	UV5B
Nylon 6.6	Ultraviolet Dark Blue	UV6
Nylon 6.6	Ultraviolet Light Blue	UV6A
Nylon 6.6	Ultraviolet Cobalt Blue	UV6B
Nylon 6.6	Ultraviolet Purple	UV7A
Nylon 6.6	Ultraviolet Gray	UV8
Nylon 6.6	Ultraviolet Charcoal Gray	UV8A
Nylon 6.6	Ultraviolet Teal	UV11
Nylon 6.6	Ultraviolet Magenta	UV16B
Nylon 6.6	Ultraviolet Tan	UV18

Part Number Availability List

Standard Packaging			Bulk Packaging		
Part Number	Natural Nylon 6.6	Material/Color Suffix	Part Number	Natural Nylon 6.6	Material/Color Suffix
			CBR1M-M	✓	0,30
			CBR1.5M-M	✓	0
			CBR2M-M	✓	0,1,2,3,4Y,5,6,7
			CBR1.5I-M	✓	0,30
			CBR3I-M	✓	0,1,2,3,4Y,5,6,7,8,10
			CBR4I-M	✓	0
			CBR2S-M	✓	0,30,39
			CBR3S-M	✓	0,30,69
			CBR4S-M	✓	0,30
			CBR2HS-D	✓	0
			CBR4LH-TL	✓	0,30
			CBR6LH-C	✓	0,30
			HV965-C	✓	0
			HV9100-C	✓	0
			HV9150-C	✓	0
			HV9250-C	✓	0
ILT2S-C	✓	0	ILT2S-M	✓	0
ILT3S-C	✓	0	ILT3S-M	✓	0
ILT4S-C	✓	0	ILT4S-M	✓	0
			ILT4LH-TL	✓	0
			ILT6LH-C	✓	0
			IT940-C	✓	0
			IT965-C	✓	0
			IT9100-C	✓	0,UV2,UV4Y,UV6,UV7A,UV8,UV16B
			IT9115-C	✓	0,UV2,UV2A,UV4Y,UV4A,UV5A,UV5B,UV6,UV6A,UV6B,UV7A,UV8,UV8A,UV11,UV16B,UV18

Features and Benefits – Sta-Strap® Cable Ties

Two-piece design incorporates a separate nylon head and strap.

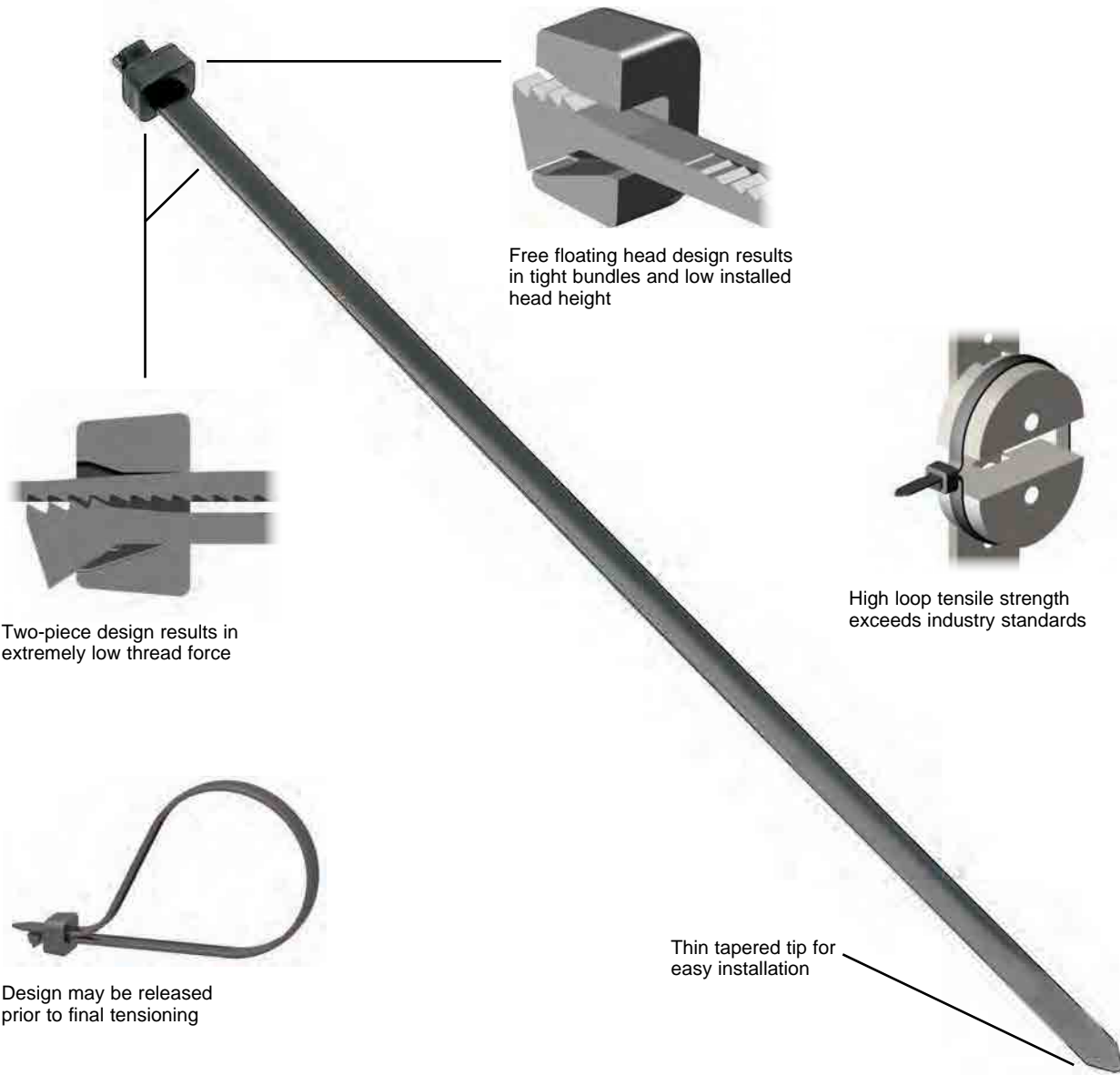

Cable tie tools speed installation and reduce total installed cost. Visit www.panduit.com/tools.



Cable tie accessories are used to speed and simplify the mounting of wires, cables, and tubing. See pages B2.1 – B2.26.

Selection Guide – Sta-Strap® Cable Ties



Material, Color (Suffix)	Style/Function	Part Number Prefix	Catalog Page
Nylon 6.6, Natural (No Suffix)	Locking Ties/Bundle	SST	B1.65
	Clamp Ties/Mount	SSC	B1.67
	Marker Ties/Identify	SSM	B1.68
Weather Resistant Nylon 6.6, Black (0)	Locking Ties/Bundle	SST	B1.66
	Clamp Ties/Mount	SSC	B1.67
	Marker Ties/Identify	SSM	B1.68
Heat Stabilized Nylon 6.6, Black (30)	Clamp Ties/Mount	SSC	B1.67

Part Number System for Sta-Strap® Cable Ties

SST	1	M	—	C	—
Type	Size	Cross Section	Screw Hole Size	Package Size	Material/Color
SST = Locking Tie SSC = Clamp Tie SSM = Flag Tie	Approx. Maximum Bundle Dia. (In.)	M = Miniature I = Intermediate S = Standard H = Heavy HH = Heavy Head	(Clamp Ties Only) -S6 = #6 (M3) -S10 = #10 (M5) -S25 = 1/4 (M6)	L = 50 C = 100 D = 500 M = 1000	See Page B1.69



Sta-Strap® Cable Ties – Nylon 6.6

- For indoor use
- Used for normal bundling and through-panel applications
- Small head height allows more efficient use of space in compact areas

- Exclusive two-piece design offers the lowest threading force in the industry
- Average 14% lighter than one-piece cable ties
- Releasable prior to final tensioning for bundle modifications

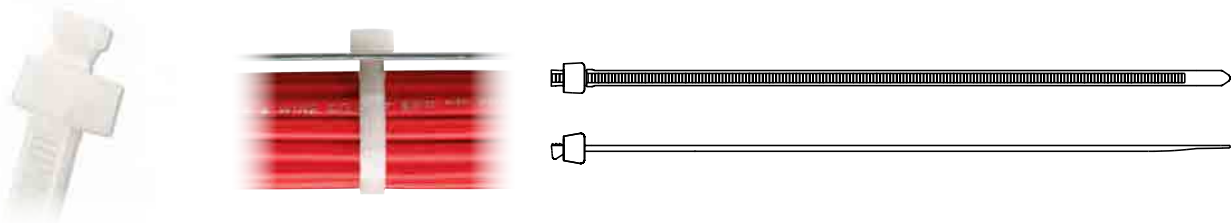

Part Number	Length		Width		Thickness		Max. Bundle Dia.		Min. Loop Tensile Str.		Recommended Installation Tool	Std. Pkg. Qty.	Std. Ctn. Qty.
	In.	mm	In.	mm	In.	mm	In.	mm	Lbs.	N			
Miniature Cross Section													
SST1M-C	4.0	102	0.095	2.4	0.035	.9	.78	20	18	80	GTS-E, GS2B, PTS, PPTS, STS2	100	1000
SST1.5M-C	5.5	140	0.095	2.4	0.037	.9	1.25	32	18	80		100	1000
Intermediate Cross Section													
SST1.5I-C	5.3	137	0.135	3.4	0.037	.9	1.25	32	40	178	GTS-E, GS2B, PTS, PPTS, STS2	100	1000
SST2I-C	8.1	206	0.135	3.4	0.040	1.0	2.00	51	40	178		100	1000
SST3I-C	11.0	279	0.135	3.4	0.040	1.0	3.00	76	40	178		100	1000
SST4I-C	14.7	375	0.135	3.4	0.040	1.0	4.00	102	40	178		100	1000
Standard Cross Section													
SST1.5S-M	5.7	146	0.180	4.6	0.045	1.2	1.25	32	50	222	GTS-E, GS2B, GTH-E, GS4H, PTS, PTH, PPTS, STS2, STH2	1000	25000
SST2S-C	6.7	172	0.180	4.6	0.045	1.2	1.75	45	50	222		100	1000
SST3S-C	11.0	279	0.180	4.6	0.048	1.2	3.00	76	50	222		100	1000
SST4S-C	15.0	381	0.180	4.6	0.048	1.2	4.00	102	50	222		100	1000
Light-Heavy Cross Section													
SST2H-D	8.0	203	0.300	7.6	0.062	1.6	2.00	51	120	534	GTH-E, GS4H, GS4EH, PTH, STH2, ST3EH	500	5000
SST4H-L	14.8	376	0.300	7.6	0.067	1.7	4.00	102	120	534		50	500
SST8H-L	27.5	699	0.300	7.6	0.067	1.7	8.00	203	120	534		50	500

Sta-Strap® Cable Ties – Weather Resistant Nylon 6.6

- Greater resistance to damage caused by ultraviolet light – indoor or outdoor use
- Used for normal bundling and through-panel applications
- Small head height allows more efficient use of space in compact areas
- Exclusive two-piece design offers the lowest threading force in the industry
- Average 14% lighter than one-piece cable ties
- Releasable prior to final tensioning for bundle modifications

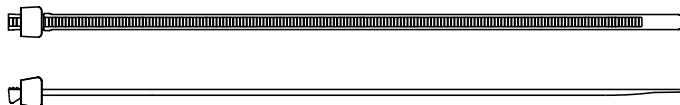

Part Number	Length		Width		Thickness		Max. Bundle Dia.		Min. Loop Tensile Str.		Recommended Installation Tool	Std. Pkg. Qty.	Std. Ctn. Qty.
	In.	mm	In.	mm	In.	mm	In.	mm	Lbs.	N			
Miniature Cross Section													
SST1M-C0	4.0	102	0.095	2.4	0.035	0.9	.78	20	18	80	GTS-E, GS2B, PTS, PPTS, STS2	100	1000
SST1.5M-M0	5.5	140	0.095	2.4	0.037	0.9	1.25	32	18	80		1000	50000
Intermediate Cross Section													
SST1.5I-M0	5.3	137	0.135	3.4	0.037	0.9	1.25	32	40	178	GTS-E, GS2B, PTS, PPTS, STS2	1000	25000
SST2I-M0	8.1	206	0.135	3.4	0.040	1.0	2.00	51	40	178		1000	25000
SST3I-C0	11.1	279	0.135	3.4	0.040	1.0	3.00	76	40	178		100	1000
SST4I-M0	14.7	375	0.135	3.4	0.040	1.0	4.00	102	40	178		1000	10000
Standard Cross Section													
SST1.5S-M0	5.7	146	0.180	4.6	0.045	1.2	1.25	32	50	222	GTS-E, GS2B, GTH-E, GS4H, PTS, PTH, PPTS, STS2, STH2	1000	25000
SST2S-C0	6.7	172	0.180	4.6	0.045	1.2	1.75	45	50	222		100	1000
SST3S-C0	11.0	279	0.180	4.6	0.048	1.2	3.00	76	50	222		100	1000
SST4S-C0	15.0	381	0.180	4.6	0.048	1.2	4.00	102	50	222		100	1000
Light-Heavy Cross Section													
SST2H-D0	8.0	203	0.300	7.6	0.062	1.6	2.00	51	120	534	GTH-E, GS4H, GS4EH, PTH, STH2, ST3EH	500	5000
SST4H-L0	14.8	376	0.300	7.6	0.067	1.7	4.00	102	120	534		50	500
SST8H-L0	27.5	699	0.300	7.6	0.067	1.7	8.00	203	120	534		50	500

UL **CS** **Sta-Strap® Clamp Ties**

- Natural nylon material for indoor use
- Weather resistant material has greater resistance to damage caused by ultraviolet light – indoor or outdoor use
- Heat stabilized material for high temperature applications up to 239°F (115°C) – indoor use
- Design allows for bundling before or after screwing clamp in place

- Exclusive two-piece design offers the lowest threading force in the industry
- Used to secure a cable bundle to another surface such as a control panel, communication rack, wall or ceiling
- Only clamp tie that is releasable prior to final tensioning



SSC2S-S10-C



SSC2S-S10-M0

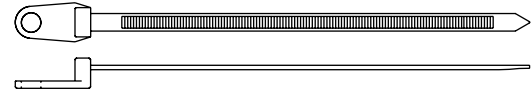

Part Number	Length		Width		Thickness		Nominal Hole Dia.		Screw Size	Metric Screw Size	Max. Bundle Dia.		Min. Loop Tensile Str.		Recommended Installation Tool	Std. Pkg. Qty.	Std. Ctn. Qty.
	In.	mm	In.	mm	In.	mm	In.	mm			In.	mm	Lbs.	N			

Nylon 6.6

Standard Cross Section

SSC2S-S6-C	7.4	187	0.180	4.6	0.045	1.1	0.148	3.8	#6	M3	1.75	45	50	222	GTS-E, GS2B, GTH-E, GS4H, PTS, PTH, PPTS, STS2, STH2	100	1000
SSC2S-S10-C	7.4	187	0.180	4.6	0.045	1.1	0.200	5.1	#10	M5	1.75	45	50	222		100	1000
SSC4S-S10-C	15.7	398	0.180	4.6	0.045	1.1	0.200	5.1	#10	M5	4.00	102	50	222		100	500

Light-Heavy Cross Section

SSC4H-S25-L	15.6	395	0.300	7.6	0.065	1.7	0.260	6.6	1/4	M6	4.00	102	120	534	GTH-E, GS4H, GS4EH, PTH, STH2, ST3EH	50	500
-------------	------	-----	-------	-----	-------	-----	-------	-----	-----	----	------	-----	-----	-----	--------------------------------------	----	-----

Weather-Resistant Nylon 6.6

Standard Cross Section

SSC2S-S6-M0	7.4	187	0.180	4.6	0.045	1.1	0.148	3.8	#6	M3	1.75	45	50	222	GTS-E, GS2B, GTH-E, GS4H, PTS, PTH, PPTS, STS2, STH2	1000	10000
SSC2S-S10-M0	7.4	187	0.180	4.6	0.045	1.1	0.200	5.1	#10	M5	1.75	45	50	222		1000	10000
SSC4S-S10-M0	15.7	398	0.180	4.6	0.045	1.1	0.200	5.1	#10	M5	4.00	102	50	222		1000	5000

Light-Heavy Cross Section

SSC4H-S25-D0	15.6	395	0.300	7.6	0.065	1.7	0.260	6.6	1/4	M6	4.00	102	120	534	GTH-E, GS4H, GS4EH, PTH, STH2, ST3EH	500	2500
--------------	------	-----	-------	-----	-------	-----	-------	-----	-----	----	------	-----	-----	-----	--------------------------------------	-----	------

Heat Stabilized Nylon 6.6

Standard Cross Section

SSC2S-S10-M30	7.4	187	0.180	4.6	0.045	1.2	0.200	5.1	#10	M5	1.75	45	50	222	GTS-E, GS2B, GTH-E, GS4H, PTS, PTH, PPTS, STS2, STH2	1000	10000
---------------	-----	-----	-------	-----	-------	-----	-------	-----	-----	----	------	----	----	-----	--	------	-------

Light-Heavy Cross Section

SSC4H-S25-D30	15.6	395	0.300	7.6	0.065	1.7	0.260	6.6	1/4	M6	4.00	102	120	534	GTH-E, GS4H, GS4EH, PTH, STH2, ST3EH	500	2500
---------------	------	-----	-------	-----	-------	-----	-------	-----	-----	----	------	-----	-----	-----	--------------------------------------	-----	------

Sta-Strap® Marker Ties – Nylon and Weather Resistant Nylon 6.6

- Natural nylon material for indoor use
- Weather resistant material has greater resistance to damage caused by ultraviolet light – indoor or outdoor use
- Used to fasten and identify bundles at the same time
- Unique design allows tie to be used as a wrap-around or flag marker
- Can be marked with Panduit® Marker Pens on page B1.49 or computer printable labels

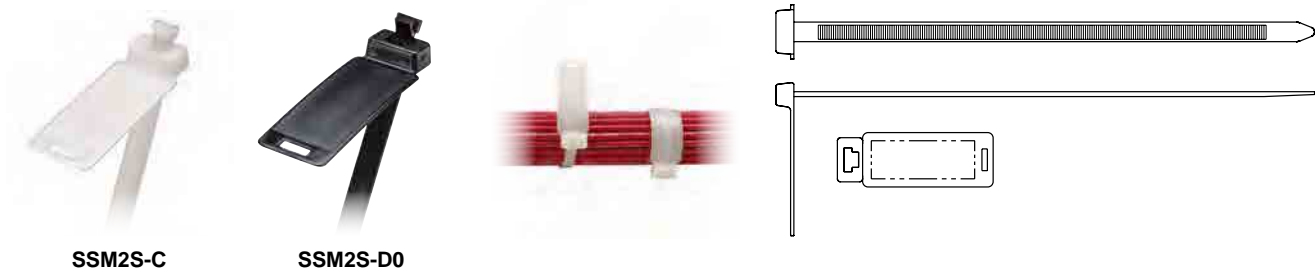

Part Number	Marker Type	Length		Width		Thickness		Marker Write-On Area		Max. Bundle Dia.		Min. Loop Tensile Str.		Recommended Installation Tool	Std. Pkg. Qty.	Std. Ctn. Qty.
		In.	mm	In.	mm	In.	mm	In.	mm	In.	mm	Lbs.	N			

Nylon 6.6 Standard Cross Section

SSM2S-C	Wrap/Flag	6.7	170	0.180	4.6	0.045	1.1	0.44 x 0.96	11.2 x 24.4	1.75	45	50	222	GTS-E, GS2B, GTH-E, GS4H, PTS, PTH, PPTS, STS2, STH2	100	500
SSM4S-D	Wrap/Flag	14.9	378	0.180	4.6	0.045	1.1	0.44 x 0.96	11.2 x 24.4	4.00	102	50	222		500	5000

Weather Resistant Nylon 6.6 Standard Cross Section

SSM2S-D0	Wrap/Flag	6.7	170	0.180	4.6	0.045	1.1	0.44 x 0.96	11.2 x 24.4	1.75	45	50	222	GTS-E, GS2B, GTH-E, GS4H, PTS, PTH, PPTS, STS2, STH	500	10000
-----------------	-----------	-----	-----	-------	-----	-------	-----	-------------	-------------	------	----	----	-----	---	-----	-------

Sta-Strap® Cable Ties

Material and Color Chart

Part Number	Color	Panduit Suffix
Nylon 6.6	Natural	✓
Weather Resistant Nylon 6.6	Black	0
Nylon 6.6	Red	2

Part Number	Color	Panduit Suffix
Nylon 6.6	Black	20
Heat Stabilized Nylon 6.6	Black	30

✓ Denotes Panduit® Natural Nylon 6.6 (no suffix).

Part Number Availability List

Standard Packaging			Bulk Packaging		
Part Number	Natural Nylon 6.6	Material/Color Suffix	Part Number	Natural Nylon 6.6	Material/Color Suffix
SSC2S-S6-C	✓		SSC2S-S6-M	✓	0
SSC2S-S10-C	✓		SSC2S-S10-M	✓	0,30
SSC4S-S10-C	✓		SSC4S-S10-M	✓	0
SSC4H-S25-L	✓		SSC4H-S25-D	✓	0
SSM2S-C	✓		SSM2S-D	✓	0
			SSM4S-D	✓	
SST1M-C	✓	0	SST1M-M	✓	0,20,30
SST1.5M-C	✓		SST1.5M-M	✓	0,20,30
SST1.5I-C	✓		SST1.5I-M	✓	0
SST2I-C	✓		SST2I-M	✓	0
SST3I-C	✓	0	SST3I-M	✓	0
SST4I-C	✓		SST4I-M	✓	0
			SST1.5S-M	✓	0
SST2S-C	✓	0	SST2S-M	✓	0,20,30
SST3S-C	✓	0	SST3S-M	✓	0,20,30
SST4S-C	✓	0	SST4S-M	✓	0,2,30
			SST2H-D	✓	0
			SST2HH-D		30
SST4H-L	✓	0	SST4H-D	✓	0,30
		0	SST4HH-D		30
SST8H-L	✓	0	SST8H-D	✓	0,30

Selection Guide – Specialty Ties



	Material, Color (Suffix)	Style/Function	Part Number Prefix	Catalog Page
Stud Mounted Cable Ties	Heat Stabilized Nylon 6.6, Black (30)	Locking Ties/Bundle	PLST	B 1.71
		Releasable/Re-usable	PRST	B 1.71
Ladder Style Stud Mount	Heat Stabilized Weather Resistant Nylon 6.6, Black (300)	Locking/Bundle	PLST	B 1.71
	Heat Stabilized Nylon 6.6, Black (30)	Releasable/Re-usable	PRST	B 1.72
Double Loop Ties – One-Piece	Nylon 6.6, Natural (No Suffix)	Locking/Bundle	PLB	B 1.72
	Weather Resistant Nylon 6.6, Black (0)			
	Heat Stabilized Nylon 6.6, Black (30)			
Double Loop Ties – Two-Piece	Nylon 6.6, Natural (No Suffix)	Locking/Bundle	SSB	B 1.73
	Weather Resistant Nylon 6.6, Black (0)			
	Heat Stabilized Nylon 6.6, Black (30)			
Triple Loop Ties	Weather Resistant Nylon 6.6, Black (0)	Locking/Bundle	PL3B	B 1.74
Double Hose Clamp	Weather Resistant Nylon 6.6, Black (0)	Locking/Bundle	DHC	B 1.74
Chassis/Panel Mount Ties	Heat Stabilized Weather Resistant Nylon 6.6, Black (300)	Locking/Bundle	SSPM	B 1.75
Cable Marker Strap	Polyethylene (No Suffix)	Releasable/Re-usable	CM4S	B 1.76

Part Number System for Specialty Cable Ties

PLST	4	H	S25	—	TL	300
Type	Size	Cross Section	Stud Size		Package Size	Material/Color
CM4S = Cable Marker Strap	Approx. Maximum Bundle Dia. (In.)	S = Standard H = Heavy EH = Extra-Heavy	-S25 = M6 -SC = 5mm -S14 = 5mm		L = 50 C = 100 TL = 250 D = 500 M = 1000	See Page B1.77
PLB = Locking Bow Tie						
PL3B = Triple Loop Tie						
DHC = Double Hose Clamp						
PLST = Locking Stud Mounted Tie						
PRST = Releasable Stud Mount Ladder Style						
SSB = Sta-Strap® Bow-Ty™ Tie						
SSPM = Sta-Strap® Panel Mount						



Cable tie tools speed installation and reduce total installed cost. Visit www.panduit.com/tools.



Cable tie accessories are used to speed and simplify the mounting of wires, cables, and tubing. See pages B2.1 – B2.26.



Pan-Ty® Stud Mounted Cable Ties – Heat Stabilized and Heat Stabilized Weather Resistant Nylon 6.6

- Heat stabilized material for high temperature applications up to 239°F (115°C) – indoor use
- Heat stabilized weather resistant material has greater resistance to damage caused by ultraviolet light and for high temperature applications up to 293°F (115°C) – indoor or outdoor use
- Integral mount pushes onto a threaded stud and tie wraps around bundle
- Mid-mount style (PLST_SC) centers the wire bundle over the stud
- Tie can be removed from the stud by turning counterclockwise
- Releasable style available (PRST)
- Curved tip is easy to pick up from flat surfaces and allows faster initial threading to speed installation



PLST30SC/50SC



PRST40SC

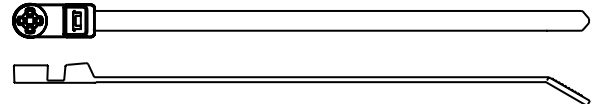

PLST4H

Part Number	Length		Width		Thickness		Recommended Stud Size		Max. Bundle Dia.		Min. Loop Tensile Str.		Recommended Installation Tool	Std. Pkg. Qty.	Std. Ctn. Qty.
	In.	mm	In.	mm	In.	mm	In.	mm	In.	mm	Lbs.	N			
Heat Stabilized Nylon 6.6 Standard Cross Section															
PLST30SC-D30	5.7	146	0.190	4.8	0.050	1.3	10-24	5.0	1.18	30	50	222	GTS-E, GS2B, GTH-E, GS4H, PTS, PTH, PPTS, STS2, STH2	500	5000
PLST50SC-D30	8.1	207	0.190	4.8	0.050	1.3	10-24	5.0	1.97	50	50	222		500	5000
PRST40SC-D30	6.9	176	0.190	4.8	0.050	1.3	10-24	5.0	1.57	40	50	222		Hand install only	500
Heat Stabilized Weather Resistant Nylon 6.6 Light-Heavy Cross Section															
PLST4HS25-TL300	15.3	389	0.300	7.6	0.075	1.9	1/4-20	6.4	4.00	102	120	534	GTH-E, GS4H, GS4EH, PTH, STH2, ST3EH	250	2500

Note: UL Recognized and CSA Certified except PLST4H.

US C US C Pan-Ty® Ladder Style Stud Mounted Cable Tie – Heat Stabilized Nylon 6.6

- For high temperature applications up to 239°F (115°C) – indoor use
- Tie can be removed from the stud by turning counterclockwise
- Integral mount pushes onto a threaded stud and tie wraps around bundle
- Adjustable, releasable, and re-usable
- Install by hand – no tools required



Boss Height

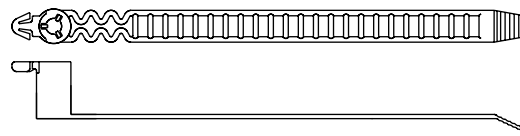

Part Number	Length		Width		Thickness		Boss Height		Recommended Stud Size		Max. Bundle Dia.		Min. Loop Tensile Str.		Std. Pkg. Qty.	Std. Ctn. Qty.
	In.	mm	In.	mm	In.	mm	In.	mm	In.	mm	In.	mm	Lbs.	N		
Standard Cross Section																
PRST30S-S14-M30	5.2	132	0.380	9.7	0.050	1.3	0.59	15	10-24	5.0	1.18	30	35	156	1000	10000

US C US C Pan-Ty® Double Loop Cable Ties

- Natural nylon material for indoor use
- A fast and economical method to secure and separate two bundles
- Weather resistant material has greater resistance to damage caused by ultraviolet light – indoor or outdoor use
- Reduces part number inventory – single part covers multiple bundle sizes
- Heat stabilized material for high temperature applications up to 239°F (115°C) – indoor use
- Installs easily by hand – second loop can be installed with Panduit® cable tie installation tools

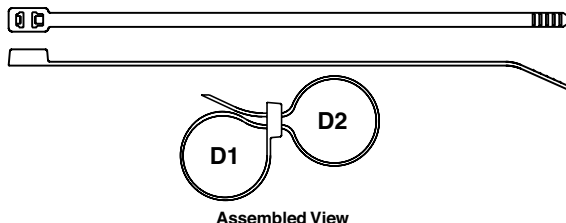

Part Number	Max. Combined Bundle Dia. D1 + D2		Length		Width		Thickness		Min. Loop Tensile Str.		Recommended Installation Tool	Std. Pkg. Qty.	Std. Ctn. Qty.
	In.	mm	In.	mm	In.	mm	In.	mm	Lbs.	N			

Nylon 6.6

Standard Cross Section

PLB2S-C	1.80	46	7.6	193	0.190	4.8	0.052	1.3	50	222	GTS-E, GS2B, GTH-E, GS4H, PTS, PTH, PPTS, STS2, STH2	100	1000
PLB3S-C	3.00	76	11.8	300	0.190	4.8	0.052	1.3	50	222		100	1000
PLB4S-C	4.10	104	14.8	376	0.190	4.8	0.052	1.3	50	222		100	1000

Light-Heavy Cross Section

PLB4H-TL	3.60	91	14.7	373	0.300	7.6	0.075	1.9	120	534	GTH-E, GS4H, GS4EH, PTH, STH2, ST3EH	250	2500
-----------------	------	----	------	-----	-------	-----	-------	-----	-----	-----	--------------------------------------	-----	------

Weather Resistant Nylon 6.6

Standard Cross Section

PLB2S-C0	1.80	46	7.6	193	0.190	4.8	0.052	1.3	50	222	GTS-E, GS2B, GTH-E, GS4H, PTS, PTH, PPTS, STS2, STH2	100	1000
PLB3S-C0	3.00	76	11.8	300	0.190	4.8	0.052	1.3	50	222		100	1000
PLB4S-M0	4.10	104	14.8	376	0.190	4.8	0.052	1.3	50	222		1000	5000

Light-Heavy Cross Section

PLB4H-TL0	3.60	91	14.7	373	0.300	7.6	0.075	1.9	120	534	GTH-E, GS4H, GS4EH, PTH, STH2, ST3EH	250	2500
------------------	------	----	------	-----	-------	-----	-------	-----	-----	-----	--------------------------------------	-----	------

Heat Stabilized Nylon 6.6

Standard Cross Section

PLB2S-M30	1.80	46	7.6	193	0.190	4.8	0.052	1.3	50	222	GTS-E, GS2B, GTH-E, GS4H, PTS, PTH, PPTS, STS2, STH2	1000	10000
PLB3S-M30	3.00	76	11.8	300	0.190	4.8	0.052	1.3	50	222		1000	10000
PLB4S-M30	4.10	104	14.8	376	0.190	4.8	0.052	1.3	50	222		1000	5000

Light-Heavy Cross Section

PLB4H-TL30	3.60	91	14.7	373	0.300	7.6	0.075	1.9	120	534	GTH-E, GS4H, GS4EH, PTH, STH2, ST3EH	250	2500
-------------------	------	----	------	-----	-------	-----	-------	-----	-----	-----	--------------------------------------	-----	------

UL[®] US **CSA[®] US** **Sta-Strap[®] Bow-Ty[™] Cable Ties**

- Natural nylon material for indoor use
- Weather resistant material has greater resistance to damage caused by ultraviolet light – indoor or outdoor use
- Heat stabilized material for high temperature applications up to 239°F (115°C) – indoor use

- A fast and economical method to secure and separate two bundles
- Exclusive two-piece design offers the lowest threading force in the industry
- First loop is releasable prior to final tensioning



SSB2S-C

SSB2S-M0 (30)

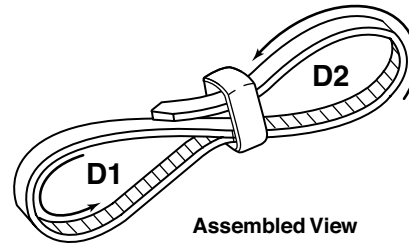
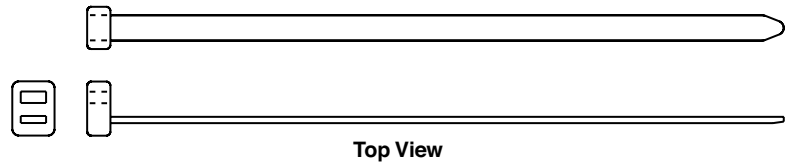

Part Number	Max. Combined Bundle Dia. D1 + D2		Length		Width		Thickness		Min. Loop Tensile Str.		Recommended Installation Tool	Std. Pkg. Qty.	Std. Ctn. Qty.
	In.	mm	In.	mm	In.	mm	In.	mm	Lbs.	N			

Nylon 6.6

Standard Cross Section

SSB2S-C	1.25	32	6.8	172	0.18	4.6	0.045	1.1	30	133	Hand install only	100	1000
---------	------	----	-----	-----	------	-----	-------	-----	----	-----	-------------------	-----	------

Weather Resistant Nylon 6.6

Standard Cross Section

SSB2S-M0	1.25	32	6.8	172	0.18	4.6	0.045	1.1	30	133	Hand install only	1000	10000
----------	------	----	-----	-----	------	-----	-------	-----	----	-----	-------------------	------	-------

Heat Stabilized Nylon 6.6

Standard Cross Section

SSB2S-M30	1.25	32	6.8	172	0.18	4.6	0.045	1.1	30	133	Hand install only	1000	10000
-----------	------	----	-----	-----	------	-----	-------	-----	----	-----	-------------------	------	-------

Pan-Ty® Triple Loop Cable Tie – Weather Resistant Nylon 6.6

- Greater resistance to damage caused by ultraviolet light – indoor or outdoor use
- A fast and economical method to secure and separate three bundles
- Third loop can be installed with Panduit® cable tie installation tools

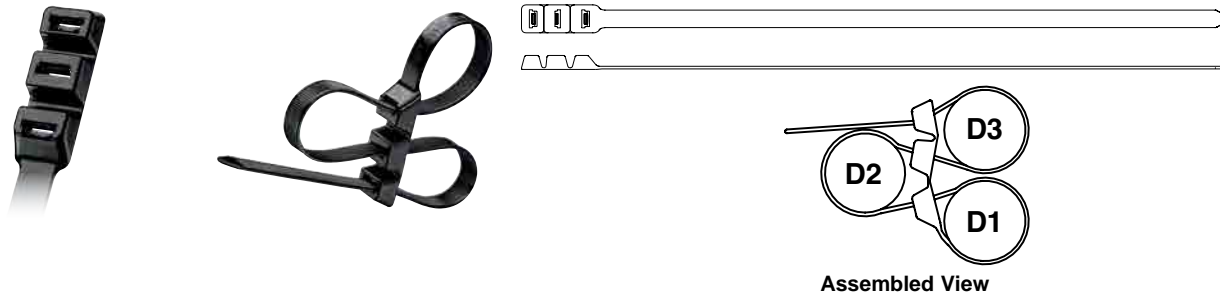

Part Number	Max. Combined Bundle Dia. D1 + D2 + D3		Length		Width		Thickness		Min. Loop Tensile Str.		Recommended Installation Tool	Std. Pkg. Qty.	Std. Ctn. Qty.
	In.	mm	In.	mm	In.	mm	In.	mm	Lbs.	N			
Extra-Heavy Cross Section													
PL3B5EH-C0	5.00	127	20.0	508	0.500	12.7	0.075	1.9	125	556	GS4EH, ST3EH	100	1000

Double Hose Clamp – Weather Resistant Nylon 6.6

- Greater resistance to damage caused by ultraviolet light – indoor or outdoor use
- Holds and separates two gasoline, hydraulic, or pneumatic hoses
- Holds each hose individually to prevent abrasion and twisting

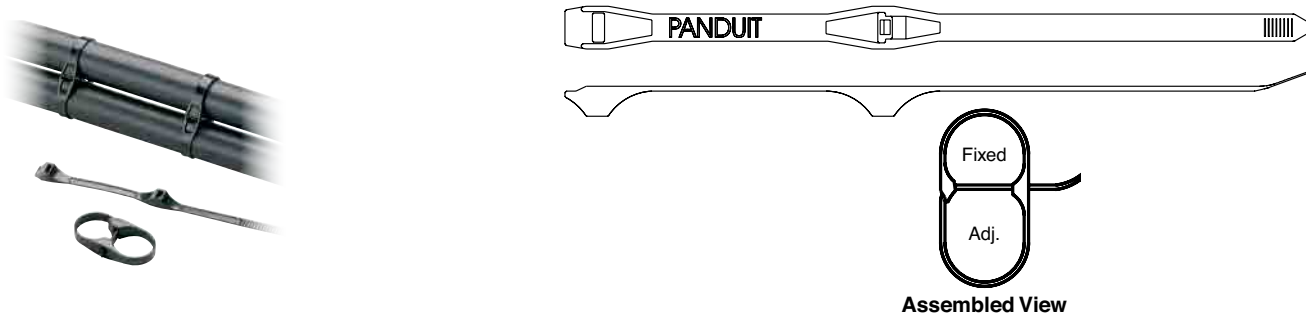

Part Number	Length		Width		Thickness		Fixed Loop Dia.		Adjustable Loop Dia.		Min. Loop Tensile Str.		Recommended Installation Tool	Std. Pkg. Qty.	Std. Ctn. Qty.
	In.	mm	In.	mm	In.	mm	In.	mm	In.	mm	Lbs.	N			
DHC1.12X1.75-D0	11.0	279	0.280	7.1	0.050	1.3	1.12	28	1.00 – 1.75	25 – 44	100	445	GTH-E, GS4H, PTH, STH2, ST3EH	500	2500

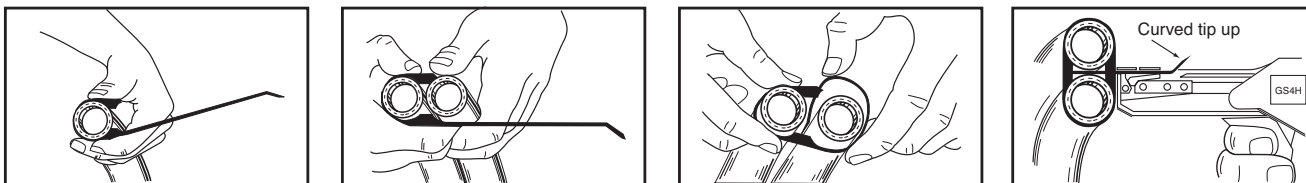

- 1) Wrap clamp around hose
- 2) Position second hose in clamp
- 3) Loop tail around second hose and thread tail through both spacer heads
- 4) Tension and cut off with recommended tool



Sta-Strap® Chassis/Panel Mount Ties – Heat Stabilized Weather Resistant Nylon 6.6

- Greater resistance to damage caused by ultraviolet light and for high temperature applications up to 239°F (115°C) – indoor or outdoor use
- Unique design allows tie to secure a bundle directly to a chassis or panel without the need for separate fasteners or mounting devices
- Releasable prior to final tensioning for bundle modifications
- Engages clearance hole with optional centering pilot to prevent tie from shifting or abrading in high vibration environments

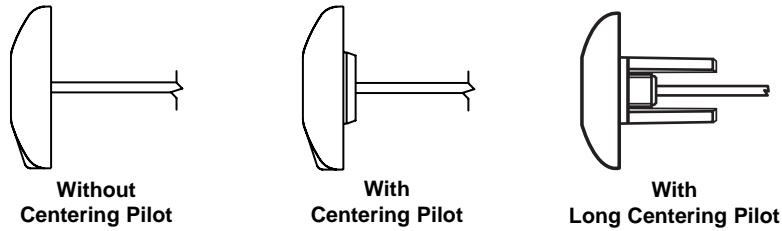

Part Number	Length		Width		Thickness		Hole Diameter Range		Max. Bundle Dia.		Min. Loop Tensile Str.		Recommended Installation Tool	Std. Pkg. Qty.	Std. Ctn. Qty.
	In.	mm	In.	mm	In.	mm	In.	mm	In.	mm	Lbs.	N			
Without Centering Pilot															
SSPM2.5H-L300	10.1	257	0.300	7.6	0.062	1.6	0.316 – 0.820	8.0 – 21.0	2.76	70	120	534	GTH-E, GS4H, GS4EH, PTH, STH2, ST3EH	50	2500
SSPM4H-L300	14.8	376	0.300	7.6	0.062	1.6	0.316 – 0.820	8.0 – 21.0	4.00	102	120	534	GTH-E, GS4H, GS4EH, PTH, STH2, ST3EH	50	2500
With Centering Pilot															
SSPM2.5HP-L300	10.1	257	0.300	7.6	0.062	1.6	0.440 – 0.820	11.2 – 21.0	2.76	70	120	534	GTH-E, GS4H, GS4EH, PTH, STH2, ST3EH	50	2500
SSPM4HP-L300	14.8	376	0.300	7.6	0.062	1.6	0.440 – 0.820	11.2 – 21.0	4.00	102	120	534	GTH-E, GS4H, GS4EH, PTH, STH2, ST3EH	50	2500
With Long Centering Pilot															
SSPM4HLP-TL300	14.8	376	0.300	7.6	0.062	1.6	0.440 – 0.820	11.2 – 21.0	4.00	102	120	534	GTH-E, GS4H, GS4EH, PTH, STH2, ST3EH	250	2500

Through-Panel Mount Installation in Three Easy Steps:

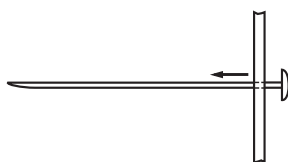

1) Insert tip of cable tie through the pre-drilled hole in the panel.

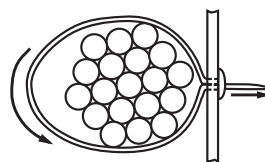

2) Wrap cable tie around the bundle and insert tip back through the hole and head of the cable tie.

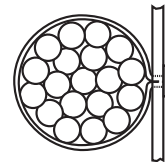

3) Pull tip until cable tie is snug on bundle. Tension and cut off excess portion with installation tool.

Cable Marker Straps – Polyethylene

- Identify and code telephone and fiber optic cable
- Eliminate the need for costly and cumbersome lead marking tags
- Lightweight and easy to install
- Use as wrap-around or flag marker
- For underground identification applications
- Can be marked with Panduit® marker pens, see page B1.49
- Custom imprinting with text, symbols, or trademarks available using Panduit Custom Hot Stamping Service, see page B1.89

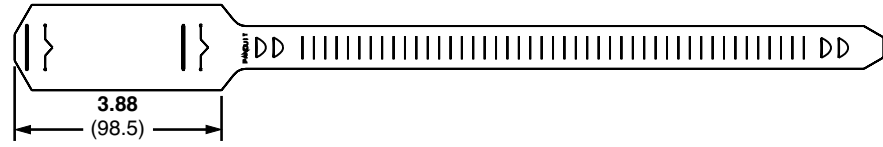

Wrap-Around Marker
(Min. Dia.: 1.27")

Flag Marker
(Min. Dia.: .25")

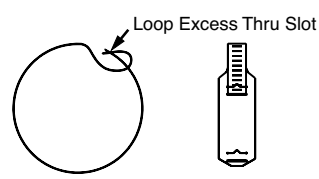

Part Number	Length		Width		Thickness		Color	Marker Write-On Area		Max. Bundle Dia.		Recommended Installation Tool	Std. Pkg. Qty.	Std. Ctn. Qty.
	In.	mm	In.	mm	In.	mm		In.	mm	In.	mm			
Extra-Heavy Cross Section														
CM4S-L2	15.3	387	0.750	19.1	0.033	0.84	Red	1.50 x 2.62	38.1 x 66.5	4.38	111	Hand install only	50	500
CM4S-L8	15.3	387	0.750	19.1	0.033	0.84	Gray	1.50 x 2.62	38.1 x 66.5	4.38	111		50	500

Specialty Cable Ties

Material and Color Chart

Part Number	Color	Panduit Suffix
Nylon 6.6	Natural	✓
Weather Resistant Nylon 6.6	Black	0
Nylon 6.6	Red	2
Nylon 6.6	Gray	8

Part Number	Color	Panduit Suffix
Heat Stabilized Nylon 6.6	Black	30
Heat Stabilized Weather Resistant Nylon 6.6	Black	300

✓Denotes Panduit® Natural Nylon 6.6 (no suffix).

Part Number Availability List

Standard Packaging			Bulk Packaging		
Part Number	Natural Nylon 6.6	Material/Color Suffix	Part Number	Natural Nylon 6.6	Material/Color Suffix
CM4S-L		2.8	DHC1.12X1.75-D		0
PLB2S-C	✓	0	PLB2S-M	✓	0,30
PLB3S-C	✓	0	PLB3S-M	✓	0,30
PLB4S-C	✓		PLB4S-M	✓	0,30
			PLB4H-TL	✓	0,30
			PL3B5EH-C		0
			PLST4HS25-TL		300
			PLST30SC-D		30
			PLST50SC-D		30
			PRST30S-S14-M		30
			PRST40SC-D		30
SSB2S-C	✓		SSB2S-M	✓	0,30
SSPM2.5H-L		300	SSPM2.5H-TL		300
SSPM2.5HP-L		300	SSPM2.5HP-TL		300
SSPM4H-L		300	SSPM4H-TL		300
SSPM4HP-L		300	SSPM4HP-TL		300
			SSPM4HLP-TL		300

UL US CSF US Pan-Ty® Striped Cable Ties – Nylon 6.6

- Nylon material for indoor use
- Striped Pan-Ty® Cable Ties in 25 color combinations match the universally accepted Even-Count Color Code
- Solid color ties are available for identification of “super groups” in cable containing more than 600 pairs
- Each 50-piece package fits in the Pan-Pouch™ Kit or pocket pouch shown on the next page

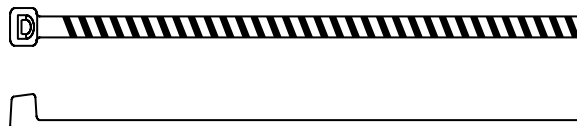
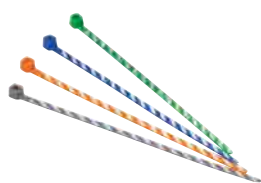

Part Number	Color	Length		Width		Thickness		Max. Bundle Dia.		Min. Loop Tensile Str.		Std. Pkg. Qty.	Std. Ctn. Qty.
		In.	mm	In.	mm	In.	mm	In.	mm	Lbs.	N		
Miniature Cross Section (Straight Tip)													
PLT1M-L6-10	Blue/White Stripe	4.0	102	0.100	2.5	0.036	0.9	0.82	21	18	80	50	1000
PLT1M-L3-10	Orange/White Stripe	4.0	102	0.100	2.5	0.036	0.9	0.82	21	18	80	50	1000
PLT1M-L5-10	Green/White Stripe	4.0	102	0.100	2.5	0.036	0.9	0.82	21	18	80	50	1000
PLT1M-L1-10	Brown/White Stripe	4.0	102	0.100	2.5	0.036	0.9	0.82	21	18	80	50	1000
PLT1M-L8-10	Slate/White Stripe	4.0	102	0.100	2.5	0.036	0.9	0.82	21	18	80	50	1000
PLT1M-L6-2	Blue/Red Stripe	4.0	102	0.100	2.5	0.036	0.9	0.82	21	18	80	50	1000
PLT1M-L3-2	Orange/Red Stripe	4.0	102	0.100	2.5	0.036	0.9	0.82	21	18	80	50	1000
PLT1M-L5-2	Green/Red Stripe	4.0	102	0.100	2.5	0.036	0.9	0.82	21	18	80	50	1000
PLT1M-L1-2	Brown/Red Stripe	4.0	102	0.100	2.5	0.036	0.9	0.82	21	18	80	50	1000
PLT1M-L8-2	Slate/Red Stripe	4.0	102	0.100	2.5	0.036	0.9	0.82	21	18	80	50	1000
PLT1M-L6-0	Blue/Black Stripe	4.0	102	0.100	2.5	0.036	0.9	0.82	21	18	80	50	1000
PLT1M-L3-0	Orange/Black Stripe	4.0	102	0.100	2.5	0.036	0.9	0.82	21	18	80	50	1000
PLT1M-L5-0	Green/Black Stripe	4.0	102	0.100	2.5	0.036	0.9	0.82	21	18	80	50	1000
PLT1M-L1-0	Brown/Black Stripe	4.0	102	0.100	2.5	0.036	0.9	0.82	21	18	80	50	1000
PLT1M-L8-0	Slate/Black Stripe	4.0	102	0.100	2.5	0.036	0.9	0.82	21	18	80	50	1000
PLT1M-L6-4	Blue/Yellow Stripe	4.0	102	0.100	2.5	0.036	0.9	0.82	21	18	80	50	1000
PLT1M-L3-4	Orange/Yellow Stripe	4.0	102	0.100	2.5	0.036	0.9	0.82	21	18	80	50	1000
PLT1M-L5-4	Green/Yellow Stripe	4.0	102	0.100	2.5	0.036	0.9	0.82	21	18	80	50	1000
PLT1M-L1-4	Brown/Yellow Stripe	4.0	102	0.100	2.5	0.036	0.9	0.82	21	18	80	50	1000
PLT1M-L8-4	Slate/Yellow Stripe	4.0	102	0.100	2.5	0.036	0.9	0.82	21	18	80	50	1000
PLT1M-L6-7	Blue/Violet Stripe	4.0	102	0.100	2.5	0.036	0.9	0.82	21	18	80	50	1000
PLT1M-L3-7	Orange/Violet Stripe	4.0	102	0.100	2.5	0.036	0.9	0.82	21	18	80	50	1000
PLT1M-L5-7	Green/Violet Stripe	4.0	102	0.100	2.5	0.036	0.9	0.82	21	18	80	50	1000
PLT1M-L1-7	Brown/Violet Stripe	4.0	102	0.100	2.5	0.036	0.9	0.82	21	18	80	50	1000
PLT1M-L8-7	Slate/Violet Stripe	4.0	102	0.100	2.5	0.036	0.9	0.82	21	18	80	50	1000
PLT1M-L0	Black	4.0	102	0.100	2.5	0.036	0.9	0.82	21	18	80	50	1000
PLT1M-L1	Brown	4.0	102	0.100	2.5	0.036	0.9	0.82	21	18	80	50	1000
PLT1M-L2	Red	4.0	102	0.100	2.5	0.036	0.9	0.82	21	18	80	50	1000
PLT1M-L3	Orange	4.0	102	0.100	2.5	0.036	0.9	0.82	21	18	80	50	1000
PLT1M-L4Y	Yellow	4.0	102	0.100	2.5	0.036	0.9	0.82	21	18	80	50	1000
PLT1M-L5	Green	4.0	102	0.100	2.5	0.036	0.9	0.82	21	18	80	50	1000
PLT1M-L6	Blue	4.0	102	0.100	2.5	0.036	0.9	0.82	21	18	80	50	1000
PLT1M-L8	Slate	4.0	102	0.100	2.5	0.036	0.9	0.82	21	18	80	50	1000

Note: CSA Certified on solid colors only.

Telephone Cable Identification Kits

- Pan-Pouch™ Kit is made of two-ply laminated black nylon/vinyl and folds for easy storage
- Easily hang pouch from cable by using hook and loop fasteners
- Pocket pouch holds five (50-piece) packages and is made of a white vinyl



PPC25X50F



PP5X50F

Part Number	Description	Dimensions		Std. Pkg. Qty.
		Open	Closed	
PPC25X50F	Pouch filled with 1,250 cable ties (50 each of all 24 striped ties and 50 solid red ties)	10.5" x 38" (267mm x 965mm)	10.5" x 6" (267mm x 152mm)	1
PPC25X50	Empty pouch	10.5" x 38" (267mm x 965mm)	10.5" x 6" (267mm x 152mm)	1
PP5X50F	Pocket pouch filled with 250 cable ties (50 of each color: blue, orange, green, brown and slate – all with white stripe)	—	3.5" x 5.25" (89mm x 133mm)	1

Cable Tie Kits in Steel Boxes



K-205



K-504/SR2

Part Number	Part Description	Std. Pkg. Qty.
K-205	Kit for Indoor Use Pan-Ty® Cable Ties, cable tie installation tool, terminals, splices and crimp tool: (1) GTS tool (1) CT-100 crimp tool <u>Natural Nylon 6.6 Cable Ties</u> (100) PLT1M (100) PLT1.5I (100) PLT2S <u>Terminals</u> (100) PV18-6LF (100) PV14-8LF (100) PV14-10LF (50) PV10-10LF <u>Splices</u> (50) BSV10X (100) BSV14X (100) BSV18X	1
K-504	Kit for Indoor Use Pan-Ty® Cable Ties, cable tie installation tool, and mounts: (1) STS2 tool <u>Natural Nylon 6.6 Cable Ties</u> (100) PLT1M (100) PLT1.5I (100) PLT2S (100) PLC2S-S10 <u>Mounts</u> (100) TM2S8 (100) ABM2S-A	1
SR2	Two-drawer slide rack to hold K-504 cable tie kit or K-1000 series terminal kit. Dimensions: 6.25"H x 15.25"W x 11.75"D (158.7mm x 387.4mm x 298.5mm)	1

Cable Tie Kits in Plastic Boxes and Bags



KP-506A



KP-506A-0



KP-509



KB-550



KB-551

Part Number	Part Description	Std. Pkg. Qty.
KP-506A	Kit for Indoor Use Pan-Ty® Cable Ties and Mounts: <u>Natural Nylon 6.6</u> (100) PLT1M (100) PLT1.5I (100) PLT2S (50) ABM2S-A mounts	1
KP-506A-0	Kit for Outdoor Use Pan-Ty® Cable Ties and Mounts: <u>Black Weather Resistant Nylon 6.6</u> (100) PLT1M-0 (100) PLT1.5I-0 (100) PLT2S-0 (50) ABM2S-AT-0 mounts	1
KP-509	Kit for Indoor Use For prototyping and new product development – contains over 600 pieces. Pan-Ty® Cable Ties in different styles, sizes, and colors. Huge assortment of cable tie mounts and wiring accessories.	1
KB-550	Assortment Pack for Indoor and Outdoor Use Pan-Ty® Cable Ties: <u>Natural Nylon 6.6</u> (15) PLT1M (15) PLT1.5I (15) PLT2S (15) PLT3S <u>Black Weather Resistant Nylon 6.6</u> (10) PLT1M-0 (10) PLT1.5I-0 (10) PLT2S-0 (10) PLT3S-0	1
KB-551	Assortment Pack for Indoor and Outdoor Use Dome-Top® Barb Ty Cable Ties: <u>Natural Nylon 6.6</u> (15) BT1M (15) BT1.5I (15) BT2S (15) BT3S <u>Black Weather Resistant Nylon 6.6</u> (10) BT1M-0 (10) BT1.5I-0 (10) BT2S-0 (10) BT3S-0	1

Features and Benefits – Hook and Loop Cable Ties

The comprehensive family of hook and loop cable ties delivers reliability by protecting against over-tensioning of high performance fiber and copper cables. These ties are adjustable, releasable, and re-usable to effectively support frequent moves, adds, and changes (MACs). A wide range of colors provides flexibility and an aesthetically pleasing appearance. The complete line of Panduit® Hook and Loop Cable Ties help maintain the reliable, scalable, and aesthetic requirements of data centers.

Tak-Ty® Hook & Loop Cable Ties – Premium, durable designs and sizes

Loop Style



Allows for pre-wrapping of bundles

Roll/Strip/Brick Style



Available in continuous or perforated rolls and stacked strips

Plenum-Rated



Distinctive maroon color (also available in black)

Tak-Tape™ Hook & Loop Rolls

Strong, low profile hook and loop material

Convenient packaging

Ultra-Cinch™ Hook & Loop Cable Ties

Unique same-sided material secures a greater range of bundle diameters

Available in three styles and eight colors; grommet styles used for bundle mounting applications

Low profile contoured cinch ring reduces overall bundle size



Wire management accessories speed and simplify the mounting of high performance cabling.

See pages B2.4, B2.10, B2.19, B2.22, C3.2, C3.3, C3.7, and C3.8.

Selection Guide – Hook and Loop Cable Ties



Product, Color (Suffix)	Style/Function	Part Number Prefix	Catalog Page
Tak-Ty® Ties, Black (0)	Loop Ties/Re-usable	HLT	B1.83
	Strip Ties/Re-usable	HLS	B1.83
	15' and 75' Rolls/Re-usable	HLM, HLS	B1.83
	Strip Ties/Re-usable/Brick	HLB	B1.83
Tak-Ty® Plenum-Rated Ties, UL Listed Black, Maroon (0, 12)	Loop Ties/Re-usable	HLTP	B1.84
	Strip Ties/Re-usable	HLSP	B1.84
Tak-Tape™ Rolls, Black (0)	20' and 35' Rolls/Re-usable	TTS	B1.84
Ultra-Cinch™ Ties, Black (0)	Cinch Ties/Re-usable	UCT	B1.85
	Cinch Ties – Center Mount Grommet/Re-usable	UGCTC	B1.85
	Cinch Ties – End Mount Grommet/Re-usable	UGCTE	B1.85

Part Number System for Hook and Loop Ties

HLT	2	I	—	X	0
Type	Size	Cross Section		Package Size	Color
HL = Hook and Loop	Approx. Maximum Bundle Dia. (In.)	I = Intermediate S = Standard		X = 10 C = 100 15R = 15' Roll 20R = 20' Roll 35R3 = 35' Rolls (3) 35RX = 35' Rolls (10) 75R = 75' Roll	See Page B1.86
HLB = HL Brick					
HLM = HL Miniature					
HLT = HL Loop Tie					
HLTP = HL Loop Tie Plenum-Rated					
HLS = HL Strip Tie					
HLSP = HL Strip Tie Plenum-Rated					
TTS = Tak-Tape™ Roll					
UCT = Ultra-Cinch™ Tie					
UGCTC = UCT Grommet Cinch Tie – Center Mount					
UGCTE = UCT Grommet Cinch Tie – End Mount					

Tak-Ty® Hook & Loop Cable Ties

- Soft, premium material is safe to use on high performance cabling protecting against over-tensioning
 - Broadest selection of durable designs and sizes to meet your application needs
 - Adjustable, releasable, and re-usable multiple times – ideal for applications requiring frequent moves, adds, or changes
 - A full range of colors
 - Operating temperature range: 0°F to 220°F (-18°C to 104°C)
 - Complementary mounts available, see page B2.5
- Note: Minimum 2" overlap required to achieve loop tensile rating.



HLT (Loop Ties)



HLS (Strip Ties)



HLM/HLS (Rolls)



HLB2S (Stacked Strips)

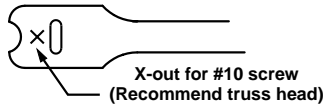

Part Number	Length		Width		Max. Bundle Dia.		Min. Loop Tensile Str.		Std. Pkg. Qty.	Std. Ctn. Qty.
	In.	mm	In.	mm	In.	mm	Lbs.	N		

Loop Ties – Slot allows for pre-wrapping of bundles

HLT2I-X0	8.0	203	0.500	12.7	1.91	49	40	178	10	100
HLT3I-X0	12.0	305	0.500	12.7	3.18	81	40	178	10	100

Strip Ties – Perforated in convenient 6", 12", and 18" strips

HLS1.5S-X0	6.0	152	0.750	19.1	1.50	38	50	222	10	100
HLS3S-X0	12.0	305	0.750	19.1	3.20	81	50	222	10	100
HLS5S-X0	18.0	457	0.750	19.1	5.00	127	50	222	10	100

**Stacked Strip Ties – Eliminates cutting ties to length and staging them for each job
Rounded edges for installer safety – 100 pieces**

HLB2S-C0	7.0	178	0.750	19.1	1.60	41	50	222	100	1000
----------	-----	-----	-------	------	------	----	----	-----	-----	------

Part Number	Length		Width		Max. Bundle Dia.		Min. Loop Tensile Str.		Std. Pkg. Qty.	Std. Ctn. Qty.
	In.	mm	In.	mm	In.	mm	Lbs.	N		

15' and 75' Continuous Rolls – Can be cut to desired length, eliminating waste

HLM-15R0	15.0	4.6	0.330	8.4	Various	Various	40	178	1	10
HLS-15R0	15.0	4.6	0.750	19.1	Various	Various	50	222	1	10
HLS-75R0	75.0	22.9	0.750	19.1	Various	Various	50	222	1	10

Tak-Ty® Hook & Loop Cable Ties – Plenum-Rated

- Soft, premium material is safe to use on high performance cabling protecting against over-tensioning
- UL Listed for use in plenum or air handling spaces (such as ceiling voids and underfloor areas) per NEC, Section 300-22 (C) and (D)
- Flammability rating: UL 94V-2
- Adjustable, releasable, and re-usable multiple times – ideal for applications requiring frequent moves, adds, or changes
- Operating temperature range: 0°F to 122°F (-18°C to 50°C)

Note: Minimum 2" overlap required to achieve loop tensile rating.

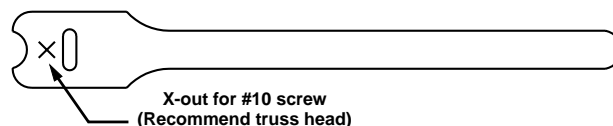

Part Number	Length		Width		Max. Bundle Dia.		Min. Loop Tensile Str.		Std. Pkg. Qty.	Std. Ctn. Qty.
	In.	mm	In.	mm	In.	mm	Lbs.	N		
UL Listed Loop Ties (Maroon) – Slot allows for pre-wrapping of bundles										
HLTP2I-X12	8.0	203	0.500	12.7	1.91	49	40	178	10	100
HLTP3I-X12	12.0	305	0.500	12.7	3.18	81	40	178	10	100
UL Listed Loop Ties (Black) – Slot allows for pre-wrapping of bundles										
HLTP2I-X0	8.0	203	0.500	12.7	1.91	49	40	178	10	100
HLTP3I-X0	12.0	305	0.500	12.7	3.18	81	40	178	10	100
UL Listed Strip Ties (Maroon) – Perforated in convenient 6", 12", and 18" strips										
HLSP1.5S-X12	6.0	152	0.750	19.1	1.50	38	50	222	10	100
HLSP3S-X12	12.0	305	0.750	19.1	3.20	81	50	222	10	100
HLSP5S-X12	18.0	457	0.750	19.1	5.00	127	50	222	10	100
UL Listed Strip Ties (Black) – Perforated in convenient 6", 12", and 18" strips										
HLSP1.5S-X0	6.0	152	0.750	19.1	1.50	38	50	222	10	100
HLSP3S-X0	12.0	305	0.750	19.1	3.20	81	50	222	10	100
HLSP5S-X0	18.0	457	0.750	19.1	5.00	127	50	222	10	100

Tak-Tape™ Hook & Loop Cable Tie Rolls

- Strong, low profile, flexible material is safe to use on high performance cabling protecting against over-tensioning
- Adjustable, releasable, and re-usable
- Cost-effective for general purpose bundling
- Continuous rolls can be easily cut to size – Panduit® cutter included with TTS-35RX0
- Handy, re-usable plastic case with TTS-20R0, keeps material clean
- Leaves no residue
- Available in black color
- Operating temperature range: -22°F to 194°F (-30°C to 90°C)
- Complementary mounts available, see page B2.5

Note: Minimum 2" overlap required to achieve loop tensile rating.



Part Number	Length		Width		Max. Bundle Dia.		Min. Loop Tensile Str.		Std. Pkg. Qty.	Std. Ctn. Qty.
	In.	mm	In.	mm	In.	mm	Lbs.	N		
TTS-20R0	20.0	6.1	0.750	19.1	Various	Various	40	178	1	10
TTS-35R3-0	35.0	10.7	0.750	19.1	Various	Various	40	178	1	8
TTS-35RX0	35.0	10.7	0.750	19.1	Various	Various	40	178	1	10

Std. Pkg. Qty. of TTS-35R3-0 denotes 1 package of three 35' rolls, TTS-35RX0 denotes 1 package of ten 35' rolls.

Ultra-Cinch™ Hook & Loop Cable Ties

- Unique material with hooks and loops on same side allows user to secure a greater range of bundle diameters, including smaller bundles
- Soft, premium material is safe to use on high performance cabling, protecting against over-tensioning
- Adjustable, releasable, and re-usable multiple times – ideal for applications requiring frequent moves, adds, or changes
- Low profile contoured cinch ring provides extra strength and bundle tightness while reducing overall bundle size
- Grommet (UGCTC and UGCTE styles) offers strength and assures reliable installations that resist pullout when bundling and mounting cables within cabinet applications
- Tapered tip facilitates easy, snag-free threading to speed installation
- Use flat-head screws for grommet applications shown below

Note: Minimum 2" overlap required to achieve loop tensile rating.

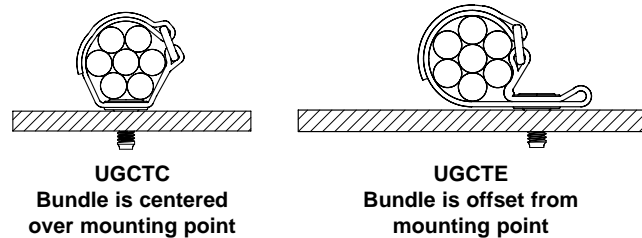
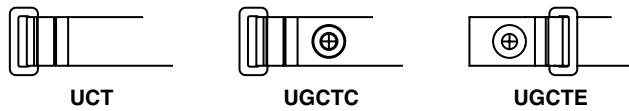

Part Number	Length		Width		Max. Bundle Dia.		Min. Loop Tensile Str.		Std. Pkg. Qty.	Std. Ctn. Qty.
	In.	mm	In.	mm	In.	mm	Lbs.	N		
Cinch Ties										
UCT3S-X0	12.0	305	0.850	21.6	3.00	76	50	222	10	100
UCT5S-X0	18.0	457	0.850	21.6	5.00	127	50	222	10	100
Cinch Ties – Center Mount Grommet (Bundle is centered over mounting point)										
UGCTC3S-X0	12.0	305	0.850	21.6	3.00	76	50	222	10	100
UGCTC5S-X0	18.0	457	0.850	21.6	5.00	127	50	222	10	100
Cinch Ties – End Mount Grommet (Bundle is offset from mounting point)										
UGCTE3S-X0	12.0	305	0.850	21.6	3.00	76	50	222	10	100
UGCTE5S-X0	18.0	457	0.850	21.6	5.00	127	50	222	10	100

Note: 1/4" (6mm) diameter mounting hole on grommet style cinch ties.

Flat Head Screws for Grommet Cinch Ties

Part Number	Part Description	Std. Pkg. Qty.	Std. Ctn. Qty.
UCTGS1224-X	12-24 UNC x 5/8mm (.625") flat head phillips screw	10	100
UCTGSM5-X	M5 x 16mm flat head phillips screw	10	100
UCTGSM6-X	M6 x 16mm flat head phillips screw	10	100

Hook and Loop Cable Ties**Color Chart**

Color	Panduit® Suffix	Color	Panduit Suffix
Black	0	Blue	6
Red	2	Gray	8
Orange	3	White	10
Yellow	4	Maroon	12
Green	5		

Part Number Availability List

Standard Packaging	
Part Number	Color
HLB2S	0
HLM-15R	0,2,3,4,5,6,8,10
HLS-15R	0,2,3,4,5,6,8,10
HLS-75R	0,2,3,4,5,6,8,10
HLS1.5S-X	0,2,3,4,5,6,8,10
HLS3S-X	0,2,3,4,5,6,8,10
HLS5S-X	0,2,3,4,5,6,8,10
HLSP1.5S-X	0,12
HLSP3S-X	0,12
HLSP5S-X	0,12
HLT2I-X	0,2,3,4,5,6,8,10
HLT3I-X	0,2,3,4,5,6,8,10
HLTP2I-X	0,12
HLTP3I-X	0,12
TTS-20R	0
TTS-35RX	0
TTS-35R3	0
UCT3S-X	0,2,3,4,5,6,8,10
UCT5S-X	0,2,3,4,5,6,8,10
UGCTC3S-X	0,2,3,4,5,6,8,10
UGCTC5S-X	0,2,3,4,5,6,8,10
UGCTE3S-X	0,2,3,4,5,6,8,10
UGCTE5S-X	0,2,3,4,5,6,8,10

HLW Marker Hook and Loop Wrap Ties

- Safe choice for network cable bundling
- Re-usable multiple times; use where frequent moves, adds, and changes are anticipated
- Black tie contains a white rectangular “write-on” area where users can write a message using Panduit® permanent marking pens on page B2.26
- Minimum 2" overlap required to achieve loop tensile rating



Part Number	Max. Bundle Diameter		Length		Width		Thickness		Marker Write-on Area		Min. Loop Tensile Str.		Std. Pkg. Qty.	Std. Ctn. Qty.
	In.	mm	In.	mm	In.	mm	In.	mm	In.	mm	Lbs.	N		
Miniature Cross Section (Straight Tip)														
HLWM1.5S-X0	1.5	38	6.0	152	0.790	20.1	0.17	4.3	2.5 x 0.50	63.5 x 12.7	50	222	10	100
HLWM3S-X0	3.2	81	12.0	305	0.790	20.1	0.17	4.3	2.5 x 0.50	63.5 x 12.7	50	222	10	100

Elastomeric Cable Ties – ERT

- Elastic material provides a flexible tie body that safely contours around cable bundle to prevent over-tensioning of data cables to maintain network integrity
- UL 94V-0 material provides greater flame resistance and meets stringent telecommunication flammability requirements (i.e. NEBS GR-63-CORE)
- Greater resistance to damage caused by ultraviolet light – indoor or outdoor use
- Soft material has no sharp edges to protect the installer and cable bundle for improved jobsite safety and reliability
- The high coefficient of friction material provides a tight grip and prevents lateral movement along cable bundle, minimizing overall installation time and potential re-work
- Releasable design allows release and re-use to accommodate frequent moves, adds, and changes to support evolving equipment and cabling needs
- Halogen-free, non-toxic and environmentally safe material will not release toxic or corrosive gases upon combustion
- Locking head design; the tapered tip tail threads into locking head to speed productivity; industry-accepted, intuitive tie design



Part Number	Color	Length		Width		Thickness		Head Height		Head Width		Min. Loop Tensile Str.		Std. Pkg. Qty.	Std. Ctn. Qty.
		In.	mm	In.	mm	In.	mm	In.	mm	In.	mm	Lbs.	N		
ERT2M-C20	Black	8.5	216	0.500	12.70	0.090	2.29	0.323	8.20	0.841	21.36	18	80	100	1000
ERT3M-C20	Black	11.0	279	0.500	12.70	0.090	2.29	0.323	8.20	0.841	21.36	18	80	100	1000
ERT4.5M-C20	Black	16.0	406	0.500	12.70	0.090	2.29	0.323	8.20	0.841	21.36	18	80	100	1000

Cable Bundle Organizing Tool

- Reduces cable installation time up to 50% compared to traditional methods
- Arranges 24 cables prior to applying Panduit® network cable ties
- Optimizes bundle size and improves installed appearance
- Two inserts handle multiple network cable diameters
- Unique design allows twist-free bundling from the end or the middle of bundle
- Smooth edges; safe for use on network cables preventing cable abrasion
- Ergonomic fit and compact design
- Impact resistant material and low friction design to glide smoothly across cable bundle



Part Number	Description	Recommended for Cable Outer Diameter Range	Use the Following Insert	Insert Used with the Following Panduit® Cable Types	Std. Pkg. Qty.	Std. Ctn. Qty.
CBOT24K	Kit contains jacket cover with hook and loop fastener and two inserts.	0.180" – 0.248" (4.57mm – 6.30mm)	Fluorescent Green	TX5500™ Category 5e UTP TX6000™ Category 6 UTP	1	10
		0.230" – 0.310" (5.84mm – 7.87mm)	Fluorescent Yellow	TX6500™ Enhanced Category 6 TX6A™ 10Gig™ Category 6A** All Shielded Cables		

**When using the CBOT24K on 10 Gigabit cables, it is recommended that Panduit 10Gig™ Category 6A cables be used for optimum performance of installed cable. See www.panduit.com for cable details.

Hot Stamping Service
Custom Printed Cable Ties

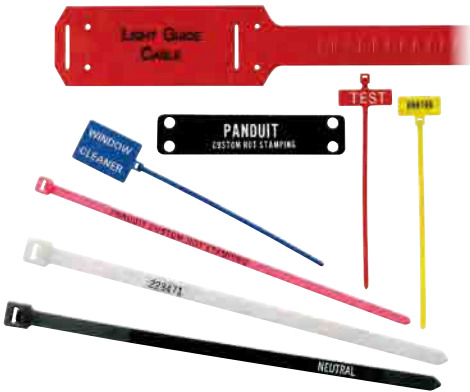

Custom Hot Stamping Service provides a permanent, high quality imprinted message on Panduit® cable ties and marker plates. Graphics, text, numbers and colors provide a variety of choices for customization.

Hot stamped cable ties and marker plates are typically used for identification, or for labeling critical components. Panduit cable ties, marker ties, marker plates and marker straps are available to suit your application.

Your choice of:

- Seven text colors (black, blue, green, red, yellow, orange, white)
- A variety of characters and fonts
- Sequential numbering
- Special customer logos and diagrams

Minimum Order: (Pieces/part number and message)

- 5,000 for Miniature, Intermediate, Standard and Heavy-Standard cross section cable ties
- 3,000 for Light-Heavy, Heavy, and Extra-Heavy cross section cable ties
- 3,000 for Hook and Loop Wrap Ties

For hot stamping orders and inquiries, please call 1-800-777-3300

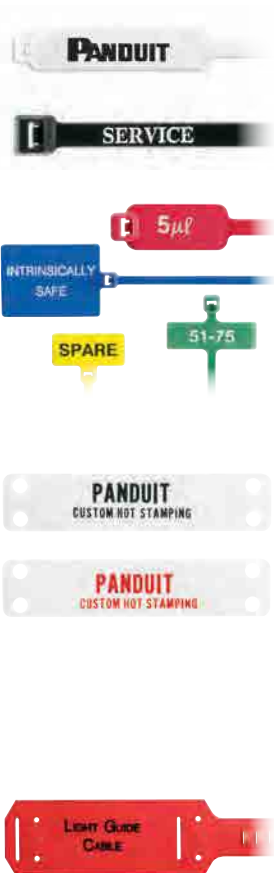

Cable Ties

- Used wherever you need to bundle wire, cable, hose or tubing
- A variety of colors for color-coding applications
- Cross Sections: Intermediate, Standard, Heavy-Standard, Light-Heavy, Heavy and Extra-Heavy

Marker and Flag Ties

- Fasten and identify bundles at the same time
- A variety of colors for color-coding applications
- Cross Sections: Miniature and Standard

Marker Plates

- Mount in any direction, either vertically or horizontally as flags, tags, or wrap-around identification plates.
- White or Weather Resistant black color
- Marker plate sizes:

1.50" x 0.75"	2.50" x 0.75"
1.75" x 0.75"	3.50" x 0.75"
2.00" x 0.75"	2.50" x 1.75"

Cable Marker Straps

- Identify and code telephone and fiber optic cable – replaces costly and cumbersome lead marking tags
- Lightweight and easy to install
- Can be used as wrap-around or flag marker
- Also can be used in underground identification applications
- Polyethylene material available in red and gray
- Marking area: 1.50" x 2.62"

Panduit® Cable Tie Approvals



Logo (Symbol)	Agency	Spec/Approval	Requirement	Applicable Products
	Underwriters Laboratories, Inc.	File E56854 and MH29590	ZODZ(7), ZODZ2(8), ALKW	Most miniature, intermediate, standard, light-heavy and heavy cross section ties are Recognized or Listed in the US and Canada
	Canadian Standards Association	File 031212	C22.2 No. 18.5-02 under the category "Fittings – Positioning Devices"	Most miniature, intermediate, standard, light-heavy and heavy cross section ties are Recognized or Listed in the US and Canada
	Conformity European	Low Voltage Directive 2014/35/EU. Pan-Ty and Dome-Top Barb Ty cable ties also meet the requirements from EN62275	CE Marking is required for products sold within the European Union. CE Marking Directives specify the minimum performance of these products. Applying the CE mark signifies compliance with essential requirements of specific directives.	All cable tie products
	ABS (American Bureau of Shipping)	14-HS1245078-PDA	Steel Vessel Rules 1-1-4/7.7, 4-8-4/21.9.3 MODU Rules 4-3-3/5.9.1	PLT Series, BT Series
	Bureau Veritas	Cert 05968/E0 BV File ACE 14/601/01	Bureau Veritas Rules for the Classification of Steel Ships	PLT Series, BT Series, PRT Series, CBR Series
	Det Norske Veritas	E-12385	Det Norske Veritas' Rules for Classification of Ships and Mobile Offshore Units	PLT Series, PLC Series, PLM Series, PRT Series, PLWP Series, PRWP Series, PRST Series
	Lloyd's Register of Shipping	15/600006 (E1)	Lloyd's Register Type Approval	PLT Series, BT Series, SST Series
	NRC (Nuclear Regulatory Commission)	NRC 10CFR50	Quality Assurance Criteria for Nuclear Plants and Reprocessing Plants	All cable tie products
	Plenum-Rated	Panduit logo	Panduit® symbol indicates that the cable ties represented are suitable for use in plenum or air handling spaces in accordance with Sec. 300.22(C) and (D) of the National Electrical Code and Rules 12-010 (3), (4) and (5) and 12-020 of the Canadian Electrical Code, Part I.	Halar (702Y) and select Nylon 6.6 cable ties as noted throughout catalog
	US Military Aerospace Standard	QPL-AS23190	SAE spec AS23190	See Military Cross Reference Page B1.91

Military Cross Reference

The Panduit® cable ties and marker ties listed in the following tables meet all of the testing requirements of SAE Aerospace Standard AS23190 and the dimensional requirements of SAE Aerospace Standards AS33671 and AS33681.

Cable Tie Cross Reference						
Mil. Std. Part Number	Color	Pan-Ty®	Dome-Top® Barb Ty	Sta-Strap®	Belt-Ty™ In-Line	Contour-Ty®
MS3367-1-0	Black*	PLT2S-C00, -M00	—	—	—	—
MS3367-1-1	Brown	PLT2S-C1, -M1	BT2S-M1	—	—	—
MS3367-1-2	Red	PLT2S-C2, -M2	BT2S-M2	—	—	—
MS3367-1-3	Orange	PLT2S-C3, -M3	BT2S-M3	—	—	—
MS3367-1-4	Yellow	PLT2S-C4Y, -M4Y	BT2S-M4Y	—	—	—
MS3367-1-5	Green	PLT2S-C5, -M5	BT2S-M5	—	—	—
MS3367-1-6	Blue	PLT2S-C6, -M6	BT2S-M6	—	—	—
MS3367-1-7	Purple	PLT2S-C7, -M7	BT2S-M7	—	—	—
MS3367-1-8	Gray	PLT2S-C8, -M8	BT2S-M8	—	—	—
MS3367-1-9	Natural	PLT2S-C, -M, -VMR	BT2S-C, -M	SST2S-C, -M	—	—
MS3367-2-0	Black*	PLT4S-C00, -M00	—	—	—	—
MS3367-2-1	Brown	PLT4S-M1	—	—	—	—
MS3367-2-2	Red	PLT4S-C2, -M2	BT4S-M2	SST4S-M2	—	—
MS3367-2-3	Orange	PLT4S-C3, -M3	BT4S-M3	—	—	—
MS3367-2-4	Yellow	PLT4S-C4Y, -M4Y	BT4S-M4Y	—	—	—
MS3367-2-5	Green	PLT4S-C5, -M5	BT4S-M5	—	—	—
MS3367-2-6	Blue	PLT4S-C6, -M6	BT4S-M6	—	—	—
MS3367-2-7	Purple	PLT4S-M7	BT4S-M7	—	—	—
MS3367-2-8	Gray	PLT4S-C8, -M8	BT4S-M8	—	—	—
MS3367-2-9	Natural	PLT4S-C, -M	BT4S-C, -M	SST4S-C, -M	—	—
MS3367-3-0	Black*	PLT4H-L00, -TL00	—	—	—	—
MS3367-3-1	Brown	PLT4H-TL1	—	—	—	—
MS3367-3-2	Red	PLT4H-TL2	—	—	—	—
MS3367-3-3	Orange	PLT4H-TL3	—	—	—	—
MS3367-3-4	Yellow	PLT4H-TL4Y	—	—	—	—
MS3367-3-5	Green	PLT4H-TL5	—	—	—	—
MS3367-3-6	Blue	PLT4H-TL6	—	—	—	—
MS3367-3-9	Natural	PLT4H-L, -C, -TL	BT4LH-L, -TL	SST4H-L, -D	—	—
MS3367-4-0	Black*	PLT1M-C00, -M00, -XMR00	—	—	—	—
MS3367-4-0	Black*	PLT1.5M-XMR00	—	—	—	—
MS3367-4-1	Brown	PLT1M-C1, -M1	BT1M-M1	—	—	—
MS3367-4-2	Red	PLT1M-C2, -M2, -XMR2	BT1M-M2	—	—	—
MS3367-4-3	Orange	PLT1M-C3, -M3, -XMR3	BT1M-M3	—	—	—
MS3367-4-4	Yellow	PLT1M-C4Y, -M4Y	BT1M-M4Y	—	—	—
MS3367-4-5	Green	PLT1M-C5, -M5, -XMR5	BT1M-M5	—	—	—
MS3367-4-6	Blue	PLT1M-C6, -M6, -XMR6	BT1M-M6	—	—	—
MS3367-4-7	Purple	PLT1M-C7, -M7, -XMR7	BT1M-M7	—	—	—
MS3367-4-8	Gray	PLT1M-C8, -M8, -XMR8	BT1M-M8	—	—	—
MS3367-4-9	Natural	PLT1M-C, -M, -XMR	BT1M-C, -M, -XMR	SST1M-C, -M	—	—
MS3367-4-9	Natural	PLT.7M-C, -M	—	—	—	—
MS3367-4-9	Natural	PLT1.5M-XMR	BT1.5M-XMR	—	—	—
MS3367-5-0	Black*	PLT1.5I-M00	—	—	—	—
MS3367-5-1	Brown	PLT1.5I-C1, -M1	BT1.5I-M1	—	—	—
MS3367-5-2	Red	PLT1.5I-C2, -M2	BT1.5I-M2	—	—	—
MS3367-5-3	Orange	PLT1.5I-C3, -M3	BT1.5I-M3	—	—	—
MS3367-5-4	Yellow	PLT1.5I-C4Y, -M4Y	BT1.5I-M4Y	—	—	—

*Weather resistant per ASTM D 4066-94B.

Continues on next page

Military Cross Reference (continued)

		Cable Tie Cross Reference				
Mil. Std. Part Number	Color	Pan-Ty [®]	Dome-Top [®] Barb Ty	Sta-Strap [®]	Belt-Ty [™] In-Line	Contour-Ty [®]
MS3367-5-5	Green	PLT1.5I-C5, -M5	BT1.5I-M5	—	—	—
MS3367-5-6	Blue	PLT1.5I-C6, -M6	BT1.5I-M6	—	—	—
MS3367-5-7	Purple	PLT1.5I-C7, -M7	BT1.5I-M7	—	—	—
MS3367-5-8	Gray	PLT1.5I-C8, -M8	BT1.5I-M8	—	—	—
MS3367-5-9	Natural	PLT1.5I-C, -M	BT1.5I-C, -M	SST1.5I-C, -M	—	—
MS3367-6-9	Natural	PLT8LH-L, -C	BT8LH-L, -C	SST8H-L, -D	—	—
MS3367-6-9	Natural	—	BT9LH-L, -C	—	—	—
MS3367-7-0	Black*	PLT3S-C00, -M00	—	—	—	—
MS3367-7-1	Brown	PLT3S-M1	—	—	—	—
MS3367-7-2	Red	PLT3S-C2, -M2	BT3S-C2	—	—	—
MS3367-7-3	Orange	PLT3S-M3	—	—	—	—
MS3367-7-4	Yellow	PLT3S-M4Y	—	—	—	—
MS3367-7-5	Green	PLT3S-M5	—	—	—	—
MS3367-7-6	Blue	PLT3S-M6	—	—	—	—
MS3367-7-7	Purple	PLT3S-M7	—	—	—	—
MS3367-7-8	Gray	PLT3S-M8	—	—	—	—
MS3367-7-9	Natural	PLT3S-C, -M	BT3S-C, -M	SST3S-C, -M	—	—
MS3367-8-9	Natural	PLT5H-L, -C	—	—	—	—
MS3367-9-9	Natural	PLT6H-L, -C	—	—	—	—
MS3367-11-9	Natural	PLT8H-L, -C	—	—	—	—
MS3367-14-9	Natural	PLT13H-Q, -C	—	—	—	—
MS3367-20-9	Natural	PLT5EH-Q, -C	—	—	—	—
MS3367-21-9	Natural	PLT6EH-Q, -C	—	—	—	—
MS3367-22-9	Natural	PLT8EH-C	—	—	—	—
MS3367-23-9	Natural	—	—	—	ILT2S-C, -M	—
MS3367-24-9	Natural	—	—	—	ILT4S-C, -M	—
MS3367-25-9	Natural	—	—	—	ILT4LH-TL	—
MS3367-29-9	Natural	—	—	—	ILT3S-C, -M	—
MS3367-30-9	Natural	—	—	—	—	CBR1M-M
MS3367-31-9	Natural	—	—	—	—	CBR1.5M-M
MS3367-32-1	Brown	—	—	—	—	CBR2M-M1
MS3367-32-2	Red	—	—	—	—	CBR2M-M2
MS3367-32-3	Orange	—	—	—	—	CBR2M-M3
MS3367-32-4	Yellow	—	—	—	—	CBR2M-M4Y
MS3367-32-5	Green	—	—	—	—	CBR2M-M5
MS3367-32-6	Blue	—	—	—	—	CBR2M-M6
MS3367-32-7	Purple	—	—	—	—	CBR2M-M7
MS3367-32-9	Natural	—	—	—	—	CBR2M-M
MS3367-33-9	Natural	—	—	—	—	CBR1.5I-M
MS3367-34-2	Red	—	—	—	—	CBR3I-M2
MS3367-34-3	Orange	—	—	—	—	CBR3I-M3
MS3367-34-4	Yellow	—	—	—	—	CBR3I-M4Y
MS3367-34-6	Blue	—	—	—	—	CBR3I-M6
MS3367-34-8	Gray	—	—	—	—	CBR3I-M8
MS3367-34-9	Natural	—	—	—	—	CBR3I-M
MS3367-35-9	Natural	—	—	—	—	CBR4I-M

*Weather resistant per ASTM D 4066-94B.

Continues on next page

Military Cross Reference (continued)

Mil. Std. Part Number	Color	Cable Tie Cross Reference				
		Pan-Ty®	Dome-Top® Barb Ty	Sta-Strap®	Belt-Ty™ In-Line	Contour-Ty®
MS3367-36-9	Natural	—	—	—	—	CBR2S-M
MS3367-37-9	Natural	—	—	—	—	CBR3S-M
MS3367-38-9	Natural	—	—	—	—	CBR4S-M
MS3367-39-9	Natural	—	—	—	—	CBR2HS-D
MS3367-40-9	Natural	—	—	—	—	CBR4LH-TL
MS3367-41-9	Natural	—	—	—	—	CBR6LH-C
MS3368-1-2A	Red	PLM2S-D2	—	—	—	—
MS3368-1-3A	Orange	PLM2S-D3	—	—	—	—
MS3368-1-4A	Yellow	PLM2S-C4Y, -D4Y	—	—	—	—
MS3368-1-5A	Green	PLM2S-D5	—	—	—	—
MS3368-1-6A	Blue	PLM2S-D6	—	—	—	—
MS3368-1-8A	Gray	PLM2S-D8	—	—	—	—
MS3368-1-9A	Natural	PLM2S-C, -D	BM2S-C, -D	—	—	—
MS3368-1-9B	Natural	—	—	SSM2S-C, -D	—	—
MS3368-2-2A	Red	PLM4S-D2	—	—	—	—
MS3368-2-4A	Yellow	PLM4S-D4Y	—	—	—	—
MS3368-2-6A	Blue	PLM4S-D6	—	—	—	—
MS3368-2-9A	Natural	PLM4S-C, -D	BM4S-C, -D	—	—	—
MS3368-2-9B	Natural	—	—	SSM4S-D	—	—
MS3368-3-4C	Yellow	PL2M2S-D4Y	—	—	—	—
MS3368-3-9C	Natural	PL2M2S-L, -D	B2M2S-D	—	—	—
MS3368-4-4D	Yellow	PL3M2S-D4Y	—	—	—	—
MS3368-4-9D	Natural	PL3M2S-L, -D	B3M2S-TL	—	—	—
MS3368-5-1E	Brown	PLM1M-M1	—	—	—	—
MS3368-5-2E	Red	PLM1M-M2	—	—	—	—
MS3368-5-3E	Orange	PLM1M-M3	—	—	—	—
MS3368-5-4E	Yellow	PLM1M-M4Y	—	—	—	—
MS3368-5-5E	Green	PLM1M-M5	—	—	—	—
MS3368-5-6E	Blue	PLM1M-M6	—	—	—	—
MS3368-5-7E	Purple	PLM1M-M7	—	—	—	—
MS3368-5-8E	Gray	PLM1M-M8	—	—	—	—
MS3368-5-9E	Natural	PLM1M-C, -M	BM1M-C, -M	—	—	—

Installation Tools

The Panduit® installation tools listed in the table below meet all of the testing requirements of SAE Aerospace Standard AS81306 and the dimensional requirements of AS90387.

Mil. Std. Part Number	Panduit Part Number
MS90387-1	GS2B, GS2BL
MS90387-2	GS4H
MS90387-4	GS4EH

Cable Tie Selection and Specification Guidelines

Selecting the Proper Cable Tie Material for Your Application

By using the information on our material selection chart on pages B1.2 and B1.3 as a guide, the user will be better equipped to select the best cable tie and material suited to perform its intended function over a long period of time.

For long life and dependable service, there are many factors to consider when selecting the proper cable tie for each application. Since it is impossible for Panduit® to provide data on all the various combinations of conditions which may arise, it is suggested that this data be used as a guide. Sample cable ties should be tested under actual end-use conditions to determine the correct cable tie for the application.

To select the optimum cable tie for a specific application, the chart on pages B1.2 and B1.3 can be used as a reference. First, determine the most critical design criteria and then read across the table to find which material is most suitable to meet this need. Next, review the other criteria by scanning in a vertical direction on the chart and then make your final selection.

Example No. 1

Application	Selection
The application requires high radiation (2 x 10 ⁸ rads) resistance and excellent resistance to hydrocarbons.	The best choice is PEEK, TEFZEL■, or HALAR▲. The price is higher than other materials, but all have high ratings in resistance to radiation and hydrocarbons.

Example No. 2

Application	Selection
The application requires a low cost material, good ultraviolet resistance, and good resistance to acid rains.	The best choice is Weather Resistant Polypropylene. Price is medium, the UV rating is 6, and the acid resistance rating is 9.

Weathering

Over a period of time, ultraviolet light (a component of sunlight) attacks most plastic materials and reduces their properties by breaking the molecular chain. The material breakdown is accompanied by reductions in tensile strength and elongation, increased brittleness, color changes and loss of surface gloss.

Carbon black, which is used in Panduit® nylon, polypropylene, and acetal cable ties, is one of the most effective stabilizers known today. A uniform dispersion of carbon black provides good ultraviolet light resistance without adversely affecting physical properties. The addition of carbon black, or any other ultraviolet light stabilizer, prolongs the useful outdoor life of plastic products, but it does not totally eliminate the destructive effects of the light. Some plastics, such as TEFZEL■ or HALAR▲, are intrinsically very resistant to ultraviolet light and do not require stabilizing additives.

Weathering Test Methods

In order to monitor the effects of ultraviolet light and the effectiveness of ultraviolet stabilizers, Panduit, in conformance with industry standards, adopted two methods of weatherability testing: Outdoor Aging and Accelerated Weather Aging.

Outdoor Aging

The Outdoor Aging method is probably the best and most realistic method of the two. It is conducted in accordance with ASTM D 1435 Standard Practice for Outdoor Weathering of Plastics, and allows the material to be affected by not only ultraviolet light, but by all other outdoor elements as well. Although this may more closely approximate an actual application, two drawbacks do exist. The period of time required to produce property decay and material failure may be quite long, and varying adverse chemical environments cannot be tested.

- TEFZEL is a registered trademark of E.I. du Pont de Nemours and Company.
- ▲ HALAR is a registered trademark of Solvay Solexis

Weathering (continued)

Accelerated Weather Aging

Accelerated weathering tests are conducted to estimate the rate of degradation due to a combination of ultraviolet light, temperature, and moisture. The methods used are in accordance with the following standards:

- ASTM D 1499, Operating Light and Water Exposure Apparatus (Carbon-Arc type) for exposure to plastics
- ASTM G 154-04, Operating Light and Water Exposure (Fluorescent UV Condensation type) for exposure of non-metallic materials

The condition specified in ASTM D 1499 utilizes a water spray and a carbon arc to simulate natural sunshine. The test chamber is operated 20 hrs./day with a two-hour cycle of 108 minutes of simulated sunshine and twelve minutes of sunshine and water spray. The temperature of a black body inside the chamber is approximately 63°C (145°F) during the “sunshine only” portion of the cycle. Humidity is not controlled inside the chamber.

The test chamber per ASTM G 154-04 uses fluorescent sun lamps to generate ultraviolet light only. A heated water pan produces condensation during a portion of the cycle. The daily cycle is composed of 20 hours of light followed by 4 hours of condensation. Black body temperatures during the light cycle are 50°C (122°F) and 40°C (104°F) during the condensation cycle.

Panduit® has also designed a special chamber, which is used to simulate the effect of acid rain and ultraviolet light on cable tie materials. The effects of other common chemicals, such as road salt, are also evaluated in this chamber.

These methods are effective in quickly determining the ultraviolet light resistance of the various cable tie materials, but it must be emphasized that there are no exact correlations between accelerated aging and actual outdoor exposure.

Material Failure Testing

Property decay can lead to three different modes of failure: loss of strength, loss of toughness, or change in appearance. The critical mode for any given application would depend upon the application and the requirements it places upon the material itself.

Loss of strength is monitored by tensile testing samples of the material before and after it has been weathered. This test will reveal the decreasing strength accompanied by extended weathering.

Loss of toughness can be monitored by measuring changes in elongation and impact strength. As ultraviolet light exposure time increases and the material becomes brittle, its elongation and impact strength are greatly reduced. It is important to note that brittle failures can occur even when the tensile strength shows no change.

Although change in appearance is normally not a failure mode for cable ties, the plastic does tend to discolor and lose its surface gloss as exposure increases. These changes can be measured by color difference using Adams units, which are similar to National Bureau of Standard units.

Panduit has its own weathering test program to determine estimated life of various cable tie materials. This includes examining many previously aged samples obtained throughout the world.

In all cases, the amount of property decay increased with increasing exposure to ultraviolet light. The principal signs of degradation were found to be brittleness, cracking, and loss of surface gloss. It was also determined that the time for failure to occur was shorter than indicated from industry tests performed on material samples. This discrepancy is in part due to the fact that cable ties were tested in an end use, stressed condition, while most plastic resin suppliers conduct weathering tests using unstressed test bars.

Five cable tie materials have superior ultraviolet light resistance: TEFZEL■, HALAR▲, Weather Resistant Acetal, Nylon 12 and Stainless Steel.

Determining the outdoor life expectancy of any material is difficult since there are other factors, besides ultraviolet light stability, which have to be considered. These factors are listed below and should be considered before specifying a cable tie material.

■ TEFZEL is a registered trademark of E.I. du Pont de Nemours and Company.

▲ HALAR is a registered trademark of Solvay Solexis

Weathering (continued)

Table A – External Factors That Affect the Life of a Cable Tie

Factor	Effect on Cable Tie Life
Chemicals	Applications which have chemicals present can reduce the life of a tie. This is the most detrimental factor to the life of a tie.
Bundle Diameter	As the bundle diameter is reduced, the tie has more bending stress. A thick strap on a small bundle diameter has more stress.
Loading	If the tie is under high loading, this will add additional stress on the tie body.
Thickness	A thinner tie will have a decreased life since surface cracks will penetrate the thickness of the tie faster.
Vibration	Applications with high vibrations will cause impact, which will propagate any surface cracks.
Degree of Exposure	No shield or shade, southern exposure, higher altitudes and high temperatures, decrease the life of a cable tie.
Moisture	High humidity plus high temperature can result in degradation due to hydrolysis in nylon.
Galvanized metals	Acid rain and acid moisture acting on galvanized metals release chemicals known to attack Nylon 6.6.

Weathering Life Expectancy	
Material, Color (Part Number Suffix)	Years*
Polypropylene, Green (109)	1
Nylon 6.6, Natural (No suffix)	1 – 2
Flame Retardant Nylon 6.6, Black (60)	1 – 2
Flame Retardant Nylon 6.6, Ivory (69)	1 – 2
Heat Stabilized Nylon 6.6, Natural (39)	1 – 2
PEEK, Polyetheretherketone, Translucent Brown (71)	1 – 2
Heat Stabilized Nylon 6.6, Black (30)	4 – 5
Weather Resistant Polypropylene, Black (100)	7 – 9
Weather Resistant Nylon 6.6, Black (0 and 00)	7 – 9
Heat Stabilized Weather Resistant Nylon 6.6, Black (300)	7 – 9
Weather Resistant Nylon 12, Black (120)	12 – 15
TEFZEL■, Aqua Blue (76)	>15
HALAR▲, Maroon (702Y)	>15
Weather Resistant Acetal, Black	>20
Stainless Steel	>30

*Based on the assumption of minimum loading, no chemical attack and impact-free conditions.

■TEFZEL is a registered trademark of E.I. du Pont de Nemours and Company.

▲HALAR is a registered trademark of Solvay Solexis

Flammability

Flammability

A number of test procedures have been developed which can be used for the evaluation and comparison of various materials to support combustion.

UL 94 Vertical Burning Test

Samples of a material, with dimensions 127mm by 12.7mm and the thickness of the intended end use product, are tested in an unaged “as manufactured” state and in an aged state (seven days at 158°F, 70°C). The test requires the placement of a precisely controlled flame under a vertically supported specimen for a ten second period. The controlled flame is removed and the duration of flaming combustion of the specimen is recorded. When the flaming combustion of the specimen extinguishes, it is immediately subjected to an additional controlled flame exposure. After the additional ten seconds of exposure, the controlled flame is removed, and the duration of flaming combustion of the specimen is recorded. A piece of surgical cotton is placed under the specimen. If drips ignite the cotton, this fact is also recorded.

Materials Classed 94V-0

Requirements:

- None of the specimens will burn with flaming combustion for more than ten seconds after either application of the controlled flame
- The total flaming combustion time will not exceed 50 seconds for the ten controlled flame applications (two controlled flame applications for each of the five specimens)
- None of the specimens will burn with flaming or glowing combustion up to the holding clamp
- None of the specimens will drip flaming particles that ignite the dry absorbent surgical cotton located 12 inches (305mm) below the test specimen
- None of the specimens will exhibit glowing combustion that persists for more than 30 seconds after the second removal of the controlled flame

Continues on next page

B2. Cable Accessories

B3. Stainless Steel Cable Ties & Accessories

C1. Wiring Duct

C2. Abrasion Protection

C3. Cable Management

D1. Terminals

D2. Power Connectors

D3. Grounding Connectors

E1. Labeling Systems

E2. Labels

E3. Pre-Printed & Write-On Markers

E4. Permanent Identification

E5. Industrial Safety Solutions

F. Keystone Cabling Systems

G. Part Number Index

Flammability (continued)

Materials Classed 94V-1

Requirements:

- None of the specimens will burn with flaming combustion for more than 30 seconds after either application of the controlled flame
- The total flaming combustion time will not exceed 250 seconds for the ten controlled flame applications (two controlled flame applications for each of the five specimens)
- None of the specimens will burn with flaming or glowing combustion up to the holding clamp
- Specimens may drip flaming particles which burn only briefly, and may not ignite the dry absorbent surgical cotton located 12 inches (305mm) below the test specimen
- None of the specimens will exhibit glowing combustion that persists for more than 60 seconds after the second removal of the controlled flame

Materials Classed 94V-2

Requirements:

- None of the specimens will burn with flaming combustion for more than 30 seconds after either application of the controlled flame
- The total flaming combustion time will not exceed 250 seconds for the ten controlled flame applications (two controlled flame applications for each of the five specimens)
- None of the specimens will burn with flaming or glowing combustion up to the holding clamp
- Specimens may drip flaming particles which burn only briefly, and may ignite the dry absorbent surgical cotton placed 12 inches (305mm) below the test specimen
- None of the specimens will exhibit glowing combustion that persists for more than 60 seconds after the second removal of the controlled flame

ASTM D 635

Samples of a material, with dimensions 125mm by 12.5mm and the thickness of the intended end use product, are tested in an unaged “as manufactured” state. A precisely controlled flame is applied to the specimen and a stopwatch is started. The flame is applied for 30 seconds. The stopwatch is stopped when burning or glowing combustion ceases or when the flame has proceeded to a mark 100mm from the free end. Ten specimens are tested. If any of the specimens burn to the 100mm mark, an additional ten specimens are tested.

Burning Rate

- If two or more specimens have burned to the 100mm mark then Average Burning Rate (cm/min.) shall be reported as the average of the burning rates of all specimens which have burned to the 100mm mark

Average Time of Burning and Average Extent of Burning

- Average time of burning and average extent of burning of the sample shall be reported if none of the ten samples or no more than one of the twenty specimens have burned to the 100mm mark
- Average Time of Burning (ATB):
- Average Extent of Burning (AEB):

$$ATB, s = \frac{\sum_0^N [time(sec) - 30(sec)]}{N}$$

N = Number of specimens tested
Rounded to the nearest 5 seconds

$$AEB, mm = \frac{\sum_0^N [10(mm) - unburned length(mm)]}{N}$$

N = Number of specimens tested
Rounded to the nearest 5mm

Continues on next page

Flammability (continued)

Table B – Flammability Ratings

Materials	Part Number Suffix	UL 94	ASTM D 635
Nylon 6.6, Natural	None	94V-2 @ .71mm	AEB = 20mm, ATB = 5 seconds
Weather Resistant Nylon 6.6, Black (Meets Mil. Spec.)	00	94V-2 @ .71mm	AEB = 20mm, ATB = 5 seconds
Weather Resistant Nylon 6.6, Black*	0	94V-2** @ .71mm	AEB = 20mm, ATB = 5 seconds
Heat Stabilized Nylon 6.6, Black	30	94V-2 @ .71mm	AEB = 20mm, ATB = 5 seconds
Heat Stabilized Nylon 6.6, Natural	39	94V-2 @ .71mm	AEB = 20mm, ATB = 5 seconds
Heat Stabilized Weather Resistant Nylon 6.6, Black	300	94V-2 @ .71mm	AEB = 20mm, ATB = 5 seconds
Flame Retardant Nylon 6.6, Black	60	94V-0 @ .81mm	AEB = 15mm, ATB = < 5 seconds
Flame Retardant Nylon 6.6, Natural (Ivory)	69	94V-0 @ .81mm	AEB = 15mm, ATB = < 5 seconds
PEEK, Polyetheretherketone, Translucent Brown	71	94V-0 @ 1.5mm	—
Metal Detectable Nylon 6.6, Blue	86	94 HB @ .71mm	AEB = 20mm, ATB = 5 seconds
Weather Resistant Nylon 12, Black	120	94 HB @ 1.6mm	Avg. Burning Rate 1.6cm/min.
Polypropylene, Green	109	94 HB @ .94mm	Avg. Burning Rate 2cm/min.
Weather Resistant Polypropylene, Black	100	94 HB @ .94mm	Avg. Burning Rate 2cm/min.
TEFZEL ■, Aqua Blue	76	94V-0 @ 1.5mm	AEB = 15mm, ATB = < 5 seconds
HALAR ▲, Maroon	702Y	94V-0 @ .18mm	AEB = 15mm, ATB = < 5 seconds
Weather Resistant Acetal, Black	DT Prefix	94 HB @ 1.5mm	Avg. Burning Rate, 2.8cm/min

*UL Recognized cable ties meet stated ratings. **UL Recognized -0 parts

■TEFZEL is a registered trademark of E.I. du Pont de Nemours and Company.

▲HALAR is a registered trademark of Solvay Solexis

Radiation/Moisture/Temperature/Tensile Strength

Radiation

Installed cable ties of various materials have been exposed to different amounts of radiation to determine the maximum acceptable limit. These tests were conducted by Panduit® to determine the acceptability for use in various areas of nuclear power plants (for radiation exposure accumulated over a 40 year life). See Cable Tie Selection Chart (pages B1.2 and B1.3) for radiation resistance rating.

Moisture

Many plastics when exposed to high relative humidity absorb water and, as such, the tensile strength of the material can change dramatically. Nylon 6.6 when exposed to 100% relative humidity, will absorb as much as 8.5% water which will reduce tensile strength by 50% when compared to a dry cable tie. Polypropylene, HALAR ▲, Type 12 Nylon, TEFZEL ■, Acetal and PEEK are low water absorbing materials and, as such, the effect of water is minimal. See Cable Tie Selection Chart (pages B1.2 and B1.3) for moisture absorption.

Proper Storage

Nylon 6.6 is a hygroscopic material (affected by atmospheric moisture variations). The optimum storage requirement for Nylon 6.6 cable ties is 73°F (± 15°F) and 50% RH (relative humidity) in sealed containers. Improper storage, especially in cold/dry conditions can result in moisture loss, which impedes cable tie performance. Panduit packaging provides Nylon 6.6 cable ties conditioned to 2.5% moisture added by weight in heavy-wall, polyethylene heat-sealed bags.

Temperature

Plastic materials normally undergo property loss due to oxidation caused by exposure to high temperatures. The maximum continuous use temperature for cable tie materials depends upon the time at the elevated temperature as well as other environmental conditions. Initially, plastics become more flexible and weaker when exposed to high temperatures. After a period of time, oxidation may occur which will cause embrittlement, making plastic cable ties more susceptible to failure from impact and vibration.

The maximum continuous use temperature, is based on the UL Relative Thermal Index (mechanical without impact) as determined by UL per UL 746B. It is one indicator of a material's ability to retain a particular physical property when exposed to elevated temperatures over an extended period of time. It is based on the assumption that there is no loading, no chemical attack, and impact-free condition. The continuous use temperature range for cable tie materials are listed in the Cable Tie Selection Chart (pages B1.2 and B1.3).

Continues on next page

Radiation/Moisture/Temperature/Tensile Strength (continued)

Temperature (continued)

Low temperature exposure will also make most plastics more brittle during the exposure, but little property loss occurs when the material is returned to room temperatures. The minimum installation temperatures for cable tie materials are listed in the Cable Tie Selection Chart (pages B1.2 and B1.3).

Tensile Strength

Most cable ties are selected based on material, length, and minimum loop tensile strength. Minimum loop tensile strength was established under SAE Aerospace Standard AS23190. Each cable tie cross section (SM = Subminiature, M = Miniature, I = Intermediate, S = Standard, HS = Heavy-Standard, LH = Light-Heavy, H = Heavy and EH = Extra-Heavy) has a different loop tensile strength when tested per AS23190.

The cable tie is first conditioned at 49°C (120°F), 20% relative humidity for 24 hours, then the cable tie is installed on a split mandrel and the halves of the mandrel separated at a rate of 1 inch (25.4mm) per minute. The separating force required to unlock or break the cable tie is the loop tensile strength. Loop tensile strength is dependent both on the locking design and the tensile strength (psi) of the material. As an example, the tensile strength of polypropylene material is approximately 1/2 to 1/3 of Nylon 6.6; thus the loop tensile strength of a given cross section tie made of polypropylene would be much less than a tie made of Nylon 6.6. This is another property to be considered when selecting a cable tie. The various representative loop tensile strengths are listed in the Cable Tie Selection Chart (pages B1.2 and B1.3).

Halogen-Free

All Panduit® cable ties (with the exception of TEFZEL ■ and HALAR ▲) are halogen-free per IEC Specification 61249-2-21.

B1.
Cable
Ties

B2.
Cable
Accessories

B3.
Stainless
Steel Cable
Ties &
Accessories

C1.
Wiring
Duct

C2.
Abrasion
Protection

C3.
Cable
Management

D1.
Terminals

D2.
Power
Connectors

D3.
Grounding
Connectors

E1.
Labeling
Systems

E2.
Labels

E3.
Pre-Printed
&
Write-On
Markers

E4.
Permanent
Identification

E5.
Industrial
Safety
Solutions

F.
Keystone
Cabling
Systems

G.
Part
Number
Index

▲ HALAR is a registered trademark of Ausimont USA, Inc.
■ TEFZEL is a registered trademark of E.I. du Pont de Nemours and Company.

Table C – Chemical Resistance Table

Many factors combine to determine the useful life of a cable tie material and none is as important as chemical exposure. Various chemicals will have different effects on plastics depending on such variables as chemical concentrations, temperature, stress and ultraviolet light. This table is an excellent guideline for the selection of the best cable tie material for various cable tie environments. It should be noted that the exposure for this chemical resistance chart is at 70°F (21°C).

Resistance of Panduit® cable tie materials to chemical attack at 70°F (21°C)

- A = Excellent
- B = Satisfactory
- C = Slight Attack
- D = Attacked
- = Not Tested
- ¹ = Pitting occurs under some conditions
- ² = Attack may occur if sulfuric acid present
- Aq. = Aqueous
- C.S. = Cold Saturated

Materials	Percent Concentration	Nylon 6.6*	Nylon 12	Polypropylene	TEFZEL■	HALAR▲	PEEK	304 Stainless Steel	316 Stainless Steel
Acetaldehyde	90	B	—	C	A	A	A	—	—
Acetic Acid	97	D	D	A	A	A	A	A	A
Acetic Acid	10	C	B	A	A	A	—	A	A
Acetic Anhydride	90	—	B	A	A	A	—	A	A
Acetone	100	A	A	A	A	A	A	A	A
Acetophenone	100	—	—	B	A	A	—	A	A
Acetylene	100	—	—	A	A	A	A	A	A
Aluminum Chloride	10	B	A	A	A	A	A		
Aluminum Fluoride	10	B	A	A	A	A	—		
Aluminum Hydroxide	Aq. C.S.	—	A	A	A	A	—	A	A
Aluminum Potassium Sulfate	10	B	A	A	A	A	—	A ¹	A ¹
Ammonia	All	—	A	A	A	A	A	A	A
Ammonium Carbonate	1 to 5	—	A	—	A	A	—	A	A
Ammonium Chloride	10 to 25	D	A	A	A	A	A	A	A
Ammonium Hydroxide	10	A	—	—	A	A	A	—	—
Ammonium Nitrate	100	—	A	A	A	A	A	A	A ¹
Ammonium Sulfate	10	—	A	A	A	A	A	E ¹	A
Amyl Acetate	100	—	—	C	A	A	A	A	A
Aniline	100	—	B	A	A	A	A	A	A
Antimony Trichloride	All	D	—	A	A	A	A	A	A
Arsenic Acid	1 to 80	—	—	A	A	A	—	A	A
Barium Carbonate	All	—	A	A	A	A	—	A	A
Barium Chloride	All	—	A	A	A	A	—	A ¹	A
Barium Sulfate	All	—	A	A	A	A	—	A	A
Barium Sulfide	All	—	A	A	A	A	—	A	A
Benzene	100	A	A	C	A	A	A	A	A
Benzoic Acid	100	D	A	A	A	A	A	A	A
Benzoyl Chloride	100	—	—	C	A	A	—	—	—
Benzyl Alcohol	100	—	—	A	A	A	A	—	—
Boric Acid	All	D	A	A	A	A	A	B	—
Bromine	100	D	D	D	A	A	D	D	D
Butadiene	100	—	—	C	A	A	—	A	A
Butane	100	—	A	A	A	A	A	A	A
Butanediol	100	—	—	A	A	A	—	—	—
Butyl Acetate	100	—	A	C	A	A	A	—	—
N. Butyl Alcohol	100	—	A	A	A	A	A	A	A
Butyl Phthalate	100	—	—	A	A	A	—	—	—
Butyraldehyde	100	—	—	A	A	A	—	—	—
Butyric Acid	10 to 100	D	—	A	A	A	—	A	A
Calcium Carbonate	Aq. C.S.	—	—	A	A	A	A	A	A
Calcium Chlorate	Aq. C.S.	—	—	A	A	A	—	A	A
Calcium Chloride	5	C	A	A	A	A	A	A ¹	A ¹
Calcium Hydroxide	50	—	—	A	A	A	A	A	A

*Includes all 6.6 Nylons (weather resistant, heat stabilized, and flame retardant).
 ■TEFZEL is a registered trademark of E.I. du Pont de Nemours and Company.
 ▲HALAR is a registered trademark of Solvay Solexis

Continues on next page

Table C – Chemical Resistance Table (continued)

Materials	Percent Concentration	Nylon 6.6*	Nylon 12	Polypropylene	TEFZEL ■	HALAR ▲	PEEK	304 Stainless Steel	316 Stainless Steel
Calcium Hypochlorite	2	D	—	A	A	A	A	A ¹	A ¹
Calcium Nitrate	50	—	A	A	A	A	A	—	—
Calcium Sulfate	2	C	—	A	A	A	A	A	A
Carbon Tetrachloride	100	A	A	—	A	A	A	A	A
Carbon Tetrachloride	Aq. 10	—	—	—	—	A	—	C ¹	A ¹
Chlorine	Dry	—	D	D	A	A	D	C	C
Chlorine	Wet	—	D	C	A	A	D	D	D
Chloroacetic Acid	10 to 50	D	—	A	A	A	A	D	C
Chlorobenzene	100	—	C	A	A	A	A	—	—
Chloroform	100	A	C	C	A	A	A	A	A
Chlorosulphonic Acid	10 to 100	D	D	D	B	A	D	D	D
Chromic Acid	10 to 50	D	D	A	A	A	A	C	C
Citric Acid	10 to 50	B	B	A	—	A	A	A	A
Copper Chloride	1 to 10	D	—	A	A	A	A	A ¹ -D	A ¹ -C ¹
Copper Cyanide	Aq. C.S.	—	—	A	A	A	A	A	A
Copper Nitrate	50	—	—	A	A	A	A	A	A
Cresol	100	D	D	—	A	A	—	A	A
Crotonaldehyde	100	—	—	A	A	A	—	—	—
Cyclohexane	100	—	A	C	A	A	A	A	—
Cyclohexanol	100	—	A	A	A	A	A	A	—
Cyclohexanone	100	—	A	C	A	A	A	A	—
Dibutyl Phthalate	100	—	—	A	A	A	A	—	—
Dichloroethane	100	—	—	A	—	A	A	A	A
Dichloroethylene	100	—	—	C	A	A	—	—	—
Diesel Fuel	100	—	A	C	A	A	A	A	A
Diethyl Ether	100	—	A	A	A	A	A	A	A
Diglycolic Acid	Aq. C.S.	—	—	A	A	A	—	—	—
Diisobutyl Ketone	100	—	—	A	A	A	—	—	—
Dimethyl Amine	100	—	—	A	A	A	—	—	—
Dimethyl Formamide	100	—	A	A	A	A	A	A	—
Dimethyl Sulfate	100	—	—	C	A	A	—	—	—
Diocetyl Phthalate	100	—	—	A	A	A	A	A	—
1,4-Dioxane	100	—	B	C	A	A	A	A	—
Ethyl Acetate	100	A	A	B	A	A	A	A	A
Ethyl Alcohol	100	A	A	A	A	A	A	A	A
Ethyl Chloride	100	—	—	C	A	A	—	A	A
Ethylene Chloride	100	A	C	C	A	A	—	A	A
Ethylene Glycol	100	A	A	A	A	A	A	A	A
Ethylene Oxide	100	—	—	C	A	A	A	—	—
Fatty Acids	100	—	—	A	A	A	—	—	—
Ferric Chloride	50	D	—	A	A	A	C	D	D
Ferric Hydroxide	All	—	—	A	A	A	—	A	A
Ferric Nitrate	All	—	—	A	A	A	A	A	A
Ferrous Chloride	Aq. C.S.	D	—	A	A	A	A	D	C
Ferrous Sulfate	10	—	—	A	A	A	A	A ¹	A
Fluorine (Dry)	100	—	—	D	A	—	D	D	D
Formaldehyde	40	A	B	A	A	A	A	A ¹	A
Formic Acid	All	D	D	A	A	A	C	A	A
Freons	100	A	—	—	A	A	A	—	—
Fuel Oil	100	—	A	—	A	A	A	A	A
Furfural	100	A	—	—	A	A	—	A	A
Gallic Acid	Aq. C.S.	—	—	—	A	A	—	A	A
Gasoline	100	A	—	C	A	A	A	A	A
Glycerin	100	—	A	A	—	A	—	A	A
Glycolic Acid	40	D	—	A	A	A	—	—	—
Heptane	100	—	A	A	A	A	A	A	A
Hexane	100	—	A	A	A	A	A	A	A

*Includes all 6.6 Nylons (weather resistant, heat stabilized, and flame retardant).
 ■ TEFZEL is a registered trademark of E.I. du Pont de Nemours and Company.
 ▲ HALAR is a registered trademark of Solvay Solexis

Continues on next page

Table C – Chemical Resistance Table (continued)

Materials	Percent Concentration	Nylon 6.6*	Nylon 12	Polypropylene	TEFZEL ■	HALAR ▲	PEEK	304 Stainless Steel	316 Stainless Steel
Hydrobromic Acid	All	D	D	A	A	A	D	D	D
Hydrochloric Acid	All	D	D	A	A	A	A	D	D
Hydrocyanic Acid	All	—	D	A	A	A	A	C	C
Hydrofluoric Acid	All	D	D	A	A	A	D	D	D
Hydrofluorosilicic Acid	30	—	D	A	A	A	—	D	D
Hydrogen Peroxide	30	D	B	B	A	A	A	B	A
Hydrogen Sulfide	Dry	—	—	A	A	A	A	A	A
Hydrogen Sulfide	Wet	D	—	A	A	A	—	C ²	A ²
Hydroquinone	100	—	—	A	A	A	—	—	—
Iodine	100	—	—	A	A	A	C	D	D
Iodoform	100	—	—	—	A	A	—	A	A
Isopropyl Alcohol	100	A	A	A	A	A	A	A	A
Jet Fuel	100	A	—	A	A	A	A	A	A
Lactic Acid	10	A	B	A	A	A	—	A	A
Lanolin	10	A	A	A	A	A	—	A	A
Lead Acetate	Aq. C.S.	—	—	A	A	A	A	A	A
Linseed Oil	100	A	A	A	A	A	—	A	A
Magnesium Carbonate	Aq. C.S.	—	A	A	A	A	—	A	A
Magnesium Chloride	Aq. C.S.	C	A	A	A	A	A	A ¹	A ¹
Magnesium Nitrate	Aq. C.S.	—	A	A	A	A	—	A	A
Maleic Acid	100	—	—	A	A	A	A	—	—
Malic Acid	Aq. C.S.	—	—	A	A	A	—	A	A
Mercuric Chloride	Dilute	—	A	A	A	A	A	D	D
Mercury	100	—	A	A	A	A	A	A	A
Methyl Alcohol	100	A	A	A	A	A	A	A	A
Methyl Bromide	100	—	—	D	A	A	—	—	—
Methyl Chloride	100	—	—	C	A	A	—	—	A
Methyl Chloroform	100	A	—	C	A	A	—	—	—
Methyl Ethyl Ketone	100	—	A	C	A	A	A	A	A
Methyl Isobutyl Ketone	100	A	—	C	A	A	—	A	A
Methylene Chloride	100	C	D	C	A	A	A	A	A
Naphtha	100	—	—	A	A	A	A	A	A
Naphthalene	100	—	B	A	A	A	A	A	A
Nickel Chloride	Aq. C.S.	—	A	A	A	A	A	A ¹	A ¹
Nickel Sulfate	Aq. C.S.	—	A	A	A	A	A	A ¹	A ¹
Nitric Acid	10 to 30	D	D	A	A	A	—	A	A
Nitric Acid	30 to 68	D	D	D	B	A	C	A	A
Nitro Benzene	100	—	C	C	A	A	A	A	A
Nitro Methane	100	A	—	—	A	A	—	—	—
Nitrous Acid	5	—	—	—	A	A	A	A	A
Oleic Acid	100	—	C	A	A	A	A	A	A
Oxalic Acid	10	—	C	A	A	A	A	A	A
Oxygen	All	—	—	A	A	A	A	—	—
Paraffin	100	A	A	A	A	A	—	A	A
Perchloroethylene	100	—	—	C	A	A	A	A	A
Petroleum Ether	100	—	A	A	A	A	A	A	A
Phenol	90	D	D	A	A	A	D	A	A
Phosphoric Acid	10	D	D	A	A	A	A	A	A
Phosphorous Pentoxide	100	—	D	A	A	A	A	—	—
Phosphorous Trichloride	100	—	D	C	A	A	—	A	A
Phthalic Acid	50	—	—	C	A	A	—	A	A
Picric Acid	1	—	—	A	A	A	A	A	A
Potassium Borate	1	—	—	A	A	A	—	—	—
Potassium Bromide	Aq. C.S.	—	—	A	A	A	A	A ¹	A ¹
Potassium Carbonate	Aq. C.S.	—	C	A	A	A	A	A	A
Potassium Chlorate	Aq. C.S.	—	B	A	A	A	A	A	A
Potassium Chloride	5	—	A	A	A	A	A	A ¹	A ¹
Potassium Dichromate	Aq. C.S.	—	D	A	A	A	A	A	A

*Includes all 6.6 Nylons (weather resistant, heat stabilized, and flame retardant).
 ■ TEFZEL is a registered trademark of E.I. du Pont de Nemours and Company.
 ▲ HALAR is a registered trademark of Solvay Solexis

Continues on next page

Table C – Chemical Resistance Table (continued)

Materials	Percent Concentration	Nylon 6.6*	Nylon 12	Polypropylene	TEFZEL■	HALAR▲	PEEK	304 Stainless Steel	316 Stainless Steel
Potassium Ferrocyanide	25	—	—	A	A	A	A	A	A
Potassium Hydroxide	30	C	—	A	A	A	A	C	C
Potassium Iodide	Aq. C.S.	—	A	A	—	A	—	A	A
Potassium Nitrate	Aq. C.S.	—	A	A	A	A	A	A	A
Potassium Perchlorate	1	—	—	A	A	A	—	—	—
Potassium Permanganate	5	D	D	A	A	A	A	A	A
Potassium Persulfate	All	—	—	A	A	A	—	—	—
Potassium Sulfate	Aq. C.S.	—	A	A	A	A	A	A	A
Potassium Sulfide	Aq. C.S.	—	—	A	A	A	A	A	A
Propionic Acid	50	—	—	A	A	A	—	—	—
Propyl Alcohol	100	A	—	A	A	A	A	A	A
Pyridine	100	—	A	C	A	A	A	C	C
Sea Water	100	—	A	A	A	A	—	A ¹	A ¹
Silver Chloride	Aq. C.S.	—	A	A	A	A	—	D	D
Silver Nitrate	10	—	A	A	A	A	A	A	A
Sodium Acetate	Aq. C.S.	A	—	A	A	A	A	A ¹	A
Sodium Benzoate	Aq. C.S.	—	—	A	A	A	—	—	—
Sodium Bicarbonate	Aq. C.S.	A	A	A	A	A	A	A	A
Sodium Bisulfate	10	—	—	A	A	A	—	A	A
Sodium Bisulfite	Aq. C.S.	—	B	A	A	A	—	A	A
Sodium Borate	Aq. C.S.	—	—	A	A	A	—	A	A
Sodium Carbonate	2	A	A	A	A	A	A	A	A
Sodium Chlorate	25	—	C	A	A	A	A	A	A
Sodium Chloride	10	A	A	A	A	A	A	A ¹	A ¹
Sodium Chromate	Aq. C.S.	D	—	A	A	A	—	A	A
Sodium Fluoride	5	—	—	A	A	A	—	A ¹	A ¹
Sodium Hydroxide	10	A	A	A	A	A	A	A	A
Sodium Hypochlorite	5	B	C	A	A	A	A	C ¹	A ¹
Sodium Hyposulfite	Aq. C.S.	—	—	—	A	A	—	A	A
Sodium Nitrate	5	A	A	A	A	A	A	A	A
Sodium Perborate	Aq. C.S.	—	B	A	A	A	—	—	C
Sodium Perchlorate	10	—	—	—	A	A	—	A	A
Sodium Phosphate	5	—	A	A	A	A	—	A	A
Sodium Sulfate	5	—	A	A	A	A	A	A	A
Sodium Sulfide	5	—	A	A	A	A	A	A ¹	A
Sodium Thiosulfate	25	—	A	A	A	A	—	A ²	A ²
Stannic Chloride	Aq. C.S.	D	—	A	A	A	A	D	C
Stannous Chloride	Aq. C.S.	—	A	A	A	A	A	C	B
Stearic Acid	100	—	C	A	A	A	—	A	A
Succinic Acid	100	—	B	A	A	A	—	—	—
Sulfur	100	—	A	A	A	A	A	B	C
Sulfur Dioxide	All	D	—	C	A	A	A	A	A
Sulfuric Acid	5	D	C	A	A	A	C	C	A
Sulfuric Acid	50	D	D	A	A	A	D	D	C
Sulfuric Acid	Concentrate	D	D	C	A	A	D	C	C
Sulfurous Acid	10	A	—	A	A	A	A	C ¹	A ¹
Tannic Acid	10	—	A	A	A	A	A	A	A
Tartaric Acid	50	—	B	A	A	A	A	A	A
Tetrahydrofuran	100	—	C	C	A	A	A	A	A
Toluene	100	A	A	C	A	A	A	A	A
Trichloroacetic Acid	10	D	—	B	A	A	—	D	D
Trichloroethylene	100	—	D	C	A	A	A	A ¹	A ¹
Turpentine	100	—	B	D	A	A	A	A	A
Urea	50	—	A	A	A	A	—	—	—
Vinyl Acetate	100	—	—	A	A	A	—	—	—
Xylene	100	A	—	D	A	A	A	A	A
Zinc Chloride	70	D	A	A	A	A	A	A	A
Zinc Nitrate	Aq. C.S.	—	A	A	A	A	—	A	A
Zinc Sulfate	Aq. C.S.	—	A	A	A	A	A	A	A

*Includes all 6.6 Nylons (weather resistant, heat stabilized, and flame retardant).

■ TEFZEL is a registered trademark of E.I. du Pont de Nemours and Company.

▲ HALAR is a registered trademark of Solvay Solexis

PLT-XMR Reel-Fed Cable Ties

- Continuously molded cable ties (5,000 ties/reel) provide continuous feeding for high productivity and reduced downtime due to fewer reel changes
- All-nylon, one-piece locking ties with 18 lbs. minimum loop tensile strength in miniature cross section
- Available in a variety of colors and materials
- Reel-fed cable ties in Nylon 6.6 material (except black) are UL Listed for use in plenum or air handling spaces per NEC



Part Number	Tie Style	Material	Color	Max. Bundle Dia.		Length		Width		Min. Loop Tensile Str.	
				In.	mm	In.	mm	In.	mm	Lbs.	N
Reel-Fed Cable Ties for PAT1M4.0 System											
PLT1M-XMR*	All-Nylon	Nylon 6.6	Natural	0.82	21	4.0	102	0.100	2.5	18	80
PLT1M-XMR0	All-Nylon	Weather Resistant Nylon 6.6	Black	0.82	21	4.0	102	0.100	2.5	18	80
PLT1M-XMR00*	All-Nylon	Weather Resistant Nylon 6.6	Black	0.82	21	4.0	102	0.100	2.5	18	80
PLT1M-XMR30	All-Nylon	Heat Stabilized Nylon 6.6	Black	0.82	21	4.0	102	0.100	2.5	18	80
Reel-Fed Cable Ties for PAT1.5M4.0 System											
PLT1.5M-XMR	All-Nylon	Nylon 6.6	Natural	1.31	33	5.6	142	0.100	2.5	18	80
PLT1.5M-XMR0	All-Nylon	Weather Resistant Nylon 6.6	Black	1.31	33	5.6	142	0.100	2.5	18	80
PLT1.5M-XMR00*	All-Nylon	Weather Resistant Nylon 6.6	Black	1.31	33	5.6	142	0.100	2.5	18	80
PLT1.5M-XMR30	All-Nylon	Heat Stabilized Nylon 6.6	Black	1.31	33	5.6	142	0.100	2.5	18	80

*Military grade weather resistant material.

Note: PLT_XMR cable ties (natural, 00, and colors) are Class 2 Mil. Spec. per AS23190 and AS33671.

Please visit www.panduit.com for additional colors



PLT-VMR Reel-Fed Cable Ties

- Continuously molded cable ties (2,500 ties/reel) provide continuous feeding for high productivity and reduced downtime due to fewer reel changes
- All-nylon, one-piece locking ties with 50 lbs. minimum loop tensile strength in standard cross section for larger bundles up to 1.94" (49mm) diameter
- Reel-fed cable ties in Nylon 6.6 material (Natural color) are UL Listed for use in plenum or air handling spaces per NEC



Part Number	Tie Style	Material	Color	Max. Bundle Dia.		Length		Width		Min. Loop Tensile Str.	
				In.	mm	In.	mm	In.	mm	Lbs.	N
Reel-Fed Cable Ties for PAT25 System											
PLT2S-VMR	All-Nylon	Nylon 6.6	Natural	1.94	49	8.1	206	0.190	4.8	50	222
PLT2S-VMR0	All-Nylon	Weather Resistant Nylon 6.6	Black	1.94	49	8.1	206	0.190	4.8	50	222
PLT2S-VMR30	All-Nylon	Heat Stabilized Nylon 6.6	Black	1.94	49	8.1	206	0.190	4.8	50	222
Reel-Fed Cable Ties for PAT35 System											
PLT3S-VMR	All-Nylon	Nylon 6.6	Natural	2.75	70	11.3	287	0.190	4.8	50	222
PLT3S-VMR30	All-Nylon	Heat Stabilized Nylon 6.6	Black	2.75	70	11.3	287	0.190	4.8	50	222

Note: PLT_VMR Nylon 6.6 cable ties are Class 2 Mil. Spec. per AS23190 and AS33671.



BT-XMR Reel-Fed Cable Ties

- Continuously molded cable ties (5,000 ties/reel) provide continuous feeding for high productivity and reduced downtime due to fewer reel changes
- Reel-fed cable ties with exclusive stainless steel locking barb and 30 lbs. minimum loop tensile strength permit higher tension for demanding applications
- Metal locking barb and tie body design provide greater bundle tightness, reducing both rotational and lateral movement of the tie
- Reel-fed cable ties in Nylon 6.6 material (Natural color) are UL Listed for use in plenum or air handling spaces per NEC



BT_XMR



BT_XMR (0, 30)



Part Number	Tie Style	Material	Color	Max. Bundle Dia.		Length		Width		Min. Loop Tensile Str.	
				In.	mm	In.	mm	In.	mm	Lbs.	N
Reel-Fed Cable Ties for PAT1M4.0-BT System											
BT1M-XMR	Barbed	Nylon 6.6	Natural	0.82	21	4.0	102	0.100	2.5	30	133
BT1M-XMR0	Barbed	Weather Resistant Nylon 6.6	Black	0.82	21	4.0	102	0.100	2.5	30	133
BT1M-XMR30	Barbed	Heat Stabilized Nylon 6.6	Black	0.82	21	4.0	102	0.100	2.5	30	133
Reel-Fed Cable Ties for PAT1.5M4.0-BT System											
BT1.5M-XMR	Barbed	Nylon 6.6	Natural	1.31	33	5.6	142	0.100	2.5	30	133
BT1.5M-XMR0	Barbed	Weather Resistant Nylon 6.6	Black	1.31	33	5.6	142	0.100	2.5	30	133
BT1.5M-XMR30	Barbed	Heat Stabilized Nylon 6.6	Black	1.31	33	5.6	142	0.100	2.5	30	133

Cable Accessories



Panduit® provides a comprehensive offering of cable accessories. These accessories are engineered to speed installation and lower installed costs for routing and managing cable. Panduit cable accessories are designed and manufactured to meet applicable quality standards including International, UL, Military, ISO and Aerospace.



- Largest selection of mounts, clips, and clamps for cable management
- Panduit cable ties and accessories can be used in a variety of applications and environments, providing the optimal cable management solution
- Installation methods include adhesive backed, user applied adhesive, screws, rivets or push barb



Panduit mounts, clips, and clamps are manufactured in an environment committed to design innovation, high quality, and knowledgeable service to our customers. Adhesive backed mounts provide a strong adhesive bond for long-term reliability. Cable clips offer a one-piece solution to save time and reduce inventory. Harness board accessories speed the routing and forming of cable bundles in the fabrication of a harness. They hold bundles at a uniform height above the board and are ideal for use with Panduit manual and automatic cable tie tooling.

Cable Accessories Products Overview – Used with Cable Ties

Adhesive Backed Cable Tie Mounts

Pages B2.4 – B2.8



- Uses premium Panduit adhesive for a long-term, reliable bond
- Adhesive backing allows routing of wires and cables where mounting holes cannot be drilled
- Mounts should be used with Panduit cable ties for a complete wire routing solution

Screw Applied Cable Tie Mounts

Pages B2.9 – B2.15



- Screw/riev applied cable tie mounts offer a countersunk or through hole in the mount through which a screw or rivet can be secured
- Offered in a wide selection of specialty materials for resistance to severe conditions such as heat, radiation, chemicals, and outdoor environments
- Available in styles ranging from low profile mounts with integral push-rivet to high stability cradle mounts for Extra-Heavy strength cable ties

Other Cable Tie Mounts

Pages B2.16 – B2.26



- Push mount designs lock into a hole in a metallic panel or in a blind masonry hole
- Edge clip mounts secure to a panel edge using metal barbs that dig into panel surface
- Stud mounts secure onto threaded bolts by screwing or hammering on the bolt
- Connector rings can be used to attach adjacent bundles to provide spacing and prevent vibration damage

Cable Accessories Products Overview – Used without Cable Ties

Adhesive Back Clips and Clamps

Pages B2.27 – B2.36

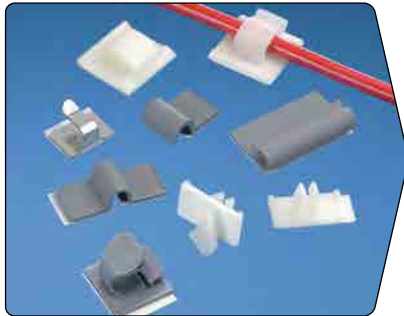

- A wide range of styles and sizes of adhesive backed clips and clamps to secure a variety of cables, from individual small diameter wires to large flat cables
- Products come in designs that use friction to hold a few cables, or more secure releasable latching designs
- Uses premium Panduit adhesive for a long-term, reliable bond

Other Clips and Clamps

Pages B2.36 – B2.43



- Screw clips use a screw, nail, or rivet to secure the clip to surface
- Plastic edge clips secure to an edge in a panel which incorporates a punched hole to provide mechanical retention
- Push-in clips use an arrow-head shaped barb to lock into a hole in a panel, and is available in a range of bundle sizes

Harness Board Accessories

Pages B2.44 – B2.50



- Allow an installer to quickly configure a specific arrangement of wires, to aid in required wire bundling and termination
- Hold wire bundles at a uniform height from a harness board to ease manual or automatic cable tie installation
- Aid in the proper routing and forming of wire bundles to help maintain end product consistency, reduce expensive rework and maximize safety

4-Way Adhesive Backed Cable Tie Mounts

- Allow cable tie entry from all four sides
- Available in multiple sizes to match application load requirements
- Produced 2-up or 4-up for fast and easy liner removal to speed installation



ABM1M 0.50" x 0.50"	ABMM 0.75" x 0.75"	ABM2S 1.00" x 1.00"	ABM100 1.00" x 1.00"	ABM112 1.12" x 1.12"	ABM3H 1.50" x 1.50"	ABM4H 2.00" x 2.00"
Accepts M Cable Ties	Accepts M, I Cable Ties	Accepts M, I, S Cable Ties	Accepts M, I, S Cable Ties	Accepts M, I, S Cable Ties	Accepts M, I, S, HS, LH, H, HLM Cable Ties	Accepts M, I, S, HS, LH, H, HLM Cable Ties

White Nylon 6.6; Rubber Adhesive; Indoor Environment	ABM1M-A-C 100 pc/pkg	-	-	ABM200-A-C** 100 pc/pkg	ABM112-A-C 100 pc/pkg	ABM3H-A-L 100 pc/pkg	ABM4H-A-L 100 pc/pkg
White Nylon 6.6; Acrylic Adhesive; Indoor/High Temp Environment	ABM1M-AT-C 100 pc/pkg	-	-	ABM100-AT-C 100 pc/pkg	ABM112-AT-C 100 pc/pkg	ABM3H-AT-L 100 pc/pkg	ABM4H-AT-L 100 pc/pkg
Black Weather Resistant Nylon 6.6; Acrylic Adhesive; Outdoor/High Temp Environment	-	-	-	ABM100-AT-C0 100 pc/pkg	ABM112-AT-C0 100 pc/pkg	-	-
White ABS; Rubber Adhesive; Indoor Environment	-	ABMM-A-C	ABM2S-A-C*^ 100 pc/pkg	-	-	-	-
White ABS; Acrylic Adhesive; Indoor/High Temp Environment	-	ABMM-AT-C 100 pc/pkg	ABM2S-AT-C 100 pc/pkg	-	-	-	-
Black Weather Resistant ABS; Acrylic Adhesive; Outdoor/High Temp Environment	-	ABMM-AT-C0 100 pc/pkg	ABM2S-AT-C0 100 pc/pkg	-	-	-	-
White ABS; Indoor Environment; User Supplied Adhesive	-	ABMM-D 500 pc/pkg	-	-	-	-	-
White ABS; Indoor Environment; User Supplied Adhesive or #6 screw(s)	-	-	ABM2S-S6-D 500 pc/pkg	-	-	-	-
White Nylon 6.6; Indoor Environment; User Supplied Adhesive or #6 (M3) screw(s)	-	-	-	ABM100-S6-C 100 pc/pkg	ABM112-S6-C 100 pc/pkg	ABM3H-S6-T 200 pc/pkg	ABM4H-S6-T 200 pc/pkg
Natural Flame Retardant Nylon 6.6; Indoor Environment; User Supplied Adhesive or #6 (M3) screw(s)	-	-	-	ABM100-S6-C69 100 pc/pkg	ABM112-S6-C69 100 pc/pkg	-	-

*Also available in Gray ABS material with Rubber Adhesive for Indoor environments. Part number ABM2S-A-C14

^Also available in Ivory ABS material with Rubber Adhesive for Indoor environments. Part number ABM2S-A-C15

**Also available in Ivory Nylon 6.6 material with Rubber Adhesive for Indoor environments. Part number ABM100-A-C15

UL US ABMQ Multiple Bridge Adhesive Backed Cable Tie Mounts

- Multiple cable tie bridges on one mount speeds installation of cable bundles by reducing the number of mounts applied
- Dovetail connection system provides alignment and a joining method to expand routing capabilities
- V-groove allows for easy separation into two mounts with two bridges each for separate applications
- 4-way cable tie bridges allow cable bundles to be secured perpendicular to the mount for even spacing or inline to secure a bundle in multiple places
- Large adhesive surface area provides long-term reliability and keeps product in place despite heavy load or high stress

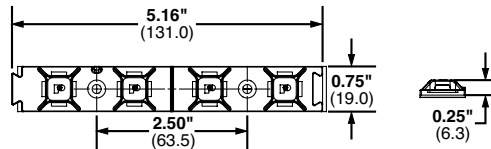

Part Number	Used with Cable Ties	Material	Color	Environment	Mounting Method	Std. Pkg. Qty.	Std. Ctn. Qty.
ABMQS-A-C	M, I, S	ABS	White	Indoors	Rubber	100	1000
ABMQS-A-Q		ABS	White	Indoors	Rubber	25	250
ABMQS-A-Q20		ABS	Black	Indoors	Rubber	25	250

UL LISTED US ABMQ Mounts for Installation with Screws or User-Supplied Adhesive

ABMQS-S6-C	M, I, S	ABS	White	Indoors/High Temp	Two #6 M3 Screws	100	1000
------------	---------	-----	-------	-------------------	------------------	-----	------

‡Cable tie cross section sizes: M = Miniature, I = Intermediate, and S = Standard.

Tak-Ty® Hook & Loop Cable Tie Mounts

- For use with hook and loop cable ties, see page B1.83, B1.84
- Unique cradle design provides maximum stability for cable bundle
- For indoor use only
- Dimensions: 1.10"L x 1.12"W x 0.34"H (27.9mm x 28.4mm x 8.6mm)

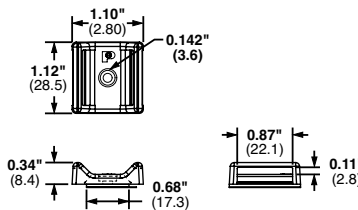

Part Number	Used with Cable Ties‡	Material	Color	Max. Static Load		Mounting Method	Std. Pkg. Qty.	Std. Ctn. Qty.
				Lbs.	g			
ABMT-A-C	HLT, HLS, TTS, UCT	Nylon 6.6	Natural	0.38	174	Pre-Installed Rubber Adhesive	100	1000
ABMT-A-C20			Black				100	1000
ABMT-S6-C			Natural	100	1000			
ABMT-S6-C20			Black	100	1000			
ABMT-S6-C60		Flame Retardant Nylon 6.6	Black	—	—	#6 (M3) Screw	100	1000
ABMT-S6-C69		Natural	100	1000				

‡Cable tie cross section sizes: HLT = Tak-Ty™ Hook & Loop Ties, HLS = Tak-Ty™ Hook & Loop Strip Tie, TTS = Tak-Tape™ Roll, UCT = Ultra-Cinch™ Tie.

*For proper selection of adhesives see page B2.53.

Super-Grip™ Adhesive Backed Cable Tie Mounts

- Low profile design keeps bundle close to mounting surface
- Small overall size allows use where space is limited
- For use with Super-Grip™ Cable Ties found on page B1.36
- High Bond Adhesive available

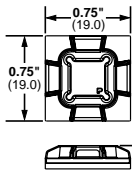
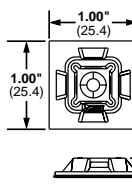
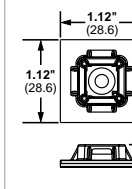
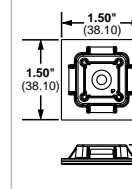
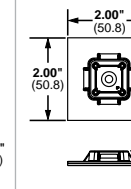

					
	0.75" (19.0) 0.75" (19.0) 0.20" (5.2)	1.00" (25.4) 1.00" (25.4) 0.33" (8.4)	1.12" (28.6) 1.12" (28.6) 0.30" (7.7)	1.50" (38.1) 1.50" (38.1) 0.355" (9.02)	2.00" (50.8) 2.00" (50.8) 0.36" (9.0)
	SGABM20 0.75" x 0.75"	SGABM25 1.00" x 1.00"	SGABM30 1.12" x 1.12"	SGABM40 1.50" x 1.50"	SGABM50 2.00" x 2.00"
	Accepts SGM, SGI Cable Ties	Accepts SGM, SGI, SGS Cable Ties	Accepts SGM, SGI, SGS Cable Ties	Accepts SGM, SGI, SGS, SGLH, SGH Cable Ties	Accepts SGM, SGI, SGS, SGLH, SGH Cable Ties
White Nylon 6.6; Rubber Adhesive; Indoor Environment	SGABM20-A-C 100 pc/pkg	SGABM25-A-C 100 pc/pkg	SGABM30-A-C 100 pc/pkg	SGABM40-A-L 50 pc/pkg	SGABM50-A-L 50 pc/pkg
Black Weather Resistant Nylon 6.6; Acrylic Adhesive; Outdoor/High Temp Environment	SGABM20-AT-C0 100 pc/pkg	SGABM25-AT-C0 100 pc/pkg	SGABM30-AT-C0 100 pc/pkg	SGABM40-AT-L0 50 pc/pkg	SGABM50-AT-L0 50 pc/pkg
Black Weather Resistant Heat Stabilized Nylon 6.6; High Bond Acrylic Adhesive; Outdoor/High Temp Environment	SGABM20-AV-C300 100 pc/pkg	SGABM25-AV-C300 100 pc/pkg	SGABM30-AV-C300 100 pc/pkg	-	-
White Nylon 6.6; Indoor Environment; User Supplied Adhesive or #6 (M3) screw(s)	-	SGABM25-S6-C 100 pc/pkg	-	-	-
Black Weather Resistant Nylon 6.6; Outdoor Environment; User Supplied Adhesive or #6 (M3) screw(s)	-	SGABM25-S6-C0 100 pc/pkg	-	-	-

Combination Adhesive Mount/Cable Ties

- Adhesive mount and cable tie molded as one-piece helps reduce inventory costs
- Available with locking or releasable tie
- For indoor use only
- Material: Nylon 6.6

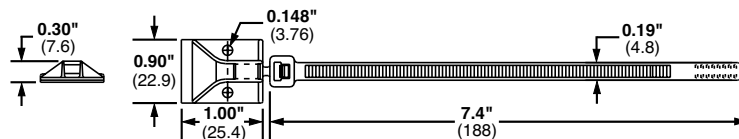

Part Number	Tool	Color	Adhesive Type	Std. Pkg. Qty.	Std. Ctn. Qty.
Locking Cable Tie					
PLA2S-A-Q	GTS, GTSL, GS2B, GS4H, PTS, PTH, PPTS, STS2, STH2	White	Rubber	25	250
Releasable Cable Tie					
PRA2S-A-Q	Hand installed only	White	Rubber	25	250

cUL[®] US Snap-In Cable Tie Mounts – Mechanically Applied

- For use with Panduit Standard cross section cable ties including PLT1S, PLT1.5S, PLT2S, PRT1.5S and PRT2S
- Integral retaining notch holds cable tie head in place below bundle
- Eliminates protruding tie head and facilitates one hand tie threading
- Quickly route wire and cable where mounting holes cannot be drilled
- For indoor use only
- Material: ABS

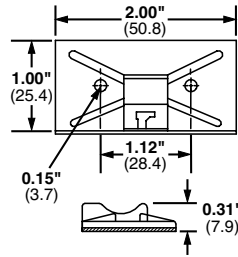

Part Number	Used with Cable Ties‡	Color	Mounting Method	Std. Pkg. Qty.	Std. Ctn. Qty.
-------------	-----------------------	-------	-----------------	----------------	----------------

Snap-In Mounts with Pre-Installed Adhesive

SMS-A-C	S	White	Rubber	100	500
SMS-A-C14		Gray	Rubber	100	500
SMS-A-C15		Ivory	Rubber	100	500

cUL[®] US LISTED Snap-In Mounts for Application with Screws or User-Supplied Adhesive

SMS-S6-D	S	White	User Supplied Adhesive and/or Two #6 M3 Screws	500	5000
----------	---	-------	--	-----	------

‡Cable tie cross section size: S = Standard.

Epoxy Applied Mounts

- Provide a fast, strong, economical method to secure wire/cable to most surfaces
- Eliminate the need to drill holes

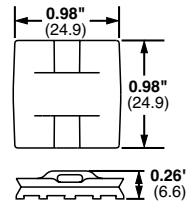

Part Number	Used with Cable Ties‡	Material	Color	Environment	Mounting Method	Std. Pkg. Qty.	Std. Ctn. Qty.
EMS-A-C	M, I, S	Nylon 6.6	Natural	Indoors	EMA epoxy	100	1000
EMS-A-C0		Weather Resistant Nylon 6.6	Black	Outdoors			

‡Cable tie cross section sizes: M = Miniature, I = Intermediate, and S = Standard.

Epoxy Applied Swivel Mount

- Swivels 360° to assure proper orientation with harness
- For indoor use only
- Four inspection holes to check adhesive coverage

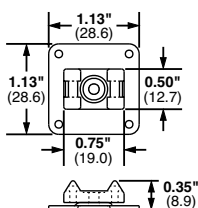

Part Number	Used with Cable Ties‡	Mounting Method	Std. Pkg. Qty.	Std. Ctn. Qty.
ASMS-A-X	M, I, S, SGM, SGI	EMA epoxy	10	100

‡Cable tie cross section sizes: M = Miniature, I = Intermediate, S = Standard, SGM = Super-Grip® Miniature, and SGI = Super-Grip® Intermediate.

Epoxy Applied Cable Tie Mount Kits

- EMA Epoxy supplied in convenient two-compartment mixer cup with a mixer stick for each cup
- After full 24 hour cure time, bonding strength will exceed 50 lbs. on a clean, grease-free surface
- Each cup contains adhesive for three EMS or ASMS mounts
- Not recommended for use on polyethylene and polypropylene surfaces
- Epoxy hardens in approximately five minutes



Part Number	Used with Cable Ties‡	Environment	Epoxy Cups	Mixer Sticks	EMS Mounts	Cable Ties	Std. Pkg. Qty.	Std. Ctn. Qty.
-------------	-----------------------	-------------	------------	--------------	------------	------------	----------------	----------------

Epoxy Adhesive Only

EMA-X	—	Indoors/Outdoors	10	10	—	—	10	—
-------	---	------------------	----	----	---	---	----	---

Epoxy Mounting Kit with EMS Mounts

EMSK3-1-X0	M, I, S	Indoors/Outdoors	1	1	3	3	1	10
------------	---------	------------------	---	---	---	---	---	----

Epoxy Mounting Kit with EMS Mounts and Cable Ties

EMSK3-1-3-0	M, I, S	Indoors/Outdoors	1	1	3	3	1	10
EMSK12-4-12-X0		Indoors/Outdoors	4	4	12	12	10	10

‡Cable tie cross section sizes: M = Miniature, I = Intermediate, and S = Standard.

RU[®] Tie Mounts – Applied with User Supplied Adhesives

- Solid flat bottom surface provides maximum holding area
- Material: Nylon 6.6
- For indoor use only



Part Number	Used with Cable Ties‡	Color	Mounting Method	Std. Pkg. Qty.	Std. Ctn. Qty.
TM1A-C	M	Natural	User Supplied Adhesive	100	1000
TM2A-C	M, I, S			100	500
TM3A-C	M, I, S, HS, LH			100	500

‡Cable tie cross section sizes: M = Miniature, I = Intermediate, S = Standard, HS = Heavy Standard and LH = Light-Heavy.

RU[®] Low Profile Tie Mounts – User Supplied Adhesive Mounts

- Low profile design keeps bundle close to mounting surface
- For indoor use only
- Material: Nylon 6.6

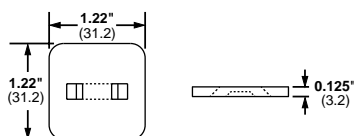

Part Number	Used with Cable Ties‡	Color	Mounting Method	Std. Pkg. Qty.	Std. Ctn. Qty.
AM2-C	M, I, S	Natural	User Supplied Adhesive	100	500

‡Cable tie cross section sizes: M = Miniature, I = Intermediate, and S = Standard.

Cable Tie Mounts – Screw Applied

- Unique cradle design provides maximum stability for the cable bundle
- Low profile design keeps bundle close to mounting surface
- Wide selection of materials available
- UL Recognized except HVTM and SGTM series

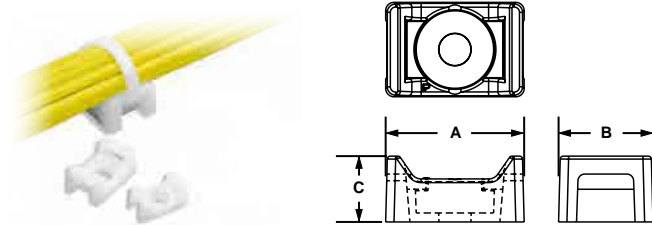

Part Number	Used with Cable Ties†	Counterbore Diameter		Length A		Width B		Height C		Mounting Method	Std. Pkg. Qty.	Std. Ctn. Qty.
		In.	mm	In.	mm	In.	mm	In.	mm			
TM1S4-C	M	0.23	5.7	0.51	13.0	0.32	8.0	0.23	5.8	#4 (M2.5) Screw	100	500
TM1S6-C		0.28	7.0	0.51	13.0	0.32	8.0	0.23	5.8	#6 (M3) Screw	100	500
TM2S6-C	M, I, S	0.29	7.1	0.63	16.0	0.43	10.8	0.28	7.0	#6 (M3) Screw	100	500
TM2S8-C		0.33	8.4	0.63	16.0	0.43	10.8	0.28	7.0	#8 (M4) Screw	100	500
TM3S8-C	M, I, S, LH	0.32	8.1	0.86	21.9	0.61	15.5	0.37	9.4	#8 (M4) Screw	100	500
TM3S10-C		0.38	9.7	0.86	21.9	0.61	15.8	0.37	9.4	#10 (M5) Screw	100	500

Super-Grip® Cable Tie Mounts

SGTM1S6-C	SGM	0.28	7.0	0.51	13.0	0.38	9.7	0.22	5.6	#6 (M3) Screw	100	500
SGTM2S8-C	SGM,SGI,SGS	0.33	8.4	0.66	16.7	0.48	12.2	0.34	8.6	#8 (M4) Screw	100	500
SGTM3S10-C	SGM, SGI, SGS, SGLH	0.38	9.7	0.91	23.1	0.61	15.4	0.43	11.0	#10 (M5) Screw	100	500

Hyper-V™ Cable Tie Mounts

HVTM-06-C0	HV	0.40	10.2	0.81	20.6	0.68	17.3	0.41	10.4	#12 (M6) Screw	100	500
------------	----	------	------	------	------	------	------	------	------	----------------	-----	-----

†Cable tie cross section sizes: M = Miniature, I = Intermediate, S = Standard, LH = Light-Heavy, SGM = Super-Grip® Miniature, SGI = Super-Grip® Intermediate, SGS = Super-Grip® Standard, SGLH = Super-Grip® Light-Heavy, and HV = Hyper-V™.

Additional tie mounts available in specified materials.
All are available as standard Panduit® parts.

Metal Detectable Nylon	Metal Detectable Polypropylene	PEEK	Heat Stabilized Nylon	Flame Retardant Nylon	Weather Resistant Nylon	Weather Resistant Polypropylene	Tefzel®
TM2S8-C86	TM2S8-C186	TM2S8-C71	TM1S4-M30	TM1S4-M69	TM1S6-M0	TM2S8-C100	TM2S8-C76
TM3S8-C86	TM3S8-C186		TM1S6-M30	TM1S6-M69	TM2R6-M0	TM3S8-C100	TM3S8-C76
TM3S10-C86	TM3S10-C186		TM2R6-M30	TM2S6-M69	TM2S6-M0	TM3S8-M100	TM3S10-C76
			TM2S6-M30	TM2S8-M69	TM2S8-M0		
			TM2S8-M30	TM3S8-C69	TM3R6-M0		
			TM3S8-M30	TM3S8-M69	TM3S10-M0		
			TM3S10-M30	TM3S10-M69	TM3S25-M0		
			TM3S25-M30		SGTM1S6-C0		
					SGTM2S8-C0		
					SGTM3S10-C0		

■TEFZEL is a registered trademark of E.I. du Pont de Nemours and Company.



Extra-Heavy Cable Tie Mounts – Screw Applied

- Unique cradle design provides maximum stability for cable bundle
- Route and support large diameter and heavy cable bundles

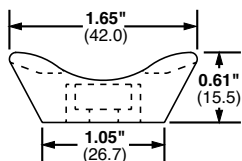

Part Number	Used with Cable Ties‡	Material	Color	Environment	Mounting Method	Std. Pkg. Qty.	Std. Ctn. Qty.
TMEH-S8-Q0	M, I, S, HS, LH, H, EH, HLM	Weather Resistant Nylon 6.6	Black	Outdoors	#8 (M4) Screw	25	250
TMEH-S10-Q0					#10 (M5) Screw	25	250
TMEH-S25-Q0					1/4 (M6) Screw	25	250
TMEH-S10-C100		Weather Resistant Polypropylene	Green	Indoors	#10 (M5) Screw	100	500
TMEH-S10-C109		Polypropylene			#10 (M5) Screw	100	500

‡Cable tie cross section sizes: M = Miniature, I = Intermediate, S = Standard, HS = Heavy-Standard, LH = Light-Heavy, H = Heavy, EH = Extra-Heavy and HLM = Miniature Tak-Ty® Hook & Loop Ties.

Swivel Mounts

- The two mounts are securely fastened together with a connecting rivet that allows both mounts to rotate
- Can join bundles of cable, tubing, or hoses that may need to move or are not parallel
- Separates bundles to avoid abrasion
- Material: Weather Resistant Nylon 6.6

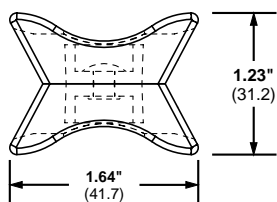

TMEH

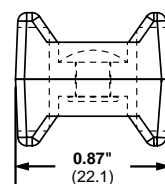
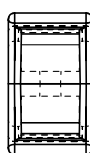

TM3

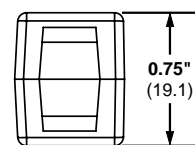

Part Number	Used with Cable Ties‡	Pull Apart Force		Color	Environment	Std. Pkg. Qty.	Std. Ctn. Qty.
		Lbs.	g				
TM3-X2-C0Y	M, I, S, HS, LH	120	54,431	Black	Indoors/Outdoors	25	250
TMEH-X2-L0Y	M, I, S, HS, H, H, EH, HLM	250	113,398				

‡Cable tie cross section sizes: M = Miniature, I = Intermediate, S = Standard, HS = Heavy-Standard, LH = Light-Heavy, H = Heavy, EH = Extra-Heavy and HLM = Miniature Tak-Ty® Hook & Loop Ties.

UL LISTED 4-Way Tie Anchor Mounts – Screw Applied

- 4-way cable tie entry makes part orientation fast and easy
- Small overall size allows for use where space is limited

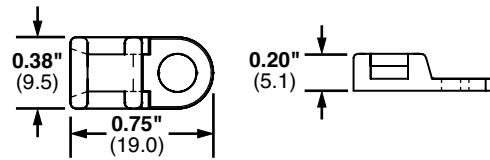

Part Number	Used with Cable Ties†	Hole Diameter A		Material	Color	Environment	Mounting Method	Std. Pkg. Qty.	Std. Ctn. Qty.
		In.	mm						
TA1S8-C	M, I, S	0.17	4.3	Nylon 6.6	Natural	Indoors	#8 (M4) Screw	100	500
TA1S8-M0		0.17	4.3	Weather Resistant Nylon 6.6	Black	Outdoors	#8 (M4) Screw	1000	5000
TA1S8-M30		0.17	4.3	Heat Stabilized Nylon 6.6	Black	Indoors	#8 (M4) Screw	1000	5000
TA1S8-M69		0.17	4.3	Flame Retardant Nylon 6.6	Natural	Indoors	#8 (M4) Screw	1000	5000
TA1S10-C		0.17	4.3	Nylon 6.6	Natural	Indoors	#10 (M5) Screw	100	500
TA1S10-M0		0.20	5.1	Weather Resistant Nylon 6.6	Black	Outdoors	#10 (M5) Screw	1000	5000

Super-Grip® Cable Tie Mounts

SGTA1S8-C	SGM,SGI,SGS	0.17	4.3	Nylon 6.6	Natural	Indoors	#8 (M4) Screw	100	500
-----------	-------------	------	-----	-----------	---------	---------	---------------	-----	-----

†Cable tie cross section sizes: M = Miniature, I = Intermediate, S = Standard, SGM = Super-Grip® Miniature, SGI = Super-Grip® Intermediate, and SGS = Super-Grip® Standard.

UL LISTED Tie Anchor Mounts – Screw Applied

- Install perpendicular to the wire bundle
- Elongated slot permits cable bundle adjustment in application
- Low profile design keeps bundle close to mounting surface where overhead space is limited
- Material: Nylon 6.6

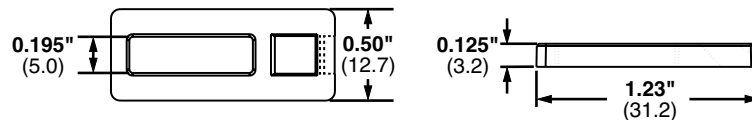
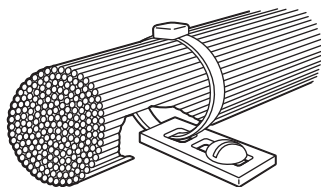

Part Number	Used with Cable Ties†	Color	Environment	Mounting Method	Std. Pkg. Qty.	Std. Ctn. Qty.
TA2-C	M, I, S	Natural	Indoors	#10 (M5) Screw	100	1000
TA2-M					1000	500

†Cable tie cross section sizes: M = Miniature, I = Intermediate, and S = Standard.



Low Profile Mounts – Screw Applied

- Low profile design keeps bundle close to mounting surface
- Small overall size

- Install with a screw or rivet for a strong, secure installation
- For indoor use only
- Material: Nylon 6.6

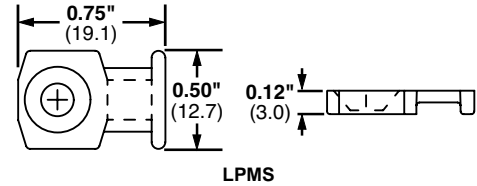
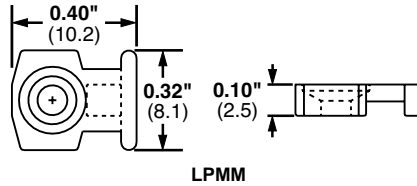

Part Number	Used with Cable Ties‡	Color	Mounting Method	Std. Pkg. Qty.	Std. Ctn. Qty.
LPMM-S2-C	M	Natural	#2 (M2) Countersunk Screw	100	1000
LPMM-S5-C	M		#5 (M3) Countersunk Screw	100	1000
LPMS-S8-C	M, I, S		#8 (M4) Countersunk Screw	100	1000

‡Cable tie cross section sizes: M = Miniature, I = Intermediate, and S = Standard.



Low Profile Mounts – Push Rivet Applied

- Eliminate screws
- Secure wires to any pre-drilled panel
- Can be installed in any panel thickness

- Low profile design keeps bundle close to mounting surface
- For indoor use only
- Material: Nylon 6.6

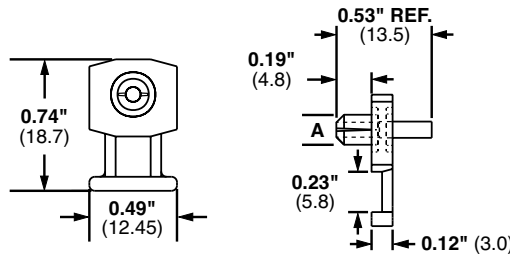

Part Number	Used with Cable Ties‡	Hole Diameter A		Color	Mounting Method	Std. Pkg. Qty.	Std. Ctn. Qty.
		In.	mm				
KIMS-H366-C2	M, I, S	0.144	3.7	Red	Integral Push Rivet	100	1000
KIMS-H430-C6		0.169	4.3	Blue	Integral Push Rivet	100	1000
KIMS-H500-C4		0.196	5.0	Yellow	Integral Push Rivet	100	1000

‡Cable tie cross section sizes: M = Miniature, I = Intermediate, and S = Standard.

UL LISTED Cable Tie Plates

- Slotted mounting hole accommodates various fastener spacing
- Low profile design keeps bundle close to mounting surface
- For indoor use only
- Material: Nylon 6.6

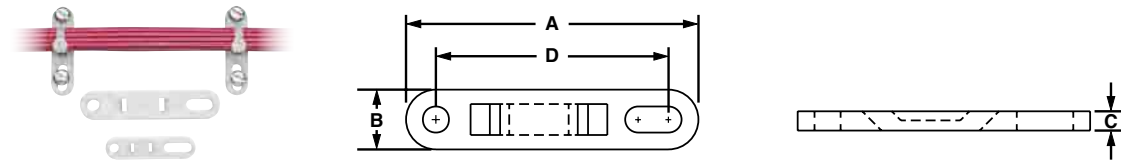

Part Number	Used with Cable Ties‡	Length A		Width B		Height C		Hole Spacing D		Color	Mil. Std. Part Number	Mounting Method	Std. Pkg. Qty.	Std. Ctn. Qty.
		In.	mm	In.	mm	In.	mm	In.	mm					
TP2-C	M, I, S	1.98	50.3	0.50	12.7	0.13	3.2	1.60	40.6	Natural	MS3341-2-9	#10 (M5) Screw	100	1000
TP4H-C	M, I, S, HS, LH, H	3.08	78.2	0.62	15.7	0.20	5.2	2.50	63.5	Natural	MS3341-2-9	1/4 (M6) Screw	500	1000

‡Cable tie cross section sizes: M = Miniature, I = Intermediate, S = Standard, HS = Heavy-Standard, LH = Light-Heavy and H = Heavy.

Contour Multiple Tie Plates

- Designed for aerospace industry to minimize chance for abrasion
- Low profile design keeps bundle close to mounting surface
- For indoor use only
- Heat stabilized Nylon 6.6 material

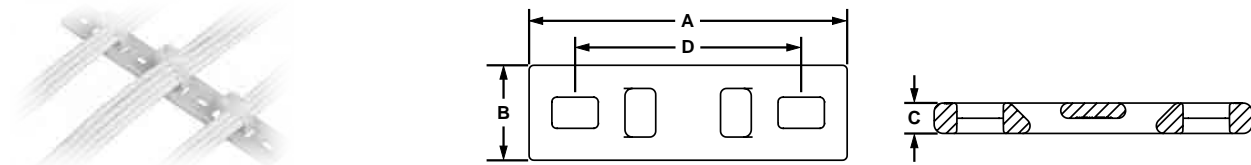

Part Number	No. of Bundles	Used with Cable Ties‡	Length A		Width B		Height C		Hole Spacing D		Mounting Method	Mil. Std. Part Number	Std. Pkg. Qty.	Std. Ctn. Qty.
			In.	mm	In.	mm	In.	mm	In.	mm				
MTPC1H-E10-C39	1	M, I, S, HS, LH, H	2.09	53.1	0.63	16.0	0.20	5.2	1.5	38.1	#10 (M5) Screw	—	100	1000
MTPC2H-E10-C39	2		3.59	91.2	0.63	16.0	0.20	5.2	3.0	6.2	#10 (M5) Screw	—	100	1000
MTPC3H-E10-C39	3		5.09	129.3	0.63	16.0	0.20	5.2	4.50	114.3	#10 (M5) Screw	—	100	1000
MTPC4H-E10-C39	4		6.59	167.4	0.63	15.7	0.20	5.2	6.00	152.4	#10 (M5) Screw	—	100	1000
MTPC5H-E10-C39	5		8.09	205.5	0.63	16.0	0.20	5.2	7.50	190.5	#10 (M5) Screw	—	100	1000
MTPC6H-E10-C39	6		9.59	243.6	0.63	16.0	0.20	5.2	9.00	228.6	#10 (M5) Screw	—	100	1000

‡Cable tie cross section sizes: M = Miniature, I = Intermediate, S = Standard, HS = Heavy-Standard, LH = Light-Heavy and H = Heavy.



Multiple Tie Plates

- Used to secure closely spaced wire bundles
- Low profile design keeps bundle close to mounting surface
- For indoor use only
- Material: Nylon 6.6

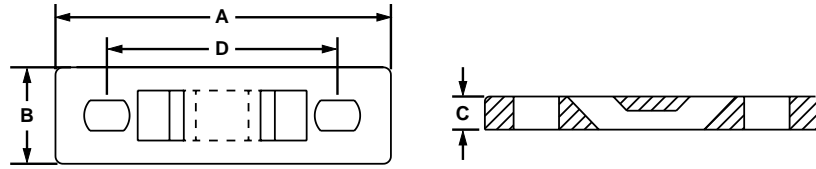

Part Number	No. of Bundles	Used with Cable Ties†	Length A		Width B		Height C		Hole Spacing D		Mounting Method	Mil. Std. Part Number	Std. Pkg. Qty.	Std. Ctn. Qty.
			In.	mm	In.	mm	In.	mm	In.	mm				
MTP1S-E6-C	1	M, I, S	1.75	44.5	0.50	12.7	0.13	3.2	1.25	31.8	#6 (M3) Screw	MS3339-1-9	100	1000
MTP1S-E10-C			1.75	44.5	0.50	12.7	0.13	3.2	1.25	31.8	#10 (M5) Screw	—	100	1000
MTP1H-E6-C		M, I, S, HS, LH, H	2.09	53.1	0.63	16.0	0.20	5.2	1.50	31.8	#6 (M3) Screw	MS3339-6-9	100	1000
MTP1H-E10-C			2.09	53.1	0.63	16.0	0.20	5.2	1.50	31.8	#10 (M5) Screw	—	100	1000
MTP2S-E6-C	2	M, I, S	3.00	76.2	0.50	12.7	0.13	3.2	2.50	63.5	#6 (M3) Screw	MS3339-2-9	100	1000
MTP2S-E10-C			3.00	76.2	0.50	12.7	0.13	3.2	2.50	63.5	#10 (M5) Screw	—	100	1000
MTP2H-E6-C		M, I, S, HS, LH, H	3.59	91.2	0.63	16.0	0.20	5.2	3.00	76.2	#6 (M3) Screw	MS3339-7-9	100	1000
MTP2H-E10-C			3.59	91.2	0.63	16.0	0.20	5.2	3.00	76.2	#10 (M5) Screw	—	100	1000
MTP3S-E6-C	3	M, I, S	4.25	108.0	0.50	12.7	0.13	3.2	3.75	95.3	#6 (M3) Screw	MS3339-3-9	100	1000
MTP3S-E10-C			4.25	108.0	0.50	12.7	0.13	3.2	3.75	95.3	#10 (M5) Screw	—	100	1000
MTP3H-E6-C		M, I, S, HS, LH, H	5.09	129.3	0.63	16.0	0.20	5.2	4.50	114.3	#6 (M3) Screw	MS3339-8-9	100	1000
MTP3H-E10-C			5.09	129.3	0.63	16.0	0.20	5.2	4.50	114.3	#10 (M5) Screw	—	100	1000
MTP4S-E6-C	4	M, I, S	5.50	139.7	0.50	12.7	0.13	3.2	5.00	127.0	#6 (M3) Screw	MS3339-4-9	100	1000
MTP4S-E10-C			5.50	139.7	0.50	12.7	0.13	3.2	5.00	127.0	#10 (M5) Screw	—	100	1000
MTP4H-E6-C		M, I, S, HS, LH, H	6.59	167.4	0.63	16.0	0.20	5.2	6.00	152.4	#6 (M3) Screw	MS3339-9-9	100	1000
MTP4H-E10-C			6.59	167.4	0.63	16.0	0.20	5.2	6.00	152.4	#10 (M5) Screw	—	100	1000
MTP5S-E6-C	5	M, I, S	6.75	171.5	0.50	12.7	0.13	3.2	6.25	158.8	#6 (M3) Screw	MS3339-5-9	100	1000
MTP5S-E10-C			6.75	171.5	0.50	12.7	0.13	3.2	6.25	158.8	#10 (M5) Screw	—	100	1000
MTP5H-E6-C		M, I, S, HS, LH, H	8.09	205.5	0.63	16.0	0.20	5.2	7.50	190.5	#6 (M3) Screw	MS3339-10-9	100	1000
MTP5H-E10-C			8.09	205.5	0.63	16.0	0.20	5.2	7.50	190.5	#10 (M5) Screw	—	100	1000
MTP6H-E6-C	6	M, I, S, HS, LH, H	9.59	243.6	0.63	16.0	0.20	5.2	9.00	228.6	#6 (M3) Screw	MS3339-11-9	100	1000
MTP6H-E10-C			9.59	243.6	0.63	16.0	0.20	5.2	9.00	228.6	#10 (M5) Screw	—	100	1000

†Cable tie cross section sizes: M = Miniature, I = Intermediate, S = Standard, HS = Heavy-Standard, LH = Light-Heavy and H = Heavy.

UL LISTED **Right Angle Mounts**

- Hold cable bundles away from the sharp edges of bulkheads or cabinet holes
- Can also be used to mount cable bundles adjacent to any surface
- For indoor use only
- Material: Nylon 6.6

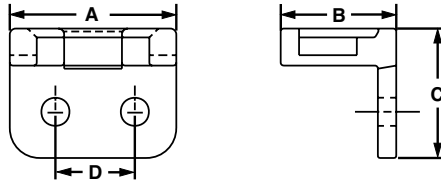

Part Number	Used with Cable Ties‡	Length A		Width B		Height C		Hole Spacing D		Color	Mil. Std. Part Number	Mounting Method	Std. Pkg. Qty.	Std. Ctn. Qty.
		In.	mm	In.	mm	In.	mm	In.	mm					
RAMS-S3-M	M, I, S	0.56	14.2	0.39	0.99	0.44	11.0	0.28	7.1	Natural	MS3341-2-9	#3 (M2.5) Screw or 3/32 (2.4) Rivet	100	5000
RAMH-S6-D	M, I, S, HS, LH, H	1.00	25.4	0.75	19.1	1.00	0.28	0.28	7.1		MS3341-2-9	#6 (M3) Screw or 1/8 (3.2) Rivet	500	5000
RAMH-S10-D	M, I, S, HS, LH, H	1.00	25.4	0.75	19.1	1.00	0.50	0.50	12.7		—	#10 (M5) Screw or 3/16 (4.7) Rivet	500	5000

‡Cable tie cross section sizes: M = Miniature, I = Intermediate, S = Standard, HS = Heavy Standard, LH = Light-Heavy and H = Heavy.

UL LISTED **Lightening Hole Mounts**

- Secure cable bundles that run through bulkhead lightening holes
- Protect cable bundles from sharp edges
- For indoor use only
- Material: Nylon 6.6

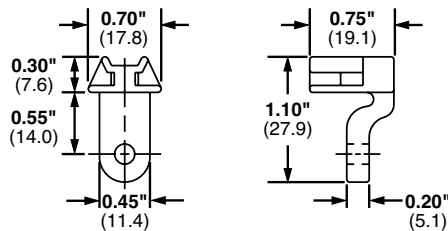

Part Number	Used with Cable Ties‡	Color	Mil. Std. Part Number	Mounting Method	Std. Pkg. Qty.	Std. Ctn. Qty.
LHMSS-S5-D	M, I, S	Natural	—	#5 (M3) Screw or 1/8 (3.2) Rivet	500	2500
LHMS-S6-D			MS3340-1-9	#6 (M3) Screw or 9/64 (3.5) Rivet	500	2500
LHMS-S10-D			—	#10 (M5) Screw or 3/16 (4.7) Rivet	500	2500

‡Cable tie cross section sizes: M = Miniature, I = Intermediate, and S = Standard.

Stud Tie Mounts

- Easily applied to bolts or studs with a light hammer blow or turning of the mount
- Designed for use with cable ties to route and secure cable bundles, air, water and hydraulic lines
- Material: Impact Modified Weather Resistant Nylon 6.6

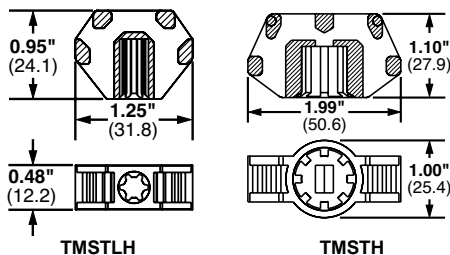

Part Number	Used with Cable Ties‡	Color	Environment	Mounting Method	Std. Pkg. Qty.	Std. Ctn. Qty.
TMSTLHS6-M0	M, I, S, HS, LH	Black	Outdoors	1/4" stud dia. (6mm)	1000	5000
TMSTLHS8-M0	M, I, S, HS, LH			5/16" stud dia (8mm)	1000	5000
TMSTHS10-D0	M, I, S, HS, LH, H			3/8" stud dia. (10mm)	500	—
TMSTHS11-D0	M, I, S, HS, LH, H			7/16" stud dia. (11mm)	500	—
TMSTHS12-D0	M, I, S, HS, LH, H			12mm stud dia.	500	—
TMSTHS13-D0	M, I, S, HS, LH, H			1/2" stud dia. (13mm)	500	—
TMSTHS16-D0	M, I, S, HS, LH, H			5/8" stud dia. (16mm)	500	—
TMSTHS19-D0	M, I, S, HS, LH, H			3/4" stud dia. (19mm)	500	—

‡Cable tie cross section sizes: M = Miniature, I = Intermediate, S = Standard, HS = Heavy-Standard, LH = Light-Heavy and H = Heavy.

Metal Clip-On Mounts

- Clips on sheet metal edges for fast mounting of harness with cable ties
- Allows cable tie entry from all four sides for easy harness orientation
- For indoor use only
- Material: Zinc plated steel

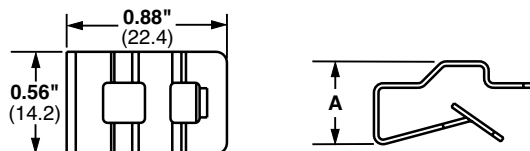

Part Number	Used with Cable Ties‡	Height A		Max. Panel Thickness		Mounting Method	Std. Pkg. Qty.	Std. Ctn. Qty.
		In.	mm	In.	mm			
MCMS12-P-C	M, I, S	0.31	8.0	0.13	3.2	Clip-On	100	500
MCMS25-P-C		0.46	11.5	0.24	6.1		100	500
MCMS30-P-C		0.55	14.0	0.27	6.9		100	500

‡Cable Tie Cross Section Sizes: M = Miniature, I = Intermediate, and S = Standard.

UL LISTED **Metal Screw-On Mount**

- Screw applied aluminum mounting base for a secure support in demanding applications

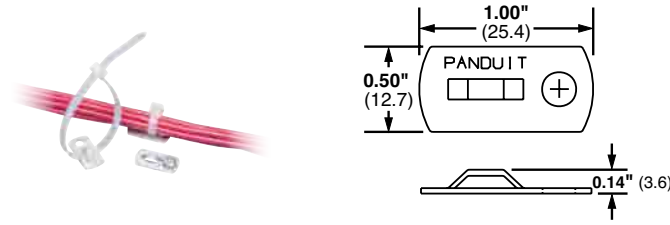

Part Number	Used with Cable Ties‡	Material	Environment	Mounting Method	Max Static Load		Std. Pkg. Qty.	Std. Ctn. Qty.
					Lbs.	g		
MBMS-S10-CY	M, I, S	Aluminum	Indoors/Outdoors	#10 (M5) Screw	10.00	4540	100	1000

‡Cable Tie Cross Section Sizes: M = Miniature, I = Intermediate, and S = Standard.

UL **Push Barb Cable Tie Mounts**

- Wing provides added stability
- Requires no adhesive or additional mounting hardware
- Can be used where only one side of the panel is accessible

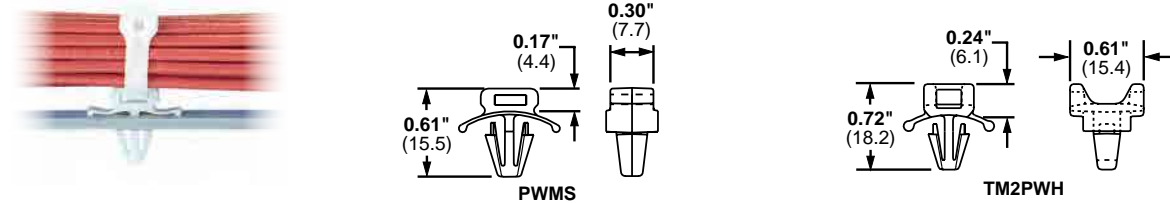

Part Number	Used with Cable Ties‡	Max. Panel Thickness		Panel Hole Diameter		Material	Color	Environment	Mounting Method	Std. Pkg. Qty.	Std. Ctn. Qty.
		In.	mm	In.	mm						
PWMS-H25-C	M, I, S	0.11	2.7	0.25	6.5	Nylon 6.6	Natural	Indoors	Push Barb	100	1000
PWMS-H25-M0		0.11	2.7	0.25	6.5	Weather Resistant Nylon 6.6	Black	Outdoors	Push Barb	1000	5000
TM2PWH25-C		0.10	2.3	0.25	6.5	Nylon 6.6	Natural	Indoors	Push Barb	100	500

‡Cable tie cross section Sizes: M = Miniature, I = Intermediate, and S = Standard.

Push Mounts

- Require no adhesive or additional mounting hardware
- Can be used where only one side of the panel is accessible

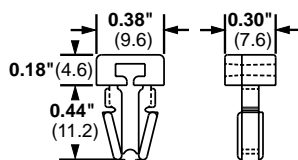

Part Number	Used with Cable Ties‡	Max. Panel Thickness		Panel Hole Diameter		Material	Color	Environment	Mounting Method	Std. Pkg. Qty.	Std. Ctn. Qty.
		In.	mm	In.	mm						
PM2H25-C	M, I, S	0.125	3.2	0.250	6.4	Nylon 6.6	Natural	Indoors	Push Barb	100	500
PM2H25-M0		0.125	3.2	0.250	6.4	Weather Resistant Nylon 6.6	Black	Outdoors		1000	5000
PM2H25-M30		0.125	3.2	0.250	6.4	Nylon 6.6	Black	Indoors		1000	5000

‡Cable tie cross section sizes: M = Miniature, I = Intermediate, and S = Standard.

Push Button Mounts

- Require no adhesive or additional mounting hardware
- Designed for use where both sides of the panel are accessible

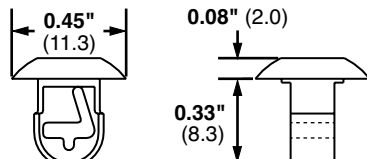

Part Number	Used with Cable Ties‡	Max. Panel Thickness		Panel Hole Diameter		Material	Color	Environment	Mounting Method	Std. Pkg. Qty.	Std. Ctn. Qty.
		In.	mm	In.	mm						
PBMS-H25-C	M, I, S	0.13	3.2	0.250	6.4	Nylon 6.6	Natural	Indoors	Push Barb	100	1000
PBMS-H25-C14		0.13	3.2	0.250	6.4	Nylon 6.6	Gray	Indoors		100	1000
PBMS-H25-M0		0.13	3.2	0.250	6.4	Weather Resistant Nylon 6.6	Black	Outdoors		1000	5000
PBMS-H25-M30		0.13	3.2		6.4	Heat Stabilized Nylon 6.6	Black	Indoors		1000	5000
PBMSL-H25-M30*		0.29	7.2		6.4	Heat Stabilized Nylon 6.6	Black	Indoors		1000	5000

‡Cable tie cross section sizes: M = Miniature, I = Intermediate, and S = Standard.

*not cULus listed

Masonry Push Mounts

- Used to secure wire, cable, or tubing to masonry surfaces
- Installed quickly into pre-drilled holes; design holds bundle securely
- Material: Impact Modified Weather Resistant Nylon 6.6

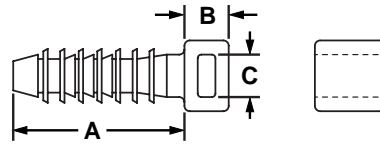

Part Number	Used with Cable Ties‡	Grip Length A		Height B		Hole Diameter D		Color	Environment	Mounting Method	Std. Pkg. Qty.	Std. Ctn. Qty.
		In.	mm	In.	mm	In.	mm					

Pan-Ty® Masonry Push Mounts

MPMS19-C0	M, I, S	0.97	24.6	0.25	6.4	0.19	5.0	Black	Indoors/ Outdoors	Fir Tree Hole Mount	100	500
MPMS25-C0		0.97	24.6	0.27	6.9	0.25	6.4				100	500
MPMH38-L0	M, I, S, HS, LH, H, HLM	1.25	31.8	0.30	7.5	0.38	9.5				50	500
MPMWH32-L0*	M, I, S, HS, LH, H, HLM	1.41	35.8	0.28	7.1	0.32	8.0				50	500

Super-Grip® Masonry Push Mounts

SGMPMS19-C0	SGM, SGI, SGS	0.97	24.6	1.19	30.2	0.19	5.0	Black	Indoors/ Outdoors	Fir Tree Hole Mount	100	500
SGMPMS25-C0		0.97	24.6	1.24	31.5	0.25	6.4				100	500
SGMPMH38-L0		1.25	31.8	1.49	37.8	0.38	9.5				50	500
SGMPMWH32-L0*	SGM, SGI, SGS, SGLH, SGH	1.41	35.8	0.28	7.1	0.32	8.0				50	500

Hyper-V™ Masonry Push Mounts

HVMPM-08-C0	HV	1.41	35.8	1.63	41.4	0.31	8.0	Black	Indoors/ Outdoors	Fir Tree Hole Mount	100	500
-------------	----	------	------	------	------	------	-----	-------	----------------------	---------------------	-----	-----

‡Cable Tie Cross Section Sizes: M = Miniature, I = Intermediate, S = Standard, HS = Heavy-Standard, LH = Light-Heavy, H = Heavy, HLM = Tak-Ty® Miniature, SGM = Super-Grip® Miniature, SGI = Super-Grip® Intermediate, SGS = Super-Grip® Standard, SGLH = Super-Grip® Light-Heavy, SGH = Super-Grip® Heavy, and HV = Hyper-V™.
 *cRUus listed

Fir Tree Push Mounts

- Unique alternating barb design
- Lock securely into position
- Umbrella tensiing
- Exclusive contoured anvil head
- Material: Heat Stabilized Nylon 6.6

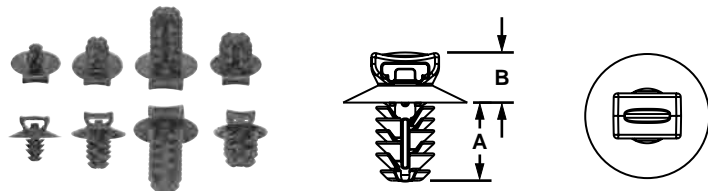

Part Number	Used with Cable Ties‡	Head Diameter		Panel to Top of Mount		Overall Height		Panel Hole Diameter Range		Panel Thickness Range		Std. Pkg. Qty.	Std. Ctn. Qty.
		In.	mm	In.	mm	In.	mm	In.	mm	In.	mm		
PUM-049-M30	M, I, S	0.67	17.0	0.26	6.6	0.54	13.8	0.18 – 0.19	4.6 – 4.9	0.03 – 0.19	0.7 – 3.0	1000	5000
PUM-071-M30	M, I, S	0.67	17.0	0.26	6.5	0.67	16.9	0.25 – 0.28	6.3 – 7.1	0.03 – 0.28	0.8 – 7.0	1000	5000
PUM-100-M30	M, I, S	0.64	16.0	0.26	6.5	0.67	16.9	0.35 – 0.40	9.0 – 10.0	0.03 – 0.28	0.8 – 7.0	1000	5000
PUM-925-M30	M, I, S, LH	0.77	20.0	0.30	7.6	1.05	26.7	0.34 – 0.36	8.8 – 9.3	0.04 – 0.62	1.0 – 16.0	1000	5000

‡Cable Tie Cross Section: M = Miniature, I = Intermediate, S = Standard, and LH = Light-Heavy.

Fir Tree Push Mount Assemblies

- Cable tie/mount assemblies significantly reduce installation time compared to loose parts
- Heat Stabilized Nylon 6.6 standard on cable ties and mounts
- Fewer parts throughout the manufacturing/assembly process

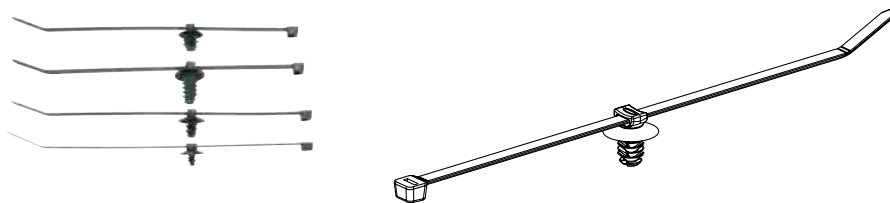

Part Number	Head Diameter		Panel to Top of Mount		Overall Height		Panel Hole Diameter Range		Panel Thickness Range		Max. Bundle Diameter		Std. Pkg. Qty.	Std. Ctn. Qty.
	In.	mm	In.	mm	In.	mm	In.	mm	In.	mm	In.	mm		
PUM-049-2S-D30	0.67	17.0	0.26	6.6	0.54	13.8	0.18 – 0.19	4.6 – 4.9	0.03 – 0.19	0.7 – 3.0	1.88	48.0	500	5000
PUM-071-2S-D30	0.67	17.0	0.26	6.6	0.67	16.9	0.25 – 0.28	6.3 – 7.1	0.03 – 0.28	0.8 – 7.0			500	5000
PUM-100-2S-D30	0.64	16.0	0.26	6.6	0.67	16.9	0.35 – 0.40	9.0 – 10.0	0.03 – 0.28	0.8 – 7.0			500	5000
PUM-925-3H-T30	0.77	20.0	0.30	7.6	1.05	26.7	0.34 – 0.36	8.8 – 9.3	0.04 – 0.62	1.0 – 16.0	3.00	76.0	200	1000

‡Use with PLT2S Cable Ties except PUM-925-3H-T30, use with PLT3H Cable Ties.

Control Panel Mounts

- Installed behind control panel switch
- Ideal for high strain areas where cable is routed from panel to panel door
- Compatible with most control panel switch designs
- Indoor use only

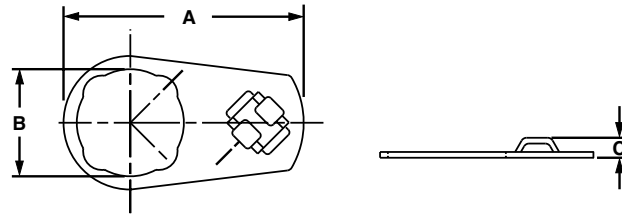

Part Number	Used with Cable Ties‡	Length A		Width B		Height C		Material	Mounting Method	Std. Pkg. Qty.	Std. Ctn. Qty.
		In.	mm	In.	mm	In.	mm				
CPM87S-C	M, I, S	2.01	51.1	0.89	22.6	0.17	4.3	Zinc plated steel	Control panel switch	100	1000
CPM122S-C	M, I, S	2.82	71.7	1.22	31.0	0.17	4.3	Zinc plated steel	Control panel switch	100	1000

‡Cable tie cross section sizes: M = Miniature, I = Intermediate, and S = Standard.

 **Pan-Post™ Standoff**

- Supports cable bundles above or away from surface
- For indoor use only
- Material: Nylon 6.6

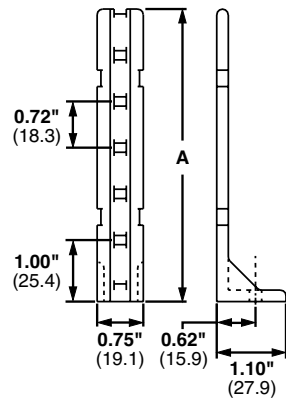

Part Number	Used with Cable Ties‡	Height A		Color	Mounting Method	Std. Pkg. Qty.	Std. Ctn. Qty.
		In.	mm				
PP1S-S10-X	M, I, S	2.00	50.8	Natural	#10 (M5) Screw	10	100
PP1S-S12-X		2.00	50.8		#12 (M5.5) Screw	10	100
PP2S-S10-X		4.60	116.8		#10 (M5) Screw	10	100
PP2S-S12-X		4.60	116.8		#12 (M5.5) Screw	10	100

‡Cable tie cross section sizes: M = Miniature, I = Intermediate, and S = Standard.

Flat Pan-Post™ Standoffs

- Standard EIA hole spacing allows product to be mounted with user supplied screws up to 1/4" diameter
- Organize cables in standard cabinets and racks
- Mounting method: 1/4" (M6) screw
- Use where space is limited
- For indoor use only

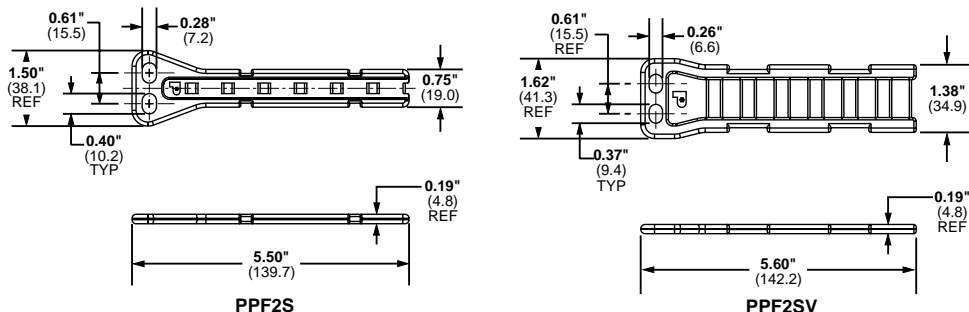

Part Number	Used with Cable Ties‡	Material	Color	Mounting Method	Std. Pkg. Qty.	Std. Ctn. Qty.
PPF2S-S25-V	M, I, S	Nylon 6.6	Natural	Two 1/4" (M6) screws	5	100
PPF2S-S25-V69		Flame Retardant Nylon 6.6				
PPF2SV-S25-V	M, I, S, HS, LH, H, HLM, HLS	Nylon 6.6				
PPF2SV-S25-V69		Flame Retardant Nylon 6.6				

‡Cable Tie Cross Section Sizes: M = Miniature, I = Intermediate, S = Standard, HS = Heavy-Standard, LH = Light-Heavy, H = Heavy, HLM = Miniature Tak-Ty® Hook & Loop Ties and HLS = Standard Tak-Ty® Hook & Loop Ties.

Right Angle Bases

- Support cable above the mounting surface

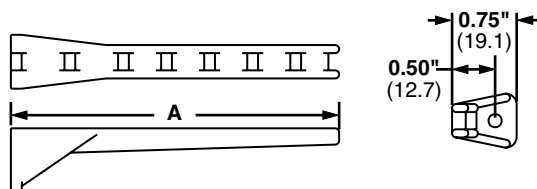

Part Number	Used with Cable Ties‡	Max. Flat Cable Width		Length A		Material	Color	Environment	Mounting Method	Std. Pkg. Qty.	Std. Ctn. Qty.
		In.	mm	In.	mm						
RAFCB11-S6-C20	I	1.00	25.4	1.75	44.4	Nylon 6.6	Black	Indoors	#6 (M3) Screw	100	1000
RAFCB12-S6-C20	I	2.00	50.8	2.78	70.6						
RAFCB13-S6-C20	I	3.00	76.2	3.81	96.8						

‡Cable tie cross section sizes: I = Intermediate.

Flat Cable Mounting System – FCB Base and FCPI Plate

- Secures stacked cables, folds, and breakouts, as well as laminated and molded bus bars
- Use one base, one corresponding size plate (FCPI), and one Intermediate cross section cable tie
- For indoor use only
- See also Latching Flat Cable Mounts on page B2.35
- Material: Nylon 6.6

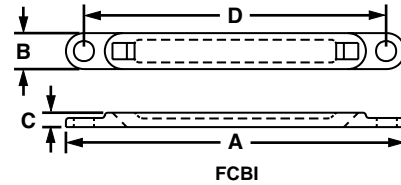
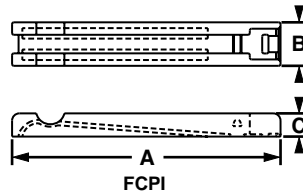
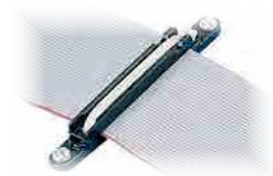

Part Number	Max. Flat Cable Width		Length A		Width B		Height C		Hole Spacing D		Color	Mounting Method	Std. Pkg. Qty.	Std. Ctn. Qty.
	In.	mm	In.	mm	In.	mm	In.	mm	In.	mm				
FCBI1-A-C20	1.04	26.4	2.50	63.5	0.38	9.5	0.15	3.8	—	—	Black	User Supplied Adhesive	100	1000
FCBI2-A-C20	2.04	51.8	3.50	88.9	0.38	9.5	0.15	3.8	—	—		User Supplied Adhesive	100	1000
FCBI3-A-C20	3.32	7.72	4.52	114.8	0.38	9.5	0.15	3.8	—	—		User Supplied Adhesive	100	1000
FCBI1-S10-C20	1.04	26.4	2.50	63.5	0.38	9.5	0.15	3.8	2.08	52.8		#10 (M5) Screw	100	1000
FCBI2-S10-C20	2.04	51.8	3.50	88.9	0.38	9.5	0.15	3.8	3.10	78.7		#10 (M5) Screw	100	1000
FCBI3-S10-C20	3.32	7.72	4.52	114.8	0.38	9.5	0.15	3.8	4.12	104.6		#10 (M5) Screw	100	1000
FCPI1-C20*	1.04	26.4	1.29	32.8	0.38	9.5	0.20	5.1	—	—		Cable Ties	100	1000
FCPI2-C20*	2.04	51.8	2.31	58.7	0.38	9.5	0.20	5.1	—	—		Cable Ties	100	1000
FCPI3-C20*	3.32	7.72	3.32	84.3	0.38	9.5	0.20	5.1	—	—		Cable Ties	100	1000

*Recommend for use with PLT2I cable ties on page B1.8

Closed Connector Rings

- Connect multiple cable bundles

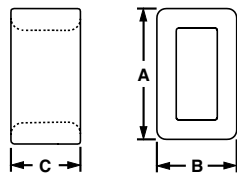

Part Number	Used with Cable Ties‡	Length A		Width B		Height C		Material	Color	Environment	Mounting Method	Std. Pkg. Qty.	Std. Ctn. Qty.
		In.	mm	In.	mm	In.	mm						
CR2-M	M, I, S	0.33	8.4	0.20	5.1	0.20	5.0	Nylon 6.6	Natural	Indoors	Cable Ties	1000	10000
CR4H-M	M, I, S, HS, LH	0.57	14.5	0.36	9.1	0.30	7.6			Indoors			
CR4H-M0	M, I, S, HS, LH	0.57	14.5	0.36	9.1	0.30	7.6	Weather Resistant Nylon 6.6	Black	Indoors/Outdoors			

‡Cable tie cross section sizes: M = Miniature, I = Intermediate, S = Standard, HS = Heavy-Standard and LH = Light-Heavy.

Open Connector Ring

- Designed to add on cable bundles without removing cable ties

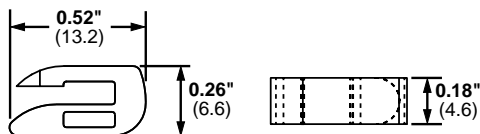

Part Number	Used with Cable Ties‡	Material	Color	Environment	Mounting Method	Std. Pkg. Qty.	Std. Ctn. Qty.
CROS-M	M, I, S	Nylon 6.6	Natural	Indoors	Cable Ties	1000	5000

‡Cable tie cross section sizes: M = Miniature, I = Intermediate, and S = Standard.

Cable Spacers

- Used to separate and/or hang cords, cables, and tubing

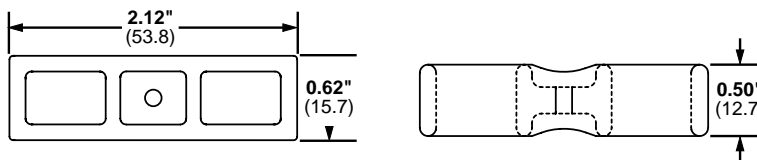

Part Number	Used with Cable Ties‡	Material	Color	Environment	Mounting Method	Std. Pkg. Qty.	Std. Ctn. Qty.
CSH-D20	M, I, S, HS, LH, H	Nylon 6.6	Black	Indoors	Cable Ties	500	2500
CSH-D0	M, I, S, HS, LH, H	Weather Resistant Nylon 6.6	Black	Indoors/Outdoors	Cable Ties	500	2500

‡Cable tie cross section sizes: M = Miniature, I = Intermediate, S = Standard, HS = Heavy-Standard, LH = Light-Heavy and H = Heavy.

Cable Spacer Cross

- Connects two bundles at 90°
- Separates bundles to prevent abrasion
- Dual cradle design stabilizes cable bundle

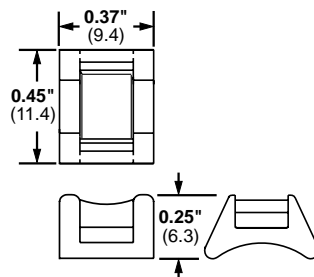

Part Number	Used with Cable Ties‡	Material	Color	Environment	Mounting Method	Std. Pkg. Qty.	Std. Ctn. Qty.
CSCS-M	M, I, S	Nylon 6.6	Natural	Indoors	Cable Ties	1000	10000

‡Cable tie cross section sizes: M = Miniature, I = Intermediate, and S = Standard.

Stackable Aerial Cable Spacer

- Greater resistance to damage caused by ultraviolet light – indoor or outdoor use
- Each spacer snaps into another to increase spacer heights by 1/2" increments
- Designed for use in parallel or perpendicular applications
- For use with Dura-Ty™ Cable Ties shown on page B1.51 or Pan-Steel® Self-Locking Ties on page B3.5 – B3.6.

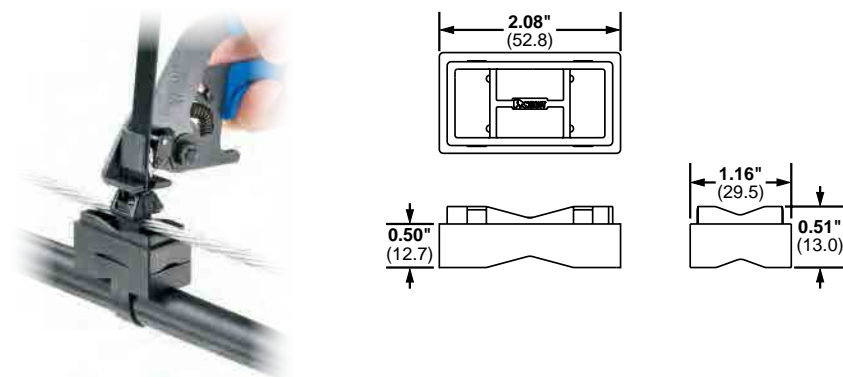

Part Number	Used with Cable Ties†	Material	Color	Environment	Mounting Method	Std. Pkg. Qty.	Std. Ctn. Qty.
SACS50-T100	LH, H, EH	Weather Resistant Polypropylene	Black	Outdoors	Cable Ties	200	2000

*Cable tie cross sizes: LH = Light-Heavy, H = Heavy, and EH = Extra-Heavy.

Aerial Support Ties – Weather Resistant Polypropylene

- Designed to attach coax or telephone cable to the 1/4" (6.4mm) or 5/16" (7.9mm) support strand to form the expansion loop and keep equipment and cables clear of pole hardware
- One-piece construction with integral 1/2" (12.7mm) spacer reduces inventory costs of separate spacer and bands, and installs faster to lower installed cost
- Releasable and re-usable
- Hand install only

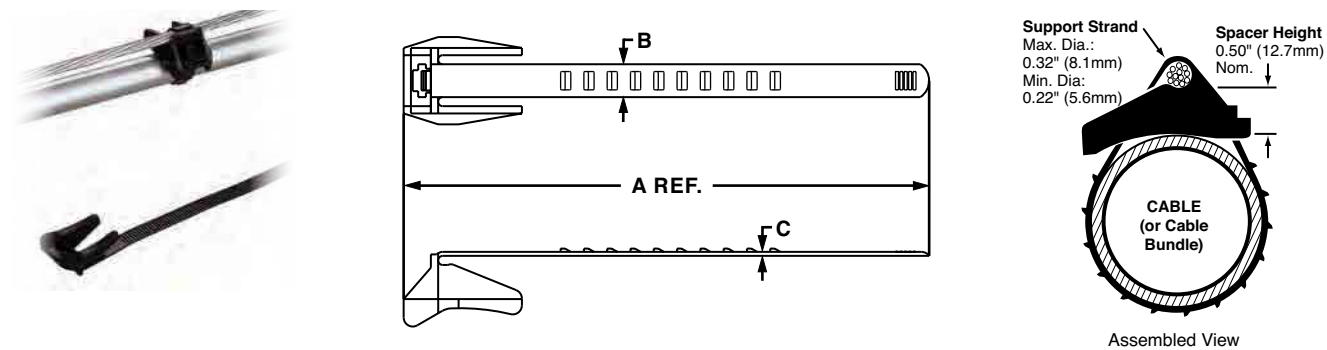

Part Number	Length A		Width B		Thickness C		Max. Bundle Diameter		Min. Loop Tensile Strength		Std. Pkg. Qty.	Std. Ctn. Qty.
	In.	mm	In.	mm	In.	mm	In.	mm	In.	mm		
AST10-5-C100	5.6	142	0.448	11.4	0.55	1.4	1.00	25	75	334	100	1000
AST15-5-C100	6.9	175	0.448	11.4	0.55	1.4	1.50	38	75	334	100	1000
AST20-5-C100	8.4	214	0.448	11.4	0.55	1.4	2.00	51	75	334	100	1000
AST25-5-C100	10.0	254	0.448	11.4	0.55	1.4	2.50	64	75	334	100	1000

Permanent Marking Pens

- Fast drying, permanent ink for identification on marker ties (pages B1.32, B1.50), marker plates (page B2.26), or cable marker straps (page B1.76)
- May be used with any label shown in the catalog when a printer is not available



PX-0
PX-2

PX-10

Part Number	Color	Description	Std. Pkg. Qty.	Std. Ctn. Qty.
PX-0	Black	Permanent marking pen – regular tip.	12	144
PX-2	Red	Permanent marking pen – regular tip.	12	144
PX-10	White	Marking pen for black or other dark colored parts – regular tip.	12	300

Marker Plates – Loose Piece

- Install as flags, tags, or wrap-around identification plates to clearly identify all wire harnesses
- Use with nylon marking pens for an easy and economic alternative to identify wire harnesses
- Available in black or white to match the wire harness
- Thickness: 0.02 inches (0.5mm)

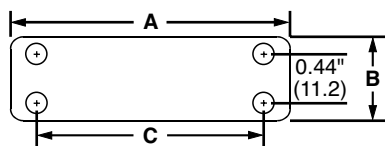

Part Number	Used with Cable Ties‡	Length A		Width B		Hole Spacing C		Material	Color	Environment	Mounting Method	Std. Pkg. Qty.	Std. Ctn. Qty.
		In.	mm	In.	mm	In.	mm						
MP150-C	M, I, S	1.50	38.1	0.75	19.0	1.03	26.2	Nylon 6.6	White	Indoors	Cable Ties	100	500
MP175-C	M, I, S	1.75	44.4	0.75	19.0	1.28	32.5					100	500
MP200-C	M, I, S	2.00	50.8	0.75	19.0	1.53	38.9					100	500
MP250-C	M, I, S	2.50	63.5	0.75	19.0	2.03	51.6					100	500
MP350-C	M, I, S	3.50	88.9	0.75	19.0	3.03	77.7					100	1000
MP250W175-C	M, I, S	2.50	63.5	1.75	44.5	2.03	51.6	Weather Resistant Nylon 6.6	Black	Indoors/Outdoors		100	1000
MP150-C0	M, I, S	1.50	38.1	0.75	19.0	1.03	26.2					100	500
MP175-C0	M, I, S	1.75	44.4	0.75	19.0	1.28	32.5					100	500
MP200-C0	M, I, S	2.00	50.8	0.75	19.0	1.53	38.9					100	500
MP250-C0	M, I, S	2.50	63.5	0.75	19.0	2.03	51.6					100	500
MP350-C0	M, I, S	3.50	88.9	0.75	19.0	3.03	77.7	100	1000				

‡Cable tie cross section sizes: M = Miniature, I = Intermediate, and S = Standard.

Cable and Wire Mounting Devices (Used without Cable Ties)



Wiring accessories are an integral part of the Panduit comprehensive selection of wire management products.

These accessories are one piece solutions that help provide the lowest installed cost for controlling, mounting, and protecting wire and cable. Mounting methods include:

- Adhesive-backed
- Screw applied
- Rivet applied
- Push mounts

Adhesive Backed Mounting Devices

Faster Liner Removal Speeds Installation and Lowers Installed Cost

- The adhesive backed mounts are offered either as one or two mounts per liner
- The 2-up mounts are easily removed by bending the mounts away from the liner
- The individual mounts have a convenient tear tab for quick removal

us Clincher™ Adjustable Releasable Clamp

- Adjustable clamp designed to contain a range of cable bundle diameters
- Latch can be released to provide access to cable bundles
- For indoor use only
- Material: Polypropylene

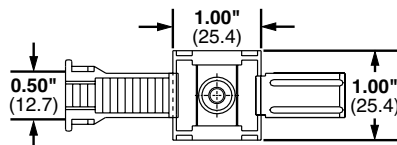

Part Number	Bundle Diameter Range		Color	Mounting Method	Std. Pkg. Qty.	Std. Ctn. Qty.
	In.	mm				
ARC.68-A-Q	0.19 – 0.68	4.8 – 17.3	White	Rubber Adhesive Tape	25	250
ARC.68-A-Q14	0.19 – 0.68	4.8 – 17.3	Gray	Rubber Adhesive Tape	25	250
ARC.68-S6-Q	0.19 – 0.69	4.8 – 17.5	White	#6 (M3) Screw	25	250
ARC.68-S6-Q14	0.19 – 0.69	4.8 – 17.5	Gray	#6 (M3) Screw	25	250

Adhesive Backed Cord Clips

- Cables are easily snapped into or out of the clips

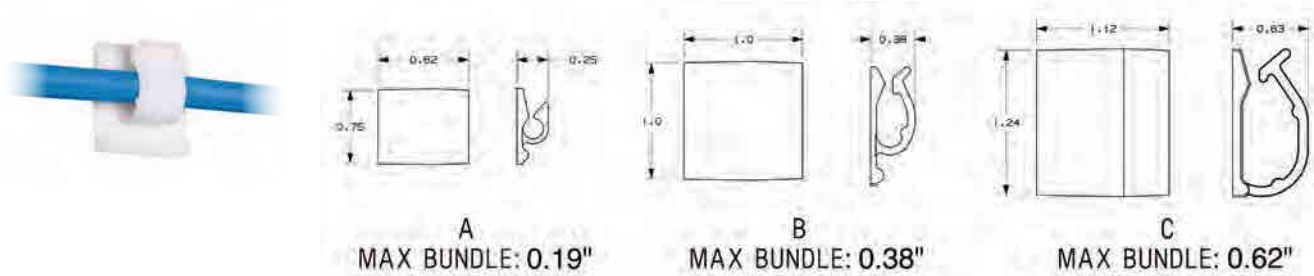

	Max. Bundle Dia.: 0.19"	Max. Bundle Dia.: 0.38"	Max. Bundle Dia.: 0.62"
Natural Nylon 6.6; Rubber Adhesive; 100 pc/pkg	ACC19-A-C	ACC38-A-C	ACC62-A-C
Natural Nylon 6.6; Acrylic Adhesive; 100 pc/pkg	ACC19-AT-C	ACC38-AT-C	ACC62-AT-C
Black Nylon 6.6; Rubber Adhesive; 100 pc/pkg	ACC19-A-C0	ACC38-A-C0	ACC62-A-C0
Black Weather Resistant Nylon 6.6; Acrylic Adhesive; 100 pc/pkg	ACC19-AT-C0	ACC38-AT-C0	ACC62-AT-C0
Black Heat Stabilized Weather Resistant Nylon; High Bond Acrylic Adhesive, 1,000 pc/pkg	ACC19-AV-M300*	ACC38-AV-M300*	ACC62-AV-M300*

*Not UL recognized

Push Mount Cord Clip

- Cables are easily snapped into or out of clips
- Winged design holds mount in place even in applications where vibration is present
- Design of wing provides added stability

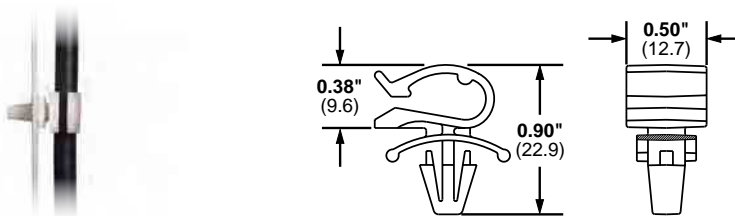

Part Number	Max. Bundle Diameter		Max. Panel Thickness		Panel Hole Diameter		Material	Color	Environment	Mounting Method	Std. Pkg. Qty.	Std. Ctn. Qty.
	In.	mm	In.	mm	In.	mm						
PMCC38H25-C	0.38	9.6	0.105	2.7	0.250	6.4	Nylon 6.6	Natural	Indoors	Push Barb	100	1000
PMCC38H25-M0	0.38	9.6	0.105	2.7	0.250	6.4	Weather Resistant Nylon 6.6	Black	Outdoors		1000	5000

c "J" Clips

- Low profile clips retain cords, cables, or tubing
- Flexible design allows for easy cord insertion, yet holds bundle tightly
- For indoor use only
- Material: PVC

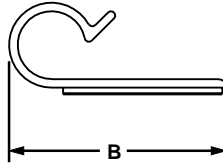

Part Number	Max. Bundle Diameter		Length A		Width B		Height C		Diameter		Color	Adhesive Type	Std. Pkg. Qty.	Std. Ctn. Qty.
	In.	mm	In.	mm	In.	mm	In.	mm	In.	mm				
AJC12-A-C	0.12	3.0	1.00	2.54	0.86	21.8	0.19	4.8	0.13	3.3	Light Gray	Rubber Adhesive Tape	100	500
AJC19-A-C	0.19	4.8	1.25	3.18	0.87	22.1	0.26	6.6	0.18	4.6			100	500
AJC25-A-C	0.25	6.4	1.50	38.1	0.97	24.6	0.31	7.9	0.23	5.8			100	500
AJC31-A-C	0.31	7.9	1.75	44.5	1.22	30.1	0.40	10.2	0.29	7.4			100	500
AJC38-A-C	0.38	9.6	2.00	50.8	1.27	32.3	0.50	12.7	0.39	9.9			100	1000

c A1C Type Clips

- Hold cords, cables, and tubing
- Single rubber adhesive pad for confined areas
- For indoor use only
- Material: PVC

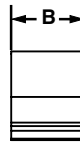
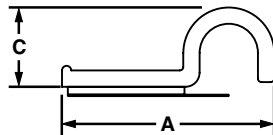

Part Number	Max. Bundle Diameter		Length A		Width B		Height C		Color	Adhesive Type	Std. Pkg. Qty.	Std. Ctn. Qty.
	In.	mm	In.	mm	In.	mm	In.	mm				
A1C12-A-C8	0.12	3.0	0.77	19.6	0.63	16.0	0.23	5.8	Light Gray	Rubber	100	1000
A1C25-A-C8	0.25	6.4	0.91	23.1	0.63	16.0	0.38	9.7			100	1000
A1C38-A-C8	0.38	9.5	1.04	26.4	0.63	16.0	0.51	13.0			100	1000
A1C50-A-C8	0.50	12.7	1.17	29.7	0.63	16.0	0.64	16.3			100	1000

c A2C Type Clips

- Hold cords, cables, and tubing
- Two rubber adhesive pads for added strength
- For indoor use only
- Material: PVC

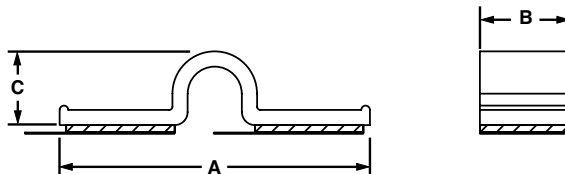

Part Number	Max. Bundle Diameter		Length A		Width B		Height C		Color	Adhesive Type	Std. Pkg. Qty.	Std. Ctn. Qty.
	In.	mm	In.	mm	In.	mm	In.	mm				
A2C12-A-C8	0.12	3.0	1.30	33.0	0.63	16.0	0.23	5.8	Light Gray	Rubber	100	1000
A2C25-A-C8	0.25	6.4	1.43	36.3	0.63	16.0	0.36	9.1			100	1000
A2C38-A-C8	0.38	9.5	1.56	39.6	0.63	16.0	0.49	12.4			100	1000
A2C50-A-C8	0.50	12.7	1.72	43.7	0.63	16.0	0.61	15.5			100	1000

Metal Adhesive Backed Cord Clips

- Can be opened and closed without damaging clip in order to remove or add cables quickly and easily
- For indoor use only

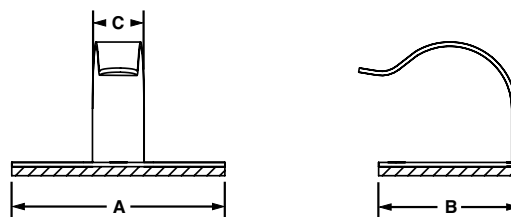

Part Number	Max. Bundle Diameter		Length A		Width B		Clip Width C		Material	Adhesive Type	Std. Pkg. Qty.	Std. Ctn. Qty.
	In.	mm	In.	mm	In.	mm	In.	mm				
MACC25-A-C	0.25	6.4	0.77	19.6	0.54	13.7	0.29	7.4	Zinc Plated Steel	Rubber	100	1000
MACC62-A-C	0.62	15.7	1.18	30.0	0.78	19.7	0.29	7.4			100	1000
MACC25-AV-D	0.25	6.4	0.77	19.6	0.54	13.7	0.29	7.4		High Bond Acrylic	500	1000
MACC62-AV-C	0.62	15.7	1.18	30.0	0.78	19.7	0.29	7.4			100	1000

c Latching Wire Clips

- Route and secure cords and cables
- Convenient releasable latch
- Available in six sizes with releasable latch
- Push barb parts are for use with a max panel thickness of 0.11" (2.7mm) and a hole diameter of 0.22" (5.6mm)
- For indoor use only
- Material: Nylon 6.6

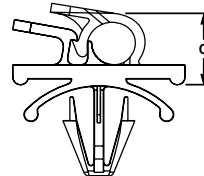
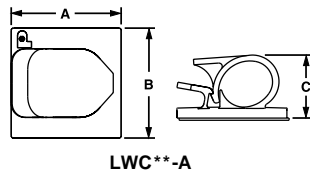

Part Number	Max. Bundle Diameter		Length		Width		Height		Color	Mounting Method	Std. Pkg. Qty.	Std. Ctn. Qty.
	In.	mm	In.	mm	In.	mm	In.	mm				
Adhesive Backed												
LWC19-A-C	0.19	4.8	0.85	21.6	0.61	15.5	0.39	9.9	Natural	Rubber Adhesive	100	1000
LWC19-A-C14	0.19	4.8	0.85	21.6	0.61	15.5	0.39	9.9	Gray		100	1000
LWC19-A-C20	0.19	4.8	0.85	21.6	0.61	15.5	0.39	9.9	Black		100	1000
LWC25-A-C	0.25	6.4	0.88	22.2	1.00	25.4	0.45	11.4	Natural		100	1000
LWC25-A-C14	0.25	6.4	0.88	22.2	1.00	25.4	0.45	11.4	Gray		100	1000
LWC25-A-C20	0.25	6.4	0.88	22.2	1.00	25.4	0.45	11.4	Black		100	1000
LWC38-A-C	0.38	9.5	1.00	25.4	1.00	25.4	0.56	14.2	Natural		100	1000
LWC38-A-C14	0.38	9.5	1.00	25.4	1.00	25.4	0.56	14.2	Gray		100	1000
LWC38-A-C20	0.38	9.5	1.00	25.4	1.00	25.4	0.56	14.2	Black		100	1000
LWC50-A-L	0.50	12.7	1.26	32.0	1.00	25.4	0.67	17.0	Natural		50	1000
LWC50-A-L14	0.50	12.7	1.26	32.0	1.00	25.4	0.67	17.0	Gray		50	1000
LWC50-A-L20	0.50	12.7	1.26	32.0	1.00	25.4	0.67	17.0	Black		50	1000
LWC75-A-L	0.75	19.1	1.48	37.6	1.24	31.5	0.90	22.9	Natural		50	1000
LWC75-A-L14	0.75	19.1	1.48	37.6	1.24	31.5	0.90	22.9	Gray		50	1000
LWC75-A-L20	0.75	19.1	1.48	37.6	1.24	31.5	0.90	22.9	Black		50	1000
LWC100-A-L	1.00	25.4	2.21	56.1	1.97	50.0	1.26	32.0	Natural		50	1000
LWC100-A-L14	1.00	25.4	2.21	56.1	1.97	50.0	1.26	32.0	Gray		50	1000
LWC100-A-L20	1.00	25.4	2.21	56.1	1.97	50.0	1.26	32.0	Black		50	1000
Push Mount												
LWC19-H25-C	0.19	4.8	0.85	21.6	0.51	12.8	0.41	10.4	Natural	Push Barb	100	1000
LWC19-H25-C14	0.19	4.8	0.85	21.6	0.51	12.8	0.41	10.4	Gray		100	1000
LWC25-H25-C	0.25	6.4	0.86	21.8	0.58	14.7	0.47	11.9	Natural		100	1000
LWC25-H25-C14	0.25	6.4	0.86	21.8	0.58	14.7	0.47	11.9	Gray		100	1000
LWC25-H25-C20	0.25	6.4	0.86	21.8	0.58	14.7	0.47	11.9	Black		100	1000
LWC38-H25-C	0.38	9.5	0.94	23.9	0.58	14.7	0.57	14.5	Natural		100	1000
LWC38-H25-C14	0.38	9.5	0.94	23.9	0.58	14.7	0.57	14.5	Gray		100	1000
LWC38-H25-C20	0.38	9.5	0.94	23.9	0.58	14.7	0.57	14.5	Black		100	1000
LWC50-H25-L	0.50	12.7	1.25	31.8	0.76	19.3	0.78	19.8	Natural		50	1000
LWC50-H25-L14	0.50	12.7	1.25	31.8	0.76	19.3	0.78	19.8	Gray		50	1000
LWC50-H25-L20	0.50	12.7	1.25	31.8	0.76	19.3	0.78	19.8	Black		50	1000
LWC75-H25-L	0.75	19.1	1.45	36.8	0.87	22.1	0.97	24.7	Natural		50	1000
LWC75-H25-L14	0.75	19.1	1.45	36.8	0.87	22.1	0.97	24.7	Gray		50	1000
LWC75-H25-L20	0.75	19.1	1.45	36.8	0.87	22.1	0.97	24.7	Black		50	1000
LWC100-H25-L	1.00	25.4	1.89	47.9	0.99	25.2	1.30	33.0	Natural		50	1000
LWC100-H25-L14	1.00	25.4	1.89	47.9	0.99	25.2	1.30	33.0	Gray		50	1000
LWC100-H25-L20	1.00	25.4	1.89	47.9	0.99	25.2	1.30	33.0	Black		50	1000

Bevel Entry Clips

- Beveled entry allows for easy insertion of cable bundle

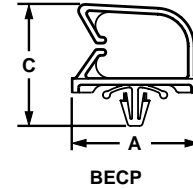
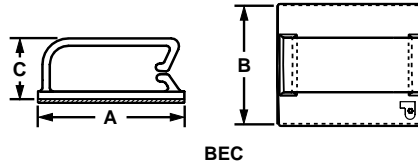

Part Number	Max. Bundle Diameter		Length A		Width B		Height C		Material	Color	Environment	Mounting Method	Std. Pkg. Qty.	Std. Ctn. Qty.
	In.	mm	In.	mm	In.	mm	In.	mm						

Adhesive Backed

BEC38-A-L	0.38	9.6	1.46	37.1	1.24	31.5	0.52	13.2	Nylon 6.6	Natural	Indoors	Rubber Adhesive	50	500
BEC38-A-L20	0.38	9.6	1.46	37.1	1.24	31.5	0.52	13.2		Black			50	500
BEC62-A-L	0.62	15.7	1.46	37.1	1.24	31.5	0.79	20.1		Natural			50	500
BEC62-A-L20	0.62	15.7	1.46	37.1	1.24	31.5	0.79	20.1		Black			50	500
BEC75-A-L	0.75	19.0	1.46	37.1	1.49	37.8	0.89	22.6		Natural			50	500
BEC75-A-L20	0.75	19.0	1.46	37.1	1.49	37.8	0.89	22.6		Black			50	500

Push Barb

BECP38H25-L	0.38	9.6	1.46	37.1	0.73	18.5	1.00	25.4	Nylon 6.6	Natural	Indoors	Push Barb	50	500
BECP38H25-L20	0.38	9.6	1.46	37.1	0.73	18.5	1.00	25.4		Black			50	500
BECP75H25-L	0.75	19.0	1.47	37.3	0.73	18.5	1.00	25.4		Black			50	500
BECP75H25-L20	0.75	19.0	1.47	37.3	0.73	18.5	1.00	25.4		Natural			50	500

*For proper selection of adhesive see page B2.53.

Adhesive Backed Dual Cord Clip

- Holds two cables in high temperature applications

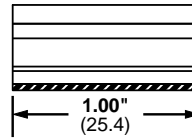
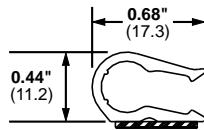

Part Number	Max. Bundle Diameter		Material	Color	Environment	Adhesive Type	Std. Pkg. Qty.	Std. Ctn. Qty.
	In.	mm						

Adhesive Backed								
ADCC31-AT-C10	0.33	9.0	NORYL*	White	Indoors	Acrylic	100	500

*NORYL Thermoplastic Resin is a registered trademark of General Electric Company.

Adhesive Backed Mount Cord Clip

- Holds a single cable
- Vertical cable entry for ease of installation
- Funnel entry speeds cable insertion

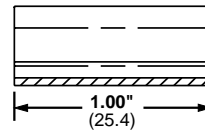
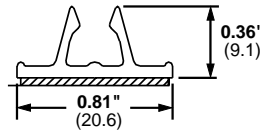

Part Number	Max. Bundle Diameter		Material	Color	Environment	Adhesive Type	Std. Pkg. Qty.	Std. Ctn. Qty.
	In.	mm						

Adhesive Backed								
AMC25-AT-C10	0.22 – 0.28	6.0 – 7.0	PVC	White	Indoors	Acrylic	100	1000

Vertical Cord Clips

- Funnel entry design allows for easy insertion of cords and cables
- Vertical cable entry for ease of installation
- For indoor use only

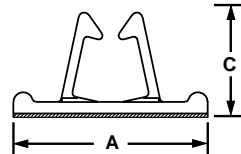
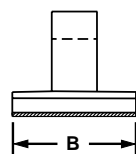

Part Number	Max. Bundle Diameter		Length A		Width B		Height C		Material	Color	Adhesive Type	Std. Pkg. Qty.	Std. Ctn. Qty.
	In.	mm	In.	mm	In.	mm	In.	mm					

Adhesive Backed													
VCC25-A-C	0.25	6.4	1.00	25.4	0.50	12.7	0.44	11.2	Nylon 6.6	Natural	Rubber	100	500
VCC50-A-C	0.25	12.7	1.56	39.7	1.00	25.4	0.81	20.6		Natural			

Adhesive Backed Latching Clips

- Latching cover withstands vibration
- For indoor use only

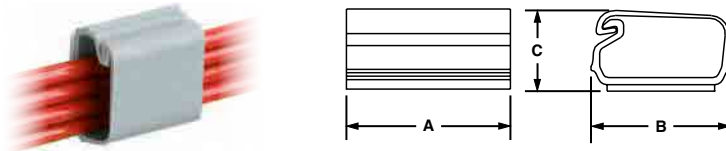

Part Number	Max. Bundle Diameter		Length A		Width B		Height C		Material	Color	Adhesive Type	Std. Pkg. Qty.	Std. Ctn. Qty.
	In.	mm	In.	mm	In.	mm	In.	mm					
LC3-A-C8	0.20	5.0	0.75	19.1	0.75	19.0	0.47	11.9	PVC	Light Gray	Rubber	100	1000
LC5-A-C8	0.36	9.1	1.01	25.7	1.01	25.7	0.61	15.5				100	1000
LC10-A-L8	0.93	23.6	1.51	38.4	1.51	38.4	0.84	21.3				50	500

Cable Holder – Adhesive Backed

- Convenient releasable latch allows easy addition and removal of cables
- Low profile design provides a compact cable routing solution
- For indoor use only

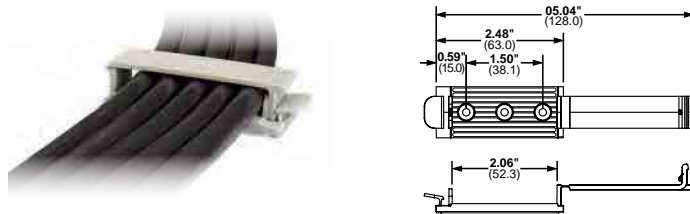

Part Number	Cable Width		Material	Color	Mounting Method	Std. Pkg. Qty.	Std. Ctn. Qty.
	In.	mm					
CH105-A-C14	2.06	52.3	Nylon 6.6	Gray	Rubber Adhesive Tape	100	1000
CH105-S6-C14	2.06	52.3			#6 (M3) Screw	100	1000

Low Profile Flat Cable Mounts

- Three sizes provide a cost effective flat cable containment for stack heights up to 0.105 inches (2.7mm)
- Features a matte, textured surface, for either hand written identification or application of computer labels
- Low profile design holds wires, cables, and tubing
- For indoor use only

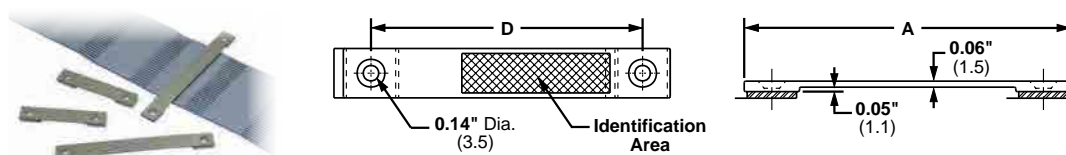

Part Number	Cable Width		Length A		Hole Spacing D		Material	Color	Adhesive Type	Std. Pkg. Qty.	Std. Ctn. Qty.
	In.	mm	In.	mm	In.	mm					
Adhesive Backed											
LPFCM14-A-C14	1.44	37.0	2.56	65.0	0.75	19.0	Nylon 6.6	Gray	Rubber	100	500
LPFCM22-A-C14	2.19	56.0	3.31	84.0	1.01	25.7				100	500
LPFCM34-A-C14	3.44	87.0	4.56	115.8	1.51	38.4				100	500

FCM[®] US Latching Flat Cable Mounts

- Available in four sizes with a stack height of 0.17 inches (4.3mm) to accommodate different flat cable widths
- Low profile design holds wires, cables, and tubing
- Convenient releasable latch
- Large mounting base for high bonding strength
- For indoor use only
- Material: Nylon 6.6

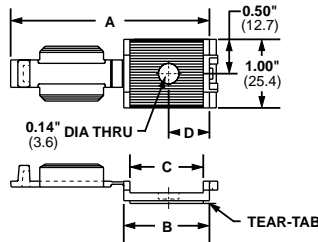

FCM1 and FCM1.2

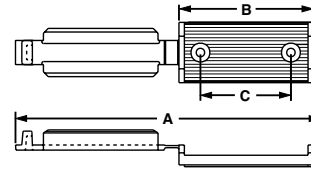

FCM2 and FCM3.25

Part Number	Cable Width		Length A		Width B		Hole Spacing C		Color	Mounting Method	Std. Pkg. Qty.	Std. Ctn. Qty.
	In.	mm	In.	mm	In.	mm	In.	mm				
Adhesive Backed												
FCM1-A-C14	1.05	26.7	2.90	73.7	1.05	26.7	—	—	Gray	Rubber Adhesive	100	500
FCM1.2-A-C14	1.20	30.5	3.16	80.3	1.37	34.8	—	—			100	1000
FCM2-A-C14	2.05	52.1	5.06	128.5	2.22	56.4	1.53	38.9			100	500
FCM3.25-A-L14	3.38	85.9	7.30	185.4	3.38	85.9	1.50	38.1			50	500
Screw Mounted												
FCM1-S6-C14	1.05	26.7	2.90	73.7	1.05	26.7	—	—	Gray	#6 (M3) Screw	100	1000
FCM1.2-S6-C14	1.20	30.5	3.16	80.3	1.37	34.8	—	—			100	1000
FCM2-S6-C14	2.05	52.1	5.06	128.5	2.22	56.4	1.53	38.9			100	1000
FCM3.25-S6-L14	3.38	85.9	7.30	185.4	3.38	85.9	1.50	38.1			50	500

FCM[®] US Latching Flat Cable Holders

- Low profile design holds wires, cables, and tubing
- Convenient releasable latch
- Large mounting base for high bonding strength
- For indoor use only
- See also Flat Cable Mounting System on Page B2.23
- Material: Nylon 6.6

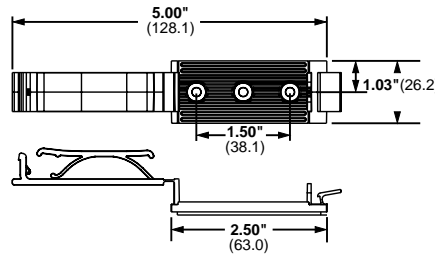

Part Number	Length		Cable Width		Color	Mounting Method	Std. Pkg. Qty.	Std. Ctn. Qty.
	In.	mm	In.	mm				
Adhesive Backed								
FCH2-A-C14	2.48	63.0	2.00	50.8	Gray	Rubber Adhesive	100	500
FCH2-S6-C14	2.48	63.0	2.00	50.8	Gray	#6 (M3) Screw	100	500

See also Flat Cable Mounting System on Page B2.23.

c Flat Cable Clips

- Use with any width flat cable for a maximum stack height of 0.17 inches (4.3mm)
- Low profile design holds wires, cables, and tubing
- For indoor use only
- Material: PVC

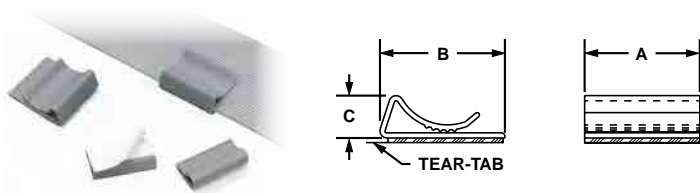

Part Number	Cable Width	Length A		Width B		Height C		Color	Mounting Method	Std. Pkg. Qty.	Std. Ctn. Qty.
		In.	mm	In.	mm	In.	mm				
FCC5-A-C8	Any width flat cable	1.00	25.4	0.56	14.2	0.29	7.4	Gray	Rubber	100	1000
FCC-A-C8		1.00	25.4	1.09	27.7	0.38	9.7			100	1000

Pan-Clamp™ Heavy Duty Fixed Diameter Clamps

- One-piece design significantly reduces installation time
- Integrated ribs prevent rotation of cable bundles and ensures secure grip on hoses
- Material: Impact modified Weather Resistant Nylon 6.6

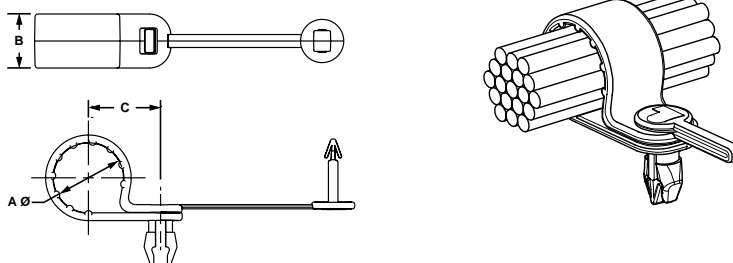

Part Number	Max. Bundle Diameter A		Width B		Bundle Offset C		Max. Panel Thickness		Panel Hole Diameter		Color	Std. Pkg. Qty.	Std. Ctn. Qty.
	In.	mm	In.	mm	In.	mm	In.	mm	In.	mm			
PC038-H25D-C0	0.38	9.5	0.62	15.7	0.64	16.3	0.13	3.2	0.28	7.1	Black	100	500
PC050-H25D-C0	0.50	12.7	0.62	15.7	0.71	17.9	0.13	3.2	0.28	7.1		100	500
PC062-H25D-C0	0.63	15.8	0.62	15.7	0.77	19.5	0.13	3.2	0.28	7.1		100	500
PC075-H25D-C0	0.75	19.1	0.62	15.7	0.83	21.1	0.13	3.2	0.28	7.1		100	1000
PC087-H25D-C0	0.88	22.1	0.62	15.7	0.89	22.7	0.13	3.2	0.28	7.1		100	1000
PC100-H25D-C0	1.00	25.4	0.62	15.7	0.96	24.3	0.13	3.2	0.28	7.1		100	1000
PC112-H25D-C0	1.13	28.5	0.62	15.7	1.02	25.8	0.13	3.2	0.28	7.1		100	1000
PC125-H25D-C0	1.25	31.8	0.62	15.7	1.08	27.4	0.13	3.2	0.28	7.1		100	1000

US Fixed Diameter Cable Clamps

- Durable Nylon 6.6 cable clamps

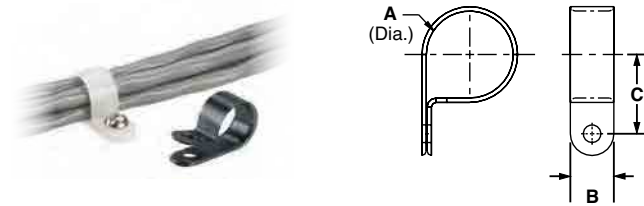

Part Number	Max. Bundle Diameter A		Width B		Bundle Offset C		Mounting Method	Std. Pkg. Qty.	Std. Ctn. Qty.
	In.	mm	In.	mm	In.	mm			
CCS12-S8-C	0.12	3.1	0.37	9.4	0.33	8.4	#8 (M4) Screw	100	500
CCS19-S8-C	0.19	4.8	0.37	9.4	0.43	10.9	#8 (M4) Screw	100	500
CCS25-S8-C	0.25	6.3	0.37	9.4	0.41	10.4	#8 (M4) Screw	100	500
CCS25-S10-C	0.25	6.3	0.37	9.4	0.41	10.4	#10 (M5) Screw	100	500
CCS31-S8-C	0.31	7.9	0.37	9.4	0.49	12.4	#8 (M4) Screw	100	500
CCS38-S8-C	0.38	9.5	0.37	9.4	0.59	15.0		100	500
CCS44-S8-C	0.44	11.1	0.37	9.4	0.57	14.5		100	500
CCS50-S8-C	0.50	12.7	0.37	9.4	0.60	15.2		100	500
CCH12-S10-C	0.12	3.1	0.50	12.7	0.36	9.1	#10 (M5) Screw	100	500
CCH19-S10-C	0.19	4.8	0.50	12.7	0.42	10.7		100	500
CCH25-S10-C	0.25	6.3	0.50	12.7	0.46	11.7		100	500
CCH31-S10-C	0.31	7.9	0.50	12.7	0.50	12.7		100	500
CCH38-S10-C	0.38	9.5	0.50	12.7	0.53	13.5		100	500
CCH44-S10-C	0.44	11.1	0.50	12.7	0.56	14.2		100	500
CCH50-S10-C	0.50	12.7	0.50	12.7	0.59	15.0		100	500
CCH56-S10-C	0.56	14.2	0.50	12.7	0.61	15.5		100	500
CCH62-S10-C	0.62	15.7	0.50	12.7	0.65	16.5		100	500
CCH69-S10-C	0.69	17.5	0.50	12.7	0.75	19.1		100	500
CCH75-S10-C	0.75	19.1	0.50	12.7	0.78	19.8		100	500
CCH81-S10-C	0.81	20.6	0.50	12.7	0.81	20.6		100	500
CCH87-S10-C	0.87	22.1	0.50	12.7	0.84	21.3		100	500
CCH100-S10-C	1.00	25.4	0.50	12.7	0.91	23.1		100	500
CCH112-S10-C	1.12	28.4	0.50	12.7	0.97	24.6		100	500
CCH119-S10-C	1.19	30.2	0.50	12.7	1.00	25.4		100	500
CCH125-S10-C	1.25	31.8	0.50	12.7	1.06	26.9	100	500	
CCH138-S10-C	1.37	34.8	0.50	12.7	1.12	28.4	100	500	
CCH150-S10-C	1.50	38.1	0.50	12.7	1.19	30.2	100	500	

All parts listed are also available in black weather resistant material (add suffix 0). Bulk package only.

c Wire Retainers

- Wires slide into the clip and are held in place by tension
- Low profile design holds wires, cables, and tubing
- Funnel entry design allows for easy insertion of cords and cables

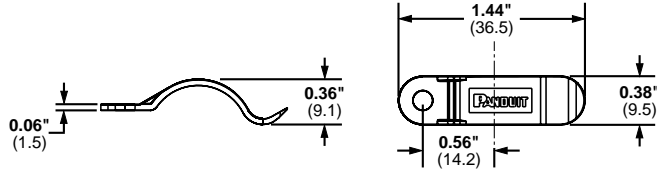

Part Number	Max. Bundle Diameter		Material	Color	Environment	Mounting Method	Std. Pkg. Qty.	Std. Ctn. Qty.
	In.	mm						
TWR-C	0.38	9.5	Nylon 6.6	Natural	Indoors	#6 (M3) Screw	100	500
TWR-C0	0.38	9.5	Weather Resistant Nylon 6.6	Black	Outdoors		100	500

Horizontal Siding Clips

- Low profile installs without drilling or nailing
- Will not corrode or stain siding
- Attach coax cable to buildings having "Pittsburgh Interlok" type aluminum or steel siding

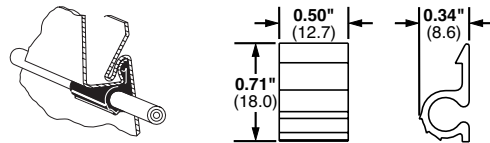

Part Number	Max. Bundle Diameter		Material	Color	Mounting Method	Std. Pkg. Qty.	Std. Ctn. Qty.
	In.	mm					
HSC.25-L	0.25	6.4	Nylon 6.6	White	Clip	50	500
HSC.25-L100	0.25	6.4	Weather Resistant Nylon 6.6	Black		50	500

c **PA** **US** Wire Standoffs

- For retaining wires, cable, components or tubing away from panel or conductive chassis
- Design of wing provides added stability
- Material: Nylon 6.6
- Finger grip flanges can be easily locked or unlocked for revisions
- For indoor use only

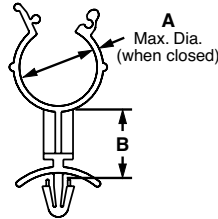

Part Number	Max. Bundle Diameter A		Standoff Height B		Max. Panel Thickness		Panel Hole Diameter		Color	Mounting Method	Std. Pkg. Qty.	Std. Ctn. Qty.
	In.	mm	In.	mm	In.	mm	In.	mm				
WS25-25-C	0.25	6.4	0.25	6.4	0.08	2.0	0.19	4.7	Natural	Push Barb	100	500
WS25-50-C	0.25	6.4	0.50	12.7	0.08	2.0	0.19	4.7			100	500
WS25-75-C	0.25	6.4	0.75	19.1	0.08	2.0	0.19	4.7			100	500
WS35-25-C	0.35	8.9	0.25	6.4	0.08	2.0	0.19	4.7			100	500
WS35-50-C	0.35	8.9	0.50	12.7	0.08	2.0	0.19	4.7			100	500
WS35-75-C	0.35	8.9	0.75	19.1	0.08	2.0	0.19	4.7			100	500
WS50-25-C	0.47	11.9	0.25	6.4	0.08	2.0	0.19	4.7			100	500
WS50-50-C	0.47	11.9	0.50	12.7	0.08	2.0	0.19	4.7			100	500
WS50-75-C	0.47	11.9	0.75	19.1	0.08	2.0	0.19	4.7			100	500
WS75-25-C	0.78	19.8	0.25	6.4	0.08	2.0	0.19	4.7			100	500
WS75-50-C	0.78	19.8	0.50	12.7	0.08	2.0	0.19	4.7			100	500
WS75-75-C	0.78	19.8	0.75	19.1	0.08	2.0	0.19	4.7			100	500

c **PA** **US** Snap-In Clips

- Clip around bundle to hold securely in place
- Material: Nylon 6.6
- Clips are placed on the bundle then attached to the panel
- For indoor use only

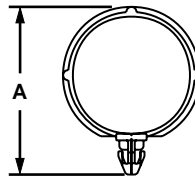

Part Number	Max. Bundle Diameter A		Standoff Height B		Max. Panel Thickness		Panel Hole Diameter		Color	Mounting Method	Std. Pkg. Qty.	Std. Ctn. Qty.
	In.	mm	In.	mm	In.	mm	In.	mm				
SICH25-C	0.25	6.4	0.40	20.9	0.10	2.5	2.5	6.4	Natural	Push Barb	100	500
SICH38-C	0.38	9.7	0.54	24.9	0.10	2.5	2.5	6.4			100	500
SICH50-C	0.50	12.7	0.67	28.2	0.10	2.5	2.5	6.4			100	500
SICH75-C	0.75	19.1	0.96	35.6	0.10	2.5	2.5	6.4			100	500
SICH100-C	1.00	25.4	1.21	41.9	0.10	2.5	2.5	6.4			100	500
SICH150-C	1.50	38.0	1.71	54.6	0.10	2.5	2.5	6.4			100	500

c Wire Saddles

- Funnel entry design for fast insertion of wires and cables
- Available in vertical and horizontal loading configurations
- Design of wing provides added stability
- Material: Nylon 6.6
- For indoor use only

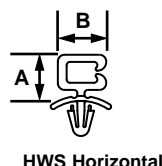
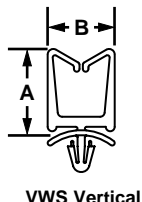

Part Number	Max. Bundle Diameter		Height A		Width B		Max. Panel Thickness		Panel Hole Diameter		Color	Mounting Method	Std. Pkg. Qty.	Std. Ctn. Qty.
	In.	mm	In.	mm	In.	mm	In.	mm	In.	mm				
VWS3750-C	0.38 x 0.50	9.7 x 12.7	0.90	22.9	0.25	6.4	0.08	2.0	0.19	4.7	Natural	Push Barb	100	500
VWS3775-C	0.38 x 0.75	9.7 x 19.1	1.17	29.7	0.25	6.4	0.08	2.0	0.19	4.7			100	500
VWS50100-C	0.50 x 1.00	12.7 x 25.4	1.47	37.3	0.25	6.4	0.08	2.0	0.19	4.7			100	1,000
HWS2819-C	0.19 x 0.28	5.0 x 7.1	0.42	10.7	0.44	11.2	0.08	2.0	0.19	4.7			100	500

Corrugated Tubing Holder with Push Mount

- Use to secure and route all standard sizes of solid wall or slit corrugated loom tubing
- Rugged clip prevents accidental disassembly of tubing due to shock or vibration
- Ribs prevent lateral movement of corrugated loom tubing along the mount

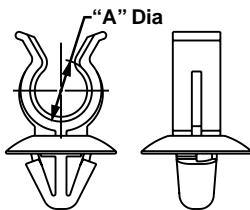

Part Number	Nominal Diameter A		Max. Panel Thickness		Panel Hole Diameter		Std. Pkg. Qty.	Std. Ctn. Qty.
	In.	mm	In.	mm	In.	mm		
CTH19U04-C30	0.19	5	0.125	3.2	0.386	9.8	100	—
CTH35U08-C30	0.35	9	0.125	3.2	0.386	9.8	100	500
CTH38U10-C30	0.38	10	0.125	3.2	0.386	9.8	100	—
CTH50U13-C30	0.50	13	0.125	3.2	0.386	9.8	100	—
CTH62U17-C30	0.62	17	0.125	3.2	0.386	9.8	100	—
CTH87U22-C30	0.87	22	0.125	3.2	0.386	9.8	100	—

Harness Clips

- Integral “spring” holds wire bundles tightly
- Available in vertical and horizontal loading configurations

- Design of wing provides added stability

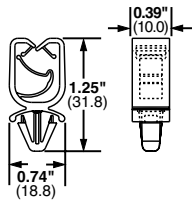

HCMP06B

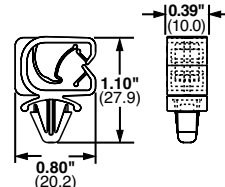

HCMP06C

Part Number	Max. Bundle Diameter Range		Max. Panel Thickness		Panel Hole Diameter		Material	Color	Mounting Method	Std. Pkg. Qty.	Std. Ctn. Qty.
	In.	mm	In.	mm	In.	mm					
HCMP06B12-M20	0.24 – 0.47	5.9 – 12.5	0.118	3.0	0.25	6.4	Nylon 6.6	Black	Push Mount	100	500
HCMP06C12-M20	0.24 – 0.47	5.9 – 12.5	0.105	2.7	0.25	6.4					

Optical Fiber Network Saddles

- Use in pre-drilled 0.18 inch (4.0mm) holes in panels up to 0.09 inch (2.0mm) thick

- Smooth rounded edges eliminate potential for snagging and stress on cable

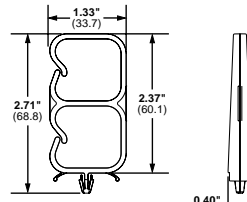

VWSDC

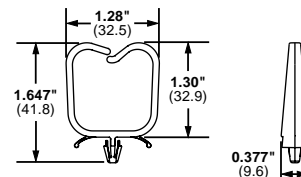

VWS106

Part Number	Max. Bundle Diameter		Material	Mounting Method	Color	Std. Pkg. Qty.	Std. Ctn. Qty.
	In.	mm					
VWSDC-C*	1.06	26.9	Nylon 6.6	Push Barb	Natural	100	500
VWSDC-C20*	1.06	26.9	Nylon 6.6	Push Barb	Black	100	—
VWS106-C	1.06	26.9	Nylon 6.6	Push Barb	Natural		500
VWS106-C20	1.06	26.9	Nylon 6.6	Push Barb	Black		500

*Accepts two bundles.

Nylon Edge Clips

- Integral “spring” holds wire bundles tightly
- Available in vertical and horizontal loading configurations
- Design of wing provides added stability
- Indoor/Outdoor use

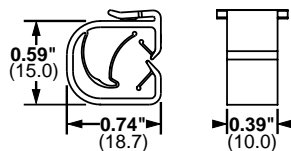

HCME06A12

Part Number	Max. Bundle Diameter Range		Max. Panel Thickness		Material	Color	Mounting Method	Std. Pkg. Qty.
	In.	mm	In.	mm				
HCME06Y12-M30	0.16 - 0.35	4.0 - 9.0	0.16	4	Heat Stabilized Nylon 6.6	Black	Clip onto Edge	1000
HCME06A12-M130	0.24 - 0.47	6.0 - 12.0	0.05	1.2	Acetal	Black	Clip onto Edge	1000
HCME04Y09-M130	0.16 - 0.35	4.0 - 9.0	0.16	4	Acetal	Black	Clip onto Edge	1000
HCME04Y09-M30	0.16 - 0.35	4.0 - 9.0	0.16	4	Heat Stabilized Nylon 6.6	Black	Clip onto Edge	1000
HCME06X12-VM139	0.24 - 0.47	6.0 - 12.0	0.09	2.2	Acetal	Natural	Clip onto Edge	5000

Wire Bundle Strap

- Securely routes large cable bundles
- Rounded edges prevent damage to cable jackets

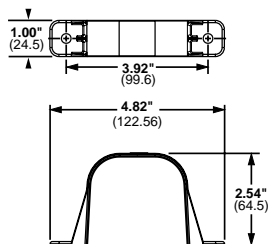

Part Number	Bundle Retaining Area In. ²	Material	Color	Mounting Method	Std. Pkg. Qty.	Std. Ctn. Qty.
WBS6-Q	6.00	ABS	White	Natural	25	125

Circuit Board Posts

- For board-to-board or board-to-chassis mounting
- Bell flange on bottom end provides greater stability
- Releasable and reusable
- Material: Nylon 6.6
- Color: Natural

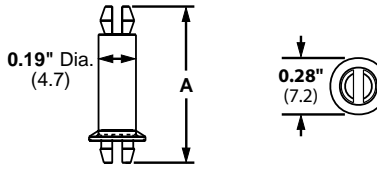

Part Number	Standoff Height		Height A		Panel Hole Diameter		Mounting Method	Std. Pkg. Qty.	Std. Ctn. Qty.
	In.	mm	In.	mm	In.	mm			
CBP12-C	0.12	3.0	0.40	10.2	0.156	3.96	Push Barb	100	500
CBP25-C	0.25	6.4	0.54	13.5	0.156	3.96		100	500
CBP31-C	0.31	7.9	0.59	15.0	0.156	3.96		100	500
CBP37-C	0.37	9.4	0.62	15.7	0.156	3.96		100	500
CBP50-C	0.50	12.7	0.78	19.8	0.156	3.96		100	500
CBP62-C	0.62	15.7	0.91	23.0	0.156	3.96		100	500
CBP75-C	0.75	19.1	1.04	26.2	0.156	3.96		100	500
CBP87-C	0.87	22.1	1.15	29.2	0.156	3.96		100	500
CBP100-C	1.00	25.4	1.28	32.5	0.156	3.96		100	500

Circuit Board Locking Supports

- For board-to-chassis support
- Snap-in design for fast assembly
- Design of wing provides added stability
- Releasable and reusable
- Material: Nylon 6.6

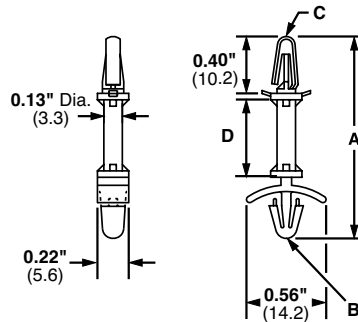

Part Number	Height A		Panel Hole Diameter A		Chassis Panel Hole Diameter C		Standoff Height D		Color	Mounting Method	Std. Pkg. Qty.	Std. Ctn. Qty.
	In.	mm	In.	mm	In.	mm	In.	mm				
CBLS18-C	0.92	23.4	0.19	4.8	0.16	4.0	0.19	4.7	Natural	Push Barb	100	500
CBLS25-C	0.98	24.9	0.19	4.8	0.16	4.0	0.25	6.4			100	500
CBLS37-C	1.11	28.2	0.19	4.8	0.16	4.0	0.38	9.5			100	500
CBLS50-C	1.23	31.2	0.19	4.8	0.16	4.0	0.50	12.7			100	500
CBLS62-C	1.35	34.3	0.19	4.8	0.16	4.0	0.63	15.9			100	500
CBLS75-C	1.48	37.5	0.19	4.8	0.16	4.0	0.75	19.1			100	500

Quick-Build™ Harness Board System

A Revolutionary Modular Solution for Harness Manufacturers

The modular, reusable solution consists of 1' X 1' (305mm x 305mm) grid tiles and specially designed, repositionable accessories that improve the productivity of wire harness assembly builds by up to 18%. The Quick-Build™ Accessories are more effective than nail, magnetic, or snap-in routing fixture methods. Accessories easily twist and lock in place until you're ready to make a change for faster routing of wires and design flexibility.

Low-Volume-High-Mix (LVHM) manufacturers achieve the greatest savings due to reduced material costs — up to 65% of layout and board builds. By reducing the number of bulky plywood boards, the Quick-Build™ Harness Board System delivers more than 50% in storage space savings. Whether you need to build a variety of wire and cable assemblies to meet different customer specifications or for prototyping new harness designs, the more you build, the greater your profitability.

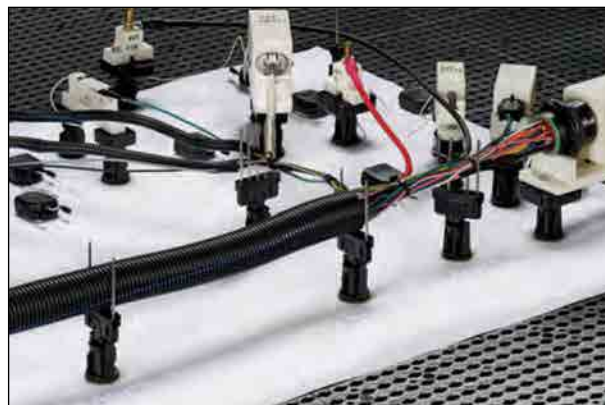

Quick-Build™ Starter Kit

- Kit of Quick-Build™ components and various harness board accessories allows customers to evaluate the Quick-Build™ solution by simply ordering a single part number



Part Number	Description	Std. Pkg. Qty.
QB-KIT1	Starter Kit with initial assortment of Quick-Build™ components essential for faster wire harness builds. Kit include (8) grid tiles, (30) mounting pegs, (20) mounting platforms, and a wide assortment of harness board accessories and nail/nail bases.	1

Quick-Build™ Grid Tile

- Install on top of plywood backing to provide mounting surface
- Secure to plywood with user supplied screws



Part Number	Description	Std. Pkg. Qty.
QB-TILE	1' X 1' (305mm x 305mm) square base component that allows Quick-Build™ mounting pegs and platforms to create a modular harness system. One package includes 8 tiles. Black.	1 PK

Quick-Build™ Mounting Pegs

- Repositionable to allow user to build different harness configurations as needed
- Pointed end inserts through drawing secured to grid tiles, providing the ability to create a harness on top of a drawing

Replacement Washers	
Part Number	Qty
QB-WASHER-Q	25

Note: Required for use with Quick-Build™ mounting platform and Quick-Build™ nail holders to provide a modular harness board system



Part Number	Description	Std. Pkg. Qty
QB-MOUNT-L	Peg can be positioned and relocated. Accepts single nail holders, five nail holders, and Quick-Build™ mounting platforms. Allows accessories to rotate as needed even after mounting peg is installed into grid tile. Black.	50

Quick-Build™ Mounting Platform

- Requires the use of the Quick-Build™ mounting pegs to provide a modular solution
- Repositionable, allowing user to build different harness configurations as needed
- Provides the ability to rotate to allow breakouts and cable pathways to accommodate various harness design requirements
- Use Quick-Build™ mounting screws (sold separately, see page B2.45) to secure harness board accessories to the Quick-Build™ mounting platform



Part Number	Description	Std. Pkg. Qty
QB-BASE175-Q	Mounting platform that is inserted in Quick-Build™ mounting pegs 1.75" x 1.75" (44.45mm x 44.45mm). Allows elastic retainers, wire end holders, corner posts, bundle retainers and other harness board accessories to create a complete Quick-Build™ harness system. Compatible with: #4, #6, #8, and 1/4" screws. Black.	25
QB-BASE120-Q	Mounting platform that is inserted in Quick-Build™ pegs 1.2" x 1.2" (30.48mm x 30.48mm). Allows test fixtures corner posts, wire end holders, and other harness board accessories to be installed to provide a complete Quick-Build™ harness system. Compatible with #8 screw size. Screw length will vary based on test fixtures and accessories used. Note: Consider multiple QB-BASE120-Q components for large test fixtures. Black.	25

Quick-Build™ Screws

- Used to secure traditional harness board accessories and test fixtures to Quick-Build™ mounting platform
- Phillips/slot combination screw style



Part Number	Description	Std. Pkg. Qty
QB-S6-500-C	#6 screw; 1/2" long	100
QB-S8-500-C	#8 screw; 1/2" long	100
QB-S8-750-C	#8 screw; 3/4" long	100
QB-S25-500-C	1/4" screw; 1/2" long	100
QB-S25-1000-L	1/4" screw; 1" long	50

Quick-Build™ Single Nail Holder

- Requires the use of the Quick-Build™ mounting pegs to provide a modular solution
- Repositionable, allowing user to build different harness configurations as needed
- Allows the use of harness board nails (sold separately, see page B2.47)
- Use with single nails to create pathways and breakout channels



Part Number	Description	Compatible Harness Board Single Nail Part Number (see Page B2.47)	Std. Pkg. Qty.
QB-SN1-Q	Single nail holder to accommodate one 1" nail. White	HBN1-T	25
QB-SN2-Q	Single nail holder to accommodate one 2" nail. Black	HBN2-T	25
QB-SN3-Q	Single nail holder to accommodate one 3" nail. Gray	HBN3-T	25

Quick-Build™ Five Nail Holder

- Requires the use of Quick-Build™ mounting pegs to provide a modular solution
- Repositionable, allowing user to build different harness configurations as needed
- Allows the use of up to five harness board nails (sold separately, see B2.47)
- Use with nails to create pathways and breakout channels with harness board nails



Part Number	Description	Compatible Harness Board Single Nail Part Number (see Page B2.47)	Std. Pkg. Qty.
QB-FN1-Q	Five nail holder to accommodate up to five 1" nails. White	HBN1-T	25
QB-FN2-Q	Five nail holder to accommodate up to five 2" nails. Black	HBN2-T	25
QB-FN3-Q	Five nail holder to accommodate up to five 3" nails. Gray	HBN3-T	25

Quick-Build™ Grid Tile Connector

- Optional accessory for use with grid tiles to prevent the need for plywood backing and ensure accurate alignment of grid system
- Recommended for adjacent tiles where corners of two or four tiles come together



Part Number	Description	Std. Pkg. Qty.
QB-CONN	Grid tile connector to ensure accurate alignment of Grid System. One package includes five pieces. Black	1

Traditional Harness Board Accessories

Panduit harness board accessories have been around for a long time and continue to provide easy routing and forming of wires in harness fabrication.

Harness Board Nails

- Manufactured from Nickel Plated Steel
- Smooth finish on nails prevents abrasion to wire jackets



Part Number	Description	Compatible QB Components (see Page B2.46)	Std. Pkg. Qty.
HBN1-T	Harness Board Nail - 1" long (1.65" overall).	QB-SN1-Q and QB-FN1-Q	200
HBN2-T	Harness Board Nail - 2" long (2.66" overall).	QB-SN2-Q and QB-FN2-Q	200
HBN3-T	Harness Board Nail - 3" long (3.67" overall).	QB-SN3-Q and QB-FN3-Q	200

Elastic Retainers – Replaceable Version

- Cable bundles are formed as individual wires are inserted
- The elastic band is replaceable
- Completed bundles can be easily removed



Replacement Elastic	
Part Number	Qty
RER.5E-X	10
RER.75E-X	10
RER1.25E-X	10
RER2.0E-X	10

Part Number	Description	Compatible QB Components (see Page B2.45)	Std. Pkg. Qty.
RER.5-S6-X	Elastic retainer with replaceable elastic band. Suitable for 0.5" maximum bundle capacity.	QB-BASE175-Q and QB-S6-500-C	10
RER.75-S6-X	Elastic retainer with replaceable elastic band. Suitable for 0.75" maximum bundle capacity.		10
RER1.25-S6-X	Elastic retainer with replaceable elastic band. Suitable for 1.25" maximum bundle capacity.		10
RER2.0-S6-X	Elastic retainer with replaceable elastic band. Suitable for 2.0" maximum bundle capacity.		10

Elastic Retainers

- Cable bundles are formed as individual wires are inserted
- Completed bundles can be easily removed



Part Number	Description	Compatible QB Components (see B2.45)	Std. Pkg. Qty.
ER.5-E4-X	Elastic Retainer. Suitable for 0.5" maximum bundle capacity.	QB-BASE175-Q and QB-S6-500-C	10
ER1.25-E4-X	Elastic Retainer. Suitable for 1.25" maximum bundle capacity.	QB-BASE175-Q and QB-S6-500-C	10

Bundle Retainers

- Funnel entry allows fast cable insertion
- Completed bundles can be easily removed



Part Number	Description	Compatible QB Components (see pages B2.45)	Std. Pkg. Qty.
BR.5-E6-C	Bundle Retainer. Suitable for 0.5" maximum bundle capacity. 1.07" standoff height. Black	QB-BASE175-Q and QB-S6-500-L	100
BR.75-E6-C	Bundle Retainer. Suitable for 0.75" maximum bundle capacity. 0.95" standoff height. Black	QB-BASE175-Q and QB-S6-500-L	100
BR2-1.3-X	Bundle Retainer. Suitable for 2.0" maximum bundle capacity. 1.32" standoff height. Black	QB-BASE175-Q and QB-S25-500-L	10
BR2-1.5-X	Bundle Retainer. Suitable for 2.0" maximum bundle capacity. 1.59" standoff height. Black	QB-BASE175-Q and QB-S25-1000-L	10
BR2-4-X	Bundle Retainer. Suitable for 2.0" maximum bundle capacity. 4.06" standoff height. Black	QB-BASE175-Q and QB-S25-1000-L	10
BR2-6-X	Bundle Retainer. Suitable for 2.0" maximum bundle capacity. 6.02" standoff height. Black	QB-BASE175-Q and QB-S25-1000-L	10

Corner Posts

- Designed to pre-form tight bundles at harness corners and breakouts
- Top arm rotates upward for easy removal of completed harness



Part Number	Description	Compatible QB Components (see pages B2.45)	Std. Pkg. Qty.
CPH.75-S8-X	Corner post to assist in tight corners of harness systems. 0.75" maximum bundle diameter. Center of bundle is 1.35" from surface.	QB-BASE120-Q or QB-BASE175-Q and QB-S8-500-C	10
CPL.75-S8-X	Corner post to assist in tight corners of harness systems. 0.75" maximum bundle diameter. Center of bundle is 0.56" from surface.	QB-BASE120-Q or QB-BASE175-Q and QB-S8-500-C	10

Wire End Holder

- Secures wire ends while harness is being fabricated
- Use with #28 thru #16 AWG wires



Part Number	Description	Compatible QB Components (see pages B2.45)	Std. Pkg. Qty.
WEH-E8-C	Use to retain end of wire in secure position. Helps when making terminations or dressing harness.	QB-BASE120-Q or QB-BASE175-Q and QB-S8-500-C	100

Fanning Strip System

- Holds wires in a specific orientation
- No sharp edges to damage wire insulation
- Accepts wires up to 18 AWG
- Fanning strip can remain as part of completed harness



Part Number	Description	Compatible QB Components (see pages B2.45)	Std. Pkg. Qty.
FSH40-X	Fanning strip holder to elevate FS156 Fanning Strip 0.62" above surface. 6.00" long. Black	QB-BASE120-Q or QB-BASE175-Q and QB-S8-500-C	10
FSHH-X	Fanning strip holder to elevate FS156 Fanning Strip 1.42" above surface. 3.2" long. Black	QB-BASE120-Q or QB-BASE175-Q and QB-S8-500-C	10
FS156-C	Fanning strip with 76 spaces for wires up to 18 AWG. 12.1" long and 0.31" tall.	N/A	100

Spring Wire Breakout System

- Harness board spring and spring holder secures wire ends while harness is being fabricated
- Wires simply pull out from spring when harness is removed
- Each SHH Spring Holder is supplied with one rigid wire piece to hold the spring laterally and two #8 (M4), 2" (50.8mm) hex head wood screws; purchase spring separately

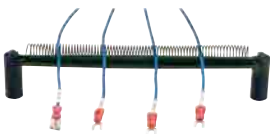

Part Number	Description	Compatible QB Components (see pages B2.45)	Std. Pkg. Qty.
SHH1-S8-X	Spring Wire Holder that elevates spring 1.3" above surface. Compatible with PBSC1-X spring. Black	QB-BASE120-Q or QB-BASE175-Q and QB-S8-500-C	10
SHH3-S8-X	Spring Wire Holder that elevates spring 1.3" above surface. Compatible with PBSC3-X spring. Black	QB-BASE120-Q or QB-BASE175-Q and QB-S8-500-C	10
PBSC1-X	Spring compatible with SHH1-S8-X Spring Wire Holder.	NA	10
PBSC3-X	Spring compatible with SHH3-S8-X Spring Wire Holder.	NA	10
PBSC6-X	Spring used independent of Spring Wire Holder. Requires 6" spacing for mounting. Can be secured directly to Quick-Build™ Mounting Platform.	QB-BASE175-Q and QB-S25-500-L	10
PBSC12-X	Spring used independent of Spring Wire Holder. Requires 12" spacing for mounting. Can be secured directly to Quick-Build™ Mounting Platform.	QB-BASE175-Q and QB-S25-500-L	10

US Tie Harness Mounts for Corrugated Tubing

- Designed to be attached to the wire harness during assembly
- Cable ties can be installed by hand or with Panduit® automatic cable tie tools
- Used with harness board standoff posts
- A location tab on the mount shelf aligns with the corrugated tubing grooves to ensure proper mount location during assembly
- Natural nylon material for indoor use
- Heat stabilized nylon material (30) for high temperature applications – indoor use

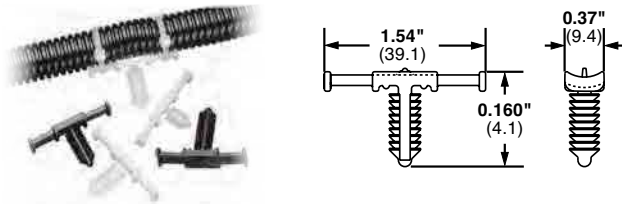

Part Number	Used with Cable Ties†	Maximum Panel Thickness		Panel Hole Diameter		Hole Spacing C		Material	Color	Mounting Method	Std. Pkg. Qty.	Std. Ctn. Qty.
		In.	mm	In.	mm	In.	mm					
THMSP20-C	M, I, S	0.160	4.1	0.244 – 0.283	6.2 – 7.2	1.03	26.2	Nylon 6.6	Natural	Push Barb	100	1000
THMSP20-C30	M, I, S	0.160	4.1	0.244 – 0.283	6.2 – 7.2	1.28	32.5	Heat Stabilized Nylon 6.6	Black	Push Barb	100	1000
THMSP25-C	M, I, S	0.230	5.8	0.244 – 0.283	6.2 – 7.2	1.53	38.9	Nylon 6.6	Natural	Push Barb	100	1000
THMSP25-C30	M, I, S	0.230	5.8	0.244 – 0.283	6.2 – 7.2	2.03	51.6	Heat Stabilized Nylon 6.6	Black	Push Barb	100	1000

*Cable tie cross section sizes: M = Miniature, I = Intermediate, S = Standard.

Harness Board Standoff Posts and Adapter

- Used to hold a push mount accessory or cable tie at a specific location on a harness board

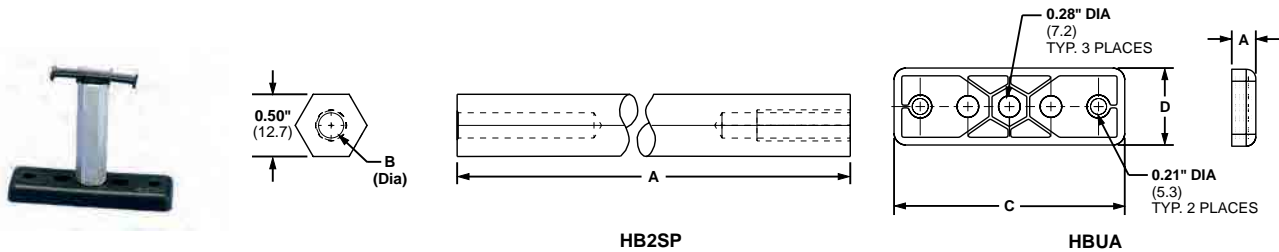

Part Number	Height A		Hole Diameter A		Length C		Width D		For Use With	Material	Mounting Method	Std. Pkg. Qty.	Std. Ctn. Qty.
	In.	mm	In.	mm	In.	mm	In.	mm					
Posts													
HB2SP19-X	2.00	50.8	0.20	5.2	—	—	0.50	12.7	PLWP, PRWP, WS, VWS, HWS, TPM	Aluminum	Bolt – Included	10	100
HB2SP25-X	2.00	50.8	0.30	7.5	—	—	0.50	12.7	PLWP, PRWP, PLP, THMS, HCMP, PMCC	Aluminum	Bolt – Included	10	100
Adapter													
HBUA-X	0.31	7.9	0.28	7.1	3.00	76.2	1.00	25.4	HB2SP19-X, HB2SP25-X	Nylon 6.6	#10 (M5) Screw	10	100

Order number of pieces required, in multiples of Standard Package Quantity.

Physical Properties and Colors of Cable Accessory Materials

Design Criteria	Nylon 6.6	Flame Retardant Nylon 6.6	Weather Resistant Nylon 6.6	Heat Stabilized Nylon 6.6	Heat Stabilized Weather Resistant Nylon 6.60	Impact Resistant Nylon 6.6
Part Number Suffix	None (Natural or White), 14 (Gray), 20 (Black), 15 (Ivory)	60, 69, 20	0	30	300	None
Color	Natural, White, Gray, Black, Ivory	Black, Natural	Black	Black	Black	Black
Maximum Continuous Use Temperature	185F (85C)	230F (110C)	167F (75C)	167F (75C)	167F (75C)	185F (85C)
Minimum Continuous Use Temperature	-40F (-40C)	-40F (-40C)	-40F (-40C)	-40F (-40C)	-40F (-40C)	-40F (-40C)
UL Flammability - UL94	V-2	V-0	V-2	V-2	V-2	HB
UV Resistance	Poor	Poor	Good	Fair	Good	Poor
Water Absorption	1.3% (24 hrs)	1.1% (24 hrs)	1.2% (24hrs)	1.2% (24hrs)	1.2% (24hrs)	1.0% (24 hrs)
Gamma Radiation Resistance	Good	1x10^5 Rads	Good	Good	Good	Good

Design Criteria	PVC	Acetal	Acetal Heat Stabilized	-39 Material for Contour Multiple Tie Plates	Metal Detectable Nylon	Metal Detectable Polypropylene
Part Number Suffix	None, 8, 810	None	130, 139	39	86	186
Color	Gray, White	Black	Natural	Natural	Light Blue	Dark Blue
Maximum Continuous Use Temperature	122F (50C)	194F (90C)	194F (90C)	257F (125C)	149F (65C)	149F (65C)
Minimum Continuous Use Temperature	-40F (-40C)	-40F (-40C)	-40F (-40C)	-40F (-40C)	-40F (-40C)	-40F (-40C)
UL Flammability - UL94	V-0	HB	HB	V-2	N/A	N/A
UV Resistance	Poor	Good	Good	Poor	N/A	N/A
Water Absorption	0.3% (24 hrs)	0.43% (24 hrs)	0.65% (24hrs)	1.2% (24hrs)	N/A	N/A
Gamma Radiation Resistance	N/A	Poor	Poor	Good	N/A	N/A

Continues on next page

Physical Properties and Colors of Cable Accessory Materials (continued)

Design Criteria	Glass Filled Nylon 6.6	Impact Modified Weather Resistant Nylon 6.6	Glass Filled Flame Retardant Nylon 6.6	ABS	Nylon 66	Weather Resistant ABS
Part Number Suffix	None	0	60,69	None, 15 (Ivory)	20	0
Color	Black	Black	Black, Natural	White, Natural, Ivory	Black	Black
Maximum Continuous Use Temperature	167F (75C)	185F (85C)	230F (110C)	203F (95C)	167F (75C)	203F (95C)
Minimum Continuous Use Temperature	-40F (-40C)	-40F (-40C)	-40F (-40C)	-40F (-40C)	-40F (-40C)	-40F (-40C)
UL Flammability - UL94	HB	HB	V-0	HB	V-2	HB
UV Resistance	Poor	Poor	Poor	Poor	Poor	Fair
Water Absorption	1.2% (24hrs)	1.2% (24hrs)	0.7% (24 hrs)	0.3% (24 hrs)	1.2% (24hrs)	0.3% (24 hrs)
Gamma Radiation Resistance	Good	N/A	N/A	Good	Good	Good

Design Criteria	PEEK	Polypropylene	Weather Resistant Polypropylene	Flame Retardant Polypropylene	Tefzel	NORYL
Part Number Suffix	71	None / 14	100	None	76	10
Color	Natural	White, Gray	Black	Black	Aqua	White
Maximum Continuous Use Temperature	266F (130C)	230F (110C)	221F (105C)	257F (125C)	302F (150C)	176F (80C)
Minimum Continuous Use Temperature	-40F (-40C)	-40F (-40C)	-40F (-40C)	-40F (-40C)	-40F (-40C)	-40F (-40C)
UL Flammability - UL94	N/A	HB	HB	V-0	N/A	V-1
UV Resistance	Fair	Poor	Good	Good	Excellent	Good
Water Absorption	0.1% (24hrs)	0.1% (24 hrs)	0.1% (24 hrs)	0.15% (24 hrs)	<0.01% (24 HRS)	0.7% (24 hrs)
Gamma Radiation Resistance	Good	1x10^5 Rads	1x10^5 Rads	N/A	Good	N/A

Application Chart

Since Panduit manufactures adhesive backed mounts with a variety of adhesive types, this chart should be used as a guideline for choosing the best adhesive for often-encountered conditions. Each type of adhesive is rated good, fair or poor for some specific mounting surfaces and/or chemical environments.

Mount Spacing

To determine the number of mounts to use in a given application, the following formula can be used as a guideline:

$$\frac{\text{Cable or weight (Lbs./ft.)}}{\text{Static Load rating of Mount (Lbs./mt.)}} = \text{Spacing} \frac{\text{Mounts}}{\text{Ft.}}$$

Surfaces	Rubber Based Foam Tape Mounts	Acrylic Based Foam Tape Mounts	Epoxy Applied Adhesive Mounts
Plastics	Good	Good	Good
Wood	Good	Good	Good
Glass	Fair	Good	Good
Painted Surfaces	Good	Good	Fair
Powder Coating	Good	Fair	Good
Metal	Good ₁	Good ₁	Good
Paper	Good	Good	Fair
Concrete, Stone, Masonry	Not Recommended	Not Recommended	Good

Chemical Resistance			
Water	Good	Good	Poor
Oil	Poor	Fair ₃	Good
Gasoline	Poor	Fair ₃	Fair
Dilute Acids	Poor	Fair ₃	Fair
Dilute Alkalis	Good	Fair ₃	Fair
Organic Solvents	Poor	Fair ₃	Not Recommended
Outdoor Exposure	Not Recommended	Good	Good ₂

1. Not recommended for use on copper or brass.
2. Mounts manufactured from outdoor material only. For specific applications, individual testing prior to extensive use is suggested.
3. Depends on concentration, exposure time, and chemical composition.

Selection and Use of Adhesive Mounts

Panduit® adhesive mounts provide a quick, economical, and dependable method of supporting, routing, and protecting wires or cables. Some are used with Panduit cable ties and others can be used without cable ties. Adhesive backed mounts adhere to a variety of surfaces. This alternative to mechanical fasteners offers the advantage of lower installed cost with safe, easy to use, quality products.



Applications

- To route wires in control panels and switchboards
- To support bundles of wires away from moving mechanical devices
- Routing and harnessing cables, both indoors and out, to prevent safety hazards
- To organize flat cables in many locations with low profile construction
- Ideal for supporting wire bundles where holes cannot be made in the substrate
- To separate groups of wires for identification

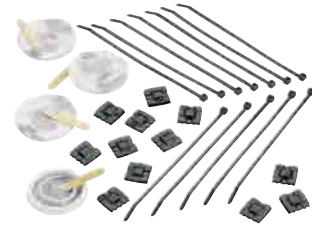

General Mount Guidelines

Panduit pressure sensitive adhesive (foam tape) mounts are intended to secure wire bundles or other light objects to smooth surfaces. These mounts are not designed to support excessive loads and should not be used when the maximum expected load exceeds the rated capacity of the mount.

Choosing the Right Adhesive

Panduit offers two standard pressure sensitive foam tapes which are available on most adhesive backed wiring accessories products. The general purpose tape is produced with a rubber based adhesive and is identified by an “-A” in the part number. This tape develops its strength extremely fast and can be used in environments with temperatures ranging from -20°F (-29°C) to 120°F (49°C). It is recommended that rubber based adhesive mounts dwell 2 hours after installation, prior to loading. Rubber based adhesive tape is the best choice for most adhesive mount applications, including powder coated surfaces.

Acrylic based adhesive tape is also available and is identified by an “-AT” in the part number. This tape is for use in environments where continuous exposure to temperatures ranging from -20°F (-29°C) to 180°F (82°C) is possible. Acrylic based adhesive develops its maximum strength over a longer period of time than rubber based adhesive. It is recommended that acrylic adhesive mounts dwell 8 hours after installation, prior to loading. Acrylic based adhesive tape is a good choice for environments with exposure to UV rays or temperatures above 120°F (49°C).

Panduit adhesive backed cable accessories are also available pre-installed with high bond acrylic-based adhesive. This adhesive can be used in applications with continuous use temperatures ranging from -31°F (-35°C) to 200°F (93°C), though higher temperatures may be possible for short-term exposure. High Bond cable accessories are recommended for use in demanding applications such as where high temperatures are required, or where fatigue loading is expected.

Panduit also offers a 2-part epoxy for use in applications where excessive loading is required, or where the surface to which the mount must be applied is porous rather than smooth. Panduit EMA adhesive is a 2-part epoxy cement which is packaged in convenient mixer cups containing an equal amount of resin and hardener. Peel the protective covering off and pop the center of the cup in to form a mixing bowl. Each cup is supplied with a mixer stick and contains enough epoxy to properly apply three EMS mounts. The resin and hardener should be thoroughly mixed together until the epoxy is a consistent and uniform color. The mixer stick can then be used to apply the adhesive to the mount. The epoxy should be forced into the grooves on the bottom of the mount to obtain optimum bond performance. The mount should be applied to the surface with light pressure and a back-and-forth twisting motion. Hardening of the epoxy begins five minutes after mixing at room temperature.

Continues on next page

Selection and Use of Adhesive Mounts (continued)

Surface Preparation

For best results, Panduit® adhesive mounts should be applied to clean, dry, grease-free surfaces. We recommend that the surface be cleaned prior to mount installation. For rubber and acrylic based foam tape adhesives, a blend of isopropyl alcohol and water 50/50 may be used to clean most surfaces.

For epoxy type adhesives, especially masonry surfaces, be sure to clean all loose particles away before mount installation. Some surface abrasion is recommended to achieve maximum strength. A light rubbing with medium grit emery cloth or sandpaper is best. Wash after abrading.

Proper Installation Techniques For Pressure Sensitive Adhesive Mounts

For proper installation of adhesive mounts with foam tape, simply remove the release liner and place the mount in the desired location. Avoid touching the adhesive prior to positioning the mount. Apply firm pressure to the mount for 5 seconds to insure proper adhesion.

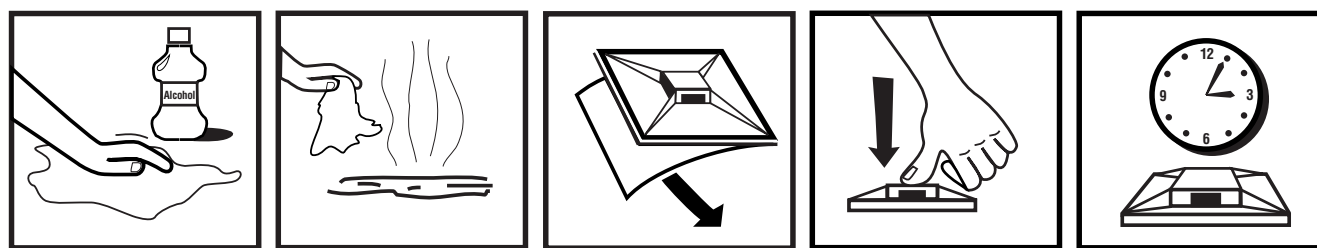

- 1) Clean surface with a clean cloth and isopropyl alcohol.
- 2) Allow surface to air dry.
- 3) Remove the release liner, being careful not to touch the adhesive.
- 4) Apply full thumb pressure for at least 5 seconds.
- 5) Allow mount to properly dwell.

Proper Storage Conditions

All Panduit adhesive products have an expiration date printed on the package label. Use the following storage guidelines:

1. For rubber and acrylic based foam tape adhesives, store in temperatures of 70°F (21°C) and 45% Relative Humidity (R.H.).
2. For epoxy type adhesives, store in temperatures of 40°F (4°C) to 75°F (25°C) and relative humidity not in excess of 45%. Storage in opened containers is not recommended. Using the guidelines above, the shelf life of foam tape is 3 years. Shelf life of epoxy is 1 year. Deviation from the recommended storage conditions may reduce the shelf life or adhesive strength. In any case, adhesive products should never be stored near heating vents or other heat sources, and storage in lower temperatures than those recommended may increase the shelf life.

Stock Rotation

Adhesive mount inventory should be rotated in order to insure the quality of the adhesive foam tape. Each package of Panduit adhesive backed mounts has a quality control number and a best-if-used-by date on the package label. The best-if-used-by date provides the customer with an accurate way to control the rotation of inventory, and, as is the case with all Panduit products, the quality control number provides complete traceability for all components that go into a specific production run of product.

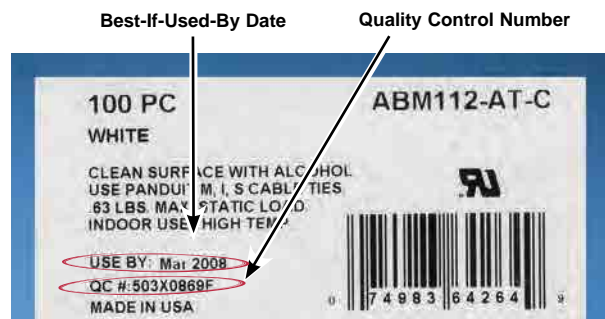

Mount Removal

There is no simple or easy method for removing Panduit adhesives. A thin wire or razor blade can be moved in between the surfaces when removing foam tape mounts; however, the adhesive residue will remain on the surface. Epoxy adhesives may be removed with a commercial paint stripping solution.

Stainless Steel Cable Ties and Accessories

The Pan-Steel® System provides a strong, durable method of bundling and mechanical fastening, for all indoor, outdoor, and underground (including direct burial) applications. The ties are designed for use in critical applications where strength, vibration, radiation, weathering, corrosion and temperature extremes are a factor.

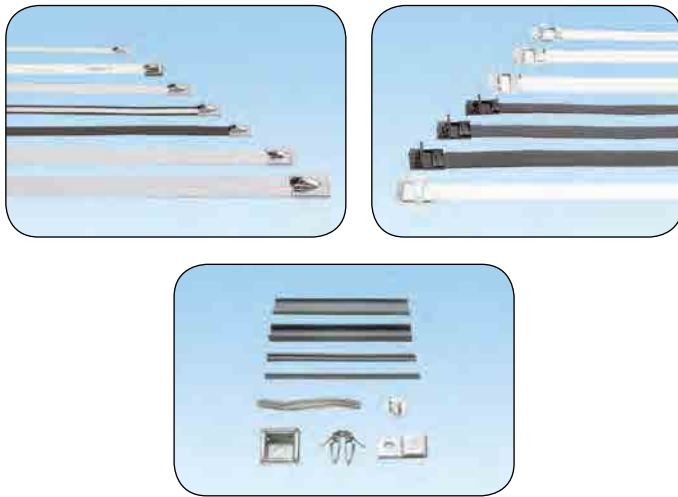

- **Patented locking head design assures locking in any position, with a high rated loop tensile strength for a durable solution that delivers an extra margin of safety**
- **201, 304, or 316 grade stainless steel provides a strong, long-lasting method of bundling and mechanical fastening in harsh environments**
- **Accessories available to protect, speed, and simplify the mounting of wires, cable, and tubing with Panduit® Pan-Steel® Stainless Steel Cable Ties**
- **Complete line of manual and powered installation tools available with controlled tension and automatic cut-off for lower installed cost**
- **Large selection of stainless steel cable ties to deliver maximum design flexibility to match specific application requirements**

Panduit continues to develop stainless steel solutions for harsh environment applications by solving customer problems with innovative products and reliable tooling to achieve lowest installed cost.

Pan-Steel® Products Overview

Pan-Steel® Cable Ties

Pages B3.4 – B3.6, B3.11 – B3.13



- Designed for use in indoor, outdoor, and underground applications
- Self-locking head design speeds installation
- Strong, durable method of cable bundling
- Rounded edges assure cable protection and worker safety

Pan-Steel® Coated Cable Ties

Pages B3.8 – B3.9, B3.12 – B3.13



- Designed for use in indoor, outdoor, and underground applications
- Self-locking head design speeds installation
- Provides additional edge protection
- Prevents corrosion between dissimilar metals

Pan-Steel® Retained Tension Ties

Pages B3.14 – B3.16

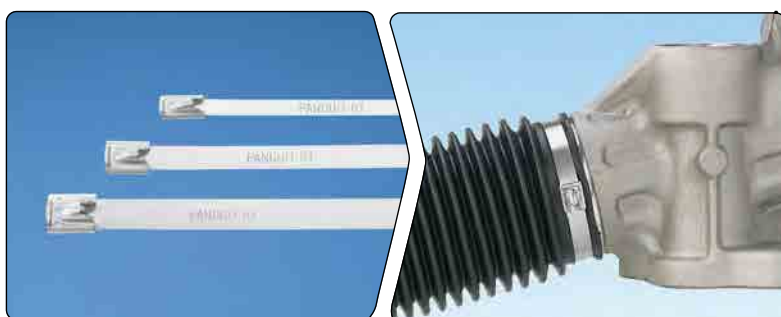

- Designed for use in Industrial, OEM, and Transportation Markets
- Provides tight bundling of armored cables, pipes, conduit and rigid materials
- Locks into place at any length along the tie body
- 360° seal design option eliminates gaps for a completely sealed installation

Continues on next page

Pan-Steel® Products Overview (continued)

Pan-Steel® Strapping



Pages B3.17 – B3.21

- Fold over design provides high retained tension
- Cut end is locked inside low profile buckle – no sharp edges Coil-in-box packaging option for job site versatility with minimum inventory
- Coated design option for additional edge protection

B1.
Cable
Ties

B2.
Cable
Accessories

B3.
Stainless
Steel Cable
Ties &
Accessories

C1.
Wiring
Duct

C2.
Abrasion
Protection

Accessories

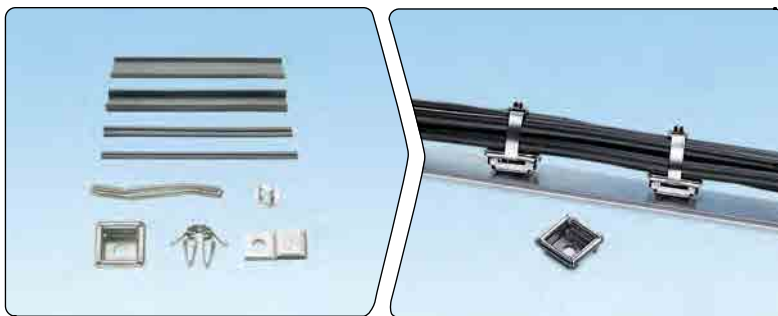

Pages B3.22 – B3.25

- Cushion sleeving provides full separation between ties and bundles
- Multiple mount options for range of applications and panel thicknesses
- Mounts secure ties to structure quickly and easily

C3.
Cable
Management

D1.
Terminals

D2.
Power
Connectors

Pan-Steel® Wave-Ty™



Pages B3.7 – B3.8

- Patented Wave-Ty™ wave-form spring maintains greater installed tension on non-resilient objects
- Heat trace Wave-Ty™ cable tie is a safe, efficient and reliable method to install heat trace, commonly used for temperature maintenance, viscosity control or freeze protection

D3.
Grounding
Connectors

E1.
Labeling
Systems

E2.
Labels

E3.
Pre-Printed
&
Write-On
Markers

E4.
Permanent
Identification

E5.
Industrial
Safety
Solutions

F.
Keystone
Cabling
Systems

G.
Part
Number
Index

Features and Benefits – Pan-Steel® Cable Ties

Panduit® Pan-Steel® Stainless Steel Ties are engineered for safety, productivity, and durability by providing round edges and smooth surfaces, easy threading, high loop tensile strength and tight clamping.

Self-Locking Head Construction

Patented Aggressive locking head
Quicker locking, tighter installation

Unique locking ramp
Assures locking in any position

Patented Lead in design
Wider entrance for easier threading

Strengthening ribs
Stronger head increases lock strength

Patented Innovative displacement lock
Assures superior locking strength

Extended retaining tab
Increases overall tie strength

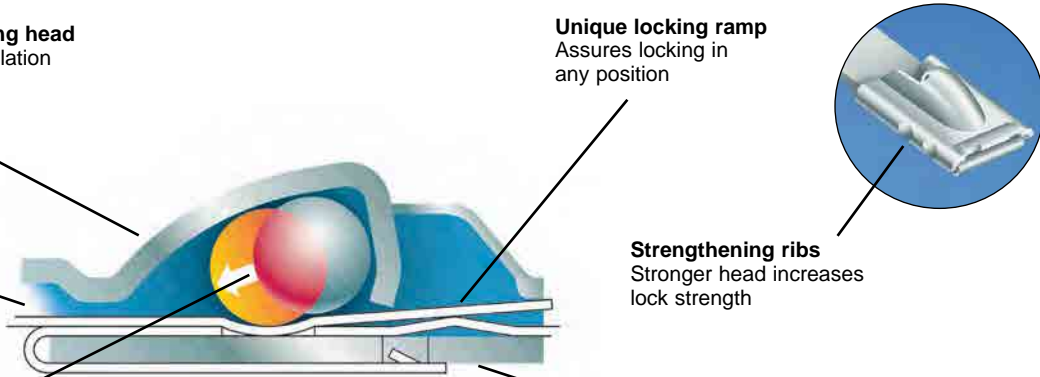

Fully Rounded Edges

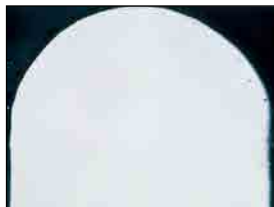

Panduit tie body



Other manufacturer's tie body

The Pan-Steel® Stainless Steel Cable Tie features fully rounded edges to assure bundle protection and operator safety. Panduit not only removes the burr, but actually passes the material through a secondary process which removes the top and bottom corners of the material.

Self-Locking for Fast Installation



Self-locking design can be fastened by hand requiring no fold over or additional installation steps.



Pan-Steel® Installation Tools for adjustable tension control and automatic cut-off for quick, consistent, and secure installation.



Pan-Steel® System Accessories are used with Pan-Steel® Stainless Steel Cable Ties to speed and simplify the mounting of wires, cables, and tubing. Installation methods include screw mounts and push mounts. See pages B3.22 – B3.25.

Part Number System for Pan-Steel® Cable Ties

MLT	6	S	—	CP	—
Type	Bundle Reference Diameter (In.)	Cross Section		Standard Package Size	Material
MLT = Metal Locking Tie		S = Standard LH = Light-Heavy H = Heavy EH = Extra-Heavy EH15 = Extra-Heavy-15 SH = Super-Heavy		Q = 25 L* = 50 LP** = 50 CP = 100 *Standard Cross Section **Heavy Cross Section	(blank) = 304 316 = 316

 Pan-Steel® Self-Locking Cable Ties – MLT Series

- Self-locking head design speeds installation and locks into place at any length along the tie body
- Provides a strong, durable method of cable bundling
- Can be used in a wide range of indoor, outdoor, and underground (including direct burial) applications
- Smooth surfaces and rounded edges assures cable protection and worker safety
- Available in AISI 304 stainless steel for general-purpose applications
- Available in AISI 316 stainless steel for the most corrosive environments



Part Number	Max. Bundle Diameter		Length*		Min. Loop Tensile Strength**		Min. Bundle Diameter		Width		Thickness		Recommended Installation Tool***	Std. Pkg. Qty.	Std. Ctn. Qty.
	In.	mm	In.	mm	Lbs.	N	In.	mm	In.	mm	In.	mm			

AISI 304 Stainless Steel — For General Purpose

Standard Cross Section

MLT1S-CP	1.0	25	5.0	127	200	890	0.50	12.7	0.18	4.6	0.010	0.25	GS4MT, HTMT, PPTMT, ST2MT	100	500
MLT2S-CP	2.0	51	7.9	201	200	890	0.50	12.7	0.18	4.6	0.010	0.25		100	500
MLT2S-L	2.0	51	7.9	201	200	890	0.50	12.7	0.18	4.6	0.010	0.25		50	500
MLT2.7S-CP	2.7	69	10.2	259	200	890	0.50	12.7	0.18	4.6	0.010	0.25		100	500
MLT4S-CP	4.0	102	14.3	362	200	890	0.50	12.7	0.18	4.6	0.010	0.25		100	500
MLT4S-L	4.0	102	14.3	362	200	890	0.50	12.7	0.18	4.6	0.010	0.25		50	500
MLT6S-CP	6.0	152	20.5	521	200	890	0.50	12.7	0.18	4.6	0.010	0.25		100	500
MLT8S-CP	8.0	203	26.8	679	200	890	0.50	12.7	0.18	4.6	0.010	0.25		100	500
MLT10S-CP	10.0	254	33.0	838	200	890	0.50	12.7	0.18	4.6	0.010	0.25		100	500
MLT12S-Q	12.0	304	39.3	998	200	890	0.50	12.7	0.18	4.6	0.010	0.25		25	125
MLT14S-Q	14.0	355	45.5	1156	200	890	0.50	12.7	0.18	4.6	0.010	0.25		25	125
MLT15S-Q	15.0	380	49.2	1250	200	890	0.50	12.7	0.18	4.6	0.010	0.25		25	125

*Other lengths available, contact Panduit Customer Service.
 **Per SAE Standard AS23190/3 (formerly MIL). For additional details, refer to page B3.28.
 ***For information on installation tools, refer to www.panduit.com/tools.

Continues on next page

Pan-Steel® Self-Locking Cable Ties – MLT Series (continued)

Part Number	Max. Bundle Diameter		Length*		Min. Loop Tensile Strength**		Min. Bundle Diameter		Width		Thickness		Recommended Installation Tool***	Std. Pkg. Qty.	Std. Ctn. Qty.
	In.	mm	In.	mm	Lbs.	N	In.	mm	In.	mm	In.	mm			

Light-Heavy Cross Section

MLT2LH-LP	2.0	51	7.9	201	250	1112	0.50	12.7	0.25	6.4	0.010	0.25	GS4MT, HTMT, PPTMT, ST2MT	50	250
MLT4LH-LP	4.0	102	14.3	362	250	1112	0.50	12.7	0.25	6.4	0.010	0.25		50	250
MLT6LH-LP	6.0	152	20.5	521	250	1112	0.50	12.7	0.25	6.4	0.010	0.25		50	250
MLT8LH-LP	8.0	203	26.8	679	250	1112	0.50	12.7	0.25	6.4	0.010	0.25		50	250

Heavy Cross Section

MLT2H-LP	2.0	51	7.9	201	450	2000	0.50	12.7	0.31	7.9	0.010	0.25	GS4MT, ST2MT, HTMT, PPTMT, PBTMT	50	250
MLT4H-LP	4.0	102	14.3	362	450	2000	0.50	12.7	0.31	7.9	0.010	0.25		50	250
MLT6H-LP	6.0	152	20.5	521	450	2000	0.50	12.7	0.31	7.9	0.010	0.25		50	250
MLT8H-LP	8.0	203	26.8	679	450	2000	0.50	12.7	0.31	7.9	0.010	0.25		50	250
MLT10H-LP	10.0	254	33.0	838	450	2000	0.50	12.7	0.31	7.9	0.010	0.25		50	250
MLT14H-Q	14.0	355	45.5	1156	450	2000	0.50	12.7	0.31	7.9	0.010	0.25		25	125

Extra-Heavy Cross Section

MLT4EH-LP	4.0	102	17.1	434	600	2670	1.00	25.4	0.50	12.7	0.010	0.25	ST2MT, RT2HT, RT2HTN, PBTMT	50	250
MLT6EH-LP	6.0	152	23.4	594	600	2670	1.00	25.4	0.50	12.7	0.010	0.25		50	250
MLT8EH-LP	8.0	203	29.7	754	600	2670	1.00	25.4	0.50	12.7	0.010	0.25		50	250
MLT10EH-LP	10.0	254	35.9	912	600	2670	1.00	25.4	0.50	12.7	0.010	0.25		50	250
MLT12EH-Q	12.0	305	42.2	1072	600	2670	1.00	25.4	0.50	12.7	0.010	0.25		25	125

Super-Heavy Cross Section

MLT4SH-LP	4.0	102	17.1	434	900	4005	1.00	25.4	0.63	15.9	0.015	0.38	RT2HT, RT2HTN, PBTMT	50	250
MLT6SH-LP	6.0	152	23.4	594	900	4005	1.00	25.4	0.63	15.9	0.015	0.38		50	250
MLT8SH-LP	8.0	203	29.7	754	900	4005	1.00	25.4	0.63	15.9	0.015	0.38		50	250
MLT10SH-LP	10.0	254	35.9	912	900	4005	1.00	25.4	0.63	15.9	0.015	0.38		50	250
MLT12SH-Q	12.0	305	42.2	1072	900	4005	1.00	25.4	0.63	15.9	0.015	0.38		25	125

*Other lengths, thickness and material grade (316SS) available, contact Panduit Customer Service or refer to www.panduit.com.

**Per SAE Standard AS23190/3 (formerly MIL). For additional details, refer to page B3.28.

***For information on installation tools, refer to www.panduit.com/tools.

Heat Trace Applications

- Electric Heat Trace is commonly used for temperature maintenance, viscosity control and freeze protection
- Installing Heat Trace Wavy-Ty™ tie does not damage mineral insulated heat trace and prevents damage to electric heat trace due to installation
- Installs 2-3 times faster than tie wire depending upon fixture
- Significantly lowers risk of health and safety concerns vs tie wire

Features and Benefits

Safety:	Significantly lower risk of health and safety concerns vs. tie wire. Tie wire can result in puncture risk along with blood poisoning concerns due to residual coating. Tie wire installation can result in repetitive strain injuries and carpal tunnel syndrome.
Installation Speed:	Installs 2 – 3 times faster than tie wire depending upon fixture. Ball valve took 883 seconds to install using tie wire and only 271 seconds using a Heat Trace Wave-Ty™ for 225% savings (time).
Lower Installed Cost:	Can deliver approximately 30% lower overall installed cost versus tie wire depending upon pipe diameter. Approximately 50% of the overall cost for installation of heat trace can be attributed to labor.
Reliability:	Heat Trace Wave-Ty™ tie does not damage mineral insulated electric heat trace. Wide, flat profile along with spring design does not damage heat trace.
Reduced Down Time:	Prevents damage to electric heat trace due installation. Over tensioning of tie wire can result in damage to electric heat trace ultimately lead to failures and an increase in downtime.

Information based upon results of Test Report SS-PLR-367 – Heat Trace Wire and Insulation Installation Time Study.

Application

Electric Heat Trace is commonly used for temperature maintenance, viscosity control or freeze protection. This is typically done by using traced pipes with insulation and cladding. The traced pipes can be accomplished in several ways. For the purposes of this document, we will be focusing solely on mineral insulated electric heat trace.

Tie wire is commonly used within the industry to install mineral insulated electric heat trace. Heat trace installation using tie wire requires training and tensioning is dependent on installer skill and experience. Tooling used with tie wire consists of a pair of nippers or linesman’s pliers. The installer twists and turns the tie wire in order pull the heat trace closer to the pipes. Too much tension can result in damage to the heat trace. The installation process requires a great deal of repetitive twisting and pulling to position the heat trace close to the pipes.

Heat trace tie wire is generally applied approximately every 12 inches on vertical and horizontal runs. In a time study, Panduit found that the installers took approximately 1.6 minutes on average for vertical and horizontal runs. Elbows, ball valves, flanges and T-valves just added to the complexity with average times ranging from 2.58 minutes to 14.72 minutes depending upon fixture. Installation problems associated with tie wire tend to fall into two categories. The first are safety concerns ranging from puncture hazards (from cut tie wire), blood poisoning, pulling and twisting tie wire (RSI, CTS) and more. The other area is around damage to, and system reliability of the heat trace. Tie wire if over tensioned can damage the heat trace.

Technical Information

Material:	304 Grade Stainless Steel
Minimum Loop Tensile Strength:	700 lbs., 3115 Newtons
Maximum Temperature Rating:	538 °C, 1000 °F
Minimum Temperature Rating:	-80 °C, -112 °F
RoHS:	Compliant
Flammability:	Non Flammable
Ultra-Violet Light Resistance:	Excellent

Heat Trace Wave-Ty™ Cable Ties



Continues on next page

Heat Trace Applications (continued)

Ordering Information

Part Number	Length In.	Width In.	Qty. (Units)	Tools
HTMLT2.7WEH-LP	10.2	0.5	50	ST4MT and RT2HT
HTMLT4WEH-LP	14.3	0.5	50	ST4MT and RT2HT
HTMLT6WEH-LP	20.5	0.5	50	ST4MT and RT2HT
HTMLT8WEH-LP	26.8	0.5	50	ST4MT and RT2HT
HTMLT10WEH-LP	33.0	0.5	50	ST4MT and RT2HT
HTMLT12WEH-Q	42.2	0.5	25	ST4MT and RT2HT
HTMLT16WEH-Q	54.8	0.5	25	ST4MT and RT2HT
HTMLT26WEH-Q	86.2	0.5	25	ST4MT and RT2HT
HTMLT38WEH-Q	123.9	0.5	25	ST4MT and RT2HT

Pan-Steel® Polyester Fully Coated Cable Ties – MLTFC Series

- Polyester coating available in six color options provides visual indication for easy identification in color-coding applications (heavy cross section only)
- Self-locking head design speeds installation and locks into place at any length along the tie body
- Polyester coating provides additional edge protection and prevents corrosion between dissimilar metals
- AISI 316 stainless steel for the most corrosive environments
- Available in standard, heavy, extra-heavy and super-heavy cross sections
- UV resistant, low smoke, halogen-free material
- Temperature tolerance -40°F (-40°C) to 302°F (150°C)



Part Number	Max. Bundle Diameter		Length*		Color	Min. Loop Tensile Strength**		Width		Thickness^		Recommended Installation Tool***	Std. Pkg. Qty.	Std. Ctn. Qty.
	In.	mm	In.	mm		Lbs.	N	In.	mm	In.	mm			

Standard Cross Section^^

MLTFC2S-CP316	2.0	51	7.9	201	Black	100	445	0.18	4.6	0.010	0.25	GS4MT, HTMT, PPTMT, ST2MT	100	500
MLTFC4S-CP316	4.0	102	14.3	362	Black	100	445	0.18	4.6	0.010	0.25		100	500
MLTFC6S-CP316	6.0	152	20.5	521	Black	100	445	0.18	4.6	0.010	0.25		100	500
MLTFC8S-CP316	8.0	203	26.8	679	Black	100	445	0.18	4.6	0.010	0.25		100	500

Heavy Cross Section^^

MLTFC2H-LP316RD	2.0	51	7.9	201	Red	250	1112	0.31	7.9	0.010	0.25	GS4MT, ST2MT, HTMT, PPTMT, PBTMT	50	250
MLTFC4H-LP316RD	4.0	102	14.3	362	Red	250	1112	0.31	7.9	0.010	0.25		50	250
MLTFC6H-LP316RD	6.0	152	20.5	521	Red	250	1112	0.31	7.9	0.010	0.25		50	250
MLTFC2H-LP316YL	2.0	51	7.9	201	Yellow	250	1112	0.31	7.9	0.010	0.25		50	250
MLTFC4H-LP316YL	4.0	102	14.3	362	Yellow	250	1112	0.31	7.9	0.010	0.25		50	250
MLTFC6H-LP316YL	6.0	152	20.5	521	Yellow	250	1112	0.31	7.9	0.010	0.25		50	250
MLTFC2H-LP316GR	2.0	51	7.9	201	Green	250	1112	0.31	7.9	0.010	0.25		50	250
MLTFC4H-LP316GR	4.0	102	14.3	362	Green	250	1112	0.31	7.9	0.010	0.25		50	250
MLTFC6H-LP316GR	6.0	152	20.5	521	Green	250	1112	0.31	7.9	0.010	0.25		50	250

*Other lengths available, contact Panduit Customer Service.

**Per SAE Standard AS23190/3 (formerly MIL). For additional details, refer to page B3.28.

***For information on installation tools, refer to www.panduit.com/tools.

^Base material less coating. ^^Minimum bundle diameter is 0.50"(12.7mm). ^^Minimum bundle diameter is 1.0"(25.4mm).

Continues on next page

Pan-Steel® Polyester Fully Coated Cable Ties – MLTFC Series (continued)

Part Number	Max. Bundle Diameter		Length*		Color	Min. Loop Tensile Strength**		Width		Thickness^		Recommended Installation Tool***	Std. Pkg. Qty.	Std. Ctn. Qty.
	In.	mm	In.	mm		Lbs.	N	In.	mm	In.	mm			
Heavy Cross Section^^														
MLTFC2H-LP316BU	2.0	51	7.9	201	Blue	250	1112	0.31	7.9	0.010	0.25	GS4MT, ST2MT, HTMT, PPTMT, PBTMT	50	250
MLTFC4H-LP316BU	4.0	102	14.3	362	Blue	250	1112	0.31	7.9	0.010	0.25		50	250
MLTFC6H-LP316BU	6.0	152	20.5	521	Blue	250	1112	0.31	7.9	0.010	0.25		50	250
MLTFC2H-LP316WH	2.0	51	7.9	201	White	250	1112	0.31	7.9	0.010	0.25		50	250
MLTFC4H-LP316WH	4.0	102	14.3	362	White	250	1112	0.31	7.9	0.010	0.25		50	250
MLTFC6H-LP316WH	6.0	152	20.5	521	White	250	1112	0.31	7.9	0.010	0.25		50	250
MLTFC2H-LP316	2.0	51	7.9	201	Black	250	1112	0.31	7.9	0.010	0.25		50	250
MLTFC4H-LP316	4.0	102	14.3	362	Black	250	1112	0.31	7.9	0.010	0.25		50	250
MLTFC6H-LP316	6.0	152	20.5	521	Black	250	1112	0.31	7.9	0.010	0.25		50	250
MLTFC8H-LP316	8.0	203	26.8	679	Black	250	1112	0.31	7.9	0.010	0.25		50	250

Extra-Heavy Cross Section^^^														
MLTFC4EH-LP316	4.0	102	17.1	434	Black	300	1335	0.50	12.7	0.010	0.25	ST2MT, RT2HT, RT2HTN, PBTMT	50	250
MLTFC6EH-LP316	6.0	152	23.4	594	Black	300	1335	0.50	12.7	0.010	0.25		50	250
MLTFC8EH-LP316	8.0	203	29.7	754	Black	300	1335	0.50	12.7	0.010	0.25		50	250

Super-Heavy Cross Section^^^														
MLTFC4SH-LP316	4.0	102	17.1	434	Black	450	2000	0.63	15.9	0.015	0.38	RT2HT, RT2HTN, PBTMT	50	250
MLTFC6SH-LP316	6.0	152	23.4	594	Black	450	2000	0.63	15.9	0.015	0.38		50	250
MLTFC8SH-LP316	8.0	203	29.7	754	Black	450	2000	0.63	15.9	0.015	0.38		50	250

*Other lengths available, contact Panduit Customer Service.
 **Per SAE Standard AS23190/3 (formerly MIL). For additional details, refer to page B3.28.
 ***For information on installation tools, refer to www.panduit.com/tools.
 ^Base material less coating. ^^Minimum bundle diameter is 0.50"(12.7mm). ^^Minimum bundle diameter is 1.0"(25.4mm).

Pan-Steel® Nylon 11 Selectively Coated Cable Ties – MLTC Series

- Self-locking head design speeds installation and locks into place at any length along the tie body
- Nylon 11 coating provides additional edge protection and prevents corrosion between dissimilar metals
- AISI 316 stainless steel for the most corrosive environments
- Available in heavy cross section
- UV resistant, low smoke, halogen-free material
- Temperature tolerance -40°F (-40°C) to 285°F (140°C)



Part Number	Max. Bundle Diameter		Length*		Min. Loop Tensile Strength**		Min. Bundle Diameter		Width		Thickness^		Recommended Installation Tool***	Std. Pkg. Qty.	Std. Ctn. Qty.
	In.	mm	In.	mm	Lbs.	N	In.	mm	In.	mm	In.	mm			

AISI 316 Stainless Steel – For Nylon 11 Selectively Coated Cable Ties

Heavy Cross Section															
MLTC2H-LP316	2.0	51	7.9	201	250	1112	0.50	12.7	0.31	7.9	0.010	0.25	GS4MT, ST2MT, HTMT, PPTMT, PBTMT	50	250
MLTC4H-LP316	4.0	102	14.3	362	250	1112	0.50	12.7	0.31	7.9	0.010	0.25		50	250
MLTC6H-LP316	6.0	152	20.5	521	250	1112	0.50	12.7	0.31	7.9	0.010	0.25		50	250
MLTC8H-LP316	8.0	203	26.8	679	250	1112	0.50	12.7	0.31	7.9	0.010	0.25		50	250
MLTC10H-LP316	10.0	254	33.0	838	250	1112	0.50	12.7	0.31	7.9	0.010	0.25		50	250

*Other lengths available, contact Panduit Customer Service.
 **Per SAE Standard AS23190/3 (formerly MIL). For additional details, refer to page B3.28.
 ***For information on installation tools, refer to www.panduit.com/tools.
 ^Base material less coating.

Pan-Alum™ Aluminum Cable Ties – MLT Series

- Self-locking head design speeds installation and locks into place at any length along the tie body
- Lightweight, aluminum construction for flexibility and ease of handling
- Smooth surfaces and rounded edges assures cable protection and worker safety
- For use with Pan-Alum™ Marker Plates on page E4.5, for fast installation at the lowest installed cost



Part Number	Max. Bundle Diameter		Length*		Color	Min. Loop Tensile Strength*		Max. Bundle Diameter		Width		Thickness		Recommended Installation Tool***	Std. Pkg. Qty.	Std. Ctn. Qty.
	In.	mm	In.	mm		Lbs.	N	In.	mm	In.	mm	In.	mm			

Heavy Cross Section^^

MLT1H-LPAL	1.0	25	5.5	140	Aluminum	50	222	0.50	12.7	0.31	7.9	0.012	0.03	ST2MT, HTMT	50	250
MLT2H-LPAL	2.0	51	7.9	201	Aluminum	50	222	0.50	12.7	0.31	7.9	0.012	0.03		50	250
MLT4H-LPAL	4.0	102	14.3	362	Aluminum	50	222	0.50	12.7	0.31	7.9	0.012	0.03		50	250

*Per SAE Standard AS23190/3 (formerly MIL). For additional details, refer to page B3.28.

**For information on installation tools, refer to www.panduit.com/tools.

Pan-Steel® Double Wrapped Cable Ties – MLTD Series

- Self-locking head design speeds installation and locks into place at any length along the tie body
- Cable tie body passes through the head two times for additional strength
- Available in heavy, extra-heavy, and super-heavy cross sections
- Available in AISI 304 stainless steel for general-purpose applications
- Available in AISI 316 stainless steel for EH and SH cross sections
- Super-heavy double wrapped tested for short circuit applications up to 71.5 kA

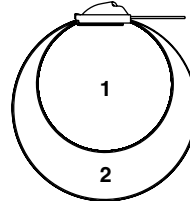

Part Number	Max. Bundle Diameter		Length*		Min. Loop Tensile Strength**		Min. Bundle Diameter		Width		Thickness		Recommended Installation Tool***	Std. Pkg. Qty.	Std. Ctn. Qty.
	In.	mm	In.	mm	Lbs.	N	In.	mm	In.	mm	In.	mm			

AISI 304 Stainless Steel — MLTD Double Wrapped Ties

Heavy Cross Section

MLT2DH-L	2.0	51	18.5	470	600	2670	1.00	25.4	0.31	7.9	0.010	0.25	GS4MT, HTMT, PPTMT, ST2MT	50	250
MLT4DH-L	4.0	102	28.0	711	600	2670	1.00	25.4	0.31	7.9	0.010	0.25		50	250
MLT6DH-Q	6.0	152	40.0	1016	600	2670	1.00	25.4	0.31	7.9	0.010	0.25		25	250

Extra-Heavy Cross Section

MLT4DEH-Q	4.0	102	29.5	749	800	3560	1.00	25.4	0.50	12.7	0.010	0.25	ST2MT, RT2HT, RT2HTN, PBTMT	25	125
MLT6DEH-Q	6.0	152	41.5	1054	800	3560	1.00	25.4	0.50	12.7	0.010	0.25		25	125
MLT8DEH-Q	8.0	203	53.5	1359	800	3560	1.00	25.4	0.50	12.7	0.010	0.25		25	125

Super-Heavy Cross Section

MLT6DSH-Q	6.0	152	41.5	1054	1200	5340	1.00	25.4	0.62	15.9	0.015	0.38	RT2HT, RT2HTN, PBTMT	25	125
MLT8DSH-Q	8.0	203	53.5	1359	1200	5340	1.00	25.4	0.62	15.9	0.015	0.38		25	125

AISI 316 Stainless Steel — For MLTD Double Wrapped Ties

Extra-Heavy Cross Section

MLT6DEH-Q316	6.0	152	41.5	1054	800	3560	1.00	25.4	0.50	12.7	0.010	0.25	ST2MT, RT2HT, RT2HTN, PBTMT	25	125
MLT8DEH-Q316	8.0	203	53.5	1359	800	3560	1.00	25.4	0.50	12.7	0.010	0.25		25	125

Super-Heavy Cross Section

MLT6DSH-Q316	6.0	152	41.5	1054	1200	5340	1.00	25.4	0.63	15.9	0.015	0.38	RT2HT, RT2HTN, PBTMT	25	125
MLT8DSH-Q316	8.0	203	53.5	1359	1200	5340	1.00	25.4	0.63	15.9	0.015	0.38		25	125

*Other lengths, thickness and material grade (316SS) available, contact Panduit Customer Service or refer to www.panduit.com.

**Per SAE Standard AS23190/3 (formerly MIL). For additional details, refer to page B3.28.

***For information on installation tools, refer to www.panduit.com/tools.

Pan-Steel® Custom Length Banding MBS, MBH, MBEH, and MBSH Series

- For applications that require various bundle diameters
- Supplied in reels of 82.50 feet (25.0m), 200.00 feet (60.9m), 250.00 feet (76.2m) or 1000.00 feet (304.8m)
- Provides job site versatility with minimum inventory
- Packaging speeds removal of steel and includes bundle diameter cut-off guide

Polyester coating (optional):

- Polyester coating provides additional edge protection and prevents corrosion between dissimilar metals
- UV resistant, low smoke, halogen-free material
- Temperature tolerance -40°F (-40°C) to 302°F (150°C)
- AISI 316 stainless steel for the most corrosive environments

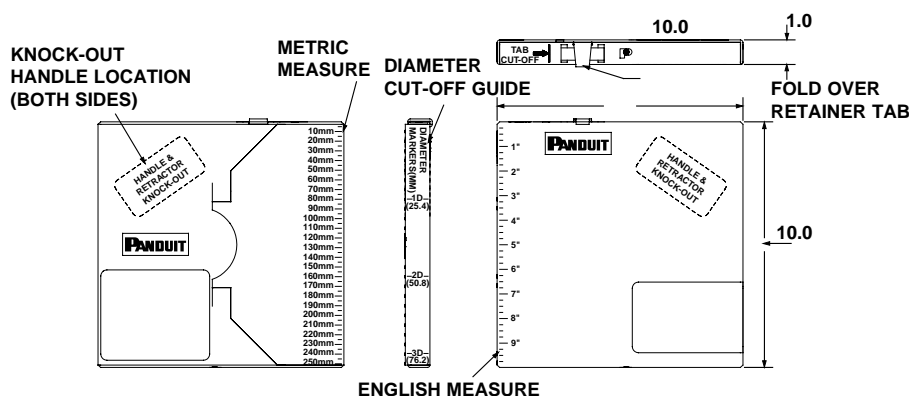

Part Number	Max. Bundle Diameter		Length*		Min. Loop Tensile Strength**		Min. Bundle Diameter		Width		Thickness [^]		Recommended Installation Tool***	Recommended Banding Head	Std. Pkg. Qty.‡
	In.	mm	Ft.	m	Lbs.	N	In.	mm	In.	mm	In.	mm			

AISI 304 Stainless Steel — For General Purpose Banding

Standard Cross Section

MBS-TLR	Any	Any	250	76	100	445	0.50	12.7	0.18	4.4	0.010	0.25	GS4MT, ST2MT, HTMT, PPTMT	MTHS-C	1
MBS-MR	Any	Any	1000	305	100	445	0.50	12.7	0.18	4.4	0.010	0.25		MTHS-C	1

Heavy Cross Section

MBH-TLR	Any	Any	250	76	250	1112	0.50	12.7	0.31	7.9	0.010	0.25	GS4MT, ST2MT, HTMT, PPTMT, PBTMT	MTHH-C	1
MBH-MR	Any	Any	1000	305	250	1112	0.50	12.7	0.31	7.9	0.010	0.25		MTHH-C	1

Extra-Heavy Cross Section

MBEH-TLR	Any	Any	250	76	300	1335	1.00	25.4	0.50	12.7	0.010	0.25	ST2MT, RT2HT, RT2HTN, PBTMT	MTHEH-C	1
----------	-----	-----	-----	----	-----	------	------	------	------	------	-------	------	-----------------------------	---------	---

Super-Heavy Cross Section

MBSH-TR	Any	Any	200	61	450	2000	1.00	25.4	0.63	15.9	0.015	0.38	RT2HT, RT2HTN, PBTMT	MTHSH-C	1
---------	-----	-----	-----	----	-----	------	------	------	------	------	-------	------	----------------------	---------	---

*Other lengths, thickness and material grade (316SS) available, contact Panduit Customer Service or refer to www.panduit.com.

**Per SAE Standard AS23190/3 (formerly MIL). For additional details, refer to page B3.28.

***For information on installation tools, refer to www.panduit.com/tools.

[^]Base material less coating

[‡]Order in number of reels required.

Pan-Steel® Custom Length Banding – MBCH, MBCEH, and MBCSH Series

Part Number	Max. Bundle Diameter		Length*		Min. Loop Tensile Strength**		Min. Bundle Diameter		Width		Thickness^		Recommended Installation Tool***	Recommended Banding Head	Std. Pkg. Qty.‡
	In.	mm	Ft.	m	Lbs.	N	In.	mm	In.	mm	In.	mm			
Polyester Coated AISI 316 Stainless Steel															
Heavy Cross Section															
MBCH-QR316	Any	Any	82	25	250	1112	0.50	12.7	0.31	7.9	0.010	0.25	GS4MT, ST2MT, HTMT, PPTMT, PBTMT	MTHCH-C316	1
Extra-Heavy Cross Section															
MBCEH-QR316	Any	Any	82	25	300	1335	1.00	25.4	0.50	12.7	0.010	0.25	ST2MT, RT2HT, RT2HTN, PBTMT	MTHCEH-C316	1
Super-Heavy Cross Section															
MBCSH-QR316	Any	Any	82	25	450	2000	1.00	25.4	0.63	15.9	0.015	0.38	RT2HT, RT2HTN, PBTMT	MTHCSH-C316	1

*Other lengths available, contact Panduit Customer Service.
 **Per SAE Standard AS23190/3 (formerly MIL). For additional details, refer to page B3.28.
 ***For information on installation tools, refer to www.panduit.com/tools.
 ^Base material less coating
 ‡Order in number of reels required.

To determine the proper amount of banding required, use the following formula:

Calculate S and H Cross Section	Diameter inches (mm) x 3.14 + 3 inches (76mm)
Calculate EH and SH Cross Section	Diameter inches (mm) x 3.14 + 4.5 inches (114mm)

Pan-Steel® Custom Length Banding Heads – MTH Series

- Self-locking head design speeds installation and locks into place at any length along the tie body



Part Number	Part Description	Std. Pkg. Qty.	Std. Ctn. Qty.
AISI 304 Stainless Steel			
MTHS-C	Loose piece banding head for standard cross section banding.	100	1000
MTHH-C	Loose piece banding head for heavy cross section banding.	100	1000
MTHEH-C	Loose piece banding head for extra-heavy cross section banding.	100	1000
MTHSH-C	Loose piece banding head for super-heavy cross section banding.	100	1000

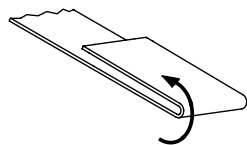

1) Take one end of the cut banding and bend back 1/2" (13mm).

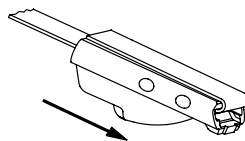

2) Take a self-locking head and slide it the entire length of the band until it reaches the bend.

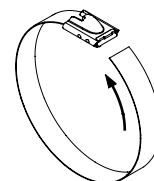

3) Bend tail flat against bottom of banding head to complete assembly.

Features and Benefits – Pan-Steel® Retained Tension Ties – MRT/MRS Series

Panduit® Pan-Steel® Retained Tension Ties are engineered for safety, productivity, and durability by providing round edges and smooth surfaces, easy threading, high loop tensile strength and tight clamping.

Panduit Retained Tension Tie Technology

Features of Retained Tension Ties (MRT and MRS Series)

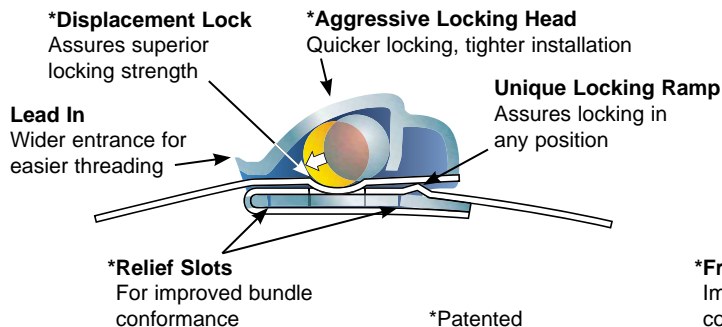

Additional Features of 360° Radial Seal Retained Tension Ties (MRS Series Only)

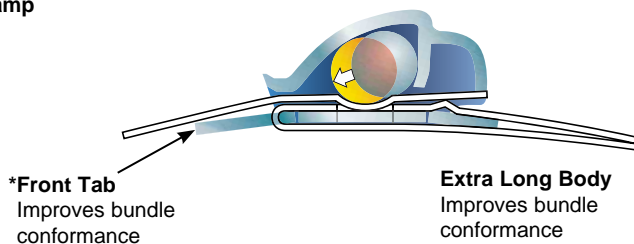

Retained Tension Performance Comparison**

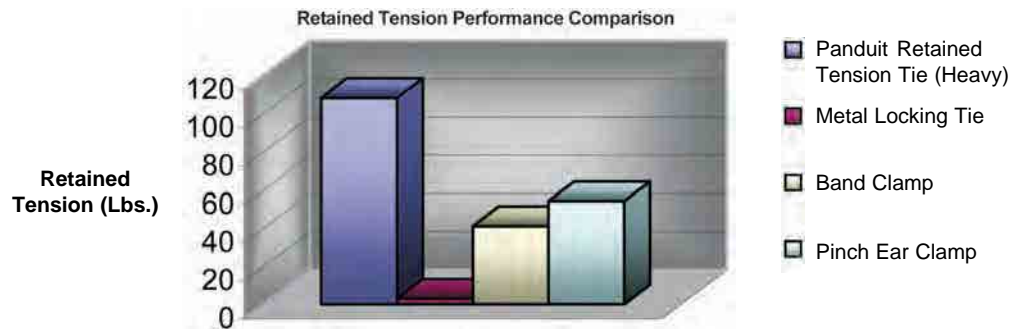

**Representative sample, actual results may vary.

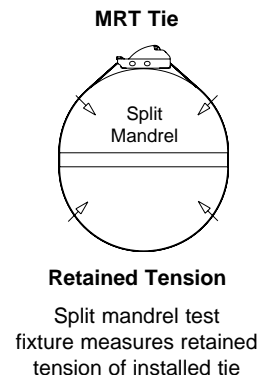

Part Number System for Pan-Steel® Retained Tension Ties – MRT Series

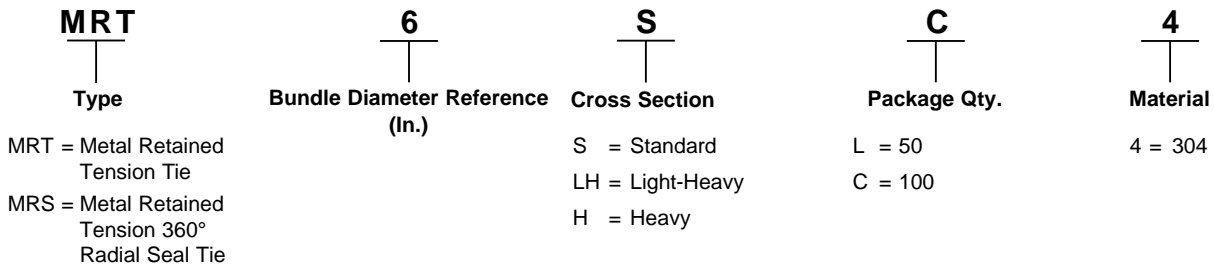

Pan-Steel® Retained Tension Ties – MRT Series

- Provide tight bundling of armored cables, pipes, conduit and other rigid materials in harsh conditions for a reliable, easy to install fastening solution
- Self-locking cable tie design locks into place at any length along the tie body, unlike fixed diameter band clamps
- Available in AISI 304 stainless steel with a thickness of 0.010" (0.25mm)

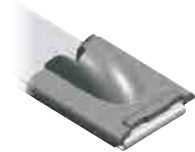

Part Number	Max. Bundle Diameter		Length		Min. Loop Tensile Strength		Min. Bundle Diameter		Width		Recommended Installation Tool***	Std. Pkg. Qty.	Std. Ctn. Qty.
	In.	mm	Ft.	m	Lbs.	N	In.	mm	In.	mm			

AISI 304 Stainless Steel — For General Purpose

Standard Cross Section

MRT1S-C4	1.0	25	9.0	229	180	800	0.75	19.1	0.18	4.4	MTRTLS	100	500
MRT2S-C4	2.0	51	12.2	310	180	800	0.75	19.1	0.18	4.4		100	500
MRT4S-C4	4.0	102	18.5	470	180	800	0.75	19.1	0.18	4.4		100	500
MRT6S-C4	6.0	152	24.8	630	180	800	0.75	19.1	0.18	4.4		100	500

Light-Heavy Cross Section

MRT1.5LH-L4	1.5	38	10.6	269	225	1000	1.00	25.4	0.25	6.4	MTRTLS	50	250
MRT2LH-L4	2.0	51	12.2	310	225	1000	1.00	25.4	0.25	6.4		50	250
MRT4LH-L4	4.0	102	18.5	470	225	1000	1.00	25.4	0.25	6.4		50	250
MRT6LH-L4	6.0	152	24.8	630	225	1000	1.00	25.4	0.25	6.4		50	250

Heavy Cross Section

MRT1.5H-L4	1.5	38	10.6	269	400	1780	1.00	25.4	0.31	7.9	MTRTLS	50	250
MRT2H-L4	2.0	51	12.2	310	400	1780	1.00	25.4	0.31	7.9		50	250
MRT4H-L4	4.0	102	18.5	470	400	1780	1.00	25.4	0.31	7.9		50	250
MRT6H-L4	6.0	152	24.8	630	400	1780	1.00	25.4	0.31	7.9		50	250

Double Wrapped — For Additional Strength

Standard Cross Section

MRT1.5DS-C4	1.5	38	14.4	366	250	1112	1.00	25.4	0.17	4.4	MTRTLS	100	500
MRT2.5DS-C4	2.5	63	20.7	526	250	1112	1.00	25.4	0.17	4.4		100	500

Light-Heavy Cross Section

MRT2.5DLH-L4	2.5	63	20.7	526	350	1556	1.00	25.4	0.25	6.4	MTRTLS	50	250
--------------	-----	----	------	-----	-----	------	------	------	------	-----	--------	----	-----

Heavy Cross Section

MRT2DH-L4	2.0	51	18.5	470	550	2447	1.00	25.4	0.31	7.9	MTRTH	50	250
MRT4DH-L4	4.0	102	31.1	790	550	2447	1.00	25.4	0.31	7.9		50	250

***For information on installation tools, refer to www.panduit.com/tools.

Pan-Steel® 360° Radial Seal Retained Tension Ties – MRS Series

- 360° radial seal eliminates gaps under the head of the tie to provide a completely sealed installation
- Available in AISI 304 stainless steel with a thickness of 0.010" (0.25mm)
- Self-locking cable tie design locks into place at any length along the tie body, unlike fixed diameter band clamps



Part Number	Max. Bundle Diameter		Length		Min. Loop Tensile Strength		Min. Bundle Diameter		Width		Recommended Installation Tool***	Std. Pkg. Qty.	Std. Ctn. Qty.
	In.	mm	Ft.	m	Lbs.	N	In.	mm	In.	mm			

AISI 304 Stainless Steel — For General Purpose

Standard Cross Section

Part Number	In.	mm	Ft.	m	Lbs.	N	In.	mm	In.	mm	Recommended Installation Tool***	Std. Pkg. Qty.	Std. Ctn. Qty.
MRS1S-C4	1.0	25	9.0	229	180	800	0.75	19.1	0.18	4.4	MTRTLS	100	500
MRS2S-C4	2.0	51	12.2	310	180	800	0.75	19.1	0.18	4.4		100	500
MRS4S-C4	4.0	102	18.5	470	180	800	0.75	19.1	0.18	4.4		100	500
MRS6S-C4	6.0	152	24.8	630	180	800	0.75	19.1	0.18	4.4		100	500

Light-Heavy Cross Section

Part Number	In.	mm	Ft.	m	Lbs.	N	In.	mm	In.	mm	Recommended Installation Tool***	Std. Pkg. Qty.	Std. Ctn. Qty.
MRS1.5LH-L4	1.5	38	10.6	269	225	1000	1.00	25.4	0.25	6.4	MTRTLS	50	250
MRS2LH-L4	2.0	51	12.2	310	225	1000	1.00	25.4	0.25	6.4		50	250
MRS4LH-L4	4.0	102	18.5	470	225	1000	1.00	25.4	0.25	6.4		50	250
MRS6LH-L4	6.0	152	24.8	630	225	1000	1.00	25.4	0.25	6.4		50	250

Heavy Cross Section

Part Number	In.	mm	Ft.	m	Lbs.	N	In.	mm	In.	mm	Recommended Installation Tool***	Std. Pkg. Qty.	Std. Ctn. Qty.
MRS1.5H-L4	1.5	38	10.6	269	400	1780	1.00	25.4	0.31	7.9	MTRTLS	50	250
MRS2H-L4	2.0	51	12.2	310	400	1780	1.00	25.4	0.31	7.9		50	250
MRS4H-L4	4.0	102	18.5	470	400	1780	1.00	25.4	0.31	7.9		50	250
MRS6H-L4	6.0	152	24.8	630	400	1780	1.00	25.4	0.31	7.9		50	250

***For information on installation tools, refer to www.panduit.com/tools.

Features and Benefits – Pan-Steel® Strapping System

The Panduit® Pan-Steel® Stainless Steel Strapping is the ultimate solution for strapping applications. The buckle design and tension controlled installation tool offer a quick and safe installation for all harsh environments. Available in four widths 3/8" (9.5mm), 1/2" (12.7mm) 5/8" (15.9mm) and 3/4" (19.1mm) in base 201 (3/4" width only), 304, or 316 stainless steel with a temperature range of -60°C (76°F) to 1000°F (538°C).

Unique Locking Methods Pan-Steel® Stainless Steel Strapping

***Patented Hooked Clamping Tab**

Bends strap body within retention area of buckle for increased loop tensile strength and full coverage of cut end of strap

***Patented Cross Rib Support**

Enhanced rigidity for higher loop tensile strength

Buckle Design

Provides a low finished profile

***Patented Concave Cross Section**

Enhanced support to improve tensile strength

***Patented Concave Buckle Recess**

Increases body resistance for increased loop tensile strength

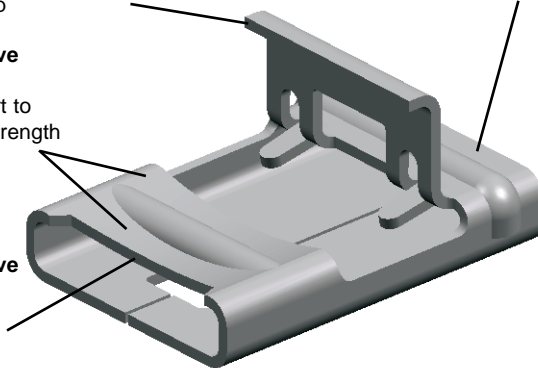

No Sharp Edges

After tensioning, cut end is locked inside buckle

Pan-Steel® Stainless Steel MS75 Strapping

Hooked Clamping Tab

Provides full coverage of cut end of strap for enhanced safety

Buckle Screwdriver Slot

Allows use of screwdriver for buckle closure for a simple quick installation

No Sharp Edges

After tensioning, cut end is locked inside buckle

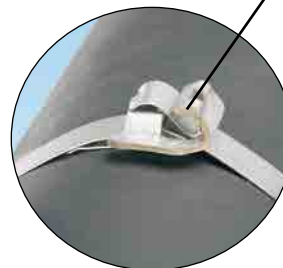
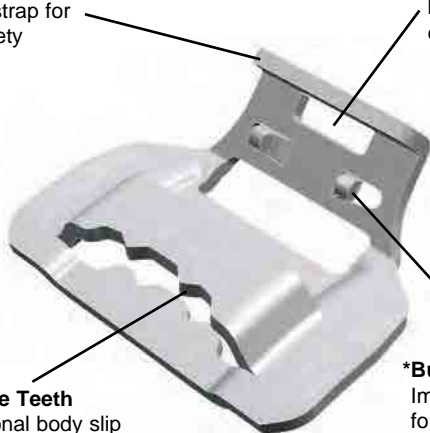

Buckle Bridge Teeth

Deliver additional body slip resistance for optimum strength

***Buckle Locking Tabs**

Improve locking mechanism for higher strength

*Patented



Custom length strapping available for applications that require various bundle diameters, to provide job safety and versatility with minimum inventory. See page B3.21.

The Panduit Method Reduces Installation Time

Pan-Steel® Stainless Steel Strapping



1) Place strap around the material, insert tail of strap through buckle. Pull strapping tight and bend up to hold in place. Insert tail of strapping into tool nose section. Squeeze handle to tension.



2) Once proper tension is reached, maintain tension and raise tool 90° – 120° over buckle and pull down on cutter lever, cutting strap.



3) Remove tool, press cut end down and toward retaining tab.



4) Using the closure lever on the handle of the tool, bend retaining tab down and over cut end.



Provides finished, safe, and secure closure.

Pan-Steel® Stainless Steel MS75 Strapping



1) Place strap around the material, insert tail of strap through buckle. Pull strapping tight and bend up to hold in place.

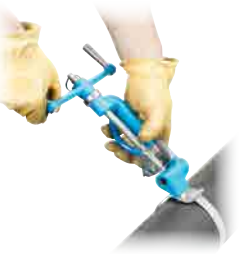

2) Insert tail of strapping into tool nose section. Rotate handle to tension.



3) After tensioning raise tool 90° – 120° over buckle and pull down on cutter lever, cutting strap.



4) Remove tool, press cut end down toward retaining tab.



5) Using flathead screwdriver, bend retaining tab down and over cut end.



Provides finished, safe, and secure closure.

Part Number System for Discrete Length Strapping

MS	4	W	38	T	15	L	4
Type	Bundle Diameter (In.)	Width	Inches	Thickness	15 = 0.015" 30 = 0.030"	Standard Package Size	Material
MS = Metal Strap MSC = Metal Strap Coated			38 = 3/8 50 = 1/2 63 = 5/8 75 = 3/4			L = 50 Pcs. Q = 25 Pcs.	2 = 201 SS 4 = 304 SS 6 = 316 SS

Pan-Steel® Strapping – MS Series

- Fold over design provides high-retained tension in mechanical fastening and cable bundling applications
- After tensioning, cut end is locked inside low profile buckle – no sharp edges
- Can be used in a wide range of indoor, outdoor, and underground (including direct burial) applications
- Smooth surfaces and rounded edges assures cable protection and worker safety
- Available in AISI 201 (3/4" width only) and 304 stainless steel for general-purpose applications
- Available in AISI 316 stainless steel for the most corrosive environments



Part Number	Max. Bundle Diameter		Length*		Strap Breaking Strength		Min. Bundle Diameter		Width		Thickness		Recommended Installation Tool***	Std. Pkg. Qty.	Std. Ctn. Qty.
	In.	mm	In.	mm	Lbs.	N	In.	mm	In.	mm	In.	mm			
AISI 201 Stainless Steel															
MS4W75T30-Q2	4.0	102	20.2	513	2400	10656	1.00	25.4	0.75	19.1	0.030	0.76	BT75SDT	25	25
MS6W75T30-Q2	6.0	152	26.5	673	2400	10656	1.00	25.4	0.75	19.1	0.030	0.76		25	25
MS8W75T30-Q2	8.0	203	32.7	831	2400	10656	1.00	25.4	0.75	19.1	0.030	0.76		25	25
MS10W75T30-Q2	10.0	254	39.0	991	2400	10656	1.00	25.4	0.75	19.1	0.030	0.76		25	25
AISI 304 Stainless Steel															
MS2W38T15-L4	2.0	51	11.8	300	502	2229	1.00	25.4	0.38	9.5	0.015	0.38	BT2HT	50	250
MS4W38T15-L4	4.0	102	18.0	457	502	2229	1.00	25.4	0.38	9.5	0.015	0.38		50	250
MS6W38T15-L4	6.0	152	24.4	620	502	2229	1.00	25.4	0.38	9.5	0.015	0.38		50	250
MS8W38T15-L4	8.0	203	30.7	780	502	2229	1.00	25.4	0.38	9.5	0.015	0.38		50	250
MS10W38T15-L4	10.0	254	37.0	940	502	2229	1.00	25.4	0.38	9.5	0.015	0.38		50	250
MS4W50T15-L4	4.0	102	18.0	457	671	2979	1.00	25.4	0.50	12.7	0.015	0.38		50	250
MS6W50T15-L4	6.0	152	24.4	620	671	2979	1.00	25.4	0.50	12.7	0.015	0.38		50	250
MS8W50T15-L4	8.0	203	30.7	780	671	2979	1.00	25.4	0.50	12.7	0.015	0.38		50	250
MS10W50T15-L4	10.0	254	37.0	940	671	2979	1.00	25.4	0.50	12.7	0.015	0.38		50	250
MS4W63T15-L4	4.0	102	18.0	457	839	3725	1.00	25.4	0.63	15.9	0.015	0.38		50	250
MS6W63T15-L4	6.0	152	24.4	620	839	3725	1.00	25.4	0.63	15.9	0.015	0.38		50	250
MS8W63T15-L4	8.0	203	30.7	780	839	3725	1.00	25.4	0.63	15.9	0.015	0.38		50	250
MS10W63T15-L4	10.0	254	37.0	940	839	3725	1.00	25.4	0.63	15.9	0.015	0.38		50	250

*Other lengths, thickness and material grade (316SS) available, contact Panduit Customer Service or refer to www.panduit.com.

***For information on installation tools, refer to www.panduit.com/tools.

Pan-Steel® Nylon 11 Coated Strapping – MSC Series

- Fold over design provides high-retained tension in mechanical fastening and cable bundling applications
- After tensioning, cut end is locked inside low profile buckle – no sharp edges
- AISI 316 stainless steel for the most corrosive environments
- Available in 0.38 inch (9.5mm), 0.50 inch (12.7mm), 0.63 inch (15.9mm) cross sections
- UV resistant, low smoke, halogen-free material
- Temperature tolerance -40°F (-40°C) to 285°F (140°C)



Part Number	Max. Bundle Diameter		Length*		Strap Breaking Strength		Min. Bundle Diameter		Width		Thickness^		Recommended Installation Tool***	Std. Pkg. Qty.	Std. Ctn. Qty.
	In.	mm	Ft.	m	Lbs.	N	In.	mm	In.	mm	In.	mm			
MSC2W38T15-L6	2.0	51	11.8	300	502	2229	1.00	2.54	0.38	9.5	0.015	0.38	BT2HT	50	250
MSC4W38T15-L6	4.0	102	18.0	457	502	2229	1.00	2.54	0.38	9.5	0.015	0.38		50	250
MSC6W38T15-L6	6.0	152	24.4	620	502	2229	1.00	2.54	0.38	9.5	0.015	0.38		50	250
MSC8W38T15-L6	8.0	203	30.7	780	502	2229	1.00	2.54	0.38	9.5	0.015	0.38		50	250
MSC10W38T15-L6	10.0	254	37.0	940	502	2229	1.00	2.54	0.38	9.5	0.015	0.38		50	250
MSC4W50T15-L6	4.0	102	18.0	457	671	2979	1.00	2.54	0.50	12.7	0.015	0.38		50	250
MSC6W50T15-L6	6.0	152	24.4	620	671	2979	1.00	2.54	0.50	12.7	0.015	0.38		50	250
MSC8W50T15-L6	8.0	203	30.7	780	671	2979	1.00	2.54	0.50	12.7	0.015	0.38		50	250
MSC10W50T15-L6	10.0	254	37.0	940	671	2979	1.00	2.54	0.50	12.7	0.015	0.38		50	250
MSC4W63T15-L6	4.0	102	18.0	457	839	3725	1.00	2.54	0.63	15.9	0.015	0.38		50	250
MSC6W63T15-L6	6.0	152	24.4	620	839	3725	1.00	2.54	0.63	15.9	0.015	0.38		50	250
MSC8W63T15-L6	8.0	203	30.7	780	839	3725	1.00	2.54	0.63	15.9	0.015	0.38		50	250
MSC10W63T15-L6	10.0	254	37.0	940	839	3725	1.00	2.54	0.63	15.9	0.015	0.38		50	250

*Other lengths available, contact Panduit Customer Service.

***For information on installation tools, refer to www.panduit.com/tools.

^Base material less coating.

Pan-Steel® Custom Length Strapping

- Fold over design provides high retained tension in mechanical fastening and cable bundling applications
- After tensioning, cut end is locked inside low profile buckle – no sharp edges
- For applications that require various bundle diameters
- Supplied in reels of 82.5 feet (25m) (coated) or 100 feet (30.5m) (uncoated)
- Provides job site versatility with minimum inventory
- Packaging speeds removal of steel and includes bundle diameter cut-off guide
- Available in AISI 201 (3/4" width only) and 304 stainless steel for general-purpose applications
- Available in AISI 316 stainless steel for the most corrosive environments

Nylon 11 coating (optional):

- Nylon 11 coating provides additional edge protection and prevents corrosion between dissimilar metals
- UV resistant, low smoke, halogen-free material
- Temperature tolerance -40°F (-40°C) to 285°F (140°C)
- AISI 316 stainless steel for the most corrosive environments

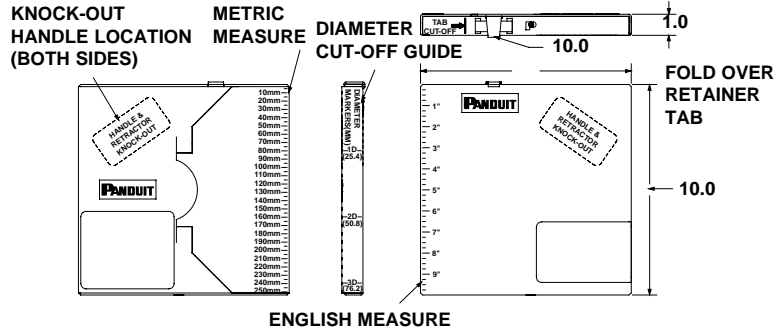

Part Number	Length*		Strap Breaking Strength		Width		Thickness [^]		Used With Buckle	Recommended Installation Tool***	Std. Pkg. Qty.‡
	Ft.	m	Lbs.	N	In.	mm	In.	mm			
201 Stainless Steel											
MSW75T30-CR2	100	30.5	2400	10656	0.75	19.1	0.030	0.80	MSBW75-C2	BT75SDT	1
304 Stainless Steel											
MSW38T15-CR4	100	30.5	502	2229	0.38	9.5	0.015	0.38	MSBW38-C4	BT2HT	1
MSW50T15-CR4	100	30.5	671	2979	0.50	12.7	0.015	0.38	MSBW50-C4		1
MSW63T15-C4	100	30.5	839	3275	0.63	15.9	0.015	0.38	MSBW63-C4		1
Coated Custom Length Strapping											
MSCNW38T15-QR6	82.5	25.0	502	2229	0.38	9.5	0.015	0.38	MSBW38-C6	BT2HT	1
MSCNW50T15-QR6	82.5	25.0	671	2979	0.50	12.7	0.015	0.38	MSBW50-C6		1
MSCNW63T15-QR6	82.5	25.0	839	3275	0.63	15.9	0.015	0.38	MSBW63-C6		1

*Other lengths, thickness and material grade (316SS) available, contact Panduit Customer Service or refer to www.panduit.com. ‡Order in number of reels required.***For information on installation tools, refer to www.panduit.com/tools.

To determine the proper amount of strapping required, use the following formula:

Calculate Diameter inches (mm) x 3.14 + 6 inches (152.4 mm)

Pan-Steel® Buckles for Custom Length Strapping

- Buckle design provides a low finished profile
- After tensioning cut end is locked inside buckle – no sharp edges



Part Number	Material	Width		Part Description	Std. Pkg. Qty.	Std. Ctn. Qty.
		In.	mm			
AISI 201 Stainless Steel						
MSBW75-C2	201	0.75	19.1	Individual low profile buckles used with metal strapping.	100	—
AISI 304 Stainless Steel						
MSBW38-C4	304	0.38	9.5	Individual low profile buckles used with custom length strapping	100	1000
MSBW50-C4	304	0.50	12.7		100	1000
MSBW63-C4	304	0.63	15.9		100	1000

PCS Cushion Sleeve

- Black neoprene sleeving used with Pan-Steel® Stainless Steel Ties, custom length banding, and MS strap
- Used on applications requiring improved gripping on non-resilient objects
- Can be used indoors or outdoors (excellent ultraviolet resistance, good resistance to petroleum, and many chemicals)
- Isolation between dissimilar metals allows the ties and straps to be used with aluminum cable tray
- Provides full separation between the ties and the bundle
- Operating temperature range -40°F (-40°C) to 200°F (93°C)



Part Number	Used with Pan-Steel® Ties/Strapping	Width		Length		Std. Pkg. Qty. (reels)‡
		In.	mm	Ft.	m	
PCSS-B-CR	MLT/S	0.33	8.4	100	30.5	1
PCSH-B-CR	MLT/LH/H	0.47	11.9	100	30.5	1
PCSSH-B-CR*	MLT/EH/SH and MS Straps	0.91	23.1	100	30.5	1
PCSLSH-B-CR	MLT/EH/SH and MS Straps	1.05	26.8	100	30.5	1

*Meets MIL-R-6855
‡Order in number of reels required.
Pkg. -CR = 100 ft. (30.5m) reel.

Metal Uniclip Brackets

- Allows Panduit stainless steel ties and straps to be installed on any style or design of cable tray; slotted or un-slotted
- Eliminate consideration of diagonal installations
- High resistance to lateral and axial movement



Part Number	Material	Used with Pan-Steel® Ties	Description
UCSQ1-VC	Galvanized Steel	MLTS/LH/H/EH/EH15/SH, MLTC/H, MLTFC/S/LH/H/EH/SH, or MSW75	Universal Metal Rung Bracket – Strut Type
UCRND1-VC			Universal Metal Rung Bracket – Round
UCIB1-VC			Universal Metal Rung Bracket – I-Beam
UCTH1-VC			Universal Metal Rung Bracket – Top Hat
UCSQ1-V316	Stainless Steel Type 316		Universal Metal Rung Bracket – Strut Type
UCRND1-V316			Universal Metal Rung Bracket – Round
UCIB1-V316			Universal Metal Rung Bracket – I-Beam
UCTH1-V316			Universal Metal Rung Bracket – Top Hat

Contact Customer Service for additional sizes, styles, or material grade.

Stainless Steel Tie Mounts

- Low profile
- One hole mounting



- For use with standard, light-heavy, and heavy cross section Pan-Steel® Ties as well as 0.38 inch (9.5mm) wide strapping
- 304 Stainless Steel

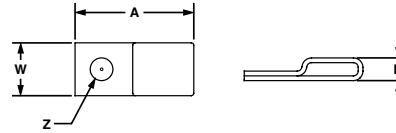

Part Number	Used with Pan-Steel® Ties/Strapping	Mounting Method*	Length A		Width W		Height H		Hole Diameter Z		Used With Buckle	Std. Pkg. Qty.	Std. Ctn. Qty.
			In.	mm	In.	mm	In.	mm	In.	mm			
MTM1H-C	MLTS/LH/H, MLTC/H, MLTFC/S/LH/H or MSW38	#8 (4mm) screw	0.90	22.6	0.40	10.2	0.17	4.4	0.17	4.4	MSBW75-C2	100	1000
MTM1H10-C		#10 (5mm) screw	0.90	22.6	0.40	10.2	0.17	4.4	0.21	5.4	MSBW38-C4	100	1000
MTM1H25-C		1/4" (6mm) screw	0.90	22.6	0.40	10.2	0.17	4.4	0.28	7.1	MSBW50-C4	100	1000

*Stainless steel screws are recommended for fastening to avoid corrosion problems associated with dissimilar metals. Contact Customer Service for additional sizes and material grades available.

Stainless Steel Push Mount

- No tapping required
- Used where only one side of the panel is accessible
- Nothing to assemble



- For use with standard, light-heavy, and heavy cross section Pan-Steel® Ties
- 304 Stainless Steel

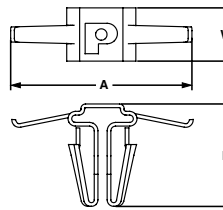

Part Number	Used with Pan-Steel® Ties/Strapping	Mounting Method	Length A		Width W		Height H		Panel Thickness		Std. Pkg. Qty.	Std. Ctn. Qty.
			In.	mm	In.	mm	In.	mm	In.	mm		
MPWM-H56-Q	MLTS/LH/H, MLTC/H or MLTFC/S/LH/H	Inserted into pre-drilled hole 5/16" (8mm)	0.84	21.3	0.29	7.3	0.56	14.2	0.03 – 0.09	0.8 – 2.4	25	250

Stainless Steel Push Button Mount

- Low profile
- No tapping required
- Designed for use only where both sides of the panel are accessible

- For use with standard cross section Pan-Steel® Ties
- 304 Stainless Steel

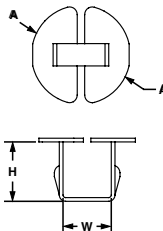

Part Number	Used with Pan-Steel® Ties/Strapping	Mounting Method	Diameter A		Width W		Height H		Panel Thickness		Std. Pkg. Qty.	Std. Ctn. Qty.
			In.	mm	In.	mm	In.	mm	In.	mm		
MBM-H25-Q	MLT/S or MLTFC/S	Inserted into pre-drilled hole 0.25" (6.4mm)	0.40	10.0	0.20	5.0	0.26	6.5	0.03 – 0.12	0.8 – 3.0	25	250

Stainless Steel 2-Way Tie Mount

- Allows stainless steel cable ties to be inserted from either of two sides
- Low profile
- Single hole center mounting for maximum holding and stability

- Maximum screw head height 0.09 inches (2.3mm)
- For use with standard, light-heavy, and heavy cross section Pan-Steel® Ties
- 304 Stainless Steel

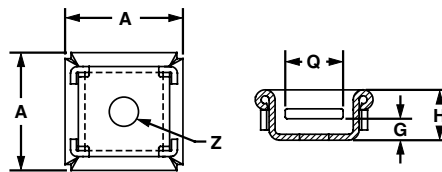

Part Number	Used with Pan-Steel® Ties/Strapping	Mounting Method*	Length A		Height H		Screw Head Height G		Slot Width Q		Hole Diameter Z		Std. Pkg. Qty.	Std. Ctn. Qty.
			In.	mm	In.	mm	Lbs.	N	In.	mm	In.	mm		
MTM2H-Q	MLTS/LH/H, MLTC/H or MLTFC/S/LH/H	#8 (4mm) screw	0.71	18.0	0.30	8.0	0.09	2.3	0.35	9.0	0.17	4.5	25	250

*Stainless steel screws are recommended for fastening to avoid corrosion problems associated with dissimilar metals.

Stainless Steel Bulkhead Mount

- Zero profile
- Mounts directly to surface
- Used where only one side of the panel is accessible

- Permanent, secure application
- Used with standard, light-heavy, and heavy cross section Pan-Steel® Ties
- 304 Stainless Steel

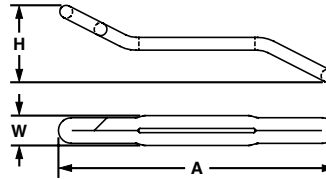

Part Number	Used with Pan-Steel® Ties/Strapping	Mounting Method	Length A		Width W		Height H		Max. Panel Thickness		Std. Pkg. Qty.	Std. Ctn. Qty.
			In.	mm	In.	mm	In.	mm	In.	mm		
MBM-H25-Q	MLTS/LH/H/EH/SH, MLTC/H, or MLTFC/S/LH/H/EH/SH	Pre-drilled hole size standard and light-heavy cross section MLT-S/LH 0.38" (9.5mm) – 0.50" (12.7mm). Heavy cross section MLT-H 0.50" (12.7mm) – 0.63" (15.9mm).	1.92	48.5	0.21	5.3	0.54	13.7	0.50	12.7	25	250

To Install Bulkhead Mount:

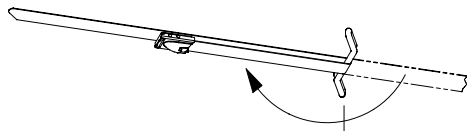

1) Insert cable tie through mount slot and fold cable tie.

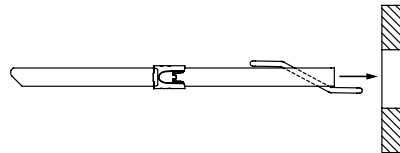

2) Insert cable tie and mount through panel/framework hole.

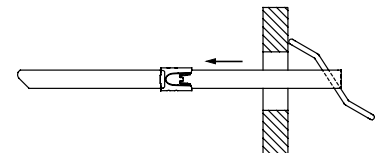

3) Pull cable tie back to secure the mount in the panel/framework.

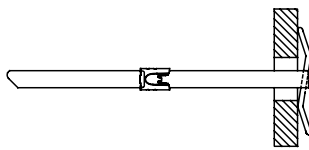

4) Mount shown in correct position for installation.

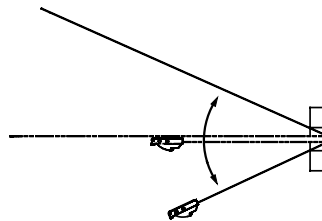

5) Separate cable tie to allow for bundling of cables/wires, etc.

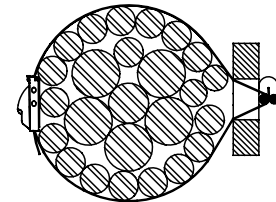











6) Install cable tie around bundle and fasten.

Stainless Steel Technical Information

Physical Characteristics of Stainless Steel and Aluminum

	Pan-Steel® Stainless Steel MS Strapping and Buckles	Pan-Steel® Stainless Steel Cable Ties
Material:	201, 304 and 316 GRADE STAINLESS STEEL	304 and 316 Grade Stainless Steel
MAXIMUM UL TEMPERATURE RATING	1000°F (538°C)	1000°F (538°C)
MINIMUM UL TEMPERATURE RATING	-76°F (-60°C)	-76°F (-60°C)
RoHS:	Compliant	Compliant
Flammability:	Non-Flammable	Non-Flammable
Ultraviolet light resistance:	Excellent	Excellent

Panduit Stainless Steel Cable Tie and Strapping Approvals

Logo (Symbol)	Agency	Spec/Approval	Requirement	Applicable Products
	Underwriters Laboratories, Inc.	Listing E56854	Dimensional, tensile, temp., cycling, humidity	MLT-S, MLT-LH, MLT-H, MLTEH15, MLTSH, MLTDEH and MLTDSH in 304, and 316. MSW38T15, MSW50T15, MSW63T15, MSBW38, MSBW50, MSBW63 in both 304 and 316 material. MSCW38T15, MSCW50T15, MSCW63T15, MSCNW38T15, MLTFCS, SH, MLTCH, MSCNW50T15, and MSW63T15 in 316 material.
	Conformite European	Low Voltage Directive 73/23/EEC (amended 93/68/EEC) MLT cable ties and MS straps also meet the requirements from EN62275	CE Marking is required for products sold within the European Union. CE Marking Directives specify the minimum performance of these products. Applying the CE mark signifies compliance with essential requirements of specific directives.	All MLT, MRT, MRS ties and MS straps.
	Amer. Bureau of Shipping	Cert. #14-HS1189616 PDA	Mechanical	All MLT ties and MS straps.
	Bureau Veritas	Cert. #05968/EO BV	Material specification, dimensional, visual	All uncoated MLT ties in 304 and 316 material.
	Det Norske Veritas	Cert. #E-12387 and E-12388	Salt mist test, tensile test, accelerated aging, vibration tests	All uncoated MLTS, MLTH, MLTE15, MLTDEH15, MLTSH, and MS strap coated and uncoated 316 material.
	Germanischer Lloyd	Cert. #32666-83HH, 51796-89HH	Mechanical	All uncoated stainless steel MLT ties and all MS straps.
	Lloyd's Register of Shipping	Cert. # L5/60006(E1)	Material specification, tensile test, vibration tests	All uncoated stainless steel MLT ties and all MS straps.
	SAE Int'l formerly US MIL	AS23190 formerly MS23109E	Dimensional, visual, vibration, temp. cycling, immersion	MLT-S and MLT-H ties in 304 and 306 material.
	US Coast Guard	File No.16703/46	Mechanical	MLT-H series cable ties.
	US Military	SAE AS81306/MS90387-3	Mechanical	GS4MT installation tools.

Chemical Resistance at 70°F (21°C) Temperature

Chemical	%	304 and 316 Stainless Steel*	Chemical	%	304 and 316 Stainless Steel*	Chemical	%	304 and 316 Stainless Steel*	Chemical	%	304 and 316 Stainless Steel*
Arsenic Acid	40	E	Cider	?	E	Methyl Alcohol	100	E	Sodium Bisulfate	10	E
Acetone	100	E	Dichloroethane	100	E	Methyl Chloride	100	E	Sodium Borate	All	E
Aluminum Hydroxide	AQ C.S.	E	Diethyl Ether	100	E	Methyl Ethyl Ketone	100	E	Sodium Carbonate	5	E
Ammonium Carbonate	5	E	Ethyl Alcohol	100	E	Naphtha	100	E	Sodium Chlorate	25	E
Ammonium Hydroxide	10	E	Ethyl Chloride	100	E	Nitric Acid	30-70	E	Sodium Chloride	2	E
Ammonium Nitrate	100	E	Ethyl Glycol	100	E	Nitrous Acid	5	E	Sodium Fluoride	5	F
Ammonium Sulfate	10	E	Ferric Hydroxide	All	E	Oleic Acid	100	E	Sodium Hydroxide	10	E
Barium Carbonate	All	E	Ferric Nitrate	10	E	Oxalic Acid	10	E	Sodium Hyposulfite	AQ C.S.	E
Barium Chloride	5	E	Ferrous Sulfate	10	E	Paraffin	100	E	Sodium Nitrate	5	E
Barium Sulfate	10	E	Fuel Oil	100	E	Petroleum Ether	100	E	Sodium Nitrite	AQ C.S.	E
Barium Sulfide	10	E	Futural	100	E	Phenol	90	E	Sodium Percolate	10	E
Benzene	100	E	Gallic Acid	AQ C.S.	E	Phosphoric Acid	10	E	Sodium Phosphate	5	E
Benzoic Acid	100	E	Gasoline	100	E	Picric Acid	1	S	Sodium Sulfate	5	E
Butyric Acid	50	E	Glycerine	100	E	Potassium Bromide	AQ C.S.	S	Sodium Thiosulfate	5	S
Calcium Carbonate	AQ C.S.	E	Hydrocyanic Acid	All	E	Potassium Carbonate 1%	1	E	Stearic Acid	100	E
Calcium Chlorate	10	E	Hydrogen Peroxide	30	E	Potassium Chlorate	AQ C.S.	E	Sulfur	100	E
Calcium Hydroxide	20	E	Hydrogen Sulfide	Dry	E	Potassium Dichromate	40	E	Sulfur Dioxide	All	E
Calcium Hydrochlorite	2	F	Iodoform	100	E	Potassium Ferrocyanide	25	E	Sulfuric Acid	100	E
Calcium Sulfate	2	E	Isopropyl Alcohol	100	E	Potassium Hydroxide	5	E	Sulfuric Acid	5	F
Carbon	100	E	Jet Fuel	100	E	Potassium Iodide	All	E	Tannic Acid	10	E
Chlorine (Wet)	Wet	F	Lactic Acid	100	E	Potassium Nitrate	50	E	Tartaric Acid	50	E
Chlorine (Dry)	Dry	F	Lanolin	10	E	Potassium Permanganate	5	E	Tetrahydrofuran	100	E
Chloroacetic Acid	30	F	Lead Acetate	5	E	Potassium Sulfate	5	E	Toluene	100	F
Chloroform	100	E	Magnesium Carbonate	All	E	Potassium Sulfide	AQ C.S.	E	Xylene	100	E
Chromic Acid	5	E	Magnesium Chloride	10	E	Propyl Alcohol	100	E	Zinc Chloride	70	E
Citric Acid	50	E	Magnesium Nitrate	All	E	Silver Nitrate	10	E	Zinc Nitrate	AQ C.S.	E
Copper Cyanide	10	E	Malic Acid	AQ C.S.	E	Sodium Acetate	60	E	Zinc Sulfate	AQ C.S.	E
Copper Nitrate	50	E	Mercury	100	E	Sodium Bicarbonate	All	E			

* E = Excellent, S = Satisfactory, F = Fair, AQ C.S. = Aqueous Cold Saturated, All = All % Concentrations.

Rigorous Tests and Physical Properties of Stainless Steel

STRENGTH: Panduit® Pan-Steel® Stainless Steel Ties and Straps are tested per the SAE Standard AS23190 formerly U.S. Military Specification MIL-S-23190, minimum loop tensile test. This test consists of applying a tie to a split mandrel and then measuring the force required to separate the (two) halves until the tie fails. These minimum loop tensile strengths are given for the various products on pages B3.5 – B3.24.

TEMPERATURE EXTREMES: Panduit® Pan-Steel® Stainless Steel Ties and Straps are 100% stainless steel in the alloy provided (locking head, locking ball, and body all provided from the same grade of material ordered).

Various temperature tests have been successfully completed. One such test is the U.S. Military Temperature Cycling Test per Thermal Shock Method 107, Test Condition B of MIL-STD-202. This test exposes the parts from low temperature -85°F (-65°C) to high temperature 275°F (135°C) to low temperature -85°F (-65°C). After exposure, the parts must be free of cracks, distortions, breaks, release of locking device; and meet the minimum loop tensile requirements.

SHOCK AND VIBRATION: Panduit® Pan-Steel® Standard and Heavy Cross Section ties have passed the U.S. Military random vibration Test Method 214. Test Condition II, Letter J of MIL-STD-202. This test consists of applying parts to a bundle and then vibrating them with random vibration for eight hours in each of two mutually perpendicular directions. The parts are then subjected to further temperature testing and finally have to pass the minimum loop tensile strength test.

Panduit® Pan-Steel® Extra-Heavy, Super-Heavy, MSW50 Strapping and MSW63 Strapping have passed the U.S. Military Shock and Vibration Testing per MIL-STD-167 and MIL-S-901D. The ties were subjected to vibrations in all three planes from 4 – 50 Hz and Shock testing in all three planes utilizing a hammer shock machine.

SALT SPRAY: Panduit® Pan-Steel® Stainless Steel Ties and Straps have been subjected to salt spray tests without signs of corrosion or reduction in performance.

OUTDOOR EXPOSURE: Panduit® Pan-Steel® Stainless Steel Ties and Straps have been exposed outdoors at New Lenox, Illinois USA since 1985. At the printing of this catalog, there has been no sign of corrosion or loss of performance.

FLUID IMMERSION: Panduit® Pan-Steel® Stainless Steel Ties were immersed in: 1-Hydraulic Fluid, 2-Turbine Fuel, 3-Lubricating Oil, and 4-Isopropyl Alcohol for four hours at temperatures of 122°F (50°C). Per SAE Standard AS23190, the parts were then subjected to and passed the minimum loop tensile test.

RADIATION: Installed cable ties of various materials have been exposed to different amounts of radiation to determine the maximum acceptable limit. These tests were conducted by Panduit to determine the acceptability for use in various areas of nuclear power plants (accumulated over 40 year life). Radiation resistance is 2×10^8 rads.



Military Cross Reference (AS23190)

Military Standard Part Number	Panduit Part Number
AS23190/3-1	MLT2S-CP
AS23190/3-1	MLT2S-CP316
AS23190/3-2	MLT4S-CP
AS23190/3-2	MLT4S-CP316
AS23190/3-3	MLT6S-CP
AS23190/3-3	MLT6S-CP316
AS23190/3-4	MLT8S-CP
AS23190/3-4	MLT8S-CP316
AS23190/3-5	MLT2H-LP
AS23190/3-5	MLT2H-LP316
AS23190/3-6	MLT4H-LP
AS23190/3-6	MLT4H-LP316
AS23190/3-7	MLT6H-LP
AS23190/3-7	MLT6H-LP316
AS23190/3-8	MLT8H-LP
AS23190/3-8	MLT8H-LP316
AS23190/3-9	MLT10H-LP
AS23190/3-9	MLT10H-LP316

Wiring Duct

From the smallest wall mounted panels to the largest integrated turnkey systems Panduit® Panduct® Wiring Duct is the premium wire management solution for routing and concealing wiring in electrical control panels. Panduct® Wiring Duct provide solutions for the original equipment manufacturing, transportation, contract manufacturing, maintenance and repair and communications markets. Panduct® Wiring Duct is UL recognized and CSA Certified and most carry the CE mark.

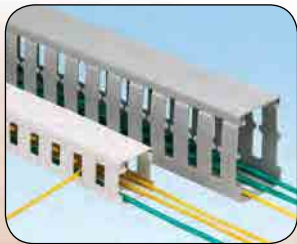
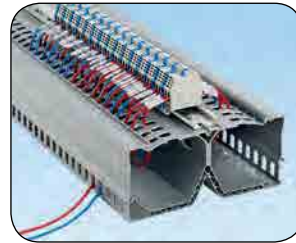
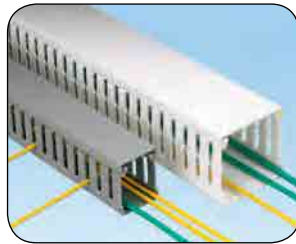
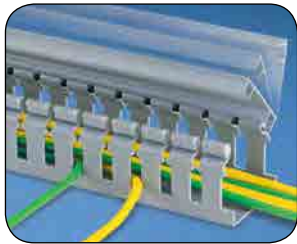
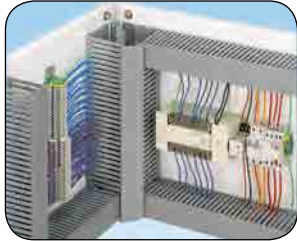

Some of the features and benefits found in Panduct® Wiring Duct include:

- **Smooth corners and edges that will not abrade wiring or irritate hands**
- **Integrated nonskid liners and unique cover designs insure the duct cover will not slide once installed or during vibration**
- **Specially formulated lead-free PVC material meets the NFPA79: 2015 flame retardancy requirements and carries a UL 94V-0 flammability rating**
- **Scorelines for easy removal of duct fingers and sidewalls**
- **Accessories and tools that increase productivity and lower the installed cost**

Panduit continues to develop new Panduct® Wiring Duct solutions to satisfy the challenges facing our customers worldwide. Maximize the utilization of enclosure space with PanelMax™ Corner Wiring Duct, DIN Rail Wiring Duct, and Noise Shield. PanelMax™ Corner Wiring Duct fits into unused space in the corner of enclosures providing up to 20% enclosure space savings*. Integrate component mounting with wire management with PanelMax™ DIN Rail Wiring Duct for up to 30% enclosure space savings. PanelMax™ Noise Shield provides noise mitigation between noisy and sensitive cabling and can reduce air space requirements within the enclosure.

*Versus panel layouts using conventional wiring duct.

Wiring Duct for Control Panel Applications

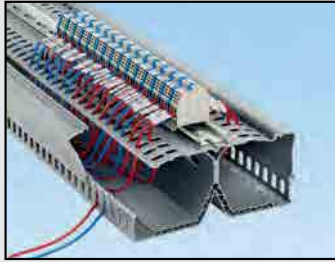

PanelMax™ DIN Rail Wiring Duct 1

Up to 30% space savings vs. conventional duct/rail layouts.

(pages C1.4 – C1.5)



PanelMax™ Shielded Wiring Duct and Noise Shield 2

Shielded products help mitigate noise up to 20 dB or create up to 6 inches of air space.

(pages C1.6 – C1.7)



PanelMax™ Corner Wiring Duct 3

Up to 20% space savings in layouts with side and back panels

(pages C1.8 – C1.9)

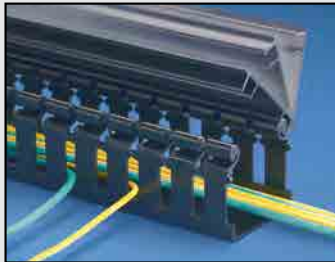

Hinged Cover Wiring Duct 4

Wide slot, narrow slot, and solid wall wiring duct with hinging cover.

(pages C1.10 – C1.12)

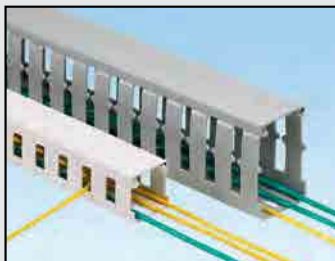

Type NE and NNC Halogen Free Wiring Duct
Up to 203°F (95°C) operating temperature

Type TNC Low-Smoke, Halogen Free Wiring Duct
Up to 221°F (105°C) operating temperature

(pages C1.24 – C1.28)



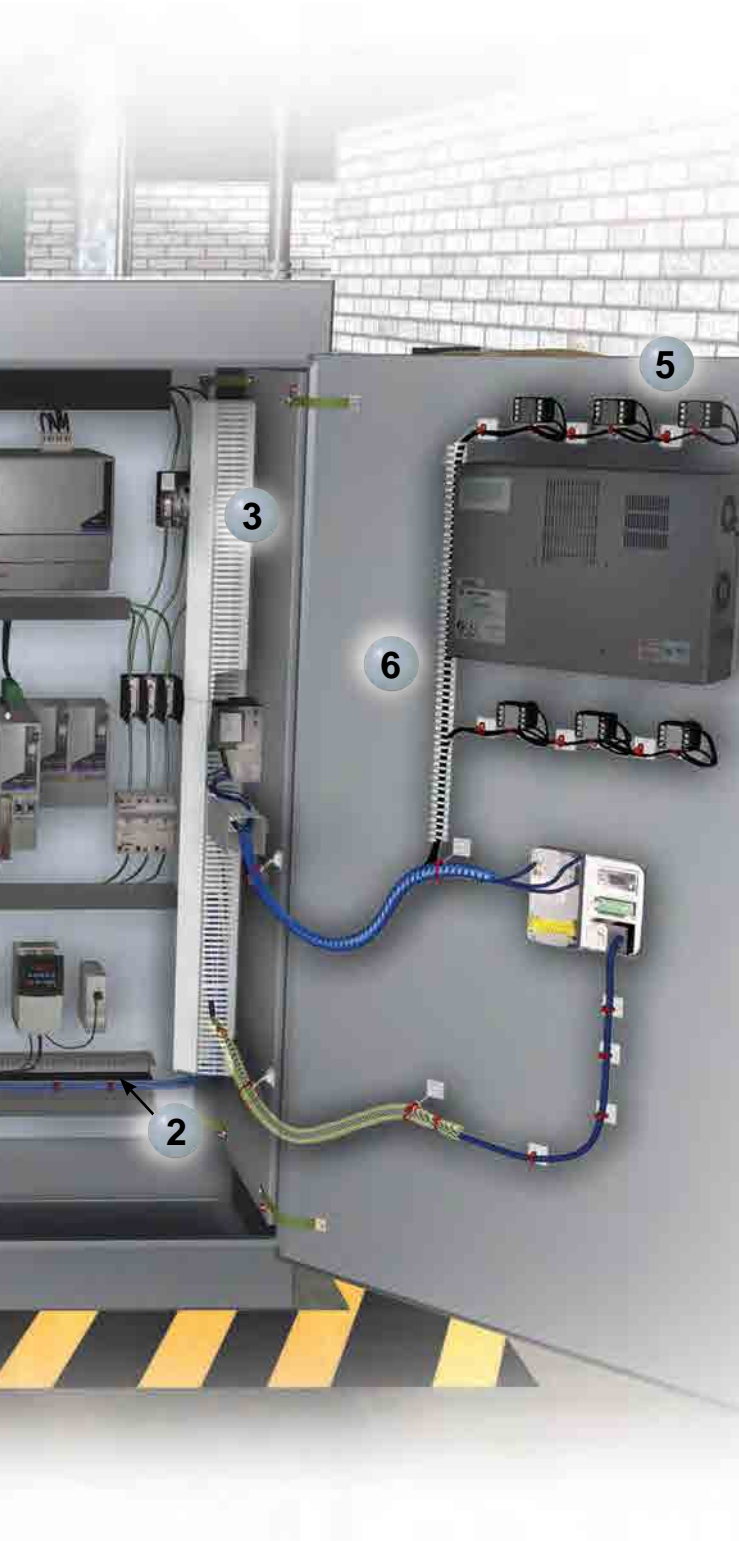

Accessories
(pages C1.29 – C1.36)

5

Type F Narrow Slot Wiring Duct

Narrow slot, narrow finger design fits the spacing of high-density terminal blocks.

(pages C1.16 – C1.17)

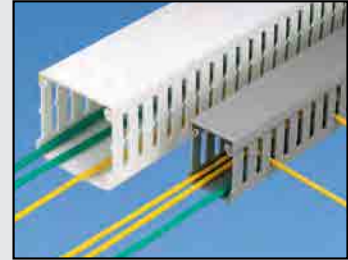

Type G Wide Slot Wiring Duct

Wide slot, wide finger design.

(pages C1.14 – C1.15)

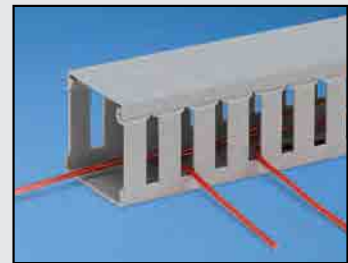

Type D Round Hole Wiring Duct

Multiple rows of holes to retain and support wire of variable heights and positions.

(pages C1.18 – C1.19)

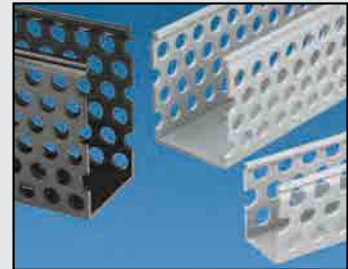

Type MC Metric Wiring Duct

Narrow slot, narrow finger design with DIN 43 659 mounting holes.

(pages C1.20 – C1.21)

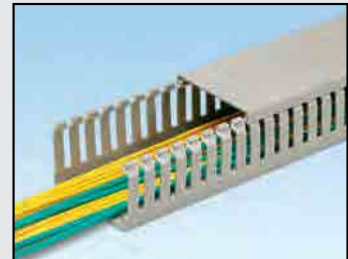

6

Type FL Flexible Wiring Duct

Solution for door mounted push-button wiring or tight spaces without cover access.

(page C1.30)



Features and Benefits – Panduit® PanelMax™ DIN Rail Wiring Duct

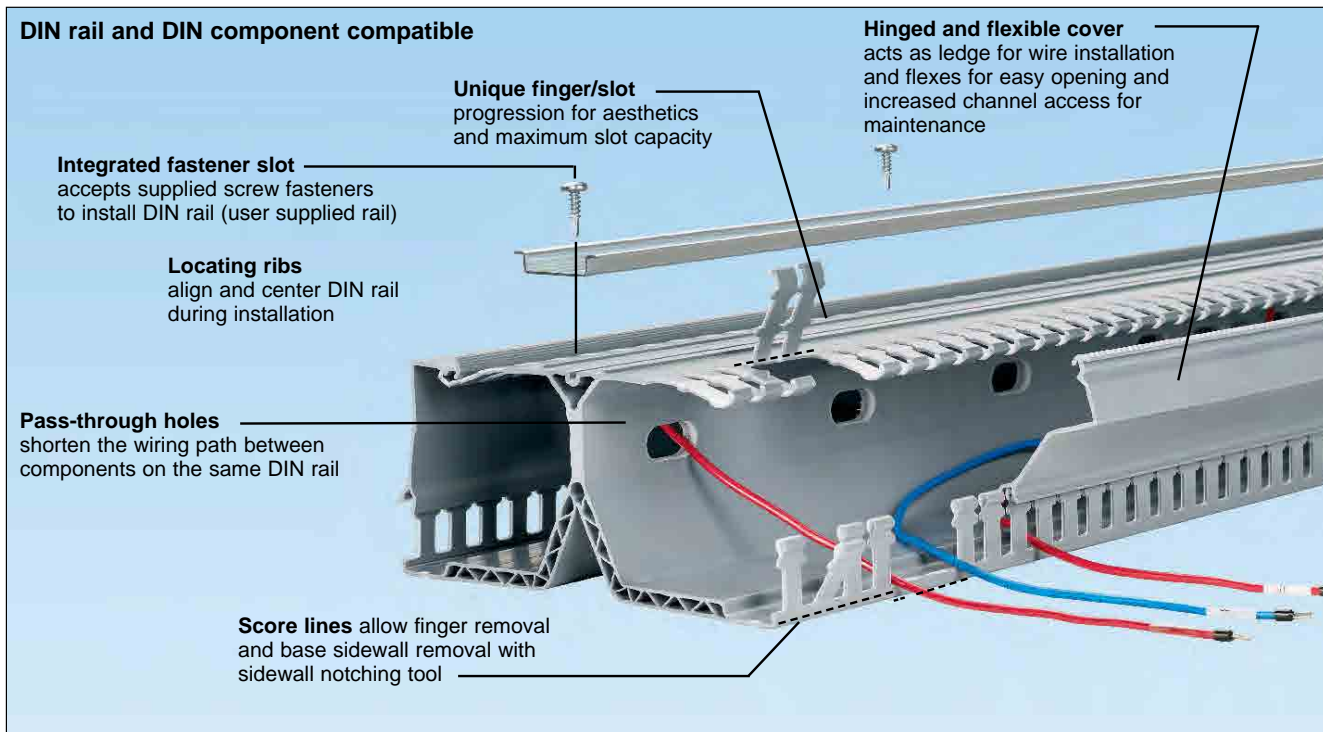

Conventional Wiring Duct Panel Layout:



DIN Rail Wiring Duct Panel Layout with 30% Space Savings:



Panduit® PanelMax™ DIN Rail Wiring Duct positions DIN rail and components off the panel directly above an integrated wire management channel for a 30%+ smaller footprint to the panel layout.

Panduct® PanelMax™ DIN Rail Wiring Duct

- Space saving design positions DIN rail and components off the panel directly above an integrated wire management channel for up to a 30% smaller footprint for duct and components; increased design flexibility and component access for easier installation and maintenance
- DIN rail and DIN component compatible with standard 35mm or 15mm rails and many DIN rail mount components for design flexibility
- Integrated DIN rail fastening slot allows the DIN rail to mount directly to product with plastic thread cutting screws for up to 40% faster duct and rail installation and reduced labor costs
- Hinged cover remains attached during maintenance and upgrades preventing lost covers, ensuring panel integrity, safety and aesthetics; L-shaped cover acts as ledge to aid wire installation for ease of use
- Slotted platform (horizontal) manage the wire from channel mounted components, outer sidewall slots (vertical) manage wire from adjacent panel mounted components; unique finger and slot progression for optimal wire management and aesthetics
- Channel pass through slots allows wires to transition internally between channels to ease wire connections to either side of components mounted on the same rail minimizing wire length and reducing material cost
- Optional wire retainer accessory retains cabling with cover opened or removed easing wire installation and future wire additions



DRD



DRDWR



DRDCS

Part Number	Part Description	Std. Pkg. Qty.	Std. Ctn. Qty.
DRD22LG6	2" height PanelMax™ DIN Rail Wiring Duct with dual wiring channels. 6.25" W x 2.12" H (158.7mm x 54.0mm). Base, covers and DIN rail fasteners included.	6 Ft.	6 Ft.
DRD33LG6	3" height PanelMax™ DIN Rail Wiring Duct with dual wiring channels. 7.25" W x 3.14" H (184.1mm x 79.9mm). Base, covers and DIN rail fasteners included.	6 Ft.	6 Ft.
DRD44LG6	4" height PanelMax™ DIN Rail Wiring Duct with dual wiring channels. 8.23" W x 4.12" H (209.0mm x 104.8mm). Base, covers and DIN rail fasteners included.	6 Ft.	6 Ft.
DRDC2LG6	2" replacement cover for PanelMax™ DIN Rail Wiring Duct. 1.58" W x 72" L (40.1mm x 1828.8mm)	6 Ft.	24 Ft.
DRDC3LG6	3" replacement cover for PanelMax™ DIN Rail Wiring Duct. 2.26" W x 72" L (57.4mm x 1828.8mm)	6 Ft.	24 Ft.
DRDC4LG6	4" replacement cover for PanelMax™ DIN Rail Wiring Duct. 2.76" W x 72" L (70.1mm x 1828.8mm)	6 Ft.	24 Ft.
DRDSF-C	Replacement DIN rail fasteners for PanelMax™ DIN Rail Wiring Duct.	100	—
DRDWR2-X	2" wire retainer for PanelMax™ DIN Rail Wiring Duct.	10	100
DRDWR3-X	3" wire retainer for PanelMax™ DIN Rail Wiring Duct.	10	100
DRDWR4-X	4" wire retainer for PanelMax™ DIN Rail Wiring Duct.	10	100
DRDCS2-X	2" corner strip for PanelMax™ DIN Rail Wiring Duct.	10	100
DRDCS3-X	3" corner strip for PanelMax™ DIN Rail Wiring Duct.	10	100
DRDCS4-X	4" corner strip for PanelMax™ DIN Rail Wiring Duct.	10	100

Product sold base and cover together in 6 ft. lengths. Replace LG with WH for white color. Dimensions in parenthesis are metric.

Features and Benefits – Panduct® PanelMax™ Shielded Wiring Duct and Noise Shield

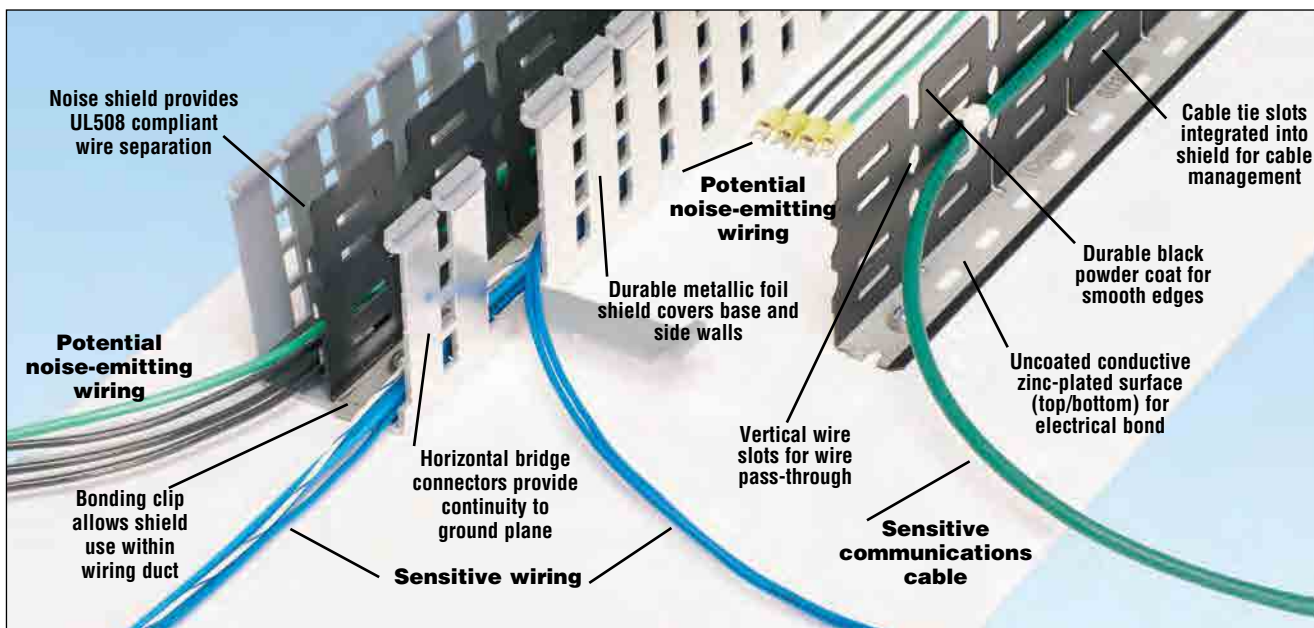

PanelMax™ Noise Shield separates drive cables and sensitive communication/signal cables within industrial control panels to reduce electromagnetic interference (EMI) while saving valuable space.

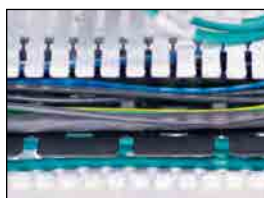

Metal noise barrier equivalent to 6 inches of air spacing between power and signal cables, saves valuable panel space.



Perforated and pre-scored sections make it easy to cut to length with minimal deburring required.



Design Flexibility
Can be installed directly to metal panel surface or within Panduit wiring duct. Compatible with 2", 3", and 4" height wiring ducts.



Bonding Clips
Noise Shield includes four bonding clips when mounting Noise Shield inside wiring duct.

Panduct® PanelMax™ Noise Shield

- Reduces EMI/RFI noise between sensitive and noisy wiring for up to 20dB reduction in noise, or 90% NVR (equivalent to 6 inches of air spacing); innovative design installs easily within Panduit wiring duct or when mounted separately, delivering greater design flexibility to satisfy a wide range of applications
- Perforated and pre-scored sections speed installation by allowing sections of the shield to be snapped off at pre-scored locations to easily cut to length with minimal deburring required
- Vertical wall slots allow wires to cross the barrier at 90° when necessary, providing greater design flexibility

- Horizontal cable tie slots allow cable bundles to be held in place using cable ties so cabling is kept near barrier for greater reliability and optimal aesthetics
- Zinc plated steel surface in contact areas with sub-panel and bonding clip ensures continuity and is corrosion resistant
- Black powder coated vertical surface for smooth edges
- Meets UL 508/508A requirements as a barrier between conductors



PanelMax™ Noise Shield and Bonding Clips

Part Number	Part Description	Std. Pkg. Qty.
SD2EMI	EMI Noise Shield kit for 2" height Panduit Wiring Duct; (2) three foot sections, bonding clips, and anti-oxidizing paste.	1
SD3EMI	EMI Noise Shield kit for 3" height Panduit Wiring Duct; (2) three foot sections, bonding clips, and anti-oxidizing paste.	1
SD4EMI	EMI Noise Shield kit for 4" height Panduit Wiring Duct; (2) three foot sections, bonding clips, and anti-oxidizing paste.	1
SDCLIP	Noise Shield replacement bonding clips – 2 clips.	1

Panduct® PanelMax™ Shielded Wiring Duct

- Durable and continuous metallic foil covers and shields outer duct surfaces providing EMI/RFI noise reduction between sensitive and noisy wiring for up to 20dB reduction in noise, or 90% NVR (equivalent to 6 inches of air spacing)
- Slotted sidewalls with horizontal bridge connectors provide wire management capability and noise reduction in the full height of the duct; slot size compatible with various wire types and sizes, including UTP Ethernet cabling

- High-quality Panduit PVC wiring duct base fully contains and protects wiring, easy to cut and install, and uses standard Panduit wiring duct covers
- Installs with standard fasteners including Panduit NR1 rivets



PanelMax™ Shielded Wiring Duct

Part Number	Part Description	Std. Pkg. Qty.
G2X2LG6EMI	2" x 2" PanelMax™ Shielded Wiring Duct; 6-foot length. Foil metal finish includes anti-oxidizing paste. Cover sold separately.	12
G2X3LG6EMI	2" x 3" PanelMax™ Shielded Wiring Duct; 6-foot length. Foil metal finish includes anti-oxidizing paste. Cover sold separately.	12
G2X4LG6EMI	2" x 4" PanelMax™ Shielded Wiring Duct; 6-foot length. Foil metal finish includes anti-oxidizing paste. Cover sold separately.	12

Use C2LG6 or C2WH6 cover with shielded wiring duct. Standard package quantity in feet.

Performance Characteristics

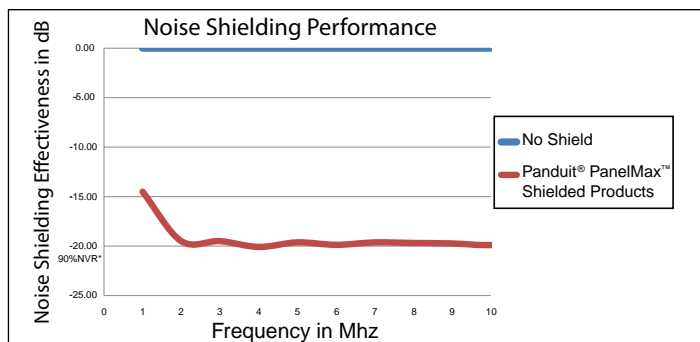

Relative noise reduction in decibels over frequency range of Panduit® PanelMax™ Shielded Wiring Duct and Noise Shield

PanelMax™ Shielded Wiring Duct and Noise Shield deliver approximately 20dB of noise reduction across common industrial noise frequencies at 30mm wire separation with an approximate 1-meter coupling length.

*NVR (Noise Voltage Reduction percentage).

Features and Benefits – Panduct® PanelMax™ Corner Wiring Duct

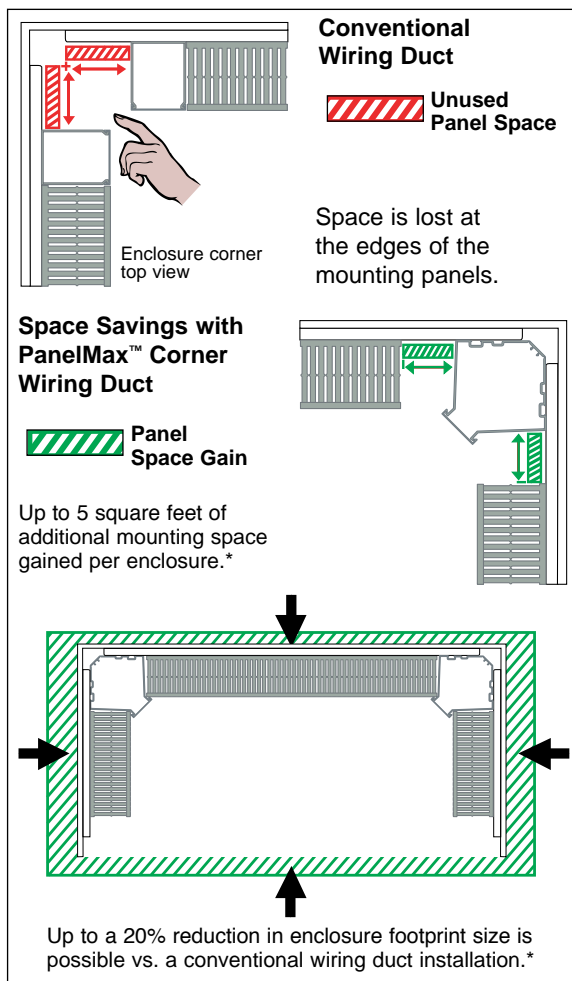
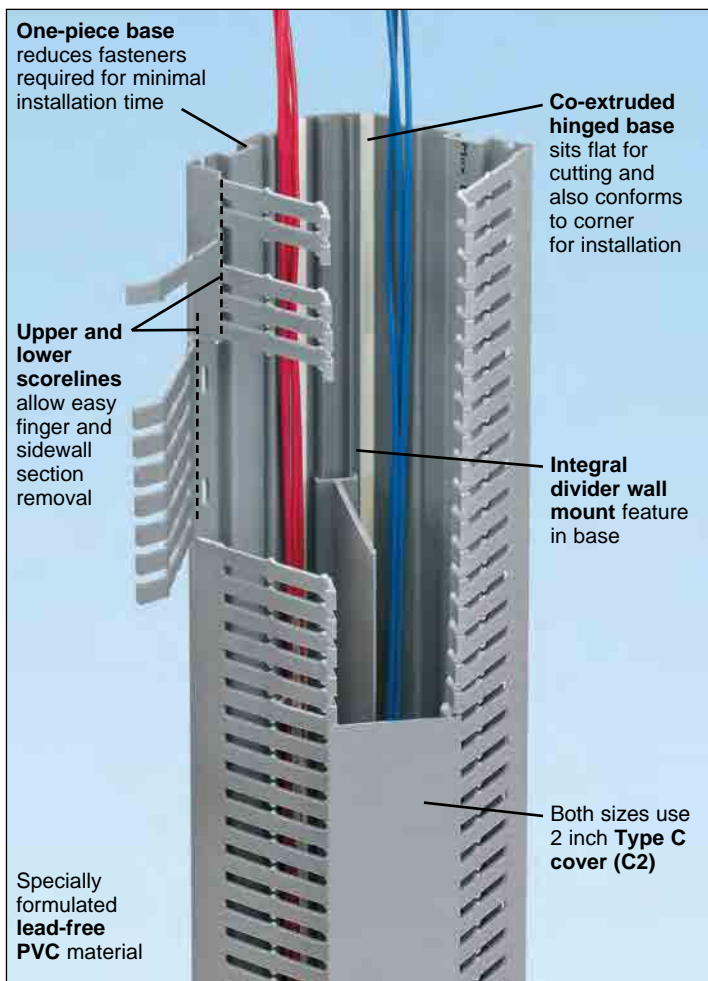

Panduct® Type C Cover with Protective Film

Reduces scrap and labor costs by protecting the surface during storage, handling, and installation.
(see page C1.9)



Panduct® Divider Wall

Creates separate wiring channels within the wiring duct base. Available in solid or slotted wall styles.
(see page C1.30)

*Actual subpanel space savings will vary depending on wiring duct size, component layout, and enclosure size and type. Footprint savings is based on commercially available enclosures and may not be achievable in some applications.

PanelMax™ Corner Wiring Duct

- Fits in the unused space in the vertical corner of enclosures, gaining sub-panel space or saving enclosure footprint area
- One-piece base requires less time to install than multi-piece solutions
- Optional quick mount clips engage anywhere along the product base further reducing assembly costs
- Panduit® divider wall snaps directly to the integrated mounting feature in the channel to create two separate channels
- Compatible with Panduit 2", 3", and 4" height wiring duct; all product sizes use standard 2 inch wiring duct cover
- Base and cover length is 6 feet
- Base and covers sold separately

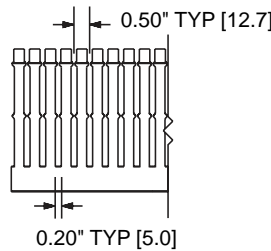
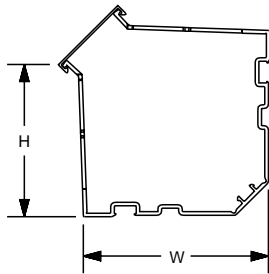

To order cover with protective film add "-F" to part number. 6" cover not available with protective film.



Part Number	Duct Size W x H		Slot Width		Cover Part Number	Std. Pkg. Qty.	Base Ctn. Qty.	Cover Ctn. Qty.
	In.	mm	In.	mm				
CWD2LG6	3.35 x 2.57	85.0 x 65.3	0.2	5.0	C2LG6	6	24	120
CWD3LG6	4.40 x 3.57	111.8 x 90.7	0.2	5.0	C2LG6	6	24	120
CWD4LG6	5.33 x 4.58	135.3 x 115.7	0.2	5.0	C2LG6	6	24	120
CWD2WH6	3.35 x 2.57	85.0 x 65.3	0.2	5.0	C2WH6	6	24	120
CWD3WH6	4.40 x 3.57	111.8 x 90.7	0.2	5.0	C2WH6	6	24	120
CWD4WH6	5.33 x 4.58	135.3 x 115.7	0.2	5.0	C2WH6	6	24	120



Part Number	Part Description	Fastener Size	Std. Pkg. Qty.	Std. Ctn. Qty.
Quick Mount Clips				
CDLB3	L-bracket with quick mounting clip for installing CWD3 to back panel only.	#10-32 x 1/4 (user supplied)	16	—
CDLB4	L-bracket with quick mounting clip for installing CWD4 to back panel only.	#10-32 x 1/4 (user supplied)	16	—
CDCLP2	Quick mounting clip for installing CWD2 corner wiring duct.	#10-32 x 1/4 (user supplied)	16	—
CDCLP3	Quick mounting clip for installing CWD3 corner wiring duct.	#10-32 x 1/4 (user supplied)	16	—
CDCLP4	Quick mounting clip for installing CWD4 corner wiring duct.	#10-32 x 1/4 (user supplied)	16	—

4 brackets are needed for each 6' of corner wiring duct

Features and Benefits – Panduct® Type H and HN Hinged Cover Wiring Duct

Available in eight sizes from 1.5" x 2" up to 4" x 4" in light gray, black, and white colors.

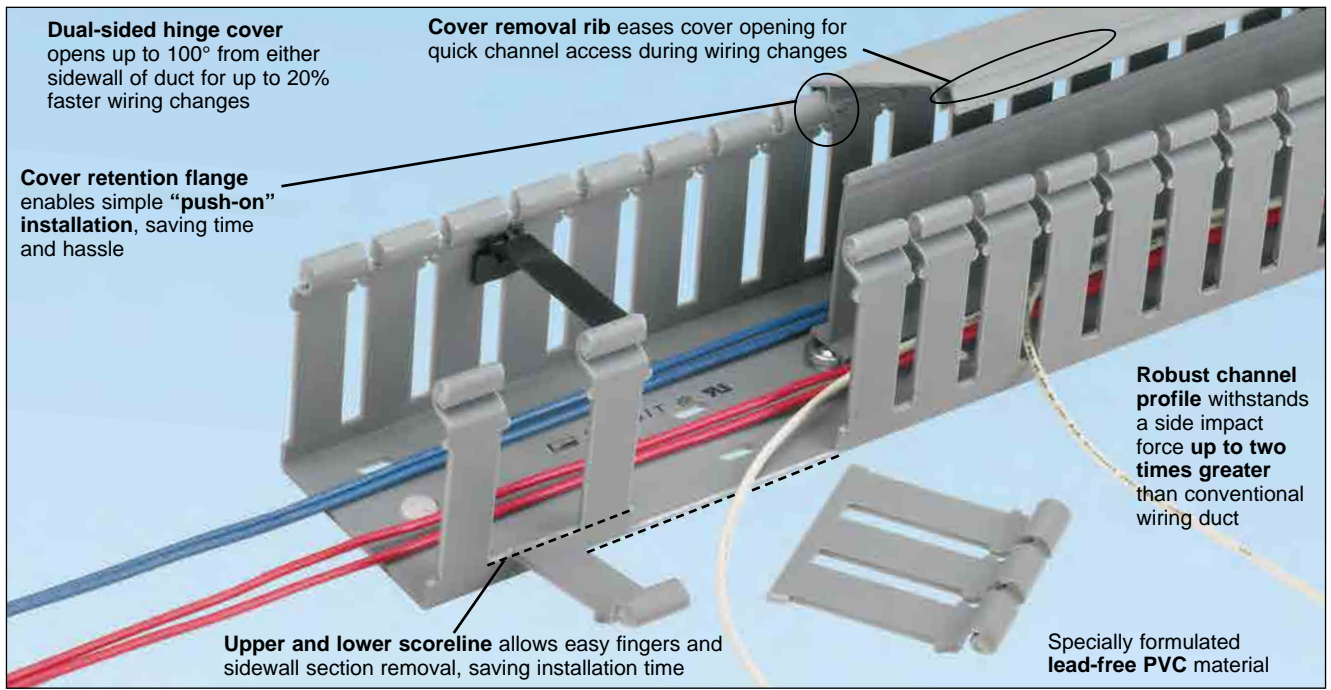

Labor Savings

- By avoiding the time and hassle in removing and replacing covers, simple wiring changes can be made up to **20% faster** compared to conventional wiring duct installations*

Avoid Cover Replacement Costs

- Covers represent 20% of the cost of the wiring duct purchase
- Misplaced covers are a common occurrence after years of use
- Not needing to remove covers during maintenance ensures **better aesthetics and safety** and **avoids the cost to replace lost covers**

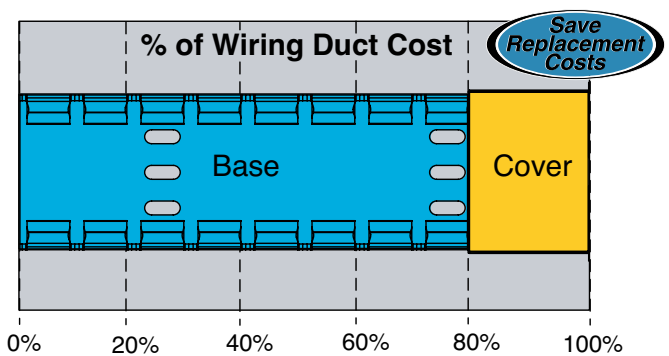

Panduct® Wire Retainers
Contain wiring when duct cover is opened. Wire retainers snap easily between duct fingers.
(see page C1.31)



Panduct® Divider Wall
Create separate wiring channels within the wiring duct base. Available in solid or slotted wall styles.
(see page C1.30)

*Based on mock panel installations of type H hinged cover wiring duct and other commonly available wiring ducts adding a single component with four wires.

Panduct® Type HN Hinged Cover Narrow Slot Wiring Duct

- Narrow slot/finger design provides excellent wire management with smaller wire diameters and high-density components such as terminal blocks, input/output devices, and other hardware
- Material: Lead-free PVC
- UL Recognized continuous use temperature: 122°F (50°C)
- UL 94 flammability rating of V-0
- Conforms with NFPA 79-2015 section 13.3.1 requirement for flame retardant material
- Provided with mounting holes
- Base and cover length is 6 feet

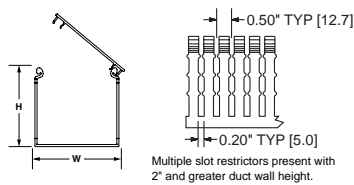
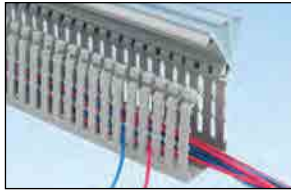

Base Part Number	Duct Size W x H*		Slot Width		Cover Part Number	Std. Pkg. Qty.	Base Ctn. Qty.	Cover Ctn. Qty.
	In.	mm	In.	mm				
HN1.5X2LG6	1.75 x 1.98	44.5 x 50.3	0.20	5.0	HC1.5LG6	6	120	120
HN1.5X3LG6	1.75 x 3.06	44.5 x 77.7	0.20	5.0	HC1.5LG6	6	120	120
HN2X2LG6	2.17 x 1.98	55.1 x 50.3	0.20	5.0	HC2LG6	6	120	120
HN2X3LG6	2.17 x 3.06	55.1 x 77.7	0.20	5.0	HC2LG6	6	60	120
HN2X4LG6	2.17 x 4.10	55.1 x 104.1	0.20	5.0	HC2LG6	6	60	120
HN3X3LG6	3.25 x 3.06	82.6 x 77.7	0.20	5.0	HC3LG6	6	60	120
HN3X4LG6	3.25 x 4.10	82.6 x 104.1	0.20	5.0	HC3LG6	6	60	120
HN4X4LG6	4.25 x 4.10	108.0 x 104.1	0.20	5.0	HC4LG6	6	60	120

Part Number shown for LG (Light Gray). Available in WH (White).
 Base and cover sold separately.
 **"H" dimension includes duct and cover.

Panduct® Type H Hinged Cover Wide Slot Wiring Duct

- Wide slot/finger design provides excellent wire management in general purpose applications and is compatible with a wide range of wire sizes and component types
- Material: Lead-free PVC
- Rated for continuous use temperature: 122°F (50°C)
- UL 94 flammability rating of V-0
- Conforms with NFPA 79-2015 section 13.3.1 requirement for flame retardant material
- Provided with standard mounting holes
- Base and cover length is 6 ft.

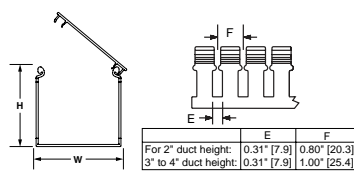
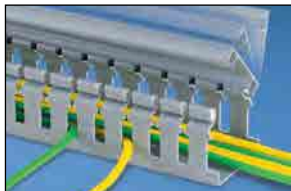

Base Part Number	Duct Size W x H*		Slot Width		Cover Part Number	Std. Pkg. Qty.	Base Ctn. Qty.	Cover Ctn. Qty.
	In.	mm	In.	mm				
H1.5X2LG6	1.75 x 1.98	44.5 x 50.3	0.31	7.9	HC1.5LG6	6	120	120
H1.5X3LG6	1.75 x 3.06	44.5 x 77.7	0.31	7.9	HC1.5LG6	6	120	120
H2X2LG6	2.17 x 1.98	55.1 x 50.3	0.31	7.9	HC2LG6	6	120	120
H2X3LG6	2.17 x 3.06	55.1 x 77.7	0.31	7.9	HC2LG6	6	60	120
H2X4LG6	2.17 x 4.10	55.1 x 104.1	0.31	7.9	HC2LG6	6	60	120
H3X3LG6	3.25 x 3.06	82.6 x 77.7	0.31	7.9	HC3LG6	6	60	120
H3X4LG6	3.25 x 4.10	82.6 x 104.1	0.31	7.9	HC3LG6	6	60	120
H4X4LG6	4.25 x 4.10	108.0 x 104.1	0.31	7.9	HC4LG6	6	60	60

Part Number shown for LG (Light Gray). Available in BL (Black) and WH (White).
 Base and cover sold separately.
 **"H" dimension includes duct and cover.

Panduct® Type HS Hinged Cover Solid Wall Wiring Duct

- Solid wall wiring duct conceals and protects wiring in continuous runs such as in low-voltage cord management applications between control panel stations in conveyor systems
- Material: Lead-free PVC
- UL recognized continuous use temperature: 122°F (50°C)
- UL 94 flammability rating of V-0
- Supplied without mounting holes
- Base and cover length is 6 feet
- Conforms with NFPA 79-2015 section 13.3.1 requirement for flame retardant material

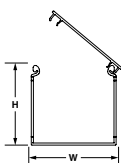

Base Part Number	Duct Size W x H*		Cover Part Number	Std. Pkg. Qty.	Base Ctn. Qty.	Cover Ctn. Qty.
	In.	mm				
HS1.5X2LG6NM	1.75 x 1.98	44.5 x 50.3	HC1.5LG6	6	120	120
HS1.5X3LG6NM	1.75 x 3.06	44.5 x 77.7	HC1.5LG6	6	120	120
HS2X2LG6NM	2.17 x 1.98	55.1 x 50.3	HC2LG6	6	120	120
HS2X3LG6NM	2.17 x 3.06	55.1 x 77.7	HC2LG6	6	120	120
HS2X4LG6NM	2.17 x 4.10	55.1 x 104.1	HC2LG6	6	120	120
HS3X3LG6NM	3.25 x 3.06	82.6 x 77.7	HC3LG6	6	120	120
HS3X4LG6NM	3.25 x 4.10	82.6 x 104.1	HC3LG6	6	120	120
HS4X4LG6NM	4.25 x 4.10	108.0 x 104.1	HC4LG6	6	120	120

Part Number shown for LG (Light Gray). For BL (Black) and WH (White) colors see color selection guide, page C1.50.

Base and cover sold separately.

**"H" dimension includes duct and cover.

Notes

Features and Benefits – Panduct® Type G Wide Slot Wiring Duct

Available in 35 sizes from 0.5" x 0.5" up to 6" x 4" in a variety of colors.

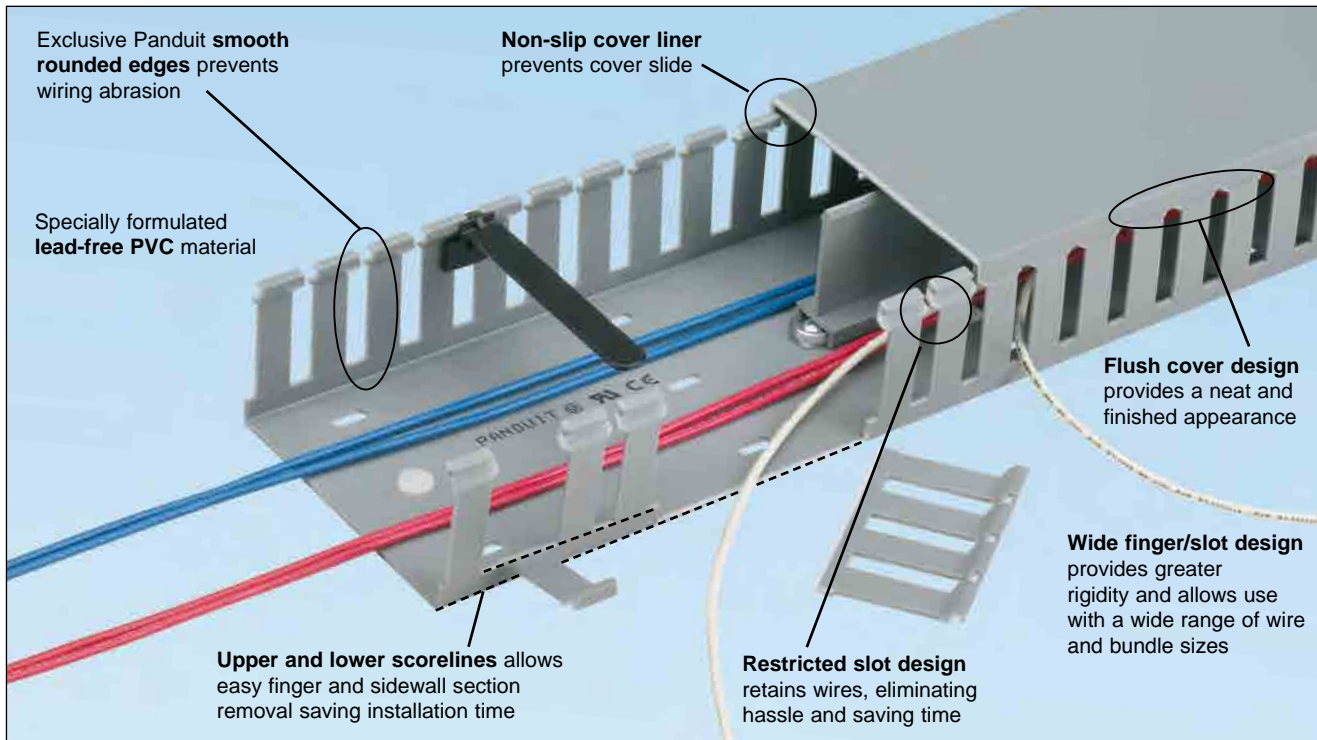

Panduct® Wire Retainers

Contain wiring when duct cover is opened. Wire retainers snap easily between duct fingers.

(see page C1.31)



Panduct® Divider Wall

Create separate wiring channels within the wiring duct base. Available in solid or slotted wall styles.

(see page C1.30)



Panduct® Type C Cover with Protective Film

Reduces scrap and labor costs by protecting the surface during storage, handling, and installation.

(see page C1.15)

UL LISTED **CE** Panduct® Type G Wide Slot Wiring Duct

- Wide slot/finger design provides greater sidewall rigidity and can be used with a wide range of wire bundle sizes
- Material: Lead-free PVC
- UL recognized continuous use temperature: 122°F (50°C)
- UL 94 flammability rating of V-0
- Conforms with NFPA 79-2015 section 13.3.1 requirement for flame retardant material
- Provided with mounting holes
- Base and cover length is 6 feet

B1.
Cable
Ties

B2.
Cable
Accessories

B3.
Stainless
Steel Cable
Ties &
Accessories

C1.
Wiring
Duct

C2.
Abrasion
Protection

C3.
Cable
Management

D1.
Terminals

D2.
Power
Connectors

D3.
Grounding
Connectors

E1.
Labeling
Systems

E2.
Labels

E3.
Pre-Printed
&
Write-On
Markers

E4.
Permanent
Identification

E5.
Industrial
Safety
Solutions

F.
Keystone
Cabling
Systems

G.
Part
Number
Index

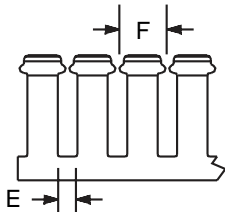
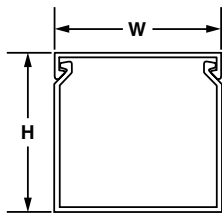
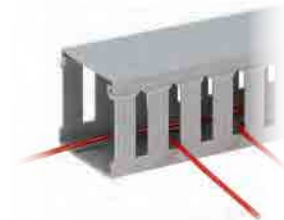

	E	F
For 0.5" duct height:	0.37" [9.4]	0.80" [20.3]
0.75" to 2" duct height:	0.31" [7.9]	0.80" [20.3]
3" to 4" duct height:	0.31" [7.9]	1.00" [25.4]
5" duct height:	0.38" [9.4]	1.33" [33.8]



To order cover with protective film add "-F" to part number. 6" cover not available with film.

Base Part Number	Duct Size W x H*		Slot Width		Cover Part Number	Std. Pkg. Qty.	Base Ctn. Qty.	Cover Ctn. Qty.
	In.	mm	In.	mm				
G.5X.5LG6	0.69 x 0.60	17.5 x 15.2	0.38	9.7	C.5LG6	6	120	120
G.5X1LG6	0.69 x 1.06	17.5 x 26.9	0.31	7.9	C.5LG6	6	120	120
G.5X2LG6	0.69 x 2.03	17.5 x 51.6	0.31	7.9	C.5LG6	6	120	120
G.5X4LG6	0.69 x 4.10	17.5 x 104.1	0.31	7.9	C.5LG6	6	120	120
G.75X.75LG6	0.92 x 0.82	23.6 x 20.8	0.31	7.9	C.75LG6	6	120	120
G.75X1LG6	0.92 x 1.06	23.6 x 26.9	0.31	7.9	C.75LG6	6	120	120
G.75X1.5LG6	0.92 x 1.57	23.6 x 39.9	0.31	7.9	C.75LG6	6	120	120
G.75X2LG6	0.94 x 2.03	23.6 x 51.7	0.31	7.9	C.75LG6	6	120	120
G1X1LG6	1.25 x 1.12	32.0 x 28.4	0.31	7.9	C1LG6	6	120	120
G1X1.5LG6	1.25 x 1.62	32.0 x 41.1	0.31	7.9	C1LG6	6	120	120
G1X2LG6	1.25 x 2.12	32.0 x 53.8	0.31	7.9	C1LG6	6	120	120
G1X3LG6	1.25 x 3.12	32.0 x 79.2	0.31	7.9	C1LG6	6	120	120
G1X4LG6	1.25 x 4.10	32.0 x 104.1	0.31	7.9	C1LG6	6	60	120
G1.5X1LG6	1.75 x 1.12	44.5 x 28.4	0.31	7.9	C1.5LG6	6	120	120
G1.5X1.5LG6	1.75 x 1.62	44.5 x 41.1	0.31	7.9	C1.5LG6	6	120	120
G1.5X2LG6	1.75 x 2.12	44.5 x 53.8	0.31	7.9	C1.5LG6	6	120	120
G1.5X3LG6	1.75 x 3.12	44.5 x 79.2	0.31	7.9	C1.5LG6	6	120	120
G1.5X4LG6	1.74 x 4.10	44.5 x 104.1	0.31	7.9	C1.5LG6	6	60	120
G 2X1LG6	2.25 x 1.12	57.2 x 28.4	0.31	7.9	C2LG6	6	120	120
G2X1.5LG6	2.25 x 1.62	57.2 x 41.1	0.31	7.9	C2LG6	6	120	120
G2X2LG6	2.25 x 2.12	57.2 x 53.8	0.31	7.9	C2LG6	6	120	120
G2X3LG6	2.25 x 3.12	57.2 x 79.2	0.31	7.9	C2LG6	6	60	120
G2X4LG6	2.25 x 4.10	57.2 x 104.1	0.31	7.9	C2LG6	6	60	120
G2X5LG6	2.25 x 5.10	57.2 x 129.5	0.38	9.7	C2LG6	6	60	120
G2.5X3LG6	2.75 x 3.12	69.9 x 79.2	0.31	7.9	C2.5LG6	6	120	120
G3X1LG6	3.25 x 1.12	82.6 x 28.4	0.31	7.9	C3LG6	6	120	120
G3X2LG6	3.25 x 2.12	82.6 x 53.8	0.31	7.9	C3LG6	6	120	120
G3X3LG6	3.25 x 3.12	82.6 x 79.2	0.31	7.9	C3LG6	6	60	120
G3X4LG6	3.25 x 4.10	82.6 x 104.1	0.31	7.9	C3LG6	6	60	120
G3X5LG6	3.25 x 5.10	82.6 x 129.5	0.38	9.7	C3LG6	6	60	120
G4X1.5LG6	4.25 x 1.62	108.0 x 41.1	0.31	7.9	C4LG6	6	120	120
G4X2LG6	4.25 x 2.12	108.0 x 53.8	0.31	7.9	C4LG6	6	60	120
G4X3LG6	4.25 x 3.12	108.0 x 79.2	0.31	7.9	C4LG6	6	60	120
G4X4LG6	4.25 x 4.10	108.0 x 104.1	0.31	7.9	C4LG6	6	60	120
G4X5LG6	4.25 x 5.10	108.0 x 129.5	0.38	9.7	C4LG6	6	60	120
G6X4LG6	6.23 x 4.15	158.8 x 105.4	0.31	7.9	C6LG6	6	60	120

Part number shown for LG (Light Gray). For other color availability see color selection guide, page C1.50.

Base and cover sold separately.

**H" dimension includes duct and cover.

Some sizes and colors are available with adhesive tape. See page C1.36 for availability.

Features and Benefits – Panduct® Type F Narrow Slot Wiring Duct

Available in 31 sizes from 0.5" x 0.5" up to 6" x 4" in a variety of colors.

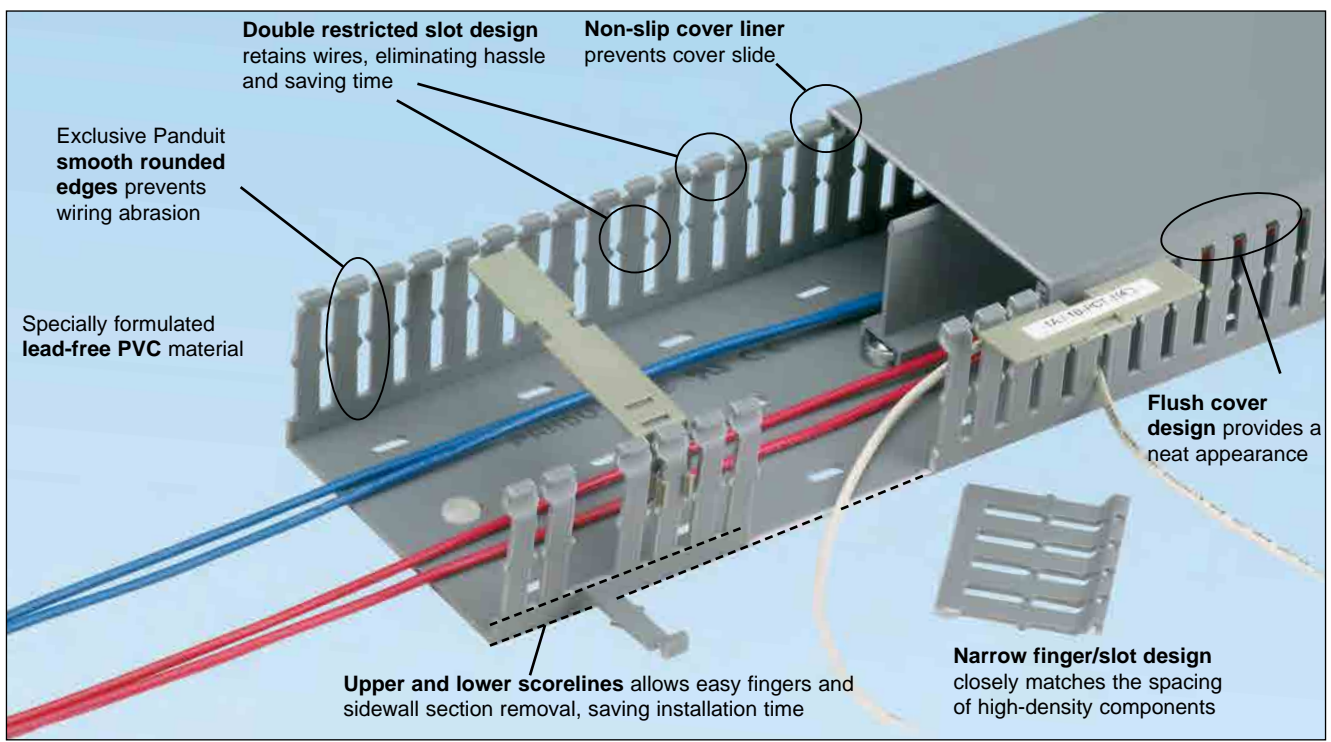

Panduct® Wire Retainers for Type F Wiring Duct
 Contain wiring when duct cover is opened. Wire retainers snap easily between duct fingers.
 (see page C1.32)



Panduct® Divider Wall
 Create separate wiring channels within the wiring duct base. Available in solid or slotted wall styles.
 (see page C1.30)



Panduct® Type C Cover with Protective Film
 Reduces scrap and labor costs by protecting the surface during storage, handling, and installation.
 (see page C1.17)

UL® CE Panduct® Type F Narrow Slot Wiring Duct

- Narrow slot/finger design provides more slots to fit the spacing of high-density terminal blocks and other hardware
- Material: Lead-free PVC
- UL recognized continuous use temperature: 122°F (50°C)
- UL 94 flammability rating of V-0
- Conforms with NFPA 79-2015 section 13.3.1 requirement for flame retardant material
- Provided with mounting holes
- Base and cover length is 6 feet

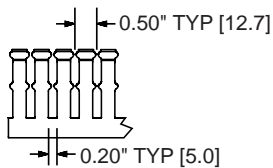
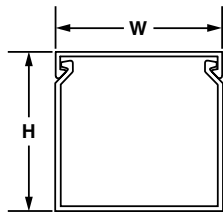

Multiple slot restrictors present with 2" and greater duct wall height.



To order cover with protective film add "-F" to part number. 6" cover not available with film.

Part Number	Duct Size (W x H)*		Slot Width		Cover Part Number	Std. Pkg. Qty.	Base Ctn. Qty.	Cover Ctn. Qty.
	In.	mm	In.	mm				
F.5X.5LG6	0.69 x 0.60	17.5 x 15.2	0.20	5.0	C.5LG6	6	120	120
F.5X1LG6	0.69 x 1.06	17.5 x 26.9	0.20	5.0	C.5LG6	6	120	120
F.75X.75LG6	0.94 x 0.82	23.6 x 20.9	0.20	5.0	C.75LG6	6	120	120
F.75X1.5LG6	0.94 x 1.57	23.6 x 39.9	0.20	5.0	C.75LG6	6	120	120
F1X1LG6	1.25 x 1.13	32.0 x 28.7	0.20	5.0	C1LG6	6	120	120
F1X1.5LG6	1.25 x 1.62	32.0 x 41.1	0.20	5.0	C1LG6	6	120	120
F1X2LG6	1.25 x 2.12	32.0 x 53.8	0.20	5.0	C1LG6	6	120	120
F1X3LG6	1.25 x 3.13	32.0 x 79.4	0.20	5.0	C1LG6	6	120	120
F1X4LG6	1.25 x 4.10	32.0 x 104.1	0.20	5.0	C1LG6	6	60	120
F1.5X1LG6	1.75 x 1.12	44.5 x 28.4	0.20	5.0	C1.5LG6	6	120	120
F1.5X1.5LG6	1.75 x 1.62	44.5 x 41.1	0.20	5.0	C1.5LG6	6	120	120
F1.5X2LG6	1.75 x 2.12	44.5 x 53.8	0.20	5.0	C1.5LG6	6	120	120
F1.5X3LG6	1.75 x 3.12	44.5 x 79.2	0.20	5.0	C1.5LG6	6	120	120
F1.5X4LG6	1.75 x 4.10	44.5 x 104.1	0.20	5.0	C1.5LG6	6	60	120
F2X1LG6	2.25 x 1.12	57.2 x 28.4	0.20	5.0	C2LG6	6	120	120
F2X1.5LG6	2.25 x 1.62	57.2 x 41.1	0.20	5.0	C2LG6	6	120	120
F2X2LG6	2.25 x 2.12	57.2 x 53.8	0.20	5.0	C2LG6	6	120	120
F2X3LG6	2.25 x 3.14	57.2 x 79.8	0.20	5.0	C2LG6	6	60	120
F2X4LG6	2.25 x 4.10	57.2 x 104.1	0.20	5.0	C2LG6	6	60	120
F2X5LG6	2.25 x 5.10	57.2 x 129.5	0.20	5.0	C2LG6	6	60	120
F2.5X3LG6	2.75 x 3.12	69.9 x 79.2	0.20	5.0	C2.5LG6	6	120	120
F3X1LG6	3.25 x 1.12	82.6 x 28.4	0.20	5.0	C3LG6	6	120	120
F3X2LG6	3.25 x 2.12	82.6 x 53.8	0.20	5.0	C3LG6	6	120	120
F3X3LG6	3.25 x 3.13	82.6 x 78.7	0.20	5.0	C3LG6	6	60	120
F3X4LG6	3.25 x 4.10	82.6 x 104.1	0.20	5.0	C3LG6	6	60	120
F3X5LG6	3.25 x 5.10	82.6 x 129.5	0.20	5.0	C3LG6	6	60	120
F4X2LG6	4.25 x 2.12	108.0 x 53.8	0.20	5.0	C4LG6	6	60	120
F4X3LG6	4.25 x 3.12	108.0 x 79.2	0.20	5.0	C4LG6	6	60	120
F4X4LG6	4.25 x 4.10	108.0 x 104.1	0.20	5.0	C4LG6	6	60	120
F4X5LG6	4.25 x 5.10	108.0 x 129.5	0.20	5.0	C4LG6	6	60	120
F6X4LG6	6.25 x 4.15	158.8 x 105.4	0.20	5.0	C6LG6	6	60	120

Part number shown for LG (Light Gray). For other color availability see color selection guide, page C1.50. Base and cover sold separately. **H" dimension includes duct and cover. Some sizes and colors are available with adhesive tape. See page C1.36 for availability.

Features and Benefits – Panduct® Flush Cover Type D Round Hole Wiring Duct

Available in sixteen sizes from 1" x 2" up to 4" x 4" in a variety of colors.

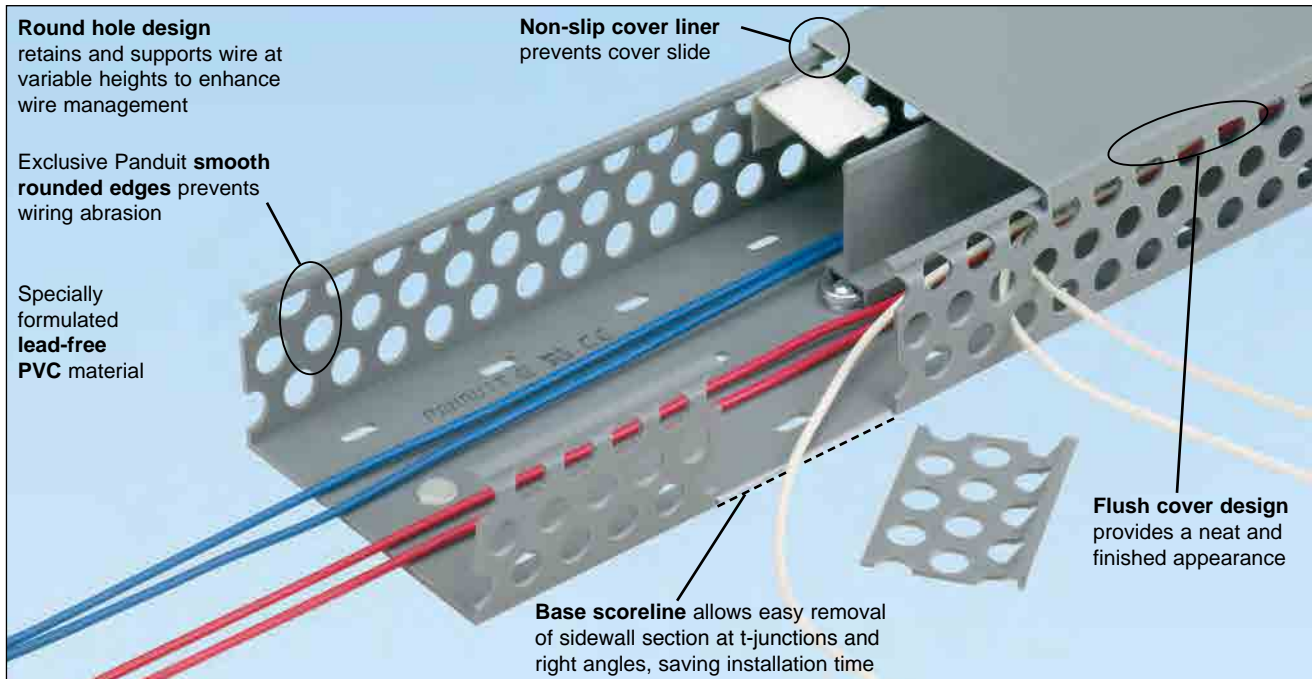

Panduct® Wire Retainers for Type D Wiring Duct

Contain wiring when duct cover is opened. Wire retainers mount onto walls with pressure sensitive adhesive.

(see page C1.31)



Panduct® Divider Wall

Create separate wiring channels within the wiring duct base. Available in solid or slotted wall styles.

(see page C1.30)



Panduct® Type C Cover with Protective Film

Reduces scrap and labor costs by protecting the surface during storage, handling, and installation.

(see page C1.19)

Panduct® Flush Cover Type D Round Hole Wiring Duct

- Round hole design has multiple rows of holes to retain and support wire at variable heights and positions
- Material: Lead-free PVC
- UL recognized continuous use temperature: 122°F (50°C)
- UL 94 flammability rating of V-0
- Conforms with NFPA 79-2015 section 13.3.1 requirement for flame retardant material
- Provided with mounting holes
- Base and cover length is 6 feet

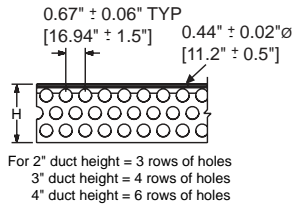
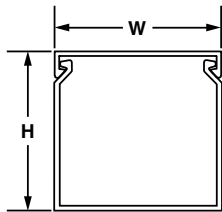

Part Number	Duct Size (W x H)*		Cover Part Number	Std. Pkg. Qty.	Base Ctn. Qty.	Cover Ctn. Qty.
	In.	mm				
D1X2LG6	1.25 x 2.12	32.0 x 53.8	C1LG6	6	120	120
D1X3LG6	1.25 x 3.12	32.0 x 79.2	C1LG6	6	120	120
D1X4LG6	1.25 x 4.10	32.0 x 104.1	C1LG6	6	120	120
D1.5X2LG6	1.75 x 2.12	44.5 x 53.8	C1.5LG6	6	120	120
D1.5X3LG6	1.75 x 3.12	44.5 x 79.2	C1.5LG6	6	120	120
D1.5X4LG6	1.75 x 4.10	44.5 x 104.1	C1.5LG6	6	60	120
D2X2LG6	2.25 x 2.14	57.2 x 54.3	C2LG6	6	120	120
D2X3LG6	2.25 x 3.12	57.2 x 79.2	C2LG6	6	60	120
D2X4LG6	2.25 x 4.10	57.2 x 104.1	C2LG6	6	60	120
D2.5X3LG6	2.75 x 3.12	69.9 x 79.2	C2.5LG6	6	120	120
D3X2LG6	3.25 x 2.12	82.6 x 53.8	C3LG6	6	120	120
D3X3LG6	3.25 x 3.12	82.6 x 79.2	C3LG6	6	60	120
D3X4LG6	3.25 x 4.10	82.6 x 104.1	C3LG6	6	60	120
D4X2LG6	4.25 x 2.12	108.0 x 53.8	C4LG6	6	60	120
D4X3LG6	4.25 x 3.12	108.0 x 79.2	C4LG6	6	60	120
D4X4LG6	4.25 x 4.10	108.0 x 104.1	C4LG6	6	60	120

Part number shown for LG (Light Gray). For other color availability see color selection guide, page C1.50.
 Base and cover sold separately.
 *"H" dimension includes duct and cover.



To order cover with protective film add "-F" to part number. 6" cover not available with film.

Features and Benefits – Panduct® Type MC Metric Narrow Slot Wiring Duct

Available in 20 sizes from 25mm x 25mm up to 100mm x 100mm in international gray and white colors.

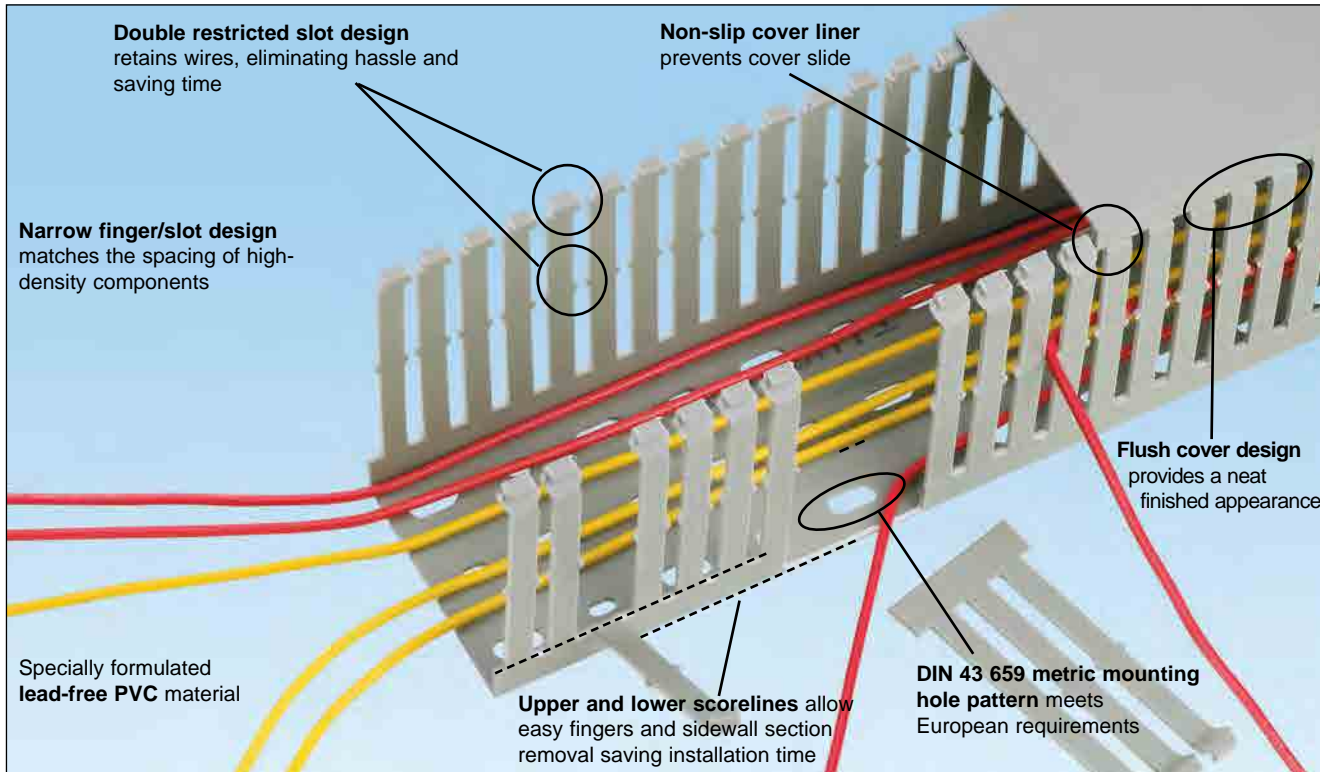

Panduct® Wire Retainers for Type MC Wiring Duct

Contain wiring when duct cover is opened. Wire retainers snap easily between duct fingers.
(see page C1.32)



Panduct® Divider Wall

Create separate wiring channels within the wiring duct base. Available in solid or slotted wall styles.
(see page C1.30)

UL® CE Panduct® Type MC Metric Narrow Slot Wiring Duct

- CE compliant and metric sizing for control panels intended for European applications
- Material: Lead-free PVC
- UL recognized continuous use temperature: 122°F (50°C)
- UL 94 flammability rating of V-0
- Conforms with NFPA 79-2015 section 13.3.1 requirement for flame retardant material
- Provided with DIN 43 659 mounting holes
- Duct and cover packaged together in 2m lengths

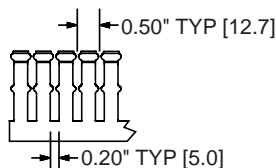
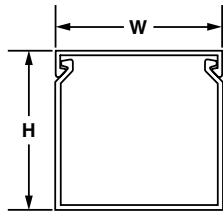
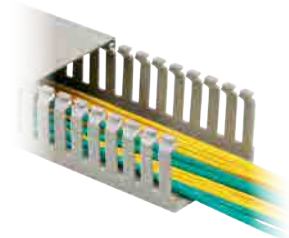

Multiple slot restrictors present with 62mm and greater duct wall height.

Base and Cover Part Number	Duct Size (W x H)*		Slot Width		Replacement Cover Part Number	Base and Cover Pkg. Qty. (m)	Replacement Cover Std. Pkg. Qty. (m)
	mm	In.	mm	In.			
MC25X25IG2	24.6 x 23.6	0.97 x 0.93	5.0	0.20	C25IG2	20	20
MC25X37IG2	24.6 x 35.8	0.97 x 1.41	5.0	0.20	C25IG2	20	20
MC25X50IG2	24.6 x 47.8	0.97 x 1.88	5.0	0.20	C25IG2	20	20
MC25X62IG2	24.6 x 59.7	0.97 x 2.35	5.0	0.20	C25IG2	20	20
MC25X75IG2	24.6 x 72.4	0.97 x 2.85	5.0	0.20	C25IG2	20	20
MC37X37IG2	37.4 x 35.8	1.47 x 1.41	5.0	0.20	C37IG2	20	20
MC37X50IG2	37.1 x 47.8	1.46 x 1.88	5.0	0.20	C37IG2	20	20
MC37X62IG2	37.1 x 59.7	1.46 x 2.35	5.0	0.20	C37IG2	20	20
MC37X75IG2	37.1 x 72.4	1.46 x 2.85	5.0	0.20	C37IG2	20	20
MC50X50IG2	49.5 x 47.8	1.95 x 1.89	5.0	0.20	C50IG2	20	20
MC50X75IG2	49.5 x 72.4	1.95 x 2.85	5.0	0.20	C50IG2	10	20
MC50X100IG2	49.5 x 97.8	1.95 x 3.85	5.0	0.20	C50IG2	10	20
MC62X62IG2	62.0 x 59.7	2.44 x 2.35	5.0	0.20	C62IG2	20	20
MC75X50IG2	74.7 x 48.0	2.94 x 1.89	5.0	0.20	C75IG2	20	20
MC75X62IG2	74.7 x 59.7	2.94 x 2.35	5.0	0.20	C75IG2	20	20
MC75X75IG2	74.7 x 72.4	2.94 x 2.85	5.0	0.20	C75IG2	10	20
MC75X100IG2	74.7 x 97.8	2.94 x 3.85	5.0	0.20	C75IG2	10	20
MC100X50IG2	99.6 x 48.0	3.92 x 1.89	5.0	0.20	C100IG2	10	20
MC100X75IG2	99.6 x 72.4	3.92 x 2.85	5.0	0.20	C100IG2	10	20
MC100X100IG2	99.6 x 97.8	3.92 x 3.85	5.0	0.20	C100IG2	10	20

Available in IG (International Gray) and WH (White) colors.
 Base and cover sold together.
 **"H" dimension includes duct and cover.

Features and Benefits – Panduct® Type FS Solid Wall Wiring Duct

Available in 27 sizes from 0.5" x 0.5" up to 6" x 4" in a variety of colors.

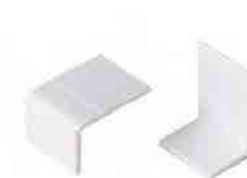
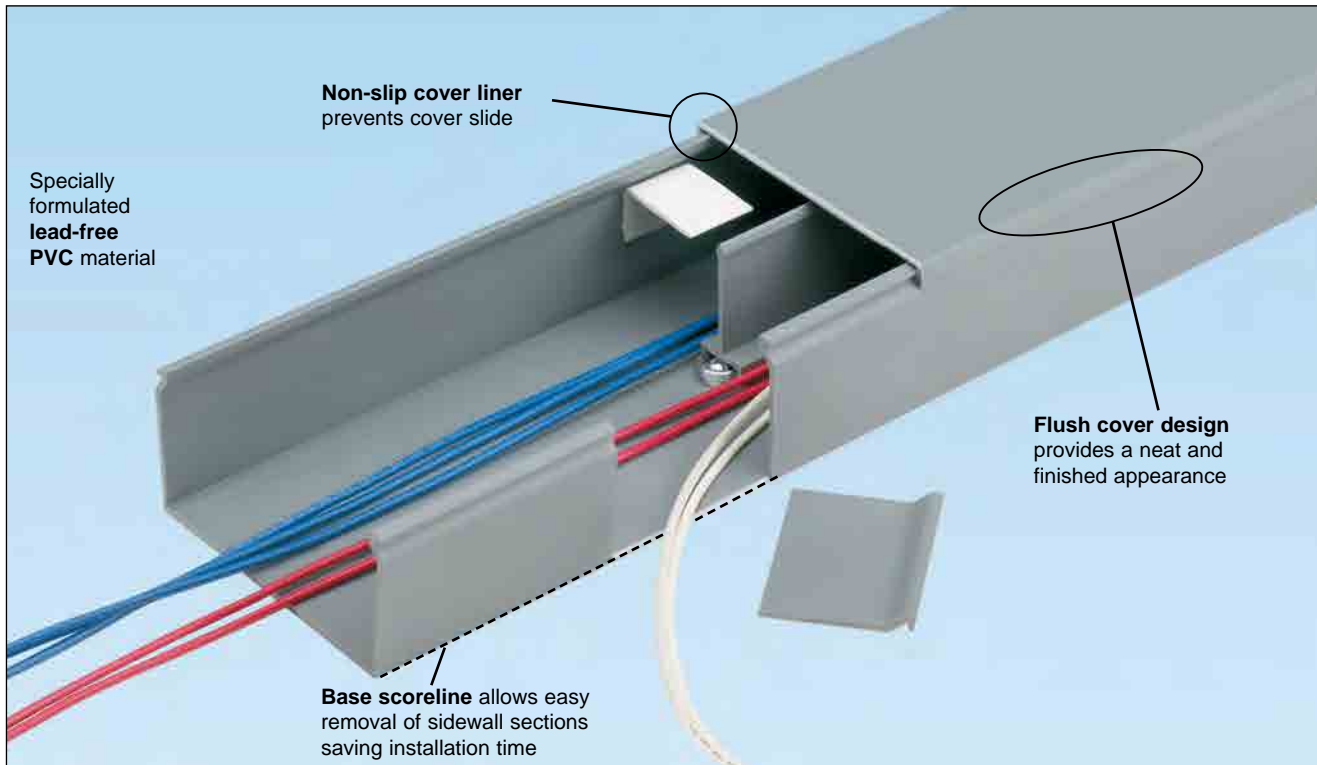

Panduct® Wire Retainers for Type FS Solid Wall Wiring Duct

Contain wiring when duct cover is opened. Wire retainers mount onto walls with pressure sensitive adhesive.

(see page C1.31)



Panduct® Divider Wall

Create separate wiring channels within the wiring duct base. Available in solid or slotted wall styles.

(see page C1.30)



Panduct® Type C Cover with Protective Film

Reduces scrap and labor costs by protecting the surface during storage, handling, and installation.

(see page C1.23)

UL® CE Panduct® Type FS Solid Wall Wiring Duct

- Solid wall design fully encloses cables providing maximum protection and aesthetics
- Material: Lead-free PVC
- UL recognized continuous use temperature: 122°F (50°C)
- UL 94 flammability rating of V-0
- Base and cover length is 6 feet
- Conforms with NFPA 79-2015 section 13.3.1 requirement for flame retardant material

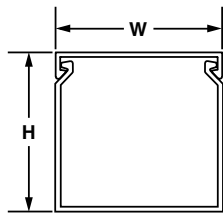
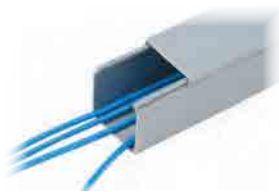

To order cover with protective film add "-F" to part number. 6" cover not available with film.

Base Part Number	Duct Size (W x H)*		Cover Part Number	Std. Pkg. Qty.	Base Ctn. Qty.	Cover Ctn. Qty.
	In.	mm				
> FS.5X.5LG6NM	0.69 x 0.60	17.5 x 15.2	C.5LG6	6	120	120
> FS.5X1LG6NM	0.69 x 1.06	17.5 x 26.9	C.5LG6	6	120	120
FS.75X.75LG6NM	0.93 x 0.82	23.6 x 20.8	C.75LG6	6	120	120
> FS1X1LG6NM	1.26 x 1.12	32.0 x 28.4	C1LG6	6	120	120
> FS1X1.5LG6NM	1.26 x 1.62	32.0 x 41.1	C1LG6	6	120	120
FS1X2LG6NM	1.26 x 2.12	32.0 x 53.8	C1LG6	6	120	120
FS1X3LG6NM	1.26 x 3.12	32.0 x 79.2	C1LG6	6	60	120
FS1X4LG6NM	1.26 x 4.10	32.0 x 104.1	C1LG6	6	120	120
> FS1.5X1LG6NM	1.75 x 1.12	44.5 x 28.4	C1.5LG6	6	120	120
> FS1.5X1.5LG6NM	1.75 x 1.62	44.5 x 41.1	C1.5LG6	6	120	120
> FS1.5X2LG6NM	1.75 x 2.12	44.5 x 53.8	C1.5LG6	6	120	120
> FS1.5X3LG6NM	1.75 x 3.12	44.5 x 79.2	C1.5LG6	6	120	120
> FS2X1LG6NM	2.25 x 1.14	57.2 x 29.0	C2LG6	6	120	120
> FS2X1.5LG6NM	2.25 x 1.64	57.2 x 41.7	C2LG6	6	120	120
> FS2X2LG6NM	2.25 x 2.14	57.2 x 54.4	C2LG6	6	60	120
> FS2X3LG6NM	2.25 x 3.14	57.2 x 79.8	C2LG6	6	60	120
> FS2X4LG6NM	2.25 x 4.12	57.2 x 104.6	C2LG6	6	120	120
> FS3X1LG6NM	3.25 x 1.12	82.6 x 28.4	C3LG6	6	120	120
> FS3X2LG6NM	3.25 x 2.12	82.6 x 53.8	C3LG6	6	60	120
> FS3X3LG6NM	3.25 x 3.12	82.6 x 79.2	C3LG6	6	60	120
FS3X4LG6NM	3.25 x 4.10	82.6 x 104.1	C3LG6	6	60	120
FS3X5LG6NM	3.25 x 5.10	82.6 x 129.5	C3LG6	6	60	120
> FS4X1.5LG6	4.25 x 1.62	108.0 x 41.1	C4LG6	6	120	120
> FS4X2LG6NM	4.25 x 2.12	108.0 x 53.8	C4LG6	6	60	120
> FS4X3LG6NM	4.25 x 3.12	108.0 x 79.2	C4LG6	6	60	120
> FS4X4LG6NM	4.25 x 4.10	108.0 x 104.1	C4LG6	6	60	120
> FS4X5LG6NM	4.25 x 5.10	108.0 x 129.5	C4LG6	6	60	120
> FS6X4LG6NM	6.25 x 4.15	158.8 x 105.4	C6LG6	6	60	120

>Parts are available with mounting holes. To order with mounting holes, remove NM from part number. Part Number shown for LG (Light Gray). For other color availability see Color Selection Guide, page C1.50. Base and cover sold separately. **"H" dimension includes duct and cover. Some sizes and colors are available with adhesive tape. See page C1.36 for availability.

Wiring Duct for Special Environments including Mass Transit Features and Benefits - Panduct Type TNC Low-Smoke, Halogen-Free Metric Wiring Duct

Available in eight sizes from 25mm x 37mm up to 100mm x 75mm in light gray.

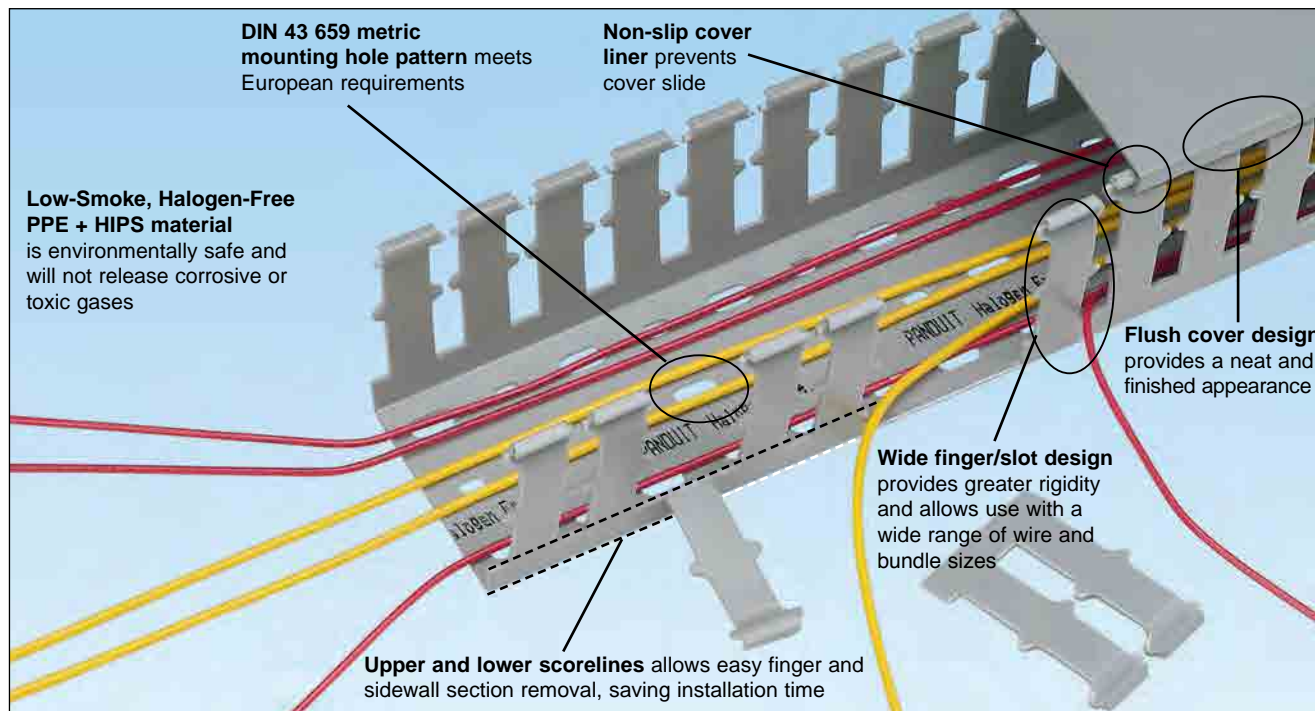

**Panduct® Type TNC
Low-smoke, Halogen-free
Solid Divider Wall**

Create separate channels within the wiring duct base.
(see page C1.25)

TNC Wiring Duct Material (PPE+HIPS)		
Properties	General	Test Method
Specific Gravity	1.11 g/cc	ASTM D 792
Heat Deflection Temperature @264 psi	105°C 221°F	ASTM D 648
Flame/Smoke/Toxicity		
Smoke Density (Flaming) @ 1.5 and 4 min.	Ds @ 1.5 min = 16 Ds @ 4.0 min = 66	ASTM E 662
Flammability Class	V-0	UL94
Flame Spread Index	Is =15	ASTM E 162
Total Heat Release	66.21 MJ/m ²	ASTM E1354
Low Toxicity	Yes	BSS 7239
Mechanical		
Tensile Strength at Yield	8,100 psi	ASTM D 638
Tensile Modulus	355,000 psi	ASTM D 638
Flexural Strength at Yield	11,500 psi	ASTM D 790
Flexural Modulus	340,000 psi	ASTM D 790
Notched Izod Impact Strength @ 23°C (73°F)	3.7 ft-lb/in.	ASTM D 256

PPE + HIPS (Polyphenylene Ether + High Impact Polystyrene)

Rail Standard Compliance/Ratings		
NFPA 130 (U.S. Standard for Fixed Guideway Transit and Passenger Rail Systems)	Pass (Is<35, Ds1.5<100, Ds4<200)	ASTM E 162; ASTM E 662
EN 45545-2 (EU Standard: Railway applications - Fire protection on railway vehicles - Part 2: Requirements for fire behavior of materials and components)	HL2 – R22 (Interior) HL2 – R23 (Exterior)	EN 45545-2 BS EN ISO 4589-2 NF X 70-100 ISO 5659-2
DIN 5510 (Preventative fire protection in railway vehicles)	Burning class: S-4 Smoke class: SR-2 Dripping class: ST-2	DIN 5510-2; DIN54837
NF F16 101, NF F 16 102 (smoke density, toxicity, glowing filament, oxygen index)	F1/4	NF X 1-702 NF X 70-100 NF EN 60695-2 NF EN ISO 4589-2
UNIFER Italian Railway Standard	Pass	EN UNI 11925-2 (EN ISO 11925-2)

Panduct® Type TNC Low-Smoke, Halogen-Free Metric Wiring Duct

- Material: Polyphenylen Ether + High Impact Polystyrene (PPE+HIPS)
- Low-Smoke, Halogen-Free is non-toxic, lead-free, and environmentally safe. Will not exhibit a high rate of smoke generation or release toxic, corrosive gases in the event of a fire that could endanger public safety or damage sensitive electronics in enclosed environments (passenger rail, oil and gas platforms)
- UL recognized continuous use temperature: 221°F (105°C)
- UL 94 flammability rating of V-0
- Conforms with NFPA 79-2015 section 13.3.1 requirement for flame retardant material
- Meets NFPA 130 and FRA requirements for surface flammability and smoke density.
- Meets a Hazard Level Classification of HL2 per European Standard EN 45545-2 for R22 (Interior).
- Meets a Hazard Level Classification of HL2 per European Standard EN 45545-2 for R23 (Exterior).
- Other Rail Standard Compliances (see page C1.53 for details):
 - DIN 5510-2
 - BSS 7239
 - AFNOR NF F 16 101 and NF F 16 102
 - UNIFER EN UNI 11925-2 (EN ISO 11925-2)

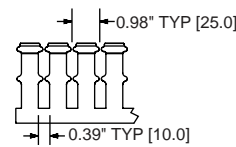
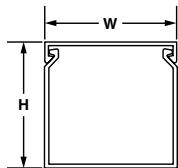

Multiple slot restrictors present with 75mm and greater duct wall height.

Base and Cover Part Number	Duct Size (W x H)*		Slot Width		Replacement Cover Part Number	Base and Cover Ctn. Qty. (m)	Replacement Cover Ctn. Qty. (m)
	mm	In.	mm	In.			
TNC25X37LG2	24.6 x 35.8	0.97 x 1.41	10.0	0.39	TNC25LG2	20	20
TNC25X75LG2	24.6 x 72.1	0.97 x 2.84	10.0	0.39	TNC25LG2	20	20
TNC37X37LG2	37.1 x 35.5	1.46 x 1.40	10.0	0.39	TNC37LG2	20	20
TNC37X75LG2	37.1 x 72.4	1.46 X 2.85	10.0	0.39	TNC37LG2	20	20
TNC50X50LG2	49.6 x 47.8	1.95 x 1.88	10.0	0.39	TNC50LG2	20	20
TNC75X75LG2	74.6 x 72.8	2.94 x 2.86	10.0	0.39	TNC75LG2	10	20
TNC100X50LG2	99.6 x 47.8	3.92 x 1.88	10.0	0.39	TNC100LG2	10	20
TNC100X75LG2	99.6 x 72.6	3.92 x 2.86	10.0	0.39	TNC100LG2	10	20

Available in LG (Light Gray) only. Do not allow cutting, tapping, or cleaning fluids that contain hydrocarbons to come in contact with the Type TNC wiring duct as it will cause stress cracking. See page C1.51 for a list of chemicals to avoid. Also visit Panduit.com for a list of safe and acceptable lubricants and cleaners that can be used. "H" dimension includes duct and cover.

Panduct Type TNC Divider Wall

- TNC solid divider wall can be mounted inside TNC wiring duct to create multiple channels
- Material: Polyphenylen Ether + High Impact Polystyrene (PPE+HIPS)
- Simply install the divider wall base when mounting the duct and snap the divider wall onto mounting base, DB-C



Part Number	Length (m)	For Nominal Duct Height (mm)	Std. Pkg. Qty.	Std. Ctn. Qty.
TNC50D2	2	50	2	40
TNC75D2	2	75	2	40

Available in LG (Light Gray) only. NOTE: Must be used with mounting base DB-C (see page C1.30), which is sold separately. Install mounting bases to the duct channel, locate within 2" of each divider wall end and at least every 12" along the length.

Wiring Duct for Special Environments

Features and Benefits – Panduct® Type NNC Halogen-Free Metric Wiring Duct

Available in fourteen sizes from 25mm x 25mm up to 100mm x 100mm in light gray and white.

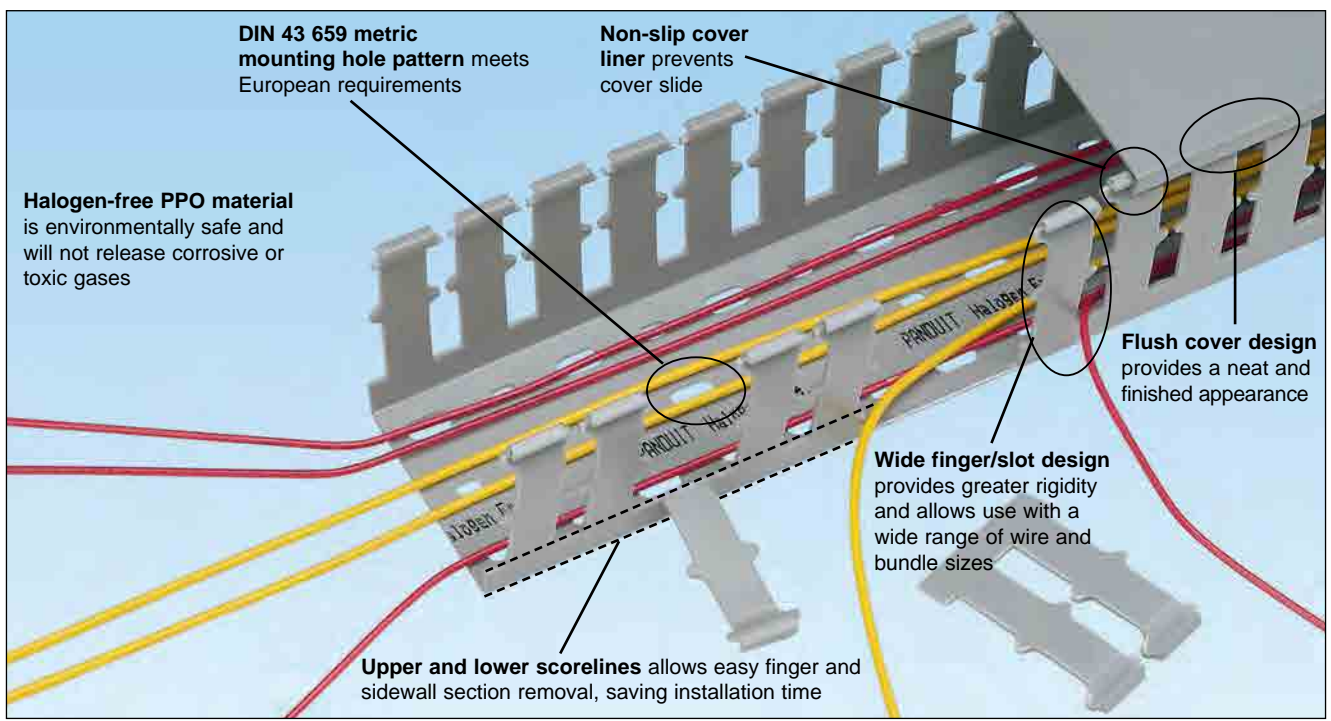

Properties	Halogen-Free PPO Material	Test Method
General		
Specific Gravity	1.09 g/cc	ASTM D 792
Mechanical		
Tensile Strength at Yield	7,700 psi	ASTM D 638
Flexural Strength	11,500 psi	ASTM D 790
Flexural Modulus	340,000 psi	ASTM D 790
Notched Izod Impact @ 23°C (73°F)	5.0 ft. – lbs./in.	ASTM D 256
Heat Deflection Temperature @264 psi	102°C (215°F)	ASTM D 648

Properties	Halogen-Free PPO Material	Test Method
Flammability		
Limited Oxygen Index (LOI)	30	ASTM D 2863
Smoke Density (Flaming) @ 4 min.	534	ASTM E 662
Flammability Class @ 0.060"	V-0	UL94
Halogen Free	Yes	IEC 60754-2
Agency Approvals		
UL Recognized file E147128 CSA Certified file 016446-0-00 CE Compliant: EN 45545-2; HL1 to R R23 (exterior)		

Note: DO NOT allow cutting, tapping, or cleaning fluids that contain hydrocarbons to come in contact with Type NNC wiring duct. For a list of recommended lubricants to use with Type NNC wiring duct log on to www.panduit.com

Panduct® Type NNC Halogen-Free Metric Wiring Duct

- Material: Halogen-free polyphenylene oxide (PPO) material as verified with IEC 60754-2 test method (test on gases evolved during combustion of electric cables)
- UL recognized continuous use temperature: 203°F (95°C)
- UL 94 flammability rating of V-0
- Meets a Hazard Level Classification of HL1 per European Standard EN 45545-2 for R23 (exterior).
- Conforms with NFPA 79-2015 section 13.3.1 requirement for flame retardant material
- Provided with DIN 43 659 mounting holes
- Metric sizing and finger progression
- Duct and cover packaged together in two meter lengths

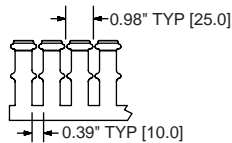
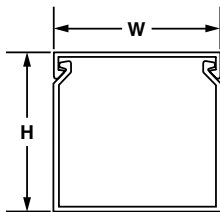
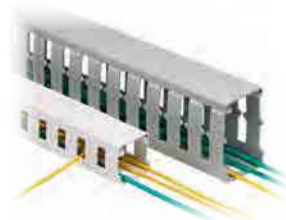

Multiple slot restrictors present with 75mm and greater duct wall height.

Base and Cover Part Number	Duct Size (W x H)*		Slot Width		Replacement Cover Part Number	Base and Cover Ctn. Qty. (m)	Replacement Cover Ctn. Qty. (m)
	mm	In.	mm	In.			
NNC25X25LG2	24.6 x 23.6	0.97 x 0.93	10.0	0.39	NC25LG2	20	20
NNC25X37LG2	24.6 x 35.8	0.97 x 1.41	10.0	0.39	NC25LG2	20	20
NNC25X50LG2	25.1 x 47.8	0.99 x 1.88	10.0	0.39	NC25LG2	20	20
NNC25X75LG2	24.6 x 72.4	0.97 x 2.85	10.0	0.39	NC25LG2	20	20
NNC37X37LG2	37.1 x 35.8	1.46 x 1.41	10.0	0.39	NC37LG2	20	20
NNC37X50LG2	37.1 x 47.8	1.46 x 1.88	10.0	0.39	NC37LG2	20	20
NNC37X75LG2	37.1 x 72.4	1.46 x 2.85	10.0	0.39	NC37LG2	20	20
NNC50X50LG2	49.5 x 47.8	1.95 x 1.88	10.0	0.39	NC50LG2	20	20
NNC50X75LG2	49.5 x 72.4	1.95 x 2.85	10.0	0.39	NC50LG2	10	20
NNC50X100LG2	49.5 x 97.8	1.95 x 3.85	10.0	0.39	NC50LG2	10	20
NNC75X75LG2	75.4 x 72.4	2.97 x 2.85	10.0	0.39	NC75LG2	10	20
NNC100X50LG2	99.6 x 47.8	3.92 x 1.88	10.0	0.39	NC100LG2	10	20
NNC100X75LG2	99.6 x 72.4	3.92 x 2.85	10.0	0.39	NC100LG2	10	20
NNC100X100LG2	99.6 x 97.8	3.92 x 3.85	10.0	0.39	NC100LG2	10	20

Available in LG (Light Gray) and WH (White).

Do not allow cutting, tapping, or cleaning fluids that contain hydrocarbons to come in contact with type NNC wiring duct as it will cause stress cracking. See page C1.51 for a list of chemicals to avoid.

**"H" dimension includes duct and cover.

Panduct® Type NNC Divider Wall

- NNC solid divider wall can be mounted inside NNC and NE wiring duct to create multiple channels
- Material: Halogen-free polyphenylene oxide (PPO)
- Simply install the divider wall base when mounting the duct and snap the divider wall onto mounting base, DB-C



Part Number	TLength (m)	For Nominal Duct Height (mm)	Std. Pkg. Qty. (m)	Std. Ctn. Qty. (m)
NNC50DWH2	2	50	2	40
NNC75DWH2	2	75	2	40

Available in WH (White) color only.

NOTE: Must be used with mounting base DB-C (see page C1.30), which is sold separately. Install mounting bases to the duct channel, locate within 2" of each divider wall end and at least every 12" along the length.

Panduct® Type NE Halogen-Free Wiring Duct

- Material: Halogen-free polyphenylene oxide (PPO)
- UL recognized continuous use temperature: 203°F (95°C)
- UL 94 flammability rating of V-0
- Meets a Hazard Level Classification of HL1 per European Standard EN 45545-2 for R23 (exterior)
- Provided with mounting holes
- Base and cover length is 6 feet
- Conforms with NFPA 79-2015 section 13.3.1 requirement for flame retardant material

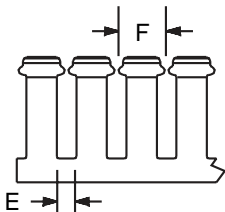
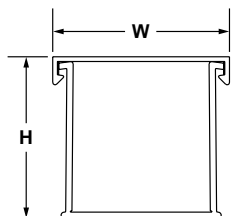
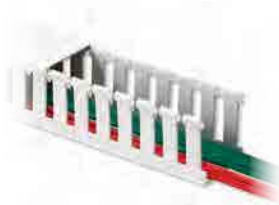

	E	F
For 0.5" duct height:	0.37" [9.4]	0.80" [20.3]
1" to 2" duct height:	0.31" [7.9]	0.80" [20.3]
3" to 4" duct height:	0.31" [7.9]	1.00" [25.4]
5" duct height:	0.38" [9.4]	1.33" [33.8]

Base Part Number	Duct Size (W x H)*		Slot Width		Cover Part Number	Std. Pkg. Qty.	Base Ctn. Qty.	Cover Ctn. Qty.
	In.	mm	In.	mm				
NE.5X.5WH6	0.63 x 0.56	16.0 x 14.2	0.38	9.7	NC.5WH6	6	120	120
NE.5X1WH6	0.63 x 1.06	16.0 x 26.9	0.31	7.9	NC.5WH6	6	120	120
NE1X1WH6	1.14 x 1.06	29.0 x 26.9	0.31	7.9	NC1WH6	6	120	120
NE1X1.5WH6	1.14 x 1.62	29.0 x 41.1	0.31	7.9	NC1WH6	6	120	120
NE1X2WH6	1.14 x 2.06	29.0 x 52.3	0.31	7.9	NC1WH6	6	120	120
NE1X3WH6	1.14 x 3.06	29.0 x 77.7	0.31	7.9	NC1WH6	6	120	120
NE1X4WH6	1.14 x 4.06	29.0 x 103.1	0.31	7.9	NC1WH6	6	60	120
NE1.5X1.5WH6	1.64 x 1.62	41.7 x 41.1	0.31	7.9	NC1.5WH6	6	120	120
NE1.5X2WH6	1.64 x 2.06	41.7 x 52.3	0.31	7.9	NC1.5WH6	6	120	120
NE1.5X3WH6	1.64 x 3.06	41.7 x 77.7	0.31	7.9	NC1.5WH6	6	60	120
NE1.5X4WH6	1.64 x 4.06	41.7 x 103.1	0.31	7.9	NC1.5WH6	6	60	120
NE2X1WH6	2.14 x 1.08	54.4 x 27.4	0.31	7.9	NC2WH6	6	120	120
NE2X2WH6	2.14 x 2.08	54.4 x 52.8	0.31	7.9	NC2WH6	6	120	120
NE2X3WH6	2.14 x 3.06	54.4 x 77.7	0.31	7.9	NC2WH6	6	60	120
NE2X4WH6	2.14 x 4.06	54.4 x 103.1	0.31	7.9	NC2WH6	6	60	120
NE3X1WH6	3.14 x 1.06	79.8 x 26.9	0.31	7.9	NC3WH6	6	120	120
NE3X2WH6	3.14 x 2.06	79.8 x 52.3	0.31	7.9	NC3WH6	6	120	120
NE3X3WH6	3.14 x 3.06	79.8 x 77.7	0.31	7.9	NC3WH6	6	60	120
NE3X4WH6	3.14 x 4.06	79.8 x 103.1	0.31	7.9	NC3WH6	6	60	120
NE3X5WH6	3.14 x 5.06	79.8 x 128.5	0.38	9.7	NC3WH6	6	60	120
NE4X2WH6	4.14 x 2.06	105.2 x 52.3	0.31	7.9	NC4WH6	6	60	120
NE4X3WH6	4.14 x 3.06	105.2 x 77.7	0.31	7.9	NC4WH6	6	60	120
NE4X4WH6	4.14 x 4.06	105.2 x 103.1	0.31	7.9	NC4WH6	6	60	120
NE4X5WH6	4.14 x 5.06	105.2 x 128.5	0.38	9.7	NC4WH6	6	60	120

Available in WH (White) only.
 Do not allow cutting, tapping, or cleaning fluids that contain hydrocarbons to come in contact with type NE wiring duct as it will cause stress cracking. See page C1.51 for list of chemicals to avoid.
 Base and cover sold separately.
 **H" dimension includes duct and cover.
 Some sizes and colors are available with adhesive tape. See page C1.36 for availability.

Wiring Duct Accessories

Panduit® offers a selection of Panduct® Accessories to aid cutting, modifying, and installing wiring duct.



Some of the features and benefits found in Panduct® Accessories include:

- Snap-in wire retainers to retain cabling when the cover is removed or during cable installation
- Divider walls that mount within the duct, enabling multiple channels to be created within a duct channel
- Corner strips hold corners rigid at t-junctions in control panel applications
- Mounting clips provide an alternative method to mount the duct and allow the duct to be more easily removed

Panduct® Type FL Flexible Wiring Duct

- Material: Flexible Polypropylene
- UL 94 flammability rating of V-2
- UL Recognized continuous use temperature: 149°F (65°C)
- Factory applied adhesive tape provided for easy positioning**



Part Number	Duct Size (W x H)*		Length		Std. Pkg. Qty.
	mm	In.	mm	In.	
FL12X12LG-A	12.5 x 12.5	0.49 x 0.49	500	19.7	112
FL25X25LG-A	25.0 x 25.0	0.98 x 0.98	500	19.7	70
FL50X50LG-A	50.0 x 50.0	1.97 x 1.97	500	19.7	32

Available in LG (RAL 7040 Light Gray) color only. Unit of measure is pieces.

*"H" dimension includes duct and cover.

**Adhesive tape is not meant for permanent mounting of wiring duct. One mounting hole on each end will be exposed for permanent mounting with fasteners. For best results, wiring duct should be applied to clean, dry, grease-free surfaces. We recommend the surface be cleaned prior to wiring duct installation.

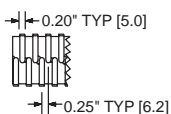
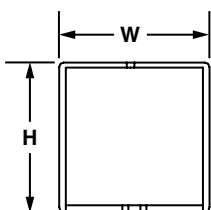

Panduct® Divider Wall

- Wiring duct divider wall can be mounted inside any type of Panduit PVC wiring duct to create multiple channels
- Meets UL508/508A insulation material requirement for barrier between conductors
- Simply install the divider wall base when mounting the duct and snap the divider wall onto the mounting base
- Divider Wall material: Lead-free PVC, UL 94 flammability rating of V-0
- All versions snap onto DB-C mounting base
- Mounting base material: Polycarbonate, UL 94 flammability rating of V-2
- Divider wall heights 2" and greater have a scoreline feature allowing sections to be removed leaving a smooth edge

Part Number	Used with Anchors	Std. Pkg. Qty.	Std. Ctn. Qty.
Panduct® Divider Wall Mounting Base			
DB-C	Panduit NR1 or #8, #10, M4 or M5 screw	100	1000



Part Number	For Nominal Duct Height		Length		Color	Std. Pkg. Qty.	Std. Ctn. Qty.	
	In.	mm	Ft.	M				
Panduct® Solid Divider Wall								
D2H6	2.00	50	6	—	Light Gray	6	120	
D3H6	3.00	75	6	—	Light Gray	6	120	
D4H6	4.00	100	6	—	Light Gray	6	120	
D2HWH6	2.00	50	6	—	White	6	120	
D3HWH6	3.00	75	6	—	White	6	120	
D4HWH6	4.00	100	6	—	White	6	120	
D50H2	2.00	50	6	—	White	6	120	
D75H2	3.00	75	6	—	White	6	120	



Panduct® Slotted Divider Wall								
SD2H6	2.00	50	6	—	Light Gray	6	120	
SD3H6	3.00	75	6	—	Light Gray	6	120	
SD4H6	4.00	100	6	—	Light Gray	6	120	
SD2HWH6	2.00	50	6	—	White	6	120	
SD3HWH6	3.00	75	6	—	White	6	120	
SD4HWH6	4.00	100	6	—	White	6	120	



Note: Must be used with mounting base, DB-C (see page C1.30) which is sold separately. Install mounting bases to the duct channel, locate within 2" of each divider wall end and at least every 12" along the length.

Panduit® Type NNC Divider Wall

- NNC solid divider wall can be mounted inside NNC and NE wiring duct to create multiple channels
- Material: Halogen-free polyphenylene oxide (PPO)
- Simply install the divider wall base when mounting the duct and snap the divider wall onto mounting base, DB-C



Part Number	For Nominal Duct Height		Std. Pkg. Qty.	Std. Ctn. Qty.
	In.	mm		
NNC50DWH2	2.00	50	2	40
NNC75DWH2	3.00	75	2	40

Available in WH (White) color only.
 NOTE: Must be used with mounting base DB-C (see page C1.30), which is sold separately. Install mounting bases to the duct channel, locate within 2" of each divider wall end and at least every 12" along the length.

Panduit® Type G and H Wiring Duct Wire Retainers

- Insert between fingers of type G and H to contain wiring when cover is removed
- Adjustable height
- Material: ABS



Part Number	For Nominal Duct Width In. (mm)	For Nominal Duct Height In. (mm)	Std. Pkg. Qty.	Std. Ctn. Qty.
WR2-C*	2.00 (50.8)	2.00 – 4.00 (50.8 – 101.6)	100	1000
WR2H-C*	2.00 (50.8)	2.00 – 4.00 (50.8 – 101.6)	100	1000
WR3-C	3.00 (76.2)	2.00 – 4.00 (50.8 – 101.6)	100	1000
WR4-C	4.00 (101.6)	2.00 – 4.00 (50.8 – 101.6)	100	1000
WR5-C	Use with: 3x5, 4x5, or 6x4	Use with: 3x5, 4x5, or 6x4	100	1000

*For 2" width type H hinged cover wiring duct use part number WR2H-C.



Panduit® Solid Wall Wiring Duct Type FS, Type HS, and Type D Wiring Duct Wire Retainer

- Mounts onto walls of type FS, type HS, and type D wiring duct with pressure sensitive adhesive
- One size fits three different duct widths
- Full length is used with 2 inch wide duct; for small widths, break off segments at scorelines
- Material: Lead-free PVC



Part Number	For Nominal Duct Height	Std. Pkg. Qty.	Std. Ctn. Qty.
WRS-A-C10	1.00 (25.4) 1.50 (38.1) 2.00 (50.8)	100	1000

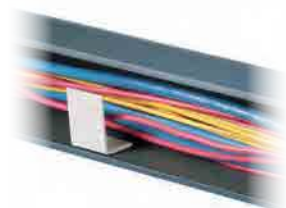

Panduit® Type F, HN and MC Duct Wire Retainers/Labeling Device

- Used to contain wiring when cover is removed and can also be used as a labeling device
- FWR-C is compatible with type F and HN duct sizes
- FMWR-C is compatible with type MC duct sizes
- Material: Lead-free PVC



Part Number	Material	For Duct Width		Std. Pkg. Qty.	Std. Ctn. Qty.
		In.	mm		
FWR-C	Rigid PVC	1.50 – 4.00	37.0 – 76.2	100	1000
FMWR-C	Rigid PVC	1.46 – 3.94	37.0 – 100.0	100	1000



Labeling Inside Duct –
Snaps onto duct fingers. Full length for use with 4" wide duct. For smaller widths, break off segments at scorelines.



Labeling Outside Duct –
Break off the last segment from wire retainer below 1.5" mark and snap onto the back of the remaining segment. Install label and mount between fingers facing outward.

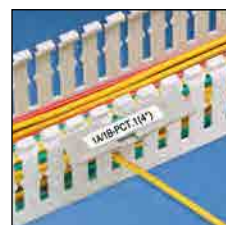

Panduit® Duct Corner Strip with 1" Bend Radius Control

- Create a strong rigid corner at wiring duct junctions
- Provide bend radius protection for cabling as required in NFPA 79-2015 section 13.1.5.9 and TIA/EIA-568-B and 569-A
- Available in 6 foot lengths that can be cut to size to meet any size requirement
- Easy to install two-piece design
- Compatible with all styles of Panduit wiring duct
- UL 94 flammability rating of V-0
- Material: Lead-free PVC



Part Number	Part Description	For Duct Height		Color	Std. Pkg. Qty.	Std. Ctn. Qty.
		In.	mm			
CSC1LG6	Cut-to-size 6 foot corner strip with a 1" bend radius.	All sizes (Cut to height)*	All sizes (Cut to height)*	Light Gray	6	120

6' Lengths for use with all Types of PVC Wiring Duct
Order number of feet required, in multiples of 6' or Standard Package Quantity.
*Refer to Cutting Guide on page C1.33.
Also available in Black (BL) and White (WH).

Panduct® Duct Corner Strip

- Slide onto duct at corner or t-junctions for smooth, round corners
- Available in 6 foot lengths that can be cut to size to meet any requirement
- Easy to install one-piece design
- Compatible with all styles of Panduit wiring duct
- UL 94 flammability rating of V-0
- Material: Lead-free PVC



Part Number	Part Description	For Nominal Duct Height		Color	Std. Pkg. Qty.	Std. Ctn. Qty.
		In.	mm			

6' Lengths for use with all Types of PVC Wiring Duct

CS1LG6	6 foot length is cut by user to fit duct height.	All sizes (Cut to height)*	All sizes (Cut to height)*	Light Gray	60	120
---------------	--	----------------------------	----------------------------	------------	----	-----

*Refer to Cutting Guide below. Available in Light (LG) and White (WH).

Cutting Guide for Duct Corner Strips (CSC1**6, CS1**6)

Used with Duct Height	Cut-to-Size*
1 inch	0.47" (11.9)
1.5 inch	1.04" (26.4)
2 inch	1.23" (31.2)
2.5 inch	1.97" (50.0)
3 inch	2.27" (57.7)
4 inch	3.25" (82.5)
5 inch	4.47" (113.5)

Used with Metric Duct Height	Cut-to-Size*
25mm	0.43" (10.9)
37mm	0.91" (23.1)
50mm	1.39" (35.3)
62mm	1.85" (47.0)
75mm	2.38" (60.5)
100mm	3.35" (85.1)

*Cut-to-size measure fits into the flat area of the duct sidewall.

Panduit® Snap-Clip Mounting Brackets

- Duct easily snaps into bracket
- No mounting holes required in duct
- Ensures no metal is inside the duct
- Snap-clip spacing is not critical
- Simplifies fabrication drawings and panel layout
- Material: Spring steel



Part Number	Screw Required	For Duct Width		Std. Pkg. Qty.	Std. Ctn. Qty.
		In.	mm		

Snap-Clip Mounting Brackets for use with Types G, F, FS and D Wiring Duct

S1F-C	#8-32 x 1/4 (Provided)	1.00	25.4	100	1000
S1.5F-C	#8-32 x 1/4 (Provided)	1.50	38.1	100	1000
S2F-C	#8-32 x 1/4 (Provided)	2.00	50.8	100	1000
S3F-C	#8-32 x 1/4 (Provided)	3.00	76.2	100	1000
S4F-C	#8-32 x 1/4 (Provided)	4.00	101.6	100	1000

Snap-Clip Mounting Brackets for use with Types MC and NNC Wiring Duct

SNS25F-C	#8-32 x 1/4 (User Supplied)	1.00	25.0	100	1000
SNS37F-C	#8-32 x 1/4 (User Supplied)	1.50	37.0	100	1000
SNS50F-C	#8-32 x 1/4 (User Supplied)	2.00	50.0	100	1000
SNS62F-C	#8-32 x 1/4 (User Supplied)	2.50	62.0	100	1000
SNS75F-C	#8-32 x 1/4 (User Supplied)	3.00	75.0	100	1000

Panduit® Snap-Clip Mounting Bracket – Type NE Wiring Duct

- Duct easily snaps into bracket
- Ensures no metal is inside the duct
- Snap-clip spacing is not critical
- Simplifies fabrication drawings and panel layout
- Material: Spring steel



Part Number	Screw Required	For Duct Width		Std. Pkg. Qty.	Std. Ctn. Qty.
		In.	mm		
SNS.5-C	#6-32 x 1/4 (User Supplied)	0.50	12.7	100	1000
SNS.75-C	#6-32 x 1/4 (User Supplied)	0.75	19.1	100	1000
SNS1-C	#8-32 x 1/4 (User Supplied)	1.00	25.4	100	1000
SNS1.5-C	#8-32 x 1/4 (User Supplied)	1.50	38.1	100	1000
SNS2-C	#8-32 x 1/4 (User Supplied)	2.00	50.8	100	1000
SNS3-C	#8-32 x 1/4 (User Supplied)	3.00	76.2	100	1000

Adhesive Tape for Wiring Duct

- Recommended installation temperature is 70°F (21°C)
- UL recognized service temperature is 32°F (0°C) to 140°F (60°C)
- Optimum recommended dwell time for acrylic adhesive is 8 hours
- Recommended tape load is 1/2 lb. per square inch of tape area



Duct Size (W x H)	Tape Part Number	Roll Length		Std. Pkg. Qty.	Std. Ctn. Qty.
		Yds.	m		
0.5 x 0.5 thru 1.5 x 4	P32W2A2-50-7	7.0	6.4	1	100
	P32W2A2-50-72	72.0	65.5	1	9
2 x 1 thru 3 x 3	P32W2A2-50-7	7.0	6.4	1	100
	P32W2A2-50-72	72.0	65.5	1	9
3 x 4 thru 3 x 5	P32W2A2-75-7	7.0	6.4	1	60
	P32W2A2-75-72	72.0	65.5	1	7
4 x 1.5 thru 4 x 3	P32W2A2-50-7	7.0	6.4	1	100
	P32W2A2-75-72	72.0	65.5	1	9
4 x 4 thru 6 x 4	P32W2A2-75-7	7.0	6.4	1	60
	P32W2A2-75-72	72.0	65.5	1	7

For wiring duct 1.5 x 1.5 use 3/4" wide tape.

Specifications for Factory Applied Tape

Duct Size (W x H)	Rows of Tape	Tape			
		Width		Thickness	
		In.	mm	In.	mm
0.5 x 0.5 through 0.75 x 2	1	0.50	12.7	0.03	0.8
1 x 1 through 1.5 x 4	1	0.75	19.1	0.03	0.8
2 x 1 through 3 x 3	2	0.50	12.7	0.03	0.8
3 x 4 through 3 x 5	2	0.75	19.1	0.03	0.8
4 x 1.5 through 4 x 3	2	0.50	12.7	0.03	0.8
4 x 4 through 6 x 4	2	0.75	19.1	0.03	0.8

Adhesive tape is not meant for permanent mounting of wiring duct. One mounting hole on each end will be exposed for permanent mounting with fasteners. For best results, wiring duct should be applied to clean, dry, grease-free surfaces. We recommend the surface be cleaned prior to wiring duct installation.

Adhesive Tape Guide

Selection of wiring duct part numbers available with factory applied adhesive tape.



	G Duct Light Gray	G Duct White	G Duct Black	F Duct Light Gray	F Duct White	FS Duct Light Gray	FS Duct White	FS Duct Black	NE Duct White
	G.5X.5LG6-A	G.5X.5WH6-A	—	F.5X.5LG6-A	—	—	—	—	—
	G.5X1LG6-A	G.5X1WH6-A	—	F.5X1LG6-A	—	—	—	—	—
	G.75X.75LG6-A	—	—	F.75X.75LG6-A	—	—	—	—	—
	G.75X1LG6-A	G.75X1WH6-A	—	—	—	—	—	—	—
	G.75X1.5LG6-A	G.75X1.5WH6-A	—	F.75X1.5LG6-A	—	—	—	—	—
	G.75X2LG6-A	G.75X2WH6-A	—	—	—	—	—	—	—
	G1X1LG6-A	G1X1WH6-A	—	F1X1LG6-A	—	—	FS1X1WH6-A	—	—
	G1X1.5LG6-A	G1X1.5WH6-A	—	F1X1.5LG6-A	—	FS1X1.5LG6-A	—	—	—
	G1X2LG6-A	G1X2WH6-A	—	F1X2LG6-A	F1X2WH6-A	—	—	—	—
	G1X3LG6-A	G1X3WH6-A	G1X3BL6-A	F1X3LG6-A	F1X3WH6-A	—	—	—	—
	G1X4LG6-A	G1X4WH6-A	—	F1X4LG6-A	F1X4WH6-A	—	—	—	—
	G1.5X1LG6-A	G1.5X1WH6-A	—	F1.5X1LG6-A	—	—	—	—	—
	G1.5X1.5LG6-A	G1.5X1.5WH6-A	—	F1.5X1.5LG6-A	—	FS1.5X1.5LG6-A	FS1.5X1.5WH6-A	FS1.5X1.5BL6-A	—
	G1.5X2LG6-A	G1.5X2WH6-A	—	F1.5X2LG6-A	—	—	—	—	NE1.5X2WH6-A
	G1.5X3LG6-A	G1.5X3WH6-A	—	F1.5X3LG6-A	F1.5X3WH6-A	—	—	—	—
	G1.5X4LG6-A	G1.5X4WH6-A	—	F1.5X4LG6-A	F1.5X4WH6-A	—	—	—	—
	G2X1LG6-A	G2X1WH6-A	—	F2X1LG6-A	—	—	—	—	—
	G2X1.5LG6-A	G2X1.5WH6-A	—	F2X1.5LG6-A	—	—	—	—	—
	G2X2LG6-A	G2X2WH6-A	G2X2BL6-A	F2X2LG6-A	F2X2WH6-A	—	—	—	NE2X2WH6-A
	G2X3LG6-A	G2X3WH6-A	—	F2X3LG6-A	F2X3WH6-A	—	—	—	—
	G2X4LG6-A	G2X4WH6-A	G2X4BL6-A	F2X4LG6-A	F2X4WH6-A	—	—	—	—
	G2X5LG6-A	G2X5WH6-A	—	F2X5LG6-A	—	—	—	—	—
	G2.5X3LG6-A	G2.5X3WH6-A	—	—	—	—	—	—	—
	G3X1LG6-A	G3X1WH6-A	—	F3X1LG6-A	—	—	—	—	—
	G3X2LG6-A	G3X2WH6-A	—	F3X2LG6-A	—	—	—	—	—
	G3X3LG6-A	G3X3WH6-A	G3X3BL6-A	F3X3LG6-A	F3X3WH6-A	—	—	—	—
	G3X4LG6-A	G3X4WH6-A	—	F3X4LG6-A	F3X4WH6-A	—	—	—	—
	G3X5LG6-A	G3X5WH6-A	—	F3X5LG6-A	—	—	—	—	—
	G4X1.5LG6-A	G4X1.5WH6-A	—	—	—	—	—	—	—
	G4X2LG6-A	G4X2WH6-A	—	F4X2LG6-A	—	—	—	—	NE4X2WH6-A
	G4X3LG6-A	G4X3WH6-A	—	F4X3LG6-A	F4X3WH6-A	—	—	—	NE4X3WH6-A
	G4X4LG6-A	G4X4WH6-A	G4X4BL6-A	F4X4LG6-A	F4X4WH6-A	—	—	—	NE4X4WH6-A
	G4X5LG6-A	G4X5WH6-A	—	F4X5LG6-A	—	—	—	—	—
	—	—	—	—	—	FS6X4LG6-A	—	—	—

All three sizes of flexible duct come provided with adhesive: FL12X12LG-A, FL25X25LG-A, FL50X50LG-A. Adhesive tape is not meant for permanent mounting of wiring duct. One mounting hole on each end will be exposed for permanent mounting with fasteners. For best results, wiring duct should be applied to clean, dry, grease-free surfaces. We recommend the surface be cleaned prior to wiring duct installation

Panduit® PanelMax™ DIN Rail Wiring Duct Dimensions

Dimensions are shown for reference only. Contact Panduit Customer Service at 800-777-3300 for specific dimensional needs.

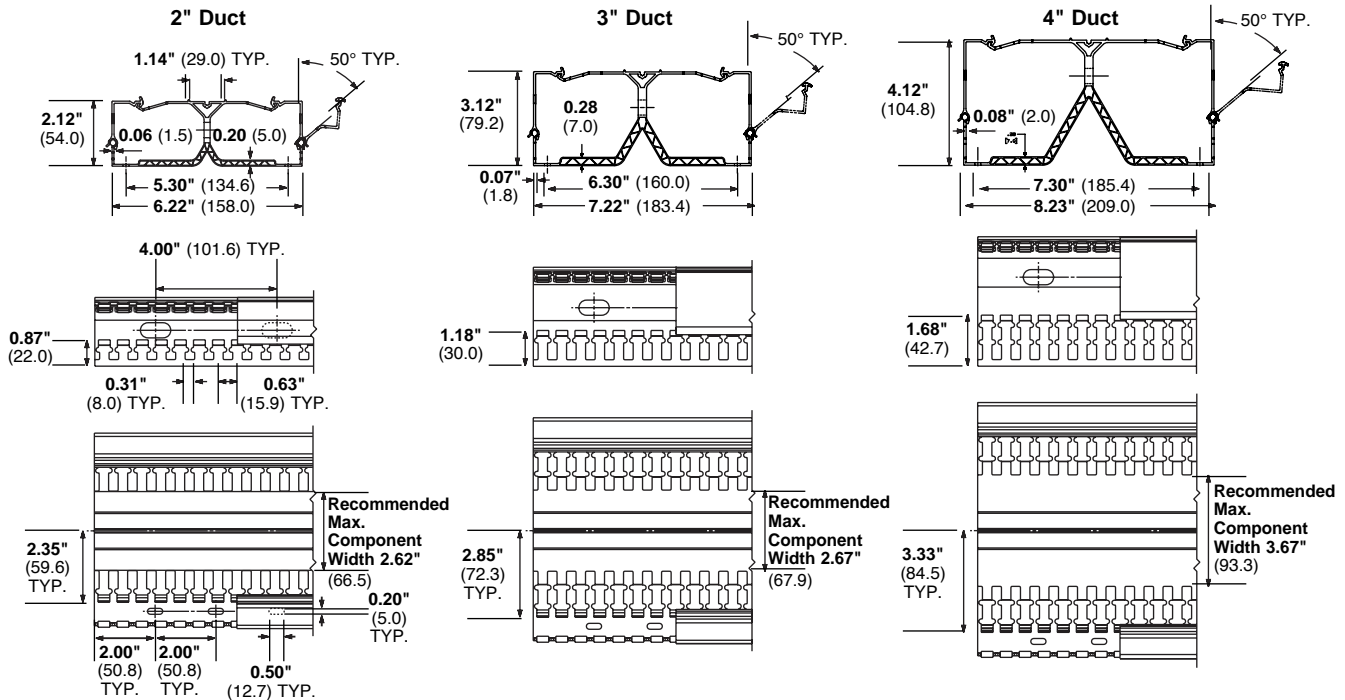

Panduit® PanelMax™ Noise Shield Dimensions

Dimensions are shown for reference only. Contact Panduit Customer Service at 800-777-3300 for specific dimensional needs.

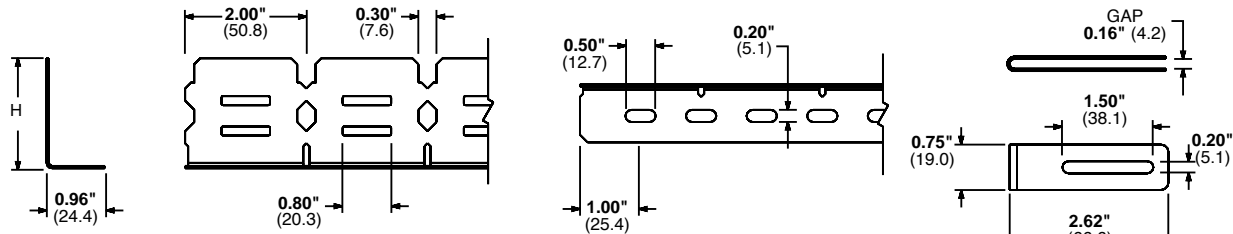

Part No.	H
SD2EMI	1.82 (46.1)
SD3EMI	2.88 (73.2)
SD4EMI	3.86 (98.2)

Sidewall: SD2EMI shown.
 SD3EMI, SD4EMI sidewall feature two pairs of cable tie slots per section.

All dimension shown in inches (mm).

Panduit® PanelMax™ Corner Wiring Duct Dimensions

Dimensions are shown for reference only. Contact Panduit Customer Service at 800-777-3300 for specific dimensional needs.

Size	Dimensions – Inches (mm)								
	A	C	D	G	H	K	T	W	Z
CWD2	3.91 (99.3)	2.25 (57.2)	1.81 (45.9)	2.10 (53.4)	2.57 (65.3)	2.93 (74.3)	0.08 (2.0)	3.35 (85.0)	3.72 (94.6)
CWD3	4.98 (126.6)	2.25 (57.2)	2.83 (71.8)	3.10 (79.1)	3.57 (90.7)	3.88 (98.6)	0.10 (2.4)	4.40 (111.8)	5.16 (131.0)
CWD4	5.94 (150.9)	2.25 (57.2)	3.84 (97.5)	4.10 (104.1)	4.58 (115.7)	4.93 (125.2)	0.11 (2.7)	5.33 (135.3)	6.54 (166.0)

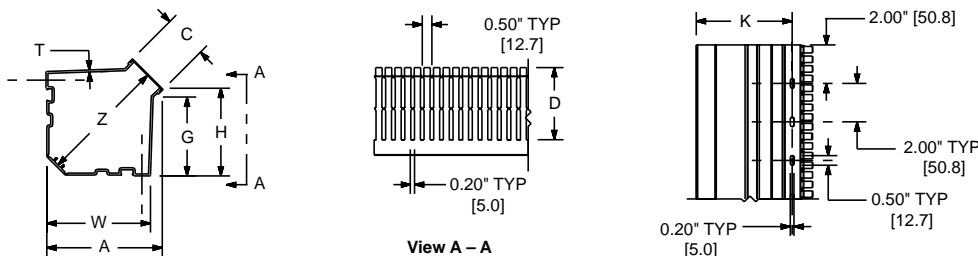

Panduct® Type G and D Wiring Duct Dimensions

Dimensions are shown for reference only. Contact Panduit Customer Service at 800-777-3300 for specific dimensional needs.

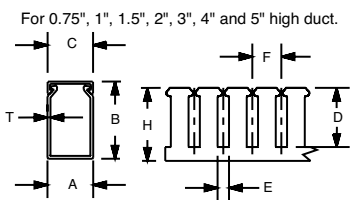
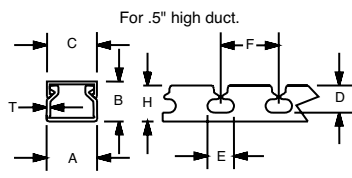

Note: 'A' dimension is measured at base.
Note: 'K' dimension shown in mounting hole dimensions below.

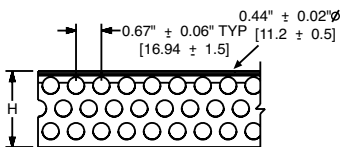

For 2" duct height = 3 rows of holes
3" duct height = 4 rows of holes
4" duct height = 6 rows of holes

Mounting Hole Dimensions
For 0.5", 0.75", 1", and 1.5" wide duct.

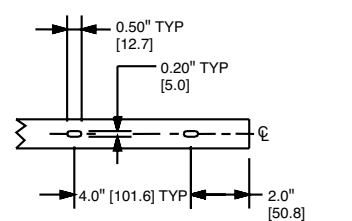

For 2.0", 2.5", 3", 4" and 6" wide duct.

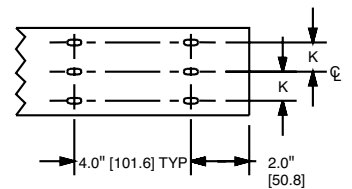

Duct Size (W x H)	Dimensions – Inches (mm)								K	T
	A	B	C	D	E	F	H			
0.5 x 0.5 (12.7 x 12.7)	0.69 (17.5)	0.60 (15.2)	0.69 (17.5)	0.38 (9.7)	0.37 (9.4)	0.80 (20.3)	0.50 (12.7)	ON CENTERLINE	0.05 (1.3)	
0.5 x 1 (12.7 x 25.4)	0.69 (17.5)	1.06 (26.9)	0.69 (17.5)	0.75 (19.1)	0.32 (8.1)	0.80 (20.3)	1.00 (25.4)		0.05 (1.3)	
0.5 x 2 (12.7 x 50.8)	0.69 (17.5)	2.03 (51.6)	0.69 (17.5)	1.63 (41.4)	0.32 (8.1)	0.80 (20.3)	2.00 (50.8)		0.08 (2.0)	
0.75 x 0.75 (19.1 x 19.1)	0.92 (23.9)	0.82 (20.8)	0.92 (23.9)	0.56 (14.2)	0.32 (8.1)	0.80 (20.3)	0.75 (19.1)		0.05 (1.3)	
0.75 x 1 (19.1 x 25.4)	0.92 (23.9)	1.06 (26.9)	0.92 (23.9)	0.75 (19.1)	0.32 (8.1)	0.80 (20.3)	1.00 (25.4)		0.05 (1.3)	
0.75 x 1.5 (19.1 x 38.1)	0.92 (23.9)	1.57 (39.9)	0.92 (23.9)	1.20 (30.5)	0.32 (8.1)	0.80 (20.3)	1.50 (38.1)		0.05 (1.3)	
0.75 x 2 (19.1 x 50.8)	0.94 (23.8)	2.03 (51.6)	0.94 (23.8)	1.63 (41.4)	0.32 (8.1)	0.80 (20.3)	2.00 (50.8)		0.08 (2.0)	
1 x 1 (25.4 x 25.4)	1.25 (31.8)	1.12 (28.4)	1.25 (31.8)	0.75 (19.1)	0.32 (8.1)	0.80 (20.3)	1.00 (25.4)		0.06 (1.5)	
1 x 1.5 (25.4 x 38.1)	1.25 (31.8)	1.62 (41.1)	1.25 (31.8)	1.20 (30.5)	0.32 (8.1)	0.80 (20.3)	1.50 (38.1)		0.07 (1.8)	
1 x 2 (25.4 x 50.8)	1.25 (31.8)	2.12 (53.8)	1.25 (31.8)	1.63 (41.4)	0.32 (8.1)	0.80 (20.3)	2.00 (50.8)		0.08 (2.0)	
1 x 3 (25.4 x 76.2)	1.25 (31.8)	3.12 (79.2)	1.25 (31.8)	2.63 (66.8)	0.32 (8.1)	1.00 (25.4)	3.00 (76.2)		0.09 (2.3)	
1 x 4 (25.4 x 101.6)	1.25 (31.8)	4.10 (104.1)	1.25 (31.8)	3.63 (92.2)	0.32 (8.1)	1.00 (25.4)	4.00 (101.6)		0.10 (2.6)	
1.5 x 1 (38.1 x 25.4)	1.75 (44.5)	1.12 (28.4)	1.75 (44.5)	0.75 (19.1)	0.32 (8.1)	0.80 (20.3)	1.00 (25.4)		0.06 (1.5)	
1.5 x 1.5 (38.1 x 38.1)	1.75 (44.5)	1.62 (41.1)	1.75 (44.5)	1.20 (30.5)	0.32 (8.1)	0.80 (20.3)	1.50 (38.1)		0.07 (1.8)	
1.5 x 2 (38.1 x 50.8)	1.75 (44.5)	2.12 (53.8)	1.75 (44.5)	1.63 (41.4)	0.32 (8.1)	0.80 (20.3)	2.00 (50.8)		0.08 (2.0)	
1.5 x 3 (38.1 x 76.2)	1.75 (44.5)	3.12 (79.2)	1.75 (44.5)	2.63 (66.8)	0.32 (8.1)	1.00 (25.4)	3.00 (76.2)		0.10 (2.5)	
1.5 x 4 (38.1 x 101.6)	1.74 (44.5)	4.10 (104.1)	1.74 (44.5)	3.63 (92.2)	0.32 (8.1)	1.00 (25.4)	4.00 (101.6)		0.11 (2.8)	
2 x 1 (50.8 x 25.4)	2.25 (57.2)	1.12 (28.4)	2.25 (57.2)	0.75 (19.1)	0.32 (8.1)	0.80 (20.3)	1.00 (25.4)		0.06 (1.5)	
2 x 1.5 (50.8 x 38.1)	2.25 (57.2)	1.62 (41.1)	2.25 (57.2)	1.20 (30.5)	0.32 (8.1)	0.80 (20.3)	1.50 (38.1)		0.07 (1.8)	
2 x 2 (50.8 x 50.8)	2.25 (57.2)	2.12 (53.8)	2.25 (57.2)	1.63 (41.4)	0.32 (8.1)	0.80 (20.3)	2.00 (50.8)		0.08 (2.0)	
2 x 3 (50.8 x 76.2)	2.25 (57.2)	3.12 (79.2)	2.25 (57.2)	2.63 (66.8)	0.32 (8.1)	1.00 (25.4)	3.00 (76.2)		0.10 (2.5)	
2 x 4 (50.8 x 101.6)	2.25 (57.2)	4.10 (104.1)	2.25 (57.2)	3.63 (92.2)	0.32 (8.1)	1.00 (25.4)	4.00 (101.6)		0.11 (2.8)	
2 x 5 (50.8 x 127.0)	2.25 (57.2)	5.10 (129.5)	2.25 (57.2)	4.63 (117.6)	0.32 (8.1)	1.33 (33.8)	5.00 (127.0)		0.12 (3.0)	
2.5 x 1 (63.5 x 25.4)	2.75 (69.9)	1.12 (28.4)	2.75 (69.9)	0.75 (19.1)	0.32 (8.1)	1.00 (25.4)	1.00 (25.4)		0.07 (1.8)	
2.5 x 2 (63.5 x 50.8)	2.75 (69.9)	1.62 (41.1)	2.75 (69.9)	1.20 (30.5)	0.32 (8.1)	1.00 (25.4)	2.00 (50.8)		0.08 (2.0)	
2.5 x 3 (63.5 x 76.2)	2.75 (69.9)	2.63 (66.8)	2.75 (69.9)	2.12 (53.8)	0.32 (8.1)	1.00 (25.4)	3.00 (76.2)		0.10 (2.5)	
2.5 x 4 (63.5 x 101.6)	2.75 (69.9)	3.63 (92.2)	2.75 (69.9)	3.12 (79.2)	0.32 (8.1)	1.00 (25.4)	4.00 (101.6)		0.11 (2.8)	
2.5 x 5 (63.5 x 127.0)	2.75 (69.9)	4.63 (117.6)	2.75 (69.9)	4.12 (104.1)	0.32 (8.1)	1.33 (33.8)	5.00 (127.0)		0.12 (3.0)	
3 x 1 (76.2 x 25.4)	3.25 (82.6)	1.12 (28.4)	3.25 (82.6)	0.75 (19.1)	0.32 (8.1)	1.00 (25.4)	1.00 (25.4)	0.07 (1.8)		
3 x 2 (76.2 x 50.8)	3.25 (82.6)	1.62 (41.1)	3.25 (82.6)	1.20 (30.5)	0.32 (8.1)	1.00 (25.4)	2.00 (50.8)	0.08 (2.0)		
3 x 3 (76.2 x 76.2)	3.25 (82.6)	2.63 (66.8)	3.25 (82.6)	2.12 (53.8)	0.32 (8.1)	1.00 (25.4)	3.00 (76.2)	0.10 (2.5)		
3 x 4 (76.2 x 101.6)	3.25 (82.6)	3.63 (92.2)	3.25 (82.6)	3.12 (79.2)	0.32 (8.1)	1.00 (25.4)	4.00 (101.6)	0.11 (2.8)		
3 x 5 (76.2 x 127.0)	3.25 (82.6)	4.63 (117.6)	3.25 (82.6)	4.12 (104.1)	0.32 (8.1)	1.33 (33.8)	5.00 (127.0)	0.12 (3.0)		
4 x 1.5 (101.6 x 38.1)	4.25 (108.0)	1.62 (41.1)	4.25 (108.0)	1.20 (30.5)	0.32 (8.1)	0.80 (20.3)	1.50 (38.1)	0.07 (1.8)		
4 x 2 (101.6 x 50.8)	4.25 (108.0)	2.12 (53.8)	4.25 (108.0)	1.63 (41.4)	0.32 (8.1)	0.80 (20.3)	2.00 (50.8)	0.08 (2.0)		
4 x 3 (101.6 x 76.2)	4.25 (108.0)	3.12 (79.2)	4.25 (108.0)	2.63 (66.8)	0.32 (8.1)	1.00 (25.4)	3.00 (76.2)	0.10 (2.5)		
4 x 4 (101.6 x 101.6)	4.25 (108.0)	4.10 (104.1)	4.25 (108.0)	3.63 (92.2)	0.32 (8.1)	1.00 (25.4)	4.00 (101.6)	0.11 (2.8)		
4 x 5 (101.6 x 127.0)	4.25 (108.0)	5.10 (129.5)	4.25 (108.0)	4.63 (117.6)	0.32 (8.1)	1.33 (33.8)	5.00 (127.0)	0.12 (3.0)		
6 x 4 (152.4 x 101.6)	6.23 (158.8)	4.15 (105.4)	6.25 (158.8)	3.63 (92.2)	0.31 (8.1)	1.00 (25.4)	4.00 (101.6)	0.11 (2.8)		

>Available for type G wiring duct only.
See page C1.15 and C1.19 for wiring duct color and size availability.

Panduit® Type F and FS Wiring Duct Dimensions

Dimensions are shown for reference only. Contact Panduit Customer Service at 800-777-3300 for specific dimensional needs.

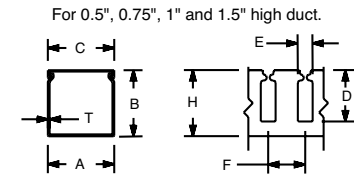

For 2", 3", 4" and 5" high duct.

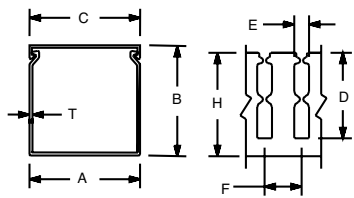

Note: 'A' dimension is measured at base.
Note: 'K' dimension shown in mounting hole dimensions below.

Mounting Hole Dimensions
For 0.5", 0.75", 1" and 1.5" wide duct.

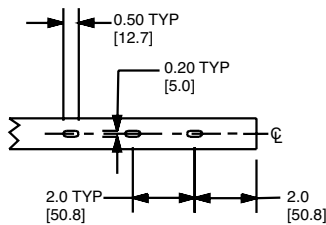

For 2.0", 2.5", 3", 4" and 6" wide duct.

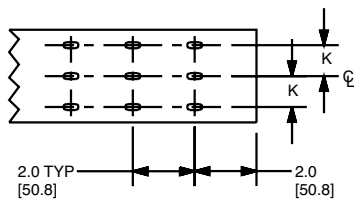

Note: For type FS wiring duct, no mounting holes is the standard condition; if mounting holes are required, delete NM from the part number.

Duct Size (W x H)	Dimensions – Inches (mm)								ON CENTERLINE	T
	A	B	C	D	E	F	H	K		
0.5 x 0.5 (12.7) x (12.7)	0.69 (17.5)	0.60 (15.2)	0.69 (17.5)	0.38 (9.5)	0.20 (5.0)	.50 (12.7)	.50 (12.7)		0.05 (1.3)	
0.5 x 1 (12.7) x (25.4)	0.69 (17.5)	1.06 (26.9)	0.69 (17.5)	0.75 (19.1)	0.20 (5.0)	.50 (12.7)	1.00 (25.4)		0.05 (1.3)	
0.75 x 0.75 (19.1) x (19.1)	0.94 (23.6)	0.82 (20.8)	0.94 (23.9)	0.56 (14.3)	0.20 (5.0)	.50 (12.7)	0.75 (19.1)		0.06 (1.4)	
0.75 x 1.5 (19.1) x (38.1)	0.94 (23.6)	1.57 (39.9)	0.94 (23.9)	1.20 (30.5)	0.20 (5.0)	.50 (12.7)	1.50 (38.1)		0.07 (1.8)	
1 x 1 (25.4) x (25.4)	1.25 (31.8)	1.13 (28.7)	1.25 (31.8)	0.75 (19.1)	0.20 (5.0)	.50 (12.7)	1.00 (25.4)		0.06 (1.4)	
1 x 1.5 (25.4) x (38.1)	1.25 (31.8)	1.62 (41.1)	1.25 (31.8)	1.20 (30.5)	0.20 (5.0)	.50 (12.7)	1.50 (38.1)		0.07 (1.8)	
1 x 2 (25.4) x (50.8)	1.25 (31.8)	2.12 (53.8)	1.25 (31.8)	1.63 (41.4)	0.20 (5.0)	0.50 (12.7)	2.00 (50.8)		0.08 (2.0)	
1 x 3 (25.4) x (76.2)	1.25 (31.8)	3.12 (79.2)	1.25 (31.8)	2.63 (66.8)	0.20 (5.0)	0.50 (12.7)	3.00 (76.2)		0.10 (2.4)	
1 x 4 (25.4) x (101.6)	1.25 (31.8)	4.10 (104.1)	1.25 (31.8)	3.63 (92.2)	0.20 (5.0)	0.50 (12.7)	4.00 (101.6)		0.11 (2.7)	
1.5 x 1 (38.1) x (25.4)	1.75 (44.5)	1.12 (28.4)	1.75 (44.5)	0.75 (19.1)	0.20 (5.0)	0.50 (12.7)	1.00 (25.4)		0.06 (1.5)	
1.5 x 1.5 (38.1) x (38.1)	1.75 (44.5)	1.62 (41.1)	1.75 (44.5)	1.20 (30.5)	0.20 (5.0)	0.50 (12.7)	1.50 (38.1)		0.07 (1.8)	
1.5 x 2 (38.1) x (50.8)	1.75 (44.5)	2.12 (53.8)	1.75 (44.5)	1.63 (41.4)	0.20 (5.0)	0.50 (12.7)	2.00 (50.8)		0.08 (2.0)	
1.5 x 3 (38.1) x (76.2)	1.75 (44.5)	3.12 (79.2)	1.75 (44.5)	2.63 (66.8)	0.20 (5.0)	0.50 (12.7)	3.00 (76.2)		0.10 (2.4)	
1.5 x 4 (38.1) x (101.6)	1.75 (44.5)	4.10 (104.1)	1.75 (44.5)	3.63 (92.2)	0.20 (5.0)	0.50 (12.7)	4.00 (101.6)		0.11 (2.7)	
2 x 1 (50.8) x (25.4)	2.25 (57.2)	1.12 (28.4)	2.25 (57.2)	0.75 (19.1)	0.20 (5.0)	0.50 (12.7)	1.00 (25.4)	0.50 (12.7)	0.06 (1.5)	
2 x 1.5 (50.8) x (38.1)	2.25 (57.2)	1.62 (41.1)	2.25 (57.2)	1.20 (30.5)	0.20 (5.0)	0.50 (12.7)	1.50 (38.1)	.50 (12.7)	0.07 (1.8)	
2 x 2 (50.8) x (50.8)	2.25 (57.2)	2.12 (53.8)	2.25 (57.2)	1.63 (41.4)	0.20 (5.0)	0.50 (12.7)	2.00 (50.8)	.50 (12.7)	0.08 (2.0)	
2 x 3 (50.8) x (76.2)	2.25 (57.2)	3.14 (79.8)	2.25 (57.2)	2.63 (66.8)	0.20 (5.0)	0.50 (12.7)	3.00 (76.2)	.50 (12.7)	0.10 (2.4)	
2 x 4 (50.8) x (101.6)	2.25 (57.2)	4.10 (104.1)	2.25 (57.2)	3.63 (92.2)	0.20 (5.0)	0.50 (12.7)	4.00 (101.6)	.50 (12.7)	0.11 (2.7)	
2 x 5 (50.8) x (127.0)	2.25 (57.2)	5.10 (129.5)	2.25 (57.2)	4.63 (117.6)	0.20 (5.0)	0.50 (12.7)	5.00 (127.0)	.50 (12.7)	0.12 (2.9)	
3 x 1 (76.2) x (25.4)	3.25 (82.6)	1.12 (28.4)	3.25 (82.6)	0.75 (19.1)	0.20 (5.0)	0.50 (12.7)	1.00 (25.4)	1.00 (25.4)	0.07 (1.8)	
3 x 2 (76.2) x (50.8)	3.25 (82.6)	2.12 (53.8)	3.25 (82.6)	1.63 (41.4)	0.20 (5.0)	0.50 (12.7)	2.00 (50.8)	1.00 (25.4)	0.08 (2.0)	
3 x 3 (76.2) x (76.2)	3.25 (82.6)	3.12 (79.2)	3.25 (82.6)	2.63 (66.8)	0.20 (5.0)	0.50 (12.7)	3.00 (76.2)	1.00 (25.4)	0.10 (2.4)	
3 x 4 (76.2) x (101.6)	3.25 (82.6)	4.10 (104.1)	3.25 (82.6)	3.63 (92.2)	0.20 (5.0)	0.50 (12.7)	4.00 (101.6)	1.00 (25.4)	0.11 (2.7)	
3 x 5 (76.2) x (127.0)	3.25 (82.6)	5.10 (129.5)	3.25 (82.6)	4.63 (117.6)	0.20 (5.0)	0.50 (12.7)	5.00 (127.0)	1.00 (25.4)	0.12 (2.9)	
4 x 1.5 (101.6) x (38.1)	4.25 (108.0)	1.62 (41.1)	4.25 (108.0)	N/A	N/A	N/A	1.50 (38.1)	N/A	0.07 (1.8)	
4 x 2 (101.6) x (50.8)	4.25 (108.0)	2.12 (53.8)	4.25 (108.0)	1.63 (41.4)	0.20 (5.0)	0.50 (12.7)	2.00 (50.8)	1.50 (38.1)	0.08 (2.0)	
4 x 3 (101.6) x (76.2)	4.25 (108.0)	3.12 (79.2)	4.25 (108.0)	2.63 (66.8)	0.20 (5.0)	0.50 (12.7)	3.00 (76.2)	1.50 (38.1)	0.10 (2.5)	
4 x 4 (101.6) x (101.6)	4.25 (108.0)	4.10 (104.1)	4.25 (108.0)	3.63 (92.2)	0.20 (5.0)	0.50 (12.7)	4.00 (101.6)	1.50 (38.1)	0.11 (2.7)	
4 x 5 (101.6) x (127.0)	4.25 (108.0)	5.10 (129.5)	4.25 (108.0)	4.63 (117.5)	0.20 (5.0)	0.50 (12.7)	5.00 (127.0)	1.50 (38.1)	0.12 (2.9)	
6 x 4 (152.4) x (101.6)	6.25 (158.8)	4.15 (105.4)	6.25 (158.8)	3.63 (92.2)	0.20 (5.0)	0.50 (12.7)	4.00 (101.6)	2.50 (63.5)	0.11 (2.8)	

>Available for type FS wiring duct only.
See page C1.50 for wiring duct color and size availability.

B1. Cable Ties

Panduct® Type MC Wiring Duct Dimensions

Dimensions are shown for reference only. Contact Panduit Customer Service at 800-777-3300 for specific dimensional needs.

B2. Cable Accessories

For 25mm, 37.5mm, and 50mm high duct.

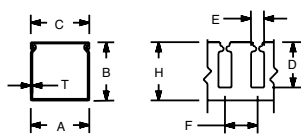

For 62.5mm, 75mm, and 100mm high duct.

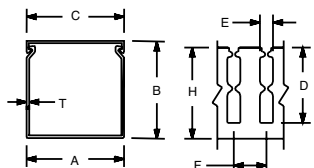

Note: 'A' dimension is measured at base.
Note: 'K' dimension shown in mounting hole dimensions below.

Mounting Hole Dimensions

For 25mm, 37.5mm, and 50mm width duct.

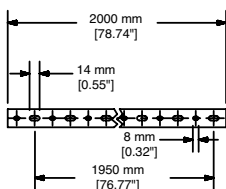

For 75mm and 100mm width duct.

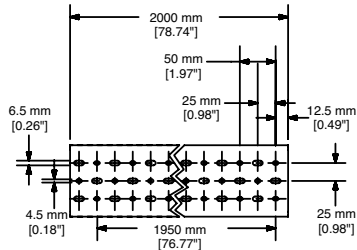

Duct Size (W x H)	Dimensions – mm (Inches)							
	A	B	C	D	E	F	H	T
25 x 25 (0.98) x (0.98)	24.6 (0.97)	23.6 (0.93)	24.6 (0.97)	13.7 (0.54)	5.0 (0.20)	12.5 (0.49)	20.5 (0.81)	1.4 (0.06)
25 x 37.5 (0.98) x (1.48)	24.6 (0.97)	35.8 (1.41)	24.6 (.97)	24.7 (.97)	5.0 (0.20)	12.5 (0.49)	33.0 (1.30)	1.4 (0.06)
25 x 50 (0.98) x (1.97)	24.6 (0.97)	47.8 (1.88)	24.6 (.97)	34.8 (1.37)	5.0 (0.20)	12.5 (0.49)	45.5 (1.79)	1.5 (0.06)
25 x 62.5 (0.98) x (2.46)	24.6 (0.97)	59.7 (2.35)	24.6 (.97)	45.8 (1.80)	5.0 (0.20)	12.5 (0.49)	58.0 (2.28)	1.5 (0.06)
25 x 75 (0.98) x (2.95)	24.6 (0.97)	73.2 (2.88)	24.6 (.97)	57.6 (2.27)	5.0 (0.20)	12.5 (0.49)	70.5 (2.78)	1.7 (0.07)
37.5 x 37.5 (1.48) x (1.48)	37.1 (1.46)	35.8 (1.41)	37.1 (1.46)	24.7 (.97)	5.0 (0.20)	12.5 (0.49)	33.0 (1.30)	1.5 (0.06)
37.5 x 50 (1.48) x (1.97)	37.1 (1.46)	47.8 (1.88)	37.1 (1.46)	34.8 (1.37)	5.0 (0.20)	12.5 (0.49)	45.5 (1.79)	1.7 (0.07)
37.5 x 62.5 (1.48) x (2.46)	37.1 (1.46)	59.7 (2.35)	37.1 (1.46)	45.8 (1.80)	5.0 (0.20)	12.5 (0.49)	58.0 (2.28)	1.7 (0.07)
37.5 x 75 (1.48) x (2.95)	37.1 (1.46)	72.4 (2.85)	37.1 (1.46)	57.6 (2.27)	5.0 (0.20)	12.5 (0.49)	70.5 (2.78)	1.8 (0.07)
50 x 50 (1.97) x (1.97)	49.5 (1.95)	48.0 (1.89)	49.5 (1.95)	34.8 (1.37)	5.0 (0.20)	12.5 (0.49)	45.5 (1.79)	1.7 (0.07)
50 x 75 (1.97) x (2.95)	49.5 (1.95)	72.4 (2.85)	49.5 (1.95)	57.6 (2.27)	5.0 (0.20)	12.5 (0.49)	70.5 (2.78)	1.9 (0.08)
50 x 100 (1.97) x (3.94)	49.5 (1.95)	97.8 (3.85)	49.5 (1.95)	81.0 (3.19)	5.0 (0.20)	12.5 (0.49)	95.5 (3.76)	2.2 (0.09)
62.5 x 62.5 (2.46) x (2.46)	62.0 (2.44)	59.7 (2.35)	62.0 (2.44)	45.8 (1.80)	5.0 (0.20)	12.5 (0.49)	58.0 (2.28)	1.8 (0.07)
75 x 50 (2.95) x (1.97)	74.7 (2.94)	48.0 (1.89)	74.7 (2.94)	34.8 (1.37)	5.0 (0.20)	12.5 (0.49)	45.5 (1.79)	2.0 (0.08)
75 x 62.5 (2.95) x (2.46)	74.7 (2.94)	59.7 (2.35)	74.7 (2.94)	45.8 (1.80)	5.0 (0.20)	12.5 (0.49)	58.0 (2.28)	2.0 (.08)
75 x 75 (2.95) x (2.95)	74.7 (2.94)	73.2 (2.88)	74.7 (2.94)	57.6 (2.27)	5.0 (0.20)	12.5 (0.49)	70.5 (2.78)	2.2 (0.09)
75 x 100 (2.95) x (3.94)	74.7 (2.94)	97.8 (3.85)	74.7 (2.94)	81.0 (3.19)	5.0 (0.20)	12.5 (0.49)	95.5 (3.76)	2.3 (0.09)
100 x 50 (3.94) x (1.97)	99.6 (3.92)	48.0 (1.89)	99.6 (3.92)	34.8 (1.37)	5.0 (0.20)	12.5 (0.49)	45.5 (1.79)	2.0 (0.08)
100 x 75 (3.94) x (2.95)	99.6 (3.92)	73.2 (2.88)	99.6 (3.92)	57.6 (2.27)	5.0 (0.20)	12.5 (0.49)	70.5 (2.78)	2.5 (0.10)
100 x 100 (3.94) x (3.94)	99.6 (3.92)	97.8 (3.85)	99.6 (3.92)	81.0 (3.19)	5.0 (0.20)	12.5 (0.49)	99.5 (3.76)	2.5 (0.10)

B3. Stainless Steel Cable Ties & Accessories

C1. Wiring Duct

C2. Abrasion Protection

C3. Cable Management

D1. Terminals

D2. Power Connectors

D3. Grounding Connectors

E1. Labeling Systems

E2. Labels

E3. Pre-Printed & Write-On Markers

E4. Permanent Identification

E5. Industrial Safety Solutions

F. Keystone Cabling Systems

G. Part Number Index

Panduit® Type TNC and Type NNC Wiring Duct Dimensions

Dimensions are shown for reference only. Contact Panduit Customer Service at 800-777-3300 for specific dimensional needs.

For 25mm, 37.5mm, and 50mm high duct.

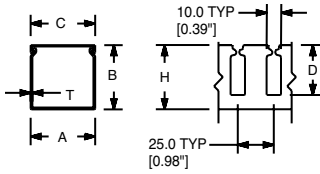

For 75mm and 100mm high duct.

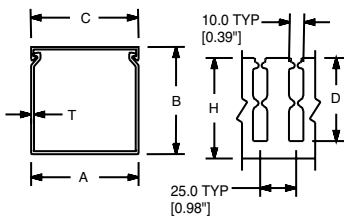

Mounting Hole Dimensions

For 25mm, 37.5mm, and 50mm width duct.

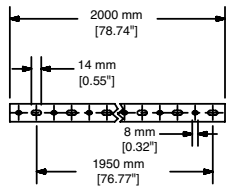

For 75mm and 100mm width duct.

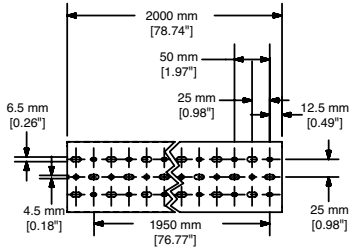

Duct Size (W x H)	Dimensions – mm (Inches)					
	A	B	C	D	H	T
25 x 25 (0.98) x (0.98)	24.6 (0.97)	23.6 (0.93)	24.6 (0.97)	13.6 (0.54)	20.5 (0.81)	1.4 (0.06)
25 x 37 (0.98) x (1.48)	24.6 (0.97)	35.8 (1.41)	24.6 (0.97)	24.6 (0.97)	33.0 (1.30)	1.8 (0.07)
25 x 50 (0.98) x (1.97)	24.6 (0.97)	47.8 (1.88)	24.6 (0.97)	34.8 (1.37)	45.5 (1.79)	2.0 (0.08)
25 x 75 (0.98) x (2.46)	24.6 (0.97)	72.4 (2.85)	24.6 (0.97)	57.6 (2.27)	70.5 (2.78)	2.0 (0.08)
37.5 x 37.5 (1.48) x (1.48)	37.1 (1.46)	35.8 (1.41)	37.1 (1.46)	24.7 (0.97)	33.0 (1.30)	1.8 (0.07)
37.5 x 50 (1.48) x (1.97)	37.1 (1.46)	47.8 (1.88)	37.1 (1.46)	34.8 (1.37)	45.5 (1.79)	2.0 (0.08)
37.5 x 75 (1.48) x (2.95)	37.1 (1.46)	72.4 (2.85)	37.1 (1.46)	57.6 (2.27)	70.5 (2.78)	2.0 (0.08)
50 x 50 (1.97) x (1.97)	49.5 (1.95)	47.8 (1.88)	49.5 (1.95)	34.8 (1.37)	45.5 (1.79)	2.0 (0.08)
50 x 75 (1.97) x (2.95)	49.5 (1.95)	72.4 (2.85)	49.5 (1.95)	57.6 (2.27)	70.5 (2.78)	2.0 (0.08)
50 x 100 (1.97) x (3.94)	49.5 (1.95)	97.8 (3.85)	49.6 (1.95)	81.0 (3.19)	95.5 (3.76)	2.3 (0.09)
75 x 75 (2.95) x (2.95)	74.7 (2.94)	72.4 (2.85)	74.7 (2.94)	57.6 (2.27)	70.5 (2.78)	2.0 (0.08)
100 x 50 (3.94) x (1.97)	99.6 (3.92)	47.8 (1.88)	99.6 (3.92)	34.8 (1.37)	45.5 (1.79)	2.0 (0.08)
100 x 75 (3.94) x (2.95)	99.6 (3.92)	72.4 (2.85)	99.6 (3.92)	57.6 (2.27)	70.5 (2.78)	2.0 (0.08)
100 x 100 (3.94) x (3.94)	99.6 (3.92)	97.8 (3.85)	99.6 (3.92)	81.0 (3.19)	99.5 (3.76)	2.3 (0.09)

> Available in type TNC.

Panduit® Type NE Wiring Duct Dimensions

Dimensions are shown for reference only. Contact Panduit Customer Service at 800-777-3300 for specific dimensional needs.

For .5" high duct.

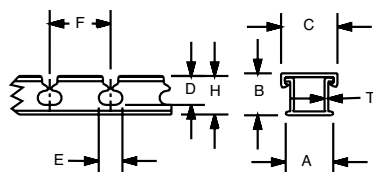

For 1", 1.5", 2", 3", 4" and 5" high duct.

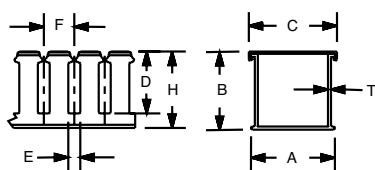

Mounting Hole Dimensions

For 25mm, 37.5mm, and 50mm width duct.

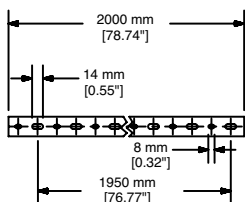

For 75mm and 100mm width duct.

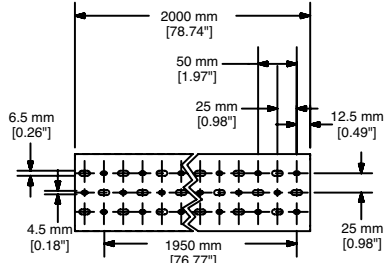

Duct Size (W x H)	Dimensions – Inches (mm)									
	A	B	C	D	E	F	H	K	T	
0.5 x 0.5 (12.7) x (12.7)	0.63 (16.0)	0.56 (14.2)	0.69 (17.5)	0.38 (9.7)	0.37 (9.4)	0.80 (20.3)	0.50 (12.7)	ON CENTERLINE	0.05 (1.3)	
0.5 x 1 (12.7) x (25.4)	0.63 (16.0)	1.06 (26.9)	0.69 (17.5)	0.75 (19.1)	0.31 (7.9)	0.80 (20.3)	1.00 (25.4)		0.06 (1.5)	
1 x 1 (25.4) x (25.4)	1.14 (29.0)	1.06 (26.9)	1.25 (31.8)	0.75 (19.1)	0.31 (7.9)	0.80 (20.3)	1.00 (25.4)		0.06 (1.5)	
1 x 1.5 (25.4) x (38.1)	1.14 (29.0)	1.62 (41.1)	1.25 (31.8)	1.20 (30.5)	0.31 (7.9)	0.80 (20.3)	1.50 (38.1)		0.07 (1.8)	
1 x 2 (25.4) x (50.8)	1.14 (29.0)	2.06 (52.3)	1.25 (31.8)	1.63 (41.4)	0.31 (7.9)	0.80 (20.3)	2.00 (50.8)		0.07 (1.8)	
1 x 3 (25.4) x (76.2)	1.14 (29.0)	3.06 (77.7)	1.25 (31.8)	2.63 (66.8)	0.31 (7.9)	1.00 (25.4)	3.00 (76.2)		0.07 (1.8)	
1 x 4 (25.4) x (101.6)	1.14 (29.0)	4.06 (103.1)	1.25 (31.8)	3.63 (92.2)	0.31 (7.9)	1.00 (25.4)	4.00 (101.6)		0.08 (2.0)	
1.5 x 1.5 (38.1) x (38.1)	1.64 (41.7)	1.62 (41.1)	1.75 (44.5)	1.20 (30.5)	0.31 (7.9)	0.80 (20.3)	1.50 (38.1)		0.07 (1.8)	
1.5 x 2 (38.1) x (50.8)	1.64 (41.7)	2.06 (52.3)	1.75 (44.5)	1.63 (41.4)	0.31 (7.9)	0.80 (20.3)	2.00 (50.8)		0.07 (1.8)	
1.5 x 3 (38.1) x (76.2)	1.64 (41.7)	3.06 (77.7)	1.75 (44.5)	2.63 (66.8)	0.31 (7.9)	1.00 (25.4)	3.00 (76.2)		0.07 (1.8)	
1.5 x 4 (38.1) x (101.6)	1.64 (41.7)	4.06 (103.1)	1.75 (44.5)	3.63 (92.2)	0.31 (7.9)	1.00 (25.4)	4.00 (101.6)		0.08 (2.0)	
2 x 1 (50.8) x (25.4)	2.14 (54.4)	1.08 (27.4)	2.25 (57.2)	.75 (19.1)	0.31 (7.9)	0.80 (20.3)	1.00 (25.4)		0.50 (12.7)	0.06 (1.5)
2 x 2 (50.8) x (50.8)	2.14 (54.4)	2.08 (52.8)	2.25 (57.2)	1.63 (41.4)	0.31 (7.9)	0.80 (20.3)	2.00 (50.8)		0.50 (12.7)	0.07 (1.8)
2 x 3 (50.8) x (76.2)	2.14 (54.4)	3.06 (77.7)	2.25 (57.2)	2.63 (66.8)	0.31 (7.9)	1.00 (25.4)	3.00 (76.2)		0.50 (12.7)	0.07 (1.8)
2 x 4 (50.8) x (101.6)	2.14 (54.4)	4.06 (103.1)	2.25 (57.2)	3.63 (92.2)	0.31 (7.9)	1.00 (25.4)	4.00 (101.6)		0.50 (12.7)	0.08 (2.0)
3 x 1 (76.2) x (25.4)	3.14 (79.8)	1.06 (26.9)	3.25 (82.6)	0.75 (19.1)	0.31 (7.9)	0.80 (20.3)	1.00 (25.4)		1.00 (25.4)	0.06 (1.5)
3 x 2 (76.2) x (50.8)	3.14 (79.8)	2.06 (52.3)	3.25 (82.6)	1.63 (41.4)	0.31 (7.9)	0.80 (20.3)	2.00 (50.8)		1.00 (25.4)	0.07 (1.8)
3 x 3 (76.2) x (76.2)	3.14 (79.8)	3.06 (77.7)	3.25 (82.6)	2.63 (66.8)	0.31 (7.9)	1.00 (25.4)	3.00 (76.2)		1.00 (25.4)	0.07 (1.8)
3 x 4 (76.2) x (101.6)	3.14 (79.8)	4.06 (103.1)	3.25 (82.6)	3.63 (92.2)	0.31 (7.9)	1.00 (25.4)	4.00 (101.6)		1.00 (25.4)	0.08 (2.0)
3 x 5 (76.2) x (127.0)	3.14 (79.8)	5.06 (128.5)	3.25 (82.6)	4.63 (117.6)	0.38 (9.7)	1.33 (33.8)	5.00 (127.0)		1.00 (25.4)	0.09 (2.3)
4 x 2 (101.6) x (50.8)	4.14 (105.2)	2.06 (52.3)	4.25 (108.0)	1.63 (41.4)	0.31 (7.9)	.80 (20.3)	2.00 (50.8)	1.50 (38.1)	0.07 (1.8)	
4 x 3 (101.6) x (76.2)	4.14 (105.2)	3.06 (77.7)	4.25 (108.0)	2.63 (66.8)	0.31 (7.9)	1.00 (25.4)	3.00 (76.2)	1.50 (38.1)	0.07 (1.8)	
4 x 4 (101.6) x (101.6)	4.14 (105.2)	4.06 (103.1)	4.25 (108.0)	3.63 (92.2)	0.31 (7.9)	1.00 (25.4)	4.00 (101.6)	1.50 (38.1)	0.08 (2.0)	
4 x 5 (101.6) x (127.0)	4.14 (105.2)	5.06 (128.5)	4.25 (108.0)	4.63 (117.6)	0.38 (9.7)	1.33 (33.8)	5.00 (127.0)	1.50 (38.1)	0.09 (2.3)	

Panduit® Type H and HS Wiring Duct Dimensions

Dimensions are shown for reference only. Contact Panduit Customer Service at 800-777-3300 for specific dimensional needs.

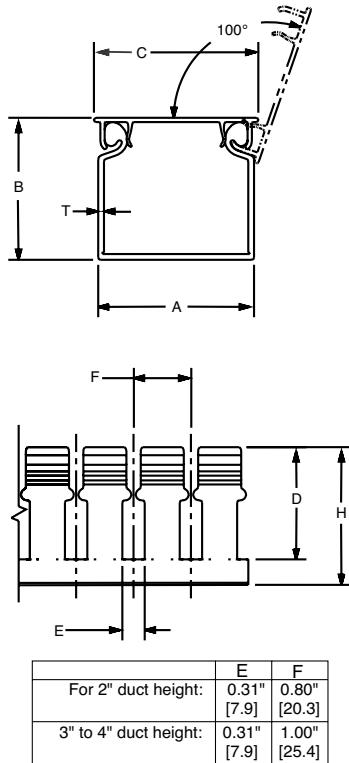

Duct Size (W x H)	Dimensions – mm (Inches)								
	A	B	C	D	E	F	H	K	T
1.5 x 2 (38.1) x (50.8)	1.75 (44.5)	1.98 (50.3)	1.89 (48.0)	1.63 (41.4)	0.31 (7.9)	0.80 (20.3)	1.92 (48.8)	On CL	0.08 (2.0)
1.5 x 3 (38.1) x (76.2)	1.75 (44.5)	3.06 (77.7)	1.89 (48.0)	2.63 (66.8)	0.31 (7.9)	1.00 (25.4)	3.00 (76.2)		0.10 (2.5)
2 x 2 (50.8) x (50.8)	2.17 (55.1)	1.98 (50.3)	2.29 (58.2)	1.57 (39.9)	0.31 (7.9)	.80 (20.3)	1.92 (48.8)	0.50 (12.7)	0.08 (2.0)
2 x 3 (50.8) x (76.2)	2.17 (55.1)	3.06 (77.7)	2.29 (58.2)	2.63 (66.8)	0.31 (7.9)	1.00 (25.4)	3.00 (76.2)	0.50 (12.7)	0.10 (2.5)
2 x 4 (50.8) x (101.6)	2.17 (55.1)	4.1 (104.1)	2.29 (58.2)	3.63 (92.2)	0.31 (7.9)	1.00 (25.4)	4.00 (101.6)	0.50 (12.7)	0.11 (2.8)
3 x 3 (76.2) x (76.2)	3.25 (82.6)	3.06 (77.7)	3.39 (86.1)	2.63 (66.8)	0.31 (7.9)	1.00 (25.4)	3.00 (76.2)	1.00 (25.4)	0.10 (2.5)
3 x 4 (76.2) x (101.6)	3.25 (82.6)	4.1 (104.1)	3.39 (86.1)	3.63 (92.2)	0.31 (7.9)	1.00 (25.4)	4.00 (101.6)	1.00 (25.4)	0.11 (2.8)
4 x 4 (101.6) x (101.6)	4.25 (108.0)	4.1 (104.1)	4.39 (111.5)	3.63 (92.2)	0.31 (7.9)	1.00 (25.4)	4.00 (101.6)	1.50 (38.1)	0.11 (2.8)

For 2", 3", and 4" wide duct.

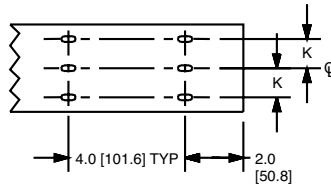

Panduit® Type HN Wiring Duct Dimensions

Dimensions are shown for reference only. Contact Panduit Customer Service at 800-777-3300 for specific dimensional needs.

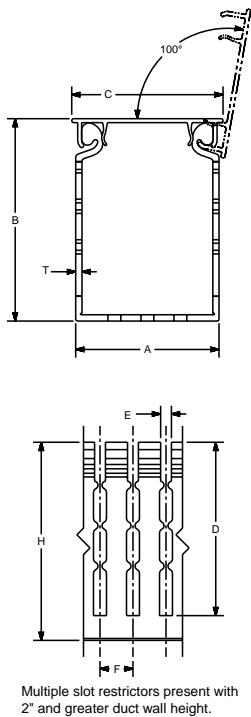

Duct Size (W x H)	Dimensions – mm (Inches)								
	A	B	C	D	E	F	H	K	T
1.5 x 2 (38.1) x (50.8)	1.75 (44.5)	1.98 (50.3)	1.89 (48.0)	1.55 (39.4)	0.20 (5.0)	0.50 (12.7)	1.92 (48.8)	On CL	0.08 (2.0)
1.5 x 3 (38.1) x (76.2)	1.75 (44.5)	3.06 (77.7)	1.89 (48.0)	2.63 (66.8)	0.20 (5.0)	0.50 (12.7)	3.00 (76.2)		0.10 (2.5)
2 x 2 (50.8) x (50.8)	2.17 (55.1)	1.98 (50.3)	2.29 (58.2)	1.55 (39.4)	0.20 (5.0)	0.50 (12.7)	1.92 (48.8)	0.50 (12.7)	0.08 (2.0)
2 x 3 (50.8) x (76.2)	2.17 (55.1)	3.06 (77.7)	2.29 (58.2)	2.63 (66.8)	0.20 (5.0)	0.50 (12.7)	3.00 (76.2)	0.50 (12.7)	0.10 (2.5)
2 x 4 (50.8) x (101.6)	2.17 (55.1)	4.1 (104.1)	2.29 (58.2)	3.63 (92.2)	0.20 (5.0)	0.50 (12.7)	4.00 (101.6)	0.50 (12.7)	0.11 (2.8)
3 x 3 (76.2) x (76.2)	3.25 (82.6)	3.06 (77.7)	3.39 (86.1)	2.63 (66.8)	0.20 (5.0)	0.50 (12.7)	3.00 (76.2)	1.00 (25.4)	0.10 (2.5)
3 x 4 (76.2) x (101.6)	3.25 (82.6)	4.1 (104.1)	3.39 (86.1)	3.63 (92.2)	0.20 (5.0)	0.50 (12.7)	4.00 (101.6)	1.00 (25.4)	0.11 (2.8)
4 x 4 (101.6) x (101.6)	4.25 (108.0)	4.1 (104.1)	4.39 (111.5)	3.63 (92.2)	0.20 (5.0)	0.50 (12.7)	4.00 (101.6)	1.50 (38.1)	0.11 (2.8)

For 2", 3", and 4" wide duct.

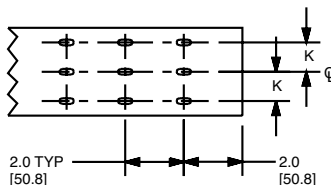

Panduct® Type FL Wiring Duct Dimensions

Dimensions are shown for reference only. Dimensions are in mm (in.). Contact Panduit Customer Service at 800-777-3300 for specific dimensional needs.

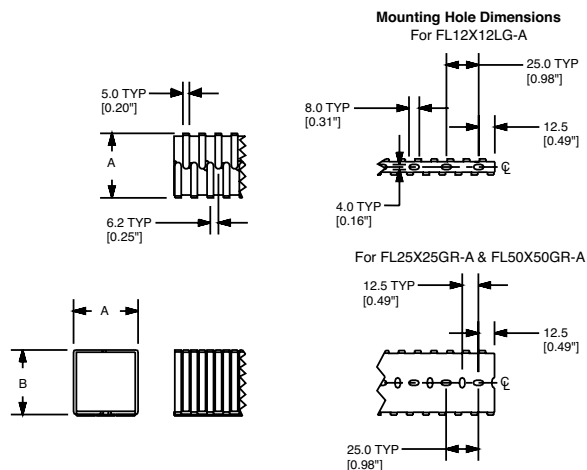

Nominal Duct Size (W x H) mm	Dimensions – mm (In.)	
	A	B
12 x 12 (0.49) x (0.49)	12.5 (0.49)	12.5 (0.49)
25 x 25 (0.98) x (0.98)	25.0 (0.98)	25.0 (0.98)
50 x 50 (1.97) x (1.97)	50.0 (1.97)	50.0 (1.97)

Note: Type FL wiring duct has factory applied adhesive. For 50 x 50 two strips of tape are used; otherwise, only one strip is centered on the part.

Note: 'B' dimension is without adhesive.

Panduct® PanelMax™ DIN Rail Wiring Duct – Wirefill Capacity

Nominal Duct Size (W x H) In.	Nominal Area In. ²	Electrical															Communication				
		8 AWG		10 AWG		12 AWG		14 AWG			16 AWG		18 AWG		22 AWG	23 AWG	23/24 AWG	24 AWG	Fiber Cable		
		0.216	0.164	0.13	0.141	0.152	0.111	0.124	0.133	0.096	0.111	0.118	0.084	0.100	0.106	0.085	0.298	0.289	0.250	0.187	0.118
		THHN	THHN	THHN	MTW	MTW	THHN	MTW	MTW	TFFN	MTW	MTW	TFFN	MTW	MTW	MTW	Cat. 6A	Cat. 6	Cat. 5e	Cat. 3.0 mm	
DRD22 6.25 x 2.15	4.760	51	88	140	119	103	193	154	134	258	193	170	337	238	211	329	26	28	38	68	170
DRD33 7.25 x 3.16	6.536	70	121	193	164	141	265	212	184	354	265	234	463	326	290	452	36	39	52	93	234
DRD44 8.25 x 4.16	9.180	98	170	271	230	198	372	298	259	498	372	329	650	459	408	635	51	54	73	131	329

Table shows maximum wirefill per channel based on 50% of duct internal cross sectional area. Formula = internal area/2.00 x D2.

Panduct® PanelMax™ Corner Wiring Duct – Wirefill Capacity

Nominal Duct Size (W x H) In.	Area In. ²	Electrical															Communication			
		8 AWG		10 AWG		12 AWG		14 AWG			16 AWG		18 AWG		22 AWG	23 AWG	23/24 AWG	24 AWG	Fiber Cable	
		0.216	0.164	0.13	0.141	0.152	0.111	0.124	0.133	0.096	0.111	0.118	0.084	0.100	0.106	0.085	0.330	0.250	0.190	0.118
		THHN	THHN	THHN	MTW	MTW	THHN	MTW	MTW	TFFN	MTW	MTW	TFFN	MTW	MTW	MTW	Cat. 6A	Cat. 6	Cat. 5e	Cat. 3.0 mm
CWD2 3.4 x 2.6	9.752	104	181	288	245	211	395	317	275	529	395	350	691	487	433	674	54	84	96	349
CWD3 4.4 x 3.6	17.580	188	326	520	442	380	713	571	496	953	713	631	1245	879	782	1216	80	140	243	630
CWD4 5.4 x 4.6	26.920	288	500	796	677	582	1092	875	760	1460	1092	966	1907	1346	1197	1862	123	215	372	964

Table shows maximum wirefill based on 50% of duct internal cross sectional area. Formula = area/2.00 x D².

Panduct® Type H, HN, and HS Wiring Duct – Wirefill Capacity

Nominal Duct Size (W x H) In.	Nominal Area In. ²	Electrical															Communication			
		8 AWG		10 AWG		12 AWG		14 AWG			16 AWG		18 AWG		22 AWG	23 AWG	23/24 AWG	24 AWG	Fiber Cable	
		0.216	0.164	0.13	0.141	0.152	0.111	0.124	0.133	0.096	0.111	0.118	0.084	0.100	0.106	0.085	0.330	0.25	0.190	0.118
		THHN	THHN	THHN	MTW	MTW	THHN	MTW	MTW	TFFN	MTW	MTW	TFFN	MTW	MTW	MTW	Cat. 6A	Cat. 6	Cat. 5e	Cat. 3.0 mm
1.50 x 2.00	3.000	34	60	95	81	70	131	105	91	175	131	116	229	162	144	224	14	25	44	116
1.50 x 3.00	4.500	52	90	143	122	105	197	158	137	263	197	174	344	243	216	336	22	38	67	174
2.00 x 2.00	4.000	46	80	127	108	93	175	140	122	234	175	155	306	216	192	299	19	34	59	154
2.00 x 3.00	6.000	69	120	191	163	140	263	210	183	351	263	232	459	324	288	448	29	51	89	232
2.00 x 4.00	8.000	92	160	255	217	187	350	281	244	469	350	310	612	432	384	598	39	69	119	309
3.00 x 3.00	9.000	104	180	287	244	210	394	316	275	527	394	349	689	486	432	673	44	77	134	348
3.00 x 4.00	12.000	139	241	383	326	280	526	421	366	703	526	465	919	648	577	897	59	103	179	464
4.00 x 4.00	16.000	185	321	511	435	374	701	562	488	938	701	621	1225	864	769	1197	79	138	239	619

Table shows maximum wirefill based on 50% of duct internal cross sectional area. Formula = nominal area/1.85 x D². See page C1.50 for wiring duct color and size availability. AWG dimensions represent typical outer cable diameter in inches.

Panduit® Type D, G, F and FS Wiring Duct – Wirefill Capacity

Nominal Duct Size (W x H) In.	Nominal Area In. ²	Electrical															Communication					
		8 AWG		10 AWG		12 AWG			14 AWG			16 AWG			18 AWG			22 AWG	23 AWG	23/24 AWG	24 AWG	Fiber Cable
		0.216	0.164	0.13	0.141	0.152	0.111	0.124	0.133	0.096	0.111	0.118	0.084	0.100	0.106	0.085	0.330	0.25	0.190	0.118		
		THHN	THHN	THHN	MTW	MTW	THHN	MTW	MTW	TFFN	MTW	MTW	TFFN	MTW	MTW	MTW	Cat. 6A	Cat. 6	Cat. 5e	3.0 mm		
0.50 x 0.50	0.250	3	5	8	7	6	11	9	8	15	11	10	20	14	12	19	1	2	3	10		
0.50 x 1.00	0.500	6	10	16	14	12	23	18	16	31	23	20	40	28	25	39	2	4	7	20		
0.50 x 2.00	1.000	12	21	33	28	24	46	37	32	62	46	41	80	57	50	79	5	9	15	40		
0.75 x 0.75	0.563	6	11	19	16	13	26	20	18	34	26	23	45	32	28	44	2	5	8	23		
0.75 x 1.00	0.750	9	15	25	21	18	34	27	24	46	34	30	60	42	38	59	3	6	11	30		
0.75 x 1.50	1.125	13	23	38	32	27	52	41	36	69	52	46	91	64	57	88	5	10	17	46		
0.75 x 2.00	1.500	18	31	50	43	37	69	55	48	93	69	61	121	85	76	118	7	13	23	61		
1.00 x 1.00	1.000	12	21	33	28	24	46	37	32	62	46	41	80	57	50	79	5	9	15	40		
1.00 x 1.50	1.500	18	31	50	43	37	69	55	48	93	69	61	121	85	76	118	7	13	23	61		
1.00 x 2.00	2.000	24	42	67	57	49	92	74	64	124	92	82	161	114	101	158	10	18	31	81		
1.00 x 3.00	3.000	36	63	101	86	74	139	111	96	186	139	123	242	171	152	237	15	27	47	122		
1.00 x 4.00	4.000	48	84	135	114	98	185	148	129	248	185	164	323	228	203	316	20	36	63	163		
1.50 x 1.00	1.500	18	31	50	43	37	69	55	48	93	69	61	121	85	76	118	7	13	23	61		
1.50 x 1.50	2.250	27	47	76	64	55	104	83	72	139	104	92	182	128	114	177	11	20	35	92		
1.50 x 2.00	3.000	36	63	101	86	74	139	111	96	186	139	123	242	171	152	237	15	27	47	122		
1.50 x 3.00	4.500	55	95	152	129	111	208	167	145	279	208	184	364	257	228	355	23	41	71	184		
1.50 x 4.00	6.000	73	127	202	172	148	278	222	193	372	278	246	485	342	305	474	31	54	94	245		
2.00 x 1.00	2.000	24	42	67	57	49	92	74	64	124	92	82	161	114	101	158	10	18	31	81		
2.00 x 1.50	3.000	36	63	101	86	74	139	111	96	186	139	123	242	171	152	237	15	27	47	122		
2.00 x 2.00	4.000	48	84	135	114	98	185	148	129	248	185	164	323	228	203	316	20	36	63	163		
2.00 x 3.00	6.000	73	127	202	172	148	278	222	193	372	278	246	485	342	305	474	31	54	94	245		
2.00 x 4.00	8.000	97	169	270	229	197	371	297	258	496	371	328	647	457	406	632	41	73	126	327		
2.00 x 5.00	10.000	122	212	338	287	247	463	371	323	620	463	410	809	571	508	790	52	91	158	409		
2.50 x 3.00	7.500	91	159	253	215	185	347	278	242	465	347	307	607	428	381	593	39	68	118	307		
3.00 x 1.00	3.000	36	63	101	86	74	139	111	96	186	139	123	242	171	152	237	15	27	47	122		
3.00 x 2.00	6.000	73	127	202	172	148	278	222	193	372	278	246	485	342	305	474	31	54	94	245		
3.00 x 3.00	9.000	110	191	304	258	222	417	334	290	558	417	369	728	514	457	711	47	82	142	368		
3.00 x 4.00	12.000	146	254	405	344	296	556	445	387	744	556	492	971	685	610	949	62	109	189	491		
3.00 x 5.00	15.000	183	318	507	431	370	695	557	484	930	695	615	1214	857	762	1186	78	137	237	614		
4.00 x 1.50	6.000	73	127	202	172	148	278	222	193	372	278	246	485	342	305	474	31	54	94	245		
4.00 x 2.00	8.000	97	169	270	229	197	371	297	258	496	371	328	647	457	406	632	41	73	126	327		
4.00 x 3.00	12.000	146	254	405	344	296	556	445	387	744	556	492	971	685	610	949	62	109	189	491		
4.00 x 4.00	16.000	195	339	540	459	395	742	594	516	992	742	656	1295	914	813	1265	83	146	253	655		
4.00 x 5.00	20.000	244	424	676	574	494	927	743	646	1240	927	820	1619	1142	1017	1581	104	182	316	819		
6.00 x 4.00	24.000	293	509	811	689	593	1113	891	775	1488	1113	984	1943	1371	1220	1898	125	219	379	983		

Table shows maximum wirefill based on 50% of duct internal cross sectional area. Formula = nominal area/1.75 x D². See page C1.50 for wiring duct color and size availability. Not all sizes available for each duct type. AWG dimensions represent typical outer cable diameter in inches.

Panduct® Types MC, TNC, and NNC Wiring Duct – Wirefill Capacity

Nominal Duct Size (W x H) mm	Nominal Area mm ²	Electrical															Communication						
		8 AWG		10 AWG			12 AWG			14 AWG			16 AWG			18 AWG			22 AWG	23 AWG	23/24 AWG	24 AWG	Fiber Cable
		5.5	4.2	3.3	3.6	3.9	2.8	3.1	3.4	2.4	2.8	3.0	2.1	2.5	2.7	2.2	8.4 Cat. 6A	6.4 Cat. 6	4.8 Cat. 5e	3.0 Cat. 3.0 mm			
25 x 25	625	11	20	32	27	23	44	36	31	60	44	39	78	55	49	76	5	8	15	39			
25 x 37	925	17	30	48	41	35	66	53	46	88	66	58	116	81	72	113	7	13	22	58			
25 x 50	1250	23	41	65	55	47	89	72	62	120	89	79	156	110	98	153	10	17	30	79			
25 x 62	1550	29	51	81	69	59	111	89	77	148	111	98	194	137	122	190	12	21	38	98			
25 x 75	1875	35	61	98	83	71	134	108	93	180	134	119	235	166	147	229	15	26	46	119			
37 x 37	1369	25	45	71	60	52	98	78	68	131	98	87	171	121	107	167	11	19	33	86			
37 x 50	1850	35	60	96	82	70	132	106	92	177	132	117	232	163	145	226	15	26	45	117			
37 x 62	2294	43	75	120	102	87	164	132	114	220	164	145	287	203	180	281	18	32	56	145			
37 x 75	2775	52	91	145	123	106	199	159	138	266	199	176	348	245	218	340	22	39	68	176			
50 x 50	2500	47	82	131	111	95	179	144	125	240	179	159	313	221	197	306	20	35	61	158			
50 x 75	3750	71	123	196	167	143	269	216	187	360	269	238	470	332	295	459	30	53	92	238			
50 x 100	5000	94	164	262	222	191	359	288	250	480	359	318	627	442	394	612	40	70	122	317			
62 x 62	3844	72	126	201	171	147	276	221	192	369	276	244	482	340	303	471	31	54	94	244			
75 x 50	3750	71	123	196	167	143	269	216	187	360	269	238	470	332	295	459	30	53	92	238			
75 x 62	4650	88	153	243	207	178	334	267	232	446	334	295	583	411	366	570	37	65	114	295			
75 x 75	5625	106	185	294	250	215	404	324	281	540	404	357	706	498	443	689	45	79	138	357			
75 x 100	7500	142	246	393	334	287	539	432	375	720	539	477	941	664	591	919	60	106	184	476			
100 x 50	5000	94	164	262	222	191	359	288	250	480	359	318	627	442	394	612	40	70	122	317			
100 x 75	7500	142	246	393	334	287	539	432	375	720	539	477	941	664	591	919	60	106	184	476			
100 x 100	10000	189	329	524	445	383	718	576	500	961	718	636	1255	885	788	1225	81	141	245	634			

Table shows maximum wirefill based on 50% of duct internal cross sectional area. Formula = nominal area/1.75 x D2. See page C1.50 for wiring duct color and size availability. Not all sizes available for each duct type. AWG dimensions represent typical outer cable diameter in millimeters.

Panduct® Type NE Wiring Duct – Wirefill Capacity

Nominal Duct Size (W x H) In.	Nominal Area In. ²	Electrical															Communication						
		8 AWG		10 AWG			12 AWG			14 AWG			16 AWG			18 AWG			22 AWG	23 AWG	23/24 AWG	24 AWG	Fiber Cable
		0.216	0.164	0.13	0.141	0.152	0.111	0.124	0.133	0.096	0.111	0.118	0.084	0.100	0.106	0.085	0.330	0.25	0.190	0.118			
		THHN	THHN	THHN	MTW	MTW	THHN	MTW	MTW	TFFN	MTW	MTW	TFFN	MTW	MTW	MTW	Cat. 6A	Cat. 6	Cat. 5e	3.0 mm			
0.50 x 0.50	0.250	2	4	7	6	5	10	8	7	13	10	8	17	12	11	17	1	2	3	8			
0.50 x 1.00	0.500	5	9	14	12	10	20	16	14	27	20	17	35	25	22	34	2	4	6	17			
1.00 x 1.00	1.000	10	18	29	25	21	40	32	28	54	40	35	70	50	44	69	4	8	13	35			
1.00 x 1.50	1.500	16	27	44	37	32	60	48	42	81	60	53	106	75	66	103	6	12	20	53			
1.00 x 2.00	2.000	21	37	59	50	43	81	65	56	108	81	71	141	100	88	138	9	16	27	71			
1.00 x 3.00	3.000	32	55	88	75	64	121	97	84	162	121	107	212	150	133	207	13	24	41	107			
1.00 x 4.00	4.000	42	74	118	100	86	162	130	113	217	162	143	283	200	177	276	18	32	55	143			
1.50 x 1.50	2.250	24	41	66	56	48	91	73	63	122	91	80	159	112	100	155	10	18	31	80			
1.50 x 2.00	3.000	32	55	88	75	64	121	97	84	162	121	107	212	150	133	207	13	24	41	107			
1.50 x 3.00	4.500	48	83	133	113	97	182	146	127	244	182	161	318	225	200	311	20	36	62	161			
1.50 x 4.00	6.000	64	111	177	150	129	243	195	169	325	243	215	425	300	266	415	27	48	83	215			
2.00 x 1.00	2.000	21	37	59	50	43	81	65	56	108	81	71	141	100	88	138	9	16	27	71			
2.00 x 2.00	4.000	42	74	118	100	86	162	130	113	217	162	143	283	200	177	276	18	32	55	143			
2.00 x 3.00	6.000	64	111	177	150	129	243	195	169	325	243	215	425	300	266	415	27	48	83	215			
2.00 x 4.00	8.000	85	148	236	201	173	324	260	226	434	324	287	566	400	355	553	36	64	110	286			
3.00 x 1.00	3.000	32	55	88	75	64	121	97	84	162	121	107	212	150	133	205	13	24	41	107			
3.00 x 2.00	6.000	64	111	177	150	129	243	195	169	325	243	215	425	300	266	415	27	48	83	215			
3.00 x 3.00	9.000	96	167	266	226	194	365	292	254	488	365	323	637	450	400	622	41	72	124	322			
3.00 x 4.00	12.000	128	223	355	301	259	486	390	339	651	486	430	850	600	533	830	55	96	166	430			
3.00 x 5.00	15.000	160	278	443	377	324	608	487	423	813	608	538	1062	750	667	1038	68	120	207	537			
4.00 x 2.00	8.000	85	148	236	201	173	324	260	226	434	324	287	566	400	355	553	36	64	110	286			
4.00 x 3.00	12.000	128	223	355	301	259	486	390	339	651	486	430	850	600	533	830	55	96	166	430			
4.00 x 4.00	16.000	171	297	473	402	346	649	520	452	868	649	574	1133	800	711	1107	73	128	221	573			
4.00 x 5.00	20.000	214	371	591	502	432	811	650	565	1085	811	718	1417	1000	889	1384	91	160	277	716			

Table shows maximum wirefill based on 50% of duct internal cross sectional area. Formula = nominal area/2.00 x D2. AWG dimensions represent typical outer cable diameter in inches.

Panduct® Type FL Wiring Duct – Wirefill Capacity

Nominal Duct Size (W x H) mm	Nominal Area mm ²	Electrical															Communication						
		8 AWG		10 AWG			12 AWG			14 AWG			16 AWG			18 AWG			22 AWG	23 AWG	23/24 AWG	24 AWG	Fiber Cable
		5.5	4.2	3.3	3.6	3.9	2.8	3.1	3.4	2.4	2.8	3.0	2.1	2.5	2.7	2.2	8.4	6.4	4.8	3.0			
		THHN	THHN	THHN	MTW	MTW	THHN	MTW	MTW	TFFN	MTW	MTW	TFFN	MTW	MTW	MTW	Cat. 6A	Cat. 6	Cat. 5e	3.0 mm			
12 x 12	144	1	3	5	4	3	7	5	5	9	7	6	12	8	7	12	0	1	2	6			
25 x 25	625	8	14	22	19	16	31	25	21	42	31	27	54	38	34	53	3	6	10	27			
50 x 50	2500	33	57	91	77	67	125	100	87	168	125	111	219	155	137	214	14	24	42	111			

Table shows maximum wirefill based on 50% of duct internal cross sectional area. Formula = nominal area/2.50 x D2. AWG dimensions represent typical outer cable diameter in millimeters.

Wirefill Formula

General Formula

Panduit Wiring Duct wirefills are calculated using the following general formula:

$$50\% \text{ Wirefill} = 50\% \text{ of } \left(\frac{\text{Usable Duct Area}}{\text{Wire Area}} \right)$$

Why use a 50% Wirefill?

As specified in NFPA79-2015 section 13.5.2, *Percentage Fills of Raceways (Ducts)*, a 50% wirefill is given as the maximum wirefill capacity in all Panduit Wiring Ducts. This helps ensure general safe wiring practices are followed. In actual practice, a 50% wirefill is the maximum amount of wiring the duct can hold given the additional airspace created between cables by non-uniform cable shapes, cable interlacing, and cable packing factors.

What is the Usable Duct Area?

The usable area we define as the calculation of internal area that can be occupied by wires or cables.

Calculation of Internal Area

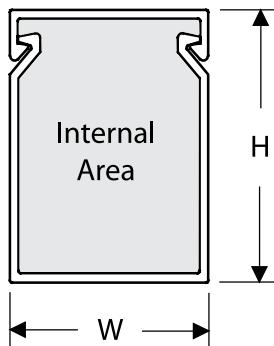

Since we use the outer channel dimensions in our calculation, we make an adjustment in our formula for the thickness of material and for design elements that extend inside the channel.

Air Space Allotment

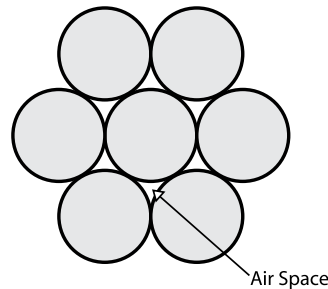

In our wirefill formula an adjustment is made to the channel internal area to account for “unusable” air space that will be present between cables when placed in the channel. Our formula assumes a uniform close packed or high-density cable arrangement (see diagram) (Note 1).

Considering these factors, the usable duct area is equal to an average of 90% of the nominal area, or $(W \times H) \times 0.90$.

Wire Area

The wire area formula is converted to allow calculation using the cable diameter:

$$A_{\text{WIRE}} = \pi r^2$$

$$A_{\text{WIRE}} = (\pi/4) \times D^2$$

$$A_{\text{WIRE}} = 0.785 \times D^2$$

Formula Derivation

Inserting the elements from above into the general formula results in the following:

Simplifying this formula results in the formula used for wirefill calculation (Note 2):

$$50\% \text{ Wirefill} = 0.50 \left(\frac{(W \times H) \times 0.90}{0.785 \times D^2} \right)$$

$$50\% \text{ Wirefill} = \left(\frac{W \times H}{1.75 \times D^2} \right)$$

Note: When calculating wirefill capacity using the above formula, variables W, H, and D must be expressed in same units (i.e. mm or inches).

- This calculation does not account for additional airspace created between cables by non-uniform cable shapes, cable interlacing, and cable packing factors.
- The resulting formula is used for all Panduit flush cover ducts, this excludes type NE duct which has a different profile design that results in a divisor of $2.0 \times D^2$ (rather than $1.75 \times D^2$ as shown here) and all Hinged Wiring Duct: H, HN, HS with a profile design that results in a divisor of $1.85 \times D^2$ and corner wiring duct which uses calculated internal area and a divisor of $2.0 \times D^2$.

Panduct® Wiring Duct Material Specifications

Properties	Units	Test Method	Lead-Free PVC	Halogen-Free PPO (NNC, NE)	Low-Smoke, Halogen-Free PPE + HIPS (TNC)	Polypropylene (FL)
General						
Specific gravity	g/cc	ASTM D 792	1.45	1.09	1.11	0.95
Heat deflection temperature @264 psi	°F	ASTM D 648	156	215	223	117
Thermal expansion	10-5 in/in/°F	ASTM D 696	3.7	3.8		N/A
Thermal conductivity	(BTU-in/hr-ft²)°F	ASTM C 177	1.3	1.3		N/A
Burning Characteristics						
Flammability class	—	UL 94	V-0	V-0	V-0	V-2
Smoke density @ 4 minutes	—	ASTM E 662	538	513	66	N/A
Limited oxygen index (LOI)	—	ASTM D 2863	35	30	28	25
Peak heat release rate	kW/m²	ASTM E 1354	N/A	N/A	N/A	N/A
Hardness						
Durometer hardness	“D”	ASTM D 2240	78	N/A	N/A	N/A
Rockwell hardness	“R”	ASTM D 785	111	116	N/A	N/A
Tensile						
Yield Strength	psi	ASTM D 638	6,200	7,700	8,100	3,770
Modulus	psi		390,000	350,000	355,000	172,000
Flexural						
Yield Strength	psi	ASTM D 790	8,700	11,500	11,500	4,350
Modulus	psi		325,000	340,000	340,000	181,250
Impact strength						
Notched Izod (.125")						
23°C (73°F)	ft-lb/in	ASTM D 256	4.0	5.0	3.7	1.8
0°C (32°F)	ft-lb/in		1.6	2.0	N/A	N/A
Electrical Properties						
Power factor:						
60 Hz @30°C (86°F)	—	ASTM D 150	2.90	N/A	N/A	N/A
1 MHz @30°C (86°F)	—		4.00	N/A	N/A	N/A
Dielectric constant:						
60 Hz @30°C (86°F)	—	ASTM D 150	3.90	N/A	N/A	N/A
1 MHz @30°C (86°F)	—		3.30	N/A	N/A	N/A
Dielectric strength:						
Unconditioned	volts/mil	ASTM D 149	690	N/A	N/A	N/A
Conditioned	volts/mil		700	N/A	N/A	N/A

Note: To the best of our knowledge the above information is accurate. Panduit assumes no liability for the accuracy or completeness of this information.

Rigid Polyvinyl Chloride (PVC)

A general purpose lead-free material for indoor applications. It has a UL 94 flame class of V-0 with a UL recognized continuous-use temperature up to 122°F (50°C). Used in the manufacture of the following types of Panduit wiring duct and covers: G, F, D, FS, MC, H, HN, HS, CWD, DRD.

Halogen-Free, Polyphenylene Oxide (PPO)

A special purpose material for use in halogen-free or high-temperature applications. It has a UL 94 flame class of V-0 with a UL recognized continuous-use temperature up to 95°C (203°F) and is 20% lighter than PVC. Used in the manufacture of the following types of Panduit wiring duct and covers: NE and NNC.

Low-Smoke, Halogen-Free, Polyphenylene Ether + High Impact Polystyrene (PPE + HIPS)

A special purpose material for use in low-smoke, halogen-free, and high-temperature applications. It has a UL 94 flame class of V-0 with a UL recognized continuous-use temperature up to 221°F (105°C). Meets the regulatory requirements of the mass transit industry and other applications where fire and public safety are critical; such as in trains, buses, offshore oil and gas platforms, and other similar environments. Used in the manufacture of Type TNC wiring duct and covers.

Polypropylene (PP)

A flexible material with a UL 94 flame class of V-2 with a UL recognized continuous-use temperature up to 65°C (149°F). Used in the manufacture of Type FL flexible wiring duct.

B1. Cable Ties

B2. Cable Accessories

B3. Stainless Steel Cable Ties & Accessories

C1. Wiring Duct

C2. Abrasion Protection

C3. Cable Management

D1. Terminals

D2. Power Connectors

D3. Grounding Connectors

E1. Labeling Systems

E2. Labels

E3. Pre-Printed & Write-On Markers

E4. Permanent Identification

E5. Industrial Safety Solutions

F. Keystone Cabling Systems

G. Part Number Index

Panduct® Wiring Duct – Color and Size Selection

Duct Size W X H (Inches)	Duct Size W X H (Metric)	LG Light Gray						WH White						BL Black			IB Intrinsic Blue [^]		IG International Gray												
0.5 X 0.5	12 x 12	G	F	FS			FL	G	F	FS	NE																				
0.5 X 1		G	F	FS				G	F		NE																				
0.5 X 2		G						G																							
0.75 X 0.75		G	F	FS				G	F																						
0.75 X 1		G						G																							
0.75 X 1.5		G	F					G	F																						
0.75 X 2		G						G									G														
1 X 1	25 X 25	G	F	FS			NNC	FL	G	F	FS	NE			NNC	MC	G	F	FS			G	F	MC							
1 X 1.5	25 X 37	G	F	FS			NNC	TNC	G	F		NE			NNC	MC	G	F				G	F	MC							
1 X 2	25 X 50	G	F	FS	D		NNC		G	F		NE			NNC	MC	G	F		D		G	F	MC							
1 X 2.5	25 X 62															MC								MC							
1 X 3	25 X 75	G	F	FS	D		NNC	TNC	G	F		D	NE		NNC	MC	G	F		D		G	F	MC							
1 X 4	25 X 100	G	F	FS	D				G	F		D	NE				G	F		D		G	F								
1.5 X 1		G	F	FS					G	F	FS																				
1.5 X 1.5	37 X 37	G	F	FS			NNC	TNC	G	F	FS	NE			NNC	MC	G	F	FS			G	F	MC							
1.5 X 2	37 X 50	G	F	FS	D	H	HN	HS	NNC			NE	H	HN	HS	NNC	MC	G	F		D	H	HS	G	F	MC					
1.5 X 2.5	37 X 62															MC								MC							
1.5 X 3	37 X 75	G	F	FS	D	H	HN	HS	NNC	TNC		D	NE	H	HN	HS	NNC	MC	G	F		D	H	HS	G	F	MC				
1.5 X 4		G	F		D				G	F		D	NE					G	F		D		G	F							
2 X 1		G	F	FS					G	F	FS	NE						G	F												
2 X 1.5		G	F	FS					G	F	FS																				
2 X 2	50 X 50	G	F	FS	D	H	HN	HS	NNC	FL	TNC	G	F	FS	D	NE	H	HN	HS	NNC	MC	G	F	FS	D	H	HS	G	F	MC	
2 X 3	50 X 75	G	F	FS	D	H	HN	HS	NNC			G	F	FS	D	NE	H	HN	HS	NNC	MC	G	F		D	H	HS	G	F	MC	
2 X 4	50 X 100	G	F	FS	D	H	HN	HS	NNC			G	F		D	NE	H	HN	HS	NNC	MC	G	F		D	H	HS	G	F	MC	
2 X 5		G	F						G	F																					
2.5 X 2.5	62 X 62															MC															MC
2.5 X 3		G	F		D				G	F								G													
3 X 1		G	F	FS					G	F	FS	NE																			
3 X 2	75 X 50	G	F	FS	D				G	F	FS	NE				MC	G	F	FS			G								MC	
3 X 2.5	75 X 62															MC															
3 X 3	75 X 75	G	F	FS	D	H	HN	HS	NNC	TNC		G	F	FS	D	NE	H	HN	HS	NNC	MC	G	F	FS	D	H	HS	G	F	MC	
3 X 4	75 X 100	G	F	FS	D	H	HN	HS				G	F	FS	D	NE	H	HN	HS		MC	G	F		D	H	HS	G	F	MC	
3 X 5		G	F	FS					G	F	FS	NE										G	F								
4 X 1.5		G		FS					G																						
4 X 2	100 X 50	G	F	FS	D			NNC	TNC			G	F	FS	NE			NNC	MC	G	F		D							MC	
4 X 3	100 X 75	G	F	FS	D			NNC	TNC			G	F	FS	NE			NNC	MC	G	F									MC	
4 X 4	100 X 100	G	F	FS	D	H	HN	HS	NNC			G	F	FS	D	NE	H	HN	HS	NNC	MC	G	F	FS	D	H	HS	G	F	MC	
4 X 5		G	F	FS					G	F		NE										G	F								
6 X 4		G	F	FS					G	F	FS																				

[^]Intrinsic Blue Color – IB

Intrinsic blue wiring duct is made from the same lead-free PVC material as our standard PVC duct. Intrinsic blue is an internationally recognized standard blue color that identifies the wiring duct as "incapable of releasing sufficient electrical or thermal energy under normal or abnormal conditions to cause ignition of a specific hazardous atmospheric mixture in its most easily ignited concentrations." *ISA-RD12.6 (Instrument Society of America)

Duct Size W X H (Inches)	Duct Size W X H (Metric)	LG Light Gray			WH White		
3.35 x 2.54*	85.0 x 64.4			CWD			CWD
4.40 x 3.57*	111.8 x 90.7			CWD			CWD
5.33 x 4.58*	135.3 x 115.7			CWD			CWD
6.25 x 2.12**	156.7 x 54.0				DRD		DRD
7.25 x 3.12**	184.1 x 79.4				DRD		DRD
8.25 x 4.12**	209.5 x 104.8				DRD		DRD

* Corner Duct Profile

** DIN Rail Duct Profile

Installation Tips:
Application of Latex Paint on Panduct® Wiring Duct



The following is recommended to properly prepare the surface of the wiring duct/raceway and covers for the best adhesion of latex paint:

1. Clean surface with mild soap and water solution or mineral spirits with a clean lint free towel. Allow to dry.
2. Using a sanding pad (such as synthetic stripping pad or medium/fine steel wool), slightly roughen the surface to be painted.
3. Apply a coat of all-purpose 100% acrylic primer and allow to dry.
4. Apply the desired topcoat of latex paint and allow to dry.
5. Install the wiring duct/raceway and covers.

Cutting Wiring Duct and Cover

For small quantities, use the DCT duct cutting tool. For larger quantities use a miter cutting saw blade for clean burr-free cuts. Recommended blade: *Carbide 80T or 100T; 0.090" thickness, 0.125 kerf.*

Recommended Precaution when Using Type TNC, NNC and NE Wiring Duct

Cleaning solvents and cutting fluids that contain any of the following chemical agents should not come in contact with type TNC, type NNC or type NE wiring duct. These chemicals are known to cause stress cracking in the halogen-free PPO material.

- Hydrocarbons
- Phenols
- Ketones
- Amines
- Ethers
- Organic, inorganic and oxidizing acids
- Petrol

Note: Panduit assumes no liability for the accuracy or completeness of this list. Please see www.panduit.com for Wiring Duct Chemical Resistance document and acceptable lubricants.

Part Number System for Panduct® Wiring Duct

G	.5	X	.5	LG	6	-A
Type	Nominal Width In. or mm		Nominal Height In. or mm	Color	Length Ft. or m	-A = Adhesive Backed = Without Adhesive (leave blank) NM = No Mounting Holes
G = Wide Slot Flush Design				LG = Light Gray		
F = Narrow Slot Flush Design				WH = White		
FL = Flexible Duct				BL = Black		
FS = Solid Wall Flush Design				IB = Intrinsic Blue		
H = Wide Slot Hinged Design				IG = International Gray		
HN = Narrow Slot Hinged Design						
HS = Solid Wall Hinged Design						
D = Round Hole Flush Design						
NNC = Halogen-Free Design						
NE = Halogen-Free Wide Slot Design						
MC = Metric Narrow Slot Design						
TNC = Low-Smoke, Halogen-Free Metric Design						

Part Number System for Panduct® PanelMax™ DIN Rail Wiring Duct

DRD

Type

DRD = DIN Rail Duct

22

Size

Capability Height
22 = 2" Height
33 = 3" Height
44 = 4" Height

LG

Color

LG = Light
Gray
WH = White

6

Length

Ft.

Part Number System for Panduct® PanelMax™ Corner Wiring Duct

CWD

Type

CWD = Corner Wiring Duct

3

Capability Height

2 = 2" Height
3 = 3" Height
4 = 4" Height

LG

Color





LG = Light
Gray
WH = White

6

Length

Ft.

Panduit Wiring Duct Approvals and Compliances

Agency Mark	Agency	Requirement	Classification/Performance	Wiring Duct Types/Products
	Underwriters Laboratories, Inc. File No. E147128	UL 1565	Material Flame Class V-0 Continuous-use temperature up to 50°C (122°F)	All wiring duct types and covers
		UL 1565 CSA C22.2 No. 18.5-13	Material Flame Class V-0 Continuous-use temperature up to 50°C (122°F)	Type H, HS, HN, and DRD
	Underwriters Laboratories, Inc.	UL 508 Section 15	An insulating barrier material shall comply with the minimum material properties indicated in Table 15.1	PVC divider walls
		UL 508 Sections 34 and 181	Qualifies as a metal barrier with required thickness as indicated in Table 6.1	SD*EMI metal barrier
	Canadian Standards Association File No. 016446	CSA C22.2 No. 18.5-13	Material Flame Class V-0 Continuous-use temperature up to 50°C (122°F)	All wiring duct types and covers (except H, HS, and HN)
	European Union	Low Voltage Directive 2014/35/EU	<ul style="list-style-type: none"> • CDS (cable ducting system for impact 2 J) • Minimum storage, transport, installation, and application temperature: -5°C (23°F) • Maximum application temperature: 60°C (140°F) • Non-flame propagating • Without electrical continuity • Cover removable without a tool 	H, HS, G, F, D, MC, FS, NNC, NE, DRD, and TNC
		EN 50085-1 EN 50085-2-3		
		EN 45545-2	Type NNC and Type NE: Exterior (R23) - HL1 Type TNC: Interior (R22)- HL2 & Exterior (R23) - HL2	NNC and TNC
	DIN German Institute for Standardization	DIN 43659	<ul style="list-style-type: none"> • Specifies dimensions for slotted trunkings used in electrical switch-gear assemblies and that conform to DIN VDE 060 Part 506 • Channel mounting hole pattern, slot dimensions, pitch, and location • Distance from first to last like-size mounting hole • Minimum overall product length 	MC, NNC, and TNC
		DIN 5510-2 DIN 54837	Burning Class: S4 Smoke Class: SR2 Dripping Class: ST2	TNC
	AFNOR French Association of Normalization	NF F 16-101 NF F 16-102	Type NNC Wiring Duct Classification = F3/I4 Type TNC Wiring Duct Classification = F1/I4	NNC and TNC
	UNIFER Italian Railway Standards	EN ISO 11925-2	Pass 30-second flame application	TNC
	FRA – Federal Railroad Administration	49 CFR Part 238	Surface Flammability: < 35 Smoke Density Ds (1.5) < 100 Ds (4.0) < 200	TNC
	NFPA – National Fire Protection Association	NFPA130		
	National Fire Protection Association	NFPA 79-2015, Section 13.3.1 IEC 60332-1	Non-metallic duct shall be permitted (inside enclosures) only when they are made with a flame-retardant material; flame-retardant material is defined in the standard by the IEC 60332-1 test method	All wiring duct types and covers (except FL)
		NFPA 79-2015, Section 13.5.2	Panduit publishes a maximum percentage wire fill for common wire types equal to 50% of the interior cross-sectional area of the wiring duct	All wiring duct types and covers
		NFPA 79-2015, section 13.1.6.9	Panduit bend radius control accessories can be mounted at right angles and T junctions created using wiring duct in order to maintain cable bend radius control	Corner strip with 1" bend radius control
	European Union	European Union Directive 2011/65/EU.	Meets the requirements on the Restriction of Hazardous Substances and is free of the six substances listed in the directive	All wiring duct products

Notes

Abrasion Protection

Panduit® abrasion protection products provide an economical and easy way to insulate, protect, bundle and color-code components and cable. A wide variety of sizes and materials are available to meet a broad range of indoor and outdoor applications. To help assure optimum quality, Panduit abrasion protection products are designed and manufactured to meet applicable quality standards including International, UL, Military, ISO, and Aerospace.



- **Pan-Wrap™ Split Harness Wrap features a patented slot pattern to improve flexibility and abrasion protection**
- **Spiral wrap bundles and protects wire and cable while providing the largest variety of colors, materials, and sizes to meet a variety of needs**
- **Grommet edging protects wire and cable from damage caused by sharp panel edges**
- **Heat shrink is available in many different materials and sizes to meet a variety of needs**
- **Corrugated loom tubing is crush, impact, and abrasion resistant to reduce the risk of damage to wire and cable**
- **Braided expandable sleeving provides continuous abrasion resistance and lightweight durable protection, with a flexible open weave that will not trap heat or humidity**

Panduit abrasion protection products provide quality at the lowest installed cost. With a continued focus on new product development, Panduit continues to meet customer needs.

Part Number System for Pan-Wrap™

PW	50	F	—	C	20
Type	Outside Diameter	Material		Package Size	Color Suffix
PW = Pan-Wrap™	50 = 1/2" 75 = 3/4" 100 = 1" 150 = 1 1/2"	F = Polyethylene FR = Flame Retardant Polyethylene		L = 50' (15.2m) C = 100' (30.5m) T = 200' (61.0m)	Leave Blank = Natural 20 = Black Weather Resistant Polyethylene** 3 = Orange 4 = Yellow

Pan-Wrap™ Split Harness Wrap



- Patented slot pattern provides improved flexibility and abrasion protection in any application
- Unique wall design provides for easy cable breakouts
- Innovative design maintains uniform bundle protection in dynamic applications
- Considerably reduces installation time
- Large overlap accommodates a wide range of bundle diameters
- Packaged on a reel for easy handling and dispensing of product
- UL File: E141152
- Voltage rating: 600 V

Part Number	Material	Color	Length Per Reel		Max. Bundle Diameter		Min. Bundle Diameter‡		Temperature Range	Nominal I.D.		Std. Pkg. Qty.*
			Ft.	m	In.	mm	In.	mm		In.	mm	
PW50F-T	Polyethylene	Natural	200	61.0	0.55	14.0	0.43	10.9	-40°F – 122°F (-40°C – 50°C)	0.50	12.7	1
PW50F-T20	Polyethylene	Black	200	61.0	0.55	14.0	0.43	10.9		0.50	12.7	1
PW50F-T3	Polyethylene	Orange	200	61.0	0.55	14.0	0.43	10.9		0.50	12.7	1
PW50F-T4	Polyethylene	Yellow	200	61.0	0.55	14.0	0.43	10.9		0.50	12.7	1
PW50FR-TY	Flame Retardant Polyethylene	Natural	200	61.0	0.55	14.0	0.43	10.9	-4°F – 122°F (-20°C – 50°C)	0.50	12.7	1
PW50FR-T20Y	Flame Retardant Polyethylene	Black	200	61.0	0.55	14.0	0.43	10.9		0.50	12.7	1
PW75F-C	Polyethylene	Natural	100	30.5	0.81	20.6	0.55	14.0	-40°F – 122°F (-40°C – 50°C)	0.75	19.1	1
PW75F-C20	Polyethylene	Black	100	30.5	0.81	20.6	0.55	14.0		0.75	19.1	1
PW75F-C3	Polyethylene	Orange	100	30.5	0.81	20.6	0.55	14.0		0.75	19.1	1
PW75F-C4	Polyethylene	Yellow	100	30.5	0.81	20.6	0.55	14.0		0.75	19.1	1
PW75FR-CY	Flame Retardant Polyethylene	Natural	100	30.5	0.81	20.6	0.55	14.0	-4°F – 122°F (-20°C – 50°C)	0.75	19.1	1
PW75FR-C20Y	Flame Retardant Polyethylene	Black	100	30.5	0.81	20.6	0.55	14.0		0.75	19.1	1
PW100F-C	Polyethylene	Natural	100	30.5	1.13	28.6	0.81	20.6	-40°F – 122°F (-40°C – 50°C)	1.00	25.4	1
PW100F-C20	Polyethylene	Black	100	30.5	1.13	28.6	0.81	20.6		1.00	25.4	1
PW100F-C3	Polyethylene	Orange	100	30.5	1.13	28.6	0.81	20.6		1.00	25.4	1
PW100F-C4	Polyethylene	Yellow	100	30.5	1.13	28.6	0.81	20.6		1.00	25.4	1
PW100FR-CY	Flame Retardant Polyethylene	Natural	100	30.5	1.13	28.6	0.81	20.6	-4°F – 122°F (-20°C – 50°C)	1.00	25.4	1
PW100FR-C20Y	Flame Retardant Polyethylene	Black	100	30.5	1.13	28.6	0.81	20.6		1.00	25.4	1
PW150F-L	Polyethylene	Natural	50	15.2	1.63	41.3	1.13	28.6	-40°F – 122°F (-40°C – 50°C)	1.50	38.1	1
PW150F-L20	Polyethylene	Black	50	15.2	1.63	41.3	1.13	28.6		1.50	38.1	1
PW150F-L3	Polyethylene	Orange	50	15.2	1.63	41.3	1.13	28.6		1.50	38.1	1
PW150F-L4	Polyethylene	Yellow	50	15.2	1.63	41.3	1.13	28.6		1.50	38.1	1
PW150FR-LY	Flame Retardant Polyethylene	Natural	50	15.2	1.63	41.3	1.13	28.6	-4°F – 122°F (-20°C – 50°C)	1.50	38.1	1
PW150FR-L20Y	Flame Retardant Polyethylene	Black	50	15.2	1.63	41.3	1.13	28.6		1.50	38.1	1

‡Diameter can be further reduced with the use of Panduit cable ties.

*Order number of reels required.

**FR-20 is not weather resistant.

Pan-Wrap™ Installation Tools

- Patented installation tool with 180° opening allows easy loading of maximum bundle diameters to speed installation, providing the lowest installed cost
- The Pan-Wrap installation tool is designed for use with our Pan-Wrap Split Harness Wrap, Pan-Wrap Braided Sleeving and Corrugated Loom Tubing Products



Part Number	Color	For Use With	Std. Pkg. Qty.**
PWT38	White	Pan-Wrap Braided Sleeving – Size: 1/4" Slit Wall Corrugated Loom Tubing – Size: 3/8"	1
PWT50	White	Pan-Wrap Split Harness Wrap – Size: 1/2" Pan-Wrap Braided Sleeving – Size: 1/2" Slit Wall Corrugated Loom Tubing – Size: 1/2"	1
PWT75	White	Pan-Wrap Split Harness Wrap – Size: 3/4" Pan-Wrap Braided Sleeving – Size: 3/4" Slit Wall Corrugated Loom Tubing – Size: 3/4"	1
PWT100	White	Pan-Wrap Split Harness Wrap – Size: 1" Pan-Wrap Braided Sleeving – Size: 1" Slit Wall Corrugated Loom Tubing – Size: 1"	1
PWT150	White	Pan-Wrap Split Harness Wrap – Size: 1 1/2" Pan-Wrap Braided Sleeving – Size: 1 1/2" Slit Wall Corrugated Loom Tubing – Size: 1 1/2"	1

**Order number of tools required.

Part Number System for Spiral Wrap

T	25	F	—	C	16
Type	Outside Diameter	Material		Package Size	Color Suffix
T = Spiral Wrap	12 = 1/8" 19 = 3/16" 25 = 1/4" 38 = 3/8" 50 = 1/2" 62 = 5/8" 75 = 3/4" 100 = 1"	F = Polyethylene R = Fire Resistant Polyethylene FR = Flame Retardant Polyethylene N = Nylon NZFR = Halogen-Free Flame Retardant Nylon T = TFE^ P = Weather Resistant Polypropylene		X = 10' Q = 25' L = 50' C = 100' T = 200' TL = 250' D = 500' M = 1,000'	See Table Below

Color	Color Suffix	Material Availability						
		Polyethylene	Fire Resistant Polyethylene	Flame Retardant Polyethylene	Nylon 6.6	Halogen-Free Flame Retardant Nylon 6	Weather Resistant Polyethylene	TFE ▲
Natural*	No Suffix Will be Listed	✓	✓	✓	✓			✓
Weather Resistant Black	0	✓			✓		✓	
Brown	1	✓						
Red	2	✓						
Orange	3	✓						
Yellow	4	✓						
Green	5	✓						
Blue	6	✓						
Purple	7	✓						
Gray	8	✓						
White	10	✓						
Pink	16	✓						
Black	20	✓	✓	✓	✓	✓		✓

^TFE is Polytetrafluorethylene material.
*Natural can range from transparent, opaque, to white.

Spiral Wrap



- Harness multiple cables into a single manageable bundle
- Allows breakouts of single/multiple cables
- Provides abrasion protection for wire, cables, hoses, and tubing
- Reverse cut
- Multiple colors allow easy identification of cable bundles
- Installation tool supplied in each package
- Available in multiple materials
- Reusable
- UL File: E141152
- Voltage Rating: 600 V

Part Number	Material*	Color	Length Per Reel		Bundle Diameter Range		Outside Diameter		Temperature Range	Wall Thickness		Std. Pkg. Qty.‡
			Ft.	m	In.	mm	In.	mm		In.	mm	
T12F-C	Polyethylene	Natural	100	30.5	1/16 – 1/2	1.6 – 12.7	0.12	3.2	-40°F – 122°F (-40°C – 50°C)	0.030	0.76	1
T12F-D	Polyethylene	Natural	500	152.4	1/16 – 1/2	1.6 – 12.7	0.12	3.2	-40°F – 122°F (-40°C – 50°C)	0.030	0.76	1
T19F-C	Polyethylene	Natural	100	30.5	1/8 – 1	3.2 – 25.4	0.19	4.8	-40°F – 122°F (-40°C – 50°C)	0.035	0.89	1
T19F-M	Polyethylene	Natural	1,000	304.8	1/8 – 1	3.2 – 25.4	0.19	4.8	-40°F – 122°F (-40°C – 50°C)	0.035	0.89	1
T25F-C	Polyethylene	Natural	100	30.5	3/16 – 2	4.8 – 50.8	0.25	6.4	-40°F – 122°F (-40°C – 50°C)	0.040	1.02	1
T25F-C1	Polyethylene	Brown	100	30.5	3/16 – 2	4.8 – 50.8	0.25	6.4	-40°F – 122°F (-40°C – 50°C)	0.040	1.02	1
T25F-C2	Polyethylene	Red	100	30.5	3/16 – 2	4.8 – 50.8	0.25	6.4	-40°F – 122°F (-40°C – 50°C)	0.040	1.02	1
T25F-C3Y	Polyethylene	Orange	100	30.5	3/16 – 2	4.8 – 50.8	0.25	6.4	-40°F – 122°F (-40°C – 50°C)	0.040	1.02	1
T25F-C4Y	Polyethylene	Yellow	100	30.5	3/16 – 2	4.8 – 50.8	0.25	6.4	-40°F – 122°F (-40°C – 50°C)	0.040	1.02	1
T25F-C5	Polyethylene	Green	100	30.5	3/16 – 2	4.8 – 50.8	0.25	6.4	-40°F – 122°F (-40°C – 50°C)	0.040	1.02	1
T25F-C6	Polyethylene	Blue	100	30.5	3/16 – 2	4.8 – 50.8	0.25	6.4	-40°F – 122°F (-40°C – 50°C)	0.040	1.02	1
T25F-C7	Polyethylene	Purple	100	30.5	3/16 – 2	4.8 – 50.8	0.25	6.4	-40°F – 122°F (-40°C – 50°C)	0.040	1.02	1
T25F-C8	Polyethylene	Gray	100	30.5	3/16 – 2	4.8 – 50.8	0.25	6.4	-40°F – 122°F (-40°C – 50°C)	0.040	1.02	1
T25F-C10	Polyethylene	White	100	30.5	3/16 – 2	4.8 – 50.8	0.25	6.4	-40°F – 122°F (-40°C – 50°C)	0.040	1.02	1
T25F-C16	Polyethylene	Pink	100	30.5	3/16 – 2	4.8 – 50.8	0.25	6.4	-40°F – 122°F (-40°C – 50°C)	0.040	1.02	1
T25F-M	Polyethylene	Natural	1,000	304.8	3/16 – 2	4.8 – 50.8	0.25	6.4	-40°F – 122°F (-40°C – 50°C)	0.040	1.02	1
T38F-C	Polyethylene	Natural	100	30.5	5/16 – 3	7.9 – 76.2	0.38	9.5	-40°F – 122°F (-40°C – 50°C)	0.055	1.40	1
T38F-TL	Polyethylene	Natural	250	76.2	5/16 – 3	7.9 – 76.2	0.38	9.5	-40°F – 122°F (-40°C – 50°C)	0.055	1.40	1
T50F-X	Polyethylene	Natural	10	3.1	3/8 – 4	9.5 – 101.6	0.50	12.7	-40°F – 122°F (-40°C – 50°C)	0.060	1.52	1
T50F-C	Polyethylene	Natural	100	30.5	3/8 – 4	9.5 – 101.6	0.50	12.7	-40°F – 122°F (-40°C – 50°C)	0.060	1.52	1
T50F-C1	Polyethylene	Brown	100	30.5	3/8 – 4	9.5 – 101.6	0.50	12.7	-40°F – 122°F (-40°C – 50°C)	0.060	1.52	1
T50F-C2	Polyethylene	Red	100	30.5	3/8 – 4	9.5 – 101.6	0.50	12.7	-40°F – 122°F (-40°C – 50°C)	0.060	1.52	1
T50F-C3Y	Polyethylene	Orange	100	30.5	3/8 – 4	9.5 – 101.6	0.50	12.7	-40°F – 122°F (-40°C – 50°C)	0.060	1.52	1
T50F-C4Y	Polyethylene	Yellow	100	30.5	3/8 – 4	9.5 – 101.6	0.50	12.7	-40°F – 122°F (-40°C – 50°C)	0.060	1.52	1
T50F-C5	Polyethylene	Green	100	30.5	3/8 – 4	9.5 – 101.6	0.50	12.7	-40°F – 122°F (-40°C – 50°C)	0.060	1.52	1

*Flame retardant products are manufactured from a material that is rated UL 94V-0.

‡Reel packaging may contain splices. Contact Panduit Customer Service for further information.

Continues on next page

Spiral Wrap (continued)

Part Number	Material*	Color	Length Per Reel		Bundle Diameter Range		Outside Diameter		Temperature Range	Wall Thickness		Std. Pkg. Qty.‡
			Ft.	m	In.	mm	In.	mm		In.	mm	
T50F-C6	Polyethylene	Blue	100	30.5	3/8 – 4	9.5 – 101.6	0.50	12.7	-40°F – 122°F (-40°C – 50°C)	0.060	1.52	1
T50F-C7	Polyethylene	Purple	100	30.5	3/8 – 4	9.5 – 101.6	0.50	12.7	-40°F – 122°F (-40°C – 50°C)	0.060	1.52	1
T50F-C8	Polyethylene	Gray	100	30.5	3/8 – 4	9.5 – 101.6	0.50	12.7	-40°F – 122°F (-40°C – 50°C)	0.060	1.52	1
T50F-C10	Polyethylene	White	100	30.5	3/8 – 4	9.5 – 101.6	0.50	12.7	-40°F – 122°F (-40°C – 50°C)	0.060	1.52	1
T50F-C16	Polyethylene	Pink	100	30.5	3/8 – 4	9.5 – 101.6	0.50	12.7	-40°F – 122°F (-40°C – 50°C)	0.060	1.52	1
T50F-TL	Polyethylene	Natural	250	76.2	3/8 – 4	9.5 – 101.6	0.50	12.7	-40°F – 122°F (-40°C – 50°C)	0.060	1.52	1
T50F-TL4Y	Polyethylene	Yellow	250	76.2	3/8 – 4	9.5 – 101.6	0.50	12.7	-40°F – 122°F (-40°C – 50°C)	0.060	1.52	1
T62F-C	Polyethylene	Natural	100	30.5	1/2 – 4 1/2	12.7 – 114.3	0.62	15.9	-40°F – 122°F (-40°C – 50°C)	0.062	1.57	1
T62F-TL	Polyethylene	Natural	250	76.2	1/2 – 4 1/2	12.7 – 114.3	0.62	15.9	-40°F – 122°F (-40°C – 50°C)	0.062	1.57	1
T75F-C	Polyethylene	Natural	100	30.5	5/8 – 5	15.9 – 127.0	0.75	19.1	-40°F – 122°F (-40°C – 50°C)	0.065	1.65	1
T75F-T	Polyethylene	Natural	200	61.0	5/8 – 5	15.9 – 127.0	0.75	19.1	-40°F – 122°F (-40°C – 50°C)	0.065	1.65	1
T100F-C	Polyethylene	Natural	100	30.5	7/8 – 6	22.2 – 152.4	1.00	25.4	-40°F – 122°F (-40°C – 50°C)	0.070	1.78	1
T12F-C0	Weather Resistant Polyethylene	Black	100	30.5	1/16 – 1/2	1.6 – 12.7	0.12	3.2	-40°F – 122°F (-40°C – 50°C)	0.030	0.76	1
T12F-D0	Weather Resistant Polyethylene	Black	500	152.4	1/16 – 1/2	1.6 – 12.7	0.12	3.2	-40°F – 122°F (-40°C – 50°C)	0.030	0.76	1
T19F-C0	Weather Resistant Polyethylene	Black	100	30.5	1/8 – 1	3.2 – 25.4	0.19	4.8	-40°F – 122°F (-40°C – 50°C)	0.035	0.89	1
T25F-X0	Weather Resistant Polyethylene	Black	10	3.1	3/16 – 2	4.8 – 50.8	0.25	6.4	-40°F – 122°F (-40°C – 50°C)	0.040	1.02	1
T25F-C0	Weather Resistant Polyethylene	Black	100	30.5	3/16 – 2	4.8 – 50.8	0.25	6.4	-40°F – 122°F (-40°C – 50°C)	0.040	1.02	1
T25F-M0	Weather Resistant Polyethylene	Black	1,000	304.8	3/16 – 2	4.8 – 50.8	0.25	6.4	-40°F – 122°F (-40°C – 50°C)	0.040	1.02	1
T38F-C0	Weather Resistant Polyethylene	Black	100	30.5	5/16 – 3	7.9 – 76.2	0.38	9.5	-40°F – 122°F (-40°C – 50°C)	0.055	1.40	1
T38F-TL0	Weather Resistant Polyethylene	Black	250	76.2	5/16 – 3	7.9 – 76.2	0.38	9.5	-40°F – 122°F (-40°C – 50°C)	0.055	1.40	1
T50F-X0	Weather Resistant Polyethylene	Black	10	3.1	3/8 – 4	9.5 – 101.6	0.50	12.7	-40°F – 122°F (-40°C – 50°C)	0.060	1.52	1
T50F-C0	Weather Resistant Polyethylene	Black	100	30.5	3/8 – 4	9.5 – 101.6	0.50	12.7	-40°F – 122°F (-40°C – 50°C)	0.060	1.52	1
T50F-TL0	Weather Resistant Polyethylene	Black	250	76.2	3/8 – 4	9.5 – 101.6	0.50	12.7	-40°F – 122°F (-40°C – 50°C)	0.060	1.52	1

*Flame retardant products are manufactured from a material that is rated UL 94V-0.
 ‡Reel packaging may contain splices. Contact Panduit Customer Service for further information.

Continues on next page

Spiral Wrap (continued)

Part Number	Material*	Color	Length Per Reel		Bundle Diameter Range		Outside Diameter		Temperature Range	Wall Thickness		Std. Pkg. Qty.‡
			Ft.	m	In.	mm	In.	mm		In.	mm	
T62F-C0	Weather Resistant Polyethylene	Black	100	30.5	1/2 – 4 1/2	12.7 – 114.3	0.62	15.9	-40°F – 122°F (-40°C – 50°C)	0.062	1.57	1
T62F-TL0	Weather Resistant Polyethylene	Black	250	76.2	1/2 – 4 1/2	12.7 – 114.3	0.62	15.9	-40°F – 122°F (-40°C – 50°C)	0.062	1.57	1
T75F-C0	Weather Resistant Polyethylene	Black	100	30.5	5/8 – 5	15.9 – 127.0	0.75	19.1	-40°F – 122°F (-40°C – 50°C)	0.065	1.65	1
T75F-T0	Weather Resistant Polyethylene	Black	200	61.0	5/8 – 5	15.9 – 127.0	0.75	19.1	-40°F – 122°F (-40°C – 50°C)	0.065	1.65	1
T100F-C0	Weather Resistant Polyethylene	Black	100	30.5	7/8 – 6	22.2 – 152.4	1.00	25.4	-40°F – 122°F (-40°C – 50°C)	0.070	1.78	1
T12R-CY	Fire Resistant Polyethylene	Natural	100	30.5	1/16 – 1/2	1.6 – 12.7	0.12	3.2	-40°F – 122°F (-40°C – 50°C)	0.030	0.76	1
T19R-CY	Fire Resistant Polyethylene	Natural	100	30.5	1/8 – 1	3.2 – 25.4	0.19	4.8	-40°F – 122°F (-40°C – 50°C)	0.035	0.89	1
T25R-CY	Fire Resistant Polyethylene	Natural	100	30.5	3/16 – 2	4.8 – 50.8	0.25	6.4	-40°F – 122°F (-40°C – 50°C)	0.040	1.02	1
T25R-C20Y	Fire Resistant Polyethylene	Black	100	30.5	3/16 – 2	4.8 – 50.8	0.25	6.4	-40°F – 122°F (-40°C – 50°C)	0.040	1.02	1
T25R-MY	Fire Resistant Polyethylene	Natural	1,000	304.8	3/16 – 2	4.8 – 50.8	0.25	6.4	-40°F – 122°F (-40°C – 50°C)	0.040	1.02	1
T25R-M20Y	Fire Resistant Polyethylene	Black	1,000	304.8	3/16 – 2	4.8 – 50.8	0.25	6.4	-40°F – 122°F (-40°C – 50°C)	0.040	1.02	1
T38R-CY	Fire Resistant Polyethylene	Natural	100	30.5	5/16 – 3	7.9 – 76.2	0.38	9.5	-40°F – 122°F (-40°C – 50°C)	0.055	1.40	1
T38R-TLY	Fire Resistant Polyethylene	Natural	250	76.2	5/16 – 3	7.9 – 76.2	0.38	9.5	-40°F – 122°F (-40°C – 50°C)	0.055	1.40	1
T50R-CY	Fire Resistant Polyethylene	Natural	100	30.5	3/8 – 4	9.5 – 101.6	0.50	12.7	-40°F – 122°F (-40°C – 50°C)	0.060	1.52	1
T50R-TLY	Fire Resistant Polyethylene	Natural	250	76.2	3/8 – 4	9.5 – 101.6	0.50	12.7	-40°F – 122°F (-40°C – 50°C)	0.060	1.52	1
T62R-CY	Fire Resistant Polyethylene	Natural	100	30.5	1/2 – 4 1/2	12.7 – 114.3	0.62	15.9	-40°F – 122°F (-40°C – 50°C)	0.062	1.57	1
T75R-CY	Fire Resistant Polyethylene	Natural	100	30.5	5/8 – 5	15.9 – 127.0	0.75	19.1	-40°F – 122°F (-40°C – 50°C)	0.065	1.65	1
T100R-CY	Fire Resistant Polyethylene	Natural	100	30.5	7/8 – 6	22.2 – 152.4	1.00	25.4	-40°F – 122°F (-40°C – 50°C)	0.070	1.78	1
T12FR-CY	Flame Retardant Polyethylene	Natural	100	30.5	1/16 – 1/2	1.6 – 12.7	0.12	3.2	-4°F – 122°F (-20°C – 50°C)	0.030	0.76	1
T12FR-C20Y	Flame Retardant Polyethylene	Black	100	30.5	1/16 – 1/2	1.6 – 12.7	0.12	3.2	-4°F – 122°F (-20°C – 50°C)	0.030	0.76	1
T19FR-CY	Flame Retardant Polyethylene	Natural	100	30.5	1/8 – 1	3.2 – 25.4	0.19	4.8	-4°F – 122°F (-20°C – 50°C)	0.032	0.80	1
T19FR-C20Y	Flame Retardant Polyethylene	Black	100	30.5	1/8 – 1	3.2 – 25.4	0.19	4.8	-4°F – 122°F (-20°C – 50°C)	0.032	0.80	1
T25FR-CY	Flame Retardant Polyethylene	Natural	100	30.5	3/16 – 2	4.8 – 50.8	0.25	6.4	-4°F – 122°F (-20°C – 50°C)	0.040	1.02	1
T25FR-C20Y	Flame Retardant Polyethylene	Black	100	30.5	3/16 – 2	4.8 – 50.8	0.25	6.4	-4°F – 122°F (-20°C – 50°C)	0.040	1.02	1

*Flame retardant products are manufactured from a material that is rated UL 94V-0.

‡Reel packaging may contain splices. Contact Panduit Customer Service for further information.

Continues on next page

Spiral Wrap (continued)

Part Number	Material*	Color	Length Per Reel		Bundle Diameter Range		Outside Diameter		Temperature Range	Wall Thickness		Std. Pkg. Qty. ‡
			Ft.	m	In.	mm	In.	mm		In.	mm	
T25FR-MY	Flame Retardant Polyethylene	Natural	1,000	304.8	3/16 – 2	4.8 – 50.8	0.25	6.4	-4°F – 122°F (-20°C – 50°C)	0.040	1.02	1
T25FR-M20Y	Flame Retardant Polyethylene	Black	1,000	304.8	3/16 – 2	4.8 – 50.8	0.25	6.4	-4°F – 122°F (-20°C – 50°C)	0.040	1.02	1
T38FR-CY	Flame Retardant Polyethylene	Natural	100	30.5	5/16 – 3	7.9 – 76.2	0.38	9.5	-4°F – 122°F (-20°C – 50°C)	0.055	1.40	1
T38FR-C20Y	Flame Retardant Polyethylene	Black	100	30.5	5/16 – 3	7.9 – 76.2	0.38	9.5	-4°F – 122°F (-20°C – 50°C)	0.055	1.40	1
T38FR-TLY	Flame Retardant Polyethylene	Natural	250	76.2	5/16 – 3	7.9 – 76.2	0.38	9.5	-4°F – 122°F (-20°C – 50°C)	0.055	1.40	1
T50FR-CY	Flame Retardant Polyethylene	Natural	100	30.5	3/8 – 4	9.5 – 101.6	0.50	12.7	-4°F – 122°F (-20°C – 50°C)	0.060	1.52	1
T50FR-C20Y	Flame Retardant Polyethylene	Black	100	30.5	3/8 – 4	9.5 – 101.6	0.50	12.7	-4°F – 122°F (-20°C – 50°C)	0.060	1.52	1
T50FR-TLY	Flame Retardant Polyethylene	Natural	250	76.2	3/8 – 4	9.5 – 101.6	0.50	12.7	-4°F – 122°F (-20°C – 50°C)	0.060	1.52	1
T62FR-CY	Flame Retardant Polyethylene	Natural	100	30.5	1/2 – 4 1/2	12.7 – 114.3	0.62	15.9	-4°F – 122°F (-20°C – 50°C)	0.062	1.57	1
T62FR-C20Y	Flame Retardant Polyethylene	Black	100	30.5	1/2 – 4 1/2	12.7 – 114.3	0.62	15.9	-4°F – 122°F (-20°C – 50°C)	0.062	1.57	1
T75FR-CY	Flame Retardant Polyethylene	Natural	100	30.5	5/8 – 5	15.9 – 127.0	0.75	19.1	-4°F – 122°F (-20°C – 50°C)	0.065	1.65	1
T75FR-C20Y	Flame Retardant Polyethylene	Black	100	30.5	5/8 – 5	15.9 – 127.0	0.75	19.1	-4°F – 122°F (-20°C – 50°C)	0.065	1.65	1
T75FR-TY	Flame Retardant Polyethylene	Natural	200	61.0	5/8 – 5	15.9 – 127.0	0.75	19.1	-4°F – 122°F (-20°C – 50°C)	0.065	1.65	1
T100FR-CY	Flame Retardant Polyethylene	Natural	100	30.5	7/8 – 6	22.2 – 152.4	1.00	25.4	-4°F – 122°F (-20°C – 50°C)	0.070	1.78	1
T100FR-C20Y	Flame Retardant Polyethylene	Black	100	30.5	7/8 – 6	22.2 – 152.4	1.00	25.4	-4°F – 122°F (-20°C – 50°C)	0.070	1.78	1
T12N-C	Nylon 6.6	Natural	100	30.5	1/16 – 1/2	1.6 – 12.7	0.12	3.2	-40°F – 149°F (-40°C – 65°C)	0.015	0.38	1
T12N-D	Nylon 6.6	Natural	500	152.4	1/16 – 1/2	1.6 – 12.7	0.12	3.2	-40°F – 149°F (-40°C – 65°C)	0.015	0.38	1
T19N-C	Nylon 6.6	Natural	100	30.5	1/8 – 1	3.2 – 25.4	0.19	4.8	-40°F – 149°F (-40°C – 65°C)	0.020	0.51	1
T19N-M	Nylon 6.6	Natural	1,000	304.8	1/8 – 1	3.2 – 25.4	0.19	4.8	-40°F – 149°F (-40°C – 65°C)	0.020	0.51	1
T25N-C	Nylon 6.6	Natural	100	30.5	3/16 – 2	4.8 – 50.8	0.25	6.4	-40°F – 149°F (-40°C – 65°C)	0.023	0.58	1
T25N-M	Nylon 6.6	Natural	1,000	304.8	3/16 – 2	4.8 – 50.8	0.25	6.4	-40°F – 149°F (-40°C – 65°C)	0.023	0.58	1
T38N-C	Nylon 6.6	Natural	100	30.5	5/16 – 3	7.9 – 76.2	0.38	9.5	-40°F – 149°F (-40°C – 65°C)	0.030	0.76	1
T38N-TL	Nylon 6.6	Natural	250	76.2	5/16 – 3	7.9 – 76.2	0.38	9.5	-40°F – 149°F (-40°C – 65°C)	0.030	0.76	1

*Flame retardant products are manufactured from a material that is rated UL 94V-0.
 ‡Reel packaging may contain splices. Contact Panduit Customer Service for further information.
 ^TFE is Polytetrafluorethylene material.

Continues on next page

Spiral Wrap (continued)

Part Number	Material*	Color	Length Per Reel		Bundle Diameter Range		Outside Diameter		Temperature Range	Wall Thickness		Std. Pkg. Qty.‡
			Ft.	m	In.	mm	In.	mm		In.	mm	
T50N-C	Nylon 6.6	Natural	100	30.5	3/8 – 4	9.5 – 101.6	0.50	12.7	-40°F – 149°F (-40°C – 65°C)	0.032	0.81	1
T50N-TL	Nylon 6.6	Natural	250	76.2	3/8 – 4	9.5 – 101.6	0.50	12.7	-40°F – 149°F (-40°C – 65°C)	0.032	0.81	1
T62N-C	Nylon 6.6	Natural	100	30.5	1/2 – 4 1/2	12.7 – 114.3	0.62	15.9	-40°F – 149°F (-40°C – 65°C)	0.035	0.89	1
T75N-C	Nylon 6.6	Natural	100	30.5	5/8 – 5	15.9 – 127.0	0.75	19.1	-40°F – 149°F (-40°C – 65°C)	0.040	1.02	1
T75N-T	Nylon 6.6	Natural	200	61	5/8 – 5	15.9 – 127.0	0.75	19.1	-40°F – 149°F (-40°C – 65°C)	0.040	1.02	1
T100N-C	Nylon 6.6	Natural	100	30.5	7/8 – 6	22.2 – 152.4	1.00	25.4	-40°F – 149°F (-40°C – 65°C)	0.045	1.14	1
T12N-C0	Weather Resistant Nylon 6.6	Black	100	30.5	1/16 – 1/2	1.6 – 12.7	0.12	3.2	-40°F – 149°F (-40°C – 65°C)	0.015	0.38	1
T19N-C0	Weather Resistant Nylon 6.6	Black	100	30.5	1/8 – 1	3.2 – 25.4	0.19	4.8	-40°F – 149°F (-40°C – 65°C)	0.020	0.51	1
T19N-M0	Weather Resistant Nylon 6.6	Black	1,000	304.8	1/8 – 1	3.2 – 25.4	0.19	4.8	-40°F – 149°F (-40°C – 65°C)	0.020	0.51	1
T25N-M0	Weather Resistant Nylon 6.6	Black	1,000	304.8	3/16 – 2	4.8 – 50.8	0.25	6.4	-40°F – 149°F (-40°C – 65°C)	0.023	0.58	1
T25N-C0	Weather Resistant Nylon 6.6	Black	100	30.5	3/16 – 2	4.8 – 50.4	0.25	6.4	-40°F – 149°F (-40°C – 65°C)	0.023	0.58	1
T38N-C0	Weather Resistant Nylon 6.6	Black	100	30.5	5/16 – 3	7.9 – 76.2	0.38	9.5	-40°F – 149°F (-40°C – 65°C)	0.030	0.76	1
T50N-C0	Weather Resistant Nylon 6.6	Black	100	30.5	3/8 – 4	9.5 – 101.6	0.50	12.7	-40°F – 149°F (-40°C – 65°C)	0.032	0.81	1
T50N-TL0	Weather Resistant Nylon 6.6	Black	250	76.2	3/8 – 4	9.5 – 101.6	0.50	12.7	-40°F – 149°F (-40°C – 65°C)	0.032	0.81	1
T62N-C0	Weather Resistant Nylon 6.6	Black	100	30.5	1/2 – 4 1/2	12.7 – 114.3	0.62	15.9	-40°F – 149°F (-40°C – 65°C)	0.035	0.89	1
T75N-C0	Weather Resistant Nylon 6.6	Black	100	30.5	5/8 – 5	15.9 – 127.0	0.75	19.1	-40°F – 149°F (-40°C – 65°C)	0.040	1.02	1
T100N-C0	Weather Resistant Nylon 6.6	Black	100	30.5	7/8 – 6	22.2 – 152.4	1.00	25.4	-40°F – 149°F (-40°C – 65°C)	0.045	1.14	1
T25NZFR-C20	Low Smoke Halogen-Free Flame-Retardant Nylon	Black	100	30.5	3/16 – 2	4.8 – 50.8	0.25	6.4	-40°F – 149°F (-40°C – 65°C)	0.023	0.58	1
T38NZFR-C20	Low Smoke Halogen-Free Flame-Retardant Nylon	Black	100	30.5	5/16 – 3	7.9 – 76.2	0.38	9.5	-40°F – 149°F (-40°C – 65°C)	0.030	0.76	1
T50NZFR-C20	Low Smoke Halogen-Free Flame-Retardant Nylon	Black	100	30.5	3/8 – 4	9.5 – 101.6	0.50	12.7	-40°F – 149°F (-40°C – 65°C)	0.032	0.81	1

*Flame retardant products are manufactured from a material that is rated UL 94V-0.

‡Reel packaging may contain splices. Contact Panduit Customer Service for further information.

^TFE is Polytetrafluorethylene material.

Continues on next page

Spiral Wrap (continued)

Part Number	Material*	Color	Length Per Reel		Bundle Diameter Range		Outside Diameter		Temperature Range	Wall Thickness		Std. Pkg. Qty.‡
			Ft.	m	In.	mm	In.	mm		In.	mm	
T75NZFR-C20	Low Smoke Halogen-Free Flame-Retardant Nylon	Black	100	30.5	5/8 – 5	15.9 – 127.0	0.75	19.1	-40°F – 149°F (-40°C – 65°C)	0.040	1.02	1
T38P-C0	Weather Resistant Polypropylene	Black	100	30.5	5/16 – 3	7.9 – 76.2	0.38	9.5	-40°F – 239°F (-40°C – 115°C)	0.030	0.76	1
T50P-C0	Weather Resistant Polypropylene	Black	100	30.5	3/8 – 4	9.5 – 101.6	0.50	12.7	-40°F – 239°F (-40°C – 115°C)	0.030	0.76	1
T100P-C0	Weather Resistant Polypropylene	Black	100	30.5	7/8 – 6	22.2 – 152.4	1.00	25.4	-40°F – 239°F (-40°C – 115°C)	0.030	0.76	1
T12T-C	TFE^	Natural	100	30.5	1/16 – 1/2	1.6 – 12.7	0.12	3.2	-454°F – 356°F (-270°C – 180°C)	0.020	0.51	1
T19T-C	TFE^	Natural	100	30.5	1/8 – 1	3.2 – 25.4	0.19	4.8	-454°F – 356°F (-270°C – 180°C)	0.030	0.76	1
T25T-L	TFE^	Natural	50	15.2	3/16 – 2	4.8 – 50.8	0.25	6.4	-454°F – 356°F (-270°C – 180°C)	0.030	0.76	1
T25T-L0	TFE^	Black	50	15.2	3/16 – 2	4.8 – 50.8	0.25	6.4	-454°F – 356°F (-270°C – 180°C)	0.030	0.76	1
T38T-L	TFE^	Natural	50	15.2	5/16 – 3	7.9 – 76.2	0.38	9.5	-454°F – 356°F (-270°C – 180°C)	0.030	0.76	1
T50T-Q	TFE^	Natural	25	7.6	3/8 – 4	9.5 – 101.6	0.50	12.7	-454°F – 356°F (-270°C – 180°C)	0.030	0.76	1
T62T-Q	TFE^	Natural	25	7.6	1/2 – 4 1/2	12.7 – 114.3	0.62	15.9	-454°F – 356°F (-270°C – 180°C)	0.030	0.76	1
T75T-X	TFE^	Natural	10	3.1	5/8 – 5	15.9 – 127.0	0.75	19.1	-454°F – 356°F (-270°C – 180°C)	0.030	0.76	1
T100T-X	TFE^	Natural	10	3.1	7/8 – 6	22.2 – 152.4	1.00	25.4	-454°F – 356°F (-270°C – 180°C)	0.040	1.02	1

*Flame retardant products are manufactured from a material that is rated UL 94V-0.
 ‡Reel packaging may contain splices. Contact Panduit Customer Service for further information.
 ^TFE is Polytetrafluorethylene material.

Part Number System for Grommet Edging

GEE	36	F	—	A	—	C	0
Type	Max. Panel Thickness	Material		Adhesive		Package Size	Color Suffix
GE = Grommet Edging Strips	36 = 0.036" thickness	F = Polyethylene		A = Adhesive Lined		Q = 25'	0 = Weather Resistant Black
GEE = Slotted Grommet Edging	62 = 0.062" thickness	N = Nylon 6.6		Leave Blank = Non-Adhesive		L = 50'	Leave Blank = Natural
GES = Solid Grommet Edging	99 = 0.099" thickness	FR = Flame Retardant Polyethylene				C = 100'	
	144 = 0.144" thickness						
	189 = 0.189" thickness						

Grommet Edging

- Use slotted product on irregularly shaped and round panel holes
- Solid product is used only on straight edges
- Provided in 0.030" (0.8mm) thick material making it highly flexible
- UL File: E351393 (Nylon Materials is not UL Recognized)
- Adhesive Lined Grommet Edging: 3 year shelf life

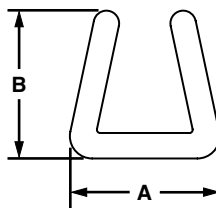
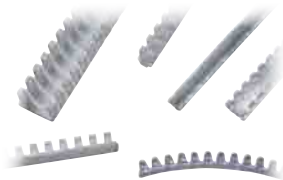
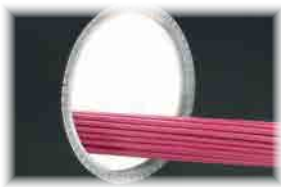

Part Number	Width A		Height B		Panel Thickness Range		Material	Color	Temperature Range	Std. Pkg. Qty.‡
	In.	mm	In.	mm	In.	mm				
Slotted										
GEE36F-C	0.11	2.7	0.12	3.0	0.026 – 0.036	0.7 – 0.9	Polyethylene	Natural	-40°F – 122°F (-40°C – 50°C)	1
GEE36F-C0	0.11	2.7	0.12	3.0	0.026 – 0.036	0.7 – 0.9	Weather Resistant Polyethylene	Black		1
GEE62F-C	0.13	3.3	0.16	4.1	0.036 – 0.062	0.9 – 1.6	Polyethylene	Natural		1
GEE62F-C0	0.13	3.3	0.16	4.1	0.036 – 0.062	0.9 – 1.6	Weather Resistant Polyethylene	Black		1
GEE99F-C	0.17	4.3	0.19	4.7	0.062 – 0.099	1.6 – 2.5	Polyethylene	Natural		1
GEE99F-C0	0.17	4.3	0.19	4.7	0.062 – 0.099	1.6 – 2.5	Weather Resistant Polyethylene	Black		1
GEE144F-C	0.21	5.4	0.22	5.6	0.099 – 0.144	2.5 – 3.7	Polyethylene	Natural		1
GEE144F-C0	0.21	5.4	0.22	5.6	0.099 – 0.144	2.5 – 3.7	Weather Resistant Polyethylene	Black		1

‡Reel packaging may contain splices. Contact Panduit Customer Service for further information. Natural color can range from opaque to clear.

Continues on next page

Grommet Edging (continued)

Part Number	Width A		Height B		Panel Thickness Range		Material	Color	Temperature Range	Std. Pkg. Qty.†
	In.	mm	In.	mm	In.	mm				
Solid – Use on straight edges only										
GES36F-C	0.11	2.7	0.12	3.0	0.026 – 0.036	0.7 – 0.9	Polyethylene	Natural	-40°F – 122°F (-40°C – 50°C)	1
GES36F-C0	0.11	2.7	0.12	3.0	0.026 – 0.036	0.7 – 0.9	Weather Resistant Polyethylene	Black		1
GES62F-C	0.13	3.3	0.16	4.1	0.036 – 0.062	0.9 – 1.6	Polyethylene	Natural		1
GES62F-C0	0.13	3.3	0.16	4.1	0.036 – 0.062	0.9 – 1.6	Weather Resistant Polyethylene	Black		1
GES99F-C	0.17	4.3	0.19	4.7	0.062 – 0.099	1.6 – 2.5	Polyethylene	Natural		1
GES99F-C0	0.17	4.3	0.19	4.7	0.062 – 0.099	1.6 – 2.5	Weather Resistant Polyethylene	Black		1
GES144F-C	0.21	5.4	0.22	5.6	0.099 – 0.144	2.5 – 3.7	Polyethylene	Natural		1
GES144F-C0	0.21	5.4	0.22	5.6	0.099 – 0.144	2.5 – 3.7	Weather Resistant Polyethylene	Black		1
GES189F-C	0.30	7.6	0.30	7.6	0.144 – 0.189	3.7 – 4.8	Polyethylene	Natural		1
GES189F-C0	0.30	7.6	0.30	7.6	0.144 – 0.189	3.7 – 4.8	Weather Resistant Polyethylene	Black		1
Slotted Adhesive Lined										
GEE62F-A-C	0.13	3.3	0.16	4.1	0.036 – 0.062	0.9 – 1.6	Polyethylene	Natural	-40°F – 122°F (-40°C – 50°C)	1
GEE62F-A-C0	0.13	3.3	0.16	4.1	0.036 – 0.062	0.9 – 1.6	Weather Resistant Polyethylene	Black		1
GEE99F-A-C	0.17	4.3	0.19	4.7	0.062 – 0.099	1.6 – 2.5	Polyethylene	Natural		1
GEE99F-A-C0	0.17	4.3	0.19	4.7	0.062 – 0.099	1.6 – 2.5	Weather Resistant Polyethylene	Black		1
GEE144F-A-C	0.21	5.4	0.22	5.6	0.099 – 0.144	2.5 – 3.7	Polyethylene	Natural		1
GEE144F-A-C0	0.21	5.4	0.22	5.6	0.099 – 0.144	2.5 – 3.7	Weather Resistant Polyethylene	Black		1
Solid Adhesive Lined – Use on straight edges only										
GES62F-A-C	0.13	3.3	0.16	4.1	0.036 – 0.062	0.9 – 1.6	Polyethylene	Natural	-40°F – 122°F (-40°C – 50°C)	1
GES62F-A-C0	0.13	3.3	0.16	4.1	0.036 – 0.062	0.9 – 1.6	Weather Resistant Polyethylene	Black		1
GES99F-A-C	0.17	4.3	0.19	4.7	0.062 – 0.099	1.6 – 2.5	Polyethylene	Natural		1
GES99F-A-C0	0.17	4.3	0.19	4.7	0.062 – 0.099	1.6 – 2.5	Weather Resistant Polyethylene	Black		1
GES144F-A-C	0.21	5.4	0.22	5.6	0.099 – 0.144	2.5 – 3.7	Polyethylene	Natural		1
GES144F-A-C0	0.21	5.4	0.22	5.6	0.099 – 0.144	2.5 – 3.7	Weather Resistant Polyethylene	Black		1
Slotted Flame Retardant										
GEE36FR-CY	0.11	2.7	0.12	3.0	0.026 – 0.036	0.7 – 0.9	Flame Retardant Polyethylene	Natural	-4°F – 122°F (-20°C – 50°C)	1
GEE62FR-CY	0.13	3.3	0.16	4.1	0.036 – 0.062	0.9 – 1.6	Flame Retardant Polyethylene	Natural		1
GEE99FR-CY	0.17	4.3	0.19	4.7	0.062 – 0.099	1.6 – 2.5	Flame Retardant Polyethylene	Natural		1
GEE144FR-CY	0.21	5.4	0.22	5.6	0.099 – 0.144	2.5 – 3.7	Flame Retardant Polyethylene	Natural		1

†Reel packaging may contain splices. Contact Panduit Customer Service for further information.

Continues on next page

Grommet Edging (continued)

Part Number	Width A		Height B		Panel Thickness Range		Material	Color	Temperature Range	Std. Pkg. Qty.‡
	In.	mm	In.	mm	In.	mm				
Solid Flame Retardant – Used on straight edges only										
GES36FR-CY	0.11	2.7	0.12	3.0	0.026 – 0.036	0.7 – 0.9	Flame Retardant Polyethylene	Natural	-4°F – 122°F (-20°C – 50°C)	1
GES62FR-CY	0.13	3.3	0.16	4.1	0.036 – 0.062	0.9 – 1.6	Flame Retardant Polyethylene	Natural		1
GES99FR-CY	0.17	4.3	0.19	4.7	0.062 – 0.099	1.6 – 2.5	Flame Retardant Polyethylene	Natural		1
GES144FR-CY	0.21	5.4	0.22	5.6	0.099 – 0.144	2.5 – 3.7	Flame Retardant Polyethylene	Natural		1

Slotted Nylon

GEE47N-C	0.13	3.2	0.14	3.6	0.039 – 0.055	1.0 – 1.4	Nylon 6	Natural	-40°F – 149°F (-40°C – 65°C)	1
GEE55N-C	0.13	3.4	0.14	3.6	0.047 – 0.063	1.2 – 1.6	Nylon 6	Natural		1
GEE71N-C	0.15	3.8	0.14	3.6	0.063 – 0.079	1.6 – 2.0	Nylon 6	Natural		1
GEE98N-C	0.18	4.6	0.14	3.6	0.091 – 0.106	2.3 – 2.7	Nylon 6	Natural		1
GEE134N-C	0.21	5.3	0.14	3.6	0.126 – 0.142	3.2 – 3.6	Nylon 6	Natural		1

National Aerospace Standard** NAMS21266 in 12.75" Lengths

GE52-C	0.15	3.8	0.16	3.9	0.015 – 0.052	0.4 – 1.3	Nylon 6.6	Natural	-40°F – 149°F (-40°C – 65°C)	100
GE52-C69*	0.15	3.8	0.16	3.9	0.015 – 0.052	0.4 – 1.3	Flame Retardant Nylon 6.6	Natural	-40°F – 212°F (-40°C – 100°C)	100
GE85-C	0.18	4.5	0.16	3.9	0.052 – 0.085	1.3 – 2.2	Nylon 6.6	Natural	-40°F – 149°F (-40°C – 65°C)	100
GE85-C69*	0.18	4.5	0.16	3.9	0.052 – 0.085	1.3 – 2.2	Flame Retardant Nylon 6.6	Natural	-40°F – 212°F (-40°C – 100°C)	100
GE128-C	0.22	5.6	0.16	3.9	0.085 – 0.128	2.2 – 3.3	Nylon 6.6	Natural	-40°F – 149°F (-40°C – 65°C)	100
GE128-C69*	0.22	5.6	0.16	3.9	0.085 – 0.128	2.2 – 3.3	Flame Retardant Nylon 6.6	Natural	-40°F – 212°F (-40°C – 100°C)	100
GE192-L	0.33	8.3	0.23	5.8	0.128 – 0.192	3.3 – 4.9	Nylon 6.6	Natural	-40°F – 149°F (-40°C – 65°C)	50
GE192-L69*	0.33	8.3	0.23	5.8	0.128 – 0.192	3.3 – 4.9	Flame Retardant Nylon 6.6	Natural	-40°F – 212°F (-40°C – 100°C)	50
GE255-L	0.39	9.8	0.24	6.1	0.192 – 0.255	4.9 – 6.5	Nylon 6.6	Natural	-40°F – 149°F (-40°C – 65°C)	50
GE318-L	0.46	11.3	0.26	6.5	0.255 – 0.318	6.5 – 8.1	Nylon 6.6	Natural		50
GE380-Q	0.52	13.1	0.26	6.5	0.318 – 0.380	8.1 – 9.7	Nylon 6.6	Natural		25
GE510-Q	0.64	16.3	0.26	6.5	0.380 – 0.510	9.7 – 13.0	Nylon 6.6	Natural		25

‡Reel packaging may contain splices. Contact Panduit Customer Service for further information.

*This material is not specified under NAMS21266

**Formerly Military Standard MS21266

Part Number System for Corrugated Loom Tubing

CLT	100	N	—	C	630
Type	Bundle Diameter	Material		Package Size	Color Suffix
CLT = Slit Wall	25 = 1/4"	N = Heat Stabilized Nylon		X = 10'	630 = Heat Stabilized Black Nylon 6
CLTS = Solid Wall	35 = 5/16"	F = Polyethylene		L = 50'	20 = Black Polyethylene
	38 = 3/8"			C = 100'	3 = Orange Polyethylene
	50 = 1/2"			T = 200'	4 = Yellow Polyethylene
	62 = 5/8"			3C = 300'	
	75 = 3/4"			D = 500'	
	100 = 1"			.75M = 750'	
	125 = 1 1/4"			125M = 1,250'	
	150 = 1 1/2"			2M = 2,000'	
	188 = 1 7/8"			2.5M = 2,500'	
				4M = 4,000'	
				5M = 5,000'	
				7M = 7,000'	
				10M = 10,000'	

Corrugated Loom Tubing



- Provides protection for cables
- For use in enclosures or indoors only
- Available in Nylon or Polyethylene, this product features a lengthwise slit which makes it easy to install onto a bundle of wires or a pre-assembled harness assembly
- Abrasion resistant and provides light crush and impact resistance

Part Number	Material	Color	Length Per Reel		Inside Diameter		Outside Diameter		Temperature Range	Std. Pkg. Qty.*
			Ft.	m	In.	mm	In.	mm		
Slit Wall										
CLT25F-C3	Polyethylene	Orange	100	30.5	0.28	7.0	0.40	10.1	-40°F – 122°F (-40°C – 50°C)	1
CLT25F-C4	Polyethylene	Yellow	100	30.5	0.28	7.0	0.40	10.1	-40°F – 122°F (-40°C – 50°C)	1
CLT25F-C20	Polyethylene	Black	100	30.5	0.28	7.0	0.40	10.1	-40°F – 122°F (-40°C – 50°C)	1
CLT25F-10M20	Polyethylene	Black	10,000	3048.0	0.28	7.0	0.40	10.1	-40°F – 122°F (-40°C – 50°C)	1
CLT35F-C3	Polyethylene	Orange	100	30.5	0.35	8.9	0.50	12.8	-40°F – 122°F (-40°C – 50°C)	1
CLT35F-C4	Polyethylene	Yellow	100	30.5	0.35	8.9	0.50	12.8	-40°F – 122°F (-40°C – 50°C)	1
CLT35F-C20	Polyethylene	Black	100	30.5	0.35	8.9	0.50	12.8	-40°F – 122°F (-40°C – 50°C)	1
CLT35F-7M20	Polyethylene	Black	7,000	2133.6	0.35	8.9	0.50	12.8	-40°F – 122°F (-40°C – 50°C)	1
CLT38F-C3	Polyethylene	Orange	100	30.5	0.39	10.0	0.52	13.3	-40°F – 122°F (-40°C – 50°C)	1
CLT38F-C4	Polyethylene	Yellow	100	30.5	0.39	10.0	0.52	13.3	-40°F – 122°F (-40°C – 50°C)	1
CLT38F-C20	Polyethylene	Black	100	30.5	0.39	10.0	0.52	13.3	-40°F – 122°F (-40°C – 50°C)	1
CLT38F-5M20	Polyethylene	Black	5,000	1524.0	0.39	10.0	0.52	13.3	-40°F – 122°F (-40°C – 50°C)	1
CLT50F-C3	Polyethylene	Orange	100	30.5	0.51	13.0	0.65	16.6	-40°F – 122°F (-40°C – 50°C)	1
CLT50F-C4	Polyethylene	Yellow	100	30.5	0.51	13.0	0.65	16.6	-40°F – 122°F (-40°C – 50°C)	1
CLT50F-C20	Polyethylene	Black	100	30.5	0.51	13.0	0.65	16.6	-40°F – 122°F (-40°C – 50°C)	1
CLT50F-4M20	Polyethylene	Black	4,000	1219.2	0.51	13.0	0.65	16.6	-40°F – 122°F (-40°C – 50°C)	1
CLT62F-C3	Polyethylene	Orange	100	30.5	0.66	16.9	0.85	21.1	-40°F – 122°F (-40°C – 50°C)	1
CLT62F-C4	Polyethylene	Yellow	100	30.5	0.66	16.9	0.85	21.1	-40°F – 122°F (-40°C – 50°C)	1
CLT62F-C20	Polyethylene	Black	100	30.5	0.66	16.9	0.85	21.1	-40°F – 122°F (-40°C – 50°C)	1
CLT62F-2.5M20	Polyethylene	Black	2,500	762.0	0.66	16.9	0.85	21.1	-40°F – 122°F (-40°C – 50°C)	1
CLT75F-C3	Polyethylene	Orange	100	30.5	0.77	19.5	0.94	23.9	-40°F – 122°F (-40°C – 50°C)	1
CLT75F-C4	Polyethylene	Yellow	100	30.5	0.77	19.5	0.94	23.9	-40°F – 122°F (-40°C – 50°C)	1
CLT75F-C20	Polyethylene	Black	100	30.5	0.77	19.5	0.94	23.9	-40°F – 122°F (-40°C – 50°C)	1
CLT75F-2M20	Polyethylene	Black	2,000	609.6	0.77	19.5	0.94	23.9	-40°F – 122°F (-40°C – 50°C)	1

*Reel packaging may contain splices. Contact Panduit Customer Service for further information.

Continues on next page

Corrugated Loom Tubing (continued)

Part Number	Material	Color	Length Per Reel		Inside Diameter		Outside Diameter		Temperature Range	Std. Pkg. Qty.*
			Ft.	m	In.	mm	In.	mm		
CLT100F-X4	Polyethylene	Yellow	10	3.1	0.91	23.2	1.10	28.0	-40°F – 122°F (-40°C – 50°C)	1
CLT100F-C3	Polyethylene	Orange	100	30.5	0.91	23.2	1.10	28.0	-40°F – 122°F (-40°C – 50°C)	1
CLT100F-C4	Polyethylene	Yellow	100	30.5	0.91	23.2	1.10	28.0	-40°F – 122°F (-40°C – 50°C)	1
CLT100F-C20	Polyethylene	Black	100	30.5	0.91	23.2	1.10	28.0	-40°F – 122°F (-40°C – 50°C)	1
CLT100F-125M20	Polyethylene	Black	1,250	381.0	0.91	23.2	1.10	28.0	-40°F – 122°F (-40°C – 50°C)	1
CLT125F-L3	Polyethylene	Orange	50	15.2	1.28	32.5	1.54	39.0	-40°F – 122°F (-40°C – 50°C)	1
CLT125F-L4	Polyethylene	Yellow	50	15.2	1.28	32.5	1.54	39.0	-40°F – 122°F (-40°C – 50°C)	1
CLT125F-L20	Polyethylene	Black	50	15.2	1.28	32.5	1.54	39.0	-40°F – 122°F (-40°C – 50°C)	1
CLT125F-.75M20	Polyethylene	Black	750	228.6	1.28	32.5	1.54	39.0	-40°F – 122°F (-40°C – 50°C)	1
CLT150F-X3	Polyethylene	Orange	10	3.1	1.58	40.0	1.85	47.0	-40°F – 122°F (-40°C – 50°C)	1
CLT150F-X4	Polyethylene	Yellow	10	3.1	1.58	40.0	1.85	47.0	-40°F – 122°F (-40°C – 50°C)	1
CLT150F-X20	Polyethylene	Black	10	3.1	1.58	40.0	1.85	47.0	-40°F – 122°F (-40°C – 50°C)	1
CLT150F-T20	Polyethylene	Black	200	61.0	1.58	40.0	1.85	47.0	-40°F – 122°F (-40°C – 50°C)	1
CLT150F-D3	Polyethylene	Orange	500	152.4	1.58	40.0	1.85	47.0	-40°F – 122°F (-40°C – 50°C)	1
CLT150F-D4	Polyethylene	Yellow	500	152.4	1.58	40.0	1.85	47.0	-40°F – 122°F (-40°C – 50°C)	1
CLT150F-D20	Polyethylene	Black	500	152.4	1.58	40.0	1.85	47.0	-40°F – 122°F (-40°C – 50°C)	1
CLT188F-X3	Polyethylene	Orange	10	3.1	1.85	47.0	2.19	55.7	-40°F – 122°F (-40°C – 50°C)	1
CLT188F-X4	Polyethylene	Yellow	10	3.1	1.85	47.0	2.19	55.7	-40°F – 122°F (-40°C – 50°C)	1
CLT188F-X20	Polyethylene	Black	10	3.1	1.85	47.0	2.19	55.7	-40°F – 122°F (-40°C – 50°C)	1
CLT188F-C20	Polyethylene	Black	100	30.5	1.85	47.0	2.19	55.7	-40°F – 122°F (-40°C – 50°C)	1
CLT188F-C3	Polyethylene	Orange	100	30.5	1.85	47.0	2.19	55.7	-40°F – 122°F (-40°C – 50°C)	1
CLT188F-C4	Polyethylene	Yellow	100	30.5	1.85	47.0	2.19	55.7	-40°F – 122°F (-40°C – 50°C)	1
CLT188F-3C20	Polyethylene	Black	300	91.4	1.85	47.0	2.19	55.7	-40°F – 122°F (-40°C – 50°C)	1

Solid Wall

CLTS25F-C	Polyethylene	Black	100	30.5	0.28	7.2	0.40	10.1	-40°F – 122°F (-40°C – 50°C)	1
CLTS25F-C3	Polyethylene	Orange	100	30.5	0.28	7.2	0.40	10.1	-40°F – 122°F (-40°C – 50°C)	1
CLTS25F-10M	Polyethylene	Black	10,000	3048.0	0.28	7.2	0.40	10.1	-40°F – 122°F (-40°C – 50°C)	1
CLTS35F-C	Polyethylene	Black	100	30.5	0.35	8.9	0.50	12.8	-40°F – 122°F (-40°C – 50°C)	1
CLTS35F-C3	Polyethylene	Orange	100	30.5	0.35	8.9	0.50	12.8	-40°F – 122°F (-40°C – 50°C)	1
CLTS38F-C	Polyethylene	Black	100	30.5	0.39	10.0	0.52	13.3	-40°F – 122°F (-40°C – 50°C)	1
CLTS38F-C3	Polyethylene	Orange	100	30.5	0.39	10.0	0.52	13.3	-40°F – 122°F (-40°C – 50°C)	1
CLTS50F-C	Polyethylene	Black	100	30.5	0.51	13.0	0.65	16.6	-40°F – 122°F (-40°C – 50°C)	1
CLTS50F-C3	Polyethylene	Orange	100	30.5	0.51	13.0	0.65	16.6	-40°F – 122°F (-40°C – 50°C)	1
CLTS62F-C	Polyethylene	Black	100	30.5	0.66	16.9	0.85	21.1	-40°F – 122°F (-40°C – 50°C)	1
CLTS62F-C3	Polyethylene	Orange	100	30.5	0.66	16.9	0.85	21.1	-40°F – 122°F (-40°C – 50°C)	1
CLTS75F-C	Polyethylene	Black	100	30.5	0.77	19.5	0.94	23.9	-40°F – 122°F (-40°C – 50°C)	1
CLTS75F-C3	Polyethylene	Orange	100	30.5	0.77	19.5	0.94	23.9	-40°F – 122°F (-40°C – 50°C)	1
CLTS75F-2M	Polyethylene	Black	2,000	609.6	0.77	19.5	0.94	23.9	-40°F – 122°F (-40°C – 50°C)	1
CLTS100F-C	Polyethylene	Black	100	30.5	0.91	23.2	1.10	28.0	-40°F – 122°F (-40°C – 50°C)	1
CLTS100F-C3	Polyethylene	Orange	100	30.5	0.91	23.2	1.10	28.0	-40°F – 122°F (-40°C – 50°C)	1
CLTS100F-1.25M	Polyethylene	Black	1,250	381.0	0.91	23.2	1.10	28.0	-40°F – 122°F (-40°C – 50°C)	1
CLTS125F-L	Polyethylene	Black	50	15.2	1.28	32.5	1.54	39.0	-40°F – 122°F (-40°C – 50°C)	1
CLTS125F-L3	Polyethylene	Orange	50	15.2	1.28	32.5	1.54	39.0	-40°F – 122°F (-40°C – 50°C)	1
CLTS150F-D	Polyethylene	Black	500	152.4	1.58	40.0	1.85	47.0	-40°F – 122°F (-40°C – 50°C)	1
CLTS150F-D3	Polyethylene	Orange	500	152.4	1.58	40.0	1.85	47.0	-40°F – 122°F (-40°C – 50°C)	1

*Reel packaging may contain splices. Contact Panduit Customer Service for further information.

Continues on next page

Corrugated Loom Tubing (continued)

Part Number	Material	Color	Length Per Reel		Inside Diameter		Outside Diameter		Temperature Range	Std. Pkg. Qty.*
			Ft.	m	In.	mm	In.	mm		
Nylon Slit										
CLT25N-C630	Heat Stabilized Nylon 6	Black	100	30.5	0.28	7.2	0.40	10.1	-40°F – 230°F (-40°C – 110°C)	1
CLT25N-10M630	Heat Stabilized Nylon 6	Black	10,000	3048.0	0.28	7.2	0.40	10.1	-40°F – 230°F (-40°C – 110°C)	1
CLT35N-C630	Heat Stabilized Nylon 6	Black	100	30.5	0.35	8.9	0.50	12.8	-40°F – 230°F (-40°C – 110°C)	1
CLT38N-C630	Heat Stabilized Nylon 6	Black	100	30.5	0.39	10.0	0.52	13.3	-40°F – 230°F (-40°C – 110°C)	1
CLT38N-5M630	Heat Stabilized Nylon 6	Black	5,000	1524.0	0.39	10.0	0.52	13.3	-40°F – 230°F (-40°C – 110°C)	1
CLT50N-C630	Heat Stabilized Nylon 6	Black	100	30.5	0.51	13.0	0.65	16.6	-40°F – 230°F (-40°C – 110°C)	1
CLT50N-4M630	Heat Stabilized Nylon 6	Black	4,000	1219.2	0.51	13.0	0.65	16.6	-40°F – 230°F (-40°C – 110°C)	1
CLT62N-C630	Heat Stabilized Nylon 6	Black	100	30.5	0.66	16.9	0.85	21.1	-40°F – 230°F (-40°C – 110°C)	1
CLT62N-2.5M630	Heat Stabilized Nylon 6	Black	2,500	762.0	0.66	16.9	0.85	21.1	-40°F – 230°F (-40°C – 110°C)	1
CLT75N-C630	Heat Stabilized Nylon 6	Black	100	30.5	0.77	19.5	0.94	23.9	-40°F – 230°F (-40°C – 110°C)	1
CLT75N-2M630	Heat Stabilized Nylon 6	Black	2,000	609.6	0.77	19.5	0.94	23.9	-40°F – 230°F (-40°C – 110°C)	1
CLT100N-C630	Heat Stabilized Nylon 6	Black	100	30.5	0.91	23.2	1.10	28.0	-40°F – 230°F (-40°C – 110°C)	1
CLT100N-125M630	Heat Stabilized Nylon 6	Black	1,250	381.0	0.91	23.2	1.10	28.0	-40°F – 230°F (-40°C – 110°C)	1
CLT125N-L630	Heat Stabilized Nylon 6	Black	50	15.2	1.28	32.5	1.54	39.0	-40°F – 230°F (-40°C – 110°C)	1
CLT125N-.75M630	Heat Stabilized Nylon 6	Black	750	228.6	1.28	32.5	1.54	39.0	-40°F – 230°F (-40°C – 110°C)	1
CLT150N-D630	Heat Stabilized Nylon 6	Black	500	152.4	1.58	40.0	1.85	47.0	-40°F – 230°F (-40°C – 110°C)	1
CLT188N-3C630	Heat Stabilized Nylon 6	Black	300	91.44	1.85	47.0	2.19	55.7	-40°F – 230°F (-40°C – 110°C)	1
Nylon Solid										
CLTS25N-C	Heat Stabilized Nylon 6	Black	100	30.5	0.28	7.2	0.40	10.1	-40°F – 230°F (-40°C – 110°C)	1
CLTS25N-10M	Heat Stabilized Nylon 6	Black	10,000	3048.0	0.28	7.2	0.40	10.1	-40°F – 230°F (-40°C – 110°C)	1
CLTS35N-C	Heat Stabilized Nylon 6	Black	100	30.5	0.35	8.9	0.50	12.8	-40°F – 230°F (-40°C – 110°C)	1
CLTS38N-C	Heat Stabilized Nylon 6	Black	100	30.5	0.39	10.0	0.52	13.3	-40°F – 230°F (-40°C – 110°C)	1
CLTS50N-C	Heat Stabilized Nylon 6	Black	100	30.5	0.51	13.0	0.65	16.6	-40°F – 230°F (-40°C – 110°C)	1
CLTS62N-C	Heat Stabilized Nylon 6	Black	100	30.5	0.66	16.9	0.85	21.1	-40°F – 230°F (-40°C – 110°C)	1
CLTS75N-C	Heat Stabilized Nylon 6	Black	100	30.5	0.77	19.5	0.94	23.9	-40°F – 230°F (-40°C – 110°C)	1
CLTS75N-2M	Heat Stabilized Nylon 6	Black	2,000	609.6	0.77	19.5	0.94	23.9	-40°F – 230°F (-40°C – 110°C)	1
CLTS100N-C	Heat Stabilized Nylon 6	Black	100	30.5	0.91	23.2	1.10	28.0	-40°F – 230°F (-40°C – 110°C)	1
CLTS125N-L	Heat Stabilized Nylon 6	Black	50	15.2	1.28	32.5	1.54	39.0	-40°F – 230°F (-40°C – 110°C)	1

*Reel packaging may contain splices. Contact Panduit Customer Service for further information.

Corrugated Loom Tubing Fittings

- Provide a secure way to join CLT at junctions and breakouts while improving the appearance of wire harnesses
- Color: Black
- Material: Halogen-Free Polypropylene
- Temperature Range: -22°F - 212°F (-30°C - 100°C)



Part Number	Branch Diameter		Trunk Diameter		Std. Pkg. Qty.	Std. Ctn. Qty.
	In.	mm	In.	mm		
CF382538F-Q	0.38	9.5	0.25	6.4	25	100
CF502550F-Q	0.50	12.7	0.25	6.4	25	100
CF503850F-Q	0.50	12.7	0.38	9.5	25	100
CF752575F-Q	0.75	19.1	0.25	6.4	25	100
CF753875F-Q	0.75	19.1	0.38	9.5	25	100

Part Number System for Braided Expandable Sleeving

<u>SE</u>	<u>25</u>	<u>PFR</u>	<u>—</u>	<u>M</u>	<u>R</u>	<u>0</u>
Type	Nominal I.D. Size	Material		Package Size		Color Suffix
SE = Sleeving Expandable	12 = 1/8" (3.2mm) 25 = 1/4" (6.4mm) 38 = 3/8" (9.5mm) 50 = 1/2" (12.7mm) 75 = 3/4" (19.1mm) 100 = 1" (25.4mm) 125 = 1 1/4" (31.8mm) 150 = 1 1/2" (38.1mm) 175 = 1 3/4" (44.5mm) 200 = 2" (50.8mm) 250 = 2 1/2" (63.5mm)	P = Polyethylene Terephthalate (PET) PFR = Polyethylene Terephthalate (PET) Flame Retardant PS = Pan-Wrap Braided Sleeving Polyethylene Terephthalate (PET) PSC = Fray Resistant Polyethylene Terephthalate (PET) PSFR = Pan-Wrap Braided Sleeving Flame Retardant Polyethylene Terephthalate (PET)		L = 50' (15.2m) LQ = 75' (22.9m) C = 100' (30.5m) CL = 150' (45.7m) T = 200' (61.0m) 4C = 400' (122.0m) D = 500' (152.4m) M = 1000' (304.8m)	R = Reel	0 = Weather Resistant Black 8 = Gray 10 = White

RA® SP® Braided Expandable Sleeving – Polyethylene Terephthalate (PET)

- Provides continuous abrasion protection for wires, cables, hoses and tubing
- Highly flexible open weave will not trap heat or humidity
- Allows for use with irregular shapes
- Lightweight, durable protection
- Rated for use up to 257°F (125°C)
- Compliant with U.S. and European passenger rail standards
- UL: E116868
- CSA: 227630



Part Number	Color	Nominal I.D.		Nominal Diameter Range		Length per reel		Std. Pkg. Qty.	Std. Ctn. Qty.
		In.	mm	In.	mm	Ft.	m		
SE12P-TR0	Black	0.12	3.2	0.094 – 0.250	2.4 – 6.4	200	61.0	1	4
SE12P-TR8	Gray	0.12	3.2	0.094 – 0.250	2.4 – 6.4	200	61.0	1	4
SE12P-MR0	Black	0.12	3.2	0.094 – 0.250	2.4 – 6.4	1000	304.8	1	2
SE12P-MR10	White	0.12	3.2	0.094 – 0.250	2.4 – 6.4	1000	304.8	1	2
SE25P-TR0	Black	0.25	6.4	0.125 – 0.375	3.2 – 9.5	200	61.0	1	4
SE25P-TR8	Gray	0.25	6.4	0.125 – 0.375	3.2 – 9.5	200	61.0	1	4
SE25P-MR0	Black	0.25	6.4	0.125 – 0.375	3.2 – 9.5	1000	304.8	1	2
SE25P-MR8	Gray	0.25	6.4	0.125 – 0.375	3.2 – 9.5	1000	304.8	1	2
SE25P-MR10	White	0.25	6.4	0.125 – 0.375	3.2 – 9.5	1000	304.8	1	2
SE38P-TR0	Black	0.38	9.5	0.188 – 0.500	4.8 – 12.7	200	61.0	1	4
SE38P-TR8	Gray	0.38	9.5	0.188 – 0.500	4.8 – 12.7	200	61.0	1	4
SE38P-MR0	Black	0.38	9.5	0.188 – 0.500	4.8 – 12.7	1000	304.8	1	2
SE38P-MR8	Gray	0.38	9.5	0.188 – 0.500	4.8 – 12.7	1000	304.8	1	2
SE38P-MR10	White	0.38	9.5	0.188 – 0.500	4.8 – 12.7	1000	304.8	1	2
SE50P-CR0	Black	0.50	12.7	0.250 – 0.750	6.4 – 19.1	100	30.5	1	4
SE50P-CR8	Gray	0.50	12.7	0.250 – 0.750	6.4 – 19.1	100	30.5	1	4
SE50P-DR0	Black	0.50	12.7	0.250 – 0.750	6.4 – 19.1	500	152.4	1	2
SE50P-DR8	Gray	0.50	12.7	0.250 – 0.750	6.4 – 19.1	500	152.4	1	2
SE50P-DR10	White	0.50	12.7	0.250 – 0.750	6.4 – 19.1	500	152.4	1	2
SE75P-CR0	Black	0.75	19.1	0.500 – 1.25	12.7 – 31.8	100	30.5	1	4
SE75P-CR8	Gray	0.75	19.1	0.500 – 1.25	12.7 – 31.8	100	30.5	1	4
SE75P-DR0	Black	0.75	19.1	0.500 – 1.25	12.7 – 31.8	500	152.4	1	2
SE75P-DR8	Gray	0.75	19.1	0.500 – 1.25	12.7 – 31.8	500	152.4	1	2
SE75P-DR10	White	0.75	19.1	0.500 – 1.25	12.7 – 31.8	500	152.4	1	2
SE125P-LR0	Black	1.25	31.8	0.750 – 1.50	19.1 – 38.1	50	15.2	1	4
SE125P-LR8	Gray	1.25	31.8	0.750 – 1.50	19.1 – 38.1	50	15.2	1	4
SE125P-TR0	Black	1.25	31.8	0.750 – 1.50	19.1 – 38.1	200	61.0	1	2
SE125P-TR8	Gray	1.25	31.8	0.750 – 1.50	19.1 – 38.1	200	61.0	1	2
SE125P-TR10	White	1.25	31.8	0.750 – 1.50	19.1 – 38.1	200	61.0	1	2
SE150P-LR0	Black	1.50	38.1	1.00 – 2.13	25.4 – 54.0	50	15.2	1	4
SE150P-LR8	Gray	1.50	38.1	1.00 – 2.13	25.4 – 54.0	50	15.2	1	4
SE150P-TR0	Black	1.50	38.1	1.00 – 2.13	25.4 – 54.0	200	61.0	1	2
SE150P-TR8	Gray	1.50	38.1	1.00 – 2.13	25.4 – 54.0	200	61.0	1	2
SE150P-TR10	White	1.50	38.1	1.00 – 2.13	25.4 – 54.0	200	61.0	1	2
SE175P-TR0	Black	1.75	44.5	1.25 – 2.75	31.8 – 69.9	200	61.0	1	2
SE200P-TR0	Black	2.00	50.8	1.50 – 3.50	38.1 – 88.9	200	61.0	1	2
SE250P-TR0	Black	2.50	63.5	1.75 – 3.64	44.5 – 92.3	200	61.0	1	2

Reel packaging may contain splices. Contact Panduit Customer Service for further information.

Braided Expandable Sleeving – Flame Retardant Polyethylene Terephthalate

- Provides continuous abrasion protection for wires, cables, hoses and tubing
- Highly flexible open weave will not trap heat or humidity
- Rated for use up to 257°F (125°C)
- Allows for use with irregular shapes
- Flammability: Meets UL 1441 VW-1
- Compliant with U.S. and European passenger rail standards
- UL E116868



Part Number	Color	Nominal I.D.		Nominal Diameter Range		Length per reel		Std. Pkg. Qty.	Std. Ctn. Qty.
		In.	mm	In.	mm	Ft.	m		
SE12PFR-TR0	Black	0.12	3.2	0.094 – 0.250	2.4 – 6.4	200	61.0	1	4
SE12PFR-MR0	Black	0.12	3.2	0.094 – 0.250	2.4 – 6.4	1000	304.8	1	2
SE12PFR-TR8	Gray	0.12	3.2	0.094 – 0.250	2.4 – 6.4	200	61.0	1	4
SE12PFR-MR8	Gray	0.12	3.2	0.094 – 0.250	2.4 – 6.4	1000	304.8	1	2
SE12PFR-MR10	White	0.12	3.2	0.094 – 0.250	2.4 – 6.4	1000	304.8	1	2
SE25PFR-TR0	Black	0.25	6.4	0.125 – 0.375	3.2 – 9.5	200	61.0	1	4
SE25PFR-MR0	Black	0.25	6.4	0.125 – 0.375	3.2 – 9.5	1000	304.8	1	2
SE25PFR-TR8	Gray	0.25	6.4	0.125 – 0.375	3.2 – 9.5	200	61.0	1	4
SE25PFR-MR8	Gray	0.25	6.4	0.125 – 0.375	3.2 – 9.5	1000	304.8	1	2
SE25PFR-MR10	White	0.25	6.4	0.125 – 0.375	3.2 – 9.5	1000	304.8	1	2
SE38PFR-MR0	Black	0.38	9.5	0.188 – 0.500	4.8 – 12.7	1000	304.8	1	2
SE38PFR-TR0	Black	0.38	9.5	0.188 – 0.500	4.8 – 12.7	200	61.0	1	4
SE38PFR-TR8	Gray	0.38	9.5	0.188 – 0.500	4.8 – 12.7	200	61.0	1	4
SE38PFR-MR8	Gray	0.38	9.5	0.188 – 0.500	4.8 – 12.7	1000	304.8	1	2
SE38PFR-MR10	White	0.38	9.5	0.188 – 0.500	4.8 – 12.7	1000	304.8	1	2
SE50PFR-CR0	Black	0.50	12.7	0.250 – 0.750	6.4 – 19.1	100	30.5	1	4
SE50PFR-CR8	Gray	0.50	12.7	0.250 – 0.750	6.4 – 19.1	100	30.5	1	4
SE50PFR-DR0	Black	0.50	12.7	0.250 – 0.750	6.4 – 19.1	500	152.4	1	2
SE50PFR-DR8	Gray	0.50	12.7	0.250 – 0.750	6.4 – 19.1	500	152.4	1	2
SE50PFR-DR10	White	0.50	12.7	0.250 – 0.750	6.4 – 19.1	500	152.4	1	2
SE75PFR-CR0	Black	0.75	19.1	0.500 – 1.25	12.7 – 31.8	100	30.5	1	4
SE75PFR-CR8	Gray	0.75	19.1	0.500 – 1.25	12.7 – 31.8	100	30.5	1	4
SE75PFR-DR0	Black	0.75	19.1	0.500 – 1.25	12.7 – 31.8	500	152.4	1	2
SE75PFR-DR8	Gray	0.75	19.1	0.500 – 1.25	12.7 – 31.8	500	152.4	1	2
SE75PFR-DR10	White	0.75	19.1	0.500 – 1.25	12.7 – 31.8	500	152.4	1	2
SE125PFR-LR0	Black	1.25	31.8	0.750 – 1.50	19.1 – 38.1	50	15.2	1	4
SE125PFR-LR8	Gray	1.25	31.8	0.750 – 1.50	19.1 – 38.1	50	15.2	1	4
SE125PFR-TR0	Black	1.25	31.8	0.750 – 1.50	19.1 – 38.1	200	61.0	1	2
SE125PFR-TR8	Gray	1.25	31.8	0.750 – 1.50	19.1 – 38.1	200	61.0	1	2
SE125PFR-TR10	White	1.25	31.8	0.750 – 1.50	19.1 – 38.1	200	61.0	1	2
SE150PFR-LR0	Black	1.50	38.1	1.00 – 2.13	25.4 – 54.0	50	15.2	1	4
SE150PFR-LR8	Gray	1.50	38.1	1.00 – 2.13	25.4 – 54.0	50	15.2	1	4
SE150PFR-TR0	Black	1.50	38.1	1.00 – 2.13	25.4 – 54.0	200	61.0	1	2
SE150PFR-TR8	Gray	1.50	38.1	1.00 – 2.13	25.4 – 54.0	200	61.0	1	2
SE150PFR-TR10	White	1.50	38.1	1.00 – 2.13	25.4 – 54.0	200	61.0	1	2
SE175PFR-TR0	Black	1.75	44.5	1.25 – 2.75	31.8 – 69.9	200	61.0	1	2

Reel packaging may contain splices. Contact Panduit Customer Service for further information.

Tooling Head

- Sleeving cutter/end sealer blade – used with popular soldering guns to cut and seal sleeving



Part Number	Part Description	Std. Pkg. Qty.
HKBS	For dual straight shank soldering guns with 0.500" spacing typical guns: WELLER Straight Shank Model 8200; WEN Model 199 or 100 (Replace tip holding screws with (2) screws included).	1

FR **SP** **Fray Resistant Braided Expandable Sleeving**

- Sleeving design resists fraying when cut with scissors
- Provides continuous abrasion protection resistance for wires, cables, and tubing
- For indoor use only
- Rated for use up to 257°F (125°C)
- Material: Polyethylene Terephthalate
- UL E116868



Part Number	Color	Nominal I.D.		Nominal Diameter Range		Length per reel‡		Std. Pkg. Qty.	Std. Ctn. Qty.
		In.	mm	In.	mm	Ft.	m		
SE12PSC-TR0	Black	0.12	3.2	0.13 – 0.25	3.2 – 6.4	200	61.0	1	4
SE25PSC-TR0	Black	0.25	6.4	0.16 – 0.44	4.0 – 11.1	200	61.0	1	4
SE38PSC-TR0	Black	0.38	9.5	0.19 – 0.63	4.8 – 15.9	200	61.0	1	4
SE50PSC-CR0	Black	0.50	12.7	0.25 – 0.75	6.4 – 19.1	100	30.5	1	4
SE75PSC-CR0	Black	0.75	19.1	0.63 – 1.0	15.9 – 25.4	100	30.5	1	4
SE125PSC-LR0	Black	1.25	31.8	1.0 – 1.5	25.4 – 38.1	50	15.2	1	4
SE150PSC-LR0	Black	1.50	38.1	1.3 – 2.0	31.8 – 50.8	50	15.2	1	4

‡Reel packaging may contain splices. Contact Panduit Customer Service for further information.

NEW! **FR** **SP** **Pan-Wrap™ Braided Sleeving**

- Split wrap design allows for installation after cable routing is complete, breakouts of single and multiple cables, and addition or removal of cables post-installation
- 25% edge overlap ensures complete coverage without opening
- Highly flexible open weave will not trap heat or humidity
- Rated for use up to 257°F (125°C)
- Polyethylene Terephthalate (PET) Flammability: Meets UL 94 V-0
- Flame Retardant Polyethylene Terephthalate (PET) Flammability: Meets UL 1441 VW-1



Part Number	Material	Color	Nominal Size Diameter		Nominal Wall Thickness		Length Per Reel		Std. Pkg. Qty.	Std. Ctn. Qty.
			In.	mm	In.	mm	Ft.	m		
SE12PS-4CR0	Polyethylene Terephthalate (PET)	Black	0.125	3.2	0.024	0.6	400	122.0	1	6
SE25PS-TR0	Polyethylene Terephthalate (PET)	Black	0.25	6.4	0.025	0.6	200	61.0	1	6
SE50PS-CLR0	Polyethylene Terephthalate (PET)	Black	0.50	12.7	0.025	0.6	150	45.7	1	2
SE75PS-CR0	Polyethylene Terephthalate (PET)	Black	0.75	19.1	0.025	0.6	100	30.5	1	2
SE100PS-CR0	Polyethylene Terephthalate (PET)	Black	1.00	25.4	0.038	1.0	100	30.5	1	2
SE150PS-LQR0	Polyethylene Terephthalate (PET)	Black	1.50	38.1	0.038	1.0	75	22.9	1	2
SE12PSFR-4CR0	Flame Retardant Polyethylene Terephthalate (PET)	Black	0.125	3.2	0.024	0.6	400	122.0	1	6
SE25PSFR-TR0	Flame Retardant Polyethylene Terephthalate (PET)	Black	0.25	6.4	0.025	0.6	200	61.0	1	6
SE50PSFR-CLR0	Flame Retardant Polyethylene Terephthalate (PET)	Black	0.50	12.7	0.025	0.6	150	45.7	1	2
SE75PSFR-CR0	Flame Retardant Polyethylene Terephthalate (PET)	Black	0.75	19.1	0.025	0.6	100	30.5	1	2
SE100PSFR-CR0	Flame Retardant Polyethylene Terephthalate (PET)	Black	1.00	25.4	0.038	1.0	100	30.5	1	2
SE150PSFR-LQR0	Flame Retardant Polyethylene Terephthalate (PET)	Black	1.50	38.1	0.038	1.0	75	22.9	1	2

Part Number System for Non-Shrink PVC Tubing

TV105
Type

TV105 = PVC Tubing

—

12
Nominal Size

12 = 12 AWG 0.38 = 3/8"
6 = 6 AWG 0.50 = 1/2"
3 = 3 AWG 0.75 = 3/4"
1 = 1 AWG 1.0 = 1"

M
Package Quantity

C = 100' (30.5m)
TL = 250' (76.2m)
D = 500' (152.4m)
M = 1000' (304.8m)

Color Suffix

Leave
Blank = Clear
20 = Black

Non-Shrink PVC Tubing



- Provides insulation and protection for lead wires, wire harness assemblies, soldered joints and components in electrical and electronic equipment
- All purpose flexible and non-shrinkable
- Resistant to heat and moisture
- Flammability: Meets UL 224 VW-1
- Voltage rating: 300 V and 600 V
- ASTM D-922 Grade CFR
- MIL-I-631 Type F, Form U, Grade C-Class 1 Category 1
- Material: Polyvinyl chloride (PVC)
- UL oil resistant class 1 rating
- Continuous use temperature range: -4°F – 221°F (-20°C – 105°C)
- UL: E122770 (Black and limited sizes in Clear)
- CSA 75192
- 5 year shelf life

Part Number	Color	Nominal Size	Length Per Reel		Max. Inside Diameter		Wall Thickness		Max. Voltage Rating	Std. Pkg. Qty.	Std. Ctn. Qty.
			Ft.	m	In.	mm	In.	mm			
TV105-12MY	Clear	12 AWG	1000	304.8	0.089	2.3	0.016	0.4	300 V	1	2
TV105-12M20Y	Black	12 AWG	1000	304.8	0.089	2.3	0.016	0.4	300 V	1	2
TV105-6MY	Clear	6 AWG	1000	304.8	0.178	4.5	0.020	0.5	300 V	1	2
TV105-6M20Y	Black	6 AWG	1000	304.8	0.178	4.5	0.020	0.5	300 V	1	2
TV105-3MY	Clear	3 AWG	1000	304.8	0.249	6.3	0.020	0.5	300 V	1	2
TV105-3M20Y	Black	3 AWG	1000	304.8	0.249	6.3	0.020	0.5	300 V	1	2
TV105-1MY	Clear	1 AWG	1000	304.8	0.311	7.9	0.020	0.5	300 V	1	—
TV105-1M20Y	Black	1 AWG	1000	304.8	0.311	7.9	0.020	0.5	300 V	1	—
TV105-.38DY	Clear	3/8	500	152.4	0.399	10.1	0.025	0.6	600 V	1	—
TV105-.38D20Y	Black	3/8	500	152.4	0.399	10.1	0.025	0.6	600 V	1	—
TV105-.50DY	Clear	1/2	500	152.4	0.524	13.3	0.025	0.6	600 V	1	—
TV105-.50D20Y	Black	1/2	500	152.4	0.524	13.3	0.025	0.6	600 V	1	—
TV105-.75TLY	Clear	3/4	250	76.2	0.786	20.0	0.035	0.9	600 V	1	—
TV105-.75TL20Y	Black	3/4	250	76.2	0.786	20.0	0.035	0.9	600 V	1	—
TV105-1.0CY	Clear	1	100	30.5	1.036	26.3	0.035	0.9	600 V	1	2
TV105-1.0C20Y	Black	1	100	30.5	1.036	26.3	0.035	0.9	600 V	1	2

Duct Seal – Sealing Compounds

- Seals irregular openings from air, dust, or water
- Non-hardening sealant that adheres to metal, masonry, wood or plastic
- Provides vibration dampening
- Safe and easy to use, non-corrosive, non-toxic, no asbestos, will not stain or harm hands, and no unpleasant odor
- Dielectric strength: 200 V/Mil, Min 0.030" thick
- Temperature range: -30°F – 210°F (-34°C – 98°C)
- 10 year minimum shelf life
- Indoor use only



Part Number	Part Description	Std. Pkg. Qty.
DS1	Duct seal (sealing compound) 1 lb. package	1
DS5	Duct seal (sealing compound) 5 lb. package	1

Abrasion Protection Materials Technical Data

Ratings and Approvals			Physical Properties					Chemical Resistance			
UL Temperature Index	Flammability (UL 94)	Melting Temperature	Abrasion Resistance (Lower number is better)	Specific Gravity (D792)	Minimum Tensile @23°C (psi)	Water Absorption (Max. 24 hrs.)	Organic Solvents	Alkalies	Acids	Petro-Chemicals	

Spiral Wrap											
Natural Polyethylene Lowest cost material for indoor use up to 122°F. Natural is available in all sizes.	-40°F (-40°C) to 122°F (50°C)	HB	239°F (115°C)	22 mg	0.91 – 0.93	1400 (D368)	0.01%	Resistant below 140°F (60°C) except to chlorinated solvents	Resistant	Resistant except to oxidizing acids	Some Discoloration
Weather Resistant Polyethylene This material has the same properties as natural polyethylene, and also has additives which allow it to resist the effects of ultraviolet light and acid rain in an outdoor environment. This product is available in black only.	-40°F (-40°C) to 122°F (50°C)	HB	239°F (115°C)	20 mg	0.93 – 1.09	2000 (D368)	0.03%	Resistant below 140°F (60°C) except to chlorinated solvents	Resistant	Resistant except to oxidizing acids	No Discoloration
Fire Resistant Polyethylene* UL94-V-2 Rating. This material is self extinguishing and passes the UL 94 flame retardant test with V-2 rating.	-40°F (-40°C) to 122°F (50°C)	V-2	239°F (115°C)	27 mg	1.00 – 1.30	1400 (D368)	0.02%	Resistant below 140°F (60°C) except to chlorinated solvents	Resistant	Resistant except to oxidizing acids	Some Discoloration
Flame Retardant Polyethylene* UL94-V-0 Rating. This material is self extinguishing and passes the UL94 flame retardant test with a V-0 rating.	-4°F (-20°C) to 122°F (50°C)	V-0	270°F (132°C)	22 mg	1.23 – 1.37	1500 (D368)	0.02%	Resistant except to halogenated hydrocarbons	Resistant	Resistant	Resistant Some Discoloration
Weather Resistant Polypropylene This material is resistant to chemical attack and is suitable for harsh environment applications requiring UV/weather resistance and withstanding high temperatures.	-40°F (-40°C) to 239°F (115°C)	HB	334°F (168°C)	—	0.902	4000 (D638)	0.1%	Resistant except to halogenated hydrocarbons	Resistant	Resistant	Resistant No Discoloration
Nylon 6.6 Nylon is strong, durable material for indoor use up to 149°F. It offers a combination of lightweight, wide temperature range, and high abrasion resistance. This material is suitable for applications where heavy vibration or stress exists on the wiring or tubing.	-40°F (-40°C) to 149°F (65°C)	HB	505°F (263°C)	7 mg	1.13 – 1.15	12,400 (D368)	1.2%	Resistant except to halogenated hydrocarbons	Resistant	Not recommended	Resistant No Discoloration
Weather Resistant Nylon 6.6 This material has the same properties as natural Nylon and also has additives which allow it to resist the effects of ultraviolet light in an outdoor environment. This product is available in black only.	-40°F (-40°C) to 149°F (65°C)	HB	505°F (263°C)	7 mg	1.13 – 1.15	12,400 (D368)	1.2%	Resistant except to halogenated hydrocarbons	Resistant	Not recommended	Resistant No Discoloration
TFE†* This material is a non-flammable, fluorocarbon resin material. Highly resistant to most chemicals, high resistance to UV exposure, wide operating temperature range, can be used in cryogenic applications. Color: Opaque to Translucent.	-454°F (-270°C) to 356°F (180°C)	V-0	648°F (342°C)	7 mg	2.13 – 2.22	3000 (D876)	0.01%	Resistant	Resistant	Resistant	Resistant No Discoloration

Pan-Wrap™											
Natural Polyethylene Lowest cost material for indoor use up to 122°C. Natural is available in all sizes.	-40°F (-40°C) to 122°F (50°C)	HB	239°F (115°C)	22 mg	0.91 – 0.93	1400 (D638)	0.01%	Resistant below 140°F (60°C) except to chlorinated solvents	Resistant	Resistant except to oxidizing acids	Some Discoloration
Flame Retardant Polyethylene* UL94-V-0 Rating. This material is self extinguishing and passes the UL94 flame retardant test with a V-0 rating.	-4°F (-20°C) to 122°F (50°C)	V-0	270°F (132°C)	22 mg	1.15	1500 (D876)	0.02%	Resistant except to halogenated hydrocarbons	Resistant	Resistant	Resistant Some Discoloration

Note: Typical operating temperature ranges are extended based on end use application and specific environment tests.
 †TFE is Polytetrafluoroethylene material.
 *Contains halogens. Other materials are halogen free.

Continues on next page

Abrasion Protection Materials Technical Data (continued)

UL Temperature Index	Ratings and Approvals			Physical Properties				Chemical Resistance			
	Flammability (UL 94)	Melting Temperature	Abrasion Resistance (Lower number is better)	Specific Gravity (D792)	Minimum Tensile @23°C (psi)	Water Absorption (Max. 24 hrs.)	Organic Solvents	Alkalies	Acids	Petro-Chemicals	

Sleeving

Polyethylene Terephthalate (PET) This material is a thermoplastic polyester material designed for indoor applications. It is rated for use up to 257°F and will tolerate short-term exposure up to 446°F. Colors: Weather Resistant Black, White and Gray.	-94°F (-70°C) to 257°F (125°C)	V-0	500°F (260°C)	—	1.39	100,000 (D876)	0.08%	Resistant to some solvents	Resistant to most weak bases	Resistant	Some Discoloration
Flame Retardant Polyethylene Terephthalate (PET) This material is a self-extinguishing thermoplastic polyester that can be used indoors. It is also rated for use up to 257°F and will tolerate short term exposure up to 446°F. It is provided with tracers to identify the flame retardant material.	-94°F (-70°C) to 257°F (125°C)	UL 1441 VW-1	469°F (243°C)	—	1.39	39,295 (D876)	0.08%	Resistant to some solvents	Resistant to most weak bases	Resistant	Resistant Some Discoloration

CLT

Black Polyethylene Lowest cost material is for use up to 122°F. Other colors may be available.	-40°F (-40°C) to 122°F (50°C)	HB	—	—	0.926 – 0.940	1500 (D638)	—	Resistant except to halogenated hydrocarbons	Resistant	Resistant	Resistant No Discoloration
Nylon 6 Nylon is a strong, impact modified, heat stabilized, durable high abrasion resistant material.	-40°F (-40°C) to 230°F (110°C)	HB	410°F (211°C)	—	1.06 – 1.16	8000 (D638)	—	Resistant except to halogenated hydrocarbons	Resistant	Not recommended	Resistant No Discoloration

CLT Fittings

Black Polypropylene Lowest cost material is for use up to 212°F. Halogen-Free.	-40°F (-40°C) to 122°F (50°C)	UL94 HB	—	—	1.04	3,900 (D638)	0.02 – 0.03%	Resistant except to halogenated hydrocarbons	Resistant	Resistant except to oxidizing acids	Resistant Some Discoloration
--	-------------------------------	---------	---	---	------	--------------	--------------	--	-----------	-------------------------------------	------------------------------

PVC

PVC Non-Shrink Tubing* This material provides insulation and protection for continuous use at temperature -4°F (-20°C) to 221°F(105°C).	-4°F (-20°C) to 221°F (105°C)	UL 224 VW-1**	—	—	1.35	2500 (D876)	—	Resistant except to aromatic hydrocarbons, ketones and esters	Resistant	Resistant	Resistant No Discoloration
---	-------------------------------	---------------	---	---	------	-------------	---	---	-----------	-----------	----------------------------

Grommet Edging

Natural Polyethylene Lowest cost material for indoor use up to 122° F. Natural is available in all sizes.	-40°F (-40°C) to 122°F (50°C)	HB	239°F (115°C)	22 mg	0.91 – 1.09	1400 (D638)	—	Resistant below 140°F (60°C) except to chlorinated solvents	Resistant	Resistant except to oxidizing acids	Some Discoloration
Weather Resistant Polyethylene This material has the same properties as natural polyethylene, and also has additives which allow it to resist the effects of ultraviolet light and acid rain in an outdoor environment. This product is available in black only.	-40°F (-40°C) to 122°F (50°C)	HB	239°F (115°C)	20 mg	0.93 – 1.09	2000 (D638)	0.03%	Resistant below 140°F (60°C) except to chlorinated solvents	Resistant	Resistant except to oxidizing acids	No Discoloration
Flame Retardant Polyethylene* UL94-V-0 Rating This material is self-extinguishing and passes the UL94 flame retardant test with a V-0 rating.	-4°F (-20°C) to 122°F (50°C)	V-0	270°F (132°C)	22 mg	1.23 – 1.37	1200	0.02%	Resistant below 194°F (90°C) except to chlorinated solvents	Resistant	Resistant except to oxidizing acids	Some Discoloration
Nylon Nylon is strong, durable, self-extinguishing material for indoor use up to 149°F. It offers a combination of lightweight, wide temperature range, and high abrasion resistance. This material is suitable for applications where heavy vibration or stress exists on the wiring or tubing.	-40°F (-40°C) to 149°F (65°C)	V-2	491°F (255°C)	7 mg	1.03 – 1.15	12,400 (D638)	1.5%	Resistant except to phenols and formic acid	Resistant	Resistant to most weak acids	No Discoloration

Note: Typical operating temperature ranges are extended based on end use application and specific environment tests.

*Contains halogens. Other materials are halogen free.

**Limited sizes in Clear

Part Number System for Thin Wall Heat Shrink

HSTT	12	48	Q	10
Type	Expanded Diameter	Tube Length	Package Quantity	Color
HSTT = Thin Wall	05 = 3/64" (1.2mm)	3 = 3" (76.2mm)	(If Tube Length Specified)	NONE = Black
HSTTV = Thin Wall VW-1	06 = 1/16" (1.6mm)	6 = 6" (152.4mm)	1 = 1 Pc.	C = Clear
HSTTN = Thin Wall Neoprene	09 = 3/32" (2.4mm)	9 = 9" (228.6mm)	2 = 2 Pcs.	1 = Brown
HSTTK = Thin Wall PVDF	12 = 1/8" (3.2mm)	12 = 12" (304.8mm)	3 = 3 Pcs.	2 = Red
HSTTT = Thin Wall TFE†	19 = 3/16" (4.8mm)	48 = 48" (1.2m)	5 = 5 Pcs.	3 = Orange
HSTTP = Thin Wall PVC	25 = 1/4" (6.4mm)	Y = 6" Pcs.	X = 10 Pcs.	4 = Yellow
HSTTPN = Crystal Clear Thin Wall PVC	38 = 3/8" (9.5mm)	NONE = REEL	Q = 25 Pcs.	5 = Green
HSTTVA = Flexible Adhesive Lined	50 = 1/2" (12.7mm)		LQ = 75 Pcs.	6 = Blue
HSTTRA = Semi-Rigid Adhesive Lined	75 = 3/4" (19.1mm)		CQ = 125 Pcs.	10 = White
HSTTA = Thin Wall Adhesive Lined	100 = 1" (25.4mm)		T = 200 Pcs.	45 = Yellow/Green
HSTT4A = 4:1 Thin Wall Adhesive Lined	150 = 1 1/2" (38.1mm)		TL = 250 Pcs.	
HST = Thick Wall Adhesive Lined	200 = 2" (50.8mm)		Reels	
HSEC = Heat Shrink End Caps Adhesive Lined	300 = 3" (76.2mm)		(If No Tube Length Specified)	
HSECFR = Heat Shrink End Caps Flame Retardant Adhesive Lined	400 = 4" (101.6mm)		Q = 25' (7.6m)	
	0.4 = 0.40" (10.2mm)		L = 50' (15.2m)	
	0.5 = 0.47" (11.9mm)		C = 100' (30.5m)	
	0.8 = 0.80" (20.3mm)		T = 200' (61.0m)	
	1.0 = 1.0" (25.4mm)		D = 500' (152.4m)	
	1.1 = 1.1" (27.9mm)		M = 1000' (304.8m)	
	1.5 = 1.5" (38.1mm)			
	2.0 = 2.0" (50.8mm)			
	2.7 = 2.7" (68.6mm)			
	3.0 = 3.0" (76.2mm)			
	3.5 = 3.5" (88.9mm)			
	4.0 = 4.0" (101.6mm)			

For Standard Packages containing 6" (152.4mm) lengths, refer to individual pages for complete part number offering.
 Note: The above information is to be used as a guide. For specific part number offerings review individual pages for verification.
 †TFE is Polytetrafluoroethylene material.

B1.
Cable
Ties

B2.
Cable
Accessories

B3.
Stainless
Steel Cable
Ties &
Accessories

C1.
Wiring
Duct

C2.
Abrasion
Protection

C3.
Cable
Management

D1.
Terminals

D2.
Power
Connectors

D3.
Grounding
Connectors

E1.
Labeling
Systems

E2.
Labels

E3.
Pre-Printed
&
Write-On
Markers

E4.
Permanent
Identification

E5.
Industrial
Safety
Solutions

F.
Keystone
Cabling
Systems

G.
Part
Number
Index

HSTT Heat Shrink 4 Foot Pieces and Reels

- Applications include insulating, protecting, and color coding wires and cables
- Voltage: 600 V
- Shrink ratio: 2:1
- Flammability: Flame retardant EXCEPT clear
- Mil Spec: AMS-DTL-23053/5 Class 1 (Colors) Class 2 (Clear)**
- Temperature range: -67°F to 275°F (-55°C to 135°C)
- For dry locations
- Material: Cross-linked Polyolefin
- UL: E122770
- CSA: 222627
- 5 year shelf life***



Part Number*	Nominal Diameter		Min. Expanded I.D.		Max. Recovered I.D.		Nominal Recovered Wall Thickness		Length		Length per Reel		Std. Pkg. Qty.	Std. Ctn. Qty.
	In.	mm	In.	mm	In.	mm	In.	mm	Ft.	m	Ft.	m		
HSTT05-48-Q	0.046	1.2	0.046	1.2	0.023	0.6	0.016	0.4	4	1.2	—	—	25	—
HSTT05-48-TL	0.046	1.2	0.046	1.2	0.023	0.6	0.016	0.4	4	1.2	—	—	250	—
HSTT05-C‡	0.046	1.2	0.046	1.2	0.023	0.6	0.016	0.4	—	—	100	30.5	1	10
HSTT05-M‡	0.046	1.2	0.046	1.2	0.023	0.6	0.016	0.4	—	—	1,000	304.8	1	2
HSTT06-48-Q	0.063	1.6	0.063	1.6	0.031	0.8	0.017	0.4	4	1.2	—	—	25	—
HSTT06-48-TL	0.063	1.6	0.063	1.6	0.031	0.8	0.017	0.4	4	1.2	—	—	250	—
HSTT06-C‡	0.063	1.6	0.063	1.6	0.031	0.8	0.017	0.4	—	—	100	30.5	1	10
HSTT06-M‡	0.063	1.6	0.063	1.6	0.031	0.8	0.017	0.4	—	—	1,000	304.8	1	2
HSTT09-48-Q	0.093	2.4	0.093	2.4	0.046	1.2	0.020	0.5	4	1.2	—	—	25	—
HSTT09-48-TL	0.093	2.4	0.093	2.4	0.046	1.2	0.020	0.5	4	1.2	—	—	250	—
HSTT09-C‡	0.093	2.4	0.093	2.4	0.046	1.2	0.020	0.5	—	—	100	30.5	1	10
HSTT09-M‡	0.093	2.4	0.093	2.4	0.046	1.2	0.020	0.5	—	—	1,000	304.8	1	2
HSTT12-48-Q	0.125	3.2	0.125	3.2	0.062	1.6	0.020	0.5	4	1.2	—	—	25	—
HSTT12-48-TL	0.125	3.2	0.125	3.2	0.062	1.6	0.020	0.5	4	1.2	—	—	250	—
HSTT12-C‡	0.125	3.2	0.125	3.2	0.062	1.6	0.020	0.5	—	—	100	30.5	1	10
HSTT12-M‡	0.125	3.2	0.125	3.2	0.062	1.6	0.020	0.5	—	—	1,000	304.8	1	2
HSTT19-48-Q	0.187	4.8	0.187	4.8	0.093	2.4	0.020	0.5	4	1.2	—	—	25	—
HSTT19-48-TL	0.187	4.8	0.187	4.8	0.093	2.4	0.020	0.5	4	1.2	—	—	250	—
HSTT19-C‡	0.187	4.8	0.187	4.8	0.093	2.4	0.020	0.5	—	—	100	30.5	1	10
HSTT19-M‡	0.187	4.8	0.187	4.8	0.093	2.4	0.020	0.5	—	—	1,000	304.8	1	2
HSTT25-48-Q	0.250	6.4	0.250	6.4	0.125	3.2	0.025	0.6	4	1.2	—	—	25	—
HSTT25-48-TL	0.250	6.4	0.250	6.4	0.125	3.2	0.025	0.6	4	1.2	—	—	250	—
HSTT25-C‡	0.250	6.4	0.250	6.4	0.125	3.2	0.025	0.6	—	—	100	30.5	1	10
HSTT25-D‡	0.250	6.4	0.250	6.4	0.125	3.2	0.025	0.6	—	—	500	152.4	1	2
HSTT38-48-Q	0.375	9.5	0.375	9.5	0.187	4.8	0.025	0.6	4	1.2	—	—	25	—
HSTT38-48-TL	0.375	9.5	0.375	9.5	0.187	4.8	0.025	0.6	4	1.2	—	—	250	—
HSTT38-C‡	0.375	9.5	0.375	9.5	0.187	4.8	0.025	0.6	—	—	100	30.5	1	10
HSTT38-T‡	0.375	9.5	0.375	9.5	0.187	4.8	0.025	0.6	—	—	200	61.0	1	2

*For colors, add C (Clear), 1 (Brown), 2 (Red), 3 (Orange), 4 (Yellow), 45 (Yellow/Green), 5 (Green), 6 (Blue) and 10 (White) to end of part number. Contact customer service for availability.

‡Part sold per reel.

**Material Performance Only.

***Shelf life applies only to expanded and recovered dimensions. Material performance is not affected.

Continues on next page



HSTT Heat Shrink 4 Foot Pieces and Reels (continued)



Part Number*	Nominal Diameter		Min. Expanded I.D.		Max. Recovered I.D.		Nominal Recovered Wall Thickness		Length		Length per Reel		Std. Pkg. Qty.	Std. Ctn. Qty.
	In.	mm	In.	mm	In.	mm	In.	mm	Ft.	m	Ft.	m		
HSTT50-48-5	0.500	12.7	0.500	12.7	0.250	6.4	0.025	0.6	4	1.2	—	—	5	—
HSTT50-48-Q	0.500	12.7	0.500	12.7	0.250	6.4	0.025	0.6	4	1.2	—	—	25	—
HSTT50-48-T	0.500	12.7	0.500	12.7	0.250	6.4	0.025	0.6	4	1.2	—	—	200	—
HSTT50-C‡	0.500	12.7	0.500	12.7	0.250	6.4	0.025	0.6	—	—	100	30.5	1	10
HSTT50-T‡	0.500	12.7	0.500	12.7	0.250	6.4	0.025	0.6	—	—	200	61.0	1	2
HSTT75-48-5	0.750	19.1	0.750	19.1	0.375	9.5	0.030	0.8	4	1.2	—	—	5	—
HSTT75-48-CQ	0.750	19.1	0.750	19.1	0.375	9.5	0.030	0.8	4	1.2	—	—	125	—
HSTT75-C‡	0.750	19.1	0.750	19.1	0.375	9.5	0.030	0.8	—	—	100	30.5	1	10
HSTT75-T‡	0.750	19.1	0.750	19.1	0.375	9.5	0.030	0.8	—	—	200	61.0	1	2
HSTT100-48-5	1.00	25.4	1.00	25.4	0.500	12.7	0.035	0.9	4	1.2	—	—	5	—
HSTT100-48-LQ	1.00	25.4	1.00	25.4	0.500	12.7	0.035	0.9	4	1.2	—	—	75	—
HSTT100-C‡	1.00	25.4	1.00	25.4	0.500	12.7	0.035	0.9	—	—	100	30.5	1	2
HSTT150-48-5	1.50	38.1	1.50	38.1	0.750	19.1	0.040	1.0	4	1.2	—	—	5	—
HSTT150-C‡	1.50	38.1	1.50	38.1	0.750	19.1	0.040	1.0	—	—	100	30.5	1	2
HSTT200-48-5	2.00	50.8	2.00	50.8	1.00	25.4	0.045	1.1	4	1.2	—	—	5	—
HSTT200-L‡	2.00	50.8	2.00	50.8	1.00	25.4	0.045	1.1	—	—	50	15.2	1	2
HSTT300-48-2	3.00	76.2	3.00	76.2	1.50	38.1	0.050	1.3	4	1.2	—	—	2	—
HSTT300-L‡	3.00	76.2	3.00	76.2	1.50	38.1	0.050	1.3	—	—	50	15.2	1	0
HSTT400-48-2	4.00	101.6	4.00	101.6	2.00	50.8	0.055	1.4	4	1.2	—	—	2	—
HSTT400-L‡	4.00	101.6	4.00	101.6	2.00	50.8	0.055	1.4	—	—	50	15.2	1	0

*For colors, add C (Clear), 1 (Brown), 2 (Red), 3 (Orange), 4 (Yellow), 45 (Yellow/Green), 5 (Green), 6 (Blue) and 10 (White) to end of part number. Contact customer service for availability.

‡Part sold per reel.



HSTT Heat Shrink on 25 Foot Reels

- Applications include insulating and protecting wires and cables
- Voltage: 600 V
- Shrink ratio: 2:1
- Flammability: Flame retardant EXCEPT clear
- Mil Spec: AMS-DTL-23053/5 Class 1 (Black) Class 2 (Clear)**
- Temperature range: -67°F to 275°F (-55°C to 135°C)
- For dry locations
- Material: Cross-linked Polyolefin
- UL: E122770
- CSA: 222627
- 5 year shelf life***



Part Number*	Nominal Diameter		Min. Expanded I.D.		Max. Recovered I.D.		Nominal Recovered Wall Thickness		Std. Pkg. Qty.	Std. Ctn. Qty.
	In.	mm	In.	mm	In.	mm	In.	mm		
HSTT05-Q	0.046	1.2	0.046	1.2	0.023	0.6	0.016	0.4	1	10
HSTT06-Q	0.063	1.6	0.063	1.6	0.031	0.8	0.017	0.4	1	10
HSTT09-Q	0.093	2.4	0.093	2.4	0.046	1.2	0.020	0.5	1	10
HSTT12-Q	0.125	3.2	0.125	3.2	0.062	1.6	0.020	0.5	1	10
HSTT19-Q	0.187	4.8	0.187	4.8	0.093	2.4	0.020	0.5	1	10
HSTT25-Q	0.250	6.4	0.250	6.4	0.125	3.2	0.025	0.6	1	10
HSTT38-Q	0.375	9.5	0.375	9.5	0.187	4.8	0.025	0.6	1	10
HSTT50-Q	0.500	12.7	0.500	12.7	0.250	6.4	0.025	0.6	1	10
HSTT75-Q	0.750	19.9	0.750	19.9	0.375	9.5	0.030	0.8	1	10

For colors, add C (Clear) or 45 (Yellow/Green) to end of part number. Contact customer service for availability.

**Material Performance Only.

***Shelf life applies only to expanded and recovered dimensions. Material performance is not affected.

Heat Shrink in 6 Inch Pieces; Black, Single Diameter

- Applications include insulating and protecting wires and cables
- Voltage: 600 V
- Shrink ratio: 2:1
- Flammability: Flame retardant
- Mil Spec: AMS-DTL-23053/5 Class 1**
- Temperature range: -67°F to 275°F (-55°C to 135°C)
- For dry locations
- Material: Cross-linked Polyolefin
- UL: E122770
- CSA: 222627
- 5 year shelf life***



Part Number	Nominal Diameter		Min. Expanded I.D.		Max. Recovered I.D.		Nominal Recovered Wall Thickness		Total No. Pcs.	Std. Pkg. Qty.	Std. Ctn. Qty.
	In.	mm	In.	mm	In.	mm	In.	mm			
HSTT06-Y	0.063	1.6	0.063	1.6	0.031	0.8	0.017	0.4	26	1	10
HSTT09-Y	0.093	2.4	0.093	2.4	0.046	1.2	0.020	0.5	24	1	10
HSTT12-Y	0.125	3.2	0.125	3.2	0.062	1.6	0.020	0.5	20	1	10
HSTT19-Y	0.187	4.8	0.187	4.8	0.093	2.4	0.020	0.5	18	1	10
HSTT25-Y	0.250	6.4	0.250	6.4	0.125	3.2	0.025	0.6	14	1	10
HSTT38-Y	0.375	9.5	0.375	9.5	0.187	4.8	0.025	0.6	12	1	10
HSTT50-Y	0.500	12.7	0.500	12.7	0.250	6.4	0.025	0.6	10	1	10
HSTT75-Y	0.750	19.1	0.750	19.1	0.375	9.5	0.030	0.8	8	1	10
HSTT100-Y	1.00	25.4	1.00	25.4	0.500	12.7	0.035	0.9	6	1	10

**Material Performance Only.

***Shelf life applies only to expanded and recovered dimensions. Material performance is not affected.

Heat Shrink in 6 Inch Pieces; Multi-Color, Single Diameter

- Applications include insulating, protecting, and color coding wires and cables
- Voltage: 600 V
- Shrink ratio: 2:1
- Flammability: Flame retardant EXCEPT clear
- Mil Spec: AMS-DTL-23053/5 Class 1 (Colors) Class 2 (Clear)**
- Temperature range: -67°F to 275°F (-55°C to 135°C)
- For dry locations
- Material: Cross-linked Polyolefin
- Colors include: clear, red, yellow, green, blue and white
- UL: E122770
- CSA: 222627
- 5 year shelf life***



Part Number	Nominal Diameter		Min. Expanded I.D.		Max. Recovered I.D.		Total No. Pcs.	Black No. of Pcs.	Each Color No. of Pcs.	Std. Pkg. Qty.	Std. Ctn. Qty.
	In.	mm	In.	mm	In.	mm					
HSTT06-YK1	0.063	1.6	0.063	1.6	0.031	0.8	26	8	3	1	10
HSTT09-YK1	0.093	2.4	0.093	2.4	0.046	1.2	24	6	3	1	10
HSTT12-YK1	0.125	3.2	0.125	3.2	0.062	1.6	20	2	3	1	10
HSTT19-YK1	0.187	4.8	0.187	4.8	0.093	2.4	18	6	2	1	10
HSTT25-YK1	0.250	6.4	0.250	6.4	0.125	3.2	14	2	2	1	10
HSTT38-YK1	0.375	9.5	0.375	9.5	0.187	4.8	12	6	1	1	10
HSTT50-YK1	0.500	12.7	0.500	12.7	0.250	6.4	10	4	1	1	10
HSTT75-YK1	0.750	19.1	0.750	19.1	0.375	9.5	8	2	1	1	10
HSTT100-YK1	1.00	25.4	1.00	25.4	0.500	12.7	7	1	1	1	10

**Material Performance Only.

***Shelf life applies only to expanded and recovered dimensions. Material performance is not affected.

Heat Shrink in 6 Inch Pieces; Black, Multiple Diameters

- Applications include insulating and protecting wires and cables
- Voltage: 600 V
- Shrink ratio: 2:1
- Mil Spec: AMS-DTL-23053/5 Class 1**
- Temperature range: -67°F to 275°F (-55°C to 135°C)
- For dry locations
- Material: Cross-linked Polyolefin
- UL: E122770
- CSA: 222627
- 5 year shelf life***



Part Number	Nominal Diameter	No. of Pieces by Diameter	Total No. Pcs.	Std. Pkg. Qty.	Std. Ctn. Qty.
HSTT-YK1	Various – Smaller Range	Two pcs. each 1/8", 1/16", 3/32", 1/4", 3/16", 3/8", 1/2"	14	1	10
HSTT-YK2	Various – Larger Range	Two pcs. each 3/8", 1/2", 3/4", 1"	8	1	10

**Material Performance Only.
 ***Shelf life applies only to expanded and recovered dimensions. Material performance is not affected.

Heat Shrink in 6 Inch Pieces; Yellow/Green Stripe, Multiple Diameters

- Applications include insulating, protecting, and color coding wires and cables
- Voltage: 600 V
- Shrink ratio: 2:1
- Flammability: Flame retardant
- Mil Spec: AMS-DTL-23053/5 Class 1**
- Temperature range: -67°F to 275°F (-55°C to 135°C)
- For dry locations
- Material: Cross-linked Polyolefin
- UL: E122770
- CSA: 222627
- 5 year shelf life***



Part Number	Nominal Diameter	No. of Pieces by Diameter	Total No. Pcs.	Std. Pkg. Qty.	Std. Ctn. Qty.
HSTT-YK1-45	Various – Smaller Range	Two pcs. each 1/8", 3/16", 1/4", 3/8"	8	1	10
HSTT-YK2-45	Various – Larger Range	Two pcs. each 3/8", 1/2", 3/4"	6	1	10

**Material Performance Only.
 ***Shelf life applies only to expanded and recovered dimensions. Material performance is not affected.

HSTTV Heat Shrink 4 Foot Pieces

- Applications include insulating and protecting wires and cables
- Fast shrink time
- Voltage: 600 V
- Shrink ratio: 2:1
- Flammability: Meets UL 224 VW-1
- Mil Spec: AMS-DTL-23053/5 Class 3**
- Temperature range: -67°F to 275°F (-55°C to 135°C)
- For dry locations
- Material: Black cross-linked Polyolefin
- UL: E122770
- CSA: 222627
- 5 year shelf life***



Part Number	Nominal Diameter		Min. Expanded I.D.		Max. Recovered I.D.		Nominal Recovered Wall Thickness		Std. Pkg. Qty.	Std. Ctn. Qty.
	In.	mm	In.	mm	In.	mm	In.	mm		
HSTTV05-48-Q	0.046	1.2	0.046	1.2	0.023	0.6	0.016	0.4	25	—
HSTTV06-48-Q	0.063	1.6	0.063	1.6	0.031	0.8	0.017	0.4	25	—
HSTTV09-48-Q	0.093	2.4	0.093	2.4	0.046	1.2	0.020	0.5	25	—
HSTTV12-48-Q	0.125	3.2	0.125	3.2	0.062	1.6	0.020	0.5	25	—
HSTTV19-48-Q	0.187	4.8	0.187	4.8	0.093	2.4	0.020	0.5	25	—
HSTTV25-48-Q	0.250	6.4	0.250	6.4	0.125	3.2	0.025	0.6	25	—
HSTTV38-48-Q	0.375	9.5	0.375	9.5	0.187	4.8	0.025	0.6	25	—
HSTTV50-48-Q	0.500	12.7	0.500	12.7	0.250	6.4	0.025	0.6	25	—
HSTTV75-48-5	0.750	19.1	0.750	19.1	0.375	9.5	0.030	0.8	5	—
HSTTV100-48-5	1.00	25.4	1.00	25.4	0.500	12.7	0.035	0.9	5	—
HSTTV150-48-5	1.50	38.1	1.50	38.1	0.750	19.1	0.040	1.0	5	—

**Material Performance Only.

***Shelf life applies only to expanded and recovered dimensions. Material performance is not affected.

HSTTV Heat Shrink on 100 Foot Reels

- Applications include insulating and protecting wires and cables
- Fast shrink time
- Voltage: 600 V
- Shrink ratio: 2:1
- Flammability: Meets UL 224 VW-1
- Mil Spec: AMS-DTL-23053/5 Class 3**
- Temperature range: -67°F to 275°F (-55°C to 135°C)
- For dry locations
- Material: Black Cross-linked Polyolefin
- UL: E122770
- CSA: 222627
- 5 year shelf life***



Part Number	Nominal Diameter		Min. Expanded I.D.		Max. Recovered I.D.		Nominal Recovered Wall Thickness		Std. Pkg. Qty.	Std. Ctn. Qty.
	In.	mm	In.	mm	In.	mm	In.	mm		
HSTTV05-C	0.046	1.2	0.046	1.2	0.023	0.6	0.016	0.4	1	10
HSTTV06-C	0.063	1.6	0.063	1.6	0.031	0.8	0.017	0.4	1	10
HSTTV09-C	0.093	2.4	0.093	2.4	0.046	1.2	0.020	0.5	1	10
HSTTV12-C	0.125	3.2	0.125	3.2	0.062	1.6	0.020	0.5	1	10
HSTTV19-C	0.187	4.8	0.187	4.8	0.093	2.4	0.020	0.5	1	10
HSTTV25-C	0.250	6.4	0.250	6.4	0.125	3.2	0.025	0.6	1	10
HSTTV38-C	0.375	9.5	0.375	9.5	0.187	4.8	0.025	0.6	1	10
HSTTV50-C	0.500	12.7	0.500	12.7	0.250	6.4	0.025	0.6	1	10
HSTTV75-C	0.750	19.1	0.750	19.1	0.375	9.5	0.030	0.8	1	10
HSTTV100-C	1.00	25.4	1.00	25.4	0.500	12.7	0.035	0.9	1	2
HSTTV150-C	1.50	38.1	1.50	38.1	0.750	19.1	0.040	1.0	1	2

**Material Performance Only.
 ***Shelf life applies only to expanded and recovered dimensions. Material performance is not affected.

HSTTV Heat Shrink on Bulk Reels

- Applications include insulating and protecting wires and cables
- Fast shrink time
- Voltage: 600 V
- Shrink ratio: 2:1
- Flammability: Meets UL 224 VW-1
- Mil Spec: AMS-DTL-23053/5 Class 3**
- Temperature range: -67°F to 275°F (-55°C to 135°C)
- For dry locations
- Material: Cross-linked Polyolefin
- UL: E122770
- CSA: 222627
- 5 year shelf life***



Part Number*	Nominal Diameter		Min. Expanded I.D.		Max. Recovered I.D.		Nominal Recovered Wall Thickness		Length per Reel		Color	Std. Pkg. Qty.	Std. Ctn. Qty.
	In.	mm	In.	mm	In.	mm	In.	mm	Ft.	m			
HSTTV05-M	0.046	1.2	0.046	1.2	0.023	0.6	0.016	0.4	1000	304.8	Black	1	2
HSTTV06-M	0.063	1.6	0.063	1.6	0.031	0.8	0.017	0.4	1000	304.8	Black	1	2
HSTTV09-M	0.093	2.4	0.093	2.4	0.046	1.2	0.020	0.5	1000	304.8	Black	1	2
HSTTV12-M	0.125	3.2	0.125	3.2	0.062	1.6	0.020	0.5	1000	304.8	Black	1	2
HSTTV19-M	0.187	4.8	0.187	4.8	0.093	2.4	0.020	0.5	1000	304.8	Black	1	2
HSTTV25-D	0.250	6.4	0.250	6.4	0.125	3.2	0.025	0.6	500	152.4	Black	1	2
HSTTV25-D10	0.250	6.4	0.250	6.4	0.125	3.2	0.025	0.6	500	152.4	White	1	2
HSTTV25-D5	0.250	6.4	0.250	6.4	0.125	3.2	0.025	0.6	500	152.4	Green	1	2
HSTTV38-T	0.375	9.5	0.375	9.5	0.187	4.8	0.025	0.6	200	61.1	Black	1	2
HSTTV38-T5	0.375	9.5	0.375	9.5	0.187	4.8	0.025	0.6	200	61.1	Green	1	2
HSTTV50-T	0.500	12.7	0.500	12.7	0.250	6.4	0.025	0.6	200	61.1	Black	1	2
HSTTV50-T5	0.500	12.7	0.500	12.7	0.250	6.4	0.025	0.6	200	61.1	Green	1	2
HSTTV75-T	0.750	19.1	0.750	19.1	0.375	9.5	0.030	0.8	200	61.1	Black	1	2
HSTTV75-T10	0.750	19.1	0.750	19.1	0.375	9.5	0.030	0.8	200	61.1	White	1	2

**Material Performance Only.

***Shelf life applies only to expanded and recovered dimensions. Material performance is not affected.

RA® SP® HSTTV Heat Shrink on 25 Foot Reels

- Applications include insulating and protecting wires and cables
- Fast shrink time
- Voltage: 600 V
- Shrink ratio: 2:1
- Flammability: Meets UL 224 VW-1
- Mil Spec: AMS-DTL-23053/5 Class 3**
- Temperature range: -67°F to 275°F (-55°C to 135°C)
- For dry locations
- Material: Black cross-linked Polyolefin
- UL: E122770
- CSA: 222627
- 5 year shelf life***



Part Number	Nominal Diameter		Min. Expanded I.D.		Max. Recovered I.D.		Nominal Recovered Wall Thickness		Std. Pkg. Qty.	Std. Ctn. Qty.
	In.	mm	In.	mm	In.	mm	In.	mm		
HSTTV05-Q	0.046	1.2	0.046	1.2	0.023	0.6	0.016	0.4	1	10
HSTTV06-Q	0.063	1.6	0.063	1.6	0.031	0.8	0.017	0.4	1	10
HSTTV09-Q	0.093	2.4	0.093	2.4	0.046	1.2	0.020	0.5	1	10
HSTTV12-Q	0.125	3.2	0.125	3.2	0.062	1.6	0.020	0.5	1	10
HSTTV19-Q	0.187	4.8	0.187	4.8	0.093	2.4	0.020	0.5	1	10
HSTTV25-Q	0.250	6.4	0.250	6.4	0.125	3.2	0.025	0.6	1	10
HSTTV38-Q	0.375	9.5	0.375	9.5	0.187	4.8	0.025	0.6	1	10
HSTTV50-Q	0.500	12.7	0.500	12.7	0.250	6.4	0.025	0.6	1	10
HSTTV75-Q	0.750	19.1	0.750	19.1	0.375	9.5	0.030	0.8	1	10
HSTTV100-Q	1.00	25.4	1.00	25.4	0.500	12.7	0.035	0.9	1	2

**Material Performance Only.
 ***Shelf life applies only to expanded and recovered dimensions. Material performance is not affected.

RA® SP® HSTTV Heat Shrink 6 Inch Pieces

- Applications include insulating and protecting wires and cables
- Fast shrink time
- Voltage: 600 V
- Shrink ratio: 2:1
- Flammability: Meets UL 224 VW-1
- Mil Spec: AMS-DTL-23053/5 Class 3**
- Temperature range: -67°F to 275°F (-55°C to 135°C)
- For dry locations
- Material: Cross-linked Polyolefin
- UL: E122770
- CSA: 222627
- 5 year shelf life***



Part Number	Nominal Diameter		Min. Expanded I.D.		Max. Recovered I.D.		Pieces Per Package	Std. Pkg. Qty.	Std. Ctn. Qty.
	In.	mm	In.	mm	In.	mm			
HSTTV05-Y	0.046	1.2	0.046	1.2	0.023	0.6	26	1	10
HSTTV06-Y	0.063	1.6	0.063	1.6	0.031	0.8	26	1	10
HSTTV09-Y	0.093	2.4	0.093	2.4	0.046	1.2	24	1	10
HSTTV12-Y	0.125	3.2	0.125	3.2	0.062	1.6	20	1	10
HSTTV19-Y	0.187	4.8	0.187	4.8	0.093	2.4	18	1	10
HSTTV25-Y	0.250	6.4	0.250	6.4	0.125	3.2	14	1	10
HSTTV38-Y	0.375	9.5	0.375	9.5	0.187	4.8	12	1	10
HSTTV50-Y	0.500	12.7	0.500	12.7	0.250	6.4	10	1	10
HSTTV75-Y	0.750	19.1	0.750	19.1	0.375	9.5	8	1	10
HSTTV100-Y	1.00	25.4	1.00	25.4	0.500	12.7	6	1	10

**Material Performance Only.
 ***Shelf life applies only to expanded and recovered dimensions. Material performance is not affected.

HSTTP PVC Heat Shrink

- Applications include insulating and protecting wires and cables
- Good resistance to most fuels and oils
- Voltage: 600 V
- Shrink ratio: 2:1
- Flammability: Meets UL 224 VW-1
- Temperature range: -4°F to 221°F (-20°C to 105°C)
- For dry locations
- Material: Black cross-linked Polyvinyl Chloride
- Mil Spec: AMS-DTL-23053/2 Class 1**
- UL: E122770
- CSA: 75192
- 1 year shelf life***



Part Number*	Nominal Diameter		Min. Expanded I.D.		Max. Recovered I.D.		Nominal Recovered Wall Thickness		Length Per Reel		Std. Pkg. Qty.	Std. Ctn. Qty.
	In.	mm	In.	mm	In.	mm	In.	mm	Ft.	m		
HSTTP05-QY	0.046	1.2	0.046	1.2	0.023	0.6	0.020	0.5	25	7.6	1	10
HSTTP05-CY	0.046	1.2	0.046	1.2	0.023	0.6	0.020	0.5	100	30.5	1	2
HSTTP05-MY	0.046	1.2	0.046	1.2	0.023	0.6	0.020	0.5	1000	304.8	1	2
HSTTP06-QY	0.063	1.6	0.063	1.6	0.031	0.8	0.020	0.5	25	7.6	1	10
HSTTP06-CY	0.063	1.6	0.063	1.6	0.031	0.8	0.020	0.5	100	30.5	1	2
HSTTP09-QY	0.093	2.4	0.093	2.4	0.046	1.2	0.025	0.6	25	7.6	1	10
HSTTP09-CY	0.093	2.4	0.093	2.4	0.046	1.2	0.025	0.6	100	30.5	1	2
HSTTP09-MY	0.093	2.4	0.093	2.4	0.046	1.2	0.025	0.6	1000	304.8	1	2
HSTTP12-QY	0.125	3.2	0.125	3.2	0.062	1.6	0.025	0.6	25	7.6	1	10
HSTTP12-CY	0.125	3.2	0.125	3.2	0.062	1.6	0.025	0.6	100	30.5	1	2
HSTTP12-MY	0.125	3.2	0.125	3.2	0.062	1.6	0.025	0.6	1000	304.8	1	2
HSTTP19-QY	0.187	4.8	0.187	4.8	0.093	2.4	0.025	0.6	25	7.6	1	10
HSTTP19-CY	0.187	4.8	0.187	4.8	0.093	2.4	0.025	0.6	100	30.5	1	2
HSTTP19-MY	0.187	4.8	0.187	4.8	0.093	2.4	0.025	0.6	1000	304.8	1	2
HSTTP25-QY	0.250	6.4	0.250	6.4	0.125	3.2	0.025	0.6	25	7.6	1	10
HSTTP25-CY	0.250	6.4	0.250	6.4	0.125	3.2	0.025	0.6	100	30.5	1	2
HSTTP25-DY	0.250	6.4	0.250	6.4	0.125	3.2	0.025	0.6	500	152.4	1	2
HSTTP38-QY	0.375	9.5	0.375	9.5	0.187	4.8	0.030	0.8	25	7.6	1	10
HSTTP38-CY	0.375	9.5	0.375	9.5	0.187	4.8	0.030	0.8	100	30.5	1	2
HSTTP38-TY	0.375	9.5	0.375	9.5	0.187	4.8	0.030	0.8	200	61.0	1	2
HSTTP50-QY	0.500	12.7	0.500	12.7	0.250	6.4	0.030	0.8	25	7.6	1	10
HSTTP50-CY	0.500	12.7	0.500	12.7	0.250	6.4	0.030	0.8	100	30.5	1	2
HSTTP75-QY	0.750	19.1	0.750	19.1	0.375	9.5	0.035	0.9	25	7.6	1	10
HSTTP75-CY	0.750	19.1	0.750	19.1	0.375	9.5	0.035	0.9	100	30.5	1	2
HSTTP100-QY	1.00	25.4	1.00	25.4	0.500	12.7	0.040	1.0	25	7.6	1	2
HSTTP100-CY	1.00	25.4	1.00	25.4	0.500	12.7	0.040	1.0	100	30.5	1	2
HSTTP150-QY	1.50	38.1	1.50	38.1	0.750	19.1	0.045	1.1	25	7.6	1	2
HSTTP150-CY	1.50	38.1	1.50	38.1	0.750	19.1	0.045	1.1	100	30.5	1	2
HSTTP200-QY	2.00	50.8	2.00	50.8	1.00	25.4	0.050	1.3	25	7.6	1	2

**Material Performance Only.

***Shelf life applies only to expanded and recovered dimensions. Material performance is not affected.



HSTTP PVC Heat Shrink



- Low shrink temperature (store below 90°F) to speed installation
- Crystal clear material ensures easy to read labels and splice inspections
- Voltage: 600 V
- Shrink ratio of 2:1 insulates a wide range of diameters and irregular shapes
- Highly flame retardant product manufactured from a material that is rated UL 224 VW-1
- Temperature range: -4°F to 221°F (-20°C to 105°C)
- For dry locations
- Material: Clear Polyvinyl Chloride
- Mil Spec: AMS-DTL-23053/2 Class 2**
- UL: E122770
- CSA: 75192
- 1 year shelf life***



Part Number*	Nominal Diameter		Min. Expanded I.D.		Max. Recovered I.D.		Nominal Recovered Wall Thickness		Length		Length per Reel		Std. Pkg. Qty.	Std. Ctn. Qty.
	In.	mm	In.	mm	In.	mm	In.	mm	In.	mm	Ft.	m		
HSTTPN50-438-L	0.46	11.7	0.46	11.7	0.25	6.4	0.022	0.6	4.38	111.3	—	—	50	500
HSTTPN50-713-Q	0.46	11.7	0.46	11.7	0.25	6.4	0.022	0.6	7.13	181.1	—	—	25	250
HSTTPN62-750-Q	0.56	14.3	0.56	14.3	0.31	8.0	0.027	0.7	7.50	190.5	—	—	25	250
HSTTPN75-775-Q	0.70	17.7	0.70	17.7	0.38	9.5	0.027	0.7	7.75	196.9	—	—	25	250
HSTTPN100-775-Q	0.90	22.9	0.90	22.9	0.50	12.7	0.030	0.8	7.75	196.9	—	—	25	250
HSTTPN150-925-X	1.40	35.4	1.40	35.4	0.75	19.1	0.030	0.8	9.25	235.0	—	—	10	100
HSTTPN200-950-X	1.80	45.7	1.80	45.7	1.00	25.4	0.039	1.0	9.50	241.3	—	—	10	100
HSTTPN50-CC	0.46	11.7	0.46	11.7	0.25	6.4	0.022	0.6	—	—	100	30.5	1	2
HSTTPN62-CC	0.56	14.3	0.56	14.3	0.31	8.0	0.027	0.7	—	—	100	30.5	1	2
HSTTPN75-CC	0.70	17.7	0.70	17.7	0.38	9.5	0.027	0.7	—	—	100	30.5	1	2
HSTTPN100-CC	0.90	22.9	0.90	22.9	0.50	12.7	0.030	0.8	—	—	100	30.5	1	2
HSTTPN150-CC	1.40	35.4	1.40	35.4	0.75	19.1	0.030	0.8	—	—	100	30.5	1	2
HSTTPN200-CC	1.80	45.7	1.80	45.7	1.00	25.4	0.039	1.0	—	—	100	30.5	1	2

**Material Performance Only.

***Shelf life applies only to expanded and recovered dimensions. Material performance is not affected.

HSTTN Chlorinated Polyolefin Heat Shrink

- Applications include insulating and protecting wires and cables
- Excellent chemical resistance especially to fuels and oils
- Voltage: 600 V
- Shrink ratio: 2:1
- Mil Spec: AMS-DTL-23053/1 Class 2**
- Temperature range: -94°F to 250°F (-70°C to 121°C)
- For dry locations
- Material: Black cross-linked Chlorinated Polyolefin
- 5 year shelf life***



Part Number	Nominal Diameter		Min. Expanded I.D.		Max. Recovered I.D.		Nominal Recovered Wall Thickness		Length per Reel		Std. Pkg. Qty.	Std. Ctn. Qty.
	In.	mm	In.	mm	In.	mm	In.	mm	Ft.	m		
HSTTN25-CY	0.250	6.4	0.250	6.4	0.143	3.6	0.035	0.9	100	30.5	1	2
HSTTN38-CY	0.375	9.5	0.375	9.5	0.211	5.4	0.040	1.0	100	30.5	1	2
HSTTN50-CY	0.500	12.7	0.500	12.7	0.286	7.3	0.048	1.2	100	30.5	1	2
HSTTN63-CY	0.625	15.9	0.625	15.9	0.357	9.1	0.052	1.3	100	30.5	1	2
HSTTN75-CY	0.750	19.1	0.750	19.1	0.428	10.9	0.057	1.5	100	30.5	1	2
HSTTN88-CY	0.875	22.2	0.875	22.2	0.500	12.7	0.065	1.7	100	30.5	1	2
HSTTN100-CY	1.00	25.4	1.00	25.4	0.570	14.5	0.070	1.8	100	30.5	1	2
HSTTN125-CY	1.25	31.8	1.25	31.8	0.714	18.1	0.087	2.2	100	30.5	1	2
HSTTN150-CY	1.50	38.1	1.50	38.1	0.857	21.8	0.095	2.4	100	30.5	1	2
HSTTN175-CY	1.75	44.5	1.75	44.5	1.00	25.4	0.107	2.7	100	30.5	1	1
HSTTN200-QY	2.00	50.8	2.00	50.8	1.14	29.0	0.110	2.8	25	7.6	1	2

**Material Performance Only.

***Shelf life applies only to expanded and recovered dimensions. Material performance is not affected.

HSTTT TFE Heat Shrink 4 Foot Pieces

- Applications include insulating and protecting wires and cables
- Voltage: 600 V
- Shrink ratio: 2:1
- Mil Spec: AMS-DTL-23053/12 Class 2 and 3**
- Temperature range: -88°F to 482°F (-67°C to 250°C)
- Color: Opaque
- For dry locations
- Material: Halogen-Free Polytetrafluoroethylene (TFE)
- High temperature; resists corrosive atmosphere
- See page C2.41 for shrink instructions
- 4 year shelf life***



Part Number	Nominal Diameter		Min. Expanded I.D.		Max. Recovered I.D.		Nominal Recovered Wall Thickness		Length		Std. Pkg. Qty.
	In.	mm	In.	mm	In.	mm	In.	mm	Ft.	m	
HSTTT03-48-Q	30 AWG	0.9	0.034	0.9	0.015	0.4	0.009	0.2	4	1.2	25
HSTTT04-48-Q	28 AWG	1.0	0.038	1.0	0.018	0.5	0.009	0.2	4	1.2	25
HSTTT046-48-Q	26 AWG	1.2	0.046	1.2	0.022	0.5	0.010	0.3	4	1.2	25
HSTTT05-48-Q	24 AWG	1.3	0.050	1.3	0.027	0.7	0.010	0.3	4	1.2	25
HSTTT055-48-Q	22 AWG	1.4	0.055	1.4	0.032	0.8	0.012	0.3	4	1.2	25
HSTTT06-48-Q	20 AWG	1.5	0.060	1.5	0.039	1.0	0.012	0.3	4	1.2	25
HSTTT08-48-Q	18 AWG	1.9	0.076	1.9	0.049	1.2	0.012	0.3	4	1.2	25
HSTTT09-48-Q	16 AWG	2.3	0.093	2.3	0.061	1.6	0.012	0.3	4	1.2	25
HSTTT12-48-Q	14 AWG	3.0	0.120	3.0	0.072	1.8	0.012	0.3	4	1.2	25
HSTTT15-48-Q	12 AWG	3.8	0.150	3.8	0.089	2.3	0.012	0.3	4	1.2	25
HSTTT19-48-Q	10 AWG	4.9	0.191	4.9	0.112	2.8	0.012	0.3	4	1.2	25
HSTTT24-48-Q	8 AWG	6.0	0.240	6.0	0.141	3.6	0.015	0.4	4	1.2	25
HSTTT30-48-Q	6 AWG	7.7	0.302	7.7	0.178	4.5	0.015	0.4	4	1.2	25
HSTTT37-48-Q	4 AWG	9.4	0.370	9.4	0.224	5.7	0.015	0.4	4	1.2	25
HSTTT43-48-Q	2 AWG	10.9	0.430	10.9	0.278	7.0	0.015	0.4	4	1.2	25
HSTTT47-48-Q	0 AWG	11.9	0.470	11.9	0.347	8.8	0.015	0.4	4	1.2	25
HSTTT56-48-5^	9/16	14.2	0.560	14.2	0.399	10.1	0.015	0.4	4	1.2	5
HSTTT66-48-5^	5/8	16.6	0.655	16.6	0.462	11.7	0.018	0.5	4	1.2	5
HSTTT75-48-5^	3/4	19.1	0.750	19.1	0.524	13.3	0.018	0.5	4	1.2	5
HSTTT93-48-5^	15/16	23.6	0.930	23.6	0.655	16.6	0.020	0.5	4	1.2	5
HSTTT112-48-5^	1 1/8	28.6	1.12	28.6	0.786	20.0	0.025	0.6	4	1.2	5
HSTTT131-48-2^	1 15/16	33.3	1.31	33.3	0.911	23.1	0.030	0.8	4	1.2	2
HSTTT150-48-2^	1 1/2	38.1	1.50	38.1	1.036	26.3	0.030	0.8	4	1.2	2

**Material Performance Only.

***Shelf life applies only to expanded and recovered dimensions. Material performance is not affected.

^ Part numbers are Class 2.

HSTTK PVDF Heat Shrink 4 Foot Pieces

- Applications include insulating and protecting wires and cables
- Excellent chemical and abrasion resistance
- Use in high temperature or solvent rich environment
- Voltage: 600 V
- Shrink ratio: 2:1
- Flammability: Meets UL 224 VW-1
- Mil Spec: AMS-DTL-23053/8**
- Temperature range: -67°F to 347°F (-55°C to 175°C)
- For dry locations
- Material: Halogen-Free Clear Cross-linked Polyvinylidene Fluoride (PVDF)
- UL: E122770
- CSA: 222627
- 5 year shelf life***



Part Number	Nominal Diameter		Min. Expanded I.D.		Max. Recovered I.D.		Nominal Recovered Wall Thickness		Std. Pkg. Qty.
	In.	mm	In.	mm	In.	mm	In.	mm	
HSTTK05-48-Q	0.046	1.2	0.046	1.2	0.023	0.6	0.010	0.3	25
HSTTK06-48-Q	0.063	1.6	0.063	1.6	0.031	0.8	0.010	0.3	25
HSTTK09-48-Q	0.093	2.4	0.093	2.4	0.046	1.2	0.010	0.3	25
HSTTK12-48-Q	0.125	3.2	0.125	3.2	0.062	1.6	0.010	0.3	25
HSTTK19-48-Q	0.187	4.8	0.187	4.8	0.093	2.4	0.010	0.3	25
HSTTK25-48-Q	0.250	6.4	0.250	6.4	0.125	3.2	0.012	0.3	25
HSTTK38-48-Q	0.375	9.5	0.375	9.5	0.187	4.8	0.012	0.3	25
HSTTK50-48-5	0.500	12.7	0.500	12.7	0.250	6.4	0.012	0.3	5
HSTTK75-48-5	0.750	19.1	0.750	19.1	0.375	9.5	0.017	0.4	5
HSTTK100-48-5	1.00	25.4	1.00	25.4	0.500	12.7	0.019	0.5	5

**Material Performance Only.
 ***Shelf life applies only to expanded and recovered dimensions. Material performance is not affected.

HSTTVA Heat Shrink 4 Foot and 6 Inch Pieces

- Applications include insulating and protecting wires and cables
- Flexible tubing with an adhesive inner wall which seals and protects components from moisture and corrosion
- Voltage rating: 600 V
- Shrink ratio: 2:1
- Flammability: Outer wall flame retardant
- Mil Spec: AMS-DTL-23053/4 Class 2**
- Temperature range: -67°F to 230°F (-55°C to 110°C)
- For damp locations
- Material: Adhesive lined black cross-linked Polyolefin
- UL: 342365
- 5 year shelf life***



Part Number	Nominal Diameter		Min. Expanded I.D.		Max. Recovered I.D.		Nominal Recovered Wall Thickness		Std. Pkg. Qty.
	In.	mm	In.	mm	In.	mm	In.	mm	
4' (1.22m) Pieces									
HSTTVA12-48-Q	0.125	3.2	0.125	3.2	0.063	1.6	0.021	0.5	25
HSTTVA19-48-Q	0.187	4.8	0.187	4.8	0.093	2.4	0.023	0.6	25
HSTTVA25-48-Q	0.250	6.4	0.250	6.4	0.125	3.2	0.029	0.7	25
HSTTVA38-48-Q	0.375	9.5	0.375	9.5	0.187	4.8	0.029	0.7	25
HSTTVA50-48-5	0.500	12.7	0.500	12.7	0.250	6.4	0.030	0.8	5
HSTTVA75-48-5	0.750	19.1	0.750	19.1	0.375	9.5	0.035	0.9	5
HSTTVA100-48-5	1.00	25.4	1.00	25.4	0.500	12.7	0.042	1.1	5
HSTTVA150-48-5	1.50	38.1	1.50	38.1	0.750	19.1	0.047	1.2	5

**Material Performance Only.
 ***Shelf life applies only to expanded and recovered dimensions. Material performance is not affected.

HSTTVA Heat Shrink 4 Foot and 6 Inch Pieces (continued)

Part Number	Nominal Diameter		Min. Expanded I.D.		Max. Recovered I.D.		Nominal Recovered Wall Thickness		Std. Pkg. Qty.	Pieces per Package
	In.	mm	In.	mm	In.	mm	In.	mm		
6" (152.4mm) Pieces										
HSTTVA12-Y	0.125	3.2	0.125	3.2	0.063	1.6	0.021	0.5	1	7
HSTTVA19-Y	0.187	4.8	0.187	4.8	0.093	2.4	0.023	0.6	1	7
HSTTVA25-Y	0.250	6.4	0.250	6.4	0.125	3.2	0.029	0.7	1	5
HSTTVA38-Y	0.375	9.5	0.375	9.5	0.187	4.8	0.029	0.7	1	4
HSTTVA50-Y	0.500	12.7	0.500	12.7	0.250	6.4	0.030	0.8	1	4
HSTTVA75-Y	0.750	19.1	0.750	19.1	0.375	9.5	0.035	0.9	1	3
HSTTVA100-Y	1.00	25.4	1.00	25.4	0.500	12.7	0.042	1.1	1	2

**Material Performance Only.

***Shelf life applies only to expanded and recovered dimensions. Material performance is not affected.

HSTTVA Heat Shrink 4 Foot and 6 Inch Pieces

- Applications include insulating and protecting wires and cables
- Flexible tubing with an adhesive inner wall which seals and protects components from moisture and corrosion
- Voltage rating: 600 V
- Shrink ratio: 3:1
- Flammability: Outer wall flame retardant
- Mil Spec: AMS-DTL-23053/4 Class 3**
- Temperature range: -67°F to 230°F (-55°C to 110°C)
- For damp locations
- Material: Adhesive lined black cross-linked Polyolefin
- UL: E342365
- 5 year shelf life***



Part Number	Nominal Diameter		Min. Expanded I.D.		Max. Recovered I.D.		Nominal Recovered Wall Thickness		Std. Pkg. Qty.	Std. Ctn. Qty.
	In.	mm	In.	mm	In.	mm	In.	mm		
4' (1.22m) Pieces										
HSTTA19-48-Q	0.187	4.8	0.187	4.8	0.062	1.6	0.040	1.0	25	—
HSTTA25-48-Q	0.250	6.4	0.250	6.4	0.080	2.0	0.040	1.0	25	—
HSTTA25-48-TL	0.250	6.4	0.250	6.4	0.080	2.0	0.040	1.0	250	—
HSTTA38-48-Q	0.375	9.5	0.375	9.5	0.120	3.0	0.055	1.4	25	—
HSTTA38-48-TL	0.375	9.5	0.375	9.5	0.120	3.0	0.055	1.4	250	—
HSTTA50-48-5	0.500	12.7	0.500	12.7	0.160	4.1	0.070	1.8	5	—
HSTTA50-48-T	0.500	12.7	0.500	12.7	0.160	4.1	0.070	1.8	200	—
HSTTA75-48-5	0.750	19.1	0.750	19.1	0.250	6.4	0.085	2.2	5	—
HSTTA75-48-C	0.750	19.1	0.750	19.1	0.250	6.4	0.085	2.2	100	—
HSTTA100-48-5	1.00	25.4	1.00	25.4	0.320	8.1	0.100	2.5	5	—
HSTTA100-48-L	1.00	25.4	1.00	25.4	0.320	8.1	0.100	2.5	50	—
HSTTA150-48-5	1.50	38.1	1.50	38.1	0.510	12.9	0.100	2.5	5	—
HSTTA150-48-Q	1.50	38.1	1.50	38.1	0.510	12.9	0.100	2.5	25	—

Part Number	Nominal Diameter		Min. Expanded I.D.		Max. Recovered I.D.		Nominal Recovered Wall Thickness		Std. Pkg. Qty.	Std. Ctn. Qty.	Pieces per Package
	In.	mm	In.	mm	In.	mm	In.	mm			
6" (152.4mm) Pieces											
HSTTA19-Y	0.187	4.8	0.187	4.8	0.062	1.6	0.040	1.0	1	10	6
HSTTA25-Y	0.250	6.4	0.250	6.4	0.080	2.0	0.040	1.0	1	10	4
HSTTA38-Y	0.375	9.5	0.375	9.5	0.120	3.0	0.055	1.4	1	10	3
HSTTA50-Y	0.500	12.7	0.500	12.7	0.160	4.1	0.070	1.8	1	10	3
HSTTA75-Y	0.750	19.1	0.750	19.1	0.250	6.4	0.085	2.2	1	10	2
HSTTA100-Y	1.00	25.4	1.00	25.4	0.320	8.1	0.100	2.5	1	10	2
HSTTA150-Y	1.50	38.1	1.50	38.1	0.510	12.9	0.100	2.5	1	10	1

**Material Performance Only.

***Shelf life applies only to expanded and recovered dimensions. Material performance is not affected.

HSTT4A Heat Shrink 4 Foot Pieces

- Applications include insulating and protecting oversized electrical and electronic components, cables, terminals and connectors
- Flexible tubing with an adhesive inner wall which seals and protects components from moisture and corrosion
- Voltage: 600 V
- Shrink ratio: 4:1
- Flammability: Flame retardant outer wall meets UL 224 VW-1

- Mil Spec: AMS-DTL-23053/4 Class 3**
- Temperature range: -67°F to 257°F (-55°C to 125°C)
- For damp locations
- Material: Adhesive lined black cross-linked Polyolefin
- UL: E342365
- 5 year shelf life***



Part Number	Nominal Diameter		Min. Expanded I.D.		Max. Recovered I.D.		Nominal Recovered Wall Thickness		Length		Std. Pkg. Qty.
	In.	mm	In.	mm	In.	mm	In.	mm	Ft.	m	
HSTT4A15-48-Q	0.158	4.0	0.158	4.0	0.039	1.0	0.043	1.10	4	1.2	25
HSTT4A31-48-Q	0.315	8.0	0.315	8.0	0.079	2.0	0.043	1.10	4	1.2	25
HSTT4A47-48-Q	0.472	12.0	0.472	12.0	0.118	3.0	0.055	1.40	4	1.2	25
HSTT4A62-48-5	0.630	16.0	0.630	16.0	0.158	4.0	0.070	1.80	4	1.2	5
HSTT4A94-48-5	0.945	24.0	0.945	24.0	0.236	6.0	0.088	2.25	4	1.2	5
HSTT4A125-48-5	1.26	32.0	1.26	32.0	0.315	8.0	0.100	2.54	4	1.2	5
HSTT4A200-48-5	2.05	52.0	2.05	52.0	0.512	13.0	0.100	2.54	4	1.2	5

**Material Performance Only.

***Shelf life applies only to expanded and recovered dimensions. Material performance is not affected.

HSTTRA Heat Shrink 4 Foot Pieces

- Applications include insulating and protecting wires and cables
- Semi-rigid tubing with an adhesive inner wall seals and protects components from moisture and corrosion
- Voltage rating: 600 V
- Shrink ratio: 2.5:1 Minimum

- Mil Spec: AMS-DTL-23053/4 Class 1**
- Temperature range: -67°F to 230°F (-55°C to 110°C)
- For damp locations
- Material: Adhesive lined black cross-linked Polyolefin
- UL: E342365
- 5 year shelf life***



Part Number	Nominal Diameter		Min. Expanded I.D.		Max. Recovered I.D.		Nominal Recovered Wall Thickness		Std. Pkg. Qty.
	In.	mm	In.	mm	In.	mm	In.	mm	
HSTTRA12-48-Q	0.125	3.2	0.125	3.2	0.023	0.6	0.038	1.0	25
HSTTRA19-48-Q	0.187	4.8	0.187	4.8	0.060	1.5	0.043	1.1	25
HSTTRA25-48-Q	0.250	6.4	0.250	6.4	0.080	2.0	0.047	1.2	25
HSTTRA38-48-Q	0.375	9.5	0.375	9.5	0.135	3.4	0.050	1.3	25
HSTTRA50-48-5	0.500	12.7	0.500	12.7	0.195	5.0	0.055	1.4	5
HSTTRA75-48-5	0.750	19.1	0.750	19.1	0.313	8.0	0.065	1.7	5
HSTTRA100-48-5	1.00	25.4	1.00	25.4	0.400	10.2	0.075	1.9	5

**Material Performance Only.

***Shelf life applies only to expanded and recovered dimensions. Material performance is not affected.

UL® RW® SF® HST Thick Wall Polyolefin Heat Shrink

- Applications include insulating and protecting wires and cables
- Adhesive-lined inner wall seals and protects against moisture
- Thick wall suitable for direct burial according to UL 486D and provides excellent protection
- Voltage rating: UL 486D Listed for 600 V 90°C continuous use
- Shrink ratio: 3:1
- Flammability: Flame retardant outer wall meets UL 224 VW-1
- UL/UR: E342365
- UL Listed: E173379
- CSA 244528
- Mil Spec: AMS-DTL-23053/15**
- Temperature range: -67°F to 230°F (-55°C to 110°C)
- Suitable for wet locations; Black HST suitable for outdoor, direct sunlight applications
- Material: Adhesive lined black and red cross-linked Polyolefin
- 10 year shelf life***



Part Number	Min. Expanded I.D.		Max. Recovered I.D.		Nominal Recovered Wall Thickness		Length		Std. Pkg. Qty.	Std. Ctn. Qty.
	In.	mm	In.	mm	In.	mm	In.	mm		
HST0.4-3-Q2Y*	0.40	10.2	0.16	4.1	0.08	2.0	3.0	76.2	25	100
HST0.4-3-QY*	0.40	10.2	0.16	4.1	0.08	2.0	3.0	76.2	25	100
HST0.4-48-5-2Y*	0.40	10.2	0.16	4.1	0.08	2.0	48.0	1219.2	5	20
HST0.4-48-5Y*	0.40	10.2	0.16	4.1	0.08	2.0	48.0	1219.2	5	20
HST0.4-6-3Y*	0.40	10.2	0.16	4.1	0.08	2.0	6.0	152.4	3	30
HST0.4-6-X2Y*	0.40	10.2	0.16	4.1	0.08	2.0	6.0	152.4	10	100
HST0.4-6-XY*	0.40	10.2	0.16	4.1	0.08	2.0	6.0	152.4	10	100
HST0.8-12-5-2Y*	0.75	19.1	0.22	5.6	0.09	2.3	12.0	304.8	5	50
HST0.8-12-5Y*	0.75	19.1	0.22	5.6	0.09	2.3	12.0	304.8	5	50
HST0.8-48-5-2Y*	0.75	19.1	0.22	5.6	0.09	2.3	48.0	1219.2	5	20
HST0.8-48-5Y*	0.75	19.1	0.22	5.6	0.09	2.3	48.0	1219.2	5	20
HST0.8-6-3Y*	0.75	19.1	0.22	5.6	0.09	2.3	6.0	152.4	3	30
HST0.8-6-X2Y*	0.75	19.1	0.22	5.6	0.09	2.3	6.0	152.4	10	100
HST0.8-6-XY*	0.75	19.1	0.22	5.6	0.09	2.3	6.0	152.4	10	100
HST0.8-9-X2Y*	0.75	19.1	0.22	5.6	0.09	2.3	9.0	228.6	10	100
HST0.8-9-XY*	0.75	19.1	0.22	5.6	0.09	2.3	9.0	228.6	10	100
HST1.1-12-5-2Y	1.10	27.9	0.38	9.5	0.12	3.0	12.0	304.8	5	50
HST1.1-12-5Y	1.10	27.9	0.38	9.5	0.12	3.0	12.0	304.8	5	50
HST1.1-48-5-2Y	1.10	27.9	0.38	9.5	0.12	3.0	48.0	1219.2	5	20
HST1.1-48-5Y	1.10	27.9	0.38	9.5	0.12	3.0	48.0	1219.2	5	20
HST1.1-6-3Y	1.10	27.9	0.38	9.5	0.12	3.0	6.0	152.4	3	30
HST1.1-6-X2Y	1.10	27.9	0.38	9.5	0.12	3.0	6.0	152.4	10	100
HST1.1-6-XY	1.10	27.9	0.38	9.5	0.12	3.0	6.0	152.4	10	100
HST1.1-9-2Y	1.10	27.9	0.38	9.5	0.12	3.0	9.0	228.6	2	20
HST1.1-9-X2Y	1.10	27.9	0.38	9.5	0.12	3.0	9.0	228.6	10	100
HST1.1-9-XY	1.10	27.9	0.38	9.5	0.12	3.0	9.0	228.6	10	100
HST1.5-12-1Y	1.50	38.1	0.50	12.7	0.16	4.1	12.0	304.8	1	10
HST1.5-12-5Y	1.50	38.1	0.50	12.7	0.16	4.1	12.0	304.8	5	50
HST1.5-48-5-2Y	1.50	38.1	0.50	12.7	0.16	4.1	48.0	1219.2	5	15
HST1.5-48-5Y	1.50	38.1	0.50	12.7	0.16	4.1	48.0	1219.2	5	15
HST1.5-9-XY	1.50	38.1	0.50	12.7	0.16	4.1	9.0	228.6	10	100
HST2.0-12-2Y	2.00	50.8	0.67	16.9	0.16	4.1	12.0	304.8	2	20
HST2.0-48-2Y	2.00	50.8	0.67	16.9	0.16	4.1	48.0	1219.2	2	8
HST2.0-9-5Y	2.00	50.8	0.67	16.9	0.16	4.1	9.0	228.6	5	50
HST2.7-12-2Y	2.70	68.6	0.87	22.1	0.16	4.1	12.0	304.8	2	20
HST2.7-48-2Y	2.70	68.6	0.87	22.1	0.16	4.1	48.0	1219.2	2	8

The following parts are not UL listed, UL recognized nor CSA certified.

HST3.0-12-2	3.00	76.2	1.00	25.4	0.16	4.1	12.0	304.8	2	20
HST3.0-48-2	3.00	76.2	1.00	25.4	0.16	4.1	48.0	1219.2	2	8
HST3.5-12-2Y	3.50	88.9	1.20	30.5	0.16	4.1	12.0	304.8	2	20
HST3.5-48-2Y	3.50	88.9	1.20	30.5	0.16	4.1	48.0	1219.2	2	6

*Product meets performance requirements of AMS-DTL-23053/15; some dimensions differ from specification.

**Material Performance Only.

***Shelf life applies only to expanded and recovered dimensions. Material performance is not affected.

Heat Shrink End Caps

- Applications include insulating and protecting wires and cables
- Adhesive lined inner wall seals and provides excellent protection against moisture
- Voltage rating of 600 V
- Shrink ratio: 2.5:1 (HSEC); 3:1 (HSECFR)
- Temperature range: HSEC: -40°F to 257°F (-40°C to 125°C) HSECFR: -67°F to 239°F (-55°C to 110°C)
- For wet locations
- Material: Adhesive lined black cross-linked Polyolefin; HSECFR = Flame retardant
- FR Material: UL E169922
- 10 year shelf life***



HSEC



HSECFR



Part Number	Min. Expanded I.D.		Max. Recovered I.D.		Nominal Recovered Wall Thickness		Usable Cap Length		Std. Pkg. Qty.	Std. Pkg. Qty.
	In.	mm	In.	mm	In.	mm	In.	mm		
HSEC0.5-X	0.47	11.9	0.18	4.6	0.09	2.2	1.48	37.6	10	100
HSEC0.8-X	0.79	20.1	0.30	7.6	0.10	2.4	1.79	45.5	10	100
HSEC1.0-X	1.15	29.2	0.45	11.4	0.11	2.8	2.80	71.1	10	100
HSEC1.5-5	1.58	40.1	0.68	17.3	0.14	3.6	3.23	82.0	5	50
HSEC2.0-5	2.25	57.2	0.98	24.9	0.15	3.8	4.29	109.0	5	50
HSEC4.0-2	3.92	99.6	1.78	45.2	0.15	3.8	5.37	136.4	2	10

Heat Shrink End Caps – Flame Retardant

HSECFR0.5-XY	0.51	13.0	0.16	4.1	0.09	2.3	2.50	63.5	10	100
HSECFR0.8-XY	0.75	19.1	0.24	6.1	0.09	2.3	2.50	63.5	10	100
HSECFR1.0-XY	1.10	27.9	0.35	8.9	0.12	3.0	3.00	76.2	10	100
HSECFR1.5-5Y	1.50	38.1	0.47	11.9	0.16	4.1	3.50	88.9	5	50
HSECFR2.0-5Y	2.00	50.8	0.63	16.0	0.16	4.1	3.50	88.9	5	50

***Shelf life applies only to expanded and recovered dimensions. Material performance is not affected.

B1.
Cable
Ties

B2.
Cable
Accessories

B3.
Stainless
Steel Cable
Ties &
Accessories

C1.
Wiring
Duct

C2.
Abrasion
Protection

C3.
Cable
Management

D1.
Terminals

D2.
Power
Connectors

D3.
Grounding
Connectors

E1.
Labeling
Systems

E2.
Labels

E3.
Pre-Printed
&
Write-On
Markers

E4.
Permanent
Identification

E5.
Industrial
Safety
Solutions

F.
Keystone
Cabling
Systems

G.
Part
Number
Index

Plastic Heat Shrink Tubing Kit Boxes – For Dry Locations

- 5 year shelf life***



Part Number	Part Description	Contents	Std. Pkg. Qty.
KP-HSTT1	Heat shrink kit box – plastic case, various sizes. Black only.	35 ea. of 3/32", 1/8" 21 ea. of 3/16", 1/4" 7 ea. of 3/8", 1/2"	1
KP-HSTT2	Heat shrink kit box – plastic case, various sizes, various colors.	35 ea. (5 ea. color) 3/32", 1/8" 21 ea. (3 ea. color) 3/16", 1/4" 7 ea. (1 ea. color) 3/8", 1/2"	1
KP-HSTTA	Dual Wall Adhesive Lined Thin Wall Heat Shrink: Plastic Kit Box – Black only.	14 ea. 3/16" 12 ea. 1/4" 10 ea. 3/8" 6 ea. 1/2" 3 ea. 3/4" 2 ea. 1"	1

***Shelf life applies only to expanded and recovered dimensions. Material performance is not affected.



Heat Shrink Tools and Accessories



Part Number	Part Description	Std. Pkg. Qty.	Std. Ctn. Qty.
HSG-115V-650	Heat gun with stand. Temperature range of 700°F (371°C) to 1000°F (538°C) plus stand. (Accessories not included).	1	—
HSG-A1	Shrink tube reflector for tubing up to 3/4" inside diameter. Directs heat around tubing to reduce shrink time.	1	10
HSG-A2	Shrink tube reflector for tubing up to 1 1/2" inside diameter. Directs heat around tubing to reduce shrink time.	1	10
HSG-P1	Replacement brush / spring kit.	1	5
HSG-P2	Replacement switch 20 Amp.	1	5
HSG-P3	Replacement bearing kit.	1	5
HSG-P7	Replacement heat element 700°F.	1	—

Heat Shrink Installation Instructions

General Instructions

Position heat shrink over the object to be covered. Using a heat gun, soft yellow flame torch, infrared heat source or oven, evenly heat the tubing until it has fully recovered and conforms to the object. Use caution not to char or burn the tubing.

Special Instructions for HSTTT

TFE Heat Shrink is the most difficult to recover due to its high shrink temperature. TFE shrink tubing must be heated to the gel state 621°F (327°C) to completely recover. This can be recognized when the tubing changes from milky white to clear. Because of the unique characteristics of this material, a controlled temperature oven will achieve the most reliable results – it is difficult to consistently recover this product using a high-temp heat gun or similar heat source. These methods have a tendency to overheat the tube in one area while other areas remain cool.

When recovering onto objects, use a temperature controlled oven set at 660°F – 680°F (349°C – 360°C) for approximately 10 minutes is recommended. It is best to place the product on a fiberglass mat or suspend as opposed to contacting the oven rack. Do NOT heat the product above 700°F (371°C), or degradation damage to the TFE polymer will occur. The surrounding materials and the material you are shrinking onto must be capable of withstanding the shrink temperatures.

Size Selection for Heat Shrink Tubing

Generally, the largest tube that shrinks down tightly onto an object should be chosen. This allows the heat shrink tubing maximum stress relief and this will yield the longest service life and maximize abrasion resistance and electrical insulation.

Example:

A multi-conductor cable needs to be covered with HSTT Type Dry-Shrink™ Heat Shrink. The area to be covered has a measured outside diameter of 0.700" (17.8mm). The two possibilities are HSTT75-48-5 and HSTT100-48-5.

Part Number	Expander I.D. In. (mm)	Recovered I.D. In. (mm)
HSTT75-48-5	0.750 (19.1)	0.375 (9.5)
HSTT100-48-5	1.00 (25.4)	0.500 (12.7)

The proper choice is HSTT100-48-5 since the tube will recover more than HSTT75-48-5. The HSTT75-48-5 will fit over the 0.700 inch (17.8mm) outside diameter; however, this is not the proper choice since it is smaller than the HSTT100-48-5. In general, heat shrink should recover at least 10% – 20%.

B1.
Cable
TiesB2.
Cable
AccessoriesB3.
Stainless
Steel Cable
Ties &
AccessoriesC1.
Wiring
DuctC2.
Abrasion
ProtectionC3.
Cable
ManagementD1.
TerminalsD2.
Power
ConnectorsD3.
Grounding
ConnectorsE1.
Labeling
SystemsE2.
LabelsE3.
Pre-Printed
&
Write-On
MarkersE4.
Permanent
IdentificationE5.
Industrial
Safety
SolutionsF.
Keystone
Cabling
SystemsG.
Part
Number
Index

Recommended Tubing Size for Common Wire Types Based on Location For Insulated Wire, Non-Insulated Wire, and Insulated Wire with Copper Connectors

Instructions for Tube Selection:

1) Determine location type.

LOCATION:

DRY: A location not normally subject to dampness or wetness. A location classified as dry may be temporarily subject to dampness or wetness, as in the case of a building under construction.

DAMP: Partially protected locations under canopies, marquees, roofed open porches and like locations, and interior locations subject to moderate degrees of moisture, such as some basements, barns, and cold-storage warehouses.

WET: Installations underground or in concrete slabs or masonry in direct contact with the earth, and locations subject to saturation with water or other liquids, such as vehicle washing areas, and locations exposed to weather and unprotected.

2) Match wire size to location type under required application – insulated wire, non-insulated wire, or insulated wire with copper connectors.

3) Read corresponding part number.

4) Part numbers with “-Y” are packages containing 6 inch pieces. Part numbers with “-48” are 48 inch pieces.

5) Part numbers shown below are for black heat shrink.

Wire Size	Insulated Wire with Copper Connector			Uninsulated Wire		
	Dry-Shrink™	Damp-Shrink™	Wet-Shrink™	Dry-Shrink™	Damp-Shrink™	Wet-Shrink™
24	HSTT09-Y	HSTTA19-Y	—	—	—	—
22	HSTT09-Y	HSTTA19-Y	—	HSTT05-Y	—	—
20	HSTT12-Y	HSTTA19-Y	—	HSTT05-Y	—	—
18	HSTT12-Y	HSTTA19-Y	—	HSTT06-Y	—	—
16	HSTT19-Y	HSTTA25-Y	—	HSTT09-Y	—	—
14	HSTT19-Y	HSTTA25-Y	—	HSTT09-Y	HSTTA19-Y	—
12	HSTT25-Y	HSTTA38-Y	—	HSTT012-Y	HSTTA19-Y	—
10	HSTT25-Y	HSTTA38-Y	HST0.4-48-5Y	HSTT19-Y	HSTTA25-Y	—
8	HSTT38-Y	HSTTA50-Y	HST0.4-48-5Y	HSTT19-Y	HSTTA25-Y	—
6	HSTT50-Y	HSTTA50-Y	HST0.8-48-5Y	HSTT25-Y	HSTTA38-Y	HST0.4-48-5Y
4	HSTT50-Y	HSTTA75-Y	HST0.8-48-5Y	HSTT38-Y	HSTTA50-Y	HST0.4-48-5Y
3	HSTT50-Y	HSTTA75-Y	HST0.8-48-5Y	HSTT38-Y	HSTTA50-Y	HST0.4-48-5Y
2	HSTT75-Y	HSTTA100-Y	HST1.1-48-5Y	HSTT38-Y	HSTTA50-Y	HST0.8-48-5Y
1	HSTT75-Y	HSTTA100-Y	HST1.1-48-5Y	HSTT50-Y	HSTTA75-Y	HST0.8-48-5Y
1/0	HSTT75-Y	HSTTA100-Y	HST1.1-48-5Y	HSTT50-Y	HSTTA75-Y	HST0.8-48-5Y
2/0	HSTT100-Y	HSTTA150-Y	HST1.5-48-5Y	HSTT50-Y	HSTTA100-Y	HST0.8-48-5Y
3/0	HSTT100-Y	HSTTA150-Y	HST1.5-48-5Y	HSTT75-Y	HSTTA100-Y	HST1.1-48-5Y
4/0	HSTT100-Y	HSTTA150-Y	HST1.5-48-5Y	HSTT75-Y	HSTTA100-Y	HST1.1-48-5Y
250	HSTT100-Y	HSTTA150-Y	HST2.0-48-2Y	HSTT100-Y	HSTTA100-Y	HST1.1-48-5Y
300	HSTT150-48-5	HSTTA150-Y	HST2.0-48-2Y	HSTT100-Y	HSTTA150-Y	HST1.5-48-5Y
350	HSTT150-48-5	HSTTA150-Y	HST2.0-48-2Y	HSTT100-Y	HSTTA150-Y	HST1.5-48-5Y
400	HSTT150-48-5	HSTTA150-Y	HST2.0-48-2Y	HSTT100-Y	HSTTA150-Y	HST1.5-48-5Y
500	HSTT150-48-5	HSTTA150-Y	HST2.0-48-2Y	HSTT100-Y	HSTTA150-Y	HST1.5-48-5Y
600	HSTT200-48-5	HSTTA150-Y	HST2.0-48-2Y	HSTT150-48-5	HSTTA150-Y	HST2.0-48-2Y
700	HSTT200-48-5	HSTTA150-Y	HST2.0-48-2Y	HSTT150-48-5	HSTTA150-Y	HST2.0-48-2Y
750	HSTT200-48-5	HSTTA150-Y	HST3.0-48-2Y	HSTT150-48-5	HSTTA150-Y	HST2.0-48-2Y
800	HSTT200-48-5	HSTTA150-Y	HST3.0-48-2Y	HSTT150-48-5	HSTTA150-Y	HST2.0-48-2Y
900	HSTT200-48-5	—	HST3.0-48-2Y	HSTT150-48-5	HSTTA150-Y	HST2.0-48-2Y
1000	HSTT200-48-5	—	HST3.0-48-2Y	HSTT150-48-5	HSTTA150-Y	HST2.0-48-2Y
1250	HSTT200-48-2	—	HST3.0-48-2Y	HSTT200-48-5	HSTTA150-Y	HST2.0-48-2Y
1500	HSTT300-48-2	—	HST3.0-48-2Y	HSTT200-48-5	—	HST2.0-48-2Y
1750	HSTT300-48-2	—	HST3.0-48-2Y	HSTT200-48-5	—	HST2.0-48-2Y
2000	HSTT300-48-2	—	HST3.0-48-2Y	HSTT200-48-5	—	HST2.0-48-2Y

Sizing information is based on the following wire types: MTW, THHN, THWN, TFN, THW, TW, TF, RHW, RH, RHH and UL 1015.

THHN is the most common wire type.

Portions reprinted with permission from NFPA, the National Electrical Code* Handbook, Copyright 1996, National Fire Protection Association, Quincy, MA 02269.

*All rights reserved. National Electrical Code and NEC are registered trademarks of the National Fire Protection Association, Inc., Quincy, MA 02269.

Cable Management

Panduit® offers a complete line of cable management products and accessories to route and secure cable. These products are an essential part of a clean, professional installation, which help improve quality and increase system performance.

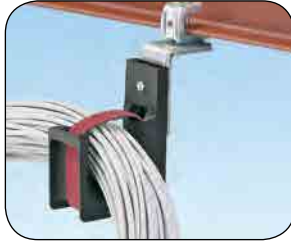

- **Maintains bend radius control and cable performance while bundling and securing cable to prevent snags and stress from over bending**
- **Allows for easier moves, adds, and changes while reducing stress on cable**
- **Organizes cable in a variety of applications where depth is critical or space is limited**

Panduit solutions provide the options necessary to handle the most demanding installations while providing the flexibility to facilitate system upgrades now and in the future.





J-Pro™ Cable Support System



- Patented design provides complete horizontal and vertical 1" (25.4mm) bend radius control that helps prevent degradation of cable performance
- UL 2043 and CAN/ULC S102.2 listed and suitable for use in air handling spaces
- Pre-riveted assemblies allow for attachment to walls, ceilings, beams, threaded rods, drop wires and underfloor supports to meet requirements of a variety of applications
- Wide cable support base prevents pinch points that could cause damage to cables
- Cable tie channel allows user to easily install 3/4" Tak-Ty® Cable Ties to retain cable bundle
- Durable non-metallic J Hook materials provide the ability to manage and support a large number of cables
- Standard product is black. For color options see page C3.4



JP2W-L20



JP2WP2B-L20



JP2CMB-L20



JP2DW-L20



JP2SBC50-L20



JP2SBC50RB-L20

Part Number*	Part Description	Max. Bundle Capacity		Max. Cable Capacity			Std. Pkg. Qty.
		In.	mm	Cat. 6A (0.30")	Cat. 6 (0.24")	Cat. 5e (0.23")	

Wall Mount

JP75W-L20	J Hook for wall mount applications. One 1/4" (M6) mounting hole for user supplied screw.	0.75	19.0	5	8	10	50
JP131W-L20		1.31	33.3	15	25	29	50
JP2W-L20		2.00	50.8	30	46	55	50
JP4W-X20		4.00	101.6	115	180	200	10

Wall Mount with Bracket

JP75WP2B-L20	J Hook for powder actuated installation on walls. One 5/32" (M4) mounting hole for user supplied fasteners.	0.75	19.0	5	8	10	50
JP131WP2B-L20		1.31	33.3	15	25	29	50
JP2WP2B-L20		2.00	50.8	30	46	55	50
JP4WP2B-X20		4.00	101.6	115	180	200	10

Ceiling Mount

JP75CMB-L20	J Hook with ceiling mount bracket that has one 3/16" (M5), 1/4" (M6), and 3/8" (M10) mounting hole.	0.75	19.0	5	8	10	50
JP131CMB-L20		1.31	33.3	15	25	29	50
JP2CMB-L20		2.00	50.8	30	46	55	50
JP4CMB-X20		4.00	101.6	115	180	200	10

Drop Wire and Threaded Rod Clip

JP75DW-L20	J Hook with clip for use with #12 wire, threaded rod up to 1/4" (6.4mm) in diameter, or 1/8" - 1/4" (3.2mm - 6.4mm) thick flanges.	0.75	19.0	5	8	10	50
JP131DW-L20		1.31	33.3	15	25	29	50
JP2DW-L20		2.00	50.8	30	46	55	50
JP4DW-L20		4.00	101.6	115	180	200	10

Screw-On Beam Clamps

JP75SBC50-L20	J Hook with screw-on beam clamp for use with flanges up to 1/2" (12.7mm) thick.	0.75	19.0	5	8	10	50
JP131SBC50-L20		1.31	33.3	15	25	29	50
JP2SBC50-L20		2.00	50.8	30	46	55	50
JP4SBC50-X20		4.00	101.6	115	180	200	10
JP75SBC50RB-L20	J Hook with screw-on beam clamp for use with flanges up to 1/2" (12.7mm) thick. Rotates 360 degrees.	0.75	19.0	5	8	10	50
JP131SBC50RBL20		1.31	33.3	15	25	29	50
JP2SBC50RB-L20		2.00	50.8	30	46	55	50
JP4SBC50RB-X20		4.00	101.6	115	180	200	10

*Suitable for use in air handling spaces in accordance with Sec. 300-22(c) and (d) of the National Electrical Code. JP4 family of parts suitable for use in single unit configurations. Listed in accordance with CAN/ULC S102.2 when mounted as single units or in pairs. Minimum spacing of 4' (1220mm) required between mount points. (Flame spread rating = 0, Smoke developed classification = 30)

Continues on next page



J-Pro™ Cable Support System (continued)



JP2SBC87-L20



JP2SBC87RB-L20



JP2HBC25RB-L20
JP2HBC50RB-L20
JP2HBC75RB-L20



JP2ZP-L20



JP2CP-L20



JP2UF100-L20

Part Number*	Part Description	Max. Bundle Capacity		Max. Cable Capacity			Std. Pkg. Qty.
		In.	mm	Cat. 6A (0.30")	Cat. 6 (0.24")	Cat. 5e (0.23")	

Screw-On Beam Clamps

JP75SBC87-L20	J Hook with screw-on beam clamp for use with flanges up to 3/4" (19.1mm) thick.	0.75	19.0	5	8	10	50
JP131SBC87-L20		1.31	33.3	15	25	29	50
JP2SBC87-L20		2.00	50.8	30	46	55	50
JP4SBC87-X20		4.00	101.6	115	180	280	10
JP75SBC87RB-L20		0.75	19.0	5	8	10	50
JP131SBC87RBL20		1.31	33.3	15	25	29	50
JP2SBC87RB-L20		2.00	50.8	30	46	55	50
JP4SBC87RB-X20		4.00	101.6	115	180	200	10

Hammer-On Beam Clamps

JP75HBC25RB-L20	J Hook with hammer-on beam clamp for use with flanges 1/8" – 1/4" (3.2mm – 6.4mm) thick. Rotates 360 degrees.	0.75	19.0	5	8	10	50
JP131HBC25RBL20		1.31	33.3	15	25	29	50
JP2HBC25RB-L20		2.00	50.8	30	46	55	50
JP4SBC50RB-X20		4.00	101.6	115	180	200	10
JP75HBC50RB-L20	J Hook with hammer-on beam clamp for use with flanges 5/16" – 1/2" (7.9mm – 12.7mm) thick. Rotates 360 degrees.	0.75	19.0	5	8	10	50
JP131HBC50RBL20		1.31	33.3	15	25	29	50
JP2HBC50RB-L20		2.00	50.8	30	46	55	50
JP4HBC50RB-X20		4.00	101.6	115	180	200	10
JP75HBC75RB-L20	J Hook with hammer-on beam clamp for use with flanges 9/16" – 3/4" (14.3mm – 19.1mm) thick. Rotates 360 degrees.	0.75	19.0	5	8	10	50
JP131HBC75RBL20		1.31	33.3	15	25	29	50
JP2HBC75RB-L20		2.00	50.8	30	46	55	50
JP4HBC75RB-X20		4.00	101.6	115	180	200	10

Z-Purlin Clips

JP75ZP-L20	J Hook with z-purlin clip for use with angled flanges up to 1/4" (6.4mm) thick.	0.75	19.0	5	8	10	50
JP131ZP-L20		1.31	33.3	15	25	29	50
JP2ZP-L20		2.00	50.8	30	46	55	50
JP4ZP-X20		4.00	101.6	115	180	200	10

C-Purlin Clips

JP75CP-L20	J Hook with c-purlin clip for use with vertical flanges up to 1/4" (6.4mm) thick.	0.75	19.0	5	8	10	50
JP131CP-L20		1.31	33.3	15	25	29	50
JP2CP-L20		2.00	50.8	30	46	55	50
JP4CP-X20		4.00	101.6	115	180	200	10

Underfloor Pedestal Support Clamp

JP75UF100-L20	J Hook with underfloor clamp for use with pedestal support 7/8" square or 1 1/8" – 1 3/8" in diameter.	0.75	19.0	5	8	10	50
JP131UF100-L20		1.31	33.3	15	25	29	50
JP2UF100-L20		2.00	50.8	30	46	55	50
JP4UF100-X20		4.00	101.6	115	180	200	10

*Suitable for use in air handling spaces in accordance with Sec. 300-22(c) and (d) of the National Electrical Code. JP4 family of parts suitable for use in single unit configurations. Listed in accordance with CAN/ULC S102.2 when mounted as single units or in pairs. Minimum spacing of 4' (1220mm) required between mount points. (Flame spread rating = 0, Smoke developed classification = 30)

Color Selection Guide

Base Part Number	Black	Red	Blue	White	Green	Orange
JP75W	-L20	-L2			-L5	-L3
JP75WP2B	-L20					
JP75CMB	-L20	-L2				
JP75DW	-L20	-L2	-L6			
JP75ZP	-L20					
JP75CP	-L20					
JP75SBC50	-L20					
JP75SBC87	-L20					
JP75SBC50RB	-L20	-L2		-L		
JP75SBC87RB	-L20					
JP75HBC25RB	-L20					
JP75HBC50RB	-L20	-L2		-L		
JP75HBC75RB	-L20					
JP75UF100	-L20					
JP131W	-L20		-L6		-L5	-L3
JP131WP2B	-L20					
JP131CMB	-L20					
JP131DW	-L20		-L6			
JP131ZP	-L20					
JP131CP	-L20					
JP131SBC50	-L20					
JP131SBC87	-L20					
JP131SBC50RB	-L20	-L2		-L		
JP131SBC87RB	-L20					
JP131HBC25RB	-L20					
JP131HBC50RB	-L20	-L2		-L		
JP131HBC75RB	-L20					
JP131UF100	-L20					
JP2W	-L20	-L2	-L6	-L	-L5	-L3
JP2WP2B	-L20					
JP2CMB	-L20	-L2				
JP2DW	-L20	-L2	-L6	-L		
JP2ZP	-L20					
JP2CP	-L20					
JP2SBC50	-L20			-L		
JP2SBC87	-L20					
JP2SBC50RB	-L20	-L2		-L		
JP2SBC87RB	-L20	-L2				
JP2HBC25RB	-L20					
JP2HBC50RB	-L20	-L2		-L		
JP2HBC75RB	-L20					
JP2UF100	-L20					
JP4W	-X20	-X2	-X6	-X		
JP4WP2B	-X20					
JP4CMB	-X20					
JP4DW	-X20					
JP4ZP	-X20					
JP4CP	-X20					
JP4SBC50	-X20			-X		
JP4SBC87	-X20					
JP4SBC50RB	-X20	-X2		-X		
JP4SBC87RB	-X20					
JP4HBC25RB	-X20					
JP4HBC50RB	-X20	-X2		-X		
JP4HBC75RB	-X20					
JP4UF100	-X20					

Other colors available. Please refer to www.panduit.com.

Order number of pieces required, in multiples of Standard Package Quantity.



J-Mod® Cable Support System PATENTED

- Modular design allows flexibility to assemble system in multiple configurations
- Unique chaining bracket design creates a strong metal backbone and allows expansion of the system without disturbance of an existing installation
- Brackets allow for attachment to ceilings, beams, threaded rods and drop wires to meet requirements of a variety of applications

- Manufactured from materials that meet UL 2043 and are suitable for use in air handling spaces
- Complete horizontal and vertical 1" bend radius control
- Cables do not come in contact with metal



JMJB2W-X20 JMJB2-X20



JMJB-X JMJB25-1-X



JMJB25-3-X JMJB25-1-X



JMJB25-3-X JMJB25-1-X



JMJB25-3-X JMJB25-1-X

Part Number	Part Description	Material	Std. Pkg. Qty.	Std. Ctn. Qty.
J Hook with Maximum 2" Bundle Capacity				
JMJB2W-X20*	J Hook for wall mount applications only. Two 1/4" (M6) mounting holes for user supplied screws.	Nylon 6.6	10	50
JMJB2-X20*	J Hook with snap lock attachments for use with all brackets listed below.	Nylon 6.6	10	50
Chaining Bracket				
JMJB-X	Chaining bracket to extend J-Mod® capacity one level. Capacity: three levels maximum. For use with all single-level mounting brackets listed below.	Zinc Plated Steel	10	50
Ceiling Mount Brackets				
JMJB25-1-X	Single-level ceiling mount bracket with one 1/4" (M6) mounting hole.	Nylon 6.6	10	50
JMJB25-3-X**	Three-level ceiling mount bracket with one 1/4" (M6) mounting hole. Maximum capacity of six J Hooks.	Nylon 6.6	10	50
Drop Wire Brackets				
JMJB25-1-X	Single-level drop wire bracket. Attaches to #12 wire or 1/4" (6.4mm) plain rod. Maximum capacity of one J Hook per level.	Galvanized Steel with Metal Attachments	10	50
JMJB25-3-X**	Three-level drop wire bracket. Attaches to #12 wire or 1/4" (6.4mm) plain rod. Maximum capacity of one J Hook for each of three levels. Maximum static load of 40 pounds.	Galvanized Steel with Metal Attachments	10	50
Threaded Rod Brackets				
JMJB25-1-X	Single-level threaded rod bracket. Accepts 1/4" – 3/8" (6.4mm – 9.5mm) threaded rod.	Galvanized Steel with Metal Attachments	10	50
JMJB25-3-X**	Three-level threaded rod bracket. Accepts 1/4" – 3/8" (6.4mm – 9.5mm) threaded rod. Maximum capacity of six J Hooks.	Galvanized Steel with Metal Attachments	10	50

*Suitable for use in air handling spaces and listed in accordance with UL 2043 and CAN/ULC S102.2 when mounted as single units or in pairs. Maximum spacing of 4' (1220mm) required between mount points. (Flame Spread Rating = 0, Smoke Developed Classification = 30)

**Not for use with chaining brackets.

Continues on next page



J-Mod® Cable Support System (continued)



JMTRB38-3-X JMSBCB87-1-X



JMSBCB87-3-X

Part Number	Part Description	Material	Std. Pkg. Qty.	Std. Ctn. Qty.
Screw-On Beam Clamp Brackets				
JMSBCB87-1-X	Single-level screw-on beam clamp bracket for use with flanges up to 3/4" (19.1mm) thick.	Galvanized Steel with Metal Attachments	10	50
JMSBCB87-3-X**	Three-level screw-on beam clamp bracket for use with flanges up to 3/4" (19.1mm) thick. Maximum capacity of six J Hooks.	Galvanized Steel with Metal Attachments	10	50

*Suitable for use in air handling spaces and listed in accordance with UL 2043 and CAN/ULC S102.2 when mounted as single units or in pairs. Maximum spacing of 4' (1220mm) required between mount points. (Flame Spread Rating = 0, Smoke Developed Classification = 30)

**Not for use with chaining brackets.

	Max. Cable Capacity		
	Cat. 6A (0.310")	Cat. 6 (0.236")	Cat. 5e (0.193")
JMJH2W or JM JH2	30	50	70

Bridle Rings and Fastening Clip

- Multiple diameters, thread sizes, and configurations
- Threaded and non-threaded sizes are compatible with spring steel clip (BR-MPCL) clamp providing a solid securing point for the bridle ring
- Other unique labor saving assemblies differentiate from competition – including pre-assemblies with powder actuated fasteners, toggle wings, and clearance holes for user supplied fasteners



Non-Threaded #8 Wire Threaded



Wood Screw Thread Power Actuated Fastener



User Supplied Nail or Fastener Integrated Toggle Screw

Part Number	Part Description	Std. Pkg. Qty.
J Hook with Maximum 2" Bundle Capacity		
BR-2.0	Bridle ring, 2.00" dia., non-threaded #8 wire (.162).	100
BR-.50-10-24	Bridle ring, 0.50" dia., 10 – 24 threaded.	100
BR-.75-10-24	Bridle ring, 0.75" dia., 10 – 24 threaded.	100
BR-1.25-10-24	Bridle ring, 1.25" dia., 10 – 24 threaded.	100
BR-2.0-10-24	Bridle ring, 2.00" dia., 10 – 24 threaded.	100
BR-1.25-1/4-20	Bridle ring, 1.25" dia., 1/4 – 20 threaded.	100
BR-2.0-1/4-20	Bridle ring, 2.00" dia., 1/4 – 20 threaded.	100
BR-4.0-1/4-20	Bridle ring, 4.00" dia., 1/4 – 20 threaded.	50
BR-1.25-14WS	Bridle ring, 1.25" dia., 16 wood screw thread.	100
BR-2.0-14WS	Bridle ring, 2.00" dia., 16 wood screw thread.	100
BR-1.5-PAF	Bridle ring, 1.50" dia., with powder actuated fastener.	50
BR-2.0-PAF	Bridle ring, 2.00" (50.8mm) dia., with powder actuated fastener.	50
BR-1.5-SN	Bridle ring, 1.50" dia., user supplied nail or fastener.	100
BR-2.0-SN	Bridle ring, 2.00" dia., user supplied nail or fastener.	100
BR-1.5-TW	Bridle ring, 1.50" dia., with integrated toggle screw.	25
BR-2.0-TW	Bridle ring, 2.00" dia., with integrated toggle screw.	25

Low Voltage Mounting Brackets

- Choose design styles for new install or retrofit install
- Available in both single and double gang configurations

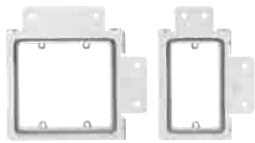

New Install

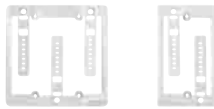

Retrofit Install

Part Number	Part Description	Std. Pkg. Qty.
LV-S-1G	Low voltage integral mounting bracket for new installations, single gang stud bracket.	25
LV-S-2G	Low voltage integral mounting bracket for new installations, double gang stud bracket.	25
LV-W-1G	Low voltage mounting bracket for retrofit installations; single gang box with screws; suitable for wall material thicknesses of 1/2" to 1 1/2".	100
LV-W-2G	Low voltage mounting bracket for retrofit installations; double gang box with screws; suitable for wall material thicknesses of 1/2" to 1 1/2".	50

Metal Stud Accessories

- Metal stud grommets and cable support manager support and protect cable within the building structure
- Metal Stud Punching Tool punches a 1-11/32" (34.1mm) round hole in 25 GA. min. to 20 GA max. mild steel studs; contoured handle; lightweight aluminum head; automatic hole centering on standard width (3.625") studs; replaceable punch and dies; self-stripping design that eliminates or reduces punch hang-ups

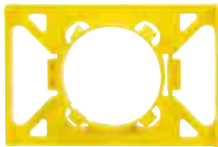

MSG-1.3-C



MSGV-1.3-C



CSM-1.25-C



MSPT-1.3

Part Number*	Part Description	Std. Pkg. Qty.	Std. Ctn. Qty.
MSG-1.3-C	Metal stud grommet, 1-11/32" hole.	100	1000
MSGV-1.3-C	Metal stud grommet, 1-11/32" hole, anti-vibration for 1/2" to 1" pipe.	100	1000
CSM-1.25-C	Cable stud manager for 1.25" cable spacing.	100	1000
MSPT-1.3	Metal stud punch tool with contoured handle for increased leverage.	1	—

Vertical D-Rings PATENTED

- Patented cable manager ring
- Standard EIA hole spacing allows product to be mounted to any standard rack
- Flexible material allows arm to rotate so entire cable bundle can be inserted and removed
- 1/4" mounting holes allow for a variety of screws to secure the D-ring to a surface
- Material: Black Polycarbonate



CMVDR1 CMVDR1S



CMVDR2 CMVDR2S



CMVDRC

Part Number	Part Description	Fiber	ScTP	UTP	Std. Pkg. Qty.	Std. Ctn. Qty.
CMVDR1	Vertical D-ring. Outside dimensions 5.70"L x 2.00"W.	252	48	96	1	10
CMVDR1S	Vertical D-ring. Outside dimensions 3.30"L x 2.00"W.	132	32	52	1	10
CMVDR2	Vertical D-ring. Outside dimensions 5.70"L x 3.00"W.	504	96	192	1	10
CMVDR2S	Vertical D-ring. Outside dimensions 3.30"L x 3.00"W.	252	48	96	1	10
CMVDRC	Center mounted vertical D-ring for routing cables between two adjacent racks. Requires 8.25" spacing between the center lines of the adjacent rack's mounting holes. Outside dimensions 5.60"L x 8.00"W.	1000	200	400	1	10

All product color is black.

Tak-Ty® Hook & Loop Cable Tie Mounts

- For use with hook and loop cable ties, see page B1.83 and B1.84
- Unique cradle design provides maximum stability for cable bundle
- For indoor use only
- Dimensions: 1.10"L x 1.12"W x 0.34"H (27.9mm x 28.4mm x 8.6mm)

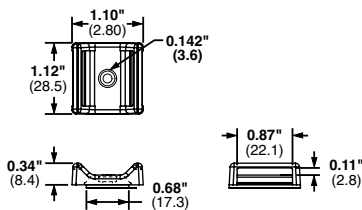

Part Number	Used with Cable Ties†	Material	Color	Max. Static Load		Mounting Method*	Std. Pkg. Qty.	Std. Ctn. Qty.
				Lbs.	g			
ABMT-A-C	HLS, HLT, TTS, UCT	Nylon 6.6	Natural	0.38	174	Pre-installed Rubber Adhesive	100	1000
ABMT-A-C20			Black					
ABMT-S6-C			Natural	—	—	#6 (M3) Screw	100	1000
ABMT-S6-C20			Black					
ABMT-S6-C60		Flame Retardant Nylon 6.6	Black	—	—		100	1000
ABMT-S6-C69		Natural	100					

†Cable tie cross section sizes: HLT = Tak-Ty® Hook & Loop Ties, HLS = Tak-Ty® Hook & Loop Strip Tie, TTS = Tak-Tape™ Roll, UCT = Ultra-Cinch™ Tie.
*For proper selection of adhesives see page B2.52.

Terminals

Panduit® Pan-Term® Terminals are designed and manufactured for fast assembly, and reliable performance. Panduit provides an extensive line of tooling designed specifically to provide optimum performance. As the demand for loose piece terminals increases, it becomes essential to provide a complete system for termination products.



- **Funnel entry available on vinyl and nylon insulated terminals and disconnects, speeds insertion, and minimizes turned back wire strands**
- **Made of electrolytic copper to provide an optimum combination of crimp forming and high conductivity properties to provide superior terminations**
- **Available in sizes from #26 – 2 AWG and stud hole diameters from #2 – 1/2 inch; non-insulated tubular terminals sizes from #8 – 250 kcmil**
- **Applicable sizes are UL Listed and CSA Certified, RoHS compliant, ABS (American Bureau of Shipping) Approved, Class IE Nuclear Rated, DFARS 252.225-7014 Compliant and meet Military Specifications MS25036 and MS20659 as noted**
- **Wide assortment of manual, controlled cycle, battery operated hydraulic and pneumatic crimping tools for reliable connections at the lowest installed cost**
- **Standard pack terminals are now offered in a new ergonomic, reusable, clear plastic bottle with color-coded flip top lids for easy product selection, dispensing and size identification**
- **Convenience Packs offer premium terminal products in a clear, resealable, 20 piece package, designed for quick product selection and identification**

Panduit continually provides new designs to meet the application challenges encountered by our customers. Panduit offers a wide assortment of Pan-Term® termination products to meet customer needs at the lowest installed cost.

Features and Benefits – Pan-Term® Terminals

All Panduit® terminals feature high quality materials made with electrolytic copper for high conductivity and are tin-plated for corrosion resistance.

Non-Insulated Terminals Type P

Maximum recommended operating temperature 302°F (150°C)

Product markings provide easy identification of wire size

Extended barrel length assures a good quality crimp and makes crimping easier

Internal barrel serrations assure good wire contact and maximum tensile strength

Brazed seam assures crimp reliability

Internally beveled barrel for quick easy wire insertion

UL and CSA rated up to 2000 V per UL 486A/B. Nickel plated terminals rated up to 650°F (343°C) maximum operating temperature.

Nylon Insulated Terminals with Insulation Grip Sleeve Type PN or PNF

Internal barrel serrations assure good wire contact and maximum tensile strength

Insulation grip sleeve provides a superior insulation crimp for high vibration and high strain relief applications

Funnel entry for faster insertion and lower installed cost

Maximum insulation temperature 221°F (105°C)

Sleeved barrel assures crimp reliability

Color coded insulation identifies wire range

UL and CSA rated up to 600 V per UL 486A/B. Flammability – UL 94 HB. Proprietary blend of UL 94V-2 and UL 94HB flammability rated materials.

Vinyl Insulated Terminals With Insulation Support Type PV

Internal barrel serrations assure good wire contact and maximum tensile strength

Insulation crimp provides insulation support to protect electrical crimp

Funnel entry for faster insertion and lower installed cost

Maximum insulation temperature 221°F (105°C)

Brazed seam assures crimp reliability

Color coded insulation identifies wire range

UL and CSA rated up to 600 V per UL 486A/B. Flammability – UL 94V-0.

Non-Insulated Seamless Tubular Terminals Type S

Internally beveled barrel for quick easy wire insertion

Seamless tubular barrel provides consistent, high performance, quality crimps

Maximum recommended operating temperature 302°F (150°C)

Inspection hole allows visual inspection for proper wire insertion

Product markings provide easy identification of wire sizes

Double thickness provides a strong ring tongue

UL and CSA rated up to 2000 V per UL 486A/B.



Panduit designs and manufactures a full line of labeling products, software and printers to assist you with your labeling requirements. See pages E1.1 – E2.27.

Selection Guide – Pan-Term® Ring Terminals

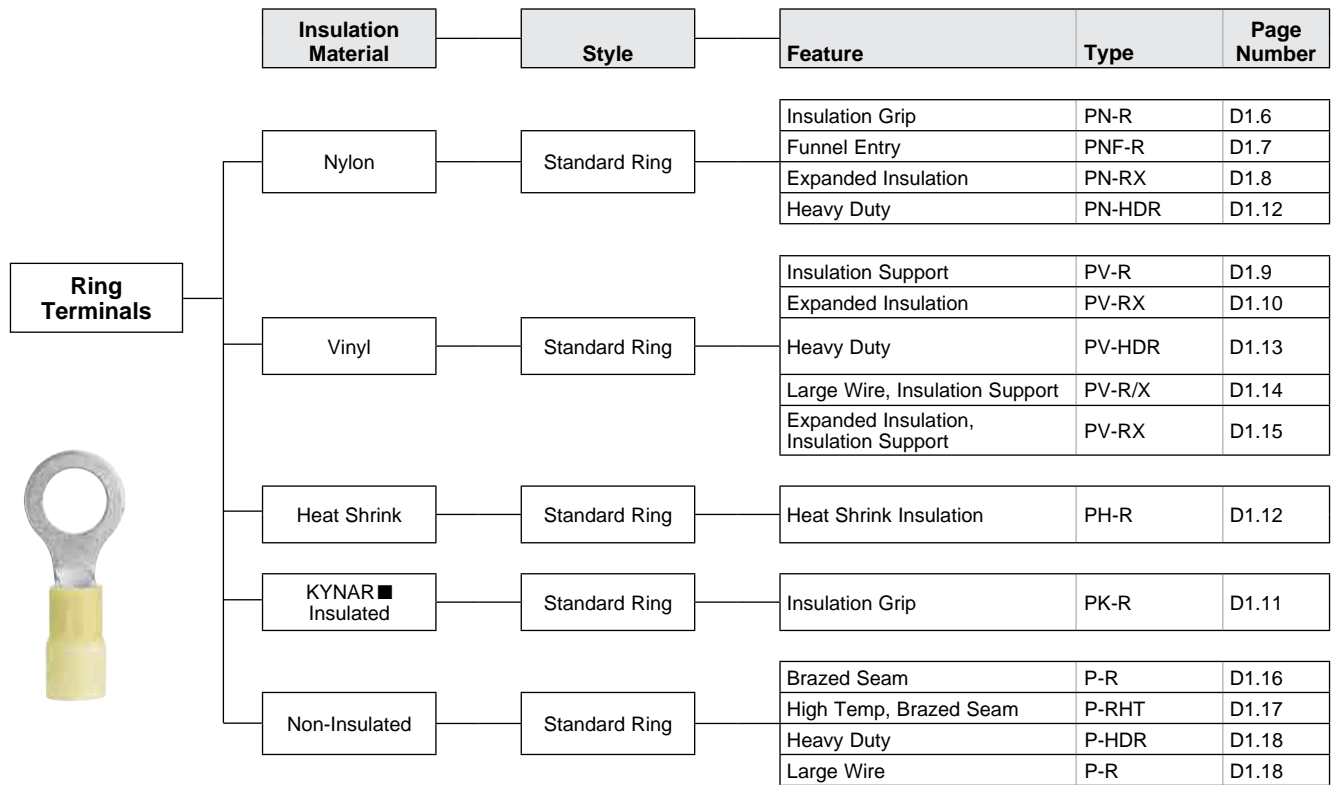

■ KYNAR is a registered trademark of Atofina Chemicals, Inc.

Selection Guide – Pan-Term® Fork Terminals

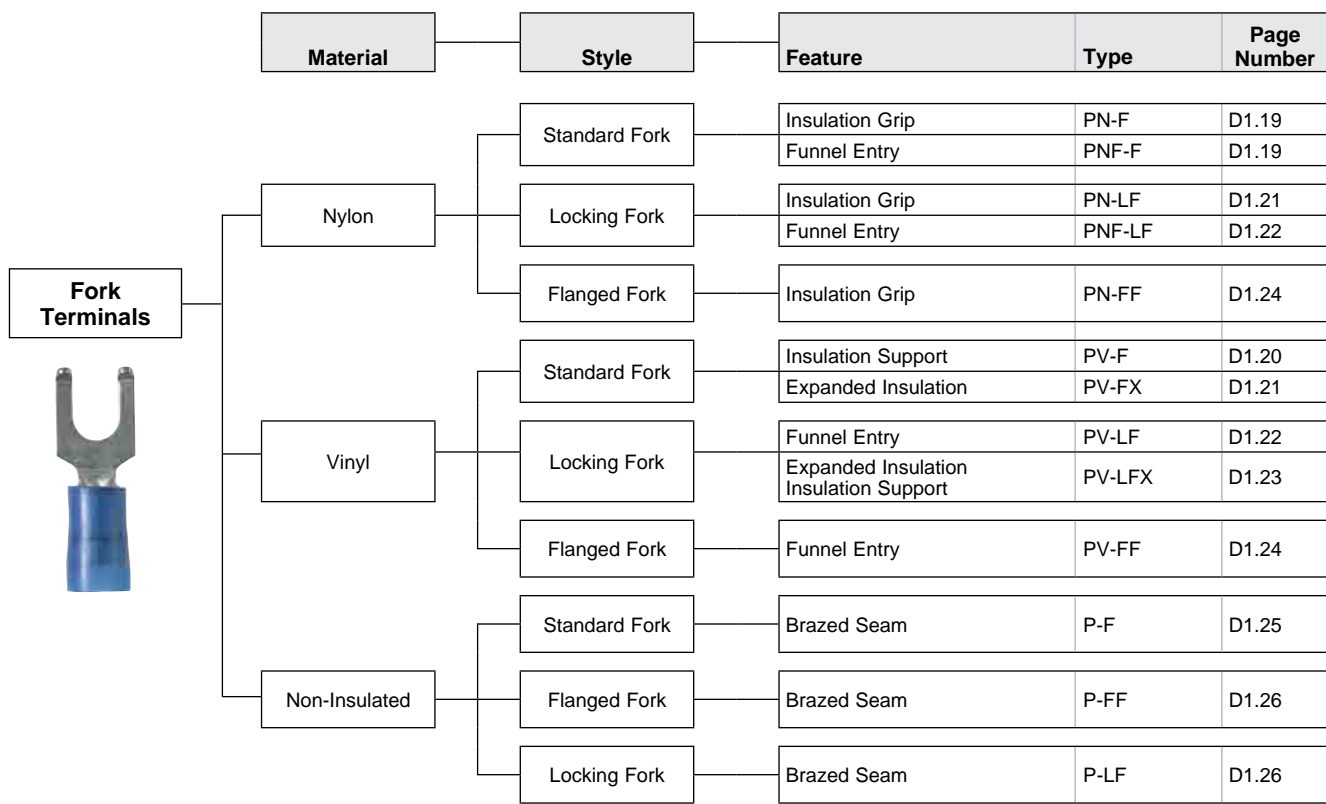

Part Number System for Pan-Term® Terminals

P	N	14	—	4	R	X	—	C
Type	Insulation	Wire Range		Stud Size	Tongue Configuration	Special Configuration		Std. Pkg. Size
P = Seamed Barrel	H = Heat Shrink	22 = #26 – 22		2 = #2	HDR = Heavy Duty Ring	HT6 = High Temperature		5 = 5
S = Seamless Tubular Barrel	K = KYNAR ■ Insulated	18 = #22 – 18		4 = #4	F = Fork	N = Narrow Tongue		X = 10
	N = Nylon Insulated	14 = #16 – 14		5 = #5	FF = Flanged Fork	W = Wide Tongue		E = 20
	NF = Nylon Insulated	12 = #16 – 12		6 = #6	LF = Locking Fork	X = Expanded Insulation		Q = 25
	Funnel Entry	10 = #12 – 10		8 = #8	R = Ring	= Non-Expanded Insulation (leave blank)		L = 50
	V = Vinyl Insulated	8 = #8		10 = #10				C = 100
	= Non-Ins. (leave blank)	6 = #6		14 = 1/4"				T = 200
		4 = #4		56 = 5/16"				D = 500
		2 = #2		38 = 3/8"				M = 1000
		1 = #1		76 = 7/16"				
		1/0 = 1/0		12 = 1/2"				
		2/0 = 2/0						
		3/0 = 3/0						
		4/0 = 4/0						
		250 = 250kcmil						

■ KYNAR is a registered trademark of Atofina Chemicals, Inc.



Ring Terminal, Nylon Insulated

Type PN-R

- Ring tongue design assures a secure connection in high vibration applications
- Metal insulation grip sleeve crimps to wire insulation, providing protection to the crimp joint during high vibration applications
- Internal barrel serrations assure good wire contact and maximum tensile strength
- UL Flammability UL 94 HB, maximum insulation temperature 221°F (105°C)
- UL and CSA rated up to 600 V per UL 486A/B

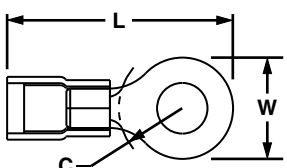

Part Number	Wire Range	Color Code	Stock Thickness (In.)	Max. Ins. (In.)	Stud Size	Figure Dimensions (In.)			Recommended Installation Tool	Std. Pkg. Qty.**	Std. Ctn. Qty.			
						L	W	C						
PN22-10R-C*	26 – 22 AWG	Yellow	0.02	0.090	#10	0.78	0.31	0.24	CT-600-A, CT-1525, CT-2500	100	1000			
PN18-4RN-C^	22 – 18 AWG	Red	0.03	0.145	#4	0.74	0.22	0.18	CT-100A‡, CT-600-A‡, CT-1550‡, CT-1551‡, CT-2500‡	100	500			
PN18-4R-C			0.03	0.145	#4	0.80	0.25	0.22		100	500			
PN18-6RN-C^			0.03	0.145	#6	0.77	0.22	0.18		100	500			
PN18-6R-C^			0.03	0.145	#6	0.80	0.25	0.22		100	500			
PN18-8R-C^			0.03	0.145	#8	0.86	0.31	0.25		100	500			
PN18-10R-C^			0.03	0.145	#10	0.88	0.31	0.25		100	500			
PN18-14R-C^			0.03	0.145	1/4"	1.09	0.45	0.38		100	500			
PN18-56R-C^			0.03	0.145	5/16"	1.09	0.46	0.38		100	500			
PN18-38R-C^			0.03	0.145	3/8"	1.17	0.53	0.43		100	500			
PN18-12R-L			0.03	0.145	1/2"	1.35	0.72	0.53		50	500			
PN14-4R-C^			18 – 14 AWG	Blue	0.03	0.162	#4	0.78		0.25	0.20	CT-100A‡, CT-600-A‡, CT-1550‡, CT-1551‡, CT-2500‡	100	500
PN14-6RN-C^					0.03	0.162	#6	0.76		0.25	0.20		100	500
PN14-6R-C^	0.03	0.162			#6	0.85	0.31	0.25	100	500				
PN14-8R-C^	0.03	0.162			#8	0.85	0.31	0.25	100	500				
PN14-10R-C^	0.03	0.162			#10	0.85	0.31	0.25	100	500				
PN14-14R-C^	0.03	0.162			1/4"	1.05	0.46	0.38	100	500				
PN14-56R-C^	0.03	0.162			5/16"	1.05	0.46	0.38	100	500				
PN14-38R-L^	0.03	0.162			3/8"	1.14	0.53	0.43	50	500				
PN14-12R-Q	0.03	0.162			1/2"	1.35	0.72	0.53	25	125				
PN10-6R-L^	12 – 10 AWG	Yellow			0.04	0.225	#6	1.06	0.37	0.31	CT-100A‡, CT-600-A‡, CT-1550‡, CT-1551‡, CT-2500‡		50	500
PN10-8R-L^					0.04	0.225	#8	1.06	0.37	0.31			50	500
PN10-10R-L^					0.04	0.225	#10	1.06	0.38	0.31			50	500
PN10-14R-L^			0.04	0.225	1/4"	1.21	0.52	0.38	50	500				
PN10-56R-L^			0.04	0.225	5/16"	1.21	0.52	0.38	50	500				
PN10-38R-L^			0.04	0.225	3/8"	1.29	0.58	0.43	50	500				
PN10-12R-Q			0.04	0.225	1/2"	1.47	0.72	0.53	25	125				

*Wire sizes #26-22 AWG, are not UL Listed or CSA Certified.
 **Bulk and/or convenience packaging may be available, contact Panduit® Customer Service for additional information.
 ^For military specification cross reference see page D1.65.
 ‡UL and CSA approved tooling/product combinations. For crimping tool information see www.panduit.com/tools.



Ring Terminal, Nylon Insulated – Funnel Entry

Type PNF-R

- Ring tongue design assures a secure connection in high vibration applications
- Metal insulation grip sleeve crimps to wire insulation, providing protection to the crimp joint during high vibration applications
- Internal barrel serrations assure good wire contact and maximum tensile strength
- UL Flammability UL 94 HB, maximum insulation temperature 221°F (105°C)
- UL and CSA rated up to 600 V per UL 486A/B

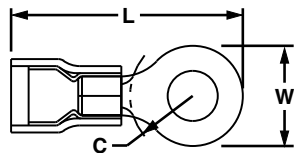

Part Number	Wire Range	Color Code	Stock Thickness (In.)	Max. Ins. (In.)	Stud Size	Figure Dimensions (In.)			Recommended Installation Tool	Std. Pkg. Qty.**	Std. Ctn. Qty.
						L	W	C			
PNF18-4R-C	22 – 18 AWG	Red	0.03	0.136	#4	0.77	0.25	0.20	CT-100A‡, CT-600-A‡, CT-1550‡, CT-1551‡, CT-2500‡	100	500
PNF18-6RN-C^			0.03	0.136	#6	0.76	0.22	0.18		100	500
PNF18-6R-C^			0.03	0.136	#6	0.77	0.25	0.20		100	500
PNF18-8R-C^			0.03	0.136	#8	0.87	0.31	0.24		100	500
PNF18-10R-C^			0.03	0.136	#10	0.87	0.32	0.25		100	500
PNF18-14R-C^			0.03	0.136	1/4"	1.08	0.46	0.38		100	500
PNF18-56R-C^			0.03	0.136	5/16"	1.08	0.46	0.39		100	500
PNF18-38R-C^			0.03	0.136	3/8"	1.16	0.53	0.41		100	500
PNF14-4R-C^			16 – 14 AWG	Blue	0.03	0.162	#4	0.78		0.25	0.18
PNF14-6RN-C^	0.03	0.162			#6	0.78	0.25	0.18	100	500	
PNF14-6R-C^	0.03	0.162			#6	0.87	0.31	0.24	100	500	
PNF14-8R-C^	0.03	0.162			#8	0.87	0.31	0.25	100	500	
PNF14-10R-C^	0.03	0.162			#10	0.85	0.31	0.29	100	500	
PNF14-14R-C^	0.03	0.162			1/4"	1.06	0.46	0.40	100	500	
PNF14-56R-C^	0.03	0.162			5/16"	1.06	0.46	0.40	100	500	
PNF14-38R-L^	0.03	0.162			3/8"	1.14	0.53	0.45	50	500	
PNF10-6R-L^	12 – 10 AWG	Yellow			0.04	0.225	#6	1.06	0.37	0.31	CT-100A‡, CT-600-A‡, CT-1550‡, CT-1551‡, CT-2500‡
PNF10-8R-L^			0.04	0.225	#8	1.06	0.37	0.31	50	500	
PNF10-10R-L^			0.04	0.225	#10	1.06	0.37	0.31	50	500	
PNF10-14R-L^			0.04	0.225	1/4"	1.21	0.52	0.38	50	500	
PNF10-56R-L^			0.04	0.225	5/16"	1.21	0.52	0.38	50	500	
PNF10-38R-L^			0.04	0.225	3/8"	1.29	0.58	0.43	50	500	

**Bulk and/or convenience packaging may be available, contact Panduit® Customer Service for additional information.

^For military specification cross reference see page D1.65.

‡UL and CSA approved tooling/product combinations. For crimping tool information see www.panduit.com/tools.



Ring Terminal, Nylon Insulated – Expanded Insulation

Type PN-RX

- Expanded wire entry designed to accommodate wire with a larger insulation thickness
- Ring tongue design assures a secure connection in high vibration applications
- Metal insulation grip sleeve crimps to wire insulation, providing protection to the crimp joint during high vibration applications
- Internal barrel serrations assure good wire contact and maximum tensile strength
- UL Flammability UL 94 HB, maximum insulation temperature 221°F (105°C)
- UL and CSA rated up to 600 V per UL 486A/B

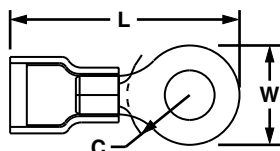

Part Number	Wire Range	Color Code	Stock Thickness (In.)	Max. Ins. (In.)	Stud Size	Figure Dimensions (In.)			Recommended Installation Tool	Std. Pkg. Qty.**	Std. Ctn. Qty.
						L	W	C			
PN14-6RX-C	16 – 14 AWG	Blue	0.03	0.200	#6	0.93	0.31	0.25	CT-100A‡, CT-600-A‡, CT-1550‡, CT-1551‡, CT-2500‡	100	500
PN14-8RX-C			0.03	0.200	#8	0.93	0.31	0.25			
PN14-10RX-C			0.03	0.200	#10	0.93	0.31	0.25			
PN14-14RX-L			0.03	0.200	1/4"	1.13	0.46	0.38			
PN10-6RX-L	12 – 10 AWG	Yellow	0.04	0.265	#6	1.13	0.37	0.33	CT-100A‡, CT-600-A‡, CT-1550‡, CT-1551‡, CT-2500‡	50	500
PN10-8RX-L			0.04	0.265	#8	1.13	0.37	0.33			
PN10-10RX-L			0.04	0.265	#10	1.13	0.37	0.33			
PN10-14RX-L			0.04	0.265	1/4"	1.27	0.52	0.42			
PN10-56RX-L			0.04	0.265	5/16"	1.27	0.52	0.42			
PN10-38RX-L			0.04	0.265	3/8"	1.35	0.58	0.46			

**Bulk and/or convenience packaging may be available, contact Panduit® Customer Service for additional information.
‡UL and CSA approved tooling/product combinations. For crimping tool information see www.panduit.com/tools.



Ring Terminal, Vinyl Insulated – Funnel Entry

Type PV-R

- Insulation support helps to prevent wire damage in bending applications
- Ring tongue design assures a secure connection in high vibration applications
- Brazed seam protects terminal barrel from splitting during the crimp process
- Internal barrel serrations assure good wire contact and maximum tensile strength
- UL Flammability UL 94V-0, maximum insulation temperature 221°F (105°C)
- UL and CSA rated up to 600 V per UL 486A/B

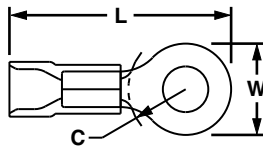

Part Number	Wire Range	Color Code	Stock Thickness (In.)	Max. Ins. (In.)	Stud Size	Figure Dimensions (In.)			Recommended Installation Tool	Std. Pkg. Qty.**	Std. Ctn. Qty.			
						L	W	C						
PV22-2R-CY*	26 – 22 AWG	Yellow	0.02	0.110	#2	0.68	0.21	0.18	CT-600-A, CT-1525, CT-2500	100	1000			
PV22-4R-CY*			0.02	0.110	#4	0.68	0.21	0.18		100	1000			
PV22-6R-CY*			0.02	0.110	#6	0.68	0.21	0.18		100	1000			
PV22-8R-CY*			0.02	0.110	#8	0.78	0.26	0.26		100	1000			
PV22-10R-CY*			0.02	0.110	#10	0.78	0.32	0.24		100	1000			
PV18-4R-CY	22 – 18 AWG	Red	0.03	0.150	#4	0.84	0.25	0.22	CT-100A‡, CT-600-A‡, CT-1550‡, CT-1551‡, CT-2500‡	100	500			
PV18-6R-CY			0.03	0.150	#6	0.86	0.25	0.22		100	500			
PV18-8R-CY			0.03	0.150	#8	0.91	0.31	0.26		100	500			
PV18-10R-CY			0.03	0.150	#10	0.94	0.31	0.27		100	500			
PV18-14R-CY			0.03	0.150	1/4"	1.11	0.46	0.37		100	500			
PV18-56R-CY			0.03	0.150	5/16"	1.11	0.46	0.39		100	500			
PV18-38R-LY			0.03	0.150	3/8"	1.19	0.53	0.42		50	500			
PV18-12R-LY			0.03	0.150	1/2"	1.42	0.72	0.53		50	500			
PV14-4R-C			16 – 14 AWG	Blue	0.03	0.170	#4	0.84		0.25	0.19	CT-100A‡, CT-600-A‡, CT-1550‡, CT-1551‡, CT-2500‡	100	500
PV14-6RN-C					0.03	0.170	#6	0.84		0.25	0.19		100	500
PV14-6R-C	0.03	0.170			#6	0.92	0.31	0.25	100	500				
PV14-8R-C	0.03	0.170			#8	0.92	0.31	0.25	100	500				
PV14-10R-C	0.03	0.170			#10	0.92	0.31	0.25	100	500				
PV14-14R-C	0.03	0.170			1/4"	1.12	0.46	0.38	100	500				
PV14-56R-C	0.03	0.170			5/16"	1.12	0.46	0.38	100	500				
PV14-38R-L	0.03	0.170			3/8"	1.21	0.53	0.43	50	500				
PV14-12R-L	0.03	0.170			1/2"	1.42	0.72	0.53	50	500				
PV10-6R-L	12 – 10 AWG	Yellow			0.04	0.225	#6	1.05	0.31	0.31	CT-100A‡, CT-600-A‡, CT-1550‡, CT-1551‡, CT-2500‡		50	500
PV10-8R-L			0.04	0.225	#8	1.05	0.31	0.31	50	500				
PV10-10R-L			0.04	0.225	#10	1.05	0.31	0.31	50	500				
PV10-14R-L			0.04	0.225	1/4"	1.23	0.52	0.38	50	500				
PV10-56R-L			0.04	0.225	5/16"	1.23	0.52	0.38	50	500				
PV10-38R-L			0.04	0.225	3/8"	1.31	0.58	0.41	50	500				
PV10-12R-Q			0.04	0.225	1/2"	1.46	0.72	0.53	25	250				

*Wire sizes #26 – 22 AWG, are not UL Listed or CSA Certified.

**Bulk and/or convenience packaging may be available, contact Panduit® Customer Service for additional information.

‡UL and CSA approved tooling/product combinations. For crimping tool information see www.panduit.com/tools.

B1.
Cable
Ties

B2.
Cable
Accessories

B3.
Stainless
Steel Cable
Ties &
Accessories

C1.
Wiring
Duct

C2.
Abrasion
Protection

C3.
Cable
Management

D1.
Terminals

D2.
Power
Connectors

D3.
Grounding
Connectors

E1.
Labeling
Systems

E2.
Labels

E3.
Pre-Printed
&
Write-On
Markers

E4.
Permanent
Identification

E5.
Industrial
Safety
Solutions

F.
Keystone
Cabling
Systems

G.
Part
Number
Index



Ring Terminal, Vinyl Expanded Insulation

Type PV-RX

- Expanded wire entry designed to accommodate wire with a larger insulation thickness
- Brazed seam protects terminal barrel from splitting during the crimp process
- Ring tongue design assures a secure connection in high vibration applications
- Internal barrel serrations assure good wire contact and maximum tensile strength
- Insulation support helps to prevent wire damage in bending applications
- UL Flammability UL 94V-0, maximum insulation temperature 221°F (105°C)
- UL and CSA rated up to 600 V per UL 486A/B

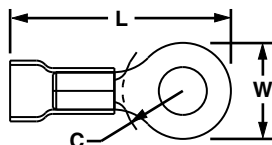

Part Number	Wire Range	Color Code	Stock Thickness (In.)	Max. Ins. (In.)	Stud Size	Figure Dimensions (In.)			Recommended Installation Tool	Std. Pkg. Qty.**	Std. Ctn. Qty.
						L	W	C			
PV18-4RX-CY	22 – 18 AWG	Red	0.03	0.170	#4	0.88	0.25	0.22	CT-100A‡, CT-600-A‡, CT-1550‡, CT-1551‡, CT-2500‡	100	500
PV18-6RX-CY			0.03	0.170	#6	0.89	0.25	0.22		100	500
PV18-8RX-CY			0.03	0.170	#8	0.97	0.31	0.27		100	500
PV18-10RX-CY			0.03	0.170	#10	0.96	0.31	0.27		100	500
PV18-14RX-CY			0.03	0.170	1/4"	1.17	0.46	0.40		100	500
PV18-56RX-LY			0.03	0.170	5/16"	1.17	0.46	0.40		50	500
PV18-38RX-LY			0.03	0.170	3/8"	1.25	0.53	0.45		50	500
PV14-4RX-C	16 – 14 AWG	Blue	0.03	0.200	#4	0.87	0.25	0.19	CT-100A‡, CT-600-A‡, CT-1550‡, CT-1551‡, CT-2500‡	100	500
PV14-6RX-C			0.03	0.200	#6	0.96	0.31	0.25		100	500
PV14-8RX-C			0.03	0.200	#8	0.96	0.31	0.25		100	500
PV14-10RX-C			0.03	0.200	#10	0.96	0.31	0.25		100	500
PV14-14RX-L			0.03	0.200	1/4"	1.16	0.46	0.37		50	500
PV14-56RX-L			0.03	0.200	5/16"	1.16	0.46	0.37		50	500
PV14-38RX-L			0.03	0.200	3/8"	1.25	0.53	0.42		50	500
PV10-6RX-L	12 – 10 AWG	Yellow	0.04	0.250	#6	1.10	0.31	0.30	CT-100A‡, CT-600-A‡, CT-1550‡, CT-1551‡, CT-2500‡	50	500
PV10-8RX-L			0.04	0.250	#8	1.10	0.31	0.30		50	500
PV10-10RX-L			0.04	0.250	#10	1.10	0.31	0.30		50	500
PV10-14RX-L			0.04	0.250	1/4"	1.29	0.52	0.39		50	500
PV10-56RX-L			0.04	0.250	5/16"	1.29	0.52	0.42		50	500
PV10-38RX-L			0.04	0.250	3/8"	1.39	0.58	0.46		50	500

**Bulk and/or convenience packaging may be available, contact Panduit® Customer Service for additional information.
 ‡UL and CSA approved tooling/product combinations. For crimping tool information see www.panduit.com/tools.



Ring Terminal, KYNAR[®] Insulated

Type PK-R

- For nuclear containment areas and high temperature to 300°F (150°C) applications
- Color code: natural with appropriate color stripe to identify wire range
- Ring tongue design assures a secure connection in high vibration applications
- UL and CSA rated up to 600 V per UL 486A/B

Note: For PK18 – PK10 Terminals the following applies:

- Classified as Class 1E in accordance with IEEE 323-2003
- Metal insulation grip sleeve crimps to wire insulation, providing protection to the crimp joint during high vibration applications

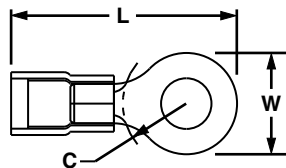

Part Number	Wire Range	Color Code	Stock Thickness (In.)	Max. Ins. (In.)	Stud Size	Figure Dimensions (In.)			Recommended Installation Tool	Std. Pkg. Qty.**	Std. Ctn. Qty.
						L	W	C			
PK18-4R-C	22 – 16 AWG	Red Stripe	0.03	0.145	#4	0.80	0.25	0.22	CT-100A, CT-600-A‡, CT-1550‡, CT-1551‡, CT-2500‡	100	500
PK18-6R-C			0.03	0.145	#6	0.80	0.25	0.22		100	500
PK18-8R-C			0.03	0.145	#8	0.89	0.31	0.29		100	500
PK18-10R-C			0.03	0.145	#10	0.89	0.31	0.29		100	500
PK18-14R-C			0.03	0.145	1/4"	1.10	0.46	0.40		100	500
PK18-38R-C			0.03	0.145	3/8"	1.18	0.53	0.45		100	500
PK14-4R-C	18 – 14 AWG	Blue Stripe	0.03	0.162	#4	0.78	0.25	0.22	CT-100A, CT-600-A‡, CT-1550‡, CT-1551‡, CT-2500‡	100	500
PK14-6R-C			0.03	0.162	#6	0.87	0.31	0.29		100	500
PK14-8R-C			0.03	0.162	#8	0.87	0.31	0.29		100	500
PK14-10R-C			0.03	0.162	#10	0.87	0.31	0.29		100	500
PK14-14R-C			0.03	0.162	1/4"	1.08	0.46	0.40		100	500
PK14-38R-C			0.03	0.162	3/8"	1.15	0.53	0.43		100	500
PK14-56R-C	0.03	0.162	5/16"	1.08	0.46	0.40	100	500			
PK10-6R-L	12 – 10 AWG	Yellow Stripe	0.04	0.225	#6	1.06	0.37	0.33	CT-100A, CT-600-A‡, CT-1550‡, CT-1551‡, CT-2500‡	50	500
PK10-8R-L			0.04	0.225	#8	1.06	0.37	0.33		50	500
PK10-10R-L			0.04	0.225	#10	1.06	0.37	0.33		50	500
PK10-14R-L			0.04	0.225	1/4"	1.25	0.38	0.42		50	500
PK10-38R-Q	0.04	0.225	3/8"	1.34	0.58	0.42	25	125			

Large Wire, KYNAR[®] Insulated

PK8-8R-T	8 AWG	Red Stripe	0.04	0.326	#8	1.50	0.42	0.43	CT-2600, CD-2600-PV8	200	1200
PK8-10R-T			0.04	0.326	#10	1.52	0.47	0.43		200	1200
PK8-14R-T			0.04	0.326	1/4"	1.52	0.47	0.43		200	1200
PK8-56R-T			0.04	0.326	5/16"	1.63	0.59	0.51		200	1200
PK8-38R-T			0.04	0.326	3/8"	1.63	0.59	0.51		200	1200
PK8-12R-T			0.04	0.326	1/2"	1.73	0.82	0.51		200	1200
PK6-8R-T	6 AWG	Blue Stripe	0.05	0.360	#8	1.59	0.47	0.43	CT-2600, CD-2600-PV6	200	1200
PK6-10R-T			0.05	0.360	#10	1.60	0.47	0.43		200	1200
PK6-14R-T			0.05	0.360	1/4"	1.63	0.47	0.48		200	1200
PK6-56R-T			0.05	0.360	5/16"	1.72	0.62	0.53		200	1200
PK6-38R-T			0.05	0.360	3/8"	1.72	0.62	0.51		200	1200
PK6-12R-T			0.05	0.360	1/2"	1.82	0.82	0.51		200	1200
PK4-10R-T	4 AWG	Yellow Stripe	0.05	0.450	#10	1.86	0.55	0.50	CT-2600, CD-2600-PV4	200	1200
PK4-14R-T			0.05	0.450	1/4"	1.86	0.55	0.50		200	1200
PK4-56R-T			0.05	0.450	5/16"	1.93	0.68	0.50		200	1200
PK4-38R-T			0.05	0.450	3/8"	1.93	0.68	0.50		200	1200
PK4-12R-T	0.05	0.450	1/2"	2.02	0.86	0.50	200	1200			
PK2-14R-T	2 AWG	Red Stripe	0.06	0.550	1/4"	1.95	0.68	0.58	CT-2600, CD-2600-PV2	200	1200
PK2-56R-T			0.06	0.550	5/16"	1.95	0.68	0.58		200	1200
PK2-38R-T			0.06	0.550	3/8"	1.95	0.68	0.58		200	1200
PK4-12R-T			0.06	0.550	1/2"	2.04	0.86	0.58		200	1200

■ KYNAR is a registered trademark of Atofina Chemicals, Inc.

‡UL approved tooling/product combinations. For crimping tool information see www.panduit.com/tools.

B1. Cable Ties

B2. Cable Accessories

B3. Stainless Steel Cable Ties & Accessories

C1. Wiring Duct

C2. Abrasion Protection

C3. Cable Management

D1. Terminals

D2. Power Connectors

D3. Grounding Connectors

E1. Labeling Systems

E2. Labels

E3. Pre-Printed & Write-On Markers

E4. Permanent Identification

E5. Industrial Safety Solutions

F. Keystone Cabling Systems

G. Part Number Index

UL LISTED CERTIFIED SR Heat Shrink, Ring Terminal

Type PH-R

- Heat shrink sleeving forms a protective barrier to provide environmentally sealed terminations ideal for high moisture applications
- Ring tongue design assures a secure connection in high vibration applications
- Brazed seam protects terminal barrel from splitting during the crimp process
- Heat shrink installation is completed with a standard heat gun
- Minimum continuous operating temperature -65°F (-55°C)
- Maximum continuous operation temperature 230°F (110°C)
- Shrink temperature 300°F (150°C)
- UL and CSA rated up to 600 V per UL 486A/B



Part Number	Wire Range	Color Code	Max. Ins. (In.)	Stud Size	Figure Dimensions (In.)		Wire Strip Length (In.)	Recommended Installation Tool	Std. Pkg. Qty.	Std. Ctn. Qty.
					L	W				
PH18-6R-Q	22 – 18 AWG	Red	0.170	#6	1.05	0.25	5/16	CT-310	25	125
PH18-8R-Q			0.170	#8	1.08	0.31	5/16		25	125
PH18-10R-Q			0.170	#10	1.08	0.31	5/16		25	125
PH18-14R-Q			0.170	1/4"	1.24	0.47	5/16		25	125
PH14-6R-Q	16 – 14 AWG	Blue	0.200	#6	1.06	0.31	5/16	CT-310	25	125
PH14-8R-Q			0.200	#8	1.03	0.31	5/16		25	125
PH14-10R-Q			0.200	#10	1.05	0.32	5/16		25	125
PH14-14R-Q			0.200	1/4"	1.24	0.46	5/16		25	125
PH14-56R-Q			0.200	5/16"	1.24	0.46	5/16		25	125
PH14-38R-Q			0.200	3/8"	1.24	0.53	5/16		25	125
PH10-8R-E	12 – 10 AWG	Yellow	0.240	#8	1.22	0.37	5/16	CT-310	20	100
PH10-10R-E			0.240	#10	1.20	0.37	5/16		20	100
PH10-14R-E			0.240	1/4"	1.20	0.52	5/16		20	100
PH10-38R-E			0.240	3/8"	1.20	0.59	5/16		20	100
PH10-12R-E			0.240	1/2"	1.54	0.72	5/16		20	100

UL LISTED CERTIFIED SR Ring Terminal, Heavy Duty, Nylon Insulated

Type PN-HDR

- Manufactured from stock 56% thicker than a standard #16 – #14 AWG terminal for use in heavy-duty applications
- Insulation housing is marked with "HDR" to signify heavy-duty ring
- Ring tongue design assures a secure connection in high vibration applications
- Metal insulation grip sleeve crimps to wire insulation, providing protection to the crimp joint during high vibration applications
- Internal barrel serrations assure good wire contact and maximum tensile strength
- UL Flammability UL 94 HB, maximum insulation temperature 221°F (105°C)
- UL and CSA rated up to 600 V per UL 486A/B

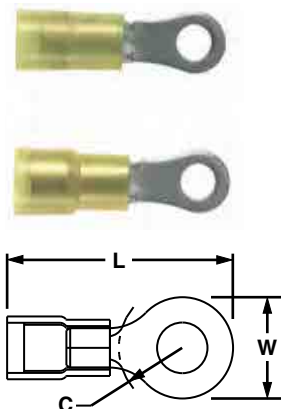

Part Number	Wire Range	Color Code	Stock Thickness (In.)	Max. Ins. (In.)	Stud Size	Figure Dimensions (In.)			Recommended Installation Tool	Std. Pkg. Qty.**	Std. Ctn. Qty.
						L	W	C			
PN12-8HDR-L	16 – 12 AWG	Yellow	0.05	0.225	#8	1.06	0.31	0.35	CT-1550‡, CT-1551‡, CT-2500‡	50	500
PN12-10HDR-L			0.05	0.225	#10	1.09	0.37	0.33		50	500
PN12-14HDR-L			0.05	0.225	1/4"	1.24	0.52	0.42		50	500
PN12-56HDR-L			0.05	0.225	5/16"	1.24	0.52	0.42		50	500
PN12-38HDR-L			0.05	0.225	3/8"	1.30	0.58	0.46		50	500

**Bulk packaging may be available, contact Panduit Customer Service for additional information.

‡UL and CSA approved tooling/product combinations. For crimping tool information see www.panduit.com/tools.



Ring Terminal, Heavy Duty, Vinyl Insulated – Funnel Entry

Type PV-HDR

- Manufactured from stock 56% thicker than a standard #16 – 14 AWG terminal for use in heavy-duty applications
- Insulation housing is marked with “HDR” to signify heavy-duty ring
- Ring tongue design assures a secure connection in high vibration applications
- Insulation support helps to prevent wire damage in bending applications
- Brazed seam protects terminal barrel from splitting during the crimp process
- Internal barrel serrations assure good wire contact and maximum tensile strength
- UL Flammability UL 94V-0, maximum insulation temperature 221°F (105°C)
- UL and CSA rated up to 600 V per UL 486A/B

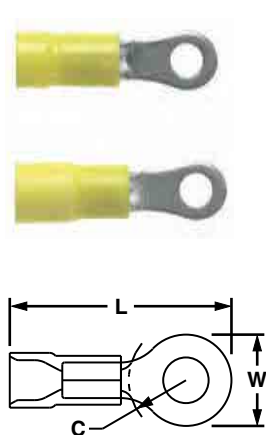

Part Number	Wire Range	Color Code	Stock Thickness (In.)	Max. Ins. (In.)	Stud Size	Figure Dimensions (In.)			Recommended Installation Tool	Std. Pkg. Qty.**	Std. Ctn. Qty.
						L	W	C			
Standard Heavy Duty Insulation											
PV12-6HDR-L	16 – 12 AWG	Yellow	0.05	0.225	#6	1.05	0.31	0.35	CT-600-A‡, CT-1550‡, CT-1551‡, CT-2500‡	50	500
PV12-8HDR-L			0.05	0.225	#8	1.05	0.31	0.35		50	500
PV12-10HDR-L			0.05	0.225	#10	1.08	0.37	0.33		50	500
PV12-14HDR-L			0.05	0.225	1/4"	1.23	0.52	0.42		50	500
PV12-56HDR-L			0.05	0.225	5/16"	1.23	0.52	0.42		50	500
PV12-38HDR-L			0.05	0.225	3/8"	1.31	0.58	0.46		50	500
Expanded Heavy Duty Insulation*											
PV12-6HDRX-L	16 – 12 AWG	Yellow	0.05	0.250	#6	1.05	0.31	0.35	CT-600-A‡, CT-1550‡, CT-1551‡, CT-2500‡	50	500
PV12-8HDRX-L			0.05	0.250	#8	1.05	0.31	0.35		50	500
PV12-10HDRX-L			0.05	0.250	#10	1.08	0.37	0.33		50	500
PV12-14HDRX-L			0.05	0.250	1/4"	1.23	0.52	0.42		50	500
PV12-56HDRX-L			0.05	0.250	5/16"	1.23	0.52	0.42		50	500
PV12-38HDRX-L			0.05	0.250	3/8"	1.31	0.58	0.46		50	500

*Expanded insulation parts do not have funnel entry.

**Bulk packaging may be available, contact Panduit® Customer Service for additional information.

‡UL and CSA approved tooling/product combinations. For crimping tool information see www.panduit.com/tools.

B1.
Cable
Ties

B2.
Cable
Accessories

B3.
Stainless
Steel Cable
Ties &
Accessories

C1.
Wiring
Duct

C2.
Abrasion
Protection

C3.
Cable
Management

D1.
Terminals

D2.
Power
Connectors

D3.
Grounding
Connectors

E1.
Labeling
Systems

E2.
Labels

E3.
Pre-Printed
&
Write-On
Markers

E4.
Permanent
Identification

E5.
Industrial
Safety
Solutions

F.
Keystone
Cabling
Systems

G.
Part
Number
Index

cULus LISTED Ring Terminal, Large Wire, Vinyl Insulated

Type PV-R

- Ring tongue design assures a secure connection in high vibration applications
- Insulation support helps to prevent wire damage in bending applications
- Brazed seam protects terminal barrel from splitting during the crimp process
- Internal barrel serrations assure good wire contact and maximum tensile strength
- UL Flammability UL 94V-0, maximum insulation temperature 221°F (105°C)
- UL rated up to 600 V per UL 486A/B

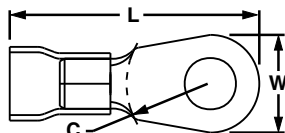
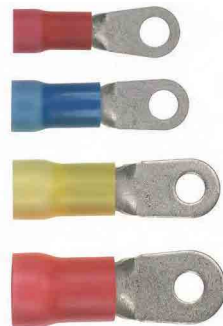

Part Number	Wire Range	Color Code	Stock Thickness (In.)	Max. Ins. (In.)	Stud Size	Figure Dimensions (In.)			Recommended Installation Tool	Std. Pkg. Qty.**	Std. Ctn. Qty.
						L	W	C			
PV8-8R-QY	8 AWG	Red	0.04	0.280	#8	1.51	0.42	0.43	CT-720, CD-720PV8-2‡, CT-2600, CD-2600-PV8‡	25	250
PV8-8RN-Q			0.04	0.280	#8	1.48	0.36	0.43		25	250
PV8-10R-QY			0.04	0.280	#10	1.53	0.47	0.43		25	250
PV8-14R-QY			0.04	0.280	1/4"	1.53	0.47	0.43		25	250
PV8-56R-QY			0.04	0.280	5/16"	1.64	0.59	0.49		25	250
PV8-38R-QY			0.04	0.280	3/8"	1.64	0.59	0.51		25	250
PV8-12R-XY			0.04	0.280	1/2"	1.74	0.82	0.51		10	100
PV6-8R-E	6 AWG	Blue	0.05	0.340	#8	1.61	0.47	0.43	CT-720, CD-720PV8-2‡, CT-2600, CD-2600-PV6‡	20	200
PV6-10R-X			0.05	0.340	#10	1.62	0.47	0.43		10	100
PV6-14R-X			0.05	0.340	1/4"	1.65	0.47	0.48		10	100
PV6-56R-X			0.05	0.340	5/16"	1.74	0.62	0.53		10	100
PV6-38R-X			0.05	0.340	3/8"	1.74	0.62	0.51		10	100
PV6-12R-X			0.05	0.340	1/2"	1.84	0.82	0.51		10	100
PV4-10R-E			4 AWG	Yellow	0.05	0.450	#10	1.88		0.55	0.50
PV4-14R-E	0.05	0.450			1/4"	1.88	0.55	0.50	20	200	
PV4-56R-E	0.05	0.450			5/16"	1.95	0.68	0.50	20	200	
PV4-38R-E	0.05	0.450			3/8"	1.95	0.68	0.50	20	200	
PV4-12R-E	0.05	0.450			1/2"	2.04	0.86	0.50	20	200	
PV2-10R-XY	2 AWG	Red	0.06	0.560	#10	1.96	0.68	0.58	CT-720, CD-720PV8-2‡, CT-2600, CD-2600-PV2‡	10	100
PV2-14R-XY			0.06	0.560	1/4"	1.96	0.68	0.58		10	100
PV2-56R-XY			0.06	0.560	5/16"	1.96	0.68	0.58		10	100
PV2-38R-XY			0.06	0.560	3/8"	1.96	0.68	0.58		10	100
PV2-12R-XY			0.06	0.560	1/2"	2.05	0.86	0.58		10	100

**Bulk packaging may be available, contact Panduit® Customer Service for additional information.
‡UL approved tooling/product combinations. For crimping tool information see www.panduit.com/tools.



Ring Terminal, Large Wire, Vinyl Expanded Insulation

Type PV-RX

- Ring tongue design assures a secure connection in high vibration applications
- Expanded wire entry designed to accommodate wire with a larger insulation thickness
- Insulation support helps to prevent wire damage in bending applications
- Brazed seam protects terminal barrel from splitting during the crimp process
- Internal barrel serrations assure good wire contact and maximum tensile strength
- UL Flammability UL 94V-0, maximum insulation temperature 221°F (105°C)
- UL rated up to 600 V per UL 486A/B

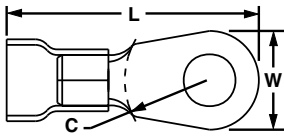
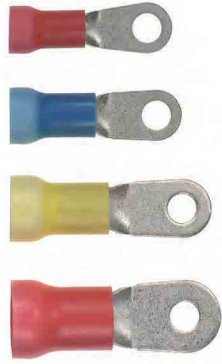

Part Number	Wire Range	Color Code	Stock Thickness (In.)	Max. Ins. (In.)	Stud Size	Figure Dimensions (In.)			Recommended Installation Tool	Std. Pkg. Qty.**	Std. Ctn. Qty.
						L	W	C			
PV8-8RX-QY	8 AWG	Red	0.04	0.360	#8	1.50	0.42	0.43	CT-720, CD-720PV8-2‡, CT-2600, CD-2600-PV8‡	25	250
PV8-10RX-QY			0.04	0.360	#10	1.52	0.47	0.43		25	250
PV8-14RX-QY			0.04	0.360	1/4"	1.52	0.47	0.43		25	250
PV8-56RX-QY			0.04	0.360	5/16"	1.62	0.59	0.51		25	250
PV8-38RX-QY			0.04	0.360	3/8"	1.62	0.59	0.51		25	250
PV8-12RX-XY			0.04	0.360	1/2"	1.74	0.82	0.51		10	100
PV6-8RX-E			6 AWG	Blue	0.05	0.436	#8	1.61		0.47	0.43
PV6-10RX-X	0.05	0.436			#10	1.61	0.47	0.51	10	100	
PV6-14RX-X	0.05	0.436			1/4"	1.61	0.47	0.51	10	100	
PV6-56RX-X	0.05	0.436			5/16"	1.73	0.62	0.51	10	100	
PV6-38RX-X	0.05	0.436			3/8"	1.73	0.62	0.53	10	100	
PV4-10RX-E	4 AWG	Yellow	0.05	0.515	#10	1.87	0.55	0.53	CT-720, CD-720PV8-2‡, CT-2600, CD-2600-PV4‡	20	200
PV4-14RX-E			0.05	0.515	1/4"	1.87	0.55	0.53		20	200
PV4-56RX-E			0.05	0.515	5/16"	1.94	0.68	0.53		20	200
PV4-38RX-E			0.05	0.515	3/8"	1.94	0.68	0.53		20	200
PV4-12RX-E			0.05	0.515	1/2"	2.03	0.86	0.53	20	200	
PV2-10RX-XY	2 AWG	Red	0.06	0.632	#10	1.94	0.68	0.58	CT-720, CD-720PV8-2‡, CT-2600, CD-2600-PV2‡	10	100
PV2-14RX-XY			0.06	0.632	1/4"	1.94	0.68	0.58		10	100
PV2-56RX-XY			0.06	0.632	5/16"	1.94	0.68	0.58		10	100
PV2-38RX-XY			0.06	0.632	3/8"	1.94	0.68	0.58		10	100
PV2-12RX-XY			0.06	0.632	1/2"	2.03	0.86	0.58		10	100

**Bulk packaging may be available, contact Panduit® Customer Service for additional information.

‡UL approved tooling/product combinations. For crimping tool information see www.panduit.com/tools.

B1.
Cable
Ties

B2.
Cable
Accessories

B3.
Stainless
Steel Cable
Ties &
Accessories

C1.
Wiring
Duct

C2.
Abrasion
Protection

C3.
Cable
Management

D1.
Terminals

D2.
Power
Connectors

D3.
Grounding
Connectors

E1.
Labeling
Systems

E2.
Labels

E3.
Pre-Printed
&
Write-On
Markers

E4.
Permanent
Identification

E5.
Industrial
Safety
Solutions

F.
Keystone
Cabling
Systems

G.
Part
Number
Index



Ring Terminal, Non-Insulated

Type P-R

- Ring tongue design assures a secure connection in high vibration applications
- Internal barrel serrations assure good wire contact and maximum tensile strength
- Brazed seam protects terminal barrel from splitting during the crimp process
- Barrel of terminal internally beveled to provide quick and easy wire insertion
- Maximum recommended operating temperature 302°F (150°C)
- UL and CSA rated up to 2000 V per UL 486A/B

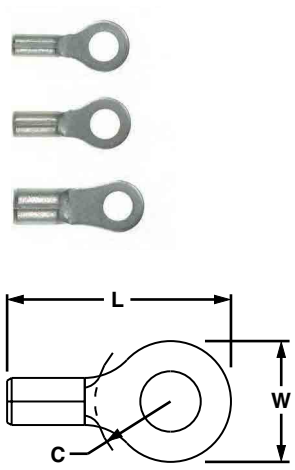

Part Number	Wire Range	Stock Thickness (In.)	Stud Size	Figure Dimensions (In.)			Recommended Installation Tool	Std. Pkg. Qty.**	Std. Ctn. Qty.		
				L	W	C					
P22-2R-C*	26 – 22 AWG	0.02	#2	0.52	0.20	0.16	CT-200 CT-100A PKT B	100	1000		
P22-4R-C*		0.02	#4	0.52	0.20	0.16		100	1000		
P22-6R-C*		0.02	#6	0.52	0.20	0.16		100	1000		
P22-8R-C*		0.02	#8	0.63	0.26	0.25		100	1000		
P22-10R-C*		0.02	#10	0.63	0.31	0.22		100	1000		
P18-4R-C	22 – 16 AWG	0.03	#4	0.62	0.25	0.21	CT-100A‡, CT-200‡, CT-600-A‡, CT-1570‡, CT-2500‡	100	1000		
P18-6RN-C		0.03	#6	0.60	0.22	0.19		100	1000		
P18-6R-C		0.03	#6	0.62	0.25	0.21		100	1000		
P18-8R-C		0.03	#8	0.71	0.31	0.25		100	1000		
P18-10R-C		0.03	#10	0.71	0.31	0.25		100	1000		
P18-14R-C		0.03	1/4"	0.91	0.46	0.38		100	1000		
P18-56R-C		0.03	5/16"	0.91	0.46	0.38		100	1000		
P18-38R-C		0.03	3/8"	1.0	0.53	0.43		100	1000		
P18-12R-C		0.03	1/2"	1.20	0.72	0.53		100	1000		
P14-4R-C		18 – 14 AWG	0.03	#4	0.62	0.25		0.20	CT-100A‡, CT-200‡, CT-600-A‡, CT-1570‡, CT-2500‡	100	1000
P14-6R-C	0.03		#6	0.62	0.25	0.20	100	1000			
P14-8R-C	0.03		#8	0.71	0.31	0.25	100	1000			
P14-10R-C	0.03		#10	0.71	0.31	0.25	100	1000			
P14-14R-C	0.03		1/4"	0.91	0.46	0.38	100	1000			
P14-56R-C	0.03		5/16"	0.91	0.46	0.38	100	1000			
P14-38R-C	0.03		3/8"	1.0	0.53	0.43	100	1000			
P14-12R-L	0.03		1/2"	1.20	0.72	0.53	50	500			
P10-6R-L^	14 – 10 AWG		0.04	#6	0.78	0.31	0.31	CT-100A‡, CT-200‡, CT-600-A‡, CT-1570‡, CT-1701‡, CT-2500‡		50	500
P10-8R-L			0.04	#8	0.78	0.31	0.31			50	500
P10-10R-L^		0.04	#10	0.81	0.38	0.31	50		500		
P10-14R-L		0.04	1/4"	0.96	0.52	0.38	50		500		
P10-56R-L^		0.04	5/16"	0.95	0.52	0.38	50		500		
P10-38R-L^		0.04	3/8"	1.05	0.58	0.44	50		500		
P10-12R-L		0.04	1/2"	1.20	0.72	0.53	50		500		

*Wire sizes #26 – 22 AWG are not UL Listed or CSA Certified.
 **Bulk packaging may be available, contact Panduit® Customer Service for additional information.
 ^For military specification cross reference see page D1.65.
 ‡UL and CSA approved tooling/product combinations. For crimping tool information see www.panduit.com/tools.



Ring Terminal, Non-Insulated – High Temperature

Type P-RHT

- Ring tongue design assures a secure connection in high vibration applications
- Nickel plated copper for temperatures up to 650°F (343°C)
- Internal barrel serrations assure good wire contact and maximum tensile strength
- Brazed seam protects terminal barrel from splitting during the crimp process
- Barrel of terminal internally beveled to provide quick and easy wire insertion
- Rated up to 2000 V



Part Number	Wire Range	Stock Thickness (In.)	Stud Size	Figure Dimensions (In.)			Recommended Installation Tool	Std. Pkg. Qty.**	Std. Ctn. Qty.
				L	W	C			
P18-6RHT6-C	22 – 16 AWG	0.03	#6	0.62	0.25	0.21	CT-100A, CT-200, CT-600-A, CT-1570, CT-2500	100	1000
P18-8RHT6-C		0.03	#8	0.71	0.31	0.25		100	1000
P18-10RHT6-C		0.03	#10	0.71	0.31	0.25		100	1000
P14-6RHT6-C	18 – 14 AWG	0.03	#6	0.62	0.25	0.20	CT-100A, CT-200, CT-600-A, CT-1570, CT-2500	100	1000
P14-8RHT6-C		0.03	#8	0.71	0.31	0.25		100	1000
P14-10RHT6-C		0.03	#10	0.71	0.31	0.25		100	1000
P10-6RHT6-L	12 – 10 AWG	0.04	#6	0.78	0.31	0.35	CT-100A, CT-200, CT-600-A, CT-1570, CT-1701, CT-2500	50	500
P10-8RHT6-L		0.04	#8	0.78	0.31	0.35		50	500
P10-10RHT6-L		0.04	#10	0.81	0.38	0.33		50	500
P10-14RHT6-L		0.04	1/4"	0.96	0.53	0.42		50	500

Large Wire, Non-Insulated – High Temperature

P8-8RHT6-Q	8 AWG	0.04	#8	1.12	0.42	0.43	CT-2600, CD-2600-P8	25	250
P8-8RNHT6-Q		0.04	#8	1.09	0.36	0.43		25	250
P8-10RHT6-Q		0.04	#10	1.14	0.42	0.43		25	250
P8-10RNHT6-Q		0.04	#10	1.09	0.36	0.43		25	250
P8-14RHT6-Q		0.04	1/4"	1.14	0.47	0.43		25	250
P8-56RHT6-Q		0.04	5/16"	1.25	0.59	0.51		25	250
P8-38RHT6-Q		0.04	3/8"	1.25	0.59	0.51		25	250
P8-12RHT6-Q		0.04	1/2"	1.36	0.82	0.54		25	250
P6-8RHT6-E	6 AWG	0.05	#8	1.21	0.47	0.43	CT-2600, CD-2600-P6	20	200
P6-10RHT6-E		0.05	#10	1.21	0.47	0.43		20	200
P6-14RHT6-E		0.05	1/4"	1.21	0.47	0.43		20	200
P6-56RHT6-E		0.05	5/16"	1.33	0.62	0.51		20	200
P6-38RHT6-E		0.05	3/8"	1.33	0.62	0.51		20	200
P6-12RHT6-E		0.05	1/2"	1.43	0.82	0.51		20	200
P4-10RHT6-E	4 AWG	0.05	#10	1.40	0.55	0.50	CT-2600, CD-2600-P4	20	200
P4-14RHT6-E		0.05	1/4"	1.40	0.55	0.50		20	200
P4-56RHT6-E		0.05	5/16"	1.46	0.68	0.50		20	200
P4-38RHT6-E		0.05	3/8"	1.46	0.68	0.50		20	200
P4-12RHT6-E	2 AWG	0.05	1/2"	1.55	0.86	0.53	CT-2600, CD-2600-P2	20	200
P2-10RHT6-X		0.06	#10	1.46	0.68	0.58		10	100
P2-14RHT6-X		0.06	1/4"	1.46	0.68	0.58		10	100
P2-56RHT6-X		0.06	5/16"	1.46	0.68	0.58		10	100
P2-38RHT6-X		0.06	3/8"	1.46	0.68	0.58		10	100
P2-12RHT6-X		0.06	1/2"	1.55	0.86	0.58		10	100

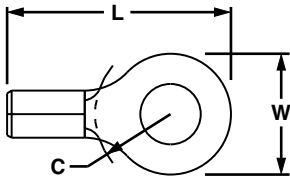

**Bulk packaging may be available, contact Panduit® Customer Service for additional information.



Ring Terminal, Heavy Duty Non-Insulated

Type P-HDR

- Ring tongue design assures a secure connection in high vibration applications
- Manufactured from stock 56% thicker than a standard #16 – 14 AWG terminal for use in heavy-duty applications
- Internal barrel serrations assure good wire contact and maximum tensile strength
- Brazed seam protects terminal barrel from splitting during the crimp process
- Barrel of terminal internally beveled to provide quick and easy wire insertion
- Maximum recommended operating temperature 302°F (150°C)
- UL and CSA rated up to 2000 V per UL 486A/B

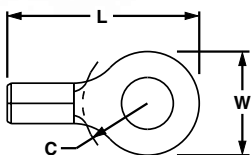

Part Number	Wire Range	Stock Thickness (In.)	Stud Size	Figure Dimensions (In.)			Recommended Installation Tool	Std. Pkg. Qty.**	Std. Ctn. Qty.
				L	W	C			
P12-6HDR-L	16 – 12 AWG	0.05	#6	0.78	0.31	0.36	CT-100A, CT-200, CT-1570‡, CT-2500‡	50	500
P12-8HDR-L		0.05	#8	0.78	0.31	0.36		50	500
P12-10HDR-L		0.05	#10	0.81	0.37	0.36		50	500
P12-14HDR-L		0.05	1/4"	0.96	0.52	0.43		50	500
P12-56HDR-L		0.05	5/16"	0.96	0.52	0.43		50	500
P12-38HDR-L		0.05	3/8"	1.04	0.58	0.48		50	500

**Bulk packaging may be available, contact Panduit® Customer Service for additional information.
 ‡UL and CSA approved tooling/product combinations. For crimping tool information see www.panduit.com/tools.



Ring Terminal, Large Wire Non-Insulated

Type P-R

- Designed for use with #8 - #2 AWG copper wire
- Ring tongue design assures a secure connection in high vibration applications
- Internal barrel serrations assure good wire contact and maximum tensile strength
- Brazed seam protects terminal barrel from splitting during the crimp process
- Barrel of terminal internally beveled to provide quick and easy wire insertion
- Maximum recommended operating temperature 302°F (150°C)
- UL and CSA rated up to 2000 V per UL 486A/B

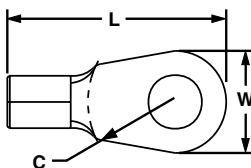

Part Number	Wire Range	Stock Thickness (In.)	Stud Size	Figure Dimensions (In.)			Recommended Installation Tool	Std. Pkg. Qty.**	Std. Ctn. Qty.
				L	W	C			
P8-8R-Q	8 AWG	0.04	#8	1.12	0.42	0.43	CT-1701‡, CT-2600, CD-2600-P8‡	25	250
P8-8RN-Q		0.04	#8	1.09	0.36	0.43		25	250
P8-10R-Q		0.04	#10	1.14	0.47	0.43		25	250
P8-14R-Q		0.04	1/4"	1.14	0.47	0.43		25	250
P8-56R-Q		0.04	5/16"	1.25	0.59	0.51		25	250
P8-38R-Q		0.04	3/8"	1.25	0.59	0.51		25	250
P8-12R-Q	6 AWG	0.04	1/2"	1.36	0.82	0.54	CT-1701‡, CT-2600, CD-2600-P6‡	25	250
P6-8R-E		0.05	#8	1.21	0.47	0.43		20	200
P6-10R-E		0.05	#10	1.21	0.47	0.43		20	200
P6-14R-E		0.05	1/4"	1.21	0.47	0.43		20	200
P6-56R-E		0.05	5/16"	1.33	0.62	0.51		20	200
P6-38R-E		0.05	3/8"	1.33	0.62	0.51		20	200
P6-12R-E	4 AWG	0.05	1/2"	1.43	0.82	0.51	CT-1701‡, CT-2600, CD-2600-P4‡	20	200
P4-10R-E		0.05	#10	1.40	0.55	0.50		20	200
P4-14R-E		0.05	1/4"	1.40	0.55	0.50		20	200
P4-56R-E		0.05	5/16"	1.46	0.68	0.50		20	200
P4-38R-E		0.05	3/8"	1.46	0.68	0.50		20	200
P4-12R-E		0.05	1/2"	1.55	0.86	0.53		20	200
P2-10R-X	2 AWG	0.06	#10	1.46	0.68	0.58	CT-1701‡, CT-2600, CD-2600-P2‡	10	100
P2-14R-X		0.06	1/4"	1.46	0.68	0.58		10	100
P2-56R-X		0.06	5/16"	1.46	0.68	0.58		10	100
P2-38R-X		0.06	3/8"	1.46	0.68	0.58		10	100
P2-12R-X*		0.06	1/2"	1.55	0.86	0.58		10	100

*Not CSA Certified.
 **Bulk packaging may be available, contact Panduit Customer Service for additional information.
 ‡UL and CSA approved tooling/product combinations. For crimping tool information see www.panduit.com/tools.



Fork Terminal, Nylon Insulated

Type PN-F

- Fork design provides for fast and easy installation, without the need to remove fastener
- Metal insulation grip sleeve crimps to wire insulation, providing protection to the crimp joint during high vibration applications
- Internal barrel serrations assure good wire contact and maximum tensile strength
- UL Flammability UL 94 HB, maximum insulation temperature 221°F (105°C)
- UL and CSA rated up to 600 V per UL 486A/B



Part Number	Wire Range	Color Code	Stock Thickness (In.)	Max. Ins. (In.)	Stud Size	Figure Dimensions (In.)			Recommended Installation Tool	Std. Pkg. Qty.**	Std. Ctn. Qty.
						L	W	C			
PN22-4F-C*	26 – 22 AWG	Yellow	0.02	0.090	#4	0.67	0.20	0.21	CT-600-A, CT-1525, CT-2500	100	1000
PN22-6F-C*			0.02	0.090	#6	0.77	0.25	0.26			
PN18-6FN-C***	22 – 18 AWG	Red	0.03	0.145	#6	0.78	0.24	0.20	CT-100A‡, CT-600-A‡, CT-1550‡, CT-1551‡, CT-2500‡	100	500
PN18-6F-C			0.03	0.145	#6	0.78	0.30	0.20			
PN18-8F-C			0.03	0.145	#8	0.85	0.32	0.23			
PN18-10FN-C***			0.03	0.145	#10	0.86	0.31	0.25			
PN18-10F-C			0.03	0.145	#10	0.86	0.35	0.25			
PN18-14F-C			0.03	0.145	1/4"	1.03	0.44	0.33			
PN14-6FN-C***	18 – 14 AWG	Blue	0.03	0.162	#6	0.79	0.24	0.19	CT-100A‡, CT-600-A‡, CT-1550‡, CT-1551‡, CT-2500‡	100	500
PN14-6F-C			0.03	0.162	#6	0.79	0.28	0.19			
PN14-8F-C			0.03	0.162	#8	0.85	0.31	0.23			
PN14-10FN-C***			0.03	0.162	#10	0.87	0.31	0.24			
PN14-10F-C			0.03	0.162	#10	0.87	0.34	0.24			
PN14-14F-C			0.03	0.162	1/4"	1.02	0.44	0.32			
PN10-6F-L	12 – 10 AWG	Yellow	0.04	0.225	#6	1.00	0.31	0.22	CT-100A‡, CT-600-A‡, CT-1550‡, CT-1551‡, CT-2500‡	50	500
PN10-8F-L			0.04	0.225	#8	1.03	0.37	0.22			
PN10-10F-L			0.04	0.225	#10	1.04	0.37	0.22			
PN10-14F-L			0.04	0.225	1/4"	1.14	0.49	0.30			

*Not UL Listed or CSA Certified.

**Bulk and/or convenience packaging may be available, contact Panduit® Customer Service for additional information.

***Not CSA certified.

‡UL and CSA approved tooling/product combinations. For crimping tool information see www.panduit.com/tools.



Fork Terminal, Nylon Insulated – Funnel Entry

Type PNF-F

- Fork design provides for fast and easy installation, without the need to remove fastener
- Metal insulation grip sleeve crimps to wire insulation, providing protection to the crimp joint during high vibration applications
- Internal barrel serrations assure good wire contact and maximum tensile strength
- UL Flammability UL 94 HB, maximum insulation temperature 221°F (105°C)
- UL and CSA rated up to 600 V per UL 486A/B

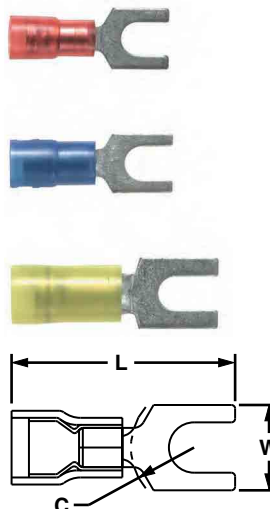

Part Number	Wire Range	Color Code	Stock Thickness (In.)	Max. Ins. (In.)	Stud Size	Figure Dimensions (In.)			Recommended Installation Tool	Std. Pkg. Qty.**	Std. Ctn. Qty.
						L	W	C			
PNF18-6F-C	22 – 18 AWG	Red	0.03	0.136	#6	0.80	0.30	0.22	CT-100A‡, CT-600-A‡, CT-1550‡, CT-1551‡, CT-2500‡	100	500
PNF18-8F-C			0.03	0.136	#8	0.86	0.31	0.25			
PNF18-10F-C			0.03	0.136	#10	0.87	0.34	0.26			
PNF18-14F-C			0.03	0.136	1/4"	1.05	0.44	0.35			
PNF14-6F-C	16 – 14 AWG	Blue	0.03	0.162	#6	0.80	0.28	0.22	CT-100A‡, CT-600-A‡, CT-1550‡, CT-1551‡, CT-2500‡	100	500
PNF14-8F-C			0.03	0.162	#8	0.85	0.31	0.25			
PNF14-10F-C			0.03	0.162	#10	0.87	0.34	0.26			
PNF14-14F-C			0.03	0.162	1/4"	1.05	0.44	0.35			
PNF10-6F-L	12 – 10 AWG	Yellow	0.04	0.225	#6	1.01	0.31	0.24	CT-100A‡, CT-600-A‡, CT-1550‡, CT-1551‡, CT-2500‡	50	500
PNF10-8F-L			0.04	0.225	#8	1.02	0.37	0.24			
PNF10-10F-L			0.04	0.225	#10	1.04	0.37	0.24			
PNF10-14F-L			0.04	0.225	1/4"	1.15	0.50	0.31			

**Bulk and/or convenience packaging may be available, contact Panduit Customer Service for additional information.

‡UL and CSA approved tooling/product combinations. For crimping tool information see www.panduit.com/tools.



Fork Terminal, Vinyl Insulated – Funnel Entry

Type PV-F

- Fork design provides for fast and easy installation, without the need to remove fastener
- Insulation support helps to prevent wire damage in bending applications
- Brazed seam protects terminal barrel from splitting during the crimp process
- Internal barrel serrations assure good wire contact and maximum tensile strength
- UL Flammability UL 94V-0, maximum insulation temperature 221°F (105°C)
- UL and CSA rated up to 600 V per UL 486A/B

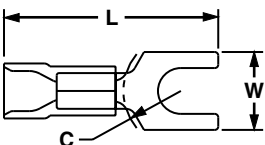

Part Number	Wire Range	Color Code	Stock Thickness (In.)	Max. Ins. (In.)	Stud Size	Figure Dimensions (In.)			Recommended Installation Tool	Std. Pkg. Qty.**	Std. Ctn. Qty.
						L	W	C			
PV22-4F-CY*	26 – 22 AWG	Yellow	0.02	0.110	#4	0.67	0.20	0.21	CT-600-A, CT-1525, CT-2500	100	1000
PV22-6F-CY*			0.02	0.110	#6	0.76	0.25	0.26		100	1000
PV18-6FN-CY***	22 – 16 AWG	Red	0.03	0.150	#6	0.85	0.24	0.21	CT-100A‡, CT-600-A‡, CT-1550‡, CT-1551‡, CT-2500‡	100	500
PV18-6F-CY			0.03	0.150	#6	0.86	0.30	0.21		100	500
PV18-8F-CY			0.03	0.150	#8	0.93	0.32	0.25		100	500
PV18-10FN-CY***			0.03	0.150	#10	0.93	0.31	0.25		100	500
PV18-10F-CY			0.03	0.150	#10	0.93	0.35	0.25		100	500
PV14-6FN-C***	16 – 14 AWG	Blue	0.03	0.170	#6	0.84	0.24	0.19	CT-100A‡, CT-600-A‡, CT-1550‡, CT-1551‡, CT-2500‡	100	500
PV14-6F-C			0.03	0.170	#6	0.84	0.28	0.19		100	500
PV14-8F-C			0.03	0.170	#8	0.90	0.31	0.23		100	500
PV14-10FN-C***			0.03	0.170	#10	0.92	0.31	0.24		100	500
PV14-10F-C			0.03	0.170	#10	0.92	0.34	0.24		100	500
PV14-14F-C			0.03	0.170	1/4"	1.09	0.44	0.32		100	1000
PV10-6F-L			14 – 10 AWG	Yellow	0.04	0.225	#6	1.01		0.31	0.25
PV10-8F-L	0.04	0.225			#8	1.04	0.37	0.25	50	500	
PV10-10F-L	0.04	0.225			#10	1.04	0.37	0.25	50	500	
PV10-14F-L	0.04	0.225			1/4"	1.14	0.49	0.32	50	500	

*Not UL Listed or CSA Certified.

**Bulk and/or convenience packaging may be available, contact Panduit® Customer Service for additional information.

***Not CSA certified.

‡UL and CSA approved tooling/product combinations. For crimping tool information see www.panduit.com/tools.



Fork Terminal, Vinyl Insulated – Expanded Insulation

Type PV-FX

- Expanded wire entry designed to accommodate wire with a larger insulation thickness
- Fork design provides for fast and easy installation, without the need to remove fastener
- Insulation support helps to prevent wire damage in bending applications
- Brazed seam protects terminal barrel from splitting during the crimp process
- Internal barrel serrations assure good wire contact and maximum tensile strength
- UL Flammability UL 94V-0, maximum insulation temperature 221°F (105°C)
- UL and CSA rated up to 600 V per UL 486A/B

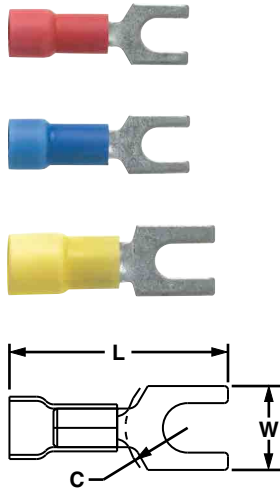

Part Number	Wire Range	Color Code	Stock Thickness (In.)	Max. Ins. (In.)	Stud Size	Figure Dimensions (In.)			Recommended Installation Tool	Std. Pkg. Qty.**	Std. Ctn. Qty.
						L	W	C			
PV18-6FX-CY	22 – 18 AWG	Red	0.03	0.170	#6	0.83	0.30	0.21	CT-100A‡, CT-600-A‡, CT-1550‡, CT-1551‡, CT-2500‡	100	500
PV18-8FX-CY			0.03	0.170	#8	0.89	0.32	0.25			
PV18-10FX-CY			0.03	0.170	#10	0.91	0.35	0.25			
PV14-6FX-C	18 – 14 AWG	Blue	0.03	0.200	#6	0.89	0.28	0.16	CT-100A‡, CT-600-A‡, CT-1550‡, CT-1551‡, CT-2500‡	100	500
PV14-8FX-C			0.03	0.200	#8	0.96	0.31	0.20			
PV14-10FX-C			0.03	0.200	#10	0.97	0.34	0.22			
PV10-8FX-L	12 – 10 AWG	Yellow	0.04	0.250	#8	1.11	0.37	0.24	CT-100A‡, CT-600-A‡, CT-1550‡, CT-1551‡, CT-2500‡	50	500
PV10-10FX-L			0.04	0.250	#10	1.11	0.37	0.24			
PV10-14FX-L			0.04	0.250	1/4"	1.22	0.50	0.32			

**Bulk packaging may be available, contact Panduit® Customer Service for additional information.
‡UL and CSA approved tooling/product combinations. For crimping tool information see www.panduit.com/tools.



Locking Fork Terminal, Nylon Insulated

Type PN-LF

- Locks in place for secure connection
- Fork design provides for fast and easy installation, without the need to remove fastener
- Metal insulation grip sleeve crimps to wire insulation, providing protection to the crimp joint during high vibration applications
- Internal barrel serrations assure good wire contact and maximum tensile strength
- UL Flammability UL 94 HB, maximum insulation temperature 221°F (105°C)
- UL and CSA rated up to 600 V per UL 486A/B



Part Number	Wire Range	Color Code	Stock Thickness (In.)	Max. Ins. (In.)	Stud Size	Figure Dimensions (In.)			Recommended Installation Tool	Std. Pkg. Qty.**	Std. Ctn. Qty.
						L	W	C			
PN18-6LF-C	22 – 18 AWG	Red	0.03	0.145	#6	0.82	0.27	0.22	CT-100A‡, CT-600-A‡, CT-1550‡, CT-1551‡, CT-2500‡	100	500
PN18-6LFW-C			0.03	0.145	#6	0.85	0.29	0.22			
PN18-8LF-C			0.03	0.145	#8	0.89	0.29	0.25			
PN18-10LF-C			0.03	0.145	#10	0.89	0.33	0.25			
PN18-10LFN-C***			0.03	0.145	#10	0.91	0.29	0.25			
PN14-6LF-C	18 – 14 AWG	Blue	0.03	0.162	#6	0.86	0.25	0.22	CT-100A‡, CT-600-A‡, CT-1550‡, CT-1551‡, CT-2500‡	100	500
PN14-6LFW-C			0.03	0.162	#6	0.84	0.29	0.22			
PN14-8LF-C			0.03	0.162	#8	0.92	0.29	0.25			
PN14-10LF-C			0.03	0.162	#10	0.91	0.33	0.25			
PN14-10LFN-C***			0.03	0.162	#10	0.91	0.28	0.25			
PN10-6LF-L	12 – 10 AWG	Yellow	0.04	0.225	#6	1.02	0.30	0.23	CT-100A‡, CT-600-A‡, CT-1550‡, CT-1551‡, CT-2500‡	50	500
PN10-8LF-L			0.04	0.225	#8	1.05	0.30	0.23			
PN10-10LF-L			0.04	0.225	#10	1.05	0.34	0.23			
PN10-14LF-L			0.04	0.225	1/4"	1.17	0.46	0.32			

**Bulk and/or convenience packaging may be available, contact Panduit Customer Service for additional information.

***Not CSA certified.

‡UL and CSA approved tooling/product combinations. For crimping tool information see www.panduit.com/tools.



Locking Fork Terminal, Nylon Insulated – Funnel Entry

Type PNF-LF

- Locks in place for secure connection
- Fork design provides for fast and easy installation, without the need to remove fastener
- Metal insulation grip sleeve crimps to wire insulation, providing protection to the crimp joint during high vibration applications
- Internal barrel serrations assure good wire contact and maximum tensile strength
- UL Flammability UL 94 HB, maximum insulation temperature 221°F (105°C)
- UL and CSA rated up to 600 V per UL 486A/B

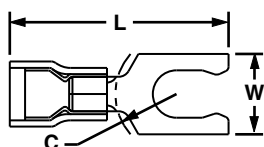

Part Number	Wire Range	Color Code	Stock Thickness (In.)	Max. Ins. (In.)	Stud Size	Figure Dimensions (In.)			Recommended Installation Tool	Std. Pkg. Qty.**	Std. Ctn. Qty.
						L	W	C			
PNF18-6LF-C	22 – 18 AWG	Red	0.03	0.145	#6	0.82	0.27	0.20	CT-100A‡, CT-600-A‡, CT-1550‡, CT-1551‡, CT-2500‡	100	500
PNF18-6LFW-C			0.03	0.145	#6	0.85	0.29	0.20		100	500
PNF18-8LF-C			0.03	0.145	#8	0.89	0.29	0.26		100	500
PNF18-10LF-C			0.03	0.145	#10	0.89	0.33	0.25		100	500
PNF14-6LF-C	18 – 14 AWG	Blue	0.03	0.162	#6	0.87	0.25	0.20	CT-100A‡, CT-600-A‡, CT-1550‡, CT-1551‡, CT-2500‡	100	500
PNF14-6LFW-C			0.03	0.162	#6	0.84	0.29	0.20		100	500
PNF14-8LF-C			0.03	0.162	#8	0.93	0.29	0.25		100	500
PNF14-10LF-C			0.03	0.162	#10	0.93	0.33	0.25		100	500
PNF10-6LF-L	12 – 10 AWG	Yellow	0.04	0.225	#6	1.02	0.30	0.20	CT-100A‡, CT-600-A‡, CT-1550‡, CT-1551‡, CT-2500‡	50	500
PNF10-8LF-L			0.04	0.225	#8	1.05	0.30	0.20		50	500
PNF10-10LF-L			0.04	0.225	#10	1.05	0.34	0.22		50	500
PNF10-14LF-L			0.04	0.225	1/4"	1.19	0.46	0.33		50	500

**Bulk and/or convenience packaging may be available, contact Panduit® Customer Service for additional information.
‡UL and CSA approved tooling/product combinations. For crimping tool information see www.panduit.com/tools.



Locking Fork Terminal, Vinyl Insulated – Funnel Entry

Type PV-LF

- Locks in place for secure connection
- Fork design provides for fast and easy installation, without the need to remove fastener
- Insulation support helps to prevent wire damage in bending applications
- Internal barrel serrations assure good wire contact and maximum tensile strength
- UL Flammability UL 94V-0, maximum insulation temperature 221°F (105°C)
- UL and CSA rated up to 600 V per UL 486A/B

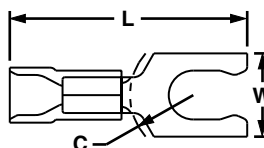

Part Number	Wire Range	Color Code	Stock Thickness (In.)	Max. Ins. (In.)	Stud Size	Figure Dimensions (In.)			Recommended Installation Tool	Std. Pkg. Qty.**	Std. Ctn. Qty.
						L	W	C			
PV18-6LF-CY	22 – 18 AWG	Red	0.03	0.150	#6	0.90	0.27	0.22	CT-100A‡, CT-600-A‡, CT-1550‡, CT-1551‡, CT-2500‡	100	500
PV18-6LFW-CY			0.03	0.150	#6	0.90	0.29	0.22		100	500
PV18-8LF-CY			0.03	0.150	#8	0.97	0.29	0.25		100	500
PV18-10LF-CY			0.03	0.150	#10	0.97	0.33	0.25		100	500
PV18-10LFN-CY***			0.03	0.150	#10	0.97	0.29	0.25		100	500
PV14-6LF-C	18 – 14 AWG	Blue	0.03	0.170	#6	0.90	0.25	0.22	CT-100A‡, CT-600-A‡, CT-1550‡, CT-1551‡, CT-2500‡	100	500
PV14-6LFW-C			0.03	0.170	#6	0.90	0.29	0.22		100	500
PV14-8LF-C			0.03	0.170	#8	0.97	0.29	0.25		100	500
PV14-10LF-C			0.03	0.170	#10	0.97	0.33	0.25		100	500
PV14-10LFN-C***			0.03	0.170	#10	0.97	0.29	0.25		100	500
PV10-6LF-L	12 – 10 AWG	Yellow	0.04	0.225	#6	1.03	0.30	0.23	CT-100A‡, CT-600-A‡, CT-1550‡, CT-1551‡, CT-2500‡	50	500
PV10-8LF-L			0.04	0.225	#8	1.05	0.30	0.23		50	500
PV10-10LF-L			0.04	0.225	#10	1.04	0.34	0.23		50	500
PV10-14LF-L			0.04	0.225	1/4"	1.19	0.46	0.36		50	500

**Bulk and/or convenience packaging may be available, contact Panduit Customer Service for additional information.

***Not CSA certified.

‡UL and CSA approved tooling/product combinations. For crimping tool information see www.panduit.com/tools.



Locking Fork Terminal, Vinyl Insulated – Expanded Insulation

Type PV-LFX

- Fork design provides for fast and easy installation, without the need to remove fastener
- Expanded wire entry designed to accommodate wire with a larger insulation thickness
- Locks in place for secure connection
- Insulation support helps to prevent wire damage in bending applications
- Brazed seam protects terminal barrel from splitting during the crimp process
- Internal barrel serrations assure good wire contact and maximum tensile strength
- UL Flammability UL 94V-0, maximum insulation temperature 221°F (105°C)
- UL and CSA rated up to 600 V per UL 486A/B

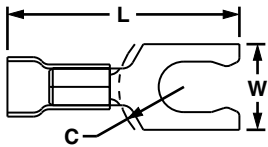
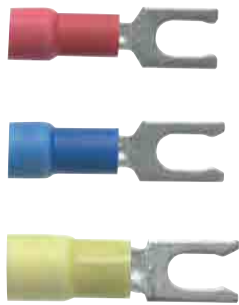

Part Number	Wire Range	Color Code	Stock Thickness (In.)	Max. Ins. (In.)	Stud Size	Figure Dimensions (In.)			Recommended Installation Tool	Std. Pkg. Qty.**	Std. Ctn. Qty.
						L	W	C			
PV18-6LFX-CY	22 – 16 AWG	Red	0.03	0.170	#6	0.95	0.27	0.20	CT-100A‡, CT-600-A‡, CT-1550‡, CT-2500‡	100	500
PV18-8LFX-CY			0.03	0.170	#8	1.01	0.29	0.20			
PV18-10LFX-CY			0.03	0.170	#10	1.04	0.33	0.23			
PV14-6LFX-C	18 – 14 AWG	Blue	0.03	0.200	#6	0.95	0.25	0.20	CT-100A‡, CT-600-A‡, CT-1550‡, CT-2500‡	100	500
PV14-8LFX-C			0.03	0.200	#8	1.01	0.29	0.23			
PV14-10LFX-C			0.03	0.200	#10	1.01	0.33	0.23			
PV10-6LFX-L	12 – 10 AWG	Yellow	0.04	0.250	#6	1.09	0.30	0.23	CT-100A‡, CT-600-A‡, CT-1550‡, CT-2500‡	50	500
PV10-8LFX-L			0.04	0.250	#8	1.12	0.30	0.23			
PV10-10LFX-L			0.04	0.250	#10	1.12	0.34	0.23			
PV10-14LFX-L			0.04	0.250	1/4"	1.25	0.46	0.32			

**Bulk packaging may be available, contact Panduit® Customer Service for additional information.

‡UL and CSA approved tooling/product combinations. For crimping tool information see www.panduit.com/tools.



Flanged Fork Terminal, Nylon Insulated

Type PN-FF

- Fork design provides for fast and easy installation, without the need to remove fastener
- Flange design provides extra secure connection on a variety of applications
- Metal insulation grip sleeve crimps to wire insulation, providing protection to the crimp joint during high vibration applications
- Internal barrel serrations assure good wire contact and maximum tensile strength
- UL Flammability UL 94 HB, maximum insulation temperature 221°F (105°C)
- UL and CSA rated up to 600 V per UL 486A/B

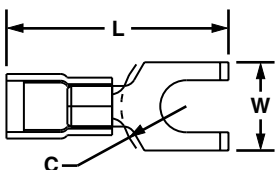

Part Number	Wire Range	Color Code	Stock Thickness (In.)	Max. Ins. (In.)	Stud Size	Figure Dimensions (In.)			Recommended Installation Tool	Std. Pkg. Qty.**	Std. Ctn. Qty.
						L	W	C			
PN18-6FF-C	22 – 16 AWG	Red	0.03	0.136	#6	0.81	0.28	0.20	CT-100A‡, CT-600-A‡, CT-1550‡, CT-1551‡, CT-2500‡	100	500
PN18-8FF-C			0.03	0.136	#8	0.88	0.31	0.23			
PN18-10FF-C			0.03	0.136	#10	0.86	0.35	0.23			
PN14-6FF-C	18 – 14 AWG	Blue	0.03	0.162	#6	0.79	0.28	0.20	CT-100A‡, CT-600-A‡, CT-1550‡, CT-1551‡, CT-2500‡	100	500
PN14-8FF-C			0.03	0.162	#8	0.86	0.31	0.23			
PN14-10FF-C			0.03	0.162	#10	0.86	0.36	0.23			
PN10-8FF-L	12 – 10 AWG	Yellow	0.04	0.225	#8	1.05	0.37	0.28	CT-100A‡, CT-600-A‡, CT-1550‡, CT-1551‡, CT-2500‡	50	500
PN10-10FF-L			0.04	0.225	#10	1.05	0.37	0.28			

**Bulk packaging may be available, contact Panduit® Customer Service for additional information.
‡UL and CSA approved tooling/product combinations. For crimping tool information see www.panduit.com/tools.



Flanged Fork Terminal, Vinyl Insulated – Funnel Entry

Type PV-FF

- Fork design provides for fast and easy installation, without the need to remove fastener
- Flange design provides extra secure connection on a variety of applications
- Insulation support helps to prevent wire damage in bending applications
- Brazed seam protects terminal barrel from splitting during the crimp process
- Internal barrel serrations assure good wire contact and maximum tensile strength
- UL Flammability UL 94V-0, maximum insulation temperature 221°F (105°C)
- UL and CSA rated up to 600 V per UL 486A/B

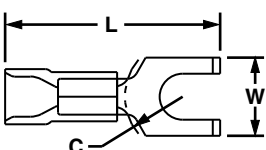

Part Number	Wire Range	Color Code	Stock Thickness (In.)	Max. Ins. (In.)	Stud Size	Figure Dimensions (In.)			Recommended Installation Tool	Std. Pkg. Qty.**	Std. Ctn. Qty.
						L	W	C			
PV18-6FF-CY	22 – 16 AWG	Red	0.03	0.136	#6	0.87	0.28	0.19	CT-100A‡, CT-600-A‡, CT-1550‡, CT-1551‡, CT-2500‡	100	500
PV18-8FF-CY			0.03	0.136	#8	0.94	0.31	0.23			
PV18-10FF-CY			0.03	0.136	#10	0.93	0.35	0.23			
PV14-6FF-C	16 – 14 AWG	Blue	0.03	0.165	#6	0.88	0.28	0.19	CT-100A‡, CT-600-A‡, CT-1550‡, CT-1551‡, CT-2500‡	100	500
PV14-8FF-C			0.03	0.165	#8	0.94	0.31	0.23			
PV14-10FF-C			0.03	0.165	#10	0.94	0.35	0.23			
PV10-8FF-L	14 – 10 AWG	Yellow	0.04	0.225	#8	1.03	0.37	0.22	CT-100A‡, CT-600-A‡, CT-1550‡, CT-1551‡, CT-2500‡	50	500
PV10-10FF-L			0.04	0.225	#10	1.03	0.37	0.22			

**Bulk packaging may be available, contact Panduit Customer Service for additional information.
‡UL and CSA approved tooling/product combinations. For crimping tool information see www.panduit.com/tools.



Fork Terminal, Non-Insulated

Type P-F

- Fork design provides for fast and easy installation, without the need to remove fastener
- Internal barrel serrations assure good wire contact and maximum tensile strength
- Brazed seam protects terminal barrel from splitting during the crimp process
- Barrel of terminal internally beveled to provide quick and easy wire insertion
- Maximum recommended operating temperature 302°F (150°C)
- UL and CSA rated up to 2000 V per UL 486A/B

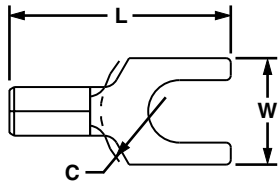

Part Number	Wire Range	Stock Thickness (In.)	Stud Size	Figure Dimensions (In.)			Recommended Installation Tool	Std. Pkg. Qty.**	Std. Ctn. Qty.
				L	W	C			
P22-4F-C*	26 – 22 AWG	0.02	#4	0.49	0.20	0.19	CT-200	100	1000
P22-6F-C*		0.02	#6	0.59	0.25	0.26		100	1000
P18-6FN-C***	22 – 16 AWG	0.03	#6	0.63	0.24	0.19	CT-100A‡, CT-200‡, CT-600-A‡, CT-1570‡, CT-2500‡	100	1000
P18-6F-C		0.03	#6	0.63	0.30	0.21		100	1000
P18-8F-C		0.03	#8	0.69	0.32	0.25		100	1000
P18-10FN-C***		0.03	#10	0.71	0.31	0.25		100	1000
P18-10F-C		0.03	#10	0.71	0.35	0.25		100	1000
P18-14F-C		0.03	1/4"	0.88	0.44	0.33		100	1000
P14-6FN-C		0.03	#6	0.63	0.24	0.20		CT-100A‡, CT-200‡, CT-600-A‡, CT-1570‡, CT-2500‡	100
P14-6F-C	0.03	#6	0.63	0.28	0.20	100	1000		
P14-8F-C	18 – 14 AWG	0.03	#8	0.69	0.31	0.23	100		1000
P14-10FN-C		0.03	#10	0.71	0.31	0.25	100		1000
P14-10F-C		0.03	#10	0.71	0.34	0.25	100		1000
P14-14F-C		0.03	1/4"	0.88	0.44	0.33	100		1000
P10-6F-L		12 – 10 AWG	0.04	#6	0.75	0.31	0.22		CT-100A‡, CT-200‡, CT-600-A‡, CT-1570‡, CT-1701‡, CT-2500‡
P10-8F-L	0.04		#8	0.78	0.37	0.22	50	500	
P10-10F-L	0.04		#10	0.78	0.37	0.23	50	500	
P10-14F-L	0.04		1/4"	0.89	0.50	0.30	50	500	

*Not UL Listed or CSA Certified.

**Bulk packaging may be available, contact Panduit® Customer Service for additional information.

***Not CSA certified.

‡UL and CSA approved tooling/product combinations. For crimping tool information see www.panduit.com/tools.



Flanged Fork Terminal, Non-Insulated

Type P-FF

- Fork design provides for fast and easy installation, without the need to remove fastener
- Flange design provides extra secure connection on a variety of applications
- Internal barrel serrations assure good wire contact and maximum tensile strength
- Brazed seam protects terminal barrel from splitting during the crimp process
- Barrel of terminal internally beveled to provide quick and easy wire insertion
- Maximum recommended operating temperature 302°F (150°C)
- UL and CSA rated up to 2000 V per UL 486A/B

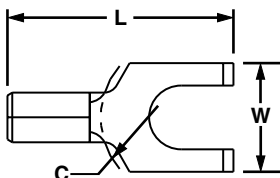

Part Number	Wire Range	Stock Thickness (In.)	Stud Size	Figure Dimensions (In.)			Recommended Installation Tool	Std. Pkg. Qty.**	Std. Ctn. Qty.
				L	W	C			
P18-8FF-C	22 – 16 AWG	0.03	#8	0.72	0.31	0.25	CT-100A‡, CT-200‡	100	500
P14-6FF-C	16 – 14 AWG	0.03	#6	0.65	0.28	0.22	CT-600-A‡, CT-1570‡, CT-2500‡	100	500
P14-8FF-C		0.03	#8	0.72	0.31	0.25	CT-100A‡, CT-200‡, CT-600-A‡, CT-1570‡, CT-1701‡, CT-2500‡	100	500
P10-10FF-L	12 – 10 AWG	0.04	#10	0.80	0.38	0.28	CT-100A‡, CT-200‡, CT-600-A‡, CT-1570‡, CT-1701‡, CT-2500‡	50	500

**Bulk packaging may be available, contact Panduit® Customer Service for additional information.
‡UL and CSA approved tooling/product combinations. For crimping tool information see www.panduit.com/tools.



Locking Fork Terminal, Non-Insulated

Type P-LF

- Locks in place for secure connection
- Fork design provides for fast and easy installation, without the need to remove fastener
- Internal barrel serrations assure good wire contact and maximum tensile strength
- Brazed seam protects terminal barrel from splitting during the crimp process
- Barrel of terminal internally beveled to provide quick and easy wire insertion
- Maximum recommended operating temperature 302°F (150°C)
- UL and CSA rated up to 2000 V per UL 486A/B

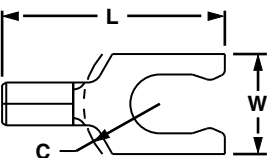

Part Number	Wire Range	Stock Thickness (In.)	Stud Size	Figure Dimensions (In.)			Recommended Installation Tool	Std. Pkg. Qty.**	Std. Ctn. Qty.
				L	W	C			
P18-6LF-C	22 – 16 AWG	0.03	#6	0.68	0.27	0.22	CT-100A‡, CT-200‡	100	500
P18-6LFW-C		0.03	#6	0.70	0.29	0.22	CT-600-A‡, CT-1570‡, CT-2500‡	100	500
P18-8LF-C		0.03	#8	0.74	0.29	0.23	CT-100A‡, CT-200‡, CT-600-A‡, CT-1570‡, CT-2500‡	100	500
P18-10LFN-C***		0.03	#10	0.74	0.28	0.23	CT-100A‡, CT-200‡, CT-600-A‡, CT-1570‡, CT-2500‡	100	500
P18-10LF-C		0.03	#10	0.74	0.33	0.23	CT-100A‡, CT-200‡, CT-600-A‡, CT-1570‡, CT-2500‡	100	500
P14-6LF-C	18 – 14 AWG	0.03	#6	0.70	0.25	0.22	CT-100A‡, CT-200‡	100	500
P14-6LFW-C		0.03	#6	0.70	0.29	0.22	CT-600-A‡, CT-1570‡, CT-2500‡	100	500
P14-8LF-C		0.03	#8	0.77	0.29	0.27	CT-100A‡, CT-200‡, CT-600-A‡, CT-1570‡, CT-2500‡	100	500
P14-10LFN-C***		0.03	#10	0.77	0.29	0.27	CT-100A‡, CT-200‡, CT-600-A‡, CT-1570‡, CT-2500‡	100	500
P14-10LF-C		0.03	#10	0.77	0.33	0.27	CT-100A‡, CT-200‡, CT-600-A‡, CT-1570‡, CT-2500‡	100	500
P10-6LF-L	14 – 10 AWG	0.04	#6	0.77	0.30	0.23	CT-100A‡, CT-200‡	50	500
P10-8LF-L		0.04	#8	0.79	0.30	0.23	CT-600-A‡, CT-1570‡, CT-2500‡	50	500
P10-10LF-L		0.04	#10	0.79	0.34	0.23	CT-100A‡, CT-200‡, CT-600-A‡, CT-1570‡, CT-2500‡	50	500
P10-14LF-L		0.04	1/4"	0.92	0.46	0.33	CT-1701‡, CT-2500‡	50	500

**Bulk packaging may be available, contact Panduit Customer Service for additional information.
***Not CSA certified.
‡UL and CSA approved tooling/product combinations. For crimping tool information see www.panduit.com/tools.

Plastic Box Terminal Kits

- Ideal for maintenance and construction wiring
- Positive latching case prevents accidental opening
- With the case top closed, parts remain in their compartments
- Case features a hanging tab for storage



KP-1075Y



KP-1165Y

Part Number	Part Description	Std. Pkg. Qty.
KP-1075Y	Terminal kit without crimping tool. Includes the following: (20) PV18-8R; PV18-6F; PV14-8F; PV14-10R; (10) PV10-8R; PV10-10R; DNF14-250; DNF18-250; BSV18X; BSV14X; BSV10X; (10) JN418-212.	1
KP-1000	Empty plastic box, twelve terminal compartments and one tool compartment, measures 11" wide x 6 3/4" deep x 1 3/4" high. Positive latch prevents accidental opening. Once top is closed, terminals remain in their compartments.	1
KP-1165Y	Includes the following: (18) PV18-8R; PV14-10R; PV18-6F; PV14-8F; (10) PV10-8R; PV10-10R; BSV18X; BSV14X; BSV10X; DV18-250B; DV14-188B; (5) JN418-212; (1) CT-160 Tool; KP-1000 box.	1
KP-1166	Includes the following: (18) P18-8R; P14-10R; P18-6F; P14-8F; (10) P10-8R; P10-10R; BS18; BS14; BS10; D18-250; D14-188; (5) JN218-216; (1) CT-160 tool; KP-1000 box.	1

Steel Kit Boxes

- Latch prevents accidental opening
- Once lid is closed, terminals remain in their compartments
- Handle for portability or as drawer pull when used in rack
- Drop-in label area on front measures: 2.13"H x 13.75"W x 9.75"D (54.0mm x 349.3mm x 247.7mm)



Part Number	Part Description	Std. Pkg. Qty.
K-1000	Empty steel box, 20 terminal compartments and one tool compartment, dimensions: 2.00"H x 13.33"W x 9.33"D (50.8mm x 338.6mm x 237.0mm).	1
K-1001	Empty steel kit box, 16 terminal compartments and one tool compartment, box dimensions: 2.00"H x 13.33"W x 9.33"D (50.8mm x 338.6mm x 237.0mm).	1
K-1100	Steel box and CT-100A crimping tool.	1
K-1102Y	Includes the following: (100) PV18-6LF; PV18-8LF; PV14-8LF; PV14-10LF; BSV18X; BSV14X; (50) PV10-10LF; BSV10X; (1) CT-100A tool; K-1000 box.	1
K-1103Y	Includes the following: (100) DV18-250B; DV14-250B; DV14-250MB; D18-250; D14-250; (50) DV10-250; D10-250; (1) CT-100A tool; K-1000 box.	1
K-1104	Includes the following: (50) PN18-10R; PN14-6R; PN14-10R; PN18-6F; PN14-6F; PN14-10F; (25) PN10-10R; PN10-56R; PN10-10F; BSN14; BSN10; JN418-212; (1) CT-100A tool; K-1000 box.	1

Steel Slide Racks

- Steel boxes for cable tie kits and K-1000 terminal kits
- Steel boxes and storage slide racks can be combined for neat and organized storage of cable ties and terminals
- Rugged and durable steel construction
- Empty boxes, full kits, and slide racks are purchased according to your application needs



Part Number	Part Description	Std. Pkg. Qty.
SR2	2-drawer slide rack to hold K-504 cable tie kit or K-1000 series terminal kit. Dimensions: 6.25"H x 15.25"W x 11.75"D (158.7mm x 387.4mm x 298.5mm).	1
SR4	4-drawer slide rack to hold K-1000 series terminal kit. Dimensions: 11.25"H x 15.25"W x 11.75"D (285.8mm x 387.4mm x 298.5mm).	1
SR6	6-drawer slide rack to hold K-1000 series terminal kit. Dimensions: 16.38"H x 15.25"W x 11.75"D (416.1mm x 387.4mm x 298.5mm).	1

Slide racks will accommodate the following Panduit® kits:

K-1000	K-1100	K-1103Y	K1-PNKIT
K-1001	K-1102Y	K-1104	K2-PVKITY

Industrial Maintenance Kits

- Steel kits have individual compartments for storage of terminals
- Convenient carrying handle
- Once top is closed, terminals remain in their compartments



K1-PNKIT



K2-PVKITY



K-205

Part Number	Part Description	Std. Pkg. Qty.
K1-PNKIT	Kit contains: (1) K-1001 steel kit box (1) CT-100A installation tool Cable Ties (100) PLT2S cable ties Terminals (100) PN18-6LF locking fork terminals (100) PN14-8LF locking fork terminals (50) PN10-10LF locking fork terminals (100) PN18-8F fork terminals (100) PN18-10R ring terminals (100) PN14-6R ring terminals (100) PN14-10R ring terminals (50) PN10-10R ring terminals Disconnects (100) DNF18-250 disconnects (100) DNF14-250 disconnects (50) DV10-250 disconnects Splices (50) BSN18 butt splices (50) BSN14 butt splices (25) BSN10 butt splices Marking System (1) PMD-0-9 marking dispenser and tape (100) MP150 marker tags (1) PX-0 marker	1
K2-PVKITY	Kit contains: (1) K-1001 steel kit box (1) CT-100A installation tool Cable Ties (100) PLT2S cable ties Terminals (100) PV18-8F fork terminals (100) PV18-6LF locking fork terminals (100) PV14-8LF locking fork terminals (50) PV10-10LF locking fork terminals (100) PV18-8R ring terminals (100) PV14-10R ring terminals (50) PV10-10R ring terminals Disconnects (100) DNF18-250 disconnects (100) DV14-250B disconnects (50) DV10-250 disconnects Splices (50) BSV18X butt splices (50) BSV14X butt splices (25) BSV10X butt splices Wire Joints (30) JN224-318 (15) JN418-212 Marking System (1) PMD-0-9 marking dispenser and tape	1
K-205*	Kit for Indoor Use Pan-Ty® Cable Ties, cable tie installation tool, terminals, splices and crimp tool: (1) GTS tool (1) CT-100A crimp tool Natural Nylon 6.6 Cable Ties (100) PLT1M (100) PLT1.5I (100) PLT2S Terminals (100) PV18-6LF (100) PV14-8LF (100) PV14-10LF (50) PV10-10LF Splices (50) BSV10X (100) BSV14X (100) BSV18X	1

*The K-205 does not fit into the SR2, SR4, or SR6.

Disconnects

Panduit® Pan-Term® Disconnects are designed and precision made to function as a reliable method of making quick, repeatable interconnections. Available with nylon, premium nylon, vinyl insulation or non-insulated.



- **Fully insulated design provides excellent protection from electrical shorts and provides additional installer protection for safety from electrical shocks**
- **Funnel entry speeds insertion and minimizes turned back wire strands**
- **Integrated metal insulation grip provides double crimp insulation grip for high vibration or conductor strain environments on select *Supra-Grip™* Disconnects and *DiscoGrip™* Disconnects**
- **Applicable sizes are UL Listed and CSA Certified, as noted**
- **Wide assortment of manual, controlled cycle, battery operated hydraulic and pneumatic crimping tools for reliable connections at the lowest installed cost**

Panduit continually provides new designs to meet the application challenges encountered by our customers. Panduit offers a wide assortment of Pan-Term® termination products at the lowest installed cost.

Features and Benefits – Pan-Term® Disconnects

Pan-Term® Disconnects are fabricated from brass and are electro tin-plated for a long, corrosion resistant operating life.

Nylon Fully Insulated Female Receptacles and Male Tabs Type DNF-FIB

Available in tab sizes to accommodate 0.110", 0.187", 0.205" or 0.250" tabs

Fully insulated design provides protection from electrical shorts

Expanded wire entry (on select sizes) accommodates large insulation or multiple wires

Maximum insulation temperature 221°F (105°C)

Insulation support restricts excessive wire movement to minimize stress on crimp joint

Funnel entry for faster wire insertion and lower installed cost



UL and CSA rated up to 600 V per UL 310. Flammability – UL 94 HB.

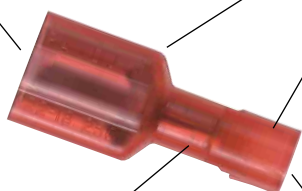

Disco-Grip™ Premium Nylon Fully Insulated Female Receptacles and Male Tabs Type DPF

Available in tab sizes to accommodate 0.110", 0.187", 0.205" or 0.250" tabs

Fully insulated design provides protection from electrical shorts

Maximum insulation temperature 221°F (105°C)

Funnel entry for faster wire insertion and lower installed cost



UL and CSA rated up to 600 V per UL 310. Flammability – UL 94V-2. Male products available 0.250" width in standard and oversized housing configurations.

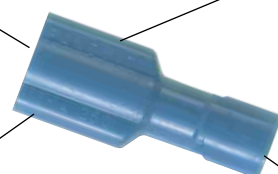

Supra-Grip™ Nylon Fully Insulated Female Disconnects Type DNG-FB

Available in tab sizes to accommodate 0.187" or 0.250" tabs

Fully insulated design provides protection from electrical shorts

Maximum insulation temperature 221°F (105°C)

Funnel entry for faster wire insertion and lower installed cost

Fully integrated metal insulation grip for high vibration, high strain relief, and double crimp requirements



UL and CSA rated up to 600 V per UL 310. Flammability – UL 94 HB.



Panduit® designs and manufactures a full line of labeling products, software, and printers to assist you with your labeling requirements.

See pages E1.1 – E2.27.

Continues on next page

Features and Benefits – Pan-Term® Disconnects (continued)

Nylon Barrel Insulated Female Receptacles and Male Tabs Type DNF

Available in tab sizes to accommodate 0.110", 0.187", 0.205" or 0.250" tabs

Maximum insulation temperature 194°F (90°C)

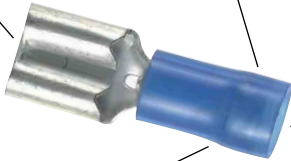

Funnel entry for faster wire insertion and lower installed cost

Insulation grip sleeve provides a superior insulation crimp for high vibration and high strain relief applications



UL and CSA rated up to 300 V per UL 310.
Flammability – UL 94 HB.
Male products available 0.250" width.

Vinyl Barrel Insulated Female Receptacles and Male Tabs Type DV and DVF

Available in tab sizes to accommodate 0.187", 0.205", or 0.250" tabs

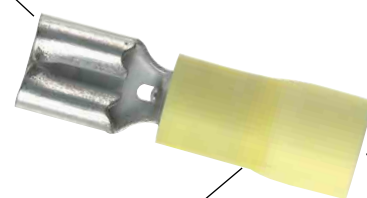

Insulation support to protect electrical crimp

Insulation grip sleeve provides a superior insulation crimp for high vibration and high strain relief applications



UL and CSA rated up to 300 V per UL 310.
Male products available 0.250" width.
Flammability – UL 94V-0.

Non-Insulated Female Receptacles and Male Tabs Type D

Available in tab sizes to accommodate 0.187" or 0.250" tabs

Sleeved barrel assures crimp reliability



Maximum recommended operating temperature 302°F (150°C)



UL and CSA rated up to 2000 V per UL 310.
Male products available 0.250" width.



Panduit® wiring duct offers a wide variety of sizes and types to meet the wire capacity needs and space constraints of the smallest wall mounted to the largest integrated systems.

See pages C1.1 – C1.53.



A comprehensive selection of cable ties used to bundle, mount, and identify wire and cable.

See pages B1.1 – B1.106.

B1.
Cable
Ties

B2.
Cable
Accessories

B3.
Stainless
Steel Cable
Ties &
Accessories

C1.
Wiring
Duct

C2.
Abrasion
Protection

C3.
Cable
Management

D1.
Terminals

D2.
Power
Connectors

D3.
Grounding
Connectors

E1.
Labeling
Systems

E2.
Labels

E3.
Pre-Printed
&
Write-On
Markers

E4.
Permanent
Identification

E5.
Industrial
Safety
Solutions

F.
Keystone
Cabling
Systems

G.
Part
Number
Index

Selection Guide – Pan-Term® Disconnects

Material	Style	Design	Feature	Type	Page Number	
Nylon	Fully Insulated	Female	Funnel Entry, Ins. Grip	DNG-FB	D1.33	
		Female	Funnel, Ins. Support, Two-Pc.	DNF-FIB	D1.35	
		Female	Funnel, Ins. Support, Three-Pc.	DNF-FI	D1.35	
		Female	Funnel Entry, Premium Nylon	DPF-FIB	D1.36	
		Male	Funnel, Ins. Support, Two-Pc.	DNF-FIM	D1.34	
		Male	Premium Nylon	DPF-FIM	D1.36	
		Female Right Angle	Funnel Entry, Ins. Support	DNFR-FIB	D1.39	
		Female Right Angle	Funnel Entry, Open Top	DNFR-B	D1.40	
		Barrel Insulated	Female	Funnel Entry, Ins. Grip	DNF	D1.37
			Male	Funnel Entry, Ins. Grip	DNF-M	D1.41
Vinyl	Barrel Insulated	Female	Funnel Entry, Ins. Grip, Three-Pc.	DVF	D1.38	
		Female	Funnel Entry, Butted Seam, Two-Pc.	DV-B	D1.38	
		Male	Funnel Entry, Butted Seam, Two-Pc.	DV-MB	D1.42	
		Piggyback	Funnel Entry, Ins. Grip	DV-P	D1.41	
Heat Shrink	Fully Insulated	Female	Heat Shrink Insulated	DNH-FIB	D1.37	
		Male	Heat Shrink Insulated	DNH-FIM	D1.37	
Non-Insulated		Female	Sleeved Barrel	D	D1.39	
		Female Right Angle	Sleeved Barrel	DR	D1.40	
		Male	Butted Seam	D-MB	D1.42	
		Adapter	Two Female to One Male	D-A	D1.41	



Part Number System for Pan-Term® Disconnects

P	NF	—	14	250	—	FIB	—	M
Type	Insulation		Wire Range	Tab Size		Special Configuration		Std. Pkg. Size
D = Disconnects	N = Nylon NF = Nylon, Funnel Entry NFR = Nylon, Funnel Entry, Right Angle NG = Nylon, Funnel Entry, Metal Insulation Grip NH = Heat Shrink PF = Premium Grade Nylon, Funnel Entry R = Non-insulated, Right Angle V = Vinyl VF = Vinyl Funnel Entry = Non-Insulated (leave blank)		18 = #22 – 18 14 = #16 – 14 10 = #12 – 10	110 = 0.110 x 0.032 111 = 0.110 x 0.020 187 = 0.187 x 0.032 188 = 0.187 x 0.020 205 = 0.187/0.205 x 0.032 206 = 0.187/0.205 x 0.020 250 = 0.250 x 0.032		A = Adapter B = Butted Seam FB = Metal Insulation Grip, Female FI = Fully Insulated, Female FIB = Fully Insulated, Butted Seam, Female FIM = Fully Insulated, Male FIMB = Fully Insulated, Male with oversized housing M = Male MB = Butted, Male P = Piggyback = Female (leave blank)		Q = 25 L = 50 C = 100 D = 500 M = 1000

Supra-Grip™ Female Disconnect, Nylon Fully Insulated – Funnel Entry

Type DNG-FB

- Disconnect can be inserted and removed from the male tab without the use of tools for lower installed cost
- Flared barrel extension integrated into stamping to provide insulation grip for double crimp requirements
- Fully insulated design provides protection from electrical shorts
- Internal barrel serrations assure good wire contact and maximum tensile strength
- Internal wire stop assures proper length of insertion into terminal barrel, providing a higher-quality connection
- Mates with DNF-FIMB family
- UL Flammability UL 94 HB, maximum insulation temperature 221°F (105°C)
- UL and CSA rated up to 600 V per UL 310

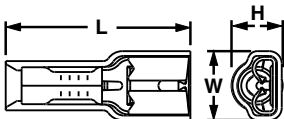

Part Number	Wire Range	Color Code	Max. Ins. (In.)	Figure Dimensions (In.)			Tab Size (In.)	Recommended Installation Tool	Std. Pkg. Qty.**	Std. Ctn. Qty.
				L	W	C				
DNG18-187FB-C	22 – 18 AWG	Red	0.126	0.89	0.29	0.22	0.187 x 0.032	CT-1015	100	1000
DNG18-188FB-C			0.126	0.89	0.29	0.22	0.187 x 0.020			
DNG18-250FB-L			0.126	0.93	0.35	0.22	0.250 x 0.032			
DNG14-187FB-L*	16 – 14 AWG	Blue	0.153	0.89	0.29	0.25	0.187 x 0.032	CT-1015	50	250
DNG14-188FB-L*			0.153	0.89	0.29	0.25	0.187 x 0.020			
DNG14-250FB-L			0.153	0.93	0.35	0.25	0.250 x 0.032			

*UL Recognized for use with copper alloy tabs.

**Bulk packaging may be available, contact Panduit® Customer Service for additional information. For crimping tool information see www.panduit.com/tools.



Male/Female Coupler, Nylon Fully Insulated – Funnel Entry

Type DNF

- Disconnect can be inserted and removed from the male tab without the use of tools for lower installed cost
- Fully insulated design provides protection from electrical shorts
- Internal barrel serrations assure good wire contact and maximum tensile strength
- Internal wire stop assures proper length of insertion into terminal barrel, providing a higher quality connection
- Coupler, male, and female parts sold separately
- UL Flammability UL 94 HB, maximum insulation temperature 221°F (105°C)
- UL and CSA rated up to 600 V per UL 310



MALE



FEMALE

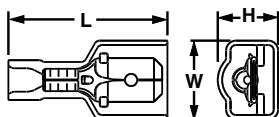

MALE

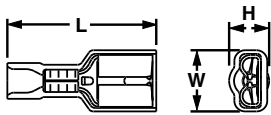

FEMALE

Part Number	Wire Range	Color Code	Max. Ins. (In.)	Figure Dimensions (In.)			Tab Size (In.)	Recommended Installation Tool	Std. Pkg. Qty.**	Std. Ctn. Qty.
				L	W	C				
DNF18-250FIM-L Male	22 – 18 AWG	Red	0.133	0.90	0.42	0.27	0.250 x 0.032	CT-100A‡, CT-600-A, CT-1525‡, CT-2500‡	50	250
DNF18-250FIMB-L Male			0.136	0.91	0.45	0.34	0.250 x 0.032	CT-100A, CT-600-A, CT-1525‡, CT-2500‡	50	500
DNF18-250FIB-C Female			0.136	0.84	0.35	0.22	0.250 x 0.032	CT-100A, CT-600-A, CT-1525‡, CT-2500‡	100	1000
DNF14-250FIM-L Male	16 – 14 AWG	Blue	0.158	0.90	0.42	0.27	0.250 x 0.032	CT-600-A, CT-1525‡, CT-2500‡	50	250
DNF14-250FIMB-Q Male			0.160	0.91	0.45	0.34	0.250 x 0.032	CT-600-A, CT-1525‡, CT-2500‡	25	125
DNF14-250FIB-C Female			0.160	0.84	0.35	0.22	0.250 x 0.032	CT-100A, CT-600-A, CT-1525‡, CT-2500‡	100	1000
DNF10-250FIMB-Q Male	12 – 10 AWG	Yellow	0.220	0.96	0.45	0.36	0.250 x 0.032	CT-600-A‡, CT-1550‡, CT-1551‡, CT-2500‡	25	125
DNF10-250FI-L Female			0.220	0.95	0.36	0.27	0.250 x 0.032	CT-100A‡, CT-600-A‡, CT-1550‡, CT-1551‡, CT-2500‡	50	500

**Bulk packaging may be available, contact Panduit® Customer Service for additional information.

‡UL and CSA approved tooling/product combinations. For crimping tool information see www.panduit.com/tools.



Female Disconnect, Nylon Fully Insulated – Funnel Entry

Type DNF-FIB

- Disconnect can be inserted and removed from the male tab without the use of tools for lower installed cost
- Fully insulated design provides protection from electrical shorts
- Internal wire stop assures proper length of insertion into terminal barrel, providing a higher quality connection
- UL Flammability UL 94 HB, maximum insulation temperature 221°F (105°C)
- UL and CSA rated up to 600 V per UL 310



Part Number	Wire Range	Color Code	Max. Ins. (In.)	Figure Dimensions (In.)			Tab Size (In.)	Recommended Installation Tool	Std. Pkg. Qty.**	Std. Ctn. Qty.
				L	W	C				
DNF18-110FIB-C	22 – 18 AWG	Red	0.120	0.71	0.19	0.16	0.110 x 0.032	CT-100A, CT-600-A, CT-1525‡, CT-2500‡	100	1000
DNF18-111FIB-C			0.120	0.71	0.19	0.16	0.110 x 0.020		100	1000
DNF18-187FIB-C			0.136	0.78	0.29	0.16	0.187 x 0.032		100	1000
DNF18-188FIB-C			0.136	0.78	0.29	0.16	0.187 x 0.020		100	1000
DNF18-205FIB-L			0.136	0.78	0.31	0.22	0.205/0.187 x 0.032		50	250
DNF18-206FIB-L			0.136	0.78	0.31	0.22	0.205/0.187 x 0.020		50	250
DNF18-250FIB-C	16 – 14 AWG	Blue	0.136	0.84	0.35	0.22	0.250 x 0.032	CT-100A, CT-600-A, CT-1525‡, CT-2500‡	100	1000
DNF14-187FIB-C			0.160	0.78	0.29	0.18	0.187 x 0.032		100	1000
DNF14-188FIB-C			0.160	0.78	0.29	0.18	0.187 x 0.020		100	1000
DNF14-205FIB-C			0.160	0.78	0.31	0.22	0.205/0.187 x 0.032		100	1000
DNF14-206FIB-C			0.160	0.78	0.31	0.22	0.205/0.187 x 0.020		100	1000
DNF14-250FIB-C			0.160	0.84	0.35	0.22	0.250 x 0.032		100	1000
DNF10-250FIB-L	12 – 10 AWG	Yellow	0.220	0.96	0.35	0.23	0.250 x 0.032	CT-1525‡, CT-2500‡	50	500

Female Disconnect Nylon Insulated – Expanded Entry

DNF18205FIBX-L*	22 – 18 AWG	Red	0.210	0.87	0.31	0.22	0.205/0.187 x 0.032	CT-100A	50	250
DNF18206FIBX-L*			0.210	0.87	0.31	0.22	0.205/0.187 x 0.020		50	250
DNF18250FIBX-L*			0.210	0.93	0.35	0.22	0.250 x 0.032		50	250
DNF14206FIBX-L*	16 – 14 AWG	Blue	0.240	0.87	0.31	0.22	0.205/0.187 x 0.020	CT-100A	50	250
DNF14250FIBX-L*			0.240	0.93	0.35	0.22	0.250 x 0.032		50	250

*Not UL or CSA certified

**Bulk packaging may be available, contact Panduit® Customer Service for additional information.

‡UL and CSA approved tooling/product combinations. For crimping tool information see www.panduit.com/tools.



Female Disconnect, Nylon Fully Insulated – Funnel Entry, Metal Collar

Type DNF-FI

- Disconnect can be inserted and removed from the male tab without the use of tools for lower installed cost
- Fully insulated design provides protection from electrical shorts
- Internal wire stop assures proper length of insertion into terminal barrel, providing a higher quality connection
- Barrel design with larger outside diameter for use with more common hand tools
- UL Flammability UL 94 HB, maximum insulation temperature 221°F (105°C)
- UL and CSA rated up to 600 V per UL 310

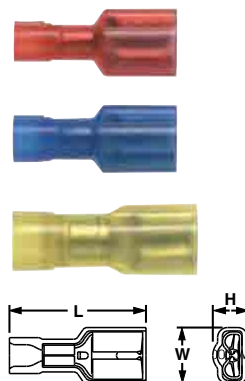

Part Number	Wire Range	Color Code	Max. Ins. (In.)	Figure Dimensions (In.)			Tab Size (In.)	Recommended Installation Tool	Std. Pkg. Qty.**	Std. Ctn. Qty.
				L	W	C				
DNF18-250FI-L	22 – 18 AWG	Red	0.140	0.94	0.36	0.21	0.250 x 0.032	CT-100A, CT-600-A, CT-1550, CT-1551, CT-2500	50	250
DNF14-250FI-L	16 – 14 AWG	Blue	0.160	0.94	0.36	0.24	0.250 x 0.032		50	250
DNF10-250FI-L	12 – 10 AWG	Yellow	0.220	0.95	0.36	0.27	0.250 x 0.032	CT-100A‡, CT-600-A‡, CT-1550‡, CT-1551‡, CT-2500‡	50	500

**Bulk packaging may be available, contact Panduit Customer Service for additional information.

‡UL and CSA approved tooling/product combinations. For crimping tool information see www.panduit.com/tools.

DiscoGrip™ Male Disconnect, Premium Nylon Fully Insulated – Funnel Entry

Type DPF-FIM

- Disconnect can be inserted and removed from the male tab without the use of tools for lower installed cost
- Premium nylon insulation retains its shape when crimped and provides a tight grip around the wire insulation for maximum strain relief
- Fully insulated design provides protection from electrical shorts
- Oversized housing designed for maximum versatility to mate with most commercially available fully insulated female disconnects
- Internal wire stop assures proper length of insertion into terminal barrel, providing a higher quality connection
- UL Flammability UL 94V-2, maximum insulation temperature 221°F (105°C)
- UL and CSA rated up to 600 V per UL 310

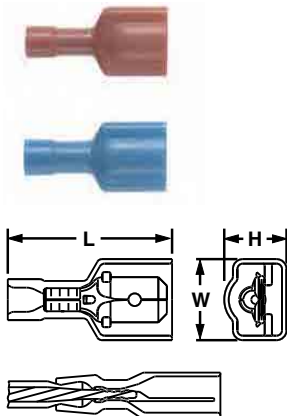

Part Number	Wire Range	Color Code	Max. Ins. (In.)	Figure Dimensions (In.)			Tab Size (In.)	Recommended Installation Tool	Std. Pkg. Qty.**	Std. Ctn. Qty.
				L	W	C				
DPF18-250FIM-L	22 – 18 AWG	Red	0.133	0.90	0.41	0.29	0.250 x 0.032	CT-600-A, CT-1525, CT-2500	50	250
DPF14-250FIM-L	16 – 14 AWG	Blue	0.156	0.90	0.41	0.29	0.250 x 0.032		50	250
DPF18-250FIMB-L*	22 – 18 AWG	Red	0.133	0.92	0.46	0.34	0.250 x 0.032		50	500
DPF14-250FIMB-Q*	16 – 14 AWG	Blue	0.156	0.92	0.46	0.34	0.250 x 0.032		25	125

*Oversized housing design will mate with receptacles up to 0.390" wide and 0.235" (0.285" high for parts with orientation bump).

**Bulk packaging may be available, contact Panduit® Customer Service for additional information. For crimping tool information see www.panduit.com/tools.

DiscoGrip™ Female Disconnect, Premium Nylon Fully Insulated – Funnel Entry

Type DPF-FIB

- Disconnect can be inserted and removed from the male tab without the use of tools for lower installed cost
- Premium nylon insulation retains its shape when crimped and provides a tight grip around the wire insulation for maximum strain relief
- Fully insulated design provides protection from electrical shorts
- Internal wire stop assures proper length of insertion into terminal barrel, providing a higher quality connection
- UL Flammability UL 94V-2, maximum insulation temperature 221°F (105°C)
- UL and CSA rated up to 600 V per UL 310

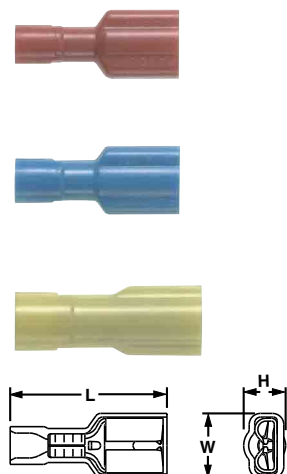

Part Number	Wire Range	Color Code	Max. Ins. (In.)	Figure Dimensions (In.)			Tab Size (In.)	Recommended Installation Tool	Std. Pkg. Qty.**	Std. Ctn. Qty.
				L	W	C				
DPF18-110FIB-C	22 – 18 AWG	Red	0.132	0.71	0.19	0.16	0.110 x 0.032	CT-600-A‡, CT-1525‡, CT-2500‡	100	1000
DPF18-111FIB-C			0.132	0.71	0.19	0.16	0.110 x 0.020		100	1000
DPF18-205FIB-C			0.133	0.78	0.31	0.22	0.205/0.187 x 0.032		100	1000
DPF18-206FIB-C			0.133	0.78	0.31	0.22	0.205/0.187 x 0.020		100	1000
DPF18-250FIB-C	16 – 14 AWG	Blue	0.133	0.84	0.35	0.22	0.250 x 0.032	CT-600-A‡, CT-1525‡, CT-2500‡	100	1000
DPF14-205FIB-C			0.156	0.78	0.31	0.22	0.205/0.187 x 0.032		100	1000
DPF14-206FIB-C			0.156	0.78	0.31	0.22	0.205/0.187 x 0.020		100	1000
DPF14-250FIB-C			0.156	0.84	0.35	0.22	0.250 x 0.032		100	1000
DPF10-250FI-L*	12 – 10 AWG	Yellow	0.218	0.95	0.36	0.27	0.250 x 0.032	CT-600-A, CT-1525, CT-2500	50	500
DPF10-250FIB-L			0.220	0.96	0.35	0.23	0.250 x 0.032		50	500

*Not UL listed or CSA approved.

**Bulk packaging may be available, contact Panduit Customer Service for additional information.

‡UL and CSA approved tooling/product combinations. For crimping tool information see www.panduit.com/tools.

Heat Shrink Disconnects, Fully Insulated – Funnel Entry

Type DNH

- Disconnect can be inserted and removed from the male tab without the use of tools for lower installed cost
- Fully insulated design provides protection from electrical shorts
- Heat shrink sleeving forms a protective barrier to provide environmentally sealed terminations ideal for high moisture applications
- Heat shrink sleeving provides additional level of strain relief for the wire
- Minimum continuous operating temperature -65°F (-55°C)
- Maximum continuous operation temperature 230°F (110°C)
- Shrink temperature 300°F (150°C)
- Rated up to 600 V

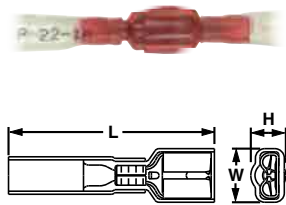

Part Number	Wire Range	Color Code	Max. Ins. (In.)	Figure Dimensions (In.)			Type	Tab Size (In.)	Recommended Installation Tool	Std. Pkg. Qty.	Std. Ctn. Qty.
				L	W	C					
DNH18-250FIM-Q	22 – 18 AWG	Red	0.133	1.50	0.41	0.31	Male	0.250 x 0.032	CT-310	25	125
DNH18-250FIB-Q			0.132	1.44	0.35	0.22	Female			25	125
DNH14-250FIM-Q	16 – 14 AWG	Blue	0.158	1.50	0.41	0.31	Male			25	125
DNH14-250FIB-Q			0.156	1.44	0.35	0.22	Female			25	125
DNH10-250FI-E	12 – 10 AWG	Yellow	0.230	1.44	0.35	0.27	Female		20	100	

For crimping tool information see www.panduit.com/tools.



Female Disconnect, Nylon Barrel Insulated – Funnel Entry

Type DNF

- Disconnect can be inserted and removed from the male tab without the use of tools for lower installed cost
- Metal insulation grip sleeve crimps to wire insulation, providing protection to the crimp joint during high vibration applications
- Internal barrel serrations assure good wire contact and maximum tensile strength
- Internal wire stop assures proper length of insertion into terminal barrel, providing a higher quality connection
- UL Flammability UL 94 HB, maximum insulation temperature 194°F (90°C)
- UL and CSA rated up to 300 V per UL 310

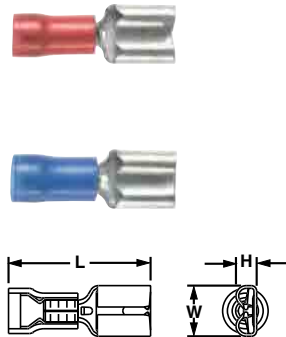

Part Number	Wire Range	Color Code	Max. Ins. (In.)	Figure Dimensions (In.)			Tab Size (In.)	Recommended Installation Tool	Std. Pkg. Qty.**	Std. Ctn. Qty.		
				L	W	C						
DNF18-110-C	22 – 18 AWG	Red	0.100	0.69	0.15	0.08	0.110 x 0.032	CT-600-A‡, CT-1525‡, CT-2500‡	100	500		
DNF18-111-C			0.100	0.69	0.15	0.07	0.110 x 0.020		100	500		
DNF18-187-C			0.137	0.76	0.23	0.10	0.187 x 0.032		100	500		
DNF18-188-C			0.137	0.76	0.23	0.10	0.187 x 0.020	CT-600-A‡, CT-1550, CT-1551, CT-2500	100	500		
DNF18-205-C			0.137	0.76	0.25	0.12	0.205/0.187 x 0.032		100	500		
DNF18-206-C			0.137	0.76	0.25	0.12	0.205/0.187 x 0.020		100	500		
DNF18-250-C			0.138	0.81	0.29	0.12	0.250 x 0.032		100	500		
DNF14-110-C*			16 – 14 AWG	Blue	0.162	0.75	0.15	0.08	0.110 x 0.032	CT-1525, CT-2500	100	500
DNF14-111-C*					0.162	0.75	0.15	0.07	0.110 x 0.020		100	500
DNF14-187-C					0.162	0.76	0.23	0.10	0.187 x 0.032	CT-600-A‡, CT-1550, CT-1551, CT-2500	100	500
DNF14-188-C	0.162	0.76			0.23	0.10	0.187 x 0.020	100	500			
DNF14-205-C	0.162	0.76			0.25	0.12	0.205/0.187 x 0.032	100	500			
DNF14-206-C	0.162	0.76			0.25	0.12	0.205/0.187 x 0.020	100	500			
DNF14-250-C	0.162	0.83			0.29	0.12	0.250 x 0.032	100	500			

*Not UL listed or CSA approved.

**Bulk packaging may be available, contact Panduit® Customer Service for additional information.

‡UL and CSA approved tooling/product combinations. For crimping tool information see www.panduit.com/tools.



Female Disconnect, Vinyl Barrel Insulated – Funnel Entry

Type DVF

- Disconnect can be inserted and removed from the male tab without the use of tools for lower installed cost
- Metal insulation grip sleeve crimps to wire insulation, providing protection to the crimp joint during high vibration applications
- Internal barrel serrations assure good wire contact and maximum tensile strength
- Internal wire stop assures proper length of insertion into terminal barrel, providing a higher quality connection
- UL Flammability UL 94V-0, maximum insulation temperature 194°F (90°C)
- UL and CSA rated up to 300 V per UL 310

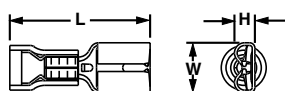

Part Number	Wire Range	Color Code	Max. Ins. (In.)	Figure Dimensions (In.)			Tab Size (In.)	Recommended Installation Tool	Std. Pkg. Qty.**	Std. Ctn. Qty.
				L	W	C				
DVF18-187-CY	22 – 18 AWG	Red	0.137	0.76	0.23	0.10	0.187 x 0.032	CT-1550‡, CT-1551‡, CT-2500‡	100	1000
DVF18-188-CY			0.137	0.76	0.23	0.10	0.187 x 0.020		100	500
DVF18-205-CY			0.137	0.76	0.25	0.12	0.205/0.187 x 0.032		100	500
DVF18-206-CY			0.137	0.76	0.25	0.12	0.205/0.187 x 0.020		100	500
DVF18-250-CY	16 – 14 AWG	Blue	0.137	0.81	0.29	0.12	0.250 x 0.032	CT-1550‡, CT-1551‡, CT-2500‡	100	500
DVF14-187-C			0.162	0.76	0.23	0.10	0.187 x 0.032		100	500
DVF14-188-C			0.162	0.76	0.23	0.10	0.187 x 0.020		100	500
DVF14-205-C			0.162	0.76	0.25	0.12	0.205/0.187 x 0.032		100	500
DVF14-206-C			0.162	0.76	0.25	0.12	0.205/0.187 x 0.020		100	500
DVF14-250-C			0.162	0.81	0.29	0.12	0.250 x 0.032		100	500

**Bulk packaging may be available, contact Panduit® Customer Service for additional information.

‡UL and CSA approved tooling/product combinations. For crimping tool information see www.panduit.com/tools.



Female Disconnect, Vinyl Barrel Insulated – Butted Seam

Type DV-B

- Disconnect can be inserted and removed from the male tab without the use of tools for lower installed cost
- Internal barrel serrations assure good wire contact and maximum tensile strength
- Internal wire stop assures proper length of insertion into terminal barrel, providing a higher quality connection
- UL Flammability UL 94V-0, maximum insulation temperature 221°F (105°C)
- UL and CSA rated up to 600 V per UL 310

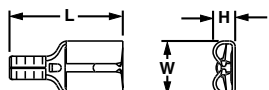

Part Number	Wire Range	Color Code	Max. Ins. (In.)	Figure Dimensions (In.)			Tab Size (In.)	Recommended Installation Tool	Std. Pkg. Qty.**	Std. Ctn. Qty.
				L	W	C				
DV18-187B-CY	22 – 18 AWG	Red	0.150	0.75	0.23	0.10	0.187 x 0.032	CT-1525‡, CT-2500‡	100	500
DV18-188B-CY			0.150	0.76	0.23	0.10	0.187 x 0.020		100	500
DV18-205B-CY			0.150	0.75	0.25	0.12	0.187/0.205 x 0.032		100	500
DV18-206B-CY			0.150	0.75	0.25	0.12	0.187/0.205 x 0.020		100	500
DV18-250B-CY	16 – 14 AWG	Blue	0.150	0.81	0.29	0.12	0.250 x 0.032	CT-1525^, CT-2500	100	500
▲ DV14-187B-C			0.170	0.75	0.23	0.10	0.187 x 0.032		100	500
▲ DV14-188B-C			0.162	0.79	0.23	0.10	0.187 x 0.020		100	500
▲ DV14-205B-C			0.170	0.75	0.25	0.12	0.187/0.205 x 0.032		100	500
▲ DV14-206B-C			0.170	0.75	0.25	0.12	0.187/0.205 x 0.020		100	500
▲ DV14-250B-C			0.170	0.81	0.29	0.12	0.250 x 0.032		100	500
▲ DV10-250-L*	12 – 10 AWG	Yellow	0.229	1.03	0.30	0.13	0.250 x 0.032	CT-600-A, CT-1550^, CT-1551^, CT-2500	50	500

*Sleeved barrel, maximum insulation temperature 194°F (90°C).

**Bulk packaging may be available, contact Panduit Customer Service for additional information.

‡UL and CSA approved tooling/product combinations. For crimping tool information see www.panduit.com/tools.

^CSA approved tooling/product combinations.

▲UL Recognized only.



Female Disconnect, Non-Insulated – Metal Sleeve

Type D

- Disconnect can be inserted and removed from the male tab without the use of tools for lower installed cost
- Sleeved barrel helps to facilitate high mechanical and electrical performance when crimping
- Barrel of terminal internally beveled to provide quick and easy wire insertion
- Internal barrel serrations assure good wire contact and maximum tensile strength
- Internal wire stop assures proper length of insertion into terminal barrel, providing a higher quality connection
- Maximum recommended operating temperature 302°F (150°C)
- UL and CSA rated up to 2000 V per UL 310

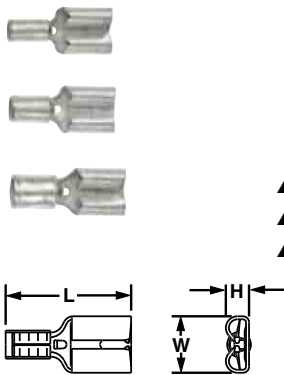

Part Number	Wire Range	Figure Dimensions (In.)			Tab Size (In.)	Recommended Installation Tool	Std. Pkg. Qty.**	Std. Ctn. Qty.
		L	W	C				
D18-187-C	22 – 18 AWG	0.58	0.23	0.10	0.187 x 0.032	CT-100A‡, CT-200‡, CT-1570‡, CT-2500‡	100	500
D18-188-C		0.58	0.23	0.10	0.187 x 0.020		100	500
D18-250-C		0.66	0.30	0.12	0.250 x 0.032		100	500
▲ D14-187-C	16 – 14 AWG	0.58	0.23	0.10	0.187 x 0.032	CT-100A, CT-200, CT-600-A, CT-1570, CT-2500	100	500
▲ D14-188-C		0.58	0.23	0.10	0.187 x 0.020		100	500
▲ D14-250-C		0.66	0.30	0.12	0.250 x 0.032		100	500
D10-250-L	12 – 10 AWG	0.72	0.30	0.12	0.250 x 0.032	CT-600-A‡, CT1570‡, CT-1701‡, CT-2500‡	50	500

**Bulk packaging may be available, contact Panduit® Customer Service for additional information.
 ‡UL and CSA approved tooling/product combinations. For crimping tool information see www.panduit.com/tools.
 ▲UL Recognized only.

B1.
Cable
Ties

B2.
Cable
Accessories

B3.
Stainless
Steel Cable
Ties &
Accessories

C1.
Wiring
Duct

C2.
Abrasion
Protection

C3.
Cable
Management

D1.
Terminals

D2.
Power
Connectors

D3.
Grounding
Connectors



Right Angle Female Disconnect, Nylon Fully Insulated – Funnel Entry

Type DNFR-FIB

- Right angle design for use in limited space applications
- Fully insulated design provides protection from electrical shorts
- Internal wire stop assures proper length of insertion into terminal barrel, providing a higher quality connection
- Disconnect can be inserted and removed from the male tab without the use of tools for lower installed cost
- UL Flammability UL 94 HB, maximum insulation temperature 221°F (105°C)
- UL and CSA rated up to 600 V per UL 310

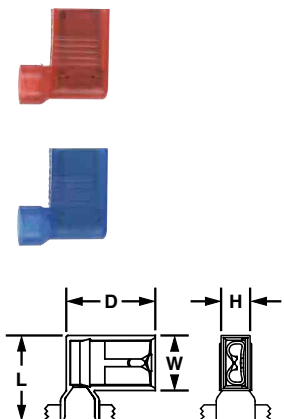

Part Number	Wire Range	Color Code	Max. Ins. (In.)	Figure Dimensions (In.)				Tab Size (In.)	Recommended Installation Tool	Std. Pkg. Qty.**	Std. Ctn. Qty.
				L	W	H	D				
DNFR18-205FIB-L	22 – 18 AWG	Red	0.178	0.58	0.37	0.21	0.60	0.205/0.187 x 0.032	CT-300-1	50	250
DNFR18-206FIB-L			0.178	0.58	0.37	0.21	0.60	0.205/0.187 x 0.020		50	250
DNFR18-250FIB-L			0.178	0.58	0.37	0.21	0.60	0.250 x 0.032		50	250
DNFR14-205FIB-L	16 – 14 AWG	Blue	0.178	0.58	0.37	0.21	0.60	0.205/0.187 x 0.032	CT-300-1	50	250
DNFR14-206FIB-L			0.178	0.58	0.37	0.21	0.60	0.205/0.187 x 0.020		50	250
DNFR14-250FIB-L			0.178	0.58	0.37	0.21	0.60	0.250 x 0.032		50	250

**Bulk packaging may be available, contact Panduit Customer Service for additional information. For crimping tool information see www.panduit.com/tools.

E1.
Labeling
Systems

E2.
Labels

E3.
Pre-Printed
&
Write-On
Markers

E4.
Permanent
Identification

E5.
Industrial
Safety
Solutions

F.
Keystone
Cabling
Systems

G.
Part
Number
Index



Right Angle Female Disconnect, Nylon Insulated – Funnel Entry

Type DNFR-B

- Right angle design for use in limited space applications
- Disconnect can be inserted and removed from the male tab without the use of tools for lower installed cost
- Longer barrel design for use with Panduit® standard disconnect tool
- UL Flammability UL 94 HB, maximum insulation temperature 221°F (105°C)
- UL and CSA rated up to 600 V per UL 310



Part Number	Wire Range	Color Code	Max. Ins. (In.)	Figure Dimensions (In.)				Tab Size (In.)	Recommended Installation Tool	Std. Pkg. Qty.	Std. Ctn. Qty.
				L	W	H	D				
DNFR18-205B-L	22 – 18 AWG	Red	0.130	0.78	0.36	0.20	0.62	0.205/0.187 x 0.032	CT-1525‡, CT-2500‡	50	500
DNFR18-206B-L			0.130	0.78	0.36	0.20	0.62	0.205/0.187 x 0.020			
DNFR18-250B-L			0.130	0.78	0.36	0.20	0.62	0.250 x 0.032			
DNFR14-205B-L	16 – 14 AWG	Blue	0.155	0.78	0.36	0.20	0.63	0.205/0.187 x 0.032	CT-1525‡, CT-2500‡	50	500
DNFR14-206B-L			0.155	0.78	0.36	0.20	0.63	0.205/0.187 x 0.020			
DNFR14-250B-L			0.155	0.78	0.36	0.20	0.63	0.250 x 0.032			

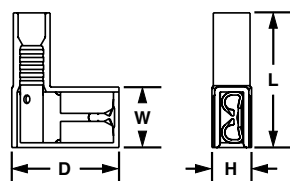

**Bulk packaging may be available, contact Panduit® Customer Service for additional information.
‡UL and CSA approved tooling/product combinations. For crimping tool information see www.panduit.com/tools.



Right Angle Female Disconnect, Non-Insulated – Metal Sleeve

Type DR

- Right angle design for use in limited space applications
- Disconnect can be inserted and removed from the male tab without the use of tools for lower installed cost
- Sleeved barrel helps to facilitate high mechanical and electrical performance when crimping
- Barrel of terminal internally beveled to provide quick and easy wire insertion
- Internal barrel serrations assure good wire contact and maximum tensile strength
- Maximum recommended operating temperature 302°F (150°C)
- UL and CSA rated up to 2000 V per UL 310



Part Number	Wire Range	Figure Dimensions (In.)				Tab Size (In.)	Recommended Installation Tool	Std. Pkg. Qty.	Std. Ctn. Qty.
		L	W	H	D				
DR18-205-C	22 – 18 AWG	0.54	0.25	0.12	0.53	0.205/0.187 x 0.032	CT-100A‡, CT-200‡, CT-600-A‡, CT-1570‡, CT-2500‡	100	1000
DR18-206-C		0.54	0.25	0.12	0.53	0.205/0.187 x 0.020			
DR18-250-C		0.57	0.30	0.12	0.54	0.250 x 0.032			
DR14-205-C	16 – 14 AWG	0.54	0.25	0.12	0.55	0.205/0.187 x 0.032	CT-100A‡, CT-200‡, CT-600-A‡, CT-1570‡, CT-2500‡	100	1000
DR14-206-C		0.54	0.25	0.12	0.55	0.205/0.187 x 0.020			
DR14-250-C		0.57	0.30	0.12	0.55	0.250 x 0.032			
DR10-250-L	12 – 10 AWG	0.61	0.30	0.12	0.57	0.250 x 0.032	CT-100A‡, CT-200‡, CT-600-A‡, CT-1570‡, CT-1701‡, CT-2500‡	50	500

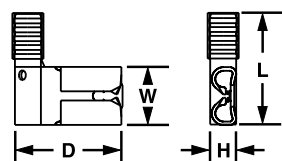

**Bulk packaging may be available, contact Panduit Customer Service for additional information.
‡UL and CSA approved tooling/product combinations. For crimping tool information see www.panduit.com/tools.
▲UL Recognized only.

Piggyback Disconnect, Vinyl Insulated

Type DV-P

- Disconnect can be inserted and removed from the male tab without the use of tools for lower installed cost
- Combination of female disconnect and male tab allows versatility in points of connection
- Multiple connection points allow additional circuits to be added to existing equipment without expensive rework
- Metal insulation grip sleeve crimps to wire insulation, providing protection to the crimp joint during high vibration applications
- UL Flammability UL 94 HB, maximum insulation temperature 194°F (90°C)
- Rated up to 300 V

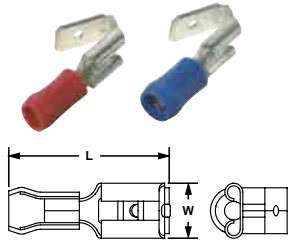

Part Number	Wire Range	Color Code	Max. Ins. (In.)	Figure Dimensions (In.)		Tab Size (In.)	Recommended Installation Tool	Std. Pkg. Qty.**	Std. Ctn. Qty.
				L	W				
DV18-250P-LY	22 – 18 AWG	Red	0.130	0.88	0.29	0.250 x 0.032	CT-100A, CT-260, CT-1550, CT-1551, CT-2500	50	250
DV14-250P-L	16 – 14 AWG	Blue	0.160	0.88	0.29	0.250 x 0.032		50	250

**Bulk packaging may be available, contact Panduit® Customer Service for additional information. For crimping tool information see www.panduit.com/tools.

Disconnect Adapter, Non-Insulated

Type D-A

- Couples two female disconnects to one male disconnect (all 0.250 x 0.032)
- Multiple connection points allow additional circuits to be added to existing equipment without expensive rework
- Disconnect can be inserted and removed from the male tab without the use of tools for lower installed cost
- Maximum recommended operating temperature 302°F (150°C)
- Rated up to 2000 V

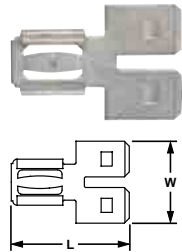

Part Number	Figure Dimensions (In.)		Tab Size (In.)	Std. Pkg. Qty.**	Std. Ctn. Qty.
	L	W			
D-250A-C	0.82	0.57	0.250 x 0.032	100	1000

**Bulk packaging may be available, contact Panduit Customer Service for additional information.



Male Disconnect, Nylon Barrel Insulated – Funnel Entry

Type DNF-M

- Male tab couples with (all 0.250 x 0.032) female disconnects
- Male tab can be inserted and removed from the female disconnect without the use of tools for lower installed cost
- Metal insulation grip sleeve crimps to wire insulation, providing protection to the crimp joint during high vibration applications
- Internal barrel serrations assure good wire contact and maximum tensile strength
- UL Flammability UL 94 HB, maximum insulation temperature 221°F (105°C)
- Rated up to 600 V

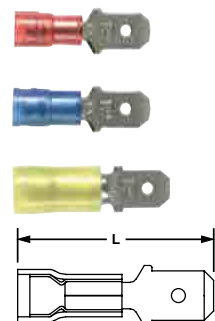

Part Number	Wire Range	Color Code	Max. Ins. (In.)	Figure Dimensions (In.)	Tab Size (In.)	Recommended Installation Tool	Std. Pkg. Qty.**	Std. Ctn. Qty.
				L				
DNF18-250M-C	22 – 18 AWG	Red	0.136	0.90	0.250 x 0.032	CT-1550, CT-1551, CT-2500	100	1000
DNF14-250M-C	16 – 14 AWG	Blue	0.162	0.90	0.250 x 0.032		100	1000
DNF10-250M-L*	12 – 10 AWG	Yellow	0.230	1.03	0.250 x 0.032		50	500

*Not UL Listed or CSA Certified.

**Bulk packaging may be available, contact Panduit Customer Service for additional information. For crimping tool information see www.panduit.com/tools.



Male Disconnect, Vinyl Barrel Insulated – Funnel Entry

Type DV-MB

- Male tab couples with (all 0.250 x 0.032) female disconnects
- Insulation support helps to prevent wire damage in bending applications
- Male tab can be inserted and removed from the female disconnect without the use of tools for lower installed cost
- UL Flammability UL 94V-0, maximum insulation temperature 221°F (105°C)
- Rated up to 600 V

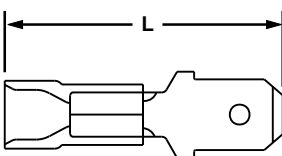

Part Number	Wire Range	Color Code	Max. Ins. (In.)	Figure Dimensions (In.)	Tab Size (In.)	Recommended Installation Tool	Std. Pkg. Qty.**	Std. Ctn. Qty.
				L				
DV18-250MB-CY	22 – 18 AWG	Red	0.154	0.98	0.250 x 0.032	CT-1550, CT-1551, CT-2500	100	500
DV14-250MB-C	16 – 14 AWG	Blue	0.180	0.96	0.250 x 0.032		100	500
DV10-250M-L*	12 – 10 AWG	Yellow	0.235	0.98	0.250 x 0.032		50	500

*Not UL Listed or CSA Certified.

**Bulk packaging may be available, contact Panduit® Customer Service for additional information. For crimping tool information see www.panduit.com/tools.

Male Disconnect, Non-Insulated – Butted Seam

Type D-MB

- Male tab couples with (all 0.250 x 0.032) female disconnects
- Male tab can be inserted and removed from the female disconnect without the use of tools for lower installed cost
- Internal barrel serrations assure good wire contact and maximum tensile strength
- Barrel of terminal internally beveled to provide quick and easy wire insertion
- Maximum recommended operating temperature 302°F (150°C)
- Rated up to 2000 V

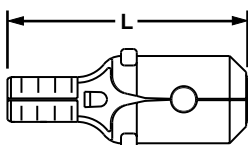

Part Number	Wire Range	Figure Dimensions (In.)	Tab Size (In.)	Recommended Installation Tool	Std. Pkg. Qty.**	Std. Ctn. Qty.
		L				
DV18-250MB-CY	22 – 18 AWG	0.69	0.250 x 0.032	CT-100A	100	500
DV14-250MB-C	16 – 14 AWG	0.69	0.250 x 0.032		100	500
DV10-250M-L*	12 – 10 AWG	0.72	0.250 x 0.032	CT-100A, CT-200, CT-260, CT-1570, CT-2500	50	500

*Brazed seam.

**To order in bulk, replace -C in the part number with -M for a bulk package of 1000 and replace -L with -D for a bulk package of 500. For crimping tool information see www.panduit.com/tools.

Selection Guide – Specialty Terminals



Material	Style	Feature	Type	Page Number
Vinyl	Pin Terminal	Insulation Support	PV-P	D1.43
Non-Insulated	Pin Terminal	Brazed Seam	P-P	D1.43

Pin Terminal, Vinyl Insulated – Funnel Entry

Type PV-P

- Solid pin designed to prevent damage to the wire from over tightening, resulting in a reliable electrical connection
- Insulation support helps to prevent wire damage in bending applications
- Brazed seam protects terminal barrel from splitting during the crimp process
- Internal barrel serrations assure good wire contact and maximum tensile strength
- For use with pin-type terminal blocks
- UL Flammability UL 94V-0, maximum insulation temperature 221°F (105°C)
- UL rated up to 600 V per UL 486A/B

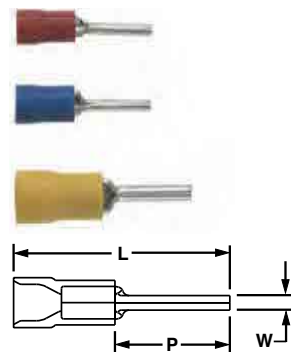

Part Number	Wire Range	Color Code	Max. Ins. (In.)	Figure Dimensions (In.)			Recommended Installation Tool	Std. Pkg. Qty.**	Std. Ctn. Qty.
				L	W	P			
PV18-P47-CY	22 – 18 AWG	Red	0.150	0.97	0.07	0.49	CT-100A, CT-260, CT-1550, CT-1551, CT-2500	100	1000
PV14-P47-C	16 – 14 AWG	Blue	0.170	0.97	0.07	0.49		100	1000
PV10-P55-LY*	12 – 10 AWG	Yellow	0.250	1.10	0.10	0.55		50	500

*Not UL Listed.

**Bulk packaging may be available, contact Panduit® Customer Service for additional information. For crimping tool information see www.panduit.com/tools.

Pin Terminal, Non-Insulated

Type P-P

- Solid pin designed to prevent damage to the wire from over tightening, resulting in a reliable electrical connection
- Brazed seam protects terminal barrel from splitting during the crimp process
- Internal barrel serrations assure good wire contact and maximum tensile strength
- Barrel of terminal internally beveled to provide quick and easy wire insertion
- For use with pin-type terminal blocks
- Maximum recommended operating temperature 302°F (150°C)
- UL rated up to 2000 V per UL 486A/B

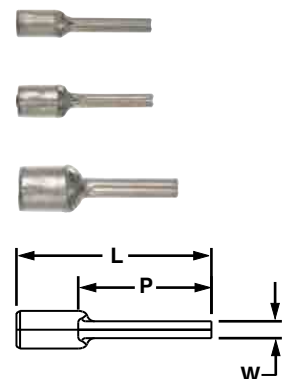

Part Number	Wire Range	Figure Dimensions (In.)			Recommended Installation Tool	Std. Pkg. Qty.**	Std. Ctn. Qty.
		L	W	P			
P18-P47-C	22 – 18 AWG	0.75	0.07	0.49	CT-100A, CT-200, CT-260, CT-1570, CT-2500	100	1000
P14-P47-C	16 – 14 AWG	0.75	0.07	0.49		100	1000
P10-P55-L*	12 – 10 AWG	0.79	0.10	0.55	CT-100A, CT-200, CT-260, CT-1570, CT-2500	50	500

*Not UL Listed.

**Bulk packaging may be available, contact Panduit Customer Service for additional information.

‡UL and CSA approved tooling/product combinations. For crimping tool information see www.panduit.com/tools.

B1.
Cable
Ties

B2.
Cable
Accessories

B3.
Stainless
Steel Cable
Ties &
Accessories

C1.
Wiring
Duct

C2.
Abrasion
Protection

C3.
Cable
Management

D1.
Terminals

D2.
Power
Connectors

D3.
Grounding
Connectors

E1.
Labeling
Systems

E2.
Labels

E3.
Pre-Printed
&
Write-On
Markers

E4.
Permanent
Identification

E5.
Industrial
Safety
Solutions

F.
Keystone
Cabling
Systems

G.
Part
Number
Index

Notes

Splices

Panduit® Pan-Term® Splices are designed and manufactured for fast assembly, and long reliable performance. As the demand for splices increases, it becomes essential to provide a complete system for termination products. We provide an extensive line of tooling designed specifically to provide optimum performance when used as a system for terminating.



- Suitable for in-line, parallel, and group splicing of wires
- Nylon and vinyl insulated as well as non-insulated
- Available in sizes from #26 – 10 AWG
- Internal wire stops on butt splices prevent over insertion of wires
- Applicable sizes are UL Listed and CSA Certified, as noted
- Wide assortment of manual, controlled cycle, battery operated hydraulic and pneumatic crimping tools for reliable connections at the lowest installed cost

Panduit continually provides new designs to meet the application challenges encountered by our customers. Panduit offers a wide assortment of Pan-Term® termination products to meet customer needs at the lowest installed cost.

Features and Benefits – Pan-Term® Splices and Wire Joints

**Non-Insulated Wire Joints
Type J**

Only one crimp needed to complete splice

Maximum recommended operating temperature 302°F (150°C)



Internally beveled barrel for quick easy wire insertion

UL and CSA rated up to 2000 V per UL 486C.

**Non-Insulated Parallel Splices
Type PS**

Seamless tubular barrel provides consistent high performance quality crimps

Maximum recommended operating temperature 302°F (150°C)



Only one crimp needed to complete splice

UL and CSA rated up to 2000 V per UL 486C.

**Nylon Wire Joints
Type JN**

Fully insulated housing protects crimp joint

Maximum insulation temperature 221°F (105°C)



Deep skirt to accommodate multiple variations of wire combinations

Only one crimp needed to complete splice

UL and CSA rated up to 600 V per UL 486C.
Metric versions available.
Flammability – UL 94 HB.

**Nylon Parallel Splices
Type PSN**

Maximum insulation temperature 221°F (105°C)



Only one crimp needed to complete splice

Rated up to 300 V.
Flammability – UL 94 HB.



Panduit® designs and manufactures a full line of labeling products, software, and printers to assist you with your labeling requirements.
See pages E1.1 – E2.27.

Features and Benefits – Pan-Term® Splices

Nylon Butt Splices
Type BSN

Internal wire stops assure proper insertion length



Maximum insulation temperature 221°F (105°C)

Brazed seam assures crimp reliability

UL and CSA rated up to 600 V per UL 486C. Flammability – UL 94 HB.

Vinyl Butt Splices
Type BSV

Internal wire stops assure proper insertion, length



Maximum insulation temperature 221°F (105°C)

Brazed seam assures crimp reliability

Expanded wire entry accommodates larger insulation

UL and CSA rated up to 600 V per UL 486C. Flammability – UL 94V-0. Metric versions available.

Non-Insulated Butt Splices
Type BS

Internal wire stops assure proper insertion length



Brazed seam assures crimp reliability

Maximum recommended operating temperature 302°F (150°C)

Internally beveled barrel for quick easy wire insertion

UL and CSA rated up to 2000 V per UL 486C. Metric versions available.



Panduit wiring duct offers a wide variety of sizes and types to meet the wire capacity needs and space constraints of the smallest wall mounted to the largest integrated systems.

See pages C1.1 – C1.53.



A comprehensive selection of cable ties used to bundle, mount, and identify wire and cable. See pages B1.1 – B1.106.

Selection Guide – Pan-Term® Splices and Wire Joints



Splices and Wire Joints

Material	Style	Feature	Type	Page Number
Nylon	Butt Splice	Brazed Seam	BSN	D1.49
	Parallel Splice	Seamless Barrel	PSN	D1.50
	Wire Joint	Multiple Wire Connector	JN	D1.51
Vinyl	Butt Splice	Expanded Insulation	BSV	D1.49
	Butt Splice	Heat Shrink Insulation	BSH	D1.52
Non-Insulated	Butt Splice	Brazed Seam	BS	D1.50
	Parallel Splice	Seamless Barrel	PS	D1.51
	Wire Joint		J	D1.52

Part Number System for Pan-Term® Splices

BS Type	V Insulation	14 Wire Range	X Special Configuration	—	M Std. Pkg. Size
BS = Butt Splice PS = Parallel Splice	H = Heat Shrink N = Nylon V = Vinyl = Non-Insulated (leave blank)	22 = #26 – 22 18 = #22 – 18 14 = #16 – 14 13 = #14 – 12 10 = #12 – 10	X = Expanded Insulation		Q = 25 L = 50 C = 100 T = 200 D = 500 M = 1000

Part Number System for Pan-Term® Wire Joints

JN Type	418-212 Wire Range	—	C Std. Pkg. Size
J = Non-Insulated JN = Nylon-Insulated	J Types 214 – 312 = (2) #14 – (3) #12 318 – 412 = (3) #14 – (4) #12 216 – 410 = (2) #16 – (4) #10 JN Types 224 – 318 = (2) #24 – (3) #18 218 – 216 = (2) #18 – (2) #16 418 – 212 = (4) #18 – (2) #12 314 – 412 = (3) #14 – (4) #12		Q = 25 L = 50 C = 100 T = 200 D = 500 M = 1000



Butt Splice, Nylon Insulated

Type BSN

- Designed to splice two solid or stranded wires together to repair or lengthen wires
- Butted configuration provides low profile for limited space applications
- Brazed seam protects terminal barrel from splitting during the crimp process
- Internal wire stop assures proper length of insertion into terminal barrel
- UL Flammability UL 94 HB, maximum insulation temperature 221°F (105°C)
- UL and CSA rated up to 600 V per UL 486C

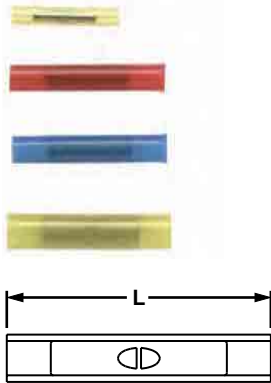

Part Number	Wire Range	Color Code	Max. Ins. (In.)	Figure Dimensions (In.)	Recommended Installation Tool	Std. Pkg. Qty.**	Std. Ctn. Qty.
				L			
BSN22-C*	26 – 22 AWG	Yellow	0.080	0.79	CT-1525, CT-2500	100	1000
BSN18-C	22 – 18 AWG	Red	0.115	1.15	CT-100A, CT-600-A, CT-1550, CT-1551, CT-2500	100	1000
BSN14-C	16 – 14 AWG	Blue	0.148	1.15	CT-100A, CT-600-A, CT-1550, CT-1551, CT-2500	100	1000
BSN10-L	12 – 10 AWG	Yellow	0.210	1.14	CT-100A, CT-600-A, CT-1550, CT-1551, CT-2500	50	500

*Not UL Listed.

**Bulk packaging may be available, contact Panduit® Customer Service for additional information. For crimping tool information see www.panduit.com/tools.



Butt Splice, Vinyl Insulated

Type BSV

- Expanded wire entry designed to accommodate wire with a larger insulation thickness
- Designed to splice two solid or stranded wires together to repair or lengthen wires
- Brazed seam protects terminal barrel from splitting during the crimp process
- Internal wire stop assures proper length of insertion into terminal barrel
- UL Flammability UL 94V-0, maximum insulation temperature 221°F (105°C)
- UL and CSA rated up to 600 V per UL 486C

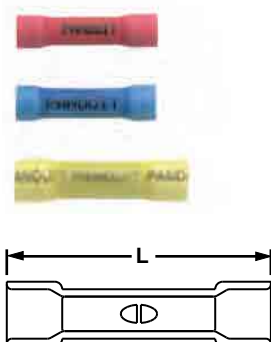

Part Number	Wire Range	Color Code	Max. Ins. (In.)	Figure Dimensions (In.)	Recommended Installation Tool	Std. Pkg. Qty.**	Std. Ctn. Qty.
				L			
BSV18X-LY	22 – 18 AWG	Red	0.170	1.03	CT-100A, CT-600-A, CT-1550, CT-1551, CT-2500	50	500
BSV14X-L	16 – 14 AWG	Blue	0.200	1.04		50	500
BSV10X-Q	12 – 10 AWG	Yellow	0.250	1.18		25	250

**Bulk packaging may be available, contact Panduit Customer Service for additional information. For crimping tool information see www.panduit.com/tools.

B1.
Cable
Ties

B2.
Cable
Accessories

B3.
Stainless
Steel Cable
Ties &
Accessories

C1.
Wiring
Duct

C2.
Abrasion
Protection

C3.
Cable
Management

D1.
Terminals

D2.
Power
Connectors

D3.
Grounding
Connectors

E1.
Labeling
Systems

E2.
Labels

E3.
Pre-Printed
&
Write-On
Markers

E4.
Permanent
Identification

E5.
Industrial
Safety
Solutions

F.
Keystone
Cabling
Systems

G.
Part
Number
Index



Butt Splice, Non-Insulated

Type BS

- Designed to splice two solid or stranded wires together to repair or lengthen wires
- Non-insulated barrel can be used to provide an economical termination when insulation is not required
- Butted configuration provides low profile for limited space applications
- Maximum recommended operating temperature 302°F (150°C)
- Brazed seam protects terminal barrel from splitting during the crimp process
- UL and CSA rated up to 2000 V per UL 486C
- Internal wire stop assures proper length of insertion into terminal barrel

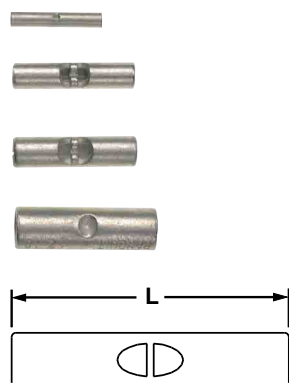

Part Number	Wire Range	Figure Dimensions (In.)	Recommended Installation Tool	Std. Pkg. Qty.**	Std. Ctn. Qty.
		L			
BS22-C*	26 – 22 AWG	0.47	CT-100A	100	1000
BS18-C	22 – 18 AWG	0.62	CT-100A, CT-200, CT-600-A, CT-1570, CT-2500	100	1000
BS14-C	16 – 14 AWG	0.62	CT-100A, CT-200, CT-600-A, CT-1570, CT-2500	100	1000
BS10-L	12 – 10 AWG	0.63	CT-100A, CT-200, CT-600-A, CT-1570, CT-2500, CT-1701‡	50	500

*Not UL Listed.

**Bulk packaging may be available, contact Panduit® Customer Service for additional information.

‡UL and CSA approved tooling/product combinations. For crimping tool information see www.panduit.com/tools.

Parallel Splice, Nylon Insulated

Type PSN

- Designed to splice two solid or stranded wires together to repair or lengthen wires
- Seamless tubular barrel provides a consistent high performance quality crimp
- Parallel design results in only one crimp required to complete splice
- Maximum insulation temperature 221°F (105°C)
- Rated up to 300 V

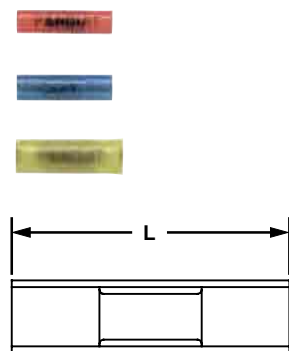

Part Number	Wire Range	Color Code	Max. Ins. (In.)	Figure Dimensions (In.)	Wire Strip Length (In.)	Recommended Installation Tool	Std. Pkg. Qty.**	Std. Ctn. Qty.
				L				
PSN18-C	22 – 18 AWG	Red	0.120	0.75	5/16	CT-100A, CT-1525, CT-2500	100	500
PSN16-C	20 – 16 AWG	Blue	0.150	0.75	5/16	CT-100A, CT-1525, CT-2500	100	500
PSN12-L	14 – 12 AWG	Yellow	0.210	0.83	7/16	CT-100A	50	500

**Bulk packaging may be available, contact Panduit Customer Service for additional information.

For crimping tool information see www.panduit.com/tools.



Parallel Splice, Non-Insulated

Type PS

- Designed to splice two solid or stranded wires together to repair or lengthen wires
- Parallel design results in only one crimp required to complete splice
- Seamless tubular barrel provides a consistent high performance quality crimp
- Non-insulated barrel can be used to provide an economical termination when insulation is not required
- Maximum recommended operating temperature 302°F (150°C)
- UL and CSA rated up to 2000 V per UL 486C

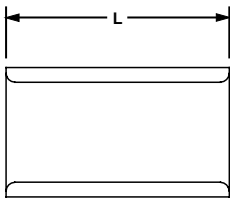

Part Number	Wire Range	Figure Dimensions (In.)		Recommended Installation Tool	Std. Pkg. Qty.**	Std. Ctn. Qty.
		L	Wire Strip Length (In.)			
PS18-C	22 – 18 AWG	0.29	5/16	CT-100A, CT-200	100	500
PS16-C	20 – 16 AWG	0.29	5/16		100	500
PS12-L	14 – 12 AWG	0.38	7/16		50	500

**Bulk packaging may be available, contact Panduit® Customer Service for additional information. For crimping tool information see www.panduit.com/tools.



Wire Joint, Nylon Insulated

Type JN

- Large barrel, designed to accommodate from one to seven wires with just one crimp
- Accommodates multiple wire sizes in varying combinations
- Barrel of terminal internally beveled to provide quick and easy wire insertion
- UL Flammability UL 94 HB, maximum insulation temperature 221°F (105°C)
- UL and CSA rated up to 600 V per UL 486C

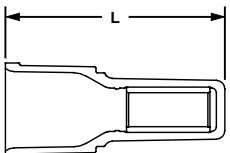

Part Number	Wire Range	Color Code	CMA Range		Figure Dimensions (In.)		Wire Strip Length (In.)	Recommended Installation Tool	Std. Pkg. Qty.**	Std. Ctn. Qty.
			Min.	Max.	L	L				
JN224-318-C	(2) #24 – (2) #16	Red	808	5160	0.79	7/16	CT-1550‡, CT-1551‡, CT-2500‡	100	1000	
JN218-216-C	(2) #22 – (2) #16	Clear	1284	5160	0.78	7/16	CT-1550‡, CT-1551‡, CT-2500‡	100	1000	
JN418-212-C	(4) #18 – (2) #12	Clear	6480	14750	0.93	1/2	CT-100A‡, CT-1550‡, CT-1551‡, CT-2500‡	100	1000	
JN314-412-C*	(3) #14 – (4) #12	Clear	10320	26120	0.97	5/8	CT-100A, CT-160, CT-260	100	1000	

*Not UL or CSA Listed.

**Bulk packaging may be available, contact Panduit Customer Service for additional information.

‡UL and CSA approved tooling/product combinations. For crimping tool information see www.panduit.com/tools.

Note: Wire combinations using #24 AWG wire are not UL Listed or CSA Certified.



Wire Joint, Non-Insulated

Type J

- Large barrel, designed to accommodate from one to seven wires with just one crimp
- Accommodates multiple wire sizes in varying combinations
- Non-insulated barrel can be used to provide an economical termination when insulation is not required
- Barrel of terminal internally beveled to provide quick and easy wire insertion
- Maximum recommended operating temperature 302°F (150°C)
- UL and CSA rated up to 2000 V per UL 486C

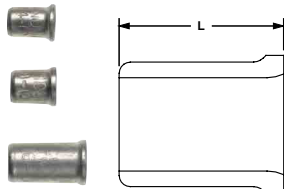

Part Number	Wire Range	CMA Range		Figure Dimensions (In.)	Wire Strip Length (In.)	Recommended Installation Tool	Std. Pkg. Qty.**	Std. Ctn. Qty.
		Min.	Max.	L				
J214-312-T	(2) #14 – (3) #12	5760	19590	0.37	1/2	CT-100A‡, CT-200‡	200	2000
J318-412-T	(3) #18 – (4) #12	4860	27330	0.37	1/2	CT-100A‡, CT-200‡	200	2000
J216-410-L*	(2) #16 – (4) #10	5160	41600	0.62	3/4	CT-100A‡, CT-200‡	50	500

*Part number J216-410, is not UL Listed or CSA Certified.

**Bulk packaging may be available, contact Panduit® Customer Service for additional information.

‡UL and CSA approved tooling/product combinations. For crimping tool information see www.panduit.com/tools.



Heat Shrink, Butt Splices

Type BSH

- Designed to splice two solid or stranded wires together to repair or lengthen wires
- Butted configuration provides low profile for limited space applications
- Heat shrink polyolefin sleeve with hot melt adhesive protects against moisture
- After crimping, heat shrink insulation is completed with a standard heat gun
- Minimum continuous operating temperature -65°F (-55°C)
- Maximum continuous operation temperature 230°F (110°C)
- Shrink temperature 300°F (150°C)
- UL and CSA rated up to 600 V per UL 486C

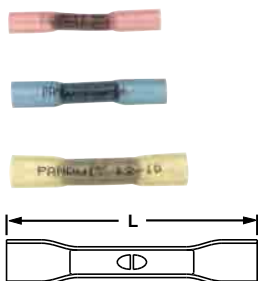

Part Number	Wire Range	Color Code	Max. Ins. (In.)	Figure Dimensions (In.)	Wire Strip Length (In.)	Recommended Installation Tool	Std. Pkg. Qty.**	Std. Ctn. Qty.
				L				
BSH18-Q	22 – 18 AWG	Red	0.170	1.45	5/16	CT-310	25	125
BSH14-Q	16 – 14 AWG	Blue	0.190	1.45	5/16	CT-310	25	125
BSH10-E	12 – 10 AWG	Yellow	0.240	1.64	5/16	CT-310	25	100

**Bulk packaging may be available, contact Panduit Customer Service for additional information.

For crimping tool information see www.panduit.com/tools.

Ferrules



Panduit® Pan-Term® Ferrule end sleeves terminate stranded wire into terminal blocks with superior termination performance. A wide assortment of ferrule styles and tool designs provide a proven way to make reliable connections, especially for limited space applications. Insulation flare allows for ease of wire insertion and eliminates loose strands of wire. Encapsulated crimp contains loose wires to eliminate stray wire breakage.

- Ferrules are UL 486F (1/0-20 AWG) listed and CSA certified
- Ideal for control panel and terminal block applications
- Insulated single wire range of #26 – 300 kcmil sizes meets DIN color code standards
- Insulated twin wire end sleeve range of #22 – 6 AWG, sizes meets DIN color code standard
- Non-insulated wire range of #24 – 500 kcmil
- Insulated ferrules single wire range #20 – 14 AWG, available in strips of 50 for use with the semiautomatic ferrule crimping tool, CT-1000, for improved reliability and productivity
- Wide assortment of controlled cycle, crimping tools for reliable connections at the lowest installed cost

Panduit continually provides new designs to meet the application challenges encountered by our customers. Panduit offers a wide assortment of Pan-Term® termination products to meet customer needs at the lowest installed cost.

Features and Benefits – Pan-Term® Ferrules

Panduit® ferrules are available for wiring applications from #26 – 500 kcmil. Offerings include insulated and non-insulated ferrules, in single-wire or double-wire configurations. Insulated ferrules are color-coded to DIN standards. Crimped on the metal barrel these ferrules provide improved performance for terminal block and panel building applications. All Panduit ferrules are CSA Certified. Panduit 1/0 to 20 AWG ferrules are UL listed per UL486F Standard.

<p>Insulated Ferrules — Single Wire Type FSD</p>	<p>Insulated Ferrules — Twin Wire Type FTD</p>
---	---

Non-Insulated Ferrules Type F



Panduit designs and manufactures a full line of labeling products, software, and printers to assist you with your labeling requirements. See pages E1.1 – E2.27.

Selection Guide – Pan-Term® Ferrules

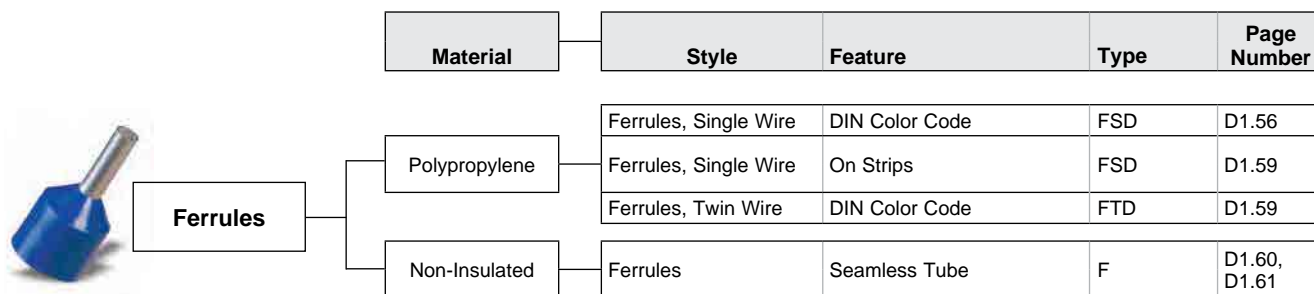

Part Number System for Pan-Term® Ferrules

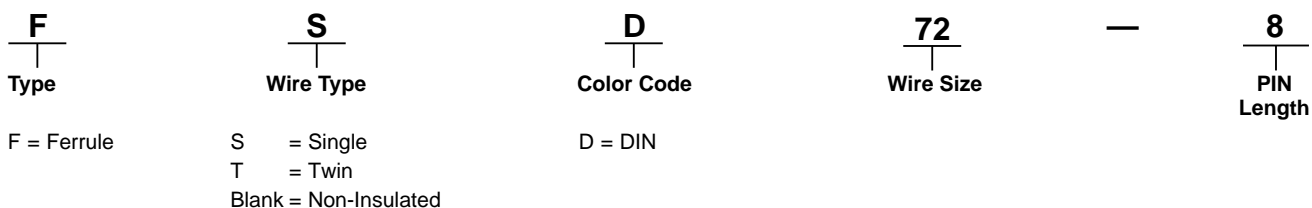



Insulated Ferrules – Single Wire DIN End Sleeve

Type FSD

- Polypropylene insulation housing conforms to DIN color requirements
- Meets DIN standards for single wire containment
- Funnel entry for faster insertion and lower installed cost
- Designed with a seamless barrel to contain loose wire strands for superior terminations
- Eases insertion of wire into terminal block
- Suitable for limited space panel applications
- Multiple pin lengths available for a variety of terminal blocks

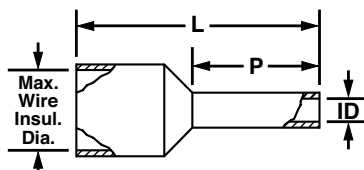

Part Number	Wire Size		Color Code	Max. Wire Insul. Dia.		Figure Dimensions						Wire Strip Length		Recommended Installation Tool	Std. Pkg. Qty.
	AWG	mm ²		In.	mm	L		P		ID		In.	mm		
FSD72-6-D	26 AWG	0.14	Gray	0.07	2.0	0.41	10.5	24.0	6.0	0.03	0.8	3/8	9.5	CT-1002, CT-1123	500
FSD72-8-D				0.07	2.0	0.49	12.5	31.0	8.0	0.03	0.8	15/32	11.9		500
FSD73-6-D	24 AWG	0.25	Yellow	0.07	2.0	0.41	10.5	24.0	6.0	0.03	0.8	3/8	9.5	CT-1002, CT-1123	500
FSD73-8-D				0.07	2.0	0.49	12.5	31.0	8.0	0.03	0.8	15/32	11.9		500
FSD74-6-D	24-22 AWG	0.34	Turquoise	0.07	2.0	0.41	10.5	24.0	6.0	0.03	0.8	3/8	9.5	CT-1002, CT-1123	500
FSD74-8-D				0.07	2.0	0.49	12.5	31.0	8.0	0.03	0.8	15/32	11.9		500
FSD75-6-D*	22-20 AWG	0.5	White	0.09	2.5	0.45	11.5	24.0	6.0	0.04	1.1	3/8	9.5	CT-1002, CT-1123	500
FSD75-8-D*				0.09	2.5	0.53	13.5	31.0	8.0	0.04	1.1	15/32	11.9		500
FSD75-10-D*				0.09	2.5	0.61	15.5	0.39	10.0	0.04	1.1	3/8	9.5		500
FSD76-6-D	18 AWG	0.75	Gray	0.11	2.8	0.47	12.0	0.24	6.0	0.05	1.3	15/32	11.9	CT-1002, CT-1003, CT-1123	500
FSD76-8-D				0.11	2.8	0.55	14.0	0.31	8.0	0.05	1.3	17/32	13.5		500
FSD76-10-D				0.11	2.8	0.63	16.0	0.39	10.0	0.05	1.3	3/8	9.5		500
FSD76-12-D				0.11	2.8	0.71	18.0	0.47	12.0	0.05	1.3	15/32	11.9		500
FSD77-6-D	16 AWG	1.0	Red	0.12	3.0	0.49	12.5	0.24	6.0	0.06	1.5	17/32	13.5	CT-1002, CT-1003, CT-1123	500
FSD77-8-D				0.12	3.0	0.57	14.5	0.31	8.0	0.06	1.5	5/8	15.9		500
FSD77-10-D				0.12	3.0	0.65	16.5	0.39	10.0	0.06	1.5	3/8	9.5		500
FSD77-12-D				0.12	3.0	0.73	18.5	0.47	12.0	0.06	1.5	15/32	11.9		500
FSD78-6-D	16 AWG	1.5	Black	0.12	3.0	0.49	12.5	0.24	6.0	0.07	1.8	17/32	13.5	CT-1002, CT-1003, CT-1123	500
FSD78-8-D				0.12	3.0	0.57	14.5	0.31	8.0	0.07	1.8	5/8	15.9		500
FSD78-10-D				0.12	3.0	0.65	16.5	0.39	10.0	0.07	1.8	3/8	9.5		500
FSD78-12-D				0.12	3.0	0.73	18.5	0.47	12.0	0.07	1.8	15/32	11.9		500
FSD78-18-D				0.12	3.0	0.96	24.5	0.71	18.0	0.07	1.8	17/32	13.5		500
FSD79-8-D	14 AWG	2.08	Yellow	0.14	3.6	0.57	14.5	0.31	8.0	0.08	2.1	5/8	15.9	CT-1002, CT-1123, CT-1104	500
FSD80-8-D				0.17	4.2	0.59	15.0	0.31	8.0	0.09	2.3	7/8	22.2		500
FSD80-12-D	14 AWG	2.5	Blue	0.17	4.2	0.75	19.0	0.47	12.0	0.09	2.3	15/32	11.9	CT-1002, CT-1123, CT-1104	500
FSD80-18-D				0.17	4.2	0.98	25.0	0.71	18.0	0.09	2.3	15/32	11.9		500
FSD81-10-D	12 AWG	4.0	Gray	0.19	4.8	0.69	17.5	0.39	10.0	0.11	2.9	5/8	15.9	CT-1002, CT-1123, CT-1104	500
FSD81-12-C				0.19	4.8	0.79	20.0	0.47	12.0	0.11	2.9	7/8	22.2		100
FSD81-18-C				0.19	4.8	1.02	26.0	0.71	18.0	0.11	2.9	17/32	13.5		100
FSD82-12-C	10 AWG	6.0	Yellow	0.24	6.2	0.79	20.0	0.47	12.0	0.14	3.6	5/8	15.9	CT-1002, CT-1123, CT-1104	100
FSD82-18-C				0.24	6.2	1.02	26.0	0.71	18.0	0.14	3.6	7/8	22.2		100
FSD83-12-C	8 AWG	10.0	Red	0.30	7.5	0.83	21.0	0.47	12.0	0.18	4.6	5/8	15.9	CT-1002, CT-1123, CT-1104	100
FSD83-18-C				0.30	7.5	1.06	27.0	0.71	18.0	0.18	4.6	7/8	22.2		100

‡ Tool/part not a UL listed combination For crimping tool information see www.panduit.com/tools.

*Not UL listed with 22 AWG wire

**Dies used with CT-3001 or CT-3001/E Tool



Insulated Ferrules – Single Wire DIN End Sleeve (continued)

Part Number	Wire Size		Color Code	Max. Wire Insul. Dia.		Figure Dimensions						Wire Strip Length		Recommended Installation Tool	Std. Pkg. Qty.
	AWG	mm ²		In.	mm	L		P		ID		In.	mm		
FSD84-12-C	6 AWG	16.0	Blue	0.35	8.8	0.91	23.0	0.47	12.0	0.24	6.0	5/8	15.9	‡CT-1004, CT-1104	100
FSD84-18-C				0.35	8.8	1.14	29.0	0.71	18.0	0.24	6.0	7/8	22.2		100
FSD85-16-L	4 AWG	25.0	Yellow	0.43	11.0	1.14	29.0	0.63	16.0	0.30	7.5	5/8	15.9	CT-1005	50
FSD85-18-L				0.43	11.0	1.22	31.0	0.71	18.0	0.30	7.5	7/8	22.2		50
FSD85-22-L				0.43	11.0	1.38	35.0	0.87	22.0	0.30	7.5	1	25.4		50
FSD86-16-L	2 AWG	35.0	Red	0.49	12.5	1.18	30.0	0.63	16.0	0.33	8.5	3/4	19.1	CT-1005	50
FSD86-18-L				0.49	12.5	1.26	32.0	0.71	18.0	0.33	8.5	7/8	22.2		50
FSD86-25-L				0.49	12.5	1.54	39.0	0.98	25.0	0.33	8.5	1 1/8	28.6		50
FSD87-20-L	1 AWG-1/0	50.0	Blue	0.59	15.0	1.42	36.0	0.79	20.0	0.41	10.5	15/16	23.8	CT-1006, **CD-2001-F87	50
FSD87-25-Q				0.59	15.0	1.61	41.0	0.98	25.0	0.41	10.5	1 1/8	28.6		25
FSD89-20-Q	2/0	70.0	Yellow	0.63	16.0	1.46	37.0	0.79	20.0	0.50	12.7	15/16	23.8	CT-3001 (CD-2001-F89)	25
FSD89-27-Q				0.63	16.0	1.73	44.0	1.06	27.0	0.50	12.7	1 1/4	31.0		25
FSD90-25-Q	3/0	95.0	Red	0.71	18.0	1.73	44.0	0.98	25.0	0.58	14.7	1 1/8	28.6	CT-3001 (CD-2001-F90)	25
FSD91-27-Q	4/0-250 kcmil	120.0	Blue	0.83	21.1	1.89	48.0	1.06	27.0	0.66	16.7	1 1/4	31.0	CT-3001 (CD-2001-F91)	25
FSD92-32-Q	300 kcmil	150.0	Yellow	0.91	23.1	2.28	58.0	1.26	32.0	0.78	19.7	1 1/2	37.0	CT-3001 (CD-2001-F92)	25

‡Tool/part not a UL listed combination. For crimping tool information see www.panduit.com/tools.

*Not UL listed

**Dies used with CT-3001 or CT-3001/E Tool



Insulated Ferrules - Single Wire Expanded Sleeve

Type FSDX

- Expanded polypropylene sleeve: Provides a wider inside diameter to allow ferrules to fit easily over thick insulated wire, ideal for use in the U.S. and for use with flexible wire
- Funnel wire entry: Forms a guide for easy insertion of wire strands into the crimp barrel to enhance the installation process and improve productivity
- Colored sleeves: Allows visual color designation of wire size to aid in identification and quality inspection
- Meets UL 486F, CSA-C22.2 No. 291-14 and DIN 46228 Standards: Ensures ferrules meet both dimensional and performance requirements for improved safety and product compatibility



Part Number	Wire Size		Color Code	Max. Wire Insul. Dia.		Figure Dimensions						Wire Strip Length		Recommended Installation Tool	Std. Pkg. Qty.
	AWG	mm ²		In.	mm	L		P		ID		In.	mm		
FSDX75-8-D	22-20	0.5	White	0.12	3.0	0.53	13.5	0.32	8.0	0.04	1.1	15/32	11.91	CT-1002, CT-1003, CT-1123	500
FSDX76-8-D	18	0.75	Gray	0.14	3.4	0.55	14.0	0.32	8.0	0.05	1.3	15/32	11.91		500
FSDX77-8-D	18	1.0	Red	0.14	3.4	0.57	14.5	0.32	8.0	0.06	1.5	15/32	11.91		500
FSDX78-8-D	16	1.5	Black	0.15	3.8	0.57	14.5	0.32	8.0	0.07	1.8	15/32	11.91		500
FSDX84-12-C	6	16.0	Blue	0.37	9.5	.91	23.0	0.47	12.0	0.24	6.0	7/8	22.2	CT-1004, CT-1104	100

For crimping tool information see www.panduit.com/tools.



Insulated Ferrules - Single Wire for Short Circuit Protection

Type FSDXL

- Wider polypropylene sleeve: Delivers a much wider inside diameter to provide a significant air gap between the wire and the outside of the sleeve: to prevent a electrical arc to adjacent material
- Flanged wire entry: Polypropylene sleeve forms a guide for easy insertion of wire strands into crimp barrel to enhance the installation process and improve productivity
- Colored sleeves: Allows visual color designation of wire size to aid in identification and quality inspection
- Seamless barrel design: A tin-plated copper barrel provides a crimp barrel without any weak points for a consistent and reliable installation
- Meets UL 486F, CSA-C22.2 No. 291-14 and DIN 46228 Standards: Ensures ferrules meet dimensional expectations and performance requirements for improved safety and product compatibility



Part Number	Wire Size		Color Code	Max. Wire Insul. Dia.		Figure Dimensions						Wire Strip Length		Recommended Installation Tool	Std. Pkg. Qty.
	AWG	mm ²		In.	mm	L		P		ID		In.	mm		
FSDXL78-8-C	16	1.5	Black	0.27	6.9	0.69	17.5	0.32	8.0	0.07	1.8	15/32	11.9	CT-1002, CT-1003, CT-1123	100
FSDXL78-10-C	16	1.5	Black	0.27	6.9	0.77	19.5	0.39	10.0	0.07	1.8	17/32	13.5		100
FSDXL80-8-C	14	2.5	Blue	0.31	7.8	0.69	17.5	0.32	8.0	0.09	2.3	15/32	11.9		100
FSDXL80-12-C	14	2.5	Blue	0.31	7.8	0.85	21.5	0.47	12.0	0.09	2.3	5/8	15.9		100
FSDXL81-10-C	12	4.0	Gray	0.31	7.8	0.77	19.5	0.39	10.0	0.11	2.9	17/32	13.5	CT-1002, +CT-1003, CT-1123	100
FSDXL82-12-C	10	6.0	Yellow	0.33	8.3	0.91	23.0	0.47	12.0	0.14	3.6	5/8	15.9		100
FSDXL83-12-C	8	10.0	Red	0.39	9.8	0.94	24.0	0.47	12.0	0.18	4.6	5/8	15.9	+CT-1003, CT-1004, +CT-1104, CT-1123	100
FSDXL84-12-C	6	16.0	Blue	0.47	12	1.00	25.5	0.47	12.0	0.24	6.0	5/8	15.9	+CT-1003, CT-1004, CT-1104, CT-1123	100

+Tool/part is not a UL listed combination. For crimping tool information see www.panduit.com/tools.



Insulated Ferrules – Twin Wire DIN End Sleeve

Type FTD

- Meets DIN standards for twin wire containment
- Polypropylene insulation housing conforms to DIN color requirements
- Funnel entry for faster insertion and lower installed cost
- Designed with a seamless barrel to contain loose wire strands for superior terminations
- Eases insertion of wire into terminal block
- Suitable for limited space panel applications
- Multiple pin lengths available for a variety of terminal blocks

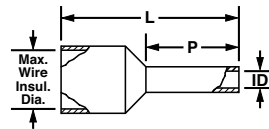
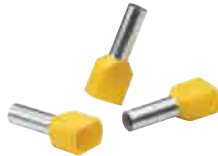

Part Number	Wire Size		Color Code	Max. Wire Insul. Dia.		Figure Dimensions						Wire Strip Length		Recommended Installation Tool	Std. Pkg. Qty.
	AWG	mm ²		In.	mm	L		P		ID		In.	mm		
FTD75-8-D*	22-20 AWG	0.5	White	0.87	2.2	0.59	15.0	0.31	8.0	0.06	1.5	7/16	11.2	CT-1002, CT-1003, CT-1123	500
FTD76-8-D	18 AWG	0.75	Gray	0.09	2.4	0.59	15.0	0.31	8.0	0.07	1.8	7/16	11.2		500
FTD76-10-D				0.09	2.4	0.67	17.0	0.39	10.0	0.07	1.8	9/16	14.0		500
FTD77-8-D	1.0	Red	0.11	2.7	0.59	15.0	0.31	8.0	0.08	2.1	7/16	11.2	500		
FTD77-10-D			0.11	2.7	0.67	17.0	0.39	10.0	0.08	2.1	9/16	14.0	500		
FTD78-8-D	16 AWG	1.5	Black	0.12	3.0	0.63	16.0	0.31	8.0	0.09	2.3	7/16	11.2		500
FTD78-12-D				0.12	3.0	0.79	20.0	0.47	12.0	0.09	2.3	21/32	16.8		500
FTD80-10-TL	14 AWG	2.5	Blue	0.15	3.7	0.73	18.5	0.39	10.0	0.11	2.9	9/16	14.0		250
FTD80-13-TL				0.15	3.7	0.85	21.5	0.51	13.0	0.11	2.9	21/32	16.2		250
FTD81-12-C+	12 AWG	4.0	Gray	0.17	4.3	0.91	23.0	0.47	12.0	0.15	3.8	23/32	16.8		100
FTD82-14-C+	10 AWG	6.0	Yellow	0.19	4.8	0.98	25.0	0.55	14.0	0.18	4.6	21/32	19.6	CT-1003, CT-1004, CT-1104	100
FTD83-14-C	8 AWG	10.0	Red	0.28	7.1	1.02	26.0	0.55	14.0	0.26	6.6	3/4	19.0	CT-1005	100
FTD84-16-C	6 AWG	16.0	Blue	0.35	8.9	1.22	31.0	0.63	16.0	0.33	8.4	13/16	21.0		100

*UL listed with 20 AWG only, UL486F scope is 1/0-20AWG. White is DIN color for 20 AWG
 +Tool/Part is not a UL listed combination. For crimping tool information see www.panduit.com/tools.



Insulated Ferrules on Strips – Single Wire

Type FSD

- Polypropylene insulation housing available in DIN standard colors in strips of 50
- Continuously molded design provides consistent placement of ferrules in tool to ensure fast, reliable terminations
- Available in #20 – 14 AWG featuring a seamless barrel design to contain loose wire strands for superior terminations
- Designed for use with the Semiautomatic Ferrule Crimping Tool CT-1000 for medium volume applications

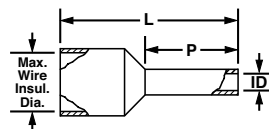

Part Number	Wire Size		Color Code	Max. Wire Insul. Dia.		Figure Dimensions						Wire Strip Length		Recommended Installation Tool	Std. Pkg. Qty.	
	AWG	mm ²		In.	mm	L		P		ID		In.	mm			
DIN End Sleeves																
FSD75-8-DSL10	20 AWG	0.50	White	0.10	2.6	0.60	15.2	0.31	8.0	0.04	1.0	13/32	10.0	CT-1000	500	
FSD76-8-DSL8	18 AWG	0.75	Gray	0.11	2.7	0.60	15.2	0.31	8.0	0.06	1.5	13/32	10.0		500	
FSD77-8-DSL2	1.00	Red	0.12	3.0	0.60	15.2	0.31	8.0	0.07	1.8	13/32	10.0	500			
FSD78-8-DSL0	16 AWG	1.50	Black	0.13	3.2	0.60	15.2	0.31	8.0	0.09	2.3	13/32	10.0		500	
FSD80-8-DSL6	14 AWG	2.50	Blue	0.16	4.0	0.60	15.2	0.31	8.0	0.09	2.3	13/32	10.0		500	

For crimping tool information see www.panduit.com/tools.



Ferrules, Non-Insulated

Type F

- Designed with a seamless barrel to contain loose wire strands for superior terminations
- Eases insertion of wire into terminal block
- Meets DIN standards for wire containment
- Suitable for limited space panel applications
- Multiple pin lengths available for a variety of terminal blocks

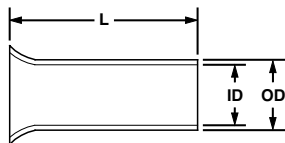

Part Number	Wire Size		Figure Dimensions						Wire Strip Length		Recommended Installation Tool	Std. Pkg. Qty.		
	AWG	mm ²	L		ID		OD		In.	mm				
F73-5-M*	24 AWG	0.25	0.20	5.0	0.03	0.80	0.04	1.1	7/32	5.0	CT-1002, CT-1123	1000		
F73-7-M*			0.28	7.0	0.03	0.80	0.04	1.1	9/32	7.0		1000		
F74-5-M*	24 – 22 AWG	0.34	0.20	5.0	0.04	0.90	0.05	1.2	7/32	5.0		1000		
F74-7-M*			0.28	7.0	0.04	0.90	0.05	1.2	9/32	7.0		1000		
F75-6-M+	22 – 20 AWG	0.50	0.24	6.0	0.04	1.0	0.05	1.3	1/4	6.0		CT-1002, CT-1003, CT-1123	1000	
F75-8-M+			0.31	8.0	0.04	1.0	0.05	1.3	5/16	8.0			1000	
F75-10-M+			0.39	10.0	0.04	1.0	0.05	1.3	13/32	10.0	1000			
F76-6-M	18 AWG	0.75	0.24	6.0	0.05	1.2	0.06	1.5	1/4	6.0	1000			
F76-8-M			0.31	8.0	0.05	1.2	0.06	1.5	5/16	8.0	1000			
F76-10-M			0.39	10.0	0.05	1.2	0.06	1.5	13/32	10.0	1000			
F76-12-M			0.47	12.0	0.05	1.2	0.06	1.5	15/32	12.0	1000			
F77-6-M	16 AWG	1.0	0.24	6.0	0.06	1.4	0.07	1.7	1/4	6.0	CT-1002, CT-1003, CT-1123	1000		
F77-7-M			0.28	7.0	0.06	1.4	0.07	1.7	9/32	7.0		1000		
F77-8-M			0.31	8.0	0.06	1.4	0.07	1.7	5/16	8.0		1000		
F77-10-M			0.39	10.0	0.06	1.4	0.07	1.7	13/32	10.0		1000		
F77-12-M			0.47	12.0	0.06	1.4	0.07	1.7	15/32	12.0		1000		
F78-7-M	14 AWG	1.5	0.28	7.0	0.07	1.7	0.08	2.0	9/32	7.0		CT-1002, CT-1003, CT-1123	1000	
F78-8-M			0.31	8.0	0.07	1.7	0.08	2.0	5/16	8.0	1000			
F78-10-M			0.39	10.0	0.07	1.7	0.08	2.0	13/32	10.0	1000			
F78-12-M			0.47	12.0	0.07	1.7	0.08	2.0	15/32	12.0	1000			
F78-15-M			0.59	15.0	0.07	1.7	0.08	2.0	19/32	15.0	1000			
F78-18-M			0.71	18.0	0.07	1.7	0.08	2.0	23/32	18.0	1000			
F78-20-M			0.79	20.0	0.07	1.7	0.08	2.0	25/32	20.0	1000			
F80-7-M			12 AWG	2.5	0.28	7.0	0.09	2.2	0.10	2.5	9/32	7.0	CT-1002, CT-1003, CT-1123	1000
F80-8-M	0.31	8.0			0.09	2.2	0.10	2.5	5/16	8.0	1000			
F80-10-M	0.39	10.0			0.09	2.2	0.10	2.5	13/32	10.0	1000			
F80-12-M	0.47	12.0			0.09	2.2	0.10	2.5	15/32	12.0	1000			
F80-15-M	0.59	15.0			0.09	2.2	0.10	2.5	19/32	15.0	1000			
F80-18-M	0.71	18.0			0.09	2.2	0.10	2.5	23/32	18.0	1000			
F80-20-M	0.79	20.0			0.09	2.2	0.10	2.5	25/32	20.0	1000			
F81-9-M	10 AWG	4.0			0.35	9.0	0.11	2.8	0.13	3.2	11/32	8.0	CT-1002, CT-1003, CT-1123	1000
F81-10-M			0.39	10.0	0.11	2.8	0.13	3.2	13/32	10.0	1000			
F81-12-M			0.47	12.0	0.11	2.8	0.13	3.2	15/32	12.0	1000			
F81-15-M			0.59	15.0	0.11	2.8	0.13	3.2	19/32	15.0	1000			
F81-18-M			0.71	18.0	0.11	2.8	0.13	3.2	23/32	18.0	1000			
F81-20-M			0.79	20.0	0.11	2.8	0.13	3.2	25/32	20.0	1000			
F82-10-M‡			10 AWG	6.0	0.39	10.0	0.14	3.5	0.15	3.9	13/32	10.0	CT-1002, ‡CT-1003, CT-1123	1000
F82-12-M‡					0.47	12.0	0.14	3.5	0.15	3.9	15/32	12.0		1000
F82-15-M‡	0.59	15.0			0.14	3.5	0.15	3.9	19/32	15.0	1000			
F82-18-M‡	0.71	18.0			0.14	3.5	0.15	3.9	23/32	18.0	1000			
F82-20-M‡			0.79	20.0	0.14	3.5	0.15	3.9	25/32	20.0	1000			

*Not UL listed, UL 486F scope is 20 - 1/0 AWG only

+UL listed with 20 AWG only

‡Tool/Part is not a UL listed Combination. For crimping tool information see www.panduit.com/tools.



Ferrules, Non-Insulated (continued)

Type F

Part Number	Wire Size		Figure Dimensions						Wire Strip Length		Recommended Installation Tool	Std. Pkg. Qty.
			L		ID		OD					
	AWG	mm ²	In.	mm	In.	mm	In.	mm	In.	mm		
F83-12-D‡	8 AWG	10.0	0.47	12.0	0.18	4.5	0.19	4.9	15/32	12.0	‡CT-1003, ‡CT-1004, CT-1123, CT-1104	500
F83-15-D‡			0.59	15.0	0.18	4.5	0.19	4.9	19/32	15.0		500
F83-18-D‡			0.71	18.0	0.18	4.5	0.19	4.9	23/32	18.0		500
F83-20-D‡			0.79	20.0	0.18	4.5	0.19	4.9	25/32	20.0		500
F83-25-D‡			0.98	25.0	0.18	4.5	0.19	4.9	31/32	25.0		500
F84-12-TL‡	6 AWG	16.0	0.47	12.0	0.23	5.8	0.24	6.2	15/32	12.0	‡CT-1004, CT-1104	250
F84-15-TL‡			0.59	15.0	0.23	5.8	0.24	6.2	19/32	15.0		250
F84-18-TL‡			0.71	18.0	0.23	5.8	0.24	6.2	23/32	18.0		250
F84-20-TL‡			0.79	20.0	0.23	5.8	0.24	6.2	25/32	20.0		250
F84-25-TL‡			0.98	25.0	0.23	5.8	0.24	6.2	31/32	25.0		250
F84-32-TL‡	1.26	32.0	0.23	5.8	0.24	6.2	1 1/4	32.0	250			
F85-12-C	4 AWG	25.0	0.47	12.0	0.29	7.3	0.30	7.7	15/32	12.0	CT-1005	100
F85-15-C			0.59	15.0	0.29	7.3	0.30	7.7	19/32	15.0		100
F85-18-C			0.71	18.0	0.29	7.3	0.30	7.7	23/32	18.0		100
F85-25-C			0.98	25.0	0.29	7.3	0.30	7.7	31/32	25.0		100
F85-32-C			1.26	32.0	0.29	7.3	0.30	7.7	1 1/4	32.0		100
F86-18-C	2 AWG	35.0	0.71	18.0	0.33	8.3	0.34	8.7	23/32	18.0	CT-1005	100
F86-20-C			0.79	20.0	0.33	8.3	0.34	8.7	25/32	20.0		100
F86-25-C			0.98	25.0	0.33	8.3	0.34	8.7	31/32	25.0		100
F86-32-C			1.26	32.0	0.33	8.3	0.34	8.7	1 1/4	32.0		100
F87-18-C			0.71	18.0	0.41	10.3	0.43	10.9	23/32	18.0		100
F87-22-C	1 AWG-1/0	50.0	0.87	22.0	0.41	10.3	0.43	10.9	7/8	22.0	CT-1006, **CD-2001-F87	100
F87-25-C			0.98	25.0	0.41	10.3	0.43	10.9	31/32	25.0		100
F87-32-C			1.26	32.0	0.41	10.3	0.43	10.9	1 1/4	32.0		100
F89-25-L*	2/0	70.0	0.98	25.0	0.49	12.5	0.52	13.3	31/32	25.0	**CD-2001-F89	50
F89-32-L*			1.26	32.0	0.49	12.5	0.52	13.3	1 1/4	32.0		50
F90-25-L*	3/0	95.0	0.98	25.0	0.57	14.5	0.60	15.3	31/32	25.0	**CD-2001-F90	50
F90-30-L*			1.18	30.0	0.57	14.5	0.60	15.3	13/16	30.0		50
F90-32-L*			1.26	32.0	0.57	14.5	0.60	15.3	1 1/4	32.0		50
F91-32-L*	4/0-250 kcmil	120.0	1.26	32.0	0.65	16.5	0.69	16.5	1 1/4	32.0	**CD-2001-F91	50
F91-40-L*			1.57	40.0	0.65	16.5	.069	16.5	1 19/32	40.0		50
F92-32-L*	300 kcmil	150	1.26	32.0	0.73	18.5	0.77	19.5	1 1/4	32.0	**CD-2001-F92	50
F92-38-L*			1.50	38.0	0.73	18.5	0.77	19.5	1 1/2	38.0		50
F93-32-Q*	350 kcmil	185	1.26	32.0	0.79	20.0	0.83	21.2	1 1/4	32.0	**CD-2001-F93	25
F93-40-Q*			1.57	40.0	0.79	20.0	0.83	21.2	1 19/32	40.0		25
F94-40-Q*	500 kcmil	240	1.57	40.0	0.90	22.8	0.94	24.0	1 19/32	40.0	**CD-2001-F94	25

*Not UL listed, UL486F scope is 20 - 1/0 AWG only

+UL listed with 20 AWG only

‡Tool/Part is not a UL listed Combination. For crimping tool information see www.panduit.com/tools.

**Dies used with CT-3001 or CT-3001/E tool

B1.
Cable
Ties

B2.
Cable
Accessories

B3.
Stainless
Steel Cable
Ties &
Accessories

C1.
Wiring
Duct

C2.
Abrasion
Protection

C3.
Cable
Management

D1.
Terminals

D2.
Power
Connectors

D3.
Grounding
Connectors

E1.
Labeling
Systems

E2.
Labels

E3.
Pre-Printed
&
Write-On
Markers

E4.
Permanent
Identification

E5.
Industrial
Safety
Solutions

F.
Keystone
Cabling
Systems

G.
Part
Number
Index

Ferrule Assortment Kits

- Large selection of ferrules in a convenient compact case
- Plastic case is both durable and reusable keeping ferrules organized and separated



KP-FSD1, KP-FSD2,
and KP-FSD3



KP-F1 and KP-F2

Part Number	Part Description	Std. Pkg. Qty.
KP-FSD1	Ferrule kit includes: #24 – 18 AWG insulated DIN ferrules. Case includes: 30 pieces each of FSD73-6, FSD74-6, FSD75-8, FSD76-8 and FSD77-8.	1
KP-FSD2	Ferrule kit includes: #22 – 14 AWG insulated DIN ferrules. Case includes: 100 pieces each of FSD76-8, FSD77-8, FSD78-8 50 pieces each of FSD75-8 and FSD80-8.	1
KP-FSD3	Ferrule kit includes: #12 – 6 AWG insulated DIN ferrules. Case includes: 50 pieces of FSD81-10 20 pieces each of FSD82-12 and FSD83-12 10 pieces of FSD84-12.	1
KP-F1	Ferrule kit includes: #22 – 14 AWG non-insulated ferrules. Case includes: 500 pieces of F75-6 400 pieces each of F76-6 and F77-6 300 pieces of F78-7 200 pieces of F80-7.	1
KP-F2	Ferrule kit includes: #12 – 6 AWG non-insulated ferrules. Case includes: 150 pieces of F81-9 100 pieces of F82-10 80 pieces of F83-12 40 pieces of F84-12.	1

Ferrule kits do not include crimping tool.

Tooling Selection Guide for Panduit® Ferrules

Panduit Ferrule Series	Ferrule Description	Wire Range (AWG)	Wire Range (mm ²)	Wire Strip Length	CT-1000	CT-1002	CT-1003	CT-1004	CT-1005	CT-1006	CT-1104	CT-1123	CT-3001		
F	Non-insulated ferrules	24	0.25	Please See Ferrule Tables – Pages D1.56 – D1.61		X	X					X			
		22 – 18	0.50 – 1.00			X	X						X		
		16	1.50			X	X						X		
		14	2.50			X	X						X		
		12	4.00			X	X						X		
		10	6.00			X	X						X		
		8	10.0					X	X				X		
		6	16.0					X	X				X		
		4 – 2	25.0 – 35.0								X		X		
		1 – 1/0	50.0									X			X
		2/0	70.0												X
		3/0	95.0												X
		4/0 – 250 kcmil	120.0												X
		300 kcmil	150.0												X
		350 kcmil	185.0												X
400 – 500 kcmil	240.0											X			
FSD	Insulated Single Wire Ferrules (DIN Color Code)	26 – 18	0.41 – 1.00			X	X					X			
		16 – 14	1.50 – 2.00			X	X					X			
		12 – 10	4.00 – 6.00			X	X					X			
		8	10.0				X	X				X	X		
		6	16.0				X	X				X			
		4 – 2	25.0 – 35.0						X						
		1 – 1/0	50.0								X			X	
		2/0	70.0											X	
		3/0	95.0											X	
		4/0 – 250 kcmil	120.0											X	
300 kcmil	150.0											X			
FTD	Insulated Twin Wire Ferrules (DIN Color Code)	22 – 18	0.50 – 1.00			X	X					X			
		16 – 14	1.50 – 2.00			X	X					X			
		12	4.00			X	X					X			
		10	6.00				X	X				X			
		8 – 6	10.0 – 16.0						X			X			
FSD-DSL	Insulated Single Wire Ferrules on Strips of 50 (DIN Color Code)	20 – 14	0.5 – 2.5	0.31" (8mm)	X										

Technical Specification and Selection Information

The following pages provide information helpful in specifying Panduit® terminals and selecting the appropriate terminal and tooling for your applications.



Panduit Terminal Approvals

Logo (Symbol)	Agency	Spec/Approval	Requirement	Applicable Products
	Underwriters Laboratories, Inc.	#E52164 – UL486A	Minimum tensile strength (pull out force for the crimp terminal) and test current for max. 50°C rise (amps)	All Ring and Fork Terminals
		#E78522 – UL310	Minimum tensile strength (pull out force for the crimp terminal) and continuous test current for max. 30°C rise (amps) (for 0.187", 0.205", 0.250" tab widths) and (0.110" tab width)	All Disconnects
		#E52164 – UL486C	Minimum tensile strength (pull out force for the crimp terminal) and test current for max. 50°C rise (amps)	All Splices
		#E472545 – UL486F	Minimum tensile strength (pull force for the crimped ferrule), Mold Stress Relief, and Dielectric Voltage Withstand	Select Ferrules
	Canadian Standards Association	#LR31212 – C22.2 No. 65	Minimum tensile strength (pull out force for the crimp terminal) and test current for max. 50°C rise (amps)	All Ring and Fork Terminals
		#LR31212 – C22.2 No. 153		All Disconnects
		#LR31212 – C22.2 No.291-14	Minimum tensile strength (pull force for the crimped ferrule), Mold Stress Relief, and Dielectric Voltage Withstand	All Ferrules
	American Bureau of Shipping	ABS Rules, Steel Vessel Rules 1-1-4/7.7, 4-8-3/9.19, 4-8-4/21.28	Passed extensive testing requirements to verify that product will perform reliably in marine and offshore environments.	Fork Terminals: P-F, PN-F, PV-F, PN-LF, PNF-LF, PV-LF, P-LF Ring Terminals: P-R, PN-R, PNF-R, PV-R, S-R Wire Joints: JN224-318, JN218-216, JN418-212 Splices: BSN, BSV, BS Disconnects: DNF, DNF-FIB, DVF, D, DNF-FL, DNF-M, DNF18-250M, DNF14-250M, DNF18-250FIM, FIMB, FIB, 14-250FIM, FIMB, and FIB
	IEEE (Institute of Electrical and Electronics Engineers)	IEEE std 323-2003 for Qualifying Class 1E Eqpt. for Nuclear Power Generating Stations	Meets criteria for use in harsh, high radiation environments in nuclear power plants	■Kynar Ring Terminals
	Dept. of Defense	Mil Spec Qualification Test Ref #01017302.AE/05-24-2016	Approved for listing on QPL AS 7928 Class I and Class II	Ring Terminals

■KYNAR is a registered trademark of Atofina Chemicals, Inc.

Performance Requirements

	Wire Size (AWG)							
	#26	#24	#22	#20	#18	#16	#14	#12

UL 486A (TERMINALS), UL 310 (MALE BLADE ADAPTERS)

Test Current for Max. 50°C Rise (Amps)	3.5	7	9	12	17	18	30	35	50
Min. Tensile Strength* (Lbs.)	3	5	8	13	20	30	50	70	80

UL 486C (SPICES)

Test Current for Max. 50°C Rise (Amps)	5.5	7	9	12	17	18	30	35	50
Min. Tensile Strength* (Lbs.)	3	5	8	10	10	15	25	35	40

*Pull-out force of the crimped terminal.

	Wire Size (AWG)						
	#22	#20	#18	#16	*#14	#12	#10

UL 310 (DISCONNECTS)

Continuous Test Current for Max. 30°C Rise (amps) (for 187", 205", 250" tab widths)	3	4	7	10	15	20	24
Continuous Test Current for Max. 30°C Rise (amps) (for 0.110", tab width)	2	3	4	5	Not Applicable		
Min. Tensile Strength* (Lbs.)	8	13	20	30	50	70	80

*Pull-out force of the crimped disconnect.

Applicable Pan-Term® products meet or exceed the following test specifications:

- UL 486A (Terminals)
- UL 486C (Splices)
- UL 310 (Blade Adapters)
- CSA C22.2 No. 65 (all designs)

UL and CSA approved products are shown with the applicable logos in the product section. UL file #E52164, CSA File #LR31212.

Applicable Pan-Term® products meet or exceed the following test specifications:

- UL 310 (Disconnects)
- CSA C22.2 No. 153 (all designs)

UL and CSA Listed products are shown with the applicable logos in the product section. UL file #E78522 and CSA file #LR31212.

Applicable Panduit® ferrules meet or exceed the following test specifications:

- UL 486F (Ferrules)
- CSA-C22.2 No.291-14
- DIN color code

UL and CSA Listed products are shown with the applicable logos in the product section. UL file #E472545 and CSA file #LR31212

Panduit® Pan-Term® Terminal Military Cross Reference

Current Mil. Std Part No., Class 1	Ring Terminals Nylon Insulated
MS25036-101	PN18-6RN
MS25036-102	PN18-6R
MS25036-103	PN18-10R
MS25036-104	PN18-56R
MS25036-105	PN18-38R
MS25036-106	PN14-6RN
MS25036-107	PN14-6R
MS25036-108	PN14-10R
MS25036-109	PN14-56R
MS25036-110	PN14-38R
MS25036-111	PN10-6R
MS25036-112	PN10-10R
MS25036-113	PN10-56R
MS25036-114	PN10-38R
MS25036-148	PN18-4RN
MS25036-149	PN18-8R
MS25036-150	PN18-14R
MS25036-152	PN14-4R
MS25036-153	PN14-8R
MS25036-154	PN14-14R
MS25036-156	PN10-8R
MS25036-157	PN10-14R

Current Mil. Std Part No., Class 2	Ring Terminals, Nylon Insulated or Nylon Insulated with Funnel Entry
MS25036-101	PN18-6RN or PNF18-6RN
MS25036-102	PN18-6R or PNF18-6R
MS25036-103	PN18-10R or PNF18-10R
MS25036-104	PN18-56R or PNF18-56R
MS25036-105	PN18-38R or PNF18-38R
MS25036-106	PN14-6RN or PNF14-6RN
MS25036-107	PN14-6R or PNF14-6R
MS25036-108	PN14-10R or PNF14-10R
MS25036-109	PN14-56R or PNF14-56R
MS25036-110	PN14-38R or PNF14-38R
MS25036-111	PN10-6R or PNF10-6R
MS25036-112	PN10-10R or PNF10-10R
MS25036-113	PN10-56R or PNF10-56R
MS25036-114	PN10-38R or PNF10-38R
MS25036-148	PN18-4RN or PNF18-4RN
MS25036-149	PN18-8R or PNF18-8R
MS25036-150	PN18-14R or PNF18-14R
MS25036-152	PN14-4R or PNF14-4R
MS25036-153	PN14-8R or PNF14-8R
MS25036-154	PN14-14R or PNF14-14R
MS25036-156	PN10-8R or PNF10-8R
MS25036-157	PN10-14R or PNF10-14R
Crimping Tools: CT-400 and CT-460	

Current Mil. Std Part No., Class 1	Ring Terminals Non-Insulated
MS20659-165	P10-6R
MS20659-105	P10-10R
MS20659-106	P10-56R
MS20659-128	P10-38R

Stud Size Chart (Inches/Millimeters)

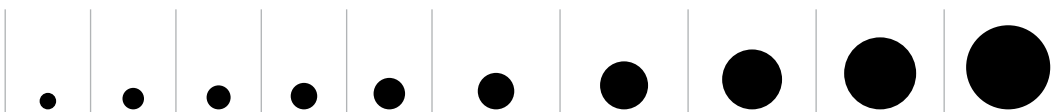

Standard Stud Size	#2	#4	#5	#6	#8	#10	14"	5/16"	3/8"	7/16"
Metric Stud Size (mm)	M2	M2.5	M3	M3.5	M4	M5	M6	M8	M10	M11
Stud Size Decimal Equivalent	0.086"	0.112"	0.127"	0.138"	0.164"	0.190"	0.250"	0.312"	0.375"	0.438"
Metric Diameter (mm)	2.18	2.84	3.18	3.51	4.17	4.83	6.35	7.92	9.53	11.13
Terminal Hole Diameter	0.090"	0.118"	0.130"	0.147"	0.173"	0.204"	0.270"	0.343"	0.392** 0.406***	0.456"
Terminal Hole Diameter Metric (mm)	2.29	3.0	3.23	3.71	4.39	5.18	6.86	8.71	9.78	11.58
Stud Size Designation in Panduit Part Number	2	4	5	6	8	10	14	56	38	76

*Terminal stud.

**Power Connector stud.

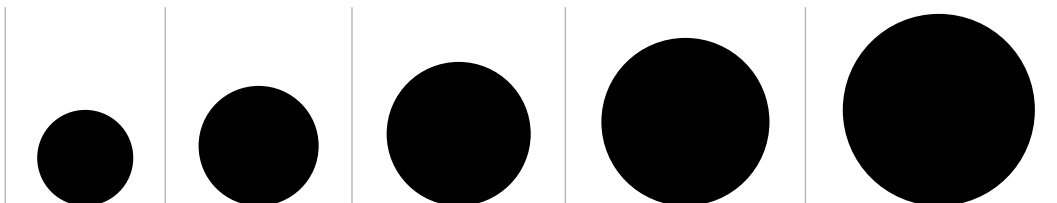









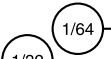
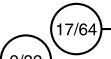
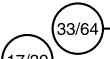
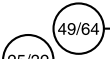
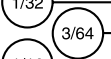
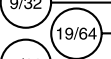
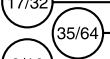
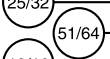
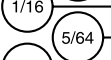
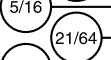
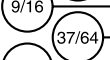
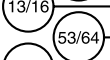
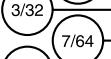
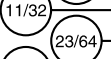
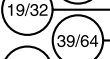
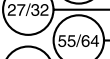
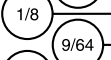
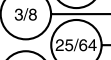
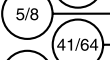
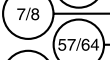
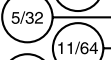
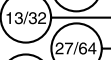
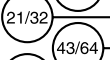
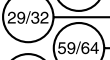
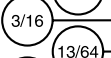
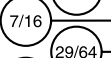
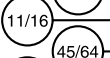
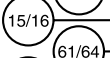
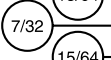
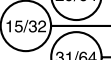
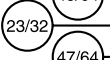
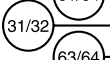

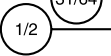
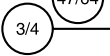
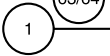

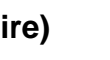

Standard Stud Size	1/2"	5/8"	3/4"	7/8"	1"
Metric Stud Size (mm)	M12	M16	M18	M20	M25
Stud Size Decimal Equivalent	0.500"	0.625"	0.750"	0.875"	1.00"
Metric Diameter (mm)	12.7	15.88	19.05	22.23	25.4
Terminal Hole Diameter	0.531"	0.656"	0.810"	0.906"	1.031"
Terminal Hole Diameter Metric (mm)	13.49	16.66	20.57	23.01	26.19
Stud Size Designation in Panduit Part Number	12	58	34	78	1

Note: Stud hole diagrams are for U.S. reference only.

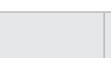
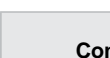
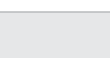
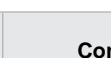
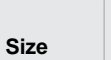
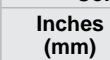
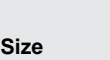
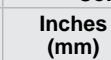
Equivalent Tables

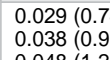
Decimal/Inches/Millimeters

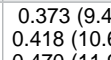
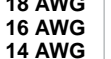
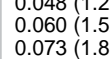
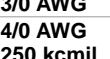
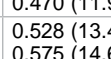
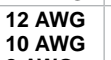
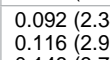
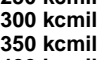
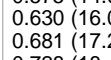
 1/64 — 0.0156 0,396	 17/64 — 0.2656 6,746	 33/64 — 0.5156 13,100	 49/64 — 0.7656 19,446
 1/32 — 0.0312 0,792	 9/32 — 0.2812 7,143	 17/32 — 0.5312 13,492	 25/32 — 0.7812 14,842
 3/64 — 0.0468 1,189	 19/64 — 0.2968 7,541	 35/64 — 0.5468 13,891	 51/64 — 0.7968 20,241
 1/16 — 0.0625 1,588	 5/16 — 0.3125 7,938	 9/16 — 0.5625 14,288	 13/16 — 0.8125 20,637
 5/64 — 0.0781 1,984	 21/64 — 0.3281 8,337	 37/64 — 0.5781 14,684	 53/64 — 0.8281 21,034
 3/32 — 0.0937 2,380	 11/32 — 0.3437 8,730	 19/32 — 0.5937 15,080	 27/32 — 0.8437 21,480
 7/64 — 0.1093 2,779	 23/64 — 0.3593 9,129	 39/64 — 0.6093 15,479	 55/64 — 0.8593 21,828
 1/8 — 0.125 3,175	 3/8 — 0.375 9,525	 5/8 — 0.625 15,875	 7/8 — 0.875 22,225
 9/64 — 0.1406 3,571	 25/64 — 0.3906 9,921	 41/64 — 0.6406 16,271	 57/64 — 0.8906 22,620
 5/32 — 0.1562 3,968	 13/32 — 0.4062 10,317	 21/32 — 0.6562 16,667	 29/32 — 0.9062 23,017
 11/64 — 0.1718 4,366	 27/64 — 0.4218 10,716	 43/64 — 0.6718 17,066	 59/64 — 0.9218 23,416
 3/16 — 0.1875 4,763	 7/16 — 0.4375 11,113	 11/16 — 0.6875 17,463	 15/16 — 0.9375 23,810
 13/64 — 0.2031 5,159	 29/64 — 0.4531 11,509	 45/64 — 0.7031 17,859	 61/64 — 0.9531 24,208
 7/32 — 0.2187 5,555	 15/32 — 0.4687 11,905	 23/32 — 0.7187 18,255	 31/32 — 0.9687 24,605
 15/64 — 0.2343 5,954	 31/64 — 0.4843 12,304	 47/64 — 0.7343 18,654	 63/64 — 0.9843 25,001
 1/4 — 0.25 6,350	 1/2 — 0.5 12,700	 3/4 — 0.75 19,050	 1 — 1. 25,400

Common Conductor Size Chart (Stranded Wire)

Size	No. of Strands	Conductor Size		
		Individual Strand Size	Inches (mm)	Circle Mil Area (mm ²)
22 AWG	7	0.0096 (0.24)	0.029 (0.74)	640 (0.324)
20 AWG	10	0.0100 (0.25)	0.038 (0.97)	1020 (0.519)
18 AWG	16	0.0100 (0.25)	0.048 (1.22)	1620 (0.823)
16 AWG	26	0.0100 (0.25)	0.060 (1.52)	2580 (1.310)
14 AWG	7	0.0242 (0.61)	0.073 (1.85)	4110 (2.080)
12 AWG	7	0.0305 (0.77)	0.092 (2.34)	6530 (3.310)
10 AWG	7	0.0385 (0.98)	0.116 (2.95)	10,380 (5.261)
8 AWG	7	0.0486 (1.23)	0.146 (3.71)	16,510 (8.367)
6 AWG	7	0.0612 (1.55)	0.184 (4.67)	26,240 (13.30)
4 AWG	7	0.0772 (1.96)	0.232 (5.89)	41,740 (21.15)
2 AWG	7	0.0974 (2.47)	0.292 (7.42)	66,360 (33.62)
1 AWG	19	0.0664 (1.69)	0.332 (8.43)	83,690 (42.41)

Size	No. of Strands	Conductor Size		
		Individual Strand Size	Inches (mm)	Circle Mil Area (mm ²)
1/0 AWG	19	0.0745 (1.89)	0.373 (9.47)	105,600 (0.823)
2/0 AWG	19	0.0837 (2.13)	0.418 (10.62)	133,100 (67.43)
3/0 AWG	19	0.0940 (2.39)	0.470 (11.94)	167,800 (85.01)
4/0 AWG	19	0.1055 (2.68)	0.528 (13.41)	211,600 (107.2)
250 kcmil	37	0.0822 (2.09)	0.575 (14.61)	250,000 (127)
300 kcmil	37	0.0900 (2.29)	0.630 (16.00)	300,000 (152)
350 kcmil	37	0.0973 (2.47)	0.681 (17.29)	350,000 (177)
400 kcmil	37	0.1040 (2.64)	0.728 (18.49)	400,000 (203)
500 kcmil	37	0.1162 (2.95)	0.813 (20.65)	500,000 (253)
600 kcmil	61	0.0992 (2.52)	0.893 (22.68)	600,000 (304)
750 kcmil	61	0.1109 (2.82)	0.998 (25.35)	750,000 (380)
800 kcmil	61	0.1145 (2.91)	1.031 (26.19)	800,000 (405)
1000 kcmil	61	0.1280 (3.25)	1.152 (29.26)	1,000,000 (507)

Common Conductor Sizes and Strandings Reference Chart

Conductor	Individual Strands			Overall Conductor Size			Conductor	Individual Strands			Overall Conductor Size									
	AWG	Metric mm ²	Diameter		Diameter			AWG	Metric mm ²	Diameter		Diameter		Circ. MILS						
			No.	mm	In.	mm				In.	mm	In.								
26	0.05	25	0.05	0.002	0.25	0.010	97	16	1.0	19	0.25	0.010	1.30	0.051	1841					
	0.06	41	0.05	0.002	0.36	0.014	159		1	1.13	0.044	1.13	0.044	1979						
	10	0.13	0.005	0.53	0.021	0.250	250		32	0.20	0.008	1.30	0.051	1984						
															1	0.41	0.016	0.41	0.016	256
	7	0.16	0.006	0.48	0.019	278	19		0.29	0.011	1.47	0.058	2426							
														65	0.16	0.006	1.50	0.059	2580	
	24	0.08	0.003	0.58	0.023	384	384		*26	0.25	0.010	1.50	0.059	2600						
															10	0.16	0.006	0.58	0.023	397
															1	0.51	0.020	0.51	0.020	400
															7	0.20	0.008	0.61	0.024	448
19	0.13	0.005	0.61	0.024	475	475	*7	0.51	0.020	1.52	0.060	2828								
													30	0.25	0.010	1.70	0.067	2906		
													21	0.30	0.012	1.60	0.063	2930		
													189	0.10	0.004	1.90	0.075	2930		
22	0.25	0.006	0.65	0.026	556	556	7	0.52	0.020	1.60	0.063	2934								
													1	1.38	0.054	1.38	0.054	2952		
													45	0.16	0.006	1.85	0.073	3786		
													19	0.38	0.014	1.85	0.073	3831		
22	0.16	0.006	0.76	0.030	635	635	1	1.63	0.064	1.63	0.064	4096								
													7	0.25	0.010	0.76	0.030	700		
													19	0.16	0.006	0.79	0.031	754		
													26	0.13	0.005	0.76	0.030	650		
19	0.10	0.004	0.80	0.031	744	744	*41	0.25	0.010	1.85	0.073	4100								
													194	0.05	0.002	0.80	0.031	752		
													100	0.07	0.003	0.80	0.031	760		
													7	0.27	0.011	0.80	0.031	791		
12	0.21	0.008	0.80	0.031	820	820	1	1.78	0.070	1.78	0.070	4911								
													21	0.16	0.006	0.80	0.031	833		
													19	0.45	0.018	2.36	0.093	6088		
													*65	0.25	0.010	2.41	0.095	6500		
12	0.30	0.012	0.90	0.035	977	977	165	0.16	0.006	2.41	0.095	6549								
													16	0.20	0.008	0.90	0.035	992		
													1	0.80	0.031	0.80	0.031	992		
													*7	0.81	0.032	0.81	0.032	1024		
20	0.25	0.010	0.89	0.035	1000	1000	*7	0.81	0.032	2.44	0.096	7168								
													1	0.81	0.032	0.81	0.032	1024		
													41	0.13	0.005	0.91	0.036	1025		
													26	0.16	0.006	0.91	0.036	1032		
10	0.32	0.013	0.97	0.038	1111	1111	56	0.30	0.012	3.10	0.122	7812								
													1	2.26	0.089	2.26	0.089	7917		
													511	0.10	0.004	3.00	0.118	7921		
													19	0.52	0.020	2.70	0.106	7963		
10	0.20	0.008	0.94	0.037	1216	1216	37	0.40	0.016	2.92	0.115	9354								
													49	0.36	0.014	2.95	0.116	9880		
													*7	0.98	0.039	2.95	0.116	10376		
													1	2.59	0.102	2.59	0.102	10404		
18	0.75	0.015	1.10	0.043	1485	1485	*105	0.25	0.010	2.95	0.116	10500								
													24	0.20	0.008	1.20	0.047	1488		
													1	1.00	0.039	1.00	0.039	1550		
													*16	0.25	0.010	1.19	0.047	1600		
6.0	1.02	0.040	1.02	0.040	1600	1600	84	0.30	0.012	3.50	0.138	11718								
													65	0.13	0.005	1.19	0.047	1625		
													41	0.16	0.006	1.19	0.047	1627		
													*7	0.40	0.016	1.22	0.048	1770		
19	0.25	0.010	1.24	0.049	1900	1900	756	0.10	0.004	3.70	0.146	11718								
													1	2.76	0.109	2.76	0.109	11807		
19	0.64	0.025	3.30	0.130	12063	12063	7	1.05	0.041	3.20	0.126	11962								
													19	0.64	0.025	3.30	0.130	12063		

*Strandings required for UL and CSA certification testing.

This chart details the different conductors commonly used in the industry. For each size, either AWG or metric, various stranding options are listed. Typically the higher stranding is used in applications requiring greater conductor flexibility.

AWG to Metric Wire Crosses	
AWG	Metric (mm ²)
26 – 22	0.1 – 0.5
22 – 18	0.5 – 1.0
16 – 14	1.5 – 2.5
12 – 10	4.0 – 6.0

Continues on next page

Common Conductor Sizes and Strandings Reference Chart (continued)

Conductor		Individual Strands			Overall Conductor Size			Conductor		Individual Strands			Overall Conductor Size		
AWG	Metric mm ²	No.	Diameter		Diameter		Circ. MILS	AWG	Metric mm ²	No.	Diameter		Diameter		Circ. MILS
			mm	In.	mm	In.					mm	In.	mm	In.	
	6	7	0.107	0.042	3.21	0.126	11840		95	19	2.57	0.101	12.8	0.505	187500
		1	2.77	0.109	2.77	0.109	11840			37	1.83	0.072	12.5	0.504	187500
9		7	1.1	0.0432	3.3	0.13	13000	4/0		19	2.89	0.1055	13.4	0.528	211600
		1	2.91	0.1144	2.91	0.114	13090			120	37	2.06	0.081	14.4	0.567
8		1	3.26	0.1285	3.25	0.128	16510	250 kcmil		37	2.07	0.0822	14.6	0.575	250 kcmil
		7	1.23	0.0486	3.7	0.146	16510			150	37	2.29	0.09	16	0.63
	10	7	1.37	0.054	4.12	0.162	19740	350 kcmil		37	2.47	0.0973	17.3	0.681	350 kcmil
		1	3.58	0.141	3.58	0.141	19740			185	37	2.54	0.1	17.8	0.7
7		7	1.38	0.0545	4.15	0.164	20520	400 kcmil		37	2.64	0.104	18.5	0.728	400 kcmil
		1	3.67	0.1443	3.67	0.144	20520			240	37	2.9	0.114	20.3	0.798
6		7	1.55	0.0612	4.66	0.184	26240	500 kcmil		61	2.26	0.089	20.3	0.801	473.6 kcmil
		1	4.11	0.162	4.11	0.162	26240			37	2.95	0.1162	20.7	0.813	500 kcmil
	16	7	1.73	0.008	5.13	0.204	31580			61	2.3	0.0905	20.7	0.814	500 kcmil
5		7	1.75	0.0688	5.24	0.206	33090		300 kcmil	61	2.51	0.099	22.6	0.891	592.1 kcmil
4		7	1.96	0.0772	5.88	0.232	41740	600 kcmil		61	2.52	0.0992	22.7	0.893	600 kcmil
	25	7	2.16	0.085	6.48	0.255	49340	700 kcmil		61	2.72	0.1071	24.5	0.964	700 kcmil
		19	1.32	0.052	6.6	0.26	49340	750 kcmil		61	2.82	0.1109	25.4	0.998	750 kcmil
3		7	2.2	0.0867	6.61	0.26	52620			91	2.31	0.0908	25.4	0.998	750 kcmil
2		7	2.47	0.0974	7.42	0.292	66300		400	61	2.9	0.114	26.1	1.026	798.4 kcmil
	35	7	2.54	0.1	7.62	0.300	69070	800 kcmil		61	2.91	0.1145	26.2	1.031	800 kcmil
		19	1.55	0.001	7.75	0.305	69070			91	2.38	0.0938	26.2	1.032	800 kcmil
1		19	1.5	0.0064	8.43	0.332	83690	1000 kcmil	500	61	3.25	0.128	28.3	1.152	986.8 kcmil
		50	1.85	0.073	9.27	0.365	98680			91	2.66	0.1048	29.3	1.153	1000 kcmil
1/0		19	1.59	0.0745	9.46	0.373	10500		625	91	2.97	0.117	32.7	1.287	1233.7 kcmil
2/0		19	2.13	0.0837	10.6	0.419	133100								
	70	19	2.18	0.086	10.9	0.43	138100								
		3/0	19	2.59	0.094	11.9	0.47	167800							
		36	1.71	0.0673	12	0.471	167800								

This chart details the different conductors commonly used in the industry. For each size, either AWG or metric, various stranding options are listed. Typically the higher stranding is used in applications requiring greater conductor flexibility.

AWG to Metric Wire Crosses	
AWG	Metric (mm ²)
26 – 22	0.1 – 0.5
22 – 18	0.5 – 1.0
16 – 14	1.5 – 2.5
12 – 10	4.0 – 6.0

B1.
Cable
Ties

B2.
Cable
Accessories

B3.
Stainless
Steel Cable
Ties &
Accessories

C1.
Wiring
Duct

C2.
Abrasion
Protection

C3.
Cable
Management

D1.
Terminals

D2.
Power
Connectors

D3.
Grounding
Connectors

E1.
Labeling
Systems

E2.
Labels

E3.
Pre-Printed
&
Write-On
Markers

E4.
Permanent
Identification

E5.
Industrial
Safety
Solutions

F.
Keystone
Cabling
Systems

G.
Part
Number
Index

Notes

Reel Smart™ System



The Panduit® Reel Smart™ System provides the best solution for quality, high volume terminations designed to dramatically reduce set-up time and production downtime. This increased efficiency translates into real cost savings throughout the termination process from start to finish.



- One applicator system terminates over 400 continuously molded terminals, reducing cost of ownership
- Continuously molded integrated carrier guarantees alignment of terminal; front to back and side to side to eliminate skewing of product resulting in consistent, high quality low cost termination
- Available in large reels requiring less product changeover, resulting in less downtime
- Applicable sizes are UL Listed and CSA Certified, as noted
- Panduit® CA9 Ezair™ Universal Applicator works with Reel Smart™ Reel-Fed Terminals to deliver the ultimate fully automatic, high-capacity termination performance
- Panduit reel fed strip ferrules combine with tooling options to support wire harness, control panel, and automatic wire processing applications

Panduit continually provides new designs with innovative features to meet the application challenges encountered by customers, while providing the lowest installed cost.

Features and Benefits – Reel Smart™ Termination System

The Panduit® continuously molded Reel Smart™ products are designed such that the terminal, disconnect, and butt splice housings are connected by an integral molded carrier in the barrel crimp zone, producing a continuous length of product. Plated metal terminals, disconnects, and splices are then assembled into the housings. During termination, the continuously molded components are fed into a universal applicator. This process produces a reel-fed solution that eliminates a variety of problems associated with other reel-fed designs and provides high quality, high capacity product on reels for longer, uninterrupted production runs – resulting in the lowest installed cost.

Pre-insulated design eliminates the need for post-insulation – resulting in labor savings



Continuously molded design always aligns product with the carrier strip – resulting in trouble free tool operation

Plastic carrier strip eliminates sharp, unplated edges as found on metal strip-fed carriers – providing better corrosion resistance

Barrel position is controlled for consistent wire feed targeting to deliver high process capability

Reel Smart™ CA9 Ezair™ Universal Applicator

The Panduit® CA9 Ezair™ applicator automatically adjusts feed stroke to the correct pitch and length for the entire product line of continuously molded products. The need for multiple applicators is eliminated. The applicator, in conjunction with the precision, continuously molded product provides perfect front-to-back and side-to-side alignment in the die pocket for a high quality termination every time – resulting in the most optimum system to terminate terminals.

Automatic, self-adjusting feed stroke – resulting in correct pitch and length

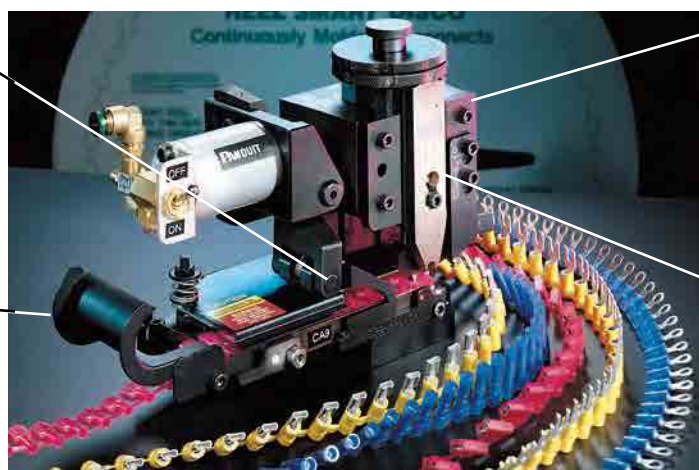

Universal applicator installs Reel Smart™ product line – resulting in lower tooling inventory costs

Quick change dies – provide fast product change-over and reduction in set-up time

Versatile applicator design – allows for installation in bench presses, and most automatic wire processing systems of 3rd party manufacturers

Nylon Insulated Terminals with Insulation Grip Sleeve (Funnel and Non-Funnel Entry Types)

The three-piece design terminal provides a permanently attached tin plated brass sleeve for insulation grip in funnel and straight entry sleeve designs. This product feature offers the most reliable terminations. Nylon insulation is rated up to 600 V maximum and designed for up to 221°F (105°C) operating temperature maximum. Supplied on rings, forks, locking forks, short locking forks and flanged forks in wire sizes #22 through #10.



- Sleeved barrel – assures crimp reliability
- PNF – funnel entry styles available
- Metal insulation crimp – provides DOUBLE CRIMP wire insulation grip sleeve for high vibration and to meet conductor strain environments
- Internal wire barrel serrations – provides increased wire contact and maximum tensile strength
- Product markings – UL and CSA rated – up to 600 V, maximum operating temperature 221°F (105°C)

Part Number System for Reel Smart™ Terminals

P	NF	14	—	6	R	N	3K
Type	Insulation	Wire Range		Stud Size	Tongue Configuration	Special Configuration	Std. Pkg. Size
P = Terminal BS = Butt Splice	N = Nylon Insulated NF = Nylon Insulated Funnel Entry V = Vinyl Insulated	18 = #22 – 18 14 = #16 – 14 12 = #16 – 12 10 = #12 – 10		4 = #4 5 = #5 6 = #6 8 = #8 10 = #10 14 = 1/4" 56 = 5/16" 38 = 3/8"	R = Ring HDR = Heavy Duty Ring F = Fork FF = Flanged fork LF = Locking fork	N = Narrow Tongue W = Wide Tongue B = Butted Seam = Standard (leave blank)	2K = 2,000 pcs. 3K = 3,000 pcs.



Ring Terminals, Nylon Insulated – Non-Funnel Entry

Type PN-R

- Continuously molded design provides reliable, consistent performance through the applicator for a high quality termination every time
- Ring tongue design assures a secure connection in high vibration applications
- Metal insulation grip sleeve crimps to wire insulation, providing protection to the crimp joint during high vibration applications
- Internal barrel serrations assure good wire contact and maximum tensile strength
- UL Flammability UL 94 HB, maximum insulation temperature 221°F (105°C)
- UL and CSA rated up to 600 V per UL 486A/B

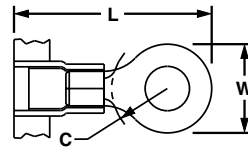

Part Number	Wire Range	Color Code	Stock Thickness (In.)	Max Ins. (In.)	Stud Size	Figure Dimensions (In.)			CA9 Series Crimp Die	CA-800/EZ Series Crimp Die	Pieces Per Reel
						L	W	C			
PN18-4R-3K	22 – 18 AWG	Red	0.03	0.145	#4	0.80	0.25	0.22	CD9-1A	CD-800-1	3000
PN18-6RN-3K					#6	0.74	0.22	0.18			3000
PN18-6R-3K					#6	0.78	0.25	0.22			3000
PN18-8R-3K					#8	0.86	0.31	0.25			3000
PN18-10R-3K					#10	0.86	0.31	0.25			3000
PN18-14R-3K					1/4"	1.05	0.45	0.38			3000
PN14-4R-3K	16 – 14 AWG	Blue	0.03	0.162	#4	0.76	0.25	0.22	CD9-2A	CD-800-2	3000
PN14-6RN-3K					#6	0.76	0.25	0.22			3000
PN14-6R-3K					#6	0.86	0.31	0.25			3000
PN14-8R-3K					#8	0.86	0.31	0.25			3000
PN14-10R-3K					#10	0.86	0.31	0.25			3000
PN14-14R-3K					1/4"	1.06	0.44	0.38			3000
PN10-6R-2K	12 – 10 AWG	Yellow	0.04	0.225	#6	1.06	0.38	0.31	CD9-3B	CD-800-3	2000
PN10-8R-2K					#8	1.06	0.38	0.31			2000
PN10-10R-2K					#10	1.06	0.38	0.31			2000
PN10-14R-2K					1/4"	1.21	0.52	0.38			2000
PN10-56R-2K					5/16"	1.21	0.52	0.38			2000
PN10-38R-2K					3/8"	1.29	0.58	0.43			2000



Ring Terminals, Nylon Insulated – Funnel Entry

Type PNF-R

- Continuously molded design provides reliable, consistent performance through the applicator for a high quality termination every time
- Ring tongue design assures a secure connection in high vibration applications
- Metal insulation grip sleeve crimps to wire insulation, providing protection to the crimp joint during high vibration applications
- Internal barrel serrations assure good wire contact and maximum tensile strength
- UL Flammability UL 94 HB, maximum insulation temperature 221°F (105°C)
- UL and CSA rated up to 600 V per UL 486A/B

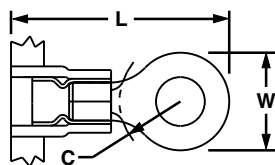

Part Number	Wire Range	Color Code	Stock Thickness (In.)	Max Ins. (In.)	Stud Size	Figure Dimensions (In.)			CA9 Series Crimp Die	CA-800/EZ Series Crimp Die	Pieces Per Reel						
						L	W	C									
PNF18-4RN-3K	22 – 18 AWG	Red	0.03	0.145	#4	0.74	0.22	0.19	CD9-1A	CD-800-1	3000						
PNF18-4R-3K					#4	0.78	0.25	0.21			3000						
PNF18-6RN-3K					#6	0.74	0.22	0.16			3000						
PNF18-6R-3K					#6	0.78	0.25	0.21			3000						
PNF18-8R-3K					#8	0.86	0.31	0.25			3000						
PNF18-10R-3K					#10	0.86	0.31	0.25			3000						
PNF18-14R-3K					1/4"	1.06	0.46	0.38			3000						
PNF14-4R-3K					16 – 14 AWG	Blue	0.03	0.162			#4	0.78	0.25	0.18	CD9-2A	CD-800-2	3000
PNF14-6RN-3K	#6	0.78	0.25	0.18					3000								
PNF14-6R-3K	#6	0.87	0.31	0.24					3000								
PNF14-8R-3K	#8	0.87	0.31	0.25					3000								
PNF14-10R-3K	#10	0.85	0.31	0.29					3000								
PNF14-14R-3K	1/4"	1.06	0.46	0.40					3000								
PNF10-6R-2K	12 – 10 AWG	Yellow	0.04	0.225					#6	1.06	0.38	0.31	CD9-3B	CD-800-3			2000
PNF10-8R-2K									#8	1.06	0.38	0.31					2000
PNF10-10R-2K					#10	1.06	0.38	0.31	2000								
PNF10-14R-2K					1/4"	1.21	0.52	0.38	2000								
PNF10-56R-2K					5/16"	1.21	0.52	0.38	2000								
PNF10-38R-2K					3/8"	1.29	0.58	0.43	2000								



Ring Terminals, Vinyl Insulated – Funnel Entry

Type PV-RB

- Continuously molded design provides reliable, consistent performance through the applicator for a high quality termination every time
- Ring tongue design assures a secure connection in high vibration applications
- Insulation support helps to prevent wire damage in bending applications
- UL Flammability UL 94V-0, maximum insulation temperature 221°F (105°C)
- UL and CSA rated up to 600 V per UL 486A/B

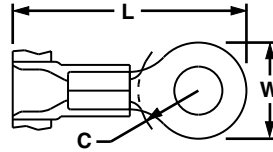

Part Number	Wire Range	Color Code	Stock Thickness (In.)	Max Ins. (In.)	Stud Size	Figure Dimensions (In.)			CA9 Series Crimp Die	CA-800/EZ Series Crimp Die	Pieces Per Reel						
						L	W	C									
PV18-4RNB-3K	22 – 18 AWG	Red	0.03	0.150	#4	0.74	0.21	0.19	CD9-1A	CD-800-1	3000						
PV18-4RB-3K					#4	0.78	0.25	0.20			3000						
PV18-6RNB-3K					#6	0.75	0.23	0.19			3000						
PV18-6RB-3K					#6	0.78	0.25	0.20			3000						
PV18-8RB-3K					#8	0.86	0.31	0.25			3000						
PV18-10RB-3K					#10	0.86	0.31	0.25			3000						
PV18-14RB-3K					1/4"	1.06	0.45	0.38			3000						
PV18-56RB-2K					5/16"	1.06	0.46	0.38			CD9-1B	2000					
PV18-38RB-2K					3/8"	1.15	0.53	0.43				2000					
PV14-4RB-3K					16 – 14 AWG	Blue	0.03	0.170			#4	0.76	0.25	0.22	CD9-2A	CD-800-2	3000
PV14-6RNB-3K	#6	0.76	0.25	0.22					3000								
PV14-6RB-3K	#6	0.86	0.31	0.25					3000								
PV14-8RB-3K	#8	0.86	0.31	0.25					3000								
PV14-10RB-3K	#10	0.86	0.31	0.25					3000								
PV14-14RB-3K	1/4"	1.05	0.45	0.38					3000								
PV14-56RB-2K	5/16"	1.06	0.46	0.38					CD9-2B	2000							
PV14-38RB-2K	3/8"	1.15	0.53	0.43						2000							
PV10-6RB-2K	12 – 10 AWG	Yellow	0.04	0.225					#6	1.02	0.31	0.31	CD9-3B	CD-800-3			2000
PV10-8RB-2K									#8	1.02	0.31	0.31					2000
PV10-10RB-2K					#10	1.02	0.31	0.31	2000								
PV10-14RB-2K					1/4"	1.20	0.52	0.38	2000								
PV10-56RB-2K					5/16"	1.20	0.52	0.38	2000								
PV10-38RB-2K					3/8"	1.23	0.58	0.43	2000								



Ring Terminals, Nylon Insulated – Heavy Duty

Type PN-HDR

- Continuously molded design provides reliable, consistent performance through the applicator for a high quality termination every time
- Manufactured from stock 56% thicker than a standard #16 – 14 AWG terminal for use in heavy duty application
- Ring tongue design assures a secure connection in high vibration applications
- Metal insulation grip sleeve crimps to wire insulation, providing protection to the crimp joint during high vibration applications
- Internal barrel serrations assure good wire contact and maximum tensile strength
- UL Flammability UL 94 HB, maximum insulation temperature 221°F (105°C)
- UL and CSA rated up to 600 V per UL 486A/B

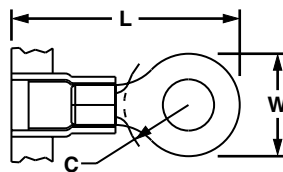

Part Number	Wire Range	Color Code	Stock Thickness (In.)	Max Ins. (In.)	Stud Size	Figure Dimensions (In.)			CA9 Series Crimp Die	CA-800/EZ Series Crimp Die	Pieces Per Reel
						L	W	C			
PN12-6HDR-2K	16 – 12 AWG	Yellow	0.05	0.225	#6	1.02	0.31	0.31	CD9-3B	CD-800-3	2000
PN12-8HDR-2K					#8	1.02	0.31	0.31			2000
PN12-10HDR-2K					#10	1.05	0.38	0.31			2000
PN12-14HDR-2K					1/4"	1.20	0.52	0.38			2000
PN12-56HDR-2K					5/16"	1.20	0.52	0.38			2000
PN12-38HDR-2K					3/8"	1.28	0.58	0.38			2000



Ring Terminals, Vinyl Insulated – Heavy Duty

Type PV-HDRB

- Continuously molded design provides reliable, consistent performance through the applicator for a high quality termination every time
- Manufactured from stock 56% thicker than a standard #16 – 14 AWG terminal for use in heavy-duty applications
- Ring tongue design assures a secure connection in high vibration applications
- Insulation support helps to prevent wire damage in bending applications
- UL Flammability UL 94V-0, maximum insulation temperature 221°F (105°C)
- UL and CSA rated up to 600 V per UL 486A/B

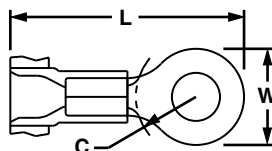

Part Number	Wire Range	Color Code	Stock Thickness (In.)	Max Ins. (In.)	Stud Size	Figure Dimensions (In.)			CA9 Series Crimp Die	CA-800/EZ Series Crimp Die	Pieces Per Reel
						L	W	C			
PV12-6HDRB-2K	16 – 12 AWG	Yellow	0.05	0.225	#6	1.03	0.31	0.36	CD9-3B	CD-800-3	2000
PV12-8HDRB-2K					#8	1.03	0.31	0.36			2000
PV12-10HDRB-2K					#10	1.06	0.37	0.36			2000
PV12-14HDRB-2K					1/4"	1.23	0.52	0.43			2000
PV12-56HDRB-2K					5/16"	1.23	0.52	0.43			2000
PV12-38HDRB-2K					3/8"	1.30	0.58	0.38			2000



Fork Terminals, Nylon Insulated – Non-Funnel Entry

Type PN-F

- Continuously molded design provides reliable, consistent performance through the applicator for a high quality termination every time
- Fork design provides for fast and easy installation, without the need to remove fastener
- Metal insulation grip sleeve crimps to wire insulation, providing protection to the crimp joint during high vibration applications
- Internal barrel serrations assure good wire contact and maximum tensile strength
- UL Flammability UL 94 HB, maximum insulation temperature 221°F (105°C)
- UL and CSA rated up to 600 V per UL 486A/B

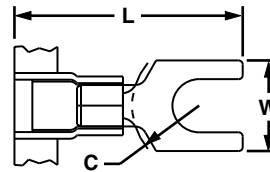

Part Number	Wire Range	Color Code	Stock Thickness (In.)	Max Ins. (In.)	Stud Size	Figure Dimensions (In.)			CA9 Series Crimp Die	CA-800/EZ Series Crimp Die	Pieces Per Reel
						L	W	C			
PN18-6FN-3K	22 – 18 AWG	Red	0.03	0.145	#6	0.78	0.25	0.20	CD9-1A	CD-800-1	3000
PN18-6F-3K					#6	0.78	0.30	0.20			3000
PN18-8F-3K					#8	0.84	0.32	0.23			3000
PN18-10FN-3K					#10	0.86	0.31	0.25			3000
PN18-10F-3K					#10	0.86	0.35	0.25			3000
PN18-14F-3K					1/4"	1.03	0.44	0.33			3000
PN14-6FN-3K	16 – 14 AWG	Blue	0.03	0.162	#6	0.78	0.24	0.19	CD9-2A	CD-800-2	3000
PN14-6F-3K					#6	0.78	0.28	0.19			3000
PN14-8F-3K					#8	0.84	0.31	0.23			3000
PN14-10FN-3K					#10	0.86	0.31	0.24			3000
PN14-10F-3K					#10	0.86	0.34	0.24			3000
PN14-14F-3K					1/4"	1.03	0.44	0.32			3000
PN10-6F-2K	12 – 10 AWG	Yellow	0.04	0.225	#6	1.00	0.31	0.24	CD9-3B	CD-800-3	2000
PN10-8F-2K					#8	1.03	0.37	0.24			2000
PN10-10F-2K					#10	1.04	0.37	0.24			2000
PN10-14F-2K					1/4"	1.14	0.49	0.32			2000



Fork Terminals, Nylon Insulated – Funnel Entry

Type PNF-F

- Continuously molded design provides reliable, consistent performance through the applicator for a high quality termination every time
- Fork design provides for fast and easy installation, without the need to remove fastener
- Metal insulation grip sleeve crimps to wire insulation, providing protection to the crimp joint during high vibration applications
- Internal barrel serrations assure good wire contact and maximum tensile strength
- UL Flammability UL 94 HB, maximum insulation temperature 221°F (105°C)
- UL and CSA rated up to 600 V per UL 486A/B

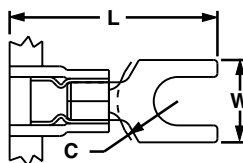

Part Number	Wire Range	Color Code	Stock Thickness (In.)	Max Ins. (In.)	Stud Size	Figure Dimensions (In.)			CA9 Series Crimp Die	CA-800/EZ Series Crimp Die	Pieces Per Reel
						L	W	C			
PNF18-6F-3K	22 – 18 AWG	Red	0.03	0.145	#6	0.77	0.30	0.19	CD9-1A	CD-800-1	3000
PNF18-6FN-3K					#6	0.78	0.24	0.19			3000
PNF18-8F-3K					#8	0.83	0.32	0.22			3000
PNF18-10F-3K					#10	0.85	0.35	0.24			3000
PNF18-14F-3K					1/4"	1.02	0.44	0.33			3000
PNF14-6FN-3K	16 – 14 AWG	Blue	0.03	0.162	#6	0.78	0.24	0.19	CD9-2A	CD-800-2	3000
PNF14-6F-3K					#6	0.78	0.28	0.19			3000
PNF14-8F-3K					#8	0.84	0.31	0.23			3000
PNF14-10F-3K					#10	0.86	0.34	0.24			3000
PNF14-14F-3K					1/4"	1.03	0.44	0.32			3000
PNF10-6F-2K	12 – 10 AWG	Yellow	0.04	0.225	#6	1.01	0.31	0.24	CD9-3B	CD-800-3	2000
PNF10-8F-2K					#8	1.02	0.37	0.24			2000
PNF10-14F-2K					1/4"	1.13	0.49	0.32			2000



Fork Terminals, Vinyl Insulated – Funnel Entry

Type PV-FB

- Continuously molded design provides reliable, consistent performance through the applicator for a high quality termination every time
- Fork design provides for fast and easy installation, without the need to remove fastener
- Insulation support helps to prevent wire damage in bending applications
- UL Flammability UL 94V-0, maximum insulation temperature 221°F (105°C)
- UL and CSA rated up to 600 V per UL 486A/B

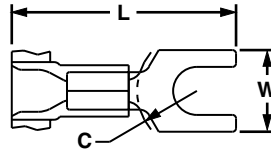

Part Number	Wire Range	Color Code	Stock Thickness (In.)	Max Ins. (In.)	Stud Size	Figure Dimensions (In.)			CA9 Series Crimp Die	CA-800/EZ Series Crimp Die	Pieces Per Reel
						L	W	C			
PV18-6FB-3K	22 – 18 AWG	Red	0.03	0.150	#6	0.78	0.30	0.20	CD9-1A	CD-800-1	3000
PV18-6FNB-3K					#6	0.78	0.25	0.20			3000
PV18-8FB-3K					#8	0.84	0.32	0.23			3000
PV18-10FB-3K					#10	0.86	0.35	0.25			3000
PV18-14FB-3K					1/4"	1.03	0.44	0.33			3000
PV14-6FB-3K	16 – 14 AWG	Blue	0.03	0.170	#6	0.78	0.24	0.19	CD9-2A	CD-800-2	3000
PV14-6FNB-3K					#6	0.78	0.28	0.19			3000
PV14-8FB-3K					#8	0.84	0.31	0.23			3000
PV14-10FB-3K					#10	0.86	0.34	0.24			3000
PV14-10FNB-3K					#10	0.86	0.31	0.24			3000
PV14-14FB-3K	1/4"	1.03	0.44	0.32	3000						
PV10-6FB-2K	12 – 10 AWG	Yellow	0.04	0.225	#6	0.99	0.31	0.22	CD9-3B	CD-800-3	2000
PV10-8FB-2K					#8	1.00	0.38	0.22			2000
PV10-10FB-2K					#10	1.04	0.38	0.22			2000
PV10-14FB-2K					1/4"	1.13	0.49	0.32			2000



Locking Fork Terminals, Nylon Insulated – Non-Funnel Entry

Type PN-LF

- Continuously molded design provides reliable, consistent performance through the applicator for a high quality termination every time
- Snap in place for secure connection
- Fork design provides for fast and easy installation, without the need to remove fastener
- Metal insulation grip sleeve crimps to wire insulation, providing protection to the crimp joint during high vibration applications
- Internal barrel serrations assure good wire contact and maximum tensile strength
- UL Flammability UL 94 HB, maximum insulation temperature 221°F (105°C)
- UL and CSA rated up to 600 V per UL 486A/B

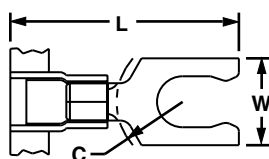

Part Number	Wire Range	Color Code	Stock Thickness (In.)	Max Ins. (In.)	Stud Size	Figure Dimensions (In.)			CA9 Series Crimp Die	CA-800/EZ Series Crimp Die	Pieces Per Reel
						L	W	C			
PN18-6LF-3K	22 – 18 AWG	Red	0.03	0.145	#6	0.82	0.27	0.19	CD9-1A	CD-800-1	3000
PN18-8LF-3K					#8	0.89	0.29	0.23			3000
PN18-10LF-3K					#10	0.89	0.33	0.23			3000
PN14-6LF-3K	16 – 14 AWG	Blue	0.03	0.162	#6	0.85	0.25	0.18	CD9-2A	CD-800-2	3000
PN14-8LF-3K					#8	0.92	0.29	0.23			3000
PN14-10LF-3K					#10	0.92	0.33	0.23			3000
PN10-6LF-2K	12 – 10 AWG	Yellow	0.04	0.225	#6	1.02	0.30	0.21	CD9-3B	CD-800-3	2000
PN10-8LF-2K					#8	1.05	0.30	0.21			2000
PN10-10LF-2K					#10	1.05	0.34	0.21			2000



Locking Fork Terminals, Nylon Insulated – Funnel Entry

Type PNF-LF

- Continuously molded design provides reliable, consistent performance through the applicator for a high quality termination every time
- Snap in place for secure connection
- Fork design provides for fast and easy installation, without the need to remove fastener
- Metal insulation grip sleeve crimps to wire insulation, providing protection to the crimp joint during high vibration applications
- Internal barrel serrations assure good wire contact and maximum tensile strength
- UL Flammability UL 94 HB, maximum insulation temperature 221°F (105°C)
- UL and CSA rated up to 600 V per UL 486A/B

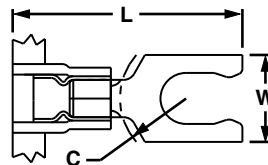

Part Number	Wire Range	Color Code	Stock Thickness (In.)	Max Ins. (In.)	Stud Size	Figure Dimensions (In.)			CA9 Series Crimp Die	CA-800/EZ Series Crimp Die	Pieces Per Reel
						L	W	C			
PNF18-6LF-3K	22 – 18 AWG	Red	0.03	0.145	#6	0.85	0.27	0.19	CD9-1A	CD-800-1	3000
PNF18-6LFW-3K					#6	0.85	0.29	0.19			3000
PNF18-8LF-3K					#8	0.89	0.29	0.23			3000
PNF18-10LF-3K					#10	0.89	0.33	0.23			3000
PNF14-6LF-3K	16 – 14 AWG	Blue	0.03	0.162	#6	0.85	0.25	0.18	CD9-2A	CD-800-2	3000
PNF14-8LF-3K					#6	0.92	0.29	0.23			3000
PNF14-10LFN-3K					#8	0.92	0.28	0.23			3000
PNF14-10LF-3K					#10	0.92	0.33	0.23			3000
PNF10-6LF-2K	12 – 10 AWG	Yellow	0.04	0.225	#6	1.02	0.30	0.21	CD9-3B	CD-800-3	2000
PNF10-8LF-2K					#8	1.05	0.30	0.21			2000
PNF10-10LF-2K					#10	1.05	0.34	0.21			2000
PNF10-14LF-2K					1/4"	1.19	0.46	0.32			2000



Locking Fork Terminals, Vinyl Insulated – Funnel Entry

Type PV-LFB

- Continuously molded design provides reliable, consistent performance through the applicator for a high quality termination every time
- Snap in place for secure connection
- Fork design provides for fast and easy installation, without the need to remove fastener
- Insulation support helps to prevent wire damage in bending applications
- UL Flammability UL 94V-0, maximum insulation temperature 221°F (105°C)
- UL and CSA rated to 600 V per UL 486A/B

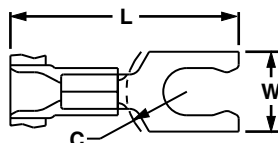

Part Number	Wire Range	Color Code	Stock Thickness (In.)	Max Ins. (In.)	Stud Size	Figure Dimensions (In.)			CA9 Series Crimp Die	CA-800/EZ Series Crimp Die	Pieces Per Reel
						L	W	C			
PV18-6LFB-3K	22 – 18 AWG	Red	0.03	0.150	#6	0.80	0.27	0.19	CD9-1A	CD-800-1	3000
PV18-6LFWB-3K					#6	0.83	0.29	0.19			3000
PV18-8LFB-3K					#8	0.87	0.29	0.23			3000
PV18-10LFNB-3K*					#10	0.87	0.29	0.23			3000
PV18-10LFB-3K					#10	0.87	0.33	0.23			3000
PV14-6LFB-3K	16 – 14 AWG	Blue	0.03	0.170	#6	0.85	0.25	0.18	CD9-2A	CD-800-2	3000
PV14-6LFWB-3K					#6	0.85	0.29	0.18			3000
PV14-8LFB-3K					#8	0.92	0.29	0.23			3000
PV14-10LFB-3K					#10	0.92	0.33	0.23			3000
PV10-6LFB-2K	12 – 10 AWG	Yellow	0.04	0.225	#6	1.02	0.30	0.21	CD9-3B	CD-800-3	2000
PV10-8LFB-2K					#8	1.04	0.30	0.21			2000
PV10-10LFB-2K					#10	1.04	0.34	0.21			2000
PV10-14LFB-2K					1/4"	1.16	0.46	0.32			2000

*Not UL Listed or CSA Certified.



Flanged Fork Terminals, Nylon Insulated – Non-Funnel Entry

Type PN-FF

- Continuously molded design provides reliable, consistent performance through the applicator for a high quality termination every time
- Flange design provides extra secure connection on a variety of applications
- Fork design provides for fast and easy installation, without the need to remove fastener
- Metal insulation grip sleeve crimps to wire insulation, providing protection to the crimp joint during high vibration applications
- Internal barrel serrations assure good wire contact and maximum tensile strength
- UL Flammability UL 94 HB, maximum insulation temperature 221°F (105°C)
- UL and CSA rated up to 600 V per UL 486A/B

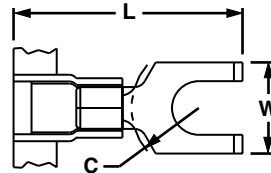

Part Number	Wire Range	Color Code	Stock Thickness (In.)	Max Ins. (In.)	Stud Size	Figure Dimensions (In.)			CA9 Series Crimp Die	CA-800/EZ Series Crimp Die	Pieces Per Reel
						L	W	C			
PN18-6FF-3K	22 – 18 AWG	Red	0.03	0.136	#6	0.80	0.28	0.19	CD9-1A	CD-800-1	3000
PN18-8FF-3K					#8	0.87	0.31	0.23			3000
PN18-10FF-3K					#10	0.87	0.35	0.23			3000
PN14-6FF-3K	16 – 14 AWG	Blue	0.03	0.162	#6	0.80	0.28	0.19	CD9-2A	CD-800-2	3000
PN14-8FF-3K					#8	0.87	0.31	0.23			3000
PN14-10FF-3K					#10	0.87	0.35	0.23			3000
PN10-8FF-2K	12 – 10 AWG	Yellow	0.04	0.225	#8	1.05	0.38	0.22	CD9-3B	CD-800-3	2000
PN10-10FF-2K					#10	1.05	0.38	0.22			2000



Flanged Fork Terminals, Nylon Insulated – Funnel Entry

Type PNF-FF

- Continuously molded design provides reliable, consistent performance through the applicator for a high quality termination every time
- Flange design provides extra secure connection on a variety of applications
- Fork design provides for fast and easy installation, without the need to remove fastener
- Metal insulation grip sleeve crimps to wire insulation, providing protection to the crimp joint during high vibration applications
- Internal barrel serrations assure good wire contact and maximum tensile strength
- UL Flammability UL 94 HB, maximum insulation temperature 221°F (105°C)
- UL and CSA rated up to 600 V per UL 486A/B

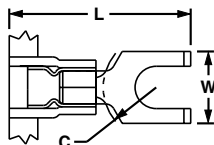

Part Number	Wire Range	Color Code	Stock Thickness (In.)	Max Ins. (In.)	Stud Size	Figure Dimensions (In.)			CA9 Series Crimp Die	CA-800/EZ Series Crimp Die	Pieces Per Reel
						L	W	C			
PNF18-6FF-3K	22 – 18 AWG	Red	0.03	0.145	#6	0.80	0.28	0.19	CD9-1A	CD-800-1	3000
PNF18-8FF-3K					#8	0.87	0.31	0.23			3000
PNF18-10FF-3K					#10	0.86	0.35	0.23			3000
PNF14-6FF-3K	16 – 14 AWG	Blue	0.03	0.162	#6	0.80	0.28	0.19	CD9-2A	CD-800-2	3000
PNF14-8FF-3K					#8	0.87	0.31	0.23			3000
PNF14-10FF-3K					#10	0.87	0.35	0.23			3000
PNF10-8FF-2K	12 – 10 AWG	Yellow	0.04	0.225	#8	1.05	0.38	0.24	CD9-3B	CD-800-3	2000
PNF10-10FF-2K					#10	1.05	0.38	0.24			2000



Flanged Fork Terminals, Vinyl Insulated – Funnel Entry

Type PV-FFB

- Continuously molded design provides reliable, consistent performance through the applicator for a high quality termination every time
- Flange design provides extra secure connection on a variety of applications
- Fork design provides for fast and easy installation, without the need to remove fastener
- Insulation support helps to prevent wire damage in bending applications
- UL Flammability UL 94V-0, maximum insulation temperature 221°F (105°C)
- UL and CSA rated up to 600 V per UL 486A/B

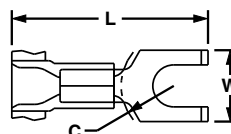

Part Number	Wire Range	Color Code	Stock Thickness (In.)	Max Ins. (In.)	Stud Size	Figure Dimensions (In.)			CA9 Series Crimp Die	CA-800/EZ Series Crimp Die	Pieces Per Reel
						L	W	C			
PV18-6FFB-3K	22 – 18 AWG	Red	0.03	0.150	#6	0.80	0.28	0.19	CD9-1A	CD-800-1	3000
PV18-8FFB-3K					#8	0.87	0.31	0.23			3000
PV18-10FFB-3K					#10	0.86	0.35	0.23			3000
PV14-6FFB-3K	16 – 14 AWG	Blue	0.03	0.170	#6	0.80	0.28	0.19	CD9-2A	CD-800-2	3000
PV14-8FFB-3K					#8	0.87	0.31	0.23			3000
PV14-10FFB-3K					#10	0.87	0.35	0.23			3000
PV10-8FFB-2K	12 – 10 AWG	Yellow	0.04	0.225	#8	1.03	0.37	0.22	CD9-3B	CD-800-3	2000
PV10-10FFB-2K					#10	1.03	0.37	0.22			2000

Features and Benefits – Reel Smart™ Disconnects

Supra-Grip™ Nylon Fully Insulated Funnel Entry, Female Receptacle Type DNG-FB

Available in tab sizes to accommodate 0.187" or 0.250" tabs

Maximum insulation temperature 221°F (105°C)

Continuously molded design provides reliable, consistent performance through applicator

Funnel entry for faster wire insertion and lower installed cost

Fully insulated design provides protection from electrical shorts

Fully integrated metal insulation grip for high vibration, high strain relief, and double crimp requirements



UL and CSA Rated up to 600 V per UL 310.
Flammability UL 94 HB.

Standard and Premium Nylon Fully Insulated, Funnel Entry, Females Receptacles and Male Tabs Type DPF

Available in tab sizes to accommodate 0.110", 0.187", 0.205" or 0.250" tabs

Maximum insulation temperature 257°F (125°C)

Continuously molded design provides reliable, consistent performance through applicator

Funnel entry for faster wire insertion and lower installed cost

Fully insulated design provides protection from electrical shorts

Insulation support restricts excessive wire movement to minimize stress on crimp joint

Expanded wire entry (on select sizes) accommodates large insulation or multiple wires



UL and CSA Rated up to 600 V per UL 310.
Flammability UL 94V-2.

Vinyl Barrel Insulated Funnel Entry, Female Receptacles and Male Tabs Type DV

Available in tab sizes to accommodate 0.187", 0.205", or 0.250" tabs

Continuously molded design provides reliable, consistent performance through applicator

Insulation grip sleeve provides a superior insulation crimp for high vibration and high strain relief applications

Insulation support to protect electrical crimp



UL and CSA Rated up to 600 V.
Flammability UL 94V-0.

B1.
Cable
Ties

B2.
Cable
Accessories

B3.
Stainless
Steel Cable
Ties &
Accessories

C1.
Wiring
Duct

C2.
Abrasion
Protection

C3.
Cable
Management

D1.
Terminals

D2.
Power
Connectors

D3.
Grounding
Connectors

E1.
Labeling
Systems

E2.
Labels

E3.
Pre-Printed
&
Write-On
Markers

E4.
Permanent
Identification

E5.
Industrial
Safety
Solutions

F.
Keystone
Cabling
Systems

G.
Part
Number
Index

Part Number System for Reel Smart™ Disconnects

D	NF	14	—	250	FIB	3K
Type	Insulation	Wire Range		Size and Type	Special Configuration	Std. Pkg. Size
D = Disconnects	NF = Nylon Funnel Entry NG = Nylon Funnel Entry Metal Insulation Grip NFR = Nylon Funnel Entry Right Angle PF = Premium Grade Nylon (Double Crimp) V = Vinyl	18 = #22 – 18 14 = #16 – 14 10 = #12 – 10		110 = 0.110 x 0.032 tab size 111 = 0.110 x 0.020 tab size 187 = 0.187 x 0.032 tab size 188 = 0.187 x 0.020 tab size 205 = 0.187/0.205 x 0.032 tab size 206 = 0.187/0.205 x 0.020 tab size 250 = 0.250 x 0.032 tab size 0.187/0.205: Expandable receptacle will accept male tabs from 0.187" to 0.205" widths in 0.032" or 0.020" thick styles. Fully reliable connection through all widths.	B = Butted seam C = Compression tab FB = Metal insulation grip, female FIB = Fully insulated, butted seam, female FIBX = Fully insulated, butted seam, female, expanded wire entry FIM = Fully insulated male FIMB = Fully insulated, male, oversized housing FIMX = Fully insulated, male, expanded wire entry M = Male MB = Male butted seam	K = 1,000 KD = 1,500 2K = 2,000 3K = 3,000

UL LISTED CERTIFIED Supra-Grip™ Female Disconnects, Nylon Fully Insulated – Funnel Entry

Type DNG-FB

- Continuously molded design provides reliable, consistent performance through the applicator for a high quality termination every time
- Disconnect can be inserted and removed from the male tab without the use of tools for lower installed cost
- Flared barrel extension integrated into stamping to provide insulation grip for double crimp requirements
- Internal barrel serrations assure good wire contact and maximum tensile strength
- Internal wire stop assures proper length of insertion into terminal barrel, providing a higher-quality connection
- Mates with DNF-FIMB family
- UL Flammability UL 94 HB, maximum insulation temperature 221°F (105°C)
- UL and CSA rated up to 600 V per UL 310

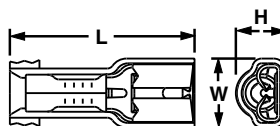

Part Number	Wire Range	Color Code	Max Ins. (In.)	Figure Dimensions (In.)			Tab Size		CA9 Series Crimp Die	CA-800/EZ Series Crimp Die	Pieces Per Reel
				L	W	H	In.	mm			
DNG18-187FB-3K	22 – 18 AWG	Red	0.126	0.89	0.29	0.22	0.187 x 0.032	4.8 x 0.8	CD9-15A	CD-800-15	3000
DNG18-188FB-3K				0.89	0.29	0.22	0.187 x 0.020	4.8 x 0.5			3000
DNG18-250FB-3K				0.93	0.35	0.23	0.250 x 0.032	6.3 x 0.8			3000
DNG14-187FB-3K*	16 – 14 AWG	Blue	0.153	0.89	0.29	0.25	0.187 x 0.032	4.8 x 0.8	CD9-16A	CD-800-16	3000
DNG14-188FB-3K				0.89	0.29	0.25	0.187 x 0.020	4.8 x 0.5			3000
DNG14-250FB-3K				0.93	0.35	0.25	0.250 x 0.032	6.3 x 0.8			3000

*UL Recognized for copper alloy tabs only.



Female Disconnects, Nylon Fully Insulated – Funnel Entry

Type DNF-FIB

- Continuously molded design provides reliable, consistent performance through the applicator for a high quality termination every time
- Disconnect can be inserted and removed from the male tab without the use of tools for lower installed cost
- Fully insulated design provides protection from electrical shorts
- Disconnects available in common industry tab sizes
- Internal wire stop assures proper length of insertion into terminal barrel, providing a higher quality connection
- UL Flammability UL 94 HB, maximum insulation temperature 221°F (105°C)
- UL and CSA rated up to 600 V per UL 310

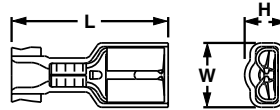

Part Number	Wire Range	Color Code	Max Ins. (In.)	Figure Dimensions (In.)			Tab Size		CA9 Series Crimp Die	CA-800/EZ Series Crimp Die	Pieces Per Reel
				L	W	H	In.	mm			
DNF18-110FIB-3K	22 – 18 AWG	Red	0.120	0.71	0.19	0.15	0.110 x 0.032	2.8 x 0.8	CD9-7A	CD-800-7	3000
DNF18-111FIB-3K		Red	0.120	0.71	0.19	0.15	0.110 x 0.020	2.8 x 0.5	CD9-7A	CD-800-7	3000
DNF18-112FIB-3K*		Natural	0.120	0.71	0.19	0.15	0.110 x 0.010	2.8 x 0.3	CD9-7A	CD-800-7	3000
DNF18-187FIB-3K		Red	0.136	0.78	0.29	0.16	0.187 x 0.032	4.8 x 0.8	CD9-4A	CD-800-4	3000
DNF18-188FIB-3K		Red	0.136	0.78	0.29	0.16	0.187 x 0.020	4.8 x 0.5	CD9-4A	CD-800-4	3000
DNF18-205FIB-3K		Red	0.136	0.78	0.31	0.22	0.187/0.205 x 0.032	4.8/5.2 x 0.8	CD9-4A	CD-800-4	3000
DNF18-206FIB-3K		Red	0.136	0.78	0.31	0.22	0.187/0.205 x 0.020	4.8/5.2 x 0.5	CD9-4A	CD-800-4	3000
DNF18-250FIB-3K**		Red	0.136	0.84	0.35	0.22	0.250 x 0.032	6.3 x 0.8	CD9-4A	CD-800-4	3000
DNF14-187FIB-3K		16 – 14 AWG	Blue	0.160	0.78	0.29	0.18	0.187 x 0.032	4.8 x 0.8	CD9-5A	CD-800-5
DNF14-188FIB-3K	0.160			0.78	0.29	0.18	0.187 x 0.020	4.8 x 0.5	CD9-5A	CD-800-5	3000
DNF14-205FIB-3K	0.160			0.78	0.31	0.22	0.187/0.205 x 0.032	4.8/5.2 x 0.8	CD9-5A	CD-800-5	3000
DNF14-206FIB-3K	0.160			0.78	0.31	0.22	0.187/0.205 x 0.020	4.8/5.2 x 0.5	CD9-5A	CD-800-5	3000
DNF14-250FIB-3K	0.160			0.84	0.35	0.22	0.250 x 0.032	6.3 x 0.8	CD9-5A	CD-800-5	3000
DNF10-250FIB-2K	12 – 10 AWG	Yellow	0.220	0.96	0.35	0.23	0.250 x 0.032	6.3 x 0.8	CD9-13B	CD-800-13	2000
DNF10250FIBC-2K‡			0.220	0.96	0.35	0.23	0.250 x 0.032	6.4 x 0.8	CD9-13B	CD-800-13	2000

*UL/CSA standards do not exist for 0.110" x 0.010" receptacles.

**UL with 17 AWG wire.

‡Compressor tab disconnect to fit 0.250" tabs with a post style support.



Disco™ Female Disconnects, Nylon Fully Insulated – Expanded Wire Entry

Type DNF-FIBX

- Continuously molded design provides reliable, consistent performance through the applicator for a high quality termination every time
- Disconnect can be inserted and removed from the male tab without the use of tools for lower installed cost
- Expanded wire entry designed to accommodate wire with a larger insulation thickness
- Fully insulated design provides protection from electrical shorts
- Internal wire stop assures proper length of insertion into terminal barrel, providing a higher quality connection
- UL Flammability UL 94 HB, maximum insulation temperature 221°F (105°C)
- UL and CSA rated up to 600 V per UL 310

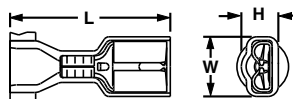

Part Number	Wire Range	Color Code	Max Ins. (In.)	Figure Dimensions (In.)			Tab Size		CA9 Series Crimp Die	CA-800/EZ Series Crimp Die	Pieces Per Reel
				L	W	H	In.	mm			
DNF18205FIBX-2K	22 – 18 AWG	Red	0.210	0.87	0.31	0.22	0.187/0.205 x 0.032	4.8/5.2 x 0.8	CD9-6B	CD-800-6	2000
DNF18206FIBX-2K				0.87	0.31	0.22	0.187/0.205 x 0.020	4.8/5.2 x 0.5			2000
DNF18250FIBX-2K				0.93	0.35	0.22	0.250 x 0.032	6.3 x 0.8			2000
DNF14205FIBX-2K	16 – 14 AWG	Blue	0.240	0.87	0.31	0.22	0.187/0.205 x 0.032	4.8/5.2 x 0.8	CD9-8B	CD-800-6	2000
DNF14206FIBX-2K				0.87	0.31	0.22	0.187/0.205 x 0.020	4.8/5.2 x 0.5			2000
DNF14250FIBX-2K				0.93	0.35	0.22	0.250 x 0.032	6.3 x 0.8			2000



Disco™ Female Disconnects, Nylon Fully Insulated – Right Angle

Type DNFR-FIB

- Continuously molded design provides reliable, consistent performance through the applicator for a high quality termination every time
- Right angle design for use in limited space applications
- Fully insulated design provides protection from electrical shorts
- Internal wire stop assures proper length of insertion into terminal barrel, providing a higher quality connection
- Disconnect can be inserted and removed from the male tab without the use of tools for lower installed cost
- UL Flammability UL 94 HB, maximum insulation temperature 221°F (105°C)
- UL and CSA rated up to 600 V per UL 310

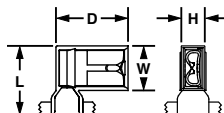

Part Number	Wire Range	Color Code	Max Ins. (In.)	Figure Dimensions (In.)				Tab Size		CA9 Series Crimp Die	CA-800/EZ Series Crimp Die	Pieces Per Reel
				L	W	H	D	In.	mm			
DNFR18205FIB-KD	22 – 18 AWG	Red	0.178	0.57	0.37	0.21	0.60	0.187/0.205 x 0.032	4.8/5.2 x 0.8	CD9-9C	CD-800-9	1500
DNFR18206FIB-KD				0.57	0.37	0.21	0.60	0.187/0.205 x 0.020	4.8/5.2 x 0.5			1500
DNFR18250FIB-KD				0.57	0.37	0.21	0.60	0.250 x 0.032	6.3 x 0.8			1500
DNFR14205FIB-KD	16 – 14 AWG	Blue	0.178	0.57	0.37	0.21	0.60	0.187/0.205 x 0.032	4.8/5.2 x 0.8	CD9-9C	CD-800-9	1500
DNFR14206FIB-KD				0.57	0.37	0.21	0.60	0.187/0.205 x 0.020	4.8/5.2 x 0.5			1500
DNFR14250FIB-KD				0.57	0.37	0.21	0.60	0.250 x 0.032	6.3 x 0.8			1500



Disco™ Female Disconnects, Vinyl Barrel Insulated – Funnel Entry

Type DV-B

- Continuously molded design provides reliable, consistent performance through the applicator for a high quality termination every time
- Disconnect can be inserted and removed from the male tab without the use of tools for lower installed cost
- Internal barrel serrations assure good wire contact and maximum tensile strength
- Internal wire stop assures proper length of insertion into terminal barrel, providing a higher quality connection
- UL Flammability UL 94V-0, maximum insulation temperature 221°F (105°C)
- UL and CSA rated up to 600 V per UL 310

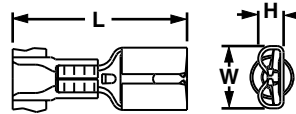

Part Number	Wire Range	Color Code	Max Ins. (In.)	Figure Dimensions (In.)			Tab Size		CA9 Series Crimp Die	CA-800/EZ Series Crimp Die	Pieces Per Reel
				L	W	H	In.	mm			
DV18-187B-3K	22 – 18 AWG	Red	0.150	0.77	0.23	0.10	0.187 x 0.032	4.8 x 0.8	CD9-1A	CD-800-1	3000
DV18-188B-3K			0.150	0.77	0.23	0.09	0.187 x 0.020	4.8 x 0.5			3000
DV18-205B-3K			0.150	0.77	0.25	0.12	0.187/0.205 x 0.032	4.8/5.2 x 0.8			3000
DV18-206B-3K			0.150	0.77	0.25	0.11	0.187/0.205 x 0.020	4.8/5.2 x 0.5			3000
DV18-250B-3K			0.150	0.83	0.29	0.12	0.250 x 0.032	6.3 x 0.8			3000
DV14-187B-3K	16 – 14 AWG	Blue	0.170	0.77	0.23	0.10	0.187 x 0.032	4.8 x 0.8	CD9-2A	CD-800-2	3000
DV14-188B-3K			0.170	0.77	0.23	0.09	0.187 x 0.020	4.8 x 0.5			3000
DV14-205B-3K			0.170	0.77	0.25	0.12	0.187/0.205 x 0.032	4.8/5.2 x 0.8			3000
DV14-206B-3K			0.170	0.77	0.25	0.11	0.187/0.205 x 0.020	4.5/5.2 x 0.5			3000
DV14-250B-3K			0.170	0.83	0.29	0.12	0.250 x 0.032	6.3 x 0.8			3000
DV10-250-2K*	12 – 10 AWG	Yellow	0.230	0.95	0.29	0.12	0.250 x 0.032	6.3 x 0.8	CD9-3B	CD-800-3	2000
DV10-250C-2K†**			0.230	0.95	0.29	0.12	0.250 x 0.032	6.4 x 0.8			2000

*Not UL Listed or CSA Certified.

**UL Recognized and CSA Certified.

†Compression tab disconnect to fit 0.250" tabs with a post style support.

B1.
Cable
Ties

B2.
Cable
Accessories

B3.
Stainless
Steel Cable
Ties &
Accessories

C1.
Wiring
Duct

C2.
Abrasion
Protection

C3.
Cable
Management

D1.
Terminals

D2.
Power
Connectors

D3.
Grounding
Connectors

E1.
Labeling
Systems

E2.
Labels

E3.
Pre-Printed
&
Write-On
Markers

E4.
Permanent
Identification

E5.
Industrial
Safety
Solutions

F.
Keystone
Cabling
Systems

G.
Part
Number
Index



DiscoGrip™ Female Disconnects, Fully Insulated

Type DPF-FIB

- Continuously molded design provides reliable, consistent performance through the applicator for a high quality termination every time
- Disconnect can be inserted and removed from the male tab without the use of tools for lower installed cost
- Premium nylon insulation retains its shape when crimped and provides a tight grip around the wire insulation for maximum strain relief
- Fully insulated design provides protection from electrical shorts
- Internal wire stop assures proper length of insertion into terminal barrel, providing a higher quality connection
- UL Flammability UL 94V-2, maximum insulation temperature 221°F (105°C)
- UL and CSA rated up to 600 V per UL 310

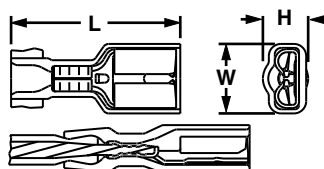

Cross section of DiscoGrip™ Crimp showing insulation crimp of the wire insulation.

Part Number	Wire Range	Color Code	Max Ins. (In.)	Figure Dimensions (In.)			Tab Size		CA9 Series Crimp Die	CA-800/EZ Series Crimp Die	Pieces Per Reel				
				L	W	H	In.	mm							
DPF18-110FIB-3K	22 – 18 AWG	Red	0.132	0.71	0.19	0.17	0.110 x 0.032	2.8 x 0.8	CD9-12A	CD-800-12	3000				
DPF18-111FIB-3K			0.132	0.71	0.19	0.17	0.110 x 0.020	2.8 x 0.5			3000				
DPF18-187FIB-3K			0.136	0.78	0.29	0.16	0.187 x 0.032	4.8 x 0.8			CD9-10A	CD-800-10	3000		
DPF18-188FIB-3K			0.136	0.78	0.29	0.16	0.187 x 0.020	4.8 x 0.5	3000						
DPF18-205FIB-3K			0.136	0.78	0.31	0.22	0.187/0.205 x 0.032	4.8/5.2 x 0.8	3000						
DPF18-206FIB-3K			0.136	0.78	0.31	0.22	0.187/0.205 x 0.020	4.8/5.2 x 0.5	3000						
DPF18-250FIB-3K			0.136	0.84	0.35	0.22	0.250 x 0.032	6.3 x 0.8	3000						
DPF14-187FIB-3K			16 – 14 AWG	Blue	0.160	0.78	0.29	0.18	0.187 x 0.032	4.8 x 0.8			CD9-11A	CD-800-11	3000
DPF14-205FIB-3K					0.160	0.78	0.31	0.22	0.187/0.205 x 0.032	4.8/5.2 x 0.8					3000
DPF14-206FIB-3K					0.160	0.78	0.31	0.22	0.187/0.205 x 0.020	4.8/5.2 x 0.5	3000				
DPF14-250FIB-3K	0.160	0.84			0.35	0.22	0.250 x 0.032	6.3 x 0.8	3000						
DPF10-250FIB-2K	12 – 10 AWG	Yellow	0.220	0.96	0.35	0.23	0.250 x 0.032	6.3 x 0.8	CD9-13B	CD-800-13	2000				



DiscoGrip™ Male Disconnects, Fully Insulated

Type DPF-FIM

- Continuously molded design provides reliable, consistent performance through the applicator for a high quality termination every time
- Disconnect can be inserted and removed from the male tab without the use of tools for lower installed cost
- Fully insulated design provides protection from electrical shorts
- Premium nylon insulation retains its shape when crimped and provides a tight grip around the wire insulation for maximum strain relief
- Oversized housing designed for maximum versatility to mate with most commercially available fully insulated female disconnects
- Internal wire stop assures proper length of insertion into terminal barrel, providing a higher quality connection
- UL Flammability UL 94V-2, maximum insulation temperature 221°F (105°C)
- UL and CSA rated up to 600 V per UL 310

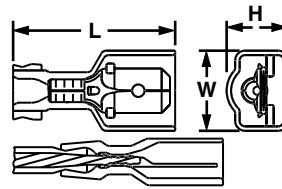
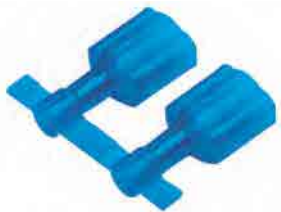

Cross section of DiscoGrip™ Crimp showing insulation crimp of the wire insulation.

Part Number	Wire Range	Color Code	Max Ins. (In.)	Figure Dimensions (In.)			Tab Size		CA9 Series Crimp Die	CA-800/EZ Series Crimp Die	Pieces Per Reel
				L	W	P	In.	mm			
Standard Housing											
DPF18-250FIM-2K	22 – 18 AWG	Red	0.133	0.90	0.41	0.29	0.250 x 0.032	6.3 x 0.8	CD9-10B	CD-800-10	2000
DPF14-250FIM-2K	16 – 14 AWG	Blue	0.156						CD9-11B	CD-800-11	2000
Oversized Housing											
DPF18-250FIMB-K*	22 – 18 AWG	Red	0.133	0.92	0.46	0.34	0.250 x 0.032	6.3 x 0.8	CD9-10B	CD-800-10	1000
DPF14-250FIMB-K*	16 – 14 AWG	Blue	0.156						CD9-11B	CD-800-11	1000

*To mate with other manufacturers' fully insulated 0.250 x 0.032 female receptacles.



Disco™ Male Disconnects, Nylon Fully Insulated – Funnel Entry

Type DNF-FIM

- Continuously molded design provides reliable, consistent performance through the applicator for a high quality termination every time
- Male tab couples with (all 0.250 x 0.032) female disconnects
- Fully insulated design provides protection from electrical shorts
- Male tab can be inserted and removed from the female disconnect without the use of tools for lower installed cost
- UL Flammability UL 94 HB, maximum insulation temperature 221°F (105°C)
- UL and CSA rated up to 600 V per UL 310

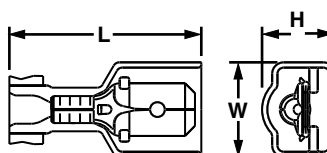

Part Number	Wire Range	Color Code	Max Ins. (In.)	Figure Dimensions (In.)			Tab Size		CA9 Series Crimp Die	CA-800/EZ Series Crimp Die	Pieces Per Reel
				L	W	P	In.	mm			
Standard Housing											
DNF18-250FIM-2K	22 – 18 AWG	Red	0.133	0.90	0.42	0.30	0.250 x 0.032	6.3 x 0.8	CD9-4B	CD-800-4	2000
DNF14-250FIM-2K	16 – 14 AWG	Blue	0.158	0.90	0.42	0.30	0.250 x 0.032	6.3 x 0.8	CD9-5B	CD-800-5	2000
Oversized Housing											
DNF18-250FIMB-K*	22 – 18 AWG	Red	0.135	0.91	0.45	0.34	0.250 x 0.032	6.3 x 0.8	CD9-4B	CD-800-4	1000
DNF14-250FIMB-K*	16 – 14 AWG	Blue	0.160	0.91	0.46	0.34	0.250 x 0.032	6.3 x 0.8	CD9-5B	CD-800-5	1000
DNF10-250FIMB-K	12 – 10 AWG	Yellow	0.220	0.96	0.45	0.36	0.250 x 0.032	6.3 x 0.8	CD9-18B	CD-800-18	1000

*To mate with other manufacturers' fully insulated 0.250 x 0.032 female receptacles.



Disco™ Male Disconnects, Nylon Fully Insulated – Expanded Wire Entry

Type DNF-FIMX

- Continuously molded design provides reliable, consistent performance through the applicator for a high quality termination every time
- Expanded wire entry designed to accommodate wire with a larger insulation thickness
- Male tab couples with (all 0.250 x 0.032) female disconnects
- Fully insulated design provides protection from electrical shorts
- Male tab can be inserted and removed from the female disconnect without the use of tools for lower installed cost
- Internal barrel serrations assure good wire contact and maximum tensile strength
- UL Flammability UL 94 HB, maximum insulation temperature 221°F (105°C)
- UL and CSA rated up to 600 V per UL 310

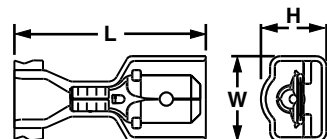

Part Number	Wire Range	Color Code	Max Ins. (In.)	Figure Dimensions (In.)			Tab Size		CA9 Series Crimp Die	CA-800/EZ Series Crimp Die	Pieces Per Reel
				L	W	H	In.	mm			
DNF18250FIMX-2K*	22 – 18 AWG	Red	0.244	0.97	0.41	0.29	0.250 x 0.032	6.3 x 0.8	CD9-8B	CD-800-8	2000
DNF14250FIMX-2K**	16 – 14 AWG	Blue		0.97	0.41	0.29	0.250 x 0.032	6.3 x 0.8	CD9-8B	CD-800-8	2000

*CSA Certified for use with (2) #18 AWG, (2) #20 AWG, or (2) #22 AWG wires.

**CSA Certified for use with (2) #16 AWG or (2) #18 AWG wires.

Pin Terminals, Vinyl Insulated – Funnel Entry

Type PV-PB

- Continuously molded design provides reliable, consistent performance through the applicator for a high quality termination every time
- Solid pin designed to prevent damage to the wire from over tightening, resulting in a reliable electrical connection
- For use with pin-type terminal blocks
- Insulation support helps to prevent wire damage in bending applications
- UL Flammability UL 94V-0, maximum insulation temperature 221°F (105°C)
- UL rated up to 600 V per UL 486A/B

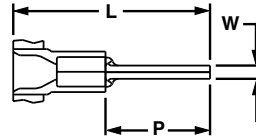

Part Number	Wire Range	Color Code	Max Ins. (In.)	Figure Dimensions (In.)			CA9 Series Crimp Die	CA-800/EZ Series Crimp Die	Pieces Per Reel
				L	W	P			
PV18-P47B-3K	22 – 18 AWG	Red	0.150	0.90	0.07	0.49	CD9-1A	CD-800-1	3000
PV14-P47B-3K	16 – 14 AWG	Blue	0.170	0.90	0.07	0.49	CD9-2A	CD-800-2	3000



Butt Splices Nylon Insulated and Premium Grade Nylon

Type BSN, BSP

- Continuously molded design provides reliable, consistent performance through the applicator for a high quality termination every time
- Designed to splice two solid or stranded wires together to repair or lengthen wires
- Butted configuration provides low profile for limited space applications
- Brazed seam protects terminal barrel from splitting during the crimp process
- Internal wire stop assures proper length of insertion into terminal barrel
- Premium grade nylon insulation available for applications requiring a tighter grip around the wire insulation for maximum strain relief
- UL Flammability UL 94V-2/HB, maximum insulation temperature 221°F (105°C)
- UL and CSA rated up to 600 V per UL 486C

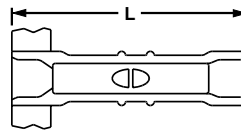

Part Number	Wire Range	Color Code	Max Ins. (In.)	Figure Dimensions (In.)	CA9 Series Crimp Die	CA-800/EZ Series Crimp Die	Pieces Per Reel
				L			
BSN18-3K	22 – 16 AWG	Red	0.150	0.95	CD9-1A	CD-800-1	3000
BSN14-3K	18 – 14 AWG	Blue	0.170	0.95	CD9-2A	CD-800-2	3000
BSN10-2K	12 – 10 AWG	Yellow	0.230	0.95	CD9-17B	CD-800-17	2000
BSP18-3K	22 – 16 AWG	Red	0.150	0.96	CD9-1A	CD-800-1	3000
BSP14-3K	18 – 14 AWG	Blue	0.170	0.96	CD9-2A	CD-800-2	3000

Features and Benefits – Reel Smart™ Ferrules

Panduit® ferrules are available in strips and reels for wiring applications from #20 – 14 AWG. Offerings include insulated ferrules in single wire configurations. These insulated ferrules are color-coded to DIN standards.

Insulated Ferrules – Single Wire Type FSD

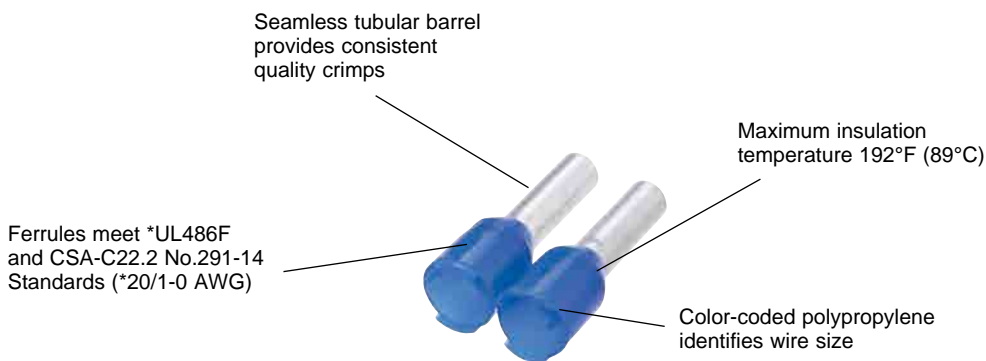

Part Number System for Reel Smart® Ferrules

F	S	D	75	—	8	3K or DSL	10
Type	Wire Type	Color Code	Wire Size (mm ²)		PIN Length	Std. Pkg. Size	Color-Code Number
F = Ferrule	S = Single	D = DIN = Standard (leave blank)				3K = 3,000 2KD = 2500 KD = 1500 K = 1000 DSL = 500	0 = Black 2 = Red 6 = Blue 8 = Gray 10 = White



Insulated Ferrules on Strips – Single Wire

Type FS

- Polypropylene insulation housing available in DIN standard colors in strips of 50
- Continuously molded design provides consistent placement of ferrules in tool to ensure fast, reliable terminations

- Available in #20 – 14 AWG featuring a seamless barrel design to contain loose wire strands for superior terminations
- Designed for use with the Semiautomatic Ferrule Crimping Tool CT-1000 for medium volume applications

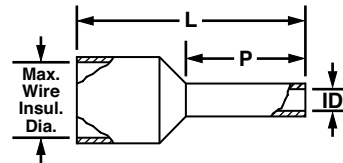
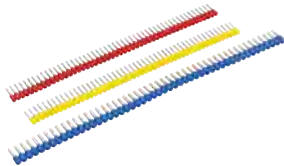

Part Number	Wire Size		Color	Max. Wire Ins. Dia.		Figure Dimensions						Wire Strip Length		Recommended Installation Tool	Std. Pkg. Qty.	
	AWG	mm ²		In.	mm.	L		P		ID		In.	mm.			
DIN End Sleeves:																
FSD75-8-DSL10	22- 20 AWG	0.50	White	0.10	2.6	0.60	15.2	0.31	8.0	0.04	1.0	13/32	10.0	CT-1000	500	
FSD76-8-DSL8	18 AWG	0.75	Gray	0.11	2.7	0.60	15.2	0.31	8.0	0.06	1.5	13/32	10.0		500	
FSD77-8-DSL2		1.00	Red	0.12	3.0	0.60	15.2	0.31	8.0	0.07	1.8	13/32	10.0		500	
FSD78-8-DSL0	16 AWG	1.50	Black	0.13	3.2	0.60	15.2	0.31	8.0	0.09	2.3	13/32	10.0		500	
FSD80-8-DSL6	14 AWG	2.50	Blue	0.16	4.0	0.60	15.2	0.31	8.0	0.09	2.3	13/32	10.0		500	

Part Number	Wire Size		Color	Max. Wire Ins. Dia.		Figure Dimensions						Wire Strip Length		Recommended Installation Tool	Pieces per Reel	
	AWG	mm ²		In.	mm.	L		P		ID		In.	mm.			
Mini Reels																
FSD75-8-K	20 AWG	0.5	White	0.09	2.4	0.57	14.5	0.31	8	0.04	1.1	13/32	10.0	CP-881	1000	
FSD76-8-K	18 AWG	0.75	Gray	0.1	2.6	0.57	14.5	0.31	8	0.05	1.3	13/32	10.0		1000	
FSD77-8-K		1	Red	0.11	2.8	0.57	14.5	0.31	8	0.06	1.5	13/32	10.0		1000	
FSD78-8-K	16 AWG	1.5	Black	0.13	3.2	0.57	14.5	0.31	8	0.07	1.8	13/32	10.0		1000	
FSD80-8-DK	14 AWG	2.5	Blue	0.15	3.9	0.57	14.5	31	8	0.09	2.3	13/32	10.0		500	



Insulated Ferrules on Reels – Single Wire

Type FS

- Polypropylene insulation housing available in DIN standard colors in reels of 500 - 3000
- Designed specifically for use with the Ferrule Applicator SCA-712022002 (CA10) for high volume applications
- Continuously molded design provides consistent placement of ferrules in applicator to ensure fast, reliable terminations
- Available in #20 – 14 AWG featuring a seamless barrel design to contain loose wire strands for superior terminations

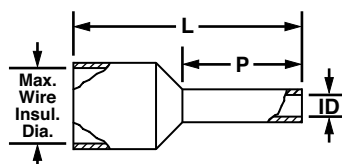

Part Number	Wire Size		Color	Max. Wire Ins. Dia.		Figure Dimensions						Wire Strip Length		CA10 Series Dies	CP-881 Inserts	Pieces per Reel
	AWG	mm ²		In.	mm.	L		P		ID		In.	mm.			
DIN End Sleeves:																
FSD75-8-3K10	20 AWG	0.5	White	0.09	2.4	0.57	14.5	0.31	8	0.04	1.1	13/32	10.0	SCA-712022005WE (CD10-1)	White	3000
FSD76-8-3K8	18 AWG	0.75	Gray	0.1	2.6	0.57	14.5	0.31	8	0.05	1.3	13/32	10.0		Gray	3000
FSD77-8-3K2		1	Red	0.11	2.8	0.57	14.5	0.31	8	0.06	1.5	13/32	10.0	SCA-712022006WE (CD10-2)	Red	3000
FSD78-8-3K0	16 AWG	1.5	Black	0.13	3.2	0.57	14.5	0.31	8	0.07	1.8	13/32	10.0		Black	2500
FSD80-8-3K6	14 AWG	2.5	Blue	0.15	3.9	0.57	14.5	31	8	0.09	2.3	13/32	10.0	SCA-712022007WE (CD10-3)	Blue	1500

Compression Connector Reference Information

Industrial Electrical Solutions

Selection Guide – Pan-Lug Copper Compression Connectors for Copper Code Conductor

Connector	Barrel Style	Type	Page Number
One-Hole Lug	Standard Barrel	CS	02-18, 02-19, 02-20, 02-21, 02-22, 02-23, 02-24
Two-Hole Lug	Standard Barrel	CS	02-18, 02-19, 02-20, 02-21, 02-22, 02-23, 02-24
Stud Lug	Standard Barrel	CS	02-25, 02-26, 02-27, 02-28, 02-29, 02-30, 02-31, 02-32, 02-33, 02-34, 02-35, 02-36, 02-37, 02-38, 02-39, 02-40, 02-41, 02-42, 02-43, 02-44, 02-45, 02-46, 02-47, 02-48, 02-49, 02-50, 02-51, 02-52, 02-53, 02-54, 02-55, 02-56, 02-57, 02-58, 02-59, 02-60, 02-61, 02-62, 02-63, 02-64, 02-65, 02-66, 02-67, 02-68, 02-69, 02-70, 02-71, 02-72, 02-73, 02-74, 02-75, 02-76, 02-77, 02-78, 02-79, 02-80, 02-81, 02-82, 02-83, 02-84, 02-85, 02-86, 02-87, 02-88, 02-89, 02-90, 02-91, 02-92, 02-93, 02-94, 02-95, 02-96, 02-97, 02-98, 02-99, 02-100
Panel Lug	Standard Barrel	CS	02-35

Selection Guide

- Provides a quick and easy method to select the proper connector to meet the specific application requirements

Conductor Type

Barrel Style

Stud Hole Configuration

Product Type and Page Number

Terminate

Code Conductor, Two-Hole, Standard Barrel with Window Lug

Agency Listings

Features and Benefits

- Color-coded barrels marked with Panduit and specific code conductor size for easy identification.
- Insulation stripping length is clearly marked on the barrel.
- The plated barrel provides corrosion resistance.
- UL Listed for use on 35 kV and temperature range to 100°C.

Full Color Photo and 2-View Drawing

Panduit and Competitor Die Information

Part Number	Code Conductor Size	Stud Hole Spacing (mm)	Stud Hole Diameter (mm)	Flange Dimensions (mm)	Color	Panduit Die	Competitor Die	Notes
LC09-MA-L	#14	50.8	5.0	1.0	Blue	P51	—	—
LC09-MA-L	#12	50.8	5.0	1.0	Blue	P51	—	—
LC09-MA-L	#10	50.8	5.0	1.0	Blue	P51	—	—
LC09-MA-L	#8	50.8	5.0	1.0	Blue	P51	—	—
LC09-MA-L	#6	50.8	5.0	1.0	Blue	P51	—	—
LC09-MA-L	#4	50.8	5.0	1.0	Blue	P51	—	—
LC09-MA-L	#2	50.8	5.0	1.0	Blue	P51	—	—

Page Reference for Panduit and Competitor Installation Tooling and Die Selection Charts

Product Page

- Includes all necessary information for part identification and selection

Agency Listings

Features and Benefits

Full Color Photo and 2-View Drawing

Panduit and Competitor Die Information

Page Reference for Panduit and Competitor Installation Tooling and Die Selection Charts

B1. Cable Ties

B2. Cable Accessories

B3. Stainless Steel Cable Ties & Accessories

C1. Wiring Duct

C2. Abrasion Protection

C3. Cable Management

D1. Terminals

D2. Power Connectors

D3. Grounding Connectors

E1. Labeling Systems

E2. Labels

E3. Pre-Printed & Write-On Markers

E4. Permanent Identification

E5. Lockout/Tagout & Safety Solutions

F. Keystone Cabling Systems

G. Part Number Index

Compression Connectors

Panduit® Pan-Lug™ Compression Connectors provide permanent terminations for a variety of power and grounding applications, with innovation, highest reliability, and lowest installed cost. Panduit offers the first and only copper compression lugs and splices that meet Network Equipment-Building Systems (NEBS) Level 3 requirements as tested by Telcordia Technologies. NEBS Level 3 assures that product performance is suitable for equipment applications that demand minimal service interruptions over the life span of the equipment.

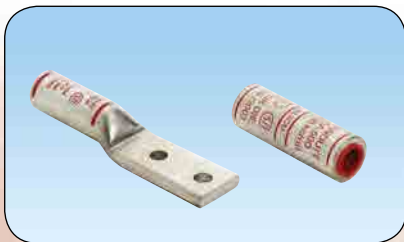



- **Functional product information is marked directly on the connector, facilitating the identification, ordering, and usage of the compression connector**
- **Color-coded to facilitate quick identification of the proper crimping die**
- **Made from high strength, high conductivity electrolytic copper and aluminum alloy materials to provide optimum connectivity for power and grounding applications**
- **UL Listed or Recognized, CSA Certified, ABS Type Approved and tested by Telcordia – meets NEBS Level 3, as noted**
- **Terminations using Panduit® Pan-Lug™ Compression Connectors are also UL Listed and CSA Certified with specified competitor tools**
- **Wide assortment of manual, controlled cycle, battery operated hydraulic and pneumatic crimping tools for reliable connections at the lowest installed cost**

Panduit® Pan-Lug™ Compression Connectors are designed for use with many different code and flex conductor types and are available in a broad range of styles and sizes including copper one-hole, two-hole, and blank tongue lugs and splices; aluminum one-hole and two-hole lugs and splices; and copper in-line reducing splices. Panduit offers a wide assortment of Pan-Lug™ Power Connectors to meet customer needs and today's application requirements.

Features and Benefits – Pan-Lug™ Compression Connectors

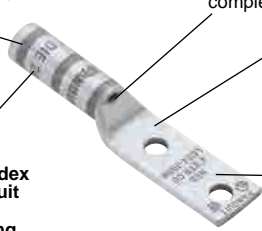
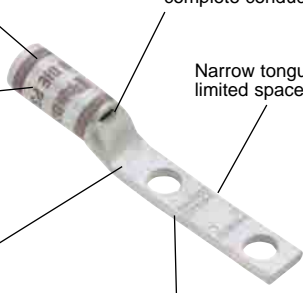
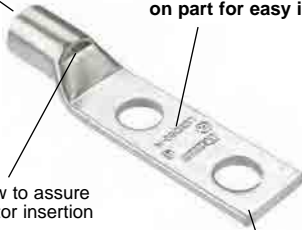
Bolded features are unique to Panduit.

<h3>Copper Lugs</h3> <p>Color-coded bands for proper die selection and crimp placement</p> <p>Easy-to-read, color-coded die index numbers for Panduit and specified competitor crimping dies for selection</p> <p>Made from seamless, high conductivity copper tubing and electro tin-plated and burnished to inhibit corrosion</p> <p>Internally beveled barrel end for easy conductor insertion (types LCCF and LCAF available with flared entry for flex conductor)</p> <p>Inspection windows available to assure complete conductor insertion</p> <p>Part number, stud size, and conductor size marked on part for easy identification</p>  <p>UL LISTED SF CERTIFIED</p>	<h3>Flex Lugs</h3> <p>Color-coded bands for proper die selection and crimp placement</p> <p>Inspection window to assure complete conductor insertion</p> <p>Made from seamless, high conductivity copper tubing and electro tin-plated and burnished to inhibit corrosion</p> <p>Easy-to-read, color-coded die index numbers for Panduit and specified competitor crimping dies for selection</p> <p>Product information marked on part for easy identification</p> <p>Can be used with code conductor and flex conductor class: G, H, I, K, M and Diesel Locomotive</p>  <p>UL LISTED SF CERTIFIED</p>
<h3>Narrow Tongue Lugs</h3> <p>Color-coded bands for proper die selection and crimp placement</p> <p>Easy-to-read, color-coded die index numbers for Panduit and specified competitor crimping dies for selection</p> <p>Made from seamless, high conductivity copper tubing and electro tin-plated and burnished to inhibit corrosion</p> <p>Inspection window to assure complete conductor insertion</p> <p>Narrow tongue width for limited space applications</p> <p>Product information marked on part for easy identification</p>  <p>UL LISTED SF CERTIFIED</p>	<h3>Copper Metric Lugs</h3> <p>Internally beveled barrel ends for easy conductor insertion</p> <p>Inspection window to assure complete conductor insertion</p> <p>Product information marked on part for easy identification</p> <p>Made from 99.9% pure copper for high quality connection and tin-plated to inhibit corrosion</p>  <p>UL LISTED SF CERTIFIED</p>
<h3>Copper Parallel Splice</h3> <p>Chamfered on both ends for fast and easy conductor insertion</p> <p>Made from seamless, high conductivity copper tubing and electro tin-plated and burnished to inhibit corrosion</p> <p>Largest part marking in the industry – easier to read in low light conditions</p> <p>Intuitive part numbering for fast and accurate part selection in the field</p> <p>Industry recognized color-coding for selection</p>  <p>UL LISTED SF CERTIFIED</p>	<h3>Aluminum Lugs</h3> <p>Easy-to-read die index numbers for Panduit and specified competitor crimping dies for selection</p> <p>Part number and conductor size marked on part for easy identification</p> <p>Made from seamless wrought aluminum and electro tin-plated to inhibit corrosion</p> <p>Crimping areas marked on part for proper crimp placement</p> <p>Factory pre-filled with oxide inhibitor to prevent oxidation</p>  <p>cUL US LISTED</p>

B1.
Cable
Ties

B2.
Cable
Accessories

B3.
Stainless
Steel Cable
Ties &
Accessories

C1.
Wiring
Duct

C2.
Abrasion
Protection

C3.
Cable
Management

D1.
Terminals

D2.
Power
Connectors

D3.
Grounding
Connectors

E1.
Labeling
Systems

E2.
Labels

E3.
Pre-Printed
&
Write-On
Markers

E4.
Permanent
Identification

E5.
Lockout/
Tagout &
Safety
Solutions

F.
Keystone
Cabling
Systems

G.
Part
Number
Index



Compression connector crimping tools speed installation and reduce total installed cost. Visit www.panduit.com/tools.



Panduit designs and manufactures a full line of labeling products, software and printers to assist you with your labeling requirements. See pages E1.1 – E2.27.



Heat shrink tubing provides an economical and easy way to insulate, protect, harness and color code electrical and electronic components. See pages C2.23 – C2.42.

Selection Guide – Pan-Lug™ Copper Compression Connectors for Copper Code Conductor









Code



Connector	Barrel Style	Type	Page Number
One-Hole Lugs	Standard Barrel with Inspection Window	LCA	D2.9, D2.10
		LCAN narrow tongue	D2.11, D2.12
	Long Barrel no Inspection Window	LCB	D2.13, D2.14
Two-Hole Lugs	Standard Barrel with Inspection Window	LCD	D2.15, D2.16, D2.17
		LCDN narrow tongue	D2.18
	Long Barrel no Inspection Window	LCC	D2.19, D2.20
		Long Barrel with Inspection Window	LCC-W
LCCN-W narrow tongue	D2.25		
Butt Splices	Standard Barrel	SCS	D2.26
	Long Barrel	SCL	D2.27
Parallel Splices		PSC	D2.28

Selection Guide – Pan-Lug™ Copper Compression Connectors for Copper Code and/or Flex Conductor



Connector	Barrel Style	Type	Page Number
 One-Hole Lugs	Standard Barrel with Inspection Window Code and Flex	LCAX	D2.30, D2.31
		LCAXN narrow tongue	D2.32
	Long Barrel with Inspection Window Code and Flex	LCBX	D2.33
 Two-Hole Lugs	Standard Barrel with Inspection Window Code and Flex	LCDX	D2.34, D2.35, D2.36
		LCDXN narrow tongue	D2.37
	Long Barrel with Inspection Window Code and Flex	LCCX	D2.38, D2.39
		LCCXN narrow tongue	D2.40
 Butt Splices with Flared Entry for Flex		SCSF	D2.41
 Reducing Splices with Inspection Window for Code and Flex		RSCK kits with reducing splice and clear heat shrink	D2.42, D2.43
		RSC reducing splices	D2.43, D2.44
 One-Hole Metric Lugs	Long Barrel	LCMB	D2.51, D2.52
		LCMA	D2.45, D2.46
		NEW! LCMA-H	D2.47, D2.48
		NEW! LCMA-F	D2.49, D2.50
 Two-Hole Metric Lugs	Long Barrel	NEW! LCMD	D2.53, D2.54
		NEW! LCMC	D2.55, D2.56
 Metric Splices		SCMS	D2.57

Selection Guide – Pan-Lug™ Aluminum Compression Connectors for Aluminum or Copper Code Conductor

Connector	Type	Page Number
-----------	------	-------------



One-Hole Lugs	LAA	D2.58
---------------	-----	-------



Two-Hole Lugs	LAB	D2.59
---------------	-----	-------



Butt Splices	SA	D2.61
--------------	----	-------



B-Metallic Pin Connectors for Aluminum Conductors Only	BPC	D2.62
--	-----	-------



Belleville Washers	CW	D2.60
--------------------	----	-------



Joint Compounds	CMP	D2.60, D2.91
-----------------	-----	--------------

Part Number System for Pan-Lug™ Compression Lugs

LCD Type	2/0 Conductor Size	— 38 Stud Hole Size	D Two Stud Hole Spacing	F Tongue Angle	— X Standard Package Size
example: LCD = Lug, Copper Two-Hole Standard Barrel	2/0 = 2/0 AWG	10 = #10 14 = 1/4" 56 = 5/16" 38 = 3/8" 12 = 1/2" 58 = 5/8" 34 = 3/4" 78 = 7/8" 00 = Blank Tongue	A = 0.625" B = 0.750" C = 0.875" D = 1.0" E = 1.25" G = 1.5" J = 0.5" K = 2" M = 1.375" P = 0.688" Q = 1.125" No Letter = 1.75" or 44.5mm CD = 22.0-25.0mm	H = 45° F = 90° No Letter = Straight	1 = 1 3 = 3 5 = 5 6 = 6 X = 10 E = 20 Q = 25 L = 50 C = 100
		5 = M5 6 = M6 8 = M8 10 = M10 12 = M12 14 = M14 16 = M16 20 = M20			



Code Conductor, One-Hole, Tubular Ring Terminal with Inspection Window

For Use with Stranded Copper Conductors

Type S-R

- Seamless tubular barrel provides a consistent high performance quality crimp
- Round double thick tongue for reliable power applications
- Barrel of terminal internally beveled to provide quick and easy wire insertion
- Inspection window allows visual inspection of proper wire insertion
- UL Listed and CSA Certified to 35 kV** and temperature rated to 90°C when crimped with specified Panduit® crimping tools and dies
- Tin plated to inhibit corrosion

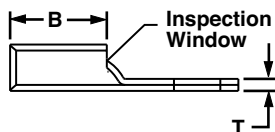
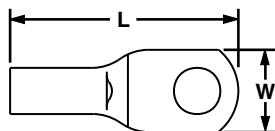

Part Number	Wire Range	Stud Hole Size	Tongue Width (in.)	Figure Dimensions (In.)			Recommended Installation Tool	Std. Pkg. Qty.			
			W	L	B	T					
S8-10R-Q	8 AWG	#10	0.41	1.10	0.40	0.08	CT-1700, CT-720, CT-930, CT-930CH, CT-940CH, CT-2001, CT-2002, CT-2931, CT-2940, CT-3001	25			
S8-14R-Q		1/4"	0.48	1.20	0.40	0.07		25			
S8-56R-Q		5/16"	0.60	1.30	0.40	0.05		25			
S8-38R-Q		3/8"	0.60	1.40	0.40	0.05		25			
S6-10R-E	6 AWG	#10	0.45	1.20	0.48	0.09		CT-1700, CT-720, CT-930, CT-930CH, CT-940CH, CT-2001, CT-2002, CT-2931, CT-2940, CT-3001	20		
S6-14R-E		1/4"	0.48	1.30	0.48	0.08			20		
S6-56R-E		5/16"	0.56	1.40	0.48	0.07			20		
S6-38R-E		3/8"	0.62	1.50	0.48	0.06			20		
S4-10R-E	4 AWG	#10	0.55	1.20	0.48	0.09			CT-1700, CT-720, CT-930, CT-930CH, CT-940CH, CT-2001, CT-2002, CT-2931, CT-2940, CT-3001	20	
S4-14R-E		1/4"	0.55	1.30	0.48	0.09				20	
S4-56R-E		5/16"	0.55	1.40	0.48	0.09				20	
S4-38R-E		3/8"	0.62	1.50	0.48	0.07				20	
S2-10R-X	1 - 2 AWG	#10	0.70	1.60	0.48	0.11				CT-1700, CT-720, CT-930, CT-930CH, CT-940CH, CT-2001, CT-2002, CT-2931, CT-2940, CT-3001	10
S2-14R-X		1/4"	0.70	1.60	0.59	0.11					10
S2-56R-X		5/16"	0.70	1.70	0.59	0.11					10
S2-38R-X		3/8"	0.70	1.70	0.59	0.11					10
S2-12R-X		1/2"	0.79	1.90	0.59	0.09	10				
S1/0-14R-X	1/0 AWG	1/4"	0.76	1.60	0.58	0.12	CT-1700, CT-720, CT-930, CT-930CH, CT-940CH, CT-2001, CT-2002, CT-2931, CT-2940, CT-3001				10
S1/0-56R-X		5/16"	0.76	1.70	0.58	0.12					10
S1/0-38R-X		3/8"	0.76	1.70	0.58	0.12					10
S1/0-12R-X		1/2"	0.82	1.90	0.58	0.12		10			
S2/0-14R-X	2/0 AWG	1/4"	0.85	1.90	0.66	0.13		CT-1700, CT-720, CT-930, CT-930CH, CT-940CH, CT-2001, CT-2002, CT-2931, CT-2940, CT-3001			10
S2/0-56R-X		5/16"	0.85	1.90	0.66	0.13					10
S2/0-38R-X		3/8"	0.85	1.90	0.66	0.13					10
S2/0-76R-X		7/16"	0.85	2.10	0.83	0.13			10		
S2/0-12R-X		1/2"	0.85	2.10	0.83	0.13			10		
S3/0-14R-5	3/0 AWG	1/4"	0.96	2.10	0.83	0.13			CT-1700, CT-720, CT-930, CT-930CH, CT-940CH, CT-2001, CT-2002, CT-2931, CT-2940, CT-3001		5
S3/0-56R-5		5/16"	0.96	2.10	0.83	0.13					5
S3/0-38R-5		3/8"	0.96	2.10	0.83	0.13				5	
S3/0-76R-5		7/16"	0.96	2.30	0.91	0.13				5	
S3/0-12R-5		1/2"	0.96	2.30	0.91	0.13				5	
S4/0-56R-5	4/0 AWG	5/16"	1.06	2.30	0.91	0.14				CT-1700, CT-720, CT-930, CT-930CH, CT-940CH, CT-2001, CT-2002, CT-2931, CT-2940, CT-3001	5
S4/0-38R-5		3/8"	1.06	2.30	0.91	0.14					5
S4/0-76R-5		7/16"	1.06	2.50	0.91	0.14	5				
S4/0-12R-5		1/2"	1.06	2.50	0.91	0.14	5				
S250-56R-5	250 kcmil	5/16"	1.17	2.50	1.01	0.14	CT-1700, CT-720, CT-930, CT-930CH, CT-940CH, CT-2001, CT-2002, CT-2931, CT-2940, CT-3001				5
S250-38R-5		3/8"	1.17	2.50	1.01	0.14					5
S250-76R-5		7/16"	1.17	2.60	1.01	0.14		5			
S250-12R-5		1/2"	1.17	2.60	1.01	0.14		5			

For crimping tool information, visit www.panduit.com/tools.

**Consult cable manufacturer for voltage stress relief instructions with applications greater than 2000 V.



Code Conductor, One-Hole, Standard Barrel with Window Lug

For Use with Stranded Copper Conductors

Type LCA

- Color-coded barrels marked with Panduit and specified competitor die index numbers for proper crimp die selection
- Inspection window to visually assure full conductor insertion
- Tin-plated to inhibit corrosion
- UL Listed and CSA Certified to 35 kV** and temperature rated to 90°C when crimped with Panduit and specified competitor crimping tools and dies
- UL Listed and CSA Certified for wide wire range-taking capability when crimped with Panduit® Uni-Die™ Dieless Crimping Tools‡
- Tested by Telcordia – meets NEBS Level 3
- American Bureau of Shipping Approved
- Lugs available in 90 and 45 degree bent tongue. Please refer to www.panduit.com

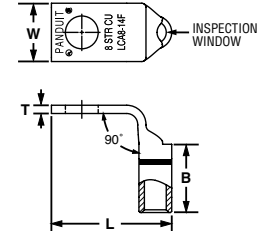
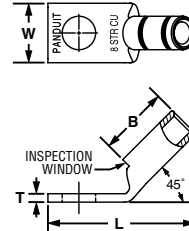
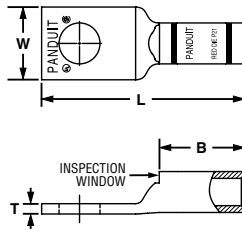

Part Number	Copper Conductor Size	Stud Hole Size (In.)	Figure Dimensions (In.)				Panduit Color Code	Panduit Die Index No.‡	Burndy Die Index No.‡	T&B Die Index No.‡	Wire Strip Length (In.)	Std. Pkg. Qty.
			W	B	T	L						
LCA10-10-L*	#14 – #10 AWG STR,	#10	0.38	0.38	0.06	1.07	—	—	—	—	7/16	50
LCA10-14-L*		1/4	0.42	0.38	0.05	1.16	—	—	—	—	7/16	50
LCA10-56-L*		5/16	0.54	0.38	0.04	1.28	—	—	—	—	7/16	50
LCA10-38-L*	#12 – #10 AWG SOL	3/8	0.56	0.38	0.04	1.38	—	—	—	—	7/16	50
LCA8-10-L	#8 AWG	#10	0.41	0.56	0.08	1.25	Red	P21	49	21	5/8	50
LCA8-14-L		1/4	0.48	0.56	0.07	1.34	Red	P21	49	21	5/8	50
LCA8-56-L		5/16	0.56	0.56	0.05	1.46	Red	P21	49	21	5/8	50
LCA8-38-L		3/8	0.60	0.56	0.05	1.56	Red	P21	49	21	5/8	50
LCA6-10-L	#6 AWG	#10	0.45	0.81	0.09	1.52	Blue	P24	7	24	7/8	50
LCA6-14-L		1/4	0.48	0.81	0.08	1.61	Blue	P24	7	24	7/8	50
LCA6-56-L		5/16	0.56	0.81	0.07	1.73	Blue	P24	7	24	7/8	50
LCA6-38-L		3/8	0.62	0.81	0.06	1.83	Blue	P24	7	24	7/8	50
LCA6-12-L		1/2	0.75	0.81	0.07	2.23	Blue	P24	7	24	7/8	50
LCA4-10-L	#4 – #3 AWG STR, #2 AWG SOL	#10	0.55	0.81	0.09	1.54	Gray	P29	8	29	7/8	50
LCA4-14-L		1/4	0.55	0.81	0.09	1.63	Gray	P29	8	29	7/8	50
LCA4-56-L		5/16	0.55	0.81	0.09	1.75	Gray	P29	8	29	7/8	50
LCA4-38-L		3/8	0.62	0.81	0.07	1.85	Gray	P29	8	29	7/8	50
LCA4-12-L		1/2	0.75	0.81	0.07	2.23	Gray	P29	8	29	7/8	50
LCA2-14-Q	#2 AWG	1/4	0.60	0.88	0.10	1.77	Brown	P33	10	33	15/16	25
LCA2-56-Q		5/16	0.66	0.88	0.10	1.90	Brown	P33	10	33	15/16	25
LCA2-38-Q		3/8	0.66	0.88	0.10	1.97	Brown	P33	10	33	15/16	25
LCA2-12-Q		1/2	0.75	0.88	0.08	2.21	Brown	P33	10	33	15/16	25
LCA1-14-E	#1 AWG	1/4	0.70	0.88	0.11	1.79	Green	P37	11	37	15/16	20
LCA1-56-E		5/16	0.70	0.88	0.11	1.92	Green	P37	11	37	15/16	20
LCA1-38-E		3/8	0.70	0.88	0.11	1.99	Green	P37	11	37	15/16	20
LCA1-12-E		1/2	0.75	0.88	0.09	2.23	Green	P37	11	37	15/16	20

‡Visit www.panduit.com/tools for tool and die information.

*Not tested to NEBS Level 3 requirements.

**Consult cable manufacturer for voltage stress relief instructions with applications greater than 2000 V.

Continues on next page



Code Conductor, One-Hole, Standard Barrel with Window Lug (continued)

Part Number	Copper Conductor Size	Stud Hole Size (In.)	Figure Dimensions (In.)				Panduit Color Code	Panduit Die Index No.‡	Burndy Die Index No.‡	T&B Die Index No.‡	Wire Strip Length (In.)	Std. Pkg. Qty.
			W	B	T	L						
LCA1/0-14-X	1/0 AWG	1/4	0.76	0.94	0.12	1.95	Pink	P42	12	42	1	10
LCA1/0-56-X		5/16	0.76	0.94	0.12	2.00	Pink	P42	12	42	1	10
LCA1/0-38-X		3/8	0.76	0.94	0.12	2.08	Pink	P42	12	42	1	10
LCA1/0-12-X		1/2	0.80	0.94	0.12	2.31	Pink	P42	12	42	1	10
LCA2/0-14-X	2/0 AWG	1/4	0.85	0.98	0.13	2.09	Black	P45	13	45	1 1/16	10
LCA2/0-56-X		5/16	0.85	0.98	0.13	2.09	Black	P45	13	45	1 1/16	10
LCA2/0-38-X		3/8	0.85	0.98	0.13	2.15	Black	P45	13	45	1 1/16	10
LCA2/0-12-X		1/2	0.85	0.98	0.13	2.40	Black	P45	13	45	1 1/16	10
LCA3/0-14-X	3/0 AWG	1/4	0.96	1.14	0.13	2.28	Orange	P50	14	50	1 3/16	10
LCA3/0-56-X		5/16	0.96	1.14	0.13	2.28	Orange	P50	14	50	1 3/16	10
LCA3/0-38-X		3/8	0.96	1.14	0.13	2.34	Orange	P50	14	50	1 3/16	10
LCA3/0-12-X		1/2	0.96	1.14	0.13	2.59	Orange	P50	14	50	1 3/16	10
LCA4/0-14-X	4/0 AWG	1/4	1.06	1.19	0.14	2.36	Purple	P54	15	54	1 1/4	10
LCA4/0-56-X		5/16	1.06	1.19	0.14	2.38	Purple	P54	15	54	1 1/4	10
LCA4/0-38-X		3/8	1.06	1.19	0.14	2.45	Purple	P54	15	54	1 1/4	10
LCA4/0-12-X		1/2	1.06	1.19	0.14	2.68	Purple	P54	15	54	1 1/4	10
LCA250-14-X	250 kcmil	1/4	1.17	1.25	0.14	2.47	Yellow	P62	16	62	1 5/16	10
LCA250-56-X		5/16	1.17	1.25	0.14	2.48	Yellow	P62	16	62	1 5/16	10
LCA250-38-X		3/8	1.17	1.25	0.14	2.55	Yellow	P62	16	62	1 5/16	10
LCA250-12-X		1/2	1.17	1.25	0.14	2.78	Yellow	P62	16	62	1 5/16	10
LCA300-56-X	300 kcmil	5/16	1.19	1.44	0.16	2.94	White	P66	17	66	1 1/2	10
LCA300-38-X		3/8	1.19	1.44	0.16	2.94	White	P66	17	66	1 1/2	10
LCA300-12-X		1/2	1.19	1.44	0.16	3.05	White	P66	17	66	1 1/2	10
LCA300-58-X		5/8	1.19	1.44	0.16	3.26	White	P66	17	66	1 1/2	10
LCA300-78-X		7/8	1.19	1.44	0.16	3.70	White	P66	17	66	1 1/2	10
LCA350-38-X		350 kcmil	3/8	1.28	1.44	0.17	2.98	Red	P71	18	71	1 1/2
LCA350-12-X	1/2		1.28	1.44	0.17	3.09	Red	P71	18	71	1 1/2	10
LCA350-58-X	5/8		1.28	1.44	0.17	3.30	Red	P71	18	71	1 1/2	10
LCA350-78-X	7/8		1.28	1.44	0.17	3.74	Red	P71	18	71	1 1/2	10
LCA400-38-6	400 kcmil	3/8	1.39	1.50	0.18	3.22	Blue	P76	19	76	1 9/16	6
LCA400-12-6		1/2	1.39	1.50	0.18	3.22	Blue	P76	19	76	1 9/16	6
LCA400-58-6		5/8	1.39	1.50	0.18	3.43	Blue	P76	19	76	1 9/16	6
LCA400-78-6		7/8	1.39	1.50	0.18	3.82	Blue	P76	19	76	1 9/16	6
LCA500-38-6	500 kcmil	3/8	1.54	1.75	0.22	3.39	Brown	P87	20	87	1 13/16	6
LCA500-12-6		1/2	1.54	1.75	0.22	3.55	Brown	P87	20	87	1 13/16	6
LCA500-58-6		5/8	1.54	1.75	0.22	3.76	Brown	P87	20	87	1 13/16	6
LCA500-34-6		3/4	1.54	1.75	0.22	3.90	Brown	P87	20	87	1 13/16	6
LCA500-78-6		7/8	1.54	1.75	0.22	4.15	Brown	P87	20	87	1 13/16	6
LCA500-1-6		1	1.54	1.75	0.22	4.27	Brown	P87	20	87	1 13/16	6
LCA600-12-6	600 kcmil	1/2	1.70	1.75	0.26	4.20	Green	P94	22	94	1 13/16	6
LCA600-58-6		5/8	1.70	1.75	0.26	4.20	Green	P94	22	94	1 13/16	6
LCA600-78-6		7/8	1.70	1.75	0.26	4.20	Green	P94	22	94	1 13/16	6
LCA750-58-6	750 kcmil	5/8	1.89	1.88	0.26	4.59	Black	P106	24	106	1 15/16	6

‡Visit www.panduit.com/tools for tool and die information.
 *Not tested to NEBS Level 3 requirements.



Code Conductor, One-Hole, Standard Barrel with Window, Narrow Tongue Lug

For Use with Stranded Copper Conductors

Type LKAN

- Narrow tongue width for limited space applications
- Color-coded barrels marked with Panduit and specified competitor die index numbers for proper crimp die selection
- Inspection window to visually assure full conductor insertion
- Tin-plated to inhibit corrosion
- UL Listed and CSA Certified to 35 kV** and temperature rated to 90°C when crimped with Panduit and specified competitor crimping tools and dies
- UL Listed and CSA Certified for wide wire range-taking capability when crimped with Panduit® Uni-Die™ Dieless Crimping Tools‡

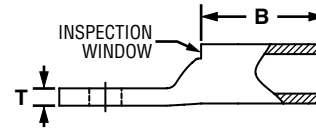
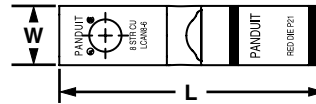

Part Number	Copper Conductor Size	Stud Hole Size (In.)	Figure Dimensions (In.)				Panduit Color Code	Panduit Die Index No.‡	Burndy Die Index No.‡	T&B Die Index No.‡	Wire Strip Length (In.)	Std. Pkg. Qty.
			W	B	T	L						
LCAN8-6-L	#8 AWG	#6	0.27	0.56	0.10	1.24	Red	P21	49	21	5/8	50
LCAN6-6-L	#6 AWG	#6	0.31	0.81	0.10	1.51	Blue	P24	7	24	7/8	50
LCAN4-10-L	#4 – #3 AWG STR, #2 AWG SOL	#10	0.40	0.81	0.11	1.54	Gray	P29	8	29	7/8	50
LCAN4-14-L		1/4	0.40	0.81	0.11	1.63	Gray	P29	8	29	7/8	50
LCAN2-10-Q	#2 AWG	#10	0.42	0.88	0.12	1.67	Brown	P33	10	33	15/16	25
LCAN2-14-Q		1/4	0.42	0.88	0.12	1.77	Brown	P33	10	33	15/16	25
LCAN1-10-E	#1 AWG	#10	0.47	0.88	0.11	1.69	Green	P37	11	37	15/16	20
LCAN1-14-E		1/4	0.47	0.88	0.12	1.79	Green	P37	11	37	15/16	20
LCAN1/0-10-X	1/0 AWG	#10	0.52	0.94	0.13	1.78	Pink	P42	12	42	1	10
LCAN1/0-14-X		1/4	0.52	0.94	0.13	1.95	Pink	P42	12	42	1	10
LCAN1/0-56-X		5/16	0.52	0.94	0.13	2.00	Pink	P42	12	42	1	10
LCAN2/0-10-X	2/0 AWG	#10	0.58	0.98	0.13	1.84	Black	P45	13	45	1 1/16	10
LCAN2/0-14-X		1/4	0.58	0.98	0.14	2.09	Black	P45	13	45	1 1/16	10
LCAN2/0-56-X		5/16	0.58	0.98	0.14	2.09	Black	P45	13	45	1 1/16	10
LCAN2/0-38-X		3/8	0.58	0.98	0.13	2.15	Black	P45	13	45	1 1/16	10
LCAN3/0-14-X	3/0 AWG	1/4	0.64	1.14	0.14	2.28	Orange	P50	14	50	1 3/16	10
LCAN3/0-56-X		5/16	0.64	1.14	0.13	2.28	Orange	P50	14	50	1 3/16	10
LCAN3/0-38-X		3/8	0.64	1.14	0.13	2.34	Orange	P50	14	50	1 3/16	10
LCAN4/0-14-X	4/0 AWG	1/4	0.71	1.19	0.14	2.36	Purple	P54	15	54	1 1/4	10
LCAN4/0-56-X		5/16	0.71	1.19	0.14	2.38	Purple	P54	15	54	1 1/4	10
LCAN4/0-38-X		3/8	0.71	1.19	0.15	2.45	Purple	P54	15	54	1 1/4	10

‡Visit www.panduit.com/tools for tool and die information.

**Consult cable manufacturer for voltage stress relief instructions with applications greater than 2000 V.

Continues on next page

**Code Conductor, One-Hole, Standard Barrel with Window,
Narrow Tongue Lug (continued)**

Part Number	Copper Conductor Size	Stud Hole Size (In.)	Figure Dimensions (In.)				Panduit Color Code	Panduit Die Index No.‡	Burndy Die Index No.‡	T&B Die Index No.‡	Wire Strip Length (In.)	Std. Pkg. Qty.
			W	B	T	L						
LCAN250-14-X	250 kcmil	1/4	0.77	1.25	0.14	2.47	Yellow	P62	16	62	1 5/16	10
LCAN250-38-X		3/8	0.77	1.25	0.15	2.55	Yellow	P62	16	62	1 5/16	10
LCAN300-14-X	300 kcmil	1/4	0.81	1.44	0.16	2.90	White	P66	17	66	1 1/2	10
LCAN300-38-X		3/8	0.81	1.44	0.16	2.94	White	P66	17	66	1 1/2	10
LCAN350-38-X	350 kcmil	3/8	0.88	1.44	0.17	2.98	Red	P71	18	71	1 1/2	10
LCAN350-12-X		1/2	0.88	1.44	0.17	3.09	Red	P71	18	71	1 1/2	10
LCAN400-38-6	400 kcmil	3/8	0.95	1.50	0.18	3.22	Blue	P76	19	76	1 9/16	6
LCAN400-12-6		1/2	0.95	1.50	0.18	3.22	Blue	P76	19	76	1 9/16	6
LCAN500-38-6	500 kcmil	3/8	1.06	1.75	0.23	3.39	Brown	P87	20	87	1 13/16	6
LCAN500-12-6		1/2	1.06	1.75	0.22	3.55	Brown	P87	20	87	1 13/16	6
LCAN600-38-6	600 kcmil	3/8	1.19	1.75	0.27	3.44	Green	P94	22	94	1 13/16	6
LCAN600-12-6		1/2	1.19	1.75	0.27	4.20	Green	P94	22	94	1 13/16	6
LCAN750-38-6	750 kcmil	3/8	1.30	1.88	0.28	3.84	Black	P106	24	106	1 15/16	6
LCAN750-12-6		1/2	1.30	1.88	0.28	4.03	Black	P106	24	106	1 15/16	6
LCAN750-58-6		5/8	1.30	1.88	0.28	4.59	Black	P106	24	106	1 15/16	6

‡Visit www.panduit.com/tools for tool and die information.

**Consult cable manufacturer for voltage stress relief instructions with applications greater than 2000 V.



Code Conductor, One-Hole, Long Barrel Lug

For Use with Stranded Copper Conductors

Type LCB

- Long barrel maximizes number of crimps and provides premium wire pull-out strength and electrical performance
- Color-coded barrels marked with Panduit and specified competitor die index numbers for proper crimp die selection
- Enclosed barrel prevents corrosive material from entering barrel when used in harsh environments
- Tin-plated to inhibit corrosion
- Lugs available in 90 and 45 degree bent tongue. Please refer to www.panduit.com
- UL Listed and CSA Certified to 35 kV** and temperature rated to 90°C when crimped with Panduit and specified competitor crimping tools and dies
- UL Listed and CSA Certified for wide wire range-taking capability when crimped with Panduit® Uni-Die™ Dieless Crimping Tools‡
- Tested by Telcordia – meets NEBS Level 3
- American Bureau of Shipping Approved

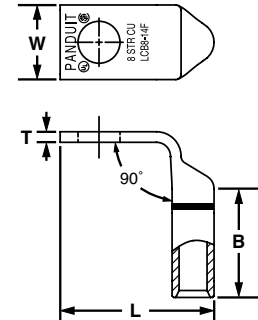
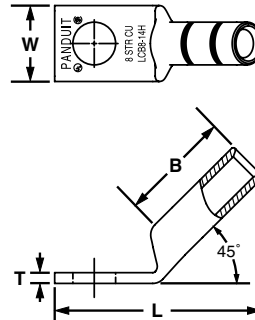
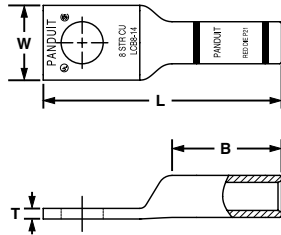

Part Number	Copper Conductor Size	Stud Hole Size (In.)	Figure Dimensions (In.)				Panduit Color Code	Panduit Die Index No.‡	Burndy Die Index No.‡	T&B Die Index No.‡	Wire Strip Length (In.)	Std. Pkg. Qty.
			W	B	T	L						
LCB8-10-L	#8 AWG	#10	0.41	0.70	0.08	1.44	Red	P21	49	21	3/4	50
LCB8-14-L		1/4	0.48	0.70	0.07	1.53	Red	P21	49	21	3/4	50
LCB8-38-L		3/8	0.60	0.70	0.05	1.75	Red	P21	49	21	3/4	50
LCB6-10-L	#6 AWG	#10	0.45	1.07	0.09	1.84	Blue	P24	7	24	1 1/8	50
LCB6-14-L		1/4	0.48	1.07	0.08	1.93	Blue	P24	7	24	1 1/8	50
LCB6-38-L		3/8	0.62	1.07	0.05	2.15	Blue	P24	7	24	1 1/8	50
LCB4-10-L	#4 – #3 AWG STR, #2 AWG SOL	#10	0.55	1.05	0.09	1.86	Gray	P29	8	29	1 1/8	50
LCB4-14-L		1/4	0.55	1.05	0.09	1.95	Gray	P29	8	29	1 1/8	50
LCB4-56-L		5/16	0.62	1.05	0.07	2.13	Gray	P29	8	29	1 1/8	50
LCB4-38-L		3/8	0.62	1.05	0.07	2.17	Gray	P29	8	29	1 1/8	50
LCB2-10-Q	#2 AWG	#10	0.60	1.16	0.10	2.07	Brown	P33	10	33	1 1/4	25
LCB2-14-Q		1/4	0.60	1.16	0.10	2.14	Brown	P33	10	33	1 1/4	25
LCB2-56-Q		5/16	0.66	1.16	0.10	2.27	Brown	P33	10	33	1 1/4	25
LCB2-38-Q		3/8	0.66	1.16	0.10	2.34	Brown	P33	10	33	1 1/4	25
LCB2-12-Q		1/2	0.75	1.16	0.08	2.58	Brown	P33	10	33	1 1/4	25
LCB1-10-E	#1 AWG	#10	0.70	1.36	0.11	2.30	Green	P37	11	37	1 7/16	20
LCB1-56-E		5/16	0.70	1.36	0.11	2.50	Green	P37	11	37	1 7/16	20
LCB1-38-E		3/8	0.70	1.36	0.11	2.57	Green	P37	11	37	1 7/16	20
LCB1-12-E		1/2	0.75	1.36	0.09	2.81	Green	P37	11	37	1 7/16	20
LCB1/0-10-X	1/0 AWG	#10	0.76	1.44	0.12	2.41	Pink	P42	12	42	1 1/2	10
LCB1/0-56-X		5/16	0.76	1.44	0.12	2.61	Pink	P42	12	42	1 1/2	10
LCB1/0-38-X		3/8	0.76	1.44	0.12	2.69	Pink	P42	12	42	1 1/2	10
LCB1/0-12-X		1/2	0.80	1.44	0.12	2.92	Pink	P42	12	42	1 1/2	10

‡Visit www.panduit.com/tools for tool and die information.

**Consult cable manufacturer for voltage stress relief instructions with applications greater than 2000 V.

Continues on next page



Code Conductor, One-Hole, Long Barrel Lug (continued)

Part Number	Copper Conductor Size	Stud Hole Size (In.)	Figure Dimensions (In.)				Panduit Color Code	Panduit Die Index No.‡	Burndy Die Index No.‡	T&B Die Index No.‡	Wire Strip Length (In.)	Std. Pkg. Qty.
			W	B	T	L						
LCB2/0-38-X	2/0 AWG	3/8	0.85	1.50	0.13	2.82	Black	P45	13	45	1 9/16	10
LCB2/0-12-X		1/2	0.85	1.50	0.13	3.07	Black	P45	13	45	1 9/16	10
LCB3/0-38-X	3/0 AWG	3/8	0.96	1.50	0.13	2.87	Orange	P50	14	50	1 9/16	10
LCB3/0-12-X		1/2	0.96	1.50	0.13	3.12	Orange	P50	14	50	1 9/16	10
LCB4/0-38-X	4/0 AWG	3/8	1.06	1.56	0.14	3.03	Purple	P54	15	54	1 5/8	10
LCB4/0-12-X		1/2	1.06	1.56	0.14	3.22	Purple	P54	15	54	1 5/8	10
LCB250-12-X	250 kcmil	1/2	1.17	1.61	0.14	3.32	Yellow	P62	16	62	1 11/16	10
LCB250-78-X		7/8	1.25	1.61	0.12	3.85	Yellow	P62	16	62	1 11/16	10
LCB300-56-X	300 kcmil	5/16	1.19	2.24	0.16	3.95	White	P66	17	66	2 5/16	10
LCB300-38-X		3/8	1.19	2.24	0.16	3.95	White	P66	17	66	2 5/16	10
LCB300-12-X		1/2	1.19	2.24	0.16	4.06	White	P66	17	66	2 5/16	10
LCB350-12-X	350 kcmil	1/2	1.28	2.24	0.17	4.11	Red	P71	18	71	2 5/16	10
LCB350-78-X		7/8	1.28	2.24	0.17	4.78	Red	P71	18	71	2 5/16	10
LCB400-38-6	400 kcmil	3/8	1.39	2.30	0.18	4.27	Blue	P76	19	76	2 3/8	6
LCB400-12-6		1/2	1.39	2.30	0.18	4.27	Blue	P76	19	76	2 3/8	6
LCB400-58-6		5/8	1.39	2.30	0.18	4.48	Blue	P76	19	76	2 3/8	6
LCB400-78-6		7/8	1.39	2.30	0.18	4.88	Blue	P76	19	76	2 3/8	6
LCB500-12-6	500 kcmil	1/2	1.54	2.50	0.22	4.53	Brown	P87	20	87	2 9/16	6
LCB500-58-6		5/8	1.54	2.50	0.22	4.74	Brown	P87	20	87	2 9/16	6
LCB500-78-6		7/8	1.54	2.50	0.22	5.13	Brown	P87	20	87	2 9/16	6
LCB600-12-6	600 kcmil	1/2	1.70	2.69	0.26	5.40	Green	P94	22	94	2 3/4	6
LCB600-58-6		5/8	1.70	2.69	0.26	5.40	Green	P94	22	94	2 3/4	6
LCB750-58-6	750 kcmil	5/8	1.89	2.88	0.26	5.98	Black	P106	24	106	2 15/16	6
LCB750-78-6		7/8	1.89	2.88	0.26	6.07	Black	P106	24	106	2 15/16	6
LCB800-58-6	800 kcmil	5/8	1.95	2.94	0.29	6.06	Orange	P107	25	107	3	6
LCB1000-58-3	1000 kcmil	5/8	2.17	3.00	0.32	6.32	White	P125	27	125	3 1/16	3

‡Visit www.panduit.com/tools for tool and die information.

**Consult cable manufacturer for voltage stress relief instructions with applications greater than 2000 V.



Code Conductor, Two-Hole, Standard Barrel with Window Lug

For Use with Stranded Copper Conductors

Type LCD

- Color-coded barrels marked with Panduit and specified competitor die index numbers for proper crimp die selection
- Inspection window to visually assure full conductor insertion
- Tin-plated to inhibit corrosion
- UL Listed and CSA Certified to 35 kV** and temperature rated to 90°C when crimped with Panduit and specified competitor crimping tools and dies
- UL Listed and CSA Certified for wide wire range-taking capability when crimped with Panduit® Uni-Die™ Dieless Crimping Tools‡
- Tested by Telcordia – meets NEBS Level 3
- American Bureau of Shipping approved
- Available with NEMA hole sizes and spacing
- Lugs available in 90 and 45 degree bent tongue. Please refer to www.panduit.com

B1.
Cable
Ties

B2.
Cable
Accessories

B3.
Stainless
Steel Cable
Ties &
Accessories

C1.
Wiring
Duct

C2.
Abrasion
Protection

C3.
Cable
Management

D1.
Terminals

D2.
Power
Connectors

D3.
Grounding
Connectors

E1.
Labeling
Systems

E2.
Labels

E3.
Pre-Printed
&
Write-On
Markers

E4.
Permanent
Identification

E5.
Lockout/
Tagout &
Safety
Solutions

F.
Keystone
Cabling
Systems

G.
Part
Number
Index

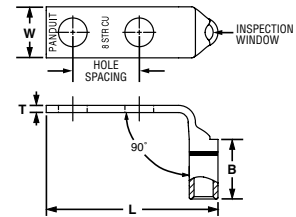
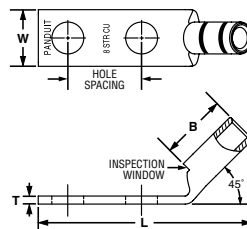
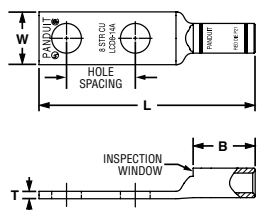

Part Number	Copper Conductor Size	Stud Hole Size (In.)	Stud Hole Spacing (In.)	Figure Dimensions (In.)				Panduit Color Code	Panduit Die Index No.‡	Burndy Die Index No.‡	T&B Die Index No.‡	Wire Strip Length (In.)	Std. Pkg. Qty.
				W	B	T	L						
LCD10-10A-L*	#14 – #10 AWG STR, #12 – #10 AWG SOL	#10	0.63	0.38	0.38	0.06	1.69	—	—	—	—	7/16	50
LCD10-14A-L*		1/4	0.63	0.42	0.38	0.05	1.78	—	—	—	—	7/16	50
LCD10-14B-L*		1/4	0.75	0.42	0.38	0.05	1.91	—	—	—	—	7/16	50
LCD10-14D-L*		1/4	1.00	0.42	0.38	0.05	2.16	—	—	—	—	7/16	50
LCD10-38D-L*		3/8	1.00	0.56	0.38	0.04	2.38	—	—	—	—	7/16	50
LCD8-10A-L	#8 AWG	#10	0.63	0.41	0.56	0.08	1.88	Red	P21	49	21	5/8	50
LCD8-14A-L		1/4	0.63	0.48	0.56	0.07	1.97	Red	P21	49	21	5/8	50
LCD8-14B-L		1/4	0.75	0.48	0.56	0.07	2.09	Red	P21	49	21	5/8	50
LCD8-14D-L		1/4	1.00	0.48	0.56	0.07	2.34	Red	P21	49	21	5/8	50
LCD8-38D-L		3/8	1.00	0.60	0.56	0.05	2.56	Red	P21	49	21	5/8	50
LCD6-10A-L	#6 AWG	#10	0.63	0.46	0.81	0.08	2.15	Blue	P24	7	24	7/8	50
LCD6-10B-L		#10	0.75	0.46	0.81	0.08	2.27	Blue	P24	7	24	7/8	50
LCD6-10D-L		#10	1.00	0.46	0.81	0.08	2.52	Blue	P24	7	24	7/8	50
LCD6-14A-L		1/4	0.63	0.48	0.81	0.08	2.24	Blue	P24	7	24	7/8	50
LCD6-14B-L		1/4	0.75	0.48	0.81	0.08	2.36	Blue	P24	7	24	7/8	50
LCD6-14D-L		1/4	1.00	0.48	0.81	0.08	2.61	Blue	P24	7	24	7/8	50
LCD6-56D-L		5/16	1.00	0.56	0.81	0.07	2.73	Blue	P24	7	24	7/8	50
LCD6-38D-L	3/8	1.00	0.62	0.81	0.06	2.83	Blue	P24	7	24	7/8	50	
LCD4-10A-L	#4 – #3 AWG STR, #2 AWG SOL	#10	0.63	0.55	0.81	0.09	2.17	Gray	P29	8	29	7/8	50
LCD4-10B-L		#10	0.75	0.55	0.81	0.09	2.29	Gray	P29	8	29	7/8	50
LCD4-14A-L		1/4	0.63	0.55	0.81	0.09	2.26	Gray	P29	8	29	7/8	50
LCD4-14B-L		1/4	0.75	0.55	0.81	0.09	2.38	Gray	P29	8	29	7/8	50
LCD4-14D-L		1/4	1.00	0.55	0.81	0.09	2.63	Gray	P29	8	29	7/8	50
LCD4-38D-L		3/8	1.00	0.62	0.81	0.08	2.85	Gray	P29	8	29	7/8	50

‡Visit www.panduit.com/tools for tool and die information.

*Not tested to NEBS Level 3 requirements.

**Consult cable manufacturer for voltage stress relief instructions with applications greater than 2000 V.

Continues on next page



Code Conductor, Two-Hole, Standard Barrel with Window Lug (continued)

Part Number	Copper Conductor Size	Stud Hole Size (In.)	Stud Hole Spacing (In.)	Figure Dimensions (In.)				Panduit Color Code	Panduit Die Index No.‡	Burndy Die Index No.‡	T&B Die Index No.‡	Wire Strip Length (In.)	Std. Pkg. Qty.
				W	B	T	L						
LCD2-14A-Q	#2 AWG	1/4	0.63	0.60	0.88	0.10	2.40	Brown	P33	10	33	15/16	25
LCD2-14B-Q		1/4	0.75	0.60	0.88	0.10	2.52	Brown	P33	10	33	15/16	25
LCD2-14D-Q		1/4	1.00	0.60	0.88	0.10	2.77	Brown	P33	10	33	15/16	25
LCD2-56B-Q		5/16	0.75	0.66	0.88	0.10	2.65	Brown	P33	10	33	15/16	25
LCD2-38D-Q		3/8	1.00	0.66	0.88	0.10	3.00	Brown	P33	10	33	15/16	25
LCD2-12-Q		1/2	1.75	0.75	0.88	0.08	4.14	Brown	P33	10	33	15/16	25
LCD1-14A-E	#1 AWG	1/4	0.63	0.70	0.88	0.11	2.42	Green	P37	11	37	15/16	20
LCD1-14B-E		1/4	0.75	0.70	0.88	0.11	2.54	Green	P37	11	37	15/16	20
LCD1-56C-E		5/16	0.88	0.70	0.88	0.11	2.79	Green	P37	11	37	15/16	20
LCD1-38D-E		3/8	1.00	0.70	0.88	0.11	2.99	Green	P37	11	37	15/16	20
LCD1-12-E	1/0 AWG	1/2	1.75	0.75	0.88	0.09	4.16	Green	P37	11	37	15/16	20
LCD1/0-14A-X		1/4	0.63	0.76	0.94	0.12	2.57	Pink	P42	12	42	1	10
LCD1/0-14B-X		1/4	0.75	0.76	0.94	0.12	2.70	Pink	P42	12	42	1	10
LCD1/0-56C-X		5/16	0.88	0.76	0.94	0.12	2.88	Pink	P42	12	42	1	10
LCD1/0-38D-X		3/8	1.00	0.76	0.94	0.12	3.08	Pink	P42	12	42	1	10
LCD1/0-12-X		1/2	1.75	0.80	0.94	0.12	4.25	Pink	P42	12	42	1	10
LCD2/0-14A-X	2/0 AWG	1/4	0.63	0.85	0.98	0.13	2.70	Black	P45	13	45	1 1/16	10
LCD2/0-14B-X		1/4	0.75	0.85	0.98	0.13	2.83	Black	P45	13	45	1 1/16	10
LCD2/0-56C-X		5/16	0.88	0.85	0.98	0.13	2.95	Black	P45	13	45	1 1/16	10
LCD2/0-38D-X		3/8	1.00	0.85	0.98	0.13	3.14	Black	P45	13	45	1 1/16	10
LCD2/0-12-X		1/2	1.75	0.85	0.98	0.13	4.30	Black	P45	13	45	1 1/16	10
LCD3/0-14B-X	3/0 AWG	1/4	0.75	0.96	1.14	0.13	3.02	Orange	P50	14	50	1 3/16	10
LCD3/0-56D-X		5/16	1.00	0.96	1.14	0.13	3.27	Orange	P50	14	50	1 3/16	10
LCD3/0-38D-X		3/8	1.00	0.96	1.14	0.13	3.33	Orange	P50	14	50	1 3/16	10
LCD3/0-12-X		1/2	1.75	0.96	1.14	0.13	4.49	Orange	P50	14	50	1 3/16	10
LCD4/0-14B-X	4/0 AWG	1/4	0.75	1.06	1.19	0.14	3.10	Purple	P54	15	54	1 1/4	10
LCD4/0-38D-X		3/8	1.00	1.06	1.19	0.14	3.44	Purple	P54	15	54	1 1/4	10
LCD4/0-12-X		1/2	1.75	1.06	1.19	0.14	4.58	Purple	P54	15	54	1 1/4	10
LCD250-38D-X	250 kcmil	3/8	1.00	1.17	1.25	0.14	3.54	Yellow	P62	16	62	1 5/16	10
LCD250-12-X		1/2	1.75	1.17	1.25	0.14	4.68	Yellow	P62	16	62	1 5/16	10
LCD300-38D-X	300 kcmil	3/8	1.00	1.19	1.44	0.16	3.74	White	P66	17	66	1 1/2	10
LCD300-12-X		1/2	1.75	1.19	1.44	0.16	4.92	White	P66	17	66	1 1/2	10
LCD350-14B-X	350 kcmil	1/4	0.75	1.28	1.44	0.17	3.30	Red	P71	18	71	1 1/2	10
LCD350-38D-X		3/8	1.00	1.28	1.44	0.17	3.78	Red	P71	18	71	1 1/2	10
LCD350-12E-X		1/2	1.25	1.28	1.44	0.17	4.33	Red	P71	18	71	1 1/2	10
LCD350-12-X		1/2	1.75	1.28	1.44	0.17	4.96	Red	P71	18	71	1 1/2	10
LCD400-38D-6	400 kcmil	3/8	1.00	1.39	1.50	0.18	3.86	Blue	P76	19	76	1 9/16	6
LCD400-12-6		1/2	1.75	1.39	1.50	0.18	5.04	Blue	P76	19	76	1 9/16	6

‡Visit www.panduit.com/tools for tool and die information.

**Consult cable manufacturer for voltage stress relief instructions with applications greater than 2000 V.

◆ NEMA hole sizes and spacing

Continues on next page



Code Conductor, Two-Hole, Standard Barrel with Window Lug (continued)

Part Number	Copper Conductor Size	Stud Hole Size (In.)	Stud Hole Spacing (In.)	Figure Dimensions (In.)				Panduit Color Code	Panduit Die Index No.‡	Burndy Die Index No.‡	T&B Die Index No.‡	Wire Strip Length (In.)	Std. Pkg. Qty.
				W	B	T	L						
LCD500-14B-6	500 kcmil	1/4	0.75	1.54	1.75	0.22	3.71	Brown	P87	20	87	1 13/16	6
LCD500-38D-6		3/8	1.00	1.54	1.75	0.22	4.19	Brown	P87	20	87	1 13/16	6
LCD500-12E-6		1/2	1.25	1.54	1.75	0.22	4.74	Brown	P87	20	87	1 13/16	6
◆ LCD500-12-6		1/2	1.75	1.54	1.75	0.22	5.37	Brown	P87	20	87	1 13/16	6
LCD600-38D-6	600 kcmil	3/8	1.00	1.70	1.75	0.26	4.24	Green	P94	22	94	1 13/16	6
◆ LCD600-12-6		1/2	1.75	1.70	1.75	0.26	5.42	Green	P94	22	94	1 13/16	6
LCD750-38D-6	750 kcmil	3/8	1.00	1.89	1.88	0.26	4.71	Black	P106	24	106	1 15/16	6
◆ LCD750-12-6		1/2	1.75	1.89	1.88	0.26	5.65	Black	P106	24	106	1 15/16	6
LCD750-58G-6		5/8	1.50	1.89	1.88	0.26	5.46	Black	P106	24	106	1 15/16	6
◆ LCD1000-12-3	1000 kcmil	1/2	1.75	2.17	1.88	0.32	5.77	White	P125	27	125	1 15/16	3
LCD1000-12E-3		1/2	1.25	2.17	1.88	0.32	5.27	White	P125	27	125	1 15/16	3

‡Visit www.panduit.com/tools for tool and die information.

**Consult cable manufacturer for voltage stress relief instructions with applications greater than 2000 V.

◆ NEMA hole sizes and spacing



Code Conductor, Two-Hole, Standard Barrel with Window, Narrow Tongue Lug

For Use with Stranded Copper Conductors

Type LCDN

- Narrow tongue width for limited space applications
- Color-coded barrels marked with Panduit® and specified competitor die index numbers for proper crimp die selection
- Inspection window to visually assure full conductor insertion
- Tin-plated to inhibit corrosion
- UL Listed and CSA Certified to 35 kV** and temperature rated to 90°C when crimped with Panduit and specified competitor crimping tools and dies
- UL Listed and CSA Certified for wide wire range-taking capability when crimped with Panduit® Uni-Die™ Dieless Crimping Tools‡
- Lugs available in 90 and 45 degree bent tongue. Please refer to www.panduit.com

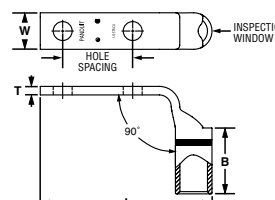
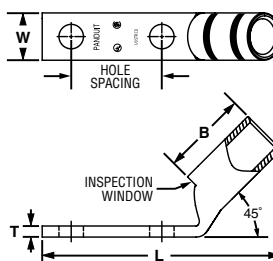
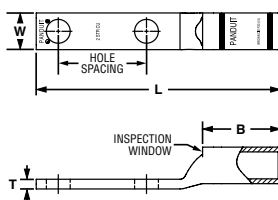

Part Number	Copper Conductor Size	Stud Hole Size (In.)	Stud Hole Spacing (In.)	Figure Dimensions (In.)				Panduit Color Code	Panduit Die Index No.‡	Burndy Die Index No.‡	T&B Die Index No.‡	Wire Strip Length (In.)	Std. Pkg. Qty.
				W	B	T	L						
LCDN2-10B-Q	#2 AWG	#10	0.75	0.42	0.88	0.11	2.43	Brown	P33	10	33	15/16	25
LCDN2-14A-Q		1/4	0.63	0.42	0.88	0.12	2.40	Brown	P33	10	33	15/16	25
LCDN2-14B-Q		1/4	0.75	0.42	0.88	0.11	2.52	Brown	P33	10	33	15/16	25
LCDN2-14D-Q		1/4	1.00	0.42	0.88	0.11	2.77	Brown	P33	10	33	15/16	25
LCDN1-14B-E	#1 AWG	1/4	0.75	0.47	0.88	0.11	2.54	Green	P37	11	37	15/16	20
LCDN1/0-14D-X	1/0 AWG	1/4	1.00	0.52	0.94	0.13	2.95	Pink	P42	12	42	1	10
LCDN1/0-56D-X		5/16	1.00	0.52	0.94	0.13	3.00	Pink	P42	12	42	1	10
LCDN2/0-14A-X	2/0 AWG	1/4	0.63	0.58	0.98	0.14	2.71	Black	P45	13	45	1 1/16	10
LCDN2/0-14D-X		1/4	1.00	0.58	0.98	0.13	3.09	Black	P45	13	45	1 1/16	10
LCDN2/0-56A-X		5/16	0.63	0.58	0.98	0.13	2.71	Black	P45	13	45	1 1/16	10
LCDN2/0-56D-X		5/16	1.00	0.58	0.98	0.13	3.09	Black	P45	13	45	1 1/16	10
LCDN350-38D-X	350 kcmil	3/8	1.00	0.88	1.44	0.17	3.79	Red	P71	18	71	1 1/2	10
LCDN500-38D-6	500 kcmil	3/8	1.00	1.06	1.75	0.22	4.20	Brown	P87	20	87	1 13/16	6
LCDN500-12D-6		1/2	1.00	1.06	1.75	0.22	4.63	Brown	P87	20	87	1 13/16	6
LCDN750-38D-6	750 kcmil	3/8	1.00	1.30	1.88	0.26	4.72	Black	P106	24	106	1 15/16	6

‡Visit www.panduit.com/tools for tool and die information.

**Consult cable manufacturer for voltage stress relief instructions with applications greater than 2000 V.



Code Conductor, Two-Hole, Long Barrel Lug

For Use with Stranded Copper Conductors

Type LCC

- Long barrel maximizes number of crimps and provides premium wire pull-out strength and electrical performance
- Color-coded barrels marked with Panduit and specified competitor die index numbers for proper crimp die selection
- Enclosed barrel prevents corrosive material from entering barrel when used in harsh environments
- Tin-plated to inhibit corrosion
- UL Listed and CSA Certified to 35 kV** and temperature rated to 90°C when crimped with Panduit and specified competitor crimping tools and dies
- UL Listed and CSA Certified for wide wire range-taking capability when crimped with Panduit® Uni-Die™ Dieless Crimping Tool‡
- Tested by Telcordia – meets NEBS Level 3
- American Bureau of Shipping approved
- Lugs available in 90 and 45 degree bent tongue. Please refer to www.panduit.com

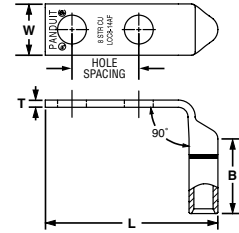
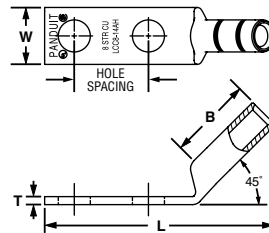
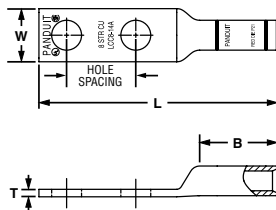

Part Number	Copper Conductor Size	Stud Hole Size (In.)	Stud Hole Spacing (In.)	Figure Dimensions (In.)				Panduit Color Code	Panduit Die Index No.‡	Burndy Die Index No.‡	T&B Die Index No.‡	Wire Strip Length (In.)	Std. Pkg. Qty.
				W	B	T	L						
LCC8-10A-L	#8 AWG	#10	0.63	0.41	0.70	0.08	2.07	Red	P21	49	21	3/4	50
LCC8-14A-L		1/4	0.63	0.48	0.70	0.07	2.16	Red	P21	49	21	3/4	50
LCC8-14B-L		1/4	0.75	0.48	0.70	0.07	2.28	Red	P21	49	21	3/4	50
LCC8-14D-L		1/4	1.00	0.48	0.70	0.07	2.53	Red	P21	49	21	3/4	50
LCC8-38D-L		3/8	1.00	0.60	0.70	0.05	2.75	Red	P21	49	21	3/4	50
LCC6-10A-L	#6 AWG	#10	0.63	0.46	1.07	0.08	2.47	Blue	P24	7	24	1 1/8	50
LCC6-14A-L		1/4	0.63	0.48	1.07	0.08	2.56	Blue	P24	7	24	1 1/8	50
LCC6-14B-L		1/4	0.75	0.48	1.07	0.08	2.68	Blue	P24	7	24	1 1/8	50
LCC6-14D-L		1/4	1.00	0.48	1.07	0.08	2.93	Blue	P24	7	24	1 1/8	50
LCC6-38D-L		3/8	1.00	0.62	1.07	0.06	3.15	Blue	P24	7	24	1 1/8	50
LCC6-12-L		1/2	1.75	0.75	1.07	0.07	4.04	Blue	P24	7	24	1 1/8	50
LCC4-14A-L	#4 - #3 AWG STR, #2 AWG SOL	1/4	0.63	0.55	1.05	0.09	2.58	Gray	P29	8	29	1 1/8	50
LCC4-14B-L		1/4	0.75	0.55	1.05	0.09	2.70	Gray	P29	8	29	1 1/8	50
LCC4-38D-L		3/8	1.00	0.62	1.05	0.08	3.17	Gray	P29	8	29	1 1/8	50
LCC4-12-L		1/2	1.75	0.75	1.05	0.07	4.09	Gray	P29	8	29	1 1/8	50
LCC2-14A-Q	#2 AWG	1/4	0.63	0.60	1.16	0.10	2.77	Brown	P33	10	33	1 1/4	25
LCC2-14B-Q		1/4	0.75	0.60	1.16	0.10	2.89	Brown	P33	10	33	1 1/4	25
LCC2-56B-Q		5/16	0.75	0.66	1.16	0.10	3.02	Brown	P33	10	33	1 1/4	25
LCC2-56C-Q		5/16	0.88	0.66	1.16	0.10	3.14	Brown	P33	10	33	1 1/4	25
LCC2-38D-Q		3/8	1.00	0.66	1.16	0.10	3.34	Brown	P33	10	33	1 1/4	25
LCC2-38-Q		3/8	1.75	0.66	1.16	0.10	4.09	Brown	P33	10	33	1 1/4	25
LCC2-12-Q		1/2	1.75	0.75	1.16	0.08	4.51	Brown	P33	10	33	1 1/4	25
LCC1-14A-E	#1 AWG	1/4	0.63	0.70	1.36	0.11	3.00	Green	P37	11	37	1 7/16	20
LCC1-14B-E		1/4	0.75	0.70	1.36	0.11	3.12	Green	P37	11	37	1 7/16	20

‡Visit www.panduit.com/tools for tool and die information.

**Consult cable manufacturer for voltage stress relief instructions with applications greater than 2000 V.

•NEMA hole sizes and spacing.

Continues on next page



Code Conductor, Two-Hole, Long Barrel Lug (continued)

Part Number	Copper Conductor Size	Stud Hole Size (In.)	Stud Hole Spacing (In.)	Figure Dimensions (In.)				Panduit Color Code	Panduit Die Index No.‡	Burndy Die Index No.‡	T&B Die Index No.‡	Wire Strip Length (In.)	Std. Pkg. Qty.
				W	B	T	L						
LCC1-56B-E	#1 AWG	5/16	0.75	0.70	1.36	0.11	3.25	Green	P37	11	37	1 7/16	20
LCC1-56C-E		5/16	0.88	0.70	1.36	0.11	3.37	Green	P37	11	37	1 7/16	20
LCC1-38D-E		3/8	1.00	0.70	1.36	0.11	3.57	Green	P37	11	37	1 7/16	20
LCC1-12-E		1/2	1.75	0.75	1.36	0.09	4.74	Green	P37	11	37	1 7/16	20
LCC1/0-14A-X	1/0 AWG	1/4	0.63	0.76	1.44	0.12	3.18	Pink	P42	12	42	1 1/2	10
LCC1/0-14B-X		1/4	0.75	0.76	1.44	0.12	3.31	Pink	P42	12	42	1 1/2	10
LCC1/0-56C-X		5/16	0.88	0.76	1.44	0.12	3.49	Pink	P42	12	42	1 1/2	10
LCC1/0-56D-X		5/16	1.00	0.76	1.44	0.12	3.61	Pink	P42	12	42	1 1/2	10
LCC1/0-38D-X		3/8	1.00	0.76	1.44	0.12	3.69	Pink	P42	12	42	1 1/2	10
LCC1/0-12D-X		1/2	1.00	0.80	1.44	0.12	3.95	Pink	P42	12	42	1 1/2	10
LCC1/0-12-X	2/0 AWG	1/2	1.75	0.80	1.44	0.12	4.86	Pink	P42	12	42	1 1/2	10
LCC2/0-14A-X		1/4	0.63	0.85	1.50	0.13	3.38	Black	P45	13	45	1 9/16	10
LCC2/0-14B-X		1/4	0.75	0.85	1.50	0.13	3.51	Black	P45	13	45	1 9/16	10
LCC2/0-56D-X		5/16	1.00	0.85	1.50	0.13	3.76	Black	P45	13	45	1 9/16	10
LCC2/0-38D-X		3/8	1.00	0.85	1.50	0.13	3.82	Black	P45	13	45	1 9/16	10
LCC2/0-12D-X		1/2	1.00	0.85	1.50	0.13	4.07	Black	P45	13	45	1 9/16	10
LCC2/0-12-X	3/0 AWG	1/2	1.75	0.85	1.50	0.13	4.98	Black	P45	13	45	1 9/16	10
LCC3/0-14B-X		1/4	0.75	0.96	1.50	0.13	3.56	Orange	P50	14	50	1 9/16	10
LCC3/0-38D-X		3/8	1.00	0.96	1.50	0.13	3.87	Orange	P50	14	50	1 9/16	10
LCC3/0-12D-X		1/2	1.00	0.96	1.50	0.13	4.12	Orange	P50	14	50	1 9/16	10
LCC3/0-12-X		1/2	1.75	0.96	1.50	0.13	5.03	Orange	P50	14	50	1 9/16	10
LCC4/0-14B-X		4/0 AWG	1/4	0.75	1.06	1.56	0.14	3.66	Purple	P54	15	54	1 5/8
LCC4/0-56D-X	5/16		1.00	1.06	1.56	0.14	3.92	Purple	P54	15	54	1 5/8	10
LCC4/0-38D-X	3/8		1.00	1.06	1.56	0.14	3.99	Purple	P54	15	54	1 5/8	10
LCC4/0-38-X	3/8		1.75	1.06	1.56	0.14	4.74	Purple	P54	15	54	1 5/8	10
LCC4/0-12D-X	1/2		1.00	1.06	1.56	0.14	4.22	Purple	P54	15	54	1 5/8	10
LCC4/0-12-X	1/2		1.75	1.06	1.56	0.14	5.13	Purple	P54	15	54	1 5/8	10
LCC250-38D-X	250 kcmil	3/8	1.00	1.17	1.60	0.14	4.09	Yellow	P62	16	62	1 11/16	10
LCC250-12D-X		1/2	1.00	1.17	1.60	0.14	4.32	Yellow	P62	16	62	1 11/16	10
LCC250-12-X		1/2	1.75	1.17	1.60	0.14	5.23	Yellow	P62	16	62	1 11/16	10
LCC300-38D-X	300 kcmil	3/8	1.00	1.19	2.24	0.16	4.76	White	P66	17	66	2 5/16	10
LCC300-12-X		1/2	1.75	1.19	2.24	0.16	5.94	White	P66	17	66	2 5/16	10
LCC350-14B-X	350 kcmil	1/4	0.75	1.28	2.24	0.17	4.33	Red	P71	18	71	2 5/16	10
LCC350-38D-X		3/8	1.00	1.28	2.24	0.17	4.81	Red	P71	18	71	2 5/16	10
LCC350-12-X		1/2	1.75	1.28	2.24	0.17	5.99	Red	P71	18	71	2 5/16	10
LCC400-14B-6	400 kcmil	1/4	0.75	1.39	2.30	0.18	4.44	Blue	P76	19	76	2 3/8	6
LCC400-38D-6		3/8	1.00	1.39	2.30	0.18	4.92	Blue	P76	19	76	2 3/8	6
LCC400-12-6		1/2	1.75	1.39	2.30	0.18	6.10	Blue	P76	19	76	2 3/8	6

‡Visit www.panduit.com/tools for tool and die information.

**Consult cable manufacturer for voltage stress relief instructions with applications greater than 2000 V.

◆NEMA hole sizes and spacing.

Continues on next page



Code Conductor, Two-Hole, Long Barrel Lug (continued)

B1. Cable Ties

B2. Cable Accessories

B3. Stainless Steel Cable Ties & Accessories

C1. Wiring Duct

C2. Abrasion Protection

C3. Cable Management

D1. Terminals

D2. Power Connectors

D3. Grounding Connectors

E1. Labeling Systems

E2. Labels

E3. Pre-Printed & Write-On Markers

E4. Permanent Identification

E5. Lockout/Tagout & Safety Solutions

F. Keystone Cabling Systems

G. Part Number Index

Part Number	Copper Conductor Size	Stud Hole Size (In.)	Stud Hole Spacing (In.)	Figure Dimensions (In.)				Panduit Color Code	Panduit Die Index No.‡	Burndy Die Index No.‡	T&B Die Index No.‡	Wire Strip Length (In.)	Std. Pkg. Qty.
				W	B	T	L						
LCC500-14B-6	500 kcmil	1/4	0.75	1.54	2.50	0.22	4.70	Brown	P87	20	87	2 9/16	6
LCC500-38D-6		3/8	1.00	1.54	2.50	0.22	5.18	Brown	P87	20	87	2 9/16	6
◆ LCC500-12-6		1/2	1.75	1.54	2.50	0.22	6.36	Brown	P87	20	87	2 9/16	6
◆ LCC600-38D-6	600 kcmil	3/8	1.00	1.70	2.69	0.26	5.45	Green	P94	22	94	2 3/4	6
◆ LCC600-12-6		1/2	1.75	1.70	2.69	0.26	6.63	Green	P94	22	94	2 3/4	6
LCC750-38D-6	750 kcmil	3/8	1.00	1.89	2.87	0.26	6.10	Black	P106	24	106	2 15/16	6
◆ LCC750-12-6		1/2	1.75	1.89	2.87	0.26	7.04	Black	P106	24	106	2 15/16	6
◆ LCC800-12-6	800 kcmil	1/2	1.75	1.95	2.94	0.29	7.13	Orange	P107	25	—	3	6
◆ LCC1000-38D-3	1000 kcmil	3/8	1.00	2.17	3.00	0.32	6.35	White	P125	27	125	3 1/16	3
◆ LCC1000-12-3		1/2	1.75	2.17	3.00	0.32	7.29	White	P125	27	125	3 1/16	3

‡Visit www.panduit.com/tools for tool and die information.
 **Consult cable manufacturer for voltage stress relief instructions with applications greater than 2000 V.
 ◆NEMA hole sizes and spacing.



Code Conductor, Two-Hole, Long Barrel with Window Lug

For Use with Stranded Copper Conductors

Type LCC-W

- Long barrel maximizes number of crimps and provides premium wire pull-out strength and electrical performance
- Inspection window to visually assure full conductor insertion
- Color-coded barrels marked with Panduit and specified competitor die index numbers for proper crimp die selection
- Tin-plated to inhibit corrosion
- UL Listed and CSA Certified to 35 kV** and temperature rated to 90°C when crimped with Panduit and specified competitor crimping tools and dies
- UL Listed and CSA Certified for wide wire range-taking capability when crimped with Panduit® Uni-Die™ Dieless Crimping Tools‡
- Tested by Telcordia – meets NEBS Level 3
- Lugs available in 90 and 45 degree bent tongue. Please refer to www.panduit.com

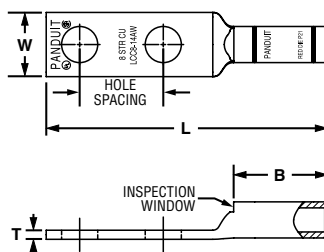

Figure 1

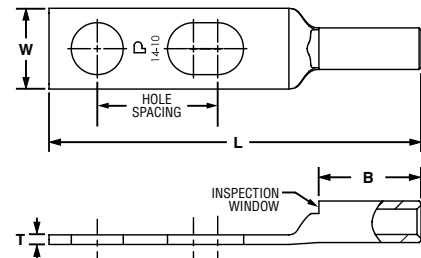

Figure 2: Slotted

Part Number	Figure No.	Copper Conductor Size	Stud Hole Size (In.)	Stud Hole Spacing (In.)	Figure Dimensions (In.)				Panduit Color Code	Panduit Die Index No.‡	Burndy Die Index No.‡	T&B Die Index No.‡	Wire Strip Length (In.)	Std. Pkg. Qty.
					W	B	T	L						
LCC10-14JAW-L*	2	#14 – 10 AWG STR, #12 – 10 AWG SOL	1/4	0.50 – 0.63	0.42	0.53	0.05	1.93	—	—	—	—	9/16	50
LCC10-14AW-L*	1		1/4	0.63	0.42	0.53	0.05	1.93	—	—	—	—	9/16	50
LCC10-14BW-L*	1		1/4	0.75	0.42	0.53	0.05	2.06	—	—	—	—	9/16	50

‡Visit www.panduit.com/tools for tool and die information.
 *Not tested to NEBS level 3 requirements.
 **Consult cable manufacturer for voltage stress relief instructions with applications greater than 2000 V.
 ◆NEMA hole sizes and spacing.

Continues on next page



Code Conductor, Two-Hole, Long Barrel with Window Lug (continued)

Part Number	Figure No.	Copper Conductor Size	Stud Hole Size (In.)	Stud Hole Spacing (In.)	Figure Dimensions (In.)				Panduit Color Code	Panduit Die Index No.‡	Burndy Die Index No.‡	T&B Die Index No.‡	Wire Strip Length (In.)	Std. Pkg. Qty.
					W	B	T	L						
LCC8-10AW-L	1	#8 AWG	#10	0.63	0.41	0.70	0.08	2.01	Red	P21	49	21	3/4	50
LCC8-10BW-L	1		#10	0.75	0.41	0.70	0.08	2.14	Red	P21	49	21	3/4	50
LCC8-10ABW-L	2		#10	0.63 – 0.75	0.41	0.70	0.08	2.14	Red	P21	49	21	3/4	50
LCC8-14AW-L	1		1/4	0.63	0.48	0.70	0.07	2.10	Red	P21	49	21	3/4	50
LCC8-14BW-L	1		1/4	0.75	0.48	0.70	0.07	2.23	Red	P21	49	21	3/4	50
LCC8-14ABW-L	2		1/4	0.63 – 0.75	0.48	0.70	0.07	2.23	Red	P21	49	21	3/4	50
LCC8-14DW-L	1	#6 AWG	1/4	1.00	0.48	0.70	0.07	2.48	Red	P21	49	21	3/4	50
LCC8-38DW-L	1		3/8	1.00	0.60	0.70	0.05	2.70	Red	P21	49	21	3/4	50
LCC6-10AW-L	1		#10	0.63	0.46	1.07	0.08	2.40	Blue	P24	7	24	1 1/8	50
LCC6-10BW-L	1		#10	0.75	0.46	1.07	0.08	2.52	Blue	P24	7	24	1 1/8	50
LCC6-10ABW-L	2		#10	0.63 – 0.75	0.46	1.07	0.08	2.52	Blue	P24	7	24	1 1/8	50
LCC6-14JW-L	1		1/4	0.50	0.48	1.07	0.08	2.36	Blue	P24	7	24	1 1/8	50
LCC6-14AW-L	1	#6 AWG	1/4	0.63	0.48	1.07	0.08	2.49	Blue	P24	7	24	1 1/8	50
LCC6-14JAW-L	2		1/4	0.50 – 0.63	0.48	1.07	0.08	2.49	Blue	P24	7	24	1 1/8	50
LCC6-14BW-L	1		1/4	0.75	0.48	1.07	0.08	2.61	Blue	P24	7	24	1 1/8	50
LCC6-14DW-L	1		1/4	1.00	0.48	1.07	0.08	2.86	Blue	P24	7	24	1 1/8	50
LCC6-14BDW-L	2		1/4	0.75 – 1.00	0.48	1.07	0.08	2.86	Blue	P24	7	24	1 1/8	50
LCC6-14EW-L	1		1/4	1.25	0.48	1.07	0.08	3.11	Blue	P24	7	24	1 1/8	50
LCC6-14W-L	1	#4 – 3 AWG STR, #2 AWG SOL	1/4	1.75	0.48	1.07	0.08	3.61	Blue	P24	7	24	1 1/8	50
LCC6-56BW-L	1		5/16	0.75	0.56	1.07	0.07	2.73	Blue	P24	7	24	1 1/8	50
LCC6-38BW-L	1		3/8	0.75	0.62	1.07	0.06	2.83	Blue	P24	7	24	1 1/8	50
LCC6-38CW-L	1		3/8	0.88	0.62	1.07	0.06	2.96	Blue	P24	7	24	1 1/8	50
LCC6-38DW-L	1		3/8	1.00	0.62	1.07	0.06	3.08	Blue	P24	7	24	1 1/8	50
LCC6-38BDW-L	2		3/8	0.75 – 1.00	0.62	1.07	0.06	3.08	Blue	P24	7	24	1 1/8	50
LCC6-12W-L	1	#4 – 3 AWG STR, #2 AWG SOL	1/2	1.75	0.75	1.07	0.07	3.97	Blue	P24	7	24	1 1/8	50
LCC4-10AW-L	1		#10	0.63	0.55	1.05	0.09	2.40	Gray	P29	8	29	1 1/8	50
LCC4-10BW-L	1		#10	0.75	0.55	1.05	0.09	2.53	Gray	P29	8	29	1 1/8	50
LCC4-14AW-L	1		1/4	0.63	0.55	1.05	0.09	2.50	Gray	P29	8	29	1 1/8	50
LCC4-14BW-L	1		1/4	0.75	0.55	1.05	0.09	2.63	Gray	P29	8	29	1 1/8	50
LCC4-14DW-L	1		1/4	1.00	0.55	1.05	0.09	2.63	Gray	P29	8	29	1 1/8	50
LCC4-14ADW-L	2	1/4	0.63 – 1.00	0.55	1.05	0.09	2.87	Gray	P29	8	29	1 1/8	50	
LCC4-38DW-L	1	#2 AWG	3/8	1.00	0.62	1.05	0.08	3.09	Gray	P29	8	29	1 1/8	50
LCC4-12W-L	1		1/2	1.75	0.75	1.05	0.07	4.01	Gray	P29	8	29	1 1/8	50
LCC2-10AW-Q	1		#10	0.63	0.60	1.16	0.10	2.57	Brown	P33	10	33	1 1/4	25
LCC2-10BW-Q	1		#10	0.75	0.60	1.16	0.10	2.69	Brown	P33	10	33	1 1/4	25
LCC2-14AW-Q	1		1/4	0.63	0.60	1.16	0.10	2.67	Brown	P33	10	33	1 1/4	25
LCC2-14BW-Q	1		1/4	0.75	0.60	1.16	0.10	2.79	Brown	P33	10	33	1 1/4	25
LCC2-14DW-Q	1	1/4	1.00	0.60	1.16	0.10	3.04	Brown	P33	10	33	1 1/4	25	

‡Visit www.panduit.com/tools for tool and die information.

*Not tested to NEBS level 3 requirements.

**Consult cable manufacturer for voltage stress relief instructions with applications greater than 2000 V.

◆NEMA hole sizes and spacing.

Continues on next page



Code Conductor, Two-Hole, Long Barrel with Window Lug (continued)

Part Number	Figure No.	Copper Conductor Size	Stud Hole Size (In.)	Stud Hole Spacing (In.)	Figure Dimensions (In.)				Panduit Color Code	Panduit Die Index No.‡	Burndy Die Index No.‡	T&B Die Index No.‡	Wire Strip Length (In.)	Std. Pkg. Qty.
					W	B	T	L						
LCC2-56BW-Q	1	#2 AWG	5/16	0.75	0.66	1.16	0.10	2.92	Brown	P33	10	33	1 1/4	25
LCC2-56CW-Q	1		5/16	0.88	0.66	1.16	0.10	3.04	Brown	P33	10	33	1 1/4	25
LCC2-38BW-Q	1		3/8	0.75	0.66	1.16	0.10	2.99	Brown	P33	10	33	1 1/4	25
LCC2-38CW-Q	1		3/8	0.88	0.66	1.16	0.10	3.12	Brown	P33	10	33	1 1/4	25
LCC2-38DW-Q	1		3/8	1.00	0.66	1.16	0.10	3.24	Brown	P33	10	33	1 1/4	25
LCC2-38W-Q	1		3/8	1.75	0.66	1.16	0.10	3.99	Brown	P33	10	33	1 1/4	25
LCC2-12W-Q	1		1/2	1.75	0.75	1.16	0.08	4.41	Brown	P33	10	33	1 1/4	25
LCC1-14AW-E	1	#1 AWG	1/4	0.63	0.70	1.36	0.11	2.89	Green	P37	11	37	1 7/16	20
LCC1-14BW-E	1		1/4	0.75	0.70	1.36	0.11	3.01	Green	P37	11	37	1 7/16	20
LCC1-56BW-E	1		5/16	0.75	0.70	1.36	0.11	3.14	Green	P37	11	37	1 7/16	20
LCC1-56CW-E	1		5/16	0.88	0.70	1.36	0.11	3.26	Green	P37	11	37	1 7/16	20
LCC1-38DW-E	1		3/8	1.00	0.70	1.36	0.11	3.46	Green	P37	11	37	1 7/16	20
LCC1-12W-E	1		1/2	1.75	0.75	1.36	0.09	4.63	Green	P37	11	37	1 7/16	20
LCC1/0-14AW-X	1		1/0 AWG	1/4	0.63	0.76	1.44	0.12	3.07	Pink	P42	12	42	1 1/2
LCC1/0-14BW-X	1	1/4		0.75	0.76	1.44	0.12	3.19	Pink	P42	12	42	1 1/2	10
LCC1/0-14DW-X	1	1/4		1.00	0.76	1.44	0.12	3.44	Pink	P42	12	42	1 1/2	10
LCC1/0-38DW-X	1	3/8		1.00	0.76	1.44	0.12	3.57	Pink	P42	12	42	1 1/2	10
LCC1/0-38W-X	1	3/8		1.75	0.76	1.44	0.12	4.32	Pink	P42	12	42	1 1/2	10
LCC1/0-12DW-X	1	1/2		1.00	0.80	1.44	0.12	3.84	Pink	P42	12	42	1 1/2	10
LCC1/0-12W-X	1	1/2		1.75	0.80	1.44	0.12	4.74	Pink	P42	12	42	1 1/2	10
LCC2/0-14AW-X	1	2/0 AWG	1/4	0.63	0.85	1.50	0.13	3.23	Black	P45	13	45	1 9/16	10
LCC2/0-14BW-X	1		1/4	0.75	0.85	1.50	0.13	3.36	Black	P45	13	45	1 9/16	10
LCC2/0-56DW-X	1		5/16	1.00	0.85	1.50	0.13	3.61	Black	P45	13	45	1 9/16	10
LCC2/0-38DW-X	1		3/8	1.00	0.85	1.50	0.13	3.67	Black	P45	13	45	1 9/16	10
LCC2/0-12DW-X	1		1/2	1.00	0.85	1.50	0.13	3.92	Black	P45	13	45	1 9/16	10
LCC2/0-12W-X	1		1/2	1.75	0.85	1.50	0.13	4.83	Black	P45	13	45	1 9/16	10
LCC3/0-14BW-X	1		3/0 AWG	1/4	0.75	0.96	1.50	0.13	3.39	Orange	P50	14	50	1 9/16
LCC3/0-56DW-X	1	5/16		1.00	0.96	1.50	0.13	3.64	Orange	P50	14	50	1 9/16	10
LCC3/0-38DW-X	1	3/8		1.00	0.96	1.50	0.13	3.70	Orange	P50	14	50	1 9/16	10
LCC3/0-12DW-X	1	1/2		1.00	0.96	1.50	0.13	3.95	Orange	P50	14	50	1 9/16	10
LCC3/0-12W-X	1	1/2		1.75	0.96	1.50	0.13	4.87	Orange	P50	14	50	1 9/16	10
LCC4/0-14AW-X	1	4/0 AWG	1/4	0.63	1.06	1.56	0.14	3.35	Purple	P54	15	54	1 5/8	10
LCC4/0-14BW-X	1		1/4	0.75	1.06	1.56	0.14	3.48	Purple	P54	15	54	1 5/8	10
LCC4/0-56DW-X	1		5/16	1.00	1.06	1.56	0.14	3.74	Purple	P54	15	54	1 5/8	10
LCC4/0-38DW-X	1		3/8	1.00	1.06	1.56	0.14	3.81	Purple	P54	15	54	1 5/8	10
LCC4/0-38W-X	1		3/8	1.75	1.06	1.56	0.14	4.56	Purple	P54	15	54	1 5/8	10
LCC4/0-12DW-X	1		1/2	1.00	1.06	1.56	0.14	4.04	Purple	P54	15	54	1 5/8	10
LCC4/0-12W-X	1		1/2	1.75	1.06	1.56	0.14	4.95	Purple	P54	15	54	1 5/8	10

‡Visit www.panduit.com/tools for tool and die information.
 *Not tested to NEBS level 3 requirements.
 **Consult cable manufacturer for voltage stress relief instructions with applications greater than 2000 V.
 ◆NEMA hole sizes and spacing.

Continues on next page



Code Conductor, Two-Hole, Long Barrel with Window Lug (continued)

Part Number	Figure No.	Copper Conductor Size	Stud Hole Size (In.)	Stud Hole Spacing (In.)	Figure Dimensions (In.)				Panduit Color Code	Panduit Die Index No.‡	Burndy Die Index No.‡	T&B Die Index No.‡	Wire Strip Length (In.)	Std. Pkg. Qty.
					W	B	T	L						
LCC250-56DW-X	1	250 kcmil	5/16	1.00	1.17	1.61	0.14	3.82	Yellow	P62	16	62	1 11/16	10
LCC250-38DW-X	1		3/8	1.00	1.17	1.61	0.14	3.89	Yellow	P62	16	62	1 11/16	10
LCC250-12DW-X	1		1/2	1.00	1.17	1.61	0.14	4.12	Yellow	P62	16	62	1 11/16	10
◆ LCC250-12W-X	1	300 kcmil	1/2	1.75	1.17	1.61	0.14	5.03	Yellow	P62	16	62	1 11/16	10
LCC300-38DW-X	1		3/8	1.00	1.19	2.24	0.16	4.54	White	P66	17	66	2 5/16	10
◆ LCC300-12W-X	1		1/2	1.75	1.19	2.24	0.16	5.72	White	P66	17	66	2 5/16	10
LCC350-14BW-X	1	350 kcmil	1/4	0.75	1.28	2.24	0.17	4.10	Red	P71	18	71	2 5/16	10
LCC350-38DW-X	1		3/8	1.00	1.28	2.24	0.17	4.58	Red	P71	18	71	2 5/16	10
◆ LCC350-12W-X	1		1/2	1.75	1.28	2.24	0.17	5.76	Red	P71	18	71	2 5/16	10
LCC400-14BW-6	1	400 kcmil	1/4	0.75	1.39	2.30	0.18	4.18	Blue	P76	19	76	2 3/8	6
LCC400-38DW-6	1		3/8	1.00	1.39	2.30	0.18	4.66	Blue	P76	19	76	2 3/8	6
◆ LCC400-12W-6	1		1/2	1.75	1.28	2.30	0.17	5.84	Blue	P76	19	76	2 3/8	6
LCC500-14BW-6	1	500 kcmil	1/4	0.75	1.54	2.50	0.22	4.46	Brown	P87	20	87	2 9/16	6
LCC500-38DW-6	1		3/8	1.00	1.54	2.50	0.22	4.94	Brown	P87	20	87	2 9/16	6
◆ LCC500-12W-6	1		1/2	1.75	1.54	2.50	0.22	6.12	Brown	P87	20	87	2 9/16	6
LCC600-38DW-6	1	600 kcmil	3/8	1.00	1.70	2.69	0.26	5.18	Green	P94	22	94	2 3/4	6
◆ LCC600-12W-6	1		1/2	1.75	1.70	2.69	0.26	6.36	Green	P94	22	94	2 3/4	6
LCC750-38DW-6	1	750 kcmil	3/8	1.00	1.89	2.88	0.26	5.71	Black	P106	24	106	2 15/16	6
◆ LCC750-12W-6	1		1/2	1.75	1.89	2.88	0.26	6.65	Black	P106	24	106	2 15/16	6
◆ LCC800-12W-6	1	800 kcmil	1/2	1.75	1.95	2.94	0.30	6.74	Orange	P107	25	107	3	6
LCC1000-38DW-3	1	1000 kcmil	3/8	1.00	2.17	3.00	0.32	5.95	White	P125	27	125	3 1/16	3
◆ LCC1000-12W-3	1		1/2	1.75	2.17	3.00	0.32	6.89	White	P125	27	125	3 1/16	3

‡Visit www.panduit.com/tools for tool and die information.

*Not tested to NEBS level 3 requirements.

**Consult cable manufacturer for voltage stress relief instructions with applications greater than 2000 V.

◆NEMA hole sizes and spacing.



Code Conductor, Two-Hole, Long Barrel with Window, Narrow Tongue Lug

For Use with Stranded Copper Conductors

Type LCCN-W

- Narrow tongue width for limited space applications
- Long barrel maximizes number of crimps and provides premium wire pull-out strength and electrical performance
- Inspection window to visually assure full conductor insertion
- Color-coded barrels marked with Panduit and specified competitor die index numbers for proper crimp die selection
- Tin-plated to inhibit corrosion
- UL Listed and CSA Certified to 35 kV** and temperature rated to 90°C when crimped with Panduit and specified competitor crimping tools and dies
- UL Listed and CSA Certified for wide wire range-taking capability when crimped with Panduit® Uni-Die™ Dieless Crimping Tools‡
- Tested by Telcordia – meets NEBS Level 3
- Available with NEMA hole sizes and spacing

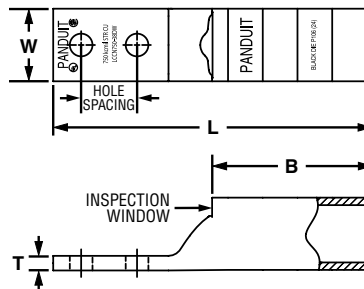

Part Number	Copper Conductor Size	Stud Hole Size (In.)	Stud Hole Spacing (In.)	Figure Dimensions (In.)				Panduit Color Code	Panduit Die Index No.‡	Burndy Die Index No.‡	T&B Die Index No.‡	Wire Strip Length (In.)	Std. Pkg. Qty.
				W	B	T	L						
LCCN750-38DW-6	750 kcmil	3/8	1.00	1.30	2.88	0.28	5.72	Black	P106	24	106	2 15/16	6
◆ LCCN750-12W-6	750 kcmil	1/2	1.75	1.30	2.88	0.28	6.66	Black	P106	24	106	2 15/16	6

‡Visit www.panduit.com/tools for tool and die information.

**Consult cable manufacturer for voltage stress relief instructions with applications greater than 2000 V.

◆NEMA hole sizes and spacing.



Code Conductor, Standard Barrel, Butt Splice

For Use with Stranded Copper Conductors

Type SCS

- Color-coded barrels marked with Panduit and specified competitor die index numbers for proper crimp die selection
- Internal wire stops to prevent over-insertion of conductor
- Tin-plated to inhibit corrosion
- UL Listed and CSA Certified to 35 kV** and temperature rated to 90°C when crimped with Panduit and specified competitor crimping tools and dies
- UL Listed and CSA Certified for wide wire range-taking capability when crimped with Panduit® Uni-Die™ Dieless Crimping Tools‡
- Tested by Telcordia – meets NEBS Level 3
- American Bureau of Shipping approved

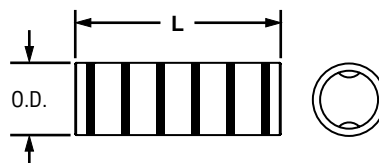

Part Number	Copper Conductor Size	Figure Dimensions (In.)		Panduit Color Code	Panduit Die Index No.‡	Burndy Die Index No.‡	T&B Die Index No.‡	Wire Strip Length (In.)	Std. Pkg. Qty.
		Barrel O.D.	L						
SCS8-L	#8 AWG	0.27	1.50	Red	P21	49	21	11/16	50
SCS6-L	#6 AWG	0.31	1.75	Blue	P24	7	24	13/16	50
SCS4-L	#4 – #3 AWG STR, #2 AWG SOL	0.38	1.75	Gray	P29	8	29	13/16	50
SCS2-Q	#2 AWG	0.42	1.87	Brown	P33	10	33	7/8	25
SCS1-E	#1 AWG	0.47	1.87	Green	P37	11	37	7/8	20
SCS1/0-X	1/0 AWG	0.52	1.87	Pink	P42	12	42	7/8	10
SCS2/0-X	2/0 AWG	0.58	2.00	Black	P45	13	45	15/16	10
SCS3/0-X	3/0 AWG	0.64	2.12	Orange	P50	14	50	1	10
SCS4/0-X	4/0 AWG	0.71	2.12	Purple	P54	15	54	1	10
SCS250-X	250 kcmil	0.77	2.25	Yellow	P62	16	62	1 1/16	10
SCS300-X	300 kcmil	0.81	2.25	White	P66	17	66	1 1/16	10
SCS350-X	350 kcmil	0.87	2.37	Red	P71	18	71	1 1/8	10
SCS400-6	400 kcmil	0.95	2.50	Blue	P76	19	76	1 3/16	6
SCS500-6	500 kcmil	1.05	2.87	Brown	P87	20	87	1 3/8	6
SCS600-6	600 kcmil	1.18	2.87	Green	P94	22	94	1 3/8	6
SCS750-6	750 kcmil	1.29	3.37	Black	P106	24	106	1 5/8	6
SCS1000-3	1000 kcmil	1.50	3.87	White	P125	27	125	1 7/8	3

‡Visit www.panduit.com/tools for tool and die information.
 **Consult cable manufacturer for voltage stress relief instructions with applications greater than 2000 V.



Code Conductor, Long Barrel, Butt Splice

For Use with Stranded Copper Conductors

Type SCL

- Long barrel maximizes the number of crimps and provides premium wire pull-out strength and electrical performance
- Color-coded barrels marked with Panduit and specified competitor die index numbers for proper crimp die selection
- Internal wire stops to prevent over-insertion of conductor
- Tin-plated to inhibit corrosion
- UL Listed and CSA Certified to 35 kV** and temperature rated to 90°C when crimped with Panduit and specified competitor crimping tools and dies
- UL Listed and CSA Certified for wide wire range-taking capability when crimped with Panduit® Uni-Die™ Dieless Crimping Tools‡
- Tested by Telcordia – meets NEBS Level 3

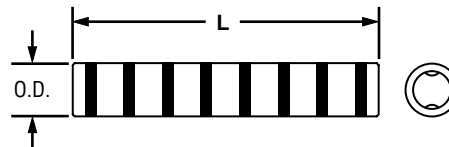

Part Number	Copper Conductor Size	Figure Dimensions (In.)		Panduit Color Code	Panduit Die Index No.‡	Burdny Die Index No.‡	T&B Die Index No.‡	Wire Strip Length (In.)	Std. Pkg. Qty.
		Barrel O.D.	L						
SCL8-L	#8 AWG	0.27	2.25	Red	P21	49	21	1 1/16	50
SCL6-L	#6 AWG	0.31	2.38	Blue	P24	7	24	1 1/8	50
SCL4-L	#4 – #3 AWG STR, #2 AWG SOL	0.38	2.38	Gray	P29	8	29	1 1/8	50
SCL2-Q	#2 AWG	0.42	2.62	Brown	P33	10	33	1 1/4	25
SCL1-E	#1 AWG	0.47	2.87	Green	P37	11	37	1 3/8	20
SCL1/0-X	1/0 AWG	0.52	2.87	Pink	P42	12	42	1 3/8	10
SCL2/0-X	2/0 AWG	0.58	3.13	Black	P45	13	45	1 1/2	10
SCL3/0-X	3/0 AWG	0.64	3.12	Orange	P50	14	54	1 1/2	10
SCL4/0-X	4/0 AWG	0.71	3.37	Purple	P54	15	54	1 5/8	10
SCL250-X	250 kcmil	0.77	3.38	Yellow	P62	16	62	1 5/8	10
SCL300-X	300 kcmil	0.81	4.12	White	P66	17	66	2	10
SCL350-X	350 kcmil	0.88	4.12	Red	P71	18	71	2	10
SCL400-6	400 kcmil	0.95	4.37	Blue	P76	19	76	2 1/8	6
SCL500-6	500 kcmil	1.06	4.62	Brown	P87	20	87	2 1/4	6
SCL600-6	600 kcmil	1.19	5.50	Green	P94	22	94	2 11/16	6
SCL750-6	750 kcmil	1.30	5.87	Black	P106	24	106	2 7/8	6
SCL1000-3	1000 kcmil	1.50	6.12	White	P125	27	125	3	3

‡Visit www.panduit.com/tools for tool and die information.

**Consult cable manufacturer for voltage stress relief instructions with applications greater than 2000 V.



Code Conductor, Color-Coded Parallel Splice

For Use with Stranded Copper Conductors

Type PSC

- Industry recognized color-coding allows proper part selection and quick identification of crimping dies to speed installation
- Large easy-to-read part numbering for verification in demanding low light conditions
- Tin-plated to inhibit corrosion
- UL Listed and CSA Certified to 35 kV** and temperature rated to 90°C when crimped with Panduit dieless and die type crimping tools
- Single crimp design speeds installation and reduces labor costs
- Chamfered on both ends to facilitate fast and easy conductor insertion to speed installation

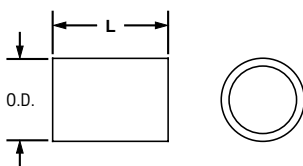

Part Number	Figure Dimensions (In.)		Panduit Color Code	Panduit Die Index No.‡	Wire Strip Length (In.)	Std. Pkg. Qty.
	Barrel O.D.	L				
PSCRED-L	0.27	0.50	Red	P21	7/16	50
PSCBLU-L	0.31	0.50	Blue	P24	7/16	50
PSCGRY-L	0.38	0.50	Gray	P29	7/16	50
PSCBRN-L	0.47	0.62	Brown	P33	11/16	50
PSCGRN-L	0.52	0.62	Green	P37	11/16	50
PSCPnk-L	0.58	0.62	Pink	P42	11/16	50
PSCBLK-Q	0.64	0.81	Black	P45	7/8	25
PSCORG-Q	0.71	0.81	Orange	P50	7/8	25
PSCPUR-Q	0.77	0.88	Purple	P54	1	25
PSCYEL-Q	0.81	1.05	Yellow	P62	1 1/16	25

‡Visit www.panduit.com/tools for tool and die information. For smaller wires sizes, see pages D1.49 – D1.52.

For heat shrink end caps and tubing see pages C2.35 – C2.41.

For thermal transfer labeling solutions see pages E1.1 – E2.27.

**Consult cable manufacturer for voltage stress relief instructions with applications greater than 2000 V.

Copper Compression Parallel Splice

How to Use This Guide

Example: (3) #14 AWG wires
(2) #12 AWG wires

- In Table 1 find #14 AWG wire size and # of wires on vertical axis.
- Find #12 AWG wire size and # of wires on horizontal axis.
- Find the intersection of ① and ② to identify the correct color coded splice, which corresponds to the part number in Table 2. ■ blue = PSCBLU-L
- See tool solutions catalog for proper die index number, wire strip length, and number of crimps.



Part Number	Barrel O.D. (In.)	Length (In.)	Panduit Color Code	Panduit Die Index No.	Std. Pkg. Qty.
PSCRED-L	0.27	0.50	Red	P21	50
PSCBLU-L	0.31	0.50	Blue	P24	50
PSCGRY-L	0.38	0.50	Gray	P29	50
PSCBRN-L	0.47	0.62	Brown	P33	50
PSCGRN-L	0.52	0.62	Green	P37	50
PSCPNK-L	0.58	0.62	Pink	P42	50
PSCBLK-Q	0.64	0.81	Black	P45	25
PSCORG-Q	0.71	0.81	Orange	P50	25
PSCPUR-Q	0.77	0.88	Purple	P54	25
PSCYEL-Q	0.81	1.05	Yellow	P62	25

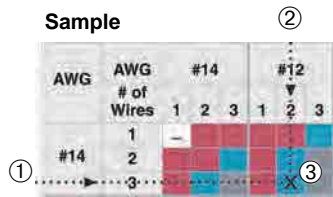

Table 2

AWG	AWG # of Wires	#14			#12			#10			#8			#6			#4			#2			#1			1/0			2/0			3/0		
		1	2	3	1	2	3	1	2	3	1	2	3	1	2	3	1	2	3	1	2	3	1	2	3	1	2	3	1	2	3			
#14	1	-	-	-	-	-	-	-	-	-	-	-	-	-	-	-	-	-	-	-	-	-	-	-	-	-	-	-	-	-	-			
	2	-	-	-	-	-	-	-	-	-	-	-	-	-	-	-	-	-	-	-	-	-	-	-	-	-	-	-	-	-	-			
	3	-	-	-	-	-	-	-	-	-	-	-	-	-	-	-	-	-	-	-	-	-	-	-	-	-	-	-	-	-	-			
#12	1	-	-	-	-	-	-	-	-	-	-	-	-	-	-	-	-	-	-	-	-	-	-	-	-	-	-	-	-	-	-			
	2	-	-	-	-	-	-	-	-	-	-	-	-	-	-	-	-	-	-	-	-	-	-	-	-	-	-	-	-	-	-			
	3	-	-	-	-	-	-	-	-	-	-	-	-	-	-	-	-	-	-	-	-	-	-	-	-	-	-	-	-	-	-			
#10	1	-	-	-	-	-	-	-	-	-	-	-	-	-	-	-	-	-	-	-	-	-	-	-	-	-	-	-	-	-	-			
	2	-	-	-	-	-	-	-	-	-	-	-	-	-	-	-	-	-	-	-	-	-	-	-	-	-	-	-	-	-	-			
	3	-	-	-	-	-	-	-	-	-	-	-	-	-	-	-	-	-	-	-	-	-	-	-	-	-	-	-	-	-	-			
#8	1	-	-	-	-	-	-	-	-	-	-	-	-	-	-	-	-	-	-	-	-	-	-	-	-	-	-	-	-	-	-			
	2	-	-	-	-	-	-	-	-	-	-	-	-	-	-	-	-	-	-	-	-	-	-	-	-	-	-	-	-	-	-			
	3	-	-	-	-	-	-	-	-	-	-	-	-	-	-	-	-	-	-	-	-	-	-	-	-	-	-	-	-	-	-			
#6	1	-	-	-	-	-	-	-	-	-	-	-	-	-	-	-	-	-	-	-	-	-	-	-	-	-	-	-	-	-	-			
	2	-	-	-	-	-	-	-	-	-	-	-	-	-	-	-	-	-	-	-	-	-	-	-	-	-	-	-	-	-	-			
	3	-	-	-	-	-	-	-	-	-	-	-	-	-	-	-	-	-	-	-	-	-	-	-	-	-	-	-	-	-	-			
#4	1	-	-	-	-	-	-	-	-	-	-	-	-	-	-	-	-	-	-	-	-	-	-	-	-	-	-	-	-	-	-			
	2	-	-	-	-	-	-	-	-	-	-	-	-	-	-	-	-	-	-	-	-	-	-	-	-	-	-	-	-	-	-			
	3	-	-	-	-	-	-	-	-	-	-	-	-	-	-	-	-	-	-	-	-	-	-	-	-	-	-	-	-	-	-			
#2	1	-	-	-	-	-	-	-	-	-	-	-	-	-	-	-	-	-	-	-	-	-	-	-	-	-	-	-	-	-	-			
	2	-	-	-	-	-	-	-	-	-	-	-	-	-	-	-	-	-	-	-	-	-	-	-	-	-	-	-	-	-	-			
	3	-	-	-	-	-	-	-	-	-	-	-	-	-	-	-	-	-	-	-	-	-	-	-	-	-	-	-	-	-	-			
#1	1	-	-	-	-	-	-	-	-	-	-	-	-	-	-	-	-	-	-	-	-	-	-	-	-	-	-	-	-	-	-			
	2	-	-	-	-	-	-	-	-	-	-	-	-	-	-	-	-	-	-	-	-	-	-	-	-	-	-	-	-	-	-			
	3	-	-	-	-	-	-	-	-	-	-	-	-	-	-	-	-	-	-	-	-	-	-	-	-	-	-	-	-	-	-			
1/0	1	-	-	-	-	-	-	-	-	-	-	-	-	-	-	-	-	-	-	-	-	-	-	-	-	-	-	-	-	-	-			
	2	-	-	-	-	-	-	-	-	-	-	-	-	-	-	-	-	-	-	-	-	-	-	-	-	-	-	-	-	-	-			
	3	-	-	-	-	-	-	-	-	-	-	-	-	-	-	-	-	-	-	-	-	-	-	-	-	-	-	-	-	-	-			
2/0	1	-	-	-	-	-	-	-	-	-	-	-	-	-	-	-	-	-	-	-	-	-	-	-	-	-	-	-	-	-	-			
	2	-	-	-	-	-	-	-	-	-	-	-	-	-	-	-	-	-	-	-	-	-	-	-	-	-	-	-	-	-	-			
	3	-	-	-	-	-	-	-	-	-	-	-	-	-	-	-	-	-	-	-	-	-	-	-	-	-	-	-	-	-	-			
3/0	1	-	-	-	-	-	-	-	-	-	-	-	-	-	-	-	-	-	-	-	-	-	-	-	-	-	-	-	-	-	-			
	2	-	-	-	-	-	-	-	-	-	-	-	-	-	-	-	-	-	-	-	-	-	-	-	-	-	-	-	-	-	-			
	3	-	-	-	-	-	-	-	-	-	-	-	-	-	-	-	-	-	-	-	-	-	-	-	-	-	-	-	-	-	-			

Table 1



Flex Conductor, One-Hole, Standard Barrel with Window Lug

For Use with Flexible, Extra-Flexible, and Code Stranded Copper Conductors

Type LCAX

- Can be used with code conductor and flex conductor class: G, H, I, K, M and Diesel Locomotive
- Generously beveled wire entry prevents bent back strands when inserting conductor into barrel
- Color-coded barrels marked with Panduit and specified competitor die index numbers for proper crimp die selection
- Inspection window to visually assure full conductor insertion
- Tin-plated to inhibit corrosion
- UL Listed and CSA Certified to 35 kV** and temperature rated to 90°C when crimped with Panduit® and specified competitor crimping tools and dies
- American Bureau of Shipping approved
- Lugs available in 90 and 45 degree bent tongue. Please refer to www.panduit.com

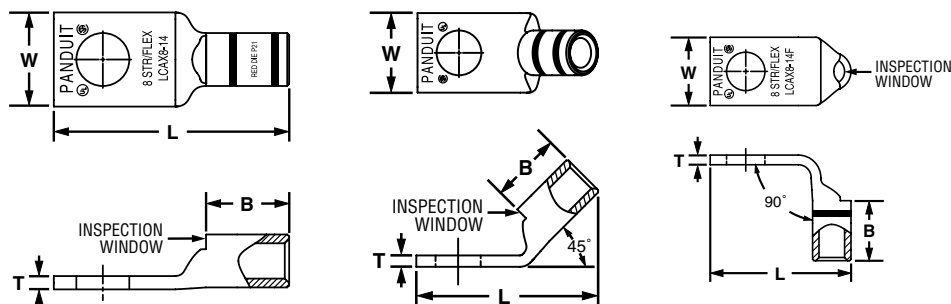

Part Number	Flex Conductor Size		Code Conductor Size	Stud Hole Size (In.)	Figure Dimensions (In.)				Panduit Color Code	Panduit Die Index No.‡	Burdny Die Index No.‡	T&B Die Index No.‡	Wire Strip Length (In.)	Std. Pkg. Qty.
	Class G, H, I, K, M	Diesel Locomotive			W	B	T	L						
LCAX8-10-L	#8 AWG	#8 AWG	#8 AWG	#10	0.41	0.42	0.08	1.11	Red	P21	49	21	1/2	50
LCAX8-14-L				1/4	0.48	0.42	0.07	1.20	Red	P21	49	21	1/2	50
LCAX8-56-L				5/16	0.56	0.42	0.05	1.32	Red	P21	49	21	1/2	50
LCAX8-38-L				3/8	0.60	0.42	0.05	1.42	Red	P21	49	21	1/2	50
LCAX6-10-L	#6 AWG	#6 AWG	#6 AWG	#10	0.45	0.48	0.09	1.19	Blue	P24	7	24	9/16	50
LCAX6-14-L				1/4	0.48	0.48	0.08	1.28	Blue	P24	7	24	9/16	50
LCAX6-56-L				5/16	0.56	0.48	0.07	1.40	Blue	P24	7	24	9/16	50
LCAX6-38-L				3/8	0.62	0.48	0.06	1.50	Blue	P24	7	24	9/16	50
LCAX4-10-L	#4 AWG	#5, #4, #3 AWG	#4 AWG	#10	0.55	0.53	0.09	1.26	Gray	P29	8	29	5/8	50
LCAX4-14-L				1/4	0.55	0.53	0.09	1.35	Gray	P29	8	29	5/8	50
LCAX4-56-L				5/16	0.55	0.53	0.09	1.47	Gray	P29	8	29	5/8	50
LCAX4-38-L				3/8	0.62	0.53	0.07	1.57	Gray	P29	8	29	5/8	50
LCAX2-10-E*	#2 AWG	#2 AWG	#2 AWG	#10	0.70	0.59	0.11	1.40	Brown	P33	10	33	11/16	20
LCAX2-14-E*				1/4	0.70	0.59	0.11	1.50	Brown	P33	10	33	11/16	20
LCAX2-56-E*				5/16	0.70	0.59	0.11	1.63	Brown	P33	10	33	11/16	20
LCAX2-38-E*				3/8	0.70	0.59	0.11	1.70	Brown	P33	10	33	11/16	20
LCAX2-12-E*				1/2	0.75	0.59	0.09	1.94	Brown	P33	10	33	11/16	20
LCAX1-10-X	#1 AWG	#1 AWG	#1 AWG	#10	0.76	0.66	0.12	1.50	Green	P37	11	37	3/4	10
LCAX1-14-X				1/4	0.76	0.66	0.12	1.67	Green	P37	11	37	3/4	10
LCAX1-56-X				5/16	0.76	0.66	0.12	1.72	Green	P37	11	37	3/4	10
LCAX1-38-X				3/8	0.76	0.66	0.12	1.80	Green	P37	11	37	3/4	10
LCAX1-12-X				1/2	0.80	0.66	0.12	2.03	Green	P37	11	37	3/4	10

‡Visit www.panduit.com/tools for tool and die information.
 *Not UL Listed or CSA Certified with Class K flex conductor when crimped with Burndy tools.
 **Consult cable manufacturer for voltage stress relief instructions with applications greater than 2000 V.

Continues on next page



Flex Conductor, One-Hole, Standard Barrel with Window Lug (continued)

Part Number	Flex Conductor Size		Code Conductor Size	Stud Hole Size (In.)	Figure Dimensions (In.)				Panduit Color Code	Panduit Die Index No.‡	Burdny Die Index No.‡	T&B Die Index No.‡	Wire Strip Length (In.)	Std. Pkg. Qty.
	Class G, H, I, K, M	Diesel Locomotive			W	B	T	L						
LCAX1/0-14-X	1/0 AWG	1/0 AWG	1/0 AWG	1/4	0.85	0.72	0.13	1.82	Pink	P42	12	42	3/4	10
LCAX1/0-56-X				5/16	0.85	0.72	0.13	1.82	Pink	P42	12	42	3/4	10
LCAX1/0-38-X				3/8	0.85	0.72	0.13	1.89	Pink	P42	12	42	3/4	10
LCAX1/0-12-X				1/2	0.85	0.72	0.13	2.14	Pink	P42	12	42	3/4	10
LCAX1/0-58-X				5/8	0.96	0.72	0.11	2.38	Pink	P42	12	42	3/4	10
LCAX2/0-10-X	2/0 AWG	2/0 AWG	2/0 AWG	#10	0.96	0.83	0.13	1.72	Black	P45	13	45	7/8	10
LCAX2/0-14-X				1/4	0.96	0.83	0.13	1.97	Black	P45	13	45	7/8	10
LCAX2/0-56-X				5/16	0.96	0.83	0.13	1.97	Black	P45	13	45	7/8	10
LCAX2/0-38-X				3/8	0.96	0.83	0.13	2.03	Black	P45	13	45	7/8	10
LCAX2/0-12-X				1/2	0.96	0.83	0.13	2.28	Black	P45	13	45	7/8	10
LCAX2/0-58-X	5/8	0.96	0.83	0.13	2.52	Black	P45	13	45	7/8	10			
LCAX3/0-10-X	3/0 AWG	3/0 AWG	3/0 AWG	#10	1.06	0.91	0.14	1.84	Orange	P50	14	50	1	10
LCAX3/0-14-X				1/4	1.06	0.91	0.14	2.08	Orange	P50	14	50	1	10
LCAX3/0-56-X				5/16	1.06	0.91	0.14	2.10	Orange	P50	14	50	1	10
LCAX3/0-38-X				3/8	1.06	0.91	0.14	2.17	Orange	P50	14	50	1	10
LCAX3/0-12-X				1/2	1.06	0.91	0.14	2.40	Orange	P50	14	50	1	10
LCAX3/0-58-X	5/8	1.06	0.91	0.14	2.64	Orange	P50	14	50	1	10			
LCAX4/0-14-X	4/0 AWG	4/0 AWG	4/0 AWG	1/4	1.19	1.03	0.16	2.30	Purple	P54	15	54	1 1/16	10
LCAX4/0-56-X				5/16	1.19	1.03	0.16	2.53	Purple	P54	15	54	1 1/16	10
LCAX4/0-38-X				3/8	1.19	1.03	0.16	2.53	Purple	P54	15	54	1 1/16	10
LCAX4/0-12-X				1/2	1.19	1.03	0.16	2.64	Purple	P54	15	54	1 1/16	10
LCAX4/0-58-X				5/8	1.19	1.03	0.16	2.85	Purple	P54	15	54	1 1/16	10
LCAX4/0-34-X	3/4	1.19	1.03	0.16	3.04	Purple	P54	15	54	1 1/16	10			
LCAX250-14-X	250 kcmil	262.6 kcmil	—	1/4	1.28	1.03	0.17	2.34	Yellow	P62	16	62	1 1/16	10
LCAX250-56-X				5/16	1.28	1.03	0.17	2.57	Yellow	P62	16	62	1 1/16	10
LCAX250-38-X				3/8	1.28	1.03	0.17	2.57	Yellow	P62	16	62	1 1/16	10
LCAX250-12-X				1/2	1.28	1.03	0.17	2.68	Yellow	P62	16	62	1 1/16	10
LCAX250-58-X				5/8	1.28	1.03	0.17	2.89	Yellow	P62	16	62	1 1/16	10
LCAX250-34-X	3/4	1.28	1.03	0.17	3.08	Yellow	P62	16	62	1 1/16	10			
LCAX300-38-6	300 kcmil	313.1 kcmil	—	3/8	1.39	1.19	0.18	2.91	Red	P71	18	71H	1 1/4	6
LCAX300-12-6				1/2	1.39	1.19	0.18	2.91	Red	P71	18	71H	1 1/4	6
LCAX300-58-6				5/8	1.39	1.19	0.18	3.12	Red	P71	18	71H	1 1/4	6
LCAX350-56-6	350 kcmil	373.7 kcmil	—	5/16	1.54	1.29	0.22	2.93	Blue	P76	19	76H	1 3/8	6
LCAX350-38-6				3/8	1.54	1.29	0.22	2.93	Blue	P76	19	76H	1 3/8	6
LCAX350-12-6				1/2	1.54	1.29	0.22	3.09	Blue	P76	19	76H	1 3/8	6
LCAX350-58-6	5/8	1.54	1.29	0.22	3.30	Blue	P76	19	76H	1 3/8	6			
LCAX450-12-6	450 kcmil	444.4 kcmil	—	1/2	1.70	1.40	0.26	3.60	Brown	P87	20	87H	1 7/16	6
LCAX450-58-6				5/8	1.70	1.40	0.26	3.73	Brown	P87	20	87H	1 7/16	6
LCAX500-56-6	500 kcmil	535.3 kcmil	—	5/16	1.89	1.48	0.26	3.27	Pink	P99	L99	99H	1 9/16	6
LCAX500-38-6				3/8	1.89	1.48	0.26	3.27	Pink	P99	L99	99H	1 9/16	6
LCAX500-12-6				1/2	1.89	1.48	0.26	3.64	Pink	P99	L99	99H	1 9/16	6
LCAX500-58-6	5/8	1.89	1.48	0.26	4.20	Pink	P99	L99	99H	1 9/16	6			

‡Visit www.panduit.com/tools for tool and die information.

*Not UL Listed or CSA Certified with Class K flex conductor when crimped with Burndy tools.

**Consult cable manufacturer for voltage stress relief instructions with applications greater than 2000 V.

B1.
Cable
Ties

B2.
Cable
Accessories

B3.
Stainless
Steel Cable
Ties &
Accessories

C1.
Wiring
Duct

C2.
Abrasion
Protection

C3.
Cable
Management

D1.
Terminals

D2.
Power
Connectors

D3.
Grounding
Connectors

E1.
Labeling
Systems

E2.
Labels

E3.
Pre-Printed
&
Write-On
Markers

E4.
Permanent
Identification

E5.
Lockout/
Tagout &
Safety
Solutions

F.
Keystone
Cabling
Systems

G.
Part
Number
Index

Continues on next page



Flex Conductor, One-Hole, Standard Barrel with Window Lug (continued)

Part Number	Flex Conductor Size		Code Conductor Size	Stud Hole Size (In.)	Figure Dimensions (In.)				Panduit Color Code	Panduit Die Index No.‡	Burndy Die Index No.‡	T&B Die Index No.‡	Wire Strip Length (In.)	Std. Pkg. Qty.
	Class G, H, I, K, M	Diesel Locomotive			W	B	T	L						
LCAX650-56-6	—	646.4 kcmil	—	5/16	1.95	1.45	0.30	3.27	Black	P106	24	106H	1 1/2	6
LCAX650-38-6	—	646.4 kcmil	—	3/8	1.95	1.45	0.30	3.27	Black	P106	24	106H	1 1/2	6
LCAX650-12-6	—	646.4 kcmil	—	1/2	1.95	1.45	0.30	3.64	Black	P106	24	106H	1 1/2	6
LCAX650-58-6	—	646.4 kcmil	—	5/8	1.95	1.45	0.30	4.20	Black	P106	24	106H	1 1/2	6
LCAX750-12-3	—	777.7 kcmil	—	1/2	2.17	1.66	0.32	3.94	Yellow	P115	L115	115H	1 3/4	3
LCAX750-58-3	—	777.7 kcmil	—	5/8	2.17	1.66	0.32	4.59	Yellow	P115	L115	115H	1 3/4	3

‡Visit www.panduit.com/tools for tool and die information.
 *Not UL Listed or CSA Certified with Class K flex conductor when crimped with Burndy tools.
 **Consult cable manufacturer for voltage stress relief instructions with applications greater than 2000 V.



Flex Conductor, One-Hole, Standard Barrel with Window, Narrow Tongue Lug

For Use with Flexible Copper Conductors

Type LCAXN

- Narrow tongue width for limited space applications
- Can be used with flex conductor class: Diesel Locomotive
- Generously beveled wire entry prevents bent back strands when inserting conductor into barrel
- Color-coded barrels marked with Panduit and specified competitor die index numbers for proper crimp die selection
- Inspection window to visually assure full conductor insertion
- Tin-plated to inhibit corrosion
- UL Listed and CSA Certified to 35 kV** and temperature rated to 90°C when crimped with Panduit and specified competitor crimping tools and dies

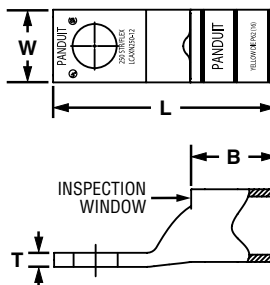

Part Number	Flex Conductor Size		Stud Hole Size (In.)	Figure Dimensions (In.)				Panduit Color Code	Panduit Die Index No.‡	Burndy Die Index No.‡	T&B Die Index No.‡	Wire Strip Length (In.)	Std. Pkg. Qty.
	Class G, H, I, K, M	Diesel Locomotive		W	B	T	L						
LCAXN4/0-14-X	4/0 AWG	4/0 AWG	1/4	0.81	1.03	0.20	2.32	Purple	P54	15	54	1 1/16	10
LCAXN4/0-56-X	4/0 AWG	4/0 AWG	5/16	0.81	1.03	0.20	2.55	Purple	P54	15	54	1 1/16	10
LCAXN4/0-38-X	4/0 AWG	4/0 AWG	3/8	0.81	1.03	0.20	2.55	Purple	P54	15	54	1 1/16	10
LCAXN750-12-3	—	777.7 kcmil	1/2	1.50	1.66	0.33	3.94	Yellow	P115	L115	115H	1 3/4	3

‡Visit www.panduit.com/tools for tool and die information.
 **Consult cable manufacturer for voltage stress relief instructions with applications greater than 2000 V.



Flex Conductor, One-Hole, Long Barrel with Window Lug

For Use with Flexible, Extra-Flexible, and Code Stranded Copper Conductors

Type LCBX

- Can be used with code conductor and flex conductor class: G, H, I, K, M and Diesel Locomotive
- Long barrel maximizes number of crimps and provides premium wire pull-out strength and electrical performance
- Generously beveled wire entry prevents bent back strands when inserting conductor into barrel
- Color-coded barrels marked with Panduit and specified competitor die index numbers for proper crimp die selection
- Inspection window to visually assure full conductor insertion
- Tin-plated to inhibit corrosion
- UL Listed and CSA Certified to 35 kV** and temperature rated to 90°C when crimped with Panduit and specified competitor crimping tools and dies
- Lugs available in 90 and 45 degree bent tongue. Please refer to www.panduit.com

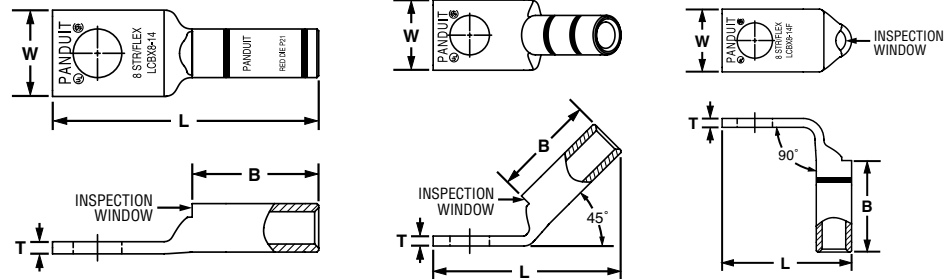

Part Number	Flex Conductor Size		Code Conductor Size	Stud Hole Size (In.)	Figure Dimensions (In.)				Panduit Color Code	Panduit Die Index No.‡	Burdny Die Index No.‡	T&B Die Index No.‡	Wire Strip Length (In.)	Std. Pkg. Qty.
	Class G, H, I, K, M	Diesel Locomotive			W	B	T	L						
LCBX8-10-L				#10	0.41	0.70	0.08	1.39	Red	P21	49	21	3/4	50
LCBX8-14-L	#8 AWG	#8 AWG	#8 AWG	1/4	0.48	0.70	0.07	1.48	Red	P21	49	21	3/4	50
LCBX8-38-L				3/8	0.60	0.70	0.05	1.70	Red	P21	49	21	3/4	50
LCBX6-14-L	#6 AWG	#6 AWG	#6 AWG	1/4	0.48	1.07	0.08	1.86	Blue	P24	7	24	1 1/8	50
LCBX6-38-L				3/8	0.62	1.07	0.06	2.08	Blue	P24	7	24	1 1/8	50
LCBX4-14-L	#4 AWG	#5, #4, #3 AWG	#4 AWG	1/4	0.55	1.05	0.09	1.87	Gray	P29	8	29	1 1/8	50
LCBX4-38-L				3/8	0.62	1.05	0.07	2.09	Gray	P29	8	29	1 1/8	50
LCBX2-14-E*				1/4	0.70	1.36	0.11	2.26	Brown	P33	10	33	1 7/16	20
LCBX2-38-E*	#2 AWG	#2 AWG	#2 AWG	3/8	0.70	1.36	0.11	2.46	Brown	P33	10	33	1 7/16	20
LCBX2-12-E*				1/2	0.75	1.36	0.09	2.70	Brown	P33	10	33	1 7/16	20
LCBX1-14-X				1/4	0.76	1.44	0.12	2.44	Green	P37	11	37	1 1/2	10
LCBX1-56-X	#1 AWG	#1 AWG	#1 AWG	5/16	0.76	1.44	0.12	2.50	Green	P37	11	37	1 1/2	10
LCBX1-38-X				3/8	0.76	1.44	0.12	2.57	Green	P37	11	37	1 1/2	10
LCBX1/0-14-X				1/4	0.85	1.50	0.13	2.61	Pink	P42	12	42	1 9/16	10
LCBX1/0-38-X	1/0 AWG	1/0 AWG	1/0 AWG	3/8	0.85	1.50	0.13	2.67	Pink	P42	12	42	1 9/16	10
LCBX1/0-12-X				1/2	0.85	1.50	0.13	2.92	Pink	P42	12	42	1 9/16	10
LCBX2/0-14-X				1/4	0.96	1.50	0.13	2.64	Black	P45	13	45	1 9/16	10
LCBX2/0-38-X	2/0 AWG	2/0 AWG	2/0 AWG	3/8	0.96	1.50	0.13	2.70	Black	P45	13	45	1 9/16	10
LCBX2/0-12-X				1/2	0.96	1.50	0.13	2.96	Black	P45	13	45	1 9/16	10
LCBX3/0-38-X	3/0 AWG	3/0 AWG	3/0 AWG	3/8	1.06	1.56	0.14	2.81	Orange	P50	14	50	1 5/8	10
LCBX4/0-38-X	4/0 AWG	4/0 AWG	4/0 AWG	3/8	1.19	2.24	0.16	3.74	Purple	P54	15	54	2 5/16	10
LCBX4/0-12-X				1/2	1.19	2.24	0.16	3.85	Purple	P54	15	54	2 5/16	10

‡Visit www.panduit.com/tools for tool and die information.

*Not UL Listed or CSA Certified with Class K flex conductor when crimped with Burndy tools.

**Consult cable manufacturer for voltage stress relief instructions with applications greater than 2000 V.



Flex Conductor, One-Hole, Long Barrel with Window Lug (continued)

Part Number	Flex Conductor Size		Code Conductor Size	Stud Hole Size (In.)	Figure Dimensions (In.)				Panduit Color Code	Panduit Die Index No.‡	Burndy Die Index No.‡	T&B Die Index No.‡	Wire Strip Length (In.)	Std. Pkg. Qty.
	Class G, H, I, K, M	Diesel Locomotive			W	B	T	L						
LCBX250-38-X	250 kcmil	262.6 kcmil	—	3/8	1.28	2.24	0.17	3.78	Yellow	P62	16	62	2 5/16	10
LCBX250-12-X			1/2	1.28	2.24	0.17	3.89	Yellow	P62	16	62	2 5/16	10	
LCBX250-58-X			5/8	1.28	2.24	0.17	4.10	Yellow	P62	16	62	2 5/16	10	
LCBX300-38-6	300 kcmil	313.1 kcmil	—	3/8	1.39	2.30	0.18	4.02	Red	P71	18	71H	2 3/8	6
LCBX350-38-6	350 kcmil	373.7 kcmil	—	3/8	1.54	2.50	0.22	4.14	Blue	P76	19	76H	2 9/16	6
LCBX350-12-6				1/2	1.54	2.50	0.22	4.30	Blue	P76	19	76H	2 9/16	6
LCBX450-38-6	450 kcmil	444.4 kcmil	—	3/8	1.70	2.69	0.26	5.14	Brown	P87	20	87H	2 3/4	6
LCBX500-38-6	500 kcmil	535.3 kcmil	—	3/8	1.89	2.88	0.26	4.84	Pink	P99	L99	99H	2 15/16	6
LCBX500-12-6				1/2	1.89	2.88	0.26	5.03	Pink	P99	L99	99H	2 15/16	6

‡Visit www.panduit.com/tools for tool and die information.
 *Not UL Listed or CSA Certified with Class K flex conductor when crimped with Burndy tools.
 **Consult cable manufacturer for voltage stress relief instructions with applications greater than 2000 V.



Flex Conductor, Two-Hole, Standard Barrel with Window Lug

For Use with Flexible, Extra-Flexible, and Code Stranded Copper Conductors

Type LCDX

- Can be used with code conductor and flex conductor class: G, H, I, K, M and Diesel Locomotive
- Generously beveled wire entry prevents bent back strands when inserting conductor into barrel
- Color-coded barrels marked with Panduit and specified competitor die index numbers for proper crimp die selection
- Inspection window to visually assure full conductor insertion
- Tin-plated to inhibit corrosion
- UL Listed and CSA Certified to 35 KV** and temperature rated to 90°C when crimped with Panduit and specified competitor crimping tools and dies
- American Bureau of Shipping approved
- Available with NEMA hole sizes and spacing
- Lugs available in 90 and 45 degree bent tongue. Please refer to www.panduit.com

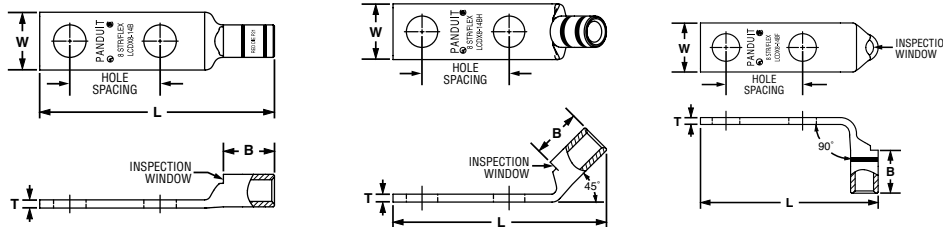

Part Number	Flex Conductor Size		Code Conductor Size	Stud Hole Size (In.)	Stud Hole Spacing (In.)	Figure Dimensions (In.)				Panduit Color Code	Panduit Die Index No.‡	Burndy Die Index No.‡	T&B Die Index No.‡	Wire Strip Length (In.)	Std. Pkg. Qty.
	Class G, H, I, K, M	Diesel Locomotive				W	B	T	L						
LCDX8-10A-L	#8 AWG	#8 AWG	#8 AWG	#10	0.63	0.41	0.42	0.08	1.74	Red	P21	49	21	1/2	50
LCDX8-14A-L				1/4	0.63	0.48	0.42	0.07	1.83	Red	P21	49	21	1/2	50
LCDX8-14B-L				1/4	0.75	0.48	0.42	0.07	1.95	Red	P21	49	21	1/2	50
LCDX8-14D-L				1/4	1.00	0.48	0.42	0.07	2.20	Red	P21	49	21	1/2	50
LCDX8-38D-L				3/8	1.00	0.60	0.42	0.05	2.42	Red	P21	49	21	1/2	50

‡Visit www.panduit.com/tools for tool and die information.
 *Not UL Listed or CSA Certified with Class K flex conductor when crimped with Burndy tools.
 **Consult cable manufacturer for voltage stress relief instructions with applications greater than 2000 V.
 ◆NEMA hole sizes and spacing.

Continues on next page



Flex Conductor, One-Hole, Long Barrel with Window Lug (continued)

Part Number	Flex Conductor Size		Code Conductor Size	Stud Hole Size (In.)	Stud Hole Spacing (In.)	Figure Dimensions (In.)				Panduit Color Code	Panduit Die Index No.‡	Burdny Die Index No.‡	T&B Die Index No.‡	Wire Strip Length (In.)	Std. Pkg. Qty.
	Class G, H, I, K, M	Diesel Locomotive				W	B	T	L						
LCDX6-10A-L	#6 AWG	#6 AWG	#6 AWG	#10	0.63	0.46	0.48	0.08	1.82	Blue	P24	7	24	9/16	50
LCDX6-10B-L				#10	0.75	0.46	0.48	0.08	1.94	Blue	P24	7	24	9/16	50
LCDX6-10G-L				#10	1.50	0.46	0.48	0.08	2.69	Blue	P24	7	24	9/16	50
LCDX6-10P-L				#10	0.69	0.46	0.48	0.08	1.88	Blue	P24	7	24	9/16	50
LCDX6-14A-L				1/4	0.63	0.48	0.48	0.08	1.91	Blue	P24	7	24	9/16	50
LCDX6-14B-L				1/4	0.75	0.48	0.48	0.08	2.03	Blue	P24	7	24	9/16	50
LCDX6-14D-L				1/4	1.00	0.48	0.48	0.08	2.28	Blue	P24	7	24	9/16	50
LCDX6-56D-L				5/16	1.00	0.56	0.48	0.07	2.40	Blue	P24	7	24	9/16	50
LCDX6-38D-L				3/8	1.00	0.62	0.48	0.06	2.50	Blue	P24	7	24	9/16	50
LCDX4-14A-L				#4 AWG	#5, #4, #3 AWG	#4 AWG	1/4	0.63	0.55	0.53	0.09	1.98	Gray	P29	8
LCDX4-14B-L	1/4	0.75	0.55				0.53	0.09	2.10	Gray	P29	8	29	5/8	50
LCDX4-14D-L	1/4	1.00	0.55				0.53	0.09	2.35	Gray	P29	8	29	5/8	50
LCDX4-56D-L	5/16	1.00	0.55				0.53	0.09	2.47	Gray	P29	8	29	5/8	50
LCDX4-38D-L	3/8	1.00	0.62				0.53	0.08	2.57	Gray	P29	8	29	5/8	50
LCDX2-14A-E*	#2 AWG	#2 AWG	#2 AWG	1/4	0.63	0.70	0.59	0.11	2.13	Brown	P33	10	33	11/16	20
LCDX2-14B-E*				1/4	0.75	0.70	0.59	0.11	2.25	Brown	P33	10	33	11/16	20
LCDX2-14D-E*				1/4	1.00	0.70	0.59	0.11	2.50	Brown	P33	10	33	11/16	20
LCDX2-56D-E*				5/16	1.00	0.70	0.59	0.11	2.63	Brown	P33	10	33	11/16	20
LCDX2-38D-E*				3/8	1.00	0.70	0.59	0.11	2.70	Brown	P33	10	33	11/16	20
LCDX2-12-E*				1/2	1.75	0.75	0.59	0.09	3.87	Brown	P33	10	33	11/16	20
LCDX1-14A-X	#1 AWG	#1 AWG	#1 AWG	1/4	0.63	0.76	0.66	0.12	2.29	Green	P37	11	37	3/4	10
LCDX1-14B-X				1/4	0.75	0.76	0.66	0.12	2.42	Green	P37	11	37	3/4	10
LCDX1-14D-X				1/4	1.00	0.76	0.66	0.12	2.67	Green	P37	11	37	3/4	10
LCDX1-56D-X				5/16	1.00	0.76	0.66	0.12	2.72	Green	P37	11	37	3/4	10
LCDX1-38D-X				3/8	1.00	0.76	0.66	0.12	2.80	Green	P37	11	37	3/4	10
LCDX1-12-X				1/2	1.75	0.80	0.66	0.12	3.97	Green	P37	11	37	3/4	10
LCDX1/0-14A-X				1/0 AWG	1/0 AWG	1/0 AWG	1/4	0.63	0.85	0.72	0.13	2.45	Pink	P42	12
LCDX1/0-14B-X	1/4	0.75	0.85				0.72	0.13	2.57	Pink	P42	12	42	3/4	10
LCDX1/0-56B-X	5/16	0.75	0.85				0.72	0.13	2.57	Pink	P42	12	42	3/4	10
LCDX1/0-56D-X	5/16	1.00	0.85				0.72	0.13	2.82	Pink	P42	12	42	3/4	10
LCDX1/0-38D-X	3/8	1.00	0.85				0.72	0.13	2.89	Pink	P42	12	42	3/4	10
LCDX1/0-12D-X	1/2	1.00	0.85				0.72	0.13	3.14	Pink	P42	12	42	3/4	10
LCDX1/0-12-X	1/2	1.75	0.85				0.72	0.13	4.05	Pink	P42	12	42	3/4	10
LCDX2/0-14A-X	2/0 AWG	2/0 AWG	2/0 AWG	1/4	0.63	0.96	0.83	0.13	2.59	Black	P45	13	45	7/8	10
LCDX2/0-14B-X				1/4	0.75	0.96	0.83	0.13	2.72	Black	P45	13	45	7/8	10
LCDX2/0-56D-X				5/16	1.00	0.96	0.83	0.13	2.97	Black	P45	13	45	7/8	10
LCDX2/0-38D-X				3/8	1.00	0.96	0.83	0.13	3.03	Black	P45	13	45	7/8	10
LCDX2/0-12D-X				1/2	1.00	0.96	0.83	0.13	3.28	Black	P45	13	45	7/8	10
LCDX2/0-12-X				1/2	1.75	0.96	0.83	0.13	4.19	Black	P45	13	45	7/8	10
LCDX3/0-14A-X	3/0 AWG	3/0 AWG	3/0 AWG	1/4	0.63	1.06	0.91	0.14	2.71	Orange	P50	14	50	1	10
LCDX3/0-56D-X				5/16	1.00	1.06	0.91	0.14	3.10	Orange	P50	14	50	1	10
LCDX3/0-38D-X				3/8	1.00	1.06	0.91	0.14	3.17	Orange	P50	14	50	1	10
LCDX3/0-12-X				1/2	1.75	1.06	0.91	0.14	4.31	Orange	P50	14	50	1	10

‡Visit www.panduit.com/tools for tool and die information.

*Not UL Listed or CSA Certified with Class K flex conductor when crimped with Burndy tools.

**Consult cable manufacturer for voltage stress relief instructions with applications greater than 2000 V.

◆NEMA hole sizes and spacing.

Continues on next page



Flex Conductor, Two-Hole, Standard Barrel with Window Lug (continued)

Part Number	Flex Conductor Size		Code Conductor Size	Stud Hole Size (In.)	Stud Hole Spacing (In.)	Figure Dimensions (In.)				Panduit Color Code	Panduit Die Index No.‡	Burdny Die Index No.‡	T&B Die Index No.‡	Wire Strip Length (In.)	Std. Pkg. Qty.
	Class G, H, I, K, M	Diesel Locomotive				W	B	T	L						
LCDX4/0-14A-X	4/0 AWG	4/0 AWG	4/0 AWG	1/4	0.63	1.19	1.03	0.16	2.74	Purple	P54	15	54	1 1/16	10
LCDX4/0-14B-X				1/4	0.75	1.19	1.03	0.16	2.96	Purple	P54	15	54	1 1/16	10
LCDX4/0-56D-X				5/16	1.00	1.19	1.03	0.16	3.31	Purple	P54	15	54	1 1/16	10
LCDX4/0-38D-X				3/8	1.00	1.19	1.03	0.16	3.34	Purple	P54	15	54	1 1/16	10
LCDX4/0-12D-X				1/2	1.00	1.19	1.03	0.16	3.61	Purple	P54	15	54	1 1/16	10
LCDX4/0-12E-X				1/2	1.25	1.19	1.03	0.16	3.89	Purple	P54	15	54	1 1/16	10
◆ LCDX4/0-12-X				1/2	1.75	1.19	1.03	0.16	4.52	Purple	P54	15	54	1 1/16	10
LCDX250-38D-X	250 kcmil	262.6 kcmil	—	3/8	1.00	1.28	1.03	0.17	3.38	Yellow	P62	16	62	1 1/16	10
LCDX250-38-X				3/8	1.75	1.28	1.03	0.17	4.13	Yellow	P62	16	62	1 1/16	10
LCDX250-12E-X				1/2	1.25	1.28	1.03	0.17	3.93	Yellow	P62	16	62	1 1/16	10
◆ LCDX250-12-X				1/2	1.75	1.28	1.03	0.17	4.56	Yellow	P62	16	62	1 1/16	10
LCDX300-38D-6	300 kcmil	313.1 kcmil	—	3/8	1.00	1.39	1.19	0.18	3.56	Red	P71	18	71H	1 1/4	6
◆ LCDX300-12-6				1/2	1.75	1.39	1.19	0.18	4.74	Red	P71	18	71H	1 1/4	6
LCDX350-56D-6	350 kcmil	373.7 kcmil	—	5/16	1.00	1.54	1.29	0.22	3.71	Blue	P76	19	76H	1 3/8	6
LCDX350-38D-6				3/8	1.00	1.54	1.29	0.22	3.74	Blue	P76	19	76H	1 3/8	6
LCDX350-38-6				3/8	1.75	1.54	1.29	0.22	4.49	Blue	P76	19	76H	1 3/8	6
LCDX350-12E-6				1/2	1.25	1.54	1.29	0.22	4.29	Blue	P76	19	76H	1 3/8	6
◆ LCDX350-12-6				1/2	1.75	1.54	1.29	0.22	4.92	Blue	P76	19	76H	1 3/8	6
LCDX450-38D-6	450 kcmil	444.4 kcmil	—	3/8	1.00	1.70	1.40	0.26	3.90	Brown	P87	20	87H	1 7/16	6
◆ LCDX450-12-6				1/2	1.75	1.70	1.40	0.26	5.08	Brown	P87	20	87H	1 7/16	6
LCDX500-56D-6	500 kcmil	535.3 kcmil	—	5/16	1.00	1.89	1.48	0.26	4.05	Pink	P99	L99	99H	1 9/16	6
LCDX500-38D-6				3/8	1.00	1.89	1.48	0.26	4.08	Pink	P99	L99	99H	1 9/16	6
LCDX500-12E-6				1/2	1.25	1.89	1.48	0.26	4.76	Pink	P99	L99	99H	1 9/16	6
◆ LCDX500-12-6				1/2	1.75	1.89	1.48	0.26	5.26	Pink	P99	L99	99H	1 9/16	6
◆ LCDX600-12-6	600 kcmil Class G, H, I only	—	—	1/2	1.75	1.89	1.48	0.26	5.26	Pink	P99	400	99H	1 9/16	6
LCDX650-38D-6	—	646.4 kcmil	—	3/8	1.00	1.95	1.45	0.30	4.08	Black	P106	24	106H	1 1/2	6
◆ LCDX650-12-6				1/2	1.75	1.95	1.45	0.30	5.26	Black	P106	24	106H	1 1/2	6
LCDX750-38D-3	—	777.7 kcmil	—	3/8	1.00	2.17	1.66	0.32	4.62	Yellow	P115	L115	115H	1 3/4	3
LCDX750-12E-3				1/2	1.25	2.17	1.66	0.32	5.06	Yellow	P115	L115	115H	1 3/4	3
LCDX750-12G-3				1/2	1.50	2.17	1.66	0.32	5.31	Yellow	P115	L115	115H	1 3/4	3
◆ LCDX750-12-3				1/2	1.75	2.17	1.66	0.32	5.56	Yellow	P115	L115	115H	1 3/4	3
LCDX750-58G-3				5/8	1.50	2.17	1.66	0.32	5.37	Yellow	P115	L115	115H	1 3/4	3

‡Visit www.panduit.com/tools for tool and die information.

*Not UL Listed or CSA Certified with Class K flex conductor when crimped with Burndy tools.

**Consult cable manufacturer for voltage stress relief instructions with applications greater than 2000 V.

◆NEMA hole sizes and spacing.



Flex Conductor, Two-Hole, Standard Barrel with Window, Narrow Tongue Lug

For Use with Flexible, Extra-Flexible, and Code Stranded Copper Conductors

Type LCDXN

- Narrow tongue width for limited space applications
- Can be used with code conductor and flex conductor class: G, H, I, K, M and Diesel Locomotive
- Generously beveled wire entry prevents bent back strands when inserting conductor into barrel
- Color-coded barrels marked with Panduit and specified competitor die index numbers for proper crimp die selection
- Inspection window to visually assure full conductor insertion
- Tin-plated to inhibit corrosion
- UL Listed and CSA Certified to 35 kV** and temperature rated to 90°C when crimped with Panduit and specified competitor crimping tools and dies
- Available with NEMA hole sizes and spacing
- Lugs available in 90 and 45 degree bent tongue. Please refer to www.panduit.com

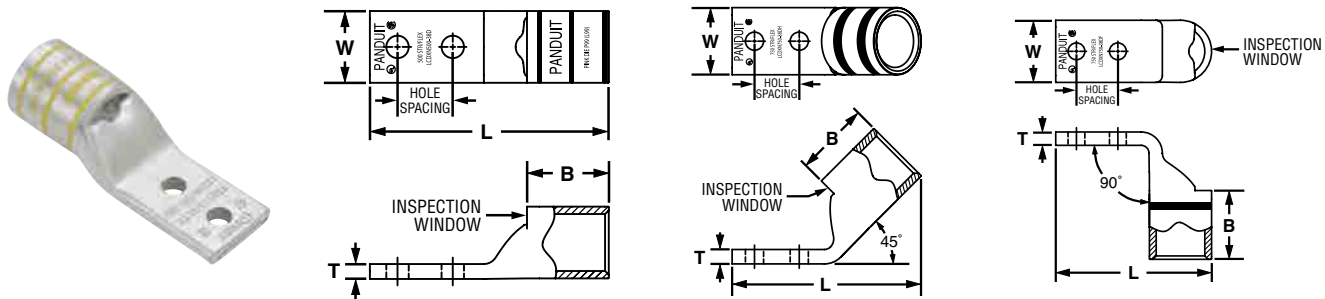

Part Number	Flex Conductor Size		Code Conductor Size	Stud Hole Size (In.)	Stud Hole Spacing (In.)	Figure Dimensions (In.)				Panduit Color Code	Panduit Die Index No.‡	Burdny Die Index No.‡	T&B Die Index No.‡	Wire Strip Length (In.)	Std. Pkg. Qty.
	Class G, H, I, K, M	Diesel Locomotive				W	B	T	L						
LCDXN2-14A-E*	#2 AWG	#2 AWG	#2 AWG	1/4	0.63	0.47	0.59	0.11	2.13	Brown	P33	10	33	11/16	20
LCDXN4/0-38D-X	4/0 AWG	4/0 AWG	4/0 AWG	3/8	1.00	0.81	1.03	0.16	3.34	Purple	P54	15	54	1 1/16	10
LCDXN350-38D-6	350 kcmil	373.7 kcmil	—	3/8	1.00	1.06	1.29	0.22	3.74	Blue	P76	19	76H	1 3/8	6
LCDXN500-38D-6	500 kcmil	535.3 kcmil	—	3/8	1.00	1.30	1.48	0.28	4.32	Pink	P99	L99	99H	1 9/16	6
◆ LCDXN500-12-6	500 kcmil	535.3 kcmil	—	1/2	1.75	1.30	1.48	0.32	5.31	Pink	P99	L99	99H	1 9/16	6
LCDXN750-38D-3	—	777.7 kcmil	—	3/8	1.00	1.50	1.66	0.34	4.62	Yellow	P115	L115	115H	1 3/4	3
◆ LCDXN750-12-3	—	777.7 kcmil	—	1/2	1.75	1.50	1.66	0.35	5.55	Yellow	P115	L115	115H	1 3/4	3

*Not UL Listed or CSA Certified with Class K flex conductor when crimped with Burdny tools.
◆NEMA hole sizes and spacing.



Flex Conductor, Two-Hole, Long Barrel with Window Lug

For Use with Flexible, Extra-Flexible, and Code Stranded Copper Conductors

Type LCCX

- Can be used with code conductor and flex conductor class: G, H, I, K, M and Diesel Locomotive
- Long barrel maximizes number of crimps and provides premium wire pull-out strength and electrical performance
- Generously beveled wire entry prevents bent back strands when inserting conductor into barrel
- Color-coded barrels marked with Panduit and specified competitor die index numbers for proper crimp die selection
- Inspection window to visually assure full conductor insertion
- Tin-plated to inhibit corrosion
- UL Listed and CSA Certified to 35 kV** and temperature rated to 90°C when crimped with Panduit and specified competitor crimping tools and dies
- Available with NEMA hole sizes and spacing
- Lugs available in 90 and 45 degree bent tongue. Please refer to www.panduit.com

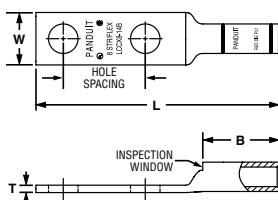

Figure 1

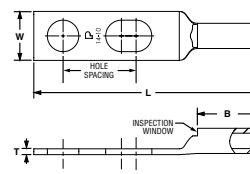

Figure 2: Slotted

Part Number	Flex Conductor Size		Code Conductor Size	Stud Hole Size (In.)	Stud Hole Spacing (In.)	Figure Dimensions (In.)				Panduit Color Code	Panduit Die Index No.‡	Burndy Die Index No.‡	T&B Die Index No.‡	Wire Strip Length (In.)	Std. Pkg. Qty.
	Class G, H, I, K, M	Diesel Locomotive				W	B	T	L						
LCCX8-10A-L	#8 AWG	#8 AWG	#8 AWG	#10	0.63	0.41	0.70	0.08	2.01	Red	P21	49	21	3/4	50
LCCX8-10B-L				#10	0.75	0.41	0.70	0.08	2.14	Red	P21	49	21	3/4	50
LCCX8-10AB-L^				#10	0.63 – 0.75	0.41	0.70	0.08	2.14	Red	P21	49	21	3/4	50
LCCX8-14A-L				1/4	0.63	0.48	0.70	0.07	2.10	Red	P21	49	21	3/4	50
LCCX8-14B-L				1/4	0.75	0.48	0.70	0.07	2.23	Red	P21	49	21	3/4	50
LCCX8-14AB-L^				1/4	0.63 – 0.75	0.48	0.70	0.07	2.23	Red	P21	49	21	3/4	50
LCCX8-14D-L				1/4	1.00	0.48	0.70	0.07	2.48	Red	P21	49	21	3/4	50
LCCX8-38D-L				3/8	1.00	0.60	0.70	0.05	2.70	Red	P21	49	21	3/4	50
LCCX6-10B-L				#6 AWG	#6 AWG	#6 AWG	#10	0.75	0.46	1.07	0.08	2.52	Blue	P24	7
LCCX6-14A-L	1/4	0.63	0.48				1.07	0.08	2.49	Blue	P24	7	24	1 1/8	50
LCCX6-14B-L	1/4	0.75	0.48				1.07	0.08	2.61	Blue	P24	7	24	1 1/8	50
LCCX6-14AB-L^	1/4	0.63 – 0.75	0.48				1.07	0.08	2.61	Blue	P24	7	24	1 1/8	50
LCCX6-14D-L	1/4	1.00	0.48				1.07	0.08	2.86	Blue	P24	7	24	1 1/8	50
LCCX6-38A-L	3/8	0.63	0.62				1.07	0.06	2.71	Blue	P24	7	24	1 1/8	50
LCCX6-38C-L	3/8	0.88	0.62				1.07	0.06	2.96	Blue	P24	7	24	1 1/8	50
LCCX6-38AC-L^	3/8	0.63 – 0.88	0.62				1.07	0.06	2.96	Blue	P24	7	24	1 1/8	50
LCCX6-38D-L	3/8	1.00	0.62				1.07	0.06	3.08	Blue	P24	7	24	1 1/8	50
LCCX4-14A-L	#4 AWG	#5, #4, #3 AWG	#4 AWG	1/4	0.63	0.55	1.05	0.09	2.49	Gray	P29	8	29	1 1/8	50
LCCX4-14B-L				1/4	0.75	0.55	1.05	0.09	2.63	Gray	P29	8	29	1 1/8	50
LCCX4-14AB-L^				1/4	0.63 – 0.75	0.55	1.05	0.09	2.63	Gray	P29	8	29	1 1/8	50
LCCX4-14CE-L^				1/4	0.88 – 1.25	0.55	1.05	0.09	3.12	Gray	P29	8	29	1 1/8	50
LCCX4-38B-L				3/8	0.75	0.62	1.05	0.08	2.84	Gray	P29	8	29	1 1/8	50
LCCX4-38D-L				3/8	1.00	0.62	1.05	0.08	3.09	Gray	P29	8	29	1 1/8	50
LCCX4-38BD-L^				3/8	0.75 – 1.00	0.62	1.05	0.08	3.09	Gray	P29	8	29	1 1/8	50

‡Visit www.panduit.com/tools for tool and die information.

*Not UL Listed or CSA Certified with Class K flex conductor when crimped with Burndy tools.

**Consult cable manufacturer for voltage stress relief instructions with applications greater than 2000 V.

^Slotted lug, refer to Figure 2.

Continues on next page



Flex Conductor, Two-Hole, Long Barrel with Window Lug (continued)

Part Number	Flex Conductor Size		Code Conductor Size	Stud Hole Size (In.)	Stud Hole Spacing (In.)	Figure Dimensions (In.)				Panduit Color Code	Panduit Die Index No.‡	Burndy Die Index No.‡	T&B Die Index No.‡	Wire Strip Length (In.)	Std. Pkg. Qty.
	Class G, H, I, K, M	Diesel Locomotive				W	B	T	L						
LCCX2-14A-E*	#2 AWG	#2 AWG	#2 AWG	1/4	0.63	0.70	1.36	0.11	2.89	Brown	P33	10	33	1 7/16	20
LCCX2-14B-E*				1/4	0.75	0.70	1.36	0.11	3.01	Brown	P33	10	33	1 7/16	20
LCCX2-38D-E*				3/8	1.00	0.70	1.36	0.11	3.46	Brown	P33	10	33	1 7/16	20
LCCX2-12-E*				1/2	1.75	0.75	1.36	0.09	4.63	Brown	P33	10	33	1 7/16	20
LCCX1-14A-X	#1 AWG	#1 AWG	#1 AWG	1/4	0.63	0.76	1.44	0.12	3.07	Green	P37	11	37	1 1/2	10
LCCX1-14B-X				1/4	0.75	0.76	1.44	0.12	3.19	Green	P37	11	37	1 1/2	10
LCCX1-14D-X				1/4	1.00	0.76	1.44	0.12	3.44	Green	P37	11	37	1 1/2	10
LCCX1-56C-X				5/16	0.88	0.76	1.44	0.12	3.37	Green	P37	11	37	1 1/2	10
LCCX1-56D-X				5/16	1.00	0.76	1.44	0.12	3.50	Green	P37	11	37	1 1/2	10
LCCX1-38D-X				3/8	1.00	0.76	1.44	0.12	3.57	Green	P37	11	37	1 1/2	10
LCCX1/0-14A-X	1/0 AWG	1/0 AWG	1/0 AWG	1/4	0.63	0.85	1.50	0.13	3.23	Pink	P42	12	42	1 9/16	10
LCCX1/0-14B-X				1/4	0.75	0.85	1.50	0.13	3.36	Pink	P42	12	42	1 9/16	10
LCCX1/0-38D-X				3/8	1.00	0.85	1.50	0.13	3.67	Pink	P42	12	42	1 9/16	10
LCCX1/0-12-X				1/2	1.75	0.85	1.50	0.13	4.83	Pink	P42	12	42	1 9/16	10
LCCX2/0-14A-X	2/0 AWG	2/0 AWG	2/0 AWG	1/4	0.63	0.96	1.50	0.13	3.27	Black	P45	13	45	1 9/16	10
LCCX2/0-14B-X				1/4	0.75	0.96	1.50	0.13	3.39	Black	P45	13	45	1 9/16	10
LCCX2/0-38D-X				3/8	1.00	0.96	1.50	0.13	3.70	Black	P45	13	45	1 9/16	10
LCCX2/0-12-X				1/2	1.75	0.96	1.50	0.13	4.87	Black	P45	13	45	1 9/16	10
LCCX3/0-14B-X	3/0 AWG	3/0 AWG	3/0 AWG	1/4	0.75	1.06	1.56	0.14	3.48	Orange	P50	14	50	1 5/8	10
LCCX3/0-38D-X				3/8	1.00	1.06	1.56	0.14	3.81	Orange	P50	14	50	1 5/8	10
LCCX4/0-14B-X	4/0 AWG	4/0 AWG	4/0 AWG	1/4	0.75	1.19	2.24	0.16	4.07	Purple	P54	15	54	2 5/16	10
LCCX4/0-38D-X				3/8	1.00	1.19	2.24	0.16	4.55	Purple	P54	15	54	2 5/16	10
LCCX4/0-12-X				1/2	1.75	1.19	2.24	0.16	5.73	Purple	P54	15	54	2 5/16	10
LCCX250-14B-X	250 kcmil	262.6 kcmil	—	1/4	0.75	1.28	2.24	0.17	4.11	Yellow	P62	16	62	2 5/16	10
LCCX250-38D-X				3/8	1.00	1.28	2.24	0.17	4.59	Yellow	P62	16	62	2 5/16	10
LCCX250-12-X				1/2	1.75	1.28	2.24	0.17	5.77	Yellow	P62	16	62	2 5/16	10
LCCX300-38D-6	300 kcmil	313.1 kcmil	—	3/8	1.00	1.39	2.30	0.18	4.67	Red	P71	18	71H	2 3/8	6
LCCX300-12-6	300 kcmil	313.1 kcmil	—	1/2	1.75	1.39	2.30	0.18	5.85	Red	P71	18	71H	2 3/8	6
LCCX350-14B-6	350 kcmil	373.7 kcmil	—	1/4	0.75	1.54	2.50	0.22	4.47	Blue	P76	19	76H	2 9/16	6
LCCX350-38D-6				3/8	1.00	1.54	2.50	0.22	4.95	Blue	P76	19	76H	2 9/16	6
LCCX350-12-6				1/2	1.75	1.54	2.50	0.22	6.13	Blue	P76	19	76H	2 9/16	6
LCCX450-12-6	450 kcmil	444.4 kcmil	—	1/2	1.75	1.70	2.69	0.26	6.37	Brown	P87	20	87	2 3/4	6
LCCX500-38D-6	500 kcmil	535.3 kcmil	—	3/8	1.00	1.89	2.88	0.26	5.72	Pink	P99	L99	99H	2 15/16	6
LCCX500-12-6				1/2	1.75	1.89	2.88	0.26	6.66	Pink	P99	L99	99H	2 15/16	6
LCCX650-12-6	—	646.4 kcmil	—	1/2	1.75	1.95	2.94	0.30	6.75	Black	P106	24	106H	3.00	6

‡Visit www.panduit.com/tools for tool and die information.

*Not UL Listed or CSA Certified with Class K flex conductor when crimped with Burndy tools.

**Consult cable manufacturer for voltage stress relief instructions with applications greater than 2000 V.

^Slotted lug, refer to Figure 2.

◆NEMA hole sizes and spacing.



Flex Conductor, Two-Hole, Long Barrel with Window, Narrow Tongue Lug

For use with Flexible and Extra-Flexible Stranded Copper Copper Conductors

Type LCCXN

- Narrow tongue width for limited space applications
- Can be used with flex conductor class: G, H, I, K, M and Diesel Locomotive
- Long barrel maximizes number of crimps and provides premium wire pull-out strength and electrical performance
- Generously beveled wire entry prevents bent back strands when inserting conductor into barrel
- Color-coded barrels marked with Panduit and specified competitor die index numbers for proper crimp die selection
- Inspection window to visually assure full conductor insertion
- Tin-plated to inhibit corrosion
- UL Listed and CSA Certified to 35 kV** and temperature rated to 90°C when crimped with Panduit and specified competitor crimping tools and dies
- Available with NEMA hole sizes and spacing

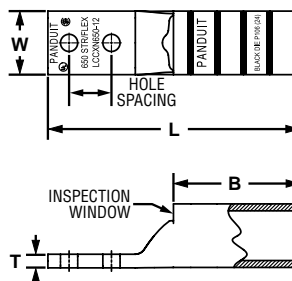

Part Number	Flex Conductor Size		Stud Hole Size (In.)	Stud Hole Spacing (In.)	Figure Dimensions (In.)				Panduit Color Code	Panduit Die Index No.‡	Burdny Die Index No.‡	T&B Die Index No.‡	Wire Strip Length (In.)	Std. Pkg. Qty.
	Class G, H, I, K, M	Diesel Locomotive			W	B	T	L						
LCCXN2-14A-E	2 AWG	2 AWG	1/4	0.625	0.47	1.36	0.13	3.01	Brown	P33	10	33	1 7/16	20
LCCXN2-14B-E	2 AWG	2 AWG	1/4	0.75	0.47	1.36	0.13	3.01	Brown	P33	10	33	1 7/16	20
LCCXN2-14D-E	2 AWG	2 AWG	1/4	1.0	0.47	1.36	0.13	3.01	Brown	P33	10	33	1 7/16	20
◆ LCCXN450-12-6	450 kcmil	444.4 kcmil	1/2	1.75	1.19	2.69	0.33	6.41	Brown	P87	20	87H	2 3/4	6
◆ LCCXN500-12-6	500 kcmil	535.3 kcmil	1/2	1.75	1.30	2.88	0.32	6.71	Pink	P99	L99	99H	2 15/16	6
◆ LCCXN650-12-6	–	646.4 kcmil	1/2	1.75	1.35	2.94	0.36	6.78	Black	P106	24	106	3	6
◆ LCCXN750-12-3	–	750 kcmil	1/2	1.75	1.5	3	0.32	6.9	Yellow	P115	L115	115H	3	3

‡Visit www.panduit.com/tools for tool and die information.
 **Consult cable manufacturer for voltage stress relief instructions with applications greater than 2000 V.
 ◆NEMA hole sizes and spacing.



Flex Conductor, Standard Barrel, Flared, NEBS Butt Splice

For Use with Flexible and Extra-Flexible Copper Conductors

Type SCSF

- Can be used with flex conductor class: K, M, and Diesel Locomotive
- Flared entry prevents bent back strands when inserting fine strand conductor into barrel
- Color-coded barrels marked with Panduit die index numbers for proper crimp die selection
- Internal wire stops to prevent over-insertion of conductor
- Tin-plated to inhibit corrosion
- UL Listed and CSA Certified to 35 kV** and temperature rated to 90°C when crimped with Panduit crimping tools and dies
- Tested by Telcordia – meets NEBS Level 3
- American Bureau of Shipping approved

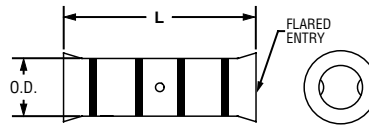

Part Number	Flex Conductor Size		Figure Dimensions (In.)		Panduit Color Code	Panduit Die Index No.‡	Wire Strip Length (In.)	Std. Pkg. Qty.
	Class K and M	Diesel Locomotive	Barrel O.D.	L				
SCSF8-L	—	#8 AWG	0.27	1.50	Red	P21	11/16	50
SCSF6-L	#6 AWG	#6 AWG	0.31	1.75	Blue	P24	13/16	50
SCSF4-L	#4 AWG	#4 AWG	0.38	1.75	Gray	P29	13/16	50
SCSF2-E	#2 AWG	#2 AWG	0.47	1.87	Brown	P33	7/8	20
SCSF1-X	#1 AWG	#1 AWG	0.52	1.87	Pink	P42	7/8	10
SCSF1/0-X	1/0 AWG	1/0 AWG	0.58	2.50	Black	P45	1 3/16	10
SCSF2/0-X	2/0 AWG	2/0 AWG	0.64	2.50	Orange	P50	1 3/16	10
SCSF3/0-X	3/0 AWG	3/0 AWG	0.71	2.50	Purple	P54	1 3/16	10
SCSF4/0-X	4/0 AWG	4/0 AWG	0.77	2.50	Yellow	P62	1 3/16	10
SCSF250-X	250 kcmil	262.6 kcmil	0.88	2.50	White	P66	1 3/16	10
SCSF300-6	300 kcmil	313.1 kcmil	0.95	2.56	Red	P71	1 1/4	6
SCSF350-6	350 kcmil	373.7 kcmil	1.06	2.94	Blue	P76	1 1/2	6

‡Visit www.panduit.com/tools for tool and die information.

**Consult cable manufacturer for voltage stress relief instructions with applications greater than 2000 V.

Code/Flex Conductor, with Window, In-Line Reducing Splice Kit**Type RSCK**

- Includes all components in one package for making a complete electrical connection: Panduit copper compression RSC in-line reducing splice (see pages D2.43 and D2.44) and crystal clear PVC heat shrink sleeves pre-cut to length to insulate reducing splice
- Panduit® RSC in-line reducing splice is UL Listed and temperature rated to 90°C when crimped with Panduit crimping tools and dies
- Panduit crystal clear PVC heat shrink has a UL 224 VW-1 flammability rating and passes Telcordia GR-347-CORE Compression and Cut-Through Penetration Test and Abrasion Resistance Test
- Panduit crystal clear PVC heat shrink is UL Recognized with a temperature rating of 150°C, high temperature insulating property
- Rated for 600 V applications when Panduit crystal clear PVC heat shrink is applied



Part Number	Part Description	Std. Pkg. Qty.
RSCK4-6-1	Kit contains: 1 pc. RSC4-6-L copper compression in-line reducing splice. 1 pc. HSTTPN50-713-Q crystal clear PVC heat shrink 1/2" dia. x 7.125" long.	1
RSCK2-6-1	Kit contains: 1 pc. RSC2-6-Q copper compression in-line reducing splice. 1 pc. HSTTPN62-750-Q crystal clear PVC heat shrink 5/8" dia. x 7.500" long.	1
RSCK2-4-1	Kit contains: 1 pc. RSC2-4-Q copper compression in-line reducing splice. 1 pc. HSTTPN62-750-Q crystal clear PVC heat shrink 5/8" dia. x 7.500" long.	1
RSCK1/0-6-1	Kit contains: 1 pc. RSC1/0-6-X copper compression in-line reducing splice. 1 pc. HSTTPN75-775-Q crystal clear PVC heat shrink 3/4" dia. x 7.750" long. 1 pc. HSTTPN50-438-L crystal clear PVC heat shrink 1/2" dia. x 4.375" long.	1
RSCK1/0-4-1	Kit contains: 1 pc. RSC1/0-4-X copper compression in-line reducing splice. 1 pc. HSTTPN75-775-Q crystal clear PVC heat shrink 3/4" dia. x 7.750" long. 1 pc. HSTTPN50-438-L crystal clear PVC heat shrink 1/2" dia. x 4.375" long.	1
RSCK2/0-6-1	Kit contains: 1 pc. RSC2/0-6-X copper compression in-line reducing splice. 1 pc. HSTTPN75-775-Q crystal clear PVC heat shrink 3/4" dia. x 7.750" long. 1 pc. HSTTPN50-438-L crystal clear PVC heat shrink 1/2" dia. x 4.375" long.	1
RSCK2/0-4-1	Kit contains: 1 pc. RSC2/0-4-X copper compression in-line reducing splice. 1 pc. HSTTPN75-775-Q crystal clear PVC heat shrink 3/4" dia. x 7.750" long. 1 pc. HSTTPN50-438-L crystal clear PVC heat shrink 1/2" dia. x 4.375" long.	1
RSCK4/0-6-1	Kit contains: 1 pc. RSC4/0-6-X copper compression in-line reducing splice. 1 pc. HSTTPN100-775-Q crystal clear PVC heat shrink 1" dia. x 7.750" long. 1 pc. HSTTPN50-438-L crystal clear PVC heat shrink 1/2" dia. x 4.375" long.	1
RSCK4/0-4-1	Kit contains: 1 pc. RSC4/0-4-X copper compression in-line reducing splice. 1 pc. HSTTPN100-775-Q crystal clear PVC heat shrink 1" dia. x 7.750" long. 1 pc. HSTTPN50-438-L crystal clear PVC heat shrink 1/2" dia. x 4.375" long.	1
RSCK4/0-1/0-1	Kit contains: 1 pc. RSC4/0-1/0-X copper compression in-line reducing splice. 1 pc. HSTTPN100-775-Q crystal clear PVC heat shrink 1" dia. x 7.750" long. 1 pc. HSTTPN75-775-Q crystal clear PVC heat shrink 3/4" dia. x 7.750" long.	1
RSCK4/0-2/0-1	Kit contains: 1 pc. RSC4/0-2/0-X copper compression in-line reducing splice. 1 pc. HSTTPN100-775-Q crystal clear PVC heat shrink 1" dia. x 7.750" long. 1 pc. HSTTPN75-775-Q crystal clear PVC heat shrink 3/4" dia. x 7.750" long.	1
RSCK500-X4/0-1	Kit contains: 1 pc. RSC500-X4/0-6 copper compression in-line reducing splice. 1 pc. HSTTPN150-925-X crystal clear PVC heat shrink 1 1/2" dia. x 9.250" long.	1
RSCK500-X350-1	Kit contains: 1 pc. RSC500-X350-6 copper compression in-line reducing splice. 1 pc. HSTTPN150-925-X crystal clear PVC heat shrink 1 1/2" dia. x 9.250" long.	1
RSCK750-4/0-1	Kit contains: 1 pc. RSC750-4/0-6 copper compression in-line reducing splice. 1 pc. HSTTPN150-925-X crystal clear PVC heat shrink 1 1/2" dia. x 9.250" long. 1 pc. HSTTPN100-775-Q crystal clear PVC heat shrink 1" dia. x 7.750" long.	1

Continues on next page

Code/Flex Conductor, with Window, In-Line Reducing Splice Kit (continued)



Part Number	Part Description	Std. Pkg. Qty.
RSC750-X4/0-1	Kit contains: 1 pc. RSC750-X4/0-6 copper compression in-line reducing splice. 1 pc. HSTTPN150-925-X crystal clear PVC heat shrink 1 1/2" dia. x 9.250" long.	1
RSC750-X350-1	Kit contains: 1 pc. RSC750-X350-6 copper compression in-line reducing splice. 1 pc. HSTTPN150-925-X crystal clear PVC heat shrink 1 1/2" dia. x 9.250" long.	1
RSC750-500-1	Kit contains: 1 pc. RSC750-500-6 copper compression in-line reducing splice. 1 pc. HSTTPN150-925-X crystal clear PVC heat shrink 1 1/2" dia. x 9.250" long.	1
RSC750-X500-1	Kit contains: 1 pc. RSC750-X500-6 copper compression in-line reducing splice. 1 pc. HSTTPN150-925-X crystal clear PVC heat shrink 1 1/2" dia. x 9.250" long.	1
RSC750-750-1	Kit contains: 1 pc. RSC750-750-6 copper compression in-line reducing splice. 1 pc. HSTTPN150-925-X crystal clear PVC heat shrink 1 1/2" dia. x 9.250" long.	1
RSCX750-4/0-1	Kit contains: 1 pc. RSCX750-4/0-3 copper compression in-line reducing splice. 1 pc. HSTTPN200-950-X crystal clear PVC heat shrink 2" dia. x 9.500" long. 1 pc. HSTTPN100-775-Q crystal clear PVC heat shrink 1" dia. x 7.750" long.	1
RSCX750-750-1	Kit contains: 1 pc. RSCX750-750-3 copper compression in-line reducing splice. 1 pc. HSTTPN200-950-X crystal clear PVC heat shrink 2" dia. x 9.500" long.	1

Code/Flex Conductor, with Window, In-Line Reducing Splice

For Use with Stranded Copper Code and Class I Flex Conductors

Type RSC

- Low profile design provides minimum space requirements
- Manufactured from seamless, high conductivity copper tubing
- Color-coded barrels marked with Panduit and specified competitor die index numbers for proper crimp die selection
- Inspection windows in each barrel to visually assure full conductor insertion
- Generous internally beveled wire entry for easy conductor insertion
- Tin-plated to inhibit corrosion
- UL Listed and CSA Certified to 35 kV** and temperature rated to 90°C when crimped with Panduit and specified competitor crimping tools and dies

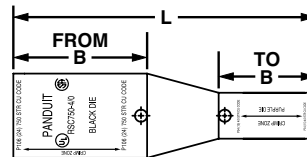

Part Number	Code Conductor Size	Figure Dimensions (In.)		Panduit Color Code	Panduit Die Index No. ‡	Burdny Die Index No. ‡	T&B Die Index No. ‡	Wire Strip Length (In.)	Std. Pkg. Qty.
		B	L						
RSC4-6-L	Reduces From	#4 – 3 AWG STR, #2 AWG SOL	1.05	2.54	Gray	P29	8	29	1
	Reduces To	#6 AWG	1.38		Blue	P24	7	24	1 5/16

‡ Visit www.panduit.com/tools for tool and die information.
 ** Consult cable manufacturer for voltage stress relief instructions with applications greater than 2000 V.

Continues on next page



Code/Flex Conductor, with Window, In-Line Reducing Splice (continued)

Part Number		Code Conductor Size	Figure Dimensions (In.)		Panduit Color Code	Panduit Die Index No.‡	Burdny Die Index No.‡	T&B Die Index No.‡	Wire Strip Length (In.)	Std. Pkg. Qty.
			B	L						
RSC2-6-Q	Reduces From	#2 AWG	1.05	2.62	Brown	P33	10	33	1	1
	Reduces To	#6 AWG	1.38		Blue	P24	7	34		
RSC2-4-Q	Reduces From	#2 AWG	1.05	2.50	Brown	P33	10	33	1	1
	Reduces To	#4 – 3 AWG STR,#2 AWG SOL	1.38		Gray	P29	8	29		
RSC1/0-6-X	Reduces From	1/0 AWG	1.05	2.81	Pink	P42	12	42	1	1
	Reduces To	#6 AWG	1.38		Blue	P24	7	24		
RSC1/0-4-X	Reduces From	1/0 AWG	1.05	2.70	Pink	P42	12	42	1	1
	Reduces To	#4 – 3 AWG STR,#2 AWG SOL	1.38		Gray	P29	8	29		
RSC2/0-6-X	Reduces From	2/0 AWG	1.13	2.99	Black	P45	13	45	1	1
	Reduces To	#6 AWG	1.38		Blue	P24	7	24		
RSC2/0-4-X	Reduces From	2/0 AWG	1.13	2.88	Black	P45	13	45	1	1
	Reduces To	#4 – 3 AWG STR,#2 AWG SOL	1.38		Gray	P29	8	29		
RSC4/0-6-X	Reduces From	4/0 AWG	1.13	3.24	Purple	P54	15	54	1	1
	Reduces To	#6 AWG	1.38		Blue	P24	7	24		
RSC4/0-4-X	Reduces From	4/0 AWG	1.13	3.12	Purple	P54	15	54	1	1
	Reduces To	#4 – 3 AWG STR,#2 AWG SOL	1.38		Gray	P29	8	29		
RSC4/0-1/0-X	Reduces From	4/0 AWG	1.16	3.13	Purple	P54	15	54	1	1
	Reduces To	1/0 AWG	1.63		Pink	P42	12	42		
RSC4/0-2/0-X	Reduces From	4/0 AWG	1.16	2.90	Purple	P54	15	54	1	1
	Reduces To	2/0 AWG	1.50		Black	P45	13	45		
RSC500-X4/0-6	Reduces From	500 kcmil	1.94	3.97	Brown	P87	20	87	1	1
	Reduces To	4/0 Flex	1.50		Yellow	P62	16	62		
RSC500-X350-6	Reduces From	500 kcmil	1.94	4.38	Brown	P87	20	87	1	1
	Reduces To	350 Flex	1.94		Blue	P76	19	76		
RSC750-4/0-6	Reduces From	750 kcmil	2.06	4.66	Black	P106	24	106	2	1
	Reduces To	4/0 AWG	1.50		Purple	P54	15	54		
RSC750-X4/0-6	Reduces From	750 kcmil	2.06	4.54	Black	P106	24	106	2	1
	Reduces To	4/0 Flex	1.50		Yellow	P62	16	62		
RSC750-X350-6	Reduces From	750 kcmil	2.06	4.45	Black	P106	24	106	2	1
	Reduces To	350 Flex	1.94		Blue	P76	19	76		
RSC750-500-6	Reduces From	750 kcmil	2.06	4.45	Black	P106	24	106	2	1
	Reduces To	500 kcmil	1.94		Brown	P87	20	87		
RSC750-X500-6	Reduces From	750 kcmil	2.06	4.63	Black	P106	24	106	2	1
	Reduces To	500 Flex	2.06		Pink	P99	400	99		
RSC750-750-6	Reduces From	750 kcmil	2.06	4.63	Black	P106	24	106	2	1
	Reduces To	750 kcmil	2.06		Black	P106	24	106		
RSCX750-4/0-3	Reduces From	750 Flex	2.06	5.04	Yellow	P115	115	115	2	1
	Reduces To	4/0 AWG	1.50		Purple	P54	15	54		
RSCX750-750-3	Reduces From	750 Flex	2.06	4.50	Yellow	P115	115	115	2	1
	Reduces To	750 kcmil	2.06		Black	P106	24	106		

‡Visit www.panduit.com/tools for tool and die information.

**Consult cable manufacturer for voltage stress relief instructions with applications greater than 2000 V.



Metric Conductor, One-Hole, Standard Barrel with Window Lug

For use with Class 2R Rigid Strand and Flexible Strand Class 5F and 6F Copper Conductors

Type LCMA

- Inspection window to visually assure full conductor insertion
- Tin-plated to inhibit corrosion
- UL Listed and CSA Certified to 35 kV** and temperature rated to 90°C when crimped with Panduit tools and dies
- Approved for Marine use by American Bureau of Shipping
- Meets EN61238-1:2003/IEC 61238-1:2003 Class B for 4mm²-240mm² Class 2r wire sizes
- Class 2r, Class 5f and Class 6f wire sizes and stud hole size marked on connector for selection and installation
- CE compliant sizes 4mm²-240mm² Class 2r wire sizes
- Product information marked on connector for selection and installation
- Rounded tongue for use in tight spaces
- Internally beveled wire entry for fast and easy installation

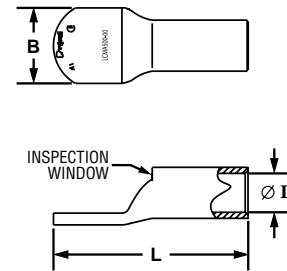
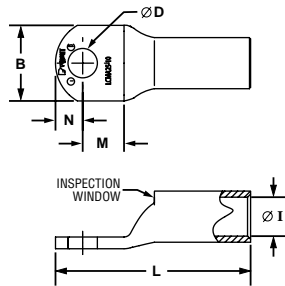

Part Number	Copper Conductor Size Class 2r (mm ²)	Copper Conductor Size class 5f/6f*** (mm ²)	Stud Hole Size (mm)	Figure Dimensions (mm)					Std. Pkg. Qty.
				ØI	B	M	N	L	
LCMA6-5-C	4 – 6	4 – 6 [^]	M5	3.8	10	7.8	6.2	27.5	100
LCMA6-6-C	4 – 6	4 – 6 [^]	M6	3.8	10.8	7.8	6.2	27.5	100
LCMA6-8-C	4 – 6	4 – 6 [^]	M8	3.8	13	8	8	30.5	100
LCMA10-5-C	10	—	M5	4.5	11	9.8	6	30.8	100
LCMA10-6-C	10	—	M6	4.5	11	9.8	6	30.8	100
LCMA10-8-C	10	—	M8	4.5	13	8.5	8	30.8	100
LCMA10-10-C	10	—	M10	4.4	14.5	8.5	8	30.8	100
LCMA16-5-C	16	10	M5	5.5	13	10.3	6.5	34.5	100
LCMA16-6-C	16	10	M6	5.5	13	10.3	6.5	34.5	100
LCMA16-8-C	16	10	M8	5.5	13	10.3	6.5	34.5	100
LCMA16-10-C	16	10	M10	5.5	15	10.2	8	36.7	100
LCMA25-6-C	25	16	M6	6.9	14	10	8	37	100
LCMA25-8-C	25	16	M8	6.9	15.5	10	8	37	100
LCMA25-10-C	25	16	M10	6.9	15.5	10	8	37	100
LCMA35-6-C	35	25	M6	8.2	15.5	12.3	8.5	42	100
LCMA35-8-C	35	25	M8	8.2	15.5	12.3	8.5	42	100
LCMA35-10-C	35	25	M10	8.2	15.5	12.3	8.5	42	100
LCMA35-12-C	35	25	M12	8.2	21.5	14.5	11.5	48	100
LCMA50-6-L	50	35	M6	9.8	18	11.5	10	46.5	50
LCMA50-8-L	50	35	M8	9.8	18	11.5	10	46.5	50
LCMA50-10-L	50	35	M10	9.8	18	11.5	10	46.5	50
LCMA50-12-L	50	35	M12	9.8	23	14	11	50	50
LCMA70-6-L	70	50	M6	11.5	20.8	14.5	11.5	53.5	50
LCMA70-8-L	70	50	M8	11.5	20.8	14.5	11.5	53.5	50
LCMA70-10-L	70	50	M10	11.5	20.8	14.5	11.5	53.5	50
LCMA70-12-L	70	50	M12	11.5	20.8	14.5	11.5	53.5	50

Visit www.panduit.com/tools for tool and die information.

**Consult cable manufacturer for voltage stress relief instructions with applications greater than 2000 V.

***Not CE compliant and not tested to EN 61238-1:2003/IEC 61238-1:2003 for terminations with metric Class 5f or Class 6f flexible stranded conductor.

[^]Class 5f conductor only



Metric Conductor, One-Hole, Standard Barrel with Window Lug (continued)

Part Number	Copper Conductor Size Class 2r (mm ²)	Copper Conductor Size class 5f/6f*** (mm ²)	Stud Hole Size (mm)	Figure Dimensions (mm)					Std. Pkg. Qty.
				ØI	B	M	N	L	
LCMA95-8-L	95	70	M8	13.5	24.5	15	13.5	60.5	50
LCMA95-10-L	95	70	M10	13.5	24.5	15	13.5	60.5	50
LCMA95-12-L	95	70	M12	13.5	24.5	15	13.5	60.5	50
LCMA95-16-L	95	70	M16	13.5	24.5	15	13.5	60.5	50
LCMA120-8-L	120	95	M8	15.2	27.5	15.5	14.5	65	50
LCMA120-10-L	120	95	M10	15.2	27.5	15.5	14.5	65	50
LCMA120-12-L	120	95	M12	15.2	27.5	15.5	14.5	65	50
LCMA120-16-L	120	95	M16	15.2	27.5	15.5	14.5	65	50
LCMA150-8-X	150	120	M8	16.5	30.5	18	16.5	70.5	10
LCMA150-10-X	150	120	M10	16.5	30.5	18	16.5	70.5	10
LCMA150-12-X	150	120	M12	16.5	30.5	18	16.5	70.5	10
LCMA150-16-X	150	120	M16	16.5	30.5	18	16.5	70.5	10
LCMA150-20-X	150	120	M20	16.5	30.5	22	16.5	74	10
LCMA185-10-X	185	150	M10	18.6	33.5	16.5	17.5	72.5	10
LCMA185-12-X	185	150	M12	18.6	33.5	16.5	17.5	72.5	10
LCMA185-16-X	185	150	M16	18.6	33.5	16.5	17.5	72.5	10
LCMA185-20-X	185	150	M20	18.6	33.5	21	17.5	77	10
LCMA240-10-X	240	185	M10	20.8	37.5	21	19.5	86.5	10
LCMA240-12-X	240	185	M12	20.8	37.5	21	19.5	86.5	10
LCMA240-16-X	240	185	M16	20.8	37.5	21	19.5	86.5	10
LCMA240-20-X	240	185	M20	20.8	37.5	21	19.5	86.5	10
LCMA300-10-5	300	240	M10	23.5	42.5	22	20	94.5	5
LCMA300-12-5	300	240	M12	23.5	42.5	22	20	94.5	5
LCMA300-16-5	300	240	M16	23.5	42.5	22	20	94.5	5
LCMA300-20-5	300	240	M20	23.5	42.5	22	20	94.5	5
LCMAX300-10-5	—	300^	M10	26.2	48.0	26.5	23.5	107.0	5
LCMAX300-12-5	—	300^	M12	26.2	48.0	26.5	23.5	107.0	5
LCMAX300-16-5	—	300^	M16	26.2	48.0	26.5	23.5	107.0	5
LCMAX300-20-5	—	300^	M20	26.2	48.0	26.5	23.5	107.0	5
LCMA400-12-5	400	—	M12	27	49.5	26.5	23.5	107	5
LCMA400-16-5	400	—	M16	27	49.5	26.5	23.5	107	5
LCMA400-20-5	400	—	M20	27	49.5	26.5	23.5	107	5
LCMA500-12-1	500	—	M12	31	57.5	28.5	25.5	120	1
LCMA500-16-1	500	—	M16	31	57.5	28.5	25.5	120	1
LCMA500-20-1	500	—	M20	31	57.5	28.5	25.5	120	1
LCMA500-00-1	500	—	Blank	31	57.5	—	—	120	1
LCMA630-16-1	630	—	M16	34.5	63	28.5	27.5	131	1
LCMA630-20-1	630	—	M20	34.5	63	28.5	27.5	131	1
LCMA630-00-1	630	—	Blank	34.5	63	—	—	131	1

Visit www.panduit.com/tools for tool and die information.

**Consult cable manufacturer for voltage stress relief instructions with applications greater than 2000 V.

***Not CE compliant and not tested to EN 61238-2:2003/IEC 61238-1:2003 for terminations with metric Class 5f or Class 6f flexible stranded conductor.

^Class 5f conductor only



Rigid and Flexible Stranded Metric Conductor, One-Hole, Standard Barrel with Window Lug, 45° Angle



For use with Class 2R Rigid Strand and Flexible Strand Class 5F and 6F Copper Conductors

Type LCMA-H

- Inspection window to visually assure full conductor insertion
- Tin-plated to inhibit corrosion
- UL Listed and CSA Certified to 35 kV** and temperature rated to 90°C when crimped with Panduit tools and dies
- Approved for Marine use by American Bureau of Shipping
- Class 2r, Class 5f and Class 6f wire sizes and stud hole size marked on connector for selection and installation
- Rounded tongue for use in tight spaces
- Internally beveled wire entry for fast and easy installation
- Meets EN61238-1:2003/IEC 61238-1-2003 Class B for 4mm²-240mm² Class 2r wire sizes
- CE compliant sizes 4mm²-240mm² Class 2r wire sizes

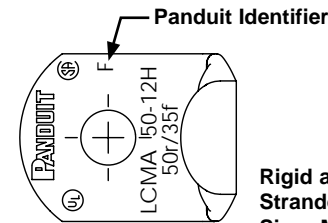
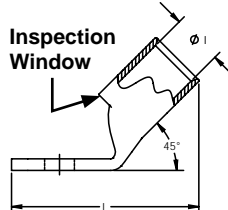
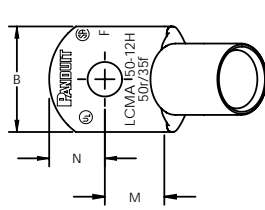

Rigid and Flexible Stranded Conductor Sizes Marked on Part

Part Number	Copper Conductor Size Class 2r (mm ²)	Copper Conductor Size class 5f/6f [^] (mm ²)	Stud Hole Size (mm)	Figure Dimensions					Std. Pkg. Qty.
				ØI	B	M	N	L	
LCMA10-5H-C	10	—	M5	4.5	11	9.8	6	27.6	100
LCMA10-6H-C	10	—	M6	4.5	11	9.8	6	27.6	100
LCMA10-8H-C	10	—	M8	4.5	13	8.5	8	27.7	100
LCMA10-10H-C	10	—	M10	4.4	14.5	8.5	8	28	100
LCMA16-5H-C	16	10	M5	5.5	13	10.3	6.5	30.4	100
LCMA16-6H-C	16	10	M6	5.5	13	10.3	6.5	30.4	100
LCMA16-8H-C	16	10	M8	5.5	13	10.3	6.5	30.3	100
LCMA16-10H-C	16	10	M10	5.5	15	10.2	8	32.3	100
LCMA25-6H-C	25	16	M6	6.9	14	10	8	31.8	100
LCMA25-8H-C	25	16	M8	6.9	15.5	10	8	31.8	100
LCMA25-10H-C	25	16	M10	6.9	15.5	10	8	31.7	100
LCMA35-6H-C	35	25	M6	8.2	15.5	12.3	8.5	36.7	100
LCMA35-8H-C	35	25	M8	8.2	15.5	12.3	8.5	36.7	100
LCMA35-10H-C	35	25	M10	8.2	15.5	12.3	8.5	36.7	100
LCMA35-12H-C	35	25	M12	8.2	21.5	14.5	11.5	42.1	100
LCMA50-6H-L	50	35	M6	9.8	18	11.5	10	40.1	50
LCMA50-8H-L	50	35	M8	9.8	18	11.5	10	40.1	50
LCMA50-10H-L	50	35	M10	9.8	18	11.5	10	40.1	50
LCMA50-12H-L	50	35	M12	9.8	23	14	11	43.1	50

Visit www.panduit.com/tools for tool and die information.

[^]Class 5f conductor only.

**Consult cable manufacturer for voltage stress relief instructions with applications greater than 2000 V.

[^]Not CE compliant and not tested to EN 61238-1:2003/IEC 61238-1:2003 for terminations with metric Class 5f or Class 6f flexible stranded conductor.

Continues on next page

**Rigid and Flexible Stranded Metric Conductor, One-Hole,
Standard Barrel with Window Lug, 45° Angle (continued)**

Part Number	Copper Conductor Size Class 2r (mm ²)	Copper Conductor Size class 5f/6f [^] (mm ²)	Stud Hole Size (mm)	Figure Dimensions					Std. Pkg. Qty.
				ØI	B	M	N	L	
LCMA70-6H-L	70	50	M6	11.5	20.8	14.5	11.5	46.8	50
LCMA70-8H-L	70	50	M8	11.5	20.8	14.5	11.5	46.8	50
LCMA70-10H-L	70	50	M10	11.5	20.8	14.5	11.5	46.8	50
LCMA70-12H-L	70	50	M12	11.5	20.8	14.5	11.5	46.7	50
LCMA95-8H-L	95	70	M8	13.5	24.5	15	13.5	52.6	50
LCMA95-10H-L	95	70	M10	13.5	24.5	15	13.5	52.6	50
LCMA95-12H-L	95	70	M12	13.5	24.5	15	13.5	52.6	50
LCMA95-16H-L	95	70	M16	13.5	24.5	15	13.5	52.5	50
LCMA120-8H-L	120	95	M8	15.2	27.5	15.5	14.5	56.6	50
LCMA120-10H-L	120	95	M10	15.2	27.5	15.5	14.5	56.6	50
LCMA120-12H-L	120	95	M12	15.2	27.5	15.5	14.5	56.6	50
LCMA120-16H-L	120	95	M16	15.2	27.5	15.5	14.5	56.6	50
LCMA150-8H-X	150	120	M8	16.5	30.5	18	16.5	64.7	10
LCMA150-10H-X	150	120	M10	16.5	30.5	18	16.5	64.7	10
LCMA150-12H-X	150	120	M12	16.5	30.5	18	16.5	64.7	10
LCMA150-16H-X	150	120	M16	16.5	30.5	18	16.5	64.6	10
LCMA150-20H-X	150	120	M20	16.5	30.5	22	16.5	68.3	10
LCMA185-10H-X	185	150	M10	18.6	33.5	16.5	17.5	66	10
LCMA185-12H-X	185	150	M12	18.6	33.5	16.5	17.5	66	10
LCMA185-16H-X	185	150	M16	18.6	33.5	16.5	17.5	66	10
LCMA185-20H-X	185	150	M20	18.6	33.5	21	17.5	70.5	10
LCMA240-10H-X	240	185	M10	20.8	37.5	21	19.5	79.3	10
LCMA240-12H-X	240	185	M12	20.8	37.5	21	19.5	79.3	10
LCMA240-16H-X	240	185	M16	20.8	37.5	21	19.5	79.3	10
LCMA240-20H-X	240	185	M20	20.8	37.5	21	19.5	79.3	10
LCMA300-10H-5	300	240	M10	23.5	42.5	22	20	85.5	5
LCMA300-12H-5	300	240	M12	23.5	42.5	22	20	82.5	5
LCMA300-16H-5	300	240	M16	23.5	42.5	22	20	85.5	5
LCMA300-20H-5	300	240	M20	23.5	42.5	22	20	85.4	5
LCMAX300-10H-5 [^]	–	300*	M10	26.2	48	26.5	23.5	98.4	5
LCMAX300-12H-5 [^]	–	300*	M12	26.2	48	26.5	23.5	98.4	5
LCMAX300-16H-5 [^]	–	300*	M16	26.2	48	26.5	23.5	98.4	5
LCMAX300-20H-5 [^]	–	300*	M20	26.2	48	26.5	23.5	98.4	5

Visit www.panduit.com/tools for tool and die information.

*Class 5f conductor only.

**Consult cable manufacturer for voltage stress relief instructions with applications greater than 2000 V.

[^]Not CE compliant and not tested to EN 61238-:2003/IEC 61238-1:2003 for terminations with metric Class 5f or Class 6f flexible stranded conductor.



Rigid and Flexible Stranded Metric Conductor, One-Hole, Standard Barrel with Window Lug, 90° Angle



For use with Class 2R Rigid Strand and Flexible Strand Class 5F and 6F Copper Conductors

Type LCMA-F

- Inspection window to visually assure full conductor insertion
- Tin-plated to inhibit corrosion
- UL Listed and CSA Certified to 35 kV** and temperature rated to 90°C when crimped with Panduit tools and dies
- Approved for Marine use by American Bureau of Shipping
- Class 2r, Class 5f and Class 6f wire sizes and stud hole size marked on connector for selection and installation
- Rounded tongue for use in tight spaces
- Internally beveled wire entry for fast and easy installation
- Meets EN61238-1:2003/IEC 61238-1-2003 Class B for 4mm²-240mm² Class 2r wire sizes
- CE compliant sizes 4mm²-240mm² Class 2r wire sizes

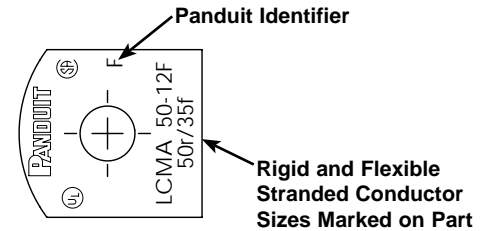
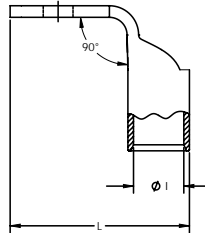
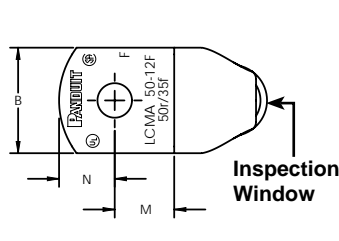

Part Number	Copper Conductor Size Class 2r (mm ²)	Copper Conductor Size class 5f/6f ^A (mm ²)	Stud Hole Size (mm)	Figure Dimensions					Std. Pkg. Qty.
				Ø1	B	M	N	L	
LCMA10-5F-C	10	—	M5	4.5	11	9.8	6	24.5	100
LCMA10-6F-C	10	—	M6	4.5	11	9.8	6	24.5	100
LCMA10-8F-C	10	—	M8	4.5	13	8.5	8	25.2	100
LCMA10-10F-C	10	—	M10	4.4	14.5	8.5	8	26.2	100
LCMA16-5F-C	16	10	M5	5.5	13	10.3	6.5	26.5	100
LCMA16-6F-C	16	10	M6	5.5	13	10.3	6.5	26.5	100
LCMA16-8F-C	16	10	M8	5.5	13	10.3	6.5	26.5	100
LCMA16-10F-C	16	10	M10	5.5	15	10.2	8	27.9	100
LCMA25-6F-C	25	16	M6	6.9	14	10	8	29.9	100
LCMA25-8F-C	25	16	M8	6.9	15.5	10	8	29.3	100
LCMA25-10F-C	25	16	M10	6.9	15.5	10	8	29.9	100
LCMA35-6F-C	35	25	M6	8.2	15.5	12.3	8.5	34.7	100
LCMA35-8F-C	35	25	M8	8.2	15.5	12.3	8.5	34.7	100
LCMA35-10F-C	35	25	M10	8.2	15.5	12.3	8.5	34.7	100
LCMA35-12F-C	35	25	M12	8.2	21.5	14.5	11.5	40	100
LCMA50-6F-L	50	35	M6	9.8	18	11.5	10	38.4	50
LCMA50-8F-L	50	35	M8	9.8	18	11.5	10	38.4	50
LCMA50-10F-L	50	35	M10	9.8	18	11.5	10	38.4	50
LCMA50-12F-L	50	35	M12	9.8	23	14	11	41.9	50
LCMA70-6F-L	70	50	M6	11.5	20.8	14.5	11.5	42.3	50
LCMA70-8F-L	70	50	M8	11.5	20.8	14.5	11.5	42.3	50
LCMA70-10F-L	70	50	M10	11.5	20.8	14.5	11.5	42.3	50
LCMA70-12F-L	70	50	M12	11.5	20.8	14.5	11.5	42.3	50
LCMA95-8F-L	95	70	M8	13.5	24.5	15	13.5	50.1	50
LCMA95-10F-L	95	70	M10	13.5	24.5	15	13.5	50.1	50
LCMA95-12F-L	95	70	M12	13.5	24.5	15	13.5	50.1	50
LCMA95-16F-L	95	70	M16	13.5	24.5	15	13.5	50.1	50

Visit www.panduit.com/tools for tool and die information.

^AClass 5f conductor only.

**Consult cable manufacturer for voltage stress relief instructions with applications greater than 2000 V.

^ANot CE compliant and not tested to EN 61238-1:2003/IEC 61238-1:2003 for terminations with metric Class 5f or Class 6f flexible stranded conductor.

Continues on next page



Rigid and Flexible Stranded Metric Conductor, One-Hole, Standard Barrel with Window Lug, 90° Angle (continued)

Part Number	Copper Conductor Size Class 2r (mm ²)	Copper Conductor Size class 5f/6f [^] (mm ²)	Stud Hole Size (mm)	Figure Dimensions					Std. Pkg. Qty.
				ØI	B	M	N	L	
LCMA120-8F-L	120	95	M8	15.2	27.5	15.5	14.5	54.2	50
LCMA120-10F-L	120	95	M10	15.2	27.5	15.5	14.5	54.2	50
LCMA120-12F-L	120	95	M12	15.2	27.5	15.5	14.5	54.2	50
LCMA120-16F-L	120	95	M16	15.2	27.5	15.5	14.5	54.2	50
LCMA150-8F-X	150	120	M8	16.5	30.5	18	16.5	60.5	10
LCMA150-10F-X	150	120	M10	16.5	30.5	18	16.5	60.5	10
LCMA150-12F-X	150	120	M12	16.5	30.5	18	16.5	60.5	10
LCMA150-16F-X	150	120	M16	16.5	30.5	18	16.5	60.5	10
LCMA150-20F-X	150	120	M20	16.5	30.5	22	16.5	64.5	10
LCMA185-10F-X	185	150	M10	18.6	33.5	16.5	17.5	62	10
LCMA185-12F-X	185	150	M12	18.6	33.5	16.5	17.5	62	10
LCMA185-16F-X	185	150	M16	18.6	33.5	18.5	17.5	64	10
LCMA185-20F-X	185	150	M20	18.6	33.5	21	17.5	66.5	10
LCMA240-10F-X	240	185	M10	20.8	37.5	21	19.5	71.5	10
LCMA240-12F-X	240	185	M12	20.8	37.5	21	19.5	71.5	10
LCMA240-16F-X	240	185	M16	20.8	37.5	21	19.5	71.5	10
LCMA240-20F-X	240	185	M20	20.8	37.5	21	19.5	71.5	10
LCMA300-10F-5	300	240	M10	23.5	42.5	22	20	77.3	5
LCMA300-12F-5	300	240	M12	23.5	42.5	22	20	77.3	5
LCMA300-16F-5	300	240	M16	23.5	42.5	22	20	77.3	5
LCMA300-20F-5	300	240	M20	23.5	42.5	22	20	77.3	5
LCMAX300-10F-5 [^]	–	300 [*]	M10	26.2	48	26.5	23.5	88	5
LCMAX300-12F-5 [^]	–	300 [*]	M12	26.2	48	26.5	23.5	88	5
LCMAX300-16F-5 [^]	–	300 [*]	M16	26.2	48	26.5	23.5	88	5
LCMAX300-20F-5 [^]	–	300 [*]	M20	26.2	48	26.5	23.5	88	5

Visit www.panduit.com/tools for tool and die information.

^{*}Class 5f conductor only.

^{**}Consult cable manufacturer for voltage stress relief instructions with applications greater than 2000 V.

[^]Not CE compliant and not tested to EN 61238-:2003/IEC 61238-1:2003 for terminations with metric Class 5f or Class 6f flexible stranded conductor.



Rigid and Flexible Stranded Metric Conductor, One-Hole, Long Barrel Lug, No Window



For use with Class 2R Rigid Strand and Flexible Strand Class 5F and 6F Copper Conductors

Type LCMB

- Long barrel design to maximize number of crimps
- No inspection window to prevent contaminants from entering barrel
- Tin-plated to inhibit corrosion
- UL Listed and CSA Certified to 35 kV** and temperature rated to 90°C when crimped with Panduit® tools and dies
- Approved for Marine use by American Bureau of Shipping
- Class 2r, Class 5f and Class 6f wire sizes and stud hole size marked on connector for selection and installation
- Rounded tongue for use in tight spaces
- Internally beveled wire entry for fast and easy installation
- Meets EN61238-1:2003/IEC 61238-1-2003 Class B for 4mm²-240mm² Class 2r wire sizes
- CE compliant sizes 10mm²-240mm² Class 2r wire sizes

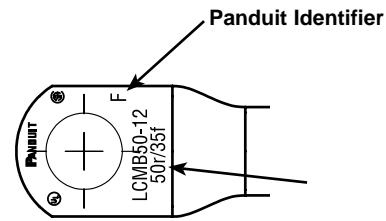
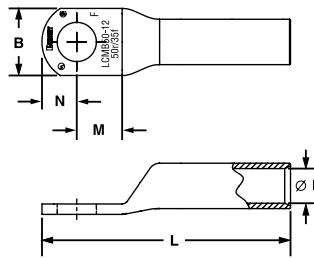

Rigid and Flexible Stranded Conductor Sizes Marked on Part

Part Number	Copper Conductor Size Class 2r (mm ²)	Copper Conductor Size class 5f/6f ^A (mm ²)	Stud Hole Size (mm)	Figure Dimensions					Std. Pkg. Qty.
				ØI	B	M	N	L	
LCMB10-5-L	10	—	M5	4.5	11	9.8	6	43.8	50
LCMB10-6-L	10	—	M6	4.5	11	9.8	6	43.8	50
LCMB10-8-L	10	—	M8	4.5	13	8.5	8	43.8	50
LCMB10-10-L	10	—	M10	4.4	14.5	8.5	8	43.8	50
LCMB16-5-L	16	10	M5	5.5	13	10.3	6.5	47.2	50
LCMB16-6-L	16	10	M6	5.5	13	10.3	6.5	47.2	50
LCMB16-8-L	16	10	M8	5.5	13	10.3	6.5	47.2	50
LCMB16-10-L	16	10	M10	5.5	15	10.2	8	49.4	50
LCMB25-6-L	25	16	M6	6.9	14	10	8	48.7	50
LCMB25-8-L	25	16	M8	6.9	15.5	10	8	48.7	50
LCMB25-10-L	25	16	M10	6.9	15.5	10	8	48.7	50
LCMB35-6-Q	35	25	M6	8.2	15.5	12.3	8.5	57.3	25
LCMB35-8-Q	35	25	M8	8.2	15.5	12.3	8.5	57.3	25
LCMB35-10-Q	35	25	M10	8.2	15.5	12.3	8.5	57.3	25
LCMB35-12-Q	35	25	M12	8.2	21.5	14.5	11.5	63.3	25
LCMB50-6-E	50	35	M6	9.8	18	11.5	10	62.8	20
LCMB50-8-E	50	35	M8	9.8	18	11.5	10	62.8	20
LCMB50-10-E	50	35	M10	9.8	18	11.5	10	62.8	20
LCMB50-12-E	50	35	M12	9.8	23	14	11	66.3	20
LCMB70-8-X	70	50	M8	11.5	20.8	14.5	11.5	68.2	10
LCMB70-10-X	70	50	M10	11.5	20.8	14.5	11.5	68.2	10
LCMB70-12-X	70	50	M12	11.5	20.8	14.5	11.5	68.2	10

Visit www.panduit.com/tools for tool and die information.

^AClass 5f conductor only.

**Consult cable manufacturer for voltage stress relief instructions with applications greater than 2000 V.

^ANot CE compliant and not tested to EN 61238-1:2003/IEC 61238-1:2003 for terminations with metric Class 5f or Class 6f flexible stranded conductor.



Rigid and Flexible Stranded Metric Conductor, One-Hole, Long Barrel Lug, No Window (continued)

Part Number	Copper Conductor Size Class 2r (mm ²)	Copper Conductor Size class 5f/6f [^] (mm ²)	Stud Hole Size (mm)	Figure Dimensions					Std. Pkg. Qty.
				ØI	B	M	N	L	
LCMB95-8-X	95	70	M8	13.5	24.5	15	13.5	79	10
LCMB95-10-X	95	70	M10	13.5	24.5	15	13.5	79	10
LCMB95-12-X	95	70	M12	13.5	24.5	15	13.5	79	10
LCMB95-16-X	95	70	M16	13.5	24.5	15	13.5	79	10
LCMB120-8-X	120	95	M8	15.2	27.5	15.5	14.5	80.2	10
LCMB120-10-X	120	95	M10	15.2	27.5	15.5	14.5	80.2	10
LCMB120-12-X	120	95	M12	15.2	27.5	15.5	14.5	80.2	10
LCMB120-16-X	120	95	M16	15.2	27.5	15.5	14.5	80.2	10
LCMB150-8-X	150	120	M8	16.5	30.5	18	16.5	100	10
LCMB150-10-X	150	120	M10	16.5	30.5	18	16.5	100	10
LCMB150-12-X	150	120	M12	16.5	30.5	18	16.5	100	10
LCMB150-16-X	150	120	M16	16.5	30.5	18	16.5	100	10
LCMB150-20-X	150	120	M20	16.5	30.5	22	16.5	103.5	10
LCMB185-10-X	185	150	M10	18.6	33.5	16.5	17.5	100.6	10
LCMB185-12-X	185	150	M12	18.6	33.5	16.5	17.5	100.6	10
LCMB185-16-X	185	150	M16	18.6	33.5	16.5	17.5	100.6	10
LCMB185-20-X	185	150	M20	18.6	33.5	21	17.5	105.1	10
LCMB240-10-6	240	185	M10	20.8	37.5	21	19.5	115	6
LCMB240-12-6	240	185	M12	20.8	37.5	21	19.5	115	6
LCMB240-16-6	240	185	M16	20.8	37.5	21	19.5	115	6
LCMB240-20-6	240	185	M20	20.8	37.5	21	19.5	115	6
LCMB300-10-6	300	240	M10	23.5	42.5	22	20	122.6	6
LCMB300-12-6	300	240	M12	23.5	42.5	22	20	122.6	6
LCMB300-16-6	300	240	M16	23.5	42.5	22	20	122.6	6
LCMB300-20-6	300	240	M20	23.5	42.5	22	20	122.6	6
LCMBX300-10-6 [^]	—	300*	M10	26.2	48	26.5	23.5	135.2	6
LCMBX300-12-6 [^]	—	300*	M12	26.2	48	26.5	23.5	135.2	6
LCMBX300-16-6 [^]	—	300*	M16	26.2	48	26.5	23.5	135.2	6
LCMBX300-20-6 [^]	—	300*	M20	26.2	48	26.5	23.5	135.2	6
LCMB400-12-6	400	—	M12	27	49.5	26.5	23.5	127.4	6
LCMB400-16-6	400	—	M16	27	49.5	26.5	23.5	127.4	6
LCMB400-20-6	400	—	M20	27	49.5	26.5	23.5	127.4	6
LCMB500-12-3	500	—	M12	31	57.5	28.5	25.5	149.7	3
LCMB500-16-3	500	—	M16	31	57.5	28.5	25.5	149.7	3
LCMB500-20-3	500	—	M20	31	57.5	28.5	25.5	149.7	3
LCMB630-16-3	630	—	M16	34.5	63	28.5	27.5	159.1	3
LCMB630-20-3	630	—	M20	34.5	63	28.5	27.5	159.1	3

Visit www.panduit.com/tools for tool and die information.

*Class 5f conductor only.

**Consult cable manufacturer for voltage stress relief instructions with applications greater than 2000 V.

[^]Not CE compliant and not tested to EN 61238-2:2003/IEC 61238-1:2003 for terminations with metric Class 5f or Class 6f flexible stranded conductor.



Metric Conductor, Two-Hole, Standard Barrel with Window Lug

For use with Class 2R Rigid Strand and Flexible Strand Class 5F and 6F Copper Conductors

Type LCMD

- Inspection window to visually assure full conductor insertion
- Tin-plated to inhibit corrosion
- UL Listed and CSA Certified to 35 kV** and temperature rated to 90°C when crimped with Panduit® tools and dies
- Class 2r, Class 5f and Class 6f wire sizes and stud hole size marked on connector for selection and installation
- Internally beveled wire entry for fast and easy installation
- Approved for Marine use by American Bureau of Shipping
- Meets EN61238-1:2003/IEC 61238-1-2003 Class B for 4mm²-630mm² Class 2r wire sizes
- CE compliant sizes 4mm²-630mm² Class 2r wire sizes

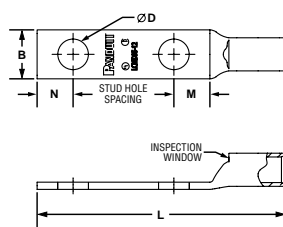

Figure 1

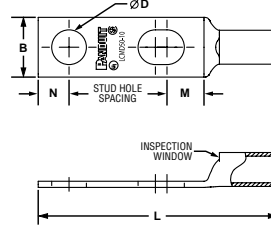

Figure 2

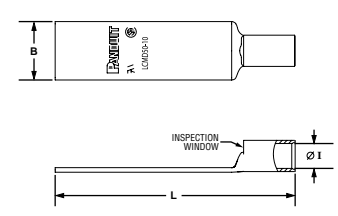

Figure 3

Part Number	Figure No.	Copper Conductor Size Class 2r (mm ²)	Copper Conductor Size class 5f/6f*** (mm ²)	Stud Hole Size (mm)	Stud Hole Spacing (mm)	Figure Dimensions (mm)					Std. Pkg. Qty.	
						ØI	B	M	N	L		ØD
LCMD6-5CD-Q	2	4 – 6	4-6^	M5	22.0 – 25.0	3.8	10	7.8	6.2	52.5	5.5	25
LCMD10-6CD-Q	2	10	—	M6	22.0 – 25.0	4.5	11	9.8	6	55.8	6.6	25
LCMD10-8-Q	1	10	—	M8	44.5	4.5	13	8.5	8	75.3	9.0	25
LCMD10-00-Q	3	10	—	Blank	—	4.4	14.5	—	—	75.3	—	25
LCMD16-6CD-Q	2	16	10	M6	22.0 – 25.0	5.5	13	10.3	6.5	59.5	6.6	25
LCMD16-8-Q	1	16	10	M8	44.5	5.5	13	10.3	6.5	79	9.0	25
LCMD16-00-Q	3	16	10	Blank	—	5.5	15	—	—	81.2	—	25
LCMD25-8CD-Q	2	25	16	M8	22.0 – 25.0	6.9	15.5	10	8	62	9.0	25
LCMD25-8-Q	1	25	16	M8	44.5	6.9	15.5	10	8	81.5	9.0	25
LCMD25-10-Q	1	25	16	M10	44.5	6.9	15.5	10	8	81.5	11.0	25
LCMD25-12-Q	1	25	16	M12	44.5	7.1	20	14.5	11.5	89.5	14.0	25
LCMD25-00-Q	3	25	16	Blank	—	7.1	20	—	—	89.5	—	25
LCMD35-8CD-Q	2	35	25	M8	22.0 – 25.0	8.2	15.5	12.3	8.5	67	9.0	25
LCMD35-10-Q	1	35	25	M10	44.5	8.2	15.5	12.3	8.5	86.5	11.0	25
LCMD35-12-Q	1	35	25	M12	44.5	8.2	21.5	14.5	11.5	92.5	14.0	25
LCMD35-00-Q	3	35	25	Blank	—	8.2	21.5	—	—	92.5	—	25
LCMD50-10CD-X	2	50	35	M10	22.0 – 25.0	9.8	18	11.5	10	71.5	11.0	10
LCMD50-10-X	1	50	35	M10	44.5	9.8	18	11.5	10	91	11.0	10
LCMD50-12-X	1	50	35	M12	44.5	9.8	23	14	11	94.5	14.0	10
LCMD50-00-X	3	50	35	Blank	—	9.8	23	—	—	94.5	—	10
LCMD70-10CD-X	2	70	50	M10	22.0 – 25.0	11.5	20.5	14.5	11	78.5	11.0	10
LCMD70-10-X	1	70	50	M10	44.5	11.5	20.8	14.5	11.5	98	11.0	10
LCMD70-12-X	1	70	50	M12	44.5	11.5	20.8	14.5	11.5	98	14.0	10
LCMD70-00-X	3	70	50	Blank	—	11.5	20.8	—	—	98	—	10
LCMD95-10CD-X	2	95	70	M10	22.0 – 25.0	13.5	24.5	15	13	85.5	11.0	10
LCMD95-12-X	1	95	70	M12	44.5	13.5	24.5	15	13.5	105	14.0	10

Visit www.panduit.com/tools for tool and die information.

**Consult cable manufacturer for voltage stress relief instructions with applications greater than 2000 V.

***Not CE compliant and not tested to EN 61238-1:2003/IEC 61238-1-2003 for terminations with metric Class 5f or Class 6f flexible stranded conductor.

^Class 5f conductor only

**Metric Conductor, Two-Hole, Standard Barrel
with Window Lug (continued)**

Part Number	Figure No.	Copper Conductor Size Class 2r (mm ²)	Copper Conductor Size class 5f/6f*** (mm ²)	Stud Hole Size (mm)	Stud Hole Spacing (mm)	Figure Dimensions (mm)						Std. Pkg. Qty.
						ØI	B	M	N	L	ØD	
LCMD95-14-X	1	95	70	M14	44.5	13.5	24.5	15	13.5	105	16.0	10
LCMD95-00-X	3	95	70	Blank	—	13.5	24.5	—	—	105	—	10
LCMD120-10CD-X	2	120	95	M10	22.0 – 25.0	15.2	27.5	15.5	14	90	11.0	10
LCMD120-12-X	1	120	95	M12	44.5	15.2	27.5	15.5	14.5	109.5	14.0	10
LCMD120-14-X	1	120	95	M14	44.5	15.2	27.5	15.5	14.5	109.5	16.0	10
LCMD120-00-X	3	120	95	Blank	—	15.2	27.5	—	—	109.5	—	10
LCMD150-10CD-X	2	150	120	M10	22.0 – 25.0	16.5	30.5	18	16	95.5	11.0	10
LCMD150-12-X	1	150	120	M12	44.5	16.5	30.5	18	16.5	115	14.0	10
LCMD150-14-X	1	150	120	M14	44.5	16.5	30.5	22	16.5	118.5	16.0	10
LCMD150-00-X	3	150	120	Blank	—	16.5	30.5	—	—	118.5	—	10
LCMD185-10CD-X	2	185	150	M10	22.0 – 25.0	18.6	33.5	16.5	17	97.5	11.0	10
LCMD185-12-X	1	185	150	M12	44.5	18.6	33.5	16.5	17.5	117	14.0	10
LCMD185-14-X	1	185	150	M14	44.5	18.6	33.5	21	17.5	121.5	16.0	10
LCMD185-00-X	3	185	150	Blank	—	18.6	33.5	—	—	121.5	—	10
LCMD240-10CD-5	2	240	185	M10	22.0 – 25.0	20.8	37.5	21	19	111.5	11.0	5
LCMD240-12-5	1	240	185	M12	44.5	20.8	37.5	21	19.5	131	14.0	5
LCMD240-14-5	1	240	185	M14	44.5	20.8	37.5	21	19.5	131	16.0	5
LCMD240-00-5	3	240	185	Blank	—	20.8	37.5	—	—	131	—	5
LCMD300-12-5	1	300	240	M12	44.5	23.5	42.5	22	20	139	14.0	5
LCMD300-14-5	1	300	240	M14	44.5	23.5	42.5	22	20	139	16.0	5
LCMD300-00-5	3	300	240	Blank	—	23.5	42.5	—	—	139	—	5
LCMDX300-12-5	1	—	300 [^]	M12	44.5	26.2	48	26.5	23.5	151.5	14.0	5
LCMDX300-14-5	1	—	300 [^]	M14	44.5	26.2	48	26.5	23.5	151.5	16.0	5
LCMDX300-00-5	3	—	300 [^]	Blank	—	26.2	48	—	—	151.5	—	5
LCMD400-12-5	1	400	—	M12	44.5	27	49.5	26.5	23.5	151.5	14.0	5
LCMD400-14-5	1	400	—	M14	44.5	27	49.5	26.5	23.5	151.5	16.0	5
LCMD400-16-5	1	400	—	M16	44.5	27	49.5	26.5	23.5	151.5	18.0	5
LCMD400-00-5	3	400	—	Blank	—	27	49.5	—	—	151.5	—	5
LCMD500-12-1	1	500	—	M12	44.5	31	57.5	28.5	25.5	164.5	14.0	1
LCMD500-14-1	1	500	—	M14	44.5	31	57.5	28.5	25.5	164.5	16.0	1
LCMD500-16-1	1	500	—	M16	44.5	31	57.5	28.5	25.5	164.5	18.0	1
LCMD500-00-1	3	500	—	Blank	—	31	57.5	—	—	164.5	—	1
LCMD630-12-1	1	630	—	M12	44.5	34.5	63	28.5	27.5	175.5	14.0	1
LCMD630-14-1	1	630	—	M14	44.5	34.5	63	28.5	27.5	175.5	16.0	1
LCMD630-16-1	1	630	—	M16	44.5	34.5	63	28.5	27.5	175.5	18.0	1
LCMD630-00-1	3	630	—	Blank	—	34.5	63	—	—	175.5	—	1

Visit www.panduit.com/tools for tool and die information.

**Consult cable manufacturer for voltage stress relief instructions with applications greater than 2000 V.

***Not CE compliant and not tested to EN 61238-2:2003/IEC 61238-1:2003 for terminations with metric Class 5f or Class 6f flexible stranded conductor.

[^]Class 5f conductor only



Rigid and Flexible Stranded Metric Conductor, Two-Hole, Long Barrel Lug, No Window



For use with Class 2R Rigid Strand and Flexible Strand Class 5F and 6F Copper Conductors

Type LCMC

- Long barrel design to maximize number of crimps
- No inspection window to prevent contaminants from entering barrel
- Tin-plated to inhibit corrosion
- UL Listed and CSA Certified to 35 kV** and temperature rated to 90°C when crimped with Panduit® tools and dies
- Approved for Marine use by American Bureau of Shipping
- Class 2r, Class 5f, and Class 6f wire sizes and stud hole size marked on connector for selection and installation
- Internally beveled wire entry for fast and easy installation
- Meets EN61238-1:2003/IEC 61238-1-2003 Class B for 10mm²-630mm² Class 2r wire sizes
- CE compliant sizes 10mm²-630mm² Class 2r wire sizes

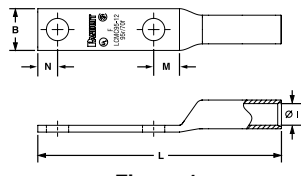

Figure 1.
Two-Hole

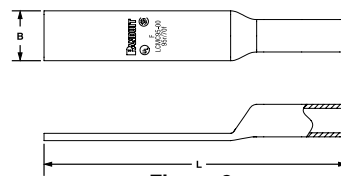
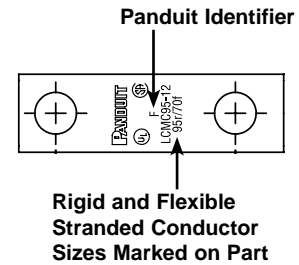

Figure 2.
Blank Tongue



Part Number	Figure No.	Copper Conductor Size Class 2r (mm ²)	Copper Conductor Size Class 5f/6f ^A (mm ²)	Stud Hole Size (mm)	Stud Hold Spacing (mm)	Figure Dimensions (mm)					Std. Pkg. Qty.
						ØI	B	M	N	L	
LCMC10-00-L	2	10	—	Blank	—	4.4	14.5	—	—	87.8	50
LCMC10-8-L	1	10	—	M8	44.5	4.5	13	8.5	8	87.8	50
LCMC16-00-L	2	16	10	Blank	—	5.5	15	—	—	93.9	50
LCMC16-8-L	1	16	10	M8	44.5	5.5	13	10.3	6.5	91.7	50
LCMC25-00-L	2	25	16	Blank	—	7.1	20	—	—	101.2	50
LCMC25-8-L	1	25	16	M8	44.5	6.9	15.5	10	8	93.2	50
LCMC25-10-L	1	25	16	M10	44.5	6.9	15.5	10	8	93.2	50
LCMC25-12-L	1	25	16	M12	44.5	7.1	20	14.5	11.5	101.2	50
LCMC35-00-Q	2	35	25	Blank	—	8.2	21.5	—	—	107.8	25
LCMC35-10-Q	1	35	25	M10	44.5	8.2	15.5	12.3	8.5	101.8	25
LCMC35-12-Q	1	35	25	M12	44.5	8.2	21.5	14.5	11.5	107.8	25
LCMC50-00-E	2	50	35	Blank	—	9.8	23	—	—	110.8	20
LCMC50-10-E	1	50	35	M10	44.5	9.8	18	11.5	10	107.3	20
LCMC50-12-E	1	50	35	M12	44.5	9.8	23	14	11	110.8	20
LCMC70-00-X	2	70	50	Blank	—	11.5	20.8	—	—	112.7	10
LCMC70-10-X	1	70	50	M10	44.5	11.5	20.8	14.5	11.5	112.7	10
LCMC70-12-X	1	70	50	M12	44.5	11.5	20.8	14.5	11.5	112.7	10
LCMC95-00-X	2	95	70	Blank	—	13.5	24.5	—	—	123.5	10
LCMC95-12-X	1	95	70	M12	44.5	13.5	24.5	15	13.5	123.5	10
LCMC95-14-X	1	95	70	M14	44.5	13.5	24.5	15	13.5	123.5	10
LCMC120-00-X	2	120	95	Blank	—	15.2	27.5	—	—	124.7	10
LCMC120-12-X	1	120	95	M12	44.5	15.2	27.5	15.5	14.5	124.7	10
LCMC120-14-X	1	120	95	M14	44.5	15.2	27.5	15.5	14.5	124.7	10

Visit www.panduit.com/tools for tool and die information.

^AClass 5f conductor only.

**Consult cable manufacturer for voltage stress relief instructions with applications greater than 2000 V.

^ANot CE compliant and not tested to EN 61238-1:2003/IEC 61238-1:2003 for terminations with metric Class 5f or Class 6f flexible stranded conductor.

Continues on next page



Rigid and Flexible Stranded Metric Conductor, Two-Hole, Long Barrel Lug, No Window (continued)

Part Number	Figure No.	Copper Conductor Size Class 2r (mm ²)	Copper Conductor Size Class 5f/6f [^] (mm ²)	Stud Hole Size (mm)	Stud Hold Spacing (mm)	Figure Dimensions (mm)					Std. Pkg. Qty.
						ØI	B	M	N	L	
LCMC150-00-X	2	150	120	Blank	—	16.5	30.5	—	—	148	10
LCMC150-12-X	1	150	120	M12	44.5	16.5	30.5	18	16.5	144.5	10
LCMC150-14-X	1	150	120	M14	44.5	16.5	30.5	22	16.5	148	10
LCMC185-00-X	2	185	150	Blank	—	18.6	33.5	—	—	149.6	10
LCMC185-12-X	1	185	150	M12	44.5	18.6	33.5	16.5	17.5	145.1	10
LCMC185-14-X	1	185	150	M14	44.5	18.6	33.5	21	17.5	149.6	10
LCMCX300-14-6 [^]	1	—	300*	M14	44.5	26.2	48	26.5	23.5	179.7	6
LCMC400-00-6	2	400	—	Blank	—	27	49.5	—	—	171.9	6
LCMC400-12-6	1	400	—	M12	44.5	27	49.5	26.5	23.5	171.9	6
LCMC400-14-6	1	400	—	M14	44.5	27	49.5	26.5	23.5	171.9	6
LCMC400-16-6	1	400	—	M16	44.5	27	49.5	26.5	23.5	171.9	6
LCMC500-00-3	2	500	—	Blank	—	31	57.5	—	—	194.2	3
LCMC500-12-3	1	500	—	M12	44.5	31	57.5	28.5	25.5	194.2	3
LCMC500-14-3	1	500	—	M14	44.5	31	57.5	28.5	25.5	194.2	3
LCMC500-16-3	1	500	—	M16	44.5	31	57.5	28.5	25.5	194.2	3
LCMC630-00-3	2	630	—	Blank	—	34.5	63	—	—	203.6	3
LCMC630-12-3	1	630	—	M12	44.5	34.5	63	28.5	27.5	203.6	3
LCMC630-14-3	1	630	—	M14	44.5	34.5	63	28.5	27.5	203.6	3
LCMC630-16-3	1	630	—	M16	44.5	34.5	63	28.5	27.5	203.6	3
LCMC240-00-6	2	240	185	Blank	—	20.8	37.5	—	—	159.5	6
LCMC240-12-6	1	240	185	M12	44.5	20.8	37.5	21	19.5	159.5	6
LCMC240-14-6	1	240	185	M14	44.5	20.8	37.5	21	19.5	159.5	6
LCMC300-00-6	2	300	240	Blank	—	23.5	42.5	—	—	167.1	6
LCMC300-12-6	1	300	240	M12	44.5	23.5	42.5	22	20	167.1	6
LCMC300-14-6	1	300	240	M14	44.5	23.5	42.5	22	20	167.1	6
LCMCX300-00-6 [^]	2	—	300*	Blank	—	26.2	48	—	—	179.7	6
LCMCX300-12-6 [^]	1	—	300*	M12	44.5	26.2	48	26.5	23.5	179.7	6

Visit www.panduit.com/tools for tool and die information.

*Class 5f conductor only.

**Consult cable manufacturer for voltage stress relief instructions with applications greater than 2000 V.

[^]Not CE compliant and not tested to EN 61238-1:2003/IEC 61238-1:2003 for terminations with metric Class 5f or Class 6f flexible stranded conductor.



Metric Conductor, Standard Barrel, Butt Splice

For use with Class 2R Rigid Strand and Flexible Strand Class 5F and 6F Copper Conductors

Type SCMS

- Tin-plated to inhibit corrosion
- UL Listed and CSA Certified to 35 kV** and temperature rated to 90°C when crimped with Panduit tools and dies
- Internal wire stop barrel of splice
- Class 2r, Class 5f, and Class 6f wire sizes and stud hole size marked on connector for selection and installation
- Internally beveled wire entry for fast and easy installation
- Approved for Marine use by American Bureau of Shipping
- Meets EN61238-1:2003/IEC 61238-1-2003 Class B for 10mm²-630mm² Class 2r wire sizes
- CE compliant with 10mm²-630mm² Class 2r wire sizes

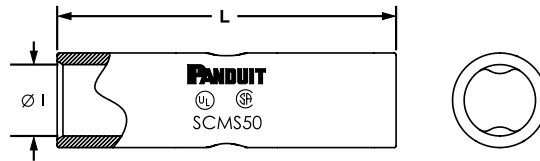

Part Number	Copper Conductor Size Class 2r (mm ²)	Copper Conductor Size class 5f/6f*** (mm ²)	Figure Dimensions (mm)		Std. Pkg. Qty.
			Ø1	L	
SCMS10-C	10	—	4.5	30	100
SCMS16-C	16	10	5.5	35	100
SCMS25-L	25	16	6.9	36	50
SCMS35-L	35	25	8.2	36	50
SCMS50-L	50	35	9.8	49	50
SCMS70-L	70	50	11.5	52	50
SCMS95-Q	95	70	13.5	54	25
SCMS120-Q	120	95	15.2	57	25
SCMS150-X	150	120	16.5	57	10
SCMS185-X	185	150	18.6	61	10
SCMS240-X	240	185	20.8	72	10
SCMS300-5	300	240	23.5	75	5
SCMSX300-5	—	300 [^]	26.2	95	5
SCMS400-5	400	—	27	95	5
SCMS500-6	500	—	31	96	6
SCMS630-6	630	—	34.5	131	6

Visit www.panduit.com/tools for tool and die information.

**Consult cable manufacturer for voltage stress relief instructions with applications greater than 2000 V.

***Not CE compliant and not tested to EN 61238-1:2003/IEC 61238-1:2003 for terminations with metric Class 5f or Class 6f flexible stranded conductor.

[^]Class 5f conductor only

A. System Overview

B1. Cable Ties

B2. Cable Accessories

B3. Stainless Steel Cable Ties & Accessories

C1. Wiring Duct

C2. Abrasion Protection

C3. Cable Management

D1. Terminals

D2. Power Connectors

D3. Grounding Connectors

E1. Labeling Systems

E2. Labels

E3. Pre-Printed & Write-On Markers

E4. Permanent Identification

E5. Lockout/Tagout & Safety Solutions

F. Keystone Cabling Systems

G. Part Number Index



Code Conductor, One-Hole, Aluminum Lug

For Use with Stranded Aluminum or Copper Code Conductors

Type LAA

- Manufactured from high conductivity thick wall wrought aluminum
- Factory pre-filled with joint compound and sealed with easy pull-out end plug to inhibit corrosion
- Color-coded barrels and Panduit and specified competitor die index numbers marked on barrel for proper crimp die selection
- Enclosed barrel prevents corrosive material from entering barrel when used in harsh environments
- Tin-plated to inhibit corrosion
- cULus listed Certified to 35 kV** and temperature rated to 90°C when crimped with Panduit and specified competitor crimping tools and dies

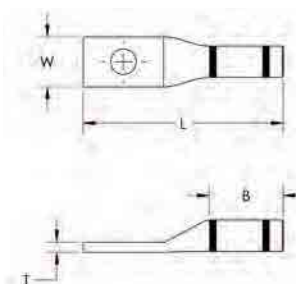

Part Number	Aluminum or Copper Conductor Size	Stud Hole Size (in.)	Figure Dimensions (In.)				Panduit Color Code	Panduit Die Index No.‡	Burdny Die Index No.‡	T&B Die Index No.‡	Wire Strip Length (in.)	Std. Pkg. Qty.
			W	B	T	L						
LAA6-14-X	6	1/4	0.55	0.86	0.11	2.2	Gray	P29	346	29	1	10
LAA6-56-X	6	5/16	0.55	1	0.11	2.2	Gray	P29	346	29	1	10
LAA4-14-X	4	1/4	0.66	1.05	0.19	2.05	Green	P37	375	37	1 1/16	10
LAA4-56-X	4	5/16	0.69	1.08	0.16	2.23	Green	P37	375	37	1 1/16	10
LAA4-38-X	4	3/8	0.69	0.92	0.16	2.33	Green	P37	375	37	1 1/16	10
LAA2-14-X	2	1/4	0.75	0.98	0.17	2.63	Pink	P42	348	42	1	10
LAA2-56-X	2	5/16	0.75	0.98	0.17	2.63	Pink	P42	348	42	1	10
LAA2-38-X	2	3/8	0.75	0.98	0.17	2.63	Pink	P42	348	42	1	10
LAA1-14-X	1	1/4	0.75	0.98	0.17	2.63	Gold	P45	471	45	1	10
LAA1-56-X	1	5/16	0.75	0.98	0.17	2.63	Gold	P45	471	45	1	10
LAA1-38-X	1	3/8	0.75	0.98	0.17	2.63	Gold	P45	471	45	1	10
LAA1/0-56-5	1/0	5/16	0.88	1.3	0.25	3.23	Tan	P50	296	50	1 9/16	5
LAA1/0-38-5	1/0	3/8	0.88	1.3	0.25	3.23	Tan	P50	296	50	1 9/16	5
LAA1/0-12-5	1/0	1/2	0.88	1.3	0.25	3.23	Tan	P50	296	50	1 9/16	5
LAA2/0-38-5	2/0	3/8	0.95	1.31	0.23	3.19	Olive	P54	297	54	1 9/16	5
LAA2/0-12-5	2/0	1/2	0.95	1.3	0.23	3.19	Olive	P54	297	54	1 9/16	5
LAA3/0-38-5	3/0	3/8	1.07	1.5	0.25	3.44	Ruby	P60	467	60	1 9/16	5
LAA3/0-12-5	3/0	1/2	1.07	1.5	0.25	3.44	Ruby	P60	467	60	1 9/16	5
LAA4/0-38-5	4/0	3/8	1.19	1.44	0.32	3.56	White	P66	298	66	1 3/4	5
LAA4/0-12-5	4/0	1/2	1.19	1.44	0.32	3.56	White	P66	298	66	1 3/4	5
LAA250-38-5	250 kcmil	3/8	1.24	1.56	0.3	3.63	Red	P71	324	71	1 9/16	5
LAA250-12-5	250 kcmil	1/2	1.24	1.56	0.3	3.63	Red	P71	324	71	1 9/16	5
LAA300-38-2	300 kcmil	3/8	1.38	2.25	0.34	4	Blue	P76	470	76	2 5/16	2
LAA300-12-2	300 kcmil	1/2	1.38	2.25	0.34	4	Blue	P76	470	76	2 5/16	2
LAA350-12-2	350 kcmil	1/2	1.51	2.25	0.38	4.28	Brown	P87	299	87	2 5/16	2
LAA400-58-2R	400 kcmil	5/8	1.61	2.5	0.41	4.88	Green	P94	472	94	2 9/16	2

‡Visit www.panduit.com/tools for tool and die information.

**Consult cable manufacturer for voltage stress relief instructions with applications greater than 2000 V.

Continues on next page



Code Conductor, One-Hole, Aluminum Lug (continued)

Part Number	Aluminum or Copper Conductor Size	Stud Hole Size (in.)	Figure Dimensions (In.)				Panduit Color Code	Panduit Die Index No.‡	Burndy Die Index No.‡	T&B Die Index No.‡	Wire Strip Length (in.)	Std. Pkg. Qty.
			W	B	T	L						
LAA500-12-2	500 kcmil	1/2	1.74	3	0.45	5.5	Pink	P99	300	99	3 1/16	2
LAA500-58-2	500 kcmil	5/8	1.74	3	0.45	5.5	Pink	P99	300	99	3 1/16	2
LAA750-12-1	750 kcmil	1/2	1.74	3.38	0.54	6.5	Red	P125	301	125	3 7/16	1
LAA750-58-1	750 kcmil	5/8	1.74	3.38	0.54	6.5	Red	P125	301	125	3 7/16	1
LAA900-58-1	900 kcmil	5/8	1.74	3.38	0.59	6.63	Gray	P140	474	140	3 7/16	1
LAA1000-58-1	1000 kcmil	5/8	2.56	4.5	0.63	7.31	Brown	P161	302	161	4 3/4	1

‡Visit www.panduit.com/tools for tool and die information.

**Consult cable manufacturer for voltage stress relief instructions with applications greater than 2000 V.



Code Conductor, Two-Hole, Aluminum Lug

For Use with Stranded Aluminum or Copper Code Conductors

Type LAB

- Manufactured from high conductivity thick wall wrought aluminum
- Factory pre-filled with joint compound and sealed with easy pull-out end plug to inhibit corrosion
- Color-coded barrel markings and Panduit and specified competitor die index numbers marked on barrel for proper crimp die selection
- Enclosed barrel prevents corrosive material from entering barrel when used in harsh environments
- Tin-plated to inhibit corrosion
- cULus listed to 35 kV** and temperature rated to 90°C when crimped with Panduit and specified competitor crimping tools and dies
- Available with NEMA hole sizes and spacing

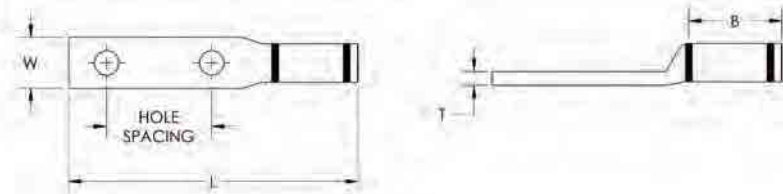

Part Number	Aluminum or Copper Conductor Size	Stud Hole Size (in.)	Stud Hole Spacing (in.)	Figure Dimensions (in.)				Panduit Color Code	Panduit Die Index No.‡	Burndy Die Index No.‡	T&B Die Index No.‡	Wire Strip Length (in.)	Std. Pkg. Qty.
				W	B	T	L						
LAB1/0-38-X	1/0 AWG	3/8	1.75	0.86	1.5	0.23	5.39	Tan	P50	296	50	1 9/16	10
LAB1/0-12-X	1/0 AWG	1/2	1.75	0.86	1.5	0.23	5.39	Tan	P50	296	50	1 9/16	10
◆ LAB2/0-12-5	2/0 AWG	1/2	1.75	0.94	1.5	0.25	5.56	Olive	P54	297	54	1 9/16	5
◆ LAB3/0-12-5	3/0 AWG	1/2	1.75	1.03	1.55	0.27	5.56	Ruby	P60	467	60	1 9/16	5
◆ LAB4/0-12-5R	4/0 AWG	1/2	1.75	1.19	1.75	0.31	5.94	White	P66	298	66	1 3/4	5
◆ LAB250-12-5	250 kcmil	1/2	1.75	1.26	2	0.33	5.28	Red	P71	324	71	1 3/4	5
◆ LAB300-12-2	300 kcmil	1/2	1.75	1.32	2.25	0.34	6.56	Blue	P76	470	76	2 5/16	2
◆ LAB350-12-2R	350 kcmil	1/2	1.75	1.52	2.31	0.39	6.07	Brown	P87	299	87	2 5/16	2
◆ LAB400-12-2	400 kcmil	1/2	1.75	1.66	2.5	0.39	6.94	Green	P94	472	94	2 9/16	2
◆ LAB500-12-2R	500 kcmil	1/2	1.75	1.62	3	0.46	6.8	Pink	P99	300	99	3 1/16	2
◆ LAB600-12-2	600 kcmil	1/2	1.75	1.73	3	0.5	7.56	Black	P106	473	106	3 1/16	2
◆ LAB750-12-1R	750 kcmil	1/2	1.75	1.69	3.44	0.57	7.31	Red	P125	301	125	3 7/16	1
◆ LAB800-12-1	800 kcmil	1/2	1.75	1.75	3.38	0.59	8.31	Gray	P140	474	140	3 7/16	1
◆ LAB900-12-1	900 kcmil	1/2	1.75	1.74	3.38	0.59	8.31	Gray	P140	474	140	3 7/16	1
◆ LAB1000-12-1	1000 kcmil	1/2	1.75	2.56	4.5	0.63	8.73	Brown	P161	302	161	4 3/4	1

‡Visit www.panduit.com/tools for tool and die information.

**Consult cable manufacturer for voltage stress relief instructions with applications greater than 2000 V.

◆NEMA hole sizes and spacing.

Belleville Compression Washers

Type CW

- Conical spring washer for use when assembling aluminum connectors to copper and/or steel pads, compensates for differing rates of thermal expansion to keep hardware assembly from loosening

- For assembly information, see page D2.94
- Made from hardened steel to provide high strength
- Cadmium-plated to inhibit corrosion

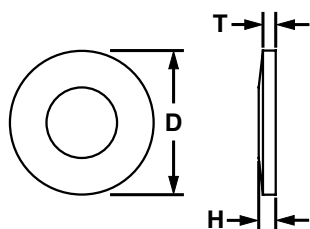

Part Number	Stud Hole Size (in.)	Figure Dimensions (in.)			Std. Pkg. Qty.
		D	H	T	
CW-14-L	1/4	0.68	0.09	0.05	50
CW-56-L	5/16	0.81	0.08	0.06	50
CW-38-L	3/8	0.93	0.10	0.07	50
CW-12-Q	1/2	1.18	0.12	0.09	25
CW-58-Q	5/8	1.49	0.15	0.12	25

Joint Compounds

For Use with Aluminum Connectors

Type CMP

- Oxide inhibitor for compression conductor connections lowers electrical resistance of compression joint while sealing out air and moisture to prevent the formation of surface oxides

- Wide operating temperature range; can be used in a wide range of electrical and environmental conditions
- Packaged in convenient dispenser bottles



Part Number	Part Description	Std. Pkg. Qty.
CMP-100-1	Contact aid for pad-to-pad or thread-to-thread aluminum connections, 8 oz. Operating temperature range -60°F (-51°C) to 400°F (204°C).	1
CMP-200-1	Contact aid for cable connections with compression connections made on aluminum conductor, 8 oz. Operating temperature range -40°F (-40°C) to 400°F (204°C). Compatible with all insulating materials.	1

cUL_{us} Code Conductor, Aluminum Splice

For Use with Stranded Aluminum-to-Aluminum or Copper-to-Copper Conductors

Type SA

- Manufactured from high conductivity thick wall wrought aluminum
- Factory pre-filled with joint compound and sealed with easy pull-out end plug to inhibit corrosion
- Color-coded barrel markings with Panduit® and specified competitor die index numbers marked on barrel for proper crimp die selection
- Tin-plated to inhibit corrosion
- Internal solid center prevents over-insertion of conductor
- cULus listed to 35 kV** and temperature rated to 90°C when crimped with Panduit and specified competitor crimping tools and dies

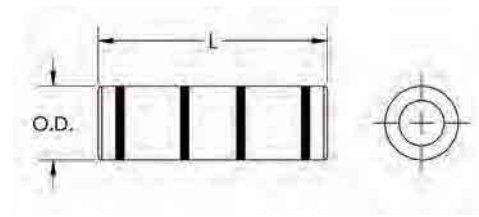

Part Number	Aluminum or Copper Conductor Size	Figure Dimensions (in.)		Panduit Color Code	Panduit Die Index No.‡	Burdny Die Index No.‡	T&B Die Index No.‡	Wire Strip Length (in.)	Std. Pkg. Qty.
		Barrel O.D.	L						
SA6-X	6 AWG	0.34	1.62	Gray	P29	346	29	3/4	10
SA4-XR	4 AWG	0.48	2.13	Green	P37	375	37	7/8	10
SA2-X	2 AWG	0.53	2.00	Pink	P42	348	45	7/16	10
SA1-X	1 AWG	0.53	2.00	Gold	P45	471	45	7/16	10
SA1/0-X	1/0 AWG	0.64	2.12	Tan	P50	296	50	1	10
SA2/0-5	2/0 AWG	0.69	2.31	Olive	P54	297	54	1 1/8	5
SA3/0-5	3/0 AWG	0.76	2.62	Ruby	P60	467	60	1 1/4	5
SA4/0-5	4/0 AWG	0.88	2.75	White	P66	298	66	1 5/16	5
SA250-5	250 kcmil	0.91	2.94	Red	P71	324	71	1 7/16	5
SA300-2	300 kcmil	1.01	3.12	Blue	P76	470	76	1 1/2	2
SA350-2	350 kcmil	1.12	3.37	Brown	P87	299	87	1 5/8	2
SA400-2	400 kcmil	1.19	3.75	Green	P94	472	94	1 13/16	2
SA500-2	500 kcmil	1.32	3.87	Pink	P99	300	99	1 7/8	2
SA600-2	600 kcmil	1.44	4.12	Black	P106	473	106	2	2
SA750-1	750 kcmil	1.60	4.62	Red	P125	301	115	2 1/4	1
SA800-1	800 kcmil	1.66	4.75	Gray	P140	474	125	2 5/16	1
SA1000-1	1000 kcmil	1.84	5.25	Brown	P161	302	161	2 9/16	1

‡Visit www.panduit.com/tools for tool and die information.

**Consult cable manufacturer for voltage stress relief instructions with applications greater than 2000 V. See page D2.60 for Panduit joint compounds recommended for pad to pad and conductor connections.



Code Conductor, Aluminum, Bi-Metallic Pin Connector

Provides Copper Pigtail for Connecting Aluminum Conductors to a Copper or Aluminum/Copper Rated Mechanical Lug

Type BPC

- Factory pre-filled with joint compound and sealed with easy pull-out end plug to inhibit corrosion
- Panduit die index number and color code embossed on barrel for proper crimp die selection
- Insulating rubber sleeve included to insulate aluminum barrel from contact with copper connector when attached to pin
- Tin-plated to inhibit corrosion
- UL Listed per UL 486B; temperature rated 90°C and for use up to 600 V when crimped with Panduit and specified competitor crimping tools and dies

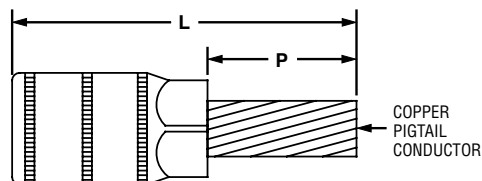

Part Number	Aluminum Conductor Size	Copper Pigtail Size	Figure Dimensions (in.)		Panduit Color Code	Panduit Die Index No.‡	Burdny Die Index No.‡	T&B Die Index No.‡	Wire Strip Length (in.)	Std. Pkg. Qty.
			L	P						
BPC6-L	6 AWG	8 AWG	2.45	0.88	Tan	P50	296	50	1 1/16	50
BPC4-L	4 AWG	6 AWG	2.45	0.88	Tan	P50	296	50	1 1/16	50
BPC2-L	2 AWG	4 AWG	2.45	0.88	Tan	P50	296	50	1 1/16	50
BPC1-X	1 AWG	3 AWG	2.58	1.00	Tan	P50	296	50	1 1/16	10
BPC1/0-X	1/0 AWG	2 AWG	3.33	1.25	Red	P71	298	76	1 5/16	10
BPC2/0-X	2/0 AWG	1 AWG	3.33	1.25	Red	P71	298	76	1 5/16	10
BPC3/0-X	3/0 AWG	1/0 AWG	3.46	1.38	Red	P71	298	76	1 5/16	10
BPC4/0-X	4/0 AWG	2/0 AWG	3.46	1.38	Red	P71	298	76	1 5/16	10
BPC250-X	250 kcmil	3/0 AWG	3.71	1.50	Green	P94	299	99, 87	1 7/16	10
BPC300-X	300 kcmil	4/0 AWG	4.10	1.63	Green	P94	299	99, 87	1 7/16	10
BPC350-X	350 kcmil	4/0 AWG	4.10	1.63	Green	P94	299	99, 87	1 7/16	10
BPC400-X	400 kcmil	250 kcmil	4.35	1.88	Black	P106	300	106	1 7/16	10
BPC500-X	500 kcmil	350 kcmil	4.35	1.88	Black	P106	300	106	1 7/16	10
BPC600-6	600 kcmil	350 kcmil	4.77	1.88	Red	P125	936	115	1 15/16	6
BPC750-6	750 kcmil	500 kcmil	4.90	2.00	Red	P125	936	115	1 15/16	6

‡Visit www.panduit.com/tools for tool and die information.
See page D2.60 for Panduit joint compounds recommended for pad to pad and conductor connections.

Mechanical Connectors

Panduit® offers a broad variety of mechanical lugs, splices, and split bolt connectors suitable for a wide range of electrical terminations using code conductor. Designed to be reusable and installed without special tooling, Pan-Lug™ Mechanical Connectors provide quality performance, ease of installation, and lowest installed cost.



- **Functional product information is marked directly on the connector, facilitating the identification, ordering, and usage of the mechanical connector**
- **Incorporate wide wire range-taking capability to minimize inventory requirements**
- **Made from high strength, high conductivity electrolytic copper and aluminum alloy materials to provide optimum connectivity for power and grounding applications**
- **UL Listed and CSA Certified, as noted**

Pan-Lug™ Mechanical Connectors include split bolt connectors, copper mechanical lugs, aluminum mechanical lugs and aluminum multi-tap connectors with clear PVC insulation. Products are available in stamped and formed, extruded and cast varieties of multiple barrel and tongue configurations to provide solutions for diverse power and grounding needs. Panduit offers a wide assortment of Pan-Lug™ Power and Grounding Connectors to meet customer needs and today's application requirements.

Features and Benefits – Pan-Lug™ Mechanical Connectors

Copper Split Bolt Connectors

Part number and conductor range marked on part for easy identification

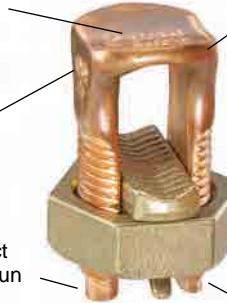

Hex head with large wrench flats for easy assembly

Waxed body to prohibit binding of contact pad or nut

250 kcmil and larger sizes have contact serrations for higher pull-out strength

Extra-long body available to connect two taps with one run

Made from high strength copper alloy



Cast Copper Connectors

Made from high strength copper alloy

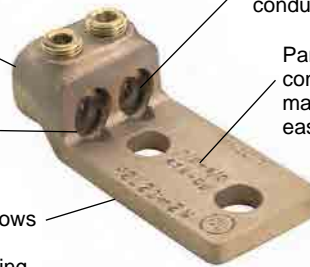

Inspection windows to assure complete conductor insertion

Serrated barrel available for high pull-out strength

Part number and conductor range marked on part for easy identification

Flat bottom allows full contact surface mounting



Stamped and Formed Copper Connectors

Made from high strength, electrolytic copper alloy



Hex head or internal hex bolt for sizes larger than 1/0 AWG

Part number and conductor range marked on part for easy identification

Two styles of tongues available: fixed and floating



Aluminum Connectors

Dual rated for aluminum or copper conductors

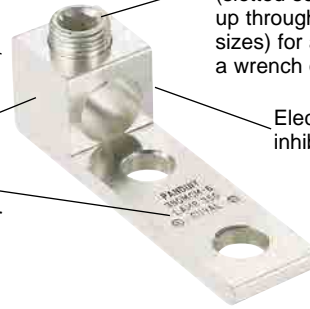

Hex socket set screw (slotted set screw used up through 2/0 AWG sizes) for assembly with a wrench or screwdriver

Made from high strength, extruded aluminum alloy

Electro tin-plated to inhibit corrosion

Part number and conductor range marked on part for easy identification



Multi-Tap Connectors

Hex socket set screws (slotted set screw for smallest size) for assembly with a wrench or screwdriver



Clear PVC insulation for visual inspection of the complete conductor insertion

Pre-insulated aluminum body to eliminate the need for taping

Factory pre-filled with oxide inhibitor to prevent oxidation

Dual-sided conductor entry

Made from high strength, extruded aluminum alloy



Available with two isolated mounting holes at either end of connector to facilitate direct mounting using 1/4" bolts.



Split Bolt, Copper

For Use with Copper Code Conductors

Type SBC

- Made from high strength copper alloy to resist corrosion and provide premium electrical and mechanical performance
- Offered with extra long body to allow connection of one or two taps to a single run conductor
- Wide wire range-taking capability minimizes inventory requirements
- Nut hex provides correct fit with socket, box, or open end wrenches resulting in proper torquing of electrical connection
- Pressure bar provides secure connection on a full range of conductor combinations used with each connector assuring premium wire pull-out strength
- UL Listed and CSA Certified for use up to 600 V and temperature rated 90°C

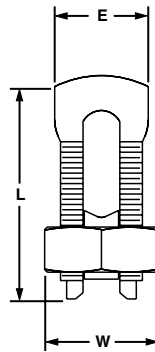

Part Number	Copper Conductor			Max. Conductor	Figure Dimensions (In.)			Std. Pkg. Qty.
	Range of Equal Run and Tap		Min. Tap with One Max. Run	Copperweld STR	E	W	L	
	Min.	Max.						
SBC8-C	#10 STR	#8 STR	#16 STR	—	0.39	0.55	0.86	100
SBC8L-C*	#16 STR	#8 STR	#16 STR	—	0.38	0.50	0.84	100
SBC6S-C	#8 STR	#6 STR	#16 STR	—	0.41	0.62	0.95	100
SBC6SL-C*	#8 STR	#6 STR	#16 STR	—	0.41	0.63	1.10	100
SBC4S-C	#8 STR	#6 STR	#14 STR	—	0.45	0.69	0.98	100
SBC4SL-C*	#8 STR	#6 STR	#14 STR	—	0.45	0.69	1.30	100
SBC3-C	#8 STR	#4 STR	#14 STR	—	0.58	0.81	1.16	100
SBC2-C	#6 STR	#2 STR	#14 STR	—	0.59	0.86	1.23	100
SBC2L-C*	#14 STR	#2 STR	#14 STR	3 No. 7	0.63	0.81	1.55	100
SBC1/0-L	#4 STR	1/0 STR	#14 STR	—	0.75	0.93	1.55	50
SBC2/0-Q	#2 STR	2/0 STR	#14 STR	—	0.79	1.05	1.72	25
SBC3/0-Q	#1 STR	3/0 STR	#8 STR	—	0.95	1.24	2.07	25
SBC250-Q	#1 STR	250 kcmil	#8 STR	—	1.03	1.36	2.09	25
SBC350-1	2/0 STR	350 kcmil	1/0 STR	—	1.16	1.48	2.42	1
SBC500-1	300 kcmil	500 kcmil	2/0 STR	—	1.33	1.74	2.83	1
SBC750-1	#8 SOL	750 kcmil	#8 SOL	19 No. 5	1.94	2.13	3.75	1
SBC1000-1	#8 SOL	1000 kcmil	#8 SOL	—	2.25	2.50	4.00	1

*Long body accommodates two tap conductors with single run; not cULus Listed.



Split Bolt, Copper, Tin-Plated

For Specified Combinations of Copper and Aluminum Code Conductors

Type SBCT

- Made from high strength copper alloy to provide premium electrical and mechanical performance
- Tin-plated to inhibit corrosion and oxidation
- Offered with dual rating for use with aluminum or copper conductors
- Wide wire range-taking capability minimizes inventory requirements
- Nut hex provides correct fit with socket, box, or open end wrenches resulting in proper torquing of electrical connection
- Free floating pressure bar separates conductors of dissimilar materials for secure connection on a full range of conductor combinations
- UL Listed and CSA Certified for use up to 600 V and UL temperature rated 90°C

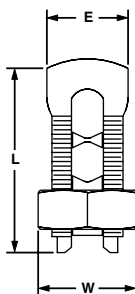

Part Number	Copper and Aluminum Code Conductor			ACSR Range	Max. Conductor	Figure Dimensions (In.)			Std. Pkg. Qty.
	Range of Equal Run and Tap		Min. Tap with One Max. Run			Copperweld STR	E	W	
	Min.	Max.							

UL Listed and CSA Certified with Copper and Aluminum Conductors

SBCT8-C	#8 STR	#6 SOL	#14 STR	—	—	0.41	0.62	1.06	100
SBCT6-C	#6 STR	#10 STR	#10 STR	—	—	0.49	0.68	1.10	100
SBCT3-C	#8 STR	#4 STR	#10 STR	—	—	0.58	0.81	1.24	100
SBCT2-C	#6 STR	#2 STR	#14 STR	—	—	0.60	0.86	1.45	100
SBCT1/0-L	#4 STR	1/0 STR	#10 STR	—	—	0.75	0.93	1.73	50
SBCT2/0-Q	#2 STR	2/0 STR	#8 STR	—	—	0.79	1.05	1.71	25

UL Listed and CSA Certified with Copper Code Conductors Only

SBCT10-C	#16 STR	#10 STR	#16 STR	—	—	0.38	0.49	0.87	100
SBCT3/0-Q	#1 STR	3/0 STR	#8 STR	—	—	0.75	1.25	2.12	25
SBCT250-Q	#1 STR	250 kcmil	#8 STR	—	—	1.03	1.36	2.22	25
SBCT350-1	2/0 STR	350 kcmil	1/0 STR	—	—	1.17	1.49	2.55	1
SBCT500-1	300 kcmil	500 kcmil	2/0 STR	—	—	1.32	1.74	2.95	1
SBCT750-1	2/0 STR	750 kcmil	2/0 STR	4/0 – 666.6	19 No. 5	1.93	2.11	3.78	1
SBCT1000-1	4/0 STR	1000 kcmil	4/0 STR	300 – 900	—	2.29	2.53	4.02	1

The use of Panduit oxide inhibiting joint compound (CMP-100) is recommended. See pages D2.91.



Split Bolt, Aluminum

For Use with Copper and Aluminum Code Conductors

Type SBA

- Made from lightweight, durable aluminum alloy to resist corrosion and provide premium electrical and mechanical performance
- Dual rated for use with aluminum to aluminum, aluminum to copper, and copper to copper conductor combinations
- Tin-plated to inhibit corrosion and oxidation
- Wide wire range-taking capability minimizes inventory requirements
- True hex design for body and nut hex provides correct fit with socket, box, or open end wrenches resulting in proper torquing of electrical connection
- Free floating pressure bar separates conductors of dissimilar materials for secure connection on a full range of conductor combinations
- UL Listed and CSA Certified for use up to 600 V and UL temperature rated 90°C

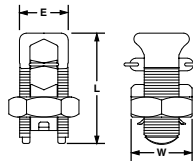

Part Number	Max. Run to Max. Tap	Min. Run to Min. Tap	Max. Run to Min. Tap	Figure Dimensions (In.)			Std. Pkg. Qty.
				E	W	L	
SBA6-C	#6 STR – #6 STR	#10 SOL – #10 SOL	#6 STR – #10 SOL	0.56	0.75	1.58	100
SBA4-C	#4 STR – #4 STR	#8 SOL – #10 SOL	#4 STR – #10 SOL	0.62	0.81	1.38	100
SBA2-C	#2 STR – #2 STR	#6 SOL – #8 STR	#2 STR – #8 STR	0.69	0.94	1.58	100
SBA1/0-Q	1/0 STR – 1/0 STR	#2 STR (Compact) – #8 SOL	1/0 STR – #8 SOL	0.75	1.00	1.92	25
SBA2/0-Q	2/0 STR – 2/0 STR	#2 STR (Compact) – #8 STR	2/0 STR – #8 STR	0.88	1.12	1.92	25
SBA4/0-Q	4/0 STR – 4/0 STR	#2 STR (Compact) – #6 STR	4/0 STR – #6 STR	1.13	1.49	2.54	25
SBA350-1 ^	350 kcmil – 350 kcmil	1/0 STR (Compact) – #4 STR	350 kcmil – #4 STR	1.50	1.69	3.24	1
SBA500-1 ^	500 kcmil – 500 kcmil	400 kcmil (Compact) – #2 STR (Compact)	500 kcmil – #2 STR (Compact)	1.73	2.00	3.62	1

The use of Panduit oxide inhibiting joint compound (CMP-100) is recommended. See page D2.91.

^Not CSA Certified.



Two-Bolt Connector, Bronze

For Use with Copper Code Conductors

Type VT

- Made from high strength bronze for heavy duty connections and to inhibit corrosion
- Cap swivels for easy installation of conductors
- Rubber washer retains hardware to connector and eliminates loose parts
- High strength silicon-bronze hardware provides premium mechanical performance when assembled to conductor
- Wide wire range-taking capability minimizes inventory requirements
- UL Listed for use up to 600 V and 90°C temperature rated

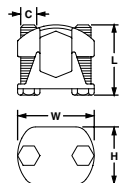

Part Number	Copper Conductor Size		Figure Dimensions (In.)				Hex Size (In.)	Std. Pkg. Qty.
	Run	Tap	L	W	H	C		
VT-0-Q	#2 STR – 1/0 STR	#10 STR – 1/0 STR	1.50	1.44	0.94	0.31	1/2	25
VT-1-Q	#2 STR – 2/0 STR	#10 STR – 2/0 STR	1.50	1.56	1.13	0.31	1/2	25
VT-2-Q	1/0 STR – 4/0 STR	#10 STR – 4/0 STR	1.75	1.84	1.34	0.38	9/16	25
VT-3-12	250 kcmil – 350 kcmil	#10 STR – 350 kcmil	2.00	2.31	1.63	0.50	3/4	12
VT-4-12	250 kcmil – 500 kcmil	#10 STR – 500 kcmil	2.25	2.44	1.69	0.50	3/4	12
VT-5-6	400 kcmil – 800 kcmil	3/0 STR – 800 kcmil	2.50	2.69	1.88	0.50	9/16	6
VT-6-6	500 kcmil – 1000 kcmil	3/0 STR – 1000 kcmil	2.75	3.06	2.25	0.63	15/16	6

Two-Bolt Connector, Bronze, Tin-Plated

For Use with Copper and Aluminum Code Conductors

Type VTA

- Made from high strength bronze for heavy duty connections
- Tin-plated to inhibit corrosion and oxidation
- Cap swivels for easy installation of conductors
- Rubber washer retains hardware to connector and eliminates loose parts
- High strength silicon-bronze hardware provides premium mechanical performance when assembled to conductor
- Offered for use with aluminum conductors, but not UL Listed
- UL Listed for use up to 600 V and 90°C temperature rated when used with copper code conductor

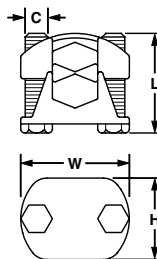

Part Number	Copper Conductor Size Range		Copperweld Solid	Aluminum		Figure Dimensions (In.)				Hex Size (In.)	Std. Pkg. Qty.
	Run	Tap		AWG	ACSR	L	W	H	C		
VTA-0-Q	2 STR – 1/0 STR	10 STR – 1/0 STR	2/0	1/0 STR	1	1.25	1.44	0.94	5/16	1/2	25
VTA-1-Q	2 STR – 2/0 STR	10 STR – 2/0 STR	3/0	—	—	1.50	1.56	1.13	5/16	1/2	25
VTA-2-Q	1/0 STR – 4/0 STR	10 STR – 4/0 STR	4/0	—	—	1.75	1.84	1.34	3/8	9/16	25
VTA-3-12	250 – 350 kcmil	10 STR – 350 kcmil	—	—	—	2.00	2.31	1.63	1/2	3/4	12
VTA-4-12	250 – 500 kcmil	10 STR – 500 kcmil	—	—	—	2.25	2.44	1.69	1/2	3/4	12
VTA-5-6	400 – 800 kcmil	3/0 STR – 800 kcmil	—	—	—	2.50	2.69	1.88	1/2	3/4	6
VTA-6-6	500 – 1000 kcmil	3/0 STR – 1000 kcmil	—	—	—	2.75	3.06	2.25	5/8	15/16	6

One-Hole, Straight Tongue, Barrel Post Lug

For Use with Copper Code Conductors

Type ML

- Made from high strength electrolytic copper to provide premium electrical and mechanical performance
- Compact design saves space
- Wide wire range-taking capability minimizes inventory requirements
- Inspection window to visually assure full conductor insertion
- Plated steel set screw provides high strength, durable electrical contact between conductor and connector
- Flat bottom allows for complete contact with mounting surface
- UL Listed for use up to 600 V and temperature rated 90°C
- Tin plating is available, contact customer service

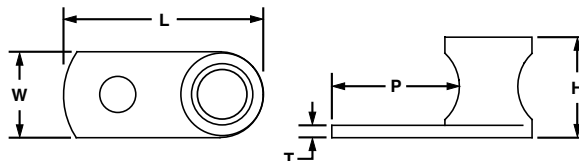

Part Number	Copper Conductor Size Range	Stud Hole Size (In.)	Hex Key Size (In.)	Figure Dimensions (In.)					Std. Pkg. Qty.
				L	W	H	T	P	
ML8-CY	#14 SOL – #8 STR	3/16	**	0.81	0.38	0.42	0.08	0.48	100
ML4-CY	#14 SOL – #4 STR	1/4	**	1.11	0.54	0.55	0.09	0.63	100
ML1/0-LY	#14 SOL – 1/0 STR	5/16	1/4	1.54	0.73	0.79	0.09	0.80	50
ML250-QY	#6 STR – 250 kcmil	3/8	1/4	1.94	0.94	1.06	0.12	1.00	25

**Uses slotted head set screw.



One-Hole, Straight Tongue Lug

For Use with Copper Code Conductors

Type PNL

- Cast from high strength corrosion resistant copper alloy to provide premium electrical and mechanical performance
- Compact design saves space
- Wide wire range-taking capability minimizes inventory requirements
- Inspection window to visually assure full conductor insertion
- Plated steel set screw provides high strength, durable electrical contact between conductor and connector
- Flat bottom allows for complete contact with mounting surface
- UL Listed and CSA Certified for use up to 600 V and UL temperature rated 90°C

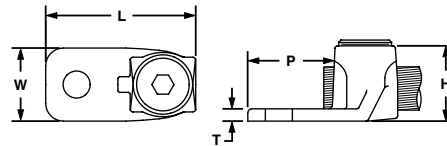

Part Number	Copper Conductor Size Range	Stud Hole Size (In.)	Hex Key Size (In.)	Figure Dimensions (In.)					Std. Pkg. Qty.
				L	W	H	T	P	
PNL-4-C	#14 SOL – #4 STR	1/4	**	1.25	0.53	0.56	0.14	0.66	100
PNL-1/0-L	#8 SOL – 1/0 STR	5/16	1/4	1.59	0.73	0.78	0.14	0.85	50
PNL-250-Q	#6 SOL – 250 kcmil	3/8	5/16	1.97	0.94	1.05	0.13	1.00	25
PNL-500-3	#4 SOL – 500 kcmil	1/2	3/8	3.00	1.38	1.47	0.25	1.63	3
PNL-1000-3	500 kcmil – 1000 kcmil	1/2	1/2	3.88	1.75	2.00	0.38	2.13	3

**Uses slotted head set screw.



One-Hole, Straight Tongue Lug with Internal Pressure Plate

For Use with Copper Code Conductors

Type HL

- Cast from high strength corrosion resistant copper alloy to provide premium electrical and mechanical performance
- Compact design saves space
- Wide wire range-taking capability minimizes inventory requirements
- Pressure plate* provides uniform clamping force on conductor for premium electrical performance
- Plated steel set screw provides high strength, durable electrical contact between conductor and connector
- Flat bottom allows for complete contact with mounting surface
- Inspection window to visually assure full conductor insertion
- UL Listed for use up to 600 V and temperature rated 90°C

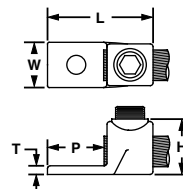

Part Number	Copper Conductor Size Range	Stud Hole Size (In.)	Hex Key Size (In.)	Figure Dimensions (In.)					Std. Pkg. Qty.
				L	W	H	T	P	
HL1-25-X	#14 SOL – #8 STR	1/4	**	1.38	0.56	0.79	0.19	0.81	10
HL4-1-X	#8 SOL – #4 STR	1/4	**	1.38	0.56	0.79	0.19	0.81	10
HL8-1-X	#4 SOL – #1 STR	1/4	7/16	1.56	0.75	0.90	0.22	0.69	10
HL13-1-5	#1 STR – 2/0 STR	3/8	9/16	1.88	0.81	1.14	0.22	0.88	5
HL21-1-5	2/0 STR – 4/0 STR	3/8	9/16	2.19	1.00	1.31	0.25	1.00	5
HL30-1-2	4/0 STR – 300 kcmil	1/2	5/8	2.50	1.06	1.47	0.31	1.25	2
HL50-1-2	300 kcmil – 500 kcmil	1/2	3/8	3.00	1.38	1.65	0.34	1.50	2

*HL1-25-X and HL4-1-X do not include pressure plates.

**Uses slotted head set screw.

Two-Hole, Straight Tongue Lug with Internal Pressure Plate

For Use with Copper Code Conductors

Type HL-2

- Cast from high strength corrosion resistant copper alloy to provide premium electrical and mechanical performance
- Wide wire range-taking capability minimizes inventory requirements
- Internal pressure plate provides uniform clamping force on conductor for premium electrical performance
- Plated steel set screw provides high strength, durable electrical contact between conductor and connector
- Inspection window to visually assure full conductor insertion
- Flat bottom allows for complete contact with mounting surface
- UL Listed for use up to 600 V and temperature rated 90°C

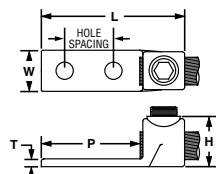

Part Number	Copper Conductor Size Range	Stud Hole Size (In.)	Hex Key Size (In.)	Figure Dimensions (In.)					Std. Pkg. Qty.
				L	W	H	T	P	
HL1-2-25-X	#14 SOL – #8 STR	1/4	**	2.00	0.56	0.70	0.19	1.25	10
HL4-2-X	#8 SOL – #4 STR	1/4	**	2.00	0.56	0.69	0.18	1.25	10
HL8-2-X	#4 SOL – #1 STR	1/4	7/16	2.44	0.75	0.92	0.22	1.50	10
HL13-2-5	#1 STR – 2/0 STR	3/8	9/16	2.88	0.81	1.07	0.22	1.88	5
HL21-2-5	2/0 STR – 4/0 STR	3/8	9/16	3.00	1.00	1.33	0.25	1.75	5
HL30-2-2	4/0 STR – 300 kcmil	3/8	5/8	3.13	1.06	1.45	0.31	2.00	2
HL50-2-2	300 kcmil – 500 kcmil	3/8	3/4	3.44	1.38	1.66	0.34	2.00	2

**Uses slotted head set screw.

Two-Hole, Straight Tongue Lug with NEMA Hole Sizes and Spacing

For Use with Copper Code Conductors

Type HL-2N

- Cast from high strength corrosion resistant copper alloy to provide premium electrical and mechanical performance
- Wide wire range-taking capability minimizes inventory requirements
- Internal pressure plate provides uniform clamping force on conductor for premium electrical performance
- Internal barrel serrations allow for premium wire pull-out strength
- Inspection window to visually assure full conductor insertion
- Flat bottom allows for complete contact with mounting surface
- UL Listed for use up to 600 V and temperature rated 90°C
- Available with NEMA hole sizes and spacing

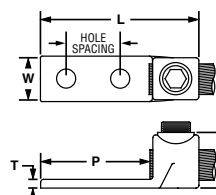

Part Number	Copper Conductor Size Range	Stud Hole Size (In.)	Stud Hole Spacing (In.)	Hex Key Size (In.)	Figure Dimensions (In.)					Std. Pkg. Qty.
					L	W	H	T	P	
◆ HL1-2-25-X	#4 SOL – #1 STR	1/2	1.75	7/16	3.94	1.00	0.90	0.22	3.00	10
◆ HL4-2-X	#1 STR – 2/0 STR	1/2	1.75	9/16	4.25	1.00	1.07	0.22	3.00	10
◆ HL8-2-X	2/0 STR – 4/0 STR	1/2	1.75	9/16	4.19	1.25	1.34	0.25	3.00	10
◆ HL13-2-5	4/0 STR – 300 kcmil	1/2	1.75	5/8	4.25	1.25	1.46	0.31	3.00	5

◆NEMA hole sizes and spacing.

Two-Hole, Straight Tongue, Tandem Set Screw Lug

For Use with Copper Code Conductors

Type HHL-2N

- Cast from high strength corrosion resistant copper alloy to provide premium electrical and mechanical performance
- Double set screws provide additional wire secureness for use in heavy duty applications
- Wide wire range-taking capability minimizes inventory requirements
- Internal pressure plate provides uniform clamping force on conductor for premium electrical performance
- Internal barrel serrations allow for premium wire pull-out strength
- Inspection window to visually assure full conductor insertion
- Flat bottom allows for complete contact with mounting surface
- UL Listed for use up to 600 V and temperature rated 90°C
- Available with NEMA hole sizes and spacing

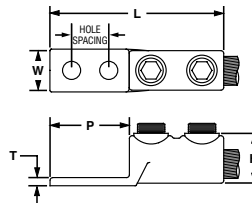

Part Number	Copper Conductor Size Range	Stud Hole Size (In.)	Stud Hole Spacing (In.)	Hex Key Size (In.)	Figure Dimensions (In.)					Std. Pkg. Qty.
					L	W	H	T	P	
◆ HHL8-2N-X	#4 SOL – #1 STR	1/2	1.75	7/16	5.13	1.00	0.80	0.22	3.00	10
◆ HHL13-2N-5	#1 STR – 2/0 STR	1/2	1.75	9/16	4.88	1.25	1.00	0.22	3.00	5
◆ HHL21-2N-5	2/0 STR – 4/0 STR	1/2	1.75	9/16	5.63	1.50	1.37	0.25	3.00	5
◆ HHL30-2N-1	4/0 STR – 300 kcmil	1/2	1.75	5/8	5.88	1.50	1.45	0.31	3.00	1

◆NEMA hole sizes and spacing.

Two-Hole, Straight Tongue, Two-Barrel Lug

For Use with Copper Code Conductors

Type H2L-2N

- Allows for termination of two copper conductors
- Cast from high strength corrosion resistant copper alloy to provide premium electrical and mechanical performance
- Wide wire range-taking capability minimizes inventory requirements
- Internal pressure plate provides uniform clamping force on conductor for premium electrical performance
- Internal barrel serrations provide premium wire pull-out strength
- Inspection window to visually assure full conductor insertion
- Flat bottom allows for complete contact with mounting surface
- UL Listed for use up to 600 V and temperature rated 90°C
- Available with NEMA hole sizes and spacing

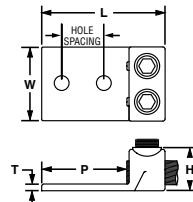

Part Number	Copper Conductor Size Range	Stud Hole Size (In.)	Stud Hole Spacing (In.)	Hex Key Size (In.)	Figure Dimensions (In.)					Std. Pkg. Qty.
					L	W	H	T	P	
◆ H2L4-2N-X	#8 SOL – #4 STR	1/2	1.75	**	3.75	1.25	0.76	0.19	3.00	10
◆ H2L8-2N-2	#4 SOL – #1 STR	1/2	1.75	7/16	3.94	1.38	0.92	0.22	3.00	2
◆ H2L13-2N-2	#1 STR – 2/0 STR	1/2	1.75	9/16	4.00	1.63	1.06	0.22	3.00	2
◆ H2L21-2N-2	2/0 STR – 4/0 STR	1/2	1.75	9/16	4.19	1.88	1.34	0.31	3.00	2
◆ H2L30-2N-1	4/0 STR – 300 kcmil	1/2	1.75	5/8	4.38	2.00	1.45	0.31	3.00	1

**Uses slotted head set screw.
◆NEMA hole sizes and spacing.

Two-Set Screw Splice with Internal Pressure Plate

For Use with Copper Code Conductors

Type HC

- Cast from high strength corrosion resistant copper alloy to provide premium electrical and mechanical performance
- Wide wire range-taking capability minimizes inventory requirements
- Internal pressure plate provides uniform clamping force on conductor for premium electrical performance
- Internal barrel serrations provide premium wire pull-out strength
- Internal wire stops to prevent over-insertion of conductor
- UL Listed for use up to 600 V and temperature rated 90°C

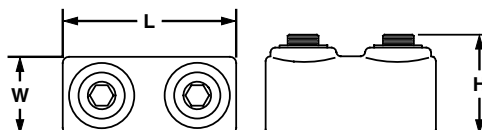

Part Number	Copper Conductor Size Range	Hex Key Size (In.)	Figure Dimensions (In.)			Std. Pkg. Qty.
			L	W	H	
HC4-3*	#8 SOL – #4 STR	**	1.25	0.50	0.56	3
HC8-3*	#4 SOL – #1 STR	7/16	1.75	0.69	0.81	3
HC13-3	#1 STR – 2/0 STR	1/4	2.00	0.81	0.94	3
HC21-1	2/0 STR – 4/0 STR	9/16	2.25	1.00	1.19	1
HC30-1	4/0 STR – 300 kcmil	5/16	2.56	1.19	1.44	1
HC50-1	300 kcmil – 500 kcmil	3/4	3.00	1.38	1.63	1

*Includes swivel screws, not internal pressure plate.

**Uses slotted head set screw.

One-Hole, Single Piece, Straight Fixed Tongue Lug

For Use with Stranded Copper Code Conductors

Type CXS

- Made from a single piece of high strength electrolytic copper to provide premium electrical and mechanical performance
- Patented one piece design. Provides premium electrical and mechanical
- Wide wire range-taking capability minimizes inventory requirements
- Serrations incorporated in barrel of connector to provide premium wire pullout strength of wire termination
- Plated, fillister head, steel set screw provides high strength, durable electrical contact between conductor and connector
- cULus Listed for use for up to 600 V and temperature rated to 90 C where applicable

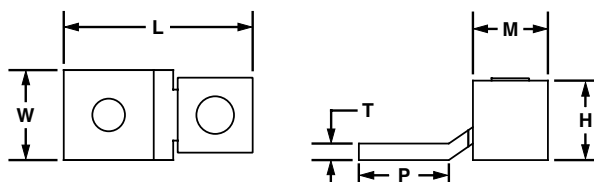

Part Number	Copper Conductor Size Range	Stud Hole Size (in.)	Figure Dimensions (in.)					Std. Pkg. Qty.
			L	W	H	T	M	
CXS35-36-C	14 AWG - 6 AWG	3/16	1.08	0.38	0.39	0.05	0.47	100
CXS70-14-C	14 AWG - 4 AWG	1/4	1.28	0.5	0.5	0.06	0.53	100
CXS125-14-Q	4 AWG - 1/0 AWG	1/4	1.6	0.62	0.73	0.09	0.65	25
CXS125-56-Q	4 AWG - 1/0 AWG	5/16	1.6	0.62	0.73	0.09	0.65	25



One-Hole, Single Piece, Straight Fixed Tongue, Tin-Plated

For Use with Stranded Copper Code Conductors

Type CXS-T

- Made from a single piece of high strength electrolytic copper to provide premium electrical and mechanical performance
- Patented one piece design. Provides premium electrical and mechanical
- Wide wire range-taking capability minimizes inventory requirements
- Serrations incorporated in barrel of connector to provide premium wire pullout strength of wire termination
- Plated, fillister head, steel set screw provides high strength, durable electrical contact between conductor and connector
- cULus Listed for use for up to 600 V and temperature rated to 90°C where applicable
- Tin-plated to inhibit corrosion

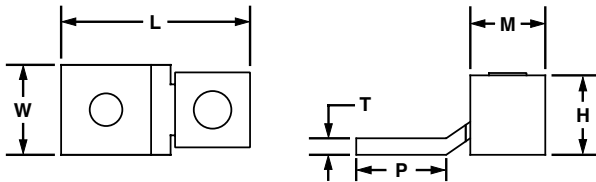

Part Number	Copper Conductor Size Range	Stud Hole Size (in.)	Figure Dimensions (in.)					Std. Pkg. Qty.
			L	W	H	T	M	
CXS35-36T-C	14 AWG - 6 AWG	3/16	1.08	0.38	0.39	0.05	0.47	100
CXS70-14-T-C	14 AWG - 4 AWG	1/4	1.28	0.5	0.5	0.06	0.53	100
CXS125-14T-Q	4 AWG - 1/0 AWG	1/4	1.6	0.62	0.73	0.09	0.65	25
CXS125-56T-Q	4 AWG - 1/0 AWG	5/16	1.6	0.62	0.73	0.09	0.65	25



One-Hole, Straight Floating Tongue Lug

For Use with Stranded Copper Code Conductors

Type CS

- Made from high strength electrolytic copper to provide premium electrical and mechanical performance
- Wide wire range-taking capability minimizes inventory requirements
- Internal pressure bar and V-bottom collar provide uniform clamping force on conductor to assure positive contact between conductor and connector
- Inspection window to visually assure full conductor insertion
- Plated steel set screw provides high strength, durable electrical contact between conductor and connector
- cULus Listed for use up to 600 V and temperature rated to 90°C where applicable

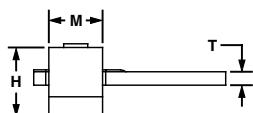
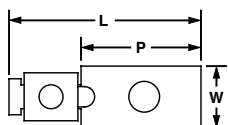

Part Number	Copper Conductor Size Range	Current Rating (Amps)	Stud Hole Size (In.)	Hex Size (In.)	Figure Dimensions (In.)						Std. Pkg. Qty.
					L	W	H	T	P	M	
CS25-18SL-CY	#14 AWG – #10 AWG	25	1/8	**	1.16	0.31	0.36	0.07	0.75	0.28	100
CS35-36SL-CY	#14 AWG – #6 AWG, (2) #10 AWG, (2) #12 AWG, (2) #14 AWG, (1) #10 AWG with (1) #12 AWG, (1) #12 AWG with (1) #14 AWG	50	3/16	**	1.14	0.38	0.49	0.07	0.60	0.43	100
CSA70-14-CY	#14 AWG – #4 AWG	70	1/4	**	1.30	0.50	0.64	0.08	0.81	0.50	100
CS70-14SL-CY	#12 AWG – #2 AWG, (1) #8 AWG with (1) #4 AWG, (1) #8 AWG with (1) #6 AWG	90	1/4	**	1.30	0.50	0.64	0.08	0.81	0.50	100
CS125-14SL-QY	#2 AWG – 1/0 AWG	125	1/4	**	1.94	0.62	0.88	0.11	1.00	0.60	25
CS175-38HK-QY	#4 AWG – 3/0 AWG	175	3/8	3/16	2.19	0.75	1.01	0.16	1.25	0.72	25
CS225-56HK-QY	#2 AWG – 4/0 AWG	225	5/16	3/16	2.38	0.99	1.13	0.12	1.19	0.94	25
CS300-38HK-QY	#1 AWG – 350 kcmil	300	3/8	5/16	3.19	0.99	1.39	0.12	1.63	1.23	25
CS400-38HK-3Y	1/0 AWG – 500 kcmil	400	3/8	5/16	3.88	1.50	1.61	0.18	2.19	1.41	3
CS650-12HK-3Y	600 kcmil – 1000 kcmil	650	1/2	3/8	5.13	2.00	2.32	0.25	2.82	1.85	3

**Uses slotted head set screw.



Two-Hole, Straight Floating Tongue Lug

For Use with Stranded Copper Code Conductors

Type CD

- Made from high strength electrolytic copper to provide premium electrical and mechanical performance
- Wide wire range-taking capability minimizes inventory requirements
- Internal pressure bar and V-bottom collar provide uniform clamping force on conductor to assure positive contact between conductor and connector
- Inspection window to visually assure full conductor insertion
- Plated steel set screw provides high strength, durable electrical contact between conductor and connector
- cULus Listed for use up to 600 V and temperature rated to 90°C where applicable
- Available with NEMA hole sizes and spacing

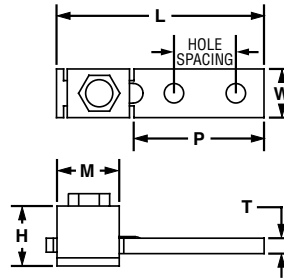

Part Number	Copper Conductor Size Range	Current Rating (Amps)	Stud Hole Size (In.)	Stud Hole Spacing (In.)	Hex Size (In.)	Figure Dimensions (In.)						Std. Pkg. Qty.
						L	W	H	T	P	M	
CD35-36SL-QY	#14 AWG – #6 AWG, (2) #10 AWG, (2) #12 AWG, (2) #14 AWG, (1) #10 AWG with (1) #12 AWG, (1) #12 AWG with (1) #14 AWG	50	3/16	1.00	**	2.13	0.38	0.49	0.07	1.60	0.43	25
CD70-14SL-QY	#12 AWG – #2 AWG (1) #8 AWG with (1) #4 AWG, (1) #8 AWG with (1) #6 AWG	90	1/4	1.00	**	2.26	0.50	0.64	0.09	1.63	0.50	25
CD125-14SL-QY	#2 – 1/0 AWG	125	1/4	1.00	**	2.94	0.62	0.88	0.13	1.88	0.60	25
CD225-56HK-QY	#6 AWG – 4/0 AWG	225	5/16	1.00	3/16	3.38	1.00	1.13	0.13	2.13	.94	25
CD300-38HK-3Y	#1 AWG – 350 kcmil	300	3/8	1.00	5/16	4.94	1.00	1.39	0.19	3.32	1.23	3
CD400-38HK-3Y	1/0 AWG – 500 kcmil	400	3/8	1.75	5/16	5.62	1.50	1.61	0.19	3.57	1.41	3
◆ CD650-12HK-3Y	600 kcmil – 1000 kcmil	650	1/2	1.75	3/8	6.88	2.00	2.32	0.25	4.69	1.85	3

**Uses slotted head set screw.

◆NEMA hole sizes and spacing.

B1.
Cable
Ties

B2.
Cable
Accessories

B3.
Stainless
Steel Cable
Ties &
Accessories

C1.
Wiring
Duct

C2.
Abrasion
Protection

C3.
Cable
Management

D1.
Terminals

D2.
Power
Connectors

D3.
Grounding
Connectors

E1.
Labeling
Systems

E2.
Labels

E3.
Pre-Printed
&
Write-On
Markers

E4.
Permanent
Identification

E5.
Lockout/
Tagout &
Safety
Solutions

F.
Keystone
Cabling
Systems

G.
Part
Number
Index



One-Hole, Offset Floating Tongue Lug

For Use with Stranded Copper Code Conductors

Type CB

- Made from high strength electrolytic copper to provide premium electrical and mechanical performance
- Wide wire range-taking capability minimizes inventory requirements
- Internal pressure bar and V-bottom collar provide uniform clamping force on conductor to assure positive contact between conductor and connector
- Inspection window to visually assure full conductor insertion
- Plated steel set screw provides high strength, durable electrical contact between conductor and connector
- cULus Listed for use up to 600 V and temperature rated to 90°C where applicable

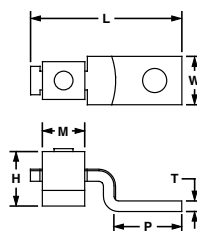

Part Number	Conductor Size Range	Current Rating (Amps)	Stud Hole Size (In.)	Hex Size (In.)	Figure Dimensions (In.)						Std. Pkg. Qty.
					L	W	H	T	P	M	
CB25-18-CY	#14 AWG – #10 AWG	25	1/8	**	1.00	0.31	0.36	0.07	0.55	0.28	100
CB35-36-CY	#14 AWG – #6 AWG, (2) #10 AWG, (2) #12 AWG, (2) #14 AWG, (1) #10 AWG with (1) #12 AWG, (1) #12 AWG with (1) #14 AWG	50	3/16	**	1.24	0.39	0.49	0.07	0.59	0.43	100
CBA70-14-CY	#14 AWG – #4 AWG	70	1/4	**	1.31	0.47	0.64	0.08	0.61	0.50	100
CB70-14-CY	#8 AWG – #2 AWG, (1) #8 AWG with (1) #4 AWG, (1) #8 AWG with (1) #6 AWG	90	1/4	**	1.55	0.47	0.64	0.08	0.80	0.50	100
CB125-14-QY	#6 AWG – 1/0 AWG	125	1/4	**	1.98	0.62	0.88	0.10	1.02	0.60	25
CB175-38-QY	#4 AWG – 3/0 AWG	175	3/8	3/16	2.20	0.74	1.01	0.12	1.18	0.72	25
CB225-56-QY	#2 AWG – 4/0 AWG	225	5/16	3/16	2.55	0.99		0.12		0.94	25
CB300-38-QY	1/0 AWG – 350 kcmil	300	3/8	5/16	2.83	0.99	1.39	0.12	1.33	1.23	25
CB400-38-3Y	1/0 AWG – 500 kcmil	400	3/8	5/16	4.09	1.49	1.61	0.17	2.22	1.61	3
CB650-12-3Y	600 kcmil – 1000 kcmil	650	1/2	3/8	4.84	2.00	2.32	0.25	2.44	1.85	3

**Uses slotted head set screw.



Two-Hole, Offset Floating Tongue Lug

For Use with Stranded Copper Code Conductors

Type CO

- Made from high strength electrolytic copper to provide premium electrical and mechanical performance
- Wide wire range-taking capability minimizes inventory requirements
- Internal pressure bar and V-bottom collar provide uniform clamping force on conductor to assure positive contact between conductor and connector
- Inspection window to visually assure full conductor insertion
- Plated steel set screw provides high strength, durable electrical contact between conductor and connector
- cULus Listed for use up to 600 V and temperature rated to 90°C where applicable
- Available with NEMA hole sizes and spacing

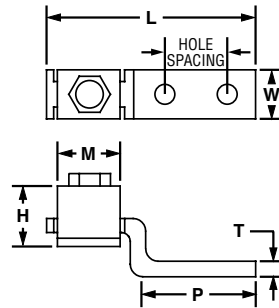

Part Number	Conductor Size Range	Current Rating (Amps)	Stud Hole Size (In.)	Stud Hole Spacing (In.)	Hex Key Size (In.)	Figure Dimensions (In.)						Std. Pkg. Qty.
						L	W	H	T	P	M	
CO35-36SL-QY	#14 AWG – #6 AWG, (2) #10 AWG, (2) #12 AWG, (2) #14 AWG, (1) #10 AWG with (1) #12 AWG, (1) #12 AWG with (1) #14 AWG	50	3/16	1.00	**	2.19	0.38	0.49	0.07	1.46	0.43	25
CO70-14SL-QY	#12 AWG – #1 AWG, (1) #8 AWG with (1) #4 AWG, (1) #8 AWG with (1) #6 AWG	90	1/4	1.00	**	2.50	0.50	0.64	0.09	1.60	0.50	25
CO125-14SL-QY	#2 AWG – 1/0 AWG	125	1/4	1.00	**	2.97	0.63	0.88	0.13	1.87	0.60	25
CO225-56HK-QY	#6 AWG – 4/0 AWG	225	5/16	1.00	3/16	3.62	1.00	1.13	0.13	2.28	0.94	25
CO300-38HK-3Y	#1 AWG – 350 kcmil	300	3/8	1.87	5/16	5.69	1.00	1.39	0.19	3.99	1.23	3
CO400-38HK-3Y	1/0 AWG – 500 kcmil	400	3/8	1.75	5/16	6.00	1.50	1.61	0.19	3.79	1.41	3
◆ CO650-12HK-3Y	600 kcmil – 1000 kcmil	650	1/2	1.75	3/8	6.25	2.00	2.32	0.25	3.68	1.85	3

**Uses slotted head set screw.

◆NEMA hole sizes and spacing.



One-Hole, Single Barrel Lug

For Use with Stranded Aluminum or Copper Code Conductors

Type LAMA

- Made from high strength, extruded aluminum alloy to provide premium electrical and mechanical performance
- Tin-plated to inhibit corrosion
- Compact design saves space
- Wide wire range-taking capability minimizes inventory requirements
- Inspection window to visually assure full conductor insertion
- Plated steel or aluminum set screw provides high strength, durable electrical contact between conductor and connector
- UL Listed and CSA Certified for use up to 600 V and temperature rated 90°C

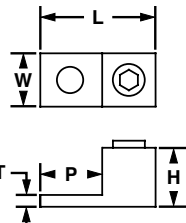

Part Number	Conductor Size Range	Stud Hole Size (In.)	Hex Key Size (In.)	Figure Dimensions (In.)					Std. Pkg. Qty.
				L	W	H	T	P	
LAMA6-14-QY	#14 AWG – #6 AWG	1/4	**	1.06	0.50	0.50	0.09	0.68	25
LAMA2-14-QY	#14 AWG – #2 AWG	1/4	**	1.16	0.50	0.55	0.10	0.69	25
LAMA1/0-14-QY	#14 AWG – 1/0 AWG	1/4	**	1.47	0.62	0.79	0.19	0.85	25
LAMA1/0-56-Q	#14 AWG – 1/0 AWG	5/16	**	1.47	0.62	0.79	0.19	0.85	25
LAMA2/0-14-QY	#14 AWG – 2/0 AWG	1/4	3/16	1.47	0.62	0.79	0.19	0.85	25
LAMA250-56-QY	#6 AWG – 250 kcmil	5/16	5/16	2.01	1.00	1.13	0.25	0.99	25
LAMA300-56-QY	#6 AWG – 300 kcmil	5/16	5/16	2.00	1.00	1.13	0.25	1.00	25
LAMA350-38-QY	#6 AWG – 350 kcmil	3/8	5/16	2.25	1.13	1.25	0.25	1.12	25
LAMA500-38-6Y	#4 AWG – 500 kcmil	3/8	1/2	2.81	1.50	1.56	0.31	1.59	6
LAMA600-38-6Y	#2 AWG – 600 kcmil	3/8	1/2	3.18	1.60	1.57	0.44	1.81	6
LAMA600S-38-6Y‡	#4 AWG – 600 kcmil – (2) 1/0 AWG – 250 kcmil	3/8	3/8	2.81	1.38	1.81	0.31	1.50	6
LAMA1000-58-6Y	500 kcmil – 1000 kcmil	5/8	3/8	3.50	1.75	1.94	0.50	1.88	6

The use of Panduit oxide inhibiting joint compound (CMP-100) is recommended for pad to pad and conductor connections. See page D2.91.

**Uses slotted head set screw.

‡Accommodates two conductors for conductor range 1/0 AWG – 250 kcmil.



Two-Hole, Single Barrel Lug

For Use with Stranded Aluminum or Copper Code Conductors

Type LAMB

- Made from high strength, extruded aluminum alloy to provide premium electrical and mechanical performance
- Tin-plated to inhibit corrosion
- Compact design saves space
- Wide wire range-taking capability minimizes inventory requirements
- Inspection window to visually assure full conductor insertion
- Plated steel or aluminum set screw provides high strength, durable electrical contact between conductor and connector
- LAMLB provided with dual set screws for premium clamping of conductor to connector for heavy duty applications
- UL Listed and CSA Certified for use up to 600 V and temperature rated 90°C
- Available with NEMA hole sizes and spacing

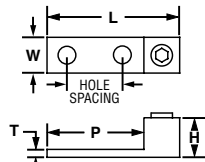

Figure 1

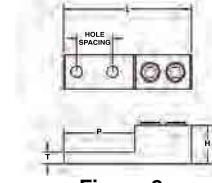

Figure 2

Part Number	Figure No.	Conductor Size Range	Stud Hole Size (In.)	Stud Hole Spacing (In.)	Hex Key Size (In.)	Figure Dimensions (In.)					Std. Pkg. Qty.
						L	W	H	T	P	
◆ LAMB350-12-6Y	1	#6 AWG – 350 kcmil	1/2	1.75	5/16	4.19	1.13	1.28	0.28	3.05	6
◆ LAMB600-12-3Y	1	#2 AWG – 600 kcmil	1/2	1.75	1/2	4.69	1.60	1.57	0.44	3.31	3
◆ LAMLB1000-12-3	2	500 – 1000 kcmil	1/2	1.75	1/2	6.19	1.63	1.88	0.56	3.44	3

The use of Panduit oxide inhibiting joint compound (CMP-100) is recommended for pad to pad and conductor connections. See page D2.91.
◆NEMA hole sizes and spacing.



One-Hole, Two-Barrel Lug

For Use with Stranded Aluminum or Copper Code Conductors

Type LAM2A

- Dual barrel provides termination of two conductors
- Made from high strength, extruded aluminum alloy to provide premium electrical and mechanical performance
- Tin-plated to inhibit corrosion
- Wide wire range-taking capability minimizes inventory requirements
- Inspection window to visually assure full conductor insertion
- Plated steel or aluminum set screw provides high strength, durable electrical contact between conductor and connector
- UL Listed and CSA Certified for use up to 600 V and temperature rated 90°C
- Available with NEMA hole sizes and spacing

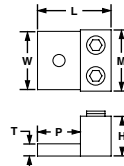

Part Number	Conductor Size Range	Stud Hole Size (In.)	Hex Key Size (In.)	Figure Dimensions (In.)						Std. Pkg. Qty.
				L	W	H	T	P	M	
LAM2A1/0-14-6Y	#14 AWG – 1/0 AWG	1/4	**	1.47	1.13	0.78	0.19	0.85	1.13	6
LAM2A2/0-14-6Y	#14 AWG – 2/0 AWG	1/4	3/16	1.47	1.20	0.78	0.19	0.85	1.20	6
LAM2A250-38-6Y	#6 AWG – 250 kcmil	3/8	3/8	2.56	1.50	1.19	0.25	1.56	1.64	6
LAM2A350-12-6Y	#6 AWG – 350 kcmil	1/2	5/16	2.87	1.73	1.25	0.25	1.74	1.91	6
LAM2A600-12-6Y	#2 AWG – 600 kcmil	1/2	3/8	3.19	2.00	1.56	0.44	1.81	2.38	6
LAM2A1000-58-6Y	500 kcmil – 1000 kcmil	5/8	3/8	3.50	3.50	1.94	0.50	1.88	3.50	6

The use of Panduit oxide inhibiting joint compound (CMP-100) is recommended for pad to pad and conductor connections. See page D2.91.
**Uses slotted head set screw.



One-Hole, Vertical Two-Barrel Lug

For Use with Stranded Aluminum or Copper Code Conductors

Type LAM2SA

- Dual barrel provides termination of two conductors
- Made from high strength, extruded aluminum alloy to provide premium electrical and mechanical performance
- Tin-plated to inhibit corrosion
- Wide wire range-taking capability minimizes inventory requirements
- Inspection window to visually assure full conductor insertion
- Plated steel or aluminum set screw provides high strength, durable electrical contact between conductor and connector
- UL Listed and CSA Certified for use up to 600 V and temperature rated 90°C

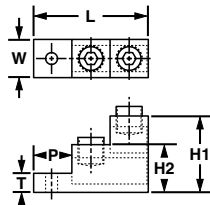

Part Number	Conductor Size Range	Stud Hole Size (In.)	Hex Key Size (In.)	Figure Dimensions (In.)						Std. Pkg. Qty.
				L	W	H1	H2	T	P	
LAM2SA300-56-3	#6 AWG – 300 kcmil	5/16	5/16	3.00	1.00	2.00	1.25	0.50	1.00	3
LAM2SA300-38-3	#6 AWG – 300 kcmil	3/8	5/16	3.00	1.00	2.00	1.25	0.50	1.00	3

The use of Panduit® oxide inhibiting joint compound (CMP-100) is recommended for pad to pad and conductor connections. See page D2.91.



Two-Hole, Two-Barrel Lug

For Use with Stranded Aluminum or Copper Code Conductors

Type LAM2B

- Dual barrel provides termination of two conductors
- Made from high strength, extruded aluminum alloy to provide premium electrical and mechanical performance
- Tin-plated to inhibit corrosion
- Wide wire range-taking capability minimizes inventory requirements
- Inspection window to visually assure full conductor insertion
- Plated steel or aluminum set screw provides high strength, durable electrical contact between conductor and connector
- LAM2LB connector provided with dual set screws for premium clamping of conductor to connector for heavy duty applications
- UL Listed and CSA certified for use up to 600 V and temperature rated 90°C
- Available with NEMA hole sizes and spacing

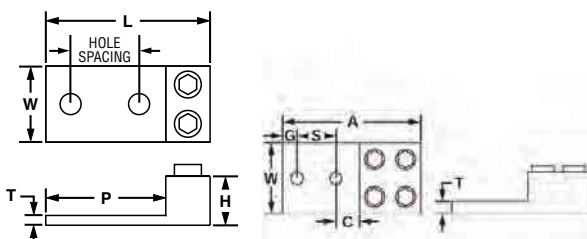

Figure 1

Figure 2

Part Number	Figure No.	Conductor Size Range	Stud Hole Size (In.)	Stud Hole Spacing (In.)	Hex Key Size (In.)	Figure Dimensions (In.)					Std. Pkg. Qty.
						L	W	H	T	P	
◆ LAM2B350-12-3Y	1	#6 AWG – 350 kcmil	1/2	1.75	5/16	4.19	1.91	1.28	0.25	3.06	3
◆ LAM2LB600-12-3	2	#2 AWG – 600 kcmil	1/2	1.75	3/8	5.50	2.85	1.50	0.38	3.25	3
◆ LAM2LB1000-12-3	2	500 – 1000 kcmil	1/2	1.75	1/2	6.19	3.48	1.88	0.56	3.44	3

The use of Panduit oxide inhibiting joint compound (CMP-100) is recommended for pad to pad and conductor connections. See page D2.91.

◆NEMA hole sizes and spacing.



Two-Hole, Vertical Two-Barrel Lug

For Use with Stranded Aluminum or Copper Code Conductors

Type LAM2SB

- Dual barrel provides termination of two conductors
- Vertical configuration saves space
- Made from high strength, extruded aluminum alloy to provide premium electrical and mechanical performance
- Tin-plated to inhibit corrosion
- Wide wire range-taking capability minimizes inventory requirements
- Inspection window to visually assure full conductor insertion
- Plated steel or aluminum set screw provides high strength, durable electrical contact between conductor and connector
- UL Listed and CSA Certified for use up to 600 V and temperature rated 90°C

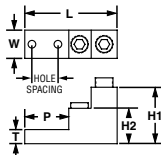

Figure 1

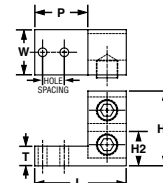

Figure 2

Part Number	Figure No.	Conductor Size Range	Stud Hole Size (In.)	Stud Hole Spacing (In.)	Hex Key Size (In.)	Figure Dimensions (In.)						Std. Pkg. Qty.
						L	W	H1	H2	T	P	
LAM2SB600-38-1Y	1	#2 AWG – 600 kcmil	3/8	1.38	3/8	4.91	1.50	3.00	1.88	0.75	2.34	1
LAM2SB750-38-1Y	1	1/0 AWG – 750 kcmil	3/8	1.38	3/8	4.91	1.50	3.00	1.88	0.75	2.34	1
LAM2SSB500-141Y	2	4/0 AWG – 500 kcmil	1/4	0.69	1/2	2.91	1.44	2.38	1.77	0.63	1.69	1

The use of Panduit oxide inhibiting joint compound (CMP-100) is recommended for pad to pad and conductor connections. See page D2.91.



Two-Hole, Three-Barrel Lug

For Use with Stranded Aluminum or Copper Code Conductors

Type LAM3B

- Triple barrel provides termination of three conductors
- Made from high strength, extruded aluminum alloy to provide premium electrical and mechanical performance
- Tin-plated to inhibit corrosion
- Wide wire range-taking capability minimizes inventory requirements
- Inspection window to visually assure full conductor insertion
- Plated steel or aluminum set screw provides high strength, durable electrical contact between conductor and connector
- LAM3LB connector is provided with dual set screws to allow premium clamping of conductor to connector for heavy duty applications
- UL Listed and CSA Certified for use up to 600 V and temperature rated 90°C
- Available with NEMA hole sizes and spacing

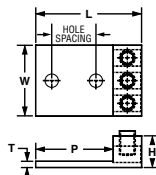

Figure 1

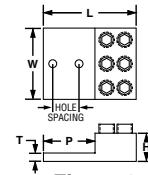

Figure 2

Part Number	Figure No.	Conductor Size Range	Stud Hole Size (In.)	Stud Hole Spacing (In.)	Hex Key Size (In.)	Figure Dimensions (In.)					Std. Pkg. Qty.
						L	W	H	T	P	
LAM3B2-14-6Y*	1	#14 AWG – #2 AWG	1/4	0.87	**	2.49	1.63	0.47	0.19	2.03	6
LAM3B1/0-38-6Y	1	#14 AWG – 1/0 AWG	3/8	1.00	**	2.91	2.00	0.88	0.25	2.16	6
◆ LAM3B3/0-12-3Y	1	#6 AWG – 3/0 AWG	1/2	1.75	1/4	4.25	2.81	1.19	0.31	3.25	3
◆ LAM3B250-12-1Y	1	#6 AWG – 250 kcmil	1/2	1.75	5/16	4.00	2.82	1.19	0.31	3.00	1
◆ LAM3B350-12-1Y	1	#6 AWG – 350 kcmil	1/2	1.75	5/16	4.50	3.50	1.38	0.31	3.25	1
◆ LAM3LB600-12-1	2	#2 AWG – 600 kcmil	1/2	1.75	3/8	5.50	4.32	1.50	0.38	3.25	1
◆ LAM3LB1000-121Y	2	500 kcmil – 1000 kcmil	1/2	1.75	1/2	6.19	5.27	1.88	0.56	3.44	1

The use of Panduit oxide inhibiting joint compound (CMP-100) is recommended for pad to pad and conductor connections. See page D2.91.

◆NEMA hole sizes and spacing.

*cULus Listed

**Uses slotted head set screw



Four-Hole, Three-Barrel Lug

For Use with Stranded Aluminum or Copper Code Conductors

Type LAM3D

- Triple barrel provides termination of three conductors
- Made from high strength, extruded aluminum alloy to provide premium electrical and mechanical performance
- Tin-plated to inhibit corrosion
- Wide wire range-taking capability minimizes inventory requirements
- Inspection window to visually assure full conductor insertion
- Plated steel or aluminum set screw provides high strength, durable electrical contact between conductor and connector
- LAM3LD connector is provided with dual set screws to allow premium clamping of conductor to connector for heavy duty applications
- UL Listed and CSA certified for use up to 600 V and temperature rated 90°C
- Available with NEMA hole sizes and spacing

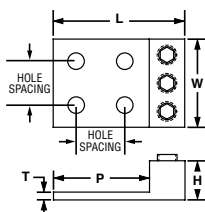

Figure 1

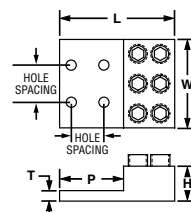

Figure 2

Part Number	Figure No.	Conductor Size Range	Stud Hole Size (In.)	Stud Hole Spacing (In.)	Hex Key Size (In.)	Figure Dimensions (In.)					Std. Pkg. Qty.
						L	W	H	T	P	
◆ LAM3D3/0-12-3Y	1	#6 AWG – 3/0 AWG	1/2	1.75	1/4	4.25	2.81	1.19	0.31	3.25	3
◆ LAM3D250-12-1Y	1	#6 AWG – 250 kcmil	1/2	1.75	5/16	4.25	3.00	1.19	0.31	3.25	1
◆ LAM3D350-12-1Y	1	#6 AWG – 350 kcmil	1/2	1.75	5/16	4.50	3.50	1.38	0.31	3.25	1
◆ LAM3LD600-12-1	2	#2 AWG – 600 kcmil	1/2	1.75	3/8	5.50	4.32	1.50	0.38	3.25	1
◆ LAM3LD1000-121Y	2	500 kcmil – 1000 kcmil	1/2	1.75	1/2	6.19	5.27	1.88	0.56	3.44	1

The use of Panduit oxide inhibiting joint compound (CMP-100) is recommended for pad to pad and conductor connections. See page D2.91.

◆NEMA hole sizes and spacing.



Two-Hole, Vertical Four-Barrel Lug

For Use with Stranded Aluminum or Copper Code Conductors

Type LAM4SB

- Four barrels provide termination of four conductors
- Vertical configuration saves space
- Made from high strength, extruded aluminum alloy to provide premium electrical and mechanical performance
- Tin-plated to inhibit corrosion
- Wide wire range-taking capability minimizes inventory requirements
- Inspection window to visually assure full conductor insertion
- Plated steel or aluminum set screw provides high strength, durable electrical contact between conductor and connector
- UL Listed and CSA Certified for use up to 600 V and temperature rated 90°C

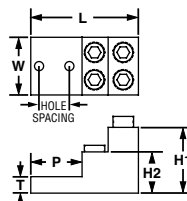

Part Number	Conductor Size Range	Stud Hole Size (In.)	Stud Hole Spacing (In.)	Hex Key Size (In.)	Figure Dimensions (In.)						Std. Pkg. Qty.
					L	W	H1	H2	T	P	
LAM4SB600-38-1Y	#2 AWG – 600 kcmil	3/8	1.38	3/8	4.91	2.47	3.00	1.88	0.75	2.34	1
LAM4SB750-38-1Y	1/0 AWG – 750 kcmil	3/8	1.38	3/8	4.91	2.84	3.00	1.88	0.75	2.34	1

The use of Panduit oxide inhibiting joint compound (CMP-100) is recommended for pad to pad and conductor connections. See page D2.91.



Four-Hole, Four-Barrel Lug

For Use with Stranded Aluminum or Copper Code Conductors

Type LAM4D

- Four barrels provide termination of four conductors
- Made from high strength, extruded aluminum alloy to provide premium electrical and mechanical performance
- Tin-plated to inhibit corrosion
- Wide wire range-taking capability minimizes inventory requirements
- Inspection window to visually assure full conductor insertion
- Plated steel or aluminum set screw provides high strength, durable electrical contact between conductor and connector
- LAM4LD connector is provided with dual set screws to allow premium clamping of conductor to connector for heavy duty applications
- UL Listed and CSA certified for use up to 600 V and temperature rated 90°C
- Available with NEMA hole sizes and spacing

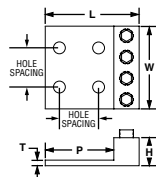

Figure 1

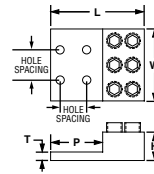

Figure 2

Part Number	Figure No.	Conductor Size Range	Stud Hole Size (In.)	Stud Hole Spacing (In.)	Hex Key Size (In.)	Figure Dimensions (In.)					Std. Pkg. Qty.
						L	W	H	T	P	
◆ LAM4D250-12-1Y	1	# 6 AWG – 250 kcmil	1/2	1.75	5/16	4.25	4.04	1.19	0.31	3.25	1
◆ LAM4D350-12-1Y	1	# 6 AWG – 350 kcmil	1/2	1.75	5/16	4.50	4.72	1.37	0.31	3.25	1
◆ LAM4LD600-12-1	2	#2 – 600 kcmil	1/2	1.75	3/8	5.50	5.31	1.50	0.38	3.25	1
◆ LAM4LD1000-12-1	2	350 – 1000 kcmil	1/2	1.75	3/8	6.19	7.11	1.88	0.56	3.44	1

The use of Panduit oxide inhibiting joint compound (CMP-100) is recommended for pad to pad and conductor connections. See page D2.91.
◆NEMA hole sizes and spacing.

Transformer Lug Kit

For Use with Stranded Aluminum or Copper Code Conductors

Type KLM

- Kits include all of the connectors and hardware to make a complete transformer connection in a single convenient package
- Lugs are made from high strength, extruded aluminum alloy and are tin-plated to inhibit corrosion and oxidation
- Plated steel cap screws, belleville and flat washers, and hex nuts are provided to assure that terminal to bus connections are made using proper hardware resulting in true torque to pressure performance
- Hardware is packaged in a sealed plastic bag to prevent lost hardware prior to installation
- Lugs are UL Listed and CSA Certified for use up to 600 V and UL temperature rated 90°C



Part Number	Transformer KVA Rating	Aluminum Mechanical Lug		Conductor Size Range	Hardware (Sizes in Inches)					
		Part No.	Qty.		Hex Bolt Size	Qty.	Nut Size	Qty.	Washer Size	Qty.
KLM14-250Y	15 – 37.5 KVA 1PH 15 – 45 KVA 3PH	LAMA2-14	8	#14 – 2 AWG	1/4 – 20 x 3/4 HH	8	1/4 – 20 HN	8	1/4 FLAT 1/4 CMP	16 8
		LAMA250-56	4	#6 AWG – 250 kcmil	1/4 – 20 x 3/4 HH 1/4 – 20 x 2 HH	8 8	1/4 – 20 HN	16	1/4 FLAT 1/4 CMP	32 16
KLM6-250Y	50 – 75 KVA 1 PH 75 – 112.5 KVA 3 PH	LAMA250-56	12	#6 AWG – 250 kcmil	1/4 – 20 x 3/4 HH 1/4 – 20 x 2 HH	8 8	1/4 – 20 HN	16	1/4 FLAT 1/4 CMP	32 16
		LAMA250-56 LAMA600-38	3 3	#6 AWG – 250 kcmil #4 AWG – 600 kcmil	1/4 – 20 x 3/4 HH 3/8 – 16 x 2 HH	3 16	1/4 – 20 HN 3/8 – 16 HN	3 16	3/8 FLAT 1/4 FLAT 3/8 CMP 1/4 CMP	32 6 16 3

Suffix: HH = Hex Head; HN = Hex Nut; FLAT = Flat Washer; CMP = Compression Washer.

The use of Panduit oxide inhibiting joint compound (CMP-100) is recommended for pad to pad and conductor connections. See page D2.91.



Splicer/Reducer

For Use with Stranded Aluminum or Copper Code Conductors

Type SR

- Made from high strength extruded aluminum alloy to provide premium electrical and mechanical performance
- Tin-plated to inhibit corrosion
- Rounded bottoms to facilitate taping
- Solid center barrier prevents contact of dissimilar metal conductors
- Wide wire range-taking capability minimizes inventory requirements
- UL Listed and CSA Certified for use up to 600 V and UL temperature rated 90°C

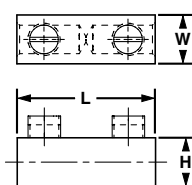

Figure 1

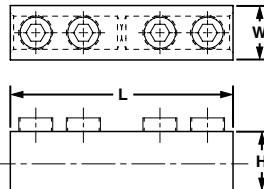

Figure 2

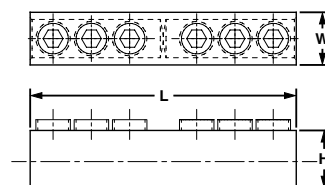

Figure 3

Part Number	Figure No.	Conductor Size Range		Figure Dimensions (In.)			Hex Key Size (In.)	Std. Pkg. Qty.
		Max.	Min.	L	W	H		
SR-2-XY	1	#2 AWG STR, #10 AWG SOL	#14 AWG STR, #14 AWG SOL	1.38	0.50	0.56	**	10
SR-0-XY	1	1/0 AWG STR, #10 AWG SOL	#14 AWG STR, #14 AWG SOL	1.91	0.75	0.75	**	10
SR-4/0-XY*	1	4/0 AWG	#6 AWG	2.31	1.00	1.13	5/16	10
SR-250-XY	2	250 kcmil	#6 AWG	3.94	1.00	1.13	5/16	10
SR-350-XY	2	350 kcmil	#6 AWG	4.19	1.13	1.19	5/16	10
SR-500-3Y	2	500 kcmil	3/0 AWG	5.00	1.37	1.40	3/8	3
SR-750-1Y	2	750 kcmil	250 kcmil	6.25	1.63	1.75	1/2	1
SR-1000-1Y	3	1000 kcmil	500 kcmil	8.69	1.72	1.88	9/16	1

The use of Panduit oxide inhibiting joint compound (CMP-100) is recommended. See page D2.91.

*Not CSA certified.

**Uses slotted screws.



Multi-Tap Connector with Clear Insulation, Single-Sided

For Use with Aluminum or Copper Code Conductors

Type PCSB-S

- Flexible design – can be used as a tap, splice, or dead end connector
- Body made from high strength, extruded aluminum alloy to provide premium electrical and mechanical performance
- Insulated with clear PVC to eliminate the need for taping and allow for visual inspection of the complete conductor insertion
- Each port pre-filled with oxide inhibiting joint compound seals out air and moisture to deter surface oxidation
- Wide wire range-taking capability minimizes inventory requirements
- Plated steel or aluminum set screw provides high strength, durable electrical contact between conductor and connector
- UL Listed and CSA Certified for use up to 600 V and temperature rated 90°C*

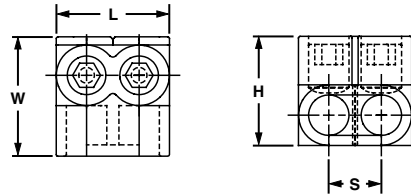

Part Number	Conductor Size Range	No. of Ports	Figure Dimensions (In.)				Hex Key Size (In.)	Std. Pkg. Qty.	
			L	W	H	S			
PCSB4-2S-12Y	#4 – #14 AWG STR #10 – #14 AWG SOL	2	1.23	1.25	1.25	0.53	1/8	12	
PCSB4-3S-12Y		3	1.76	1.25	1.25	0.53	1/8	12	
PCSB4-4S-6Y		4	2.29	1.25	1.25	0.53	1/8	6	
PCSB4-5S-6Y		5	2.82	1.25	1.25	0.53	1/8	6	
PCSB4-6S-6Y		6	3.35	1.25	1.25	0.53	1/8	6	
PCSB4-10S-4Y		10	5.47	1.25	1.25	0.53	1/8	4	
PCSB4-12S-3Y		12	6.53	1.25	1.25	0.53	1/8	3	
PCSB4-14S-2Y		14	7.59	1.25	1.25	0.53	1/8	2	
PCSB2/0-2S-6		2/0 – #14 AWG STR #10 – #14 AWG SOL	2	1.52	1.31	1.38	0.67	3/16	6
PCSB2/0-3S-6Y			3	2.19	1.31	1.38	0.67	3/16	6
PCSB2/0-4S-6Y			4	2.86	1.31	1.38	0.67	3/16	6
PCSB2/0-5S-4Y			5	3.53	1.31	1.38	0.67	3/16	4
PCSB2/0-6S-4Y			6	4.20	1.31	1.38	0.67	3/16	4
PCSB2/0-8S-3Y			8	5.55	1.31	1.38	0.67	3/16	3
PCSB2/0-10S-2Y	10		6.89	1.31	1.38	0.67	3/16	2	
PCSB2/0-12S-1Y	12		8.24	1.31	1.38	0.67	3/16	1	
PCSB2/0-14S-1Y	14		9.58	1.31	1.38	0.67	3/16	1	
PCSB250-2S-6Y	250 kcmil – #10 AWG STR		2	2.03	2.00	2.13	0.94	5/16	6
PCSB250-3S-6Y			3	2.97	2.00	2.13	0.94	5/16	6
PCSB250-4S-6Y			4	3.91	2.00	2.13	0.94	5/16	6
PCSB250-5S-4Y			5	4.84	2.00	2.13	0.94	5/16	4
PCSB250-6S-4Y			6	5.78	2.00	2.13	0.94	5/16	4
PCSB250-8S-3Y		8	7.66	2.00	2.13	0.94	5/16	3	
PCSB250-10S-2Y		10	9.53	2.00	2.13	0.94	5/16	2	
PCSB250-12S-2Y		12	11.41	2.00	2.13	0.94	5/16	2	
PCSB250-14S-1Y		14	13.29	2.00	2.13	0.94	5/16	1	
PCSB350-2S-4Y		350 kcmil – #10 AWG STR	2	2.17	2.25	2.50	1.00	5/16	4
PCSB350-3S-4Y			3	3.17	2.25	2.50	1.00	5/16	4
PCSB350-4S-3Y			4	4.17	2.25	2.50	1.00	5/16	3
PCSB350-5S-3Y			5	5.17	2.25	2.50	1.00	5/16	3
PCSB350-6S-2Y			6	6.17	2.25	2.50	1.00	5/16	2
PCSB350-8S-2Y	8		8.17	2.25	2.50	1.00	5/16	2	
PCSB350-10S-2Y	10		10.17	2.25	2.50	1.00	5/16	2	
PCSB350-12S-1Y	12		12.17	2.25	2.50	1.00	5/16	1	
PCSB350-14S-1Y	14		14.17	2.25	2.50	1.00	5/16	1	

Continues on next page



Multi-Tap Connector with Clear Insulation, Single-Sided (continued)

Part Number	Conductor Size Range	No. of Ports	Figure Dimensions (In.)				Hex Key Size (In.)	Std. Pkg. Qty.
			L	W	H	S		
PCSB600-2S-4Y	600 kcmil – #6 AWG STR	2	2.72	2.25	2.75	1.28	3/8	4
PCSB600-3S-3Y		3	4.00	2.25	2.75	1.28	3/8	3
PCSB600-4S-2Y		4	5.28	2.25	2.75	1.28	3/8	2
PCSB600-5S-2Y		5	6.56	2.25	2.75	1.28	3/8	2
PCSB600-6S-2Y		6	7.84	2.25	2.75	1.28	3/8	2
PCSB600-8S-2Y		8	10.41	2.25	2.75	1.28	3/8	2
PCSB600-10S-1Y		10	12.97	2.25	2.75	1.28	3/8	1
PCSB600-12S-1Y		12	15.93	2.25	2.75	1.28	3/8	1
PCSB600-14S-1Y		14	18.09	2.25	2.75	1.28	3/8	1
PCSB750-2S-1		750 kcmil – #2 AWG STR	2	2.88	2.63	3.00	1.38	3/8

*PCSB750-2S-1 is not UL Listed or CSA Certified.



Multi-Tap Connector with Clear Insulation, Double-Sided

For Use with Aluminum or Copper Code Conductors

Type PCSB

- Flexible design – can be used as a tap, splice, or dead end connector
- Body made from high strength, extruded aluminum alloy to provide premium electrical and mechanical performance
- Insulated with clear PVC to eliminate the need for taping and allow for visual inspection of the complete conductor insertion
- Each port pre-filled with oxide inhibiting joint compound seals out air and moisture to deter surface oxidation
- Wide wire range-taking capability minimizes inventory requirements
- Dual-sided entry allows offset and opposite entry for primary and secondary conductors
- Plated steel or aluminum set screw provides high strength, durable electrical contact between conductor and connector
- UL Listed and CSA Certified for use up to 600 V and temperature rated 90°C

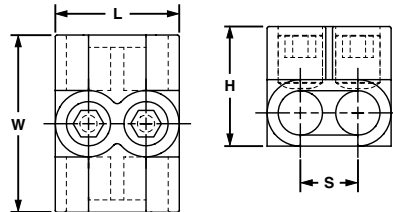

Part Number	Conductor Size Range	No. of Ports	Figure Dimensions (In.)				Hex Key Size (In.)	Std. Pkg. Qty.	
			L	W	H	S			
PCSB4-2-12Y	#4 – #14 AWG STR	2	1.23	1.50	1.25	0.53	1/8	12	
PCSB4-3-12Y		3	1.76	1.50	1.25	0.53	1/8	12	
PCSB4-4-6Y		4	2.29	1.50	1.25	0.53	1/8	6	
PCSB4-5-6Y		5	2.82	1.50	1.25	0.53	1/8	6	
PCSB4-6-6Y		6	3.35	1.50	1.25	0.53	1/8	6	
PCSB4-8-4Y		#10 – #14 AWG SOL	8	4.41	1.50	1.25	0.53	1/8	4
PCSB4-10-4Y		10	5.47	1.50	1.25	0.53	1/8	4	
PCSB4-12-3Y		12	6.53	1.50	1.25	0.53	1/8	3	
PCSB4-14-2Y		14	7.59	1.50	1.25	0.53	1/8	2	
PCSB2/0-2-12		2/0 – #14 AWG STR	2	1.52	1.56	1.38	0.67	3/16	12
PCSB2/0-3-6	3		2.19	1.56	1.38	0.67	3/16	6	
PCSB2/0-4-6	4		2.86	1.56	1.38	0.67	3/16	6	
PCSB2/0-5-6	5		3.53	1.56	1.38	0.67	3/16	6	
PCSB2/0-6-6	#10 – #14 AWG SOL		6	4.20	1.56	1.38	0.67	3/16	6
PCSB2/0-8-4	8		5.55	1.56	1.38	0.67	3/16	4	
PCSB2/0-10-2Y	10		6.89	1.56	1.38	0.67	3/16	2	
PCSB2/0-12-2Y	12		8.24	1.56	1.38	0.67	3/16	2	

Continues on next page



Multi-Tap Connector with Clear Insulation, Double-Sided (continued)

Part Number	Conductor Size Range	No. of Ports	Figure Dimensions (In.)				Hex Key Size (In.)	Std. Pkg. Qty.	
			L	W	H	S			
PCSB2/0-14-1Y	250 kcmil – #10 AWG STR	14	9.58	1.56	1.38	0.67	3/16	1	
PCSB250-2-6Y		2	2.03	2.63	2.13	0.94	5/16	6	
PCSB250-3-6Y		3	2.97	2.63	2.13	0.94	5/16	6	
PCSB250-4-6Y		4	3.91	2.63	2.13	0.94	5/16	6	
PCSB250-5-4Y		5	4.84	2.63	2.13	0.94	5/16	4	
PCSB250-6-4Y		6	5.78	2.63	2.13	0.94	5/16	4	
PCSB250-8-3Y		8	7.66	2.63	2.13	0.94	5/16	3	
PCSB250-10-2Y		10	9.53	2.63	2.13	0.94	5/16	2	
PCSB250-12-2Y		12	11.41	2.63	2.13	0.94	5/16	2	
PCSB250-14-1Y		14	13.29	2.63	2.13	0.94	5/16	1	
PCSB350-2-4		350 kcmil – #10 AWG STR #10 AWG SOL	2	2.17	3.00	2.50	1.00	3/8	4
PCSB350-3-4	3		3.17	3.00	2.50	1.00	3/8	4	
PCSB350-4-3	4		4.17	3.00	2.50	1.00	3/8	3	
PCSB350-5-3	5		5.17	3.00	2.50	1.00	3/8	3	
PCSB350-6-2	6		6.17	3.00	2.50	1.00	3/8	2	
PCSB350-8-2	8		8.17	3.00	2.50	1.00	3/8	2	
PCSB350-10-2Y	10		10.17	3.00	2.50	1.00	5/16	2	
PCSB350-12-1Y	12		12.17	3.00	2.50	1.00	5/16	1	
PCSB350-14-1Y	14		14.17	3.00	2.50	1.00	5/16	1	
PCSB600-2-4Y	600 kcmil – #6 AWG STR		2	2.72	3.00	2.75	1.28	3/8	4
PCSB600-3-3Y			3	4.00	3.00	2.75	1.28	3/8	3
PCSB600-4-2Y		4	5.28	3.00	2.75	1.28	3/8	2	
PCSB600-6-2Y		6	7.84	3.00	2.75	1.28	3/8	2	
PCSB600-8-2Y		8	10.41	3.00	2.75	1.28	3/8	2	
PCSB600-10-1Y		10	12.97	3.00	2.75	1.28	3/8	1	
PCSB600-12-1Y		12	15.53	3.00	2.75	1.28	3/8	1	
PCSB600-14-1Y		14	18.09	3.00	2.75	1.28	3/8	1	
PCSB750-2-2Y‡‡	750 kcmil – #2 AWG STR	2	2.88	3.38	3.00	1.38	3/8	2	
PCSB750-3-2Y‡‡		3	4.25	3.38	3.00	1.38	3/8	2	
PCSB750-4-2Y‡‡		4	5.63	3.38	3.00	1.38	3/8	2	
PCSB750-5-1Y‡‡		5	7.00	3.38	3.00	1.38	3/8	1	
PCSB750-6-1Y‡‡		6	8.38	3.38	3.00	1.38	3/8	1	
PCSB750-8-1Y‡‡		8	11.13	3.38	3.00	1.38	3/8	1	
PCSB750-10-1Y‡‡		10	13.88	3.38	3.00	1.38	3/8	1	

‡‡Not UL Listed or CSA Certified.

B1.
Cable
Ties

B2.
Cable
Accessories

B3.
Stainless
Steel Cable
Ties &
Accessories

C1.
Wiring
Duct

C2.
Abrasion
Protection

C3.
Cable
Management

D1.
Terminals

D2.
Power
Connectors

D3.
Grounding
Connectors

E1.
Labeling
Systems

E2.
Labels

E3.
Pre-Printed
&
Write-On
Markers

E4.
Permanent
Identification

E5.
Lockout/
Tagout &
Safety
Solutions

F.
Keystone
Cabling
Systems

G.
Part
Number
Index



In-Line Splicer/Reducer with Clear Insulation

For Use with Aluminum or Copper Code Conductors

Type PISR

- Flexible design – can be used as a splice or reducer
- Dual rated for use with copper or aluminum conductors
- Made from high strength, extruded aluminum alloy to provide premium electrical and mechanical performance
- Insulated with clear PVC to eliminate the need for taping and allow for visual inspection of the complete conductor insertion
- Each port pre-filled with oxide inhibiting joint compound seals out air and moisture to deter surface oxidation
- Wide wire range-taking capability minimizes inventory requirements
- Plated steel or aluminum set screw provides high strength, durable electrical contact between conductor and connector
- UL Listed and CSA Certified for use up to 600 V and UL temperature rated 90°C

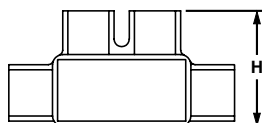
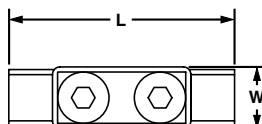

Part Number	Conductor Size Range	Figure Dimensions (In.)			Std. Pkg. Qty.
		L	W	H	
PISR2-1	#2 AWG STR – #14 AWG STR, #8 AWG SOL – #10 AWG SOL	2.38	0.75	1.25	1
PISR1/0-1	1/0 AWG STR – #14 AWG STR, #8 AWG SOL – #14 AWG SOL	2.91	0.95	1.41	1
PISR250-1	250 kcmil – #10 AWG STR, #8 AWG SOL – #10 AWG SOL	4.00	1.25	2.24	1
PISR350-1	350 kcmil – #10 AWG STR, #8 AWG SOL – #10 AWG SOL	4.63	1.40	2.34	1
PISR500-1	500 kcmil – #6 AWG STR	5.25	1.72	2.63	1



Multi-Tap Connector with Clear Insulation, Single-Sided, with Mounting Holes

For Use with Aluminum or Copper Code Conductors

Type PCSBMT-S

- Flexible design – can be used as a tap, splice, or dead end connector
- Body made from high strength, extruded aluminum alloy to provide premium electrical and mechanical performance
- Two isolated mounting holes at either end of connector facilitate direct mounting using 1/4" bolts
- Insulated with clear PVC to eliminate the need for taping and allow for visual inspection of the complete conductor insertion
- Each port pre-filled with oxide inhibiting joint compound seals out air and moisture to deter surface oxidation
- Wide wire range-taking capability minimizes inventory requirements
- Plated steel or aluminum set screw provides high strength, durable electrical contact between conductor and connector
- UL Listed and CSA Certified for use up to 600 V and temperature rated 90°C

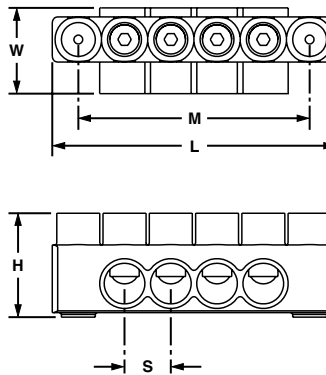

Part Number	Conductor Size Range	No. of Ports	Figure Dimensions (In.)					Mounting Hole Size (In.)	Hex Key Size (In.)	Std. Pkg. Qty.
			L	W	H	S	M			
PCSBMT2/0-4S-3Y	2/0 – #14 AWG STR #10 – #14 AWG SOL	4	4.20	1.31	1.50	0.67	3.61	1/4	3/16	3
PCSBMT2/0-6S-2Y		6	5.55	1.31	1.50	0.67	4.96	1/4	3/16	2
PCSBMT2/0-8S-2Y		8	6.89	1.31	1.50	0.67	6.30	1/4	3/16	2
PCSBMT2/0-10S2Y		10	8.24	1.31	1.50	0.67	7.65	1/4	3/16	2
PCSBMT2/0-12S1Y		12	9.58	1.31	1.50	0.67	8.99	1/4	3/16	1
PCSBMT250-4S-2Y	250 kcmil – #10 AWG STR	4	5.78	2.00	2.25	0.94	4.94	1/4	5/16	2
PCSBMT250-6S-2Y		6	7.66	2.00	2.25	0.94	6.82	1/4	5/16	2
PCSBMT250-8S-2Y		8	9.53	2.00	2.25	0.94	8.69	1/4	5/16	2
PCSBMT250-10S2Y		10	11.41	2.00	2.25	0.94	10.57	1/4	5/16	2
PCSBMT250-12S1Y		12	13.29	2.00	2.25	0.94	12.45	1/4	5/16	1
PCSBMT350-4S-2Y	350 kcmil – #10 AWG STR	4	6.17	2.25	2.63	1.00	5.25	1/4	5/16	2
PCSBMT350-6S-2Y		6	8.17	2.25	2.63	1.00	7.25	1/4	5/16	2
PCSBMT350-8S-2Y		8	10.17	2.25	2.63	1.00	9.25	1/4	5/16	2
PCSBMT350-10S1Y		10	12.17	2.25	2.63	1.00	11.25	1/4	5/16	1
PCSBMT350-12S1Y		12	14.17	2.25	2.63	1.00	13.25	1/4	5/16	1
PCSBMT600-4S-2Y	600 kcmil – #6 AWG STR	4	7.84	2.25	2.88	1.28	6.65	1/4	3/8	2
PCSBMT600-6S-2Y		6	10.41	2.25	2.88	1.28	9.22	1/4	3/8	2
PCSBMT600-8S-2Y		8	12.97	2.25	2.88	1.28	11.78	1/4	3/8	2
PCSBMT600-10S1Y		10	15.53	2.25	2.88	1.28	14.34	1/4	3/8	1
PCSBMT600-12S1Y		12	18.09	2.25	2.88	1.28	16.90	1/4	3/8	1



Multi-Tap Connector with Clear Insulation, Double-Sided, with Mounting Holes

For Use with Aluminum or Copper Code Conductors

Type PCSBMT

- Flexible design – can be used as a tap, splice, or dead end connector
- Body made from high strength, extruded aluminum alloy to provide premium electrical and mechanical performance
- Two isolated mounting holes at either end of connector facilitate direct mounting using 1/4" bolts
- Insulated with clear PVC to eliminate the need for taping and allow for visual inspection of the complete conductor insertion
- Each port pre-filled with oxide inhibiting joint compound seals out air and moisture to deter surface oxidation
- Wide wire range-taking capability minimizes inventory requirements
- Dual-sided entry allows offset and opposite entry for primary and secondary conductors
- Plated steel or aluminum set screw provides high strength, durable electrical contact between conductor and connector
- UL Listed and CSA Certified for use up to 600 V and temperature rated 90°C

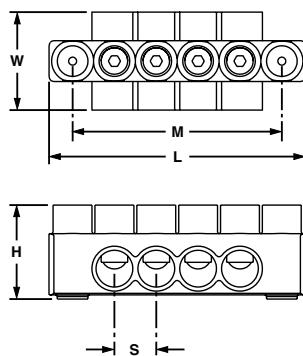

Part Number	Conductor Size Range	No. of Ports	Figure Dimensions (In.)					Mounting Hole Size (In.)	Hex Key Size (In.)	Std. Pkg. Qty.
			L	W	H	S	M			
PCSBMT2/0-4-3Y	2/0 – #14 AWG STR, #10 – #14 AWG SOL	4	4.20	1.56	1.50	0.67	3.61	1/4	3/16	3
PCSBMT2/0-6-2Y		6	5.55	1.56	1.50	0.67	4.96	1/4	3/16	2
PCSBMT2/0-8-2Y		8	6.89	1.56	1.50	0.67	6.30	1/4	3/16	2
PCSBMT2/0-10-2Y		10	8.24	1.56	1.50	0.67	7.65	1/4	3/16	2
PCSBMT2/0-12-1Y		12	9.58	1.56	1.50	0.67	8.99	1/4	3/16	1
PCSBMT250-4-2Y	250 kcmil – #10 AWG STR	4	5.78	2.63	2.26	0.94	4.94	1/4	5/16	2
PCSBMT250-6-2Y		6	7.66	2.63	2.26	0.94	6.82	1/4	5/16	2
PCSBMT250-8-2Y		8	9.53	2.63	2.26	0.94	8.69	1/4	5/16	2
PCSBMT250-10-2Y		10	11.41	2.63	2.26	0.94	10.57	1/4	5/16	2
PCSBMT250-12-1Y	12	13.29	2.63	2.26	0.94	12.45	1/4	5/16	1	
PCSBMT350-4-2Y	350 kcmil – #10 AWG STR	4	6.17	3.00	2.63	1.00	5.25	1/4	5/16	2
PCSBMT350-6-2Y		6	8.17	3.00	2.63	1.00	7.25	1/4	5/16	2
PCSBMT350-8-2Y		8	10.17	3.00	2.63	1.00	9.25	1/4	5/16	2
PCSBMT350-10-1Y		10	12.17	3.00	2.63	1.00	11.25	1/4	5/16	1
PCSBMT350-12-1Y	12	14.17	3.00	2.63	1.00	13.25	1/4	5/16	1	
PCSBMT600-4-2Y	600 kcmil – #6 AWG STR	4	7.84	3.00	2.88	1.28	6.65	1/4	3/8	2
PCSBMT600-6-2Y		6	10.41	3.00	2.88	1.28	9.22	1/4	3/8	2
PCSBMT600-8-2Y		8	12.97	3.00	2.88	1.28	11.78	1/4	3/8	2
PCSBMT600-10-1Y		10	15.53	3.00	2.88	1.28	14.34	1/4	3/8	1
PCSBMT600-12-1Y		12	18.09	3.00	2.88	1.28	16.90	1/4	3/8	1

Joint Compounds

For Use with Aluminum Connectors

Type CMP

- Oxide inhibitor for compression conductor connections lowers electrical resistance of compression joint while sealing out air and moisture to prevent the formation of surface oxides
- Wide operating temperature range; can be used in a wide range of electrical and environmental conditions
- Packaged in convenient dispenser bottles



Part Number	Part Description	Std. Pkg. Qty.
CMP-100-1	Contact aid for pad-to-pad or thread-to-thread aluminum connections, 8 oz. Operating temperature range -60°F (-51°C) to 400°F (204°C).	1

Guidelines for Installing Aluminum Mechanical Connectors



1. Select the correct connector for your application.

- Always use an aluminum conductor with an aluminum connector
- Verify that the connector is marked for the conductor size and type that you are using



2. Remove the insulation from insulated cable.

- Visit www.panduit.com/tools for Panduit® cable stripping tools
- Use care to avoid nicking the conductor strands
- Strip the insulation to the proper length as listed in the installation instructions provided with Panduit connectors



3. Clean the exposed conductor using a wire brush or an emery cloth.

- In a similar manner, clean an unplated connector pad and the surface to which the connector will be attached
- Solvent should be used to clean plated parts that are dirty, but the plating should never be disturbed with abrasives



4. Apply Panduit joint compound to the clean conductor for mechanical connector applications (see page D2.91).







- Joint compound will deter the formation of surface oxides after installation
- Aluminum compression connectors and insulated mechanical connectors are pre-filled with joint compound



5. Insert the conductor into the connector and:

- For mechanical connectors, tighten the screws to the recommended torque values
- For compression connectors, use the recommended die and crimping tool to make the proper compression connection

Panduit Power Connector Approvals

Logo (Symbol)	Agency	Spec/Approval	Applicable Products
	Underwriters Laboratories, Inc.	UL 486A-486B Wire Connectors and Soldering Lugs for use in US and Canada	As shown on product pages.
	Underwriters Laboratories, Inc.	UL 486A-486B Wire Connectors and Soldering Lugs for use in US	As shown on product pages.
	Underwriters Laboratories, Inc.	UL 486A-486B Wire Connectors and Soldering Lugs for use in US	As shown on product pages.
	Canadian Standards Association	C22.2 No. 65-13 Wire Connectors	As shown on product pages.
	American Bureau of Shipping	ABS Rules Steel Vessel Rules 1-1-4/7.7, 4-8-3/9.19, 4-8-4/21.27	Copper compression connectors LCA, LCAF, LCAS, LCAX, LCB, LCC, LCD, S-R, LCCX, LCDX, SCS, SCSF, LCMA, LCMD, LCMC, LCMB, SCMS
NEBS Level 3	Telcordia Technologies, Inc.	Network Equipment – Building Systems	Copper compression connectors LCAS, LCA, LCD, LCB, LCC, LCAF, LCCF, SCSS, SCS, SCL, SCSF
	International Stand, European Norm	IEC 61238-1: 2003 CLASS B EN 61238-1:2003	Metric Copper Compression Connectors and Splices for Class 2r Conductor as specified: LCMA, LCMD, SCMS, LCMB, LCMC
	European Compliance	Low Voltage Directive	Metric Copper Compression Connectors and Splices for Class 2r Conductor as specified: LCMA, LCMD, SCMS, LCMB, LCMC

B1.
Cable
Ties

B2.
Cable
Accessories

B3.
Stainless
Steel Cable
Ties &
Accessories

C1.
Wiring
Duct

C2.
Abrasion
Protection

C3.
Cable
Management

D1.
Terminals

D2.
Power
Connectors

D3.
Grounding
Connectors

E1.
Labeling
Systems

E2.
Labels

E3.
Pre-Printed
&
Write-On
Markers

E4.
Permanent
Identification

E5.
Lockout/
Tagout &
Safety
Solutions

F.
Keystone
Cabling
Systems

G.
Part
Number
Index

Recommended Termination Hardware

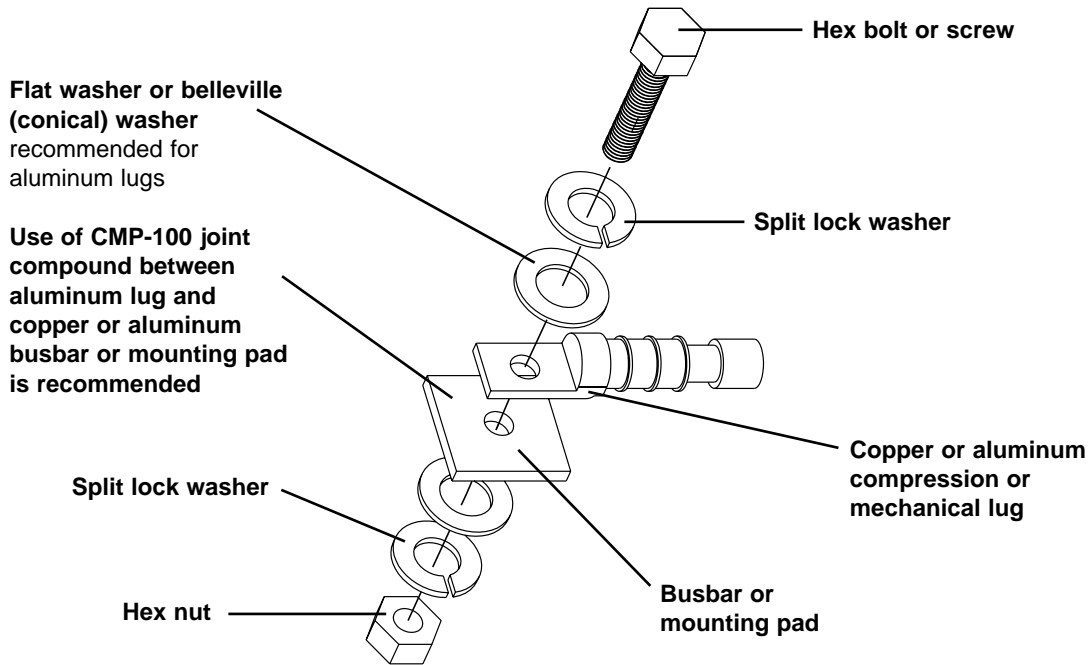
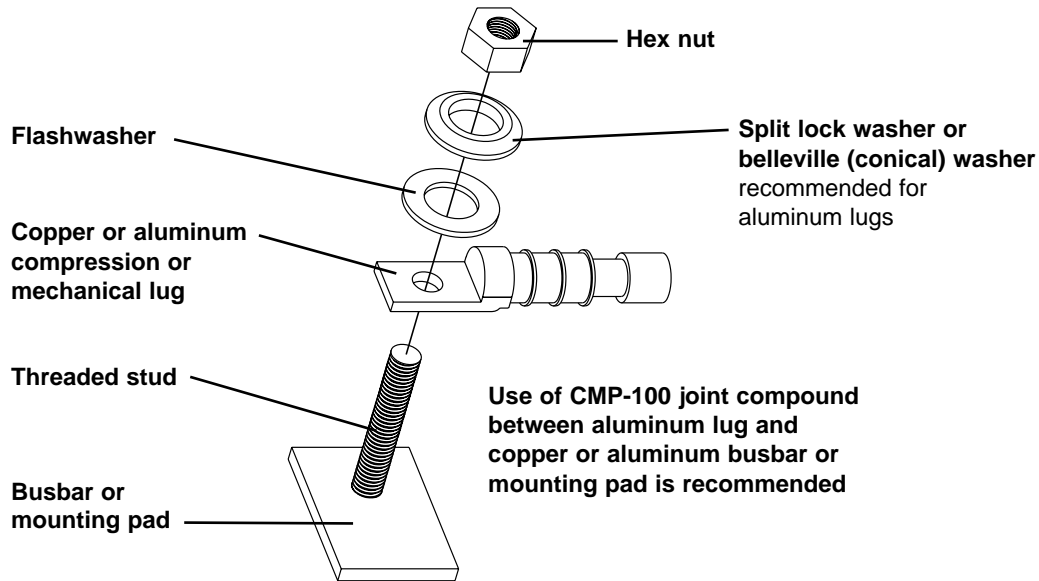

Recommended Hardware Material

Material Configuration of Lug/Mounting Surface

Copper to Copper	Aluminum to Copper	Aluminum to Aluminum	Copper to Steel	Aluminum to Steel
1. Silicon bronze 2. Stainless steel	1. Silicon bronze 2. Aluminum 3. Stainless steel	1. Aluminum 2. Stainless steel 3. Plated silicon bronze	1. Silicon bronze 2. Stainless steel	1. Aluminum 2. Stainless steel

Conductor Sizes

Copper Concentric Stranded Conductor Sizes

Conductor Size AWG or kcmil	Number of Strands	Nominal Diameter (In.)	Class
#20	7	0.036 /3	B
#18	7	0.045 /6	B
#16	7	0.057 /6	B
#14	7	0.072 /6	B
#12	7	0.091 /5	B
#10	7	0.116	B
#9	7	0.130	B
#8	7	0.146	B
#7	7	0.164	B
#6	7	0.184	B
#5	7	0.206	B
#4	3	0.254	AA
#4	7	0.232	B&A
#3	3	0.285	AA
#3	7	0.260	B&A
#2	3	0.320	AA
#2	7	0.292	B&A
#1	3	0.360	AA
#1	7	0.328	AA
#1	19	0.332	B
1/0	7	0.368	A&A
1/0	12	0.390	—
1/0	19	0.373	B
2/0	7	0.414	A&A
2/0	12	0.438	—
2/0	19	0.419	B
3/0	7	0.464	A&A
3/0	12	0.492	—
3/0	19	0.470	B
4/0	7	0.522	A&A
4/0	12	0.522	—
4/0	19	0.528	B
250	12	0.600	AA
250	19	0.574	A
250	37	0.575	B
300	12	0.657	AA
300	19	0.628	A
300	37	0.630	B
350	12	0.710	AA
350	19	0.679	A
350	37	0.681	B
400	19	0.726	A&AA
400	37	0.728	B
450	19	0.770	AA
450	37	0.772	B&A
500	19	0.811	AA
500	37	0.813	B&A
600	37	0.891	A&AA
600	61	0.893	B
700	37	0.963	BB
700	61	0.964	B&A
750	37	0.977	AA
750	61	0.998	B&A
800	37	1.029	AA
800	61	1.031	B&A
900	37	1.092	AA
900	61	1.094	B&A
1000	37	1.151	AA
1000	61	1.152	B&A
1000	61	1.152	B&A

Flexible Copper Conductor Sizes

Conductor Size AWG or kcmil	Number of Strands	Nominal Diameter (In.)	Class
#8	41/.0201	0.156	I
#8	49/.0184	0.166	G
#8	133/.0111	0.167	H
#8	168/.010	0.157	K
#8	37	0.330	Locomotive (DLO)
#8	420/.0063	0.162	M
#7	49/.0206	0.185	G
#7	52/.0201	0.185	I
#7	133/.0125	0.188	H
#7	210/.010	0.179	K
#7	—	—	Locomotive (DLO)
#7	532/.0063	0.196	M
#6	49/.0231	0.208	G
#6	63/.0201	0.207	I
#6	133/.0140	0.210	H
#6	266/.010	0.210	K
#6	61	0.410	Locomotive (DLO)
#6	665/.0063	0.215	M
#5	49/.0260	0.234	G
#5	84/.0201	0.235	I
#5	133/.0158	0.237	H
#5	336/.010	0.235	K
#5	—	—	Locomotive (DLO)
#5	836/.0063	0.240	M
#4	49/.0292	0.263	G
#4	105/.0201	0.263	I
#4	133/.0177	0.266	H
#4	420/.010	0.272	K
#4	105	0.460	Locomotive (DLO)
#4	1064/.0063	0.269	M
#3	49/.0328	0.295	G
#3	133/.0199	0.299	H
#3	133/.0201	0.291	I
#3	532/.010	0.304	K
#3	125	0.480	Locomotive (DLO)
#3	1323/.0063	0.305	M
#2	49/.0368	0.331	G
#2	133/.0223	0.335	H
#2	161/.0201	0.319	I
#2	665/.010	0.338	K
#2	150	0.510	Locomotive (DLO)
#2	1666/.0063	0.337	M
#1	133/.0251	0.337	G
#1	210/.0201	0.367	I
#1	259/.018	0.378	H
#1	836/.010	0.397	K
#1	225	0.650	Locomotive (DLO)
#1	2107/.0063	0.376	M
1/0	133/.0282	0.423	G
1/0	259/.0202	0.424	H
1/0	266/.0201	0.441	I
1/0	1064/.010	0.451	K
1/0	275	0.680	Locomotive (DLO)
1/0	2646/.0063	0.423	M
2/0	133/.0316	0.474	G
2/0	259/.0227	0.477	H
2/0	342/.0201	0.500	I
2/0	1323/.010	0.470	K
2/0	325	0.720	Locomotive (DLO)
2/0	3325/.0063	0.508	M

Continues on next page

B1. Cable Ties

Conductor Sizes (continued)

B2. Cable Accessories

Flexible Copper Conductor Sizes

Conductor Size AWG or kcmil	No. of Strands/ Strand Dia.	Nominal Diameter (In.)	Class
3/0	133/.0355	0.533	G
3/0	259/.0255	0.536	H
3/0	418/.0201	0.549	I
3/0	1666/.010	0.533	K
3/0	450	0.565	Locomotive (DLO)
3/0	4256/.0063	0.576	M
4/0	133/.0399	0.599	G
4/0	259/.0286	0.601	H
4/0	532/.0201	0.613	I
4/0	2107/.010	0.627	K
4/0	550	0.840	Locomotive (DLO)
4/0	5320/.0063	0.645	M
250	259/.0311	0.650	G
250	427/.0242	0.653	H
250	637/.0201	0.682	I
250	2499/.010	0.682	K
262.6	650	0.960	Locomotive (DLO)
250	6384/.0063	0.713	M
300	259/.0340	0.714	G
300	427/.0265	0.716	H
300	735/.0201	0.737	I
300	2989/.010	0.768	K
313.1	775	1.040	Locomotive (DLO)
300	7581/.0063	0.768	M
350	259/.0368	0.773	G
350	427/.0268	0.772	H
350	882/.0201	0.800	I
350	3458/.010	0.809	K
373.7	925	1.140	Locomotive (DLO)
350	8806/.0063	0.825	M
400	259/.0393	0.825	G
400	427/.0306	0.826	H
400	980/.0201	0.831	I
400	3990/.010	0.878	K
400	—	—	Locomotive (DLO)
400	10101/.0063	0.901	M
450	259/.0417	0.876	G
450	427/.325	0.878	H
450	1127/.0201	0.894	I
450	4522/.010	0.933	K
444.4	1100	1.230	Locomotive (DLO)
450	11396/.0063	0.940	M
500	259/.0439	0.922	G
500	427/.0342	0.923	H
500	1125/.0201	0.941	I
500	5054/.010	0.988	K
535.3	1325	1.320	Locomotive (DLO)
500	12691/.0063	0.997	M
600	427/.0375	1.013	G
600	703/.0292	1.022	H
600	1470/.0201	1.027	I
600	5985/.010	1.125	K
646.4	1600	1.450	Locomotive (DLO)
600	14945/.0063	1.084	M

C1. Wiring Duct

C2. Abrasion Protection

C3. Cable Management

D1. Terminals

D2. Power Connectors

D3. Grounding Connectors

E1. Labeling Systems

E2. Labels

E3. Pre-Printed & Write-On Markers

E4. Permanent Identification

E5. Lockout/Tagout & Safety Solutions

F. Keystone Cabling Systems

G. Part Number Index

Flexible Copper Conductor Sizes

Conductor Size AWG or kcmil	No. of Strands/ Strand Dia.	Nominal Diameter (In.)	Class
700	427/.0405	1.094	G
700	703/.0316	1.106	H
700	1729/.0201	1.194	I
700	6916/.010	1.207	K
777.7	1925	1.540	Locomotive (DLO)
700	17507/.0063	1.183	M
800	427/.0433	1.169	G
800	703/.0337	1.180	H
800	1995/.0201	1.290	I
800	7980/.010	1.305	K
800	—	—	Locomotive (DLO)
800	20069/.0063	1.256	M
900	427/.0459	1.239	G
900	703/.0358	1.253	H
900	2261/.0201	1.372	I
900	9065/.010	1.323	K
900	—	—	Locomotive (DLO)
900	22631/.0063	1.331	M
1000	427/.0484	1.307	G
1000	703/.0377	1.320	H
1000	2527/.0201	1.427	I
1000	10101/.010	1.419	K
1000	—	—	Locomotive (DLO)
1000	25193/.0063	1.404	M

Copper Compact Stranded Conductor Sizes

Conductor Size AWG or kcmil	Number of Strands	Conductor Diameter (In.)	Class
#8	7	0.134	Compact
#6	7	0.169	Compact
#4	7	0.213	Compact
#2	7	0.268	Compact
#1	19	0.299	Compact
1/0	19	0.336	Compact
1/0	19	0.376	Compact
3/0	19	0.423	Compact
4/0	19	0.475	Compact
250	37	0.520	Compact
300	37	0.570	Compact
350	37	0.616	Compact
400	37	0.659	Compact
450	37	0.700	Compact
500	37	0.736	Compact
550	61	0.775	Compact
600	61	0.813	Compact
650	61	0.845	Compact
700	61	0.877	Compact
750	61	0.908	Compact
800	61	0.938	Compact
900	61	0.999	Compact
1000	61	1.060	Compact

Continues on next page

Conductor Sizes (continued)

Copper Solid Conductor Sizes

Solid Copper Conductor Size AWG or kcmil	Conductor Diameter (In.)
#18	0.040
#17	0.045
#16	0.050
#15	0.057
#14	0.064
#13	0.071
#12	0.080
#11	0.090
#10	0.101
#9	0.114
#8	0.128
#7	0.128
#6	0.162
#5	0.181
#4	0.204
#3	0.229
#2	0.257
#1	0.289
1/0	0.324
2/0	0.364
3/0	0.409
4/0	0.460

Aluminum Concentric Stranded Conductor Sizes

Class B Aluminum Concentric AWG or kcmil	Number of Strands	Diameter of each Strand (Mils)
#8	7	48.6
#7	7	54.5
#6	7	61.2
#5	7	68.8
#4	7	77.2
#3	7	86.7
#2	7	97.4
#1	19	66.4
1/0	19	74.5
2/0	19	83.7
3/0	19	94.0
4/0	19	105.5
250	37	82.2
300	37	90.0
350	37	97.3
400	37	104.0
450	37	110.3
500	37	116.2
550	61	95.0
600	61	99.2
650	61	103.2
700	61	107.1
750	61	110.9
800	61	114.5
900	61	121.5
1000	61	128.0

Aluminum Compact Stranded Conductor Sizes

Compact Aluminum AWG or kcmil	Class ASTM B400	Number of Strands	Conductor Diameter (In.)
#8	A, B	7	0.134
#6	A, B	7	0.169
#4	A, B	7	0.213
#3	A, B	7	0.238
#2	AA, A, B	7	0.268
#1	AA, A	7	0.299
#1	B	19	0.299
1/0	AA, A	7	0.336
1/0	B	19	0.336
2/0	AA, A	7	0.376
2/0	B	19	0.376
3/0	AA, A	7	0.423
3/0	B	19	0.423
4/0	AA, A	7	0.475
4/0	B	19	0.475
250	AA	7	0.520
250	A	19	0.520
250	B	37	0.520
266	AA	7	0.337
266	A	19	0.337
300	AA	7	0.570
300	A	19	0.570
300	B	37	0.570
336	AA	7	0.603
336	A	19	0.603
350	A	19	0.616
350	B	37	0.616
397	AA, A	19	0.659
400	B	37	0.659
450	B	37	0.700
477	AA	19	0.722
500	AA	19	0.736
500	B	37	0.736
550	B	61	0.775
556	AA	19	0.780
600	B	61	0.813
650	B	61	0.845
700	B	61	0.877
750	B	61	0.908
800	B	61	0.938
900	B	61	0.999
1000	B	61	1.060

Common Conductor Sizes and Strandings Reference Chart

Conductor	Individual Strands						Overall Conductor Size			Conductor	Individual Strands			Overall Conductor Size							
	AWG	Metric mm ²	Diameter		Diameter		Area Circ. MILS	AWG	Metric mm ²		Diameter		Diameter		Area Circ. MILS						
			No.	mm	In.	mm					In.	mm	In.								
	.05	25	0.05	0.002	0.25	0.010	97									19	0.25	0.010	1.30	0.051	1841
																1	1.13	0.044	1.13	0.044	1979
	.06	41	0.05	0.002	0.36	0.014	159									32	0.20	0.008	1.30	0.051	1984
																7	0.43	0.017	1.30	0.051	2006
26		10	0.13	0.005	0.53	0.021	250									19	0.29	0.011	1.47	0.058	2426
																1	0.41	0.016	0.41	0.016	256
																7	0.16	0.006	0.48	0.019	278
																19	0.10	0.004	0.51	0.020	304
24		41	0.08	0.003	0.58	0.023	384	16								65	0.16	0.006	1.50	0.059	2580
																*26	0.25	0.010	1.50	0.059	2600
																1	1.30	0.051	1.30	0.051	2601
																105	0.13	0.005	1.50	0.059	2625
																*7	0.51	0.020	1.52	0.060	2828
22		19	0.13	0.005	0.61	0.024	475									30	0.25	0.010	1.70	0.067	2906
																21	0.30	0.012	1.60	0.063	2930
																128	0.05	0.002	0.65	0.026	496
																32	0.10	0.004	0.65	0.026	496
20	0.25	14	0.16	0.006	0.65	0.026	556									1	1.38	0.054	1.38	0.054	2952
																1	0.64	0.025	0.64	0.025	625
																16	0.16	0.006	0.76	0.030	635
22		26	0.13	0.005	0.76	0.030	650	14								1	1.63	0.064	1.63	0.064	4096
																7	0.10	0.010	0.76	0.030	700
																19	0.16	0.006	0.79	0.031	754
																*41	0.25	0.010	1.85	0.073	4100
20	0.38	48	0.10	0.004	0.80	0.031	744									*7	0.64	0.025	1.85	0.073	4481
																194	0.05	0.002	0.80	0.031	752
																100	0.07	0.003	0.80	0.031	760
																7	0.27	0.011	0.80	0.031	791
																12	0.21	0.008	0.80	0.031	820
20	0.5	21	0.16	0.006	0.80	0.031	833									19	0.45	0.018	2.36	0.093	6088
																0.30	0.012	0.90	0.035	977	
																16	0.20	0.008	0.90	0.035	992
																1	0.80	0.031	0.80	0.031	992
20		*10	0.25	0.010	0.89	0.035	1000									50	0.25	0.010	2.20	0.087	4844
																1	0.81	0.032	0.81	0.032	1024
																41	0.13	0.005	0.91	0.036	1025
																26	0.16	0.006	0.91	0.036	1032
																*7	0.32	0.013	0.97	0.038	1111
20	0.75	19	0.20	0.008	0.94	0.037	1216									56	0.30	0.012	3.10	0.122	7812
																1	0.37	0.015	1.10	0.043	1485
																24	0.20	0.008	1.20	0.047	1488
18		1	1.00	0.039	1.00	0.039	1550	10								1	2.06	0.081	2.06	0.081	6561
																*7	0.81	0.032	2.44	0.096	7168
18		*16	0.25	0.010	1.19	0.047	1600									19	0.52	0.020	2.70	0.106	7963
																1	1.02	0.040	1.02	0.040	1600
																65	0.13	0.005	1.19	0.047	1625
																41	0.16	0.006	1.19	0.047	1627
																*7	0.40	0.016	1.22	0.048	1770
18		19	0.25	0.010	1.24	0.049	1900									37	0.40	0.016	2.92	0.115	9354
																49	0.36	0.014	2.95	0.116	9880
																*7	0.98	0.039	2.95	0.116	10376
18		1	2.59	0.102	2.59	0.102	10404									1	2.59	0.102	2.59	0.102	10404
																*105	0.25	0.010	2.95	0.116	10500
																84	0.30	0.012	3.50	0.138	11718
																756	0.10	0.004	3.70	0.146	11718
																1	2.76	0.109	2.76	0.109	11807
18		7	1.05	0.041	3.20	0.126	11962									7	1.05	0.041	3.20	0.126	11962
																19	0.64	0.025	3.30	0.130	12063

*Strandings required for UL and CSA certification testing.

Continues on next page











Common Conductor Sizes and Strandings Reference Chart (continued)



Conductor		Individual Strands			Overall Conductor Size			Conductor		Individual Strands			Overall Conductor Size		
		No.	Diameter		Diameter		Area			No.	Diameter		Diameter		Area
AWG	Metric mm ²		mm	In.	mm	In.	Circ. MILS	AWG	Metric mm ²		mm	In.	mm	In.	Circ. MILS
6	6	7	0.107	0.042	3.21	0.126	11840	95	19	2.57	0.101	12.8	0.505	187500	
		1	2.77	0.109	2.77	0.109	11840		37	1.83	0.072	12.5	0.504	187500	
9		7	1.1	0.0432	3.3	0.13	13000	4/0	19	2.89	0.1055	13.4	0.528	211600	
		1	2.91	0.1144	2.91	0.114	13090	120	37	2.06	0.081	14.4	0.567	237.8 kcmil	
8		1	3.26	0.1285	3.25	0.128	16510	250 kcmil	37	2.07	0.0822	14.6	0.575	250 kcmil	
		7	1.23	0.0486	3.7	0.146	16510	300 kcmil	150	37	2.29	0.09	16	0.63	300 kcmil
10		7	1.37	0.054	4.12	0.162	19740	350 kcmil	37	2.47	0.0973	17.3	0.681	350 kcmil	
		1	3.58	0.141	3.58	0.141	19740	185	37	2.54	0.1	17.8	0.7	365.1 kcmil	
7		7	1.38	0.0545	4.15	0.164	20520	400 kcmil	37	2.64	0.104	18.5	0.728	400 kcmil	
		1	3.67	0.1443	3.67	0.144	20520	240	37	2.9	0.114	20.3	0.798	473.6 kcmil	
6		7	1.55	0.0612	4.66	0.184	26240	500 kcmil	61	2.26	0.089	20.3	0.801	473.6 kcmil	
		1	4.11	0.162	4.11	0.162	26240		37	2.95	0.1162	20.7	0.813	500 kcmil	
16		7	1.73	0.08	5.13	0.204	31580	500 kcmil	61	2.3	0.0905	20.7	0.814	500 kcmil	
5		7	1.75	0.0688	5.24	0.206	33090	300 kcmil	61	2.51	0.099	22.6	0.891	592.1 kcmil	
4		7	1.96	0.0772	5.88	0.232	41740	600 kcmil	61	2.52	0.0992	22.7	0.893	600 kcmil	
25		7	2.16	0.085	6.48	0.255	49340	700 kcmil	61	2.72	0.1071	24.5	0.964	700 kcmil	
		19	1.32	0.052	6.6	0.26	49340	750 kcmil	61	2.82	0.1109	25.4	0.998	750 kcmil	
3		7	2.2	0.0867	6.61	0.26	52620	750 kcmil	91	2.31	0.0908	25.4	0.998	750 kcmil	
2		7	2.47	0.0974	7.42	0.292	66300	400	61	2.9	0.114	26.1	1.026	798.4 kcmil	
35		7	2.54	0.1	7.62	0.300	69070	800 kcmil	61	2.91	0.1145	26.2	1.031	800 kcmil	
		19	1.55	0.001	7.75	0.305	69070		91	2.38	0.0938	26.2	1.032	800 kcmil	
1		19	1.5	0.0064	8.43	0.332	83690	1000 kcmil	500	61	3.25	0.128	28.3	1.152	986.8 kcmil
		50	1.85	0.073	9.27	0.365	98680		91	2.66	0.1048	29.3	1.153	1000 kcmil	
1/0		19	1.59	0.0745	9.46	0.373	10500	625	91	2.97	0.117	32.7	1.287	1233.7 kcmil	
2/0		19	2.13	0.0837	10.6	0.419	133100								
70		19	2.18	0.086	10.9	0.43	138100								
		3/0	19	2.59	0.094	11.9	0.47	167800							
3/0		36	1.71	0.0673	12	0.471	167800								

This chart details the different conductors commonly used in the industry. For each size, either AWG or Metric, various stranding options are listed. Typically the higher stranding is used in applications requiring greater conductor flexibility.







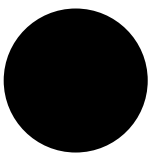
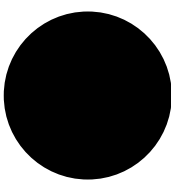
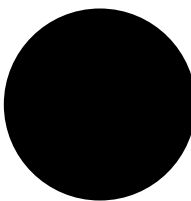

AWG	Metric (mm ²)
26 - 22	0.1 - 0.5
22 - 18	0.5 - 1.0
16 - 14	1.5 - 2.5
12 - 10	4.0 - 6.0









Stud Size Chart (Inches)









										
Standard Stud Size	#2	#4	#5	#6	#8	#10	1/4"	5/16"	3/8"	7/16"
Stud Size Decimal Equivalent	0.086"	0.112"	0.127"	0.138"	0.164"	0.190"	0.250"	0.312"	0.375"	0.438"
Terminal Hole Diameter	0.090"	0.118"	0.130"	0.147"	0.173"	0.204"	0.270"	0.343"	0.392** 0.406***	0.456"
Stud Size Designation in Panduit Part Number	2	4	5	6	8	10	14	56	38	76









					
Standard Stud Size	1/2"	5/8"	3/4"	7/8"	1"
Stud Size Decimal Equivalent	0.500"	0.625"	0.750"	0.875"	1.00"
Terminal Hole Diameter	0.531"	0.656"	0.810"	0.906"	1.031"
Stud Size Designation in Panduit Part Number	12	58	34	78	1

Equivalent Tables Decimal/Inches

	1/64	0.0156
	3/64	0.0468
	5/64	0.0781
	7/64	0.1093
	9/64	0.1406
	11/64	0.1718
	13/64	0.2031
	15/64	0.2343
	1/4	0.25

	17/64	0.2656
	19/64	0.2968
	21/64	0.3281
	23/64	0.3593
	25/64	0.3906
	27/64	0.4218
	29/64	0.4531
	31/64	0.4843
	1/2	0.5

	33/64	0.5156
	35/64	0.5468
	37/64	0.5781
	39/64	0.6093
	41/64	0.6406
	43/64	0.6718
	45/64	0.7031
	47/64	0.7343
	3/4	0.75

	49/64	0.7656
	51/64	0.7968
	53/64	0.8281
	55/64	0.8593
	57/64	0.8906
	59/64	0.9218
	61/64	0.9531
	63/64	0.9843
	1	1.

Grounding Connectors



Panduit® StructuredGround™ Grounding Connectors provide innovative solutions for joining ground conductors to water pipe, ground rods, rebar, conduit, iron pipe and structural steel. Designed with the needs of the end user in mind, StructuredGround™ Grounding Connectors feature easy installation, lowest installed cost, and long-term reliability.

- **Functional product information is marked directly on the connector, facilitating the identification, ordering, and usage of the grounding connector**
- **Compression connectors are color-coded to facilitate quick identification of the proper crimping die**
- **Mechanical connectors are designed for easy installation – no special tools required**
- **Incorporate wide wire range-taking capability to minimize inventory requirements**
- **Made from high strength, high conductivity electrolytic copper and aluminum alloy materials to provide optimum connectivity for both power and grounding applications**
- **Wide assortment of manual, controlled cycle, battery operated hydraulic and pneumatic crimping tools for reliable connections at the lowest installed cost**

Panduit® StructuredGround™ Grounding Connectors are designed for use with many different code and flex conductor types and are available in a broad range of styles and sizes. A full line of manual, controlled cycle, and battery operated hydraulic crimping tools meet application needs and provide lowest installed cost. Panduit offers a wide variety of StructuredGround™ Grounding Connectors to meet customer needs and today's application requirements.

StructuredGround™ Direct Burial Compression Grounding System Roadmap

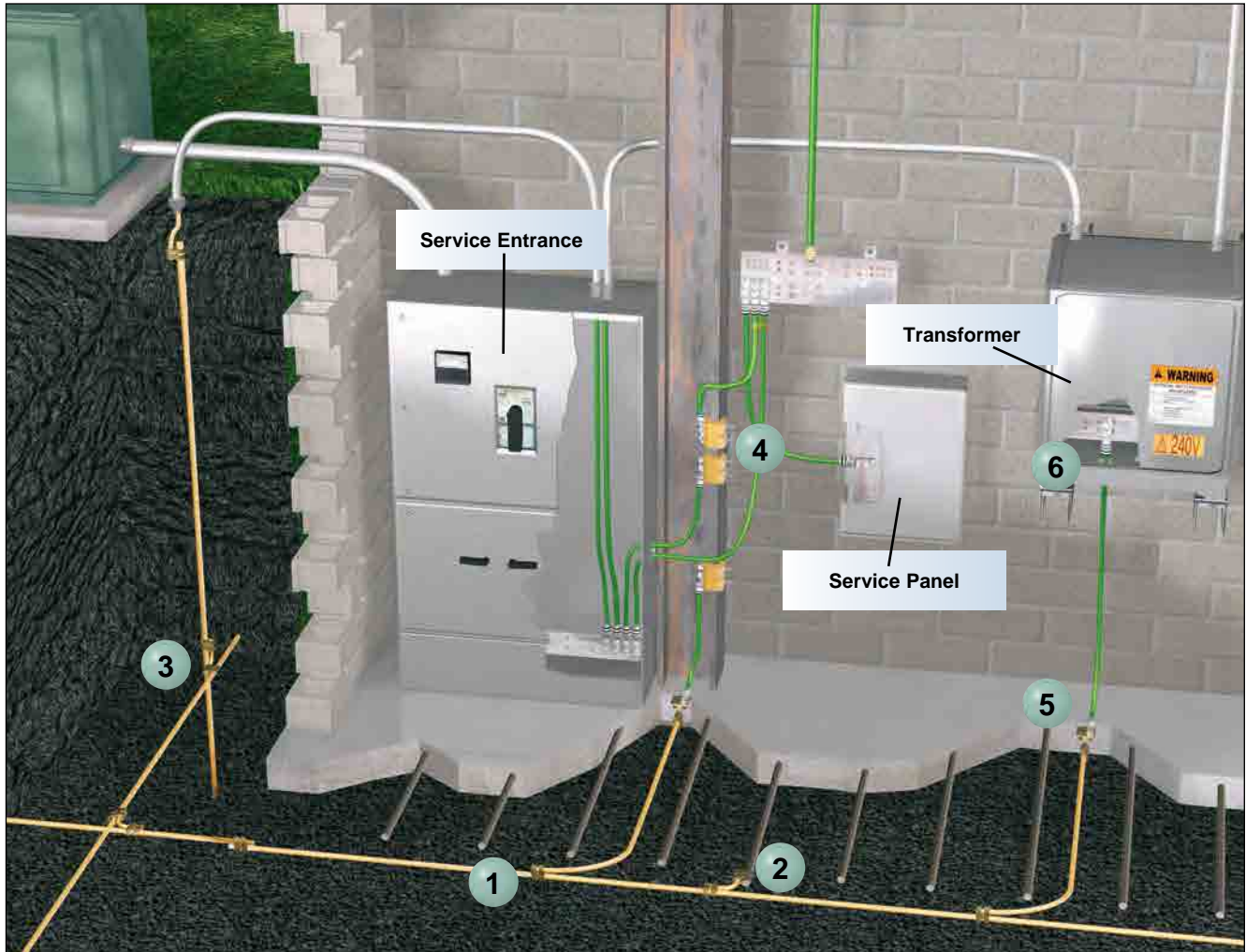

1 Conductor to Conductor

E Style Grounding Connectors: Create bonds between parallel grounding conductors. (see page D3.7)



4 Conductor to Building Steel

Universal Beam Grounding Clamp: Bonds structural steel to grounding conductor system. (see page D3.9)



2 Conductor to Rebar

E Style Grounding Connectors: Allow bonds to reinforcing bars. (see page D3.7)



5 Conductor to Grounding Electrodes

Grounding Plate Connector: Allows bonds through concrete. (see page D3.9)



3 Conductor to Ground Rod

Grounding Cross Connectors: Create bonds between perpendicular grounding conductors. (see page D3.8)



6 Related Product LCC-W







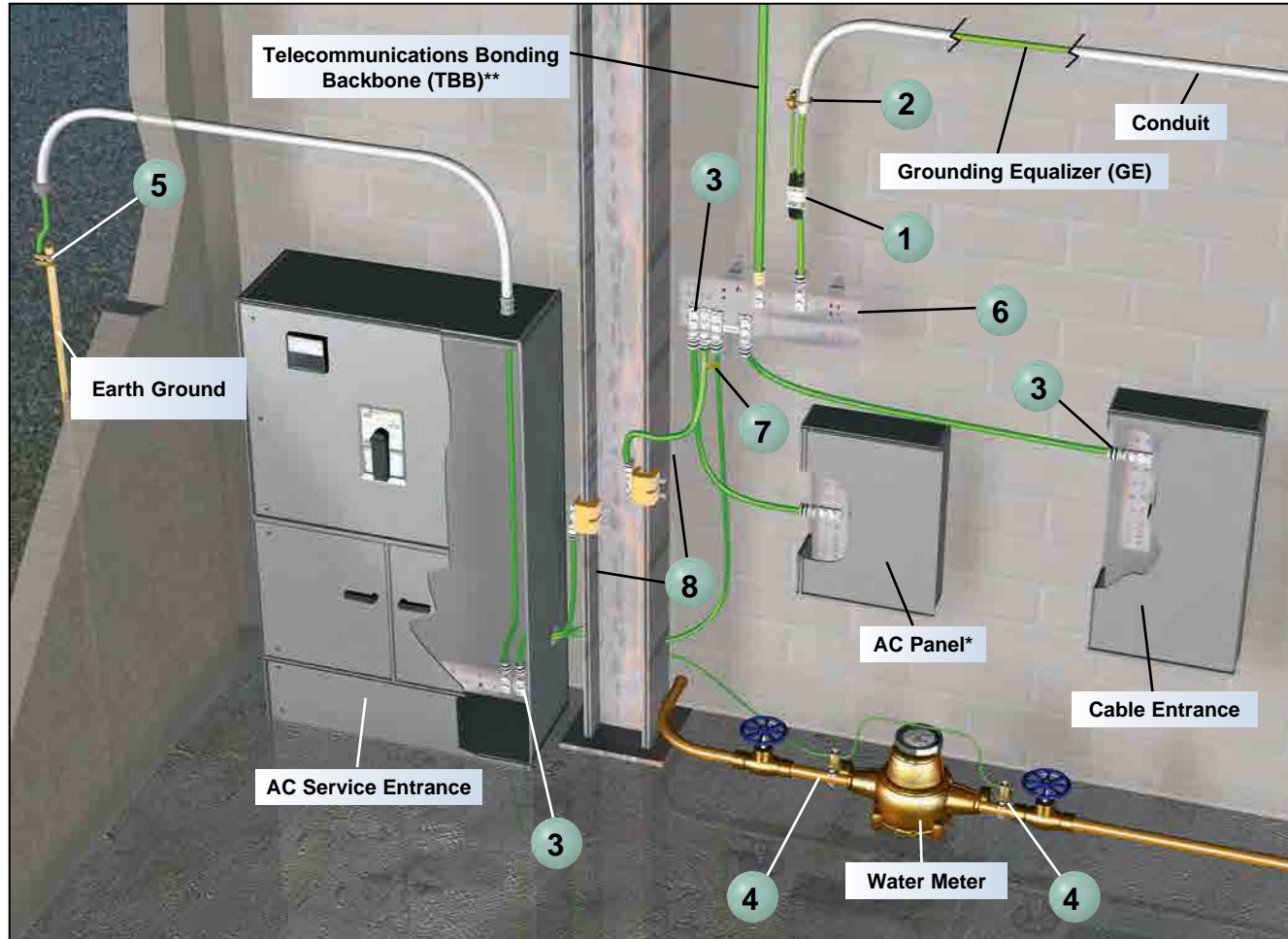

Long Barrel Two-Hole Code Conductor Lugs: For use with stranded copper conductors. (see pages D2.21 – D2.24)

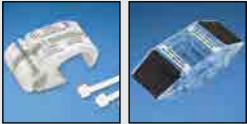

Service Entrance Grounding Roadmap

- Complies with TIA-607-C and IEEE Std 1100 (IEEE Emerald Book)
- Grounding Equalizer (GE) is required when two or more Telecommunications Bonding Backbones (TBB) are used within a multi-story building; bond TBBs together with a GE at the top floor and at a minimum of every third floor in between



<p>1 Copper Compression HTAP and Clear Cover: HTWC (see page D3.14)</p> 	<p>5 E Style Grounding Connector: GCE (see page D3.9)</p> 
<p>2 Bronze, U-Bolt Grounding Clamp: GPL (see page D3.19) connected by a cable 1 to (HTAP)</p> 	<p>6 Telecommunications Main Grounding Busbar (TMGB) and Busbar Label (see page D3.5)</p> 
<p>3 Copper Compression, Two-Hole, Long Barrel with Window Lug: LCC-W (see pages D2.21 – D2.24)</p> 	<p>7 Telecommunications Grounding and Bonding Conductor Label Kit: LTYK (see page D3.5)</p> 
<p>4 Bronze, Water Pipe Grounding Clamp: GPC (see page D3.20)</p> 	<p>8 Universal Beam Grounding Clamp: GUBC (see page D3.9)</p> 

*AC Panel should be grounded per NEC standards. Enclosure should be grounded per manufacturer's specifications.

**Specification TIA-607-C specifies different size conductors based on the length of the Telecommunications Bonding Backbone (TBB).



Access Floor Grounding Clamp

Type GPQC

- Bond mesh common bonding network (MCBN) conductors to each other and bond the access floor pedestals to the conductors
- Specifically designed to bond perpendicular MCBN conductors per TIA-607-C
- Bond to the pedestal with a single bolt to simplify installation
- Accommodate conductors from #6 – 1/0 AWG, minimizes inventory requirements
- Bond round and square access floor pedestals for greater flexibility

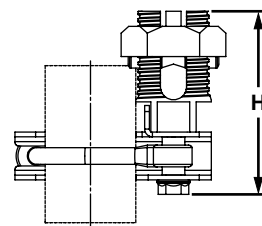
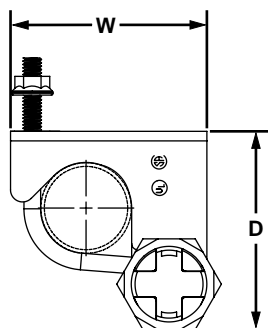

Part Number	Round Pedestal (In.)	Square Pedestal (In.)	MCBN Conductor Size Range AWG (mm ²)	Figure Dimensions In. (mm)			Std. Pkg. Qty.	Std. Ctn. Qty.
				D	W	H		
GPQC07-1/0	3/4 – 7/8	—	#6 SOL – 1/0 STR (16 – 50)	4.25 (108.0)	3.38 (85.9)	03.19 (81.0)	1	10
GPQC10-1/0	1 – 1 1/8	7/8	#6 SOL – 1/0 STR (16 – 50)	4.19 (106.4)	3.38 (85.9)	3.19 (81.0)	1	10
GPQC12-1/0	1 1/4	—	#6 SOL – 1/0 STR (16 – 50)	4.53 (115.1)	3.44 (87.4)	3.19 (81.0)	1	10
GPQC15-1/0	1 1/2	—	#6 SOL – 1/0 STR (16 – 50)	4.47 (113.5)	3.44 (87.4)	3.19 (81.0)	1	10
GPQC17-1/0	1 3/4	—	#6 SOL – 1/0 STR (16 – 50)	5.19 (131.8)	4.00 (101.6)	3.19 (81.0)	1	10
GPQC20-1/0	2	—	#6 SOL – 1/0 STR (16 – 50)	5.06 (128.5)	4.00 (101.6)	3.19 (81.0)	1	10

BICSI/TIA-607-C Telecommunications Grounding Busbars

Type GB

- Meets BICSI and TIA-607-C requirements for network systems grounding applications
- Made of high conductivity copper and tin-plated to inhibit corrosion
- Comes pre-assembled with brackets and insulators attached for quick installation
- Insulators provide 600 V of insulation
- Use Panduit self-laminating laser/ink jet labels to identify busbars to meet TIA/EIA-606-B, see chart below



TGB



TMGB

Part Number	Bar Size	No. of Mounting Positions		Std. Pkg. Qty.
		1/4" Stud Hole with 5/8" Hole Spacing	3/8" Stud Hole with 1" Hole Spacing	

Telecommunications Grounding Busbars (TGB)

GB2B0304TPI-1	1/4" x 2" x 10"	4	3	1
GB2B0306TPI-1	1/4" x 2" x 12"	6	3	1
GB2B0312TPI-1	1/4" x 2" x 20"	12	3	1
GB2B0514TPI-1	1/4" x 2" x 24"	14	5	1

Telecommunications Main Grounding Busbars (TMGB)

GB4B0612TPI-1	1/4" x 4" x 12"	12	6	1
GB4B0624TPI-1	1/4" x 4" x 24"	24	6	1
GB4B1028TPI-1	1/4" x 4" x 28"	28	10	1

For additional label sizes, materials, and print technologies and to see the complete line of Panduit identification products, see pages E1.1 – E2.27.

Component Labels for BICSI/TIA-607-C Telecommunications Grounding Busbars

1A-TMGB

Suggested Label Solutions for TIA/EIA-606-B Compliance

Telecommunications Grounding Busbar Part Number	Laser/Ink Jet Desktop Printer Label	TDP43MY Thermal Transfer Desktop Printer Label	PanTher™ LS8E Hand-Held Printer Label	Cougar™ LS9 Hand-Held Printer Label
All GB2B and GB4B Parts	C200X100FJJ	C200X100YPT	C200X100FJC	T100X000VPC-BK

For complete labeling solutions and product information, reference charts on pages E1.1 – E2.27.

Telecommunications Grounding and Bonding Conductor Label Kit

- Meets labeling requirements of TIA-607-C; each telecommunications grounding and bonding conductor shall be labeled as close as practicable to its point of termination in a readable position
- Can be applied as a wrap-around marker (parallel to cable) or flag marker (45° or 90°) to cable
- Kit includes everything needed to properly label cables; ten flame retardant cable ties and ten rigid plastic yellow tags printed with "IF THIS CONNECTOR OR CABLE IS LOOSE OR MUST BE REMOVED, PLEASE CALL THE BUILDING TELECOMMUNICATIONS MANAGER."



Part Number	Part Description	Std. Pkg. Qty.
LTYK	Label kit includes ten printed tags and ten flame retardant cable ties.	1

UL LISTED **NEMA Hole Pattern Grounding Busbars**

Type GBN

- Provided with standard NEMA hole pattern spacing
- Made of high conductivity copper and tin-plated to inhibit corrosion
- Come pre-assembled with brackets and insulators attached for quick installation
- Insulators provide 600 V of insulation



Part Number	Bar Size	No. of Mounting Positions	Std. Pkg. Qty.
		1/2" Stud Hole with 1 3/4" Hole Spacing	
GB4N0007TPI-1	1/4" x 4" x 12"	7	1
GB4N0016TPI-1	1/4" x 4" x 24"	16	1
GB4N0024TPI-1	1/4" x 4" x 36"	24	1
GB4N0026TPI-1	1/4" x 4" x 48"	26	1
GB4N0034TPI-1	1/4" x 4" x 60"	34	1

UL LISTED **Grounding Busbar 1" Hole Spacings**

Type GBD

- Provided with 1" hole D pattern spacing
- Made of high conductivity copper and tin-plated to inhibit corrosion
- Come pre-assembled with brackets and insulators attached for quick installation
- Insulators provide 600 V of insulation



Part Number	Bar Size	No. of Mounting Positions	Std. Pkg. Qty.
		7/16" Stud Hole with 1" Hole Spacing	
GB2D0008TPI-1	1/4" x 2" x 12"	8	1
GB2D0021TPI-1	1/4" x 2" x 24"	21	1
GB2D0033TPI-1	1/4" x 2" x 36"	33	1
GB2D0044TPI-1	1/4" x 2" x 48"	44	1
GB2D0056TPI-1	1/4" x 4" x 60"	56	1

Stainless Steel Hardware for Busbars

- Bulk hardware for attaching connectors to TMGBs and TGBs



Part Number	Part Description	Std. Pkg. Qty.
1/4" Hardware		
SSNTS1420-C	Stainless steel mounting hardware; 1/4" stainless steel bolts.	100
SSCW14-C	Stainless steel mounting hardware; 1/4" stainless steel Belleville washers (locking).	100
SSFW14-C	Stainless steel mounting hardware; 1/4" stainless steel flat washers.	100
SSN1420-C	Stainless steel mounting hardware; 1/4" stainless steel nuts.	100
3/8" Hardware		
SSNTS3816-C	Stainless steel mounting hardware; 3/8" stainless steel bolts.	100
SSCW38-C	Stainless steel mounting hardware; 3/8" stainless steel Belleville washers (locking).	100
SSFW38-C	Stainless steel mounting hardware; 3/8" stainless steel flat washers.	100
SSN3816-C	Stainless steel mounting hardware; 3/8" stainless steel nuts.	100
Hardware Kit		
GLMHK	Stainless steel hardware for use in mounting lugs for grounding plates and universal beam grounding clamps; includes: two hex head bolts 1/2-13 thread 1" long, two split lock washers for 1/2" diameter bolt, and two SAE flat washers for 1/2" diameter bolt.	1



E Style Grounding Connectors

Type GCE

- Wide range-taking ability and multi-conductor design provide flexibility with a minimum number of parts, allowing for conductor to conductor, conductor to rebar, and conductor to ground rod applications
- Designed for the enhanced crimp process using patent pending technology meets IEEE Std 837*
- Slotted design allows quick and easy assembly of conductor to connector using Panduit cable ties, included
- Pre-applied conductive antioxidant compound ensures a high quality mechanical and electrical bond, speeding installation
- Color-coded and marked with Panduit die index numbers for proper crimp die selection
- UL 467 Listed and CSA 22.2 Certified for grounding and bonding suitable for direct burial in earth or concrete when crimped with Panduit or industry standard crimping tools and Panduit dies
- Complies with vibration tests per MIL-STD-202G (METHOD 201A)
- Not rated for use with galvanized ground rods and/or galvanized cable

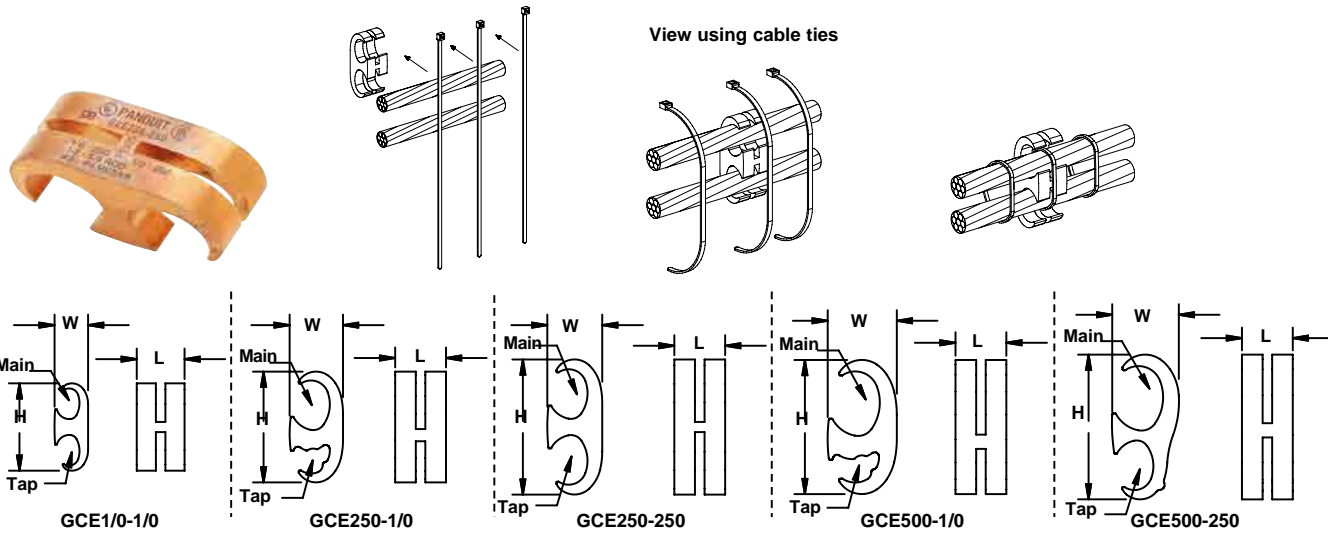

Part Number	Element	Copper Conductor Size Range AWG (mm ²)	Ground Rod Size In. (mm)	Rebar Size In. (mm)	Figure Dimensions In. (mm)			Panduit Color Code	Panduit Part and Die Index No.	Std. Pkg. Qty.
					L	W	H			
GCE1/0-1/0	Main	#6 SOL – 1/0 STR (16 – 50)	—	—	0.94 (23.9)	0.66 (16.8)	1.72 (43.7)	Red	CD-930G-1/0 PG10	1
	Tap									
GCE250-1/0	Main	1/0 STR – 250 kcmil (70 – 120)	1/2 – 5/8 (12.7 – 15.9)	3/8 – 1/2, #3 – #4 (9.5 – 12.7), (#10 – #13)	1.00 (25.4)	1.05 (26.7)	2.18 (55.4)	Black	CD-930G-250 PG25	1
	Tap									
GCE250-250	Main	1/0 STR – 250 kcmil (70 – 120)	1/2 – 5/8 (12.7 – 15.9)	3/8 – 1/2, #3 – #4 (9.5 – 12.7), (#10 – #13)	1.00 (25.4)	1.08 (27.4)	2.66 (67.6)	Black	CD-930G-250 PG25	1
	Tap									
GCE500-1/0	Main	250 – 500 kcmil (150 – 240)	1/2 – 3/4 (12.7 – 19.1)	5/8 – 3/4, #5 – #6 (15.9 – 19.1), (#16 – #19)	1.00 (25.4)	1.36 (34.5)	2.64 (67.1)	Blue	CD-930G-500 PG50	1
	Tap									
GCE500-250	Main	250 – 500 kcmil (150 – 240)	1/2 – 3/4 (12.7 – 19.1)	5/8 – 3/4, #5 – #6 (15.9 – 19.1), (#16 – #19)	1.00 (25.4)	1.32 (33.4)	2.85 (72.4)	Blue	CD-930G-500 PG50	1
	Tap									

*Contact customer service (cs@panduit.com) for specifics on compliance to IEEE Std 837 - 2014



Grounding Cross Connectors

Type GCC

- Only a single die required to crimp each element, which speeds installation and reduces costs
- Wide range-taking ability and multi-conductor design provide flexibility with a minimum number of parts, allowing for conductor to conductor, conductor to rebar, and conductor to ground rod applications
- Designed for the enhanced crimp process using patent pending technology meets IEEE Std 837*
- Slotted design allows quick and easy assembly of conductor to connector using Panduit cable ties, included
- Pre-applied conductive antioxidant compound ensures a high quality mechanical and electrical bond, speeding installation
- Color-coded and marked with Panduit die index numbers for proper crimp die selection
- UL 467 Listed and CSA 22.2 Certified for grounding and bonding suitable for direct burial in earth or concrete when crimped with Panduit or industry standard crimping tools and Panduit dies
- Complies with vibration tests per MIL-STD-202G (METHOD 201A)
- Not rated for use with galvanized ground rods and/or galvanized cable

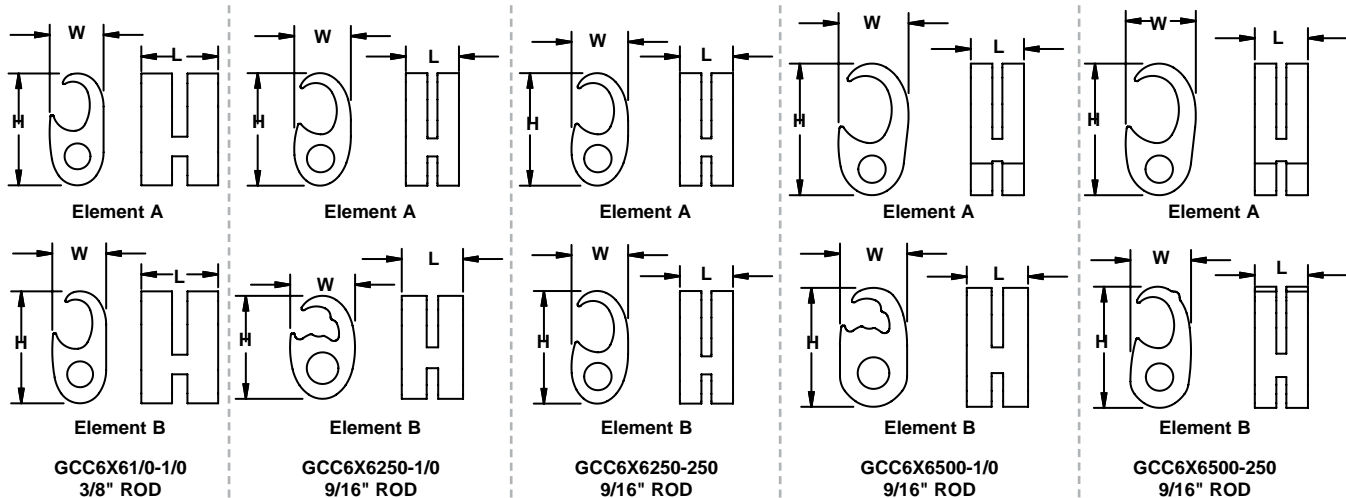

Part Number	Element	Copper Conductor Size Range AWG (mm ²)	Ground Rod Size In. (mm)	Rebar Size In. (mm)	Figure Dimensions In. (mm)			Panduit Color Code	Panduit Part and Die Index No.	Std. Pkg. Qty.
					L	W	H			
GCC6X61/0-1/0	A	#6 SOL – 1/0 STR (16 – 50)	—	—	0.94 (23.9)	0.66 (16.8)	1.37 (34.8)	Red	CD-930G-1/0 PG10	1
	B									
GCC6X6250-1/0	A	#2 SOL – 250 kcmil (35 – 120)	1/2 – 5/8 (12.7 – 15.9)	3/8 – 1/2, #3 – #4 (9.5 – 12.7), (#10 – #13)	1.00 (25.4)	1.06 (26.9)	2.12 (53.8)	Black	CD-930G-250 PG25	1
	B						1.68 (42.7)			
GCC6X6250-250	A	#2 SOL – 250 kcmil (35 – 120)	1/2 – 5/8 (12.7 – 15.9)	3/8 – 1/2, #3 – #4 (9.5 – 12.7), (#10 – #13)	1.00 (25.4)	1.06 (26.9)	2.66 (67.6)	Blue	CD-930G-500 PG50	1
	B						1.09 (27.7)			
GCC6X6500-1/0	A	250 – 500 kcmil (150 – 240)	1/2 – 3/4 (12.7 – 19.1)	5/8 – 3/4, #5 – #6 (15.9 – 19.1), (#16 – #19)	1.00 (25.4)	1.32 (33.5)	2.48 (63.0)	Blue	CD-930G-500 PG50	1
	B						1.09 (27.7)			
GCC6X6500-250	A	250 – 500 kcmil (150 – 240)	1/2 – 3/4 (12.7 – 19.1)	5/8 – 3/4, #5 – #6 (15.9 – 19.1), (#16 – #19)	1.00 (25.4)	1.32 (33.5)	2.48 (63.0)	Blue	CD-930G-500 PG50	1
	B						1.16 (29.5)			

*Contact customer service (cs@panduit.com) for specifics on compliance to IEEE Std 837 - 2014



Universal Beam Grounding Clamp

Type GUBC

- Universal, fits on a wide range of standard (angled) and wide flange (parallel) structural steel beams
- Provide a mounting pad suitable for a two-hole compression lug
- Install quickly and easily with standard 1/4" key hex wrench tooling
- UL 467 Listed and CSA 22.2 Certified for grounding and bonding suitable for direct burial in earth or concrete
- Comply with vibration tests per MIL-STD-202G (METHOD 201A)

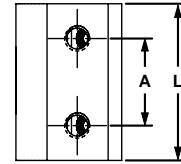
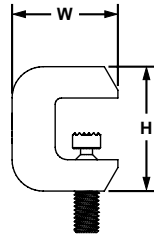
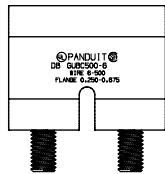

Part Number	Copper Conductor Size Range AWG (mm ²)	Flange Thickness In. (mm)	Thread Size In.	Figure Dimensions In. (mm)				Std. Pkg. Qty.
				A	L	W	H	
GUBC500-6	#6 – 500 kcmil (16 – 240)	0.250 – 0.675 (6.3 – 17.1)	1/2 – 13	1.75 (44.4)	3.15 (80.0)	2.13 (54.0)	2.50 (63.5)	1

For stainless steel mounting hardware kit, see part number GLMHK on page D3.6.



Grounding Plate Connector

Type GPC

- Slotted design allows quick and easy assembly of conductor to connector using Panduit cable ties, included
- Pre-applied conductive antioxidant compound ensures a high quality mechanical and electrical bond, speeding installation
- Complies with vibration tests per MIL-STD-202G (METHOD 201A)
- Made from high conductivity copper; provides strength and premium electrical properties
- Color-coded and marked with Panduit die index numbers for proper crimp die selection
- UL 467 Listed and CSA 22.2 Certified for grounding and bonding suitable for direct burial in earth or concrete when crimped with Panduit or industry standard crimping tools and Panduit dies

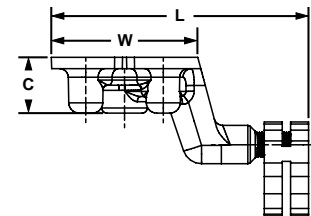
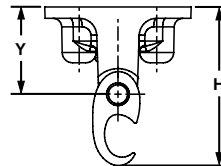
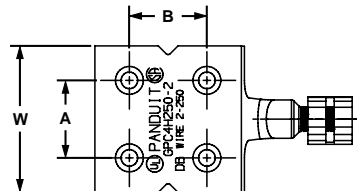

Part Number	Copper Conductor Size Range AWG (mm ²)	Thread Size In.	Figure Dimensions In. (mm)							Panduit Color Code	Panduit Part and Die Index No.	Std. Pkg. Qty.
			L	W	H	Y	A	B	C			
GPC4H250-2	#6 – 500 kcmil (16 – 240)	1/2 – 13	5.81 (147.5)	3.31 (84.0)	3.58 (90.9)	1.97 (50.0)	1.75 (44.4)	1.75 (44.4)	1.26 (32.0)	Black	CD-930G-250 PG25	1

For stainless steel mounting hardware kit, see part number GLMHK (1 Kit per lug) on page D3.6.



Code Conductor, Thin Wall, CTAP

For Copper Code Stranded Connections

Type CTAPF

- For copper-to-copper tapping, splicing or pigtailing
- Wide wire range-taking capability minimizes inventory requirements
- Color-coded for proper crimp die selection
- Ribbed design provides high strength
- Made from high conductivity wrought copper
- UL Listed and CSA Certified to 600 V and temperature rated to 90°C when crimped with Panduit and specified competitor crimping tools and dies[^]

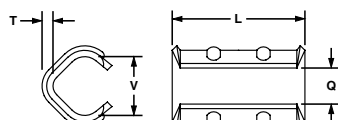

Part Number	Copper Conductor Size		Number of Ribs	Figure Dimensions In. (mm)				Panduit Color Code	Wire Strip Length In. (mm)	Std. Pkg. Qty.
	AWG Run (mm²)	AWG Tap (mm²)		L	T	V	Q			
CTAPF10-16-C*	#14 AWG (2.5)	#16 – #14 AWG (1.5 – 2.5)	0	0.41 (10.4)	0.06 (1.5)	0.19 (4.8)	0.13 (3.3)	Red	1/2 (12.7)	100
	#12 AWG (4.0)	#16 – #12 AWG (1.5 – 4.0)								
	#10 AWG (6.0)	#14 AWG (2.5)								
CTAPF8-12-C‡	#10 AWG (6.0)	#10 AWG (6.0)	0	0.67 (17.0)	0.07 (1.8)	0.26 (6.6)	0.19 (4.8)	Blue	11/16 (17.5)	100
	#8 AWG (10.0)	#12 AWG (4.0)								
CTAPF6-12-C‡	#8 AWG (10.0)	#10 – #8 AWG (6.0 – 10.0)	0	0.67 (17.0)	0.07 (1.8)	0.32 (8.1)	0.24 (6.1)	Gray	11/16 (17.5)	100
	#6 AWG (16.0)	#12 – #10 AWG (4.0 – 6.0)								
CTAPF4-12-C‡	#6 AWG (16)	#8 – #6 AWG (10 – 16)	1	1.25 (31.8)	0.07 (1.8)	0.40 (10.2)	0.28 (7.1)	Brown	1 5/16 (33.3)	100
	#5, #4 AWG (16, 25)	#12 – #8 AWG (4 – 10)								
CTAPF3-12-C‡	#5, #4 AWG (16, 25)	#6 – #5 AWG (16)	1	1.25 (31.8)	0.08 (2.0)	0.46 (11.7)	0.31 (7.9)	Green	1 5/16 (33.3)	100
	#3 AWG (25)	#12 – #6 AWG (4 – 16)								
CTAPF2-12-C‡	#4 AWG (25)	#4 AWG (25)	1	1.25 (31.8)	0.08 (2.0)	0.51 (13.0)	0.33 (8.4)	Pink	1 5/16 (33.3)	100
	#3 AWG (25)	#5 AWG (16)								
	#2 AWG (35)	#12 – #6 AWG (4 – 16)								
CTAPF1-12-C	#3 AWG (25)	#4 – #3 AWG (25)	2	1.82 (46.2)	0.08 (2.0)	0.57 (14.5)	0.40 (10.2)	Black	1 7/8 (47.6)	100
	#2 AWG (35)	#5 – #4 AWG (16 – 25)								
	#1 AWG (35)	#12 – #5 AWG (4 – 16)								
CTAPF1/0-12-L	#2 AWG (35)	#4 – #2 AWG (25 – 35)	2	1.82 (46.2)	0.09 (2.3)	0.63 (16.0)	0.42 (10.7)	Orange	1 7/8 (47.6)	50
	#1 AWG (35)	#4 – #3 AWG (25)								
	1/0 AWG (50)	#12 – #4 AWG (4 – 25)								
CTAPF2/0-12-Q	#1 AWG (35)	#2 – #1 AWG (35)	2	1.82 (46.2)	0.09 (2.3)	0.71 (18.0)	0.48 (12.2)	Purple	1 7/8 (47.6)	25
	1/0 AWG (50)	#3 – #2 AWG (25 – 35)								
	2/0 AWG (70)	#12 – #3 AWG (4 – 35)								
CTAPF3/0-12-Q	1/0 AWG (50)	#1 – 1/0 AWG (50)	2	1.82 (46.2)	0.09 (2.3)	0.81 (20.6)	0.55 (14.0)	Yellow	1 7/8 (47.6)	25
	2/0 AWG (70)	#2 – #1 AWG (35)								
	3/0 AWG (95)	#12 – #2 AWG (4 – 35)								

*CTAPF10-16-C available with square, not flared ends.

All parts available in tin-plated; add TP before packaging code – example: CTAPF6-12TP-C.

[^]Note: CTAPF parts are UL Listed and CSA Certified with AWG wire only.

‡CSA Certified for grounding and bonding.

Not Direct Burial Rated.



Code Conductor, Heavy Duty, CTAP

For Use with Solid and Stranded Copper Code Conductors

Type CTAP

- For tapping into unbroken continuous main, as a wire joint or two-way splice
- Wide wire range-taking capability minimizes inventory requirements
- Made from heavy wall, extruded, high conductivity copper; provides high strength and premium electrical properties
- UL Listed per UL 486 for use up to 35 KV** and temperature rated 90°C when crimped with Panduit and specified competitor crimping tools and dies
- UL Listed per UL 467 for grounding and bonding suitable for direct burial in earth or concrete when crimped with Panduit and specified competitor crimping tools and dies^

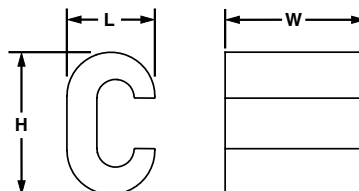

Part Number	Copper Conductor Size		Figure Dimensions In. (mm)			Panduit Die Index No.‡	Burndy Die Index No.‡	Wire Strip Length In. (mm)	Tap Cover*	Std. Pkg. Qty.
	AWG Run (mm²)	AWG Tap (mm²)	L	T	V					
CTAP4-8-L	#6 – #4 AWG SOL or STR	#8 AWG SOL or STR	0.46 (11.7)	0.63 (16.0)	0.73 (18.5)	PBG	BG	3/4 (19)	CVR6-1	50
CTAP4-6-L	#6 AWG STR, #4 AWG SOL or STR	#6 AWG SOL or STR	0.48 (12.2)	0.63 (16.0)	0.76 (19.3)	PBG	BG	3/4 (19)	CVR6-1	50
CTAP4-4-L	#4 AWG SOL or STR	#4 AWG STR	0.46 (11.7)	0.63 (16.0)	0.81 (20.6)	PBG	BG	3/4 (19)	CVR6-1	50
CTAP2-4-Q	#2 AWG SOL or STR	#8 – #4 AWG SOL or STR	0.60 (15.2)	0.76 (19.3)	0.96 (24.4)	PC	C	7/8 (22)	CVR2-1	25
CTAP2-2-X	#2 AWG SOL or STR	#2 AWG SOL or STR	0.60 (15.2)	0.75 (19.0)	1.05 (26.7)	PC	C	7/8 (22)	CVR2-1	10
CTAP2/0-2-X	1/0 – 2/0 AWG STR	#8 – #2 AWG SOL or STR	0.80 (20.3)	0.93 (23.6)	1.32 (8.1)	PO	O	1 1/16 (27)	CVR2-1	10
CTAP2/0-2/0-X	1/0 – 2/0 AWG STR	1/0 – 2/0 AWG STR	0.80 (20.3)	0.93 (23.6)	1.37 (34.8)	PO	O	1 1/16 (27)	CVR250-1	10
CTAP4/0-2-X	3/0 – 4/0 AWG STR	#6 – #2 AWG SOL or STR	0.94 (23.9)	1.08 (27.4)	1.66 (42.2)	PD3	F	1 1/4 (32)	CVR500-1	10
CTAP4/0-2/0-X	3/0 – 4/0 AWG STR	1/0 – 2/0 AWG STR	1.00 (25.4)	1.08 (27.3)	1.57 (39.9)	PD3	F	1 1/4 (32)	CVR500-1	10
CTAP4/0-4/0-X	3/0 – 4/0 AWG STR	3/0 – 4/0 AWG STR	1.00 (25.4)	1.08 (27.4)	1.57 (39.9)	PD3	F	1 1/4 (32)	CVR500-1	10

*See page D3.12 for type CVR CTAP covers.

**Consult cable manufacturer for voltage stress relief instructions with applications greater than 2000 V.

^Note: CTAP parts are UL Listed and CSA Certified with AWG wire only.

Not UL/CSA approved for use with metric wire. See GCE & GCC series parts for UL/CSA approved connections for metric wire (Pages D3.7, D3.8).



Clear Covers for HTCT HTAPs

Type CLRCVR

- Made of high impact plastic to provide high impact strength and 360° inspections of crimped connection to assure the crimp is complete and the correct die was used
- Incorporate dual self-latching spring loaded latches and supplied with two Panduit UL 94 V-0 cable ties to allow for easy snap-on assembly and ensure covers are secured
- Low profile design minimizes space requirements
- Each cover half supports installation information labels inside plastic retainer strips to allow labels to be viewed on either side of cover and to protect labels from being removed
- Incorporate molded in flash barriers which encompass the HTAP installation providing protection against electrical flash over
- UL 94 V-0 flame rating and oxygen index of 28 providing self-extinguishing, flame retardant properties
- Part number, voltage rating, temperature rating and HTCT part number molded into cover for easy identification

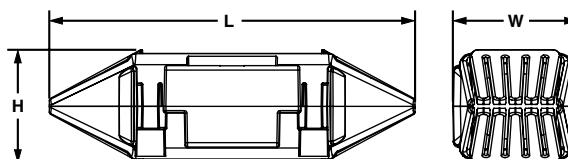

Part Number	Use With HTAP Part Number	Figure Dimensions In. (mm)			Std. Pkg. Qty.
		L	W	H	
CLRCVR1-1	HTCT6X-6X	4.48 (113.8)	1.41 (35.8)	2.13 (54.0)	1
CLRCVR2-1	HTCT2-2	5.10 (129.5)	1.66 (42.2)	1.40 (35.6)	1
CLRCVR3-1	HTCT250-2, HTCT250-250	5.35 (135.9)	2.16 (54.9)	1.40 (35.6)	1



Black Covers for Copper HTAPs and CTAPs

- Used to insulate connectors and protect tap connections from corrosive environments
- Made of durable, weather-resistant black polypropylene
- Double locking latches provide secure cover installation
- UL Listed and CSA Certified with approved connectors for use up to 600 V and temperature rated to 90° C

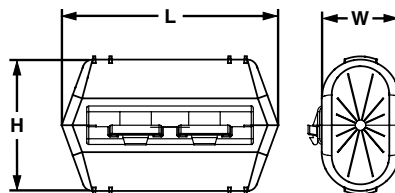

Part Number	Use with CTAP Part Number	Use with HTAP Part Number	Figure Dimensions In.			Std. Pkg. Qty.
			L	W	H	
CVR6-1	CTAP4-8-L, CTAP4-6-L, CTAP4-4-L	HTCT6X-6X-1	2.00	1.20	1.26	1
CVR2-1	CTAP2-4-Q, CTAP2-2-X, CTAP2/0-2-X	HTCT2-2-1	3.38	1.40	2.00	1
CVR250-1	CTAP2/0-2/0-X	HTCT250-2-1, HTCT250-250-1	3.38	1.55	2.05	1
CVR500-1*	CTAP4/0-2-X, CTAP4/0-2/0-X, CTAP4/0-4/0-X	—	3.86	1.97	2.66	1
CVR1000-1*	—	—	5.62	2.45	3.72	1

For information on copper HTAPs, see page D3.13

For information on copper CTAPs, see page D3.11

*Not CSA Certified.



Code/Flex Conductor HTAP

For Making Parallel and Multiple Tap Connections on Code and Flex Conductors

Type HTCT

- Used to tap into continuous conductors as a splice or pigtail
- Each HTAP terminates a wide range of conductor sizes and combinations of code and flex conductors Class G, H, I and Diesel Locomotive to suit a variety of applications
- Slotted design allows quick and easy assembly of conductor to HTAP using three Panduit 94V-0 cable ties included
- Tap grooves are separated from one another allowing them to function independently so HTAP can be used with a single or multiple taps providing maximum design and installation flexibility
- Color-coded and marked with Panduit die index numbers for proper crimp die selection
- UL Listed and CSA Certified for applications up to 600 V when crimped with Panduit and specified competitor crimping tools and Panduit crimping dies[^]
- Tin-plated to inhibit corrosion

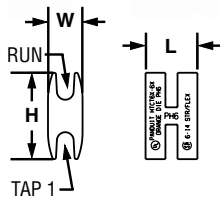

HTCT6X-6X

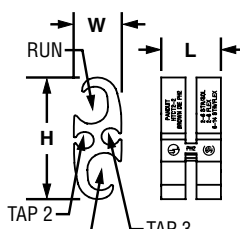

HTCT2-2

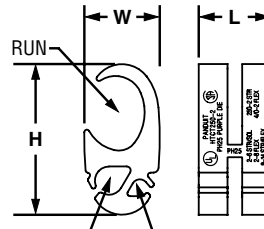

HTCT250-2

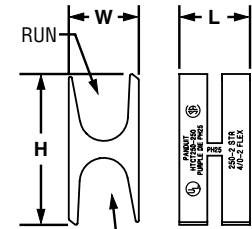

HTCT250-250

Part Number	Copper Conductor Size Range					Figure Dimensions In. (mm)			Panduit Die Color and Die No.	Wire Strip Length In. (mm)	Std. Pkg. Qty.
	Wire Strand Type	Run	Tap 1	Tap 2	Tap 3	L	W	H			
HTCT6X-6X-1	Code	#6 – #14 AWG (10 – 2.5)	#6 – #14 AWG (10 – 2.5)	—	—	0.60 (15.2)	0.40 (10.2)	1.00 (25.4)	Orange PH6	11/16 (18)	1
	Flex	#6 – #14 AWG (10 – 2.5)	#6 – #14 AWG (10 – 2.5)	—	—						
HTCT2-2-1	Code	#2 – #6 AWG STR/SOL (25 – 16)	#2 – #6 AWG STR/SOL (25 – 16)	#8 – #14 AWG (6 – 2.5)	#8 – #14 AWG (6 – 2.5)	0.76 (19.3)	0.61 (15.5)	1.55 (39.4)	Brown PH2	13/16 (21)	1
	Flex	#2 – #8 AWG (25 – 10)	#2 – #8 AWG (25 – 10)	#8 – #14 AWG (6 – 2.5)	#8 – #14 AWG (6 – 2.5)						
HTCT250-2-1	Code	250 kcmil – #2 AWG (120 – 35)	#2 – #6 AWG STR/SOL (25 – 16)	#8 – #14 AWG (6 – 2.5)	—	0.92 (23.4)	0.96 (24.4)	1.92 (48.8)	Purple PH25	1 (25)	1
	Flex	4/0 – #2 AWG (95 – 35)	#2 – #8 AWG (25 – 10)	#8 – #14 AWG (6 – 2.5)	—						
HTCT250-250-1	Code	250 kcmil – #2 AWG (120 – 35)	250 kcmil – #2 AWG (120 – 35)	—	—	0.90 (22.9)	0.89 (22.6)	1.92 (48.8)	Purple PH25	1 (25)	1
	Flex	4/0 – #2 AWG (95 – 35)	4/0 – #2 AWG (95 – 35)	—	—						

[^]Note: HTCT parts are UL Listed and CSA Certified with AWG wire only.



Code/Flex Conductor HTAP Kit

Type HTWC

- Include all components to make a complete HTAP and cover installation: HTCT HTAP, matching CLRCVR clear cover, and cable ties
- Each HTCT HTAP designed to terminate a wide range of copper code and flex conductor combinations to accommodate a variety of applications
- HTAPs incorporate a unique slotted design that allows for quick and easy installation using supplied Panduit cable ties; saves time and cost
- Matching clear covers are made from high impact plastic and provide high impact strength and 360° viewing of installed HTAP
- Clear covers have a UL 94 V-0 flame rating and an oxygen index of 28 providing self-extinguishing, flame retardant properties
- UL Listed and CSA Certified for applications up to 600 V when crimped with Panduit and specified competitor crimping tools and Panduit crimping dies[^]

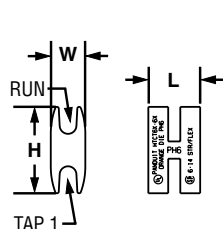

HTCT6-6

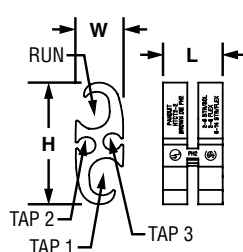

HTCT2-2

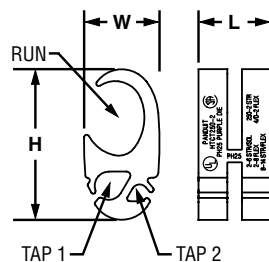

HTCT250-2

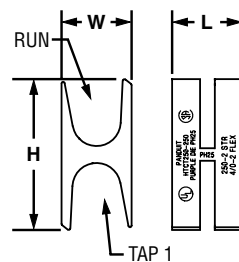

HTCT250-250

Part Number	Components		Wire Strand Type	Copper Conductor Size Range AWG (mm ²)				Std. Pkg. Qty.
	HTAP Part No.	Clear Cover Part No.		Run	Tap 1	Tap 2	Tap 3	
HTWC6X-6X-1	HTCT6X-6X-1	CLRCVR1-1	Code	#6 – #14 AWG (10 – 2.5)	#6 – #14 AWG (10 – 2.5)	—	—	1
			Flex	#6 – #10 AWG (10 – 2.5)	#6 – #14 AWG (10 – 2.5)	—	—	
HTWC2-2-1	HTCT2-2-1	CLRCVR2-1	Code	#2 – #6 AWG STR/SOL (25 – 16)	#2 – #6 AWG STR/SOL (25 – 16)	#8 – #14 AWG (6 – 2.5)	#8 – #14 AWG (6 – 2.5)	1
			Flex	#2 – #8 AWG (25 – 10)	#2 – #8 AWG (25 – 10)	#8 – #14 AWG (6 – 2.5)	#8 – #14 AWG (6 – 2.5)	
HTWC250-2-1	HTCT250-2-1	CLRCVR3-1	Code	250 kcmil – #2 AWG (120 – 35)	#2 – #6 AWG STR/SOL (25 – 16)	#8 – #14 AWG (6 – 2.5)	—	1
			Flex	4/0 – #2 AWG (95 – 35)	#2 – #8 AWG (25 – 10)	#8 – #14 AWG (6 – 2.5)	—	
HTWC250-250-1	HTCT250-250-1	CLRCVR3-1	Code	250 kcmil – #2 AWG (120 – 35)	250 kcmil – #2 AWG (120 – 35)	—	—	1
			Flex	4/0 – #2 AWG (95 – 35)	4/0 – #2 AWG (95 – 35)	—	—	

See pages D3.12 – D3.13 for more information on HTAPs and clear covers, including tap sizes and locations.

[^]Note: HTCT parts are UL Listed and CSA Certified with AWG wire only.

Panduit® Grounding Connector Approvals



Logo (Symbol)	Agency	Spec/Approval	Applicable Products
	Underwriters Laboratories, Inc.	UL 486A Wire Connectors and Soldering Lugs for use in US and Canada	As shown on product pages.
	Underwriters Laboratories, Inc.	UL 486A – 486B Wire Connectors and Soldering Lugs for use in US	As shown on product pages.
	Underwriters Laboratories, Inc.	UL 467 Grounding and Bonding Equipment for use in US and Canada	As shown on product pages.
	Underwriters Laboratories, Inc.	UL 467 Grounding and Bonding Equipment for use in US	As shown on product pages.
	Canadian Standards Association	C22.2 No. 65-03 Wire Connectors	As shown on product pages.
	Canadian Standards Association	C22.2 No. 41-M1987 (R1999) Grounding and Bonding Equipment	As shown on product pages.
	Institute of Electrical and Electronics Engineers	IEEE Std. 837 IEEE Standard for Qualifying Permanent Connection used in Substation Grounding	As shown on product pages.



Bronze Service Post Connector, Male Stud, Single Conductor

- For grounding one copper code conductor to steel structures, busbars, or transformers or for tapping from busbar with hex nut and washer
- Made from high copper content, hard drawn copper rod provides high strength

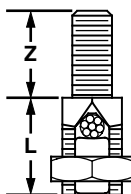

- Pressure bar provides secure connection on a full range of conductor combinations used with each connector providing premium wire pull-out strength
- cULus 467 Listed for grounding and bonding and suitable for direct burial in earth or concrete

Type SP1 — Premium Grade

- True hex design for body and nut hex provides correct fit with socket, box, or open end wrenches for easy installation process
- Offered with standard and long stud lengths for optimized fit of the threaded stud through the mounting surface

Type GSP1 — Value Grade

- Incorporates longer stud length than standard SP1 stud length to accommodate a variety of mounting applications
- Greater wire range-taking capability allows one GSP1 part to substitute for up to four SP1 parts (see Table for comparatives) — reduces inventory, saves costs



Part Number	Conductor Size Range (AWG)	Stud Size* (UNC Threads)	Figure Dimensions (In.)		Nut Hex (In.)	Body Hex (In.)	Std. Pkg. Qty.
			L	Z			
SP1-8-C	#12 SOL – #8 STR	1/4 – 20	0.63	0.50	0.50	0.38	100
SP1-8L-C			0.63	1.00			
GSP1-12-6-C¹	#12 SOL – #6 STR	1/4 – 20	0.87	0.83	0.69	0.56	100
SP1-7-C	#8 SOL – #7 STR	1/4 – 20	0.88	0.50	0.69	0.50	100
SP1-7L-C			0.88	1.00			
SP1-4-C	#10 SOL – #4 STR	5/16 – 18	0.94	0.56	0.75	0.56	100
SP1-4L-C			0.94	1.00			
GSP1-10-4-C²	#10 SOL – #4 STR	5/16 – 18	1.06	0.83	0.81	0.69	100
SP1-3-C	#6 SOL – #3 STR	3/8 – 16	1.06	0.63	0.81	0.63	100
SP1-3L-C			1.06	1.13			
GSP1-6-2-C³	#6 SOL – #2 STR	3/8 – 16	1.06	0.83	0.81	0.69	100
SP1-2-C	#4 STR – #2 STR	3/8 – 16	1.06	0.63	0.88	0.69	100
SP1-2L-C			1.06	1.13			
SP1-1/0-L	#6 SOL – 1/0 STR	1/2 – 13	1.31	0.75	1.00	0.75	50
SP1-1/0L-L			1.31	1.25			
GSP1-4-2/0-L⁴	#4 SOL – 2/0 STR	3/8 – 16	1.32	0.83	1.06	0.88	50
SP1-2/0-Q	#1 SOL – 2/0 STR	1/2 – 13	1.44	0.75	1.13	0.88	25
SP1-2/0L-Q			1.44	1.25			
SP1-4/0-Q	3/0 SOL – 4/0 STR	5/8 – 11	1.69	1.00	1.38	1.13	25
SP1-4/0L-Q			1.69	1.50			
SP1-350-12	4/0 SOL – 350 kcmil	5/8 – 11	2.00	1.00	1.50	1.25	12
SP1-350L-12			2.00	1.50			
SP1-500-12	250 kcmil – 500 kcmil	3/4 – 10	2.31	1.38	1.81	1.50	12
SP1-500L-12			2.31	1.75			

*Type GSP1 does not have a true hex body. Apply open-end wrench to body width normal to conductor slot

¹Alternate offering for SP1-8 and SP1-7. Review stud length (Dim. Z) for potential replacement for SP1-8L and SP1-L7

²Alternate offering for SP1-4. Review stud length (Dim. Z) for potential replacement for SP1-4L

³Alternate offering for SP1-3 and SP1-2. Review stud length (Dim. Z) for potential replacement for SP1-3L and SP1-2L

⁴Alternate offering for SP1-1/0 and SP1-2/0. Note stud size difference. Review stud length (Dim. Z) for potential replacement for SP1-1/0L and SP1-2/0L



Bronze Service Post Connector, Male Stud, Two Conductor

- For grounding two copper code conductors to steel structures, busbars, or transformers or for tapping from busbar with hex nut and washer
- Made from high copper content, hard drawn copper rod provides high strength
- Pressure bar provides secure connection on a full range of conductor combinations used with each connector providing premium wire pull-out strength
- cULus 467 Listed for grounding and bonding and suitable for direct burial in earth or concrete

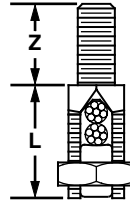

Type SP2 — Premium Grade

- True hex design for body and nut hex provides correct fit with socket, box, or open end wrenches for easy installation process
- Offered with standard and long stud lengths for optimized fit of the threaded stud through the mounting surface

Type GSP2 — Value Grade

- Incorporates longer stud length than standard SP2 stud length to accommodate a variety of mounting applications
- Greater wire range-taking capability allows one GSP2 part to substitute for up to four SP2 parts (see Table for comparatives) — reduces inventory, saves costs

Part Number	Conductor Size Range (AWG)	Stud Size* (UNC Threads)	Figure Dimensions (In.)		Nut Hex (In.)	Body Hex (In.)	Std. Pkg. Qty.
			L	Z			
SP2-8-C	#12 SOL – #8 STR	1/4 – 20	0.75	0.50	0.50	0.38	100
SP2-8L-C			0.75	1.00			
NEW! GSP2-12-6-C ¹	#12 SOL – #6 STR	1/4 – 20	0.94	0.83	0.69	0.56	100
SP2-7-C	#10 SOL – #7 STR	1/4 – 20	1.00	0.50	0.69	0.50	100
SP2-7L-C			1.00	1.00			
SP2-4-C	#10 SOL – #4 STR	5/16 – 18	1.16	0.56	0.75	0.56	100
SP2-4L-C			1.16	1.00			
NEW! GSP2-10-4-C ²	#10 SOL – #4 STR	5/16 – 18	1.30	0.83	0.81	0.69	100
SP2-3-C	#10 SOL – #3 STR	3/8 – 16	1.09	0.63	0.81	0.63	100
SP2-3L-C			1.09	1.13			
NEW! GSP2-10-2-C ³	#10 SOL – #2 STR	3/8 – 16	1.30	0.83	0.81	0.69	100
SP2-2-C	#10 STR – #2 STR	3/8 – 16	1.38	0.63	0.88	0.69	100
SP2-2L-C			1.28	1.13			
SP2-1/0-L	#2 SOL – 1/0 STR	1/2 – 13	1.69	0.75	1.00	0.75	50
SP2-1/0L-L			1.69	1.25			
NEW! GSP2-2-2/0-L ⁴	#2 SOL – 2/0 STR	3/8 – 16	1.65	0.83	1.06	0.88	50
SP2-2/0-Q	#2 SOL – 2/0 STR	1/2 – 13	1.88	0.75	1.13	0.88	25
SP2-2/0L-Q			1.88	1.25			
SP2-4/0-Q	#1 SOL – 4/0 STR	5/8 – 11	2.25	1.00	1.38	1.13	25
SP2-4/0L-Q			2.25	1.50			
SP2-350-12	#1 STR – 350 kcmil	5/8 – 11	2.69	1.00	1.50	1.25	12
SP2-350L-12			2.69	1.50			
SP2-500-12	3/0 STR – 500 kcmil	3/4 – 10	3.19	1.38	1.81	1.50	12
SP2-500L-12			3.19	1.75			

*Type GSP1 does not have a true hex body. Apply open-end wrench to body width normal to conductor slot

¹Alternate offering for SP2-8 and SP2-7. Review stud length (Dim. Z) for potential replacement for SP2-8L and SP2-L7

²Alternate offering for SP2-4. Review stud length (Dim. Z) for potential replacement for SP2-4L

³Alternate offering for SP2-3 and SP2-2. Review stud length (Dim. Z) for potential replacement for SP2-3L and SP2-2L

⁴Alternate offering for SP2-1/0 and SP2-2/0. Note stud size difference. Review stud length (Dim. Z) for potential replacement for SP2-1/0L and SP2-2/0L



Copper and Aluminum One-Hole Grounding Lay-in Lug

Type LI

- Used for quick installation of a continuous grounding conductor
- UL 467 Listed for grounding and bonding; copper body lugs are UL Listed for direct burial in earth or concrete (aluminum body lugs are not direct burial rated)
- cULus Listed for use up to 600 V and temperature rated 90°C
- Wire range-taking capability minimizes inventory requirements, saves cost



Copper



Tin-Plated Copper



Aluminum

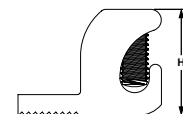
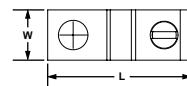

Part Number	Set Screw Material	Conductor Size Range (AWG)	Stud Hole Size (In.)	Hex Key Size (In.)	Figure Dimensions (In.)			Std. Pkg. Qty.
					L	W	H	
Copper Body								
LICC4-22-C	Stainless Steel	#14 SOL – #4 STR	0.22	**	1.16	0.39	0.87	100
Tin-Plated Copper Body								
LICC4-22TP-C	Stainless Steel	#14 SOL – #4 STR	0.22	**	1.16	0.39	0.87	100
Tin-Plated Aluminum Body*								
LIAC4-22-C*	Stainless Steel	#14 SOL – #4 STR	0.22	**	1.06	0.39	0.78	100
LIAS1/0-14-L*	Zinc Plated Steel	#14 SOL – 1/0 STR	0.27	**	1.50	0.61	1.10	50
LIAS250-56-Q*	Zinc Plated Steel	#6 SOL – 250 STR	0.33	1/4	2.20	0.80	1.70	25

*Not DB Rated.

**Uses slotted head set screw.

The use of Panduit oxide inhibiting joint compound (CMP) is recommended for pad and conductor connections.

Joint Compounds

Type CMP

- Oxide inhibitor for compression conductor connections lowers electrical resistance of compression joint while sealing out air and moisture to prevent the formation of surface oxides
- Wide operating temperature range; can be used in a wide range of electrical and environmental conditions
- Packaged in convenient dispenser bottles



Part Number	Part Description	Std. Pkg. Qty.
CMP-100-1	Contact aid for pad-to-pad or thread-to-thread aluminum connections, 8 oz. Operating temperature range -60°F (-51°C) to 400°F (204°C).	1
CMP-200-1	Contact aid for cable connections with compression connections made on aluminum conductor, 8 oz. Operating temperature range -40°F (-40°C) to 400°F (204°C). Compatible with all insulating materials.	1
CMP-300-1	Contact aid for copper-to-copper and copper-to-steel connections, 8 oz. Operating temperature range -40°F (-40°C) to 350°F (177°C). Good for all voltages and suitable for grounding. Also used for anti-seizing thread lubricant.	1
CMP-300-4-1	Contact aid for copper-to-copper and copper-to-steel connections, 4 oz. Operating temperature range -40°F (-40°C) to 350°F (177°C). Good for all voltages and suitable for grounding. Also used for anti-seizing thread lubricant.	1



Grounding Clamp, U-Bolt, Bronze

Type GPL

- Used to ground copper conductor parallel or at a right angle to a rod, tube, or pipe
- Made from high strength, electrolytic cast bronze
- High strength silicon bronze hardware provides long term reliable assembly
- Accommodates a wide range of pipe, tube, rod and conductor sizes – minimizes inventory requirements
- cULus 467 Listed for grounding and bonding and suitable for direct burial in earth or concrete

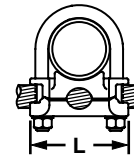
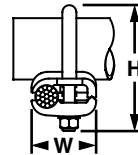

Part Number	Ground Rod Size (In.)	Iron Pipe Size (In.)	Conductor Size Range	Figure Dimensions In. (mm)			Bolt Dia. (In.)	Hex Size (In.)	Std. Pkg. Qty.
				L	W	H			
GPL-4-Q	5/8 or 3/4	3/8	#8 SOL – #4 STR	2.00 (50.8)	1.38 (35.1)	2.75 (69.9)	3/8	9/16	25
GPL-5-Q	5/8 or 3/4	3/8	#4 SOL – 2/0 STR	2.00 (50.8)	1.63 (41.4)	2.75 (69.9)	3/8	9/16	25
GPL-6-Q	5/8 or 3/4	3/8	2/0 SOL – 250 kcmil	2.00 (50.8)	1.88 (47.8)	2.75 (69.9)	3/8	9/16	25
GPL-8-Q	7/8 or 1	1/2 or 3/4	#8 SOL – #4 STR	2.38 (60.5)	1.38 (35.1)	2.63 (66.8)	3/8	9/16	25
GPL-9-Q	7/8 or 1	1/2 or 3/4	#4 SOL – 2/0 STR	2.38 (60.5)	1.63 (41.4)	2.63 (66.8)	3/8	9/16	25
GPL-10-Q	7/8 or 1	1/2 or 3/4	2/0 SOL – 250 kcmil	2.38 (60.5)	1.88 (47.8)	3.00 (76.2)	3/8	9/16	25
GPL-14-X	—	1	#8 SOL – #4 STR	2.63 (66.8)	1.38 (35.1)	2.75 (69.9)	3/8	9/16	10
GPL-15-X	—	1	#4 SOL – 2/0 STR	2.63 (66.8)	1.63 (41.4)	2.75 (69.9)	3/8	9/16	10
GPL-16-X	—	1	2/0 SOL – 250 kcmil	2.63 (66.8)	1.88 (47.8)	3.25 (82)	3/8	9/16	10
GPL-20-X	—	1 1/4	#8 SOL – #4 STR	3.00 (76.2)	1.38 (35.1)	3.50 (88.9)	3/8	9/16	10
GPL-21-X	—	1 1/4	#4 SOL – 2/0 STR	3.00 (76.2)	1.63 (41.4)	3.50 (88.9)	3/8	9/16	10
GPL-22-X	—	1 1/4	2/0 SOL – 250 kcmil	3.00 (76.2)	1.88 (47.8)	3.50 (88.9)	3/8	9/16	10
GPL-26-X	—	1 1/2	#8 SOL – #4 STR	3.25 (82.6)	1.38 (35.1)	4.00 (101.6)	3/8	9/16	10
GPL-27-X	—	1 1/2	#4 SOL – 2/0 STR	3.25 (82.6)	1.63 (41.4)	4.00 (101.6)	3/8	9/16	10
GPL-28-X	—	1 1/2	2/0 SOL – 250 kcmil	3.25 (82.6)	1.88 (47.8)	4.00 (101.6)	3/8	9/16	10
GPL-32-3	—	2	#8 SOL – #4 STR	3.75 (95.3)	1.38 (35.1)	4.25 (107.9)	3/8	9/16	3
GPL-33-3	—	2	#4 SOL – 2/0 STR	3.75 (95.3)	1.63 (41.4)	4.25 (107.9)	3/8	9/16	3
GPL-34-3	—	2	2/0 SOL – 250 kcmil	3.75 (95.3)	1.88 (47.8)	4.25 (107.9)	3/8	9/16	3
GPL-39-3	—	2 1/2	#4 SOL – 2/0 STR	4.25 (107.9)	1.63 (41.4)	5.00 (127)	3/8	9/16	3
GPL-40-3	—	2 1/2	2/0 SOL – 250 kcmil	4.25 (107.9)	1.88 (47.8)	5.00 (127)	3/8	9/16	3
GPL-44-1	—	3	#8 SOL – #4 STR	4.75 (120.6)	1.38 (35.1)	5.50 (139.7)	3/8	9/16	1
GPL-45-1	—	3	#4 SOL – 2/0 STR	4.75 (120.6)	1.63 (41.4)	5.50 (139.7)	3/8	9/16	1
GPL-46-1	—	3	2/0 SOL – 250 kcmil	4.75 (120.6)	1.88 (47.8)	5.50 (139.7)	3/8	9/16	1
GPL-51-1	—	3 1/2	#4 SOL – 2/0 STR	5.25 (133.4)	1.63 (41.4)	6.25 (158)	3/8	9/16	1

Continues on next page



Grounding Clamp, U-Bolt, Bronze (continued)

Part Number	Ground Rod Size (In.)	Iron Pipe Size (In.)	Conductor Size Range	Figure Dimensions In. (mm)			Bolt Dia. (In.)	Hex Size (In.)	Std. Pkg. Qty.
				L	W	H			
GPL-52-1	—	3 1/2	2/0 SOL – 250 kcmil	5.25 (133.4)	1.88 (47.8)	6.25 (158)	3/8	9/16	1
GPL-57-1	—	4	#4 SOL – 2/0 STR	5.75 (146.0)	1.63 (41.4)	6.38 (162.1)	3/8	9/16	1
GPL-58-1	—	4	2/0 SOL – 250 kcmil	5.75 (146.0)	1.88 (47.8)	6.38 (162.1)	3/8	9/16	1
GPL-75-X	—	6	#4 SOL – 2/0 STR	7.88 (200.2)	1.58 (40.1)	7.85 (199.4)	3/8	1 1/4	10



Bronze Grounding Clamp, U-Bolt, for Two Cables

Type GU

- Used to ground two copper code conductors parallel to a rod, tube, or pipe
- Made from high strength, electrolytic cast bronze
- High strength silicon bronze hardware provides long term reliable assembly
- Accommodates a wide range of pipe, tube, rod and conductor sizes – minimizes inventory requirements, saves cost
- cULus 467 Listed for grounding and bonding and suitable for direct burial in earth or concrete

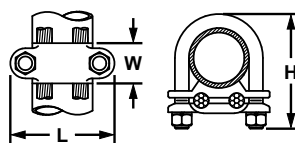

Part Number	Ground Rod Size (In.)	Iron Pipe Size (In.)	Figure Dimensions (In.)			Bolt Dia. (In.)	Hex Size (In.)	Std. Pkg. Qty.
			L	W	H			
GU-2-X	#4 SOL – 2/0 STR	1	2.75	1.13	3.25	3/8	9/16	10
GU-4-X	#8 SOL – #4 STR	1 1/4	3.00	1.13	3.25	3/8	9/16	10
GU-11-X	#4 SOL – 2/0 STR	2	1.31	3.62	4.44	3/8	9/16	10
GU-13-3	300 kcmil – 500 kcmil	2	4.00	1.50	4.63	1/2	3/4	3



Bronze Ground Clamp

Type GPC

- Bonds water pipe to copper conductors
- Made from high strength, electrolytic cast bronze
- Zinc plated steel hardware
- Wire range-taking capability minimizes inventory requirements, saves cost
- cULus 467 Listed for grounding and bonding

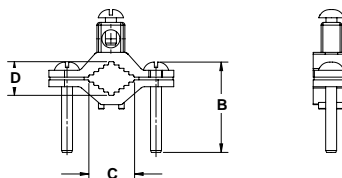

Part Number	Conductor Size Range (AWG)	Iron Pipe Size (In.)	Figure Dimensions (In.)			Std. Pkg. Qty.
			B	C	D	
Standard Duty						
GPC2-1-Q	#10 SOL – #2 STR	1/2 – 1	1.65	0.78	0.63	25
GPC2-2-L	#10 SOL – #2 STR	1 1/4 – 2	2.22	2.09	1.44	50
GPC2-4-X	#10 SOL – #2 STR	2 1/2 – 4	4.25	4.15	2.73	10
GPC2-6-X	#10 SOL – #2 STR	4 1/2 – 6	5.20	6.00	2.85	10
Light Duty						
GPCJ2-1-C	#10 SOL – #2 STR	1/2 – 1	1.65	0.90	0.51	10



Bronze Ground Clamp for Conduit with Strap

Type GPCS

- Bonds water pipe to rigid conduit and to copper conductors in EMT and rigid conduit
- Copper contact strip included to isolate conduit system from water pipe vibrations
- Includes high strength bronze conduit hub to ensure a durable connection to conduit
- Made from high strength, electrolytic cast bronze
- Zinc plated steel hardware
- Wire range-taking capability minimizes inventory requirements, saves cost
- cULus 467 Listed for grounding and bonding

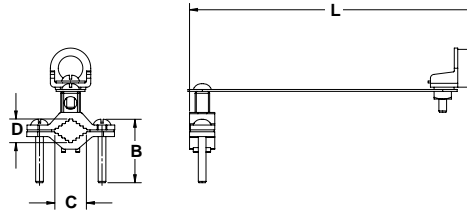

Part Number	Conductor Size Range (AWG)	Iron Pipe Size (In.)	Conduit Hub Size (In.)	Figure Dimensions (In.)				Std. Pkg. Qty.
				B	C	D	L	
GPCS4-1-12-L	#8 SOL – #4 STR	1/2 – 1	1/2	1.65	0.78	0.63	7.25	50
GPCS4-2-12-L	#8 SOL – #4 STR	1/2 – 1	3/4	1.65	0.78	0.63	7.50	50
GPCS4-4-12-L	#8 SOL – #4 STR	1/2 – 1	1	1.65	0.78	0.63	7.75	50



Bronze Ground Clamp for Conduit

Type GPC

- Bonds water pipe to rigid conduit and to copper conductors in EMT and rigid conduit
- Includes high strength bronze conduit hub to ensure a durable connection to conduit
- Made from high strength, electrolytic cast bronze
- Zinc plated steel hardware
- Wire range-taking capability minimizes inventory requirements, saves cost
- cULus 467 Listed for grounding and bonding

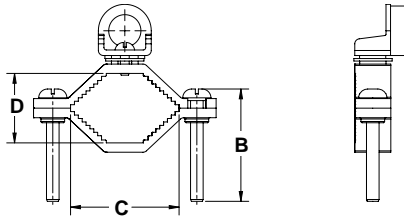

Part Number	Conductor Size Range (AWG)	Iron Pipe Size (In.)	Conduit Hub Size (In.)	Figure Dimensions (In.)			Std. Pkg. Qty.
				B	C	D	
GPC4-1-12-Q	#8 SOL – #4 STR	1/2 – 1	1/2	1.65	1.00	0.56	25
GPC4-1-34-L	#8 SOL – #4 STR	1/2 – 1	3/4	1.65	1.00	0.56	50
GPC4-1-1-L	#8 SOL – #4 STR	1/2 – 1	1	1.65	1.00	0.56	50
GPC4-2-12-L	#8 SOL – #4 STR	1 1/4 – 2	1/2	2.22	2.08	1.33	50
GPC4-2-34-Q	#8 SOL – #4 STR	1 1/4 – 2	3/4	2.22	2.08	1.33	25
GPC4-2-1-Q	#8 SOL – #4 STR	1 1/4 – 2	1	2.22	2.08	1.33	25
GPC4-4-12-X	#8 SOL – #4 STR	2 1/2 – 4	1/2	4.25	3.81	2.75	10
GPC4-4-34-X	#8 SOL – #4 STR	2 1/2 – 4	3/4	4.25	3.81	2.75	10
GPC4-4-1-X	#8 SOL – #4 STR	2 1/2 – 4	1	4.25	3.81	2.75	10
GPC4-6-12-X	#8 SOL – #4 STR	4 1/2 – 6	1/2	5.20	6.00	2.90	10
GPC4-6-34-5	#8 SOL – #4 STR	4 1/2 – 6	3/4	5.20	6.00	2.90	5
GPC4-6-1-X	#8 SOL – #4 STR	4 1/2 – 6	1	5.20	6.00	2.90	10



Grounding Clamp for Water Pipes, Aluminum

Type GC

- Dual-rated for grounding aluminum or copper code conductors to copper water pipe, galvanized pipe, or steel conduit
- Made from high strength, extruded aluminum alloy to provide long term durability
- Tin-plated to inhibit corrosion and oxidation and for low contact resistance
- Plated steel screws provide high strength and inhibit corrosion
- Accommodates a wide range of pipe, tube, and conductor sizes – minimizes inventory requirements
- UL 467 Listed and CSA Certified for grounding and bonding

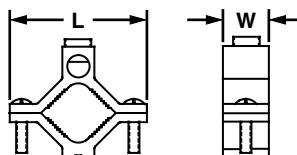

Part Number	Conduit Pipe or Water Tube Size	Conductor Size Range	Figure Dimensions (In.)		Std. Pkg. Qty.
			L	W	
GC-15A-Q	1/2 – 3/4 – 1	#14 AWG – 1/0 AWG	2.25 (57.2)	0.69 (17.5)	25
GC-18A-X	1 1/4 – 1 1/2 – 2	#6 AWG – 250 kcmil	3.75 (95.3)	0.81 (20.6)	10
GC-22A-4	2 1/2 – 3 – 3 1/2 – 4	#6 AWG – 250 kcmil	6.31 (95.3)	1.00 (25.4)	4



Bronze Ground Clamp, Armored Cable

- Bonds water pipe to copper conductors in armored cables
- Made from high strength, electrolytic cast bronze
- Wire range-taking capability minimizes inventory requirements, saves cost
- cULus 467 Listed for grounding and bonding; GPCA2-1D-C is suitable for direct burial in earth or concrete

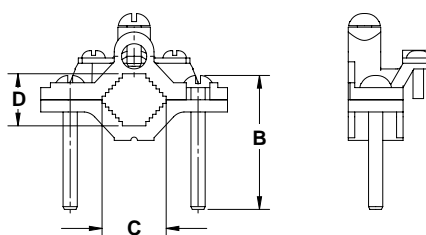

Part Number	Conductor Size Range (AWG)	Iron Pipe Size (In.)	Figure Dimensions (In.)			Std. Pkg. Qty.
			B	C	D	
Phos Bronze Hardware						
GPCA2-1D-C	#8 SOL – #4 STR	1/2 – 1	1.65	1.00	0.59	100
Zinc Plated Steel Hardware*						
GPCA2-1-C*	#8 SOL – #4 STR	1/2 – 1	1.65	1.00	0.59	100
GPCA2-2-L*	#8 SOL – #4 STR	1 1/4 – 2	2.22	2.22	1.19	50
GPCA2-4-X*	#8 SOL – #4 STR	2 1/2 – 4	4.25	3.83	2.70	10
GPCA2-6-X*	#8 SOL – #4 STR	4 1/2 – 6	5.20	5.96	4.50	10

*Not DB rated



Bronze Ground Rod Clamps, Direct Burial

- Used for grounding copper conductor parallel to ground rods
- Made from high strength, seamless electrolytic bronze to provide long term durability
- High strength phos bronze hardware provides long term reliable assembly

- cULus 467 Listed for grounding and bonding and suitable for direct burial in earth or concrete – for type GRC and GRCH
- UL Listed and CSA Certified for grounding and bonding and suitable for direct burial in earth or concrete – for Type WB

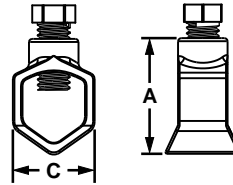

Part Number	Conductor Size Range (AWG)	Ground Rod Size (In.)	Figure Dimensions (In.)		Hex Head Size (In.)	Std. Pkg. Qty.
			A	C		
Standard Duty						
GRC4-38-TL	#10 SOL – #4 STR	3/8	1.00	0.82	1/2	250
GRC2-12-TL	#10 SOL – #2 STR	1/2	1.19	0.68	1/2	250
GRC2-58-TL	#10 SOL – #2 STR	5/8	1.34	0.64	1/2	250
GRC2-34-T	#10 SOL – #2 STR	3/4	1.48	0.71	1/2	200
WB12-L	#10 SOL – #2 STR	1/2	1.28	0.88	1/2	50
WB34-X	#8 SOL – 1/0 STR #8 SOL – #2 STR	5/8 3/4	1.54	1.03	1/2	10
WB58-Q	#8 SOL – 1/0 STR	5/8	1.40	1.04	1/2	25
Heavy Duty						
GRCH2-12-T	#10 SOL – #2 STR	1/2	1.25	0.82	1/2	200
GRCH1/0-58-T	#8 SOL – 1/0 STR	5/8	1.42	0.99	1/2	200
GRCH1/0-34-E	#8 SOL – 1/0 STR	3/4	1.60	0.97	1/2	20



Bronze Grounding Clamp with Spacer for Flat Surfaces

- Used to ground copper code conductor to flat surfaces
- Cast from high strength, electrolytic bronze to provide reliable grounding connections
- High strength silicon bronze hardware for long term reliable assembly

- Accommodates a wide range of conductor sizes – minimizes inventory requirement, saves cost
- Incorporates spacer plate to separate conductor from mounting surface
- cULus 467 Listed for grounding and bonding and suitable for direct burial in earth or concrete

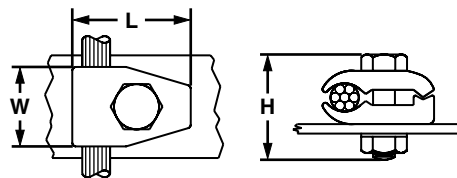

Part Number	Conductor Size Range (AWG)	Figure Dimensions (In.)			Hex Size (In.)		Std. Pkg. Qty.
		L	W	H	Bolt	Nut	
GM-2-Q	#4 SOL – 2/0 STR	1.63	1.13	1.75	9/16	9/16	25
GM-3-Q	2/0 SOL – 250 kcmil	2.13	1.50	2.00	3/4	3/4	25



Bronze Grounding Clamp with Spacer for Flat Surfaces, Two Conductor

- Used to ground copper code conductors to flat surfaces
- Cast from high strength, electrolytic bronze
- Cast body includes anti-rotational flanges to keep hex head bolt from spinning
- High strength silicon bronze hardware for long term reliable assembly
- Accommodates a wide range of conductor sizes – minimizes inventory requirement, saves cost
- Incorporates spacer plate to separate conductors from mounting surface
- cULus 467 Listed for grounding and bonding and suitable for direct burial in earth or concrete

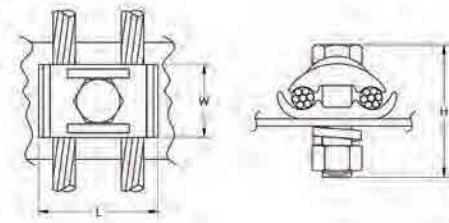

Part Number	Conductor Size Range (AWG)	Figure Dimensions (In.)			Hex Size (In.)		Std. Pkg. Qty.
		L	W	H	Bolt*	Nut	
GBC2250-12-X	2/0 SOL – 250 kcmil	2.04	1.25	2.27	3/4	3/4	10



*Bolt head will be contained within the anti-rotational flanges of cast body



Bronze Grounding Clamp with Spacer for Flat Surfaces, One Conductor

- Used to ground copper code conductor to flat surfaces
- Cast from high strength, electrolytic bronze to provide reliable grounding connections
- High strength silicon bronze hardware for long term reliable assembly
- Accommodates a wide range of conductor sizes – minimizes inventory requirement, saves cost
- cULus 467 Listed for grounding and bonding and suitable for direct burial in earth or concrete

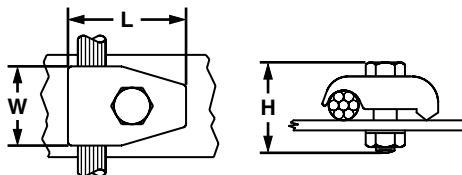

Part Number	Conductor Size Range (AWG)	Figure Dimensions (In.)			Hex Size (In.)		Std. Pkg. Qty.
		L	W	H	Bolt	Nut	
GMS-1-X	#8 SOL – #4 STR	1.25	1.00	1.63	9/16	9/16	10
GMS-2-Q	#4 SOL – 2/0 STR	1.63	1.13	1.75	9/16	9/16	25
GMS-3-Q	2/0 SOL – 250 kcmil	2.13	1.50	2.00	3/4	3/4	25

Labeling Systems

Panduit® is a global leader in reliable and innovative solutions for identification and safety. Products are engineered for a wide variety of industries and applications – including electrical, electronics, industrial and network. Panduit provides enhanced productivity, reliability, and value with leading-edge software development, materials and equipment by designing and manufacturing a full line of labeling products, software and printers to assist you with your labeling requirements.



- **World-class quality – ISO 9001 and ISO 14001**
- **High performance and reliability**
- **Wide variety of system solutions to meet the most demanding requirements**
- **Meet and exceed the requirements of UL, CSA, ISO, NEC and OSHA**
- **Strong service and support network – distributor partners, knowledgeable sales people, expert technical support and world-class customer service**

Panduit provides a complete range of industrial products and tools – including hand-held labeling systems, desktop labeling systems, pre-printed labels and safety systems. Use Panduit for all identification needs for wire and cable, electrical and electronic devices, agency compliance, workplace safety and more.

A. System Overview

B1. Cable Ties

B2. Cable Accessories

B3. Stainless Steel Cable Ties & Accessories

C1. Wiring Duct

C2. Abrasion Protection

C3. Cable Management

D1. Terminals

D2. Power Connectors

D3. Grounding Connectors

E1. Labeling Systems

E2. Labels

E3. Pre-Printed & Write-On Markers

E4. Permanent Identification

E5. Industrial Safety Solutions

F. Keystone Cabling Systems

G. Part Number Index

Printers: Thermal Transfer Desktop and Hand-Held

Panduit® desktop thermal transfer printers enable fast, high quality label production for all your identification requirements. Use Panduit labeling software and desktop thermal transfer printers to produce on demand identification solutions quickly and economically. Panduit hand-held printers are designed for flexibility. Programmed with advanced functionality, Panduit printers make custom labeling easy.



Hand-Held Printers

- Create labels at remote job sites
- Provide crisp, clear, high quality thermal transfer print
- Easily identify moves, adds, or changes



Desktop Printers

- Compatible with Panduit® Easy-Mark™ Labeling Software
- Provide crisp, clear, high quality thermal transfer print
- Compatible with Windows^ based PC operating systems



Panduit printers and our wide variety of labels provide solutions for all your project labeling needs.

^Windows is a registered trademark of Microsoft Corporation in the United States and/or other countries.

PanTher™ LS8E/LS8EQ Hand-Held Thermal Transfer Printers and Accessories

- Cut-to-length functionality eliminates label waste and label trimming labor
- Partial cut feature available to provide tear-apart strips of labels
- P1™ Label Cassette contains an integrated memory device for automatic formatting, recall of last legend used, and number of labels remaining in the cassette
- Market specific labeling tools simplify label creation for electrical components, panel building, and construction and maintenance
- USB interface for importing data, system upgrades, and printing from a wireless laptop or desktop computer
- Prints self-laminating labels, heat shrink tubing, die-cut component labels and continuous tapes
- Fast loading label cassette includes both label material and ribbon to make changing labels easy
- Large graphic display with backlight for improved visibility



LS8E-KIT



LS8EQ

Part Number	Part Description	Std. Pkg. Qty.
LS8EQ-KIT-ACS	Includes LS8EQ printer with QWERTY keypad, one cassette of S100X150VAC self-laminating labels, six AA alkaline batteries, LS8E-ACS, LS8-CASE, LS8-PCKIT, LS8-IB, LS8-WS, quick reference card and operator's manual.	1
LS8EQ-KIT	Includes LS8EQ printer with QWERTY keypad, one cassette of S100X150VAC self-laminating labels, six AA alkaline batteries, LS8-CASE, LS8-PCKIT, LS8-IB, LS8-WS, quick reference card and operator's manual.	1
LS8EQ	Includes LS8EQ printer with QWERTY keypad, one cassette of S100X150VAC self-laminating labels, six AA alkaline batteries and quick reference card.	1
LS8E-KIT-ACS	Includes LS8E printer, one cassette of S100X150VAC self-laminating labels, six AA alkaline batteries, LS8E-ACS, LS8-CASE, LS8-PCKIT, LS8-IB, LS8-WS, quick reference card and operator's manual.	1
LS8E-KIT	Includes LS8E printer, one cassette of S100X150VAC self-laminating labels, six AA alkaline batteries, LS8-CASE, LS8-PCKIT, LS8-IB, LS8-WS, quick reference card and operator's manual.	1
LS8E	Includes LS8E printer, one cassette of S100X150VAC self-laminating labels, six AA alkaline batteries and quick reference card.	1
LS8E-ACS*	120 VAC power adapter for North America.	1
LS8-CASE	Rigid carrying case.	1
LS8-PCKIT	Includes USB cable and PC interface software for importing data, system upgrades, or printing from a wireless laptop or desktop computer.	1
LS8-IB	Protective impact bumper.	1
LS8-WS	Wrist strap.	1
LS8-CLN	LS8/LS8E cleaning kit – contains bottle of cleaning solution with MSDS, cleaning pen, swabs, alcohol wipes and cleaning instructions.	1

*Cannot be used to charge batteries. Other adapters available, replace S with A (Australia), and E (Europe) and U (UK).

B1.
Cable
Ties

B2.
Cable
Accessories

B3.
Stainless
Steel Cable
Ties &
Accessories

C1.
Wiring
Duct

C2.
Abrasion
Protection

C3.
Cable
Management

D1.
Terminals

D2.
Power
Connectors

D3.
Grounding
Connectors

E1.
Labeling
Systems

E2.
Labels

E3.
Pre-Printed
&
Write-On
Markers

E4.
Permanent
Identification

E5.
Industrial
Safety
Solutions

F.
Keystone
Cabling
Systems

G.
Part
Number
Index



Hand-Held Thermal Transfer Printing Solutions

Self-Laminating Labels	Page E1.4	Die-Cut Component Labels	Page E1.9
Die-Cut Vinyl Cloth Labels	Page E1.6	Vinyl Cloth Continuous Tapes	Page E1.5
Turn-Tell® Labels	Page E1.6	Nylon Cloth Continuous Tapes	Page E1.5
Marker Plates	Page E1.7	Continuous Heat Shrink Tubing	Page E1.8
Flag Labels	Page E1.7	Continuous Tapes	Page E1.10
Die-Cut Heat Shrink Tubing	Page E1.8	Continuous Reflective Tapes	Page E1.10



PanTher™ LS8E/LS8EQ

P1™ Self-Laminating Label Cassettes for PanTher™ LS8E/LS8EQ Hand-Held Thermal Transfer Printer

- P1™ Label Cassette contains an integrated memory device for automatic formatting, recall of last legend used, and number of labels remaining in the cassette
- Self-laminating adhesive labels for wire/cable identification include a colored print-on area and clear overlamine
- Labels are available in a large range of wire/cable sizes
- Fast loading label cassette includes both label material and ribbon to make changing labels easy
- Temperature range: -50°F to 225°F (-45.6°C to 107°C)



Part Number	Print-On Area Color	Width		Length		Print-On Area Height		Min. Cable O.D.		Max. Cable O.D.		Wire Range	Std. Pkg. Qty.	Std. Ctn. Qty.
		In.	mm	In.	mm	In.	mm	In.	mm	In.	mm			
S050X075VAC	White	0.50	12.7	0.75	19.1	0.25	6.4	0.08	2.0	0.16	4.1	Cat. 6 28 AWG/ 18 – 14 AWG	1	10
S050X125VAC				1.25	31.8	0.38	9.7	0.12	3.1	0.28	7.0	Cat. 3 UTP/ 12 – 10 AWG		
S050X150VAC				1.50	38.1	0.50	12.7	0.16	4.1	0.32	8.1	Cat. 5e UTP/Cat. 6 UTP/ Cat. 5e FTP/ 10 – 6 AWG		
S075X075VAC		0.75	19.1	0.75	19.1	0.25	6.4	0.08	2.0	0.16	4.1	Cat. 6 28 AWG/ 18 – 14 AWG		
S075X100VAC				1.00	25.4	0.38	9.7	0.12	3.1	0.28	7.1	Cat. 3 UTP/ 12 – 10 AWG		
S075X125VAC				1.25	31.8							Cat. 5e UTP/Cat. 6 UTP/ Cat. 6A UTP/ Cat. 5e FTP/ 10 – 6 AWG		
S075X150VAC		1.50	38.1	0.50	12.7	0.16	4.1	0.32	8.1	Cat. 5e UTP/Cat. 6 UTP/ Cat. 5e FTP/ 10 – 6 AWG				
S100X075VAC		1.00	25.4	0.75	19.1	0.25	6.4	0.08	2.0	0.16	4.1	Cat. 6 28 AWG/ 18 – 14 AWG		
S100X125VAC				1.25	31.8	0.38	9.7	0.12	3.1	0.28	7.1	Cat. 3 UTP/ 12 – 10 AWG		
S100X150VAC				1.50	38.1	0.50	12.7	0.16	4.1	0.32	8.1	Cat. 5e UTP/Cat. 6 UTP/ Cat. 6A UTP/ Cat. 5e FTP/ 10 – 6 AWG		
S100X150VBC	TIA Blue													
S100X150VDC	TIA Green													
S100X150VHC	TIA Red													
S100X150VIC	TIA Yellow													
S100X225VAC	White			2.25	57.2	0.75	19.1	0.24	6.1	0.48	12.2	Cat. 6 FTP/Cat. 6A UTP/Cat. 6A FTP/8 – 4 AWG		
S100X225VAC	TIA Blue													
S100X225VDC	TIA Green													
S100X225VHC	TIA Red													
S100X225VIC	TIA Yellow													
S100X400VAC	White	4.00	101.6	1.00	25.4	0.32	8.1	0.95	24.3	2 – 1 AWG				
S100X650VAC		6.50	165.1	1.50	38.1	0.48	12.2	1.59	40.4	1/0 – 250 AWG				

P1™ Non-Laminated Label Cassettes for PanTher™ LS8E/LS8EQ Hand-Held Thermal Transfer Printers

- P1™ Label Cassette contains an integrated memory device for automatic formatting, recall of last legend used, and number of labels remaining in the cassette
- Fast loading label cassette includes both label material and ribbon to make changing labels easy
- Non-laminated adhesive labels for wire/cable identification
- Temperature range – Vinyl Cloth: -40°F to 170°F (-40°C to 77°C)
- Temperature range – Nylon Cloth: -65°F to 275°F (-54°C to 135°C)



P1™ Non-Laminated Continuous Tape Cassettes

Part Number	Color	Material	Height		Length		Std. Pkg. Qty.	Std. Ctn. Qty.
			In.	mm	Ft.	m		
T038X000C1C-BK	White	Nylon	0.38	9.7	18.0	5.5	1	10
T038X000C2C-BK	Yellow							
T050X000C1C-BK	White		0.50	12.7	12.5	3.8		
T050X000C2C-BK	Yellow							
T050X000CBC-BK	White	Vinyl	0.75	19.1	18.0	5.5		
T075X000C1C-BK		Nylon						
T075X000C2C-BK	Yellow	Nylon	1.00	25.4	12.5	3.8		
T100X000C1C-BK	White							
T100X000C2C-BK	Yellow							
T100X000CBC-BK	White	Vinyl	1.00	25.4	18.0	5.5		

Order number of pieces required in multiples of Standard Package Quantity.

P1™ Non-Laminated Die-Cut Cassettes

Part Number	Color	Material	Width		Length		Min. Cable O.D.		Max. Cable O.D.		Wire Range	Labels Per Cassette	Std. Pkg. Qty.	Std. Ctn. Qty.
			In.	mm	In.	mm	In.	mm	In.	mm				
N050X075C1C	White	Nylon	0.50	12.7	0.75	19.1	0.12	3.1	0.16	4.1	12 – 10 AWG	250	1	10
N050X075C2C	Yellow											125		
N050X075CBC	White	Vinyl			1.25	31.8	0.20	5.1	0.32	8.1	10 – 6 AWG	150		
N050X125C1C	White	Nylon										75		
N050X125C2C	Yellow	Nylon	1.00	25.4	1.50	38.1	0.24	6.1	0.40	10.2	8 – 2 AWG	75		
N050X150CBC	White											Vinyl	0.75	19.1
N100X075C1C	White				Nylon	125								
N100X075C2C	Yellow	Nylon			1.25	31.8	0.20	5.1	0.32	8.1	10 – 6 AWG	150		
N100X075CBC	White											Vinyl	75	
N100X125C1C	White	Nylon			1.00	25.4	1.50	38.1	0.24	6.1	0.40	10.2	8 – 2 AWG	75
N100X125C2C	Yellow		Nylon	50										
N100X125CBC	White	Vinyl	1.75	44.5			0.28	7.1	0.48	12.2	6 – 1 AWG	50		
N100X150CBC	White	Vinyl										75		
N100X175CBC	White	Vinyl	50											



P1™ Turn-Tell® Label Cassettes for PanTher™ LS8E/LS8EQ Hand-Held Thermal Transfer Printers

- Fast loading P1™ Label Cassette includes both label material and ribbon to make changing labels easy
- Innovative label design allows labels to rotate for visibility from any angle, and for repositioning on the wire/cable to align legends and improve aesthetics
- Labels can be easily installed on existing terminated wires and assemblies without disconnecting the wires/cables
- Temperature range: -40°F to 150°F (-40°C to 65.6°C)



Part Number	Print-On Area Color	Width		Length		Print-On Area Height		Min. Cable O.D.		Max. Cable O.D.		Wire Range	Std. Pkg. Qty.	Std. Ctn. Qty.	
		In.	mm	In.	mm	In.	mm	In.	mm	In.	mm				
R100X075V1C	White	1.00	25.4	0.75	19.1	0.25	6.4	0.12	3.1	0.16	4.1	Cat. 6 28 AWG/ 18 – 14 AWG	1	10	
R100X125VIC				1.25	31.8	0.38	9.7	0.16	4.1	0.22	5.6	Cat. 3 UTP/ 12 – 10 AWG			
R100X150V1C															
R100X150V2C	TIA Blue														Cat. 5e UTP/ Cat. 6 UTP/ Cat. 6A UTP/ Cat. 5e FTP/ 10 – 6 AWG
R100X150V3C	TIA Green			1.50	38.1	0.50	12.7	0.22	5.6	0.28	7.1				
R100X150V7C	TIA Red														
R100X150V8T	TIA Yellow														
R100X225V1C	White														Cat. 6 FTP/ Cat. 6 UTP/ Cat. 6A FTP/ 8 – 4 AWG
R100X225V2C	TIA Blue														
R100X225V3C	TIA Green			2.25	57.2	0.75	19.1	0.28	7.1	0.39	9.9				
R100X225V7C	TIA Red														
R100X225V8C	TIA Yellow														

P1™ Marker Plate Label Cassettes for PanTher™ LS8E/LS8EQ Hand-Held Thermal Transfer Printers

- Fast loading P1™ Label Cassette includes both label material and ribbon to make changing labels easy
- Marker plates are designed for use on larger diameter wire/cables and may be applied after all terminations are complete
- Meets requirements for MIL-STD-202G, Method 215K, Solutions A, C and D
- Temperature range: -58°F to 221°F (-50°C to 105°C)



Part Number	Color	Width		Length		Print-On Area Width		Recommended Cable Tie		Std. Pkg. Qty.	Std. Ctn. Qty.
		In.	mm	In.	mm	In.	mm	Vertical	Horizontal		
M300X050Y6C	Yellow	3.00	76.2	0.50	12.7	1.80	45.7	PLT2.5I-C	PLT2.5I-C	1	10
M300X050Y7C	White	3.00	76.2	0.50	12.7	1.80	45.7	PLT2.5I-C	PLT2.5I-C	1	10

Order number of cassettes required.

P1™ Flag Label Cassettes for PanTher™ LS8E/LS8EQ Hand-Held Thermal Transfer Printers

- Fast loading P1™ Label Cassette includes both label material and ribbon to make changing labels easy
- Provides larger labeling area for small cables
- Innovative design allows flag labels to be applied in either adhesive or non-adhesive orientations
- Temperature range: -40°F to 302°F (-40°C to 150°C)



Part Number	Width		Length		Min. Cable O.D.		Max. Wire O.D.		Std. Pkg. Qty.	Std. Ctn. Qty.
	In.	mm	In.	mm	In.	mm	In.	mm		
F100X150AJC	1.00	25.4	1.50	38.1	0.12	3.1	0.20	5.1	1	10

Order number of cassettes required.

P1™ Military Grade Die Cut and Continuous Heat Shrink Label Cassettes for PanTher™ LS8E/LS8EQ Thermal Transfer Printers

- P1™ Label Cassette contains an integrated memory device for automatic formatting, recall of last legend used, and number of labels remaining in the cassette
- Fast loading label cassette includes both label material and ribbon to make changing labels easy
- Meets print performance requirements of MIL-STD-883F Method 2015.13, Solutions A, B and D, and MIL-STD-202G Method 215K, Solutions A, C and D
- Meets UL Standard 224 for flammability
- Shrink ratio 3:1
- Each cassette contains a roll of non-adhesive flattened polyolefin
- Temperature Range: -67°F to 275°F (-55°C to 135°C)



Military Grade Die-Cut Heat Shrink Label Cassettes

Part Number	Color	Diameter		Width		Length		Min. Cable O.D.		Max. Cable O.D.		Wire Range	Labels Per Cassette	Std. Pkg. Qty.	Std. Ctn. Qty.	
		In.	mm	In.	mm	In.	mm	In.	mm	In.	mm					
H100X025H1C	White	0.13	3.1	0.25	6.4	1.00	25.4	0.04	1.0	0.13	3.3	22 – 18 AWG	100	1	10	
H100X025H2C	Yellow			0.06	1.5			0.19	4.8	18 – 12 AWG						
H100X034H1C	White	0.19	4.7	0.34	8.6			0.08	2.0	0.25	6.4	16 – 10 AWG				
H100X034H2C	Yellow			0.08	2.0			0.25	6.4	16 – 10 AWG						
H100X044H1C	White	0.25	6.3	0.44	11.2			0.13	3.3	0.38	9.7	12 – 6 AWG				75
H100X044H2C	Yellow							0.13	3.3	0.38	9.7	12 – 6 AWG				
H100X064H1C	White	0.38	9.7	0.64	16.3	0.17	4.3	0.50	12.7	8 – 1 AWG						
H100X064H2C	Yellow					0.17	4.3	0.50	12.7	8 – 1 AWG						
H100X084H1C	White	0.50	12.7	0.84	21.3											
H100X084H2C	Yellow															

Military Grade Continuous Heat Shrink Tape Cassettes

Part Number	Color	Diameter		Width		Length		Min. Cable O.D.		Max. Cable O.D.		Wire Range	Labels Per Cassette	Std. Pkg. Qty.	Std. Ctn. Qty.	
		In.	mm	In.	mm	Ft.	m	In.	mm	In.	mm					
H000X025H1C	White	0.13	3.1	0.25	6.4	8.0	2.4	0.04	1.0	0.13	3.3	22 – 18 AWG	100	1	10	
H000X025H2C	Yellow			0.06	1.5			0.19	4.8	18 – 12 AWG						
H000X034H1C	White	0.19	4.7	0.34	8.6			0.08	2.0	0.25	6.4	16 – 10 AWG				
H000X034H2C	Yellow			0.08	2.0	0.25	6.4	16 – 10 AWG								
H000X044H1C	White	0.25	6.3	0.44	11.2	6.0	1.8	0.13	3.3	0.38	9.7	12 – 6 AWG				75
H000X044H2C	Yellow							0.13	3.3	0.38	9.7	12 – 6 AWG				
H000X064H1C	White	0.38	9.7	0.64	16.3			0.17	4.3	0.50	12.7	8 – 1 AWG				
H000X064H2C	Yellow							0.17	4.3	0.50	12.7	8 – 1 AWG				
H000X084H1C	White	0.50	12.7	0.84	21.3											
H000X084H2C	Yellow															

P1™ General Component Label Cassettes for PanTher™ LS8E/LS8EQ Hand-Held Thermal Transfer Printers

- P1™ Label Cassette contains an integrated memory device for automatic formatting, recall of last legend used, and number of labels remaining in the cassette
- Fast loading label cassette includes both label material and ribbon to make changing labels easy
- Use for identifying flat surfaces such as components, control panels, circuit boards and general labeling
- Die-cut labels designed to provide maximum aesthetic quality and appearance
- Available in polyester and vinyl cloth materials
- Polyester, Super-Tack Polyester temperature range: -40°F to 302°F (-40°C to 150°C)
- Vinyl Cloth temperature range: -40°F to 170°F (10°C to 77°C)



Part Number	Color	Material	Width		Height		Labels Per Cassette	Std. Pkg. Qty.	Std. Ctn. Qty.
			In.	mm	In.	mm			
C060X020YJC	White	Polyester	0.60	15.2	0.20	5.1	750	1	10
C075X025YLC	Yellow		0.75	19.1	0.25	6.4	500		
C100X025YJC	White		1.00	25.4					
C100X025YLC	Yellow	Polyester			500	250			
C100X050CBC	White		Vinyl Cloth	1.50			38.1		
C100X050YJC	White	Polyester	175						
C100X050YMC	Silver	Super-Tack Polyester		1.89	48.0	0.47	12.0		
C100X050YPC	White	Polyester	2.00						
C150X075YJC		Super-Tack Polyester		150					
C150X075YPC		Tamper-Resistant Polyolefin	200						
C189X047FNC		Vinyl Cloth		150					
C200X050CBC		Polyester	150						
C200X050YJC		Super-Tack Polyester		150					
C200X050YPC		Polyester	150						
C200X100YJC		Silver		Super-Tack Polyester	150				
C200X100YMC		White	Super-Tack Polyester						
C200X100YPC									

P1™ Continuous Tape Cassettes for PanTher™ LS8E/LS8EQ and Hand-Held Thermal Transfer Printers

- P1™ Label Cassette contains an integrated memory device for automatic formatting, recall of last legend used, and number of labels remaining in the cassette
- For flat label applications only
- Fast loading label cassette includes both label material and ribbon to make changing labels easy
- Polyolefin Temperature Range: -40°F to 180°F (-40°C to 82°C)
- Print custom pipe markers, voltage markers, signs and bin marker labels on demand
- Polyester Temperature Range: -40°F to 302°F (-40°C to 150°C)
- Available in a variety of colors, widths, and adhesive materials including continuous polyolefin, polyester, vinyl, and reflective
- Vinyl Temperature Range: -50°F to 225°F (-45.6°C to 107°C)
- Reflective Temperature Range: -40°F to 180°F (-40°C to 82°C)



Part Number	Color	Material	Height		Length		Std. Pkg. Qty.	Std. Ctn. Qty.
			In.	mm	Ft.	m		
T019X000FJC-BK	Black on White	Polyolefin	0.19	4.8	25.0	7.6	1	10
T024X000FJC-BK			0.27	6.1				
T024X000VPC-BK		Vinyl	0.24	6.1				
T024X000VYC-WH	White on Black							
T024X000YKC-BK	Black on Clear	Polyester	0.31	7.9				
T031X000FJC-BK	Black on White	Polyolefin						
T038X000FJC-BK								
T038X000VPC-BK								
T038X000VQC-BK	Black on Blue	Vinyl	0.38	9.7				
T038X000VQC-WH	White on Blue							
T038X000VSC-BK	Black on Green							
T038X000VSC-WH	White on Green							
T038X000VUC-BK	Black on Orange							
T038X000VWC-BK	Black on Red							
T038X000VWC-WH	White on Red							
T038X000VXC-BK	Black on Yellow							
T038X000VYC-WH	White on Black							
T038X000YKC-BK	Black on Clear				Polyester	0.50	12.7	
T050X000VPC-BK	Black on White							
T050X000VPC-RD	Red on White							
T050X000VQC-BK	Black on Blue							
T050X000VQC-WH	White on Blue							
T050X000VSC-BK	Black on Green							
T050X000VSC-WH	White on Green							
T050X000VUC-BK	Black on Orange							
T050X000VWC-BK	Black on Red							
T050X000VWC-WH	White on Red							
T050X000VXC-BK	Black on Yellow							
T050X000VYC-WH	White on Black							
T050X000YKC-BK	Black on Clear	Polyester						
T050X000YKC-WH	White on Clear							

Continues on next page

P1™ Continuous Tape Cassettes for PanTher™ LS8E/LS8EQ and Hand-Held Thermal Transfer Printers (continued)

Part Number	Color	Material	Height		Length		Std. Pkg. Qty.	Std. Ctn. Qty.	
			In.	mm	Ft.	m			
T075X000VPC-BK	Black on White	Vinyl	0.75	19.1	25.0	7.6	1	10	
T075X000VQX-BK	Black on Blue								
T075X000VQC-WH	White on Blue								
T075X000VSC-BK	Black on Green								
T075X000VSC-WH	White on Green								
T075X000VUC-BK	Black on Orange								
T075X000VWC-BK	Black on Red								
T075X000VWC-WH	White on Red								
T075X000VXC-BK	Black on Yellow								
T075X000VYC-WH	White on Black								
T075X000YKC-BK	Black on Clear								Polyester
T100X000RPC-BK	Black on White								Reflective
T100X000RUC-BK	Black on Orange								
T100X000RXC-BK	Black on Yellow								
T100X000VPC-BK	Black on White	Vinyl	1.00	25.4	25.0	7.6	1	10	
T100X000VPC-RD	Red on White								
T100X000VQC-BK	Black on Blue								
T100X000VQC-WH	White on Blue								
T100X000VSC-BK	Black on Green								
T100X000VWC-WH	White on Green								
T100X000VUC-OR	Black on Orange								
T100X000VWC-BK	Black on Red								
T100X000VWC-WH	White on Red								
T100X000VXC-BK	Black on Yellow								
T100X000VYC-WH	White on Black								
T100X000YKC-BK	Black on Clear								Polyester
T100X000YKC-WH	White on Clear								

TDP43ME Thermal Transfer Desktop Printer and Accessories

- Compact, lightweight design enables use in office or remote locations
- 300 dpi thermal transfer printer creates crisp, clear legends with superior legibility
- Up to 4.00 inches per second print speed for fast label production
- Use to print a wide variety of self-laminating labels, component labels, non-laminated labels, heat shrink labels, marker plates and continuous tapes up to 4" wide
- Easy-Mark™ Labeling Software and hybrid ribbon included with printer
- UL 60950 listed, File # E165747



Part Number	Part Description	Std. Pkg. Qty.
TDP43ME	300 dpi printer; includes printer, Panduit® Easy-Mark™ Labeling Software, RMEH4BL black hybrid ribbon, AC power adapter with US power cord, USB cable, user manual, quick start card, and driver disk; for use in North America.	1
TDP43ME-KIT	TDP43ME printer kit. Includes: printer, Panduit® Easy-Mark™ Labeling Software, RMEH4BL black hybrid ribbon, AC power adapter with US power cord, USB cable, user manual, quick start card, TDP43ME-RS Roll Stand, TDP43ME-CASE, one roll of S100X150VATY labels, and driver disk; for use in North America.	1
TDP43ME-RS	External label roll stand – used to rear feed labels that are supplied on 3.00" cores.	1
TDP43ME-AC	Replacement AC power adapter with power cord (US cord only).	1
TDP43ME-CASE	Hard-side carrying case accommodates printer, AC power adapter, ribbons, printer cable, external roll stand, labels, and tools.	1
TDP43ME-CUTTER	Optional power/automatic cutter for TDP43ME Thermal Transfer Desktop Printer; easy to install for automatic cutting of labels.	1
TDP43ME-SPINDLE	Replacement ribbon spindle for TDP43ME Thermal Transfer Desktop Printer, package of two spools.	1
PTR-CLN	Printer cleaning kit – contains bottle of cleaning solution with MSDS, cleaning pen, swabs, alcohol wipes and cleaning instructions.	1

Ribbons for Use with the TDP43ME Thermal Transfer Desktop Printer

- **Hybrid** – Recommended for use with self-laminating, heat shrink, component and non-laminated labels
- **Resin** – Recommended for use with component labels, marker plates, and continuous tape



Part Number	Part Description	Width		Length		Std. Pkg. Qty.
		In.	mm	Ft.	m	
RMEH4BL*	Black hybrid thermal transfer ribbon. Use with heat shrink, self-laminating, Turn-Tell®, tan polyimide labels, and vinyl cloth labels.	4.25	108.0	300.0	91.4	1
RMER4BL*	Black resin thermal transfer ribbon. Use with polyester labels, continuous vinyl tape, marker plates, and raised panel labels.					
RMER4BU	Blue resin thermal transfer ribbon. Use with polyester labels, continuous vinyl tape, marker plates, and raised panel labels.					
RMER4GR	Green resin thermal transfer ribbon. Use with polyester labels, continuous vinyl tape, marker plates, and raised panel labels.					
RMER4RD	Red resin thermal transfer ribbon. Use with polyester labels, continuous vinyl tape, marker plates, and raised panel labels.					
RMER4WH*	White resin thermal transfer ribbon. Use with polyester labels, continuous vinyl tape, marker plates, and raised panel labels.					
RMER4BL-A	Black resin thermal transfer ribbon. Use with high-temperature marker plates.					
RMER4BL-C	Black resin thermal transfer ribbon. Use with fluid-resistant heat shrink labels and white polyimide labels.					

Order number of ribbons required in multiples of Standard Package Quantity.
 *For 2.5" wide ribbons, replace 4 in part number with 2. For example, the part number of a 2.5" wide black hybrid thermal transfer ribbon is RMEH2BL.

TDP43HE and TDP46HE Thermal Transfer Desktop Printers

- Convenient, easy setup; quickly begin producing labels
- Durable, clear communication through superior legibility
- Print small, fine characters and high-quality images and bar codes
- Allow continuous use in construction, industrial, and harsh environments
- Reduce time required to switch between label styles
- Fast label production without sacrificing print quality
- Easy-Mark™ Labeling Software included with printer
- Up to 8 inches per second print speed
- Connect quickly and easily to PC, and offers connectivity flexibility to print by USB, parallel, Ethernet, and serial
- UL 6050 listed, File # E165747



Part Number	Part Description	Std. Pkg. Qty.
TDP43HE	300 dpi printer; includes printer, Panduit® Easy-Mark™ Labeling Software, RHEH4BL black hybrid ribbon, USB cable, user manual, quick start card, driver disk and US power cord; for use in North America.	1
TDP46HE	600 dpi printer; includes printer, Panduit® Easy-Mark™ Labeling Software, RHEH4BL black hybrid ribbon, USB cable, user manual, quick start card, driver disk, and US power cord; for use in North America.	1

Ribbons for use with the TDP43HE and TDP46HE Thermal Transfer Desktop Printers

- **Hybrid** – Recommended for use with self-laminating, heat shrink, component and non-laminated labels
- **Resin** – Recommended for use with component labels, marker plates, and continuous tape



Part Number	Part Description	Width		Length		Std. Pkg. Qty.
		In.	mm	Ft.	m	
RHEH4BL	Black hybrid thermal transfer ribbon. Use with heat shrink, self-laminating, Turn-Tell®, and vinyl cloth and tan polyimide labels.	4.33	110.0	1181.0	363.0	1
RHER4BL	Black resin thermal transfer ribbon. Use with polyester labels, continuous vinyl tape, marker plates, and raised panel labels.					
RHER4WH	White resin thermal transfer ribbon. Use with polyester labels, continuous vinyl tape, marker plates, and raised panel labels.					
RHER4BL-A	Black resin thermal transfer ribbon. Use with high-temperature marker plates.	4.33	110.0	1345.0	410.0	
RHER4BL-C	Black resin thermal transfer ribbon. Use with fluid resistant heat shrink markers and white polyimide labels.					
RHER4BL-E	Black resin thermal transfer ribbon. Use with standard marker plates and component labels for extra durability for harsh environments.					

Order number of ribbons required.

B1.
Cable
Ties

B2.
Cable
Accessories

B3.
Stainless
Steel Cable
Ties &
Accessories

C1.
Wiring
Duct

C2.
Abrasion
Protection

C3.
Cable
Management

D1.
Terminals

D2.
Power
Connectors

D3.
Grounding
Connectors

E1.
Labeling
Systems

E2.
Labels

E3.
Pre-Printed
&
Write-On
Markers

E4.
Permanent
Identification

E5.
Industrial
Safety
Solutions

F.
Keystone
Cabling
Systems

G.
Part
Number
Index

Notes

Labeling Software

Panduit® labeling software is custom designed to address your requirements for wire/cable labeling, component identification, network administration, and safety and facility identification. From control panel wire identification, terminal block and facility pipe marking to patch panel, faceplate and wire/cable marking, Panduit software is the solution for your on-demand identification requirements.



- **Easy-Mark™ Labeling Software is an easy-to-use, intuitive general purpose labeling software**
- **CAD-Connect™ Labeling Software generates labels quickly and easily, directly from an electronic CAD file**

Panduit user-friendly software packages meet the unique requirements of your applications.

Easy-Mark™ Labeling Software

- Quickly and easily generate labels
- Market specific labeling application tools assist in creation of identification solutions for data centers, network applications, panel shops, and construction and maintenance applications
- Saves times and money (up to 75%) with features such as WYSIWYG user interface, data import, symbol import and pre-loaded formats
- Site license available for up to five additional installs per license
- Upgrades available at www.panduit.com

System Requirements:

- 64 MB hard drive space and 64 MB RAM (256 MB RAM recommended)
- Windows^2000, XP, Vista, 7, 8, or 10
- Mouse or compatible pointing device
- Microsoft.NET Framework 2.0 or higher
- CD-ROM Drive or USB Port



Part Number	Part Description	Std. Pkg. Qty.	Std. Ctn. Qty.
PROG-EMCD3	Easy-Mark™ Labeling Software supplied on CD-ROM.	1	10
PROG-EM2GO	Easy-Mark™ Portable Application, USB Flash Drive.	1	10

^Windows is a registered trademark of Microsoft Corporation in the United States and/or other countries.

CAD-Connect™ Labeling Software

- Facilitates quick and easy organization of identifiers from CAD for printing within Easy-Mark™ Labeling Software
- Easily captures and organized CAD data for future use and documentation
- Saves time and reduces errors by utilizing identifiers previously created in CAD files to eliminate manual entry of data into labeling software
- Compatible with full versions of AutoCAD* 2002 to 2016 or Visio^ version 2002 or newer
- Exports to alternative formats such as Excel^ (XLS) or Text (CSV) files for future use and documentation
- Upgrades available at www.panduit.com

System Requirements:

- 64 MB hard drive space and 64 MB RAM (256 MB RAM recommended)
- Windows^2000, XP, Vista, 7, 8, or 10
- Mouse or compatible pointing device
- Microsoft.NET Framework 2.0 or higher
- CD-ROM Drive



Part Number	Part Description	Std. Pkg. Qty.	Std. Ctn. Qty.
PROG-CCCD	CAD-Connect™ Labeling Software, including Easy-Mark™ Labeling Software, supplied on CD-ROM.	1	10

*AutoCAD is a registered trademark of Autodesk, Inc.

^Visio, Windows, and Excel are registered trademarks of Microsoft Corporation in the United States and/or other countries.

Labels: Thermal Transfer, Laser, and Ink Jet

Panduit® provides a full line of on demand printable labels designed to meet all of your identification needs.

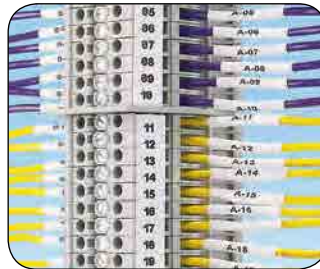
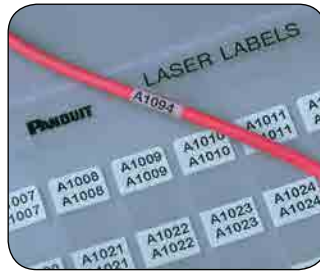

- Thermal transfer labels supplied on rolls offer crisp, clear legends with superior legibility and can be printed on Panduit thermal transfer desktop printers or commercially available models
- Laser/ink jet labels supplied on 8.50" x 11.00" sheets and can be printed in commercially available laser and ink jet printers not sold by Panduit

Panduit labeling solutions meet customer needs at the lowest total installed cost.



Thermal Transfer Turn-Tell® Labels PATENTED

- Innovative label design allows labels to rotate for visibility from any angle, and for repositioning on the wire/cable to align legends and improve aesthetics
- Labels can be easily installed on existing terminated wires and assemblies without disconnecting the wires/cables
- Use thermal transfer hybrid ribbon
- Temperature range: -40°F to 150°F (-40°C to 65.6°C)



Part Number	Print-On Area Color	Width		Length		Print-On Area Height		Min. Cable O.D.		Max. Cable O.D.		Wire Range	Labels Per Row	Labels Per Pkg.
		In.	mm	In.	mm	In.	mm	In.	mm	In.	mm			
R050X075V1T	White	0.50	12.7	0.75	19.1	0.25	6.4	0.12	3.1	0.16	4.0	Cat. 6 28 AWG/ 18 – 14 AWG	8	5000
R050X125V1T				1.25	31.8	0.38	9.7	0.16	4.1	0.22	5.6	Cat. 3 UTP/12 – 10 AWG		
R050X150V1T				1.50	38.1	0.50	12.7	0.22	5.6	0.28	7.1	Cat. 5e UTP/Cat. 6 UTP/ Cat. 6A UTP/Cat. 5e FTP/10 – 6 AWG		
R100X075V1T	White	1.00	25.4	0.75	19.1	0.25	6.4	0.12	3.1	0.16	4.0	Cat. 6 28 AWG/ 18 – 14 AWG	4	2500
R100X125V1T				1.25	31.8	0.38	9.7	0.16	4.1	0.22	5.6	Cat. 3 UTP/12 – 10 AWG		
R100X150V1T				1.50	38.1	0.50	12.7	0.22	5.6	0.28	7.1	Cat. 5e UTP/Cat. 6 UTP/ Cat. 6A UTP		
R100X150V2T	TIA Blue													
R100X150V3T	TIA Green													
R100X150V4T	TIA Gray													
R100X150V7T	TIA Red													
R100X150V8T	TIA Yellow													
R100X225V1T	White	2.25	57.2	0.75	19.1	0.28	7.1	0.39	9.9	Cat. 6 FTP/Cat. 6A UTP/ Cat. 6A FTP/8 – 4 AWG				
R100X225V2T	TIA Blue													
R100X225V3T	TIA Green													
R100X225V4T	TIA Gray													
R100X225V7T	TIA Red													
R100X225V8T	TIA Yellow													
R100X400V1T	White	1.50	38.1	4.00	101.6	1.00	25.4	0.39	9.9	0.95	24.1	2 – 1 AWG	2	1000
R150X150V1T				1.50	38.1	0.50	12.7	0.22	5.6	0.28	7.1	Cat. 5e UTP/Cat. 6 UTP/ Cat. 6A UTP/CAT. 5e FTP/10 – 6 AWG		
R200X150V1T				2.00	50.8	2.25	57.2	0.75	19.1	0.28	7.1	0.39		
R200X225V1T														
R200X400V1T	4.00	101.6	1.00										25.4	0.39

Labels are roll mounted on 3.00" cores; when using the TDP43ME printer and 3.00" cores, the roll stand (TDP43ME-RS) is required.

Thermal Transfer Self-Laminating Labels

- Includes a colored print-on area and clear over-laminate to protect the legend for clear and durable identification
- Sized specifically for wire and cable applications
- Thin and conformable; preferred material for most general wire/cable labeling
- Use thermal transfer hybrid ribbon
- Temperature range: -40°F to 150°F (-40°C to 66°C)



Part Number	Print-On Area Color	Width		Length		Print-On Area Height		Min. Cable O.D.		Max. Cable O.D.		Wire Range	Labels Per Row	Std. Pkg. Qty.	
		In.	mm	In.	mm	In.	mm	In.	mm	In.	mm				
S050X075VA1Y	White	0.50	12.7	0.75	19.1	0.25	6.4	0.08	2.0	0.16	4.1	Cat. 6 28 AWG/ 18 – 14 AWG	8	5000	
S050X075VATY*														2500	
S050X125VA1Y				1.25	31.8	0.38	9.7	0.12	3.1	0.28	7.0		Cat. 3 UTP/ 12 – 10 AWG		
S050X125VATY*															
S050X150VA1Y				1.50	38.1	0.50	12.7	0.16	4.0	0.32	8.1			Cat. 5e UTP/ Cat. 6 UTP/ Cat. 6A UTP/ Cat. 5e FTP/ 10 – 6 AWG	
S050X150VATY*															
S050X250VATY*		2.50	63.5	1.00	25.4	0.32	8.1	0.48	12.1	6 – 2 AWG					
S075X075VATY*															
S075X100VATY*		0.75	19.1	0.75	19.1	0.25	6.4	0.08	2.0	0.16	4.0	Cat. 6 28 AWG/ 18 – 14 AWG	5	5000	
S075X125VATY*															
S075X150VATY*															
S100X075VA1Y	TIA Blue	1.00	25.4	0.75	19.1	0.25	6.4	0.08	0.50	2.0	4.0	Cat. 6 28 AWG/ 18 – 14 AWG	4	2500	
S100X075VATY*														5000	
S100X125VA1Y		1.25	31.8	0.38	9.7	0.12	3.1	0.28	7.0	Cat. 3 UTP/ 12 – 10 AWG					
S100X125VATY*											2500				
S100X150VA1Y		1.50	38.1	0.50	12.7	0.16	4.0	0.32	8.1	Cat. 5e UTP/ Cat. 6 UTP/ Cat. 6A UTP/ Cat. 5e FTP/ 10 – 6 AWG					
S100X150VATY*											5000				
S100X150VBTY*		TIA Brown	1.00	25.4	1.50	38.1	0.50	12.7	0.16	4.0	0.32	8.1	Cat. 5e UTP/ Cat. 6 UTP/ Cat. 6A UTP/ Cat. 5e FTP/ 10 – 6 AWG	4	5000
S100X150VCTY*		TIA Green													
S100X150VDTY*		TIA Gray													
S100X150VET Y*		TIA Orange													
S100X150VFTY*		TIA Purple													
S100X150VGT Y*		TIA Red													
S100X150VHTY*		TIA Yellow													
S100X150VITY*		Black													
S100X150VOTY*	Gold														
S100X150V9TY*															

Order number of labels required in multiples of Standard Package Quantity.

*Labels are roll mounted on 3.00" cores; when using the TDP43ME printer and 3.00" cores, the roll stand (TDP43ME-RS) is required.

Thermal Transfer Self-Laminating Labels (continued)

Part Number	Print-On Area Color	Width		Length		Print-On Area Height		Min. Cable O.D.		Max. Cable O.D.		Wire Range	Labels Per Row	Std. Pkg. Qty.																		
		In.	mm	In.	mm	In.	mm	In.	mm	In.	mm																					
S100X225VA1Y	White	1.00	25.4	2.25	57.2	0.75	19.1	0.24	6.1	0.48	12.1	Cat. 6 FTP/ Cat. 6A UTP/ Cat. 6A FTP/ 8 – 4 AWG	4	5000																		
S100X225VATY*																																
S100X225VBTY*																																
S100X225VCTY*																																
S100X225VDTY*																																
S100X225VETY*																																
S100X225VFTY*																																
S100X225VGTY*																																
S100X225VHTY*																																
S100X225VITY*																																
S100X225V0TY*																																
S100X225V9TY*																																
S100X250VA1Y															White	1.00	25.4	2.50	63.5	1.00	25.4	0.32	8.1	0.48	12.1	6 – 2 AWG	4	1500				
S100X250VATY*	5000																															
S100X400VA1Y	4.00	101.6	0.95	24.3	2 – 1 AWG	1000																										
S100X400VATY*	2500																															
S100X650VA1Y	6.50	165.1	1.50	38.1	0.48	12.1	1.59	40.4	1/0 – 250 MCM	250																						
S100X650VATY*										1000																						
S150X150VATY*	White	1.50	38.1	1.50	38.1	0.50	12.7	0.16	4.0	0.32	8.1	Cat. 5e UTP/ Cat. 6 UTP/ Cat. 6A UTP/ Cat. 5e FTP/ 10 – 6 AWG	2	5000																		
S150X225VATY*				2.25	57.2	0.75	19.1	0.24	6.1	0.48	12.1							Cat. 6 FTP/ Cat. 6A UTP/ Cat. 6A FTP/ 8 – 4 AWG														
S150X400VATY*				4.00	101.6	1.00	25.4	0.32	8.1	0.95	24.1								2 – 1 AWG									2500				
S200X150VATY*				2.00	50.8	1.50	38.1	0.50	12.7	0.16	4.0							0.32	8.1									Cat. 5e UTP/ Cat. 6 UTP/ Cat. 6A UTP/ Cat. 5e FTP/ 10 – 6 AWG	2	5000		
S200X225VA1Y						2.25	57.2	0.75	19.1	0.24	6.1							0.48	12.4												Cat. 6 FTP/ Cat. 6A UTP/ Cat. 6A FTP/ 8 – 4 AWG	500
S200X225VATY*																																1000
S200X250VATY*						2.50	63.5	1.00	25.4	0.32	8.1							0.48	12.1												6 – 2 AWG	500
S200X400VA1Y						4.00	101.6								0.95	24.3	2 – 1 AWG			1000												
S200X400VATY*						6.50	165.1	1.50	38.1	0.48	12.1							1.59	40.4	1/0 – 250 MCM	250											
S200X650VA1Y															1000																	
S200X650VATY*															1000																	

Order number of labels required in multiples of Standard Package Quantity.

*Labels are roll mounted on 3.00" cores; when using the TDP43ME printer and 3.00" cores, the roll stand (TDP43ME-RS) is required.

Thermal Transfer Self-Laminating Polyvinylidene Fluoride (PVDF) Labels

- Self-extinguishing material
- Recommended alternative to Tedlar*
- Use with thermal transfer hybrid ribbon
- Labels are sized specifically for wire and cable applications
- Temperature range: -65°F to 275°F (-53.9°C to 135°C)



Part Number	Print-On Area Color	Width		Length		Print-On Area Height		Min. Cable O.D.		Max. Cable O.D.		Wire Range	Labels Per Row	Std. Pkg. Qty.
		In.	mm	In.	mm	In.	mm	In.	mm	In.	mm			
S050X150T1T	White	0.50	12.7	1.50	38.1	0.50	12.7	0.16	4.0	0.32	8.1	Cat. 5e UTP/ Cat. 6 UTP/ Cat. 6A UTP/ Cat. 5e FTP/ 10 – 6 AWG	8	5000
S075X125T1T	White	0.75	19.1	1.25	31.8	0.38	9.7	0.12	3.1	0.28	7.0	Cat. 3 UTP/ 12 – 10 AWG	5	5000
S100X075T1T	White	0.75	19.1	0.75	19.1	0.25	6.4	0.08	2.0	0.16	4.0	Cat. 6 28 AWG/ 18 – 14 AWG	4	2500
S100X125T1T	White	1.00	25.4	1.25	31.8	0.38	9.7	0.12	3.1	0.28	7.0	12 – 10 AWG	4	2500
S100X150T1T	White	1.00	25.4	1.50	38.1	0.50	12.7	0.16	4.0	0.28	7.1	Cat. 5e UTP/ Cat. 6 UTP/ Cat. 6A UTP/ Cat. 5e FTP/ 10 – 6 AWG	4	2500
S100X225T1T	White	1.00	25.4	2.25	57.2	0.75	19.1	0.24	6.1	0.48	12.1	Cat. 6 FTP/ Cat. 6A UTP/ Cat. 6A FTP/ 8 – 4 AWG	4	1500
S100X400T1T	White	1.00	25.4	4.00	101.6	1.00	25.4	0.32	8.1	0.95	24.3	2 – 1 AWG	4	2500
S200X400T1T	White	2.00	50.8	4.00	101.6	1.00	25.4	0.32	8.1	0.95	24.3	2 – 1 AWG	2	500

Order number of labels required in multiples of Standard Package Quantity.
*Tedlar is a registered trademark of E.I. du Pont de Nemours and Company.

B1.
Cable
Ties

B2.
Cable
Accessories

B3.
Stainless
Steel Cable
Ties &
Accessories

C1.
Wiring
Duct

C2.
Abrasion
Protection

C3.
Cable
Management

D1.
Terminals

D2.
Power
Connectors

D3.
Grounding
Connectors

E1.
Labeling
Systems

E2.
Labels

E3.
Pre-Printed
&
Write-On
Markers

E4.
Permanent
Identification

E5.
Industrial
Safety
Solutions

F.
Keystone
Cabling
Systems

G.
Part
Number
Index

Thermal Transfer Non-Laminated Vinyl Cloth Labels

- Labels offer crisp, clear legends with superior legibility
- Use as a wrap-around label or flag style marker for wire/cable labeling
- Works well on Teflon™ coated wires*
- Use thermal transfer hybrid ribbon
- Temperature range: -40°F to 170°F (-40°C to 77°C)



Part Number	Color	Width		Length		Min. Cable O.D.		Max. Cable O.D.		Wire Range	Labels Per Row	Std. Pkg. Qty.
		In.	mm	In.	mm	In.	mm	In.	mm			
N025X075CBT	White	0.25	6.4	0.75	19.1	0.12	3.1	0.16	4.1	12 – 10 AWG	7	10000
N025X125CBT				1.25	31.8	0.20	5.1	0.32	8.1	10 – 6 AWG		
N025X150CBT				1.50	38.1	0.24	6.1	0.40	10.2	8 – 2 AWG		
N025X175CBT				1.75	44.5	0.28	7.1	0.48	12.2	6 – 1 AWG		
N050X075CBT		0.50	12.7	0.75	19.1	0.12	3.1	0.16	4.1	12 – 10 AWG		10000
N050X100CBT				1.00	25.4	0.16	4.1	0.24	6.1	10 – 8 AWG		
N050X125CBT				1.25	31.8	0.20	5.1	0.32	8.1	10 – 6 AWG		
N050X150CBT				1.50	38.1	0.24	6.1	0.40	10.2	8 – 2 AWG		
N050X175CBT		1.75	44.5	0.28	7.1	0.48	12.2	6 – 1 AWG				
N100X075CBT		1.00	25.4	0.75	19.1	0.12	3.1	0.16	4.1	12 – 10 AWG	10000	
N100X125CBT				1.25	31.8	0.20	4.1	0.32	8.1	10 – 6 AWG		
N100X150CBT				1.50	38.1	0.24	6.1	0.40	10.2	8 – 2 AWG		
N100X175CBT				1.75	44.5	0.28	7.1	0.48	12.2	6 – 1 AWG	2500	
N150X075CBT				1.50	38.1	0.75	19.1	0.12	3.1	0.16		4.1

Labels are roll mounted on 3.00" cores; when using the TDP43ME printer and 3.00" cores, the roll stand (TDP43ME-RS) is required.
*Teflon is a registered trademark of E.I. du Pont de Nemours and Company.

Thermal Transfer Non-Laminated Nylon Cloth Labels

- Offer crisp, clear legends with superior legibility
- Used in flat applications and in a wrap format for wire/cable marking
- Use thermal transfer resin ribbon
- Temperature range: -65°F to 275°F (-54°C to 135°C)



Part Number	Color	Width		Length		Min. Cable O.D.		Max. Cable O.D.		Wire Range	Labels Per Row	Std. Pkg. Qty.
		In.	mm	In.	mm	In.	mm	In.	mm			
N050X075C1T	White	0.50	12.7	0.75	19.1	0.12	3.1	0.16	4.1	12 – 10 AWG	5	10000
N050X075C2T	Yellow			1.25	31.8	0.20	5.1	0.32	8.1	10 – 6 AWG		
N050X125C1T	White			1.50	38.1	0.24	6.1	0.40	10.5	8 – 2 AWG		
N050X125C2T	Yellow											
N050X150C1T	White											
N050X150C2T	Yellow											
N100X075C1T	White	1.00	25.4	0.75	19.1	0.12	3.1	0.16	4.1	12 – 10 AWG	3	5000
N100X075C2T	Yellow			1.25	31.8	0.20	5.1	0.32	8.1	10 – 6 AWG		
N100X125C1T	White			1.50	38.1	0.24	6.1	0.40	10.2	8 – 2 AWG		
N100X125C2T	Yellow											
N100X150C1T	White											
N100X150C2T	Yellow											

Order number of labels required in multiples of Standard Package Quantity.

Labels are roll mounted on 3.00" cores; when using the TDP43ME Printer and 3.00" cores, the roll stand (TDP43ME-RS) is required.

Thermal Transfer Halogen-Free Flame-Retardant Marker Plates

- Used to identify wires, cables, equipment, and many other applications
- Offer crisp, clear legend with superior legibility and engineered to withstand high temperatures, harsh solvents, oils, and chemicals without over-lamination
- Compatible with Intermediate Cross Section cable ties
- Use thermal transfer resin ribbon
- Temperature range: -40°F to 193°F (-40°C to 90°C)



Part Number	Color	Width		Height		Print-On Area				Labels Per Roll	Std. Pkg. Qty. (Roll)
						Width		Height			
		In.	mm	In.	mm	In.	mm	In.	mm		
M200X042UPT	White	2.00	50.8	0.42	10.7	0.42	10.7	1.30	33.0	500	1
M200X042UPT-B	White	2.00	50.8	0.42	10.7	0.42	10.7	1.30	33.0	2000	1
M200X080UPT	White	2.00	50.8	0.80	20.3	0.80	20.3	1.30	33.0	500	1
M200X080UPT-B	White	2.00	50.8	0.80	20.3	0.80	20.3	1.30	33.0	2000	1

Order number of marker plates required in multiples of Standard Package Quantity.
Labels are roll mounted on 3.00" cores; when using the TDP43ME printer and 3.00" cores, the roll stand (TDP43ME-RS) is required.

Thermal Transfer High-Temperature Flame-Retardant Marker Plates

- Used for identification markers in (Class 1E) harsh environments
- Compatible with Intermediate Cross Section cable ties
- Use thermal transfer RMER4BL-A resin ribbon
- Temperature range: -67°F to 275°F (-55°C to 135°C)



Part Number	Color	Width		Height		Print-On Area				Labels Per Roll	Std. Pkg. Qty. (Roll)
						Width		Height			
		In.	mm	In.	mm	In.	mm	In.	mm		
M200X042FQT	White	2.00	50.8	0.42	10.7	0.42	10.7	1.22	31.0	500	1
M200X042FQT-B	White	2.00	50.8	0.42	10.7	0.42	10.7	1.22	31.0	2000	1
M200X080FQT	White	2.00	50.8	0.80	20.3	0.80	20.3	1.22	31.0	250	1
M200X080FQT-B	White	2.00	50.8	0.80	20.3	0.80	20.3	1.22	31.0	1000	1

Order number of marker plates required in multiples of Standard Package Quantity.
Labels are roll mounted on 3.00" cores; when using the TDP43ME printer and 3.00" cores, the roll stand (TDP43ME-RS) is required.

Thermal Transfer Standard Marker Plates

- Non-adhesive and halogen-free; used to identify wires, cables, equipment, and many other applications
- Attachable in horizontal or vertical orientation
- Use thermal transfer resin ribbon
- Recommended cable ties: Standard Marker Plates - Intermediate Cross Section for 0.5" length and Standard Cross Section for 1" length
- Temperature range: -58°F to 221°F (-50°C to 105°C)



Part Number	Color	Width		Height		Print-On Area Width		Labels Per Roll	Std. Pkg. Qty. (Roll)
		In.	mm	In.	mm	In.	mm		
M200X050Y6T	TIA Yellow	2.00	50.8	0.50	12.7	1.07	27.3	500	1
M200X050Y7T	White								
M200X050ACT	TIA Blue								
M200X050AET	TIA Green								
M200X050AFT	TIA Gray								
M200X050AGT	TIA Orange								
M200X050AIT	TIA Red								
M200X100Y6T	TIA Yellow	2.00	50.8	1.00	25.4	0.80	20.3	2000	
M200X100Y6T-B	White							500	
M200X100Y7T	TIA Blue							2000	
M200X100Y7T-B	TIA Green							500	
M200X100ACT	TIA Gray								
M200X100AET	TIA Orange								
M200X100AFT	TIA Red								
M200X100AGT	TIA Yellow								
M300X050Y6T	White	3.00	76.2	0.50	12.7	2.07	52.6	500	
M300X050Y7T	TIA Blue								
M300X050ACT	TIA Green								
M300X050AET	TIA Gray								
M300X050AFT	TIA Orange								
M300X050AGT	TIA Red								
M300X050AIT	TIA Yellow								
M300X100Y6T	White	3.00	76.2	1.00	25.4	1.80	45.7	500	
M300X100Y7T	TIA Blue								
M300X100ACT	TIA Green								
M300X100AET	TIA Gray								
M300X100AFT	TIA Orange								
M300X100AGT	TIA Red								
M300X100AIT	TIA Yellow								

Order number of marker plates required in multiples of Standard Package Quantity.

B1. Cable Ties

B2. Cable Accessories

B3. Stainless Steel Cable Ties & Accessories

C1. Wiring Duct

C2. Abrasion Protection

C3. Cable Management

D1. Terminals

D2. Power Connectors

D3. Grounding Connectors

E1. Labeling Systems

E2. Labels

E3. Pre-Printed & Write-On Markers

E4. Permanent Identification

E5. Industrial Safety Solutions

F. Keystone Cabling Systems

G. Part Number Index

Thermal Transfer Military Grade Single-Sided Heat Shrink Labels

- Permanent, one-piece, heat shrink sleeve designed to provide clear, durable identification of wires and cables
- Meet UL Standard 224 with a VW-1 rating for flammability and AMS-DTL-23053/5C (Class 1 and Class 3)
- Meet SAE-AS81531, MIL-STD-883F Method 2015.13, Solutions A, B, and D, and MIL-STD-202G Method 215K, Solutions A, C, and D when printed with resin and hybrid thermal transfer ribbons
- Shrink ratio 3:1
- Tested for use as an identification marker in (Class 1E) harsh environments
- Use thermal transfer hybrid ribbon or white resin ribbon
- Temperature range: -67°F to 275°F (-55°C to 135°C)
- UL224 recognized, File # E205133; CSA certified, C22.2 No. 198.1.06, File # 256205



Part Number	Part Number	Diameter		Width		Height		Min. Cable O.D.		Max Cable O.D.		Wire Range	Labels Per Row	Labels Per Roll	Std. Pkg. Qty. (Roll)
		In.	mm	In.	mm	In.	mm	In.	mm	In.	mm				
H050X025H1T*+	H050X025H2T	0.13	3.1	0.50	12.7	0.25	6.4	0.04	1.0	0.13	3.3	22 – 18 AWG	4	2000	1
H075X025H1T*+	H075X025H2T			0.75	19.1								2	1000	
H100X025H1T*+	H100X025H2T			1.00	25.4								1	500	
H150X025H1T*+	H150X025H2T			1.50	38.1										
H200X025H1T*+	H200X025H2T			2.00	50.8										
H050X034H1T*+	H050X034H2T	0.19	4.7	0.50	12.7	0.34	8.6	0.06	1.5	0.19	4.8	18 – 12 AWG	4	2000	
H075X034H1T*+	H075X034H2T			0.75	19.1								2	1000	
H100X034H1T*+	H100X034H2T			1.00	25.4								1	500	
H150X034H1T*+	H150X034H2T			1.50	38.1										
H200X034H1T*+	H200X034H2T			2.00	50.8										
H050X044H1T*+	H050X044H2T	0.25	6.3	0.50	12.7	0.44	11.2	0.08	2.0	0.25	6.4	16 – 10 AWG	4	2000	
H075X044H1T*+	H075X044H2T			0.75	19.1								2	1000	
H100X044H1T*+	H100X044H2T			1.00	25.4								1	500	
H150X044H1T*+	H150X044H2T			1.50	38.1										
H200X044H1T*+	H200X044H2T			2.00	50.8										
H050X064H1T*+	H050X064H2T	0.38	9.7	0.50	12.7	0.64	16.3	0.13	3.3	0.38	9.7	12 – 6 AWG	4	2000	
H100X064H1T*+	H100X064H2T			1.00	25.4								2	1000	
H200X064H1T*+	H200X064H2T			2.00	50.8								1	500	
H050X084H1T	—			0.50	12.7								4	2000	
H100X084H1T+	H100X084H2T			1.00	25.4								2	1000	
H200X084H1T+	H200X084H2T	2.00	50.8	1	500										
H050X165H1T	—	1.00	25.4	0.50	12.7	1.65	41.9	0.33	8.4	1.00	25.4	4 AWG – 500 MCM	4	1000	
H100X165H1T+	H100X165H2T			1.00	25.4								2	500	
H200X165H1T+	H200X165H2T			2.00	50.8								1	250	
H200X240H1T	H200X240H2T	1.50	38.1	2.00	50.8	2.40	61.0	0.50	12.7	1.50	38.1	1 AWG – 1000 MCM	1	100	

Order number of labels required in multiples of Standard Package Quantity.
 *Available in Bulk packages (5 times Labels Per Roll), add -B to end of part number
 +Available in two additional colors, replace suffix H1T with (H3T) Black or (H4T) Red

Thermal Transfer Military Grade Two-Sided Heat Shrink Labels PATENTED

- Permanent, one-piece, heat shrink sleeve designed to provide clear, durable identification of wires and cables
- Can be printed on both sides for improved visibility
- Meets the material requirements and physical properties of AMS-DTL-23053/5C (Class 1 and Class 3) and UL standard 224 with a VW-1 rating
- Meet SAE-AS81531, MIL-STD-883F Method 2015.13, Solutions A, B and D, and MIL-STD-202G Method 215K, Solutions A,C and D when printed using resin or hybrid thermal transfer ribbons
- Shrink ratio 3:1
- Tested as an identification marker for use in (Class 1E) harsh environments
- Use thermal transfer hybrid ribbon
- Temperature range: -67°F to 275°F (-55°C to 135°C)
- UL224 recognized, File # E205133; CSA certified, C22.2 No. 198.1-06, File # 256205



Part Number	Part Number	Diameter		Width		Height		Min. Cable O.D.		Max. Cable O. D.		Wire Range	Labels Per Row	Labels Per Roll	Std. Pkg. Qty. (Roll)
		In	mm	In.	mm	In.	mm	In.	mm	In.	mm				
H100X025H1T-2*	H100X025H2T-2*	0.13	3.1	1.00	25.4	0.25	6.4	0.04	1.0	0.13	3.3	22 – 18 AWG	2	1000	1
H200X025H1T-2*	H200X025H2T-2*			2.00	50.8	0.25	6.4						1	500	1
H100X034H1T-2*	H100X034H2T-2*	0.19	4.7	1.00	25.4	0.34	8.6	0.06	1.5	0.19	4.8	18 – 12 AWG	1	1000	1
H200X034H1T-2*	H200X034H2T-2*			2.00	50.8	0.34	8.6						1	500	1
H100X044H1T-2*	H100X044H2T-2*	0.25	6.3	1.00	25.4	0.44	11.2	0.08	2.0	0.25	6.4	16 – 10 AWG	2	1000	1
H200X044H1T-2*	H200X044H2T-2*			2.00	50.8	0.44	11.2						1	500	1
H100X064H1T-2*	H100X064H2T-2*	0.38	9.7	1.00	25.4	0.64	16.3	0.13	3.3	0.38	9.7	12 – 6 AWG	2	1000	1
H200X064H1T-2*	H200X064H2T-2*			2.00	50.8	0.64	16.3						1	500	1
H100X084H1T-2*	H100X084H2T-2*	0.50	12.7	1.00	25.4	0.84	21.3	0.17	4.3	0.50	12.7	8 – 1 AWG	2	1000	1
H200X084H1T-2*	H200X084H2T-2*			2.00	50.8	0.84	21.3						1	500	1
H100X122H1T-2	H100X122H2T-2	0.75	19.0	1.00	25.4	1.22	31.0	0.25	6.3	0.75	19.0	8 – 4/0 AWG	2	500	1
H200X122H1T-2	H200X122H2T-2			2.00	50.8	1.22	31.0						1	250	1
H100X165H1T-2	H100X165H2T-2	1.00	25.4	1.00	25.4	1.65	41.9	0.33	8.4	1.00	25.4	4 AWG – 500 kcmil	2	500	1
H200X165H1T-2	H200X165H2T-2			2.00	50.8	1.65	41.9						1	250	1

Order number of labels required in multiples of Standard Package Quantity.
 *Available in Bulk packages (5 times Labels Per Roll), add -B to end of part number

Thermal Transfer Halogen-Free Two-Sided Heat Shrink Labels PATENTED

- Permanent, one-piece, heat shrink sleeve designed to provide clear, durable identification of wires and cables
- Can be printed on both sides for improved visibility
- Meet SAE-AS5942, MIL-STD-883F Method 2015.13, Solutions A, B, and D, and MIL-STD-202G Method 215K, Solutions A, C, and D when printed with resin and hybrid thermal transfer ribbons
- Meet BS6853; 1999 Vehicle Category 1A for burning behavior and toxic gas emissions; Smoke Density Class II
- Shrink ratio 2:1
- Use thermal transfer hybrid ribbon
- Temperature range: -22°F to 221°F (-30°C to 105°)



Part Number	Part Number	Diameter		Width		Height		Min. Cable O.D.		Max. Cable O.D.		Wire Range	Labels Per Row	Labels Per Roll	Std. Pkg. Qty. (Roll)
		In.	mm	In.	mm	In.	mm	In.	mm	In.	mm				
H100X025HFT-2	H100X025HGT-2	0.13	3.1	1.00	25.4	0.25	6.4	0.06	1.5	0.13	3.3	22 – 18 AWG	2	1000	1
H200X025HFT-2	H200X025HGT-2			2.00	50.8	0.25	6.4						1	500	1
H100X034HFT-2	H100X034HGT-2	0.19	4.7	1.00	25.4	0.34	8.6	0.09	2.3	0.19	4.8	18 – 12 AWG	2	1000	1
H200X034HFT-2	H200X034HGT-2			2.00	50.8	0.34	8.6						1	500	1
H100X044HFT-2	H100X044HGT-2	0.25	6.4	1.00	25.4	0.44	11.1	0.13	3.3	0.25	6.4	16 – 10 AWG	2	1000	1
H200X044HFT-2	H200X044HGT-2			2.00	50.8	0.44	11.1						1	500	1
H100X064HFT-2	H100X064HGT-2	0.38	9.7	1.00	25.4	0.64	16.2	0.19	4.8	0.38	9.7	12 – 6 AWG	2	1000	1
H200X064HFT-2	H200X064HGT-2			2.00	50.8	0.64	16.2						1	500	1
H100X084HFT-2	H100X084HGT-2	0.50	12.7	1.00	25.4	0.84	21.3	0.25	6.4	0.50	12.7	8 – 1 AWG	2	1000	1
H200X084HFT-2	H200X084HGT-2			2.00	50.8	0.84	21.3						1	500	1
H100X165HFT-2	H100X165HGT-2	1.00	25.4	1.00	25.4	1.65	41.9	0.50	12.7	1.00	25.4	8 AWG – 500 kcmil	2	500	1
H200X165HFT-2	H200X165HGT-2			2.00	50.8	1.65	41.9						1	250	1

Order number of labels required in multiples of Standard Package Quantity.

Thermal Transfer Fluid-Resistant Two-Sided Heat Shrink Labels PATENTED

- Permanent, one-piece, heat shrink sleeve designed to provide clear, durable identification of wires and cables
- Cross-linked, semi-rigid, fluid-resistant, shrinkable polyolefin material
- Available in yellow only
- Can be printed on both sides for improved visibility
- Meet the material requirements and physical properties AMS-DTL-23053/6 Class 1 and NF F00-608 Class A and H when printed with resin thermal transfer ribbons
- Meet SAE-AS5942, MIL-STD-883F Method 2015.13 Solutions A and D, and MIL-STD-202G Method 215K, Solutions A and D when printed with resin thermal transfer ribbons
- Shrink ratio 3:1
- Use thermal transfer RMER4BL-C resin ribbon
- Temperature range: -67°F to 275°F (-55°C to 135°C)



Part Number	Diameter		Width		Height		Min. Cable O.D.		Max. Cable O.D.		Wire Range	Labels Per Row	Labels Per Roll	Std. Pkg. Qty. (Roll)
	In.	mm	In.	mm	In.	mm	In.	mm	In.	mm				
H100X034HST-2	0.19	4.7	1.00	25.4	0.34	8.6	0.06	1.5	0.19	4.8	18 – 12 AWG	2	1000	1
H200X034HST-2			2.00	50.8	0.34	8.6						1	500	1
H100X044HST-2	0.25	6.4	1.00	25.4	0.44	11.1	0.08	2.0	0.25	6.4	16 – 10 AWG	2	1000	1
H200X044HST-2			2.00	50.8	0.44	11.1						1	500	1
H100X064HST-2	0.38	9.7	1.00	25.4	0.64	16.2	0.13	3.3	0.38	9.7	12 – 6 AWG	2	1000	1
H200X064HST-2			2.00	50.8	0.64	16.2						1	500	1
H100X084HST-2	0.50	12.7	1.00	25.4	0.84	21.3	0.17	4.3	0.50	12.7	8 – 1 AWG	2	1000	1
H200X084HST-2			2.00	50.8	0.84	21.3						1	500	1
H100X165HST-2	1.00	25.4	1.00	25.4	1.65	41.9	0.33	8.4	1.00	25.4	8 AWG – 500 kcmil	2	500	1
H200X165HST-2			2.00	50.8	1.65	41.9						1	250	1

Heat Shrink Tools and Accessories

- Adjustable air intake regulator provides variable temperature adjustment within the units rated heat range
- Toggle type control switch provides hot/cold/off operation
- Replaceable brushes are easy to service and extend the operating life of the gun
- Unique suspended quick change heating element design prolongs life and eases servicing



Part Number	Part Description	Std. Pkg. Qty.	Std. Ctn. Qty.
HSG-115V-650	Heat gun with temperature range of 650°F (344°C) to 900°F (482°C).	1	—
HSG-A1	Shrink tube reflector for tubing up to 3/4" inside diameter. Directs heat around tubing to reduce shrink time.	1	10
HSG-A2	Shrink tube reflector for tubing up to 1 1/2" inside diameter. Directs heat around tubing to reduce shrink time.	1	10
HSG-A3	Shrink tube concentrator. Directs heat toward tubing and away from heat sensitive items.	1	10
HSG-P1	Replacement brush/spring kit.	1	5
HSG-P2	Replacement switch 20 Amps.	1	5
HSG-P3	Replacement bearing kit.	1	5
HSG-P7	Replacement heat element 650°F.	1	—

Thermal Transfer Component Labels

- Polyester labels provide durability; high-temperature resistance and dimensional stability; does not easily stretch or tear
 - Super-Tack Polyester labels are used on rough textured, painted, and coated surfaces
 - Tedlar® labels are self-extinguishing and ideal for high-temperature areas. Meet Federal Motor Vehicle Safety Standard (FMVSS-302)*
 - Vinyl Cloth labels are ideal for temporary marking of chips, boards, and ICs. Pliable material is suitable for rough texture surfaces
 - Polyimide labels are ideal for electronic components and internal circuitry applications
 - Paper labels are for general purpose use
- Use recommended ribbon below:
 - Polyester, Super-Tack Polyester, Tedlar®, and Non-Adhesive Polyester use thermal transfer resin ribbon
 - White Polyimide use thermal transfer RMER4BL-C resin ribbon
 - Vinyl Cloth, Tan Polyimide, and Paper use thermal transfer hybrid ribbon
 - Temperature range:
 - Polyester, Super-Tack Polyester, Non-Adhesive Polyester: -40°F to 302°F (-40°C to 150°C)
 - Tedlar®: -40°F to 225°F (-40°C to 106°C)
 - Vinyl Cloth: -40°F to 170°F (-40°C to 77°C)
 - Polyimide: -40°F to 350°F (-40°C to 177°C)
 - Paper: -65°F to 160°F (-54°C to 71°C)



Part Number	Color	Material	Width		Height		Type of Application	Labels Per Row	Std. Pkg. Qty.
			In.	mm	In.	mm			
C025X025KBT	White	Polyimide	0.25	6.4	0.25	6.4	General Identifier	12	10000
C025X025KCT	Tan								
C025X025YJT	White	Polyester	0.38	9.7	0.38	9.7			
C038X038KBT		Polymide							
C038X038KCT	Tan	Polyester	0.50	12.7	0.13	3.3			
C038X038YJT	White								
C050X013KBT	White	Polyimide	0.50	12.7	0.20	5.1			
C050X013KCT								Tan	
C050X020KBT	White	Vinyl Cloth	0.60	15.3	0.20	5.1			
C050X044CBT								White	
C050X044KBT	Tan	Polyimide	0.61	15.5	0.30	7.6			
C050X044KCT		Tan							
C050X044YJT	White	Polyester	0.65	16.5	0.19	4.8			
C060X020CBT		White							
C060X020KBT	Tan	Polyimide	0.61	15.5	0.30	7.6			
C060X020KCT							Tan		
C060X020TJT	White	Tedlar*	0.61	15.5	0.30	7.6			
C060X020YJT		White							
C061X030YPT	White	Super-Tack Polyester	0.61	15.5	0.30	7.6	1-Port Identifier	4	2500
C065X019KBT	White	Polyimide	0.65	16.5	0.19	4.8	General Identifier	3	10000
C065X019KCT	Tan								

Labels are roll mounted on 3.00" cores; when using the TDP43ME printer and 3.00" cores, the roll stand (TDP43ME-RS) is required.

Other colors and sizes available. Refer to www.panduit.com for additional information.

*Tedlar is a registered trademark of E.I. du Pont de Nemours and Company.

Continues on next page

Thermal Transfer Component Labels (continued)

Part Number	Color	Material	Width		Height		Type of Application	Labels Per Row	Std. Pkg. Qty.		
			In.	mm	In.	mm					
C075X025AAT	Silver	Tamper-Evident Polyester	0.75	19.1	0.25	6.4	General Identifier	3	10000		
C075X025CBT	White	Vinyl Cloth									
C075X025KBT		Tan								Polyimide	
C075X025KCT	Paper										
C075X025PBT	White	Polyester									
C075X025YJT		Polyester									
C075X025YMT	Silver	Polyester	0.80	20.3	0.20	5.1					
C080X020KBT	White	Polyimide									
C080X020KCT	Tan	Polyester									
C080X020YJT	White	Polyimide	0.90	22.9	0.25	6.4					
C090X025KBT	Tan	Tedlar*									
C090X025KCT		Polyester									
C090X025TJT	White	Polyester	1.00	25.4	0.19	4.8					
C090X025YJT		Polyimide									
C100X019KBT	Tan	Vinyl Cloth									
C100X019KCT		Polyimide									
C100X025CBT	White	Polyester								0.25	6.4
C100X025KBT		Polyester									
C100X025KCT	Tan	Polyester	1.00	25.4	0.38	9.7					
C100X025YJT	White	Vinyl Cloth									
C100X038CBT	White	Polyimide									
C100X038KBT	Tan	Tedlar*	1.00	25.4	0.50	12.7					
C100X038KCT		Polyester									
C100X038TJT	White	Tedlar*									
C100X038YJT	Clear	Polyester									
C100X050AAT	Silver	Tamper-Evident Polyester									
C100X050CBT	White	Vinyl Cloth									
C100X050PBT		Paper									
C100X050TJT	White	Tedlar*									
C100X050YJT		Polyester									
C100X050YKT	Clear	Polyester									
C100X050YMT	Silver	Polyester	1.25	31.8	0.25	6.4					
C100X050YPT	White	Super-Tack Polyester									
C125X025KBT	Tan	Polyimide	1.25	31.8	0.30	7.6	2-port identifier	3	2500		
C125X025KCT		Super-Tack Polyester									
C125X030YPT	White	Tedlar*									
C125X038TJT	White	Polyester	0.38	9.7	General Identifier	3	10000				
C125X038YJT		Polyester									
C138X019Y0T	Black	Super-Tack Polyester	1.38	35.1	0.19	4.8	Module	1	2500		
C138X019YPT	White	Super-Tack Polyester									
C150X025KBT	White	Polyimide	1.50	38.1	0.25	6.4	General Identifier	2	5000		
C150X025KCT		Tan								Polyimide	

Labels are roll mounted on 3.00" cores; when using the TDP43ME printer and 3.00" cores, the roll stand (TDP43ME-RS) is required.
 Other colors and sizes available. Refer to www.panduit.com for additional information.
 *Tedlar is a registered trademark of E.I. du Pont de Nemours and Company.

Continues on next page

Thermal Transfer Component Labels (continued)

Part Number	Color	Material	Width		Height		Type of Application	Labels Per Row	Std. Pkg. Qty.	
			In.	mm	In.	mm				
C150X030Y1T	White	Non-Adhesive Polyester	1.50	38.1	0.30	7.6	3-Port Identifier	2	1000	
C150X050YJT		Polyester			0.50	12.7	General Identifier	1	5000	
C150X075CBT		Vinyl Cloth			0.75	19.1				
C150X075PBT		Paper								
C150X075YJT		Polyester								
C150X075YMT	Silver	Polyester	1.60	40.6	0.20	5.1	10000			
C160X020CBT	White	Vinyl Cloth								
C160X020KBT	Tan	Polyimide								
C160X020KCT		Polyester								
C160X020YJT	White	Super-Tack Polyester	1.88	47.8	0.30	7.6	3-Port Identifier	2500		
C188X030YPT		Non-Adhesive Polyester	1.95	49.5	0.40	10.2	Single-Gang Faceplate	2	1000	
C195X040Y1T		Tan	Polyimide	2.00	50.8	0.25	6.4	General Identifier	1	2500
C200X025KBT	Polyester									
C200X025KCT	Polyimide									
C200X025YJT	Polyester									
C200X038KBT	Polyimide									
C200X038TJT	White	Tedlar*	2.00	50.8	0.38	9.7	General Identifier	1	2500	
C200X038YJT		Polyester								
C200X050CBT		Vinyl Cloth								
C200X050YJT		Polyester								
C200X100AAT		Silver			Tamper-Evident Polyester					
C200X100PBT	White	Paper	2.52	64.0	0.30	7.6	4-Port	1	2500	
C200X100TJT		Tedlar*								
C200X100Y0T	Black	Super-Tack Polyester	2.61	66.3	0.30	7.6				
C200X100YJT	White	Polyester			2.61	66.3	0.35	8.9	2	1000
C200X100YKT	Clear									
C200X100YMT	Silver	Super-Tack Polyester	2.75	69.9	1.25	31.8	General Identifier	1	2500	
C200X100YPT	White									
C252X030YPT	White	Super-Tack Polyester								
C261X030YPT		Non-Adhesive Polyester								
C261X035Y1T	Silver	Tamper-Evident Polyester	2.75	69.9	1.25	31.8	General Identifier	1	2500	
C275X125AAT		White								Polyester
C275X125YJT		Silver								Polyester
C275X125YMT		Black								Super-Tack Polyester
C275X125Y0T		White								Super-Tack Polyester
C275X125YPT	Non-Adhesive Polyester		0.40	10.2	Double-Gang Faceplate	2				
C288X030YPT										
C288X040Y1T										

Labels are roll mounted on 3.00" cores; when using the TDP43ME printer and 3.00" cores, the roll stand (TDP43ME-RS) is required.

Other colors and sizes available. Refer to www.panduit.com for additional information.

*Tedlar is a registered trademark of E.I. du Pont de Nemours and Company.

Continues on next page

Thermal Transfer Component Labels (continued)

Part Number	Color	Material	Width		Height		Type of Application	Labels Per Row	Std. Pkg. Qty.						
			In.	mm	In.	mm									
C300X025KBT	White	Polyimide	3.00	76.2	0.25	6.4	General Identifier	1	5000						
C300X025KCT	Tan														
C300X025YJT	White	Polyester													
C300X038TJT		Tedlar*													
C300X038YJT		Polyester													
C300X100YJT	Silver	Paper			1.00	25.4				2.00	50.8	2500	1000		
C300X100YMT															
C300X200PBT	White	Polyester			4.00	101.6				1.00	25.4	2	2500		
C300X200YJT	Silver	Polyester													
C300X200YMT	White	Super-Tack Polyester													
C300X200YPT		Polyester													
C315X030YPT		Super-Tack Polyester													
C350X100YJT	White	Non-Adhesive Polyester	3.15	80.0			0.30	7.6	5-Port Identifier					2500	
C379X030YPT		Polyester	3.50	88.9			1.00	25.4	General Identifier						
C390X030Y1T	White	Vinyl Cloth	3.79	96.3			0.30	7.6	6-Port Identifier					2	2500
C400X100CBT			Polyester	3.90			99.1	0.30							
C400X100PBT	Yellow	Paper	4.00	101.6			1.00	25.4	General Identifier					1	1000
C400X100YJT															
C400X200PBT	Super-Tack Polyester														
C400X200Y8T	White	Polyester													
C400X200YJT	Silver	Polyester													
C400X200YMT	White	Paper													
C400X300PBT		Polyester													
C400X300YJT		Super-Tack Polyester													
C400X300YPT	White	Paper			3.00	76.2	4.00	101.6		110 Block	1	2500			
C400X400YJT					Polyester	5.00	127.0								
C400X500PBT	White	Polyester	4.00	101.6	6.00	152.4	GP6™ Punchdown System	1	1000						
C400X600PBT			Paper	7.50	190.5	0.50				12.7					
C400X600YJT	White	Non-Adhesive Polyester	5.00	127.0	0.50	12.7	GP6™ Punchdown System	1	1000						
C750X050Y1T			Polyester	7.88						200.2					
C788X050Y1T	White	Polyester	7.50	190.5	0.50	12.7	GP6™ Punchdown System	1	1000						

Labels are roll mounted on 3.00" cores; when using the TDP43ME printer and 3.00" cores, the roll stand (TDP43ME-RS) is required.

Other colors and sizes available. Refer to www.panduit.com for additional information.

*Tedlar is a registered trademark of E.I. du Pont de Nemours and Company.

Thermal Transfer Raised Panel Labels

- Raised thermal transfer printable surface with high-tack adhesive for strong holding power
- Variety of sizes and colors for a wide range of applications
- Thermal transfer print technology provides crisp, clear, and durable text
- Use with thermal transfer resin ribbon
- Temperature range: -40°F to 212°F (-40°C to 100°C)



Raised Panel Push Button Labels

Part Number	Color	Width		Height		Print-On Area Height		Hole Diameter		Labels Per Row	Std. Pkg. Qty.
		In.	mm	In.	mm	In.	mm	In.	mm		
C120X150APT-22	White	1.20	30.5	1.50	38.1	0.45	11.4	0.87	22.0	3	500
C120X150A8T-22	Yellow										
C120X150AST-22	Green										
C120X150AWT-22	Red										
C120X150A0T-22	Black										
C120X190APT-22	White	1.90	48.3	1.90	48.3	0.85	21.6	1.18	30.0	2	
C120X190A8T-22	Yellow										
C120X190AST-22	Green										
C120X190AWT-22	Red										
C120X190A0T-22	Black										
C180X180APT-30	White	2.40	61.0	2.40	61.0	0.90	22.9	1.18	30.0	1	
C180X180A8T-30	Yellow										
C180X180AST-30	Green										
C180X180AWT-30	Red										
C180X180A0T-30	Black										
C240X240APT-30	White	2.40	61.0	2.40	61.0	0.90	22.9	1.18	30.0	1	
C240X240A8T-30	Yellow										
C240X240AST-30	Green										
C240X240AWT-30	Red										
C240X240A0T-30	Black										

Labels are roll mounted on 3.00" cores; when using the TDP43ME printer and 3.00" cores, the roll stand (TDP43ME-RS) is required.

Raised Panel Half Push Button Labels

Part Number	Color	Width		Height		Print-On Area Height		Hole Diameter		Labels Per Row	Std. Pkg. Qty.
		In.	mm	In.	mm	In.	mm	In.	mm		
C180X130APT-30H	White	1.80	45.7	1.30	33.0	0.73	18.5	1.18	30.0	1	500
C240X200APT-30H		2.40	61.0	2.00	50.8	1.43	36.3				

Labels are roll mounted on 3.00" cores; when using the TDP43ME printer and 3.00" cores, the roll stand (TDP43ME-RS) is required.

Continues on next page

Thermal Transfer Raised Panel Labels (continued)

Raised Panel Component Labels

Part Number	Color	Width		Height		Labels Per Row	Std. Pkg. Qty.
		In.	mm	In.	mm		
C100X050APT	White	1.00	25.4	0.50	12.7	3	500
C100X050A8T	Yellow						
C100X050AST	Green						
C100X050AUT	Orange						
C100X050AWT	Red						
C100X050A0T	Black						
C100X050AMT	Silver	1.25	31.8	0.30	7.6	1	
C125X030APT	White						
C125X030A0T	Black						
C170X090APT	White						
C170X090A8T	Yellow						
C170X090AST	Green						
C170X090AWT	Red						
C170X090AMT	Silver	1.70	43.2	0.90	22.9	1	
C200X100APT	White						
C200X100A8T	Yellow						
C200X100AST	Green						
C200X100AUT	Orange						
C200X100AWT	Red						
C200X100A0T	Black						
C200X100AMT	Silver	2.00	50.8	1.00	25.4	1	
C252X030APT	White						
C252X030A0T	Black						
C300X100APT	White						
C300X100A8T	Yellow						
C300X100AUT	Orange						
C300X100AWT	Red						
C300X100A0T	Black	3.00	76.2	1.00	25.4	1	
C300X250APT	White						
C300X250A8T	Yellow						
C300X250AST	Green						
C300X250AUT	Orange						
C300X250AWT	Red						
C300X250A0T	Black	3.50	88.9	3.00	76.2	1	
C300X250AMT	Silver						
C350X300APT	White						
C350X300A8T	Yellow						
C350X300AUT	Orange						
C350X300A0T	Black						3.79
C379X030APT	White						
C379X030AQT	Blue						
C379X030AWT	Red						
C379X030A0T	Black						

Labels are roll mounted on 3.00" cores; when using the TDP43ME printer and 3.00" cores, the roll stand (TDP43ME-RS) is required.

Continues on next page

Thermal Transfer Raised Panel Labels (continued)

Part Number	Part Description	Width		Length		Labels Per Row	Std. Pkg. Qty.
		In.	mm	In.	mm		
C400X100APT	White	4.00	101.6	1.00	25.4	1.00	25.4
C400X100A8T	Yellow						
C400X100AST	Green						
C400X100AUT	Orange						
C400X100AWT	Red						
C400X100A0T	Black						
C400X100AMT	Silver						

Labels are roll mounted on 3.00" cores; when using the TDP43ME printer and 3.00" cores, the roll stand (TDP43ME-RS) is required.

Thermal Transfer Continuous Tapes

- Tapes offer crisp, clear legends with superior legibility
- Conformable material for flat applications and safety and facility identification
- Can be over-laminated to increase durability
- Use thermal transfer resin ribbon
- Temperature ranges:
Vinyl: -58°F to 176°F (-50°C to 80°C)
Polyolefin: -40°F to 180°F (-40°C to 82°C)
Polyester & Super-Tack Polyester: -40°F to 302°F (-40°C to 150°C)
Reflective: -40°F to 180°F (-40°C to 82°C)



Part Number	Color	Material	Width		Length		Std. Pkg. Qty. (Roll)
			In.	mm	Ft.	m	
T024X000FJT*	White	Polyolefin	0.24	6.1	100.0	30.5	1
T031X000FJT*			0.31	7.9			
T038X000FJT*			0.38	9.7			
T038X000Y01	Black	Super-Tack Polyester	0.50	12.7	100.0	30.5	1
T038X000YP1	White						
T050X000FJT*	Black	Super-Tack Polyester	0.50	12.7	100.0	30.5	1
T050X000Y01							
T050X000YP1	White	Reflective	1.00	25.4	50.0	15.2	1
T100X000RP1	White						
T100X000RU1	Orange						
T100X000RW1	Red						
T100X000RX1	Yellow						
T100X000VP1Y	White	Vinyl	1.00	25.4	100.0	30.5	1
T100X000VQ1Y	Blue						
T100X000VS1Y	Green						
T100X000VU1Y	Orange						
T100X000VW1Y	Red						
T100X000VX1Y	Yellow	Super-Tack Polyester	2.00	50.8	100.0	30.5	1
T100X000VY1Y	Black						
T100X000Y01	Yellow	Polyester	2.00	50.8	100.0	30.5	1
T100X000Y81	Clear						
T100X000YK1	White	Super-Tack Polyester	2.00	50.8	100.0	30.5	1
T100X000YP1	Blue						
T100X000YQ1	Green						
T100X000YS1	Orange						
T100X000YU1	Red						
T100X000YW1	White	Reflective	2.00	50.8	100.0	30.5	1
T200X000RP1	Orange						
T200X000RU1	Red						
T200X000RW1	Yellow						
T200X000RX1	White						
T200X000VP1Y	Blue	Vinyl	2.00	50.8	100.0	30.5	1
T200X000VQ1Y	Brown						
T200X000VR1Y	Green						
T200X000VS1Y	Gray						
T200X000VT1Y	Orange						
T200X000VU1Y	Purple	Super-Tack Polyester	2.00	50.8	100.0	30.5	1
T200X000VV1Y	Red						
T200X000VW1Y	Yellow	Polyester	2.00	50.8	100.0	30.5	1
T200X000VX1Y	Black						
T200X000VY1Y	Yellow	Polyester	2.00	50.8	100.0	30.5	1
T200X000Y01	Clear						
T200X000Y81	Yellow	Polyester	2.00	50.8	100.0	30.5	1
T200X000YK1	Clear						

Order number of rolls required in multiples of Standard Package Quantity.

*Labels are roll mounted on 3.00" cores; when using the TDP43ME printer and 3.00" cores, the roll stand (TDP43ME-RS) is required.

Continues on next page

Thermal Transfer Continuous Tapes (continued)

Part Number	Color	Material	Width		Length		Std. Pkg. Qty. (Roll)
			In.	mm	Ft.	m	
T200X000YP1	White	Super-Tack Polyester	2.00	50.8	100.0	30.5	1
T200X000YQ1	Blue						
T200X000YS1	Green						
T200X000YU1	Orange						
T200X000YW1	Red						
T225X000YK1	Clear	Polyester	2.25	57.2			
T300X000RP1	White	Polyester	3.00	76.2			
T400X000RP1							
T400X000RQ1	Blue	Reflective	3.00	76.2	50.0	15.2	
T400X000RU1	Orange						
T400X000RW1	Red						
T400X000RX1	Yellow						
T400X000VP1Y	White	Vinyl	4.00	101.6	100.0	30.5	
T400X000VQ1Y	Blue						
T400X000VR1Y	Brown						
T400X000VS1Y	Green						
T400X000VT1Y	Gray						
T400X000VU1Y	Orange						
T400X000VV1Y	Purple						
T400X000VW1Y	Red						
T400X000VX1Y	Yellow						
T400X000VY1Y	Black						
T400X000Y01	Yellow	Super-Tack Polyester					
T400X000YK1	Clear	Polyester					
T400X000YP1	White	Super-Tack Polyester					
T400X000YQ1	Blue						
T400X000YS1	Green						
T400X000TU1	Orange						
T400X000YW1	Red						
T425X000YK1	Clear	Polyester					

Order number of rolls required in multiples of Standard Package Quantity.
 *Labels are roll mounted on 3.00" cores; when using the TDP43ME printer and 3.00" cores, the roll stand (TDP43ME-RS) is required.

Laser/Ink Jet Turn-Tell® Labels PATENTED

- Labels rotate and slide along cables after installation for visibility from any angle, and allow repositioning on the wire/cable to align legends for improved aesthetics
- Ideal for use in high-density or space-constrained cable applications
- Eliminate the need to disconnect wire or replace label in the event of re-termination
- Temperature range: -0°F to 275°F (-18°C to 135°C)



Part Number	Print-On Area Color	Width		Length		Print-On Area Height		Min. Cable O.D.		Max. Cable O.D.		Wire/Cable Size Range	Labels Per Row	Labels Per Sheet	Labels Per Pkg.								
		In.	mm	In.	mm	In.	mm	In.	mm	In.	mm												
R050X075X1J	White	0.50	12.7	0.75	19.1	0.25	6.4	0.12	3.1	0.16	4.1	Cat. 6 28 AWG/ 18 – 14 AWG	12	84	5000								
R050X125X1J				1.25	31.8	0.38	9.7	0.16	4.1	0.22	5.6	Cat. 3 UTP/ 12 – 10 AWG		60									
R050X150X1J				1.50	38.1	0.50	12.7	0.22	5.6	0.28	7.1	Cat. 5e UTP/ Cat. 6 UTP/ Cat. 6A UTP/ CAT. 5e FTP/ 10 – 6 AWG		48	2500								
R100X075X1J		1.00	25.4	0.75	19.1	0.25	6.4	0.12	3.1	0.16	4.1	Cat. 6 28 AWG/ 18 – 14 AWG	6	42		1000							
R100X125X1J				1.25	31.8	0.38	9.7	0.16	4.1	0.22	5.6	Cat. 3 UTP/ 12 – 10 AWG		30									
R100X150X1J				TIA Blue	1.50	38.1	0.50	12.7	0.22	5.6	0.28	7.1		0.28	7.1	Cat. 5e UTP/ Cat. 6 UTP/ Cat. 6A UTP/ Cat. 5e FTP/ 10 – 6 AWG	24	18	500				
R100X150X2J	TIA Green																						
R100X150X3J	TIA Red																						
R100X150X7J	TIA Yellow																						
R100X150X8J	White																						
R100X225X1J	TIA Blue																						
R100X225X2J	TIA Green																						
R100X225X3J	TIA Red																						
R100X225X7J	TIA Yellow																						
R100X225X8J	White	2.00	50.8	2.25	57.2	0.75	19.1	0.28	7.1	0.39	9.9	Cat. 6 FTP/ Cat. 6A UTP/ Cat. 6A FTP/ 8 – 4 AWG	3	9	500								
R100X400X1J														4.00		101.6	1.00	25.4	0.39	9.9	0.95	24.1	2 – 1 AWG
R150X150X1J														1.50	38.1	1.50	38.1	0.50	12.7	0.22	5.6	0.28	7.1
R200X150X1J	4.00	101.6	1.00	25.4	0.39	9.9	0.95	24.1	2 – 1 AWG	6													

Laser/Ink Jet Self-Laminating Labels

- Labels can be printed in both laser and ink jet printers
- Self-laminating adhesive labels include a colored print-on area and clear overlaminate
- Provide durability; high-temperature resistance, and dimensional stability; do not stretch or easily tear; preferred method for wire/cable labeling
- Meets ASTM E-595 for air space handling (white only)
- Temperature range: -65°F to 225°F (-54°C to 107°C)



Part Number	Print-On Area Color	Width		Length		Print-On Area Height		Min. Cable O.D.		Max. Cable O.D.		Wire/Cable Size Range	Labels Per Row	Labels Per Sheet	Labels Per Pkg.
		In.	mm	In.	mm	In.	mm	In.	mm	In.	mm				
S050X075YAJ	White	0.50	12.7	0.75	19.1	0.25	6.4	0.08	2.0	0.16	4.0	Cat. 6 28 AWG / 18 - 14 AWG	13	169	5000
S050X125YAJ				1.25	31.8	0.38	9.7	0.12	3.1	0.28	7.0	Cat. 3 UTP/12 - 10 AWG		104	
S050X150YAJ				1.50	38.1	0.50	12.7	0.16	4.0	0.32	8.1	Cat. 5e UTP/Cat. 6 UTP/Cat. 6A UTP/ Cat. 5e FTP/10 - 6 AWG		78	
S075X075YAJ	White	0.75	19.1	0.75	19.1	0.25	6.4	0.08	2.0	0.16	4.0	Cat. 6 28 AWG / 18 - 14 AWG	9	117	2500
S075X125YAJ				1.25	31.8	0.38	9.7	0.12	3.1	0.28	7.0	Cat. 3 UTP/ 12 - 10 AWG		72	
S075X150YAJ				1.50	38.1	0.50	12.7	0.16	4.0	0.32	8.1	Cat. 5e UTP/Cat. 6 UTP/Cat. 6A UTP/Cat. 5e FTP/10 - 6 AWG		54	
S100X075YAJ	White	1.00	25.4	0.75	19.1	0.25	6.4	0.08	2.0	0.16	4.0	18 - 14 AWG	7	91	1000
S100X125YAJ				1.25	31.8	0.38	9.7	0.12	3.1	0.28	7.0	Cat. 3 UTP/ 12 - 10 AWG		56	
S100X150YAJ				1.50	38.1	0.50	12.7	0.16	4.0	0.32	8.1	Cat. 5e UTP/Cat. 6 UTP/Cat. 6A UTP /Cat. 5e FTP/10 - 6 AWG		42	
S100X150YBJ	TIA Blue														
S100X150YCJ	TIA Brown														
S100X150YDJ	TIA Green														
S100X150YEJ	TIA Gray														
S100X150YFJ	TIA Orange														
S100X150YGJ	TIA Purple														
S100X150YHJ	TIA Red														
S100X150YIJ	TIA Yellow														
S100X225YAJ	White	2.25	57.2	0.75	19.1	0.24	6.1	0.48	12.4	Cat. 6 FTP/Cat. 6A UTP/Cat. 6A FTP/8 - 4 AWG	8	32	1000		
S100X225YBJ	TIA Blue														
S100X225YCJ	TIA Brown														
S100X225YDJ	TIA Green														
S100X225YEJ	TIA Gray														
S100X225YFJ	TIA Orange														
S100X225YGJ	TIA Purple														
S100X225YHJ	TIA Red														
S100X225YIJ	TIA Yellow														
S100X400YAJ	White	1.50	38.1	4.00	101.6	1.00	25.4	0.32	8.1	0.95	24.3	2 - 1 AWG	5	14	500
S100X650YAJ				6.50	165.1	1.50	38.1	0.48	12.1	1.59	40.4	1/0 - 350 MCM		7	
S150X400YAJ	TIA Yellow	1.50	38.1	4.00	101.6	1.00	25.4	0.32	8.1	0.95	24.3	2 - 1 AWG	4	14	500
S200X150YAJ				White	2.00	50.8	1.50	38.1	0.50	12.7	0.16	4.0		0.32	
S200X225YAJ	2.25	57.2	0.75				19.1	0.24	6.1	0.48	12.1	Cat. 6 FTP/Cat. 6A UTP/Cat. 6A FTP/ 8 - 4 AWG	16		
S200X400YAJ	4.00	101.6	1.00				25.4	0.32	8.1	0.95	24.3	2 - 1 AWG	8		
S200X650YAJ	6.50	165.1	1.50	38.1	0.48	12.1	1.59	40.4	1/0 - 350 MCM	4	500				

Order number of labels required in multiples of Standard Package Quantity.

Order number of pieces required, in multiples of Standard Package Quantity.

Laser/Ink Jet Self-Laminating Polyvinylidene Fluoride (PVDF) Labels

- Self-extinguishing material
- Recommended alternative to Tedlar*
- Labels are sized specifically for wire and cable applications
- Temperature range: -65°F to 275°F (-53.9°C to 135°C)



Part Number	Print-On Area Color	Width		Length		Print-On Area Height		Min. Cable O.D.		Max. Cable O.D.		Wire/Cable Size Range	Labels Per Row	Labels Per Sheet	Labels Per Pkg.
		In.	mm	In.	mm	In.	mm	In.	mm	In.	mm				
S100X150T1J	White	1.00	25.4	1.50	38.1	0.50	12.7	0.16	4.0	0.28	7.1	Cat. 5e UTP/Cat. 6 UTP/Cat. 6A UTP/Cat. 5e FTP/10 – 6 AWG	7	42	2500
S100X225T1J				2.25	57.2	0.75	19.1	0.28	7.1	0.39	9.9	Cat. 6 FTP/Cat. 6A UTP/ Cat. 6A FTP/8 – 4 AWG	8	28	1000

Laser/Ink Jet Non-Laminated Labels

- Labels can be printed in both laser and ink jet printers
- Use as a wrap around label or flag style labels for wire/cable labeling
- Temperature range: -40°F to 180°F (-40°C to 82°C)



Part Number	Color	Width		Length		Min. Cable O.D.		Max. Cable O.D.		Wire/Cable Size Range	Labels Per Row	Labels Per Sheet	Labels Per Pkg.	
		In.	mm	In.	mm	In.	mm	In.	mm					
N025X075FJJ	White	0.25	6.4	0.75	19.1	0.12	3.1	0.16	4.1	12 – 10 AWG	25	275	10000	
N025X125FJJ				1.25	31.8	0.20	5.1	0.32	8.1	10 – 6 AWG		175		
N025X150FJJ				1.50	38.1	0.24	6.1	0.40	10.2	8 – 2 AWG		67		150
N050X075FJJ		0.50	12.7	0.75	19.1	0.12	3.1	0.16	4.1	12 – 10 AWG	14	154		
N050X125FJJ				1.25	31.8	0.20	5.1	0.32	8.1	10 – 6 AWG		98		
N050X150FJJ				1.50	38.1	0.24	6.1	0.40	10.2	8 – 2 AWG		84		
N100X075FJJ		1.00	25.4	0.75	19.1	0.12	3.1	0.16	4.1	12 – 10 AWG	7	77		5000
N100X125FJJ				1.25	31.8	0.20	4.1	0.32	8.1	10 – 6 AWG		49		
N100X150FJJ				1.50	38.1	0.24	6.1	0.40	10.2	8 – 2 AWG		42		

Order number of labels required in multiples of Standard Package Quantity.

Laser/Ink Jet Component Labels

- Labels can be printed in both laser and ink jet printers
- Tamper-evident labels allow you to see if there has been label tampering by leaving a checkerboard of silver material when label is removed
- Temperature range for polyester labels: -40°F to 311°F (-40°C to 154°C)
- Temperature range for silver polyester labels (Laser printable only): -65°F to 275°F (-54°C to 135°C)
- Temperature range for tamper-evident polyester labels (Laser printable only): -40°F to 302°F (-40°C to 150°C)
- Temperature range for polyolefin labels: -40°F to 180°F (-40°C to 82°C)



Part Number	Color	Materials	Width		Height		Labels Per Row	Labels Per Sheet	Labels Per Pkg.			
			In.	mm	In.	mm						
C038X038YJJ	White	Polyester	0.38	9.7	0.38	9.7	16	352	10000			
C038X038YLJ	Yellow											
C050X044YJJ	White											
C060X020YJJ	White	0.60	15.2	0.20	5.1	11	385					
C075X024AAL	Silver	Tamper-Evident Polyester	0.75	19.1	0.25	6.4	9	270				
C075X025YJJ	White	Polyester										
C075X025YLJ	Yellow											
C075X025YML	Silver	Polyester	0.80	20.3	0.20	5.1	8	280				
C075X050YJJ	White											
C080X020YJJ	White									0.25	6.4	210
C100X025YJJ	White	Polyester	1.00	25.4	0.50	12.7	7	119				
C100X038YJJ	White								0.38	9.7	140	5000
C100X050AAL	Silver								Tamper-Evident Polyester	10000		
C100X050YJJ	White	Polyester	1.50	38.1	0.50	12.7	5	80				
C100X050YLJ	Yellow								5000			
C100X050YML	Silver								10000			
C100X075YJJ	White	Polyester	1.50	38.1	0.75	19.1	60	64				
C150X050YJJ	White								2500			
C150X050YLJ	Yellow								80			
C150X050YML	Silver	Polyester	1.60	40.6	0.20	5.1	140	5000				
C150X075YJJ	White								5000			
C160X020YJJ	White								64			
C200X050YJJ	White	Polyester	2.00	50.8	1.00	25.4	4	28				
C200X100AAL	Silver								Tamper-Evident Polyester	1000		
C200X100YJJ	White											
C200X100YLJ	Yellow	Polyester	2.75	69.9	1.25	31.8	6	18				
C200X125YJJ	White											
C275X125AAL	Silver								Tamper-Evident Polyester			
C275X125YJJ	White	Polyester	2.75	69.9	1.25	31.8	6	18				
C275X125YML	Silver											

Continues on next page

Laser/Ink Jet Component Labels (continued)

Part Number	Color	Materials	Width		Height		Labels Per Row	Labels Per Sheet	Labels Per Pkg.
			In.	mm	In.	mm			
C300X038YJJ	White	Polyester	3.00	76.2	0.38	9.7	2	40	1000
C300X100YJJ					1.00	25.4		18	
C300X200YJJ					2.00	50.8		8	
C350X100YJJ			3.50	88.9	1.00	25.4		20	1000
C400X100YJJ			4.00	101.6	2.00	50.8		10	
C400X200YJJ					4.00	101.6		4	
C400X400YJJ			7.88	200.2	0.50	12.7		16	400
C788X050YJJ			8.50	215.9	11.00	279.4		1	16
C850X1100YJJ	1	25							
C850X1100YLJ	Yellow								

B1.
Cable
Ties

B2.
Cable
Accessories

B3.
Stainless
Steel Cable
Ties &
Accessories

C1.
Wiring
Duct

C2.
Abrasion
Protection

C3.
Cable
Management

D1.
Terminals

D2.
Power
Connectors

D3.
Grounding
Connectors

E1.
Labeling
Systems

E2.
Labels

E3.
Pre-Printed
&
Write-On
Markers

E4.
Permanent
Identification

E5.
Industrial
Safety
Solutions

F.
Keystone
Cabling
Systems

G.
Part
Number
Index

Notes

Pre-Printed and Write-On Markers

Panduit® offers a variety of pre-printed and write-on marker solutions in multiple formats to meet your specific requirements.



- **Marker books are a convenient pocket-sized method to identify many electrical and network components**
- **Marker cards are available in a variety of legends and combination packs**
- **Dispensers are available in both pre-printed and write-on formats for quick identification of wire/cable**
- **Clip-on markers provide a fast, convenient, non-adhesive method to identify wire/cable**

Panduit offers a variety of innovative books, cards, clip-ons and dispensers for a wide variety of wire/cable labeling needs.

Pre-Printed Marker Books

- Convenient, pocket-sized book
- Markers are perforated and can be torn in half to mark both ends of conductors
- Terminal block markers are included to properly identify connectors
- Ten pages of markers per book
- Temperature Range: -50°F to 170°F (-46°C to 77°C)

Perforation for half marker

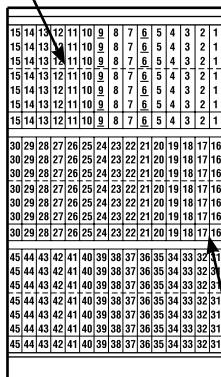

Terminal Block Marker

Part Number	Legend	Total Markers Each Legend	Std. Pkg. Book(s)	Std. Ctn. Book(s)
PCMB-1	0 thru 9	45	1	10
PCMB-2	A thru Z, 0 thru 15, +, -, /	10	1	10
PCMB-3	1 thru 45	10	1	10
PCMB-4	1, 2, 3	150	1	10
PCMB-5	A, B, C	150	1	10
PCMB-6	T1, T2, T3	150	1	10
PCMB-7	L1, L2, L3	150	1	10
PCMB-8	1 thru 15 16 thru 90 A thru Z, +, -, /, 0	6 4 2	1	10
PCMB-9	1, 2, 3, A, B, C L1, L2, L3, T1, T2, T3	45 30	1	10
PCMB-11	1 thru 30	15	1	10
PCMB-12	A thru Z + - Blank (write-on)	15 8 7 21	1	10
PCMB-13	+, -, AC, DC POS, NEG, GND NEUT SPARE, Blank (write-on)	45 21 21 21	1	10
PCMB-14	46 thru 90	10	1	10
PCMB-15	0, +, - 1 thru 45	15 10	1	10
PCMB-16	0 thru 33, A, B, C, +, -, L1, L2, L3, T1, T2, T3	10	1	10
PCMB-25	0 thru 9 L1, L2, L3, T1, T2, T3	45 15	1	10

Legend: Black Background: White
 Marker sizes:
 Full size marker – 0.22" x 1.38" (5.60mm x 34.90mm). Maximum wire O.D., 0.38" (9.50mm).
 Half size marker – 0.22" x 0.69" (5.60mm x 17.40mm). Maximum wire O.D., 0.19" (4.70mm).
 Terminal block marker – 0.22" x 0.25" (5.60mm x 6.30mm).

Blank Self-Laminating Write-On Cable Marker Books

- 10 pages of markers per book
- Clear section of marker over laminates and protects printed legend
- Markers have ink receptive area to allow handwritten legends



Part Number	Width		Length		Markers Per Book	Std. Pkg. Book(s)	Std. Ctn. Book(s)
	In.	mm	In.	mm			
PSCB-12Y	0.50	12.7	1.50	38.1	180	1	10
PSCB-13Y	1.50	38.1	3.00	76.2	40	1	10
PSCB-16Y	1.50	38.1	6.00	152.4	20	1	10
PSCB-3Y	1.00	25.4	3.00	76.2	60	1	10
PSCB-3YELY*	1.00	25.4	3.00	76.2	60	1	10
PSCB-5Y	1.00	25.4	5.00	127.0	30	1	10
PSCB-6Y	1.00	25.4	6.00	152.4	30	1	10

*Yellow

Can be clearly identified with Panduit® Permanent Marker Pens shown on page B1.49.

Pre-Printed Marker Cards PCM Type

- Marker cards printed in a variety of legends allows “kitting” for project builds
- Plastic liner provides easy removal of markers while protecting unused markers
- Temperature Range: -50°F to 170°F (-46°C to 77°C)

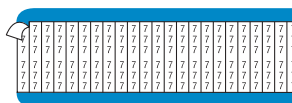

PCM-7

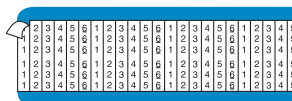

PCM-1-6

Part Number	Legend	Width		Length		Markers Per Card	Std. Pkg. Card(s)	Std. Ctn. Card(s)
		In.	mm	In.	mm			
PCM-0 thru PCM-99	0 thru 99	0.25	6.35	1.50	38.10	36	25	100
PCM-100 thru PCM-202	100 thru 202	0.36	9.14	1.50	38.10	25	25	100
PCMH-0 thru PCMH-25	0 thru 25	0.25	6.35	1.50	38.10	72	25	100
PCM-1-3	1 thru 3	0.25	6.35	1.50	38.10	36	25	100
PCM-1-4	1 thru 4	0.25	6.35	1.50	38.10		25	100
PCM-1-5	1 thru 5	0.25	6.35	1.50	38.10		25	100
PCM-1-6	1 thru 6	0.25	6.35	1.50	38.10		25	100
PCM-1-8	1 thru 8	0.25	6.35	1.50	38.10		25	100
PCM-1-9	1 thru 9	0.25	6.35	1.50	38.10		25	100
PCM-0-9	0 thru 9	0.25	6.35	1.50	38.10		25	100
PCM-1-10	1 thru 10	0.25	6.35	1.50	38.10		25	100
PCM-1-12	1 thru 12	0.25	6.35	1.50	38.10		25	100
PCM-1-16	1 thru 16	0.25	6.35	1.50	38.10	33	25	100
PCM-1-18	1 thru 18	0.25	6.35	1.50	38.10		25	100
PCM-19-36	19 thru 36	0.25	6.35	1.50	38.10		25	100
PCM-1-33	1 thru 33	0.27	6.91	1.50	38.10		25	100
PCM-34-66	34 thru 66	0.27	6.91	1.50	38.10		25	100
PCM-67-99	67 thru 99	0.27	6.91	1.50	38.10		25	100
PCM-100-124	100 thru 124	0.36	9.14	1.50	38.10	25	25	100
PCM-125-149	125 thru 149	0.36	9.14	1.50	38.10		25	100
PCM-150-174	150 thru 174	0.36	9.14	1.50	38.10		25	100
PCM-175-199	175 thru 199	0.36	9.14	1.50	38.10		25	100
PCM-200-224	200 thru 224	0.36	9.14	1.50	38.10		25	100
PCM-225-249	225 thru 249	0.36	9.14	1.50	38.10		25	100
PCM-250-274	250 thru 274	0.36	9.14	1.50	38.10		25	100
PCM-275-299	275 thru 299	0.36	9.14	1.50	38.10		25	100
PCM-300-324	300 thru 324	0.36	9.14	1.50	38.10		25	100
PCM-325-349	325 thru 349	0.36	9.14	1.50	38.10		25	100
PCM-350-374	350 thru 374	0.36	9.14	1.50	38.10		25	100
PCM-375-399	375 thru 399	0.36	9.14	1.50	38.10		25	100
PCM-400-424	400 thru 424	0.36	9.14	1.50	38.10		25	100
PCM-425-449	425 thru 449	0.36	9.14	1.50	38.10		25	100
PCM-450-474	450 thru 474	0.36	9.14	1.50	38.10		25	100
PCM-475-499	475 thru 499	0.36	9.14	1.50	38.10	25	100	
PCM-500-524	500 thru 524	0.36	9.14	1.50	38.10	25	100	

Continues on next page

Order number of pieces required, in multiples of Standard Package Quantity.

Pre-Printed Marker Cards PCM Type (continued)



PCM-A1

Part Number	Legend	Width		Length		Markers Per Card	Std. Pkg. Card(s)	Std. Ctn. Card(s)
		In.	mm	In.	mm			
PCM-A thru PCM-Z	A thru Z	0.25	6.35	1.50	38.1	36	25	100
PCM-A-Z	A thru Z	0.25	6.35	1.50	38.1		25	100
PCM-A-Z-0-9	A thru Z 0 thru 9	0.25	6.35	1.50	38.1		25	100
PCM-A1 thru PCM-A4	A1 thru A4	0.25	6.35	1.50	38.1		25	100
PCM-B1 thru PCM-B5	B1 thru B5	0.25	6.35	1.50	38.1		25	100
PCM-C1 thru PCM-C4	C1 thru C4	0.25	6.35	1.50	38.1		25	100
PCM-E1 thru PCM-E3	E1 thru E3	0.25	6.35	1.50	38.1		25	100
PCM-F1 thru PCM-F4	F1 thru F4	0.25	6.35	1.50	38.1		25	100
PCM-H1 thru PCM-H5	H1 thru H5	0.25	6.35	1.50	38.1		25	100
PCM-L1 thru PCM-L5	L1 thru L5	0.25	6.35	1.50	38.1		25	100
PCM-M1 thru PCM-M2	M1 thru M2	0.25	6.35	1.50	38.1		25	100
PCM-P1 thru PCM-P3	P1 thru P3	0.25	6.35	1.50	38.1		25	100
PCM-R1 thru PCM-R5	R1 thru R5	0.25	6.35	1.50	38.1		25	100
PCM-S1 thru PCM-S5	S1 thru S5	0.25	6.35	1.50	38.1		25	100
PCM-T1 thru PCM-T9	T1 thru T9	0.25	6.35	1.50	38.1		25	100
PCM-X1 thru PCM-X4	X1 thru X4	0.25	6.35	1.50	38.1		25	100

Continues on next page

Pre-Printed Marker Cards PCM Type (continued)

Part Number	Legend	Width		Length		Markers Per Card	Std. Pkg. Card(s)	Std. Ctn. Card(s)
		In.	mm	In.	mm			
PCM-1L1 thru PCM-1L3	1L1 thru 1L3	0.36	9.14	1.50	38.10	25	25	100
PCM-2L1 thru PCM-2L3	2L1 thru 2L3	0.36	9.14	1.50	38.10		25	100
PCM-3L1 thru PCM-3L3	3L1 thru 3L3	0.36	9.14	1.50	38.10		25	100
PCM-4L1 thru PCM-4L3	4L1 thru 4L3	0.36	9.14	1.50	38.10		25	100
PCM-1T1 thru PCM-1T3	1T1 thru 1T3	0.36	9.14	1.50	38.10		25	100
PCM-3T1 thru PCM-3T3	3T1 thru 3T3	0.36	9.14	1.50	38.10		25	100

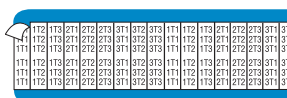

PCM-1T1

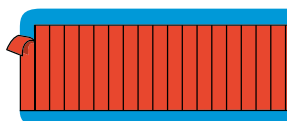

PCM-RED

Part Number	Color	Width		Length		Markers Per Card	Std. Pkg. Card(s)	Std. Ctn. Card(s)
		In.	mm	In.	mm			
PCM-BLK	Black	0.25	6.4	1.50	38.1	36	25	100
PCM-BRN	Brown							
PCM-DBL	Dark Blue							
PCM-DGN	Dark Green							
PCM-GRY	Gray							
PCM-LBL	Light Blue							
PCM-LGN	Light Green							
PCM-ORN	Orange							
PCM-PNK	Pink							
PCM-PUR	Purple							
PCM-RED	Red							
PCM-TAN	Tan							
PCM-WHT	White							
PCM-YEL	Yellow							

Marker size:
Full size marker – 1.50" (38.10mm). Maximum wire O.D., 0.38" (9.50mm).

Wire Marker Card Number Combination Packs



Numbers



Letters

Part Number	Legend	Cards Per Legend	Markers Per Card	Std. Pkg. Qty.	Std. Ctn. Qty.
PCMCP-1-25*	1 thru 25	1 each	36	1	4
PCMCP-26-50*	26 thru 50	1 each		1	4
PCMCP-51-75*	51 thru 75	1 each		1	4
PCMCP-76-100*	76 thru 99 100	1 each	36 25	1	4
PCMCP-101-125*	101 thru 125	1 each	25	1	4
PCMCP-126-150*	126 thru 150	1 each		1	4
PCMCP-A-Z**	A thru Z	1 each	36	1	4

Marker size:

Full size marker – 1.50" (38.10mm). Maximum wire O.D. 0.38" (9.50mm).

*One card each number, 25 cards per package.

**One card each letter, 26 cards per package.

Pre-Printed Marker Cards PPM Type

- Choose from the many legends available in general purpose vinyl cloth, or from special materials available to meet a variety of application environments
- All markers are offered in full size 1.50" (38.1mm) long for wire outside diameter up to 0.38" (9.5mm); half size markers for wire outside diameter up to 0.19" (4.7mm)
- Each marker on card has a different legend
- Temperature Range: -40°F to 275°F (-40°C to 135°C)

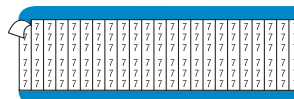

PPM-7



PPM-1-33



PPM-A

Part Number	Legend	Width		Length		Markers Per Card	Std. Pkg. Card(s)	Std. Ctn. Card(s)
		In.	mm	In.	mm			
PPM-0 thru PPM-25	0 thru 25	0.25	6.35	1.50	38.10	36	25	100
PPM-1-33	1 thru 33	0.27	6.91	1.50	38.10	33	25	100
PPM-A thru PPM-C	A thru C	0.25	6.35	1.50	38.10	36	25	100

Legend: Black Background: White

Marker size:

Half size marker – 1.50" (38.10mm). Maximum wire O.D., 0.38" (9.50mm).

Self-Laminating Write-On Marker Cards

- Clear section of marker overlaminates and protects write-on legend
- Markers have ink receptive area to allow hand-written legends

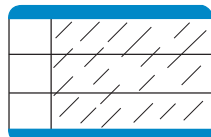

Type PSCC



Type PSWM

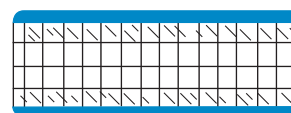

Type PSWMH

Part Number	Width		Length		Print-On Height		Min. Cable O.D.		Max. Cable O.D.		Markers Per Card	Std. Pkg. Card(s)	Std. Ctn. Card(s)
	In.	mm	In.	mm	In.	mm	In.	mm	In.	mm			
PSCC-3Y	1.00	25.40	3.00	76.20	0.75	19.05	0.240	6.1	0.72	18.2	3	25	100
PSCC-5Y	1.00	25.40	5.00	127.00	1.00	25.40	0.320	8.1	1.27	32.3	3	25	100
PSWM-375Y	0.38	9.53	1.50	38.05	0.75	19.05	0.240	6.1	0.24	6.1	25	25	100
PSWM-750Y	0.75	19.05	1.50	38.05	0.75	19.05	0.240	6.1	0.24	6.1	12	25	100
PSWM-1500Y	1.50	38.05	1.50	38.05	0.75	19.05	0.240	6.1	0.24	6.1	6	25	100
PSWMH-375Y	0.38	9.53	0.75	19.05	0.38	9.53	0.120	3.1	0.12	3.0	50	25	100
PSWMH-750Y	0.75	19.05	0.75	19.05	0.38	9.53	0.120	3.1	0.12	3.0	24	25	100

Can be clearly identified with Panduit Permanent Marker Pens shown on page B1.49.

Pre-Printed Marker Tape Dispenser

- Flexible polyester marker tape conforms tightly to wires/cables
- Dispenser allows marker tape to be cut to the exact length required for marking any size wire/cable
- Durable plastic dispenser can be attached to tool belt for industrial use
- Temperature Range: -40°F to 250°F (-40°C to 121°C)



Part Number	Part Description	Roll		Rolls Per Legend Per Pkg.	Std. Pkg. Qty.	Std. Ctn. Qty.
		Ft.	m			
PMD	Empty dispenser.	—	—	—	1	10
PMD-0-9	Dispenser filled with one roll each legend 0 thru 9.	8.0	2.4	1	1	10
PMD-NEMA	Dispenser filled with one roll each of solid NEMA colors: black, light blue, brown, gray, light green, orange, purple, red, white and yellow.	8.0	2.4	1	1	10

Pre-Printed Marker Tape Refills



Part Number	Legend	Roll Length		Rolls Per Legend Per Pkg.	Std. Pkg. Roll(s)	Std. Ctn. Roll(s)
		Ft.	m			
PMDR-0-9 thru PMDR-90-99	0 thru 9 thru 90 thru 99	8.0	2.4	10	1	10
PMDR-0 thru PMDR-9	0 thru 9				10	100
PMDR-A thru PMDR-Z	A thru Z				10	100
PMDR-L1 thru PMDR-L3	L1 thru L3				10	100
PMDR-T1 thru PMDR-T3	T1 thru T3				10	100
PMDR-GRS	Ground symbol	8.0	2.4	10	10	100
PMDR-MIN	Minus symbol				10	100
PMDR-PLS	Plus symbol				10	100
PMDR-BLK	Black				10	100
PMDR-BL	Light Blue				10	100
PMDR-BRN	Brown				10	100
PMDR-GRN	Light Green				10	100
PMDR-GRY	Gray				10	100
PMDR-ORN	Orange				10	100
PMDR-PUR	Purple				10	100
PMDR-RED	Red				10	100
PMDR-WHT	White				10	100
PMDR-YEL	Yellow				10	100
PMDR-NEMA	One of each of the NEMA colors featured above	1	1	10		

B1.
Cable
Ties

B2.
Cable
Accessories

B3.
Stainless
Steel Cable
Ties &
Accessories

C1.
Wiring
Duct

C2.
Abrasion
Protection

C3.
Cable
Management

D1.
Terminals

D2.
Power
Connectors

D3.
Grounding
Connectors

E1.
Labeling
Systems

E2.
Labels

E3.
Pre-Printed
&
Write-On
Markers

E4.
Permanent
Identification

E5.
Industrial
Safety
Solutions

F.
Keystone
Cabling
Systems

G.
Part
Number
Index

Self-Laminating Wire Marker Dispenser

- Self-laminating labels are provided in handy dispenser which protects markers when not in use
- Clear section of marker overlaminates and protects write-on legend
- Quick, easy to use for smaller installations and maintenance
- Temperature Range: -40°F to 150°F (-40°C to 66°C)



Part Number	Part Description	Width		Length		Print-On Height		Min. Cable O.D.		Max. Cable O.D.		Std. Pkg. Qty.	Std. Ctn. Qty.
		In.	mm	In.	mm	In.	mm	In.	mm	In.	mm		
Dispenser Kit													
S100X125VARY	(1) Dispenser. (1) Roll, white write-on, vinyl label, 200/roll. (1) PFX-0 pen.	1.00	25.40	1.25	31.75	0.38	9.65	0.12	3.07	0.28	7.03	1	10
S100X225VARY	(1) Dispenser. (1) Roll, white write-on, vinyl label, 100/roll. (1) PFX-0 pen.	1.00	25.40	2.25	57.15	0.75	19.05	0.24	6.06	0.48	12.13	1	10

Refill Rolls

S100X125VAFY	Replacement roll. White write-on, vinyl label, 200/roll.	1.00	25.40	1.25	31.75	0.38	9.65	0.12	3.07	0.28	7.03	1	10
S100X225VAFY	Replacement roll. White write-on, vinyl label 100/roll.	1.00	25.40	2.25	57.15	0.75	19.05	0.24	6.06	0.48	12.13	1	10

Can be clearly identified with Panduit permanent marking pens shown on page B1.49.

Pre-Printed Clip-On Wire Markers

- Non-adhesive markers grip tightly to wire/cable
- Markers supplied on application wand tool
- Chevron cut keeps multiple markers aligned
- Black legend is embossed into wire marker clip
- Temperature Range: -22°F to 194°F (-30°C to 90°C)



Part Number	Legend	No. of Markers Per Wand	Markers Per Pkg.	Std. Pkg. Qty.	Std. Ctn. Qty.
Wire/Cable Diameter 0.08" – 0.10" (2.00mm – 2.50mm)					
PCA07-A thru PCA07-Z	A thru Z	30	300	1	10
PCA07-A-J	A-J			1	10
PCA07-K-T	K-T			1	10
PCA07-U-Z	U-Z			1	10
PCA07-0 thru PCA07-9	0 thru 9			1	10
PCA07-0-9	0-9			1	10
PCA07-MIN	—			1	10
PCA07-PLS	+			1	10

Continues on next page

Pre-Printed Clip-On Wire Markers (continued)

Part Number	Legend	No. of Markers Per Wand	Markers Per Pkg.	Std. Pkg. Qty.	Std. Ctn. Qty.
Wire/Cable Diameter 0.11" – 0.13" (2.80mm – 3.30mm)					
PCA11-A thru PCA11-Z	A thru Z	30	300	1	10
PCA11-A-J	A-J			1	10
PCA11-K-T	K-T			1	10
PCA11-U-Z	U-Z			1	10
PCA11-0 thru PCA11-9	0 thru 9			1	10
PCA11-0-9	0-9			1	10
PCA11-MIN	—			1	10
PCA11-PLS	+			1	10
Wire/Cable Diameter 0.13" – 0.15" (3.30mm – 3.80mm)					
PCA13-A thru PCA13-Z	A thru Z	30	300	1	10
PCA13-A-J	A-J			1	10
PCA13-K-T	K-T			1	10
PCA13-U-Z	U-Z			1	10
PCA13-0 thru PCA13-9	0 thru 9			1	10
PCA13-0-9	0-9			1	10
PCA13-MIN	—			1	10
PCA13-PLS	+			1	10
Wire/Cable Diameter 0.19" – 0.23" (4.80mm – 5.80mm)					
PCA18-A thru PCA18-Z	A thru Z	30	300	1	10
PCA18-A-J	A-J			1	10
PCA18-K-T	K-T			1	10
PCA18-U-Z	U-Z			1	10
PCA18-0 thru PCA18-9	0 thru 9			1	10
PCA18-0-9	0-9			1	10
PCA18-MIN	—			1	10
PCA18-PLS	+			1	10
Wire/Cable Diameter 0.23" – 0.37" (5.80mm – 9.40mm)					
PCA23-A thru PCA23-Z	A thru Z	20	60	1	10
PCA23-A-D	A-D		80	1	10
PCA23-E-H	E-H		80	1	10
PCA23-I-L	I-L		80	1	10
PCA23-M-P	M-P		80	1	10
PCA23-Q-T	Q-T		80	1	10
PCA23-U-X	U-X		80	1	10
PCA23-Y-Z	Y-Z, +, -		80	1	10
PCA23-0 thru PCA23-9	0 thru 9		60	1	10
PCA23-0-3	0-3		80	1	10
PCA23-4-7	4-7		80	1	10
PCA23-8-9	8, 9, +, -		80	1	10
PCA23-MIN	—		60	1	10
PCA23-PLS	+		60	1	10

B1.
Cable
Ties

B2.
Cable
Accessories

B3.
Stainless
Steel Cable
Ties &
Accessories

C1.
Wiring
Duct

C2.
Abrasion
Protection

C3.
Cable
Management

D1.
Terminals

D2.
Power
Connectors

D3.
Grounding
Connectors

E1.
Labeling
Systems

E2.
Labels

E3.
Pre-Printed
&
Write-On
Markers

E4.
Permanent
Identification

E5.
Industrial
Safety
Solutions

F.
Keystone
Cabling
Systems

G.
Part
Number
Index

B1.
Cable
Ties

B2.
Cable
Accessories

B3.
Stainless
Steel Cable
Ties &
Accessories

C1.
Wiring
Duct

C2.
Abrasion
Protection

C3.
Cable
Management

D1.
Terminals

D2.
Power
Connectors

D3.
Grounding
Connectors

E1.
Labeling
Systems

E2.
Labels

E3.
Pre-Printed
&
Write-On
Markers

E4.
Permanent
Identification

E5.
Industrial
Safety
Solutions

F.
Keystone
Cabling
Systems

G.
Part
Number
Index

Notes

Permanent Identification

Panduit® offers the widest range of permanent identification solutions in the industry to withstand the test of time and provide legibility in harsh environments. Safe, quick, and easy to install, Panduit permanent identification solutions include stainless steel and aluminum marker plates, tags, marking tools and ties to deliver improved productivity and workplace safety.

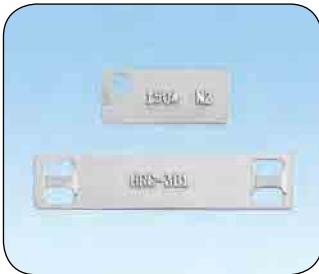

- **Factory Custom Marking Service** creates embossed or laser etched metal plates, tags, and ties to speed installation time and reduce labor costs
- **Portable on-site marking tools** for quick and easy identification on demand
- **Large identification selection** delivers maximum design flexibility to match your specific application requirements
- **Optimized for easy use with Panduit self-locking stainless steel and aluminum ties**; for details, refer to Pan-Steel® System Section B3

Panduit Factory Custom Marking Service

Panduit® factory custom marking service simplifies identification with high quality, made-to-order custom embossed marker plates and tags or laser etched cable ties, marker plates, and tags. Panduit offers rapid direct shipment with fast turn around on custom marking orders worldwide. Work with Panduit to create an effectively identified workplace.

EMBOSSING SERVICE



- Used on rectangular metal marker plates and tags which are a maximum of 0.020 inches (0.5mm) thick and minimum 0.38 inches (10mm) width
- Excellent for applications that are exposed to dirt and paint
- Upper case "raised" character
- Alphanumeric and sequential numbering

LASER MARKING SERVICE



- Used on all metal marker plates, tags, and cable ties
- BOLD block letters
- Upper and lower case character capability
- Ability to create text and graphics
- Alphanumeric and sequential numbering

Character Sizes Available:

- 1/8 inches (3.18mm) – For high character volume tags
- 3/16 inches (4.77mm) – The most common size

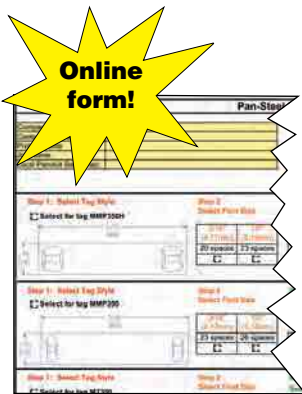

To select and order custom laser and embossed marker plates and tags:

Use on-line order form GA2-0218

<http://www.panduit.com/en/solutions/industrial-construction-mro/products-applications/labeling-identification> to select the proper marker plate or tag for your application. Email order form to your Authorized Panduit Distributor for order placement or contact Panduit Customer Service for assistance.



Panduit offers a full line of labeling products, software and printers.

See pages E1.1 – E2.27.



Panduit permanent identification products are optimized for easy use with Panduit self-locking stainless steel and aluminum ties. For details, refer to Pan-Steel® System Section B3.

Stainless Steel and Brass Marker Plates and Tags

- Provides permanent identification of pipes, conduit, valves, cables and equipment in harsh environments
- Designed for use with Panduit® Pan-Steel® Stainless Steel Cable Ties for fast installation at lowest installed cost
- All marker plates/tags can be embossed or laser etched with Panduit Factory Custom Marking Service
- For on-site custom marking see page E4.6
- Designated plates feature easy feed design with a raised slot to simplify cable tie installation and improve productivity
- Temperature range:
Stainless Steel Marker Plates, Tags, and Cable Ties:
-112°F to 1000°F (-80°C to 538°C)
- Aluminum Marker Plates and Cable Ties:
-112°F to 212°F (-80°C to 100°C)
- Brass Tags:
-112°F to 302°F (-80°C to 150°C)

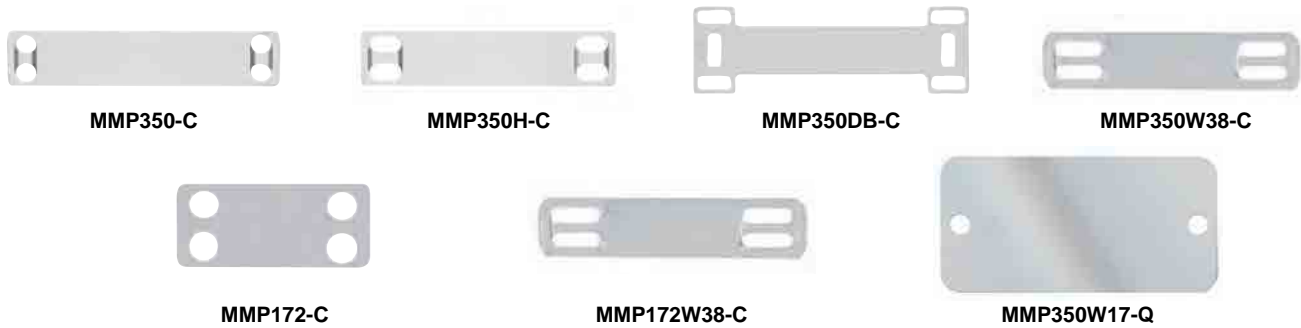

Part Number	Material	Length/ Diameter		Width		Custom Marking Parameters*		Used with Pan-Steel Cable Ties**	Thickness		Std. Pkg. Qty.	Std. Ctn. Qty.
		In.	mm	In.	mm	Max. 3/16" (4.77mm) Character per Line	Max. Lines of Text		In.	mm		
MMP350-C	304 Stainless Steel	3.50	89.0	0.75	19.0	23	3	MLT-S	0.010	0.25	100	1000
MMP350-C316	316 Stainless Steel	3.50	89.0	0.75	19.0	23	3	MLT-S	0.010	0.25	100	1000
MMP350H-C	304 Stainless Steel	3.50	89.0	0.75	19.0	20	3	MLT-H	0.010	0.25	100	1000
MMP350H-C316	316 Stainless Steel	3.50	89.0	0.75	19.0	20	3	MLT-H	0.010	0.25	100	1000
MMP350DB-C	304 Stainless Steel	3.50	89.0	1.12	29.0	20	3	MLT-H	0.015	0.38	100	1000
MMP350DB-C316	316 Stainless Steel	3.50	89.0	1.12	29.0	20	3	MLT-H	0.015	0.38	100	1000
MMP350W38-C	304 Stainless Steel	3.50	89.0	0.38	10.0	23	1	MLT-S	0.010	0.25	100	1000
MMP350W38-C316	316 Stainless Steel	3.50	89.0	0.38	10.0	23	1	MLT-S	0.010	0.25	100	1000
MMP172-C	304 Stainless Steel	1.72	44.0	0.75	19.0	8	3	MLT-S	0.010	0.25	100	1000
MMP172-C316	316 Stainless Steel	1.72	44.0	0.75	19.0	8	3	MLT-S	0.010	0.25	100	1000
MMP172W38-C	304 Stainless Steel	1.72	44.0	0.38	10.0	8	1	MLT-S	0.010	0.25	100	1000
MMP172W38-C316	316 Stainless Steel	1.72	44.0	0.38	10.0	8	1	MLT-S	0.010	0.25	100	1000
MMP350W17-Q	304 Stainless Steel	3.50	89.0	1.73	44.0	23	6	MLT-S	0.015	0.38	25	1000

*See page E4.2 for Panduit Factory Custom Marking Service information.

**See pages B3.5 – B3.6 for Pan-Steel® Stainless Steel Cable Ties.

Continues on next page

Stainless Steel and Brass Marker Plates and Tags (continued)

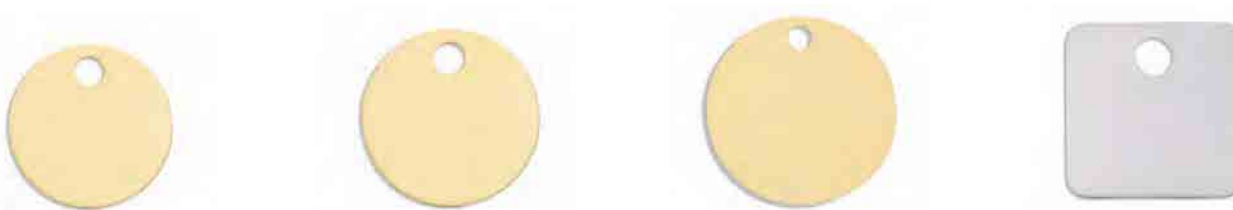

Part Number	Material	Length/ Diameter		Width		Custom Marking Parameters*		Used with Pan-Steel® Cable Ties**	Thickness		Std. Pkg. Qty.	Std. Ctn. Qty.
		In.	mm	In.	mm	Max. 3/16" (4.77mm) Character per Line	Max. Lines of Text		In.	mm		
MT350-C	304 Stainless Steel	3.50	89.0	0.75	19.0	26	3	MLT-S	0.010	0.25	100	1000
MT350-C316	316 Stainless Steel	3.50	89.0	0.75	19.0	26	3	MLT-S	0.010	0.25	100	1000
MT350W17-Q	304 Stainless Steel	3.50	89.0	1.73	44.0	26	6	MLT-S	0.015	0.38	25	250
MT172-C	304 Stainless Steel	1.72	44.0	0.75	19.0	10	3	MLT-S	0.010	0.25	100	1000
MT172-C316	316 Stainless Steel	1.72	44.0	0.75	19.0	10	3	MLT-S	0.010	0.25	100	1000
MT172W38-C	304 Stainless Steel	1.72	44.0	0.38	10.0	10	1	MLT-S	0.010	0.25	100	1000
MT1D-Q	304 Stainless Steel	—	—	1.00 Circular	25.0	5	1	MLT-S	0.035	0.89	25	250
MT1D-Q316	316 Stainless Steel	—	—	1.00 Circular	25.0	5	1	MLT-S	0.035	0.89	25	250
MTB1D-Q	Brass	—	—	1.00 Circular	25.0	5	1	MLT-S	0.040	1.02	25	250
MT150D-Q	304 Stainless Steel	—	—	1.50 Circular	38.0	5, 6, 5	3	MLT-S	0.035	0.89	25	250
MT150D-Q316	316 Stainless Steel	—	—	1.50 Circular	38.0	5, 6, 5	3	MLT-S	0.035	0.89	25	250
MTB150D-Q	Brass	—	—	1.50 Circular	38.0	5, 6, 5	3	MLT-S	0.040	1.02	25	250
MT213D-Q	304 Stainless Steel	—	—	2.13 Circular	54.0	6, 12, 8	3	MLT-S	0.015	0.38	25	250
MT213D-Q316	316 Stainless Steel	—	—	2.13 Circular	54.0	6, 12, 8	3	MLT-S	0.015	0.38	25	250
MTB213D-Q	Brass	—	—	2.13 Circular	54.0	6, 12, 8	3	MLT-S	0.015	0.38	25	250
MT125S-Q	304 Stainless Steel	1.25 Square	32.0	1.25 Circular	32.0	5	2	MLT-S	0.035	0.89	25	250

*See page E4.2 for Panduit Factory Custom Marking Service information.

**See pages B3.5 – B3.6 for Pan-Steel® Stainless Steel Cable Ties.

Aluminum Marker Plates – Pan-Alum™ MMP Series



- Lightweight, aluminum construction for flexibility and ease of handling
- Easy feed marker plate design includes a raised slot to simplify cable tie installation and improve productivity

Part Number	Material	Length		Width		Custom Marking Parameters**		Used with Pan-Alum™ Cable Ties	Std. Pkg. Qty.	Std. Ctn. Qty.
		In.	mm	In.	mm	Max. 3/16" (4.77mm) Character per Line	Max. Lines			
MMP350H-CAL	Aluminum	3.50	89.0	0.75	19.0	20	3	MLT1H-LPAL* MLT2H-LPAL* and MLT4H-LPAL*	100	1000

*See Pan-Alum™ Aluminum Ties on page B3.10 for matching natural finish and five colors.

**See page E4.2 for Panduit Factory Custom Marking Service.

Metal Embossing Hand Tool and Tape System

- Multi-functional cutting die design creates embossed marker plates with raised cable tie slot in one step instead of three, for faster installation
- Lightweight, compact and portable, allows user to create custom length identification on demand at remote job sites
- Embosses 3/16" characters onto stainless steel or aluminum tape, to improve visibility in applications that are subjected to dirt or paint



Part Number	Part Description	Std. Ctn. Qty.
-------------	------------------	----------------

Tool Kit

MEHT187	Includes tool, additional marking wheel, carrying case, one roll each META (aluminum) and METS (stainless steel) tape. Characters included: A B C D E F G H I J K L M N O P Q R S T U V W X Y Z 1 2 3 4 5 6 7 8 9 / ()	1
---------	---	---

Tape

META-X	0.50" x 16' (12.7mm x 4.9m) aluminum tape*.	10
METS3-X	0.50" x 21' (12.7mm x 6.4m) 316 grade stainless steel tape.	10
METS4-X	0.50" x 21' (12.7mm x 6.4m) 304 grade stainless steel tape.	10

*Aluminum ties are recommended for use with aluminum tape to prevent galvanic reaction (corrosion that can occur between stainless steel and aluminum in certain environments).



Metal Indenting Machine

- Provides quick, easy, and permanent identification with Panduit® Stainless Steel and Aluminum marker plates, tags, and cable ties
- Automatic table indexing advances material forward for convenience and improved productivity
- New, improved design features aluminum base and durable construction



Part Number	Part Description	Std. Ctn. Qty.
-------------	------------------	----------------

Indenting Machine

MIM094	Indenting machine with 3/32" (2.38mm) character wheel.	1
MIM125	Indenting machine with 1/8" (3.18mm) character wheel.	1
MIM187	Indenting machine with 3/16" (4.77mm) character wheel.	1

Interchangeable Wheel Kits

MIW094	3/32" (2.38mm) character wheel kit (wheel and indexing gear).	1
MIW125	1/8" (3.18mm) character wheel kit (wheel and indexing gear).	1
MIW187	3/16" (4.77mm) character wheel kit (wheel and indexing gear).	1



Portable Embossing System

- Ideal for on-site permanent identification
- Improves productivity by providing a reliable connection from the embossing machine to your PC using Easy-Mark™ Software
- Creates raised characters on stainless steel and aluminum marker plates, to deliver maximum visibility for medium to high volume applications that are exposed to dirt and paint
- Easy-Mark™ Software allows for a quick print legend and exact preview saving time and reducing print costs
- Easy loading hopper allows for easy stacking of up to 200 plates, saving time and money



Part Number	Part Description	Std. Ctn. Qty.
PES197*	Portable embossing system 3/16" (4.77mm) character, 11.5" (292mm) x 21.0" (534mm) x 19.0" (483mm), 95 lbs. (43 kg), 115 volt, 60 Hz with Easy-Mark™ Software.	1

Characters include: A to Z, 0 to 9, ! @ # \$ % & * () - + = : " ' . / ?

*For use with 1000 pack marker plates only.

System Requirements: Designed for Windows^ 2000, XP, Vista, 7, 8 or 10; 64 MB hard drive space, and 64 MB RAM (256 MB RAM recommended). Female DB9 serial communication port.

^Windows is a registered trademark of Microsoft Corporation in the United States and/or other countries.

Part Number	Material	Color	Length/ Diameter		Width		3/16" (4.77mm) Characters per Line	Thickness		Std. Pkg. Qty.	Std. Ctn. Qty.	
			In.	mm	In.	mm		In.	mm			
MMP350-M	304 Stainless Steel	Natural	3.50	89.0	0.75	19.0	18	0.01	0.25	1000	4000	
MMP350-M316	316 Stainless Steel									1000	4000	
MMP350H-M	304 Stainless Steel									1000	4000	
MMP350H-M316	316 Stainless Steel									1000	4000	
MMP350H-MAL	Aluminum	Natural	3.50	89.0	0.54	13.7	16	0.01	0.30	1000	4000	
MMP350HW54-MAL										1000	4000	
MMP350W38-M	304 Stainless Steel				0.38	10.0		18	0.01	0.25	1000	4000
MMP350W38-M316	316 Stainless Steel										1000	4000

Order number of pieces required, in multiples of Standard Package Quantity.

Industrial Safety Solutions

From the front gate to the back of the facility Panduit provides durable, easy-to-use solutions to create a safer workplace. These facility identification and safety products reduce the risk to workers and businesses through greater awareness and communication of workplace hazards and assist with effective compliance of OSHA Safety Regulations. The Facility Identification solutions compliment Panduit's broad offering of engineered solutions for electrical and industrial environments.



- Safety signs and labels offered in a variety of materials, colors, sizes, and legends
- Voltage markers in adhesive and snap-on style
- Utility tapes in a variety of materials, colors, sizes, and legends
- Letters and numbers in a variety of materials and sizes
- Tags in a variety of materials, colors, sizes, and legends
- Training manuals and videos to help train employees on the requirements of lockout/tagout
- Extensive line of universal, high quality devices to lockout a variety of energy sources
- Lockout/tagout kits and stations that offer a convenient method to store and contain lockout devices, tags, and padlocks
- High quality, durable, secure padlocks in a variety of styles, colors, and keying configurations that ensure safety and security
- Extensive line of safety identification products that include barriers, barricades, floor marking signs and tapes, and traffic and motivational signs

B1. Cable Ties

B2. Cable Accessories

B3. Stainless Steel Cable Ties & Accessories

C1. Wiring Duct

C2. Abrasion Protection

C3. Cable Management

D1. Terminals

D2. Power Connectors

D3. Grounding Connectors

E1. Labeling Systems

E2. Labels

E3. Pre-Printed & Write-On Markers

E4. Permanent Identification

E5. Industrial Safety Solutions

F. Keystone Cabling Systems

G. Part Number Index

Stock Safety Signs & Labels

Our stock signs and labels are ready-to-ship ... today. Safely made in the USA!



DANGER RED	WARNING ORANGE	CAUTION YELLOW	NOTICE BLUE	SAFETY FIRST GREEN
Indicates a hazardous situation that, if not avoided, will result in death or serious injury .	Indicates a hazardous situation that, if not avoided, could result in death or serious injury .	Indicates a hazardous situation that, if not avoided, could result in minor or moderate injury .	Indicates information considered important but not hazard-related.	Indicates specific safety-related instructions or procedures that are related to safe work practices.
OSHA 	OSHA 	OSHA 	OSHA 	OSHA
ANSI 	ANSI 	ANSI 	ANSI 	ANSI

OSHA 29 CFR § 1910.145

Traditional OSHA-style signs and labels are the most widely recognized design format in industry. They use upper case lettering, and the message is generally centered underneath the header. This standardized sign format continues today to be the choice for selecting messages in safety signs.



ANSI Z535

Newer ANSI-style signs and labels are gaining in popularity and are recognized by OSHA as an acceptable safety notification device. Signs often include a visual alert symbol (triangle with an exclamation point!), a large symbol, and left-justified upper and lower case message lettering. These signs are clearly visible and provide concise safety alert messages.



Choose the Right Stock Material

Your facility signs are used indoors and outdoors, in ordinary conditions or extreme. We offer materials to match your needs. Select a material based upon your application requirements to ensure your message is conveyed clearly and effectively.

Every sign we make is American-made and skillfully crafted with quality in mind. Our stock signs are available in a variety of materials and printed with technologically advanced inks. With many materials featuring no-hassle extended guarantees, your printed sign will continue to notify and alert employees for years. For additional information, please give us a call.

What is my sign printed on and will it last?

Along with looking great, your sign should last as long as it's needed. The material depends on where your sign is going to be displayed. For indoor, choose light-duty materials; for harsh environments and long-term/extended outdoor exposure, choose from our selection of durable materials listed below.

Adhesive Vinyl (PVS)

Stick with Adhesive Vinyl for light-duty applications. The ideal choice for a variety of indoor, and sheltered outdoor, marking needs. Easily mounts to all curved areas such as pipes, poles and secondary containers.

Material Features

- 0.004" thick printed matte surface
- Permanent acrylic adhesive
- Moisture-resistant
- Service temperature range: -20° to 176°F
- Square corners and scored backing for quick peel-off and application
- Durability: **2 years outdoors**

Applications

- Adheres to most surfaces
- Indoor usage
- Light-duty application
- Sheltered outdoor locations

Peel-off liner Printed Message



0.004" Vinyl

Polyethylene Plastic (PRS)

Appropriate for everyday medium-duty marking needs. Semi-flexible, economical design with 50% recycled content is ideal for indoor and sheltered outdoor environments.

Material Features

- 0.055" thick with good impact resistance and surface image with non-glare finish
- Manufactured with 50% recycled plastic and is recyclable
- Ideal for flat surfaces, with enough flex to mount on slightly curved areas
- Contains UV inhibitors
- Service temperature range: -90° to 168°F
- Rounded corners and 0.1875" mounting holes
- Durability: **2 years outdoors**

Applications

- Indoor usage
- Medium-duty marking needs
- Sheltered outdoor locations
- Ideal for low-cost informational usage

Printed Message



0.055" Thick Polyethylene



Polyester Laminated Vinyl (PLVS)

Dual-layered Polyester Laminated Vinyl delivers exceptional flexibility and performance. Durability, even in the toughest indoor and outdoor conditions.

Material Features

- 0.006" thick poly-composite with UV protective coating
- Sub-surface image is protected by high-gloss polyester film from water, chemicals and abrasion
- Permanent acrylic adhesive backing
- Service temperature range: -20° to 176°F
- Round corners without holes; scored backing for quick peel-off and application
- Durability: **5 years outdoors**

Applications

- Indoor and outdoor usage
- Adheres to most surfaces
- Excellent in harsh environments

Peel-Off Liner Printed Message



0.006" Vinyl

Protective Coating

Aluminum (PAS)

Get the strength of metal, without the rust. Aluminum has superior abrasion and chemical resistance for indoor and outdoor environments.

Material Features

- Printed image on rigid 0.040" aluminum sheet
- UV protective coating
- Service temperature range: -40° to 250°F
- Withstands splashes and washdowns
- Endures outdoor environmental conditions
- Rounded corners and 0.1875" mounting holes on most sizes, will be adjusted for larger sizes
- Durability: **5 years outdoors**

Applications

- Indoor and outdoor usage
- Excellent for harsh environments
- Ideal for longer-term marking needs

Printed Message



0.040" Thick Aluminum

Protective Coating

Admittance & Exit

Signs

B2. Cable Accessories	 7" x 10" 10" x 14" D7001	 7" x 10" 10" x 14" D7002	 14" x 10" D4007	 7" x 10" 10" x 14" D7003	 7" x 10" 10" x 14" D7013	 14" x 10" D4140
C1. Wiring Duct	 14" x 10" D5142	 7" x 10" 10" x 14" D7016	 7" x 10" 10" x 14" D7017	 7" x 10" 10" x 14" D7018	 14" x 10" D4147	 7" x 10" 10" x 14" D7019
C2. Abrasion Protection	 7" x 10" 10" x 14" D7020	 14" x 10" D4077	 7" x 10" 10" x 14" D7034	 7" x 10" 10" x 14" D7035	 7" x 10" 10" x 14" D7004	 7" x 10" 10" x 14" W7014
C3. Cable Management	 7" x 10" 10" x 14" W7021	 7" x 10" 10" x 14" W7036	 7" x 10" 10" x 14" W7005	 7" x 10" 10" x 14" C7007	 7" x 10" 10" x 14" C7015	 7" x 10" 10" x 14" C7061
D1. Terminals	 7" x 10" 10" x 14" C7062	 7" x 10" 10" x 14" C7063	 7" x 10" 10" x 14" N7057	 7" x 10" 10" x 14" N7043	 7" x 10" 10" x 14" N7008	 7" x 10" 10" x 14" N7009
D2. Power Connectors	 14" x 10" N4802	 7" x 10" 10" x 14" N7010	 7" x 10" 10" x 14" N7064	 7" x 10" 10" x 14" N7065	 7" x 10" 10" x 14" N7044	 7" x 10" 10" x 14" N7045
D3. Grounding Connectors	 7" x 10" 10" x 14" N7046	 7" x 10" 10" x 14" N7047	 7" x 10" 10" x 14" N7066	 14" x 10" N4826	 7" x 10" 10" x 14" N7051	 7" x 10" 10" x 14" N7067
E1. Labeling Systems	See How to Order Signs on next page ▶					
E2. Labels						
E3. Pre-Printed & Write-On Markers						
E4. Permanent Identification						
E5. Industrial Safety Solutions						
F. Keystone Cabling Systems						
G. Part Number Index						



7" x 10" 10" x 14"
N7048



7" x 10" 10" x 14"
N7058



14" x 10"
N5813



7" x 10" 10" x 14"
N7049



7" x 10" 10" x 14"
N7022



7" x 10" 10" x 14"
N7068



7" x 10" 10" x 14"
N7069



7" x 10" 10" x 14"
N7011



7" x 10" 10" x 14"
N7023



7" x 10" 10" x 14"
N7037



7" x 10" 10" x 14"
N7070



7" x 10" 10" x 14"
N7071

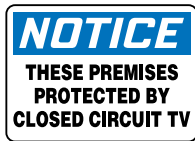

7" x 10" 10" x 14"
N7052



7" x 10" 10" x 14"
N7053



14" x 10"
N4813



7" x 10" 10" x 14"
N7054



7" x 10" 10" x 14"
N7072



7" x 10" 10" x 14"
N7073

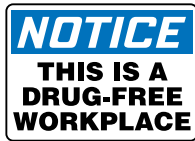

7" x 10" 10" x 14"
N7059



7" x 10" 10" x 14"
N7074



7" x 10" 10" x 14"
N7055



7" x 10" 10" x 14"
N7056



14" x 10"
N4811



7" x 10" 10" x 14"
B7028



10" x 7" 14" x 10"
B7031



7" x 10" 10" x 14"
B7029



14" x 10"
B4511



7" x 10" 10" x 14"
B7030



7" x 10" 10" x 14"
B7032



7" x 10" 10" x 14"
B7033



7" x 10" 10" x 14"
B7040



14" x 10"
B4520



7" x 10" 10" x 14"
B7041



7" x 10" 10" x 14"
B7042



7" x 10" 10" x 14"
B7012



7" x 10" 10" x 14"
B7075

Available Materials

Adhesive Vinyl (Each)
Polyester Laminated Vinyl (Each)
Polyethylene Plastic (Each)
Aluminum (Each)

Codes

PVS
PLVS
PRS
PAS

Available Sizes

7" x 10"
10" x 14"
14" x 10"

Codes

0710
1014
1410

How to Order Signs:

1 Select Material Code:
PVS

3 Select Sign Base Part Number:
D7018

2 Select Size Code:
0710

4 Combine Codes in Specific Order
for Complete Part Number: PVS0710D7018



Signs



7" x 10" 10" x 14"
B7078



7" x 10" 10" x 14"
B7077



10" x 14"
B3533



10" x 14"
B4535



10" x 14"
B4907



14" x 10"
B4908

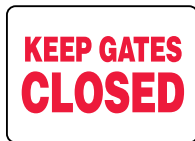

7" x 10" 10" x 14"
B7076



7" x 10" 10" x 14"
B7081



7" x 10" 10" x 14"
B7024



7" x 10" 10" x 14"
B7025



7" x 10" 10" x 14"
B7080



10" x 14"
B4912



14" x 10"
B3513



7" x 10" 10" x 14"
B7026



7" x 10" 10" x 14"
B7027



7" x 10" 10" x 14"
B7039



7" x 10" 10" x 14"
B7038



7" x 10" 10" x 14"
B7079



7" x 10" 10" x 14"
B7050

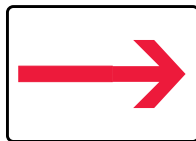

7" x 10" 10" x 14"
B7082

Available Materials

- Adhesive Vinyl (Each)
- Polyester Laminated Vinyl (Each)
- Polyethylene Plastic (Each)
- Aluminum (Each)

Codes

- PVS
- PLVS
- PRS
- PAS

Available Sizes

- 7" x 10"
- 10" x 14"

Codes

- 0710
- 1014

How to Order Signs:

- Select Material Code: PVS
- Select Size Code: 0710
- Select Label Sign Part Number: B7078
- Combine Codes in Specific Order for Complete Part Number: PVS0710B7078



Lighted UL LED Exit Signs

Light the way of egress routes with illuminated EXIT.

- Long-life, energy efficient, LED lamps, rated at 25+ years
- Ceiling, end, or surface mount
- Emergency style includes rechargeable battery back-up to keep sign lit for 1 1/2 hours during power failure
- Red, 6" letters with knock-out left and right arrows
- Hardwire connection to reliable electrical source required
- 120 or 277 field selectable inputs



Meets OSHA 29 CFR §1910.37



Thermoplastic Exit Signs

- Scratch- and corrosion-resistant plastic housing
- Measures 7 1/2" x 12 1/4" x 1 3/4"
- UL924 listed

Part No.	Description	UOM
PSSE001	Standard	Each
PSSE002	Emergency	Each



Steel Exit Signs

- Durable, 20-gauge, steel housing with white powder-coat finish
- Measures 7 1/2" x 12" x 2 1/4"
- UL924 and ULC/ORD-C924-02 listed

Part No.	Description	UOM
PSSE003	Standard	Each
PSSE004	Emergency	Each



Self-Luminous UL Exit Signs



Complies with OSHA 29 CFR §1910.37, NFPA Life Safety Code 7.10.4, and NFPA 7.10.7.1

Exit signs stay continuously lit without external power.

- Illuminated by tritium gas-filled, hermetically-sealed glass tubes
- Consumes no energy, maintenance free
- 6" H letters, red polycarbonate faceplate, removable directional arrows
- Injection molded, black, ABS plastic frame
- Highly durable, vibration- and waterproof
- Listed to UL924
- Meets codes: NFPA Life Safety Code 101, BOCA and ICBO
- Measures 14 3/16" x 9 5/8" x 1 1/2"
- Hardware included for ceiling, end, or surface mount

Part No.	Life Span	UOM
PSSE005	10 Years	Each
PSSE006	20 Years	Each

Glow-in-the-Dark UL Exit Signs

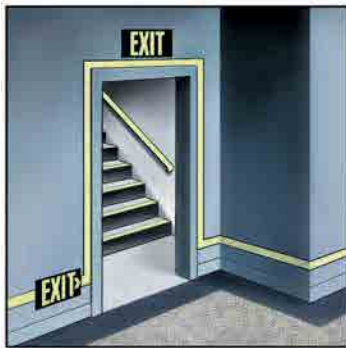

Normal lighting



Blackout

The Next Generation in Technology

UL Glow Exit Signs store energy from virtually any artificial light source. When properly charged, UL Glow Signs will glow for over six hours in the event of a blackout. Low-profile, non-radioactive signs can be used for both high-level and low-level applications, and require no electrical hook-up.

- Recyclable
- Energy-saving
- Easy to install
- Maintenance free, 25+ year life

Meets The Following Standards:

- Meets NFPA Life Safety Code 101 and OSHA requirements
- Meets current Building Codes: IBC, ICBO, BOCA and SBCCI, NFPA 5000

- ICC ES report #ER-6040
- California State Fire Marshal listing #6200-1617; 100
- City of Los Angeles Research Report: RR 25531 (GSI #16530)
- Ontario Building Materials Evaluation Commission
- Authorization Report BMEC # 03-12-291



Steel Case Style

- 50-ft. viewing distance
- Glow-in-the-dark letters on your choice of three background colors
- Photoluminescent panel is housed inside a durable steel casing
- "Punch-out" directional arrows included
- Surface, flag, or ceiling mount
- Sign size: 8 1/4"H x 15 1/4"W x 1/4"D
- Letter size: 7"H x 7/8" stroke

When ordering, specify case color:
Red – RD, Green – GN, or Black – BK.

Part No.	Description	UOM
PSSE007	Single-face	Each
PSSE010	Single-face w/mounting brackets	Each
PSSE013	Double-face w/mounting brackets	Each



Plastic Case Style

- 50-ft. viewing distance
- Choose glow-in-the-dark letters on your choice of three background colors
- Photoluminescent panel is housed inside a durable plastic casing
- "Punch-out" directional arrows included
- Surface, flag, or ceiling mount
- Mounting hardware included
- Sign size: 8 3/4"H x 15 3/8"W x 3/4"D
- Letter size: 7"H x 7/8" stroke

When ordering, specify case color:
Red – RD, Green – GN, or Black – BK.

Part No.	Description	UOM
PSSE020	Single-face	Each
PSSE023	Double-face	Each

Standard Letters



Reflective Letters



One-Dimensional Plate Style

- 50-ft. viewing distance
- Colored letters on glow-in-the-dark background with optional black plastic frame
- Choose standard or high visibility, reflective lettering in your choice of two colors
- Durable, impact-resistant plastic with 4 corner mounting holes
- "Punch-out" directional arrows included
- Wall mount only
- Sign size: 7 1/2"H x 13"W
- Letter size: 6"H x 13/16" stroke

When ordering, specify letter color:
Red – RD, or Green – GN.

Part No.	Description	UOM
PSSE016	Standard Letters	Each
PSSE018	Reflective Letters	Each

B1. Cable Ties

B2. Cable Accessories

B3. Stainless Steel Cable Ties & Accessories

C1. Wiring Duct

C2. Abrasion Protection

C3. Cable Management

D1. Terminals

D2. Power Connectors

D3. Grounding Connectors

E1. Labeling Systems

E2. Labels

E3. Pre-Printed & Write-On Markers

E4. Permanent Identification

E5. Industrial Safety Solutions

F. Keystone Cabling Systems

G. Part Number Index



Chemicals & Hazardous Materials

Signs

 7" x 10" 10" x 14" D7083	 7" x 10" 10" x 14" D7084	 7" x 10" 10" x 14" D7085	 7" x 10" 10" x 14" D7086	 7" x 10" 10" x 14" D7087	 7" x 10" 10" x 14" D7088
 7" x 10" 10" x 14" D7101	 7" x 10" 10" x 14" D7089	 7" x 10" 10" x 14" D7104	 7" x 10" 10" x 14" D7105	 7" x 10" 10" x 14" D7106	 7" x 10" 10" x 14" D7107
 7" x 10" 10" x 14" D7090	 7" x 10" 10" x 14" D7091	 7" x 10" 10" x 14" D7092	 7" x 10" 10" x 14" D7093	 7" x 10" 10" x 14" D7094	 7" x 10" 10" x 14" D7095
 7" x 10" 10" x 14" D7096	 7" x 10" 10" x 14" D7097	 7" x 10" 10" x 14" D7108	 7" x 10" 10" x 14" D7098	 7" x 10" 10" x 14" C7099	 7" x 10" 10" x 14" N7102
 7" x 10" 10" x 14" N7103	 7" x 10" 10" x 14" N7109	 14" x 10" B4524	 14" x 10" B4518	 7" x 10" 10" x 14" B7100	

See How to Order Signs on next page ▶

Labels

 3 1/2" x 5" D3026	 3 1/2" x 5" D3029	 3 1/2" x 5" D3296	 3 1/2" x 5" D3304
 3 1/2" x 5" C3686	 3 1/2" x 5" B3517	 3 1/2" x 5" B3548	

Available Materials	Codes	Available Size	Codes
Adhesive Vinyl (Pkg. of 5)	PVS	3 1/2" x 5"	0305
Polyester Laminated Vinyl (Each)	PLVS		

- How to Order Labels:**
- Select Material Code: **1** PVS
 - Select Size Code: **2** 0305
 - Select Label Base Part Number: **3** D3304
 - Combine Codes in Specific Order for Complete Part Number: **4** PVS0305D3304

Labels – Polyester Laminated Vinyl (PLVS)

DIESEL FUEL 2" x 9" B3502	GASOLINE 2" x 9" B3516	GAS/OIL MIX 2" x 9" B3587	DIESEL 1" x 6" B3501
GASOLINE 2" x 5" B3542	DIESEL FUEL 2" x 5" B3500	UNLEADED GAS 1" x 9" B3534	MIXED TWO-CYCLE FUEL 2" x 5" B3556

Available Material	Code	Available Sizes	Codes
Polyester Laminated Vinyl (Each)	PLVS	1" x 6" 1" x 9" 2" x 5" 2" x 9"	0106 0109 0205 0209

How to Order Labels:

- Select Material Code: PLVS
- Select Size Code: 0205
- Select Label Base Part Number: B3542
- Combine Codes in Specific Order for Complete Part Number: PLVS0205B3542

Confined Space

Signs



Available Materials	Codes	Available Sizes	Codes
Adhesive Vinyl (Each)	PVS	7" x 10"	0710
Polyester Laminated Vinyl (Each)	PLVS	10" x 14"	1014
Polyethylene Plastic (Each)	PRS	14" x 10"	1410
Aluminum (Each)	PAS		

How to Order Signs:

- Select Material Code: PVS
- Select Size Code: 0710
- Select Sign Base Part Number: D7084
- Combine Codes in Specific Order for Complete Part Number: PVS0710D7084

Labels



Available Materials	Codes	Available Sizes	Codes
Adhesive Vinyl (Pkg. of 5)	PVS	3 1/2" x 5"	0305
Polyester Laminated Vinyl (Each)	PLVS	6" x 6"	0606

How to Order Labels:

- Select Material Code: PVS
- Select Size Code: 0305
- Select Label Base Part Number: D3277
- Combine Codes in Specific Order for Complete Part Number: PVS0305D3277

Cross Barrier

Cross out open entryway to a Confined Space.

- Crossbuck design fits onto bolt pattern of vertical confined space entry
- Attention-getting diagonal red-white stripes are surface-printed and protected by laminate film
- Adjustable crossbuck pivots flat for easy transport and storage
- Crossbuck arms measure 6" x 42" with 1.5" x 9" slotted cutouts at each end
- 11.5" x 11.5" octagonal sign is printed on 0.055" polyethylene plastic
- Fits 22" to 38" outside bolt-to-bolt*

- Crossbucks available in two materials:
 - **Standard** style is 0.060" polycarbonate plastic – durable to withstand initial impacts and scratches
 - **Heavy-Duty** style is 0.118" Poly-Aluminum – combines aluminum and thermoplastic core for high strength and impact protection

* To verify proper fit of the Barrier for your entryway, measure the length across the entryway from bolt to bolt; then measure the bolt diameter and compare to slot width.



Description	Material	UOM
Standard	Plastic	Each
Heavy-Duty	Poly-Aluminum	Each



Plastic Poly-Aluminum PCSP0006 PCSP0009



Plastic Poly-Aluminum PCSP0008 PCSP0011



Plastic Poly-Aluminum PCSP0007 PCSP0010



Plastic Poly-Aluminum PCSP0012 PCSP0013

Permit Holder Board



Board communicates Confined Space requirements and holds related permits.

- Hang or set board near or at entrance of confined space to be readily seen by all
- Features large sign legend with clear acrylic pocket
- Holds 8.5" x 11" entry permit sheets (available separately)
- Constructed of durable 0.125" thick PVC
- Measures 12"H x 19"W with mounting holes
- Not recommended for outdoor use

Part No.	UOM
PCSP0001	Each

Entry Permit Pad

- Easy to write on, 8.5" x 11" sheets
- Conveniently packaged in easy to tear off pads
- 100 sheets per pad

Part No.	UOM
PCSP0002	100 Sheets/Pad

Comply with OSHA 29 CFR § 1910.146(e)(1)

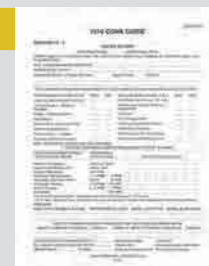

Stencils

Mark confined spaces that are otherwise difficult to label by using ink or paint stencils.

- 0.010" thermo-plastic stencils
- Fits a 7" x 10" image area
- Header line has approx. 2" H letters
- Message area has 1" H letters

UOM
Each



7" x 10" PCSP0003



7" x 10" PCSP0004



7" x 10" PCSP0005

Construction

Signs



14" x 10"
D4136



7" x 10" 10" x 14"
D7119



14" x 10"
D4015



7" x 10" 10" x 14"
D7120



7" x 10" 10" x 14"
D7121



7" x 10" 10" x 14"
D7122



7" x 10" 10" x 14"
D7123



7" x 10" 10" x 14"
D7124



7" x 10" 10" x 14"
D7125



7" x 10" 10" x 14"
D7126



7" x 10" 10" x 14"
D7127



7" x 10" 10" x 14"
D7128



7" x 10" 10" x 14"
C7129



10" x 14"
D4017

Available Materials

Adhesive Vinyl (Each)
Polyester Laminated Vinyl (Each)
Polyethylene Plastic (Each)
Aluminum (Each)

Codes

PVS
PLVS
PRS
PAS

Available Sizes

7" x 10"
10" x 14"
14" x 10"

Codes

0710
1014
1410

How to Order Signs:

- Select Material Code: PVS
- Select Size Code: 0710
- Select Sign Base Part Number: D7125
- Combine Codes in Specific Order for Complete Part Number: PVS0710D7125



Crane and Construction Signals

Choose from Standard, Mobile and Overhead Crane Signal Styles, as well as Ready Mix Truck Signals Style. Available as wallet cards, labels, and signs. Select styles also available as laminated, durable, flexible plastic posters.



29 CFR § 1926.1422 Signals – Hand Signal Chart.

Hand signal charts must be either posted on the equipment or conspicuously posted in the vicinity of the hoisting operations.

Crane Hand Signals

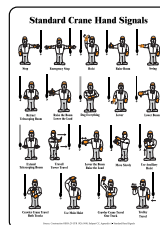

Standard

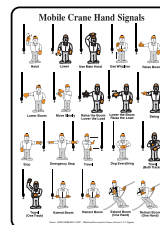

Mobile

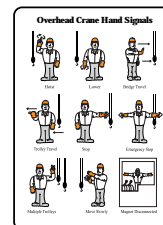

Overhead

Truck Signals

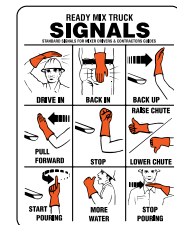

Ready Mix

Plastic Wallet Card – 3 3/8" x 2 1/8"

Standard (2-sided)
Mobile (2-sided)
Overhead (1-sided)
Ready Mix (1-sided)

PSS027
PSS028
PSS026
PSS029

Description	UOM
Wallet Card, 2-sided	Each
Wallet Card, 1-sided	Each

Label - Adhesive Vinyl (PVS) 5" x 3 1/2" (0503)

To Order Labels: Select Material Code, Size Code, & Base Part Number. Combine Codes in Specific Order for Complete Part Number

Standard
Mobile
Overhead

B3507
B3552
B3546

Description	UOM
Label	Pkg. of 5

Sign (see How to Order Signs above box)

Available size 14" x 10" (1410) only

Standard
Mobile
Overhead
Ready Mix

B4542
B4547
B5616
B4513

Description	UOM
Sign	Each

Large Signs



Mark pathways, warn of hazards, and display safety reminders in a big way around the construction site with these Large Signs. On an active job site, signs with bold messages and large letters are visible to gain the necessary attention from varying distances.



18" x 24" 24" x 36"
D7334



18" x 24" 24" x 36"
D7335



18" x 24" 24" x 36"
D7336



18" x 24" 24" x 36"
D7337



18" x 24" 24" x 36"
D7338



18" x 24" 24" x 36"
D7339



18" x 24" 24" x 36"
B7340



18" x 24" 24" x 36"
B7341



18" x 24" 24" x 36"
B7342



18" x 24" 24" x 36"
B7343



18" x 24" 24" x 36"
B7344



24" x 18"
B4505

Available Materials	Codes	Available Sizes	Codes
Adhesive Vinyl (Each)	PVS	18" x 24"	1824
Polyethylene Plastic (Each)	PRS	24" x 18"	2418
Aluminum (Each)	PAS	24" x 36"	2436

































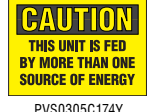



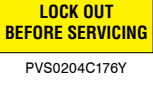

How to Order Signs:

- Select Material Code:
PVS
- Select Size Code:
1824
- Select Label Sign
Part Number: D7336
- Combine Codes in Specific Order for Complete Part Number: PVS1824D7336

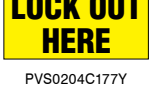

Electrical

Signs

 7" x 10" 10" x 14" D7130	 7" x 10" 10" x 14" D7131	 7" x 10" 10" x 14" D7132	 7" x 10" 10" x 14" D7133	 14" x 10" D4115	 14" x 10" D4012	 7" x 10" 10" x 14" D7135
 14" x 10" D4188	 7" x 10" 10" x 14" D7136	 7" x 10" 10" x 14" D7137	 7" x 10" 10" x 14" D7134	 7" x 10" 10" x 14" D7142	 7" x 10" 10" x 14" D7143	 7" x 10" 10" x 14" D7144
 7" x 10" 10" x 14" D7145	 7" x 10" 10" x 14" D7146	 7" x 10" 10" x 14" W7138	 7" x 10" 10" x 14" W7139	 7" x 10" 10" x 14" C7140	 7" x 10" 10" x 14" C7147	 7" x 10" 10" x 14" N7141
 PVS0109D72Y PVS0204D72Y	 PVS0204D72Y	 PVS0305C174Y PVS0505C174Y PPS03050174	 PVS0710C173Y	 PVS0209D445Y	 PVS0204C171Y	 PVS0710C180Y
 PVS0204C176Y	 PVS0503N458Y	 PVS0204C179Y	 PPS0710D28	 PRS1014D71	 PRS1420D75	 PRS0910D453
 PVS0204C177Y		 PVS0204C178Y	 PPS0710D66	 PPS0710D73 PPS1014D73 PPS1014D73	 PPS0710D77	 PPS0305W2201Y PPS0507W2201Y

Available Materials Adhesive Vinyl (Each) Polyester Laminated Vinyl (Each) Polyethylene Plastic (Each) Aluminum (Each)	Codes PVS PLVS PRS PAS	Available Sizes 7" x 10" 10" x 14" 14" x 10"	Codes 0710 1014 1410	How to Order Signs: 1 Select Material Code: PVS 2 Select Size Code: 0710 3 Select Sign Base Part Number: D7130 4 Combine Codes in Specific Order for Complete Part Number: PVS0710D7130
---	---	--	--------------------------------------	--

Roll of Signs

Keep multiple safety signs for on-the-spot placement.

- Convenient, portable and economical
- 7" x 10" signs are surface-printed on 0.004" vinyl with permanent acrylic adhesive back
- Matte material is moisture-resistant
- Compact roll protects additional sign versions underneath
- Simply peel-and-stick; adheres to most surfaces
- Available in two roll size options: 50 per roll and 100 per roll



50 / Roll PVS0710D4019-L
100 / Roll PVS0710D4019-C



50 / Roll PVS0710W4025-L
100 / Roll PVS0710W4025-C



50 / Roll PVS0710C4029-L
100 / Roll PVS0710C4029-C

Labels

3 1/2" x 5" 5" x 7" D7148	3 1/2" x 5" 5" x 7" D7149	3 1/2" x 5" 5" x 7" D7150	3 1/2" x 5" 5" x 7" D7151	3 1/2" x 5" 5" x 7" D7152	3 1/2" x 5" 5" x 7" D7153	3 1/2" x 5" 5" x 7" D7154	3 1/2" x 5" 5" x 7" D7155
3 1/2" x 5" D3161	3 1/2" x 5" D3164	3 1/2" x 5" D3165	3 1/2" x 5" D3167	3 1/2" x 5" D3166	3 1/2" x 5" D3168	3 1/2" x 5" D3170	3 1/2" x 5" D3175
6" x 2" B3536	3 1/2" x 5" D3176	3 1/2" x 5" D3177	3 1/2" x 5" D3178	3 1/2" x 5" D3306	3 1/2" x 5" D3297	3 1/2" x 5" C3622	3 1/2" x 5" B3512
	3 1/2" x 5" B3530	3 1/2" x 5" B3541 With Detached Arrow					

Magnetic Lockout Label

Apply, move, and re-apply to most steel surfaces when servicing equipment.



5" x 3 1/2" 7" x 5" D3120

Available Materials	Codes	Available Sizes	Codes
Polyester Laminated Vinyl (Each)	PLVS	3 1/2" x 5"	0305
		6" x 2"	0602
		5" x 7"	0507

Available Material	Code	Available Sizes	Codes
Magnetic Vinyl (Each)	PVMS	5" x 3 1/2"	0503
		7" x 5"	0705

How to Order Labels:

- Select Material Code: PLVS
- Select Size Code: 0305
- Select Label Base Part Number: D7149
- Combine Codes in Specific Order for Complete Part Number: PLVS0305D7149

How to Order:

- Select Material Code: PVMS
- Select Size Code: 0503
- Select Label Base Part Number: D3120
- Combine Codes in Specific Order for Complete Part Number: PVMS0503D3120

Arc Flash Protection Labels



Post labels clearly identifying electrical hazards to protect workers from arc flash, shock and electrocution.

- Bold type and graphics to be clearly seen
- Labels define specifics of electrical hazards and appropriate PPE

Available Materials	Codes	Available Sizes	Codes
Adhesive Vinyl (Pkg. of 5)	PVS	3 1/2" x 5"	0305
Polyester Laminated Vinyl (Each)	PLVS	5" x 7"	0507

How to Order Labels:

- Select Material Code: PVS
- Select Size Code: 0305
- Select Label Base Part Number: W7162
- Combine Codes in Specific Order for Complete Part Number: PVS0305W7162

3 1/2" x 5" 5" x 7" D7156	3 1/2" x 5" 5" x 7" D7157	3 1/2" x 5" 5" x 7" W7158
3 1/2" x 5" 5" x 7" W7159	3 1/2" x 5" 5" x 7" W7160	3 1/2" x 5" 5" x 7" W7161
3 1/2" x 5" 5" x 7" W7162	3 1/2" x 5" 5" x 7" W7163	3 1/2" x 5" 5" x 7" W7164

Voltage and Fiber Optic Markers

- Available in Adhesive-backed vinyl and Pre-coiled polyester protects legend with excellent life and adhesion properties
- Indoor/outdoor rated for resistance to UV light, chemical atmosphere, and abrasion
- Black on orange labels provide a highly visible warning for electrical hazards
- Temperature Range: -40° to 250°F

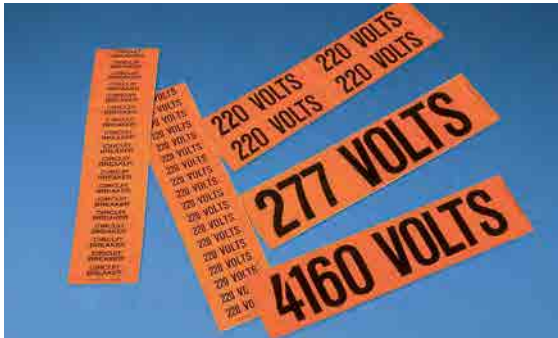

To Order Adhesive-Backed: Add size code after part number. Available sizes AY, BY, CY.

Part No.	Legend
PCV-110	110 VOLTS
PCV-115	115 VOLTS
PCV-120/208	120/208 VOLTS
PCV-120	120 VOLTS
PCV-12470	12470 VOLTS
PCV-13200	13200 VOLTS
PCV-13800	13800 VOLTS
PCV-1PH	SINGLE PHASE
PCV-208	208 VOLTS
PCV-220	220 VOLTS
PCV-2300	2300 VOLTS

Part No.	Legend
PCV-230	230 VOLTS
PCV-2400	2400 VOLTS
PCV-240	240 VOLTS
PCV-277/480	277/480 VOLTS
PCV-277	277 VOLTS
PCV-380	380 VOLTS
PCV-3PH	THREE PHASE
PCV-415	415 VOLTS
PCV-4160	4160 VOLTS
PCV-440	440 VOLTS
PCV-460	460 VOLTS

Part No.	Legend
PCV-480	480 VOLTS
PCV-600	600 VOLTS
PCV-BLANK	BLANK – NO LEGEND
PCV-ES	EMERGENCY SERVICE
PCV-FA	FIRE ALARM
PCV-FO	FIBER OPTIC
PCV-FOC	FIBER OPTIC CABLE
PCV-MAIN	MAIN
PCV-TELE	TELEPHONE

Adhesive-Backed Vinyl Markers

Size Code	Marker Size	Pipe/Conduit O.D. Range	Markers Per Card	Cards/Pkg.	Total Markers
AY	2.25"H x 9"W	3" and Over	1	5	5
BY	1.13"H x 4.5"W	1.25" – 3"	4	5	20
CY	0.5"H x 2.2"W	1.25" – Under	18	5	90

Pre-Coiled Poly Markers

Size Code	Marker Size	Pipe/Conduit O.D. Range	Markers Per Card	Cards/Pkg.	Total Markers
MY	23"H x 14"W	2.25" – 6"	1	1	1
RY	8"H x 8"W	0.75" – 2.25"	1	1	1

How to Order:

- 1 Select Legend Code: PCV-110
- 2 Select Size Code: 2.25"H x 9"W – AY
- 3 Combine Codes in Specific Order for Complete Part Number: PCV-110AY

To Order Pre-Coiled: Add size code after part number. Available sizes MY, RY.

Style M Part No.	Style R Part No.	Legend
–	PCV-120	120 Volts
–	PCV-480	480 Volts
PCV-FO	PCV-FO	Fiber Optic

Voltage Marker Books

- Black on orange labels provide a highly visible warning for electrical hazards
- Indoor rated economical general purpose vinyl
- Excellent adhesion properties when applied to a clean, dry surface
- Temperature Range: -40° to 200°F



Part No.	Legend
PCVB-110Y	110 VOLTS
PCVB-220Y	220 VOLTS
PCVB-277Y	277 VOLTS
PCVB-277/480Y	277/480 VOLTS
PCVB-440Y	440 VOLTS
PCVB-480Y	480 VOLTS
PCVB-4160Y	4160 VOLTS

Marker Size	Markers/ Page	Markers/ Book
1.5"H x 3.25"W	3	30

Safety Marker Books

- Red/Black on white labels provide a highly visible warning for electrical hazards
- Indoor rated economical general purpose vinyl
- Excellent adhesion properties when applied to a clean, dry surface
- Temperature Range: -40° to 200°F

Part No.	Legend
PSSB-13	Danger High Voltage

Marker Size	Markers/ Page	Markers/ Book
1.5"H x 3.25"W	3	30

ISO Warning Symbol Labels

Paper

- Indoor rated general purpose
- Excellent adhesion properties when applied to a clean, dry surface
- Temperature Range: -65° to 200°F



WL1



WL3

Part No.	Description	Size	Labels Per Roll.
WL1	STATIC AWARENESS WARNING	2" x 2"	500
WL3		2" x 2"	500

Vinyl

- Laminated label material protects legend from abrasion and chemicals
- Indoor/outdoor rated for resistance to UV light, chemical atmosphere, and abrasion
- Excellent life and adhesion properties
- Temperature Range: -40° to 176°F

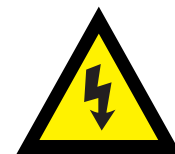

WL33Y

Part No.	Description	Size	Labels Per Roll.
WL32Y	RISK OF ELECTRIC SHOCK symbol	1.5" x 1.5"	50
WL33Y	RISK OF ELECTRIC SHOCK symbol	4.5" x 4.5"	50
WL35Y	RISK OF ELECTRIC SHOCK symbol	2.0" x 2.0"	50
WL36Y	RISK OF ELECTRIC SHOCK symbol	2.0" x 2.0"	50

Electrical Labels in Dispenser

1" x 1.5" PLD-30	1" x 1.5" PLD-36	1" x 1.5" PLD-37	1" x 1.5" PLD-45	1" x 1.5" PLD-52	1" x 1.5" PLD-56
1" x 1.5" PLD-38	1" x 1.5" PLD-46	1" x 1.5" PLD-91	1" x 1.5" PLD-47	1" x 1.5" PLD-74	1" x 1.5" PLD-72
1" x 1.5" PLD-58	1" x 3" PLD-60*	1.5" x 1" PLD-67	1" x 1.5" PLD-43	1" x 1.5" PLD-68	1" x 1.5" PLD-12
<ul style="list-style-type: none"> Laminated polyester label protects legend from abrasion and chemicals Indoor/outdoor rated for resistance to UV light, chemical atmosphere, and abrasion Excellent life and adhesion properties Temperature Range: -40° to 250°F 200* labels/dispenser 					
<p>*PLD-57, 300 labels/dispenser *PLD-60, 100 labels/dispenser *PLD-71, 150 labels/dispenser</p>			 1" x 1.5" PLD-81 .75" dia. PLD-57* 1" x 2" PLD-71*		

Conductor Identification Labels

CE symbol Size: A, B, C, D, E	ES Earth (ground) Size: A, B, C, D, E	L1 Outer conductor Size: A, B, C, D, E	L2 Outer conductor 2 Size: A, B, C, D, E	L3 Outer conductor 2 Size: A, B, C, D, E
LF Lead free symbol Size: A	N Neutral conductor Size: A, B, C, D	PE Protective conductor Size: A	ROHS RoHS wheeled bin symbol Size: A	SS Safety function Size: A, B, C, D

- Pre-printed polyester laminated label protects legend from abrasion and chemicals
- Indoor/outdoor rated for resistance to UV light, chemical atmosphere, and abrasion
- Excellent life and adhesion properties
- Temperature Range: -40° to 250°F
- Package of 10 sheets

Size Code	Label Size Diameter	Labels/Sheet	Pkg. Qty.
A	0.49"	20	200
B	0.63"	20	200
C	0.79"	10	100
D	0.98"	10	100
E	1.24"	10	100

How to Order:

- Material Code: PESS-
- Select Size Code: .49" - A-
- Select Symbol Code: - CE
- Combine Codes in Specific Order for Complete Part Number: PESS-A-CE

Electrical Symbol Labels on Cards

0.5" x 0.5" 0.75" x 0.75" AT Warning of dangerous electrical voltage	0.5" x 0.5" 0.75" x 0.75" E Earth (ground)	0.5" x 0.5" 0.75" x 0.75" EC Safety function
<ul style="list-style-type: none"> Pre-printed black on yellow with adhesive back vinyl cloth Conformable material with repositionable adhesive allows label to be removed and reused or used in temporary applications Indoor/outdoor rated for durability, high temperature resistance, and dimensional stability for rough or textured surfaces Temperature Range: -50° to 170°F Packages of 10 cards 		 0.5" x 0.5" 0.75" x 0.75" HT Static sensitive device - handling precautions required
		 0.5" x 0.5" 0.75" x 0.75" PE Protective conductor

Size Code	Label Size	Labels/Card	Pkg. Qty.
H	0.5" x 0.5"	68	680
J	0.75" x 0.75"	36	360

How to Order:

- Material Code: PESC-
- Select Size Code: 1/2" - H-
- Select Symbol Code: - AT
- Combine Codes in Specific Order for Complete Part Number: PESC-H-AT

Equipment

Signs

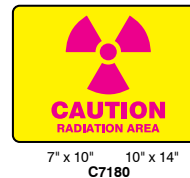

Available Materials

Adhesive Vinyl (Each)
Polyester Laminated Vinyl (Each)
Polyethylene Plastic (Each)
Aluminum (Each)

Codes

PVS
PLVS
PRS
PAS

Available Sizes

7" x 10"
10" x 14"
14" x 10"

Codes

0710
1014
1410

How to Order Signs:

- Select Material Code: PVS
- Select Sign Base Part Number: D7165



- Select Size Code: 0710

- Combine Codes in Specific Order for Complete Part Number: PVS0710D7165

Labels

California Code of Regulations, Title 8, Section 2946, Article 37

Available Materials

Available Materials	Codes	Available Sizes	Codes
Adhesive Vinyl (Pkg. of 5)	PVS	1 1/2" x 3"	0103
Polyester Laminated Vinyl (Each)	PLVS	3 1/2" x 5"	0305
		3" x 7"	0307
		4" x 7"	0407
		5" x 7"	0507

How to Order Labels:

- Select Material Code: **1** PVS
- Select Size Code: **2** 0305
- Select Label Base Part Number: **3** D3304
- Combine Codes in Specific Order for Complete Part Number: **4** PVS0305D3304

Production Control Labels in Dispenser

Shape	Size	Labels/Dispenser
Rectangle	1" x 1.5"	200
Circle	0.75" dia.	300

- Laminated polyester label protects legend from abrasion and chemicals
- Indoor/outdoor rated for resistance to UV light, chemical atmosphere, and abrasion
- Excellent life and adhesion properties
- Temperature Range: -40° to 250°F
- Can be clearly identified with Panduit permanent marking pens

Production Control Labels on Cards

Labels/Card	Total Labels
14	350

- Conformable vinyl cloth with repositionable adhesive allows label to be removed and reused or used in temporary applications
- Indoor/outdoor rated provides durability, high temperature resistance, and dimensional stability for rough or textured surfaces
- Temperature Range: -50° to 170°F
- Package of 25 cards
- Can be clearly identified with Panduit permanent marking pens

Fire & Emergency

Signs



7" x 10" 10" x 14"
B7182



7" x 10" 10" x 14"
B7183



7" x 10" 10" x 14"
B7184



7" x 10" 10" x 14"
B7185



7" x 10" 10" x 14"
B7186

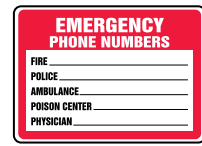

7" x 10" 10" x 14"
B7199



7" x 10" 10" x 14"
B7200



10" x 7" 14" x 10"
B7209



7" x 10" 10" x 14"
B7201



7" x 10" 10" x 14"
B7203



7" x 10" 10" x 14"
B7204



7" x 10" 10" x 14"
B7206



7" x 10" 10" x 14"
B7187



7" x 10" 10" x 14"
B7192



10" x 7" 14" x 10"
B7194



10" x 7" 14" x 10"
B7196



10" x 7" 14" x 10"
B7193



10" x 7" 14" x 10"
B7208



14" x 10"
B4519



7" x 10" 10" x 14"
B7195



7" x 10" 10" x 14"
B7205



7" x 10" 10" x 14"
B7188



10" x 7" 14" x 10"
B7191



7" x 10" 10" x 14"
B7189



18" x 4"
B4585



12" x 4"
18" x 4"
24" x 4"
B7202



18" x 4"
B4581



18" x 4"
B4935



12" x 4"
18" x 4"
24" x 4"
B7210



18" x 4"
B7211

Column Markers



Adhesive Vinyl (12" x 24") PVS1224B3437
Glow Adhesive (12" x 24") PVS1224B3505

Material	UOM
Adhesive Vinyl	Each
Glow Adhesive	Each

Available Materials

Adhesive Vinyl (Each)
Polyester Laminated Vinyl (Each)
Polyethylene Plastic (Each)
Aluminum (Each)

Codes

PVS
PLVS
PRS
PAS

Available Sizes

7" x 10"
10" x 7"
10" x 14"
14" x 10"
12" x 4"
18" x 4"
24" x 4"

Codes

0710
1007
1014
1410
1204
1804
2404

How to Order Signs:

- Select Material Code: PVS
- Select Size Code: 0710
- Select Sign Base Part Number: B7182



- Combine Codes in Specific Order for Complete Part Number: PVS0710B7182

Labels

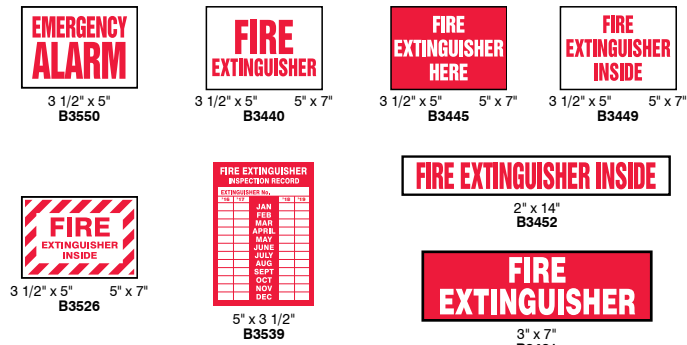

Available Materials
Adhesive Vinyl (Pkg. of 5)
Polyester Laminated Vinyl (Each)

Codes
PVS
PLVS

Available Sizes
3 1/2" x 5"
5" x 3 1/2"
3" x 7"
5" x 7"
2" x 14"

Codes
0305
0503
0307
0507
0214

How to Order Labels:

- Select Material Code: PVS
- Select Size Code: 0305
- Select Label Base Part Number: B3550
- Combine Codes in Specific Order for Complete Part Number: PVS0305B3550

First Aid

Signs

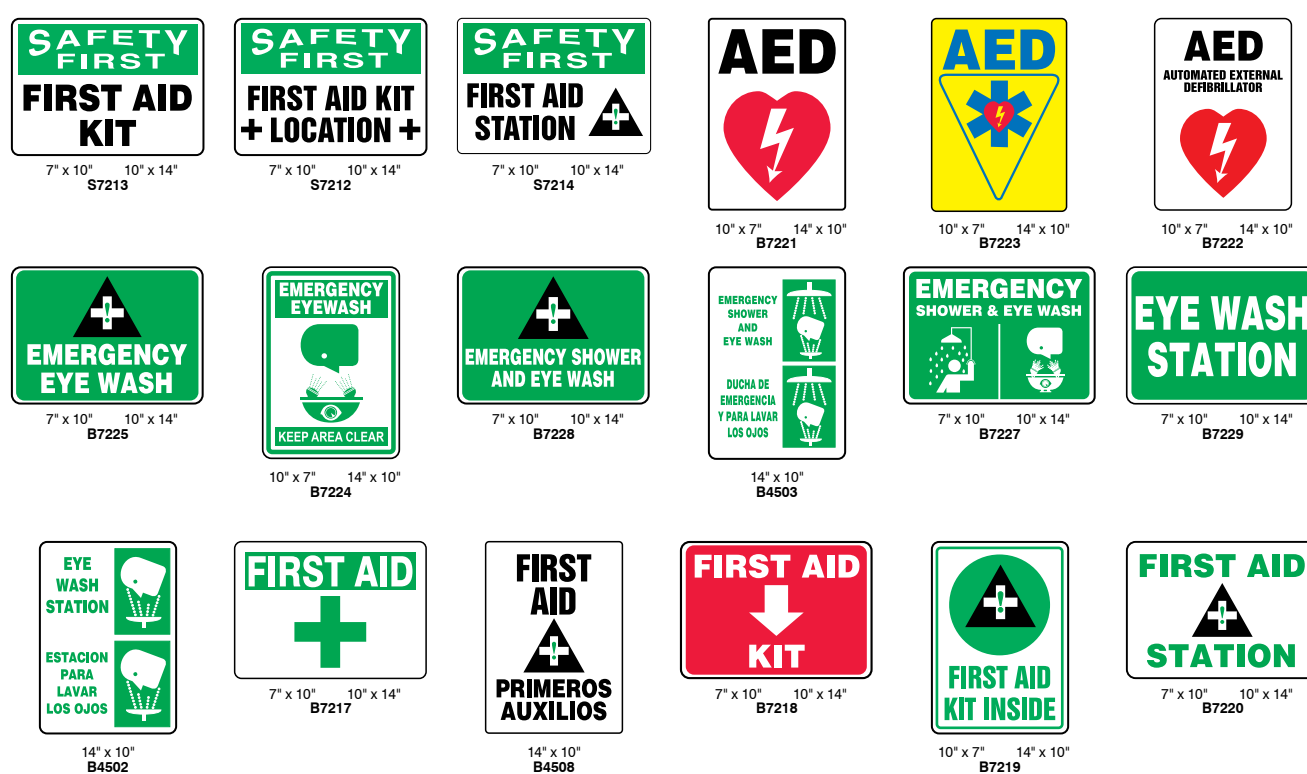

See How to Order Signs on next page ▶

Labels

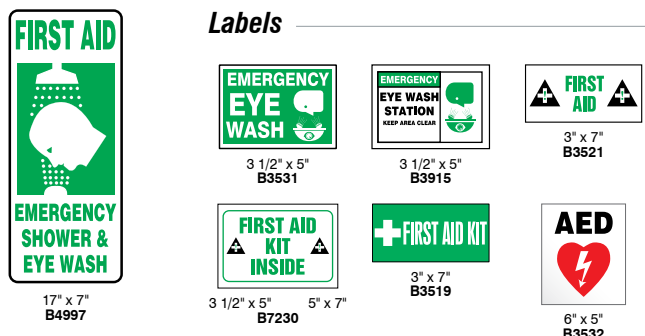

Available Materials
Adhesive Vinyl (Pkg. of 5)
Polyester Laminated Vinyl (Each)

Codes
PVS
PLVS

Available Sizes
3 1/2" x 5"
3" x 7"
6" x 5"
5" x 7"

Codes
0305
0307
0605
0507

How to Order Labels:

- Select Material Code: PVS
- Select Size Code: 0305
- Select Label Base Part Number: B3531
- Combine Codes in Specific Order for Complete Part Number: PVS0305B3531

Housekeeping & Hygiene

Signs – Adhesive Vinyl (PVS) and Polyethylene Plastic (PRS)

 7" x 10" 10" x 14" C7231	 7" x 10" 10" x 14" C7232	 7" x 10" 10" x 14" C7233	 14" x 10" C4643	 7" x 10" 10" x 14" C7234	 7" x 10" 10" x 14" C7235
 7" x 10" 10" x 14" C7236	 7" x 10" 10" x 14" C7237	 14" x 10" C4663	 7" x 10" 10" x 14" N7264	 7" x 10" 10" x 14" N7265	 7" x 10" 10" x 14" N7266
 7" x 10" 10" x 14" N7238	 14" x 10" N4804	 7" x 10" 10" x 14" N7242	 7" x 10" 10" x 14" N7243	 14" x 10" N4814	 7" x 10" 10" x 14" S7239
 7" x 10" 10" x 14" B7240	 7" x 10" 10" x 14" B7241	 7" x 10" 10" x 14" B7267	 7" x 10" 10" x 14" B7268	 14" x 10" B4944	 7" x 10" 10" x 14" B7269
 14" x 10" B4974	 7" x 10" 10" x 14" B7245	 14" x 10" B4586	 7" x 10" 10" x 14" B7244	 7" x 10" 10" x 14" B7271	 7" x 10" 10" x 14" B7270

Available Materials	Codes	Available Sizes	Codes
Adhesive Vinyl (Each)	PVS	7" x 10"	0710
Polyester Laminated Vinyl (Each)	PLVS	10" x 7"	1007
Polyethylene Plastic (Each)	PRS	10" x 14"	1014
Aluminum (Each)	PAS	14" x 10"	1410
		17" x 7"	1707

How to Order Signs:

- Select Material Code:
PVS
- Select Size Code:
0710
- Select Sign Base Part Number:
S7213
- Combine Codes in Specific Order for Complete Part Number: PVS0710S7213



Signs – Adhesive Vinyl (PVS) and Polyethylene Plastic (PRS) continued

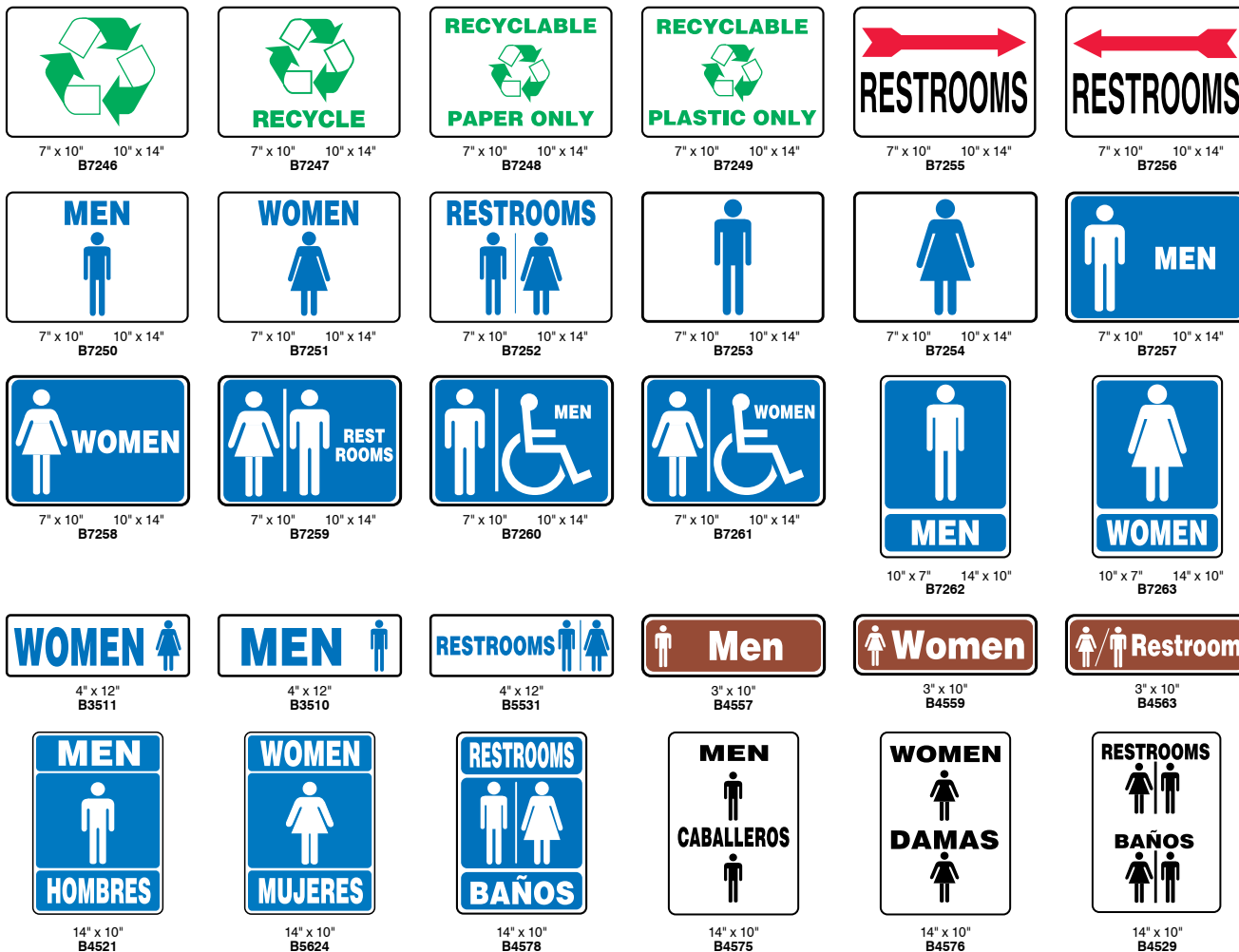

See How to Order Signs on next page ▶

Labels – Adhesive Vinyl (PVS)

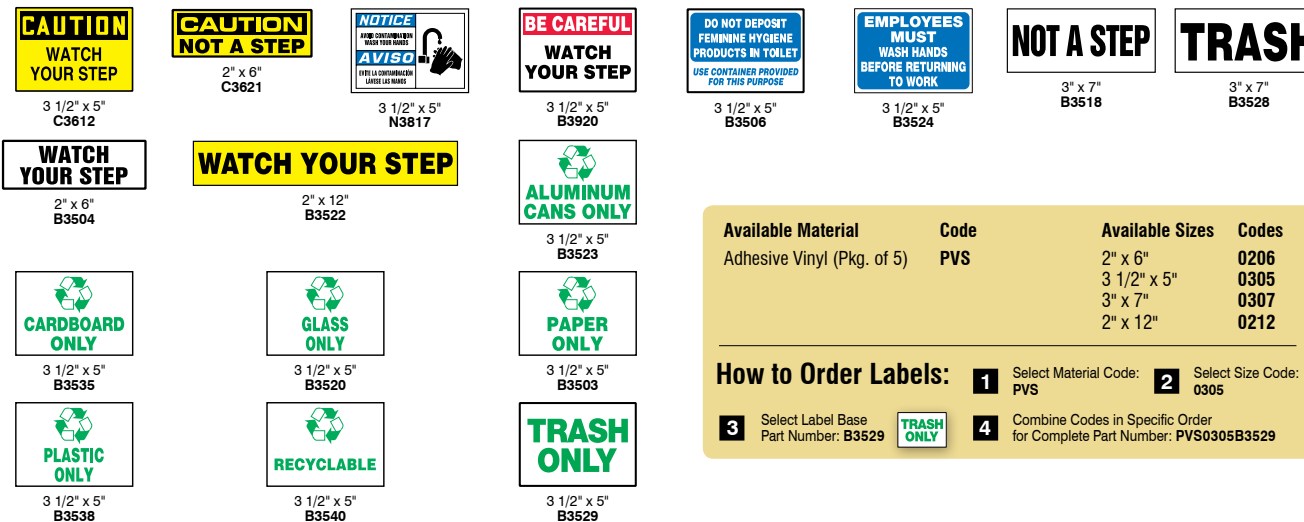

Available Material	Code	Available Sizes	Codes
Adhesive Vinyl (Pkg. of 5)	PVS	2" x 6"	0206
		3 1/2" x 5"	0305
		3" x 7"	0307
		2" x 12"	0212

- How to Order Labels:**
- Select Material Code: PVS
 - Select Size Code: 0305
 - Select Label Base Part Number: B3529
 - Combine Codes in Specific Order for Complete Part Number: PVS0305B3529

Personal Protection

Signs



7" x 10" 10" x 14"
D7272



14" x 10"
D4106



7" x 10" 10" x 14"
D7273



7" x 10" 10" x 14"
D7274



7" x 10" 10" x 14"
D7275



7" x 10" 10" x 14"
D7276



7" x 10" 10" x 14"
D7277



7" x 10" 10" x 14"
C7278



14" x 10"
C4683



7" x 10" 10" x 14"
C7279



7" x 10" 10" x 14"
C7280



14" x 10"
C4627



7" x 10" 10" x 14"
C7281



7" x 10" 10" x 14"
C7282



7" x 10" 10" x 14"
C7283



7" x 10" 10" x 14"
C7284



14" x 10"
C4756



7" x 10" 10" x 14"
N7285



7" x 10" 10" x 14"
N7286



7" x 10" 10" x 14"
N7287

Available Materials

Adhesive Vinyl (Each)
Polyester Laminated Vinyl (Each)
Polyethylene Plastic (Each)
Aluminum (Each)

Codes

PVS
PLVS
PRS
PAS

Available Sizes

3" x 10"
4" x 12"
7" x 10"
10" x 7"
10" x 14"
14" x 10"

Codes

0310
0412
0710
1007
1014
1410

How to Order Signs:

- Select Material Code: PVS
- Select Size Code: 0710
- Select Sign Base Part Number: B7246
- Combine Codes in Specific Order for Complete Part Number: PVS0710B7246



Labels



3 1/2" x 5"
D3307



3 1/2" x 5"
D3298



3 1/2" x 5"
C3617



3 1/2" x 5"
C3618



3 1/2" x 5"
C3623

Available Materials

Adhesive Vinyl (Pkg. of 5)
Polyester Laminated Vinyl (Each)

Codes

PVS
PLVS

Available Size

3 1/2" x 5"

Code

0305

How to Order Labels:

- Select Material Code: PVS
- Select Size Code: 0305
- Select Label Base Part Number: D3298
- Combine Codes in Specific Order for Complete Part Number: PVS0305D3298



Hard Hat Labels / Helmet Decals

Display your skill or commitment to safety in a personal way.
Adhesive vinyl 2.25" dia. Labels are flexible to conform to the curve of a hard hat. Package of 10.

Standard

 PHL3381	 PHL3343	 PHL3361	 PHL3345	 PHL3125	 PHL3354	 PHL3347	 PHL3355	 PHL3351
 PHL3358	 PHL3165	 PHL3163	 PHL3365	 PHL3188	 PHL3315	 PHL3317	 PHL3204	 PHL3359
 PHL3357	 PHL3126	 PHL3132	 PHL3323	Reflective (Each)				
				 PHL3619	 PHL3632	 PHL3649		

Flag Helmet Stickers

















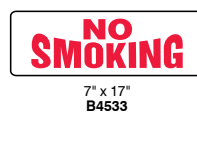

Show personal country pride.
Adhesive vinyl label has permanent adhesive back with peel-off liner.

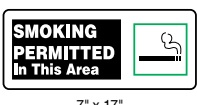

USA Part No.	Canada Part No.	Mexico Part No.	Size	Std. Pkg. Qty.
PHL3377	PHL3402	PHL3386	1" x 1 3/4"	10
PHL3212	PHL3404	PHL3388	1 1/2" x 3"	10

Smoking Control

Signs

 7" x 10" 10" x 14" N7296	 7" x 10" 10" x 14" B7292	 7" x 10" 10" x 14" B7293	 7" x 10" 10" x 14" B7288	 7" x 10" 10" x 14" B7289	 7" x 10" 10" x 14" B7290		
 7" x 10" 10" x 14" B7295	 10" x 7" 14" x 10" B7294	 7" x 10" 10" x 14" B7300	 7" x 17" B4533	 7" x 17" B4501	 4" x 12" B4531		
 7" x 17" B4526	 7" x 5" 10" x 7" B7291	 7" x 5" 10" x 7" B7297	 7" x 5" 10" x 7" B7298	 7" x 5" 10" x 7" B7301	 7" x 5" 10" x 7" B7302	 7" x 5" 10" x 7" B7299	 7" x 5" 10" x 7" B7303

See [How to Order Signs](#) on next page ▶

Labels



3" x 7"
B3589



1 1/2" x 3"
B3515



1 1/2" x 3"
B3514



1 1/2" x 1 1/2" 4" x 4"
B7304

Available Materials

Adhesive Vinyl (Pkg. of 5)
Polyester Laminated Vinyl (Each)

Codes

PVS
PLVS

Available Sizes

1 1/2" x 1 1/2"
1 1/2" x 3"
4" x 4"
3" x 7"

Codes

0101
0103
0404
0307

How to Order Labels:

- Select Material Code: PVS
- Select Size Code: 0101
- Select Label Base Part Number: B7304
- Combine Codes in Specific Order for Complete Part Number: PLVS0101B7304



Traffic Industrial

Signs



7" x 10" 10" x 14"
D7321



7" x 10" 10" x 14"
W7305



7" x 10" 10" x 14"
C7322



7" x 10" 10" x 14"
C7307



14" x 10"
C5662



7" x 10" 10" x 14"
C7308



7" x 10" 10" x 14"
C7309



7" x 10" 10" x 14"
C7310



7" x 10" 10" x 14"
C7311



7" x 10" 10" x 14"
C7312



7" x 10" 10" x 14"
C7313



7" x 10" 10" x 14"
C7314



14" x 10"
C4604



14" x 10"
C4601



7" x 10" 10" x 14"
C7315



7" x 10" 10" x 14"
C7306



14" x 10"
N4816



7" x 10" 10" x 14"
N7316



7" x 10" 10" x 14"
N7317



7" x 10" 10" x 14"
N7318



7" x 10" 10" x 14"
N7319



7" x 10" 10" x 14"
N7320

Available Materials

Adhesive Vinyl (Each)
Polyester Laminated Vinyl (Each)
Polyethylene Plastic (Each)
Aluminum (Each)

Codes

PVS
PLVS
PRS
PAS

Available Sizes

4" x 12"
7" x 5"
7" x 10"
10" x 7"
10" x 14"
14" x 10"
7" x 17"

Codes

0412
0705
0710
1007
1014
1410
0717

How to Order Signs:

- Select Material Code: PVS
- Select Size Code: 0710
- Select Sign Base Part Number: B7288
- Combine Codes in Specific Order for Complete Part Number: PVS0710B7288



Labels



3 1/2" x 5"
C3613



3 1/2" x 5"
B3576



3 1/2" x 5"
B3571



3 1/2" x 5"
B3562



3 1/2" x 5"
B3527



3 1/2" x 5"
B3525

Available Materials
Adhesive Vinyl (Pkg. of 5)
Polyester Laminated Vinyl (Each)

Codes	Available Size	Code
PVS	3 1/2" x 5"	0305
PLVS		

How to Order Labels:

- Select Material Code: PVS
- Select Size Code: 0305
- Select Label Base Part Number: B3562
- Combine Codes in Specific Order for Complete Part Number: PVS0305B3562

Labels – Polyester Laminated Vinyl (PLVS)



2" x 5"
B3557



2" x 5"
B3559



2" x 5"
B3545



2" x 5"
B3549



2" x 5"
B3543



2" x 5"
B3567



2" x 5"
B3565



2" x 5"
B3569

Available Material
Polyester Laminated Vinyl (Each)

Code	Available Size	Code
PLVS	2" x 5"	0205

How to Order Labels:

- Select Material Code: PLVS
- Select Size Code: 0205
- Select Label Base Part Number: B3545
- Combine Codes in Specific Order for Complete Part Number: PLVS0205B3545

Fluorescent Alert Signs

Bright, attention-getting signs for cross traffic areas.

- Highly visible fluorescent red-orange or lime-yellow
- Durable 0.060" plastic
- Pre-drilled mounting holes
- For indoor use only



24" x 18"
PSSFB4055



24" x 18"
PSSFB4059



24" x 18"
PSSFB4057



18" x 12"
PSSFC4038



18" x 12"
PSSFC4040



18" x 12"
PSSFC4034



18" x 12"
PSSFC4036



Vinyl Cloth Letters and Numbers Markers

- Contrasting colors for easy visibility
- Thin conformable material with repositionable adhesive allows label to be removed and reused
- Indoor/outdoor rated provides durability, high temperature resistance and dimensional stability for rough or textured surfaces
- Black on yellow characters
- Temperature Range: -50° to 170°F



Individual Letter and Number Markers

Part No.	Character Height	Marker Size	Markers/Card	Cards/Pkg.
PCL037-*	0.38"	0.50"H x 0.34"W	78	25
PCL062-*	0.63"	0.75"H x 0.56"W	32	25
PCL100-*	1"	1.5"H x 0.88"W	10	25
PCL200-*	2"	2.25"H x 0.88"W	10	25
PCL300-*	3"	3.5"H x 1.5"W	6	25

How to Order:

- 1 Refer to Part Number (No.): 0.38" – PCL037-*
- 2 Specify Character Legend A thru Z, 0 thru 9, – (dash) for Asterisk (*): PCL037-A

Vinyl Letter and Number Markers

- Indoor/outdoor rated conformable heavy duty adhesive back vinyl for flat applications
- Resistant to UV light, chemical atmosphere and abrasion
- Black on yellow characters for visible safety and facility identification
- Temperature Range: -50° to 225°F



Part No.	Character Height	Label Size	Markers/Card	Cards/Pkg.	Total Markers
PVL100BY-*Y	1"	1.5"H x 0.88"W	10	25	250
PVL200BY-*Y	2"	2.25"H x 0.88"W	10	25	250

How to Order:

- 1 Refer to Part Number (No.): 1" – PVL100BY-*Y
- 2 Specify Character Legend A thru Z, 0 thru 9, – (dash) for Asterisk (*): PVL100BY-A-Y

Consecutive Number Marker Sets

Part No.	Series	Character Height	Marker Size	Markers/Card	Cards/Pkg.
PCL037-0-9	0 thru 9	0.38"	0.50"H x 0.34"W	78	25
PCLCP037-0-9	0 thru 9	0.38"	0.50"H x 0.34"W	78	1
PCL062-0-9	0 thru 9	0.63"	0.75"H x 0.56"W	32	25
PCLCP062-0-9	0 thru 9	0.63"	0.75"H x 0.56"W	32	1
PCL100-0-9	0 thru 9	1"	1.5"H x 0.88"W	10	25
PCLCP100-0-9	0 thru 9	1"	1.5"H x 0.88"W	10	1
PCL200-0-9	0 thru 9	2"	2.25"H x 0.88"W	10	25
PCLCP200-0-9	0 thru 9	2"	2.25"H x 0.88"W	10	1
PCLCP300-0-9	0 thru 9	3"	3.5"H x 1.5"W	6	1

Consecutive Letter Marker Sets

Part No.	Series	Character Height	Marker Size	Markers/Card	Cards/Pkg.
PCL037-A-Z	A thru Z	0.38"	0.50"H x 0.34"W	78	25
PCLCP037-A-Z	A thru Z	0.38"	0.50"H x 0.34"W	78	1
PCL062-A-Z	A thru Z	0.63"	0.75"H x 0.56"W	32	25
PCLCP062-A-Z	A thru Z	0.63"	0.75"H x 0.56"W	32	1
PCL100-A-J	A thru J	1"	1.5"H x 0.88"W	10	25
PCL100-K-T	K thru T	1"	1.5"H x 0.88"W	10	25
PCL100-U-Z	U thru Z	1"	1.5"H x 0.88"W	10	25
PCLCP100-A-Z	A thru Z	1"	1.5"H x 0.88"W	10	1
PCL200-A-J	A thru J	2"	2.25"H x 0.88"W	10	25
PCL200-K-T	K thru T	2"	2.25"H x 0.88"W	10	25
PCL200-U-Z	U thru Z	2"	2.25"H x 0.88"W	10	25
PCLCP200-A-Z	A thru Z	2"	2.25"H x 0.88"W	10	1
PCLCP300-A-Z	A thru Z	3"	3.5"H x 1.5"W	6	1

Reflective Vinyl Letters and Numbers Markers

- Contrasting black and yellow visibility
- Heavy-duty reflective vinyl with adhesive back flat applications for safety and facility identification
- Indoor/outdoor rated for resistance to UV light, chemical atmosphere, and abrasion
- Temperature Range: -30° to 200°F



Individual Letter and Number Markers

Part No.	Character Height	Marker Size	Color Character on Background	Markers/Card
PRL100BY-*	1"	1.63"H x 1"W	Black on Yellow	25
PRL150BY-*	1.50"	1.88"H x 1.38"W	Yellow on Black	25
PRL250BY-*	2.50"	2.88"H x 1.75"W	Yellow on Black	25

How to Order:

- 1 Refer to Part Number (No.): 1" – PRL100BY-*
- 2 Specify Character Legend A thru Z, 0 thru 9, – (dash) for Asterisk (*): PRL100BY-A

Consecutive Letter and Number Marker Sets

Part No.	Series	Character Height	Marker Size	Color Character on Background	Markers/Card
PRL100BY-18KIT	0 thru 9, A thru D, L, P, R, S	1"	1.63"H x 1"W	Black on Yellow	900
PRL100BY-36KIT	0 thru 9, A thru Z	1"	1.63"H x 1"W	Black on Yellow	950

ANSI ISO Safety Signs

<p>10" x 14" D4107</p>	<p>10" x 14" D4105</p>	<p>10" x 14" D5107</p>	<p>10" x 14" D5113</p>	<p>10" x 14" D4104</p>	<p>10" x 14" D4108</p>
<p>10" x 14" D4009</p>	<p>10" x 14" D4081</p>	<p>10" x 14" D4113</p>	<p>10" x 14" W4303</p>	<p>10" x 14" W4307</p>	<p>10" x 14" W4308</p>
<p>10" x 14" W4312</p>	<p>10" x 14" W4305</p>	<p>10" x 14" C4647</p>	<p>10" x 14" C4644</p>	<p>10" x 14" C4603</p>	<p>10" x 14" C5643</p>
<p>10" x 14" N4809</p>	<p>10" x 14" N4805</p>	<p>10" x 14" N4825</p>	<p>10" x 14" B4913</p>	<p>10" x 14" B7226</p>	<p>10" x 14" B4509</p>

Available Materials

Adhesive Vinyl (Each)
Polyester Laminated Vinyl (Each)
Polyethylene Plastic (Each)
Aluminum (Each)

Codes

PVS
PLVS
PRS
PAS

Available Size

10" x 14"

Code

1014

How to Order Signs:

- Select Material Code: PVS
- Select Size Code: 1014
- Select Sign Base Part Number: D4107
- Combine Codes in Specific Order for Complete Part Number: PVS1014D4107



ISO Warning Symbols

Use internationally recognized symbols to warn and identify of hazards

- International Organization for Standardization (ISO) labels communicate safety without words
- Warning-shaped triangles with symbols to communicate hazard message
- Made of self-adhesive vinyl with durable overlamine

Part Number	Label Width In. (mm)	Marker Qty.	Std. Pkg. Qty.
PESW-A*	0.50 (13.0)	10/card	10 cards
PESW-AA-11Y	0.30 (7.6)	80/card	10 cards
PESW-B*	1.00 (25.4)	10/card	10 cards
PESW-C*	1.97 (50.0)	10/card	10 cards
PESW-D*	3.90 (99.1)	3/card	10 cards
PLVS0202*	2	1/card	10 cards
PLVS0404*	4	1/card	5 cards

<p>PESW-*-1Y Caution - Risk of Electric Shock</p>	<p>PESW-*-6Y Caution - Risk of Ionizing Radiation</p>	<p>PESW-*-8Y Caution - Laser Beam</p>	<p>PESW-*-9Y Caution - General Warning, Risk of Danger</p>
<p>PESW-*-11Y Warning of Static Sensitive Device</p>	<p>PESW-AA-11Y Warning of Static Sensitive Device</p>	<p>W3152 Crush Hazard</p>	<p>W3153 Pinch Point Hazard</p>
<p>W3154 Belt Drive Entanglement Hazard</p>	<p>W3156 Gear Entanglement Hazard</p>	<p>W3158 Cut or Sever Hazard</p>	<p>W3198 Heated/Hot Surface Hazard</p>

Glow Clear-Shield Signs



Contemporary Clear-Shield signs look good in regular light and perform in the dark.

- Architectural-style signs for the office as well as industrial environments
- Printed on photoluminescent film
- Can be seen when power goes out
- Sub-surface protected from top wear
- Mounts with double-sided adhesive foam tape (included)



Glow Signs



Severe Weather Signs



Exit & Emergency Signs



Fire Signs

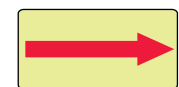

Available Materials	Codes	Available Sizes	Codes	Available Sizes	Codes
Glow Adhesive (Each)	PVSG	7" x 10"	0710	14" x 10"	1410
Glow Plastic (Each)	PRSG	7" x 14"	0714	12" x 4"	1204
		10" x 7"	1007	18" x 4"	1804
		10" x 14"	1014	24" x 4"	2404

How to Order Signs:

- Select Material Code: PVSG
- Select Size Code: 0714
- Select Label Sign Part Number: B4515
- Combine Codes in Specific Order for Complete Part Number: PVSG0714B4515

Projecting Signs

When you need identification, location and direction, signs can be seen from various angles for extra visibility.

Hang signs along hallways, stairways, corridors, and doorways. Projecting Signs are 0.100" thick high-impact plastic with images on the two panels that are covered by a UV protective coating. Flanged edges have pre-drilled mounting holes. Wall mount with screws or self-adhesive foam tape (both included).

3D Signs

Project 45° from the wall, provide optimum viewing from the front and sides



90D Signs

Project 90° from the wall, are viewed from either side



3D - 8" x 12" Panel
PSS3P4034
90D - 8" x 12" Panel
PSS9P4034

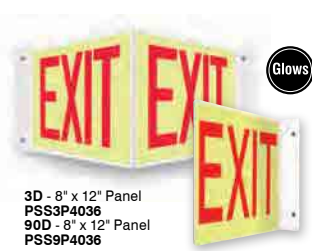

3D - 8" x 12" Panel
PSS3P4036
90D - 8" x 12" Panel
PSS9P4036

Glow



3D - 6" x 5" Panel
PSS3P4021
90D - 8" x 8" Panel
PSS9P4021



3D - 6" x 5" Panel
PSS3P4019
90D - 8" x 8" Panel
PSS9P4019



3D - 18" x 4" Panel
90D - 18" x 4" Panel
PSS3P4029
PSS9P4029



3D - 6" x 5" Panel
PSS3P4049
90D - 8" x 8" Panel
PSS9P4049

Glow



3D - 12" x 9" Panel
PSS3P4392
90D - 12" x 9" Panel
PSS9P4392



3D - 6" x 5" Panel
PSS3P4014
90D - 8" x 8" Panel
PSS9P4014

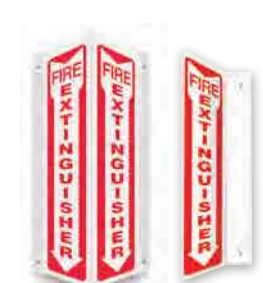

3D - 18" x 4" Panel
90D - 18" x 4" Panel
PSS3P4016M
PSS9P4016M



3D - 24" x 4" Panel
90D - 24" x 4" Panel
PSS3P4026
PSS9P4026

Glow



3D - 6" x 5" Panel
PSS3P4006
90D - 8" x 8" Panel
PSS9P4006

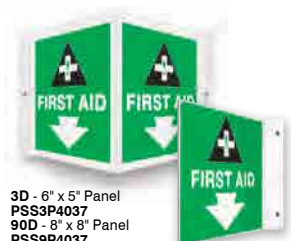

3D - 6" x 5" Panel
PSS3P4037
90D - 8" x 8" Panel
PSS9P4037



3D - 18" x 4" Panel PSS3P4069
90D - 18" x 4" Panel PSS9P4069



3D - 6" x 5" Panel PSS3P4008
90D - 8" x 8" Panel PSS9P4008



3D - 6" x 5" Panel PSS3P4062
90D - 8" x 8" Panel PSS9P4062



3D - 12" x 9" Panel PSS3P4658
90D - 12" x 9" Panel PSS9P4658



3D - 6" x 5" Panel PSS3P4011
90D - 8" x 8" Panel PSS9P4011

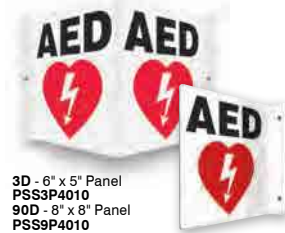

3D - 6" x 5" Panel PSS3P4010
90D - 8" x 8" Panel PSS9P4010



3D - 6" x 5" Panel PSS3P4002
90D - 8" x 8" Panel PSS9P4002



3D - 18" x 4" Panel PSS3P4070
90D - 18" x 4" Panel PSS9P4070



3D - 6" x 5" Panel PSS3P4042
90D - 8" x 8" Panel PSS9P4042



3D - 6" x 5" Panel PSS3P4053
90D - 8" x 8" Panel PSS9P4053



3D - 6" x 5" Panel PSS3P4047
90D - 8" x 8" Panel PSS9P4047



3D - 6" x 5" Panel PSS3P4055
90D - 8" x 8" Panel PSS9P4055



3D - 12" x 9" Panel PSS3P4443
90D - 12" x 9" Panel PSS9P4443



3D - 12" x 9" Panel PSS3P4444
90D - 12" x 9" Panel PSS9P4444



3D - 8" x 12" Panel PSS3P4087
90D - 8" x 8" Panel PSS9P4087



3D - 8" x 12" Panel PSS3P4071
90D - 8" x 12" Panel PSS9P4071
*SDS - Safety Data Sheets



3D - 8" x 12" Panel PSS3P4058
90D - 8" x 12" Panel PSS9P4058



3D - 6" x 5" Panel PSS3P4081
90D - 8" x 8" Panel PSS9P4081

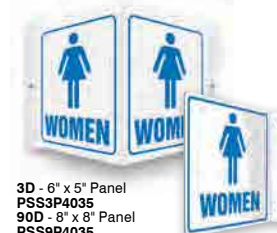

3D - 6" x 5" Panel PSS3P4035
90D - 8" x 8" Panel PSS9P4035

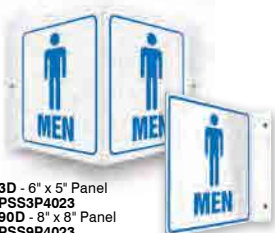

3D - 6" x 5" Panel PSS3P4023
90D - 8" x 8" Panel PSS9P4023

Panel Size	3D Projection Overall Size	90D Projection Overall Size
6" x 5"	6" x 8 1/2" x 4"	—
8" x 8"	—	8" x 8" x 1 1/2"
8" x 12"	8" x 18" x 9"	8" x 12" x 1 1/2"

Panel Size	3D Projection Overall Size	90D Projection Overall Size
18" x 4"	18" x 7 1/2" x 3"	18" x 4" x 1 1/2"
12" x 9"	12" x 14" x 7"	12" x 9" x 1 1/2"
24" x 4"	24" x 7 1/2" x 3"	24" x 4" x 1 1/2"

Sign Panels – Blank Space for Custom Messages

Sub-Surface Printed Adhesive Polyester (Type PPS):

- High quality signs for use indoors and outdoors
- Excellent resistance to UV light, chemical atmosphere and abrasion
- Excellent life and adhesion properties
- Printed graphics are protected by clear polyester laminate
- Temperature Range: -40° to 275°F

Rigid Polyethylene (Type PRS):

- Rugged signs for indoors and outdoors
- Abrasion resistant
- Used where adhesives will not work
- Can be used with Panduit Thermal Transfer Desktop Printers and Easy-Mark™ Labeling Software to create your own custom signs
- Print your own legend on clear polyester tape with the TDP43ME Thermal Transfer Desktop Printer and adhere label to adhesive or non-adhesive sign panel
- Can also be used with Panduit Die Cut Letter and Numbers
- Temperature Range: -105° to 250°F

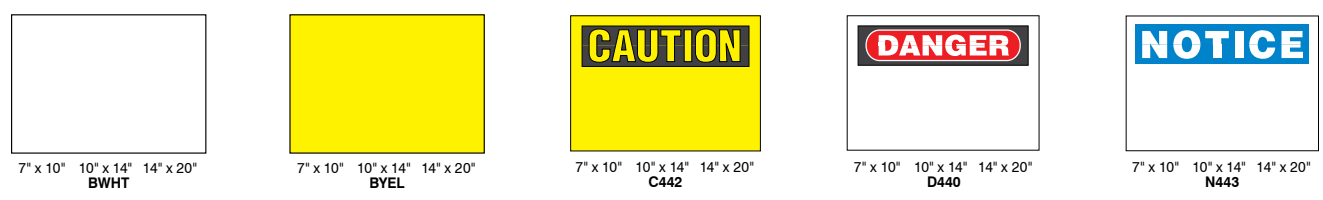

Available Materials	Codes	Available Sizes	Codes
Printed Adhesive Polyester (Each)	PPS	7" x 10"	0710
Rigid Polyethylene (Each)	PRS	10" x 14"	1014
		14" x 20"	1420

How to Order Signs:

- Select Material Code: PPS
- Select Size Code: 0710
- Select Sign Base Part Number: D440
- Combine Codes in Specific Order for Complete Part Number: PPS0710D440

Laser Printable Adhesive Signs

- Signs can be printed with a standard laser printer
- Indoor polyolefin pressure sensitive signs with square corners on stay-flat liner
- 25 signs per package

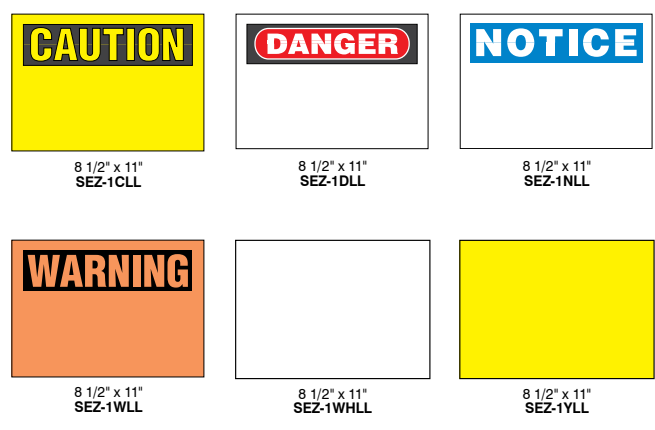

Self-Laminating Adhesive Sign Carriers

- Indoor/outdoor rated for resistance to UV light, chemical atmosphere and abrasion
- Excellent for applications where adhesives will not work
- Temperature Range: -40° to 150°F
- 5 carriers/pkg.

Part No.	Size
Adhesive	
SEZ-SNC1	6"H x 7"W
SEZ-SNC2	7"H x 10.5"W
SEZ-SNC3	6"H x 12"W
SEZ-SNC4	9.5"H x 12"W
Non-Adhesive	
SEZ-RSC1	6"H x 7"W
SEZ-RSC2	7"H x 10.5"W
SEZ-RSC3	9.5"H x 12"W
SEZ-RSC4	6"H x 12"W



Safety Tags

Our selection of safety tags is just as diverse as your workplace.

- Prevent the potential for accidental injury and property damage
- Alert, call out or draw attention to temporary hazards
- Required critical tool in safety, performance and maintenance operations

We Have What You Need

Look to us for the tags that you need! In addition to standard OSHA safety tags, our comprehensive selection of safety tags incorporates key categories like Lockout/Tagout, Equipment Status and Record Inspection.

Safety Tags Identify Temporary Hazards

Safety Tags...

- Call out attention to hazards
- Prevent the potential for accidental injury or property damage
- Identify and inform that a hazardous condition exists

Attach and hang the tags as close as possible to the hazard situation where the tag can be readily seen. Tags are to remain in-place until the hazard is eliminated or the hazardous operation is complete.

The Occupational Safety and Health Administration (OSHA 29 CFR §1910.145) and American National Standards Institute (ANSI Z535) provide specifications, designs, applications, and uses of accident prevention tags. Tags can be printed in a variety of colors and messages to meet your needs. They are typically designed with an attention-getting signal word for a degree of hazard along with a specific message and areas to write in particular information.

Safety tags are an inexpensive, fast solution for temporary marking and identification of hazards.

Note: A tag shall not be used in place of a permanent sign or label for hazards in normal use, operation or maintenance.

Choose the Right Tag Material

Select a material based on your application requirements to ensure your message is conveyed clearly and effectively.

Poly Cardstock (PCT)

Pulp-free tags have no wood pulp or paper content, unlike standard cardstock tags, and are available at an economical price.

Material Features

- Thin, pliable 0.010" poly-based tags will not crack, distort, or shrink
- Waterproof and tear-resistant from incidental pulls and snags
- Can be printed on both sides
- Scuff-resistant matte surface is easy to write on with pen or marker
- 3/8" non-reinforced hole

Applications

- Indoor usage
- Non-reinforceable hole



Rigid Plastic (PVT)

High-strength rigid plastic tag is ideal for use in tough industrial environments – resists chemicals, tears, and abrasions.

Material Features

- 0.015" thick rigid plastic tags are relatively bendable
- Matte surface is easy to write on with pen or marker
- Can be printed on both sides
- 3/8" hole, reinforced by a pull-proof metal grommet
- Includes cable ties

Applications

- Indoor and temporary outdoor usage
- Chemical and dirty/greasy environments



Laminate Plastic (PCTL)

Nearly indestructible tag is made to withstand tough, abusive conditions.

Material Features

- 0.010" cardstock tag sealed by a thick, 0.007" laminate on both sides – right to the edges – to protect the printed image
- Tear-proof, weatherproof and chemical-resistant
- Durable to withstand dirt, grease, liquid splashes and rough handling
- Scratch-resistant matte-finish laminate surface is easy to write on with pen or marker
- 3/8" hole, reinforced by a pull-proof metal grommet
- Available in Lockout Tags
- Includes cable ties

Applications

- Indoor and outdoor usage - when the most durable tags are required
- Chemical applications and tough industrial settings



Self-Laminating Tags (PST)

Protect written messages and photos when your life is on the line.

- Write information and insert a photo (where applicable), then laminate your own tag
- Protection from moisture, chemicals and dirt
- Prevents tampering with the information
- Dual self-laminating polyester flaps pre-attached at the top
- 3/8" hole, reinforced by a pull-proof metal grommet
- Includes cable ties



Standard Safety Tags

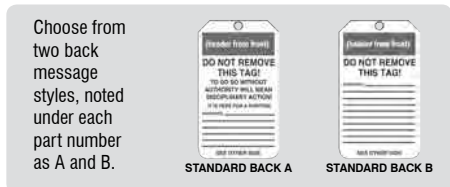
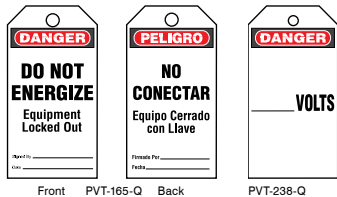
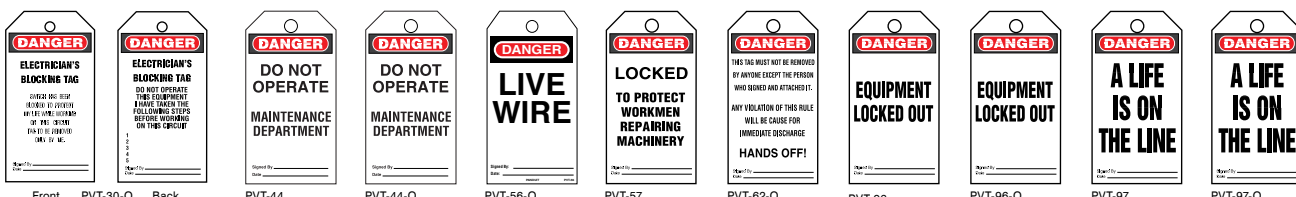
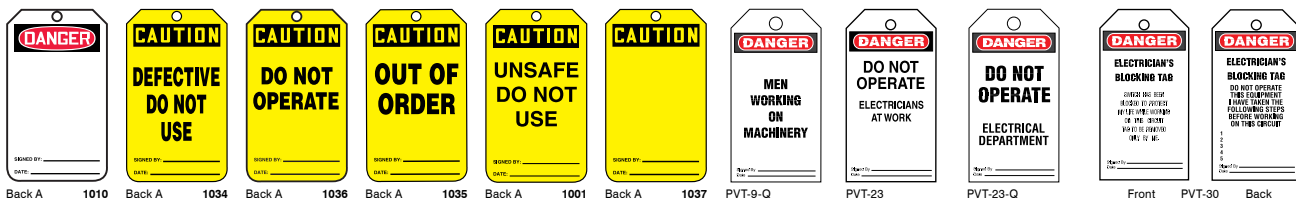
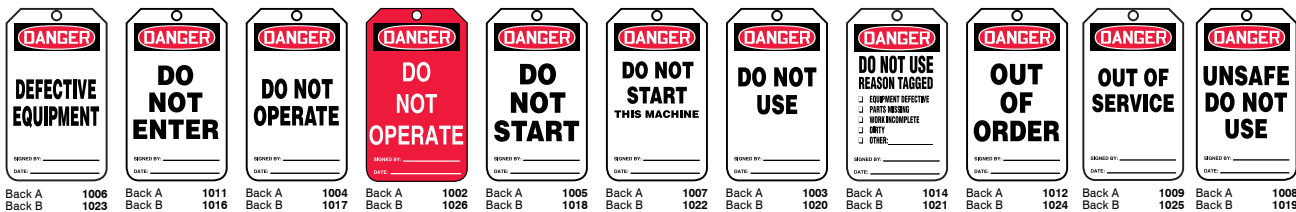

Blank Header Tags

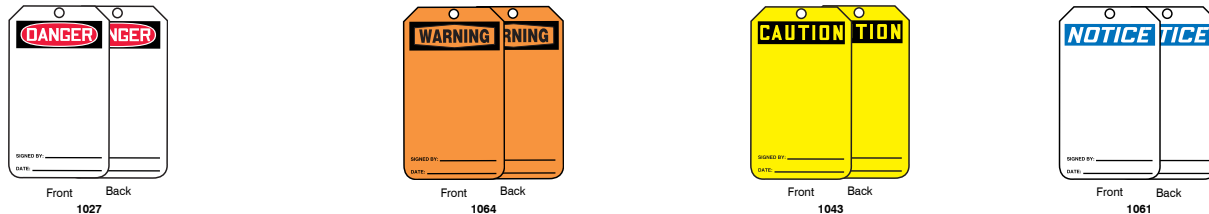

Bilingual Spanish Safety Tags



Inspection & Status Record Tags

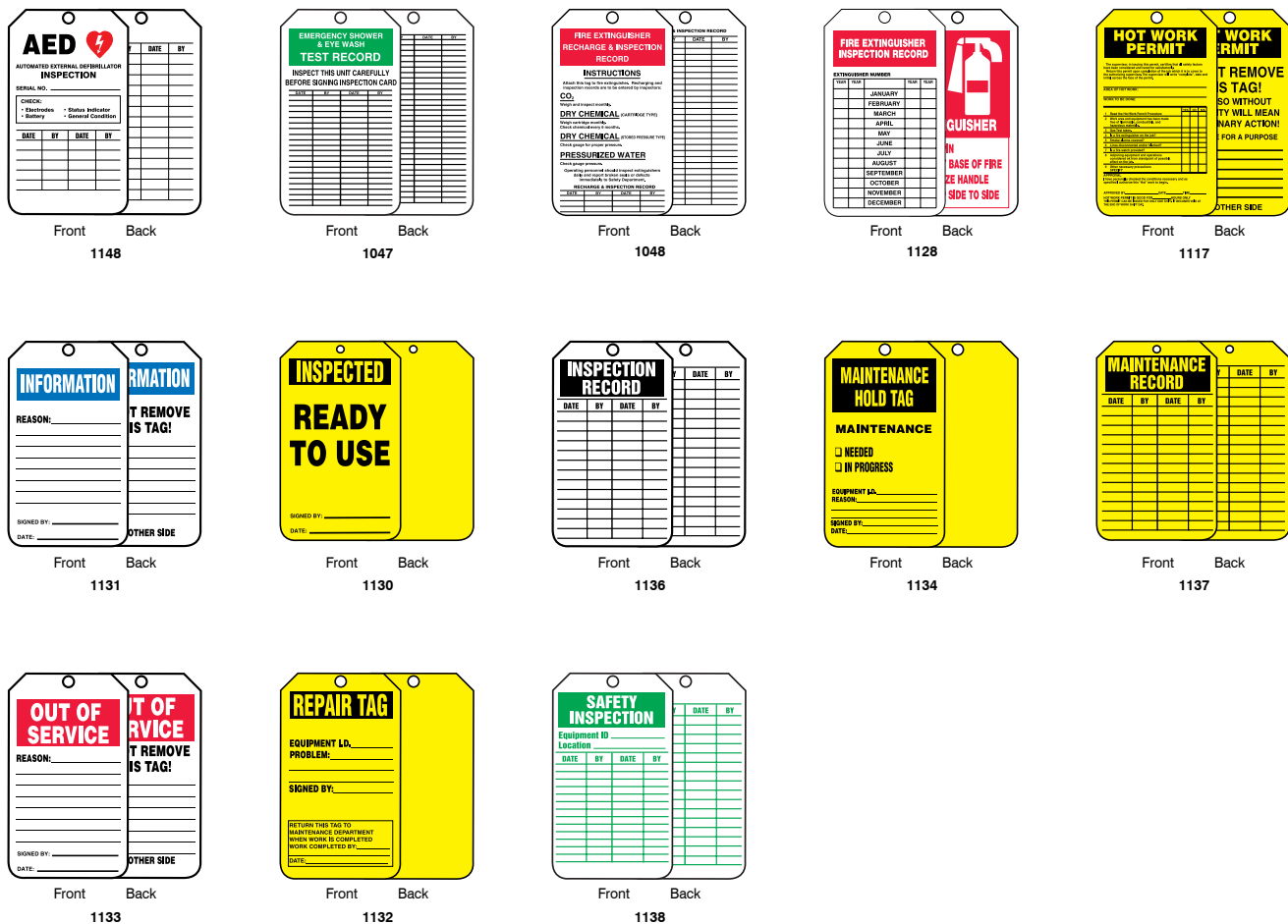

Available Materials Poly Cardstock Rigid Plastic	Codes PCT- PVT-	Available Packages Pk. of 5 Pk. of 25	Codes (blank) -Q	How to Order Tags:
				1 Select Material Code: PCT-
				2 Select Tag Base Part Number: 1011
				3 Select Package: 5/Pk - (blank); 25/Pk - -Q
				4 Combine Codes in Specific Order for Complete Part Number: 5/Pk - PCT-1011; 25/Pk - PCT-1011-Q

Status Tags

Scaffold Tags



Front Back
1143



Front Back
1155



Front Back
1154



Front Back
1156

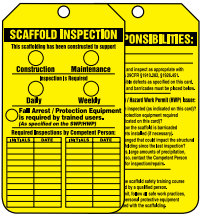

Front Back
1139

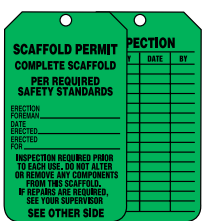

Front Back
1142

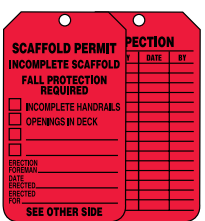

Front Back
1140



Front Back
1141



Front Back
1066



Front Back
1067

Barricade Tags



Front Back
1065



Front Back
1068



Front Back
1146



Front Back
1135

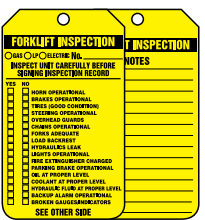

Front Back
1145

Forklift Tags

Cylinder Tags

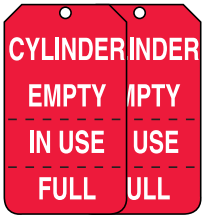

Front Back
1046



Front Back
1050

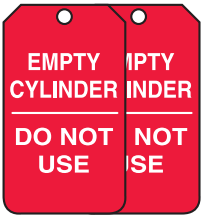

Front Back
1044

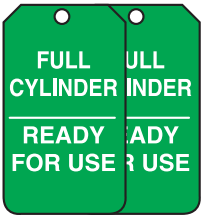

Front Back
1045



Front Back
1049

Ladder Tags



Front Back
1144



Front Back
1013

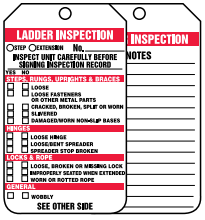

Front Back
1147

Available Materials
Poly Cardstock
Rigid Plastic

Codes
PCT-
PVT-

Available Packages
Pk. of 5
Pk. of 25

Codes
(blank)
-Q

How to Order Tags:

- Select Material Code: PCT-
- Select Tag Base Part Number: 1050
- Select Package: 5/Pk - (blank); 25/Pk - -Q
- Combine Codes in Specific Order for Complete Part Number: 5/Pk - PCT-1050; 25/Pk - PCT-1050-Q



Lockout Tags



Available Materials	Codes	Available Packages	Codes	How to Order Tags:
Rigid Plastic	PVT-	Pk. of 5	(blank)	<ol style="list-style-type: none"> Select Material Code: PVT- Select Tag Base Part Number: 1051 Select Package: 5/Pk - (blank); 25/Pk - -Q Combine Codes in Specific Order for Complete Part Number: 5/Pk - PVT-1051; 25/Pk - PVT-1051-Q
Laminate Plastic (Pk. of 5)	PCTL-	Pk. of 25	-Q	

Self-Laminating Lockout Tags



Available Materials	Codes	Available Packages	Codes	How to Order Tags:
Rigid Plastic	PST-	Pk. of 5	(blank)	<ol style="list-style-type: none"> Select Material Code: PST- Select Tag Base Part Number: 1060 Select Package: 5/Pk - (blank); 25/Pk - -Q Combine Codes in Specific Order for Complete Part Number: 5/Pk - PST-1060; 25/Pk - PST-1060-Q
		Pk. of 25	-Q	

Tag Holder Systems

Insert, enclose and contain your status alert tags in a secure tag holder system.

- Mount durable plastic holder and insert tag to display alert status
- Default "DO NOT USE" message shows when no tag is inserted
- Available in two styles:

(A) Secure-Status – Durable plastic holder measures 10"H x 3 1/2"W x 3/8" overall with 5 1/2"H x 2 3/4"W clear view front window. Upper jaws close to fit onto post rails or poles up to 2 3/8" diameter or through any 1/2" opening to lock out a device. Accommodates up to four padlocks (sold separately).

(B) Status Alert – Durable 0.060" thick plastic holder measures 12"H x 4 1/2"W overall with a 2 3/4" diameter opening at top. Insert tag into the 5 1/2"H x 4 1/2"W clear polycarbonate plastic front pocket, secure with nylon tie (sold separately) and mount in a visible location with large opening at the top.



(A) Secure-Status Holder



PT-1164



PT-1162



PT-1165



PT-1163

(B) Status Alert Holder



PT-1160



PT-1158



PT-1161



PT-1159

Roll of Tags

Portable Dispenser Roll for your On-The-Go Needs

- Keep a large quantity of tags readily available
- Tags are connected end-to-end with perforations, and housed in an convenient cardboard dispenser
- Dispenser box measures 6 5/8"H x 6 5/8"W x 3 5/8"D
- Box features 1 1/2" perforated center hole for mounting
- Poly Cardstock tags are tear- and water-resistant
- Tags measure 6 1/4"H x 3"W, with 3/8" hole
- Writable matte surface, printed on both sides with space to sign, date and add notes
- Available in 100 and 250 tags per roll

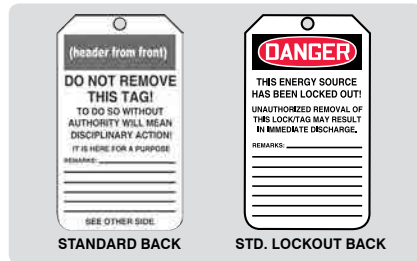

General Safety Tags



100/Roll PCT-1077-C
250/Roll PCT-1086-B



100/Roll PCT-1078-C
250/Roll PCT-1081-B



100/Roll PCT-1080-C
250/Roll PCT-1087-B



100/Roll PCT-1093-C
250/Roll PCT-1096-B



100/Roll PCT-1083-C
250/Roll PCT-1088-B



100/Roll PCT-1084-C
250/Roll PCT-1089-B



100/Roll PCT-1085-C
250/Roll PCT-1090-B

Thick Plastic Tags

This tag can take the abuse of the harshest industrial environment. It's thick, tough, and rigid to withstand tugging, pulling, twisting and bending.

- Made of tough recycled polycarbonate
- Relief text increases visibility
- Double-sided
- Polycarbonate plastic resists most corrosive environments
- Write on these tags with permanent marker
- 3/8" hole without grommet meets dielectric requirements
- Measures 5 7/16" x 3 1/16" x 1/8"
- Available in packages of 5 and 25



Pkg/5 PVT-1062
Pkg/25 PVT-1062-Q



Pkg/5 PVT-1162
Pkg/25 PVT-1162-Q



STANDARD BACK

Scaffold Status 3 'n 1 Fold Tag

Quickly and conveniently change the safety status of your scaffold with our 3 'n 1 Fold Tag.

- Display DANGER, CAUTION or ATTENTION messages all from the same tag with a simple fold
- Ideal for use with Secure-Status or Status Alert Holder (sold separately)
- Front and back display the same color with related info
- Folded tag size: 5 3/4" x 3 1/4". Unfolded size: 11 1/2" x 6 1/2"
- Available in Poly Cardstock (PCT) or Rigid Plastic (PVT) in packs of 5 or 25



Simply fold tag to display appropriate message. When status changes remove tag from holder and unfold to change message. Shown with Secure-Status Holder.

Material	Part No.	UOM	Part No.	UOM
Poly Cardstock	PCT-1157	Pkg. of 5	PCT-1157-Q	Pkg. of 25
Rigid Plastic	PVT-1157	Pkg. of 5	PVT-1157-Q	Pkg. of 25

Aluminum Inspection Record Tag

FIRE EXTINGUISHER
INSPECTION RECORD

EXTINGUISHER NO. _____

2016	2017	2018	2019
		JAN	
		FEB	
		MAR	
		APRIL	
		MAY	
		JUNE	
		JULY	
		AUG	
		SEPT	
		OCT	
		NOV	
		DEC	

- Four-year aluminum tag is made to withstand the inspection period
- 0.020" Aluminum
- Pack of 5



Meets OSHA 29 CFR §1910.157(e)

Start Year 2016 PT-1129

Loop Strap Tags

Attach tags by the self-fastening strap for quick marking of hazards.

- Hangs on its own strap by looping the vertical strap around itself
- Flexible 0.014" polyethylene plastic
- 5 1/4" x 3 1/4" tag body with the strap being 1 3/8"W x 6"L x 7/16" wide opening
- Resists grease, dirt, and moisture
- Message is printed on one side only
- Can be written on with permanent marker
- Available in packs of 25

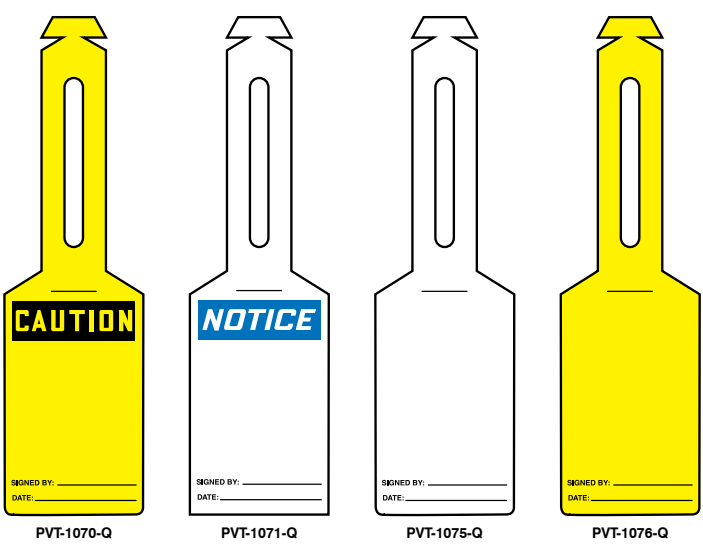
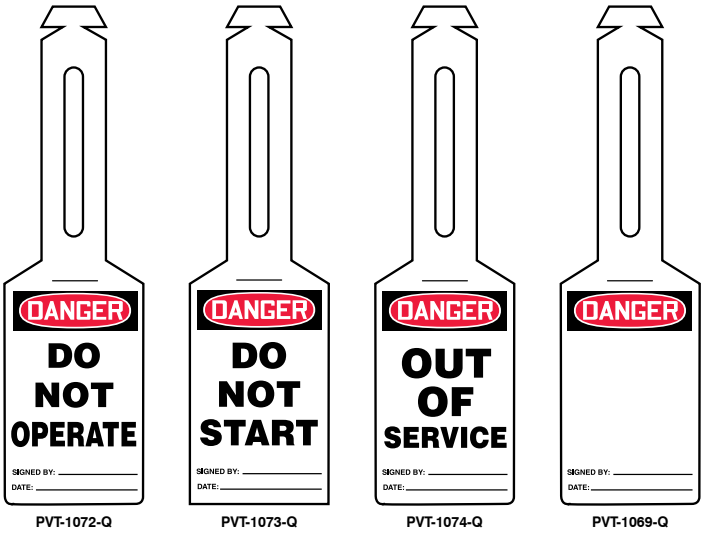

Blank Tags

Blank tags allow you to write any message in pen, pencil or marker. Use for coding, marking, quick identification, production status or inventory.

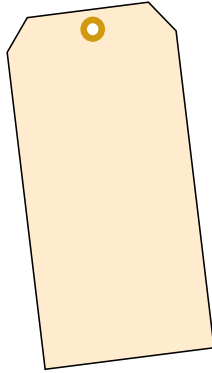

Standard Color Blank Cardstock Tags

- 0.0013" coated tags with patch-reinforced 3/16" hole
- Pack of 100

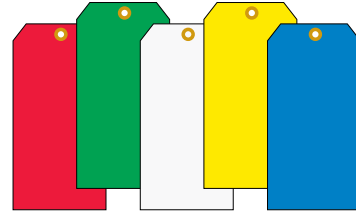

To Order: Add color code after part number: Blue – B-C, Green – G-C, Red – R-C, White – W-C, Yellow – Y-C.
Example: Part No. PCT-1107 + Color Code B-C = PCT-1107B-C

Manila Cardstock Tags

- 0.0013" tags with patch-reinforced 3/16" hole
- Pack of 100

Part No.	Size	Size No.
<i>Hole Only</i>		
PCT-1101-C	4 3/4" x 2 3/8"	5
PCT-1102-C	5 1/4" x 2 5/8"	6
PCT-1103-C	6 1/4" x 3 1/8"	8
<i>Hole with 12" Galvanized Steel Wire</i>		
PCT-1104-C	4 3/4" x 2 3/8"	5
PCT-1105-C	5 1/4" x 2 5/8"	6
PCT-1106-C	6 1/4" x 3 1/8"	8

Premium Blank Tags

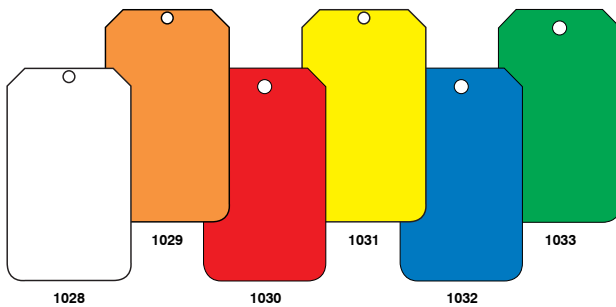

White Tyvek® Tags

- Lightweight, pressure-bonded fibers
- Flexible 0.075" thick material is abrasion- and tear-resistant
- Withstands moisture, chemicals, and frequent handling
- Patch- and metal-reinforced 3/16" hole is available plain or looped with 12" galvanized steel wire
- Pack of 100

Part No.	Size	Size No.
<i>Hole Only</i>		
PCT-1225-C	4 3/4" x 2 3/8"	5
PCT-1114-C	6 1/4" x 3 1/8"	8
<i>Hole with Galvanized Steel Wire</i>		
PCT-1115-C	4 3/4" x 2 3/8"	5
PCT-1116-C	6 1/4" x 3 1/8"	8

Tyvek® is a registered trademark of DuPont™

Available Materials	Codes	Available Packages	Codes
Poly Cardstock	PCT-	Pk. of 5	(blank)
Rigid Plastic	PVT-	Pk. of 25	-Q
Self-Laminating Poly Cardstock	PSCT-		
Self-Laminating Rigid Plastic	PST-		

How to Order Tags:

- Select Material Code: PCT-
- Select Tag Base Part Number: 1030
- Select Package: 5/Pk – (blank); 25/Pk – -Q
- Combine Codes in Specific Order for Complete Part Number: 5/Pk – PCT-1030; 25/Pk – PCT-1030-Q

Self-Laminating Safety Tag Carriers



- Cut out paper to fit and insert into the self-laminating carrier allows tags to be resistant to mild chemicals and acids
- Sturdy brass grommet provides extra durability
- Panduit PLT2S (7.40") nylon ties included for quick and easy installation
- Meet OSHA Standard 1910.147 for lockout tag 50 lb. pull force requirement

Part No.	Lamination Style	Tag Size	Pkg. Qty.
PST-4	Front only	3.50" x 5.75"	25
PST-5	Front and back	3.50" x 5.75"	25
PST-1	Front only	3.00" x 2.00"	10
PST-2	Front only	3.25" x 5.75"	5

Create Your Own Cardstock Tags



- Create your own economical cardstock tags on ink jet printers
- Economical solution for temporary, indoor tags
- Cardstock is semi-rigid tag with perforation for easy tag separation and punched hole for hanging
- Tags measure 3" x 5"
- 4 tags/sheet; 25 sheets for 100 tags per package
- Can be used with Self-Laminating Safety Tag Carrier for extra durability

Part No.	Color
SEZ-TAGWH	Red and Black/White
SEZ-TAGOR	Red and Black/Orange
SEZ-TAGY	Red and Black/Yellow

Self-Laminating Cable Marker Holders for Large Cables or Cable Bundles

- Rigid Vinyl, Self-Laminating materials
- Indoor/outdoor rated high quality rugged material resistant to abrasion
- Legend is protected by overlamine
- Use where adhesives will not work
- Temperature range: 0°F to 176°F (-18°C to 80°C)

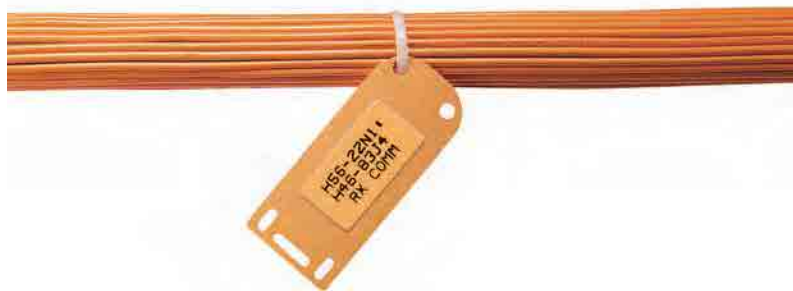

Part No.	Color	Width		Height		Tags Per Pkg.	Std. Pkg. Qty.	Std. Ctn. Qty.
		In.	mm	In.	mm			
SLCT-IG	Gray	3.00	76.2	1.31	33.3	25	1	4
SLCT-OR	Orange	3.00	76.2	1.31	33.3	25	1	4
SLCT-WH	White	3.00	76.2	1.31	33.3	25	1	4
SLCT-YL	Yellow	3.00	76.2	1.31	33.3	25	1	4
SLCT-3	White	4.00	101.6	0.50	12.7	25	1	4
SLCT-3OR	Orange	4.00	101.6	0.50	12.7	25	1	4
SLCT-3YL	Yellow	4.00	101.6	0.50	12.7	25	1	4

Attach with Panduit Intermediate or Standard Cross-Section Cable Ties.

Component Labels for Laser/Ink Jet Printers Supplied on 8.5" x 11" Sheets

C200X100YJJ	White, polyester label.	2.00	50.8	1.00	25.4	—	1000	5000
-------------	-------------------------	------	------	------	------	---	------	------

Component Labels for Thermal Transfer Desktop Printers Supplied on Rolls

C200X100YJT	White, polyester label.	2.00	50.8	1.00	25.4	—	2500	10000
-------------	-------------------------	------	------	------	------	---	------	-------

Component Cassettes for Panther™ LS8 Hand-Held Thermal Transfer Printer

--	--	--	--	--	--	--	--	--

Thermal Transfer Printable Arc Flash Labels

- Provide employees with the highest degree of safety through proper identification and communication
- Clearly visible and recognizable hazard information to communicate arc flash hazards present
- Labels are constructed of durable polyester designed to withstand UV exposure, outdoor use, water, abrasion
- Custom Arc Flash Hazard Labels can be printed using Panduit labeling software with desktop thermal transfer printers
- Use thermal transfer resin ribbon

Custom Die-Cut

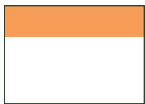

4" x 6"
C400X600YX1
100/Roll



4" x 6"
C400X600YZ1
100/Roll



4" x 6"
C400X600A51
100/Roll



4" x 4"
C400X400A51
250/Roll



4" x 4"
C400X400YZ1
250/Roll

Custom Continuous Color Header Tape

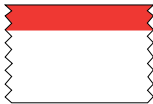

4" x 50-ft.
T400X000A91



4" x 50-ft.
T400X000YX1

Please refer to page E1.12-E1.13 for Thermal Printers

Thermal Transfer Continuous Label Tapes

- Tapes offer crisp, clear legends with superior legibility
- Indoor/outdoor rated
- Conformable flat label applications for safety and facility identification
- Can be overlaminated to increase durability
- Use thermal transfer resin ribbon
- Vinyl Tapes: 4" x 100-ft.
- Reflective Tapes: 4" x 50-ft.
- Temperature Ranges:
Vinyl: -58° to 176°F
Polyester: -40° to 302°F
Reflective: -40° to 180°F



Vinyl Tapes, 4" x 100-ft.

Part No.	Color
T400X000VP1Y	White
T400X000VQ1Y	Blue
T400X000VR1Y	Brown
T400X000VS1Y	Green
T400X000VT1Y	Gray
T400X000VU1Y	Orange
T400X000VV1Y	Purple
T400X000VW1Y	Red
T400X000VX1Y	Yellow
T400X000VY1Y	Black

Reflective Tapes, 4" x 50-ft.

Part No.	Color
T400X000RP1	White
T400X000RQ1	Blue
T400X000RU1	Orange
T400X000RW1	Red
T400X000RX1	Yellow

Non-Printable Clear Overlaminates Tapes, 4.25" x 100-ft.

Part No.	Color
T425X000YK1	Clear

Valve Identifier Plastic Tags

Mark and identify the status of the valve and prevent accidental adjustment.

- 0.015" Rigid Vinyl
- 2 1/2"H x 2"W with 3/8" metal grommet
- Sold in Packs of 5

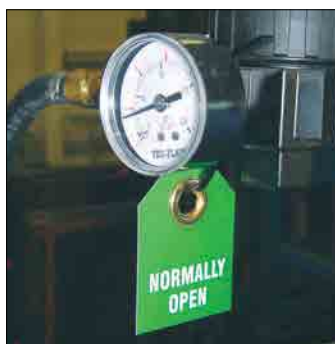
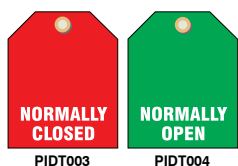
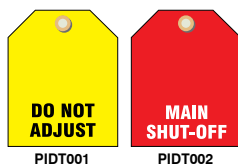

Soft Aluminum Tags

Imprint to leave a lasting impression even if ink wears off.

- 24-gauge (0.020") thick, double-sided soft aluminum laminate over tag board
- 3/16" plain or eyelet hole
- Writing permanently debosses



Plain Hole Part No.	Eyelet Hole Part No.	Size	Std. Pkg. Qty.
PIDT005	PIDT009	3/4" x 3"	Pkg. of 25
PIDT006	PIDT010	1 3/8" x 3 1/8"	Pkg. of 25
PIDT007	PIDT011	2" x 4"	Pkg. of 25
PIDT008	PIDT012	3" x 5"	Pkg. of 25

Stainless Steel and Brass Marker Plates and Tags

- Provides permanent identification of pipes, conduit, valves, cables and equipment in harsh environments
- Designed for use with Panduit's Pan-Steel® Stainless Steel Cable Ties for fast installation at lowest installed cost
- All marker plates/tags can be embossed or laser etched with Panduit Factory Custom Marking Service
- Designated plates feature easy feed design with a raised slot to simplify cable tie installation and improve productivity
- Temperature ranges:
Stainless Steel Marker Plates, Tags, & Cable Ties: -112° to 1000°F
Brass Tags: -112° to 302°F

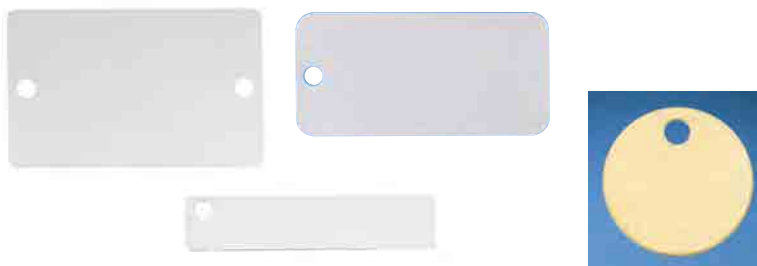

Part No.	Material	Color	Custom Marking Parameters		Size	Thickness	Used with Pan-Steel® Cable Ties	Std. Pkg. Qty.
			Max. 3/16" (4.77mm) Character Per Line	Max. Lines of Text				
MMP350W17-Q	304 Stainless Steel	Natural	23	6	1.73"W x 3.5"L	0.015"	MLT-S	25
MT350-C	304 Stainless Steel	Natural	26	3	0.75"W x 3.5"L	0.010"	MLT-S	100
MT350W17-Q	304 Stainless Steel	Natural	26	6	1.70"W x 3.5"L	0.015"	MLT-S	25
MT150D-Q	304 Stainless Steel	Natural	5, 6, 5	3	1.5" dia.	0.035"	MLT-S	25
MTB150D-Q	Brass	Brass	5, 6, 5	3	1.5" dia.	0.040"	MLT-S	25

Self-Laminating Fiber Optic Cable Marker Tags

- Rigid Vinyl, Self-Laminating Material
- Indoor/outdoor rated; high quality, rugged material resistant to abrasion; legend is protected by overlamine; use where adhesives will not work
- Temperature range: 0°F to 176°F (-18°C to 80°C)

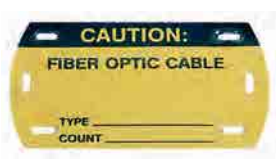

Part No.	Legend	Color (Legend/Background)	Width		Height		Tags Per Pkg.	Std. Pkg. Qty.	Std. Ctn. Qty.
			In.	mm	In.	mm			
PST-FO	CAUTION FIBER OPTIC CABLE TYPE _____ COUNT _____	Black/Yellow	3.50	89.0	2.00	51.0	5	1	40
PST-FOBLNK	BLANK	Yellow	3.50	89.0	2.00	51.0	5	1	40

Order number of packages required in multiples of Std. Pkg. Qty.

Ground Warning Tags

- Rigid Polyethylene Material
- Indoor/outdoor rated; high quality, rugged material resistant to abrasion; use where adhesives will not work
- Temperature range: -30°F to 250°F (-34°C to 121°C)



Part No.	Legend	Color (Legend/Background)	Width		Height		Tags Per Pkg.	Std. Pkg. Qty.	Std. Ctn. Qty.
			In.	mm	In.	mm			
PT-BGND	NETWORK BUILDING GROUND	Green/Yellow	2.75	70.0	1.38	35.0	100	1	5
PT-GND	WARNING GROUND WIRE DO NOT REMOVE	Black/Yellow	2.75	70.0	1.38	35.0	100	1	5
PT-TGND	WARNING TELEPHONE CO. REPAIR SERVICE	Black/Yellow	2.75	70.0	1.38	35.0	100	1	5

Order number of packages required in multiples of Std. Pkg. Qty.

Pipe Markers

Marking and identification of contents in pipes and piping systems is important to safety and maintenance. Pipe markers are to visibly identify contents, flow directions and hazard classification, thus promoting a safe working environment.

Installation recommendations:

- Above or below center visual line of pipe
- Frequent intervals on straight pipe runs
- Close to valves
- Near branches and T's
- Any change in direction
- Before and after pipe going through walls



Designed to meet or exceed ASME (ANSI) A13.1-2007 recommendations for size, color and visibility.

CONTENTS OF THE PIPE	COLOR
Fire quenching fluids	WHITE ON RED
Toxic and corrosive fluids	BLACK ON ORANGE
Flammable fluids	BLACK ON YELLOW
Combustible fluids	WHITE ON BROWN
Potable, cooling, boiler feed, and other water	WHITE ON GREEN
Compressed Air	WHITE ON BLUE



Self Stick Vinyl (PPMA)

- 0.004" flexible vinyl marker has UV-resistant polyester overlamine with high-tack, acrylic adhesive back
- Included arrow provides proper directional flow marking
- Durable, protective gloss surface withstands fading, abrasions, splashes, grease, dust, and dirt
- Service temperature is -20° to 176° F



Snap On Pipe Markers (PPMS)

- Precoiled, heavy gauge 0.020" rigid vinyl plastic is lightweight, yet durable to withstand tough industrial environments
- Fits over pipes with dirty, greasy, or rough surfaces or other less than perfect surfaces
- Easy to remove and reapply
- Service temperature range is -4° to 158° F (not recommended for hot pipes)

Part No.	Legend
1001	ACETONE
1003	ACETYLENE GAS
1005	ACETYLENE GAS
1007	ACID
1009	ACID
1011	ACID VENT
1013	ACID VENT
1015	ACID WASTE
1017	ACID WASTE
1019	AIR
1021	AIR
1023	AIR
1025	AIR RETURN
1027	AIR SUPPLY
1029	ALCOHOL
1031	ALUM
1033	ALUM
1035	AMMONIA
1037	AMMONIA
1039	ARGON
1041	ARGON

Part No.	Legend
1043	ARGON
1045	ASBESTOS FREE
1047	ASBESTOS FREE INSULATION
1049	ASBESTOS INSULATION
1051	BACKWASH
1053	BLOWER AIR
1057	BOILER BLOW DOWN
1059	BOILER BLOW DOWN
1061	BOILER DRAIN
1063	BOILER DRAIN
1065	BOILER FEED
1067	BOILER FEED
1069	BOILER FEED WATER
1071	BOILER FEED WATER
1073	BREATHING AIR
1075	BRINE
1077	BRINE
1079	CARBON DIOXIDE
1081	CARBON DIOXIDE
1083	CAUSTIC
1085	CAUSTIC

Part No.	Legend
1087	CAUSTIC SODA
1089	CAUSTIC SODA
1091	CHEMICAL
1093	CHEMICAL
1095	CHEMICAL FEED
1097	CHEMICAL FEED
1099	CHILLED WATER
1101	CHILLED WATER RETURN
1103	CHILLED WATER SUPPLY
1105	CHLORINE
1107	CHLORINE
1109	CIRCULATING WATER
1111	CITY GAS
1113	CITY GAS
1115	CITY WATER
1117	COLD WATER
1119	COLD WATER DRAIN
1121	COLD WATER RETURN
1123	COLD WATER SUPPLY
1125	COMPRESSED AIR
1127	COMPRESSED AIR

Part No.	Legend
1129	CONDENSATE
1131	CONDENSATE
1133	CONDENSATE DRAIN
1135	CONDENSATE PUMP DISCHARGE
1137	CONDENSATE RETURN
1139	CONDENSATE SUPPLY
1141	CONDENSER WATER
1143	CONDENSER WATER RETURN
1145	CONDENSER WATER SUPPLY
1147	COOLING WATER
1149	COOLING WATER RETURN
1151	COOLING WATER SUPPLY
1153	DEIONIZED WATER
1157	DEIONIZED WATER SUPPLY
1159	DIESEL OIL
1161	DIESEL WASTE OIL
1163	DIESEL WASTE OIL
1165	DISCHARGE
1167	DISTILLED WATER
1169	DOMESTIC
1171	DOMESTIC COLD WATER

Part No.	Legend
1173	DOMESTIC COLD WATER RETURN
1175	DOMESTIC COLD WATER SUPPLY
1177	DOMESTIC HOT WATER
1179	DOMESTIC HOT WATER
1181	DOMESTIC HOT WATER RECIRCULATION
1183	DOMESTIC HOT WATER RECIRCULATION
1185	DOMESTIC HOT WATER RETURN
1187	DOMESTIC HOT WATER RETURN
1189	DOMESTIC HOT WATER SUPPLY
1191	DOMESTIC HOT WATER SUPPLY
1193	DRAIN
1195	DRAIN
1197	DRAIN WATER
1199	DRINKING WATER
1201	EFFLUENT
1203	ELECTRIC TRACED
1205	ELECTRIC TRACED
1207	EXHAUST
1209	EXHAUST AIR
1211	FEED
1213	FEED

B1. Cable Ties

B2. Cable Accessories

B3. Stainless Steel Cable Ties & Accessories

C1. Wiring Duct

C2. Abrasion Protection

C3. Cable Management

D1. Terminals

D2. Power Connectors

D3. Grounding Connectors

E1. Labeling Systems

E2. Labels

E3. Pre-Printed & Write-On Markers

E4. Permanent Identification

E5. Industrial Safety Solutions

F. Keystone Cabling Systems

G. Part Number Index

Part No.	Legend
1215	FILTERED WATER
1217	FILTRATE
1219	FIRE AUTO SPRINKLER
1221	FIRE MAIN
1223	FIRE PROTECTION WATER
1225	FIRE SPRINKLER WATER
1227	FREON
1229	FREON
1231	FRESH WATER
1233	FUEL GAS
1235	FUEL GAS
1237	FUEL OIL
1239	FUEL OIL RETURN
1241	FUEL OIL SUPPLY
1243	FUEL OIL VENT
1245	GAS
1247	GAS
1249	GAS
1251	GASOLINE
1253	GASOLINE
1257	GLYCOL
1259	GLYCOL
1261	GLYCOL
1263	GLYCOL RETURN
1265	GLYCOL RETURN
1267	GLYCOL RETURN
1269	GLYCOL SUPPLY
1271	GLYCOL SUPPLY
1273	GLYCOL SUPPLY
1275	HALON

Part No.	Legend
1277	HEATING
1279	HEATING HOT WATER RETURN
1281	HEATING HOT WATER RETURN
1283	HEATING HOT WATER SUPPLY
1285	HEATING HOT WATER SUPPLY
1287	HEATING RETURN
1289	HEATING SUPPLY
1291	HEATING WATER RETURN
1293	HEATING WATER SUPPLY
1295	HEATING WATER SUPPLY
1297	HIGH PRESSURE AIR
1299	HIGH PRESSURE AIR
1301	HIGH PRESSURE CONDENSATE
1303	HIGH PRESSURE GAS
1305	HIGH PRESSURE GAS
1307	HIGH PRESSURE HOT WATER
1309	HIGH PRESSURE HOT WATER
1311	HIGH PRESSURE NITROGEN
1313	HIGH PRESSURE STEAM
1315	HIGH PRESSURE WATER
1317	HIGH PRESSURE WATER
1319	HIGH PRESSURE NATURAL GAS
1321	HOT
1323	HOT WATER
1325	HOT WATER
1327	HOT WATER RETURN
1329	HOT WATER RETURN
1331	HOT WATER SUPPLY
1333	HOT WATER SUPPLY
1335	HYDRAULIC FLUID

Part No.	Legend
1337	HYDRAULIC FLUID
1339	HYDRAULIC LINE
1341	HYDRAULIC LINE
1343	HYDRAULIC OIL
1345	HYDRAULIC OIL
1347	HYDRAULIC SUPPLY
1349	HYDROCHLORIC ACID
1351	HYDROCHLORIC ACID
1353	HYDROGEN
1357	HYDROGEN
1359	HYDROGEN PEROXIDE
1361	HYDROGEN PEROXIDE
1363	INDUSTRIAL WATER
1365	INERT GAS
1367	INERT GAS
1369	INSTRUMENT AIR
1371	INSTRUMENT AIR
1373	KEROSENE
1375	LAB VACUUM
1377	LAB VENT
1379	LAB WASTE
1381	LIQUID NITROGEN
1383	LOW PRESSURE AIR
1385	LOW PRESSURE CONDENSATE
1387	LOW PRESSURE GAS
1389	LOW PRESSURE GAS
1391	LOW PRESSURE NATURAL GAS
1393	LOW PRESSURE NATURAL GAS
1395	LOW PRESSURE NITROGEN
1397	LOW PRESSURE NITROGEN

Part No.	Legend
1399	LOW PRESSURE STEAM
1401	LOW PRESSURE WATER
1403	LUBE OIL
1405	MAKE-UP WATER
1407	MEDICAL AIR
1409	MEDICAL VACUUM
1411	MEDIUM PRESSURE CONDENSATE
1413	MEDIUM PRESSURE STEAM
1415	MED-PRESSURE STEAM
1417	MILL AIR
1419	MILL WATER
1421	MIXED GAS
1423	NATURAL GAS
1425	NATURAL GAS
1427	NITRIC ACID
1429	NITRIC ACID
1431	NITROGEN
1433	NITROGEN
1435	NITROUS OXIDE
1437	NITROUS OXIDE
1439	NITROUS OXIDE
1441	NON-POTABLE WATER
1443	OIL
1445	OUTSIDE AIR
1447	OVERFLOW
1449	OXYGEN
1451	OXYGEN
1453	OXYGEN
1457	OXYGEN
1459	PEROXIDE

Part No.	Legend
1461	PEROXIDE
1463	PLANT AIR
1465	PLANT WATER
1467	PLUMBING VENT
1469	POLYMER
1471	POLYMER SOLUTION
1473	POTABLE
1475	POTABLE WATER
1477	PROCESS WATER
1479	PROCESS WATER
1481	PROCESS WATER RETURN
1483	PROCESS WATER SUPPLY
1485	PROPANE GAS
1487	PROPANE GAS
1489	PULP
1491	PUMP
1493	PUMPED CONDENSATE
1495	RAINWATER
1497	RAW WATER
1499	REFRIGERANT LIQUID
1501	REFRIGERANT SUCTION
1503	REFRIGERATED LIQUID
1505	REFRIGERATED SUCTION
1507	REFRIGERATION
1509	RETURN
1511	RETURN
1513	RETURN
1515	RETURN
1517	ROOF DRAIN
1519	SALT WATER

Self Stick (PPMA)

Size Code	Pipe Diameter	Marker Size	UOM
A	3/4" to 1 1/4"	1" x 8"	Each
B	1 1/2" to 2"	1 1/2" x 8"	Each
D	2 1/2" to 6"	2 1/2" x 12"	Each
H	8" to 10"	4" x 24"	Each

Snap On Pipe Markers (PPMS)

Size Code	Pipe Diameter	Marker Size	UOM
A	3/4" to 1 1/4"	6" x 8"	Each
B	1 1/2" to 2"	9" x 8"	Each
C	2 1/4" to 3"	14" x 12"	Each
E	3 1/4" to 5"	19" x 12**	Each
F	5 1/4" to 6"	25" x 12**	Each

*Have self-adhesive leading edge for secure fit

How to Order Pipe Markers:

- Select Material Code: Self Stick - PPMA
- Select Pipe Marker Base Part Number: 1001 **ACETONE**
- Select Size Code: 3/4" to 1 1/4" - A
- Combine Codes in Specific Order for Complete Part Number: PPMA1001A

Part No.	Legend
1521	SANITARY DRAIN
1523	SANITARY SEWER
1525	SANITARY VENT
1527	SANITARY WASTE
1529	SEAL WATER
1531	SERVICE AIR
1533	SERVICE WATER
1535	SEWAGE
1537	SEWER
1539	SLUDGE
1541	SOAP
1543	SODIUM HYDROXIDE
1545	SODIUM HYDROXIDE
1547	SODIUM HYPOCHLORITE
1549	SODIUM HYPOCHLORITE

Part No.	Legend
1551	SOFT WATER
1553	SOLVENT
1557	SPENT ACID
1559	SPENT ACID
1561	SPRINKLER
1563	SPRINKLER FIRE
1565	SPRINKLER WATER
1567	STEAM
1569	STEAM RETURN
1571	STEAM SUPPLY
1573	STORM DRAIN
1575	STORM SEWER
1577	STORM WATER
1579	SULFUR DIOXIDE
1581	SULFUR DIOXIDE

Part No.	Legend
1583	SULFURIC ACID
1585	SULFURIC ACID
1587	SUMP PUMP DISCHARGE
1589	SUPPLY
1591	SUPPLY
1593	SUPPLY
1595	TANK DRAIN
1597	TEMPERED WATER
1599	TEMPERED WATER
1601	TOLUENE
1603	TOLUENE
1605	TOWER WATER
1607	TOWER WATER RETURN
1609	TOWER WATER SUPPLY
1611	TREATED WATER

Part No.	Legend
1613	UTILITY WATER
1615	UTILITY WATER
1617	VACUUM
1619	VACUUM
1621	VENT
1623	VENT
1625	WARM WATER
1627	WASTE
1629	WASTE WATER
1631	WASTE WATER
1633	WATER
1635	WATER
1637	WELL WATER
1639	WHITE LIQUOR
1641	WHITE LIQUOR

Part No.	Legend
1643	WHITE LIQUOR
1645	→
1647	→
1649	→
1651	→
1653	→
1657	→
1659	→
1661	→
1663	→
1665	→
1667	→
1669	→

Self Stick (PPMA)

Size Code	Pipe Diameter	Marker Size	UOM
A	3/4" to 1 1/4"	1" x 8"	Each
B	1 1/2" to 2"	1 1/2" x 8"	Each
D	2 1/2" to 6"	2 1/2" x 12"	Each
H	8" to 10"	4" x 24"	Each

Snap On Pipe Markers (PPMS)

Size Code	Pipe Diameter	Marker Size	UOM
A	3/4" to 1 1/4"	6" x 8"	Each
B	1 1/2" to 2"	9" x 8"	Each
C	2 1/4" to 3"	14" x 12"	Each
E	3 1/4" to 5"	19" x 12**	Each
F	5 1/4" to 6"	25" x 12**	Each

*Have self-adhesive leading edge for secure fit

How to Order Pipe Markers:

- Select Material Code: Self Stick – PPMA
- Select Pipe Marker Base Part Number: 1523 **SANITARY SEWER**
- Select Size Code: 3/4" to 1 1/4" – A
- Combine Codes in Specific Order for Complete Part Number: PPMA1523A

Color Banding Pipe Marking Tapes

Variety of colors are ideal for coding pipes.

- 0.005" tapes with self-adhesive back, no liner
- Service temperature range -20° to 140°F
- Available in 1", 2" and 3" widths
- 108-ft. rolls



Available colors with color code:

Red – RED, Green – GRN, Blue – BLU, Gray – GRY, Brown – BRN, Black – BLK, Yellow – YEL, Orange – ORN, White – WHT, Purple – PUR

To Order: Add color code after part number.

Example: Part No. PFM1X36 + Color Code YEL = PFM1X36YEL

Part No.	Size	UOM
PFM1X36	1" x 108-ft.	Roll
PFM2X36	2" x 108-ft.	Roll
PFM3X36	3" x 108-ft.	Roll

Directional Flow Arrow Tapes

Provide 360° visibility for flow direction, with repeated arrows on the tape's length.

- 0.006" self-adhesive vinyl
- Available in 1", 2" and 4" widths
- 54-ft. and 108-ft. rolls



Available colors with color code:

Black/Yellow – BY, Green/White – GW, Blue/White – BLW, Red/White – RW, Black/Orange – BO, White/Brown – WBR



Meets ASME A13.1, 3.1

To Order: Add color code after part number.

Example: Part No. PPMR1X54 + Color Code BY = PPMR1X54BY

Part No.	Size	UOM	Part No.	Size	UOM
PPMR1X54	1" x 54-ft.	Roll	PPMR1X108	1" x 108-ft.	Roll
PPMR2X54	2" x 54-ft.	Roll	PPMR2X108	2" x 108-ft.	Roll
PPMR4X54	4" x 54-ft.	Roll	PPMR4X108	4" x 108-ft.	Roll

Roll Tape Pipe Markers

Easily mark pipes quickly at various locations along a piping system.

- 72 identical legends per roll, with perforations between each length
- Use in continuous lengths, or tear at perforations

- 0.006" vinyl with protective laminate surface
- Peel-off liner with self-adhesive back applies to smooth, clean, dry surface
- Service temperature is -20° to 140°F
- Available in 1" x 54-ft. or 2" x 54-ft. rolls



Roll Tape Pipe Marker & Directional Flow Arrow Tapes shown.

Part No.	Legend
PPMR0102	AIR
PPMR0101	AIR
PPMR0144	AMMONIA
PPMR0145	ARGON
PPMR0103	BOILER FEED
PPMR0146	CAUSTIC
PPMR0104	CHILLED WATER
PPMR0147	CHILLED WTR RTN
PPMR0148*	CHILLED WTR SPLY
PPMR0149	CITY GAS
PPMR0150	CITY WATER
PPMR0151	COLD WATER
PPMR0105*	COLD WATER RTN
PPMR0106*	COLD WTR SUPPLY
PPMR0152	COMPRESSED AIR
PPMR0153	COMPRESSED AIR

Part No.	Legend
PPMR0154	CONDENSATE
PPMR0155	CONDENSATE RETURN
PPMR0108	DEIONIZED WATER
PPMR0109*	DOMESTIC COLD WTR
PPMR0110	DOM HOT WATER
PPMR0112	DRAIN
PPMR0111*	FIRE PROTECT WATER
PPMR0113	GAS
PPMR0114	GLYCOL
PPMR0116	HI PRESSURE AIR
PPMR0117*	HI PRESSURE STEAM
PPMR0118	HOT WATER
PPMR0119	HOT WATER RETURN
PPMR0120	HOT WATER SUPPLY
PPMR0115	MIXED GAS
PPMR0121	NATURAL GAS

Part No.	Legend
PPMR0122	NITROGEN
PPMR0123*	NON POTABLE WATER
PPMR0124	OIL
PPMR0125	OXYGEN
PPMR0126	PLANT AIR
PPMR0127*	POTABLE WATER
PPMR0128	PROPANE GAS
PPMR0129	RAW WATER
PPMR0130	SANITARY DRAIN
PPMR0131	SANITARY SEWER
PPMR0132	SPRINKLER FIRE
PPMR0133	SPRINKLER WATER

Part No.	Legend
PPMR0136	STEAM
PPMR0134	STEAM RETURN
PPMR0135	STEAM SUPPLY
PPMR0137	STORM DRAIN
PPMR0138	VACUUM
PPMR0139	VACUUM
PPMR0140	VENT
PPMR0141	WASTE WATER
PPMR0143	WATER
PPMR0142	WATER

*Legends for 2" x 9" marker size will be abbreviated for space

To Order: Add size code after part number.
Example: Part No. PPMR0102 + Size Code B = PPMR0102B

Size Code	Pipe Diameter	Roll Size	Marker Size	Letter Height	UOM
B	Up to 2"	1" x 54-ft.	1" x 9"	3/4"	Roll
H	Up to 6"	2" x 54-ft.	2" x 9"	1 1/4"	Roll

Roll Form Pipe Markers

Wrap around virtually any size pipe when you have multiple pipes or pipes of unknown sizes.

- Unroll, measure, and easily cut to length on-site for proper fit
- 0.004" gloss, overlaminated poly vinyl marker wraps to adhere to itself

- High-tack, acrylic adhesive back stays on dirty, greasy, and rusty pipes
- Legend and arrow repeated, upright and upside-down, for universal direction and visibility
- Service temperature is -20° to 140°F
- Available 8" x 30-ft. or 12" x 30-ft. in rolls



Part No.	Legend
PPMR0028	AIR
PPMR0029	ARGON
PPMR0001	ASBESTOS FREE
PPMR0030	CARBON DIOXIDE
PPMR0002	CHLORINE
PPMR0003	CITY WATER
PPMR0004	COLD WATER
PPMR0006	COMPRESSED AIR
PPMR0005	COMPRESSED AIR
PPMR0007	CONDENSATE
PPMR0008	CONTAINS ASBESTOS
PPMR0009	DOMESTIC COLD WATER
PPMR0010	DRAIN

Part No.	Legend
PPMR0011	FIRE PROTECTION WATER
PPMR0031	FIRE SPRINKLER WATER
PPMR0012	GAS
PPMR0013	HOT WATER
PPMR0014	LOW PRESSURE STEAM
PPMR0015	NATURAL GAS
PPMR0016	NON-POTABLE WATER
PPMR0032	OXYGEN
PPMR0017	OXYGEN
PPMR0018	PLANT AIR
PPMR0019	POTABLE WATER
PPMR0020	PROCESS WATER
PPMR0021	RETURN

Part No.	Legend
PPMR0022	SPRINKLER FIRE
PPMR0023	SPRINKLER WATER
PPMR0024	STEAM
PPMR0025	VACUUM
PPMR0027	WATER
PPMR0026	WATER

To Order: Add size code after part number.
Example: Part No. PPMR0029 + Size Code H = PPMR0029H

Size Code	Pipe Diameter	Roll Size	Letter Height	UOM
B	Up to 2"	8" x 30-ft.	3/4"	Roll
H	Up to 6"	12" x 30-ft.	1 1/4"	Roll

IIAR Ammonia Pipe Markers



Meets IIAR guidelines for proper pipe marking as specified in Bulletin No. 114.

Identify Ammonia refrigeration piping and system components.

- 0.004" flexible vinyl, self-sticking markers have high-tack adhesive backed with liner
- One legend with directional flow arrows on each end to cut off for proper placement
- Glossy UV-resistant surface withstands dust, dirt and grease
- Service temperature range is -20° to 176°F
- Install onto clean smooth pipe surface

To Order: Add size code after part number.

Example: Part No. PPMA3001 + Size Code A = PPMA3001A

Size Code	Pipe Diameter	Marker Size	UOM
A	3/4" x 1 1/4"	1" x 11"	Each
B	1 1/2" x 2"	1 1/2" x 15 7/8"	Each
D	2 1/2" x 6"	2 1/2" x 23 5/8"	Each
H	8" x 10"	3 1/2" x 33 1/2"	Each

System Abbreviation

The ammonia system type with an abbreviation code (as shown in the table).

Physical State

The physical state of the ammonia using an abbreviation.

LIQ - Liquid (black letters on yellow background)
VAP - Vapor (black letters on blue background)

Pressure Level

The pressure level of the flow by a single word.

LOW - 70 psig or less (black letters on green background)
HIGH - more than 70 psig (black letters on red background)

Self Stick Part No.	System	System Abbreviation	Physical State	Pressure Level
PPMA3001	Booster Discharge	BD	VAP	LOW
PPMA3002	Condenser Drain	CD	LIQ	HIGH
PPMA3003	Defrost Condensate	DC	LIQ	HIGH
PPMA3004	Hot Gas	HG	VAP	HIGH
PPMA3005	Hot Gas Defrost	HGD	VAP	HIGH
PPMA3006	High Pressure Liquid	HPL	LIQ	HIGH
PPMA3007	High Stage Discharge	HSD	VAP	HIGH
PPMA3008	High Stage Suction	HSS	VAP	LOW
PPMA3009	High Temperature Recirculated Liquid	HTRL	LIQ	LOW
PPMA3010	High Temperature Recirculated Suction	HTRS	LIQ/VAP	LOW
PPMA3011	Liquid Injection Cooling	LIC	LIQ	HIGH
PPMA3012	Low Stage Suction	LSS	VAP	LOW
PPMA3013	Low Temperature Recirculated Liquid	LTRL	LIQ	LOW
PPMA3014	Low Temperature Recirculated Suction	LTRS	LIQ/VAP	LOW
PPMA3015	Low Temperature Suction	LTS	VAP	LOW
PPMA3016	Relief Vent	RV	—	—

Duct Markers



Mark air flow and its equipment purpose in duct work systems.

- Single legend printed on poly overlaminated self-stick vinyl
- High-tack adhesive back
- Available in two sizes

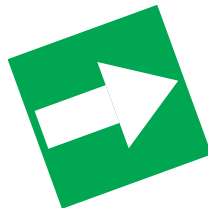

Part No.	Legend
PPMA41	EXHAUST
PPMA42	EXHAUST AIR
PPMA43	INTAKE AIR
PPMA44	OUTSIDE AIR

Part No.	Legend
PPMA45	RELIEF
PPMA46	RELIEF AIR
PPMA47	RETURN AIR
PPMA48	SUPPLY AIR

Available colors with color code:

Black/Yellow – BY, White/Green – WG, White/Blue – WBL

To Order: Add color code, then size code after part number.

Example: Part No. PPMA41 + Color Code BY + Size Code D = PPMA41BYD

Size Code	Pipe Diameter	Marker Size	Arrow Size	Letter Height	UOM
D	Up to 6"	2 1/2" x 12"	2 1/2" x 2 1/2"	1 1/4"	Each
H	Up to 10"	4" x 24"	4" x 4"	2 1/2"	Each

Medical Gas Pipe Markers

Identify the contents of medical gas piping systems.

- 0.004" gloss vinyl, 3" x 3" marker with legend repeated five times, upright and upside-down for universal fit and visibility
- Adhesive backed and peel-off liner
- Adhere to pipes up to 3/4" OD size
- Service temperature is -20° to 140°F
- 20 markers per package

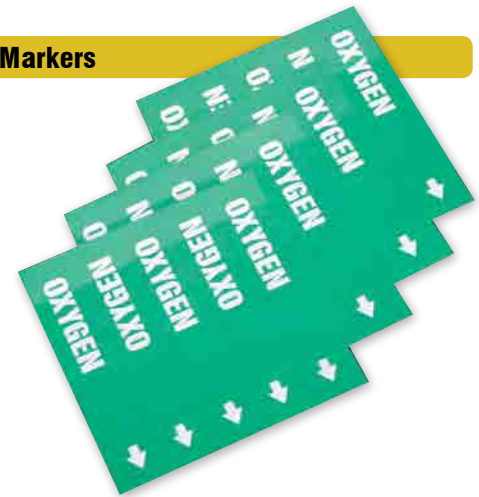

Part No.	Legend
PPMA4001	CARBON DIOXIDE
PPMA4002	CYCLOPROPANE
PPMA4012	EVAC
PPMA4003	HELIUM
PPMA4010	INSTRUMENT AIR
PPMA4013	LABORATORY AIR
PPMA4004	MEDICAL AIR
PPMA4005	MEDICAL VACUUM

Part No.	Legend
PPMA4006	NATURAL GAS 2 PSI
PPMA4007	NITROGEN
PPMA4008	NITROUS OXIDE
PPMA4009	OXYGEN
PPMA4011	WAGD

Size	Std. Pkg. Qty.
3" x 3"	20



Meets NFPA 99C-Section 4-3.5.4.1. and CGA Pamphlet C-9 Section 4.1 color requirements

- A. System Overview
- B1. Cable Ties
- B2. Cable Accessories
- B3. Stainless Steel Cable Ties & Accessories
- C1. Wiring Duct
- C2. Abrasion Protection
- C3. Cable Management
- D1. Terminals
- D2. Power Connectors
- D3. Grounding Connectors
- E1. Labeling Systems
- E2. Labels
- E3. Pre-Printed & Write-On Markers
- E4. Permanent Identification
- E5. Industrial Safety Solutions
- F. Keystone Cabling Systems
- G. Part Number Index



Just shutting down or disconnecting equipment is not enough... Lockout/Tagout keeps employees safe by making it inoperable. Comply with OSHA Regulations and LOCK IT OUT!

Before repairs, servicing, maintenance, or set-up of machines and equipment can begin, prevent the unexpected — the accidental start-up!

Procedures, devices, and personnel must be set in place to prevent the serious injury or death that could occur when someone thinks something is safely off. To ensure machines and equipment remain inoperable means establishing a “program consisting of energy control procedures, employee training, and periodic inspections...” as described in the OSHA standard. The standard also identifies products used for achieving these goals, such as lockout and tagout devices.

Highlighted here are seven steps to creating an effective lockout/tagout program.

1. Be Aware of the Lockout Regulations

Become familiar with the federal regulations known as The Control of Hazardous Energy (Lockout/Tagout).

2. Develop List of Machinery & Equipment

Survey your facility for all machinery and equipment that have the potential for requiring lockout.

3. Identify & Mark Energy Sources & Lockout Points

Locate and document start-up areas of energy sources, such as:

- Mechanical • Electrical • Hydraulic
- Thermal • Pressure • Process Control
- Stored Energy (gravity, springs)

4. Determine the Lockout Controls

Identify and document the necessary devices that isolate and lock out energy sources, and secure them for on-site use. Standardize the devices for various functions for proper identification.

5. Set up Lockout Training & Procedure Program

Develop, standardize, and document the lockout process for each energy source. Identify employees' level of involvement in the program – those that are made aware, affected, and to perform the lockout procedures. Accomplish this through comprehensive training programs and certifications.

6. Implement the Lockout Program

Initiate and enact the lockout/tagout program in accordance with the training procedures. Post reminders and have the necessary lockout/tagout devices readily available.

7. Review Lockout Program

Identify and document changes to existing procedures and new energy sources that require lockout. Make corrections, changes, and additions to the program. Conduct periodic review of lockout procedures (required at least annually) to ensure they are up to date and requirements are being met.

Post signs, apply labels and tags...

...to warn and identify energy source areas and points requiring shut-down and lockout/tagout procedures.



29 CFR § 1910.147... The Control of Hazardous Energy (Lockout/Tagout) ...requires the employers to establish a program and utilize procedures for affixing appropriate lockout devices or tagout devices to energy isolating devices, and to otherwise disable machines or equipment to prevent unexpected energization, start-up or release of stored energy in order to prevent injury to employees.

We offer solutions to help meet your lockout/tagout requirements and make your employees aware of the energy source hazards found throughout your facility. Look for products to meet your specific lockout needs on the following pages - ranging from lockout devices to training materials. Call us for consultation and on-site assessment of your lockout/tagout requirements.

Lockout Hasps

These devices provide the ideal solution when procedures require multiple workers on locked-out equipment.

Workers can be assigned a padlock (sold separately) with shackle diameter up to 9/32" to attach to the hasp before starting their task. Ensure the energy source stays locked out — with multiple workers' padlocks in the holes of the closed hasp. Once each worker completes their task, they remove their padlock. The hasp cannot be removed until the last padlock is removed.

Aluminum Tag Hasps

Lock out more equipment with the large reach hasp made to withstand tough and abusive environments.

- Scissor-style hasp comprised of two high-strength 0.090" thick red anodized aluminum plates
- Accommodates up to six padlocks (sold separately)
- Crossover jaw ends prevent prying and tampering
- Get true 1 1/2" round reach with the full jaw opening
- Measures 7"H x 2 3/4"W
- Bold, contrasting red/white/black lockout hazard message labels on both sides — with space to write in necessary information
- Red octagon shape reinforces lockout status and conveys STOP



English, Spanish, and French labels included.

UOM
Each



Tag Hasp

Change out, insert, and secure a tag for each lockout situation with the Tag Hasp.

- 5 1/4" x 3" hasp fits in the palm of the hand
- Lightweight, all-dielectric plastic design
- STOP-shaped octagon front panel contains changeable Tab Tag (sold separately below)

Easy to use:

- Insert lockout tag over the top hole inside the front panel
- Close down the 2 1/4" octagon panel to hold the tag in place
- Insert the open end of the 1/4" wide loop to lockout the device
- Hasp hangs by the 1 3/8" x 2 3/4" closed oval loop
- Secures with up to three padlocks (sold separately)
- Red octagon shape reinforces lockout status and conveys STOP



Part No.	UOM
PSL-1020	Each



Open position to insert tag



Loop end brace and secure in place by padlock

Tab Tags

- Unique tag design fits over special octagon-shaped tab
- For use with Tag Hasp (above)
- Tag is secured when the device is in the locked position
- Show the full face of the tag at all times
- Tags measure 4 1/2" x 2 1/8"
- Durable, 0.015" rigid plastic material
- Pack of 25

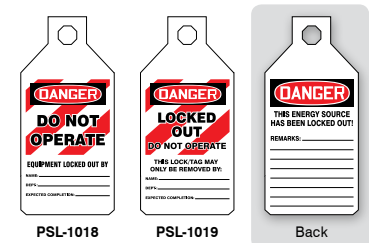

Std. Qty. Pkg.
25

Double-Cross Aluminum Tag Hasps

Lock out equipment with large reach, pry-resistant hasps.

- Made of two red anodized, 0.090" aluminum plates
- Double-crossed, octagon-shaped jaws are offset to cross over one another when closed, preventing the hasp from being easily pried apart
- Openings provide optimal reach - 1 3/4" dia. on one end and 3/4" dia. on the other
- Measures 7"H x 3 1/8"W (2 3/4" in the body) with hazard message labels on both sides
- Red octagon shape reinforces lockout status and conveys STOP



English, Spanish, and French labels included.

UOM
Each



Aluminum Hasps

Non-Sparking style

- Padlock keeps hasp closed until the last padlock is removed
- Red vinyl-coating
- Non-sparking aluminum
- Comes in 1" and 1 1/2" diameter openings
- Accommodates up to six padlocks (sold separately)

Part No.	Opening	Length	UOM
PSL-1013	1"	4 1/2"	Each
PSL-1014	1 1/2"	5"	Each



Circuit Breaker Lockout System

OSHA (Occupational Safety and Health Administration) mandates that all energy sources be turned off and locked out to protect employees from injuries caused by the accidental startup of equipment under repair and service. To support compliance with OSHA 1910.147, Panduit offers a complete line of high quality, Circuit Breaker Lockout Devices to ensure that electrical energy sources are isolated for optimal work place safety. These Circuit Breaker Lockouts are part of an extensive line of innovative safety devices designed by Panduit to protect employees from risks associated with all forms of hazardous energy, while meeting safety and regulatory requirements.

PowerLOK™ Circuit Breaker Lockout Devices

Panduit's new PowerLOK™ Circuit Breaker Lockout Devices include many innovative features to provide a versatile, easy to use lockout/tagout device. These devices can be applied to single or multi-pole circuit breakers (such as 120/277V breakers) to prevent the breaker from being turned back on; for safe performance of maintenance or service in accordance with lockout/tagout procedures.

- Two Metal Contacts
- Fits Single and Multi-Pole Circuit Breakers
- Two-Position Padlock Design
- Two-Piece Construction



Part No.	Description	Std. Pkg. Qty.
PSL-PCB	PowerLOK™ Circuit Breaker Lockout	1
PSL-PCB-V	PowerLOK™ Circuit Breaker Lockout	5
PSL-PCBNT	PowerLOK™ "No Tool" Circuit Breaker Lockout	1
PSL-PCBNT-V	PowerLOK™ "No Tool" Circuit Breaker Lockout	5

Universal & I-LINE™ Circuit Breaker Lockout Devices

- Quickly locks out circuit breakers (such as 120/277V breakers); ideal for industrial and harsh applications
- PSL-CB and PSL-CBIL can be installed using a screwdriver
- PSL-CBNT and PSL-CBILNT can be installed by hand, with no tool required



Part No.	Description	Std. Pkg. Qty.
PSL-CB	Universal circuit breaker lockout	1
PSL-CB-V	Universal circuit breaker lockout	5
PSL-CBNT	"No Tool" Universal circuit breaker lockout	1
PSL-CBNT-V	"No Tool" Universal circuit breaker lockout	5
PSL-CBIL	Circuit breaker lockout device for use with Square D I-LINE®/Federal Pacific (FPE) circuit breakers*	1
PSL-CBILNT	"No Tool" circuit breaker lockout for use with Square D I-LINE®/Federal Pacific (FPE) circuit breakers*	1
PSL-CBKIT	Circuit breaker lockout kit (1 each PSL-CBL, PSL-CBNT, PSL-CBILNT)	1
PSL-CB-3PC	(3) PSL-CB universal circuit breaker lockout	1

*I-LINE® is a registered trademark of Square D Company®.

Miniature Circuit Breaker Lockout Devices

- Quickly locks out miniature circuit breakers commonly used in industrial automation and motor control
- On the PSL-MCBNT, multiple padlock orientations allow adjacent circuit breakers to be locked out individually
- PSL-MCB can be installed using a screwdriver
- PSL-MCBNT can be installed by hand with no tool required

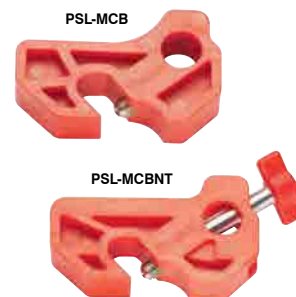

Part No.	Description	Std. Pkg. Qty.
PSL-MCB	Universal miniature circuit breaker lockout	1
PSL-MCB-V	Universal miniature circuit breaker lockout	5
PSL-MCBNT	"No Tool" miniature circuit breaker lockout	1
PSL-MCBNT-V	"No Tool" miniature circuit breaker lockout	5

Large Handle Circuit Breaker Lockout Device

- Quickly locks out large molded-case circuit breakers (such as 480/600V breakers)
- Can be installed by hand, with no tool required



Part No.	Description	Std. Pkg. Qty.
PSL-CBL	Large handle circuit breaker lockout	1
PSL-CBL-V	Large handle circuit breaker lockout	5

Lockout Warning Strip Label

- Write-on area for adding your own warning message
- Made of vinyl cloth material that allows label to be removed easily after repairs are completed
- Features the international prohibition symbol for "Do Not Throw Switch"



Part No.	Description	Std. Pkg. Qty.	Std. Ctn. Qty.
PSL-CBWL	0.54" x 4.84" (13.7mm x 122.9mm) warning label, 60 markers per book, red/white.	1	10

Large Handle Lever Lockout



Position Mounting Rail Secure Slide Set Slide Stop Bar into position over breaker

Lock out large handle or lever circuit breakers.

- Also works on up to three individual circuit breakers, including a variety of flip-lever switches
- Constructed of red dielectric ABS plastic and incorporates the octagon shape to convey STOP
- Consists of three parts: Mounting Rail, Slide Set and Stop Bar
- Installs without drilling using 3M™ VHB™ industrial bonding tape (included)*
- Additional mounting rails available for use on multiple panels
- Dimensions: Mounting Rail: 5"L x 3/4"W x 1/4"D, Slide Set: 2"L x 2"W x 1 3/8"D, and Stop Bar: 5"L x 1"W x 1"D
- Padlock and tag sold separately

*For best adhesion, ideal bond time is 24 to 72 hours prior to lockout application

Part No.	Description	UOM
PSL-1006	Large Handle Lever Lockout	Each
PSL-1007	Additional Mounting Rails, 5" L	Each

VHB™ is a registered trademark of 3M™

Cinch Cable Lockout



Internal cable spooling feature for storage.

Funnel-shaped cable feeder for quick placement.

Universal spooling cable locks out multiple devices at one time.

- Unique, compact internal spooling feature
- Lock out multiple devices quickly, neatly, and easily
- Simply extend and loop the 6-ft. nylon-coated steel cable through several devices to lock them out; then insert the cable end back into the device to cinch tight
- When cable is cinched tight, device can then be secured with a padlock (sold separately)
- Durable plastic, octagon-shaped device measures 3 1/2" x 4 1/4" x 1 1/4"
- When finished, spool the cable back inside the device for neat, easy storage
- Octagon shape reinforces lockout status and conveys STOP

Part No.	Description	UOM
PSL-1008	Cinch Lockout with 6-ft. cable	Each
PSL-1016	15-ft. cable (separate)	Each

Lockout Hasps



- Energy sources can be locked out quickly and easily by more than one worker for group lockout applications
- Heavy duty hasps with tamper-resistant designs to deter vandalism
- Variety of lockout hasp styles and sizes to accommodate a wide range of lockout applications

Part No.	Part Description	Max. No. Locks	Std. Pkg. Qty.	Std. Ctn. Qty.
PSL-1	Hasp with 1.00" (25.4mm) diameter jaw and overlapping tabs.	6	12	144
PSL-1.5	Hasp with 1.50" (38.1mm) diameter jaw and overlapping tabs.	6	12	144
PSL-1A	Hasp with 1.00" (25.4mm) diameter jaw.	6	12	144
PSL-1.5A	Hasp with 1.50" (38.1mm) diameter jaw.	6	12	48
PSL-HD1	Heavy duty hasp with 1.00" x 1.00" (25.4mm x 25.4mm) clearance.	5	12	—
PSL-HD2.4	Heavy duty hasp with 1.00" x 2.40" (25.4mm x 60.0mm) clearance.	5	12	—
PSL-HD3	Heavy duty hasp with 1.00" x 3.00" (25.4mm x 76.0mm) clearance.	7	12	—
PSL-MLD	Multiple lockout device; includes lockout hasp and 6.00' (1.8m) vinyl coated galvanized steel cable with loophead.	6	1	20

Twist & Turn Cinch Cable Lockout

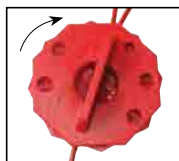

Turn the hasp halves to cinch cable.



Cinch closed position with holes aligned.

Run the cable through various devices; then, with a quick twist of the hasp, cinch the cable to prevent unauthorized access.

- Easy-to-use cable and cinch lockout hasp solution
- Polycarbonate, compact hasp is comprised of two 3" dia. x 1 1/2" thick rotating halves with 6-ft. red plastic-coated steel cable
- Visible red octagon shape reinforces the lockout situation

Part No.	UOM
PSL-1017	Each

Ball Valve Lockouts



English, Spanish, and French labels included.

Stop valves from being turned with unique gull-wing design ball valve lockout.

- Quickly and simply secure over any closed ball valve handle
- Secure with padlock (sold separately)
- Bright red, plastic device works with ball valve handles either perpendicular or parallel to pipe
- Includes red "Danger Locked Out" label
- Red octagon shape reinforces lockout status and conveys STOP



Wingspan halves open and close

Part No.	Fits Ball Valve	Fits Handle	Overall Size	UOM
PSL-1059	3/8" – 1 1/4"	up to 5/8"W x 1/4" thick	3 1/8" x 4 1/2" x 4 1/2"	Each
PSL-1058	1 1/2" – 2"	up to 1 1/2"W x 1/2" thick	4 1/2" x 5 2/3" x 5 2/3"	Each

Labels

Additional adhesive labels are available each in ANSI or APWA colors: Red – RED, Yellow – YEL, Blue – BLU, Green – GRN, Purple – PUR.



Part No.	Fits Ball Valve	UOM
PSL-1065	3/8" – 1 1/4"	Each
PSL-1070	1 1/2" – 2"	Each

To Order: Add color code after part number.
Example: Part No. PSL-1065 + Color Code RED = PSL-1065RED

Gate Valve Lockout Devices

- Gate valves regulating hydraulic, pneumatic, and chemical energy can be locked out quickly and easily
- Accommodates valve handles ranging from 1.00 inch (25.40mm) to 13.00 inches (330.20mm) in diameter
- Constructed of rugged polypropylene providing strength, durability, and added security

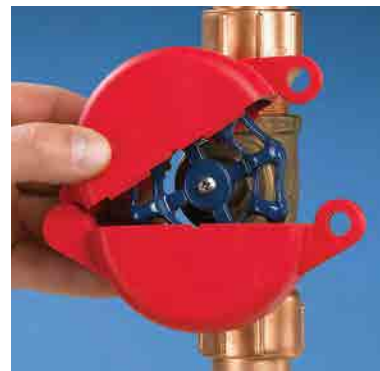

Part No.	Part Description	Std. Pkg. Qty.	Std. Ctn. Qty.
PSL-V2A	Gate valve lockout, accommodates 1.00" – 2.50" diameter handle.	1	10
PSL-V6A	Gate valve lockout, accommodates 2.50" – 6.50" diameter handle.	1	10
PSL-V9	Gate valve lockout, accommodates 6.50" – 10.00" diameter handle.	1	10
PSL-V13	Gate valve lockout, accommodates 10.00" – 13.00" diameter handle.	1	—

Ball/Butterfly Valve Lockout Devices

- Ball valves regulating hydraulic, pneumatic, and chemical energy can be locked out quickly and easily
- Accommodates valve diameters ranging from 0.25" (6.4mm) to 8.00" (203.2mm)
- Constructed of rugged polypropylene providing strength, durability, and added security



Part No.	Part Description	Std. Pkg. Qty.	Std. Ctn. Qty.
PSL-BV1	Ball valve lockout, accommodates 0.25" – 1.00" (6.4mm – 25.4mm) valve pipe diameter.	1	10
PSL-BV2	Ball valve lockout, accommodates 1.25" – 3.00" (31.8mm – 76.2mm) valve pipe diameter.	1	10
PSL-BV3	Ball valve lockout, accommodates 2.00" – 8.00" (50.8mm – 203.2mm) valve pipe diameter.	1	10
PSL-BFV	Butterfly valve lockout, accommodates most butterfly valve handles.	1	10

Toggle Switch Cover Device

- Compact secure design fits most toggle switches and some small circuit breakers
- Easily attached without removal of faceplate or screws
- Accommodates switches
 - 0.45 – 0.78 inches tall x
 - 0.25 – 0.38 inches x
 - 0.25 – 0.40 inches thick
- Constructed of rugged nylon and stainless steel providing strength, durability, added security and corrosion resistance

Part No.	UOM
PSL-WS	Each



Universal Wall Switch Cover

Flip the switch, flip the lockout.

- Dual use - works on both rocker/toggle and flat paddle switches
- Attaches to existing switch plate screw(s)
- Fully encloses entire switch
- Cover folds down to block screws and switch access
- Secure with a padlock (sold separately)
- Measures 4 1/2"H x 1 5/8"W x 7/8"D
- Unique design reduces error – applies only in direction of desired lockout position – on or off

Part No.	UOM
PSL-1015	Each

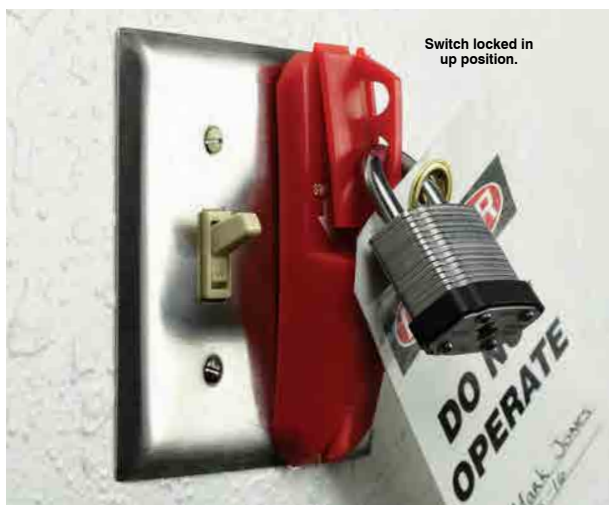

Switch locked in up position.

Push Button Cover

Prevent accidental startups of push / pull operation buttons, such as emergency stop buttons.

- Consists of one semi-permanent aluminum ring and a clear polycarbonate top
- Semi-removable design allows for easy storage
- Clear top allows user to see push button
- Tough polycarbonate cover and aluminum ring make it tamper- and impact-resistant, as well as extremely durable
- Overall dimensions are 2 1/8"H x 2"W x 2 1/2"L
- Available in two sizes to fit over 22.5 and 30mm diameter buttons
- Additional new aluminum rings available
- Octagon shape reinforces lockout status and conveys STOP
- Secures with a padlock (sold separately)

Part No.	Description	UOM
PSL-1003	Push Button Cover with 22.5mm base	Each
PSL-1004	Push Button Cover with 30mm base	Each
PSL-1005	Additional 22.5mm metal ring only	Each
PSL-1002	Additional 30mm metal ring only	Each



Toggle-Switch Cover

Prevent access to a toggle switch, yet still see its position.

Quick and easy to install, tough lockout includes clear, industrial strength 3M™ VHB™ tape for secure adhesion*.

- Fits over toggle, button, or knob switch
- The top half can be removed and stored when not in use
- Clear polycarbonate maintains visibility of the switch position and doesn't disrupt existing decals, markings, or messages
- 3 1/2" x 1 1/2" base which covers up to 3/4" x 1"H switch area
- Secures with a padlock (sold separately)
- Octagon shape reinforces lockout status and conveys STOP

* For best adhesion, ideal bond time is 24 to 72 hours prior to lockout application.

Part No.	UOM
PSL-1001	Each



VHB™ is a trademark of 3M™

Corded AC Plug Cover Lockout Devices

- Insert plugs, close cover, and secure with padlock and tag (sold separately)
- Individual corded plugs in a wide range of sizes can be locked out to prevent energization
- Constructed of rugged polypropylene providing strength, durability, and added security



Part No.	Description	UOM
PSL-CL110	Lockout fits 120 VAC corded plug, 2.0" x 2.0" x 3.5" inside dimensions	Each
PSL-CL480	Lockout fits 240 – 480 VAC corded plug, 3.25" x 3.25" x 6.50" inside dimensions	Each

Global Plug Lockout Device



- Compact universal design accommodates most 220 – 240 Volt plugs
- Quickly and easily installed
- Polycarbonate construction offers great strength and durability
- Required lock with shackle diameter between 0.20" (6.0mm) and 0.37" (9.0mm)
- Accepts Panduit PSL-6, PSL-7, and PSL-8 series locks

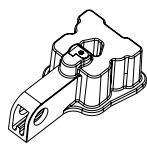

PSL-PI

Part No.	Part Description	Std. Pkg. Qty.	Std. Ctn. Qty.
PSL-PI	Global plug lockout for 220 – 240 Volt AC/Industrial Plugs.	1	10

Note: Cannot be used with North American 120 VAC plugs

AC Plug End Lockout Device

- Individual plugs in a wide range of sizes can be locked out to prevent energization
- Accommodates padlocks with shackle lengths of 1.50 inches or greater and plugs with a hole in a blade
- Constructed of rugged polycarbonate providing strength, durability, added security, and corrosion resistance



Part No.	Description	UOM
PSL-P	Plug Lockout	Each
PSL-P1	Global Plug Lockout for 220-240 Volt AC/Industrial Plugs	Each

Receptacle Blockout Device



- Blocks out receptacles to prevent equipment damage from overloading circuits or electrical interference
- Accommodates industrial electrical receptacles with two or three blades



PSL-ERB

Part No.	Part Description	Std. Pkg. Qty.	Std. Ctn. Qty.
PSL-ERB	Blockout for 120 V electrical receptacle.	1	25
PSL-PL1BLUY	Blue	25	150

Pneumatic Energy Lockout Device

- Pneumatic energy devices can be locked out quickly and easily without costly tool modifications or inconvenient in-line valves
- When installed on the male pneumatic fitting, prevents the ability to engage into the female fitting
- Universal compact design makes the pneumatic lockout device easy to transport
- Five openings install on almost any fitting, even in tight spaces
- Rugged stainless steel construction offers superior strength, durability, added security and corrosion resistance
- Overall dimensions are 3.5" (88.9mm) diameter x 0.10" (2.54mm) thick

Part No.	UOM
PSL-PEL	Each



OSHA Lockout/Tagout Compliance and Training Kit



- Takes you step-by-step through the process of bringing your company into compliance with OSHA Standard 1910.147; also provides training materials and devices for educating employees on the the elements and applications of lockout tagout
- This complete package includes:
 - Training video:** DVD video "Life is on the Line" for training employees on the elements and application of lockout/tagout (LOTO)
 - Compliance CD** containing:
 - Training materials:** Training agenda, quiz, certificate, and key points for hands on device training
 - Templates:** Step-by-step interactive presentation facility and machine specific procedure templates; equipment, training, and inspection logs; lockout/tagout program template, periodic and lockout/tagout checklists
 - Components:** Demonstration components for thorough "hands-on" training including circuit breakers, ball valves, etc., and the compatible lockout devices

Part No.	Part Description	Std. Pkg. Qty.
PSL-LOTO-TRAIN	OSHA lockout/tagout compliance kit	1

Versatile Pneumatic Lockout



Keep employees safe with this rugged, tamper resistant method to lock out your pneumatic equipment/source.

- Device has seven openings ranging from 9/32" to 1/2" diameter that accommodate most male and female pneumatic end-fittings
- Clear cover allows user to see what is locked out
- Constructed of polycarbonate with steel hinge for tamper-resistance and durability
- Red octagon shape reinforces lockout status and conveys STOP
- Overall dimensions are 3 7/8" x 3 1/4" x 1 7/8"

Part No.	UOM
PSL-1012	Each

Lockout Quick Reference Card

DANGER

A LIFE IS ON THE LINE!

OSHA LOCKOUT STEPS
SHUTDOWN

Inform operator and supervisor about work to be done

- 1) Prepare for shutdown
- 2) Shutdown/turn off equipment
- 3) Isolate from energy source
- 4) Apply lockout/tagout to energy isolating device
- 5) Release all potentially hazardous stored or residual energy
- 6) Verify the isolation

STARTUP

- 1) Assure equipment operationally intact, clear all personnel & tools
- 2) Notify all affected employees about startup and lockout/tagout device removal
- 3) Assure lockout/tagout is removed from each energy-isolating device
(See section 6(e) and 6(f) of 29 CFR 1910.147 for specific requirements of the standard)

- Provides those employees responsible for lockout/tagout with a constant reminder of the OSHA recommended steps for shutdown and startup
- Current calendar year is printed on back side

Part No.	Part Description	Number of Cards Included	Std. Pkg. Qty.	Std. Ctn. Qty.
PSL-STEPS	2.13" x 3.38", lockout/tagout steps/ calendar wallet card.	25	1	4

Plastic Group Lock Box



English, Spanish, and French labels included.

Look to view the keys and padlocks in a secure lock box that is shaped to say STOP!

Four rows of aluminum strips contain 16 hooks to hang keys – identifiable through the clear front cover. Once closed, holes and slots along the edges of box and cover align. Secure with up to 42 padlocks (sold separately). Plus, there is a hole on the left backside for a supervisor's padlock.

- Cover pry guard edge provides security when using minimal padlocks
- Visible safety red shows through the clear front cover
- Familiar octagon box shape conveys STOP message
- Front cover slides to hinge open
- 13" x 13" x 3 1/2" box is made of durable, impact-resistant plastic, designed for industrial environments

Each padlock represents a worker on the lockout project. Each padlock removed signifies the worker has completed their portion of the project. Yet there is no access to the keys of the locked-out devices until the last padlock is removed.

Additional features of the lock box include:

- Top carry handle for portability to lockout location
- Two rear keyholes for wall mounting
- Flange foot to set down on flat surface
- Front slot to drop in additional keys after lockout procedures have started

Part No.	UOM
PSL-1026	Each

Compact Plastic Group Lock Box

Small, portable group lock box goes with you on the job – from the office to the production floor.

- Slots in lid to insert and store keys of locked-out devices
- Unique twist-to-turn lid for secure close
- Inner pry guard prevents tamper access
- Lid has two see-through windows and carry handle
- Octagon-shaped box in red conveys the STOP message
- 7 3/4" x 7 3/4" x 4" box is durable, impact-resistant plastic

Part No.	UOM
PSL-1025	Each



Metal Group Lock Box

- Manage multiple employees and energy sources involved in a group lockout procedure
- Accommodates up to 13 padlocks (not included)
- Available in industrial powder-coated or stainless steel construction
- Dimensions: 9.00"W x 6.00"H x 3.25"D



Part No.	Description	UOM
PSL-GLBN	Group Lock Box	Each
PSL-GLBNSS	Stainless Steel Group Lock Box	Each

6-Padlock Lockout Shadow Board Kit

Shadow printed on board shows lockout/tagout devices are removed for use.

Durable 14" x 14" x 0.063" aluminum board has aluminum pronged hooks to hang padlocks and hasps. A thick, molded, clear, plastic tag pockets measure 4 3/4"H x 3 5/8"W x 2"D.



Board shown w/Kit



Shadow effect enlarged for detail

Kit Contents:

- 6 Steel Padlocks, 3/4" shackle (keyed differently)
- 10 Laminated Lockout Tags
- 10 Plastic Ties
- 1 Scissor Hasp, 1" opening
- 1 Scissor Hasp, 1 1/2" opening

Part No.	Description	Size	UOM
PSL-1010	Board w/Kit	14" x 14"	Each
PSL-1011	Board Only	14" x 14"	Each

6-Padlock Hanger Board Kit

Identifies and displays lockout/tagout devices while storing supplies – at the same place.

Durable 14" x 14" x 0.063" aluminum board with metal hooks to hang padlocks and clear plastic tag pocket.



Kit Contents:

- 6 Steel Padlocks, 3/4" shackle(keyed differently)
- 10 Laminated Lockout Tags
- 10 Plastic Ties
- 1 Scissor Hasp, 1" opening
- 1 Scissor Hasp, 1 1/2" opening

Part No.	Description	Size	UOM
PSL-1009	Board w/Kit	14" x 14"	Each

Lockout Stations

- Conveniently store padlocks, tags and lockout devices in one common area
- Designs available to accommodate four, ten, or twenty people



Part No.	Part Description	Std. Pkg. Qty.
PSL-20SWCA	23.00" x 23.00" (584.2mm x 584.2mm), 20 person lockout station with components; components include: (20) PSL-8 red non-conductive lockout padlocks (keyed differently), (6) PSL-1.5 lockout hasps, (25 tags) PVT-98 safety tags, and (25 tags) PVT-41 safety tags.	1
PSL-20SA	23.00" x 23.00" (584.2mm x 584.2mm), 20 person lockout station (sign only).	1
PSL-10SWCA	11.50" x 23.00" (292.2mm x 584.2mm), 10 person lockout station with components; components include: (10) PSL-8 red non-conductive lockout padlocks (keyed differently), (3) PSL-1.5 lockout hasps, (15 tags) PVT-98 safety tags, and (10 tags) PVT-41 safety tags.	1
PSL-10SA	11.50" x 23.00" (292.2mm x 584.2mm), 10 person lockout station (sign only).	1
PSL-4SWCA	11.50" x 11.50" (292.2mm x 292.2mm), 4 person lockout station with components, components include: (4) PSL-8 red non-conductive padlocks (keyed differently), (3) PSL-1.5 lockout hasps, and (15 tags) PVT-98 safety tags.	1
PSL-4SA	11.50" x 11.50" (292.2mm x 292.2mm), 4 person lockout station (sign only).	1

Electrician Lockout Kit



PSL-PK-EAP

Part No.	Kit Contents	Std. Pkg. Qty.
PSL-PK-EA	(1) Screwdriver (1) PSL-PK pouch (1) PSL-8 padlock (1) PSL-MLD multiple lockout (1) PSL-WS wall switch lockout (1) PSL-CBNT "No Tool" circuit breaker lockout (1) PSL-P plug lockout (5) PVT-30 blocking tags	1
PSL-PK-EAP	(1) Screwdriver (1) PSL-PK pouch (1) PSL-8 padlock (1) PSL-MLD multiple lockout (1) PSL-WS wall switch lockout (1) PSL-PCBNT PowerLOK™ "No Tool" circuit breaker lockout (1) PSL-P plug lockout (5) PVT-30 blocking tags	1
PSL-PK-EAPX	(1) Screwdriver (1) PSL-PK pouch (1) PSL-MLD multiple lockout (1) PSL-WS wall switch lockout (1) PSL-PCBNT PowerLOK™ "No Tool" circuit breaker lockout (1) PSL-P plug lockout (5) PVT-30 blocking tags	1
PSL-PK-EA-F	(1) Screwdriver (1) PSL-PK pouch (1) PSL-8 padlock (1) PSL-MLD multiple lockout (1) PSL-WS wall switch lockout (1) PSL-CBNT "No Tool" circuit breaker lockout (1) PSL-P plug lockout (5) PVT-30 blocking tags	1
PSL-PK-EAKS	(1) Klein Screwdriver (1) PSL-PK pouch (1) PSL-8 red non-conductive lockout padlock (1) PSL-MLD multiple lockout (1) PSL-WS wall switch lockout (1) PSL-CBNT "No Tool" circuit breaker lockout (1) PSL-P plug lockout (5) PVT-30 blocking tags	1
PSL-PK	Empty pouch for PSL-PK-EA	1

Metal Wall Mount Cabinet

- Conveniently store lockout tools and accessories in one common area
- Durable steel case can be wall-mounted (nine mounting holes) or used as a portable case
- 14.75" x 10.25" x 4.63"



Part No.	Description	Std. Pkg. Qty.
PSL-STATION	Metal Wall Mount Cabinet	1

Contractor Lockout Kit



PSL-KT-PWRP

Part No.	Kit Contents	Std. Pkg. Qty.
PSL-KT-CONA	(1) Screwdriver (1) PSL-KT case (6) PSL-8 padlocks (1) PSL-1A hasp (1) PSL-MLD lockout (3) PSL-WS wall switch lockout (3) PSL-CBNT "No Tool" circuit breaker lockout (3) PSL-P plug lockouts (15) PVT-98 tags	1
PSL-KT-CONAP	(1) Screwdriver (1) PSL-KT case (6) PSL-8 padlocks (1) PSL-1A hasp (1) PSL-MLD lockout (3) PSL-WS wall switch lockout (3) PSL-PCBNT PowerLOK™ "No Tool" circuit breaker lockout (3) PSL-P plug lockouts (15) PVT-98 tags	1
PSL-KT-CONAPX	(1) Screwdriver (1) PSL-KT case (1) PSL-1A hasp (1) PSL-MLD lockout (3) PSL-WS wall switch lockout (3) PSL-P plug lockouts (15) PVT-98 tags.	1
PSL-KT-CONA-F	(1) Screwdriver, (1) PSL-KT case (6) PSL-8 padlocks (1) PSL-1A hasp (1) PSL-MLD lockout (3) PSL-WS wall switch lockout (3) PSL-CBNT "No Tool" circuit breaker lockout (3) PSL-P plug lockouts (15) PVT-98 "EQUIPMENT LOCKED OUT BY..." safety tags in French	1
PSL-KT	Empty plastic kit box for PSL-KT-CONA	1

Safety Tool Bag

Red/Black Polyester Fabric

- Width: 18 inches
- Height: 11 inches
- Depth: 11 inches

Part No.	Color	Std. Pkg. Qty.
PSL-BG	Red	1



Maintenance Lockout Kit



Part No.	Kit Content	Std. Pkg. Qty.
PSL-KT-MROA	(1) Screwdriver (1) PSL-BX case (3) PSL-8 padlocks (1) PSL-MLD multiple lockout device (2) PSL-WS wall switch lockout (2) PSL-CBNT "No Tool" circuit breaker lockout (2) PSL-P plug lockout (1) PSL-V6A gate valve lockout, 2.50" to 6.50" diam. handle (1) PSL-V2A gate valve lockout, 1.00" to 2.50" diam. handle (1) PSL-BV2 ball-valve lockout (1) PSL-CL110 120 volt AC cord lockout (10) PVT-44 maintenance tags	1
PSL-KT-MROAP	(1) Screwdriver (1) PSL-BX case (3) PSL-8 padlocks (1) PSL-MLD multiple lockout device (2) PSL-WS wall switch lockout (2) PSL-PCBNT PowerLOK™ "No Tool" circuit breaker lockout (2) PSL-P plug lockout (1) PSL-V6A gate valve lockout, 2.50" to 6.50" diam. handle (1) PSL-V2A gate valve lockout, 1.00" to 2.50" diam. handle (1) PSL-BV2 ball-valve lockout (1) PSL-CL110 120 volt AC cord lockout (10) PVT-44 maintenance tags	1
PSL-KT-MROAPX	(1) Screwdriver (1) PSL-BX case (1) PSL-MLD multiple lockout device (2) PSL-WS wall switch lockout (2) PSL-PCBNT PowerLOK™ "No Tool" circuit breaker lockout (2) PSL-P plug lockout (1) PSL-V6A gate valve lockout, 2.50" to 6.50" diam. handle (1) PSL-V2A gate valve lockout, 1.00" to 2.50" diam. handle (1) PSL-BV2 ball-valve lockout (1) PSL-CL110 120 volt AC cord lockout (10) PVT-44 maintenance tags	1
PSL-KT-MROA-F	(1) Screwdriver (1) PSL-BX case (3) PSL-8 padlocks (1) PSL-MLD multiple lockout device (2) PSL-WS wall switch lockout (2) PSL-CBNT "No Tool" circuit breaker lockout (2) PSL-P plug lockout (1) PSL-V6A gate valve lockout, 2.50" to 6.50" diam. handle (1) PSL-V2A gate valve lockout, 1.00" to 2.50" diam. handle (1) PSL-BV2 ball-valve lockout (1) PSL-CL110 120 volt AC cord lockout (10) PVT-44 "DO NOT OPERATE" maintenance tags in French	1
PSL-BX	Empty plastic kit box for PSL-KT-MROA	1

Power and Panel Distribution Lockout Kit



Part No.	Kit Content	Std. Pkg. Qty.
PSL-KT-PWR	(1) Screwdriver (1) PSL-STATION metal wall mount cabinet (2) PSL-8 padlocks (1) PSL-MLD multiple lockout device (2) PSL-CBNT "No Tool" circuit breaker lockout for I-Line™ (2) PSL-CBL large handle circuit breaker lockout (1) PSL-P plug lockout (25) PVT-23-Q tags	1
PSL-KT-PWRP	(1) Screwdriver (1) PSL-STATION metal wall mount cabinet (2) PSL-8 padlocks (1) PSL-MLD multiple lockout device (2) PSL-PCBNT PowerLOK™ "No Tool" circuit breaker lockout (2) PSL-CBILNT "No Tool" circuit breaker lockout for I-Line™ (2) PSL-CBL large handle circuit breaker lockout (1) PSL-P plug lockout (25) PVT-23-Q tags	1
PSL-KT-PWRPX	(1) Screwdriver (1) PSL-STATION metal wall mount cabinet (1) PSL-MLD multiple lockout device (2) PSL-PCBNT PowerLOK™ "No Tool" circuit breaker lockout (2) PSL-CBILNT "No Tool" circuit breaker lockout for I-Line™ (2) PSL-CBL large handle circuit breaker lockout (1) PSL-P plug lockout (25) PVT-23-Q tags	1
PSL-KT-PWR-F	(1) Screwdriver (1) PSL-STATION metal wall mount cabinet (2) PSL-8 padlocks (1) PSL-MLD multiple lockout device (2) PSL-CBNT "No Tool" circuit breaker lockout (2) PSL-CBILNT "No Tool" circuit breaker lockout for I-Line™ (2) PSL-CBL large handle circuit breaker lockout (1) PSL-P plug lockout (25) PVT-23-Q "DO NOT OPERATE ELECTRICIANS AT WORK" tags in French	1

Steering Wheel Covers

Prevent others from driving a vehicle that is disabled or undergoing maintenance.

- Flexible, reinforced vinyl cover
- Backside of upper half has stitched pocket to slip over steering wheel
- Secure cover to steering wheel to prevent removal
- 3/8" metal grommeted hole at bottom accommodates 1 1/2" hasp with padlocks (sold separately)
- Octagon shape reinforces lockout status and conveys STOP



16" PSL-1075
20" PSL-1078
24" PSL-1081



16" PSL-1076
20" PSL-1079
24" PSL-1082



16" PSL-1077
20" PSL-1080
24" PSL-1083

Non-Conductive Safety Padlocks

Aluminum body and shackle with non-conductive vinyl cover delivers protection against electrical hazards for maximum safety, specifically in lockout/tagout applications. Padlock is available with the standard 1.77" body or 3.00" long body design that allows safety message to be displayed on the padlocks in two languages.



PSL-8 and PSL-8-LB

Color	Body Height 1.77" (45.2mm)	Body Height 3.00" (76.2mm)	Std. Pkg. Qty.
	Part Number		
Black	PSL-8BL	PSL-8BL-LB	1
Blue	PSL-8BU	PSL-8BU-LB	1
Green	PSL-8GR	PSL-8GR-LB	1
Orange	PSL-8OR	PSL-8OR-LB	1
Red	PSL-8	PSL-8-LB	1
Yellow	PSL-8YL	PSL-8YL-LB	1
Purple	PSL-8PU	PSL-8PU-LB	1
Brown	PSL-8BR	PSL-8BR-LB	1

Specialty Padlocks

Harsh environment padlocks are created with a solid brass body with a chrome finish and stainless steel shackle for use in severe weather and environmental conditions. Flexible shackle padlocks allow movement of the lock body in order to close the panel door



PSL-9 and PSL-9-LS

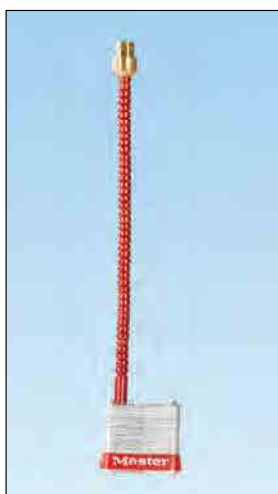

PSL-CS

Part No.	Color	Part Description	Std. Pkg. Qty.
PSL-9	Silver	Harsh environment padlock; shackle height 1.00" (25.4mm)	1
PSL-9-LS	Silver	Harsh environment padlock; shackle height 3.00" (76.2mm)	1
PSL-CS	Red	Flexible shackle padlock; shackle height 5.00" (127.0mm)	1

Aluminum Padlocks



PSL-7 and PSL-7-LS



PSL-12

Solid aluminum body with anodized aluminum finish design can withstand extreme environmental conditions for improved durability and enhanced corrosion resistance. These padlocks are available with standard 1.50" x 1.62" body or ultra-compact 1.25" x 1.37" body for lockout operations in tight spaces.

Color	Body Height 1.62" (41.1mm) Shackle Height 1.00" (25.4mm)	Body Height 1.62" (41.1mm) Shackle Height 3.00" (76.2mm)	Body Height 1.25" (41.1mm) Shackle Height 1.00" (25.4mm)	Std. Pkg. Qty.
	Part Number			
Black	PSL-7BL	PSL-7BL-LS	PSL-12BL	1
Blue	PSL-7BU	PSL-7BU-LS	PSL-12BU	1
Green	PSL-7GR	PSL-7GR-LS	PSL-12GR	1
Orange	PSL-7OR	PSL-7OR-LS	PSL-12OR	1
Red	PSL-7	PSL-7-LS	PSL-12	1
Yellow	PSL-7YL	PSL-7YL-LS	PSL-12YL	1
Purple	PSL-7PU	PSL-7PU-LS	PSL-12PU	1
Brown	PSL-7BR	PSL-7BR-LS	PSL-12BR	1

Self-Laminating Padlock Labels

- Used to identify employees' locks; employees sign the label, attach it to the padlock, and overwrap with the clear vinyl to protect the legend
- Available in six colors for departmental coding
- One-piece design is easy to use
- Width: 10.00 inches
- Height: 0.75 inches



Part No.	Color	Std. Pkg. Qty.	Std. Ctn. Qty.
PSL-PL1BLKY	Black	25	150
PSL-PL1BLUY	Blue	25	150
PSL-PL1GRNY	Green	25	150
PSL-PL1REDY	Red	25	150
PSL-PL1WHTY	White	25	150
PSL-PL1YELY	Yellow	25	150
PSL-PL1REDY-D	Red Label with DANGER header	25	150
PSL-PL1REDY-P	Red Label with DANGER header in Portuguese	25	150

Labels are designed with blank write-on area for name and department designation and can be clearly identified with Panduit permanent marking pens.

NFPA Sign Kits

Display the four-color NFPA diamond format for the hazard categories.

- 10" x 7" sign available in 0.040" Aluminum
- Adhesive hazard panels printed black on clear to apply on-site
- Kit includes: 1 sign, 15 numbers (3 sets, 0-4), 7 specific hazard symbols, NFPA wallet guide

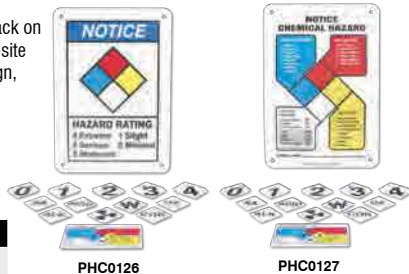

UOM
Kit
PHC0126

PHC0127

Hazardous Material Classification Sign

Properly identify the four hazard ratings of chemicals and materials on hand.

- Post on or in area of chemical containers
- Write in hazard ratings and chemical name for on-the-spot identification

To Order: Add material code before part number.
Example: Material Code PVS + Part No. 1007B4845 = PVS1007B4845



10" x 7" 1007B4845

Material	Code	UOM
Adhesive Vinyl	PVS	Each
Polyethylene Plastic	PRS	Each

Wallet Cards

Quick reference fits in employee's pocket.

- Color-printed plastic in three front styles: NFPA, HMCIS and Combo
- Back features hazard rating code index definitions
- Measures 2 1/8" x 3 3/8"
- Available each

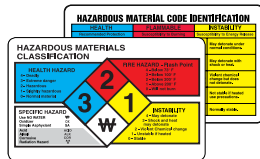

NFPA PHC0122

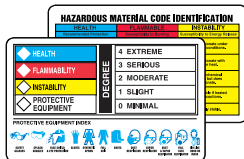

HMCIS PHC0078

UOM
Each

Chemical Identifier Roll Labels

Identify hazardous chemicals with appropriate information.

- Write-in chemical name, hazard ratings and PPE
- Self-Laminating has clear flap to protect writing
- Adhesive-Poly in Roll of 500
- Self-Laminating Vinyl in Roll of 100

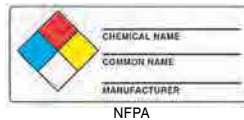

NFPA



HMCIS

NFPA Part No.	HMCIS Part No.	Material/Size	Std. Pkg. Qty.
PHC0075	PHC0079	Adhesive-Poly, 1 1/2" x 3 3/8"	500
PHC0074	PHC0076	Self-Laminating Vinyl, 1" x 3"	100

NFPA Placard Kits

Easy installation and convenient for instant on-site classification of chemical hazard identification.

- Kit includes: 1 blank placard, 15 numbers (3 sets of 0-4), 7 hazard symbols, and NFPA wallet guide
- 0.004" Adhesive Vinyl placards with clear, self-adhesive hazard panels
- Blank colored placards and self-adhesive hazard panels also available separately

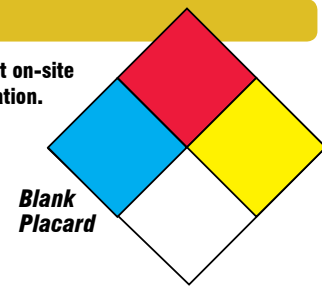

Blank Placard

Hazard Panels

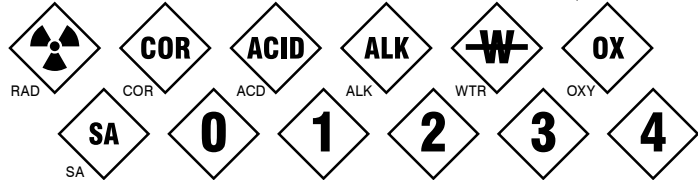

Placard Kit		Blank Placard		Size
Part No.	UOM	Part No.	UOM	
PHC0124	Kit	PHC0082	Each	4" x 4"
PHC0123	Kit	PHC0080	Each	10" x 10"
PHC0125	Kit	PHC0081	Each	15" x 15"

To Order Hazard Panels: *Add desired hazard panel number or symbol code after part number.
Number Example: Part No. PHC4X4N + Hazard Panel Number 2 = PHC4X4N2
Symbol Example: Part No. PHC4X4 + Symbol Code RAD = PHC4X4RAD

Number Part No.	Symbol Part No.	Fits Placard	Char. Height	UOM
PHC4X4N*	PHC4X4*	4" x 4"	1"	Each
PHC10X10N*	PHC10X10*	10" x 10"	4"	Each
PHC15X15N*	PHC15X15*	15" x 15"	6"	Each

Additional sizes and materials available.

NFPA Flip Placard Sign

Flip and change panels to reflect any hazard.

- Aluminum flip panels display the hazard rating required by NFPA 704
- 15 1/2" x 15 1/2", 0.063" sturdy, rust-proof aluminum backboard
- 0.120" clear plastic face fits over placard with center screw
- Withstands weather and other environmental conditions
- 3/16" corner mounting holes



Part No.	UOM
PHC0128	Each



Comply with OSHA standard 29 CFR §1910.1200, commonly known as the "Right-To-Know" standard.

Hazardous Material Labels

On-the-spot chemical hazard identification.

- Write-in chemical name, hazard ratings, and PPE information
- Adhesive Vinyl

Size	UOM
3 1/2" x 5"	Each

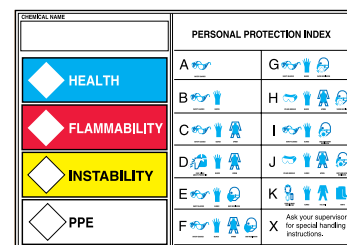

HMCIS Protective Equipment

PHC0077

Drum & Container Labels



Label drums and containers to identify contents considered hazardous for handling.

- Available with peel-off liner in: Adhesive Coated Paper and flexible Adhesive-Poly Sheet
- Labels measure 6" x 6"
- Package of 25 or 100



PHC0139



PHC0134

PCB Labels

Available in Adhesive-Poly Sheet. Package of 25 only

Std. Pkg. Qty.

25



PHC0132



PHC0138



PHC0135



PHC0136



PHC0137

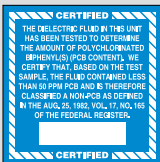

PHC0133

To Order Labels: Add material/quantity code after part number.
Example: Part No. PHC0139 + Material/Quantity Code PQ = PHC0139PQ

Adhesive Coated Paper		Adhesive-Poly Sheet		Std. Pkg. Qty.
Code		Code		
PQ		VQ		25
PC		VC		100

Hazardous Material Tags

Attach tags to hazardous material containers that are difficult to label with adhesive marking.

Tags contain NFPA or HMCIS symbols to help communicate and comply with OSHA 29 CFR 1910.1200 by conveying important chemical hazard information. Fill in the hazard code and related information for handling and exposure to hazardous chemicals.

Use Hazardous Waste tags to comply with EPA (40 CFR part 262.32) and DOT (49 CFR part 172) regulations to mark hazardous waste.

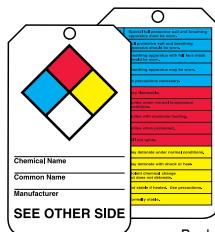

Front 1118

Back - quick reference to the hazard code index; definitions.

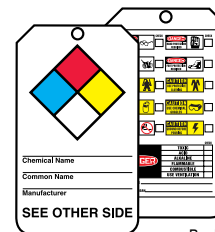

Front 1119

Back - protective equipment; chemical's severity; chemical name; target organ.

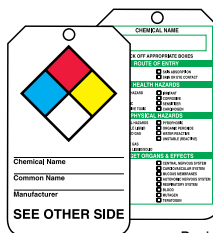

Front 1120

Back - chemical name; route of entry; health hazards; physical hazards; target organs and effects.

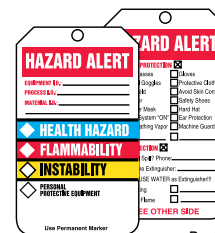

Front 1124

Back - protective equipment; chemical's severity; chemical name; target organ.

Available Materials
Poly Cardstock
Rigid Plastic

Codes
PCT-
PVT-

Available Packages
Pk. of 5
Pk. of 25

Codes
(blank)
-Q

How to Order Tags:

- 1 Select Material Code: PCT-
- 2 Select Tag Base Part Number: 1118
- 3 Select Package: 5/Pk - (blank); 25/Pk - -Q
- 4 Combine Codes in Specific Order for Complete Part Number:
5/Pk - PCT-1118; 25/pk - PCT-1118-Q



GHS Pictogram Labels



Pictogram labels comply with the Globally Harmonized System.

- Identify hazards associated with chemicals
- The Hazard Communication Standard (HCS) requires eight of the nine GHS pictograms
- The environment pictogram is non-mandatory since environmental hazards fall outside OSHA's jurisdiction
- Available in Adhesive Coated Paper and Adhesive-Poly Sheet
- 250 or 500 per roll

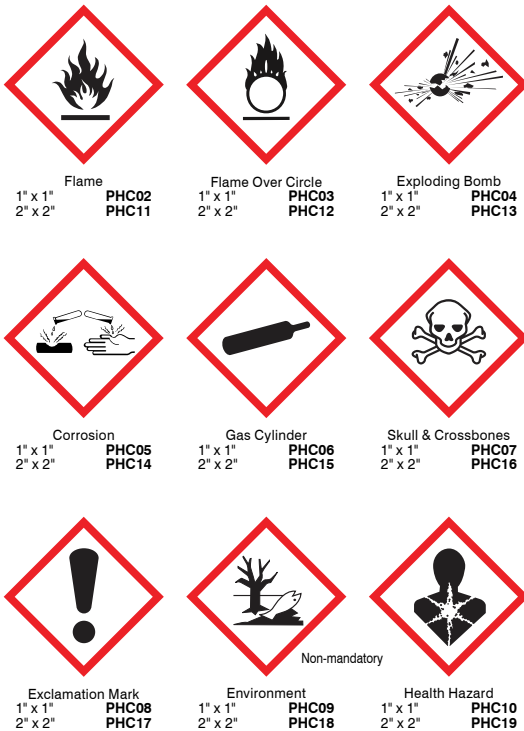

To Order Labels: Add material/quantity code after part number.
Example: Part No. PHC02 + Material/Quantity Code PB = PHC02PB

Adhesive Coated Paper		Adhesive-Poly Sheet	Std. Pkg. Qty.
Code	Code	Code	
PS	VS		250
PB	VB		500

GHS Jumbo Tags



Attach tags to chemicals in the workplace, and add the appropriate signal word and GHS pictogram labels to identify the hazards.

- Large tags with space to write in the product/chemical identification, hazard statements and additional comments on the back
- Label set of nine pictograms and the two approved signal words "Danger" and "Warning" are included for each tag and made of Adhesive Vinyl
- Available in two stock materials, in packs of 5

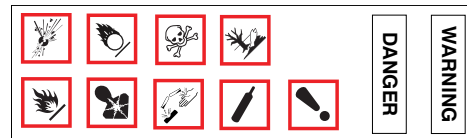

Label set includes 9 pictograms and 2 signal words

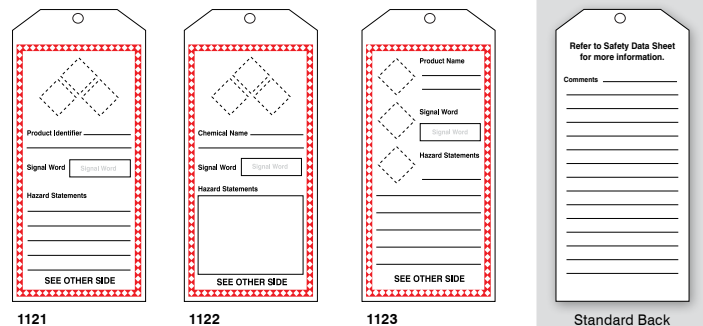

To Order Tags: Add material code before part number.
Example: Material Code PCT- + Part No. 1121 = PCT-1121

Size	Material	Code	Std. Pkg. Qty.
8 1/2" x 3 7/8"	Poly Cardstock	PCT-	5
8 1/2" x 3 7/8"	Rigid Plastic	PVT-	5

GHS Hazard Pictogram and Classes

Physical/Chemical Risk



Explosion Bomb
Explosives, Self-Reacting, Organic Peroxides



Gas Cylinder
Gases under pressure



Flame over Circle
Oxidizers



Flame
Flammables, Pyrophoric, Self-Heating, Emits Flammable Gas, Self-Reacting, Organic Peroxides



Corrosion
Corrosive to Metals

Health Risk



Corrosion
Skin Corrosion/Burns and Eye Damage



Skull and Crossbones
Acute Toxicity (fatal or toxic)



Exclamation Mark
Irritant (skin and eye), Skin Sensitizer, Acute Toxicity (harmful), Narcotic Effects, Respiratory Tract Irritant, Hazardous to Ozone Layer



Health Danger
Carcinogen, Mutagenicity, Reproductive Toxicity, Respiratory Sensitizer, Target Organ Toxicity, Aspiration Toxicity

Environmental Risk



Environmental
Aquatic Toxicity

New Globally Harmonized Standard (GHS) Label Format Required Elements

1. **Product Identifier or Name:**

3. **Signal Word:**
Indicates relative level of hazard. "DANGER" is used for most severe instances; "WARNING" is less severe.

2. **Pictogram Hazard Symbols in Red Diamonds:**

Indicates what type of risk physical/chemical, health, or environmental.



5. **Hazard Statement:**
Describes the nature of the hazard(s) of a chemical and often the degree of the hazard.

6. **Manufacturer Information:**
Company name, address, and phone number.

4. **Precautionary Statement:**
Indicates recommended measures to be taken to minimize or prevent adverse effects from exposure to a hazardous chemical.

GHS Pre-Printed Hazard Symbols

Nine hazard pictograms available on cards are in compliance with the GHS standard. Labels are vinyl material for indoor or outdoor use. Available in four size options:

- 0.63" with 36 labels per card
- 1.00" with 16 labels per card
- 2.00" with 4 labels per card
- 4.00" with 2 labels per card

Hazard Pictogram	Part Number Size 0.63"	Part Number Size 1.00"	Part Number Size 2.00"	Part Number Size 4.00"
Explosion Bomb	PVS0606GEX	PVS0101GEX	PVS0202GEX	PVS0404GEX
Gas Cylinder	PVS0606GPP	PVS0101GPP	PVS0202GPP	PVS0404GPP
Flame Over Circle	PVS0606GOX	PVS0101GOX	PVS0202GOX	PVS0404GOX
Flame	PVS0606GFF	PVS0101GFF	PVS0202GFF	PVS0404GFF
Corrosion	PVS0606GCC	PVS0101GCC	PVS0202GCC	PVS0404GCC
Skull and Crossbones	PVS0606GST	PVS0101GST	PVS0202GST	PVS0404GST
Exclamation Mark	PVS0606GAT	PVS0101GAT	PVS0202GAT	PVS0404GAT
Health Danger	PVS0606GHD	PVS0101GHD	PVS0202GHD	PVS0404GHD
Environmental	PVS0606GE	PVS0101GE	PVS0202GE	PVS0404GE

Write-On GHS Tags and Signs

Write-on tags and signs allow for quick and easy labeling for compliance with the new GHS requirements. GHS tags and signs are for use with PVS006006G*

Pictogram Labels (sold separately).



Vinyl Tag
5.75"H x 3.00"W PVT-GHS-Q

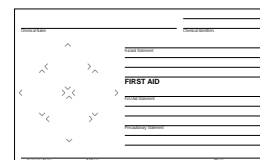

Vinyl Sign
3.00"H x 5.90"W
PVS0305GHS

*Custom Printed GHS Labels are also available. Please visit www.panduit.com/ghs for more information.

GHS Print On-Demand Thermal Transfer Labels



Print from the Safety Ease™ GHS Labeling Software or Easy-Mark™ Labeling Software directly to die cut polyester labels that match the formats in the software. Labels feature 1, 2, 3, or 4 red pre-printed diamonds for one-pass printing of the two-color GHS labels; 250 labels per roll.

1 Diamond Thermal Transfer Labels

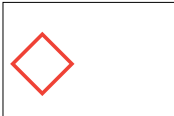

Part No.	Size
C400X200YPT-G1	2.50" x 4.00"
C400X400YPT-G1	4.00" x 4.00"
C400X600YPT-G1	4.00" x 6.00"

2 Diamond Thermal Transfer Labels



Part No.	Size
C400X200YPT-G2	2.50" x 4.00"
C400X400YPT-G2	4.00" x 4.00"
C400X600YPT-G2	4.00" x 6.00"

3 Diamond Thermal Transfer Labels



Part No.	Size
C400X200YPT-G3	2.50" x 4.00"
C400X400YPT-G3	4.00" x 4.00"
C400X600YPT-G3	4.00" x 6.00"

4 Diamond Thermal Transfer Labels

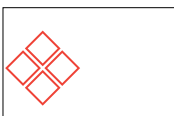

Part No.	Size
C400X200YPT-G4	2.50" x 4.00"
C400X400YPT-G4	4.00" x 4.00"
C400X600YPT-G4	4.00" x 6.00"

Safety Ease™ Printable Media for Ink Jet and Laser Printers



Print from the Safety Ease™ GHS Labeling Software directly to die cut adhesive sheets that match the formats in the software.

Part No.	Part Description	Signs Per Sheet	Sign Size				Std. Pkg. Qty.
			Height		Width		
			In.	mm	In.	mm	
8.50"W x 11.00"H Adhesive Sheets for Use with Ink Jet Printers							
SEZ0811I	Polyester ink jet permanent adhesive.	1	8.50	215.9	11.00	279.4	25
SEZ0810I		1	8.00	203.2	10.00	254.0	25
SEZ0508I		2	5.00	127.0	8.00	203.2	25
SEZ0405I		4	4.00	101.6	5.00	127.0	25
SEZ0204I		8	2.50	63.5	4.00	101.6	25
8.50"W x 11.00"H Adhesive Sheets for Use with Laser Printers							
SEZ0811L	Polyester laser permanent adhesive.	1	8.50	215.9	11.00	279.4	25
SEZ0810L		1	8.00	203.2	10.00	254.0	25
SEZ0508L		2	5.00	127.0	8.00	203.2	25
SEZ0405L		4	4.00	101.6	5.00	127.0	25
SEZ0204L		8	2.50	63.5	4.00	101.6	25

GHS Hazard Communication Training Kit



Panduit GHS Hazard Communication Training Kit provides instruction on OSHA 1910.1200 Hazard Communication Standard, including changes related to Globally Harmonized System for the Classification of Hazardous Chemicals (GHS). Included is a seventy minute video with instructor led training on setting up a Hazard Communication Program and understanding the new labeling and safety data sheet requirements. The Companion CD provided consists of PowerPoint slides, PDF files of the quiz, training record and certificate of completion.

Part No.	Kit Contents
PSL-GHS-TRAIN	(1) Panduit GHS Hazard Communication Training DVD (1) Panduit GHS Hazard Communication Training Companion CD (1) Leaders Guide (1) Participant Quiz (1) Training Record (4) 4" x 8" Acetone GHS label sample (1) PSL-GHSPSTE GHS Training Poster (25) PSL-GHSWALLETE GHS Training Wallet Cards

GHS Posters

Globally Harmonized System (GHS)

GHS Labels

The illustration below identifies the components of a GHS label. Actual label design and layout may vary and are subject to the discretion of the competent authority.

GHS Pictograms

Picture are the standard hazard symbols used in the GHS. Symbols can be used individually and in combinations to define the specific hazard(s) of the chemical.

English PHC0131

Post GHS label and pictogram guidelines for quick reference.

- 18" x 24" plastic laminate poster
- Displays easy-to-understand information on GHS labels and pictograms
- Label & Pictogram. Guidelines for quick reference.

Part No.	Description	UOM
PHC0131	English	Each
PHC0120	Spanish	Each

Sistema Globalmente Armonizado (SGA)

Etiquetas SGA

La siguiente ilustración identifica los componentes de la etiqueta SGA. El diseño de la etiqueta actual y su apariencia pueden variar y están sujetos a la discreción de la autoridad competente.

Pictogramas SGA

En la siguiente ilustración se muestran los símbolos de peligro estándar utilizados en el SGA. Los símbolos pueden utilizarse individualmente y en combinaciones para definir el peligro específico de un producto químico.

Spanish PHC0120

GHS Wallet Cards

GHS Label

Product Identifier: Should match the product identifier used on the Material Safety Data Sheet.

Pictograms: Graphical compositions intended to convey specific hazard information.

Precautionary Statements: Describe recommended measures to minimize or prevent adverse effects resulting from exposure.

Supplier Identification: The name, address and telephone number of the manufacturer or supplier.

GHS Pictograms

English Front PHC0001

English Back

Keep a visual reminder of GHS label and pictogram requirements close at hand.

- Double-sided plastic wallet card
- One side shows a representation of the nine standard GHS pictograms, while the flip side shows a GHS label example
- Measures 3 3/8" x 2 1/8"

Part No.	Description	UOM
PHC0001	English	Each
PHC0119	Spanish	Each

Training Posters

Inform employees and support your hazard communication program.

- Plastic laminated posters provide instructional information regarding chemical identification and hazard communication
- SDS poster summarizes the information found in the 16 sections OSHA outlines in its revised Haz-Com standard
- Haz-Com poster includes information pertaining to both NFPA and HMCS

Part No.	Description	UOM
PHC0130	SDS	Each
PHC0129	Haz-Com	Each

Safety Data Sheets (HCS 2012/GHS Format)

SDS, 20" x 32"

PHC0130

HAZ-COM / HAZ-MAT WARNING SYMBOLS

CHEMICAL HAZARDS IN THIS AREA

HAZARD	HEALTH HAZARD	FIRE HAZARD
NFPA	HEALTH	FLAMMABILITY
HMCS	HEALTH HAZARD	INSTABILITY

PROTECTIVE EQUIPMENT INDEX

These symbols are for immediate warning — refer to SDS for detailed information

Haz-Com, 18" x 24"

PHC0129



Traffic Signs

Post traffic signs to safely control and regulate the flow of vehicles and pedestrians.

- Constructed of heavy-duty, 0.080" aluminum, rustproof to withstand weather conditions
- Reflective face for added bounce-back light visibility from headlights and other light sources
- Abrasion-resistant face is also UV-resistant to prevent fading for years of outdoor exposure
- Top and bottom center holes for post- or fence-mount installation

Materials

Engineer-Grade Prismatic – Good choice for added visibility in low-light conditions. Type I

High-Intensity Prismatic – Better choice for greater visibility with 3X brighter than Engineer-Grade. Type III, IV, X

Stop Signs & Yield Signs



Engineer-Grade Prismatic	High-Intensity Prismatic	Size
Part No.	Part No.	
PTS075	PTS080	18" x 18"
PTS186	PTS083	24" x 24"
PTS187	PTS084	30" x 30"
PTS188	PTS085	36" x 36"

Engineer-Grade Prismatic	High-Intensity Prismatic	Size
Part No.	Part No.	
PTS141	PTS140	24" x 24"
PTS143	PTS142	30" x 30"
PTS145	PTS144	36" x 36"



















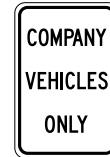







Speed Limit Signs



Engineer-Grade Prismatic				High-Intensity Prismatic				Size
SPEED LIMIT 5 Part No.	SPEED LIMIT 10 Part No.	SPEED LIMIT 15 Part No.	SPEED LIMIT 20 Part No.	SPEED LIMIT 5 Part No.	SPEED LIMIT 10 Part No.	SPEED LIMIT 15 Part No.	SPEED LIMIT 20 Part No.	
PTS103	PTS091	PTS093	PTS095	PTS102	PTS090	PTS092	PTS094	18" x 12"
PTS123	PTS111	PTS113	PTS115	PTS122	PTS110	PTS112	PTS114	24" x 18"



Parking Signs

Material – Engineer-Grade Prismatic

						
18" x 12" PTS051	18" x 12" PTS053	18" x 12" PTS054	18" x 12" PTS052	18" x 12" PTS055	18" x 12" PTS056	18" x 12" PTS057
						
18" x 12" PTS065	18" x 12" PTS069	18" x 12" PTS067	18" x 12" PTS068	18" x 12" PTS070	18" x 12" PTS063	18" x 12" PTS058
						
18" x 12" PTS066	18" x 12" PTS064	18" x 12" PTS061	18" x 12" PTS059	18" x 12" PTS060	18" x 12" PTS062	18" x 12" PTS005
						
18" x 12" PTS004	18" x 12" PTS006	18" x 12" PTS001	18" x 12" PTS007	18" x 12" PTS003	18" x 12" PTS002	

Traffic Direction Signs

Material – Engineer-Grade Prismatic

						
24" x 18" PTS198	24" x 18" PTS200	18" x 12" PTS147	18" x 12" PTS149	24" x 18" PTS089	24" x 18" Arrow rt. PTS196 Arrow lt. PTS194	24" x 18" PTS087
						
18" x 24" PTS082	18" x 24" PTS077 18" x 30" PTS079	24" x 24" PTS190 30" x 30" PTS192	18" x 18" PTS151	18" x 18" PTS153	18" x 12" PTS165	18" x 12" PTS167

Spring-Less Sign Stand



Economy-grade, roll-up stand for use in moderate winds and light traffic conditions.

- Opens quickly and easily to a wide, 66 1/2" x 43 1/2", stable footprint
- Folds to compact size, 6 1/2" x 8 1/2" x 25"
- Powder-coated, galvanized steel frames with non-slip rubber tips
- Weight: 22 lbs.
- For use with 36" or 48" diamond shaped roll-up construction signs with fiberglass cross-ribs (sold separately on next page)
- Meets Manual on Uniform Traffic Control Devices (MUTCD) specifications



NCHRP-350 compliant.

Part No.	UOM
PTS201	Each

Single Spring Sign Stand



Single coil spring-loaded design adds stability and flexibility to stand up to wind loads and gusts.

- Leg levers for easy deployment – opens to a wide footprint of 67 1/2" x 42"
- Ergonomic design also allows users to lift up on legs to drop them into place
- Folds to compact size, 8" x 6" x 25 1/4"
- Powder-coated, galvanized steel frames with non-slip rubber tips
- Weight: 24 lbs.
- For use with 36" or 48" diamond shaped roll-up construction signs with fiberglass cross-ribs (sold separately on next page)
- Meets Manual on Uniform Traffic Control Devices (MUTCD) specifications



NCHRP-350 compliant.

Part No.	UOM
PTS202	Each

Roll-Up Construction Signs

Quickly set up highly visible signs for temporary warning of hazard and construction areas.

- Flexible fabric, quick and easy to setup and takedown – roll up for compact storage and portability
- Safety orange with contrasting black messages and symbols
- Cross-Ribs (sold separately) insert into four corner pockets, providing rigid support
- Overlay signs snap on to change directional or distance message

Materials:

Mesh Vinyl (V) - Non-reflective, ideal for daytime only applications

Fluorescent Vinyl (F) - Non-reflective, UV stable bright colored vinyl for daytime use only

Reflective Vinyl (R) - High-Intensity retro-reflective fiber reinforced nylon fabric, ideal for attention getting and low-light conditions

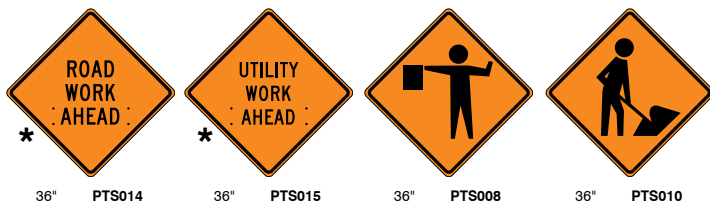

Cautionary Signs

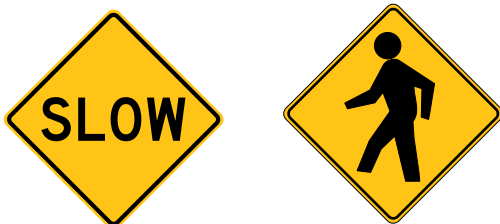

Engineer-Grade Prismatic		High-Intensity Prismatic		Size
SLOW Part No.	PEDXING Part No.	SLOW Part No.	PEDXING Part No.	
PTS163	PTS161	PTS162	PTS160	24" x 24"
—	PTS170	—	PTS169	30" x 30"



To Order : Add material & size code after part number.
Example: Part No. PTS009 + Material/Size Code V36 = PTS009V36

Material & Size Code		Signs	Overlays*
		36"	36"
Mesh Vinyl	V36	Each	Each
Fluorescent Vinyl	F36	Each	Each
Reflective Vinyl	R36	Each	Each

Cross-Ribs

Rigid support keeps roll-up signs deployed and visible.

- Constructed of durable fiberglass material
- Inserts into roll-up sign four-corner pockets
- For use with 36" Roll-Up Construction Signs

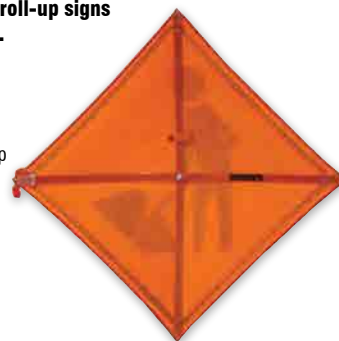

Part No.	UOM
PTS203	Each

Steel U-Channel Posts



Everything you need to post-mount your sign.

- Available in 2 colors, green or galvanized
- Two lengths – 6-ft., 8-ft.
- Hardware set (sold separately) includes – 2 bolts, 2 nuts, 4 washers

Price per Each

Length	Green Finish		Galvanized Finish	
	Part No.	UOM	Part No.	UOM
<i>Standard Weight – 1.12 lb/foot</i>				
6-ft.	PTS174	Each	PTS175	Each
<i>Heavy Weight – 2.00 lb/foot</i>				
6-ft.	PTS173	Each	PTS172	Each
8-ft.	PTS176	Each	PTS177	Each
Description		Part No.	UOM	
Hardware Set		PTS171	Set	

Sign Mounting Brackets and Plate



Fence Mount Brackets

- Easily secure your sign to a chain link fence
- Rust-proof aluminum with mounting holes to attach sign through fence spaces

Part No.	Fits Sign	UOM
PTS183	12"H	Each
PTS184	18"H	Each
PTS185	24"H	Each

Sign Mounting Plate

- Keep signs flat when mounting to U-Channel post
- Includes adaptor ringbolt, washer, plate and hex nut
- Two sets required per sign

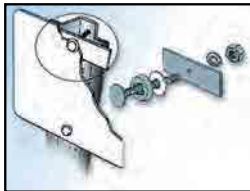

Part No.	UOM
PTS182	Set

Fence Sign Holder Bracket



Post signs and warnings on chain link fences.

- Galvanized steel bracket
- Universal to work with nearly any size chain link fence
- Protects signs from damage by distributing pressure along the surface area of the bracket
- Two brackets required for post mounting
- Includes 5/16"-18 thread, 3/4" long stainless steel bolt and nylon washer – works well for use with 3/8" sign mounting holes
- Sized to fit most signs

Part No.	UOM
PBB0080	Each

Cast Iron Base and Steel Post

Mount signs with stable post and weighted base that can be moved as needed.

- Solid, heavyweight cast iron base available in 14" and 18" diameters
- 1 7/8" outside diameter x 48"H steel post can accommodate sign sizes up to 24" x 24"
- Sign mounting hardware included

Part No.	Base Size	Weight	UOM
PTS179	14" dia.	27 lbs.	Each
PTS180	18" dia.	37 lbs.	Each



Optional wheel attachment for easy tilting and moving – fits 14" base only.

Part No.	UOM
PTS178	Each



Sign sold separately

Portable Sign Stand

Ideal for temporary applications or crosswalks.

- 6-ft., white powder-coated steel post with pre-drilled mounting holes
- Base plate with locking pin, and a road-gripping, 40 lb., recycled rubber base
- When disassembled, bases nest for easy storage
- NCHRP-350 compliant

Part No.	Description	UOM
PTS181*	Portable Sign Stand	Each

*Sign sold separately

Part No.	Description	UOM
PTS154	Stop Sign Kit	Kit

Includes – (1) Portable Sign Stand, (1) 24" x 24" Engineer-Grade Prismatic Aluminum Stop Sign, (1) Hardware Set



Blinker Signs

Maximum Visibility in any Environment.

- Flashing LED lights, combined with DG High-Prism sheeting, provide superior luminance and visibility
- Eco-friendly, 13 watt solar panel, 6VDC battery charger require no AC
- Low power allows for smaller panel and cleaner look
- LED automatically measures available light and adjusts the LED flash brightness accordingly
- Up to 30 day autonomy (flashing 24/7)
- Heavy-duty aluminum construction with fully enclosed wiring withstands harsh elements
- Attaches to 2 3/8" post with mounting brackets (sold separately)
- MUTCD-compliant for public roadway use

Size	UOM
30" x 30"	Each



Security Stop Safety Signs



12" x 12"
B4221



12" x 12"
B4203



12" x 12"
B4209



12" x 12"
B4219



12" x 12"
B4201

Available Materials	Codes	Available Sizes	Codes
Adhesive Vinyl (Each)	PVS	12" x 12"	1212
Polyester Laminated Vinyl (Each)	PLVS		

How to Order Signs:

- Select Material Code: PVS
- Select Size Code: 1212
- Select Sign Base Part Number: B4201
- Combine Codes in Specific Order for Complete Part Number: PVS1212B4201



Speed Bump Signs

Engineer-Grade Prismatic – Good choice for added visibility in low-light conditions



24" x 24"
30" x 30"

PTS159
PTS158



18" x 12"
PTS157



18" x 12"
PTS167



18" x 12"
PTS168

Non-Regulatory Traffic Signs

These signs are on non-reflective material. Intended for indoor or non-public roadway use.



12" x 12" 18" x 18" 24" x 24"
B4472



12" x 12" 18" x 18" 24" x 24"
B4481



12" x 12" 18" x 18"
B4477



12" x 12" 18" x 18"
B4939



12" x 12" 18" x 18"
B4933

Available Materials	Codes	Available Sizes	Codes
Adhesive Vinyl (Each)	PVS	12" x 12"	1212
Polyester Laminated Vinyl (Each)	PLVS	18" x 18"	1818
Polyethylene Plastic (Each)	PRS	24" x 24"	2424
Aluminum (Each)	PAS		

How to Order Signs:

- Select Material Code: PVS
- Select Size Code: 1212
- Select Sign Base Part Number: B4481
- Combine Codes in Specific Order for Complete Part Number: PVS1212B4481



Marking Tapes



Colors and combinations meet specific industry and OSHA 29 CFR §1910.144 warning requirements



Mark specific areas and promote safety by identifying potential hazard areas with visible tapes.

- 0.006" vinyl adheres to floors, walls, piping, posts, beams, handrails, stairways, machinery, and equipment
- Waterproof, wear-resistant, minor resistance to acids, oils, grease, caustics, alkalis, and most solvents
- Permanent self-adhesive back



Color/Combination	Code	Application
Solid Colors		
White	WHT	General Facility
Gray	GRY	General Facility
Brown	BRN	General Facility
Black	BLK	General Facility
Red	RED	Fire Protection Equipment & Danger Hazards
Orange	ORN	Danger Points on Machines
Yellow	YEL	Physical Hazards
Green	GRN	First Aid & Safety Equipment
Blue	BLU	Machinery being Worked On
Purple	PUR	X-ray & Radiation Hazards
Checkerboard and Stripe Pattern		
Black/Yellow	BY	General, Physical Hazards
Red/White	RW	Fire Protection & Equipment
Black/White	BW	Housekeeping, Aisles, Traffic, & Passageways
Magenta/Yellow	MY	Radiation Areas
Green/White	GW	Safety & First Aid
Blue/White	BLW	Defective Equipment
Orange/White	OW	Traffic and Caution

To Order: Add color code after part number.
Example: Part No. PFM2X36 + Color Code WHT = PFM2X36WHT

Part No.	Size	UOM	Part No.	Size	UOM
Solid Colors					
PFM2X36	2" x 108-ft.	Roll	PFM3X36	3" x 108-ft.	Roll
PFM2X60	2" x 180-ft.	Roll	PFM3X60	3" x 180-ft.	Roll
Checkerboard Pattern					
PFMC2X18	2" x 54-ft.	Roll	PFMC3X18	3" x 54-ft.	Roll
Stripe Pattern					
PFM2X18	2" x 54-ft.	Roll	PFM3X18	3" x 54-ft.	Roll
PFM2X36	2" x 108-ft.	Roll	PFM3X36	3" x 108-ft.	Roll

Reflective Tapes



- Safety-grade with 'bounce-back' reflectivity
- Improved daytime, low-light and night time visibility
- 0.0055" thick urethane tape
- Permanent adhesive with peel-off liner
- Suitable for outdoor use on poles, barricades, fences, buildings, private roads, and off-road vehicles

Available colors with color code:

Color	Code
Solid Colors	
Black	BLK
Blue	BLU
Green	GRN
Orange	ORN
Red	RED
White	WHT
Yellow	YEL
Stripe Colors	
Black/White	BW
Black/Yellow	BY
Orange/White	OW
Red/White	RW

To Order: Add color code after part number.
Example: Part No. PFM2X15 + Color Code BW = PFM2X15BW

Part No.	Size	UOM
PFMR2X15	2" x 15-ft.	Roll
PFMR2X30	2" x 30-ft.	Roll
PFMR3X15	3" x 15-ft.	Roll

Message Marking Tapes

Use marking tape with specific message to point out potential hazard areas.

- Bold contrasting message printed repeatedly
- 6-mil vinyl adheres to floors, walls, and equipment
- Clear overlaminated protective film resists dirt, light chemicals and light abrasions
- Permanent, self-adhesive back
- 2" x 54-ft. rolls

UOM
Roll



PFM0114



PFM0115



PFM0116

Non-Slip Floor Marking Tapes



Use non-slip tapes to mark and identify aisles, pathways, and designated locations in your facility.

Sub-surface printed 0.004" vinyl tapes are overlaminated with a 0.017" clear, protective pebble-textured tread. The dimpled non-slip surface is ideal for pedestrian traffic areas.

- Dual-layer, color vinyl and clear textured vinyl construction
- Strong acrylic-based adhesive peel-off back liner
- Adhere to clean, smooth, dry surface
- Service temperature range: -20° to 140°F
- Available in solid colors or with messages

Color is sub-surface printed

Overlaminated non-slip vinyl pebble-textured surface



To Order Solid Color Tapes:

Add color code after part number: Red – RED, Orange – ORN, Yellow – YEL, Green – GRN, Blue – BLU, White – WHT, Black – BLK.

Example: Part No. PFMT2X100 + Color Code YEL = PFMT2X100YEL



Part No.	Size	UOM
PFMT2X100	2"W x 100-ft.	Roll
PFMT3X100	3"W x 100-ft.	Roll

Message Tapes

Size	UOM
3"W x 50-ft.	Roll



Non-Slip Floor Marking Shapes

Mark pallets, storage, and walkways in your facility – ideal for 5S programs.

- Self-adhesive 0.004" vinyl
- Protective non-slip, pebble-textured overlamine
- Strong acrylic-based adhesive peel-off back liner
- Adhere to clean, smooth, dry surface
- Service temperature range: -20° to 140°F



Color is sub-surface printed

Overlaminated non-slip vinyl pebble-textured surface

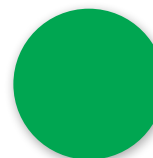
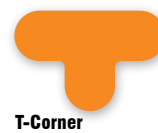
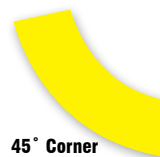
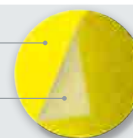

To Order: Add color code after part number: Red – RED, Orange – ORN, Yellow – YEL, Green – GRN, Blue – BLU, White – WHT, Black – BLK.

Example: Part No. PFMTS09 + Color Code GRN = PFMTS09GRN

Part No.	Size	UOM
Corner		
PFMTS09	6" x 6"	Each
PFMTS10	12" x 12"	Each
45° Corner		
PFMTS20	6"	Each
PFMTS19	12"	Each
T-Corner		
PFMTS11	6" x 9"	Each
PFMTS12	8" x 12"	Each
Quad Corner		
PFMTS17	9" x 9"	Each
PFMTS18	12" x 12"	Each

Part No.	Size	UOM
Arrow		
PFMTS14	3"	Each
PFMTS15	6"	Each
PFMTS16	12"	Each
Square		
PFMTS05	3" x 3"	Each
PFMTS06	6" x 6"	Each
Circle, Dot		
PFMTS03	3" dia	Each
PFMTS04	6" dia	Each
Triangle		
PFMTS07	3"	Each
PFMTS08	6"	Each

Part No.	Length	UOM
Footprints		
PFMTS01	6"	Pair
PFMTS02	12"	Pair

Floor Marking Shapes

Mark directional traffic paths or hazardous areas on floors, stairways, and walls.

- 0.005" vinyl
- Individually die-cut shapes
- Aggressive, permanent, self-adhesive back
- Peel-off liner

Available colors with color code:

Red – RED, Blue – BLU, Green – GRN, Black – BLK, Yellow – YEL, Orange – ORN, White – WHT

To Order: Add color code after part number.

Example: Part No. PFM2 + Color Code BLU = PFM2BLU

Size*	Std. Pkg. Qty.	UOM
2"	250	Roll
3"	250	Roll
4"	100	Roll
6"	5 Pair	Pkg.
12"	5 Pair	Pkg.



Dots

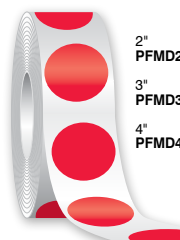

*Size for: Dot by diameter

Arrows

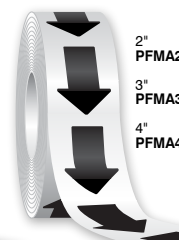

*Size for: Arrow measured by width of point

Footprints



*Size for: Footprint is 6" or 12" length

Glow-in-the-Dark Tapes & Shapes

Glows

Visibility and safety in emergency blackout situations

- Photoluminescent tapes and shapes store energy from any light source
- 10-hour glow rating
- 0.010" polyester with laminated gloss surface
- Permanent adhesive backing with peel-off liner



Glow-in-the-Dark Tapes

Solid Color		Stripe Pattern		Arrow Pattern		Size
Part No.	UOM	Part No.	UOM	Part No.	UOM	
PFM0243	Roll	PFM0246	Roll	PFM0249	Roll	2" x 15-ft.
PFM0244	Roll	PFM0247	Roll	PFM0250	Roll	2" x 30-ft.
PFM0245	Roll	PFM0248	Roll	PFM0251	Roll	3" x 15-ft.

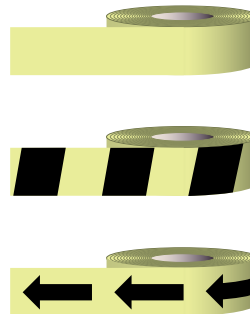

Glow-in-the-Dark Shapes

Size	Std. Pkg. Qty.	UOM
2"	50	Roll
3"	50	Roll
6"	1 Pair	Pkg.
12"	1 Pair	Pkg.

Dots

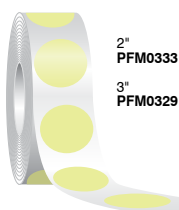

Arrows

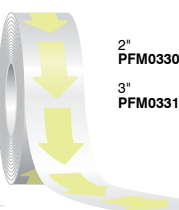

Footprints



B1.
Cable
Ties

B2.
Cable
Accessories

B3.
Stainless
Steel Cable
Ties &
Accessories

C1.
Wiring
Duct

C2.
Abrasion
Protection

C3.
Cable
Management

D1.
Terminals

D2.
Power
Connectors

D3.
Grounding
Connectors

E1.
Labeling
Systems

E2.
Labels

E3.
Pre-Printed
&
Write-On
Markers

E4.
Permanent
Identification

E5.
Industrial
Safety
Solutions

F.
Keystone
Cabling
Systems

G.
Part
Number
Index

Non-Skid Floor Tapes

Create a high-traction surface to prevent slips, trips, and falls.

- Durable surface provides good grip, wear resistance, and water resistance
- Suitable for indoor and outdoor environments
- Resists sliding, buckling, wrinkling, and peeling
- Black tape is 60-grit aluminum oxide compound layer fused onto thick PVC base; colored and striped tapes are 46-grit
- High-tack acrylic adhesive back
- Peel-off liner



OSHA 29 CFR §1910.24 (f)



Part No.	Size	UOM
Solid Black		
PFM0090	1" x 60-ft.	Roll
PFM0092	2" x 60-ft.	Roll
PFM0094	3" x 60-ft.	Roll
PFM0095	4" x 60-ft.	Roll
PFM0097	6" x 60-ft.	Roll



Part No.	Size	UOM
Solid Yellow		
PFM0091	1" x 60-ft.	Roll
PFM0093	2" x 60-ft.	Roll
PFM0096	4" x 60-ft.	Roll
Striped Black/Yellow		
PFM0103	2" x 60-ft.	Roll
PFM0105	4" x 60-ft.	Roll



• Muted yellow appearance masks dirt and grime

Part No.	Size	UOM
Muted Yellow w/ Black Particles		
PFM0107	2" x 60-ft.	Roll
PFM0108	4" x 60-ft.	Roll

Non-Skid Floor Signs

High-traction, anti-skid, clear grit surface. 6" x 24". Sub-surface printed vinyl floor signs. High-tack, acrylic adhesive back. Peel-off liner.

UOM
Each



PFM0040



PFM0041



PFM0042



PFM0046



PFM0045



PFM0043



PFM0047



PFM0044



Non-Skid Floor Shape Tapes

Get a finished look to your anti-skid tapes in pre-cut shapes.

- Rounded corners to prevent corners from lifting
- Aggressive 60-grit aluminum oxide compound layer fused onto a thick PVC base
- Peel-off liner with high-tack acrylic adhesive back
- Suitable for indoor and outdoor environments, water resistant



Cleat w/ Reflective Yellow

Cleat w/ Glow

Part No.	Description	Size	UOM
PFM0110	Square	5 1/2" x 5 1/2"	Each
PFM0109	Wide Strip	3" x 24"	Each
PFM0111	Cleat	6" x 24"	Each
PFM0112	Cleat w/ Refl. Yellow	6" x 24"	Each
PFM0113	Cleat w/ Glow	6" x 24"	Each

High Performance Marking Tapes

Heavy-duty composite tape outperforms standard floor marking tapes.

Printed 0.002" polyester tape with 2-mil gloss overlamine provides superior durability for industrial facility and high plant traffic.

- High-gloss surface resists marks and smudges
- Resistant to abrasions, water, chemicals and heat
- High tack, acrylic adhesive back minimizes peel or lift
- Applies to clean, non-coated, smooth or rough surfaces, including concrete
- Low-profile reduces tears and scratches from skids and pallet jacks
- Removes easily without leaving residue or damage to the floor
- Minimum application temperature: 50°F
- Available in solid colors or with messages



To Order Solid Color Tapes: Add color code after part number: Red – RED, Orange – ORN, Yellow – YEL, Green – GRN, Blue – BLU, White – WHT, Black – BLK.
Example: Part No. PFMH2X100 + Color Code BLK = PFMH2X100BLK

Part No.	Size	UOM
PFMH2X100	2"W x 100-ft.	Roll
PFMH3X100	3"W x 100-ft.	Roll

Message Tapes

Size	UOM
3"W x 50-ft.	Roll



Floor Label Frame System

Place and protect message, barcode and other identification on the floor in a sturdy frame system.

Metal frame mounts directly to the floor with four concrete screws (included) and contains a clear protective cover to protect your label (not included) underneath. Beveled edges prevent damage from rollover of pallet jacks and forklift vehicles.

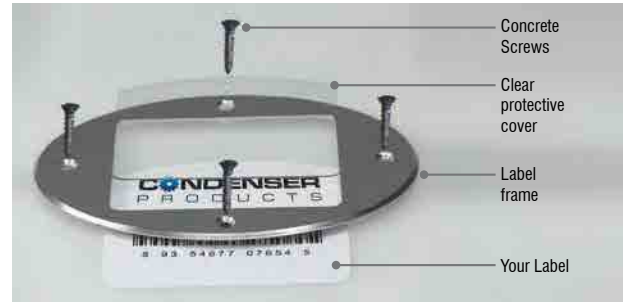

Small size:

- 8 1/2" x 5 1/2" x 1/8" all-aluminum oval frame
- 3 1/2" x 5" x 0.063" clear visible protective polycarbonate cover

Large size:

- 12" x 7 1/2" x 1/8" all-aluminum oval frame
- 5" x 7" x 0.063" clear visible protective polycarbonate cover

Small Part No.	Large Part No.	Std. Pkg. Qty.	UOM
PBB0085	PBB0086	Each	Each
PBB0081	PFM0001	10	Pkg.
PBB0083	PFM0002	25	Pkg.
PBB0084	PFM0003	50	Pkg.
PBB0082	PFM0004	100	Pkg.

Textured Marking Tapes

Low-profile grip vinyl tapes are ideal for indoor/outdoor and wet or dry environments.

- Reinforced vinyl with weather-proof adhesive system
- Slip-resistant, mild abrasive surface
- Install on smooth, clean and dry surfaces
- Low level reflectivity
- 3"W x 108-ft. long rolls
- Service temperature range: 0° to 150°F



To Order:

Add color code after part number:
Red – RED, Blue – BLU, Yellow – YEL,
White – WHT, Green – GRN.
Example: Part No. PFMT3X36 + Color Code YEL = PFMT3X36YEL

Part No.	UOM
PFMT3X36	Roll

Non-Slip Shape Floor Signs

Grab attention with non-slip floor message signs.

- Bold colors and graphics in unique shapes
- Self-adhesive vinyl floor signs are sub-surface printed
- Overlaminated with pebble-textured, non-slip layer
- Can withstand heavy foot traffic
- Permanent adhesive back with peel-off liner
- Signs adhere to smooth, clean, and dry surface

Diamond



Triangle



Pavement-Print Signs



Place message and graphic signs outdoors on pavement.

- Adheres to asphalt, concrete and step-stones
- Conforms to rough, untreated surfaces like stone and cement
- High-performance adhesive back, foil-base material
- Non-laminate surface contains embedded glass beads for a non-slip texture - meeting NFSI and ASTM D2047 specifications
- Withstands normal to heavy walking foot traffic and other abrasions
- Apply to swept, clean, dry surface
- Application temperature range: 50° to 100°F
- For short- to long-term applications
- Removes easily, usually without any residues



Non-Slip Floor Signs

Non-slip, pebble-textured, clear surface withstands heavy pedestrian traffic. Image is sub-surface printed. Permanent, self-adhesive vinyl with peel-off liner.

Description	UOM
Round-Style	Each
Round-Style Glow Adhesive	Each
Mat-Style	Each
Step-Style	Each



Round-Style

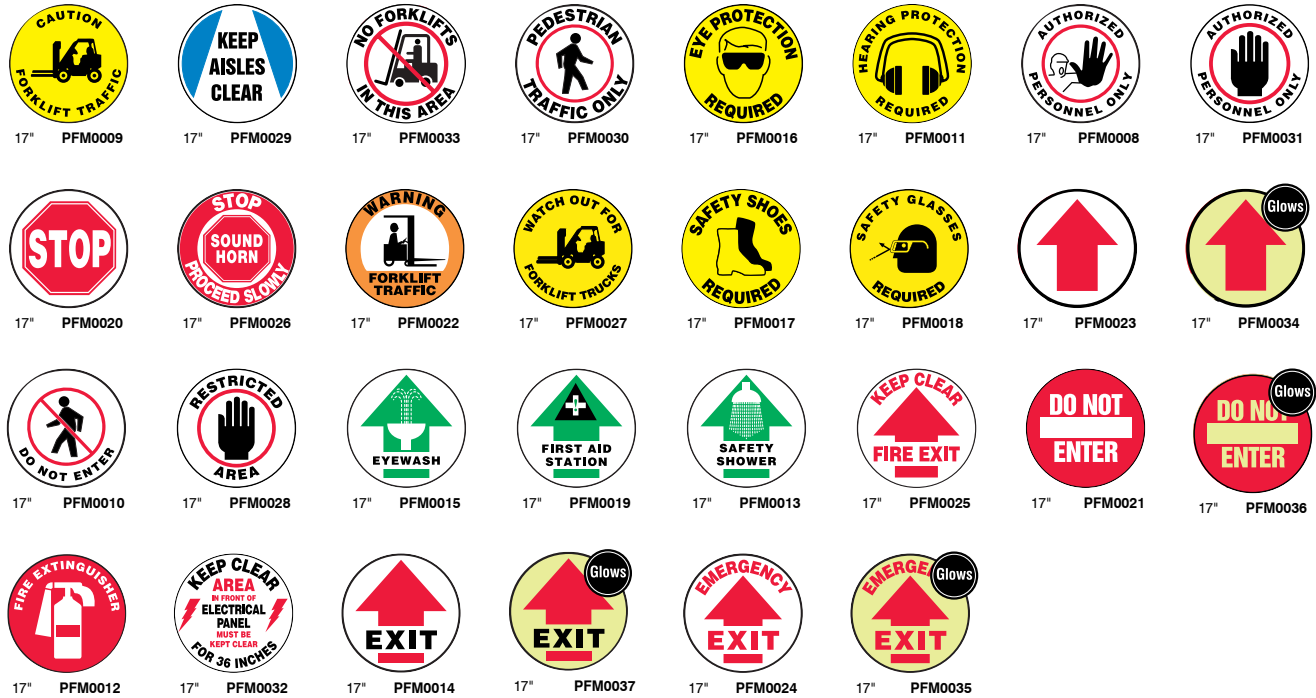

Mat-style



Step-Style



Cone Top Warning Signs



Cone sold separately

Temporarily and quickly direct facility traffic.

- Slips into top of any standard, flexible traffic cone
- Rugged, 0.060" plastic
- Same message both sides
- Weather- and fade-resistant
- 10" x 14"

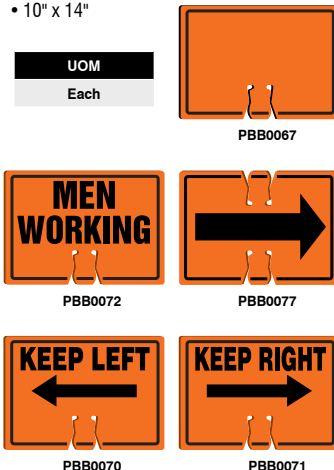

Pennant Flag Tapes

Attention-getting pennant flag tapes warn of hazardous areas.

Standard style

- 9" x 12" red, polyethylene plastic pennants
- Sewn onto durable cord - approx. 66" lead cord each end
- Ideal for indoor and temporary outdoor applications

Heavy-Duty style

- Large 18" x 18" fluorescent orange 9-oz. vinyl laminated, nylon pennants
- Tough, tear-resistant
- Sewn onto high-tensile strength cord - approx. 20-ft. lead each end
- Ideal for extended periods outdoors, withstands harsh conditions

OSHA-Compliant style

- Large 18" x 18", fluorescent orange 9-oz. vinyl laminated, nylon pennants
- Sewn onto heavy-duty reinforced chord that exceeds OSHA's 500 lb. tensile strength requirements
- Meets OSHA 1926.502(f)(2)(iv) withstanding the harshest conditions



Part No.	Description	No. of Pennants	UOM
Standard			
PBB0025	60-ft.	36	Each
Heavy-Duty			
PFM0038	83-ft.	15	Each
PBB0004	113-ft.	25	Each
OSHA-Compliant Style			
PFM0039	83-ft.	15	Each
PBB0003	113-ft.	25	Each

Cones

Brightly colored cones are ideal to mark hazardous areas.



Meets applicable MUTCD and State Standards

- Durable, flexible spring-back design
- Molded PVC (Poly-Vinyl-Chloride) plastic
- UV stabilizers for fade resistance
- Stackable for easy transport and storage



Part No.	Height	Weight	UOM
All Red/Orange - Standard			
PBB0165	12"	1.5 lbs	Each
PBB0126	18"	3 lbs	Each
PBB0167	28"	7 lbs	Each
PBB0169	36"	10 lbs	Each
PBB0170	36"	12 lbs	Each
All Red/Orange - w/ reflective collars			
PBB0017	28"	7 lbs	Each
PBB0022	36"	12 lbs	Each
Fluorescent Yellow/Green - Standard			
PBB0166	18"	3 lbs	Each
PBB0168	28"	7 lbs	Each
PBB0171	36"	10 lbs	Each

Universal Cone Adapter

Universal Cone Adapter fits most standard traffic cones.

- Quickly and easily mount signs, flags and lights
- Can also be used with rope or barricade tape to form various sized barriers

Orange No.	Yellow Part No.	UOM
PBB0065	PBB0066	Each



Sign and cone sold separately

Underground Hazard Tape



- Polyethylene (HTU, HTB) materials
- Temperature range: -30°F to 200°F (-34°C to 93°C)
- Detectable Laminated Aluminum (HTDU) materials temper
- Temperature range: -30°F to 220°F (-34°C to 104°C)
- Pre-Printed
- Indoor/outdoor rated
- Designed for direct burial
- Highly visible legend is protected from abrasion and chemicals
- Resistant to UV light, chemical atmosphere, and abrasion
- Will not biodegrade

Part Number	Legend	Color (Legend/Background)	Height		Length		Std. Pkg. Qty.
			In.	mm	Ft.	m	

Laminated Detectable Aluminum

HTDU2B-W	CAUTION WATER LINE BURIED BELOW	Black/Blue	2.00	50.80	1000.00	305.00	1
HTDU2O-FO	CAUTION FIBER OPTIC CABLE BURIED BELOW	Black/Orange					1
HTDU2O-T	CAUTION TELEPHONE LINE BURIED BELOW	Black/Orange					1
HTDU2R-E	CAUTION ELECTRIC LINE BURIED BELOW	Black/Red					1
HTDU3O-FO	CAUTION FIBER OPTIC CABLE BURIED BELOW	Black/Orange	3.00	76.00	1000.00	305.00	1
HTDU3O-T	CAUTION TELEPHONE LINE BURIED BELOW	Black/Orange					1
HTDU3R-E	CAUTION ELECTRIC LINE BURIED BELOW	Black/Red					1
HTDU6O-FO	CAUTION FIBER OPTIC CABLE BURIED BELOW	Black/Orange	6.00	152.00	1000.00	305.00	1
HTDU6O-T	CAUTION TELEPHONE LINE BURIED BELOW	Black/Orange					1
HTDU6R-E	CAUTION ELECTRIC LINE BURIED BELOW	Black/Red					1

Polyethylene

HTU3G-T-M	CAUTION TELEPHONE LINE BURIED BELOW	Black/Green	3.00	76.00	1000.00	305.00	1
HTU3O-FO-M	CAUTION BURIED FIBER OPTIC CABLE	Black/Orange					1
HTU3O-T-M	CAUTION TELEPHONE LINE BURIED BELOW	Black/Orange					1
HTU3R-E-M	CAUTION ELECTRIC LINE BURIED BELOW	Black/Red					1
HTU3Y-E-M	CAUTION ELECTRIC LINE BURIED BELOW	Black/Yellow					1
HTU6R-E	CAUTION ELECTRIC LINE BURIED BELOW	Black/Red	6.00	152.00	1000.00	305.00	1
HTU6O-FO	CAUTION BURIED FIBER OPTIC CABLE	Black/Orange					1
HTU6O-T	CAUTION TELEPHONE LINE BURIED BELOW	Black/Orange					1
HTU6O-TV	CAUTION CABLE TV LINE BURIED BELOW	Black/Orange					1
HTU6Y-E	CAUTION ELECTRIC LINE BURIED BELOW	Black/Yellow					1
HTU6Y-G	CAUTION GAS LINE BURIED BELOW	Black/Yellow					1

B1.
Cable
Ties

B2.
Cable
Accessories

B3.
Stainless
Steel Cable
Ties &
Accessories

C1.
Wiring
Duct

C2.
Abrasion
Protection

C3.
Cable
Management

D1.
Terminals

D2.
Power
Connectors

D3.
Grounding
Connectors

E1.
Labeling
Systems

E2.
Labels

E3.
Pre-Printed
&
Write-On
Markers

E4.
Permanent
Identification

E5.
Industrial
Safety
Solutions

F.
Keystone
Cabling
Systems

G.
Part
Number
Index

Plastic Barricade Tapes

Quick and effective temporary way to section-off hazards and danger zones.

- Bold warning message continuously repeated the length of the roll
- Lightweight, 0.003" polyethylene plastic
- Durable for indoor and outdoor environments
- Easily cut and secure with nails, tape, staples or tie-off
- 3" x 1000-ft.



PBB0034



PBB0041



PBB0076



PBB0040



PBB0037



PBB0038



PBB0036



PBB0035



PBB0030



PBB0039



PBB0029



PBB0031



PBB0033



PBB0032



PBB0042



PBB0175



Comply with requirements of ANSI Z535.5-3.2

Woven Barricade Tapes



Mark off hazard areas with extra-strong, durable polypropylene tapes.

- Woven polypropylene
- 300-lbs. tensile strength
- Chemical- and weather-resistant
- Ideal outdoor use
- Reusable
- 2" x 200-ft. rolls

Part No.	Color	UOM
PBB0173	Black/Red	Roll
PBB0174	Black/Yellow	Roll

Barricade Rope

Mark off restricted and hazardous areas with high visibility rope.

- Twisted strands in two-tone, contrasting safety colors
- 5/16" diameter polypropylene
- Floats, resistant to mildew and light chemical exposure
- 600-ft. per roll



Black/Yellow Part No.	Magenta/Yellow Part No.	Red/White Part No.	UOM
PFM0005	PFM0006	PFM0007	Roll

Reflective Plastic Barricade Tapes



Get reflective visibility in low light areas.

- 0.003" polyethylene tape
- Words alternate in black and reflective silver print
- 3" x 1000-ft.

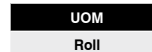

PBB0023



PBB0024

Free Standing Signs



Set out free-standing signs to identify temporary hazardous conditions.

- Panels have message on both sides
- Rugged 0.125" thick high-impact plastic
- Folds flat for transport and storage
- 20"H x 12"W

UOM
Each

7" x 5" clear pocket for holding a tag or folded permit sheet.



PBB0075



PBB0097

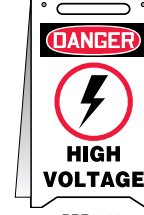

PBB0099



PBB0100



PBB0098



PBB0101



PBB0108



PBB0058



PBB0087



PBB0092



PBB0093



PBB0094



PBB0095



PBB0091



PBB0096



PBB0103



PBB0105



PBB0104



PBB0089



PBB0090



PBB0102



PBB0088

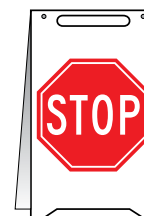

PBB0107



PBB0106

B1. Cable Ties

B2. Cable Accessories

B3. Stainless Steel Cable Ties & Accessories

C1. Wiring Duct

C2. Abrasion Protection

C3. Cable Management

D1. Terminals

D2. Power Connectors

D3. Grounding Connectors

E1. Labeling Systems

E2. Labels

E3. Pre-Printed & Write-On Markers

E4. Permanent Identification

E5. Industrial Safety Solutions

F. Keystone Cabling Systems

G. Part Number Index

Reversible Free Standing Signs

Mark temporary hazards with lightweight plastic stand-up signs.

- Versatile - two signs in one!
- Rugged 0.125" thick high-impact plastic
- Economical - ideal for limited purposes or disposable for one-time use
- Flip and fold sign inside-out to reveal second message
- Lightweight, waterproof corrugated plastic with fold-and-insert-tab
- Stands 20"H x 12"W
- Carry handle cut-out on top
- Folds flat



Molded 2-Sided Free Standing Signs



PBB0018

Open up floor signs to mark temporary hazards.

- Sturdy molded plastic to withstand elements indoors and outdoors
- Message on both sides of the 12"W x 25"H Free Standing Signs stand-up floor sign
- Easy-carry handle
- Sign folds flat for storage

UOM
Each

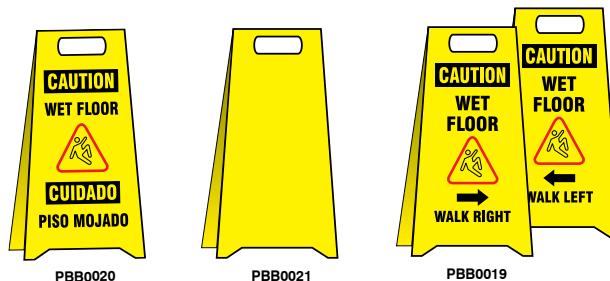

PBB0020

PBB0021

PBB0019



Unique, industrial design ideal for plant or facility.

- All-plastic, yellow, polyethylene post and base
- 3" dia. post stands 38"H with 16"W, low-profile fillable base
- Base has pre-drilled holes to secure to floor
- Snap lock ensures post will not pull out from base when lifted and moved
- Breaks down and stacks for compact storage
- Finishing cap and C-Hooks included
- Optional color striping in standard and specialty reflective, fluorescent, or glow-in-the-dark
- Connect several posts with 2" x 1" x 1/4" Plastic Chain Links sold separately by the foot

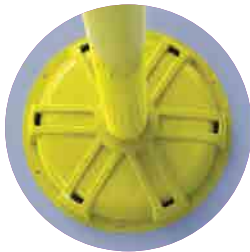

Standard Yellow Post

Part No.	Height	UOM
PBB0149	38"	Each

Striped Post

Yellow Post w/ Standard Color Vinyl Stripe

Color	Code
Red	RED
Green	GRN
Black	BLK
White	WHT
Blue	BLU
Orange	ORN
Magenta	MAG

Add stripe color code after part number.
 Example: Part No. PBB0150 +
 Color Code MAG = PBB0150MAG

Part No.	Height	UOM
PBB0150	38"	Each

Yellow Post w/ Specialty Color Vinyl Stripe

Color	Code
Reflective Red	RRED
Reflective Yellow	RYEL
Reflective White	RWHT
Fluorescent Red	REDF
Fluorescent Orange	ORNF
Fluorescent Green	GRNF
Glow-in-the-Dark	GLOW

Add specialty stripe color code after part number.
 Example: Part No. PBB0152 +
 Color Code RRED = PBB0152RRED

Part No.	Height	UOM
PBB0152	38"	Each



Barrier Cone Bars



Cones sold separately

In an immediate situation, deploy a bar – placed between two traffic cones – to create a quick and temporary visible barrier.

- Portable, expandable barrier bar
- Ring-ends fit over traffic cones
- Expands up to 6 1/2-ft.
- Collapses to 4-ft. for storage and transport
- Available in two contrasting colors
- Reflective strips for visibility in low light conditions

Part No.	Color	UOM
PBB0078	Black/Yellow	Each
PBB0079	Orange/White	Each

Ring Weight



Prevent post from easily tipping. Fill vinyl ring weight with water to add 3-lbs. for stability. The 11 3/4" x 1" ring weight fits and conceals inside the base of the post.

Part No.	UOM
PBB0148	Each

Chain Links

- Lightweight, yet strong polyethylene plastic
- Each link measures 2" x 1" x 1/4"
- Alternating colors change every two feet
- Available by the foot up to 500-ft.
- Indoor and limited outdoor use



To Order Chain Links: Add color code after part number.
Example: Part No. PBB0115 + Color Code YEL = PBB0115YEL

Part No.	Description	Color Code	UOM
PBB0115	Standard	WHT, YEL, BLK, RED	Foot
PBB0115	Alternating	RW, BY	Foot

Part No.	Description	Color Code	Std. Pkg. Qty.
PBB0119	Standard	WHT, YEL, BLK, RED	100 ft.



Master Link

- Permanently joins separate lengths of chain



S-Hooks

- Open ends quickly link separate lengths of chain

To Order Chain Accessories: Add color code after part number.
Example: Part No. PBB0109 + Color Code WHT = PBB0109WHT

Part No.	Description	Color Code	UOM
PBB0109	Master Link Standard	WHT, YEL, BLK, RED	Each
PBB0138	S-Hook Standard	WHT, YEL, BLK, RED	Each

Steel Safety Post & Chain

Set out a sturdy post and chain system that stays in place.

Steel Post

- 2" dia. x 34" H powder-coated yellow steel
- 13.5" dia. base covered with durable, black ABS plastic
- Forged universal loop on top
- Indoor and outdoor use

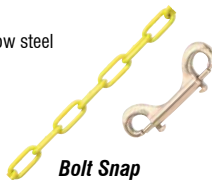

Bolt Snap

- 4" nickel-plated cast zinc
- Double-ended

Steel Chain

- Poly-coated yellow steel
- 2/0 straight link coil - 0.18" material dia., 1.29" inside length x 0.34" inside width (Maximum continuous length is 120 ft.)

Part No.	Description	UOM
PBB0164	Steel Post	Each
PBB0057	Bolt Snap	Each
PBB0123	Poly-Coated Steel Chain	Foot



Retractable Banner Barrier



Convey safety or warning messages with bold barriers.

- 0.060" aluminum roller housing holds 40"H x 54"W poly-vinyl banner
- Total viewable area: 32"H x 54"W
- Banner housing connects to Stanchion Posts via (2) paddle sleeves (included) that insert into interchangeable accessory caps (2 included)
- Sets up and breaks down easily



PBB0027



PBB0028

UOM
Each

Rack Mount Retractable Belt Tape Barriers

Extend belt tape from the end of a storage rack.

- Mount with choice of hose clamp for semi-permanent installation or magnet for quick install and removal
- Durable 2" wide belt tape end has S-Clip to wrap and secure
- Yellow case with diagonal yellow/black striped tape or 'Caution' message tape



To Order: Add belt style code after part number. Black/Yellow - BY, Caution - C
Example: Part No. PBB0006 + Belt Style Code BY = PBB0006BY

Hose Clamp			Magnetic Mount		
Part No.	UOM	Belt Length	Part No.	UOM	Belt Length
PBB0006	Each	15-ft.	PBB0007	Each	15-ft.
PBB0009	Each	20-ft.	PBB0011	Each	20-ft.
PBB0013	Each	25-ft.	PBB0015	Each	25-ft.

Retractable Belt Tape Barriers



Connect belt tape in any combination of posts and wall mounts to control pedestrian traffic indoors.

Belt Tape:

- Woven-polyester tape, wound in a self-tension, spring-loaded unit
- 2"W tape extends up to 8-ft – with straight tension without sag or slack
- Retracts smoothly back into the head unit for storage
- Safety mechanism in the spring-tension reduces the whip action of the belt braking, in case of accidental release

Post Barriers:

- 2 1/2" dia. x 38"H with 14" dia. weighted base
- Available as Post Barrier with Belt Tape or as Receiver Posts (do not contain belt tape)

To Order Post Barriers: Add belt tape color code after Post Barriers part number: Black – BLK, Yellow – YEL, Red – RED.
Example: Part No. PBB0177 + Color Code BLK = PBB0177BLK

Part No.	Post Color	UOM
PBB0177	Brushed Steel	Each
PBB0178	Black	Each
PBB0179	Yellow	Each

Receiver Posts Only (Without Belt Tape)

Part No.	Post Color	UOM
PBB0181STL	Brushed Steel	Each
PBB0181BLK	Black	Each
PBB0181YEL	Yellow	Each

Wall Mount Retractable Belt Tape Barriers

Close off doorways or hallways.

- 2"W woven-polyester tape, wound in self-tension, spring-loaded unit
- Extends up to 8-ft. without sagging, retracts smoothly
- Head unit with bracket installs with four screws
- Wall Mount Receiver (sold separately) connects end of belt tape to facing wall

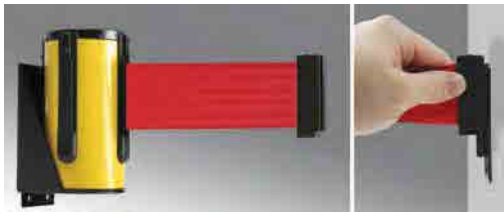

To Order: Add belt tape color code after part number: Black – BLK, Yellow – YEL, Red – RED.
Example: Part No. PBB0045 + Color Code YEL = PBB0045YEL

Part No.	Case Color	UOM
PBB0045	Brushed Steel	Each
PBB0043	Black	Each
PBB0049	Yellow	Each

Wall Mount Receiver

Part No.	UOM
PBB0172	Each



Outdoor Retractable Belt Tape Barriers

Sturdy aluminum stanchion is ideal for use outdoors and in tough indoor environments

- 2 1/2" diameter aluminum post measures 40" high with a sturdy 14" diameter base
- Uses rust-proof stainless steel hardware
- Belt top has 2" wide retractable belt tape with ergonomic, rounded corner belt end and noticeable red slide action lock
- Can accept up to 3 additional belt ends from other belt tape posts
- Available with either 10-ft. or 15-ft. belt tape with contrasting black and yellow hazard stripes.
- Receiver Posts available separately

Part No.	Description	UOM
PBB0001	Black Post, Head, & Base	Each
PBB0002	Yellow Post, Black Head & Base	Each

Aluminum Receiver Posts

Accepts up to 4 belts. Does not contain belt tape.

Part No.	Description	UOM
PBB0124	Black	Each
PBB0125	Yellow	Each

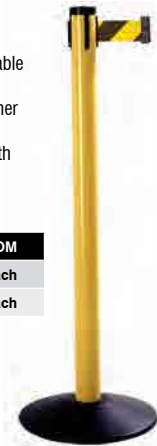

Electronic Safety Scoreboards

Count the number of safe work days in two colors.

- Innovative, durable, frameless construction
- Count days without an accident in green, and if a lost time accident occurs, set the display back to red until you meet your new safe-days goal
- Display can be set to count days or flash between days, date and clock
- Track the 7-day week, or set the display to track only your company's work days
- Display count can be set to freeze or hold
- In a power failure, all information is stored*
- Tamper-proof display easily sets with handheld remote control

* Indicators notify when a hold or power failure has occurred

Specifications:

- For indoor use only
- 28" x 20" x 2" aluminum construction
- Built-in hidden rear mounting brackets
- Four-digit, bright LED display with 2 1/2"H numbers
- Operates on 110 VAC with 6-ft. power cord

UOM
Each



Automatically count safe work days with 2 color LED display – red and green.



PSTB009



PSTB010



PSTB007



PSTB006



PSTB005



PSTB008*

*Scoreboards featuring "BEST PREVIOUS RECORD" include: One (1) electronic display to count safe days and one (1) magnetic display with changeable numbers set to track record number of days.

Turn-A-Day Scoreboards



Safety scoreboard has built-in turn dial to display safe days.

- Number dials are plastic and independently rotate from behind
- Lightweight, durable plastic
- Corner mounting holes

UOM
Each



36" x 24" PSTB001

Write-A-Day Scoreboards

Update safe working days on large scoreboard by writing in the number with dry-erase marker.

- Keep score of consecutive days
- Wipe-off and write-in on poly-coated space provided
- Constructed of durable plastic
- Corner mounting holes



Marker not included.

Size	UOM
20" x 14"	Each
36" x 24"	Each



36" x 24" PSTB003



36" x 24" PSTB004



20" x 14" PSTB002

Keystone Cabling System

The Keystone Copper Cabling System provides a complete component and standards compliant cabling infrastructure solution for voice, data and video applications.

Keystone modules feature the universal “keystone” design and are compatible with a wide assortment of modular patch panels, faceplates, and surface mount boxes. When combined with complementary Panduit products, NetKey[®] connectivity provides solutions from the telecommunication room to the work area with proven innovation and quality.

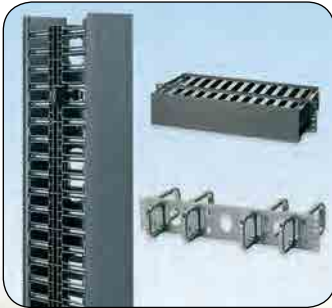

A.
System
Overview

B1.
Cable
Ties

B2.
Cable
Accessories

B3.
Stainless
Steel Cable
Ties &
Accessories

C1.
Wiring
Duct

C2.
Abrasion
Protection

C3.
Cable
Management

D1.
Terminals

D2.
Power
Connectors

D3.
Grounding
Connectors

E1.
Labeling
Systems

E2.
Labels

E3.
Pre-Printed
&
Write-On
Markers

E4.
Permanent
Identification

E5.
Industrial
Safety
Solutions

F.
Keystone
Cabling
Systems

G.
Part
Number
Index

NetKey® Category 6A, 6 and 5e Jack Modules

- Meet all industry performance standards for Category 6A, 6 and 5e
- Punchdown jack modules are 100% performance tested and individually serialized for future traceability
- Keystone punchdown jacks meet ANSI/TIA 568-C.2 and ISO 11801 component requirements
- Snap in and out of keystone openings for easy moves, adds and changes
- Universal label includes T568A and T568B wiring schemes

Part Number	Description	Color	Std. Pkg. Qty.	Std. Ctn. Qty.
-------------	-------------	-------	----------------	----------------

NetKey® Category 6A UTP Jack Modules*

NK6X88MIW	Category 6A, component compliant, 8-position, 8-wire keystone punchdown jack module.	Off White	1	50
NK6X88MIW-Q	Convenience pack of 25, Category 6A, component compliant, 8-position, 8-wire keystone punchdown jack modules.	Off White	25	250

NetKey® Category 6 UTP Jack Modules

NK688MIW	Category 6, component compliant, 8-position, 8-wire, keystone punchdown jack module.	Off White	1	50
NK688MIW-Q	Convenience pack of 25, Category 6, component compliant, 8-position, 8-wire, keystone punchdown jack modules.	Off White	25	250

NetKey® Category 5e UTP Jack Modules*

NKP5E88MIW	Category 5e, component compliant, 8-position, 8-wire, keystone punchdown jack module.	Off White	1	50
NKP5E88MIW-Q	Convenience pack of 25, Category 5e, component compliant, 8-position, 8-wire, keystone punchdown jack modules.	Off White	25	250

*For standard colors other than IW (Off White), replace IW in part number with EI (Electric Ivory), IG (International Gray), WH (White), BL (Black), BU (Blue), RD (Red), YL (Yellow), GR (Green), OR (Orange) or VL (Violet).



NK6X88MIW
NK688MIW
NKP5E88MIW

NetKey® Copper UTP Patch Cords

- Meet all industry performance standards for Category 6A, 6 and 5e
- 100% performance tested
- Available in a variety of colors and lengths for design flexibility



NK6APC^*
NK6PC^*Y



NK5EPC^*Y

Part Number	Description	Std. Pkg. Qty.	Std. Ctn. Qty.
-------------	-------------	----------------	----------------

Category 6A UTP Patch Cord

NK6APC^*	Category 6A, UTP patch cord with modular plugs on each end.	1	10
----------	---	---	----

Category 6 UTP Patch Cord

NK6PC^*Y	Category 6, UTP patch cord with modular plugs on each end.	1	10
----------	--	---	----

Category 5e UTP Patch Cord

NK5EPC^*Y	Category 5e, UTP patch cord with modular plugs on each end.	1	10
-----------	---	---	----

^Available in 3, 5, 7, 10, 14 and 20-foot lengths.

*For standard colors other than Off White, add suffix BU (Blue), RD (Red), YL (Yellow) or GR (Green) before Y in the part number. For example, the part number of a blue, Category 6, 5-foot patch cord is NK6PC5BUY.

NetKey® Keystone Patch Panels

- Mount to standard ANSI/TIA 19" racks
- Punchdown patch panels meet all industry performance standards for Category 6A, 6 and 5e
- Modular patch panels accept all NetKey® Modules
- Optional angled versions available for high density installations
- Optional strain relief bars assist in cable management and bend radius control
- Not compatible with Mini-Com® Jacks and Modules



NK6XPPG24Y



NKA6XPPG24Y



NK6PPG12WY
NK5EPPG12WY



NKFP12W



NKFP24Y



NKFP48Y



NKPPA48FMY



WB89D



SRB19BLY



SRBM19BLY

Part Number	Description	Std. Pkg. Qty.	Std. Ctn. Qty.
-------------	-------------	----------------	----------------

Punchdown Patch Panels* – Category 6A

NKA6XPPG24Y	Category 6A angled punchdown patch panel, 24 port, 1 RU.	1	10
NKA6XPPG48Y	Category 6A angled punchdown patch panel, 48 port, 2 RU.	1	10
NK6XPPG24Y	Category 6A punchdown patch panel, 24 port, 1 RU.	1	10
NK6XPPG48Y	Category 6A punchdown patch panel, 48 port, 2 RU.	1	10

Punchdown Patch Panels – Category 6

NK6PPG12WY	Category 6, 12-port punchdown patch panel. Mounts to wall with standard 89D bracket (WB89D).	1	10
NKA6PPG24Y	Category 6, 24-port, angled punchdown patch panel, 1 RU.	1	10
NKA6PPG48Y	Category 6, 48-port, angled punchdown patch panel, 2 RU.	1	10
NK6PPG24Y	Category 6, 24-port, punchdown patch panel, 1 RU.	1	10
NK6PPG48Y	Category 6, 48-port, punchdown patch panel, 2 RU.	1	10

Punchdown Patch Panels – Category 5e

NK5EPPG12WY	Category 5e, 12-port punchdown patch panel. Mounts to wall with standard 89D bracket (WB89D).	1	10
NKA5EPPG24Y	Category 5e, 24-port, angled punchdown patch panel, 1 RU.	1	10
NKA5EPPG48Y	Category 5e, 48-port, angled punchdown patch panel, 2 RU.	1	10
NK5EPPG24Y	Category 5e, 24-port, punchdown patch panel, 1 RU.	1	10
NK5EPPG48Y	Category 5e, 48-port, punchdown patch panel, 2 RU.	1	10

*Punchdown patch panels are color-coded for T568A and T568B wiring schemes.

Modular Patch Panels

NKFP12W	12-port modular patch panel with front removable faceplate. Mounts to wall with standard 89D bracket (WB89D).	1	10
NKFP24Y	24-port modular patch panel with front removable faceplate, 1 RU.	1	10
NKFP48Y	48-port modular patch panel with front removable faceplate, 2 RU.	1	10
NKPPA24FMY	24-port flush mount angled modular patch panel, 1 RU.	1	10
NKPPA48FMY	48-port flush mount angled modular patch panel, 2 RU.	1	10
NKPP24FMY	24-port flush mount modular patch panel, 1 RU.	1	10
NKPP48FMY	48-port flush mount modular patch panel, 2 RU.	1	10

Wall Mount Bracket

WB89D	Wall mount bracket. Ideal for use with 12-port punchdown or modular patch panels.	1	10
-------	---	---	----

Strain Relief Bars

SRB19BLY	Strain relief bar extends 2" from standard 19" rack for additional cable support.	1	10
SRBM19BLY	Strain relief bar and Tak-Ty® Hook & Loop Cable Ties for additional cable support.	1	10
SRBS19BL-XY	Straight strain relief bar.	10	—

NetKey® Keystone Faceplates

- Accept all NetKey® Modules
- Available in a variety of port densities
- Optional labels for easy port identification
- Not compatible with Mini-Com® Jacks and Modules



NK2FNIW NK2FIWY



NK2HSFIWY NK4VSVFIWY



NK2S

Part Number	Part Description	Color‡	Std. Pkg. Qty.	Std. Ctn. Qty.
-------------	------------------	--------	----------------	----------------

Flush Mount Screw-On Faceplates

NK*FNIW	Single gang, flush mount vertical faceplate.	—	1	10
NK**FIWY	Single or double gang, flush mount vertical faceplate with labels.	—	1	10
NK^HSFIWY	Single gang, sloped, horizontal faceplate with labels.	—	1	10
NK4VSF	Single gang, 4-port, sloped, vertical faceplate with labels.	Off White	1	10

Stainless Steel Faceplates

NKF^^S	Single gang, stainless steel, vertical faceplate with labels.	—	1	10
--------	---	---	---	----

*Available in 1, 2, 3 and 4-port density configurations.

**Available in single gang 1, 2, 4, and 6-port density configurations and 8 or 12-port double gang port density configurations.

^Available in 2 or 4-port density configurations.

^^Available in 2, 4 or 6-port density configurations. When mounting, opening should be a minimum of 2" wide.

‡For standard colors other than IW (Off White), replace suffix with EI (Electric Ivory), WH (White), IG (International Gray) or BL (Black). NK2HSF**Y and NK4HSF**Y not available in BL (Black).



Pan-Way® NetKey® Snap-On Sloped Keystone Faceplates

- Accept all Panduit® NetKey® Keystone Copper Modules and Duplex Fiber Optic Modules
- Snap into raceway channel, requires no additional mounting hardware or adapters – greatly reducing installation time
- Lowest cost for moves, adds, and changes
- Tamper resistant
- Can be used with Pan-Way® Cove, TG-70, T70, Twin-70, T-45 Raceway Systems, Fast-Snap™ Outlet Boxes, and Pan-Pole™ Aluminum Outlet Poles



NK2HSRF NK4HSRF



NK4VSRF

Part Number	Part Description	Color‡	Std. Pkg. Qty.	Std. Ctn. Qty.
NK2HSRFIW	Snap-On 2-position sloped horizontal faceplate accepts any Panduit® NetKey® Module. Compatible with Panduit® NetKey® Outlet Boxes, Surface Raceway Systems, and Pan-Pole™ Outlet Poles.	Off White	1	10
NK4HSRFIW	Snap-On 4-position sloped horizontal faceplate accepts any Panduit® NetKey® Module. Compatible with Panduit® NetKey® Outlet Boxes, Surface Raceway Systems, and Pan-Pole™ Outlet Poles.	Off White	1	10
NK4VSRFIW	Snap-On 4-position sloped vertical faceplate accepts any Panduit® NetKey® Module. Compatible with Panduit® NetKey® Outlet Boxes, Surface Raceway Systems, and Pan-Pole™ Outlet Poles.	Off White	1	10

Panduit® NetKey® faceplates are NOT compatible with Panduit® Mini-Com® Modules.

‡For other colors replace IW (Off White) with EI (Electric Ivory), IG (International Gray), or WH (White).

For complete labeling solutions refer to www.panduit.com.



Pan-Way® NetKey® Snap-On Flush Universal Keystone Faceplates

- Wider module spacing to accept common manufacturers' keystone modules 0.900 inches wide or less
- Can be used with Pan-Way® Cove, TG-70, T70, Twin-70, T-45 Raceway Systems, Fast-Snap™ Outlet Boxes, and Pan-Pole™ Aluminum Outlet Poles



T70KW2 T70KW4

Part Number	Part Description	Color‡	Std. Pkg. Qty.	Std. Ctn. Qty.
T70KW2IW	Snap-On 2-position flush mount faceplate accepts any Panduit® NetKey® Module and most other manufacturers' keystone modules. Compatible with Panduit® Fast-Snap™ Outlet Boxes, Surface Raceway Systems, and Pan-Pole™ Outlet Poles.	Off White	1	10
T70KW4IW	Snap-On 4-position flush mount faceplate accepts any Panduit® NetKey® Module and most other manufacturers' keystone modules. Compatible with Panduit® Fast-Snap™ Outlet Boxes, Surface Raceway Systems, and Pan-Pole™ Outlet Poles.	Off White	1	10

Panduit® NetKey® faceplates are NOT compatible with Panduit® Mini-Com® Modules.
 ‡For other colors replace IW (Off White) in part number with EI (Electric Ivory), IG (International Gray), or WH (White).
 For complete labeling solutions refer to www.panduit.com.

NetKey® Keystone Module Frames and Furniture Faceplate



NK2106MFIW NK4106MFIW
 NK2RMFIW NK4RMFIW

Part Number	Part Description	Color‡	Std. Pkg. Qty.	Std. Ctn. Qty.
NK2106MFIW	Screw mount "106" duplex module frame. Accepts two NetKey® Modules.	Off White	1	10
NK4106MFIW	Screw mount "106" duplex module frame. Accepts four NetKey® Modules.	Off White	1	10
NK2RMFIW	Screw mount module frame. Accepts two NetKey® Modules. Compatible with standard NEMA outlet boxes and rectangular faceplates.	Off White	1	10
NK4RMFIW	Screw mount module frame. Accepts four NetKey® Modules. Compatible with standard NEMA outlet boxes and rectangular faceplates.	Off White	1	10
NK4MFIW	Snap on modular furniture faceplate. Accepts four NetKey® Modules.	Off White	1	10

‡For standard colors other than Off White, replace IW in part number with EI (Electric Ivory), WH (White), IG (International Gray) or BL (Black).



NK4MFIW

Keystone Phone Plates



KWPY KWP3Y

Part Number	Part Description	Std. Pkg. Qty.	Std. Ctn. Qty.
KWPY	Stainless steel wall phone plate accepts one module.	1	10
KWP3Y	Stainless steel wall phone plate supplied with one Category 3 keystone leadframe module.	1	10

Wall mount faceplate kits compatible with wall mountable phones with short patch cord connections to the jack module.

NetKey® Keystone Surface Mount Boxes

- Accept all NetKey® Modules
- Include mounting screws and adhesive tape
- Compatible with Panduit® LD3, LD5, and LD10 Raceway
- Not compatible with Mini-Com® Jacks and Modules



NK2BXIW-A NK4BXIW-AY



NK6BXIW-AY CBM-X

Part Number	Part Description	Color‡	Std. Pkg. Qty.	Std. Ctn. Qty.
NK2BXIW-A	Surface mount box accepts two NetKey® Modules.	Off White	1	10
NK4BXIW-AY	Surface mount box accepts four NetKey® Modules.	Off White	1	10
NK6BXIW-AY	Surface mount box accepts six NetKey® Modules.	Off White	1	10
CBM-X	Optional magnet for mounting on metal surfaces. Compatible with NK2BXIW-A and NK4BXIW-AY.	—	10	100

‡For surface mount box standard colors other than IW (Off White), replace suffix with EI (Electric Ivory), IG (International Gray) or WH (White).

NetKey® Audio/Video Modules



NKFIW NKBNCFMIWY



NKHDMIW NKUSBAAIW



NKBMIW-X

Part Number	Part Description	Color‡	Std. Pkg. Qty.	Std. Ctn. Qty.
F-Type Module				
NKFIW	Keystone module supplied with 75 ohm industry standard F-Type coax bulkhead coupler.	Off White	1	10
50 Ohm BNC Coax Module				
NKBNCFMIWY	Keystone module supplied with 50 ohm industry standard coax bulkhead coupler.	Off White	1	10
HDMI Coupler				
NKHDMIW	Keystone module supplied with one HDMI 1.3 Type A female to female coupler module.	Off White	1	10
USB Coupler				
NKUSBAAIW	Keystone module supplied with one USB 2.0 female A to female A coupler module.	Off White	1	10
Blank Module				
NKBMIW-X	Blank keystone module reserves space for future use.	Off White	1	10

‡For standard colors other than IW (Off White), replace IW in part number with EI (Electric Ivory), WH (White), IG (International Gray) or BL (Black). 5-Way Binding Post Module (NKBP*IWY) only available in EI (Electric Ivory) and WH (White).

Termination Tool



Part Number	Part Description	Std. Pkg. Qty.	Std. Ctn. Qty.
Punchdown Base			
NKSPB	Base used to assist in terminating keystone punchdown modules.	1	50

Part Number Index

Part Number	Page Number
-------------	-------------

A	
A1C12-A-C8	B2.29
A1C25-A-C8	B2.29
A1C38-A-C8	B2.29
A1C50-A-C8	B2.29
A2C12-A-C8	B2.30
A2C25-A-C8	B2.30
A2C38-A-C8	B2.30
A2C50-A-C8	B2.30
ABM1M	B2.4
ABM2S	B2.4
ABM3H	B2.4
ABM4H	B2.4
ABM100	B2.4
ABM112	B2.4
ABMM	B2.4
ABMQS-A-C	B2.5
ABMQS-A-Q	B2.5
ABMQS-A-Q20	B2.5
ABMQS-S6-C	B2.5
ABMT-A-C	C3.8, B2.5
ABMT-A-C20	C3.8, B2.5
ABMT-S6-C	C3.8, B2.5
ABMT-S6-C20	C3.8, B2.5
ABMT-S6-C60	C3.8, B2.5
ABMT-S6-C69	C3.8, B2.5
ACC19-A-C	B2.28
ACC19-A-C0	B2.28
ACC19-AT-C	B2.28
ACC19-AT-C0	B2.28
ACC19-AV-M300	B2.28
ACC38-A-C	B2.28
ACC38-A-C0	B2.28
ACC38-AT-C	B2.28
ACC38-AT-C0	B2.28
ACC38-AV-M300	B2.28
ACC62-A-C	B2.28
ACC62-A-C0	B2.28
ACC62-AT-C	B2.28
ACC62-AT-C0	B2.28
ACC62-AV-M300	B2.28
ADCC31-AT-C10	B2.33
AJC12-A-C	B2.29
AJC19-A-C	B2.29
AJC25-A-C	B2.29
AJC31-A-C	B2.29
AJC38-A-C	B2.29
AM2-C	B2.8
AMC25-AT-C10	B2.33
ARC.68-A-Q	B2.27
ARC.68-A-Q14	B2.27
ARC.68-S6-Q	B2.27
ARC.68-S6-Q14	B2.27
ASMS-A-X	B2.8
AST10-5-C100	B2.25
AST15-5-C100	B2.25
AST20-5-C100	B2.25
AST25-5-C100	B2.25

Part Number	Page Number
-------------	-------------

B	
B2M2S-D	B1.50, B1.53
B2M2S-D0	B1.50
B3M2S-TL	B1.50, B1.53
B3M2S-TL0	B1.50
B4M2S-TL	B1.50, B1.53
B4M2S-TL0	B1.50
BC1.5I-S8-M	B1.46, B1.53
BC1.5I-S8-M0	B1.47
BC1M-S4-M	B1.46, B1.53
BC1M-S4-M0	B1.47
BC2M-S4-M	B1.46, B1.53
BC2M-S4-M0	B1.47
BC2S-S10-C	B1.46, B1.53
BC2S-S10-C0	B1.47
BC2S-S10-D	B1.53
BC3S-S10-D	B1.46, B1.53
BC3S-S10-D0	B1.47
BC4LH-S25-L	B1.46, B1.53
BC4LH-S25-L0	B1.47
BC4LH-S25-TL	B1.53
BC4S-S10-C	B1.46, B1.53
BC4S-S10-C0	B1.47
BC4S-S10-D	B1.53
BC4S-S10-D30	B1.47
BEC38-A-L	B2.32
BEC38-A-L20	B2.32
BEC62-A-L	B2.32
BEC62-A-L20	B2.32
BEC75-A-L	B2.32
BEC75-A-L20	B2.32
BECP38H25-L	B2.32
BECP38H25-L20	B2.32
BECP75H25-L	B2.32
BECP75H25-L20	B2.32
BF1M-C	B1.50, B1.53
BF1M-M	B1.53
BF1M-M0	B1.50
BF2M-C	B1.50, B1.53
BF2M-M	B1.53
BF2M-M0	B1.50
BM1M-C	B1.50, B1.53
BM1M-M	B1.53
BM1M-M0	B1.50
BM2M-C	B1.50, B1.53
BM2M-M	B1.53
BM2M-M0	B1.50
BM2S-C	B1.50, B1.53
BM2S-D	B1.53
BM2S-D0	B1.50
BM4S-C	B1.50, B1.53
BM4S-D	B1.53
BM4S-D0	B1.50
BP2S-D	B1.53
BP2S-D0	B1.49
BPC1/0-X	D2.62
BPC1-X	D2.62
BPC2/0-X	D2.62
BPC2-L	D2.62

Part Number	Page Number
-------------	-------------

BPC3/0-X	D2.62
BPC4/0-X	D2.62
BPC4-L	D2.62
BPC6-L	D2.62
BPC250-X	D2.62
BPC300-X	D2.62
BPC350-X	D2.62
BPC400-X	D2.62
BPC500-X	D2.62
BPC600-6	D2.62
BPC750-6	D2.62
BR-1.5-PAF	C3.6
BR-1.5-SN	C3.6
BR-1.5-TW	C3.6
BR-1.25-1/4-20	C3.6
BR-1.25-10-24	C3.6
BR-1.25-14WS	C3.6
BR-2.0	C3.6
BR-2.0-1/4-20	C3.6
BR-2.0-10-24	C3.6
BR-2.0-14WS	C3.6
BR-2.0-PAF	C3.6
BR-2.0-SN	C3.6
BR-2.0-TW	C3.6
BR2-1.3-X	B2.48
BR2-1.5-X	B2.48
BR2-4-X	B2.48
BR2-6-X	B2.48
BR-4.0-1/4-20	C3.6
BR.5-E6-C	B2.48
BR-50-10-24	C3.6
BR-75-10-24	C3.6
BR.75-E6-C	B2.48
BS10-L	D1.50
BS14-C	D1.50
BS18-C	D1.50
BS22-C	D1.50
BSH10-E	D1.52
BSH14-Q	D1.52
BSH18-Q	D1.52
BSN10-2K	D1.93
BSN10-L	D1.49
BSN14-3K	D1.93
BSN14-C	D1.49
BSN18-3K	D1.93
BSN18-C	D1.49
BSN22-C	D1.49
BSP14-3K	D1.93
BSP18-3K	D1.93
BSV10X-Q	D1.49
BSV14X-L	D1.49
BSV18X-LY	D1.49
BT1.5I-C	B1.43, B1.53
BT1.5I-C0	B1.44
BT1.5I-M	B1.53
BT1.5I-M30	B1.45
BT1.5I-M39	B1.45
BT1.5M-C	B1.43, B1.53
BT1.5M-C0	B1.44

Part Number Index

Part Number	Page Number	Part Number	Page Number	Part Number	Page Number
BT1.5M-M.....	B1.53	BT5LH-L0.....	B1.44	C75IG2.....	C1.21
BT1.5M-M30.....	B1.45	BT6LH-C.....	B1.53	C.75LG6.....	C1.15, C1.17, C1.23
BT1.5M-XMR.....	B1.53, B1.106	BT6LH-L.....	B1.43, B1.53	C075X024AAL.....	E2.26
BT1.5M-XMR0.....	B1.106	BT6LH-L0.....	B1.44	C075X025AAT.....	E2.15
BT1.5M-XMR30.....	B1.106	BT7LH-C.....	B1.53	C075X025CBT.....	E2.15
BT1M-C.....	B1.43, B1.53	BT7LH-L.....	B1.43, B1.53	C075X025KBT.....	E2.15
BT1M-C0.....	B1.44	BT7LH-L0.....	B1.44	C075X025KCT.....	E2.15
BT1M-C30.....	B1.45	BT8LH-C.....	B1.53	C075X025PBT.....	E2.15
BT1M-M.....	B1.53	BT8LH-L.....	B1.43, B1.53	C075X025YJJ.....	E2.26
BT1M-M39.....	B1.45	BT8LH-L0.....	B1.44	C075X025YJT.....	E2.15
BT1M-XMR.....	B1.53, B1.106	BT9LH-C.....	B1.53	C075X025YLC.....	E1.9
BT1M-XMR0.....	B1.106	BT9LH-L.....	B1.43, B1.53	C075X025YLJ.....	E2.26
BT1M-XMR30.....	B1.106	BT9LH-L0.....	B1.44	C075X025YML.....	E2.26
BT2I-C.....	B1.43, B1.53	BW1.5I-D.....	B1.48, B1.53	C075X025YMT.....	E2.15
BT2I-C0.....	B1.44	BW2S-D.....	B1.48, B1.53	C075X050YJJ.....	E2.26
BT2I-M.....	B1.53	BW2S-D0.....	B1.48	C080X020KBT.....	E2.15
BT2I-M30.....	B1.45	BW3S-D.....	B1.48, B1.53	C080X020KCT.....	E2.15
BT2LH-L.....	B1.43, B1.53	BW3S-D0.....	B1.48	C080X020YJJ.....	E2.26
BT2LH-L0.....	B1.44			C080X020YJT.....	E2.15
BT2LH-TL.....	B1.53	C		C090X025KBT.....	E2.15
BT2M-C.....	B1.43, B1.53	C1.5LG6.....	C1.15, C1.17, C1.19, C1.23	C090X025KCT.....	E2.15
BT2M-C0.....	B1.44	C1LG6.....	C1.15, C1.17, C1.19, C1.23	C090X025TJT.....	E2.15
BT2M-M.....	B1.53	C2.5LG6.....	C1.15, C1.17, C1.19	C090X025YJT.....	E2.15
BT2M-M30.....	B1.45	C2LG6.....	C1.9, C1.15, C1.17, C1.19, C1.23	C100IG2.....	C1.21
BT2S-C.....	B1.43, B1.53	C2WH6.....	C1.9	C100X019KBT.....	E2.15
BT2S-C0.....	B1.44	C3LG6.....	C1.15, C1.17, C1.19, C1.23	C100X019KCT.....	E2.15
BT2S-M.....	B1.53	C4LG6.....	C1.15, C1.17, C1.19, C1.23	C100X025CBT.....	E2.15
BT2S-M30.....	B1.45	C.5LG6.....	C1.15, C1.17, C1.23	C100X025KBT.....	E2.15
BT2S-M39.....	B1.45	C6LG6.....	C1.15, C1.17, C1.23	C100X025KCT.....	E2.15
BT3I-C.....	B1.43, B1.53	C25IG2.....	C1.21	C100X025YJC.....	E1.9
BT3I-C0.....	B1.44	C025X025KBT.....	E2.14	C100X025YJJ.....	E2.26
BT3I-M.....	B1.53	C025X025KCT.....	E2.14	C100X025YJT.....	E2.15
BT3I-M30.....	B1.45	C025X025YJT.....	E2.14	C100X025YLC.....	E1.9
BT3LH-L.....	B1.43, B1.53	C37IG2.....	C1.21	C100X038CBT.....	E2.15
BT3LH-L0.....	B1.44	C038X038KBT.....	E2.14	C100X038KBT.....	E2.15
BT3LH-TL.....	B1.53	C038X038KCT.....	E2.14	C100X038KCT.....	E2.15
BT3S-C.....	B1.43, B1.53	C038X038YJJ.....	E2.26	C100X038TJT.....	E2.15
BT3S-C0.....	B1.44	C038X038YJT.....	E2.14	C100X038YJJ.....	E2.26
BT3S-M.....	B1.53	C038X038YLJ.....	E2.26	C100X038YJT.....	E2.15
BT3S-M30.....	B1.45	C50IG2.....	C1.21	C100X050A0T.....	E2.19
BT3S-M39.....	B1.45	C050X013KBT.....	E2.14	C100X050A8T.....	E2.19
BT4I-C.....	B1.43, B1.53	C050X013KCT.....	E2.14	C100X050AAL.....	E2.26
BT4I-C0.....	B1.44	C050X020KBT.....	E2.14	C100X050AAT.....	E2.15
BT4I-M.....	B1.53	C050X044CBT.....	E2.14	C100X050AMT.....	E2.19
BT4LH-L.....	B1.43, B1.53	C050X044KBT.....	E2.14	C100X050APT.....	E2.19
BT4LH-L0.....	B1.44	C050X044KCT.....	E2.14	C100X050AST.....	E2.19
BT4LH-TL.....	B1.53	C050X044YJJ.....	E2.26	C100X050AUT.....	E2.19
BT4LH-TL30.....	B1.45	C050X044YJT.....	E2.14	C100X050AWT.....	E2.19
BT4LH-TL39.....	B1.45	C060X020CBT.....	E2.14	C100X050CBC.....	E1.9
BT4M-C.....	B1.43, B1.53	C060X020KBT.....	E2.14	C100X050CBT.....	E2.15
BT4M-C0.....	B1.44	C060X020KCT.....	E2.14	C100X050PBT.....	E2.15
BT4M-M.....	B1.53	C060X020TJT.....	E2.14	C100X050TJT.....	E2.15
BT4S-C.....	B1.43, B1.53	C060X020YJC.....	E1.9	C100X050YJC.....	E1.9
BT4S-C0.....	B1.44	C060X020YJJ.....	E2.26	C100X050YJJ.....	E2.26
BT4S-M.....	B1.53	C060X020YJT.....	E2.14	C100X050YJT.....	E2.15
BT4S-M30.....	B1.45	C061X030YPT.....	E2.14	C100X050YKT.....	E2.15
BT4S-M39.....	B1.45	C62IG2.....	C1.21	C100X050YLJ.....	E2.26
BT5LH-C.....	B1.53	C065X019KBT.....	E2.14	C100X050YMC.....	E1.9
BT5LH-L.....	B1.43, B1.53	C065X019KCT.....	E2.14	C100X050YML.....	E2.26

Part Number Index

Part Number	Page Number	Part Number	Page Number	Part Number	Page Number
C100X050YMT	E2.15	C200X025YJT	E2.16	C300X038YJJ	E2.27
C100X050YPC	E1.9	C200X038KBT	E2.16	C300X038YJT	E2.17
C100X050YPT	E2.15	C200X038TJT	E2.16	C300X100A0T	E2.19
C100X075YJJ	E2.26	C200X038YJT	E2.16	C300X100A8T	E2.19
C100X150YJJ	E2.26	C200X050CBC	E1.9	C300X100APT	E2.19
C120X150A0T-22	E2.18	C200X050CBT	E2.16	C300X100AUT	E2.19
C120X150A8T-22	E2.18	C200X050YJC	E1.9	C300X100AWT	E2.19
C120X150APT-22	E2.18	C200X050YJJ	E2.26	C300X100YJJ	E2.27
C120X150AST-22	E2.18	C200X050YJT	E2.16	C300X100YJT	E2.17
C120X150AWT-22	E2.18	C200X050YPC	E1.9	C300X100YMT	E2.17
C120X190A0T-22	E2.18	C200X100A0T	E2.19	C300X200PBT	E2.17
C120X190A8T-22	E2.18	C200X100A8T	E2.19	C300X200YJJ	E2.27
C120X190APT-22	E2.18	C200X100AAL	E2.26	C300X200YJT	E2.17
C120X190AST-22	E2.18	C200X100AAT	E2.16	C300X200YMT	E2.17
C120X190AWT-22	E2.18	C200X100AMT	E2.19	C300X200YPT	E2.17
C125X025KBT	E2.15	C200X100APT	E2.19	C300X250A0T	E2.19
C125X025KCT	E2.15	C200X100AST	E2.19	C300X250A8T	E2.19
C125X030A0T	E2.19	C200X100AUT	E2.19	C300X250AMT	E2.19
C125X030APT	E2.19	C200X100AWT	E2.19	C300X250APT	E2.19
C125X030YPT	E2.15	C200X100FJC	D3.5	C300X250AST	E2.19
C125X038TJT	E2.15	C200X100FJJ	D3.5	C300X250AUT	E2.19
C125X038YJT	E2.15	C200X100PBT	E2.16	C300X250AWT	E2.19
C138X019Y0T	E2.15	C200X100TJT	E2.16	C315X030YPT	E2.17
C138X019YPT	E2.15	C200X100Y0T	E2.16	C350X100YJJ	E2.27
C150X025KBT	E2.15	C200X100YJC	E1.9	C350X100YJT	E2.17
C150X025KCT	E2.15	C200X100YJJ	E2.26	C350X300A0T	E2.19
C150X030Y1T	E2.16	C200X100YJT	E2.16	C350X300A8T	E2.19
C150X050YJJ	E2.26	C200X100YKT	E2.16	C350X300APT	E2.19
C150X050YJT	E2.16	C200X100YLJ	E2.26	C350X300AUT	E2.19
C150X050YLJ	E2.26	C200X100YMC	E1.9	C379X030A0T	E2.19
C150X050YML	E2.26	C200X100YMT	E2.16	C379X030APT	E2.19
C150X075CBT	E2.16	C200X100YPC	E1.9	C379X030AQT	E2.19
C150X075PBT	E2.16	C200X100YPT	E2.16, D3.5	C379X030AWT	E2.19
C150X075YJC	E1.9	C200X125YJJ	E2.26	C379X030YPT	E2.17
C150X075YJJ	E2.26	C240X200APT-30H	E2.18	C390X030Y1T	E2.17
C150X075YJT	E2.16	C240X240A0T-30	E2.18	C400X100A0T	E2.20
C150X075YMT	E2.16	C240X240A8T-30	E2.18	C400X100A8T	E2.20
C150X075YPC	E1.9	C240X240APT-30	E2.18	C400X100AMT	E2.20
C160X020CBT	E2.16	C240X240AST-30	E2.18	C400X100APT	E2.20
C160X020KBT	E2.16	C240X240AWT-30	E2.18	C400X100AST	E2.20
C160X020KCT	E2.16	C252X030A0T	E2.19	C400X100AUT	E2.20
C160X020YJJ	E2.26	C252X030APT	E2.19	C400X100AWT	E2.20
C160X020YJT	E2.16	C252X030YPT	E2.16	C400X100CBT	E2.17
C170X090A8T	E2.19	C261X030YPT	E2.16	C400X100PBT	E2.17
C170X090AMT	E2.19	C261X035Y1T	E2.16	C400X100YJJ	E2.27
C170X090APT	E2.19	C275X125AAL	E2.26	C400X100YJT	E2.17
C170X090AST	E2.19	C275X125AAT	E2.16	C400X200PBT	E2.17
C170X090AWT	E2.19	C275X125Y0T	E2.16	C400X200Y8T	E2.17
C180X130APT-30H	E2.18	C275X125YJJ	E2.26	C400X200YJJ	E2.27
C180X180A0T-30	E2.18	C275X125YJT	E2.16	C400X200YJT	E2.17
C180X180A8T-30	E2.18	C275X125YML	E2.26	C400X200YMT	E2.17
C180X180APT-30	E2.18	C275X125YMT	E2.16	C400X300PBT	E2.17
C180X180AST-30	E2.18	C275X125YPT	E2.16	C400X300YJT	E2.17
C180X180AWT-30	E2.18	C288X030YPT	E2.16	C400X300YPT	E2.17
C188X030YPT	E2.16	C288X040Y1T	E2.16	C400X400YJJ	E2.27
C189X047FNC	E1.9	C300X025KBT	E2.17	C400X400YJT	E2.17
C195X040Y1T	E2.16	C300X025KCT	E2.17	C400X500PBT	E2.17
C200X025KBT	E2.16	C300X025YJT	E2.17	C400X600PBT	E2.17
C200X025KCT	E2.16	C300X038TJT	E2.17	C400X600YJT	E2.17

Part Number Index

Part Number	Page Number	Part Number	Page Number	Part Number	Page Number
C750X050Y1T	E2.17	CBR4S-M	B1.56, B1.62	CLT25N-10M630	C2.15
C788X050Y1T	E2.17	CBR4S-M0	B1.57	CLT25N-C630	C2.15
C788X050YJJ	E2.27	CBR4S-M30	B1.58	CLT35F-7M20	C2.13
C850X1100YJJ	E2.27	CBR6LH-C	B1.56, B1.62	CLT35F-C3	C2.13
C850X1100YLJ	E2.27	CBR6LH-C0	B1.57	CLT35F-C4	C2.13
CB25-18-CY	D2.76	CBR6LH-C30	B1.58	CLT35F-C20	C2.13
CB35-36-CY	D2.76	CCH12-S10-C	B2.37	CLT35N-C630	C2.15
CB70-14-CY	D2.76	CCH19-S10-C	B2.37	CLT38F-5M20	C2.13
CB125-14-QY	D2.76	CCH25-S10-C	B2.37	CLT38F-C3	C2.13
CB175-38-QY	D2.76	CCH31-S10-C	B2.37	CLT38F-C4	C2.13
CB225-56-QY	D2.76	CCH38-S10-C	B2.37	CLT38F-C20	C2.13
CB300-38-QY	D2.76	CCH44-S10-C	B2.37	CLT38N-5M630	C2.15
CB400-38-3Y	D2.76	CCH50-S10-C	B2.37	CLT38N-C630	C2.15
CB650-12-3Y	D2.76	CCH56-S10-C	B2.37	CLT50F-4M20	C2.13
CBA70-14-CY	D2.76	CCH62-S10-C	B2.37	CLT50F-C3	C2.13
CBLS18-C	B2.43	CCH69-S10-C	B2.37	CLT50F-C4	C2.13
CBLS25-C	B2.43	CCH75-S10-C	B2.37	CLT50F-C20	C2.13
CBLS37-C	B2.43	CCH81-S10-C	B2.37	CLT50N-4M630	C2.15
CBLS50-C	B2.43	CCH87-S10-C	B2.37	CLT50N-C630	C2.15
CBLS62-C	B2.43	CCH100-S10-C	B2.37	CLT62F-2.5M20	C2.13
CBLS75-C	B2.43	CCH112-S10-C	B2.37	CLT62F-C3	C2.13
CBM-X	F.6	CCH119-S10-C	B2.37	CLT62F-C4	C2.13
CBOT24K	B1.88	CCH125-S10-C	B2.37	CLT62F-C20	C2.13
CBP12-C	B2.43	CCH138-S10-C	B2.37	CLT62N-2.5M630	C2.15
CBP25-C	B2.43	CCH150-S10-C	B2.37	CLT62N-C630	C2.15
CBP31-C	B2.43	CCS12-S8-C	B2.37	CLT75F-2M20	C2.13
CBP37-C	B2.43	CCS19-S8-C	B2.37	CLT75F-C3	C2.13
CBP50-C	B2.43	CCS25-S8-C	B2.37	CLT75F-C4	C2.13
CBP62-C	B2.43	CCS25-S10-C	B2.37	CLT75F-C20	C2.13
CBP75-C	B2.43	CCS31-S8-C	B2.37	CLT75N-2M630	C2.15
CBP87-C	B2.43	CCS38-S8-C	B2.37	CLT75N-C630	C2.15
CBP100-C	B2.43	CCS44-S8-C	B2.37	CLT100F-125M20	C2.14
CBR1.5I-M	B1.56, B1.62	CCS50-S8-C	B2.37	CLT100F-C3	C2.14
CBR1.5I-M0	B1.57	CD35-36SL-QY	D2.75	CLT100F-C4	C2.14
CBR1.5I-M30	B1.58	CD70-14SL-QY	D2.75	CLT100F-C20	C2.14
CBR1.5M-M	B1.56, B1.62	CD125-14SL-QY	D2.75	CLT100F-X4	C2.14
CBR1.5M-M0	B1.57	CD225-56HK-QY	D2.75	CLT100N-125M630	C2.15
CBR1M-M	B1.56, B1.62	CD300-38HK-3Y	D2.75	CLT100N-C630	C2.15
CBR1M-M0	B1.57	CD400-38HK-3Y	D2.75	CLT125F-75M20	C2.14
CBR1M-M30	B1.58	CD650-12HK-3Y	D2.75	CLT125F-L3	C2.14
CBR2HS-D	B1.56, B1.62	CDCLP2	C1.9	CLT125F-L4	C2.14
CBR2HS-D0	B1.57	CDCLP3	C1.9	CLT125F-L20	C2.14
CBR2M-M	B1.56, B1.62	CDCLP4	C1.9	CLT125N-75M630	C2.15
CBR2M-M0	B1.57	CDLB3	C1.9	CLT125N-L630	C2.15
CBR2S-M	B1.56, B1.62	CDLB4	C1.9	CLT150F-D3	C2.14
CBR2S-M0	B1.57	CF382538F-Q	C2.16	CLT150F-D4	C2.14
CBR2S-M30	B1.58	CF502550F-Q	C2.16	CLT150F-D20	C2.14
CBR2S-M39	B1.58	CF503850F-Q	C2.16	CLT150F-T20	C2.14
CBR3I-M	B1.56, B1.62	CF752575F-Q	C2.16	CLT150F-X3	C2.14
CBR3I-M0	B1.57	CF753875F-Q	C2.16	CLT150F-X4	C2.14
CBR3S-M	B1.56, B1.62	CH105-A-C14	B2.34	CLT150F-X20	C2.14
CBR3S-M0	B1.57	CH105-S6-C14	B2.34	CLT150N-D630	C2.15
CBR3S-M30	B1.58	CLRCVR1-1	D3.12, D3.14	CLT188F-3C20	C2.14
CBR3S-M69	B1.58	CLRCVR2-1	D3.12, D3.14	CLT188F-C3	C2.14
CBR4I-M	B1.56, B1.62	CLRCVR3-1	D3.12, D3.14	CLT188F-C4	C2.14
CBR4I-M0	B1.57	CLT25F-10M20	C2.13	CLT188F-C20	C2.14
CBR4LH-TL	B1.56, B1.62	CLT25F-C3	C2.13	CLT188F-X3	C2.14
CBR4LH-TL0	B1.57	CLT25F-C4	C2.13	CLT188F-X4	C2.14
CBR4LH-TL30	B1.58	CLT25F-C20	C2.13	CLT188F-X20	C2.14

Part Number Index

Part Number	Page Number	Part Number	Page Number	Part Number	Page Number
CLT188N-3C630.....	C2.15	CS1LG6.....	C1.33	CWD4LG6.....	C1.9
CLTS25F-10M.....	C2.14	CS25-18SL-CY.....	D2.74	CWD4WH6.....	C1.9
CLTS25F-C.....	C2.14	CS35-36SL-CY.....	D2.74	CXS35-36-C.....	D2.72
CLTS25F-C3.....	C2.14	CS70-14SL-CY.....	D2.74	CXS35-36T-C.....	D2.73
CLTS25N-10M.....	C2.15	CS125-14SL-QY.....	D2.74	CXS70-14-C.....	D2.72
CLTS25N-C.....	C2.15	CS175-38HK-QY.....	D2.74	CXS70-14-T-C.....	D2.73
CLTS35F-C.....	C2.14	CS225-56HK-QY.....	D2.74	CXS125-14-Q.....	D2.72
CLTS35F-C3.....	C2.14	CS300-38HK-QY.....	D2.74	CXS125-14T-Q.....	D2.73
CLTS35N-C.....	C2.15	CS400-38HK-3Y.....	D2.74	CXS125-56-Q.....	D2.72
CLTS38F-C.....	C2.14	CS650-12HK-3Y.....	D2.74	CXS125-56T-Q.....	D2.73
CLTS38F-C3.....	C2.14	CSA70-14-CY.....	D2.74		
CLTS38N-C.....	C2.15	CSC1LG6.....	C1.32	D	
CLTS50F-C.....	C2.14	CSCS-M.....	B2.24	D1.5X2LG6.....	C1.19
CLTS50F-C3.....	C2.14	CSH-D0.....	B2.24	D1.5X3LG6.....	C1.19
CLTS50N-C.....	C2.15	CSH-D20.....	B2.24	D1.5X4LG6.....	C1.19
CLTS62F-C.....	C2.14	CSM-1.25-C.....	C3.7	D1X2LG6.....	C1.19
CLTS62F-C3.....	C2.14	CTAP2/0-2/0-X.....	D3.11	D1X3LG6.....	C1.19
CLTS62N-C.....	C2.15	CTAP2/0-2-X.....	D3.11	D1X4LG6.....	C1.19
CLTS75F-2M.....	C2.14	CTAP2-2-X.....	D3.11	D2.5X3LG6.....	C1.19
CLTS75F-C.....	C2.14	CTAP2-4-Q.....	D3.11	D2H6.....	C1.30
CLTS75F-C3.....	C2.14	CTAP4/0-2/0-X.....	D3.11	D2HWH6.....	C1.30
CLTS75N-2M.....	C2.15	CTAP4/0-2-X.....	D3.11	D2X2LG6.....	C1.19
CLTS75N-C.....	C2.15	CTAP4/0-4/0-X.....	D3.11	D2X3LG6.....	C1.19
CLTS100F-1.25M.....	C2.14	CTAP4-4-L.....	D3.11	D2X4LG6.....	C1.19
CLTS100F-C.....	C2.14	CTAP4-6-L.....	D3.11	D3H6.....	C1.30
CLTS100F-C3.....	C2.14	CTAP4-8-L.....	D3.11	D3HWH6.....	C1.30
CLTS100N-C.....	C2.15	CTAPF1/0-12-L.....	D3.10	D3X2LG6.....	C1.19
CLTS125F-L.....	C2.14	CTAPF1-12-C.....	D3.10	D3X3LG6.....	C1.19
CLTS125F-L3.....	C2.14	CTAPF2/0-12-Q.....	D3.10	D3X4LG6.....	C1.19
CLTS125N-L.....	C2.15	CTAPF2-12-C.....	D3.10	D4H6.....	C1.30
CLTS150F-D.....	C2.14	CTAPF3/0-12-Q.....	D3.10	D4HWH6.....	C1.30
CLTS150F-D3.....	C2.14	CTAPF3-12-C.....	D3.10	D4X2LG6.....	C1.19
CM4S-L.....	B1.77	CTAPF4-12-C.....	D3.10	D4X3LG6.....	C1.19
CM4S-L2.....	B1.76	CTAPF6-12-C.....	D3.10	D4X4LG6.....	C1.19
CM4S-L8.....	B1.76	CTAPF8-12-C.....	D3.10	D10-250-L.....	D1.39
CMP-100-1.....	D3.18, D2.60, D2.91	CTAPF10-16-C.....	D3.10	D14-187-C.....	D1.39
CMP-200-1.....	D3.18, D2.60	CTH19U04-C30.....	B2.40	D14-188-C.....	D1.39
CMP-300-1.....	D3.18	CTH35U08-C30.....	B2.40	D14-250-C.....	D1.39
CMP-300-4-1.....	D3.18	CTH38U10-C30.....	B2.40	D18-187-C.....	D1.39
CMVDR1.....	C3.8	CTH50U13-C30.....	B2.40	D18-188-C.....	D1.39
CMVDR1S.....	C3.8	CTH62U17-C30.....	B2.40	D18-250-C.....	D1.39
CMVDR2.....	C3.8	CTH87U22-C30.....	B2.40	D50H2.....	C1.30
CMVDR2S.....	C3.8	CVR2-1.....	D3.12	D75H2.....	C1.30
CMVDRC.....	C3.8	CVR6-1.....	D3.12	D-250A-C.....	D1.41
CO35-36SL-QY.....	D2.77	CVR250-1.....	D3.12	DB-C.....	C1.30
CO70-14SL-QY.....	D2.77	CVR500-1.....	D3.11, D3.12	DHC1.12X1.75-D.....	B1.77
CO125-14SL-QY.....	D2.77	CVR1000-1.....	D3.12	DHC1.12X1.75-D0.....	B1.74
CO225-56HK-QY.....	D2.77	CW-12-Q.....	D2.60	DNF10-250FIB-2K.....	D1.87
CO300-38HK-3Y.....	D2.77	CW-14-L.....	D2.60	DNF10-250FIB-L.....	D1.35
CO400-38HK-3Y.....	D2.77	CW-38-L.....	D2.60	DNF10-250FI-L.....	D1.34, D1.35
CO650-12HK-3Y.....	D2.77	CW-56-L.....	D2.60	DNF10-250FIMB-K.....	D1.92
CPH.75-S8-X.....	B2.48	CW-58-Q.....	D2.60	DNF10-250FIMB-Q.....	D1.34
CPL.75-S8-X.....	B2.48	CWD2.....	C1.37	DNF10-250M-L.....	D1.41
CPM87S-C.....	B2.21	CWD2LG6.....	C1.9	DNF14-110-C.....	D1.37
CPM122S-C.....	B2.21	CWD2WH6.....	C1.9	DNF14-111-C.....	D1.37
CR2-M.....	B2.23	CWD3.....	C1.37	DNF14-187-C.....	D1.37
CR4H-M.....	B2.23	CWD3LG6.....	C1.9	DNF14-187FIB-3K.....	D1.87
CR4H-M0.....	B2.23	CWD3WH6.....	C1.9	DNF14-187FIB-C.....	D1.35
CROS-M.....	B2.24	CWD4.....	C1.37	DNF14-188-C.....	D1.37

Part Number Index

Part Number	Page Number	Part Number	Page Number	Part Number	Page Number
DNF14-188FIB-3K.....	D1.87	DNFR14-205B-L.....	D1.40	DPF18-250FIB-3K.....	D1.90
DNF14-188FIB-C.....	D1.35	DNFR14-205FIB-L.....	D1.39	DPF18-250FIB-C.....	D1.36
DNF14-205-C.....	D1.37	DNFR14-206B-L.....	D1.40	DPF18-250FIM-2K.....	D1.91
DNF14-205FIB-3K.....	D1.87	DNFR14-206FIB-L.....	D1.39	DPF18-250FIMB-K.....	D1.91
DNF14-205FIB-C.....	D1.35	DNFR14-250B-L.....	D1.40	DPF18-250FIMB-L.....	D1.36
DNF14-206-C.....	D1.37	DNFR14-250FIB-L.....	D1.39	DPF18-250FIM-L.....	D1.36
DNF14-206FIB-3K.....	D1.87	DNFR18-205B-L.....	D1.40	DR10-250-L.....	D1.40
DNF14-206FIB-C.....	D1.35	DNFR18-205FIB-L.....	D1.39	DR14-205-C.....	D1.40
DNF14-250-C.....	D1.37	DNFR18-206B-L.....	D1.40	DR14-206-C.....	D1.40
DNF14-250FIB-3K.....	D1.87	DNFR18-206FIB-L.....	D1.39	DR14-250-C.....	D1.40
DNF14-250FIB-C.....	D1.34, D1.35	DNFR18-250B-L.....	D1.40	DR18-205-C.....	D1.40
DNF14-250FI-L.....	D1.35	DNFR18-250FIB-L.....	D1.39	DR18-206-C.....	D1.40
DNF14-250FIM-2K.....	D1.92	DNFR14205FIB-KD.....	D1.88	DR18-250-C.....	D1.40
DNF14-250FIMB-K.....	D1.92	DNFR14206FIB-KD.....	D1.88	DRD22LG6.....	C1.5
DNF14-250FIMB-Q.....	D1.34	DNFR14250FIB-KD.....	D1.88	DRD33LG6.....	C1.5
DNF14-250FIM-L.....	D1.34	DNFR18205FIB-KD.....	D1.88	DRD44LG6.....	C1.5
DNF14-250M-C.....	D1.41	DNFR18206FIB-KD.....	D1.88	DRDC2LG6.....	C1.5
DNF18-110-C.....	D1.37	DNFR18250FIB-KD.....	D1.88	DRDC3LG6.....	C1.5
DNF18-110FIB-3K.....	D1.87	DNG14-187FB-3K.....	D1.86	DRDC4LG6.....	C1.5
DNF18-110FIB-C.....	D1.35	DNG14-187FB-L.....	D1.33	DRDCS2-X.....	C1.5
DNF18-111-C.....	D1.37	DNG14-188FB-3K.....	D1.86	DRDCS3-X.....	C1.5
DNF18-111FIB-3K.....	D1.87	DNG14-188FB-L.....	D1.33	DRDCS4-X.....	C1.5
DNF18-111FIB-C.....	D1.35	DNG14-250FB-3K.....	D1.86	DRDSF-C.....	C1.5
DNF18-112FIB-3K.....	D1.87	DNG14-250FB-L.....	D1.33	DRDWR2-X.....	C1.5
DNF18-187-C.....	D1.37	DNG18-187FB-3K.....	D1.86	DRDWR3-X.....	C1.5
DNF18-187FIB-3K.....	D1.87	DNG18-187FB-C.....	D1.33	DRDWR4-X.....	C1.5
DNF18-187FIB-C.....	D1.35	DNG18-188FB-3K.....	D1.86	DS1.....	C2.20
DNF18-188-C.....	D1.37	DNG18-188FB-C.....	D1.33	DS5.....	C2.20
DNF18-188FIB-3K.....	D1.87	DNG18-250FB-3K.....	D1.86	DT4EH-L0.....	B1.51, B1.53
DNF18-188FIB-C.....	D1.35	DNG18-250FB-L.....	D1.33	DT8EH-Q0.....	B1.51, B1.53
DNF18-205-C.....	D1.37	DNH10-250FI-E.....	D1.37	DT14EH-C0.....	B1.53
DNF18-205FIB-3K.....	D1.87	DNH14-250FIB-Q.....	D1.37	DT14EH-L0.....	B1.51, B1.53
DNF18-205FIB-L.....	D1.35	DNH14-250FIM-Q.....	D1.37	DT15EH-L0.....	B1.51, B1.53
DNF18-206-C.....	D1.37	DNH18-250FIB-Q.....	D1.37	DT28EH-C0.....	B1.51, B1.53
DNF18-206FIB-3K.....	D1.87	DNH18-250FIM-Q.....	D1.37	DT44EH-C0.....	B1.51, B1.53
DNF18-206FIB-L.....	D1.35	DPF10-250FIB-2K.....	D1.90	DTHEH-Q0.....	B1.51, B1.53
DNF18-250-C.....	D1.37	DPF10-250FIB-L.....	D1.36	DTHH-Q0.....	B1.51, B1.53
DNF18-250FIB-3K.....	D1.87	DPF10-250FI-L.....	D1.36	DTKEH-0.....	B1.51, B1.53
DNF18-250FIB-C.....	D1.34, D1.35	DPF14-187FIB-3K.....	D1.90	DTKH-0.....	B1.51, B1.53
DNF18-250FI-L.....	D1.35	DPF14-205FIB-3K.....	D1.90	DTREH-LR0.....	B1.51, B1.53
DNF18-250FIM-2K.....	D1.92	DPF14-205FIB-C.....	D1.36	DTRH-LR0.....	B1.51, B1.53
DNF18-250FIMB-K.....	D1.92	DPF14-206FIB-3K.....	D1.90	DV10-250-2K.....	D1.89
DNF18-250FIMB-L.....	D1.34	DPF14-206FIB-C.....	D1.36	DV10-250C-2K.....	D1.89
DNF18-250FIM-L.....	D1.34	DPF14-250FIB-3K.....	D1.90	DV10-250-L.....	D1.38
DNF18-250M-C.....	D1.41	DPF14-250FIB-C.....	D1.36	DV10-250M-L.....	D1.42
DNF10250FIBC-2K.....	D1.87	DPF14-250FIM-2K.....	D1.91	DV14-187B-3K.....	D1.89
DNF14205FIBX-2K.....	D1.88	DPF14-250FIMB-K.....	D1.91	DV14-187B-C.....	D1.38
DNF14206FIBX-2K.....	D1.88	DPF14-250FIMB-Q.....	D1.36	DV14-188B-3K.....	D1.89
DNF14206FIBX-L.....	D1.35	DPF14-250FIM-L.....	D1.36	DV14-188B-C.....	D1.38
DNF14250FIBX-2K.....	D1.88	DPF18-110FIB-3K.....	D1.90	DV14-205B-3K.....	D1.89
DNF14250FIBX-L.....	D1.35	DPF18-110FIB-C.....	D1.36	DV14-205B-C.....	D1.38
DNF14250FIMX-2K.....	D1.92	DPF18-111FIB-3K.....	D1.90	DV14-206B-3K.....	D1.89
DNF18205FIBX-2K.....	D1.88	DPF18-111FIB-C.....	D1.36	DV14-206B-C.....	D1.38
DNF18205FIBX-L.....	D1.35	DPF18-187FIB-3K.....	D1.90	DV14-250B-3K.....	D1.89
DNF18206FIBX-2K.....	D1.88	DPF18-188FIB-3K.....	D1.90	DV14-250B-C.....	D1.38
DNF18206FIBX-L.....	D1.35	DPF18-205FIB-3K.....	D1.90	DV14-250MB-C.....	D1.42
DNF18250FIBX-2K.....	D1.88	DPF18-205FIB-C.....	D1.36	DV14-250P-L.....	D1.41
DNF18250FIBX-L.....	D1.35	DPF18-206FIB-3K.....	D1.90	DV18-187B-3K.....	D1.89
DNF18250FIMX-2K.....	D1.92	DPF18-206FIB-C.....	D1.36	DV18-187B-CY.....	D1.38

Order number of pieces required, in multiples of Standard Package Quantity.

Part Number Index

Part Number	Page Number	Part Number	Page Number	Part Number	Page Number
DV18-188B-3K	D1.89	F4X4LG6	C1.17	F85-12-C	D1.61
DV18-188B-CY	D1.38	F4X5LG6	C1.17	F85-15-C	D1.61
DV18-205B-3K	D1.89	F5X1LG6	C1.17	F85-18-C	D1.61
DV18-205B-CY	D1.38	F5X.5LG6	C1.17	F85-25-C	D1.61
DV18-206B-3K	D1.89	F6X4LG6	C1.17	F85-32-C	D1.61
DV18-206B-CY	D1.38	F73-5-M	D1.60	F86-18-C	D1.61
DV18-250B-3K	D1.89	F73-7-M	D1.60	F86-20-C	D1.61
DV18-250B-CY	D1.38	F74-5-M	D1.60	F86-25-C	D1.61
DV18-250MB-CY	D1.42	F74-7-M	D1.60	F86-32-C	D1.61
DV18-250P-LY	D1.41	F75-6-M	D1.60	F87-18-C	D1.61
DVF14-187-C	D1.38	F75-8-M	D1.60	F87-22-C	D1.61
DVF14-188-C	D1.38	F75-10-M	D1.60	F87-25-C	D1.61
DVF14-205-C	D1.38	F75X1.5LG6	C1.17	F87-32-C	D1.61
DVF14-206-C	D1.38	F75X.75LG6	C1.17	F89-25-L	D1.61
DVF14-250-C	D1.38	F76-6-M	D1.60	F89-32-L	D1.61
DVF18-187-CY	D1.38	F76-8-M	D1.60	F90-25-L	D1.61
DVF18-188-CY	D1.38	F76-10-M	D1.60	F90-30-L	D1.61
DVF18-205-CY	D1.38	F76-12-M	D1.60	F90-32-L	D1.61
DVF18-206-CY	D1.38	F77-6-M	D1.60	F91-32-L	D1.61
DVF18-250-CY	D1.38	F77-7-M	D1.60	F91-40-L	D1.61
		F77-8-M	D1.60	F92-32-L	D1.61
		F77-10-M	D1.60	F92-38-L	D1.61
		F77-12-M	D1.60	F93-32-Q	D1.61
		F78-7-M	D1.60	F93-40-Q	D1.61
		F78-8-M	D1.60	F94-40-Q	D1.61
		F78-10-M	D1.60	F100X150AJC	E1.7
		F78-12-M	D1.60	FCBI1-A-C20	B2.23
		F78-15-M	D1.60	FCBI1-S10-C20	B2.23
		F78-18-M	D1.60	FCBI2-A-C20	B2.23
		F78-20-M	D1.60	FCBI2-S10-C20	B2.23
		F80-7-M	D1.60	FCBI3-A-C20	B2.23
		F80-8-M	D1.60	FCBI3-S10-C20	B2.23
		F80-10-M	D1.60	FCC5-A-C8	B2.36
		F80-12-M	D1.60	FCC-A-C8	B2.36
		F80-15-M	D1.60	FCH2-A-C14	B2.35
		F80-18-M	D1.60	FCH2-S6-C14	B2.35
		F80-20-M	D1.60	FCM1.2-A-C14	B2.35
		F81-9-M	D1.60	FCM1.2-S6-C14	B2.35
		F81-10-M	D1.60	FCM1-A-C14	B2.35
		F81-12-M	D1.60	FCM1-S6-C14	B2.35
		F81-15-M	D1.60	FCM2-A-C14	B2.35
		F81-18-M	D1.60	FCM2-S6-C14	B2.35
		F81-20-M	D1.60	FCM3.25-A-L14	B2.35
		F82-10-M	D1.60	FCM3.25-S6-L14	B2.35
		F82-12-M	D1.60	FCPI1-C20	B2.23
		F82-15-M	D1.60	FCPI2-C20	B2.23
		F82-18-M	D1.60	FCPI3-C20	B2.23
		F82-20-M	D1.60	FL12X12LG-A	C1.30
		F83-12-D	D1.61	FL25X25LG-A	C1.30
		F83-15-D	D1.61	FL50X50LG-A	C1.30
		F83-18-D	D1.61	FMWR-C	C1.32
		F83-20-D	D1.61	FS1.5X1.5LG6NM	C1.23
		F83-25-D	D1.61	FS1.5X1LG6NM	C1.23
		F84-12-TL	D1.61	FS1.5X2LG6NM	C1.23
		F84-15-TL	D1.61	FS1.5X3LG6NM	C1.23
		F84-18-TL	D1.61	FS1X1.5LG6NM	C1.23
		F84-20-TL	D1.61	FS1X1LG6NM	C1.23
		F84-25-TL	D1.61	FS1X2LG6NM	C1.23
		F84-32-TL	D1.61	FS1X3LG6NM	C1.23

Part Number Index

Part Number	Page Number	Part Number	Page Number	Part Number	Page Number
FS1X4LG6NM	C1.23	FSD80-8-DSL6	D1.95,	G1.5X3LG6	C1.15
FS2X1.5LG6NM	C1.23	FSD80-12-D	D1.56	G1.5X4LG6	C1.15
FS2X1LG6NM	C1.23	FSD80-18-D	D1.56	G1X1.5LG6	C1.15
FS2X2LG6NM	C1.23	FSD81-10-D	D1.56	G1X1LG6	C1.15
FS2X3LG6NM	C1.23	FSD81-12-C	D1.56	G1X2LG6	C1.15
FS2X4LG6NM	C1.23	FSD81-18-C	D1.56	G1X3LG6	C1.15
FS3X1LG6NM	C1.23	FSD82-12-C	D1.56	G1X4LG6	C1.15
FS3X2LG6NM	C1.23	FSD82-18-C	D1.56	G2.5X3LG6	C1.15
FS3X3LG6NM	C1.23	FSD83-12-C	D1.56	G2X1.5LG6	C1.15
FS3X4LG6NM	C1.23	FSD83-18-C	D1.56	G 2X1LG6	C1.15
FS3X5LG6NM	C1.23	FSD84-12-C	D1.57	G2X2LG6	C1.15
FS4X1.5LG6	C1.23	FSD84-18-C	D1.57	G2X2LG6EMI	C1.7
FS4X2LG6NM	C1.23	FSD85-16-L	D1.57	G2X3LG6	C1.15
FS4X3LG6NM	C1.23	FSD85-18-L	D1.57	G2X3LG6EMI	C1.7
FS4X4LG6NM	C1.23	FSD85-22-L	D1.57	G2X4LG6	C1.15
FS4X5LG6NM	C1.23	FSD86-16-L	D1.57	G2X4LG6EMI	C1.7
FS.5X1LG6NM	C1.23	FSD86-18-L	D1.57	G2X5LG6	C1.15
FS.5X.5LG6NM	C1.23	FSD86-25-L	D1.57	G3X1LG6	C1.15
FS6X4LG6NM	C1.23	FSD87-20-L	D1.57	G3X2LG6	C1.15
FS.75X.75LG6NM	C1.23	FSD87-25-Q	D1.57	G3X3LG6	C1.15
FS156-C	B2.49	FSD89-20-Q	D1.57	G3X4LG6	C1.15
FSD72-6-D	D1.56	FSD89-27-Q	D1.57	G3X5LG6	C1.15
FSD72-8-D	D1.56	FSD90-25-Q	D1.57	G4X1.5LG6	C1.15
FSD73-6-D	D1.56	FSD91-27-Q	D1.57	G4X2LG6	C1.15
FSD73-8-D	D1.56	FSD92-32-Q	D1.57	G4X3LG6	C1.15
FSD74-6-D	D1.56	FSDX75-8-D	D1.57	G4X4LG6	C1.15
FSD74-8-D	D1.56	FSDX76-8-D	D1.57	G4X5LG6	C1.15
FSD75-6-D	D1.56	FSDX77-8-D	D1.57	G.5X1LG6	C1.15
FSD75-8-3K10	D1.96	FSDX78-8-D	D1.57	G.5X2LG6	C1.15
FSD75-8-D	D1.56	FSDX84-12-C	D1.57	G.5X4LG6	C1.15
FSD75-8-DSL10	D1.95	FSDXL78-8-C	D1.58	G.5X.5LG6	C1.15
FSD75-8-K	D1.95	FSDXL78-10-C	D1.58	G6X4LG6	C1.15
FSD75-10-D	D1.56	FSDXL80-8-C	D1.58	G.75X1.5LG6	C1.15
FSD76-6-D	D1.56	FSDXL80-12-C	D1.58	G.75X1LG6	C1.15
FSD76-8-3K8	D1.96	FSDXL81-10-C	D1.58	G.75X2LG6	C1.15
FSD76-8-D	D1.56	FSDXL82-12-C	D1.58	G.75X.75LG6	C1.15
FSD76-8-DSL8	D1.95,	FSDXL83-12-C	D1.58	GB2B0304TPI-1	D3.5
FSD76-8-K	D1.95	FSDXL84-12-C	D1.58	GB2B0306TPI-1	D3.5
FSD76-10-D	D1.56	FSH40-X	B2.49	GB2B0312TPI-1	D3.5
FSD76-12-D	D1.56	FSHH-X	B2.49	GB2B0514TPI-1	D3.5
FSD77-6-D	D1.56	FTD75-8-D	D1.59	GB2D0008TPI-1	D3.6
FSD77-8-3K2	D1.96	FTD76-8-D	D1.59	GB2D0021TPI-1	D3.6
FSD77-8-D	D1.56	FTD76-10-D	D1.59	GB2D0033TPI-1	D3.6
FSD77-8-DSL2	D1.95,	FTD77-8-D	D1.59	GB2D0044TPI-1	D3.6
FSD77-8-K	D1.95	FTD77-10-D	D1.59	GB2D0056TPI-1	D3.6
FSD77-10-D	D1.56	FTD78-8-D	D1.59	GB4B0612TPI-1	D3.5
FSD77-12-D	D1.56	FTD78-12-D	D1.59	GB4B0624TPI-1	D3.5
FSD78-6-D	D1.56	FTD80-10-TL	D1.59	GB4B1028TPI-1	D3.5
FSD78-8-3K0	D1.96	FTD80-13-TL	D1.59	GB4N0007TPI-1	D3.6
FSD78-8-D	D1.56	FTD81-12-C	D1.59	GB4N0016TPI-1	D3.6
FSD78-8-DSL0	D1.95,	FTD82-14-C	D1.59	GB4N0024TPI-1	D3.6
FSD78-8-K	D1.95	FTD83-14-C	D1.59	GB4N0026TPI-1	D3.6
FSD78-10-D	D1.56	FTD84-16-C	D1.59	GB4N0034TPI-1	D3.6
FSD78-12-D	D1.56	FWR-C	C1.32	GBC2250-12-X	D3.24
FSD78-18-D	D1.56			GC-15A-Q	D3.22
FSD79-8-D	D1.56	G		GC-18A-X	D3.22
FSD80-8-3K6	D1.96	G1.5X1.5LG6	C1.15	GC-22A-4	D3.22
FSD80-8-D	D1.56	G1.5X1LG6	C1.15	GCC6X61/0-1/0	D3.8
FSD80-8-DK	D1.95	G1.5X2LG6	C1.15	GCC6X6250-1/0	D3.8

Part Number Index

Part Number	Page Number	Part Number	Page Number	Part Number	Page Number
GCC6X6250-250	D3.8	GES144F-C0	C2.11	GPL-51-1	D3.19
GCC6X6500-1/0	D3.8	GES144FR-CY	C2.12	GPL-52-1	D3.20
GCC6X6500-250	D3.8	GES189F-C	C2.11	GPL-57-1	D3.20
GCE1/0-1/0	D3.7	GES189F-C0	C2.11	GPL-58-1	D3.20
GCE250-1/0	D3.7	GLMHK	D3.6	GPL-75-X	D3.20
GCE250-250	D3.7	GM-2-Q	D3.23	GPQC07-1/0	D3.4
GCE500-1/0	D3.7	GM-3-Q	D3.23	GPQC10-1/0	D3.4
GCE500-250	D3.7	GMS-1-X	D3.24	GPQC12-1/0	D3.4
GE52-C	C2.12	GMS-2-Q	D3.24	GPQC15-1/0	D3.4
GE52-C69	C2.12	GMS-3-Q	D3.24	GPQC17-1/0	D3.4
GE85-C	C2.12	GPC2-1-Q	D3.20	GPQC20-1/0	D3.4
GE85-C69	C2.12	GPC2-2-L	D3.20	GRC2-12-TL	D3.23
GE128-C	C2.12	GPC2-4-X	D3.20	GRC2-34-T	D3.23
GE128-C69	C2.12	GPC2-6-X	D3.20	GRC2-58-TL	D3.23
GE192-L	C2.12	GPC4-1-1-L	D3.21	GRC4-38-TL	D3.23
GE192-L69	C2.12	GPC4-1-12-Q	D3.21	GRCH1/0-34-E	D3.23
GE255-L	C2.12	GPC4-1-34-L	D3.21	GRCH1/0-58-T	D3.23
GE318-L	C2.12	GPC4-2-1-Q	D3.21	GRCH2-12-T	D3.23
GE380-Q	C2.12	GPC4-2-12-L	D3.21	GSP1-4-2/0-L	D3.16
GE510-Q	C2.12	GPC4-2-34-Q	D3.21	GSP1-6-2-C	D3.16
GEE36F-C	C2.10	GPC4-4-1-X	D3.21	GSP1-10-4-C	D3.16
GEE36F-C0	C2.10	GPC4-4-12-X	D3.21	GSP1-12-6-C	D3.16
GEE36FR-CY	C2.11	GPC4-4-34-X	D3.21	GSP2-2-2/0-L	D3.17
GEE47N-C	C2.12	GPC4-6-1-X	D3.21	GSP2-10-2-C	D3.17
GEE55N-C	C2.12	GPC4-6-12-X	D3.21	GSP2-10-4-C	D3.17
GEE62F-A-C	C2.11	GPC4-6-34-5	D3.21	GSP2-12-6-C	D3.17
GEE62F-A-C0	C2.11	GPC4H250-2	D3.9	GU-2-X	D3.20
GEE62F-C	C2.10	GPCA2-1-C	D3.22	GU-4-X	D3.20
GEE62F-C0	C2.10	GPCA2-1D-C	D3.22	GU-11-X	D3.20
GEE62FR-CY	C2.11	GPCA2-2-L	D3.22	GU-13-3	D3.20
GEE71N-C	C2.12	GPCA2-4-X	D3.22	GUBC500-6	D3.9
GEE98N-C	C2.12	GPCA2-6-X	D3.22		
GEE99F-A-C	C2.11	GPCJ2-1-C	D3.20	H	
GEE99F-A-C0	C2.11	GPCS4-1-12-L	D3.21	H000X025H1C	E1.8
GEE99F-C	C2.10	GPCS4-2-12-L	D3.21	H000X025H2C	E1.8
GEE99F-C0	C2.10	GPCS4-4-12-L	D3.21	H000X034H1C	E1.8
GEE99FR-CY	C2.11	GPL-4-Q	D3.19	H000X034H2C	E1.8
GEE134N-C	C2.12	GPL-5-Q	D3.19	H000X044H1C	E1.8
GEE144F-A-C	C2.11	GPL-6-Q	D3.19	H000X044H2C	E1.8
GEE144F-A-C0	C2.11	GPL-8-Q	D3.19	H000X064H1C	E1.8
GEE144F-C	C2.10	GPL-9-Q	D3.19	H000X064H2C	E1.8
GEE144F-C0	C2.10	GPL-10-Q	D3.19	H000X084H1C	E1.8
GEE144FR-CY	C2.11	GPL-14-X	D3.19	H000X084H2C	E1.8
GES36F-C	C2.11	GPL-15-X	D3.19	H1.5X2LG6	C1.11
GES36F-C0	C2.11	GPL-16-X	D3.19	H1.5X3LG6	C1.11
GES36FR-CY	C2.12	GPL-20-X	D3.19	H2L4-2N-X	D2.71
GES62F-A-C	C2.11	GPL-21-X	D3.19	H2L8-2N-2	D2.71
GES62F-A-C0	C2.11	GPL-22-X	D3.19	H2L13-2N-2	D2.71
GES62F-C	C2.11	GPL-26-X	D3.19	H2L21-2N-2	D2.71
GES62F-C0	C2.11	GPL-27-X	D3.19	H2L30-2N-1	D2.71
GES62FR-CY	C2.12	GPL-28-X	D3.19	H2X2LG6	C1.11
GES99F-A-C	C2.11	GPL-32-3	D3.19	H2X3LG6	C1.11
GES99F-A-C0	C2.11	GPL-33-3	D3.19	H2X4LG6	C1.11
GES99F-C	C2.11	GPL-34-3	D3.19	H3X3LG6	C1.11
GES99F-C0	C2.11	GPL-39-3	D3.19	H3X4LG6	C1.11
GES99FR-CY	C2.12	GPL-40-3	D3.19	H4X4LG6	C1.11
GES144F-A-C	C2.11	GPL-44-1	D3.19	H050X025H1T	E2.10
GES144F-A-C0	C2.11	GPL-45-1	D3.19	H050X025H2T	E2.10
GES144F-C	C2.11	GPL-46-1	D3.19	H050X034H1T	E2.10

Part Number Index

Part Number	Page Number	Part Number	Page Number	Part Number	Page Number
H050X034H2T	E2.10	H100X165H1T	E2.10	HB2SP25-X	B2.50
H050X044H1T	E2.10	H100X165H1T-2	E2.11	HBN1-T	B2.47
H050X044H2T	E2.10	H100X165H2T	E2.10	HBN2-T	B2.47
H050X064H1T	E2.10	H100X165H2T-2	E2.11	HBN3-T	B2.47
H050X064H2T	E2.10	H100X165HFT-2	E2.12	HBUA-X	B2.50
H050X084H1T	E2.10	H100X165HGT-2	E2.12	HC1.5LG6	C1.11, C1.12
H050X165H1T	E2.10	H100X165HST-2	E2.13	HC2LG6	C1.11, C1.12
H075X025H1T	E2.10	H150X025H1T	E2.10	HC3LG6	C1.11, C1.12
H075X025H2T	E2.10	H150X025H2T	E2.10	HC4-3	D2.72
H075X034H1T	E2.10	H150X034H1T	E2.10	HC4LG6	C1.11, C1.12
H075X034H2T	E2.10	H150X034H2T	E2.10	HC8-3	D2.72
H075X044H1T	E2.10	H150X044H1T	E2.10	HC13-3	D2.72
H075X044H2T	E2.10	H150X044H2T	E2.10	HC21-1	D2.72
H100X025H1C	E1.8	H200X025H1T	E2.10	HC30-1	D2.72
H100X025H1T	E2.10	H200X025H1T-2	E2.11	HC50-1	D2.72
H100X025H1T-2	E2.11	H200X025H2T	E2.10	HCME04Y09-M30	B2.42
H100X025H2C	E1.8	H200X025H2T-2	E2.11	HCME04Y09-M130	B2.42
H100X025H2T	E2.10	H200X025HFT-2	E2.12	HCME06A12-M130	B2.42
H100X025H2T-2	E2.11	H200X025HGT-2	E2.12	HCME06X12-VM139	B2.42
H100X025HFT-2	E2.12	H200X034H1T	E2.10	HCME06Y12-M30	B2.42
H100X025HGT-2	E2.12	H200X034H1T-2	E2.11	HCMP06B12-M20	B2.41
H100X034H1C	E1.8	H200X034H2T	E2.10	HCMP06C12-M20	B2.41
H100X034H1T	E2.10	H200X034H2T-2	E2.11	HHL8-2N-X	D2.71
H100X034H1T-2	E2.11	H200X034HFT-2	E2.12	HHL13-2N-5	D2.71
H100X034H2C	E1.8	H200X034HGT-2	E2.12	HHL21-2N-5	D2.71
H100X034H2T	E2.10	H200X034HST-2	E2.13	HHL30-2N-1	D2.71
H100X034H2T-2	E2.11	H200X044H1T	E2.10	HKBS	C2.18
H100X034HFT-2	E2.12	H200X044H1T-2	E2.11	HL1-2-25-X	D2.70
H100X034HGT-2	E2.12	H200X044H2T	E2.10	HL1-25-X	D2.69
H100X034HST-2	E2.13	H200X044H2T-2	E2.11	HL4-1-X	D2.69
H100X044H1C	E1.8	H200X044HFT-2	E2.12	HL4-2-X	D2.70
H100X044H1T	E2.10	H200X044HGT-2	E2.12	HL8-1-X	D2.69
H100X044H1T-2	E2.11	H200X044HST-2	E2.13	HL8-2-X	D2.70
H100X044H2C	E1.8	H200X064H1T	E2.10	HL13-1-5	D2.69
H100X044H2T	E2.10	H200X064H1T-2	E2.11	HL13-2-5	D2.70
H100X044H2T-2	E2.11	H200X064H2T	E2.10	HL21-1-5	D2.69
H100X044HFT-2	E2.12	H200X064H2T-2	E2.11	HL21-2-5	D2.70
H100X044HGT-2	E2.12	H200X064HFT-2	E2.12	HL30-1-2	D2.69
H100X044HST-2	E2.13	H200X064HGT-2	E2.12	HL30-2-2	D2.70
H100X064H1C	E1.8	H200X064HST-2	E2.13	HL50-1-2	D2.69
H100X064H1T	E2.10	H200X084H1T	E2.10	HL50-2-2	D2.70
H100X064H1T-2	E2.11	H200X084H1T-2	E2.11	HLB2S	B1.86
H100X064H2C	E1.8	H200X084H2T	E2.10	HLB2S-C0	B1.83
H100X064H2T	E2.10	H200X084H2T-2	E2.11	HLM-15R	B1.86
H100X064H2T-2	E2.11	H200X084HFT-2	E2.12	HLM-15R0	B1.83
H100X064HFT-2	E2.12	H200X084HGT-2	E2.12	HLS1.5S-X	B1.86
H100X064HGT-2	E2.12	H200X084HST-2	E2.13	HLS1.5S-X0	B1.83
H100X064HST-2	E2.13	H200X122H1T-2	E2.11	HLS3S-X	B1.86
H100X084H1C	E1.8	H200X122H2T-2	E2.11	HLS3S-X0	B1.83
H100X084H1T	E2.10	H200X165H1T	E2.10	HLS5S-X	B1.86
H100X084H1T-2	E2.11	H200X165H1T-2	E2.11	HLS5S-X0	B1.83
H100X084H2C	E1.8	H200X165H2T	E2.10	HLS-15R	B1.86
H100X084H2T	E2.10	H200X165H2T-2	E2.11	HLS-15R0	B1.83
H100X084H2T-2	E2.11	H200X165HFT-2	E2.12	HLS-75R	B1.86
H100X084HFT-2	E2.12	H200X165HGT-2	E2.12	HLS-75R0	B1.83
H100X084HGT-2	E2.12	H200X165HST-2	E2.13	HLSP1.5S-X	B1.86
H100X084HST-2	E2.13	H200X240H1T	E2.10	HLSP1.5S-X0	B1.84
H100X122H1T-2	E2.11	H200X240H2T	E2.10	HLSP1.5S-X12	B1.84
H100X122H2T-2	E2.11	HB2SP19-X	B2.50	HLSP3S-X	B1.86

Part Number Index

Part Number	Page Number	Part Number	Page Number	Part Number	Page Number
HLSP3S-X0	B1.84	HST0.4-48-5-2Y	C2.38	HSTT09-M	C2.24
HLSP3S-X12	B1.84	HST0.4-48-5Y	C2.38, C2.42	HSTT09-Q	C2.25
HLSP5S-X	B1.86	HST0.8-6-3Y	C2.38	HSTT09-Y	C2.26, C2.42
HLSP5S-X0	B1.84	HST0.8-6-X2Y	C2.38	HSTT09-YK1	C2.26
HLSP5S-X12	B1.84	HST0.8-6-XY	C2.38	HSTT12-48-Q	C2.24
HLT2I-X	B1.86	HST0.8-9-X2Y	C2.38	HSTT12-48-TL	C2.24
HLT2I-X0	B1.83	HST0.8-9-XY	C2.38	HSTT12-C	C2.24
HLT3I-X	B1.86	HST0.8-12-5-2Y	C2.38	HSTT12-M	C2.24
HLT3I-X0	B1.83	HST0.8-12-5Y	C2.38	HSTT12-Q	C2.25
HLTP2I-X	B1.86	HST0.8-48-5-2Y	C2.38	HSTT12-Y	C2.26, C2.42
HLTP2I-X0	B1.84	HST0.8-48-5Y	C2.38, C2.42	HSTT12-YK1	C2.26
HLTP2I-X12	B1.84	HST1.1-6-3Y	C2.38	HSTT19-48-Q	C2.24
HLTP3I-X	B1.86	HST1.1-6-X2Y	C2.38	HSTT19-48-TL	C2.24
HLTP3I-X0	B1.84	HST1.1-6-XY	C2.38	HSTT19-C	C2.24
HLTP3I-X12	B1.84	HST1.1-9-2Y	C2.38	HSTT19-M	C2.24
HLWM1.5S-X0	B1.87	HST1.1-9-X2Y	C2.38	HSTT19-Q	C2.25
HLWM3S-X0	B1.87	HST1.1-9-XY	C2.38	HSTT19-Y	C2.26, C2.42
HN1.5X2LG6	C1.11	HST1.1-12-5-2Y	C2.38	HSTT19-YK1	C2.26
HN1.5X3LG6	C1.11	HST1.1-12-5Y	C2.38	HSTT25-48-Q	C2.24
HN2X2LG6	C1.11	HST1.1-48-5-2Y	C2.38	HSTT25-48-TL	C2.24
HN2X3LG6	C1.11	HST1.1-48-5Y	C2.38, C2.42	HSTT25-C	C2.24
HN2X4LG6	C1.11	HST1.5-9-XY	C2.38	HSTT25-D	C2.24
HN3X3LG6	C1.11	HST1.5-12-1Y	C2.38	HSTT25-Q	C2.25
HN3X4LG6	C1.11	HST1.5-12-5Y	C2.38	HSTT25-Y	C2.26, C2.42
HN4X4LG6	C1.11	HST1.5-48-5-2Y	C2.38	HSTT25-YK1	C2.26
HS1.5X2LG6NM	C1.12	HST1.5-48-5Y	C2.38, C2.42	HSTT38-48-Q	C2.24
HS1.5X3LG6NM	C1.12	HST2.0-9-5Y	C2.38	HSTT38-48-TL	C2.24
HS2X2LG6NM	C1.12	HST2.0-12-2Y	C2.38	HSTT38-C	C2.24
HS2X3LG6NM	C1.12	HST2.0-48-2Y	C2.38, C2.42	HSTT38-Q	C2.25
HS2X4LG6NM	C1.12	HST2.7-12-2Y	C2.38	HSTT38-T	C2.24
HS3X3LG6NM	C1.12	HST2.7-48-2Y	C2.38	HSTT38-Y	C2.26, C2.42
HS3X4LG6NM	C1.12	HST3.0-12-2	C2.38	HSTT38-YK1	C2.26
HS4X4LG6NM	C1.12	HST3.0-48-2	C2.38	HSTT50-48-5	C2.25
HSC.25-L	B2.38	HST3.0-48-2Y	C2.42	HSTT50-48-Q	C2.25
HSC.25-L100	B2.38	HST3.5-12-2Y	C2.38	HSTT50-48-T	C2.25
HSEC0.5-X	C2.39	HST3.5-48-2Y	C2.38	HSTT50-C	C2.25
HSEC0.8-X	C2.39	HSTT4A15-48-Q	C2.37	HSTT50-Q	C2.25
HSEC1.0-X	C2.39	HSTT4A31-48-Q	C2.37	HSTT50-T	C2.25
HSEC1.5-5	C2.39	HSTT4A47-48-Q	C2.37	HSTT50-Y	C2.26, C2.42
HSEC2.0-5	C2.39	HSTT4A62-48-5	C2.37	HSTT50-YK1	C2.26
HSEC4.0-2	C2.39	HSTT4A94-48-5	C2.37	HSTT75-48-5	C2.25, C2.41
HSECFR0.5-XY	C2.39	HSTT4A125-48-5	C2.37	HSTT75-48-CQ	C2.25
HSECFR0.8-XY	C2.39	HSTT4A200-48-5	C2.37	HSTT75-C	C2.25
HSECFR1.0-XY	C2.39	HSTT05-48-Q	C2.24	HSTT75-Q	C2.25
HSECFR1.5-5Y	C2.39	HSTT05-48-TL	C2.24	HSTT75-T	C2.25
HSECFR2.0-5Y	C2.39	HSTT05-C	C2.24	HSTT75-Y	C2.26, C2.42
HSG-115V-650	E2.13, C2.40	HSTT05-M	C2.24	HSTT75-YK1	C2.26
HSG-A1	E2.13, C2.40	HSTT05-Q	C2.25	HSTT100-48-5	C2.25, C2.41
HSG-A2	E2.13, C2.40	HSTT05-Y	C2.42	HSTT100-48-LQ	C2.25
HSG-A3	E2.13, C2.40	HSTT06-48-Q	C2.24	HSTT100-C	C2.25
HSG-P1	E2.13, C2.40	HSTT06-48-TL	C2.24	HSTT100-Y	C2.26, C2.42
HSG-P2	E2.13, C2.40	HSTT06-C	C2.24	HSTT100-YK1	C2.26
HSG-P3	E2.13, C2.40	HSTT06-M	C2.24	HSTT150-48-5	C2.25, C2.42
HSG-P7	E2.13, C2.40	HSTT06-Q	C2.25	HSTT150-C	C2.25
HST0.4-3-Q2Y	C2.38	HSTT06-Y	C2.26, C2.42	HSTT200-48-2	C2.42
HST0.4-3-QY	C2.38	HSTT06-YK1	C2.26	HSTT200-48-5	C2.25, C2.42
HST0.4-6-3Y	C2.38	HSTT09-48-Q	C2.24	HSTT200-L	C2.25
HST0.4-6-X2Y	C2.38	HSTT09-48-TL	C2.24	HSTT300-48-2	C2.25, C2.42
HST0.4-6-XY	C2.38	HSTT09-C	C2.24	HSTT300-L	C2.25

Part Number Index

Part Number	Page Number	Part Number	Page Number	Part Number	Page Number
HSTT400-48-2	C2.25	HSTTP25-QY	C2.32	HSTTV05-Q	C2.31
HSTT400-L	C2.25	HSTTP38-CY	C2.32	HSTTV05-Y	C2.31
HSTTA19-48-Q	C2.36	HSTTP38-QY	C2.32	HSTTV06-48-Q	C2.28
HSTTA19-Y	C2.36, C2.42	HSTTP38-TY	C2.32	HSTTV06-C	C2.29
HSTTA25-48-Q	C2.36	HSTTP50-CY	C2.32	HSTTV06-M	C2.30
HSTTA25-48-TL	C2.36	HSTTP50-QY	C2.32	HSTTV06-Q	C2.31
HSTTA25-Y	C2.36, C2.42	HSTTP75-CY	C2.32	HSTTV06-Y	C2.31
HSTTA38-48-Q	C2.36	HSTTP75-QY	C2.32	HSTTV09-48-Q	C2.28
HSTTA38-48-TL	C2.36	HSTTP100-CY	C2.32	HSTTV09-C	C2.29
HSTTA38-Y	C2.36, C2.42	HSTTP100-QY	C2.32	HSTTV09-M	C2.30
HSTTA50-48-5	C2.36	HSTTP150-CY	C2.32	HSTTV09-Q	C2.31
HSTTA50-48-T	C2.36	HSTTP150-QY	C2.32	HSTTV09-Y	C2.31
HSTTA50-Y	C2.36, C2.42	HSTTP200-QY	C2.32	HSTTV12-48-Q	C2.28
HSTTA75-48-5	C2.36	HSTTPN50-438-L	C2.33	HSTTV12-C	C2.29
HSTTA75-48-C	C2.36	HSTTPN50-713-Q	C2.33	HSTTV12-M	C2.30
HSTTA75-Y	C2.36, C2.42	HSTTPN50-CC	C2.33	HSTTV12-Q	C2.31
HSTTA100-48-5	C2.36	HSTTPN62-750-Q	C2.33	HSTTV12-Y	C2.31
HSTTA100-48-L	C2.36	HSTTPN62-CC	C2.33	HSTTV19-48-Q	C2.28
HSTTA100-Y	C2.36, C2.42	HSTTPN75-775-Q	C2.33	HSTTV19-C	C2.29
HSTTA150-48-5	C2.36	HSTTPN75-CC	C2.33	HSTTV19-M	C2.30
HSTTA150-48-Q	C2.36	HSTTPN100-775-Q	C2.33	HSTTV19-Q	C2.31
HSTTA150-Y	C2.36, C2.42	HSTTPN100-CC	C2.33	HSTTV19-Y	C2.31
HSTTK05-48-Q	C2.35	HSTTPN150-925-X	C2.33	HSTTV25-48-Q	C2.28
HSTTK06-48-Q	C2.35	HSTTPN150-CC	C2.33	HSTTV25-C	C2.29
HSTTK09-48-Q	C2.35	HSTTPN200-950-X	C2.33	HSTTV25-D	C2.30
HSTTK12-48-Q	C2.35	HSTTPN200-CC	C2.33	HSTTV25-D5	C2.30
HSTTK19-48-Q	C2.35	HSTTRA12-48-Q	C2.37	HSTTV25-D10	C2.30
HSTTK25-48-Q	C2.35	HSTTRA19-48-Q	C2.37	HSTTV25-Q	C2.31
HSTTK38-48-Q	C2.35	HSTTRA25-48-Q	C2.37	HSTTV25-Y	C2.31
HSTTK50-48-5	C2.35	HSTTRA38-48-Q	C2.37	HSTTV38-48-Q	C2.28
HSTTK75-48-5	C2.35	HSTTRA50-48-5	C2.37	HSTTV38-C	C2.29
HSTTK100-48-5	C2.35	HSTTRA75-48-5	C2.37	HSTTV38-Q	C2.31
HSTTN25-CY	C2.33	HSTTRA100-48-5	C2.37	HSTTV38-T	C2.30
HSTTN38-CY	C2.33	HSTTT03-48-Q	C2.34	HSTTV38-T5	C2.30
HSTTN50-CY	C2.33	HSTTT04-48-Q	C2.34	HSTTV38-Y	C2.31
HSTTN63-CY	C2.33	HSTTT05-48-Q	C2.34	HSTTV50-48-Q	C2.28
HSTTN75-CY	C2.33	HSTTT06-48-Q	C2.34	HSTTV50-C	C2.29
HSTTN88-CY	C2.33	HSTTT08-48-Q	C2.34	HSTTV50-Q	C2.31
HSTTN100-CY	C2.33	HSTTT09-48-Q	C2.34	HSTTV50-T	C2.30
HSTTN125-CY	C2.33	HSTTT12-48-Q	C2.34	HSTTV50-T5	C2.30
HSTTN150-CY	C2.33	HSTTT15-48-Q	C2.34	HSTTV50-Y	C2.31
HSTTN175-CY	C2.33	HSTTT19-48-Q	C2.34	HSTTV75-48-5	C2.28
HSTTN200-QY	C2.33	HSTTT24-48-Q	C2.34	HSTTV75-C	C2.29
HSTTP05-CY	C2.32	HSTTT30-48-Q	C2.34	HSTTV75-Q	C2.31
HSTTP05-MY	C2.32	HSTTT37-48-Q	C2.34	HSTTV75-T	C2.30
HSTTP05-QY	C2.32	HSTTT43-48-Q	C2.34	HSTTV75-T10	C2.30
HSTTP06-CY	C2.32	HSTTT046-48-Q	C2.34	HSTTV75-Y	C2.31
HSTTP06-QY	C2.32	HSTTT47-48-Q	C2.34	HSTTV100-48-5	C2.28
HSTTP09-CY	C2.32	HSTTT055-48-Q	C2.34	HSTTV100-C	C2.29
HSTTP09-MY	C2.32	HSTTT56-48-5	C2.34	HSTTV100-Q	C2.31
HSTTP09-QY	C2.32	HSTTT66-48-5	C2.34	HSTTV100-Y	C2.31
HSTTP12-CY	C2.32	HSTTT75-48-5	C2.34	HSTTV150-48-5	C2.28
HSTTP12-MY	C2.32	HSTTT93-48-5	C2.34	HSTTV150-C	C2.29
HSTTP12-QY	C2.32	HSTTT112-48-5	C2.34	HSTTV12-48-Q	C2.35
HSTTP19-CY	C2.32	HSTTT131-48-2	C2.34	HSTTV12-Y	C2.36
HSTTP19-MY	C2.32	HSTTT150-48-2	C2.34	HSTTV19-48-Q	C2.35
HSTTP19-QY	C2.32	HSTTV05-48-Q	C2.28	HSTTV19-Y	C2.36
HSTTP25-CY	C2.32	HSTTV05-C	C2.29	HSTTV25-48-Q	C2.35
HSTTP25-DY	C2.32	HSTTV05-M	C2.30	HSTTV25-Y	C2.36

Part Number Index

Part Number	Page Number
HSTTVA38-48-Q	C2.35
HSTTVA38-Y	C2.36
HSTTVA50-48-5	C2.35
HSTTVA50-Y	C2.36
HSTTVA75-48-5	C2.35
HSTTVA75-Y	C2.36
HSTTVA100-48-5	C2.35
HSTTVA100-Y	C2.36
HSTTVA150-48-5	C2.35
HSTT-YK1	C2.27
HSTT-YK1-45	C2.27
HSTT-YK2	C2.27
HSTT-YK2-45	C2.27
HTCT2-2-1	D3.13, D3.14
HTCT6X-6X-1	D3.13, D3.14
HTCT250-2-1	D3.13, D3.14
HTCT250-250-1	D3.13, D3.14
HTMLT2.7WEH-LP	B3.8
HTMLT4WEH-LP	B3.8
HTMLT6WEH-LP	B3.8
HTMLT8WEH-LP	B3.8
HTMLT10WEH-LP	B3.8
HTMLT12WEH-Q	B3.8
HTMLT16WEH-Q	B3.8
HTMLT26WEH-Q	B3.8
HTMLT38WEH-Q	B3.8
HTWC2-2-1	D3.14
HTWC6X-6X-1	D3.14
HTWC250-2-1	D3.14
HTWC250-250-1	D3.14
HV965-C	B1.62
HV965-C0	B1.60
HV9100-C	B1.62
HV9100-C0	B1.60
HV9150-C	B1.62
HV9150-C0	B1.60
HV9250-C	B1.62
HV9250-C0	B1.60
HVMPPM-08-C0	B1.60, B2.19
HVTM-06-C0	B1.60, B2.9
HWS2819-C	B2.40
I	
ILT2S-C	B1.59, B1.62
ILT2S-C0	B1.59
ILT2S-M	B1.62
ILT3S-C	B1.59, B1.62
ILT3S-C0	B1.59
ILT3S-M	B1.62
ILT4LH-TL	B1.59, B1.62
ILT4LH-TL0	B1.59
ILT4S-C	B1.59, B1.62
ILT4S-C0	B1.59
ILT4S-M	B1.62
ILT6LH-C	B1.59, B1.62
ILT6LH-C0	B1.59
IT940-C	B1.62
IT940-C0	B1.61
IT965-C	B1.62

Part Number	Page Number
IT965-C0	B1.61
IT9100-C	B1.62
IT9100-C0	B1.61
IT9100-CUV2	B1.61
IT9100-CUV4Y	B1.61
IT9100-CUV6	B1.61
IT9100-CUV6A	B1.61
IT9100-CUV7A	B1.61
IT9100-CUV8	B1.61
IT9100-CUV16B	B1.61
IT9115-C	B1.62
IT9115-C0	B1.61
IT9115-CUV2	B1.61
IT9115-CUV2A	B1.61
IT9115-CUV4A	B1.61
IT9115-CUV4Y	B1.61
IT9115-CUV5A	B1.61
IT9115-CUV5B	B1.61
IT9115-CUV6	B1.61
IT9115-CUV6A	B1.61
IT9115-CUV6B	B1.61
IT9115-CUV7A	B1.61
IT9115-CUV8	B1.61
IT9115-CUV8A	B1.61
IT9115-CUV11	B1.61
IT9115-CUV16B	B1.61
IT9115-CUV18	B1.61
J	
J214-312-T	D1.52
J216-410-L	D1.52
J318-412-T	D1.52
JMCB-X	C3.5
JMCMB25-1-X	C3.5
JMCMB25-3-X	C3.5
JMDWB-1-X	C3.5
JMDWB-3-X	C3.5
JMJH2	C3.6
JMJH2W	C3.6
JMJH2W-X20	C3.5
JMJH2-X20	C3.5
JMSBCB87-1-X	C3.6
JMSBCB87-3-X	C3.6
JMTRB38-1-X	C3.5
JMTRB38-3-X	C3.5, C3.6
JN218-216-C	D1.51
JN224-318-C	D1.51
JN314-412-C	D1.51
JN418-212-C	D1.51
JP2CMB	C3.4
JP2CMB-L20	C3.2
JP2CP	C3.4
JP2CP-L20	C3.3
JP2DW	C3.4
JP2DW-L20	C3.2
JP2HBC25RB	C3.4
JP2HBC25RB-L20	C3.3
JP2HBC50RB	C3.4
JP2HBC50RB-L20	C3.3

Part Number	Page Number
JP2HBC75RB	C3.4
JP2HBC75RB-L20	C3.3
JP2SBC50	C3.4
JP2SBC50-L20	C3.2
JP2SBC50RB	C3.4
JP2SBC50RB-L20	C3.2
JP2SBC87	C3.4
JP2SBC87-L20	C3.3
JP2SBC87RB	C3.4
JP2SBC87RB-L20	C3.3
JP2UF100	C3.4
JP2UF100-L20	C3.3
JP2W	C3.4
JP2W-L20	C3.2
JP2WP2B	C3.4
JP2WP2B-L20	C3.2
JP2ZP	C3.4
JP2ZP-L20	C3.3
JP4CMB	C3.4
JP4CMB-X20	C3.2
JP4CP	C3.4
JP4CP-X20	C3.3
JP4DW	C3.4
JP4DW-L20	C3.2
JP4HBC25RB	C3.4
JP4HBC50RB	C3.4
JP4HBC50RB-X20	C3.3
JP4HBC75RB	C3.4
JP4HBC75RB-X20	C3.3
JP4SBC50	C3.4
JP4SBC50RB	C3.4
JP4SBC50RB-X20	C3.2, C3.3
JP4SBC50-X20	C3.2
JP4SBC87	C3.4
JP4SBC87RB	C3.4
JP4SBC87RB-X20	C3.3
JP4SBC87-X20	C3.3
JP4UF100	C3.4
JP4UF100-X20	C3.3
JP4W	C3.4
JP4WP2B	C3.4
JP4WP2B-X20	C3.2
JP4W-X20	C3.2
JP4ZP	C3.4
JP4ZP-X20	C3.3
JP75CMB	C3.4
JP75CMB-L20	C3.2
JP75CP	C3.4
JP75CP-L20	C3.3
JP75DW	C3.4
JP75DW-L20	C3.2
JP75HBC25RB	C3.4
JP75HBC25RB-L20	C3.3
JP75HBC50RB	C3.4
JP75HBC50RB-L20	C3.3
JP75HBC75RB	C3.4
JP75HBC75RB-L20	C3.3
JP75SBC50	C3.4
JP75SBC50-L20	C3.2

Part Number Index

Part Number	Page Number	Part Number	Page Number	Part Number	Page Number
JP75SBC50RB	C3.4	KLM6-250Y	D2.83	LAB250-12-5	D2.59
JP75SBC50RB-L20	C3.2	KLM6-600Y	D2.83	LAB300-12-2	D2.59
JP75SBC87	C3.4	KLM14-250Y	D2.83	LAB350-12-2R	D2.59
JP75SBC87-L20	C3.3	KP-506A	B1.80	LAB400-12-2	D2.59
JP75SBC87RB	C3.4	KP-506A-0	B1.80	LAB500-12-2R	D2.59
JP75SBC87RB-L20	C3.3	KP-509	B1.80	LAB600-12-2	D2.59
JP75UF100	C3.4	KP-1000	D1.27	LAB750-12-1R	D2.59
JP75UF100-L20	C3.3	KP-1075Y	D1.27	LAB800-12-1	D2.59
JP75W	C3.4	KP-1165Y	D1.27	LAB900-12-1	D2.59
JP75W-L20	C3.2	KP-1166	D1.27	LAB1000-12-1	D2.59
JP75WP2B	C3.4	KP-F1	D1.62	LAM2A1/0-14-6Y	D2.79
JP75WP2B-L20	C3.2	KP-F2	D1.62	LAM2A2/0-14-6Y	D2.79
JP75ZP	C3.4	KP-FSD1	D1.62	LAM2A250-38-6Y	D2.79
JP75ZP-L20	C3.3	KP-FSD2	D1.62	LAM2A350-12-6Y	D2.79
JP131CMB	C3.4	KP-FSD3	D1.62	LAM2A600-12-6Y	D2.79
JP131CMB-L20	C3.2	KP-HSTT1	C2.40	LAM2A1000-58-6Y	D2.79
JP131CP	C3.4	KP-HSTT2	C2.40	LAM2B350-12-3Y	D2.80
JP131CP-L20	C3.3	KP-HSTTA	C2.40	LAM2LB600-12-3	D2.80
JP131DW	C3.4	KWP3Y	F.5	LAM2LB1000-12-3	D2.80
JP131DW-L20	C3.2	KWPY	F.5	LAM2SA300-38-3	D2.80
JP131HBC25RB	C3.4			LAM2SA300-56-3	D2.80
JP131HBC25RBL20	C3.3	L		LAM2SB600-38-1Y	D2.81
JP131HBC50RB	C3.4	LAA1/0-12-5	D2.58	LAM2SB750-38-1Y	D2.81
JP131HBC50RBL20	C3.3	LAA1/0-38-5	D2.58	LAM2SSB500-141Y	D2.81
JP131HBC75RB	C3.4	LAA1/0-56-5	D2.58	LAM3B1/0-38-6Y	D2.81
JP131HBC75RBL20	C3.3	LAA1-14-X	D2.58	LAM3B2-14-6Y	D2.81
JP131SBC50	C3.4	LAA1-38-X	D2.58	LAM3B3/0-12-3Y	D2.81
JP131SBC50-L20	C3.2	LAA1-56-X	D2.58	LAM3B250-12-1Y	D2.81
JP131SBC50RB	C3.4	LAA2/0-12-5	D2.58	LAM3B350-12-1Y	D2.81
JP131SBC50RBL20	C3.2	LAA2/0-38-5	D2.58	LAM3D3/0-12-3Y	D2.82
JP131SBC87	C3.4	LAA2-14-X	D2.58	LAM3D250-12-1Y	D2.82
JP131SBC87-L20	C3.3	LAA2-38-X	D2.58	LAM3D350-12-1Y	D2.82
JP131SBC87RB	C3.4	LAA2-56-X	D2.58	LAM3LB600-12-1	D2.81
JP131SBC87RBL20	C3.3	LAA3/0-12-5	D2.58	LAM3LB1000-121Y	D2.81
JP131UF100	C3.4	LAA3/0-38-5	D2.58	LAM3LD600-12-1	D2.82
JP131UF100-L20	C3.3	LAA4/0-12-5	D2.58	LAM3LD1000-121Y	D2.82
JP131W	C3.4	LAA4/0-38-5	D2.58	LAM4D250-12-1Y	D2.83
JP131W-L20	C3.2	LAA4-14-X	D2.58	LAM4D350-12-1Y	D2.83
JP131WP2B	C3.4	LAA4-38-X	D2.58	LAM4LD600-12-1	D2.83
JP131WP2B-L20	C3.2	LAA4-56-X	D2.58	LAM4LD1000-12-1	D2.83
JP131ZP	C3.4	LAA6-14-X	D2.58	LAM4SB600-38-1Y	D2.82
JP131ZP-L20	C3.3	LAA6-56-X	D2.58	LAM4SB750-38-1Y	D2.82
		LAA250-12-5	D2.58	LAMA1/0-14-QY	D2.78
		LAA250-38-5	D2.58	LAMA1/0-56-Q	D2.78
K		LAA300-12-2	D2.58	LAMA2/0-14-QY	D2.78
K1-PNKIT	D1.28	LAA300-38-2	D2.58	LAMA2-14-QY	D2.78
K2-PVKITY	D1.28	LAA350-12-2	D2.58	LAMA6-14-QY	D2.78
K-205	B1.79, D1.28	LAA400-58-2R	D2.58	LAMA250-56-QY	D2.78
K-504	B1.79	LAA500-12-2	D2.59	LAMA300-56-QY	D2.78
K-1000	D1.27	LAA500-58-2	D2.59	LAMA350-38-QY	D2.78
K-1001	D1.27	LAA750-12-1	D2.59	LAMA500-38-6Y	D2.78
K-1100	D1.27	LAA750-58-1	D2.59	LAMA600-38-6Y	D2.78
K-1102Y	D1.27	LAA900-58-1	D2.59	LAMA600S-38-6Y	D2.78
K-1103Y	D1.27	LAA1000-58-1	D2.59	LAMA1000-58-6Y	D2.78
K-1104	D1.27	LAB1/0-12-X	D2.59	LAMB350-12-6Y	D2.79
KB-550	B1.80	LAB1/0-38-X	D2.59	LAMB600-12-3Y	D2.79
KB-551	B1.80	LAB2/0-12-5	D2.59	LAMLB1000-12-3	D2.79
KIMS-H366-C2	B2.12	LAB3/0-12-5	D2.59	LC3-A-C8	B2.34
KIMS-H430-C6	B2.12	LAB4/0-12-5R	D2.59	LC5-A-C8	B2.34
KIMS-H500-C4	B2.12				

Order number of pieces required, in multiples of Standard Package Quantity.

Part Number Index

Part Number	Page Number	Part Number	Page Number	Part Number	Page Number
LCA10-A-L8	B2.34	LCA400-78-6	D2.10	LCAX2/0-14-X	D2.31
LCA1/0-12-X	D2.10	LCA500-1-6	D2.10	LCAX2/0-38-X	D2.31
LCA1/0-14-X	D2.10	LCA500-12-6	D2.10	LCAX2/0-56-X	D2.31
LCA1/0-38-X	D2.10	LCA500-34-6	D2.10	LCAX2/0-58-X	D2.31
LCA1/0-56-X	D2.10	LCA500-38-6	D2.10	LCAX2-10-E	D2.30
LCA1-12-E	D2.9	LCA500-58-6	D2.10	LCAX2-12-E	D2.30
LCA1-14-E	D2.9	LCA500-78-6	D2.10	LCAX2-14-E	D2.30
LCA1-38-E	D2.9	LCA600-12-6	D2.10	LCAX2-38-E	D2.30
LCA1-56-E	D2.9	LCA600-58-6	D2.10	LCAX2-56-E	D2.30
LCA2/0-12-X	D2.10	LCA600-78-6	D2.10	LCAX3/0-10-X	D2.31
LCA2/0-14-X	D2.10	LCA750-58-6	D2.10	LCAX3/0-12-X	D2.31
LCA2/0-38-X	D2.10	LCAN1/0-10-X	D2.11	LCAX3/0-14-X	D2.31
LCA2/0-56-X	D2.10	LCAN1/0-14-X	D2.11	LCAX3/0-38-X	D2.31
LCA2-12-Q	D2.9	LCAN1/0-56-X	D2.11	LCAX3/0-56-X	D2.31
LCA2-14-Q	D2.9	LCAN1-10-E	D2.11	LCAX3/0-58-X	D2.31
LCA2-38-Q	D2.9	LCAN1-14-E	D2.11	LCAX4/0-12-X	D2.31
LCA2-56-Q	D2.9	LCAN2/0-10-X	D2.11	LCAX4/0-14-X	D2.31
LCA3/0-12-X	D2.10	LCAN2/0-14-X	D2.11	LCAX4/0-34-X	D2.31
LCA3/0-14-X	D2.10	LCAN2/0-38-X	D2.11	LCAX4/0-38-X	D2.31
LCA3/0-38-X	D2.10	LCAN2/0-56-X	D2.11	LCAX4/0-56-X	D2.31
LCA3/0-56-X	D2.10	LCAN2-10-Q	D2.11	LCAX4/0-58-X	D2.31
LCA4/0-12-X	D2.10	LCAN2-14-Q	D2.11	LCAX4-10-L	D2.30
LCA4/0-14-X	D2.10	LCAN3/0-14-X	D2.11	LCAX4-14-L	D2.30
LCA4/0-38-X	D2.10	LCAN3/0-38-X	D2.11	LCAX4-38-L	D2.30
LCA4/0-56-X	D2.10	LCAN3/0-56-X	D2.11	LCAX4-56-L	D2.30
LCA4-10-L	D2.9	LCAN4/0-14-X	D2.11	LCAX6-10-L	D2.30
LCA4-12-L	D2.9	LCAN4/0-38-X	D2.11	LCAX6-14-L	D2.30
LCA4-14-L	D2.9	LCAN4/0-56-X	D2.11	LCAX6-38-L	D2.30
LCA4-38-L	D2.9	LCAN4-10-L	D2.11	LCAX6-56-L	D2.30
LCA4-56-L	D2.9	LCAN4-14-L	D2.11	LCAX8-10-L	D2.30
LCA6-10-L	D2.9	LCAN6-6-L	D2.11	LCAX8-14-L	D2.30
LCA6-12-L	D2.9	LCAN8-6-L	D2.11	LCAX8-38-L	D2.30
LCA6-14-L	D2.9	LCAN250-14-X	D2.12	LCAX8-56-L	D2.30
LCA6-38-L	D2.9	LCAN250-38-X	D2.12	LCAX250-12-X	D2.31
LCA6-56-L	D2.9	LCAN300-14-X	D2.12	LCAX250-14-X	D2.31
LCA8-10-L	D2.9	LCAN300-38-X	D2.12	LCAX250-34-X	D2.31
LCA8-14-L	D2.9	LCAN350-12-X	D2.12	LCAX250-38-X	D2.31
LCA8-38-L	D2.9	LCAN350-38-X	D2.12	LCAX250-56-X	D2.31
LCA8-56-L	D2.9	LCAN400-12-6	D2.12	LCAX250-58-X	D2.31
LCA10-10-L	D2.9	LCAN400-38-6	D2.12	LCAX300-12-6	D2.31
LCA10-14-L	D2.9	LCAN500-12-6	D2.12	LCAX300-38-6	D2.31
LCA10-38-L	D2.9	LCAN500-38-6	D2.12	LCAX300-58-6	D2.31
LCA10-56-L	D2.9	LCAN600-12-6	D2.12	LCAX350-12-6	D2.31
LCA250-12-X	D2.10	LCAN600-38-6	D2.12	LCAX350-38-6	D2.31
LCA250-14-X	D2.10	LCAN750-12-6	D2.12	LCAX350-56-6	D2.31
LCA250-38-X	D2.10	LCAN750-38-6	D2.12	LCAX350-58-6	D2.31
LCA250-56-X	D2.10	LCAN750-58-6	D2.12	LCAX450-12-6	D2.31
LCA300-12-X	D2.10	LCAX1/0-12-X	D2.31	LCAX450-58-6	D2.31
LCA300-38-X	D2.10	LCAX1/0-14-X	D2.31	LCAX500-12-6	D2.31
LCA300-56-X	D2.10	LCAX1/0-38-X	D2.31	LCAX500-38-6	D2.31
LCA300-58-X	D2.10	LCAX1/0-56-X	D2.31	LCAX500-56-6	D2.31
LCA300-78-X	D2.10	LCAX1/0-58-X	D2.31	LCAX500-58-6	D2.31
LCA350-12-X	D2.10	LCAX1-10-X	D2.30	LCAX650-12-6	D2.32
LCA350-38-X	D2.10	LCAX1-12-X	D2.30	LCAX650-38-6	D2.32
LCA350-58-X	D2.10	LCAX1-14-X	D2.30	LCAX650-56-6	D2.32
LCA350-78-X	D2.10	LCAX1-38-X	D2.30	LCAX650-58-6	D2.32
LCA400-12-6	D2.10	LCAX1-56-X	D2.30	LCAX750-12-3	D2.32
LCA400-38-6	D2.10	LCAX2/0-10-X	D2.31	LCAX750-58-3	D2.32
LCA400-58-6	D2.10	LCAX2/0-12-X	D2.31	LCAXN4/0-14-X	D2.32

B1.
Cable
Ties

B2.
Cable
Accessories

B3.
Stainless
Steel Cable
Ties &
Accessories

C1.
Wiring
Duct

C2.
Abrasion
Protection

C3.
Cable
Management

D1.
Terminals

D2.
Power
Connectors

D3.
Grounding
Connectors

E1.
Labeling
Systems

E2.
Labels

E3.
Pre-Printed
&
Write-On
Markers

E4.
Permanent
Identification

E5.
Industrial
Safety
Solutions

F.
Keystone
Cabling
Systems

G.
Part
Number
Index

Part Number Index

Part Number	Page Number	Part Number	Page Number	Part Number	Page Number
LCAXN4/0-38-X	D2.32	LCBX2/0-14-X	D2.33	LCC2/0-38D-X	D2.20
LCAXN4/0-56-X	D2.32	LCBX2/0-38-X	D2.33	LCC2/0-56DW-X	D2.23
LCAXN750-12-3	D2.32	LCBX2-12-E	D2.33	LCC2/0-56D-X	D2.20
LCB1/0-10-X	D2.13	LCBX2-14-E	D2.33	LCC2-10AW-Q	D2.22
LCB1/0-12-X	D2.13	LCBX2-38-E	D2.33	LCC2-10BW-Q	D2.22
LCB1/0-38-X	D2.13	LCBX3/0-38-X	D2.33	LCC2-12-Q	D2.19
LCB1/0-56-X	D2.13	LCBX4/0-12-X	D2.33	LCC2-12W-Q	D2.23
LCB1-10-E	D2.13	LCBX4/0-38-X	D2.33	LCC2-14A-Q	D2.19
LCB1-12-E	D2.13	LCBX4-14-L	D2.33	LCC2-14AW-Q	D2.22
LCB1-38-E	D2.13	LCBX4-38-L	D2.33	LCC2-14B-Q	D2.19
LCB1-56-E	D2.13	LCBX6-14-L	D2.33	LCC2-14BW-Q	D2.22
LCB2/0-12-X	D2.14	LCBX6-38-L	D2.33	LCC2-14DW-Q	D2.22
LCB2/0-38-X	D2.14	LCBX8-10-L	D2.33	LCC2-38BW-Q	D2.23
LCB2-10-Q	D2.13	LCBX8-14-L	D2.33	LCC2-38CW-Q	D2.23
LCB2-12-Q	D2.13	LCBX8-38-L	D2.33	LCC2-38D-Q	D2.19
LCB2-14-Q	D2.13	LCBX250-12-X	D2.34	LCC2-38DW-Q	D2.23
LCB2-38-Q	D2.13	LCBX250-38-X	D2.34	LCC2-38-Q	D2.19
LCB2-56-Q	D2.13	LCBX250-58-X	D2.34	LCC2-38W-Q	D2.23
LCB3/0-12-X	D2.14	LCBX300-38-6	D2.34	LCC2-56B-Q	D2.19
LCB3/0-38-X	D2.14	LCBX350-12-6	D2.34	LCC2-56BW-Q	D2.23
LCB4/0-12-X	D2.14	LCBX350-38-6	D2.34	LCC2-56C-Q	D2.19
LCB4/0-38-X	D2.14	LCBX450-38-6	D2.34	LCC2-56CW-Q	D2.23
LCB4-10-L	D2.13	LCBX500-12-6	D2.34	LCC3/0-12DW-X	D2.23
LCB4-14-L	D2.13	LCBX500-38-6	D2.34	LCC3/0-12D-X	D2.20
LCB4-38-L	D2.13	LCC1/0-12DW-X	D2.23	LCC3/0-12W-X	D2.23
LCB4-56-L	D2.13	LCC1/0-12D-X	D2.20	LCC3/0-12-X	D2.20
LCB6-10-L	D2.13	LCC1/0-12W-X	D2.23	LCC3/0-14BW-X	D2.23
LCB6-14-L	D2.13	LCC1/0-12-X	D2.20	LCC3/0-14B-X	D2.20
LCB6-38-L	D2.13	LCC1/0-14AW-X	D2.23	LCC3/0-38DW-X	D2.23
LCB8-10-L	D2.13	LCC1/0-14A-X	D2.20	LCC3/0-38D-X	D2.20
LCB8-14-L	D2.13	LCC1/0-14BW-X	D2.23	LCC3/0-56DW-X	D2.23
LCB8-38-L	D2.13	LCC1/0-14B-X	D2.20	LCC4/0-12DW-X	D2.23
LCB250-12-X	D2.14	LCC1/0-14DW-X	D2.23	LCC4/0-12D-X	D2.20
LCB250-78-X	D2.14	LCC1/0-38DW-X	D2.23	LCC4/0-12W-X	D2.23
LCB300-12-X	D2.14	LCC1/0-38D-X	D2.20	LCC4/0-12-X	D2.20
LCB300-38-X	D2.14	LCC1/0-38W-X	D2.23	LCC4/0-14AW-X	D2.23
LCB300-56-X	D2.14	LCC1/0-56C-X	D2.20	LCC4/0-14BW-X	D2.23
LCB350-12-X	D2.14	LCC1/0-56D-X	D2.20	LCC4/0-14B-X	D2.20
LCB350-78-X	D2.14	LCC1-12-E	D2.20	LCC4/0-38DW-X	D2.23
LCB400-12-6	D2.14	LCC1-12W-E	D2.23	LCC4/0-38D-X	D2.20
LCB400-38-6	D2.14	LCC1-14A-E	D2.19	LCC4/0-38W-X	D2.23
LCB400-58-6	D2.14	LCC1-14AW-E	D2.23	LCC4/0-38-X	D2.20
LCB400-78-6	D2.14	LCC1-14B-E	D2.19	LCC4/0-56DW-X	D2.23
LCB500-12-6	D2.14	LCC1-14BW-E	D2.23	LCC4/0-56D-X	D2.20
LCB500-58-6	D2.14	LCC1-38D-E	D2.20	LCC4-10AW-L	D2.22
LCB500-78-6	D2.14	LCC1-38DW-E	D2.23	LCC4-10BW-L	D2.22
LCB600-12-6	D2.14	LCC1-56B-E	D2.20	LCC4-12-L	D2.19
LCB600-58-6	D2.14	LCC1-56BW-E	D2.23	LCC4-12W-L	D2.22
LCB750-58-6	D2.14	LCC1-56C-E	D2.20	LCC4-14ADW-L	D2.22
LCB750-78-6	D2.14	LCC1-56CW-E	D2.23	LCC4-14A-L	D2.19
LCB800-58-6	D2.14	LCC2/0-12DW-X	D2.23	LCC4-14AW-L	D2.22
LCB1000-58-3	D2.14	LCC2/0-12D-X	D2.20	LCC4-14B-L	D2.19
LCBX1/0-12-X	D2.33	LCC2/0-12W-X	D2.23	LCC4-14BW-L	D2.22
LCBX1/0-14-X	D2.33	LCC2/0-12-X	D2.20	LCC4-14DW-L	D2.22
LCBX1/0-38-X	D2.33	LCC2/0-14AW-X	D2.23	LCC4-38D-L	D2.19
LCBX1-14-X	D2.33	LCC2/0-14A-X	D2.20	LCC4-38DW-L	D2.22
LCBX1-38-X	D2.33	LCC2/0-14BW-X	D2.23	LCC6-10ABW-L	D2.22
LCBX1-56-X	D2.33	LCC2/0-14B-X	D2.20	LCC6-10A-L	D2.19
LCBX2/0-12-X	D2.33	LCC2/0-38DW-X	D2.23	LCC6-10AW-L	D2.22

Part Number Index

Part Number	Page Number	Part Number	Page Number	Part Number	Page Number
LCC6-10BW-L	D2.22	LCC500-12-6	D2.21	LCCX6-38C-L	D2.38
LCC6-12-L	D2.19	LCC500-12W-6	D2.24	LCCX6-38D-L	D2.38
LCC6-12W-L	D2.22	LCC500-14B-6	D2.21	LCCX8-10AB-L	D2.38
LCC6-14A-L	D2.19	LCC500-14BW-6	D2.24	LCCX8-10A-L	D2.38
LCC6-14AW-L	D2.22	LCC500-38D-6	D2.21	LCCX8-10B-L	D2.38
LCC6-14BDW-L	D2.22	LCC500-38DW-6	D2.24	LCCX8-14AB-L	D2.38
LCC6-14B-L	D2.19	LCC600-12-6	D2.21	LCCX8-14A-L	D2.38
LCC6-14BW-L	D2.22	LCC600-12W-6	D2.24	LCCX8-14B-L	D2.38
LCC6-14D-L	D2.19	LCC600-38D-6	D2.21	LCCX8-14D-L	D2.38
LCC6-14DW-L	D2.22	LCC600-38DW-6	D2.24	LCCX8-38D-L	D2.38
LCC6-14EW-L	D2.22	LCC750-12-6	D2.21	LCCX250-12-X	D2.39
LCC6-14JAW-L	D2.22	LCC750-12W-6	D2.24	LCCX250-14B-X	D2.39
LCC6-14JW-L	D2.22	LCC750-38D-6	D2.21	LCCX250-38D-X	D2.39
LCC6-14W-L	D2.22	LCC750-38DW-6	D2.24	LCCX300-12-6	D2.39
LCC6-38BDW-L	D2.22	LCC800-12-6	D2.21	LCCX300-38D-6	D2.39
LCC6-38BW-L	D2.22	LCC800-12W-6	D2.24	LCCX350-12-6	D2.39
LCC6-38CW-L	D2.22	LCC1000-12-3	D2.21	LCCX350-14B-6	D2.39
LCC6-38D-L	D2.19	LCC1000-12W-3	D2.24	LCCX350-38D-6	D2.39
LCC6-38DW-L	D2.22	LCC1000-38D-3	D2.21	LCCX450-12-6	D2.39
LCC6-56BW-L	D2.22	LCC1000-38DW-3	D2.24	LCCX500-12-6	D2.39
LCC8-10ABW-L	D2.22	LCCN750-12W-6	D2.25	LCCX500-38D-6	D2.39
LCC8-10A-L	D2.19	LCCN750-38DW-6	D2.25	LCCX650-12-6	D2.39
LCC8-10AW-L	D2.22	LCCX1/0-12-X	D2.39	LCCXN2-14A-E	D2.40
LCC8-10BW-L	D2.22	LCCX1/0-14A-X	D2.39	LCCXN2-14B-E	D2.40
LCC8-14ABW-L	D2.22	LCCX1/0-14B-X	D2.39	LCCXN2-14D-E	D2.40
LCC8-14A-L	D2.19	LCCX1/0-38D-X	D2.39	LCCXN450-12-6	D2.40
LCC8-14AW-L	D2.22	LCCX1-14A-X	D2.39	LCCXN500-12-6	D2.40
LCC8-14B-L	D2.19	LCCX1-14B-X	D2.39	LCCXN650-12-6	D2.40
LCC8-14BW-L	D2.22	LCCX1-14D-X	D2.39	LCCXN750-12-3	D2.40
LCC8-14D-L	D2.19	LCCX1-38D-X	D2.39	LCD1/0-12-X	D2.16
LCC8-14DW-L	D2.22	LCCX1-56C-X	D2.39	LCD1/0-14A-X	D2.16
LCC8-38D-L	D2.19	LCCX1-56D-X	D2.39	LCD1/0-14B-X	D2.16
LCC8-38DW-L	D2.22	LCCX2/0-12-X	D2.39	LCD1/0-38D-X	D2.16
LCC10-14AW-L	D2.21	LCCX2/0-14A-X	D2.39	LCD1/0-56C-X	D2.16
LCC10-14BW-L	D2.21	LCCX2/0-14B-X	D2.39	LCD1-12-E	D2.16
LCC10-14JAW-L	D2.21	LCCX2/0-38D-X	D2.39	LCD1-14A-E	D2.16
LCC250-12DW-X	D2.24	LCCX2-12-E	D2.39	LCD1-14B-E	D2.16
LCC250-12D-X	D2.20	LCCX2-14A-E	D2.39	LCD1-38D-E	D2.16
LCC250-12W-X	D2.24	LCCX2-14B-E	D2.39	LCD1-56C-E	D2.16
LCC250-12-X	D2.20	LCCX2-38D-E	D2.39	LCD2/0-12-X	D2.16
LCC250-38DW-X	D2.24	LCCX3/0-14B-X	D2.39	LCD2/0-14A-X	D2.16
LCC250-38D-X	D2.20	LCCX3/0-38D-X	D2.39	LCD2/0-14B-X	D2.16
LCC250-56DW-X	D2.24	LCCX4/0-12-X	D2.39	LCD2/0-38D-X	D2.16
LCC300-12W-X	D2.24	LCCX4/0-14B-X	D2.39	LCD2/0-56C-X	D2.16
LCC300-12-X	D2.20	LCCX4/0-38D-X	D2.39	LCD2-12-Q	D2.16
LCC300-38DW-X	D2.24	LCCX4-14AB-L	D2.38	LCD2-14A-Q	D2.16
LCC300-38D-X	D2.20	LCCX4-14A-L	D2.38	LCD2-14B-Q	D2.16
LCC350-12W-X	D2.24	LCCX4-14B-L	D2.38	LCD2-14D-Q	D2.16
LCC350-12-X	D2.20	LCCX4-14CE-L	D2.38	LCD2-38D-Q	D2.16
LCC350-14BW-X	D2.24	LCCX4-38BD-L	D2.38	LCD2-56B-Q	D2.16
LCC350-14B-X	D2.20	LCCX4-38B-L	D2.38	LCD3/0-12-X	D2.16
LCC350-38DW-X	D2.24	LCCX4-38D-L	D2.38	LCD3/0-14B-X	D2.16
LCC350-38D-X	D2.20	LCCX6-10B-L	D2.38	LCD3/0-38D-X	D2.16
LCC400-12-6	D2.20	LCCX6-14AB-L	D2.38	LCD3/0-56D-X	D2.16
LCC400-12W-6	D2.24	LCCX6-14A-L	D2.38	LCD4/0-12-X	D2.16
LCC400-14B-6	D2.20	LCCX6-14B-L	D2.38	LCD4/0-14B-X	D2.16
LCC400-14BW-6	D2.24	LCCX6-14D-L	D2.38	LCD4/0-38D-X	D2.16
LCC400-38D-6	D2.20	LCCX6-38AC-L	D2.38	LCD4-10A-L	D2.15
LCC400-38DW-6	D2.24	LCCX6-38A-L	D2.38	LCD4-10B-L	D2.15

B1.
Cable
Ties

B2.
Cable
Accessories

B3.
Stainless
Steel Cable
Ties &
Accessories

C1.
Wiring
Duct

C2.
Abrasion
Protection

C3.
Cable
Management

D1.
Terminals

D2.
Power
Connectors

D3.
Grounding
Connectors

E1.
Labeling
Systems

E2.
Labels

E3.
Pre-Printed
&
Write-On
Markers

E4.
Permanent
Identification

E5.
Industrial
Safety
Solutions

F.
Keystone
Cabling
Systems

G.
Part
Number
Index

Part Number Index

Part Number	Page Number	Part Number	Page Number	Part Number	Page Number
LCD4-14A-L	D2.15	LCDX1/0-12-X	D2.35	LCDX300-38D-6	D2.36
LCD4-14B-L	D2.15	LCDX1/0-14A-X	D2.35	LCDX350-12-6	D2.36
LCD4-14D-L	D2.15	LCDX1/0-14B-X	D2.35	LCDX350-12E-6	D2.36
LCD4-38D-L	D2.15	LCDX1/0-38D-X	D2.35	LCDX350-38-6	D2.36
LCD6-10A-L	D2.15	LCDX1/0-56B-X	D2.35	LCDX350-38D-6	D2.36
LCD6-10B-L	D2.15	LCDX1/0-56D-X	D2.35	LCDX350-56D-6	D2.36
LCD6-10D-L	D2.15	LCDX1-12-X	D2.35	LCDX450-12-6	D2.36
LCD6-14A-L	D2.15	LCDX1-14A-X	D2.35	LCDX450-38D-6	D2.36
LCD6-14B-L	D2.15	LCDX1-14B-X	D2.35	LCDX500-12-6	D2.36
LCD6-14D-L	D2.15	LCDX1-14D-X	D2.35	LCDX500-12E-6	D2.36
LCD6-38D-L	D2.15	LCDX1-38D-X	D2.35	LCDX500-38D-6	D2.36
LCD6-56D-L	D2.15	LCDX1-56D-X	D2.35	LCDX500-56D-6	D2.36
LCD8-10A-L	D2.15	LCDX2/0-12D-X	D2.35	LCDX600-12-6	D2.36
LCD8-14A-L	D2.15	LCDX2/0-12-X	D2.35	LCDX650-12-6	D2.36
LCD8-14B-L	D2.15	LCDX2/0-14A-X	D2.35	LCDX650-38D-6	D2.36
LCD8-14D-L	D2.15	LCDX2/0-14B-X	D2.35	LCDX750-12-3	D2.36
LCD8-38D-L	D2.15	LCDX2/0-38D-X	D2.35	LCDX750-12E-3	D2.36
LCD10-10A-L	D2.15	LCDX2/0-56D-X	D2.35	LCDX750-12G-3	D2.36
LCD10-14A-L	D2.15	LCDX2-12-E	D2.35	LCDX750-38D-3	D2.36
LCD10-14B-L	D2.15	LCDX2-14A-E	D2.35	LCDX750-58G-3	D2.36
LCD10-14D-L	D2.15	LCDX2-14B-E	D2.35	LCDXN2-14A-E	D2.37
LCD10-38D-L	D2.15	LCDX2-14D-E	D2.35	LCDXN4/0-38D-X	D2.37
LCD250-12-X	D2.16	LCDX2-38D-E	D2.35	LCDXN350-38D-6	D2.37
LCD250-38D-X	D2.16	LCDX2-56D-E	D2.35	LCDXN500-12-6	D2.37
LCD300-12-X	D2.16	LCDX3/0-12-X	D2.35	LCDXN500-38D-6	D2.37
LCD300-38D-X	D2.16	LCDX3/0-14A-X	D2.35	LCDXN750-12-3	D2.37
LCD350-12E-X	D2.16	LCDX3/0-38D-X	D2.35	LCDXN750-38D-3	D2.37
LCD350-12-X	D2.16	LCDX3/0-56D-X	D2.35	LCMA6-5-C	D2.45
LCD350-14B-X	D2.16	LCDX4/0-12D-X	D2.36	LCMA6-6-C	D2.45
LCD350-38D-X	D2.16	LCDX4/0-12E-X	D2.36	LCMA6-8-C	D2.45
LCD400-12-6	D2.16	LCDX4/0-12-X	D2.36	LCMA10-5-C	D2.45
LCD400-38D-6	D2.16	LCDX4/0-14A-X	D2.36	LCMA10-5F-C	D2.49
LCD500-12-6	D2.17	LCDX4/0-14B-X	D2.36	LCMA10-5H-C	D2.47
LCD500-12E-6	D2.17	LCDX4/0-38D-X	D2.36	LCMA10-6-C	D2.45
LCD500-14B-6	D2.17	LCDX4/0-56D-X	D2.36	LCMA10-6F-C	D2.49
LCD500-38D-6	D2.17	LCDX4-14A-L	D2.35	LCMA10-6H-C	D2.47
LCD600-12-6	D2.17	LCDX4-14B-L	D2.35	LCMA10-8-C	D2.45
LCD600-38D-6	D2.17	LCDX4-14D-L	D2.35	LCMA10-8F-C	D2.49
LCD750-12-6	D2.17	LCDX4-38D-L	D2.35	LCMA10-8H-C	D2.47
LCD750-38D-6	D2.17	LCDX4-56D-L	D2.35	LCMA10-10-C	D2.45
LCD750-58G-6	D2.17	LCDX6-10A-L	D2.35	LCMA10-10F-C	D2.49
LCD1000-12-3	D2.17	LCDX6-10B-L	D2.35	LCMA10-10H-C	D2.47
LCD1000-12E-3	D2.17	LCDX6-10G-L	D2.35	LCMA16-5-C	D2.45
LCDN1/0-14D-X	D2.18	LCDX6-10P-L	D2.35	LCMA16-5F-C	D2.49
LCDN1/0-56D-X	D2.18	LCDX6-14A-L	D2.35	LCMA16-5H-C	D2.47
LCDN1-14B-E	D2.18	LCDX6-14B-L	D2.35	LCMA16-6-C	D2.45
LCDN2/0-14A-X	D2.18	LCDX6-14D-L	D2.35	LCMA16-6F-C	D2.49
LCDN2/0-14D-X	D2.18	LCDX6-38D-L	D2.35	LCMA16-6H-C	D2.47
LCDN2/0-56A-X	D2.18	LCDX6-56D-L	D2.35	LCMA16-8-C	D2.45
LCDN2/0-56D-X	D2.18	LCDX8-10A-L	D2.34	LCMA16-8F-C	D2.49
LCDN2-10B-Q	D2.18	LCDX8-14A-L	D2.34	LCMA16-8H-C	D2.47
LCDN2-14A-Q	D2.18	LCDX8-14B-L	D2.34	LCMA16-10-C	D2.45
LCDN2-14B-Q	D2.18	LCDX8-14D-L	D2.34	LCMA16-10F-C	D2.49
LCDN2-14D-Q	D2.18	LCDX8-38D-L	D2.34	LCMA16-10H-C	D2.47
LCDN350-38D-X	D2.18	LCDX250-12E-X	D2.36	LCMA25-6-C	D2.45
LCDN500-12D-6	D2.18	LCDX250-12-X	D2.36	LCMA25-6F-C	D2.49
LCDN500-38D-6	D2.18	LCDX250-38D-X	D2.36	LCMA25-6H-C	D2.47
LCDN750-38D-6	D2.18	LCDX250-38-X	D2.36	LCMA25-8-C	D2.45
LCDX1/0-12D-X	D2.35	LCDX300-12-6	D2.36	LCMA25-8F-C	D2.49

Part Number Index

Part Number	Page Number	Part Number	Page Number	Part Number	Page Number
LCMA25-8H-C	D2.47	LCMA120-12H-L	D2.48	LCMA500-00-1	D2.46
LCMA25-10-C	D2.45	LCMA120-12-L	D2.46	LCMA500-12-1	D2.46
LCMA25-10F-C	D2.49	LCMA120-16F-L	D2.50	LCMA500-16-1	D2.46
LCMA25-10H-C	D2.47	LCMA120-16H-L	D2.48	LCMA500-20-1	D2.46
LCMA35-6-C	D2.45	LCMA120-16-L	D2.46	LCMA630-00-1	D2.46
LCMA35-6F-C	D2.49	LCMA150-8F-X	D2.50	LCMA630-16-1	D2.46
LCMA35-6H-C	D2.47	LCMA150-8H-X	D2.48	LCMA630-20-1	D2.46
LCMA35-8-C	D2.45	LCMA150-8-X	D2.46	LCMAX300-10-5	D2.46
LCMA35-8F-C	D2.49	LCMA150-10F-X	D2.50	LCMAX300-10F-5	D2.50
LCMA35-8H-C	D2.47	LCMA150-10H-X	D2.48	LCMAX300-10H-5	D2.48
LCMA35-10-C	D2.45	LCMA150-10-X	D2.46	LCMAX300-12-5	D2.46
LCMA35-10F-C	D2.49	LCMA150-12F-X	D2.50	LCMAX300-12F-5	D2.50
LCMA35-10H-C	D2.47	LCMA150-12H-X	D2.48	LCMAX300-12H-5	D2.48
LCMA35-12-C	D2.45	LCMA150-12-X	D2.46	LCMAX300-16-5	D2.46
LCMA35-12F-C	D2.49	LCMA150-16F-X	D2.50	LCMAX300-16F-5	D2.50
LCMA35-12H-C	D2.47	LCMA150-16H-X	D2.48	LCMAX300-16H-5	D2.48
LCMA50-6F-L	D2.49	LCMA150-16-X	D2.46	LCMAX300-20-5	D2.46
LCMA50-6H-L	D2.47	LCMA150-20F-X	D2.50	LCMAX300-20F-5	D2.50
LCMA50-6-L	D2.45	LCMA150-20H-X	D2.48	LCMAX300-20H-5	D2.48
LCMA50-8F-L	D2.49	LCMA150-20-X	D2.46	LCMB10-5-L	D2.51
LCMA50-8H-L	D2.47	LCMA185-10F-X	D2.50	LCMB10-6-L	D2.51
LCMA50-8-L	D2.45	LCMA185-10H-X	D2.48	LCMB10-8-L	D2.51
LCMA50-10F-L	D2.49	LCMA185-10-X	D2.46	LCMB10-10-L	D2.51
LCMA50-10H-L	D2.47	LCMA185-12F-X	D2.50	LCMB16-5-L	D2.51
LCMA50-10-L	D2.45	LCMA185-12H-X	D2.48	LCMB16-6-L	D2.51
LCMA50-12F-L	D2.49	LCMA185-12-X	D2.46	LCMB16-8-L	D2.51
LCMA50-12H-L	D2.47	LCMA185-16F-X	D2.50	LCMB16-10-L	D2.51
LCMA50-12-L	D2.45	LCMA185-16H-X	D2.48	LCMB25-6-L	D2.51
LCMA70-6F-L	D2.49	LCMA185-16-X	D2.46	LCMB25-8-L	D2.51
LCMA70-6H-L	D2.48	LCMA185-20F-X	D2.50	LCMB25-10-L	D2.51
LCMA70-6-L	D2.45	LCMA185-20H-X	D2.48	LCMB35-6-Q	D2.51
LCMA70-8F-L	D2.49	LCMA185-20-X	D2.46	LCMB35-8-Q	D2.51
LCMA70-8H-L	D2.48	LCMA240-10F-X	D2.50	LCMB35-10-Q	D2.51
LCMA70-8-L	D2.45	LCMA240-10H-X	D2.48	LCMB35-12-Q	D2.51
LCMA70-10F-L	D2.49	LCMA240-10-X	D2.46	LCMB50-6-E	D2.51
LCMA70-10H-L	D2.48	LCMA240-12F-X	D2.50	LCMB50-8-E	D2.51
LCMA70-10-L	D2.45	LCMA240-12H-X	D2.48	LCMB50-10-E	D2.51
LCMA70-12F-L	D2.49	LCMA240-12-X	D2.46	LCMB50-12-E	D2.51
LCMA70-12H-L	D2.48	LCMA240-16F-X	D2.50	LCMB70-8-X	D2.51
LCMA70-12-L	D2.45	LCMA240-16H-X	D2.48	LCMB70-10-X	D2.51
LCMA95-8F-L	D2.49	LCMA240-16-X	D2.46	LCMB70-12-X	D2.51
LCMA95-8H-L	D2.48	LCMA240-20F-X	D2.50	LCMB95-8-X	D2.52
LCMA95-8-L	D2.46	LCMA240-20H-X	D2.48	LCMB95-10-X	D2.52
LCMA95-10F-L	D2.49	LCMA240-20-X	D2.46	LCMB95-12-X	D2.52
LCMA95-10H-L	D2.48	LCMA300-10-5	D2.46	LCMB95-16-X	D2.52
LCMA95-10-L	D2.46	LCMA300-10F-5	D2.50	LCMB120-8-X	D2.52
LCMA95-12F-L	D2.49	LCMA300-10H-5	D2.48	LCMB120-10-X	D2.52
LCMA95-12H-L	D2.48	LCMA300-12-5	D2.46	LCMB120-12-X	D2.52
LCMA95-12-L	D2.46	LCMA300-12F-5	D2.50	LCMB120-16-X	D2.52
LCMA95-16F-L	D2.49	LCMA300-12H-5	D2.48	LCMB150-8-X	D2.52
LCMA95-16H-L	D2.48	LCMA300-16-5	D2.46	LCMB150-10-X	D2.52
LCMA95-16-L	D2.46	LCMA300-16F-5	D2.50	LCMB150-12-X	D2.52
LCMA120-8F-L	D2.50	LCMA300-16H-5	D2.48	LCMB150-16-X	D2.52
LCMA120-8H-L	D2.48	LCMA300-20-5	D2.46	LCMB150-20-X	D2.52
LCMA120-8-L	D2.46	LCMA300-20F-5	D2.50	LCMB185-10-X	D2.52
LCMA120-10F-L	D2.50	LCMA300-20H-5	D2.48	LCMB185-12-X	D2.52
LCMA120-10H-L	D2.48	LCMA400-12-5	D2.46	LCMB185-16-X	D2.52
LCMA120-10-L	D2.46	LCMA400-16-5	D2.46	LCMB185-20-X	D2.52
LCMA120-12F-L	D2.50	LCMA400-20-5	D2.46	LCMB240-10-6	D2.52

Part Number Index

Part Number	Page Number	Part Number	Page Number	Part Number	Page Number
LCMB240-12-6	D2.52	LCMC500-12-3	D2.56	LCMD400-14-5	D2.54
LCMB240-16-6	D2.52	LCMC500-14-3	D2.56	LCMD400-16-5	D2.54
LCMB240-20-6	D2.52	LCMC500-16-3	D2.56	LCMD500-00-1	D2.54
LCMB300-10-6	D2.52	LCMC630-00-3	D2.56	LCMD500-12-1	D2.54
LCMB300-12-6	D2.52	LCMC630-12-3	D2.56	LCMD500-14-1	D2.54
LCMB300-16-6	D2.52	LCMC630-14-3	D2.56	LCMD500-16-1	D2.54
LCMB300-20-6	D2.52	LCMC630-16-3	D2.56	LCMD630-00-1	D2.54
LCMB400-12-6	D2.52	LCMCX300-00-6	D2.56	LCMD630-12-1	D2.54
LCMB400-16-6	D2.52	LCMCX300-12-6	D2.56	LCMD630-14-1	D2.54
LCMB400-20-6	D2.52	LCMCX300-14-6	D2.56	LCMD630-16-1	D2.54
LCMB500-12-3	D2.52	LCMD6-5CD-Q	D2.53	LCMDX300-00-5	D2.54
LCMB500-16-3	D2.52	LCMD10-00-Q	D2.53	LCMDX300-12-5	D2.54
LCMB500-20-3	D2.52	LCMD10-6CD-Q	D2.53	LCMDX300-14-5	D2.54
LCMB630-16-3	D2.52	LCMD10-8-Q	D2.53	LHMS-S6-D	B2.15
LCMB630-20-3	D2.52	LCMD16-00-Q	D2.53	LHMS-S10-D	B2.15
LCMBX300-10-6	D2.52	LCMD16-6CD-Q	D2.53	LHMSS-S5-D	B2.15
LCMBX300-12-6	D2.52	LCMD16-8-Q	D2.53	LIAC4-22-C	D3.18
LCMBX300-16-6	D2.52	LCMD25-00-Q	D2.53	LIAS1/0-14-L	D3.18
LCMBX300-20-6	D2.52	LCMD25-8CD-Q	D2.53	LIAS250-56-Q	D3.18
LCMC10-00-L	D2.55	LCMD25-8-Q	D2.53	LICC4-22-C	D3.18
LCMC10-8-L	D2.55	LCMD25-10-Q	D2.53	LICC4-22TP-C	D3.18
LCMC16-00-L	D2.55	LCMD25-12-Q	D2.53	LPFCM14-A-C14	B2.34
LCMC16-8-L	D2.55	LCMD35-00-Q	D2.53	LPFCM22-A-C14	B2.34
LCMC25-00-L	D2.55	LCMD35-8CD-Q	D2.53	LPFCM34-A-C14	B2.34
LCMC25-8-L	D2.55	LCMD35-10-Q	D2.53	LPMM-S2-C	B2.12
LCMC25-10-L	D2.55	LCMD35-12-Q	D2.53	LPMM-S5-C	B2.12
LCMC25-12-L	D2.55	LCMD50-00-X	D2.53	LPMS-S8-C	B2.12
LCMC35-00-Q	D2.55	LCMD50-10CD-X	D2.53	LS8-CASE	E1.3
LCMC35-10-Q	D2.55	LCMD50-10-X	D2.53	LS8-CLN	E1.3
LCMC35-12-Q	D2.55	LCMD50-12-X	D2.53	LS8E	E1.3
LCMC50-00-E	D2.55	LCMD70-00-X	D2.53	LS8E-ACS	E1.3
LCMC50-10-E	D2.55	LCMD70-10CD-X	D2.53	LS8E-KIT	E1.3
LCMC50-12-E	D2.55	LCMD70-10-X	D2.53	LS8E-KIT-ACS	E1.3
LCMC70-00-X	D2.55	LCMD70-12-X	D2.53	LS8EQ	E1.3
LCMC70-10-X	D2.55	LCMD95-00-X	D2.54	LS8EQ-KIT	E1.3
LCMC70-12-X	D2.55	LCMD95-10CD-X	D2.53	LS8EQ-KIT-ACS	E1.3
LCMC95-00-X	D2.55	LCMD95-12-X	D2.53	LS8-IB	E1.3
LCMC95-12-X	D2.55	LCMD95-14-X	D2.54	LS8-PCKIT	E1.3
LCMC95-14-X	D2.55	LCMD120-00-X	D2.54	LS8-WS	E1.3
LCMC120-00-X	D2.55	LCMD120-10CD-X	D2.54	LTYK	D3.5
LCMC120-12-X	D2.55	LCMD120-12-X	D2.54	LV-S-1G	C3.7
LCMC120-14-X	D2.55	LCMD120-14-X	D2.54	LV-S-2G	C3.7
LCMC150-00-X	D2.56	LCMD150-00-X	D2.54	LV-W-1G	C3.7
LCMC150-12-X	D2.56	LCMD150-10CD-X	D2.54	LV-W-2G	C3.7
LCMC150-14-X	D2.56	LCMD150-12-X	D2.54	LWC19-A-C	B2.31
LCMC185-00-X	D2.56	LCMD150-14-X	D2.54	LWC19-A-C14	B2.31
LCMC185-12-X	D2.56	LCMD185-00-X	D2.54	LWC19-A-C20	B2.31
LCMC185-14-X	D2.56	LCMD185-10CD-X	D2.54	LWC19-H25-C	B2.31
LCMC240-00-6	D2.56	LCMD185-12-X	D2.54	LWC19-H25-C14	B2.31
LCMC240-12-6	D2.56	LCMD185-14-X	D2.54	LWC25-A-C	B2.31
LCMC240-14-6	D2.56	LCMD240-00-5	D2.54	LWC25-A-C14	B2.31
LCMC300-00-6	D2.56	LCMD240-10CD-5	D2.54	LWC25-A-C20	B2.31
LCMC300-12-6	D2.56	LCMD240-12-5	D2.54	LWC25-H25-C	B2.31
LCMC300-14-6	D2.56	LCMD240-14-5	D2.54	LWC25-H25-C14	B2.31
LCMC400-00-6	D2.56	LCMD300-00-5	D2.54	LWC25-H25-C20	B2.31
LCMC400-12-6	D2.56	LCMD300-12-5	D2.54	LWC38-A-C	B2.31
LCMC400-14-6	D2.56	LCMD300-14-5	D2.54	LWC38-A-C14	B2.31
LCMC400-16-6	D2.56	LCMD400-00-5	D2.54	LWC38-A-C20	B2.31
LCMC500-00-3	D2.56	LCMD400-12-5	D2.54	LWC38-H25-C	B2.31

Order number of pieces required, in multiples of Standard Package Quantity.

Part Number Index

Part Number	Page Number
LWC38-H25-C14	B2.31
LWC38-H25-C20	B2.31
LWC50-A-L	B2.31
LWC50-A-L14	B2.31
LWC50-A-L20	B2.31
LWC50-H25-L	B2.31
LWC50-H25-L14	B2.31
LWC50-H25-L20	B2.31
LWC75-A-L	B2.31
LWC75-A-L14	B2.31
LWC75-A-L20	B2.31
LWC75-H25-L	B2.31
LWC75-H25-L14	B2.31
LWC75-H25-L20	B2.31
LWC100-A-L	B2.31
LWC100-A-L14	B2.31
LWC100-A-L20	B2.31
LWC100-H25-L	B2.31
LWC100-H25-L14	B2.31
LWC100-H25-L20	B2.31

M

M200X042FQT	E2.8
M200X042FQT-B	E2.8
M200X042UPT	E2.8
M200X042UPT-B	E2.8
M200X050ACT	E2.9
M200X050AET	E2.9
M200X050AFT	E2.9
M200X050AGT	E2.9
M200X050AIT	E2.9
M200X050Y6T	E2.9
M200X050Y7T	E2.9
M200X080FQT	E2.8
M200X080FQT-B	E2.8
M200X080UPT	E2.8
M200X080UPT-B	E2.8
M200X100ACT	E2.9
M200X100AET	E2.9
M200X100AFT	E2.9
M200X100AGT	E2.9
M200X100AIT	E2.9
M200X100Y6T	E2.9
M200X100Y6T-B	E2.9
M200X100Y7T	E2.9
M200X100Y7T-B	E2.9
M300X050ACT	E2.9
M300X050AET	E2.9
M300X050AFT	E2.9
M300X050AGT	E2.9
M300X050AIT	E2.9
M300X050Y6C	E1.7
M300X050Y6T	E2.9
M300X050Y7C	E1.7
M300X050Y7T	E2.9
M300X100ACT	E2.9
M300X100AET	E2.9
M300X100AFT	E2.9
M300X100AGT	E2.9

Part Number	Page Number
M300X100AIT	E2.9
M300X100Y6T	E2.9
M300X100Y7T	E2.9
MACC25-A-C	B2.30
MACC25-AV-D	B2.30
MACC62-A-C	B2.30
MACC62-AV-C	B2.30
MBCEH-QR316	B3.13
MBCH-QR316	B3.13
MBCSH-QR316	B3.13
MBEH-TLR	B3.12
MBH-MR	B3.12
MBH-TLR	B3.12
MBM-H25-Q	B3.24, B3.25
MBSM-S10-CY	B2.17
MBSH-TR	B3.12
MBS-MR	B3.12
MBS-TLR	B3.12
MC25X25IG2	C1.21
MC25X37IG2	C1.21
MC25X50IG2	C1.21
MC25X62IG2	C1.21
MC25X75IG2	C1.21
MC37X37IG2	C1.21
MC37X50IG2	C1.21
MC37X62IG2	C1.21
MC37X75IG2	C1.21
MC50X50IG2	C1.21
MC50X75IG2	C1.21
MC50X100IG2	C1.21
MC62X62IG2	C1.21
MC75X50IG2	C1.21
MC75X62IG2	C1.21
MC75X75IG2	C1.21
MC75X100IG2	C1.21
MC100X50IG2	C1.21
MC100X75IG2	C1.21
MC100X100IG2	C1.21
MCEH-S25-C0	B1.11, B1.22
MCMS12-P-C	B2.16
MCMS25-P-C	B2.16
MCMS30-P-C	B2.16
MEHT187	E4.5
META-X	E4.5
METS3-X	E4.5
METS4-X	E4.5
MIM094	E4.6
MIM125	E4.6
MIM187	E4.6
MIW094	E4.6
MIW125	E4.6
MIW187	E4.6
ML1/0-LY	D2.68
ML4-CY	D2.68
ML8-CY	D2.68
ML250-QY	D2.68
MLT1H-LPAL	B3.10
MLT1S-CP	B3.5
MLT2.7S-CP	B3.5

Part Number	Page Number
MLT2DH-L	B3.11
MLT2H-LP	B3.6, B3.28
MLT2H-LP316	B3.28
MLT2H-LPAL	B3.10
MLT2LH-LP	B3.6, B3.8
MLT2S-CP	B3.5, B3.28
MLT2S-CP316	B3.28
MLT2S-L	B3.5
MLT4DEH-Q	B3.11
MLT4DH-L	B3.11
MLT4EH-LP	B3.6
MLT4H-LP	B3.6, B3.28
MLT4H-LP316	B3.28
MLT4H-LPAL	B3.10
MLT4LH-LP	B3.6
MLT4S-CP	B3.5, B3.28
MLT4S-CP316	B3.28
MLT4SH-LP	B3.6
MLT4S-L	B3.5
MLT6DEH-Q	B3.11
MLT6DEH-Q316	B3.11
MLT6DH-Q	B3.11
MLT6DSH-Q	B3.11
MLT6DSH-Q316	B3.11
MLT6EH-LP	B3.6
MLT6H-LP	B3.6, B3.28
MLT6H-LP316	B3.28
MLT6LH-LP	B3.6
MLT6S-CP	B3.5, B3.28
MLT6S-CP316	B3.28
MLT6SH-LP	B3.6
MLT8DEH-Q	B3.11
MLT8DEH-Q316	B3.11
MLT8DSH-Q	B3.11
MLT8DSH-Q316	B3.11
MLT8EH-LP	B3.6
MLT8H-LP	B3.6, B3.28
MLT8H-LP316	B3.28
MLT8LH-LP	B3.6
MLT8S-CP	B3.5, B3.28
MLT8S-CP316	B3.28
MLT8SH-LP	B3.6
MLT10EH-LP	B3.6
MLT10H-LP	B3.6, B3.28
MLT10H-LP316	B3.28
MLT10S-CP	B3.5
MLT10SH-LP	B3.6
MLT12EH-Q	B3.6
MLT12SH-Q	B3.6
MLT12S-Q	B3.5
MLT14H-Q	B3.6
MLT14S-Q	B3.5
MLT15S-Q	B3.5
MLTC2H-LP316	B3.9
MLTC4H-LP316	B3.9
MLTC6H-LP316	B3.9
MLTC8H-LP316	B3.9
MLTC10H-LP316	B3.9
MLTFC2H-LP316	B3.9

Part Number Index

	Part Number	Page Number	Part Number	Page Number	Part Number	Page Number
B2. Cable Accessories						
B3. Stainless Steel Cable Ties & Accessories	MLTFC2H-LP316BU.....	B3.9	MP350-C0.....	B2.26	MS3367-1-7.....	B1.91
	MLTFC2H-LP316GR.....	B3.8	MPMH38-L0.....	B2.19	MS3367-1-8.....	B1.91
	MLTFC2H-LP316RD.....	B3.8	MPMS19-C0.....	B2.19	MS3367-1-9.....	B1.91
	MLTFC2H-LP316WH.....	B3.9	MPMS25-C0.....	B2.19	MS3367-2-0.....	B1.91
	MLTFC2H-LP316YL.....	B3.8	MPMWH32-L0.....	B2.19	MS3367-2-1.....	B1.91
C1. Wiring Duct	MLTFC4EH-LP316.....	B3.9	MPWM-H56-Q.....	B3.23	MS3367-2-2.....	B1.91
	MLTFC4H-LP316.....	B3.9	MRS1.5H-L4.....	B3.16	MS3367-2-3.....	B1.91
	MLTFC4H-LP316BU.....	B3.9	MRS1.5LH-L4.....	B3.16	MS3367-2-4.....	B1.91
	MLTFC4H-LP316GR.....	B3.8	MRS1S-C4.....	B3.16	MS3367-2-5.....	B1.91
C2. Abrasion Protection	MLTFC4H-LP316RD.....	B3.8	MRS2H-L4.....	B3.16	MS3367-2-6.....	B1.91
	MLTFC4H-LP316WH.....	B3.9	MRS2LH-L4.....	B3.16	MS3367-2-7.....	B1.91
	MLTFC4H-LP316YL.....	B3.8	MRS2S-C4.....	B3.16	MS3367-2-8.....	B1.91
	MLTFC4S-CP316.....	B3.8	MRS4H-L4.....	B3.16	MS3367-2-9.....	B1.91
	MLTFC4SH-LP316.....	B3.9	MRS4LH-L4.....	B3.16	MS3367-3-0.....	B1.91
C3. Cable Management	MLTFC6EH-LP316.....	B3.9	MRS4S-C4.....	B3.16	MS3367-3-1.....	B1.91
	MLTFC6H-LP316.....	B3.9	MRS6H-L4.....	B3.16	MS3367-3-2.....	B1.91
	MLTFC6H-LP316BU.....	B3.9	MRS6LH-L4.....	B3.16	MS3367-3-3.....	B1.91
	MLTFC6H-LP316GR.....	B3.8	MRS6S-C4.....	B3.16	MS3367-3-4.....	B1.91
	MLTFC6H-LP316RD.....	B3.8	MRT1.5DS-C4.....	B3.15	MS3367-3-5.....	B1.91
D1. Terminals	MLTFC6H-LP316WH.....	B3.9	MRT1.5H-L4.....	B3.15	MS3367-3-6.....	B1.91
	MLTFC6H-LP316YL.....	B3.8	MRT1.5LH-L4.....	B3.15	MS3367-3-9.....	B1.91
	MLTFC6S-CP316.....	B3.8	MRT1S-C4.....	B3.15	MS3367-4-0.....	B1.91
	MLTFC6SH-LP316.....	B3.9	MRT2.5DLH-L4.....	B3.15	MS3367-4-1.....	B1.91
D2. Power Connectors	MLTFC8EH-LP316.....	B3.9	MRT2.5DS-C4.....	B3.15	MS3367-4-2.....	B1.91
	MLTFC8H-LP316.....	B3.9	MRT2DH-L4.....	B3.15	MS3367-4-3.....	B1.91
	MLTFC8S-CP316.....	B3.8	MRT2H-L4.....	B3.15	MS3367-4-4.....	B1.91
	MLTFC8SH-LP316.....	B3.9	MRT2LH-L4.....	B3.15	MS3367-4-5.....	B1.91
D3. Grounding Connectors	MMP172-C.....	E4.3	MRT2S-C4.....	B3.15	MS3367-4-6.....	B1.91
	MMP172-C316.....	E4.3	MRT4DH-L4.....	B3.15	MS3367-4-7.....	B1.91
	MMP172W38-C.....	E4.3	MRT4H-L4.....	B3.15	MS3367-4-8.....	B1.91
	MMP172W38-C316.....	E4.3	MRT4LH-L4.....	B3.15	MS3367-4-9.....	B1.91
	MMP350-C.....	E4.3	MRT4S-C4.....	B3.15	MS3367-5-0.....	B1.91
E1. Labeling Systems	MMP350-C316.....	E4.3	MRT6H-L4.....	B3.15	MS3367-5-1.....	B1.91
	MMP350DB-C.....	E4.3	MRT6LH-L4.....	B3.15	MS3367-5-2.....	B1.91
	MMP350DB-C316.....	E4.3	MRT6S-C4.....	B3.15	MS3367-5-3.....	B1.91
	MMP350H-C.....	E4.3	MS2W38T15-L4.....	B3.19	MS3367-5-4.....	B1.91
E2. Labels	MMP350H-C316.....	E4.3	MS4W38T15-L4.....	B3.19	MS3367-5-5.....	B1.92
	MMP350H-CAL.....	E4.5	MS4W50T15-L4.....	B3.19	MS3367-5-6.....	B1.92
	MMP350H-M.....	E4.6	MS4W63T15-L4.....	B3.19	MS3367-5-7.....	B1.92
	MMP350H-M316.....	E4.6	MS4W75T30-Q2.....	B3.19	MS3367-5-8.....	B1.92
E3. Pre-Printed & Write-On Markers	MMP350H-MAL.....	E4.6	MS6W38T15-L4.....	B3.19	MS3367-5-9.....	B1.92
	MMP350HW54-MAL.....	E4.6	MS6W50T15-L4.....	B3.19	MS3367-6-9.....	B1.92
	MMP350-M.....	E4.6	MS6W63T15-L4.....	B3.19	MS3367-7-0.....	B1.92
	MMP350-M316.....	E4.6	MS6W75T30-Q2.....	B3.19	MS3367-7-1.....	B1.92
	MMP350W17-Q.....	E4.3	MS8W38T15-L4.....	B3.19	MS3367-7-2.....	B1.92
E4. Permanent Identification	MMP350W38-C.....	E4.3	MS8W50T15-L4.....	B3.19	MS3367-7-3.....	B1.92
	MMP350W38-C316.....	E4.3	MS8W63T15-L4.....	B3.19	MS3367-7-4.....	B1.92
	MMP350W38-M.....	E4.6	MS8W75T30-Q2.....	B3.19	MS3367-7-5.....	B1.92
	MMP350W38-M316.....	E4.6	MS10W38T15-L4.....	B3.19	MS3367-7-6.....	B1.92
E5. Industrial Safety Solutions	MP150-C.....	B2.26	MS10W50T15-L4.....	B3.19	MS3367-7-7.....	B1.92
	MP150-C0.....	B2.26	MS10W63T15-L4.....	B3.19	MS3367-7-8.....	B1.92
	MP175-C.....	B2.26	MS10W75T30-Q2.....	B3.19	MS3367-7-9.....	B1.92
	MP175-C0.....	B2.26	MS3367-1-0.....	B1.91	MS3367-8-9.....	B1.92
F. Keystone Cabling Systems	MP200-C.....	B2.26	MS3367-1-1.....	B1.91	MS3367-9-9.....	B1.92
	MP200-C0.....	B2.26	MS3367-1-2.....	B1.91	MS3367-11-9.....	B1.92
	MP250-C.....	B2.26	MS3367-1-3.....	B1.91	MS3367-14-9.....	B1.92
	MP250-C0.....	B2.26	MS3367-1-4.....	B1.91	MS3367-20-9.....	B1.92
	MP250W175-C.....	B2.26	MS3367-1-5.....	B1.91	MS3367-21-9.....	B1.92
G. Part Number Index	MP350-C.....	B2.26	MS3367-1-6.....	B1.91	MS3367-22-9.....	B1.92

Part Number Index

Part Number	Page Number	Part Number	Page Number	Part Number	Page Number
MS3367-23-9	B1.92	MSBW63-C4	B3.21	MTP3S-E6-C	B2.14
MS3367-24-9	B1.92	MSBW75-C2	B3.21	MTP3S-E10-C	B2.14
MS3367-25-9	B1.92	MSC2W38T15-L6	B3.20	MTP4H-E6-C	B2.14
MS3367-29-9	B1.92	MSC4W38T15-L6	B3.20	MTP4H-E10-C	B2.14
MS3367-30-9	B1.92	MSC4W50T15-L6	B3.20	MTP4S-E6-C	B2.14
MS3367-31-9	B1.92	MSC4W63T15-L6	B3.20	MTP4S-E10-C	B2.14
MS3367-32-1	B1.92	MSC6W38T15-L6	B3.20	MTP5H-E6-C	B2.14
MS3367-32-2	B1.92	MSC6W50T15-L6	B3.20	MTP5H-E10-C	B2.14
MS3367-32-3	B1.92	MSC6W63T15-L6	B3.20	MTP5S-E6-C	B2.14
MS3367-32-4	B1.92	MSC8W38T15-L6	B3.20	MTP5S-E10-C	B2.14
MS3367-32-5	B1.92	MSC8W50T15-L6	B3.20	MTP6H-E6-C	B2.14
MS3367-32-6	B1.92	MSC8W63T15-L6	B3.20	MTP6H-E10-C	B2.14
MS3367-32-7	B1.92	MSC10W38T15-L6	B3.20	MTPC1H-E10-C39	B2.13
MS3367-32-9	B1.92	MSC10W50T15-L6	B3.20	MTPC2H-E10-C39	B2.13
MS3367-33-9	B1.92	MSC10W63T15-L6	B3.20	MTPC3H-E10-C39	B2.13
MS3367-34-2	B1.92	MSCNW38T15-QR6	B3.21	MTPC4H-E10-C39	B2.13
MS3367-34-3	B1.92	MSCNW50T15-QR6	B3.21	MTPC5H-E10-C39	B2.13
MS3367-34-4	B1.92	MSCNW63T15-QR6	B3.21	MTPC6H-E10-C39	B2.13
MS3367-34-6	B1.92	MSG-1.3-C	C3.7		
MS3367-34-8	B1.92	MSGV-1.3-C	C3.7	N	
MS3367-34-9	B1.92	MSPT-1.3	C3.7	N025X075CBT	E2.6
MS3367-35-9	B1.92	MSW38T15-CR4	B3.21	N025X075FJJ	E2.25
MS3367-36-9	B1.93	MSW50T15-CR4	B3.21	N025X125CBT	E2.6
MS3367-37-9	B1.93	MSW63T15-C4	B3.21	N025X125FJJ	E2.25
MS3367-38-9	B1.93	MSW75T30-CR2	B3.21	N025X150CBT	E2.6
MS3367-39-9	B1.93	MT1D-Q	E4.4	N025X150FJJ	E2.25
MS3367-40-9	B1.93	MT1D-Q316	E4.4	N025X175CBT	E2.6
MS3367-41-9	B1.93	MT125S-Q	E4.4	N050X075C1C	E1.5
MS3368-1-2A	B1.93	MT150D-Q	E4.4	N050X075C1T	E2.7
MS3368-1-3A	B1.93	MT150D-Q316	E4.4	N050X075C2C	E1.5
MS3368-1-4A	B1.93	MT172-C	E4.4	N050X075C2T	E2.7
MS3368-1-5A	B1.93	MT172-C316	E4.4	N050X075CBC	E1.5
MS3368-1-6A	B1.93	MT172W38-C	E4.4	N050X075CBT	E2.6
MS3368-1-8A	B1.93	MT213D-Q	E4.4	N050X075FJJ	E2.25
MS3368-1-9A	B1.93	MT213D-Q316	E4.4	N050X100CBT	E2.6
MS3368-1-9B	B1.93	MT350-C	E4.4	N050X125C1C	E1.5
MS3368-2-2A	B1.93	MT350-C316	E4.4	N050X125C1T	E2.7
MS3368-2-4A	B1.93	MT350W17-Q	E4.4	N050X125C2C	E1.5
MS3368-2-6A	B1.93	MTB1D-Q	E4.4	N050X125C2T	E2.7
MS3368-2-9A	B1.93	MTB150D-Q	E4.4	N050X125CBT	E2.6
MS3368-2-9B	B1.93	MTB213D-Q	E4.4	N050X125FJJ	E2.25
MS3368-3-4C	B1.93	MTHEH-C	B3.13	N050X150C1T	E2.7
MS3368-3-9C	B1.93	MTHH-C	B3.13	N050X150C2T	E2.7
MS3368-4-4D	B1.93	MTHS-C	B3.13	N050X150CBC	E1.5
MS3368-4-9D	B1.93	MTHSH-C	B3.13	N050X150CBT	E2.6
MS3368-5-1E	B1.93	MTM1H10-C	B3.23	N050X150FJJ	E2.25
MS3368-5-2E	B1.93	MTM1H25-C	B3.23	N050X175CBT	E2.6
MS3368-5-3E	B1.93	MTM1H-C	B3.23	N100X075C1C	E1.5
MS3368-5-4E	B1.93	MTM2H-Q	B3.24	N100X075C1T	E2.7
MS3368-5-5E	B1.93	MTP1H-E6-C	B2.14	N100X075C2C	E1.5
MS3368-5-6E	B1.93	MTP1H-E10-C	B2.14	N100X075C2T	E2.7
MS3368-5-7E	B1.93	MTP1S-E6-C	B2.14	N100X075CBC	E1.5
MS3368-5-8E	B1.93	MTP1S-E10-C	B2.14	N100X075CBT	E2.6
MS3368-5-9E	B1.93	MTP2H-E6-C	B2.14	N100X075FJJ	E2.25
MS90387-1	B1.93	MTP2H-E10-C	B2.14	N100X125C1C	E1.5
MS90387-2	B1.93	MTP2S-E6-C	B2.14	N100X125C1T	E2.7
MS90387-4	B1.93	MTP2S-E10-C	B2.14	N100X125C2C	E1.5
MSBW38-C4	B3.21	MTP3H-E6-C	B2.14	N100X125C2T	E2.7
MSBW50-C4	B3.21	MTP3H-E10-C	B2.14	N100X125CBC	E1.5

Part Number Index

Part Number	Page Number	Part Number	Page Number	Part Number	Page Number
N100X125CBT	E2.6	NK6BXIW-AY	F.6	P2-12R-X	D1.18
N100X125FJJ	E2.25	NK6PC^Y	F.2	P2-14RHT6-X	D1.17
N100X150C1T	E2.7	NK6PPG12WY	F.3	P2-14R-X	D1.18
N100X150C2T	E2.7	NK6PPG24Y	F.3	P2-38RHT6-X	D1.17
N100X150CBC	E1.5	NK6PPG48Y	F.3	P2-38R-X	D1.18
N100X150CBT	E2.6	NK6X88MIW	F.2	P2-56RHT6-X	D1.17
N100X150FJJ	E2.25	NK6X88MIW-Q	F.2	P2-56R-X	D1.18
N100X175CBC	E1.5	NK6XPPG24Y	F.3	P4-10R-E	D1.18
N100X175CBT	E2.6	NK6XPPG48Y	F.3	P4-10RHT6-E	D1.17
N150X075CBT	E2.6	NK688MIW	F.2	P4-12R-E	D1.18
NC1.5WH6	C1.28	NK688MIW-Q	F.2	P4-12RHT6-E	D1.17
NC1WH6	C1.28	NK2106MFIW	F.5	P4-14R-E	D1.18
NC2WH6	C1.28	NK4106MFIW	F.5	P4-14RHT6-E	D1.17
NC3WH6	C1.28	NKA5EPPG24Y	F.3	P4-38R-E	D1.18
NC4WH6	C1.28	NKA5EPPG48Y	F.3	P4-38RHT6-E	D1.17
NC.5WH6	C1.28	NKA6PPG24Y	F.3	P4-56R-E	D1.18
NC25LG2	C1.27	NKA6PPG48Y	F.3	P4-56RHT6-E	D1.17
NC37LG2	C1.27	NKA6XPPG24Y	F.3	P6-8R-E	D1.18
NC50LG2	C1.27	NKA6XPPG48Y	F.3	P6-8RHT6-E	D1.17
NC75LG2	C1.27	NKBMIW-X	F.6	P6-10R-E	D1.18
NC100LG2	C1.27	NKBNCMIWY	F.6	P6-10RHT6-E	D1.17
NE1.5X1.5WH6	C1.28	NKFIW	F.6	P6-12R-E	D1.18
NE1.5X2WH6	C1.28	NK**FIWY	F.4	P6-12RHT6-E	D1.17
NE1.5X3WH6	C1.28	NK*FNIW	F.4	P6-14R-E	D1.18
NE1.5X4WH6	C1.28	NKFP12W	F.3	P6-14RHT6-E	D1.17
NE1X1.5WH6	C1.28	NKFP24Y	F.3	P6-38R-E	D1.18
NE1X1WH6	C1.28	NKFP48Y	F.3	P6-38RHT6-E	D1.17
NE1X2WH6	C1.28	NKF^MS	F.4	P6-56R-E	D1.18
NE1X3WH6	C1.28	NKHDMIW	F.6	P6-56RHT6-E	D1.17
NE1X4WH6	C1.28	NK^HSFIWY	F.4	P8-8RHT6-Q	D1.17
NE2X1WH6	C1.28	NKP5E88MIW	F.2	P8-8RNHT6-Q	D1.17
NE2X2WH6	C1.28	NKP5E88MIW-Q	F.2	P8-8RN-Q	D1.18
NE2X3WH6	C1.28	NKPP24FMY	F.3	P8-8R-Q	D1.18
NE2X4WH6	C1.28	NKPP48FMY	F.3	P8-10RHT6-Q	D1.17
NE3X1WH6	C1.28	NKPPA24FMY	F.3	P8-10RNHT6-Q	D1.17
NE3X2WH6	C1.28	NKPPA48FMY	F.3	P8-10R-Q	D1.18
NE3X3WH6	C1.28	NKSPB	F.6	P8-12RHT6-Q	D1.17
NE3X4WH6	C1.28	NKUSBAIIV	F.6	P8-12R-Q	D1.18
NE3X5WH6	C1.28	NNC25X25LG2	C1.27	P8-14RHT6-Q	D1.17
NE4X2WH6	C1.28	NNC25X37LG2	C1.27	P8-14R-Q	D1.18
NE4X3WH6	C1.28	NNC25X50LG2	C1.27	P8-38RHT6-Q	D1.17
NE4X4WH6	C1.28	NNC25X75LG2	C1.27	P8-38R-Q	D1.18
NE4X5WH6	C1.28	NNC37X37LG2	C1.27	P8-56RHT6-Q	D1.17
NE.5X1WH6	C1.28	NNC37X50LG2	C1.27	P8-56R-Q	D1.18
NE.5X.5WH6	C1.28	NNC37X75LG2	C1.27	P10-6F-L	D1.25
NK2BXIW-A	F.6	NNC50DWH2	C1.27, C1.31	P10-6LF-L	D1.26
NK2HSRFIW	F.4	NNC50X50LG2	C1.27	P10-6R	D1.65
NK2RMFIW	F.5	NNC50X75LG2	C1.27	P10-6RHT6-L	D1.17
NK4BXIW-AY	F.6	NNC50X100LG2	C1.27	P10-6R-L	D1.16
NK4HSRFIW	F.4	NNC75DWH2	C1.27, C1.31	P10-8F-L	D1.25
NK4MFIW	F.5	NNC75X75LG2	C1.27	P10-8LF-L	D1.26
NK4RMFIW	F.5	NNC100X50LG2	C1.27	P10-8RHT6-L	D1.17
NK4VSF	F.4	NNC100X75LG2	C1.27	P10-8R-L	D1.16
NK4VSRFIW	F.4	NNC100X100LG2	C1.27	P10-10FF-L	D1.26
NK5EPC^Y	F.2			P10-10F-L	D1.25
NK5EPPG12WY	F.3	P		P10-10LF-L	D1.26
NK5EPPG24Y	F.3	P2-10RHT6-X	D1.17	P10-10R	D1.65
NK5EPPG48Y	F.3	P2-10R-X	D1.18	P10-10RHT6-L	D1.17
NK6APC	F.2	P2-12RHT6-X	D1.17	P10-10R-L	D1.16

Part Number Index

Part Number	Page Number	Part Number	Page Number	Part Number	Page Number
P10-12R-L	D1.16	P18-10RHT6-C	D1.17	PCA13-A-J	E3.11
P10-14F-L	D1.25	P18-12R-C	D1.16	PCA13-K-T	E3.11
P10-14LF-L	D1.26	P18-14F-C	D1.25	PCA13-MIN	E3.11
P10-14RHT6-L	D1.17	P18-14R-C	D1.16	PCA13-PLS	E3.11
P10-14R-L	D1.16	P18-38R-C	D1.16	PCA13-U-Z	E3.11
P10-38R	D1.65	P18-56R-C	D1.16	PCA13-Z	E3.11
P10-38R-L	D1.16	P18-P47-C	D1.43	PCA18-0	E3.11
P10-56R	D1.65	P22-2R-C	D1.16	PCA18-0-9	E3.11
P10-56R-L	D1.16	P22-4F-C	D1.25	PCA18-9	E3.11
P10-P55-L	D1.43	P22-4R-C	D1.16	PCA18-A	E3.11
P12-6HDR-L	D1.18	P22-6F-C	D1.25	PCA18-A-J	E3.11
P12-8HDR-L	D1.18	P22-6R-C	D1.16	PCA18-K-T	E3.11
P12-10HDR-L	D1.18	P22-8R-C	D1.16	PCA18-MIN	E3.11
P12-14HDR-L	D1.18	P22-10R-C	D1.16	PCA18-PLS	E3.11
P12-38HDR-L	D1.18	P32W2A2-50-7	C1.35	PCA18-U-Z	E3.11
P12-56HDR-L	D1.18	P32W2A2-50-72	C1.35	PCA18-Z	E3.11
P14-4R-C	D1.16	P32W2A2-75-7	C1.35	PCA23-0	E3.11
P14-6F-C	D1.25	P32W2A2-75-72	C1.35	PCA23-0-3	E3.11
P14-6FF-C	D1.26	PBMS-H25-C	B2.18	PCA23-4-7	E3.11
P14-6FN-C	D1.25	PBMS-H25-C14	B2.18	PCA23-8-9	E3.11
P14-6LF-C	D1.26	PBMS-H25-M0	B2.18	PCA23-9	E3.11
P14-6LFW-C	D1.26	PBMS-H25-M30	B2.18	PCA23-A	E3.11
P14-6R-C	D1.16	PBMSL-H25-M30	B2.18	PCA23-A-D	E3.11
P14-6RHT6-C	D1.17	PBSC1-X	B2.49	PCA23-E-H	E3.11
P14-8F-C	D1.25	PBSC3-X	B2.49	PCA23-I-L	E3.11
P14-8FF-C	D1.26	PBSC6-X	B2.49	PCA23-MIN	E3.11
P14-8LF-C	D1.26	PBSC12-X	B2.49	PCA23-M-P	E3.11
P14-8R-C	D1.16	PC038-H25D-C0	B2.36	PCA23-PLS	E3.11
P14-8RHT6-C	D1.17	PC050-H25D-C0	B2.36	PCA23-Q-T	E3.11
P14-10F-C	D1.25	PC062-H25D-C0	B2.36	PCA23-U-X	E3.11
P14-10FN-C	D1.25	PC075-H25D-C0	B2.36	PCA23-Y-Z	E3.11
P14-10LF-C	D1.26	PC087-H25D-C0	B2.36	PCA23-Z	E3.11
P14-10LFN-C	D1.26	PC100-H25D-C0	B2.36	PCM-0	E3.4
P14-10R-C	D1.16	PC112-H25D-C0	B2.36	PCM-0-9	E3.4
P14-10RHT6-C	D1.17	PC125-H25D-C0	B2.36	PCM-1-3	E3.4
P14-12R-L	D1.16	PCA07-0	E3.10	PCM-1-4	E3.4
P14-14F-C	D1.25	PCA07-0-9	E3.10	PCM-1-5	E3.4
P14-14R-C	D1.16	PCA07-9	E3.10	PCM-1-6	E3.4
P14-38R-C	D1.16	PCA07-A	E3.10	PCM-1-8	E3.4
P14-56R-C	D1.16	PCA07-A-J	E3.10	PCM-1-9	E3.4
P14-P47-C	D1.43	PCA07-K-T	E3.10	PCM-1-10	E3.4
P18-4R-C	D1.16	PCA07-MIN	E3.10	PCM-1-12	E3.4
P18-6F-C	D1.25	PCA07-PLS	E3.10	PCM-1-16	E3.4
P18-6FN-C	D1.25	PCA07-U-Z	E3.10	PCM-1-18	E3.4
P18-6LF-C	D1.26	PCA07-Z	E3.10	PCM-1-33	E3.4
P18-6LFW-C	D1.26	PCA11-0	E3.11	PCM-1L1	E3.6
P18-6R-C	D1.16	PCA11-0-9	E3.11	PCM-1L3	E3.6
P18-6RHT6-C	D1.17	PCA11-9	E3.11	PCM-1T1	E3.6
P18-6RN-C	D1.16	PCA11-A	E3.11	PCM-1T3	E3.6
P18-8F-C	D1.25	PCA11-A-J	E3.11	PCM-2L1	E3.6
P18-8FF-C	D1.26	PCA11-K-T	E3.11	PCM-2L3	E3.6
P18-8LF-C	D1.26	PCA11-MIN	E3.11	PCM-3L1	E3.6
P18-8R-C	D1.16	PCA11-PLS	E3.11	PCM-3L3	E3.6
P18-8RHT6-C	D1.17	PCA11-U-Z	E3.11	PCM-3T1	E3.6
P18-10F-C	D1.25	PCA11-Z	E3.11	PCM-3T3	E3.6
P18-10FN-C	D1.25	PCA13-0	E3.11	PCM-4L1	E3.6
P18-10LF-C	D1.26	PCA13-0-9	E3.11	PCM-4L3	E3.6
P18-10LFN-C	D1.26	PCA13-9	E3.11	PCM-19-36	E3.4
P18-10R-C	D1.16	PCA13-A	E3.11	PCM-34-66	E3.4

Part Number Index

Part Number	Page Number	Part Number	Page Number	Part Number	Page Number
PCM-67-99	E3.4	PCM-F1	E3.5	PCSB4-8-4Y	D2.86
PCM-99	E3.4	PCM-F4	E3.5	PCSB4-10-4Y	D2.86
PCM-100	E3.4	PCM-GRY	E3.6	PCSB4-10S-4Y	D2.85
PCM-100-124	E3.4	PCMH-0	E3.4	PCSB4-12-3Y	D2.86
PCM-125-149	E3.4	PCM-H1	E3.5	PCSB4-12S-3Y	D2.85
PCM-150-174	E3.4	PCM-H5	E3.5	PCSB4-14-2Y	D2.86
PCM-175-199	E3.4	PCMH-25	E3.4	PCSB4-14S-2Y	D2.85
PCM-200-224	E3.4	PCM-L1	E3.5	PCSB250-2-6Y	D2.87
PCM-202	E3.4	PCM-L5	E3.5	PCSB250-2S-6Y	D2.85
PCM-225-249	E3.4	PCM-LBL	E3.6	PCSB250-3-6Y	D2.87
PCM-250-274	E3.4	PCM-LGN	E3.6	PCSB250-3S-6Y	D2.85
PCM-275-299	E3.4	PCM-M1	E3.5	PCSB250-4-6Y	D2.87
PCM-300-324	E3.4	PCM-M2	E3.5	PCSB250-4S-6Y	D2.85
PCM-325-349	E3.4	PCM-ORN	E3.6	PCSB250-5-4Y	D2.87
PCM-350-374	E3.4	PCM-P1	E3.5	PCSB250-5S-4Y	D2.85
PCM-375-399	E3.4	PCM-P3	E3.5	PCSB250-6-4Y	D2.87
PCM-400-424	E3.4	PCM-PNK	E3.6	PCSB250-6S-4Y	D2.85
PCM-425-449	E3.4	PCM-PUR	E3.6	PCSB250-8-3Y	D2.87
PCM-450-474	E3.4	PCM-R1	E3.5	PCSB250-8S-3Y	D2.85
PCM-475-499	E3.4	PCM-R5	E3.5	PCSB250-10-2Y	D2.87
PCM-500-524	E3.4	PCM-RED	E3.6	PCSB250-10S-2Y	D2.85
PCM-A	E3.5	PCM-S1	E3.5	PCSB250-12-2Y	D2.87
PCM-A1	E3.5	PCM-S5	E3.5	PCSB250-12S-2Y	D2.85
PCM-A4	E3.5	PCM-T1	E3.5	PCSB250-14-1Y	D2.87
PCM-A-Z	E3.5	PCM-T9	E3.5	PCSB250-14S-1Y	D2.85
PCM-A-Z-0-9	E3.5	PCM-TAN	E3.6	PCSB350-2-4	D2.87
PCM-B1	E3.5	PCM-WHT	E3.6	PCSB350-2S-4Y	D2.85
PCMB-1	E3.2	PCM-X1	E3.5	PCSB350-3-4	D2.87
PCMB-2	E3.2	PCM-X4	E3.5	PCSB350-3S-4Y	D2.85
PCMB-3	E3.2	PCM-YEL	E3.6	PCSB350-4-3	D2.87
PCMB-4	E3.2	PCM-Z	E3.5	PCSB350-4S-3Y	D2.85
PCM-B5	E3.5	PCSB2/0-2-12	D2.86	PCSB350-5-3	D2.87
PCMB-5	E3.2	PCSB2/0-2S-6	D2.85	PCSB350-5S-3Y	D2.85
PCMB-6	E3.2	PCSB2/0-3-6	D2.86	PCSB350-6-2	D2.87
PCMB-7	E3.2	PCSB2/0-3S-6Y	D2.85	PCSB350-6S-2Y	D2.85
PCMB-8	E3.2	PCSB2/0-4-6	D2.86	PCSB350-8-2	D2.87
PCMB-9	E3.2	PCSB2/0-4S-6Y	D2.85	PCSB350-8S-2Y	D2.85
PCMB-11	E3.2	PCSB2/0-5-6	D2.86	PCSB350-10-2Y	D2.87
PCMB-12	E3.2	PCSB2/0-5S-4Y	D2.85	PCSB350-10S-2Y	D2.85
PCMB-13	E3.2	PCSB2/0-6-6	D2.86	PCSB350-12-1Y	D2.87
PCMB-14	E3.2	PCSB2/0-6S-4Y	D2.85	PCSB350-12S-1Y	D2.85
PCMB-15	E3.2	PCSB2/0-8-4	D2.86	PCSB350-14-1Y	D2.87
PCMB-16	E3.2	PCSB2/0-8S-3Y	D2.85	PCSB350-14S-1Y	D2.85
PCMB-25	E3.2	PCSB2/0-10-2Y	D2.86	PCSB600-2-4Y	D2.87
PCM-BLK	E3.6	PCSB2/0-10S-2Y	D2.85	PCSB600-2S-4Y	D2.86
PCM-BRN	E3.6	PCSB2/0-12-2Y	D2.86	PCSB600-3-3Y	D2.87
PCM-C1	E3.5	PCSB2/0-12S-1Y	D2.85	PCSB600-3S-3Y	D2.86
PCM-C4	E3.5	PCSB2/0-14-1Y	D2.87	PCSB600-4-2Y	D2.87
PCMCP-1-25	E3.7	PCSB2/0-14S-1Y	D2.85	PCSB600-4S-2Y	D2.86
PCMCP-26-50	E3.7	PCSB4-2-12Y	D2.86	PCSB600-5S-2Y	D2.86
PCMCP-51-75	E3.7	PCSB4-2S-12Y	D2.85	PCSB600-6-2Y	D2.87
PCMCP-76-100	E3.7	PCSB4-3-12Y	D2.86	PCSB600-6S-2Y	D2.86
PCMCP-101-125	E3.7	PCSB4-3S-12Y	D2.85	PCSB600-8-2Y	D2.87
PCMCP-126-150	E3.7	PCSB4-4-6Y	D2.86	PCSB600-8S-2Y	D2.86
PCMCP-A-Z	E3.7	PCSB4-4S-6Y	D2.85	PCSB600-10-1Y	D2.87
PCM-DBL	E3.6	PCSB4-5-6Y	D2.86	PCSB600-10S-1Y	D2.86
PCM-DGN	E3.6	PCSB4-5S-6Y	D2.85	PCSB600-12-1Y	D2.87
PCM-E1	E3.5	PCSB4-6-6Y	D2.86	PCSB600-12S-1Y	D2.86
PCM-E3	E3.5	PCSB4-6S-6Y	D2.85	PCSB600-14-1Y	D2.87

Order number of pieces required, in multiples of Standard Package Quantity.

Part Number Index

Part Number	Page Number	Part Number	Page Number	Part Number	Page Number
PCSB600-14S-1Y.....	D2.86	PH14-6R-Q.....	D1.12	PL3M2S-D0.....	B1.32
PCSB750-2-2Y.....	D2.87	PH14-8R-Q.....	D1.12	PL3M2S-L.....	B1.32, B1.34
PCSB750-2S-1.....	D2.86	PH14-10R-Q.....	D1.12	PLA2S-A-Q.....	B2.6
PCSB750-3-2Y.....	D2.87	PH14-14R-Q.....	D1.12	PLB2S-C.....	B1.72, B1.77
PCSB750-4-2Y.....	D2.87	PH14-38R-Q.....	D1.12	PLB2S-C0.....	B1.72
PCSB750-5-1Y.....	D2.87	PH14-56R-Q.....	D1.12	PLB2S-M.....	B1.77
PCSB750-6-1Y.....	D2.87	PH18-6R-Q.....	D1.12	PLB2S-M30.....	B1.72
PCSB750-8-1Y.....	D2.87	PH18-8R-Q.....	D1.12	PLB3S-C.....	B1.72, B1.77
PCSB750-10-1Y.....	D2.87	PH18-10R-Q.....	D1.12	PLB3S-C0.....	B1.72
PCSBMT2/0-4-3Y.....	D2.90	PH18-14R-Q.....	D1.12	PLB3S-M.....	B1.77
PCSBMT2/0-4S-3Y.....	D2.89	PISR1/0-1.....	D2.88	PLB3S-M30.....	B1.72
PCSBMT2/0-6-2Y.....	D2.90	PISR2-1.....	D2.88	PLB4H-TL.....	B1.72, B1.77
PCSBMT2/0-6S-2Y.....	D2.89	PISR250-1.....	D2.88	PLB4H-TL0.....	B1.72
PCSBMT2/0-8-2Y.....	D2.90	PISR350-1.....	D2.88	PLB4H-TL30.....	B1.72
PCSBMT2/0-8S-2Y.....	D2.89	PISR500-1.....	D2.88	PLB4S-C.....	B1.72, B1.77
PCSBMT2/0-10-2Y.....	D2.90	PK2-14R-T.....	D1.11	PLB4S-M.....	B1.77
PCSBMT2/0-10S2Y.....	D2.89	PK2-38R-T.....	D1.11	PLB4S-M0.....	B1.72
PCSBMT2/0-12-1Y.....	D2.90	PK2-56R-T.....	D1.11	PLB4S-M30.....	B1.72
PCSBMT2/0-12S1Y.....	D2.89	PK4-10R-T.....	D1.11	PLC1.5I-S8-C.....	B1.24, B1.33
PCSBMT250-4-2Y.....	D2.90	PK4-12R-T.....	D1.11	PLC1.5I-S8-C0.....	B1.25
PCSBMT250-4S-2Y.....	D2.89	PK4-14R-T.....	D1.11	PLC1.5I-S8-M.....	B1.33
PCSBMT250-6-2Y.....	D2.90	PK4-38R-T.....	D1.11	PLC1.5I-S8-M30.....	B1.25
PCSBMT250-6S-2Y.....	D2.89	PK4-56R-T.....	D1.11	PLC1M-S4-C.....	B1.24, B1.33
PCSBMT250-8-2Y.....	D2.90	PK6-8R-T.....	D1.11	PLC1M-S4-C0.....	B1.25
PCSBMT250-8S-2Y.....	D2.89	PK6-10R-T.....	D1.11	PLC1M-S4-M.....	B1.33
PCSBMT250-10-2Y.....	D2.90	PK6-12R-T.....	D1.11	PLC1M-S4-M30.....	B1.25
PCSBMT250-10S2Y.....	D2.89	PK6-14R-T.....	D1.11	PLC2H-S25-L.....	B1.24, B1.33
PCSBMT250-12-1Y.....	D2.90	PK6-38R-T.....	D1.11	PLC2H-S25-TL.....	B1.33
PCSBMT250-12S1Y.....	D2.89	PK6-56R-T.....	D1.11	PLC2H-S25-TL0.....	B1.25
PCSBMT350-4-2Y.....	D2.90	PK8-8R-T.....	D1.11	PLC2H-S25-TL30.....	B1.25
PCSBMT350-4S-2Y.....	D2.89	PK8-10R-T.....	D1.11	PLC2S-S6-C.....	B1.24, B1.33
PCSBMT350-6-2Y.....	D2.90	PK8-12R-T.....	D1.11	PLC2S-S6-C0.....	B1.25
PCSBMT350-6S-2Y.....	D2.89	PK8-14R-T.....	D1.11	PLC2S-S6-M.....	B1.33
PCSBMT350-8-2Y.....	D2.90	PK8-38R-T.....	D1.11	PLC2S-S10-C.....	B1.24, B1.33
PCSBMT350-8S-2Y.....	D2.89	PK8-56R-T.....	D1.11	PLC2S-S10-C0.....	B1.25
PCSBMT350-10-1Y.....	D2.90	PK10-6R-L.....	D1.11	PLC2S-S10-M.....	B1.33
PCSBMT350-10S1Y.....	D2.89	PK10-8R-L.....	D1.11	PLC2S-S10-M30.....	B1.25
PCSBMT350-12-1Y.....	D2.90	PK10-10R-L.....	D1.11	PLC3S-S10-C.....	B1.24, B1.33
PCSBMT350-12S1Y.....	D2.89	PK10-14R-L.....	D1.11	PLC3S-S10-C0.....	B1.25
PCSBMT600-4-2Y.....	D2.90	PK10-38R-Q.....	D1.11	PLC3S-S10-M.....	B1.33
PCSBMT600-4S-2Y.....	D2.89	PK14-4R-C.....	D1.11	PLC4H-S25-L.....	B1.24, B1.33
PCSBMT600-6-2Y.....	D2.90	PK14-6R-C.....	D1.11	PLC4H-S25-L0.....	B1.25
PCSBMT600-6S-2Y.....	D2.89	PK14-8R-C.....	D1.11	PLC4H-S25-TL.....	B1.33
PCSBMT600-8-2Y.....	D2.90	PK14-10R-C.....	D1.11	PLC4H-S25-TL30.....	B1.25
PCSBMT600-8S-2Y.....	D2.89	PK14-14R-C.....	D1.11	PLC4S-S10-C.....	B1.24, B1.33
PCSBMT600-10-1Y.....	D2.90	PK14-38R-C.....	D1.11	PLC4S-S10-C0.....	B1.25
PCSBMT600-10S1Y.....	D2.89	PK14-56R-C.....	D1.11	PLC4S-S10-M.....	B1.33
PCSBMT600-12-1Y.....	D2.90	PK18-4R-C.....	D1.11	PLC4S-S10-M30.....	B1.25
PCSBMT600-12S1Y.....	D2.89	PK18-6R-C.....	D1.11	PLF1MA-C.....	B1.32, B1.33
PCSH-B-CR.....	B3.22	PK18-8R-C.....	D1.11	PLF1MA-M.....	B1.33
PCSLSH-B-CR.....	B3.22	PK18-10R-C.....	D1.11	PLF1MA-M0.....	B1.32
PCSS-B-CR.....	B3.22	PK18-14R-C.....	D1.11	PLF1MB-C.....	B1.32, B1.33
PCSSH-B-CR.....	B3.22	PK18-38R-C.....	D1.11	PLF1MB-M.....	B1.33
PES197.....	E4.6	PL2M2S-D.....	B1.34	PLF1M-C.....	B1.32, B1.33
PH10-8R-E.....	D1.12	PL2M2S-L.....	B1.32, B1.34	PLF1M-C0.....	B1.32
PH10-10R-E.....	D1.12	PL2M2S-L0.....	B1.32	PLF1MC-M.....	B1.32, B1.33
PH10-12R-E.....	D1.12	PL3B5EH-C.....	B1.77	PLF1M-M.....	B1.33
PH10-14R-E.....	D1.12	PL3B5EH-C0.....	B1.74	PLF1M-M69.....	B1.32
PH10-38R-E.....	D1.12	PL3M2S-D.....	B1.34	PLM1M-C.....	B1.32, B1.33

Part Number Index

Part Number	Page Number	Part Number	Page Number	Part Number	Page Number
PLM1M-C0	B1.32	PLT1M-C186	B1.19	PLT2EH-C	B1.9, B1.35
PLM1M-M	B1.33	PLT1M-C702Y	B1.16	PLT2EH-Q	B1.35
PLM1M-M69	B1.32	PLT1M-L0	B1.78	PLT2EH-Q0	B1.11
PLM2M-C	B1.32, B1.33	PLT1M-L1	B1.78	PLT2H-L	B1.8, B1.34
PLM2M-M	B1.33	PLT1M-L1-0	B1.78	PLT2H-L0	B1.10
PLM2M-M0	B1.32	PLT1M-L1-2	B1.78	PLT2H-TL	B1.34
PLM2S-C	B1.32, B1.33	PLT1M-L1-4	B1.78	PLT2H-TL30	B1.12
PLM2S-C0	B1.32	PLT1M-L1-7	B1.78	PLT2H-TL100	B1.16
PLM2S-D	B1.33	PLT1M-L1-10	B1.78	PLT2H-TL109	B1.15
PLM4S-C	B1.32, B1.33	PLT1M-L2	B1.78	PLT2H-TL300	B1.13
PLM4S-D	B1.33	PLT1M-L3	B1.78	PLT2I-C	B1.8, B1.34
PLM4S-D0	B1.32	PLT1M-L3-0	B1.78	PLT2I-C0	B1.10
PLP1.5I-C	B1.31, B1.34	PLT1M-L3-2	B1.78	PLT2I-C30	B1.12
PLP1.5I-M	B1.34	PLT1M-L3-4	B1.78	PLT2I-C76	B1.17
PLP1.5I-M0	B1.31	PLT1M-L3-7	B1.78	PLT2I-C86	B1.19
PLP1.5I-M30	B1.31	PLT1M-L3-10	B1.78	PLT2I-C186	B1.19
PLP1.5S-M	B1.31, B1.34	PLT1M-L4Y	B1.78	PLT2I-M	B1.34
PLP1S-M	B1.31, B1.34	PLT1M-L5	B1.78	PLT2I-M69	B1.14
PLP1S-M0	B1.31	PLT1M-L5-0	B1.78	PLT2I-M300	B1.13
PLP1S-M30	B1.31	PLT1M-L5-2	B1.78	PLT2M-C	B1.8, B1.34
PLP2S-C	B1.31, B1.34	PLT1M-L5-4	B1.78	PLT2M-C0	B1.10
PLP2S-M	B1.34	PLT1M-L5-7	B1.78	PLT2M-M	B1.34
PLP2S-M0	B1.31	PLT1M-L5-10	B1.78	PLT2M-M30	B1.12
PLP2S-M30	B1.31	PLT1M-L6	B1.78	PLT2M-M69	B1.14
PLST4HS25-TL	B1.77	PLT1M-L6-0	B1.78	PLT2S-C	B1.8, B1.34
PLST4HS25-TL300	B1.71	PLT1M-L6-2	B1.78	PLT2S-C0	B1.10
PLST30SC-D	B1.77	PLT1M-L6-4	B1.78	PLT2S-C30	B1.12
PLST30SC-D30	B1.71	PLT1M-L6-7	B1.78	PLT2S-C71	B1.18
PLST50SC-D	B1.77	PLT1M-L6-10	B1.78	PLT2S-C76	B1.17
PLST50SC-D30	B1.71	PLT1M-L8	B1.78	PLT2S-C86	B1.19
PLT1.5I-C	B1.8, B1.34	PLT1M-L8-0	B1.78	PLT2S-C186	B1.19
PLT1.5I-C0	B1.10	PLT1M-L8-2	B1.78	PLT2S-C702Y	B1.16
PLT1.5I-C30	B1.12	PLT1M-L8-4	B1.78	PLT2S-M	B1.34
PLT1.5I-M	B1.34	PLT1M-L8-7	B1.78	PLT2S-M39	B1.12
PLT1.5I-M69	B1.14	PLT1M-L8-10	B1.78	PLT2S-M60	B1.14
PLT1.5I-M100	B1.16	PLT1M-M	B1.34	PLT2S-M69	B1.14
PLT1.5I-M109	B1.15	PLT1M-M60	B1.14	PLT2S-M100	B1.16
PLT1.5I-M120	B1.15	PLT1M-M69	B1.14	PLT2S-M109	B1.15
PLT1.5I-M300	B1.13	PLT1M-M100	B1.16	PLT2S-M120	B1.15
PLT1.5M-C	B1.8, B1.34	PLT1M-M109	B1.15	PLT2S-M300	B1.13
PLT1.5M-C0	B1.10	PLT1M-M300	B1.13	PLT2S-VMR	B1.34, B1.105
PLT1.5M-C71	B1.18	PLT1M-XMR	B1.34, B1.36, B1.104	PLT2S-VMR0	B1.105
PLT1.5M-M	B1.34	PLT1M-XMR0	B1.104, B1.104	PLT2S-VMR30	B1.105
PLT1.5M-M30	B1.12	PLT1M-XMR30	B1.104	PLT3EH-NB-C	B1.35
PLT1.5M-XMR	B1.34, B1.104	PLT1S-C	B1.8, B1.34	PLT3EH-NB-C0	B1.11
PLT1.5M-XMR0	B1.104	PLT1S-C0	B1.10	PLT3H-L	B1.8, B1.34
PLT1.5M-XMR00	B1.104	PLT1S-M	B1.34	PLT3H-L0	B1.10
PLT1.5M-XMR30	B1.104	PLT1S-M30	B1.12	PLT3H-L76	B1.17
PLT1.5S-C	B1.8, B1.34	PLT1S-M300	B1.13	PLT3H-L86	B1.19
PLT1.5S-C0	B1.10	PLT2.5H-L	B1.8, B1.34	PLT3H-L186	B1.19
PLT1.5S-M	B1.34	PLT2.5H-L0	B1.10	PLT3H-TL	B1.34
PLT1.5S-M30	B1.12	PLT2.5H-TL	B1.34	PLT3H-TL30	B1.12
PLT1M	B1.78	PLT2.5I-C	B1.8, B1.34	PLT3H-TL100	B1.16
PLT1M-C	B1.8, B1.34	PLT2.5I-C0	B1.10	PLT3H-TL109	B1.15
PLT1M-C0	B1.10	PLT2.5I-M	B1.34	PLT3I-C	B1.8, B1.34
PLT1M-C30	B1.12	PLT2.5S-C	B1.8, B1.34	PLT3I-C0	B1.10
PLT1M-C71	B1.18	PLT2.5S-C0	B1.10	PLT3I-M	B1.34
PLT1M-C76	B1.17	PLT2.5S-M	B1.34	PLT3I-M30	B1.12
PLT1M-C86	B1.19	PLT2.5S-M30	B1.12	PLT3S-C	B1.8, B1.34

Part Number Index

Part Number	Page Number	Part Number	Page Number	Part Number	Page Number
PLT3S-C0	B1.10	PLT6EH-NB-C	B1.35	PLWP1.5S-D30	B1.27
PLT3S-C30	B1.12	PLT6EH-NB-C0	B1.11	PLWP1M-C	B1.26, B1.35
PLT3S-C76	B1.17	PLT6EH-Q	B1.9, B1.35	PLWP1M-D	B1.35
PLT3S-C86	B1.19	PLT6EH-Q0	B1.11	PLWP1M-D0	B1.27
PLT3S-C186	B1.19	PLT6H-C	B1.34	PLWP1M-D30	B1.27
PLT3S-C702Y	B1.16	PLT6H-C30	B1.12	PLWP1SA-D	B1.26, B1.35
PLT3S-M	B1.34	PLT6H-L	B1.8, B1.34	PLWP1SB-D	B1.26, B1.35
PLT3S-M100	B1.16	PLT6H-L0	B1.10	PLWP1S-C	B1.26, B1.35
PLT3S-M109	B1.15	PLT6LH-C	B1.34	PLWP1S-C0	B1.27
PLT3S-VMR	B1.105	PLT6LH-L	B1.8, B1.34	PLWP1S-D	B1.35
PLT3S-VMR30	B1.105	PLT6LH-L0	B1.10	PLWP1S-D30	B1.27
PLT4.5S-C	B1.8, B1.34	PLT.6SM-C	B1.8, B1.34	PLWP2H-TL	B1.26, B1.35
PLT4.5S-C0	B1.10	PLT.6SM-C0	B1.10	PLWP2H-TL0	B1.27
PLT4.5S-M	B1.34	PLT.6SM-M	B1.34	PLWP2SA-D	B1.26, B1.35
PLT4H-C	B1.34	PLT.6SM-M30	B1.12	PLWP2SB-D	B1.26, B1.35
PLT4H-L	B1.8, B1.34	PLT7LH-C	B1.34	PLWP2S-C	B1.26, B1.35
PLT4H-L0	B1.10	PLT7LH-C30	B1.12	PLWP2S-C0	B1.27
PLT4H-L76	B1.17	PLT7LH-L	B1.8, B1.34	PLWP2S-D	B1.35
PLT4H-L86	B1.19	PLT7LH-L0	B1.10	PLWP2S-D30	B1.27
PLT4H-L186	B1.19	PLT.7M-C	B1.8, B1.34	PLWP3H-TL	B1.26, B1.35
PLT4H-TL	B1.34	PLT.7M-M	B1.34	PLWP3H-TL0	B1.27
PLT4H-TL0/147	B1.10	PLT.7M-M0	B1.10	PLWP30SC-D	B1.35
PLT4H-TL30	B1.12	PLT.7M-M30	B1.12	PLWP30SC-D30	B1.29
PLT4H-TL30/147	B1.12	PLT8EH-C	B1.9, B1.35	PLWP40SC-D	B1.35
PLT4H-TL69	B1.14	PLT8EH-Q	B1.35	PLWP40SC-D30	B1.29
PLT4H-TL100	B1.16	PLT8EH-Q0	B1.11	PLWP40SD-D	B1.35
PLT4H-TL109	B1.15	PLT8H-C	B1.34	PLWP40SD-D30	B1.29
PLT4H-TL120	B1.15	PLT8H-C30	B1.12	PLWP50SC-D	B1.35
PLT4H-TL300	B1.13	PLT8H-L	B1.8, B1.34	PLWP50SC-D30	B1.29
PLT4I-C	B1.8, B1.34	PLT8H-L0	B1.10	PLWP50SE-D	B1.35
PLT4I-C0	B1.10	PLT8LH-C	B1.34	PLWP50SE-D30	B1.29
PLT4I-M	B1.34	PLT8LH-C120	B1.15	PM2H25-C	B2.18
PLT4I-M30	B1.12	PLT8LH-L	B1.8, B1.34	PM2H25-M0	B2.18
PLT4S-C	B1.8, B1.34	PLT8LH-L0	B1.10	PM2H25-M30	B2.18
PLT4S-C0	B1.10	PLT8LH-Q	B1.34	PMCC38H25-C	B2.28
PLT4S-C30	B1.12	PLT9LH-C	B1.34	PMCC38H25-M0	B2.28
PLT4S-C76	B1.17	PLT9LH-C30	B1.12	PMD	E3.8
PLT4S-C86	B1.19	PLT9LH-L	B1.8, B1.34, B1.36	PMD-0-9	E3.8
PLT4S-C186	B1.19	PLT9LH-L0	B1.10	PMD-NEMA	E3.8
PLT4S-M	B1.34	PLT10EH-C	B1.9, B1.35	PMDR-0	E3.9
PLT4S-M69	B1.14	PLT10EH-Q	B1.35	PMDR-0-9	E3.9
PLT4S-M100	B1.16	PLT10EH-Q0	B1.11	PMDR-9	E3.9
PLT4S-M109	B1.15	PLT10LH-C	B1.34	PMDR-90-99	E3.9
PLT4S-M120	B1.15	PLT10LH-L	B1.8, B1.34, B1.36	PMDR-A	E3.9
PLT4S-M300	B1.13	PLT12EH-C	B1.9, B1.35	PMDR-BL	E3.9
PLT5EH-C	B1.35	PLT12EH-Q	B1.35	PMDR-BLK	E3.9
PLT5EH-NB-C	B1.35	PLT12EH-Q0	B1.11	PMDR-BRN	E3.9
PLT5EH-NB-C0	B1.11	PLT13H-C	B1.34	PMDR-GRN	E3.9
PLT5EH-Q	B1.35, B1.9	PLT13H-Q	B1.8, B1.34	PMDR-GRS	E3.9
PLT5EH-Q0	B1.11	PLT13H-Q0	B1.10	PMDR-GRY	E3.9
PLT5H-C	B1.34	PLUP40S-D	B1.35	PMDR-L1	E3.9
PLT5H-C30	B1.12	PLUP40S-D30	B1.30	PMDR-L3	E3.9
PLT5H-L	B1.8, B1.34	PLUP40SE-D	B1.30, B1.35	PMDR-MIN	E3.9
PLT5H-L0	B1.10	PLUP40SE-D30	B1.30	PMDR-NEMA	E3.9
PLT5S-C	B1.8, B1.34	PLWP1.5I-C	B1.26, B1.35	PMDR-ORN	E3.9
PLT5S-C0	B1.10	PLWP1.5I-D	B1.35	PMDR-PLS	E3.9
PLT5S-M	B1.34	PLWP1.5I-D30	B1.27	PMDR-PUR	E3.9
PLT5S-M30	B1.12	PLWP1.5SA-D	B1.26, B1.35	PMDR-RED	E3.9
PLT6EH-C	B1.35	PLWP1.5S-D	B1.26, B1.35	PMDR-T1	E3.9

Part Number Index

Part Number	Page Number	Part Number	Page Number	Part Number	Page Number
PMDR-T3.....	E3.9	PN14-4R.....	D1.65	PN18-6FF-3K	D1.83
PMDR-WHT.....	E3.9	PN14-4R-3K	D1.73	PN18-6FF-C	D1.24
PMDR-YEL.....	E3.9	PN14-4R-C	D1.6	PN18-6FN-3K	D1.77
PMDR-Z.....	E3.9	PN14-6F-3K.....	D1.77	PN18-6FN-C.....	D1.19
PN10-6F-2K.....	D1.77	PN14-6F-C	D1.19	PN18-6LF-3K.....	D1.80
PN10-6F-L.....	D1.19	PN14-6FF-3K	D1.83	PN18-6LF-C	D1.21
PN10-6LF-2K.....	D1.80	PN14-6FF-C	D1.24	PN18-6LFW-C	D1.21
PN10-6LF-L.....	D1.21	PN14-6FN-3K.....	D1.77	PN18-6R.....	D1.65
PN10-6R.....	D1.65	PN14-6FN-C.....	D1.19	PN18-6R-3K.....	D1.73
PN10-6R-2K.....	D1.73	PN14-6LF-3K.....	D1.80	PN18-6R-C	D1.6
PN10-6R-L.....	D1.6	PN14-6LF-C	D1.21	PN18-6RN	D1.65
PN10-6RX-L	D1.8	PN14-6LFW-C	D1.21	PN18-6RN-3K.....	D1.73
PN10-8F-2K.....	D1.77	PN14-6R.....	D1.65	PN18-6RN-C	D1.6
PN10-8FF-2K	D1.83	PN14-6R-3K	D1.73	PN18-8F-3K	D1.77
PN10-8FF-L.....	D1.24	PN14-6R-C	D1.6	PN18-8F-C	D1.19
PN10-8F-L.....	D1.19	PN14-6RN	D1.65	PN18-8FF-3K	D1.83
PN10-8LF-2K.....	D1.80	PN14-6RN-3K.....	D1.73	PN18-8FF-C	D1.24
PN10-8LF-L.....	D1.21	PN14-6RN-C	D1.6	PN18-8LF-3K.....	D1.80
PN10-8R.....	D1.65	PN14-6RX-C.....	D1.8	PN18-8LF-C	D1.21
PN10-8R-2K.....	D1.73	PN14-8F-3K.....	D1.77	PN18-8R.....	D1.65
PN10-8R-L.....	D1.6	PN14-8F-C	D1.19	PN18-8R-3K	D1.73
PN10-8RX-L.....	D1.8	PN14-8FF-3K.....	D1.83	PN18-8R-C.....	D1.6
PN10-10F-2K.....	D1.77	PN14-8FF-C	D1.24	PN18-10F-3K.....	D1.77
PN10-10FF-2K	D1.83	PN14-8LF-3K.....	D1.80	PN18-10F-C	D1.19
PN10-10FF-L.....	D1.24	PN14-8LF-C	D1.21	PN18-10FF-3K	D1.83
PN10-10F-L.....	D1.19	PN14-8R.....	D1.65	PN18-10FF-C	D1.24
PN10-10LF-2K.....	D1.80	PN14-8R-3K	D1.73	PN18-10FN-3K.....	D1.77
PN10-10LF-L.....	D1.21	PN14-8R-C	D1.6	PN18-10FN-C.....	D1.19
PN10-10R.....	D1.65	PN14-8RX-C.....	D1.8	PN18-10LF-3K.....	D1.80
PN10-10R-2K.....	D1.73	PN14-10F-3K.....	D1.77	PN18-10LF-C	D1.21
PN10-10R-L.....	D1.6	PN14-10F-C	D1.19	PN18-10LFN-C.....	D1.21
PN10-10RX-L.....	D1.8	PN14-10FF-3K	D1.83	PN18-10R.....	D1.65
PN10-12R-Q.....	D1.6	PN14-10FF-C	D1.24	PN18-10R-3K	D1.73
PN10-14F-2K.....	D1.77	PN14-10FN-3K.....	D1.77	PN18-10R-C.....	D1.6
PN10-14F-L.....	D1.19	PN14-10FN-C.....	D1.19	PN18-12R-L.....	D1.6
PN10-14LF-L.....	D1.21	PN14-10LF-3K.....	D1.80	PN18-14F-3K.....	D1.77
PN10-14R.....	D1.65	PN14-10LF-C	D1.21	PN18-14F-C	D1.19
PN10-14R-2K.....	D1.73	PN14-10LFN-C.....	D1.21	PN18-14R.....	D1.65
PN10-14R-L.....	D1.6	PN14-10R.....	D1.65	PN18-14R-3K.....	D1.73
PN10-14RX-L.....	D1.8	PN14-10R-3K.....	D1.73	PN18-14R-C.....	D1.6
PN10-38R.....	D1.65	PN14-10R-C.....	D1.6	PN18-38R.....	D1.65
PN10-38R-2K.....	D1.73	PN14-10RX-C.....	D1.8	PN18-38R-C.....	D1.6
PN10-38R-L.....	D1.6	PN14-12R-Q.....	D1.6	PN18-56R.....	D1.65
PN10-38RX-L.....	D1.8	PN14-14F-3K.....	D1.77	PN18-56R-C.....	D1.6
PN10-56R.....	D1.65	PN14-14F-C	D1.19	PN22-4F-C	D1.19
PN10-56R-2K.....	D1.73	PN14-14R.....	D1.65	PN22-6F-C	D1.19
PN10-56R-L.....	D1.6	PN14-14R-3K.....	D1.73	PN22-10R-C.....	D1.6
PN10-56RX-L.....	D1.8	PN14-14R-C.....	D1.6	PNF10-6F-2K	D1.78
PN12-6HDR-2K.....	D1.76	PN14-14RX-L.....	D1.8	PNF10-6F-L.....	D1.19
PN12-8HDR-2K.....	D1.76	PN14-38R.....	D1.65	PNF10-6LF-2K	D1.81
PN12-8HDR-L.....	D1.12	PN14-38R-L.....	D1.6	PNF10-6LF-L.....	D1.22
PN12-10HDR-2K.....	D1.76	PN14-56R.....	D1.65	PNF10-6R.....	D1.65
PN12-10HDR-L.....	D1.12	PN14-56R-C.....	D1.6	PNF10-6R-2K.....	D1.74
PN12-14HDR-2K.....	D1.76	PN18-4R-3K.....	D1.73	PNF10-6R-L.....	D1.7
PN12-14HDR-L.....	D1.12	PN18-4R-C	D1.6	PNF10-8F-2K	D1.78
PN12-38HDR-2K.....	D1.76	PN18-4RN	D1.65	PNF10-8FF-2K.....	D1.84
PN12-38HDR-L.....	D1.12	PN18-4RN-C.....	D1.6	PNF10-8F-L.....	D1.19
PN12-56HDR-2K.....	D1.76	PN18-6F-3K.....	D1.77	PNF10-8LF-2K.....	D1.81
PN12-56HDR-L.....	D1.12	PN18-6F-C	D1.19	PNF10-8LF-L.....	D1.22

Part Number Index

Part Number	Page Number	Part Number	Page Number	Part Number	Page Number
PNF10-8R	D1.65	PNF14-14R-3K	D1.74	PPC25X50	B1.79
PNF10-8R-2K	D1.74	PNF14-14R-C	D1.7	PPC25X50F	B1.79
PNF10-8R-L	D1.7	PNF14-38R	D1.65	PPF2S-S25-V	B2.22
PNF10-10FF-2K	D1.84	PNF14-38R-L	D1.7	PPF2S-S25-V69	B2.22
PNF10-10F-L	D1.19	PNF14-56R	D1.65	PPF2SV-S25-V	B2.22
PNF10-10LF-2K	D1.81	PNF14-56R-C	D1.7	PPF2SV-S25-V69	B2.22
PNF10-10LF-L	D1.22	PNF18-4R-3K	D1.74	PPM-0	E3.7
PNF10-10R	D1.65	PNF18-4R-C	D1.7	PPM-1-33	E3.7
PNF10-10R-2K	D1.74	PNF18-4RN	D1.65	PPM-25	E3.7
PNF10-10R-L	D1.7	PNF18-4RN-3K	D1.74	PPM-A	E3.7
PNF10-14F-2K	D1.78	PNF18-6F-3K	D1.78	PPM-C	E3.7
PNF10-14F-L	D1.19	PNF18-6F-C	D1.19	PRA2S-A-Q	B2.6
PNF10-14LF-2K	D1.81	PNF18-6FF-3K	D1.84	PRLWP30S-D	B1.35
PNF10-14LF-L	D1.22	PNF18-6FN-3K	D1.78	PRLWP30S-D30	B1.30
PNF10-14R	D1.65	PNF18-6LF-3K	D1.81	PRLWP50S-D	B1.35
PNF10-14R-2K	D1.74	PNF18-6LF-C	D1.22	PRLWP50S-D30	B1.30
PNF10-14R-L	D1.7	PNF18-6LFW-3K	D1.81	PROG-CCCD	E1.16
PNF10-38R	D1.65	PNF18-6LFW-C	D1.22	PROG-EM2GO	E1.16
PNF10-38R-2K	D1.74	PNF18-6R	D1.65	PROG-EMCD3	E1.16
PNF10-38R-L	D1.7	PNF18-6R-3K	D1.74	PRST30S-S14-M	B1.77
PNF10-56R	D1.65	PNF18-6R-C	D1.7	PRST30S-S14-M30	B1.72
PNF10-56R-2K	D1.74	PNF18-6RN	D1.65	PRST40SC-D	B1.77
PNF10-56R-L	D1.7	PNF18-6RN-3K	D1.74	PRST40SC-D30	B1.71
PNF14-4R	D1.65	PNF18-6RN-C	D1.7	PRT1.5S-C	B1.20, B1.35
PNF14-4R-3K	D1.74	PNF18-8F-3K	D1.78	PRT1.5S-C0	B1.21
PNF14-4R-C	D1.7	PNF18-8F-C	D1.19	PRT1.5S-M	B1.35
PNF14-6F-3K	D1.78	PNF18-8FF-3K	D1.84	PRT1.5S-M30	B1.21
PNF14-6F-C	D1.19	PNF18-8LF-3K	D1.81	PRT1S-C	B1.20, B1.35
PNF14-6FF-3K	D1.84	PNF18-8LF-C	D1.22	PRT1S-C0	B1.21
PNF14-6FN-3K	D1.78	PNF18-8R	D1.65	PRT1S-M	B1.35
PNF14-6LF-3K	D1.81	PNF18-8R-3K	D1.74	PRT2EH-C	B1.20, B1.35
PNF14-6LF-C	D1.22	PNF18-8R-C	D1.7	PRT2EH-C100	B1.23
PNF14-6LFW-C	D1.22	PNF18-10F-3K	D1.78	PRT2EH-Q	B1.35
PNF14-6R	D1.65	PNF18-10F-C	D1.19	PRT2EH-Q0	B1.22
PNF14-6R-3K	D1.74	PNF18-10FF-3K	D1.84	PRT2H-L	B1.20, B1.35
PNF14-6R-C	D1.7	PNF18-10LF-3K	D1.81	PRT2H-L0	B1.21
PNF14-6RN	D1.65	PNF18-10LF-C	D1.22	PRT2H-TL	B1.35
PNF14-6RN-3K	D1.74	PNF18-10R	D1.65	PRT2S-C	B1.20, B1.35
PNF14-6RN-C	D1.7	PNF18-10R-3K	D1.74	PRT2S-C0	B1.21
PNF14-8F-3K	D1.78	PNF18-10R-C	D1.7	PRT2S-M	B1.35
PNF14-8F-C	D1.19	PNF18-14F-3K	D1.78	PRT3H-L	B1.20, B1.35
PNF14-8FF-3K	D1.84	PNF18-14F-C	D1.19	PRT3H-L0	B1.21
PNF14-8LF-3K	D1.81	PNF18-14R	D1.65	PRT3H-TL	B1.35
PNF14-8LF-C	D1.22	PNF18-14R-3K	D1.74	PRT3S-C	B1.20, B1.35
PNF14-8R	D1.65	PNF18-14R-C	D1.7	PRT3S-C0	B1.21
PNF14-8R-3K	D1.74	PNF18-38R	D1.65	PRT3S-M	B1.35
PNF14-8R-C	D1.7	PNF18-38R-C	D1.7	PRT4H-L	B1.20, B1.35
PNF14-10F-3K	D1.78	PNF18-56R	D1.65	PRT4H-L0	B1.21
PNF14-10F-C	D1.19	PNF18-56R-C	D1.7	PRT4H-TL	B1.35
PNF14-10FF-3K	D1.84	PNL-1/0-L	D2.69	PRT4S-C	B1.20, B1.35
PNF14-10LF-3K	D1.81	PNL-4-C	D2.69	PRT4S-C0	B1.21
PNF14-10LF-C	D1.22	PNL-250-Q	D2.69	PRT4S-M	B1.35
PNF14-10LFN-3K	D1.81	PNL-500-3	D2.69	PRT5EH-C	B1.35
PNF14-10R	D1.65	PNL-1000-3	D2.69	PRT5EH-C30	B1.22
PNF14-10R-3K	D1.74	PP1S-S10-X	B2.21	PRT5EH-C100	B1.23
PNF14-10R-C	D1.7	PP1S-S12-X	B2.21	PRT5EH-Q	B1.20, B1.22, B1.35
PNF14-14F-3K	D1.78	PP2S-S10-X	B2.21	PRT5EH-Q0	B1.22
PNF14-14F-C	D1.19	PP2S-S12-X	B2.21	PRT6EH-C	B1.35
PNF14-14R	D1.65	PP5X50F	B1.79	PRT6EH-C100	B1.23

Part Number Index

Part Number	Page Number	Part Number	Page Number	Part Number	Page Number
PRT6EH-Q	B1.20, B1.35	PUM-100-M30	B2.20	PV10-8FX-L	D1.21
PRT6EH-Q0	B1.22	PUM-925-3H-T30	B2.20	PV10-8LFB-2K	D1.82
PRT8EH-C	B1.20, B1.35	PUM-925-M30	B2.20	PV10-8LF-L	D1.22
PRT8EH-C100	B1.23	PV2-10RX-XY	D1.15	PV10-8LFX-L	D1.23
PRT8EH-Q	B1.35	PV2-10R-XY	D1.14	PV10-8RB-2K	D1.75
PRT8EH-Q0	B1.22	PV2-12RX-XY	D1.15	PV10-8R-L	D1.9
PRT10EH-C	B1.20, B1.35	PV2-12R-XY	D1.14	PV10-8RX-L	D1.10
PRT10EH-Q	B1.35	PV2-14RX-XY	D1.15	PV10-10FB-2K	D1.79
PRT10EH-Q0	B1.22	PV2-14R-XY	D1.14	PV10-10FFB-2K	D1.84
PRT12EH-C	B1.20, B1.35	PV2-38RX-XY	D1.15	PV10-10FF-L	D1.24
PRT12EH-Q	B1.35	PV2-38R-XY	D1.14	PV10-10F-L	D1.20
PRT12EH-Q0	B1.22	PV2-56RX-XY	D1.15	PV10-10FX-L	D1.21
PRWP1.5S-D	B1.28, B1.35	PV2-56R-XY	D1.14	PV10-10LFB-2K	D1.82
PRWP1.5S-D0	B1.28	PV4-10R-E	D1.14	PV10-10LF-L	D1.22
PRWP1.5S-D30	B1.28	PV4-10RX-E	D1.15	PV10-10LFX-L	D1.23
PRWP1SA-D	B1.28, B1.35	PV4-12R-E	D1.14	PV10-10RB-2K	D1.75
PRWP1SB-D	B1.28, B1.35	PV4-12RX-E	D1.15	PV10-10R-L	D1.9
PRWP1S-C	B1.28, B1.35	PV4-14R-E	D1.14	PV10-10RX-L	D1.10
PRWP1S-D	B1.35	PV4-14RX-E	D1.15	PV10-12R-Q	D1.9
PRWP1S-D0	B1.28	PV4-38R-E	D1.14	PV10-14FB-2K	D1.79
PRWP2H-TL	B1.28, B1.35	PV4-38RX-E	D1.15	PV10-14F-L	D1.20
PRWP2S-D	B1.28, B1.35	PV4-56R-E	D1.14	PV10-14FX-L	D1.21
PRWP2S-D0	B1.28	PV4-56RX-E	D1.15	PV10-14LFB-2K	D1.82
PS12-L	D1.51	PV6-8R-E	D1.14	PV10-14LF-L	D1.22
PS16-C	D1.51	PV6-8RX-E	D1.15	PV10-14LFX-L	D1.23
PS18-C	D1.51	PV6-10R-X	D1.14	PV10-14RB-2K	D1.75
PSCB-3Y	E3.3	PV6-10RX-X	D1.15	PV10-14R-L	D1.9
PSCB-3YEYLY	E3.3	PV6-12R-X	D1.14	PV10-14RX-L	D1.10
PSCB-5Y	E3.3	PV6-14R-X	D1.14	PV10-38RB-2K	D1.75
PSCB-6Y	E3.3	PV6-14RX-X	D1.15	PV10-38R-L	D1.9
PSCB-12Y	E3.3	PV6-38R-X	D1.14	PV10-38RX-L	D1.10
PSCB-13Y	E3.3	PV6-38RX-X	D1.15	PV10-56RB-2K	D1.75
PSCB-16Y	E3.3	PV6-56R-X	D1.14	PV10-56R-L	D1.9
PSCBLK-Q	D2.28, D2.29	PV6-56RX-X	D1.15	PV10-56RX-L	D1.10
PSCBLU-L	D2.28, D2.29	PV8-8RN-Q	D1.14	PV10-P55-LY	D1.43
PSCBRN-L	D2.28, D2.29	PV8-8R-QY	D1.14	PV12-6HDRB-2K	D1.76
PSCC-3Y	E3.8	PV8-8RX-QY	D1.15	PV12-6HDR-L	D1.13
PSCC-5Y	E3.8	PV8-10R-QY	D1.14	PV12-6HDRX-L	D1.13
PSCGRN-L	D2.28, D2.29	PV8-10RX-QY	D1.15	PV12-8HDRB-2K	D1.76
PSCGRY-L	D2.28, D2.29	PV8-12RX-XY	D1.15	PV12-8HDR-L	D1.13
PSCORG-Q	D2.28, D2.29	PV8-12R-XY	D1.14	PV12-8HDRX-L	D1.13
PSCPNK-L	D2.28, D2.29	PV8-14R-QY	D1.14	PV12-10HDRB-2K	D1.76
PSCPUR-Q	D2.28, D2.29	PV8-14RX-QY	D1.15	PV12-10HDR-L	D1.13
PSCRED-L	D2.28, D2.29	PV8-38R-QY	D1.14	PV12-10HDRX-L	D1.13
PSCYEL-Q	D2.28, D2.29	PV8-38RX-QY	D1.15	PV12-14HDRB-2K	D1.76
PSN12-L	D1.50	PV8-56R-QY	D1.14	PV12-14HDR-L	D1.13
PSN16-C	D1.50	PV8-56RX-QY	D1.15	PV12-14HDRX-L	D1.13
PSN18-C	D1.50	PV10-6FB-2K	D1.79	PV12-38HDRB-2K	D1.76
PSWM-375Y	E3.8	PV10-6F-L	D1.20	PV12-38HDR-L	D1.13
PSWM-750Y	E3.8	PV10-6LFB-2K	D1.82	PV12-38HDRX-L	D1.13
PSWM-1500Y	E3.8	PV10-6LF-L	D1.22	PV12-56HDRB-2K	D1.76
PSWMH-375Y	E3.8	PV10-6LFX-L	D1.23	PV12-56HDR-L	D1.13
PSWMH-750Y	E3.8	PV10-6RB-2K	D1.75	PV12-56HDRX-L	D1.13
PTR-CLN	E1.12	PV10-6R-L	D1.9	PV14-4RB-3K	D1.75
PUM-049-2S-D30	B2.20	PV10-6RX-L	D1.10	PV14-4R-C	D1.9
PUM-049-M30	B2.20	PV10-8FB-2K	D1.79	PV14-4RX-C	D1.10
PUM-071-2S-D30	B2.20	PV10-8FFB-2K	D1.84	PV14-6FB-3K	D1.79
PUM-071-M30	B2.20	PV10-8FF-L	D1.24	PV14-6F-C	D1.20
PUM-100-2S-D30	B2.20	PV10-8F-L	D1.20	PV14-6FFB-3K	D1.84

Part Number Index

Part Number	Page Number
PV14-6FF-C	D1.24
PV14-6FNB-3K	D1.79
PV14-6FN-C	D1.20
PV14-6FX-C	D1.21
PV14-6LFB-3K	D1.82
PV14-6LF-C	D1.22
PV14-6LFWB-3K	D1.82
PV14-6LFW-C	D1.22
PV14-6LFX-C	D1.23
PV14-6RB-3K	D1.75
PV14-6R-C	D1.9
PV14-6RNB-3K	D1.75
PV14-6RN-C	D1.9
PV14-6RX-C	D1.10
PV14-8FB-3K	D1.79
PV14-8F-C	D1.20
PV14-8FFB-3K	D1.84
PV14-8FF-C	D1.24
PV14-8FX-C	D1.21
PV14-8LFB-3K	D1.82
PV14-8LF-C	D1.22
PV14-8LFX-C	D1.23
PV14-8RB-3K	D1.75
PV14-8R-C	D1.9
PV14-8RX-C	D1.10
PV14-10FB-3K	D1.79
PV14-10F-C	D1.20
PV14-10FFB-3K	D1.84
PV14-10FF-C	D1.24
PV14-10FNB-3K	D1.79
PV14-10FN-C	D1.20
PV14-10FX-C	D1.21
PV14-10LFB-3K	D1.82
PV14-10LF-C	D1.22
PV14-10LFN-C	D1.22
PV14-10LFX-C	D1.23
PV14-10RB-3K	D1.75
PV14-10R-C	D1.9
PV14-10RX-C	D1.10
PV14-12R-L	D1.9
PV14-14FB-3K	D1.79
PV14-14F-C	D1.20
PV14-14RB-3K	D1.75
PV14-14R-C	D1.9
PV14-14RX-L	D1.10
PV14-38RB-2K	D1.75
PV14-38R-L	D1.9
PV14-38RX-L	D1.10
PV14-56RB-2K	D1.75
PV14-56R-C	D1.9
PV14-56RX-L	D1.10
PV14-P47B-3K	D1.93
PV14-P47-C	D1.43
PV18-4RB-3K	D1.75
PV18-4R-CY	D1.9
PV18-4RNB-3K	D1.75
PV18-4RX-CY	D1.10
PV18-6FB-3K	D1.79
PV18-6F-CY	D1.20

Part Number	Page Number
PV18-6FFB-3K	D1.84
PV18-6FF-CY	D1.24
PV18-6FNB-3K	D1.79
PV18-6FN-CY	D1.20
PV18-6FX-CY	D1.21
PV18-6LFB-3K	D1.82
PV18-6LF-CY	D1.22
PV18-6LFWB-3K	D1.82
PV18-6LFW-CY	D1.22
PV18-6LFX-CY	D1.23
PV18-6RB-3K	D1.75
PV18-6R-CY	D1.9
PV18-6RNB-3K	D1.75
PV18-6RX-CY	D1.10
PV18-8FB-3K	D1.79
PV18-8F-CY	D1.20
PV18-8FFB-3K	D1.84
PV18-8FF-CY	D1.24
PV18-8FX-CY	D1.21
PV18-8LFB-3K	D1.82
PV18-8LF-CY	D1.22
PV18-8LFX-CY	D1.23
PV18-8RB-3K	D1.75
PV18-8R-CY	D1.9
PV18-8RX-CY	D1.10
PV18-10FB-3K	D1.79
PV18-10F-CY	D1.20
PV18-10FFB-3K	D1.84
PV18-10FF-CY	D1.24
PV18-10FN-CY	D1.20
PV18-10FX-CY	D1.21
PV18-10LFB-3K	D1.82
PV18-10LF-CY	D1.22
PV18-10LFNB-3K	D1.82
PV18-10LFN-CY	D1.22
PV18-10LFX-CY	D1.23
PV18-10RB-3K	D1.75
PV18-10R-CY	D1.9
PV18-10RX-CY	D1.10
PV18-12R-LY	D1.9
PV18-14FB-3K	D1.79
PV18-14RB-3K	D1.75
PV18-14R-CY	D1.9
PV18-14RX-CY	D1.10
PV18-38RB-2K	D1.75
PV18-38R-LY	D1.9
PV18-38RX-LY	D1.10
PV18-56RB-2K	D1.75
PV18-56R-CY	D1.9
PV18-56RX-LY	D1.10
PV18-P47B-3K	D1.93
PV18-P47-CY	D1.43
PV22-2R-CY	D1.9
PV22-4F-CY	D1.20
PV22-4R-CY	D1.9
PV22-6F-CY	D1.20
PV22-6R-CY	D1.9
PV22-8R-CY	D1.9
PV22-10R-CY	D1.9

Part Number	Page Number
PW50FR-T20Y	C2.2
PW50FR-TY	C2.2
PW50F-T	C2.2
PW50F-T3	C2.2
PW50F-T4	C2.2
PW50F-T20	C2.2
PW75F-C	C2.2
PW75F-C3	C2.2
PW75F-C4	C2.2
PW75F-C20	C2.2
PW75FR-C20Y	C2.2
PW75FR-CY	C2.2
PW100F-C	C2.2
PW100F-C3	C2.2
PW100F-C4	C2.2
PW100F-C20	C2.2
PW100FR-C20Y	C2.2
PW100FR-CY	C2.2
PW150F-L	C2.2
PW150F-L3	C2.2
PW150F-L4	C2.2
PW150F-L20	C2.2
PW150FR-L20Y	C2.2
PW150FR-LY	C2.2
PWMS-H25-C	B2.17
PWMS-H25-M0	B2.17
PWT38	C2.3
PWT50	C2.3
PWT75	C2.3
PWT100	C2.3
PWT150	C2.3
PX-0	B1.49, B2.26
PX-2	B1.49, B2.26
PX-10	B1.49, B2.26

Q

QB-BASE120-Q	B2.45
QB-BASE175-Q	B2.45
QB-CONN	B2.46
QB-FN1-Q	B2.46
QB-FN2-Q	B2.46
QB-FN3-Q	B2.46
QB-KIT1	B2.44
QB-MOUNT-L	B2.45
QB-S6-500-C	B2.45
QB-S8-500-C	B2.45
QB-S8-750-C	B2.45
QB-S25-500-C	B2.45
QB-S25-1000-L	B2.45
QB-SN1-Q	B2.46
QB-SN2-Q	B2.46
QB-SN3-Q	B2.46
QB-TILE	B2.44
QB-WASHER-Q	B2.45

R

R050X075V1T	E2.2
R050X075X1J	E2.23
R050X125V1T	E2.2

Part Number Index

Part Number	Page Number	Part Number	Page Number	Part Number	Page Number
R050X125X1J	E2.23	RER2.0-S6-X.....	B2.47	RSCX750-4/0-3	D2.44
R050X150V1T	E2.2	RER.5E-X.....	B2.47	RSCX750-750-3	D2.44
R050X150X1J	E2.23	RER.5-S6-X.....	B2.47	S	
R100X075V1C.....	E1.6	RER.75E-X.....	B2.47	S1/0-12R-X.....	D2.8
R100X075V1T.....	E2.2	RER.75-S6-X.....	B2.47	S1/0-14R-X.....	D2.8
R100X075X1J	E2.23	RHEH4BL.....	E1.13	S1/0-38R-X.....	D2.8
R100X125V1T.....	E2.2	RHER4BL.....	E1.13	S1/0-56R-X.....	D2.8
R100X125VIC.....	E1.6	RHER4BL-A.....	E1.13	S1.5F-C.....	C1.34
R100X125X1J	E2.23	RHER4BL-C.....	E1.13	S1F-C.....	C1.34
R100X150V1C.....	E1.6	RHER4BL-E.....	E1.13	S2/0-12R-X.....	D2.8
R100X150V1T.....	E2.2	RHER4WH.....	E1.13	S2/0-14R-X.....	D2.8
R100X150V2C.....	E1.6	RMEH4BL.....	E1.12	S2/0-38R-X.....	D2.8
R100X150V2T.....	E2.2	RMER4BL.....	E1.12	S2/0-56R-X.....	D2.8
R100X150V3C.....	E1.6	RMER4BL-A.....	E1.12	S2/0-76R-X.....	D2.8
R100X150V3T.....	E2.2	RMER4BL-C.....	E1.12	S2-10R-X.....	D2.8
R100X150V4T.....	E2.2	RMER4BU.....	E1.12	S2-12R-X.....	D2.8
R100X150V7C.....	E1.6	RMER4GR.....	E1.12	S2-14R-X.....	D2.8
R100X150V7T.....	E2.2	RMER4RD.....	E1.12	S2-38R-X.....	D2.8
R100X150V8T.....	E1.6, E2.2	RMER4WH.....	E1.12	S2-56R-X.....	D2.8
R100X150X1J	E2.23	RSC1/0-4-X.....	D2.44	S2F-C.....	C1.34
R100X150X2J	E2.23	RSC1/0-6-X.....	D2.44	S3/0-12R-5.....	D2.8
R100X150X3J	E2.23	RSC2/0-4-X.....	D2.44	S3/0-14R-5.....	D2.8
R100X150X7J	E2.23	RSC2/0-6-X.....	D2.44	S3/0-38R-5.....	D2.8
R100X150X8J	E2.23	RSC2-4-Q.....	D2.44	S3/0-56R-5.....	D2.8
R100X225V1C.....	E1.6	RSC2-6-Q.....	D2.44	S3/0-76R-5.....	D2.8
R100X225V1T.....	E2.2	RSC4/0-1/0-X.....	D2.44	S3F-C.....	C1.34
R100X225V2C.....	E1.6	RSC4/0-2/0-X.....	D2.44	S4/0-12R-5.....	D2.8
R100X225V2T.....	E2.2	RSC4/0-4-X.....	D2.44	S4/0-38R-5.....	D2.8
R100X225V3C.....	E1.6	RSC4/0-6-X.....	D2.44	S4/0-56R-5.....	D2.8
R100X225V3T.....	E2.2	RSC4-6-L.....	D2.43	S4/0-76R-5.....	D2.8
R100X225V4T.....	E2.2	RSC500-X4/0-6.....	D2.44	S4-10R-E.....	D2.8
R100X225V7C.....	E1.6	RSC500-X350-6.....	D2.44	S4-14R-E.....	D2.8
R100X225V7T.....	E2.2	RSC750-4/0-6.....	D2.44	S4-38R-E.....	D2.8
R100X225V8C.....	E1.6	RSC750-500-6.....	D2.44	S4-56R-E.....	D2.8
R100X225V8T.....	E2.2	RSC750-750-6.....	D2.44	S4F-C.....	C1.34
R100X225X1J	E2.23	RSC750-X4/0-6.....	D2.44	S6-10R-E.....	D2.8
R100X225X2J	E2.23	RSC750-X350-6.....	D2.44	S6-14R-E.....	D2.8
R100X225X3J	E2.23	RSC750-X500-6.....	D2.44	S6-38R-E.....	D2.8
R100X225X7J	E2.23	RSCK1/0-4-1.....	D2.42	S6-56R-E.....	D2.8
R100X225X8J	E2.23	RSCK1/0-6-1.....	D2.42	S8-10R-Q.....	D2.8
R100X400V1T.....	E2.2	RSCK2/0-4-1.....	D2.42	S8-14R-Q.....	D2.8
R100X400X1J	E2.23	RSCK2/0-6-1.....	D2.42	S8-38R-Q.....	D2.8
R150X150V1T.....	E2.2	RSCK2-4-1.....	D2.42	S8-56R-Q.....	D2.8
R150X150X1J	E2.23	RSCK2-6-1.....	D2.42	S050X075VA1Y.....	E2.3
R200X150V1T.....	E2.2	RSCK4/0-1/0-1.....	D2.42	S050X075VAC.....	E1.4
R200X150X1J	E2.23	RSCK4/0-2/0-1.....	D2.42	S050X075VATY.....	E2.3
R200X225V1T.....	E2.2	RSCK4/0-4-1.....	D2.42	S050X075YAJ.....	E2.24
R200X225X1J	E2.23	RSCK4/0-6-1.....	D2.42	S050X125VA1Y.....	E2.3
R200X400V1T.....	E2.2	RSCK4-6-1.....	D2.42	S050X125VAC.....	E1.4
R200X400X1J	E2.23	RSCK500-X4/0-1.....	D2.42	S050X125VATY.....	E2.3
RAFCB1-S6-C20.....	B2.22	RSCK500-X350-1.....	D2.42	S050X125YAJ.....	E2.24
RAFCB2-S6-C20.....	B2.22	RSCK750-4/0-1.....	D2.42	S050X150T1T.....	E2.5
RAFCB3-S6-C20.....	B2.22	RSCK750-500-1.....	D2.43	S050X150VA1Y.....	E2.3
RAMH-S6-D.....	B2.15	RSCK750-750-1.....	D2.43	S050X150VAC.....	E1.4
RAMH-S10-D.....	B2.15	RSCK750-X4/0-1.....	D2.43	S050X150VATY.....	E2.3
RAMS-S3-M.....	B2.15	RSCK750-X350-1.....	D2.43	S050X150YAJ.....	E2.24
RER1.25E-X.....	B2.47	RSCK750-X500-1.....	D2.43	S050X250VATY.....	E2.3
RER1.25-S6-X.....	B2.47	RSCKX750-4/0-1.....	D2.43	S075X075VAC.....	E1.4
RER2.0E-X.....	B2.47	RSCKX750-750-1.....	D2.43		

Part Number Index

Part Number	Page Number	Part Number	Page Number	Part Number	Page Number
S075X075VATY	E2.3	S100X225VATY	E2.4	SA4/0-5	D2.61
S075X075YAJ	E2.24	S100X225VBTY	E2.4	SA4-XR	D2.61
S075X100VAC	E1.4	S100X225VCTY	E2.4	SA6-X	D2.61
S075X100VATY	E2.3	S100X225VDC	E1.4	SA250-5	D2.61
S075X125T1T	E2.5	S100X225VDTY	E2.4	SA300-2	D2.61
S075X125VAC	E1.4	S100X225VETY	E2.4	SA350-2	D2.61
S075X125VATY	E2.3	S100X225VFTY	E2.4	SA400-2	D2.61
S075X125YAJ	E2.24	S100X225VFTY	E2.4	SA500-2	D2.61
S075X150VAC	E1.4	S100X225VGTY	E2.4	SA600-2	D2.61
S075X150VATY	E2.3	S100X225VHC	E1.4	SA750-1	D2.61
S075X150YAJ	E2.24	S100X225VHTY	E2.4	SA800-1	D2.61
S100X075T1T	E2.5	S100X225VIC	E1.4	SA1000-1	D2.61
S100X075VA1Y	E2.3	S100X225VITY	E2.4	SACS50-T100	B1.52, B2.25
S100X075VAC	E1.4	S100X225YAJ	E2.24	SBA1/0-Q	D2.67
S100X075VATY	E2.3	S100X225YBJ	E2.24	SBA2/0-Q	D2.67
S100X075YAJ	E2.24	S100X225YCJ	E2.24	SBA2-C	D2.67
S100X125T1T	E2.5	S100X225YDJ	E2.24	SBA4/0-Q	D2.67
S100X125VA1Y	E2.3	S100X225YEJ	E2.24	SBA4-C	D2.67
S100X125VAC	E1.4	S100X225YFJ	E2.24	SBA6-C	D2.67
S100X125VAFY	E3.10	S100X225YGJ	E2.24	SBA6-C	D2.67
S100X125VARY	E3.10	S100X225YHJ	E2.24	SBA350-1	D2.67
S100X125VATY	E2.3	S100X225YIJ	E2.24	SBA500-1	D2.67
S100X125YAJ	E2.24	S100X250VA1Y	E2.4	SBC1/0-L	D2.65
S100X150T1J	E2.25	S100X250VATY	E2.4	SBC2/0-Q	D2.65
S100X150T1T	E2.5	S100X400T1T	E2.5	SBC2-C	D2.65
S100X150V0TY	E2.3	S100X400VA1Y	E2.4	SBC2L-C	D2.65
S100X150V9TY	E2.3	S100X400VAC	E1.4	SBC3/0-Q	D2.65
S100X150VA1Y	E2.3	S100X400VATY	E2.4	SBC3-C	D2.65
S100X150VAC	E1.4	S100X400YAJ	E2.24	SBC4S-C	D2.65
S100X150VATY	E2.3	S100X650VA1Y	E2.4	SBC4SL-C	D2.65
S100X150VBC	E1.4	S100X650VAC	E1.4	SBC6S-C	D2.65
S100X150VBTY	E2.3	S100X650VATY	E2.4	SBC6SL-C	D2.65
S100X150VCTY	E2.3	S100X650YAJ	E2.24	SBC8-C	D2.65
S100X150VDC	E1.4	S150X150VATY	E2.4	SBC8L-C	D2.65
S100X150VDTY	E2.3	S150X225VATY	E2.4	SBC250-Q	D2.65
S100X150VETY	E2.3	S150X400VATY	E2.4	SBC350-1	D2.65
S100X150VFTY	E2.3	S150X400YAJ	E2.24	SBC500-1	D2.65
S100X150VGTY	E2.3	S150X400YIJ	E2.24	SBC750-1	D2.65
S100X150VHC	E1.4	S200X150VATY	E2.4	SBC1000-1	D2.65
S100X150VHTY	E2.3	S200X150YAJ	E2.24	SBCT1/0-L	D2.66
S100X150VIC	E1.4	S200X225VA1Y	E2.4	SBCT2/0-Q	D2.66
S100X150VITY	E2.3	S200X225VATY	E2.4	SBCT2-C	D2.66
S100X150YAJ	E2.24	S200X225YAJ	E2.24	SBCT3/0-Q	D2.66
S100X150YBJ	E2.24	S200X250VATY	E2.4	SBCT3-C	D2.66
S100X150YCJ	E2.24	S200X400T1T	E2.5	SBCT6-C	D2.66
S100X150YDJ	E2.24	S200X400VA1Y	E2.4	SBCT8-C	D2.66
S100X150YEJ	E2.24	S200X400VATY	E2.4	SBCT10-C	D2.66
S100X150YFJ	E2.24	S200X400YAJ	E2.24	SBCT250-Q	D2.66
S100X150YGJ	E2.24	S200X650VA1Y	E2.4	SBCT350-1	D2.66
S100X150YHJ	E2.24	S200X650VATY	E2.4	SBCT500-1	D2.66
S100X150YIJ	E2.24	S200X650YAJ	E2.24	SBCT750-1	D2.66
S100X225T1J	E2.25	S250-12R-5	D2.8	SBCT1000-1	D2.66
S100X225T1T	E2.5	S250-38R-5	D2.8	SCL1/0-X	D2.27
S100X225V0TY	E2.4	S250-56R-5	D2.8	SCL1-E	D2.27
S100X225V9TY	E2.4	S250-76R-5	D2.8	SCL2/0-X	D2.27
S100X225VA1Y	E2.4	SA1/0-X	D2.61	SCL2-Q	D2.27
S100X225VAC	E1.4	SA1-X	D2.61	SCL3/0-X	D2.27
S100X225VAFY	E3.10	SA2/0-5	D2.61	SCL4/0-X	D2.27
S100X225VARY	E3.10	SA2-X	D2.61	SCL4-L	D2.27
		SA3/0-5	D2.61	SCL6-L	D2.27

Part Number Index

Part Number	Page Number	Part Number	Page Number	Part Number	Page Number
SCL8-L	D2.27	SD3HWH6	C1.30	SE75PFR-CR0	C2.18
SCL250-X	D2.27	SD4EMI	C1.7, C1.37	SE75PFR-CR8	C2.18
SCL300-X	D2.27	SD4H6	C1.30	SE75PFR-DR0	C2.18
SCL350-X	D2.27	SD4HWH6	C1.30	SE75PFR-DR8	C2.18
SCL400-6	D2.27	SDCLIP	C1.7	SE75PFR-DR10	C2.18
SCL500-6	D2.27	SE12PFR-MR0	C2.18	SE75PSC-CR0	C2.19
SCL600-6	D2.27	SE12PFR-MR8	C2.18	SE75PS-CR0	C2.19
SCL750-6	D2.27	SE12PFR-MR10	C2.18	SE75PSFR-CR0	C2.19
SCL1000-3	D2.27	SE12PFR-TR0	C2.18	SE100PS-CR0	C2.19
SCMS10-C	D2.57	SE12PFR-TR8	C2.18	SE100PSFR-CR0	C2.19
SCMS16-C	D2.57	SE12P-MR0	C2.17	SE125PFR-LR0	C2.18
SCMS25-L	D2.57	SE12P-MR10	C2.17	SE125PFR-LR8	C2.18
SCMS35-L	D2.57	SE12PS-4CR0	C2.19	SE125PFR-TR0	C2.18
SCMS50-L	D2.57	SE12PSC-TR0	C2.19	SE125PFR-TR8	C2.18
SCMS70-L	D2.57	SE12PSFR-4CR0	C2.19	SE125PFR-TR10	C2.18
SCMS95-Q	D2.57	SE12P-TR0	C2.17	SE125P-LR0	C2.17
SCMS120-Q	D2.57	SE12P-TR8	C2.17	SE125P-LR8	C2.17
SCMS150-X	D2.57	SE25PFR-MR0	C2.18	SE125PSC-LR0	C2.19
SCMS185-X	D2.57	SE25PFR-MR8	C2.18	SE125P-TR0	C2.17
SCMS240-X	D2.57	SE25PFR-MR10	C2.18	SE125P-TR8	C2.17
SCMS300-5	D2.57	SE25PFR-TR0	C2.18	SE125P-TR10	C2.17
SCMS400-5	D2.57	SE25PFR-TR8	C2.18	SE150PFR-LR0	C2.18
SCMS500-6	D2.57	SE25P-MR0	C2.17	SE150PFR-LR8	C2.18
SCMS630-6	D2.57	SE25P-MR8	C2.17	SE150PFR-TR0	C2.18
SCMSX300-5	D2.57	SE25P-MR10	C2.17	SE150PFR-TR8	C2.18
SCS1/0-X	D2.26	SE25PSC-TR0	C2.19	SE150PFR-TR10	C2.18
SCS1-E	D2.26	SE25PSFR-TR0	C2.19	SE150P-LR0	C2.17
SCS2/0-X	D2.26	SE25PS-TR0	C2.19	SE150P-LR8	C2.17
SCS2-Q	D2.26	SE25P-TR0	C2.17	SE150PSC-LR0	C2.19
SCS3/0-X	D2.26	SE25P-TR8	C2.17	SE150PSFR-LQR0	C2.19
SCS4/0-X	D2.26	SE38PFR-MR0	C2.18	SE150PS-LQR0	C2.19
SCS4-L	D2.26	SE38PFR-MR8	C2.18	SE150P-TR0	C2.17
SCS6-L	D2.26	SE38PFR-MR10	C2.18	SE150P-TR8	C2.17
SCS8-L	D2.26	SE38PFR-TR0	C2.18	SE150P-TR10	C2.17
SCS250-X	D2.26	SE38PFR-TR8	C2.18	SE175PFR-TR0	C2.18
SCS300-X	D2.26	SE38P-MR0	C2.17	SE175P-TR0	C2.17
SCS350-X	D2.26	SE38P-MR8	C2.17	SE200P-TR0	C2.17
SCS400-6	D2.26	SE38P-MR10	C2.17	SE250P-TR0	C2.17
SCS500-6	D2.26	SE38PSC-TR0	C2.19	SG100M-C	B1.38, B1.40
SCS600-6	D2.26	SE38P-TR0	C2.17	SG100M-C0	B1.39
SCS750-6	D2.26	SE38P-TR8	C2.17	SG100M-M	B1.40
SCS1000-3	D2.26	SE50P-CR0	C2.17	SG150I-C	B1.38, B1.40
SCSF1/0-X	D2.41	SE50P-CR8	C2.17	SG150I-C0	B1.39
SCSF1-X	D2.41	SE50P-DR0	C2.17	SG150I-M	B1.40
SCSF2/0-X	D2.41	SE50P-DR8	C2.17	SG200S-C	B1.38, B1.40
SCSF2-E	D2.41	SE50P-DR10	C2.17	SG200S-C0	B1.39
SCSF3/0-X	D2.41	SE50PFR-CR0	C2.18	SG200S-M	B1.40
SCSF4/0-X	D2.41	SE50PFR-CR8	C2.18	SG200S-M30	B1.39
SCSF4-L	D2.41	SE50PFR-DR0	C2.18	SG250S-C	B1.38, B1.40
SCSF6-L	D2.41	SE50PFR-DR8	C2.18	SG250S-C0	B1.39
SCSF8-L	D2.41	SE50PFR-DR10	C2.18	SG300S-C	B1.38, B1.40
SCSF250-X	D2.41	SE50PSC-CR0	C2.19	SG300S-C0	B1.39
SCSF300-6	D2.41	SE50PS-CLR0	C2.19	SG300S-M	B1.40
SCSF350-6	D2.41	SE50PSFR-CLR0	C2.19	SG300S-M30	B1.39
SD2EMI	C1.7, C1.37	SE75P-CR0	C2.17	SG350LH-L	B1.38, B1.40
SD2H6	C1.30	SE75P-CR8	C2.17	SG350LH-L0	B1.39
SD2HWH6	C1.30	SE75P-DR0	C2.17	SG350LH-TL	B1.40
SD3EMI	C1.7, C1.37	SE75P-DR8	C2.17	SG350LH-TL30	B1.39
SD3H6	C1.30	SE75P-DR10	C2.17	SG370S-C	B1.38, B1.40

Part Number Index

Part Number	Page Number	Part Number	Page Number	Part Number	Page Number
SG370S-C0	B1.39	SP1-8L-C	D3.16	SSFW14-C	D3.6
SG370S-M	B1.40	SP1-350-12	D3.16	SSFW38-C	D3.6
SG450H-C	B1.40	SP1-350L-12	D3.16	SSM2S-C	B1.68, B1.69
SG450H-L	B1.38, B1.40	SP1-500-12	D3.16	SSM2S-D	B1.69
SG450H-L0	B1.39	SP1-500L-12	D3.16	SSM2S-D0	B1.68
SGABM20	B2.6	SP2-1/0-L	D3.17	SSM4S-D	B1.68, B1.69
SGABM25	B2.6	SP2-1/0L-L	D3.17	SSN1420-C	D3.6
SGABM30	B2.6	SP2-2/0L-Q	D3.17	SSN3816-C	D3.6
SGABM40	B2.6	SP2-2/0-Q	D3.17	SSNTS1420-C	D3.6, D3.18
SGABM50	B2.6	SP2-2-C	D3.17	SSNTS3816-C	D3.6
SGMPMH38-L0	B2.19	SP2-2L-C	D3.17	SSPM2.5H-L	B1.77
SGMPMS19-C0	B2.19	SP2-3-C	D3.17	SSPM2.5H-L300	B1.75
SGMPMS25-C0	B2.19	SP2-3L-C	D3.17	SSPM2.5HP-L	B1.77
SGMPMWH32-L0	B2.19	SP2-4/0L-Q	D3.17	SSPM2.5HP-L300	B1.75
SGTA1S8-C	B2.11	SP2-4/0-Q	D3.17	SSPM2.5HP-TL	B1.77
SGTM1S6-C	B2.9	SP2-4-C	D3.17	SSPM2.5H-TL	B1.77
SGTM1S6-C0	B2.9	SP2-4L-C	D3.17	SSPM4H-L	B1.77
SGTM2S8-C	B2.9	SP2-7-C	D3.17	SSPM4H-L300	B1.75
SGTM2S8-C0	B2.9	SP2-7L-C	D3.17	SSPM4HLP-TL	B1.77
SGTM3S10-C	B2.9	SP2-8-C	D3.17	SSPM4HLP-TL300	B1.75
SGTM3S10-C0	B2.9	SP2-8L-C	D3.17	SSPM4HP-L	B1.77
SHH1-S8-X	B2.49	SP2-350-12	D3.17	SSPM4HP-L300	B1.75
SHH3-S8-X	B2.49	SP2-350L-12	D3.17	SSPM4HP-TL	B1.77
SICH25-C	B2.39	SP2-500-12	D3.17	SSPM4H-TL	B1.77
SICH38-C	B2.39	SP2-500L-12	D3.17	SST1.5I-C	B1.65, B1.69
SICH50-C	B2.39	SR-0-XY	D2.84	SST1.5I-M	B1.69
SICH75-C	B2.39	SR2	B1.79, D1.27	SST1.5I-M0	B1.66
SICH100-C	B2.39	SR-2-XY	D2.84	SST1.5M-C	B1.65, B1.69
SICH150-C	B2.39	SR4	D1.27	SST1.5M-M	B1.69
SMS-A-C	B2.7	SR-4/0-XY	D2.84	SST1.5M-M0	B1.66
SMS-A-C14	B2.7	SR6	D1.27	SST1.5S-M	B1.65, B1.69
SMS-A-C15	B2.7	SR-250-XY	D2.84	SST1.5S-M0	B1.66
SMS-S6-D	B2.7	SR-350-XY	D2.84	SST1M-C	B1.65, B1.69
SNS1.5-C	C1.34	SR-500-3Y	D2.84	SST1M-C0	B1.66
SNS1-C	C1.34	SR-750-1Y	D2.84	SST1M-M	B1.69
SNS2-C	C1.34	SR-1000-1Y	D2.84	SST2H-D	B1.65, B1.69
SNS3-C	C1.34	SRB19BLY	F.3	SST2H-D0	B1.66
SNS.5-C	C1.34	SRBM19BLY	F.3	SST2HH-D	B1.69
SNS25F-C	C1.34	SRBS19BL-XY	F.3	SST2I-C	B1.65, B1.69
SNS37F-C	C1.34	SSB2S-C	B1.73, B1.77	SST2I-M	B1.69
SNS50F-C	C1.34	SSB2S-M	B1.77	SST2I-M0	B1.66
SNS62F-C	C1.34	SSB2S-M0	B1.73	SST2S-C	B1.65, B1.69
SNS.75-C	C1.34	SSB2S-M30	B1.73	SST2S-C0	B1.66
SNS75F-C	C1.34	SSC2S-S6-C	B1.67, B1.69	SST2S-M	B1.69
SP1-1/0-L	D3.16	SSC2S-S6-M	B1.69	SST3I-C	B1.65, B1.69
SP1-1/0L-L	D3.16	SSC2S-S6-M0	B1.67	SST3I-C0	B1.66
SP1-2/0L-Q	D3.16	SSC2S-S10-C	B1.67, B1.69	SST3I-M	B1.69
SP1-2/0-Q	D3.16	SSC2S-S10-M	B1.69	SST3S-C	B1.65, B1.69
SP1-2-C	D3.16	SSC2S-S10-M0	B1.67	SST3S-C0	B1.66
SP1-2L-C	D3.16	SSC2S-S10-M30	B1.67	SST3S-M	B1.69
SP1-3-C	D3.16	SSC4H-S25-D	B1.69	SST4H-D	B1.69
SP1-3L-C	D3.16	SSC4H-S25-D0	B1.67	SST4HH-D	B1.69
SP1-4/0L-Q	D3.16	SSC4H-S25-D30	B1.67	SST4H-L	B1.65, B1.69
SP1-4/0-Q	D3.16	SSC4H-S25-L	B1.67, B1.69	SST4H-L0	B1.66
SP1-4-C	D3.16	SSC4S-S10-C	B1.67, B1.69	SST4I-C	B1.65, B1.69
SP1-4L-C	D3.16	SSC4S-S10-M	B1.69	SST4I-M	B1.69
SP1-7-C	D3.16	SSC4S-S10-M0	B1.67	SST4I-M0	B1.66
SP1-7L-C	D3.16	SSCW14-C	D3.6, D3.18	SST4S-C	B1.65, B1.69
SP1-8-C	D3.16	SSCW38-C	D3.6	SST4S-C0	B1.66

Part Number Index

Part Number	Page Number	Part Number	Page Number	Part Number	Page Number
SST4S-M.....	B1.69	T25R-CY.....	C2.6	T50N-C.....	C2.8
SST8H-D.....	B1.69	T25R-M20Y.....	C2.6	T50N-C0.....	C2.8
SST8H-L.....	B1.65, B1.69	T25R-MY.....	C2.6	T50N-TL.....	C2.8
SST8H-L0.....	B1.66	T25T-L.....	C2.9	T50N-TL0.....	C2.8
T		T25T-L0.....	C2.9	T50NZFR-C20.....	C2.8
T12F-C.....	C2.4	T031X000FJC-BK.....	E1.10	T50P-C0.....	C2.9
T12F-C0.....	C2.5	T031X000FJT.....	E2.21	T50R-CY.....	C2.6
T12F-D.....	C2.4	T38F-C.....	C2.4	T50R-TLY.....	C2.6
T12F-D0.....	C2.5	T38F-C0.....	C2.5	T50T-Q.....	C2.9
T12FR-C20Y.....	C2.6	T38FR-C20Y.....	C2.7	T050X000C1C-BK.....	E1.5
T12FR-CY.....	C2.6	T38FR-CY.....	C2.7	T050X000C2C-BK.....	E1.5
T12N-C.....	C2.7	T38FR-TLY.....	C2.7	T050X000CBC-BK.....	E1.5
T12N-C0.....	C2.8	T38F-TL.....	C2.4	T050X000FJT.....	E2.21
T12N-D.....	C2.7	T38F-TL0.....	C2.5	T050X000VPC-BK.....	E1.10
T12R-CY.....	C2.6	T38N-C.....	C2.7	T050X000VPC-RD.....	E1.10
T12T-C.....	C2.9	T38N-C0.....	C2.8	T050X000VQC-BK.....	E1.10
T19F-C.....	C2.4	T38N-TL.....	C2.7	T050X000VQC-WH.....	E1.10
T19F-C0.....	C2.5	T38NZFR-C20.....	C2.8	T050X000VSC-BK.....	E1.10
T19F-M.....	C2.4	T38P-C0.....	C2.9	T050X000VSC-WH.....	E1.10
T19FR-C20Y.....	C2.6	T38P-CY.....	C2.6	T050X000VUC-BK.....	E1.10
T19FR-CY.....	C2.6	T38R-TLY.....	C2.6	T050X000VWC-BK.....	E1.10
T19N-C.....	C2.7	T38T-L.....	C2.9	T050X000VWC-WH.....	E1.10
T19N-C0.....	C2.8	T038X000C1C-BK.....	E1.5	T050X000VXC-BK.....	E1.10
T19N-M.....	C2.7	T038X000C2C-BK.....	E1.5	T050X000VYC-WH.....	E1.10
T19N-M0.....	C2.8	T038X000FJC-BK.....	E1.10	T050X000Y01.....	E2.21
T19R-CY.....	C2.6	T038X000FJT.....	E2.21	T050X000YKC-BK.....	E1.10
T19T-C.....	C2.9	T038X000VPC-BK.....	E1.10	T050X000YKC-WH.....	E1.10
T019X000FJC-BK.....	E1.10	T038X000VQC-BK.....	E1.10	T050X000YP1.....	E2.21
T024X000FJC-BK.....	E1.10	T038X000VQC-WH.....	E1.10	T62F-C.....	C2.5
T024X000FJT.....	E2.21	T038X000VSC-BK.....	E1.10	T62F-C0.....	C2.6
T024X000VPC-BK.....	E1.10	T038X000VSC-WH.....	E1.10	T62FR-C20Y.....	C2.7
T024X000VYC-WH.....	E1.10	T038X000VUC-BK.....	E1.10	T62FR-CY.....	C2.7
T024X000YKC-BK.....	E1.10	T038X000VUC-BK.....	E1.10	T62FR-TL.....	C2.5
T25F-C.....	C2.4	T038X000VWC-BK.....	E1.10	T62F-TL0.....	C2.6
T25F-C0.....	C2.5	T038X000VWC-WH.....	E1.10	T62N-C.....	C2.8
T25F-C1.....	C2.4	T038X000VXC-BK.....	E1.10	T62N-C0.....	C2.8
T25F-C2.....	C2.4	T038X000VYC-WH.....	E1.10	T62R-CY.....	C2.6
T25F-C3Y.....	C2.4	T038X000Y01.....	E2.21	T62T-Q.....	C2.9
T25F-C4Y.....	C2.4	T038X000YKC-BK.....	E1.10	T70KW2IW.....	F.5
T25F-C5.....	C2.4	T038X000YP1.....	E2.21	T70KW4IW.....	F.5
T25F-C6.....	C2.4	T50F-C.....	C2.4	T75F-C.....	C2.5
T25F-C7.....	C2.4	T50F-C0.....	C2.5	T75F-C0.....	C2.6
T25F-C8.....	C2.4	T50F-C1.....	C2.4	T75FR-C20Y.....	C2.7
T25F-C10.....	C2.4	T50F-C2.....	C2.4	T75FR-CY.....	C2.7
T25F-C16.....	C2.4	T50F-C3Y.....	C2.4	T75FR-TY.....	C2.7
T25F-M.....	C2.4	T50F-C4Y.....	C2.4	T75F-T.....	C2.5
T25F-M0.....	C2.5	T50F-C5.....	C2.4	T75F-T0.....	C2.6
T25FR-C20Y.....	C2.6	T50F-C6.....	C2.5	T75N-C.....	C2.8
T25FR-CY.....	C2.6	T50F-C7.....	C2.5	T75N-C0.....	C2.8
T25FR-M20Y.....	C2.7	T50F-C8.....	C2.5	T75N-T.....	C2.8
T25FR-MY.....	C2.7	T50F-C10.....	C2.5	T75NZFR-C20.....	C2.9
T25F-X0.....	C2.5	T50F-C16.....	C2.5	T75R-CY.....	C2.6
T25N-C.....	C2.7	T50FR-C20Y.....	C2.7	T75T-X.....	C2.9
T25N-C0.....	C2.8	T50FR-CY.....	C2.7	T075X000C1C-BK.....	E1.5
T25N-M.....	C2.7	T50FR-TLY.....	C2.7	T075X000C2C-BK.....	E1.5
T25N-M0.....	C2.8	T50F-TL.....	C2.5	T075X000VPC-BK.....	E1.11
T25NZFR-C20.....	C2.8	T50F-TL0.....	C2.5	T075X000VQC-WH.....	E1.11
T25R-C20Y.....	C2.6	T50F-TL4Y.....	C2.5	T075X000VQC-BK.....	E1.11
		T50F-X.....	C2.4	T075X000VSC-BK.....	E1.11
		T50F-X0.....	C2.5		

Part Number Index

Part Number	Page Number
T075X000VSC-WH	E1.11
T075X000VUC-BK	E1.11
T075X000VWC-BK	E1.11
T075X000VWC-WH	E1.11
T075X000VXC-BK	E1.11
T075X000VYC-WH	E1.11
T075X000YKC-BK	E1.11
T100F-C	C2.5
T100F-C0	C2.6
T100FR-C20Y	C2.7
T100FR-CY	C2.7
T100N-C	C2.8
T100N-C0	C2.8
T100P-C0	C2.9
T100R-CY	C2.6
T100T-X	C2.9
T100X000C1C-BK	E1.5
T100X000C2C-BK	E1.5
T100X000CBC-BK	E1.5
T100X000RP1	E2.21
T100X000RPC-BK	E1.11
T100X000RU1	E2.21
T100X000RUC-BK	E1.11
T100X000RW1	E2.21
T100X000RX1	E2.21
T100X000RXC-BK	E1.11
T100X000VP1Y	E2.21
T100X000VPC-BK	E1.11, D3.5
T100X000VPC-RD	E1.11
T100X000VQ1Y	E2.21
T100X000VQC-BK	E1.11
T100X000VQC-WH	E1.11
T100X000VS1Y	E2.21
T100X000VSC-BK	E1.11
T100X000VU1Y	E2.21
T100X000VUC-OR	E1.11
T100X000VW1Y	E2.21
T100X000VWC-BK	E1.11
T100X000VWC-WH	E1.11
T100X000VX1Y	E2.21
T100X000VXC-BK	E1.11
T100X000VY1Y	E2.21
T100X000VYC-WH	E1.11
T100X000Y01	E2.21
T100X000Y81	E2.21
T100X000YK1	E2.21
T100X000YKC-BK	E1.11
T100X000YKC-WH	E1.11
T100X000YP1	E2.21
T100X000YQ1	E2.21
T100X000YS1	E2.21
T100X000YU1	E2.21
T100X000YW1	E2.21
T200X000RP1	E2.21
T200X000RU1	E2.21
T200X000RW1	E2.21
T200X000RX1	E2.21
T200X000RX1	E2.21
T200X000VP1Y	E2.21
T200X000VQ1Y	E2.21

Part Number	Page Number
T200X000VR1Y	E2.21
T200X000VS1Y	E2.21
T200X000VT1Y	E2.21
T200X000VU1Y	E2.21
T200X000VV1Y	E2.21
T200X000VW1Y	E2.21
T200X000VX1Y	E2.21
T200X000VY1Y	E2.21
T200X000Y01	E2.21
T200X000Y81	E2.21
T200X000YK1	E2.21
T200X000YP1	E2.22
T200X000YQ1	E2.22
T200X000YS1	E2.22
T200X000YU1	E2.22
T200X000YW1	E2.22
T225X000YK1	E2.22
T300X000RP1	E2.22
T400X000RP1	E2.22
T400X000RQ1	E2.22
T400X000RU1	E2.22
T400X000RW1	E2.22
T400X000RX1	E2.22
T400X000TU1	E2.22
T400X000VP1Y	E2.22
T400X000VQ1Y	E2.22
T400X000VR1Y	E2.22
T400X000VS1Y	E2.22
T400X000VT1Y	E2.22
T400X000VU1Y	E2.22
T400X000VV1Y	E2.22
T400X000VW1Y	E2.22
T400X000VX1Y	E2.22
T400X000VY1Y	E2.22
T400X000Y01	E2.22
T400X000Y81	E2.22
T400X000YK1	E2.22
T400X000YP1	E2.22
T400X000YQ1	E2.22
T400X000YS1	E2.22
T400X000YW1	E2.22
T425X000YK1	E2.22
TA1S8-C	B2.11
TA1S8-M0	B2.11
TA1S8-M30	B2.11
TA1S8-M69	B2.11
TA1S10-C	B2.11
TA1S10-M0	B2.11
TA2-C	B2.11
TA2-M	B2.11
TDP43HE	E1.13
TDP43ME	E1.12
TDP43ME-AC	E1.12
TDP43ME-CASE	E1.12
TDP43ME-CUTTER	E1.12
TDP43ME-KIT	E1.12
TDP43ME-RS	E1.12
TDP43ME-SPINDLE	E1.12
TDP46HE	E1.13

Part Number	Page Number
THMSP20-C	B2.50
THMSP20-C30	B2.50
THMSP25-C	B2.50
THMSP25-C30	B2.50
TM1A-C	B2.8
TM1S4-C	B2.9
TM1S4-M30	B2.9
TM1S4-M69	B1.14, B2.9
TM1S6-C	B2.9
TM1S6-M0	B2.9
TM1S6-M30	B2.9
TM1S6-M69	B1.14, B2.9
TM2A-C	B2.8
TM2PWH25-C	B2.17
TM2R6-M0	B2.9
TM2R6-M30	B2.9
TM2S6-C	B2.9
TM2S6-M0	B2.9
TM2S6-M30	B2.9
TM2S6-M69	B1.14, B2.9
TM2S8-C	B2.9
TM2S8-C71	B1.18, B2.9
TM2S8-C76	B1.17, B2.9
TM2S8-C86	B1.19, B2.9
TM2S8-C100	B2.9
TM2S8-C186	B1.19, B2.9
TM2S8-M0	B2.9
TM2S8-M30	B2.9
TM2S8-M69	B1.14, B2.9
TM3A-C	B2.8
TM3R6-M0	B2.9
TM3S8-C	B2.9
TM3S8-C69	B1.14, B2.9
TM3S8-C76	B1.17, B2.9
TM3S8-C86	B1.19, B2.9
TM3S8-C100	B2.9
TM3S8-C186	B1.19, B2.9
TM3S8-M30	B2.9
TM3S8-M69	B2.9
TM3S8-M100	B2.9
TM3S10-C	B2.9
TM3S10-C76	B1.17, B2.9
TM3S10-C86	B1.19, B2.9
TM3S10-C186	B1.19, B2.9
TM3S10-M0	B2.9
TM3S10-M30	B2.9
TM3S10-M69	B1.14, B2.9
TM3S25-M0	B2.9
TM3S25-M30	B2.9
TM3-X2-C0Y	B2.10
TMEH-S8-Q0	B2.10
TMEH-S10-C100	B2.10
TMEH-S10-C109	B2.10
TMEH-S10-Q0	B2.10
TMEH-S25-Q0	B2.10
TMEH-X2-LOY	B2.10
TMSTHS10-D0	B2.16
TMSTHS11-D0	B2.16
TMSTHS12-D0	B2.16

B1.
Cable
Ties

B2.
Cable
Accessories

B3.
Stainless
Steel Cable
Ties &
Accessories

C1.
Wiring
Duct

C2.
Abrasion
Protection

C3.
Cable
Management

D1.
Terminals

D2.
Power
Connectors

D3.
Grounding
Connectors

E1.
Labeling
Systems

E2.
Labels

E3.
Pre-Printed
&
Write-On
Markers

E4.
Permanent
Identification

E5.
Industrial
Safety
Solutions

F.
Keystone
Cabling
Systems

G.
Part
Number
Index

Part Number Index

Part Number	Page Number	Part Number	Page Number	Part Number	Page Number
TMSTHS13-D0.....	B2.16	TV105-.50DY.....	C2.20	VTA-0-Q.....	D2.68
TMSTHS16-D0.....	B2.16	TV105-.75TL20Y.....	C2.20	VTA-1-Q.....	D2.68
TMSTHS19-D0.....	B2.16	TV105-.75TLY.....	C2.20	VTA-2-Q.....	D2.68
TMSTLHS6-M0.....	B2.16	TWR-C.....	B2.38	VTA-3-12.....	D2.68
TMSTLHS8-M0.....	B2.16	TWR-C0.....	B2.38	VTA-4-12.....	D2.68
TNC25LG2.....	C1.25			VTA-5-6.....	D2.68
TNC25X37LG2.....	C1.25	U		VTA-6-6.....	D2.68
TNC25X75LG2.....	C1.25	UCIB1-V316.....	B3.22	VWS106-C.....	B2.41
TNC37LG2.....	C1.25	UCIB1-VC.....	B3.22	VWS106-C20.....	B2.41
TNC37X37LG2.....	C1.25	UCRND1-V316.....	B3.22	VWS3750-C.....	B2.40
TNC37X75LG2.....	C1.25	UCRND1-VC.....	B3.22	VWS3775-C.....	B2.40
TNC50D2.....	C1.25	UCSQ1-V316.....	B3.22	VWS50100-C.....	B2.40
TNC50LG2.....	C1.25	UCSQ1-VC.....	B3.22	VWSDC-C.....	B2.41
TNC50X50LG2.....	C1.25	UCT3S-X.....	B1.86	VWSDC-C20.....	B2.41
TNC75D2.....	C1.25	UCT3S-X0.....	B1.85		
TNC75LG2.....	C1.25	UCT5S-X.....	B1.86	W	
TNC75X75LG2.....	C1.25	UCT5S-X0.....	B1.85	WB12-L.....	D3.23
TNC100LG2.....	C1.25	UCTGS1224-X.....	B1.85	WB34-X.....	D3.23
TNC100X50LG2.....	C1.25	UCTGSM5-X.....	B1.85	WB58-Q.....	D3.23
TNC100X75LG2.....	C1.25	UCTGSM6-X.....	B1.85	WB89D.....	F.3
TP2-C.....	B2.13	UCTH1-V316.....	B3.22	WBS6-Q.....	B2.42
TP4H-C.....	B2.13	UCTH1-VC.....	B3.22	WEH-E8-C.....	B2.48
TTS-20R.....	B1.86	UGCTC3S-X.....	B1.86	WR2-C.....	C1.31
TTS-20R0.....	B1.84	UGCTC3S-X0.....	B1.85	WR2H-C.....	C1.31
TTS-35R3.....	B1.86	UGCTC5S-X.....	B1.86	WR3-C.....	C1.31
TTS-35R3-0.....	B1.84	UGCTC5S-X0.....	B1.85	WR4-C.....	C1.31
TTS-35RX.....	B1.86	UGTE3S-X.....	B1.86	WR5-C.....	C1.31
TTS-35RX0.....	B1.84	UGTE3S-X0.....	B1.85	WRS-A-C10.....	C1.31
TV105-1.0C20Y.....	C2.20	UGTE5S-X.....	B1.86	WS25-25-C.....	B2.39
TV105-1.0CY.....	C2.20	UGTE5S-X0.....	B1.85	WS25-50-C.....	B2.39
TV105-1M20Y.....	C2.20			WS25-75-C.....	B2.39
TV105-1MY.....	C2.20	V		WS35-25-C.....	B2.39
TV105-3M20Y.....	C2.20	VCC25-A-C.....	B2.33	WS35-50-C.....	B2.39
TV105-3MY.....	C2.20	VCC50-A-C.....	B2.33	WS35-75-C.....	B2.39
TV105-6M20Y.....	C2.20	VT-0-Q.....	D2.67	WS50-25-C.....	B2.39
TV105-6MY.....	C2.20	VT-1-Q.....	D2.67	WS50-50-C.....	B2.39
TV105-12M20Y.....	C2.20	VT-2-Q.....	D2.67	WS50-75-C.....	B2.39
TV105-12MY.....	C2.20	VT-3-12.....	D2.67	WS75-25-C.....	B2.39
TV105-.38D20Y.....	C2.20	VT-4-12.....	D2.67	WS75-50-C.....	B2.39
TV105-.38DY.....	C2.20	VT-5-6.....	D2.67	WS75-75-C.....	B2.39
TV105-.50D20Y.....	C2.20	VT-6-6.....	D2.67		

Industrial Safety Solutions Index

Part	Page Number
A	
AC Plug Lockout Device	
B	
Ball/Butterfly Valve Lockout Devices ..	E5.54
Barricade	
Barricade Rope	E5.84
Reflective Plastic	
Barricade Tapes	E5.84
Plastic Barricade Tapes	E5.84
Woven Barricade Tapes	E5.84
Barrier Cone Bars.....	E5.87
C	
Circuit Breaker Lockouts	E5.52
Cast Iron Base and Steel Post	E5.73
Chain Links	E5.88
Cones	E5.82
Corded AC Plug Cover	
Lockout Devices	E5.56
Crane & Construction Signals.....	E5.11
Cross Barrier	E5.10
Cross-Ribs	E5.72
D	
Duct Markers	E5.49
E	
Entry Permit Pad	E5.10
F	
Fence Sign Holder Bracket	E5.73
Fire & Emergency Column Marker.....	E5.19
Floor Label System	E5.79
Floor Marking Shapes	E5.77
Floor Signs	
Non-Skid Floor Signs.....	E5.78
Non-Slip Floor Signs.....	E5.80, E5.81
G	
Gate Valve Lockout Devices	E5.54
GHS	
Hazard Communication	
Training Kit	E5.68
Jumbo Tags.....	E5.65
Pictogram Labels	E5.65
Posters	E5.68
Pre-Printed Hazard Symbols	E5.66
Print On-Demand Thermal	
Transfer Labels	E5.67
Wallet Card	E5.68
Global Plug Lockout Device	E5.56
Group Lock Box.....	E5.58

Part	Page Number
H	
Hasps	
Aluminum	E5.51
Lockout	E5.53
L	
Labels	
Arc Flash Protection	E5.14
Chemical Identifier Roll.....	E5.63
Chemicals & Hazardous	
Materials	E5.8, E5.9
Conductor Identification	E5.16
Confined Space	E5.9
Drum & Container	E5.64
Electrical	E5.14, E5.16
Equipment.....	E5.18
Fire & Emergency.....	E5.20
First Aid.....	E5.20
Hard Hat & Helmet	E5.24
Hazardous Material	E5.63
Housekeeping & Hygiene	E5.22
ISO Warning Symbols.....	E5.15
Lockout Warning Strip.....	E5.52
Magnetic Lockout.....	E5.14
Personal Protection	E5.23
Production Control	E5.18
Smoking Control	E5.25
Traffic Industrial	E5.26
Letters & Number Markers	E5.27
Lockouts	
Ball Valve	E5.54
Cinch Cable	E5.53
Large Handle Lever	E5.53
Twist & Turn Cinch Cable	E5.54
Versatile Pneumatic	E5.57
Lockout Kits	
Contractor	E5.60
Electrician	E5.60
Maintenance	E5.61
Power and Panel Distribution	E5.61
Lockout Quick Reference Card	E5.57
Lockout Stations	E5.59
M	
Marking Tapes	E5.75
Color Banding Pipe.....	E5.47
High Performance.....	E5.79
Message	E5.75
Non-Slip Floor.....	E5.76
Textured	E5.79
Metal Wall Mount Cabinet.....	E5.60

Part	Page Number
N	
NFPA	
Flip Placard Sign	E5.63
Placard Kits.....	E5.63
Sign Kits.....	E5.63
Non-Slip Floor Marking Shapes	E5.76
O	
OSHA Lockout/Tag out Compliance and Training Kit	E5.57
P	
Padlocks	
Aluminum	E5.62
Non-Conductive Safety.....	E5.62
Specialty	E5.62
Pipe Markers	E5.45-E5.47
IIAR Ammonia	E5.49
Medical Gas	E5.49
Roll Form	E5.48
Roll Tape.....	E5.48
Permit Holder Board	E5.10
Pneumatic Energy Lockout Device ..	E5.57
Portable Sign Stand	E5.73
Push Button Cover.....	E5.55
R	
Rack Mount Retractable Belt	
Tape Barriers.....	E5.88
Receptacle Lockout Device	E5.56
Retractable Banner Barrier	E5.88
Retractable Belt Tape Barriers	E5.89
Ring Weight	E5.87
S	
Safety Ease™ Printable Media	
for Ink Jet and Laser Printers	E5.67
Safety Scoreboards	E5.90
Safety Tool Bag	E5.60
Self-Laminating Adhesive	
Sign Carriers	E5.32
Self-Laminating Cable	
Marker Holders	E5.42
Self-Laminating Fiber Optic	
Cable Marker Tags	E5.44
Self-laminating Lockout Tags	E5.37
Self-Laminating Padlock Labels.....	E5.62
Self-Laminating Safety Tag Carriers ..	E5.42
Signs	
Admittance & Exit	E5.4-E5.6
ANSI ISO Safety	E5.28
Blinker	E5.73
Cautionary.....	E5.72
Chemicals & Hazardous Materials... E5.8	

Industrial Safety Solutions Index

Part	Page Number	Part	Page Number	Part	Page Number
Cone Top Warning	E5.82	Sign Mounting Brackets		Tapes	E5.35
Confined Space	E5.9	and Plate	E5.73	Directional Flow Arrow	E5.47
Construction	E5.11	Single Spring Sign Stand	E5.71	Glow-in-the-Dark Shapes	E5.77
Electrical	E5.13	Spring-less Sign Stand	E5.71	Non-Skid Floor Shape	E5.78
Equipment.....	E5.17	Stainless Steel and Brass		Non-Skid Floor	E5.78
Fire & Emergency	E5.18	Marker Plates & Tags	E5.44	Pennant Flag	E5.82
First Aid	E5.20	Steel Safety Post & Chain	E5.88	Reflective	E5.75
Florescent Alert	E5.26	Steel U-Channel Posts	E5.73	Underground Hazard	E5.83
Free Standing	E5.85, E5.86	Steering Wheel Covers	E5.61	Thermal Transfer Continuous	
Glow Clear-Shield.....	E5.29	Stencils.....	E5.10	Label Tapes.....	E5.43
Glow.....	E5.29	Striped Post	E5.87	Thermal Transfer Printable	
Glow-in-the-Dark UL Exit	E5.7			Arc Flash Labels	E5.43
Hazardous Material Classification .	E5.63	T		Toggle Switch Cover Device	E5.55
Housekeeping & Hygiene	E5.21-E5.22	Tags		Toggle-Switch Cover	E5.55
Large	E5.12	Aluminum Inspection Record	E5.40	Training Posters	E5.68
Laser Printable Adhesive	E5.32	Bilingual Spanish Safety.....	E5.35		
Lighted UL LED Exit	E5.6	Blank	E5.41	U	
Non-Regulatory Traffic.....	E5.74	Blank Header	E5.34	Universal Cone Adapter	E5.82
Parking	E5.70	Create Your Own Cardstock	E5.42	Universal Wall Switch Cover	E5.55
Pavement-Print	E5.80	Ground Warning	E5.44		
Personal Protection	E5.23	Hazardous Material	E5.64	V	
Projecting	E5.30, E5.31	Inspection & status Record	E5.35	Voltage & Fiber Optic Markers	E5.15
Roll of	E5.15	Lockout	E5.37	Voltage & Safety Marker Books	E5.15
Roll-Up Construction.....	E5.72	Loop Strap	E5.40		
Security Stop Safety	E5.74	Roll of	E5.39	W	
Self-Luminous UL Exit	E5.6	Scaffold Status 3'n1 Fold	E5.40	Wallet Cards.....	E5.63
Sign Panels (Blank)	E5.32	Soft Aluminum	E5.44		
Smoking Control	E5.24	Standard Safety	E5.34	Numbers	
Speed	E5.69, E5.74	Status.....	E5.36	6-Padlock Board Kits	E5.59
Stop & Yield	E5.69	Thick Plastic	E5.39		
Traffic Industrial	E5.25	Valve Identifier Plastic.....	E5.44		
Traffic Direction.....	E5.70	Tag Hasps	E5.51		
Write-On GHS	E5.66	Tag Holder System	E5.38		

Notes

B1.
Cable
Ties

B2.
Cable
Accessories

B3.
Stainless
Steel Cable
Ties &
Accessories

C1.
Wiring
Duct

C2.
Abrasion
Protection

C3.
Cable
Management

D1.
Terminals

D2.
Power
Connectors

D3.
Grounding
Connectors

E1.
Labeling
Systems

E2.
Labels

E3.
Pre-Printed
&
Write-On
Markers

E4.
Permanent
Identification

E5.
Industrial
Safety
Solutions

F.
Keystone
Cabling
Systems

G.
Part
Number
Index

Notes

Notes

B1.
Cable
Ties

B2.
Cable
Accessories

B3.
Stainless
Steel Cable
Ties &
Accessories

C1.
Wiring
Duct

C2.
Abrasion
Protection

C3.
Cable
Management

D1.
Terminals

D2.
Power
Connectors

D3.
Grounding
Connectors

E1.
Labeling
Systems

E2.
Labels

E3.
Pre-Printed
&
Write-On
Markers

E4.
Permanent
Identification

E5.
Industrial
Safety
Solutions

F.
Keystone
Cabling
Systems

G.
Part
Number
Index

Notes

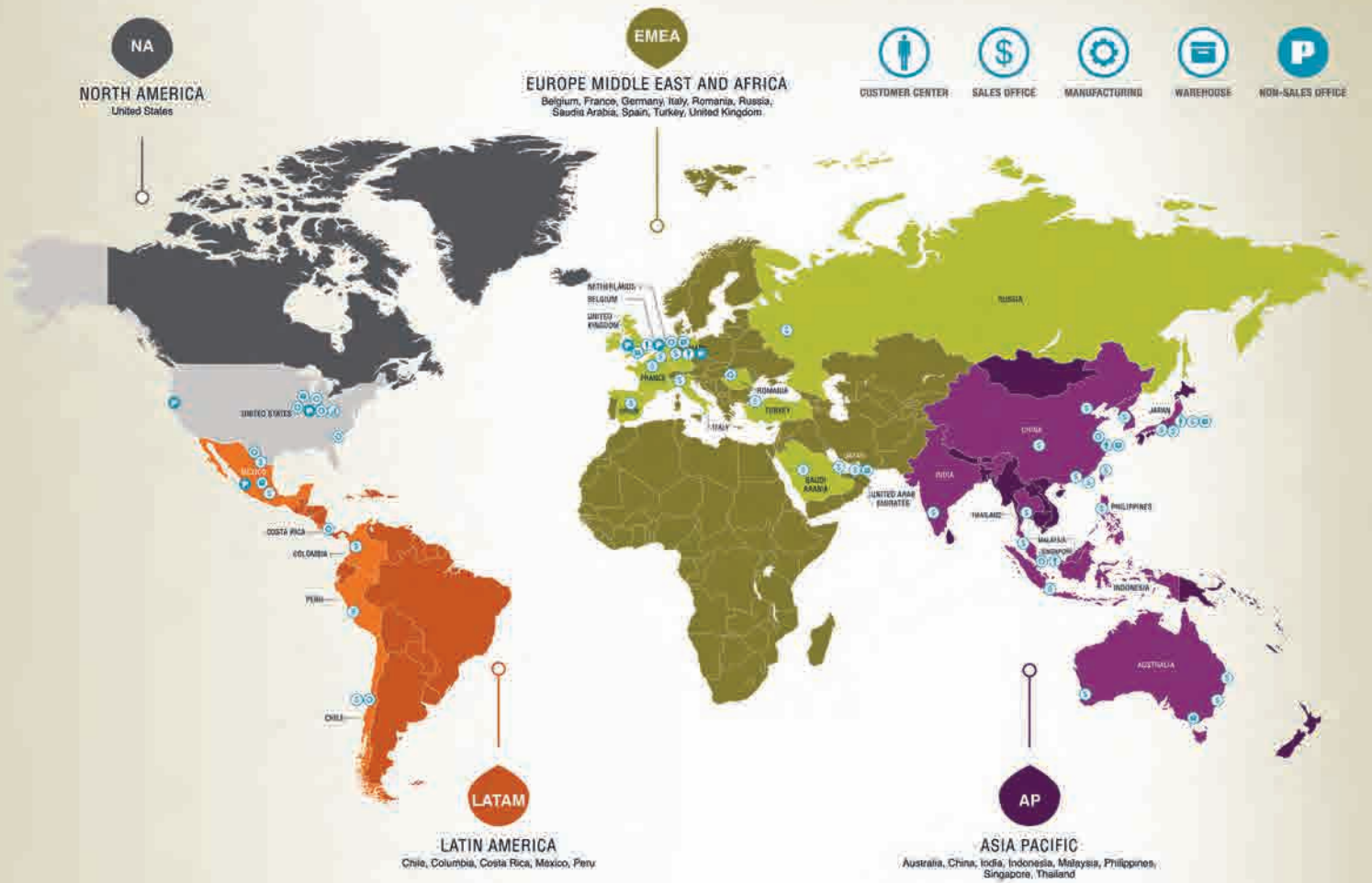

THE INFORMATION CONTAINED IN THIS CATALOG IS INTENDED AS A GUIDE FOR USE BY PERSONS HAVING TECHNICAL SKILL AT THEIR OWN DISCRETION AND RISK. BEFORE USING ANY PANDUIT PRODUCT, THE BUYER MUST DETERMINE THE SUITABILITY OF THE PRODUCT FOR HIS/HER INTENDED USE AND BUYER ASSUMES ALL RISK AND LIABILITY WHATSOEVER IN CONNECTION THEREWITH. PANDUIT DISCLAIMS ANY LIABILITY ARISING FROM ANY INFORMATION CONTAINED HEREIN OR FOR ABSENCE OF THE SAME.

All Panduit products are subject to the terms, conditions and limitation of its then current Limited Product Warranty, which can be found at www.panduit.com/warranty.

All trademarks, service marks, trade names, product names, and logos appearing in this document are the property of their respective owners.



PANDUIT[®]

Panduit Corp.
World Headquarters
Tinley Park, IL 60487

800.777.3300

www.panduit.com