20 | **FAN**
18 | **CATALOG**



go **ABOVE**[™]

NEW FANS & ACCESSORIES FOR 2018



LINDELL
CF825 - pg 13



SWEEP ECO
CF275 - pg 37



RAH ECO
CF915 - pg 39



ION ECO
CF5300 - pg 41

▶ **NEW!** SOLID WOOD BLADES



B77/78/79CR
NEW! Solid Wood
CHARCOAL
pg 149



B77/78/79TM
NEW! Solid Wood
TIMBER GRAY
pg 149

▶ **NEW!** WOOD VENEER BLADES



G54CR
NEW! Wood Veneer
CHARCOAL
pg 150



G54TM
NEW! Wood Veneer
TIMBER GRAY
pg 150



G44SW
NEW! Wood Veneer
SATIN WHITE
pg 150



Emerson Residential Ceiling Fans

provide customers with innovative and customized products that exceed expectations for quality, performance and design - setting the industry standard with versatile ceiling fans to compliment any aesthetic.

Blade Select Series®	pg 3
Bluetooth Controls	pg 4
Motor Standards	pg 5
How We Test Airflow	pg 5
EcoMotor & K55	pg 6
Fan Installation Information	pg 7
Downrods & Finishes	pg 9
Icons Index	pg 10

T TRANSITIONAL

Traditional Introduction	pg 11
NEW! Lindell	pg 13
Ashland	pg 15
Penbrooke Select Eco	pg 17
Penbrooke Select	pg 19
Carrera	pg 21
Carrera Grande Eco	pg 23
Laclede Eco	pg 25
Amhurst LED	pg 27
52" Monterey II	pg 29
Braddock	pg 31
52" & 42" Bella	pg 33

M MODERN

Modern Introduction	pg 35
NEW! Sweep Eco	pg 37
NEW! 60" & 72" Rah Eco	pg 39
NEW! Ion Eco	pg 41
Ideal	pg 43
Euclid	pg 45
Veloce	pg 47
Keane	pg 49
Luray Eco	pg 51
Aira Eco LED	pg 53
Highrise	pg 55
4 th Avenue LED	pg 57
Midway Eco LED	pg 59
Luxe Eco LED	pg 61
Highpointe LED	pg 63
Loft	pg 65
52" & 44" Curva Sky LED Indoor	pg 67
52" & 44" Curva Sky LED Outdoor	pg 69
52" & 44" Curva LED Indoor	pg 71
52" & 44" Curva LED Outdoor	pg 73
Atomical	pg 75
Volta	pg 77
Tilo	pg 79

T TRADITIONAL

Traditional Introduction	pg 81
Avant Eco	pg 83
Premium Select	pg 85
Zurich	pg 87
Prima	pg 89
Designer	pg 91
29" Northwind	pg 93
Prima Snugger	pg 95
52" Snugger	pg 97
42" Snugger	pg 99
Monaco	pg 101
Crown Select	pg 103
Cornerstone	pg 105

I/O INDOOR/OUTDOOR

Indoor/Outdoor Introduction	pg 107
Rockpointe	pg 109
Kailua Cove	pg 111
Batalie Breeze	pg 113
Welland	pg 115
52" & 42" Veranda	pg 117
Summerhaven	pg 119
52" & 42" Summer Night	pg 121
Devonshire	pg 123
Sea Breeze	pg 125

P PRO SERIES

Pro Series Introduction	pg 127
Pro Series	pg 129
Pro Series ES	pg 131
50" Pro Series II	pg 133
42" Pro Series II	pg 135
Pro Series Builder	pg 137
60" Industrial Fan	pg 139
56" Industrial Fan	pg 141
48" Industrial Fan	pg 143

A ACCESSORIES

Accessories Introduction	pg 145
Blade Select Series	pg 148
2 1/4 Glass	pg 151
1k GLO Series Light Fixtures	pg 152
LED & Custom Finish Light Fixtures	pg 153
Fitters	pg 156
Controls & Receivers	pg 157
Downrods	pg 9
Fan Specifications	pg 165
Warranty	pg 169

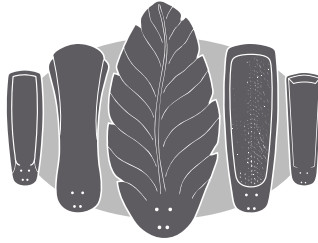

BLADE SELECT™

SERIES

STEP
1

Choose *Your* Fan



AVANT ECO

STEP
2

Choose *Your* Finish



OIL RUBBED BRONZE

STEP
3

Choose *Your* Blade



HONEY OAK

+ Optional Light Fixtures, Controls, Downrods and More!

**YOUR STYLE,
HUNDREDS
OF POSSIBILITIES**

7
Fan
Models

11
Finishes
Available

50+
Blade
Options



PENBROOKE
SELECT ECO
pg 17



PENBROOKE
SELECT
pg 19



CARRERA
GRANDE ECO
pg 23



ION ECO
pg 41



AVANT ECO
pg 83



PREMIUM
SELECT
pg 85



CROWN
SELECT
pg 103

* Some restrictions apply. See product pages for details.



RCBT100 is compatible with these Emerson Ceiling Fans:

- | | | | |
|--------|-----------------------|---------|--------------------|
| CF1 | Cornerstone | CF630 | Rockpointe |
| CF130 | Tilo | CF652 | 52" Summer Night |
| CF144L | 44" Curva Sky Outdoor | CF654 | Sea Breeze |
| CF152L | 52" Curva Sky Outdoor | CF670 | Devonshire |
| CF145L | 44" Curva Sky Indoor | CF700 | Pro Series Builder |
| CF153L | 52" Curva Sky Indoor | CF702 | 29" Northwind |
| CF205L | Highpointe | CF710 | 42" Pro Series II |
| CF230 | Veloce | CF711 | 50" Pro Series II |
| CF244L | 44" Curva Outdoor | CF712 | Pro Series |
| CF252L | 52" Curva Outdoor | CF713 | Pro Series ES |
| CF245L | 44" Curva Indoor | CF717 | Ashland |
| CF253L | 52" Curva Indoor | CF742PF | 42" Summer Night |
| CF320 | Keane | CF755 | Designer |
| CF430 | Highrise | CF765 | Loft |
| CF440 | Braddock | CF766 | 4th Avenue |
| CF442 | 42" Bella | CF772 | 52" Monterey II |
| CF4501 | Crown Select | CF784 | Carrera |
| CF452 | 52" Bella | CF825 | Lindell |
| CF4801 | Premium Select | CF830 | Monaco |
| CF500 | Euclid | CF850 | Summerhaven |
| CF5100 | Penbrooke Select | CF880 | Amhurst |
| CF542 | 42" Veranda | CF901 | Prima |
| CF552 | 52" Veranda | CF905 | Prima Snugger |
| CF590 | Volta | CF930 | Atomical |
| CF610 | Welland | CF935 | Zurich |
| CF621 | Batalie Breeze | | |

WHEN LEAVING THE COUCH IS OUT OF THE QUESTION

The **BLUETOOTH**® Ceiling Fan Control with App by Emerson

emersonfans.com | Share pictures of your Emerson fans using #MyEmersonFan



Google Play and the Google Play logo are trademarks of Google Inc. "The Bluetooth" word mark and logos are registered trademarks owned by the Bluetooth SIG, Inc. and any use of such marks by Emerson is under license. Other trademarks and trade names are those of their respective owners.

EMERSON VS. TYPICAL RETAIL

HIGHER MOTOR STANDARDS

- Quieter
- Higher Quality Bearings
- Stricter Sound Testing Criteria
- Flatter Laminations to Prevent Motor Buzz Noise
- Limited Lifetime Motor Warranty
- Higher Grade Materials
- Precision-Machined Motor Endshields
- More Quality Checkpoints for Defect-Free Motors



HOW WE TEST AIRFLOW

Emerson tests every ceiling fan to standardized industry testing parameters. The CFM data (Cubic Feet per Minute) is printed on the energy guide label of every fan carton and in every catalog. This is the amount of air movement the user feels when beneath the fan. CFM is an objective approach to making competitive comparisons. Blade pitch, RPM (revolutions per minute), blade length and overall design are used to maximize CFM. CFM is the true measure of air flow.

UNDERSTANDING ENERGY RATINGS

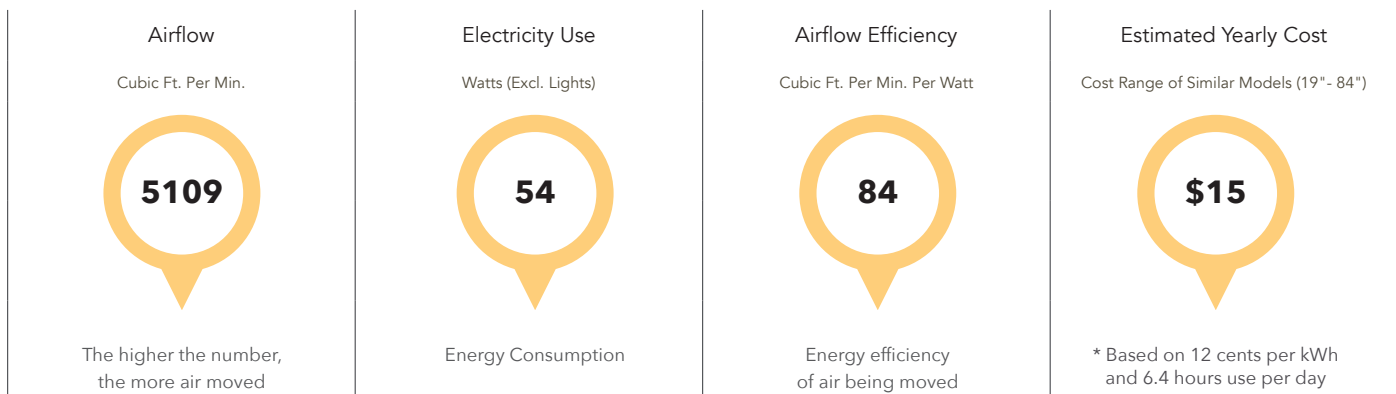

Data shown for reference only. Data reflects a weighted average of high and low speeds using the method defined by US Department of Energy 10 CFR Part 430.

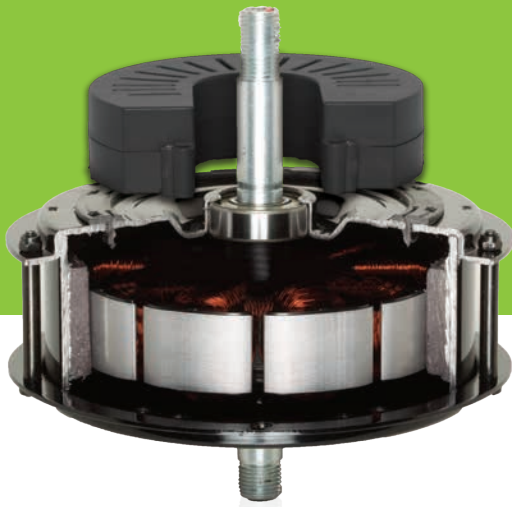

when ENERGY matters

ECOMOTOR



Look for this logo for fans that carry Emerson's most energy efficient motor

Up to 3 times more efficient than typical ceiling fan motors - costs less than 1¢ per hour to run

- Uses a maximum of 33 watts of energy
- Higher degree blade pitch moves air more efficiently
- 6-Speed control with every fan
- EcoMotor fans, which are featured in our Blade Select Series, are adaptable to 42/44", 52/54", 58/60" or 70/72" fans for added versatility & quiet operation*

*Some blade restrictions apply. Please refer to individual product pages for more information



when POWER matters

K55XL MOTOR

Look for this logo for fans that carry Emerson's excellent power & performance motor

Excellent power & performance motor

- The largest steel ball bearings in the ceiling fan industry ensure quiet operation
- Thick motor laminations and over 2,200 feet of quality copper wiring for optimal performance and longevity
- The patented K55XL Silent Rubber Hub works as a shock absorber to isolate the blades and eliminate noise transmission

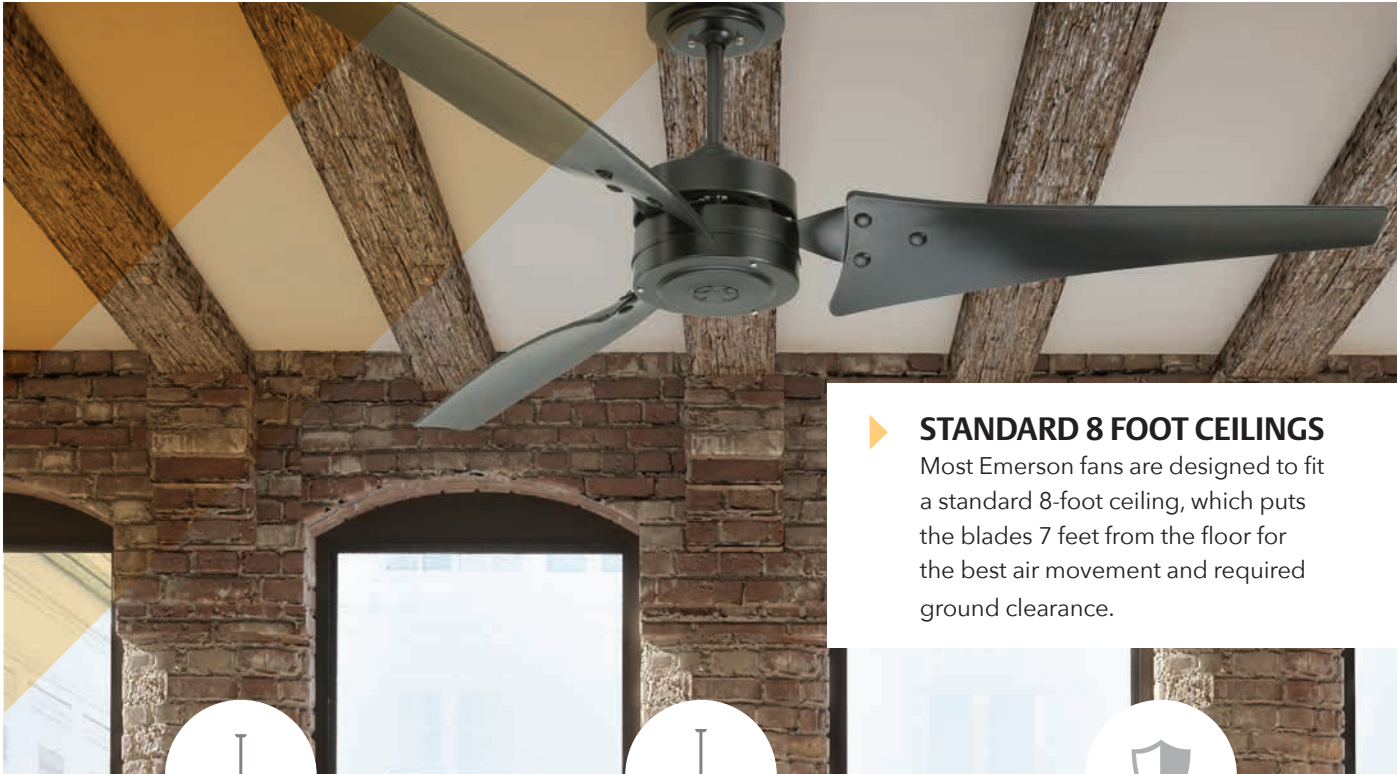

▶ **STANDARD 8 FOOT CEILINGS**

Most Emerson fans are designed to fit a standard 8-foot ceiling, which puts the blades 7 feet from the floor for the best air movement and required ground clearance.



CEILING LESS THAN 8 FEET

Choose an Emerson Snugger model to achieve the minimum 7-foot blade clearance or consider a close-to-the-ceiling downrod (CFDR25). See pg 165 -168 for model compatibility.



CEILING ABOVE 8 FEET

To maximize air movement, the fan should be hung by a downrod 8 to 9 feet from the floor. If necessary, order an accessory downrod to achieve the proper length. See the Accessory Downrod chart at the top of pg 9.



WARRANTY

All Emerson fans, except Industrial Fans, carry our Limited Lifetime Motor Warranty when purchased through an authorized Emerson distributor.

▶ **DOWNROD LENGTH TO CEILING**

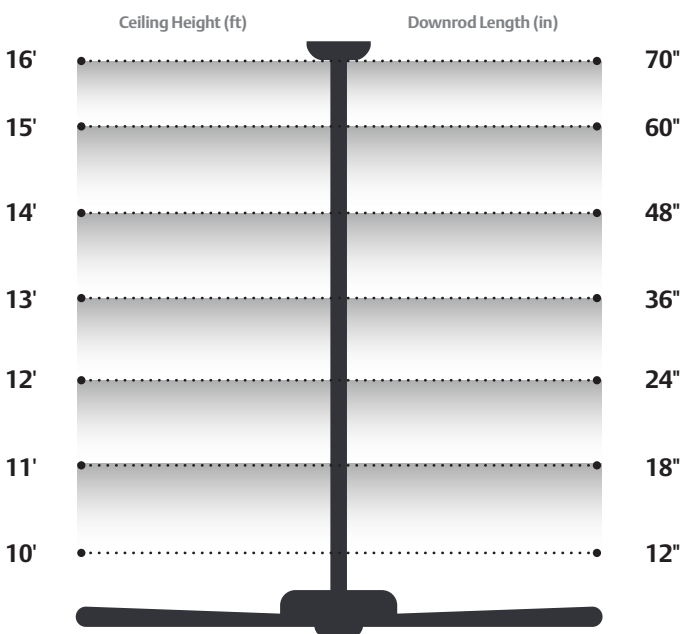

HANGING SYSTEM

All Emerson residential ceiling fans feature a die-cast zinc hanger ball and bracket for durability. This system is textured to minimize wobble and provide superior stability. Emerson Industrial Fans feature a J-hook hanging system or ball and bracket for easy installation and smooth performance.

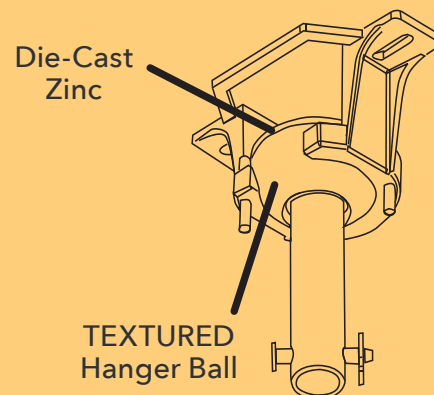

▶ **INSTALLATION MOUNTING CHART**

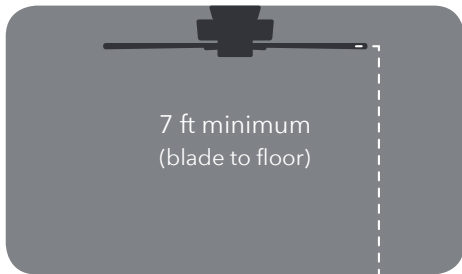

7 ft minimum
(blade to floor)

FLUSH MOUNT

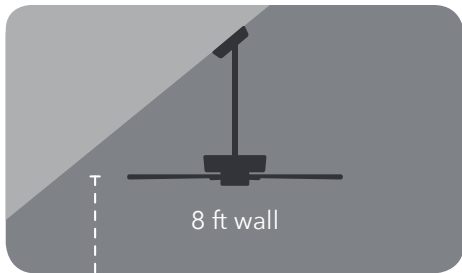

8 ft wall

**SLOPED CEILING MOUNT
WITH DOWNROD**

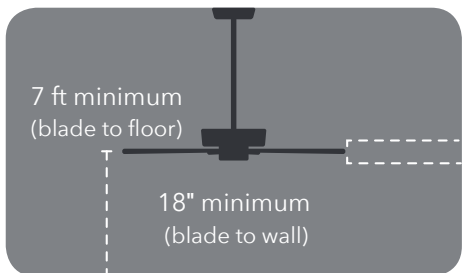

7 ft minimum
(blade to floor)

18" minimum
(blade to wall)

**STANDARD MOUNT
WITH DOWNROD**

▶ **CHOOSE THE RIGHT FAN TO FIT YOUR ROOM**

To maximize performance, choose the right fan size for your room. For long or large rooms, consider using more than one fan to handle your cooling requirements. For maximum comfort, the fan should be placed as close to the center of the room as possible and blade tips should be at least 18 inches from any wall.

▶ **RECOMMENDED BLADE SPAN FOR ROOM SIZE BASED ON AESTHETIC & AIRFLOW CONSIDERATIONS**

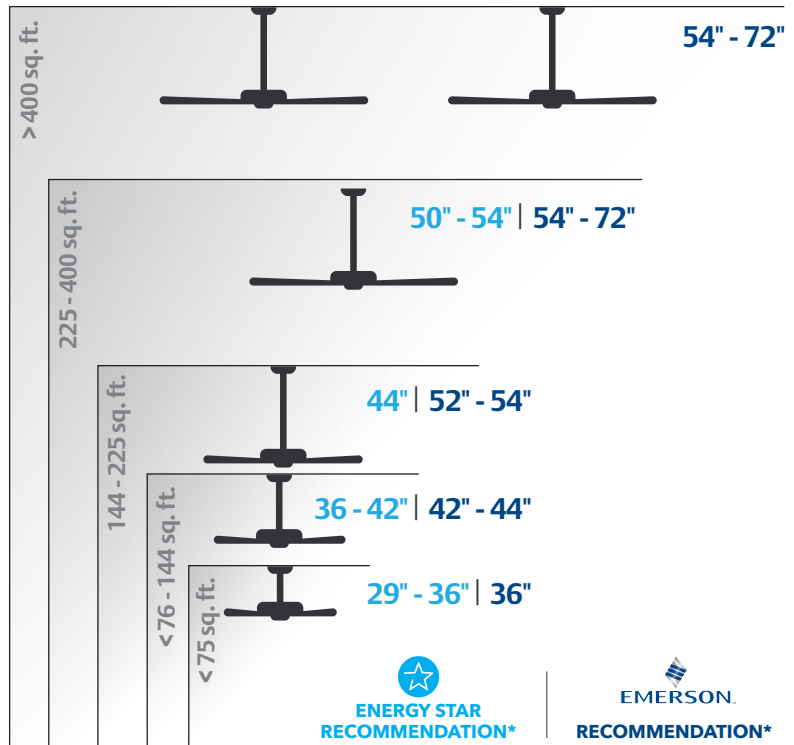

* Not all models are Energy Star approved.

▶ **ENERGY SAVINGS CREATED BY THE ADDITION OF A CEILING FAN**



SUMMER

**Counter-Clockwise
Blade Rotation**

Ceiling fans create a wind chill effect that can make a person feel cooler, allowing the user to raise his or her thermostat setting by 4°, resulting in a reduction of overall usage costs.

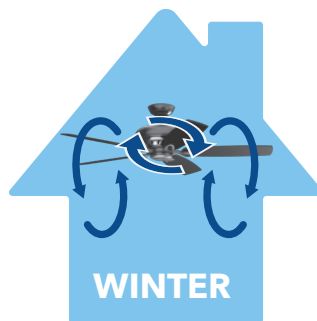

WINTER

**Clockwise
Blade Rotation**

Setting a ceiling fan to rotate clockwise at a low speed during the winter will also create energy savings. This warms the entire room by mixing the warm air sitting at the ceiling with the cooler air at the bottom of the room.

**REDUCED
ENERGY CONSUMPTION**

Room with a Ceiling Fan

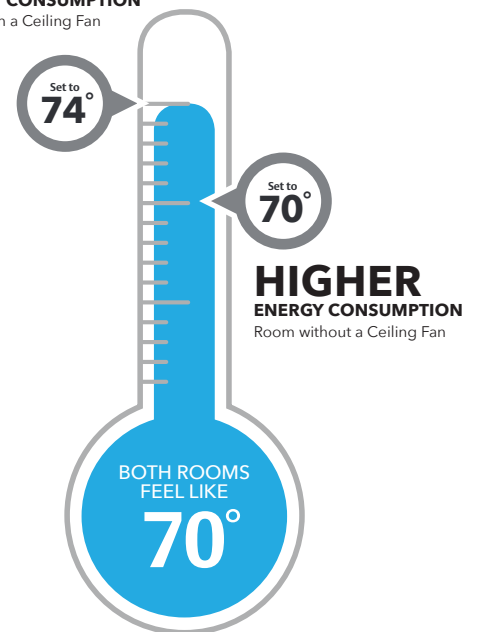

▶ SELECTING YOUR DOWNROD LENGTH

Complete catalog number by selecting your downrod length, then adding the finish code to the model number.

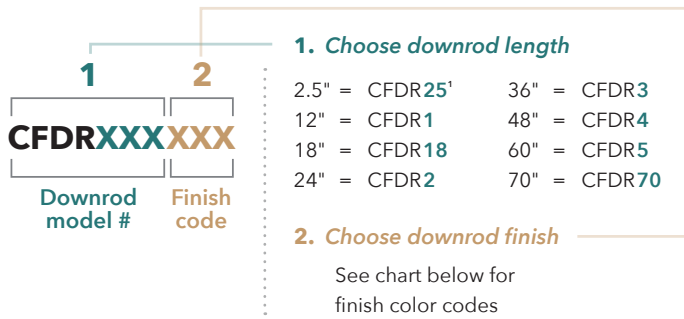

CFSCKXXX - SLOPED CEILING KIT (Up to 45°)



- For use on cathedral and sloped ceilings up to 45°
- Features a screw-in safety strap to lock the hanger ball in place
- Complete catalog number by adding the finish code to the model number. See chart above.
- Shown in **GRT**. Also available in **AB, AP, AW, BQ, BS, GBZ, GES, ORB, SW, VNB, VS** and **WW**
- For use with horseshoe receivers: RC188 and RCK55

Our standard hanging system can be used for sloped ceilings up to 26° and 5/12 pitch ceiling.

CFDR25 - CLOSE-TO-THE-CEILING DOWNRODS



- 2½" downrod allows fans to be installed closer to the ceiling
- In most instances you will save at least 2" of space if you bring your fan closer to the ceiling
- Shown in **WW**. Also available in **AB, AP, AW, BQ, BS, GBZ, GES, GRT, ORB, PT, SW, VNB,** and **VS**

CFDC - DOWNROD COUPLER



- Connect 2 or more downrods for taller ceiling applications.
- Shown in **BS**. Also available in **AB, AP, AW, BQ, GBZ, GES, GRT, ORB, SW, VNB, VS** and **WW**



AB - Antique Brass



AP - Antique Pewter



AW - Summer White



BS - Brushed Steel



BQ - Barbeque Black



GBZ - Gilded Bronze



GES - Golden Espresso



GRT - Graphite



ORB - Oil Rubbed Bronze



PT - Platinum



SW - Satin White



VNB - Venetian Bronze



VS - Vintage Steel



WW - Appliance White

¹ Only certain fan models accommodate with the 2½" downrod.



BLADE SELECT SERIES
Choose from 6 fan models,
10 finishes and 50+ blade options



ECOMOTOR
Emerson's most energy
efficient fan motor



K55 MOTOR
Emerson's excellent power
and performance fan motor



DAMP LOCATION
Fans rated for use in
covered outdoor areas



WET LOCATION
Fans rated for use in outdoor areas
directly exposed to precipitation



ENERGY STAR
Fans that earned an
Energy Star listing for
superb energy efficiency



LED LIGHTING
Emerson's most efficient and
longest-lasting lighting



LED LIGHT FIXTURE ADAPTABLE
Emerson's newest line of LED lKGLo Light
Fixtures (pg 126) can be added to compatible
Emerson fans as an optional accessory



ACCENT LIGHTING
Fans that come with
integrated accent lighting



OPTIONAL ACCENT LIGHTING
An accent lighting fixture can be
added to these Emerson Fans as an
optional accessory



SHIPS TO CANADA
Fans and compatible optional
accessories that can be ordered
and shipped to Canada



SHIPS TO CANADA FAN ONLY
Fans that can be ordered and
shipped to Canada but not with all
compatible optional accessories



BLUETOOTH® COMPATIBLE
Fan controlled by Bluetooth®
technology via Apple®
or Android® device



QUICK & EASY INSTALLATION
Fans built with special features for
easy, time-saving installation

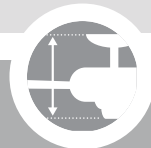

FAN HEIGHT
Measurement of a fan model from
its lowest point to its highest



LIMITED LIFETIME MOTOR



LIMITED 5 YEAR MOTOR

We're so confident our fans will last for years to come that we've backed them with **Emerson's Limited Lifetime Motor Warranty**
Industrial fans carry Emerson's Limited 5-Year Motor Warranty.

HAVE A QUESTION? CONTACT CUSTOMER SERVICE
1-800-237-6511 or FANCS@EMERSON.COM



Penbrooke Select Eco CF5200



TRANSITIONAL

Designed to combine the luster of our traditional fans with modern aesthetics, this line will bring a timeless look to your favorite room.



LINDELL
CF825 - pg 13



ASHLAND
CF717 - pg 15



PENBROOKE SELECT ECO
CF5200 - pg 17



PENBROOKE SELECT
CF5100 - pg 19



CARRERA
CF784 - pg 21



CARRERA GRANDE ECO
CF788 - pg 23



LACLEDE ECO
CF995 - pg 25



AMHURST LED
CF880L - pg 27



MONTEREY II
CF772 - pg 29



BRADDOCK
CF440 - pg 31



52" BELLA & 42" BELLA
CF452/CF442 - pg 33



*Certain finishes only. See fan pages for details.



A.



Shown in Brushed Steel with Walnut Blades



Lindell

MODEL FEATURES

- 52" Blade Span
- 5 Reversible Blades
- LED Light Fixture
- 4.5" Downrod Included
- 3-Speed Pull Chain Operation
- No-Light Option Included

17.75"
13.38"

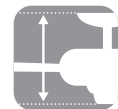

FAN HEIGHT

Energy Guide Information

Airflow Cubic Ft Per Min.	Electricity Use Watts (Excl. Lights)	Airflow Efficiency Cubic Ft Per Min. Per Watt	Estimated Yearly Cost Cost Range of Similar Models (19" - 84")
3418	41	83	\$11



B. Shown in Oil Rubbed Bronze with Walnut Blades



C. Shown in Satin White with Timber Gray Blades



D. Shown in Antique Pewter with Charcoal Blades

- A. **LINDELL – BRUSHED STEEL**
CF825BS - Dark Cherry/Walnut Blades
- B. **LINDELL – OIL RUBBED BRONZE**
CF825ORB - Dark Cherry/Walnut Blades
- C. **LINDELL – SATIN WHITE**
CF825SW - Satin White/Timber Gray Blades
- D. **LINDELL – ANTIQUE PEWTER**
CF825AP - Timber Gray/Charcoal Blades



Included

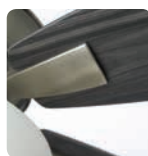

**5 REVERSIBLE
BLADES**

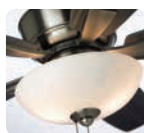

LED Light Fixture

- LED Specifications**
- 600 Lumens (each bulb)
 - 6.5 Watts
 - 80 CRI
 - 3000 K CCT

Optional Control



SW90
4-Speed
Dual Slide
Control
pg 158

Ashland



B. Shown in Oil Rubbed Bronze with Walnut Blades and Opal Matte Glass

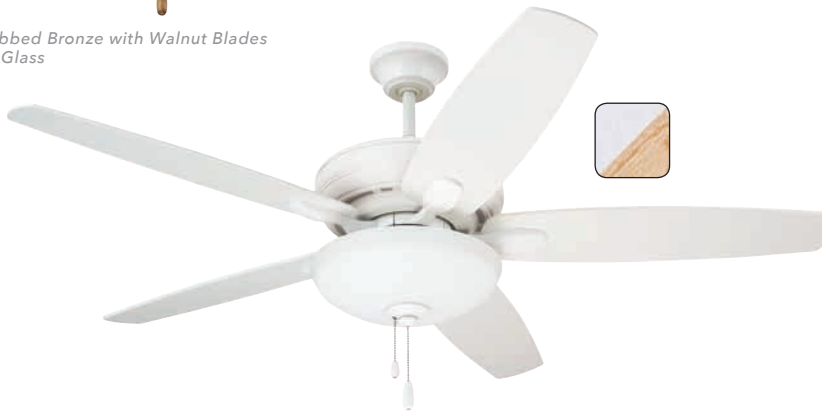

C. Shown in Satin White with Satin White Blades and Opal Matte Glass



D. Shown in Brushed Steel with Dark Cherry Blades and Opal Matte Glass

- A. **ASHLAND- ANTIQUE PEWTER**
CF717AP - Charcoal/Timber Gray Blades with Opal Matte Glass
- B. **ASHLAND - OIL RUBBED BRONZE**
CF717ORB - Walnut/Dark Cherry Blades with Opal Matte Glass
- C. **ASHLAND - SATIN WHITE**
CF717SW - Satin White/Maple Blades with Opal Matte Glass
- D. **ASHLAND - BRUSHED STEEL**
CF717BS - Walnut/Dark Cherry Blades with Opal Matte Glass

Included



5 REVERSIBLE BLADES



NO-LIGHT OPTION



LIGHT FIXTURE



DUAL-MOUNT FEATURE

Optional Controls



SW90W/LA
4-Speed Dual Slide Control
pg 158



SW95
4-Speed Fan Knob Control
pg 158

Recommended Accessories

Sold Separately



ACCESSORY DOWNROD
pg 9



A.



Shown in Antique Pewter with Charcoal Blades and Opal Matte Glass



Ashland

MODEL FEATURES

- 52" Blade Span
- Medium-Base Light Fixture with (3) 13-Watt CFL Bulbs
- No-Light Option
- 5 Reversible Blades
- Dual-Mount Feature
- 4.5" Downrod Included

17.5"
13.0"

FAN HEIGHT

Energy Guide Information

<p>Airflow Cubic Ft Per Min.</p> <p>2120</p>	<p>Electricity Use Watts (Excl. Lights)</p> <p>35</p>	<p>Airflow Efficiency Cubic Ft Per Min. Per Watt</p> <p>60</p>	<p>Estimated Yearly Cost Cost Range of Similar Models (19" - 84")</p> <p>\$10</p>
--	---	--	---



C.

Shown in Oil Rubbed Bronze with accessory 22" Heritage Walnut Blades (pg 150), Four-Light Arm Fitter (pg156) and Vintage Bulb Adapters (pg 156). Bulbs not included.



Penbrooke Select Eco

MODEL FEATURES

- 44", 54", 60" or 72" Blade Span
- Blades Sold Separately (see pg 149-150)
- 4.5" Downrod Included
- Light Fixture and Accent Light Adaptable (AL200)
- 6-Speed Wall Control with Receiver

13.0" 
FAN HEIGHT

Energy Guide Information

Airflow Cubic Ft Per Min.	Electricity Use Watts (Excl. Lights)	Airflow Efficiency Cubic Ft Per Min. Per Watt	Estimated Yearly Cost Cost Range of Similar Models (19" - 84")
4482	20	229	\$5



A. Shown in Brushed Steel with accessory Riley LED Light Fixture (LK180LEDBS, pg 154), 25" Dark Mahogany Solid Wood Blades (B78DM, pg 149) and 12" accessory downrod (CFDR1BS, pg 9)



B. Shown in Satin White with accessory 22" Satin White Blades (B77SW, pg 149)

- A. **PENBROOKE SELECT ECO – BRUSHED STEEL**
CF5200BS - Blade Select Series Blades (Sold Separately)
- B. **PENBROOKE SELECT ECO – SATIN WHITE**
CF5200SW - Blade Select Series Blades (Sold Separately)
- C. **PENBROOKE SELECT ECO – OIL RUBBED BRONZE**
CF5200ORB - Blade Select Series Blades (Sold Separately)



Included



SW605
6-Speed
Wall Control

Optional Control



SR600
6-Speed
Remote Control
pg 157

Recommended Accessories

Sold Separately



BLADE SELECT
SERIES BLADES
pg 148



LK GLO SERIES
LED Light Fixture
pg 153



AL200
LED Light Accessory
pg 156

Penbrooke Select



A. Shown in Oil Rubbed Bronze with accessory 22" Walnut Solid Wood Blades (B77WA, pg 149)



B. Shown in Satin White with accessory 22" Satin White Blades (G54SW, pg 150)



C. Shown in Brushed Steel with accessory LED Light Fixture (LK180LEDBS, pg 154), 25" Dark Mahogany Solid Wood Blades (B78DM, pg 149) and accessory 12" downrod (CFDR1BS, pg 9)

- A. **PENBROOKE SELECT – OIL RUBBED BRONZE**
CF5100ORB - Blade Select Series Blades (Sold Separately)
- B. **PENBROOKE SELECT – SATIN WHITE**
CF5100SW - Blade Select Series Blades (Sold Separately)
- C. **PENBROOKE SELECT – BRUSHED STEEL**
CF5100BS - Blade Select Series Blades (Sold Separately)
- D. **PENBROOKE SELECT – VINTAGE STEEL**
CF5100VS - Blade Select Series Blades (Sold Separately)

Included



SMOOTH AND PULL CHAIN SWITCHCUPS

Optional Controls



SR600
6-Speed Remote Control
pg 157



SW605
6-Speed Wall Control
pg 157



BLADE SELECT SERIES BLADES
pg 148

Recommended Accessories

Sold Separately



LK GLO SERIES
LED Light Fixture
pg 153



RC188
Horseshoe Receiver
pg 158



AL200
LED Light Accessory
pg 156

¹ B79 Blades not recommended for use on the CF5100.

² Installation option for use with accessory control and transmitter. Secondary switch cup does not have pull chain or reverse switch holes.

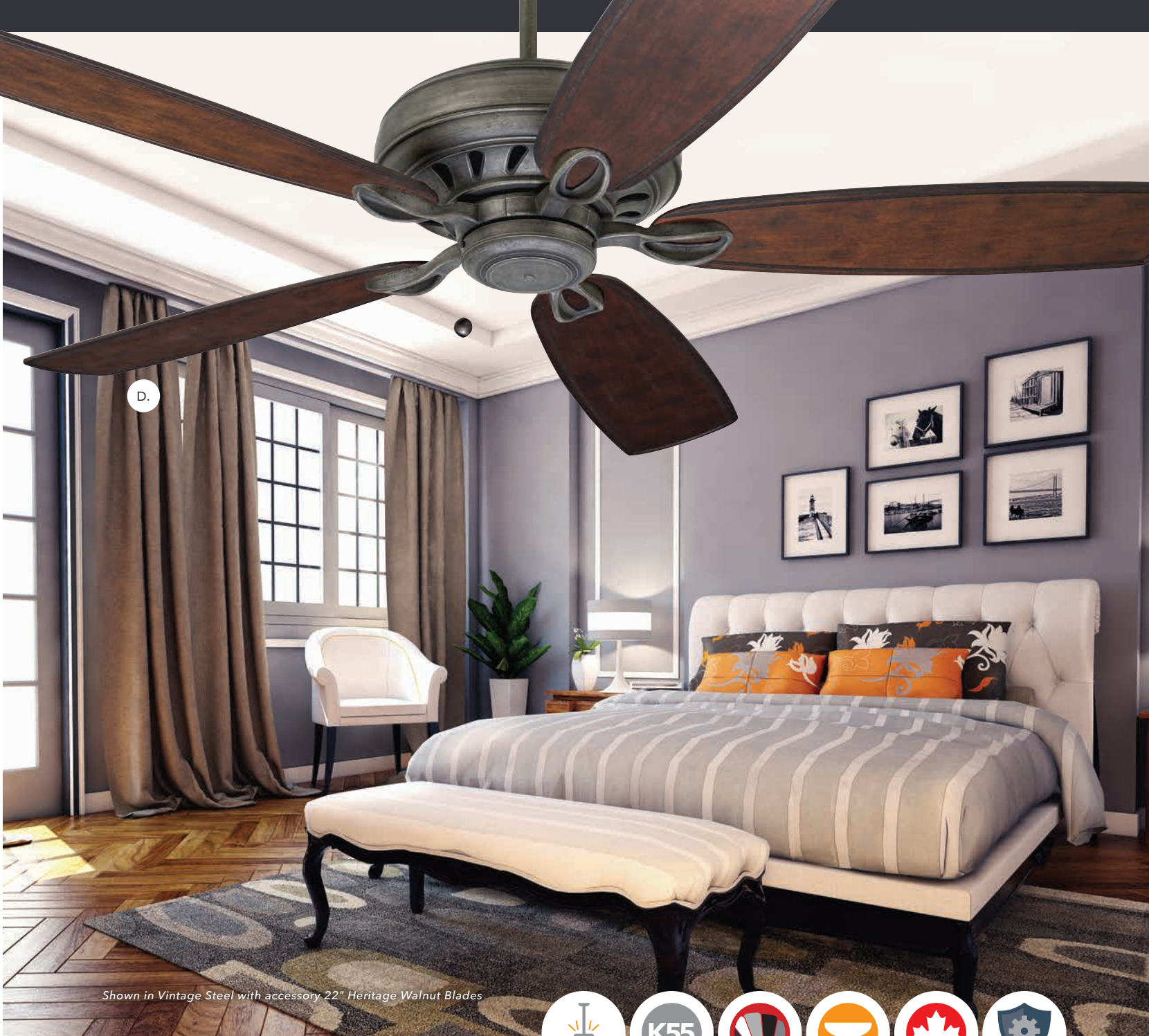

Shown in Vintage Steel with accessory 22" Heritage Walnut Blades



Penbrooke Select

MODEL FEATURES

- 44", 54", 60" or 72" Blade Span
- Blades Sold Separately (see pg 149-150)
- 4.5" Downrod Included
- Light Fixture and Accent Light Adaptable
- "Smooth" and Pull Chain Switchcup

13.0"

FAN HEIGHT

Energy Guide Information

Airflow Cubic Ft Per Min.	Electricity Use Watts (Excl. Lights)	Airflow Efficiency Cubic Ft Per Min. Per Watt	Estimated Yearly Cost Cost Range of Similar Models (19" - 84")
3540	56	64	\$16

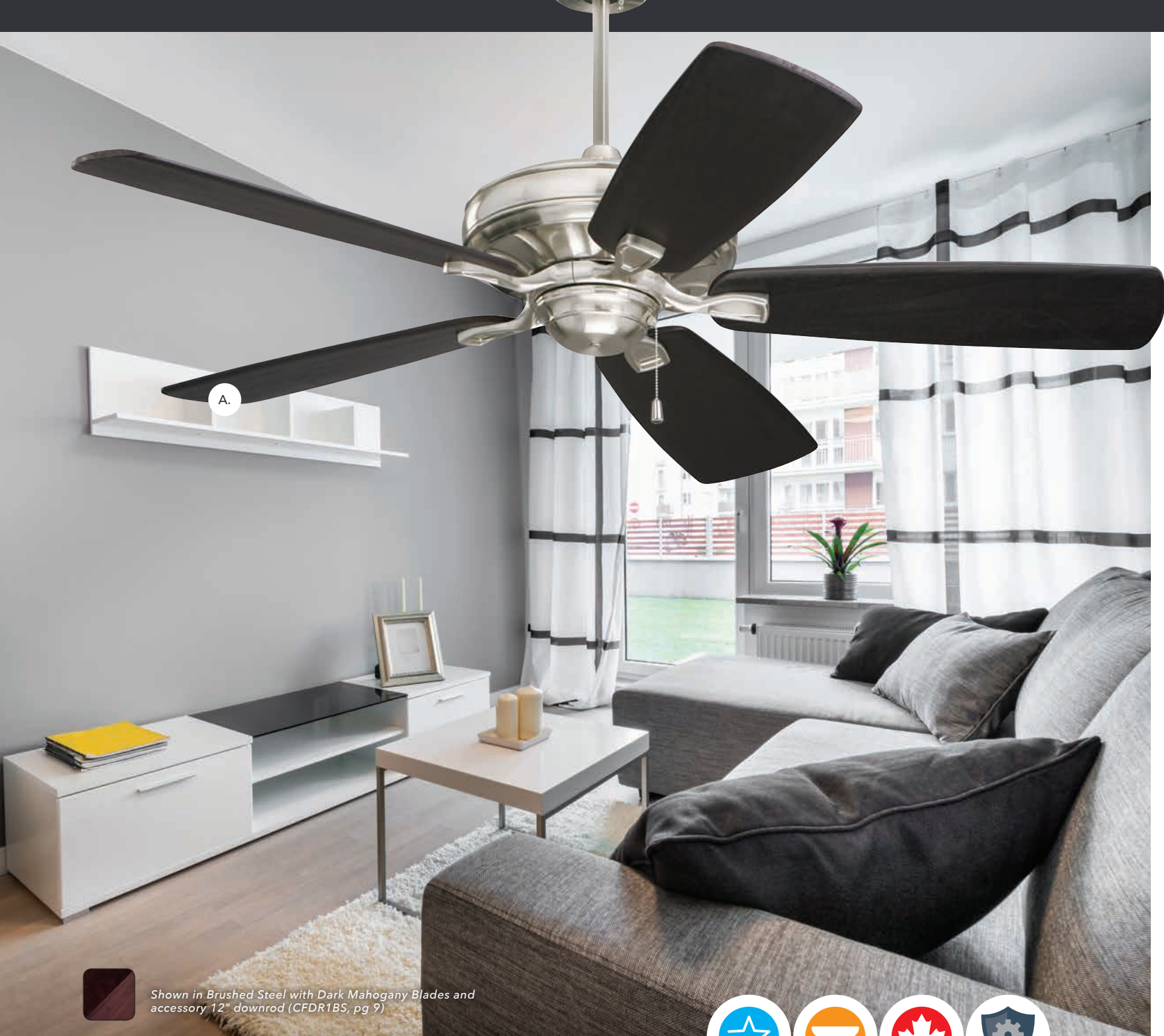

A.



Shown in Brushed Steel with Dark Mahogany Blades and accessory 12" downrod (CFDR1BS, pg 9)



Carrera®

MODEL FEATURES

- 60" Blade Span
- Light Fixture Adaptable
- 4.5" Downrod Included

14.5"



FAN HEIGHT

Energy Guide Information

Airflow Cubic Ft Per Min.	Electricity Use Watts (Excl. Lights)	Airflow Efficiency Cubic Ft Per Min. Per Watt	Estimated Yearly Cost Cost Range of Similar Models (19" - 84")
4339	57	76	\$16



B. Shown in Oil Rubbed Bronze with Walnut Blades and accessory 12" downrod (CFDR1ORB, pg 9)



C. Shown in Satin White with Satin White Blades



D. Shown in Golden Espresso with Chocolate Blades and accessory 12" downrod (CFDR1GES, pg 9)

- A. **CARRERA – BRUSHED STEEL**
CF784BS - Dark Mahogany/Walnut Blades
- B. **CARRERA – OIL RUBBED BRONZE**
CF784ORB - Dark Mahogany/Walnut Blades
- C. **CARRERA – SATIN WHITE**
CF784SW - Satin White/Maple Blades
- D. **CARRERA – GOLDEN ESPRESSO**
CF784GES - Dark Cherry/Chocolate Blades



Included



**5 REVERSIBLE
BLADES**



**SMOOTH AND PULL CHAIN
SWITCHCUPS¹**

Optional Controls



SR600
6-Speed
Remote Control
pg 157



RC188
Horseshoe
Receiver
pg 158

Recommended Accessories

Sold Separately



LK GLO SERIES
LED Light Fixture
pg 153



**ACCESSORY
DOWNROD**
pg 9

¹ Installation option for use with accessory control and transmitter. Secondary switch cup does not have pull chain or reverse switch holes.

Carrera® Grande Eco



A. Shown in Gilded Bronze with accessory 22" Dark Oak Hand Carved Blades (B100DO, pg 150)



B. Shown in Satin White with accessory 25" Solid Wood Satin White Blades (B78SW, pg 149)



C. Shown in Venetian Bronze with accessory 22" Honey Oak Blades (G54HO, pg 149)



D. Shown in Antique Pewter with accessory 31" Chocolate Solid Wood Blades (B79CH, pg 149) and accessory 12" Downrod (pg 9)



E. Shown in Oil Rubbed Bronze with accessory 22" Riverwash Blades (G54RW, 150)



F. Shown in Vintage Steel with accessory 54" Dark Mahogany Blades (G54DM, pg 150)



G. Shown in Brushed Steel with accessory 22" Walnut Blades (G54WA, pg 150)

- A. **CARRERA GRANDE® ECO – GILDED BRONZE**
CF788GBZ - Blade Select Series Blades (Sold Separately)
- B. **CARRERA GRANDE® ECO – SATIN WHITE**
CF788SW - Blade Select Series Blades (Sold Separately)
- C. **CARRERA GRANDE® ECO – VENETIAN BRONZE**
CF788VNB - Blade Select Series Blades (Sold Separately)
- D. **CARRERA GRANDE® ECO – ANTIQUE PEWTER²**
CF788AP - Blade Select Series Blades (Sold Separately)
- E. **CARRERA GRANDE® ECO – OIL RUBBED BRONZE**
CF788ORB - Blade Select Series Blades (Sold Separately)
- F. **CARRERA GRANDE® ECO – VINTAGE STEEL**
CF788VS - Blade Select Series Blades (Sold Separately)
- G. **CARRERA GRANDE® ECO – BRUSHED STEEL**
CF788BS - Blade Select Series Blades (Sold Separately)
- H. **CARRERA GRANDE® ECO – GOLDEN ESPRESSO**
CF788GES - Blade Select Series Blades (Sold Separately)

Included



SR401
4-Speed
Remote Control
pg 157

Optional Controls



SR650³
2-in-1
6-Speed
Remote Control
pg 157



SR600³
6-Speed
Remote Control
with Receiver
pg 157

Recommended Accessories

Sold Separately



**BLADE SELECT
SERIES BLADES**
pg 148



LK GLO SERIES
LED Light Fixture
pg 153

1 Energy Star testing completed with B78 blade series.
2 Damp Location rated for GES, SW, VNB, GBZ & ORB finishes only. AP finish not suitable for Damp Locations.
3 Controls are recommended for indoor use only.



Shown in Golden Espresso with accessory 25" Hand Carved Classic Vintage Black Blades (B90VBL, pg 149) and accessory Riley LED Light Fixture (LK180LEDBS, pg 154)



Carrera Grande® Eco

MODEL FEATURES

- 44", 54", 60" or 72" Blade Span
- Blades Sold Separately (see pg 149-150)
- 6-Speed Wall Control with Receiver
- Light Fixture Adaptable
- 4.5" Downrod Included

14.5"



FAN HEIGHT

Energy Guide Information

Airflow Cubic Ft Per Min.	Electricity Use Watts (Excl. Lights)	Airflow Efficiency Cubic Ft Per Min. Per Watt	Estimated Yearly Cost Cost Range of Similar Models (19" - 84")
4284	23	188	\$6



B.



Shown in Venetian Bronze with Dark Mahogany Blades and Vintage Cream Glass



Laclede Eco

MODEL FEATURES

- 62" Blade Span
- Integrated Light Fixture Uses Five 13-watt medium base compact fluorescent bulbs *(included)* and the accent light uses four 13-watt medium base compact fluorescent bulbs *(included)*
- 10" Downrod Included
- 5 Reversible Blades
- 6-Speed Remote Control with Receiver
- Removable Decorative Sleeve

20.0" 
FAN HEIGHT

Energy Guide Information

Airflow Cubic Ft Per Min.	Electricity Use Watts (Excl. Lights)	Airflow Efficiency Cubic Ft Per Min. Per Watt	Estimated Yearly Cost Cost Range of Similar Models (19" - 84")
4965	20	254	\$5



A. Shown in Brushed Steel with Dark Mahogany Blades and Opal Matte Glass



A. Shown in Brushed Steel with Charcoal Blades and Opal Matte Glass



B. Shown in Venetian Bronze with Walnut Blades and Vintage Cream Glass

A. **LACLEDE ECO – BRUSHED STEEL**
CF995BS - Dark Mahogany/Charcoal Blades,
 Opal Matte Glass

B. **LACLEDE ECO – VENETIAN BRONZE**
CF995VNB - Dark Mahogany/Walnut Blades,
 Vintage Cream Glass



Included



**5 REVERSIBLE
 BLADES**



**REMOVABLE DECORATIVE
 SLEEVE**



SR600
 6-Speed
 Remote Control
 with Receiver

Optional Control



SW605
 6-Speed
 Wall Control
 pg 157

Amhurst LED



NOW FEATURING!
LED Lighting



A. Shown in Brushed Steel with Chocolate Blades and Opal Matte Glass



B. Shown in Venetian Bronze with Honey Oak Blades and Vintage Cream Glass

- A. **AMHURST – BRUSHED STEEL**
CF880LBS - Dark Mahogany/Chocolate Blades, Opal Matte Glass

- B. **AMHURST – VENETIAN BRONZE**
CF880LVNB - Dark Cherry/Honey Oak Blades, Vintage Cream Glass

- C. **AMHURST – VINTAGE STEEL**
CF880LVS - Riverwash/Walnut Blades, Vintage Cream Glass

Included



**5 REVERSIBLE
BLADES**



**INTEGRATED DIMMABLE
LED Light Fixture**



SW405
4-Speed
Wall Control
with Receiver
pg 157

Optional Control



SR401
4-Speed
Remote Control
pg 157

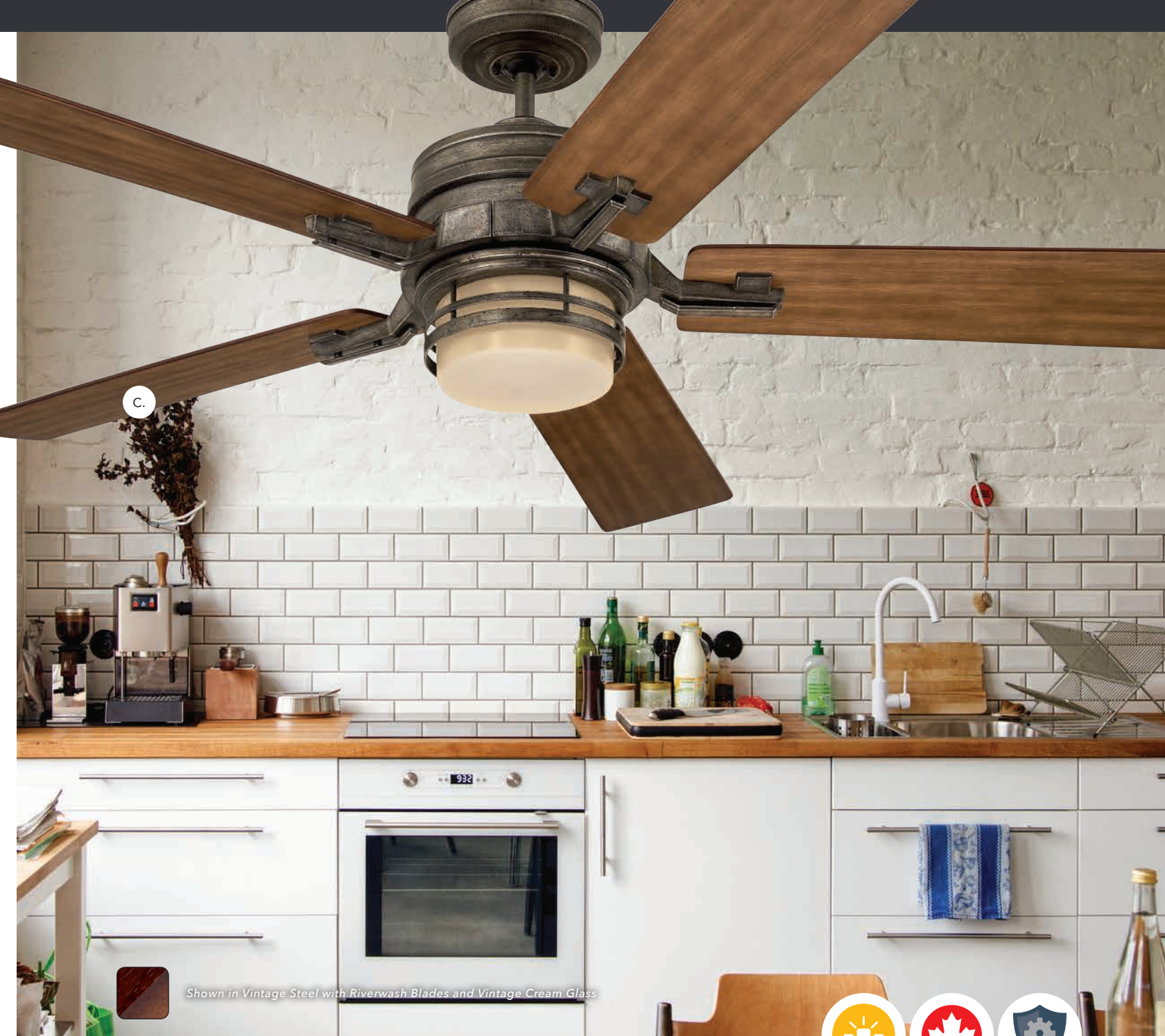

c.

Shown in Vintage Steel with Riverwash Blades and Vintage Cream Glass



Amhurst LED

MODEL FEATURES

- 54" Blade Span
- 5 Reversible Blades
- Integrated Dimmable LED Light Fixture
- 4-Speed Wall Control with Receiver
- 4.5" Downrod Included

15.1"



FAN HEIGHT

Energy Guide Information

Airflow Cubic Ft Per Min.	Electricity Use Watts (Excl. Lights)	Airflow Efficiency Cubic Ft Per Min. Per Watt	Estimated Yearly Cost Cost Range of Similar Models (19" - 84")
3737	44	84	\$12



Shown in Brushed Steel with Dark Cherry Blades



52" Monterey II

MODEL FEATURES

- 5 Reversible Blades
- Light Fixture Adaptable
- 4.5" Downrod Included

15.0"

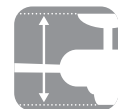

FAN HEIGHT

Energy Guide Information

Airflow Cubic Ft Per Min.	Electricity Use Watts (Excl. Lights)	Airflow Efficiency Cubic Ft Per Min. Per Watt	Estimated Yearly Cost Cost Range of Similar Models (19" - 84")
3726	41	91	\$11



A. Shown in Oil Rubbed Bronze with Dark Cherry Blades



C. Shown in Satin White with Satin White Blades

- A. **MONTEREY II – OIL RUBBED BRONZE**
CF772ORB - Dark Cherry/Walnut Blades
- B. **MONTEREY II – BRUSHED STEEL**
CF772BS - Dark Cherry/Dark Mahogany Blades
- C. **MONTEREY II – SATIN WHITE**
CF772SW - Satin White/Maple Blades

Included



**5 REVERSIBLE
BLADES**

Optional Controls



SR400
4-Speed
Remote Control
with Receiver
pg 157



SW405
4-Speed
Wall Control
with Receiver
pg 157

Recommended Accessories

Sold Separately



GLO SERIES
LED Light Fixture
pg 153



A. Shown in Venetian Bronze with Custom Hand Carved Dark Mahogany Blades and Amber Mist Glass



A. **BRADDOCK – VENETIAN BRONZE**
CF440VNB - Custom Hand Carved Dark Mahogany Blades, Amber Mist Glass

Included



**5 WOOD, HAND
CARVED BLADES**



SR400
4-Speed
Remote Control
with Receiver*

Optional Control



SW406
4-Speed
Wall Control
pg 157

* SR600 or SW605 must be used to control the accent light and the downlight separately. Please note that the SR400 (included) or the SW405/SW406 will operate the accent light and downlight simultaneously.



A.



Braddock

MODEL FEATURES

- 54" Blade Span
- 5 Custom Hand-Carved Wood Blades
- 4-Speed Remote Control with Receiver
- Integrated Light Fixture and Accent Light
- 4.5" Downrod Included

16.2"



FAN HEIGHT

Energy Guide Information

Airflow Cubic Ft Per Min.	Electricity Use Watts (Excl. Lights)	Airflow Efficiency Cubic Ft Per Min. Per Watt	Estimated Yearly Cost Cost Range of Similar Models (19" - 84")
4787	42	113	\$12



D.



Shown in Oil Rubbed Bronze with 52" Dark Mahogany Blades



52" & 42" Bella

MODEL FEATURES

- 5 Reversible Blades
- Light Fixture Adaptable
- 4.5" Downrod Included

14.0"



FAN HEIGHT

Energy Guide Information

Blade Span Inches	Airflow Cubic Ft Per Min.	Electricity Use Watts (Excl. Lights)	Airflow Efficiency Cubic Ft Per Min. Per Watt	Estimated Yearly Cost Cost Range of Similar Models (19" - 84")
42"	2993	36	82	\$10
52"	3104	40	77	\$11

52" & 42" Bella



A. Shown in Brushed Steel with 52" Walnut Blades and accessory LED Light Fixture (LK91LEDBS, pg 154)



B. Shown in Satin White with 52" Satin White Blades, Harlow Opal Matte Light Fixture (LK1500MSW, pg 154) and 12" downrod (CFDR1SW, pg 9)



C. Shown in Vintage Steel with 52" Dark Mahogany Blades

- A. **52" BELLA – BRUSHED STEEL**
CF452BS - Dark Cherry/Walnut Blades
- B. **52" & 42" BELLA – SATIN WHITE**
CF452SW - 52" Satin White/Maple Blades
CF442SW - 42" Satin White/Maple Blades
- C. **52" BELLA – VINTAGE STEEL**
CF452VS - 52" Dark Mahogany/Walnut Blades
- D. **52" & 42" BELLA – OIL RUBBED BRONZE**
CF452ORB - 52" Dark Mahogany/Walnut Blades
CF442ORB - 42" Dark Mahogany/Walnut Blades



Included



5 REVERSIBLE BLADES

Optional Controls



SR400
4-Speed Remote Control with Receiver
pg 157



SW405
4-Speed Wall Control with Receiver
pg 157

Recommended Accessories

Sold Separately



LK GLO SERIES
LED Light Fixture
pg 153



LK53
Low Profile Light Fixture
pg 153



LK92XXX
Ashton Light Fixture
pg 153

* SR600 or SW605 must be used to control the accent light and the downlight separately. Please note that the SR400 (included) or the SW405/SW406 will operate the accent light and downlight simultaneously.



52" & 44" Curva™ LED Indoor
CF253L/CF245L



MODERN

Whether for a high-rise penthouse or a man-cave, this sleek collection features design aesthetics and finishes to enhance today's home fashions.



SWEEP ECO
CF275 - pg 37



60" & 72" RAH ECO
CF915 - pg 39



ION ECO
CF5300 - pg 41



IDEAL
CF330 - pg 43



EUCLID
CF500 - pg 45



VELOCE
CF230 - pg 47



KEANE
CF320 - pg 49



LURAY ECO
CF860 - pg 51



AIRA ECO LED
CF985L - pg 53



HIGHRISE
CF430 - pg 55



4TH AVENUE LED
CF766L - pg 57



MIDWAY ECO LED
CF955L - pg 59





LUXE ECO LED
CF550L - pg 61



HIGHPOINTE LED
CF205L - pg 63



LOFT
CF765 - pg 65



**52" & 44" CURVA™ SKY
LED INDOOR**
CF153L/CF145L - pg 67



**52" & 44" CURVA™ SKY
LED OUTDOOR**
CF152L/CF144L - pg 69



**52" & 44" CURVA™
LED INDOOR**
CF253L/CF245L - pg 71



**52" & 44" CURVA™
LED OUTDOOR**
CF252L/CF244L - pg 73



ATOMICAL
CF930 - pg 75



VOLTA
CF590 - pg 77



TILO
CF130 - pg 79

*Certain finishes only. See fan pages for details.



Shown in Barbeque Black Finish with Barbeque Black Blades



Sweep Eco

MODEL FEATURES

- 60" Blade Span
- 3 Custom Blades
- 6-Speed LED Wall Control with Receiver
- Integrated Dimmable LED Light Fixture
- EcoMotor



FAN HEIGHT

Energy Guide Information

Airflow Cubic Ft. Per Min.	Electricity Use Watts (Excl. Lights)	Airflow Efficiency Cubic Ft. Per Min. Per Watt	Estimated Yearly Cost Cost Range of Similar Models (19" - 84")
4412	14	318	\$4

NEW!

Sweep Eco



B. Shown in Satin White Finish with Satin White Blades



C. Shown in Brushed Steel Finish with Brushed Steel Blades



D. Shown in Graphite Finish with Graphite Blades

- A. **SWEEP ECO – BARBEQUE BLACK**
CF275BQ - Barbeque Black Blades
- B. **SWEEP ECO – SATIN WHITE**
CF275SW - Satin White Blades
- C. **SWEEP ECO – BRUSHED STEEL**
CF275BS - Brushed Steel Blades
- D. **SWEEP ECO – GRAPHITE**
CF275GRT - Graphite Blades



Included



**3 CUSTOM
BLADES**



**INTEGRATED DIMMABLE
LED Light Fixture**

LED Specifications

- 1,500 Lumens
- 90+ CRI
- 3,000 K CCT



SR600
6-Speed
Remote Control

Optional Control



SW605
6-Speed
Wall Control
pg 157

NEW!

Rah Eco



B. Shown in Oil Rubbed Bronze Finish with Sunburst Walnut Blades



C. Shown in Oil Rubbed Bronze Finish with Sunburst Walnut Blades



D. Shown in Brushed Steel Finish with Sunburst Walnut Blades

- A. **72" RAH ECO – BRUSHED STEEL**
CF915W72BS - Sunburst Walnut Blades
- B. **72" RAH ECO – OIL RUBBED BRONZE**
CF915W72ORB - Sunburst Walnut Blades
- C. **60" RAH ECO – OIL RUBBED BRONZE**
CF915W60ORB - Sunburst Walnut Blades
- D. **60" RAH ECO – BRUSHED STEEL**
CF915W60BS - Sunburst Walnut Blades

M

Included



**6 DECORATIVE
BLADE MEDALLIONS**

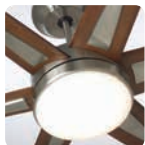

**INTEGRATED DIMMABLE
LED Light Fixture**

LED Specifications

- 2,400 Lumens
- 90+ CRI
- 3,000 K CCT



SR600
6-Speed
Remote Control

Optional Control



SW605
6-Speed
Wall Control
pg 157



Shown in Brushed Steel Finish with 72" Walnut Blades



*Certain finishes only. See fan pages for details

Rah Eco

MODEL FEATURES

- 60" or 72" Blade Spans
- 6 Custom Blades
- 6" Downrod Included
- Integrated Dimmable LED Light Fixture
- 6-Speed Remote Control with Receiver
- EcoMotor

17.75"



FAN HEIGHT

Energy Guide Information

Blade Span	Airflow	Electricity Use	Airflow Efficiency	Estimated Yearly Cost
Inches	Cubic Ft. Per Min.	Watts (Excl. Lights)	Cubic Ft. Per Min. Per Watt	Cost Range of Similar Models (19" - 84")
60"	4644	21	220	\$6
72"	5152	22	239	\$6



Shown in Graphite with 22" Timber Gray Blades (B77TM, pg 150)



Ion Eco

MODEL FEATURES

- 44", 54", 60", or 72" Blade Span
- Blades Sold Separately
- Integrated Dimmable LED Light Fixture
- Blade Select Series
- 6-Speed Control with Receiver



FAN HEIGHT

Energy Guide Information (not available at time of printing)

Airflow Cubic Ft. Per Min.	Electricity Use Watts (Excl. Lights)	Airflow Efficiency Cubic Ft. Per Min. Per Watt	Estimated Yearly Cost Cost Range of Similar Models (19" - 84")
N/A	N/A	N/A	N/A



A. Shown in Brushed Steel with 25" Dark Mahogany Blades (G60DM, pg 156)



B. Shown in Oil Rubbed Bronze with 25" Walnut Blades (G60WA, pg 156)



C. Shown in Satin White with 22" Charcoal Blades (B77CR, pg 149)

- A. **ION ECO – BRUSHED STEEL**
CF5300BS - Blade Select Series Blades (Sold Separately)
- B. **ION ECO – OIL RUBBED BRONZE**
CF5300ORB - Blade Select Series Blades (Sold Separately)
- C. **ION ECO – SATIN WHITE**
CF5300SWS - Blade Select Series Blades (Sold Separately)
- D. **ION ECO – GRAPHITE**
CF5300GRT - Blade Select Series Blades (Sold Separately)



Included



- LED Specifications**
- 1,500 Lumens
 - 90+ CRI
 - 3,000 K CCT

INTEGRATED DIMMABLE
LED Light Fixture



SW605
6-Speed
Wall Control

Optional Control



SR600
6-Speed
Remote Control
pg 157

Ideal Eco



A. Shown in Barbeque Black with Polished Nickel Accents and Barbeque Black Blades



B. Shown in Satin White with Polished Nickel Accents and Satin White Blades



C. Shown in Graphite with Brushed Nickel Accents and Graphite Blades



E. Shown in Satin White with Satin Gold Accents and Satin White Blades

A. **IDEAL ECO – BARBEQUE BLACK**
CF330BQ - Barbeque Black Blades,
Polished Nickel Accents

B. **IDEAL ECO – SATIN WHITE**
CF330SW - Satin White Blades,
Polished Nickel Accents

C. **IDEAL ECO – GRAPHITE**
CF330GRT - Graphite Blades,
Brushed Nickel Accents

D. **IDEAL ECO – BARBEQUE BLACK**
CF330GBQ - Barbeque Black Blades,
Satin Gold Accents

E. **IDEAL ECO – SATIN WHITE**
CF330GSW - Satin White Blades,
Satin Gold Accents

Included



INTEGRATED DIMMABLE
LED Light Fixture

LED Specifications

- 2,000 Lumens
- 20 Watts
- 95 CRI
- 3,000 K CCT



SW605
6-Speed
Wall Control
with Receiver

Optional Control



SR600
6-Speed
Remote Control
pg 157

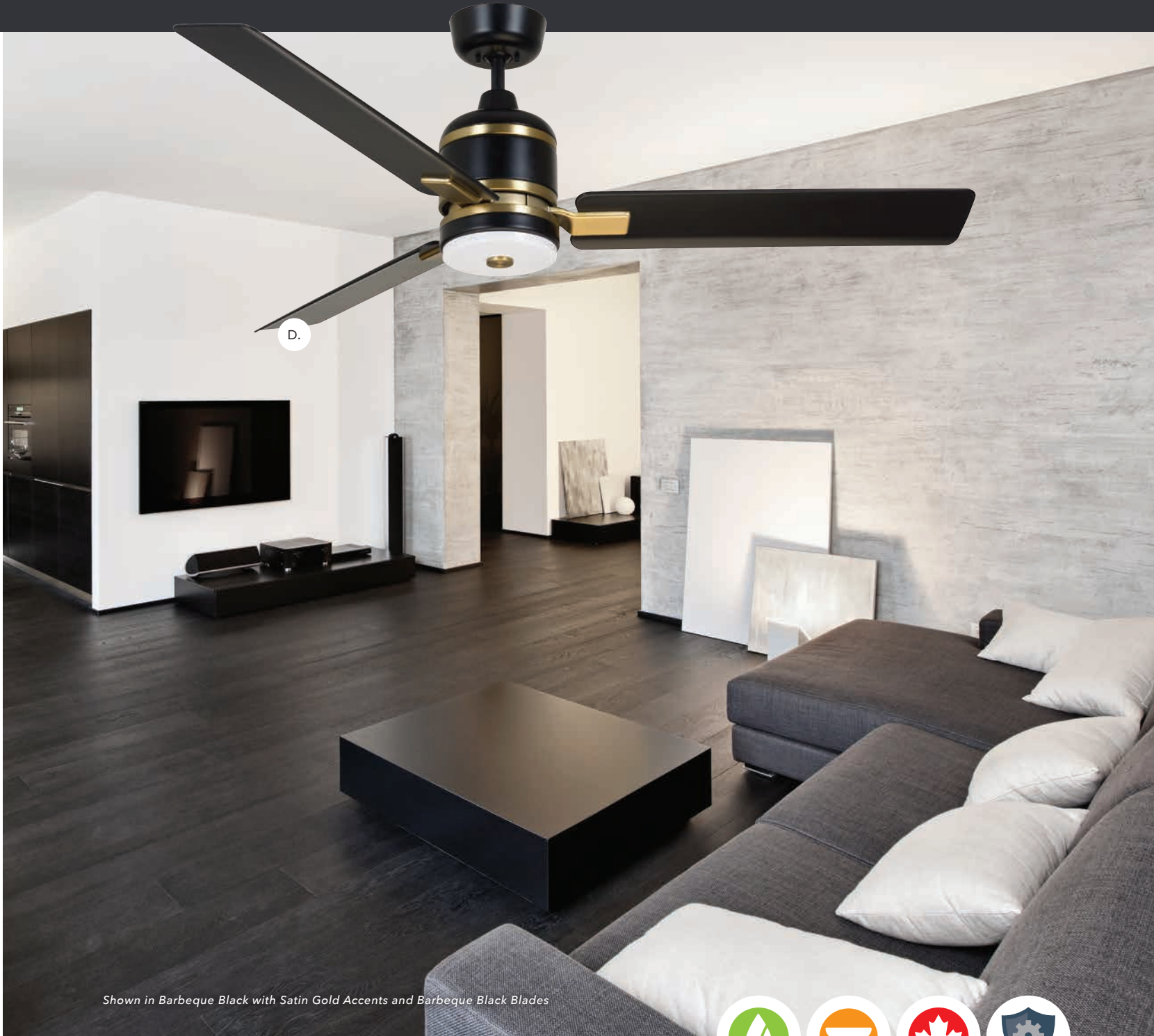

Shown in Barbeque Black with Satin Gold Accents and Barbeque Black Blades



Ideal Eco

MODEL FEATURES

- 54" Blade Span
- 3 Custom Blades
- Integrated Dimmable LED Light Fixture
- 6-Speed Wall Control with Receiver
- 4.5" Downrod Included
- EcoMotor

14.4"

FAN HEIGHT

Energy Guide Information

Airflow Cubic Ft. Per Min.	Electricity Use Watts (Excl. Lights)	Airflow Efficiency Cubic Ft. Per Min. Per Watt	Estimated Yearly Cost Cost Range of Similar Models (19" - 84")
3989	20	199	\$6



Shown in Brushed Steel with Natural Cherry Blades



Euclid

MODEL FEATURES

- 56" Blade Span
- 5 Reversible Blades
- 4-Speed Wall Control
- Light Fixture Adaptable
- 4.5" Downrod Included



Custom Accessory Euclid Light Fixture

Designed to complement the Euclid Ceiling Fan, but also fits all other light fixture adaptable Emerson ceiling fans. Uses (3) 9.5 Watt Medium Base A19 LED Bulbs (included).

Available in four finishes:

- Brushed Steel (LK500BS)
- Oil Rubbed Bronze (LK500ORB)
- Antique Pewter (LK500AP)
- Satin White (LK500SW)



14"
FAN HEIGHT

Energy Guide Information

Airflow Cubic Ft. Per Min.	Electricity Use Watts (Excl. Lights)	Airflow Efficiency Cubic Ft. Per Min. Per Watt	Estimated Yearly Cost Cost Range of Similar Models (19" - 84")
4058	44	93	\$12



B. Shown in Oil Rubbed Bronze with Dark Mahogany Blades and accessory Euclid light fixture (LK500ORB, pg 155)



C. Shown in Antique Pewter with Timber Gray Blades

A. **EUCLID – BRUSHED STEEL**
CF500BS - Walnut/Natural Cherry Blades

B. **EUCLID – OIL RUBBED BRONZE**
CF500ORB - Dark Cherry/Dark Mahogany Blades

C. **EUCLID – ANTIQUE PEWTER**
CF500AP - Charcoal/Timber Gray Blades



Included



SW46
4-Speed
Slide Control



LK500XXX
Euclid LED
Light Fixture
pg 155



RC188
Horseshoe
Receiver
pg 157



SR600
6-Speed
Remote Control
(Pair with RC188)
pg 157



SR400
6-Speed
Remote Control
with Receiver
pg 157

Recommended Accessories

Sold Separately

Veloce



B. Shown in Brushed Steel with Chocolate Blades and CP230BS Optional No-Light Plate



M

A. **VELOCE – BRUSHED STEEL**
CF230BS - Brushed Steel/Chocolate Blades

B. **VELOCE – BRUSHED STEEL**
CF230BS - Brushed Steel/Chocolate Blades

Included



4 REVERSIBLE BLADES



INTEGRATED
Light Fixture



DUAL-MOUNT
FEATURE



SR400
4-Speed
Remote Control
with Receiver

Optional Control



SW605
6-Speed
Wall Control
pg 157

**Recommended
Accessories**

Sold Separately



CP230BS
No-Light Plate

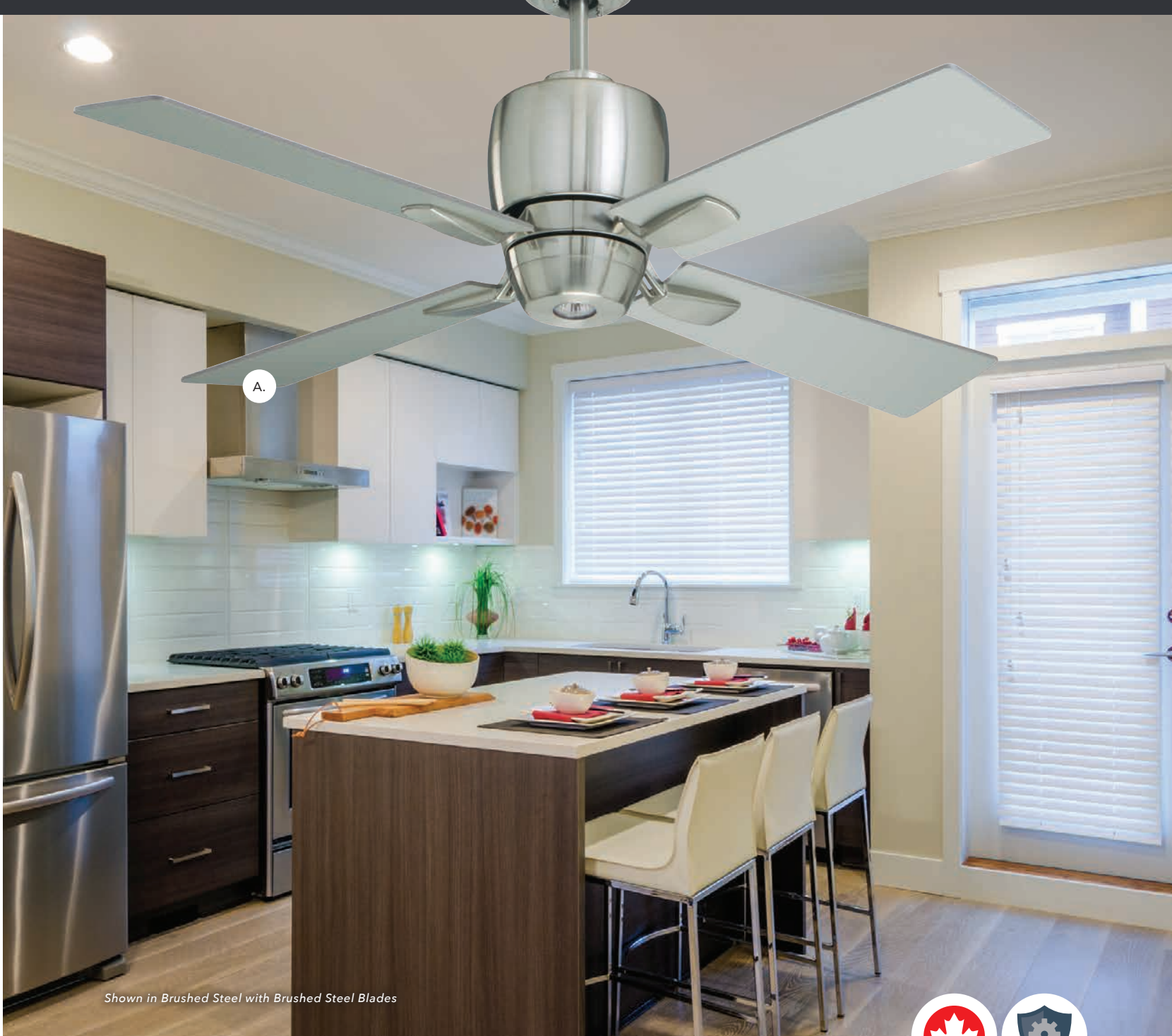

Shown in Brushed Steel with Brushed Steel Blades



Veloce

MODEL FEATURES

- 46" Blade Span
- 4 Reversible Blades
- Dual-Mount Feature
- Integrated Light Fixture
- 4-Speed Remote Control with Receiver
- 4.5" Downrod Included

14.4"
11.1"



FAN HEIGHT

Energy Guide Information

Airflow Cubic Ft. Per Min.	Electricity Use Watts (Excl. Lights)	Airflow Efficiency Cubic Ft. Per Min. Per Watt	Estimated Yearly Cost Cost Range of Similar Models (19" - 84")
3049	36	84	\$10

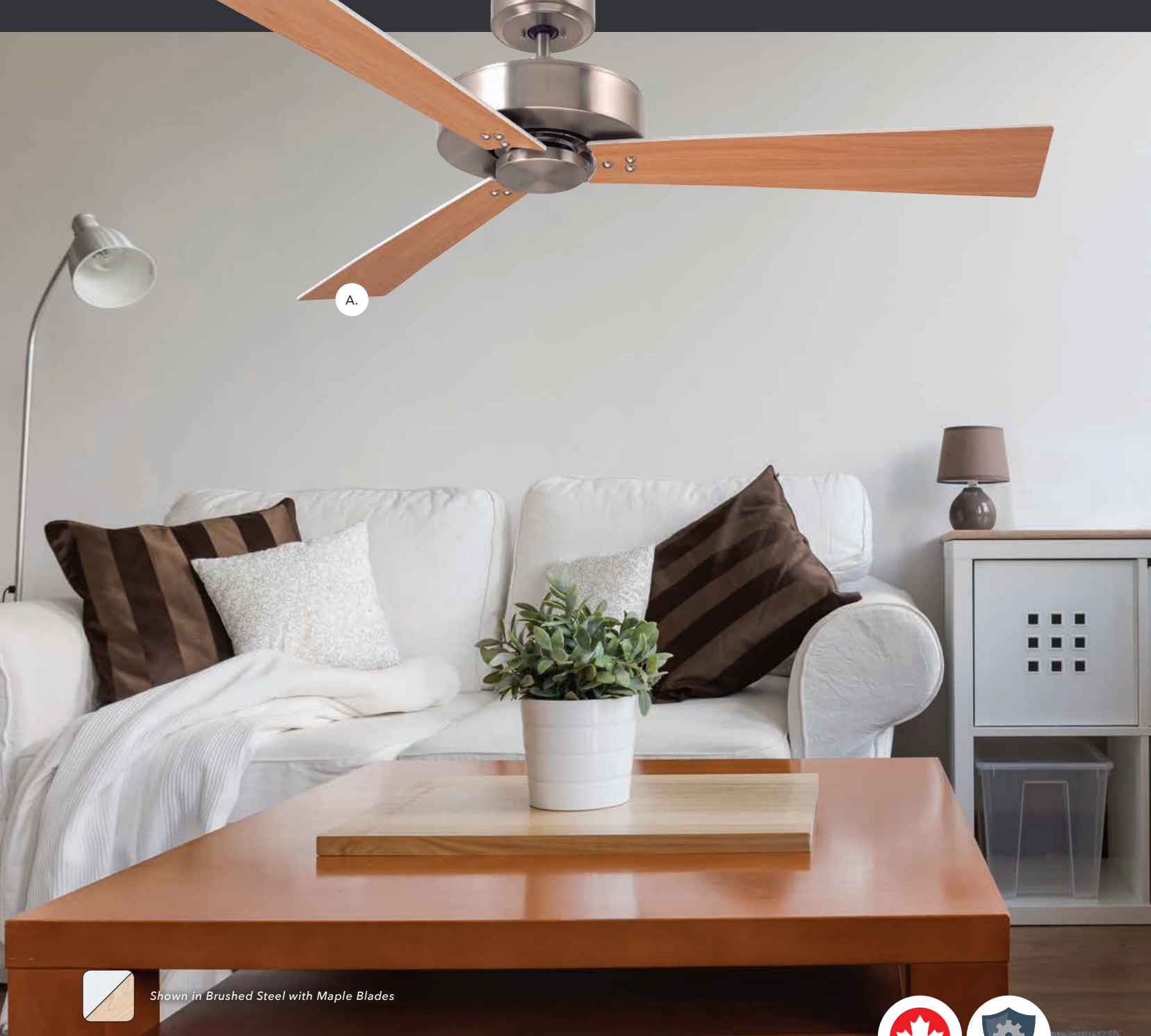

A.



Shown in Brushed Steel with Maple Blades



Keane

MODEL FEATURES

- 52" Blade Span
- 3 Reversible Blades
- 4.5" Downrod Included
- 4-Speed Slide Control
- Not Light Fixture Adaptable

10.9"



FAN HEIGHT

Energy Guide Information

Airflow Cubic Ft. Per Min.	Electricity Use Watts (Excl. Lights)	Airflow Efficiency Cubic Ft. Per Min. Per Watt	Estimated Yearly Cost Cost Range of Similar Models (19" - 84")
3198	34	93	\$10



B. Shown in Brushed Steel with Barbeque Black Blades

C. Shown in Brushed Steel with Walnut Blades



D. Shown in Brushed Steel with Timber Gray Blades

E. Shown in Satin White with Satin White Blades



F. Shown in Satin White with Natural Cherry Blades

G. Shown in Satin White with Timber Gray Blades

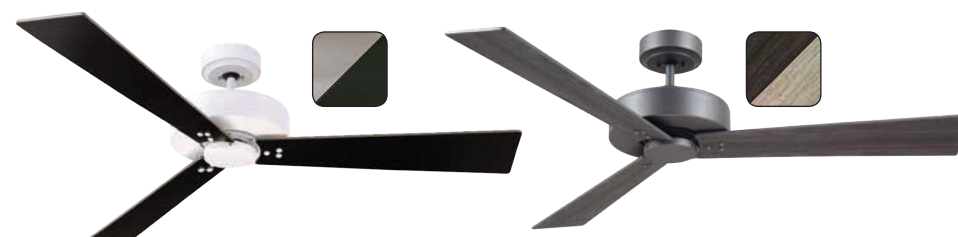

H. Shown in Satin White with Barbeque Black Blades

I. Shown in Graphite with Charcoal Blades



J. Shown in Graphite with Barbeque Blades

K. Shown in Graphite with Natural Cherry Blades

L. Shown in Graphite with Satin White Blades

A. **KEANE – BRUSHED STEEL**
CF320WBS - Satin White/Maple Blades

B. **KEANE – BRUSHED STEEL**
CF320SBS - Brushed Steel/
Barbeque Black Blades

C. **KEANE – BRUSHED STEEL**
CF320CBS - Natural Cherry/
Walnut Blades

D. **KEANE – BRUSHED STEEL**
CF320RBS - Charcoal/Timber Gray Blades

E. **KEANE – SATIN WHITE**
CF320WSW - Satin White/Maple Blades

F. **KEANE – SATIN WHITE**
CF320CSW - Natural Cherry/
Walnut Blades

G. **KEANE – SATIN WHITE**
CF320RSW - Charcoal/
Timber Gray Blades

H. **KEANE – SATIN WHITE**
CF320SSW - Brushed Steel/
Barbeque Black Blades

I. **KEANE – GRAPHITE**
CF320RGRT - Charcoal/
Timber Gray Blades

J. **KEANE – GRAPHITE**
CF320SGRT - Brushed Steel/
Barbeque Black Blades

K. **KEANE – GRAPHITE**
CF320CGRT - Natural Cherry/
Walnut Blades

L. **KEANE – GRAPHITE**
CF320WGRT - Satin White/Maple Blades



CF320 X XX

Keane model # **1** **2**

1. Choose blades



S:
Brushed Steel/
Barbeque Black

C:
Natural Cherry/
Walnut

W:
Satin White/
Maple

R:
Charcoal/
Timber Gray

2. Choose fan finish



BS:
Brushed Steel

SW:
Satin White

GRT:
Graphite

Included



**3 REVERSIBLE
BLADES**



SW46W
4-Speed
Fan Slide Control

Luray Eco



B. Shown in Barbeque Black with Barbeque Black Blades



C. Shown in Appliance White with Appliance White Blades

M

- A. **LURAY ECO – PLATINUM**
CF860PT - Platinum Blades
- B. **LURAY ECO – BARBEQUE BLACK**
CF860BQ - Barbeque Black Blades
- C. **LURAY ECO – APPLIANCE WHITE**
CF860WW - Appliance White Blades

Included



**3 CUSTOM
BLADES**



**INTEGRATED DIMMABLE
LED Light Fixture**

LED Specifications

- 2,600 Lumens
- 32 Watts
- 95 CRI
- 3,000 K CCT



**REMOVABLE
NO-LIGHT PLATE**



SW605¹
6-Speed
Wall Control



SR600¹
6-Speed
Remote Control
pg 157

Optional Control

¹ Controls recommended for indoor use only.

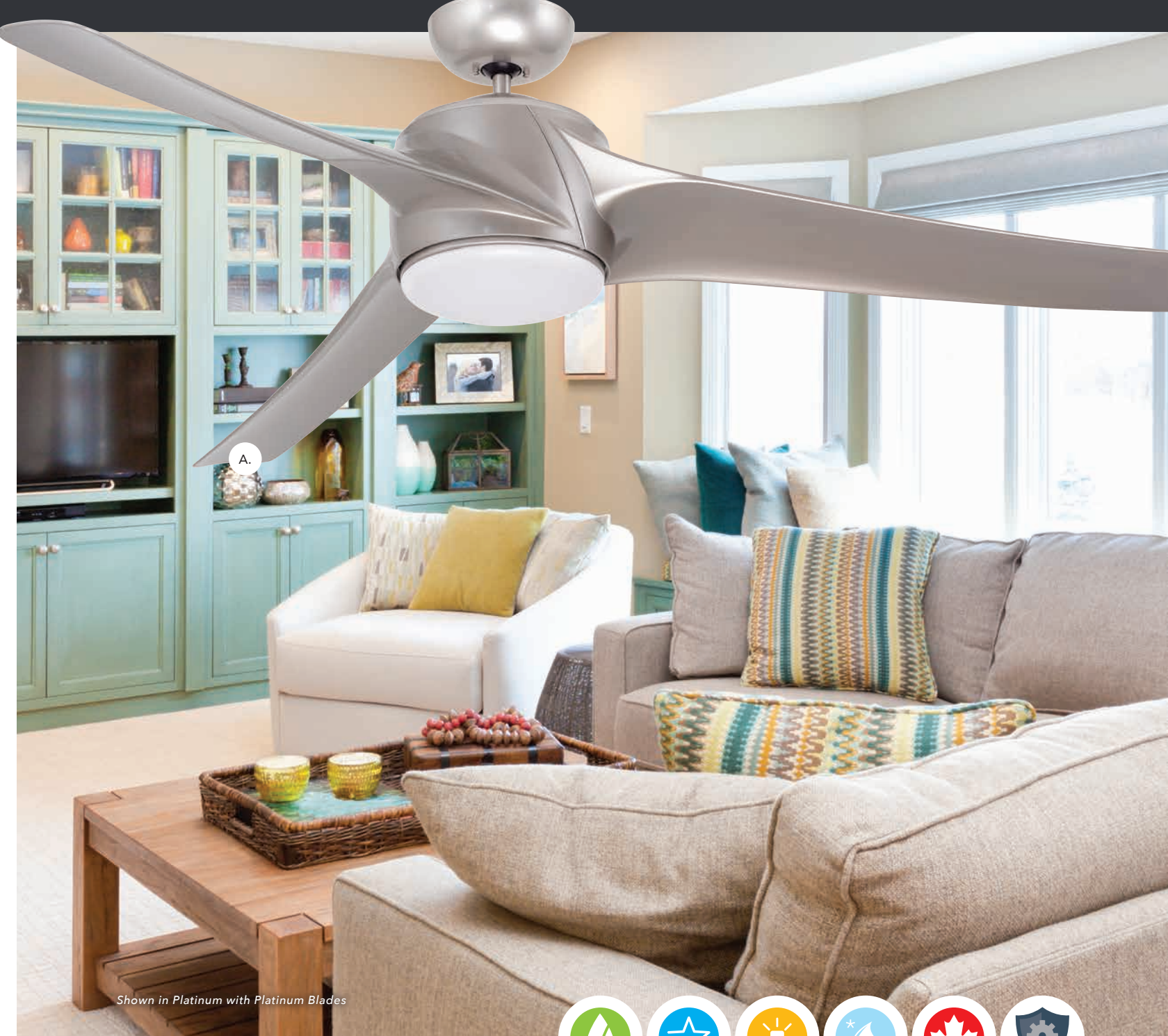

Shown in Platinum with Platinum Blades



*Certain finishes only. See fan pages for details

Luray Eco

MODEL FEATURES

- 60" Blade Span
- 3 Custom Blades
- Integrated Dimmable LED Light Fixture
- 6-Speed Wall Control with Receiver
- No-Light Option
- 4.5" Downrod Included



FAN HEIGHT

Energy Guide Information

Airflow Cubic Ft. Per Min.	Electricity Use Watts (Excl. Lights)	Airflow Efficiency Cubic Ft. Per Min. Per Watt	Estimated Yearly Cost Cost Range of Similar Models (19" - 84")
5787	20	295	\$6

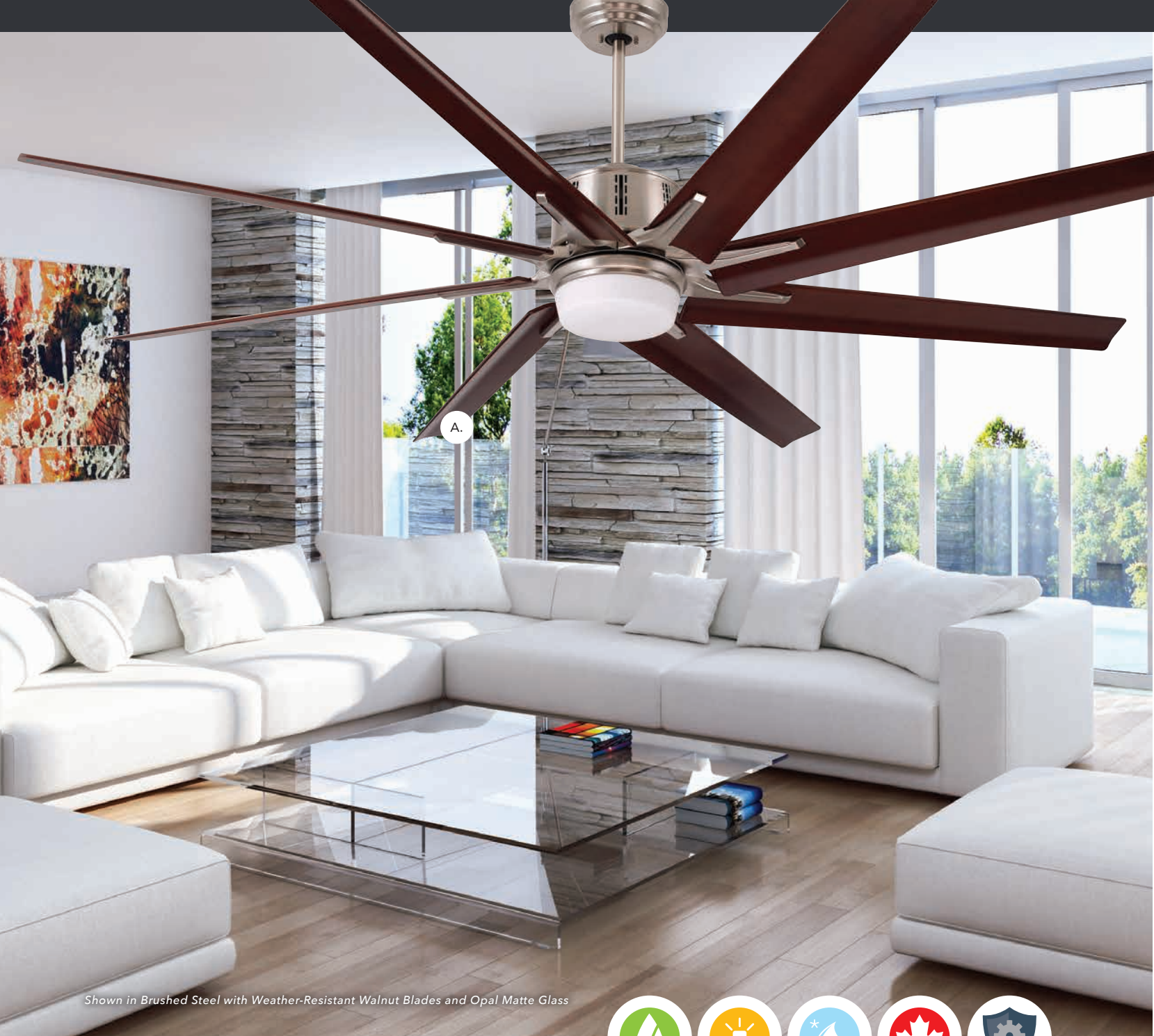

A.

Shown in Brushed Steel with Weather-Resistant Walnut Blades and Opal Matte Glass



*Certain finishes only. See fan pages for details

Aira Eco LED

MODEL FEATURES

- 72" Blade Span
- 8 Weather-Resistant Blades
- Integrated Dimmable LED Light Fixture
- 6-Speed Wall Control with Receiver
- 6" Downrod Included
- No-Light Option

12.5" 
FAN HEIGHT

Energy Guide Information

Airflow Cubic Ft. Per Min.	Electricity Use Watts (Excl. Lights)	Airflow Efficiency Cubic Ft. Per Min. Per Watt	Estimated Yearly Cost Cost Range of Similar Models (19" - 84")
5735	21	270	\$6



NOW FEATURING!
LED Lighting



B. Shown in Oil Rubbed Bronze with Weather-Resistant Walnut Blades and Opal Matte Glass



C. Shown in Graphite with Weather-Resistant Driftwood Blades and Opal Matte Glass



D. Shown in Platinum with Weather-Resistant Platinum Blades and Opal Matte Glass

- A. **AIRA ECO LED – BRUSHED STEEL¹**
CF985LBS - Walnut Blades
- B. **AIRA ECO LED – OIL RUBBED BRONZE**
CF985LORB - Walnut Blades
- C. **NEW! AIRA ECO LED – GRAPHITE**
CF985LGRT - Driftwood Blades
- D. **NEW! AIRA ECO LED – PLATINUM**
CF985LPT - Platinum Blades



Included



8 WEATHER RESISTANT BLADES



INTEGRATED DIMMABLE LED Light Fixture

LED Specifications

- 1,500 Lumens
- 18 Watts
- 90 CRI
- 3,000 K CCT



REMOVABLE NO-LIGHT PLATE



SW605²
6-Speed Wall Control



SR650²
6-Speed 2-in-1 Remote Control
pg 157



SR600²
6-Speed Remote Control
pg 157

Optional Controls

¹ Damp Location rated for ORB, GRT and PT finish. BS finish not suitable for damp locations
² Controls are recommended for indoor use only.

Highrise



A. Shown in Oil Rubbed Bronze with Natural Cherry Blades and Opal Matte Glass

M

- A. **HIGHRISE – BRUSHED STEEL**
CF430BS - Natural Cherry/Dark Mahogany Blades

- B. **HIGHRISE – OIL RUBBED BRONZE**
CF430ORB - Natural Cherry/Dark Mahogany Blades

Included



**4 REVERSIBLE
BLADES**



INTEGRATED LED
Light Fixture

LED Specifications

- 1,300 Lumens
- 17 Watts
- 80 CRI
- 3,000 K CCT



SW405
6-Speed
Wall Control
with Receiver

Optional Control



SR650²
6-Speed
2-in-1
Remote Control
pg 157



A.

Shown in Brushed Steel with Dark Mahogany Blades and Opal Matte Glass



Highrise

MODEL FEATURES

- 50" Blade Span
- 4 Reversible Blades
- Integrated LED Light Fixture
- 6-Speed Wall Control with Receiver
- 4.5" Downrod Included

13.5" 
FAN HEIGHT

Energy Guide Information

Airflow Cubic Ft. Per Min.	Electricity Use Watts (Excl. Lights)	Airflow Efficiency Cubic Ft. Per Min. Per Watt	Estimated Yearly Cost Cost Range of Similar Models (19" - 84")
3036	33	93	\$9



NOW FEATURING!
LED Lighting

C.

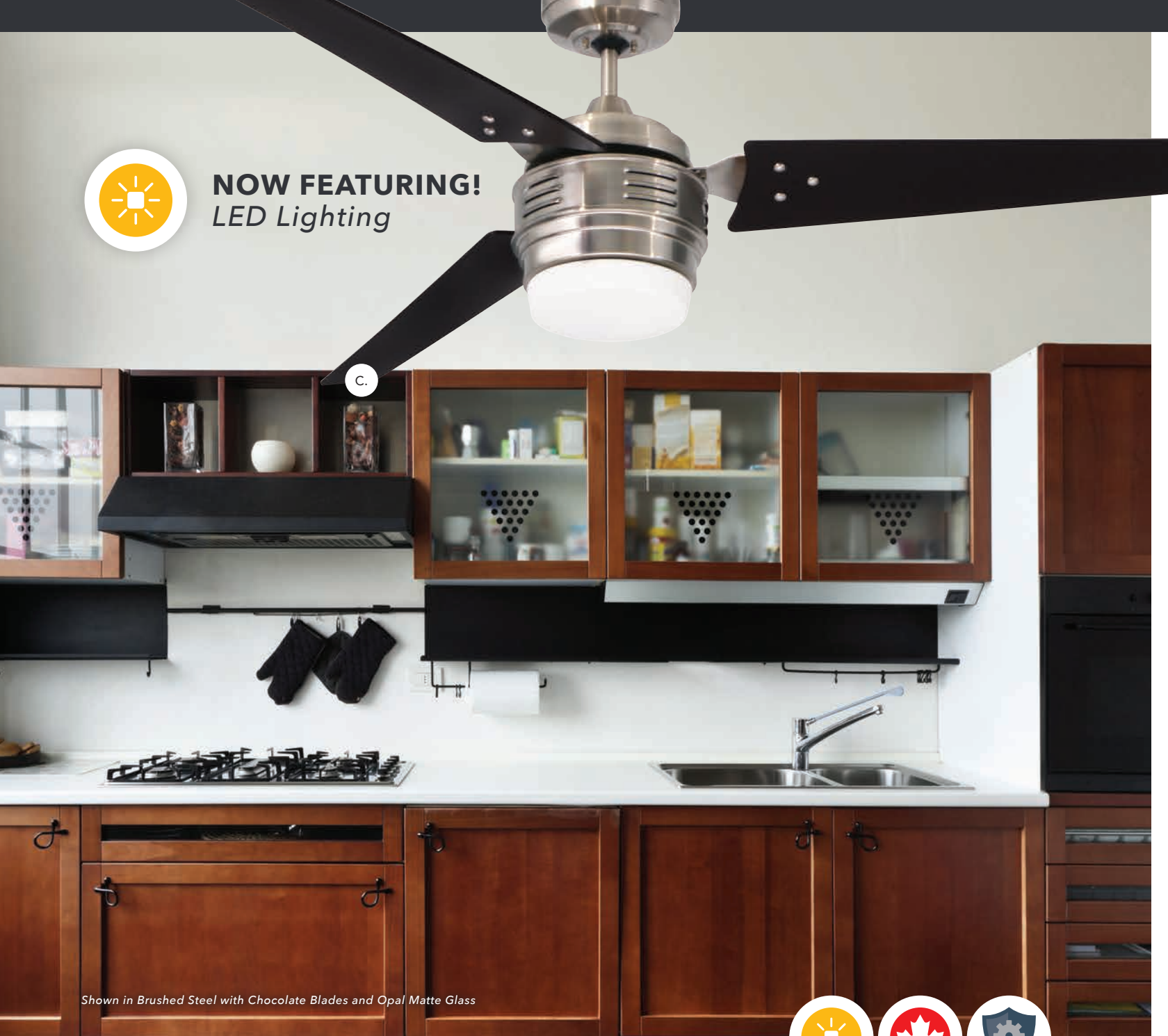

Shown in Brushed Steel with Chocolate Blades and Opal Matte Glass



4th Avenue LED

MODEL FEATURES

- 60" Blade Span
- 3 Custom Blades
- Integrated Dimmable LED Light Fixture
- 4-Speed Wall Control with Receiver
- 8" Downrod Included

17.9"



FAN HEIGHT

Energy Guide Information

Airflow Cubic Ft. Per Min.	Electricity Use Watts (Excl. Lights)	Airflow Efficiency Cubic Ft. Per Min. Per Watt	Estimated Yearly Cost Cost Range of Similar Models (19" - 84")
4364	36	120	\$10



A. Shown in Brushed Steel with Brushed Steel Blades and Opal Matte Glass



B. Shown in Vintage Steel with Riverwash Blades and Vintage Cream Glass



- A. **4TH AVENUE LED – BRUSHED STEEL**
CF766LSBS - Brush Steel Blades
- B. **4TH AVENUE LED – VINTAGE STEEL**
CF766LVS - Riverwash Blades
- C. **4TH AVENUE LED – BRUSHED STEEL**
CF766LBS - Chocolate Blades

Included



**3 CUSTOM
BLADES**



**INTEGRATED DIMMABLE
LED Light Fixture**

LED Specifications

- 1,500 Lumens
- 18 Watts
- 90 CRI
- 3,000 K CCT



SW405
4-Speed
Wall Control
with Receiver

Optional Control



SR600²
6-Speed
Remote Control
pg 157

Midway Eco LED



NOW FEATURING!
LED Lighting

B. Shown in Oil Rubbed Bronze with Oil Rubbed Bronze Blades and Opal Matte Glass



C. Shown in Appliance White with Appliance White Blades and Opal Matte Glass

M

- A. **MIDWAY ECO LED – BRUSHED STEEL**
CF955LBS - Midnight Bordeaux Blades, Opal Matte Glass
- B. **MIDWAY ECO LED – OIL RUBBED BRONZE**
CF955LORB - Oil Rubbed Bronze Blades, Opal Matte Glass
- C. **MIDWAY ECO LED – APPLIANCE WHITE**
CF955LWW - Appliance White Blades, Opal Matte Glass

Included

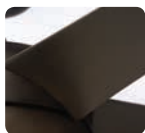

**5 AIRFOIL
BLADES**



**INTEGRATED DIMMABLE¹
LED Light Fixture**

LED Specifications

- 2,400 Lumens
- 30 Watts
- 90 CRI
- 3,600 K CCT



SR600
6-Speed
Remote Control

Optional Controls



SR650²
6-Speed
Remote Control
pg 157



SW605
6-Speed
Wall Control
with Receiver
pg 157

¹ GU24 base fluorescent bulbs are not dimmable.



Shown in Brushed Steel with Midnight Bordeaux Blades and Opal Matte Glass



Midway Eco LED

MODEL FEATURES

- 54" Blade Span
- 5 Airfoil Blades
- Integrated Dimmable LED Light Fixture
- 6-Speed Remote Control with Receiver
- 4.5" Downrod Included

16.5" 
FAN HEIGHT

Energy Guide Information

Airflow Cubic Ft. Per Min.	Electricity Use Watts (Excl. Lights)	Airflow Efficiency Cubic Ft. Per Min. Per Watt	Estimated Yearly Cost Cost Range of Similar Models (19" - 84")
4290	11	374	\$3



Shown in Brushed Steel with Dark Mahogany Blades and Opal Matte Glass



Luxe Eco LED

MODEL FEATURES

- 54" Blade Span
- 5 Custom Wood Veneer Blades
- Integrated Dimmable LED Light Fixture
- 6-Speed Wall Control with Receiver
- 4.5" Downrod Included
- No-Light Option

15.8"



FAN HEIGHT

Energy Guide Information

Airflow Cubic Ft. Per Min.	Electricity Use Watts (Excl. Lights)	Airflow Efficiency Cubic Ft. Per Min. Per Watt	Estimated Yearly Cost Cost Range of Similar Models (19" - 84")
3760	22	174	\$6



NOW FEATURING!
LED Lighting



A. Shown in Brushed Steel with Walnut Blades and Opal Matte Glass



B. Shown in Oil Rubbed Bronze with Walnut Blades and Opal Matte Glass



C. Shown in Oil Rubbed Bronze with Dark Mahogany Blades and Opal Matte Glass

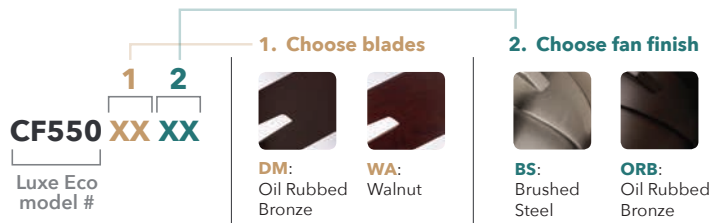

- A. **LUXE ECO LED – BRUSHED STEEL**
CF550LWABS - Walnut Blades, Opal Matte Glass
- B. **LUXE ECO LED – OIL RUBBED BRONZE**
CF550LWAORB - Walnut Blades, Opal Matte Glass
- C. **LUXE ECO LED – OIL RUBBED BRONZE**
CF550LDMORB - Dark Mahogany Blades, Opal Matte Glass
- D. **LUXE ECO LED – BRUSHED STEEL**
CF550LDMBS - Dark Mahogany Blades, Opal Matte Glass



Included



5 CUSTOM WOOD
Veneer Blades



NO-LIGHT OPTION



INTEGRATED DIMMABLE
LED Light Fixture

LED Specifications

- 1,500 Lumens
- 90 CRI
- 3,000 K CCT



SW605
6-Speed
Wall Control
with Receiver

Optional Controls



SR600
6-Speed
Remote
Control
pg 157



SR650
6-Speed
Remote
Control
pg 157

Recommended Accessories
Sold Separately



DOWNRODS
See page 9
for longer
length rod
options

Highpointe LED



A. Shown in Brushed Steel with Dark Mahogany Blades and Opal Matte Glass



NOW FEATURING!
LED Lighting



B. Shown in Golden Espresso with Chocolate Blades and Sandstone Glass

M

- A. **HIGHPOINTE LED – BRUSHED STEEL**
CF205LBS - Dark Mahogany Blades, Opal Matte Glass
- B. **HIGHPOINTE LED – GOLDEN ESPRESSO**
CF205LGES - Chocolate Blades, Sandstone Glass
- C. **HIGHPOINTE LED – VINTAGE STEEL**
CF205LVS - Riverwash/Honey Oak Reversible Blades, Sandstone Glass
- D. **HIGHPOINTE LED – GRAPHITE**
CF205LGRT - Timber Gray Blades, Opal Matte Glass



D. Shown in Graphite with Reversible Charcoal/Timber Gray Blades

Included



**3 CUSTOM
BLADES**

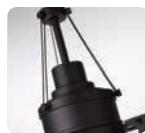

REMOVABLE¹
Decorative Cables



INTEGRATED DIMMABLE
LED Light Fixture

- LED Specifications**
- 1,500 Lumens
 - 90 CRI
 - 3,000 K CCT



**NO-LIGHT
OPTION**



SR400
4-Speed
Remote Control
with Receiver



SW406
4-Speed
Wall Control
pg 157

Optional Control

¹ Removable decorative cables for use on 9' ceilings or higher



Shown in Vintage Steel with Honey Oak Blades, Removable Decorative Cables and Sandstone Glass with 12" Downrod



Highpointe LED

MODEL FEATURES

- 54" Blade Span
- 3 Custom Blades
- Integrated Dimmable LED Light Fixture
- No-Light Option
- Removable Decorative Cables
- 4-Speed Remote Control with Receiver
- 2 Downrods Included: 6" & 12"

16.5"
22.5"



FAN HEIGHT

Energy Guide Information

Airflow Cubic Ft. Per Min.	Electricity Use Watts (Excl. Lights)	Airflow Efficiency Cubic Ft. Per Min. Per Watt	Estimated Yearly Cost Cost Range of Similar Models (19" - 84")
3257	41	80	\$11

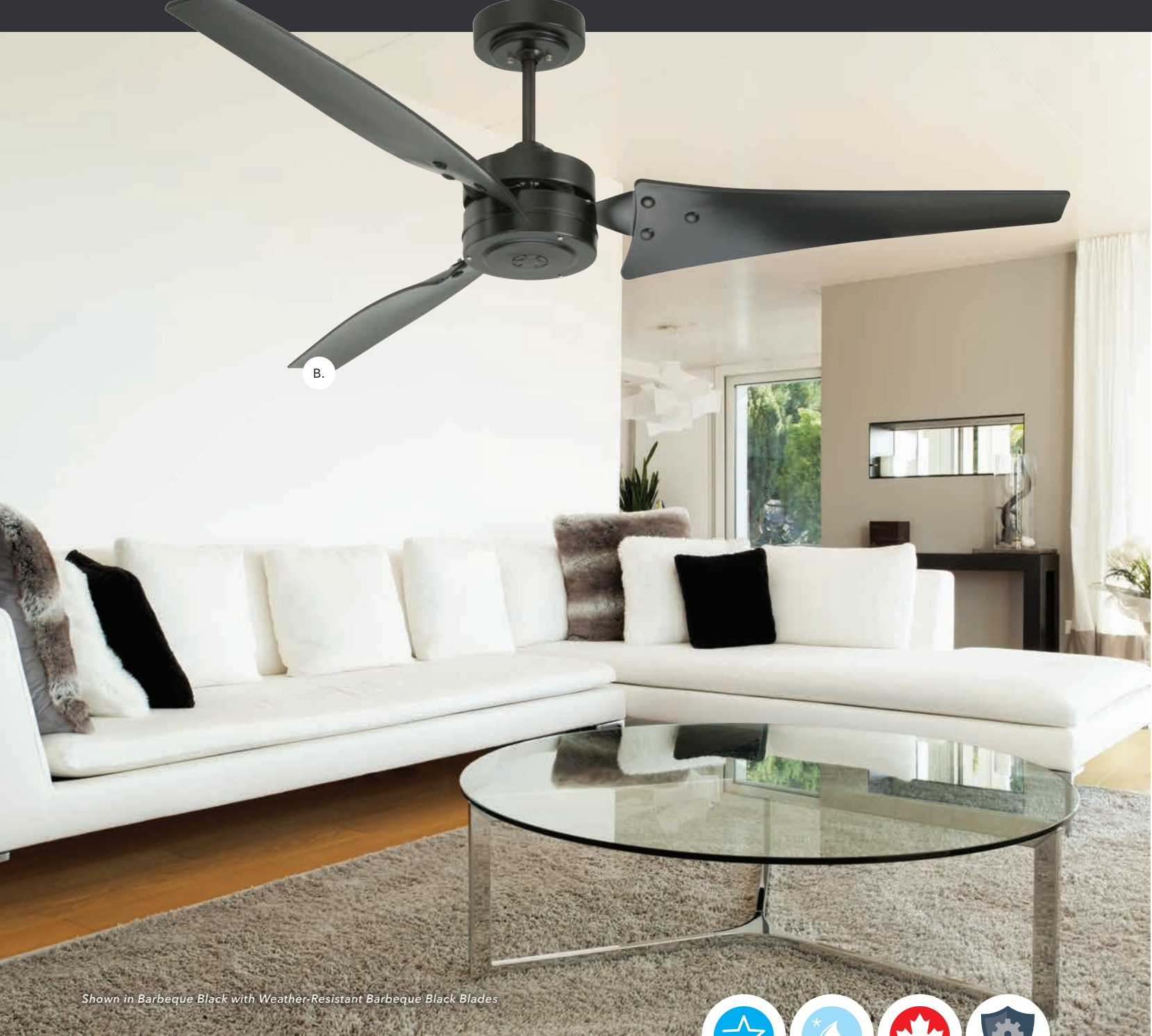

Shown in Barbeque Black with Weather-Resistant Barbeque Black Blades



*Certain finishes only. See fan pages for details

Loft

MODEL FEATURES

- 60" Blade Span
- 3 High-Efficiency Airfoil Blades
- 4-Speed Wall Control
- 6" Downrod Included
- Not Light Fixture Adaptable

12.8" 
FAN HEIGHT

Energy Guide Information

Airflow Cubic Ft. Per Min.	Electricity Use Watts (Excl. Lights)	Airflow Efficiency Cubic Ft. Per Min. Per Watt	Estimated Yearly Cost Cost Range of Similar Models (19" - 84")
4906	43	115	\$12



A. Shown in Brushed Steel with Brushed Steel Blades



C. Shown in Appliance White with Weather-Resistant Appliance White Blades



- A. **LOFT – BRUSHED STEEL¹**
CF765BS - Brushed Steel Blades
- B. **LOFT – BARBEQUE BLACK**
CF765BQ - Weather-Resistant Barbeque Black Blades
- C. **LOFT – APPLIANCE WHITE**
CF765WW - Weather-Resistant Appliance White Blades

Included



3 HIGH-EFFICIENCY AIRFOIL BLADES



SW46
4-Speed
Slide Control

Recommended Accessories



SR400
4-Speed
Remote Control
with Receiver
pg 157



ACCESSORY DOWNROD
pg 9

¹ Damp Location rated for BQ and WW finishes. BS finish not suitable for Damp locations
² Controls are recommended for indoor use only.



NOW FEATURING!
LED Lighting



B. Shown in Brushed Steel with Brushed Steel Blades and Removable No-Light Plate



A. **52" CURVA SKY LED INDOOR – BRUSHED STEEL¹**
CF153LBS - Brushed Steel Blades, Opal Matte Glass

B. **44" CURVA SKY LED INDOOR – BRUSHED STEEL¹**
CF145LBS - Brushed Steel Blades, Opal Matte Glass

Included

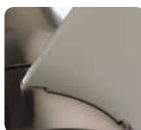

3 CUSTOM BLADES



**NO-LIGHT
OPTION**



**INTEGRATED DIMMABLE
LED Light Fixture**

LED Specifications

- 1,500 Lumens
- 90 CRI
- 3,000 K CCT



SR600
6-Speed
Remote Control
with Receiver



SR650
6-Speed
2-in-1
Remote Control²
pg 157



SW605²
6-Speed
Wall Control
pg 157



Shown in Brushed Steel with Brushed Steel Blades and Opal Matte Glass



52" & 44" Curva Sky LED Indoor

MODEL FEATURES

- 3 Custom Blades
- Integrated Dimmable LED Light Fixture
- No-Light Option
- 6-Speed Remote Control with Receiver
- For Indoor Use Only

12.6"



FAN HEIGHT

Energy Guide Information

Blade Span Inches	Airflow Cubic Ft. Per Min.	Electricity Use Watts (Excl. Lights)	Airflow Efficiency Cubic Ft. Per Min. Per Watt	Estimated Yearly Cost Cost Range of Similar Models (19" - 84")
44"	2820	34	84	\$9
52"	2952	34	86	\$10



Shown in Graphite with Weather-Resistant Graphite Blades and Opal Matte Glass



*Certain finishes only. See fan pages for details

52" & 44" Curva Sky LED Outdoor

MODEL FEATURES

- 3 Weather-Resistant Blades
- Integrated Dimmable LED Light Fixture
- Suitable for Indoor or Outdoor Use
- No-Light Option
- 6-Speed Remote Control with Receiver

12.6" 
FAN HEIGHT

Energy Guide Information

Blade Span Inches	Airflow Cubic Ft. Per Min.	Electricity Use Watts (Excl. Lights)	Airflow Efficiency Cubic Ft. Per Min. Per Watt	Estimated Yearly Cost Cost Range of Similar Models (19" - 84")
44"	2820	34	84	\$9
52"	2952	34	86	\$10



NOW FEATURING!
LED Lighting

A. Shown in Appliance White with Weather-Resistant, Appliance White Blades and Opal Matte Glass



B. Shown in Oil Rubbed Bronze with Weather-Resistant, Oil Rubbed Bronze Blades and Removeable No-Light Plate



- A. **52" & 44" CURVA SKY LED OUTDOOR – APPLIANCE WHITE**
52": CF152LWW - Weather-Resistant Appliance White Blades, Opal Matte Glass
44": CF144LWW - Weather-Resistant Appliance White Blades, Opal Matte Glass
- B. **52" & 44" CURVA SKY LED OUTDOOR – OIL RUBBED BRONZE**
52": CF152LORB - Weather-Resistant Oil Rubbed Bronze Blades, Opal Matte Glass
44": CF144LORB - Weather-Resistant Oil Rubbed Bronze Blades, Opal Matte Glass
- C. **52" & 44" CURVA SKY LED OUTDOOR – GRAPHITE**
52": CF152LGRT - Weather-Resistant Graphite Blades, Opal Matte Glass
44": CF144LGRT - Weather-Resistant Graphite Blades, Opal Matte Glass

Included

Optional Controls



3 WEATHER RESISTANT BLADES



NO-LIGHT OPTION



INTEGRATED DIMMABLE LED Light Fixture

LED Specifications

- 1,500 Lumens
- 90 CRI
- 3,000 K CCT



SR600
6-Speed Remote Control with Receiver



SR650
6-Speed 2-in-1 Remote Control pg 157



SW605²
6-Speed Wall Control pg 157



NOW FEATURING!
LED Lighting



A. Shown in Brushed Steel with Brushed Steel Blades



A. 52" & 44" CURVA LED – BRUSHED STEEL¹

52": CF253LBS - Brushed Steel Blades, Opal Matte Glass

44": CF245LBS - Brushed Steel Blades, Opal Matte Glass

Included



3 CUSTOM BLADES



**NO-LIGHT
OPTION**



**INTEGRATED DIMMABLE
LED Light Fixture**

LED Specifications

- 1,500 Lumens
- 90 CRI
- 3,000 K CCT



SR600
6-Speed
Remote Control
with Receiver



SR650
6-Speed
2-in-1
Remote Control
pg 157



SW605²
6-Speed
Wall Control
pg 157



A.

Shown in Brushed Steel with Brushed Steel Blades and Opal Matte Glass



52" & 44" Curva LED Indoor

MODEL FEATURES

- 3 Weather-Resistant Blades
- Integrated Dimmable LED Light Fixture
- No-Light Option
- 6-Speed Remote Control with Receiver
- 4.5" Downrod Included
- Suitable for Indoor Use Only



FAN HEIGHT

Energy Guide Information

Blade Span Inches	Airflow Cubic Ft. Per Min.	Electricity Use Watts (Excl. Lights)	Airflow Efficiency Cubic Ft. Per Min. Per Watt	Estimated Yearly Cost Cost Range of Similar Models (19" - 84")
44"	2948	34	87	\$9
52"	3130	34	92	\$10



A.

Shown in Oil Rubbed Bronze with Weather-Resistant, Oil Rubbed Bronze Blades and Opal Matte Glass



*Certain finishes only. See fan pages for details

52" & 44" Curva LED Outdoor

MODEL FEATURES

- 3 Weather-Resistant Blades
- Integrated Dimmable LED Light Fixture
- No-Light Option
- Suitable for Indoor or Outdoor Use
- 6-Speed Remote Control with Receiver
- 4.5" Downrod Included

14.9" 
FAN HEIGHT

Energy Guide Information

Blade Span Inches	Airflow Cubic Ft. Per Min.	Electricity Use Watts (Excl. Lights)	Airflow Efficiency Cubic Ft. Per Min. Per Watt	Estimated Yearly Cost Cost Range of Similar Models (19" - 84")
44"	2948	34	87	\$9
52"	3130	34	92	\$10

52" & 44" Curva LED Outdoor



NOW FEATURING!
LED Lighting



B. Shown in Oil Rubbed Bronze with Weather-Resistant, Oil Rubbed Bronze Blades and Removeable No-Light Plate



C. Shown in Appliance White with Weather-Resistant, Appliance White Blades and Opal Matte Glass



D. Shown in Graphite with Weather-Resistant Graphite Blades and Opal Matte Glass

- A. **52" CURVA LED OUTDOOR – OIL RUBBED BRONZE**
CF252LORB - Oil Rubbed Bronze Blades, Opal Matte Glass
- B. **44" CURVA LED OUTDOOR – OIL RUBBED BRONZE**
CF244LORB - Oil Rubbed Bronze Blades, Opal Matte Glass
- C. **52" & 44" CURVA LED OUTDOOR – APPLIANCE WHITE**
CF252LWW - 52" - Appliance White Blades, Opal Matte Glass
CF244LWW - 44" - Appliance White Blades, Opal Matte Glass
- D. **52" & 44" CURVA LED OUTDOOR – GRAPHITE**
CF252LGRT - 52" - Graphite Blades, Opal Matte Glass
CF244LGRT - 44" - Graphite Blades, Opal Matte Glass



Included



3 WEATHER RESISTANT BLADES



NO-LIGHT OPTION



INTEGRATED DIMMABLE LED Light Fixture

- LED Specifications**
- 1,500 Lumens
 - 90 CRI
 - 3,000 K CCT



SR600
6-Speed Remote Control with Receiver



SR650
6-Speed 2-in-1 Remote Control pg 157



SW605²
6-Speed Wall Control pg 157



A. Shown in Oil Rubbed Bronze with Mahogany Blades and Removeable No-Light Plate



B. Shown in Appliance White with Appliance White Blades and Opal Matte Glass

- A. **ATOMICAL – OIL RUBBED BRONZE**
CF930ORB - Mahogany Blades
- B. **ATOMICAL – APPLIANCE WHITE**
CF930WW - Appliance White Blades, Opal Matte Glass
- C. **ATOMICAL – BRUSHED STEEL¹**
CF930BS - Dark Cherry Blades, Opal Matte Glass

Included



**5 CUSTOM
BLADES**



**INTEGRATED
Light Fixture**



**SR400
4-Speed
Remote Control
with Receiver**

Optional Control



**SW406²
4-Speed
Wall Control
pg 157**

Recommended Accessories

Sold Separately



**OPTIONAL
No-Light Plates**

¹ Damp Location rated for ORB and WW finishes. BS is not suitable for Damp Locations.
² Controls are recommended for indoor use only.



C.

Shown in Brushed Steel with Dark Cherry Blades and Opal Matte Glass



*Certain finishes only. See fan pages for details

Atomical

MODEL FEATURES

- 5 Custom Blades
- Integrated Dimmable Light Fixture
- 4-Speed Remote Control with Receiver
- 4.5" Downrod Included

15.8" 
FAN HEIGHT

Energy Guide Information

Airflow Cubic Ft. Per Min.	Electricity Use Watts (Excl. Lights)	Airflow Efficiency Cubic Ft. Per Min. Per Watt	Estimated Yearly Cost Cost Range of Similar Models (19" - 84")
3023	39	78	\$11



A.

Shown in Graphite with Weather-Resistant Driftwood Blades and Opal Matte Glass



*Certain finishes only. See fan pages for details

Volta

MODEL FEATURES

- 3 Custom Blades
- 4-Speed Remote Control with Receiver
- Integrated Dimmable LED Light Fixture
- No-Light Option
- 4.5" Downrod Included

14.5" 
FAN HEIGHT

Energy Guide Information

Airflow Cubic Ft. Per Min.	Electricity Use Watts (Excl. Lights)	Airflow Efficiency Cubic Ft. Per Min. Per Watt	Estimated Yearly Cost Cost Range of Similar Models (19" - 84")
4244	41	102	\$12



B. Shown in Platinum with Weather-Resistant Platinum Blades and Opal Matte Glass



C. Shown in Satin White with Weather-Resistant Satin White Blades and Opal Matte Glass



D. Shown in Barbeque Black with Weather-Resistant Natural Cherry Blades and Removable No-Light Plate

- A. **VOLTA – GRAPHITE**
CF590GRT - Weather-Resistant Driftwood Blades, Opal Matte Glass
- B. **VOLTA – PLATINUM**
CF590PT - Weather-Resistant Platinum Blades, Opal Matte Glass
- C. **VOLTA – SATIN WHITE**
CF590SW - Weather-Resistant Satin White Blades, Opal Matte Glass
- D. **VOLTA – BARBEQUE BLACK**
CF590BQ - Weather-Resistant Natural Cherry Blades, Opal Matte Glass



Included



**3 CUSTOM
BLADES**



**NO-LIGHT
OPTION**

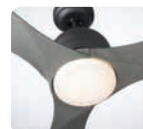

**INTEGRATED DIMMABLE
LED Light Fixture**

- LED Specifications**
- 2,000 Lumens
 - 95 CRI
 - 3,000 K CCT
 - 22 Watts



SR401¹
4-Speed
Remote Control
with Receiver

¹ Controls recommended for indoor use only.



A. Shown in Oil Rubbed Bronze with Dark Cherry Blades



B. Shown in Brushed Steel with Dark Cherry Blades

A. **TILO – OIL RUBBED BRONZE**
CF130ORB - Dark Cherry Blades

B. **TILO – BRUSHED STEEL**
CF130BS - Dark Cherry Blades

C. **TILO – APPLIANCE WHITE**
CF130WW - Appliance White Blades

Included



**3 CURVED
BLADES**



**DUAL-MOUNT
FEATURE**



SW46
4-Speed
Wall Control

Recommended Accessories
Sold Separately



LK130
Light Fixture
pg 151-152

¹ Damp Location rated for ORB and WW finishes. BS is not suitable for Damp Locations.

² Controls are recommended for indoor use only.



C.

Shown in Appliance White with Optional Tilo Light Fixture (LK130, pg 155) and Appliance White Blades



*Certain finishes only. See fan pages for details

Tilo

MODEL FEATURES

- 3 Curved Blades
- Dual-Mount Feature
- 4-Speed Wall Control
- 4.5" Downrod Included



Optional Tilo Light Fixture LK130 - Opal Matte Glass

- Includes BS, ORB, and WW bowl caps
- (2) 50-watt Mini-Candelabra Halogen Bulbs (included)

9.5"
13.3"

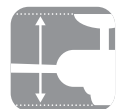

FAN HEIGHT

Energy Guide Information

Airflow Cubic Ft. Per Min.	Electricity Use Watts (Excl. Lights)	Airflow Efficiency Cubic Ft. Per Min. Per Watt	Estimated Yearly Cost Cost Range of Similar Models (19" - 84")
1870	25	74	\$7



Avant Eco CF921



TRADITIONAL

Conventional combinations of motor housings and blades can enhance any style. Choose any of our customizable traditional fan models for a unique décor addition.



AVANT ECO
CF921 - pg 83



PREMIUM SELECT
CF4801 - pg 85



ZURICH
CF935 - pg 87



PRIMA
CF901 - pg 89



DESIGNER
CF755 - pg 91



29" NORTHWIND
CF702 - pg 93



PRIMA SNUGGER
CF905 - pg 95



52" SNUGGER
CF805S - pg 97



42" SNUGGER
CF804S - pg 99



MONACO
CF830 - pg 101



CROWN SELECT
CF4501 - pg 103



CORNERSTONE
CF1 - pg 105



*Certain finishes only. See fan pages for details.



D.

Shown in Venetian Bronze with 22" Art Deco Hand Carved Wood Blades (B101WA, pg 150)



Avant Eco™

MODEL FEATURES

- 42", 52" or 58" Blade Span
- Blades Sold Separately (pg 149-150)
- 6-Speed Remote Control with Receiver
- Light Fixture Adaptable
- Accent Light Adaptable (AL200)
- 4.5" Downrod Included

13.0" 
FAN HEIGHT

Energy Guide Information

Airflow Cubic Ft Per Min.	Electricity Use Watts (Excl. Lights)	Airflow Efficiency Cubic Ft Per Min. Per Watt	Estimated Yearly Cost Cost Range of Similar Models (19" - 84")
4555	22	208	\$6



A. Shown in Brushed Steel with 22" Hand Carved Leaf Dark Oak Blades (B109DO, pg 150)



B. Shown in Satin White with 22" Satin White Blades (G54SW, pg 150) and 12" Downrod (CFDR1SW, pg 9)



C. Shown in Oil Rubbed Bronze with 22" Honey Oak Blades (G54HO, pg 150) and 12" Downrod (CFDR1ORB, pg 9)

- A. **AVANT ECO – BRUSHED STEEL**
CF921BS - Blade Select Series Blades (Sold Separately)
- B. **AVANT ECO – SATIN WHITE**
CF921SW - Blade Select Series Blades (Sold Separately)
- C. **AVANT ECO – OIL RUBBED BRONZE**
CF921ORB - Blade Select Series Blades (Sold Separately)
- D. **AVANT ECO – VENETIAN BRONZE**
CF921VNB - Blade Select Series Blades (Sold Separately)



Included

Optional Controls

Recommended Accessories
Sold Separately



SR600
6-Speed Remote Control
pg 157



SR650
6-Speed 2-in-1 Remote Control
pg 157



SW605
6-Speed Wall Control
pg 157



BLADE SELECT SERIES BLADES
pg 148



LK GLO SERIES
LED Light Fixture
pg 151-152



AL200
OPTIONAL ACCENT
LED Light Accessory
pg 157

¹ Energy Star testing completed with B78 blade series.

Premium Select



B. Shown in Brushed Steel with 22" Mahogany Veneer Blades (G54MH, pg 150) and 12" Downrod (CFDR1BS, pg 9)



C. Shown in Satin White with 22" Satin White Blades (B77SW, pg 149)

T

- A. **PREMIUM SELECT – OIL RUBBED BRONZE**
CF4801ORB - Blade Select Series Blades (Sold Separately)
- B. **PREMIUM SELECT – BRUSHED STEEL**
CF4801BS - Blade Select Series Blades (Sold Separately)
- C. **PREMIUM SELECT – SATIN WHITE**
CF4801SW - Blade Select Series Blades (Sold Separately)

Included



ACCENT LIGHTING
with Patented
Swivel Socket

Optional Controls



SR650
6-Speed
2-in-1
Remote Control
pg 157



SR600
6-Speed
Remote Control
pg 157



SW605
6-Speed
Wall Control
pg 157

Recommended Accessories

Sold Separately



RCK55
Horseshoe
Receiver
pg 157



**BLADE SELECT
SERIES BLADES¹**
pg 148



LK GLO SERIES
LED Light Fixture
pg 151-152

¹ CF4801 is not suitable for use with B79

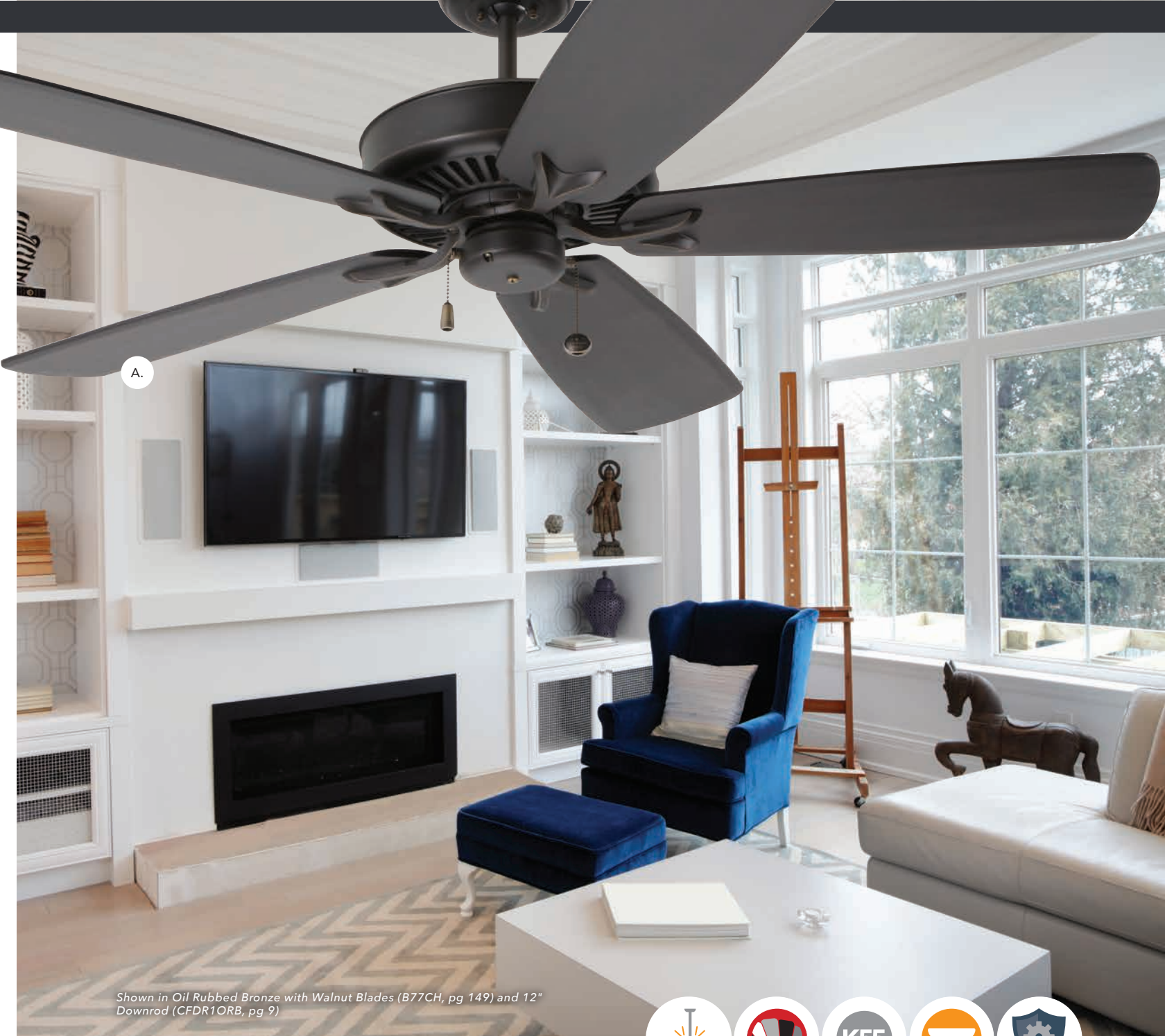

Shown in Oil Rubbed Bronze with Walnut Blades (B77CH, pg 149) and 12" Downrod (CFDR1ORB, pg 9)



Premium Select™

MODEL FEATURES

- 42", 52" or 58" Blade Span
- Blades Sold Separately (pg 149-150)
- Accent Lighting with Patented Swivel Sockets
- Light Fixture Adaptable
- 4.5" Downrod Included

15.0" 
FAN HEIGHT

Energy Guide Information

Airflow Cubic Ft Per Min.	Electricity Use Watts (Excl. Lights)	Airflow Efficiency Cubic Ft Per Min. Per Watt	Estimated Yearly Cost Cost Range of Similar Models (19" - 84")
3232	56	57	\$16

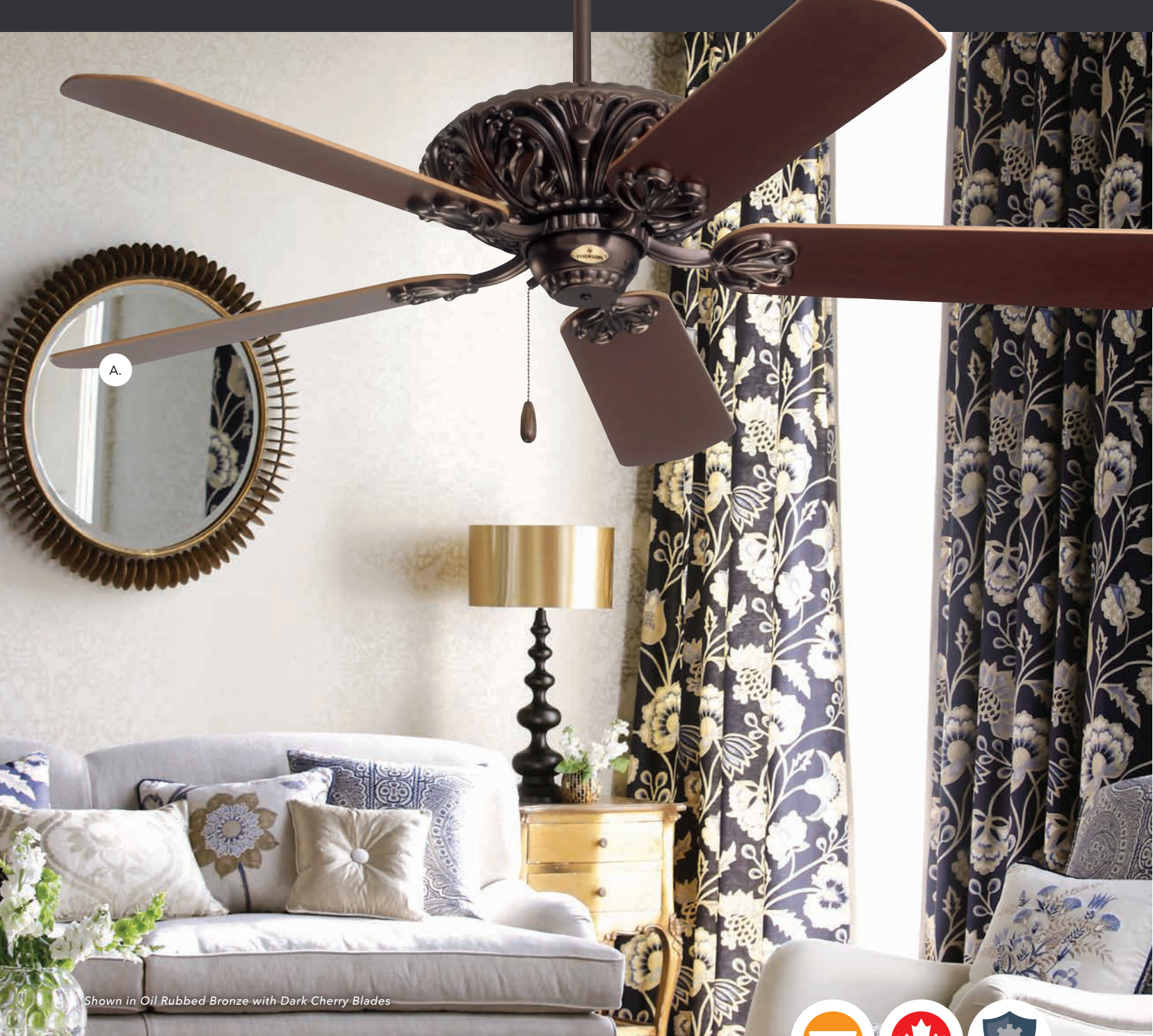

Shown in Oil Rubbed Bronze with Dark Cherry Blades



Zurich™

MODEL FEATURES

- 52" Blade Span
- 5 Reversible Blades
- Light Fixture Adaptable
- 4.5" Downrod Included

Energy Guide Information

Airflow Cubic Ft Per Min.	Electricity Use Watts (Excl. Lights)	Airflow Efficiency Cubic Ft Per Min. Per Watt	Estimated Yearly Cost Cost Range of Similar Models (19" - 84")
4232	42	102	\$12



A. Shown in Oil Rubbed Bronze with Dark Cherry Blades, Amber Mist LED (LK70LEDORB, pg 154) Light Fixture and 12" Downrod (CFDR1ORB, pg 9)



A. **ZURICH – OIL RUBBED BRONZE**
CF935ORB - Dark Cherry/Medium
 Oak Blades

Included



**5 REVERSIBLE
 BLADES**

Optional Controls



SR400
 4-Speed
 Remote Control
 with Receiver
 pg 157



SW405
 4-Speed
 Wall Control
 with Receiver
 pg 157

Recommended Accessories
 Sold Separately



LK GLO SERIES
 LED Light Fixture
 pg 151-152

Prima



B. Shown in Venetian Bronze with Walnut Blades and 12" Downrod (CFDR1ORB, pg 9)



C. Shown in Brushed Steel with Dark Cherry Blades and Low Profile Light Fixture (LK53BS, pg 151)



D. Shown with Satin White Blades, Moon Light Fixture (LK65SW, pg 151) and 12" Downrod (CFDR1SW, pg 9)

- A. **PRIMA – OIL RUBBED BRONZE**
CF901ORB - Dark Cherry/Walnut Blades
- B. **PRIMA – VENETIAN BRONZE**
CF901VNB - Dark Cherry/Walnut Blades
- C. **PRIMA – BRUSHED STEEL**
CF901BS - Dark Cherry/Chocolate Blades
- D. **PRIMA – SATIN WHITE**
CF901SW - Satin White/Maple Blades

Included



5 REVERSIBLE
BLADES



SW 46
6-Speed
Wall Control
pg 158

Recommended Accessories

Sold Separately



LK GLO SERIES
LED Light Fixture
pg 151-152



AL200
OPTIONAL ACCENT
Light Accessory
pg 157

T



A.



Shown in Oil Rubbed Bronze with Dark Cherry Blades



Prima

MODEL FEATURES

- 52" Blade Span
- 5 Reversible Blades
- 6-Speed Wall Control
- Light Fixture Adaptable
- Accent Light Adaptable
- 4.5" Downrod Included

13.0" 
FAN HEIGHT

Energy Guide Information

Airflow Cubic Ft Per Min.	Electricity Use Watts (Excl. Lights)	Airflow Efficiency Cubic Ft Per Min. Per Watt	Estimated Yearly Cost Cost Range of Similar Models (19" - 84")
4072	37	109	\$10



D.



Shown in Venetian Bronze with Dark Cherry Blades



Designer[®]

MODEL FEATURES

- 5 Reversible Blades
- Light Fixture Adaptable
- 3.5" Downrod Included

14.0" 
FAN HEIGHT

Energy Guide Information

Airflow Cubic Ft Per Min.	Electricity Use Watts (Excl. Lights)	Airflow Efficiency Cubic Ft Per Min. Per Watt	Estimated Yearly Cost Cost Range of Similar Models (19" - 84")
3340	41	81	\$12



A. Shown in Oil Rubbed Bronze with Dark Cherry Blades and Low Profile Light Fixture (LK53ORB, pg 151)



B. Shown in Appliance White with Appliance White Blades & Moon Light Fixture (LK65WW, pg 151)



C. Shown in Brushed Steel with Dark Cherry Blades

- A. **DESIGNER – OIL RUBBED BRONZE**
CF755ORB - Dark Cherry/Medium Oak Blades
- B. **DESIGNER – APPLIANCE WHITE**
CF755WW - Appliance White/Bleached Oak Blades
- C. **DESIGNER – BRUSHED STEEL**
CF755BS - Dark Cherry/Mahogany Blades
- D. **DESIGNER – VENETIAN BRONZE**
CF755VNB - Dark Cherry/Mahogany Blades



Included



**5 REVERSIBLE
BLADES**

Optional Controls



SR400
4-Speed
Remote Control
with Receiver
pg 157



SW405
4-Speed
Wall Control
with Receiver
pg 157

Recommended Accessories

Sold Separately



LK1500MLEDXXX
Opal Matte Harlow
LED Light Fixture
pg 154



CFFC4XXX
4-Light
Contemporary Fitter
pg 156

See Accessories Section (pg 145-164) for additional light accessories & finishes.

29" Northwind



B. Shown in Appliance White with Appliance White Blades



B. Shown in Appliance White with Bleached Oak Blades

A. **29" NORTHWIND – OIL RUBBED BRONZE**
CF702ORB - Dark Cherry/Walnut Blades

B. **29" NORTHWIND – APPLIANCE WHITE**
CF702WW - Appliance White/Bleached Oak Blades

Included



**5 REVERSIBLE
 BLADES**

Optional Controls



SW46
 4-Speed
 Slide Control
 pg 158



SW90
 Fan & Light Dual
 Slide Control
 pg 158

Recommended Accessories

Sold Separately



1K GLO SERIES
 LED Light Fixture
 pg 153

T



Shown with Dark Cherry Blades



29" Northwind

MODEL FEATURES

- 5 Reversible Blades
- Light Fixture Adaptable
- 3.5" Downrod Included

10.8" 
FAN HEIGHT

Energy Guide Information

<p>Airflow Cubic Ft Per Min.</p> <p>1651</p>	<p>Electricity Use Watts (Excl. Lights)</p> <p>30</p>	<p>Airflow Efficiency Cubic Ft Per Min. Per Watt</p> <p>54</p>	<p>Estimated Yearly Cost Cost Range of Similar Models (19" - 84")</p> <p>\$9</p>
--	---	--	--



Shown in Brushed Steel with Dark Cherry Blades



Prima Snugger™

MODEL FEATURES

- 5 Reversible Blades
- Light Fixture Adaptable



8.0"

FAN HEIGHT

Energy Guide Information

Airflow Cubic Ft Per Min.	Electricity Use Watts (Excl. Lights)	Airflow Efficiency Cubic Ft Per Min. Per Watt	Estimated Yearly Cost Cost Range of Similar Models (19" - 84")
1990	43	46	\$12

Prima Snugger™



A. Shown in Brushed Steel with Dark Cherry Blades and Low Light Fixture (LK53BS)



B. Shown in Venetian Bronze with Walnut Blades



C. Shown in Oil Rubbed Bronze with Walnut Blades and Ashton LED Light Fixture in Amber Mist (LK92LEDORB)

A. **PRIMA SNUGGER – BRUSHED STEEL**
CF905BS - Dark Cherry/Chocolate Blades

B. **PRIMA SNUGGER – VENETIAN BRONZE**
CF905VNB - Dark Cherry/Walnut Blades

C. **PRIMA SNUGGER – OIL RUBBED BRONZE**
CF905ORB - Dark Cherry/Walnut Blades

D. **PRIMA SNUGGER – BRUSHED STEEL**
CF905BS - Dark Cherry/Chocolate Blades



Included

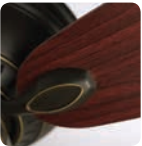

**5 REVERSIBLE
BLADES**

Optional Controls



SW46
4-Speed
Slide Control
pg 158



SW90
Fan & Light Dual
Slide Control
pg 158



SR400
4-Speed
Remote Control
with Receiver
pg 157



SW405
4-Speed
Wall Control
with Receiver
pg 157

Recommended Accessories
Sold Separately



LK GLO SERIES
LED Light Fixture
pg 153

52" Snugger



B. Shown in Brushed Steel with Dark Cherry Blades and Low Profile Light Fixture (LK53BS, pg 154)



C. Shown in Appliance White with Appliance White Blades

T

- A. **52" SNUGGER – OIL RUBBED BRONZE**
CF805SORB - Dark Cherry/Medium Oak Blades
- B. **52" SNUGGER – BRUSHED STEEL**
CF805SBS - Dark Cherry/Mahogany Blades
- C. **52" SNUGGER – APPLIANCE WHITE**
CF805SWW - Appliance White/Bleached Oak Blades

Included



**5 REVERSIBLE
BLADES**

Optional Controls



SW46
4-Speed
Slide Control
pg 158



SW90
Fan & Light Dual
Slide Control
pg 158

Recommended Accessories

Sold Separately



**LK GLO SERIES
LED LIGHT FIXTURE**
pg 153



A.



Shown in Oil Rubbed Bronze with Dark Cherry Blades



52" Snugger

MODEL FEATURES

- 5 Reversible Blades
- Light Fixture Adaptable



FAN HEIGHT

Energy Guide Information

Airflow Cubic Ft Per Min.	Electricity Use Watts (Excl. Lights)	Airflow Efficiency Cubic Ft Per Min. Per Watt	Estimated Yearly Cost Cost Range of Similar Models (19" - 84")
1479	39	38	\$11



Shown in Brushed Steel with Dark Cherry Blades



42" Snugger

MODEL FEATURES

- 5 Reversible Blades
- Light Fixture Adaptable



7.3"

FAN HEIGHT

Energy Guide Information

<p>Airflow Cubic Ft Per Min.</p> <p>1114</p>	<p>Electricity Use Watts (Excl. Lights)</p> <p>31</p>	<p>Airflow Efficiency Cubic Ft Per Min. Per Watt</p> <p>36</p>	<p>Estimated Yearly Cost Cost Range of Similar Models (19" - 84")</p> <p>\$9</p>
--	---	--	--



B. Shown in Appliance White with Appliance White Blades



C. Shown in Oil Rubbed Bronze with Dark Cherry Blades and Moon Light Fixture (LK65ORB, pg 151)

A. **42" SNUGGER – BRUSHED STEEL**
CF804SBS - Dark Cherry/Mahogany Blades

B. **42" SNUGGER – APPLIANCE WHITE**
CF804SWW - Appliance White/Bleached Oak Blades

C. **42" SNUGGER – OIL RUBBED BRONZE**
CF804SORB - Dark Cherry/Medium Oak Blades



Included



**5 REVERSIBLE
BLADES**

Optional Controls



SW46
4-Speed
Slide Control
pg 158



SW90
Fan & Light Dual
Slide Control
pg 158

Recommended Accessories

Sold Separately



LK GLO SERIES
LED Light Fixture
pg 153



A.

T

A. **MONACO – GOLDEN ESPRESSO**
CF830GES - Vintage Black Hand Carved Blades

Included

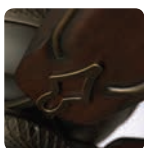

**5 HAND CARVED
WOOD BLADES**



Removable¹
Decorative
Sleeve



SW90
Fan & Light Dual
Slide Control

Optional Controls



SR400
4-Speed
Remote Control
with Receiver
pg 157



SW405
4-Speed
Wall Control
with Receiver
pg 157



SR600²
6-Speed
Remote Control
pg 157



SW605²
6-Speed
Wall Control
pg 157



RC188
Horseshoe
Receiver
pg 158

Recommended Accessories

Sold Separately



1K GLO SERIES
LED Light Fixture
pg 153

¹ Recommended for ceiling height of at least 9 feet (for lower ceilings, use a shorter downrod without decorative sleeve).

² For use with an accessory light fixture. Reverse button will not function. Please note that the SR400/SW405 will control the accent light and an accessory light kit simultaneously. To operate the accent light and an accessory light kit separately, the SR600/SW605 controls with the RC188 Receiver must be used.

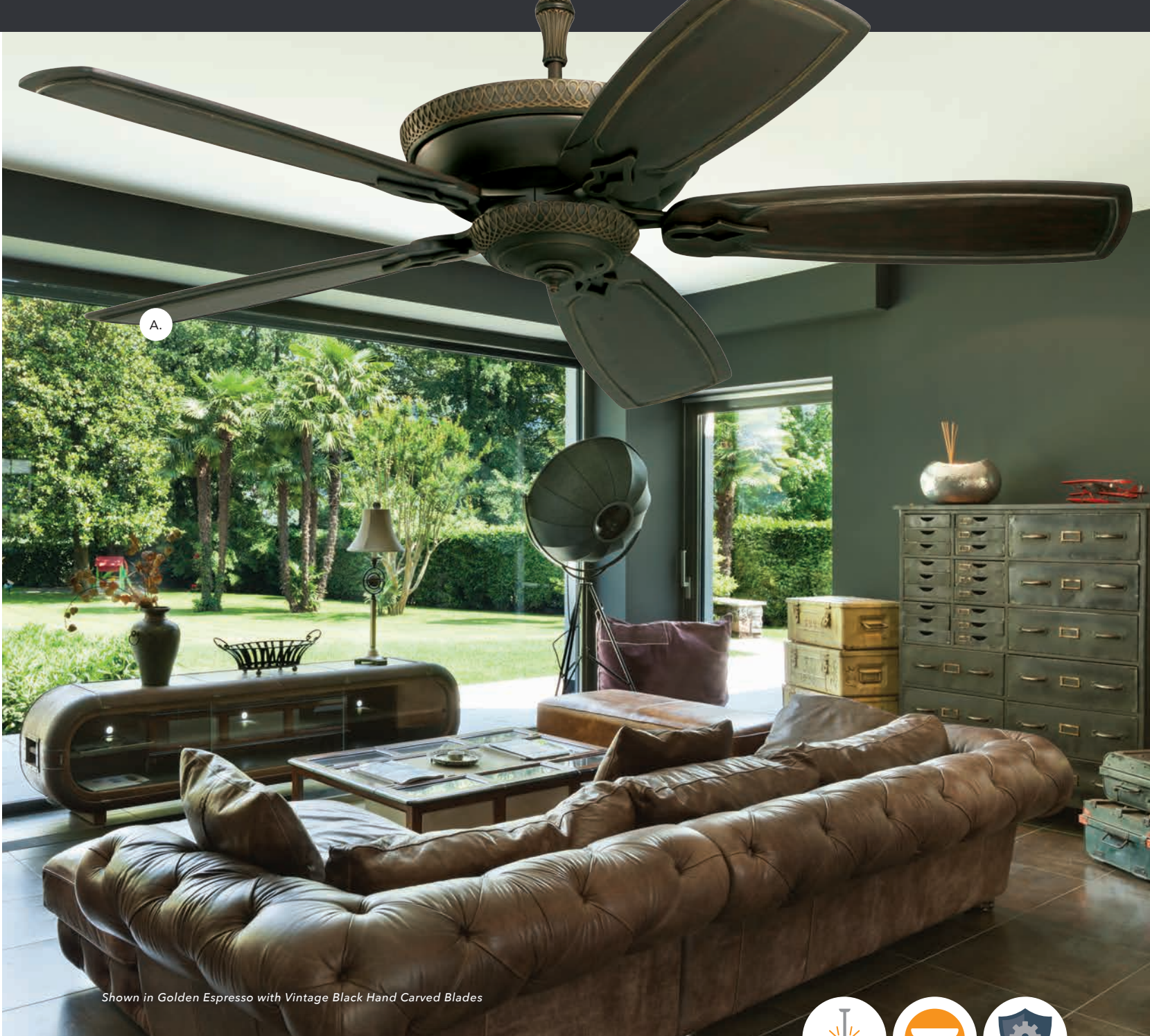

Shown in Golden Espresso with Vintage Black Hand Carved Blades



Monaco™

MODEL FEATURES

- 60" Blade Span
- 5 Hand Carved Wood Blades
- Removable Decorative Sleeve
- Accent Lighting Uses (4) 40-watt Candelabra Bulbs
- Light Fixture Adaptable
- 4-Speed Wall Control
- 4.5" & 10" Downrods Included

15.5"
21.0"
FAN HEIGHT

Energy Guide Information

Airflow Cubic Ft Per Min.	Electricity Use Watts (Excl. Lights)	Airflow Efficiency Cubic Ft Per Min. Per Watt	Estimated Yearly Cost Cost Range of Similar Models (19" - 84")
3334	56	59	\$16



Shown in Venetian Bronze with 22" Walnut Blades, Transitional Fitter (F490, pg 156) and Vintage Bulb Adapters (VB100ORB, pg 149). Bulbs Not Included.



Crown Select™

MODEL FEATURES

- 42", 52" or 58" Blade Span
- Blades Sold Separately (pg 149-150)
- Accent Lighting with Patented Swivel Socket Uses (3) 25-watt Candelabra Bulbs
- Light Fixture Adaptable
- 4.5" Downrod Included

14.0" 
FAN HEIGHT

Energy Guide Information

Airflow Cubic Ft Per Min.	Electricity Use Watts (Excl. Lights)	Airflow Efficiency Cubic Ft Per Min. Per Watt	Estimated Yearly Cost Cost Range of Similar Models (19" - 84")
3224	56	58	\$16



A. Shown in Gilded Bronze with 25" Hand Carved Ornate Blades (B97DWA, pg 149)



B. Shown in Antique Pewter with 22" Solid Wood Dark Mahogany Blades (B77DM, pg 149)



- A. **CROWN SELECT – GILDED BRONZE**
CF4501GBZ - Blade Select Series Blades (Sold Separately)
- B. **CROWN SELECT – ANTIQUE PEWTER**
CF4501AP - Blade Select Series Blades (Sold Separately)
- C. **CROWN SELECT – VENETIAN BRONZE**
CF4501VNB - Blade Select Series Blades (Sold Separately)

Included

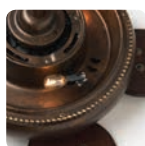

ACCENT LIGHTING
with Patented
Swivel Socket

Optional Controls



SR650
2-in-1
Remote Control
pg 157



SR600
6-Speed
Remote Control
pg 157



SW605
6-Speed
Wall Control
pg 157



RCK55
Horseshoe
Receiver
pg 158

Recommended Accessories
Sold Separately



BLADE SELECT¹
SERIES BLADES
pg 148



Lx GLO SERIES
LED Light Fixture
pg 153

¹ CF4501 not suitable with B79 blades.



B. Shown in Oil Rubbed Bronze with Mahogany Blades, 4-blade Installation Option and Removable Decorative Sleeve

A. Shown in Oil Rubbed Bronze with Mahogany Blades, 2-blade Installation Option and Removable Decorative Sleeve



T

A. CORNERSTONE – OIL RUBBED BRONZE
CF1ORB - Mahogany Blades

Included



UNIQUE
SERIALIZED
NAMEPLATE



REMOVABLE¹
Decorative
Sleeve

Optional Control



SR400
4-Speed
Remote Control
with Receiver
pg 157

Recommended Accessories
Sold Separately



B1 BLADES
Sold in Sets
of 4
pg 150



LK GLO SERIES
LED LIGHT FIXTURE
pg 153

¹ Recommended for ceiling height of at least 9 feet (for lower ceilings, use a shorter downrod without decorative sleeve).

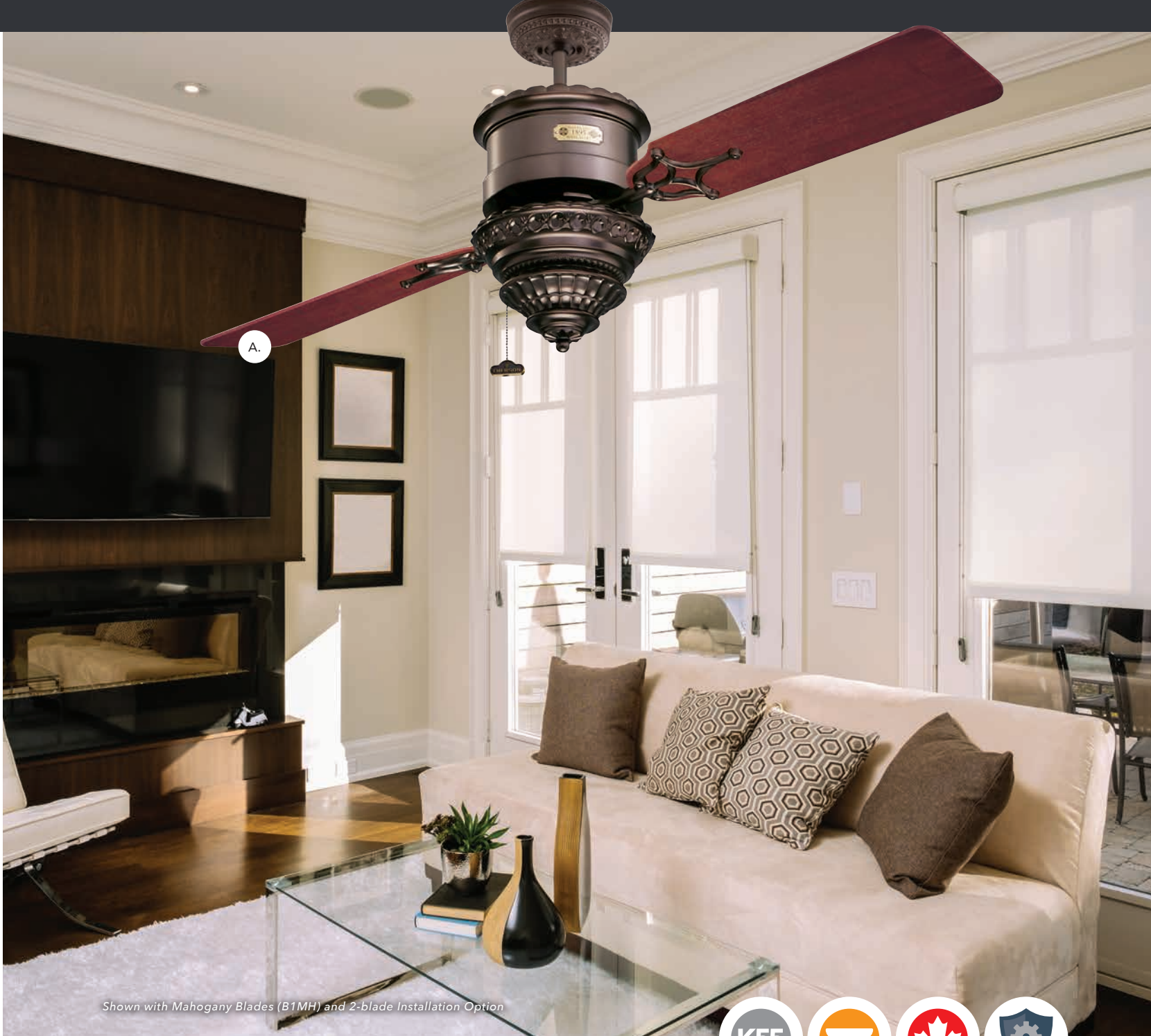

Shown with Mahogany Blades (B1MH) and 2-blade Installation Option



Cornerstone™

MODEL FEATURES

- 54" Blade Span
- Blades Sold Separately
- Adaptable to 2 or 4 Blades
- Light Fixture Adaptable
- Removable Decorative Sleeve
- Unique Serialized Nameplate
- 4.5" & 18" Downrods Included

17.8"
31.3"



FAN HEIGHT

Energy Guide Information

Blade Span Inches	Airflow Cubic Ft Per Min.	Electricity Use Watts (Excl. Lights)	Airflow Efficiency Cubic Ft Per Min. Per Watt	Estimated Yearly Cost Cost Range of Similar Models (19" - 84")
Two Blades	3658	56	65	\$16
Four Blades	3941	56	70	\$16



Rockpointe CF630



INDOOR/OUTDOOR

Enhance your outdoor living space with our line of indoor/outdoor fans featuring weather-resistant motor housings and blades in a wide array of styles.



ROCKPOINTE
CF630 - pg 109



KAILUA COVE
CF380 - pg 111



BATALIE BREEZE
CF621 - pg 113



WELLAND
CF610 - pg 115



52" & 42" VERANDA
CF552/CF542 - pg 117



SUMMERHAVEN
CF850 - pg 119



52" & 42" SUMMER NIGHT
CF652 - pg 121



DEVONSHIRE
CF670 - pg 123



SEA BREEZE
CF654 - pg 125

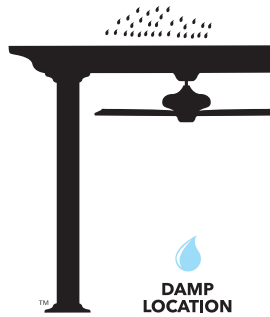

*Certain finishes only. See fan pages for details.



A.

Shown in Vintage Steel with Weather-Resistant Walnut Blades



Rockpointe

MODEL FEATURES

- 54" Blade Span
- 5 Weather-Resistant Blades
- Integrated Light Fixture Uses (3) 13-Watt CFL E26 Bulbs
- SW405 Wall Control
- 4.5" Downrod Included

16.9" 
FAN HEIGHT

Energy Guide Information

Airflow Cubic Ft Per Min.	Electricity Use Watts (Excl. Lights)	Airflow Efficiency Cubic Ft Per Min. Per Watt	Estimated Yearly Cost Cost Range of Similar Models (19" - 84")
3871	44	87	\$12



B. Shown in Oil Rubbed Bronze with Weather-Resistant Walnut Blades



C. Shown in Satin White with Weather-Resistant Driftwood Blades

- A. **ROCKPOINTE – VINTAGE STEEL**
CF630VS - Weather-Resistant Walnut Blades, Opal Matte Glass
- B. **ROCKPOINTE – OIL RUBBED BRONZE**
CF630ORB - Weather-Resistant Walnut Blades, Opal Matte Glass
- C. **ROCKPOINTE – SATIN WHITE**
CF630SW - Weather-Resistant Driftwood Blades, Opal Matte Glass

Included



SW405
4-Speed
Wall Control
with Receiver

Optional Control



SR401
4-Speed
Remote Control
pg 161

¹ Controls recommended for indoor use only.



B. Shown in Satin White with Weather-Resistant Driftwood Blades, Opal Matte Light Fixture (LK81LED, pg 154) and Wet Plate Location (WLP100, pg 154) (Sold Separately)

A. **KAILUA COVE – VENETIAN BRONZE**
CF380VNB - Weather-Resistant Medium Antique Brown Blades

B. **KAILUA COVE – SATIN WHITE**
CF380SW - Weather-Resistant Driftwood Blades

Optional Controls



SR400¹
 4-Speed
 Remote Control
 with Receiver
 pg 161



SW405¹
 4-Speed
 Wall Control
 with Receiver
 pg 159



SW46¹
 4-Speed Slide
 Wall Control
 pg 162

Recommended Accessories

Sold Separately



LK81XXX
 Opal Matte Light Fixture
 pg 154



WLP100XXX
 Wet Location Plate
 pg 154

¹ Controls recommended for indoor use only.

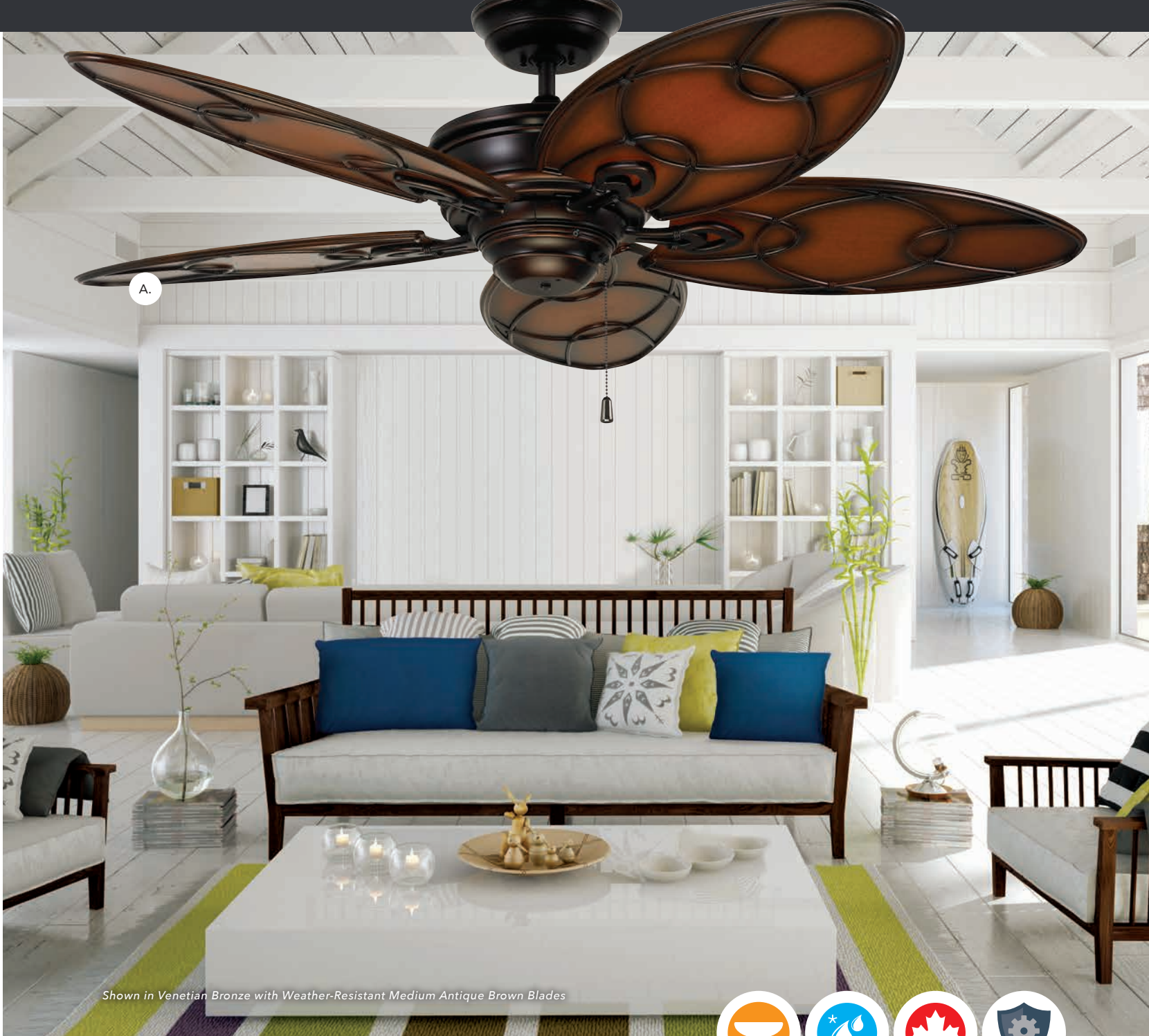

Shown in Venetian Bronze with Weather-Resistant Medium Antique Brown Blades



Kailua Cove

MODEL FEATURES

- 52" Blade Span
- 5 Weather-Resistant Blades
- Light Fixture Adaptable
- 4.5" Downrod Included

13.3" 
FAN HEIGHT

Energy Guide Information

Airflow Cubic Ft Per Min.	Electricity Use Watts (Excl. Lights)	Airflow Efficiency Cubic Ft Per Min. Per Watt	Estimated Yearly Cost Cost Range of Similar Models (19" - 84")
3073	39	78	\$11

Indoor/Outdoor 112



A.

Shown in Venetian Bronze with Weather-Resistant Antique Stain Wicker Leaf Blades



Batalie Breeze

MODEL FEATURES

- 52" Blade Span
- 5 Weather-Resistant Blades
- Light Fixture Adaptable
- 4.5" Downrod Included

14.5" 
FAN HEIGHT

Energy Guide Information

Airflow Cubic Ft Per Min.	Electricity Use Watts (Excl. Lights)	Airflow Efficiency Cubic Ft Per Min. Per Watt	Estimated Yearly Cost Cost Range of Similar Models (19" - 84")
3831	46	83	\$13



B. Shown in Satin White with Weather-Resistant Satin White Highlights Wicker Leaf Blades



- A. **BATALIE BREEZE – VENETIAN BRONZE**
CF621VNB - Weather-Resistant Antique Stain Wicker Leaf Blades
- B. **BATALIE BREEZE – SATIN WHITE**
CF621SW - Weather-Resistant Satin White Highlights Wicker Leaf Blades

Included

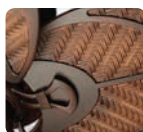

**5 WEATHER-RESISTANT
BLADES**

Optional Controls



SR400¹
4-Speed
Remote Control
with Receiver
pg 161



SW405¹
4-Speed
Wall Control
with Receiver
pg 159



SW46¹
4-Speed Slide
Wall Control
pg 162

Recommended Accessories

Sold Separately



LK92VNB
Ashton Wet Light Fixture
pg 154

¹ Controls recommended for indoor use only.



A. Shown in Venetian Bronze with Rustic Tropical Medium Antique Brown Blades

A. **WELLAND – VENETIAN BRONZE**
CF610VNB - Rustic Tropical Medium Antique Brown Blades

B. **WELLAND – VINTAGE STEEL**
CF610VS - Rustic Tropical Medium Antique Brown Blades

Included



**5 WEATHER-RESISTANT
CUSTOM BLADES**

Optional Controls



SR400¹
4-Speed
Remote Control
with Receiver
pg 161



SW405¹
4-Speed
Wall Control
with Receiver
pg 159



SW46¹
4-Speed Slide
Wall Control
pg 162

Recommended Accessories

Sold Separately



LK92VNB
Ashton Wet Light Fixture
pg 154

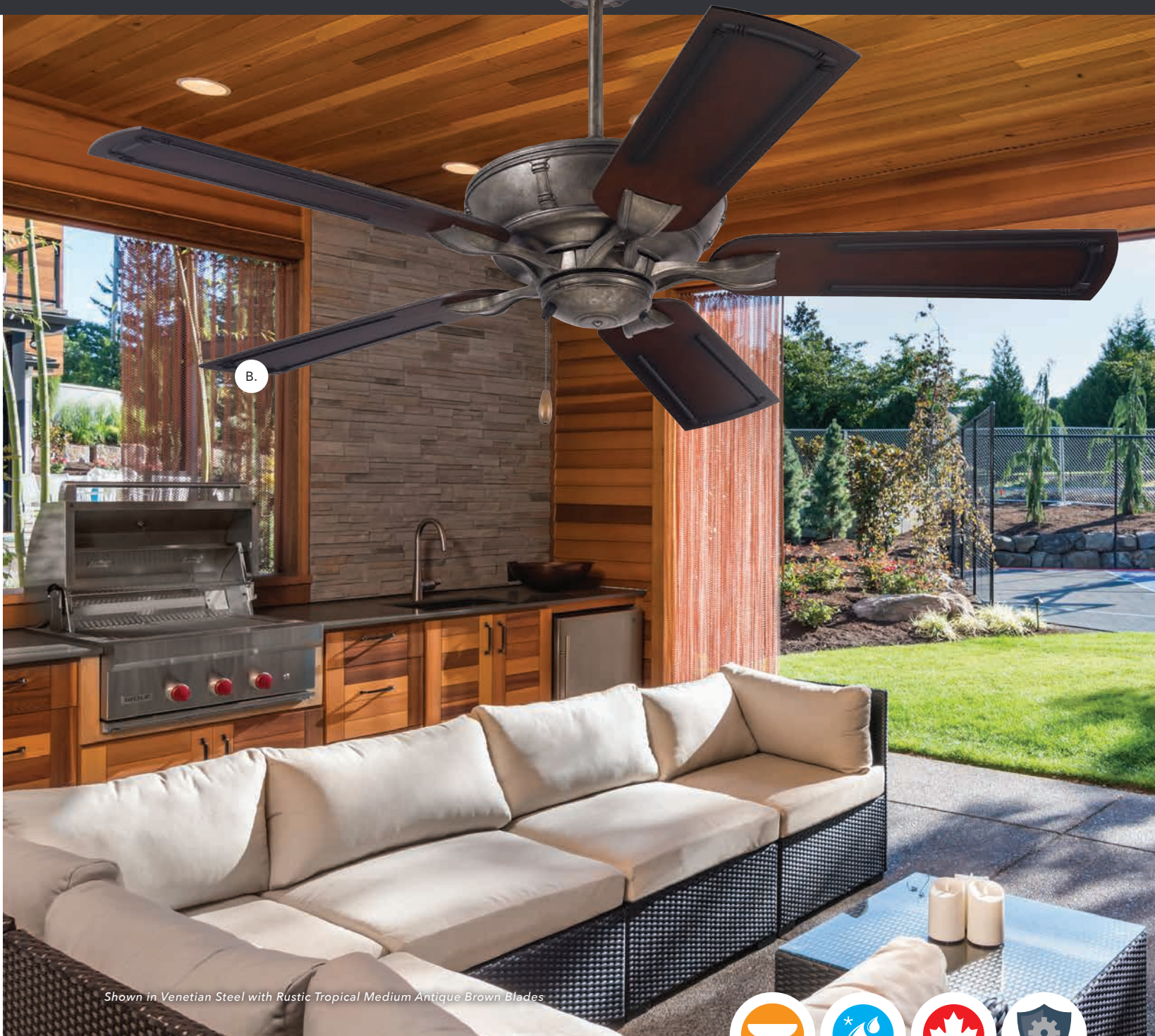

B.

Shown in Venetian Steel with Rustic Tropical Medium Antique Brown Blades



Welland

MODEL FEATURES

- 54" Blade Span
- 5 Weather-Resistant Blades
- Light Fixture Adaptable
- 4.5" Downrod Included

12.3" 
FAN HEIGHT

Energy Guide Information

<p>Airflow Cubic Ft Per Min.</p> <p>3646</p>	<p>Electricity Use Watts (Excl. Lights)</p> <p>36</p>	<p>Airflow Efficiency Cubic Ft Per Min. Per Watt</p> <p>100</p>	<p>Estimated Yearly Cost Cost Range of Similar Models (19" - 84")</p> <p>\$10</p>
--	---	---	---



D.

Shown in Vintage Steel with Weather-Resistant Walnut Blades



52" & 42" Veranda

MODEL FEATURES

- 5 Weather-Resistant Blades
- Light Fixture Adaptable
- 4.5" Downrod Included

14.0" 

FAN HEIGHT

Energy Guide Information

Blade Span Inches	Airflow Cubic Ft Per Min.	Electricity Use Watts (Excl. Lights)	Airflow Efficiency Cubic Ft Per Min. Per Watt	Estimated Yearly Cost Cost Range of Similar Models (19" - 84")
42"	2420	28	88	\$8
52"	3558	41	86	\$12

52" & 42" Veranda



A. Shown in Oil Rubbed Bronze with Weather-Resistant Oil Rubbed Bronze Blades, 12" Downrod (CFDR1ORB, pg 9) and Boardwalk Light Fixture (LK40ORB, pg 155)



B. Shown in Golden Espresso with Weather-Resistant Chocolate Blades



C. Shown in Summer White with Weather-Resistant Summer White Blades

- A. **52" & 42" VERANDA – OIL RUBBED BRONZE**
52": CF552ORB - Weather Resistant Oil Rubbed Bronze Blades
42": CF542ORB - Weather Resistant Oil Rubbed Bronze Blades
- B. **52" VERANDA – GOLDEN ESPRESSO**
CF552GES - Weather Resistant Chocolate Blades
- C. **52" VERANDA – SUMMER WHITE**
CF552AW - Weather Resistant Summer White Blades
- D. **52" VERANDA – VINTAGE STEEL**
CF552VS - Weather Resistant Walnut Blades

Included



**5 CUSTOM
BLADES**

Optional Controls



SR400¹
4-Speed
Remote Control
with Receiver
pg 161



SW405¹
4-Speed
Wall Control
with Receiver
pg 159



SW46¹
4-Speed Slide
Wall Control
pg 162

Recommended Accessories

Sold Separately



LK40
Boardwalk Cage
Light Fixture
pg 155



LK92
Ashton Wet
Light Fixture
pg 154

¹ Controls recommended for indoor use only.

Summerhaven



B. Shown in Golden Espresso with Weather-Resistant Golden Espresso Blades and Amber Mist Glass



|o

A. **SUMMERHAVEN – VENETIAN BRONZE**
CF850VNB - Venetian Bronze Blades, Amber Mist Glass

B. **SUMMERHAVEN – GOLDEN ESPRESSO**
CF850GES - Golden Espresso Blades, Amber Mist Glass

Included



5 WEATHER-RESISTANT
BLADES



INTEGRATED
Light Fixture

Optional Controls



SR400¹
4-Speed
Remote Control
with Receiver
pg 161



SW405¹
4-Speed
Wall Control
with Receiver
pg 159

¹ Controls are recommended for indoor use only.



Shown in Venetian Bronze with Weather-Resistant Venetian Bronze Blades and Amber Mist Glass



Summerhaven

MODEL FEATURES

- 52" Blade Span
- 5 Weather-Resistant Blades
- Integrated Light Fixture Uses (3) 25-Watt Candelabra Bulbs
- 4.5" Downrod Included

14.4" 
FAN HEIGHT

Energy Guide Information

Airflow Cubic Ft Per Min.	Electricity Use Watts (Excl. Lights)	Airflow Efficiency Cubic Ft Per Min. Per Watt	Estimated Yearly Cost Cost Range of Similar Models (19" - 84")
3516	40	88	\$11

Indoor/Outdoor 120



A.

Shown in Oil Rubbed Bronze with Weather-Resistant Oil Rubbed Bronze Blades



52" & 42" Summer Night®

MODEL FEATURES

- 5 Weather-Resistant Blades
- Light Fixture Adaptable
- 3.5" Downrod Included



12.0"
11.8"

FAN HEIGHT

Energy Guide Information

Blade Span Inches	Airflow Cubic Ft Per Min.	Electricity Use Watts (Excl. Lights)	Airflow Efficiency Cubic Ft Per Min. Per Watt	Estimated Yearly Cost Cost Range of Similar Models (19" - 84")
42"	2242	31	73	\$9
52"	3042	38	80	\$11

52" & 42" Summer Night®



B. Shown in Appliance White with Weather-Resistant Appliance White blades



A. **52" & 42" SUMMER NIGHT – OIL RUBBED BRONZE**
52": CF652ORB - Oil Rubbed Bronze Blades
42": CF742PFORB - Oil Rubbed Bronze Blades

B. **52" & 42" SUMMER NIGHT – APPLIANCE WHITE**
52": CF652WW - 52" Appliance White Blades
42": CF742PFWW - 42" Appliance White Blades

Included



**5 WEATHER-RESISTANT
BLADES**

Optional Controls



SW90
Fan & Light Dual
Slide Control
pg 162



SW46¹
4-Speed Slide
Wall Control
pg 162

Recommended Accessories

Sold Separately



IK GLO SERIES
LED Light Fixture
pg 153

¹ Controls are recommended for indoor use only.



A. Shown with Weather-Resistant Oil Rubbed Bronze Blades



A. **DEVONSHIRE – OIL RUBBED BRONZE**
CF670ORB - Oil Rubbed Bronze Blades

Included



**5 WEATHER-RESISTANT
BLADES**

Optional Controls



SR400¹
4-Speed
Remote Control
with Receiver
pg 161



SW405¹
4-Speed
Wall Control
with Receiver
pg 159



SW46¹
4-Speed Slide
Wall Control
pg 162

Recommended Accessories

Sold Separately



WLP100XXX
Wet Location Plate
pg 154



LK GLO SERIES
LED Light Fixture
pg 153



LK92
Ashton Wet
Light Fixture
pg 154

¹ Controls are recommended for indoor use only.



Shown in Oil Rubbed Bronze with Weather-Resistant Oil Rubbed Bronze Blades



Devonshire

MODEL FEATURES

- 52" Blade Span
- 5 Weather-Resistant Blades
- Light Fixture Adaptable
- 4.5" Downrod Included

12.0" 
FAN HEIGHT

Energy Guide Information

<p>Airflow Cubic Ft Per Min.</p> <p>3775</p>	<p>Electricity Use Watts (Excl. Lights)</p> <p>43</p>	<p>Airflow Efficiency Cubic Ft Per Min. Per Watt</p> <p>88</p>	<p>Estimated Yearly Cost Cost Range of Similar Models (19" - 84")</p> <p>\$12</p>
--	---	--	---

Indoor/Outdoor 124



Shown in Appliance White with Opal Matte Light Fixture (LK81LED, pg 154), Wet Location Plate (WLP100, pg 151) and 12" Downrod (pg 9)



Sea Breeze

MODEL FEATURES

- 52" Blade Span
- 5 Weather-Resistant Blades
- Light Fixture Adaptable
- 3.5" Downrod Included

Energy Guide Information

Airflow Cubic Ft Per Min.	Electricity Use Watts (Excl. Lights)	Airflow Efficiency Cubic Ft Per Min. Per Watt	Estimated Yearly Cost Cost Range of Similar Models (19" - 84")
3485	42	83	\$12

14.0" 
FAN HEIGHT



A. Shown in Oil Rubbed Bronze with Weather-Resistant Oil Rubbed Bronze Blades

A. **SEA BREEZE – OIL RUBBED BRONZE**
CF654ORB - Oil Rubbed Bronze Blades

B. **SEA BREEZE – APPLIANCE WHITE**
CF654WW - Appliance White Blades

Included



**5 WEATHER-RESISTANT
 BLADES**

Optional Controls



SW405¹
 4-Speed
 Wall Control
 with Receiver
 pg 159



SW46¹
 4-Speed Slide
 Wall Control
 pg 162

Recommended Accessories
 Sold Separately



LK40
 Boardwalk Cage
 Light Fixture
 pg 155



LK71XXX
 Amber Parchment
 Light Fixture
 pg 153



LK46
 Seaside Light Fixture
 pg 155



WLP100XXX
 Wet Location Plate
 pg 154

¹ Controls are recommended for indoor use only.



ProSeries CF712



PRO SERIES

A line made with builders and new home-owners in mind, these fans are designed for ease of installation and to fit well within any style of home.



PRO SERIES
CF712 - pg 129



PRO SERIES ES
CF713 - pg 131



50" PRO SERIES II
CF711 - pg 133



42" PRO SERIES II
CF710 - pg 135



PRO SERIES BUILDER
CF700 - pg 137



60" INDUSTRIAL FAN
HF1160 - pg 139



56" INDUSTRIAL FAN
HF956 - pg 141



48" INDUSTRIAL FAN
HF948 - pg 143



Pro Series™



A. Shown in Oil Rubbed Bronze with Dark Cherry Blades and Opal Matte Glass



B. Shown in Appliance White with Appliance White Blades and Opal Matte Glass



C. Shown in Oil Rubbed Bronze with Dark Cherry Blades and Amber Scavo Glass



D. Shown in Summer White with Summer White Blades and Opal Matte Glass

P

- A. **PRO SERIES – OIL RUBBED BRONZE**
CF712WORB - Dark Cherry/Medium Oak Blades, Opal Matte Glass
- B. **PRO SERIES – APPLIANCE WHITE**
CF712WW - Appliance White/Bleached Oak Blades, Opal Matte Glass
- C. **PRO SERIES – OIL RUBBED BRONZE**
CF712ORB - Dark Cherry/Medium Oak Blades, Amber Scavo Glass
- D. **PRO SERIES – SUMMER WHITE**
CF712AW - Summer White/Bleached Oak Blades, Opal Matte Glass
- E. **PRO SERIES – ANTIQUE BRASS**
CF712AB - Dark Cherry/Walnut Blades, Opal Matte Glass
- F. **PRO SERIES – BRUSHED STEEL**
CF712BS - Dark Cherry/Walnut Blades, Opal Matte Glass



E. Shown in Antique Brass with Walnut Blades, 12" downrod (CFDR1AB, pg 9) and Opal Matte Glass

Included



5 REVERSIBLE
BLADES



LIGHT FIXTURE



NO-LIGHT
OPTION



DUAL-MOUNT
FEATURE

Optional Controls



SW90
Fan & Light Dual
Slide Control
pg 158



SW46
4-Speed
Slide Wall Control
pg 158

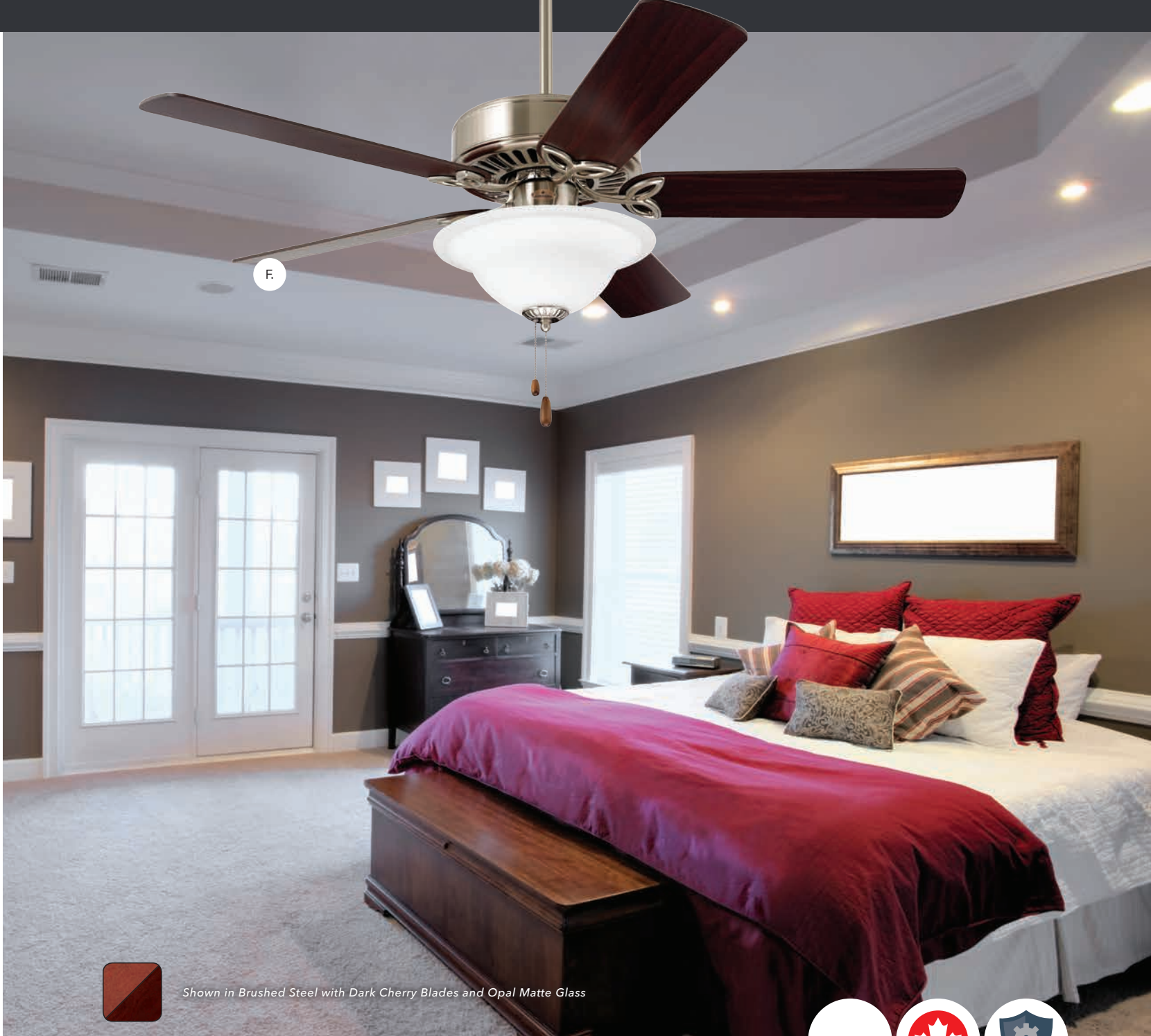

Shown in Brushed Steel with Dark Cherry Blades and Opal Matte Glass



Pro Series™

MODEL FEATURES

- 50" Blade Span
- 5 Reversible Blades
- Dual-Mount Feature
- Light Fixture
- No-Light Option
- Easy Installation Mounting Bracket
- 4.5" Downrod Included
- Adaptable up to 3' Downrod

18.5"
14.8"



FAN HEIGHT

Energy Guide Information

Airflow Cubic Ft. Per Min.	Electricity Use Watts (Excl. Lights)	Airflow Efficiency Cubic Ft. Per Min. Per Watt	Estimated Yearly Cost Cost Range of Similar Models (19" - 84")
2472	39	64	\$11



Shown in Brushed Steel with Dark Cherry Blades and Alabaster Glass



Pro Series ES

MODEL FEATURES

- 50" Blade Span
- 5 Reversible Blades
- Dual-Mount Feature
- LED Light Fixture Uses (3) Medium Base LED Bulbs
- No-Light Option
- Easy Install Mounting Bracket
- 4.5" Downrod Included
- Adaptable up to 3' Downrod

18.5"
14.8"

FAN HEIGHT

Energy Guide Information

<p>Airflow Cubic Ft. Per Min.</p> <p>2570</p>	<p>Electricity Use Watts (Excl. Lights)</p> <p>39</p>	<p>Airflow Efficiency Cubic Ft. Per Min. Per Watt</p> <p>66</p>	<p>Estimated Yearly Cost Cost Range of Similar Models (19" - 84")</p> <p>\$11</p>
---	---	---	---



NOW INCLUDES!
LED Bulbs



B. *Shown in Oil Rubbed Bronze with Dark Cherry Blades and Amber Scavo Glass*



C. *Shown in Appliance White with Appliance White Blades and Alabaster Glass*

- A. **PRO SERIES ES – BRUSHED STEEL**
CF713BS - Dark Cherry/Walnut Blades
- B. **PRO SERIES ES – OIL RUBBED BRONZE**
CF713ORB - Dark Cherry/Medium Oak
- C. **PRO SERIES ES – APPLIANCE WHITE**
CF713WW - Appliance White/Maple Blades



Included



**5 REVERSIBLE
BLADES**



LED LIGHT FIXTURE

LED Specifications

- 800 Lumens
- 80 CRI
- 3000 K CCT

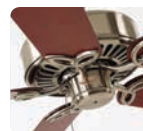

**NO-LIGHT
OPTION**

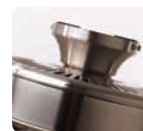

**DUAL-MOUNT
FEATURE**

50" Pro Series II



A. Shown in Oil Rubbed Bronze with Dark Cherry Blades and Opal Matte Glass



B. Shown in Appliance White with Appliance White Blades and Opal Matte Glass



C. Shown in Oil Rubbed Bronze with Dark Cherry Blades and Amber Scavo Glass



D. Shown in Antique Brass with Walnut Blades and Opal Matte Glass

P

- A. **50" PRO SERIES II – OIL RUBBED BRONZE**
CF711ORB - Dark Cherry/Medium Oak Blades, Opal Matte Glass
- B. **50" PRO SERIES II – APPLIANCE WHITE**
CF711WW - Appliance White/Bleached Oak Blades, Opal Matte Glass
- C. **50" PRO SERIES II – OIL RUBBED BRONZE**
CF711ORS - Dark Cherry/Medium Oak Blades, Amber Scavo Glass
- D. **50" PRO SERIES II – ANTIQUE BRASS**
CF711AB - Walnut/Medium Oak Blades, Opal Matte Glass
- E. **50" PRO SERIES II – BRUSHED STEEL**
CF711BS - Dark Cherry/Mahogany Blades, Opal Matte Glass

Included



5 REVERSIBLE
BLADES

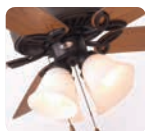

4-WAY LIGHT
FIXTURE



NO-LIGHT
OPTION



DUAL-MOUNT
FEATURE

Optional Controls



SW90
Fan & Light Dual
Slide Control
pg 158



SW46
4-Speed
Slide Wall Control
pg 158

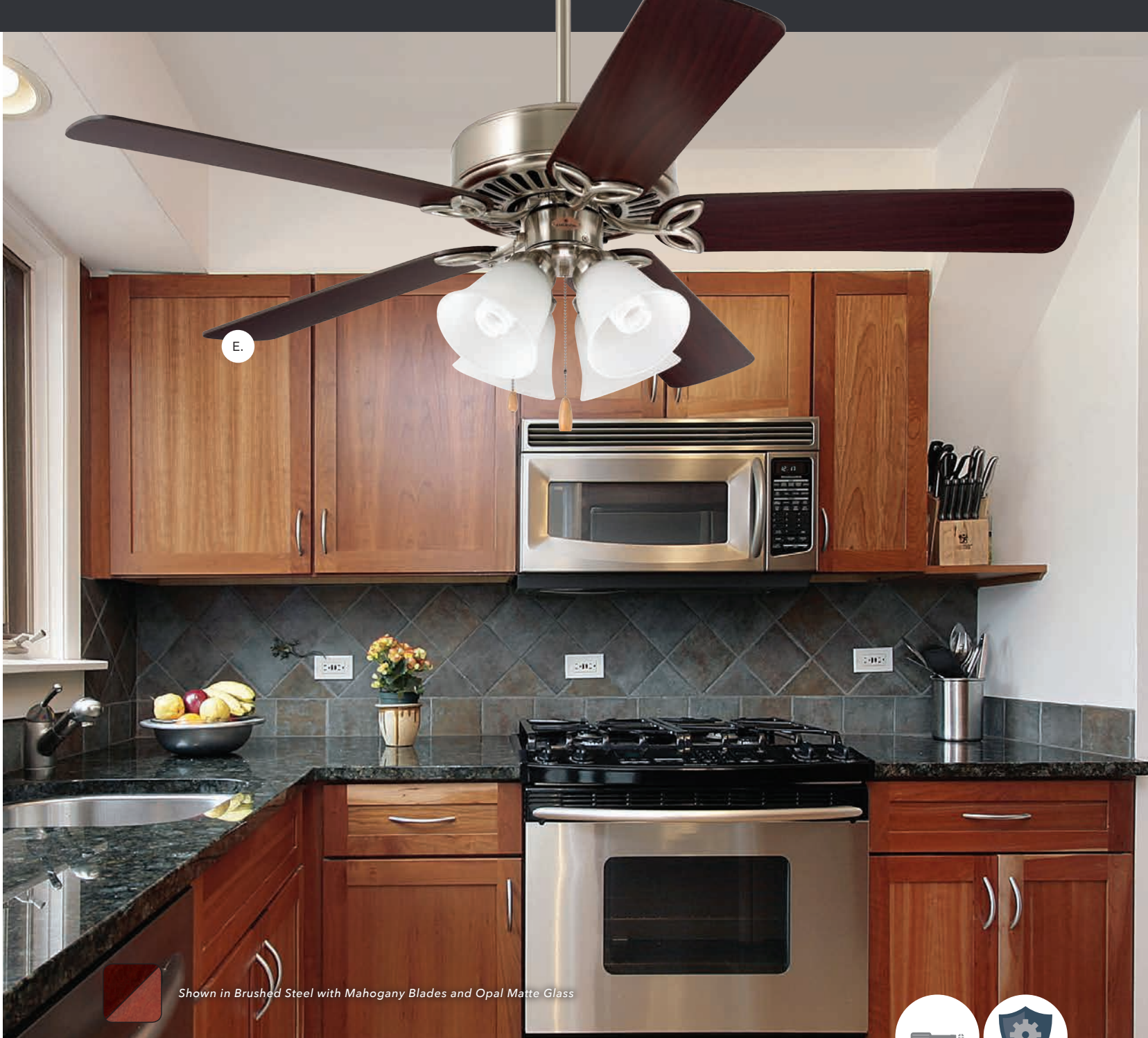

Shown in Brushed Steel with Mahogany Blades and Opal Matte Glass



50" Pro Series II

MODEL FEATURES

- 5 Reversible Blades
- 4-Way Light Fixture
- Dual-Mount Feature
- No-Light Option
- Easy Install Mounting Bracket & Snap-On Glass
- Precision-Lock™ Blade Arms with Pre-Attached Screws
- 4.5" Downrod Included
- Adaptable up to 3' Downrod

14.8"
18.5"



FAN HEIGHT

Energy Guide Information

Airflow Cubic Ft. Per Min.	Electricity Use Watts (Excl. Lights)	Airflow Efficiency Cubic Ft. Per Min. Per Watt	Estimated Yearly Cost Cost Range of Similar Models (19" - 84")
2472	39	64	\$11

Pro Series 134

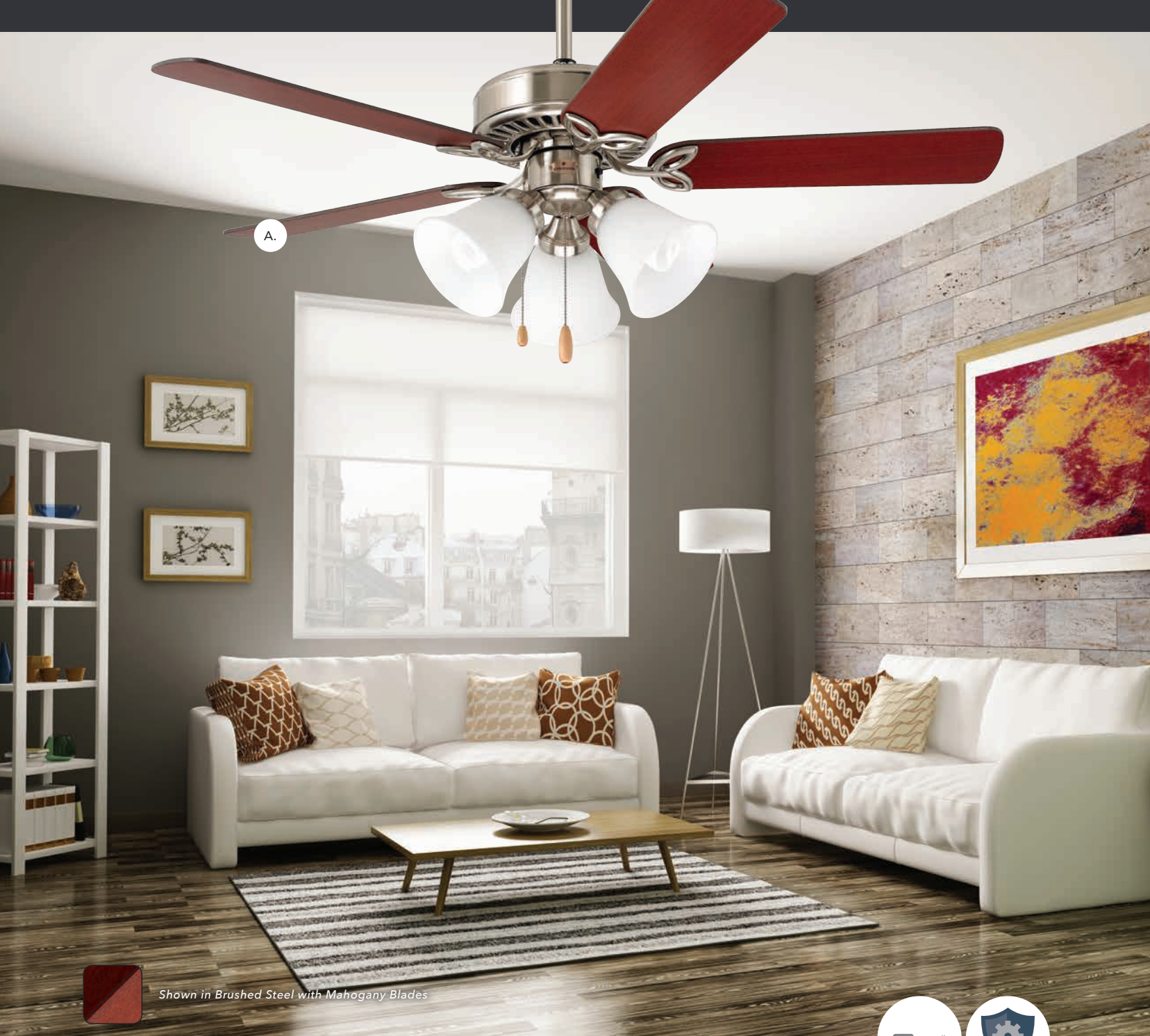

A.



Shown in Brushed Steel with Mahogany Blades



42" Pro Series II

MODEL FEATURES

- 5 Reversible Blades
- 3-Way Light Fixture
- Dual-Mount Feature
- No-Light Option
- Easy Install Mounting Bracket & Snap-On Glass
- Precision-Lock™ Blade Arms with Pre-Attached Screws
- 3.5" Downrod Included
- Adaptable up to 3' Downrod

14.5"
17.3"



FAN HEIGHT

Energy Guide Information

Airflow Cubic Ft. Per Min.	Electricity Use Watts (Excl. Lights)	Airflow Efficiency Cubic Ft. Per Min. Per Watt	Estimated Yearly Cost Cost Range of Similar Models (19" - 84")
1713	31	56	\$9



B. Shown in Oil Rubbed Bronze with Dark Cherry Blades and Opal Matte Glass



C. Shown in Appliance White with Appliance White Blades and Opal Matte Glass

- A. **42" PRO SERIES II – BRUSHED STEEL**
CF710BS - Dark Cherry/Mahogany Blades, Opal Matte Glass
- B. **42" PRO SERIES II – OIL RUBBED BRONZE**
CF710ORB - Dark Cherry/Medium Oak Blades, Opal Matte Glass
- C. **42" PRO SERIES II – APPLIANCE WHITE**
CF710WW - Appliance White/Bleached Oak Blades, Opal Matte Glass



Included

Optional Controls



**5 REVERSIBLE
BLADES**



**3-WAY LIGHT
FIXTURE**



**NO-LIGHT
OPTION**



**DUAL-MOUNT
FEATURE**



SW90
Fan & Light Dual
Slide Control
pg 158



SW46
4-Speed
Slide Wall Control
pg 158



A. Shown in Brushed Steel with Dark Cherry Blades and 12" Downrod (CFDR1BS, pg 9)



B. Shown in Appliance White with Appliance White Blades and 12" Downrod (CFDR1WW, pg 9)

P

- A. **PRO SERIES BUILDER – BRUSHED STEEL**
CF700BS - Dark Cherry/Mahogany Blades
- B. **PRO SERIES BUILDER – APPLIANCE WHITE**
CF700WW - Appliance White/Bleached Oak Blades
- C. **PRO SERIES BUILDER – OIL RUBBED BRONZE**
CF700ORB - Dark Cherry/Medium Oak Blades

Included



**5 REVERSIBLE
BLADES**

Optional Controls



SW90
Fan & Light Dual
Slide Control
pg 158



SW46
4-Speed
Slide Wall Control
pg 158

Recommended Accessories

Sold separately



LKGLO SERIES
LED Light Fixture
pg 152



LK53
Low Profile Light Fixture
pg 154



F330
3-Light Turtle Fitter
pg 147



Shown in Oil Rubbed Bronze with Dark Cherry Blades



Pro Series Builder

MODEL FEATURES

- 5 Reversible Blades
- Die-Cast Hanger Ball and Bracket
- Light Fixture Adaptable
- 4.5" Downrod Included - Adaptable up to 3' Downrod

12.0" 
FAN HEIGHT

Energy Guide Information

Airflow Cubic Ft. Per Min.	Electricity Use Watts (Excl. Lights)	Airflow Efficiency Cubic Ft. Per Min. Per Watt	Estimated Yearly Cost Cost Range of Similar Models (19" - 84")
2995	39	77	\$11

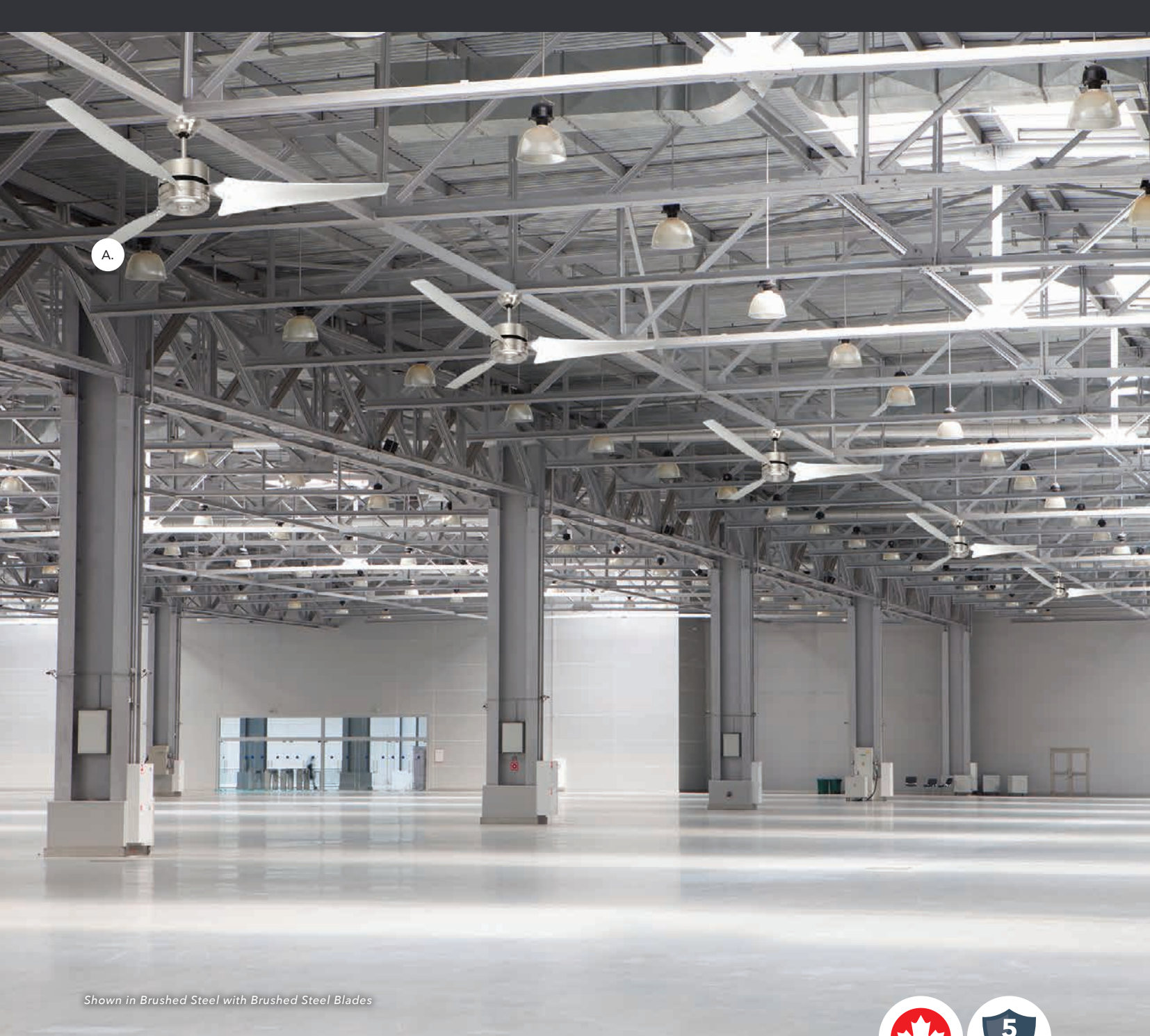

A.

Shown in Brushed Steel with Brushed Steel Blades



60" Industrial Fans

MODEL FEATURES

- SW95 Wall Control Included
- 3 High-Efficiency Airfoil Blades
- Blades Must Be Mounted At Least 10 Feet Above the Floor
- 6" Downrod Included
- Fan Hung at 20 Feet Covers 3,500 sq. ft.
- Fan Hung at 30 Feet Covers 2,900 sq. ft.
- Fan Hung at 40 Feet Covers 2,200 sq. ft.
- Not Reversible
- Approved for Residential and Commercial Use When Blades Are Installed At Least 10 Feet Above the Floor

12.8" 

FAN HEIGHT

High Speed Information

<p>Airflow</p> <p>Cubic Ft. Per Min.</p> <p>10644</p>	<p>Electricity Use</p> <p>Watts (Excl. Lights)</p> <p>91</p>	<p>Airflow Efficiency</p> <p>Cubic Ft. Per Min. Per Watt</p> <p>116</p>
---	--	---



A. Shown in Brushed Steel with Brushed Steel Blades



B. Shown in Appliance White with Appliance White Blades

- A. **60" INDUSTRIAL FAN – BRUSHED STEEL**
HF1160BS - Brushed Steel Blades
- B. **60" INDUSTRIAL FAN – APPLIANCE WHITE**
HF1160WW - Appliance White Blades
- C. **60" INDUSTRIAL FAN – BARBEQUE BLACK**
HF1160BQ - Barbeque Black Blades



Included



3 HIGH-EFFICIENCY AIRFOIL BLADES



SW95
4-Speed Knob
Wall Control



SW81
Variable Speed
Control
pg 162

Compatible with All Industrial Fans

Sold separately

- 2-wire
- Infinitely variable
- 3 amps
- Faceplate Included



SW82
Variable Speed
Wall Control
pg 162

- 2-wire
- Infinitely variable
- 12 amps
- Faceplate Included

56" Industrial Fans



A. Shown in Barbeque Black with Barbeque Black Blades



B. Shown in Appliance White with Appliance White Blades

- A. **56" INDUSTRIAL FAN – BARBEQUE BLACK**
HF956BQ - Barbeque Black Blades
- B. **56" INDUSTRIAL FAN – APPLIANCE WHITE**
HF956W - Appliance White Blades
- C. **56" INDUSTRIAL FAN – BRUSHED STEEL**
HF956BS - Brushed Steel Blades

Included



3 CONTOURED METAL BLADES



SW95
4-Speed Knob
Wall Control



SW81
Variable Speed
Control
pg 162

Compatible with All Industrial Fans

Sold separately

- 2-wire
- Infinitely variable
- 3 amps
- Faceplate included



SW82
Variable Speed
Wall Control
pg 162

- 2-wire
- Infinitely variable
- 12 amps
- Faceplate included



Shown in Brushed Steel with Brushed Steel Blades



56" Industrial Fans

MODEL FEATURES

- SW95 Wall Control Included
- 3 Contoured Metal Blades
- Supplied with "J" Hook for Easy Installation and Smooth Performance
- Blades Must Be Mounted At Least 10 Feet Above the Floor
- Single Speed Fan Using 120 Volts
- Fan Hung at 20 Feet Covers 1,800 sq. ft.
- Fan Hung at 30 Feet Covers 1,500 sq. ft.
- Fan Hung at 40 Feet Covers 900 sq. ft.
- Not Reversible
- 22" Downrod Included
- Approved for Residential and Commercial Use When Blades Are Installed At Least 10 Feet Above the Floor

33.5" 
FAN HEIGHT

High Speed Information

<p>Airflow Cubic Ft. Per Min.</p> <p>10516</p>	<p>Electricity Use Watts (Excl. Lights)</p> <p>98</p>	<p>Airflow Efficiency Cubic Ft. Per Min. Per Watt</p> <p>107</p>
--	---	--



Shown in Appliance White with Appliance White Blades



48" Industrial Fans

MODEL FEATURES

- SW95 Wall Control Included
- (3) Contoured Metal Blades
- Supplied with "J" Hook for Easy Installation and Smooth Performance
- Blades Must Be Mounted At Least 10 Feet Above the Floor
- Single Speed Fan Using 120 Volts
- Fan Hung at 20 Feet Covers 1,500 sq. ft.
- Fan Hung at 30 Feet Covers 1,200 sq. ft.
- Fan Hung at 40 Feet Covers 700 sq. ft.
- Not Reversible
- 8" and 22" Downrods Included
- Approved for Residential and Commercial Use When Blades Are Installed At Least 10 Feet Above the Floor

19.5"
33.5"



FAN HEIGHT

High Speed Information

<p>Airflow Cubic Ft. Per Min.</p> <p>6723</p>	<p>Electricity Use Watts (Excl. Lights)</p> <p>70</p>	<p>Airflow Efficiency Cubic Ft. Per Min. Per Watt</p> <p>96</p>
---	---	---



A. Shown in Brushed Steel with Brushed Steel Blades

A. **48" INDUSTRIAL FAN – BRUSHED STEEL**
HF948BS - Brushed Steel Blades

B. **48" INDUSTRIAL FAN – APPLIANCE WHITE**
HF948W - Appliance White Blades

Included



**3 CONTOURED
METAL BLADES**



SW95
4-Speed Knob
Wall Control



SW81
Variable Speed
Control
pg 162

Compatible with All Industrial Fans

Sold separately

- 2-wire
- Infinitely variable
- 3 amps
- Faceplate Included



SW82
Variable Speed
Wall Control
pg 162

- 2-wire
- Infinitely variable
- 12 amps
- Faceplate Included



Penbrooke Select CF5100

Shown in Golden Espresso with 25" Vintage Black Blades (B90VBL, pg 149) and Opal Matte Glass (LK180, pg 154)



ACCESSORIES

Enhance your ceiling fan with accessories ranging from controls to custom light fixtures.



**BLADE SELECT
SERIES BLADES**
pg 148



**2 1/4
GLASS**
pg 151



**LED & CUSTOM
LIGHT FINISH FIXTURES**
pg 153



LIGHT FIXTURES
pg 155



FITTERS
pg 156



CONTROLS & RECEIVERS
pg 157



DOWNRODS
pg 9



*Certain finishes only. See fan pages for details.



Introducing the
Ion Eco

Ion Eco CF5300 pg 41



BLADE SELECT[™]
SERIES

Shown in Graphite with 22" Timber Gray Blades (G77TM, pg 150)



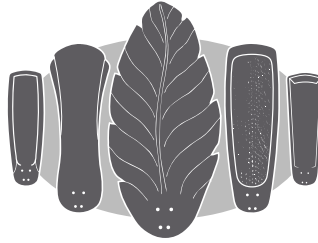

BLADE SELECT™

SERIES

STEP
1

Choose *Your* Fan



AVANT ECO

STEP
2

Choose *Your* Finish



OIL RUBBED BRONZE

STEP
3

Choose *Your* Blade



HONEY OAK

+ *Optional Light Fixtures, Controls, Downrods and More!*

**YOUR STYLE,
HUNDREDS
OF POSSIBILITIES**

7
*Fan
Models*

11
*Finishes
Available*

50+
*Blade
Options*



PENBROOKE
SELECT ECO
pg 17



PENBROOKE
SELECT
pg 19



CARRERA
GRANDE ECO
pg 23



ION ECO
pg 41



AVANT ECO
pg 83



PREMIUM
SELECT
pg 85



CROWN
SELECT
pg 103

* Some restrictions apply. See product pages for details.



BLADE SELECT™ SERIES

Choose from the blades shown on pages 149 - 150 to complete your custom Blade Select Series ceiling fan. Most Blade Select Series blades shown are compatible with the following ceiling fans:



**PENBROOKE
SELECT ECO**
pg 17



**PENBROOKE
SELECT**
pg 19



**CARRERA
GRANDE ECO**
pg 23



ION ECO
pg 41



AVANT ECO
pg 83



**PREMIUM
SELECT**
pg 85



**CROWN
SELECT**
pg 103



DECORATIVE HAND CARVED WOOD BLADES

25" Length, 58-60" Span Blades

Solid wood blades with decorative detailing. All of the following blades are suitable for damp location and indoor rated fans.



B90DO
Classic
DARK OAK



B90VBL
Classic
VINTAGE BLACK



B91WA
Deco
WALNUT



B92VWA
Rattan
VINTAGE WALNUT



B97DWA
Ornate
DARK WALNUT



SOLID WOOD BLADES

22", 25", 31" Length, 52/54", 58/60", 70/72" Span Blades

B77 blades are 22" (52-54" Span). B78 blades are 25" (58-60" Span). B79 blades are 31" (70-72" Span). All B77, B78 & B79 are suitable for damp location and indoor rated fans. These solid wood blades feature a large bevel.



B77/78/79CH
Solid
CHOCOLATE



B77/78/79DM
Solid
DARK MAHOGANY



B77/78/79NC
Solid
NATURAL CHERRY



B77/78/79SW
Solid
SATIN WHITE



B77/78/79TK
Solid
TEAK



B77/78/79WA
Solid
WALNUT



B77/78/79CR
NEW! Solid
CHARCOAL



B77/78/79TM
NEW! Solid
TIMBER GRAY

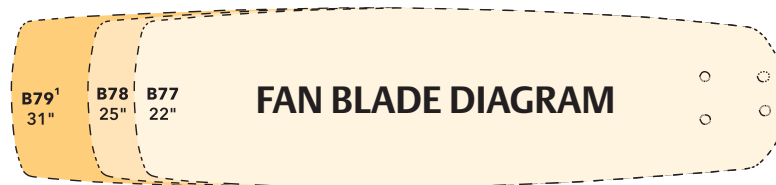

1 CH and SW are painted blades



DECORATIVE, HAND CARVED, WOOD BLADES

22" Length, 52-54" Span Blades

Solid wood blades with decorative detailing. All of the following blades are suitable for damp location and indoor rated fans.



B100DO
Classic
DARK OAK



B101WA
Deco
WALNUT



B102VWA
Rattan
VINTAGE WALNUT



B103DWA
Ornate
DARK WALNUT



B107HCT
Tapered
DARK WALNUT



B108HCW
Carved
WALNUT



B109DC
Hand Carved
DARK CHERRY



B109DO
Hand Carved
DARK OAK

WOOD VENEER BLADES³

G54 Series, 22" Length, 52-54" Span Blades, G44 Series, 18" Length, 42-44" Span Blades, G60 Series, 25" Length, 58-60" Span Blades

Micro-balanced to within one gram. 6-layer wood veneer blades are cross-laminated for stability and warp resistance. Sealed to resist moisture. **CH, SW, WW** finishes are custom painted to match housing.



G54BS
Veneer
BRUSHED STEEL



G54CR
NEW! Veneer
CHARCOAL



G54CH
Veneer
CHOCOLATE



G54DC/G44DC
Veneer
DARK CHERRY



G54DM
Veneer
DARK MAHOGANY



G54H0
Veneer
HONEY OAK



G54HWA
Veneer
HERITAGE WALNUT



G54MH
Veneer
MAHOGANY



G54MO
Veneer
MEDIUM OAK



G54RW
Veneer
RIVERWASH



G54/G44SW
NEW! Veneer
SATIN WHITE



G54TK/G44TK
Veneer
TEAK



G54TM
NEW! Veneer
TIMBER GRAY



G54WA/G44WA
Veneer
WALNUT



G54WS
Veneer
WHITE WASH

G60 SERIES 25" BLADES



G60CH
25" Blades
CHOCOLATE



G60SW
25" Blades
SATIN WHITE



G60DM
25" Blades
DARK MAHOGANY



G60WA
25" Blades
WALNUT

▶ **2 1/4 GLASS**

All glass is packaged and sold in sets of (4). All Emerson 2 1/4 glass only adapts to Emerson fitters.



CFGW1
Traditional White



G18
Frosted Ice



G19
Washed Frosted



G26
Clear Ribbed



G44
Alabaster Swirl



G47
Teastained



G53
Sandstone



G55
Opal Matte



G56
Amber Scavo



G57
Clouded Swirl



G58
Amber Mist



G59
Swirl



G65
Teadust



LK GLO 
SERIES

A. Shown with 52" Bella- Brushed Steel and Ashton LED Light Fixture in White Mist (LK91LEDBS) CF452BS



* Certain finishes only. See fan pages for details
* 5-Year Limited Warranty on all Ik GLO Series LED Light Fixtures

▶ LK GLO SERIES LIGHT FIXTURES

Optimizing the technology of LEDs, we created our most energy efficient and longest-lasting light fixtures yet and backed them with the Emerson limited 5-Year Warranty. Our state-of-the-art IkGLO Series Light Fixtures come in 13 custom finishes, produce a softer, more uniform glow than conventional bulbs and last nearly 3 times as long. Look for the LED icon throughout the catalog for ceiling fans that feature integrated LED lighting or are compatible with LED light fixtures.

LK GLO SERIES LK GLO SERIES LIGHT FIXTURES

Optimizing the technology of LEDs, we created our most energy efficient and longest-lasting light fixtures yet and backed them with the Emerson limited 5-Year Warranty. Our state-of-the-art LkGLO Series Light Fixtures come in 13 custom finishes, produce a softer, more uniform glow than conventional bulbs and last nearly 3 times as long. Look for the LED icon throughout the catalog for ceiling fans that feature integrated LED lighting or are compatible with LED light fixtures.

LED Array Features

- Lumens: 1,200 Lumens
- Color Temperature: 2,700 K
- Color Rendering Index: > 80

Finish	Model Number	Standard Fluorescent (3) - 13 Watt Bulb (4) - 13 Watt Bulb	LK GLO LED (1) - 16 Watt Array* (1) - 18 Watt Array**	Rated	Candelabra (2) - 60 Watt Bulbs (3) - 60 Watt Bulbs	Candelabra (3) - 40 Watt Bulbs	5 Year Warranty LED SKUs
A. FEATHER SWIRL GLASS Low Profile 4.5"H x 12"W	LK53				(3)		
B. MOON OPAL MATTE GLASS Low Profile 3.75"H x 10"W	LK65				(2)		
C. AMBER MIST 4.5"H x 12.38"W	LK70XXX	(3)					
	LK70LEDXXX						
D. AMBER PARCHMENT 4.5" H x 12.38" W	LK71XXX	(3)					
	LK71LEDXXX						
E. AMBER SCAVO 4.5"H x 12.38"W	LK72XXX	(3)					
	LK72LEDXXX						
F. OPAL MATTE 4.5" H x 12.38" W	LK74XXX	(3)					
	LK74LEDXXX						
G. WHITE LINEN 4.5"H x 12.38"W	LK77XXX	(3)					
	LK77LEDXXX						
H. AMBER MIST 4.25"H x 12.38"W	LK80XXX	(3)					
	LK80LEDXXX						

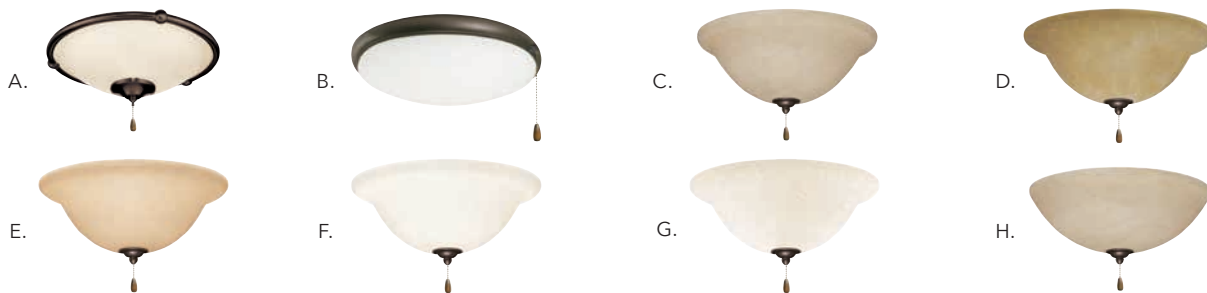

LED AND CUSTOM FINISH LIGHT FIXTURES

To complete the model number, replace **XXX** with finish code. Bowl caps available in **AB, AP, AW, BS, GBZ, GES, ORB, SW, VNB, VS** and **WW** finishes. Finial packs: Include 3 versions of plates for various pull chain configurations, no hole, 1 hole and 2 hole options included in each pack. See page 9 for images of finishes.



Wet Location Plate

Add a wet location plate to any fixture on this page for outdoor use. Available for use with LK7x, LK8x, LK14x series. Shown in **ORB**. Also available in: **AW, GES, SW, VS** and **WW**.

Please note that the pull chain can be removed when the ceiling fan is installed with a light control system.

LK GLO SERIES **LK GLO SERIES LIGHT FIXTURES**

Optimizing the technology of LEDs, we created our most energy efficient and longest-lasting light fixtures yet and backed them with the Emerson limited 5-Year Warranty. Our state-of-the-art LkGLO Series Light Fixtures come in 13 custom finishes, produce a softer, more uniform glow than conventional bulbs and last nearly 3 times as long. Look for the LED icon throughout the catalog for ceiling fans that feature integrated LED lighting or are compatible with LED light fixtures.

LED Array Features

- Lumens: 1,200 Lumens
- Color Temperature: 2,700 K
- Color Rendering Index: > 80

Finish	Model Number	Standard Fluorescent (3) - 13 Watt Bulb (4) - 13 Watt Bulb	**GLO - LED (1) - 16 Watt Array* (1) - 18 Watt Array**	Rated	Candelabra (2) - 60 Watt Bulbs (3) - 60 Watt Bulbs	Candelabra (3) - 40 Watt Bulbs	5 Year Warranty LED SKUs
I. OPAL MATTE 4.25"H x 12.38"W	LK81XXX	(3)					
	LK81LEDXXX		*				
J. WHITE LINEN 4.25"H x 12.38"W	LK83XXX	(3)					
	LK83LEDXXX		*				
K. AMBER MIST - ASHTON Low Profile 3.3"H x 11.5"W	LK90XXX				(3)		
	LK90LEDXXX		*				
L. WHITE MIST - ASHTON Low Profile 3.3" H x 11.5"W	LK91XXX				(3)		
	LK91LEDXXX		*				
M. AMBER MIST - ASHTON 3.3"H x 11.5"W	LK92XXX					(3)	
N. WHITE MIST - GRANDE 4.25" H x 12.5" W	LK141XXX				(3)		
	LK141LEDXXX		*				
O. OPAL MATTE - RILEY* 3.3"H x 15.4"W * Feature 1400 Lumens	LK180XXX	(4)			(3)		
	LK181LEDXXX		**				
P. OPAL MATTE GLASS - HARLOW* 3.8"H x 11"W * Feature 1400 Lumens	LK1500MXXX				(3)		
	LK1500MXXXLED		**				

* Opal Matte - Riley and Opal Matte Glass - Harlow feature 1400 Lumens

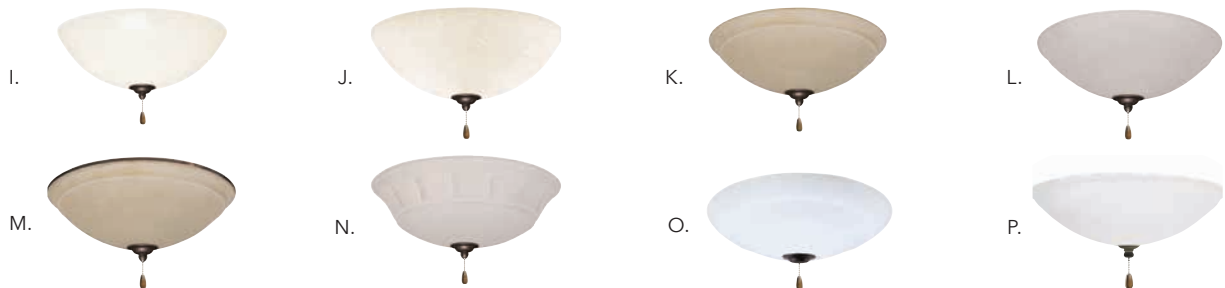

LED AND CUSTOM FINISH LIGHT FIXTURES

To complete the model number, replace **XXX** with finish code. Bowl caps available in **AB, AP, AW, BS, GBZ, GES, ORB, SW, VNB, VS** and **WW** finishes. Finial packs: Include 3 versions of plates for various pull chain configurations, no hole, 1 hole and 2 hole options included in each pack. See page 9 for images of finishes.



Wet Location Plate

Add a wet location plate to any fixture on this page for outdoor use. Available for use with LK7x, LK8x, LK14x series. Shown in **ORB**. Also available in: **AW, GES, SW, VS** and **WW**.

Please note that the pull chain can be removed when the ceiling fan is installed with a light control system.



TEASTAINED CLASSIC
5.25" H x 13" W
LK51

(3) 60-watt candelabra base bulbs included.



TILO OPAL MATTE
3.9" H X 8" W
LK130

(2) 50-watt mini candelabra halogen bulbs included.
Includes BS, ORB and WW bowl caps.



ALABASTER SWIRL CLASSIC
5.25" H X 13" W
LK52

(3) 60-watt candelabra base bulbs included.



SCHOOLHOUSE SINGLE DAMP
6.33" H x 8.5" W
CFSLKPF

Shown in WW. Also available in ORB.
(1) 23-watt, medium base, compact fluorescent bulb included. Rated for 100-watt incandescent.



FOUR SPOT MESH
7" H X 10" W
LK36

Shown in BS. Also available in ORB.
(4) 13-watt, medium base, compact fluorescent bulbs included. Rated for (4) 60-watt incandescent.



FOUR SPOT TRACK
6.5" H X 7.5" W
CFMLK4

Shown in WW. Also available in ORB.
(4) 13-watt compact fluorescent bulbs included.
Rated for (4) 60-watt incandescent.



BOARDWALK CAGE
7.5" H x 16.5" W
LK40

Shown in ORB. Also available in VNB.
(3) 9-watt, medium base, compact fluorescent bulbs included.
Rated for (3) 60-watt incandescent.



SEASIDE
7" H X 9" W
LK46

Shown in ORB. Also available in AW and WW.
(1) 13-watt, medium base, compact fluorescent bulb included.
Rated for (1) 100-watt incandescent.



EUCLID LED
9.0" W X 7.0" H
LK500XXX

Shown in Brushed Steel. Also available in ORB, AP and SW. (3) 8-watt, medium base, A-19 bulbs included.



**FOUR-LIGHT CONTEMPORARY
ADJUSTABLE FITTER**
3" H X 11" W
CFFC4

Shown in BS. Also available in ORB.
(4) 13-watt, medium base, compact fluorescent bulbs included. Rated for (4) 60-watt incandescent.



THREE-LIGHT TURTLE FITTER
3.5" H X 5.5" W
F330

Shown in WW. Also available in BS and ORB.
(3) 13-watt, medium base, compact fluorescent bulbs included. Rated for (3) 60-watt incandescent.



FOUR-LIGHT ARM FITTER
3" H X 8.75" W
F440

Shown in ORB. Also available in AB, BS, SW, VNB and WW.
(4) 13-watt, medium base, compact fluorescent bulbs included. Rated for (4) 60-watt incandescent.



TRANSITIONAL FITTER
6.5" H X 13.15" W
F490

Shown in GES. Also available in GBZ, ORB and VNB.
(4) 13-watt, medium base, compact fluorescent bulbs included. Rated for (4) 60-watt incandescent.



OPTIONAL ACCENT
Light Accessory
AL200

10-Watt, Max Dimmable, LED Array



FINIAL PACK
FN100

One pack includes no-hole, one-hole and two-hole options. Available in AB, AP, AW, BS, GBZ, GES, ORB, SW, VS, WW and VNB.

* Component Parts
(available for singular parts purchase)

▶ Fitters and glass offer one more way to personalize your Emerson fan. Simply match your favorite fitter to your glass selection. Multi-light fitters accommodate 2¼" glass. Each fitter has threaded sockets and includes an assembly tool for easy installation. Fitters are available in the finish listed below each model.



For an industrial look, convert any fitter in an instant with our Vintage Bulb Adapters. Customize the look with your favorite style of vintage bulbs.

VB100 Vintage Bulb Adapters

Shown in **ORB**. Also available in **BS** and **VNB**. Set of 4. Bulbs not included.

▶ 4-SPEED CONTROLS WITH RECEIVERS (USE WITH RCFP RECEIVER)

For remote compatibility, please refer to the Controls Guide on page 159-162.



SR400¹
4-Speed Remote Control
with Receiver



SW405²
4-Speed Remote Control
with Receiver

MODEL FEATURES

- 4 Fan Speeds
- Full Range Light Dimmer with Incandescent Bulbs (300 Watts Max)
- Canopy Mount Receiver Included (Not for use on Sloped Ceilings)
- Operates From Up to 30 ft.
- 1.0 Amp Fan Load
- Non-Reversing
- 1-Year Limited Warranty

1 Remote Only: SR401. Two AAA batteries included.

2 Wall Control Only: SW406. White light almond and ivory switch cover plate included.

BUNDLE & SAVE! UPGRADE BUNDLES

Control + Light Accessory

UB100 UPGRADE BUNDLE



SR600
Remote Control



AL200
Light Accessory



RCK188
Horseshoe
Receiver

UB200 UPGRADE BUNDLE



SW605
Wall Control



AL200
Light Accessory



RCK188
Horseshoe
Receiver

UB300 UPGRADE BUNDLE*



SR650
2-in-1
Remote Control



AL200
Light Accessory



RCK188
Horseshoe
Receiver

* Adaptable to Prima (CF901)

▶ 6-SPEED CONTROLS (USE WITH RC188 AND RCK55 RECEIVERS)

For remote compatibility, please refer to the Controls Guide on page 159-162.



SR600¹
6-Speed LED
Remote Control



SW605²
6-Speed LED
Wall Control



SR650³
6-Speed 2-in-1
Remote Control



SR650
Shown in dual-gang
decorative plate
(Rocker switch not included)

MODEL FEATURES

- 6 Fan Speeds with LED Indicator
- Full Range Light Dimmer with Incandescent Bulbs
- Independent Uplight/Downlight Operation
- One-Touch Reverse
- White, Light Almond and Ivory Switch Cover Plates Included
- Canopy Mount Receiver Sold Separately
- For Use with RC188 & RCK55 Receivers

1 Two AAA batteries included

2 1.0 amps fan load. White, light almond and ivory switch cover plates included.

3 Can be used mounted on the wall or as a remote control. Single and Dual-gang decorative plate included. Two CR2032 batteries included.

RECEIVERS



RCPF
Flat Pack Receiver

MODEL FEATURES

- 4-Speeds
- Canopy Mount Receiver
- Full Range Light Dimmer (250 Watts Max)
- 1.0 Amp Fan Load
- Non-Sloped Ceiling Mount Only
- For Use with SR401 and SW406 Controls

1 For use with 188mm motor fan models. Designed for SR600, SW605, and SR650 controls.

2 For use with Emerson K55XL motor fan models. Designed for SR600, SW605 and SR650 controls.



RC188¹
Horseshoe Receiver

MODEL FEATURES

- 6 Fan Speeds
- Reverse Module
- Independent Uplight/Downlight Operation
- Full Range Light Dimmer (500 Watts Max Total, 300 Watts Down and 200 Watts Uplight)
- 1.0 Amp Fan Load



RCK55²
Horseshoe Receiver

KNOBBS AND SLIDE CONTROLS

For remote compatibility, please refer to the Controls Guide on page 159-162.



**SW46W (WHITE)
SW46LA (ALMOND)**
4-Speed Fan Slide Control

FEATURES

- Fan Control Only
- 2-Wire Installation
- 4 Fan Speeds
- 1.2 Amps Maximum
- Includes Decorative Faceplate



**SW90W (WHITE)
SW90LA (ALMOND)**
Dual Slide Control

FEATURES

- Fan & Light Control
- 3-Wire Installation
- 4 Fan Speeds
- Continuous Light Dimming (300 Watts Max)
- 1.25 Amps Fan Load
- Includes Decorative Faceplate



SW93
2-Fan Control

FEATURES

- Fan Control Only
- 2-Wire Installation
- 3 Fan Speeds
- 3 Amps Maximum
- Faceplate Not Included
- Includes White and Almond Knobs



SW95
4-Speed Fan Knob Control

FEATURES

- Fan Control Only
- 2-Wire Installation
- 4 Fan Speeds
- 1.5 Amps Maximum
- Faceplate Not Included
- Includes White and Almond Knobs



SW96
4-Speed Fan Slide Control

FEATURES

- 4 Fan Speeds
- 5 Amps Maximum
- Includes White and Almond Knobs
- Faceplate Not Included



SW81

FEATURES

- 2-wire
- Infinitely Variable
- 3 Amps
- Includes Faceplate



SW82
2-Fan Control

FEATURES

- 2-Wire
- Infinitely Variable
- 12 Amps
- Includes Faceplate

- ✚ Fan model does not have nor is adaptable to accent light. Accent Light function will not operate.
- * Must use these controls/receivers to operate accent light and downlight separately.
- ✘ Reverse function will not operate remotely.
- ▲ Light button cannot be used.
- Supplied with fan.
- Compatible

Uses RCFP, SR400 & SW405
(Receiver Included)



Require Receiver (sold separately) for Operation
(Uses RCK55 or RC188)



Model Number	Fan Model	SR400 SR401	SR405 SR406	RCFP	SR600	SR650	SW605
CF1	Cornerstone	●	●	●	●	●	●
CF130	Tilo						
CF144 L	44" Curva Sky Outdoor				✚	✚	✚
CF152 L	52" Curva Sky Outdoor				✚	✚	✚
CF145L	44" Curva Sky Indoor						
CF253L	52" Curva Sky Indoor						
CF205	Highpointe	■	●	■			
CF230	Veloce	■	●	■			
CF244 L	44" Curva Outdoor				✚	✚	✚
CF252 L	52" Curva Outdoor				✚	✚	✚
CF245L	44" Curva Indoor						
CF253L	52" Curva Indoor						
CF275	Sweep Eco				✚	✚	✚
CF320	Keane	▲	▲	▲			
CF330	Ideal				✚	✚	✚
CF380	Kailua Cove	●	●	●	✚	✚	✚
CF430	Highrise	●	■	■			
CF440	Braddock	■	●	■			
CF442	42" Bella	●	●	●	✚	✚	✚
CF4501	Crown Select				●	●	●
CF452	52" Bella	●	●	●	✚	✚	✚
CF4801	Premium Select				●	●	●
CF4900	Southtowne				✚	✚	✚
CF5100	Penbrooke Select				●	●	●
CF5200	Penbrooke Select Eco				●	●	■
CF5300	Ion Eco				✚	✚	✚
CF500	Euclid	●	●	●	●	●	●
CF550L	Luxe Eco				✚	✚	✚
CF542	42" Veranda	●	●	●			
CF552	52" Veranda	●	●	●			
CF590	Volta	■	●	■			
CF610	Welland	●	●	●	✚	✚	✚
CF621	Batalie Breeze	●	●	●	✚	✚	✚
CF630	Rockpointe	●	■	■	✘	✘	✘
CF652	52" Summer Night						
CF654	Sea Breeze	●	●	●			
CF670	Devonshire	●	●	●	✚	✚	✚
CF700	Builder						
CF702	29" Northwind						
CF710	42" Pro Series II						
CF711	50" Pro Series II						
CF712	Pro Series						

- ✚ Fan model does not have nor is adaptable to accent light. Accent Light function will not operate.
- * Must use these controls/receivers to operate accent light and downlight separately.
- ✘ Reverse function will not operate remotely.
- ▲ Light button cannot be used.
- Supplied with fan.
- Compatible



Hardwire Controls
(Do not require a receiver)



4-Speed, Slide Wall Control 4-Speed, Knob Wall Control 4-Speed, 5-Amp Multi-Fan Knob Wall Control 3-Speed 2-Fan Knob Control Fan and Light Dual Slide Control Variable Speed Control Variable Speed Wall Control

Model Number	Fan Model	RC188	RCK55	SW46*	SW95*	SW96*	SW93*	SW90*	SW81	SW82
CF1	Cornerstone		●	●	●	●	●	●		
CF130	Tilo			■	●	●	●	●		
CF144L	44" Curva Sky Outdoor	■								
CF152L	52" Curva Sky Outdoor	■								
CF145L	44" Curva Sky Indoor									
CF253L	52" Curva Sky Indoor									
CF205	Highpointe			●	●	●	●	●		
CF230	Veloce			■	●	●	●	●		
CF244L	44" Curva Outdoor	■								
CF252L	52" Curva Outdoor	■								
CF245L	44" Curva Indoor									
CF253L	52" Curva Indoor									
CF275	Sweep Eco									
CF320	Keane			●	●	●	●	▲		
CF330	Ideal									
CF380	Kailua Cove	✚		●	●	●	●	●		
CF430	Highrise			●	●	●	●			
CF440	Braddock			●	●	●	●	●		
CF442	42" Bella	✚		●	●	●	●	●		
CF4501	Crown Select		●	●	●	●	●	●		
CF452	52" Bella	✚		●	●	●	●	●		
CF4801	Premium Select		●	●	●	●	●	●		
CF4900	Southtowne		■							
CF5100	Penbrooke Select		●	●	●	●	●	●		
CF5200	Penbrooke Select Eco									
CF5300	Ion Eco									
CF500	Euclid	●		■	●	●	●	●		
CF550L	Luxe Eco									
CF542	42" Veranda			●	●	●	●	●		
CF552	52" Veranda			●	●	●	●	●		
CF590	Volta			●	●	●	●	●		
CF610	Welland	✚		●	●	●	●	●		
CF621	Batalie Breeze	✚		●	●	●	●	●		
CF630	Rockpointe	✘		●	●	●	●	●		
CF652	52" Summer Night			●	●	●	●	●		
CF654	Sea Breeze			●	●	●	●	●		
CF670	Devonshire	✚		●	●	●	●	●		
CF700	Builder			●	●	●	●	●		
CF702	29" Northwind			●	●	●	●	●		
CF710	42" Pro Series II			●	●	●	●	●		
CF711	50" Pro Series II			●	●	●	●	●		
CF712	Pro Series			●	●	●	●	●		

* Separate lighting circuit required for fans with integrated or accessory lights

- ✦ Fan model does not have nor is adaptable to accent light. Accent Light function will not operate.
- * Must use these controls/receivers to operate accent light and downlight separately.
- ✘ Reverse function will not operate remotely.
- ▲ Light button cannot be used.
- Supplied with fan.
- Compatible

Uses RCFP, SR400 & SW405
(Receiver Included)



4-Speed Remote Control



4-Speed Wall Control



Flat Pack Receiver

Require Receiver (sold separately) for Operation
(Uses RCK55 or RC188)



6-Speed, LED Remote Control



6-Speed, 2-in-1 LED Remote Control



6-Speed, LED Wall Control

Model Number	Fan Model	SR400 SR401	SR405 SR406	RCFP	SR600	SR650	SW605
CF713	Pro Series ES						
CF717	Ashland						
CF742PF	42" Summer Night						
CF755	Designer	●	●	●	✦	✦	✦
CF765	Loft	▲	▲	▲			
CF766L	4th Avenue	●	■	■			
CF772	52" Monterey II	●	●	●			
CF773	42" Monterey II	●	●	●			
CF776	Monterey Lumina	●	●	●			
CF784	Carrera	●	●	●	✦	✦	✦
CF788	Carrera Grande Eco				✦	✦	✦
CF790	Crofton	●	■	■			
CF804S	42" Snugger						
CF8045S	52" Snugger						
CF825	Lindell	●	●	●			
CF830	Monaco	●	●	●	✘	✘	✘
CF850	Summerhaven	●	●	●			
CF860	Luray Eco				✦	✦	✦
CF880L	Amhurst	●	■	■			
CF901	Prima				*	*	*
CF905	Prima Snugger	●	●	●			
CF921	Avant Eco				■	●	●
CF915	Rah Eco				✦	✦	✦
CF930	Atomical	■	●	■			
CF935	Zurich	●	●	●			
CF955L	Midway Eco				✦	✦	✦
CF985L	Aira Eco				✦	✦	■
CF995	Laclede Eco				■	●	●
HF1160	60" Industrial Fan						
HF948	48" Industrial Fan						
HF956	56" Industrial Fan						

- ✦ Fan model does not have nor is adaptable to accent light. Accent Light function will not operate.
- * Must use these controls/receivers to operate accent light and downlight separately.
- ✘ Reverse function will not operate remotely.
- ▲ Light button cannot be used.
- Supplied with fan.
- Compatible



Hardwire Controls
(Do not require a receiver)



4-Speed, Slide Wall Control 4-Speed, Knob Wall Control 4-Speed, 5-Amp Multi-Fan Knob Wall Control 3-Speed 2-Fan Knob Control Fan and Light Dual Slide Control Variable Speed Control Variable Speed Wall Control

Model Number	Fan Model	RC188	RCK55	SW46*	SW95*	SW96*	SW93*	SW90*	SW81	SW82
CF713	Pro Series ES			●	●	●	●			
CF717	Ashland			●	●	●	●			
CF742PF	42" Summer Night			●	●	●	●	●		
CF755	Designer	✦		●	●	●	●	●		
CF765	Loft			■						
CF766L	4th Avenue			●						
CF772	52" Monterey II			●						
CF773	42" Monterey II			●						
CF776	Monterey Lumina			●						
CF784	Carrera	✦		●						
CF788	Carrera Grande Eco									
CF790	Crofton			●						
CF804S	42" Snugger			●						
CF8045S	52" Snugger			●						
CF825	Lindell			●	●	●	●	●		
CF830	Monaco	✘		●						
CF850	Summerhaven			●						
CF860	Luray Eco									
CF880	Amhurst			●						
CF901	Prima	*		■						
CF905	Prima Snugger			■						
CF921	Avant Eco									
CF915	Rah Eco									
CF930	Atomical			●	●	●	●	●		
CF935	Zurich			●	●	●	●	●		
CF955L	Midway Eco									
CF985L	Aira Eco									
CF995	Laclede Eco									
HF1160	60" Industrial Fan			●	●	●	●		●	●
HF948	48" Industrial Fan			●	●	●	●		●	●
HF956	56" Industrial Fan			●	●	●	●		●	●

* Separate lighting circuit required for fans with integrated or accessory lights

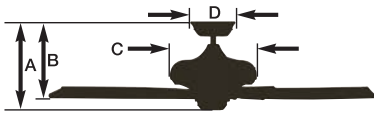

◆ Information not available at the time of printing - Visit emersonfans.com for the latest information

1 (2) Blades

2 (4) Blades

3 Damp or Wet Location ratings may apply to certain finishes only

† CFM data reflects a weighted average of high and low speeds using the method defined by US Department of Energy 10 CFR Part 430

Model Number	Model	Pg	Motor (mm)	Fan Diameter	Blade Pitch	A	B	C	D	Motor Warranty	Accepts 2.5" DR	Energy Star
CF1	Cornerstone	105	K55XL	54"	14°/20°	17.8"/31.3"	11.0"/24.5"	9.5"	6.4"	Lifetime	Y	N
CF130	Tilo	79	153x10mm	30"	12°	9.5"/13.3"	8.1"x 11.9"	7.3"	5.1"	Lifetime	Y	N
CF144L	44" Curva Sky LED Outdoor	69	153x18mm	44"	12°	12.6"	10.0"	9.6"	9.9"	Lifetime	N	N
CF145L	44" Curva Sky LED Indoor	67	153x18mm	44"	12°	12.6"	10.0"	9.6"	9.9"	Lifetime	N	N
CF152L	52" Curva Sky LED Outdoor	69	153x18mm	52"	12°	12.6"	10.0"	9.6"	9.9"	Lifetime	N	N
CF153L	52" Curva Sky LED Indoor	67	153x18mm	52"	12°	12.6"	10.0"	9.6"	9.9"	Lifetime	N	N
CF205	Highpointe LED	63	153x22mm	54"	14°	16.5"/22.5"	15.0"/21.0"	8.0"	6.3"	Lifetime	Y	N
CF230	Veloce	47	153x18mm	46"	12°	14.4"/11.1"	11.9"	7.5"	5"	Lifetime	Y	N
CF244L	44" Curva LED Outdoor	73	153x18mm	44"	12°	14.9"	12.0"	9.6"	6.5"	Lifetime	Y	N
CF245L	44" Curva LED Indoor	71	153x18mm	44"	12°	14.9"	12.0"	9.6"	6.5"	Lifetime	Y	N
CF252L	52" Curva LED Outdoor	73	153x18mm	52"	12°	14.9"	12.0"	9.6"	6.5"	Lifetime	Y	N
CF253L	52" Curva LED Indoor	71	153x18mm	52"	12°	14.9"	12.0"	9.6"	6.5"	Lifetime	Y	N
CF275	Sweep Eco	37	EcoMotor	60"	16°	13"	9.8"	10.0"	7.5"	Lifetime	Y	N
CF320	Keane	49	153x17mm	52"	12°	10.9"	10.4"	11.0"	5.9"	Lifetime	Y	Y
CF330	Ideal Eco	43	125mm EcoMotor	54"	14°	14.4"	12.7"	6.7"	5.8"	Lifetime	Y	N
CF380	Kailua Cove	111	188x15mm	52"	12°	13.3"	11.4"	11.3"	7.2"	Lifetime	N	N
CF430	Highrise	55	153x17mm	50"	13°	13.5"	11.2"	8.0"	5.9"	Lifetime	Y	N
CF440	Braddock	31	188x18mm	54"	12.5°	16.2"	11.45"	12.8"	6.4"	Lifetime	N	N
CF442	42" Bella	33	153x18mm	42"	13°	14.0"	12.0"	11.5"	7.1"	Lifetime	N	N
CF4501	Crown Select	103	K55XL	42"/52"/58"/70"	12°	14.0"	13.0"	12.3"	6.4"	Lifetime	Y	N
CF452	52" Bella	33	188x15mm	52"	13°	14.0"	12.0"	11.5"	7.1"	Lifetime	N	N
CF4801	Premium Select	85	K55XL	42"/52"/58"/70"	12°	15.0"	14.0"	12.3"	6.4"	Lifetime	Y	N
CF500	Euclid	45	188x20mm	56"	12°	14"	12.25"	9.8"	6.75"	Lifetime	Y	N
CF5100	Penbrooke Select	19	K55XL	44"/54"/60"	12°	13.0"	12.0"	13.0"	6.7"	Lifetime	Y	N
CF5200	Penbrooke Select Eco	17	EcoMotor	44"/54"/60"/72"	12°	13.0"	12.0"	13.0"	6.7"	Lifetime	Y	N
CF5300	Ion Eco	41	EcoMotor	44"/54"/60"/72"	16°	16.1"	13.4"	8"	6.1"	Lifetime	N	N
CF550L	Luxe Eco	61	EcoMotor	54"	18°	15.8"	12.0"	9.6"	6.4"	Lifetime	N	N
CF542	42" Veranda	117	153x18mm	42"	13°	14.0"	12.0"	11.5"	7.1"	Lifetime	N	N
CF552	52" Veranda	117	188x15mm	52"	13°	14.0"	12.0"	11.5"	7.1"	Lifetime	N	N
CF590	Volta	77	172x20mm	54"	12°	14.5"	13.2"	8.7"	5.8"	Lifetime	Y	N
CF610	Welland	115	188x15mm	54"	12°	14.9"	12.3"	13.75"	6.8"	Lifetime	Y	N
CF621	Batalie Breeze	113	188x20mm	52"	14°	14.5"	13.2"	9.8"	7.1"	Lifetime	Y	N
CF630	Rockpointe	109	172x20mm	54"	12.5°	16.9"	12.0"	8.7"	7.5"	Lifetime	N	N
CF652	52" Summer Night	121	153x15mm	52"	12°	11.8"	9.8"	11.5"	5.3"	Lifetime	Y	N
CF654	Sea Breeze	125	188x15mm	52"	14°	14.0"	12.0"	12.0"	6.5"	Lifetime	Y	N
CF670	Devonshire	123	188x15mm	52"	14°	12.0"	10.0"	12.0"	7.0"	Lifetime	Y	N

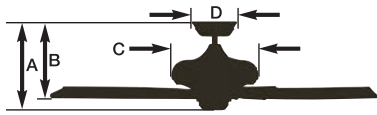

◆ Information not available at the time of printing - Visit emersonfans.com for the latest information

1 (2) Blades

2 (4) Blades

3 Damp or Wet Location ratings may apply to certain finishes only

† CFM data reflects a weighted average of high and low speeds using the method defined by US Department of Energy 10 CFR Part 430

Model Number	Model	Wet/Damp	HIGH-SPEED			ENERGY GUIDE			Control Included	Receiver Included	Manual/Remote Reverse Switch	Dimming Light	Downrod Length	Ships to Canada
			CFM	CFM/W	Amps	CFM [†]	CFM/W [†]	Watts [†]						
CF1	Cornerstone	Indoor	5509 ¹ 6054 ²	56 ¹ 61 ²	0.83	3658 ¹ 3941 ²	65 ¹ 70 ²	56 ¹ 56 ²	Pull Chain	N/A	Manual	N/A	4.5 & 18	Y
CF130	Tilo	Damp ³	2642	64	0.4	1870	74	25	SW46	N/A	Manual	N/A	4.5	Y
CF144L	44" Curva Sky LED Outdoor	Wet ³	3830	87	0.5	2820	84	34	6 Speed Remote Control	RC188	Remote	Y	N/A	Y
CF145L	44" Curva Sky LED Indoor	Indoor	3830	87	0.5	2820	84	34	6 Speed Remote Control	RC188	Remote	Y	N/A	Y
CF152L	52" Curva Sky LED Outdoor	Wet ³	3961	88	0.5	2952	86	34	6 Speed Remote Control	RC188	Remote	Y	N/A	Y
CF153L	52" Curva Sky LED Indoor	Indoor	3961	88	0.5	2952	86	34	6 Speed Remote Control	RC188	Remote	Y	N/A	Y
CF205	Highpointe LED	Indoor	5023	75	0.57	3257	80	41	SR400	RCFP	Manual	Y	6 & 12	Y
CF230	Veloce	Indoor	3998	79	0.5	3049	84	36	SR400	RCFP	Manual	Y	4.5	Y
CF244L	44" Curva LED Outdoor	Wet ³	4069	90	0.5	2948	87	34	6 Speed Remote Control	RC188	Remote	Y	4.5	Y
CF245L	44" Curva LED Indoor	Indoor	4069	90	0.5	2948	87	34	6 Speed Remote Control	RC188	Remote	Y	4.5	Y
CF252L	52" Curva LED Outdoor	Wet ³	4212	92	0.5	3130	92	34	6 Speed Remote Control	RC188	Remote	Y	4.5	Y
CF253L	52" Curva LED Indoor	Indoor	4212	92	0.5	3130	92	34	6 Speed Remote Control	RC188	Remote	Y	4.5	Y
CF275	Sweep Eco	Indoor	6683	338	0.3	4412	318	14	6 Speed Wall Control	EcoMotor Receiver	Remote	Y	8	Y
CF320	Keane	Indoor	4357	81	0.45	3198	93	34	SW46	N/A	Manual	N/A	4.5	Y
CF330	Ideal Eco	Indoor	5892	181	0.5	3989	199	20	6 Speed Wall Control	RC188	Manual	Y	4.5	Y
CF380	Kailua Cove	Wet	4173	68	0.6	3073	78	39	Pull Chain	N/A	Manual	N/A	4.5	Y
CF430	Highrise	Indoor	4062	83	0.5	3036	93	33	SW405	RCFP	Manual	N-LED	4.5	Y
CF440	Braddock	Indoor	6352	101	0.6	4787	113	42	SR400	RCFP	Manual	Y	4.5	N
CF442	42" Bella	Indoor	4141	72	0.5	2933	82	36	Pull Chain	N/A	Manual	N/A	4.5	Y
CF4501	Crown Select	Indoor	5068	52	0.84	3224	58	56	Pull Chain	N/A	Manual	N/A	4.5	N
CF452	52" Bella	Indoor	4615	69	0.57	3104	77	40	Pull Chain	N/A	Manual	N/A	4.5	Y
CF4801	Premium Select	Indoor	5147	52	0.84	3232	57	56	Pull Chain	N/A	Manual	N/A	4.5	N
CF500	Euclid	Indoor	5566	80	0.6	4058	93	44	SW46	N/A	Manual	N/A	4.5	Y
CF5100	Penbrooke Select	Indoor	5743	58	0.83	3540	64	56	N/A	N/A	Remote	Y	4.5	Y
CF5200	Penbrooke Select Eco	Indoor	6689	216	0.46	4482	229	20	SW605	EcoMotor Receiver	Remote	N/A	4.5	Y
CF5300	Ion Eco	Damp	◆	◆	0.6	◆	◆	◆	6 Speed Wall Control	EcoMotor Receiver	Remote	Y	6	Y
CF550L	Luxe Eco	Indoor	5669	184	0.4	3760	174	22	6 Speed Wall Control	EcoMotor Receiver	Remote	Y	4.5	Y
CF542	42" Veranda	Wet	3280	78	0.5	2420	88	28	Pull Chain	N/A	Manual	N/A	4.5	Y
CF552	52" Veranda	Wet	5259	75	0.6	3558	86	41	Pull Chain	N/A	Manual	N/A	4.5	Y
CF590	Volta	Wet	5835	91	0.54	4244	102	41	SR400	4 Speed	Manual	Y	4.5	Y
CF610	Welland	Wet	5214	88	0.5	3646	100	36	Pull Chain	N/A	Manual	N/A	4.5	Y
CF621	Batalie Breeze	Wet	5231	72	0.6	3831	83	46	Pull Chain	N/A	Manual	N/A	4.5	Y
CF630	Rockpointe	Wet	5375	78	0.6	3871	87	44	SW405	RCFP	Manual	N	4.5	N
CF652	52" Summer Night	Damp	4398	70	0.6	3042	80	38	Pull Chain	N/A	Manual	N/A	3.5	Y
CF654	Sea Breeze	Wet	5238	74	0.6	3485	83	42	Pull Chain	N/A	Manual	N/A	3.5	Y
CF670	Devonshire	Damp	5322	77	0.6	3775	88	43	Pull Chain	N/A	Manual	N/A	4.5	Y

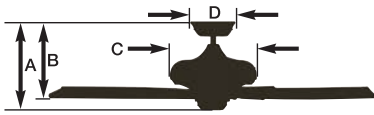

- 1 60" Blade Span
- 2 72" Blade Span
- 3 Damp or Wet Location ratings may apply to certain finishes only
- † CFM data reflects a weighted average of high and low speeds using the method defined by US Department of Energy 10 CFR Part 430

Model Number	Model	Pg	Motor (mm)	Fan Diameter	Blade Pitch	A	B	C	D	Motor Warranty	Accepts 2.5" DR	Energy Star
CF700	Pro Series Builder	137	153x15	52"	11°	12.0"	11.0"	11.5"	5.1	Lifetime	Y	Y
CF702	29" Northwind	93	153x10	29"	22°	10.8"	10.5"	9.0"	5.3"	Lifetime	Y	N
CF710	42" Pro Series II	135	153x15	42"	12°	14.5"/17.3"	8.3"/11.0"	11.5"	5.2"	Lifetime	N	N
CF711	50" Pro Series II	133	153x15	50"	12°	14.8"/18.5"	8.3"/11.0"	11.5"	5.2"	Lifetime	N	N
CF712	Pro Series	129	153x15	50"	12°	14.8"/18.5"	8.3"/11.5"	11.5"	5.2"	Lifetime	N	N
CF713	Pro Series ES	131	153x15	50"	12°	14.8"/18.5"	8.3"/11.5"	11.5"	5.2"	Lifetime	N	Y
CF717	Ashland	15	153x17	52"	11.5°	17.0"/13.0"	9.5"/13.5"	12.0"	5.3"	Lifetime	N	N
CF742PF	42" Summer Night	121	153x10	42"	12°	12.0"	10.0"	11.5"	5.2"	Lifetime	Y	N
CF755	Designer	91	188x15	52"	14°	14.0"	12.0"	12.0"	6.4"	Lifetime	Y	Y
CF765	Loft	65	188x15	60"	Contoured	12.8"	12.8"	7.5"	6.5"	Lifetime	Y	Y
CF766L	4th Avenue LED	57	188x20	60"	14°	17.9"	12.6"	8.7"	6.4"	Lifetime	N	N
CF772	52" Monterey II	29	188x15	52"	13°	15"	11.5"	13"	6.8"	Lifetime	N	N
CF784	Carrera	21	188x25	60"	14°	14.5"	13.0"	13.4"	6.8"	Lifetime	N	N
CF788	Carrera Grande Eco	23	EcoMotor	44"/54"/60"/72"	16°	14.5"	13.0"	13.4"	7.1"	Lifetime	N	Y
CF804S	42" Snugger	99	153x12	42"	12°	7.3"	6.5"	9.1"	N/A	Lifetime	N	N
CF805S	52" Snugger	97	153x15	52"	12°	7.3"	6.5"	11.0"	N/A	Lifetime	N	N
CF825	Lindell	13	153x18	52"	12°	13.4/17.8	12	10"	6.3	Lifetime	Y	N
CF830	Monaco	101	188x25	60"	14°	15.5"/21.0"	13.0"/18.5"	16.0"	8.9"	Lifetime	N	N
CF850	Summerhaven	119	188x15	52"	12°	14.4"	9.7"	11.7"	6.7"	Lifetime	Y	N
CF860	Luray Eco	51	EcoMotor	60"	Contoured	14.1"	14.5"	9.8"	6.5"	Lifetime	N	Y
CF880L	Amhurst LED	27	188x15	54"	12°	15.1"	11.8"	9.1"	6.3"	Lifetime	Y	N
CF901	Prima	89	188x15	52"	13°	13.0"	12.0"	12.0"	6.3"	Lifetime	Y	Y
CF905	Prima Snugger	95	172x14	52"	13°	8.0"	7.0"	11.6"	N/A	Lifetime	N	N
CF921	Avant Eco	83	EcoMotor	44"/54"/60"/72"	16°	13.0"	12.0"	12.0"	6.3"	Lifetime	N	Y
CF915	Rah Eco	39	EcoMotor	60"/72"	18°	17.8	14.3	10.3	7.7	Lifetime	N	N
CF930	Atomical	75	153x18	52"	13°	15.8"	12.0"	9.5"	6.5"	Lifetime	Y	N
CF935	Zurich	87	188x15	52"	14°	14.5"	13.5"	13.3"	7.0"	Lifetime	Y	N
CF955L	Midway Eco LED	59	EcoMotor	54"	29°	16.5"	9"	12.5"	5.1"	Lifetime	N	Y
CF985L	Aira Eco LED	53	EcoMotor	72"	15°	14.4"	12.5"	8.4"	6.4"	Lifetime	Y	N
CF995	Laclede Eco	25	EcoMotor	62"	12°	20.0"	16.0"	17.0"	8.0"	Lifetime	N	N
HF1160	60" Industrial Fan	139	188x20	60"	Airfoil	12.8"	12.8"	7.5"	5.2"	5 Years	N	N
HF948	48" Industrial Fan	143	188x18	48"	Contoured	19.5"/33.5"	16.0"/30.0"	7.5"	4.8"	2 Years	N	N
HF956	56" Industrial Fan	141	188x25mm	58"	Contoured	33.5"	30.0"	7.5"	4.8"	2 Years	N	N

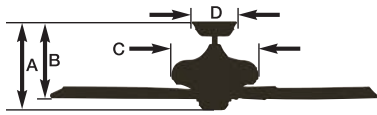

- 1 60" Blade Span
- 2 72" Blade Span
- 3 Damp or Wet Location ratings may apply to certain finishes only
- † CFM data reflects a weighted average of high and low speeds using the method defined by US Department of Energy 10 CFR Part 430

Model Number	Model	Wet/Damp	HIGH-SPEED			ENERGY GUIDE			Control Included	Receiver Included	Manual/Remote Reverse Switch	Dimming Light	Downrod Length	Ships to Canada
			CFM	CFM/W	Amps	CFM [†]	CFM/W [†]	Watts [†]						
CF700	Pro Series Builder	Indoor	4322	67	0.6	2995	77	39	Pull Chain	N/A	Manual	Y	4.5	Y
CF702	29" Northwind	Indoor	2316	48	0.5	1651	54	30	Pull Chain	N/A	Manual	N/A	3.5	Y
CF710	42" Pro Series II	Indoor	2498	51	0.5	1713	56	31	Pull Chain	N/A	Manual	N	3.5/ Dualmount	N
CF711	50" Pro Series II	Indoor	3683	57	0.6	2472	64	39	Pull Chain	N/A	Manual	N	4.5/ Dualmount	N
CF712	Pro Series	Indoor	3683	57	0.6	2472	64	39	Pull Chain	N/A	Manual	N	4.5/ Dualmount	Y
CF713	Pro Series ES	Indoor	3801	59	0.6	2570	66	39	Pull Chain	N/A	Manual	N	4.5/ Dualmount	Y
CF717	Ashland	Indoor	2998	55	0.5	2120	60	35	Pull Chain	N/A	Manual	Y	4.5/ Dualmount	Y
CF742PF	42" Summer Night	Damp	3057	63	0.5	2242	73	31	Pull Chain	N/A	Manual	N/A	3.5	Y
CF755	Designer	Indoor	4918	71	0.6	3340	81	41	Pull Chain	N/A	Manual	N/A	3.5	Y
CF765	Loft	Damp ³	6916	101	0.6	4906	115	43	SW46	N/A	Manual	N/A	6	Y
CF766L	4th Avenue LED	Indoor	5876	115	0.5	4364	120	36	SW405	RCFP	Manual	Y	8	Y
CF772	52" Monterey II	Indoor	5469	80	0.6	3726	91	41	Pull Chain	N/A	Manual	N/A	4.5	Y
CF784	Carrera	Indoor	6528	67	0.8	4339	76	57	Pull Chain	N/A	Manual	N/A	4.5	Y
CF788	Carrera Grande Eco	Damp ³	5984	180	0.53	4284	188	23	6 Speed Wall Control	EcoMotor Receiver	Remote	N/A	4.5	Y
CF804S	42" Snuggler	Indoor	1749	36	0.5	1114	36	31	Pull Chain	N/A	Manual	N/A	N/A	Y
CF805S	52" Snuggler	Indoor	2126	33	0.6	1479	38	39	Pull Chain	N/A	Manual	N/A	N/A	Y
CF825	Lindell	Indoor	4595	70	0.6	3418	83	41	Pull Chain	N/A	Manual	N/A	4.5	Y
CF830	Monaco	Indoor	5210	55	0.9	3334	59	56	SW90	N/A	Manual	Y	4.5/10	N
CF850	Summerhaven	Wet	4852	77	0.6	3516	88	40	Pull Chain	N/A	Manual	Y	4.5	Y
CF860	Luray Eco	Indoor	8604	274	0.5	5787	295	20	SW605	EcoMotor Receiver	Remote	Y	4.5	N
CF880L	Amhurst LED	Indoor	5448	79	0.57	3737	84	44	SW405	RCFP	Manual	Y	4.5	Y
CF901	Prima	Indoor	5685	93	0.6	4072	109	37	SW46	N/A	Manual	N/A	4.5	Y
CF905	Prima Snuggler	Indoor	2835	41	0.6	1990	46	43	SW46	N/A	Manual	N/A	N/A	Y
CF921	Avant Eco	Indoor	6408	196	0.6	4555	208	22	SR600	EcoMotor Receiver	Remote	N/A	4.5	Y
CF915	Rah Eco	Indoor	6610 ¹ 7407 ²	200 ¹ 224 ²	0.48	4644 ¹ 5152 ²	220 ¹ 239 ²	21 ¹ 22 ²	6 Speed Wall Control	EcoMotor Receiver	Remote	Y	8	Y
CF930	Atomical	Damp ³	4292	72	0.6	3023	78	39	SR400	RCFP	Manual	Y	4.5	Y
CF935	Zurich	Indoor	6108	88	0.6	4232	102	42	Pull Chain	N/A	Manual	N/A	4.5	Y
CF955L	Midway Eco LED	Indoor	6195	423	0.32	4290	374	11	6 Speed Remote Control	EcoMotor Receiver	Remote	N	4.5	Y
CF985L	Aira Eco LED	Damp	8133	254	0.52	5735	270	21	SW605	EcoMotor Receiver	Remote	Y	6.0	Y
CF995	Laclede Eco	Indoor	7359	258	0.32	4965	254	20	SR600	EcoMotor Receiver	Remote	N	10	N
HF1160	60" Industrial Fan	Indoor	10644	116	0.79	N/A	N/A	91	SW95	N/A	N/A	N/A	6	Y
HF948	48" Industrial Fan	Indoor	6723	96	0.6	N/A	N/A	70	SW95	N/A	N/A	N/A	8/22	Y
HF956	56" Industrial Fan	Indoor	10516	107	0.82	N/A	N/A	98	SW95	N/A	N/A	N/A	22	Y

▶ GENERAL TERMS & CONDITIONS OF SALE

Air Comfort Products, a division of Emerson Electric Co. is herein referred to as the ("Seller") and the customer or person or entity purchasing goods ("Goods") from Seller is referred to as the ("Buyer") These Terms and Conditions, any price list, quotation, acknowledgement or invoice from Seller relevant to the sale of the Goods and all documents incorporated by specific reference therein, constitute the complete and exclusive agreement governing the sale of Goods by Seller to Buyer. Buyer's acceptance of the Goods manifest Buyer's assent to these Terms and Conditions. Seller reserves the right in its sole discretion to refuse orders. Any different or additional terms in Buyer's purchase order or other Buyer documents are objected to.

1. PRICES AND TAXES: Unless otherwise specified in writing by Seller, Seller has the right to change the price for the Goods at any time prior to shipment. All prices are exclusive of taxes, transportation and insurance, which are borne by Buyer. Orders under \$100.00 are subject to a \$15.00 fee. All taxes or governmental charges (or increase in same) affecting Seller's costs or which Seller is otherwise required to pay or collect in connection with the sale, purchase, delivery, storage, processing, use or consumption of Goods are for Buyer's account and added to price.

2. TERMS OF PAYMENT: Unless otherwise specified by Seller, terms are net thirty (30) days from date of Seller's invoice in U.S. currency. Seller shall have the right, among other remedies, either to terminate this agreement or to suspend further performance under this and/or other agreements with Buyer in the event Buyer fails to make any payment when due, which other agreements Buyer and Seller hereby amend accordingly. In the event of payment default, all unpaid balances, obligations or indebtedness shall become immediately due and payable and subject to a monthly finance charge of 1-1/2%. All finance charges will not exceed local state regulations. Buyer shall be liable for all expenses, including attorneys' fees, relating to the collection of past due amounts. Should Buyer's financial responsibility become unsatisfactory to Seller, cash payments or security satisfactory to Seller may be required by Seller for future deliveries and for the Goods theretofore delivered. If such cash payment or security is not provided, in addition to Seller's other rights and remedies, Seller may discontinue deliveries.

3. SHIPMENT AND DELIVERY: Deliveries are made F.O.B. Seller's shipping point. Risk of loss, damage and liability pass to Buyer upon delivery to carrier. Shortages or damages must be acknowledged and signed for at the time of delivery. While Seller will use all reasonable commercial efforts to maintain the delivery date(s), all shipping dates are approximate and not guaranteed. Seller reserves the right to make partial shipments if the shipment of the Goods is postponed or delayed by Buyer for any reason. Buyer agrees to reimburse Seller for any and all storage costs and other resulting expenses.

Freight and handling will be allowed on orders of \$2,000 invoice net or more shipped to a Continental U.S. destinations (U.S. Territories, Alaska or Hawaii - Min. freight allowance are \$3,000 invoice net) if Seller chooses carrier, except for products designated "F.O.B. shipping point, no freight allowed," in which case Buyer pays all freight charges. Drop-Ship Fees (max-\$20.00 per order) will be assessed per the 2018 NXT Level Sales Policy Fee Schedule. Seller will not ship Goods outside the Continental U.S. without its prior written approval.

4. RETURNED GOODS: (a) Goods sold hereunder may be returned only with pre-approved written permission of Seller. If permission is granted, a Returned Goods Authorization (RGA) will be issued through a Seller Representative. When requesting RGA, include all Model Numbers / Serial Numbers / Date Codes shown on equipment. Goods must be Active SKU's in current catalog, in original unmarked Emerson packaging and in sellable condition. (b) All returns must be made with transportation charges prepaid and are subject to Seller's inspection prior to acceptance. If return is approved, Seller will charge 25% of the Buyer's net price for handling, repackaging, and refurbishing.

5. LIMITED WARRANTY: Subject to limitations in Section 6, Seller warrants that Goods manufactured by Seller will be free from defects in material and workmanship and meet Seller's published specifications at the time of shipment under normal use and regular service and maintenance for a period of one (1) year from the date of shipment of the Goods by Seller, unless otherwise specified by Seller in writing. Products purchased from a third party for resale to Buyer ("Resale Products") shall carry only the warranty extended by the original manufacturer.

THE WARRANTY PROVIDED HEREIN AND THE WARRANTY SET FORTH IN SECTION 7, ARE THE SOLE AND EXCLUSIVE WARRANTIES GIVEN BY SELLER WITH RESPECT TO THE GOODS AND ARE IN LIEU OF AND EXCLUDE ALL OTHER WARRANTIES, EXPRESS OR IMPLIED, ARISING BY OPERATION OF LAW OR OTHERWISE, INCLUDING WITHOUT LIMITATION, MERCHANTABILITY AND FITNESS FOR A PARTICULAR PURPOSE WHETHER OR NOT THE PURPOSE OR USE HAS BEEN DISCLOSED TO SELLER IN SPECIFICATIONS, DRAWINGS OR OTHERWISE, AND WHETHER OR NOT THE SELLER'S PRODUCTS ARE SPECIFICALLY DESIGNED AND/OR MANUFACTURED BY SELLER FOR BUYER'S USE OR PURPOSE.

These warranties do not extend to any losses or damages due to misuse, accident, abuse, neglect, normal wear and tear, Buyer's negligence, unauthorized modification or alteration, use beyond rated capacity, or improper installation, maintenance or application. To the extent that Seller has relied upon any specifications, information, representation of operating conditions or other

data supplied by Buyer or its agents to Seller in the Selection or design of the Goods and the preparation of Seller's quotation, or in the event that actual operation conditions differ from those represented by Buyer and relied upon by Seller, any warranties or other provisions contained herein which are affected by such conditions shall be null and void. If within thirty (30) days after Buyer's discovery of any nonconformity with warranty within the warranty period, Buyer notifies Seller thereof in writing, Seller shall, at its option, repair, correct or replace F.O.B. point of manufacture, or refund the purchase price for, that portion of the Goods found by Seller to be defective. Failure by Buyer to give such written notice within the applicable time period shall be deemed an absolute and unconditional waiver of Buyer's claim for such defects. Goods repaired or replaced during the warranty period shall be covered by the foregoing warranty for the remainder of the original warranty period or ninety (90) days, whichever is longer. Buyer assumes all other responsibility for any loss, damage, or injury to persons or property arising out of, connected with, or resulting from the use of Goods, either alone or in combination with other products/components.

6. LIMITATION OF REMEDY AND LIABILITY: THE SOLE AND EXCLUSIVE REMEDY FOR BREACH OF ANY WARRANTY HEREUNDER (OTHER THAN THE WARRANTY PROVIDED UNDER SECTION 7) SHALL BE LIMITED, AT SELLER'S OPTION, TO REPAIR, CORRECTION OR REPLACEMENT, OR REFUND OF THE PURCHASE PRICE UNDER SECTION 5.

SELLER SHALL NOT BE LIABLE FOR DAMAGES CAUSED BY DELAY IN PERFORMANCE AND THE REMEDIES OF BUYER SET FORTH IN THIS AGREEMENT ARE EXCLUSIVE. IN NO EVENT, REGARDLESS OF THE FORM OF THE CLAIM OR CAUSE OF ACTION (WHETHER BASED IN CONTRACT, INFRINGEMENT, NEGLIGENCE, STRICT LIABILITY, OTHER TORT OR OTHERWISE), SHALL SELLER'S LIABILITY TO BUYER AND/OR ITS CUSTOMERS EXCEED THE PRICE PAID BY BUYER FOR THE SPECIFIC GOODS PROVIDED BY SELLER GIVING RISE TO THE CLAIM OR CAUSE OF ACTION. BUYER AGREES THAT IN NO EVENT SHALL SELLER'S LIABILITY TO BUYER AND/OR ITS CUSTOMERS EXTEND TO INCLUDE INCIDENTAL CONSEQUENTIAL OR PUNITIVE DAMAGES. The term "consequential damages" shall include, but not be limited to, loss of anticipated profits, business interruption, loss of use, revenue, reputation and data, costs incurred, including without limitation, for capital, fuel, power and loss or damage to property or equipment. It is understood any technical advice furnished by Seller with respect to the use of the Goods is given without charge and Seller assumes no obligation or liability for the advice given or results obtained, all such advice given and accepted at Buyer's risk.

▶ GENERAL TERMS & CONDITIONS OF SALE (Continued)

7. PATENTS AND COPYRIGHTS: Subject to the limitation and the second paragraph of Section 6, Seller warrants that the Goods sold, except as are made specifically for Buyer per Buyer's specifications, do not infringe any valid U.S. Patent or copyright in existence as of the date of shipment. This warranty is given upon the condition that Buyer promptly notify Seller of any claim or suit involving Buyer in which such infringement is alleged and cooperate fully with Seller and permit Seller to control completely the defense, settlement or compromise of any such allegation of infringement. Seller's warranty as to use patents only applies to infringement arising solely out of the inherent operation according to Seller's specifications and instructions (i) of such Goods, or (ii) of any combination of Goods acquired from Seller in a system designed by Seller. In the event such Goods are held to infringe such a U.S. patent or copyright in such a suit, and the use of such Goods is enjoined, or the case of a compromise or settlement by Seller, Seller shall have the right, at its option and expense, to procure for Buyer the right to continue using such goods, or replace them with non-infringing Goods, or modify same to become non-infringing, or grant Buyer a credit for the depreciated value of such Goods and accept return of them. In the event of the foregoing, Seller may at its option, cancel the agreement as to future deliveries of such Goods, without liability.

8. EXCUSE OF PERFORMANCE: Seller shall not be liable for delays, in performance or for non-performance due to acts of God, acts of Buyer, war, fire, flood, weather; sabotage; strikes or labor disputes; civil disturbances or riots; government requests, restrictions, allocations, laws, regulations, order or actions; unavailability of or delays in transportation; default of suppliers; or unforeseen circumstances or any events or causes beyond Seller's reasonable control. Deliveries or other performance may be suspended for an appropriate period or canceled by Seller upon notice to Buyer in the event of any of the foregoing, but the balance of the agreement shall otherwise remain unaffected as a result of the foregoing. If Seller determines that its ability to supply the total demand for the Goods, or to obtain material used directly or indirectly in the manufacture of the Goods, is hindered, limited or made impracticable due to causes set forth in the preceding paragraph, Seller may allocate its available supply of the Goods or such material (without obligation to acquire other supplies of any such Goods or material) among itself and its purchasers on such basis as Seller determines to be equitable without liability for any failure of performance which may result therefrom.

9. CANCELLATION AND CHANGES: Seller may cancel this agreement at any time for any reason upon thirty (30) days written notice. Unless otherwise agreed in writing by Seller, Buyer may not cancel this agreement for any reason. Buyer may request changes or additions to the Goods consistent with Seller's specifications and criteria. In the event such changes or additions are

accepted by Seller, Seller may revise the price and dates of delivery. Seller reserves the right to change designs and specifications for the Goods without prior notice to Buyer, except with respect to Goods being made-to-order for Buyer.

10. ASSIGNMENT: Buyer shall not assign its rights or delegate its duties hereunder or any interest herein or any rights hereunder without the prior written consent of the Seller, and any such assignment without such consent, shall be void. Seller may assign its rights and delegate its duties hereunder.

11. BUYER'S COMPLIANCE WITH LAWS:

In connection with the transactions contemplated by this Agreement, Buyer is familiar with and shall fully comply with all applicable laws, regulations, rules and other requirements of the United States and of any applicable state, foreign and local governmental body in connection with the purchase, receipt, use, transfer and disposal of the Goods. Buyer agrees that all applicable import and export control laws, regulations, orders and requirements, including without limitation those of the United States and the European Union, and the jurisdictions in which the Seller and Buyer are established or from which Goods and Services may be supplied, will apply to their receipt and use. In no event shall Buyer use, transfer, release, import, export, Goods in violation of such applicable laws, regulations, order or requirements.

12. GENERAL PROVISIONS: These terms and conditions supersede all other communications, negotiations and prior oral or written statements regarding the subject matter of these terms and conditions. No change, modification, rescission, discharge, abandonment, or waiver of these terms and conditions shall be binding upon the Seller unless made in writing and signed on its behalf by a duly authorized Seller representative. No conditions, usage of trade, course of dealing or performance, understanding or agreement purporting to modify, vary, explain, or supplement these terms and conditions shall be binding unless hereafter made in writing and signed by the party to be bound, and no modification or additional terms shall be applicable to this agreement by the Seller's receipt, acknowledgement or acceptance of purchase orders, shipping instruction forms, or other documentation containing terms at variance with or in addition to those set forth herein. Any such modifications or additional terms are specifically rejected and deemed a material alteration hereof. If this document shall be deemed an acceptance of a prior offer by Buyer, such acceptance is expressly conditional upon Buyer's assent to any additional or different terms set forth herein. No waiver by other party with respect to any breach or default or of any right or remedy, and no course of dealing, shall be deemed to constitute a continuing waiver of any other breach or default or of any other right or remedy, unless such waiver be expressed in writing and signed by the party to be bound. All typographical or clerical errors made by Seller in

quotation, acknowledgement or publication are correctable. Validity and performance relating to the interpretation and effect of this agreement is governed by the law of the state of Missouri

13. DISPUTE RESOLUTION: In the event of any dispute INCLUDING, BUT NOT LIMITED TO, BREACH OF CONTRACT, BREACH OF WARRANTY, CLAIMS BASED IN TORT, NEGLIGENCE, PRODUCT LIABILITY, FRAUD, MARKETING, STATE OR FEDERAL REGULATIONS, ANY CLAIMS REGARDING THE ENFORCEABILITY OF THIS LIMITED WARRANTY, AND THE WAIVER OF CLASS ACTION TRIALS between Buyer and Seller, either may choose to resolve the dispute by binding arbitration, as described below, instead of in court. **THIS MEANS IF EITHER BUYER OR SELLER CHOOSE BINDING ARBITRATION, NEITHER PARTY SHALL HAVE THE RIGHT TO LITIGATE SUCH CLAIM IN COURT OR HAVE A JURY TRIAL. DISCOVERY AND APPEAL RIGHTS ARE LIMITED IN BINDING ARBITRATION.** Buyer and Seller agree that the proper venue if Arbitration is not so chosen by Buyer or Seller of all actions arising in connection herewith shall be only in the state of Missouri and the parties agree to submit to such jurisdiction. No action, regardless of form, arising out of transactions relating to the agreement, may be brought by either party more than two (2) years after the cause of action has accrued. The U.N. Convention on Contracts for the International Sales of Goods shall not apply to this agreement.

CLASS ACTION WAIVER: BINDING ARBITRATION MUST BE ON AN INDIVIDUAL BASIS. THIS MEANS NEITHER BUYER NOR SELLER MAY JOIN OR CONSOLIDATE CLAIMS IN ARBITRATION BY OR AGAINST OTHERS, OR LITIGATE IN COURT OR ARBITRATE ANY CLAIMS AS A REPRESENTATIVE OR MEMBER OF A CLASS OR IN A PRIVATE ATTORNEY GENERAL CAPACITY.

ADMINISTRATION OF ARBITRATION:

The binding arbitration must be administered by the American Arbitration Association ("AAA") in accordance with its Commercial Arbitration Rules and/or Supplementary Procedures for Consumer-Related Disputes (including proceedings to mitigate costs of travel). This binding arbitration is governed by the Federal Arbitration Act ("FAA") (9 USC §1, et. seq.) and will govern the interpretation and enforcement. The binding arbitration shall be held at a location determined by AAA or at such other location as mutually agreed. In addition to the terms stated above, the following will apply to the binding arbitration: (1) the arbitrator, and not any federal, state, or local court or agency, will have exclusive authority to resolve any dispute relating to the interpretation, applicability, enforceability or formation of this Agreement including any claim that all or any part of this Agreement is void or voidable; (2) the arbitrator shall apply Missouri law consistent with the FAA.



Introducing the
Lindell

Lindell CF825 pg 13



Shown in Brushed Steel with Walnut Blades





Introducing the
Sweep Eco

Sweep Eco CF275 pg 37

Shown in Barbeque Black Finish with Barbeque Black Blades





Air Comfort Products, a Division of Emerson Electric Co.

8100 West Florissant Ave. • Saint Louis, Missouri 63136

Customer Service Tel: 1-800-237-6511

Customer Service Fax: 1-800-525-7248

Customer Service Email: FanCS@emerson.com

For our full line of products, visit emersonfans.com or view our 2018 Catalog



*Share pictures of your Emerson fans on Pinterest,
Facebook and Twitter using #MyEmersonFan*