



LED Commercial Lighting

Westgate's full line of LED Commercial Lighting Products are designed with the latest office styles in mind, using the latest LED technology, and carries a full 5-Year Limited Warranty.

LP-1X4-40W

B1

LED PANEL LIGHTS (1X4) 40W

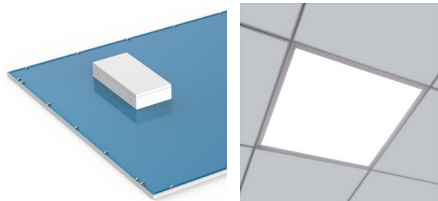

For accessories
see page B6

TECHNICAL SPECIFICATIONS:

- :: External driver mounted on top
- :: PMMA Light Guided Panel (LGP) does not turn yellow.
- :: High efficiency: 110LM/W
- :: Input Voltage: AC100V~277V
- :: Fixture Operating Voltage: 36VDC
- :: LED Type: 4014SMD LM80
- :: Color Rendering Index: Ra>80
- :: Dimmable: 0~10V dimming
- :: Power Factor: >0.9
- :: Current (mA): 1050mA 36V DC
- :: Frequency Range: 50Hz~60Hz
- :: Total harmonic distortion: ≤15 %
- :: Operating temperature: -68°F~104°F
- :: Rated life: 50,000 hrs.
- :: 5-year warranty

FEATURES:

- :: Soft and wide light emitting
- :: No infrared rays, no ultraviolet radiation, no thermal effect
- :: No flickering, no humming, no RF interference
- :: Earthquake hooks and Suspension hooks preinstalled

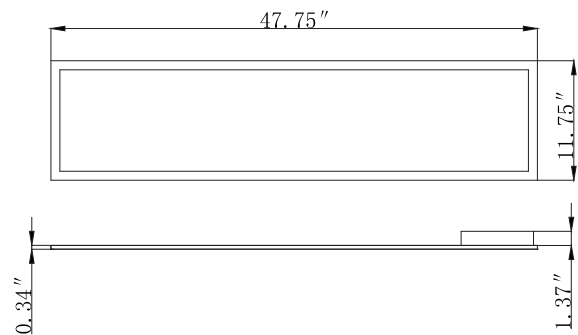

47.75" × 11.75" × 1.71"

LED PANEL LIGHTS (1X4) 40W

CATALOG NO.	CHIP	LEDs	WATTS	LUMENS	COLOR TEMP	DIMENSIONS
LP-1X4-40W-50K-DS	SMD4014	384	40W	4400LM	5000K	11.75" x 47.75" x 1.71"
LP-1X4-40W-40K-DS	SMD4014	384	40W	4400LM	4000K	
LP-1X4-40W-35K-DS	SMD4014	384	40W	4200LM	3500K	
LP-1X4-40W-27K-DS	SMD4014	384	40W	3600LM	2700K	

LP-2X2-40W

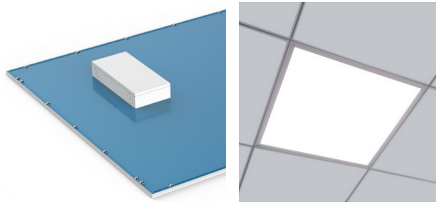

For accessories
see page B6

TECHNICAL SPECIFICATIONS:

- :: External driver mounted on top
- :: PMMA Light Guided Panel (LGP) does not turn yellow.
- :: High efficiency: 110LM/W
- :: Input Voltage: AC100V~277V
- :: Fixture Operating Voltage: 36VDC
- :: LED Type: 4014SMD LM80
- :: Color Rendering Index: Ra>80
- :: Dimmable: 0~10V dimming
- :: Power Factor: >0.9
- :: Current (mA): 1050mA 36V DC
- :: Frequency Range: 50Hz~60Hz
- :: Total harmonic distortion: ≤15 %
- :: Operating temperature: -68°F~104°F
- :: Rated life: 50,000 hrs.
- :: 5-year warranty

FEATURES:

- :: Soft and wide light emitting
- :: No infrared rays, no ultraviolet radiation, no thermal effect
- :: No flickering, no humming, no RF interference
- :: Earthquake hooks and Suspension hooks preinstalled



Except 27K

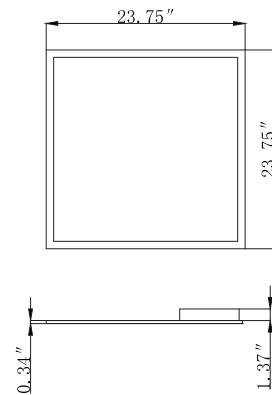

23.75" × 23.75" × 1.71"

LED PANEL LIGHTS (2X2) 40W

CATALOG NO.	CHIP	LEDs	WATTS	LUMENS	COLOR TEMP	DIMENSIONS
LP-2X2-40W-50K-DS	SMD4014	216	40W	4400LM	5000K	23.75" x 23.75" x 1.71"
LP-2X2-40W-40K-DS	SMD4014	216	40W	4400LM	4000K	
LP-2X2-40W-35K-DS	SMD4014	216	40W	4200LM	3500K	
LP-2X2-40W-27K-DS	SMD3528	204	40W	3600LM	2700K	

LP-2X4

B3

LED PANEL LIGHTS (2X4) 60W & 72W

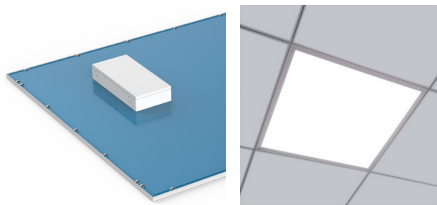

For accessories
see page B6

TECHNICAL SPECIFICATIONS:

- :: External driver mounted on top
- :: PMMA Light Guided Panel (LGP) does not turn yellow.
- :: High efficiency: 110LM/W
- :: Input Voltage: AC100V~277V
- :: Fixture Operating Voltage: 36VDC
- :: LED Type: 4014SMD (60W) / 2835SMD (72W) LM80
- :: Color Rendering Index: Ra>80
- :: Dimmable: 0~10V dimming
- :: Power Factor: >0.9
- :: Current (mA): 1500mA (60W) / 1850mA (72W) 36V DC
- :: Frequency Range: 50Hz~60Hz
- :: Total harmonic distortion: ≤15 %
- :: Operating temperature: -68°F~104°F
- :: Rated life: 50,000 hrs.
- :: 5-year warranty

FEATURES:

- :: Soft and wide light emitting
- :: No infrared rays, no ultraviolet radiation, no thermal effect
- :: No flickering, no humming, no RF interference
- :: Earthquake hooks and Suspension hooks preinstalled

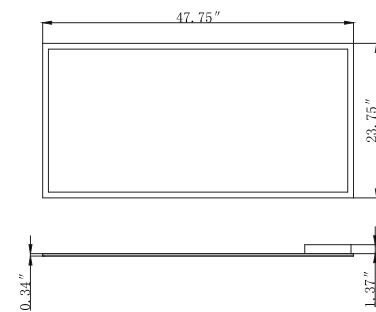

47.75" × 23.75" × 1.71"

LED PANEL LIGHTS (2X4) 60W & 72W

CATALOG NO.	CHIP	LEDs	WATTS	LUMENS	COLOR TEMP	DIMENSIONS
LP-2X4-60W-50K-DS	SMD4014	384	60W	6600LM	5000K	23.75" x 47.75" x 1.71"
LP-2X4-60W-40K-DS	SMD4014	384	60W	6600LM	4000K	
LP-2X4-60W-35K-DS	SMD4014	384	60W	6300LM	3500K	
LP-2X4-60W-27K-DS	SMD4014	384	60W	5400LM	2700K	
LP-2X4-72W-50K-DS	SMD2835	384	72W	7920LM	5000K	
LP-2X4-72W-40K-DS	SMD2835	384	72W	7920LM	4000K	
LP-2X4-72W-35K-DS	SMD2835	384	72W	7560LM	3500K	
LP-2X4-72W-27K-DS	SMD2835	384	72W	6480LM	2700K	

LP-MW MULTI WATTAGE

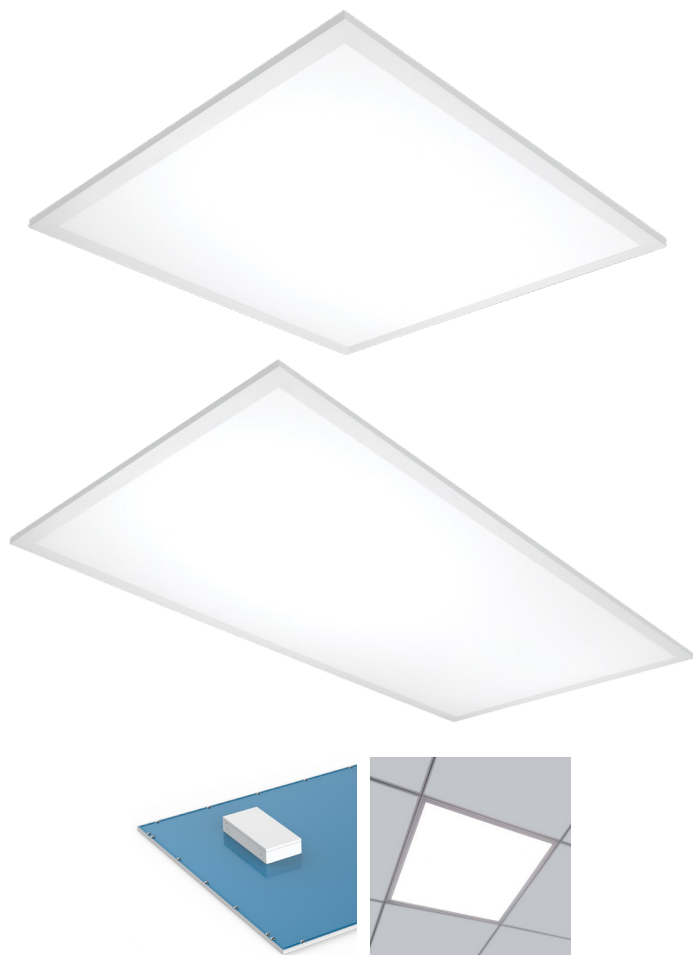

For accessories
see page B6

TECHNICAL SPECIFICATIONS:

- :: External driver mounted on top
- :: PMMA Light Guided Panel (LGP) does not turn yellow.
- :: High efficiency: 110LM/W
- :: Input Voltage: AC100V~277V
- :: Fixture Operating Voltage: 36VDC
- :: LED Type: 2835SMD LM80
- :: Color Rendering Index: Ra>80
- :: Dimmable: 0~10V dimming
- :: Power Factor: >0.9
- :: Current (mA): 780mA~1300mA36V DC
- :: Frequency Range: 50Hz~60Hz
- :: Total harmonic distortion: ≤15 %
- :: Operating temperature: -68°F~104°F
- :: Rated life: 50,000 hrs.
- :: 5-year warranty

FEATURES:

- :: Soft and wide light emitting
- :: No infrared rays, no ultraviolet radiation, no thermal effect
- :: No flickering, no humming, no RF interference
- :: Earthquake hooks and Suspension hooks preinstalled

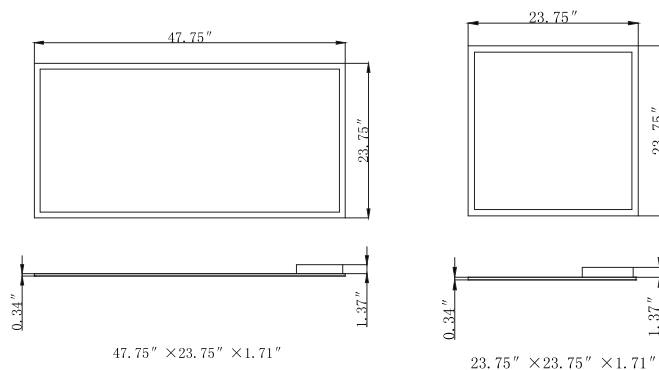

LED PANEL LIGHTS (2X2 & 2X4) MULTI WATTAGE

CATALOG NO.	CHIP	LEDs	WATTS	COLOR TEMP	DIMENSIONS
LP-2X2-MW-50K-DS	SMD2835	216	30W, 35W, 40W, 50W	5000K	23.75" x 23.75" x 1.71"
LP-2X2-MW-40K-DS	SMD2835	216	30W, 35W, 40W, 50W	4000K	
LP-2X2-MW-35K-DS	SMD2835	216	30W, 35W, 40W, 50W	3500K	
LP-2X2-MW-27K-DS	SMD2835	216	30W, 35W, 40W, 50W	2700K	
LP-2X4-MW-50K-DS	SMD2835	312	30W, 35W, 40W, 50W	5000K	23.75" x 47.75" x 1.71"
LP-2X4-MW-40K-DS	SMD2835	312	30W, 35W, 40W, 50W	4000K	
LP-2X4-MW-35K-DS	SMD2835	312	30W, 35W, 40W, 50W	3500K	
LP-2X4-MW-27K-DS	SMD2835	312	30W, 35W, 40W, 50W	2700K	

LP-EM WITH BATTERY BACKUP

B5

LED PANEL LIGHTS WITH BATTERY BACKUP

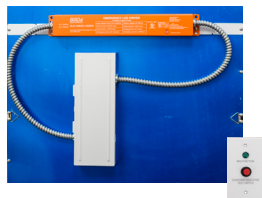
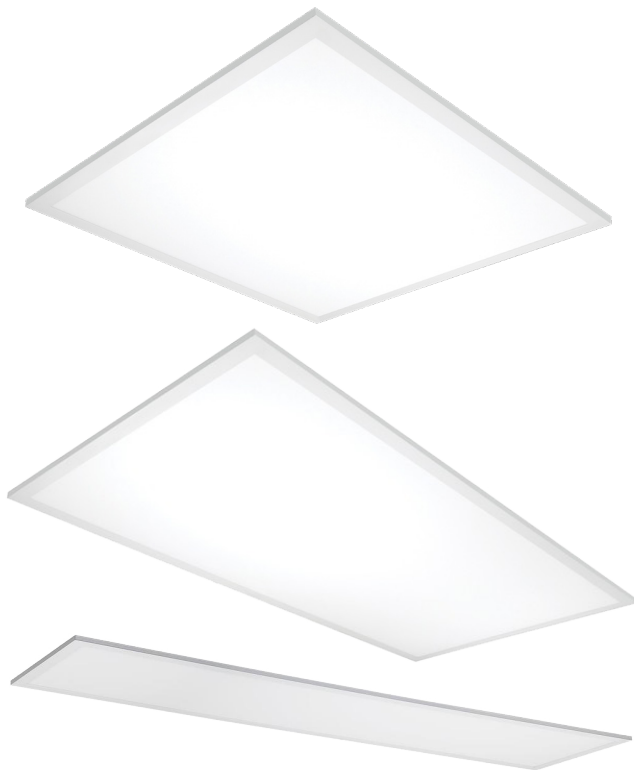

Emergency System Pre-installed
(In 1X4 Installed but not attached to fixture)

For accessories
see page B6

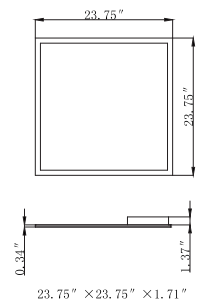
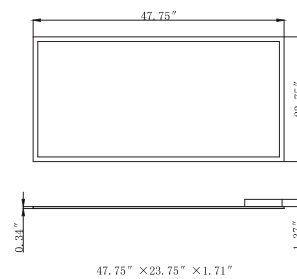
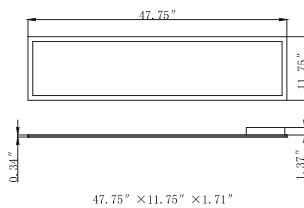

TECHNICAL SPECIFICATIONS:

- :: External driver mounted on top
- :: PMMA Light Guided Panel (LGP) does not turn yellow.
- :: High efficiency: 110LM/W
- :: Input Voltage: AC100V~277V
- :: Emergency System with 20W of output, Pre-installed for 90 mins. of operation during power outage. Test Button Plate included. Devid
- :: Fixture Operating Voltage: 36VDC
- :: LED Type: 4014SMD LM80
- :: Color Rendering Index: Ra>80
- :: Dimmable: 0~10V dimming
- :: Power Factor: >0.9
- :: Current (mA): 1050mA (40W) / 1500mA (60W) 36V DC
- :: Frequency Range: 50Hz~60Hz
- :: Total harmonic distortion: ≤15 %
- :: Operating temperature: -68°F~104°F
- :: Rated life: 50,000 hrs.
- :: 5-year warranty

FEATURES:

- :: Soft and wide light emitting
- :: No infrared rays, no ultraviolet radiation, no thermal effect
- :: No flickering, no humming, no RF interference
- :: Earthquake hooks and Suspension hooks preinstalled



LED PANEL LIGHTS WITH EMERGENCY BATTERY BACKUP

CATALOG NO.	CHIP	LEDs	WATTS	LUMENS	EMERGENCY OPERATION LUMENS	COLOR TEMP	DIMENSIONS
LP-2X2-40W-50K-DS-EM	SMD4014	216	40W	4400LM	2200LM	5000K	23.75" x 23.75" x 1.71"
LP-2X2-40W-40K-DS-EM	SMD4014	216	40W	4400LM	2200LM	4000K	
LP-2X4-60W-50K-DS-EM	SMD4014	384	60W	6600LM	2200LM	5000K	23.75" x 47.75" x 1.71"
LP-2X4-60W-40K-DS-EM	SMD4014	384	60W	6600LM	2200LM	4000K	
LP-1X4-40W-50K-DS-EM	SMD4014	384	40W	4400LM	2200LM	5000K	11.75" x 47.75" x 1.71"
LP-1X4-40W-40K-DS-EM	SMD4014	384	40W	4400LM	2200LM	4000K	
Emergency Unit Specs:	Input voltage: 100~277VAC, Output power: 20W (Max), Emergency operation: ≥90 mins., Recharge: 24 Hrs.						

LP-2X2-40W-HL



TECHNICAL SPECIFICATIONS:

- :: External driver mounted on top
- :: PMMA Light Guided Panel (LGP) does not turn yellow.
- :: High efficiency: 125LM/W
- :: Input Voltage: AC100V~277V
- :: Fixture Operating Voltage: 36VDC
- :: LED Type: 4014SMD LM80
- :: Color Rendering Index: Ra>82
- :: Dimmable: 0~10V dimming
- :: Power Factor: >0.9
- :: Current (mA): 1100mA 36V DC
- :: Frequency Range: 50Hz~60Hz
- :: Total harmonic distortion: ≤15 %
- :: Operating temperature: 68°F~113°F
- :: Rated life: 50,000 hrs.
- :: 5-year warranty

FEATURES:

- :: Soft and wide light emitting
- :: No infrared rays, no ultraviolet radiation, no thermal effect
- :: No flickering, no humming, no RF interference
- :: Earthquake hooks preinstalled



For accessories
see page B6

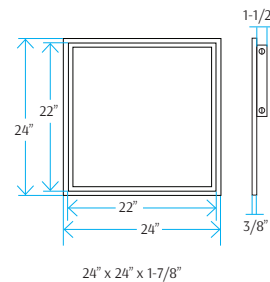

B6

DLC 4.0 PREMIUM HIGH-OUTPUT PANEL LIGHTS

DLC PREMIUM HIGH-OUTPUT LED PANELS (2X2) 40W

CATALOG NO.	CHIP	LEDs	WATTS	LUMENS	COLOR TEMP	DIMENSIONS
LP-2X2-40W-50K-D-HL	SMD4014	216	40W	5280LM	5000K	24" x 24" x 1-7/8"
LP-2X2-40W-40K-D-HL	SMD4014	216	40W	5280LM	4000K	

LP-2X4-50W-HL



TECHNICAL SPECIFICATIONS:

- :: External driver mounted on top
- :: PMMA Light Guided Panel (LGP) does not turn yellow.
- :: High efficiency: 125LM/W
- :: Input Voltage: AC100V~277V
- :: Fixture Operating Voltage: 36VDC
- :: LED Type: 4014SMD LM80
- :: Color Rendering Index: Ra>82
- :: Dimmable: 0~10V dimming
- :: Power Factor: >0.9
- :: Current (mA): 1100mA 36V DC
- :: Frequency Range: 50Hz~60Hz
- :: Total harmonic distortion: ≤15 %
- :: Operating temperature: 68°F~113°F
- :: Rated life: 50,000 hrs.
- :: 5-year warranty

FEATURES:

- :: Soft and wide light emitting
- :: No infrared rays, no ultraviolet radiation, no thermal effect
- :: No flickering, no humming, no RF interference
- :: Earthquake hooks preinstalled



For accessories
see page B6

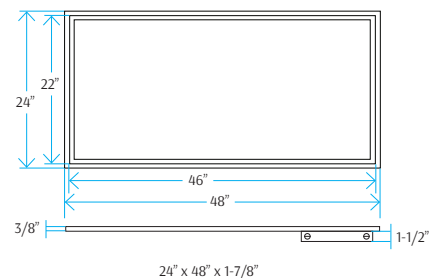

DLC PREMIUM HIGH-OUTPUT LED PANELS (2X4) 50W

CATALOG NO.	CHIP	LEDs	WATTS	LUMENS	COLOR TEMP	DIMENSIONS
LP-2X4-50W-50K-D-HL	SMD4014	384	50W	6260LM	5000K	24" x 48" x 1-7/8"
LP-2X4-50W-40K-D-HL	SMD4014	384	50W	6260LM	4000K	

ACCESSORIES FOR LED PANELS



LP-SRFC

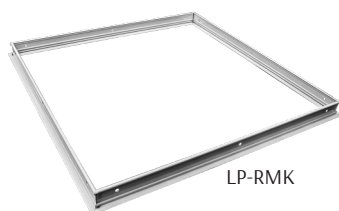

LP-RMK

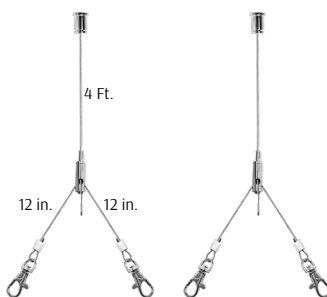

LP-SSPC-2X2-G2

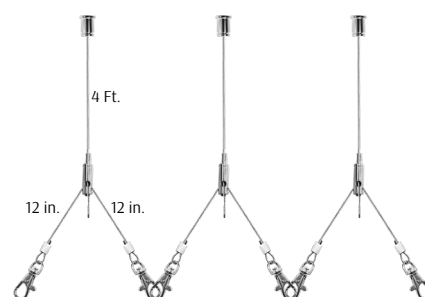

LP-SSPC-2X4-G2
LP-SSPC-1X4-G2



ELB-1248-EXTR

B8

ACCESSORIES

ACCESSORIES FOR LED PANELS

CATALOG NO.	DESCRIPTION	CATALOG NO.	DESCRIPTION
LP-SRFC-1X4-G2	Surface Mounting Kit white aluminum frame for 1'x4'x2.5" (for ceiling or wall) Opens on one end—panel slides into channel Mounting screws and plastic anchors included	LP-RMK-1X4	1x4' Recessed Mounting Flange Kit for installation in hard ceilings and surfaces white cast aluminum
LP-SRFC-2X2-G2	Surface Mounting Kit white aluminum frame for 2'x2'x2.5" (for ceiling or wall) Opens on one end—panel slides into channel Mounting screws and plastic anchors included	LP-RMK-2X2	2x2' Recessed Mounting Flange Kit for installation in hard ceilings and surfaces white cast aluminum
LP-SRFC-2X4-G2	Surface Mounting Kit white aluminum frame for 2'x4'x2.5" (for ceiling or wall) Opens on one side—panel slides into channel Mounting screws and plastic anchors included	LP-RMK-2X4	2x4' Recessed Mounting Flange Kit for installation in hard ceilings and surfaces white cast aluminum
LP-SSPC-1X4-G2	Adjustable Aircraft Cable Suspension Kit for 1x4 Panel Each kit contains 3 sets of: :: Ceiling Barrel w/ mounting hole :: 4 feet of 1/16" galv. aircraft cable with adjustable "Y" adapter & two locking hook ends :: Total max length: 4ft. :: 1-1/2" #8 mounting screws and plastic anchors provided	ELB-1248-EXTR	Field-installed emergency ballast; For 1x4, 2x2 & 2x4 flat panels and troffers Input voltage: 100~277VAC Output voltage: 12V~48VDC; Output power: 12W (Max) Emergency operation: ≥90 mins.; Recharge: 24 Hrs.
LP-SSPC-2X2-G2	Adjustable Aircraft Cable Suspension Kit for 2X2 Panel Each kit contains 2 sets of: :: Ceiling Barrel w/ mounting hole :: 4 feet of 1/16" galv. aircraft cable with adjustable "Y" adapter & two locking hook ends :: Total max length: 4ft. :: 1-1/2" #8 mounting screws and plastic anchors provided		
LP-SSPC-2X4-G2	Adjustable Aircraft Cable Suspension Kit for 2x4 Panel Each kit contains 3 sets of: :: Ceiling Barrel w/ mounting hole :: 4 feet of 1/16" galv. aircraft cable with adjustable "Y" adapter & two locking hook ends :: Total max length: 4ft. :: 1-1/2" #8 mounting screws and plastic anchors provided		

LTR

TECHNICAL SPECIFICATIONS:

- :: Input Voltage: AC100V~277V, 50/60Hz
- :: Steel Thickness: 24 Gauge
- :: Power Factor: 0.97
- :: High efficiency: 110LM/W
- :: CRI: >80
- :: Dimmable: 0~10V dimming
- :: IP rating: IP20 (Indoor)
- :: Ambient temperature: -20°F~105°F
- :: Rated life: 50,000 hrs.
- :: 5-year warranty

FEATURES:

- :: New modern look wide PC lens
- :: Exclusive design lens installs from opening on ends to prevent leakage of light
- :: Modern matte white finish
- :: Earthquake hooks built into housing

APPLICATIONS:

- :: Ideal one-for-one replacement of conventional fluorescent troffer fixtures

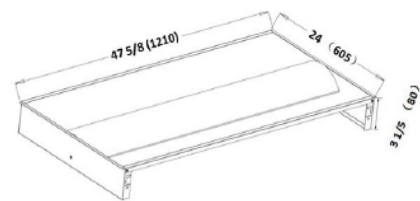
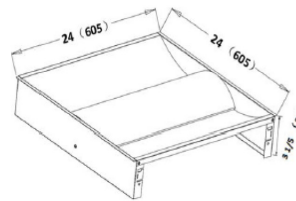

LED CENTER BASKET (PC LENS) TROFFER LIGHTS

CATALOG NO.	SIZES	WATTS	LUMENS	COLOR TEMP	DIMENSIONS
LTR-2X2-40W-50K-D	2X2	40W	4417LM	5000K	24" x 24" x 3-1/8"
LTR-2X2-40W-40K-D	2X2	40W	4281LM	4000K	24" x 24" x 3-1/8"
LTR-2X2-40W-35K-D	2X2	40W	4281LM	3500K	24" x 24" x 3-1/8"
LTR-2x4-50W-50K-D	2X4	50W	5702LM	5000K	24" x 48" x 3-1/5"
LTR-2X4-50W-40K-D	2X4	50W	5590LM	4000K	24" x 48" x 3-1/5"
LTR-2X4-50W-35K-D	2X4	50W	5590LM	3500K	24" x 48" x 3-1/5"

ACCESSORIES

CATALOG NO.	DESCRIPTION
 ELB-1248-EXTR	Field-installed emergency ballast; Input voltage: 100~277V AC, 50~60Hz; Input current: 65mA (max); Input power: 4.8W (max); Output voltage: 12V~48V DC; Output power: 12W (max); Emergency operation: ≥90 mins.; Recharge: 24 hrs.

RTR

RETROFIT TROFFER DOOR REPLACEMENT

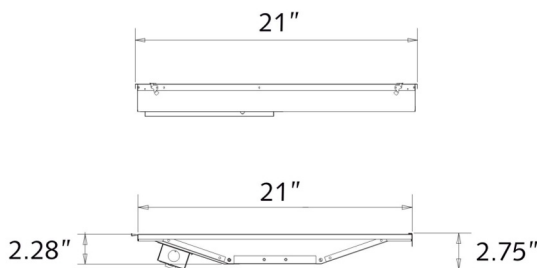

TECHNICAL SPECIFICATIONS:

- :: See application below
- :: Input Voltage: 120~277VAC, 50/60Hz
- :: Housing: Steel base with white powder coating
- :: Steel Thickness: 24 Gauge
- :: Lens: Frosted diffuse PC lens
- :: CRI: >80
- :: Dimmable: 0~10V dimming
- :: IP rating: IP20 (Indoor)
- :: Operating Temperature: -4°F~131°F
- :: Life Span: 50,000 hours
- :: 5-year warranty
- :: Retrofit baskets included

FEATURE:

- :: Replaces prismatic lens on standard fluorescent troffer fixtures to create a modern & efficient office environment

APPLICATIONS:

- :: Replaces door frame & lens of traditional fluorescent flat-lens troffer fixtures
- :: No need to remove old fixture; simply remove and discard the door frame of the existing fixture; place 2 adapter brackets (included) in the existing fixture; hinge this retrofit unit to the fixture; disconnect the ballast; connect the wires to the retrofit unit and close

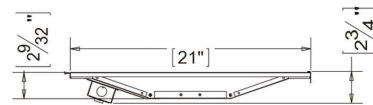
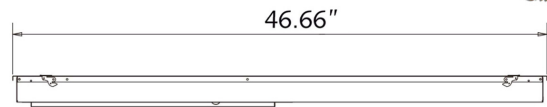

LED DOOR FRAME TROFFER RETROFITS

CATALOG NO.	SIZES	WATTS	LUMENS	COLOR TEMP	DIMENSIONS
RTR-2X2-40W-50K-D	2X2	40W	3990LM	5000K	21" x 21" x 2-3/4"
RTR-2X2-40W-40K-D	2X2	40W	3980LM	4000K	21" x 21" x 2-3/4"
RTR-2X2-40W-35K-D	2X2	40W	3847LM	3500K	21" x 21" x 2-3/4"
RTR-2x4-52W-50K-D	2X4	52W	5503LM	5000K	46-2/3" x 21" x 2-3/4"
RTR-2X4-52W-40K-D	2X4	52W	5303LM	4000K	46-2/3" x 21" x 2-3/4"
RTR-2X4-52W-35K-D	2X4	52W	5303LM	3500K	46-2/3" x 21" x 2-3/4"

SCL 4FT.

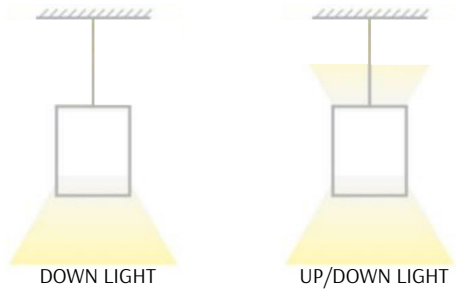

TECHNICAL SPECIFICATIONS:

- :: 4 Feet long
- :: The down only version provides 40W @ 4400 lumens
- :: The up-down version provides 15W @ 1650 lumens up light and 25W @ 2750 lumens down light.
- :: Surface Mounting Hardware & Coupling Clip for Tandem Installation included (not shown)
- :: Optional Recessed Mounting Kit available
- :: Voltage: 120~277VAC 50/60Hz
- :: Wattage: Down Light: 40W Up/Down: 15W/25W
- :: Ambient Temperature: -13°F~104°F
- :: Dimmable: 0~10V dimmable
- :: CRI:>80
- :: Power Factor:>0.95
- :: Efficacy: 110LM/W
- :: IP Rating: IP20
- :: Life Span: 50,000 hours, 5-year warranty
- :: Housing: White, Aluminum
- :: Lens: Frosted Polycarbonate

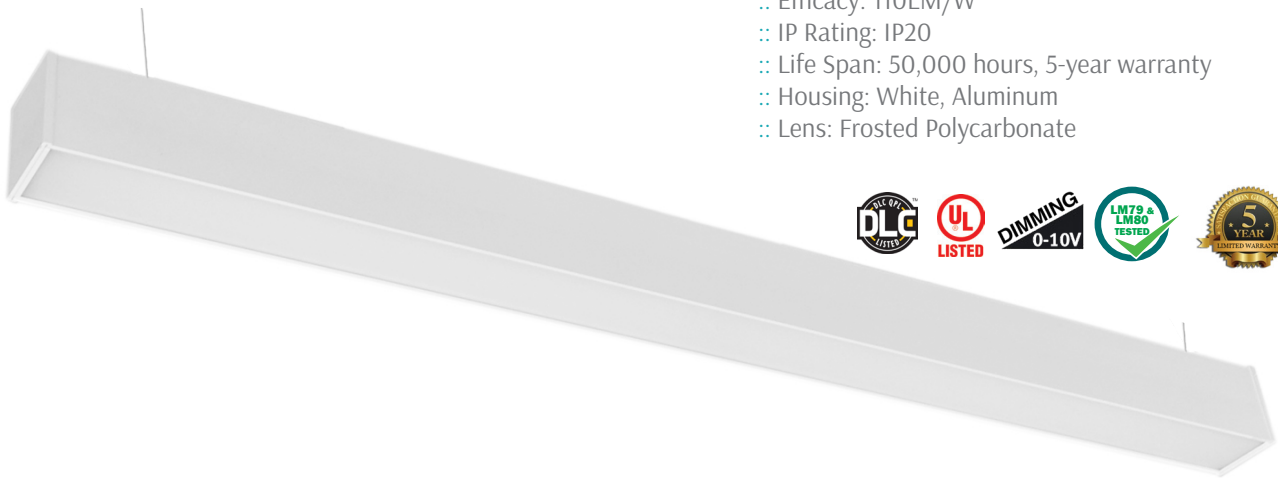



B11

LED ARCHITECTURAL SUSPENDED COMMERCIAL LIGHTS

Optional Accessories

Recessed Mounting Kit
(Not Included)
See Below

6 Ft. Cord
SJTW 18 AWG 5-Conductor
(Not Included)
See Page B34

Adjustable 6 Ft. Suspension Kit
Select a Single-Connector Key Hole Set
(Not Included)
See Page B34

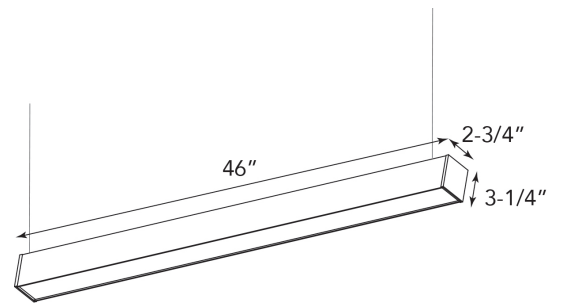

LED ARCHITECTURAL SUSPENDED LIGHTS (4FT.)

CATALOG NO.		WATTS		LUMENS		COLOR TEMP	DIMENSIONS
DOWN LIGHT	UP/DOWN LIGHT	DOWN LIGHT	UP/DOWN LIGHT	DOWN LIGHT	UP/DOWN LIGHT		
SCL-4FT-40W-50K-D	SCL-4FT-UD-40W-50K-D	40W	15W/25W	4400LM	1650LM/2750LM	5000K	46"(L) x 2-3/4"(W) x 3-1/4"(H)
SCL-4FT-40W-40K-D	SCL-4FT-UD-40W-40K-D	40W	15W/25W	4400LM	1650LM/2750LM	4000K	
SCL-4FT-40W-35K-D	SCL-4FT-UD-40W-35K-D	40W	15W/25W	4400LM	1650LM/2750LM	3500K	
SCL-RMK		Recessed Mounting Kit					

SCL 2FT.



TECHNICAL SPECIFICATIONS:

- :: 2 Feet long
- :: Wattage: 25W
- :: Lumens: 2750LM
- :: Surface Mounting Hardware & Coupling Clip for Tandem Installation included (not shown)
- :: Optional Recessed Mounting Kit available
- :: Voltage: 120~277VAC 50/60Hz
- :: Ambient Temperature: -13°F~104°F
- :: Dimmable: 0~10V dimmable
- :: CRI:>80
- :: Power Factor:>0.95
- :: Efficacy: 110LM/W
- :: IP Rating: IP20
- :: Life Span: 50,000 hours, 5-year warranty
- :: Housing: White, Aluminum
- :: Lens: Frosted Polycarbonate



B12

LED ARCHITECTURAL SUSPENDED COMMERCIAL LIGHTS

Optional Accessories



Recessed Mounting Kit
(Not Included)
See Below



6 Ft. Cord
SJTW 18 AWG 5-Conductor
(Not Included)
See Page B34



Adjustable 6 Ft. Suspension Kit
Select a Single-Connector Key Hole Set
(Not Included)
See Page B34

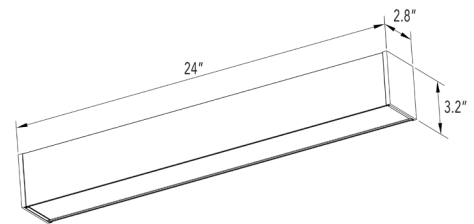

LED ARCHITECTURAL SUSPENDED LIGHTS (2FT.)

CATALOG NO.	WATTS	LUMENS	COLOR TEMP	DIMENSIONS
SCL-2FT-25W-50K-D	25W	2750LM	5000K	24"(L) x 2.8"(W) x 3.2"(H)
SCL-2FT-25W-40K-D	25W	2750LM	4000K	
SCL-2FT-25W-35K-D	25W	2750LM	3500K	
SCL-RMK	Recessed Mounting Kit			

SCLP & SCLT

TECHNICAL SPECIFICATIONS:

- :: 4 Feet long
- :: Voltage: 120~277VAC 50/60Hz
- :: Wattage: 40W
- :: Ambient Temperature: -13°F~104°F
- :: Dimmable: 0~10V dimmable
- :: CRI:>80
- :: Power Factor:>0.95
- :: Efficacy: 115LM/W
- :: IP Rating: IP20
- :: Life Span: 50,000 hours
- :: Housing: Anodized Aluminum
- :: Lens: Louver Lens
- :: 5-year warranty

B13

LED PARABOLIC SUSPENDED COMMERCIAL LIGHTS



SCLP-4FT-40W-D
Parabolic Reflector

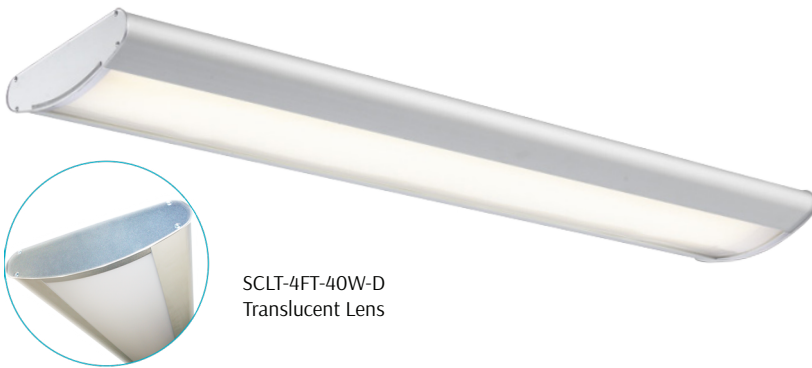

SCLT-4FT-40W-D
Translucent Lens



Optional Accessories



Coupling Bracket
(Not Included)
See Below



6 Ft. Cord
SJTW 18 AWG 5-Conductor
(Not Included)
See Page B34



Adjustable 6 Ft.
Suspension Kit
Select a Y-Connector
Key Hole Set
(Not Included)
See Page B34

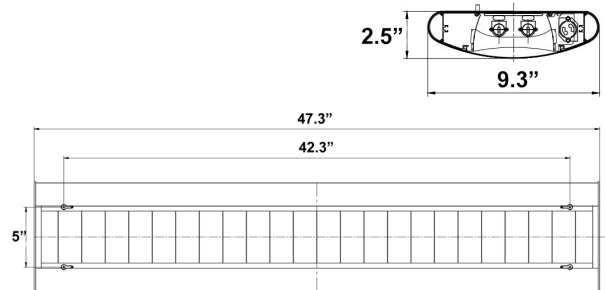

LED ARCHITECTURAL SUSPENDED LIGHTS

CATALOG NO.	WATTS	LUMENS	COLOR TEMP	Lens	DIMENSIONS
SCLP-4FT-40W-50K-D	40W	4600LM	5000K	Parabolic Reflector	47.3"(L) x 9-2/8"(W) x 2-4/8"(H)
SCLP-4FT-40W-40K-D	40W	4600LM	4000K	Parabolic Reflector	
SCLP-4FT-40W-35K-D	40W	4600LM	3500K	Parabolic Reflector	
SCLT-4FT-40W-50K-D	40W	4600LM	5000K	Translucent Lens	
SCLT-4FT-40W-40K-D	40W	4600LM	4000K	Translucent Lens	
SCLT-4FT-40W-35K-D	40W	4600LM	3500K	Translucent Lens	
SCLP-CB	Coupling Bracket				

SCLP-UD

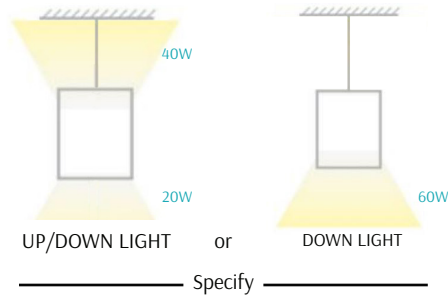

TECHNICAL SPECIFICATIONS:

- :: 4 Feet long
- :: Voltage: 120~277VAC 50/60Hz
- :: Wattage: Up/Down: 40W/20W or 60W Down only
- :: Ambient Temperature: -13°F~104°F
- :: Dimmable: 0~10V dimmable
- :: CRI:>80
- :: Power Factor:>0.95
- :: Efficacy: 110LM/W
- :: IP Rating: IP20
- :: Life Span: 50,000 hours
- :: Housing: Anodized Aluminum
- :: Lens: Louver Lens
- :: 5-year warranty



B14

LED PARABOLIC SUSPENDED COMMERCIAL LIGHTS

Optional Accessories

Coupling Bracket
(Not Included)
See Below

6 Ft. Cord
SJTW 18 AWG 5-Conductor
(Not Included)
See Page B34

Adjustable 6 Ft.
Suspension Kit
Select a Y-Connector
Key Hole Set
(Not Included)
See Page B34

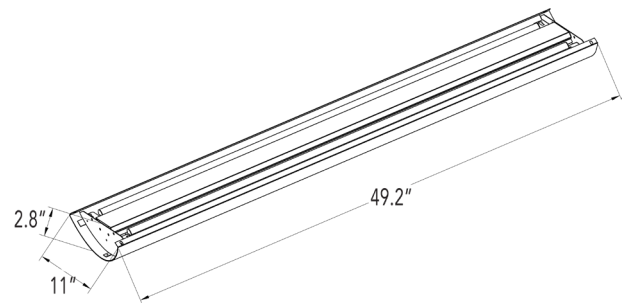

LED ARCHITECTURAL PARABOLIC SUSPENDED LIGHTS (UP/DOWN)

CATALOG NO.	WATTS (UP/DOWN or DOWN ONLY)	LUMENS (UP/DOWN)	COLOR TEMP	DIMENSIONS
SCLP-UD-4FT-60W-50K-D	40W/20W or 60W	4400LM/2100LM	5000K	49.2"(L) x 11"(W) x 2.8"(H)
SCLP-UD-4FT-60W-40K-D	40W/20W or 60W	4400LM/2100LM	4000K	
SCLP-UD-4FT-60W-35K-D	40W/20W or 60W	4400LM/2100LM	3500K	
SCLP-UD-CB		Coupling Bracket		

SCLR

TECHNICAL SPECIFICATIONS:

- :: 4 Feet long
- :: No tandem connection
- :: Voltage: 120~277VAC 50/60Hz
- :: Wattage: 40W
- :: Ambient Temperature: -13°F~104°F
- :: Dimmable: 0~10V dimmable
- :: CRI:>80
- :: Power Factor:>0.95
- :: Efficacy: 110LM/W
- :: IP Rating: IP20
- :: Life Span: 50,000 hours
- :: Housing: White, Die-cast Aluminum
- :: Lens: Prismatic Polycarbonate
- :: 5-year warranty



Optional Accessories (See Page B34)



6 Ft. Cord
SJTW 18 AWG 5-Conductor
(Not Included)



Adjustable 6 Ft.
Suspension Kit
Select a Single-
Connector Key Hole Set
(Not Included)

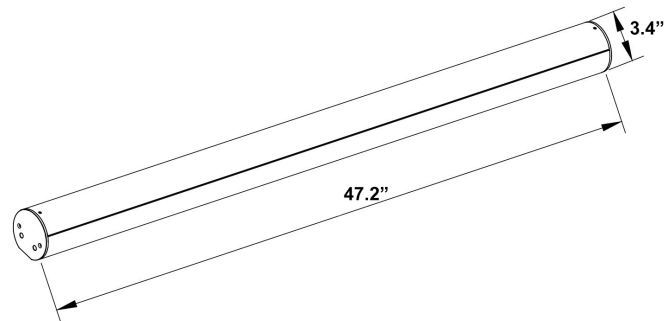

LED ARCHITECTURAL ROUND SUSPENDED LIGHTS

CATALOG NO.	WATTS	LUMENS	COLOR TEMP	DIMENSIONS
SCLR-4FT-40W-50K-D	40W	4400LM	5000K	47.2"(L) x 3.4"(W) x 3.4"(H)
SCLR-4FT-40W-40K-D	40W	4400LM	4000K	
SCLR-4FT-40W-35K-D	40W	4400LM	3500K	

SPL WITH CLEAR EDGE LIT LED PANEL

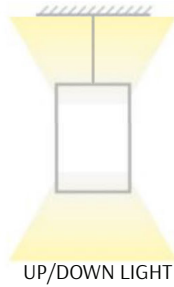

TECHNICAL SPECIFICATIONS:

- :: 4 Feet long
- :: Housing: White, Die-cast Aluminum
- :: Lens: Clear Patterned Light Guide Panel
- :: Driver integrated into the frame
- :: Coupling Brackets for Tandem Installation Pre-installed
- :: Voltage: 120~277VAC 50/60Hz
- :: Wattage: 40W
- :: Ambient Temperature: -13°F~104°F
- :: Dimmable: 0~10V dimmable
- :: CRI:>80
- :: Power Factor:>0.95
- :: Efficacy: 105LM/W
- :: IP Rating: IP20
- :: Life Span: 50,000 hours
- :: 5-year warranty



Optional Accessories (See Page B34)



6 Ft. Cord
SJTW 18 AWG 5-Conductor
(Not Included)



Adjustable 6 Ft.
Suspension Kit
Select a Y-Connector
Key Hole Set
(Not Included)

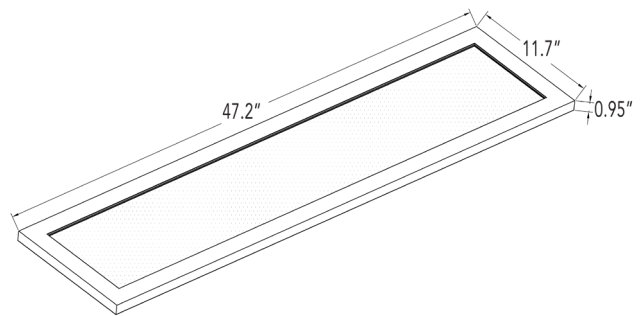

LED SUSPENDED UP/DOWN PANEL LIGHTS

CATALOG NO.	WATTS	LUMENS (UP/DOWN)	COLOR TEMP	DIMENSIONS
SPL-4FT-40W-50K-D	40W	2100LM/2100LM	5000K	47.2"(L) x 11.7"(W) x 0.95"(H)
SPL-4FT-40W-40K-D	40W	2100LM/2100LM	4000K	
SPL-4FT-40W-35K-D	40W	2100LM/2100LM	3500K	

WA

TECHNICAL SPECIFICATIONS:

- :: Housing: Die-formed heavy gauge cold rolled steel with powder coated white
- :: Steel Thickness: 24 Gauge
- :: Lens: Opal Polycarbonate
- :: Light Source: High-lumen LEDs
- :: Wattage: 30W and 25W
- :: Voltage: 100V~277V AC
- :: CRI: >82
- :: Driver: Optional
- :: Power Factor: >0.95
- :: Installation: Ceiling-mounted
- :: Ambient Temperature: -22°F ~ +107°F
- :: Color Temperature: 4000K and 5000K
- :: Efficacy: 110 LM/W
- :: Life Span: 50,000 hours, 5-year warranty

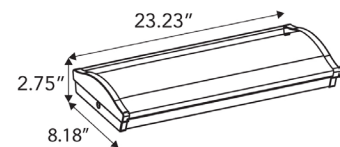
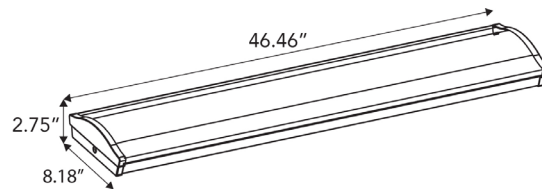

LED ARCHITECTURAL WRAP-AROUND LIGHTS

CATALOG NO.	WATTS	LUMENS	COLOR TEMP	DIMENSIONS
WA-4FT-30W-35K-D	30W	3670LM	3500K	46.46"(L) x 8.18"(W) x 2.75"(H)
WA-4FT-30W-40K-D	30W	3670LM	4000K	
WA-4FT-30W-50K-D	30W	3670LM	5000K	
WA-2FT-25W-35K-D	25W	2750LM	3500K	23.23"(L) x 8.18"(W) x 2.75"(H)
WA-2FT-25W-40K-D	25W	2750LM	4000K	
WA-2FT-25W-50K-D	25W	2750LM	5000K	

WAS

TECHNICAL SPECIFICATIONS:

- :: Housing: Die-formed heavy gauge cold rolled steel with powder coated white
- :: Steel Thickness: 24 Gauge
- :: Lens: Opal Polycarbonate
- :: Light Source: High-lumen LEDs
- :: Wattage: 42W
- :: Voltage: 100V~277V AC
- :: CRI: >82
- :: Driver: Optional
- :: Power Factor: >0.95
- :: Installation: Ceiling-mounted
- :: Ambient Temperature: -22°F ~ +107°F
- :: Color Temperature: 4000K
- :: Lumens: 4400LM
- :: Life Span: 50,000 hours, 5-year warranty

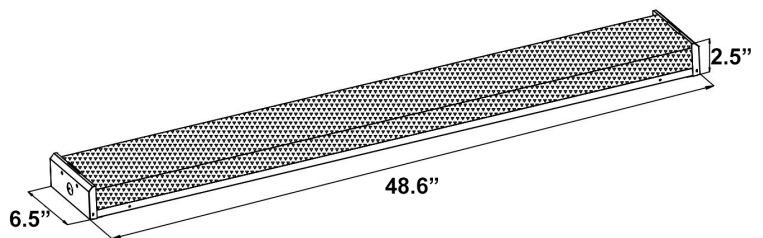

B18

LED STANDARD WRAP-AROUND FIXTURES

LED STANDARD WRAP-AROUND FIXTURE

CATALOG NO.	WATTS	LUMENS	COLOR TEMP	DIMENSIONS
WAS-4FT-42W-40K-D	42W	4400LM	4000K	48.6"(L) x 6.5"(W) x 2.5"(H)

CSL

TECHNICAL SPECIFICATIONS:

- :: 4 Feet long
- :: Steel Thickness: 24 Gauge
- :: Voltage: 120~277VAC 50/60Hz
- :: Wattage: 40W
- :: Ambient Temperature: -13°F~104°F
- :: Dimmable: 0~10V dimmable
- :: CRI:>80
- :: Power Factor:>0.95
- :: Efficacy: 110LM/W
- :: IP Rating: IP20
- :: Life Span: 50,000 hours
- :: Housing: Metal housing, White powder coated
- :: Lens: Prismatic
- :: 5-year warranty

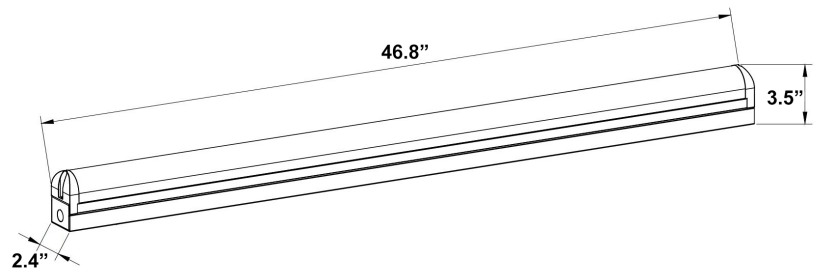

LED ARCHITECTURAL STRIP LIGHT

CATALOG NO.	WATTS	LUMENS	COLOR TEMP	DIMENSIONS
CSL-4FT-40W-50K-D	40W	4600LM	5000K	46.8"(L) x 2.4"(W) x 3.5"(H)
CSL-4FT-40W-40K-D	40W	4600LM	4000K	
CSL-4FT-40W-35K-D	40W	4600LM	3500K	

CSL STAIRWELL & GARAGE

TECHNICAL SPECIFICATIONS:

- :: High Lumen 4-Foot Stairwell Light with Programmable Ultrasonic Bi-Level Ultrasonic Motion Sensor
- :: Steel Thickness: 24 Gauge
- :: Voltage: 120~277VAC 50/60Hz
- :: Wattage: 25W
- :: Ambient Temperature: -13°F~104°F
- :: Dimmable: 0~10V dimmable
- :: CRI:>80
- :: Power Factor:>0.95
- :: Efficacy: 125LM/W
- :: IP Rating: IP20
- :: Life Span: 50,000 hours
- :: Housing: Metal housing, White powder coated
- :: Lens: Prismatic
- :: 5-year warranty



LLHB-OC-REMOTE

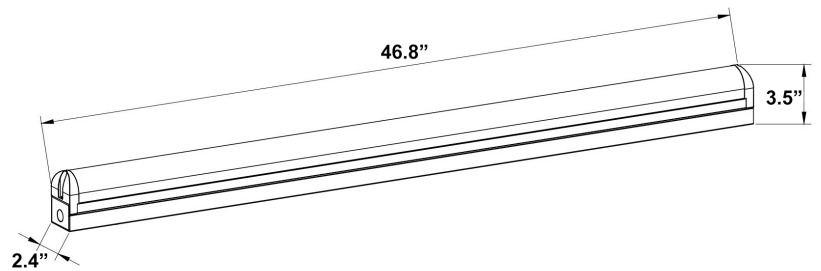

B20

LED COMMERCIAL STRIP LIGHTS

LED ARCHITECTURAL STRIP LIGHT

CATALOG NO.	WATTS	LUMENS	COLOR TEMP	DIMENSIONS
CSL-4FT-25W-50K-OC	25W	3000LM	5000K	46.8"(L) x 2.4"(W) x 3.5"(H)
CSL-4FT-25W-40K-OC	25W	3000LM	4000K	
LLHB-OC-REMOTE	Remote control for Bi-Level Motion Sensor			

LSL 4FT. & 2FT.

TECHNICAL SPECIFICATIONS:

- :: White finish
- :: Housing: Steel with powder coating
- :: Steel Thickness: 24 Gauge
- :: Lens: Frosted diffuse Polycarbonate lens with strip lines
- :: Ceiling-mounted
- :: Same footprint as traditional 2-lamp strip lights
- :: Power: 40W
- :: Voltage: 120~277V AC, 50/60Hz
- :: Chip: Samsung
- :: Dimmable 0~10V
- :: CRI: >80
- :: IP Rating: IP20
- :: Mounting: Surface mount, wall mount or suspended
- :: Indoor use only
- :: 5-year warranty

B21

LED STRIP LIGHTS



LSL-4FT-40W-D



LSL-2FT-20W-D

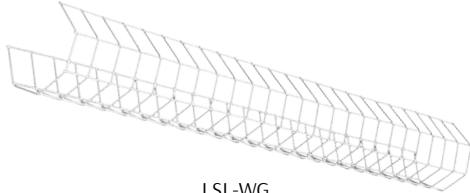

LSL-WG
Wire guard kit
(painted white)
for 2ft and 4ft
for strip light
(sold separately)

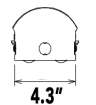
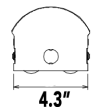
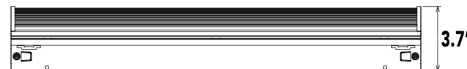

LED STRIP LIGHTS (4FT. & 2FT.)

CATALOG NO.	WATTS	LUMENS	COLOR TEMP	DIMENSIONS
LSL-4FT-40W-50K-D	40W	4193LM	5000K	48"(L) x 4-1/2"(W) x 3-3/4"(H)
LSL-4FT-40W-40K-D	40W	4070LM	4000K	
LSL-4FT-40W-35K-D	40W	4070LM	3500K	
LSL-2FT-20W-50K-D	20W	2200LM	5000K	24"(L) x 4-1/2"(W) x 3-3/4"(H)
LSL-2FT-20W-40K-D	20W	2200LM	4000K	
LSL-2FT-20W-35K-D	20W	2200LM	3500K	
LSL-4FT-WG		Wire guard kit for 4ft. strip light		
LSL-2FT-WG		Wire guard kit for 2ft. strip light		

LSL 8FT.

TECHNICAL SPECIFICATIONS:

- :: White finish
- :: Housing: Steel base with powder coating (1-Piece)
- :: Steel Thickness: 24 Gauge
- :: Lens: Frosted diffuse Polycarbonate lens (2-Piece)
- :: Ceiling-mounted
- :: Narrower footprint than traditional 2-lamp strip lights
- :: Power: 64W
- :: Voltage: 120~277V AC, 50/60Hz
- :: Dimmable 0~10V
- :: CRI: >80
- :: IP Rating: IP20
- :: Mounting: Surface mount, wall mount or suspended
- :: Damp Location
- :: 5-year warranty

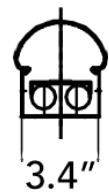

LED STRIP LIGHTS (8FT.)

CATALOG NO.	WATTS	LUMENS	COLOR TEMP	DIMENSIONS
LSL-8FT-64W-50K-D	64W	7800LM	5000K	96"(L) x 3.4"(W) x 3.6"(H)
LSL-8FT-64W-40K-D	64W	7800LM	4000K	

SLR

TECHNICAL SPECIFICATIONS:

- :: Fits traditional 4Ft. strip lights
- :: Replaces sockets and cover on existing strip light housing
- :: 4 Feet long
- :: For retrofit an 8 foot fixture, use 2 units
- :: White finish
- :: Material: Sheet Metal, White coated
- :: Steel Thickness: 24 Gauge
- :: Lens: PC lenses
- :: Ceiling-mounted
- :: Power: 40W
- :: Voltage: 120~277V AC, 50/60Hz
- :: Chip: Samsung
- :: Dimmable 0~10V
- :: CRI: >80
- :: IP Rating: IP20
- :: Life Span: 50,000 hours, 5-year warranty

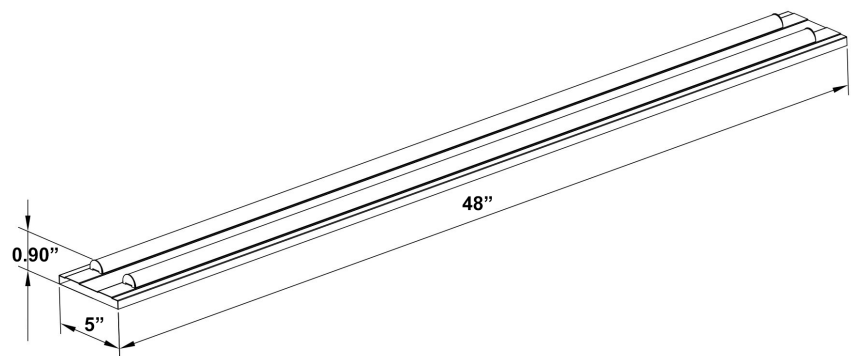

LED STRIP RETROFIT KIT

CATALOG NO.	WATTS	LUMENS	COLOR TEMP	DIMENSIONS
SLR-4FT-40W-50K-D	40W	4600LM	5000K	48"(L) x 5"(W) x 0.90"(H)

LSP

TECHNICAL SPECIFICATIONS:

- :: 4 Feet long
- :: Housing: Powder coated aluminum, PC ends
- :: 6Ft. Adjustable suspension cable set included
- :: 18" Pull chain
- :: 5Ft. Cord with plug
- :: Wattage: 40W
- :: Voltage: 120V AC
- :: Lumens: 5500LM
- :: Color Temperature: 4000K
- :: IP Rating: IP44
- :: Life Span: 50,000 hours, 5-year warranty

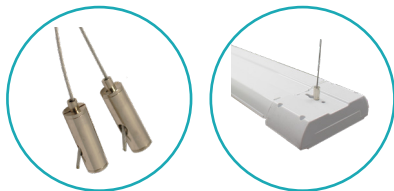

6Ft. adjustable aircraft cable with ceiling barrels & mounting hardware included

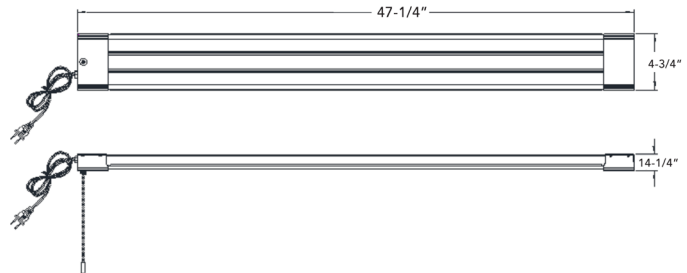

B24

LED SHOP LIGHTS

LED SHOP LIGHTS

CATALOG NO.	WATTS	LUMENS	COLOR TEMP	DIMENSIONS
LSP-4FT-40W-40K	40W	5500LM	4000K	47-1/4"(L) x 4-3/4"(W) x 1-1/2"(H)

TR1

TECHNICAL SPECIFICATIONS:

- :: Wattage: 10W
- :: Voltage: 100V~240V AC, 50/60Hz 0.08A
- :: LED: BRIDGELUX COB technology
- :: Minimum distance from illuminated object: 1 Ft.
- :: Fits Halo® and compatible tracks and accessories
- :: UL, DLC
- :: Life Span: 50,000 hours, 5-year warranty

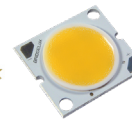

B25

LED TRACK LIGHTS



TR1-R-10W-WH



TR1-S-10W-WH



Replacement reflector for different beam angles

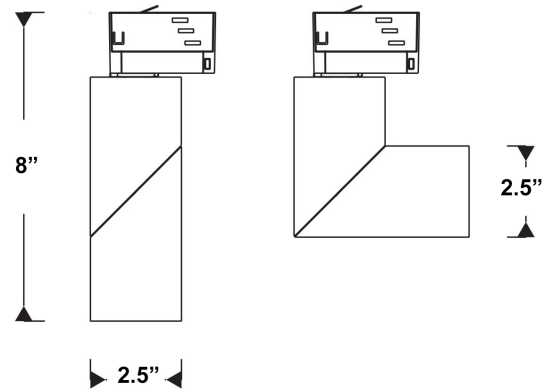

LED TRACK LIGHTS

CATALOG NO.	WATTS	LUMENS	BEAM ANGLE	COLOR TEMP	FINISH	DIMENSIONS
TR1-R-10W-WH-30K	10W	657LM	25°	3000K	White	
TR1-R-10W-WH-40K	10W	691LM	25°	4000K	White	8" (L) x 2-1/2" (Dia)
TR1-R-10W-WH-50K	10W	702LM	25°	5000K	White	
TR1-S-10W-WH-30K	10W	681LM	25°	3000K	White	
TR1-S-10W-WH-40K	10W	706LM	25°	4000K	White	8" (L) x 2-1/2" (Dia)
TR1-S-10W-WH-50K	10W	732LM	25°	5000K	White	
TR1-REFL-13D		13° replacement reflector for TR1 series Track Lights				
TR1-REFL-38D		38° replacement reflector for TR1 series Track Lights				

CRL



Light Engine and Driver Unit



Complete Unit
(Light Engine + Driver + Trim)



Trim



Housing

TECHNICAL SPECIFICATIONS:

- :: Efficacy: >89LM/W
- :: Delivered Light Output: 1606LM
- :: CRI: Ra>80
- THD: <20%
- :: Power Factor: >0.9
- :: Mounting: Recessed
- :: Driver Efficiency: >87%
- :: Non IC-Rated
- :: Life Span: 50,000 hours, 5-year warranty
- :: Temperature Rating: Designed to operate in temperatures 113°F



Ordering Guide for Complete Unit:

CRL6-27W-40K-H

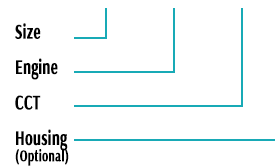

or Order Component Separately

LED COMMERCIAL RECESSED LIGHTS

CATALOG NO.	WATTS	COLOR TEMP	LUMENS	NOTES
CRL4-27W-30K	27W	3000K	1800LM	Complete unit (Light engine + Driver + Trim)
CRL4-27W-40K	27W	4000K	1900LM	
CRL4-27W-50K	27W	5000K	1950LM	
CRL-EGN-18W-30K	18W	3000K	1606LM	Light engine and driver units for 6", 8", 10" (Pick a trim below)
CRL-EGN-18W-40K	18W	4000K	1624LM	
CRL-EGN-18W-50K	18W	5000K	1639LM	
CRL-EGN-27W-30K	27W	3000K	2341LM	
CRL-EGN-27W-40K	27W	4000K	2366LM	
CRL-EGN-27W-50K	27W	5000K	2387LM	
CRL-EGN-40W-30K	40W	3000K	3346LM	
CRL-EGN-40W-40K	40W	4000K	3387LM	
CRL-EGN-40W-50K	40W	5000K	3447LM	
CRL-EGN-54W-40K	54W	4000K	4500LM	
CRL-EGN-54W-50K	54W	5000K	4500LM	
CRL-TRM-6		6" LED Commercial trim only, 6 inches		Trims only (Pick an engine above)
CRL-TRM-8		8" LED Commercial trim only, 8 inches		
CRL-TRM-10		10" LED Commercial trim only, 10 inches		
CRL-HSG-4		4" LED Commercial housing only, 4 inches		Housing only (Pick an engine & a trim above)
CRL-HSG-6		6" LED Commercial housing only, 6 inches		
CRL-HSG-8		8" LED Commercial housing only, 8 inches		
CRL-HSG-10		10" LED Commercial housing only, 10 inches		

LLVT

TECHNICAL SPECIFICATIONS:

- :: Housing: Polycarbonate
- :: Lens: Opal Polycarbonate
- :: With stainless steel clamps
- :: Stainless Steel Mounting Brackets Incorporated on the Back
- :: LED SMD type: Edison 2835
- :: Driver: ARCATA/ANTRON
- :: Optional Battery backup available for 40W units
- :: Input Voltage: 120V~277V AC
- :: Dimmable (0~10V dimming)
- :: Suitable for Wet Locations, IP65
- :: 5-year warranty

FEATURES:

- :: Ideal for offices, retail stores, showrooms and residential applications. Specially suited for areas where accessing the fixture is challenging.



LLVT-2FT



LLVT-4FT



Optional Accessories



Optional Motion Sensors
(Not Included)
See Page A53

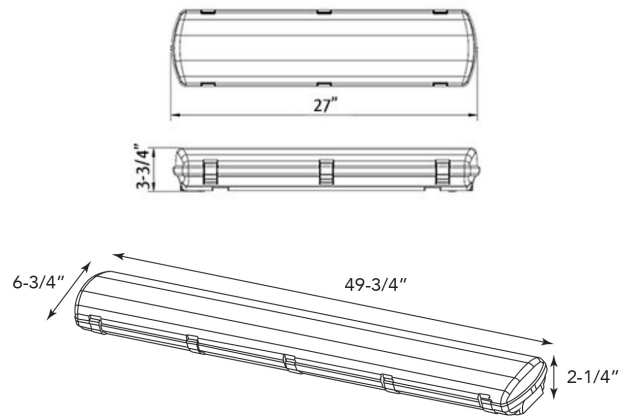

LED LINEAR VAPOR LIGHTS (25-75W)

CATALOG NO.	WATTS	LUMENS	COLOR TEMP	DIMENSIONS
LLVT-2FT-25W-40K-D	25W	3125LM	4000K	27"(L) x 6-3/4"(W) x 3-3/4"(H)
LLVT-2FT-25W-50K-D	25W	3125LM	5000K	
LLVT-4FT-40W-40K-D	40W	5000LM	4000K	
LLVT-4FT-40W-50K-D	40W	5000LM	5000K	49-3/4"(L) x 6-3/4"(W) x 3-3/4"(H)
LLVT-4FT-75W-40K-D	75W	9375LM	4000K	
LLVT-4FT-75W-50K-D	75W	9375LM	5000K	
LLVT-4FT-RL	Replacement Lens for LLVT			
LLVT-2FT-RL	Replacement Lens for LLVT			
LLVT-4FT-BU	Battery backup for LLVT-40W - Field installed - Incl. Emergency driver + Ni-Cad battery, 10W, 90 Mins.			

LLVT

TECHNICAL SPECIFICATIONS:

- :: Housing: Polycarbonate
- :: Lens: Clear Polycarbonate (Optional Opal Lens available)
- :: With stainless steel clamps
- :: Stainless Steel Mounting Brackets Incorporated on the Back
- :: LED SMD type: Edison 2835
- :: Driver: ARCATA/ANTRON
- :: Input Voltage: 120V~277V AC
- :: Dimmable (0~10V dimming)
- :: Suitable for Wet Locations, IP65
- :: 5-year warranty

FEATURES:

- :: Ideal for offices, retail stores, showrooms and residential applications. Specially suited for areas where accessing the fixture is challenging.



Shown with clear lens (Included)



Optional Accessories



Optional Motion Sensors (Not Included) See Page A53

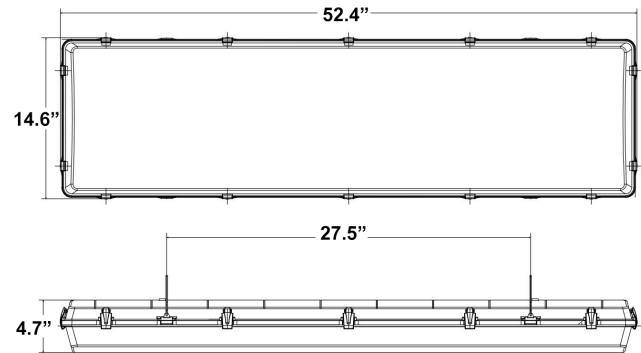

LED LINEAR VAPOR LIGHTS (100-150W)

CATALOG NO.	WATTS	LUMENS	COLOR TEMP	DIMENSIONS
LLVT-4FT-100W-40K-D	100W	12500LM	4000K	52.4"(L) x 14.6"(W) x 4.7"(H)
LLVT-4FT-100W-50K-D	100W	12500LM	5000K	
LLVT-4FT-150W-40K-D	150W	18750LM	4000K	
LLVT-4FT-150W-50K-D	150W	18750LM	5000K	
LLVT-4FT-RL2C	Replacement Clear Lens for LLVT			
LLVT-4FT-RL2T	Optional Replacement Frosted Lens for LLVT			

LLHB2

TECHNICAL SPECIFICATIONS:

- :: New Generation Linear High Bay Fixture
- :: In Excess of 140 Lumens per Watt
- :: Slim Aluminum Housing for better heat dissipation and longer life
- :: Surface Mounting Kit included
- :: Optic Polycarbonate Lens
- :: Includes 3 Ft. Adjustable Suspension Kit
- :: Offers Plug-&-Play Programmable Bi-Level PIR Motion Sensor with Optional Remote Control and Emergency Backup Options
- :: Driver: Tovin
- :: Input Voltage: 100V~277V AC
- :: Efficacy: 140LM/W
- :: Beam angle: 90°
- :: Ambient Temperature: -40°F~122°F
- :: Dimmable
- :: 7-year warranty



Shown with
Optional Sensor (not included)



B29
LED LINEAR HIGH BAYS



SK618-RC
Not Included



Included
Surface Mounting Kit

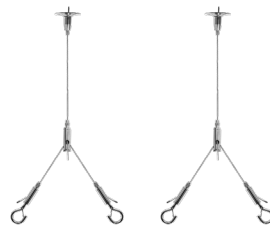

Included
3.5 Ft. Adjustable Suspension Kit
with Ceiling Mount Disks

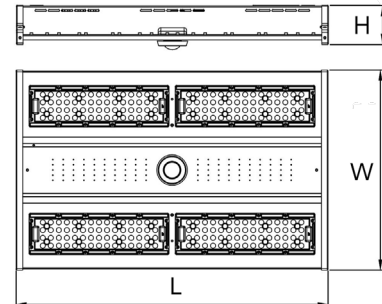

Shown with optional sensor

LED LINEAR HIGH BAYS

CATALOG NO.	WATTS	LUMENS	COLOR TEMP	DIMENSIONS
LLHB2-100W-50K-D	100W	14100LM	5000K	23-3/4"(L) x 15-1/8"(W) x 2-7/8"(H)
LLHB2-100W-40K-D	100W	14000LM	4000K	23-3/4"(L) x 15-1/8"(W) x 2-7/8"(H)
LLHB2-150W-50K-D	150W	21700LM	5000K	34-3/4"(L) x 15-1/8"(W) x 2-7/8"(H)
LLHB2-150W-40K-D	150W	21600LM	4000K	34-3/4"(L) x 15-1/8"(W) x 2-7/8"(H)
LLHB2-220W-50K-D	220W	31000LM	5000K	45-7/8"(L) x 15-1/8"(W) x 2-7/8"(H)
LLHB2-220W-40K-D	220W	30800LM	4000K	45-7/8"(L) x 15-1/8"(W) x 2-7/8"(H)
SK618	Multi-Level Programmable PIR Motion Sensor			
SK618-RC	Remote Control for Programming SK618 Motion Sensor (2 X AAA Batteries not Included)			
ELB-2548-EXTR	Field-installed emergency ballast, Input voltage: 100~277AC, Output voltage: 12V~48VDC, Output power: 25W (Max), Emergency operation: ≥90 mins., Recharge: 24 Hrs.			

LLHB



LLHB-90W



LLHB-120W
LLHB-180W
LLHB-240W

TECHNICAL SPECIFICATIONS:

- :: Housing: Steel
- :: Steel Thickness: 24 Gauge
- :: Lens: Clear PMMA (Plastic)
- :: With V-hooks
- :: LED SMD type: Edison 2835
- :: Driver: Tovin
- :: Input Voltage: 120V~277V AC
- :: Dimmable (0~10V dimming)
- :: 5-year warranty

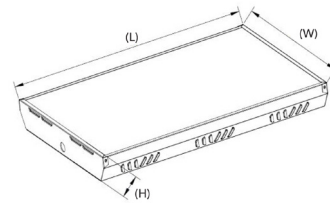









B30

LED LINEAR HIGH BAYS

LED LINEAR HIGH BAYS

CATALOG NO.	WATTS	LUMENS/WATT	LUMENS	COLOR TEMP	DIMENSIONS
LLHB-90W-50K-D	90W	160LM/W	14400LM	5000K	23-3/4"(L) x 16"(W) x 2-3/4"(H)
LLHB-90W-40K-D	90W	160LM/W	14400LM	4000K	
LLHB-120W-50K-D	120W	125LM/W	15198LM	5000K	47-7/8"(L) x 11-1/4"(W) x 3-7/8"(H)
LLHB-120W-40K-D	120W	125LM/W	15198LM	4000K	
LLHB-180W-50K-D	180W	133LM/W	24000LM	5000K	47-7/8"(L) x 15-7/8"(W) x 3-7/8"(H)
LLHB-180W-40K-D	180W	133LM/W	24000LM	4000K	
LLHB-240W-50K-D	240W	118LM/W	30722LM	5000K	47-7/8"(L) x 20-1/2"(W) x 3-7/8"(H)
LLHB-240W-40K-D	240W	118LM/W	30722LM	4000K	

ACCESSORIES

CATALOG NO.	DESCRIPTION
 LLHB-OC1	Standard Motion Sensor with Manual Settings, 120/277V 800/1300W max
 LLHB-OC-BL	Ultrasonic Bi-Level Dimming Motion Sensor Adjustable with Remote, 120/277V 800/1200W max
 LLHB-OC-REMOTE	Remote Control for LLHB-OC-BL Bi-Level Motion Sensor
 LLHB-SMK	Surface mounting kit for LLHB series. 1 Pair of L Bracket with Screws
 CH-1212	Steel jack chain, 100ft., 12GA, (Meets weight requirements for Linear High Bays)
 FH-E	Steel fixture hangers, 10GA, Top (2 Included)
 H-SCREW	Steel flat hanger screw with single hole, 1/4" x 3"
 ELB-2548-EXTR	Field-installed emergency ballast, Input voltage: 100~277VAC, Output voltage: 12V~48VDC, Output power: 25W (Max), Emergency operation: ≥90 mins., Recharge: 24 Hrs.

ULHB DLC PREMIUM

120~277V

TECHNICAL SPECIFICATIONS:

- :: Housing: ACD12 aluminum heat sink, SUS black plate. outdoor powder coating
- :: Voltage: 120~277V AC; 60Hz AC
- :: Cord type: 6' SJTW 18/3 AWG cable
- :: Efficacy: 130LM/W
- :: CRI: >80
- :: Power Factor: ≥0.9
- :: Beam Angle: 110°
- :: THD: <20%
- :: 0~10V Dimming
- :: Operating Temp: -4°F to 122°F
- :: Aluminum LED Board: High conductive, waterproof, aging resistance, salt mist resistance, long-life
- :: 5-year warranty

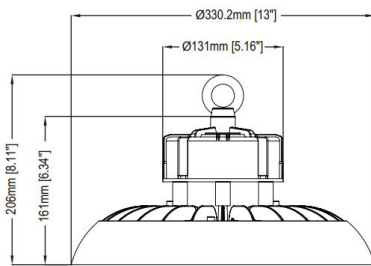

ULHB-100W

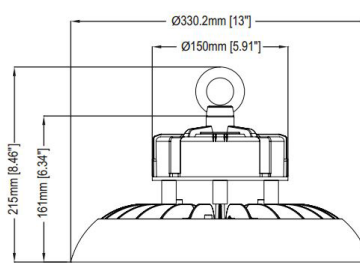

ULHB-150W

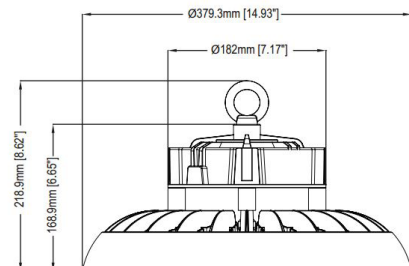

ULHB-200W/240W

LED HIGH-LUMEN UFO HIGH BAY

CATALOG NO.	WATTS	LUMENS	COLOR TEMP	REPLACEMENT RANGE	DIMENSIONS
ULHB-100W-50K	100W	13000LM	5000K	150~250 MH	13"(Diameter) x 8.11" (H)
ULHB-100W-40K	100W	13000LM	4000K	150~250 MH	
ULHB-100W-30K	100W	13000LM	3000K	150~250 MH	
ULHB-150W-50K	150W	19500LM	5000K	200~400 MH	13"(Diameter) x 8.46" (H)
ULHB-150W-40K	150W	19500LM	4000K	200~400 MH	
ULHB-150W-30K	150W	19500LM	3000K	200~400 MH	
ULHB-200W-50K	200W	26000LM	5000K	350~400 MH	14.93"(Diameter) x 8.62" (H)
ULHB-200W-40K	200W	26000LM	4000K	350~400 MH	
ULHB-200W-30K	200W	26000LM	3000K	350~400 MH	
ULHB-240W-50K	240W	31200LM	5000K	1000 MH	
ULHB-240W-40K	240W	31200LM	4000K	1000 MH	
ULHB-240W-30K	240W	31200LM	3000K	1000 MH	

ACCESSORIES FOR UFO HIGH BAYS



ULHB-PCR-100/150
ULHB-PCR-200/240/300



ULHB-ALR-100/150
ULHB-ALR-200/240/300



ULHB-90KIT-100/150
ULHB-90KIT-200/240/300

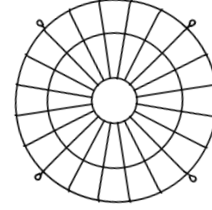

ULHB-WG-100/150
ULHB-WG-200/240/300



ULHB-SC-100/150
ULHB-SC-200/240/300



ULHB-PCC-100/150
ULHB-PCC-200/240/300



ULHB-SMB-100/150
ULHB-SMB-200/240/300



ULHB-SK
ULHB-SK-480V



ULHB-EMK

B32

LED HIGH BAYS

ULHB SERIES ACCESSORIES

CATALOG NO.	DESCRIPTION
ULHB-PCR-100/150	Polycarbonate Reflector for 100W & 150W
ULHB-PCR-200/240/300	Polycarbonate Reflector for 200W & 240W & 300W
ULHB-ALR-100/150	Aluminum Reflector for 100W & 150W
ULHB-ALR-200/240/300	Aluminum Reflector for 200W & 240W & 300W
ULHB-90KIT-100/150	90° Degree Reflector and Glass Kit for 100W & 150W (Conversion from default 110° beam angle)
ULHB-90KIT-200/240/300	90° Degree Reflector and Glass Kit for 200W & 240W & 300W (Conversion from default 110° beam angle)
ULHB-WG-100/150	Wire Guard for 100W & 150W
ULHB-WG-200/240/300	Wire Guard for 200W & 240W & 300W
ULHB-SC-100/150	Safety Cable for 100W & 150W
ULHB-SC-200/240/300	Safety Cable for 200W & 240W & 300W
ULHB-PCC-100/150	Polycarbonate Cover for 100W & 150W (for ULHB-PCR-100/150 only) - Increases heat captured in the reflector. Not recommended when not necessary.
ULHB-PCC-200/240/300	Polycarbonate Cover for 200W & 240W & 300W (for ULHB-PCR-200/240/300 only) - Increases heat captured in the reflector. Not recommended when not necessary.
ULHB-SMB-100/150	Surface Mount Bracket for 100W & 150W
ULHB-SMB-200/240/300	Surface Mount Bracket for 200W & 240W & 300W
ULHB-SK	Ultrasonic Bi-Level (Dimming) Motion Sensor Kit for 120~277V UFO High Bays Includes special junction box (mounts on fixture), auxiliary cable & push-in connectors
ULHB-SK-480V	Ultrasonic Bi-Level (Dimming) Motion Sensor Kit for 480V UFO High Bays
ULHB-EMK	Emergency Battery Backup Kit for 120~277V UFO High Bays (All wattages) Emergency output power: 11W~28W, Emergency operation: ≥90 mins., Recharge: 48 Hrs. Includes special junction box with test button (mounts on fixture), auxiliary cables & splicers & push-in connector

UHB & UHB2

HIGH WATTAGE & 480V



UHB Series

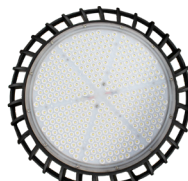

Lens view



UHB2 Series

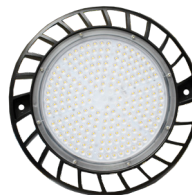

Lens view

Reflectors & Accessories

Reflectors and some other accessories from ULHB series are compatible with this series
Call your representative

TECHNICAL SPECIFICATIONS:

- :: Housing: ACD12 aluminum heat sink, SUS black plate, outdoor powder coating
- :: Optical Lens: High-transmittance PC, anti-UV and fire-resistant
- :: Voltage: 120~277V; 60Hz AC & 300~480V; 60Hz AC
- :: Cord type: 6.5' SJTW 18/3 AWG cable
- :: LED: LumiLEDs
- :: Efficacy: 120LM/W
- :: CRI: >80
- :: Power Factor: ≥0.9
- :: Beam Angle: 90°
- :: THD: <20%
- :: 0~10V Dimming
- :: Operating Temp: -4°F to 122°F
- :: Aluminum LED Board: High conductive, waterproof, aging resistant, salt mist resistance, long-life
- :: 7-year warranty

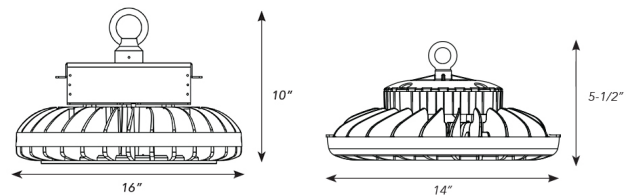

LED UFO HIGH BAY FIXTURES

CATALOG NO.	WATTS	LUMENS	COLOR TEMP	REPLACEMENT RANGE	DIMENSIONS
UHB-300-CW	300W	36000LM	5000K	1000 MH	16"(Diameter) x 10" (H)
UHB-300-NW	300W	36000LM	4000K	1000 MH	
UHB-360-CW	360W	40000LM	5000K	1000~1200 MH	
UHB-360-NW	360W	42000LM	4000K	1000~1200 MH	
UHB-300-CW-480V	300W	36000LM	5000K	1000 MH	14"(Diameter) x 5-1/2" (H)
UHB-360-CW-480V	360W	40000LM	5000K	1000~1200 MH	
UHB2-150-CW-480V	150W	19600LM	5000K	350~400 MH	
UHB2-220-CW-480V	220W	27400LM	5000K	350~400 MH	

UHB-SMB-300
 UHB2-SMB

Optional Surface Mount Bracket for 300W & 360W
 Optional Surface Mount Bracket for UHB2 series



UFHB



Lens view

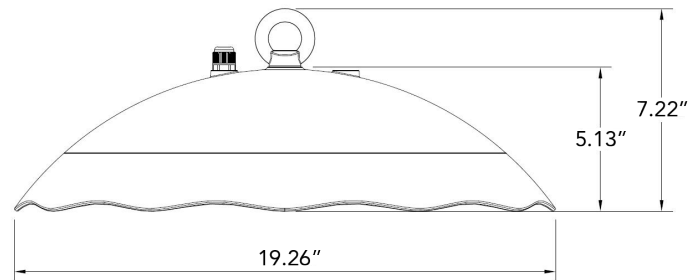

TECHNICAL SPECIFICATIONS:

- :: Housing: ACD12 aluminum heat sink, Grey finish (Chain not included)
- :: Optical Lens: Fresnel Lens
- :: Voltage: 100~277V; 60Hz AC
- :: Cord type: 6' SJTW 18/3 AWG cable
- :: LED: LumiLEDs
- :: Efficacy: 135LM/W
- :: CRI: >80
- :: Power Factor: ≥ 0.9
- :: Beam Angle: 90°
- :: THD: <20%
- :: 0~10V Dimming
- :: Operating Temp: -4°F to 122°F
- :: Aluminum LED Board: High conductive, waterproof, aging resistant, salt mist resistance, long-life
- :: 5-year warranty
- :: Suitable for Wet Locations, IP66



B34

LED FOOD SERVICE HIGH BAY

LED FOOD SERVICE & LABORATORY HIGH BAY

CATALOG NO.	WATTS	LUMENS	COLOR TEMP	REPLACEMENT RANGE	DIMENSIONS
UFHB-150W-50K	150W	20250LM	5000K	450~650 MH	19.26" (Diameter) x 7.22" (H)
UFHB-200W-50K	200W	27000LM	5000K	700~800 MH	

OCCUPANCY / VACANCY SENSORS



LLHB-SMB



LLHB-OC-BL



LLHB-OC-REMOTE

TECHNICAL SPECIFICATIONS:

- :: Input voltage: 120~277V
- :: Beam: 360°
- :: Operating Temp: 4°F~149°F



YM2301



LLHB-OC1



YM185-W

YM2108-W
YM2108-T-W

OCCUPANCY SENSORS

CATALOG NO.	DESCRIPTION
LLHB-OC-BL	Bi-Level Ultrasonic Dimming Motion Sensor adjustable with remote control, 120/277V 800/1200W max
LLHB-OC-REMOTE	Remote control for Bi-Level Motion Sensor
LLHB-OC1	PIR Highbay Motion Sensor with manual settings, 120/277V 800/1300W max
LLHB-SMB	Motion Sensor Mounting Box for LLHB series It lowers the sensor position for low-ceiling installations to improve detection range
YM2301	PIR ceiling mount occupancy sensor, 120/277V 800/1200W max

VACANCY SENSORS

CATALOG NO.	DESCRIPTION
YM185-W	PIR Sensor, 180°, 25FT (600FT), 120/277V 0/600W max, Single Pole, Neutral Req., Night light

OCCUPANCY & VACANCY SENSORS

CATALOG NO.	DESCRIPTION
YM2108-W	PIR Sensor, 180°, 30FT (720FT), 120/277V 800/1200W max, Single Pole, Neutral Req.
YM2108-T-W	PIR Sensor, 180°, 25FT (600FT), 120/277V 600/1000W max, 3-Way, Neutral Req.

SUSPENSION ACCESSORIES

Adjustable 6Ft. "Y" Suspension Kit with Key Hole Connectors



SCL-CSY

Adjustable 10Ft. Suspension Kit with Loop Gripper

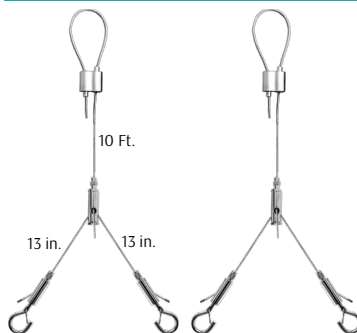

SCL-GSY10

Adjustable 20Ft. Suspension Kit with Loop Gripper

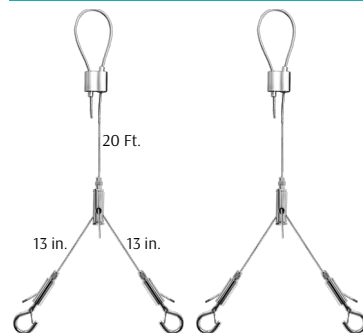

SCL-GSY20

B36

ACCESSORIES

Adjustable 6Ft. Suspension Kit with Key Hole Connectors

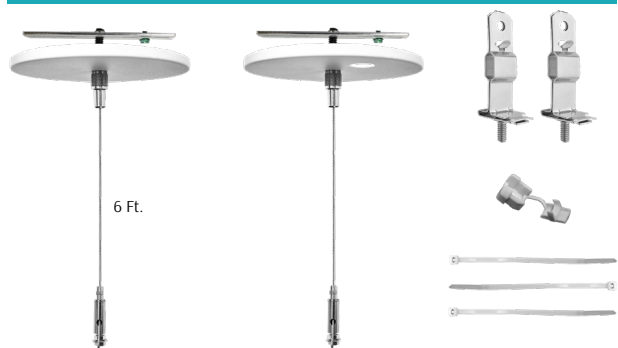

SCL-CS

Auxiliary Hook

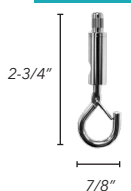

SCL-AH

5-Conductor Cord



SCL-6FT-SJTW18/5

3.3 Ft. Suspension Kit

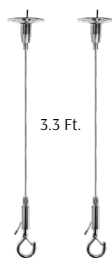

LOHB-A

Adjustable 4Ft. Suspension Kit for 2X2 Panels

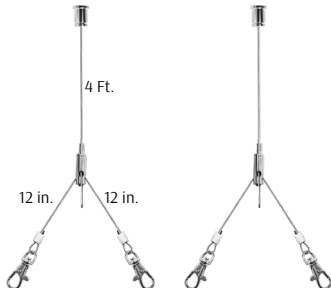

LP-SSPC-2X2

Adjustable 4Ft. Suspension Kit for 2X4 & 1X4 Panels

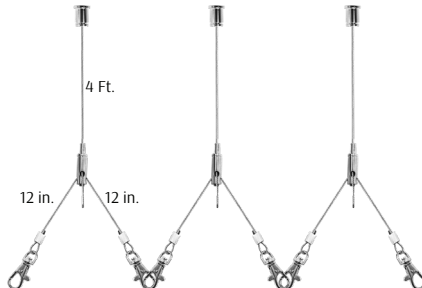

LP-SSPC-2X4

2-1/2" Hook with Locknut



HB-HOOK

SUSPENSION ACCESSORIES

CATALOG NO.	DESCRIPTION
SCL-CSY	Adjustable 1/16" 6Ft. Suspension Kit with Y-Connector Key Hole Set + 2 T-Bar Clips + 1 Cable Bushing + 3 Plastic Tie Straps
SCL-CS	Adj. 1/16" 6Ft. Suspension Kit with Single-Connector Key Hole Set + 2 T-Bar Clips + 1 Cable Bushing + 3 Plastic Tie Straps
SCL-GSY10	Heavy-Duty Adjustable 1/16" 10 Ft. Suspension Kit with Y-Connector & Loop Gripper & Hooks
SCL-GSY20	Heavy-Duty Adjustable 1/16" 20 Ft. Suspension Kit with Y-Connector & Loop Gripper & Hooks
LOHB-A	Set of 2 Adjustable 1/16" 3.3 Ft. Suspension Cable with 1" Diameter 3-Hole Mounting Disk and Hook (SCL-AH)
SCL-AH	Heavy-Duty Auxiliary Hook for up to 1/16" Aircraft Cables with Cable Adjustment
SCL-6FT-SJTW18/5	6 Ft. Cord, SJTW 18 AWG 5-Conductor
LP-SSPC-2X2	Adjustable Light-Duty 0.04" 4Ft. Suspension Kit for 2X2 Panels and Suspended Fixtures with 1/2" Ceiling Mount Barrel
LP-SSPC-2X4	Adj. Light-Duty 0.04" 4Ft. Suspension Kit for 2X4 & 1X4 Panels and Suspended Fixtures with 1/2" Ceiling Mount Barrel
HB-HOOK	High Bay 2-1/2" Heavy-duty Zinc Alloy Hook with 1/2" Steel Locknut, Set Screw, Cable Bushing