

Standby Power Systems

ST Type Transfer Switches

100A, 120/240V, 1-Phase, NEMA 1 Indoor, 10k AIC



Features and ratings

- 30 ft. pre-wired conduit for connecting the transfer switch to the external connection box
- 2 ft. pre-wired conduit for moving circuits from the main panel to the transfer switch
- Pre-wired external connection box with a weatherproof conduit for generator connections
- Compatible with Nexus controllers
- Electrically operated, mechanically contacts for fast, positive connections
- Rated for all classes of load, 100% equipment rated, both inductive and resistive
- 2 pole, 250 VAC contactors
- Open transition
- 160 millisecond transfer time
- Express install kit included
- Dual coil design
- Main contacts are silver plated or silver alloy to resist welding and sticking
- *Suitable for use only on air cooled products (8–17 kW)*

Catalog Number	Amp ^①	kW	Branch Circuits	Weight (lbs)	Dimensions (in.)
ST100R10C	100	8	10	57	27 x 13 x 7
ST100R12C		12	12	60.8	
ST100R14C		14	14	64	
ST100R16C		17	16	68	

“ST” Type automatic transfer switches

“ST” type transfer switches, denoted in the catalog number starting with “ST”, are compatible with the Nexus controller. The Nexus controller senses power outages and initiates the transfer of power to the generator via the automatic transfer switch.

Transfer switch with back up circuits

Siemens offers 4 models of automatic transfer switches with back up circuits. These panels provide transfer capability to a select number of critical circuits, as opposed to the entire house. For the chosen critical circuits, the conductors in the main house panel are removed from the breaker and connected with wire nuts to the prewired conductors on the transfer switch.

① If you require another setup, call tech support line to make sure it is possible.

Standby Power Systems

ST Type Transfer Switches



“SL” Type transfer switches

Transfer switches provide the mechanism for transferring power between utility and generator service. Engineered with Digital Load Management (DLM) technology, 100-400A single phase SL Type transfer switches have the ability to cycle on and off two air conditioners without adding additional components, allowing for a smaller generator to cover more circuits than when paired with a standard transfer switch.

Features and ratings

- 100–800A
- Outdoor NEMA 3R aluminum enclosure
- Open transition
- Compatible with Nexus controllers
- Cover more circuits with a smaller generator
- Service rated and non-service rated
- Add additional individual DLM modules (5937) and manage up to four more large loads on single phase SL type transfer switches. See page 18-19
- Cover every circuit when paired with a higher kW generator

Catalog Number	Amp	Phase	Withstand Rating (Amps)	Weight (lb.)	Dimensions (in.)
SL100R	100	120/240V, 1Ø	10,000	20	20 x 14.6 x 7.09
SL100RD [Ⓞ]				22.5	20 x 14.6 x 7.09
SL100C		120/208V, 3Ø	10,000	20	24.1 x 20.2 x 7.1
SL100J		120/240V, 3Ø	14,000	53	24.1 x 20.2 x 7.1
SL100I		277/480V, 3Ø	14,000	105	36.1 x 24 x 10
SL150RD [Ⓞ]	150	120/240V, 1Ø	22,000	39	30 x 13.5 x 7.09
SL200R	200	120/240V, 1Ø	22,000	20	20 x 14.6 x 7.09
SL200RD [Ⓞ]				39	30 x 13.5 x 7.09
SL200C		120/208V, 3Ø	10,000	20	24.1 x 20.2 x 7.1
SL200J		120/240V, 3Ø	25,000	53	24.1 x 20.2 x 7.1
SL200I		277/480V, 3Ø	25,000	105	48.1 x 30.1 x 13.1
SL200RDPM [Ⓞ]		120/240V, 1Ø	10,000	75	42 x 20 x 7.25
SL400R	400	120/240V, 1Ø	18,000	133	36.1 x 24 x 10
SL400RD [Ⓞ]			22,000	140	48 x 21.82 x 10.06
SL400C		120/208V, 3Ø	18,000	133	36.1 x 24 x 10
SL400J		120/240V, 3Ø	18,000	133	36.1 x 24 x 10
SL400I		277/480V, 3Ø	18,000	133	36.1 x 24 x 10
SL600R	600	120/240V, 1Ø	42,000	439	66 x 36 x 21
SL600C		120/208V, 3Ø	42,000	439	66 x 36 x 21
SL600J		120/240V, 3Ø	42,000	439	66 x 36 x 21
SL600I		277/480V, 3Ø	42,000	439	66 x 36 x 21
SL800R	800	120/240V, 1Ø	65,000	469	66 x 36 x 21
SL800C		120/208V, 3Ø	65,000	469	66 x 36 x 21
SL800J		120/240V, 3Ø	65,000	469	66 x 36 x 21
SL800I		277/480V, 3Ø	65,000	469	66 x 36 x 21

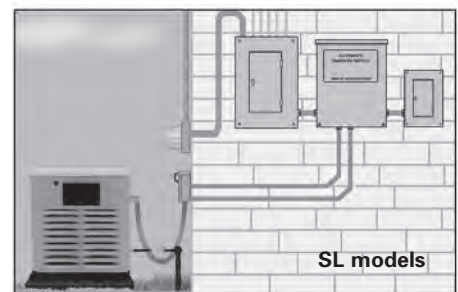
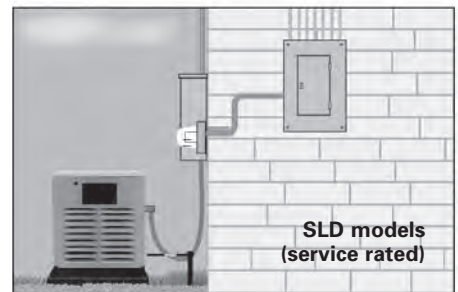
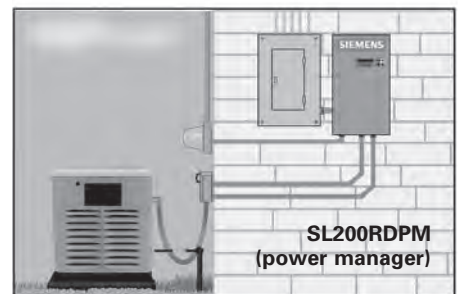

[Ⓞ] Disconnect included

Standby Power Systems

Power Manager Transfer Switch

Power Manager transfer switch



The Siemens "Power Manager" Transfer Switch is designed with a built-in 16 circuit load center, this Nexus compatible switch is the answer when more than six large loads need to be managed. Power Manager is a "SL" type transfer switch and is compatible with units 8-48kW

Catalog no.
SL200RDPM

Features and ratings

- Built-in 16 circuit priority load center
- Main contactor protects essential circuits
- Secondary contactor protects non-essential circuits
- NEMA 3R / outdoor enclosure
- Side-opening hinged cover
- Conforms to 2008 NEC sizing standards
- 200A, service entrance rated
- Dimensions (Inches) 42 x 20 x 7.25
- Interrupt rating: 10,000 AIC
- Weight: 75 lbs.

Generator Ready Load Center

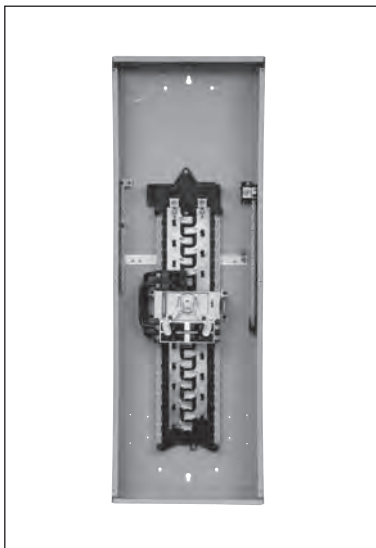

The Siemens Generator Ready Load Center can save thousands of dollars in future generator installation expenses while keeping initial expenses to a minimum. Works with an automatic standby generator or a portable generator.

Catalog no.
ECSBPK01 (mechanical interlock for manual or portable generation installation)
GENTFRSWTCH (auto transfer switch for automatic standby generation installation)

Automatic Transfer Switch features:

- UL Listed
- Operates automatically when connected to generator
- Transfers load from utility to generator and back to utility
- Includes: Q215 and Q2125S needed for installation

Features:

- NEMA 3R / Indoor Type 1
- 225A max rated
- Flush or surface mounting
- Fits between standard stud centers
- Tin plated copper bus bars
- 22 kAIC rated
- 120/240V, 1 Phase
- Main lug – convertible to main breaker with addition of MBK150A, MBK200A or MBK225A
- Installation of transfer mechanism can be performed at time of generator installation

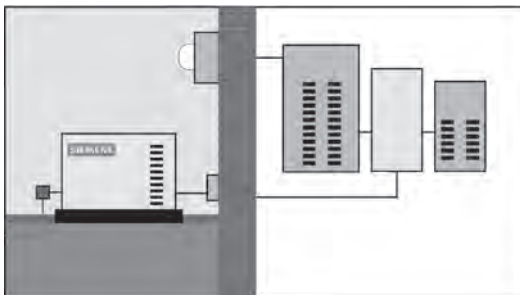

Traditional Installation



Generator Ready Load Center with Automatic Standby generator installation

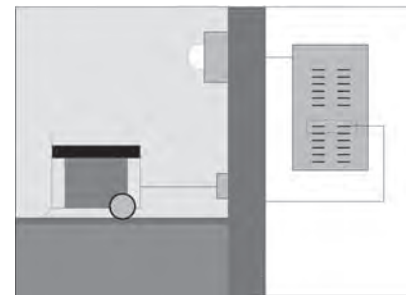

Generator Ready Load Center with Portable Generator installation

Standby Power Systems

Generator Ready Load Center

200A Main Breaker

Brand	One inch Spaces ^①	Max Circuits ^①	Indoor Enclosure - NEMA Type 1			Outdoor Enclosure - NEMA Type 3R				
			Catalog Number	Dimensions (inches)			Catalog Number	Dimensions (inches)		
				Height	Width	Depth		Height	Width	Depth
Siemens	30	42	G3042B1200GEN	42.00	14.25	4.00	W3042B1200GEN	42.00	14.63	4.00
Murray	30	42	LC3042B1200GEN	42.00	14.25	4.00	LW3042B1200GEN	42.00	14.63	4.00

225A Main Lug

Brand	One inch Spaces ^①	Max Circuits ^①	Indoor Enclosure - NEMA Type 1			Outdoor Enclosure - NEMA Type 3R				
			Catalog Number	Dimensions (inches)			Catalog Number	Dimensions (inches)		
				Height	Width	Depth		Height	Width	Depth
Siemens	30	42	G3042L1225GEN	42.00	14.25	4.00	W3042L1225GEN	42.00	14.63	4.00
Murray	30	42	LC3042L1225GEN	42.00	14.25	4.00	LW3042L1225GEN	42.00	14.63	4.00

① 2 spaces & 2 circuits are reserved for standby generator installation.

Must order a GENTFRSWTCH separately with a Generator Ready Load Center

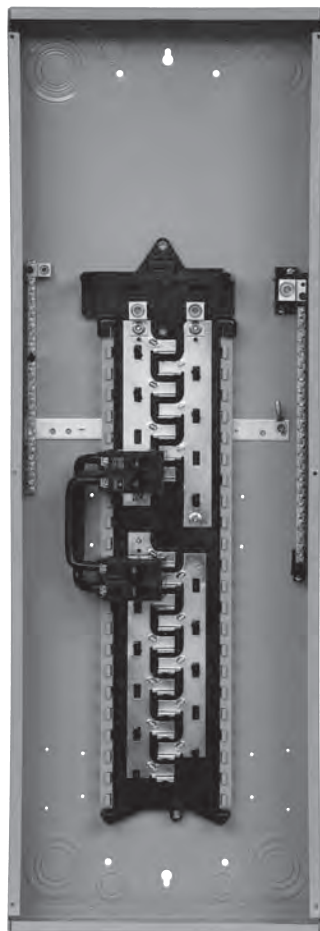

G3042L1225GEN

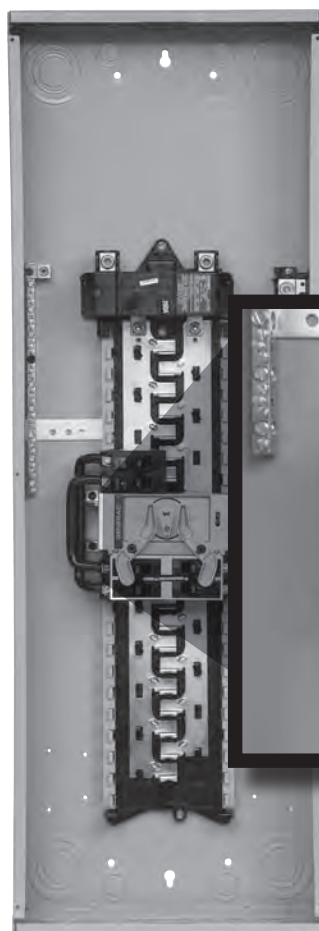

Install ECSBPK01 for portable generators

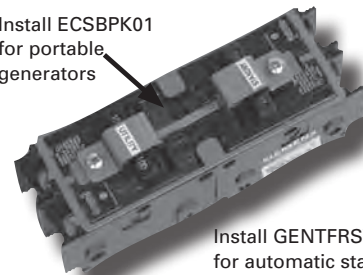

Install GENTFRSWTCH for automatic standby generators

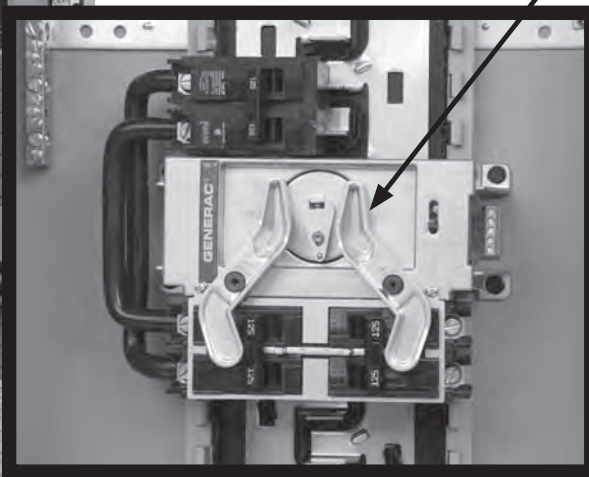

Load Centers

Manual Transfer Interlock Kits for Load Centers and Meter Combinations

Convert load centers or meter combinations into standby power panels

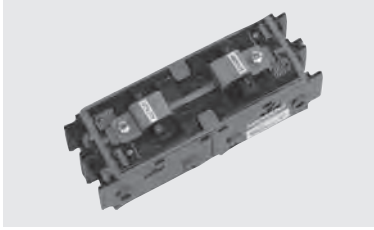

Standard features

- UL listed for use in most Siemens load centers and meter combinations
- Suitable for use with optional standby systems in accordance with article 702 of the National Electric Code
- Corrosion resistant finish
- Easy assembly requiring no modifications to the load center or meter combination
- Remains attached to the main breakers when load center cover

Panels in which the bussing or wire forms from the meter socket land on main lugs are not acceptable for use in standby systems because turning the main breaker to "OFF" does not prevent feedback to the utility power lines. Examples of such panels include catalog numbers that start with the following letters.

MC0606L1200*

MM0406L1*

MC1212L1200*

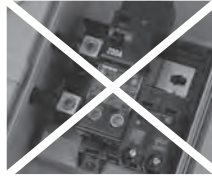

Wire forms or bussing



Utility main breaker

Standby power main breaker

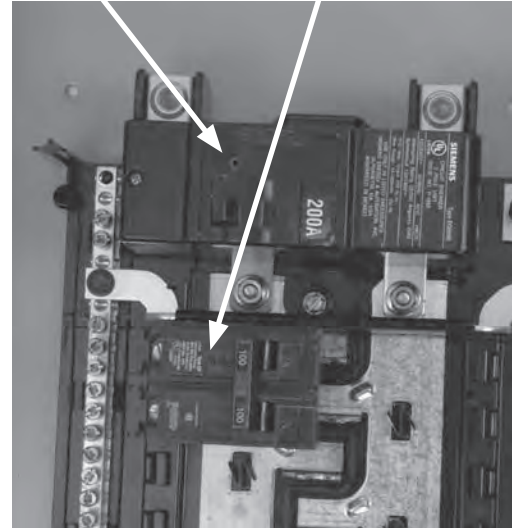

To activate standby power the utility main breaker must be in the "OFF" position to prevent dangerous feedback between the power sources.

Acceptable usage of Interlock Kits by load center/meter combination catalog numbers

ES Series Load Centers can utilize interlock kits: 1, 2, 5, 6, 7. Kits 3 and 4 can also be used on main breaker panels.

PL Series Load Centers can utilize interlock kits: 1, 2, 3, 4, 5, 6, 7.

Siemens Meter Combinations

MC0816B1150RTH	5 7	MC2040B1200	5 7
MC0816B1150T	5 7	MC2040B1200R	5 7
MC0816B1150TH	5 7	MC2442B1200FEC	2
MC0816B1200FCTM	2	MC2442B1200SEC	2
MC0816B1200RT	5 7	MC3040B1200SECW	5 7
MC0816B1200RTB	5 7	MC3042B1200FED	3
MC0816B1200RTH	5 7	MC3042B1200SED	3
MC0816B1200SCTM	2	MC3042B1225FED	3
MC0816B1200T	7	MC3042B1225SED	3
MC0816B1200TH	5 7	MC4040B1200SECW	5 7
MC0816B1350RLTM	5 7	MC0816B1200RJBT	8
MC0816B1400RLTM	5 7	MC0816B1150RJBT	8
MC1224B1100FEC	2	MC0816B1200RCT	8
MC1224B1100SEC	2	MC0816B1150RCT	8
MC1224B1125	1 2	MC0816B1200CT	8
MC1224B1125FEC	2	MC0816B1150CT	8
MC1224B1125SEC	2	MC2040B1150RCT	9
MC1632B1100SEC	2	MC2040B1150CT	9
MC1632B1125FEC	2	MC2040B1200RCT	9
MC2040B1150	5 7	MC2040B1200CT	9

Numbers 1 through 9 in these tables represent the last digit in each interlock kit catalog number. Example: 1 = ECSBPK01

When used in horizontal positions as typical in most load centers, ECSBPK07 is recommended for use only with QNR type circuit breakers.

Standby power interlock kits are not intended for use with AFCI, GFCI, 3-pole or 1/2" frame circuit breakers and 4 space, 125 amp load centers.

Siemens type EQ load centers using a "4-pole" main breaker do not have a kit available to interlock this main to branch circuits. Branch circuit positions can be interlocked.

Standby Power Systems

Manual Transfer Interlock Kits^①

Prevents dangerous feedback between two sources of power

Catalog number	Usage Information	Utility main breaker types	Standby main breaker types	Interlock number
 ECSBPK01	For use on load centers or meter combinations that will accept 2-pole circuit breakers opposite one another as shown.	QP, QPH, HQPH	QP, QPH, HQPH	1 
 ECSBPK02	For use on load centers or meter combinations that will accept 2- or 4-pole next to a 2-pole circuit breaker side by side as shown.	QP, QPH, HQPH	QP, QPH, HQPH	2 
 ECSBPK03 ^②	For use on Ultimate TM and Rock Solid load centers, 150 amp and higher, to connect the main breaker to a 2-pole circuit breaker.	MBK150A, MBK200A, OR MBK225A	QP, QPH, HQPH	3 
 ECSBPK04 ^②	For use on Ultimate and Rock Solid load centers, 125 amp and lower, to connect the main breaker to a 2-pole circuit breaker.	MBK100A or MBK125A	QP, QPH, HQPH	4 
 ECSBPK05	For use on load centers or meter combinations that will accept a QNR (MD-TR) frame circuit breaker next to a 2-pole circuit breaker as shown.	QNR, QNRH, HQNR	QP, QPH, HQPH	5 
 ECSBPK06 ^②	For use on load centers or meter combinations that will accept a QN (MD-T) frame circuit breaker next to a 2-pole circuit breaker as shown.	QN, QNH, HQN	QP, QPH, HQPH	6 
 ECSBPK07	For use on load centers or meter combinations that will accept two QNR (MD-TR) circuit breakers side by side as shown OR will accept two QN (MD-T) circuit breakers side by side as shown.	QNR, QNRH, HQNR, QN, QNH, HQN	QNR, QNRH, HQNR, QN, QNH, HQN	7 
 ECSBPK08 ^②	For use on 8 space, over/under, OH/UG feed meter combinations as shown. Limited application to specific catalog numbers.	QPP, QPPH	QP, QPH, HQPH	8 
 ECSBPK09 ^②	For use on 20 space, over/under, OH/UG feed meter combinations as shown. Limited application to specific catalog numbers.	QPP, QPPH	QP, QPH, HQPH	9 

^① Manual breaker interlock kits are attached to the breakers not the trim of the load center.

^② These kits take up 2 spaces adjacent to the 2 pole breaker being interlocked. Those spaces cannot accommodate filler plates.

Standby Power Systems

Standby Generator Ratings / Maintenance Kits

kW ^① rating	Rated amps ^②				Engine RPM at full load	Engine RPM at exercise	Natural gas fuel ^③ (ft ³ / hr)	Liquid propane vapor consumption (gal / hr)	Propane vapor ^③ consumption ft ³ /ft	A at 7 meter dBA	
	120/240 1Ø, 1.0 pf	120/208 3Ø, 0.8 pf	120/240 3Ø, 0.8 pf	277/480 3Ø, 0.8 pf						Sound level at normal load	Sound level at exercise
	33	—	—	—							
8	33	—	—	—	3600	3600	139	1.68	62	62	62
10	42	—	—	—	3600	3600	156	1.93	70	63	63
14	58	—	—	—	3600	3600	220	2.30	84	66	66
17	71	—	—	—	3600	3600	261	2.57	94	66	60
20	83	—	—	—	3600	2400	294	2.90	106	66	60
22	92	76	65	—	1800	1400	255	2.70	122	70	61
25	104	87	75	—	3600	1800	430	4.70	172	72	59
27	113	94	81	—	1800	1400	359	4.10	152	70	61
30	125	104	90	—	3600	1800	492	5.40	197	72	59
36	150	125	108	54	1800	1400	503	5.50	199	64	58
45	188	156	135	68	3600	1800	720	7.86	251	73	61
48	200	167	145	72	1800	1400	756	7.96	302	65	60
60	250	208	180	90	3600	1800	862	9.00	332	72	65
70	292	243	210	105	1800	1400	1020	11.17	411	65	61
80	333	278	241	120	3600	1800	1154	12.78	465	74	64
100	417	347	301	150	2300	1800	1260	13.80	507.8	72	61
130	542	451	391	195	3600	1800	1786	19.56	719.8	75	65
150	625	520	451	226	3600	1800	2061	22.57	830.6	79	66

① kW rating is based on LPV fuel and may be derated for natural gas.
 ② For devices with two values on top of each other, the value on top is for liquid propane vapor.
 ③ For Btu content, multiply ft³/hr x 2520 (LP) or ft³/hr x 1000
 ④ Kits for obsolete engine sizes

Maintenance Kits

Just like an engine in an automobile, generator engines require routine maintenance. Service kits, which include oil and air filters, are available and are selected based on engine size. Touch up paint is also provided to help cover minor scratches.



Oil and Air Filter Kit	
Catalog no.	Usage
GENMKIT10	8 kW, 410cc kit
GENMKIT2	10 kW, 530cc kit
GENMKIT3	14, 17 kW, 990cc kit
GENMKIT11	20 kW 990cc kit
GENMKIT5 ^④	25, 30 kW, 1.6L
GENMKIT12	22, 27 kW, 2.4L
GENMKIT13	36 kW, 2.4L
GENMKIT15	45 kW, 2.4L
GENMKIT6 ^④	48 kW, 4.2L
GENMKIT16	60 kW, 2.4L
GENMKIT8	70, 100, 130, 150 kW
GENMKIT14	80 kW, 4.6L
GENMKIT17	25, 30 Kw, 1.5 L
GENMKIT18	48 kW, 5.4 L
PORTMKIT1	Portable 15, 17.5 kW
PORTMKIT2	Portable 5 kW, 7.5 kW
PORTMKIT3	Portable 8, 6.5 kW

Standby Power Systems

Accessories



DLM load control module

The DLM Load Control Module is a 50 amp contact housed in a NEMA 3R enclosure for indoor and outdoor installation applications. Through the use of the DLM Modules in conjunction with any of the 100-400 amp single phase Nexus Smart SL Type Switches, household or business loads can be intelligently managed enabling the use of a smaller, more efficient generator system. Up to four DLM Modules can be used with a single SL type switch.

Catalog no. 5937

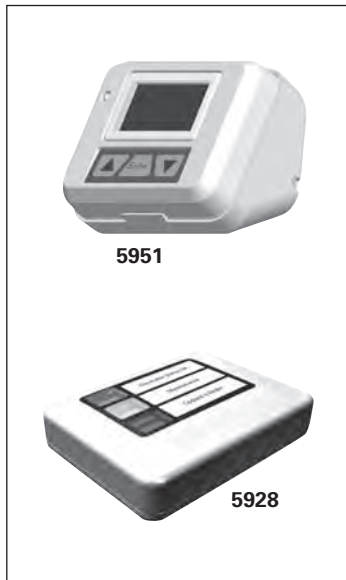

Wireless Generator Monitoring Kit

The Wireless Generator Monitoring System provides remote monitoring capability for convenient indoor observation. By adding this item, a generator owner can observe generator function, set certain operation parameters and receive maintenance reminders.

Advanced Wireless Remote in Home Monitor

Catalog No. 5951

Advanced Adapter Kit (use with 5951 Advanced Wireless Remote in Home Monitor on Liquid Cooled units 22 kW and above)

Catalog No. 5959

Standard Wireless Remote in Home Monitor

Catalog no. 5928

Standard Adapter Kit (use with 5928 Standard Wireless Remote in Home Monitor on Liquid Cooled units 22 kW and above)

Catalog no. 5958



Generator Transport Cart

The Generator Transport Cart is designed to allow a single individual to move and position any of the air-cooled generators without the need for additional people or equipment. By attaching the cart to the generator through the lifting holes, the generator is lifted from the pallet by leverage and is easily wheeled to the appropriate location for final setting.

Catalog no. GENCART

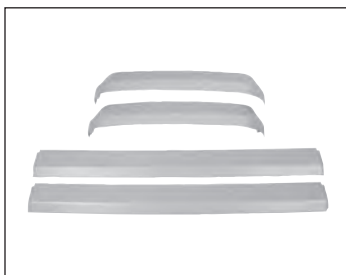

Pad Skirt for 20kW Generators

The pad skirt snaps together around the bottom of the new 20kW generators. This offers a sleek, contoured appearance as well as offering protection from rodents and insects by covering the lifting holes located in the base. Available in grey, the pad skirt fits 20kW generators manufactured after 4/2008.

Catalog no. 5666



Standby Power Systems

• Revised •
05/14/12

Accessories

Catalog Number	kW	Engine Size	Description
----------------	----	-------------	-------------

Accessories

Battery	8, 10, 14, 17, 20, 22, 25, 27, 30, 36, 45, 60		Battery: 8-45 & 60 kW 525cca g roup 26R	 <p>26R Battery</p>  <p>Auxiliary transfer switch contact</p>  <p>Touch up paint</p>
	48		Battery: 48 kW 525cca group 24F	
	70, 80, 100, 130, 150		Battery: 70-150 kW ship with battery	
5621			Auxiliary Transfer Switch Contact	
GENPAINT			Gray Touch Up Paint for 2007 units	
GENPAINT2			Generator Spray Paint Gray Textured	
GENSHELL2			Display shell, gray color	
5715	6.5, 8 kW	992, 999 cc	Lift beam kit for portables	

Cold Weather Kits

5947		992, 999 cc	includes battery wrap and crankcase heater	 <p>Battery warmer</p>
5948		410, 530 cc	includes battery wrap and crankcase heater	
5629 [Ⓞ]		1.6 L	battery warmer only	
5630		2.4 L	battery warmer only	
5631 [Ⓞ]		4.2 L	battery warmer only	
5632	70 & 150	3.0, 4.6, 5.4, 6.8 L	battery warmer only	
5633		6.8 L	battery warmer only	
5863		760, 992, 999 cc	crankcase pad warmer only	
5864		410, 530 cc	crankcase pad warmer only	
6175		1.5 L	battery warmer only	

Block Heaters

5615 [Ⓞ]	25, 30	1.6 L	<p>Must order a cold weather kit to order a block heater!</p>  <p>Block heater</p>
5616	22, 27, 36, 45, 60	2.4 L	
5618 [Ⓞ]	48	4.2 L	
5619	80	4.6 L	
5620	70, 100, 130	6.8 L	
5667	150	6.8 L	
6174	25, 30	1.5 L	
6204	48	5.4 L	

[Ⓞ] replacement for obsolete engine size