

EXCLUSIVE &

PREFAB PRODUCTS

CATALOG V2

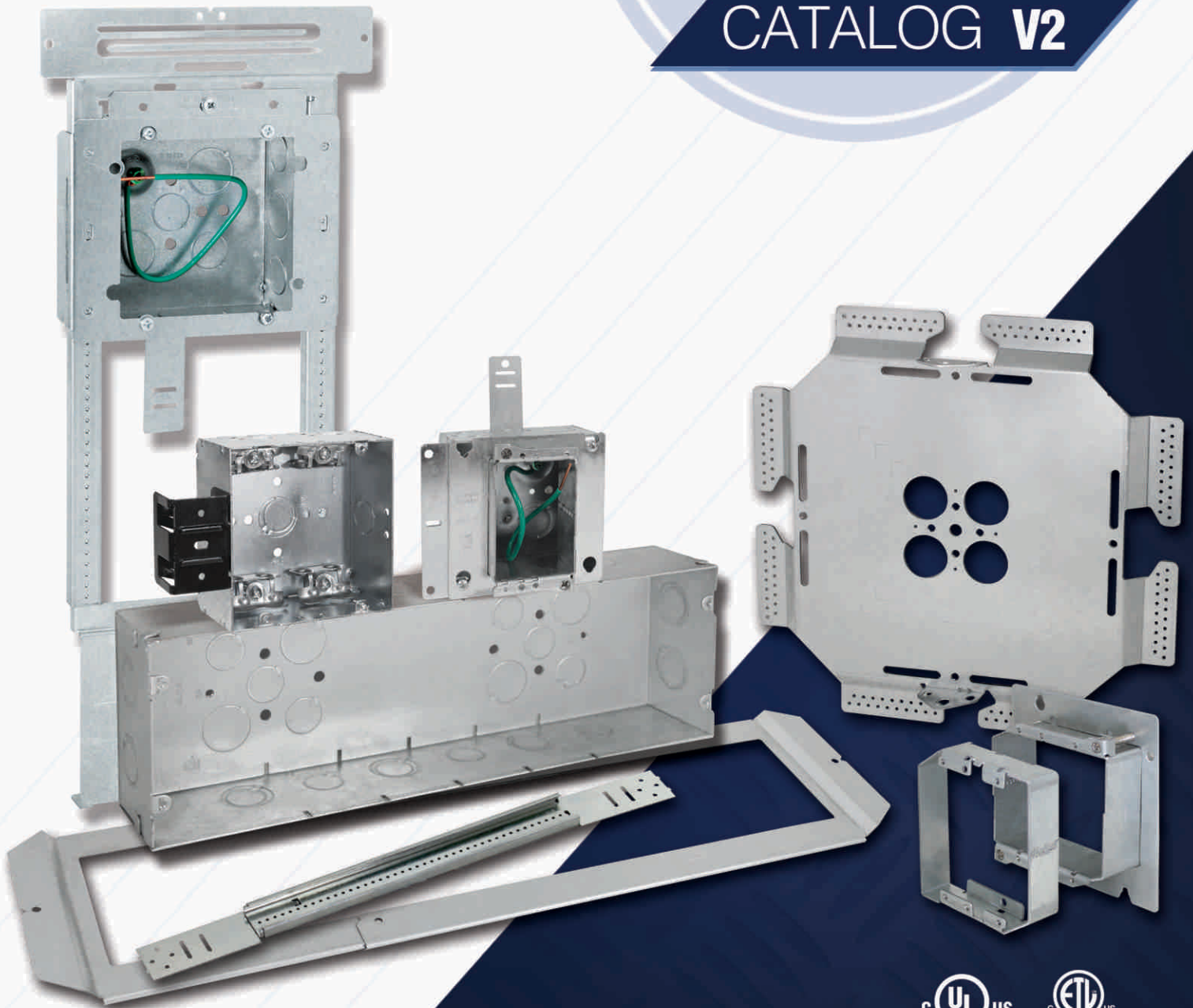

ABOUT ORBIT PREFAB

Innovative Labor Saving Solutions

As an electrical manufacturer founded by contractors, Orbit Industries has always known the importance of efficiency on the job. Since our inception in 1997, Orbit has consistently developed innovative electrical products, establishing itself as one of the leading manufacturers in the electrical industry.

Today, Orbit's Prefab line continues to deliver engineered solutions to optimize job-site productivity and provide flexibility in installation. Our products are designed with contractors in mind to provide the following features:

- *Efficient installations for reduced labor*
- *Increase safety and bring the construction environment to the comfort of a controlled environment*
- *Allow contractors to bid and complete jobs more efficiently*
- *Reduction of on-site mistakes and waste*

The Orbit Advantage

With a team of industry experienced sales representatives and talented engineers, Orbit provides innovative, quality products with convenience not found anywhere else.

The Orbit Advantage includes:

- *State-of-the-art automated manufacturing facilities that consistently produces quality products*
- *Industry experienced sales and engineering teams*
- *98.7% fill rate with over 6,000 products in more than 11 different product lines, ready to ship*
- *Compliance with safety standards and electrical codes*

Quick Response Manufacturing (QRM)

As a privately owned manufacturer, Orbit has the capabilities to produce products specifically upon request. Our 90-day Quick Response Manufacturing (QRM) policy can take your innovative ideas and bring it into market in just 90 days. Some examples of products developed through QRM are the **Wide Tiger Grip Box (pg 16)**, **Metal Stud Bracket with MC Clamps (pg 13)**, **our award winning patented Easy Access Lighting Boxes (pg 11)**, **Box & Conduit Hanger Support Plates (pg 08)**, and the **Simple Support Bracket (pg 03-04)**. We at Orbit are constantly innovating with the contractor in mind to meet all your electrical needs.

FEATURED PRODUCTS

Patent Pending

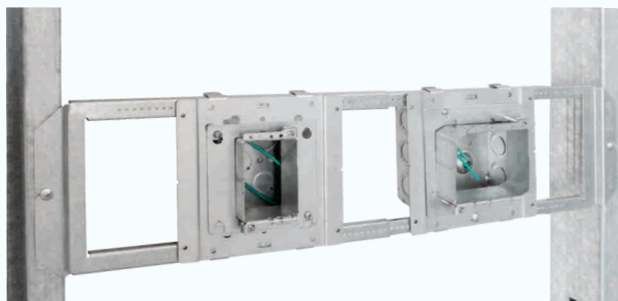

The Simple Support Bracket is a labor saving solution for installing junction boxes between wood and metal studs. Adjusts from 16" to 24" and maintains rigidity when extended. It is also compatible with Orbit's patented adjustable rings.

Simple Support Bracket
SSB

pg. 3~4

Patent Pending



The Universal Mounting Adjustable Box Series features 4" square, 3-1/2" deep boxes with a 0" to 1-1/2" adjustability range. Mount directly-to-stud or use with the SSB for between stud and hard lid installations. Available in red for fire alarm applications.

Universal Mounting Adjustable Box
UMAB/FA-UMAB

pg. 7

Patent Pending

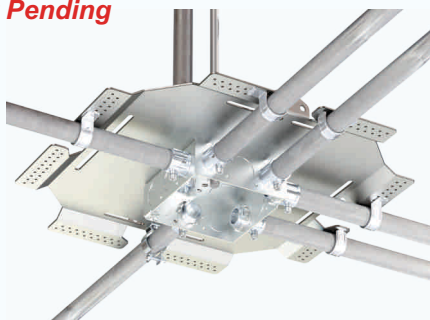

The Box and Conduit Hanger Support Plates are an innovative solution for hanging boxes and conduits using one plate and rod rather than multiple rods.

Box and Conduit Hanger Support Plates
BCHS Series

pg. 8

Patented



Traditionally, installation of hanging fixtures requires at least two people to complete. Orbit's Easy Access Lighting Boxes cut labor costs in half and requires only one person for installation.

Easy Access Lighting Boxes
EALB/S

pg. 11

Patented

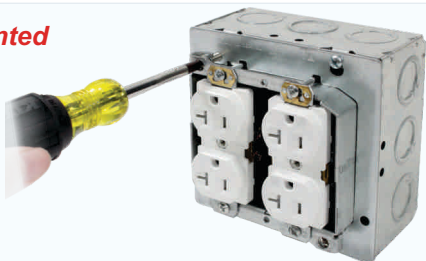

Orbit's Adjustable Rings allow for flush installations when finished wall depths are unknown. Rings are available up to 3-gang or round for either 4" (4S) or 4-11/16" (5S) square boxes and are available with versions for NEMA boxes and stud mounting.

Adjustable Rings

pg. 17~18

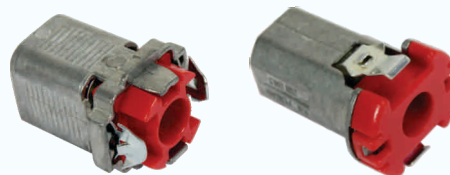

Double-Snap Cable Connectors offer a fast and tool-free installation of metal clad or armored cables to steel boxes. Simply snap the cable to the connector then snap to the box. Removable without tools and reusable.

DOUBLE-SNAP CABLE CONNECTORS

pg. 19

TABLE OF CONTENTS

1 SUPPORT SYSTEMS



01-02
All-In-One Stud Brackets
 Ultimate Support Bracket
 & Accessories

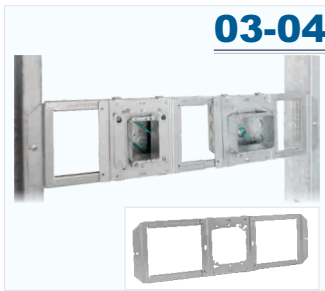

03-04
Adjustable Stud Wall Brackets
 Simple Support Bracket &
 Universal Mounting Adapter



05
Adjustable Stud Wall Brackets
 Telescoping Support Bracket &
 Adjustable Bar Hangers



06
Fixed Stud Wall Brackets
 Fixed Position Box &
 Multiple-Box Bracket

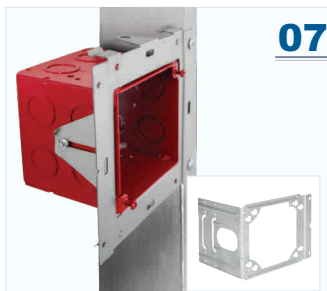

07
Stud Wall Boxes & Adapters
 Universal Mounting Adjustable Box
 & Box Mounting Adapter

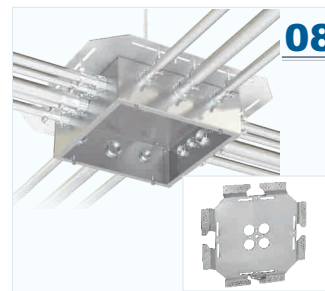

08
Ceiling Mounting Plates
 Box & Conduit Hanger
 Support Plates

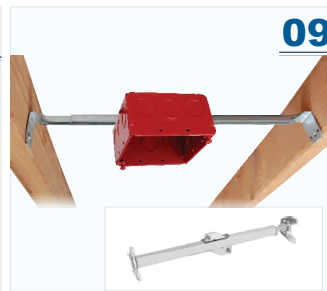

09
Fan Support Hangers
 Fan Support & Adjustable
 Bar Hangers

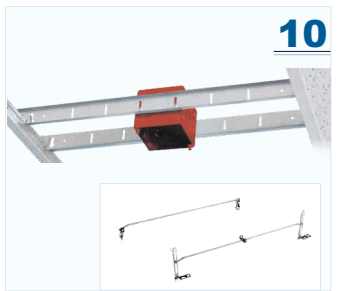

10
Bar Hangers
 Fixed Bar Hangers for
 Stud Ceilings & T-Bars

2 BOXES



11
Easy Hang Boxes
 Easy Access Lighting Boxes
 & EZ-Hang Box

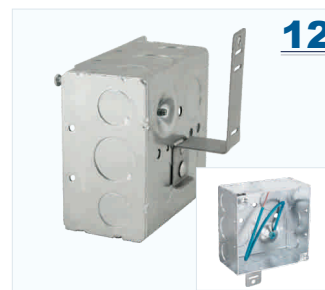

12
Adjustable Back Support Boxes
 Boxes with Adjustable
 Back Support Arms



13-14
Metal Clad Boxes
 Boxes with Metal Clad Cable Clamps



14
Pigtail Boxes
 Boxes with Pigtails

TABLE OF CONTENTS

2 BOXES



15

Large Capacity Boxes

Data Boxes & Partitions

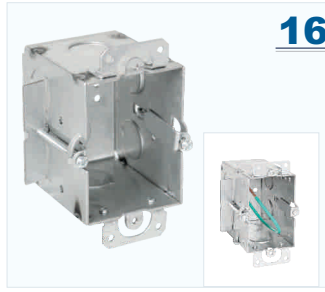

16

Extra Wide Old-Work Switch Boxes

Deep/Wide Tiger Grip Boxes

3 ACCESSORIES

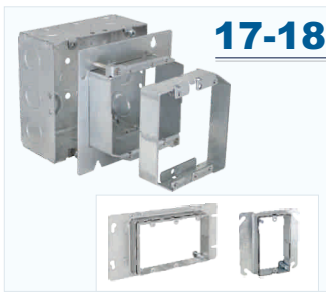

17-18

Adjustable Rings

Adjustable Plaster Rings,
Extensions, and Accessories



19

Snap-In Fittings

Double-Snap &
Fastlock Connectors



20

Connectors & Conduit Supports

NM Fittings, Conduit Locking
Connectors & Cable Support

4 FEATURED PRODUCTS

STEEL PRODUCTS 21

ELECTRICAL FITTINGS 22

BOX SPECIFICATION 23-24

PRODUCT INDEX 25

ALL-IN-ONE STUD BRACKETS

ULTIMATE SUPPORT BRACKET & ACCESSORIES

USB SERIES

PRODUCT FEATURES

- Can be floor or wall mounted on wooden or metal studs
- Infinite height and width combinations
- Provides flexibility at job site
- Works great with Orbit's adjustable rings
- Markings on bracket allow for quick and consistent adjustability.

NOTE

USB must be accompanied with either US4SB, US5SB, WBAR1G or WBAR2G mounting brackets to attach a steel box

Cat. No.	Description	Std. Pkg.
USB	Ultimate Support Bracket, Adj. 8"-24" as a floor brkt or 14"-24" as a wall brkt between studs	12
US4SB	Mounting Bracket for 4" (4S) Box, snaps to USB	24
US5SB	Mounting Bracket for 4-11/16" (5S) Box, snaps to USB	50
USBS	Far-Side Back Support for 4" (4S) and 4-11/16" (5S) Boxes	50
USDBM	For use with USB to create a double box in floor mount assembly with built-in back support	50
USTBM	For use with USB to create a triple box in floor mount assembly with built-in back support	50
USTS	USB floor mount stud-to-stud top support	50
USB-4SDB-50/75-PT	Complete Pre-Assembled Floor Bracket with a 4" (4S) 2-1/8" Deep Box mounted, Includes installed Far-Side Back Support and Ground Pigtail	12
USB-5SDB-50/75-PT	Complete Pre-Assembled Floor Bracket with a 4-11/16" (5S) 2-1/8" Deep Box mounted, Includes installed Far-Side Back Support and Ground Pigtail	12
LVS1 <small>NEW!</small>	Low Voltage Stud Mounting Bracket 1-Gang	50
LVS2 <small>NEW!</small>	Low Voltage Stud Mounting Bracket 2-Gang	25

01

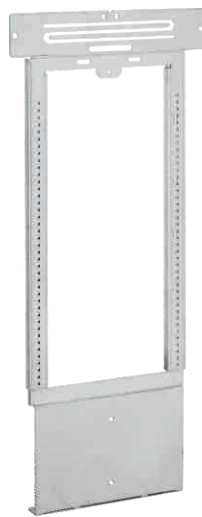

USB

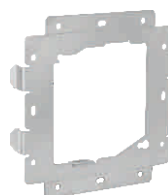

US4SB

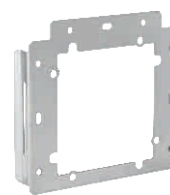

US5SB



USBS



LVS1
NEW!



LVS2
NEW!



USDBM



USTBM



USTS

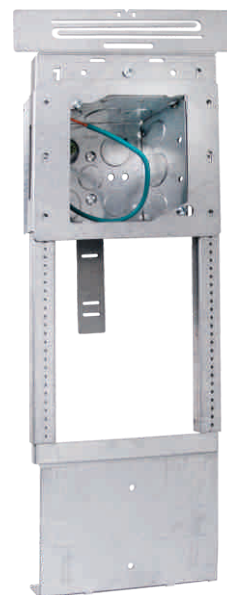

USB-4SDB-50/75-PT

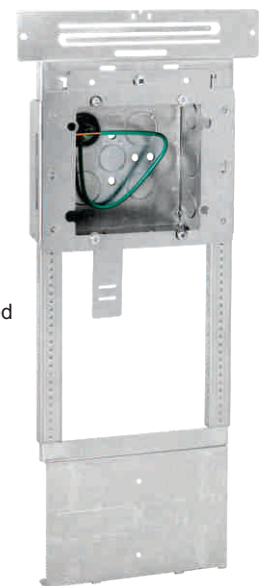

USB-5SDB-50/75-PT

Complete Prefabricated Assembly

ALL-IN-ONE STUD BRACKETS

ULTIMATE SUPPORT BRACKET & ACCESSORIES

INSTALLATION VIEWS

PATENTED REVOLUTIONARY SYSTEM

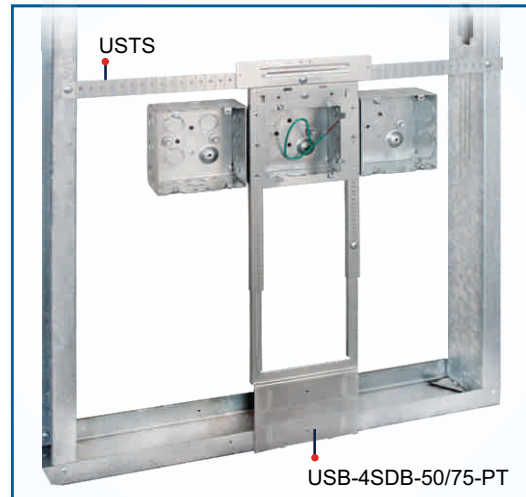

FLOOR BRACKET

Mount vertically at heights 8" to 24" and allows for the installation of the LVSB for low voltage applications

USB ASSEMBLY

USB accessories allow for vertical mounting between studs and 3 box applications using the USTBM

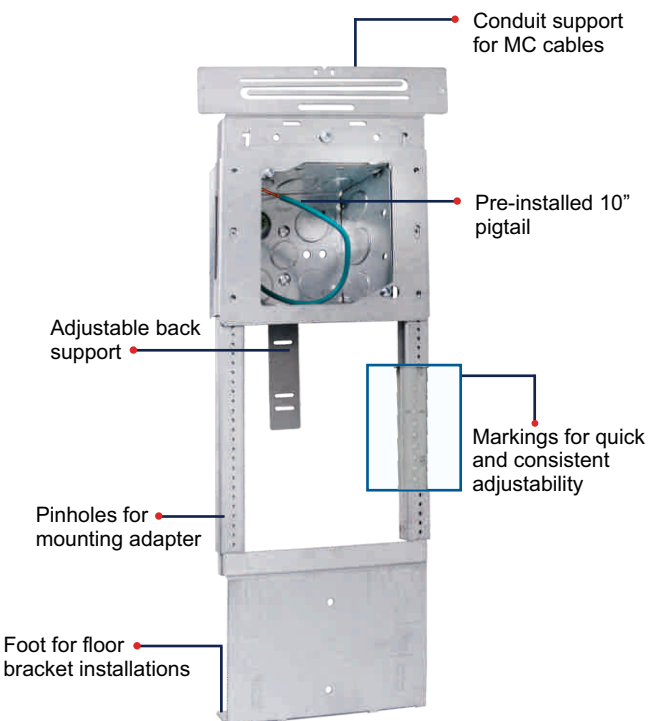

USB WITH ADJUSTABLE RINGS

Use WBAR Series or different adapters to mount boxes to USB. See Page 18 for more information on WBAR Series.

STUD WALL BRACKETS

SIMPLE SUPPORT BRACKET SERIES

SSB SERIES

PRODUCT FEATURES

- Telescoping bracket adjusts from 16" to 24"
- SSB can be preassembled to save time and reduce injury on the job site
- UMA can either mount-to-stud directly or clip onto bracket
- Rigidity eliminates need for far-side back support
- Markings on bracket allow for quick and consistent adjustability.

NOTE

SSB must be accompanied with either UMA, WBAR1G or WBAR2G mounting brackets to attach a steel box

03

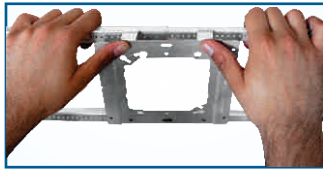

SNAP-IN

Adapter easily clips onto bracket

Cat. No.	Description	Std. Pkg.
SSB	Simple Support Bracket adjusts from 16" to 24" for mounting boxes horizontally between stud	25
SSB-4S	Preassembled SSB with UMA and 4" (4S) 2-1/8" Deep Box with 10" Ground Pigtail	12
SSB-5S	Preassembled SSB with UMA and 4-11/16" (5S) 2-1/8" Deep Box with 10" Ground Pigtail	12
SSB-5S-MKO	Preassembled SSB with UMA and 4-11/16" (5S) 2-1/8" Deep Box with MKO and 10" Ground Pigtail	12
UMA	Universal Mounting Adapter for mounting 4S and 5S boxes to SSB, USB, and directly to stud	25
LVS B1 <small>NEW!</small>	Low Voltage Stud Mounting Bracket 1-Gang	50
LVS B2 <small>NEW!</small>	Low Voltage Stud Mounting Bracket 2-Gang	25
UMAB <small>NEW!</small>	4S Box 3-1/2" Deep Adjustable Up to 1-1/2"	10
FA-UMAB <small>NEW!</small>	Fire Alarm 4S Box 3-1/2" Deep Adjustable Up to 1-1/2"	10

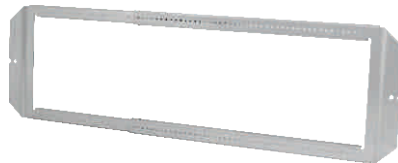

SSB



SSB-4S
Includes 4" Square Box with 1/2" & 3/4" KOs



SSB-5S
Includes 4-11/16" Square Box with 1/2" & 3/4" KOs



SSB-5S-MKO
Includes 4-11/16" Square Box with MKOs (combination 1/2" & 3/4" KO)



UMA



LVS B1
NEW!



LVS B2
NEW!



UMAB
NEW!



FA-UMAB
NEW!

FEATURES

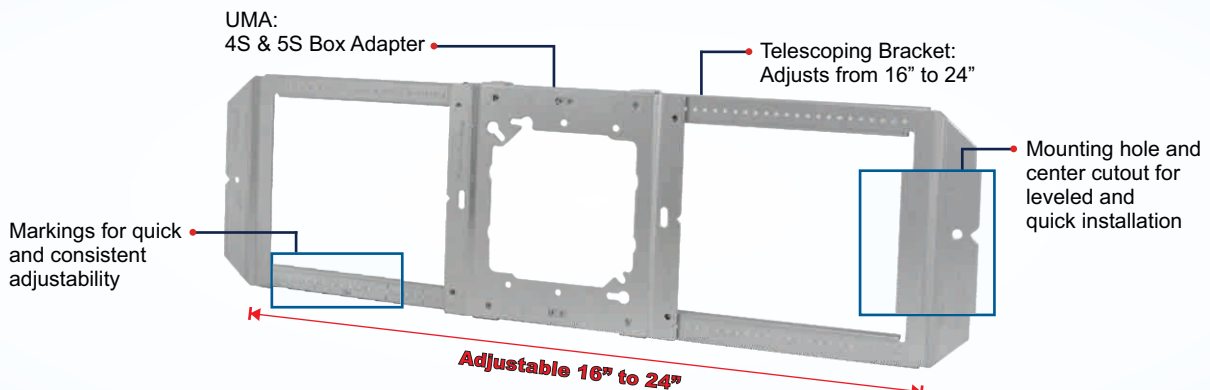

STUD WALL BRACKETS

SIMPLE SUPPORT BRACKET SERIES

INSTALLATION

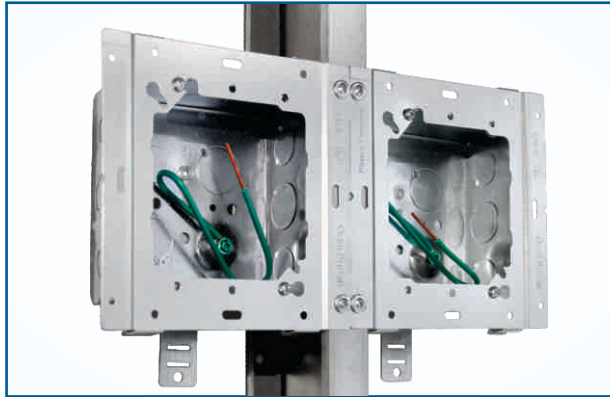

UNIVERSAL MOUNTING ADAPTER

Use the UMA for direct-to-stud applications.

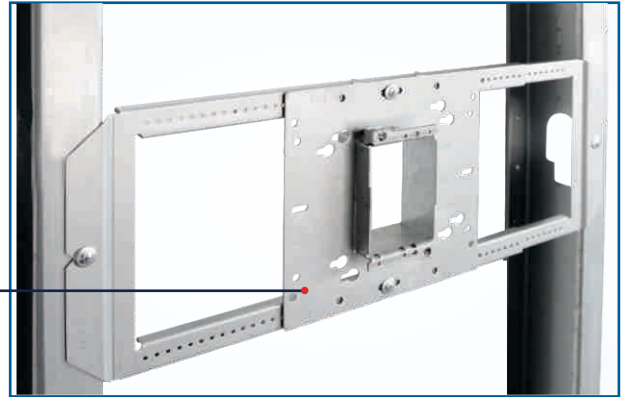

SSB WITH ADJUSTABLE RINGS

Use WBAR Series or different adjustable rings to mount boxes to SSB. See Page 17-18 for more information.

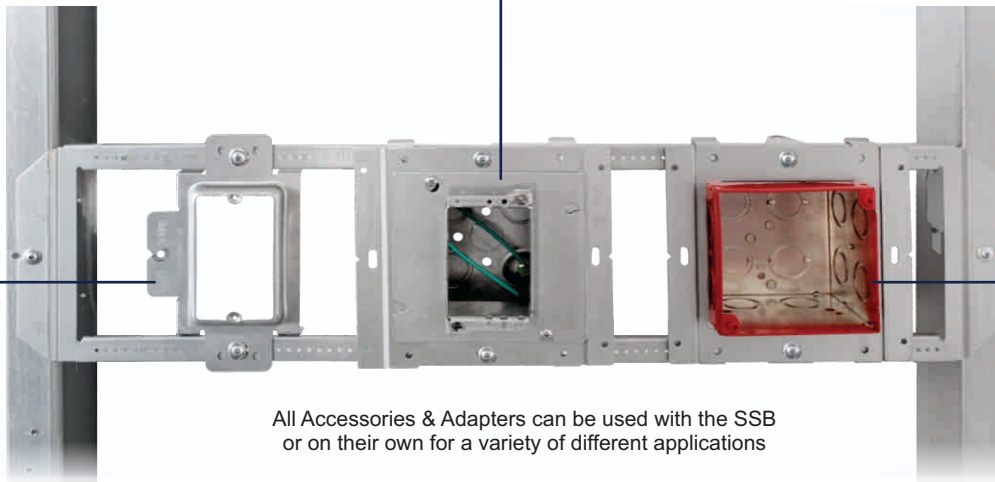

All Accessories & Adapters can be used with the SSB or on their own for a variety of different applications

04

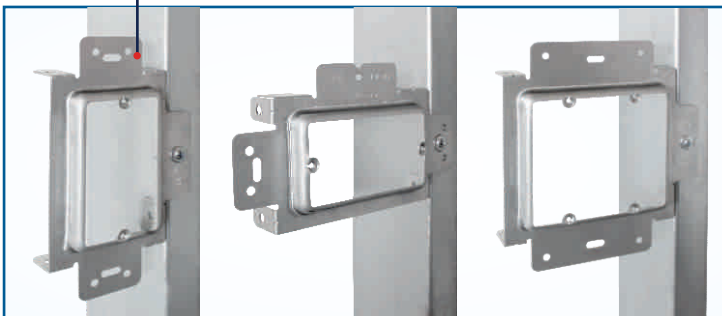

LOW VOLTAGE STUD BRACKET

Use LVSB Series with the SSB for low voltage applications. Can also be mounted alone directly to stud, vertically or horizontally.



UNIVERSAL MOUNTING ADJUSTABLE BOX

UMAB Series of 4" square, 3-1/2" deep boxes are adjustable from 0" to 1-1/2". See Page 7 for more information.

STUD WALL BRACKETS

TELESCOPING SUPPORT BRACKET & ADJUSTABLE BAR HANGERS



PRODUCT FEATURES

- Telescoping bracket adjusts from 16" to 27"
- Accepts 4" (4S), 4-11/16" (5S), and Multi-gang junction boxes
- Easily adjust position of boxes in field
- Packaged preassembled and ready to use.
- Markings on bracket allow for quick and consistent adjustability
- Rigidity eliminates need for far-side back support

SHIPS PREASSEMBLED

Cat. No.	Description	Std. Pkg.
TSB	Telescoping Support Bracket adjusts from 16" to 27" for mounting 4S and 5S boxes horizontally between studs.	25



TSB

FEATURES

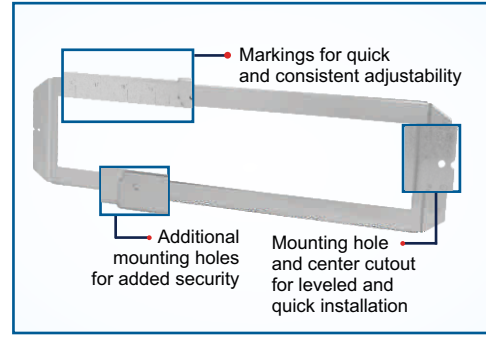

INSTALLATION

05



Adjustable 16" to 27"

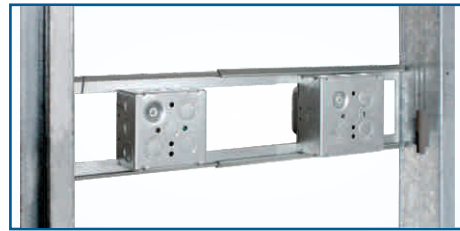

Fits 4" (4S), 4-11/16" (5S), and Multi-gang junction boxes and rings without an adapter

ADJUSTABLE BAR HANGER

PRODUCT FEATURES

- Ends bend and wrap around stud
- Can be used with boxes 1-1/2" or 2-1/8" deep

SHIPS PREASSEMBLED

Cat. No.	Description	Std. Pkg.
BHA-16	11" to 18" Adjustable Box Bracket - Mount Box with self-tapping screws Ends bend and wrap around stud - Can be used with boxes 1-1/2" or 2-1/8" deep	50
BHA-24	16" to 26" Adjustable Box Bracket - Mount Box with self-tapping screws Ends bend and wrap around stud - Can be used with boxes 1-1/2" or 2-1/8" deep	50



BHA-16



BHA-24



BOX AND CONDUIT SUPPORT BETWEEN STUDS USING BHA

Mount boxes between studs 11" to 18" using the BHA-16 or 16" to 26" using the BHA-24

FIXED STUD WALL BRACKETS

FIXED POSITION BOX BRACKET & MULTIPLE BOX BAR HANGER

FIXED POSITION BOX MOUNTING BRACKET

PRODUCT FEATURES

- Compatible with 4" (4S), 4-11/16" (5S) and 5" square boxes
- Mounting holes allow for a 4" (4S) ring and eliminates the need for an electrical box for low voltage applications
- Low profile design limits drywall bulging



Cat. No.	Description	Std. Pkg.
FMB-16 NEW!	Fixed Position Box Mounting Bracket for 16" Stud	25
FMB-24 NEW!	Fixed Position Box Mounting Bracket for 24" Stud	25

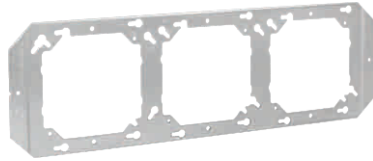

FMB-16
NEW!

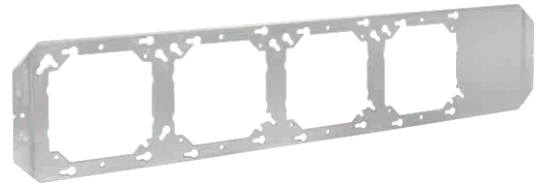

FMB-24
NEW!

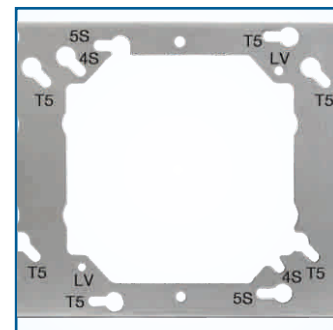
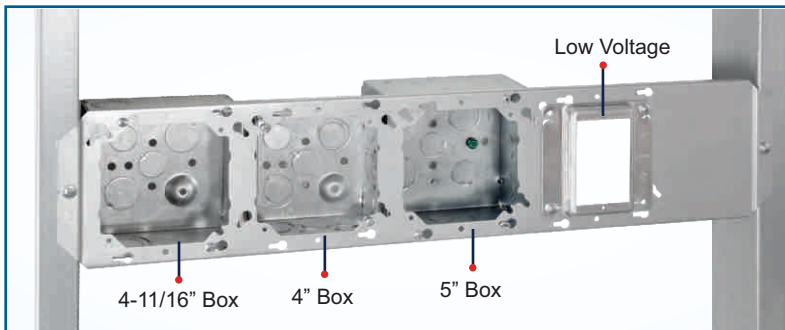

06

FMB INSTALLED ON STUDS

Mount up to 3 boxes between 16" studs with FMB-16 and 4 boxes between 24" with FMB-24

MOUNTING HOLES

Mounting Holes are marked to easily identify box and ring placement

MULTIPLE-BOX BAR HANGER FLAT

PRODUCT FEATURES

- Pre-Galvanized 18 Gauge sheet metal
- Accommodates 4" (4S), 4-11/16" (5S), and Multi-gang Boxes
- Allows steel boxes to adjust easily horizontally along the bracket
- Reduces assembly time on job site

NOTE

The MBBH-24 for 24" studs has been discontinued and replaced by Orbit's TSB or FMB-24. See Page 5 for more information on the TSB.

Cat. No.	Application	Dimensions (W x L)	Box		Std. Pkg.
			Sizes	Depth	
MBBH-16	For 16" Stud spacing	6" x 16"	4" & 4-11/16"	1-1/2" & 2-1/8"	50

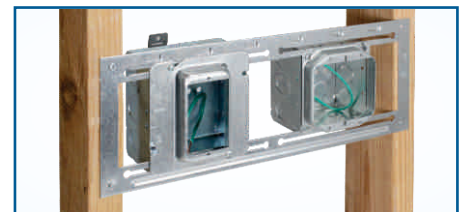
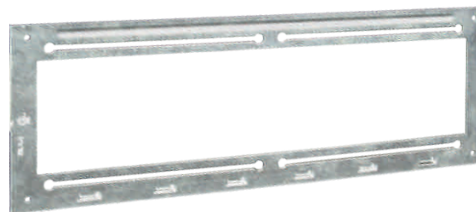

Shown installed with both 4" & 4-11/16" Square Boxes

STUD WALL BOXES & ADAPTERS

UNIVERSAL MOUNTING ADJUSTABLE BOX & BOX MOUNTING ADAPTER

Universal Mounting Adjustable Box

PRODUCT FEATURES

- Adjustable from 0" to 1-1/2"
- Compatible with Orbit's SSB (Page 3) for between stud installations.
- Can be used for Hard Lid installations
- Allows for direct-to-stud installations



SHIPS PREASSEMBLED

Cat. No.	Description	Std. Pkg.
UMAB <small>NEW!</small>	4S Box 3-1/2" Deep Adjustable Up to 1-1/2"	10
FA-UMAB <small>NEW!</small>	Fire Alarm 4S Box 3-1/2" Deep Adjustable Up to 1-1/2"	10



UMAB
NEW!



FA-UMAB
NEW!

07

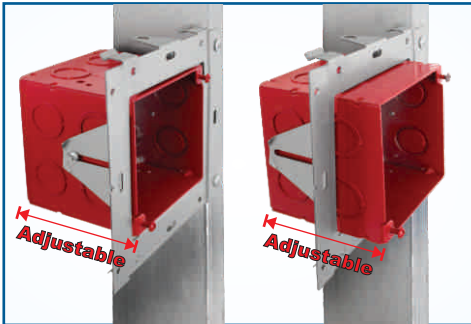

DIRECT-TO-STUD

Guided-slots on each side allow the box to be easily adjusted by simply loosening the screws. Adjustable 0" to 1-1/2"

COMPATIBLE WITH SSB

UMAB can be used with an SSB for between stud or ceiling installations.

Box Mounting Adapter

PRODUCT FEATURES

- Mounts to 4" (4S) and 4-11/16" (5S) boxes
- Mounting holes allow for installation of 4" (4S) rings for low voltage applications
- Adjustable Back Support helps maintain rigidity when installed
- Low profile design limits drywall bulging
- For use with metal or wood studs

Cat. No.	Description	Std. Pkg.
BMA-23 <small>NEW!</small>	Box Mounting Adapter with 3-1/2" & 2-1/2" Far Side Support	25
BMA-4 <small>NEW!</small>	Box Mounting Adapter with Far Side Support up to 4"	25

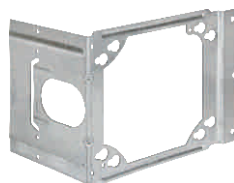

BMA-23
NEW!

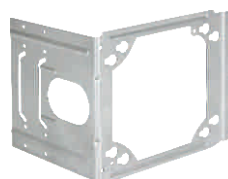

BMA-4
NEW!

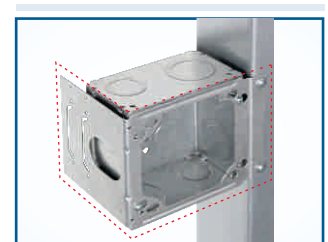

DIRECT-TO-STUD

BMA allows for boxes to be mounted directly-to-stud

CEILING MOUNTING PLATES

BOX & CONDUIT HANGER SUPPORT PLATES

BCHS SERIES

PRODUCT FEATURES

- Pre-Galvanized 16 Gauge Steel
- No cutting required
- Pin holes and slots allow for use of conduit straps
- Self-reinforcing as more conduit is added
- Requires only one rod for installation
- Stamped markings provide guide lines
- Easy to preassemble to save time and material



Cat. No.	Description	Std. Pkg.
BCHS-10	Fits up to 6" x 6" Box for horizontal mounting	25
BCHS-6	Fits up to 6" x 6" Box for horizontal mounting and provides bent tabs for vertical mounting	10
BCHS-6S	Fits up to 6" x 6" Box for horizontal mounting, provides bent tabs for vertical mounting and offsets allow for use of one-hole straps	10
BCHS-12	Fits up to 12" x 12" Box or multiple small sized boxes for horizontal mounting and provides bent tabs for vertical mounting	5

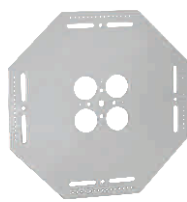

BCHS-10



BCHS-6

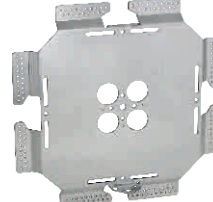

BCHS-6S

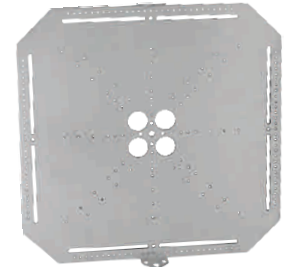

BCHS-12

INSTALLATION

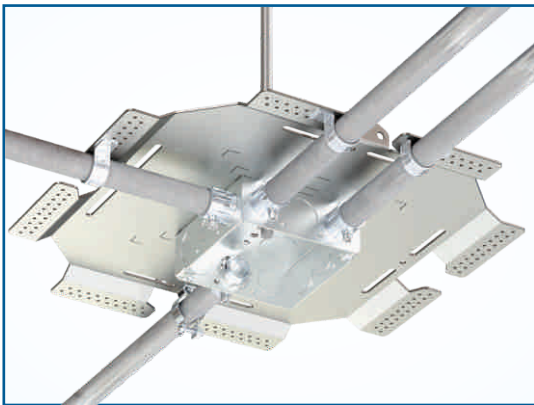

BCHS-6S

Allows for use of one-hole strap

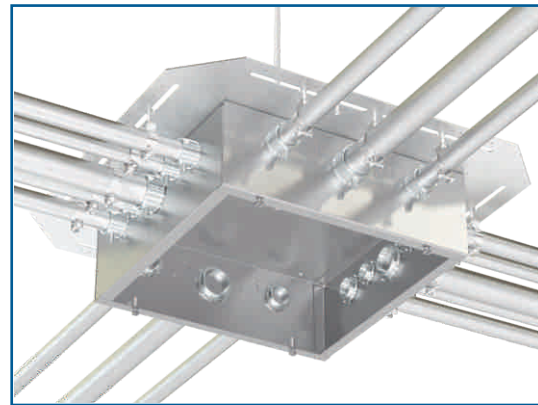

BCHS-12

12" x 12" NEMA installed

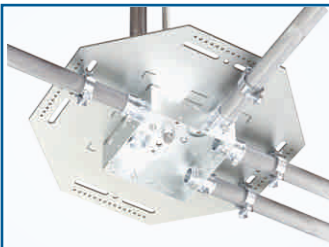

BCHS-10

Horizontally mount boxes up to 6" x 6"

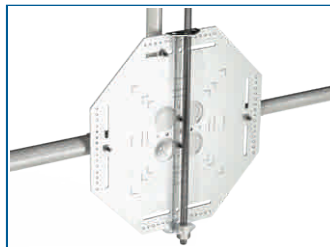

BCHS-6

Horizontally or Vertically mount boxes up to 6" x 6"

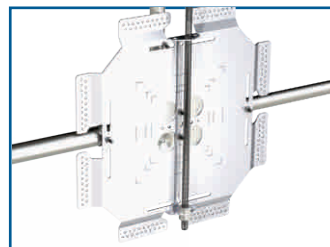

BCHS-6S

Horizontally or Vertically mount boxes up to 6" x 6" and allows for the use of one-hole straps

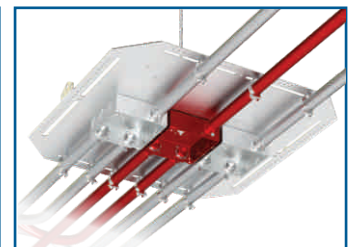

BCHS-12

Fits multiple boxes for multi-system installations

FAN SUPPORT HANGERS

FAN SUPPORT & ADJUSTABLE BAR HANGERS

FAN SUPPORT BAR HANGERS

PRODUCT FEATURES

- NBH: New Construction Bar Hanger slides apart to fit joist spacing from 16" to 24"
- OBH: Old Work Bar Hanger for joist spacing from 16" to 24", no tools necessary for expansion of the bar

More Orbit Fan Support Boxes available at www.orbitelectric.com

Cat. No.	Description	Std. Pkg.
FS-NBH	16" to 24" Adjustable New Construction Bar Hanger for use with Fan Support Boxes	10
FS-OBH	16" to 24" Adjustable Old Work Bar Hanger for use with Fan Support Boxes	10



FS-NBH

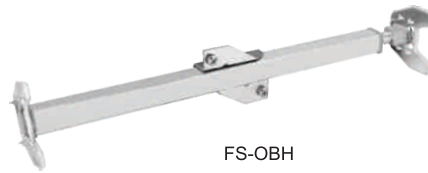

FS-OBH

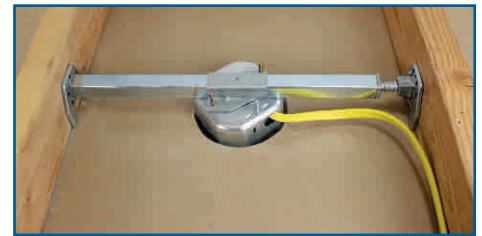

FS-OBH SHOWN INSTALLED

Mounts 1-1/2" to 2-1/8" Fan Boxes for old work application

09

ADJUSTABLE BAR HANGERS

PRODUCT FEATURES

- Steel
- Electroplated Zinc
- For Stud and T-Bar

Cat. No.	Description	Std. Pkg.
BHA-1	Adjustable Bar Hanger with stud for joist spacing 16" to 24" with #3/8-18 NPS Threaded Stud	50
BHA-1C	Adjustable Bar Hanger with stud for joist spacing 16" to 24" with Box Clip	50
ABS	Far-Side Box Support for 1-1/2" & 2-1/8" Deep Boxes, for use with 4" Metal Studs.	50
ABS-6	Far-Side Box Support for 1-1/2" & 2-1/8" Deep Boxes, for use with 6" Metal Studs.	50



BHA-1



BHA-1C



ABS



ABS-6

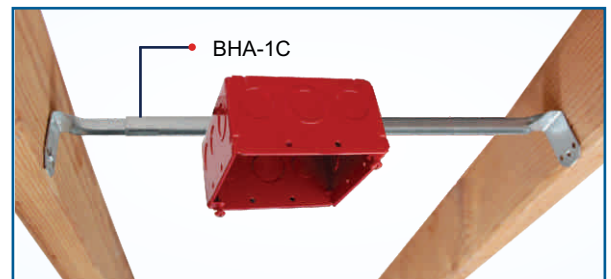

SHOWN INSTALLED

Mount boxes between 16" to 24" space studs

BAR HANGERS

FIXED BAR HANGERS FOR STUD CEILINGS & T-BARS

FIXED BAR HANGERS

PRODUCT FEATURES

- Steel
- Electroplated Zinc
- For Stud and T-Bar

Cat. No.	Description	Std. Pkg.
BHT-1	24" T-Bar bracket for use with boxes 1-1/2" or 2-1/8" deep	50
BHT-1A	24" T-Bar bracket - 8" height adjustable	50
BH-1	24" Straight bar hanger for mounting ceiling boxes, slotted, includes 2 Stove Bolts per unit	50
BH-1C	24" Straight bar hanger for mounting ceiling boxes, with BH-C Box Clip	50
BH-1S	20" Straight bar hanger for mounting ceiling boxes, slotted, includes 2 Stove Bolts per unit	50
BH-1SC	20" Straight bar hanger for mounting ceiling boxes, with Box Clip BH-C	50
BH-2	21" Offset (1-1/2") bar hanger for mounting boxes with ring	50
BH-2NC	21" Offset (1-1/2") bar hanger for mounting boxes with ring, slotted, includes 2 Stove Bolts/unit	50
BH-C	Additional box clip & screw set for use with BH-1, BH-1S & BH-2NC	100
BH-3	Straight bracket for mounting architectural recess lights 25-1/4" long with notches 24" apart for use on T-Bar	50
BHT-C	Additional box clip & screw set for use with BHT-1 & BHT-1A	100

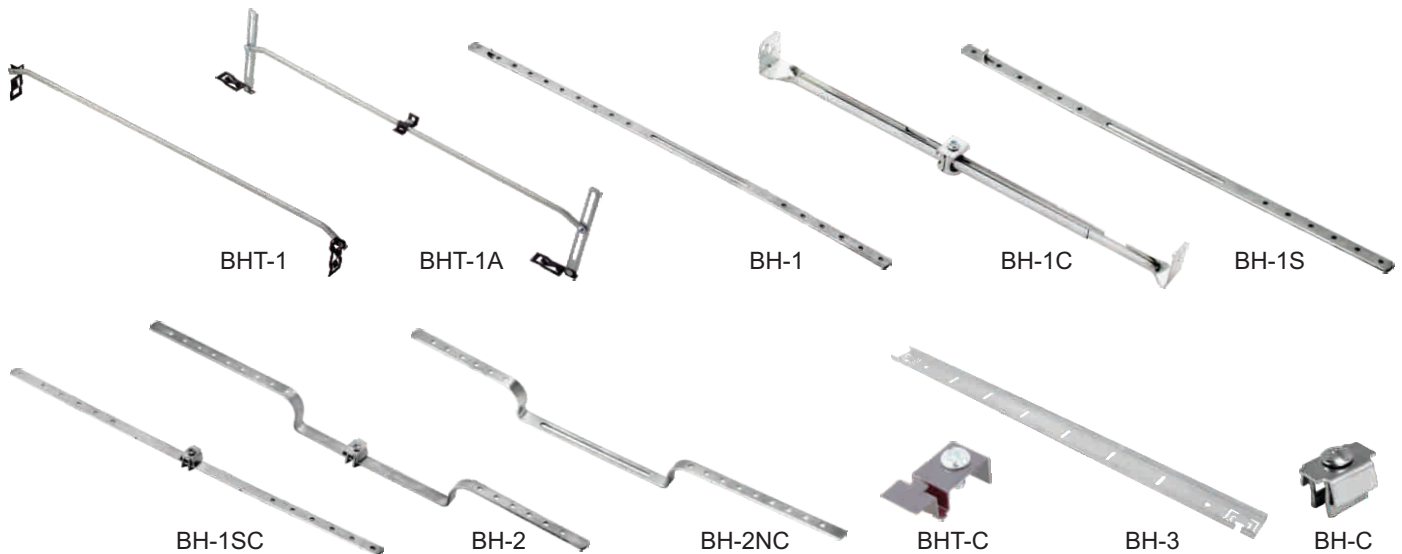

10

FEATURES & INSTALLATION

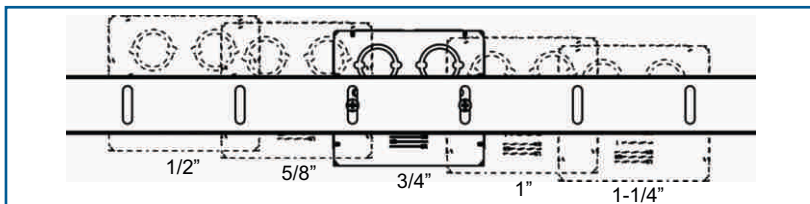

BH-3 FEATURES

Adjust vertically from 1/2" to 1-1/4" between 5 different positions

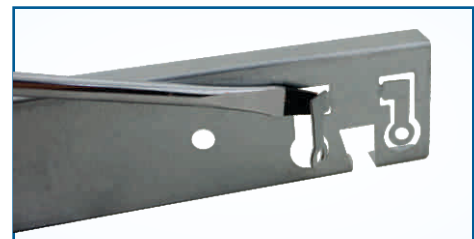
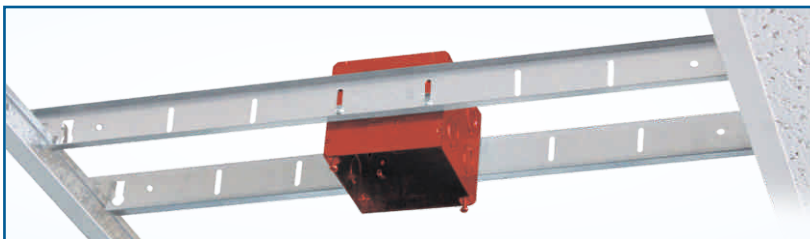

6-WAY ADJUSTABLE T-BAR HANGER

The BH-3 is ideal for recessed lighting applications, fire alarm device installation, and LED retrofit lighting applications. It's compatible with Orbit's 4SEDB-CKO and FA-4SEDB-CKO.

BH-3 FEATURES

Secure to T-Bar using bending tabs to comply with NEC 315.23(d)

EASY HANG BOXES

EASY ACCESS LIGHTING BOXES & EZ-HANG BOX

EASY ACCESS LIGHTING BOXES 2-1/8" DEEP

30.2 Cu. In.

PRODUCT FEATURES

- Fast and efficient installations
- Sliding cover plate for one person installations
- Available with either standard or swivel sliding cover plate
- Swivel reduces damage to hanging fixtures when struck
- Complies with NEC 314.27 (A)(D) for up to 90 lbs. of fixture load

Cat. No.	Description	Dimensions (W x H)	Knockouts		Std. Pkg.
			Sides	Bottom	
EALB	Easy Access Lighting Box	4" X 4"	4-CKO	3-1/2", 1-3/4"	50
EALBS	Easy Access Lighting Box with Sliding Swivel	4" X 4"	4-CKO	3-1/2", 1-3/4"	10



EALB



EALBS

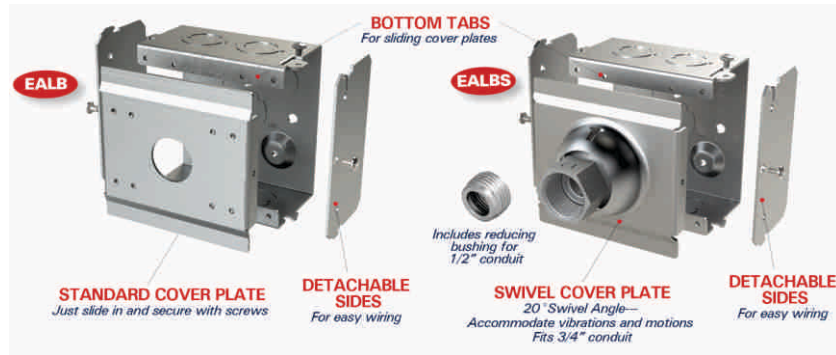

11

**50%
LABOR
SAVINGS**

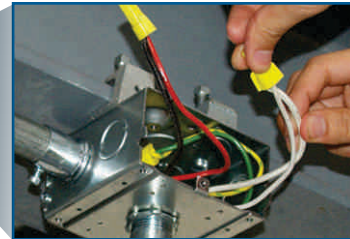
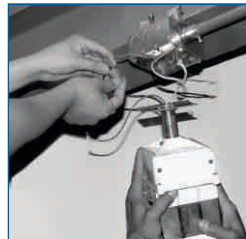

TRADITIONAL METHOD

Requires two installers

WITH ORBIT'S EALB/S

Only one installer

EZ-HANG BOX 4-11/16" SQUARE (5S) BOX

DRAWN

2-1/8" DEEP

42.0 Cu. In.

WITH RAISED GROUND EMBOSS

PRODUCT FEATURES

- Back-center KO is replaced with a 0.27" diameter back-center hole
- Back-center hole allows for use of 1/4" rod for suspended applications
- No washer is needed, allowing for a fast and efficient installation

Cat. No.	Description	Knockouts		Std. Pkg.
		Sides	Bottom	
D5SDB-CKO-S NEW!	5S Drawn Special Box with CKO	2 - 1/2", 10 - CKO	3 - 3/4"	24



D5SDB-CKO-S

NEW!

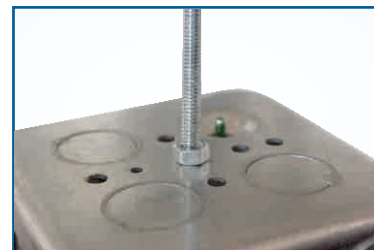

Secure box to ceiling with just a 1/4" rod and locknut

ADJUSTABLE BACK SUPPORT BOXES

BOXES WITH ADJUSTABLE BACK SUPPORT ARMS

4-11/16" SQUARE (5S) BOXES

WELDED

2-1/8" DEEP

42.0 Cu. In.

WITH RAISED GROUND EMBOSS

BOXES WITH 10" PIGTAIL

Pre-Assembled 3-Way,
10-32 Ground Screw and
Solid Cu #12AWG 10" Pigtail

BSA

- Pre-installed Back Support Arm provides support for studs up to 6" deep
- Great for prefab applications

Cat. No.	Bracket & Setback	Knockouts		Std. Pkg.
		Sides	Bottom	
5SDB-50/75-PT-BSA	Back Support Arm	8 - 1/2", 4 - 3/4"	3 - 3/4"	24
5SDB-50/75-AB-PT-BSA	AB, Flush, Back Support Arm	6 - 1/2", 3 - 3/4"	3 - 3/4"	24



5SDB-50/75-PT-BSA



5SDB-50/75-AB-PT-BSA

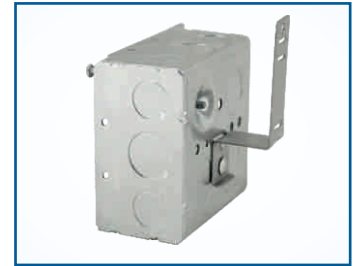

Adjustable Back Support Arm

4" SQUARE (4S) DEEP BOXES

WELDED

2-1/8" DEEP

30.3 Cu. In.

WITH RAISED GROUND EMBOSS

BOXES WITH 10" PIGTAIL

Pre-Assembled 3-Way,
10-32 Ground Screw and
Solid Cu #12AWG 10" Pigtail

BSA

- Pre-installed Back Support Arm provides support for studs up to 6" deep
- Great for prefab applications

Extensions & additional
Adjustable Rings
available on page 17-18

Cat. No.	Bracket & Setback	Knockouts		Std. Pkg.
		Sides	Bottom	
4SDB-50/75-PT-BSA	With Back Support	8 - 1/2", 4 - 3/4"	1 - 1/2", 2 - 3/4"	24
4SDB-50/75-AB-PT-BSA	With Back Support + AB Bracket	6 - 1/2", 3 - 3/4"	1 - 1/2", 2 - 3/4"	24
4SDB-MKO-PT-BSA	With Back Support	8 - 1/2", 4 - MKO	1 - 1/2", 2 - MKO	24
4SDB-MKO-AB-PT-BSA	With Back Support + AB Bracket	6 - 1/2", 3 - MKO	1 - 1/2", 2 - MKO	24
4SDB-MKO-AR1G	4SDB-MKO-AB-PT-BSA + 1G Adj. Ring	6 - 1/2", 3 - MKO	1 - 1/2", 2 - MKO	24
4SDB-MKO-AR2G	4SDB-MKO-AB-PT-BSA + 2G Adj. Ring	6 - 1/2", 3 - MKO	1 - 1/2", 2 - MKO	24



4SDB-50/75-PT-BSA



4SDB-50/75-AB-PT-BSA



4SDB-MKO-PT-BSA



4SDB-MKO-AB-PT-BSA



4SDB-MKO-AR1G



4SDB-MKO-AR2G

- **600V** MKO's and CKO's suitable for bonding without any additional bonding means up to 600V
- Acceptable for use in 2-hour fire rated walls

METAL CLAD BOXES

BOXES WITH METAL CLAD CABLE CLAMPS

4-11/16" SQUARE (5S), DEEP BOXES

WELDED

2-1/8" DEEP

42.0 Cu. In.

WITH METAL CLAD (BX/MC) CABLE CLAMPS

BX/MC CLAMP

- All MC series boxes are suitable for use with MCAP™-Aluminum
- MCAP is a trademark of Southwire Company

METAL STUD BRACKET

- U.S. Patent No.: 8,262,043
- Metal Stud (MS) Bracket engages on either side of a Metal Stud
- *Model Revised Feb. 2008

Cat. No.	Bracket & Setback	Knockouts		Std. Pkg.
		Sides	Bottom	
5SDB-MC	-	6-MKO, 4-Loom	3 - 1/2", 2 - 3/4"	24
5SDB-MC-FB	FB, Flush	3-MKO, 4-Loom	3 - 1/2", 2 - 3/4"	24
5SDB-MC-MS*	MS, Self-Gripping + Box Support Clip	3-MKO, 4-Loom	2-MKO, 3 - 1/2"	24
5SDB-MC2-MS*	MS, Self-Gripping + Box Support Clip	1-MKO, 8-Loom	1-MKO	24



5SDB-MC



5SDB-MC-FB



BX/MC Clamp



5SDB-MC-MS*



5SDB-MC2-MS*



5SDB-MC2-MS* on Metal Stud

13

4" SQUARE (4S) DEEP BOXES

WELDED

2-1/8" DEEP

30.3 Cu. In.

WITH METAL CLAD (BX/MC) CABLE CLAMPS

BX/MC CLAMP

- All MC series boxes are suitable for use with MCAP™-Aluminum
- MCAP is a trademark of Southwire Company

METAL STUD BRACKET

- U.S. Patent No.: 8,262,043
- Metal Stud (MS) Bracket engages on either side of a Metal Stud
- *Model Revised Feb. 2008

BOXES WITH PIGTAIL

Pre-Assembled 3-Way, 10-32 Ground Screw and Solid Cu #12AWG 7" Pigtail

- Acceptable for use in 2-hour fire rated walls

Cat. No.	Bracket & Setback	Knockouts		Std. Pkg.
		Sides	Bottom	
4SDB-MC	-	4 - 1/2", 2-MKO, 4-Loom	1 - 1/2"	24
4SDB-MC-B	B, Flush	2 - 1/2", 1-MKO, 4-Loom	1 - 1/2"	24
4SDB-MC-FB-PT	FB, Flush	2 - 1/2", 1-MKO, 4-Loom	1 - 1/2"	24
4SDB-MC-MS-PT*	MS, Self-Gripping	2 - 1/2", 1-MKO, 4-Loom	1 - 1/2"	24
4SDB-MC-WB	WB, Flush	2 - 1/2", 1-MKO, 4-Loom	1 - 1/2"	24



4SDB-MC

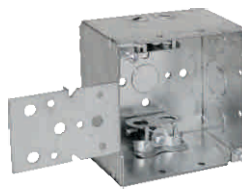

4SDB-MC-B



4SDB-MC-FB-PT



4SDB-MC-MS-PT*



4SDB-MC-WB

METAL CLAD BOXES & PIGTAIL BOXES

BOXES WITH METAL CLAD CABLE CLAMPS & PIGTAILS

4" SQUARE (4S), DEEP BOXES

WELDED

1-1/2" DEEP

30.3 Cu. In.

WITH METAL CLAD (BX/MC) CABLE CLAMPS

BX/MC CLAMP

- All MC series boxes are suitable for use with MCAP™-Aluminum
- MCAP is a trademark of Southwire Company

METAL STUD BRACKET

- U.S. Patent No.: 8,262,043
- Metal Stud (MS) Bracket engages on either side of a Metal Stud
- *Model Revised Feb. 2008**

BOXES WITH PIGTAIL

Pre-Assembled 3-Way, 10-32 Ground Screw and Solid Cu #12AWG 7" Pigtail

Cat. No.	Bracket & Setback	Knockouts		Std. Pkg.
		Sides	Bottom	
4SB-MC-PT	-	4 - 1/2", 2-MKO, 4-Loom	1 - 1/2"	50
4SB-MC-B	B, Flush	2 - 1/2", 1-MKO, 4-Loom	1 - 1/2"	24
4SB-MC-FB-PT	FB, Flush + 7" Pigtail	2 - 1/2", 1-MKO, 4-Loom	1 - 1/2"	24
4SB-MC-WB	WB, Flush	2 - 1/2", 1-MKO, 4-Loom	1 - 1/2"	24
4SB-MC-MS-PT*	MS + Box Support Clip + 7" Pigtail	2 - 1/2", 1-MKO, 4-Loom	1 - 1/2"	24



4SB-MC-PT



4SB-MC-B

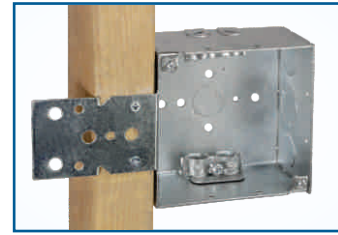

4SB-MC-B on Wood Stud



4SB-MC-FB-PT



4SB-MC-WB

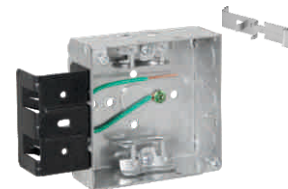

4SB-MC-MS-PT*

ADDITIONAL BOXES WITH PIGTAIL

BOXES WITH PIGTAIL

Pre-Assembled 3-Way, 10-32 Ground Screw and Solid Cu #12AWG 7" Pigtail



Pre-Assembled Ground Screw and Pigtail

Cat. No.	Mfg. Process	Dimension WxHxD	Cu. Inch	Knockouts		Std. Pkg.
				Sides	Bottom	
5SDB-MKO-PT	Welded	4-11/16" x 4-11/16" x 2-1/8"	42.0	2 - 1/2", 10 - MKO	2 - 1/2", 2 - MKO	24
4SDB-MKO-PT	Welded	4" x 4" x 2-1/8"	30.3	8 - 1/2", 4 - MKO	2 - 1/2", 2 - MKO	24
4SB-50/75-PT	Welded	4" x 4" x 1-1/8"	21.0	8 - 1/2", 4 - 3/4"	2 - 1/2", 2 - 3/4"	50
D4SB-50/75-PT	Drawn	4" x 4" x 1-1/8"	21.0	8 - 1/2", 4 - 3/4"	2 - 1/2", 2 - 3/4"	50
D4SB-75-PT	Drawn	4" x 4" x 1-1/8"	21.0	8 - 3/4"	2 - 1/2", 2 - 3/4"	50
DHB3-PT	Drawn	5-3/4" x 4" x 2-1/8"	44.0	4 - 1/2", 6 - CKO	2 - 1/2", 2 - 3/4"	25



5SDB-MKO-PT



4SDB-MKO-PT



4SB-50/75-PT



D4SB-50/75-PT



D4SB-75-PT



DHB3-PT

- 600V** MKO's and CKO's suitable for bonding without any additional bonding means up to 600V
- Acceptable for use in 2-hour fire rated walls

LARGE CAPACITY BOXES

DATA BOXES & PARTITIONS

4-11/16" SQUARE (5S) LARGE CAPACITY BOXES

WELDED
2-1/2" DEEP

49.4 Cu. In.
WITH RAISED GROUND
EMBOSS & TWO #8-32 x 1/2"
MOUNTING SCREWS

PRODUCT FEATURES

- Suitable for Datacom & Electrical Applications



Cat. No.	Knockouts		Std. Pkg.
	Sides	Bottom	
5SLB-MKO	8 - 1/2", 4 - 1/2" & 3/4" M.K.O.	2 - 1/2", 2 - 3/4"	24
5SLB-2MKO	4 - 3/4" & 1" M.K.O., 4 - 1" & 1 - 1/4" M.K.O.	2 - 1/2", 2 - 3/4"	24



5SLB-MKO



5SLB-2MKO

15

**FITS UP TO
45 FT.
OF DATA
CABLE**



5SLB-2MKO Shown Installed



5SLB-2MKO, 52058 & 5SLP-200
Shown Installed

4-11/16" SQUARE (5S) BOXES LOW-VOLTAGE PARTITIONS

PRODUCT FEATURES

- Steel Partitions allows for multi-system installations inside junction box

Cat. No.	Description	For Use with 2-Gang Rings:	Std. Pkg.
5SDP-100	For use with 2-1/8" Deep Boxes	Flat, 1/4", 1/2", 3/4", 1"	25
5SDP-200	For use with 2-1/8" Deep Boxes	5/8", 1-1/4", 1-1/2", 1-3/4", 2"	25
5SLP-100	For use with 2-1/2" Deep Boxes	Flat, 1/4", 1/2", 3/4", 1"	25
5SLP-200	For use with 2-1/2" Deep Boxes	5/8", 1-1/4", 1-1/2", 1-3/4", 2"	25



5SDP-100



5SDP-200



5SLP-100



5SLP-200

- **600V** MKO's and CKO's suitable for bonding without any additional bonding means up to 600V
- Acceptable for use in 2-hour fire rated walls

EXTRA WIDE OLD-WORK SWITCH BOXES

DEEP/WIDE TIGER GRIP BOXES

DEEP TIGER GRIP

PRODUCT FEATURES

- 3-1/2" Deep
- With Pre-Assembled 10-32 Ground Screw & 7-1/2" Long #12AWG Solid Pigtail

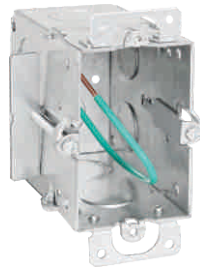

TGD-1

Cat. No.	Description	Volume	Knockouts			Std. Pkg.
			Sides	Ends	Bottom	
TGD-1	3" H x 2" W x 3-1/2" D	18.0 Cu. In.	4 - 1/2"	2 - 1/2", 2 - MKO	2 - 1/2"	50

WIDE TIGER GRIP

PRODUCT FEATURES

- Non-Gangable Switch Boxes
- Must be used with Mid-Size or Oversized Wall Plate
- Facilitates GFCI and Controls Installations
- Material: Galvanized Steel

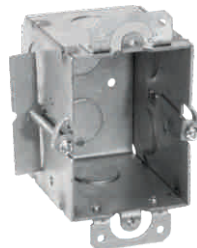

TGW



TGMW

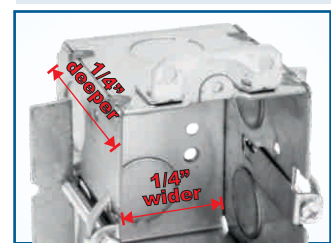

TGMW SHOWN

Cat. No.	Description	Volume	Knockouts			Std. Pkg.
			Sides	Ends	Bottom	
TGW	3" H x 2-1/4" W x 2-1/2" D	15.0 Cu. In.	4 - 1/2"	2 - 1/2"	2 - 1/2"	50
TGMW	3" H x 2-1/4" W x 2-3/4" D	18.5 Cu. In.	4 - 1/2"	2 - 1/2"	2 - 1/2"	50

INSTALLATION

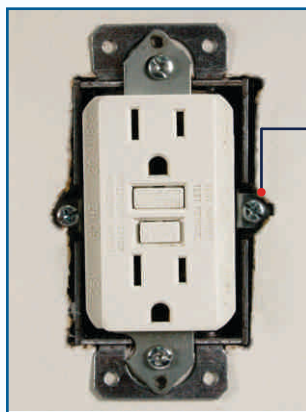

Very Little Room For Large Device Installation

VS

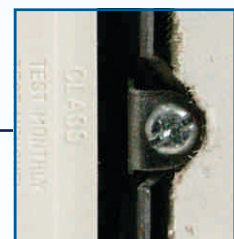
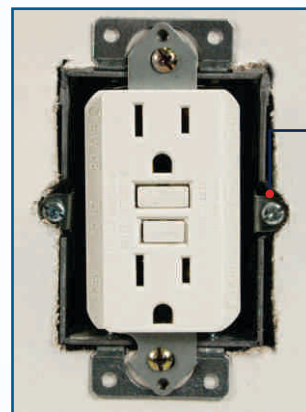

More Space For an Easier Fit!

TRADITIONAL TIGER GRIP WITH GFCI INSTALLED

TGW SHOWN WITH GFCI INSTALLED

ADJUSTABLE RINGS

ADJUSTABLE PLASTER RINGS, EXTENSIONS, AND ACCESSORIES

ADJUSTABLE RINGS

PRODUCT FEATURES

- For use with 4" Square (4S) and 4-11/16" Square (5S) Deep Boxes
- 1/4" to 1-1/4" adjustability range
- Rings achieve a flush finish every time
- Compatible with exclusive extensions for infinite wall depths

U.S. PATENT NO.:

7,468,486



**INDUSTRIES' ONLY
5S ADJUSTABLE RINGS**

Cat. No.	Description	Standard	With One Extension Installed		Std. Pkg.
			+1GX75	+2GX75	
4SAR1G	1-Gang Adjustable ring for 4S Deep Boxes	1/4" to 1-1/4"	1" to 2"	-	25
4SAR2G	2-Gang Adjustable ring for 4S Deep Boxes	1/4" to 1-1/4"	-	1" to 2"	25
5SAR1G	1-Gang Adjustable Ring for 5S Deep Boxes	1/4" to 1-1/4"	1" to 2"	-	25
5SAR2G	2-Gang Adjustable Ring for 5S Deep Boxes	1/4" to 1-1/4"	-	1" to 2"	25



4SAR1G



4SAR2G



5SAR1G



5SAR2G

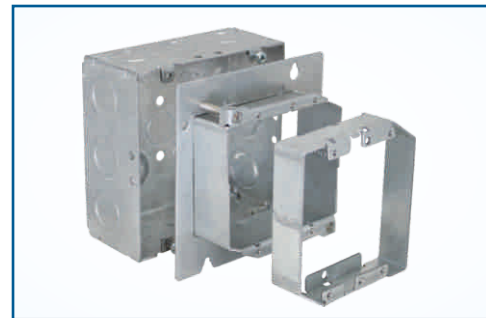

Exploded View



ACCESSIBLE ADJUSTABILITY

Corner screws are easily accessible for adjustment before and after the device has been installed

EXTENSIONS AND ACCESSORIES

PRODUCT FEATURES

- Extensions ensure flush finish regardless of wall thickness
- Attach to adjustable ring for additional 3/4" of depth
- Mount easily to ring with two 8-32 screws
- Multiple extensions can be installed on one ring

U.S. PATENT NO.:

7,468,486



Cat. No.	Description	For Use With	Std. Pkg.
1GX75	1-Gang 3/4" Extension	4SAR1G, 5SAR1G, or WBAR1G Only	50
2GX75	2-Gang 3/4" Extension	4SAR2G, 5SAR2G, or WBAR2G Only	50
UPC	Gangable, Steel Universal Protective Cover protects any device during drywall, painting, routing, mudding & plastering		25
UPCTS	Optional Plastic Insert for UPC to protect Toggle Switch		25



1GX75



2GX75



UPC



UPCTS



Complete UPC Assembly Shown Installed with Toggle Switch

ADJUSTABLE RINGS

STUD MOUNTING & UL-APPROVED ADJUSTABLE RINGS

STUD MOUNTING ADJUSTABLE RINGS

PRODUCT FEATURES

- Accepts 4" (4S) or 4-11/16" (5S) square boxes in line voltage applications
- Mount to any stud, shear wall, 6" X 6" NEMA 1 enclosure, Ultimate Support Bracket (Page 1) or Simple Support Bracket (Page 3)
- Can be used standalone for low voltage communications applications

U.S. PATENT NO.:

7,468,486



UL-APPROVED ADJUSTABLE RINGS

PRODUCT FEATURES

- Can be adjusted on the jobsite for a quick installation
- Adjusts to achieve a flush finish every time
- Patented design provides strong electrical and mechanical connections to meet UL requirements

Cat. No.	Description	Standard	With One Extension Installed		Std. Pkg.
			+1GX75	+2GX75	
WBAR1G	1-Gang Universal Box Bracket	1/4" to 1-1/4"	1" to 2"	-	25
WBAR2G	2-Gang Universal Box Bracket	1/4" to 1-1/4"	-	1" to 2"	25

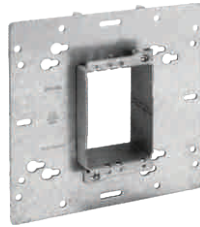

WBAR1G

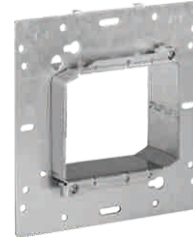

WBAR2G

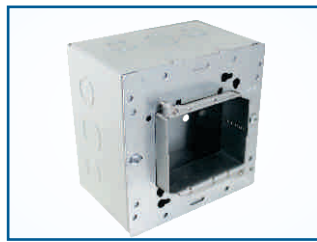

WBAR on the 6" x 6" NEMA Enclosure

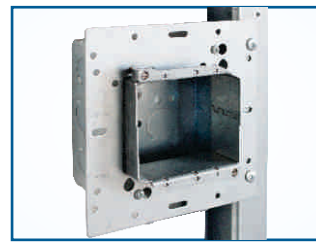

Mount 4" & 4-11/16" Square Boxes directly to stud

Cat. No.	Description	Adjustability Range	Std. Pkg.
4AR1G-58	1-Gang Adjustable ring for 4S Deep Boxes	5/8" to 1-1/4"	25
4AR1G-34	1-Gang Adjustable ring for 4S Deep Boxes	3/4" to 1-1/2"	25
4AR2G-58	2-Gang Adjustable Ring for 4S Deep Boxes	5/8" to 1-1/4"	25
4ARR-34	Round Adjustable Ring for 4S Deep Boxes	3/4" to 1-1/2"	25
3GAR-34	3-Gang Adjustable ring	3/4" to 1-1/2"	25



4AR1G-58



4AR1G-34



4AR2G-58

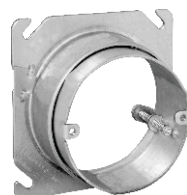

4ARR-34



3GAR-34

SNAP-IN FITTINGS

DOUBLE-SNAP & FASTLOCK CONNECTORS

ZINC DIE CAST DOUBLE-SNAP CABLE CONNECTOR

PRODUCT FEATURES

- Zinc Die Cast
- 105°C rated throat insulator
- Fast and Tool-free installation
- Removable and Reusable
- For FMC, AC, MCI, MCI-A, HCF, RWFMC
- Dry location

Cat. No.	Description	Trade Size	Std. Pkg.	Master Ctn.
DSC-38 NEW!	DOUBLE-SNAP CABLE CONNECTOR WITH INSULATOR Steel/AL AC: 14/2 (0.40") - 10/3 (0.618") Steel MCI: 0.395" - 0.638" AL MCI: 0.40" - 0.618" Steel/AL MCI-A: 14/2 (0.395") - 10/3 (0.638") Steel/AL HCF MCI-A: 14/2 (0.395") - 10/3 (0.638") AL RWFMC: 3/8"	3/8"	50	500
DSC-38C NEW!	CUT-IN DOUBLE-SNAP CABLE CONNECTOR WITH INSULATOR, FOR OLD WORK Steel/AL AC: 14/2 (0.40") - 10/3 (0.618") Steel/AL MCI: 14/2 (0.395") - 10/3 (0.638") Steel/AL MCI-A: 14/2 (0.395") - 10/3 (0.638") Steel/AL HCF MCI-A: 14/2 (0.395") - 10/3 (0.638") Steel/AL FMC: 3/8"	3/8"	50	500



DSC-38
NEW!



DSC-38C
NEW!

19

STEEL "FASTLOCK" CONNECTOR

PRODUCT FEATURES

- Steel
- Electroplated Zinc
- Saddle-Base Connector (FLC-50, FLC-50L, FLC-75L)
- Combo Head Set-Screw
- For AC, MCI, RWFMC, ALFMC

NOTE

- Insulated color may vary

Cat. No.	Description	Trade Size	Std. Pkg.	Master Ctn.
FLC-50	STEEL "FASTLOCK" CONNECTOR Steel AC 14/2 (0.440) to 10/3 AL AC 14/2 (0.475) to 10/3 Steel MC Interlocking (MCI) 0.437" to 0.565" O.D. AL MC Interlocking (MCI) 0.525" to 0.629" O.D. AL Corrugated Continuous (MCC) 0.350" to 0.592" O.D. Steel & AL Flex RWFMC: 3/8"	1/2"	50	500
FLC-50L	STEEL "FASTLOCK" WIDE-THROAT CONNECTOR Steel AC 10/4 (0.625) to 6/3 (0.842) AL AC 10/4 (0.625) to 8/4 (0.770) Steel MC Interlocking (MCI) 10/3 (0.594) to 6/2 (0.740) AL MC Interlocking (MCI) 10/3 (0.594) to 8/2 (0.650) Steel RWFMC, AL RWFMC, AL FMC: 1/2"	1/2"	50	500
FLC-75L	STEEL "FASTLOCK" WIDE-THROAT CONNECTOR Steel AC 10/4 (0.625) to 6/3 (0.840) AL AC 10/4 (0.622) to 8/4 (0.760) Steel MC Interlocking (MCI) 10/3 (0.594) to 6/2 (0.746) AL MC Interlocking (MCI) 10/3 (0.582) to 8/2 (0.650) Steel RWFMC, AL RWFMC & AL FMC: 1/2"	3/4"	25	250
FLD-50	STEEL "FASTLOCK" DUPLEX CONNECTOR Steel AC 14/2 (0.454) to 12/4 (0.556) Aluminum AC 14/2 (0.485) to 12/4 (0.565) Steel MC Interlocking (MCI) 14/2 (0.470) to 12/4 (0.520) Aluminum MC Interlocking (MCI) 14/2 (0.460) to 12/4 (0.590) Steel RWFMC, AL RWFMC, AL FMC: 3/8"	1/2"	25	250



FLC-50



FLC-50/75L



FLD-50

CONNECTORS & CONDUIT SUPPORTS

NM FITTINGS, CONDUIT LOCKING CONNECTOR & CABLE SUPPORT

ANTI-SHORT BUSHINGS THERMOPLASTIC

PRODUCT FEATURES

- High-Temperature Plastic
- Fits BX (AC) and Flex Conduits

Cat. No.	For Use With	Trade Size	Std. Pkg.	Master Ctn.
ASB-516	14/2, 14/3, 12/2	5/16"	35	3500
ASB-38	14/4, 12/3, 6/1, 4/1	3/8"	35	2100
ASB-716	12/4, 10/2, 10/3, 2/1	7/16"	35	700
ASB-50	10/4, 8/2, 8/3, 1/1	1/2"	20	400
ASB-75	8/4, 6/2, 4/2, 4/3, 6/4	3/4"	16	320

PVC NON-METALLIC (NM) CABLE CONNECTOR

PRODUCT FEATURES

- Heavy-Duty PVC

Cat. No.	For Use With	Trade Size	Std. Pkg.	Master Ctn.
NM-50	One or Two 14/2, 14/3, 12/2 One 12/3, 10/2, 10/3 One or Two 0.3000" or 0.600" cords	1/2"	50	500

NON-METALLIC CABLE CONNECTORS PUSH-IN TYPE

PRODUCT FEATURES

- Flame-Retardant Polypropylene
- Special gripping arrangement for easy cable insertion

Cat. No.	For Use With	Trade Size	Std. Pkg.	Master Ctn.
NMP-50	One 10, 12, 14 AWG two-conductor cables with or without ground wire	1/2"	100	500



ASB



NM-50

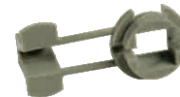

NMP-50



CONDUIT LOCKING CONNECTOR

PRODUCT FEATURES

- Steel
- Fits 4" (4S), 4-11/16" (5S) and 40 boxes as well as Orbit's patented EALB/S
- Hooks prevent rotation of fixtures such as security cameras and emergency lighting
- Holes allow for seismic wiring
- Includes set-screw and locknut
- Can replace Rigid Threaded Conduit Fittings

Cat. No.	Trade Size	Std. Pkg.	Master Ctn.
CLCSL-50	1/2"	10	100
CLCSL-75	3/4"	10	100



CLCSL



Locknut Included

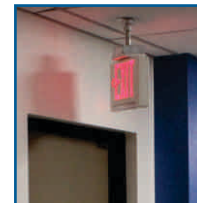

Before Installation

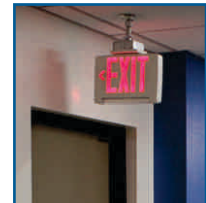

After Installation Prevents Rotation

STUD MOUNTING CABLE SUPPORT

PRODUCT FEATURES

- Pre-Galvanized Steel
- Wood or Metal Stud
- Easy to Lock

Cat. No.	Description	Non-Metallic	MC/AC/BX	Std. Pkg.
CS-CJ6	Stud Mounting Cable Support with locking tab	Max. 6	Max. 4	100

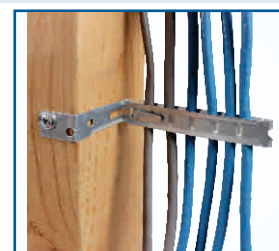
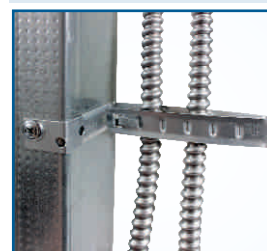

FEATURED PRODUCTS

STEEL PRODUCTS

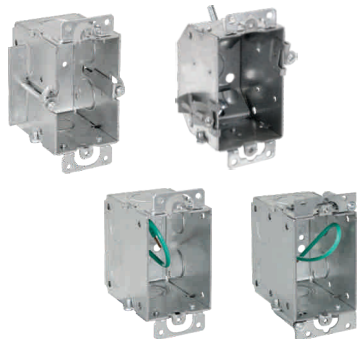

**GANGABLE
SWITCH BOXES**



HANDY BOXES

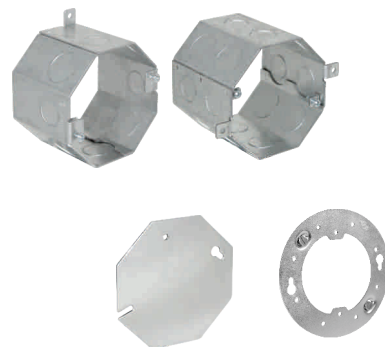

CONCRETE BOXES & RINGS

**LARGEST INVENTORY
IN THE INDUSTRY**



**MULTIGANG
BOXES & RINGS**



MASONRY BOXES



FIRE ALARM BOXES



**4" (4S) & 4-11/16" (5S)
Device Covers & Rings**



**30 & 40 PANCAKE
BOXES & RINGS**

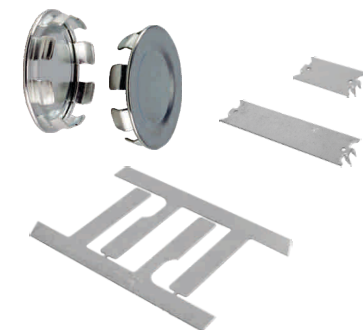

MISCELLANEOUS & MORE

FEATURED PRODUCTS

ELECTRICAL FITTINGS

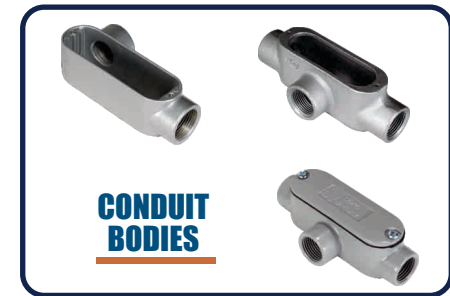
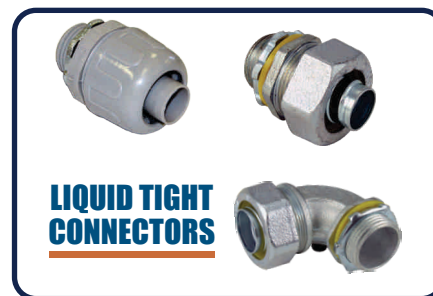
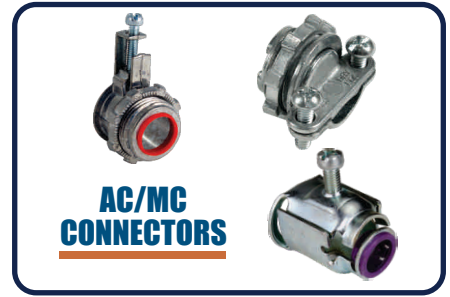

MATERIALS

**STEEL, DIE CAST ZINC,
MALLEABLE IRON, AND PVC.**



Steel



Die Cast Zinc



Malleable Iron



PVC

Orbit's fittings are available in a variety of sizes and high quality materials.

BOX SPECIFICATION

As a leading manufacturer of steel products, Orbit offers one of the largest selections of steel boxes and rings in the industry. Our state-of-the-art manufacturing facilities and industry trained engineers ensure the production and development of quality steel products. With the contractor in mind, Orbit's boxes are cleaned, deburred, and offered with a variety of brackets and knockouts.

With innovation as our main priority, Orbit's products are designed to increase productivity and efficiency on the job. All of Orbit's products are in stock and ready to ship at your convenience. As your solutions-based manufacturer, Orbit is dedicated to keeping you competitive in this rapidly changing market.

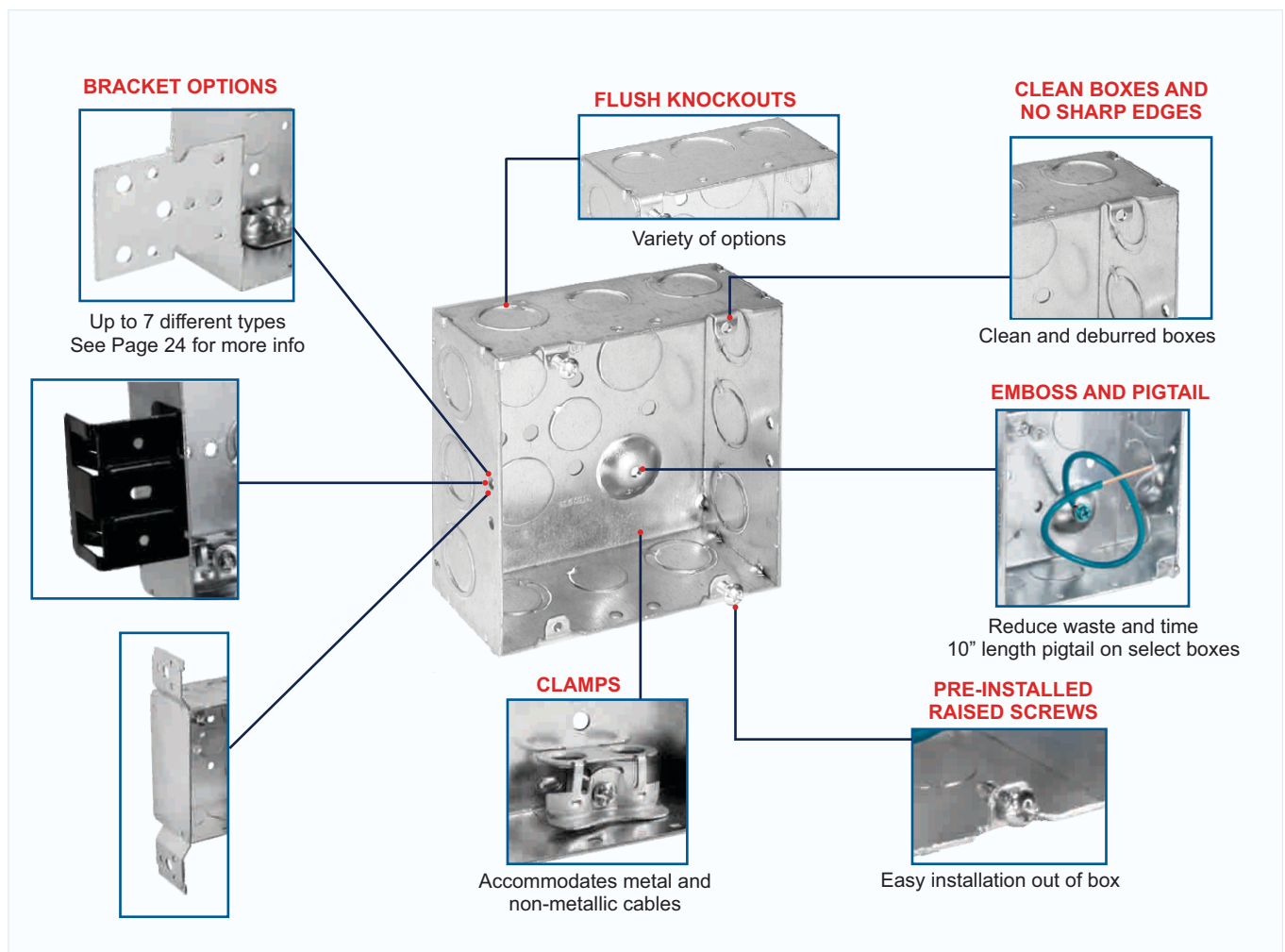
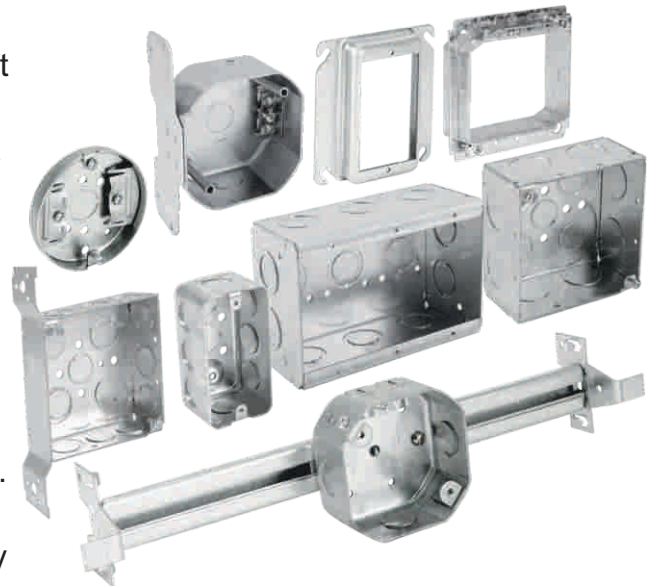

BOX SPECIFICATION

BRACKET SPECIFICATION

Bracket Type	AB	B (for S)	FB (for S)	FB (for FSB)	FB (for B)	FB (for H)	LB	MS	OB	WB
Length	5 - 7/8"	3"	7 - 3/8"	5 - 1/2"	7 - 1/4"	7"	2 - 3/8"	2 - 1/2"	6 - 3/4"	7 - 1/2"
Width	7/8"	2"	1 - 9/16"	2 - 1/8"	3/4"	1"	2 - 23/32"	1 - 3/8"	1 - 3/16"	1 - 9/16"
Offset	0" (Flush)	0" (Flush)	0" (Flush)	9/16"	1/2"	9/16"	1/4"	0" (Flush)	1 - 5/16"	0" (Flush)

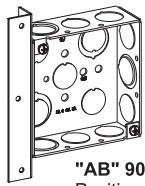

"AB" 90° BRACKET
Positions box against face and side of stud.

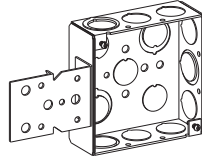

"B" BRACKET for Square Box
Face mounts on front edge of wood stud.

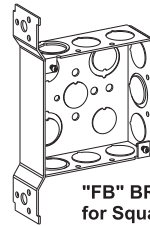

"FB" BRACKET for Square Box
Mounts on flat side of stud.

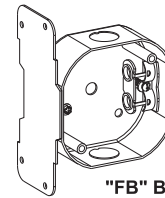

"FB" BRACKET for FSB
Flush-Mounts on flat side of stud or joist.

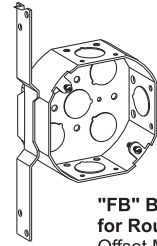

"FB" BRACKET for Round Box
Offset Mounts on flat side of stud or joist.

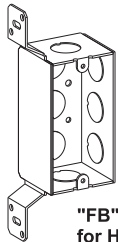

"FB" BRACKET for Handy Box
Mounts on flat side of stud.

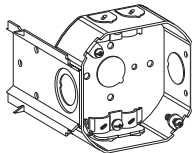

"LB" BRACKET
With spurs, slotted holes for toe-nailing.

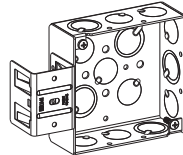

"MS" BRACKET
Self-Gripping Metal Stud Bracket with Box Support Clip.
***Model Revised Feb. 2008**

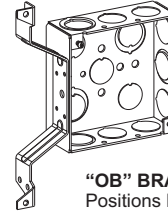

"OB" BRACKET
Positions box away from side of stud for door frame trim clearance.

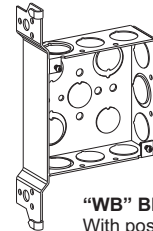

"WB" BRACKET
With positioning spurs to mount box on side of stud.

CLAMP SPECIFICATION

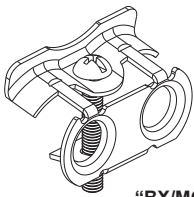

"BX/MC" Clamp
Accommodates Metal Clad Cables from size #14-2 to #10-4
****All MC series boxes are suitable for use with MCAP™-Aluminum, MCAP is a trademark of Southwire Company**

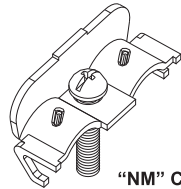

"NM" CLAMP
Accommodates #14-2 to #10-3 Non-Metallic Cables with ground.

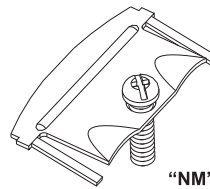

"NM" CLAMP for Pancake Box
Accommodates #14-2 Non-Metallic Sheathed Cables with ground.

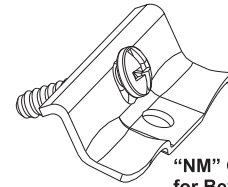

"NM" CLAMP for Beveled Switch Box
Accommodates #14-2 to #10-3 Non-Metallic Sheathed Cables with ground. 45° & 90° Screw Mounting.

KNOCKOUT & PRYOUT SPECIFICATION

1/2" K.O.

3/4" K.O.

1" K.O.

1-1/4" K.O.

MOON K.O. (MKO)

CONCENTRIC K.O. (CKO)

LOOM PRYOUTS

CIRCULAR PRYOUTS

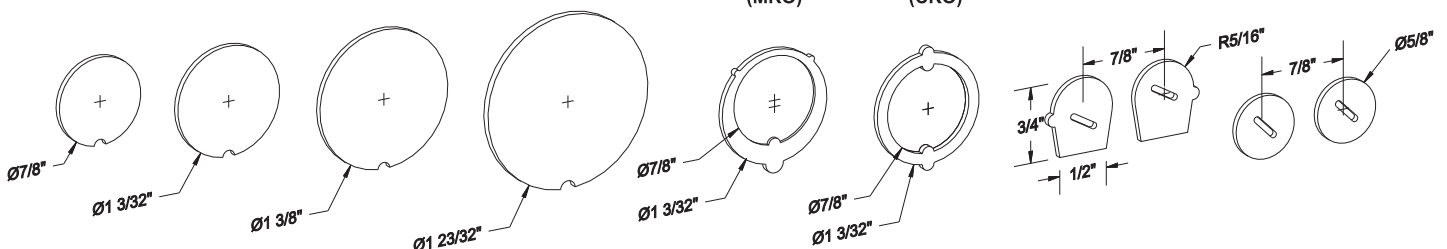

PRODUCT INDEX

Cat. No.	Page	Cat. No.	Page	Cat. No.	Page	Cat. No.	Page
1GX75	17	5SDP-100	15	CS-CJ6	20	US5SB	1
2GX75	17	5SDP-200	15	D4SB-50/75-PT	14	USB	1
3GAR-34	18	5SLB-2MKO	15	D4SB-75-PT	14	USB-4SDB-50/75-PT	1
4AR1G-34	18	5SLB-MKO	15	D5SDB-CKO-S	11	USB-5SDB-50/75-PT	1
4AR1G-58	18	5SLP-100	15	DHB3-PT	14	USBS	1
4AR2G-58	18	5SLP-200	15	DSC-38	19	USDBM	1
4ARR-34	18	ABS	9	DSC-38C	19	USTBM	1
4SAR1G	17	ABS-6	9	EALB	11	USTS	1
4SAR2G	17	ASB-38	20	EALBS	11	WBAR1G	18
4SB-50/75-PT	14	ASB-50	20	FA-UMAB	3, 7	WBAR2G	18
4SB-MC-B	14	ASB-516	20	FLC-50	19		
4SB-MC-FB-PT	14	ASB-716	20	FLC-50L	19		
4SB-MC-MS-PT	14	ASB-75	20	FLC-75L	19		
4SB-MC-PT	14	BCHS-10	8	FLD-50	19		
4SB-MC-WB	14	BCHS-12	8	FMB-16	6		
4SDB-50/75-AB-PT-BSA	12	BCHS-6	8	FMB-24	6		
4SDB-50/75-PT-BSA	12	BCHS-6S	8	FS-NBH	9		
4SDB-MC	13	BH-1	10	FS-OBH	9		
4SDB-MC-B	13	BH-1C	10	LVS1	1, 3		
4SDB-MC-FB-PT	13	BH-1S	10	LVS2	1, 3		
4SDB-MC-MS-PT	13	BH-1SC	10	MBBH-16	6		
4SDB-MC-WB	13	BH-2	10	NM-50	20		
4SDB-MKO-AB-PT-BSA	12	BH-2NC	10	NMP-50	20		
4SDB-MKO-AR1G	12	BH-3	10	SSB	3		
4SDB-MKO-AR2G	12	BH-C	10	SSB-4S	3		
4SDB-MKO-PT	14	BHA-1	9	SSB-5S	3		
4SDB-MKO-PT-BSA	12	BHA-16	5	SSB-5S-MKO	3		
5SAR1G	17	BHA-1C	9	TGD-1	16		
5SAR2G	17	BHA-24	5	TGMW	16		
5SDB-50/75-AB-PT-BSA	12	BHT-1	10	TGW	16		
5SDB-50/75-PT-BSA	12	BHT-1A	10	TSB	5		
5SDB-MC	13	BHT-C	10	UMA	3		
5SDB-MC-FB	13	BMA-23	7	UMAB	3, 7		
5SDB-MC-MS	13	BMA-4	7	UPC	17		
5SDB-MC2-MS	13	CLCSL-50	20	UPCTS	17		
5SDB-MKO-PT	14	CLCSL-75	20	US4SB	1		

Orbit Product Lines

Your Universal Source for Electrical Products



STEEL PRODUCTS



NEMA ENCLOSURES



WEATHERPROOF PRODUCTS



ELECTRICAL FITTINGS



WIRING DEVICES



EXIT & EMERGENCY LIGHTING



LANDSCAPE LIGHTING



H.I.D LIGHTING



LED LIGHTING



VENTILATION FANS



CABLES & WIRES

*“ Your solutions-based
electrical manufacturer ”*

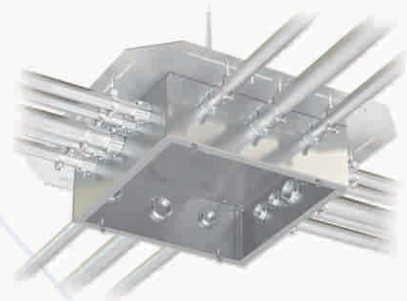
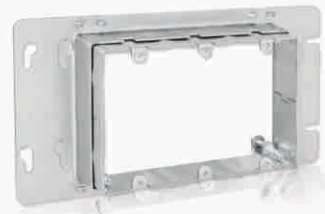

orbit[®]
Orbit Industries, Inc.

2100 S. Figueroa St.,
Los Angeles, CA 90007
Tel: 1.800.90.ORBIT (67248)
Fax: 213.745.2015

www.orbitelectric.com

Copyright© 2016, Orbit Industries, Inc. All rights reserved.