

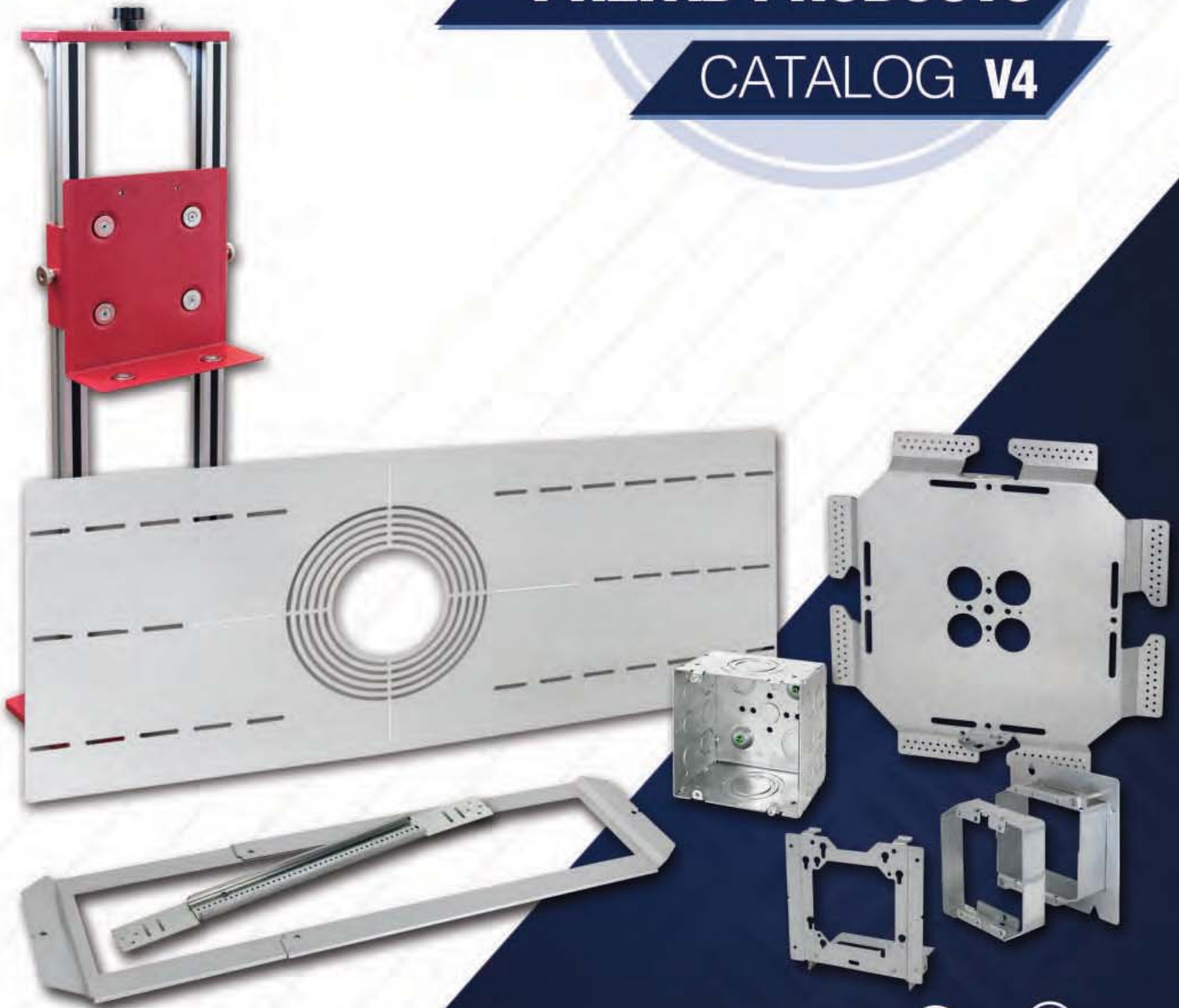

**EXCLUSIVE &**

**PREFAB PRODUCTS**

**CATALOG V4**



[www.orbitelectric.com](http://www.orbitelectric.com)

# ABOUT ORBIT PREFAB

## Innovative Labor Saving Solutions

---

As an electrical manufacturer founded by contractors, Orbit Industries has always known the importance of efficiency on the job. Since our inception in 1997, Orbit has consistently developed innovative electrical products, establishing itself as one of the leading manufacturers in the electrical industry.

Today, Orbit's Prefab line continues to deliver engineered solutions for optimizing job site productivity and flexibility during installations. Our products are designed with contractors in mind to provide the following features:

- *Efficient installations for reduced labor*
- *Increase safety and bring the construction environment to the comfort of a controlled environment*
- *Allow contractors to bid and complete jobs more effectively*
- *Reduction of on-site mistakes and waste*

## The Orbit Advantage

---

With a team of industry experienced sales representatives and talented engineers, Orbit provides innovative, quality products with convenience not found anywhere else.

The Orbit Advantage includes:

- *State-of-the-art automated manufacturing facilities that consistently produce quality products*
- *Industry experienced sales and engineering teams*
- *98.7% fill rate with over 6,000 products in more than 11 different product lines, ready to ship*
- *Compliance with safety standards and electrical codes*

## Quick Response Manufacturing (QRM)

---

As a privately owned manufacturer, Orbit has the capabilities to produce products specifically upon request. Our 90-day Quick Response Manufacturing (QRM) policy can take your innovative ideas and bring them into market in just 90 days. Some examples of products developed through QRM are the **Recessed Light Adapter Plates (pg 13)**, **Box & Conduit Hanger Support Plates (pg 14)**, **Easy Access Lighting Boxes (pg 16)** and more.

# FEATURED PRODUCTS

*Patent Pending*



Snap multiple boxes onto this adjustable bracket for a fast install

**Simple Support Bracket**

SSB

pg. 1~2

*Patent Pending*

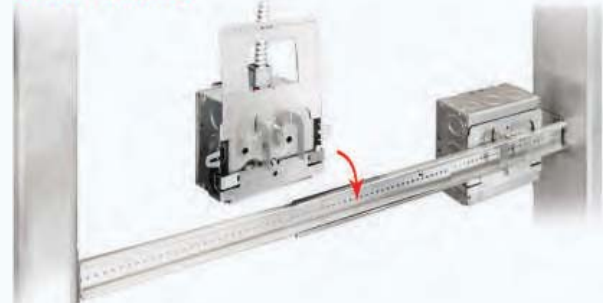

Quickly drop boxes onto Adjustable Bar Hangers

**Drop-On-Bar Slider Brackets**

BARB/BARB-CS

pg. 4

*Patent Pending*



The **BEST WAY** to mount extra deep 4" square boxes

**Universal Mounting Adjustable Box**

UMAB/FA-UMAB

pg. 10

*Patent Pending*



Tool to mount multiple brackets at a consistent height

**Height Adj. Box Install Tool**

THE HABIT

pg. 11

*Patented*



Mount recessed lighting housings up to 4x **FASTER**

**Recessed Light Adapter Plates**

RAP/RAP-T

pg. 13



*Patented*



Hang boxes and conduits with **ONLY ONE** plate and rod!

**Box and Conduit Hanger Support Plates**

BCHS Series

pg. 14





# TABLE OF CONTENTS

## 1 SUPPORT SYSTEMS



01-02

### Adjustable Stud Wall Brackets

Simple Support Bracket & Universal Mounting Adapter



03

### Adjustable Stud Wall Brackets

Telescoping Support Bracket & Adjustable Bar Hangers

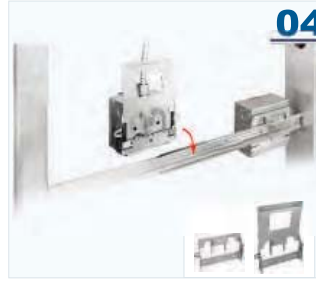

04

### Adjustable Stud Wall Brackets

The Drop-On-Bar Slider Brackets



05-06

### All-In-One Stud Brackets

Ultimate Support Bracket & Accessories



07-08

### Fixed Stud Wall Brackets

Flat Bracket Family

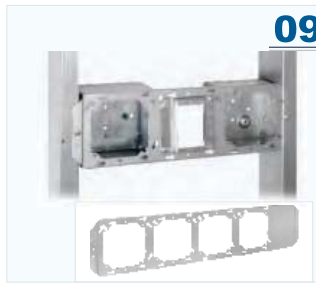

09

### Fixed Stud Wall Brackets

Fixed Position Box & Multiple-Box Bracket



10

### Mounting Boxes & Adapters

Universal Mounting Adjustable Box & Box Mounting Adapter



11

### Stud Measurement Tool

Height Adjustable Box Installation Template



12

### Roof Support Plates

Roof Coupling Plates



13

### Recessed Support Plate

Recessed Light Adapter Plates

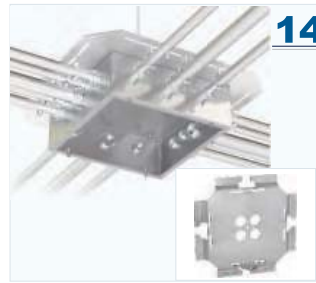

14

### Ceiling Mounting Plates

Box & Conduit Hanger Support Plates



15

### Bar Hangers & Surface Mounting Box

Fixed Bar Hangers & 4SDB-BP



16

### Easy Hang Boxes

Easy Access Lighting Boxes & EZ-Hang Box

**LOOKING TO INSTALL RIGHT OUT OF THE BOX?**

Ask us about our preassembly services!

Tel: 1.800.906.7248



# TABLE OF CONTENTS

## 2 BOXES & RINGS



17-18

### Adjustable Rings

Adjustable Plaster Rings, Extensions & Accessories



19-20

### Metal Clad Boxes

Boxes with Metal Clad Cable Clamps



20

### Pigtail Boxes

Boxes with Pigtails



21

### Adjustable Back Support Boxes

Boxes with Adjustable Back Support Arms



22

### Large Capacity Boxes

Data Boxes & Partitions



23-24

### Large Capacity Boxes

True 5" Square Boxes & Data Boxes



25

### Wide Old-Work Switch Boxes

Deep/Wide Tiger Grip Boxes

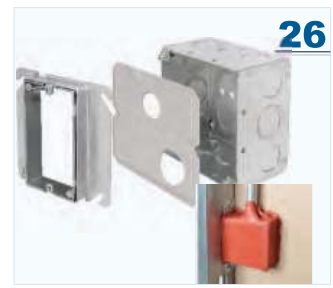

26

### Firestop Inserts & Putty Products

Firestop Pads for Electrical Boxes, Firestop Putty Pads & Sticks

## 3 ACCESSORIES



27

### Snap-In Fittings

Double-Snap & Fastlock Connectors



28

### Connectors & Conduit Supports

NM Fittings, Conduit Locking Connectors & Cable Support

## 4 FEATURED PRODUCTS

ELECTRICAL BOXES & ACCESSORIES 29

ELECTRICAL FITTINGS 30

BOX SPECIFICATION 31-32

PRODUCT INDEX 33

# STUD WALL BRACKETS

## SIMPLE SUPPORT BRACKET SERIES

### SIMPLE SUPPORT BRACKETS AND ACCESSORIES

#### PRODUCT FEATURES

- Telescoping bracket adjusts from 15" to 25"
- SSB assemblies ready to install out of the box with choice of box size and 10" Pigtail, saving time and reducing injuries
- SSB-TBAR includes two riveted clips for T-bar drop ceiling installation
- UMA or UMA-LVBS can either mount-to-stud directly or clip onto bracket
- Rigidity eliminates need for far-side back support
- Markings on bracket allow for quick and consistent adjustability
- SSB compatible with all Adjustable Rings (See Pg. 17-18)

#### NOTE

SSB must be accompanied with either UMA, UMA-LVBS, WBAR1G or WBAR2G mounting brackets to attach a steel box

Cat. No.	Description	Std. Pkg.
<b>SSB</b>	Simple Support Bracket adjusts from 15" to 25" for mounting boxes horizontally between stud	25
<b>SSB-TBAR</b> <small>NEW!</small>	SSB with T-bar Drop Ceiling Mounting Clips	20
<b>UMA</b>	Universal Mounting Adapter for 4" and 4-11/16" Boxes to mount to SSB, USB, and directly to stud	25
<b>UMA-LVBS</b> <small>NEW!</small>	Universal Mounting Adapter w/ Back Support, Stud Mounts 4", 4-11/16" & 5" Boxes. ONLY 4" and 4-11/16" snap onto the SSB, USB brackets	25
<b>SSB-4S-MKO</b>	Preassembled SSB with UMA and 4" Sq. 2-1/8" Deep Box with MKO and 10" Ground Pigtail	12
<b>SSB-5S-MKO</b>	Preassembled SSB with UMA and 4-11/16" Sq. 2-1/8" Deep Box with MKO and 10" Ground Pigtail	12
<b>LVSB1</b>	Low Voltage Stud Mounting Bracket 1-Gang, 1/2" raise	50
<b>LVSB2</b>	Low Voltage Stud Mounting Bracket 2-Gang, 1/2" raise	25
<b>UMAB</b>	4" Square Box 3-1/2" Deep Adjustable Up to 1-1/2". Adapter Included	10
<b>FA-UMAB</b>	Fire Alarm 4" Square Box 3-1/2" Deep Adjustable Up to 1-1/2". Adapter Included	10

\*SSB-4S replaced by SSB-4S-MKO



SSB



SSB-TBAR NEW!

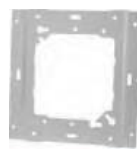

UMA



UMA-LVBS NEW!



SSB-4S-MKO  
SSB-5S-MKO



LVSB1



LVSB2



UMAB



FA-UMAB



Video Available  
On Our Website!

### FEATURES

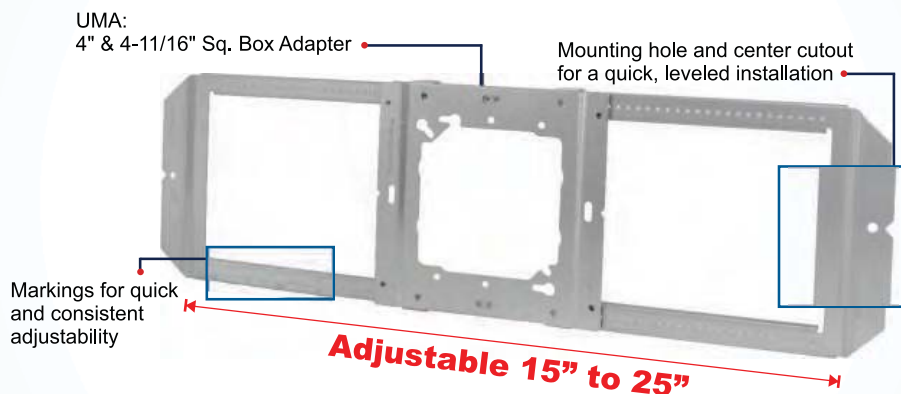

**SNAP-IN**

UMA-LVBS easily clips onto SSB



Secure SSB-TBAR to grid using a Tek Screw to comply with NEC 315.23 (d)



# STUD WALL BRACKETS

## SIMPLE SUPPORT BRACKET SERIES

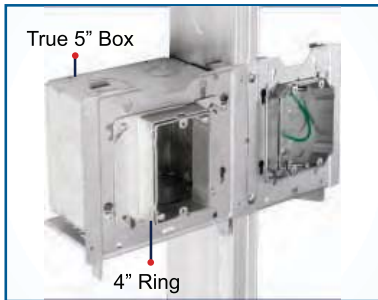

UMA-LVBS mounted directly-to-stud



4" or 4-11/16" Box on UMA-LVBS and Low Voltage Ring

*Almost any combination of box and ring can be installed!*



4" or 4-11/16" Box and Low Voltage Ring



Fit up to Three 4" and/or 4-11/16" Boxes and Rings



UMAB Installed for Ceiling Applications

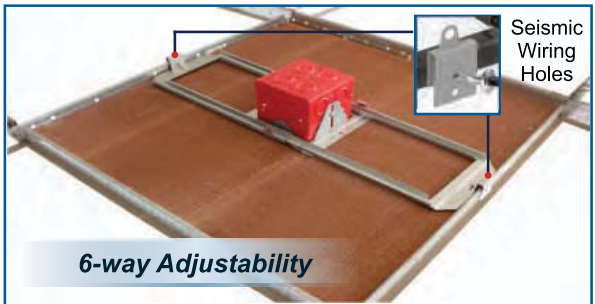

SSB-TBAR with UMAB Installed in Drop Ceiling Grid



Up to 10-Gang Multi-Gang Box Between 24" Studs



4" or 4-11/16" Box/Ring and Multi-Gang Box/Ring

**Endless Variations!**

[www.orbitelectric.com](http://www.orbitelectric.com)





# STUD WALL BRACKETS

## TELESCOPING SUPPORT BRACKET & ADJUSTABLE BAR HANGERS

### TELESCOPING SUPPORT BRACKET

#### PRODUCT FEATURES

- Telescoping bracket adjusts from 16" to 27"
- Accepts 4", 4-11/16" square, and up to 10-Gang boxes and rings
- Easily adjust position of boxes in field
- Packaged preassembled and ready to use.
- Markings on bracket allow for quick and consistent adjustability
- Rigidity eliminates need for far-side back support

**SHIPS  
PREASSEMBLED**

**Video Available  
On Our Website!**

Cat. No.	Description	Std. Pkg.
TSB	Telescoping Support Bracket adjusts from 16" to 27" for mounting 4", 4-11/16" square and up to 10-gang boxes between studs.	25

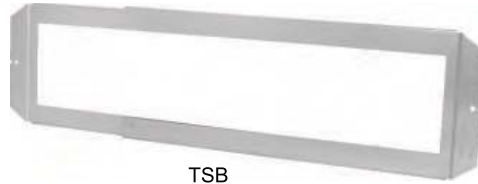

TSB



*Extra bend ensures a sturdy design*

#### FEATURES

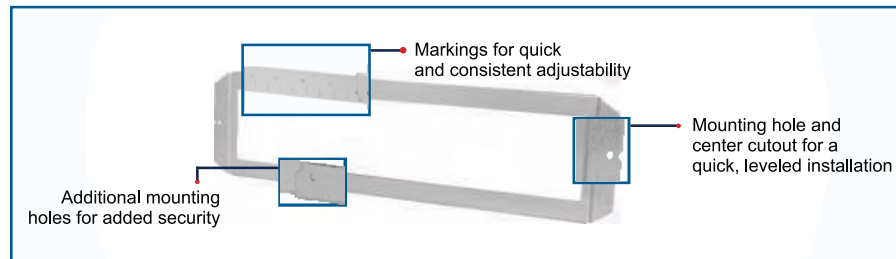

03

### INSTALLATION



Fits 4", 4-11/16" square, and up to 10-Gang boxes

### ADJUSTABLE BAR HANGER

#### PRODUCT FEATURES

- Ends bend and wrap around stud
- Can be used with boxes 1-1/2", 2-1/8" or 2-1/2" deep

**SHIPS  
PREASSEMBLED**

Cat. No.	Description	Std. Pkg.
BHA-16	11" to 18" Adjustable Box Bracket - Mount box with self-tapping screws Ends bend and wrap around stud - Can be used with boxes 1-1/2", 2-1/8" or 2-1/2" deep	50
BHA-24	15-3/4" to 26" Adjustable Box Bracket - Mount box with self-tapping screws Ends bend and wrap around stud - Can be used with boxes 1-1/2", 2-1/8" or 2-1/2" deep	50



BHA-16



BHA-24

**NEW DESIGN**

Adjust from 15-3/4" to 26"

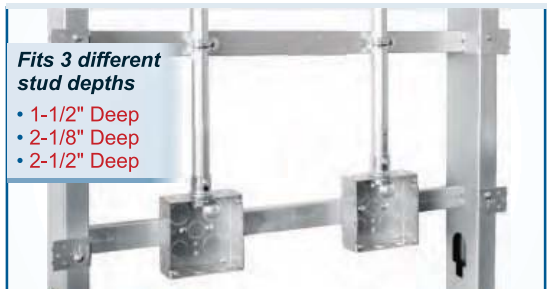

#### BOX AND CONDUIT SUPPORT BETWEEN STUDS USING BHA

BHA-16 adjusts from 11" up to 18"  
BHA-24 adjusts from 15-3/4" up to 26"

# STUD WALL BRACKETS

## DROP-ON-BAR SLIDER BRACKETS

### DROP-ON-BAR SLIDER BRACKETS

#### PRODUCT FEATURES

- Quickly attach to any 4" or 4-11/16" square box
- Easily drops onto Orbit's BHA-16 and BHA-24
- A BARB and box assembly can easily be repositioned along the hanger
- Multiple BARB assemblies can be added before and after the BHA is installed
- Can be fully prefabricated and locked onto the BHA without setting final box position
- BARB-CS comes complete with conduit & cable support pin holes

Cat. No.	Description	Std. Pkg.
BARB <b>NEW!</b>	Drop-On-Bar Slider Bracket	50
BARB-CS <b>NEW!</b>	Drop-On-Bar Slider Bracket with conduit & cable support pin holes	50



BARB  
**NEW!**



BARB-CS  
**NEW!**

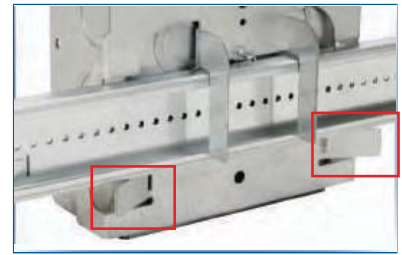

A BARB and box assembly can be locked onto a BHA before arriving on the job site for quick adjustment in the field.



#### PREASSEMBLED

#### -OR-

#### IN-FIELD



Attach to a 4" or 4-11/16" box with a single tek screw, forming a versatile box assembly



Box assemblies can be prefabricated onto a BHA before arriving to the job site, locking onto the hanger via its bendable tabs



For in-field installations, simply drop the box assembly onto a BHA before or after the hanger has been installed

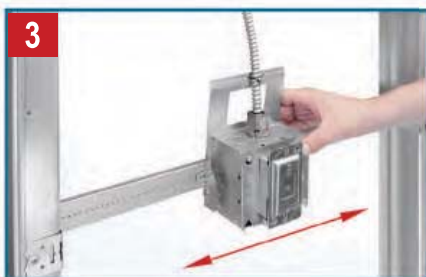

Once the BHA is installed on studs, the box assembly can be adjusted along the hanger



Secure the assembly to the BHA with tek screws, setting the box in place



Multiple box assemblies can be easily added!  
Up to 3 between 16" & 4 between 24" studs

# ALL-IN-ONE STUD BRACKETS

## ULTIMATE SUPPORT BRACKET & ACCESSORIES

### ULTIMATE SUPPORT BRACKETS AND ACCESSORIES

#### PRODUCT FEATURES

- Can be floor or wall mounted on wooden or metal studs
- Infinite height and width combinations
- Provides flexibility at job site
- Works great with Orbit's Adjustable Rings
- Markings on bracket allow for quick and consistent adjustability.

#### NOTE

USB must be accompanied with either US4SB, UMA, WBAR1G or WBAR2G mounting brackets to attach a steel box

Cat. No.	Description	Std. Pkg.
<b>USB</b>	Ultimate Support Bracket, Adj. 8"-24" as a floor brkt or 14"-24" as a wall brkt between studs	12
<b>US4SB</b>	Mounting Bracket for 4" Square Box, snaps to USB	24
<b>UMA</b>	Universal Mounting Adapter for 4" and 4-11/16" Boxes to mount to USB, and directly to stud	25
<b>USBS</b>	Far-Side Back Support for 4" Square and 4-11/16" Square Boxes	50
<b>USDBM</b>	For use with USB to create a double box in floor mount assembly with built-in back support	50
<b>USTBM</b>	For use with USB to create a triple box in floor mount assembly with built-in back support	50
<b>USTS</b>	USB floor mount stud-to-stud top support	50
<b>USB-4SDB-50/75-PT</b>	Complete Pre-Assembled Floor Bracket with a 4" Square 2-1/8" Deep Box, Includes installed Far-Side Back Support and Ground Pigtail	12
<b>USB-5SDB-50/75-PT</b>	Complete Pre-Assembled Floor Bracket with a 4-11/16" Square 2-1/8" Deep Box, Includes installed Far-Side Back Support and Ground Pigtail	12
<b>LVSB1</b>	Low Voltage Stud Mounting Bracket 1-Gang	50
<b>LVSB2</b>	Low Voltage Stud Mounting Bracket 2-Gang	25

05



USB



US4SB



UMA



USBS



LVSB1



LVSB2



USDBM



USTBM



USTS



Adjustable  
8" to 24"

USB-4SDB-50/75-PT



Complete  
Prefabricated  
Assembly

USB-5SDB-50/75-PT





# ALL-IN-ONE STUD BRACKETS

## ULTIMATE SUPPORT BRACKET & ACCESSORIES

### INSTALLATION VIEWS

PATENTED REVOLUTIONARY SYSTEM



#### FLOOR BRACKET

Mount vertically at heights 8" to 24" and allows for the installation of the LVSB for low voltage applications



#### USB ASSEMBLY

USB accessories allow for vertical mounting between studs and 3 box applications using the USTBM

06

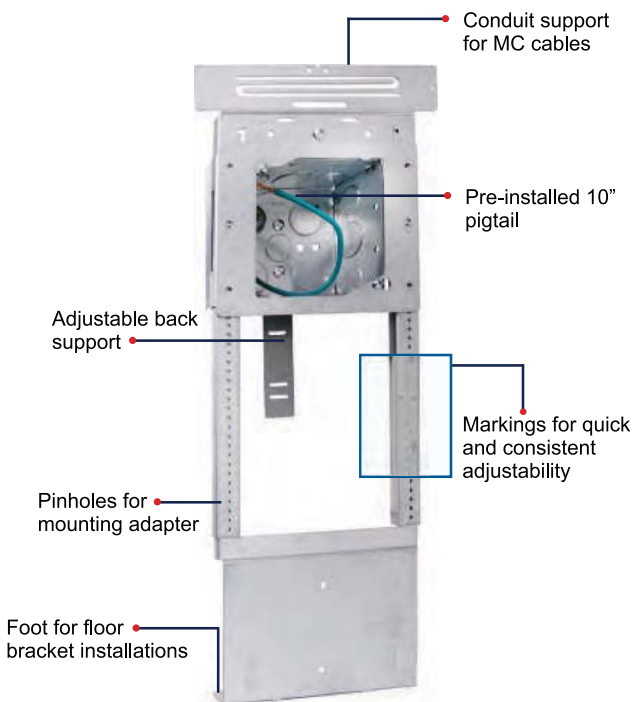

#### USB WITH ADJUSTABLE RINGS

Use WBAR Series or different adapters to mount boxes to USB  
See Page 18 for more information on WBAR Series

# FLAT BRACKET FAMILY

## HORIZONTAL AND KICK BRACKETS

### FLAT BRACKET FAMILY

#### PRODUCT FEATURES

- Compatible with 4", 4-11/16" and 5" square boxes
- Allows 5" boxes to use 4" rings, reducing material costs
- 4" rings can be mounted on their own for low voltage applications using 8/32 screws
- Low profile design accepts up to 2" fittings
- Additional width and slotted mounting holes allow for extra flexibility on studs

*Fits 5" Square Boxes!*



Cat. No.	Description	Std. Pkg.
<b>FB-3</b> <small>NEW!</small>	Flat Box Mounting Bracket 3-Box for 16" stud	25
<b>FB-4</b> <small>NEW!</small>	Flat Box Mounting Bracket 4-Box for 24" stud	25
<b>KB-18</b> <small>NEW!</small>	Kick Bracket 1-Box Position 18" height	10
<b>KFB-318</b> <small>NEW!</small>	Flat Bracket 3-Positions with 18" height kick stand for 16" stud	10
<b>KFB-418</b> <small>NEW!</small>	Flat Bracket 4-Positions with 18" height kick stand for 24" stud	10



**FB-3**  
NEW!

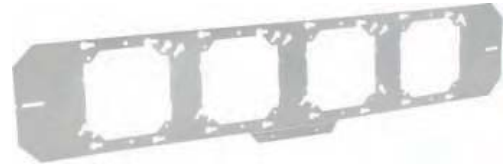

**FB-4**  
NEW!



**KB-18**  
NEW!



**KFB-318**  
NEW!



**KFB-418**  
NEW!

### INSTALLATION

**4" Ring Fits Any Size Box**

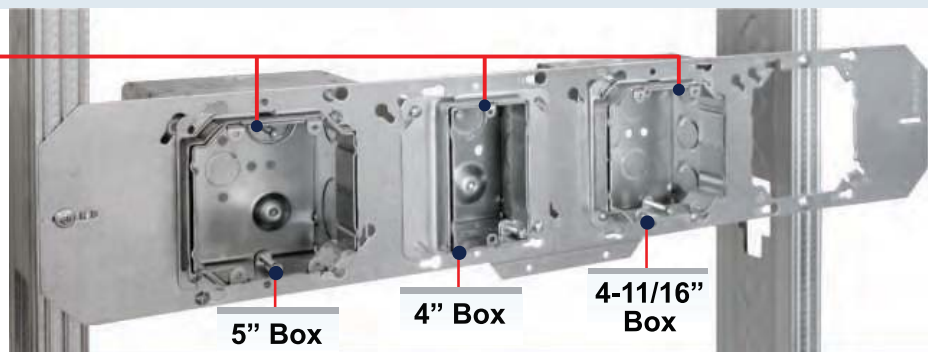

The Flat Bracket can be positioned to accommodate irregular stud spacings

# FLAT BRACKET FAMILY

HORIZONTAL AND KICK BRACKETS

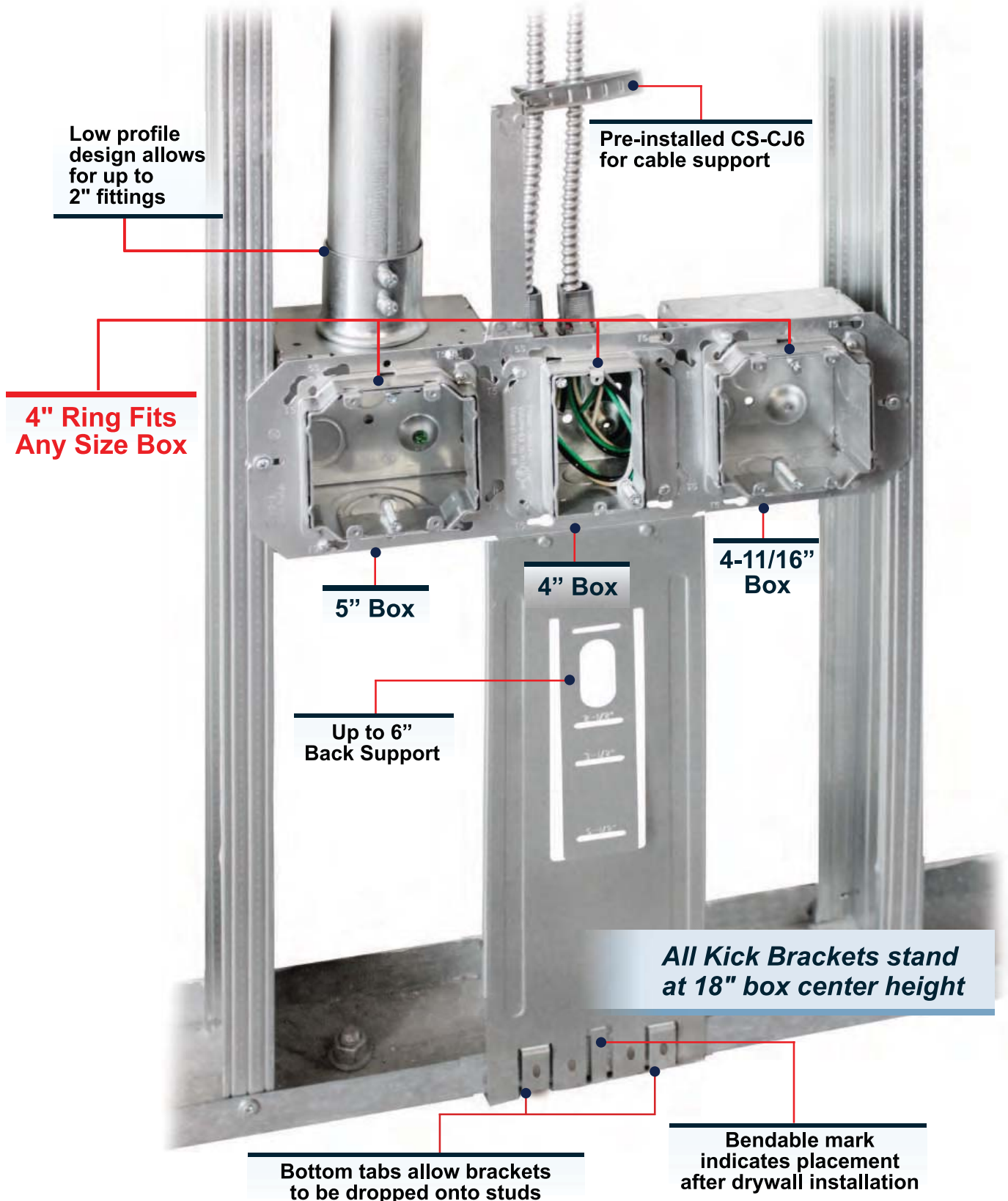



# FIXED STUD WALL BRACKETS

## FIXED POSITION BOX BRACKET & MULTIPLE BOX BAR HANGER

### FIXED POSITION BOX MOUNTING BRACKET

#### PRODUCT FEATURES

- Compatible with 4", 4-11/16" and 5" square boxes
- 4" rings can be mounted on their own for low voltage applications using 8/32 screws
- Low profile design limits drywall bulging

**Fits 5" Square Boxes!**

Cat. No.	Description	Std. Pkg.
FMB-16	Fixed Position Box Mounting Bracket for 16" Stud	25
FMB-24	Fixed Position Box Mounting Bracket for 24" Stud	25

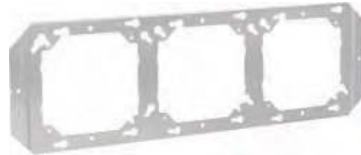

FMB-16

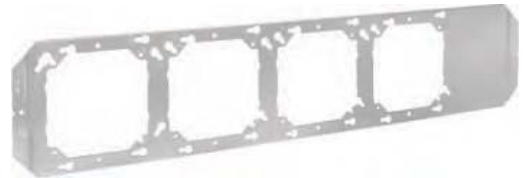

FMB-24

09

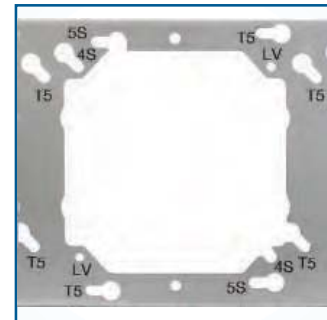
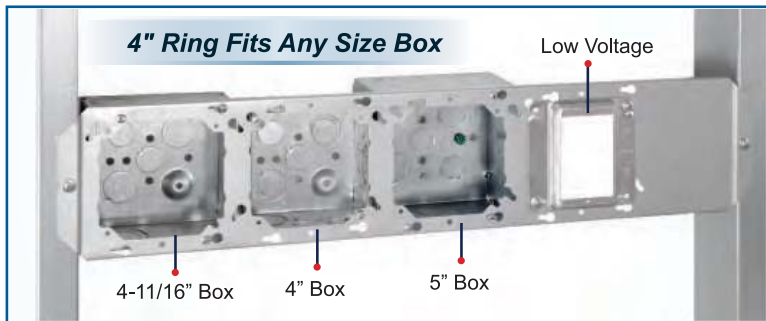

#### FMB INSTALLED ON STUDS

Mount up to 3 boxes between 16" studs with FMB-16 and 4 boxes between 24" with FMB-24

#### MOUNTING HOLES

Mounting Holes are marked to easily identify box and ring placement

### MULTIPLE-BOX BAR HANGER FLAT

#### PRODUCT FEATURES

- Pre-Galvanized 18 Gauge sheet metal
- Accommodates 4", 4-11/16" square, and multi-gang boxes
- Allows steel boxes to adjust easily horizontally along the bracket
- Reduces assembly time on job site

Cat. No.	Application	Dimensions (W x L)	Std. Pkg.
MBBH-16	For 16" stud spacing	6" x 16"	50
MBBH-24	For 24" stud spacing	6" x 24"	50



MBBH-16



MBBH-24



Shown installed with both 4" and 4-11/16" square boxes

# STUD WALL BOXES & ADAPTERS

UNIVERSAL MOUNTING ADJUSTABLE BOX & BOX MOUNTING ADAPTER

## UNIVERSAL MOUNTING ADJUSTABLE BOX

### PRODUCT FEATURES

- Adjustable from 0" to 1-1/2"
- Allows for direct-to-stud installations
- Compatible with the SSB and SSB-TBAR for between stud and overhead installations (pg 1)



**SHIPS PREASSEMBLED**

Cat. No.	Description	Std. Pkg.
UMAB	4" Square Box 3-1/2" Deep, Adjustable Up to 1-1/2". Adapter Included	10
FA-UMAB	Fire Alarm 4" Square Box 3-1/2" Deep, Adjustable Up to 1-1/2". Adapter Included	10



UMAB



FA-UMAB



### DIRECT-TO-STUD

Guided-slots on each side allow the box to be easily adjusted by simply loosening the screws.  
*Adjustable 0" to 1-1/2"*



6-way Adjustability



6-way Adjustability

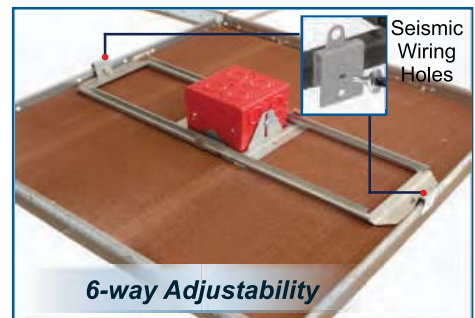

6-way Adjustability

### BETWEEN WALL STUDS

Use SSB to mount **FA-UMAB** anywhere in between wall stud cavities

### BETWEEN DRYWALL CEILING JOISTS

Use SSB to mount **FA-UMAB** between ceiling joists

### SUSPENDED/DROP CEILING GRID

Use SSB-TBAR to mount **FA-UMAB** in T-bar drop ceiling grids

## BOX MOUNTING ADAPTER

### PRODUCT FEATURES

- Mounts to 4" and 4-11/16" square boxes
- Adjustable Back Support helps maintain rigidity when installed
- Low profile design limits drywall bulging
- For use with metal or wood studs

Cat. No.	Description	Std. Pkg.
BMA-23	Box Mounting Adapter with 3-1/2" & 2-1/2" Far Side Support	25
BMA-4	Box Mounting Adapter with Far Side Support up to 4"	25



BMA-23



BMA-4



### DIRECT-TO-STUD

BMA allows for boxes to be mounted directly-to-stud

# THE HABIT

## HEIGHT ADJUSTABLE BOX INSTALLATION TEMPLATE

### HEIGHT ADJ. BOX INSTALL TOOL

#### PRODUCT FEATURES

- Features an adjustable and magnetic platform
- Platform can be preset at a specific height for a consistent box and bracket installation
- Compatible with all Orbit Stud Brackets

2017 NECA  
**Show Stopper**



ORBIT INDUSTRIES  
**EXCLUSIVE**



Video Available  
On Our Website!

Cat. No.	Description	Std. Pkg.	Mst. Ctn.
HABIT <b>NEW!</b>	Height Adjustable Box Installation Template	1	4



Front View  
**NEW!**

Back View  
**NEW!**

#### Pg.01



SSB

SSB-4S-MKO

SSB-5S-MKO

#### Pg.03



TSB

BHA

#### Pg.07



FB-3

FB-4

#### Pg.09



FMB

MBBH

Compatible with all of  
Orbit's Stud Brackets

11

### HABIT INSTALLATION

Tool-free stackability for  
switch and receptacles!

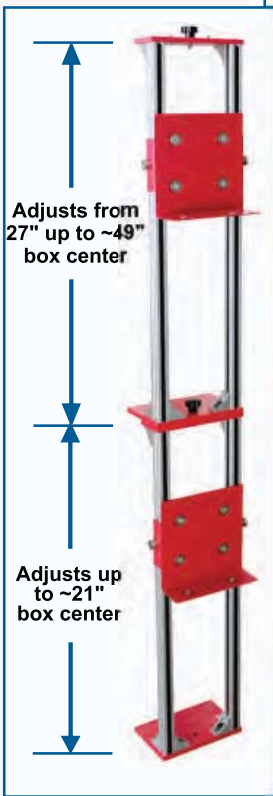

Bubble Leveler



Adjustable via  
hand nuts



Magnets hold  
box and bracket



# ROOF SUPPORT SYSTEMS

## ROOF COUPLING PLATES

### ROOF COUPLING PLATES

#### PRODUCT FEATURES

- Suitable in any type of new or old work roof construction
- Allows conduit to run below the roof line, eliminating the need to spend time derating
- Different conduit stubs can be prefabricated to plate
- Maintains roof integrity by reducing support penetrations
- Can be used for through floor conduit penetrations



Video Available  
On Our Website!

Cat. No.	Trade Size	Base Plate Size	Base Plate Thickness	Std. Pkg.
RCP-50 <b>NEW!</b>	1/2"	6" x 6"	0.064"	20
RCP-75 <b>NEW!</b>	3/4"	6" x 6"	0.064"	20
RCP-100 <b>NEW!</b>	1"	6" x 6"	0.064"	20
RCP-125 <b>NEW!</b>	1-1/4"	6" x 6"	0.064"	10
RCP-150 <b>NEW!</b>	1-1/2"	8" x 8"	0.074"	10
RCP-200 <b>NEW!</b>	2"	8" x 8"	0.074"	10



RCP-75  
**NEW!**



RCP-125  
**NEW!**

### RCP INSTALLATION



#### EASY TRANSITION

The RCP Series allows for an easy transition of different conduit types to suit your application

#### STEADY SUPPORT

Once fastened, conduit movement is eliminated up to 5' above and below the roof line



*Perfect for control, fire alarm, service receptacles and power to electrical equipment installation on roofs*

# RECESSED LIGHT ADAPTER PLATES

THE RAP AND RAP-T

## RECESSED LIGHT ADAPTER PLATES

### PRODUCT FEATURES

- Available for Hard Lid (RAP) and T-Bar (RAP-T) applications
- Multiple CKOs accommodate most 4" up to 8" round and up to 5-1/4" square downlights
- Can be easily preassembled for a quicker job site install
- A faster installation than bar hangers and recessed fixture brackets



Cat. No.	Description	Std. Pkg.
RAP <b>NEW!</b>	Recessed Lighting Fixture Adapter Plate for hard lid applications	10
RAP-T <b>NEW!</b>	Recessed Lighting Fixture Adapter Plate for T-Bar	10



RAP  
**NEW!**



RAP-T  
**NEW!**

**Installs up to 4x FASTER than traditional methods!**

13

### RAP INSTALLATION



*Offset to account for irregular stud spacing*

*Fits up to 26" stud spacing*

### RAP-T INSTALLATION

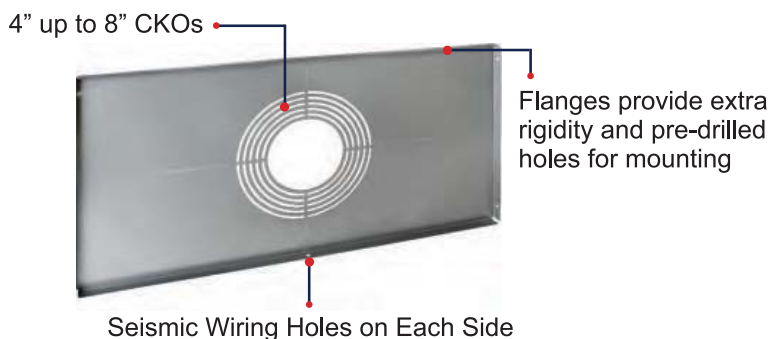

*Fits most 2' wide T-Bar grids*



RAP-T installed in T-Grid Ceiling

**Flip RAP-T for Oversized Downlights**

# CEILING MOUNTING PLATES

## BOX & CONDUIT HANGER SUPPORT PLATES

### BOX AND CONDUIT HANGER SUPPORT PLATES

#### PRODUCT FEATURES

- Pre-Galvanized 16 Gauge Steel
- No cutting required
- Pin holes and slots allow for use of conduit straps
- Self-reinforcing as more conduit is added
- Requires only one rod for installation
- Stamped markings provide guide lines
- Easy to preassemble to save time and material



Cat. No.	Description	Std. Pkg.
<b>BCHS-10</b>	Fits up to 6" x 6" Box for horizontal mounting	25
<b>BCHS-6</b>	Fits up to 6" x 6" Box for horizontal mounting and provides bent tabs for vertical mounting	10
<b>BCHS-6S</b>	Fits up to 6" x 6" Box for horizontal mounting, provides bent tabs for vertical mounting and offsets allow for use of one-hole straps	10
<b>BCHS-12</b>	Fits up to 12" x 12" Box or multiple small sized boxes for horizontal mounting and provides bent tabs for vertical mounting	5



*Use One Rod to Mount Multiple Boxes and Conduits*

### INSTALLATION

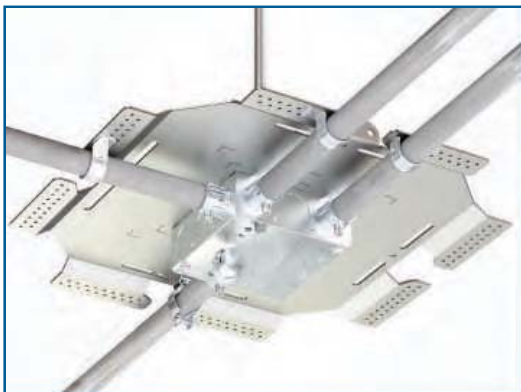

**BCHS-6S**

Allows for use of one-hole strap



**BCHS-12**

12" x 12" NEMA installed

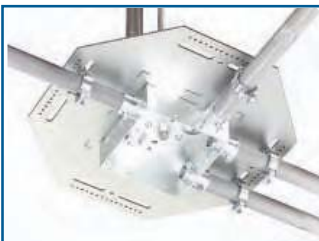

**BCHS-10**

Horizontally mount boxes up to 6" x 6"



**BCHS-6**

Horizontally or vertically mount boxes up to 6" x 6"



**BCHS-6S**

Horizontally or vertically mount boxes up to 6" x 6" and allows for the use of one-hole straps

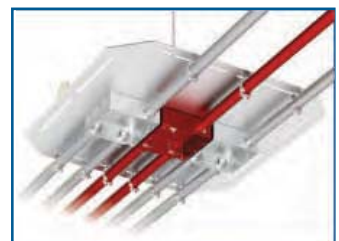

**BCHS-12**

Fits multiple boxes for multi-system installations

# BAR HANGERS & SURFACE MOUNTING BOX

## FIXED BAR HANGERS & 4SDB-BP

### FIXED BAR HANGERS

#### PRODUCT FEATURES

- Steel
- Electroplated Zinc
- For Stud and T-Bar

Cat. No.	Description	Std. Pkg.
BHT-1	24" T-Bar bracket for use with boxes 1-1/2" or 2-1/8" deep	50
BHT-1A	24" T-Bar bracket - 8" height adjustable	50
BH-3	Straight bracket for mounting architectural recess lights 25-1/4" long with notches 24" apart for use on T-Bar	50



### FEATURES & INSTALLATION

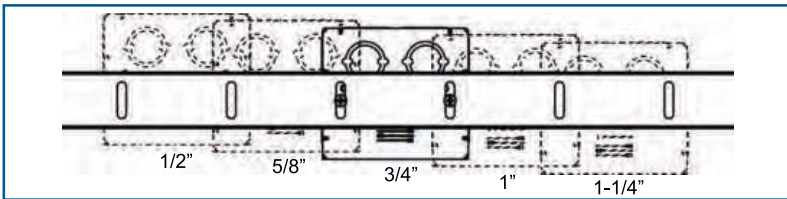

#### BH-3 FEATURES

Adjust vertically from 1/2" to 1-1/4" between 5 different positions



#### 6-WAY ADJUSTABLE T-BAR HANGER

The BH-3 is ideal for recessed lighting applications, fire alarm device installation, and LED retrofit lighting applications. Compatible with Orbit's 4SEDB-CKO and FA-4SEDB-CKO.

#### BH-3 FEATURES

Secure to T-Bar using bending tabs to comply with NEC 315.23(d)

### 4SDB-BP

#### 4" SQUARE DEEP BOX WELDED

2-1/8" DEEP

42.0 Cu. In.

WITH RAISED GROUND EMBOSS

#### PRODUCT FEATURES

- Can be mounted without having to access the inside of the box itself
- Flat back plate allows pre-wiring of box with device/cover before shipping to the field

Cat. No.	Description	Knockouts		Std. Pkg.
		Sides	Bottom	
4SDB-BP <b>NEW!</b>	4SDB-MKO-PT with Back Plate, 7" Pigtail	1/2" & 3/4" MKOs	-	24



4SDB-BP  
**NEW!**



Mount to ceilings, walls, corrugated surfaces, or underneath counters



# EASY HANG BOXES

## EASY ACCESS LIGHTING BOXES & EZ-HANG BOX

### EASY ACCESS LIGHTING BOXES

2-1/8" DEEP  
30.3 Cu. In.

#### PRODUCT FEATURES

- Fast and efficient installations
- Sliding cover plate for one person installations
- Available with either standard or swivel sliding cover plate
- Swivel reduces damage to hanging fixtures when struck
- Complies with NEC 314.27 (A)(D) for up to 90 lbs. of fixture load

Cat. No.	Description	Dimensions (W x H)	Knockouts		Std. Pkg.
			Sides	Bottom	
EALB	Easy Access Lighting Box	4" X 4"	4 - CKO	3 - 1/2", 1 - 3/4"	50
EALBS	Easy Access Lighting Box with Sliding Swivel	4" X 4"	4 - CKO	3 - 1/2", 1 - 3/4"	10



EALB



EALBS

*Only box UL-Listed for up to 90lbs of fixture load!*

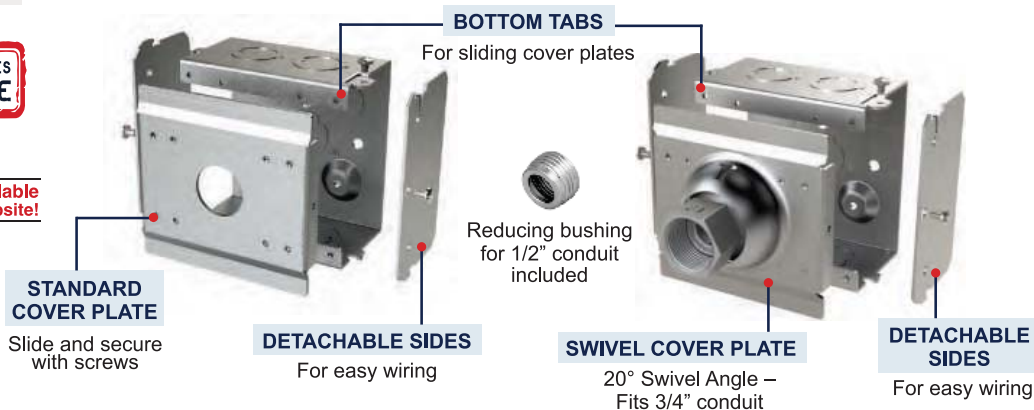

**50%  
LABOR  
SAVINGS**



#### TRADITIONAL METHOD

Requires two installers

#### WITH ORBIT'S EALB/S

Only one installer

### EZ-HANG BOX

4-11/16" SQUARE BOX  
DRAWN

2-1/8" DEEP

42.0 Cu. In.

WITH RAISED GROUND EMBOSS

#### PRODUCT FEATURES

- Back-center KO is replaced with a 0.27" diameter back-center hole
- Back-center hole allows for use of 1/4" rod for suspended applications
- No washer is needed, allowing for a fast and efficient installation

Cat. No.	Description	Knockouts		Std. Pkg.
		Sides	Bottom	
D5SDB-CKO-S	4-11/16" Sq. Drawn Special Box with CKO	2 - 1/2", 10 - CKO	3 - 3/4"	24



D5SDB-CKO-S



Secure box to ceiling with just a 1/4" rod and locknut

# ADJUSTABLE RINGS

## ADJUSTABLE PLASTER RINGS, EXTENSIONS, AND ACCESSORIES

### ADJUSTABLE RINGS

#### PRODUCT FEATURES

- For use with 4" and 4-11/16" square deep boxes
- 1/4" to 1-1/4" adjustability range
- Rings achieve a flush finish every time
- Compatible with exclusive extensions for infinite wall depths

#### U.S. PATENT NO.:

7,468,486



Video Available  
On Our Website!

Cat. No.	Description	Standard	With One Extension Installed		Std. Pkg.
			+1GX75	+2GX75	
4SAR1G	1-Gang Adjustable Ring for 4" Sq. Deep Boxes	1/4" to 1-1/4"	1" to 2"	-	25
4SAR2G	2-Gang Adjustable Ring for 4" Sq. Deep Boxes	1/4" to 1-1/4"	-	1" to 2"	25
5SAR1G	1-Gang Adjustable Ring for 4-11/16" Sq. Deep Boxes	1/4" to 1-1/4"	1" to 2"	-	25
5SAR2G	2-Gang Adjustable Ring for 4-11/16" Sq. Deep Boxes	1/4" to 1-1/4"	-	1" to 2"	25



4SAR1G



4SAR2G



5SAR1G



5SAR2G



#### ACCESSIBLE ADJUSTABILITY

Corner screws are easily accessible for adjustment before and after the device has been installed

### EXTENSIONS AND ACCESSORIES

#### PRODUCT FEATURES

- Extensions ensure flush finish regardless of wall thickness
- Attach to adjustable ring for additional 3/4" of depth
- Mount easily to ring with two 8-32 screws
- Multiple extensions can be installed on one ring

#### U.S. PATENT NO.:

7,468,486



Cat. No.	Description	For Use With	Std. Pkg.
1GX75	1-Gang 3/4" Extension	4SAR1G, 5SAR1G, or WBAR1G Only	50
2GX75	2-Gang 3/4" Extension	4SAR2G, 5SAR2G, or WBAR2G Only	50
UPC	Gangable, Steel Universal Protective Cover protects any device during drywall, painting, routing, mudding & plastering		25
UPCTS	Optional Plastic Insert for UPC to protect Toggle Switch		25



1GX75



2GX75



UPC



UPCTS



Complete UPC Assembly Shown  
Installed with Toggle Switch

# ADJUSTABLE RINGS

## STUD MOUNTING & UL-APPROVED ADJUSTABLE RINGS

### STUD MOUNTING ADJUSTABLE RINGS

#### PRODUCT FEATURES

- Accepts 4" or 4-11/16" square boxes in line voltage applications
- Mount to any stud, shear wall, 6" X 6" NEMA 1 enclosure, Simple Support Bracket (pg 1) or Ultimate Support Bracket (pg 5)
- Can be used standalone for low voltage communications applications

#### U.S. PATENT NO.:

7,468,486



Cat. No.	Description	Standard	With One Extension Installed		Std. Pkg.
			+1GX75	+2GX75	
WBAR1G	1-Gang Universal Box Bracket	1/4" to 1-1/4"	1" to 2"	-	25
WBAR2G	2-Gang Universal Box Bracket	1/4" to 1-1/4"	-	1" to 2"	25



WBAR1G



WBAR2G



WBAR on the 6" x 6" NEMA Enclosure

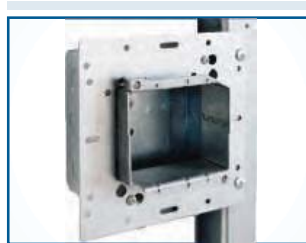

Mount 4" & 4-11/16" Square Boxes directly to stud

### UL-APPROVED ADJUSTABLE RINGS

#### PRODUCT FEATURES

- Can be adjusted on the jobsite for a quick installation
- Adjusts to achieve a flush finish every time
- Patented design provides strong electrical and mechanical connections to meet UL requirements

Cat. No.	Description	Adjustability Range	Std. Pkg.
4AR1G-58	1-Gang Adjustable Ring for 4" Square Deep Boxes	5/8" to 1-1/4"	25
4AR1G-34	1-Gang Adjustable Ring for 4" Square Deep Boxes	3/4" to 1-1/2"	25
4AR2G-58	2-Gang Adjustable Ring for 4" Square Deep Boxes	5/8" to 1-1/2"	25
5AR1G-58 <b>NEW!</b>	1-Gang Adjustable Ring for 4-11/16" Square Deep Boxes	5/8" to 1-1/4"	25
5AR2G-58 <b>NEW!</b>	2-Gang Adjustable Ring for 4-11/16" Square Deep Boxes	5/8" to 1-1/2"	25
4ARR-34	Round Adjustable Ring for 4" Square Deep Boxes	3/4" to 1-1/2"	25
3GAR-34	3-Gang Adjustable Ring	3/4" to 1-1/2"	25



4AR1G-58



4AR1G-34



4AR2G-58



5AR1G-58  
**NEW!**



5AR2G-58  
**NEW!**



4ARR-34



3GAR-34

**INDUSTRY'S ONLY  
UL LISTED**  
4-11/16" SQ.  
ADJ. RINGS

# METAL CLAD BOXES

BOXES WITH METAL CLAD CABLE CLAMPS

## 4-11/16" SQUARE DEEP BOXES

**WELDED**  
**2-1/8" DEEP**  
**42.0 Cu. In.**  
**WITH METAL CLAD (BX/MC)**  
**CABLE CLAMPS**

### BX/MC CLAMP

- All MC series boxes are suitable for use with MCAP™-Aluminum
- MCAP is a trademark of Southwire Company

### METAL STUD BRACKET

- U.S. Patent No.: 8,262,043
- Metal Stud (MS) Bracket engages on either side of a Metal Stud
- \*Model Revised Feb. 2008
- Acceptable for use in 2-hour fire rated walls

Cat. No.	Bracket & Setback	Knockouts		Std. Pkg.
		Sides	Bottom	
5SDB-MC	-	6 - MKO, 4 - Loom	3 - 1/2", 2 - 3/4"	24
5SDB-MC-FB	FB, Flush	3 - MKO, 4 - Loom	3 - 1/2", 2 - 3/4"	24
5SDB-MC-MS*	MS, Self-Gripping + Box Support Clip	3 - MKO, 4 - Loom	2 - MKO, 3 - 1/2"	24
5SDB-MC2-MS*	MS, Self-Gripping + Box Support Clip	1 - MKO, 8 - Loom	1 - MKO	24



5SDB-MC



5SDB-MC-FB



BX/MC Clamp



5SDB-MC-MS\*



5SDB-MC2-MS\*



5SDB-MC2-MS\* on Metal Stud

## 4" SQUARE DEEP BOXES

**WELDED**  
**2-1/8" DEEP**  
**30.3 Cu. In.**  
**WITH METAL CLAD (BX/MC)**  
**CABLE CLAMPS**

### BX/MC CLAMP

- All MC series boxes are suitable for use with MCAP™-Aluminum
- MCAP is a trademark of Southwire Company

### METAL STUD BRACKET

- U.S. Patent No.: 8,262,043
- Metal Stud (MS) Bracket engages on either side of a Metal Stud
- \*Model Revised Feb. 2008

### BOXES WITH PIGTAIL

Pre-Assembled 3-Way,  
 10-32 Ground Screw and  
 Solid Cu #12AWG 7" Pigtail

- Acceptable for use in 2-hour fire rated walls

Cat. No.	Bracket & Setback	Knockouts		Std. Pkg.
		Sides	Bottom	
4SDB-MC	-	4 - 1/2", 2 - MKO, 4 - Loom	1 - 1/2"	24
4SDB-MC-PT	-	4 - 1/2", 2 - MKO, 4 - Loom	1 - 1/2"	24
4SDB-MC-B	B, Flush	2 - 1/2", 1 - MKO, 4 - Loom	1 - 1/2"	24
4SDB-MC-FB-PT	FB, Flush	2 - 1/2", 1 - MKO, 4 - Loom	1 - 1/2"	24
4SDB-MC-MS-PT*	MS, Self-Gripping	2 - 1/2", 1 - MKO, 4 - Loom	1 - 1/2"	24
4SDB-MC-WB	WB, Flush	2 - 1/2", 1 - MKO, 4 - Loom	1 - 1/2"	24



4SDB-MC



4SDB-MC-PT



4SDB-MC-B



4SDB-MC-FB-PT



4SDB-MC-MS-PT\*



4SDB-MC-WB



# METAL CLAD BOXES & PIGTAIL BOXES

BOXES WITH METAL CLAD CABLE CLAMPS & PIGTAILS

## 4" SQUARE DEEP BOXES

### WELDED

1-1/2" DEEP

21 Cu. In.

WITH METAL CLAD (BX/MC)

CABLE CLAMPS

### BX/MC CLAMP

- All MC series boxes are suitable for use with MCAP™-Aluminum
- MCAP is a trademark of Southwire Company

### METAL STUD BRACKET

- U.S. Patent No.: 8,262,043
- Metal Stud (MS) Bracket engages on either side of a Metal Stud
- \*Model Revised Feb. 2008

### BOXES WITH PIGTAIL

Pre-Assembled 3-Way, 10-32 Ground Screw and Solid Cu #12AWG 7" Pigtail

Cat. No.	Bracket & Setback	Knockouts		Std. Pkg.
		Sides	Bottom	
4SB-MC-PT	-	4 - 1/2", 2 - MKO, 4-Loom	1 - 1/2"	50
4SB-MC-B	B, Flush	2 - 1/2", 1 - MKO, 4-Loom	1 - 1/2"	24
4SB-MC-FB-PT	FB, Flush + 7" Pigtail	2 - 1/2", 1 - MKO, 4-Loom	1 - 1/2"	24
4SB-MC-WB	WB, Flush	2 - 1/2", 1 - MKO, 4-Loom	1 - 1/2"	24
4SB-MC-MS-PT*	MS + Box Support Clip + 7" Pigtail	2 - 1/2", 1 - MKO, 4-Loom	1 - 1/2"	24



4SB-MC-PT

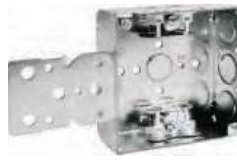

4SB-MC-B

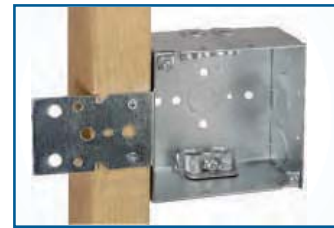

4SB-MC-B on Wood Stud



4SB-MC-FB-PT



4SB-MC-WB



4SB-MC-MS-PT\*

## ADDITIONAL BOXES WITH PIGTAIL

### BOXES WITH PIGTAIL

Pre-Assembled 3-Way, 10-32 Ground Screw and Solid Cu #12AWG 7" Pigtail



Pre-Assembled Ground Screw and Pigtail

Cat. No.	Mfg. Process	Dimension WxHxD	Cu. Inch	Knockouts		Std. Pkg.
				Sides	Bottom	
5SDB-MKO-PT	Welded	4-11/16" x 4-11/16" x 2-1/8"	42.0	2 - 1/2", 10 - MKO	2 - 1/2", 2 - MKO	24
4SDB-MKO-PT	Welded	4" x 4" x 2-1/8"	30.3	8 - 1/2", 4 - MKO	2 - 1/2", 2 - MKO	24
4SB-50/75-PT	Welded	4" x 4" x 1-1/2"	21.0	8 - 1/2", 4 - 3/4"	2 - 1/2", 2 - 3/4"	50
D4SB-50/75-PT	Drawn	4" x 4" x 1-1/2"	21.0	8 - 1/2", 4 - 3/4"	2 - 1/2", 2 - 3/4"	50
D4SB-75-PT	Drawn	4" x 4" x 1-1/2"	21.0	8 - 3/4"	2 - 1/2", 2 - 3/4"	50
DHB3-PT	Drawn	5-3/4" x 4" x 2-1/8"	44.0	4 - 1/2", 6 - CKO	2 - 1/2", 2 - 3/4"	25



5SDB-MKO-PT



4SDB-MKO-PT



4SB-50/75-PT



D4SB-50/75-PT



D4SB-75-PT



DHB3-PT

- **600V** MKO's and CKO's suitable for bonding without any additional bonding means up to 600V
- Acceptable for use in 2-hour fire rated walls

# ADJUSTABLE BACK SUPPORT BOXES

BOXES WITH ADJUSTABLE BACK SUPPORT ARMS

## 4-11/16" SQUARE BOXES

**WELDED**  
**2-1/8" DEEP**  
 42.0 Cu. In.  
 WITH RAISED GROUND EMBOSS

### BOXES WITH 10" PIGTAIL

Pre-Assembled 3-Way,  
 10-32 Ground Screw and  
 Solid Cu #12AWG 10" Pigtail

### BSA

- Pre-installed Back Support Arm provides support for studs up to 6" deep
- Great for prefab applications

Cat. No.	Bracket & Setback	Knockouts		Std. Pkg.
		Sides	Bottom	
5SDB-50/75-PT-BSA	Back Support Arm	8 - 1/2", 4 - 3/4"	3 - 3/4"	24
5SDB-50/75-AB-PT-BSA	AB, Flush, Back Support Arm	6 - 1/2", 3 - 3/4"	3 - 3/4"	24



5SDB-50/75-PT-BSA



5SDB-50/75-AB-PT-BSA



6" Adjustable Back Support Arm

## 4" SQUARE DEEP BOXES

**WELDED**  
**2-1/8" DEEP**  
 30.3 Cu. In.  
 WITH RAISED GROUND EMBOSS

### BOXES WITH 10" PIGTAIL

Pre-Assembled 3-Way,  
 10-32 Ground Screw and  
 Solid Cu #12AWG 10" Pigtail

### BSA

- Pre-installed Back Support Arm provides support for studs up to 6" deep
- Great for prefab applications

Extensions and additional  
 Adjustable Rings  
 available on page 17-18

Cat. No.	Bracket & Setback	Knockouts		Std. Pkg.
		Sides	Bottom	
4SDB-50/75-PT-BSA	With Back Support	8 - 1/2", 4 - 3/4"	1 - 1/2", 2 - 3/4"	24
4SDB-50/75-AB-PT-BSA	With Back Support + AB Bracket	6 - 1/2", 3 - 3/4"	1 - 1/2", 2 - 3/4"	24
4SDB-MKO-PT-BSA	With Back Support	8 - 1/2", 4 - MKO	1 - 1/2", 2 - MKO	24
4SDB-MKO-AB-PT-BSA	With Back Support + AB Bracket	6 - 1/2", 3 - MKO	1 - 1/2", 2 - MKO	24
4SDB-MKO-AR1G	4SDB-MKO-AB-PT-BSA + 1G Adj. Ring	6 - 1/2", 3 - MKO	1 - 1/2", 2 - MKO	24
4SDB-MKO-AR2G	4SDB-MKO-AB-PT-BSA + 2G Adj. Ring	6 - 1/2", 3 - MKO	1 - 1/2", 2 - MKO	24



4SDB-50/75-PT-BSA



4SDB-MKO-PT-BSA



4SDB-50/75-AB-PT-BSA



4SDB-MKO-AB-PT-BSA



4SDB-MKO-AR1G



4SDB-MKO-AR2G

- **600V** MKO's and CKO's suitable for bonding without any additional bonding means up to 600V
- Acceptable for use in 2-hour fire rated walls

# LARGE CAPACITY BOXES

## DATA BOXES & PARTITIONS

### 4-11/16" SQUARE LARGE CAPACITY BOXES

**WELDED**

**2-1/2" DEEP**

49.4 Cu. In.

WITH RAISED GROUND EMOSS & TWO #8-32 x 1/2" MOUNTING SCREWS

#### PRODUCT FEATURES

- Suitable for Datacom & Electrical Applications
- Available in Blue for Data Applications as the B-5SLB. See page 24

**ORBIT INDUSTRIES EXCLUSIVE**

Cat. No.	Knockouts		Std. Pkg.
	Sides	Bottom	
5SLB-2MKO	4 - 3/4" & 1" MKO, 4 - 1" & 1 - 1/4" MKO	2 - 1/2", 2 - 3/4"	24



5SLB-2MKO



5SLB-2MKO Shown Installed



5SLB-2MKO, 52058 & 5SLP-200 Shown Installed

### 4-11/16" SQUARE BOXES LOW-VOLTAGE PARTITIONS

#### PRODUCT FEATURES

- Steel Partitions allows for multi-system installations inside junction box

Cat. No.	Description	For Use with 2-Gang Rings:	Std. Pkg.
5SDP-100	For use with 2-1/8" Deep Boxes	Flat, 1/4", 1/2", 3/4", 1"	25
5SDP-200	For use with 2-1/8" Deep Boxes	5/8", 1-1/4", 1-1/2", 1-3/4", 2"	25
5SLP-100	For use with 2-1/2" Deep Boxes	Flat, 1/4", 1/2", 3/4", 1"	25
5SLP-200	For use with 2-1/2" Deep Boxes	5/8", 1-1/4", 1-1/2", 1-3/4", 2"	25



5SDP-100



5SDP-200



5SLP-100



5SLP-200

- **600V** MKO's and CKO's suitable for bonding without any additional bonding means up to 600V
- Acceptable for use in 2-hour fire rated walls

## LOOKING TO INSTALL RIGHT OUT OF THE BOX?

Ask us about our preassembly services!

Tel: 1.800.906.7248

# LARGE CAPACITY BOXES

## TRUE 5" SQUARE BOXES & PARTITIONS

### TRUE 5" SQUARE BOXES

**WELDED**  
**3-1/4" DEEP**  
 75.6 Cu. In.  
**WITH RAISED GROUND EMBOSS**

#### PRODUCT FEATURES

- More than double capacity compared to 4" square boxes
- Extra space easily meets minimum bend radius for easier installations
- Increased space reduces short circuits and ground faults due to space and cable stress
- Supports all current copper CAT and fiber optic cables as well as predicted increases

Cat. No.	Description	Sides	Bottom	Std. Pkg.
<b>T5B-50/200</b> <b>NEW!</b>	True 5" Square Box, 1/2" KO & 2" MKO	2 - 1" to 2" CKOs 4 - 1/2" & 3/4" CKOs 8 - 1/2" KO	1 - 1/2" & 3/4" MKOs 1 - 3/4" & 1" MKOs 1 - 1/2" KO	12
<b>T5B-200</b> <b>NEW!</b>	True 5" Square Box	2 - 1" to 2" CKOs 2 - 1" & 1-1/4" MKOs 2 - 1/2" & 3/4" MKOs	1 - 1/2" & 3/4" MKOs 1 - 3/4" & 1" MKOs 1 - 1/2" KO	12



T5B-50/200  
**NEW!**

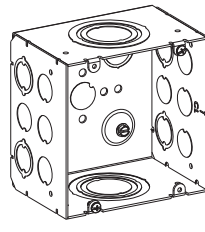

T5B-50/200  
5" x 5" x 3-1/4"



T5B-200  
**NEW!**

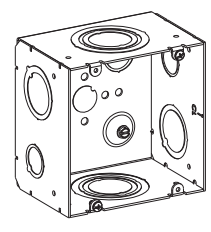

T5B-200  
5" x 5" x 3-1/4"

### INSTALLATION

23

**Brackets allow for 4" ring compatibility!**



#### INSTALLED ON FMB-16

Compatible with Orbit's Flat Bracket Family (pg 7) and Fixed Mounting Brackets (pg 9)



#### INSTALLED ON UMA-LVBS

Orbit's UMA-LVBS (pg 1) is the only direct-to-stud bracket in the industry that takes 5" Square boxes! Also allows for dual-directional box orientation with 4" rings adaptability



#### REDUCER

T5R allows for 4" ring compatibility

### 5" SQUARE BOXES ACCESSORIES

#### PRODUCT FEATURES

- Steel Partitions allows for multi-system installations inside junction box

Cat. No.	Description	For Use with 2-Gang Rings:	Pkg.
<b>T5C</b> <b>NEW!</b>	True 5" Blank Cover		50
<b>T5R</b> <b>NEW!</b>	True 5" Reducer Cover, 4" Sq Opening		50
<b>T5P-100</b> <b>NEW!</b>	True 5" Square Box Partition For 3-1/4" Deep Boxes	Flat to 1"	25
<b>T5P-200</b> <b>NEW!</b>	True 5" Square Box Partition For 3-1/4" Deep Boxes	5/8", 1-1/4" to 2"	25



T5C  
**NEW!**



T5R  
**NEW!**



T5P-100  
**NEW!**



T5P-200  
**NEW!**



# LARGE CAPACITY BOXES

BLUE DATA BOXES & PARTITIONS

## LARGE CAPACITY DATA BOXES

**WELDED**  
WITH RAISED GROUND EMBOSS

### PRODUCT FEATURES

- Provides easy identification of products containing cabling of Data Systems
  - Prevents need for repainting
  - Increased space reduces short circuits and ground faults due to space and cable stress
  - Durable Blue Powder Coat Finish
- B-5SLB available unpainted as the 5SLB-2MKO. See page 22

Cat. No.	Description	Sides	Bottom	Std. Pkg.
<b>B-T5B</b> <small>NEW!</small>	Blue True 5" Square Box	2 - 1" to 2" CKOs 2 - 1" & 1-1/4" MKOs 2 - 1/2" & 3/4" MKOs	1 - 1/2" & 3/4" MKOs 1 - 3/4" & 1" MKOs 1 - 1/2" KO	12
<b>B-5SLB</b> <small>NEW!</small>	Blue 4-11/16" Large Capacity Square Box	4 - 3/4" & 1" MKO 4 - 1" & 1 - 1/4" MKO	2 - 1/2", 2 - 3/4"	24
<b>B-T5C</b> <small>NEW!</small>	Blue True 5" Blank Cover	-	-	50
<b>B-5BC</b> <small>NEW!</small>	Blue 4-11/16" Blank Cover	-	-	50



**B-T5B**  
NEW!



**B-5SLB**  
NEW!



**B-T5C**  
NEW!



**B-5BC**  
NEW!

**UP TO 100% MORE SPACE**

EASILY FITS CURRENT CABLE BEND RADIUS REQUIREMENTS AND FUTURE INCREASES

With the introduction of the Blue Boxes, Orbit now features a box for most applications!



**DATA**



**STANDARD**



**FIRE**

# EXTRA WIDE OLD-WORK SWITCH BOXES

DEEP/WIDE SWITCH BOXES

## INSTALLATION

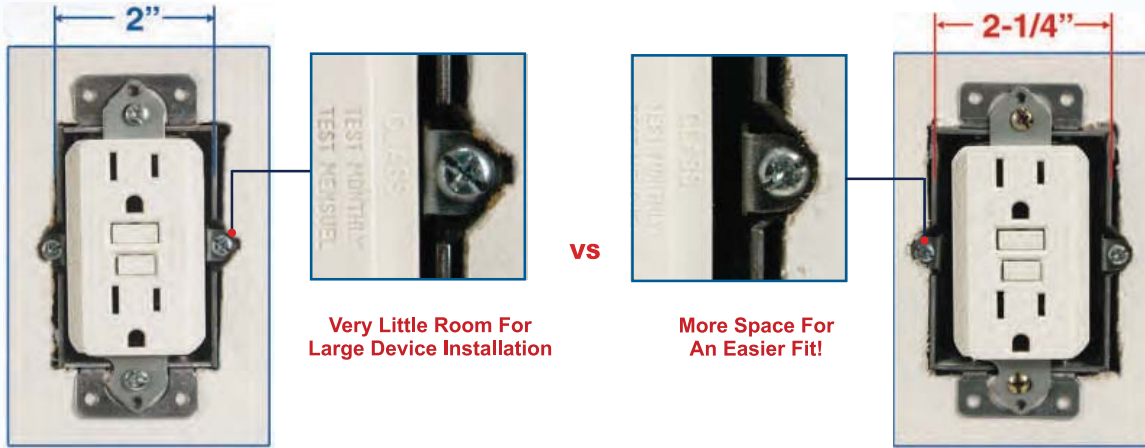

TRADITIONAL TIGER GRIP WITH GFCI INSTALLED

TGW SHOWN WITH GFCI INSTALLED

25

## WIDE OLD-WORK SWITCH BOX WITH GROUNDING "PIGTAIL"

### PRODUCT FEATURES

- Non-Gangable, Wide Switch Box
- Pre-Assembled with 10-32 Ground Screw & 7" Solid #12AWG Pigtail
- Must be used with Mid-Size or Oversized Wall Plate
- Facilitates GFCI and Controls Installations



Cat. No.	Description	Volume	Knockouts			Std. Pkg.
			Sides	Ends	Bottom	
WMB-PT <b>NEW!</b>	3" H x 2-1/4" W x 2-3/4" D	18.5 Cu. In.	4 - 1/2"	2 - MKO	2 - 1/2"	50
SBS	Switch Box Support Brackets, Bendable Tabs	-	-	-	-	100
OWG	Cut in Old-Work Clip	-	-	-	-	100

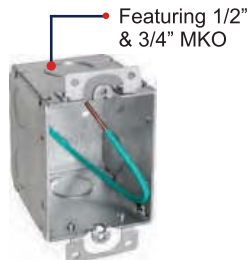

1/4" Wider for easy installation of GFCI and other large devices

## WIDE TIGER GRIP

### PRODUCT FEATURES

- Non-Gangable Switch Boxes
- Must be used with Mid-Size or Oversized Wall Plate
- Facilitates GFCI and Controls Installations
- Material: Galvanized Steel



Cat. No.	Description	Volume	Knockouts			Std. Pkg.
			Sides	Ends	Bottom	
TGW	3" H x 2-1/4" W x 2-1/2" D	15.0 Cu. In.	4 - 1/2"	2 - 1/2"	2 - 1/2"	50
TGMW	3" H x 2-1/4" W x 2-3/4" D	18.5 Cu. In.	4 - 1/2"	2 - 1/2"	2 - 1/2"	50

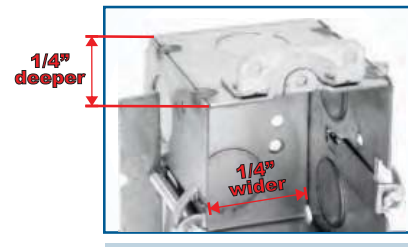

TGMW SHOWN



www.orbitelectric.com

# FIRESTOP PRODUCTS

## FIRESTOP INSERTS AND PUTTY PRODUCTS

### UNIVERSAL FIREBLOK SUPPRESSION INSERTS FOR METAL ELECTRICAL BOXES

#### PRODUCT FEATURES

- One SKU fits single gang, 4" and 4-11/16" square boxes via break-apart design
- Non-Conductive
- Intumescent thermoplastic
- Pre-molded opening to accommodate raised grounding provisions and wiring access
- Up to 2 Hour Fire Rated
- Soundproof with STC Rating of 52\*\*
- Certified for both Plastic and Metal faceplates in all fire-rated walls
- 95% labor savings over Putty Pad technology

\* By Fireblok IP Holdings  
 \*\* Tested in a UL 411 wall assembly to ASTM E90



Cat. No.	Description	Std. Pkg.
UFSI <b>NEW!</b>	Universal Firestop Insert for 1G, 4", 4-11/16" Electrical Box, White	120



UFSI **NEW!**

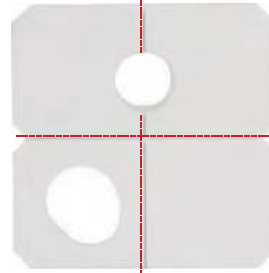

Break-apart Design



The Universal Firestop Insert adheres to the inside of most 1-Gang, 4", or 4-11/16" electrical boxes



Call on Orbit to install Firestop Inserts in the box of your choice

### FIRESTOP PUTTY PADS AND STICKS\*

#### PRODUCT FEATURES

- Applied by hand with no curing time
- Pad is soundproof with STC Rating of 60\*\*
- Intumescent at 220°F
- Will not dry out or crumble
- Reusable
- Adheres to all common building surfaces
- Up to 3 Hour Fire Rated

\* By Metacaulk  
 \*\* Tested in a UL 441 wall assembly/section to ASTM E90

Cat. No.	Description	Std. Pkg.
FSPS18 <b>NEW!</b>	Firestop Putty Stick, 18 Cu. In., Red	12
FSP67 <b>NEW!</b>	Firestop Putty Pad, 6" x 7" x 1/8", Red	20
FSP77 <b>NEW!</b>	Firestop Putty Pad, 7" x 7" x 1/8", Red	20



FSPS18 **NEW!**



FSP67  
 FSP77 **NEW!**



Putty Sticks seal around penetrating items such as cables, conduits and metal pipes.



Putty Pads are used on electrical boxes to maintain the hourly rating of fire-rated walls as well as reduce sound transmission.

#### PUTTY STICKS

#### PUTTY PADS



# SNAP-IN FITTINGS

## DOUBLE-SNAP & FASTLOCK CONNECTORS

### ZINC DIE CAST DOUBLE-SNAP CABLE CONNECTOR

#### PRODUCT FEATURES

- Zinc Die Cast
- 105°C rated throat insulator
- Fast and Tool-free installation
- Removable and Reusable
- For FMC, AC, MCI, MCI-A, HCF, RWFMC
- Dry location

Cat. No.	Description	Trade Size	Std. Pkg.	Master Ctn.
DSC-38	<b>DOUBLE-SNAP CABLE CONNECTOR WITH INSULATOR</b> Steel/AL AC: 14/2 (0.40") - 10/3 (0.618") Steel MCI: 0.395" - 0.638" AL MCI: 0.40" - 0.618" Steel/AL MCI-A: 14/2 (0.395") - 10/3 (0.638") Steel/AL HCF MCI-A: 14/2 (0.395") - 10/3 (0.638") AL RWFMC: 3/8"	3/8"	50	500
DSC-38C	<b>CUT-IN DOUBLE-SNAP CABLE CONNECTOR WITH INSULATOR, FOR OLD WORK</b> Steel/AL AC: 14/2 (0.40") - 10/3 (0.618") Steel/AL MCI: 14/2 (0.395") - 10/3 (0.638") Steel/AL MCI-A: 14/2 (0.395") - 10/3 (0.638") Steel/AL HCF MCI-A: 14/2 (0.395") - 10/3 (0.638") Steel/AL FMC: 3/8"	3/8"	50	500



DSC-38



DSC-38C

### STEEL "FASTLOCK" CONNECTOR

#### PRODUCT FEATURES

- Steel
- Electroplated Zinc
- Saddle-Base Connector (FLC-50, FLC-50L, FLC-75L)
- Combo Head Set-Screw
- For AC, MCI, RWFMC, ALFMC

#### NOTE

- Insulated color may vary

Cat. No.	Description	Trade Size	Std. Pkg.	Master Ctn.
FLC-50	<b>STEEL "FASTLOCK" CONNECTOR</b> Steel AC 14/2 (0.440) to 10/3 AL AC 14/2 (0.475) to 10/3 Steel MC Interlocking (MCI) 0.437" to 0.565" O.D. AL MC Interlocking (MCI) 0.525" to 0.629" O.D. AL Corrugated Continuous (MCC) 0.350" to 0.592" O.D. Steel & AL Flex RWFMC: 3/8"	1/2"	50	500
FLC-50L	<b>STEEL "FASTLOCK" WIDE-THROAT CONNECTOR</b> Steel AC 10/4 (0.625) to 6/3 (0.842) AL AC 10/4 (0.625) to 8/4 (0.770) Steel MC Interlocking (MCI) 10/3 (0.594) to 6/2 (0.740) AL MC Interlocking (MCI) 10/3 (0.594) to 8/2 (0.650) Steel RWFMC, AL RWFMC, AL FMC: 1/2"	1/2"	50	500
FLC-75L	<b>STEEL "FASTLOCK" WIDE-THROAT CONNECTOR</b> Steel AC 10/4 (0.625) to 6/3 (0.840) AL AC 10/4 (0.622) to 8/4 (0.760) Steel MC Interlocking (MCI) 10/3 (0.594) to 6/2 (0.746) AL MC Interlocking (MCI) 10/3 (0.582) to 8/2 (0.650) Steel RWFMC, AL RWFMC & AL FMC: 1/2"	3/4"	25	250
FLD-50	<b>STEEL "FASTLOCK" DUPLEX CONNECTOR</b> Steel AC 14/2 (0.454) to 12/4 (0.556) Aluminum AC 14/2 (0.485) to 12/4 (0.565) Steel MC Interlocking (MCI) 14/2 (0.470) to 12/4 (0.520) Aluminum MC Interlocking (MCI) 14/2 (0.460) to 12/4 (0.590) Steel RWFMC, AL RWFMC, AL FMC: 3/8"	1/2"	25	250



FLC-50



FLC-50/75L



FLD-50



# CONNECTORS & CONDUIT SUPPORTS

NM FITTINGS, CONDUIT LOCKING CONNECTOR & CABLE SUPPORT

## ANTI-SHORT BUSHINGS THERMOPLASTIC

### PRODUCT FEATURES

- High-Temperature Plastic
- Fits BX (AC) and Flex Conduits

Cat. No.	For Use With	Trade Size	Std. Pkg.	Master Ctn.
ASB-516	14/2, 14/3, 12/2	5/16"	35	3500
ASB-38	14/4, 12/3, 6/1, 4/1	3/8"	35	2100
ASB-716	12/4, 10/2, 10/3, 2/1	7/16"	35	700
ASB-50	10/4, 8/2, 8/3, 1/1	1/2"	20	400
ASB-75	8/4, 6/2, 4/2, 4/3, 6/4	3/4"	16	320

## PVC NON-METALLIC (NM) CABLE CONNECTOR

### PRODUCT FEATURES

- Heavy-Duty PVC

Cat. No.	For Use With	Trade Size	Std. Pkg.	Master Ctn.
NM-50	One or Two 14/2, 14/3, 12/2 One 12/3, 10/2, 10/3 One or Two 0.3000" or 0.600" cords	1/2"	50	500

## NON-METALLIC CABLE CONNECTORS PUSH-IN TYPE

### PRODUCT FEATURES

- Flame-Retardant Polypropylene
- Special gripping arrangement for easy cable insertion

Cat. No.	For Use With	Trade Size	Std. Pkg.	Master Ctn.
NMP-50	One 10, 12, 14 AWG two-conductor cables with or without ground wire	1/2"	100	500



ASB



NM-50



NMP-50



## CONDUIT LOCKING CONNECTOR

### PRODUCT FEATURES

- Steel
- Fits 4", 4-11/16" sq. and 40 boxes as well as Orbit's patented EALB/S
- Hooks prevent rotation of fixtures such as security cameras and emergency lighting
- Holes allow for seismic wiring
- Includes set-screw and locknut
- Can replace Rigid Threaded Conduit Fittings

Cat. No.	Trade Size	Std. Pkg.	Master Ctn.
CLCSL-50	1/2"	10	100
CLCSL-75	3/4"	10	100



CLCSL



Locknut Included



Before Installation



After Installation Prevents Rotation



Video Available  
On Our Website!

## STUD MOUNTING CABLE SUPPORT

### PRODUCT FEATURES

- Pre-Galvanized Steel
- Wood or Metal Stud
- Easy to Lock



Space Saving Packaging!

Cat. No.	Description	Non-Metallic	MC/AC/BX	Std. Pkg.
CS-CJ6	Stud Mounting Cable Support with locking tab	Max. 6	Max. 4	100



# FEATURED PRODUCTS

ELECTRICAL BOXES & ACCESSORIES



**GANGABLE SWITCH BOXES**



**HANDY BOXES**



**CONCRETE BOXES & RINGS**

**LARGEST INVENTORY  
IN THE INDUSTRY**



**MULTIGANG BOXES & RINGS**



**MASONRY BOXES**



**FIRE ALARM BOXES**



**4" & 4-11/16" Device Covers & Rings**



**30 & 40 PANCAKE BOXES & RINGS**



**MISCELLANEOUS & MORE**

# FEATURED PRODUCTS

ELECTRICAL FITTINGS

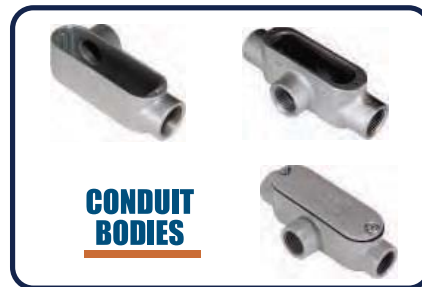

## MATERIALS

**STEEL, DIE CAST ZINC, MALLEABLE IRON, AND PVC.**



Steel



Die Cast Zinc



Malleable Iron



PVC

Orbit's fittings are available in a variety of sizes and high quality materials.

# BOX SPECIFICATION

As a leading manufacturer of steel products, Orbit offers one of the largest selections of steel boxes and rings in the industry. Our state-of-the-art manufacturing facilities and industry trained engineers ensure the production and development of quality steel products. Orbit's boxes are cleaned, deburred, and offered with a variety of brackets and knockouts.

With contractors as our main priority, Orbit's products are designed to increase productivity and efficiency on the job. All of Orbit's products are in stock and ready to ship at your convenience. As your solutions-based manufacturer, Orbit is dedicated to keeping you competitive in this rapidly changing market.

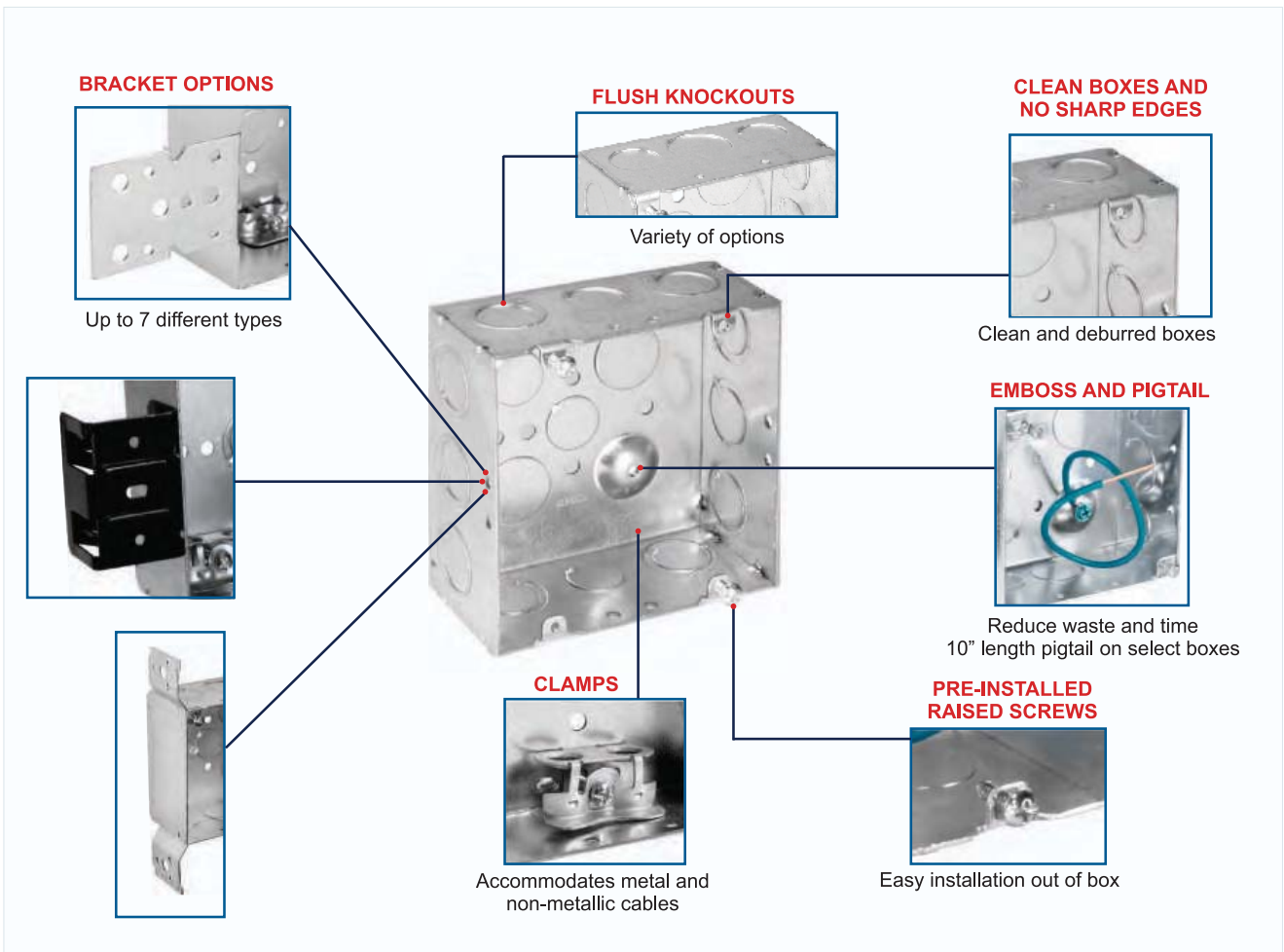



# BOX SPECIFICATION

## BRACKET SPECIFICATION

Bracket Type	AB	B (for S)	FB (for S)	FB (for FSB)	FB (for B)	FB (for H)	LB	MS	OB	WB
Length	5 - 7/8"	3"	7 - 3/8"	5 - 1/2"	7 - 1/4"	7"	2 - 3/8"	2 - 1/2"	6 - 3/4"	7 - 1/2"
Width	7/8"	2"	1 - 9/16"	2 - 1/8"	3/4"	1"	2 - 23/32"	1 - 3/8"	1 - 3/16"	1 - 9/16"
Offset	0" (Flush)	0" (Flush)	0" (Flush)	9/16"	1/2"	9/16"	1/4"	0" (Flush)	1 - 5/16"	0" (Flush)

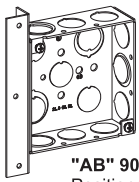

**"AB" 90° BRACKET**  
Positions box against face and side of stud.

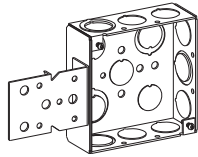

**"B" BRACKET for Square Box**  
Face mounts on front edge of wood stud.

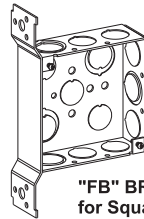

**"FB" BRACKET for Square Box**  
Mounts on flat side of stud.

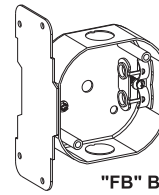

**"FB" BRACKET for FSB**  
Flush-Mounts on flat side of stud or joist.

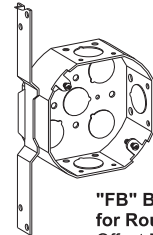

**"FB" BRACKET for Round Box**  
Offset Mounts on flat side of stud or joist.

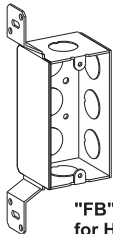

**"FB" BRACKET for Handy Box**  
Mounts on flat side of stud.

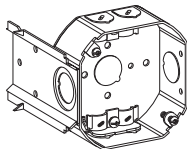

**"LB" BRACKET**  
With spurs, slotted holes for toe-nailing.

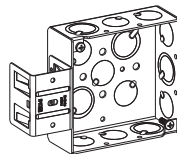

**"MS" BRACKET**  
Self-Gripping Metal Stud Bracket with Box Support Clip.  
**\*Model Revised Feb. 2008**

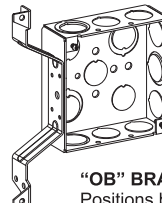

**"OB" BRACKET**  
Positions box away from side of stud for door frame trim clearance.

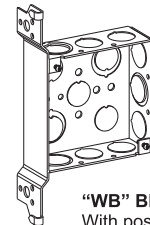

**"WB" BRACKET**  
With positioning spurs to mount box on side of stud.

## CLAMP SPECIFICATION

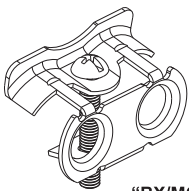

**"BX/MC" Clamp**  
Accommodates Metal Clad Cables from size #14-2 to #10-4  
**\*\*All MC series boxes are suitable for use with MCAP™-Aluminum, MCAP is a trademark of Southwire Company**

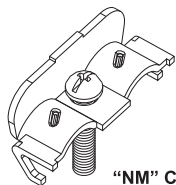

**"NM" CLAMP**  
Accommodates #14-2 to #10-3 Non-Metallic Cables with ground.

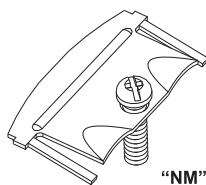

**"NM" CLAMP for Pancake Box**  
Accommodates #14-2 Non-Metallic Sheathed Cables with ground.

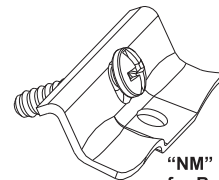

**"NM" CLAMP for Beveled Switch Box**  
Accommodates #14-2 to #10-3 Non-Metallic Sheathed Cables with ground. 45° & 90° Screw Mounting.

## KNOCKOUT & PRYOUT SPECIFICATION

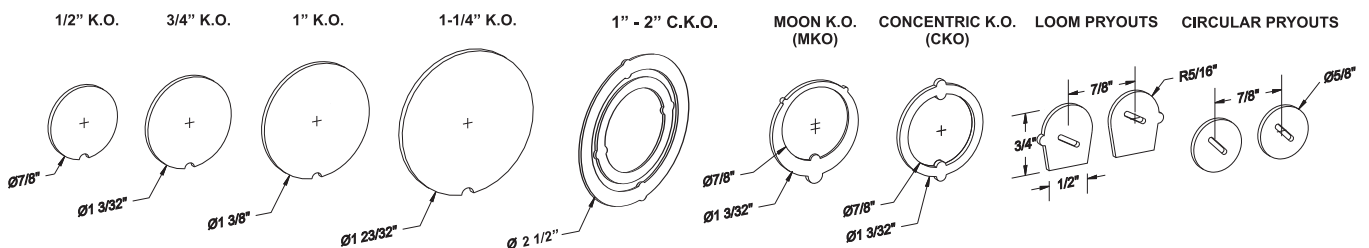

# PRODUCT INDEX

Cat. No.	Page	Cat. No.	Page	Cat. No.	Page	Cat. No.	Page
1GX75	17	5SDB-MC-FB	19	DHB3-PT	20	SBS	25
2GX75	17	5SDB-MC-MS	19	DSC-38	27	SSB	1
3GAR-34	18	5SDB-MKO-PT	20	DSC-38C	27	SSB-4S-MKO	1
4AR1G-34	18	5SDP-100	22	EALB	16	SSB-5S-MKO	1
4AR1G-58	18	5SDP-200	22	EALBS	16	T5B-200	23
4AR2G-58	18	5SLB-2MKO	22	FA-UMAB	1, 10	T5B-50/200	23
4ARR-34	18	5SLP-100	22	FB-3	7	T5C	23
4SAR1G	17	5SLP-200	22	FB-4	7	T5P-100	23
4SAR2G	17	ASB-38	28	FLC-50	27	T5P-200	23
4SB-50/75-PT	20	ASB-50	28	FLC-50L	27	T5R	23
4SB-MC-B	20	ASB-516	28	FLC-75L	27	TGMW	25
4SB-MC-FB-PT	20	ASB-716	28	FLD-50	27	TGW	25
4SB-MC-MS-PT	20	ASB-75	28	FMB-16	9	TSB	3
4SB-MC-PT	20	B-5BC	24	FMB-24	9	UFSI	26
4SB-MC-WB	20	B-5SDB	24	FSPP67	26	UMA	1
4SDB-50/75-AB-PT-BSA	21	BARB	4	FSPP77	26	UMAB	1, 10
4SDB-50/75-PT-BSA	21	BARB-CS	4	FSPS18	26	UPC	17
4SDB-BP	15	BCHS-10	14	HABIT	11	UPCTS	17
4SDB-MC	19	BCHS-12	14	KB-18	7	US4SB	5
4SDB-MC-B	19	BCHS-6	14	KFB-318	7	USB	5
4SDB-MC-FB-PT	19	BCHS-6S	14	KFB-418	7	USB-4SDB-50/75-PT	5
4SDB-MC-MS-PT	19	BH-3	15	LVS1	1, 5	USB-5SDB-50/75-PT	5
4SDB-MC-WB	19	BHA-16	3	LVS2	1, 5	USBS	5
4SDB-MKO-AB-PT-BSA	21	BHA-24	3	MBBH-16	9	USDBM	5
4SDB-MKO-AR1G	21	BHT-1	15	MBBH-24	9	USTBM	5
4SDB-MKO-AR2G	21	BHT-1A	15	NM-50	28	USTS	5
4SDB-MKO-PT	20	BMA-23	10	NMP-50	28	WBAR1G	18
4SDB-MKO-PT-BSA	21	BMA-4	10	OWG	25	WBAR2G	18
5AR1G-58	18	B-T5B	24	RAP	13	WMB-PT	25
5AR2G-58	18	B-T5C	24	RAP-T	13		
5SAR1G	17	CLCSL-50	28	RCP-100	12		
5SAR2G	17	CLCSL-75	28	RCP-125	12		
5SDB-50/75-AB-PT-BSA	21	CS-CJ6	28	RCP-150	12		
5SDB-50/75-PT-BSA	21	D4SB-50/75-PT	20	RCP-200	12		
5SDB-MC	19	D4SB-75-PT	20	RCP-50	12		
5SDB-MC2-MS	19	D5SDB-CKO-S	16	RCP-75	12		

# Orbit Product Lines

Your Universal Source for Electrical Products



**ELECTRICAL BOXES,  
COVERS & ACCESSORIES**



**NEMA ENCLOSURES**



**WEATHERPROOF  
PRODUCTS**



**ELECTRICAL FITTINGS**



**WIRING DEVICES**



**EXIT & EMERGENCY  
LIGHTING**



**LANDSCAPE  
LIGHTING**



**H.I.D. LIGHTING**



**LED LIGHTING**



**VENTILATION FANS**



**CABLES & WIRES**

**LOOKING TO INSTALL  
RIGHT OUT OF THE BOX?**

*Ask us about our preassembly services!*

**Tel: 1.800.906.7248**



*“ Your solutions-based  
electrical manufacturer ”*

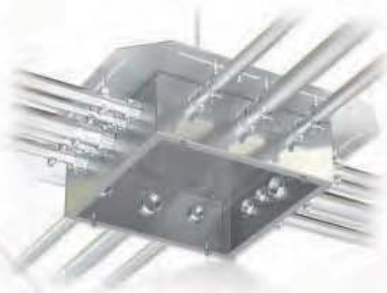

**orbit**<sup>®</sup>  
Orbit Industries, Inc.

2100 S. Figueroa St.,  
Los Angeles, CA 90007  
Tel: 1.800.90.ORBITE (67248)  
Fax: 213.745.2015

[www.orbitelectric.com](http://www.orbitelectric.com)

Copyright© 2017-2018, Orbit Industries, Inc. All rights reserved.