

QUADRIVE CONCRETE SCREW ANCHORS

MADE IN USA

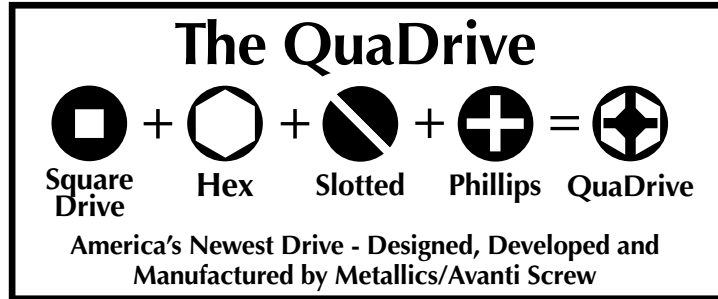

Manufactured by Avanti Screw, Inc., A Metallics Affiliate



CraftCoat® 1000 coating is applied after heat-treating to provide anti-corrosion protection. CraftCoat® 1000 coating is a Rohs compliant mechanical zinc coating that offers 1000 hours to 15% red rust corrosion in salt spray testing performed to ASTM B117 specifications.

Metallics offers our Distributor/Contractor users an alternative to the blue color of standard concrete screws. Silver color is cosmetically appealing when used with zinc plated or stainless steel brackets, electrical fixtures or conduit.

CraftCoat® is a registered trademark of Donham Craft Inc.

THE METALLICS QUADRIVE CONCRETE SCREW IT'S A RE-DESIGNED TAPPING SCREW AND ANCHORING SYSTEM WITH A CRAFTCOAT® 1000 COATING

- ← Large fillet under head to fit $3/16$ and $1/4$ " holes provides greater driving strength
- ← Fluted, interrupted threads aid tapping into masonry products
- ← Twin lead threads for faster application
- ← Silver color to match conduit, strap and concrete

We will be glad to send a sample bag of 10 pieces to our Distributors for their customer trials. Please specify size

MADE IN USA

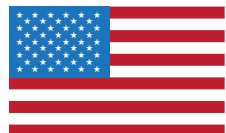

ONLY METALLICS

THE FIRST IN THE WORLD

QUADRIVE HEAD can be driven or extracted with hex, slotted, Phillips or square recess drivers.

America's Source For Premier and Innovative Fasteners & Anchors

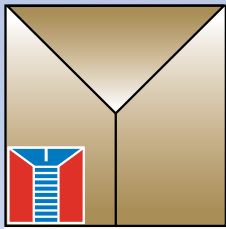

Metallics

MASTER Anchor™

The World's Strongest Fastener™



[CONTRACTOR APPROVED]

MASTER Anchor™:

- **NEVER Loosens!**
- Installs in ALL Hollow Walls - in just minutes!
- **Rated up to 300 lbs. in drywall.**
- Handles vector forces 360°.
- Objects can be easily removed or replaced.



3/4" Carbide Tipped Apache 200™ Drill Bit:

- Industrial Carbide Rated at 200 Holes in Ceramic Wall Tile.
- Designed for Ceramic, Marble and Plaster.
- **Guaranteed to NEVER Walk.**
- Fits standard and cordless drills.



Install Instructions:

Surface Preparation - Determine where to install - Drill 3/4" hole using the APACHE200. The standard MASTER Anchor is used in wall substrates up to 1.3" thick.

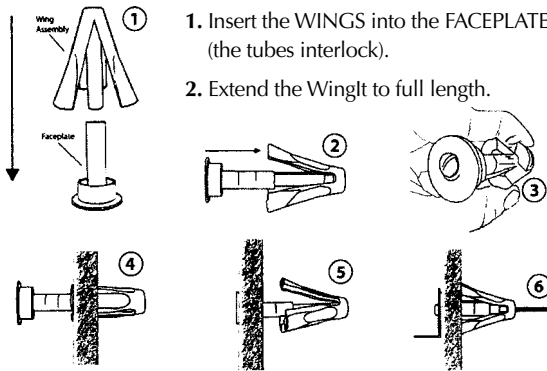

1. Insert the WINGS into the FACEPLATE (the tubes interlock).
2. Extend the WingIt to full length.
3. Compress and insert the WINGS into the holes.
4. WINGS should be FLUSH with the wall surface.
5. Pop WingIt through the hole by pushing on the Faceplate.
6. Using the enclosed 3.5" Stainless Steel Screw, attach the object to the WingIt.

NOTE: For individual mounting points where the object will be subject to considerable torque (rotational forces) - use at least TWO MASTER Anchors.

NOTE: Strength and stability are greatly affected by projection off the wall surface.

WingIts are designed to be used in vertical walls only - **DO NOT USE IN CEILINGS!**

DRILL IT. INSTALL IT. MOUNT IT.

Fire Retardant, Structural Plastic & S/S Construction

PART #	UPC #	DESCRIPTION	QTY / PKG	SUG. TRADE LIST / PKG
MAW35SD	39696	Master Anchor with #10 x 3-1/2 SS Screw	2	\$ 9.88
MAWD34	39685	3/4" Carbide Tipped Apache Drill	1	\$ 37.14

"Growth Through Innovation"

Metallics

229 Cross Street, Bristol, CT 06010
Tel 800-243-8272 • **Fax** 800-831-9358
Email sales@metallicsonline.com

Metallics West

651 North Main Street, Mancos, CO 81328
Tel 800-269-5183 • **Fax** 800-269-6278
Email saleswest@metallicsonline.com

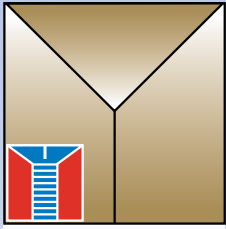

Metallics

Flat Head Concrete Screws



[CONTRACTOR APPROVED]



Square Drive for Greater Driving Strength.



- Full Diameter Under Head Provides Greater Driving Strength.
- Twin Lead Threads for Faster Application!
- Fluted Interrupted Threads and Tapping into Masonry.



Made in USA
Manufactured by
Avanti Screw, Inc.,
A Metallics
Affiliate

Products

- CraftCoat® 1000 Silver Coating Provides Anti-Corrosion Protection.
- Silver Color to Match Conduit Strap and Concrete.



Square Drive

PART #	UPC #	DESCRIPTION	QTY / PKG	SUG. TRADE LIST / PKG
FSCS1	39651	3/16 x 1-1/4" Flat Head Square Drive Nail Point Concrete Screw	100	\$ 34.72
FSCS2	39652	3/16 x 1-3/4" Flat Head Square Drive Nail Point Concrete Screw	100	\$ 36.38
FSCS3	39653	3/16 x 2-1/4" Flat Head Square Drive Nail Point Concrete Screw	100	\$ 37.44
FSCS10	39660	1/4 x 1-1/4" Flat Head Square Drive Nail Point Concrete Screw	100	\$ 37.93
FSCS20	39665	1/4 x 1-3/4" Flat Head Square Drive Nail Point Concrete Screw	100	\$ 39.49
FSCS30	39670	1/4 x 2-1/4" Flat Head Square Drive Nail Point Concrete Screw	100	\$ 42.38
FSCS40	39675	1/4 x 2-3/4" Flat Head Square Drive Nail Point Concrete Screw	100	\$ 49.19

"Growth Through Innovation"





Metallics

229 Cross Street, Bristol, CT 06010
Tel 800-243-8272 • Fax 800-831-9358
Email sales@metallicsonline.com

Metallics West

651 North Main Street, Mancos, CO 81328
Tel 800-269-5183 • Fax 800-269-6278
Email saleswest@metallicsonline.com

ANCHORING DEVICES

-  Hex
-  Slotted
-  Phillips
-  Square Drive

Four drives in one head



QUADRI CONCRETE SCREW KITS

MADE IN USA

 Manufactured by
 Avanti Screw, Inc.,
 A Metallics
 Affiliate
 SCREWS

STOCK NO.	UPC NO.	DESCRIPTION	WT. PER PKG.	SUGGESTED TRADE LIST PRICE PER
QCSHK1 3/16" Kit	39200	50 - 3/16 X 1 1/4 , 35 - 3/16 X 1 3/4 25 - 3/16 X 2 1/4 1 - 5/32 X 3 1/2 Masonry Drill 1 - 1/4 Drill Chuck	1.33	34.85/ea kit
QCSHK2 1/4" Kit	39204	50 - 1/4 X 1 1/4 , 35 - 1/4 X 1 3/4 25 - 1/4 X 2 1/4 1 - 3/16 X 3 1/2 Masonry Drill 1 - 5/16 Drill Chuck	2.11	44.13/ea kit

OTHER SIZES AND QUANTITIES AVAILABLE BY REQUEST



Metallics/Avanti Screw is Manufacturing

QUADRI CONCRETE SCREWS

FOUR DRIVES IN ONE HEAD
 (Hex, Slotted, Phillips & Square Drives)

CRAFTCOAT® 1000

The Gold Standard of Concrete Screws

IT'S A TAPPING SCREW AND AN ANCHORING SYSTEM

WE RECOMMEND A #2 SQUARE DRIVE BIT OR THE QUADRI DRIVE SOCKET DRIVER



Made by Avanti Screw, Inc., A Metallics Affiliate

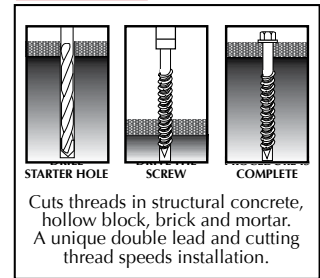

INTRODUCED IN 1999

STOCK NO.	UPC NO.	DIAMETER	LENGTH	*DRILL STOCK NO.	WT. PER PKG.	STD	SUGGESTED TRADE LIST PRICE PER
INSTALL WITH 1/4" QUADRI SOCKET DRIVER - SEE PAGE 145							
QCSH1	39145	3/16	1 1/4	CD1	.79	100	23.18/c
QCSH2	39146	3/16	1 3/4	CD1	1.12	100	24.83/c
QCSH3	39147	3/16	2 1/4	CD2	1.39	100	33.35/c
INSTALL WITH 5/16" QUADRI SOCKET DRIVER - SEE PAGE 145							
QCSH10	39148	1/4	1 1/4	CD5	1.43	100	29.08/c
QCSH20	39149	1/4	1 3/4	CD5	1.86	100	31.20/c
QCSH30	39150	1/4	2 1/4	CD6	2.29	100	35.35/c
QCSH40	39151	1/4	2 3/4	CD6	2.77	100	42.05/c

* ONE CONCRETE SCREW MASONRY DRILL PACKAGED WITH EACH HARD BODY PAC SQUARE JAR

1000 BULK PACK IN CARTON - CONCRETE SCREWS ONLY

REMEMBER TO ORDER CONCRETE SCREW MASONRY DRILLS AND QUADRI SOCKET DRIVER SEPARATELY

STOCK NO.	UPC NO.	DIAMETER	LENGTH	WT. PER PKG.	STD PKG.	SUGGESTED TRADE LIST PRICE PER
QCSH1B	39152	3/16	1 1/4	8.30	1000	197.05/M
QCSH2B	39153	3/16	1 3/4	15.10	1000	198.05/M
QCSH3B	39154	3/16	2 1/4	18.00	1000	283.33/M
QCSH10B	39155	1/4	1 1/4	10.35	1000	238.35/M
QCSH20B	39156	1/4	1 3/4	17.80	1000	265.20/M
QCSH30B	39157	1/4	2 1/4	22.47	1000	300.10/M
QCSH40B	39158	1/4	2 3/4	34.50	1000	357.15/M

MASONRY DRILLS NOT INCLUDED IN 1000 PACK

OTHER SIZES AND QUANTITIES AVAILABLE BY REQUEST

CRAFTCOAT® IS A REGISTERED TRADEMARK OF DONHAM CRAFT, INC.

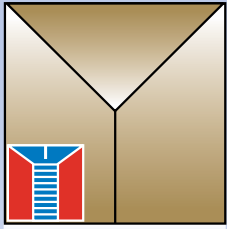

Metallics



QuaDrive Concrete Screw Anchor Display



[CONTRACTOR APPROVED]



CDQCSH10 Contains:

- 27 jars of the most common size Concrete Screw 1/4 X 1-1/4" QuaDrive.
- 100 pieces per jar.
- Free counter display and free shipping.



- Large fillet under head.
- Fluted interrupted threads.
- Twin lead threads.
- Silver seal coating (CraftCoat® 1000).

"Growth Through Innovation"

Metallics

229 Cross Street, Bristol, CT 06010
Tel 800-243-8272 • Fax 800-831-9358
Email sales@metallicsonline.com

Metallics West

651 North Main Street, Mancos, CO 81328
Tel 800-269-5183 • Fax 800-269-6278
Email saleswest@metallicsonline.com

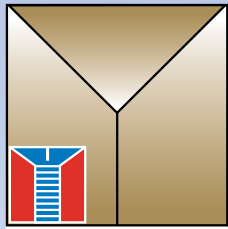

Metallics



Driller Hook™



- For light duty hanging in drywall
- No tools needed
- Anti-rotation washer prevents the hook from unscrewing

Driller Hook™ Installation Instructions:

Technical Specifications:

Driller Hook™

	Shear Max (lbs.)	Shear Safe (lbs.)
DRYWALL 3/8"	12	6
DRYWALL 1/2"	15	8
DRYWALL 5/8"	20	10

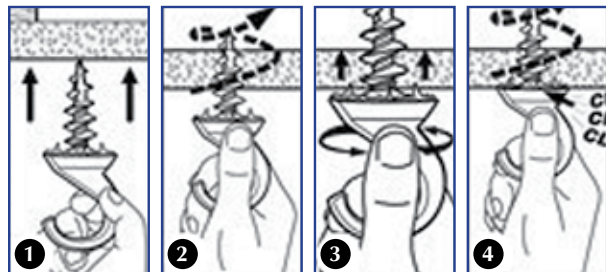

1. Using your hand, simply pierce the ceiling with the tip of the DrillHook™ and turn clockwise until you hear a locking click sound.

PART #	UPC #	DESCRIPTION	QTY / PKG	SUG. TRADE LIST / PKG
DHD1	83193	Driller Hook™ Ceiling Hook	1	\$ 6.50/ea

★ ★ ★ ★ ★ *"Growth Through Innovation"* ★ ★ ★ ★ ★

Metallics

229 Cross Street, Bristol, CT 06010
Tel 800-243-8272 • **Fax** 800-831-9358
Email sales@metallicsonline.com

Metallics West

651 North Main Street, Mancos, CO 81328
Tel 800-269-5183 • **Fax** 800-269-6278
Email saleswest@metallicsonline.com



QUADRIVE SOCKET DRIVER

QUADRIVE SOCKET DRIVERS - FOR QUADRIVE CONCRETE SCREWS

STOCK NO.	UPC NO.	HEAD SIZE	LENGTH	WT. PER PKG.	STD. PKG.	SUGGESTED TRADE LIST PRICE PER
1591910	39091	1/4	2 ⁵ / ₈	.26	1	9.00/ea
1513910	39092	5/16	2 ⁵ / ₈	.53	1	9.63/ea

Safety glasses should be worn for any driving applications.

OTHER SIZES AND QUANTITIES AVAILABLE BY REQUEST

BLUE CONCRETE SCREWS IT'S A TAPPING SCREW ANCHORING SYSTEM

One Masonry Drill Packaged with every jar.

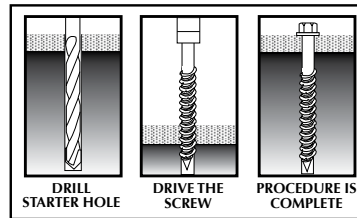

Cuts threads in structural concrete, hollow block, brick and mortar. A unique double lead and cutting thread speeds installation.

INDENTED HEX SLOTTED WASHER HEAD

STOCK NO.	UPC NO.	DIAMETER	LENGTH	DRILL STOCK NO.	WT. PER PKG.	STD. PKG.	SUGGESTED TRADE LIST PRICE PER
INSTALL WITH 1/4" HEX DRIVER—SEE PAGE 266							
CSH1F	87101	3/16	1 1/4	CD1	.80	100	23.00/c
CSH2F	87102	3/16	1 3/4	CD1	1.03	100	24.63/c
CSH3F	87103	3/16	2 1/4	CD2	1.32	100	33.03/c
CSH4F	87104	3/16	2 3/4	CD2	1.62	100	42.50/c
CSH5F	87105	3/16	3 1/4	CD3	1.88	100	49.50/c
CSH6F	87106	3/16	4	CD3	2.35	100	54.95/c
INSTALL WITH 5/16" HEX DRIVER—SEE PAGE 266							
CSH10F	87110	1/4	1 1/4	CD5	1.28	100	28.83/c
CSH20F	87120	1/4	1 3/4	CD5	1.71	100	30.95/c
CSH30F	87130	1/4	2 1/4	CD6	2.14	100	35.15/c
CSH40F	87140	1/4	2 3/4	CD6	2.57	100	41.78/c
CSH50F	87150	1/4	3 1/4	CD7	3.11	100	63.83/c
CSH60F	87160	1/4	4	CD7	3.62	100	71.45/c
CSH70F	87170	1/4	5	CD7	4.46	100	104.03/c
STAINLESS STEEL 410 TYPE INSTALL WITH 5/16" HEX DRIVER—SEE PAGE 266							
CSH10SS	90260	1/4	1 1/4	CD5	1.38	100	36.40/c
CSH20SS	90270	1/4	1 3/4	CD5	1.67	100	64.33/c

DRILL SIZES ON PAGE 150 SAFETY GLASSES SHOULD BE WORN FOR ANY DRIVING APPLICATIONS

OTHER SIZES AND QUANTITIES AVAILABLE BY REQUEST

CONTINUED ON NEXT PAGE

ANCHORING DEVICES

CONTINUED

FLAT HEAD BLUE CONCRETE SCREWS IT'S A TAPPING SCREW ANCHORING SYSTEM

One Masonry Drill Packaged with every jar.



FLAT PHILLIPS HEAD

INSTALL WITH #2 PHILLIPS BIT SEE PAGE 266

STOCK NO.	UPC NO.	DIAMETER	LENGTH	DRILL STOCK NO.	WT. PER PKG.	STD. PKG.	SUGGESTED TRADE LIST PRICE PER
CSF1F	87201	3/16	1 1/4	CD1	0.78	100	25.50/c
CSF2F	87202	3/16	1 3/4	CD1	1.05	100	27.58/c
CSF3F	87203	3/16	2 1/4	CD2	1.35	100	31.03/c
CSF4F	87204	3/16	2 3/4	CD2	1.52	100	31.38/c
CSF5F	87205	3/16	3 1/4	CD3	1.80	100	40.28/c
CSF6F	87206	3/16	4	CD3	2.12	100	64.00/c

STAINLESS STEEL 410 TYPE

INSTALL WITH #2 PHILLIPS BIT SEE PAGE 266

CSF2SS	96602	3/16	1 3/4	CD1	1.07	100	84.75/c	NEW
CSF4SS	96604	3/16	2 3/4	CD2	1.50	100	112.25/c	NEW

INSTALL WITH #3 PHILLIPS BIT SEE PAGE 266

CSF10F	87210	1/4	1 1/4	CD5	1.25	100	30.85/c	
CSF20F	87220	1/4	1 3/4	CD5	1.75	100	31.10/c	
CSF30F	87230	1/4	2 1/4	CD6	2.11	100	52.05/c	
CSF40F	87240	1/4	2 3/4	CD6	2.15	100	61.35/c	
CSF50F	87250	1/4	3 1/4	CD7	2.88	100	85.40/c	
CSF60F	87260	1/4	4	CD7	3.70	100	104.35/c	NEW
CSF70F	87270	1/4	5	CD7	4.50	100	141.03/c	NEW

OTHER SIZES AND QUANTITIES AVAILABLE BY REQUEST



KIT INCLUDES:

- 1 - Drill Driver
- 1 - Drill Adapter
- 2 - Hex Drivers
- 1 - Phillips Bit Holder
- 2 - Phillips Bits
- 1 - Allen Hex Key

DOES NOT INCLUDE DRILL BIT

IN A STURDY PLASTIC STORAGE CASE

CONCRETE SCREW INSTALLATION KIT

8 PIECE KIT

Tools and Driving Accessories

STOCK NO.	UPC NO.	DESCRIPTION	WT. PER PKG.	STD. PKG.	SUGGESTED TRADE LIST PRICE PER
IT1000	31200	Installation Tool (complete kit)	.95	1	
REPLACEMENT COMPONENTS FOR KIT					
MHD14	31205	1/4" Magnetic Hex Driver			
MHD56	31210	5/16" Magnetic Hex Driver			
PBH	31215	#2 & #3 Phillips Bit Holder			
ITSLEVE	31203	Drill/Driver Adapter			
PB2	31220	#2 Phillips Bit			
PB3	31225	#3 Phillips Bit			
HK1	31230	1/8" Allen Hex Key			

OTHER SIZES AND QUANTITIES AVAILABLE BY REQUEST

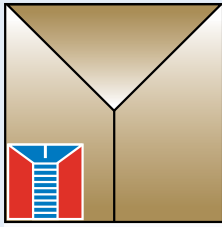

Metallics

LCS LARGE DIAMETER CONCRETE SCREW ANCHOR Self-Threading Anchor



City of Los Angeles #RR25741 #RR25560 (CMU)
Florida FL11506.7
Factory Mutual 3017082

High strength screw anchor for concrete and masonry. Designed for optimum performance in both cracked concrete and uncracked concrete under both static and seismic load conditions.

Fast Installation

- Just drill with standard ANSI bit to proper depth
- Installs with 50% less torque

Finished hex washer head

- Length identification on head
- Serrated washer

Close edge/spacing distance

Less spacing and edge distance required.

Saves Time

Installs in less than half the time of wedge or adhesive anchors.

Another NEW exciting solution from Metallics! Tired of searching for the right large diameter anchor... Here it is!

Selection Chart

Carbon Steel with Zinc Plating

Part Number	Anchor Diameter	Socket Size	Drill Bit Diameter	Effective Length
LCS3816	3/8"	9/16"	3/8"	1 3/4"
LCS3824	3/8"		3/8"	2 1/2"
LCS3830	3/8"		3/8"	3"
LCS3840	3/8"		3/8"	4"
LCS3850	3/8"		3/8"	5"
LCS1230	1/2"	3/4"	1/2"	3"
LCS1240	1/2"		1/2"	4"
LCS1250	1/2"		1/2"	5"
LCS1260	1/2"		1/2"	6"



PRODUCT SPECIFICATIONS

Diameter:
3/8" and 1/2"

Thread Form:
Serrated teeth on the tip reduces installation torque

Material:
Carbon steel with zinc plate

Head Style:
Finished hex serrated washer head

STOCK NUMBER	UPC #	DESCRIPTION	QTY PER PKG.	SUG. TRADE LIST / PKG
LCS3816	14470	3/8 x 1 3/4" Hex Washer Head Concrete Anchor	50	\$64.20
LCS3824	14471	3/8 x 2 1/2" Hex Washer Head Concrete Anchor	50	\$89.83
LCS3830	14472	3/8 x 3" Hex Washer Head Concrete Anchor	50	\$98.33
LCS3840	14473	3/8 x 4" Hex Washer Head Concrete Anchor	50	\$105.50
LCS3850	14474	3/8 x 5" Hex Washer Head Concrete Anchor	40	\$99.41
LCS1230	14480	1/2 x 3" Hex Washer Head Concrete Anchor	25	\$78.70
LCS1240	14481	1/2 x 4" Hex Washer Head Concrete Anchor	25	\$85.83
LCS1250	14482	1/2 x 5" Hex Washer Head Concrete Anchor	25	\$92.98
LCS1260	14483	1/2 x 6" Hex Washer Head Concrete Anchor	20	\$105.98

Metallics

229 Cross Street,
Bristol, Ct. 06010
Tel: 800-243-8272
Fax: 800-831-9358
Email: sales@metallicsonline.com

"Growth Through Innovation"

Metallics West

651 North Main Street
Maancos, Co. 81328
Tel: 800-269-5183
Fax: 800-269-6278
Email: saleswest@metallicsonline.com

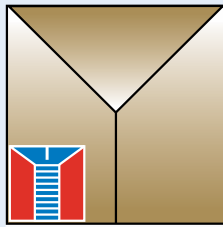

Metallics

LCSX LARGE DIAMETER CONCRETE SCREW ANCHOR Mechanically Galvanized

City of Los Angeles #RR25741 #RR25560 (CMU)
Florida FL11506.7
Factory Mutual 3017082

NEW!

Tested to
Meet
2006 IBC

High strength screw anchor for concrete and masonry. Designed for optimum performance in both cracked concrete and uncracked concrete under both static and seismic conditions.

Fast Installation

- Just drill with standard ANSI bit to proper depth
- Installs with 50% less torque

Finished hex washer head

- Length identification on head
- Serrated washer

Close edge/spacing distance

Less spacing and edge distance required.

Saves Time

Installs in less than half the time of wedge or adhesive anchors.



PRODUCT SPECIFICATIONS

Diameter:
3/8" and 1/2"

Thread Form:
Serrated teeth on the tip reduces installation torque

Material:
Carbon steel with zinc plate

Head Style:
Finished hex washer head with mechanically galvanized coating

Selection Chart

Carbon Steel with Mechanically Galvanized Coating

Part Number	Anchor Diameter	Socket Size	Drill Bit Diameter	Effective Length	Max. Thickness of Material To Be Fastened
LCSX3850	3/8"	9/16"	3/8"	5"	3 1/2"
LCSX1250	1/2"	3/4"	1/2"	5"	2 1/2"

Another NEW exciting solution from Metallics! Tired of searching for the right large diameter anchor... Here it is!

STOCK NUMBER	UPC #	DESCRIPTION	QTY PER PKG.	SUG. TRADE LIST / PKG
LCSX3850	14492	3/8 x 5" Hex Washer Head Concrete Anchor with mechanically galvanized coating	40	\$182.60
LCSX1250	14498	1/2 x 5" Hex Washer Head Concrete Anchor with mechanically galvanized coating	25	\$194.53

Metallics

229 Cross Street,
Bristol, Ct. 06010
Tel: 800-243-8272
Fax: 800-831-9358
Email: sales@metallicsonline.com

"Growth Through Innovation"

Metallics West

651 North Main Street
Maancos, Co. 81328
Tel: 800-269-5183
Fax: 800-269-6278
Email: saleswest@metallicsonline.com

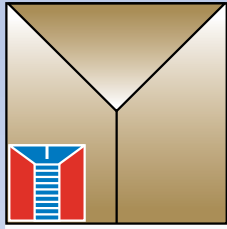

Metallics



4 Heavy Duty Ultimate Anchor Kits

*Choose the right kit that's right for you!
The right anchors for any job.*

[CONTRACTOR APPROVED]

UAKHD1



Drop-In Anchor



Double Expansion Anchor

UAKHD2



Machine Screw Anchor



Wedge Anchor

UAKHD3



Lag Screw Short & Long Anchor



Double Expansion Anchor

UAKHD4

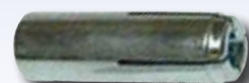

Drop-In Anchor



Sleeve Type Anchor

PART #	UPC #	DESCRIPTION	QTY / PKG	SUG. TRADE LIST / PKG
UAKHD1	33281	20 pcs 1/4-20, 15 pcs 3/8-16 and 10 pcs 1/2-13 Drop-In Anchors 20 pcs 1/4-20, 15 pcs 5/16-18 and 10 pcs 3/8-16 Double Expansion Anchors	1	\$ 47.50
UAKHD2	33282	20 pcs 1/4-20, 15 pcs 5/16-18 and 10 pcs 3/8-16 Machine Screw Anchors 20 pcs 1/4 x 1-1/4, 15 pcs 1/4 x 2-1/4 and 10 pcs 3/8 x 2-1/4 Wedge Anchors	1	\$ 50.10
UAKHD3	33283	10 pcs ea 1/4, 10 pcs ea 5/16 and 6 pcs ea 3/8 Lag Screw Short & Long Anchors 20 pcs 1/4-20, 15 pcs 5/16-18 and 10 pcs 3/8-16 Double Expansion Anchors	1	\$ 61.95
UAKHD4	33284	20 pcs 1/4-20, 15 pcs 3/8-16 and 10 pcs 1/2-13 Steel Drop-In Anchors 20 pcs 1/4 x 1-3/8, 15 pcs 5/16 x 1-1/2 and 10 pcs 3/8 x 1-7/8 Sleeve Type Anchors	1	\$ 38.70

Other sizes, materials and quantities available by request.

SETTING TOOLS SOLD SEPARATELY

"Growth Through Innovation"

Metallics

229 Cross Street, Bristol, CT 06010
Tel 800-243-8272 • **Fax** 800-831-9358
Email sales@metallicsonline.com

Metallics West

651 North Main Street, Mancos, CO 81328
Tel 800-269-5183 • **Fax** 800-269-6278
Email saleswest@metallicsonline.com

ANCHORING DEVICES



Can be used with our
QuaDrive and Blue
Concrete Screws

MASONRY DRILL BITS FOR CONCRETE SCREWS

SPECIAL SIZE AND LENGTH
For use with Installation Tool, see Page
or any standard electric rotary tool or hammer drill

STOCK NO.	UPC NO.	DIAMETER & LENGTH	SCREW DIA.	WT. PER PKG.	STD. PKG.	SUGGESTED TRADE LIST PRICE PER
CD1	31250	5/32 x 3 1/2	3/16	.02	1	3.38/ea
CD2	31255	5/32 x 4 1/2	3/16	.02	1	3.98/ea
CD3	31260	5/32 x 5 1/2	3/16	.02	1	4.53/ea
CD5	31265	3/16 x 3 1/2	1/4	.02	1	3.45/ea
CD6	31270	3/16 x 4 1/2	1/4	.02	1	4.08/ea
CD7	31275	3/16 x 5 1/2	1/4	.03	1	5.78/ea
CD8	31280	3/16 x 6	1/4	.03	1	7.43/ea

OTHER SIZES AND QUANTITIES AVAILABLE BY REQUEST



BLUE CONCRETE SCREW KITS

INDENTED HEX SLOTTED WASHER HEAD



Hex

STOCK NO.	UPC NO.	DESCRIPTION OF CONTENTS	STD. PKG./ MSTR CARTON	WEIGHT EACH	SUGGESTED TRADE LIST PRICE PER
CSH316RF	87370	50 pcs 3/16 x 1 1/4, 35 pcs 3/16 x 1 3/4, 25 pcs 3/16 x 2 1/4, 1 pc 3 1/2 x 5/32 masonry drill, 1 pc MT208 1/4" chuck	1/25	1.29	40.50/ea kit NEW
CSH14RF	87365	50 pcs 1/4 x 1 1/4, 35 pcs 1/4 x 1 3/4, 25 pcs 1/4 x 2 1/4, 1 pc 3 1/2 x 3/16 masonry drill, 1 pc MT210 5/16" chuck	1/25	2.00	44.88/ea kit NEW

OTHER SIZES AND QUANTITIES AVAILABLE BY REQUEST



Slotted

Phillips



SPRING WING TOGGLE BOLTS

STEEL ZINC CHROMATE

Bolts and Wings in One Package

STOCK NO.	JAR UPC NO.	DIAMETER & LENGTH	DRILL SIZE	WT. PER PKG.	STD. PKG.	SUGGESTED TRADE LIST PRICE PER
ROUND HEAD						
J1501 (slot/Phillips)	80809	1/8 x 2	1/8" WING USE 7/16" DRILL	0.72	50	24.80/c
J1502 (slot/Phillips)	80810	1/8 x 3	3/16" WING USE 9/16" DRILL	0.80	50	28.56/c
J1503 (slot/Phillips)	81203	1/8 x 4	9/16" DRILL	0.98	50	30.56/c
J1504 (slot/Phillips)	81204	1/8 x 6	1/4" WING USE 3/4" DRILL	2.60	50	49.10/c NEW
J1505 (slot/Phillips)	80811	3/16 x 2	3/4" DRILL	1.40	50	29.96/c
J1506 (slot/Phillips)	80812	3/16 x 3	5/16" WING USE 7/8" DRILL	1.71	50	33.26/c
J1507 (slot/Phillips)	81207	3/16 x 4	7/8" DRILL	1.95	50	34.76/c
J1508 (slotted)	81208	3/16 x 5	3/8" WING USE 1" DRILL	2.35	50	37.36/c
J1509 (slotted)	81209	3/16 x 6	1" DRILL	2.60	50	43.06/c
J1511 (slot/Phillips)	80813	1/4 x 3	1/2" WING USE 1-1/4" DRILL	2.93	50	37.66/c
J1512 (slot/Phillips)	10396	1/4 x 4	1-1/4" DRILL	3.45	50	41.96/c
J1513 (slotted)	81213	1/4 x 5	SELECT THE PROPER DRILL FOR MATERIAL TO BE DRILLED	3.93	50	49.00/c
J1514 (slotted)	81214	1/4 x 6		4.47	50	55.90/c

OTHER SIZES AND QUANTITIES AVAILABLE BY REQUEST

CONTINUED ON NEXT PAGE

ANCHORING DEVICES

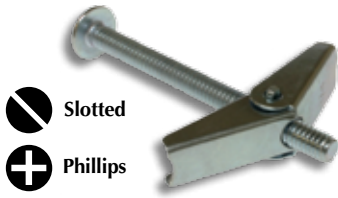

CONTINUED SPRING WING TOGGLE BOLTS

STEEL ZINC CHROMATE

Bolts and Wings in One Package

STOCK NO.	JAR UPC NO.	DIAMETER & LENGTH	DRILL SIZE	WT. PER PKG.	STD. PKG.	SUGGESTED TRADE LIST PRICE PER
ROUND HEAD						
J1516 (slotted)	10407	5/16 x 4	1/8" WING USE 7/16" DRILL	3.05	25	89.92/c
J1517 (slotted)	81217	5/16 x 5		3.81	25	127.52/c
J1518 (slotted)	81218	5/16 x 6		4.03	25	142.72/c
J1519 (slot/Phillips)	81219	3/8 x 3		3.72	25	99.92/c
J1520 (slot/Phillips)	81220	3/8 x 4		4.31	25	111.18/c
J1521 (slotted)	81221	3/8 x 5		5.06	25	136.52/c
J1522 (slot/Phillips)	81222	3/8 x 6		5.60	25	148.92/c
J1523 (slotted)	81223	1/2 x 4		3.95	10	201.80/c
J1524 (slotted)	81224	1/2 x 5		4.25	10	269.00/c
J1525 (slotted)	81225	1/2 x 6		4.85	10	295.80/c
FLAT HEAD						
J1528 (slotted)	81228	1/8 x 2	3/16" WING USE 9/16" DRILL	0.69	50	*SPECIAL ORDER ITEMS. INQUIRE ABOUT AVAIL- ABILITY AND PRICES 1-800 243-8272 EAST 1-800 269-5183 WEST
J1529 (slotted)	80814	1/8 x 3	0.87	50		
J1530 (slotted)	81230	1/8 x 4	0.97	50		
J1531 (slotted)	81231	3/16 x 2	1.48	50		
J1532 (slotted)	81232	3/16 x 3	1.68	50		
J1533 (slotted)	81233	3/16 x 4	1/4" WING USE 3/4" DRILL	2.10	50	
J1534 (slotted)	81234	3/16 x 5	2.24	50		
J1535 (slotted)	81235	3/16 x 6	2.62	50		
J1536 (slotted)	81236	1/4 x 3	2.82	50		
J1537 (slotted)	81237	1/4 x 4	3.31	50		
J1538 (slotted)	81238	1/4 x 5	5/16" WING USE 7/8" DRILL	3.96	50	
J1539 (slotted)	81239	1/4 x 6	4.46	50		
J1540 (slotted)	81240	5/16 x 3	2.55	25		
J1541 (slotted)	81241	5/16 x 4	2.88	25		
J1542 (slotted)	81242	5/16 x 5	3/8" WING USE 1" DRILL	3.22	25	
J1543 (slotted)	81243	5/16 x 6	3.79	25		
J1544 (slotted)	81244	3/8 x 3	3.49	25		
J1545 (slotted)	81245	3/8 x 4	4.22	25		
J1546 (slotted)	81246	3/8 x 5	4.90	25		
J1547 (slotted)	81247	3/8 x 6	1/2" WING USE 1-1/4" DRILL	5.75	25	
MUSHROOM - TRUSS HEAD						
J1548 (slotted)	80815	1/8 x 2	SELECT THE PROPER DRILL FOR MATERIAL TO BE DRILLED	0.75	50	24.80/c
J1549 (slot/Phillips)	80816	1/8 x 3		0.82	50	28.56/c
J1550 (slot/Phillips)	80817	1/8 x 4		1.01	50	30.56/c
J1551 (slot/Phillips)	80818	3/16 x 3		1.80	50	33.26/c
J1552 (slot/Phillips)	10397	3/16 x 4		2.01	50	34.76/c
J1553 (slot/Phillips)	10399	1/4 x 3		2.96	50	39.06/c
J1554 (slot/Phillips)	10398	1/4 x 4		3.50	50	41.96/c
SQUARE MUSHROOM - TRUSS HEAD						
J1560 (square)	80819	1/8 x 2		0.84	50	49.70/c
J1561 (square)	80820	1/8 x 3		0.95	50	28.56/c
J1562 (square)	80821	1/8 x 4		1.10	50	30.56/c
J1563 (square)	80822	3/16 x 2		1.58	50	29.96/c
J1564 (square)	80823	3/16 x 3		1.85	50	33.26/c
J1565 (square)	81265	3/16 x 4		2.00	50	34.76/c
J1566 (square)	81266	1/4 x 3		3.03	50	39.06/c

OTHER SIZES AND QUANTITIES AVAILABLE BY REQUEST

ANCHORING DEVICES

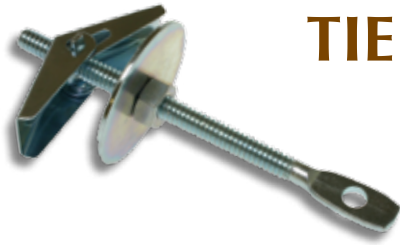

TIE WIRE ACOUSTICAL TOGGLE BOLTS

Includes: (1) Tie Wire 1/4-20 toggle bolt
 (1) 1/4-20 nut
 (1) 1/4 washer
 (1) 1/4 toggle wing

Tie wire acoustical toggle bolts are primarily for overhead applications. The winged end is inserted through the drywall, ceiling tile, etc., and expands behind that medium while the 1/4" x 1-1/4" fender washer and hex nut act to secure the anchor on the exterior of the hole.

STOCK NO.	UPC NO.	SIZE	DESCRIPTION	WT. PER PKG.	PKG. QTY.	SUGGESTED TRADE LIST PRICE PER
JTWA144	81402	1/4 x 4	Toggle bolt	2.47	50	152.00/c
JTWA145	81404	1/4 x 5	Toggle bolt	2.33	50	163.72/c

Hole Size 5/8" • Eye Size 1/4"

OTHER SIZES AND QUANTITIES AVAILABLE BY REQUEST



SHEET ROCK TOGGLES

Vertical Mount used for hanging Threaded Rod 1/4" or 3/8"
 For use in sheetrock ceilings, metal, lath & plaster, metal liners, wood, ceiling panels.

SheetRock Toggle for 1/4 Rod (Vertical Mount)
 Use Nut Driver SMDB2

STOCK NO.	UPC NO.	SIZE	DESCRIPTION	WT. PER PKG.	PKG. QTY.	SUGGESTED TRADE LIST PRICE PER
JSRT14	81388	1/4	SheetRock Toggle	3.08	25	307.12/c

OTHER SIZES AND QUANTITIES AVAILABLE BY REQUEST



SPRING TOGGLE HEADS

STEEL ZINC CHROMATE & STAINLESS STEEL 18-8 TYPE
 For Light Duty Application

STOCK NO.	JAR UPC NO.	THREAD DIAMETER	DRILL SIZE	WT. PER PKG.	STD. PKG.	SUGGESTED TRADE LIST PRICE PER
STEEL ZINC CHROMATE						
J1590	80824	6-32	FOR APPROPRIATE DRILL SIZE SEE CHART ON PAGE 151	0.71	100	15.48/c
J1592	80825	10-24		1.38	100	18.53/c
J1593	80826	1/4-20		2.25	100	20.98/c
J1594	80827	5/16-18		4.20	100	39.25/c
J1595	80828	3/8-16		1.47	25	57.12/c
J1596	80829	1/2-13		4.42	25	132.40/c
STAINLESS STEEL 18-8 TYPE						
J1593SS	96993	1/4-20		0.94	50	200.00/c NEW
J1592SS	96992	3/16		0.74	50	225.00/c NEW

OTHER SIZES AND QUANTITIES AVAILABLE BY REQUEST

MUSHROOM HEAD TOGGLE BOLT KIT



We are at it again with Kits!

Introducing 3 of the most commonly used Mushroom Head Toggle Bolts all in one convenient kit at one great low price.

Kit Includes The Following:

- 1/8" X 3" Mushroom Head Combo Drive Bolt (50 Pieces)
- 1/8" Spring Wing Toggle (50 Pieces)
- 3/16" X 3" Mushroom Head Combo Drive Bolt (34 Pieces)
- 3/16" Spring Wing Toggle (34 Pieces)
- 1/4" X 4" Mushroom Head Combo Drive Bolt (20 Pieces)
- 1/4" Spring Wing Toggle (20 Pieces)

STOCK NO.	UPC NO.	WT. PER PKG.	SUGGESTED TRADE LIST PRICE PER
TBMK1	70060	3.7 lbs.	46.28/ea. kit

OTHER SIZES AND QUANTITIES AVAILABLE BY REQUEST



MANUFACTURING CAPABILITIES

Diameter range #2 thru 5/16" / 1.5mm thru 8mm • Length range 1/8" thru 3" / 3.5mm thru 75mm

Materials: Steel, Brass, Stainless, Aluminum, Bronze.

NEED SCREWS...
Let Us Make Them For You!



A METALLICS AFFILIATE

P.O. Box 1600 • 231 Cross Street
Bristol, CT 06011-1600
Tel: 800-984-8945 • Fax: 800-984-8946

CAPABILITIES LIST

- PLANT SIZE:** 100,000 SQUARE FEET
- LOCATION:** Bristol, Connecticut
- EQUIPMENT:** 27 Hi-Speed Cold Headers
8 Burr-Free Screw Slotters
3 Shank Slotters
2 Pointers
14 High Speed Thread Rollers



ADDITIONAL PLANT INFO: Modern shipping facility utilizing digital scale counting machines. In-house packaging facilities - boxing, sorting, baggings. All material boxed, palletized & labeled with your needs in mind for domestic or export shipping.

SECONDARY WORK: All plating & heat treating is done on the outside and certified for your guarantee.

INFORMATION SYSTEMS: Our facility has new and upgraded Technology to meet your customers specific requirements.

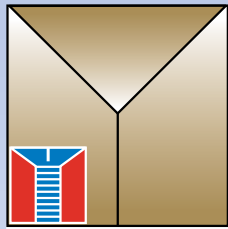

Metallics

Cobra TripleGrip™ Multi-Purpose Anchor



**[CONTRACTOR
APPROVED]**



Requires: Drill and #2 Phillips

- Two claws hold the anchor stationary while inserting the screw.
- Two powerful locking wings deploy as you screw, for strength and unparallel vibration resistance.
- The tip of the core expands for additional holding power.
- Works in 3/8", 1/2" and 5/8" Drywall; Brick; Concrete and Plaster.

MAXIMUM LOAD CAPACITY

Anchor	Drill Bit	Drywall 5/8"		Concrete 3000 psi	
		PULL	SHEAR	PULL	SHEAR
#6	1/4"	60 lbs.	91 lbs.	240 lbs.	400 lbs.
#8	1/4"	64 lbs.	102 lbs.	275 lbs.	500 lbs.
#10	5/16"	88 lbs.	154 lbs.	400 lbs.	800 lbs.
#12	3/8"	132 lbs.	204 lbs.	500 lbs.	900 lbs.



Phillips

Other sizes, materials and quantities available by request.

PART #	UPC #	DESCRIPTION	QTY / PKG	SUG. TRADE LIST / PKG
TGA6	72655	#6 Triple Grip Anchors	100	\$ 14.60
TGA8	72657	#8 Triple Grip Anchors	100	\$ 14.93
TGA10	72659	#10 Triple Grip Anchors	100	\$16.88
TGA12	72661	#12 Triple Grip Anchors	100	\$ 31.78
TGA6K	72665	#6 Triple Grip Anchors • #6 x 1-1/4" Pan Head Sheet Metal Screws • (1) 1/4 x 4" Masonry Drill	100	\$ 20.45
TGA8K	72667	#8 Triple Grip Anchors • #8 x 1-1/4" Pan Head Sheet Metal Screws • (1) 1/4 x 4" Masonry Drill	100	\$ 20.85
TGA10K	72669	#10 Triple Grip Anchors • #10 x 1-1/2" Pan Head Sheet Metal Screws • (1) 5/16 x 4" Masonry Drill	100	\$ 24.73
TGA12K	72671	#12 Triple Grip Anchors • #12 x 1-1/2" Pan Head Sheet Metal Screws • (1) 3/8 x 4" Masonry Drill	50	\$ 26.63
TGA6J	72675	#6 Triple Grip Anchors • #6 x 1-1/4" Pan Head Sheet Metal Screws • (1) 1/4 x 4" Masonry Drill	100	\$ 20.45
TGA8J	72677	#8 Triple Grip Anchors • #8 x 1-1/4" Pan Head Sheet Metal Screws • (1) 1/4 x 4" Masonry Drill	100	\$ 20.45
TGA10J	72679	#10 Triple Grip Anchors • #10 x 1-1/2" Pan Head Sheet Metal Screws • (1) 5/16 x 4" Masonry Drill	100	\$ 24.73
TGA12J	72681	#12 Triple Grip Anchors • #12 x 1-1/2" Pan Head Sheet Metal Screws • (1) 3/8 x 4" Masonry Drill	50	\$ 26.63

Note: Part numbers with a "K" are packaged in plastic boxes. Part numbers with a "J" are packaged in plastic jars.

"Growth Through Innovation"

Metallics

229 Cross Street, Bristol, CT 06010
Tel 800-243-8272 • **Fax** 800-831-9358
Email sales@metallicsonline.com

Metallics West

651 North Main Street, Mancos, CO 81328
Tel 800-269-5183 • **Fax** 800-269-6278
Email saleswest@metallicsonline.com

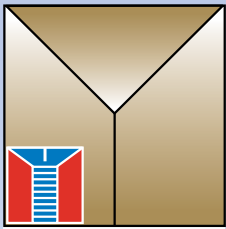

Metallics



Toggler Alligator[®] Solid Wall Anchors

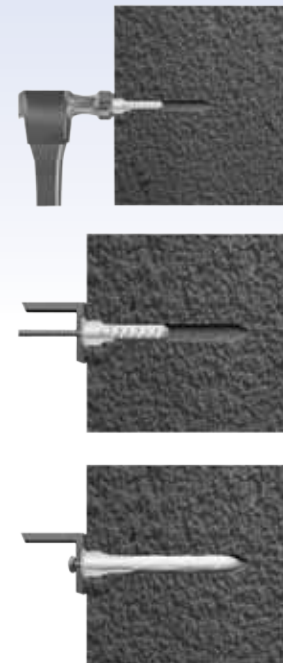
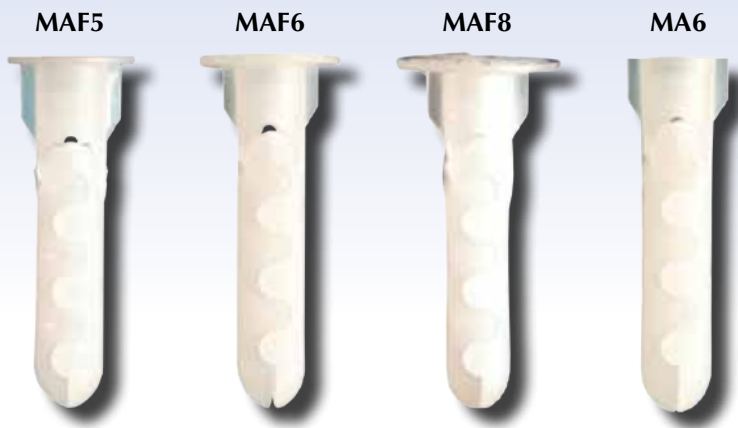

ALLIGATOR solid wall anchors are designed to support heavy loads (even under vibration).

ALLIGATOR solid wall anchors can be used in almost any material, including: Concrete, Wood, Plaster, Aerated Concrete, Brick, Masonry, Stone, Flakeboard, Cinder Block, Ceramic Tile, Stucco, Drywall

PART #	UPC #	DESCRIPTION	QTY / PKG	SUG. TRADE LIST / PKG
MAF5	73905	3/16" Toggler Alligator anchor with flange	50	\$15.88
MAF6	73905	1/4" Toggler Alligator anchor with flange	50	\$22.55
MAF8	73908	5/16" Toggler Alligator anchor with flange	50	\$30.08
MA6	73939	1/4" Toggler Alligator anchor no flange	50	\$22.55

Other sizes, materials and quantities available by request.

"Growth Through Innovation"

Metallics

229 Cross Street, Bristol, CT 06010
Tel 800-243-8272 • **Fax** 800-831-9358
Email sales@metallicsonline.com

Metallics West

651 North Main Street, Mancos, CO 81328
Tel 800-269-5183 • **Fax** 800-269-6278
Email saleswest@metallicsonline.com

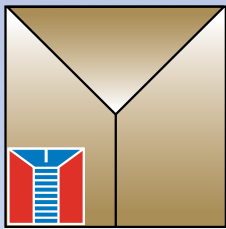

Metallics

Super Wall Plate Screw Kit

A Complete Wall Plate Kit to Make Insulation Easy and Safer



[CONTRACTOR APPROVED]



Each kit contains:

- 50 Wall plate screws in White, Ivory, and Light Almond.
- 50 Screws to secure electrical device to electrical box.
- 50 Secura-let™ spacers to shim electrical device so wall plate is flush to wall.

Other sizes, materials and quantities available by request.

PART #	UPC #	DESCRIPTION	QTY / PKG	SUG. TRADE LIST / PKG
SWPK1	20360	#6 - 32 x 1/2" Slotted Oval Head White Painted Screw	50	\$ 28.13
		#6 - 32 x 1/2" Slotted Oval Head Ivory Painted Screw	50	
		#6 - 32 x 1/2" Slotted Oval Head Almond Painted Screw	50	
		#6 - 32 x 3/4" Slotted Flat Head Machine Screw	50	
		#6 - 32 x 1" Slotted Flat Head Machine Screw	50	
		Secura-lets Stackable Spacers	50	

Secura-let spacers are stackable U.L. recognized electrical grade PVC with a U.L. 94-0 flame rating and weatherability rating.

★ ★ ★ ★ ★ *"Growth Through Innovation"* ★ ★ ★ ★ ★

Metallics

229 Cross Street, Bristol, CT 06010
Tel 800-243-8272 • **Fax** 800-831-9358
Email sales@metallicsonline.com

Metallics West

651 North Main Street, Mancos, CO 81328
Tel 800-269-5183 • **Fax** 800-269-6278
Email saleswest@metallicsonline.com

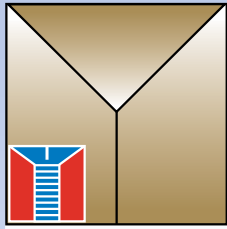

Metallics



Toggler Snapskru® Kit & Bulk

**[CONTRACTOR
APPROVED]**

Self-Drilling Drywall Anchors

Another NEW exciting solution from Metallics!
Tired of searching for the right Anchor? **Here it is!**
Toggler Snapskru®...

The Strongest, easiest-to-use self-drilling drywall anchor—

INSTALLATION INSTRUCTIONS: Tools Needed

Screw gun with #2 Phillips bit (or #2 Phillips screwdriver, or electric drill with clutch mechanism & #2 bit)

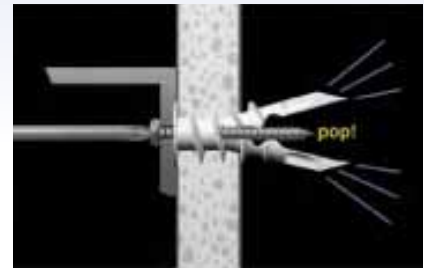
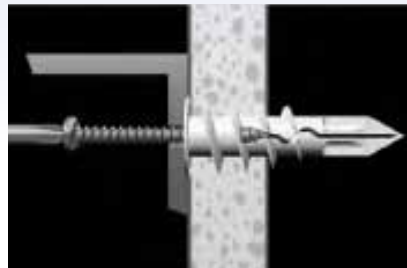

Press tip of Snapskru anchor into drywall using #2 Phillips screwdriver or screw gun. Drive anchor clockwise into drywall until anchor stops flush with the outer wall surface.
TIP: To keep anchor in precise position during installation (critical for aligning several anchors), push tip of screwdriver into drywall to mark insertion point.

Screw for *MINI* anchor:
#6 through #8 (#6 preferred).
[3.5-4.5mm, 3.5mm preferred]

Screw for *REGULAR* anchor:
#6 through #10 (#8 preferred).
[3.5-4.5mm, 4mm preferred]

Tighten screw flush with item.

The screw pops open the anchor, looking it on the wall and holding the gypsum board in compression. This reinforces the wall, increasing its holding power significantly.

Screw Length = Thickness of item being installed plus 1-1/4".

PART #	UPC #	DESCRIPTION	SUG. TRADE LIST / PKG
ASP1K	78446	50 pcs Toggler Snapskru Reg. / 50 pcs #8 x 1-1/2" Pan Hd Combo SMS / 1 #2 Phillips Power Bit 2" lg.	\$ 28.05
ASP1J	78445	50 pcs Toggler Snapskru Reg. / 50 pcs #8 x 1-1/2" Pan Hd Combo SMS / 1 #2 Phillips Power Bit 2" lg.	\$ 28.05
ASP1M	78447	1000 pcs Toggler Snapskru Regular	\$ 276.50
ASPM1K	78461	50 pcs Toggler Snapskru Mini / 50 pcs #6 x 1-1/2" Pan Hd Combo SMS / 1 #2 Phillips Power Bit 2" lg.	\$ 28.05
ASPM1J	78460	50 pcs Toggler Snapskru Mini / 50 pcs #6 x 1-1/2" Pan Hd Combo SMS / 1 #2 Phillips Power Bit 2" lg.	\$ 28.05
ASPM1M	78462	1000 pcs Toggler Snapskru Mini	\$ 224.50

Other sizes, materials and quantities available by request.

"Growth Through Innovation"

Metallics

229 Cross Street, Bristol, CT 06010
Tel 800-243-8272 • Fax 800-831-9358
Email sales@metallicsonline.com

Metallics West

651 North Main Street, Mancos, CO 81328
Tel 800-269-5183 • Fax 800-269-6278
Email saleswest@metallicsonline.com

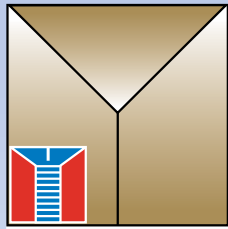

Metallics



Toggler Alligator[®] Solid Wall Anchor Kit

**[CONTRACTOR
APPROVED]**

- Alligator[®] solid-wall anchors can be used in most any material, including: Concrete, Wood, Plaster, Aerated Concrete, Block, Masonry, Stone, Flakeboard, Cinder Block, Ceramic Tile, Stucco, and Drywall.
- Alligator[®] solid-wall anchors are designed to support heavy loads. (Even under vibration!)



The Alligator anchor is the only anchor that extrudes the entire length of the screw. The screw extrudes and compresses all the plastic into the wall of the hole under tremendous pressure. The plastic molds and conforms exactly to the surface of the hole (including all the hole's imperfections). All forces supported by the screw are transmitted around the anchor to the wall of the hole. This provides greater holding power by distributing the force over the maximum area possible.



PART #	UPC #	DESCRIPTION	SUG. TRADE LIST / PKG
MAF5KJ	73985	(50) #8 x 1" Pan Head Combo Sheet Metal Screws	\$ 21.90
		(50) 3/16" Alligator Solid Wall Anchors with Flange	
		(1) 3/16" x 4" Carbide Tipped Masonry Drill Bit	
MAF6KJ	73986	(50) #10 x 1" Pan Head Combo Sheet Metal Screws	\$ 27.05
		(50) 1/4" Alligator Solid Wall Anchors with Flange	
		(1) 1/4" x 4" Carbide Tipped Masonry Drill Bit	
MAF8KJ	79388	(50) #12 x 1-1/4" Pan Head Combo Sheet Metal Screws	\$ 37.70
		(50) 5/16" Alligator Solid Wall Anchors with Flange	
		(1) 5/16" x 4" Carbide Tipped Masonry Drill Bit	

Other sizes, materials and quantities available by request.

★ ★ ★ ★ ★ "Growth Through Innovation" ★ ★ ★ ★ ★

Metallics

229 Cross Street, Bristol, CT 06010
Tel 800-243-8272 • **Fax** 800-831-9358
Email sales@metallicsonline.com

Metallics West

651 North Main Street, Mancos, CO 81328
Tel 800-269-5183 • **Fax** 800-269-6278
Email saleswest@metallicsonline.com

ANCHORING DEVICES

HOLLOW BLOCK T-ANCHORS

For Hollow Wallblock

STEEL ZINC CHROMATE



STOCK NO.	UPC NO.	SIZE	THREAD LENGTH	DRILL SIZE	WT. PER PKG.	STD. PKG.	SUGGESTED TRADE LIST PRICE PER
JTA14134	80830	1/4 x 1 3/4	1	5/16	0.93	25	241.72/c
JTA14212	80831	1/4 x 2 1/2	1 3/4	5/16	1.12	25	253.72/c
JTA14314	80832	1/4 x 3 1/4	2 3/8	5/16	0.89	25	261.80/c
JTA516212	80833	5/16 x 2 1/2	1 5/8	5/16	1.60	25	263.80/c
JTA516314	80834	5/16 x 3 1/4	2 3/8	5/16	2.03	25	274.00/c
JTA516334	80835	5/16 x 3 3/4	2 7/8	5/16	2.31	25	288.00/c
JTA38314	80836	3/8 x 3 1/4	2 1/4	3/8	2.88	25	314.32/c
JTA38334	81143	3/8 x 3 3/4	2 3/4	3/8	3.05	25	322.32/c
JTA38412	81146	3/8 x 4 1/2	3 1/2	3/8	3.59	25	352.52/c

OTHER SIZES AND QUANTITIES AVAILABLE BY REQUEST

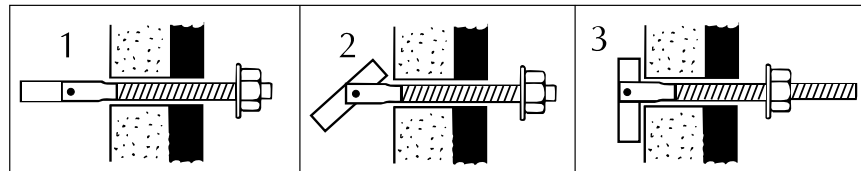

1. Drill hole using proper diameter and insert T-Anchor with washer and hex nut attached through item to be fastened.
2. Give it a quarter turn; retaining bar drops into place.
3. Tighten nut until a firm resistance is attained.

HOLLOW WALL SCREW ANCHORS, DRIVE-TYPE

STEEL ZINC CHROMATE - INCLUDES COMBO HEAD MACHINE SCREW

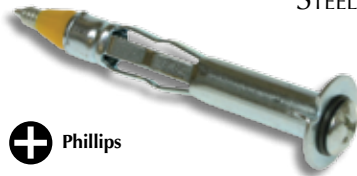

⊕ Phillips

A hammer is the only tool needed to set in place.

No predrilling required when fastening fixtures and electrical components to sheet rock.

It is a time-saver for the professional contractor.

STOCK NO.	UPC NO.	SIZE & WALL THICKNESS	GRIP RANGE	DRILL SIZE	WT. PER PKG.	STD. PKG./ MSTR SLEEVE	SUGGESTED TRADE LIST PRICE PER
J6721	80837	1/8 Short	1/8 - 1/2	5/16	1.37	100/500	38.08/C
J6726	80838	1/8 Long	1/8 - 13/16	5/16	1.84	100	39.10/C

OTHER SIZES AND QUANTITIES AVAILABLE BY REQUEST

HOLLOW WALL SCREW ANCHOR

STEEL ZINC CHROMATE

INCLUDES COMBO HEAD MACHINE SCREW

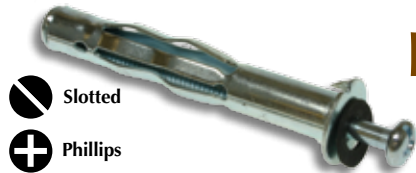

⊖ Slotted

⊕ Phillips

STOCK NO.	UPC NO.	SIZE & WALL THICKNESS	GRIP RANGE	DRILL SIZE	WT. PER PKG.	STD. PKG./ MSTR SLEEVE	SUGGESTED TRADE LIST PRICE PER
J1001	80839	1/8 X-Short	1/16 - 1/4	5/16	.91	100	33.23/c
J1002	80840	1/8 Short	1/8 - 1/2	5/16	1.36	100	33.90/c
J1003	80841	1/8 Long	5/8 - 7/8	5/16	1.81	100	36.48/c
J1004	80842	3/16 Short	1/8 - 5/8	7/16	3.45	100	66.95/c
J1005	80843	3/16 Long	5/8 - 1 3/16	7/16	2.15	50	81.96/c
J1006	80844	1/4 Short	1/8 - 5/8	1/2	2.81	50	97.30/c
J1007	80845	1/4 Long	5/8 - 1 3/16	1/2	3.65	50	110.50/c

OTHER SIZES AND QUANTITIES AVAILABLE BY REQUEST

ANCHORING DEVICES

MACHINE SCREW LEAD ANCHOR

ONE SETTING TOOL FURNISHED IN EACH JAR OF ANCHORS

We only recomend these anchors for cement floors,
not to be used overhead in ceilings or walls.



STOCK NO.	UPC NO.	SIZE	HOLE SIZE	ANCHOR LENGTH	WT. PER PKG.	STD. PKG.	SUGGESTED TRADE LIST PRICE PER
J1401	83155	6-32	5/16	17/32	0.87	100	44.75/c
J1402	80846	8-32	5/16	17/32	0.91	100	45.03/c
J1403	80847	10-24	3/8	11/16	1.78	100	45.63/c
J1404	80848	10-32	3/8	1/2	1.88	100	45.63/c
J1406	80850	1/4-20	1/2	7/8	3.75	100	51.38/c
J1407	80851	5/16-18	5/8	1 1/16	6.69	100	129.38/c
J1408	80852	3/8-16	3/4	1 5/16	5.25	50	130.50/c
J1409	80853	1/2-13	7/8	1 9/16	8.97	50	158.90/c

OTHER SIZES AND QUANTITIES AVAILABLE BY REQUEST

NOT RECOMMENDED FOR CEMENT CEILING APPLICATIONS

PLEASE NOTE THAT MACHINE SCREW ANCHORS HAVE A LEAD OUTER GRIPPING SHELL. IN APPLICATIONS WHERE LEAD IS CONSIDERED DANGEROUS, WE DO NOT RECOMMEND THEIR USE. UNTIL U.S. GOVT. SAFETY REGULATIONS TAKE A FIRM STAND ON THEIR USE, METALLICS WILL CONTINUE TO OFFER THIS PRODUCT-AS DO MANY OTHER FASTENER COMPETITORS.

E

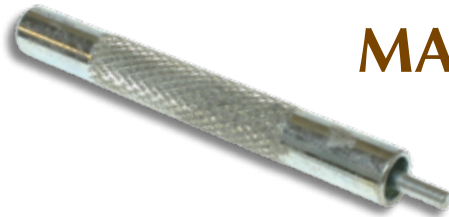

MACHINE SCREW LEAD ANCHOR SETTING TOOL

Safety glasses should be worn for any driving applications.
See Safety Glasses Pages 301, 302 and 303

STOCK NO.	UPC NO.	SIZE	WT. PER PKG.	STD. PKG.	SUGGESTED TRADE LIST PRICE PER
1401ST	17900	6-32	.04	1	4.93/ea
1402ST	17905	8-32	.07	1	4.20/ea
1403ST	17910	10-24	.08	1	5.03/ea
1404ST	17915	10-32	.14	1	5.03/ea
1406ST	17925	1/4-20	.17	1	5.58/ea
1407ST	17930	5/16-18	.27	1	5.95/ea
1408ST	17935	3/8-16	.38	1	6.28/ea
1409ST	17940	1/2-13	.58	1	12.13/ea

OTHER SIZES AND QUANTITIES AVAILABLE BY REQUEST

AMERICA'S SOURCE FOR PREMIER AND INNOVATIVE FASTENERS & ANCHORS



A Modern Up to Date Roll Threading Machine at our Affiliate, Avanti Screw.



Metallics and Avanti Screw, Inc., prime American manufacturers of fastener products, have always worked to present the latest in fastener technology to our distributors and their contractors/users.

Hex Washer Head fasteners have historically only offered three drives-the hex, phillips and the slot. In 1999, we introduced "The QuaDrive" square, hex, slotted and phillips, in fourteen of the most popular sizes of sheet metal screws.

The QuaDrive

Square Drive

+

Hex

+

Slotted

+



Phillips

=

QuaDrive

America's Newest Drive - Designed, Developed and Manufactured by Metallics/Avanti Screw

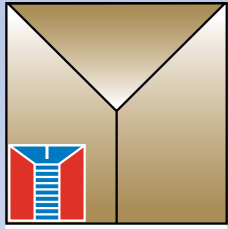
These sheet metal screws are being manufactured to fill the need of the growing demand in the North American markets.



Metallics

Multi-Purpose Anchors (Zinc Plated)



[CONTRACTOR APPROVED]



E

- Light-Duty Hammer-Drive Concrete and Masonry Anchors
- Specified for anchorage into concrete, block and brick
- As simple as using a nail – drive into predrilled holes in concrete

PART NUMBER	DRILL BIT SIZE	TOTAL LENGTH	MIN. EMBEDMENT	CLEARANCE HOLE SIZE
RD4158	1/4"	1 1/2"	1 1/4"	5/16"
RD4200	1/4"	2"	1 1/4"	5/16"
RD4212	1/4"	2 1/2"	1 1/4"	5/16"
RD4300	1/4"	3"	1 1/4"	5/16"

PART NUMBER	UPC #	DESCRIPTION	QTY / PKG.	SUG. TRADE LIST / PKG.
RD4158	74488	Mult-Purpose Mushroom Hd Anchor 1 1/2"	100	\$ 32.43
RD4200	74490	Mult-Purpose Mushroom Hd Anchor 2"	100	\$ 39.63
RD4212	74492	Mult-Purpose Mushroom Hd Anchor 2 1/2"	100	\$ 48.20
RD4300	74494	Mult-Purpose Mushroom Hd Anchor 3"	100	\$ 54.20

Other sizes, materials and quantities available by request.

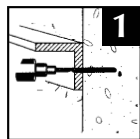

1
Drill a proper-sized diameter hole 1/2" deeper than the required embedment.

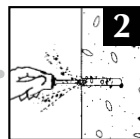

2
Clean hole.

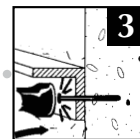

3
Insert anchor through material to be fastened and drive with hammer until head is flush with surface.

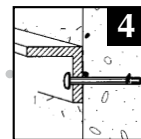

4
Multi-Purpose Anchor is now set.

"Growth Through Innovation"

Metallics

229 Cross Street, Bristol, CT 06010
Tel 800-243-8272 • **Fax** 800-831-9358
Email sales@metallicsonline.com

Metallics West

651 North Main Street, Mancos, CO 81328
Tel 800-269-5183 • **Fax** 800-269-6278
Email saleswest@metallicsonline.com

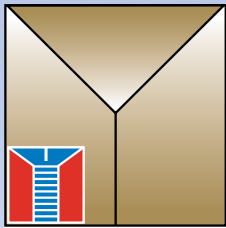

Metallics

Multi-Purpose Anchors (Zinc Plated)



Tie Wire Anchors -

For acoustical ceilings and suspended electrical fixtures.

Pipe Hanging Anchors -

For sprinkler, water lines, steam/gas and electrical conduits. Available in 1/4"-20 and 3/8"-16 internal thread.

Forming Anchors -

For wood attachments to concrete.



Selection Guide

Part Number	Drill Bit Size	Min. Embedment	Hole Size I.D.
TD4112	1/4"	1-1/8"	9/32"

Part Number	Int. Thread	Drill Bit Size	Min. Embedment
PD4112	1/4"-20"	3/16"	1-1/4"
PD8134	3/8"-16"	1/4"	1-1/2"

Part Number	Fixture Hole Size	Drill Bit Size	Min. Embedment
FD8234	5/16"	1/4"	1-1/4"

PART NUMBER	UPC #	DESCRIPTION	QTY/ PKG.	SUG. TRADE LIST / PKG
TD4112	73918	Multi-Purpose Tie Wire Anchor	100	\$116.88
PD4112	73924	Multi-Purpose Pipe Hanging Anchor 1/4"-20 Int Thread	100	\$109.13
PD8134	73925	Multi-Purpose Pipe Hanging Anchor 3/8"-16 Int Thread	100	\$131.88
FD8234	73915	Multi-Purpose Forming Anchor 2-3/4" Long	100	\$123.25

Other sizes, materials and quantities available by request.

"Growth Through Innovation"

Metallics

229 Cross Street, Bristol, CT 06010
Tel 800-243-8272 • **Fax** 800-831-9358
Email sales@metallicsonline.com

Metallics West

651 North Main Street, Mancos, CO 81328
Tel 800-269-5183 • **Fax** 800-269-6278
Email saleswest@metallicsonline.com

ANCHORING DEVICES



LAG SCREW SHIELD

ALLOY ZINC DIE CAST
Medium-Duty Application
See page 136 and 137 for Lag Bolts

A secure die cast expansion anchor of zinc rustproof alloy. Most effective for holding in brittle or soft masonry. The ideal product for mortar joints.

STOCK NO.	UPC NO.	LAG SCREW DIAMETER	HOLE SIZE	ANCHOR LENGTH	WT. PER PKG.	STD. PKG.	SUGGESTED TRADE LIST PRICE PER
SHORT							
J1201	80854	1/4	1/2	1	1.06	50	46.66/c
J1202	80855	5/16	1/2	1 1/4	1.21	50	42.70/c
J1203	80856	3/8	5/8	1 3/4	2.19	50	68.80/c
J1204	80857	1/2	3/4	2	1.73	25	111.40/c
J1205	80858	5/8	7/8	2	2.74	25	171.00/c
J1206	83081	3/4	1	2	.81	25	198.05/c
LONG							
J1207	80859	1/4	1/2	1 1/2	1.48	50	49.30/c
J1208	80860	5/16	1/2	1 3/4	1.45	50	50.26/c
J1209	80861	3/8	5/8	2	3.32	50	92.86/c
J1210	80862	1/2	3/4	3	2.57	25	141.80/c
J1211	80863	5/8	7/8	3 1/2	5.37	25	271.00/c
J1212	83086	3/4	1	3 1/2	1.06	25	365.26/c

OTHER SIZES AND QUANTITIES AVAILABLE BY REQUEST



DROP-IN ANCHOR

STEEL ZINC CHROMATE AND STAINLESS STEEL
FOR USE IN STRUCTURAL FASTENING TO CONCRETE FLOORS
ONE SETTING TOOL FURNISHED IN EACH JAR OF ANCHORS

STOCK NO.	UPC NO.	SIZE	HOLE SIZE	ANCHOR LENGTH	WT. PER PKG.	STD. PKG.	SUGGESTED TRADE LIST PRICE PER
STEEL							
JDIA14	81870	1/4-20	3/8	1	2.33	100	64.20/c
JDIA38	81875	3/8-16	1/2	1 9/16	3.30	50	88.20/c
JDIA12	81880	1/2-13	5/8	2	6.41	50	145.70/c
JDIA58	81881	5/8-11	7/8	2 1/2	8.91	25	296.60/c
JDIA34	81873	3/4-10	1	3 3/16	13.58	25	736.20/c
STAINLESS STEEL 18-8 TYPE							
JDIA14SS	81872	1/4-20	3/8	1	2.54	100	PLEASE CALL FOR TRADE LIST PRICING
JDIA38SS	81876	3/8-16	1/2	1 9/16	3.50	50	
JDIA12SS	81883	1/2-13	5/8	2	6.25	50	
JDIA58SS	81882	5/8-11	7/8	2 1/2	8.36	25	
JDIA141SS	90345	1/4-20	3/8	1	2.54	100	
STAINLESS STEEL - 316 TYPE							
JDIA381SS	90349	3/8-16	1/2	1 9/16	3.50	100	
JDIA121SS	90353	1/2-13	5/8	2	6.03	50	

OTHER SIZES AND QUANTITIES AVAILABLE BY REQUEST

STEEL DROP-IN ANCHOR SETTING TOOL

FOR SETTING DROP-IN ANCHORS
Safety glasses should be worn for any driving applications.
See our line of Safety Glasses Pages 301, 302 and 303

STOCK NO.	UPC NO.	SIZE	WT. PER PKG.	STD. PKG.	SUGGESTED TRADE LIST PRICE PER
DIA14T	12181	1/4-20	0.18	1	3.85/ea
DIA38T	12182	3/8-16	0.24	1	5.00/ea
DIA12T	12183	1/2-13	0.41	1	6.18/ea
DIA58T	12184	5/8-11	0.51	1	11.53/ea
DIA34T	17890	3/4-10	0.65	1	11.68/ea

OTHER SIZES AND QUANTITIES AVAILABLE BY REQUEST

ANCHORING DEVICES



SINGLE EXPANSION ANCHOR

ZINC ALLOY

STOCK NO.	UPC NO.	THREAD DIAMETER	HOLE SIZE	ANCHOR BODY LENGTH	WT. PER PKG.	STD. PKG.	SUGGESTED TRADE LIST PRICE PER
JSEA14	81195	1/4	1/2	1	2.57	100	63.13/c
JSEA516	81196	5/16	5/8	1 1/4	2.44	50	96.96/c
JSEA38	81197	3/8	3/4	1 1/2	2.32	50	102.36/c
JSEA12	81198	1/2	7/8	2	3.04	25	218.20/c

OTHER SIZES AND QUANTITIES AVAILABLE BY REQUEST



DOUBLE EXPANSION ANCHOR

ZINC CHROMATE

The Double Expansion Anchor is manufactured of rustproof zinc alloy and is used with machine screws or machine bolts. These Anchors work well in soft masonry, as it sets, the two opposing wedges pull towards each other, expanding the full length of the anchor body.

STOCK NO.	UPC NO.	THREAD DIAMETER	HOLE SIZE	ANCHOR BODY LENGTH	WT. PER PKG.	STD. PKG.	SUGGESTED TRADE LIST PRICE PER
ZINC ALLOY							
JDEA14	80872	1/4	1/2	1	2.94	100	126.23/c
JDEA516	80873	5/16	5/8	1 1/4	2.82	50	173.56/c
JDEA38	80874	3/8	3/4	1 1/2	4.48	50	229.50/c
JDEA12	80875	1/2	7/8	2	3.70	25	361.80/c
JDEA58	82397	5/8	1	2 1/4	8.91	25	442.12/c
JDEA34	82390	3/4	1 1/4	2 7/8	9.12	20	650.00/c

OTHER SIZES AND QUANTITIES AVAILABLE BY REQUEST



WOOD AND TAPPING SCREW LEAD ANCHOR

STOCK NO.	UPC NO.	SIZE	LENGTH	HOLE SIZE	WT. PER PKG.	STD. PKG.	SUGGESTED TRADE LIST PRICE PER
J1302	80877	6-8	1	1/4	1.47	100/500	21.50/c
J1303	80878	6-8	1 1/2	1/4	1.98	100/500	23.68/c
J1305	80879	10-14	1	5/16	2.00	100/500	27.33/c
J1306	80880	10-14	1 1/2	5/16	2.97	100/500	37.58/c
J1307	80881	16-18	1	3/8	2.75	100/500	37.58/c
J1308	80882	16-18	1 1/2	3/8	3.59	100/500	51.08/c

OTHER SIZES AND QUANTITIES AVAILABLE BY REQUEST

PLEASE NOTE THAT WOOD AND TAPPING SCREW LEAD ANCHORS HAVE A LEAD OUTER GRIPPING SHELL. IN APPLICATIONS WHERE LEAD IS CONSIDERED DANGEROUS, WE DO NOT RECOMMEND THEIR USE. UNTIL U.S. GOVT. SAFETY REGULATIONS TAKE A FIRM STAND ON THEIR USE, METALLICS WILL CONTINUE TO OFFER THIS PRODUCT, AS DO MANY OTHER FASTENER COMPETITORS.



ROD COUPLING WEDGE ANCHOR

ANCHORS THREADED ROD TO CONCRETE CEILINGS

STOCK NO.	UPC NO.	BOLT AND HOLE DIA.	BOLT LENGTH	WT. PER PKG.	STD. PKG.	SUGGESTED TRADE LIST PRICE PER
JRCA381	81585	3/8	1 7/8	9.24	100	201.23/c
JRCA38	81586	3/8	2 1/8	4.97	50	167.66/c
JRCA12	81588	1/2	2 3/4	11.40	50	271.80/c

OTHER SIZES AND QUANTITIES AVAILABLE BY REQUEST

FLAT HEAD SPLIT DRIVE ANCHOR



- Can be used in concrete, hard masonry and stone
- Load can be applied immediately
- High grade steel with a memory
- One piece, pre-expanded anchor
- Exact hole depth not required to set anchor
- Fast, permanent installation

Safety glasses should be worn for any driving applications. 301, 302, 303

STOCK NO.	UPC NO.	JAR UPC NO.	SIZE	MASONRY DRILL SIZE	WT. PER PKG.	STD. PKG.	SUGGESTED TRADE LIST PRICE PER
JFSD141	81594	81594	1/4 x 1 1/2	1/4 x 4	1.22	50	54.56/c
JFSD142	81596	81596	1/4 x 2	1/4 x 4	1.58	50	62.10/c
JFSD1421	81598	81598	1/4 x 2 1/2	1/4 x 4	1.87	50	68.20/c
JFSD143	81600	81600	1/4 x 3	1/4 x 4	2.27	50	74.26/c
JFSD1431	81602	81602	1/4 x 3 1/2	1/4 x 6	1.35	25	81.80/c
JFSD144	81604	81604	1/4 x 4	1/4 x 6	1.50	25	89.40/c

OTHER SIZES AND QUANTITIES AVAILABLE BY REQUEST

SLEEVE TYPE ANCHOR

STEEL ZINC CHROMATE



* = acorn nuts



STOCK NO.	UPC NO.	DIAMETER LENGTH	BOLT DIAMETER	FASTENS MATERIAL UP TO	DEPTH IN LENGTH	WT. PER PKG.	STD. PKG.	SUGGESTED TRADE LIST PRICE PER
STEEL ZINC CHROMATE – HEX (Acorn)								
J2505	77405	1/4 x 5/8	3/16	1 1/4	1	1.57	100	41.25/c
J2513*	80883	1/4 x 1 3/8	3/16	3/8	1	2.32	100	41.55/c
J2522*	80884	1/4 x 2 1/4	3/16	1 1/4	1	3.14	100	58.98/c
J3114	80885	5/16 x 1 1/2	1/4	1/2	1	3.54	100	69.08/c
J3124	80886	5/16 x 2 1/2	1/4	1 1/2	1	5.24	100	90.50/c
J3717	80887	3/8 x 1 7/8	5/16	5/8	1 1/4	3.58	50	92.36/c
J3730	80888	3/8 x 3	5/16	1 3/4	1 1/4	5.15	50	119.20/c
J3732	77310	3/8 x 4	5/16	1 3/4	1 1/4	6.71	50	119.20/c
J5022	80889	1/2 x 2 1/4	3/8	3/4	1 1/2	3.24	25	130.72/c
J5026	80890	1/2 x 3	3/8	1 1/4	1 1/2	4.07	25	172.72/c
J5040	81131	1/2 x 4	3/8	2 1/2	1 1/2	5.02	25	285.00/c
J5060	81135	1/2 x 6	3/8	4 1/2	1 1/2	7.15	25	401.40/c
J6222	80891	5/8 x 2 1/4	1/2	1/4	2	6.60	25	251.00/c
J6242	81345	5/8 x 4 1/4	1/2	2 1/4	2	4.14	10	353.80/c
J6256	81350	5/8 x 6	1/2	3 3/4	2	5.30	10	476.00/c
J7524	80892	3/4 x 2 1/2	5/8	1/2	2	4.07	10	377.00/c
J7542	81360	3/4 x 4 1/4	5/8	1 3/4	2 1/2	3.23	5	582.00/c
J7562	81365	3/4 x 6 1/4	5/8	3 3/4	2 1/2	4.75	5	698.60/c

LARGER DIAMETERS & LENGTHS AVAILABLE BY SPECIAL REQUEST.

OTHER SIZES AND QUANTITIES AVAILABLE BY REQUEST

CONTINUED ON NEXT PAGE

ANCHORING DEVICES



* = acorn nuts

CONTINUED

SLEEVE TYPE ANCHOR

STEEL ZINC CHROMATE

STOCK NO.	UPC NO.	DIAMETER LENGTH	BOLT DIAMETER	FASTENS MATERIAL UP TO	DEPTH IN LENGTH	WT. PER PKG.	STD. PKG.	SUGGESTED TRADE LIST PRICE PER
STEEL ZINC CHROMATE - FLAT HEAD								
J2520F	77220	1/4 x 2	3/16	1	1	3.11	100	97.38/c NEW
J2530F	77225	1/4 x 3	3/16	2	1	4.17	100	101.85/c NEW
STEEL ZINC CHROMATE - ROUND HEAD								
J2512R	81089	1/4 x 1 1/4	3/16	1/4	1	1.89	100	63.88/c NEW
J2520R	82620	1/4 x 2	3/16	1	1	2.52	100	64.88/c NEW
J2526R	82626	1/4 x 2 3/4	3/16	1	1	3.24	100	80.75/c NEW
STAINLESS STEEL 18-8 TYPE - HEX & ACORN								
J2513SS*	82106	1/4 x 1 3/8	3/16	3/8	1	2.14	100	77.53/c
J2522SS*	82107	1/4 x 2 1/4	3/16	1 1/4	1	3.30	100	92.58/c
J3114SS	82108	5/16 x 1 1/2	1/4	1/2	1	4.50	100	102.85/c
J3124SS	82109	5/16 x 2 1/2	1/4	1 1/2	1	6.30	100	147.48/c
J3717SS	82111	3/8 x 1 7/8	5/16	5/8	1 1/4	3.62	50	223.86/c
J3730SS	82112	3/8 x 3	5/16	1 3/4	1 1/4	4.87	50	223.86/c
J5022SS	82113	1/2 x 2 1/4	3/8	3/4	1 1/2	3.12	25	290.92/c
J5026SS	82114	1/2 x 3	3/8	1 1/4	1 1/2	3.88	25	467.80/c
J5030SS	82116	1/2 x 3	3/8	1 1/2	2	4.02	25	360.40/c
J5040SS	82117	1/2 x 4	3/8	2 1/2	1 1/2	5.50	25	466.72/c
J6230SS	82118	5/8 x 3	1/2	1/4	2	6.60	25	630.52/c
J6242SS	82119	5/8 x 4 1/4	1/2	2 1/4	2	4.00	10	829.00/c
J7524SS	82121	3/4 x 2 1/2	5/8	1/2	2	5.00	10	894.80/c
J7542SS	82123	3/4 x 4 1/4	5/8	1 3/4	2 1/2	3.50	5	1,263.00/c
J7554SS	82124	3/4 x 5 1/2	5/8	3 3/4	2 1/2	4.70	5	1,493.60/c

LARGER DIAMETERS & LENGTHS AVAILABLE BY SPECIAL REQUEST.

OTHER SIZES AND QUANTITIES AVAILABLE BY REQUEST

Sleeve Anchors hold more because:

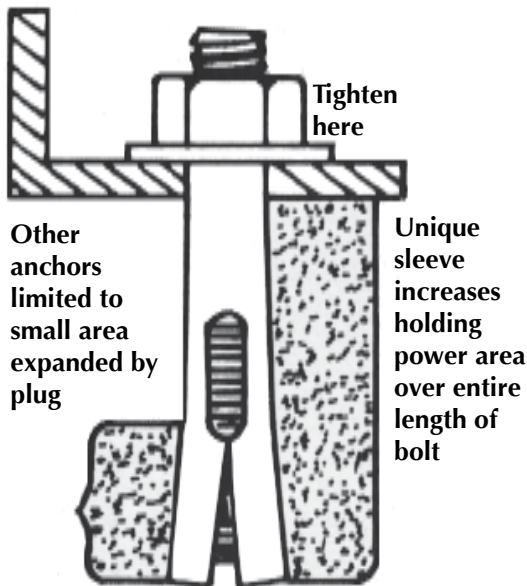

Sleeve anchors do not depend on bottom of hole to expand the anchor

Sleeve anchors work under a true expansion principle, whereby the tightening of the nut forces the expansion of an outer sleeve over a tapered portion of the bolt. The sleeve also becomes a factor in a shear load application providing increased strength in addition to the anchor's bolt.

SELECTING THE PROPER LENGTH SLEEVE ANCHOR

The selection of the proper length of sleeve anchor depends upon the thickness of the material to be fastened and the minimum depth of anchor required in masonry for maximum holding power. Add the thickness of the material (A) and the recommended depth for the anchor

(B) to determine the correct length of anchor to be used. (B) to determine the correct length of anchor to be used.

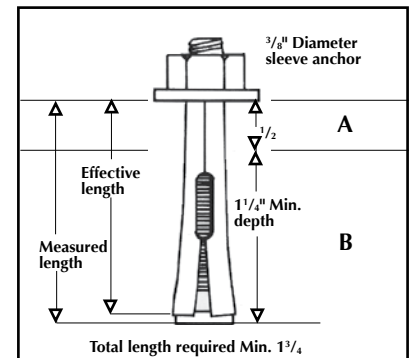

ANCHORING DEVICES



(STUD ANCHOR)

WEDGE ANCHORS

STEEL ZINC CHROMATE AND STAINLESS STEEL

A powerful product when strength is needed, eliminates drilling oversized holes; exact hole depth not required. This spring stainless steel band, when locked, acts like a fish hook that digs into concrete. Then 3 to 4 turns of the nut expands the wedge.

STOCK NO.	UPC NO.	DRILL & BODY DIAMETER/LENGTH	THREAD LENGTH	MIN. DEPTH IN LENGTH	WT. PER PKG.	STD. PKG.	SUGGESTED TRADE LIST PRICE PER
STEEL							
JTS1134	80893	1/4 x 1 3/4	3/4	1 1/8	3.12	100	66.85/c
JTS1214	80894	1/4 x 2 1/4	3/4	1 1/8	3.68	100	75.40/c
JTS103	80895	1/4 x 3 1/4	3/4	1 1/8	4.63	100	85.65/c
JTS3218	80896	3/8 x 2 1/4	7/8	1 1/2	8.05	100	108.98/c
JTS3234	81165	3/8 x 2 3/4	1 1/8	1 1/2	9.30	100	114.80/c
JTS303	80898	3/8 x 3	1 1/8	1 1/2	9.92	100	117.83/c
JTS312	80899	3/8 x 3 3/4	1 1/8	1 1/2	11.70	100	134.40/c
JTS385	81614	3/8 x 5	1 1/8	1 1/2	7.45	50	154.70/c
JTS3612	81615	3/8 x 6 1/2	1 1/4	1 5/8	9.85	50	210.46/c
JTS4234	81166	1/2 x 2 3/4	1 1/4	2 1/4	9.10	50	184.60/c
JTS4334	81770	1/2 x 3 3/4	1 1/4	2 1/4	11.00	50	206.40/c
JTS4414	81622	1/2 x 4 1/4	1 1/4	2 1/4	6.12	25	214.40/c
JTS4512	81623	1/2 x 5 1/2	1 1/4	2 1/4	7.28	25	266.00/c
JTS407	81624	1/2 x 7	1 1/4	2 1/4	9.55	25	323.72/c
JTS5312	81630	5/8 x 3 1/2	2	2 3/4	9.22	25	343.52/c
JTS5412	81631	5/8 x 4 1/2	2	2 3/4	10.48	25	377.40/c
JTS505	81632	5/8 x 5	2	2 3/4	11.60	25	395.20/c
JTS506	81633	5/8 x 6	2	2 3/4	19.00	25	432.52/c
JTS6414	81640	3/4 x 4 1/4	2	3 1/4	12.09	20	516.65/c
JTS6434	81641	3/4 x 4 3/4	2	3 1/4	13.27	20	541.50/c
JTS6512	81642	3/4 x 5 1/2	2	3 1/4	14.75	20	606.75/c
JTS6614	81643	3/4 x 6 1/4	2	3 1/4	8.25	10	672.30/c
STAINLESS STEEL 18-8 TYPE							
JTS1134SS	80900	1/4 x 1 3/4	3/4	1 1/8	1.55	50	164.16/c
JTS1214SS	80901	1/4 x 2 1/4	3/4	1 1/8	1.85	50	188.08/c
JTS103SS	80902	1/4 x 3 1/4	3/4	1 1/8	2.50	50	214.80/c
JTS3218SS	80903	3/8 x 2 1/4	7/8	1 1/2	4.02	50	304.60/c
JTS303SS	80904	3/8 x 3	1 1/8	1 1/2	5.07	50	358.96/c
JTS312SS	80905	3/8 x 3 3/4	1 1/8	1 1/2	5.96	50	517.16/c
JTS385SS	95250	3/8 x 5	1 1/8	1 1/2	7.46	50	523.26/c
JTS3612SS	95255	3/8 x 6 1/2	1 1/4	1 5/8	4.94	25	923.64/c
JTS4234SS	82126	1/2 x 2 3/4	1 1/4	2 1/4	4.11	25	592.52/c
JTS4334SS	82127	1/2 x 3 3/4	1 1/4	2 1/4	5.77	25	686.60/c
JTS4512SS	95260	1/2 x 5 1/2	1 1/4	2 1/4	14.56	50	1,285.66/c
STAINLESS STEEL 316 TYPE							
JTS1034SS	90298	1/4 x 3 1/4	3/4	1 1/8	5.02	100	PLEASE CALL
JTS3033SS	90305	3/8 x 3	1 1/8	1 1/2	5.08	50	

LARGER DIAMETERS & LENGTHS AVAILABLE BY SPECIAL REQUEST.

OTHER SIZES AND QUANTITIES AVAILABLE BY REQUEST



Metallics Avanti Screw Manufacturing Facility in Bristol, CT



None of our competitors selling to the Electrical, Plumbing and HVAC Distribution trade can claim they manufacture screws.

There is no doubt: We know the American fastener market and are ahead of our competitors. Our Avanti Screw, Inc., fastener manufacturing facility in Bristol, CT, provides you an American fastener company who makes a portion of its product, sold through electrical, plumbing and HVAC distributors.

ANCHORING DEVICES



TIE WIRE WEDGE ANCHOR

ZINC WITH STAINLESS STEEL CLIP
For various overhead suspension applications

STOCK NO.	UPC NO.	DIAMETER/LENGTH	MIN. LENGTH IN DEPTH	WT. PER PKG.	STD. PKG.	SUGGESTED TRADE LIST PRICE PER
JTWA214	80906	1/4 x 2 ³ / ₁₆	1 ³ / ₈	3.45	100	108.60/c

OTHER SIZES AND QUANTITIES AVAILABLE BY REQUEST

HAMMER DRIVE WEDGE ANCHOR

ZINC AND STAINLESS STEEL
A superior alternative
to traditional wedge anchors



- Installs six times faster than an ordinary wedge-type anchor.
- Easily installs through pre-drilled holes in plates and footings – no need for templates.
- No special tools required.
- Tensions during setting process.
- Deforms the concrete to set, eliminating creep and loss of pre-load.
- Faster, easier and more consistent installation.

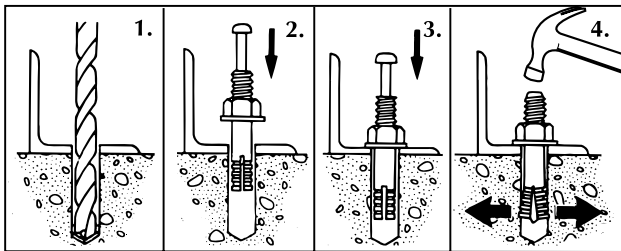

INSTALLATION:

1. Drill hole.
2. Preset nut and washer for desired embedment.
3. Hammer center pin until it is aligned with top of the bolt.
4. Anchor is set.

Safety glasses should be worn for any driving applications. See our line of Safety Glasses, pages 301, 302 and 303

STOCK NO.	UPC NO.	SIZE	THREAD LENGTH	MASONRY DRILL SIZE	WT. PER PKG.	STD. PKG.	SUGGESTED TRADE LIST PRICE PER
ZINC CHROMATE							
JHW14134	80907	1/4 x 1 ³ / ₄	5/8	1/4 x 4	1.72	50	112.46/c
JHW14238	80908	1/4 x 2 ³ / ₈	3/4	1/4 x 4	2.05	50	119.20/c
JHW5162	80909	5/16 x 2	3/4	5/16 x 4	2.70	50	146.00/c
JHW516234	80910	5/16 x 2 ³ / ₄	1	5/16 x 4	3.04	50	169.60/c
JHW38238	80911	3/8 x 2 ³ / ₈	1	3/8 x 4	4.35	50	184.60/c
JHW38312	80912	3/8 x 3 ¹ / ₂	1 ¹ / ₈	3/8 x 6	6.05	50	256.80/c
JHW38434	82630	3/8 x 4 ³ / ₄	1 ¹ / ₈	3/8 x 6	7.03	50	372.66/c
JHW12234	82635	1/2 x 2 ³ / ₄	1/2	1/2 x 4	4.80	25	305.20/c
JHW12312	82640	1/2 x 3 ¹ / ₂	1/2	1/2 x 6	5.92	25	320.92/c
JHW12434	82645	1/2 x 4 ³ / ₄	2	1/2 x 6	7.25	25	470.00/c
JHW126	82650	1/2 x 6	2	1/2 x 12	9.07	25	703.60/c
JHW584	82655	5/8 x 4	1 ⁵ / ₈	5/8 x 6	10.76	25	488.52/c
JHW58434	82660	5/8 x 4 ³ / ₄	1 ⁵ / ₈	5/8 x 6	12.22	25	676.52/c
JHW586	82665	5/8 x 6	2	5/8 x 12	6.03	10	834.50/c
JHW345	82670	3/4 x 5	2	3/4 x 12	7.36	10	904.80/c
JHW346	82675	3/4 x 6	2	3/4 x 12	8.39	10	1,326.00/c
JHW34712	82680	3/4 x 7 ¹ / ₂	2	3/4 x 12	9.21	10	1,587.80/c

LARGER DIAMETERS & LENGTHS AVAILABLE BY SPECIAL REQUEST.

OTHER SIZES AND QUANTITIES AVAILABLE BY REQUEST

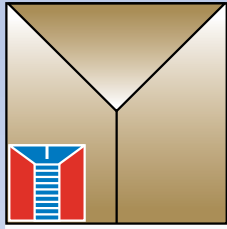

Metallics



WallClaw Anchors Hammer-In Drywall Anchors

**[CONTRACTOR
APPROVED]**

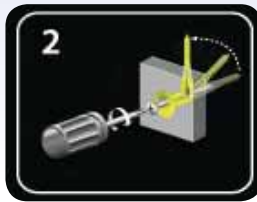
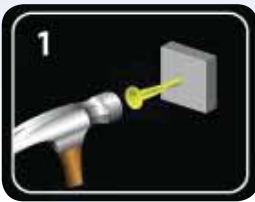

INSTALLATION

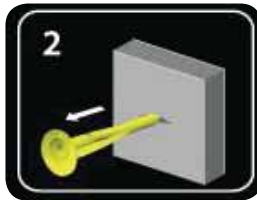
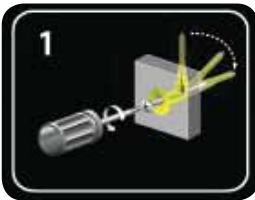

REMOVAL

- No drilling required.
- Installs in seconds.
- Industrial strength.
- Works in 1/2" and 5/8".
- Easy to remove.
- Leaves only small slit.



Phillips

PART #	UPC #	DESCRIPTION	QTY / PKG	SUG. TRADE LIST / PKG
MWCA25	83721	WallClaw Drywall Hammer-In Anchor with Screws	25	\$ 19.23
MWCA50	83723	WallClaw Drywall Hammer-In Anchor with Screws	50	\$ 23.75
MWCA100	83727	WallClaw Drywall Hammer-In Anchor with Screws	100	\$ 33.75

Other sizes, materials and quantities available by request.

"Growth Through Innovation"

Metallics

229 Cross Street, Bristol, CT 06010
Tel 800-243-8272 • **Fax** 800-831-9358
Email sales@metallicsonline.com

Metallics West

651 North Main Street, Mancos, CO 81328
Tel 800-269-5183 • **Fax** 800-269-6278
Email saleswest@metallicsonline.com

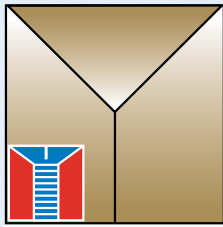

Metallics STRONG-BOLT™ Wedge Anchors

Carbon Steel Wedge Anchors for
Cracked and Uncracked Concrete

NEW!

Tested to
Meet
2006 IBC

INSTALLATION STEPS

1. Drill hole with carbide tipped masonry drill in base material the same size as the nominal diameter of the anchor.
2. Drill hole to proper embedment depth and blow clean.
3. Assemble anchor with nut and washer flush with top of anchor.
4. Place the anchor in fixture and drive into the hole until washer and nut are tight against fixture.
5. Tighten to the required installation torque.

DO NOT USE AN IMPACT WRENCH TO SET OR TIGHTEN.

Features:

- Tri-Segmented clip is able to adjust independently increasing follow-up expansion should the hole increase in size as a result of a crack.
- 316 stainless clip with superior corrosion resistance.
- Head is stamped with Simpson Strong-Tie® "±" sign and size ID.
- Carbon-steel zinc plated stud with 316 stainless-steel clip.

Codes:

ICC-ES ESR-1771; City of L.A. RR25705; Florida FL 11506.6

Test Criteria:

Strong-Bolt™ Wedge anchor has been tested in accordance with ICC-ES's *Acceptance Criteria for Mechanical Anchors in Concrete Elements (AC193) and ACI 355.2 for the following in cracked and uncracked concrete:*

- Static tension and shear loading in cracked and uncracked concrete
- Seismic and wind loading in cracked and uncracked concrete
- Performance in cracked concrete
- Performance in lightweight concrete over metal deck

Selection Guide

Part Number	Thread Length	Anchor Diameter & Drill Bit Size (Threads Per Inch)	Overall Length
SWA3830	1 1/4"	3/8" - 16	3"
SWA3836	2 3/8"	3/8" - 16	3 3/4"
SWA3850	3 3/8"	3/8" - 16	5"
SWA1236	2 1/8"	1/2" - 13	3 3/4"
SWA1244	2 7/8"	1/2" - 13	4 1/4"
SWA1254	3 7/8"	1/2" - 13	5 1/2"
SWA1270	5 3/8"	1/2" - 13	7"
SWA5850	3 3/16"	5/8" - 11	5"
SWA5860	4 3/16"	5/8" - 11	6"
SWA5870	5 3/16"	5/8" - 11	7"
SWA5884	5 3/4"	5/8" - 11	8 1/2"



PART #	UPC #	DESCRIPTION	QTY / PKG	SUG. TRADE LIST / PKG
SWA3830	14978	3/8 x 3" Strong-Bolt Wedge Anchor	50	\$125.45
SWA3836	14981	3/8 x 3-3/4" Strong-Bolt Wedge Anchor	50	\$158.63
SWA3850	14986	3/8 x 5" Strong-Bolt Wedge Anchor	50	\$183.25
SWA1236	15451	1/2 x 3-3/4" Strong-Bolt Wedge Anchor	25	\$111.55
SWA1244	15454	1/2 x 4-1/4" Strong-Bolt Wedge Anchor	25	\$115.33
SWA1254	15458	1/2 x 5-1/2" Strong-Bolt Wedge Anchor	25	\$126.58
SWA1270	15463	1/2 x 7" Strong-Bolt Wedge Anchor	25	\$140.58
SWA5850	16236	5/8 x 5" Strong-Bolt Wedge Anchor	10	\$73.75
SWA5860	16239	5/8 x 6" Strong-Bolt Wedge Anchor	10	\$81.68
SWA5870	16243	5/8 x 7" Strong-Bolt Wedge Anchor	10	\$87.20
SWA5884	16247	5/8 x 8-1/2" Strong-Bolt Wedge Anchor	10	\$96.63

Metallics

229 Cross Street,
Bristol, Ct. 06010
Tel: 800-243-8272
Fax: 800-831-9358
Email: sales@metallicsonline.com

"Growth Through Innovation"

Metallics West

651 North Main Street
Maanos, Co. 81328
Tel: 800-269-5183
Fax: 800-269-6278
Email: saleswest@metallicsonline.com

ANCHORING DEVICES

HAND DRIVE PINS

STEEL ZINC PLATED

An economical way of attaching wood and metal to masonry and block construction.

SAFETY GLASSES SHOULD BE WORN FOR ANY DRIVING APPLICATIONS. SEE PAGES 301, 302 AND 303



STOCK NO.	UPC NO.	HEAD SIZE	LENGTH	WT. PER PKG.	STD. PKG. MSTR/SLEEVE	SUGGESTED TRADE LIST PRICE PER	
JDP1	80916	1/4	1/2	.46	100/500	12.33/c	
JDP2	80917	1/4	3/4	.60	100/500	13.15/c	
JDP3	80918	1/4	1	.72	100/500	13.93/c	
JDP4	80919	1/4	1 1/4	.80	100/500	15.93/c	
JDP5	80920	1/4	1 1/2	.87	100/500	16.13/c	
JDP6	80921	1/4	2	1.18	100/500	21.13/c	
JDP7	80922	1/4	2 1/2	1.28	100/500	22.83/c	
JDP8	81595	1/4	3	1.32	100/500	31.18/c	NEW

OTHER SIZES AND QUANTITIES AVAILABLE BY REQUEST



HAND DRIVE TOOL

FOR HAND DRIVE PINS — DP1 thru 8

SAFETY GLASSES SHOULD BE WORN FOR ANY DRIVING APPLICATIONS. SEE PAGES 301, 302 AND 303

STOCK NO.	UPC NO.	DESCRIPTION	WT. PER PKG.	STD. PKG.	SUGGESTED TRADE LIST PRICE PER
HDT2	18720	Hand Drive Tool	.51	1	96.70/ea

OTHER SIZES AND QUANTITIES AVAILABLE BY REQUEST

The Metallics Alternative to Hand Drive Pins
THE MOST ECONOMICAL ANCHORING DEVICE

HEAT TEMPERED FLUTED MASONRY NAILS

STEEL

For greater bearing surface use with sae or fender washer.
We recommend for attaching wire screening over Styrofoam and block before stucco.



STOCK NO.	UPC NO.	SIZE	WT. PER PKG.	APPROX COUNT	STD. PKG.	SUGGESTED TRADE LIST PRICE PER
MN1TM	21242	1"	2.60	435	1 Jar	10.35/ea pkg
MN112TM	21243	1-1/2"	2.55	225	1 Jar	10.35/ea pkg
MN2TM	21244	2"	2.64	180	1 Jar	10.45/ea pkg
MN212TM	21245	2-1/2"	2.63	190	1 Jar	10.48/ea pkg
MN3TM	21246	3"	2.62	135	1 Jar	10.93/ea pkg

OTHER SIZES AND QUANTITIES AVAILABLE BY REQUEST

ANCHORING DEVICES

CONTRACTOR/DISTRIBUTOR SPECIAL REQUEST

FLUTED MASONRY NAIL AND FENDER WASHER KITS IN A JAR

100 EACH MASONRY NAILS
100 EACH FENDER WASHERS
CONVENIENCE TO GO!!



STOCK NO.	UPC NO.	NAIL SIZE	WASHER SIZE	WT. PER JAR	STD. PKG.	SUGGESTED TRADE LIST PRICE PER
MNK1	81660	1	3/16 x 1	1.91	1	13.90/ea pkg
MNK112	81662	1 1/2	3/16 x 1	2.15	1	13.90/ea pkg
MNK2	81664	2	3/16 x 1	2.31	1	14.50/ea pkg
MNK212	81666	2 1/2	3/16 x 1	2.54	1	14.50/ea pkg
MNK3	81668	3	3/16 x 1	2.74	1	14.93/ea pkg

OTHER SIZES AND QUANTITIES AVAILABLE BY REQUEST



FLUTED MASONRY NAIL AND WASHER ASSORTMENT KIT

STOCK NO.	UPC NO.	DESCRIPTION OF CONTENTS	STD. PKG. MSTR. CARTON	WT. EACH KIT	SUGGESTED TRADE LIST PRICE PER
MNK10 175 PIECES	21275	70 3/16 x 1 fender washers 25 x 1", 25 x 1 1/2", 20 x 2", 20 x 2 1/2", 15 x 3 masonry nails	1/25	2.35	21.73/ea kit

OTHER SIZES AND QUANTITIES AVAILABLE BY REQUEST



METAL HAMMER DRIVE NAIL-IN ANCHOR

FOR LIGHT-DUTY APPLICATION

STOCK NO.	UPC NO.	DIAMETER/LENGTH	HOLE SIZE	WT. PER JAR	STD. PKG./MSTR. SLEEVE	SUGGESTED TRADE LIST PRICE PER
JNA316	80923	3/16 x 7/8	3/16	.91	100/500	27.83/c
JNA140	80924	1/4 x 3/4	1/4	1.59	100/500	32.18/c
JNA141	80925	1/4 x 1	1/4	1.87	100/500	32.83/c
JNA1414	80926	1/4 x 1 1/4	1/4	2.25	100	36.23/c
JNA1415	80927	1/4 x 1 1/2	1/4	2.49	100	40.43/c
JNA142	80928	1/4 x 2	1/4	2.98	100	52.53/c

STAINLESS STEEL 18-8 TYPE

JNA141SS	90387	1/4 x 1	1/4	1.86	100	PLEASE CALL	NEW
JNA1414SS	81987	1/4 x 1 1/4	1/4	2.23	100		NEW
JNA142SS	91381	1/4 x 2	1/4	3.33	100		NEW

OTHER SIZES AND QUANTITIES AVAILABLE BY REQUEST



HAND DRILLING HAMMER

3-LB. - WOODEN HANDLE

SAFETY GLASSES SHOULD BE WORN FOR ANY DRIVING APPLICATIONS. SEE PAGES 301, 302 AND 303

STOCK NO.	UPC NO.	HEAD WEIGHT	STD. PKG.	SUGGESTED TRADE LIST PRICE PER
HAM3	18700	3.53	1	40.38/ea

OTHER SIZES AND QUANTITIES AVAILABLE BY REQUEST

ASSORTED PLASTIC ANCHORS

"Big Red" Conical Plastic Anchor



STOCK NO.	UPC NO.	COLOR LENGTH	SCREW SIZE	HOLE SIZE	WT. PER PKG.	STD. PKG. MSTR. SLEEVE	SUGGESTED TRADE LIST PRICE PER
JRA1	80929	Red 3/4	6-8	3/16	.10	100/500	3.38/c
JRA15	80930	Red 7/8	8-10	3/16	.10	100/500	3.50/c
JRA2	80931	Red 1	10-12	1/4	.18	100/500	4.03/c
JRA3	80932	Red 1 1/2	12-14	5/16	.31	100/500	7.60/c

OTHER SIZES AND QUANTITIES AVAILABLE BY REQUEST

"Denver Blue" Conical Plastic Anchor



JBA1	80933	Blue 3/4	6-8	3/16	.10	100/500	3.38/c
JBA15	80934	Blue 7/8	8-10	3/16	.09	100/500	3.50/c
JBA2	80935	Blue 1	10-12	1/4	.17	100/500	4.03/c
JBA3	80936	Blue 1 1/2	12-14	5/16	.28	100/500	7.60/c

OTHER SIZES AND QUANTITIES AVAILABLE BY REQUEST

"Super Yellow" Plastic Wall Anchor



JSYA316	80940	Yellow 1	6-8	3/16	.13	100/500	3.50/c
JSYA14	80941	Yellow 1 1/4	8-10	1/4	.18	100/500	4.03/c
JSYA516	80942	Yellow 1 5/8	12-14	5/16	.27	100/500	8.08/c

OTHER SIZES AND QUANTITIES AVAILABLE BY REQUEST

"Gray Ribbed" Plastic Anchor



JGA1	80953	Gray 7/8	6-8	3/16	.13	100/500	3.58/c
JGA2	80954	Gray 1	10-12	1/4	.18	100/500	4.03/c
JGA3	80955	Gray 1 1/4	14-16	5/16	.24	100/500	8.08/c

OTHER SIZES AND QUANTITIES AVAILABLE BY REQUEST

"Collarless Vinyl" Wall Anchor



J1106	80945	Green 1	10-12	1/4	.25	100/500	4.20/c
J1107	80946	Green 1 1/4	10-12	1/4	.27	100/500	7.73/c
J1108	80947	Green 1 1/2	10-12	1/4	.35	100/500	11.80/c
J1110	80948	Blue 1	14	5/16	.31	100/500	5.88/c
J1111	80949	Blue 1 1/2	14	5/16	.41	100/500	7.53/c
J1114	80950	Orange 1 1/2	5/16	3/8	.39	50/250	9.70/c
J1115	80951	Orange 2	5/16	3/8	.46	50	12.20/c
J1116	80952	Orange 2 1/2	5/16	3/8	.67	50	13.86/c

OTHER SIZES AND QUANTITIES AVAILABLE BY REQUEST

"Expandet Nylon" Anchor



JELR2	80943	Red 1 1/2	8	1/4	.26	100/500	15.25/c
JELR3	80944	Blue 1 3/4	12	5/16	.48	100/500	25.85/c

OTHER SIZES AND QUANTITIES AVAILABLE BY REQUEST

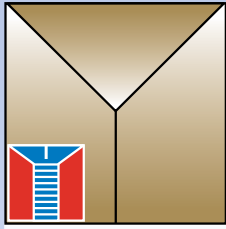

Metallics 4 Ultimate Anchor Kits



**[CONTRACTOR
APPROVED]**

Choose the right kit that's right for you! The right anchors for any job. Same price regardless of the kit you choose.



UAK1



UAK2

PART #	UPC #	DESCRIPTION	SUG. TRADE LIST / PKG
UAK1	33241	40 pcs 1/4" Plastic Red Anchor, 40 pcs #10 x 1 Panhead tapping screw, (1) 1/4" x 4" Masonry Drill Bit, 30 pcs Plastic Self-Drilling Wall Anchor, 30 pcs #8 x 1-1/4" Panhead tapping screw, 30 pcs Zinc Alloy Self-Drilling Wall Anchor, 30 pcs #8 x 1-1/4" Panhead tapping screw, 40 pcs 1/4" Plastic Blue Anchor, 40 pcs #10 x 1 Panhead tapping screw, 40 pcs 1/4" x 1-1/4" Blue Concrete Screw Anchors - Hex, (1) 5/32" x 3-1/2" Drill Bit, 20 pcs Spring Wing Toggle, 20 pcs 3/16" x 3" MH Screws	\$ 49.75
UAK2	33242	40 pcs 1/4" Plastic Red Anchor, 40 pcs #10 x 1 Panhead tapping screw, (1) 1/4" x 4" Masonry Drill Bit, 30 pcs Plastic Self-Drilling Wall Anchor, 30 pcs #8 x 1-1/4" Panhead tapping screw, 30 pcs Zinc Alloy Self-Drilling Wall Anchor, 30 pcs #8 x 1-1/4" Panhead tapping screw, 40 pcs 1/4" Plastic Yellow Anchor, 40 pcs #10 x 1 Panhead tapping screw, 40 pcs 1/4" x 1-1/4" Blue Concrete Screw Anchors - Hex, (1) 5/32" x 3-1/2" Drill Bit, 20 pcs Spring Wing Toggle, 20 pcs 3/16" x 3" MH Screws	

Other sizes, materials and quantities available by request.

Chart continued to next page.

"Growth Through Innovation"

Metallics

229 Cross Street, Bristol, CT 06010
Tel 800-243-8272 • **Fax** 800-831-9358
Email sales@metallicsonline.com

Metallics West

651 North Main Street, Mancos, CO 81328
Tel 800-269-5183 • **Fax** 800-269-6278
Email saleswest@metallicsonline.com

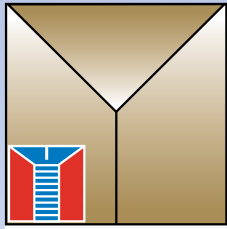

Metallics

4 Ultimate Anchor Kits



UAK3



UAK4

Chart continued from previous page.

PART #	UPC #	DESCRIPTION	SUG. TRADE LIST / PKG
UAK3	33243	40 pcs 1/4" Plastic Red Anchor, 40 pcs #10 x 1 Panhead tapping screw, (1) 1/4" x 4" Masonary Drill Bit, 30 pcs Plastic Self-Drilling Wall Anchor, 30 pcs #8 x 1-1/4" Panhead tapping screw, 30 pcs Zinc Alloy Self-Drilling Wall Anchor, 30 pcs #8 x 1-1/4" Panhead tapping screw, 40 pcs 1/4" Plastic Yellow Anchor, 40 pcs #10 x 1 Panhead tapping screw, 40 pcs 1/4" x 1-1/4" Quadrine Concrete Silver Screw Anchor, (1) 5/32" x 3-1/2" Drill Bit, 20 pcs Spring Wing Toggle, 20 pcs 3/16" x 3" MH Screws	\$ 49.75
UAK4	33244	40 pcs 1/4" Plastic Red Anchor, 40 pcs #10 x 1 Panhead tapping screw, (1) 1/4" x 4" Masonary Drill Bit, 30 pcs Plastic Self-Drilling Wall Anchor, 30 pcs #8 x 1-1/4" Panhead tapping screw, 30 pcs Zinc Alloy Self-Drilling Wall Anchor, 30 pcs #8 x 1-1/4" Panhead tapping screw, 40 pcs 1/4" Plastic Blue Anchor, 40 pcs #10 x 1 Panhead tapping screw, 40 pcs 1/4" x 1-1/4" Quadrine Concrete Silver Screw Anchor, (1) 5/32" x 3-1/2" Drill Bit, 30 pcs 1/4" x 1" Metal Hammer Drive Nail in Anchor	

Other sizes, materials and quantities available by request.

"Growth Through Innovation"

Metallics

229 Cross Street, Bristol, CT 06010
Tel 800-243-8272 • **Fax** 800-831-9358
Email sales@metallicsonline.com

Metallics West

651 North Main Street, Mancos, CO 81328
Tel 800-269-5183 • **Fax** 800-269-6278
Email saleswest@metallicsonline.com

ANCHORING DEVICES



TOGGLER ALLIGATOR® SOLID WALL ANCHORS

Alligator solid-wall anchors are designed to support heavy loads.
(even under vibration)

Alligator solid-wall anchors can be used in almost any material, including:
Concrete, Wood, Plaster, Aerated Concrete, Brick, Masonry, Stone,
Flakeboard, Cinder Block, Ceramic Tile, Stucco, Drywall.

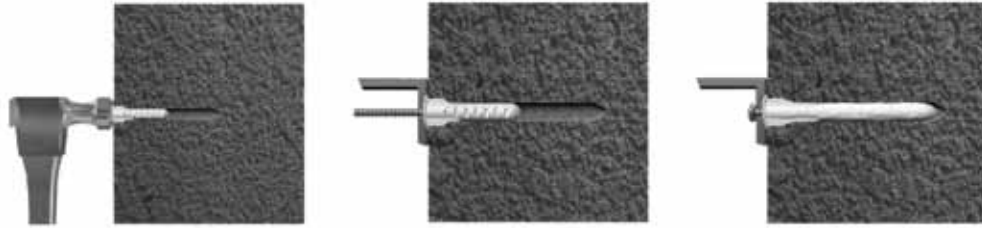

STOCK NO.	UPC NO.	DESCRIPTION	QTY. PER PKG,	SUGGESTED TRADE LIST PRICE PER
MAF5	73905	Toggler 3/16" Alligator anchor with flange	50 Anchors	15.88
MAF6	73906	Toggler 1/4" Alligator anchor with flange	50 Anchors	22.55
MAF8	73908	Toggler 5/16" Alligator anchor with flange	50 Anchors	30.08
MA6	73936	Toggler 1/4" Alligator anchor no flange	50 Anchors	22.55

OTHER SIZES AND QUANTITIES AVAILABLE BY REQUEST



TOGGLER HOLLOW WALL ANCHORS

All Toggler hollow-wall anchors install in a small 5/16" (8mm) diameter hole. With reasonable care you can even use your screwdriver to make the hole in drywall.

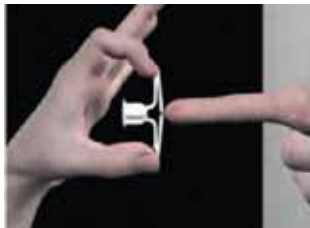

Drywall 5/16" (8mm) hole. Fold anchor in middle.

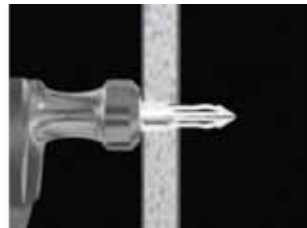

Insert anchor in hole and tap flush with wall.



Insert key to pop anchor open behind hollow wall (not necessary for thick or solid walls). Do not force or hammer key.

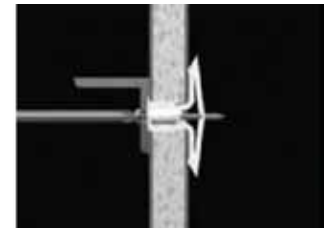

Place item over anchor and tighten until screw is flush with fixture. Then, stop.

STOCK NO.	UPC NO.	DESCRIPTION	QTY. PER PKG,	SUGGESTED TRADE LIST PRICE PER
MTB	73962	Toggler 3/8"-1/2" hollow wall anchor	50 Anchors	21.88
MTC	73963	Toggler 3/8"-3/4" hollow wall anchor	50 Anchors	25.30

OTHER SIZES AND QUANTITIES AVAILABLE BY REQUEST

TOGGLER® IS A REGISTERED TRADEMARK

NYLON DRIVE-IN ANCHORS



STOCK NO.	UPC NO.	COLOR/ LENGTH	HOLE SIZE	WT. PER PKG.	STD. PKG./ MSTR. SLEEVE	SUGGESTED TRADE LIST PRICE PER
ROUND HEAD						
J3161R	80956	White 1	3/16	.53	100/500	19.65/c
J141R	80957	White 1	1/4	.60	100/500	25.28/c
J1415R	80958	White 1 1/2	1/4	.89	100	26.75/c
J142R	80959	White 2	1/4	1.09	100	32.83/c
FLAT HEAD						
J3161F	80960	White 1	3/16	.50	100/500	19.65/c
J1434F	80961	White 3/4	1/4	.41	100/500	24.45/c
J141F	80962	White 1	1/4	.62	100/500	25.28/c
J1415F	80963	White 1 1/2	1/4	.87	100	26.75/c
J142F	80964	White 2	1/4	1.09	100	32.83/c
TRUSS - MUSHROOM HEAD						
J3161T	80965	White 1	3/16	.55	100/500	19.65/c
J1434T	80966	White 3/4	1/4	.50	100/500	24.45/c
J141T	80967	White 1	1/4	.63	100/500	25.28/c
J1415T	80968	White 1 1/2	1/4	.87	100	26.75/c
J142T	80969	White 2	1/4	1.21	100	32.83/c

OTHER SIZES AND QUANTITIES AVAILABLE BY REQUEST



PLASTIC TOGGLE

FOR LIGHT-DUTY APPLICATION

Stays in place if screw is removed. Ideal product for sheetrock.

STOCK NO.	UPC NO.	SIZE & WALL DIA.	DRILL PER PKG.	SCREW PKG.	WT. PER PKG.	STD. PKG./ MSTR. SLEEVE	SUGGESTED TRADE LIST PRICE PER
JCPT1	80970	3/8	5/16	#8	.55	100	23.45/c
JCPT2	80971	1/2	5/16	#8	.57	100	26.23/c
JCPT3	80972	5/8	5/16	#8	.59	100	27.15/c

ORDER SCREWS SEPARATELY - #8 DIAMETER - SEE SECTION A - SCREWS

OTHER SIZES AND QUANTITIES AVAILABLE BY REQUEST

PLASTIC TOGGLE ANCHOR KITS

FOR LIGHT-DUTY APPLICATION

Plastic Toggles and matching • Pan Head "Combo" Sheet Metal Screws



STOCK NO.	UPC NO.	SIZE/WALL THICKNESS	DRILL SIZE	DESCRIPTION OF CONTENTS	WT. EACH KIT	STD. PKG.	SUGGESTED TRADE LIST PRICE PER
PTK1	20480	3/8	5/16	50 3/8 Plastic Toggles 50 8 x 1 1/2 Pan Combo Screws	.67	1 Kit	13.93/ea kit
PTK2	20485	1/2	5/16	50 1/2 Plastic Toggles 50 8 x 1 1/2 Pan Combo Screws	.67	1 Kit	15.48/ea kit
PTK3	20490	5/8	5/16	50 5/8 Plastic Toggles 50 8 x 1 1/2 Pan Combo Screws	.65	1 Kit	15.93/ea kit

OTHER SIZES AND QUANTITIES AVAILABLE BY REQUEST

ATTENTION

ON LARGE ORDERS OF ANCHOR KITS — OUR PRICE CAN BE EVEN LOWER!

Please Call Us
for
Co-Labeling
on Kits!

E



JAR DISPLAY CENTER
Holds 18 Jars

**QUANTITY
DISCOUNTS:**

10% DISCOUNT ON
50-99 LIKE KITS

OR

15% DISCOUNT ON
100+ LIKE KITS





ARROW ANCHOR KIT

For Hollow Wall Use AAK68 Kit

Easy Installation And Removal
Leaves Only A Small Slit Not A Large Hole
For Use In Sheetrock Or Wallboard
Use With #6 Or #8 X 1" Sheetmetal Screw

AAK68 Kit Contains

STOCK NO.	UPC NO.	DESCRIPTION OF CONTENTS	WT. EACH KIT	SUGGESTED TRADE LIST PRICE PER
AAK68	18649	75 Hollow Wall Anchor 75 Phillips Combo T/S 1 #2x2" Phillips Pwr Bit	1.06lb	34.28/ea kit



OTHER SIZES AND QUANTITIES AVAILABLE BY REQUEST

JAA68 Anchors Only

STOCK NO.	UPC NO.	SIZE	DESCRIPTION OF CONTENTS	WT. EACH KIT	SUGGESTED TRADE LIST PRICE PER
JAA68	18643	1/8 X 1/2 X 1-7/16	Hollow Wall Anchors	.77	37.43/c

OTHER SIZES AND QUANTITIES AVAILABLE BY REQUEST



ASSORTED PLASTIC ANCHOR KIT WAKTRIO

Three Of The Most Popular Style Anchors
Screws Included
All In An E-Z To Store Plastic Case



WAKTRIO Kit Contains

STOCK NO.	UPC NO.	DESCRIPTION OF CONTENTS	WT. EACH KIT	SUGGESTED TRADE LIST PRICE PER
WAKTRIO	38990	25 - 6x1 Pan Combo Screw 25 - 3/16 Red Plastic Anchors 25 - 10x1 Pan Combo Screw 25 - 1/4 Yellow Super Anchors 25 - 10x1 Pan Combo Screw 25 - 1/4 Red Plastic Anchors	.64	8.63/ea kit

OTHER SIZES AND QUANTITIES AVAILABLE BY REQUEST



"BIG RED" CONICAL PLASTIC WALL ANCHOR KITS

FOR LIGHT-DUTY APPLICATION

NOW WITH QUADRIVE OPTION!



MASTER CARTONS CONTAIN:
25 KITS
18 JARS

STOCK NO.	UPC NO.	SIZE	DESCRIPTION OF CONTENTS	WT. EACH	SUGGESTED TRADE LIST PRICE PER
WAK13	20200/kit	3/16	100 - 3/16 Red Plastic Anchors	.55	13.25/ea kit
WAKJ13	20570/jar		100 - 6 x 1 Pan Combo Screws 1 - 3/16 Masonry Drill	.49	
WAK16	20280/kit	3/16	100 - 3/16 Red Plastic Anchors	.73	13.25/ea kit
WAKJ16	20281/jar		100 - 8 x 1 Pan Combo Screws 1 - 3/16 Masonry Drill	.68	
WAK16T	20284/kit	3/16	100 - 3/16 Red Plastic Anchors	.65	13.25/ea kit
WAKJ16T	20285/jar		100 - 8 x 1 Pan Tri-Drive  1 - 3/16 Masonry Drill	.59	
WAK16H	20288/kit	3/16	100 - 3/16 Red Plastic Anchors	.75	16.80/ea kit
WAKJ16H	20289/jar		100 - 8 x 1 Hex Slotted Screws 1/4 Head 1 - 1/4 Hex Drive 1 - 3/16 Masonry Drill	.75	

MADE IN USA
Anchors & Screws
ONLY METALLICS/Avanti Screw

OTHER SIZES AND QUANTITIES AVAILABLE BY REQUEST

CONTINUED ON NEXT PAGE

ANCHORING DEVICES



CONTINUED
"BIG RED"
**CONICAL PLASTIC
 WALL ANCHOR KITS**

FOR LIGHT-DUTY APPLICATION



MASTER
 CARTONS
 CONTAIN:
25 KITS
18 JARS

STOCK NO.	UPC NO.	SIZE	DESCRIPTION OF CONTENTS	WT. EACH	SUGGESTED TRADE LIST PRICE PER
WAK16R	20292/kit	3/16	100 - 3/16 Red Plastic Anchors	.76	13.25/ea kit
WAKJ16R	20293/jar		100 - 8 x 1 Pan Square Drive Screws 1 - 3/16 Masonry Drill	.76	
WAK14	20205/kit	1/4	100 - 1/4 Red Plastic Anchors	.95	13.25/ea kit
	20575/jar		100 - 10 x 1 Pan Combo Screws 1 - 1/4 Masonry Drill	.93	
WAK14T	20446/kit	1/4	100 - 1/4 Red Plastic Anchors	1.00	13.25/ea kit
WAKJ14T	20447/jar		100 - 10 x 1 Pan Tri-Drive 1 - 1/4 Masonry Drill, 1 - 000R2B Bit	.93	MADE IN USA Anchors & Screws ONLY METALLICS/Avanti Screw
WAK14H	20207/kit	1/4	100 - 1/4 Red Plastic Anchors	1.00	15.10/ea kit
WAKJ14H	20580/jar		100 - 10 x 1 with 5/16 Hex Slotted Screws 1 - 1/4 Masonry Drill	.93	
WAK14Q	20206/kit	1/4	100 - 1/4 Red Plastic Anchors	.79	15.10/ea kit
WAKJ14Q	20583/jar		100 - 10 x 1 with 1/4 Hex Slotted Screws 1 - 1/4 Masonry Drill	.83	
WAK14R	20445/kit	1/4	100 - 1/4 Red Plastic Anchors	.95	14.28/ea kit
WAKJ14R	20590/jar		100 - 10 x 1 Pan Combo Screws 1 - 1/4 Masonry Drill	.93	
WAK141	23841/kit	1/4	100 - 1/4 Red Plastic Anchors	1.00	13.25/ea kit
WAKJ141	20584/jar		100 - 10 x 1 1/4 Pan Combo Screws 1 - 1/4 Masonry Drill	1.00	
WAK14SS	99414/kit	1/4	100 - 1/4 Red Plastic Anchors	.96	32.38/ea kit
WAKJ14SS	99420/jar		100 - 10 x 1 Pan Slotted Screws S.S. 1 - 1/4 Masonry Drill	.94	
WAK14HSS	99415/kit	1/4	100 - 1/4 Red Plastic Anchors	.97	34.88/ea kit
WAKJ14HSS	99419/jar		100 - 10 x 1 with 5/16 Hex Slotted Screws S.S. 1 - 1/4 Masonry Drill	.95	
WAK14SSPH	99418/kit	5/16	100 - 1/4 Red Plastic Anchors	.96	32.38/ea kit
WAKJ14SSPH	99417/jar		100 - 10 x 1 with 1/4 Pan Phillips Screws S.S. 1 - 5/16 Masonry Drill	.96	
WAK15	20210/kit	5/16	50 - 5/16 Red Plastic Anchors	.85	14.28/ea kit
WAKJ15	20605/jar		50 - 12 x 1 1/4 Pan Combo Screws 1 - 5/16 Masonry Drill	.80	
WAK15R	20450/kit	5/16	50 - 5/16 Red Plastic Anchors	1.00	14.78/ea kit
WAKJ15R	20615v/jar		50 - 12 x 1 1/4 Pan Square Drive Screws 1 - 5/16 Masonry Drill	.74	
WAK15S	39162/kit	5/16	50 - 5/16 Red Plastic Anchors	.88	11.80/ea kit
WAKJ15S	39163/jar		50 - 12 x 1 1/4 Ind. Hex Slotted Screw 1 - 5/16 Masonry Drill	.81	
WAK16QD	38980/kit	5/16	100 - 3/16 Red Plastic Anchors	.79	13.25/ea kit
WAKJ16QD	38981/jar		100 - 8 x 1 QUADRIVE / 1/4 HWH 1 - 3/16 Masonry Drill	.70	MADE IN USA Anchors & Screws ONLY METALLICS/Avanti Screw
WAK14QD	39160/kit	1/4	100 - 1/4 Red Plastic Anchors	1.07	13.25/ea kit
WAKJ14QD	39161/jar		100 - 10 x 1 QUADRIVE / 5/16 HHS 1 - 1/4 Masonry Drill	1.03	MADE IN USA Anchors & Screws ONLY METALLICS/Avanti Screw
WAK15QD	39164/kit	5/16	100 - 13/16 Red Plastic Anchors	.83	13.25/ea kit
WAKJ15QD	39165/jar		100 - 12 x 1 1/4 QUADRIVE / 5/16 HHS 1 - 5/16 Masonry Drill	.77	MADE IN USA Anchors & Screws ONLY METALLICS/Avanti Screw

OTHER SIZES AND QUANTITIES AVAILABLE BY REQUEST

**METALLICS IS THE LARGEST ANCHOR KIT
 SOURCE IN AMERICA**

ANCHORING DEVICES



“DENVER BLUE” CONICAL PLASTIC WALL ANCHOR KITS

FOR LIGHT-DUTY APPLICATION

NOW WITH QUADRIVE OPTION!

IN SOME AREAS OF THE COUNTRY, TRADESMEN PREFER BLUE TO RED. SAME PRODUCT - DIFFERENT COLOR

MASTER
CARTONS
CONTAIN:
25 KITS
18 JARS

STOCK NO.	UPC NO.	SIZE	DESCRIPTION OF CONTENTS	WT. EACH	SUGGESTED TRADE LIST PRICE PER
WAK13B	20201/kit	3/16	100 - 3/16 Blue Plastic Anchors	.53	13.25/ea kit
WAKJ13B	20571/jar		100 - 6 x 1 Pan Combo Screws 1 - 3/16 Masonry Drill	.54	
WAK14B	20209/kit	1/4	100 - 1/4 Blue Plastic Anchors	.96	13.25/ea kit
WAKJ14B	20576/jar		100 - 10 x 1 Pan Combo Screws 1 - 1/4 Masonry Drill	.92	
WAK14TB	20204/kit	1/4	100 - 1/4 Blue Plastic Anchors	1.01	13.25/ea kit
WAKJ14TB	20577/jar		100 - 10 x 1 Pan Tri-Drive 1 - 1/4 Masonry Drill / 1 - 000R2B Bit	.93	
WAK14HB	20213/kit	1/4	100 - 1/4 Blue Plastic Anchors	1.01	15.10/ea kit
WAKJ14HB	20578/jar		100 - 10 x 1 with 5/16 Hex Slotted Screws 1 - 1/4 Masonry Drill	.93	
WAK14QB	20216/kit	1/4	100 - 1/4 Blue Plastic Anchors	.88	15.10/ea kit
WAKJ14QB	20581/jar		100 - 10 x 1 with 1/4 Hex Slotted Screws 1 - 1/4 Masonry Drill	.80	
WAK14HBSS	20814/kit	1/4	100 - 1/4 Blue Plastic Anchors	1.00	34.88/ea kit
WAKJ14H-BSS	99416/jar		100 - 10 x 1 with 1/4 Hex Slotted Screws S.S. 1 - 1/4 Masonry Drill	1.00	
WAK14RB	20217/kit	1/4	100 - 1/4 Blue Plastic Anchors	1.03	14.28/ea kit
WAKJ14RB	20582/jar		100 - 10 x 1 Pan Square Drive Screws 1 - 1/4 Masonry Drill	.80	
WAK141B	20585/kit	1/4	100 - 1/4 Blue Zinc Anchors	1.00	13.25/ea kit
WAKJ141B	20586/jar		100 - 10 x 1 1/4 Pan Square Drive Screws 1 - 1/4 Masonry Drill	1.00	
WAK15B	20211/kit	5/16	50 - 5/16 Blue Plastic Anchors	.84	14.28/ea kit
WAKJ15B	20606/jar		50 - 12 x 1 1/4 Pan Combo Screws 1 - 5/16 Masonry Drill	.80	
WAK15RB	20212/kit	5/16	50 - 5/16 Blue Plastic Anchors	1.00	14.78/ea kit
WAKJ15RB	20607/jar		50 - 12 x 1 1/4 Pan Square Drive Screws 1 - 5/16 Masonry Drill	.80	
WAK15SB	20417/kit	5/16	50 - 5/16 Blue Plastic Anchors	.85	11.80/ea kit
WAKJ15SB	39169/jar		50 - 12 x 1 1/4 Hex Slotted Screw 1 - 5/16 Masonry Drill	.85	



ONLY METALLICS/Avanti Screw



OTHER SIZES AND QUANTITIES AVAILABLE BY REQUEST

CONTINUED ON NEXT PAGE



Metallics Avanti Screw Manufacturing Facility in Bristol, CT



None of our competitors selling to the Electrical, Plumbing and HVAC Distribution trade can claim they manufacture screws.

There is no doubt: We know the American fastener market and are ahead of our competitors. Our Avanti Screw, Inc., fastener manufacturing facility in Bristol, CT, provides you an American fastener company who makes a portion of its product, sold through electrical, plumbing and HVAC distributors.

America's Source For Premier and Innovative Fasteners & Anchors

www.metallicsonline.com

ANCHORING DEVICES





CONTINUED

"DENVER BLUE" CONICAL PLASTIC WALL ANCHOR KITS

FOR LIGHT-DUTY APPLICATION

MASTER
CARTONS
CONTAIN:
25 KITS
18 JARS



STOCK NO.	UPC NO.	SIZE	DESCRIPTION OF CONTENTS	WT. EACH	SUGGESTED TRADE LIST PRICE PER
WAK14QDB	39166/kit	3/16	100 - 1/4 Blue Plastic Anchors	1.07	13.25/ea kit
WAKJ14QDB	39167/jar		100 - 10 x 1 QUADRIVE 3/16 Hex Head Screws 1 - 1/4 Masonry Drill	1.03	ONLY METALLICS/Avanti Screw 
WAK15QDB	39170/kit	5/16	50 - 5/16 Blue Plastic Anchors	.83	13.25/ea kit
WAKJ15QDB	39171/jar		50 - 12 x 1 1/4 QUADRIVE 5/16 Hex Head Screws 1 - 5/16 Masonry Drill	.80	ONLY METALLICS/Avanti Screw 



"SUPER YELLOW" PLASTIC WALL ANCHOR KITS

FOR LIGHT-DUTY APPLICATION

MASTER
CARTONS
CONTAIN:
25 KITS
18 JARS

STOCK NO.	UPC NO.	SIZE	DESCRIPTION OF CONTENTS	WT. EACH	SUGGESTED TRADE LIST PRICE PER
WAK18	20255/kit	3/16	100 - 3/16 Super Yellow Anchors	.58	15.93/ea kit
WAKJ18	20645/jar		100 - 6 x 1 Pan Combo Screws 1 - 3/16 Masonry Drill	.52	
WAK18T	20256/kit	3/16	100 - 3/16 Super Yellow Anchors	.75	15.93/ea kit
WAKJ18T	20646/jar		100 - 6 x 1 Pan Tri-Drive 1 - 3/16 Masonry Drill / 1 - 000R2B Bit	.55	
WAK19	20260/kit	1/4	100 - 1/4 Super Yellow Anchors	1.01	17.93/ea kit
WAKJ19	20650/jar		100 - 10 x 1 Pan Combo Screws 1 - 1/4 Masonry Drill	.92	
WAK19T	20261/kit	1/4	100 - 1/4 Super Yellow Anchors	.97	17.93/ea kit
WAKJ19T	20651/jar		100 - 10 x 1 Pan Tri-Drive 1 - 1/4 Masonry Drill 1 - 000R2B Bit	1.01	ONLY METALLICS/Avanti Screw 
WAK19H	21575/kit	1/4	100 - 1/4 Super Yellow Anchors	1.06	17.93/ea kit
WAKJ19H	20655/jar		100 - 10 x 1 with 5/16 Hex Head Screws 1 - 1/4 Masonry Drill	1.06	
WAK19S	20262/kit	1/4	100 - 1/4 Super Yellow Anchors	1.11	18.63/ea kit
WAKJ19S	20670/jar		100 - 10 x 1 1/4 with 5/16 Hex Head Screws 1 - 1/4 Masonry Drill	1.11	
WAK19SS	20263/kit	1/4	100 - 1/4 Super Yellow Anchors	1.11	34.75/ea kit
WAKJ19SS	99470/jar		100 - 10 x 1 1/2 Pan Phillips Screws S.S. 1 - 1/4 Masonry Drill	1.11	
WAK20	20265/kit	5/16	50 - 5/16 Super Yellow Anchors	.86	17.93/ea kit
WAKJ20	20680/jar		50 - 12 x 1 1/4 Pan Combo Screws 1 - 5/16 Masonry Drill	.76	
WAK191S	32192/kit	5/16	100 - 100 - 5/16 Super Yellow Anchors	1.01	18.50/ea kit
WAKJ191S	20673/jar		100 - 12 x 1 1/2 with 5/16 Hex Head Screws 1 - 5/16 Masonry Drill	1.05	
SUPER YELLOW QUADRIVE					
WAK19QD	39176/kit	1/4	100 - 1/4 Plastic Anchors	1.07	17.93/ea kit
WAKJ19QD	39177/jar		100 - 10 x 1 QUADRIVE 5/16 Hex Head Screws 1 - 1/4 Masonry Drill	1.00	ONLY METALLICS/Avanti Screw 



OTHER SIZES AND QUANTITIES AVAILABLE BY REQUEST

ANCHORING DEVICES



EXPANDET LIGHT ROSETT NYLON WALL ANCHOR KITS

FOR LIGHT-DUTY APPLICATION

STOCK NO.	UPC NO.	SIZE	DESCRIPTION OF CONTENTS	WT. EACH	SUGGESTED TRADE LIST PRICE PER
WAK33	20270/kit	1/4	50 - 1/4 Expandet Nylon Anchors	.70	12.93/ea kit
WAKJ33	22229/jar		50 - 8 x 2 Pan Combo Screws 1 - 1/4 Masonry Drill	.66	
WAK33R	20272/kit	1/4	50 - 1/4 Expandet Nylon Anchors	.80	12.93/ea kit
WAKJ33R	20761/jar		50 - 8 x 2 Square Drive Screws 1 - 1/4 Masonry Drill	.65	
WAK34	20271/kit	5/16	25 - 5/16 Expandet Nylon Anchors	.65	12.93/ea kit
WAKJ34	22240/jar		25 - 12 x 2 Pan Combo Screws 1 - 5/16 Masonry Drill	1.00	





OTHER SIZES AND QUANTITIES AVAILABLE BY REQUEST



COLLARLESS VINYL WALL ANCHOR KITS

FOR LIGHT-DUTY APPLICATION
COLOR OF ANCHOR DETERMINED BY SIZE.

MASTER CARTONS CONTAIN:
25 KITS
18 JARS

STOCK NO.	UPC NO.	SIZE	DESCRIPTION OF CONTENTS	WT. EACH	SUGGESTED TRADE LIST PRICE PER
WAK7	20230/kit	3/16	100 - 3/16 Vinyl Anchors	.75	11.05/ea kit
WAKJ7	20500/jar		100 - 6 x 1 Pan Combo Screws 1 - 3/16 Masonry Drill		
WAK8	20235/kit	1/4	100 - 1/4 Vinyl Anchors	1.01	11.75/ea kit
WAKJ8	20505/jar		100 - 10 x 1 Pan Combo Screws 1 - 1/4 Masonry Drill		
WAK8T	20402/kit	1/4	100 - 1/4 Vinyl Anchors	1.07	11.75/ea kit
WAKJ8T	20640/jar		100 - 10 x 1 Pan Tri-Drive 1 - 1/4 Masonry Drill, 000R2B		MADE IN USA Screws ONLY METALLICS/Avanti Screw 
WAK9	20240/kit	5/16	50 - 5/16 Vinyl Anchors	.86	12.93/ea kit
WAKJ9	20510/jar		50 - 12 x 1 1/4 Pan Combo Screws 1 - 5/16 Masonry Drill		

OTHER SIZES AND QUANTITIES AVAILABLE BY REQUEST

WAK8QD	39180/kit	1/4	100 - 1/4 Vinyl Anchors	1.00	11.75/ea kit
WAKJ8QD	39181/jar		100 - 10 x 1 QUADRIVE 5/16 Hex Head 1 - 1/4 Masonry Drill	1.00	11.75/ea kit

The QuaDrive



Square Drive + Hex + Slotted + Phillips = QuaDrive

America's Newest Drive - Designed, Developed and Manufactured by Metallics/Avanti Screw



ONLY METALLICS

America's newest Drive designed, developed and manufactured by Metallics/Avanti Screw

THE QUADRIVE

ONLY METALLICS/Avanti Screw

ANCHORING DEVICES



GRAY CONICAL PLASTIC WALL ANCHOR KITS

FOR LIGHT-DUTY APPLICATION

MASTER CARTONS CONTAIN:
25 KITS
18 JARS

NOW WITH QUADRIVE OPTION!

STOCK NO.	UPC NO.	SIZE	DESCRIPTION OF CONTENTS	WT. EACH	SUGGESTED TRADE LIST PRICE PER
WAK22	10500/kit	3/16	100 - 3/16 Gray Ribbed Anchors	.55	10.93/ea kit
WAKJ22	20730/jar		100 - 6x1 Pan Combo Screws 1 - 3/16 Masonry Drill	.50	
WAK25	20410/kit	3/16	100 - 3/16 Gray Ribbed Anchors	.57	12.25/ea kit
WAKJ25	20751/jar		100 - 8x1 Pan Combo Screws 1 - 3/16 Masonry Drill	.57	
WAK23	20400/kit	1/4	100 - 1/4 Gray Ribbed Anchors	1.01	13.25/ea kit
WAKJ23	20740/jar		100 - 10 x 1 Pan Combo Screws 1 - 1/4 Masonry Drill		
ANCHOR KIT DESIGNED FOR RACEWAY					
WAK23F	39182/kit	1/4	100 - 1/4 Gray Ribbed Anchors	1.01	13.25/ea kit
WAKJ23F	20745/jar		100 - 10 x 1 Flat Head Phillips Screws 1 - 1/4 Masonry Drill		
WAK23T	20401/kit	1/4	100 - 1/4 Gray Ribbed Anchors	1.01	13.25/ea kit
WAKJ23T	20767/jar		100 - 10 x 1 Pan Tri-Drive 1 - 1/4 Masonry Drill / 1 - 000R2B Bit		ONLY METALLICS/Avanti Screw 
WAK24	20405/kit	5/16	50 - 5/16 Gray Ribbed Anchors	1.00	15.48/ea kit
WAKJ24	20750/jar		50 - 12 x 1 1/4 Pan Combo Screws 1 - 5/16 Masonry Drill		

OTHER SIZES AND QUANTITIES AVAILABLE BY REQUEST

WAK23QD	39184/kit	1/4	100 - 1/4 Gray Ribbed Anchors	1.01	13.25/ea kit
WAKJ23QD	39185/jar		100 - 10 x 1 QuaDrive 5/16 Hex Head 1 - 1/4 Masonry Drill		

The QuaDrive

Square Drive + Hex + Slotted + Phillips = QuaDrive

America's Newest Drive - Designed, Developed and Manufactured by Metallics/Avanti Screw

MADE IN USA

Screws
METALLICS/Avanti Screw

ONLY METALLICS

America's newest Drive designed, developed and manufactured by Metallics/Avanti Screws

THE QUADRIVE



JAR DISPLAY CENTER
Holds 18 Jars

ATTENTION
ON LARGE ORDERS OF ANCHOR KITS —
OUR PRICE CAN BE EVEN LOWER!



50 KITS

Order two master cartons of this kit and receive an added **10% Discount!**

QUANTITY DISCOUNTS:
10% DISCOUNT ON 50-99 LIKE KITS
OR
15% DISCOUNT ON 100+ LIKE KITS

Please Call Us for Co-Labeling on Kits!



PLASTIC ANCHOR KIT

- Four Different Style Anchors
- Drill Bits Included
- Screws And Driver Bit Included
- One Four Compartment Plastic Case

STOCK NO.	UPC NO.	DESCRIPTION	QTY. PER PKG,	SUGGESTED TRADE LIST PRICE PER PKG
WAKQUAD	38995	Super Yellow $\frac{3}{16}$ " Plastic Anchors	20	28.58
		#8 x 1" Pan Head Combo Sheet Metal Screw	20	
		$\frac{3}{16}$ " x 4" High Speed Drill Bit	1	
		Big Red $\frac{1}{4}$ " Plastic Anchors	20	
		#10 x 1" Pan Head Combo Sheet Metal Screw	20	
		$\frac{1}{4}$ x 4" High Speed Drill Bit	1	
		Super Yellow $\frac{1}{4}$ " Plastic Anchor	20	
		#10 x 1" Pan Head Combo Sheet Metal Screw	20	
		$\frac{1}{4}$ x 4" High Speed Drill Bit	1	
		Denver Blue $\frac{5}{16}$ " Plastic Anchors	20	
#12 x 1- $\frac{1}{4}$ " Pan Head Combo Sheet Metal Screw	20			
$\frac{5}{16}$ x 4- $\frac{1}{2}$ " High Speed Drill Bit	1			
#2 Phillips Power Bit 2" Long	1			

OTHER SIZES AND QUANTITIES AVAILABLE BY REQUEST



TOGGLER® ALLIGATOR® SOLID WALL ANCHOR KIT

- Alligator® solid-wall anchors can be used in most any material, including: Concrete, Wood, Plaster, Aerated Concrete, Block, Masonry, Stone, Flakeboard, Cinder Block, Ceramic Tile, Stucco, and Drywall.
- Alligator® solid-wall anchors are designed to support heavy loads. (Even under vibration!)



STOCK NO.	UPC NO.	DESCRIPTION	QTY. PER PKG,	SUGGESTED TRADE LIST PRICE PER PKG
TSWAK	73998	$\frac{3}{16}$ " Alligator Solid-Wall Anchor with Flange	20	\$ 41.95
		#8 x 1" Pan Head Combo Sheet Metal Screw	20	
		$\frac{3}{16}$ x 4" Masonry Drill Bit	1	
		$\frac{1}{4}$ " Alligator Solid-Wall Anchor with Flange	20	
		#10 x 1" Pan Head Combo Sheet Metal Screw	20	
		$\frac{1}{4}$ x 4" Masonry Drill Bit	1	
		$\frac{1}{4}$ " Alligator Solid-Wall Anchor No Flange	20	
		#10 x 1" Pan Head Combo Sheet Metal Screw	20	
		$\frac{1}{4}$ x 4" Masonry Drill Bit	1	
		$\frac{5}{16}$ " Alligator Solid-Wall Anchor with Flange	15	
#12 x 1- $\frac{1}{4}$ " Pan Head Combo Sheet Metal Screw	15			
$\frac{5}{16}$ x 4" Masonry Drill Bit	1			
#2 Phillips Power Bit 2" Long	1			

OTHER SIZES AND QUANTITIES AVAILABLE BY REQUEST

ANCHORING DEVICES



SELF-DRILLING WALL ANCHORS

A unique series of self-drilling Anchoring Products distributed and sold by Metallics through a special agreement

NOTE: Due to possible differences in specifications, applications and interpretation of results, purchasers must make their own evaluation of the product to determine the suitability of anchor.

**MASTER
CARTONS
CONTAIN:
25 KITS
18 JARS**

ANCHOR TYPE	Pullout <i>(ultimate average lbs)</i> Gypsum Thickness			Shear <i>(ultimate average lbs)</i> Gypsum Thickness		
	3/8"	1/2"	5/8"	3/8"	1/2"	5/8"
#6	40	45		92	103	
#8	45	50	75	100	110	105

OTHER SIZES AND QUANTITIES AVAILABLE BY REQUEST



SELF-DRILLING WALL ANCHOR ZINC

WORKS GREAT IN DOUBLE DRYWALL AND STUDS
COMBO DRIVE #3 PHILLIPS

PULLOUT <i>(ULTIMATE AVERAGE LBS)</i> GYPSUM THICKNESS		
3/8"	1/2"	5/8"
40	50	75

STOCK NO.	UPC NO.	SIZE	DESCRIPTION	PKG. QTY.	WT. PER PKG.	SUGGESTED TRADE LIST PRICE PER
ZSTU1J	81315/jar	8 x 1 1/4	Zinc Screw Anchors w/ PPH screws	50	1.5lbs	26.73/ea kit
ZSTU1K	81319/kit	8 x 1 1/4	Zinc Screw Anchors w/ PPH screws	50	1.5lbs	26.73/ea kit
ZSTU1M	81323	8 x 1 1/4	Zinc Screw Anchors w/ PPH screws	1000	15.06	246.10/M NEW

OTHER SIZES AND QUANTITIES AVAILABLE BY REQUEST



SELF-DRILLING WALL ANCHOR ZINC

WORKS GREAT IN DRYWALL
COMBO DRIVE #3 PHILLIPS



STOCK NO.	BOX UPC NO.	JAR UPC NO.	SCREW SIZE	DESCRIPTION	WT. EACH	STD. PKG.	SUGGESTED TRADE LIST PRICE PER
JZSA1		80973	#8	100 - Zinc Screw Anchors	1.40	100	41.98/c
ZSA1M	33261	-	#8	1000 - Zinc Screw Anchors	13.15	1000	335.70/M

OTHER SIZES AND QUANTITIES AVAILABLE BY REQUEST

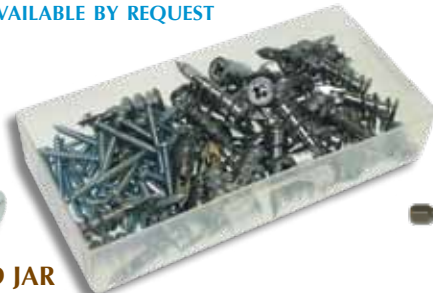

100P2B

ANCHOR KITS IN BOX AND JAR

						SUGGESTED TRADE LIST PRICE PER
ZSA1K/box	33265/box	#8	50 - Zinc Screw Anchors		1.07	26.00/ea kit
ZSA1J/jar	20710/jar		50 - 8 x 1 1/4 Pan Head Combo Screws		1.03	
ZSA1TK/box	33266/box	#8	50 - Zinc Screw Anchors		1.07	26.00/ea kit
ZSA1TJ/jar	20269/jar		50 - 8 x 1 1/4 Pan Head Tri-Drive Screws		1.01	
			1 - 100R2B Bit			

OTHER SIZES AND QUANTITIES AVAILABLE BY REQUEST



SELF-DRILLING WALL ANCHOR ZINC-LITE

WORKS GREAT IN DRYWALL • COMBO DRIVE #2 PHILLIPS
Uses #6-8 sheet metal **or** #6-8 drywall screws

STOCK NO.	JAR UPC NO.	SCREW SIZE	DESCRIPTION OF CONTENTS	WT. EACH	STD. PKG.	SUGGESTED TRADE LIST PRICE PER
JZSAL2	80974	#6 or #8	100 - Zinc Alloy Anchor Lite	.85	100	29.88/c

OTHER SIZES AND QUANTITIES AVAILABLE BY REQUEST



ANCHOR KITS IN BOX AND JAR

						SUGGESTED TRADE LIST PRICE PER KIT
ZSAL2K/box	33267/box	#6	50 - Zinc Alloy Anchor Lite	.66	1	18.15/ea kit
ZSAL2J/jar	33268/jar		50 - 6 x 1 Pan Head Combo Screws	.64	1	18.15/ea kit

OTHER SIZES AND QUANTITIES AVAILABLE BY REQUEST

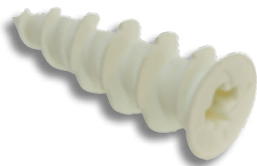

SELF-DRILLING WALL ANCHOR NYLON

WORKS GREAT IN DRYWALL • COMBO DRIVE #3 PHILLIPS

STOCK NO.	JAR UPC NO.	SCREW SIZE	DESCRIPTION OF CONTENTS	WT. EACH	STD. PKG.	SUGGESTED TRADE LIST PRICE PER
JPSA1	80975	#6, #8	100 - Plastic Anchors	.40	100	41.98/c
PSA1M	19824	#6, #8	1M/PACK - Plastic Anchors	4.50	1000	268.55/m

OTHER SIZES AND QUANTITIES AVAILABLE BY REQUEST



ANCHOR KITS IN BOX AND JAR

						SUGGESTED TRADE LIST PRICE PER KIT
PSA1K/box	29495	#6, #8	50 - Plastic Anchors	.59	1	26.00/ea kit
PSA1J/jar	20705		50 - 8 X 1-1/4 Pan Head Combo Screws	.56	1	26.00/ea kit

OTHER SIZES AND QUANTITIES AVAILABLE BY REQUEST



SELF-DRILLING WALL ANCHOR NYLON-LITE

WORKS GREAT IN DRYWALL • COMBO DRIVE #2 PHILLIPS

STOCK NO.	JAR UPC NO.	SCREW SIZE	DESCRIPTION OF CONTENTS	WT. EACH	STD. PKG.	SUGGESTED TRADE LIST PRICE PER
JPSAL2	80976	#6	100 - Plastic Anchor Lite	.23	100	29.98/c

OTHER SIZES AND QUANTITIES AVAILABLE BY REQUEST



ANCHOR KITS IN BOX AND JAR

						SUGGESTED TRADE LIST PRICE PER KIT
PSAL2K/box	19827	#6	50 - Plastic Anchor Lite	.35	1	18.15/ea kit
PSAL2J/jar	20700		50 - 6 X 1 Pan Head Combo Screws	.35	1	18.15/ea kit

OTHER SIZES AND QUANTITIES AVAILABLE BY REQUEST

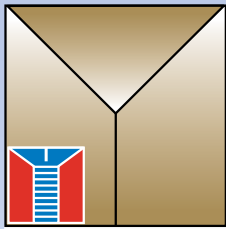

Metallics

Rapid-Set[®] Tools

The fastest, easiest and most reliable way to install machine screw lead (caulk-in) anchors



[CONTRACTOR APPROVED]



- For machine screw lead (caulk-in) anchor sizes 1/4" and 3/8".
- Designed for use with power tools.
- Automatically sets anchor just below the surface.
- Maximizes expansion of bottom portion of lead sleeve.



Made in USA

***Note:** Rapid-Set Tools draw the anchor's internal insert up into the anchor's outer sleeve; this installation process eliminates the need to maintain a back bearing surface (required by hammer setting tools).

PART #	UPC #	DESCRIPTION	QTY / PKG	SUG. TRADE LIST / PKG
MRST1420	25110	Rapid-Set Tool for 1/4-20 Machine Screw Lead (caulk-in) Anchors	1	\$ 100.35
MRST3816	25112	Rapid-Set Tool for 3/8-16 Machine Screw Lead (caulk-in) Anchors	1	\$ 142.68

"Growth Through Innovation"

Metallics

229 Cross Street, Bristol, CT 06010
Tel 800-243-8272 • **Fax** 800-831-9358
Email sales@metallicsonline.com

Metallics West

651 North Main Street, Mancos, CO 81328
Tel 800-269-5183 • **Fax** 800-269-6278
Email saleswest@metallicsonline.com

ANCHORING DEVICES

TOGGLE ANCHOR

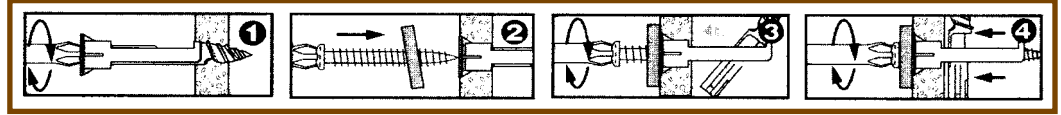

STOCK NO.	JAR UPC NO.	SCREW SIZE	DESCRIPTION OF CONTENTS	WT. EACH	STD. PKG.	SUGGESTED TRADE LIST PRICE PER
JEZT1	80977	#10	50 - Toggles 50 - 8-32 x 2 Pan Head Combo Machine Screws - Zinc Plated	2.01	50	69.18/ea kit

OTHER SIZES AND QUANTITIES AVAILABLE BY REQUEST



STOCK NO.	JAR UPC NO.	SCREW SIZE	DESCRIPTION OF CONTENTS	WT. EACH	STD. PKG.	SUGGESTED TRADE LIST PRICE PER
ANCHOR KITS IN BOX AND JAR						
EZT1K/box	33275	#10	25 Toggles	1.11	1	36.25/ea kit
EZT1J/jar	20715		25 8-32 x 2 Pan Head Combo Machine Screws Zinc Plated	1.24	1	36.25/ea kit

OTHER SIZES AND QUANTITIES AVAILABLE BY REQUEST

AMERICA'S SOURCE FOR PREMIER AND INNOVATIVE FASTENERS & ANCHORS



A Modern Up to Date Roll Threading Machine at our Affiliate, Avanti Screw.



Metallics and Avanti Screw, Inc., prime American manufacturers of fastener products, have always worked to present the latest in fastener technology to our distributors and their contractors/users.

Hex Washer Head fasteners have historically only offered three drives-the hex, phillips and the slot. In 1999, we introduced "The QuaDrive" square, hex, slotted and phillips, in fourteen of the most popular sizes of screws.

The QuaDrive

Square Drive + Hex + Slotted + Phillips = QuaDrive

America's Newest Drive - Designed, Developed and Manufactured by Metallics/Avanti Screw

These screws are being manufactured to fill the need of the growing demand in the North American markets.

ANCHORING DEVICES

STRAP-TOGGLE ANCHOR

FOR HEAVY-DUTY APPLICATION
Designed for use in plaster, wallboard,
concrete block or hollow tile

PACKAGED
IN POLY
BAG

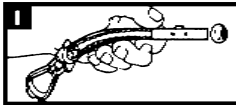
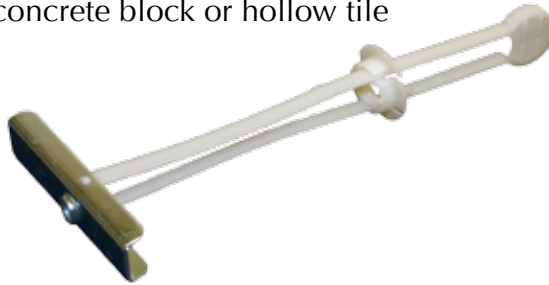

1 Drill appropriate sized hole. Hold metal channel flat alongside plastic straps and slide channel through hole.

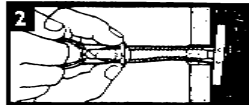

2 Pull on ring so metal channel rests flush behind wall, as you slide plastic cap along straps with other hand, until flange of cap is flush with wall.

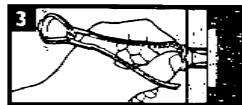

3 Place thumb between plastic straps. Push to side, snapping off straps flush with wall.

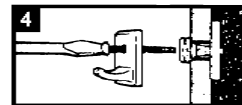

4 Insert bolt through item to be attached and tighten until flush with fixture. Minimum clearance behind wall is 17/8".

STOCK NO.	UPC NO.	SCREW SIZE	ANCHOR SIZE	DRILL	DESCRIPTION OF CONTENTS	WT. PER PKG.	STD. PKG.	SUGGESTED TRADE LIST PRICE PER
NT316	18501	10-24	3/16 x 4	1/2	50 - 3/16 x 4 Strap-Toggle Anchors	1.38	50	59.60/ea. pkg.
NT14	18502	1/4-20	1/4 x 4	1/2	50 - 1/4 x 4 Strap-Toggle Anchors	1.37	50	59.60/ea. pkg.
NT38	18510	3/8-4	3/8 x 4	1/2	100 - 3/8 x 4 Strap-Toggle Anchors	5.86	100	191.35/ea. pkg.

OTHER SIZES AND QUANTITIES AVAILABLE BY REQUEST

Because a wide variety of screws work with this Toggle Anchor, Metallics has chosen not to offer them in a kit, but rather to allow the user to choose the screw that works best for each particular application. Please see Screw/Section A for a full listing of our machine screws.

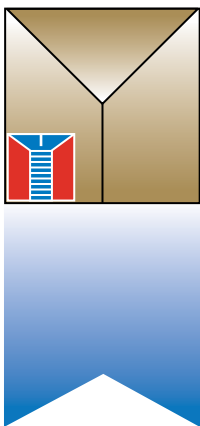

This is the
Heading Line
at
Avanti Screw, Inc.
a Metallics
Affiliate
Bristol, CT.



We work hard at trying to be the best in America!
America's Source For Premier & Innovative Fasteners.



MADE IN USA



SNAPTOGGLE

Secure Installations in Seconds – Not Minutes
Grip Range 3/8"-2 1/2" (9mm-64mm)

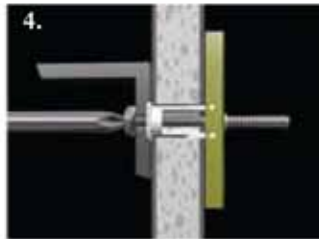
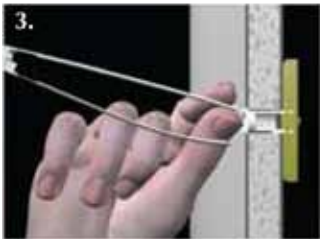
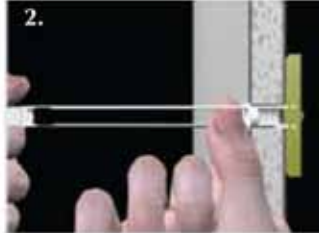
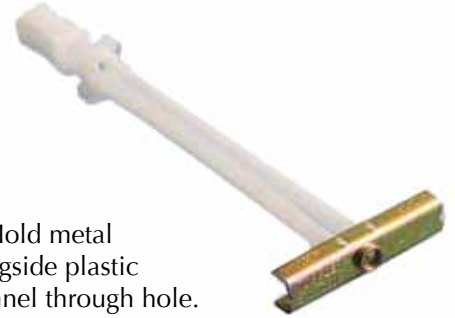

1. Drill 1/2" hole. Hold metal channel flat alongside plastic straps, slide channel through hole.
2. With one hand, pull ring so metal channel rests flush behind wall. Slide plastic cap along straps with other hand until flange of cap is flush with wall.
3. Place thumb between plastic straps. Push side to side snapping off straps flush with wall.
4. Insert bolt through item to be attached and tighten until flush with fixture. Minimum clearance behind wall: 1-7/8" (48mm)



STOCK NO.	UPC NO.	DESCRIPTION OF CONTENTS	PKG. QTY.	SUGGESTED TRADE LIST PRICE PER
MBA25	73944	Toggler Snaptoggle #10-24	25	\$41.45 Pkg.
MBA50	73971	Toggler Snaptoggle #10-24	50	\$75.83 Pkg.
MBB25	73945	Toggler Snaptoggle 1/4-20	25	\$41.45 Pkg.
MBB50	73972	Toggler Snaptoggle 1/4-20	50	\$75.83 Pkg.

OTHER SIZES AND QUANTITIES AVAILABLE BY REQUEST

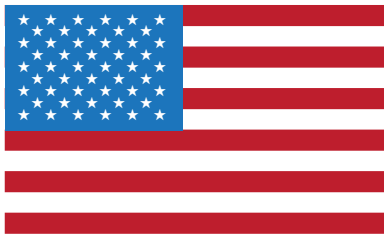

METALLICS

"Growth Through Innovation"

We believe Metallics has the largest ratio of American made to foreign produced product of any other American fastener company.

SERVING THE
ELECTRICAL, PLUMBING, HEATING AND AIR CONDITIONING
DISTRIBUTOR MARKETPLACE