

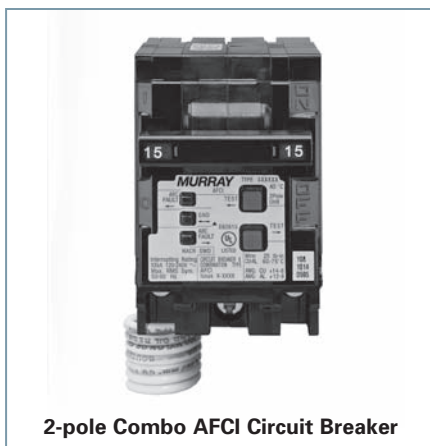

Rock Solid Load Center

Siemens would like to welcome the Murray Electrical Products into the Speedfax. The Murray Electrical Products catalog and Siemens Speedfax has been combined for our customer's convenience. All of the Murray-branded product is located in section 3 so Murray customers will not have to sort thru the entire Speedfax to find associated products. Customers can now select Murray and Siemens products without having to flip between catalogs.

Murray products have a rich tradition of quality & reliability that still lives on today. At the heart of the Murray offering is the Rock Solid load center—designed for those customers that prefer an out-board neutral design & metal basepan for installing breakers. The Rock Solid load center & Murray products remain an important part of the Siemens portfolio. Siemens is proud to carry on the tradition Murray started in 1899.



2-pole Combo AFCI Circuit Breaker

Contents

Load Centers 3-2 – 3-12

Circuit Breakers 3-13 – 3-24

Arc-Fault Interrupters (AFCI) 3-13

1" Plug-in 3-14 – 3-15

Circuit Breaker and Surge Protective Device (SPD) 3-16

Special Application Breakers 3-17

Type MSQ, 3/4 Inch Plug-In Breakers 3-18

Main and Branch Circuit Breakers 3-19

Accessories 3-20 – 3-21

Molded Case 60 – 225 AMP 3-22

Combination Meter Sockets 3-25 – 3-33

100A-400A Meter Mains 3-27

150A-200A Over-Under Construction 3-28

100A-400A Meter Load Centers 3-29

125A-400A EUSERC Side-By-Side Construction 3-30

100A-225A EUSERC Meter Load Center 3-31

400A EUSERC Side-By-Side Construction 3-32

Group Metering: NYC Gangable Metering 3-34 – 3-38

Safety Switches 3-39 – 3-49

General Information 3-39

Technical Information 3-40

General Duty – Compact 3-41

Stand-by Power Switches 3-41

General Duty Switches 3-42

Heavy Duty Switches 3-43 – 3-45

VBII Type Double Throw Switches 3-46

Protector-Lock® Switches 3-47

Accessories & Lug Data 3-48 – 3-49

Dimensions and Knockout Diagrams 3-53 – 3-54

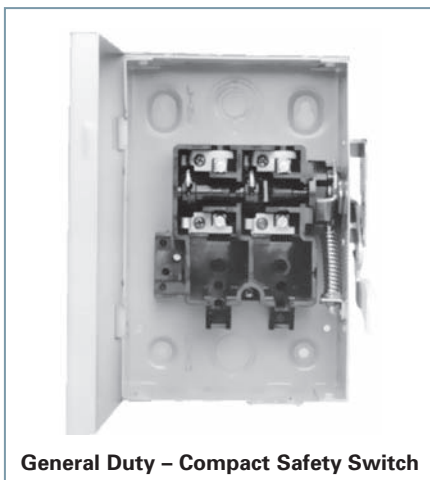

General Duty – Compact Safety Switch

Scan to connect online to the most up-to-date version of this Section of SPEEDFAX.



Features

The Murray Rock Solid Load Center is the highest quality, most versatile design in the industry. Features on the Rock Solid Load Center include:

1. "Swiss Cheese" style neutral bars provide multiple 1/0 connection points.
2. All units include factory installed ground bar and isolated neutral.
3. With the use of the included bonding strap, ground bars and neutral bars can be bonded for service entrance applications.
4. Outboard neutral and groundbars allow for all neutral and ground connections to be located away from breaker connections, making for a neat, clean installation.
5. Mounting tabs on the trim hold it in place on the load center, freeing up both hands to drive the trim screws.
6. Combination head screw on trim and upper pan screws provide installation flexibility.
7. All devices are convertible from main lug to main breaker or vice versa with the addition of main breaker or main lug kits.
8. All main breakers are straight in wired – no back feeding required.
9. A rigid, sturdy base pan with metal hook rails provides the most rugged breaker connection in the industry.
10. The outdoor enclosure has a slide hinge door for the easiest of installation and can be removed by backing out only one screw.
11. All indoor Rock Solid Load Centers are invertible for bottom feed applications.

The following offering is available in the Murray line:

- 12-60 Circuits/Spaces
- Indoor and outdoor enclosures
- 100 to 225 Amp
- Main lug and main breaker
- Value packs - a mix of branch breakers provided with the load center

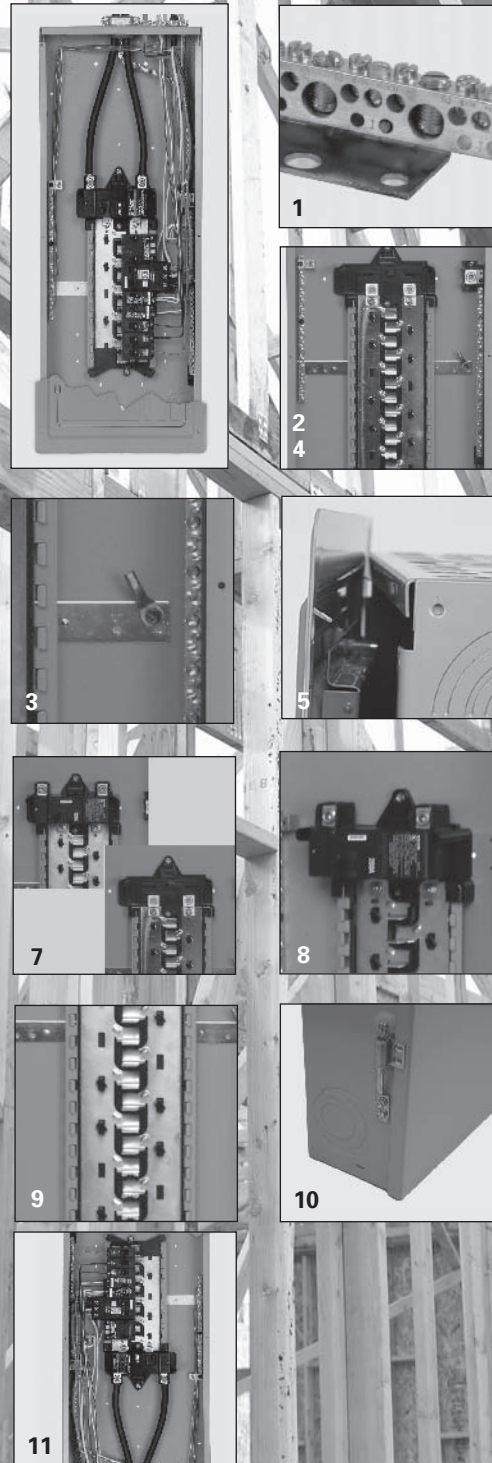

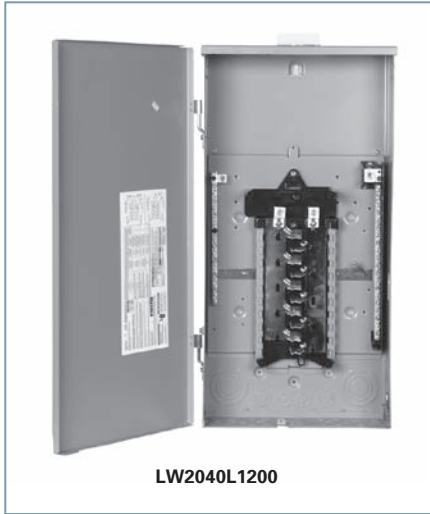

Load centers on this page through 225 amp feature a split neutral insulated bars. For service entrance applications, install bonding strap, and use both bars for neutral and ground conductors. For non service entrance applications, do not install bonding strap and use insulated bars for neutral conductors and bonded bar for ground conductors.

12-42 Circuit, 125–225 Amperes

Amps Max.	No. of Spaces	Max. Circuit	Indoor Type 1 ^③	Dimensions ^④			Outdoor Type 3R ^{③⑤}	Dimensions ^④		
			Catalog Number	Height	Width	Depth	Catalog Number	Height	Width	Depth
125	12	24	LC1224L1125	21	14 $\frac{3}{8}$	4	LW1224L1125	20	14 $\frac{1}{4}$	4 $\frac{1}{2}$
125	16	32	LC1632L1125	21	14 $\frac{3}{8}$	4	LW1632L1125	29	14 $\frac{1}{4}$	4 $\frac{1}{2}$
125	20	40	LC2040L1125	24	14 $\frac{3}{8}$	4	LW2040L1125	29	14 $\frac{1}{4}$	4 $\frac{1}{2}$
125	30	40	LC3040L1125	30	14 $\frac{3}{8}$	4	—	—	—	—
150	16	32	LC1632L1150	24	14 $\frac{3}{8}$	4	—	—	—	—
150	24	40	LC2440L1150	30	14 $\frac{3}{8}$	4	—	—	—	—
200	12	24	—	—	—	—	LW1224L1200	29	14 $\frac{1}{4}$	4 $\frac{1}{2}$
200	20	40	LC2040L1200	30	14 $\frac{3}{8}$	4	LW2040L1200	29	14 $\frac{1}{4}$	4 $\frac{1}{2}$
200	24	40	LC2440L1200	30	14 $\frac{3}{8}$	4	—	—	—	—
200	30	40	LC3040L1200	36	14 $\frac{3}{8}$	4	LW3040L1200	38	14 $\frac{1}{4}$	4 $\frac{1}{2}$
200	40	40	LC4040L1200	39	14 $\frac{3}{8}$	4	—	—	—	—
225	40	60	LC4060L1225	39	14 $\frac{3}{8}$	4	—	—	—	—

Copper Bus^⑥

Amps Max.	No. of Spaces	Max. Circuit	Indoor Type 1 ^③	Dimensions ^④			Outdoor Type 3R ^③	Dimensions ^④		
			Catalog Number	Height	Width	Depth	Catalog Number	Height	Width	Depth
125	20	40	LC2040L1125CU	24	14 $\frac{3}{8}$	4	—	—	—	—
200	20	40	LC2040L1200CU	30	14 $\frac{3}{8}$	4	—	—	—	—
200	30	40	LC3040L1200CU	36	14 $\frac{3}{8}$	4	—	—	—	—
200	40	40	LC4040L1200CU	39	14 $\frac{3}{8}$	4	—	—	—	—
225	12	24	—	—	—	—	LW1224L1225CU	29	14 $\frac{1}{4}$	4 $\frac{1}{2}$
225	42	42	LC4242L1225CU	42	14 $\frac{3}{8}$	4	LW4242L1225CU	42	14 $\frac{1}{4}$	4 $\frac{1}{2}$

① Convertible to main breaker by using the following main breaker kits:
 100A load centers: MBK100M only.
 125A load centers: MBK100M and MBK125M only.
 150A load centers: MBK150M only.
 200A load centers: MBK150M and MBK200M only.
 225A load centers: MBK150M, MBK200M, and MBK225M only.

② 100-225A only.

③ Standard package quantity equal to 1.

④ Dimensions shown are representative of outside box length, width & depth ($\pm \frac{1}{8}$ ") and do not include allowance for mounting bumps, endwalls, hubs or hardware protrusions. Allow approximately 1" additional in length and width dimensions for surface or combination overhang. Consult factory for specific details if required.

⑤ Hub provision only. Closure plate included. Panels through 225A require HS type hub; panels over 225A require HV type hub. See accessories page 3-8 for hub selection.

⑥ Copper bus load centers are recommended for those applications where the environment may be severe (ie farm and coastal areas).

Main Breaker, 1Ø, 22,000 AIC^①

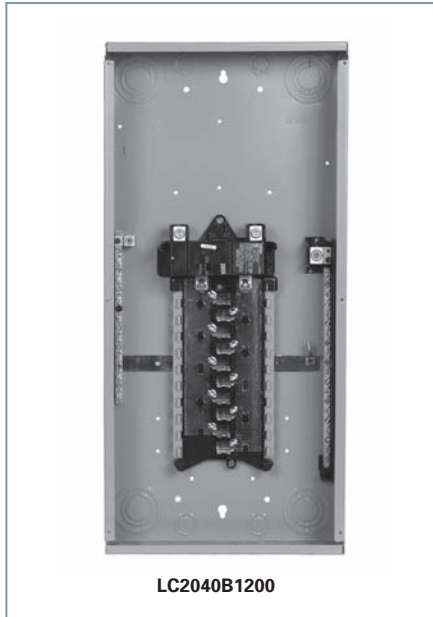

Load centers on this page through 200 amp feature a new split neutral with one bonded and one insulated bar. For service entrance applications, install bonding strap, and use both bars for neutral and ground conductors. For non service entrance applications, do not install bonding strap and use insulated bar for neutral conductors and bonded bar for ground conductors.

Load Center Short Circuit Current Rating

Murray load centers have UL recognized short circuit current ratings up to 100,000 Amps, when used with appropriate main or feeder (remote or internal) overcurrent devices. Load center ratings are shown below. For load center applications with residential or commercial metering equipment, refer to the appropriate catalog section.

1Ø, main breaker load centers are Underwriter's Laboratories Listed for use with 60/75°C conductors and accept Murray branch circuit breakers which are also UL Listed for use with 60/75°C conductors. Type 3R load centers are furnished with a hub opening closure plate.

Load Center Short Circuit Current Rating

Load Center Short Circuit Current Rating ^②	Load Center Main Rating	Internal or Remote Main or Feeder Circuit Breaker Type
10,000 AIC	Any	Any
22,000 AIC	100/125A	MP-HT, MQH ^{③④}
	150/200/225A	MD-H, MQH ^{③④} , MPP-HT ^③
42,000 AIC	100/125A	MQL ^{③④}
	150/200/225A	MQL ^{③④}
65,000 AIC	100/125A	MP-MT, MPP-MT ^③
	150/200/225A	MPP-MT ^③
100,000 AIC	100/125A	100A, 300V AC, Class "T" Fuse ^③
100,000 AIC	150/200/225A	200A, 300V AC, Class "T" Fuse ^③

12-42 Circuit, 100-200 Amperes

Amps Max.	No. of Spaces	Max. Circuit	Catalog Number	Dimensions ^⑤			Outdoor Type 3R ^{⑥⑦}	Dimensions ^⑤		
			Indoor Type 1 ^②	Height	Width	Depth	Catalog Number	Height	Width	Depth
100	12	24	LC1224B1100	18	14 $\frac{3}{8}$	4	LW1224B1100	23	14 $\frac{3}{8}$	4 $\frac{1}{2}$
100	16	32	—	—	—	—	LW1632B1100	23	14 $\frac{3}{8}$	4 $\frac{1}{2}$
100	20	40	LC2040B1100	24	14 $\frac{3}{8}$	4	—	—	—	—
100	24	40	LC2440B1100	24	14 $\frac{3}{8}$	4	—	—	—	—
100	30	40	LC3040B1100	30	14 $\frac{3}{8}$	4	—	—	—	—
150	16	32	LC1632B1150	24	14 $\frac{3}{8}$	4	—	—	—	—
150	20	40	LC2040B1150	30	14 $\frac{3}{8}$	4	LW2040B1150	29	14 $\frac{3}{8}$	4 $\frac{1}{2}$
150	24	40	LC2440B1150	30	14 $\frac{3}{8}$	4	—	—	—	—
150	30	40	LC3040B1150	36	14 $\frac{3}{8}$	4	—	—	—	—
200	12	24	—	—	—	—	LW1224B1200	29	14 $\frac{3}{8}$	4 $\frac{1}{2}$
200	16	32	LC1632B1200	30	14 $\frac{3}{8}$	4	—	—	—	—
200	20	40	LC2040B1200	30	14 $\frac{3}{8}$	4	LW2040B1200	29	14 $\frac{3}{8}$	4 $\frac{1}{2}$
200	24	40	LC2440B1200	30	14 $\frac{3}{8}$	4	—	—	—	—
200	30	40	LC3040B1200	36	14 $\frac{3}{8}$	4	LW3040B1200	38	14 $\frac{3}{8}$	4 $\frac{1}{2}$
200	40	40	LC4040B1200	39	14 $\frac{3}{8}$	4	LW4040B1200	38	14 $\frac{3}{8}$	4 $\frac{1}{2}$
200	30	54	LC3054B1200	36	14 $\frac{3}{8}$	4	—	—	—	—
200	40	40	LC4040B1200	39	14 $\frac{3}{8}$	4	—	—	—	—
200	40	60	LC4060B1200	40 $\frac{1}{2}$	15 $\frac{3}{8}$	5	—	—	—	—

Copper Bus^⑧

Amps Max.	No. of Spaces	Max. Circuit	Indoor Type 1 ^② Catalog Number	Dimensions ^⑤		
				Height	Width	Depth
100	20	40	LC2040B1100CU	24	14 $\frac{3}{8}$	4
200	20	40	LC2040B1200CU	30	14 $\frac{3}{8}$	4
200	30	40	LC3040B1200CU	36	14 $\frac{3}{8}$	4
200	40	40	LC4040B1200CU	39	14 $\frac{3}{8}$	4

① 100-225A only.

② This information is based on use of 10,000 AIC rated branch circuit breakers in load center (MP-T, MH-T, MP-GT, MG). Most series ratings exclude MH-T above 40 Amp. Consult device wiring diagram for specific data.

③ Remote Only

④ Types MQH & MQL may be mounted internal in 150-225 amp 3Ø main breaker load centers.

⑤ Dimensions shown are representative of outside box length, width & depth ($\pm\frac{1}{8}$ ") and do not include allowance for mounting bumps, endwalls, hubs or hardware protrusions. Allow approximately 1 $\frac{1}{2}$ " additional in length and width dimensions for surface or combination overhang. Consult factory for specific details if required.

⑥ Hub provision only. Closure plate included. Panels through 225A require HS type hub; panels over 225A require HV type hub.

⑦ Standard package quantity equal to 1.

⑧ Copper bus load centers are recommended for those applications where the environment may be severe (ie farm and coastal areas).



Generator Ready Load Center Features

- UL Listed
- Indoor Type 1 and outdoor Type 3R
- 225A max rated
- Flush or surface mounting
- Fits between standard stud centers
- Tin plated copper bus bars
- 22 kAIC rated
- 120/240V ~
- Main lug – convertible to main breaker with addition of MBK150M, MBK200M, or MBK225M
- Main breaker – convertible to main lug with use of lug kit part no. ECMLK225
- Installation of transfer mechanism can be performed at time of generator installation

Generator Ready Load Centers (1phase)

Branch Circuits			Indoor Enclosure - NEMA Type 1			Outdoor Enclosure - NEMA Type 3R				
Amp Rating	No. of Spaces ^①	No. of Circuits ^①	Catalog Number	Dimensions (inches)			Catalog Number	Dimensions		
				H	W	D		H	W	D
200	30	42	LC3042B1200GEN	42	14.25	4	LW3042B1200GEN	42.00	14.63	4.00
225	30	42	LC3042L1225GEN	42	14.25	4	LW3042L1225GEN	42.00	14.63	4.00

Riser Load Centers^③

Amp Rating	No. of Spaces	No. of Circuits	Catalog Number	Dimensions (inches)			Acceptable Main Breaker Kits
				H	W	D	
125	16	32	RC1632L1125CU	24	14.25	3.88	MBK100M, MBK125M
125	24	24	RC2424L1125CU	30	14.25	3.88	MBK100M, MBK125M
125	24	42	RC2442L1125CU	30	14.25	3.88	MBK100M, MBK125M
200	30	42	RC3042L1200CU	36	14.25	3.88	MBK150M, MBK200M

400A Main Breaker Load Centers (1phase & 3phase)^②

No. of Phases	Amp Rating	No. of Spaces	No. of Circuits	Catalog Number	Dimensions (inches)			Catalog Number	Dimensions		
					H	W	D		H	W	D
1	400	30	40	LC330SS	47.00	20.00	6.00	—	—	—	—
1	400	42	42	—	—	—	—	LW442SR	44.00	20.00	6.00
3	400	42	42	LP442SS	58.00	20.00	6.00	LZ442SR	58.00	20.00	6.00

400A Main Lug Load Centers (1phase & 3phase)^②

No. of Phases	Amp Rating	No. of Spaces	No. of Circuits	Catalog Number	Dimensions (inches)			Catalog Number	Dimensions		
					H	W	D		H	W	D
1	400	42	42	—	—	—	—	LW042SR	47.00	20.50	6.50
3	400	42	42	LC042SS	47.00	20.00	6.00	LW942SR	52.00	22.00	8.00



① 2 spaces and 2 circuits are reserved for standby generator installation.

② 400 amp load centers have insulated groundable center-mounted neutrals.

③ See Section 1 for knock-out diagram.

Circuit Breaker Enclosures & Small Load Centers



- Ideal for Narrow stud applications
- Eliminated "notching" needed for standard Load Centers
- Outdoor Load Center with factory installed Ground Fault Breaker
- Two extra circuits
- Factory installed feed-through lugs
- Main Breaker or Main Lug panels available

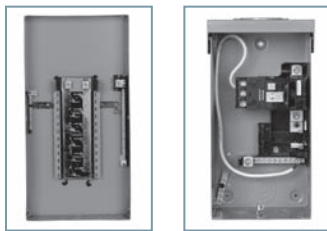

Spa Panels

Ampere Rating	No. of Spaces	Max. Circuits	Catalog Number	Dimensions ^③		
				Height	Width	Depth
125	2	4	LW004NRSPA50 [®]	12 $\frac{1}{4}$ "	6 $\frac{5}{8}$ "	4 $\frac{1}{4}$ "
125	2	4	LW004NRSPA60 [®]	12 $\frac{1}{4}$ "	6 $\frac{5}{8}$ "	4 $\frac{1}{4}$ "

Renovation Panels - 3 Wire 120/240V AC

200	24	40	LC024PFR	30	14	3 $\frac{1}{8}$ "
100	10	20	LC110DFCGP [®]	14 $\frac{3}{4}$ "	12 $\frac{3}{8}$ "	3 $\frac{1}{8}$ "

Outdoor^① Trailer Panels - 120/240V AC 208Y/120V AC

Amps Max	No. of Spaces	Max. Circuits	Indoor Type 1 Catalog No.	Dimensions ^③			Main Breaker	
				Height	Width	Depth		
100	2	4	LW102NL ^①	12 $\frac{1}{2}$ "	6"	4 $\frac{1}{4}$ "	MP2100	Factory
200	4	8	LW204TL ^①	20"	11 $\frac{1}{8}$ "	4 $\frac{1}{4}$ "	MPD2200R	Factory
200	4	8	LW004TR [®]	20"	11 $\frac{1}{8}$ "	4 $\frac{1}{4}$ "	MD-T(R), MD-HT(R)	Field
200	8	16	LW0816L1200TR [®]	29"	14 $\frac{1}{4}$ "	4 $\frac{1}{2}$ "	MBK150M or MBK200M	Field

2-8 Circuit, 60-125 Amperes (no door)

Amps Max.	No. of Spaces	Max. Circuit	Indoor Type 1 Catalog Number ^②	Dimensions ^③			Outdoor Type 3R ^① Catalog Number	Dimensions ^③		
				Height	Width	Depth		Height	Width	Depth
60	2	4	LC002GS	9 $\frac{7}{8}$ "	5 $\frac{1}{2}$ "	2 $\frac{1}{2}$ "	LW002GR [®]	8 $\frac{1}{4}$ "	5 $\frac{1}{8}$ "	4 $\frac{1}{2}$ "
100	3	3	LP003CS	17 $\frac{1}{2}$ "	7 $\frac{1}{2}$ "	5 $\frac{1}{2}$ "	—	—	—	—
125	2	4	LC002HS	17 $\frac{1}{8}$ "	7 $\frac{1}{8}$ "	4 $\frac{1}{4}$ "	LW002HR	8 $\frac{1}{4}$ "	5 $\frac{1}{8}$ "	4 $\frac{1}{2}$ "
125	4	8	LC004NF	12 $\frac{1}{2}$ "	6 $\frac{1}{2}$ "	3 $\frac{1}{2}$ "	—	—	—	—
125	4	8	LC004NS	12 $\frac{1}{2}$ "	6 $\frac{1}{2}$ "	3 $\frac{1}{2}$ "	LW004NR	12 $\frac{1}{4}$ "	6 $\frac{1}{8}$ "	4 $\frac{1}{4}$ "
200	2	4	LC004VS	19 $\frac{1}{4}$ "	8 $\frac{1}{2}$ "	4"	LW004VR	19 $\frac{1}{8}$ "	8 $\frac{1}{8}$ "	4 $\frac{1}{8}$ "
225	2	4	—	—	—	—	LW002QR	27"	10 $\frac{1}{8}$ "	5 $\frac{1}{8}$ "

8-16 Circuit, 125 Amperes (with door)

125	8	16	LC008DF	14 $\frac{1}{4}$ "	12 $\frac{1}{2}$ "	3 $\frac{1}{8}$ "	—	—	—	—
125	8	16	LC008DS	14 $\frac{1}{4}$ "	12 $\frac{1}{2}$ "	3 $\frac{1}{8}$ "	LW008NR	14 $\frac{3}{4}$ "	12 $\frac{1}{2}$ "	4 $\frac{1}{8}$ "
125	8	16	LC008DFG	14 $\frac{1}{4}$ "	12 $\frac{1}{2}$ "	3 $\frac{1}{8}$ "	—	—	—	—
125	8	16	LC008DSG	14 $\frac{1}{4}$ "	12 $\frac{1}{2}$ "	3 $\frac{1}{8}$ "	—	—	—	—

Enclosed Breakers

100	2	4	LC100CS	17 $\frac{1}{8}$ "	7 $\frac{1}{8}$ "	4 $\frac{1}{4}$ "	LW100CR	17 $\frac{1}{8}$ "	7 $\frac{1}{8}$ "	4 $\frac{1}{8}$ "
200	2	4	LC200VS	19 $\frac{1}{4}$ "	8 $\frac{1}{2}$ "	4"	LW200VR	19 $\frac{1}{8}$ "	8 $\frac{1}{8}$ "	4 $\frac{1}{8}$ "
225	3	3	—	—	—	—	LW903QR	27"	10 $\frac{1}{8}$ "	5 $\frac{1}{8}$ "

① Hub provision only. Closure plate included. Panels through 225A require HS type hub.

② Cover type is specified by character in 7th (usually last) position, as follows:

- S = Surface
- F = Flush
- C = Combination Surface/Flush

③ Dimensions shown are representative of outside box length, width & depth ($\pm\frac{1}{8}$ "') and do not include allowance for mounting bumps, endwalls, hubs or hardware protrusions. Allow approximately 1 $\frac{1}{4}$ " additional in length and width dimensions for surface or combination overhang. Consult factory for specific details if required.

④ Use of 60A GFCI requires use of 75°C copper wire.

⑤ Use neutral lug kit ECLK1 or ECLK2 as required.

⑥ Panel includes factory-installed ground bar.

⑦ Maximum breaker 100A.

⑧ Uses HA type hub. Closure plate included.

For KO diagram, see Section 1 KO diagram for W0204ML1060

⑨ Accepts type MQ breakers.

⑩ For service entrance use only 200A max. main breaker. Main breaker must be field added.

⑪ LW102NL shipped with ECHS125 hub instead of closure plate. LW204TL shipped with ECHS200 hub instead of closure plate.

⑫ Two MP115 and one MP230 provided.

⑬ 50 Amp, 2-pole GFCI breaker installed.

⑭ 60 Amp, 2-pole GFCI breaker installed.

⑮ Uses ECHA hub type.

Load Center OEM Interiors

1Ø: Small Circuit Main Lug Interiors

Amps	Catalog Number ^①	Circuits	Spaces	Dimensions	
				Height	Width
60	I0204ML1125	2	2	5.06	2.12
60	I0303ML3100	3	3	5.06	3.12
125	I0408ML1125	4	8	4.51	6.61
125	I0816ML1125CU	8	16	6.19	6.81
125	I0816ML1125CUSP	8	16	6.19	6.81
200	I0202L1200	4	4	3.88	7.13

Rock Solid 1Ø: High Circuit Main Lug Interiors (no neutrals)^③

Amps	Catalog Number ^①	Circuits	Spaces	Dimensions	
				Height	Width
125	IR1224L1125	12	24	10.80	7.40
125	IR1632L1125	16	32	12.80	7.40
125	IR2040L1125CU	20	40	14.80	7.40
125	IR3040L1125	30	40	20.80	7.40
200	IR0816L1200TR ^②	8	16	10.80	7.40
200	IR2040L1200CU	20	40	14.80	7.40
200	IR2440L1200	24	40	16.80	7.40
200	IR3040L1200CU	30	40	20.80	7.40
200	IR4040L1200CU	40	40	24.80	7.40
225	IR4242L1225CU	42	42	26.80	7.40

Lug Data

Interior	Amperage	Wire range	Torque
I0204ML1060	60	2/0 - 4 AWG	45 lb. - ins.
I0303ML3100	100	2/0 - 4 AWG	45 lb. - ins.
I1224ML1100	100	2/0 - 4 AWG	45 lb. - ins.
I0408ML1125	125	2/0 - 4 AWG	45 lb. - ins.
I0816ML1125CU/CUSP	60	2/0 - 4 AWG	45 lb. - ins.
Rock Solid	125	2/0 - 4 AWG	110 lb. - ins.
Rock Solid	200/225	300 kcmil - 4 AWG	275 lb. - ins.

Small circuit Interiors

The small circuit interiors are ideal for OEM applications requiring only a few circuits. They can also be purchased as replacement items for:

I0204ML1125 – Interior for LC100CS, LW100CR

I0303ML3100 – Interior for LP003CS

I0408ML1125 – Interior for L(C,W)004N(F,S,R)

I0816ML1125CU – Interior for L(C,W)008D(F,S,R)

I0202L1200 – Interior for JC0202 Meter Mains

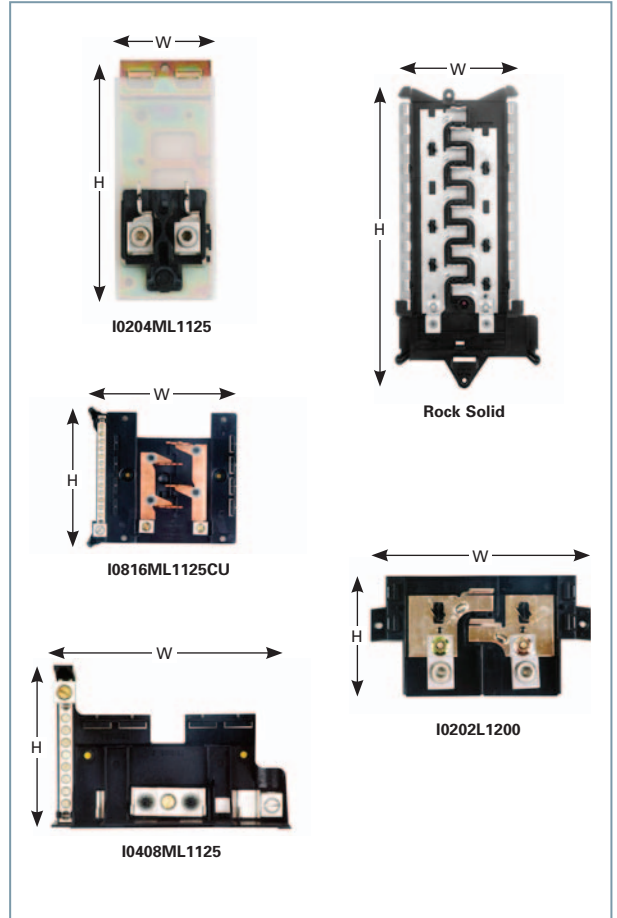

① The letters "CU" in any catalog number represent copper bus bars.
 ② Feed thru lugs provided

③ Convertible to main breaker using the MBK main breaker kits

Hubs



Catalog Number	Description	Pack Quantity
ECHS075	3/4" Hub	10
ECHS100	1" Hub	10
ECHS125	1 1/4" Hub	10
ECHS150	1 1/2" Hub	10
ECHS200	2" Hub	10
ECHS250	2 1/2" Hub	10

Backfed Main Breaker Hold Down Kits



Catalog Number	Description	Pack Quantity
ECMBR2	For use on MP-T, MP-HT, & MP-MT breakers in Rock Solid Load Centers	25
ECMBR1	For use on MP-T, MP-HT, & MP-MT breakers in 2-8 circuit Load Centers	25
ECLX378M	For use on MD-T, MD-HT, & MD-MT breakers on old style (pre 2003) load centers (12-42 circuit)	25
ECLX386HD	For use on MP-T, MP-HT, & MP-MT breakers (15-60A) on old style (pre 2003) load centers (12-42 circuit)	25
ECLX387HD	For use on MP-T, MP-HT, & MP-MT breakers (70-125A) on old style (pre 2003) load centers (12-42 circuit)	25
ECLX388HD	For use on MP-T, MP-HT, & MP-MT breakers (100-125A) on old style (pre 2003) load centers (12-42 circuit)	25

Miscellaneous



Catalog Number	Description	Pack Quantity
ECQFL2	Door lock for Rock Solid Load Centers	10
ECQF3	Filler plate (1")	10
ECMBF125	Filler plate for main breaker opening on 100-125A Rock Solid Load Centers. Use two QF3 filler plates for 150-225A load centers	25
LX077SF	Flush installation cover for 400A panels	1
ECTS2	6 Cover screws, combination cover	50 Bags
ECSMK1	Surface mount spacer kit provides 1/4" space between load center and wall	25

Main Breaker Kits



Catalog Number	Description	Pack Quantity
MBK100M	100A—For use on 100 & 125A Rock Solid Load Centers only	1
MBK125M	125A—For use on 125A Rock Solid Load Centers only	1
MBK150M	150A—For use on 150, 200, & 225A Rock Solid Load Centers only	1
MBK200M	200A—For use on 200 & 225A Rock Solid Load Centers only	1
MBK225M	225A—For use on 225A Rock Solid Load Centers only	1
ECMLK125	1 PH Main Lug Conversion Kit 100-125A	1
ECMLK225	1 PH Main Lug Conversion Kit 150-225A	1

Lug Kits

Ground Bars and Insulated Neutral Kits

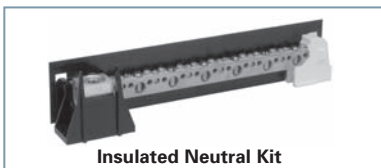

Catalog Number	Description	Pack Quantity
ECLK2SC	#2/0 max. lug for 125 amp neutral feeder for 12-42 circuit devices	50
ECLX384M	CB enclosure ground lug	20

Catalog Number	Description	Pack Quantity
ECLX068M	4 small terminals—15 1/8" long	10
ECLX069M	5 small and 2 large terminals—3" long	10
ECLX071M	8 small and 3 large terminals—3 1/2" long	10
ECLX072M	11 small and 4 large terminals—4 5/8" long	10
ECLX073M	14 small and 5 large terminals—5 3/4" long	10
ECLX074M	17 small and 6 large terminals—7" long	10
ECLX075M	21 small and 7 large terminals—8" long	10
ECINSNB27	Insulated neutral bar with 27 positions	10
ECINSNB32	Insulated neutral bar with 32 positions	10
ECINSNB33	Insulated neutral bar with 33 positions and a 300 MCM lug	10
ECINSNB41	Insulated neutral bar with 41 positions and a 300 MCM lug	10
ECINSNB43	Insulated neutral bar with 43 positions	10

Rock Solid Load Centers

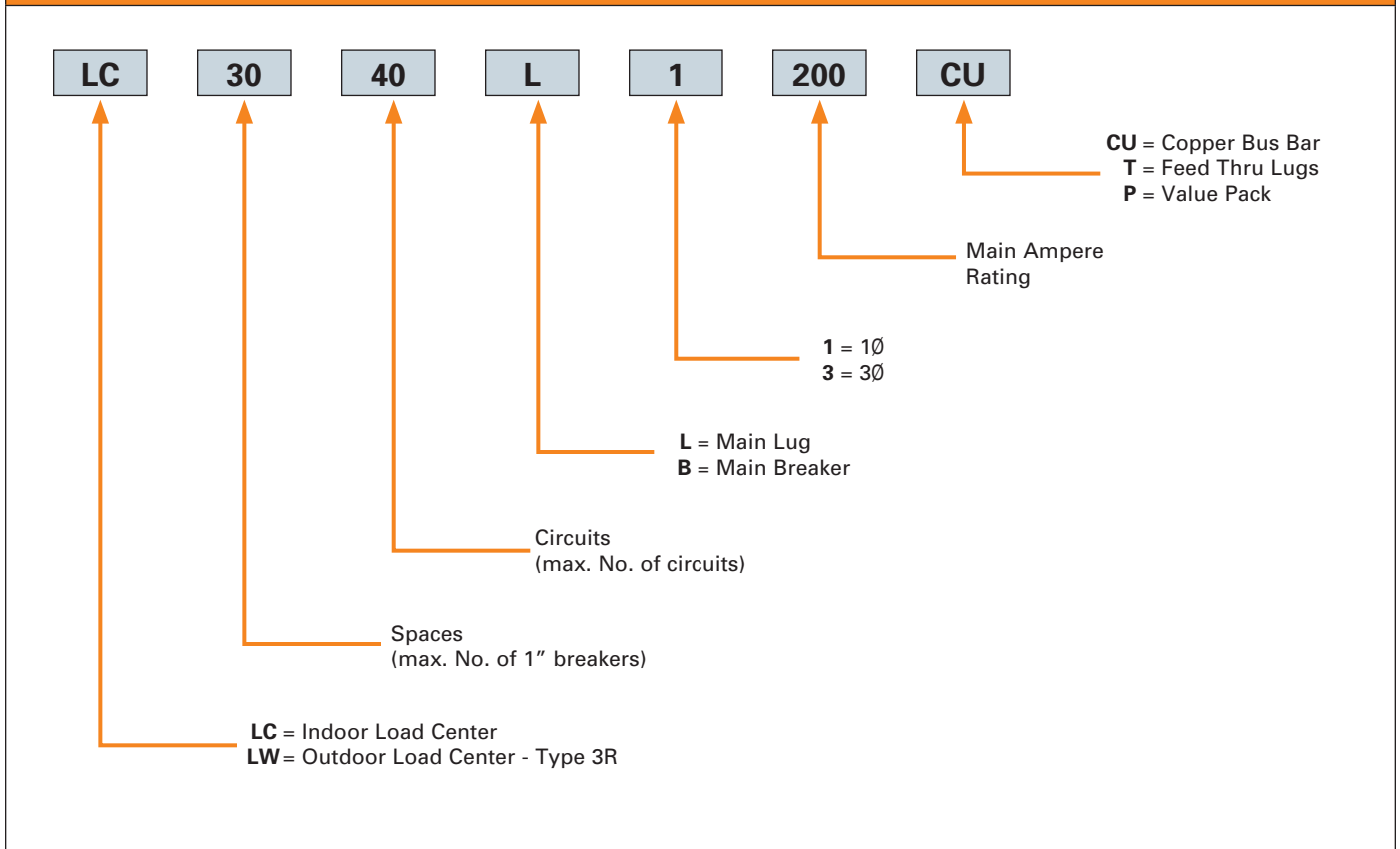

Lug Data

Amps	Phase	Wire Range ^① Main Lug Load Centers	Main Breaker Load Centers
60	1Ø	14-4	
100	1Ø	—	3-1/0
125 (4 CKT)	1Ø	14-2/0	—
(6 CKT & Above)	1Ø	4-2/0	4-2/0
150	1Ø	1/0-4/0	4-250 kcmil

Amps	Phase	Wire Range ^① Main Lug Load Centers	Main Breaker Load Centers
200	1Ø	4-250 kcmil	4-250 kcmil
225	1Ø	4-300 kcmil	4-300 kcmil
400 (24 and 42 CKT)	1Ø	(1)3/0-500 kcmil ^② (2)3/0-250 kcmil	(1or2)3/0-250 kcmil
400 (30 CKT Only)	1Ø	—	(1)3/0-500 kcmil (2)3/0-250 kcmil
400 (24 and 42 CKT)	3Ø	(1)3/0-500 kcmil ^② (2)3/0-250 kcmil	

① All lugs are rated for Cu or Al wire. Wire rang shown is maximum allowable for bending space provided. Lug may accommodate larger wire. Refer to National Electric Code for specific wire size requirements.

② 500 kcmil must be top side entry.

Murray 3-Phase Cross Reference to New SKUs

(See Section 1 for full offering)		
Legacy Murray SKU	ES™ Series Part No.	PL™ Series Part No.
LC1224B3100CU	S1224B3100	P1224B3100CU
LC1224L3125CU	S1224L3125	P1224L3125CU
LC1224L3200CU	S1224L3200	No equivalent
LC1836B3100CU	No equivalent	No equivalent
LC1836L3150CU	S1836L3150	No equivalent
LC1836L3200CU	S2442L3200	No equivalent
LC2442L3150CU	S2442L3150	P2442L3200CU
LC3042B3150CU	S4242B3150	P4242B3150CU
LC3042B3200CU	S3054B3200	P3054B3200CU
LC3042L3200CU	S3054L3200	P3054L3200CU
LC4242B3200CU	S4260B3200	P4260B3200CU
LC4242B3225CU	S4242B3225	P4260B3225TCU/P4260B3225CU
LC4242L3225CU	S4260L3225	P4260L3225CU
LW1224L3125CU	SW1224L3125	PW1224L3125CU
LW1836L3150CU	SW1836L3150	No equivalent
LW3042B3200CU	SW3054B3200	PW3054B3200CU
LW3042L3200CU	SW3054L3200	PW3054L3200CU
New	S3042B3100	—
New	S5470L3225	—
New	SW1224L3200	—
New	SW2442L3150	—
New	SW2442L3200	—
New	SW4260L3225	—
New	S3030B3100	—
New	SW2442B3150	—
New	SW4260B3200	—
New	SW4242B3225	—
New	—	P3042B3100CU

3

MURRAY

Load Centers

Indoor Main Breaker and Main Lug Enclosures

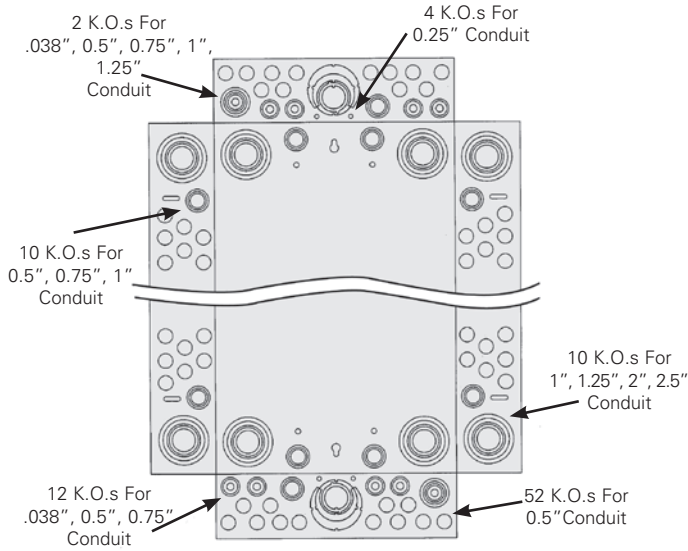

Outdoor Main Breaker and Main Lug Enclosures

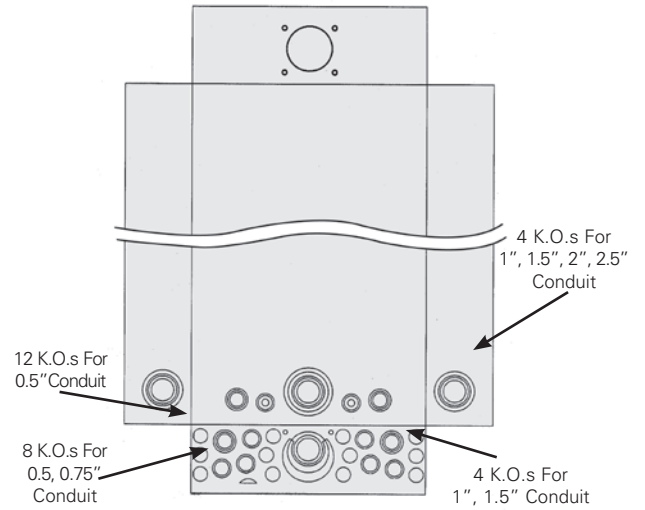

K.O. dimensions refer to conduit trade size, not actual diameter.

MURRAY
Load Centers

4 Circuit Indoor

8 Circuit Indoor

16 Circuit Indoor

Knockout Code—Conduit Sizes

● = ¼	S = 1, 1¼, 1½, 2, 2½
A = ½	T = 1¼
B = ½, ¾	U = 1¼, 1½
C = ¾, ¾, 1	V = 1¼, 1½, 2
D = ¾, 1	W = 1¼, 2
E = ¾, ¾, 1, 1¼	X = 1¼, 1½, 2, 2½
F = ¾, 1¼, 1½	Y = 1½, 2
G = ¾	Z = 1½, 2, 2½
H = ¾, 1	AA = 1½, 2, 2½, 3
J = ¾, 1, 1¼	BB = 1½, 2, 2½, 3, 3½
K = ¾, 1¼	CC = 2, 2½, 3, 3½
L = ¾, ¾, 1, 1¼, 1½	EE = 2, 2½, 3
M = ¾, 1, 1¼, 1½	FF = 2½, 3
N = ¾, 1, 1¼, 1½, 2	GG = 2½, 3, 3½
P = 1, 1¼	HH = 2½, 3, 3½, 4
Q = 1, 1¼, 1½	JJ = 3½, 4
R = 1, 1¼, 1½, 2	LL = 3
	VV = 2

Knockout Diagrams

Indoor and Outdoor Enclosures

400A Indoor

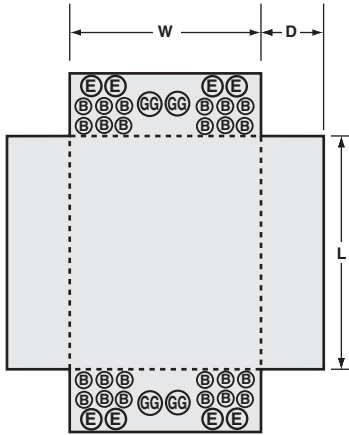

400A Outdoor

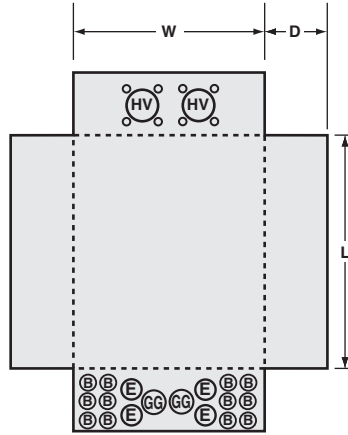

8 Circuit Outdoor

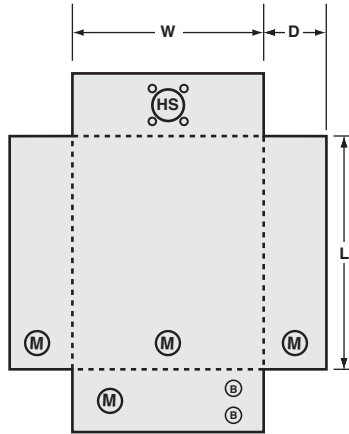

4 Circuit Outdoor

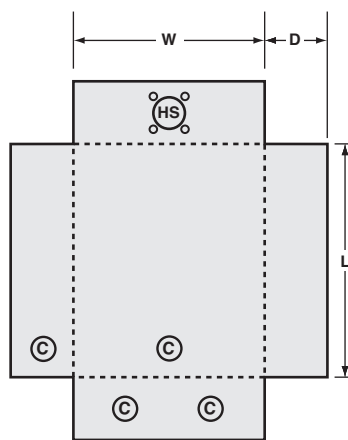

Knockout Code—Conduit Sizes

○ = 1/4	S = 1, 1 1/4, 1 1/2, 2, 2 1/2
A = 1/2	T = 1 1/4
B = 1/2, 3/4	U = 1 1/4, 1 1/2
C = 1/2, 3/4, 1	V = 1 1/4, 1 1/2, 2
D = 1/2, 1	W = 1 1/4, 2
E = 1/2, 3/4, 1, 1 1/4	X = 1 1/4, 1 1/2, 2, 2 1/2
F = 1/2, 1 1/4, 1 1/2	Y = 1 1/2, 2
G = 3/4	Z = 1 1/2, 2, 2 1/2
H = 3/4, 1	AA = 1 1/2, 2, 2 1/2, 3
J = 3/4, 1, 1 1/4	BB = 1 1/2, 2, 2 1/2, 3, 3 1/2
K = 3/4, 1 1/4	CC = 2, 2 1/2, 3, 3 1/2
L = 1/2, 3/4, 1, 1 1/4, 1 1/2	EE = 2, 2 1/2, 3
M = 3/4, 1, 1 1/4, 1 1/2	FF = 2 1/2, 3
N = 3/4, 1, 1 1/4, 1 1/2, 2	GG = 2 1/2, 3, 3 1/2
P = 1, 1 1/4	HH = 2 1/2, 3, 3 1/2, 4
Q = 1, 1 1/4, 1 1/2	JJ = 3 1/2, 4
R = 1, 1 1/4, 1 1/2, 2	LL = 3
	VV = 2

Arc-Fault Circuit Interrupters (AFCI)

Arc-Fault Circuit Interrupters (AFCI)

AFCI's detect arcing faults (an unintentional arcing condition in a circuit) that standard circuit breakers are unable to detect. The device is intended to mitigate the effects of arcing faults by functioning to de-energize the circuit when an arc fault is detected

Combination Type AFCI[®]

Detects all three possible types of arc faults: line-to-ground, line-to-neutral, and series.

Breaker Type	Ampere Rating	10,000 A IR Catalog Number	22,000 A IR Catalog Number	65,000 A IR Catalog Number
MP-AT2/MP-HAT2/MP-MAT2 1-Pole 120V AC	15	MPA115AFC ^①	MPA115AFCH ^{■①}	MPA115AFCHH
	20	MPA120AFC ^①	MPA120AFCH ^{■①}	MPA120AFCHH
MP-AT2/MP-HAT2 2-Pole 120/240V AC	15	MP215AFC ^①	MP215AFCH ^{■①}	—
	20	MP220AFC ^①	MP220AFCH ^{■①}	—

Branch-Feeder AFCI

Detects line-to-ground and line-to-neutral arcs.

Breaker Type	Ampere Rating	10,000 A IR Catalog Number	22,000 A IR Catalog Number	65,000 A IR Catalog Number
MP-AT2/MP-HAT2/MP-MAT2 1-Pole 120V AC	15	MPA115AF ^①	MPA115AFH ^{■①}	MPA115AFHH
	20	MPA120AF ^①	MPA120AFH ^{■①}	MPA120AFHH

NEW Dual Function AFCI/GFCI

The Dual Function Circuit Breaker combines Combination Type AFCI and GFCI, protecting against both Arc Faults and (5mA) Ground Faults. The device includes the Self Test feature, making it the first in class in electrical safety for homeowners.

Breaker Type	Ampere Rating	10,000 A IR Catalog Number	22,000 A IR Catalog Number	65,000 A IR Catalog Number
MP-GAT2/MP-HGAT2/MP-MGAT2 1-Pole 120V AC	15	MP115DF	MP115DFH	MP115DFM
	20	MP120DF	MP120DFH	MP120DFM

Ground Fault Interrupters and Protection

Ground-Fault Circuit Interrupters (Class A - 5mA)^②

Ground-fault circuit interrupters (GFCI) provide Class A ground fault protection. A GFCI is a device intended for personnel protection and will de-energize the circuit when a fault current to ground is 6 milliamperes or more.

Breaker Type	Amp Rating	10,000 A IR Catalog No.	22,000 A IR Catalog No.
MP-GT/MP-HGT 1-Pole 120V AC	15	MP115GFA	MP115GFAH [■]
	20	MP120GFA	MP120GFAH [■]
	25	MP125GFA	MP125GFAH [■]
	30	MP130GFA	MP130GFAH [■]
MP-GT/MP-HGT 2-Pole ^① 120/240V AC	15	MP215GFA	MP215GFAP [■]
	20	MP220GFA	MP220GFAP [■]
	30	MP230GFA	MP230GFAP [■]
	40	MP240GFA	MP240GFAP [■]
	50	MP250GFA	MP250GFAP [■]
	60	MP260GFA	MP260GFAP [■]

Ground Fault Equipment Protection (30mA)^②

Type EQF circuit breakers provide protection of equipment from damaging line-to-ground fault currents by de-energizing the circuit for all ungrounded conductors of the faulted circuit.

Breaker Type	Amp Rating	10,000 A IR Catalog No.	22,000 A IR Catalog No.
MP-ET/MP-HET 1-Pole 120V AC	15	MP115EG ^①	MP115EGH ^{■①}
	20	MP120EG ^①	MP120EGH ^{■①}
	30	MP130EG	MP130EGH [■]
MP-ET/MP-HET 2-Pole ^① 120/240V AC	15	MP215EG	MP215EGH [■]
	20	MP220EG	MP220EGH [■]
	30	MP230EG	MP230EGH [■]
	40	MP240EG	MP240EGH [■]
	50	MP250EG	MP250EGH [■]
	60	MP260EG [■]	MP260EGH [■]

AFCI and GFCI Accessories

Description	Catalog Number
Padlocking Device for 1" & Twin Breakers	ECPLD1
Padlocking Device for 2" & Quad Breakers	ECPLD2
Handle Blocking Device for 1/2" Circuit Breakers	ECBX231M

■ Built to order. Allow 8 -10 weeks for delivery.
① Not UL Listed as SWD Rated.

② White line neutral (pigtail) must be connected to the panel neutral for the device to function.

- UL Listed
- HACR Rated (Except where noted)
- Standard 1 inch per pole format with plug-in design

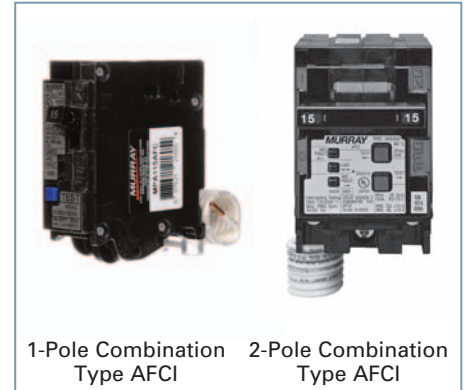

1-Pole Combination Type AFCI 2-Pole Combination Type AFCI



1-Pole Branch Feeder AFCI

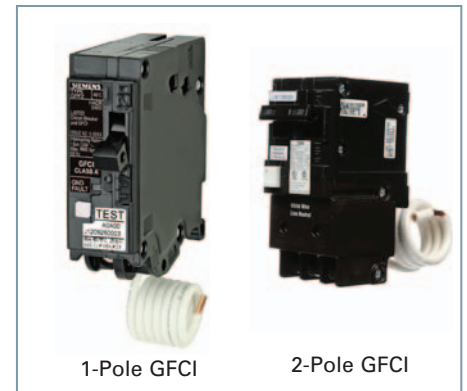

1-Pole GFCI 2-Pole GFCI

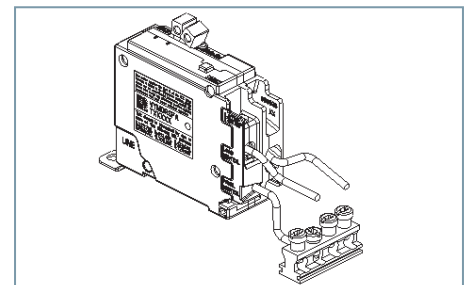

Full Size (1" per Pole) with INSTA-WIRE

Continuous Current Rating @ 40° C	Type MP-T ^①	Type MP-HT	Type MP-MT
	10,000A IR	22,000A IR	65,000A IR
	Catalog Number	Catalog Number	Catalog Number

1-Pole Plug-In (120V AC)^⑤

Rating	MP-T	MP-HT	MP-MT
10	MP110	—	—
15	MP115 ^④	MP115KH ^④	MP115KM ^④
20	MP120 ^④	MP120KH ^④	MP120KM ^④
25	MP125	MP125KH■	MP125KM■
30	MP130	MP130KH	MP130KM■
35	MP135■	MP135KH■	MP135KM■
40	MP140	MP140KH	MP140KM■
45	MP145■	MP145KH■	MP145KM■
50	MP150	MP150KH	MP150KM■
60	MP160■	MP160KH■	MP160KM■
70	MP170■	MP170KH■	MP170KM■

2-Pole Plug-In (Common-Trip 120/240V AC)^④

Rating	MP-T	MP-HT	MP-MT
15	MP215	MP215KH	MP215KM■
20	MP220	MP220KH	MP220KM■
25	MP225	MP225KH■	MP225KM■
30	MP230	MP230KH	MP230KM■
35	MP235	MP235KH■	MP235KM■
40	MP240	MP240KH	MP240KM■
45	MP245	MP245KH■	MP245KM■
50	MP250	MP250KH	MP250KM■
60	MP260	MP260KH	MP260KM■
70	MP270	MP270KH■	MP270KM■
80	MP280	MP280KH■	—
90	MP290	MP290KH■	MP290KM■
100	MP2100	MP2100KH	MP2100KM
110	MP2110	MP2110KH	MP2110KM■
125	MP2125	MP2125KH	MP2125KM

2-Pole Plug-In (Common-Trip 240V AC)^{③④}

Rating	MP-T	MP-HT	MP-MT
15	MPH215	—	—
20	MPH220	—	—
30	MPH230	—	—
40	MPH240■	—	—
50	MPH250	—	—
60	MPH260	—	—
70	MPH270■	—	—
100	MPH2100■	—	—

3-Pole Plug-In (Common-Trip 240V AC)^⑦

Rating	MP-T	MP-HT	MP-MT
15	MP315	MP315KH	MP315KM■
20	MP320	MP320KH	MP320KM■
25	MP325■	MP325KH■	—
30	MP330	MP330KH	MP330KM
35	MP335■	—	—
40	MP340	MP340KH	MP340KM
45	MP345■	—	—
50	MP350	MP350KH	MP350KM
60	MP360	MP360KH	MP360KM
70	MP370	MP370KH	MP370KM■
80	MP380	MP380KH■	MP380KM■
90	MP390	MP390KH■	MP390KM■
100	MP3100	MP3100KH	MP3100KM

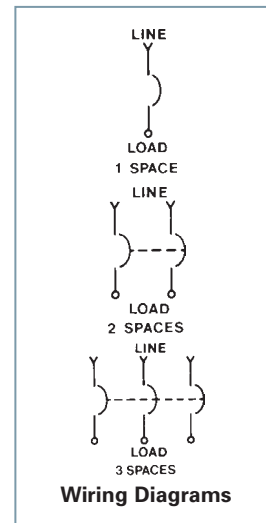

MP-T / MP-HT / MP-MT Internal Accessories

Description	Catalog Number	Field/Factory Installed
120V Shunt Trip	add suffix...ST■	Factory
24V Shunt Trip	add suffix...ST24V■	Factory
120V Auxiliary Switch	add suffix...AS■ ^②	Factory

Modifications

Description	Catalog Number
400Hz Calibration	add suffix...Y ^⑧
Marine 50° C Ambient Calibration	add suffix...M
Fungus Proofing	add suffix...F

For external accessories please refer to page 3-20.

■ Built to order. Allow 2-3 weeks for delivery

① UL Listed for use with 60/75° wire through 40 amps, UL listed for use with 75° wire only for 50 amps and above, HACR rated. 120V AC Fluorescent Lighting.

② 1A and 1B contacts.

③ UL Listed for use on 3 phase grounded "B" systems — 10,000 for this application.

④ UL Listed for frequent switching applications (SWD).

⑤ Shipped 12 per sleeve.

⑥ Shipped 6 per sleeve.

⑦ Shipped 4 per sleeve.

⑧ UL Listed 5KA IR.

⑨ Not UL Listed.

⑩ 1 & 2 Poles only.

Duplex Circuit Breakers

Breaker Type	Ampere Rating	Catalog Number	Catalog Number
MH-T 1-Pole 10K AIC 120V AC	15-15	MP1515	MP1515N ^①
	15-20	MP1520	MP1520N ^①
	20-20	MP2020	MP2020N ^①
	20-30	MP2030	MP2030N ^①
	15-30	MP3015	MP3015N ^①
	30-30	MP3030	MP3030N ^①
SHIPPING: 12 per carton, (Wt. 4.8 lbs.)			

MH-T Duplex

These space saver duplex breakers combine two independent 1/2" breaker poles in a common unit. This unit plugs into one load center stab and requires one panel space. HACR rated.

Triplex Circuit Breakers

Breaker Type	Ampere Rating		Catalog Number
	Single Pole	Common-Trip 2-Pole	
MH-T 2-Pole 10K AIC 120/240V AC Inner Poles Common Trip. Outer Poles 1 Pole Units	15	15	MP21515
	15	20	MP22015
	15	25	MP22515
	15	30	MP23015
	15	35	MP23515
	15	40	MP24015
	15	45	MP24515
	15	50	MP25015
	20	20	MP22020
	20	25	MP22520
	20	30	MP23020
	20	35	MP23520
	20	40	MP24020
	20	45	MP24520
	20	50	MP25020
	SHIPPING: 6 per carton, (Wt. 4.9 lbs.)		

MH-T Triplex

These space saver triplex breakers provide a 2-pole common trip breaker for 120/240V AC circuits and two single poles for 120V AC circuits. Triplex require two panel spaces. HACR rated.

Quadplex Circuit Breakers

Breaker Type	Ampere Rating		Catalog Number
	Common-Trip 2-Pole Outside	Common-Trip 2-Pole Inside	
MH-T 2-Pole 10K AIC 120/240V AC Outer and Inner 2 Poles Common Trip	15	15	MP21515CT2
	15	30	MP21530CT2
	20	15	MP22015CT2
	20	50	MP22050CT2
	30	20	MP23020CT2
	30	25	MP23025CT2
	30	30	MP23030CT2
	30	50	MP23050CT2
	40	20	MP24020CT2
	40	30	MP24030CT2
	40	40	MP24040CT2
	SHIPPING: 6 per carton, (Wt. 4.8 lbs.)		

MH-T Quadplex

These space saver quadplex breakers provide two sets of common trip, two-pole breakers for 120/240V AC circuits, and require two panel spaces. HACR rated.

For external accessories please refer to page 3-20.

■ Built to order. Allow 2-3 weeks for delivery.

©Non-CTL. For replacement use only in panels manufactured before 1968.

Features

- 2 inch wide plug-on design
 - Includes (2) 1 Pole circuit breakers
 - No loss of load center spaces
- Easy to install and perfect for retrofit
- LEDs provide protection status

Benefits

By installing a Siemens Circuit Breaker and Surge Protective Device (SPD) in the load center of the residence, surge protection is provided for all branch circuits[Ⓞ].

Two green LED indicator lights are provided to show that surge protection is provided for all circuits connected to the load center. These breakers should be used for circuit protection of frequently used household or facility circuits because the lights and devices connected to these circuits provide an effective indication that surge protection is being provided.

The circuit breaker and SPD utilize Siemens-built 150V AC, 40mm, metal oxide varistors (MOVs). The maximum impulse rating for the SPD module is 40kA. The standard interrupting rating for the circuit breakers is 10k AIC. All Type QP circuit breakers and SPD are plug-on style, with load terminals provided. The devices are rated for 120/240V AC and are calibrated for 40 degrees C maximum ambient applications.



Breaker Type	Ampere Rating	Catalog Number	Surge Type
QP	(2) 15	MSA1515SPD	SPD
1- Pole			
120/240V AC	(2) 20	MSA2020SPD	SPD
10K AIC			

Catalog Number	MSA1515SPD MSA2020SPD
Amperage	15 or 20 Amp
Number of Poles	(2) 1-Pole Circuit Breakers
Initial Clamping Level	240 Volts
Transient Energy Rating	360 Joules line-to-neutral 720 Joules line-to-line
Transient Suppression	500 volts peak, line-to-neutral
Voltage Rating	1000 volts peak, line-to-line
Peak Current Rating (impulse)	40,000 amperes
Discharge Voltage Characteristic	@ 1,500A, 600 volts @ 5,000A, 800 volts (both line-to-neutral)
Discharge Current Withstand Rating	10,000 amperes line-to-neutral
Circuit Breaker Interrupting Rating	10,000A, 120/240V AC
Listings/Certifications	UL, CSA Meets UL 1449 4th Edition

[Ⓞ] For warranty information please refer to the surge website www.usa.siemens.com/surge

HID Lighting

For high-intensity discharge lamp loads having in-rush currents above the instantaneous trip setting of a standard breaker.

Breaker Type	Wiring Diagram	Complete Breaker UL Unenclosed	
		Ampere Rating	Catalog Number
MP-T 1-Pole 120V AC	Figure 1	15	MP115HID■①
		20	MP120HID■①
		30	MP130HID■
QP 2-Pole 120/240V AC	Figure 1	15	MP215HID■
		20	MP220HID■
		30	MP230HID■

Molded Case Switch

Molded case non-automatic switch does not provide overload protection.

MP-T 2-Pole 240V AC Plug-In	Figure 2	30	MP260NA
		60	MP230NA

Switched Neutrals

For use where all conductors are required to be disconnected. Neutral pole of breaker does not connect to loadcenter bus. One side is wired to neutral and the other to the device.

MG 2-Wire Common Trip 120V AC	Figure 3	15	MP215SN
		20	MP220SN
MG 3-Wire Common Trip 120/240V AC	Figure 4	20	MP320SN

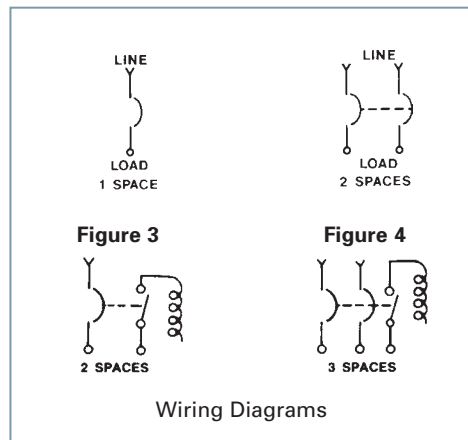
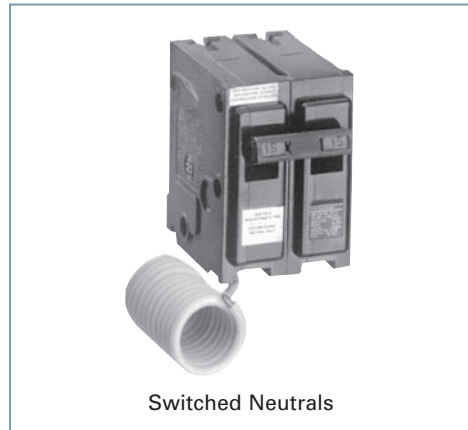

■ Built to order. Allow 2-3 weeks for delivery.
 Note: All circuit breakers on this page are 10K AIC

①UL Listed as SWD (Switching Duty) Rated, suitable for 120V AC Fluorescent Lighting.

Type MSQ, 3/4 Inch Plug-In Breakers

Features

- 3/4" format.
- HACR Rated.
- UL Classified for use in certain Square D[®] load centers.

Type MSQ Circuit Breakers

The Type MSQ circuit breaker line is available in 1-pole and 2-pole common trip versions listed on this page.

The circuit breakers are UL Classified and UL Listed.

All MSQ breakers are supplied with load side connectors suitable for 60/75°C wire and are calibrated for 40°C maximum ambient applications.

UL Classified

Murray Type MSQ circuit breakers are UL Classified for use in specific Square D[®] load centers in place of Square D[®] Type QO[®] circuit breakers. A Panelboard Compatibility List packaged with each QD breaker shows which type MSQ circuit breakers are acceptable for use in Square D[®] load centers.

The interrupting rating on these circuit breakers is 10,000A IR maximum and they are **not** series rated with Square D[®] circuit breakers or equipment. This UL Classification allows a Murray Type MSQ circuit breaker to be used in place of a Square D[®] Type QO circuit breaker in those load centers that are specifically shown on the Panelboard Compatibility list. For additional information, contact your local Murray sales engineer.



Continuous Current Rating @ 40°C	1-Pole	2-Pole
	120V	120/240V Common Trip
	Catalog Number	Catalog Number
15	MQ115 ^①	MQ215
20	MQ120 ^①	MQ220
30	MQ130	MQ230
40	MQ140	MQ240
50	MQ150	MQ250
60	MQ160	MQ260

Shipping Weights

Number of Poles	Number Per Carton	Shipping Weight (lbs.)
1	16	3.8
2	8	4.2

Panelboard Compatibility List

Listed Panelboards—Square D[®]—Catalog Numbers

QO2L30F/S	QO12M100/RB	QO120-30M150/RB	QO130-40M200
QO2-4L70F/S	QO16-20M100/RB	QO124L150G	QO130M200/RB
QO2-4L70TS	QO16M100/RB	QO124M150	QO130-40L200G/RB
QO2-4L70RB	QO20M100/RB	QO130L150G/RB	QO140M200/RB
QO6-12L100F/S	QO112L125G/RB	QO130M150/RB	QO16L200/RB
QO6-12L100DF/S	QO112-24L125G/RB	QO16L150/RB	QO16M200/RB
QO6-12L100TF/S	QO112-24L125GWGC	QO16M150/RB	QO18-16M200FTRB
QO6-12L100DTF/S	QO116L125G	QO16-30L150/RB	QO20-40L200/RB
QO6-12L100RB	QO116-24L125G/RB	QO18-16M150FTRB	QO20-40M200TF/S
QO8-16L100F/S	QO12-24L125/RB	QO20-30M150/RB	QO20-40M200/RB
QO8-16L100DF/S	QO120-24L125G	QO20-30M150TF/S	QO24L200/RB
QO8-16L100TF/S	QO120-24L125GWGC	QO20-30L150	QO24M200/RB
QO8-16L100DTF/S	QO120L125G	QO24L150/RB	QO30L200/RB
QO8-16L100RB	QO124L125G/RB	QO24M150/RB	QO30M200/RB
QO112M100/RB	QO124M125/RB	QO30L150/RB	QO30-40L200/RB
QO116M100/RB	QO16L125/RB	QO30M150/RB	QO30-40M200/RB
QO120M100/RB	QO16-12M125FTRB	QO8-16M200FT/RB	QO40M200/RB
QO124M100	QO16-24L125/RB	QO112L200G/RB	QO140M225
QO12L100DF/S	QO20L125/RB	QO120-40M200/RB	QO142L225G/RB
QO12L100RB	QO20-24L125/RB	QO120-40M200TC	
QO12-20M100/RB	QO24L125/RB	QO124M200	
QO12-20M100TF/S	QO120-30L150G	QO130L200G/RB	

1-Pole 2-Pole Wiring Diagrams



^①UL Listed for frequent switching applications (SWD). 120V AC Fluorescent Lighting. One or two load conductors.
[®]Square D is a registered trademark of Schneider Electric.

Circuit Breakers



Main and Branch Circuit Breakers^①

Breaker Type	Ampere Rating	Catalog Number	Catalog Number ^{②④}	UL Interrupting Ratings (kA)
MD-T^③ 2-Pole 120/240V AC	150	MPD2150	MPD2150R	10
	175	MPD2175■	MPD2175R■	10
	200	MPD2200	MPD2200R	10
MD-HT^③ 2-Pole 120/240V AC	150	MPD2150KH	MPD2150RH	22
	175	MPD2175KH■	MPD2175RH■	22
	200	MPD2200KH	MPD2200RH	22
MD-MT^③ 2-Pole 120/240V AC	150	MPD2150KM	MPD2150RM	65
	175	MPD2175KM■	MPD2175RM■	65
	200	MPD2200KM	MPD2200RM	65

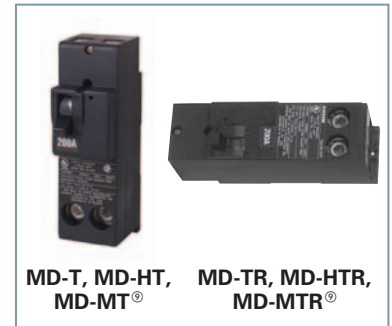

Breaker Type	Ampere Rating	Catalog Number	UL Interrupting Ratings (kA)
M1^⑤ 2-Pole 120/240V AC	100	MBK100M ^⑥	22
	125	MBK125M ^⑥	22
M2^⑤ 2-Pole 120/240V AC	150	MBK150M ^⑥	22
	175	MBK175M ^⑥	22
	200	MBK200M ^⑥	22
	225	MBK225M ^⑥	22

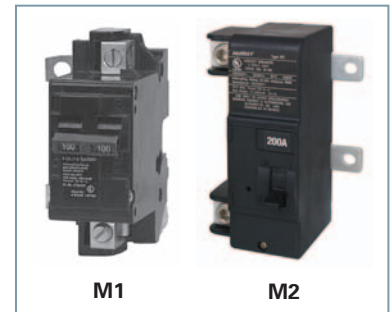

Breaker Type	Ampere Rating	Catalog Number	UL Interrupting Ratings (kA)
ED-A^⑥ 3-Pole 240V AC	125	EP3125	10
	150	EP3150	10
	200	EP3200	10
	175	EP3175	10
	225	EP3225	10

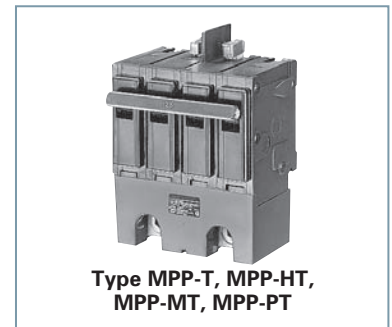

Breaker Type	Ampere Rating	Catalog Number	UL Interrupting Ratings (kA)
MPP^⑦ 2-Pole 120/240V AC	125	MPP2125	10
	150	MPP2150	10
	175	MPP2175■	10
	200	MPP2200	10
	225	MPP2225	10
MPP-HT^⑦ 2-Pole 120/240V AC	125	MPP2125KH	22
	150	MPP2150KH	22
	175	MPP2175KH■	22
	200	MPP2200KH	22
MPP-MT^⑦ 2-Pole 120/240V AC	125	MPP2125KM■	65
	150	MPP2150KM■	65
	175	MPP2175KM■	65
MPP-PT^⑦ 2-Pole 120/240V AC	200	MPP2200KM	65
	225	MPP2225KM■	65
	100	MPP2100KP■	100
	125	MPP2125KP■	100
MPP-PT^⑦ 2-Pole 120/240V AC	150	MPP2150KP■	100
	175	MPP2175KP■	100
	200	MPP2200KP■	100
	225	MPP2225KP■	100

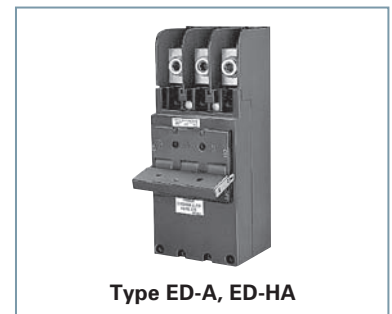

■ Built to order. Allow 2-3 weeks for delivery.
 ① All circuit breakers on this page are common trip.
 ② Reverse handle, ON toward lugs. See page 2-23.
 ③ Requires 4 panel spaces, 2 adjacent, and 2 opposite.
 ④ For use as load center branch and/or replacement main for old-style load center.
 ⑤ Main breaker kit for Rock Solid load center
 ⑥ Requires 6 spaces due to cross over design.

⑦ 4-poles wide for use with 200A modular and Uni-Pak metering
 ⑧ For use with breaker types MD-T(R), MD-HT(R), MD-MT(R)
 ⑨ MD-TR required for horizontal mounting applications as shown, or for vertical applications when the lugs are on top. MD-T required for vertical mounting applications with the lugs on the bottom as shown.

⑩ MBK100M for use with 100A and 125A Rock Solid load centers only. MBK125M for use with 125A Rock Solid load centers only.
 ⑪ MBK150M for use with 150A, 200A, and 225A Rock Solid load centers only. MBK200M for use with 200A and 225A Rock Solid load centers only. MBK225M for use with 225A Rock Solid load centers only.

Circuit Breaker Accessories ④⑤⑥⑦

Catalog Number	For Use With Breaker Type	Number of Poles	Standard Package
Padlocking Device			
For locking breaker in "OFF" position. Note "ON" position does not affect breaker functionally			
ECPLD1	Type MP-T, MP-AT2, MP-GT, MP-ET, MH-T-Duplex	1P	3 Pieces
ECPLD1R	Type MP-T, MP-AT2, MP-GT, MP-ET, MH-T-Duplex (Red Color)	1P	3 Pieces
ECPLD2	Type MP-T, MP-AT2, MP-GT, MP-ET, MH-T-Triplex & Quadplex	2P	3 Pieces
ECPLD2R	Type MP-T, MP-AT2, MP-GT, MP-ET, MH-T-Triplex & Quadplex, (Red Color)	2P	3 Pieces
ECPLD3	Type MP-T, MP-AT2, MP-GT, MP-ET	3P	1 Piece
US2:ECPLD3R	Type MP-T, MP-AT2, MP-GT, MP-ET (Red Color)	3P	1 Piece
ECQLD3	Type MP-T	1P	10 Pieces
ECQLD4	Type MH-T-Duplex	QT-Duplex Breakers	10 Pieces
ECQLN3②	150-225 M2, MD-T	n/a	1 Piece
ECQTH4	Type MP-T, BL, BQH	Designed for (3) 1P Breakers	1 Piece
Handle Tie			
Provide simultaneous swiching of 2 adjacent handles.			
ECQTH2	Type MH-T Duplex	Designed for (2) QT Duplex Breakers	25 Pieces
ECQTH3	Type MP-T, BL	2P	50 Pieces
Mechanical Interlock①			
ECQML12	Type MP-T, Interlock Bracket	Designed for 1" Breaker	10 Pieces
Handle Blocking Device			
For holding breaker in "ON" or "OFF" position. Not a lockout/tagout device			
ECQL1	Type MP-T	1P	10 Pieces
ECBX231M	Type MH-T-Duplex	1/2" Breakers	10 Pieces
Main Breaker Retainer			
ECMBR2	Rock Solid Load Centers		1 Piece
Mounting Accessories			
I0204ML1125CU	Type MP-T, Back Mounting Plates	1P, 2P	10 Pieces
I0303ML3100CU	Type MP-T, Back Mounting Plates	3P	10 Pieces
Filler Plate			
ECQF3	1" Filler Plate	n/a	5 Pieces

■ Built to order. Allow 2-3 weeks for delivery

① For a complete list of standby power mechanical interlock kits, see the Standby Generator Section XXXX

② For use with Murray Rock Solid Center Main Breakers

③ Not suitable for use on 15-50A, 10 AIC Type MP-T Circuit Breakers

④ MP-T Type includes MP-HT, MP-MT

⑤ MP-AT2 Type includes MP-HAT2

⑥ MP-GT Type includes MP-HGT

⑦ MP-ET Type includes MP-HET

Padlocking Device



ECPLD1

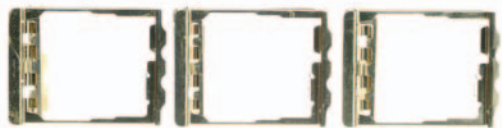

ECPLD2



ECPLD1R/2R/3R (Single pole pictured. 2-/3-pole available)



ECQLD3

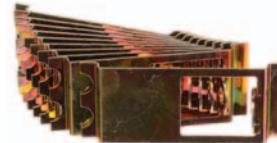

ECQLD4



ECQTH4

Handle Tie



ECQTH2

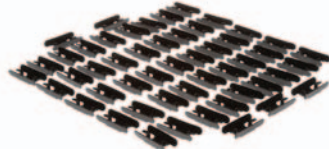

ECQTH3

Handle Blocking Device

ECQL1

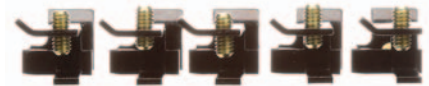

ECBX231M



Main Breaker Retainer



ECMBR2

Mechanical Interlock

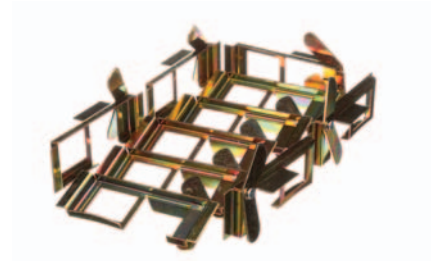

ECQML12

Molded Case 60-225 AMP



Wire range is lug capacity. Permissible maximum wire size in an enclosure may be limited by wire bending space.

Required wire sizes by ampere rating are given in National Electric Code or other local codes.

Accessories—See page 3-20.
Line Diagrams—See page 3-23.

Figure 1

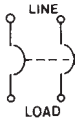
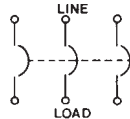

Figure 2



Amps	2 Pole Common Trip 240V AC (Fig. 1)		3 Pole Common Trip 240V AC (Fig. 2)		Wire Range	
	Catalog #	Std. Pkg. - 1 Approx. Wgt. Lbs.	Catalog #	Std. Pkg. - 1 Approx. Wgt. Lbs.	Cu	Al

Type MQ 10,000 AIC

060	MQJ260	3.00	MQJ360	4.10	#6-300 kcmil	#4-300 kcmil
070	MQJ270	3.00	MQJ370	4.10	#6-300 kcmil	#4-300 kcmil
080	MQJ280	3.00	MQJ380	4.10	#6-300 kcmil	#4-300 kcmil
090	MQJ290	3.00	MQJ390	4.10	#6-300 kcmil	#4-300 kcmil
100	MQJ2100	3.00	MQJ3100	4.10	#6-300 kcmil	#4-300 kcmil
110	MQJ2110	3.00	MQJ3110	4.10	#6-300 kcmil	#4-300 kcmil
125	MQJ2125	3.00	MQJ3125	4.10	#6-300 kcmil	#4-300 kcmil
150	MQJ2150	3.00	MQJ3150	4.10	#6-300 kcmil	#4-300 kcmil
175	MQJ2175	3.00	MQJ3175	4.10	#6-300 kcmil	#4-300 kcmil
200	MQJ2200	3.00	MQJ3200	4.10	#6-300 kcmil	#4-300 kcmil
225	MQJ2225	3.00	MQJ3225	4.10	#6-300 kcmil	#4-300 kcmil

Type MQH 22,000 AIC

060	MQJ260KH	3.00	MQJ360KH	4.10	#6-300 kcmil	#4-300 kcmil
070	MQJ270KH	3.00	MQJ370KH	4.10	#6-300 kcmil	#4-300 kcmil
080	MQJ280KH	3.00	MQJ380KH	4.10	#6-300 kcmil	#4-300 kcmil
090	MQJ290KH	3.00	MQJ390KH	4.10	#6-300 kcmil	#4-300 kcmil
100	MQJ2100KH	3.00	MQJ3100KH	4.10	#6-300 kcmil	#4-300 kcmil
110	MQJ2110KH	3.00	MQJ3110KH	4.10	#6-300 kcmil	#4-300 kcmil
125	MQJ2125KH	3.00	MQJ3125KH	4.10	#6-300 kcmil	#4-300 kcmil
150	MQJ2150KH	3.00	MQJ3150KH	4.10	#6-300 kcmil	#4-300 kcmil
175	MQJ2175KH	3.00	MQJ3175KH	4.10	#6-300 kcmil	#4-300 kcmil
200	MQJ2200KH	3.00	MQJ3200KH	4.10	#6-300 kcmil	#4-300 kcmil
225	MQJ2225KH	3.00	MQJ3225KH	4.10	#6-300 kcmil	#4-300 kcmil

Type MQL 42,000 AIC

60	MQJ260KL	3.00	MQJ360KL	4.10	#6-300 kcmil	#4-300 kcmil
070	MQJ270KL	3.00	MQJ370KL	4.10	#6-300 kcmil	#4-300 kcmil
080	MQJ280KL	3.00	MQJ380KL	4.10	#6-300 kcmil	#4-300 kcmil
090	MQJ290KL	3.00	MQJ390KL	4.10	#6-300 kcmil	#4-300 kcmil
100	MQJ2100KL	3.00	MQJ3100KL	4.10	#6-300 kcmil	#4-300 kcmil
110	MQJ2110KL	3.00	MQJ3110KL	4.10	#6-300 kcmil	#4-300 kcmil
125	MQJ2125KL	3.00	MQJ3125KL	4.10	#6-300 kcmil	#4-300 kcmil
150	MQJ2150KL	3.00	MQJ3150KL	4.10	#6-300 kcmil	#4-300 kcmil
175	MQJ2175KL	3.00	MQJ3175KL	4.10	#6-300 kcmil	#4-300 kcmil
200	MQJ2200KL	3.00	MQJ3200KL	4.10	#6-300 kcmil	#4-300 kcmil
225	MQJ2225KL	3.00	MQJ3225KL	4.10	#6-300 kcmil	#4-300 kcmil

Type QJ2/QJH2/QJ2H

Continuous Current Rating @ 40° C	Type QJ2	Type QJH2	Type QJ2H
	10,000A IR	22,000A IR	65,000A IR
	Catalog Number	Catalog Number	Catalog Number

2-Pole (240V AC)

60	QJ2060	QJ2060KH	QJ2060KL
70	QJ2070	QJ2070KH	QJ2070KL
80	QJ2080	QJ2080KH	QJ2080KL
90	QJ2090	QJ2090KH	QJ2090KL
100	QJ2100	QJ2100KH	QJ2100KL
110	QJ2110	QJ2110KH	QJ2110KL
125	QJ2125	QJ2125KH	QJ2125KL
150	QJ2150	QJ2150KH	QJ2150KL
175	QJ2175	QJ2175KH	QJ2175KL
200	QJ2200	QJ2200KH	QJ2200KL
225	QJ2225	QJ2225KH	QJ2225KL

3-Pole (240V AC)

60	QJ3060	QJ3060KH	QJ3060KL
70	QJ3070	QJ3070KH	QJ3070KL
80	QJ3080	QJ3080KH	QJ3080KL
90	QJ3090	QJ3090KH	QJ3090KL
100	QJ3100	QJ3100KH	QJ3100KL
110	QJ3110	QJ3110KH	QJ3110KL
125	QJ3125	QJ3125KH	QJ3125KL
150	QJ3150	QJ3150KH	QJ3150KL
175	QJ3175	QJ3175KH	QJ3175KL
200	QJ3200	QJ3200KH	QJ3200KL
225	QJ3225	QJ3225KH	QJ3225KL

■ Built to order. Allow 2-3 weeks for delivery.

Circuit Breakers



Line Diagrams

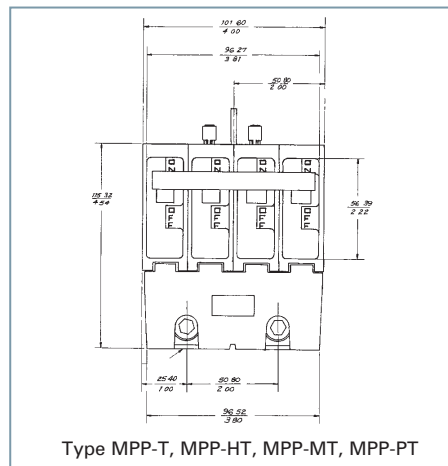
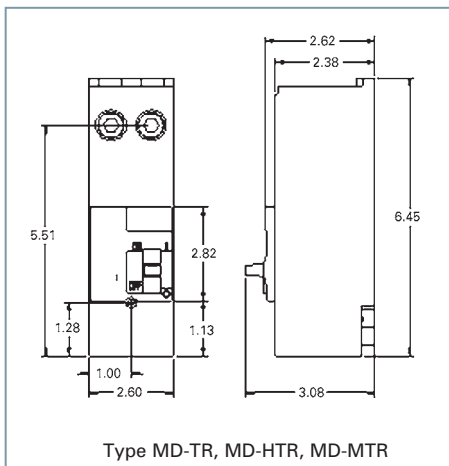
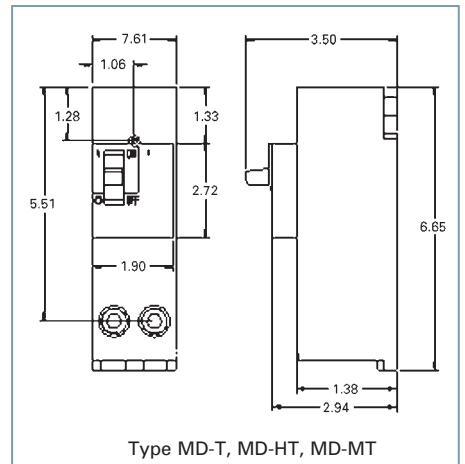
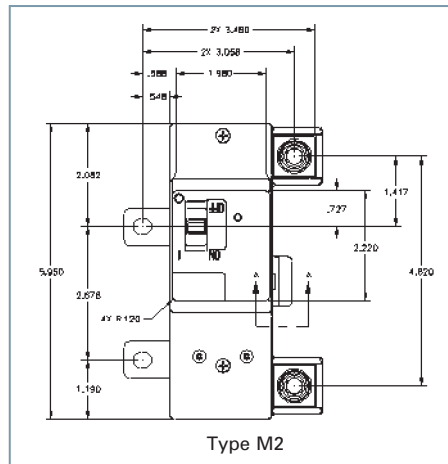
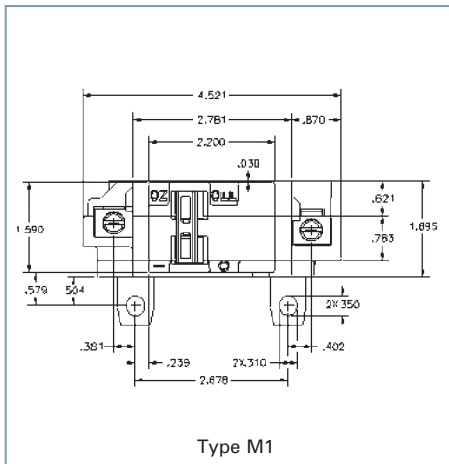
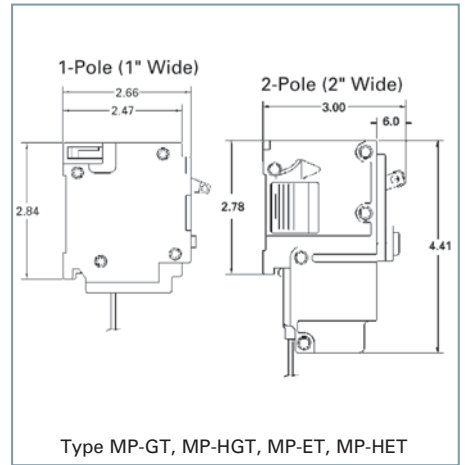
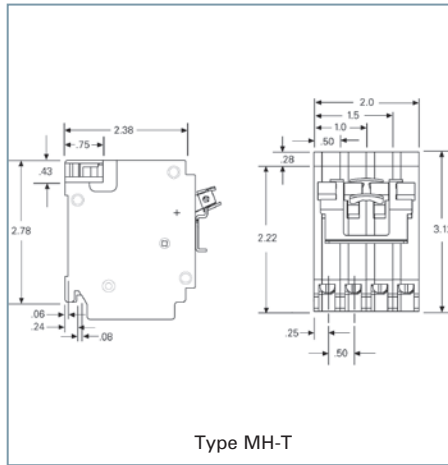
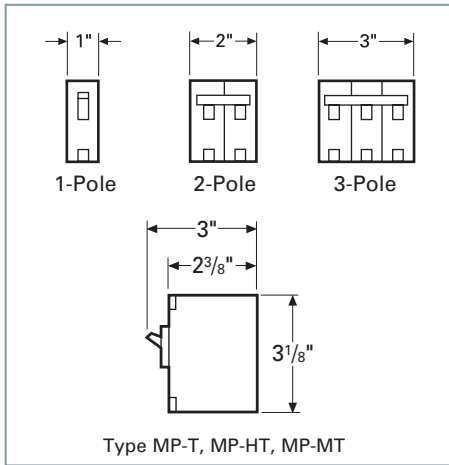

©All standard circuit breakers are calibrated to 40°C maximum ambient application.

Circuit Breakers

Lug Data

Circuit Breaker Type	Circuit Breaker Ampere Rating	Cables Per Connector	Connector Wire Range
	LOAD SIDE		
MP-T, MP-HT, MP-MT	7	2	#18-#14 CU
	10	2	#16-#14 CU
	15-35	1 1	#14-#16 AWG Cu #14-#16 AWG Al
	40-50	1 1	#8-#6 AWG Cu #8-#4 AWG Al
	55-125 (exception: 1 & 2-pole MP-T at 55-60)	1 1	#8-#2/0 Cu #8-#2/0 Al
MP-T 1 & 2-Pole ONLY	55-60	1	#6-#4 AWG Cu-Al (#3 requires AWG MP-HT or MP-MT)
MH-T	15-35	1 1	#14-#8 AWG Cu #12-#8 AWG Al
	40	1	#8 AWG CU-AL
	40-50	1 1	#8-#6 AWG Cu #8-#4 AWG Al
MP-GT, MP-HGT, MP-ET, MP-HET BLF, BLHF, BLE, BLEH	15-30	1 1	#14-#10 AWG Cu #12-#8 AWG Al
	40-60	1 1	#8-#6 AWG Cu #8-#4 AWG Al
MP-AT2, MP-HAT, BAF, BAFH	15-20	1 1	#14-#12 AWG Cu #12-#10 AWG Al
MSQ	15-20	2	#14-#8 AWG Cu Only
	15-20	1 1	#14-#12 AWG Cu #12-#10 AWG Al
	25-35	1 1	#10-#8 AWG Cu #10-#6 AWG Al
	40-60	1 1	#8-#6 AWG Cu #8-#4 AWG Al
MD-T, MD-HT, MD-MT, MD-PT, MD-TR, MD-HTR, MD-MTR, MD-PTR	150-200	1	#1-300kcmil Cu-Al
M1	100	1	#4-3/0 AWG Cu #4-3/0 AWG Al
		1	#4-3/0 AWG Cu #4-3/0 AWG Al
	125	1	#4-3/0 AWG Cu-Al
M2	150	1	#1-300kcmil Cu-Al
	200	1	#1-300kcmil Cu-Al
	225	1	#1-300kcmil Cu-Al
MPP-T, MPP-HT, MPP-MT, MPP-PT	125	1 1	#1 AWG Cu #2/0 AWG Al
	150	1 1	#1/0 AWG Cu #3/0 AWG Al
	175	1 1	#2/0 AWG Cu #4/0 AWG Al
	200	1 1	#3/0 AWG Cu 250kcmil AWG Al
	225	1 1	#4/0 AWG Cu 300kcmil AWG Al
MQ, MQH, MQL	60-225	1	#6-300kcmil Cu #4-300kcmil Al

3

MURRAY

Circuit Breakers

New Style Combination Meter Sockets

JA **30** **40** **B** **1** **200** **S** **E** **C** **W**

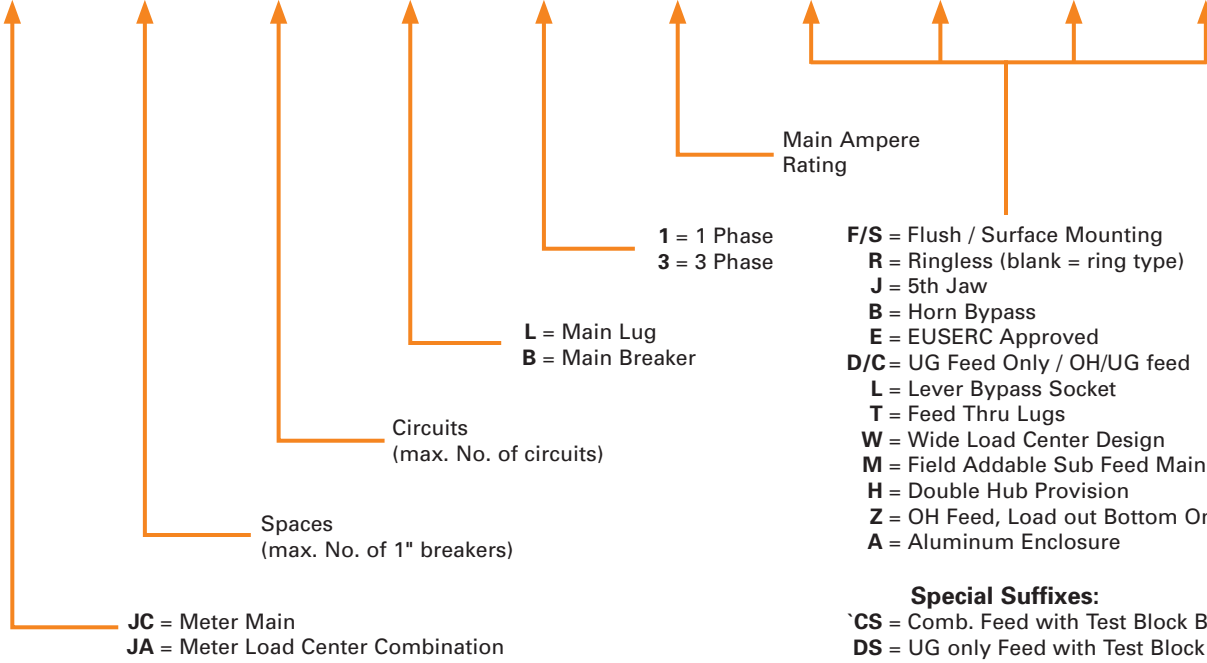

This section includes 4 product categories, which each include their own set of featured products:

Meter Mains

Murray Meter Mains are UL Listed and available from 100A to 400A services. These Meter Mains utilize a cost effective construction that is preferable in non-EUSERC areas.

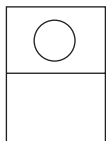

Over-Under Construction – These Murray Meter Mains feature a classic over-under construction. Available in 100A and 125A versions.

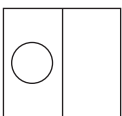

Side-By-Side Construction – These Meter Mains utilize a cost effective side-by-side construction. Meter Mains combine a socket to the left and main circuit breaker section to the right. The main breaker section includes 2 to 6 circuits.

Meter Load Center Combinations

Murray Meter Load Center Combinations offer several different configurations and include a meter socket section and a load center section. These Murray combos feature a cost effective construction that is preferable in non-EUSERC areas.

Over-Under Combination Construction

– These Murray Meter Load Center Combinations feature a over-under configuration with a unique trough allowing service from either overhead or underground to the device.

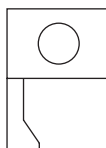

Over-Under Construction – These Murray Meter Load Center Combinations feature a classic over-under construction.

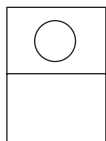

Side-By-Side Construction – These Murray Meter Load Center Combinations have a side-by-side configuration.

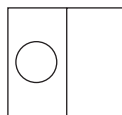

EUSERC Meter Mains

Murray EUSERC Meter Mains are UL Listed and available from 100A to 400A services. These meter mains utilize designs that meet EUSERC requirements. Two constructions are available.

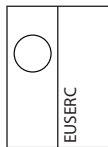

Side-By-Side Construction – These Murray Meter Mains have a side-by-side construction that is slightly larger in order to meet EUSERC requirements.

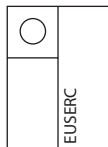

Side-By-Side 400A Construction – These Murray Meter Mains have side-by-side construction that meets EUSERC design, and provide 400A service.

EUSERC Meter Load Center Combinations

Murray Meter Load Center Combinations offer several different configurations to meet a variety of installer demands. These Murray combos feature designs that meet EUSERC requirements.

Over-Under Between the Studs Construction

– These Combos have a full width load center section above, and a meter socket section below, in a 14.3" wide configuration that allows flush mounting between typical 16" on center stud construction. Surface mounting options available.



Side-By-Side Between the Studs Construction

– These combos have a half width load center section to the right and a meter socket section to the left, in a 14.2" wide configuration that allows flush mounting between typical 16" on center stud construction. Surface mounting options available.



Side-By-Side Full Load Center Construction

– These Murray Meter Load Center Combinations have a full width load center section to the right, and a meter socket section to the left. The overall width make this combo best suited for surface mounting.

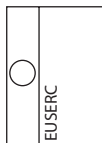

Side-By-Side 400A Construction – These Murray Meter Mains have side-by-side construction that meets EUSERC design, and provide 400A service. Available with 16 to 42 circuits.

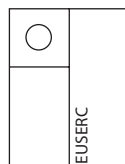

- UL listed
- Pad locking provisions on all devices
- Horn bypass and 5th jaw available as noted
- Side hinged door with one screw removal where shown
- Suitable for use only as service entrance equipment
- Contact local utility to confirm meter socket placement prior to installation
- See end of section for 5th jaw and main breaker
- See Section 2, pages 2-44 thru 2-46 for wiring diagrams and knockout details. For Murray devices, replace "MM" with "JC" details if JC number is not shown.

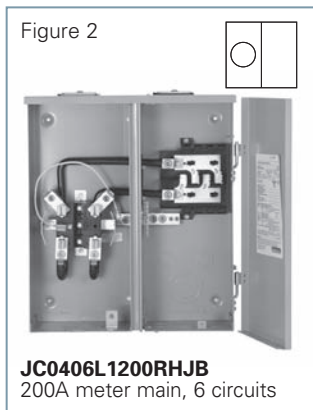

Side-By-Side Construction Meter Mains											
Amps Max.	No. of Spaces	Max. Circuits	Cover Type	Mounting	Service	Bypass Type	Catalog Number	Dimensions ^①			Figure
								Height	Width	Depth	
125	2	2	Ring	Surface	OH	—	JC002CZ ^{②④}	14.1	14.1	4.6	4
125	2	2	Ringless	Surface	OH/UG	Horn	JC0202B1125RJB ^③	17.0	16.0	5.0	1
200	2	2	Ring	Surface	OH/UG	—	JC0202B1200 ^③	17.0	16.0	5.0	1
			Ringless				JC0202B1200R ^③				
			Ringless				JC0202B1200RJB ^③				
200	4	6	Ring	Surface	OH/UG	—	JC0406L1200H ^③	19.8	17.2	5.0	2
			Ringless				JC0406L1200RH ^③				
			Ringless				JC0406L1200RHJB ^③				
400	2	2	Ringless	Surface	OH/UG	Lever	JC0404L1400RLM ^③	29.0	27.0	6.0	3

Over-Under Construction Meter Mains											
Amps Max.	No. of Spaces	Max. Circuits	Cover Type	Mounting	Service	Bypass Type	Catalog Number	Dimensions ^①			Figure
								Height	Width	Depth	
100	2	2	Ring	Surface	OH	—	JC002CS ^{②④}	18.1	7.0	3.6	5
125	2	2	Ring	Surface	OH	—	JC002AR ^{②④}	22.1	7.0	3.6	5

① Dimensions shown are representative of outside box length, width, & depth and do not include allowances for mounting bumps, endwalls, covers, hubs or hardware protrusions. Dimensions are subject to change.

② Not suitable for 5th jaw applications.
③ Closure plate included.
④ Provisions for MP-T Main Breaker.

Meter Load Center Combinations

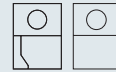

Over-Under Construction Meter Load Center Combinations, 150A-200A

- UL listed
- Overhead and underground feed applications
- Underground feed accomplished by use of removable gutter trough
- Load wires bottom or back exit only
- 22,000 AIC rated
- Pad locking provisions on all devices
- Side hinge doors removable by backing out only one screw
- Suitable for use only as service entrance equipment
- RX type hub provision on top end wall
- HC type hub provision on bottom end wall
- Field addable 5th Jaw (EC5J2)
- Contact local utility to confirm meter socket placement prior to installation
- See end of section for 5th jaw and main breaker
- See Section 2, pages 2-34 thru 2-42 for wiring diagrams and knockout details. For Murray devices, replace "MC" with "JA" details if JA number is not shown.



MURRAY
3

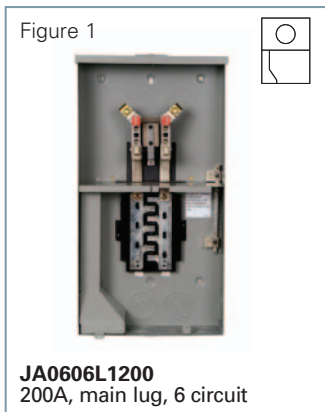

Combination
Meter Sockets

Over-Under Combination Construction Meter Load Center Combinations											
Amps Max.	No. of Spaces	Max. Circuits	Cover Type	Mounting	Service	Bypass Type	Catalog Number	Dimensions			Figure
								Height	Width	Depth	
150	4	8	Ringless	Surface	OH/UG	—	JA0408B1150RT [Ⓢ]	30.0	14.0	5.0	2
			Ring				JA0408B1150T [Ⓢ]				
150	8	16	Ring				JA0816B1150CT [Ⓢ]	32.0			3
			Ringless				JA0816B1150RCT [Ⓢ]				
200	12	6	Ring				JA0606L1200 ^{Ⓢ②③④}	27.0			1
			Ringless				JA0606L1200R ^{Ⓢ②③④}				
			Ringless				JA0606L1200RA ^{Ⓢ②③④⑤}				
200	4	8	Ringless				JA0408B1200RT [Ⓢ]	30.0			2
			Ring				JA0408B1200T [Ⓢ]				
200	8	16	Ring				JA0816B1200CT [Ⓢ]	32.0			3
			Ringless	JA0816B1200RCT [Ⓢ]							

Over-Under Construction Meter Load Center Combinations											
Amps Max.	No. of Spaces	Max. Circuits	Cover Type	Mounting	Service	Bypass Type	Catalog Number	Dimensions			Figure
								Height	Width	Depth	
200	8	16	Ringless	Surface	OH	—	JA0816B1200RT	29.0	12.0	5.2	4
			Ring				JA0816B1200T				

Ⓢ No main breaker provided. Accept MD-T or MP-T type 2 or 4-pole breakers.
 Ⓢ Suitable for use as service entrance equipment when not more than six disconnecting means are provided and when not used as a lighting or appliance panel board.

Ⓢ Due to wire space restrictions on the trough side, the left side of the interior is limited to a 60A max branch.
 Ⓢ Aluminum enclosure.
 Ⓢ Suitable for use as service entrance equipment when not more than six disconnecting means are provided and when not used as a lighting and appliance panel branch circuit panel board.

Meter Load Center Combinations



Meter Load Center Combinations, 100A-400A

- UL listed
- 22,000 AIC Rated
- Pad locking provisions on all devices
- Side hinge doors removable by backing out only one screw
- Suitable for use only as service entrance equipment
- Contact local utility to confirm meter socket approval prior to installation
- See end of section for 5th jaw and main breaker
- See Section 2, pages 2-36 thru 2-50 for wiring diagrams and knockout details. For Murray devices, replace "MC" with "JA" details if JA number is not shown.



Side-By-Side Construction Meter Load Center Combinations^②

Amps Max.	No. of Spaces	Max. Circuits	Cover Type	Mounting	Service	Bypass Type	Catalog Number	Dimensions			Figure		
								Height	Width	Depth			
150	8	16	Ringless	Surface	OH/UG	—	JA0816B1150RTH ^③	21.0	22.9	5.0	1		
			Ring				JA0816B1150TH ^③						
			Ringless				JA0816B1200RTH ^③						
			Ring				JA0816B1200TH ^③						
200	20	40	Ring			—	JA2040B1200 ^④	18.0	29.0	27.0		6.0	2
350	8	16	Ringless			Lever	JA0816B1350RLTM ^①						
400	4	8					JA0408B1400RLTM ^⑤						
400	8	16					JA0816B1400RLTM ^⑤						

Side-By-Side 400A Construction Meter Load Center Combinations

Amps Max.	No. of Spaces	Max. Circuits	Cover Type	Mounting	Service	Bypass Type	Catalog Number	Dimensions			Figure
								Height	Width	Depth	
400	30	42	Ring	Surface	UG	Lever	JA3042B1400SDL	40.0	30.0	6.5	3

Over-Under Construction Meter Load Center Combinations^{③④⑦⑧}

Amps Max	No. of Spaces	No. of Circuits	Cover Type	Mounting	Service	Bypass Type	Old Catalog Number	New Catalog Number	Dimensions			Figure
									H	W	D	
100	10	20	Ring	Flush	OH	none	JA1020B1100F	MC1020B1100F ^④	19.4	12.1	4.4	4
				Surface			JA1020B1100S	MC1020B1100S				
				Flush			—	MC1020B1100FZ ^⑤				
				Surface			—	MC1020B1100SZ ^⑤				
200	20	40	Ring	Flush	OH	none	JA2040B1200F	MC2040B1200F	30.5	14.3	5.1	5
				Surface			JA2040B1200S	MC2040B1200S			4.4	
				Flush			—	MC2040B1200FZ ^⑤			5.1	
				Surface			—	MC2040B1200SZ ^⑤			4.4	

① Feed thru lugs included.
 ② Side by side design for OH/UG applications.
 ③ Over/under design for OH applications.
 ④ Semi-Flush mounting only.

⑤ Z=Solid horizontal barrier. Load wires exit back or bottom only.
 ⑥ Dimensional and other technical data is applicable for "New Catalog Numbers" ONLY.

⑦ UL Listed for Siemens and Murray breakers.
 ⑧ Old Catalog Numbers JA1020B1100SP and JA2040B1200SP are obsolete with no replacement.

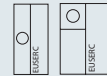

EUSERC Side-By-Side Construction Meter Mains, 125A-400A

- UL listed
- For overhead and underground feed applications
- Designed to meet EUSERC standards
- 22,000 AIC Rated
- Pad locking provisions on all devices
- Surface and semi-flush units available - semi flush rails are depth adjustable for 2x6 studs
- Side hinge door removable by backing out only one screw
- Load wiring may exit top or bottom
- Suitable for use only as service entrance equipment
- RX type hub provision on top endwall, HC type hub provision on bottom endwall
- 5th jaw accessory available (EMC5J)
- Ring type meter covers
- Contact local utility to confirm meter socket approval prior to installation
- See end of section for 5th jaw and main breaker
- See Section 2, pages 2-36 thru 2-50 for wiring diagrams and knockout details. For Murray devices, replace "MM" with "JC" details if JC number is not shown.



Side-By-Side Construction Meter Mains ^{⑥⑦}												
Amps Max	No. of Spaces	No. of Circuits	Cover Type	Mounting	Service	Bypass Type	Old Catalog Number	New Catalog Number	Dimensions			Figure
									H	W	D	
125	2	2	Ring	Flush	OH/UG	none	JC0406L1125FEC	MM0202L1125EFC	23.6	14.5	5	1
125				Surface			JC0406L1125SEC	MM0202L1125ESC				
200	2	2	Ring	Flush	OH/UG	none	—	MM0202L1200EFC	28.6	14.5	7	
200				Surface			JC0406L1200FEC	MM0202L1200ESC			5	
100	2	2	Ring	Surface	OH/UG	none	JC0406L1200SEC	MM0202B1100ESC	23.6	14.5	5	
200				Surface			—	MM0202B1200ESC				

Side-By-Side 400A Construction Meter Mains ^②									
Amps Max.	No. of Spaces	Max. Circuits	Mounting	Service	Catalog Number	Dimensions ^①			Figure
						Height	Width	Depth	
400	4	2	Surface	OH/UG	JC0404L1400SC ^{④⑤}	39.7	33.2	6.4	2
			Flush	UG	JC0404L1400FD ^{④⑤}		30.2	7.4	
400	4	2	Surface	OH/UG	JC0404L1400SCS ^{④⑥}	39.7	33.2	6.4	2
			Flush	UG	JC0404L1400FDS ^{④⑥}		30.2	7.4	

① Dimensions shown are representative of outside box length, width, and depth and do not include allowances for mounting bumps, endwalls, covers, hubs or hardware protrusions. Dimensions are subject to change.

② Main breaker not included.
 ③ Test block bypass.
 ④ Main breaker: (2) Field QP(H) or QNR(H).
 ⑤ No 5th Jaw available.

⑥ Dimensional and other technical data is applicable for "New Catalog Numbers" ONLY.
 ⑦ UL Listed for Siemens and Murray breakers.

EUSERC Meter Load Center Combos



EUSERC Meter Load Center Combinations, 100A-225A

- UL listed
- For overhead and underground feed applications
- Designed to meet EUSERC standards
- 22,000 AIC Rated
- Pad locking provisions on all devices
- Surface and semi-flush units available - semi flush rails are depth adjustable for 2x6 studs
- Side hinge door removable by backing out only one screw
- Load wiring may exit top or bottom
- Suitable for use only as service entrance equipment
- RX type hub provision on top endwall, HC type hub provision on bottom endwall
- Ring type meter covers
- Contact local utility to confirm meter socket approval prior to installation
- 5th jaw accessory available
- See end of section for 5th jaw and main breaker
- See Section 2, pages 2-36 thru 2-50 for wiring diagrams and knockout details. For Murray devices, replace "MC" with "JA" details if JA number is not shown.

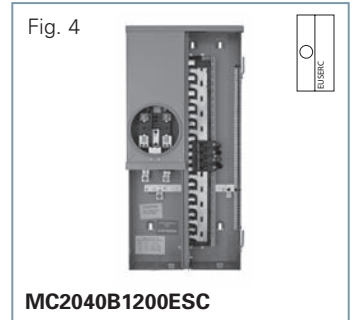
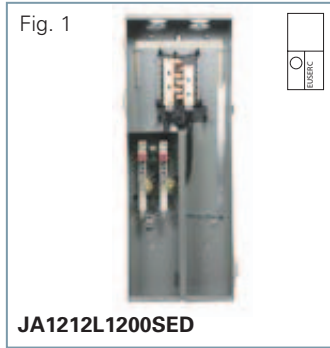

Over-Under Between the Studs Construction Meter Load Center Combinations

Amps Max.	No. of Spaces	Max. Circuits	Mounting	Service	Catalog Number	Dimensions ^①			Figure
						Height	Width	Depth	
200	12	12	Flush	UG	JA1212L1200FED ^①	38.4	14.4	7.4	1
			Surface		JA1212L1200SED ^②				
200	20	40	Surface	UG	JA2040B1200SED	41.9	14.4	7.4	2
			Flush		JA2040B1200FED				
200	30	42	Surface	UG	JA3042B1200SED	48.8	14.4	7.4	2
			Flush		JA3042B1200FED				
225	30	42	Surface		JA3042B1225SED				
			Flush		JA3042B1225FED				



Side-By-Side Full Load Center Construction Meter Load Center Combinations

Amps Max.	No. of Spaces	Max. Circuits	Mounting	Service	Catalog Number	Height	Width	Depth	Figure
200	30	40	Surface	OH/UG	JA3040B1200SECW ^③	32.3	21.0	5.2	5
	40				JA4040B1200SECW ^③				

Side-By-Side Between the Studs Construction Meter Load Center Combinations^{③④⑤}

Amps Max.	No. of Spaces	No. of Circuits	Cover Type	Mounting	Service	Bypass Type	Old Catalog Number	New Catalog Number	Dimensions			Figure
									H	W	D	
100	12	24	Ring	Flush	OH/UG	none	JA1224B1100FEC	MC1224B1100EFC	23.6	14.5	5	3
				Surface			JA1224B1100SEC	MC1224B1100ESC				
125	12	24	Ring	Flush	OH/UG	none	JA1224B1125FEC	MC1224B1125EFC	23.6	14.5	5	3
				Surface			JA1224B1125SEC	MC1224B1125ESC				
200	20	40	Ring	Flush	OH/UG	none	JA2442B1200FEC	MC2040B1200EFC	31	14.5	7	4
				Surface			JA2442B1200SEC	MC2040B1200ESC			5	
225	24	42	Ring	Surface	OH/UG	none	—	MC2442B1225ESC	35	14.5	5	—
				Flush			—	MC2442B1225EFC			7	
200	24	42	Ring	Surface	OH/UG	none	—	MC2442B1200ESC	35	14.5	5	—
				Flush			—	MC2442B1200EFC			7	
	8	16	Ring	Flush	OH/UG	none	—	MC0816B1200EFN	29.75	14.5	7	—
				Surface			—	MC0816B1200ESN			5	

① Suitable for use as service entrance equipment when not more than six main disconnecting means are provided and when not used as a lighting and appliance panel board.

② FRK1 - Flush rail kit.

③ Dimensional and other technical data is applicable for "New Catalog Numbers" ONLY.

④ Old Catalog Numbers JA1632B1100FEC, JA1632B1100SEC and JA1632B1125FEC are obsolete with no replacement.

⑤ UL Listed for Siemens and Murray breakers.

EUSERC Meter Load Center Combinations



MURRAY

EUSERC Side-By-Side Construction Meter Load Center Combinations, 400A

- UL Listed
- 400A Max, 320A Continuous
- Meter socket options include 320A (400A max) lever bypass, non-bypass, test block bypass, and bolt on
- Load center options include a meter main, 8 space panel with feed through lugs, 30 space panels
- 22,000 AIC Rated
- Accepts HD Type Hubs
- Factory installed flush mount option
- Surface mount devices accept field added flush rails
- Suitable for use only as service entrance equipment
- Contact local utility to confirm meter socket acceptance prior to installation
- Designed to meet EUSERC
- See Section 2, pages 2-36 thru 2-50 for wiring diagrams and knockout details. For Murray devices, replace "MC" with "JA" details if JA number is not shown.

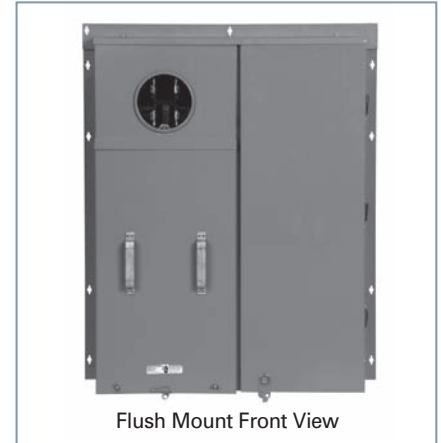

3
MURRAY



Accessories

Description	Catalog Number
Flush Rail Kit for UG only devices	ECFRK1
Flush Rail Kit for OH/UG feed devices	ECFRK2
2" HD Type Hub	EC56854
2 1/2" HD Type Hub	EC56855
3" HD Type Hub	EC56856
3 1/2" HD Type Hub	EC56857
4" HD Type Hub	EC56858
HD Closure Plate	EC56933S
Snap on Sealing Ring	SRSS
Stainless Steel Screw Type Sealing Ring	SRSW
(2) #6-350 kcmil	UK350TA
(1) #2-600 kcmil	UK600TA
(2) 500-1000 kcmil	UK1000TA

Combination
Meter Sockets

Side-By-Side 400A Construction Meter Load Center Combinations

Amps Max.	No. of Spaces	Max. Circuits	Mounting	Service	Meter Socket	Catalog Number	Main Breaker	Dimensions		
								Height	Width	Depth
400	8	16	Surface	OH/UG	Plug In	JA0816B1400SC	Factory QN2200RH, Field QP(H), QNR(H)	39.7	33.2	6.4
			Flush	UG		JA0816B1400FD			30.2	7.4
400	8	16	Surface	OH/UG	Test Blk	JA0816B1400SCS	Factory QN2200RH, Field QP(H), QNR(H)	39.7	33.2	6.4
			Flush	UG		JA0816B1400FDS			30.2	7.4
400	30	42	Surface	UG	Plug In	JA3042B1400SD	Factory QN2200RH, Field QP(H), QNR(H)	39.7	30.2	6.4
					Test Blk	JA3042B1400SDS				
					Bolt In	JA3042B1400SDB				
400	30	42	Flush	UG	Plug In	JA3042B1400FD	Factory QN2200RH, Field QP(H), QNR(H)	39.7	30.2	7.4
			Surface	OH/UG		JA3042B1400SC			33.2	6.4
400	30	42	Flush	UG	Test Blk	JA3042B1400FDS	Factory QN2200RH, Field QP(H), QNR(H)	39.7	30.2	7.4
			Surface	OH/UG		JA3042B1400SCS			33.2	6.4

© 5th Jaw available. Use H35815-2.

Combination Meter Sockets



Electriccenter Accessories

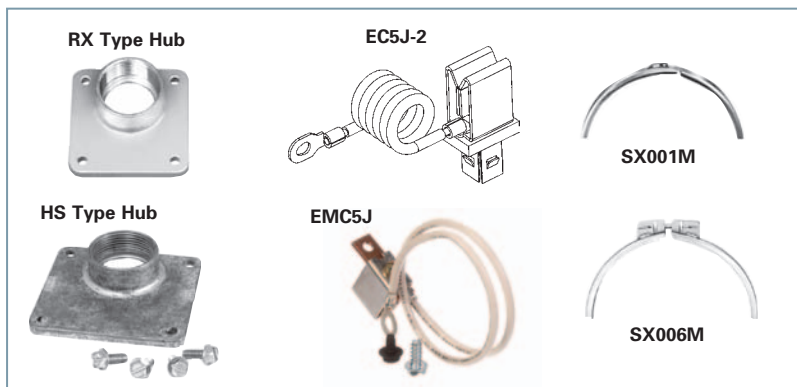

Interchangeable Hubs

Conduit Size (Inches) Lbs.	Catalog Number
RX Type Hubs	
¾	EC38594
1	EC38596
1¼	EC38597
1½	EC38598
2	EC38599
2½	EC38600
HC Type Hubs	
2	ECHC200
2½	ECHC250
3	ECHC300
Accessories and Closure Plates	
Adapter Plate HD to RX	EC9747-1113
Adapter Plate HC to RX	HCRXA
Closure Plates	ECHC000 (HC) ECHS000 (HS) ECHV000 (HV) EC38595 (RX)

Grounding Bars (Al/Cu — except where noted)

Grounding bars are for use where grounding of electrical outlets and devices is by means of conductors. Each bar is equipped with large connectors rated for one #14-1/0 or, two or three #14-10 Cu/Al and small connectors rated for one #14-6 or, two #14-12 Cu/Al. (May be restricted by wire bending space.)

Length	Number of Connectors			Catalog Number
	Total	Large	Small	
1½	4	0	4	ECLX068M
2½ ⁶	7	2	5	ECLX069M
3½	11	3	8	ECLX071M
4½	15	4	11	ECLX072M
5¾	19	5	14	ECLX073M
7	23	6	17	ECLX074M
8½	27	7	20	ECLX075M

Sealing Rings

Description	Catalog Number
Snap-on type, aluminum	SRSTD
Screw type, aluminum	SRSW

Miscellaneous Accessories

Description	Catalog Number
Plastic Meter Opening Cover (JA, JC)	ECPP
Plastic Meter Cover Ringless (JB)	ECPP3
Fifth Jaw (for old style JA & JC units only)	EC5J
5th Jaw for new style JA & JC devices	EMC5J / EC5J2
5th Jaw for 400A @ 9:00 with shield (see chart)	H35815-2
NEMA Stud Mechanical Lugs for JB, JK and JL units ^① (2) #6-350 kcmil (1) #2-600 kcmil Al/Cu (2) #500-1000 kcmil Al/Cu	UK350TA UK600TA UK1000TA
Neutral Feeder Lugs #2-1/0 #4-2/0 #1-350 kcmil	ECLK1 ECLK2 ECLK3

Catalog Number	Main Breaker	5th Jaw
JC0406L1200H	Provision for (1) MD-T, MD-HT or (2) MP-T, MP-HT	EMC5J
JC0406L1200RH		EMC5J
JC0406L1200RHJB		Included
JC0404L1400RLM	Provision for (2) MD-T(R), MD-HT(R), MP-T, MP-HT	H35815-2
JC0202B1125RJB	MP2125KH	Included
JC0202B1200	MPD2200KH	EMC5J
JC0202B1200R	MPD2200KH	EMC5J
JC0202B1200RJB	MPD2200KH	Included
JA0408B1150T	ME9683	EC5J2
JA0408B1150RT	ME9683	EC5J2
JA0816B1150CT	ME9683	EC5J2
JA0816B1150RCT	ME9683	EC5J2
JA0606L1200	②	EC5J2
JA0606L1200R	②	EC5J2
JA0606L1200RA	ME9683	EC5J2
JA0408B1200T	ME9683	EC5J2
JA0408B1200RT	ME9683	EC5J2
JA0816B1200CT	ME9683	EC5J2
JA0816B1200RCT	ME9683	EC5J2
JA0816B1200RT	QN2200RH	NA
JA0816B1200T	QN2200RH	NA
JA0816B1150RTH	MPD2150RH	EMC5J
JA0816B1150TH	MPD2150RH	EMC5J
JA0816B1200RTH	MPD2200RH	EMC5J
JA0816B1200TH	MPD2200RH	EMC5J
JA2040B1200	MPD2200RH	EMC5J
JA0816B1350RLTM	MPD2150RH	EMC5J
JA0408B1400RLTM	MPD2200RH	EMC5J
JA0816B1400RLTM	MPD2200RH	EMC5J
JA3042B1400SDL	MPD2200RH	EC35815
JA1020B1100S(Z)	MP2100KH	EC5J2
JA1020B1100F	MP2100KH	EC5J2
JA2040B1200S(Z)	EQ9685	EC5J2
JA2040B1200F	EQ9685	EC5J2
JA1212L1200FED	NA	EC5J2
JA1212L1200SED	NA	EC5J2
JA2040B1200FED	MBK200M	EC5J2
JA2040B1200SED	MBK200M	EC5J2
JA3042B1200FED	MBK200M	EC5J2
JA3042B1200SED	MBK200M	EC5J2
JA3042B1225FED	MBK225M	EC5J2
JA3042B1225SED	MBK225M	EC5J2
JA1224B1100FEC	MP2100KH	EMC5J
JA1224B1100SEC	MP2100KH	EMC5J
JA1632B1100FEC	MP2100KH	EMC5J
JA1632B1100SEC	MP2100KH	EMC5J
JA1224B1125FEC	MP2125KH	EMC5J
JA1224B1125SEC	MP2125KH	EMC5J
JA1632B1125FEC	MP2125KH	EMC5J
JC0406L1125FEC	MP2125KH	EMC5J
JC0406L1125SEC	MP2125KH	EMC5J
JA2442B1200FEC	MEQ9985	EMC5J
JA2442B1200SEC	MEQ9985	EMC5J
JC0406L1200FEC	MEQ9985	EMC5J
JC0406L1200SEC	MEQ9985	EMC5J
JA0816B1200SCTM		EMC5J
JA3040B1200SECW	MPD2200RH	EMC5J
JA4040B1200SECW	MPD2200RH	EMC5J

① Order one for each phase and neutral.

② No main breaker provided. Accept MD-T or MP-T type 2 or 4-pole breakers.

General Information

Product Descriptions

Murray New York City Apartment Metering is a versatile, unassembled modular metering product comprised of separate modules that may be assembled to produce a variety of configurations. Only those standard modules shown in this publication will be sold. Installation instructions are shipped with the product. The modules are:



Meter Stacks

Meter Stacks are available from 2 to 5 meter positions, arranged vertically and pre-bussed on the line side. Each meter position is rated 100 amps continuous (125 amps maximum), 5 jaw, with the 5th jaw located at 9 o'clock and connected to the stack neutral bus. Indoor mounting only.

Line Troughs

Line troughs are indoor horizontal wireways that support the meter stacks and supply unmetered line power to meter stack bus. Line trough is available from 2 to 5 stack positions and may be ganged by means of couplers to accommodate 6 or more stacks. Phase blocks and line terminals are required to terminate line conductors and to provide means to field wire each stack. Trough end walls are ordered separately.



Phase Blocks

Phase blocks are required to terminate line conductors and provide terminals for field connection to each stack bus. Phase blocks are available with 3, 6 or 12 take-off lugs.

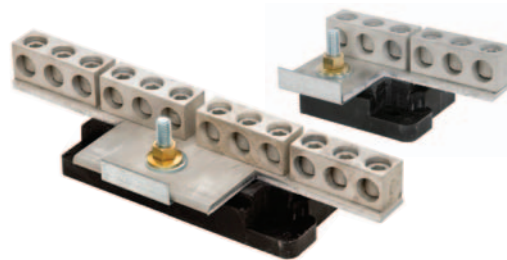

System Parameters

- Mounting: Indoor only
- Input: 208Y/120V AC, 3 Phase, 4 Wire or 120/240V AC, 1 Phase, 3 Wire
- Maximum line terminal- (2) 500 kcmil/phase
- Output: 120Y/208V AC, 1 Phase, 3 wire or 120/240V AC, 1 Phase, 3 Wire 100 Amps continuous/meter position (125 amps maximum)
- Meter Sockets: 5 jaw, with 5th jaw located at 9 o'clock and electrically connected to neutral bus
- Tenant Circuit Breakers: Use Murray Type MP-T 2 pole plug-on circuit breakers, (100 amps maximum)

Getting Started

Before ordering components, the following should be known:

- Installation instructions are shipped with the product
- Number of meter positions
- Amp rating of each meter position
- Voltage and phase of incoming line
- Line conductor size and quantity
- Vertical and horizontal space limitations, if any

Meter stacks are 10" wide and are 10" high for each meter position, or blank position. (A 3-high stack with no blank positions would be 10" wide and 30" high). When considering the overall height of an installation, you must add the height of the line trough (12") and the breaker trough (16") to the stack height.

An installation of 3-high stacks would be 58" in overall height (30" + 12" + 16" = 58").

All meter stacks in the same meter bank must be the same height to allow the breaker trough to fit on top of the stacks.

Line Terminal Kits

Line terminals are available in kits of 4 terminals each. The terminals are tang lugs which mount on threaded studs provided on the phase blocks. Terminals are available in 3 sizes:

- (1) 350 kcmil
- (1) 500 kcmil
- (2) 500 kcmil maximum



Breaker Troughs

Breaker troughs are horizontal indoor wireways that contain provisions for plug-in circuit breakers used as tenant mains. The trough bolt to the top of the meter stacks. Field wiring connects each meter socket to a circuit breaker mounting block. Breaker troughs are available in 2 to 5 stack positions and can be ganged to accommodate 6 or more stacks. Trough end walls are ordered separately.



End Wall Kits

These kits contain 4 end walls; 2 end walls for the line trough and 2 end walls for the breaker trough.

Circuit Breakers

New York City Apartment Metering uses standard 2-pole plug-on circuit breakers, Murray Type MP-T, 100 amps maximum.



Coupler Kits

These kits each contain 2 trough coupler straps; one for the line trough and one for the breaker trough. These couplers mount using the same mounting screw holes as the end walls.

Line Trough Spacer Kits

These kits may be used to increase wire bend space between the first phase block and line entrance end wall, if necessary. They connect to line troughs with a standard coupling kit. Trough end walls are ordered separately.

Use Selection Chart #1 and Specification Chart #1

Knowing the number of meter positions, and the height and width requirements, select quantity and catalog number of stacks from Selection Chart #1. The height dimension in this chart includes line and breaker troughs. For specs, refer to Specification Chart #1.

Specification Chart #1—Meter Stacks 300V AC max., 100 Amps/Position Continuous Duty, 1 or 3 Phase Network

Meter Positions	Height ^① (Inches)	Catalog Number	Wire Range Line Terminals
2	20	UVS210	#6-4/0
2	30	UVS311B	#6-4/0
3	30	UVS310	#6-4/0
3	40	UVS411B	#6-4/0
4	40	UVS410	#6-4/0
4	50	UVS511B	#6-4/0
5	50	UVS510	#6-4/0

① All stacks are 10" wide.

Selection Chart #1—Meter Bank Height and Width Meter Stack Combinations for Various Heights and Widths, by Number of Meter Positions

No. of Meter Positions	58" High			68" High			78" High		
	Use this Quantity of:		Width (Inches)	Use this Quantity of:		Width (Inches)	Use this Quantity of:		Width (Inches)
	UVS310	UVS311B		UVS410	UVS411B		UVS510	UVS511B	
9	3	0	30	Not Practical ^①		—	1	1	20
10	2	2	40	1	2	30	2	0	20
11	3	1	40	2	1	30	Not Possible ^②		—
12	4	0	40	3	0	30	Not Practical ^②		—
13	3	2	50	1	3	40	1	2	30
14	4	1	50	2	2	40	2	1	30
15	5	0	50	3	1	40	3	0	30
16	4	2	60	4	0	40	Not Practical ^②		—
17	5	1	60	2	3	50	1	3	40
18	6	0	60	3	2	50	2	2	40
19	5	2	70	4	1	50	3	1	40
20	6	1	70	5	0	50	4	0	40
21	7	0	70	3	3	60	1	4	50
22	6	2	80	4	2	60	2	3	50
23	7	1	80	5	1	60	3	2	50
24	8	0	80	6	1	60	4	1	50
25	7	2	90	4	3	70	5	0	50
26	8	1	90	5	2	70	2	4	60
27	9	0	90	6	1	70	3	3	60
28	8	2	100	7	0	70	4	2	60
29	9	1	100	5	3	80	5	1	60
30	10	0	100	6	2	80	6	0	60
31	9	2	110	7	1	80	3	4	70
32	10	1	110	8	0	80	4	3	70
33	11	0	110	6	3	90	5	2	70
34	10	2	120	7	2	90	6	1	70
35	11	1	120	8	1	90	7	0	70
36	12	0	120	9	0	90	4	4	80
37	11	2	130	7	3	100	5	3	80
38	12	1	130	8	2	100	6	2	80
39	13	0	130	9	1	100	7	1	80
40	12	2	140	10	0	100	8	0	80

① Use (3) UVS310 instead of (3) UVS411B.

② Use 3-high or 4-high stacks.

Trough & Phase Block Selection

Line Troughs

(Use Selection Chart #2 and Specification Chart #2)

Knowing the number of meter **stacks**, (not meter positions!) and the height and width requirements, select quantity and catalog number of stacks from Selection Chart #2. For specs, refer to Specification Chart #2

Breaker Troughs

(Use Selection Chart #2 and Specification Chart #3)

Using the total number of meter **stacks**, (not meter positions!), select the quantity and catalog number of breaker troughs from Selection Chart #2 and spec from Specification Chart #3. Use MP-T style breakers only. Breakers not included.

Phase Blocks

(Use Selection Chart #2 and Specification Chart #4)

Using the number of meter stacks and the incoming power supply, use Selection Chart #2 to determine the quantity and catalog number of phase blocks for line and neutral termination. Spec these from Specification Chart #4.

Selection Chart #2—Line Trough, Breaker Trough and Phase Block Selection

No. of Meter Stacks in Bank	Line Trough Selection			Breaker Trough Selection			Phase Block Section			
	Left Trough	Middle Trough	Right Trough	Left Trough	Middle Trough	Right Trough	3 Phase, 4 Wire System		1 Phase, 3 Wire System	
							Line Blocks	Neutral Block	Line Blocks	Neutral Block
3	ULT30 ^①	—	—	UBT30	—	—	(3) UPB3	(1) UPB3	(2) UPB3	(1) UPB3
4	ULT40 ^②	—	—	UBT40	—	—	(3) UPB3	(1) UPB6	(2) UPB6	(1) UPB6
5	ULT50	—	—	UBT50	—	—	(3) UPB6	(1) UPB6	(2) UPB6	(1) UPB6
6	ULT30 ^③	—	ULT30	UBT30 ^③	—	UBT30	(3) UPB6	(1) UPB6	(2) UPB6	(1) UPB6
7	ULT40 ^③	—	ULT30	UBT40 ^③	—	UBT30	(3) UPB6	(1) UPB12	(2) UPB12	(1) UPB12
8	ULT40 ^③	—	ULT40	UBT40 ^③	—	UBT40	(3) UPB6	(1) UPB12	(2) UPB12	(1) UPB12
9	ULT50 ^③	—	ULT40	UBT50 ^③	—	UBT40	(3) UPB6	(1) UPB12	(2) UPB12	(1) UPB12
10	ULT50 ^③	—	ULT50	UBT50 ^③	—	UBT50	(3) UPB12	(1) UPB12	(2) UPB12	(1) UPB12
11	ULT40 ^④	ULT40	ULT30	UBT40 ^④	UBT40	UBT30	(3) UPB12	(1) UPB12	(2) UPB12	(1) UPB12
12	ULT40 ^④	ULT40	ULT40	UBT40 ^④	UBT40	UBT40	(3) UPB12	(1) UPB12	(2) UPB12	(1) UPB12

- ① Spacer ULT10SP is required if line conductors exceed #6 AWG.
- ② Spacer ULT10SP is required if line conductors exceed #350 kcmil.
- ③ Requires (1) UCP1216 Coupler Kit. Kit provides coupling straps for both line and breaker troughs.
- ④ Requires (2) UCP1216 Coupler Kits. Kit provides coupling straps for both line and breaker troughs.

Specification Chart #2—Line Troughs 240V AC max. 1 Phase or 3 Phase

Stack Positions	Width ^① (Inches)	Catalog Number
2	20	ULT20 ^②
3	30	ULT30
4	40	ULT40
5	50	ULT50

- ① Line troughs are 12" high.
- ② Will not accommodate Phase Blocks.

Specification Chart #3— Breaker Troughs^①

Stack Positions	Width ^① (Inches)	Catalog Number
2	20	UBT20
3	30	UBT30
4	40	UBT40
5	50	UBT50

- ① Use Murray Type MP-T circuit breakers. Breakers not included.
- ② Height is 16".

Specification Chart #4—Phase Blocks 240V AC max. 1 Phase or 3 Phase

Number of Take-off Lugs	Catalog Number	Wire Range	
		Line ^①	Load
3	UPB3	3/8 x 16 Stud	#6 - #4/0
6	UPB6	3/8 x 16 Stud	#6 - #4/0
12	UPB12	3/8 x 16 Stud	#6 - #4/0

- ① Requires separate line lug kit.

Line Terminals

(Use Specification Chart #5)

Knowing the size and quantity per phase of the line conductors, select and spec these from Specification Chart #5. Line terminals come in kits of four terminal each. One kit will supply line terminals for three phase legs and neutral.

End Walls

(Use Specification Chart #6)

NOTE: Each installation MUST have an end wall kit! The kit provides end walls for each end of the line and breaker troughs. (Four end walls). Use Specification Chart #6.

Coupling Kits

(Use Selection Chart #2 and Specification Chart #6)

When more than one line trough is needed to support the number of meter stacks on a job, or when a line trough spacer is required, coupling straps are required to connect the troughs. Use Selection Chart #2 footnotes 3 and 4 to determine quantity of coupling kits required. Each kit provides one strap for line trough and one strap for breaker trough. Spec from Specification Chart #6.

Line Trough Spacer Kits

(Use Selection Chart #2 and Specification Chart #6)

In some applications, the first phase block may be too close to the end wall of the line trough to provide proper wire bend space for the line conductors being used. Selection Chart #2 footnotes 1 and 2 will show when spacer kits are required.

Tenant Circuit Breakers

Each meter position in use requires a tenant circuit breaker. Use standard Murray Type MP-T circuit breakers from the Murray Catalog.

Specification Chart #5—Line Terminals

Wire Range	Catalog Number
(1) #6-350 kcmil	ULK1350
(1) #4-500 kcmil or (2) #1/0-250 kcmil	ULK1500
(2) #2-600 kcmil	ULK2500

Specification Chart #6—End Wall and Coupling Kits

Item	Catalog Number
End Wall Kit Contains 4 end walls; 2 for line trough and 2 for breaker trough.	UEW1216
Coupling Kit Contains 2 coupling straps; 1 for line trough and 1 for breaker trough.	UCP1216

Specification Chart #7—Accessories

Item	Catalog Number
Spacer 10" spacer for use with line trough to provide wire bend space where required	ULT10SP
Meter Cover	UMCVR
Blank Position Cover	UMBCVR
Plastic Meter Cover (Ring Type)	SX087M
Breaker Filler Plate	LX100FP

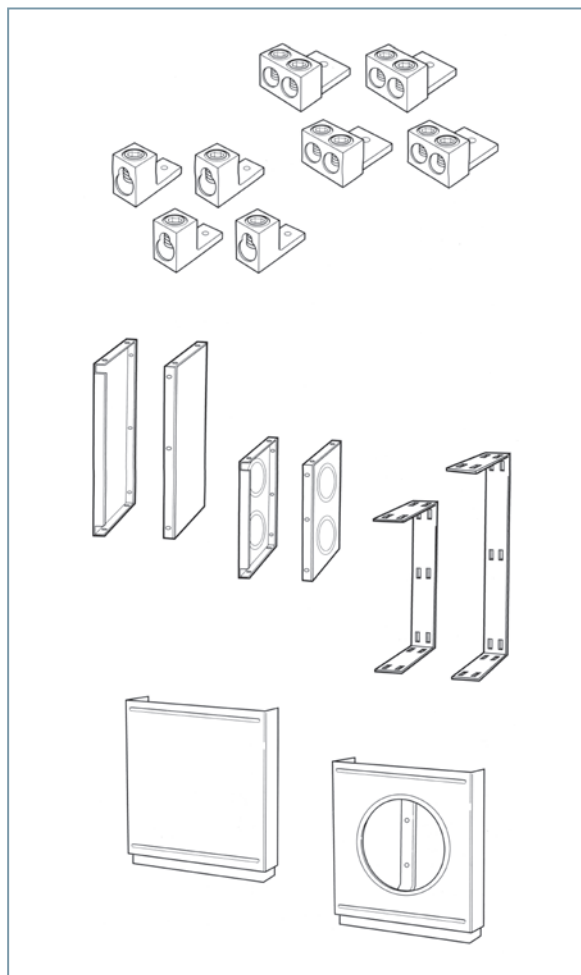

General Description

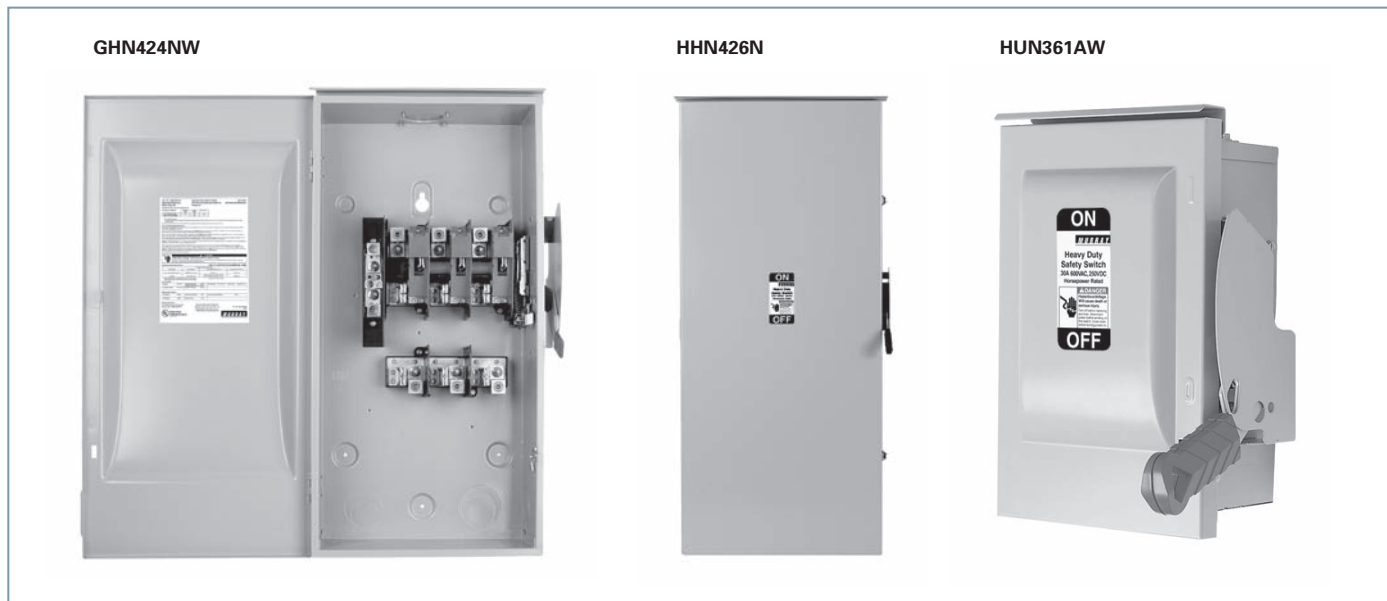

Passed The Test of Time

All Murray safety switches have passed rigid testing requirements to assure reliable performance. In addition to tests designed and conducted during the development and manufacturing processes, switches have performed successfully in tests witnessed by Underwriters' Laboratories. These tests include those for general purpose safety switches and those designed for more specialized purposes where applicable.

Handle Lock-Off

Heavy duty, "H" series safety switches have a provision to lock the handle in the "OFF" position with a maximum of three padlocks. Doors may be locked closed with a padlock. General duty, "G" series switches may be locked in the "OFF" position with one padlock. There is also a padlock feature for locking the door.

General and Heavy Duty Switches Feature a Time Proven Design

A fast, long lasting switch design with a clean, continuous contact. That's the switching system that gives you on-going reliability. The concept is simple: split the arc to shorten the break distance. Uncomplicated mechanics and common sense design assure reliable performance time after time. All switches through 1200A feature visible blade construction.

Load Break Ratings

All Murray safety switches are UL Listed for load break applications. Included in this process is a series of repeated make and break tests of the switch contacts while carrying the full rated nameplate current and rated voltage.

Horsepower Ratings

Where permitted, all Murray safety switches are UL horsepower Listed. The switch ratings are determined by tests that have been performed successfully in the UL overload test series, including repeated make and break tests of the stalled motor current of the motor for which it is being rated.

Some switches have two or more ratings for a particular voltage and current, and additional ratings if designed for multi-pole applications.

Depending on the switch and its application, various ratings may be assigned. All switches list the ratings on the inside of the cover or the door. The ampere rating and maximum AC voltage rating are always shown on the nameplate on the front of the switch.

Fault Current Performance

Murray Heavy Duty safety switches have successfully passed UL high level fault current tests. This means the risk of mechanical and thermal damage due to high level short circuit currents is minimized due to the reliable switch design.

Suitability tests for service with Class H, R, J, L, and T fuses have been conducted on heavy duty safety switches. Representative switches, with test fuses connected in series with each switch, were subjected to let-throughs in excess of the capacities of the largest fuses acceptable by the switches.

To pass the test, the switch must remain operable after being closed into a high amp available short circuit current. The test fuse is sized so that higher levels of let-through current and energy will be reached than would ever occur during normal usage in the field.

Murray General Duty safety switches have been tested to allow installation on circuits capable of delivering 100,000 AIC of fault current at 240V AC max. with Class R fuses and also with both Class J and T fuses in 100-200A ratings.

Fuse Interchangeability

General Duty Switches, Prefix G,* will accept the following UL class fuses:

- Class H
 - Class K
 - Class R — Requires class "R" fuse kit to maintain UL listing.
 - Class J — 100-200A — field convertible.
 - Class T — with proper adapter kit (100-600A).
- *Except 30 amp plug style switches.

Heavy Duty Switches, Prefix H, will accept the following UL class fuses:

- Class H
- Class K
- Class R — Requires class "R" fuse kit to maintain UL listing.
- Class J — All 30-200A, 600V and 100-200A, 240V switches — field convertible.
- Class L — 800 and 1200A switches only.
- Class T — 100-1200A switches with proper adapter kit.

Gutter Space

"G" and "H" series safety switch gutter dimensions conform to 2008 NEC Article #312.6(A). Top and bottom gutters conform to Table #312.6(B).

General Duty Switches; Prefix "G"

General duty switches are available in indoor TYPE 1 and outdoor TYPE 3R enclosures. Enclosures can be locked closed and operating handles can be locked "OFF". Series "G" switches have a quick-make, quick-break mechanism. Fusible switches are available in 1 pole S/N, 2 pole S/N and 3 pole S/N configurations. Non-fusible switches are available in 3 pole configurations. General duty switches are limited to 240V AC, 200 Amps max. rating.

All 30 Amp compact fusible and non-fusible "G" prefix switches are rated 10,000 Amp maximum withstand.

All 30–200 Amp "GF" and "GU" prefix switches are suitable for use on systems capable of delivering not more than 100,000 RMS symmetrical Amps of fault current with Class "R" fuses and the appropriate adapter kit installed. These 100–200 Amp "G" prefix switches may also be used on systems capable of delivering not more than 100,000 RMS symmetrical Amps of fault current with "T" fuses and the appropriate adapter kit installed. In addition, 100–200 general duty switches may also be used with J fuses on systems not capable of delivering more than 100,000 RMS symmetrical amperes of fault current. General duty switches are UL Listed for use as service equipment and are horsepower rated for use with motor loads.

General duty enclosed switches are used for light duty applications where loading and switching operations are not excessive.

Heavy Duty Switches, Single Throw; Prefix "H"

Heavy duty switches are available in indoor TYPE 1, outdoor TYPE 3R, Watertight Type 4/4X, and industrial TYPE 12 enclosures. Dual cover interlocks are provided, such that the door cannot be opened with the switch "ON" and the switch cannot be turned "ON" with the door open. A defeat mechanism allows servicing by authorized personnel. Handles may be locked "OFF" with up to 3 padlocks, and doors may be padlocked closed. Mechanism is "TEASE-PROOF" quick-make, quick-break. Fusible switches are available in 2 pole S/N, 3 pole and 3 pole S/N. Non-fusible switches are available in 3 pole.

Suitable for use on systems capable of delivering not more than 200,000 RMS symmetrical amperes of fault current when Class "J" or "R" fuses are installed except the 800 and 1200A switches, which are suitable for use on circuits capable of delivering not more than 200,000 RMS symmetrical amperes of fault current when Class "L" fuses are installed. 100–1200A switches with Class "T" fuses and field adapter kit 200,000 RMS symmetrical rated.

Heavy duty switches are dual horsepower rated and are listed by UL for use as service entrance equipment.

Heavy duty switches are intended for applications where rugged construction, reliable performance, continuity of service and ease of maintenance are required.

Protector-Lock® Switches; Prefix "H"

The Murray Protector-Lock® switch is designed to eliminate shock hazard due to disconnecting heavy duty portable electrical equipment under load. When the switch is in the "ON" position, the safety bar blocks the self-contained receptacle and prevents insertion or removal of the plug. When the switch is "OFF", the bar retracts, allowing insertion or removal of the plug.

Protector-Lock® switches consist of a heavy duty, 30 or 60 Amp, 600V AC, 3 pole fusible or non-fusible enclosed switch, and either Crouse-Hinds® or Arrow Hart® Industrial receptacles.

Applications include industrial plants where portable conveyors and welders are used, and truck terminals where on-board refrigeration units require stand-by power.

Double Throw Switches; Prefix "HD"

Double throw switches are available in TYPE 1 and TYPE 3R enclosures. Covers are dual interlocked with the operating mechanism such that the cover cannot be opened when the switch is in either "ON" position, and the switch handle cannot be moved to either "ON" position if the cover is open. Handle may be padlocked in the "OFF" position. Switching action is quick-make, quick-break in both "ON" positions.

They are available in 30–200 Amp ratings, 240V AC, fusible and non-fusible, two and three pole.

Double throw switches are usually applied as transfer switches to switch a load from one power source to another, but can be field converted to switch one power source between two loads. Switching mechanism is located on line side of fuses allowing for a safer fuse replacement. All are suitable for use as service equipment.

Industry and Government Specifications

Murray enclosed switches meet or exceed the latest revision of the following specifications:

Industry
NEMA

Standard #KS-1-2001

UL-Standard #98

U.S. Government

HD single throw, prefix "H":
Standard #WS-865c type "HD"
HD double throw, prefix "HD":
Standard #WS865c type "NDD"
GD 60–600 Amp, prefix "G":
Standard #WS 865c type "ND";
except where interlock is required.
GD 30 Amp, prefix "G":
Standard #WS-865c type "ND";
except where interlock is required.

Arrow Hart® and Crouse-Hinds® are registered trademarks of Cooper Industries, Inc.

Protector-Lock® is a registered trademark of Siemens Energy & Automation Inc.

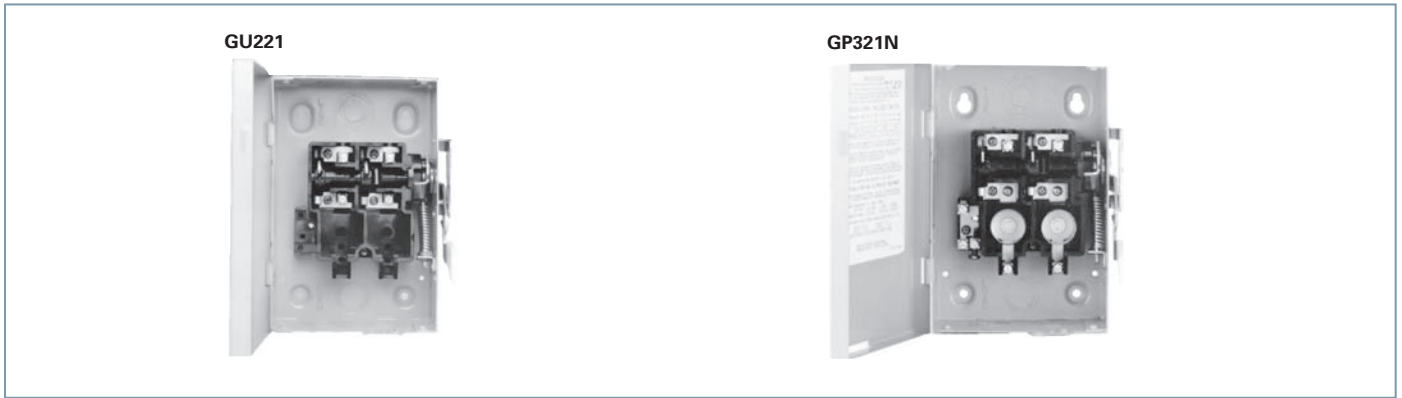

General Duty Compact Safety Switches

Symbol	Fuse Type	Indoor TYPE 1			Outdoor TYPE 3R			Hub	Horsepower Rating					
		Catalog Number	Std. Pkg.	Approx. Wgt. Lbs.	Catalog Number	Std. Pkg.	Approx. Wgt. Lbs.		Single Phase		Three Phase			
									120V AC		240V AC		240V AC	
Std	Max ^①	Std	Max ^①	Std	Max ^①									
30 AMP FUSIBLE 1 POLE 2 WIRE S/N 120V AC (INSULATED GROUNDABLE NEUTRAL)														
Fig-1	Plug	GP211N	10	33.60	—	—	—	—	½	2	—	—	—	—
30 AMP FUSIBLE 2 POLE 3 WIRE S/N 240V AC (INSULATED GROUNDABLE NEUTRAL)														
Fig-2	Plug	GP321N	10	37.00	—	—	—	ECHA	½	2	1½	3	—	—
Fig-3	None	GU221	10	33.00	GU221AW	5	35.00	ECHA	—	2	—	3	—	—
60 AMP NON-FUSIBLE 2 POLE 240V AC SPECIAL APPLICATION SWITCH														
Fig-4	None	—	—	—	GU222AW	10	36.00	— ^②	—	—	—	10	—	—

Accessories and Lug Data — See pages 3-48 and 3-49.
 Dimensions — See pages 3-50, 3-51 and 3-52.
 Knockout Drawings — See page 3-53.

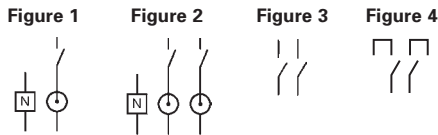

Hubs

Conduit Size (Inches)	Catalog Number	Approx. Wgt. Lbs. (Std. Pkg. — 1)
¾	ECHA075	.10
1	ECHA100	.10
1¼	ECHA125	.10

General Duty Stand-by Power Panel



This unique device provides an economical means to transfer from normal to an alternate source of power. It contains two 100A, 2-pole circuit breakers interlocked in a "double throw" configuration and supplies both overload and short circuit protection (10,000 AIC max.). The external handle is padlockable in the OFF position.

Outdoor TYPE			Hub
Catalog Number	Std. Pkg.	Approx. Wgt. Lbs.	
100A 2 POLE 3 WIRE S/N 120/240V AC OUTDOOR TYPE 3R^④			
DUL313NW ^{③⑤}	1	19.00	ECHS

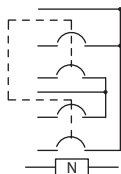

① Starting current of motors above standard horsepower rating may require use of time delay fuses.
 ② Bottom cable entry & exit only.

③ Suitable for service entrance application. Neutral factory installed. UL1008 listed as a non-automatic transfer switch under file #E315030. Suitable for use as Transfer Equipment on optional stand-by systems as defined by Article 702 of the NEC.

④ Wire ranges (75°C Cu/Al) Line, load & neutral (1) #14-1 Service ground (1) #14-4
 ⑤ Discount Schedule HDSM.



Switch Selection with Class “H” Fuse Holders 30–600 Amps (Convertible to Class “R”)^①

Symbol	Amps	Indoor TYPE 1			Outdoor TYPE 3R			Hub	Horsepower Rating				
		Catalog Number	Std. Pkg.	Approx. Wgt. Lbs.	Catalog Number	Std. Pkg.	Approx. Wgt. Lbs.		Single Phase		Three Phase		
									240V AC		240V AC		250V DC
									Std	Max ^②	Std	Max ^②	Std

FUSIBLE 2 POLE 3 WIRE S/N 240V AC (INSULATED GROUNDABLE NEUTRAL)^{③ ④ ⑤}

Fig-1	Amps	Indoor Catalog Number	Indoor Std. Pkg.	Indoor Approx. Wgt. Lbs.	Outdoor Catalog Number	Outdoor Std. Pkg.	Outdoor Approx. Wgt. Lbs.	Hub	Single Phase Std	Single Phase Max ^②	Three Phase Std	Three Phase Max ^②	250V DC Std
	30	GHN321N [®]	10	35.00	GHN321NW [®]	10	35.00	ECHA	1½	3	3	7½	5
	60	GHN322N [®]	1	14.00	GHN322NW [®]	1	14.00	ECHS	3	10	7½	15	10
	100	GHN323N [®]	1	23.00	GHN323NW [®]	1	24.00	ECHS	7½	15	15	30	20
	200	GHN324N [®]	1	47.00	GHN324NW [®]	1	48.00	ECHS	15	—	25	60	40

FUSIBLE 3 POLE 4 WIRE S/N 240V AC (INSULATED GROUNDABLE NEUTRAL)^⑤

Fig-2	Amps	Indoor Catalog Number	Indoor Std. Pkg.	Indoor Approx. Wgt. Lbs.	Outdoor Catalog Number	Outdoor Std. Pkg.	Outdoor Approx. Wgt. Lbs.	Hub	Single Phase Std	Single Phase Max ^②	Three Phase Std	Three Phase Max ^②	250V DC Std
	30	GHN421N	5	24.00	GHN421NW	5	24.00	ECHA	1½	3	3	7½	5
	60	GHN422N	1	15.00	GHN422NW	1	15.00	ECHS	3	10	7½	15	10
	100	GHN423N	1	25.00	GHN423NW	1	25.00	ECHS	7½	15	15	30	20
	200	GHN424N	1	49.00	GHN424NW	1	50.00	ECHS	15	—	25	60	40

NON-FUSIBLE 3 POLE 240V AC (SEE PREVIOUS PAGE FOR 2 POLE, 30 AMPS; USE 3 POLE FOR 2 POLE APPLICATION FOR 60–200 AMPS)

Fig-3	Amps	Indoor Catalog Number	Indoor Std. Pkg.	Indoor Approx. Wgt. Lbs.	Outdoor Catalog Number	Outdoor Std. Pkg.	Outdoor Approx. Wgt. Lbs.	Hub	Single Phase Std	Single Phase Max ^②	Three Phase Std	Three Phase Max ^②	250V DC Std
	30	GUN321	5	24.00	GUN321AW	5	24.00	ECHA	—	3	—	7½	5
	60	GUN322	1	12.00	GUN322AW	1	13.00	ECHS	—	10	—	15	10
	100	GUN323	1	23.00	GUN323AW	1	24.00	ECHS	—	15	—	30	20
	200	GUN324	1	46.00	GUN324AW	1	47.00	ECHS	—	15	—	60	40

Accessories and Lug Data —
See pages 3-48 and 3-49.
Dimensions —
See pages 3-50, 3-51 and 3-52.
Knockout Drawings —
See page 3-53 and 3-54.

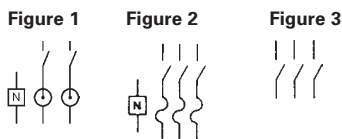

① “G” Series switches are UL Listed for use on circuits capable of delivering up to 100,000 Amps RMS symmetrical fault currents, provided Class “R” or “T” fuses and appropriate rejection or adapter kits are installed. T-fuses can only be used on 100–200 Amp. 100–200A switches can also be used with Class J fuses.

② Starting current of motors above standard horsepower rating may require use of time delay fuses.
③ These switches are UL Listed for application on grounded B systems.
④ Suitable for 3-pole motor loads.
⑤ Has service entrance label, neutral factory installed.



Switch Selection with Class "H" Fuse Holders (Convertible to Class "J", "R" or "T")^①

Symbol	Amps	Indoor TYPE 1			Outdoor TYPE 3R			Hub	Horsepower Rating				
		Catalog Number	Std. Pkg.	Approx. Wgt. Lbs.	Catalog Number	Std. Pkg.	Approx. Wgt. Lbs.		Single Phase		Three Phase		
									240V AC		240V AC		250V DC
									Std	Max ^③	Std	Max ^③	Std

FUSIBLE 2 POLE 3 WIRE S/N 240V AC (INSULATED GROUNDABLE NEUTRAL)^{④⑤⑥}

Fig-1	30	HHN321N	1	12.00	—	—	—	ECHS	1½	3	3	7½	5
	60	—	—	—	HHN322NW	1	19.00	ECHS	3	10	7½	15	10
	100	—	—	—	HHN323NW	1	24.00	ECHS	7½	15	15	30	20
	200	HHN324N	1	47.00	—	—	—	ECHS	15	—	25	60	40
	800	HLN327N ^{②④}	1	360.00	—	—	—	—	—	—	100	250	—
	1200	HLN328N ^{②④}	1	362.00	—	—	—	—	—	—	100	250	—

FUSIBLE 3 POLE 4 WIRE S/N 240V AC (INSULATED GROUNDABLE NEUTRAL)^{⑤⑥}

Fig-2	30	HHN421N	1	14.00	HHN421NW	1	15.00	ECHS	1½	3	3	7½	5
	60	HHN422N	1	19.00	HHN422NW	1	20.00	ECHS	3	10	7½	15	10
	100	—	—	—	HHN423NW	1	26.00	ECHS	7½	15	15	30	20
	200	HHN424N	1	49.00	—	—	—	ECHS	15	—	25	60	40
	800	HLN427N ^{②④}	1	380.00	HLN427NW ^{②④}	1	383.00	ECHV ^②	—	—	100	250	—
	1200	HLN428N ^{②④}	1	382.00	HLN428NW ^{②④}	1	385.00	ECHV ^②	—	—	100	250	—

Accessories and Lug Data —
See pages 3-48 and 3-49.
Dimensions —
See pages 3-51 and 3-52.
Knockout Drawings —
See pages 3-53 and 3-54.

Figure 1

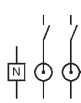
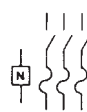

Figure 2



① Switches through 1200 Amps listed by Underwriters' Laboratories for use on circuits delivering up to 200,000 Amps RMS symmetrical fault current, provided class "R", "J", "L", or "T" fuses are used. Rejection kits must be installed for "R" fuse application. "T" fuse adapter kit required for "T" fuse application. See Accessory Page.
② "J" fuses can only be used on 100–200A ratings.
③ "T" fuses can only be used on 100–1200A ratings.

④ Factory set for use with class "L" fuses.
⑤ Starting current of motors above standard horsepower rating may require use of time delay fuses.
⑥ Suitable for 3-pole motor loads.
⑦ Suitable for service entrance application. Neutral factory-installed.
⑧ Supplied without knockouts.

⑨ 800A and larger Type 3R switches have no provisions for mounting hubs. Drill or punch hole in the field to accommodate hub size desired.
⑩ Also rated 250V DC



Switch Selection with Class "H" Fuse Holders (Convertible to Class "J", "R" or "T")^①

Symbol	Amps	Indoor TYPE 1		Outdoor TYPE 3R		Hub	Horsepower Rating									
		Catalog Number	Approx. Wgt. Lbs. (Std. Pkg. 1)	Catalog Number	Approx. Wgt. Lbs. (Std. Pkg. 1)		480V AC 1Ø		480V AC 3Ø		600V AC 1Ø		600V AC 3Ø		250V DC	600V DC
							Std	Max ^④	Std	Max ^④	Std	Max ^④	Std	Max ^④		
FUSIBLE 3 POLE 600V AC (NO NEUTRAL)^{⑤⑥}																
Fig-1	30	—	—	HHN361AW	15.00	ECHS	3	7½	5	15	3	10	7½	20	5	—
	60	HHN362	19.00	HHN362AW	20.00	ECHS	5	20	15	30	10	25	15	50	10	25
	100	HHN363	24.00	HHN363AW	25.00	ECHS	10	30	25	60	15	40	30	75	20	25
	200	HHN364	48.00	HHN364AW	49.00	ECHS	25	50	50	125	30	50	60	150	40	50
	800	HLN367 ^⑦	380.00	HLN367AW ^⑦	382.00	ECHV ^⑦	—	—	200	500	—	—	200	500	—	—
	1200	HLN368 ^⑦	383.00	HLN368AW ^⑦	385.00	ECHV ^⑦	—	—	200	500	—	—	200	500	—	—
FUSIBLE 3 POLE 4 WIRE S/N 480Y / 277V AC (INSULATED GROUNDABLE NEUTRAL)^⑥																
Fig-2	30	③	—	—	—	—	—	—	—	—	—	—	—	—	—	—
	60	③	—	—	—	—	—	—	—	—	—	—	—	—	—	—
NON-FUSIBLE 3 POLE 600V AC (USE FOR 2 POLE)^{⑤⑥⑦}																
Fig-3	30	HUN361	12.00	HUN361AW	13.00	ECHS	7½	—	—	15	—	10	—	20	5	—
	60	HUN362	18.00	HUN362AW	19.00	ECHS	20	—	—	30	—	25	—	50	10	25
	100	HUN363	23.00	HUN363AW	24.00	ECHS	30	—	—	60	—	40	—	75	20	25
	200	HUN364	46.00	HUN364AW	47.00	ECHS	50	—	—	125	—	50	—	150	40	50

Accessories and Lug Data — See pages 3-48 and 3-49.
Dimensions — See pages 3-51 and 3-52.
Knockout Drawings — See pages 3-53 and 3-54.

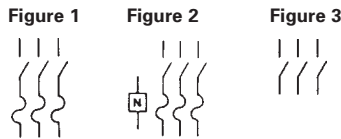

① Switches through 1200 Amps listed by Underwriters' Laboratories for use on circuits delivering up to 200,000 Amps RMS symmetrical fault current, provided class "R", "J", "L", or "T" fuses are used. Rejection kits must be installed for "R" fuse applications.
② Class "L" fuse provision. Single fuse per pole. Supplied without knockouts.
③ Order 3 pole switch from chart above, and neutral from accessory page.

④ Starting current of motors above standard horsepower rating may require use of time delay fuses.
⑤ For service equipment or applications requiring a solid neutral, order neutral kit as an accessory, page 3-8.
⑥ 60-200A switches are also rated 600V DC when 2 poles are connected in series.
⑦ 800A and larger Type 3R switches have no provisions for mounting hubs. Drill or punch hole in the field to accommodate hub size desired.

⑧ Non-fusible switches also have the following max. HP ratings.

Amps	1Ø 240V AC	3Ø 240V AC
30	5	10
60	10	20
100	15	40
200	15	60

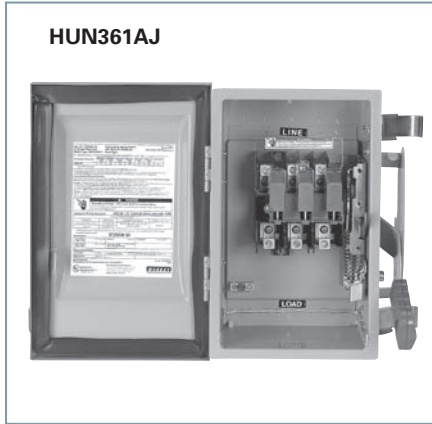

Accessories and Lug Data —
See pages 3-48 and 3-49.
Dimensions —
See pages 3-51 and 3-52.

Switch Selection With Class "H" Fuse Holders (Convertible To Class "J", "R" or "T")^①

Symbol	Amps	Industrial Type 12 Catalog Number	Approx. Wgt. Lbs. (Std. Pkg. 1)	Horsepower Rating					
				480V AC 3Ø		600V AC 3Ø		250V DC	600V DC
				Std	Max ^②	Std	Max ^②		

FUSIBLE 3 POLE 600V AC (NO NEUTRAL)^{③④}

Fig-1	Amps	Catalog Number	Approx. Wgt. Lbs. (Std. Pkg. 1)	480V AC 3Ø Std	480V AC 3Ø Max ^②	600V AC 3Ø Std	600V AC 3Ø Max ^②	250V DC	600V DC
	30	HUN361AJ	14.00	5	15	7½	20	5	—
	60	HUN362AJ	20.00	15	30	15	50	10	25

NON-FUSIBLE 3 POLE 600V AC (USE FOR 2 POLE)^{③④⑤}

Fig-2	Amps	Catalog Number	Approx. Wgt. Lbs. (Std. Pkg. 1)	480V AC 3Ø Std	480V AC 3Ø Max ^②	600V AC 3Ø Std	600V AC 3Ø Max ^②	250V DC	600V DC
	30	HUN361AJ	13.00	—	20	—	30	5	—

Symbol	Amps	Type 4X Stainless Steel Catalog Number	Approx. Wgt. Lbs. (Std. Pkg. 1)	Horsepower Rating					
				480V AC 3Ø		600V AC 3Ø		250V DC	600V DC
				Std	Max ^②	Std	Max ^②		

NON-FUSIBLE 3 POLE 600V AC (NO NEUTRAL)^{③④⑤⑥}

Fig-2	Amps	Catalog Number	Approx. Wgt. Lbs. (Std. Pkg. 1)	480V AC 3Ø Std	480V AC 3Ø Max ^②	600V AC 3Ø Std	600V AC 3Ø Max ^②	250V DC	600V DC
	60	HUN362AS	19.00	—	50	—	60	10	25
	200	HUN364AS	47.00	—	125	—	150	40	50

Figure 1



Figure 2



① Switches through 200 Amps listed by Underwriters' Laboratories for use on circuits delivering up to 200,000 Amps RMS symmetrical fault current, provided class "J", "R" or "T" fuses are used. Rejection kits must be installed for "R" fuse applications.
② Starting current of motors above standard horsepower rating may require use of time delay fuses.

③ For service equipment or applications requiring a solid neutral, order neutral kit as an accessory, page 3-8.

④ Use 3 pole switch for 2 pole applications.

⑤ 240V 3Ø HP ratings are as follows:

Amps	HP Std	HP Max. Fusible	HP Max. Non-Fusible
30	3	7½	10
60	7½	15	20
100	15	30	40
200	25	60	60

⑥ 60-200A switches are also rated 600V DC when 2 poles are connected in series.

VBII Type Double Throw Switches Type 1 & Type 3R

Double Throw Switches^{①⑦}

Symbol	Amps	Indoor TYPE 1		Outdoor TYPE 3R ^②		Hub	Horsepower Rating				
		Catalog Number	Approx. Wgt. Lbs.	Catalog Number	Approx. Wgt. Lbs.		1Ø Std	1Ø Max	3Ø Std	3Ø Max	250V DC
NON-FUSIBLE 2 POLE 240V AC											
Fig-1 ^③	100	HDUN223	37.00	— ^④	—	—	—	15	—	—	20
	200	HDUN224	79.00	HDUN224AW ^⑥	79.00	ECHS	—	15	—	—	40
FUSIBLE 3 POLE 240V AC											
Fig-3 ^③	30	HDHN321	38.00	HDHN321AW	39.00	ECHS	—	3	—	7½	5

Neutral Kits

For use with Double Throw Switches

Switch Amps	Catalog Number
60-100	HN263M

Fuse Capabilities of Fusible Switches

Amp Rating	Fuse Type			
	H	R	T	J
30 & 60 A	Std	Yes (kit)	No	No
100 & 200A	Std	Yes (kit)	Yes (kit)	Yes ^⑤

Double Throw Switches – Lug Data

Switch Amp Range	Number of Cables Per Terminal	Cu and/or Al	Wire Range
30	1 pc.	Cu or Al	#14 to #6
60	1 pc.	Cu or Al	#14 to #2
100	1 pc.	Cu or Al	#14 to #1/0
200	1 pc.	Cu or Al	#6 to 250 kcmil

Figure 1

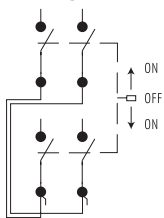
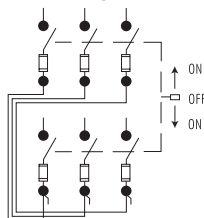

Figure 3



① Rated 10,000 AIC with Class H or 200,000 AIC when used with or protected by Class R, J or T fuses. Fuse rating must not exceed switch ampere rating.
 ② 800A and larger double throw switches do not have a hub provision.
 ③ Typical wiring diagrams for 30-200 amp switches are shown.
 ④ HP ratings at 480V.

⑤ Move load side base.
 ⑥ General Duty Double Throw Switches are also available in 100 and 200A ratings. Contact sales for additional info.
 ⑦ A 100A 2P General Duty Stand-by Power Panel is also available on page 3-41.

Protector-Lock® Switches With Crouse-Hinds® Receptacles

Symbol	Switch Amps	Recept Amps	Industrial Type 12		Use Plug # ^②
			Catalog Number	Approx. Wgt. Lbs. (Std. Pkg. 1)	

NON-FUSIBLE, 3 POLE 60V AC SWITCH (STYLE 2 RECEPTACLE, 4 WIRE, ONE WIRE GROUNDED)

Fig-2	60	60	HUN362CJ	29.00	APJ6485
-------	----	----	----------	-------	---------

Accessories and Lug Data —
See pages 3-48 and 3-49.
Dimensions —
See pages 3-51 and 3-52.

Figure 2

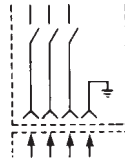

①Not UL listed.
②See Accessories page 3-49 for plug selection.

Arrow Hart®, Power Lock®, & Crouse-Hinds® are registered trademarks of Cooper Industries, Inc.
Protector-Lock® is a registered trademark of Siemens Energy & Automation, Inc.

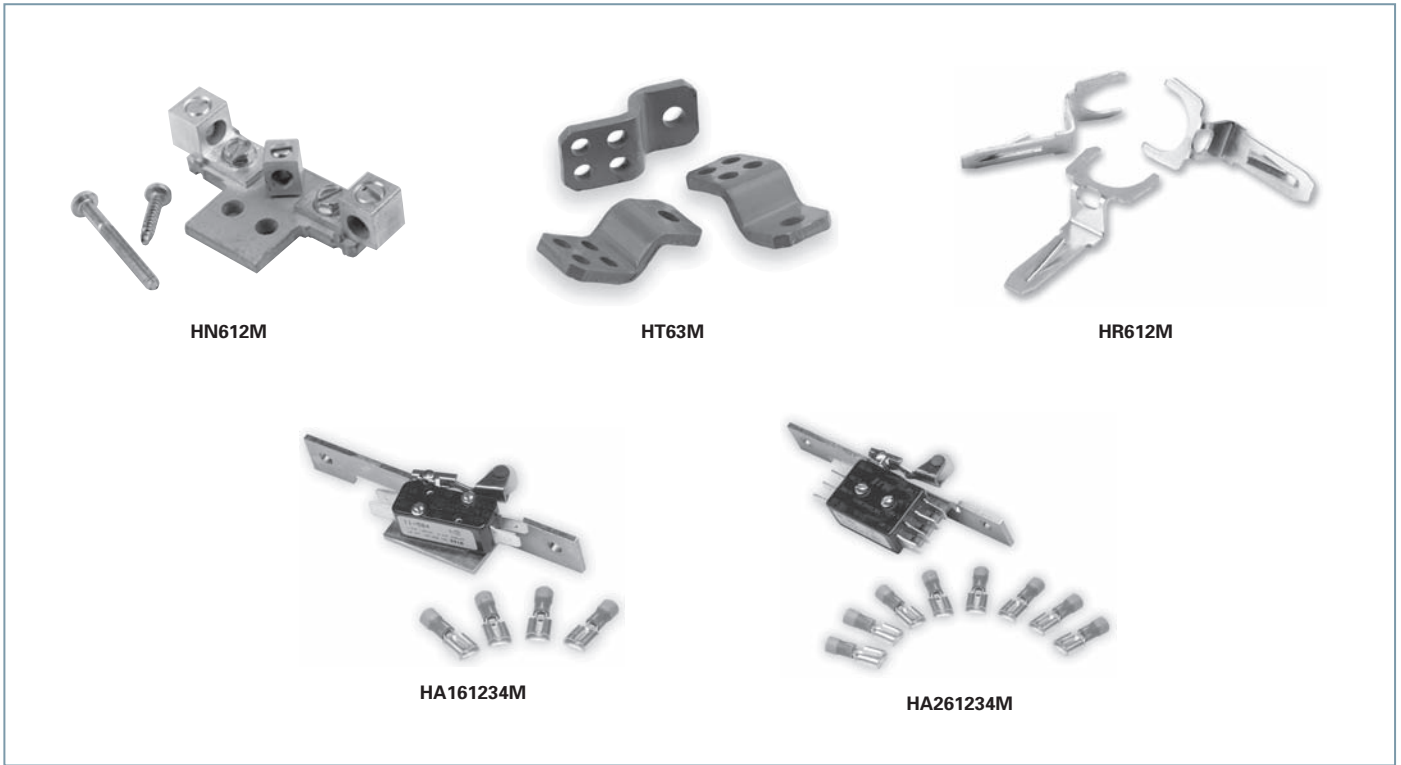

Neutral Kits^①

Standard Neutral Kits can be field installed in General and Heavy Duty Switches.

Switch Ampere Rating	Kit Catalog Number
30 GD	W410190M
30 HD, 60 GD	HN612M
60, 100 HD, 100 GD	HN623M
200	HN64M

Class T Fuse Adapter Kits^③

All 200A General Duty and 100-1200A Heavy Duty Switches are field convertible to accept Class T fuses.

Catalog Number	Description
HT23M ^④	100A, 240V Kit
HT63M	100A, 600V Kit
HT24M ^④	200A, 240V Kit
HT64M	200A, 600V Kit
HX327TF	800A, 240V Kit
HX367TF	800A, 600V Kit
HX328TF	1200A, 240V Kit

Class R Fuse Clip Kits^②

Catalog Number	Description
GSRK321M	30A, 240V Kit (GD only)
HR21M	30A, 240V Kit (HD only)
HR612M	30A, 600V Kit/60A, 240V Kit
HR62M	60A, 600V Kit
HR63M	100A Kit
HR64M	200A Kit

Equipment Ground Kits

Equipment Ground Lug Kits are available for all General Duty, Heavy Duty and Double Throw Switches. They are field installable in Type 1 and Type 3R Switches and are factory installed as standard in Type 4/4X and Type 12 Switches.

Switch Ampere Rating	Catalog Number	Number of Terminals	Wire Range Per Terminal (Cu/Al)
30A GD	GSGK60M	2	#14-8 AWG
60-200 GD	HG61234M	2	#14-4 AWG
30-200 HD	HG61234M	2	#14-4 AWG
800-1200	HG678M	8	#6 AWG-250 Kcmil

Class J Fuse

All 100-200A General Duty and 600V 30-200A Heavy Duty Switches are field convertible to accept Class J fuses by moving the load base to a pre-drilled J fuse position.

① All neutral kits are provided with a grounding lug and also contain a bonding provision.

② One kit per switch required for General and Heavy Duty switches. Two kits required per Double Throw Switch.

③ (1) kit per pole required.

④ 100 and 200A Double Throw switches are also convertible from H to T fuses by using (6) kits per switch.

Type VBII 3R Hubs^① (60–600A GD 30–1200A HD)

Conduit Size (Inches)	Catalog Number	Std. Pkg.	Ship. Wgt. (Std. Pkg.)	For Use on Switches Rated
¾	ECHS075	1	.50	30–200A HD, 60–200AGD
1	ECHS100	1	.50	30–200A HD, 60–200AGD
1¼	ECHS125	1	.50	30–200A HD, 60–200AGD
1½	ECHS150	1	.50	30–200A HD, 60–200AGD
2	ECHS200	1	.50	30–200A HD, 60–200AGD
2½	ECHS250	1	.50	30–200A HD, 60–200AGD
2½	ECHV250	1	1.00	800–1200A ^{③⑤}
3	ECHV300	1	1.00	800–1200A ^{③⑤}
3½	ECHV350	1	1.00	800–1200A ^{③⑤}
4	ECHV400	1	1.00	800–1200A ^{③⑤}

Auxiliary Contacts^⑦

Auxiliary Contacts are available only for Heavy Duty and Double Throw Switches. The auxiliary contacts are available in 1 normally open and 1 normally closed or 2 normally open and 2 normally closed configurations. All auxiliary contacts make after and break before the main switch contacts.

Switch Ampere Rating	Aux. Switch Catalog Number	Kit Ampere Rating			Kit Horsepower Rating		
		125V AC	250V AC	28V DC	125V AC	250V AC	28V DC
		Max.	Max.	Max.	Max.	Max.	Max.

With 1 NO & 1 NC Isolated Contacts

30-200	HA161234M	10	10	–	1/2	3/4	–
800-1200	HA165678M	10	10	–	1/2	3/4	–

With 2 NO & 2 NC Isolated Contacts

30-200	HA261234M	10	10	7	1/2	3/4	–
--------	-----------	----	----	---	-----	-----	---

Compact & 30A GD Switch Hubs

Conduit Size (Inches)	Catalog Number	Approx. Wgt. Lbs. (Std. Pkg.—1)
¾	ECHA075	.10
1	ECHA100	.10
1¼	ECHA125	.10

Plugs for Protector-Lock[®] Switches

Catalog Number ^②	Approx. Wgt. Lbs. (Std. Pkg.—1)	Rating	Description
APJ6485	5.00	60A, 600V AC	High impact strength, copper-free aluminum. Accepts 0.64–1.37" diameter cord.
AX103S	.80	30A, 600V AC	Armored steel with cord grip. Accepts 0.562–1.000" diameter cord.

Closure Plates

Catalog Number	Rating
ECHS000	⑥
ECHV000	800–1200A
HVHRA ^④	800–1200A

General & Heavy Duty Switches Lug Data

30-100A Switches are suitable for use with 60° or 75°C wire.
100-1200A are suitable for use with 75°C rated wire.

Wire Ranges (Line, Load and Standard Neutral)		
Switch Ampere Rating	Wire Range with Wire-Bending Space Per NEC Table 373-6	Lug Range
30 GD	#14-8 AWG (Cu/Al) ^⑧	#14-8 AWG (Cu/Al) ^⑧
30	#12-6 AWG (Al) or #14-6 AWG (Cu)	#14-2 AWG (Cu/Al)
60	#12-3 AWG (Al) or #14-3 AWG (Cu)	#14-2 AWG (Cu/Al)
100	#14-1/0 AWG (Cu/Al)	#14-1/0 AWG (Cu/Al)
200	#6 AWG-300 Kcmil (Cu/Al)	#6 AWG-300 Kcmil (Cu/Al)
800	(3) 3/0 AWG-750 Kcmil (Cu/Al) Line and Load or (6) 3/0 AWG-250 Kcmil (Cu/Al) (4) 1/0 AWG-750 Kcmil (Cu/Al) neutral	(3) 1/0 AWG-750 Kcmil (Cu/Al) Line and Load or (6) 1/0 AWG-600 Kcmil (Cu/Al) neutral (4) 1/0 AWG-750 Kcmil (Cu/Al) neutral
1200	(4) 3/0 AWG-750 Kcmil (Cu/Al) or (4) 1/0 AWG-600 Kcmil (Cu/Al) neutral	(4) 1/0 AWG-750 Kcmil (Cu/Al) Line and Load (4) 1/0 AWG-600 Kcmil (Cu/Al) neutral

①Also for 30-200 double throw switches. Not for use on compact switches.

②Net Price. No discount.

③800A and larger Type 3R switches have no provisions for mounting hubs. Drill or punch hole in the field to accommodate hub size desired.

④HV to HR adapter plate. Order ECHR series hub separately.

⑤For gasket kit for HV type hub order catalog number HVGKM.

⑥60-200A GD, 30-200A HD

⑦Two auxiliary contacts required per double throw switch.

⑧Connector will accept up to #6; conductors on line side and retain UL listing. Also applies to 30 compact switches.

⑨Max. wire size for height reduced switches is 500 kcmil (Cu/Al).

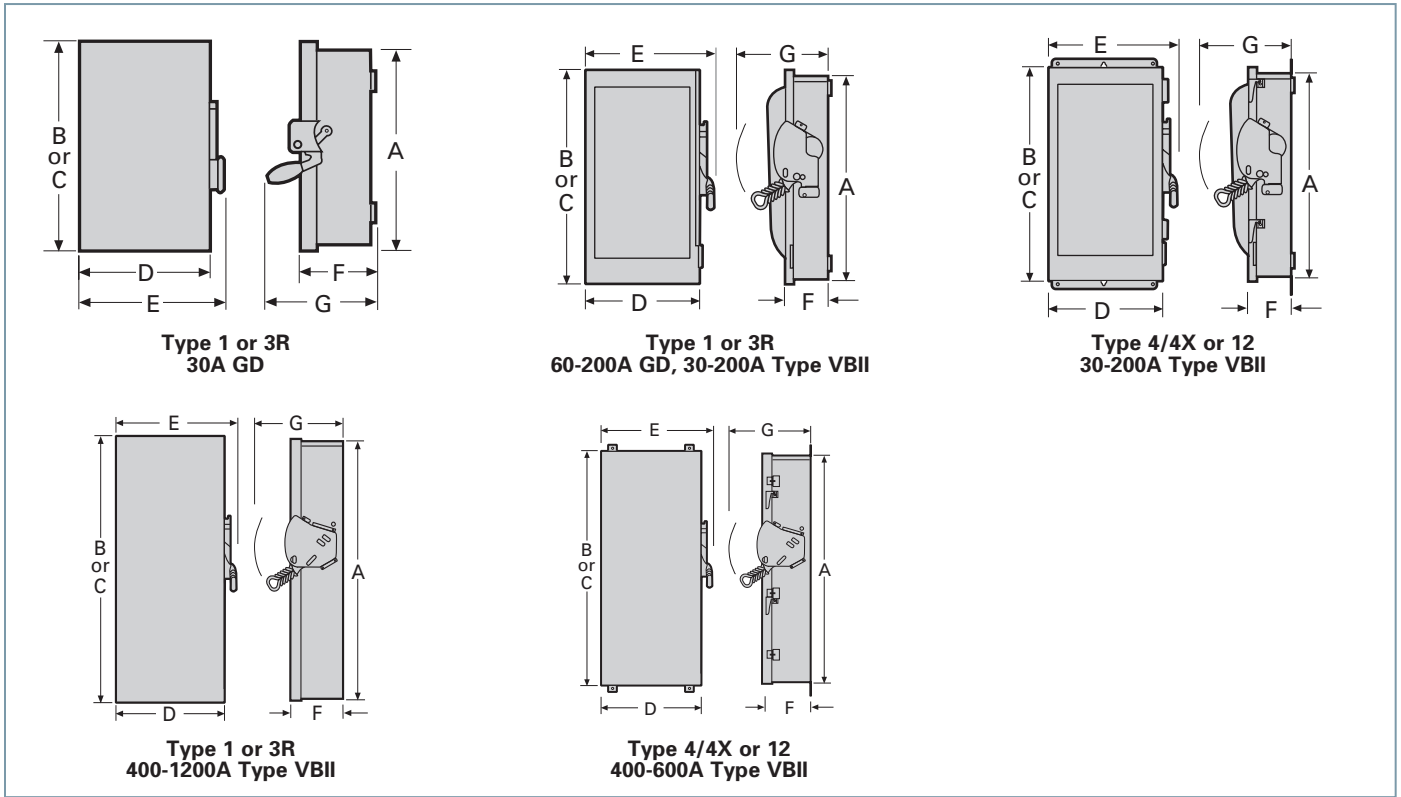

Safety Switch Dimensions^②

Catalog Number	Height			Width		Depth		Knockout Diagram ^①
	Box	With Door	With Rain Shed	Box	With Handle	Box	With Handle	
	A	B	C	D	E	F	G	
GHN321N	7.97	8.13	—	5.50	5.94	3.00	5.88	S1
GHN321NW	8.07	—	8.16	5.16	5.94	3.13	5.88	S3
GHN322N	14.26	15.45	—	6.64	8.70	5.05	8.63	S6
GHN322NW	14.39	—	15.76	6.64	8.70	5.05	8.63	S8
GHN323N	21.95	23.15	—	9.64	11.70	5.05	8.63	S10
GHN323NW	21.95	—	23.46	9.64	11.67	5.05	8.70	S11
GHN324N	29.90	31.07	—	14.62	16.68	6.36	10.92	S12
GHN324NW	29.90	—	31.42	14.61	16.68	6.36	10.92	S13
GHN325N	56.00	56.57	—	24.64	26.21	9.23	14.68	S14
GHN325NH	45.25	45.82	—	24.64	26.21	9.23	14.68	S14
GHN325NW	56.07	—	57.19	24.64	26.70	9.23	14.68	S15
GHN325NWH	45.31	—	46.44	24.64	26.70	9.23	14.68	S15
GHN326N	56.00	56.57	—	24.64	26.21	9.23	14.68	S14
GHN326NH	45.25	45.82	—	24.64	26.21	9.23	14.68	S14
GHN326NW	56.07	—	57.19	24.64	26.70	9.23	14.68	S15
GHN326NWH	45.31	—	46.44	24.64	26.70	9.23	14.68	S15
GHN421N	7.97	8.19	—	7.19	7.69	3.00	5.88	S2
GHN421NW	8.07	—	8.16	7.19	8.16	3.13	5.88	S4
GHN422N	14.26	15.45	—	6.64	8.70	5.05	8.63	S6
GHN422NW	14.39	—	15.76	6.64	8.70	5.05	8.63	S8
GHN423N	21.95	23.15	—	9.64	11.70	5.05	8.63	S10
GHN423NW	21.95	—	23.46	9.64	11.67	5.05	8.70	S11
GHN424N	29.90	31.07	—	14.62	16.68	6.36	10.92	S12
GHN424NW	29.90	—	31.42	14.61	16.68	6.36	10.92	S13
GHN425N	56.00	56.57	—	24.64	26.21	9.23	14.68	S14
GHN425NH	45.25	45.82	—	24.64	26.21	9.23	14.68	S14
GHN425NW	56.07	—	57.19	24.64	26.70	9.23	14.68	S15
GHN425NWH	45.31	—	46.44	24.64	26.70	9.23	14.68	S15
GHN426N	56.00	56.57	—	24.64	26.21	9.23	14.68	S14
GHN426NH	45.25	45.82	—	24.64	26.21	9.23	14.68	S14
GHN426NW	56.07	—	57.19	24.64	26.70	9.23	14.68	S15
GHN426NWH	45.31	—	46.44	24.64	26.70	9.23	14.68	S15
GP211N	7.97	8.13	—	5.50	5.94	3.00	5.38	S2
GP321N	7.97	8.13	—	5.50	5.94	3.00	5.38	S1
GU221	7.97	8.13	—	5.50	5.94	3.00	5.88	S1

①Knocks not provided on Type 4/4X and 12 or in 800 & 1200A Switches.

②Accurate to ±%.^①

Safety Switches



Dimensions — General & Heavy Duty Switches

Safety Switch Dimensions^②

Catalog Number	Height ^①			Width		Depth		Knockout Diagram ^①
	Box	With Door	With Rain Shed	Box	With Handle	Box	With Handle	
	A	B	C	D	E	F	G	
GU221AW	8.07	—	8.16	5.16	5.94	3.13	5.38	S5
GU222AW	8.07	—	8.16	5.22	5.94	2.94	5.38	S5
GUN321	7.97	8.19	—	7.19	7.69	3.00	5.88	S2
GUN321AW	8.07	—	8.16	7.19	7.69	3.13	5.88	S4
GUN322	11.11	12.31	—	6.64	8.71	5.05	8.61	S7
GUN322AW	11.11	—	12.62	6.64	8.71	5.05	8.61	S9
GUN323	21.95	23.15	—	9.64	11.70	5.05	8.63	S10
GUN323AW	21.95	—	23.46	9.64	11.67	5.05	8.70	S11
GUN324	29.90	31.07	—	14.62	16.68	6.36	10.92	S12
GUN324AW	29.90	—	31.42	14.61	16.68	6.36	10.92	S13
HHN321N	14.26	15.45	—	6.64	9.01	5.05	10.17	S6
HHN321NW	14.39	—	15.77	6.64	9.01	5.05	10.17	S8
HHN322NW	16.26	—	17.77	9.16	11.53	5.05	10.17	S17
HHN323NW	21.95	—	23.46	9.64	11.97	5.05	10.17	S11
HHN324N	29.90	31.07	—	14.62	16.98	6.36	12.33	S12
HHN361AJ	14.27	15.45	—	6.65	9.02	5.32	10.46	—
HHN361AW	14.39	15.45	15.77	6.64	9.01	5.05	10.17	S8
HHN362	16.26	17.46	—	9.15	11.53	5.05	10.17	S16
HHN362AJ	16.27	17.46	—	9.17	11.47	5.33	10.46	—
HHN362AW	16.26	—	17.77	9.16	11.53	5.05	10.17	S17
HHN363	21.95	23.15	—	9.64	12.01	5.05	10.17	S10
HHN363AW	21.95	—	23.46	9.64	11.97	5.05	10.17	S11
HHN364	29.90	31.07	—	14.62	16.98	6.36	12.33	S12
HHN364AW	29.90	—	31.42	14.61	16.99	6.36	12.33	S13
HHN421N	14.26	15.45	—	6.64	9.01	5.05	10.17	S6
HHN421NW	14.39	—	15.77	6.64	9.01	5.05	10.17	S8
HHN422N	16.26	17.46	—	9.15	11.53	5.05	10.17	S16
HHN422NW	16.26	—	17.77	9.16	11.53	5.05	10.17	S17
HHN423NW	21.95	—	23.46	9.64	11.97	5.05	10.17	S11
HHN424N	29.90	31.07	—	14.62	16.98	6.36	12.33	S12
HLN327N	66.67	67.16	—	38.40	39.96	9.24	14.68	—
HLN328N	66.67	67.16	—	38.40	39.96	9.24	14.68	—
HLN367	66.67	67.16	—	38.40	39.96	9.24	14.68	—
HLN367AW	66.67	—	67.74	38.40	39.96	9.24	14.68	—

①Knocks not provided on Type 4/4X and 12 or in 800 & 1200A Switches.
②Accurate to ±1/8".

③Dimensions are for switch less receptacle and mounting feet.
④Dimensions are less mounting feet on Type 12 and 4X switches.

Safety Switch Dimensions^{③④}

Catalog Number	Height			Width			Depth		Knockout Diagram ^①
	Box	With Door	With Rain Shed	Box	With Handle	Box	With Handle		
	A	B	C	D	E	F	G		
HLN368	66.67	67.16	—	38.40	39.96	9.24	14.68	—	
HLN368AW	66.67	—	67.74	38.40	39.96	9.24	14.68	—	
HLN427N	66.67	67.16	—	38.40	39.96	9.24	14.68	—	
HLN427NW	66.67	—	67.74	38.40	39.96	9.24	14.68	—	
HLN428N	66.67	67.16	—	38.40	39.96	9.24	14.68	—	
HLN428NW	66.67	—	67.74	38.40	39.96	9.24	14.68	—	
HUN361	11.11	12.31	—	6.64	9.01	5.05	10.17	S7	
HUN361AJ	11.12	12.31	—	6.65	9.02	5.56	10.46	—	
HUN361AW	11.11	—	12.63	6.64	9.01	5.05	10.17	S9	
HUN362	16.26	17.46	—	9.15	11.53	5.05	10.17	S16	
HUN362AW	16.26	—	17.77	9.16	11.53	5.05	10.17	S17	
HUN362AS	16.27	17.46	—	9.17	11.47	5.33	10.46	—	
HUN362CJ ^②	16.26	17.46	—	9.17	—	5.33	10.46	—	
HUN363	21.95	23.15	—	9.64	12.01	5.05	10.17	S10	
HUN363AW	21.95	—	23.46	9.64	11.97	5.05	10.17	S11	
HUN364	29.90	31.07	—	14.62	16.98	6.36	12.33	S12	
HUN364AS	29.96	31.07	—	14.62	16.95	6.63	12.58	—	
HUN364AW	29.90	—	31.42	14.61	16.99	6.36	12.33	S13	

VBI Design Double Throw Dimensions (Inches)^⑤

Catalog Number	Enclosure			Mounting		
	A	B	C	D	E	F
(30-600A Type 1 & 3R) ^⑤						
HDHN321, HDHN321AW	29.12	9.53	6.09	23.50	6.75	0.268
HDUN223, HDUN323, HDUN323AW,	27.62	12.18	6.09	19.36	8.00	0.268
HDUN224, HDUN224AW	36.00	19.12	6.42	31.02	15.00	0.44

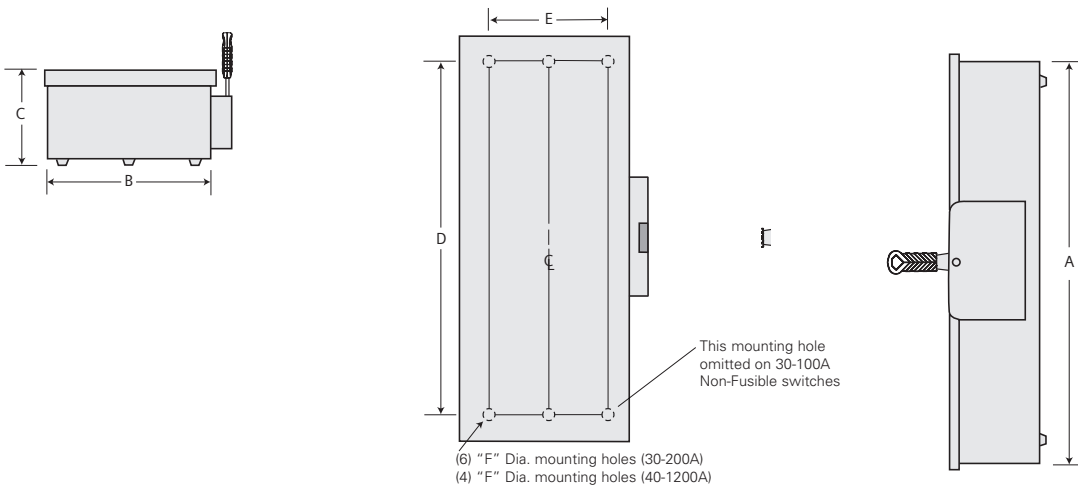

- ① Knockouts not provided on Type 4/4X and 12 or on 800 & 1200A switches.
- ② Dimensions are for switch-less receptacle & mounting feet.
- ③ Accurate to $\pm 1/8$ ".
- ④ For dimensions in millimeters, multiply inches by 25.4.
- ⑤ Drip hood not shown but supplied on Type 3R enclosures.

S1

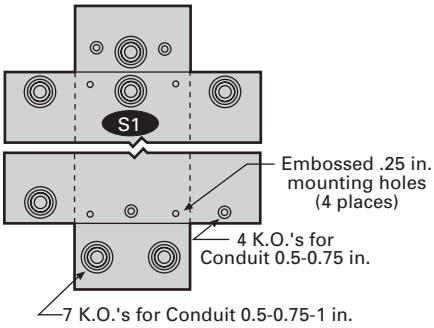

S2

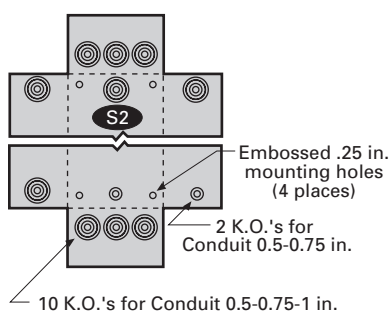

S3

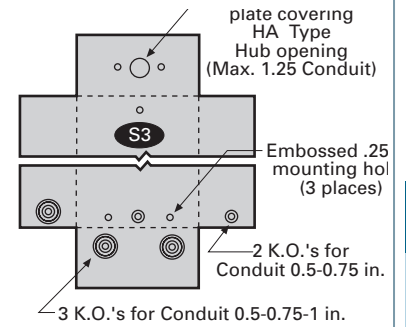

S4

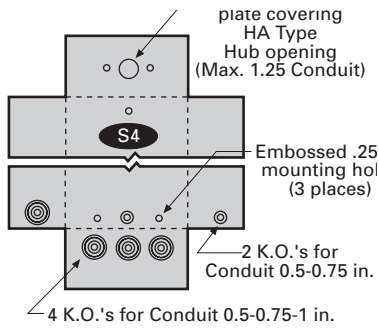

S5

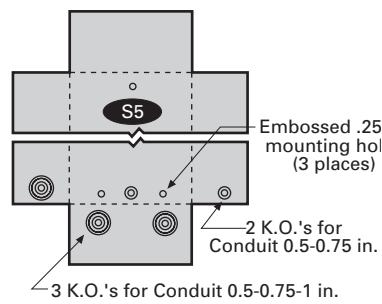

S6

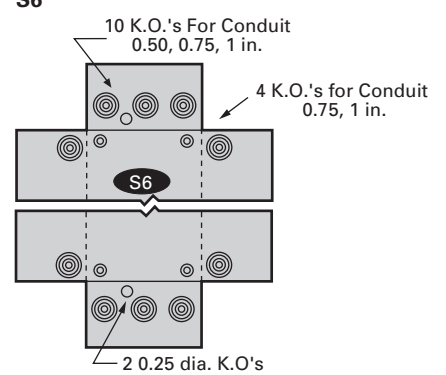

S7

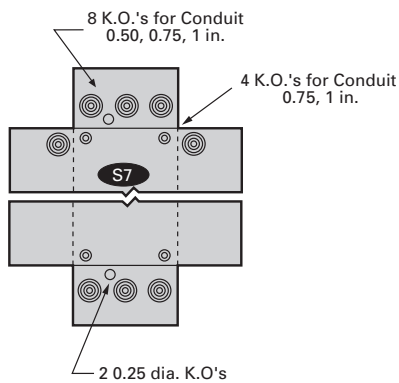

S8

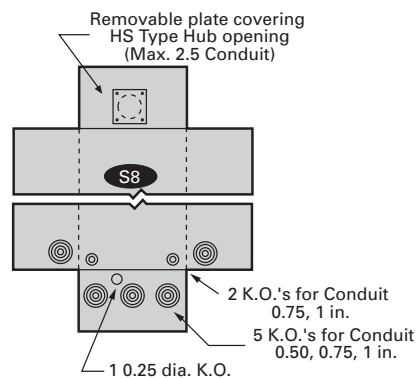

Knockout Drawings

S9

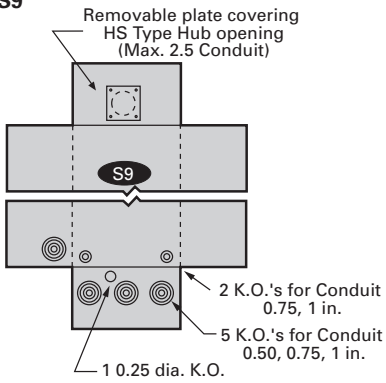

S10

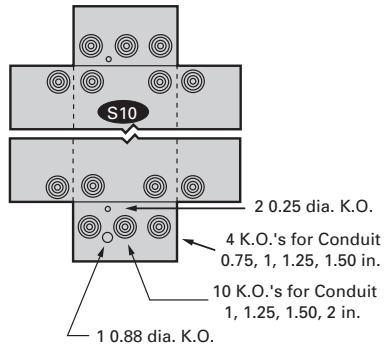

S11

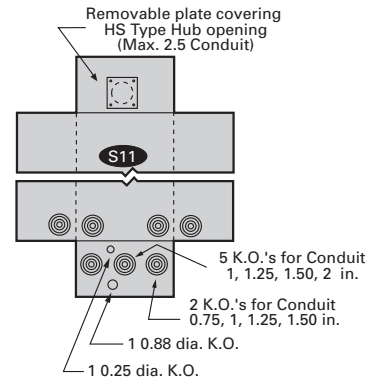

S12

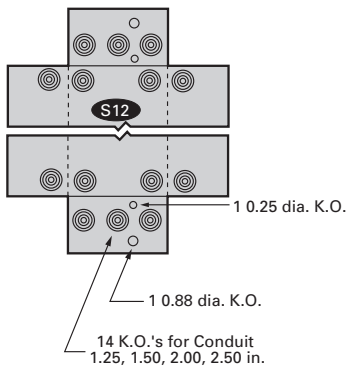

S13

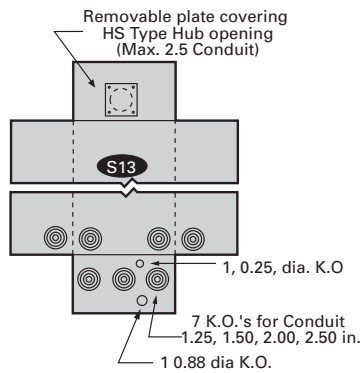

S14

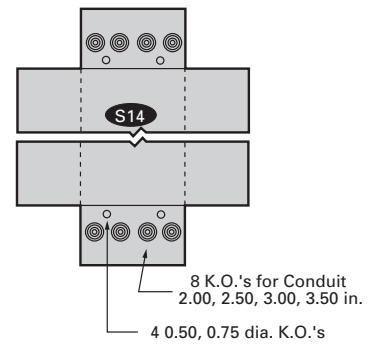

S15

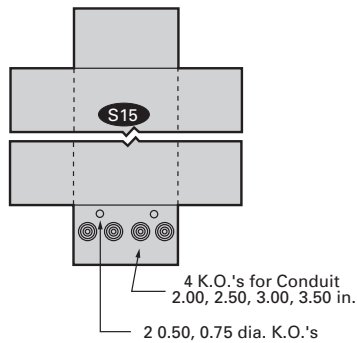

S16

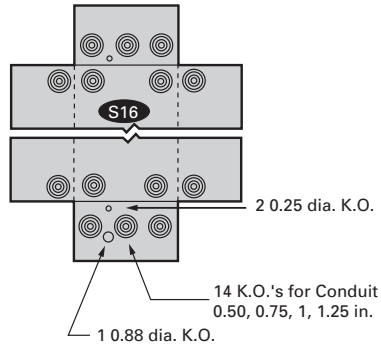

S17

