

SPECIAL PURPOSE ELECTRICAL FASTENERS

METALLICS IS THE ONLY FASTENER SUPPLIER TO AMERICA'S DISTRIBUTORS TO MANUFACTURE ITS OWN GROUNDING SCREWS



Manufactured by Avanti Screw, Inc., A Metallics Affiliate

GROUNDING SCREW

ROUND HEAD WASHER "COMBO" SLOTTED / PHILLIPS
STEEL GREEN ZINC CHROMATE



STOCK NO.	BOX UPC NO.	JAR UPC NO.	SIZE	WT. PER PKG.	STD. PKG.	SUGGESTED TRADE LIST PRICE PER
GS20	16105		10-32 x 3/8	.58	100	6.53/c
JGS20		82643	10-32 x 3/8	.54	100	6.53/c
GS20500		82005	10-32 x 3/8	2.75	500	27.70/ea pkg

OTHER SIZES AND QUANTITIES AVAILABLE BY REQUEST

* Denotes a product NOT manufactured in the USA (Drivers Only)

GROUNDING SCREW

HEX WASHER "COMBO" SLOTTED / PHILLIPS
DOG POINT - STEEL GREEN ZINC CHROMATE



STOCK NO.	BOX UPC NO.	JAR UPC NO.	SIZE	WT. PER PKG.	STD. PKG.	SUGGESTED TRADE LIST PRICE PER
JGSH19*		82079	8/32 x 5/16 Type F	.35	100	10.55/c NEW
GSH20	16110		10-32 x 3/8	.57	100	6.53/c
JGSH20		82080	10-32 x 3/8	.55	100	6.53/c
GSH20500		82010	10-32 x 3/8	2.45	500	27.70/ea pkg

*SLOTTED ONLY

*DENOTES A PRODUCT NOT MANUFACTURED IN THE USA (DRIVERS ONLY)

OTHER SIZES AND QUANTITIES AVAILABLE BY REQUEST



Manufactured by Avanti Screw, Inc., A Metallics Affiliate



GROUNDING SCREW

HEX WASHER "COMBO" SLOTTED / PHILLIPS
TYPE 23 THREAD CUTTING
STEEL GREEN ZINC CHROMATE



STOCK NO.	BOX UPC NO.	JAR UPC NO.	SIZE	WT. PER PKG.	STD. PKG.	SUGGESTED TRADE LIST PRICE PER
GSH23	16115		10-32 x 3/8	.53	100	6.53/c
JGSH23		82091	10-32 x 3/8	.54	100	6.53/c
GSH23500		82015	10-32 x 3/8	2.55	500	27.70/ea pkg

OTHER SIZES AND QUANTITIES AVAILABLE BY REQUEST

<p>EASTERN</p> <p>8:00 A.M. to 5:00 P.M.</p>  <p>Metallics, Inc. CT</p>	<p>CENTRAL</p> 	<p>MOUNTAIN</p> <p>8:00 A.M. to 5:00 P.M.</p>  <p>Metallics, West Inc. CO</p>
<p>In the event Metallics East, Bristol is CLOSED, call Metallics West at 1-800-269-5183 if you require technical information or overnight shipments</p>		

WE ARE HERE TO SERVE ALL OF YOUR FASTENER AND ANCHOR NEEDS

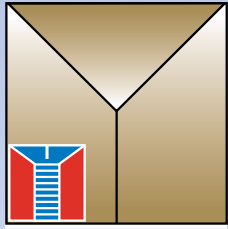

Metallics

8" Grounding Pigtails



[CONTRACTOR APPROVED]



- #12 Solid Copper Wire with Grounding Screw attached.
- 10-32 x 3/8 Hex Head Phillips/Slotted Dog Point Steel Green Zinc.



**Made in USA
Wire Only**



 Hex Head Phillips

PART #	UPC #	DESCRIPTION	QTY / PKG	SUG. TRADE LIST / PKG
PT408	16008	8" Lg. Grounding Pigtails w/Grounding Screw Attached 10-32 x 3/8 Hex Head Phillips/Slotted Dog Point Screw	100	\$ 62.83

"Growth Through Innovation"

Metallics

229 Cross Street, Bristol, CT 06010
Tel 800-243-8272 • **Fax** 800-831-9358
Email sales@metallicsonline.com





Metallics West

651 North Main Street, Mancos, CO 81328
Tel 800-269-5183 • **Fax** 800-269-6278
Email saleswest@metallicsonline.com



SPECIAL PURPOSE ELECTRICAL FASTENERS

Four drives in one head

-  Hex
-  Slotted
-  Phillips
-  Square Drive

Introduced in 1999

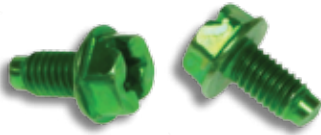

GROUNDING SCREW

"QUADRI"VE" HEX WASHER, SLOTTED, PHILLIPS
AND SQUARE DRIVE DOG POINT
STEEL GREEN ZINC CHROMATE



STOCK NO.	BOX UPC NO.	JAR UPC NO.	SIZE	WT. PER PKG.	STD. PKG.	SUGGESTED TRADE LIST PRICE PER
GSH21	16111		10-32 x 3/8	.65	100	6.53/c
JGSH21		82081	10-32 x 3/8	.63	100	6.53/c
GSH21500		82011	10-32 x 3/8	2.99	500	27.70/ea pkg

OTHER SIZES AND QUANTITIES AVAILABLE BY REQUEST

Four drives in one head

-  Hex
-  Slotted
-  Phillips
-  Square Drive

Introduced in 1999



GROUNDING SCREW

"QUADRI"VE" HEX WASHER, SLOTTED, PHILLIPS
AND SQUARE DRIVE - TYPE 23 THREAD CUTTING
STEEL GREEN ZINC CHROMATE



STOCK NO.	BOX UPC NO.	JAR UPC NO.	SIZE	WT. PER PKG.	STD. PKG.	SUGGESTED TRADE LIST PRICE PER
GSH22	16112		10-32 x 3/8	.53	100	6.53/c
JGSH22		82090	10-32 x 3/8	.57	100	6.53/c
GSH22500		82012	10-32 x 3/8	2.97	500	27.70/ea pkg

OTHER SIZES AND QUANTITIES AVAILABLE BY REQUEST



7 INCH

-  Phillips
-  Hex

GROUNDING PIGTAILS

WITH HEX WASHER "COMBO" SLOTTED
PHILLIPS DOG POINT
STEEL GREEN ZINC
GROUNDING SCREW ATTACHED



STOCK NO.	UPC NO.	SIZE	WT. PER PKG.	STD. PKG.	SUGGESTED TRADE LIST PRICE PER
SOLID COPPER INSULATED WIRE IN A PLASTIC BOX					
PT30	16000	#14 Wire	1.51	Box of 100	41.65/ea pkg
PT40	16005	#12 Wire	2.00	Box of 100	46.68/ea pkg
PT40K	10679	#12 Wire	4.77	Jar of 250	110.18/ea pkg

THE PT40K COMES IN A PLASTIC JAR

OTHER SIZES AND QUANTITIES AVAILABLE BY REQUEST

SPECIAL PURPOSE ELECTRICAL FASTENERS



GROUNDING PIGTAILS

WITH HEX WASHER "COMBO"
SLOTTED/PHILLIPS DOG POINT
STEEL GREEN ZINC
GROUNDING SCREW ATTACHED



7 INCH

STOCK NO.	UPC NO.	SIZE	WT. PER PKG.	STD. PKG.	SUGGESTED TRADE LIST PRICE PER
STRANDED COPPER INSULATED WIRE (with fork and ring terminal) IN A PLASTIC BOX					
PTS30	16001	#14 Wire	1.13	Box of 50	42.78/ea pkg
PTS40	16006	#12 Wire	1.41	Box of 50	58.25/ea pkg

OTHER SIZES AND QUANTITIES AVAILABLE BY REQUEST



GROUNDING PIGTAILS

WITH HEX WASHER "COMBO"
SLOTTED/PHILLIPS DOG POINT
STEEL GREEN ZINC
GROUNDING SCREW ATTACHED



7 INCH

STOCK NO.	UPC NO.	SIZE	WT. PER PKG.	STD. PKG.	SUGGESTED TRADE LIST PRICE PER
BARE SOLID COPPER WIRE (the economic alternative) IN A PLASTIC BOX					
PT30B	16015	#14 Wire	1.42	Box of 100	38.83/ea pkg
PT40B	16010	#12 Wire	1.87	Box of 100	46.15/ea pkg

OTHER SIZES AND QUANTITIES AVAILABLE BY REQUEST



GROUNDING PIGTAILS

WITH "QUADRI"VE" HEX WASHER, SLOTTED,
PHILLIPS, SQUARE DRIVE, DOG POINT
STEEL GREEN ZINC
GROUNDING SCREW ATTACHED



7 INCH

The QuaDrive

□
Square Drive

⬡
Hex

◌
Slotted

⊕
Phillips

⊕
QuaDrive

+ + + =

America's Newest Drive - Designed, Developed and Manufactured by Metallics/Avanti Screw

STOCK NO.	UPC NO.	SIZE	WT. PER PKG.	STD. PKG.	SUGGESTED TRADE LIST PRICE PER
SOLID COPPER INSULATED WIRE IN A PLASTIC BOX					
PT35	16021	#14 Wire	1.62	Box of 100	41.65/ea pkg
PT45	16005	#12 Wire	2.06	Box of 100	46.68/ea pkg

OTHER SIZES AND QUANTITIES AVAILABLE BY REQUEST

SPECIAL PURPOSE ELECTRICAL FASTENERS

GROUNDING PIGTAILS

WITH HEX WASHER "COMBO"
SLOTTED/PHILLIPS DOG POINT
STEEL GREEN ZINC
GROUNDING SCREW ATTACHED

Wire
MADE IN USA

Assembled in
USA

10 INCH

STOCK NO.	UPC NO.	SIZE	WT. PER PKG.	STD. PKG.	SUGGESTED TRADE LIST PRICE PER
SOLID COPPER INSULATED WIRE IN A PLASTIC BAG					
PT4010	16007	#12 Wire	.65	Bag of 25	13.45/ea pkg of 25
PT4010V	16092	#12 Wire	13.00	500	242.00/ea pkg



Hex



Phillips

OTHER SIZES AND QUANTITIES AVAILABLE BY REQUEST

GROUNDING PIGTAILS

WITH "QUADRI" HEX WASHER, SLOTTED/PHILLIPS,
SQUARE DRIVE DOG POINT
STEEL GREEN ZINC
GROUNDING SCREW ATTACHED

Wire
MADE IN USA

Screws
Manufactured by
Avanti Screw, Inc.,
A Metallics
Affiliate
Assembled in
USA

12 INCH

STOCK NO.	UPC NO.	SIZE	WT. PER PKG.	STD. PKG.	SUGGESTED TRADE LIST PRICE PER
SOLID COPPER INSULATED WIRE IN A PLASTIC BAG					
PT4012	16012	#12 Wire	.72	Bag of 25	14.28/ea pkg of 25
PT4012V	16094	#12 Wire	15.50	500	270.98/ea pkg NEW







Hex



Phillips

OTHER SIZES AND QUANTITIES AVAILABLE BY REQUEST

The QuaDrive

 +
  +
  +
  =
 

Square Drive Hex Slotted Phillips QuaDrive

America's Newest Drive - Designed, Developed and
Manufactured by Metallics/Avanti Screw

GROUNDING CLIPS

STEEL GREEN ZINC CHROMATE
DESIGNED TO FIT #10-#12-#14
COPPER OR ALUMINUM WIRE

STOCK NO.	BOX UPC NO.	UPC NO.	WT. PER PKG.	STD. PKG.	SUGGESTED TRADE LIST PRICE PER
CG20	16100		.42	100	16.33/c
JCG20		83100	1.78	5000 Jar	63.36/ea pkg
CG20500		82649	.40	100	16.33/c

OTHER SIZES AND QUANTITIES AVAILABLE BY REQUEST

SPECIAL PURPOSE ELECTRICAL FASTENERS



THREE-IN-ONE TAP THREAD CLEANING TOOL

STOCK NO.	UPC NO.	DESCRIPTION	WT. PER PKG.	STD. PKG.	SUGGESTED TRADE LIST PRICE PER
681032	16345	6-32,8-32,10-32 Thread Cleaning Tool	.21	1	29.00/ea

OTHER SIZES AND QUANTITIES AVAILABLE BY REQUEST



GRAY CONICAL PLASTIC WALL ANCHOR KITS

A SPECIAL USE WALL ANCHOR KIT FOR HANGING RACEWAY. THE 10 X 1 FLAT HEAD PHILLIPS SMS ZINC PLATED FITS FLUSH WITH METAL AND WILL NOT DAMAGE WIRE

MASTER
CARTONS
CONTAIN:
25 KITS
18 JARS



STOCK NO.	UPC NO.	DESCRIPTION OF CONTENTS	WT. EACH	SUGGESTED TRADE LIST PRICE PER
ANCHOR KIT DESIGNED FOR RACEWAY				
WAK23F	39182/kit	100 - 1/4 Gray Ribbed Anchors	.80	13.25/ea kit
WAKJ23F	20745/jar	100 - 10 x 1 Flat Head Phillips Screws 1 - 1/4 Masonry Drill	.80	13.25/ea kit

OTHER SIZES AND QUANTITIES AVAILABLE BY REQUEST

TELECOM CABINET SCREW

For use in telecom cabinets,
relay racks and patch panels

BIND HEAD (SLOTTED, PHILLIPS, SQUARE DRIVE)

TRI-DRIVE STEEL MACHINE SCREW/DOG (LEAD) POINT/ZINC PLATED/BLACK PHOSPHATE
PACKAGED IN PLASTIC VISUAL HANGING BOXES

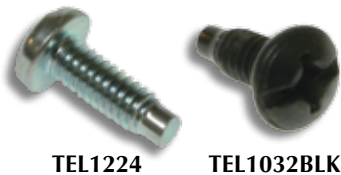

TEL1224

TEL1032BLK

STOCK NO.	UPC NO.	SIZE	WT. PER PKG.	STD. PKG.	SUGGESTED TRADE LIST PRICE PER	
TEL1024BLK	39250	10-24 x 5/8	.52	50	25.00/ea pkg	NEW
TEL1032BLK	39260	10-32 x 5/8	.52	50	25.00/ea pkg	NEW
TEL1224	39096	12-24 x 5/8	.48	50	8.73/ea pkg	
TEL1224BLK	39097	12-24 x 5/8	.48	50	26.55/ea pkg	NEW
TEL1228	39095	12-28 x 5/8	.52		8.73/ea pkg	NEW

OTHER SIZES AND QUANTITIES AVAILABLE BY REQUEST
JAR PACKAGING ALSO AVAILABLE

SPECIAL PURPOSE ELECTRICAL FASTENERS

CAGE NUTS

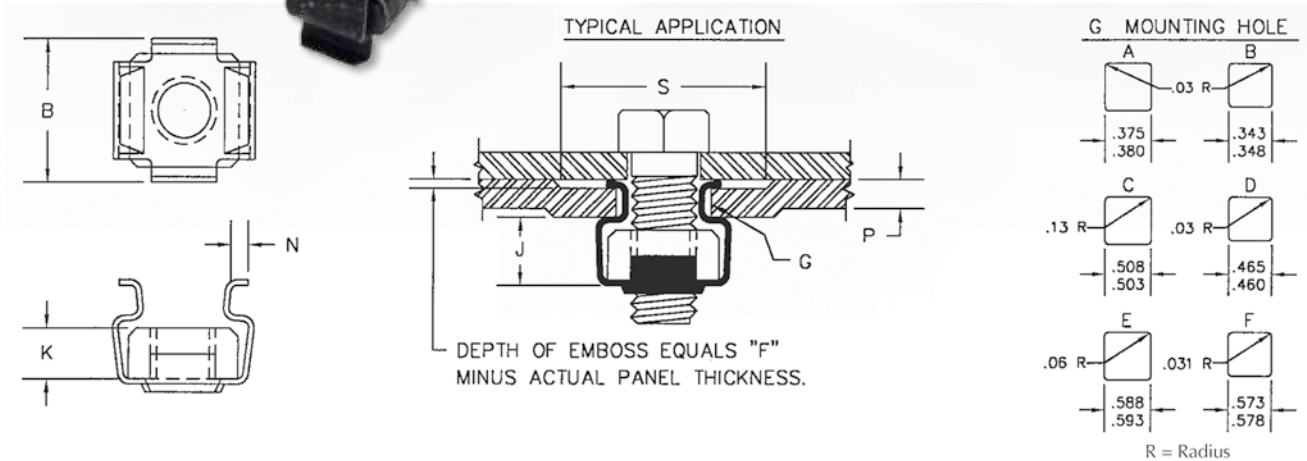

SCREW SIZE	PANEL RANGE P	F	S	MNTG. HOLE G	B	J	N	K	PART NUMBER
12-24	.025 - .063	0.1	0.531	A or B	0.52	0.06	0.6	0.156	CNN1224
10-24	.025 - .063	0.1	0.531	A or B	0.52	0.06	0.6	0.156	CNN1024
10-32	.025 - .063	0.1	0.531	A or B	0.52	0.06	0.6	0.156	CNN1032

OTHER SIZES AND QUANTITIES AVAILABLE BY REQUEST
SOME SIZES AVAILABLE IN STAINLESS STEEL

STOCK NO.	UPC NO.	DESCRIPTION OF CONTENTS	QTY./PKG.	SUGGESTED TRADE LIST PRICE PER
CNN1224	30035	12-24 Cage Nuts .025 - .063 Panel Range .343 - .348 or .375 - .380 Mounting Hole Black Phosphate Coated	50	33.35
CNN1024	30030	10-24 Cage Nut .025 - .063 Panel Range .343 - .348 or .375 - .380 Mounting Hole Black Phosphate Coated	50	29.78
CNN1032	30025	10-32 Cage Nut .025 - .063 Panel Range .343 - .348 or .375 - .380 Mounting Hole Black Phosphate Coated	50	27.30

OTHER SIZES AND QUANTITIES AVAILABLE BY REQUEST

SPECIAL PURPOSE ELECTRICAL FASTENERS

CAGE NUT KITS

FOR USE IN TELECOM CABINETS, RELAY RACKS AND PATCH PANELS



Each kits contains 50 Cage Nuts and 50 Screws

- Three Different Sizes:
 - 12-24
 - 10-24
 - 10-32
- Screws are Pan Head, Tri-Drive (Slotted, Phillips, Square Drive), Lead-Point 5/8" Long Black Phosphate.
- Cage Nuts are for Panel thickness of range .025-.063 with a mounting hole of .343-.348 or .375-.380 and are phosphate coated.

STOCK NO.	UPC NO.	DESCRIPTION OF CONTENTS	QTY./PKG.	SUGGESTED TRADE LIST PRICE PER
CNN1224K	85595	12-24 Cage Nuts .025-.063 Panel Range Mounting Hole .343-.348 or .375-.380 12-24 x 5/8" Pan Head, Tri-Drive, Lead Point, Black Screw	50 of ea.	56.88
CNN1024K	85585	10-24 Cage Nuts .025-.063 Panel Range Mounting Hole .343-.348 or .375-.380 10-24 x 5/8" Pan Head, Tri-Drive, Lead Point, Black Screw	50 of ea.	52.08
CNN1032K	85590	10-32 Cage Nuts .025-.063 Panel Range Mounting Hole .343-.348 or .375-.380 10-32 x 5/8" Pan Head, Tri-Drive, Lead Point, Black Screw	50 of ea.	49.83

OTHER SIZES AND QUANTITIES AVAILABLE BY REQUEST

MANUFACTURING CAPABILITIES

Diameter range #2 thru 5/16" / 1.5mm thru 8mm • Length range 1/8" thru 3" / 3.5mm thru 75mm
Materials: Steel, Brass, Stainless, Aluminum, Bronze.

NEED SCREWS...
Let Us Make Them For You!



A METALLICS AFFILIATE
P.O. Box 1600 • 231 Cross Street
Bristol, CT 06011-1600
Tel: 800-984-8945 • Fax: 800-984-8946

CAPABILITIES LIST

PLANT SIZE: 100,000 SQUARE FEET

LOCATION: Bristol, Connecticut

EQUIPMENT: 27 Hi-Speed Cold Headers
8 Burr-Free Screw Slotters
3 Shank Slotters
2 Pointers
14 High Speed Thread Rollers

MADE IN USA



ADDITIONAL PLANT INFO: Modern shipping facility utilizing digital scale counting machines. In-house packaging facilities - boxing, sorting, baggings. All material boxed, palletized & labeled with your needs in mind for domestic or export shipping.

SECONDARY WORK: All plating & heat treating is done on the outside and certified for your guarantee.

INFORMATION SYSTEMS: Our facility has new and upgraded Technology to meet your customers specific requirements.

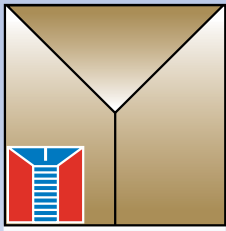

Metallics



Secura-lets™ Spacers

**[CONTRACTOR
APPROVED]**



- Stackable spacers for wiring devices
- Fill gaps and bring devices flush with surface
- Supports devices securely to wallbox
- Prevents broken faceplates
- Spacers are flame-retardant PVC
- U.L. 94 V-O flame rating and weatherability ratings
- Gray color disassociates any notion of an earth-ground connection
- U.L. recognized electrical grade PVC

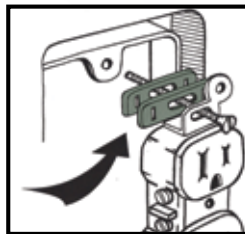

PART #	UPC #	DESCRIPTION	QTY / PKG	SUG. TRADE LIST / PKG
SLSP50	71664	Secura-Lets Spacers for Electrical Devices	50	\$ 8.08

★ ★ ★ ★ ★ *"Growth Through Innovation"* ★ ★ ★ ★ ★

Metallics

229 Cross Street, Bristol, CT 06010
Tel 800-243-8272 • **Fax** 800-831-9358
Email sales@metallicsonline.com

Metallics West

651 North Main Street, Mancos, CO 81328
Tel 800-269-5183 • **Fax** 800-269-6278
Email saleswest@metallicsonline.com

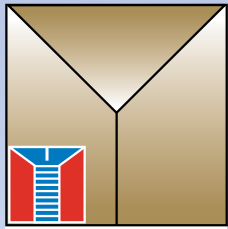

Metallics Wire Terminal Kit



MWTK1 Kit Contains 240 of the most Common Vinyl Insulated Wire Terminals, Plus Crimping Tool in a Plastic Case.

[CONTRACTOR APPROVED]

Other sizes, materials and quantities available by request.

PART #	UPC #	DESCRIPTION	QTY / PKG	SUG. TRADE LIST / PKG
MWTK1	39450	Wire Terminal Crimper 22-10 ga	1	\$ 112.03
		#22-#18 Butt Connector	20	
		#16-#14 Butt Connector	20	
		#12-#10 Butt Connector	20	
		#12-#10 Ring Connector #8 Stud	10	
		#12-#10 Ring Connector #10 Stud	10	
		#12-#10 Ring Connector 5/16 Stud	10	
		#12-#10 Ring Connector 3/8 Stud	10	
		#16-#14 Ring Connector #6 Stud	10	
		#16-#14 Ring Connector #10 Stud	10	
		#22-#18 Ring Connector #6 Stud	10	
		#22-#18 Ring Connector #10 Stud	10	
		#12-#10 Spade Connector #6 Stud	10	
		#12-#10 Spade Connector #10 Stud	10	
		#16-#14 Spade Connector #6 Stud	10	
		#16-#14 Spade Connector #10 Stud	10	
		#22-#18 Spade Connector #6 Stud	10	
		#22-#18 Spade Connector #10 Stud	10	
		#16-#14 250QDC Male	10	
		#16-#14 250QDC Female	10	
		#22-#18 250QDC Male	10	
		#22-#18 250QDC Female	10	



★ ★ ★ ★ ★ "Growth Through Innovation" ★ ★ ★ ★ ★

Metallics

229 Cross Street, Bristol, CT 06010
Tel 800-243-8272 • **Fax** 800-831-9358
Email sales@metallicsonline.com

Metallics West

651 North Main Street, Mancos, CO 81328
Tel 800-269-5183 • **Fax** 800-269-6278
Email saleswest@metallicsonline.com

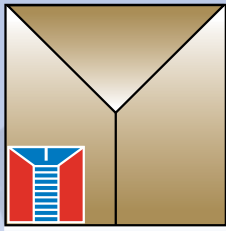

Metallics Wire Terminals



The most commonly Vinyl Insulated Terminals... Rings, Spades, Disconnects, and Butt Connectors.

[CONTRACTOR APPROVED]

Other sizes, materials and quantities available by request.

PART #	UPC #	DESCRIPTION	QTY / PKG	SUG. TRADE LIST / PKG
MWTCT1	39452	Wire Terminal Crimper 22-10 ga	1	\$ 19.82
MWBC2218	39458	#22-#18 Butt Connector	100	\$ 17.41
MWBC1614	39461	#16-#14 Butt Connector	100	\$ 19.68
MWBC1210	39464	#12-#10 Butt Connector	100	\$ 26.18
MWRC12108	40113	#12-#10 Ring Connector #8 Stud	100	\$ 28.15
MWRC121010	40114	#12-#10 Ring Connector #10 Stud	100	\$ 28.15
MWRC121056	40116	#12-#10 Ring Connector 5/16 Stud	100	\$ 34.88
MWRC121038	40117	#12-#10 Ring Connector 3/8 Stud	100	\$ 34.88
MWRC16146	40106	#16-#14 Ring Connector #6 Stud	100	\$ 19.85
MWRC161410	40108	#16-#14 Ring Connector #10 Stud	100	\$ 20.33
MWRC22186	40100	#22-#18 Ring Connector #6 Stud	100	\$ 17.25
MWRC121010	40102	#22-#18 Ring Connector #10 Stud	100	\$ 17.25
MWSC12106	40134	#12-#10 Spade Connector #6 Stud	100	\$ 24.53
MWSC121010	40136	#12-#10 Spade Connector #10 Stud	100	\$ 24.53
MWSC16146	40128	#16-#14 Spade Connector #6 Stud	100	\$ 22.25
MWSC161410	40130	#16-#14 Spade Connector #10 Stud	100	\$ 22.25
MWSC22186	40122	#22-#18 Spade Connector #6 Stud	100	\$ 20.43
MWSC221810	40124	#22-#18 Spade Connector #10 Stud	100	\$ 20.43
MQDC1614M	39470	#16-#14 250QDC Male	100	\$ 21.88
MQDC1614F	39483	#16-#14 250QDC Female	100	\$ 21.00
MQDC2218M	39469	#22-#18 250QDC Male	100	\$ 21.88
MQDC2218F	39481	#22-#18 250QDC Female	100	\$ 21.00

“Growth Through Innovation”

Metallics

229 Cross Street, Bristol, CT 06010
Tel 800-243-8272 • **Fax** 800-831-9358
Email sales@metallicsonline.com

Metallics West

651 North Main Street, Mancos, CO 81328
Tel 800-269-5183 • **Fax** 800-269-6278
Email saleswest@metallicsonline.com

SPECIAL PURPOSE ELECTRICAL FASTENERS



WALL PLATE SCREW

STEEL AND STAINLESS STEEL
SLOTTED OVAL HEAD • PLATED AND PAINTED
PACKAGED IN VISUAL PLASTIC HANGING BOX

STOCK NO.	UPC NO.	SIZE	COLOR	WT. PER PKG.	STD. PKG. MSTR. SLEEVE	SUGGESTED TRADE LIST PRICE PER	
SP170	16406	6-32 x 1/2	Stainless Steel	.29	100/500	9.55/c	
SP176	16305	6-32 x 1/2	Brass Plate	.26	100/500	8.95/c	
SP177	16310	6-32 x 1/2	Nickel Plate	.29	100/500	8.33/c	
SP178	16315	6-32 x 1/2	Antique Black	.26	100/500	7.68/c	
SP179	16320	6-32 x 1/2	White	.28	100/500	7.68/c	
SP180	16325	6-32 x 1/2	Ivory	.29	100/500	7.68/c	
SP173	16300	6-32 x 1/2	Light Almond	.30	100/500	7.68/c	
SP181	16330	6-32 x 1/2	Gray	.28	100/500	6.10/c	NEW
SP182	16335	6-32 x 3/4	Brown	.28	100/500	3.55/c	
SP190	16303	6-32 x 3/4	White	.35	100/500	9.58/c	
SP191	16304	6-32 x 3/4	Ivory	.36	100/500	9.58/c	
SP382	10323	6-32 x 7/32	Brown	.18	100/500	15.53/c	NEW
SP380	10321	6-32 x 7/32	Ivory	.18	100/500	15.53/c	NEW
SP379	10320	6-32 x 7/32	White	.18	100/500	15.53/c	NEW
SP279	16301	6-32 x 1	White	.43	100/500	9.83/c	
SP280	16302	6-32 x 1	Ivory	.43	100/500	9.83/c	
SP283	16413	6-32 x 1	Stainless Steel	.43	100/500	12.60/c	NEW
SP172	16307	6-32 x 1 1/4	Stainless Steel	.44	100/500	15.73/c	NEW
SP281	16411	6-32 x 2	Ivory Switch Plate	.72	100/500	12.05/c	NEW
SP282	16412	6-32 x 2	White Switch Plate	.72	100/500	12.05/c	NEW

OTHER SIZES AND QUANTITIES AVAILABLE BY REQUEST

SWITCH PLATE SCREW KITS

A convenient assortment of Switch Plate Screws
in the most popular colors and finishes
Plated and Painted



275 PIECE RENOVATION KIT SPK100 CONTAINS:

50 Black, 50 Nickel, 50 Light Almond, 50 Ivory, 50 White
25 6-32 x 1 1/4 Flat Head Slot Switch Plate Screw, Zinc Plated

500 PIECE NEW CONSTRUCTION SPK101 CONTAINS:

100 each 6-32 x 1/2 Ivory, White, Stainless
75 each 6-32 x 1 Ivory, White
50 6-32 x 1 1/4 Flat Head Slot Switch Plate Screw, Zinc Plated

MASTER
CARTONS
CONTAIN:
25 KITS
18 JARS

STOCK NO.	UPC NO.	DESCRIPTION OF CONTENTS	WT. EACH	SUGGESTED TRADE LIST PRICE PER
SPK100 RENOVATION	16400	6-32 x 1/2 Oval Head Steel Switch Plate Screw Assortment	1.84	21.50/ea pkg
SPK101 NEW CONSTRUCTION	16401	6-32 x 1/2 Oval Head Steel Switch Plate Screw Assortment	1.60	40.88/ea pkg

OTHER SIZES AND QUANTITIES AVAILABLE BY REQUEST

SPECIAL PURPOSE ELECTRICAL FASTENERS



NYLON SWITCH PLATE SCREW

SLOTTED OVAL HEAD
PACKAGED IN VISUAL PLASTIC HANGING BOX

STOCK NO.	UPC NO.	SIZE	STD. PKG.	WT. PER PKG.	STD. PKG./MSTR SLEEVE	SUGGESTED TRADE LIST PRICE PER
SPN300	16350	6-32 x 1/2"	100	.11	100/500	8.40/c

OTHER SIZES AND QUANTITIES AVAILABLE BY REQUEST



DECORATIVE SWITCH PLATE SCREW

STEEL, SLOTTED, UNDERCUT OVAL HEAD (PAINTED)
FOR WALL PLATES NOT ACCEPTING STANDARD
1/2" SWITCH PLATE SCREWS

STOCK NO.	UPC NO.	SIZE	COLOR	WT. PER PKG.	STD. PKG.	SUGGESTED TRADE LIST PRICE PER
SPD379	16321	6-32 x 1/4"	White	.14	50	3.33/ea pkg
SPD380	16326	6-32 x 1/4"	Ivory	.14	50	3.33/ea pkg
SPD382	16336	6-32 x 1/4"	Light Almond	.12	50	3.50/ea pkg
SPD383	16341	6-32 x 1/4"	Gray	.12	50	3.50/ea pkg
SPD381	16327	6-32 x 1/4"	Brown	.14	50	3.50/ea pkg NEW
SPD384	16342	6-32 x 1"	White	.25	50	4.35/ea pkg
SPD385	16343	6-32 x 1"	Ivory	.26	50	4.35/ea pkg

OTHER SIZES AND QUANTITIES AVAILABLE BY REQUEST



DECORATIVE SWITCH PLATE SCREW KIT

STEEL, SLOTTED, UNDERCUT OVAL HEAD
A convenient assortment of popular colors
For wall plates not accepting standard
1/2" switch plate screws.

250 PIECE SPDK200 KIT CONTAINS:

6-32 x 1/4" - 50 White, 50 Ivory, 50 Light Almond, 50 Gray
PLUS
6-32 x 1" - 25 White, 25 Ivory

STOCK NO.	UPC NO.	DESCRIPTION OF CONTENTS	WT. PER KIT	STD. PKG./MSTR. CARTON	SUGGESTED TRADE LIST PRICE PER
SPDK200	16405	6-32 x 1/4" & 1" Assorted Steel Slotted, Undercut, Oval Head Switch Plate Screws	.68	1/25 Kits	22.18/ea kit

OTHER SIZES AND QUANTITIES AVAILABLE BY REQUEST

SPECIAL PURPOSE ELECTRICAL FASTENERS

TAMPER-RESIST SPANNER OVAL HEAD SWITCH PLATE SCREW



STAINLESS STEEL

Only authorized persons would normally have a spanner driver to extract this screw

A special wall plate screw for use in public areas like restrooms where water, mist and vapors are present that could corrode ordinary steel screws. Vandalism is discouraged due to the unique nature of the Spanner Driver.*



Spanner

Packaged in Visual Plastic Hanging Boxes

STOCK NO.	UPC NO.	SIZE	WT. PER PKG.	STD. PKG.	SUGGESTED TRADE LIST PRICE PER
SPT300	10270	6-32 x 1	.27	50	36.83/ea pkg NEW
SPT200	16355	6-32 x 1/2	.19	50	35.98/ea pkg
SPT400	10275	6-32 x 1 1/2	.35	50	49.83/ea pkg

*COMES COMPLETE WITH 00SP6B SPANNER INSERT DRIVER

OTHER SIZES AND QUANTITIES AVAILABLE BY REQUEST

RECEPTACLE AND WIRING DEVICES SCREW



TRUSS HEAD COMBO (PHILLIPS/SLOTTED)

STEEL MACHINE SCREW - **HARDENED TYPE F ZINC PLATED**

For our product offering we have chosen to give an added benefit (not offered by our competition) by supplying a Type F thread-forming feature. We offer this because electricians in the field often use a screw that will thread a hole in plastic boxes or need it to clean out plaster.



Phillips

Packaged in Visual Plastic Hanging Boxes

STOCK NO.	UPC NO.	SIZE	WT. PER PKG.	STD. PKG.	SUGGESTED TRADE LIST PRICE PER
TM80	43138	6-32 x 1/2	.26	100	4.70/c
TM81	43141	6-32 x 3/4	.37	100	4.85/c
TM63	43144	6-32 x 1	.44	100	4.90/c
TM68	43147	6-32 x 1 1/4	.49	100	6.38/c
TM82	43150	6-32 x 1 1/2	.62	100	6.93/c
TM83	43153	6-32 x 2	.79	100	8.93/c

JAR PACKAGING ALSO AVAILABLE

OTHER SIZES AND QUANTITIES AVAILABLE BY REQUEST

RECEPTACLE AND WIRING DEVICES SCREW



TRUSS HEAD COMBO (PHILLIPS/SLOTTED)

STEEL MACHINE SCREW • **ZINC PLATED - LEAD POINT**

STARTS E-Z



Manufactured by Avanti Screw, Inc., A Metallics Affiliate



Phillips

Packaged in Visual Plastic Hanging Boxes

STOCK NO.	UPC NO.	SIZE	WT. PER PKG.	STD. PKG.	SUGGESTED TRADE LIST PRICE PER
TM80LP	43154	6-32 x 1/2	.28	100	4.25/c
TM81LP	43155	6-32 x 3/4	.38	100	4.35/c
TM63LP	43156	6-32 x 1	.44	100	4.38/c
TM68LP	43157	6-32 x 1 1/4	.52	100	5.73/c
TM82LP	43158	6-32 x 1 1/2	.62	100	6.23/c
TM83LP	43159	6-32 x 2	.79	100	8.03/c

OTHER SIZES AND QUANTITIES AVAILABLE BY REQUEST

JAR PACKAGING ALSO AVAILABLE

SPECIAL PURPOSE ELECTRICAL FASTENERS

INSULATING FOAM GASKETS



- Energy saving gaskets prevent heat and cold loss through outlets and switches located on outside walls.
- Constructed of UL Rated, close-cell polyethylene insulating foam.
- Available in three different designs: Toggle Switch, Duplex Receptacle & GFI or Decora

STOCK NO.	UPC NO.	DESCRIPTION	WT. PER EACH	STD. PKG.	SUGGESTED TRADE LIST PRICE PER
WGT25	71651	Toggle Switch	.14	25	6.38/ea pkg
WGR25	71652	Duplex Receptacle	.14	25	6.38/ea pkg
WGD25	71653	GFI/Decora	.14	25	6.38/ea pkg
WGT100	71654	Toggle Switch	.48	100	22.83/ea pkg
WGR100	71655	Duplex Receptacle	.48	100	22.83/ea pkg
WGD100	71656	GFI/Decora	.48	100	22.83/ea pkg
WGC100	71657	Combo Pack	.48	100	22.83/ea pkg

CONTAINS: 30 TOGGLE, 30 DUPLEX, 40 DECORA
OTHER SIZES AND QUANTITIES AVAILABLE BY REQUEST



THUMB SCREW ^{NEW}

STAINLESS STEEL 18-8 TYPE

STOCK NO.	UPC NO.	SIZE	WT. PER PKG.	STD. PKG.	SUGGESTED TRADE LIST PRICE PER
JTMS1SS	92893	1/4 - 20 x 1	1.68	100	136.55/c NEW
JTMS2SS	92894	1/4 - 20 x 2	2.67	100	235.06/c NEW

OTHER SIZES AND QUANTITIES AVAILABLE BY REQUEST



SPANNER INSERT DRIVER

For use in driving and extracting vandalism deterrent screw

STOCK NO.	UPC NO.	SIZE	WT. PER PKG.	STD. PKG.	SUGGESTED TRADE LIST PRICE PER
00SP6B	25027	#6	.01	1	5.03/ea

OTHER SIZES AND QUANTITIES AVAILABLE BY REQUEST



CONDUIT DRIVE STRAPS

ROUND TYPE
STEEL ZINC PLATED
PACKAGED IN CLEAR PLASTIC JARS



STOCK NO.	UPC NO.	SIZE EMT	SIZE PIPE & FLEX. COND.	SIZE OVERALL LENGTH	WT. PER PKG.	STD. PKG.	SUGGESTED TRADE LIST PRICE PER
STEEL ZINC PLATED For use in metal and plastic conduit and tubing							
CDS1	21200	3/8 - 1/2	3/8	2	1.93	100	21.43/c
CDS2	21205	3/4	1/2	2 1/4	2.23	100	24.33/c
CDS3	21210	1	3/4	2 1/4	2.37	100	27.73/c

OTHER SIZES AND QUANTITIES AVAILABLE BY REQUEST

CONTINUED ON NEXT PAGE

SPECIAL PURPOSE ELECTRICAL FASTENERS

CONTINUED



CONDUIT DRIVE STRAPS

ROUND TYPE
STEEL COPPER PLATED
PACKAGED IN CLEAR PLASTIC JARS



STOCK NO.	UPC NO.	SIZE COPPER TUBE	SIZE COPPER PIPE	SIZE OVERALL LENGTH	WT. PER PKG.	STD. PKG.	SUGGESTED TRADE LIST PRICE PER
-----------	---------	------------------	------------------	---------------------	--------------	-----------	--------------------------------

STEEL COPPER PLATED For use in areas requiring copper pipe and tubing

CDS5	21300	1/2	3/8 - 1/2	2	1.87	100	19.30/c
CDS6	21305	3/4	3/4	2 1/4	2.50	100	20.70/c

CONDUIT DRIVE STRAPS FOR PLUMBING ROUND TYPE, STEEL COPPER PLATED

OTHER SIZES AND QUANTITIES AVAILABLE BY REQUEST



CONDUIT DRIVE STRAPS

FLAT STAMPED TYPE GALVANIZED



EMT	UPC NO.	SIZE COPPER PIPE	SIZE	WT. PER PKG.	STD. PKG.	SUGGESTED TRADE LIST PRICE PER
-----	---------	------------------	------	--------------	-----------	--------------------------------

STAMPED GALVANIZED

SDS10	21215	3/8 - 1/2	3/8	1.70	100	18.60/c
SDS20	21220	3/4	1/2	2.13	100	21.13/c
SDS30	21225	1	3/4	2.29	100	22.55/c

OTHER SIZES AND QUANTITIES AVAILABLE BY REQUEST



PLUMBERS TAPE PERFORATED

STEEL GALVANIZED

STOCK NO.	UPC NO.	SIZE	WT. PER PKG.	STD. PKG. (100 ft total)	SUGGESTED TRADE LIST PRICE PER
HR750	22550	20 Gauge x 3/4	7.80	10 rolls of 10 ft. per pkg	34.00/ea pkg
HR770	22553	24 Gauge x 3/4	4.31	10 rolls of 10 ft. per pkg	18.25/ea pkg

COPPER AVAILABLE UPON REQUEST

OTHER SIZES AND QUANTITIES AVAILABLE BY REQUEST



NAIL PLATES

STEEL

For Romex, BX, UF, S.E.V. and other Cables
Other sizes & gauges available by request



STOCK NO.	UPC NO.	SIZE	GAUGE	WT. PER PKG.	STD. PKG.	SUGGESTED TRADE LIST PRICE PER
*NP400	16500	2 3/4" long x 1 1/2" wide	16	6.40	100	20.83/c
*NP400B	16510	1 1/2" long x 2 3/4" wide	16	33.90	500	116.56/ea pkg NEW
*NP660	16599	1 1/2" long x 5" wide	16	7.00	100	45.00/c NEW
*NP600	16503	5" long x 1 1/2" wide	20	7.18	100	30.88/c
*NP800	16504	5" long x 3" wide	16	24.25	100	53.38/c

*DIMENSIONS ON ALL NAIL PLATES/STRAPS ARE APPROXIMATE

OTHER SIZES AND QUANTITIES AVAILABLE BY REQUEST

SPECIAL PURPOSE ELECTRICAL FASTENERS



PLATE STRAP

STEEL



STOCK NO.	UPC NO.	SIZE	GAUGE	WT. PER PKG.	STD. PKG.	SUGGESTED TRADE LIST PRICE PER	
*NS1812	22548	1-1/2" x 8" hole	12	16.15	25	38.20/ea pkg	
*NS1816	22549	1-1/2" x 8" hole	16	45.45	25	28.47/ea pkg	
*NPL12	12194	1 1/2" long x 12" wide	18	19.00	50	56.25/ea pkg	NEW
*NP580	16520	5" long x 8" wide	16	32.00	50	155.15/ea pkg	NEW
*NPL188	16480	5" long x 18" wide	16	39.19	25	155.00/ea pkg	NEW

OTHER SIZES, GAUGES, AND QUANTITIES AVAILABLE BY REQUEST.

*DIMENSIONS ON ALL NAIL PLATES/STRAPS ARE APPROXIMATE



BOX SUPPORTS

STEEL

ELECTRO-GALVANIZED

STOCK NO.	UPC NO.	WT. PER PKG.	STD. PKG.	SUGGESTED TRADE LIST PRICE PER
SB300	16200	5.29	100 pairs/200 pieces total	52.70/ea pkg

OTHER SIZES AND QUANTITIES AVAILABLE BY REQUEST



100KOS

SIZE IS STAMPED ON SEAL

KNOCK-OUT SEALS

THE ULTIMATE IN HIGH QUALITY SAFETY
3-PIECE QUICK-SEAL TO PLUG HOLES IN PANEL BOXES

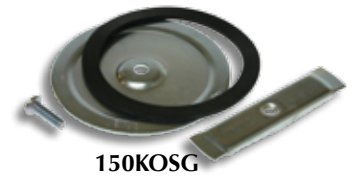

150KOSG

STOCK NO.	UPC NO.	DESCRIPTION	WT. PER PKG.	STD. PKG.	SUGGESTED TRADE LIST PRICE PER
50KOS	41301	1/2" - 3 piece K/O Seal	.25	10	15.48/ea pkg
75KOS	41302	3/4" - 3 piece K/O Seal	.33	10	20.83/ea pkg
100KOS	41303	1" - 3 piece K/O Seal	.47	10	21.15/ea pkg
125KOS	41304	1 1/4" - 3 piece K/O Seal	.74	10	22.83/ea pkg
150KOS	41306	1 1/2" - 3 piece K/O Seal	.95	10	28.88/ea pkg
200KOS	41307	2" - 3 piece K/O Seal	1.38	10	39.98/ea pkg
250KOS	41308	2 1/2" - 3 piece K/O Seal	2.10	10	69.18/ea pkg
300KOS	41309	3" - 3 piece K/O Seal	1.50	5	44.00/ea pkg
350KOS	41311	3 1/2" - 3 piece K/O Seal	1.93	5	62.08/ea pkg
400KOS	41312	4" - 3 piece K/O Seal	2.74	5	71.18/ea pkg

GASKETED

50KOSG	41650	1/2" - 4 piece K/O Seal	.30	10	29.00/ea pkg
75KOSG	41651	3/4" - 4 piece K/O Seal	.36	10	30.88/ea pkg
100KOSG	41652	1" - 4 piece K/O Seal	.45	10	34.75/ea pkg
125KOSG	41653	1 1/4" - 4 piece K/O Seal	.78	10	40.44/ea pkg
150KOSG	41654	1 1/2" - 4 piece K/O Seal	.94	10	53.58/ea pkg
200KOSG	41655	2" - 4 piece K/O Seal	1.62	10	66.75/ea pkg
250KOSG	41658	2 1/2" - 4 piece K/O Seal	2.10	10	111.63/ea pkg
300KOSG	41660	3" - 4 piece K/O Seal	1.74	5	71.45/ea pkg
400KOSG	41317	4" - 4 piece K/O Seal	2.94	5	78.63/ea pkg

OTHER SIZES AND QUANTITIES AVAILABLE BY REQUEST

SPECIAL PURPOSE ELECTRICAL FASTENERS



GALVANIZED NAIL-ON DRIVE RINGS

STEEL ZINC PLATED

PACKAGED 10 PER POLY BAG

STOCK NO.	UPC NO.	EYE SIZE	WT. PER PKG.	STD. PKG.	SUGGESTED TRADE LIST PRICE PER
MDR12	81549	1/2	.14	10	2.68/ea pkg
MDR58	81551	5/8	.14	10	3.38/ea pkg
MDR78	81553	7/8	.53	10	6.05/ea pkg
MDR114	81555	1 1/4	.78	10	8.05/ea pkg

OTHER SIZES AND QUANTITIES AVAILABLE BY REQUEST



MBR125

BRIDLE RINGS

STEEL ZINC PLATED

PACKAGED 10 PER POLY BAG



MBR150WS

STOCK NO.	UPC NO.	EYE SIZE/ THREAD SIZE	WT. PER PKG.	STD. PKG.	SUGGESTED TRADE LIST PRICE PER
MACHINE SCREW THREAD					
MBR125	81557	1 1/4 x 1/4-20	.72	10	13.45/ea pkg
MBR150	81559	1 1/2 x 1/4-20	.81	10	13.45/ea pkg
MBR200	81561	2 x 1/4-20	.97	10	13.45/ea pkg
WOOD SCREW THREAD					
MBR100WS	81560	1 x .230	.58	10	9.38/ea pkg
MBR150WS	81563	1 1/2 x .230	.79	10	19.50/ea pkg
MBR200WS	81565	2 x .230	.98	10	19.50/ea pkg

OTHER SIZES AND QUANTITIES AVAILABLE BY REQUEST

CONTRACTOR NAIL APRON

- Natural Canvas with 2 Large Pockets
- Large Pockets for Tools or Fasteners
- One Small Pocket for Pen or Pencil



STOCK NO.	UPC NO.	DESCRIPTION	QTY. PKG.	SUGGESTED TRADE LIST PRICE PER
NAP1	71740	Contractor Nail Apron - Natural Canvas - 2 Pockets	10	6.25/ea

OTHER SIZES AND QUANTITIES AVAILABLE BY REQUEST

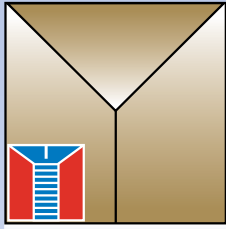

Metallics



Bright Common Nails

20D and 30D packaged in 50 lb. cartons

**[CONTRACTOR
APPROVED]**



MN30D50



MN20D50

PART #	UPC #	DESCRIPTION	APPROX. COUNT PER 50LB CARTON	SUG. TRADE LIST / PKG
MN20D50	21320	20D Bright Common Nails	1100	\$ 145.00
MN30D50	21330	30D Bright Common Nails	1450	\$ 145.00

H

★ ★ ★ ★ ★ *"Growth Through Innovation"* ★ ★ ★ ★ ★

Metallics

229 Cross Street, Bristol, CT 06010
Tel 800-243-8272 • **Fax** 800-831-9358
Email sales@metallicsonline.com

Metallics West

651 North Main Street, Mancos, CO 81328
Tel 800-269-5183 • **Fax** 800-269-6278
Email saleswest@metallicsonline.com

WE'VE GOT NAILS!



IN 2-1/2 POUND SQUARE JARS

You don't have to make an extra trip to the Home Centers to get your supply of nails. "They're Here." at your Metallics Distributor



BRIGHT COMMON NAILS

STEEL

For all types of rough-in wood construction

STOCK NO.	UPC NO.	SIZE	WT. PER PKG.	APPROX. COUNT	STD. PKG.	SUGGESTED TRADE LIST PRICE PER
MN8C	21226	8D	2.63	220	1 Jar	7.83/ea pkg
MN10C	21227	10D	2.63	140	1 Jar	7.83/ea pkg
MN16C	21228	16D	2.64	115	1 Jar	7.83/ea pkg

OTHER SIZES AND QUANTITIES AVAILABLE BY REQUEST



BRIGHT FINISH NAILS

STEEL

For interior and exterior wood finishes

STOCK NO.	UPC NO.	SIZE	WT. PER PKG.	APPROX. COUNT	STD. PKG.	SUGGESTED TRADE LIST PRICE PER
MN4F	21229	4D	2.61	1350	1 Jar	9.50/ea pkg
MN6F	21230	6D	2.62	1390	1 Jar	8.63/ea pkg

OTHER SIZES AND QUANTITIES AVAILABLE BY REQUEST



HOT GALVANIZED BOX NAILS

STEEL

For exterior areas affected by water and humidity

STOCK NO.	UPC NO.	SIZE	WT. PER PKG.	APPROX. COUNT	STD. PKG.	SUGGESTED TRADE LIST PRICE PER
MN6HG	21231	6D	2.62	450	1 Jar	10.13/ea pkg
MN8HG	21232	8D	2.63	290	1 Jar	10.13/ea pkg
MN10HG	21233	10D	2.66	190	1 Jar	9.93/ea pkg
MN16HG	21234	16D	2.64	135	1 Jar	10.13/ea pkg

OTHER SIZES AND QUANTITIES AVAILABLE UPON REQUEST



SPECIAL PURPOSE ELECTRICAL FASTENERS

Coating allows faster penetration



COATED SINKER NAILS

STEEL

For all types of rough-in wood construction

STOCK NO.	JAR UPC NO.	SIZE	WT. PER PKG.	APPROX. COUNT	STD. PKG.	SUGGESTED TRADE LIST PRICE PER
MN8S	21235	8D	2.63	340	1 Jar	7.73/ea pkg
MN10S	21236	10D	2.57	240	1 Jar	8.15/ea pkg
MN16S	21237	16D	2.67	140	1 Jar	7.55/ea pkg
MN16S50B	21295	16D	50.00	2,600	50 lb Box	180.50/ea pkg NEW
MN16SP	21285	16D	10.00	520	10 lb Pail	40.93/ea pkg NEW

OTHER SIZES AND QUANTITIES AVAILABLE UPON REQUEST

BRIGHT DUPLEX NAILS

STEEL

For temporary wood structure/Double head allows for ease of extraction and disassembly



STOCK NO.	JAR UPC NO.	SIZE	WT. PER PKG.	APPROX. COUNT	STD. PKG.	SUGGESTED TRADE LIST PRICE PER
MN8DP	21238	8D	2.61	200	1 Jar	8.73/ea pkg
MN16DP	21239	16D	2.63	105	1 Jar	8.73/ea pkg

OTHER SIZES AND QUANTITIES AVAILABLE UPON REQUEST

BRIGHT JOIST HANGER NAILS

STEEL

For all types of light brackets, straps in wood joists



STOCK NO.	JAR UPC NO.	SIZE	WT. PER PKG.	APPROX. COUNT	STD. PKG.	SUGGESTED TRADE LIST PRICE PER
MN114J	21240	1-1/4" - 9 GA	2.59	360	1 Jar	8.58/ea pkg
MN112J	21241	1-1/2" - 9 GA	2.60	300	1 Jar	8.73/ea pkg

OTHER SIZES AND QUANTITIES AVAILABLE UPON REQUEST

HEAT TEMPERED FLUTED MASONRY NAILS

STEEL

Nails designed to penetrate concrete and other masonry products



STOCK NO.	JAR UPC NO.	SIZE	WT. PER PKG.	APPROX. COUNT	STD. PKG.	SUGGESTED TRADE LIST PRICE PER
MN1TM	21242	1"	2.60	370	1 Jar	10.35/ea pkg
MN112TM	21243	1-1/2"	2.55	225	1 Jar	10.35/ea pkg
MN2TM	21244	2"	2.64	180	1 Jar	10.45/ea pkg
MN212TM	21245	2-1/2"	2.63	168	1 Jar	10.48/ea pkg
MN3TM	21246	3"	2.62	135	1 Jar	10.93/ea pkg

OTHER SIZES AND QUANTITIES AVAILABLE UPON REQUEST

SPECIAL PURPOSE ELECTRICAL FASTENERS

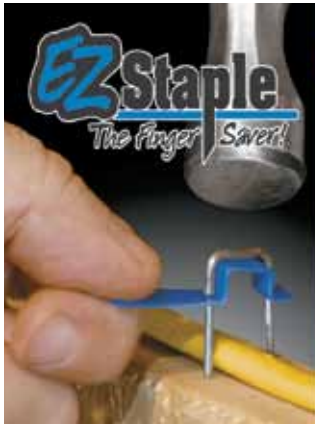

EZ STAPLES

EASY TO HANDLE, GET INTO TIGHT SPACES AND REDUCE DROPS



EZSTPL1C



EXSTPL5C



EZSTPL2M



EZ- POUR LIDS!

STOCK NO.	UPC NO.	DESCRIPTION	WT. PER PKG.	SUGGESTED TRADE LIST PRICE PER
EZSTPL1C	#85245	JAR OF 100 1/2"X1" STAPLES	.69 LBS.	4.40/C
EZSTPL5C	#85250	PAIL OF 500 1/2"X1" STAPLES	3.01 LBS.	4.25/C
EZSTPL2M	#85255	PAIL OF 2000 1/2"X1" STAPLES	12.21 LBS.	4.00/C

OTHER SIZES AND QUANTITIES AVAILABLE BY REQUEST

MANUFACTURING CAPABILITIES

Diameter range #2 thru 5/16" / 1.5mm thru 8mm • Length range 1/8" thru 3" / 3.5mm thru 75mm
Materials: Steel, Brass, Stainless, Aluminum, Bronze.

NEED SCREWS...

Let Us Make Them For You!



A METALLICS AFFILIATE

P.O. Box 1600 • 231 Cross Street
Bristol, CT 06011-1600
Tel: 800-984-8945 • Fax: 800-984-8946

CAPABILITIES LIST

PLANT SIZE: 100,000 SQUARE FEET

LOCATION: Bristol, Connecticut

EQUIPMENT: 27 Hi-Speed Cold Headers
8 Burr-Free Screw Slotters
3 Shank Slotters
2 Pointers
14 High Speed Thread Rollers



ADDITIONAL PLANT INFO: Modern shipping facility utilizing digital scale counting machines. In-house packaging facilities - boxing, sorting, baggings. All material boxed, palletized & labeled with your needs in mind for domestic or export shipping.

SECONDARY WORK: All plating & heat treating is done on the outside and certified for your guarantee.

INFORMATION SYSTEMS: Our facility has new and upgraded Technology to meet your customers specific requirements.

SPECIAL PURPOSE ELECTRICAL FASTENERS



STACKING STAPLES

FOR GROUND - NON METALLIC CABLE

PACKAGED IN PLASTIC BAGS

MADE IN USA



STOCK NO.	UPC NO.	CABLE SIZE	WT. PER PKG.	STD. PKG.	SUGGESTED TRADE LIST PRICE PER
SCT6215	21755	For stacking two 2-wire #14 or #12 NM cable	.38	50	5.03/ea pkg
SCT6315	21760	For stacking three 2-wire or a 2-wire & 3-wire #14 or #12 NM cable	.42	50	5.85/ea pkg
SCT6415	21765	For stacking two 3-wire or four 2-wire #14 or #12 NM cable	.45	50	6.98/ea pkg

OTHER SIZES AND QUANTITIES AVAILABLE BY REQUEST



SERVICE ENTRANCE STAPLES

PACKAGED IN PLASTIC BAGS

MADE IN USA



STOCK NO.	UPC NO.	CABLE SIZE	WT. PER KIT	STD. PKG.	SUGGESTED TRADE LIST PRICE PER
SES4115	21770	#6 type SER (gray)	.63	50	16.98/ea pkg
SES4215	21771	#6 type SEU (gray)	.60	50	16.98/ea pkg
SES4312	21775	#2 type SER (gray)	.45	25	10.40/ea pkg
SES4412	21776	#2 type SEU (gray)	.33	25	9.63/ea pkg
SES4512	21781	4/0 type SEU (gray)	.51	25	14.28/ea pkg
SES4612	21780	4/0 type SER (gray)	.67	25	14.28/ea pkg

OTHER SIZES AND QUANTITIES AVAILABLE BY REQUEST



PLASTIC CABLE STAPLES

SECURES NON-METALLIC CABLE

PACKAGED IN PLASTIC BAGS

MADE IN USA



STOCK NO.	UPC NO.	CABLE SIZE	WT. PER KIT	STD. PKG.	SUGGESTED TRADE LIST PRICE PER
PCS125	21790	2 & 3 wire NM cable up to #12 2-wire UF cable up to #12 & other cable up to 1/2" wide	.45	100	5.55/c
PCS345	21795	2-wire NM & UF cable up to #8 3-wire UF Cable up to #12 & other cable up to 3/4" wide	.47	100	6.10/c

OTHER SIZES AND QUANTITIES AVAILABLE BY REQUEST



CO-AXIAL STAPLES

SECURES CO-AXIAL CABLE & OTHER NON-METALLIC CABLE UP TO 1/4" WIDE

PACKAGED IN PLASTIC BAGS

MADE IN USA



STOCK NO.	UPC NO.	CABLE SIZE	WT. PER KIT	STD. PKG.	SUGGESTED TRADE LIST PRICE PER
CAS5051	21800	1/4" wide	.21	100	4.88/c

OTHER SIZES AND QUANTITIES AVAILABLE BY REQUEST

SPECIAL PURPOSE ELECTRICAL FASTENERS



SMALL WIRE STAPLES

SECURES THERMOSTAT, TELEPHONE AND BELL WIRE
NON-METALLIC CABLE UP TO 1/4" WIDE
PACKAGED IN PLASTIC BAGS



STOCK NO.	UPC NO.	CABLE SIZE	WT. PER KIT	STD. PKG.	SUGGESTED TRADE LIST PRICE PER
SPS5151	21810	1/4" x 1/8"	.20	100	4.88/c

OTHER SIZES AND QUANTITIES AVAILABLE BY REQUEST

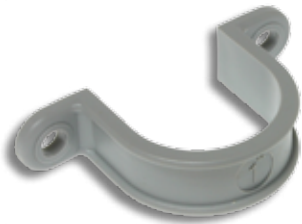

PVC CONDUIT STRAP

FOR NON-METALLIC PVC ELECTRICAL CONDUIT
PACKAGED IN PLASTIC BAGS



STOCK NO.	UPC NO.	CONDUIT SIZE	WT. PER KIT	STD. PKG.	SUGGESTED TRADE LIST PRICE PER
PCS212	21815	Gray 1/2"	.66	100	17.68/ea pkg
PCS234	21816	Gray 3/4"	.80	100	20.83/ea pkg
PCS244	21817	Gray 1"	1.05	100	29.10/ea pkg
PCS254	21818	Gray 1 1/4"	.75	50	16.98/ea pkg
PCS264	21819	Gray 1 1/2"	.95	50	18.55/ea pkg
PCS274	21821	Gray 2"	1.40	50	24.25/ea pkg
PCS284	21823	Gray 2 1/2"	.29	5	4.88/ea pkg
PCS294	21825	Gray 3"	.34	5	6.65/ea pkg
PCS204	21829	Gray 4"	.44	5	12.88/ea pkg

OTHER SIZES AND QUANTITIES AVAILABLE BY REQUEST



CONDUIT LOCK NUTS

STEEL ZINC PLATED

STOCK NO.	UPC NO.	CONDUIT SIZE	WT. PER KIT	STD. PKG.	SUGGESTED TRADE LIST PRICE PER
SFLN50	13575	1/2"	.92	100	11.20/ea pkg
SFLN75	13576	3/4"	1.65	100	15.33/ea pkg
SFLN100	13577	1"	2.80	100	22.65/ea pkg
SFLN125	13578	1 1/4"	2.01	50	15.90/ea pkg
SFLN150	13579	1 1/2"	2.49	50	18.90/ea pkg
SFLN200	13581	2"	2.90	50	25.73/ea pkg
SFLN250	13583	2 1/2"	3.05	25	35.70/ea pkg
SFLN300	13585	3"	4.35	25	45.98/ea pkg
SFLN400	13589	4"	1.49	20	210.31/ea pkg

OTHER SIZES AND QUANTITIES AVAILABLE BY REQUEST

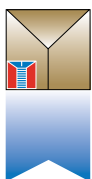

AMERICA'S SOURCE FOR PREMIER AND INNOVATIVE
FASTENERS & ANCHORS

SPECIAL PURPOSE ELECTRICAL FASTENERS

C = 100 PCS PER BOX
 F = 500 PCS PER JAR
 P = 5,000 PCS PER PAIL

NON-INSULATED CABLE STAPLES



EXAMPLE: CST40 = 100 PCS FST40 = 500 PCS PST40 = 5,000 PCS

STOCK NO.	UPC NO.	QTY. PER CONTAINER	USE	SIZE	WT. PER PKG.	SUGGESTED TRADE LIST PRICE PER
 CST40	21000	100/Box	N.M.C. 2 Romex	1 L x 1/2 W	.65	2.90/c
FST40	21005	500/Jar	#12 & #14		2.89	13.45/ea pkg
PST40	21007	5000/Pail			26.95	127.58/ea pkg

 CST100	21010	100/Box	N.M.C. & Armored	1 1/4 L x 9/16 W RX & BX	.59	3.28/c
FST100	21015	500/Jar	#14, #12, #10 w/gr		2.96	14.95/ea pkg
PST100	21017	5000/Pail			35.90	142.65/ea pkg

N.M.C. - to be used on non-metallic cable

 CST300	21020	100/Box	Service Entrance SEU3 #6	1 5/16 L x 3/4 W	1.18	6.05/c
FST300	21022	500/Jar			6.20	27.18/ea pkg

 CST350	21025	100/Box	Service Entrance SEU2 #6	1 1/2 L x 1 1/16 W For 2 #3 Full 10 Ga. Wire	1.31	7.55/c
FST350	21027	500/Jar			6.41	33.90/ea pkg

JAR PACKAGING AVAILABLE

OTHER SIZES AND QUANTITIES AVAILABLE BY REQUEST

CST100I



INSULATED CABLE STAPLES

HOT MELT PVC BONDED
 FOR BETTER CABLE PROTECTION!



STOCK NO.	UPC NO.	QTY. PER CONTAINER	USE	SIZE	WT. PER PKG.	SUGGESTED TRADE LIST PRICE PER
CST40I	21030	100/Box	#12, #14 Wire	1" x 1/2"	.59	4.55/c
CST100I	21018	100/Box	#10, #12, #14 Wire	1 1/4" x 9/16"	.71	4.43/c
CST350P	21093	2000/Pail	#10, #12, #14 Wire	1 1/4" x 9/16"	27.25	143.70/ea pkg NEW
CST100P	29006	1500/Pail	#10, #12, #14 Wire	1 1/4" x 9/16"	13.35	82.25/ea pkg NEW
FST100I	21019	250/Jar	#10, #12, #14 Wire	1 1/4" x 9/16"	2.20	10.85/ea pkg
PST100I	21021	5000/Pail	#10, #12, #14 Wire	1 1/4" x 9/16"	37.00	203.10/ea pkg
FST40I	21035	500/Jar	#10, #12, #14 Wire	1" x 1/2"	2.74	23.75/ea pkg NEW
PST40I	21040	5000/Pail	#10, #12, #14 Wire	1" x 1/2"	28.98	184.65/ea pkg NEW

JAR PACKAGING AVAILABLE

OTHER SIZES AND QUANTITIES AVAILABLE BY REQUEST

Metallics East 1-800-243-8272

Metallics West 1-800-269-5183

SPECIAL PURPOSE ELECTRICAL FASTENERS

RAFTER AND TRUSS STAPLES



- SAVE TIME AND FRUSTRATION BY FASTENING CABLE FROM THE FRONT OF THE RAFTERS AND TRUSSES
- INCREASE PRODUCTIVITY
- MADE FOR HARD TO REACH PLACES SUCH AS RAFTERS AND FLOOR JOISTS
- ELIMINATES DAMAGE TO WIRE JACKET
- REDUCES BENT OVER NAILS

STOCK NO.	UPC NO.	SIZE	DESCRIPTION	PKG. QTY.	WT. PER PKG.	SUGGESTED TRADE LIST PRICE PER
RJS1	21910	1/2	Rafter-Joist Staple	100	1.14	9.85/c
RJS2	21912	1/2	Rafter-Joist Staple	500	6.55	38.58/ea pkg

OTHER SIZES AND QUANTITIES AVAILABLE BY REQUEST



WHITE INSULATED TWO NAIL STAPLES



STOCK NO.	UPC NO.	SIZE	DESCRIPTION	PKG. QTY.	WT. PER PKG.	SUGGESTED TRADE LIST PRICE PER
CS50	21914	1/2	Plastic Staple	100	.45	8.75/c
CS50P	21916	1/2	Plastic Staple	2000	9.98	115.93/ea pkg
CS75	21918	3/4	Plastic Staple	100	.50	8.88/c
CS75P	21920	3/4	Plastic Staple	1500	8.05	96.40ea pkg
1/2 secures 14-2 or 12-2 with ground non-metallic cable and other non-metallic cable 1/2" wide						
3/4 secures 12-3 or 10-3 with ground non-metallic cable and other non-metallic cable 3/4" wide						

OTHER SIZES AND QUANTITIES AVAILABLE BY REQUEST



BLACK INSULATED TWO NAIL STAPLES



STOCK NO.	UPC NO.	SIZE	DESCRIPTION	PKG. QTY.	WT. PER PKG.	SUGGESTED TRADE LIST PRICE PER
CCS50	21926	1/2	Plastic Staple	100	.44	6.70/c
CCS50P	21928	1/2	Plastic Staple	2000	9.81	87.73/ea pkg
CCS75	21930	3/4	Plastic Staple	100	.50	7.43/c
CCS75P	21932	3/4	Plastic Staple	1500	8.50	77.58/ea pkg
1/2 secures 14-2 or 12-2 with ground non-metallic cable and other non-metallic cable 1/2" wide						
3/4 secures 12-3 or 10-3 with ground non-metallic cable and other non-metallic cable 3/4" wide						

OTHER SIZES AND QUANTITIES AVAILABLE BY REQUEST



DATA COMM. STAPLES 0.190 DIAMETER



FOR CATEGORY 5 (4 PAIR 24 GAUGE CABLE)

STOCK NO.	UPC NO.	SIZE	DESCRIPTION	PKG. QTY.	WT. PER PKG.	SUGGESTED TRADE LIST PRICE PER
DCS1	21938	0.190	Plastic Data Com. Staple	100	.23	8.05/c
DCS1B	21940	0.190	Plastic Data Com. Staple	500	1.15	31.58/ea pkg

OTHER SIZES AND QUANTITIES AVAILABLE BY REQUEST



SPECIAL PURPOSE ELECTRICAL FASTENERS

INSULATED STAPLES

FOR LOW VOLTAGE WIRING
Conforms to U.S. Government Specifications

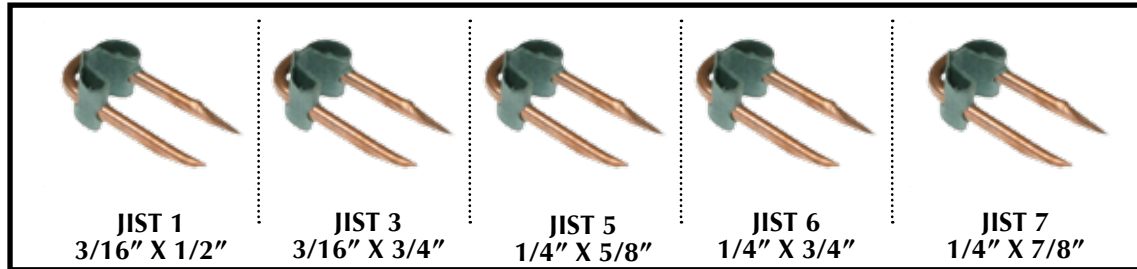

JIST 1
3/16" X 1/2"

JIST 3
3/16" X 3/4"

JIST 5
1/4" X 5/8"

JIST 6
1/4" X 3/4"

JIST 7
1/4" X 7/8"

STOCK NO.	UPC NO.	SIZE	WIDTH	LENGTH OF LEGS	WT. PER PKG.	STD. PKG./MSTR. CARTON	SUGGESTED TRADE LIST PRICE PER
JIST1	81016	#1	3/16	1/2	.19	100/500	3.00/c
JIST3	81017	#3	3/16	3/4	.24	100/500	3.00/c
JIST5	81018	#5	1/4	5/8	.22	100/500	3.73/c
JIST6	81019	#6	1/4	3/4	.24	100/500	3.28/c
JIST7	81020	#7	1/4	7/8	.25	100/500	4.33/c

OTHER SIZES AND QUANTITIES AVAILABLE BY REQUEST

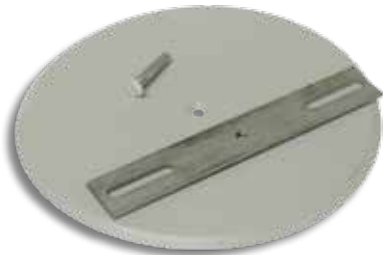

PACKAGED 10
IN POLY BAG

CEILING COVER PLATE ADJUSTABLE

ADJUSTS TO FIT 3" OR 4" OUTLET BOXES
Includes plate, strap and flat head slotted machine screw.
White color to suit most applications.



STOCK NO.	UPC NO.	DESCRIPTION	WEIGHT	STD. PKG.	SUGGESTED TRADE LIST PRICE PER
CP1A	41300	Fits 3" & 4" boxes. 5 1/4 steel canopy with adjustable strap and screws	.12	10	38.93/c

OTHER SIZES AND QUANTITIES AVAILABLE BY REQUEST



PACKAGED 10
IN POLY BAG

CEILING COVER PLATE STANDARD

ATTACHES DIRECTLY TO CEILING OUTLET BOXES
Holes predrilled. Flat head slotted machine screws included.
White color to suit most applications.



STOCK NO.	UPC NO.	DESCRIPTION	WEIGHT	STD. PKG.	SUGGESTED TRADE LIST PRICE PER
CP3S	41305	5 1/4 white canopy fits 3" boxes	.18	10	31.90/ea pkg
CP4S	41310	5 1/4 white canopy fits 4" boxes	.15	10	31.90/ea pkg

OTHER SIZES AND QUANTITIES AVAILABLE BY REQUEST