

Load Centers & Circuit Breakers

SPEEDFAX™ 2017

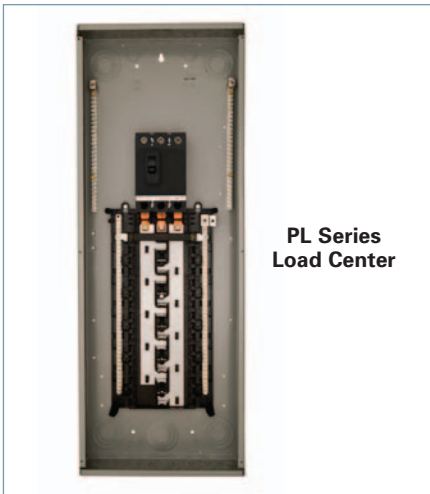

**PL Series
Load Center**



**Generator
Ready
Load Center**

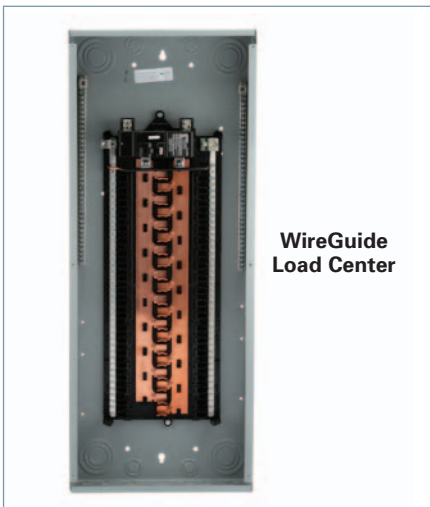

**WireGuide
Load Center**

Contents

Load Centers

Catalog Numbering System	1-2
Siemens PL and ES Series Load Centers™ Introduction	1-3
WireGuide™ Load Centers and Breakers	1-3
PL Series Load Centers Features and Product Offering	1-4 – 1-5
PL Series Single Phase Main Lug & Main Breaker Load Centers	1-6
PL Series Single Phase Special Load Centers	1-7
PL Series Three Phase Main Lug & Main Breaker Load Centers	1-8
PL Series Three Phase Unassembled Load Centers	1-9
ES Series Load Centers Features and Product Offering	1-10 – 1-11
ES Series Single Phase Main Lug & Main Breaker Load Centers	1-12
ES Series Single Phase Special Load Centers	1-14
ES Series Three Phase Main Lug & Main Breaker Load Centers	1-15
EQ® Load Centers, 300-400 Amp	1-16
Generator Ready Load Centers	1-17
Riser Panel Load Centers	1-18
EQ® Load Centers, Small Circuit and Circuit Breaker Enclosures	1-19 – 1-20
Load Centers OEM Interiors and Accessories	1-21 – 1-24
Standby Power Systems	1-25 – 1-26
Knockout Diagrams	1-27 – 1-31
Load Center Cross Reference	1-32 – 1-33

Circuit Breakers

Arc-Fault and Ground-Fault Breakers	1-34
Intelli-Arc Diagnostic Tool	1-35
Type QP, 1" Breakers	1-36
Duplex, Triplex and Quadplex Plug-In Breakers	1-37
Special Application Breakers	1-38
Type QD, 3/4" Breakers	1-39
Main and Branch Circuit Breakers	1-40
Circuit Breaker Dimension Drawings and Lug Data	1-41 – 1-42
Circuit Breaker Accessories	1-43 – 1-44

Surge Protection Products

AC Disconnects, 1-Phase, NEMA 3R Rated	1-45 – 1-47
	1-48

Scan to connect
online to the
most up-to-
date version of
this Section of
SPEEDFAX.



Load Centers

Catalog Numbering System

Catalog Numbering System

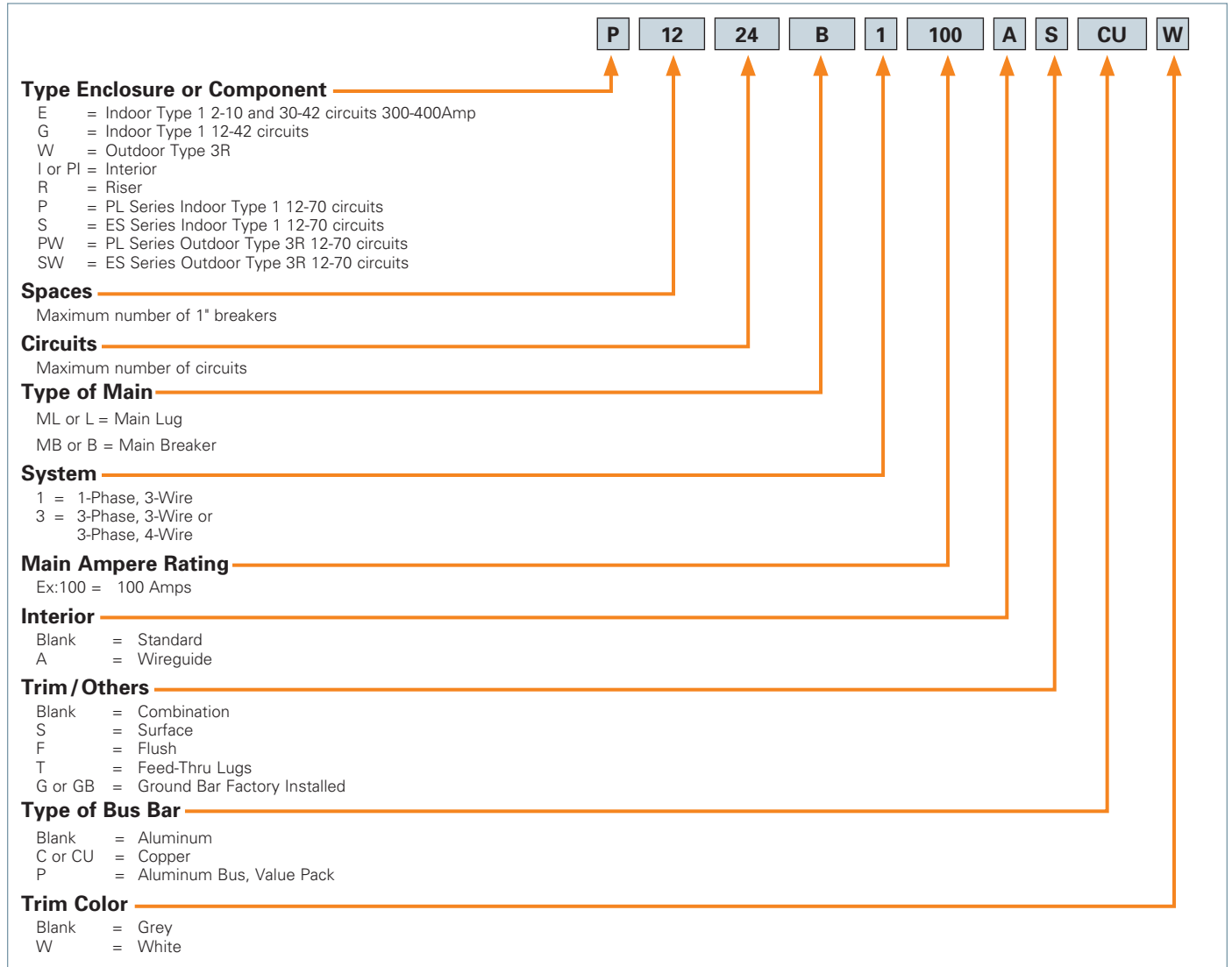

Products Shown In Sections 1 of this Speedfax Meet or Exceed the Following Standards.

- UL50 — Electric Cabinets and Boxes
- UL67 — Electric Panelboards
- UL486 — Wire Connectors
- UL489 — Molded-Case Circuit Breakers
- UL869 — Service Equipment
- UL943 — Ground Fault interrupters (Class A — Personnel Protection)
- Federal Specification W-P-115b — Panel Power Distribution
- Federal Specification W-C-375B — Circuit Breakers
- NEC
- NEMA 250

Underwriters' Laboratories, Inc. Reference File Numbers:

- Series Connected Circuit Breaker Information is recognized by UL under file #E10848(N)
- Load Centers Listed by UL under file #E10703
- Load Centers UL recognized components found under file #E10703, Volume 6 and 7. (Also referenced under the recognized components directory — section QEUY2)
- EQ Circuit Breakers are Listed by UL under file #E82615

Load Centers

Siemens PL and ES Series Load Centers™ Overview

PL Series:

- Convertible
- Invertible[Ⓞ]
- Insta-wire neutrals & grounds
- Ground bars included
- Copper busbars
- Dual neutrals on all configurations
- Carton-in-carton packaging
- Lifetime warranty



PL Series 1-phase



PL Series 3-phase

ES Series:

- Invertible[Ⓞ]
- Insta-wire neutrals & grounds
- Aluminum busbars
- Single sided neutral on 24 circuits and below
- Single piece carton packaging
- 10 year warranty



ES Series 1-phase

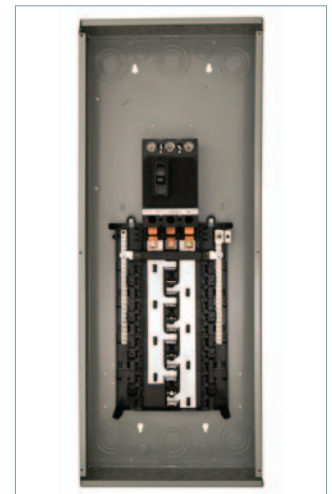

ES Series 3-phase

NEW WireGuide™ Load Centers and Breakers

WireGuide load centers accept new AFCIs with shortened neutral wires that slide directly into the neutral bar.

Features

- Over 4 inches of breaker wire bending space
- 11 SKUs each available in both grey and white[Ⓞ]
- Pre-trimmed and ready to install neutral wires have an "Oops Loop" if extra wire is needed
- Full length neutral bars
- Decreased installation time
- WireGuide breakers available by adding "WG" suffix to existing catalog numbers. See page 1-34 for more details.

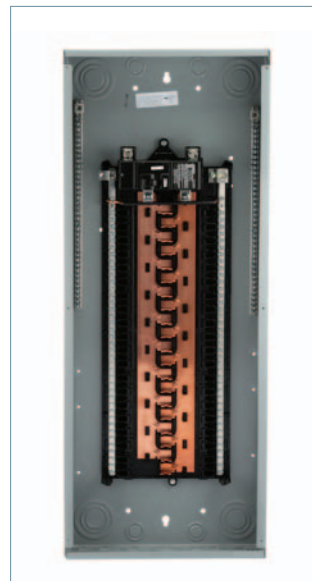

WireGuide Load Centers



Combination Type AFCI WireGuide Breaker

[Ⓞ] Applies only to NEMA 1 ES and PL Load Centers

PL Series Load Centers

Features

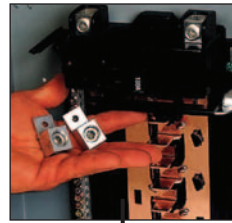

Invertible for bottom feed application.®

All devices convertible from main lug to main breaker and vice versa.

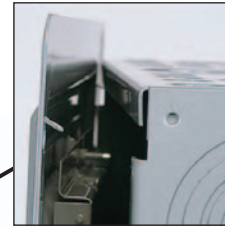

Mounting tabs on the trim hold it in place on the load center, freeing up both hands to drive the trim screws.

All devices are provided with 2 factory installed ground bars.

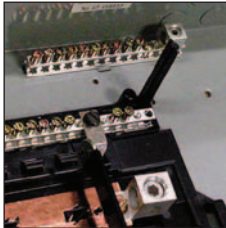

Combination head screw on the neutrals, ground, trim, upper pan, and bond screw provide installation flexibility.



A rigid, sturdy base pan provides the ruggedness required for the most harsh applications.

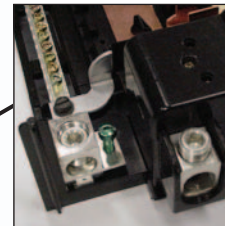

The pre-positioned bond screw eliminates bond strap/screw assemblies, and reduces the risk of losing components in the field.

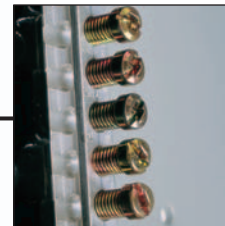

The patented INSTA-WIRE™ neutral/ground system allows for faster installation because

screws are backed out, ready for wire insertion. The visible neutral and grounds system aids in the insertion of conductors.

Copper Bus

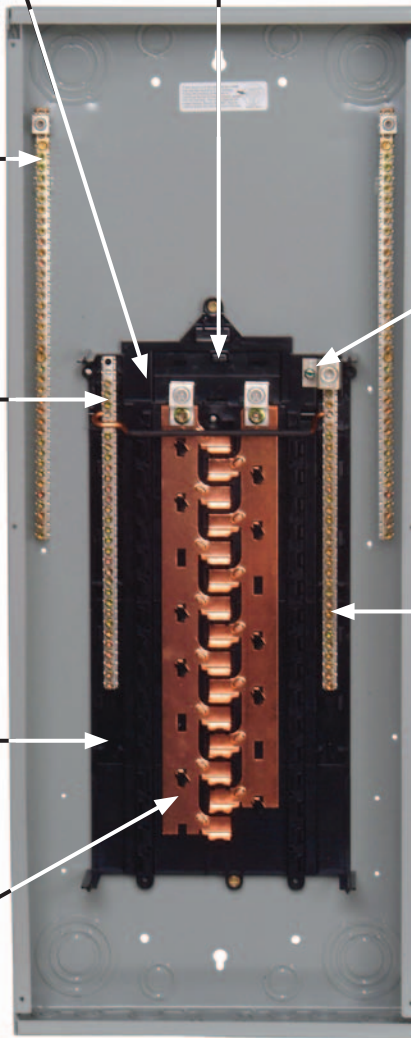

The outdoor enclosure has a slide hinge door for the easiest installation and can be removed by backing out only one screw.

PL Series Load Centers ship with trims packaged separately.



® Applies only to NEMA 1 ES and PL Load Centers

PL Series Load Centers

Product Offering

The PL Series Load Center product line provides a wide array of variation to meet any application need.

The following offering is available in the PL Series product line:

- 12-70 Circuits/Spaces
- Indoor and Outdoor enclosures
- 100 to 225 Amp
- Main Lug and Main Breakers
- Un-assembled offering in 3-phase

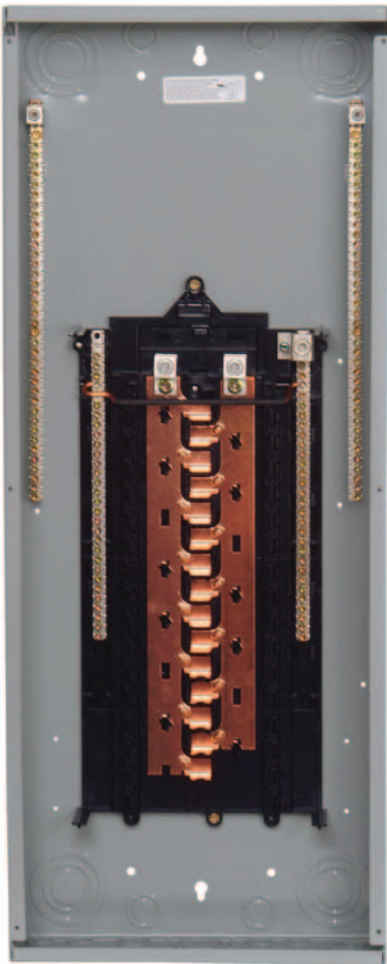

**PL Series
1-phase Main Lug**

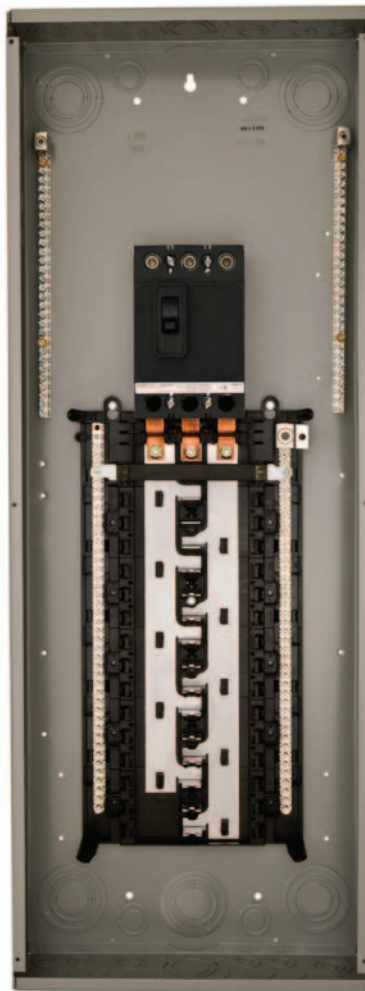

**PL Series
3-phase Main Breaker**

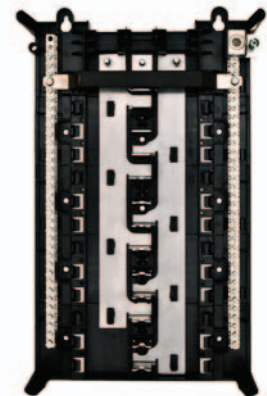

Un-assembled 3-phase

PL Series 1-Phase Main Lug & Main Breaker Load Centers

1-phase, 3-wire SN, 120/240 Volts AC

Main Breaker/Convertible Load Centers^①

Copper Bus^⑦

12-70 Circuits / 100-225 Amperes

60/75°C Rated 22,000A IR^②

Amp Rating	No. of Spaces	Indoor Enclosure - NEMA Type 1					Outdoor Enclosure - NEMA Type 3R			
		No. of Circuits	PL Catalog Number	No. of Circuits	PL with WireGuide Interior Catalog Number ^⑧	NEMA 1 - Enclosure Height (inches) ^③	No. of Circuits	Catalog Number	NEMA 3R - Enclosure Height (inches) ^④	
100	12	24	P1224B1100CU	—	—	18	24	PW1224B1100CU	21	
	16	24	P1624B1100CU ^⑤	—	—	21	24	PW1624B1100CU	23	
	20	20	P2020B1100CU	40	P2040B1100ACU	24	20	PW2020B1100CU	27	
		24	P2024B1100CU				—	—		
	24	24	P2424B1100CU	48	P2448B1100ACU	24	—	—	—	
		30	30	P3030B1100CU	60	P3060B1100ACU	30	—	—	
	40		—	—	—	40	PW3040B1100CU	35		
125	30	30	P3030B1125CU ^⑤	60	P3060B1125ACU	30	40	PW3040B1125CU	35	
150	20	30	P2030B1150CU	40	P2040B1150ACU	24	—	—	—	
		30	—	—	—	30	PW2030B1150CU	27		
	30	30	P3030B1150CU	60	P3060B1200ACU	30	—	—		
		40	—	—	—	40	PW3040B1150CU	35		
200	20	40	P2040B1200CU	40	P2040B1200ACU	30	40	PW2040B1200CU	27	
		30	40	P3040B1200CU	60	P3060B1200ACU	36	40	PW3040B1200CU	35
			40	P3040B1200 ^{⑧⑨}	60	P3060B1200A ^⑧	36	—	—	
	40	40	P4040B1200CU ^⑤	80	P4080B1200ACU	36	40	PW4040B1200CU	38	
		40	P4040B1200 ^{⑧⑨}	80	P4080B1200A ^⑧	36	—	—		
	54	70	P5470B1200CU	80	P5480B1200ACU	44	—	—		
225	42	60	P4260B1225CU ^⑤	80	P4280B1225ACU	39	60	PW4260B1225CU	42	
	54	70	P5470B1225CU ^⑤	80	P5480B1225ACU	44	—	—		

Single phase factory installed 22kA IR main circuit breaker offers 22/10kA IR series combination rating when using 10kA type QP, QT, QPF, QE, QN, and QAF2/QAF2C branch breakers.

Main Lug/Convertible Load Centers^⑥

Copper Bus^⑦

12-70 Circuits / 125-225 Amperes

60/75° Rated 100,000A IR

Amp Rating	No. of Spaces	Indoor Enclosure - NEMA Type 1					Outdoor Enclosure - NEMA Type 3R			
		No. of Circuits	PL Catalog Number	No. of Circuits	PL with WireGuide Interior Catalog Number ^⑧	NEMA 1 - Enclosure Height (inches) ^③	No. of Circuits	Catalog Number	NEMA 3R - Enclosure Height (inches) ^④	
125	12	12	P1212L1125CU ^⑤	—	—	18	12	PW1212L1125CU ^⑤	21	
		24	P1224L1125CU ^⑤	—	—	18	24	PW1224L1125CU ^⑤	21	
	16	24	P1624L1125CU	—	—	21	24	PW1624L1125CU	23	
		20	20	P2020L1125CU ^⑤	40	P2040L1125ACU	24	—	—	
	24		P2024L1125CU	24			—	—		
	24	40	P2440L1125CU ^⑤	48	P2448L1125ACU	24	—	—		
		30	P3040L1125CU ^⑤	60	P3060L1125ACU	30	40	PW3040L1125CU	35	
	40	P4040L1125CU ^⑤	80	P4080L1125ACU	36	—	—			
150	20	30	P2030L1150CU	40	P2040L1150ACU	24	30	PW2030L1150CU	27	
200	12	24	P1224L1200CU	—	—	24	24	PW1224L1200CU ^⑤	23	
		20	40	P2040L1200CU	40	P2040L1200ACU	30	40	PW2040L1200CU	27
			24	P2440L1200CU	48	P2448L1200ACU	30	—	—	
	30	30	P3030L1200CU	60	P3060L1200ACU	36	—	—	—	
		40	P3040L1200CU ^⑤				40	PW3040L1200CU	35	
		54	P3054L1200CU				54	PW3054L1200CU	35	
		40	P3040L1200 ^{⑧⑨}				60	P3060L1200A ^⑧	36	—
	40	40	P4040L1200CU ^⑤	80	P4080L1200ACU	36	40	PW4040L1200CU	38	
		40	P4040L1200 ^⑧	80	P4080L1200A ^⑧	36	—	—		
	225	12	24	—	—	—	24	PW1224L1225CU	23	
42		60	P4260L1225CU ^⑤	80	P4280L1225ACU	39	60	PW4260L1225CU	42	
54		70	P5470L1225CU	80	P5480L1225ACU	44	—	—		

① Suitable for use as service equipment.

② May be installed on higher rated systems when protected by a circuit breaker with a higher AIR rating.

③ Indoor enclosures are 14 1/4" wide by 3 7/8" deep.

④ Outdoor enclosures are 14 1/2" wide by 4 1/4" deep.

⑤ Suitable for use as service entrance equipment when

not more than six main disconnecting means are provided. See article 230.71 of the NEC®.

⑥ 125A load centers will accept MBK100A and MBK125A. 150A load centers will accept MBK150A. 200A load centers will accept MBK200A and MBK150A. 225A load centers will accept MBK225A, MBK200A, MBK150A.

⑦ Copper bus load centers are recommended for those applications where the environment may be severe (i.e. far and coastal areas).

⑧ Includes all PL Series features with aluminum bussing.

⑨ Available (made to order) in white by adding "W" to the end of the part number.

PL Series 1-Phase Special Application Load Centers

1-phase, 3-wire SN, 120/240 Volts AC

Split Ground Series Main Lug Convertible Load Centers **Copper Bus** 12-60 Circuits / 125-200 Amperes **60/75° Rated, 100,000A IR**

Branch Circuits			Indoor Enclosure – NEMA Type 1	
Amp Rating	No. of Spaces	No. of Circuits	Catalog Number	Enclosure Height (inches) ^②
125	12	24	P1224L1125CUSG	18
125	16	24	P1624L1125CUSG	21
125	20	30	P2030L1125CUSG	24
125	24	30	P2430L1125CUSG	24
150	20	30	P2030L1150CUSG	24
200	30	40	P3040L1200CUSG	36
200	30	40	P3040L1200SG ^①	36
200	40	40	P4040L1200CUSG	36
200	40	40	P4040L1200SG ^①	36
225	40	60	P4260L1225CUSG	39



Split Ground Load Centers have factory installed 100% neutral with factory bonded 75% ground. No neutral tie strap.

Split Ground Series Main Breaker Convertible Load Centers **Copper Bus** 40 Circuits / 200 Amperes **60/75° Rated, 22,000A IR^③**

Branch Circuits			Indoor Enclosure – NEMA Type 1	
Amp Rating	No. of Spaces	No. of Circuits	Catalog Number	Enclosure Height (inches) ^②
200	40	40	P4040B1200CUSG	36

First Surge PL Load Centers **Copper Bus** 54-60 Circuits **60/75° Rated, 22,000A IR**

Amp Rating	No. of Spaces	No. of Circuits	Catalog Number	Surge Protection	Enclosure Height (inches) ^②
200	30	54	P3054B1200S140	140kA	36
200	40	60	P4060B1200S140	140kA	42

Outdoor Trailer Panels **Copper Bus** 16 Circuits / 200 Amperes **60/75° Rated, 22,000A IR^⑤**

Amp Rating	No. of Spaces	No. of Circuits	Catalog Number	Main Breaker		Enclosure Height (inches) ^②
200	8	16	PW0816L1200TC	MBK150A or MBK200A	Field Installed	23
200	8	16	PW0816B1200TC	MBK200A	Factory Installed	23

① Includes all PL Series features with aluminum bussing.
② Indoor enclosures are 14 1/4" wide by 3 7/8" deep.

③ May be installed on higher rated systems when protected by a circuit breaker with a higher AIR rating.
④ Outdoor enclosures are 14 1/2" wide by 4 1/4" deep.
⑤ Main lug panel rated 100,000A IR.

⑥ Load centers with white trim have increased lead time of 3-4 weeks. Sold in pallet quantities only.
⑦ Load centers with CUW suffix indicates copper bus with white trim. Load centers with W suffix only indicates aluminum bus with white trim.

PL Series 3-Phase Main Lug & Main Breaker Load Centers

3-phase, 3-wire, 240 Volt AC or 3-phase, 4-wire, 120/240 or 120/208 Volts AC

Main Breaker/Convertible Load Centers

Copper Bus^{®10}

30-70 Circuits / 100-225 Amperes

60/75°C Rated 22,000A IR^①

Branch Circuits			Indoor Enclosure – NEMA Type 1		Outdoor Enclosure – NEMA Type 3R	
Amp Rating	No. of Spaces	No. of Circuits	Catalog Number	Enclosure Height (inches) ^③	Catalog Number	Enclosure Height (inches) ^④
100	12	24	P1224B3100CU ^②	24	—	—
100	30	42	P3042B3100CU ^②	30	—	—
125	30	30	P3030B3125CU	39	—	—
150	24	42	P2442B3150CU	36	—	—
150	42	42	P4242B3150CU	42	—	—
200	30	54	P3054B3200CU	39	PW3054B3200CU	38
200	42	60	P4260B3200CU ^⑩	42	PW4260B3200CU	42
225	42	60	P4260B3225CU	42	—	—
225	42	60	P4260B3225TCU ^⑥	49	—	—
225	54	70	P5470B3225CU	49	—	—

Main Lug/Convertible Load Centers^⑤

Copper Bus^{®10}

12-70 Circuits / 125-225 Amperes

60/75°C Rated 100,000A IR^⑨

Branch Circuits			Indoor Enclosure – NEMA Type 1		Outdoor Enclosure – NEMA Type 3R	
Amp Rating	No. of Spaces	No. of Circuits	Catalog Number	Enclosure Height (inches) ^③	Catalog Number	Enclosure Height (inches) ^④
125	12	24	P1224L3125CU ^⑦	21	PW1224L3125CU ^⑦	21
200	24	42	P2442L3200CU	36	PW2442L3200CU	35
200	30	54	P3054L3200CU	39	PW3054L3200CU	38
225	42	60	P4260L3225CU	42	PW4260L3225CU ^⑩	42
225	54	70	P5470L3225CU	49	—	—

① May be installed on higher rated systems when protected by a circuit breaker with a higher AIR rating.

② Back fed main breaker.

③ Indoor enclosures are 14 1/4" wide by 3 7/8" deep.

④ Outdoor enclosures are 14 1/2" wide by 4 1/4" deep.

⑤ Suitable for use as service entrance equipment when not more than six main disconnecting means are provided. See article 230.71 of the NEC[®].

⑥ Includes factory installed feed through lugs and is also non-convertible.

⑦ Non-convertible to main breaker.

⑧ All load centers are provided with tin plated copper bus bars.

⑨ Rated 100,000A IR in series with breakers listed on wiring diagram.

⑩ All load centers are provided with tin-plated copper bus bars.

⑪ Available (made to order) in white by adding "W" to the end of the part number

PL Series 3-Phase Unassembled Load Centers

3-phase, 3-wire, 240 Volt AC or 3-phase, 4-wire, 120/240 or 120/208 Volts AC

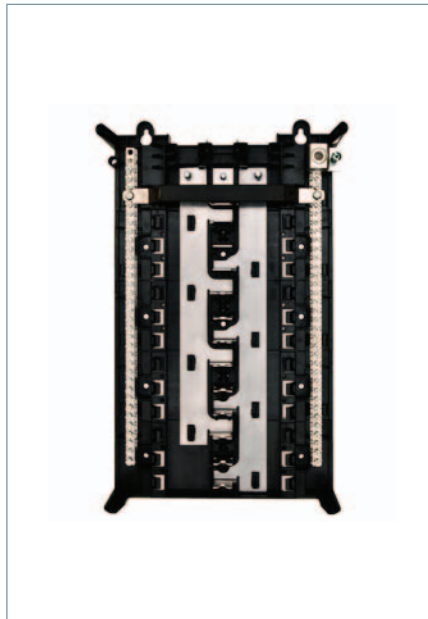

Main Breaker Convertible Unassembled Load Centers 24-70 Circuits / 100-225 Amperes

Copper Bus^⑤
60/75°C Rated 22,000A IR^①

Interiors				Enclosure		Trim Kit	
Amp Rating	No. of Spaces	No. of Circuits	Interior Catalog Number	Enclosure Height (inches) ^③	Enclosure Catalog Number	No. Breaker Spaces	Trim Catalog Number ^④
100	30	42	PI3042B3100CU ^②	30	3PE30	30	PT3042B3100
150	24	42	PI2442B3150CU	36	3PE36	24	PT2442X3150
200	30	54	PI3054B3200CU	39	3PE39	30	PT3054X3200
200	42	60	PI4260B3200CU	42	3PE42	42	PT4260X3200
225	54	70	PI5470B3225CU	49	3PE49	54	PT5470X3225

Main Lug Convertible Unassembled Load Centers 12-70 Circuits / 125-225 Amperes

Copper Bus^⑤
60/75° Rated 100,000A IR^⑥

Interiors				Enclosure		Trim Kit	
Amp Rating	No. of Spaces	No. of Circuits	Interior Catalog Number	Enclosure Height (inches) ^③	Enclosure Catalog Number	No. Breaker Spaces	Trim Catalog Number ^④
125	12	24	PI1224L3125CU	21	3PE21	12	PT1224L3125
200	24	42	PI2442L3200CU	36	3PE36	24	PT2442X3200
200	30	54	PI3054L3200CU	39	3PE39	30	PT3054X3200
225	42	60	PI4260L3225CU	42	3PE42	42	PT4260X3225
225	54	70	PI5470L3225CU	49	3PE49	54	PT5470X3225

① May be installed on higher rated systems when protected by a circuit breaker with a higher AIR rating.
② Back fed main breaker.
③ Indoor enclosures are 14 1/4" wide by 3 7/8" deep.

④ Trim catalog numbers with a "B" indicate for use with main breaker and is not convertible. "L" indicates for use with main lug and is not convertible. "X" indicates can be used with convertible interior.

⑤ All load center interiors are provided with tin plated copper bus bars.
⑥ Rated 100,000A IR in series with breakers listed on wiring diagram.

ES Series Load Centers

Features

LOAD CENTERS & CIRCUIT BREAKERS

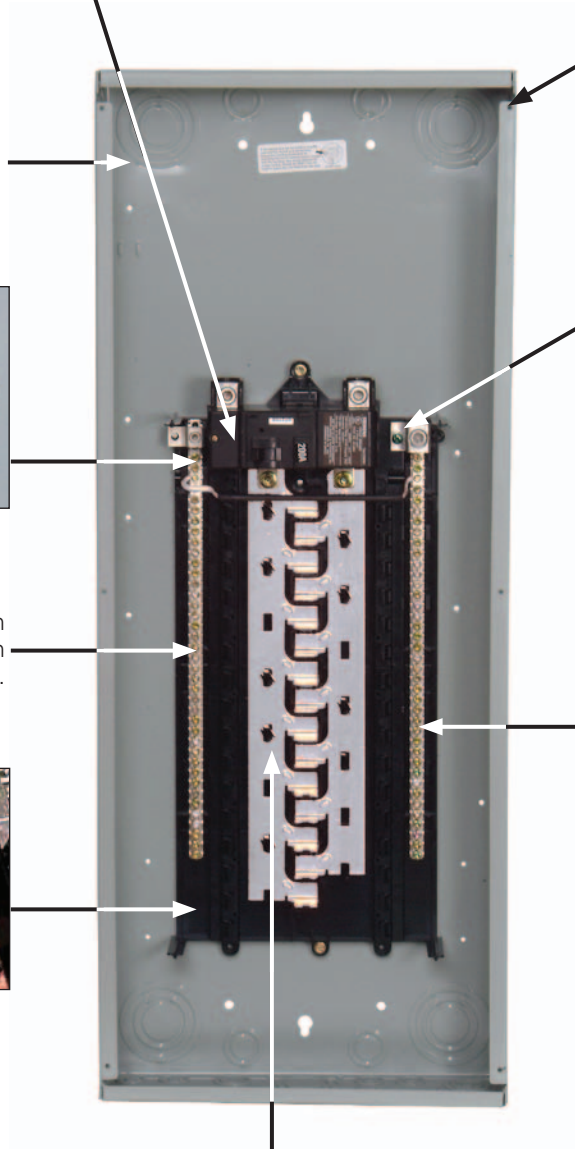

Invertible for bottom feed application.Ⓢ

Ground bar field installed (select skus with "G" suffix will have ground bar factory installed).

Combination head screw on the neutrals, ground, trim, upper pan, and bond screw provide installation flexibility.



Single side inboard neutral on 24 circuits and below; dual on 30 circuits and above.

A rigid, sturdy base pan provides the ruggedness required for the most harsh applications.



Aluminum bus.

The outdoor enclosure has a slide hinge door for the easiest installation and can be removed by backing out only one screw.

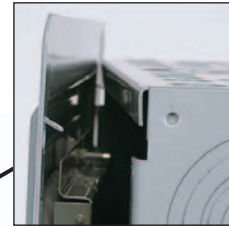

Mounting tabs on the trim hold it in place on the load center, freeing up both hands to drive the trim screws.

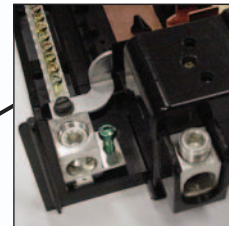

The pre-positioned bond screw eliminates bond strap/screw assemblies, and reduces the risk of

losing components in the field.

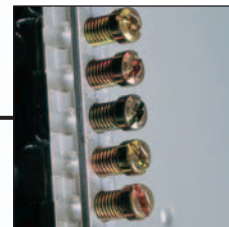

The patented INSTA-WIRE™ neutral/ground system allows for faster installation because

screws are backed out, ready for wire insertion. The visible neutral and grounds system aids in the insertion of conductors.

ES Series Load Centers ship in single piece carton.



Ⓢ Applies only to NEMA 1 ES and PL Load Centers

ES Series Load Centers

Product Offering

The ES Series Load Center product line provides a wide array of variation to meet any application need.

The following offering is available in the ES Series product line:

- 12-70 Circuits/Spaces
- Indoor and Outdoor enclosures
- 100 to 225 Amp
- Main Lug and Main Breakers
- Value packs – a mix of branch breakers provided with the load center.

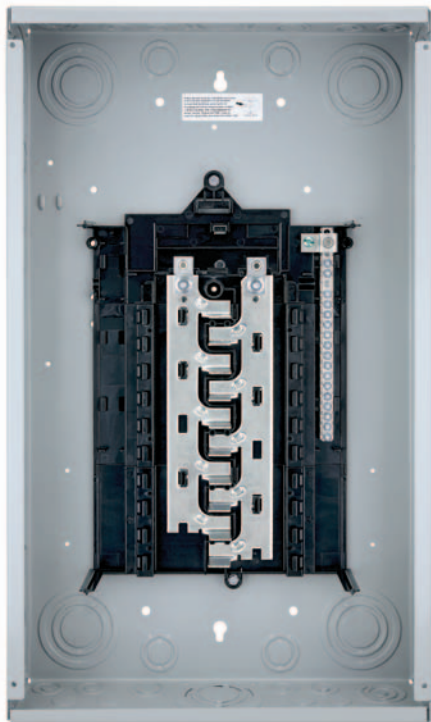

ES Series
1-phase Main Lug
125A, 12-24 circuits

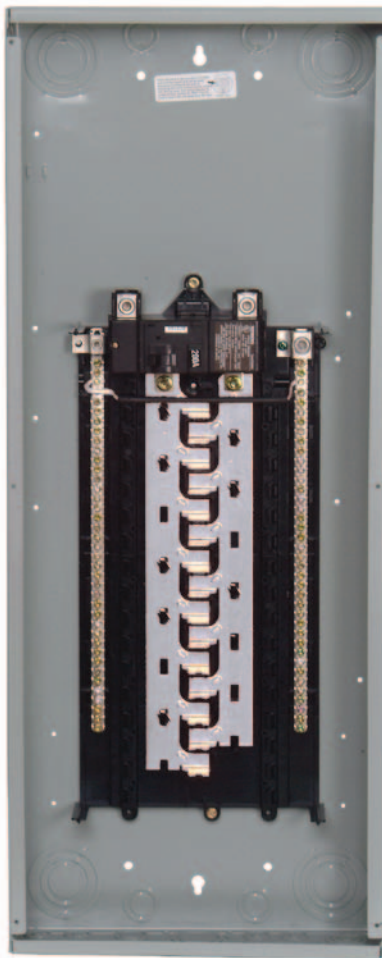

ES Series
1-phase Main Breaker
125- 225A, 30-70 circuits



ES Series
3-phase Main Breaker

ES Series 1-Phase Main Lug & Main Breaker Load Centers

1-phase, 3-wire SN, 120/240 Volts AC

LOAD CENTERS & CIRCUIT BREAKERS

Main Breaker^①

12-70 Circuits / 100-225 Amperes

Aluminum Bus

60/75°C Rated 22,000A IR^②

Amp Rating	No. of Spaces	Indoor Enclosure - NEMA Type 1					Outdoor Enclosure - NEMA Type 3R		
		No. of Circuits	ES Catalog Number	No. of Circuits	ES with WireGuide Interior Catalog Number ^③	NEMA 1 - Enclosure Height (inches) ^③	No. of Circuits	Catalog Number	NEMA 3R - Enclosure Height (inches) ^④
100	10	20	S1020B1100	—	—	18	—	—	—
	12	24	S1224B1100	—	—	18	24	SW1224B1100	21
	16	24	S1624B1100 ^⑤	—	—	21	24	SW1624B1100	23
	20	20	S2020B1100	40	S2040B1100A	24	20	SW2020B1100	27
	24	24	S2024B1100				—	—	—
30	30	S3030B1100 ^⑤	60	S3060B1100A	30	—	—	—	
125	12	24	—	—	—	—	24	SW1224B1125	21
	16	24	S1624B1125	—	—	21	—	—	—
	32	—	—	—	—	—	24	SW2024B1125	27
	24	24	S2424B1125 ^⑤	48	S2448B1125A	24	24	SW2424B1125	27
	30	30	S3030B1125 ^⑤	60	S3060B1125A	30	—	—	—
40	40	S3040B1125	40				SW3040B1125	35	
150	16	30	S1630B1150	—	—	24	—	—	—
	20	30	S2030B1150	40	S2040B1200A	24	—	—	—
	24	30	S2430B1150	48	S2448B1200A	30	—	—	—
	30	30	S3030B1150 ^⑤	60	S3060B1150A	30	—	—	—
	40	40	S3040B1150				40	SW3040B1150	35
	40	40	—	—	—	—	40	SW4040B1150	38
200	16	32	S1632B1200	—	—	24	—	—	—
	20	40	S2040B1200	40	S2040B1200A	30	40	SW2040B1200	27
	24	40	S2440B1200	48	S2448B1200A	30	—	—	—
	30	40	S3040B1200 ^⑤	60	S3060B1200A	36	40	SW3040B1200	35
	40	40	S4040B1200 ^⑤	80	S4080B1200A	36	40	SW4040B1200	38
	42	60	S4260B1200	80	S4280B1200A	39	—	—	—
	54	70	S5470B1200	80	S5480B1200A	44	—	—	—
225	42	60	S4260B1225	80	S4280B1225A	39	60	SW4260B1225	42
	54	70	S5470B1225	80	S5480B1225A	44	—	—	—

Main Lug

12-70 Circuits / 125-225 Amperes

Aluminum Bus

60/75°C Rated 100,000A IR

Amp Rating	No. of Spaces	Indoor Enclosure - NEMA Type 1					Outdoor Enclosure - NEMA Type 3R		
		No. of Circuits	ES Catalog Number ⁽⁶⁾	No. of Circuits	ES with WireGuide Interior Catalog Number ^{③⑤}	NEMA 1 - Enclosure Height (inches) ^③	No. of Circuits	Catalog Number	NEMA 3R - Enclosure Height (inches) ^④
125	12	12	S1212L1125 ^⑤	—	—	18	12	SW1212L1125 ^⑤	21
		24	S1224L1125 ^⑤	—	—	18	24	SW1224L1125 ^⑤	21
	20	24	S1624L1125	—	—	21	24	SW1624L1125	21
		20	S2020L1125 ^⑤	40	S2040L1125AG	21	—	—	—
		20	S2020L1125G ^⑤				—	—	—
		24	S2024L1125				—	—	—
	24	S2024L1125G	—				—	—	
	24	24	S2424L1125 ^⑤	48	S2448L1125AG	24	24	SW2424L1125	27
		24	S2424L1125G ^⑤				—	—	—
		40	S2440L1125 ^⑤				—	—	—
30	40	S3040L1125 ^⑤	—	S3060L1125AG	30	40	SW3040L1125	29	
	40	S3040L1125G ^⑤	—	—	—	—	—	—	
40	40	S4040L1125	80	S4080L1125AG	36	—	—	—	
150	20	30	S2030L1150 ^⑤	40	S2040L1150AG	24	30	SW2030L1150	27
200	12	24	S1224L1200 ^⑤	—	—	21	24	SW1224L1200 ^⑤	21
		20	S2040L1200	40	S2040L1200AG	24	40	SW2040L1200	27
		24	S2440L1200 ^⑤	48	S2448L1200AG	30	—	—	—
	30	30	S3030L1200 ^⑤	60	S3060L1200AG	30	—	—	—
		40	S3040L1200 ^⑤				40	SW3040L1200	35
		54	S3054L1200				54	SW3054L1200	35
		40	S3040L1200L50 ^⑦				—	—	36
40	40	S4040L1200 ^⑤	80	S4080L1200AG	36	40	SW4040L1200	35	
225	12	24	—	—	—	24	SW1224L1225	23	
	42	60	S4260L1225	80	S4280L1225AG	36	60	SW4260L1225	38
	54	70	S5470L1225	80	S5480L1225AG	42	—	—	—

① Suitable for use as service equipment.

② May be installed on higher rated systems when protected by a circuit breaker with a higher AIR rating.

③ Indoor enclosures are 14 1/4" wide by 3 7/8" deep.

④ Outdoor enclosures are 14 1/2" wide by 4 1/4" deep.

⑤ Suitable for use as service entrance equipment when not more than six main disconnecting means are provided. See article 230.71 of the NEC®.

⑥ ES Series single phase skus with a "G" suffix have ground bar included (factory installed).

⑦ Line and Neutral Lug Wire Range: 500 kcmil - #2 AL/CU

⑧ Available (made to order) in white by adding "W" to the end of the part number.

ES Series 1-Phase Unassembled Load Centers

1-phase, 3-wire SN, 120/240 Volts A

Features

- Available for the most popular ES Load Centers
- Gives the ability to order in bulk
- Enclosures will have minimal packaging for less hassle and waste at the job site
- Keeps the covers separate to prevent damage or theft
- Includes full size cardboard covers to keep the interior safe during painting
- All main lug panels include factory installed ground bars



Main Breaker ES Unassembled Load Centers^① 24-40 Circuits / 125-200 Amperes

Aluminum Bus
60/75° Rated 22,000A IR^②

Amp Rating	Box Catalog Number	Main	No. of Spaces	No. of Circuits	Dimensions			Trim Catalog Number	Pallet Quantity
					Height	Width	Depth		
125	SB2424B1125	Main Breaker	24	24	24	14.5	4.25	ST2424B1125	36
200	SB3040B1200	Main Breaker	30	40	36	14.5	4.25	ST3040B1200	30
200	SB4040B1200	Main Breaker	40	40	36	14.5	4.25	ST4040B1200 ^④	30

Selectable Main ES Unassembled Load Centers^③ 30-40 Circuits / 200 Amperes

Aluminum Bus

Amp Rating	Box Catalog Number	Main	No. of Spaces	No. of Circuits	Dimensions			Trim Catalog Number	Pallet Quantity
					Height	Width	Depth		
150/200	SB3040C1200G	Convertible	30	40	36	14.5	4.25	ST3040X1200	30
150/200	SB4040C1200G	Convertible	40	40	36	14.5	4.25	ST4040X1200	30

Main Lug ES Unassembled Load Centers^③ 24-40 Circuits / 125-200 Amperes

Aluminum Bus
60/75° Rated 100,000A IR

Amp Rating	Box Catalog Number	Main	No. of Spaces	No. of Circuits	Dimensions			Trim Catalog Number	Pallet Quantity
					Height	Width	Depth		
125	SB2440L1125G	Main Lug	24	40	24	14.5	4.25	ST2440L1125	36
125	SB3040L1125G	Main Lug	30	40	30	14.5	4.25	ST3040L1125	36
200	SB3040L1200G	Main Lug	30	40	30	14.5	4.25	ST3040L1200	36
200	SB4040L1200G	Main Lug	40	40	36	14.5	4.25	ST4040L1200	30

① Suitable for use as service equipment.

② May be installed on higher rated systems when protected by a circuit breaker with a higher AIR rating.

③ ES Series single phase skus with a "G" suffix have ground bar included (factory installed).

④ Available (made to order) in white by adding "W" to the end of the part number.

ES Series 1-Phase Special Load Centers

1-phase, 3-wire SN, 120/240 Volts AC

First Surge ES Load Centers

Aluminum Bus

54-60 Circuits

60/75° Rated, 22,000A IR

Amp Rating	No. of Spaces	No. of Circuits	Catalog Number	Surge Protection	Enclosure Height (inches) ^②
200	30	54	S3054B1200S060	60kA	36
200	40	60	S4060B1200S060	60kA	42

Outdoor Trailer Panels

Aluminum Bus

16 Circuits / 200 Amperes

60/75° Rated 100,000A IR

Amp Rating	No. of Spaces	No. of Circuits	Catalog Number	Main Breaker	Enclosure Height (inches) ^④
200	8	16	SW0816L1200T	N/A	23
200	8	16	SW0816B1200T ^⑤	MBK200A	Factory Installed 23

Value Pack Load Centers^③

Aluminum Bus

Catalog Number	Load Center	Breakers Included	Amp	NO. of Spaces	No. of Circuits
S2020B1100P	S2020B1100	(3) Q120, (1) Q230	100	20	20
S3040B1200P	S3040B1200	(3) Q120, (1) Q230	200	30	40
S3040L1200P	S3040L1200	(3) Q120, (1) Q230	200	30	40
S4040B1200P	S4040B1200	(3) Q120, (1) Q230	200	30	40
S3054B1200P	N/A	(3) Q120, (1) Q230	200	30	54

Split Ground Series Load Centers^⑥

30-40 Circuits / 125-200 Amperes

16 Circuits / 200 Amperes

Aluminum Bus

Branch Circuits			Indoor Enclosure – NEMA Type 1	
Amp Rating	No. of Spaces	No. of Circuits	Catalog Number	Enclosure Height (inches) ^②
125	20	30	S2030L1125SG	21
150	30	30	S3030B1150SG	30
200	40	40	S4040B1200SG	36

Selectable Main Load Centers^⑦

24-40 Circuits / 125-200 Amperes

Aluminum Bus

Branch Circuits			Indoor Enclosure – NEMA Type 1		Outdoor Enclosure – NEMA Type 3R		Available Kits	
Amp Rating	No. of Spaces	No. of Circuits	Catalog Number	Enclosure Height (inches) ^②	Catalog Number	Enclosure Height (inches) ^④	Main Lug	Main Breaker
125	24	24	S2424C1125	24	SW2424C1125	27	ECMLK125	MBK100A, MBK125A
200	20	40	S2040C1200	35	SW2040C1200	35	ECMLK225	MBK200A
200	30	40	S3040C1200	36	SW3040C1200	35	ECMLK225	MBK150A, MBK200A
200	40	40	S4040C1200	36	SW4040C1200	38	ECMLK225	MBK150A, MBK200A

① Load centers with white trim have increased lead time of 3-4 weeks. Sold in pallet quantities only. Additional charge will apply. Contact sales office for details.

② Indoor enclosures are 14 1/4" wide by 3 7/8" deep.

③ Breakers are shipped inside a sleeve located inside the load center.

④ Outdoor enclosures are 14 1/2" wide by 4 1/4" deep.

⑤ Main breaker rated 22,000A IR.

⑥ Split Ground load centers have factory installed 100% neutral with factory bonded 75% ground.

⑦ Selectable main load centers do not come with main lugs or main breakers. Those kits are sold separately.

ES Series 3-Phase Main Lug & Main Breaker Load Centers

3-phase, 3-wire, 240 Volt AC or 3-phase, 4-wire, 120/240 or 120/208 Volts AC

Main Breaker

30-60 Circuits / 100-225 Amperes

Aluminum Bus

60/75°C Rated 10,000A IR^①

Branch Circuits			Indoor Enclosure – NEMA Type 1		Outdoor Enclosure – NEMA Type 3R	
Amp Rating	No. of Spaces	No. of Circuits	Catalog Number	Enclosure Height (inches) ^③	Catalog Number	Enclosure Height (inches) ^④
100	12	24	S1224B3100 ^②	24	SW1224B3100	23
100	30	30	S3030B3100 ^②	30	—	—
100	30	42	S3042B3100 ^②	30	—	—
125	30	42	S3042B3125	35	—	—
150	24	42	S2442B3150	36	SW2442B3150	35
150	42	42	S4242B3150	42	—	—
150	30	54	S3054B3150	35	—	—
200	30	54	S3054B3200	39	SW3054B3200	38
200	42	60	S4260B3200	42	SW4260B3200	42
225	42	42	S4242B3225	42	SW4242B3225	42

Main Lug^⑤

12-70 Circuits / 125-225 Amperes

Aluminum Bus

60/75° Rated 100,000A IR^⑥

Branch Circuits			Indoor Enclosure – NEMA Type 1		Outdoor Enclosure – NEMA Type 3R	
Amp Rating	No. of Spaces	No. of Circuits	Catalog Number	Enclosure Height (inches) ^③	Catalog Number	Enclosure Height (inches) ^④
125	12	24	S1224L3125	21	SW1224L3125	21
150	18	36	S1836L3150	24	SW1836L3150	23
150	24	42	S2442L3150	30	SW2442L3150	27
200	12	24	S1224L3200	21	SW1224L3200	21
200	24	42	S2442L3200	30	SW2442L3200	27
200	30	54	S3054L3200 ^⑦	30	SW3054L3200	35
225	42	60	S4260L3225 ^⑦	36	SW4260L3225	38
225	54	70	S5470L3225 ^⑦	42	—	—

① May be installed on higher rated systems when protected by a circuit breaker with a higher AIR rating.

② Back fed main breaker.

③ Indoor enclosures are 14 1/4" wide by 3 7/8" deep.

④ Outdoor enclosures are 14 1/2" wide by 4 1/4" deep.

⑤ Suitable for use as service entrance equipment when not more than six main disconnecting means are provided. See article 230.71 of the NEC[®].

⑥ Rated 100,000A IR in series with breakers listed on wiring diagram.

⑦ Available (made to order) in white by adding "W" to the end of the part number.

EQ® Load Centers—300-400Amp

1-Phase, 3-Wire/3-Phase, 3-Wire, 4-Wire

Features

- UL listed for 60/75°C conductors. See equipment markings for applications.
- Copper bus standard.
- Factory installed lock on indoor enclosure.
- Outdoor enclosures use HV type hubs. See page 1-22.



Main Breaker 300-400 Ampere^①

1Ø, 3-Wire

120/240 Volts AC

Ampere Rating	Branch Circuits Type QP		Indoor Enclosure — NEMA Type 1 (65,000A IR)						Outdoor Enclosure — NEMA Type 3R (65,000A IR)					
	Max. 1-Pole	Max. 2-Poles	Catalog Number ^③	Std. Pkg.	Dimensions (inches)			Trim Style	Catalog Number	Std. Pkg.	Dimensions (inches)			
					Height	Width	Depth				Height	Width	Depth ^④	
300	42	20	E4242MB1300FCU	1	58	20	6	Flush	—	—	—	—	—	
300	42	20	E4242MB1300SCU	1	58	20	6	Surface	—	—	—	—	—	
400	30	14	E3030MB1400SCU	1	52	20	6	Surface	W3030MB1400CU	1	52	20	6	
400	42	20	E4242MB1400FCU	1	58	20	6	Flush	W4242MB1400CU	1	58	20	6	
400	42	20	E4242MB1400SCU	1	58	20	6	Surface	—	—	—	—	—	

3Ø, 3-Wire, 4-Wire

240 Volts AC

Ampere Rating	Branch Circuits Type QP		Indoor Enclosure — NEMA Type 1 (65,000A IR)						Outdoor Enclosure — NEMA Type 3R (65,000A IR)					
	Max. 1-Pole	Max. 2-Poles	Catalog Number ^③	Std. Pkg.	Dimensions (inches)			Trim Style	Catalog Number	Std. Pkg.	Dimensions (inches)			
					Height	Width	Depth				Height	Width	Depth ^④	
300	42	20	E4242MB3300SCU	1	58	20	6	Surface	—	—	—	—	—	
400	30	14	E3030MB3400SCU	1	52	20	6	Surface	—	—	—	—	—	
400	42	20	E4242MB3400FCU	1	58	20	6	Flush	W4242MB3400CU	1	58	20	6	
400	42	20	E4242MB3400SCU	1	58	20	6	Surface	—	—	—	—	—	

Main Lug 400 Ampere

1Ø, 3-Wire

120/240 Volts AC

Ampere Rating	Branch Circuits Type QP		Indoor Enclosure — NEMA Type 1 (65,000A IR)						Outdoor Enclosure — NEMA Type 3R (65,000A IR)					
	Max. 1-Pole	Max. 2-Poles	Catalog Number ^③	Std. Pkg.	Dimensions (inches)			Trim Style	Catalog Number	Std. Pkg.	Dimensions (inches)			
					Height	Width	Depth				Height	Width	Depth ^④	
400	24	12	—	—	—	—	—	—	W0606ML1400CU ^{②⑤⑥}	1	43	20	6	
400	30	14	E3030ML1400SCU	1	41	20	6	Surface	W3030ML1400CU	1	43	20	6	
400	42	20	E4242ML1400SCU	1	47	20	6	Surface	—	—	—	—	—	
400	42	20	E4242ML1400FCU	1	47	20	6	Flush	W4242ML1400CU	—	47	20	6	

3Ø, 3-Wire, 4-Wire

240 Volts AC

Ampere Rating	Branch Circuits Type QP		Indoor Enclosure — NEMA Type 1 (22,000A IR)						Outdoor Enclosure — NEMA Type 3R (22,000A IR)					
	Max. 1-Pole	Max. 2-Poles	Catalog Number	Std. Pkg.	Dimensions (inches)			Trim Style	Catalog Number	Std. Pkg.	Dimensions (inches)			
					Height	Width	Depth				Height	Width	Depth ^④	
400	30	14	E3030ML3400SCU	1	41	20	6	Surface	—	—	—	—	—	
400	42	20	E4242ML3400FCU	1	47	20	6	Flush	W4242ML3400CU	1	47	20	6	
400	42	20	E4242ML3400SCU	1	47	20	6	Surface	—	—	—	—	—	

① UL listed as suitable for use as service equipment.

② Does not include 2" rainhead overhang.

③ Suitable for use as service entrance equipment when not more than six main disconnecting means are provided.

④ W0606ML1400CU rated at 22,000A IR.

⑤ Accepts up to six QN style breakers.

⑥ Where noted suffix S = Surface, F = Flush.

Generator Ready Load Centers

1-Phase, 3-Wire SN, 120/240Volts AC

Generator Ready Load Centers

The Siemens generator ready load center can save thousands of dollars in future generator installation expenses while keeping initial expenses to a minimum. Works with an automatic standby generator or a portable generator.

Load Center Features

- UL Listed
- Indoor Type 1 and outdoor Type 3R
- 225A max rated
- Flush or surface mounting
- Fits between standard stud centers
- Tin plated copper bus bars
- 22 kAIC rated
- 120/240V ~
- Main lug – convertible to main breaker with addition of MBK150A, MBK200A, or MBK225A
- Main breaker – convertible to main lug with use of lug kit part no. ECMLK225
- Installation of transfer mechanism can be performed at time of generator installation.

Automatic transfer switch features:

- UL Listed
- Operates automatically when connected to generator
- Transfers load from utility to generator and back to utility
- Transfer switch (sold separately)
catalog number: GENTFRSWTCH[Ⓞ]

Indoor Enclosure – NEMA Type 1

Amp Rating	No. of Spaces [Ⓞ]	No. of Circuits [Ⓞ]	Catalog Number	Dimensions (inches)		
				Height	Width	Depth
200	30	42	G3042B1200GEN	42	14.25	4
225	30	42	G3042L1225GEN	42	14.25	4
200	42	54	G4254B1200GEN	44	14.25	4
225	42	54	G4254L1225GEN	44	14.25	4

Outdoor Enclosure – NEMA Type 3R

Amp Rating	No. of Spaces [Ⓞ]	No. of Circuits [Ⓞ]	Catalog Number	Dimensions (inches)		
				Height	Width	Depth
200	30	42	W3042B1200GEN	42	14.63	4
225	30	42	W3042L1225GEN	42	14.63	4

[Ⓞ] Q2125S provided with GENTFRSWTCH for use with automatic transfer mechanism.

[Ⓞ] 2 spaces and 2 circuits are reserved for standby generator installation.

[Ⓞ] Field install breaker for voltage sensing required.



NEMA 1

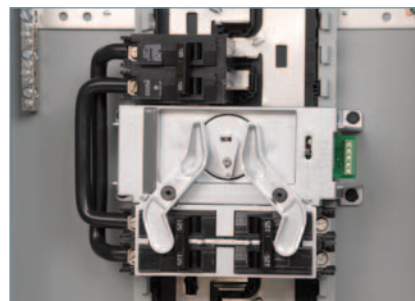

GENTFRSWTCH



NEMA 3R

Riser Panel Load Centers

1-Phase, 3-Wire SN, 120/240Volts AC

Riser Panel Load Centers^①

Riser panel load centers are ideal for high rise applications. The shifted interior provides room for conductors to pass through the load center. The tap kits allow the installer to tap off from those conductors to power the panel.

Features

- UL Listed for use in 1Ø and 3Ø riser gutter applications.
- Copper bus standard.
- Main lug factory standard - convertible to main breaker.
- Neutrals aligned on left side- keeps way clear for riser cables.
- Available in 125 and 200 amp models.
- Invertible for left and right hand applications.

Riser Gutter Tap Kit^②

The riser gutter tap kit (ECRLK250) allows the installer to tap off the main conductors, eliminating the need to cut completely through the conductor. The tap kit accepts 250 -1/0 on the main conductor side and 250-#6 on the tap side.

Riser Gutter

The riser gutter (RAG24) is used to convert any load center 24" or larger into a riser panel.

Features

- Single and 3-phase applications
- Compatible with any single or 3-phase Siemens load center 24" or higher
- Flush trim included
- Load center mounting hardware and pass through brush included (Catalog no. RAG24)



R1632L1125CU



ECRLK250

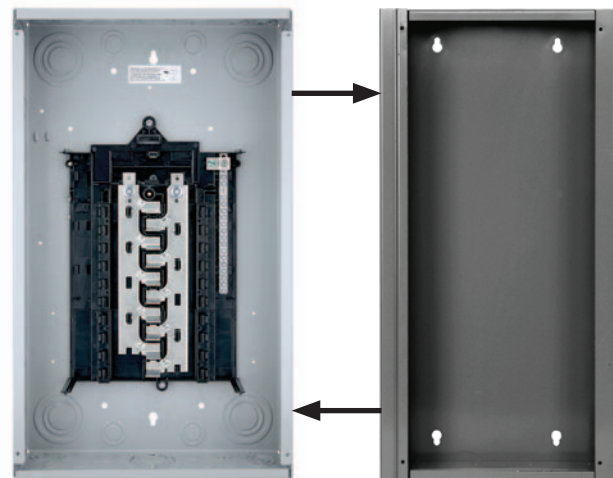

Any Load Center
24" or larger

RAG24

1-phase, 3-wire SN, 120/240 Volts AC

Amp Rating	No. of Spaces	No. of Circuits	Catalog Number				Dimensions (inches)			Acceptable Main Breaker Kits
			Aluminum Bus	Aluminum Bus White Coating	Copper Bus	Copper Bus White Coating	Height	Width	Depth	
125	16	32	R1632L1125	R1632L1125W	R1632L1125CU	—	24	14.25	3.88	MBK100A, MBK125A
125	24	24	R2424L1125	R2424L1125W	R2424L1125CU	—	30	14.25	3.88	MBK100A, MBK125A
125	24	42	R2442L1125	R2442L1125W	R2442L1125CU	R2442L1125CUW	30	14.25	3.88	MBK100A, MBK125A
200	30	42	R3042L1200	R3042L1200W	R3042L1200CU	R3042L1200CUW	36	14.25	3.88	MBK150A, MBK200A

① The riser panels are single phase only, but can be fed from 1-phase or 3-phase systems running through the gutter trough area.

② ECRLK250 is sold separately

EQ® Load Centers—Small Circuit Load Centers

1-Phase, 3-Wire SN, 120/240Volts AC

Features/Applications

EQ Load Centers with main lugs feature a combination trim box in one package.

- Interiors offer removal in seconds
- Single phase
- One piece bus bar construction designed for use only with circuit breakers
- UL Listed
- UL listed on 60/75°C conductors (see equipment markings for applications)
- Positive load side circuit breaker hook rails
- Outdoor Type 3R devices use HS Type hubs. See page 1-22.



Small Circuit Load Centers

Ideal for subfeed applications

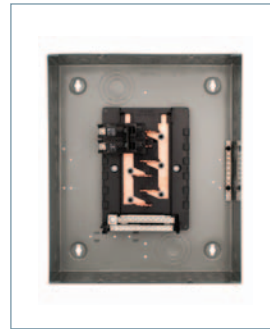

Renovation Panel

Ideal for older home renovation projects where the distance between the studs is narrower than current construction practices. The narrower panel eliminates the need to 'notch' out the existing studs.



Spa Panels

Spa Panels are ideal for outdoor applications requiring the use of ground fault protection, such as hot tubs. A factory installed 2-Pole GFCI breaker is provided, along with 2 extra circuits.

LOAD CENTERS & CIRCUIT BREAKERS

Main Lugs with Aluminum Bus[ⓐ] 4–16 circuits, 100–125 Amperes

100,000A IR

1-Phase, 3-Wire, SN 120/240 Volts AC

Branch Circuits				Indoor Enclosure — NEMA Type 1					Outdoor Enclosure — NEMA Type 3R				
Amp Rating	Max. 1-Pole No. of Spaces	No. of Circuits	QP Max. 2-Poles	Catalog Number—Replace Suffix F (Flush) with S for Surface Mounting	Std. Pkg.	Dimensions (inches)			Catalog Number	Std. Pkg.	Dimensions (inches)		
						H	W	D			H	W	D
100	12	24	6	E1224ML1100FG [ⓐ]	1	14 3/4	12 3/8	3 7/8	—	—	—	—	
125	4	8	2	E0408ML1125F ^{ⓐⓑⓓ}	5	12 5/8	6 5/8	3 1/2	W0408ML1125 ^{ⓐⓑⓓ}	5	12 1/4	6	4 1/4
125	4	8	2	—	—	—	—	—	W0408L1125SPA50 ^{ⓐⓑⓓ}	1	12 1/4	6	4 1/4
125	4	8	2	—	—	—	—	—	W0408L1125SPA60 ^{ⓐⓑⓓ}	1	12 1/4	6	4 1/4
125	8	16	4	E0816ML1125F [ⓐ]	1	14 3/4	12 3/8	3 7/8	—	—	—	—	

Main Lug and Main Breaker with Copper Bus^{ⓐⓑ} 4–16 circuits, 100–225 Amperes

100,000A IR

1-Phase, 3-Wire, SN 120/240 Volts AC

Branch Circuits				Indoor Enclosure — NEMA Type 1					Outdoor Enclosure — NEMA Type 3R				
Amp Rating	Max. 1-Pole No. of Spaces	No. of Circuits	QP Max. 2-Poles	Catalog Number	Std. Pkg.	Dimensions (inches)			Catalog Number	Std. Pkg.	Dimensions (inches)		
						H	W	D			H	W	D
100	10	20	4	E1020MB1100FCGP [ⓑ]	1	14 3/4	12 3/8	3 7/8	—	—	—	—	
100	12	24	6	E1224ML1100FCU	1	14 3/4	12 3/8	3 7/8	—	—	—	—	
125	8	16	4	E0816ML1125FCU [ⓑ]	1	14 3/4	12 3/8	3 7/8	W0816ML1125CU [ⓑ]	1	14 3/4	12 1/8	4 1/4
125	8	16	4	E0816ML1125SCU	1	14 3/4	12 3/8	3 7/8	—	—	—	—	
225	4	6	2	—	1	—	—	—	W0406ML1225CU [ⓑ]	1	23	10	4 1/8
200	4	4	2	—	1	—	—	—	W0404MB1200CT ^{ⓐⓑ}	1	20	11 1/8	4 3/4
150	4	4	2	—	1	—	—	—	W0404MB1150CTS ^{ⓐⓑ}	1	20	11 1/8	4 3/4
200	4	4	2	—	1	—	—	—	W0404MB1200CTS ^{ⓐⓑ}	1	20	11 1/8	4 3/4

ⓐ 70 amp maximum breaker.
 ⓑ Will not accommodate 2-pole GFCI or circuit breaker with shunt trip.
 ⓓ Can accommodate 2-pole GFCI breaker up to 50A. For 2-pole 60A GFCI, a restriction of #6 wire applies due to wire bend space of the enclosure. Will not accommodate circuit breaker with shunt trip.
 ⓔ 100 amp maximum breaker.

ⓑ Suitable for use as service entrance equipment when a main breaker (125A maximum) is back-fed in a branch position and used with main breaker retainer clip (Cat. No. ECMBR1).
 ⓓ Suitable for use as service entrance when not more than six main disconnecting means are provided. Check local codes and restrictions.
 ⓔ Two Q115 and one Q230 breaker included.
 ⓕ W0408L1125SPA50 provided with factory installed QF50 and ground bar. W0408L1125SPA60 provided with factory installed QF260 and ground bar.

ⓑ Copper Bus load centers are recommended for those applications where the environment may be severe (i.e. farm and coastal areas).
 ⓓ 2" HS Type hub provided.
 ⓔ Type QNR main breaker factory installed.
 ⓕ CSA Listed
 ⓖ Cover plate included

EQ[®] Load Centers—Circuit Breaker Enclosures

1-Phase and 3-Phase, 240V AC Max.

Features

- Circuit breaker enclosures range from 60A to 225A, indoor and outdoor models
- Designed for use exclusively with QP, QT, QPH, HQP, BQ, BQH, HBO, QPP, QPPH, HQPP, QJ2, QJH2 and QJ2-H circuit breakers
- UL listed
- Suitable for use as service entrance equipment
- UL listed for 60/75°C conductors (See equipment markings for applications)
- Outdoor type 3R devices use HS type hubs (pg. 1-21) except for the W0204ML1060 which uses the HA type hub



Breaker Used			Indoor Enclosure — NEMA Type 1					Outdoor Enclosure — NEMA Type 3R				
Frame Type	Ampere Rating	No. of Poles	Catalog Number	Std. Pkg.	Dimensions (inches)			Catalog Number	Std. Pkg.	Dimensions (inches)		
					Height	Width	Depth			Height	Width	Depth

1-Phase, 3-Wire SN — 120/240 Volts AC

QP, QPH, HQP	60	2	E0204ML1060S ^①	5	9 7/8	5 1/8	2 5/8	W0204ML1060 ^{①②}	5	8	5	4 1/4
	60	2	E0204ML1060F	5	9 7/8	5 1/8	2 5/8	—	—	—	—	—
	100	2	E0202MB1100 ^④	1	17 1/8	7 3/8	4 5/16	W0202MB1100CU ^④	1	17.4	7.3	4.3
	125	2	E0204ML1125SCU	1	17 1/8	7 1/8	4 1/4	W0204ML1125CU	1	17 1/8	7 3/8	4 5/16
QN, QNH, HQN	150	2	—	—	—	—	—	W0202MB1150CU ^④	1	19 3/4	8.4	4.6
	200	2	—	—	—	—	—	W0202ML1200CU	1	19 3/4	8.4	4.6
	200	2	E0202MB1200 ^④	—	19 3/8	8 1/2	4	W0202MB1200CU ^④	1	19 3/4	8.4	4.6
QPP, QPPH, HQPP, QP	225	1-4	—	—	—	—	—	W0406ML1225CU ^②	1	23	10	4 1/8
QJ2, QJH2, QJ2-H	150	2	—	—	—	—	—	WB2150B ^⑤	1	27	7 3/8	4 15/16
	200	2	—	—	—	—	—	WB2200B ^⑤	1	27	7 3/8	4 15/16
	225	2	—	—	—	—	—	WB2225 ^②	1	27	7 3/8	4 5/16

3-Phase, 3-Wire 240 Volts AC or 3-Phase, 4-Wire SN — 120/208 Volts AC, 120/240, 240 Volts AC

QP, QPH, HQP	100	2-3	E0303ML3100S ^③	1	17 1/8	7 1/8	4 1/4	W0303ML3100 ^③	1	17 1/8	7 3/8	4 5/16
BQ, BQH, HBO	100	2-3	EB3100S ^③	1	17 1/8	7 1/8	4 1/4	WB3100 ^③	1	17 1/8	7 3/8	4 5/16
QJ2, QJH2, QJ2-H	225	2-3	EB3225F ^②	1	27	10 1/8	5 1/8	WB3225 ^②	1	27	10 1/8	5 9/16

① Will not accommodate 2-pole GFCI or circuit breaker with shunt trip.
 ② 42,000A IR maximum. Copper wire only at 225A.

③ Can accommodate 2-pole GFCI breaker up to 50A. For 2-pole GFCI, a restriction of #6 wire applies due to wire bend space of the enclosure. Will not accommodate circuit breaker with shunt trip.

④ Main breaker factory installed.
 ⑤ QJ2 frame circuit breaker installed, rated 10,000A IR.
 ⑥ CSA Listed.

Load Centers

Load Center OEM Interiors^①

1Ø: Small Circuit Main Lug Interiors

Amps	Catalog Number ^②	Spaces	Circuits	Dimensions	
				Height	Width
60	I0204ML1125CU	2	2	4.40	1.85
60	I0303ML3100CU	3	3	5.77	3.42
125	I0408ML1125	4	8	4.51	6.61
125	I0816ML1125CU	8	16	6.19	6.81
125	I0816ML1125CUSP	8	16	6.19	6.81
200	I0202L1200	4	4	3.88	7.13
200	I1220L1200CT	12	20	9.00	7.00

1Ø: High Circuit Main Lug Interiors with Neutral Bars^④

Amps	Catalog Number ^②	Spaces	Circuits	Dimensions	
				Height	Width
125	I1224L1125CU	12	24	10.80	9.80
125	I1624L1125CU	16	24	12.80	9.80
125	I3040L1125CU	30	40	20.80	9.80
200	I0816L1200CT ^③	8	16	10.80	9.80
200	I1224L1200CU	12	24	10.80	9.80
200	I1632L1200CU	16	32	12.80	9.80
200	I2040L1200CU	20	40	14.80	9.80
200	I3040L1200CU	30	40	14.80	9.80
200	I4040L1200CU	40	40	24.80	9.80
225	I4242L1225CU	42	42	26.80	9.80

3Ø: Main Lug Interiors^②

Amps	Catalog Number	Spaces	Circuits	Dimensions	
				Height	Width
125	SI1224L3125B	12	24	10.04	9.95
200	SI1224L3200B	12	24	10.04	9.95
200	SI2442L3200B	24	42	16.04	9.95
200	SI3054L3200B	30	54	19.04	9.95
225	SI4242L3225B	42	42	25.04	9.95
125	PI1224L3125CUB	12	24	10.04	9.95
200	PI1224L3200CUB	12	24	10.04	9.95
200	PI1836L3200CUB	18	36	13.04	9.95
125	PI1836L3125CUB	18	36	13.04	9.95
200	PI2442L3200CUB	24	42	10.04	9.95
200	PI3054L3200CUB	30	54	19.04	9.95
225	PI4242L3225CUB	42	42	25.04	9.95

1Ø: Parallel Lug Interiors with Neutral Bars

Amps	Catalog Number ^②	Spaces	Circuits	Dimensions	
				Height	Width
200	CTI2040L1200CU	20	40	14.80	9.80
200	CTI2440L1200CU	24	40	16.80	9.80
200	CTI3040L1200CU	30	40	20.80	9.80

Lug Data

Interior	Amperage	Wire range	Torque
I0204ML1060	60	2/0 - 4 AWG	45 lb. - ins.
I0303ML3100	100	2/0 - 4 AWG	45 lb. - ins.
I1224ML1100	100	2/0 - 4 AWG	45 lb. - ins.
I0408ML1125	125	2/0 - 4 AWG	45 lb. - ins.
I0816ML1125CU/CUSP	60	2/0 - 4 AWG	45 lb. - ins.
Single Phase	125	2/0 - 4 AWG	110 lb. - ins.
Single Phase	200/225	300 kcmil - 4 AWG	250 lb. - ins.
Three Phase	125	300 kcmil - 6 AWG	340 lb. - ins.
Three Phase	200/225	300 kcmil - 6 AWG	340 lb. - ins.

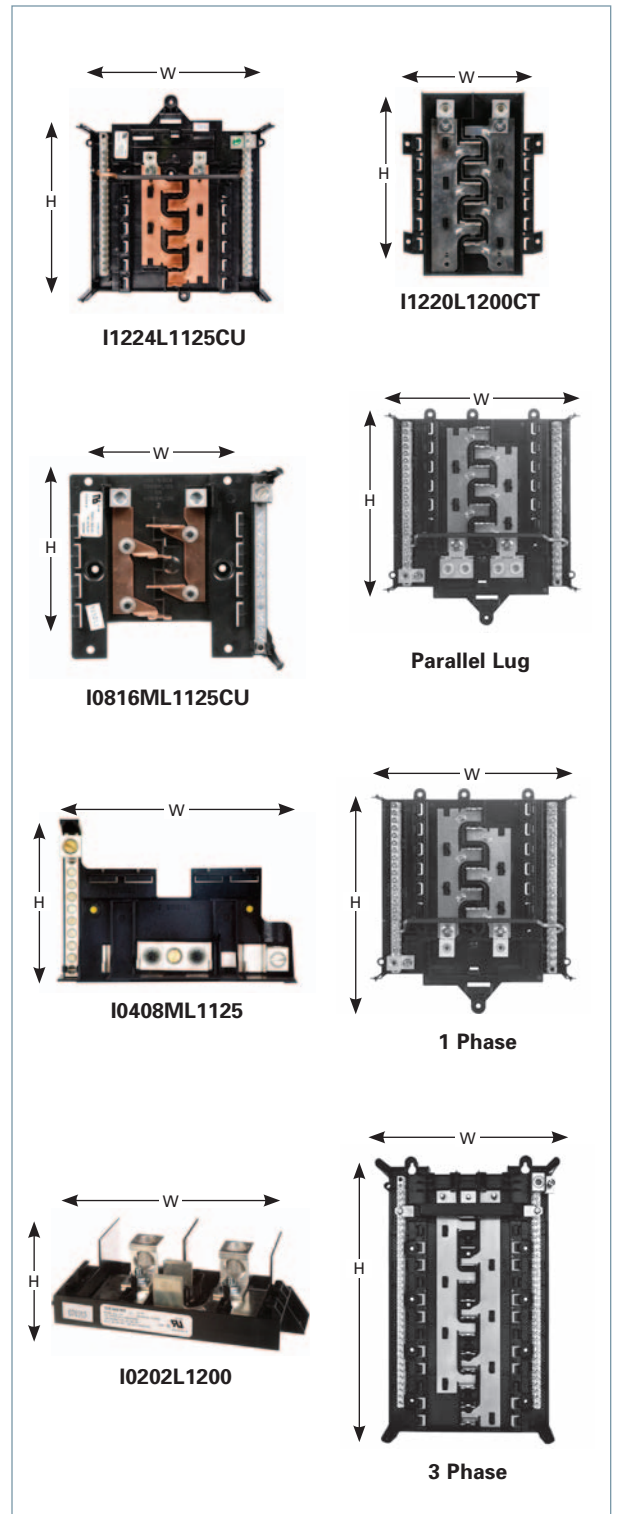

① UL Recognized Components.

② The letters "CU" in any catalog number represent copper bus bars.

③ Feed thru lugs provided.

④ Convertible to main breaker using the MBK main breaker kits.

Load Centers

Load Center Accessories^①

Catalog Number	Description	Pack Qty
----------------	-------------	----------

Ground Bar Kits (For ES and PL Load Centers)

EC1GB8	GROUND BAR KIT-8 POS	1
EC1GB82	GROUND BAR KIT-8 POS, 2/0 LUG	1
EC2GB12	GROUND BAR KIT-12 POS	1
EC2GB122	GROUND BAR KIT-12 POS, 2/0 LUG	1
EC2GB15	GROUND BAR KIT-15 POS	1
EC2GB152	GROUND BAR KIT-15 POS, 2/0 LUG	1
EC3GB21	GROUND BAR KIT-21 POS	1
EC3GB212	GROUND BAR KIT-21 POS, 2/0 LUG	1
EC3GB27	GROUND BAR KIT-27 POS	1
EC3GB272	GROUND BAR KIT-27 POS, 2/0 LUG	1
EC3GB30	GROUND BAR KIT-30 POS	1
EC3GB302	GROUND BAR KIT-30 POS, 2/0 LUG	1
EC3GB352	GROUND BAR KIT-35 POS, 2/0 LUG	1
EC3GB352G	GROUND BAR KIT-35 POS, 2/0 LUG ^②	1

Ground Bar Kits (For Legacy Load Centers)

ECGB5	GROUND BAR KIT-5 POS	1
ECGB10	GROUND BAR KIT-10 POS	1
ECGB101	GROUND BAR KIT-10 POS, 1/0 LUG	1
ECGB14	GROUND BAR KIT-14 POS	1
ECGB141	GROUND BAR KIT-14 POS, 1/0 LUG	1
ECGB142	GROUND BAR KIT-14 POS, 2/0 LUG	1
ECGB20	GROUND BAR KIT-20 POS	1
ECGB201	GROUND BAR KIT-20 POS, 1/0 LUG	1
ECGB202	GROUND BAR KIT-20 POS, 2/0 LUG	1
ECINSGB5	INSULATED GROUND BAR KIT-5 POS	1
ECINSGB14	INSULATED GROUND BAR KIT-14 POS	1
ECINSGB20	INSULATED GROUND BAR KIT-20 POS	1

Hubs

ECHS000	HS TYPE CLOSURE PLATE	1
ECHS075	HS TYPE HUB - 3/4"	1
ECHS100	HS TYPE HUB - 1"	1
ECHS125	HS TYPE HUB - 1 1/4"	1
ECHS150	HS TYPE HUB - 1 1/2"	1
ECHS200	HS TYPE HUB - 2"	1
ECHS250	HS TYPE HUB - 2 1/2"	1
ECHA000	HA TYPE CLOSURE PLATE	1
ECHA075	HA TYPE HUB - 3/4"	1
ECHA100	HA TYPE HUB - 1"	1
ECHA125	HA TYPE HUB - 1 1/4"	1
ECHA150	HA TYPE HUB - 1 1/2"	1
ECHV000	HV TYPE CLOSURE PLATE	1
ECHV200	HV TYPE HUB - 2"	1
ECHV250	HV TYPE HUB - 2.5"	1
ECHV300	HV TYPE HUB - 3"	1
ECHV350	HV TYPE HUB - 3.5"	1
ECHV400	HV TYPE HUB - 4"	1

Lock Kits

ECQFL2	FLUSH LOCK KIT FOR ULT., PL, ES, 3PH 100A-225A	1
ECQFL1	FLUSH LOCK KIT-REPLACEMENT FOR EQ LC	1
ECQFL3	ADD-A-LOCK (FLUSH LOCK) FOR 300-400A LC	1

① The pack quantity is the number that is sold in a pack. Items listed on this page must be ordered in multiples of pack quantities but items are priced per each. For example, ECRLK250 come 3 to a pack so must be ordered in multiples of 3 but pricing would be individual unit price times 3.

Catalog Number	Description	Pack Qty
----------------	-------------	----------

Load Center Conversion Kits^{③④}

MBK100A	MAIN BREAKER KIT 100-125A 1PH 22K	1
MBK125A	MAIN BREAKER KIT 125A 1PH 22K	1
MBK150A	MAIN BREAKER KIT 150A-225A 1PH 22K	1
MBK200A	MAIN BREAKER KIT 200A-225A 1PH 22K	1
MBK225A	MAIN BREAKER KIT 225A 1PH 22K	1
MBK3100	MAIN BREAKER KIT 100A 3PH QP 240V 10K	1
MBK3125R	MAIN BREAKER KIT 125A 3PH 240V 10K, QR	1
MBK3150R	MAIN BREAKER KIT 150A 3PH 240V 10K, QR	1
MBK3175R	MAIN BREAKER KIT 175A 3PH 240V 10K, QR	1
MBK3200R	MAIN BREAKER KIT 200A 3PH 240V 10K, QR	1
MBK3225R	MAIN BREAKER KIT 225A 3PH 240V 10K, QR	1
MBK3125HR	MAIN BREAKER KIT 125A 3PH 240V 22K, QR	1
MBK3150HR	MAIN BREAKER KIT 150A 3PH 240V 22K, QR	1
MBK3175HR	MAIN BREAKER KIT 175A 3PH 240V 22K, QR	1
MBK3200HR	MAIN BREAKER KIT 200A 3PH 240V 22K, QR	1
MBK3225HR	MAIN BREAKER KIT 225A 3PH 240V 22K, QR	1
MBK3125HHR	MAIN BREAKER KIT 125A 3PH 240V 65K, QR	1
MBK3150HHR	MAIN BREAKER KIT 150A 3PH 240V 65K, QR	1
MBK3175HHR	MAIN BREAKER KIT 175A 3PH 240V 65K, QR	1
MBK3200HHR	MAIN BREAKER KIT 200A 3PH 240V 65K, QR	1
MBK3225HHR	MAIN BREAKER KIT 225A 3PH 240V 65K, QR	1
HMBK3125HR	MAIN BREAKER KIT 125A 3PH 240V 100K, QR	1
HMBK3150HR	MAIN BREAKER KIT 150A 3PH 240V 100K, QR	1
HMBK3175HR	MAIN BREAKER KIT 175A 3PH 240V 100K, QR	1
HMBK3200HR	MAIN BREAKER KIT 200A 3PH 240V 100K, QR	1
HMBK3225HR	MAIN BREAKER KIT 225A 3PH 240V 100K, QR	1
ECMLK125	1 PH MAIN LUG CONVERSION KIT 100-125A	1
ECMLK225	1 PH MAIN LUG CONVERSION KIT 150-225A	1
ECMLK3125	3 PH MAIN LUG CONVERSION KIT 100-125A	1
ECMLK3225	3 PH MAIN LUG CONVERSION KIT 150-225A	1

Lug Kits

ECCS1	COLLAR STRAP FOR GRD BARS #14-1/0	1
ECCS2	COLLAR STRAP FOR GRD BARS #6-250	1
ECLKB1	NEUTRAL LUG KIT WITH BOND TAB	1
ECLK3	NEUTRAL LUG KIT #1-300 FOR EQIII LC	1
ECLK1-2	NEURTAL LUG KIT #2 TO 1/0 FOR EQIII LC	1
ECLK2	NEUTRAL LUG KIT #4-2/0 FOR EQIII LC, PL, ES	1
ECLK2SC	2/0 LUG FOR 125AMP NEUTRAL FEEDER	1
ECLK2125	125A SUB FEED LUGS-USSES 2 SPACES	1
ECLK2225	150A-225A SUB FEED LUGS-USSES 4 SPACES	1
ECLK3225	3P SUB FEED LUGS-USSES 6 SPACES	1
ECRLK250	RISER LUG KIT 250 KCMIL	3

Miscellaneous Load Center Accessories

ECCP1	PKG OF 100 CIRCUIT DIRECTORY	100
ECQF3	QP/BO/ED2 FILLER PLATE	5
ECMBF125	1 PH 100&125A MAIN BREAKER FILLER PLATE	1
EC3PMFP1	3 POLE MAIN FILLER PLATE, QJ	1
EC3PMFPR	3 POLE MAIN FILLER PLATE, QR	1
ECSMK1	SURFACE MOUNT 1/4" SPACE KIT FOR LC'S	4
ECTS2	LC TRIM SCREWS	6
ECTS2W	LC TRIM SCREWS WHITE	6
ECLCHINGE	GREY LC HINGES	100
ECADHLCDIRLBL	ADHESIVE LC DIRECTORY LABELS	100
ECSIELATCH	SIEMENS LC LATCHES	25
ECBONDSCRW	LC BOND SCREW	10
ECSN1	SCREWS & NUTS FOR HC HUB-BOTTOM USE	4
RAG24	RISER AUX GUTTER 24"	1
ECAFL	ARC FLASH LABEL	10

Neutral Bar Kits

ECLNB14	MLO NEUTRAL BAR KIT-14 POS	1
ECCNB16	CONVERTIBLE LC NEUTRAL BAR KIT-16 POS	1
ECMLK125	1 PH MAIN LUG CONVERSION KIT 100-125A	1

② Bar has green-colored screws.

③ QR Main Breaker Kits include a QR filler plate.

④ Main Breaker Kits include line terminal barriers.

Load Centers

Load Center Accessories



Lug Kit, 3-Pole, Subfeed or Feed thru Applications
ECLK3225



2 PH Main Lug Conversion Kit
150A-225A
ECMLK225



Main Breaker Kit
200A - 225A, 1PH 22K
MBK200A

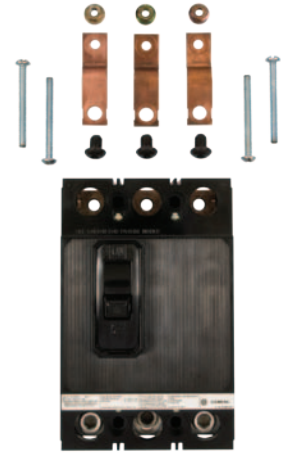

3-Pole Main Breaker Kit
MBK3200



Main Breaker Retainer Kit for EQ Load Centers
ECMBR1



Main Breaker Retainer kit for PL, ES, & Ultimate Load Centers
ECMBR2



Ground Bar Kit
20 POS. 2/0 Lug
ECGB202



Ground Bar Kit, **ECGB14**

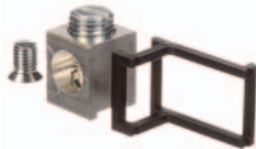

Neutral Lug Kit, **ECLK1-2**
wire range — #2-1 AWG
Cu or Al



Neutral Lug Kit, **ECLK3**
wire range — #1-300 MCM
Neutral Lug Kit, **ECLK2**
wire range — #4-#2/0 AWG
Cu or Al



For use on Ground Bar only
Collar Strap, Wire Range;
ECCS1; ECCS2



Add-A-Lock
(Flush Lock) **ECQFL1**
For EQ load centers



Filler Plate, **ECQF3**



Add-A-Lock
(Flush Lock), **ECQFL2**
PL, ES, Ultimate Load Centers
and EQ III up to 225A



Add-A-Lock
(Flush Lock), **ECQFL3**
300-400A Load Centers

Load Centers



Load Center Accessories

Load centers and meter combos

Touchsafe barriers are required for any single main service entrance application for a panel covered under UL 67. Line Terminal Barriers will be included in Main Breaker Load Centers and Single Main Meter Combos manufactured after January 1, 2017.

Single phase and 3-phase main breaker kits will include a barrier. Field installable kits are being created for replacements if needed and line terminal barriers are being added to hold down kits that can be used in back-fed applications. The barriers are designed to have minimal interference during load center installation, and can be removed and reattached as necessary.

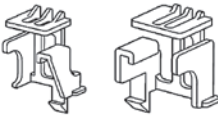
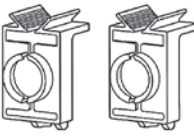
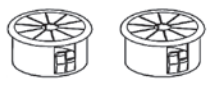
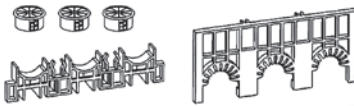
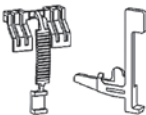
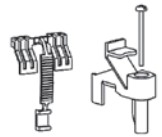
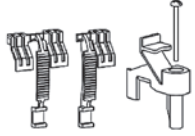

	Catalog number	Description
	ECLTB1	For EQ Main Breakers/MBK kits 100A-125A
	ECLTB2	For EQ Main Breakers/MBK kits 150A-225A
	ECLTB3	For QN / QNR type breakers
	ECLTB4	For QR 3 phase breakers
	ECMBR1	For 2 Pole QP / MP-T type breakers for EQIII (extruded basepan) and Line 5 Load Centers
	ECMBR2	For 2 Pole QP / MP-T type breakers to be used with Ultimate LCs (now ES / PL), Murray or Rock Solid
	ECMBR3	For 3 Pole QP / MP-T type breakers to be used with PL, ES 3 phase load centers
	ECLX387HD	For 2 Pole MP-T type breakers in legacy Murray load centers

Load Centers

Manual Transfer Interlock Kits for Load Centers and Meter Combinations

Convert load centers or meter combinations into standby power panels

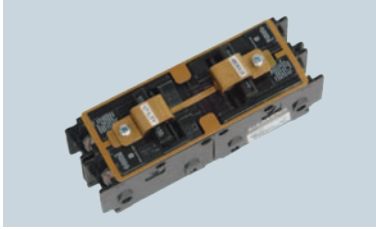

Standard features

- UL listed for use in most Siemens load centers and meter combinations
- Suitable for use with optional standby systems in accordance with article 702 of the National Electric Code
- Corrosion resistant finish
- Easy assembly requiring no modifications to the load center or meter combination
- Remains attached to the main breakers when load center cover

Panels in which the bussing or wire forms from the meter socket land on main lugs are not acceptable for use in standby systems because turning the main breaker to "OFF" does not prevent feedback to the utility power lines. Examples of such panels include catalog numbers that start with the following letters.

MC0606L1200*

MM0406L1*

MC1212L1200*



Wire forms or bussing



Utility main breaker

Standby power main breaker

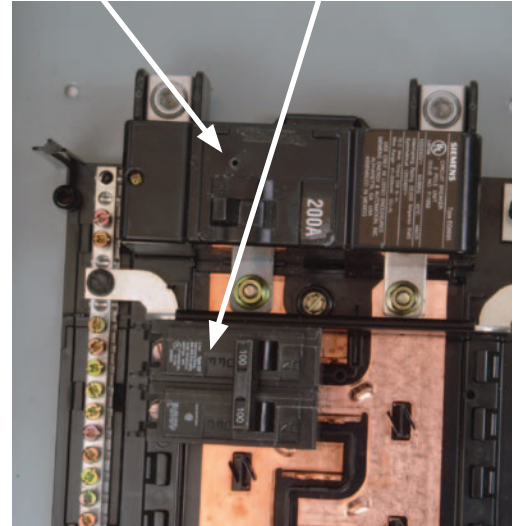

To activate standby power the utility main breaker must be in the "OFF" position to prevent dangerous feedback between the power sources.

Acceptable usage of Interlock Kits by load center/meter combination catalog numbers

ES Series Load Centers can utilize interlock kits: 1, 2, 5, 6, 7. Kits 3 and 4 can also be used on main breaker panels.

PL Series Load Centers can utilize interlock kits: 1, 2, 3, 4, 5, 6, 7.

Numbers 1 through 9 in these tables represent the last digit in each interlock kit catalog number. Example: 1 = ECSBPK01

When used in horizontal positions as typical in most load centers, ECSBPK07 is recommended for use only with QNR type circuit breakers.

Standby power interlock kits are not intended for use with AFCI, GFCI, 3-pole or 1/2" frame circuit breakers and 4 space, 125 amp load centers.

Siemens type EQ load centers using a "4-pole" main breaker do not have a kit available to interlock this main to branch circuits. Branch circuit positions can be interlocked.

Siemens Meter Combinations

MC0408B1200RGA	8	MC1020B1100S	1 2
MC0408B1200RT	8	MC1224B1100EFC	2
MC0408B1200T	8	MC1224B1100ESC	2
MC0816B1150JLT	9	MC1224B1125EFC	2
MC0816B1150RCT	8	MC1224B1125ESC	2
MC0816B1150TH	5 7	MC2040B1150JLC	8
MC0816B1200CT	8	MC2040B1200JLC	8
MC0816B1200EFN	2	MC2040B1200R	5 7
MC0816B1200ESN	2	MC2040B1200RC	9
MC0816B1200EST	2	MC2040B1200RJBC	9
MC0816B1200JLT	9	MC2442S1200FC	2
MC0816B1200RCT	8	MC2442S1200SC	2
MC0816B1200RGA	8	MC3042B1200FED	3
MC0816B1200RTH	5 7	MC3042B1200JLC	8
MC0816B1200T	7	MC3042B1400FD	5 7
MC0816B1200TH	5 7	MC3042B1400SC	5 7
MC0816B1350RLTM	5	MC3042B1400SCS	5 7
MC0816B1400RLTM	5	MC3042B1400SD	5 7
MC0816B1400SCS	5 7	MC3042B1400SDS	5 7
MC1020B1100F	1 2	MC4040S1200SC	5

Load Centers

Manual Transfer Interlock Kits for Load Centers and Meter Combinations

LOAD CENTERS & CIRCUIT BREAKERS

1 Prevents dangerous feedback between two sources of power

Manual Transfer Interlock Kits^①

Catalog number	Usage Information	Utility main breaker types	Standby main breaker types	Interlock Number
ECSBPK01 	For use on load centers or meter combinations that will accept 2-pole circuit breakers opposite one another as shown.	QP, QPH, HQPH	QP, QPH, HQPH	1 
ECSBPK02 	For use on load centers or meter combinations that will accept 2- or 4-pole next to a 2-pole circuit breaker side by side as shown.	QP, QPH, HQPH	QP, QPH, HQPH	2 
ECSBPK03 ^② 	For use on Ultimate TM and Rock Solid load centers, 150 amp and higher, to connect the main breaker to a 2-pole circuit breaker.	MBK150A, MBK200A, OR MBK225A	QP, QPH, HQPH	3 
ECSBPK04 ^② 	For use on Ultimate and Rock Solid load centers, 125 amp and lower, to connect the main breaker to a 2-pole circuit breaker.	MBK100A or MBK125A	QP, QPH, HQPH	4 
ECSBPK05 	For use on load centers or meter combinations that will accept a QNR (MD-TR) frame circuit breaker next to a 2-pole circuit breaker as shown.	QNR, QNRH, HQNR	QP, QPH, HQPH	5 
CSBPK06 ^② 	For use on load centers or meter combinations that will accept a QN (MD-T) frame circuit breaker next to a 2-pole circuit breaker as shown.	QN, QNH, HQN	QP, QPH, HQPH	6 
ECSBPK07 	For use on load centers or meter combinations that will accept two QNR (MD--TR) circuit breakers side by side as shown OR will accept two QN (MD--T) circuit breakers side by side as shown.	QNR, QNRH, HQNR, QN, QNH, HQN	QNR, QNRH, HQNR QN, QNH, HQN	7 
ECSBPK08 ^② 	For use on 8 space, over/under, OH/UG feed meter combinations as shown. Limited application to specific catalog numbers.	QPP, QPPH	QP, QPH, HQPH	8 
ECSBPK09 ^② 	For use on 20 space, over/under, OH/UG feed meter combinations as shown. Limited application to specific catalog numbers.	QPP, QPPH	QP, QPH, HQPH	9 

^① Manual breaker interlock kits are attached to the breakers not the trim of the load center.

^② These kits take up 2 spaces adjacent to the 2 pole breaker being interlocked. Those spaces cannot accommodate filler plates.

Load Centers

3-Phase Indoor and Riser Enclosures—Knockout Diagrams

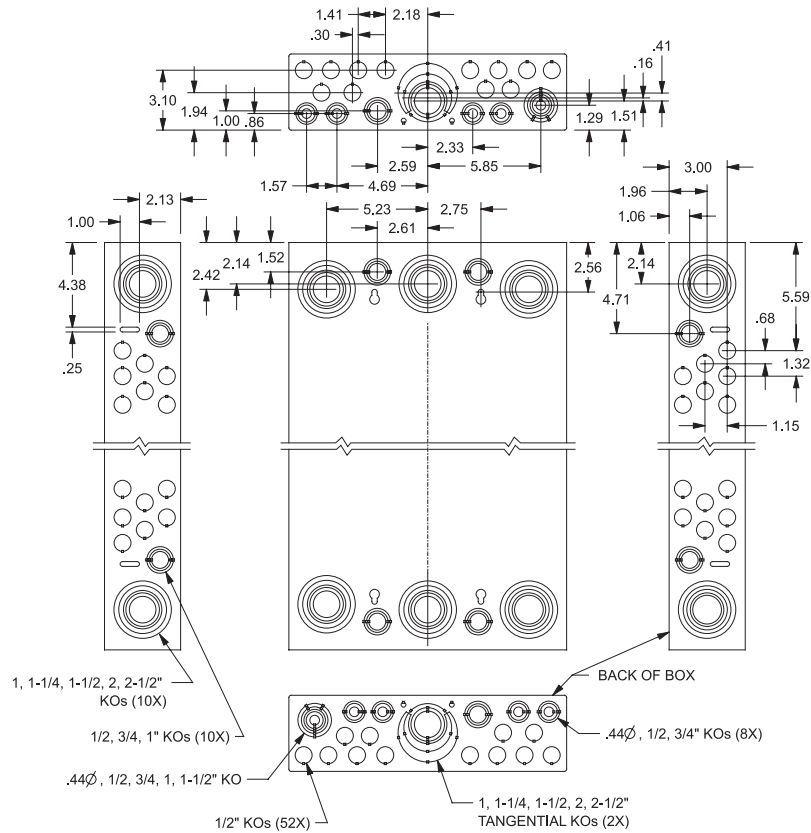

**ES and PL
3 Phase Load Centers**

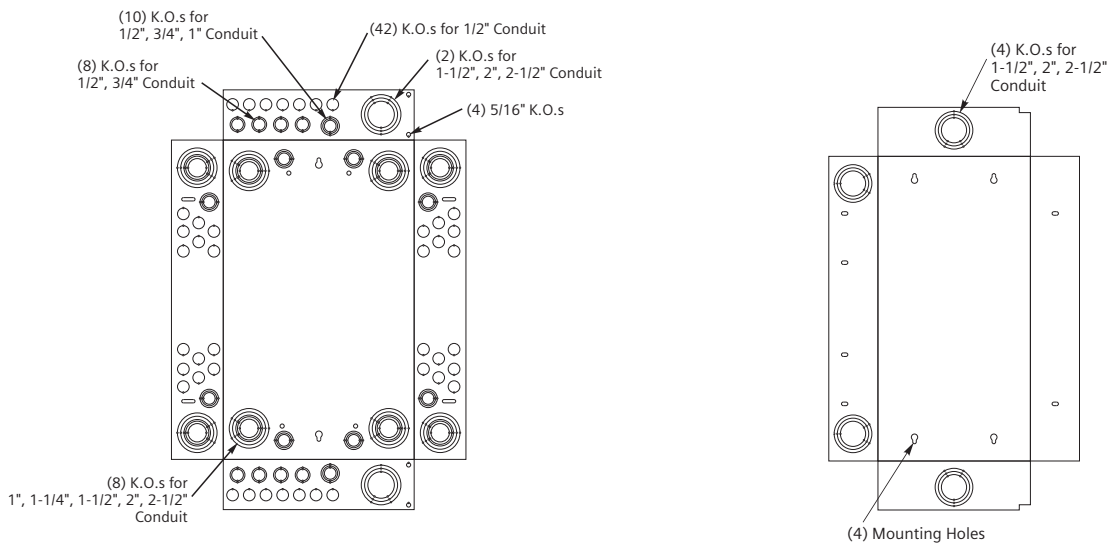

All Riser Panels

RAG24

Load Centers

Outdoor Enclosures—Knockout Diagrams

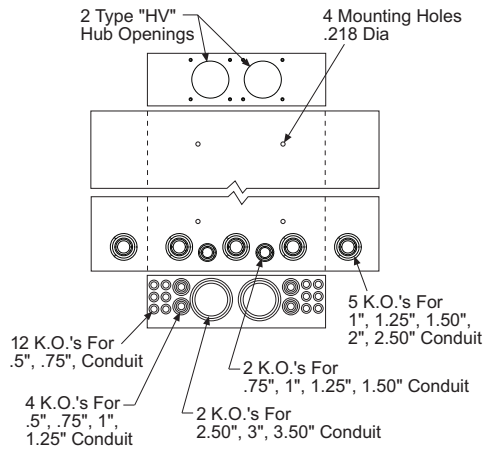

Outdoor 400A Load Center

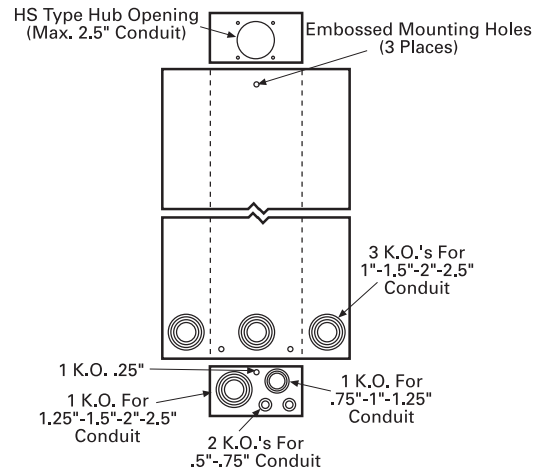

W0406ML1125CU

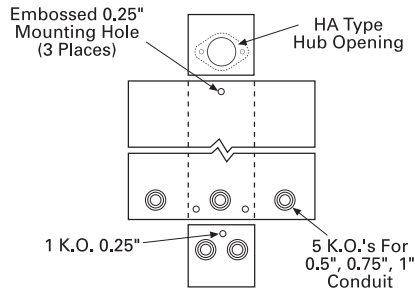

W0204ML1060

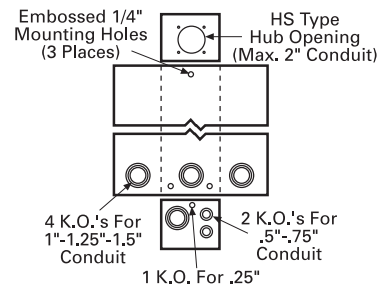

W0408ML1125

Load Centers

Outdoor Enclosures—Knockout Diagrams

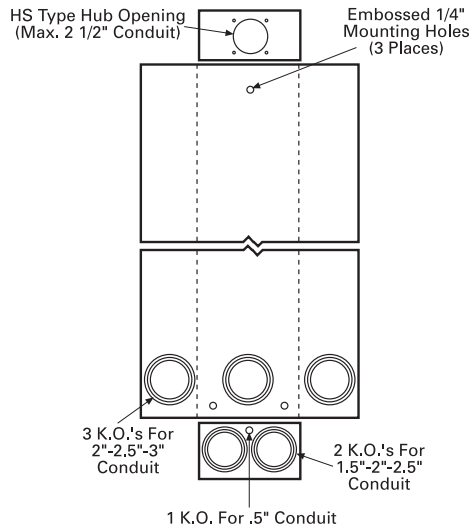

WB2225 and WB32225

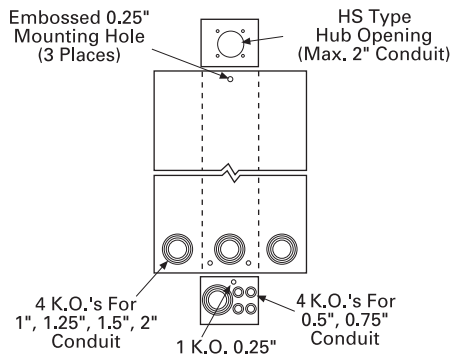

W0204ML1125

W0303ML3100

WB3100

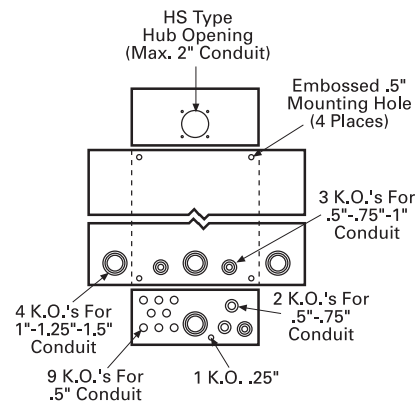

W0612ML1125

W0816ML1125

Load Centers

Indoor Enclosures—Knockout Diagrams

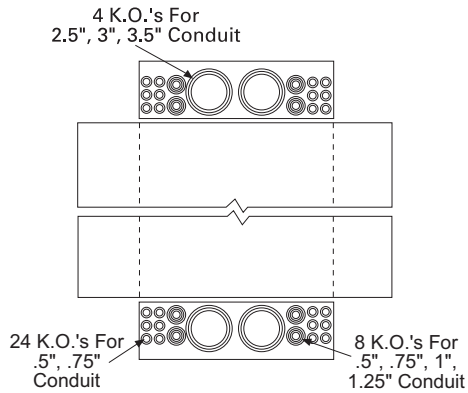

**Indoor 300-400A
Load Center**

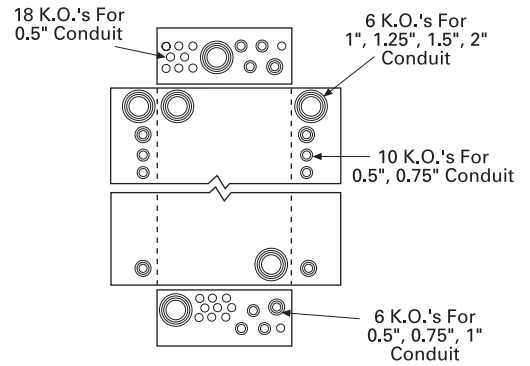

**E0612ML1125
E0816ML1125
E1224ML1100F**

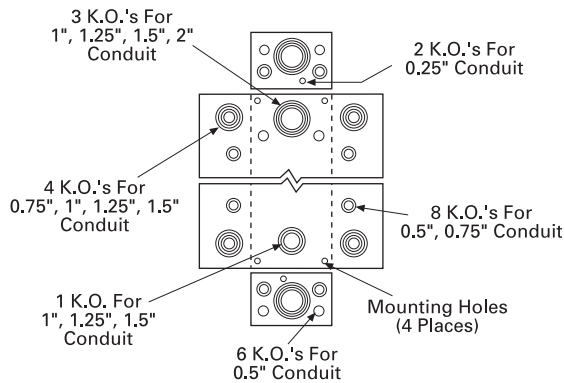

E0408ML1125

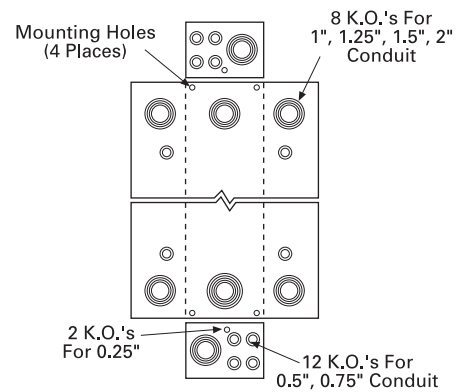

**E0303ML3100SCU
EB3100**

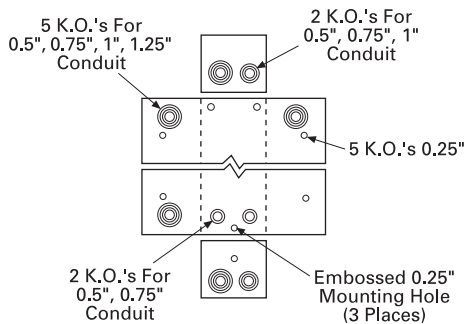

E0204ML1060

Load Centers

Cross Reference

Ultimate Load Center Cross Reference to ES Series and PL Series

Phase	Type	Current Sku	ES Series	PL Series
1 Phase	Indoor	New	—	P3040L1200SG
		New	—	P4040L1200SG
		New - Higher Circuits	—	P4260L1225CUSG
		New - Higher Circuits	S3054L1200	P3054L1200CU
		New - Higher Circuits	S5470B1225	P5470B1225CU
		New - Higher Circuits	S5470L1225	P5470L1225CU
		New - Higher Circuits	SW3054L1200	PW3054L1200CU
		G1212L1125	S1212L1125	-
		G1212L1125CU	—	P1212L1125CU
		G1224B1100	S1224B1100	-
		G1224B1100CU	—	P1224B1100CU
		G1224L1125	S1224L1125	-
		G1224L1125CU	—	P1224L1125CU
		G1224L1125CUSG	—	P1224L1125CUSG
		G1224L1200CU	S1224L1200	P1224L1200CU
		G1624B1100	S1624B1100	-
		G1624B1100CU	—	P1624B1100CU
		G1624B1100W	S1624B1100W	-
		G1624L1125	S1624L1125	-
		G1624L1125CU	—	P1624L1125CU
		G1624L1125CUSG	—	P1624L1125CUSG
		G1630B1150	S1630B1150	-
		G2020B1100	S2020B1100	-
		G2020B1100CP	S2020B1100P	-
		G2020B1100CU	—	P2020B1100CU
		G2020L1125	S2020L1125	-
		G2020L1125CU	—	P2020L1125CU
		G2020L1125CUW	S2020L1125W	—
		G2030B1150	S2030B1150	—
		G2030B1150CU	—	P2030B1150CU
		G2030L1125CUSG	—	P2030L1125CUSG
		G2030L1150	S2030L1150	—
		G2030L1150CU	—	P2030L1150CU
		G2030L1150CUSG	—	P2030L1150CUSG
		G2040B1200	S2040B1200	—
		G2040B1200CU	—	P2040B1200CU
		G2040L1200	S2040L1200	—
		G2040L1200CU	—	P2040L1200CU
		G2424B1100CU	—	P2424B1100CU
		G2424B1125	S2424B1125	—
		G2424L1125	S2424L1125	—
		G2424L1125W	S2424L1125W	—
		G2430B1150	S2430B1150	—
		G2430L1125CUSG	—	P2430L1125CUSG
		G2440B1200	S2440B1200	—
		G2440L1125CU	S2440L1125	P2440L1125CU
		G2440L1200	S2440L1200	—
		G2440L1200CU	—	P2440L1200CU
		G3030B1100CU	S3030B1100	P3030B1100CU
		G3030B1150	S3030B1150	—
		G3030B1150CU	—	P3030B1150CU
		G3030L1200	S3030L1200	—
		G3030L1200CU	—	P3030L1200CU
		G3030L1200W	S3030L1200W	—
		G3040B1200	S3040B1200	P3040B1200
		G3040B1200CP	S3040B1200P	—
		G3040B1200CU	—	P3040B1200CU
		G3040L1125CU	—	P3040L1125CU
		G3040L1125CUW	S3040L1125W	—
		G3040L1200	S3040L1200	P3040L1200
		G3040L1200CP	S3040L1200P	—
		G3040L1200CU	—	P3040L1200CU
		G3040L1200CUSG	—	P3040L1200CUSG
		G4040B1200	S4040B1200	P4040B1200
		G4040B1200CP	S4040B1200P	—
		G4040B1200CU	—	P4040B1200CU
		G4040B1200W	S4040B1200W	P4040B1200W
		G4040L1125CU	S4040L1125	P4040L1125CU
		G4040L1200	S4040L1200	P4040L1200
		G4040L1200CU	—	P4040L1200CU
		G4040L1200CUSG	—	P4040L1200CUSG
		G4242B1225CU	S4260B1225	P4260B1225CU
		G4242L1225CU	S4260L1225	P4260L1225CU
		G2020B1100SP	S2024B1100	P2024B1100CU
		G2020L1125SP	S2020L1125G	—
		G2024L1125SP	S2024L1125/S2024L1125G	P2024L1125CU
		G2424L1125SP	S2424L1125G	—
		G3030B1125CU	S3030B1125	P3030B1125CU
		G3040L1125	S3040L1125/S3040L1125G	—
		G4040B1200CUSG	—	P4040B1200CUSG

Load Centers

Cross Reference

Ultimate Load Center Cross Reference to ES Series and PL Series

Phase	Type	Current Sku	ES Series	PL Series
1 Phase	Outdoor	W0816B1200CT	SW0816B1200T	PW0816B1200TC
		W0816L1200CT	SW0816L1200T	PW0816L1200TC
		W1212L1125CU	SW1212L1125	PW1212L1125CU
		W1224B1100CU	SW1224B1100	PW1224B1100CU
		W1224L1125CU	SW1224L1125	PW1224L1125CU
		W1224L1200CU	SW1224L1200	PW1224L1200CU
		W1224L1225CU	SW1224L1225	PW1224L1225CU
		W1624B1100CU	SW1624B1100	PW1624B1100CU
		W1624L1125CU	SW1624L1125	PW1624L1125CU
		W2020B1100CU	SW2020B1100	PW2020B1100CU
		W2030L1150CU	SW2030L1150	PW2030L1150CU
		W2040B1200CU	SW2040B1200	PW2040B1200CU
		W2040L1200CU	SW2040L1200	PW2040L1200CU
		W2424L1125CU	SW2424L1125	—
		W3040B1200CU	SW3040B1200	PW3040B1200CU
		W3040L1125CU	SW3040L1125	PW3040L1125CU
		W3040L1200CU	SW3040L1200	PW3040L1200CU
		W4040B1200CU	SW4040B1200	PW4040B1200CU
		W4040L1200CU	SW4040L1200	PW4040L1200CU
		W4242B1225CU	SW4260B1225	PW4260B1225CU
W4242L1225CU	SW4260L1225	PW4260L1225CU		
3 Phase	Indoor	New	S4242B3150	—
		New – Higher Circuits	—	P5470B3225CU
		New – Higher Circuits	S5470L3225	P5470L3225CU
		G1224L3125CU	S1224L3125	P1224L3125CU
		G1224L3200CU	S1224L3200	—
		G1836L3150CU	S1836L3150	—
		G2442B3150CU	S2442B3150	P2442B3150CU
		G2442B3150CU22	—	P2442B3150CU
		G2442L3150CU	S2442L3150	—
		G2442L3200CU	S2442L3200	P2442L3200CU
		G3030B3100CU	S3030B3100	P3042B3100CU
		G3030B3100CU22	—	P3042B3100CU
		G3042B3200CU	S3054B3200	P3054B3200CU
		G3042L3200CU	S3054L3200	P3054L3200CU
		G4242B3200CU	S4260B3200	P4260B3200CU
		G4242B3225CU	S4242B3225	P4260B3225TCU/ P4260B3225CU
		G4242L3225CU	S4260L3225	P4260L3225CU
		Outdoor	W1224L3125CU	SW1224L3125
	W1224L3200CU		SW1224L3200	—
	W1836L3150CU		SW1836L3150	—
	W2442B3150CU		SW2442B3150	—
	W2442L3150CU		SW2442L3150	—
	W2442L3200CU		SW2442L3200	PW2442L3200CU
	W3042B3200CU		SW3054B3200	PW3054B3200CU
	W3042B3200CU22		—	PW3054B3200CU
	W3042L3200CU		SW3054L3200	PW3054L3200CU
	W4242B3200CU		SW4260B3200	PW4260B3200CU
	W4242B3200CU22	—	PW4260B3200CU	
W4242B3225CU	SW4242B3225	PW4260L3225CU		
W4242L3225CU	SW4260L3225	—		

Circuit Breakers

Arc-Fault and Ground-Fault Breakers

Selection/Wiring Diagrams

Arc-Fault Circuit Interrupters (AFCI)

AFCI's detect arcing faults (an unintentional arcing condition in a circuit) that standard circuit breakers are unable to detect. The device is intended to mitigate the effects of arcing faults by functioning to de-energize the circuit when an arc-fault is detected.

Combination Type AFCI

Detects all three possible types of arc faults: line-to-ground, line-to-neutral, and series.

Breaker Type	Ampere Rating	10,000 A IR Catalog No.	22,000 A IR Catalog No.	65,000 A IR Catalog No.
QAF2/QAFH2/HQAF2 1-Pole 120V AC	15	QA115AFC ①②	QA115AFCH ①	QA115AFCHH ①
	20	QA120AFC ①②	QA120AFCH ①	QA120AFCHH ①
QAF2/QAFH2 2-Pole 120/240V AC	15	Q215AFC ①②	Q215AFCH ①	—
	20	Q220AFC ①②	Q220AFCH ①	—

Branch-Feeder AFCI

Detects line-to-ground and line-to neutral arcs.

Breaker Type	Ampere Rating	10,000 A IR Catalog No.	22,000 A IR Catalog No.	65,000 A IR Catalog No.
QAF2/QAFH2/HQAF2 1-Pole 120V AC	15	QA115AF ①	QA115AFH ①	QA115AFHH ①
	20	QA120AF ①	QA120AFH ①	QA120AFHH ①

NEW Dual Function AFCI/GFCI

The Dual Function Circuit Breaker combines Combination Type AFCI and GFCI, protecting against both Arc Faults and (5mA) Ground Faults. The device includes the Self Test feature, making it the first in class in electrical safety for homeowners.

Breaker Type	Ampere Rating	10,000 A IR Catalog No.	22,000 A IR Catalog No.	65,000 A IR Catalog No.
QFGA2/QFGAH2/HQFGA2 1-Pole 120V AC	15	Q115DF ①②	Q115DFH ①	Q115DFHH ①
	20	Q120DF ①②	Q120DFH ①	Q120DFHH ①

Ground-Fault Circuit Interrupters (GFCI)

Provides Class A (5mA) ground fault protection. Intended for personnel protection. Includes Self Test as an added safety feature.

Breaker Type	Amp Rating	10,000 A IR Catalog No.	22,000 A IR Catalog No.	65,000 A IR Catalog No.
QPF2/QPHF2/HQPF2 1-Pole 120V AC Plug-in	15	QF115A ②③	QF115AH ①	QF115AHH ①
	20	QF120A ②③	QF120AH ①	QF120AHH ①
	30	QF130A ①	QF130AH ①	QF130AHH ①
QPF/QPHF 2-Pole 120/240V AC Plug-in	15	QF215A	QF215AH ①	—
	20	QF220A	QF220AH ①	—
	30	QF230A	QF230AH ①	—
	40	QF240A	QF240AH ①	—
	50	QF250A	QF250AH ①	—
	60	QF260A	QF260AH ①	—

Ground Fault Equipment Protection (30mA)

Provides protection of equipment from damaging line-to-ground faults currents. De-energizes the circuit for all ungrounded conductors of the circuit.

Breaker Type	Ampere Rating	10,000 A IR Catalog No.	22,000 A IR Catalog No.	65,000 A IR Catalog No.
QE/QEH 1-Pole 120V AC Plug-in	15	QE115	QE115H ①	—
	20	QE120	QE120H ①	—
	30	QE130	QE130H ①	—
QE/QEH 2-Pole 120/240V AC Plug-in	15	QE215	QE215H ①	—
	20	QE220	QE220H ①	—
	30	QE230	QE230H ①	—
	40	QE240	QE240H ①	—
	50	QE250	QE250H ①	—
	60	QE260	QE260H ①	—

QAF2/QPF/QE/QPF2 Accessories

Description	Catalog Number ①
Padlocking Device 1-Pole	ECPLD1
Padlocking Device 2-Pole	ECPLD2
Handle Block	ECBX231M

■ Built to order. Allow 8 -10 weeks for delivery.
 ① UL Listed as SWD (Switching Duty) Rated, suitable for 120V AC Fluorescent Lighting.
 ② Add WG to the part number for the WireGuide version.

• UL Listed

• HACR Rated



1-Pole Combination Type AFCI



2-Pole Combination Type AFCI



1-Pole Branch Feeder AFCI



1-Pole Dual Function AFCI/GFCI



1-Pole GFCI



2-Pole GFCI



1-Pole Equipment Protection



2-Pole Equipment Protection

Wiring Diagrams

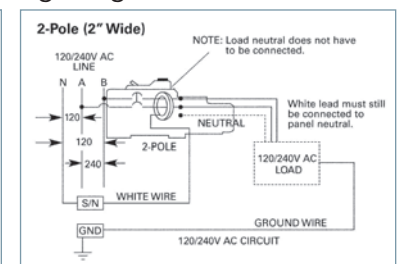
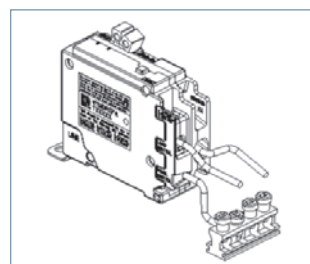

Circuit Breakers

Intelli-Arc Diagnostic Tool

Intelli-Arc Diagnostic Tool, Part Number: **IDT5000**

The Siemens Intelli-Arc Diagnostic Tool helps to accurately diagnose the circuit in which a fault has occurred. When used in conjunction with good troubleshooting techniques, this tool allows the electrical contractor to determine and locate the root cause or source of the fault. The Intelli-Arc Diagnostic Tool presents information as to the type and magnitude of fault. Since the fault may not cause an AFCI to trip for various reasons, i.e. duration too short, current level too low, the tool provides an indication showing how close an event is to causing an AFCI to trip.

The goal of the diagnostic tool is to speed the troubleshooting process for the electrical contractor. The device drastically improves the accuracy of the troubleshooting process. This, in turn, will significantly reduce the number of visits to the problem site. Every intent of this device is directed as saving the electrical contractor time for each branch circuit that must be evaluated. The Intelli-Arc Diagnostic Tool can be used with any circuit breaker regardless of brand.

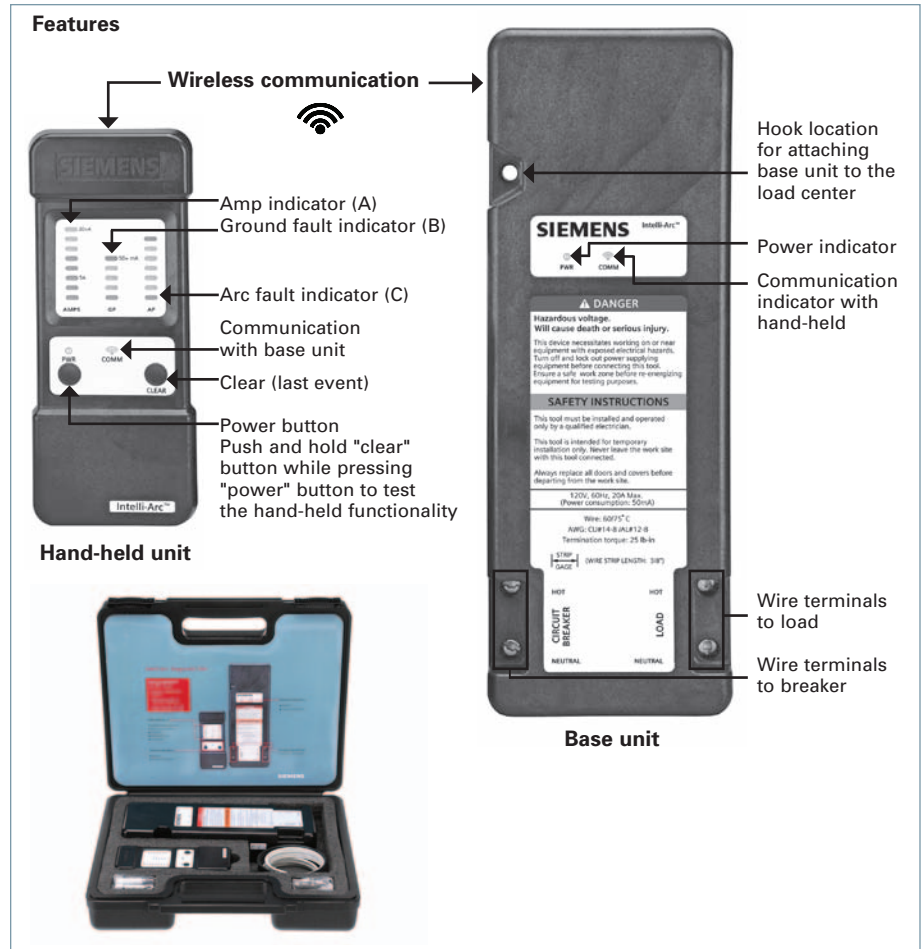

Two state-of-the-art technologies combined in one device! Dual Function Circuit Breakers: **QFGA2/QFGAH2/HQFGA2**

Introducing the Dual Function Circuit Breaker that provides Arc Fault and Ground Fault protection in one device. The 2014 National Electric Code requires Arc Fault protection on Kitchen and Laundry circuits where Ground fault protection is currently a requirement. One solution to meet this code is to pair an AFCI circuit breaker with a GFCI receptacle. The Dual function breaker will replace the Arc fault breaker and the Ground Fault receptacle. Additionally, the breaker will help eliminate the use of two separate devices and improve cost savings.

Features

- Plug-in or bolt-on branch circuit breakers for Siemens single phase load centers
- Self Test feature as required by UL 1699 effective June 2015
- Saving time – ease of installation – only One product to install vs. Two
- Saving money – Two safety devices combined into One.
- LED trip indicator – a Siemens exclusive!
- Available with interrupting rating of 10kA, 22kA or 65kA
- UL Listed
- Torque rating: 25 lb. in.
- Padlocking device available, use catalog number ECPLD1
- Both lugs at the same angle - for easier wiring

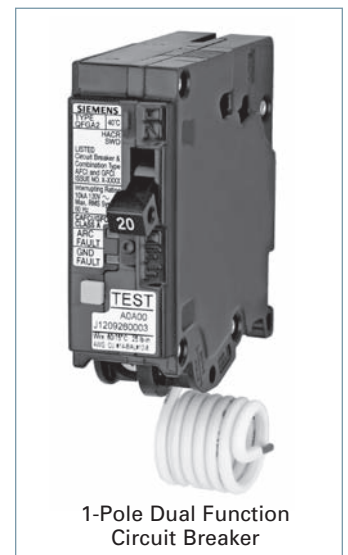

Circuit Breakers

Type QP with INSTA-WIRE

Continuous Current Rating @ 40° C	Type QP ^①	Type QPH	Type HQP
	10,000A IR	22,000A IR	65,000A IR
	Catalog Number	Catalog Number	Catalog Number

1-Pole Plug-In (120V AC)^⑤

Rating	Type QP	Type QPH	Type HQP
10	Q110 ^⑥	—	—
15	Q115 ^③	Q115H ^③	Q115HH ^③
20	Q120 ^③	Q120H ^③	Q120HH ^③
25	Q125	Q125H■	Q125HH■
30	Q130	Q130H	Q130HH■
35	Q135■	Q135H■	Q135HH■
40	Q140	Q140H	Q140HH■
45	Q145■	Q145H■	Q145HH■
50	Q150	Q150H	Q150HH■
60	Q160	Q160H■	Q160HH■
70	Q170	Q170H■	Q170HH■

2-Pole Plug-In (Common-Trip 120/240V AC)^⑥

Rating	Type QP	Type QPH	Type HQP
10	Q210 ^⑥	—	—
15	Q215	Q215H	Q215HH
20	Q220	Q220H	Q220HH
25	Q225	Q225H■	Q225HH■
30	Q230	Q230H	Q230HH
35	Q235	Q235H■	Q235HH■
40	Q240	Q240H	Q240HH■
45	Q245	Q245H■	Q245HH■
50	Q250	Q250H	Q250HH
60	Q260	Q260H	Q260HH
70	Q270	Q270H	Q270HH
80	Q280	Q280H■	Q280HH■
90	Q290	Q290H	Q290HH■
100	Q2100	Q2100H	Q2100HH
110	Q2110	Q2110H	Q2110HH■
125	Q2125	Q2125H	Q2125HH

2-Pole Plug-In (Common-Trip 240V AC)^{④⑥}

Rating	Type QP	Type QPH	Type HQP
15	Q215R	—	—
20	Q220R	—	—
30	Q230R	—	—
40	Q240R	—	—
50	Q250R	—	—

3-Pole Plug-In (Common-Trip 240V AC)^⑦

Rating	Type QP	Type QPH	Type HQP
15	Q315	Q315H	Q315HH■
20	Q320	Q320H	Q320HH
25	Q325	Q325H■	Q325HH■
30	Q330	Q330H	Q330HH
35	Q335	Q335H■	Q335HH■
40	Q340	Q340H	Q340HH
45	Q345	Q345H■	Q345HH■
50	Q350	Q350H	Q350HH
60	Q360	Q360H	Q360HH
70	Q370	Q370H	Q370HH■
80	Q380	Q380H	Q380HH■
90	Q390	Q390H	Q390HH■
100	Q3100	Q3100H	Q3100HH



QP / QPH / HQP Internal Accessories

Control Voltage AC	Catalog Number	Field/Factory Installed
120V Shunt Trip	add suffix ...00S01■	Factory
24V Shunt Trip	add suffix ...00S07■	Factory
120V Auxiliary Switch	add suffix ...01■ ^②	Factory

Modifications

Description	Catalog Number
400 Hz Calibration	add suffix ...Y ^⑧
Marine 50°C Ambient Calibration	add suffix ...M
Fungus Proofing	add suffix ...F

For external accessories please refer to page 1-43.

■ Built to order. Allow 2-3 weeks for delivery.

① UL Listed for use with 60/75° wire through 40 amps, UL listed for use with 75° wire only for 50 amps and above, HACR rated.

② 1A and 1B contacts.

③ UL Listed for frequent switching applications (SWD). 120V AC Fluorescent Lighting.

④ UL Listed for use on 3-phase grounded "B" systems — 10,000 for this application.

⑤ Shipped 12 per sleeve.

⑥ Shipped 6 per sleeve.

⑦ Shipped 4 per sleeve.

⑧ UL Listed 5 KA IR.

⑨ Type QP1, UL listed for 16 AWG conductors and multiple wires.

Circuit Breakers

Duplex, Triplex and Quadplex Plug-In Breakers

Duplex Circuit Breakers

Breaker Type	Ampere Rating	Catalog Number	Catalog Number
QT 1-Pole 10K AIC 120V AC	15-15	Q1515	Q1515NC ^①
	15-20	Q1520	Q1520NC ^①
	20-20	Q2020	Q2020NC ^①
	20-30	Q2030	—
	30-15■	Q3015	—
	30-20	Q3020	—
	30-30	Q3030	Q3030NC ^①
SHIPPING: 12 per carton, (Wt. 4.8 lbs.)			

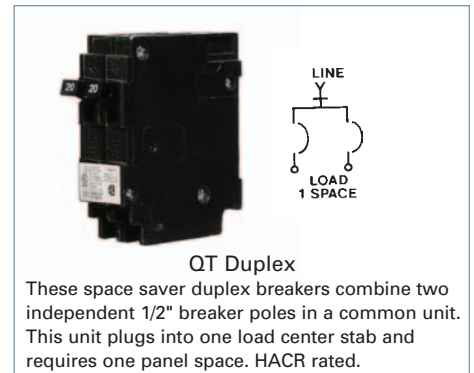

QT Duplex

These space saver duplex breakers combine two independent 1/2" breaker poles in a common unit. This unit plugs into one load center stab and requires one panel space. HACR rated.

Triplex Circuit Breakers

Breaker Type	Ampere Rating		Catalog Number
	Single Pole	Common-Trip 2-Pole	
QT 2-Pole 10K AIC 120/240V AC Inner Poles Common Trip	15	15	Q21515CT
	15	20	Q21520CT
	15	25	Q21525CT ■
	15	30	Q21530CT
	15	35	Q21535CT ■
	15	40	Q21540CT
	15	45	Q21545CT ■
	15	50	Q21550CT
	20	20	Q22020CT
	20	25	Q22025CT ■
	20	30	Q22030CT
	20	35	Q22035CT ■
	20	40	Q22040CT
	20	45	Q22045CT ■
	20	50	Q22050CT
	30	30	Q23030CT
	SHIPPING: 6 per carton, (Wt. 4.9 lbs.)		

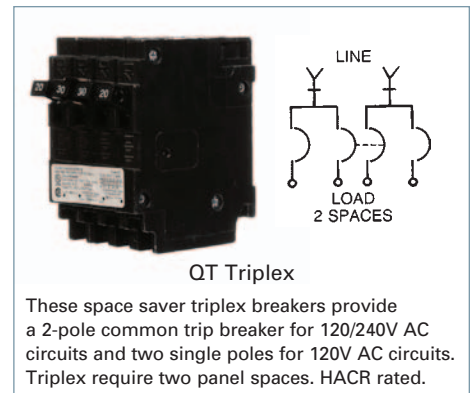

QT Triplex

These space saver triplex breakers provide a 2-pole common trip breaker for 120/240V AC circuits and two single poles for 120V AC circuits. Triplex require two panel spaces. HACR rated.

Quadplex Circuit Breakers

Breaker Type	Ampere Rating		Catalog Number
	Common-Trip 2-Pole Outside	Common-Trip 2-Pole Inside	
QT 2-Pole 10K AIC 120/240V AC Inner and Outer 2 Poles Common Trip	15	15	Q21515CT2
	15	30	Q21530CT2
	20	20	Q22020CT2
	20	50	Q22050CT2
	30	20	Q23020CT2
	30	25	Q23025CT2
	30	30	Q23030CT2
	30	50	Q23050CT2
	40	20	Q24020CT2
	40	30	Q24030CT2
	40	40	Q24040CT2
SHIPPING: 6 per carton, (Wt. 4.8 lbs.)			

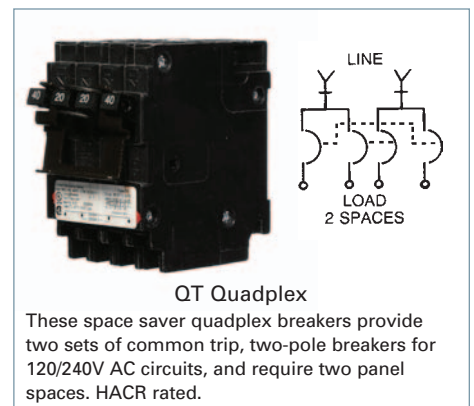

QT Quadplex

These space saver quadplex breakers provide two sets of common trip, two-pole breakers for 120/240V AC circuits, and require two panel spaces. HACR rated.

For external accessories, please refer to page 1-43.

For inches / millimeters conversion, see Application Data section.

■ Built to order. Allow 2-3 weeks for delivery.

① Non-CTL. For replacement use only in panels manufactured before 1968

Circuit Breakers

Special Application Breakers

HID Lighting

For high-intensity discharge lamp loads having in-rush currents above the instantaneous trip setting of a standard breaker.

Breaker Type	Wiring Diagram	Complete Breaker UL Unenclosed	
		Ampere Rating	Catalog Number
QP 1-Pole 120V AC	Figure 1	15	Q115HID ^① ■
		20	Q120HID ^①
		30	Q130HID
QP 2-Pole 120/240V AC	Figure 2	15	Q215HID
		20	Q220HID ■
		30	Q230HID ■

Molded Case Switch

For applications that do not require overcurrent protection.

QP 1-Pole 120V AC	Figure 1	100	Q1100S
QP 2-Pole 120/240V AC	Figure 2	30	Q230S
		50	Q250S
		60	Q260S
		125	Q2125S

No-Noise

For applications that require a reduction in the 60-cycle hum of a standard breaker.

QP 2-Pole 120/240V AC	Figure 2	50 60	Q250NN ■ Q260NN
------------------------------------	----------	----------	--------------------

Switching Neutrals

Used where all conductors are required to be disconnected. Neutral pole of the circuit breaker does not connect to load center bus. One side is wired to neutral and the other side to the device.

QG 2-Wire Common Trip 120V AC	Figure 3	15 20	QG215 QG220
QG 3-Wire Common Trip 120/240V AC	Figure 4	20	QG320



Switching Neutral

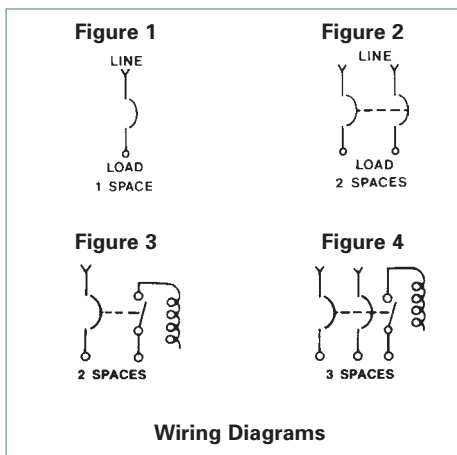

Wiring Diagrams

■ Built to order. Allow 2-3 weeks for delivery.
Note: All circuit breakers on this page are 10K AIC

① UL Listed as SWD (Switching Duty) Rated, suitable for 120V AC Fluorescent Lighting.

Circuit Breakers

3/4 Inch Plug-In Breakers

Features

- 3/4" format
- HACR Rated
- UL Classified for use in certain Square D load centers

Type QD Circuit Breakers

The Type QD circuit breaker line is available in 1-pole and 2-pole common trip versions listed on this page.

The circuit breakers are UL Classified and UL Listed.

All QD breakers are supplied with load side connectors suitable for 60/75°C wire and are calibrated for 40°C maximum ambient applications.

UL Classified

Siemens Type QD circuit breakers are UL Classified for use in specific Square D load centers in place of Square D Type QO® circuit breakers. A Panelboard Compatibility List packaged with each QD breaker shows which type QD circuit breakers are acceptable for use in Square D load centers.

The interrupting rating on these circuit breakers is 10,000A IR maximum and they are **not** series rated with Square D circuit breakers or equipment. This UL Classification allows a Siemens Type QD circuit breaker to be used in place of a Square D Type QO circuit breaker in those load centers that are specifically shown on the Panelboard Compatibility list. For additional information, contact your local Siemens sales engineer.



D120



D220

Continuous Current Rating @ 40°C	1-Pole	2-Pole
	120V	120/240V Common Trip
	Catalog Number	Catalog Number
15	D115 ^①	D215
20	D120 ^①	D220
30	D130	D230
40	D140	D240
50	D150	D250
60	D160	D260

Shipping Weights

Number of Poles	Number Per Carton	Shipping Weight (lbs.)
1	16	3.8
2	8	4.2

Panelboard Compatibility List

Listed Panelboards—Square D—Catalog Numbers

QO2L30F/S	QO12M100/RB	QO120-30M150/RB	QO130-40M200
QO2-4L70F/S	QO16-20M100/RB	QO124L150G	QO130M200/RB
QO2-4L70TS	QO16M100/RB	QO124M150	QO130-40L200G/RB
QO2-4L70RB	QO20M100/RB	QO130L150G/RB	QO140M200/RB
QO6-12L100F/S	QO112L125G/RB	QO130M150/RB	QO16L200/RB
QO6-12L100DF/S	QO112-24L125G/RB	QO16L150/RB	QO16M200/RB
QO6-12L100TF/S	QO112-24L125GWGC	QO16M150/RB	QO18-16M200FTRB
QO6-12L100DTF/S	QO116L125G	QO16-30L150/RB	QO20-40L200/RB
QO6-12L100RB	QO116-24L125G/RB	QO18-16M150FTRB	QO20-40M200TF/S
QO8-16L100F/S	QO12-24L125/RB	QO20-30M150/RB	QO20-40M200/RB
QO8-16L100DF/S	QO120-24L125G	QO20-30M150TF/S	QO24L200/RB
QO8-16L100TF/S	QO120-24L125GWGC	QO20-30L150	QO24M200/RB
QO8-16L100DTF/S	QO120L125G	QO24L150/RB	QO30L200/RB
QO8-16L100RB	QO124L125G/RB	QO24M150/RB	QO30M200/RB
QO112M100/RB	QO124M125/RB	QO30L150/RB	QO30-40L200/RB
QO116M100/RB	QO16L125/RB	QO30M150/RB	QO30-40M200/RB
QO120M100/RB	QO16-12M125FTRB	QO8-16M200FT/RB	QO40M200/RB
QO124M100	QO16-24L125/RB	QO112L200G/RB	QO140M225
QO12L100DF/S	QO20L125/RB	QO120-40M200/RB	QO142L225G/RB
QO12L100RB	QO20-24L125/RB	QO120-40M200TC	
QO12-20M100/RB	QO24L125/RB	QO124M200	
QO12-20M100TF/S	QO120-30L150G	QO130L200G/RB	

For inches / millimeters conversion, see Application Data section.

① UL Listed for frequent switching applications (SWD). 120V AC Fluorescent Lighting. One or two load conductors.

Circuit Breakers

Main and Branch Circuit Breakers^①

Breaker Type	Ampere Rating	Catalog Number	Catalog Number	UL Interrupting Ratings (kA)
QN 2-Pole 120/240V AC	150	QN2150	QN2150R ^②	10
	175	QN2175■	QN2175R ^② ■	10
	200	QN2200	QN2200R ^②	10
QNH 2-Pole 120/240V AC	150	QN2150H	QN2150RH ^②	22
	175	QN2175H■	QN2175RH ^② ■	22
	200	QN2200H	QN2200RH ^②	22
HQN 2-Pole 120/240V AC	150	HQN2150	HQN2150R ^②	65
	175	HQN2175■	—	65
	200	HQN2200	HQN2200R ^②	65

Requires 4 panel spaces, 2 adjacent and 2 opposite. **SHIPPING:** 1 per carton (Wt. 3 lbs.)



QNR^③

QN^③

Main Breaker Kits

For use in PL, ES, and Ult Load Centers ^④			For use in EQIII Load Centers			
UL Type	Ampere Rating	Catalog Number	UL Type	Ampere Rating	Catalog Number	UL Interrupting Ratings (kA)
EQ8681	100	MBK100A	EQ9675	100	MBK100	22
EQ8682	125	MBK125A	EQ9677	125	MBK125	22
EQ8693	150	MBK150A	EQ9683	150	MBK150	22
—	—	—	EQ9684	175	MBK175■	22
EQ8695	200	MBK200A	EQ9685	200	MBK200	22
EQ8696	225	MBK225A	EQ9686	225	MBK225	22



EQ9675

Breaker Type	Ampere Rating	Catalog Number	UL Interrupting Ratings (kA)
QPJ ^⑤ 3-Pole 240V AC	125	QPJ3125	10
	150	QPJ3150	10
	200	QPJ3200	10

Requires 6 spaces due to cross over design. Fits only EQIII 125-400A 3-phase load centers

SHIPPING: 5 per carton (Wt. 17 lbs.)

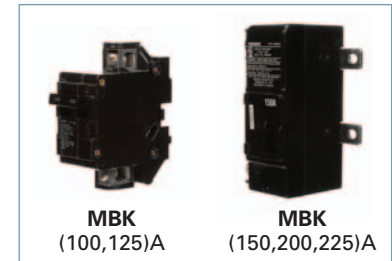

MBK
(100,125)A

MBK
(150,200,225)A

Breaker Type	Ampere Rating	Catalog Number	UL Interrupting Breaker Ratings (kA) Volts AC 120/240
QPP 2-Pole 120/240V AC	125	Q2125B	10
	150	Q2150B	10
	175	Q2175B■	10
	200	Q2200B	10
	225	Q2225B	10
QPPH 2-Pole 120/240V AC	125	Q2125BH	22
	150	Q2150BH	22
	175	Q2175BH■	22
	200	Q2200BH	22
	225	Q2225BH■	22
HQPP 2-Pole 120/240V AC	125	Q2125BHH■	65
	150	Q2150BHH	65
	175	Q2175BHH■	65
	200	Q2200BHH	65
	225	Q2225BHH■	65
HQPPH 2-Pole 120/240V AC	100	HQ2100BH■	100
	125	HQ2125BH■	100
	150	HQ2150BH■	100
	175	HQ2175BH■	100
	200	HQ2200BH■	100
225	HQ2225BH■	100	

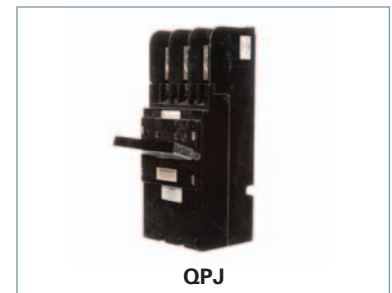

QPJ



2-Pole QPP

For inches / millimeters conversion, see Application Data section.
■ Built to order. Allow 2-3 weeks for delivery.

- ① All circuit breakers on this page are common trip.
- ② Reverse handle.
- ③ CSA Listed.
- ④ MBK100A for use in 100 and 125A load centers.
MBK125A for use in 125A load centers.
MBK150A for use in 150, 200 and 225A load centers.
MBK200A for use in 200 and 225A load centers.
MBK225A for use in 225A load centers.
MBK175A for use in 200 and 225A load centers.

⑤ QNR required for horizontal applications or vertical applications where the lugs are facing up. The QN breaker is required for vertical applications where the lugs are facing down as shown.

Circuit Breakers

Line Diagrams/Dimension Drawings

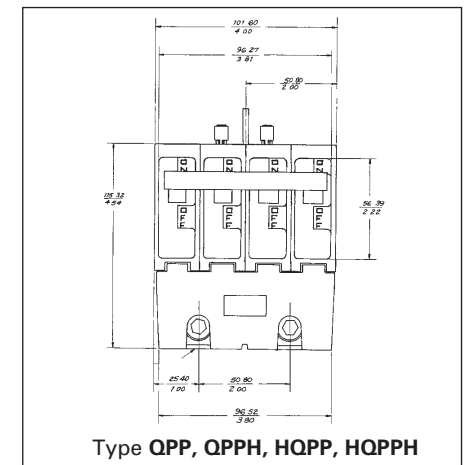
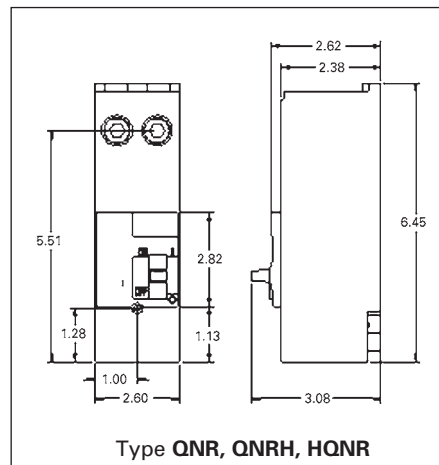
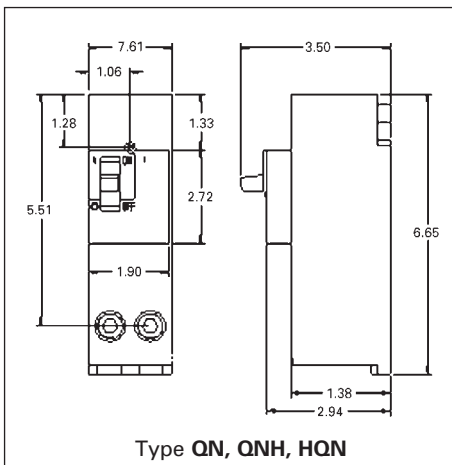
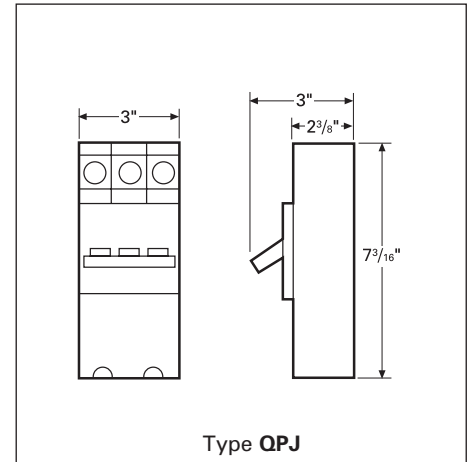
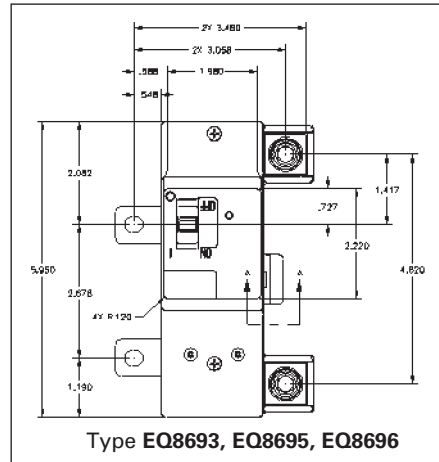
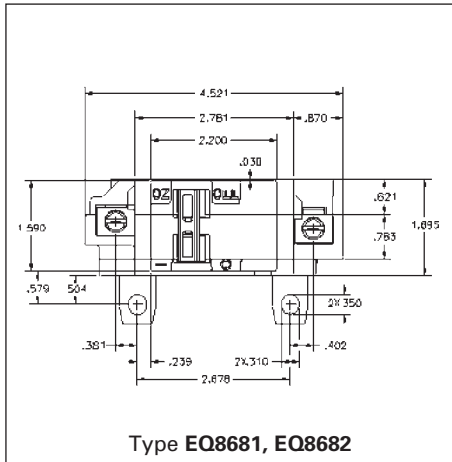
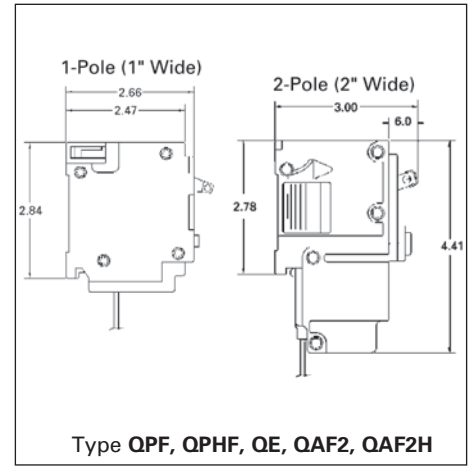
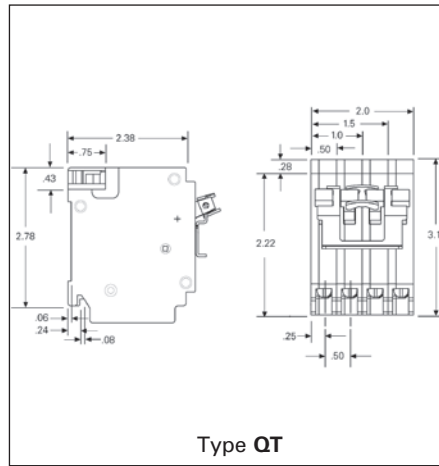
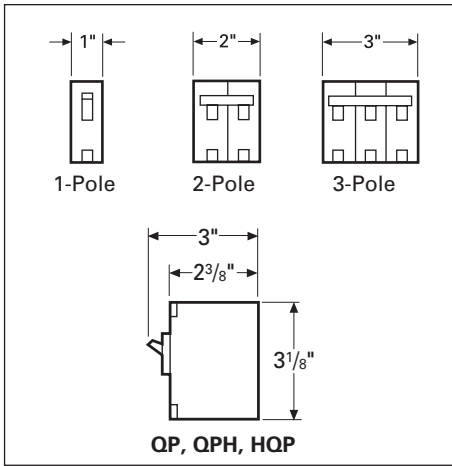

© All standard circuit breakers are calibrated to 40°C maximum ambient application.

Circuit Breakers

Lug Data

Circuit Breaker Type	Circuit Breaker Ampere Rating	Cables Per Connector	Connector Wire Range
	LOAD SIDE		
QP, QPH, HQP, Plug-in	10	2	#14-#16 AWG Cu
	15-35	1 1	#14-#6 AWG Cu #14-#6 AWG Al
	40-50	1 1	#8-#6 AWG Cu #8-#4 AWG Al
	55-125	1 1	#8-#2/0 AWG Cu #8-#2/0 AWG Al
QP 1 & 2-Pole Only	55-60	1	#6-#4 AWG Cu-Al (#3 AWG compatible with QPH & HQP)
QT	15-35	1 1	#14-#6 AWG Cu #14-#6 AWG Al
	40	1	#8 AWG CU-Al
	40-50	1 1	#8-#6 AWG Cu #8-#4 AWG Al
QPF, QPHF	15-30	1 1	#14-#10 AWG Cu #12-#8 AWG Al
	40-60	1 1	#8-#6 AWG Cu #8-#4 AWG Al
QAF2, QAFH2, QFGA2, QFGAH2	15-20	1 1	#14-#12 AWG Cu #12-#10 AWG Al
QD	15-20	2	#14-#8 AWG Cu Only
	15-20	1 1	#14-#12 AWG Cu #12-#10 AWG Al
	25-35	1 1	#10-#8 AWG Cu #10-#6 AWG Al
	40-60	1 1	#8-#6 AWG Cu #8-#4 AWG Al
QN, QNH, HQN	150-200	1	#1-300kcmil Cu-Al
QS, QSH, QSHH, HQS, HQSH	100-225	1	#3-300kcmil Cu-Al
EQ8681-Ultimate, PL, ES	100	1	#4-3/0 AWG Cu-Al
EQ8682-Ultimate, PL, ES	125	1	#4-3/0 AWG Cu-Al
EQ8693-Ultimate, PL, ES	150	1	#1-300kcmil Cu-Al
EQ8695-Ultimate, PL, ES	200	1	#1-300kcmil Cu-Al
EQ8696-Ultimate, PL, ES	225	1	#1-300kcmil Cu-Al
QPP, QPPH, HQPP, HQPPH	125	1 1	#1 AWG Cu #2/0 AWG Al
	150	1 1	#1/0 AWG Cu #3/0 AWG Al
	175	1 1	#2/0 AWG Cu #4/0 AWG Al
	200	1 1	#3/0 AWG Cu 250kcmil AWG Al
	225	1 1	#4/0 AWG Cu 300kcmil AWG Al
EQ9675-EQIII	100	1 1	#8-#2/0 AWG Cu #8-#2/0 AWG Al
EQ9677-EQIII	125	1 1	#8-#2/0 AWG Cu #8-#2/0 AWG Al
EQ9683-EQIII	150	1 1	#1/0 AWG Cu #3/0 AWG Al
EQ9684	175	1 1	#3/0 AWG Cu 250kcmil AWG AL
EQ9685-EQIII	200	1 1	#3/0 AWG Cu 250kcmil AWG Al
EQ9686-EQIII	225	1 1	#4/0 AWG Cu 300kcmil AWG Al
QPJ	125-200	1	#2-300kcmil Cu-Al

Circuit Breakers

Circuit Breaker Accessories

Circuit Breaker Accessories ④⑤⑥⑦⑧⑨

Catalog Number	For Use With Breaker Type	Number of Poles	Standard Package
Padlocking Device For locking breaker in "OFF" position. Note "ON" position does not affect breaker functionally			
ECPLD1	Type QP, BL, QAF2, QPF2, QE, QT-Duplex, BQ, BQXD	1P	3 Pieces
ECPLD1R	Type QP, BL, QAF2, QPF, QE, QT-Duplex, BQ, BQXD (Red Color)	1P	3 Pieces
ECPLD2	Type QP, BL, QAF2, QPF, QE, QT-Triplex & Quadplex, BQ, BQXD	2P	3 Pieces
ECPLD2R	Type QP, BL, QAF2, QPF, QE, QT-Triplex & Quadplex, BQ, BQXD (Red Color)	2P	3 Pieces
ECPLD3	Type QP, BL, QAF2, QPF, QE, BQ	3P	1 Piece
US2:ECPLD3R	Type QP, BL, QAF2, QPF, QE, BQ (Red Color)	3P	1 Piece
ECQLD3	Type QP, BL, BQ, BQXD	1P	10 Pieces
ECQLD4	Type QT-Duplex	QT-Duplex Breakers	10 Pieces
ECQLN3 ^②	150-225 MBKA, QN, QNR	n/a	1 Piece
ECQTH4	Type QP, BL, BQH	Designed for (3) 1P Breakers	1 Piece
Handle Tie Provide simultaneous swiching of 2 adjacent handles.			
ECQTH2	Type QT Duplex	Designed for (2) QT Duplex Breakers	25 Pieces
ECQTH3	Type QP, BL	2P	50 Pieces
Mechanical Interlock^①			
ECQML12	Type QP, BL, BQ Interlock Bracket	Designed for 1" Breaker	10 Pieces
Handle Blocking Device For holding breaker in "ON" or "OFF" position. Not a lockout/tagout device			
ECQL1	Type QP, BL, BQ, BQXD	1P	10 Pieces
ECBX231M	Type QT-Duplex	1/2" Breakers	10 Pieces
Main Breaker Retainer			
ECMBR1 ^③	EQ Load Centers		1 Piece
ECMBR2	PL, ES, and Ultimate Load Centers: 2-pole QP		1 Piece
ECMBR3	PL, ES, and Ultimate Load Centers: 3-pole QP		1 Piece
Mounting Accessories			
MB120	Type BQ, BQH Mounting Clips	1P	20 Pieces
FP9508	Type BQ, BQH FACE MOUNT PLATE	1P	10 Pieces
FP9555	Type BQ, BQH FACE MOUNT PLATE	2P	10 Pieces
FP9556	Type BQ, BQH FACE MOUNT PLATE	3P	10 Pieces
SMB6R	Type BQ MOUNTING BRACKET	1P, 2P, 3P	6 Pieces
TCH65K	Type BQ MOUNTING ADAPTER		500 Pieces
BR2	Type BQ, BQH, BQXD Back Mounting Plates	2P	10 Pieces
BR3	Type BQ, BQH, BQXD Back Mounting Plates	3P	10 Pieces
BR4	Type BQ, BQH, BQXD Back Mounting Plates	4P	10 Pieces
I0204ML1125CU	Type QP Back Mounting Plates	1P, 2P	10 Pieces
I0303ML3100CU	Type QP Back Mounting Plates	3P	10 Pieces
Replacement Lugs			
TA1Q1	Type BQ, NGG 100A Al Cu LGS	n/a	6 Pieces
TC1Q1	Type BQ, NGG 40A Al Cu LUGS	n/a	6 Pieces
Finger Shield			
BQFS1K	Type BQXD Finger Shield (Bulk Pack)	n/a	1000 Pieces
BQFS2	Type BQXD Finger Shield	n/a	2 Pieces
Filler Plate			
ECQF3	1" Filler Plate	n/a	5 Pieces

④ For a complete list of standby power mechanical interlock kits, see page 1-25

⑤ For use with Ultimate Load Center Main Breakers

⑥ Not suitable for use on 15-50A, 10 AIC Type QP Circuit Breakers

⑦ QP Type includes QPH, HQP

⑧ BL Type includes BLH, HBL

⑨ BQ Type includes BQH, HBO

① QAF2 Type includes QAFH2, BAF2, BAFH2, QFGA2, QFGAH2, BFGA2, BFGAH2

② QPF Type includes QPHF, BLF, BLHF

③ QE Type includes QEH, BLE, BLEH

Circuit Breakers

Circuit Breaker Accessories

Padlocking Device



ECPLD1

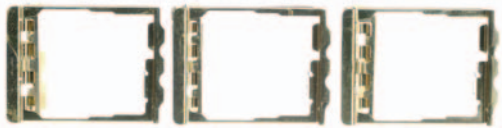

ECPLD2



ECPLD1R/2R/3R (Single pole pictured. 2-/3-pole available)



ECQLD3

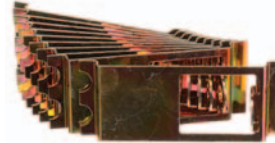

ECQLD4

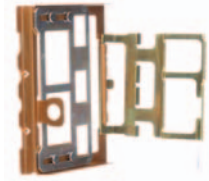

ECQTH4

Handle Tie



ECQTH2



ECQTH3

Handle Blocking Device

ECQL1



ECBX231M



Main Breaker Retainer



ECMBR1



ECMBR2

Mechanical Interlock

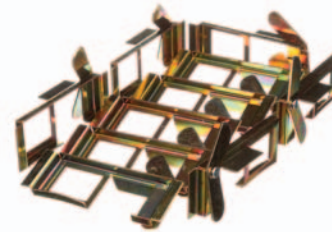

ECQML12

Mounting Accessories



MB120



SMB6R



I0204ML1125



FP9508



FP9555



FP9556

Surge Protection

Circuit Breaker and Surge Protective Device (SPD)

Features

- 2 inch wide plug-on design
 - Includes (2) 1 Pole circuits breakers
 - No loss of load center spaces
- Easy to install and perfect for retrofit
- LEDs provide protection status

Benefits

By installing a Siemens Circuit Breaker and Surge Protective Device (SPD) in the load center of the residence, surge protection is provided for all branch circuits®.

Two green LED indicator lights are provided to show that surge protection is provided for all circuits connected to the load center. These breakers should be used for circuit protection of frequently used household or facility circuits because the lights and devices connected to these circuits provide an effective indication that surge protection is being provided.

The circuit breaker and SPD utilize Siemens-built 150V AC, 40mm, metal oxide varistors (MOVs). The maximum impulse rating for the SPD module is 40kA. The standard interrupting rating for the circuit breakers is 10k AIC. All Type QP circuit breakers and SPD are plug-on style, with load terminals provided. The devices are rated for 120/240V AC and are calibrated for 40 degrees C maximum ambient applications.

Breaker Type	Ampere Rating	Catalog Number	Surge Type
QP 1- Pole 120/240V AC 10K AIC	(2) 15	QSA1515SPD	SPD
	(2) 20	QSA2020SPD	SPD

Catalog Number	QSA1515SPD QSA2020SPD
Amperage	15 or 20 Amp
Number of Poles	(2) 1-Pole Circuit Breakers
Initial Clamping Level	240 Volts
Transient Energy Rating	360 Joules line-to-neutral 720 Joules line-to-line
Transient Suppression	500 volts peak, line-to-neutral
Voltage Rating	1000 volts peak, line-to-line
Peak Current Rating (impulse)	40,000 amperes
Discharge Voltage Characteristic	@ 1,500A, 600 volts @ 5,000A, 800 volts (both line-to-neutral)
Discharge Current Withstand Rating	10,000 amperes line-to-neutral
Circuit Breaker Interrupting Rating	10,000A, 120/240V AC
Listings/Certifications	UL, CSA Meets UL 1449 4th Edition



© For warranty information please refer to the surge website www.usa.siemens.com/surge

Surge Protection

Power Service Entrance Surge Protection

1 FirstSurge™ - Power, Plus, or Pro

- 4th Listed, Type 2, Surge Protective Device (SPD)
 - Surge Current Capacities:
 - 60,000 A, FirstSurge Power (FS060)
 - 100,000 A, FirstSurge Plus (FS100)
 - 140,000 A, FirstSurge Pro (FS140)
 - 3 Stage Commercial Grade Notification:
 - Protection Status LEDs
 - Audible Alarm
 - Flashing Red Service LED
 - Ground Reference Monitoring (GRM)
 - 10 year product & connected equipment warranty*
- * See www.usa.siemens.com/surge for warranty terms and conditions.

Surge Type	Catalog Number
FirstSurge Power	FS060
FirstSurge Plus	FS100
FirstSurge Pro	FS140

AC Surge Protection	
UL and CSA Listings	1449 4th Edition & CSA 22.2 No. 269.2
Surge Spike Capacity	60kA, 100kA, or 140kA
Line Voltage	120/240 1 Phase 50/60 Hz
UL 1449 4th Edition VPR	L-N, L-G, N-G: 600 V; L-L: 900V
Rated Voltage (MCOV)	L-N, L-G, and N-G: 150V; L-L: 300V
Short Circuit Current Rating (SCCR)	100kA
Inominal (I _n) Rating	20kA
Response Time	<1 nanosecond
Enclosure	NEMA 4X Indoor and Outdoor Rated
Product Warranty	10 years

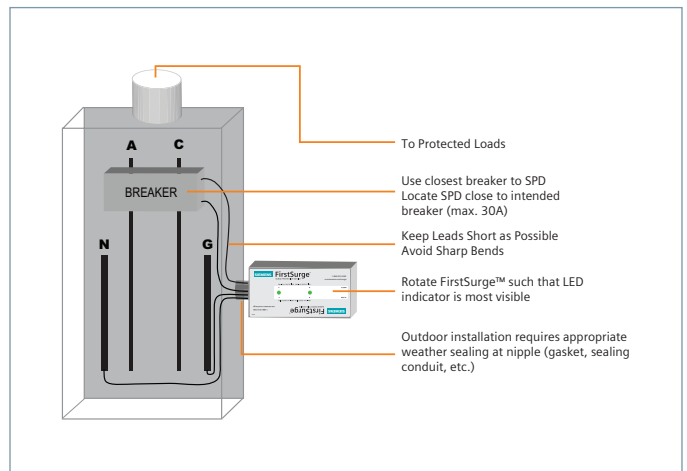
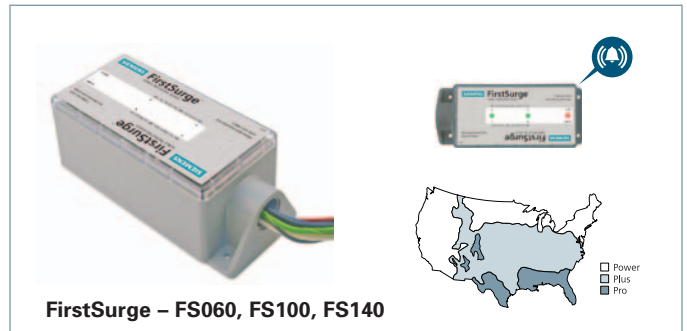

Type 1 SPD / Surge Arrestor Replacement

TPS3 03

TPS3 03 is a UL 1449 4th Edition 50 kA Type 1 compact surge protective device that can be used as a replacement secondary surge or lightning arrestors. Having a Type 1 designation allows for flexible electrical system connection location (line or load side) as well as UL 96A compliance (@ 20 kA I_n).

TPS3 03 Key Features

- UL 1449 4th Edition Listed Type 1
- Type 1 Rated SPD
- 50 kA Per Phase Surge Current
- 20 kA I_n (Most models)
- 200 kA SCCR (Most models)
- UL 96A Lightning Protection Master Labeling compliant (@ 20 kA)
- Every MOV is monitored
- Mounts external to electrical distribution equipment
 - Recommend for Line Side or Load Side Applications
- Standard compact NEMA 4X polycarbonate enclosure
- Modes of Protection: L-N or L-G and L-L
- Standard Monitoring: LED Indicator
- Dimensions: 3.25" x 3.25" x 3.3"
(82.6 mm x 82.6 mm x 83.8 mm)
- Weight: 2 lb. (0.9 kg)
- 2 Year Product Warranty

Available Options:

- Dry contacts & Audible Alarm (option "D")



Ordering Information

Catalog # **TPS3** **03**

<p>Voltage Code</p> <p>A = 120/240 V, 1Ø, 3W B = 120/240 V, 3Ø, 4W C = 120/208 V, 3Ø, 4W D = 240 V, 3Ø, 3W E = 277/480 V, 3Ø, 4W F = 480 V, 3Ø, 3W G = 600 V, 3Ø, 3W K = 380/220 V, 3Ø, 4W L = 600/347 V, 3Ø, 4W</p>	<p>Surge Current (kA)</p> <p>05 = 50 kA per phase</p>	<p>Options</p> <p>D = Dry contact & audible alarm</p> <p>N = Adds N-G Protection</p>
---	--	---

Example: **TPS3C0305D0** = Type 1 SPD for a 208/120V application with a surge current capacity of 50 kA per phase, in a standard NEMA 4X enclosure with dry contacts and audible alarm option.

When an option is not selected, include a **zero (0)** in the field.

Available Accessories: Ordered Separately

RMSIE = Remote monitor

SPD - Surge Protective Device

Telephone Service Entrance Surge Protection

FSPHONE & FSPHONE4X

- UL/cUL listed
- Hardwired Telephone/Modem/Fax/DSL protection
- Exceptionally fast response time
- Low insertion loss
- Available with or without enclosure
- 5 Year product warranty*

* See www.usa.siemens.com/surge for warranty terms and conditions.

The Siemens FSPHONE & FSPHONE4X is a 2 pair, hardwired surge protector designed to stop surges from entering through the main telephone incoming service connection. It is equipped with a failshort device to permanently ground the telephone line in the event of a power cross. The FSPHONE is designed for indoor applications where the FSPHONE4X is used for outdoor mounting is required.

The FSPHONE4X includes the FSPHONE plus a weatherproof enclosure to facilitate indoor or outdoor applications. The enclosure is molded of temperature and humidity resistant thermoplas-tic to resist cracking and discoloration. The cover can be secured with a tie wrap or similar locking device.



AC Surge Protection	
Catastrophic Surge Circuit	Yes
Spike Capacity	200 Amps
Let Through Voltage	<270V
Overcurrent Protection	Yes
Response Time	<1 nanosecond
Environmentally Sealed	Yes
UL/cUL Listings	497A
Meets Telcordia (formally Bellcore) GR-974-CORE Requirements for Telecommunications Line Protectors	Yes
Product Warranty	5 years

Surge Type	Catalog Number
Telco	FSPHONE
Telco	FSPHONE4X

Coaxial Service Entrance Surge Protection

FSCATV

- UL/cUL listed surge protection
- Rated for CATV, DSS, TV, VCR, and Cable Modem
- Easy to install
- Standard Female to Female F connector
- Low insertion loss
- Automatic recovery
- 5 Year product warranty*

* See www.usa.siemens.com/surge for warranty terms and conditions.

Siemens FSCATV shields coaxial connected electronics in residential and light commercial applications against electrical transient damage, including lightning, from entering through the main cable connection.

FSCATV includes a section of coaxial cable with female to female splice for line side application. The Siemens warranty covers product defects for 5 years. To have complete protection for your equipment, home, or business, it is important to protect AC power lines and all data lines the equipment is connected through.

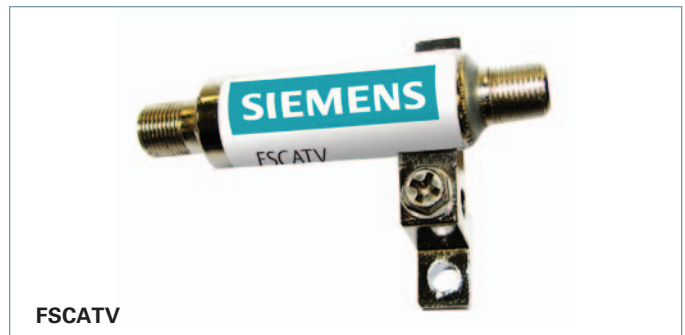

AC Surge Protection	
Frequency Range	DC thru 1.5 GHz
Catastrophic Surge Circuit	Yes
Spike Capacity	5000 Amps, 8/20 μSec
Impedance	75 Ohms
Overcurrent Protection	Yes
Return Loss	30dB @ 1 GHz
Insertion Loss	<0.1dB
UL/cUL Listings	497B
Meets IEEE C62.41.1 Requirements	Yes
Product Warranty	5 Years

Surge Type	Catalog Number
Coaxial	FSCATV

AC Disconnects

1-Phase, NEMA 3R Rated



Steel AC Disconnects^①

Ampere Rating	Disconnect Type	Catalog Number	Horse Power Rating	Dimensions			Pallet Qty.
				Height	Width	Depth	
30	Fused Pullout	WF2030	3	7¼	5	2½	360
60	Fused Pullout	WF2060	10	9	5	2½	360
60	Non-fused Pullout	WN2060	10	7¼	5	2½	360
60	Non-automatic Switch	WNAS2060	10	7¼	5	2½	360

Plastic AC Disconnects^①

Ampere Rating	Disconnect Type	Catalog Number	Horse Power Rating	Dimensions			Pallet Qty.
				Height	Width	Depth	
30	Fused Pullout	WF2030PL	3	7¼	5	2½	216
60	Fused Pullout	WF2060PL	10	7¼	5	2½	216
60	Non-fused Pullout	WN2060PL	10	7¼	5	2½	360
60	Non-Fused Pullout	WN2060PLX	10	8	5¼	3½	288
60	Non-automatic switch	WNAS2060PL	10	7¼	5	2½	360

Steel AC Disconnects with 15 Amp GFCI Receptacle^①

Ampere Rating	Disconnect Type	Catalog Number	Horse Power Rating	Dimensions			Pallet Qty.
				Height	Width	Depth	
30	Fused Pullout	WF2030GFCI	3	9	6⅝	5⅝	112
60	Fused Pullout	WF2060GFCI	10	9	6⅝	5⅝	112
60	Non-fused Pullout	WN2060GFCI	10	7⅞	5¼	5⅝	144
60	Non-automatic Switch	WNAS2060GFCI	10	7⅞	5¼	5⅝	144

Wire Range Table

Connector	Copper		Aluminum	
	Solid	Stranded	Solid	Stranded
Line	#14-8	#14-3	#12-8	#12-3
Load	#14-8	#14-3	#12-8	#12-3
Neutral	#12-8	#12-2	#12-8	#12-2
Equip. Grnd	#12-8	#12-2	#12-8	#12-2

① Accepts Class H Fuse