



Table of Contents

.....

- Iberville® FS and FD metallic boxes and covers..... B2
- Iberville® FS metallic boxesB3-B4
- Iberville® FD metallic boxes B5
- Iberville® FS and FD metallic coversB6-B10
- Iberville® metallic round boxes and covers.....B11-B13
- Red•Dot® universal device boxes and covers..... B14
- Red•Dot® universal device boxesB15-B16
- Red•Dot® universal device extensions B17
- Red•Dot® universal device coversB18-B21
- Red•Dot® metallic weatherproof covers.....B22-B24
- Red•Dot® «Extra-Duty» nonmetallic weatherproof covers B25
- Red•Dot® metallic round boxes and coversB26-B27
- Carlton® FS and FD nonmetallic boxes and coversB28-B30
- Carlton® FS, FD and round nonmetallic boxes and covers B31
- Red•Dot® outdoor lampholders.....B32-B34
- Red•Dot® weatherproof outdoor kits B35

Iberville® FS and FD metallic boxes and covers



Applications :

- FS boxes are CSA approved for wet locations
- FS device boxes are installed in applications that require a rugged unit to accept wiring devices, switches, electronic components and terminal blocks
- FS device boxes provide spacious accessible wiring chambers that are a convenient location to maintain or change a system; pull conductors; make splices or branch conduits
- FS device boxes, when used with an appropriate cover, provide a raintight installation
- Both weatherproof and dry location covers are available



Features/Benefits :

- FS device boxes are sand casted or die casted using copper free (less than 0.004 copper content) aluminum alloys.
- FS device boxes incorporate external hub design that provides maximum wiring capacity
- FS device boxes have precision molded NPT threaded hubs allowing trouble-free field installation of rigid conduit
- FS device boxes are available in 1-7/8 in. and 2-5/8 in. depth
- Carlon® nonmetallic weatherproof FS covers are UV resistant, flame retardant and non-corrosive



Standard Materials :

- CIFS and CIFD device boxes: sand cast, copper free aluminum (less than 0.004 copper content)
- CIFSU: die cast, copper free aluminum (less than 0.004 copper content)
- FS covers: die cast aluminum, sand cast aluminum or nonmetallic

Compliances :

Compliances as noted on each page of the catalogue include:

- CSA Certified
- UL Listed



Iberville® FS metallic boxes



CIFS-1G

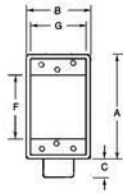

CIFS-2G

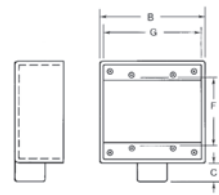

CIFS-3G



Cat. No.	Hub Size	No. of Gangs	No. of Lugs	A (in.)	B (in.)	C (in.)	D (in.)	E (in.)	F (in.)	G (in.)	H (in.)	Cu (in.)
FS Boxes - 1-7/8 in. Deep (Cast Aluminum)												
CIFS-1G-1/2	1 x 1/2	1	3	4-5/16	2-13/16	13/16	1-7/8	1-1/4	2-7/8	2-5/16	1-9/16	14.0
CIFS-1G-3/4	1 x 3/4	1	3	4-5/16	2-13/16	13/16	1-7/8	1-1/2	2-7/8	2-5/16	1-9/16	14.0
CIFS-1G-1	1 x 1	1	3	4-5/16	2-13/16	13/16	1-7/8	1-3/4	2-7/8	2-5/16	1-9/16	14.0
CIFS-2G-1/2	1 x 1/2	2	3	4-3/8	4-11/16	7/8	1-7/8	1-1/4	2-7/8	4-1/4	1-5/8	26.0
CIFS-2G-3/4	1 x 3/4	2	3	4-3/8	4-11/16	7/8	1-7/8	1-9/16	2-7/8	4-1/4	1-5/8	26.0
CIFS-2G-1	1 x 1	2	3	4-3/8	4-11/16	7/8	1-7/8	1-3/4	2-7/8	4-1/4	1-5/8	26.0
CIFS-3G-1/2	1 x 1/2	3	3	4-3/8	6-1/2	7/8	1-7/8	1-1/4	2-7/8	6-1/16	1-5/8	41.0
CIFS-3G-3/4	1 x 3/4	3	3	4-3/8	6-1/2	7/8	1-7/8	1-9/16	2-7/8	6-1/16	1-5/8	41.0



CIFS-1G-1/2-HV / CIFS-1G-3/4-HV

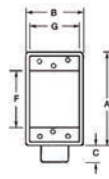

Cat. No.	Hub Size (in.)	No. of Gangs	No. of Lugs	A (in.)	B (in.)	C (in.)	D (in.)	E (in.)	F (in.)	G (in.)	H (in.)	J (in.)	Cu (in.)
347 Volt FS Box Kits - 1-7/8 in. Deep (Cast Aluminum)													
CIFS-1G-1/2-HV*	1 x 1/2	1	3	4-5/8	2-13/16	13/16	1-7/8	1-1/4	2-7/8	2-5/16	1-9/16	-	14.0
CIFS-1G-3/4-HV*	1 x 3/4	1	3	4-5/8	2-13/16	13/16	1-7/8	1-1/2	2-7/8	2-5/16	1-9/16	-	14.0

* For dry locations only
Includes stamped aluminum "CIFS-9HV" 347 V covers (not raintight)

Iberville® FS metallic boxes



CIFSC-1G

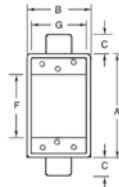

CIFSC-3G-3/4

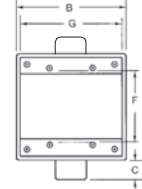

Cat. No.	Hub Size	No. of Gangs	No. of Lugs	A (in.)	B (in.)	C (in.)	D (in.)	E (in.)	F (in.)	G (in.)	H (in.)	Cu (in.)
FS Boxes - 1-7/8 in. Deep (Cast Aluminum)												
CIFSC-1G-1/2	2 x 1/2	1	4	4-5/16	2-13/16	27/32	1-7/8	1-1/4	2-7/8	2-5/16	1-9/16	14.0
CIFSC-1G-3/4	2 x 3/4	1	4	4-5/16	2-13/16	27/32	1-7/8	1-1/2	2-7/8	2-5/16	1-9/16	14.0
CIFSC-1G-1	2 x 1	1	4	4-5/16	2-13/16	27/32	1-7/8	1-3/4	2-7/8	2-5/16	1-9/16	14.0
CIFSC-2G-1/2	2 x 1/2	2	4	4-3/8	4-11/16	31/32	1-7/8	1-1/4	2-7/8	4-1/4	1-5/8	26.0
CIFSC-2G-3/4	2 x 3/4	2	4	4-3/8	4-11/16	31/32	1-7/8	1-9/16	2-7/8	4-1/4	1-5/8	26.0
CIFSC-2G-1	2 x 1	2	4	4-3/8	4-11/16	31/32	1-7/8	1-3/4	2-7/8	4-1/4	1-5/8	26.0
CIFSC-3G-3/4	2 x 3/4	3	4	4-3/8	6-1/2	29/32	1-7/8	1-9/16	2-7/8	6-1/8	1-5/8	41.0



CIFSCC-1G

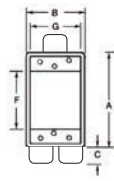

Cat. No.	Hub Size (in.)	No. of Gangs	No. of Lugs	A (in.)	B (in.)	C (in.)	D (in.)	E (in.)	F (in.)	G (in.)	H (in.)	J (in.)	Cu (in.)
FSCC Boxes - 1-7/8 in. Deep (Cast Aluminum)													
CIFSCC-1G-1/2	3 x 1/2	1	3	4-5/16	2-13/16	27/32	1-7/8	1-1/4	2-7/8	2-5/16	1-9/16	1-9/16	14.0
CIFSCC-1G-3/4	3 x 3/4	1	3	4-5/16	2-13/16	27/32	1-7/8	1-1/2	2-7/8	2-5/16	1-9/16	1-3/4	14.0

Iberville® FD metallic boxes



CIFDC-1/2

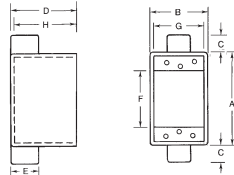

Cat. No.	Hub Size	No. of Gangs	No. of Lugs	A (in.)	B (in.)	C (in.)	D (in.)	E (in.)	F (in.)	G (in.)	H (in.)	Cu (in.)
FDC Boxes - 2-5/8 in. Deep (Cast Aluminum)												
CIFDC-1/2	2 x 1/2	1	2	4-5/16	2-13/16	15/16	2-5/8	1-3/8	2-7/8	2-3/8	2-5/32	22.5
CIFDC-3/4	2 x 3/4	1	2	4-5/16	2-13/16	15/16	2-5/8	1-3/8	2-7/8	2-3/8	2-13/32	22.5
CIFDC-1	2 x 1	1	2	4-5/16	2-13/16	1-3/8	2-5/8	1-5/8	2-7/8	2-3/8	2-13/32	22.5



CIFSU

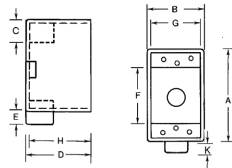

Cat. No.	Hub Size (in.)		No. of Lugs	A (in.)	B (in.)	C (in.)	D (in.)	E (in.)	F (in.)	G (in.)	H (in.)	K (in.)	Cu (in.)
Universal FSU Boxes - 2-3/8 in. Deep (Cast Aluminum)													
	End	Bottom											
CIFSU-1/2	2 x 1/2	1/2	2	4-5/16	2-3/4	13/16	2-3/8	1-1/8	2-13/16	2-1/2	1-29/32	7/16	18.5
CIFSU-3/4	2 x 3/4	3/4	2	4-5/16	2-3/4	13/16	2-3/8	1-1/8	2-13/16	2-1/2	2	7/16	18.5

Supplied with close up plugs. For dry locations.



CIFSF (1 face)



CIFST (2 faces)

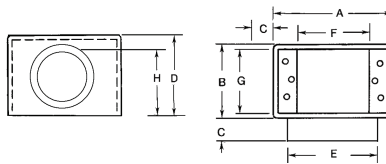

Cat. No.	Hub Size (in.)	No. of Gangs	No. of Lugs	A (in.)	B (in.)	C (in.)	D (in.)	E (in.)	F (in.)	G (in.)	H (in.)	J (in.)	Cu (in.)
FSF Box - 3 in. Deep (Cast Aluminum)													
CIFSF	2	-	-	4-5/16	2-3/4	31/32	2-7/8	2-7/8	2-13/16	2-13/32	1-15/32	-	30.5
FST Box - 3-5/8 in. Deep (Cast Aluminum)													
CIFST	2	-	-	4-5/16	2-3/4	1-3/8	3-3/8	3	2-7/8	2-5/16	2-13/16	-	38.7

Cat. No.	Description
Mounting lugs for CIFSU	
FG-09080	Mounting lugs for a 3 hole universal FSU box. 2-3/8 inches deep.



FG-09080

Iberville® FS and FD metallic covers

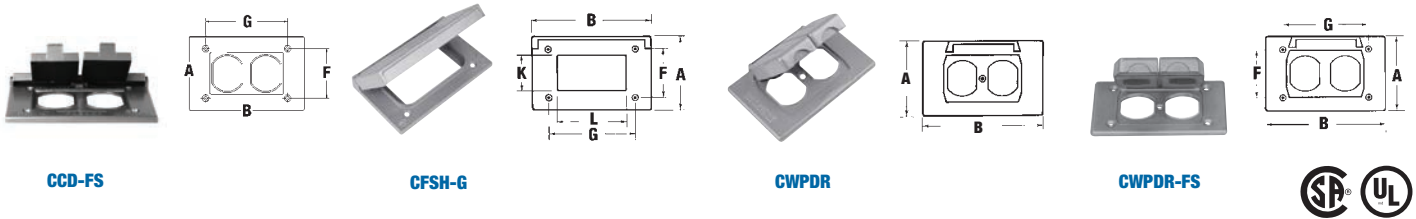

Cat. No.	Description	A (in.)	B (in.)	F (in.)	G (in.)	K (in.)	L (in.)
Single Gang Horizontal Covers (Cast Aluminum)							
CCD-FS	Silver – box mount (zinc)	2-13/16	4-9/16	1-7/8	3-1/4	–	–
CFSH-G	One GFCI receptacle – box mount	2-13/16	4-9/16	1-7/8	3-1/4	1-11/32	2-21/32
CWPDR	One duplex receptacle – device mount	2-13/16	4-9/16	–	–	–	–
CWPDR-FS	One duplex receptacle – box mount	2-13/16	4-9/16	1-7/8	3-1/4	–	–

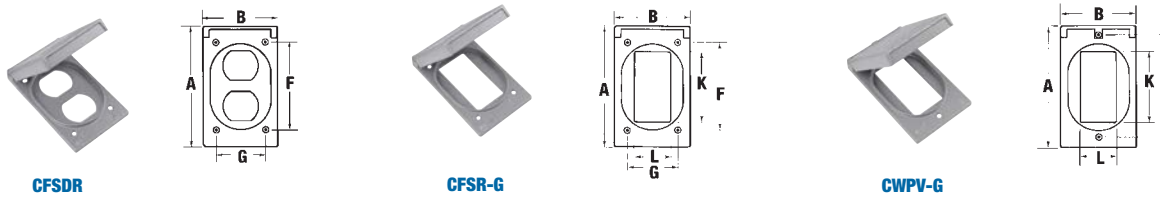

Cat. No.	Description	A (in.)	B (in.)	F (in.)	G (in.)	K (in.)	L (in.)
Single Gang Vertical Covers (Cast Aluminum)							
CFSDR	One duplex receptacle – box mount	4-9/16	2-13/16	3-1/4	1-7/8	–	–
CFSR-G	One GFCI receptacle – box mount	4-9/16	2-13/16	3-1/4	1-7/8	2-21/32	1-11/32
CWPV-G	One GFCI receptacle – device mount	4-9/16	2-13/16	3-1/4	–	2-21/32	1-11/32

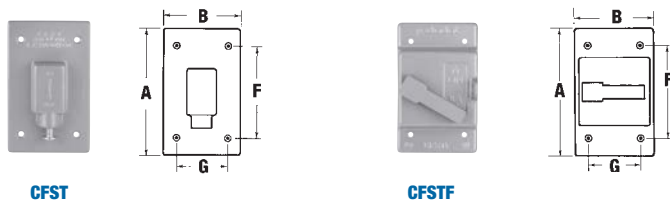

Cat. No.	Description	A (in.)	B (in.)	F (in.)	G (in.)
Single Gang Switch Covers (Cast Aluminum)					
CFST	One plunger – box mount	4-9/16	2-13/16	3-1/4	1-7/8
CFSTF	One lever switch – box mount	4-9/16	2-13/16	3-1/4	1-7/8

Iberville® FS and FD metallic covers



**CCB / CCB-AL /
DCCB-AL**

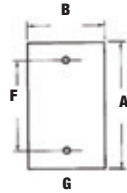

CCB-FS



CFSB

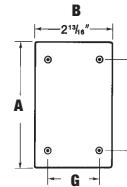

CIFS-100G



Cat. No.	Description	A (in.)	B (in.)	F (in.)	G (in.)
Single Gang Blank Covers (Cast Aluminum)					
CCB	Silver – device mount (grey paint)	4-9/16	2-13/16	3-9/32	–
CCB-FS	Silver – box mount (grey paint)	4-9/16	2-13/16	3-1/4	1-7/8
CFSB	Blank – box mount	4-9/16	2-13/16	3-1/4	1-7/8
CIFS-100G	Blank – box mount (gasket glued on cover)	4-3/8	2-14/16	3-1/4	1-7/8
CCB-AL	Blank – box mount (stamped aluminum)	4-8/16	2-13/16	3-9/32	–
DCCB-AL	Blank – box mount (stamped aluminum) Propack	4-8/16	2-13/16	3-9/32	–



CFSR Series*

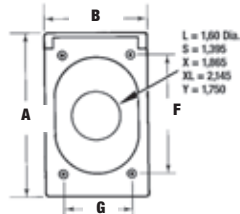

Cat. No.	Description	Nominal Size (in.)	Max. Device Face Dia.	A (in.)	B (in.)	F (in.)	G (in.)
Single Gang Vertical Covers (Cast Aluminum)							
CFSR-L	Single receptacle – box mount	1-9/16	1.600	4-9/16	2-13/16	3-1/4	1-7/8
CFSR-S	Single receptacle – box mount	1-3/8	1.395	4-9/16	2-13/16	3-1/4	1-7/8
CFSR-X	Single receptacle – box mount	1-27/32	1.865	4-9/16	2-13/16	3-1/4	1-7/8
CFSR-XL	Single receptacle – box mount	2-1/8	2.145	4-9/16	2-13/16	3-1/4	1-7/8
CFSR-Y	Single receptacle – box mount	1-3/4	1.750	4-9/16	2-13/16	3-1/4	1-7/8

*Gasket and screws included.



FS-GKV

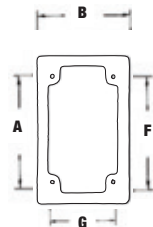

Cat. No.	Description	A (in.)	B (in.)	F (in.)	G (in.)
Single Gang Gasket					
FS-GKV	Single Gang – box mount – gasket	4-9/16	2-13/16	3-1/4	1-7/8

Iberville® FS and FD metallic covers



2CWPDR

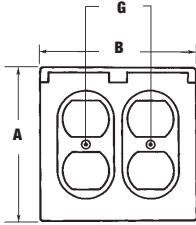

2CWPR-M

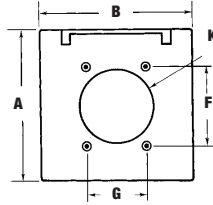

2CFSR-M

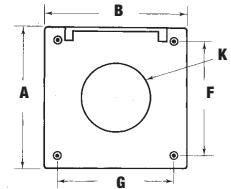

2CFST

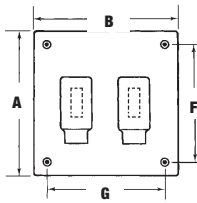

2CCB

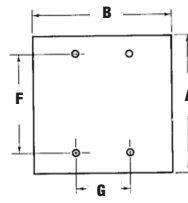

2CFSB

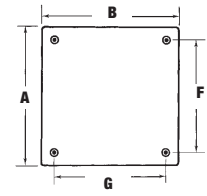

Cat. No.	Description	A (in.)	B (in.)	F (in.)	G (in.)	K (in.)
Two Gang (Cast Aluminum)						
2CWPDR	Two duplex receptacles – device mount	4-9/16	4-5/8	–	1-13/16	–
2CWPR-M	Single receptacle – hole – device mount	4-9/16	4-5/8	2-3/8	1-13/16	2-1/4
2CFSR-M	Single receptacle – hole – box mount	4-9/16	4-5/8	3-3/4	3-3/4	2-1/4
2CFST	Plunger style cover	4-9/16	4-5/8	3-3/4	3-3/4	–
2CCB	Silver – device mount (grey paint)	4-9/16	4-5/8	3-9/32	1-13/16	–
2CCB-AL	Blank cover – box mount (stamped aluminum)	4-9/16	4-5/8	3-9/32	5-5/8	–
2CFSB	Blank cover – box mount	4-9/16	4-5/8	3-3/4	3-3/4	–

Iberville® FS and FD metallic covers



CDR

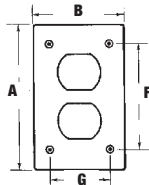

CTS

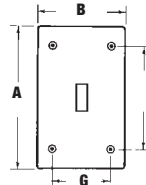

Cat. No.	Description	A (in.)	B (in.)	F (in.)	G (in.)
Single Gang (Cast Aluminum)					
CDR	One duplex receptacle – box mount	4-9/16	2-13/16	3-1/4	1-7/8
CTS	One switch receptacle – box mount	4-9/16	2-13/16	3-1/4	1-7/8



CIFS-4

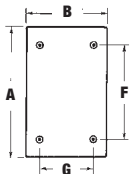

CIFS-7 / CIFS-5



CIFS-6

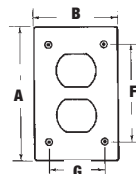

CIFS-9



CIFS-9-HV

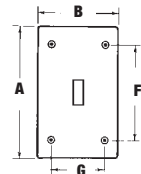

Cat. No.	Description	A (in.)	B (in.)	F (in.)	G (in.)	K (in.)
Single Gang FS Covers (Stamped Aluminum)						
CIFS-4	Blank – single gang – box mount	4-9/16	2-13/16	3-1/4	1-7/8	–
CIFS-5	15 A single receptacle – box mount	4-9/16	2-13/16	3-1/4	1-7/8	1-13/16
CIFS-6	One duplex receptacle – box mount	4-9/16	2-13/16	3-1/4	1-7/8	–
CIFS-7	20 A single locking receptacle – box mount	4-9/16	2-13/16	3-1/4	1-7/8	1-19/32
CIFS-9	One toggle switch – box mount	4-9/16	2-13/16	3-1/4	1-7/8	–
CIFS-9-HV	One toggle switch (347 V) – box mount	4-9/16	2-13/16	3-1/4	1-7/8	–



CRL

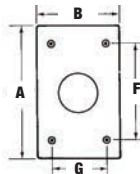

Cat. No.	Description	Nominal Size (in.)	Max. Device Face Dia.	A (in.)	B (in.)	F (in.)	G (in.)
Single Gang (Cast Aluminum)							
CRL	Single receptacle – box mount	1-9/16	1,600	4-9/16	2-13/16	3-1/4	1-7/8
CRS	Single receptacle – box mount	1-3/8	1,395	4-9/16	2-13/16	3-1/4	1-7/8

Covers are approved for dry locations only

Iberville® FS and FD metallic covers

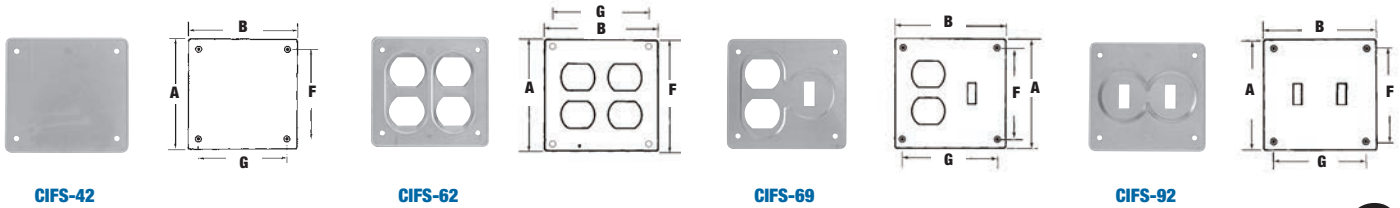

Cat. No.	Description	A (in.)	B (in.)	F (in.)	G (in.)
Two gang FS Covers* (Stamped Aluminum)					
CIFS-42*	Blank – two gang – box mount	4-5/8	4-9/16	3-1/4	3-11/16
CIFS-62*	Two duplex receptacles – box mount	4-5/8	4-9/16	3-1/4	3-11/16
CIFS-69*	One duplex receptacles, one toggle switch – box mount	4-5/8	4-9/16	3-1/4	3-11/16
CIFS-92*	Two toggle switches – box mount	4-5/8	4-9/16	3-1/4	3-11/16

* CIFS covers are CSA approved only

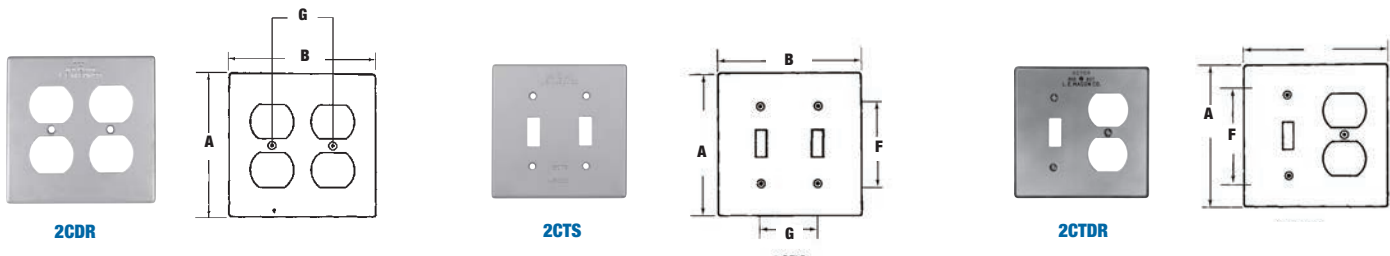

Cat. No.	Description	A (in.)	B (in.)	F (in.)	G (in.)
Two Gang (Cast Aluminum)					
2CDR	Two duplex receptacles – device mount	4-9/16	4-5/8	–	1-13/16
2CTS	Two switch – device mount	4-9/16	4-5/8	2-3/8	1-13/16
2CTDR	One switch and one duplex receptacle – device mount	4-9/16	4-5/8	2-3/8	–

Covers are approved for dry locations only

Iberville® metallic round boxes and covers

Technical Specifications



Applications :

- Boxes and covers protect wiring devices, switches, electronic components and terminal blocks in dry, damp and wet locations
- Accessible wiring chamber provides a convenient location to maintain or change a system, pull conductors and make splices
- Junction box for branch conduits

Features/Benefits :

- Alloy A380 aluminum, certified zinc alloy, and stainless steel springs provide increased corrosion resistance
- Die cast construction and industrial design combine to produce a rugged protective enclosure
- Clean cover edges provide good gasket sealing
- Precision cast and machined surfaces permit safer wire pulling
- Clear cubic content markings
- Convenient mounting lugs for a variety of mounting methods
- Securely fastened mounting plates reduce costly call backs

Standard Materials :

- Boxes: Die cast aluminum alloy A380
- Cover Plates: Stamped aluminum alloy

Compliances :

Compliances as noted on each page of the catalogue include:

- UL Listed
- Boxes: CSA Certified with factory installed ground screw
- Covers: CSA Certified
- Covers suitable for use in wet locations with lids closed



Iberville® metallic round boxes and covers



CIC-8444 / CIC-8448



CIC-8495

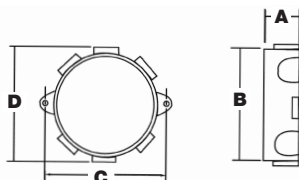

Cat. No.	Hub Size (in.)		No. of Lugs	No. of Plugs	Description	A (in.)	B (in.)	C (in.)	D (in.)	Cu. (in.)
	Side	Bottom								
Weatherproof Junction Box Kits (Cast Aluminum)										
CIC-8444	4 X 1/2	1/2	2	4 X 1/2	Includes cover, gasket, plugs and mounting screws	1-5/8	3-15/16	5	4-5/16	17,3
CIC-8446	4 X 3/4	1/2	2	3 X 3/4	Includes cover, gasket, plugs and mounting screws	1-5/8	3-15/16	5	4-5/16	17,3
		1/2	2	1 X 1/2	Includes cover, gasket, plugs and mounting screws	1-5/8	3-15/16	5	4-5/16	17,3
CIC-8448	4 X 1	1/2	2	3 X 1	Includes cover, gasket, plugs and mounting screws	1-5/8	3-15/16	5	4-5/16	17,3
		1/2	2	1 X 1/2	Includes cover, gasket, plugs and mounting screws	1-5/8	3-15/16	5	4-5/16	17,3
Outlet Box 4-1/2 Dia. (Cast Aluminum)										
CIC-8495	6 X 1/2	1/2	2	5 X 1/2	—	1-1/2	3-15/16	4-5/8	4-5/16	17,3



CIC-93



CCRB / CCRSB



Cat. No.	Description
Weatherproof Round Cover – 4-3/16 in. Dia. (Stamped Aluminum)	
CIC-93	For 4 in. weatherproof round box. Includes gasket and mounting screws

Cat. No.	Description
Blank Outlet Cover (Stamped Aluminum)	
CCRB	Stamped aluminum 5 in. round blank outlet cover with screws. Mounting holes are 3-1/2 in. on center. Painted white. Thickness 5/32 in.
CCRSB	Stamped aluminum 5 in. round blank outlet cover with screws. Mounting holes are 2-3/4 in. on center. Painted white. Thickness 5/32 in.



SJ-11



S-12 / S211BRE



S213E-R

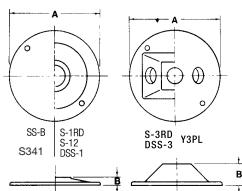

Cat. No.	Description	Hub Size (in.)	No. of Hubs	A (in.)	B (in.)
Red•Dot® Outlet Covers – 4-1/8 in. Dia. (Cast Aluminum)					
S-12*	Round standard lamp holder cover, silver, aluminum	3/4	1	4-1/8	3/8
S211E	Round standard lamp holder cover, silver, aluminum,	1/2	1	4-1/8	3/8
S213E-R	Round standard lamp holder cover, Silver, aluminum, with gasket, screws and plugs	1/2	3	4-1/8	1-1/16
SJ-11	Silver round lampholder cover with one tapped hole	1/2	—	—	—

*Not CSA Certified

Iberville® metallic round boxes and covers



PLG-1-RD / PLG-2-RD / PLG-3-RD



Cat. No.	Colour	Size (in.)	Description
Plugs			
PLG-1-RD	Silver	1/2	Close-up plugs
PLG-2-RD	Silver	3/4	Close-up plugs
PLG-3-RD	Silver	1	Close-up plugs



S621E

Cat. No.	A (in.)
Universal Round Gasket	
S621E*	4-3/16

* Not CSA Certified

Red•Dot® universal device boxes and covers

Technical Specifications



Applications :

- Boxes and covers protect wiring devices, switches, electronic components and terminal blocks in dry, damp and wet locations
- Accessible wiring chamber provides a convenient location to maintain or change a system, pull conductors and make splices
- Junction box for branch conduits
- Covers suitable for use in wet locations with lids closed
- CCB and CCT series covers suitable for use in wet locations



Features/Benefits :

- Alloy A380 aluminum, certified zinc alloy, and stainless steel springs provide increased corrosion resistance
- Die cast construction and industrial design combine to produce a rugged protective enclosure
- Clean cover edges provide good gasket sealing
- Precision cast and machined surfaces permit safer wire pulling
- Clear cubic content markings
- Convenient mounting lugs for a variety of mounting methods
- Securely fastened mounting plates reduce costly call backs

Standard Materials :

- Boxes: Die cast aluminum alloy A380
- Cover Plates: Stamped aluminum alloy or certified die cast zinc alloy ZAMAK 3
- Cover Lids: Certified die cast zinc alloy ZAMAK 3



Compliances :

Compliances as noted on each page of the catalogue include :

- UL Listed
- Boxes: CSA Certified with factory installed ground screw
- Covers: CSA Certified 

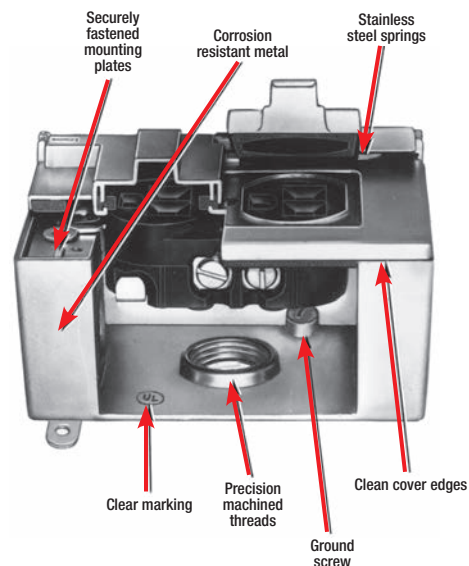

Red•Dot® universal device boxes



S100CN / S105CN / B13030G / IH3



B1502SG



DIH3-1-LM



IH4 / S101E / S121E-R-CN



S102CN / S107CN / IH5



IH6S2

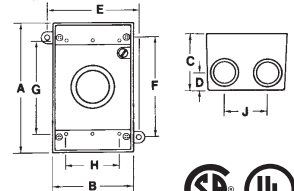

Cat. No.	Description	No. of Hubs	Hub Size (in.)	A (in.)	B (in.)	C (in.)	D (in.)	E (in.)	F (in.)	G (in.)	H (in.)	J (in.)	Cu. (in.)
Single Gang Outlet Boxes - 2 in. Deep (Cast Aluminum)													
S100CN	Single gang universal standard outlet box	3	1/2	4-9/16	2-13/16	2	5/8	3-13/16	3-1/2	3-1/4	1-7/8	-	19.0
S100BRCN	Single gang universal standard outlet box, bronze, aluminum	3	1/2	4-9/16	2-13/16	2	5/8	3-13/16	3-1/2	3-1/4	1-7/8	-	19.0
S100WHCN	Single gang universal standard outlet box, white, aluminum	3	1/2	4-9/16	2-13/16	2	5/8	3-13/16	3-1/2	3-1/4	1-7/8	-	19.0
S105CN	Single gang universal weatherproof box, silver, aluminum	3	3/4	4-9/16	2-13/16	2	5/8	3-13/16	3-1/2	3-1/4	1-7/8	-	18.3
B13030G	Single gang universal weatherproof box, silver, aluminum	3	1	4-9/16	2-13/16	2	5/8	3-13/16	3-1/2	3-1/4	1-7/8	1-1/2	17.5
IH3-1-LM	Single gang universal weatherproof box, silver, aluminum	3	1/2	4-9/16	2-13/16	2	5/8	3-13/16	3-1/2	3-1/4	1-7/8	1-1/2	19.0
IH4-1-LM	Single gang universal weatherproof box, silver, aluminum	4	1/2	4-9/16	2-13/16	2	5/8	3-13/16	3-1/2	3-1/4	1-7/8	1-1/2	19.0
IH4-2-LM	Single gang universal weatherproof box, silver, aluminum	4	3/4	4-9/16	2-13/16	2	5/8	3-13/16	3-1/2	3-1/4	1-7/8	1-1/2	18.3
S101E	Single gang universal standard outlet box, silver, aluminum	4	1/2	4-9/16	2-13/16	2	5/8	3-13/16	3-1/2	3-1/4	1-7/8	1-1/2	19.0
S102CN	Single gang universal standard outlet box, silver, aluminum	5	1/2	4-9/16	2-13/16	2	5/8	3-13/16	3-1/2	3-1/4	1-7/8	1-1/2	19.0
S107CN	Single gang universal weatherproof box, silver, aluminum	5	3/4	4-9/16	2-13/16	2	5/8	3-13/16	3-1/2	3-1/4	1-7/8	1-1/2	18.3
B1501SGR	Single gang universal weatherproof box, silver, aluminum	5	1/2	4-9/16	2-13/16	2	5/8	3-13/16	3-1/2	3-1/4	1-7/8	1-1/2	18.3
B1502SG	Single gang universal weatherproof box, hub, silver, aluminum	5	3/4	4-9/16	2-13/16	2	5/8	3-13/16	3-1/2	3-1/4	1-7/8	1-1/2	18.0
IH6S2-1	Single gang universal weatherproof box, silver, aluminum	6	1/2	4-9/16	2-13/16	2	5/8	3-13/16	3-1/2	3-1/4	1-7/8	1-1/2	17.5
IH6S2-2	Single gang universal weatherproof box, silver, aluminum	6	3/4	4-9/16	2-13/16	2	5/8	3-13/16	3-1/2	3-1/4	1-7/8	1-1/2	17.5
DIH3-1-LM	Single gang universal weatherproof box, silver, aluminum	3	1/2	4-9/16	2-13/16	2	5/8	3-13/16	3-1/2	3-1/4	1-7/8	1-1/2	19.0
DIH3-1-LM-WH	Single gang universal weatherproof box, white, aluminum	3	1/2	4-9/16	2-13/16	2	5/8	3-13/16	3-1/2	3-1/4	1-7/8	1-1/2	19.0
DIH3-2-LM	Single gang universal weatherproof box, white, aluminum	3	1/2	4-9/16	2-13/16	2	5/8	3-13/16	3-1/2	3-1/4	1-7/8	1-1/2	18.3
IH3-1	Single gang universal weatherproof box, white, aluminum	3	1/2	4-9/16	2-13/16	2	5/8	3-13/16	3-1/2	3-1/4	1-7/8	1-1/2	19.0
IH4-1	Single gang universal weatherproof box, white, aluminum	4	1/2	4-9/16	2-13/16	2	5/8	3-13/16	3-1/2	3-1/4	1-7/8	1-1/2	19.0
IH4-2	Single gang universal weatherproof box, white, aluminum	4	3/4	4-9/16	2-13/16	2	5/8	3-13/16	3-1/2	3-1/4	1-7/8	1-1/2	18.3
IH5-1-LM	Single gang universal weatherproof box, white, aluminum	5	1/2	4-9/16	2-13/16	2	5/8	3-13/16	3-1/2	3-1/4	1-7/8	1-1/2	19.0
IH5-2-LM	Single gang universal weatherproof box, white, aluminum	5	3/4	4-9/16	2-13/16	2	5/8	3-13/16	3-1/2	3-1/4	1-7/8	1-1/2	18.3



IHD3 Series



IHD4 Series

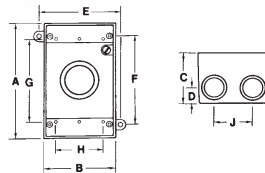

Cat. No.	Description	No. of Hubs	Hub Size (in.)	A (in.)	B (in.)	C (in.)	D (in.)	E (in.)	F (in.)	G (in.)	H (in.)	J (in.)	Cu. (in.)
Single Gang Outlet Boxes - 2-5/8 in. Deep (Cast Aluminum)													
IHD3-1	Single gang deep universal weatherproof box, 2-5/8 in. deep, silver, aluminum	3	1/2	4-9/16	2-13/16	2-5/8	5/8	3-13/16	3-1/2	3-1/4	1-7/8	-	24.8
IHD31GDC	Single gang deep universal weatherproof box, 2-5/8 in. deep, silver, aluminum	3	1/2	4-9/16	2-13/16	2-5/8	3/4	3-13/16	3-1/2	3-1/4	1-7/8	-	24.8
IHD3-2	Single gang deep universal weatherproof box, 2-5/8 in. deep, silver, aluminum	3	3/4	4-9/16	2-13/16	2-5/8	5/8	3-13/16	3-1/2	3-1/4	1-7/8	-	24.8
IHD3-3	Single gang deep universal weatherproof box, 2-5/8 in. deep, silver, aluminum	3	1	4-9/16	2-13/16	2-5/8	3/4	3-13/16	3-1/2	3-1/4	1-7/8	-	24.8
IHD4-1	Single gang deep universal weatherproof box, 2-5/8 in. deep, silver, aluminum	4	1/2	4-9/16	2-13/16	2-5/8	5/8	3-13/16	3-1/2	3-1/4	1-7/8	1-1/2	24.8
IHD4-2	Single gang deep universal weatherproof box, 2-5/8 in. deep, silver, aluminum	4	3/4	4-9/16	2-13/16	2-5/8		3-13/16	3-1/2	3-1/4	1-7/8	1-1/2	24.8

Mounting lugs and screws included in packaging
Raintight when used with appropriate Red Dot® covers

Red•Dot® universal device boxes



S400CN / S405E



2IH4



S401CN / S402CN / 2IH5-1

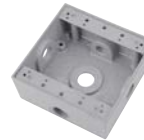

2IH5S2



2IH7



2IH7S2



2IHD5



3IHD7

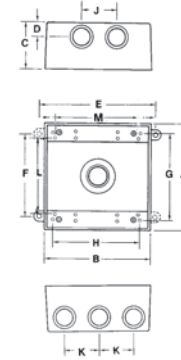

Cat. No.	Description	No. of Hubs	Hub Size (in.)	A (in.)	B (in.)	C (in.)	D (in.)	E (in.)	F (in.)	G (in.)	H (in.)	J (in.)	K (in.)	L (in.)	M (in.)	Cu. (in.)
Two Gang Outlet Boxes – 2 in. Deep (Cast Aluminum)																
S400CN	Two gang universal weatherproof box, silver, aluminum, with ground screw	3	1/2	4-9/16	4-5/8	2-1/16	5/8	5	3-1/2	3-11/16	3-3/4	-	-	3-1/4	3-9/16	31.8
S405E	Two gang universal weatherproof box, silver, aluminum, with ground screw	3	3/4	4-9/16	4-5/8	2-1/16	5/8	5	3-1/2	3-11/16	3-3/4	-	-	3-1/4	3-9/16	31.8
2IH3-2	Two gang universal weatherproof box, silver, aluminum, with ground screw	3	3/4	4-9/16	4-5/8	2-1/16	-	-	-	-	-	-	-	3-1/4	3-9/16	31.8
2IH4-1	Two gang universal weatherproof box, silver, aluminum, with ground screw	4	1/2	4-9/16	4-5/8	2-1/16	5/8	5	3-1/2	3-11/16	3-3/4	1-1/2	-	3-1/4	3-9/16	31.8
2IH4-2	Two gang universal weatherproof box, silver, aluminum, with ground screw	4	3/4	4-9/16	4-5/8	2-1/16	5/8	5	3-1/2	3-11/16	3-3/4	1-1/2	-	3-1/4	3-9/16	31.8
S401CN	Two gang universal weatherproof box, silver, aluminum, with ground screw	5	1/2	4-9/16	4-5/8	2-1/16	5/8	5	3-1/2	3-11/16	3-3/4	1-1/2	-	3-1/4	3-9/16	31.8
S402CN	Two gang universal weatherproof box, silver, aluminum, with ground screw	5	3/4	4-9/16	4-5/8	2-1/16	5/8	5	3-1/2	3-11/16	3-3/4	1-1/2	-	3-1/4	3-9/16	31.8
2IH5-1	Two gang universal weatherproof box, silver, aluminum, with ground screw	5	1/2	4-9/16	4-5/8	2-1/16	5/8	5	3-1/2	3-11/16	3-3/4	1-1/2	-	3-1/4	3-9/16	31.8
2IH5S2-1	Two gang universal weatherproof box, silver, aluminum, with ground screw	5	1/2	4-9/16	4-5/8	2-1/16	5/8	5	3-1/2	3-11/16	3-3/4	-	-	3-1/4	3-9/16	31.8
2IH5S2-2	Two gang universal weatherproof box, silver, aluminum, with ground screw	5	3/4	4-9/16	4-5/8	2-1/16	5/8	5	3-1/2	3-11/16	3-3/4	-	-	3-1/4	3-9/16	31.8
2IH7-1	Two gang universal weatherproof box, silver, aluminum, with ground screw	7	1/2	4-9/16	4-5/8	2-1/16	5/8	5	3-1/2	3-11/16	3-3/4	-	1-1/2	3-1/4	3-9/16	30.3
2IH7-2	Two gang universal weatherproof box, silver, aluminum, with ground screw	7	3/4	4-9/16	4-5/8	2-1/16	5/8	5	3-1/2	3-11/16	3-3/4	-	1-1/2	3-1/4	3-9/16	30.3
2IH7S2-1	Two gang universal weatherproof box, silver, aluminum, with ground screw	7	1/2	4-9/16	4-5/8	2-1/16	5/8	5	3-1/2	3-11/16	3-3/4	1-1/2	-	3-1/4	3-9/16	32.0
2IH7S2-2	Two gang universal weatherproof box, silver, aluminum, with ground screw	7	3/4	4-9/16	4-5/8	2-1/16	5/8	5	3-1/2	3-11/16	3-3/4	1-1/2	-	3-1/4	3-9/16	32.0



Cat. No.	No. of Hubs	Hub Size (in.)	A (in.)	B (in.)	C (in.)	D (in.)	E (in.)	F (in.)	G (in.)	H (in.)	J (in.)	L (in.)	M (in.)	Cu. (in.)
Two Gang Outlet Boxes – 2-5/8 in. Deep (Cast Aluminum)														
2IHD5-1	5	1/2	4-9/16	4-5/8	2-11/16	5/8	5	3-1/2	3-11/16	3-3/4	1-1/2	3-1/4	3-9/16	40.3
2IHD5-2	5	3/4	4-9/16	4-5/8	2-11/16	5/8	5	3-1/2	3-11/16	3-3/4	1-1/2	3-1/4	3-9/16	40.3
2IHD5-3	5	1	4-9/16	4-5/8	2-11/16	5/8	5	3-1/2	3-11/16	3-3/4	1-1/2	3-1/4	3-9/16	40.3



Cat. No.	No. of Hubs	Hub Size (in.)	A (in.)	B (in.)	C (in.)	D (in.)	E (in.)	F (in.)	G (in.)	H (in.)	K (in.)	L (in.)	M (in.)	Cu. (in.)
Three Gang Outlet Boxes - 2-5/8 in. Deep (Cast Aluminum)														
B37D20G*	7	3/4	4-9/16	6-7/16	2-11/16	1-3/16	6-13/16	3-1/2	3-1/4	5-5/8	1-1/2	3-1/4	3-9/16	54.8
B37D30G*	7	1	4-9/16	6-7/16	2-11/16	1-3/16	6-13/16	3-1/2	3-1/4	5-5/8	1-1/2	3-1/4	3-9/16	54.8

* Not CSA approved
Raintight when used with appropriate Red Dot® covers

Red•Dot® universal device extensions

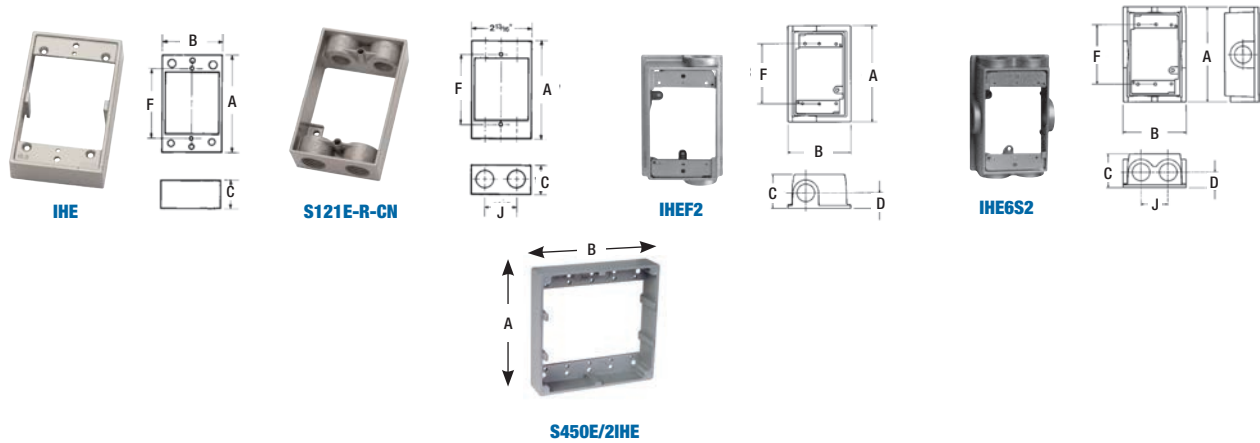

Cat. No.	Description	No. of Hubs	Hub Size (in.)	A (in.)	B (in.)	C (in.)	D (in.)	F (in.)	J (in.)	Cu. (in.)
Single Gang Extensions Ring (Cast Aluminum)										
IHE	Single gang universal box extension adapter, 1 in. deep, with gasket and screws	None	–	4-9/16	2-13/16	1	–	3-9/32	–	10.0
S121E-R-CN	Single gang universal box extension adapter, 1-3/8 in. deep, with gasket, screws and ground screws	4	1/2	4-9/16	2-13/16	1-3/8	–	3-9/32	–	11.3
IHEF6S2-1	Single gang flanged extension adapter, 1-7/8 in. deep, with gasket and screws	6 (4 plugs)	1/2	4-1/2	3-1/2	1-7/8	7/8	3-9/32	1-1/2	21.3
IHEF6S2-2	Single gang flanged extension adapter, 1-7/8 in. deep, with gasket and screws	6 (4 plugs)	3/4	4-1/2	3-1/2	1-7/8	7/8	3-9/32	1-1/2	21.3
Two Gang Extensions Ring (Cast Aluminum)										
S450E	Two gang universal square box extension ring, Silver, Aluminum, with gasket and screws	–	–	4-3/4	4-3/4	–	–	–	–	–
IHEF2-1	Single gang flanged extension adapter, 1-7/8 in. deep, with gasket and screws	2 (1 plug)	1/2	4-1/2	3-1/2	1-7/8	7/8	3-9/32	–	21.3
IHEF2-2	Single gang flanged extension adapter, 1-7/8 in. deep, with gasket and screws	2 (1 plug)	3/4	4-1/2	3-1/2	1-7/8	7/8	3-9/32	–	21.3
2IHE	Two gang universal box extension ring, silver, aluminum, gaskets and screws include	–	–	–	–	–	–	–	–	–



LM

Cat. No.	Description
Lug Mounts	
LM	2 mounting lugs with screws, for LM boxes only

Red•Dot® universal device covers



S310E-R



CCD / WR81-CN

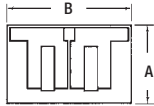

S305 / CCG / CCG-L / DCCG-BR / DCCG-WH

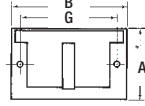

CCS / CCS-L

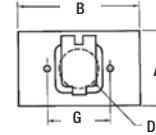

Cat. No.	Description	A (in.)	B (in.)	D (in.)	G (in.)
Single Gang Device Mount Covers – Horizontal (zinc)					
S310BRE	For duplex receptacle – Bronze	2-27/32	4-9/16	–	–
S310E-R	For duplex receptacle – Silver	2-27/32	4-9/16	–	–
S310WHE	For duplex receptacle – White	2-27/32	4-9/16	–	–
CCD-L	For duplex receptacle with lock option	2-27/32	4-9/16	–	–
WR81-CN	Natural cover with stay open lid	2-27/32	4-9/16	–	–
WRMB-87	Cover, motor base with device	2-27/32	4-9/16	–	–
DCCDSO	For duplex receptacle with lock option stay open – Silver	2-27/32	4-9/16	–	–
S305BRE	For GFCI receptacle – Bronze	2-27/32	4-9/16	–	3-13/16
S305E	For GFCI receptacle – Silver	2-27/32	4-9/16	–	3-13/16
S305WHE	For GFCI receptacle – White	2-27/32	4-9/16	–	3-13/16
CCG	GFCI receptacle box cover	2-27/32	4-9/16	–	3-13/16
CCG-L	GFCI receptacle box cover with lock option	2-27/32	4-9/16	–	3-13/16
CCS	For single receptacle, horizontal	2-13/16	4-9/16	1-1/2	2-3/8
CCS-L	For single receptacle, horizontal with lock option	2-13/16	4-9/16	1-1/2	2-3/8
DCCG-BR	GFCI receptacle, horizontal – Bronze	2-27/32	4-9/16	–	3-13/16
DCCG-WH	GFCI receptacle, horizontal – White	2-27/32	4-9/16	–	3-13/16



S309 / CCDV-L



S306 / CCGV-L / CCGV

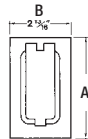

CCSV / CCSV-L

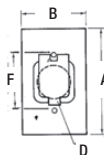

Cat. No.	Description	A (in.)	B (in.)	D (in.)	F (in.)
Single Gang Device Mount Covers – Vertical (zinc)					
S309BRE	For duplex receptacle – Bronze	4-9/16	2-13/16	–	–
S309E	For duplex receptacle – Silver	4-9/16	2-13/16	–	–
S309WHE	For duplex receptacle – White	4-9/16	2-13/16	–	–
CCDV-L	For duplex receptacle with lock option	4-9/16	2-13/16	–	–
S306BRE	For GFCI receptacle – Bronze	4-9/16	2-13/16	–	–
S306E	For GFCI receptacle – Silver	4-9/16	2-13/16	–	–
S306WHE	For GFCI receptacle – White	4-9/16	2-13/16	–	–
CCGV	GFCI Receptacle Box Cover – Silver	4-9/16	2-13/16	–	–
CCGV-L	For GFCI receptacle with lock option	4-9/16	2-13/16	–	–
CCSV	For single receptacle	4-9/16	2-13/16	1-1/2	2-3/8
CCSV-L	For single receptacle with lock option	4-9/16	2-13/16	1-1/2	2-3/8

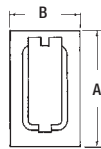

Cat. No.	Description	A (in.)	B (in.)
Single Gang Device Mount Cover – Horizontal and Vertical (zinc)			
DCCU†	Flip-lid cover - for GFCI, single, duplex or switch configuration supplied with 2 adapters and 2 screws, lockable – Silver	4-9/16	2-13/16
DCCU-BR†	Flip-lid cover - for GFCI, single, duplex or switch configuration supplied with 2 adapters and 2 screws, lockable – Bronze	4-9/16	2-13/16
DCCU-WH†	Flip-lid cover - for GFCI, single, duplex or switch configuration supplied with 2 adapters and 2 screws, lockable – White	4-9/16	2-13/16

Raintight with cover closed and when used with appropriate Red Dot® boxes. † Lock not included.

Red•Dot® universal device covers

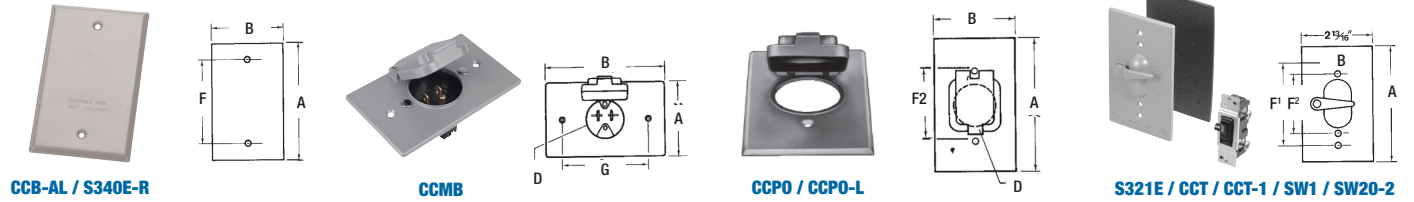

Cat. No.	Description	A (in.)	B (in.)	F (in.)
Single Gang Device Mount Covers				
S340E-R	Blank cover (painted steel) – Silver	4-9/16	2-13/16	3-9/32
S340BRE-R-CN	Blank cover (painted steel) – Bronze	4-9/16	2-13/16	3-9/32
S340WHE-R-CN	Blank cover (painted steel) – White	4-9/16	2-13/16	3-9/32
CCB-AL	Blank cover (stamped aluminum)	4-9/16	2-13/16	3-9/32
DCCB-AL	Blank cover (stamped aluminum) – Propack	4-9/16	2-13/16	3-9/32



Cat. No.	Description	A (in.)	B (in.)	D (in.)	F1 (in.)	F2 (in.)	G (in.)
Couvercles un groupe pour montage sur appareils (zinc)							
CCMB	Motor base cover with 15 A, 125 V plug	2-3/8	4-9/16	1-35/64	-	-	3-9/32
CCPO	Power outlet cover for 30 A and 50 A receptacles box mount	4-9/16	2-13/16	2-5/32	-	2-3/8	-
CCPO-L	Power outlet cover for 30 A and 50 A receptacles box mount with lock option	4-9/16	2-13/16	2-5/32	-	2-3/8	-
S321E	For switch packed with spacers	4-9/16	2-13/16	2-5/32	3-9/32	2-3/8	-
CCT	Switch receptacle cover	4-9/16	2-13/16	2-5/32	3-9/32	2-3/8	-
CCT-1	Switch cover with single pole switch 15 A, 125 V AC	4-9/16	2-13/16	2-5/32	3-9/32	2-3/8	-
CCT-1-20	Switch cover with single pole 20A switch, 120 V, 277 V AC	4-9/16	2-13/16	2-5/32	3-9/32	2-3/8	-
SW1	Switch box cover with lever switch. Single pole. 10 A 125 V	4-9/16	2-13/16	2-5/32	3-9/32	2-3/8	-
SW20-2	Switch cover with double pole 20 A switch, 120 V, 277 V AC (all with spacers and screws)	4-9/16	2-13/16	2-5/32	3-9/32	2-3/8	-

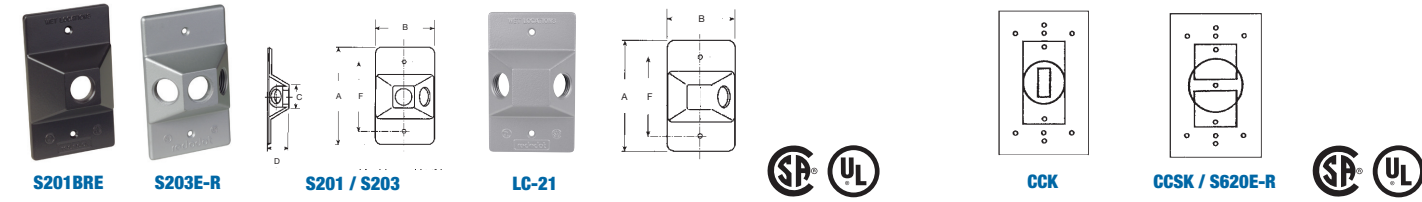

Cat. No.	Description	A (in.)	B (in.)	C (in.)	D (in.)	F (in.)
Lampholder Rectangular Covers (zinc)						
S201E	One 1/2 in. tapped hole, grey	4-9/16	2-13/16	1-5/32	1	-
S201BRE	One 1/2 in. tapped hole, bronze	4-9/16	2-13/16	1-5/32	1	-
S201WHE	One 1/2 in. tapped hole, white	4-9/16	2-13/16	1-5/32	1	-
LC-21	Two 1/2 in. tapped holes	4-9/16	2-13/16	1-5/32	1	3-9/32
S203E-R	Three 1/2 in. tapped holes, grey	4-9/16	2-13/16	1-5/32	1	3-9/32
S203BRE	Three 1/2 in. tapped holes, bronze	4-9/16	2-13/16	1-5/32	1	3-9/32
S203WHE	Three 1/2 in. tapped holes, white	4-9/16	2-13/16	1-5/32	1	3-9/32

Cat. No.	Description
Single Gang Gaskets	
CCK	Neoprene gasket
CCSK	Neoprene gasket
S620E-R	Neoprene gasket

Red•Dot® universal device covers

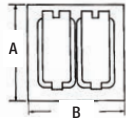

S410E / 2CCD / 2CCD-L

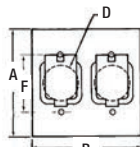

2CCS

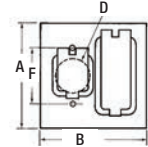

2CCSD

2CCSG / WR74-81C

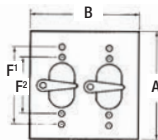

2CCT / 2CCT-1



Cat. No.	Description	A (in.)	B (in.)	D (in.)	F (in.)	F1 (in.)	F2 (in.)
Two Gang Device Mount Covers (zinc)							
S410E*	For two duplex receptacles	4-9/16	4-5/8	-	-	-	-
2CCD	2-duplex receptacle box cover	4-9/16	4-5/8	-	-	-	-
2CCD-L*	For two duplex receptacles with lock option (lock not included)	4-9/16	4-5/8	-	-	-	-
2CCS*	For two single receptacles	4-9/16	4-5/8	1-31/64	2-3/8	-	-
2CCSD*	For single and duplex receptacles	4-9/16	4-5/8	1-31/64	2-3/8	-	-
2CCSG*	For single and GFCI receptacles	4-9/16	4-5/8	1-31/64	2-3/8	-	-
WR74-81C	Cover, self-closing lids for single GFCI	4-9/16	4-5/8	-	-	-	-
2CCT	Switch receptacle cover	4-9/16	4-5/8	-	-	2-3/8	3-9/32
2CCT-1*	Switch cover with two single pole switches 15A, 125V AC	4-9/16	4-5/8	-	-	2-3/8	3-9/32
2CCTD	Switch and one duplex receptacle cover	4-9/16	4-5/8	-	-	-	-
2CCTD-1	Switch and one duplex receptacle cover 15 A, 125 V	4-9/16	4-5/8	-	-	-	-
2CCDG	One duplex and one GFCI receptacle	3-11/16	3-3/4	-	-	-	-
2CCG	GFCI receptacle box cover-horizontal	3-11/16	3-3/4	-	-	-	-
WR281-CBR	Bronze cover self-closing lids	4-9/16	4-5/8	-	-	-	-
WR281-C-WH	White cover self-closing lids	4-9/16	4-5/8	-	-	-	-
R104	Two Gang gasket	4-9/16	4-5/8	-	-	-	-

*Raintight with cover closed and when used with appropriate Red Dot® boxes

Red•Dot® universal device covers

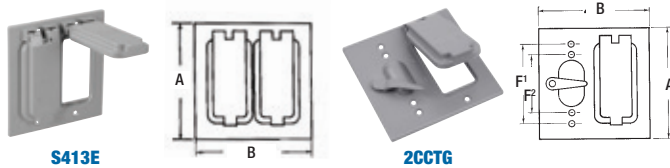

Cat. No.	Description	A (in.)	B (in.)	F1 (in.)	F2 (in.)
Two and Three Gang Device Mount Covers (zinc)					
S413E*	For two GFCI receptacles	4-9/16	4-5/8	–	–
2CCTG*	For switch and GFCI receptacle with spacers	4-9/16	4-5/8	3-9/32	2-3/8

*Raintight with cover closed and when used with appropriate Red Dot® boxes

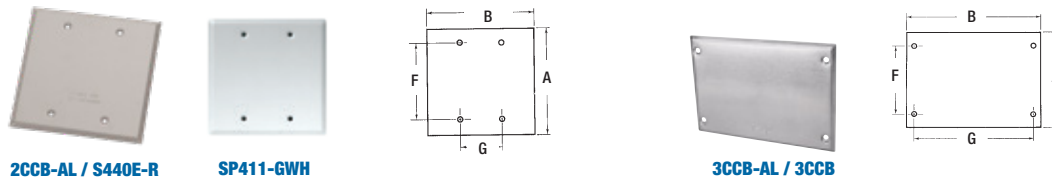

Cat. No.	Description	A (in.)	B (in.)	F (in.)	G (in.)
Two and Three Gang Device Mount Covers (Stamped Aluminum)					
S440E-R	Blank cover, two gang (stamped aluminum) – Grey	4-9/16	4-5/8	3-9/32	1-13/16
SP411-GWH	Blank cover, two gang (stamped aluminum) – White	4-1/2	6-3/8	3-1/4	5-5/8
3CCB	Blank cover, three gang	4-9/16	4-5/8	3-9/32	1-13/16
2CCB-AL	Blank cover, two gang (stamped aluminum) – with gasket and screws	4-9/16	4-5/8	3-9/32	5-5/8
3CCB-AL	Blank cover, three gang (stamped aluminum) – with gasket and screws	4-9/16	6-3/8	3-1/4	5-5/8

*Raintight with cover closed and when used with appropriate Red Dot® boxes

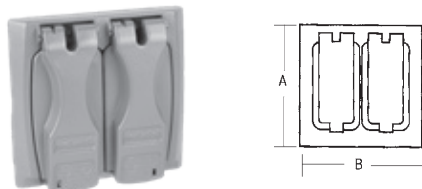

Cat. No.	Colour	Description	A (in.)	B (in.)
Two Gang Covers (zinc)				
2CCU	Silver	Flip-lid cover for GFCI, duplex or single switch configurations supplied with 4 adapters and 4 screws lockable (lock not included)	4-9/16	4-5/8
2CCU-BR	Bronze	Flip-lid cover for GFCI, duplex or single switch configurations supplied with 4 adapters and 4 screws lockable (lock not included)	4-9/16	4-5/8
2CCU-WH	White	Flip-lid cover for GFCI, duplex or single switch configurations supplied with 4 adapters and 4 screws lockable (lock not included)	4-9/16	4-5/8

Red•Dot® metallic weatherproof covers

Technical Specifications



Applications :

- Protects receptacles, switches, and plugs for single gang and two gang configurations in dry and wet locations
- Provides a lockable cover that complies with OSHA lockout/tagout requirements
- Prevents accidental equipment disconnects, reduces tampering, and deters theft and equipment removal

Features/Benefits :

- Alloy A360 copper-free (less than 0.004 copper content) aluminum provides increased corrosion resistance
- Die cast, metal construction provides long lasting durability
- NEMA 3R rating ensures protection against falling rain, sleet, and external ice formation when used with appropriate device boxes
- Clear UL and CSA markings speed approval by inspectors
- Wide range of cover depths and receptacle configurations accommodate almost every common plug and cord size
- Combination box or device mounting design provides flexibility in installation

Standard Materials :

- Covers and Plates: Die cast aluminum alloy A360
- Gaskets: Closed-cell foam

Standard Finish :

- Powder coated finish

Compliances :

Compliances as noted on each page of the catalogue in clude:

- CSA Certified
- UL Listed

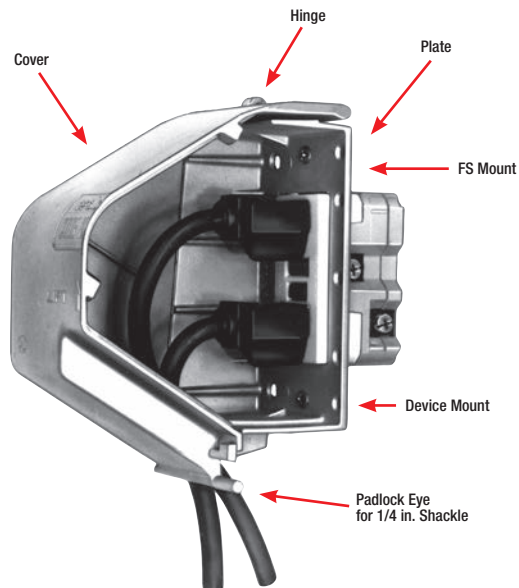

Red•Dot® metallic weatherproof covers



Duplex



GFCI



Single Receptacle



Switch



Cat. No.	Description
Single Gang Cover – 2-1/4 in. Internal Depth (Aluminum)	
CKSUU	Small vertical cover universal code keeper accommodates duplex, GFCI, single receptacle and toggle switch – lockable

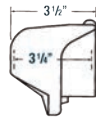

Duplex



GFCI



Single Receptacle



Switch

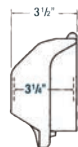

Duplex



GFCI



Single Receptacle



Switch



Cat. No.	Description
Single Gang Cover – 3-1/4 in. Internal Depth (Aluminum)	
CKMU	Medium horizontal cover universal code keeper accommodates duplex, GFCI, single receptacle and toggle switch – lockable
CKMUV	Medium vertical cover universal code keeper accommodates duplex, GFCI, single receptacle and toggle switch – lockable

Red•Dot® metallic weatherproof covers

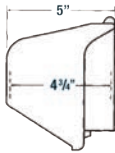

Single Receptacle



Cat. No.	Description
Single Gang Cover – 4-3/4 in. Internal Depth (Aluminum)	
CKLSVU	Large vertical cover – Box mount universal code keeper with adapter rings to accommodate 1-19/32 in. and 1-3/4 in. single receptacles – lockable

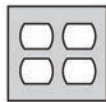

Two duplex receptacle

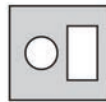

Single and GFCI receptacle

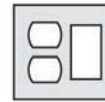

Duplex and GFCI receptacle



Toggle and duplex receptacle

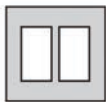

Two GFCI receptacle

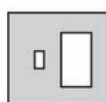

Toggle and GFCI receptacle

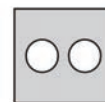

Two single receptacle



Toggle and single receptacle

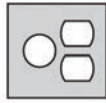

Single and duplex receptacle

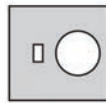

Toggle and single receptacle



Cat. No.	Description
Two Gang Cover – 4-1/4 in. Internal Depth (Aluminum)	
2CKU*	Regular cover universal code keeper accommodates various configurations – lockable

* Can be used to cover one receptacle with an oversized wall opening

Red•Dot® «Extra-Duty» nonmetallic weatherproof covers

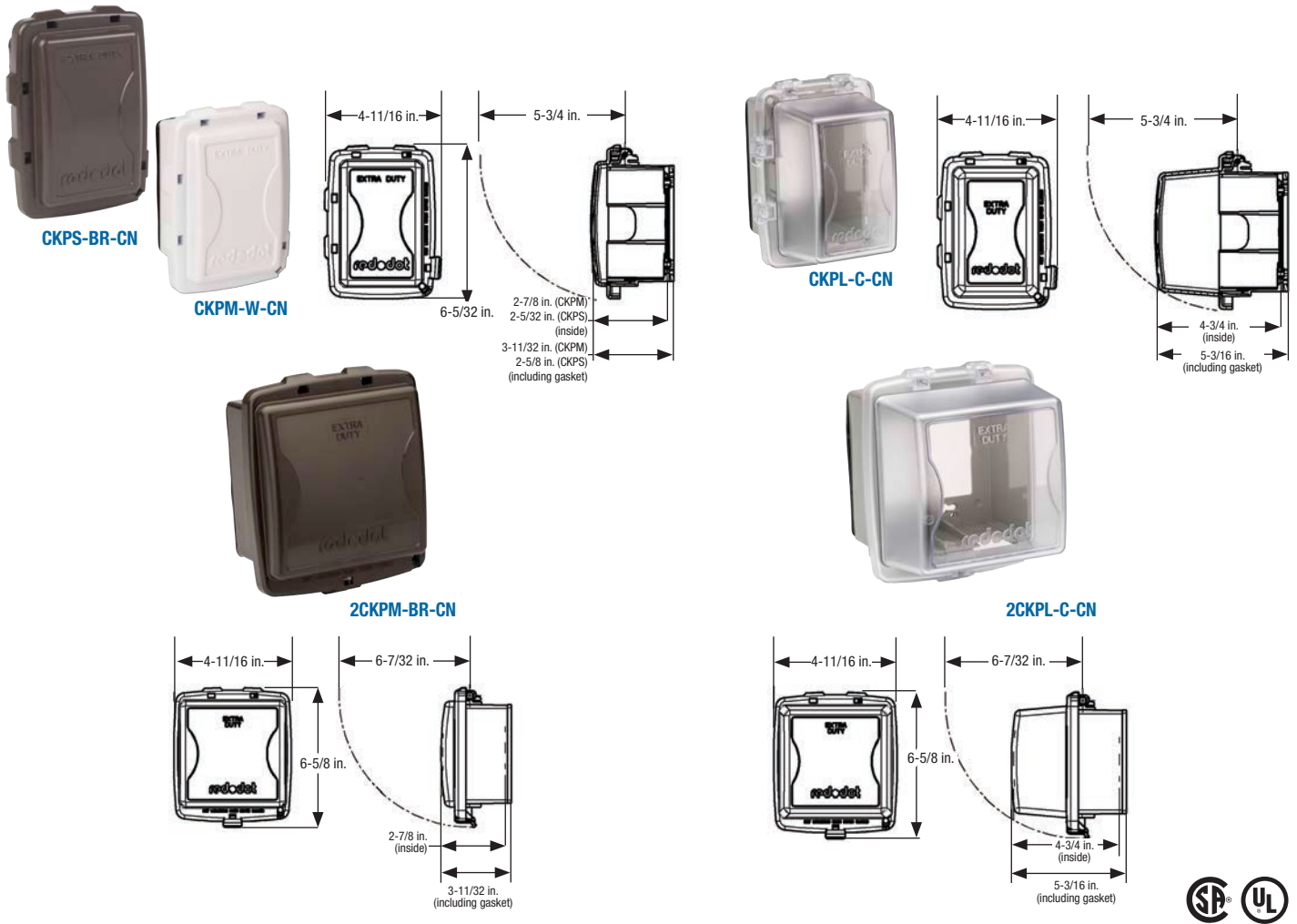

Cat. No.	Description	Deep (in.)	Top Color	Bottom Color	Std. Pkg. Qty.
CKPS-C-CN	Single-gang shallow — Vertical or horizontal	2-1/4	Clear	Grey	7
CKPS-G-CN	Single-gang shallow — Vertical or horizontal	2-1/4	Grey	Grey	7
CKPS-W-CN	Single-gang shallow — Vertical or horizontal	2-1/4	White	White	7
CKPS-BR-CN	Single-gang shallow — Vertical or horizontal	2-1/4	Bronze	Bronze	7
CKPM-C-CN	Single-gang medium — Vertical or horizontal	2-7/8	Clear	Grey	8
CKPM-G-CN	Single-gang medium — Vertical or horizontal	2-7/8	Grey	Grey	8
CKPM-W-CN	Single-gang medium — Vertical or horizontal	2-7/8	White	White	6
CKPM-BR-CN	Single-gang medium — Vertical or horizontal	2-7/8	Bronze	Bronze	6
CKPL-C-CN	Single-gang large — Vertical or horizontal	4-1/4	Clear	Grey	4
2CKPM-C-CN	Two-gang medium	2-7/8	Clear	Grey	4
2CKPM-G-CN	Two-gang medium	2-7/8	Grey	Grey	4
2CKPM-W-CN	Two-gang medium	2-7/8	White	White	4
2CKPM-BR-CN	Two-gang medium	2-7/8	Bronze	Bronze	4
2CKPL-C-CN	Two-gang large	4-3/4	Clear	Grey	4

Red•Dot® metallic round boxes and covers



S110CN / S-48 / DS47BR

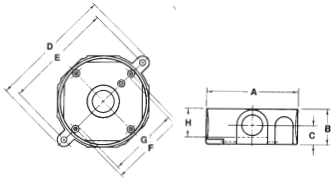

S-47



Cat. No.	Description	Hub Size (in.)	No. of Hubs	A (in.)	B (in.)	C (in.)	D (in.)	E (in.)	F (in.)	G (in.)	H (in.)	Cu. (in.)
Outlet Boxes – 4-1/8 in. Dia. (Cast Aluminum)												
S110CN*	Round outlet box, 17 Cu. in., silver, aluminum, with ground screws	1/2	5	4-1/8	1-5/8	3/4	5-9/16	4-15/16	3-1/2	3-1/8	1-1/4	16.3
S110BRCN*	Single gang universal standard outlet box, 17.3 Cu. in., bronze, aluminum, with ground screws	1/2	5	4-1/8	1-5/8	3/4	5-9/16	4-15/16	3-1/2	3-1/8	1-1/4	16.3
S110WHCN*	Single gang universal standard outlet box, 17.3 Cu. in., white, aluminum, with ground screws	1/2	5	4-1/8	1-5/8	3/4	5-9/16	4-15/16	3-1/2	3-1/8	1-1/4	16.3
DS-47-BR*	Round outlet box, 17 Cu. in., bronze, aluminum	1/2	5	4-1/8	1-5/8	3/4	5-9/16	4-15/16	3-1/2	3-1/8	1-1/4	16.3
DS-47-WH*	Round outlet box, 17 Cu. in., white, aluminum	1/2	5	4-1/8	1-5/8	3/4	5-9/16	4-15/16	3-1/2	3-1/8	1-1/4	16.3
S-48*	Round outlet box, 16 Cu. in., silver, aluminum	3/4	5	4-1/8	1-5/8	7/8	5-9/16	4-15/16	3-1/2	3-1/8	1-1/4	15.8
S-47	Round outlet box, 17 Cu. in., silver, aluminum	1/2	5	4-1/8	1-5/8	3/4	5-9/16	4-15/16	3-1/2	3-1/8	1-1/4	16.3

*Raintight with cover closed and when used with appropriate Red Dot® boxes



SE-47 / SE-48

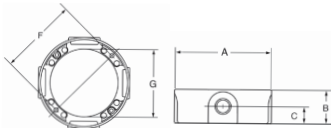

S130E-CN



Cat. No.	Description	Hub Size (in.)	No. of Hubs	A (in.)	B (in.)	C (in.)	F (in.)	G (in.)	Cu. (in.)
Outlet Box Extension – 4-1/8 in. Dia. (Cast Aluminum)									
SE-48*	Round extension ring, grey, aluminum, gaskets and screws	3/4	4	4-1/8	1-5/8	13/16	3-1/2	3-1/16	18.3
S130E-CN	Round extension adapter, silver, aluminum, with ground screws	1/2	4	4-1/8	1-5/8	13/16	3-1/2	3-1/16	18.3

*Utilisés avec les boîtes Red Dot® appropriées, ces couvercles sont étanches à la pluie lorsque les capuchons sont fermés.



DS47B / DS48B

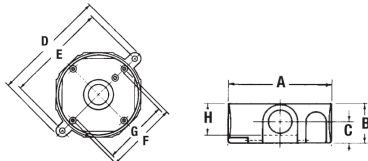

Cat. No.	Description	Hub Size (in.)	No. of Hubs	A (in.)	B (in.)	C (in.)	D (in.)	E (in.)	F (in.)	G (in.)	H (in.)	Cu. (in.)
Outlet Box Kits – 4-1/8 in. Dia. (Cast Aluminum)												
DS-47B*	Round outlet box, silver, aluminum, blank cover	1/2	5	4-1/8	2	7/8	5-9/16	4-15/16	3-1/2	3-1/8	1-1/4	17
S47CFB	Ceiling fan outlet box, silver, aluminum	1/2	5	4-1/8	2	7/8	5-9/16	4-15/16	3-1/2	3-1/8	1-1/4	17
DS-48B*	Round outlet box, silver, aluminum, blank cover	3/4	5	4-1/8	2	7/8	5-9/16	4-15/16	3-1/2	3-1/8	1-1/4	17

*Raintight with cover closed and when used with appropriate Red Dot® boxes
See page B27 for close-up plugs. Cover included

Red•Dot® metallic round boxes and covers



S341E-R



SS-B



S-12 / S211BRE



S213E-R

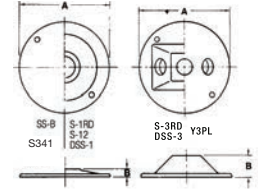

Cat. No.	Description	Hub Size (in.)	No. of Hubs	A (in.)	B (in.)
Outlet Covers – 4-1/8 in. Dia. (Cast Aluminum)					
S341E-R	Round blank weatherproof box cover, color silver	-	-	4-1/8	3/64
SS-B	Round blank weatherproof cover, silver, aluminum, with gasket and screws	-	-	4-1/8	3/64
S211E	Round standard lamp holder cover, silver, aluminum,	1/2	1	4-1/8	3/8
S211BRE	Round standard lamp holder cover, bronze, aluminium	1/2	1	4-1/8	3/8
S211WHE	Round standard lamp holder cover, white, aluminium	1/2	1	4-1/8	3/8
S-12*	Round standard lamp holder cover, silver, aluminum	3/4	1	4-1/8	3/8
S213E-R	Round standard lamp holder cover, Silver, aluminum, with gasket, screws and plugs	1/2	3	4-1/8	1-1/16
S213BRE	Round standard lamp holder cover, Bronze, aluminum, with gasket, screws and plugs	1/2	3	4-1/8	1-1/16
S213WHE	Round standard lamp holder cover, white, aluminum, with gasket, screws and plugs	1/2	3	4-1/8	1-1/16

* Not CSA Certified



PLG-1-RD / PLG-2-RD / PLG-3-RD



S603E-R / S603BRE-R / S603WHE-R



Cat. No.	Colour	Size (in.)	Description
Plugs			
PLG-1-RD	Silver	1/2	Close-up plugs
PLG-2-RD	Silver	3/4	Close-up plugs
PLG-3-RD	Silver	1	Close-up plugs
S603E-R	Silver	1/2	Close-up plugs Bag/4
S603BRE-R	Bronze	1/2	Close-up plugs Bag/4
S603WHE-R	White	1/2	Close-up plugs Bag/4

Carlon® FS and FD nonmetallic boxes and covers

Single Gang

All sizes take standard covers and accessories or devices. Integral mounting feet provide easy mounting. Grounding lugs included.

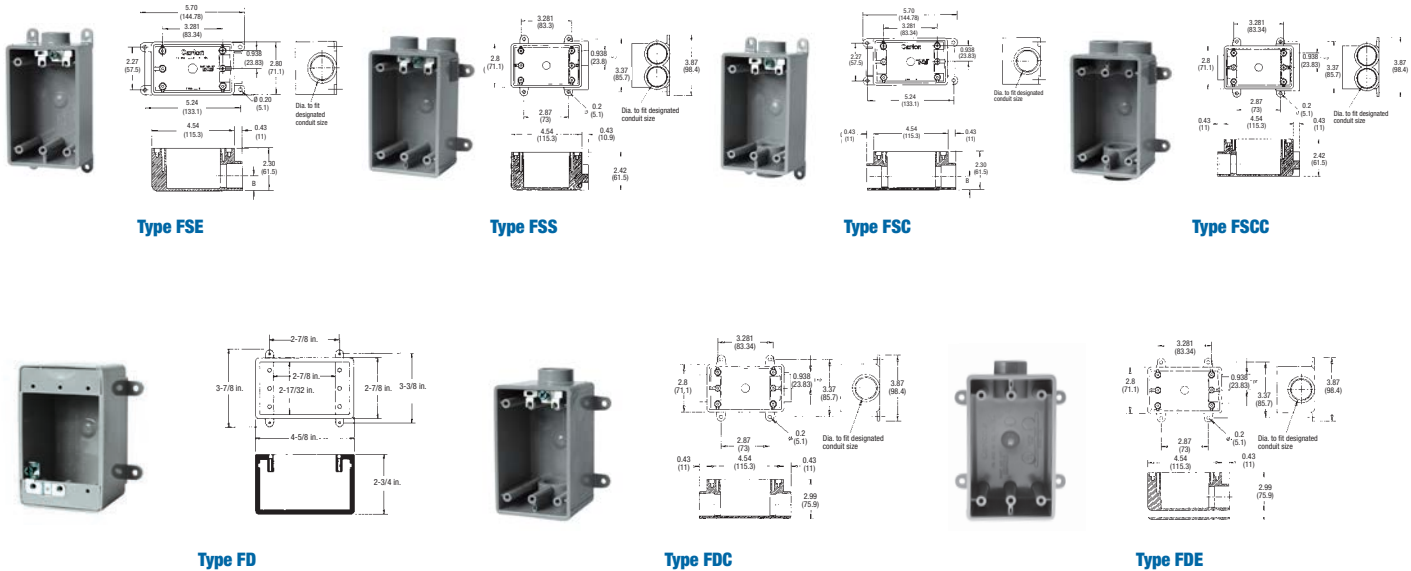

Cat. No.	Description	Size (in.)	Volume Cu. In.	Std. Ctn. Qty.
Type FSE				
C980DFN-CTN	For dead-end terminations.	1/2	18	12
C980EFN-CTN		3/4	18	12
C980FFN-CTN		1	18	8
Type FSS				
C982DFN-CTN	For multiple dead-end circuit terminations or where additional support is required in stub-up applications.	1/2	18	12
C982EFN-CTN		3/4	18	12
C982FFN-CTN		1	18	8
Type FSC				
C981DFN-CTN	For through terminations.	1/2	18	12
C981EFN-CTN		3/4	18	12
C981FFN-CTN		1	18	8
Type FSFC				
C979DFN	For multiple through circuit terminations or where additional support is required in stub-up applications.	1/2	18	15
C979EFN		3/4	18	15
C979FFN		1	18	15

Cat. No.	Description	Size (in.)	Volume Cu. In.	Std. Ctn. Qty.
Type FD				
C981DFN-CTN	For terminations where hub requirements vary according to application – hubs easily made with flared wood bit or hole saw.	–	25	10
Type FDC				
C9811EN	For terminations where hub requirements vary according to application – hubs easily made with flared wood bit or hole saw.	3/4	25	10
C9811FN		1	25	10
Type FDE				
C9801DN	For dead-end terminations where large devices or additional wiring capacity is required.	1/2	25	10
C9801EN		3/4	25	10
C9801FN		1	25	10

Carlton® FS and FD nonmetallic boxes and covers

Two gangs

All sizes take standard covers and accessories or devices. Integral mounting feet provide easy mounting. Grounding screws are included.

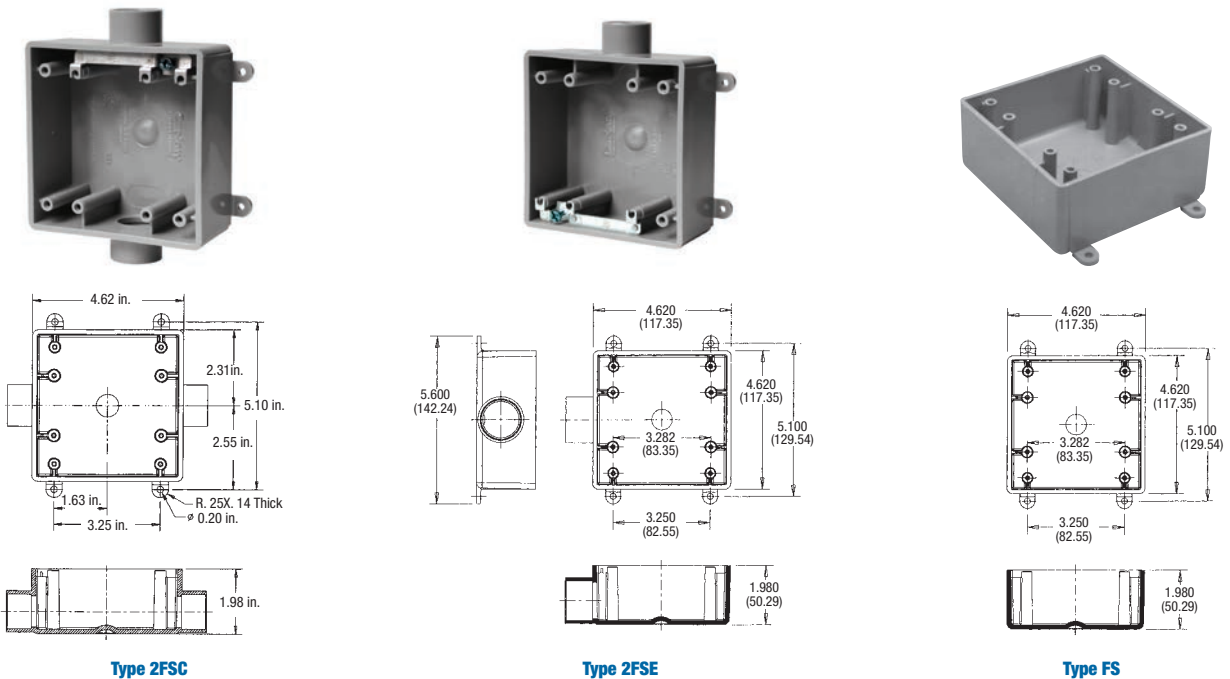

Type 2FSC

Type 2FSE

Type FS



Cat. No.	Description	Size (in.)	Volume Cu. In.	Std. Ctn. Qty.
Type 2FSC				
CE9812DR		1/2	32	4
CE9812E-CTN	For through terminations where two devices or additional wiring capacity is required.	3/4	32	10
CE9812FR		1	32	10
Type 2FSE				
CE9802D-CTN		1/2	18	10
CE9802E-CTN	For dead-end terminations where two devices or additional wiring capacity is required.	3/4	18	10
CE9802FR		1	18	1
Type FS				
CE9802	For terminations where hub requirements vary according to application - hubs easily made with flared wood bit or hole saw.	N/A	32	10

Carlon® FS and FD nonmetallic boxes and covers



E98SRCN-CAR



E98G20N



E98G30N-CAR



E98G5FN-CAR

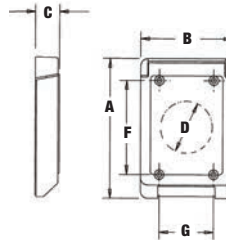

Cat. No.	Description	Colour	A (in.)	B (in.)	C (in.)	D (in.)	F (in.)	G (in.)
Single Gang Vertical Covers (Nonmetallic)								
E98SRCN-CAR	For 15 A or other single receptacles under 1.375 dia.	Grey	4-53/64	3-11/16	53/64	1-25/64 ± 1/16	3-1/4	1-57/64
E98G20N	For 20 A or other single receptacles under 1.625 dia.	Grey	4-53/64	3-11/16	53/64	1-41/64 ± 1-23/32	3-1/4	1-57/64
E98G30N-CAR	For 30 A or other single receptacles under 1.750 dia.	Grey	4-53/64	3-11/16	53/64	1-49/64 ± 1-23/32	3-1/4	1-57/64
E98G5FN-CAR	For 50 A or other single receptacles under 2.250 dia.	Grey	4-53/64	3-11/16	53/64	2-1/4 ± 1/16	3-1/4	1-57/64



E98GCBN



E98SSCN-CAR



E98GDRN-CAR



E98GFCN-CAR

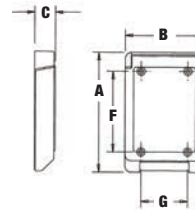

Cat. No.	Description	Colour	A (in.)	B (in.)	C (in.)	F (in.)	G (in.)
Single Gang Vertical Covers (Nonmetallic)							
E98SSCN-CAR	Single switch	Grey	4-53/64	3-11/16	53/64	3-1/4	1-57/64
E98GDRN-CAR	Duplex receptacle	Grey	4-53/64	3-11/16	53/64	3-1/4	1-57/64
E98GFCN-CAR	GFCI receptacle – device opening dimensions: 2-5/8 H x 1-5/16 W	Grey	4-53/64	3-11/16	53/64	3-1/4	1-57/64



E98TSCN

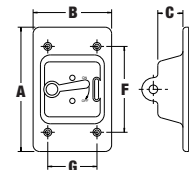

E980CN-CAR

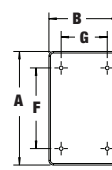

Cat. No.	Description	Colour	A (in.)	B (in.)	C (in.)	F (in.)	G (in.)
Single Gang Vertical Covers (Nonmetallic)							
E98TSCN	Toggle switch	Grey	4-3/4	3	31/32	3-9/32	1-57/64
E980CN-CAR	Supplied with stainless steel mounting screws and gasket	Grey	4-5/8	2-7/8	–	3-9/32	1-57/64
E980CM-CAR	Supplied with stainless steel mounting screws and gasket	White	4-5/8	2-7/8	–	3-9/32	1-57/64



E98DHGN-CAR



E98GHGN-CAR

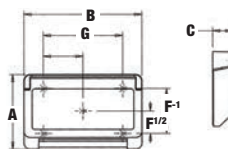

Cat. No.	Description	Colour	A (in.)	B (in.)	C (in.)	F1 (in.)	F1/2 (in.)	G (in.)
Single Gang Horizontal Covers (Nonmetallic)								
E98DHGN-CAR	Duplex receptacle	Grey	3-1/8	4-7/8	13/16	1-57/64	61/64	3-9/32
E98GHGN-CAR	GFCI horizontal	Grey	3-1/8	4-7/8	13/16	1-57/64	61/64	3-9/32

Carlton® FS, FD and round nonmetallic boxes and covers



E9G2DDN-CAR

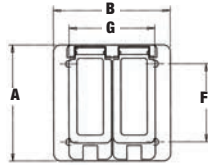

E9G2SSN

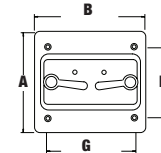

E9G2GTN-CAR



E9G2DSN-CAR

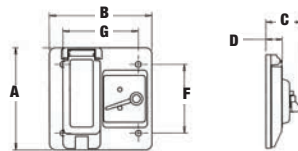

E9802CN-CAR

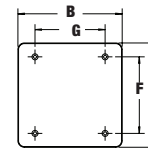

Cat. No.	Description	Colour	A (in.)	B (in.)	C (in.)	D (in.)	F (in.)	G (in.)
Two Gang Covers (Nonmetallic)								
E9G2DDN-CAR	Double duplex	Grey	4-27/34	4-27/34	–	–	3-17/64	3-9/16
E9G2SSN	Double toggle	Grey	4-55/64	3-17/64	–	–	3-17/64	3-9/16
E9802CN-CAR	Supplied with stainless steel mounting screws and gasket	Grey	4-55/64	4-55/64	–	–	3-17/64	3-9/16
E9G2GTN-CAR	Combination toggle / GFCI	Grey	4-55/64	3-17/64	1-53/64	55/64	3-17/64	3-9/16
E9G2DSN-CAR	Combination toggle / duplex receptacle	Grey	4-55/64	3-17/64	1-53/64	55/64	3-17/64	3-9/16



CE365D-CTN



CE365DW-CTN

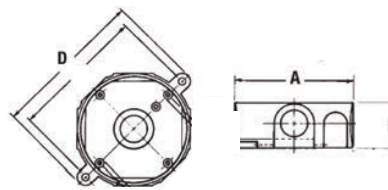

Cat. No.	Finish	Hub Size (in.)	No. of Lug	A (in.)	B (in.)	D (in.)
Lampholder with Round Covers - Internal Gasket (Nonmetallic)						
CE365D-CTN	Grey	5 x 1/2	2	4-1/4	1-1/2	4-15/16
CE365DW-CTN	White	5 x 1/2	2	4-1/4	1-1/2	4-15/16

Red•Dot® outdoor lampholders

Technical Specifications

Applications :

- Security and general outdoor lighting fixture for residential and commercial applications
- Accent lighting fixture for highlighting outdoor signs and architectural details
- Compact outdoor lighting fixture which can be mounted easily in most places and can be aimed in any direction
- Suitable for use in wet locations.

Features/Benefits :

- Clean lines and precision manufacturing result in a fixture which will enhance any application
- High-quality replaceable porcelain socket with high-temperature leads allow for easy field maintenance
- Positive locking mounting arm keeps fixture in aimed position to reduce costly callbacks
- Ground screw boss in arm

Standard Materials :

- Fixture: Certified die cast zinc alloy ZAMAK 3 (less than 0.004 copper content), or nonmetallic
- Gasket: Heat resistant composition or high-temperature silicone
- Socket: Center contact, porcelain, medium base

Compliances :

Compliances as noted on each page of the catalogue include:

- CSA Certified
- UL Listed
- cUL Listed

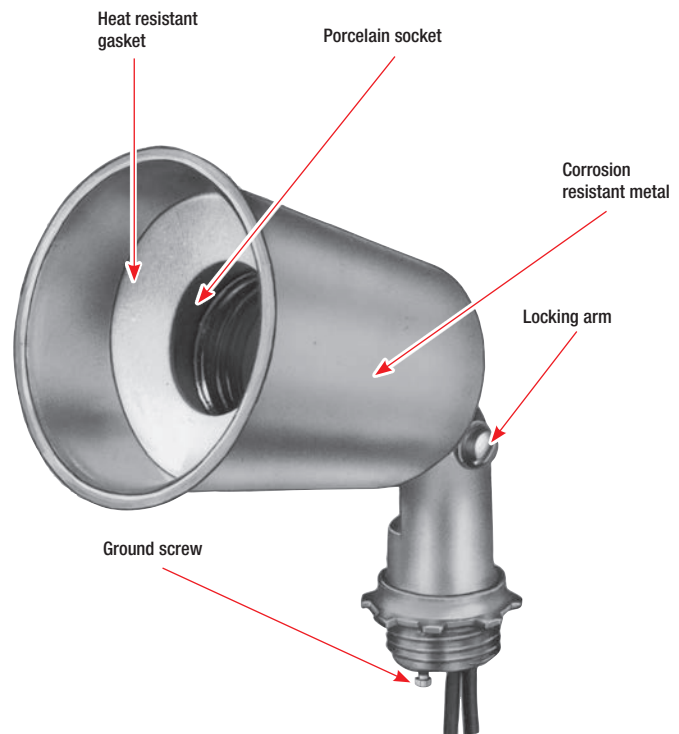

Red•Dot® outdoor lampholders

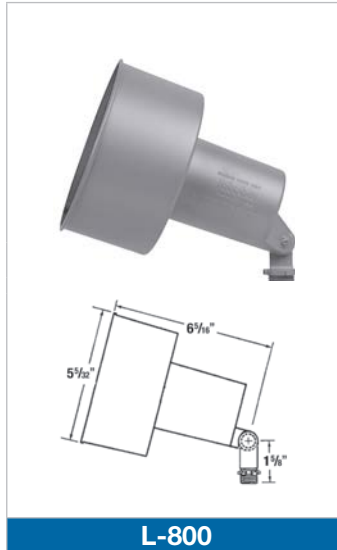

Cat. No.	Finish	Description
Economy Style – Internal Gasket (zinc)		
S500BREG-CN	Bronze	For 75 to 150 Watt Par 38 and R40 lamps
S500EG-CN	Silver	For 75 to 150 Watt Par 38 and R40 lamps
S500WHEG-CN	White	For 75 to 150 Watt Par 38 and R40 lamps
Modèle “Deep-Shielded” – Garniture interne (zinc)		
L-800	Silver	For 75 to 150 Watt Par 38 and R40 Lamps
Modèle économique double avec couvercle rond (zinc)		
S513EG-CN	Silver	For up to 150 Watt Par 38 and R40 lamps
S513BREG-CN	Bronze	For up to 150 Watt Par 38 and R40 lamps
S513WHEG-CN	White	For up to 150 Watt Par 38 and R40 lamps
Nécessaire de porte-ampoules contemporains		
B228E-R	Silver	Contemporary lampholder kit
B228BRE-R	Bronze	Contemporary lampholder kit
B228WHE-R	White	Contemporary lampholder kit



Cat. No.	Finish	Description
Spike Light (zinc)		
SPK6-P-GR	Green	Portable lamp, 6-foot cord - Metal
SPK6-P-BK	Black	Portable lamp, 6-foot cord - Metal
SPK6-P-BR	Bronze	Portable lamp, 6-foot cord - Metal



Cat. No.	Hub Size (in.)	Max. Watt	Description
Ceiling Mount (5 holes)			
MCL150C	1	150	Can be surface mounted or mounted to a junction box. Kit includes: Aluminum housing, junction box, globe and guard assembly.
Wallmount (5 holes)			
MCL150W	1	150	Can be surface mounted in a vertical position (globe pointed down only). Kit includes: Aluminum housing, junction box, globe and guard assembly.

Red•Dot® outdoor lampholders



S212G-CN



CS902



Cat. No.	Finish
Traditional 2 Lamp Round Box Kits	
S212G-CN	Silver
S212BRG-CN	Bronze
S212WHG-CN	White
Traditional 2 Lamp, Round Box w/Photocell Kits	
CS902	Silver
CS902BR	Bronze
CS902WH	White

Red•Dot® weatherproof outdoor kits



S312E-CN



S315BRE-CN

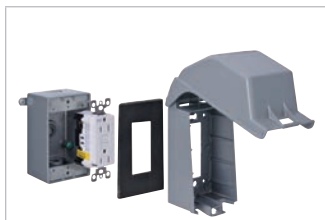

S355E-CN



DKG-CA

Cat. No.	Finish
Duplex Weatherproof Outlet Device Kits	
S312E-CN	Silver
S312BRE-CN	Bronze
S312WHE-CN	White
GFCI Weatherproof Outlet Device Kit	
S315E-CN	Silver
S315BRE-CN	Bronze
S315WHE-CN	White
GFCI Weatherproof Outlet Device Kit	
S355E-CN	Grey
S355P-CN	Grey
Nonmetallic Deck Grommet	
DKG-CA	Black

All supplied receptacles are tamper resistant

