

SAVOY HOUSE

ESSENTIALS



2018





Savoy House COLLECTIONS...

These Savoy House Lighting collections fulfill our design mission of creating recognizable and stylish products. We also continue our tradition of matching extraordinary design with great value, creating excitement and satisfaction with our lighting.

Along with our passion for great design is our commitment to quality engineering and high production standards.

Savoy House Lighting products undergo countless inspections and rigid testing, all performed by a highly trained and competent staff of inspectors and product specialists, before leaving the factory. Marvelous design, superior quality standards and notable value are all things our clients have come to expect from Savoy House since we were founded in 1965.

Our hope is that Savoy House Lighting's merchandise and exemplary service will make the demands of your job a lot easier. This commitment we have extends not only to our design and quality, but to you, our valued customers.

As always, we thank you for our continued growth, which is made possible through your kind and loyal support.

CONTENTS

ALPHABETICAL LISTING *by* FAMILY:

Akron.....	41	Lucerne	82
Alden	64	Marly.....	32
Ashmont.....	68	Mayfield	73
Austin.....	66	Melrose	120
Bally.....	77	Merrill.....	96
Benton.....	80	Middleton.....	14
Braxton.....	40	Monroe	88
Calhoun	118	Morland.....	104
Chaplin	92	Octave.....	8, 75, 78, 110
Chatham.....	4	Owen.....	102
Clifton.....	101	Payton	94
Dakota.....	106	Penrose	52
Drake	74, 108, 114	Pike.....	100
Dunbar.....	60	Rotterdam.....	24
Epsilon	34	Shane.....	70
Franklin	76	Stirling.....	36
Galea.....	30	Townsend.....	42
Garrett	56	Washburn	98
Carvey.....	72	Westbourne.....	38



CONTENTS



Collections 4



Pendants 30



Flush Mounts / Semi-Flush 78



Wall Lighting 88



Outdoor 96



Pour Le Bain / Bath 110

Index / Finish Guide 124

CHATHAM



A. 1-305-6-89

6-Light Chandelier
Matte Black Finish
28"W x 17-1/2"
Adj H 17-1/2"- 74"
6C 60W
30° Swivel
White Fabric Shades
Metal Candle Covers

B. 1-305-6-SN

6-Light Chandelier
Satin Nickel Finish
28"W x 17-1/2"H
Adj H 17-1/2"- 74"
6C 60W
30° Swivel
White Fabric Shades
Metal Candle Covers

C. 1-305-6-322

6-Light Chandelier
Warm Brass Finish
28"W x 17-1/2"H
Adj H 17-1/2"- 74"
6C 60W
30° Swivel
White Fabric Shades
Metal Candle Covers

D. 1-305-6-109

6-Light Chandelier
Polished Nickel Finish
28"W x 17-1/2"
Adj H 17-1/2"- 74"
6C 60W
30° Swivel
White Fabric Shades
Metal Candle Covers

E. 1-305-6-44

6-Light Chandelier
Classic Bronze Finish
28"W x 17-1/2"
Adj H 17-1/2"- 74"
6C 60W
30° Swivel
White Fabric Shades
Metal Candle Covers

CHATHAM

A.



B.



C.



D.

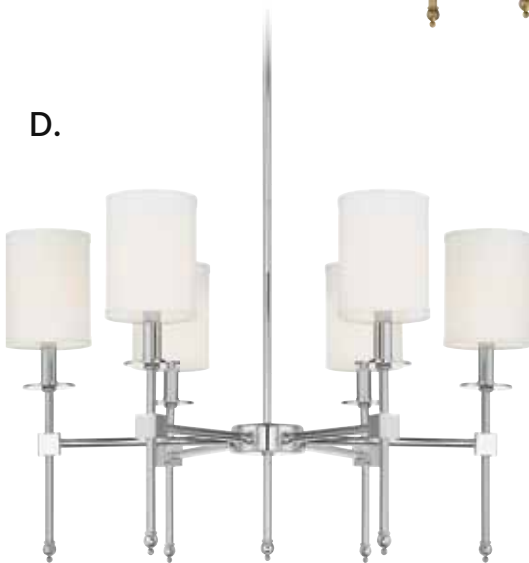

E.



Options: 7-EXT- Extension Rod - 9-1/2"

CHATHAM

A.

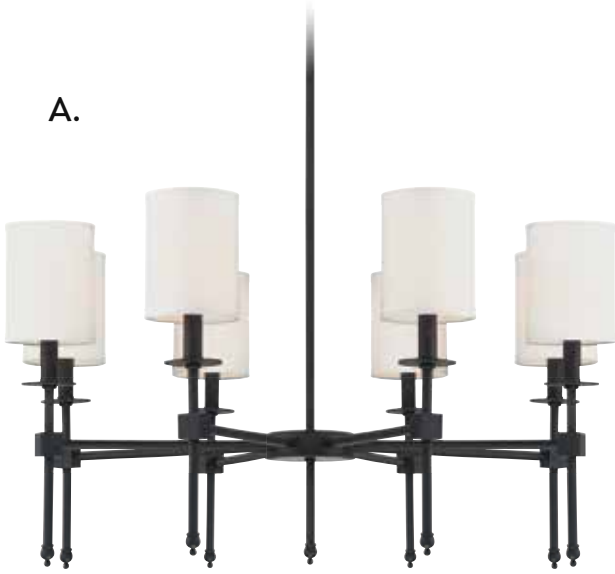

B.

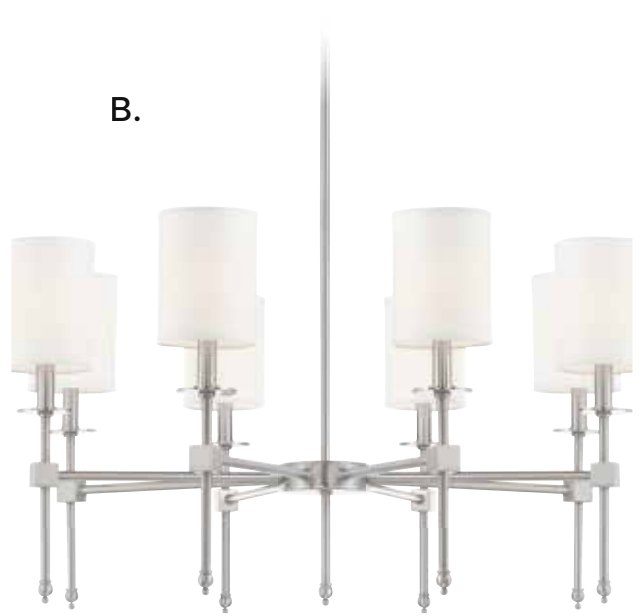

C.



D.

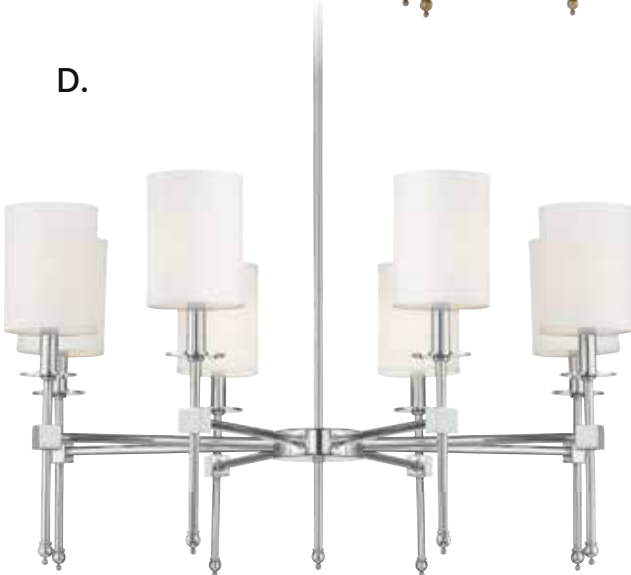

E.

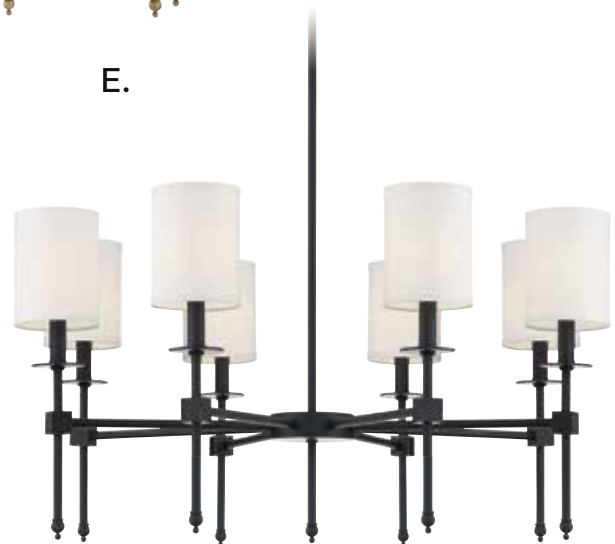

Options: 7-EXT- Extension Rod - 9-1/2"

CHATHAM



A. 1-306-8-89
8-Light Chandelier
Matte Black Finish
32"W x 17-1/2"H
Adj H 17-1/2"- 74"
8C 60W
30° Swivel
White Fabric Shades
Metal Candle Covers

B. 1-306-8-SN
8-Light Chandelier
Satin Nickel Finish
32"W x 17-1/2"H
Adj H 17-1/2"- 74"
8C 60W
30° Swivel
White Fabric Shades
Metal Candle Covers

C. 1-306-8-322
8-Light Chandelier
Warm Brass Finish
32"W x 17-1/2"H
Adj H 17-1/2"- 74"
8C 60W
30° Swivel
White Fabric Shades
Metal Candle Covers

D. 1-306-8-109
8-Light Chandelier
Polished Nickel Finish
32"W x 17-1/2"H
Adj H 17-1/2"- 74"
8C 60W
30° Swivel
White Fabric Shades
Metal Candle Covers

E. 1-306-8-44
8-Light Chandelier
Classic Bronze Finish
32"W x 17-1/2"H
Adj H 17-1/2"- 74"
8C 60W
30° Swivel
White Fabric Shades
Metal Candle Covers

OCTAVE



A. 7-4034-3-322
3-Light Pendant
Warm Brass Finish
15"W x 18"H
3E 60W
Clear Glass

B. 1-4031-3-322
3-Light Chandelier
Warm Brass Finish
18"W x 16"H
3E 60W
Clear Glass

C. 1-4032-5-322
5-Light Chandelier
Warm Brass Finish
23"W x 18-1/2"H
5E 60W
Clear Glass

D. 1-4033-9-322
9-Light Chandelier
Warm Brass Finish
30"W x 28"H
9E 60W
Clear Glass

OCTAVE

A.

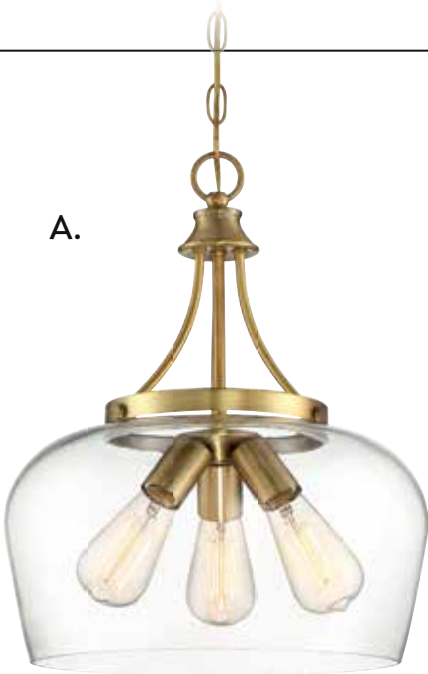

B.

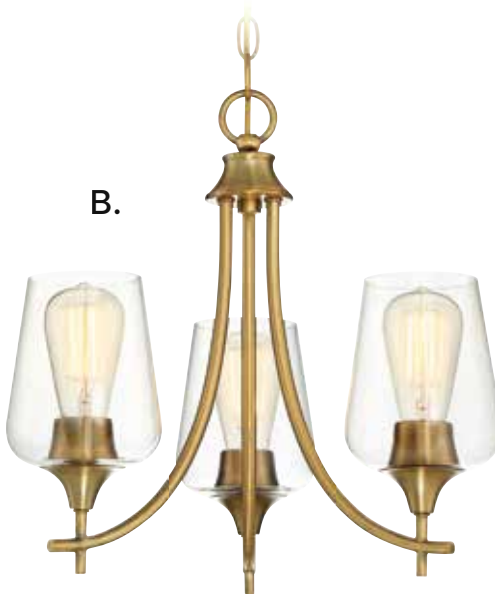

C.



D.



Ceiling, Page 79



Pendant, Page 75



Bath, Page 112



Sconce, Page 112

OCTAVE



A. 7-4034-3-11
3-Light Pendant
Polished Chrome Finish
15"W x 18"H
3E 60W
Clear Glass

B. 1-4031-3-11
3-Light Chandelier
Polished Chrome Finish
18"W x 16"H
3E 60W
Clear Glass

C. 1-4032-5-11
5-Light Chandelier
Polished Chrome Finish
23"W x 18-1/2"H
5E 60W
Clear Glass

D. 1-4033-9-11
9-Light Chandelier
Polished Chrome Finish
30"W x 28"H
9E 60W
Clear Glass

OCTAVE

A.

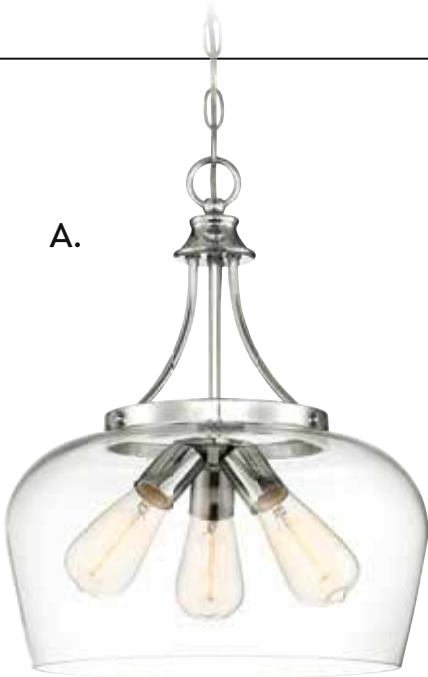

B.



C.



D.



Ceiling, Page 79



Pendant, Page 75



Bath, Page 111



Sconce, Page 111

OCTAVE



A. 7-4034-3-13
3-Light Pendant
English Bronze Finish
15"W x 18"H
3E 60W
Clear Glass

B. 1-4031-3-13
3-Light Chandelier
English Bronze Finish
18"W x 16"H
3E 60W
Clear Glass

C. 1-4032-5-13
5-Light Chandelier
English Bronze Finish
23"W x 18-1/2"H
5E 60W
Clear Glass

D. 1-4033-9-13
9-Light Chandelier
English Bronze Finish
30"W x 28"H
9E 60W
Clear Glass

OCTAVE

A.



B.



C.



D.



Ceiling, Page 79



Pendant, Page 75



Bath, Page 112



Sconce, Page 112

MIDDLETON



A. 1-307-6-89

6-Light Chandelier
Matte Black Finish
25"W x 23"H
6C 60W
Metal Candle Covers

B. 1-307-6-109

6-Light Chandelier
Polished Nickel Finish
25"W x 23"H
6C 60W
Metal Candle Covers

C. 1-307-6-322

6-Light Chandelier
Warm Brass Finish
25"W x 23"H
6C 60W
Metal Candle Covers

D. 1-307-6-SN

6-Light Chandelier
Satin Nickel Finish
25"W x 23"H
6C 60W
Metal Candle Covers

E. 1-307-6-44

6-Light Chandelier
Classic Bronze Finish
25"W x 23"H
6C 60W
Metal Candle Covers

MIDDLETON

A.



B.



C.

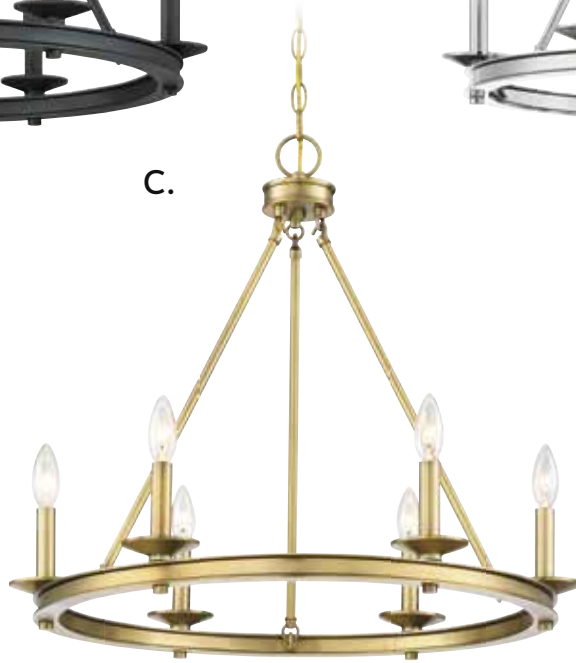

D.

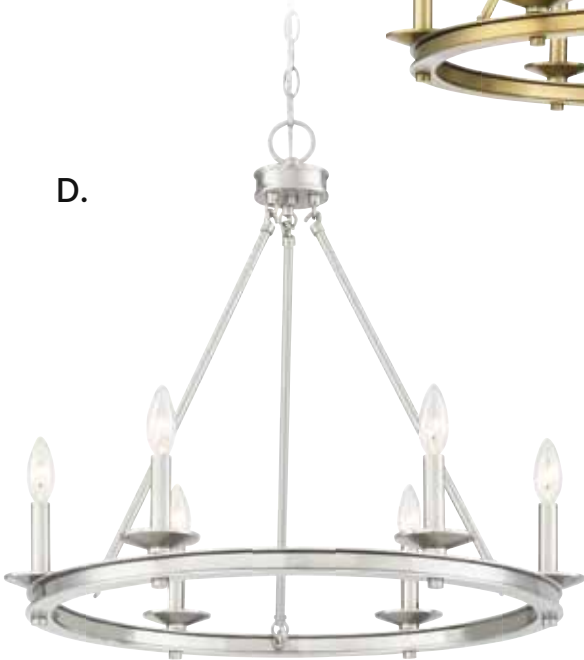

E.



MIDDLETON

A.

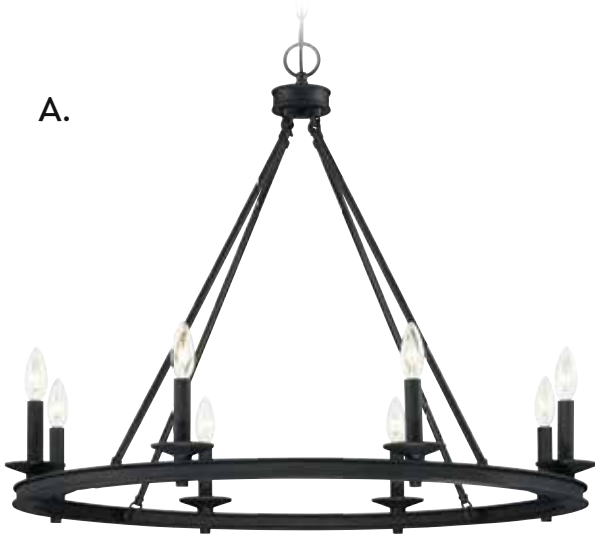

B.

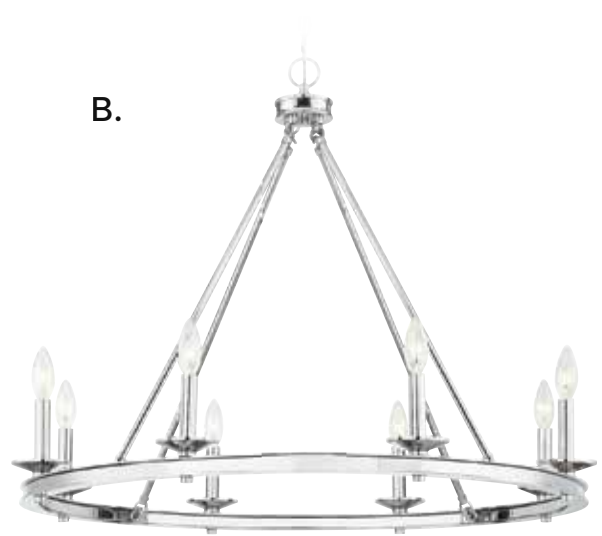

C.

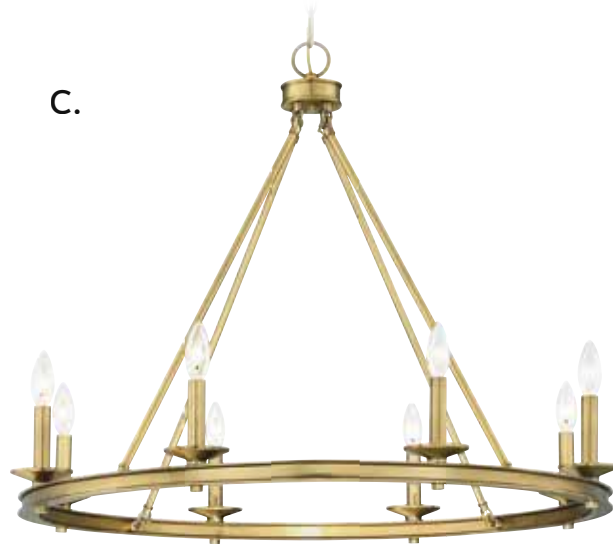

D.

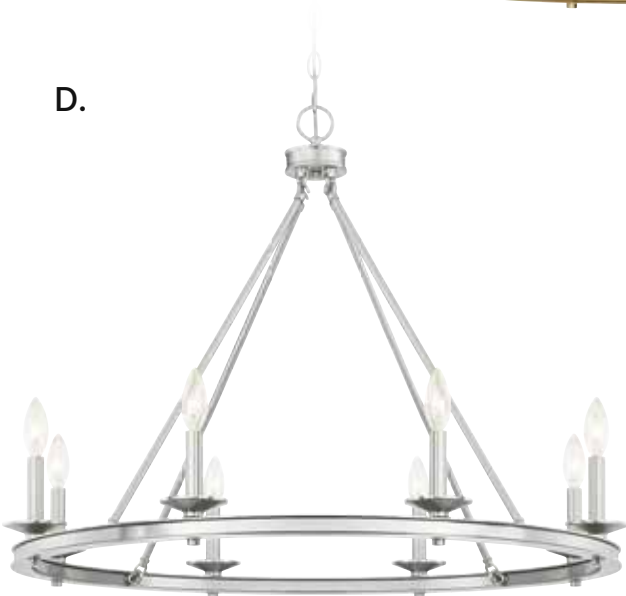

E.

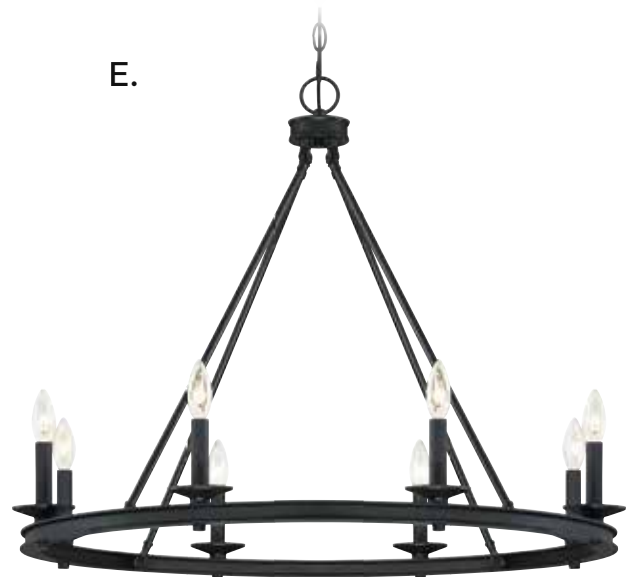

MIDDLETON



A. 1-308-8-89
8-Light Chandelier
Matte Black Finish
33"W x 25"H
8C 60W
Metal Candle Covers

B. 1-308-8-109
8-Light Chandelier
Polished Nickel Finish
33"W x 25"H
8C 60W
Metal Candle Covers

C. 1-308-8-322
8-Light Chandelier
Warm Brass Finish
33"W x 25"H
8C 60W
Metal Candle Covers

D. 1-308-8-SN
8-Light Chandelier
Satin Nickel Finish
33"W x 25"H
8C 60W
Metal Candle Covers

E. 1-308-8-44
8-Light Chandelier
Classic Bronze Finish
33"W x 25"H
8C 60W
Metal Candle Covers

MIDDLETON

A.

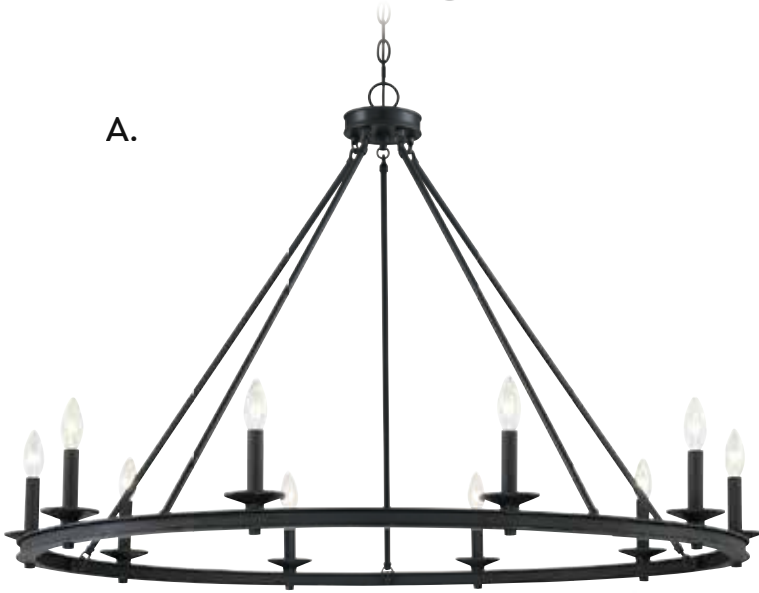

B.

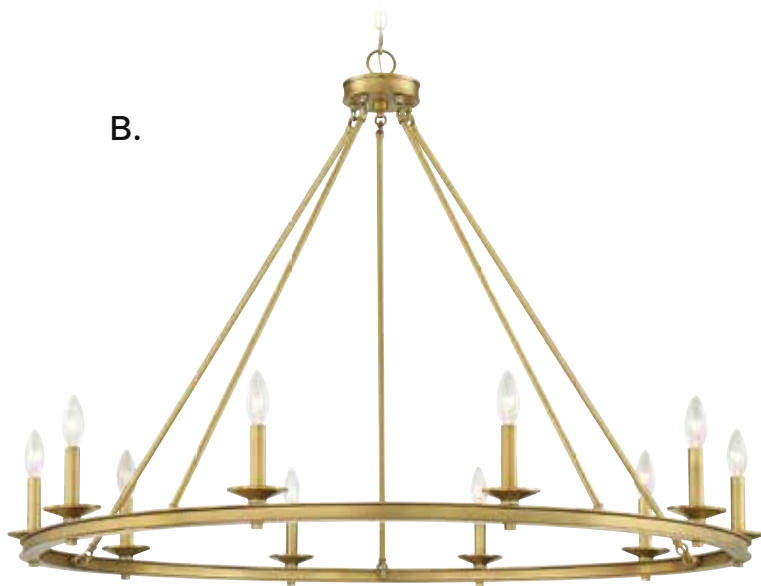

C.

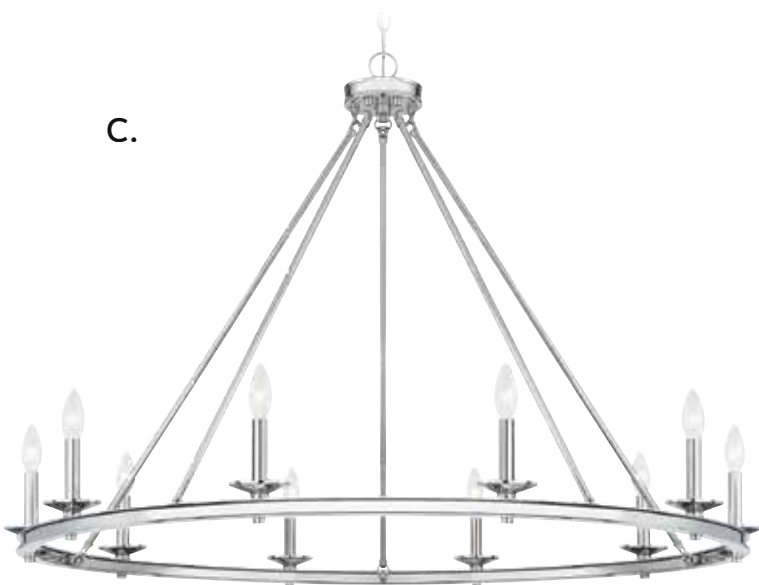

MIDDLETON



D.

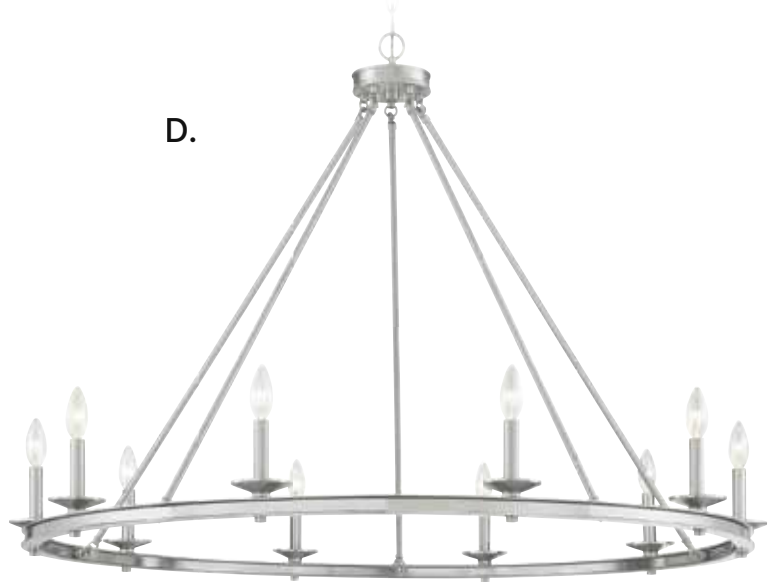

E.

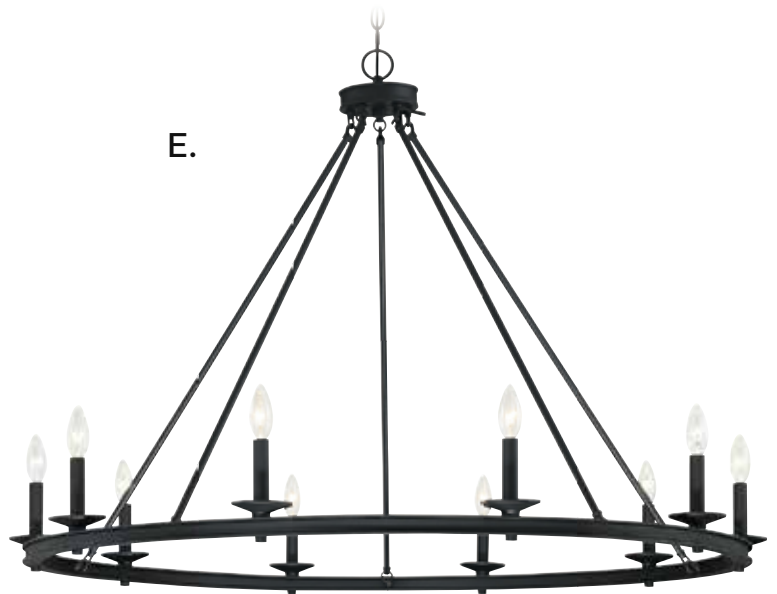

A. 1-310-10-89
10-Light Chandelier
Matte Black Finish
45"W x 32-1/4"H
10C 60W
Metal Candle Covers

B. 1-310-10-322
10-Light Chandelier
Warm Brass Finish
45"W x 32-1/4"H
10C 60W
Metal Candle Covers

C. 1-310-10-109
10-Light Chandelier
Polished Nickel Finish
45"W x 32-1/4"H
10C 60W
Metal Candle Covers

D. 1-310-10-SN
10-Light Chandelier
Satin Nickel Finish
45"W x 32-1/4"H
10C 60W
Metal Candle Covers

E. 1-310-10-44
10-Light Chandelier
Classic Bronze Finish
45"W x 32-1/4"H
10C 60W
Metal Candle Covers

MIDDLETON



MIDDLETON

A.



A. 1-312-15-89
15-Light Chandelier
Matte Black Finish
45"W x 42"H
15C 60W
Metal Candle Covers

MIDDLETON

A.



A. **1-312-15-109**
15-Light Chandelier
Polished Nickel Finish
45"W x 42"H
15C 60W
Metal Candle Covers

B. **1-312-15-322**
15-Light Chandelier
Warm Brass Finish
45"W x 42"H
15C 60W
Metal Candle Covers

C. **1-312-15-SN**
15-Light Chandelier
Satin Nickel Finish
45"W x 42"H
15C 60W
Metal Candle Covers

D. **1-312-15-44**
15-Light Chandelier
Classic Bronze Finish
45"W x 42"H
15C 60W
Metal Candle Covers

B.

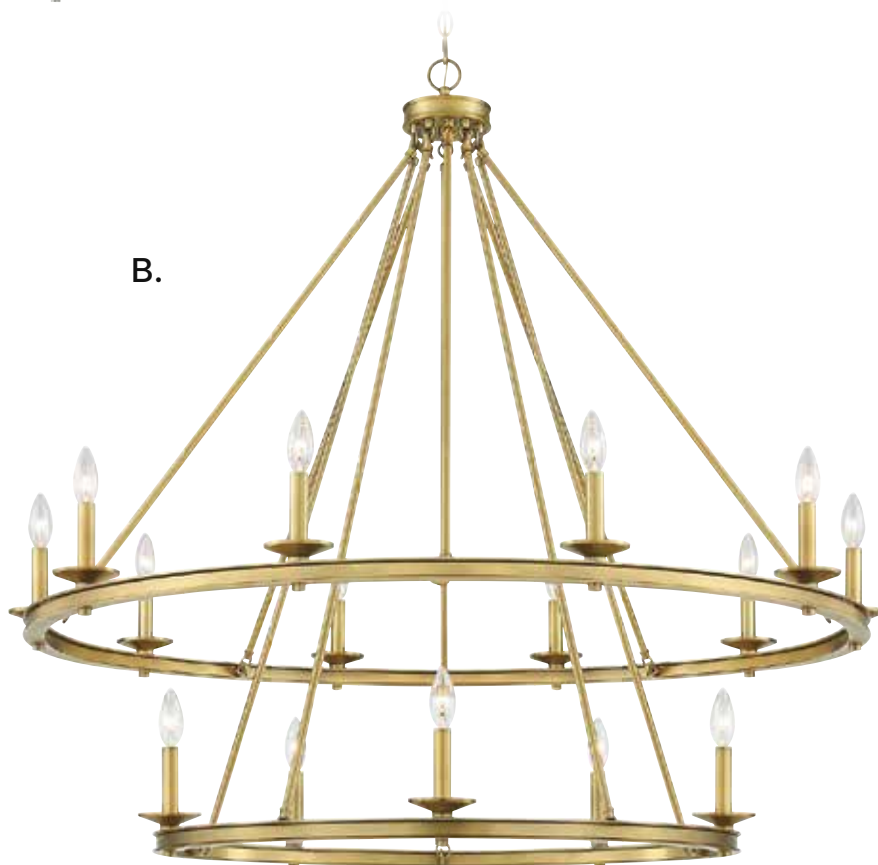

MIDDLETON

C.



D.



ROTTERDAM



A. 6-1662-4-322
4-Light Convertible
Semi-Flush/Pendant
Warm Brass Finish
20"W x 18"H
Adj H 18" - 75"
4C 60W
30° Swivel
Optic Acrylic
Metal Candle Covers

B. 7-1661-6-322
6-Light Pendant
Warm Brass Finish
20"L x 20"W x 25-1/2"H
Adj H 25-1/2" - 82-1/2"
6C 60W
30° Swivel
Optic Acrylic
Metal Candle Covers

C. 7-1660-6-322
6-Light Pendant
Warm Brass Finish
31-1/2"L x 24-3/4"W x 20-1/2"H
Adj H 20-1/2" - 77-1/2"
6C 60W
30° Swivel
Optic Acrylic
Metal Candle Covers

ROTTERDAM

*A.

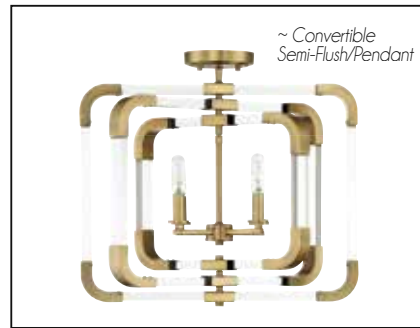
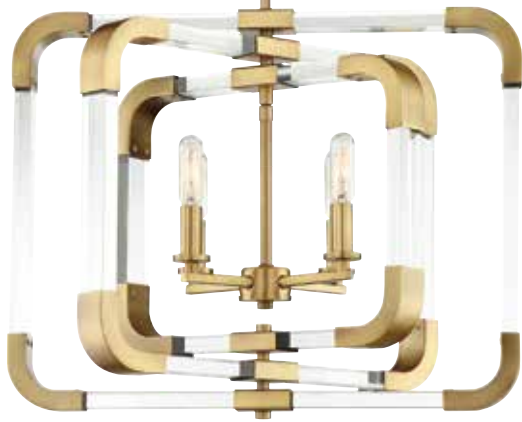

BRIAN THOMAS
COLLECTION

**B.

*Options: 7-EXT-322 Extension Rod - 9-1/2"



**C.



**Options: 7-EXTLG-322 Extension Rod - 12"

***The rings of the Rotterdam Collection are adjustable and can rotate into different positions.



Linear Chandelier, Page 29

ROTTERDAM



A. 6-1662-4-109

4-Light Convertible
Semi-Flush/Pendant
Polished Nickel Finish
20"W x 18"H
Adj H 18" - 75"
4C 60W
30° Swivel
Optic Acrylic
Metal Candle Covers

B. 7-1661-6-109

6-Light Pendant
Polished Nickel Finish
20"L x 20"W x 25-1/2"H
Adj H 25-1/2" - 82-1/2"
6C 60W
30° Swivel
Optic Acrylic
Metal Candle Covers

C. 7-1660-6-109

6-Light Pendant
Polished Nickel Finish
31-1/2"L x 24-3/4"W x 20-1/2"H
Adj H 20-1/2" - 77-1/2"
6C 60W
30° Swivel
Optic Acrylic
Metal Candle Covers

ROTTERDAM

*A.

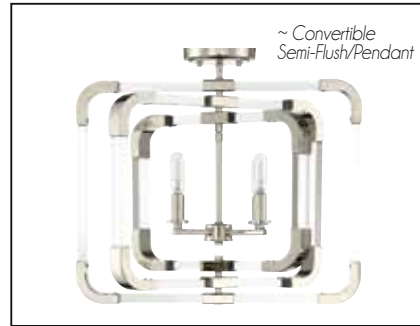

BRIAN THOMAS
COLLECTION

**B.

*Options: 7-EXT-109 Extension Rod - 9-1/2"



**C.



**Options: 7-EXTLG-109 Extension Rod - 12"

***The rings of the Rotterdam Collection are adjustable and can rotate into different positions.

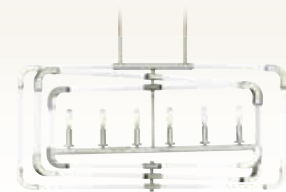

Linear Chandelier, Page 29

ROTTERDAM



ROTTERDAM

A. 1-1663-6-109

6-Light Linear Chandelier
Polished Nickel Finish
37"W x 18"H
Adj H 18" - 75"
6C 60W
30° Swivel
Optic Acrylic Elements
Metal Candle Covers

**A.

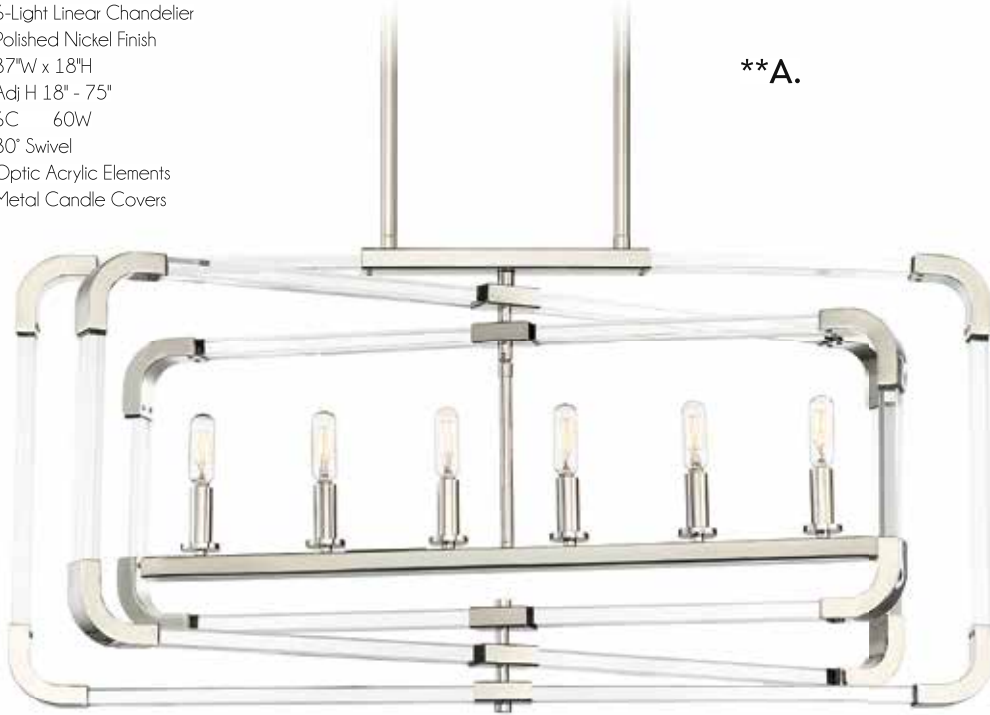

***The rings of the Rotterdam Collection are adjustable and can rotate into different positions.

**Options: 7-EXTLG-109 Extension Rod - 12"

B. 1-1663-6-322

6-Light Linear Chandelier
Warm Brass Finish
37"W x 18"H
Adj H 18" - 75"
6C 60W
30° Swivel
Optic Acrylic Elements
Metal Candle Covers



BRIAN THOMAS
COLLECTION

**B.

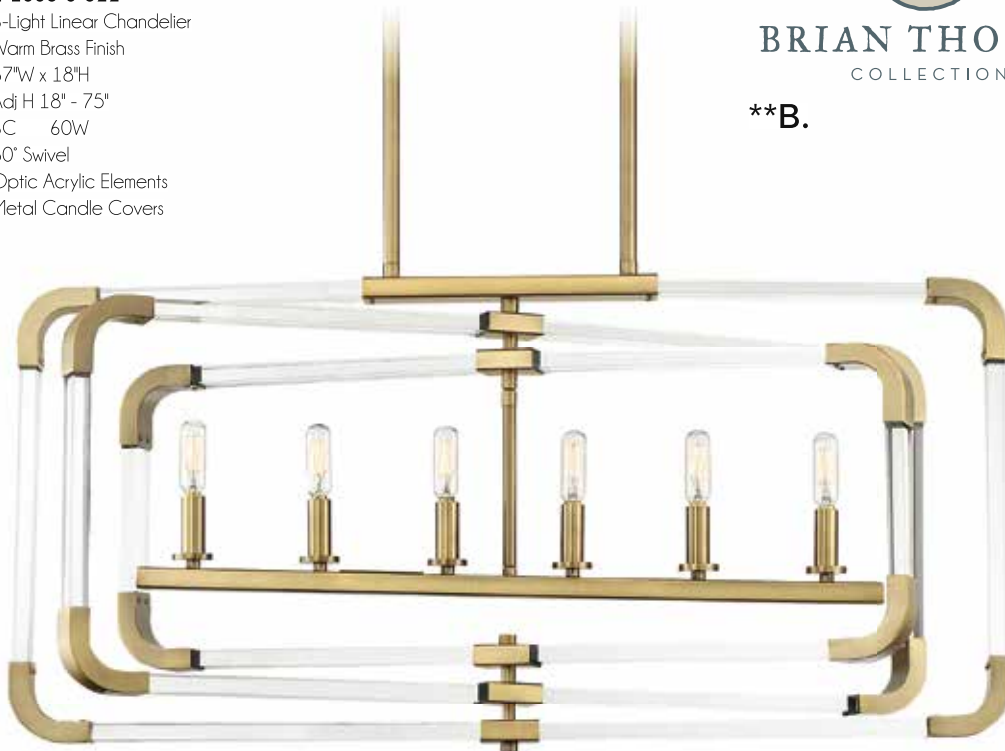

***The rings of the Rotterdam Collection are adjustable and can rotate into different positions.

**Options: 7-EXTLG-322 Extension Rod - 12"

GALEA



A. 7-6099-24-322

24-Light Chandelier
Warm Brass Finish
23"W x 23"H
Adj H 23" - 71-1/2"
24C 25W
30" Swivel

B. 7-6099-24-109

24-Light Chandelier
Polished Nickel Finish
23"W x 23"H
Adj H 23" - 71-1/2"
24C 25W
30" Swivel

C. 7-6099-24-44

24-Light Chandelier
Classic Bronze Finish
23"W x 23"H
Adj H 23" - 71-1/2"
24C 25W
30" Swivel

GALEA

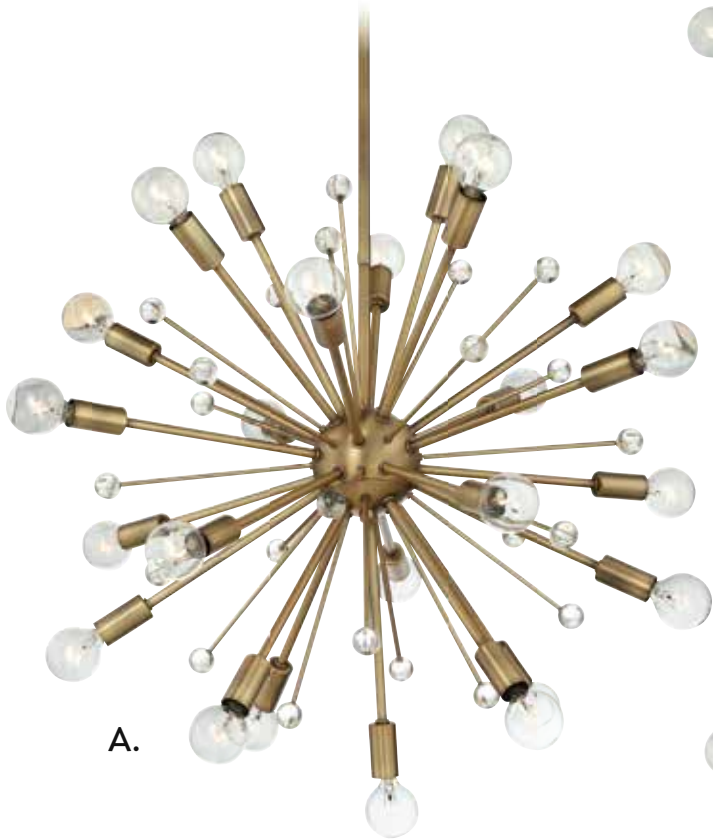

Options: 7-EXT- Extension Rod - 9-1/2"

MARLY

A.



C.



B.



Options: 7-EXT- Extension Rod - 9-1/2"



A. 7-6098-12-109
 12-Light Chandelier
 Polished Nickel Finish
 24-1/2"W x 26-1/2"H
 Adj H 26-1/2" - 80-1/2"
 12C 60W
 30° Swivel

B. 7-6098-12-44
 12-Light Chandelier
 Classic Bronze Finish
 24-1/2"W x 26-1/2"H
 Adj H 26-1/2" - 80-1/2"
 12C 60W
 30° Swivel

C. 7-6098-12-322
 12-Light Chandelier
 Warm Brass Finish
 24-1/2"W x 26-1/2"H
 Adj H 26-1/2" - 80-1/2"
 12C 60W
 30° Swivel

EPSILON



A. 7-9161-4-109
4-Light Pendant
Polished Nickel Finish
20"W x 30"H
4C 60W
Clear Acrylic
Metal Candle Covers

B. 7-9161-4-322
4-Light Pendant
Warm Brass Finish
20"W x 30"H
4C 60W
Clear Acrylic
Metal Candle Covers

C. 7-9160-1-109
1-Light Pendant
Polished Nickel Finish
12"W x 44-1/2"H
1E 60W
90° Swivel
Clear Acrylic

D. 7-9160-1-322
1-Light Pendant
Warm Brass Finish
12"W x 44-1/2"H
1E 60W
90° Swivel
Clear Acrylic

EPSILON

A.



B.



*C.



*D.

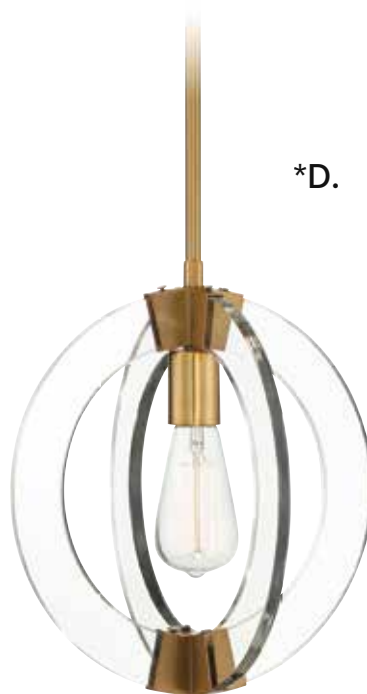

*Options: 7-EXT- Extension Rod - 9-1/2"

STIRLING

*A.



*B.



A. **7-200-3-322**
3-Light Pendant
Warm Brass Finish
12"W x 13"H
Adj H 13"H-70"
3C 60W
30° Swivel
Crackled Glass
Metal Candle Covers

B. **7-200-3-57**
3-Light Pendant
Polished Pewter Finish
12"W x 13"H
Adj H 13"H-70"
3C 60W
30° Swivel
Crackled Glass
Metal Candle Covers

*Options: 7-EXT- Extension Rod - 9-1/2"

STIRLING



**C.



**D.



C. 7-201-4-57
4-Light Pendant
Polished Pewter Finish
19-7/8"W x 21-3/4"H
Adj H 21-3/4" - 78-3/4"
4C 60W
30° Swivel
Crackled Glass
Metal Candle Covers

D. 7-201-4-322
4-Light Pendant
Warm Brass Finish
19-7/8"W x 21-3/4"H
Adj H 21-3/4" - 78-3/4"
4C 60W
30° Swivel
Crackled Glass
Metal Candle Covers

**Options: 7-EXTLG- Extension Rod - 12"

WESTBOURNE

*A.



*B.



A. 7-3100-1-322
1-Light Mini-Pendant
Warm Brass Finish
8"W x 11-1/2"H
Adj H 11-1/2" - 43"
1E 60W
90° Swivel
White Opal Glass

B. 7-3100-1-SN
1-Light Mini-Pendant
Satin Nickel Finish
8"W x 11-1/2"H
Adj H 11-1/2" - 43"
1E 60W
90° Swivel
White Opal Glass

*Options: 7-EXT- Extension Rod - 9-1/2"

WESTBOURNE



**C.



**D.



C. 7-3102-1-322
1-Light Pendant
Warm Brass Finish
12-3/4"W x 16-1/2"H
Adj H 16-1/2" - 73-1/2"
1E 60W
30° Swivel
White Opal Glass

D. 7-3102-1-SN
1-Light Pendant
Satin Nickel Finish
12-3/4"W x 16-1/2"H
Adj H 16-1/2" - 73-1/2"
1E 60W
30° Swivel
White Opal Glass

**Options: 7-EXTLG- Extension Rod - 12"

BRAXTON

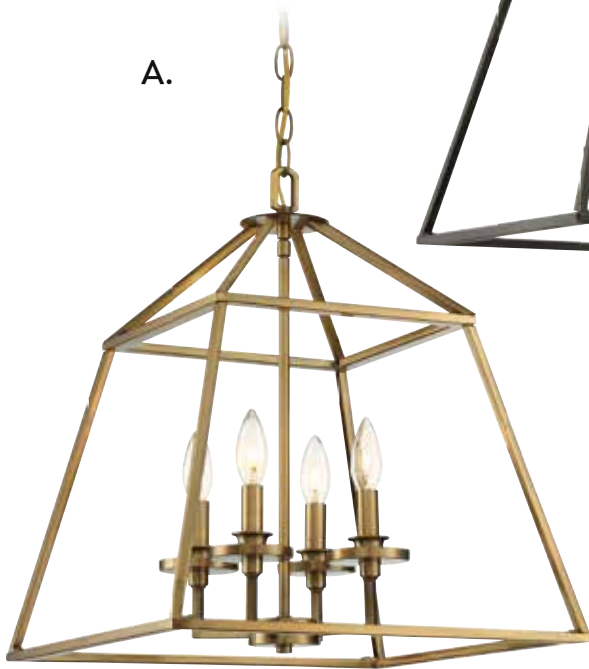

A. 3-9099-4-322
4-Light Pendant
Warm Brass Finish
24"W x 19-1/2"H
4C 60W
Metal Candle Covers

B. 3-9099-4-44
4-Light Pendant
Classic Bronze Finish
24"W x 19-1/2"H
4C 60W
Metal Candle Covers

C. 3-9099-4-109
4-Light Pendant
Polished Nickel Finish
24"W x 19-1/2"H
4C 60W
Metal Candle Covers

AKRON



D. 7-9006-3-13
3-Light Pendant
English Bronze Finish
12"W x 24"H
3C 60W
Clear Glass
Metal Candle Covers

E. 7-9006-3-109
3-Light Pendant
Polished Nickel Finish
12"W x 24"H
3C 60W
Clear Glass
Metal Candle Covers

F. 7-9006-3-SN
3-Light Pendant
Satin Nickel Finish
12"W x 24"H
3C 60W
Clear Glass
Metal Candle Covers

G. 7-9006-3-322
3-Light Pendant
Warm Brass Finish
12"W x 24"H
3C 60W
Clear Glass
Metal Candle Covers

TOWNSEND



A. 3-320-3-44
3-Light Pendant
Classic Bronze Finish
10"W x 15"H
3C 60W
Metal Candle Covers

B. 3-320-3-SN
3-Light Pendant
Satin Nickel Finish
10"W x 15"H
3C 60W
Metal Candle Covers

C. 3-320-3-322
3-Light Pendant
Warm Brass Finish
10"W x 15"H
3C 60W
Metal Candle Covers

D. 3-320-3-109
3-Light Pendant
Polished Nickel Finish
10"W x 15"H
3C 60W
Metal Candle Covers

E. 3-320-3-89
3-Light Pendant
Matte Black Finish
10"W x 15"H
3C 60W
Metal Candle Covers

TOWNSEND

A.



B.

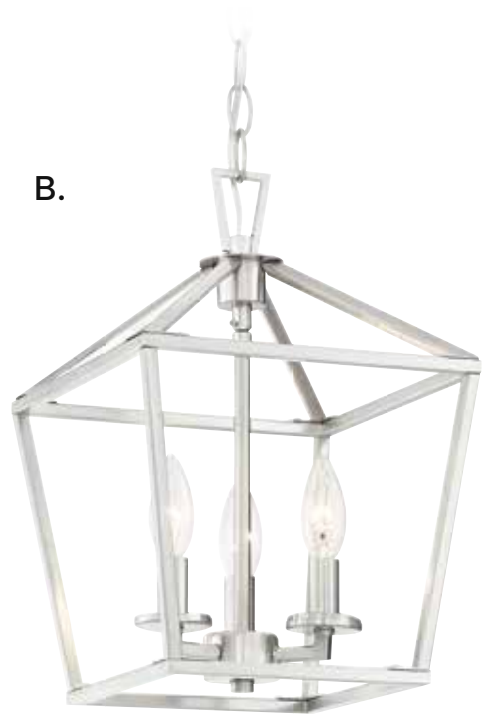

C.

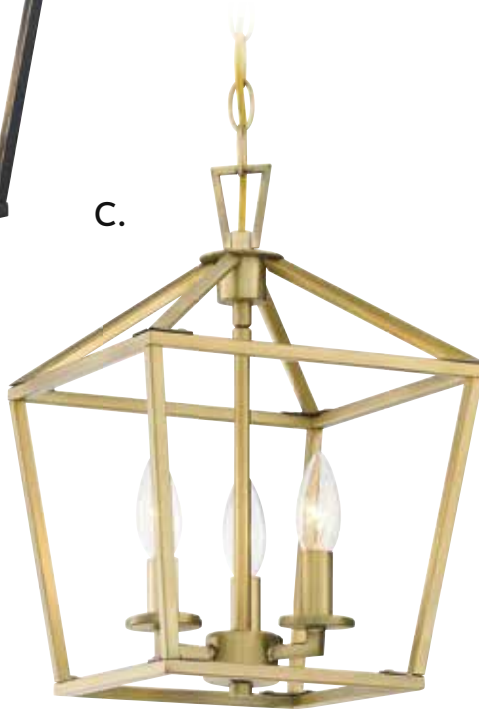

D.



E.



TOWNSEND

A.



B.

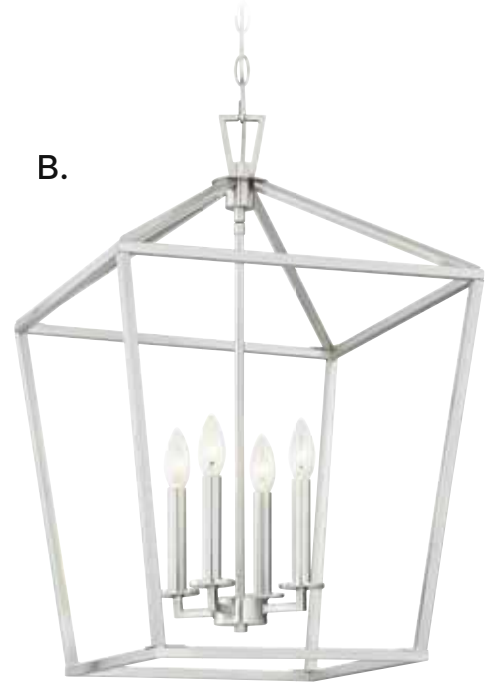

C.

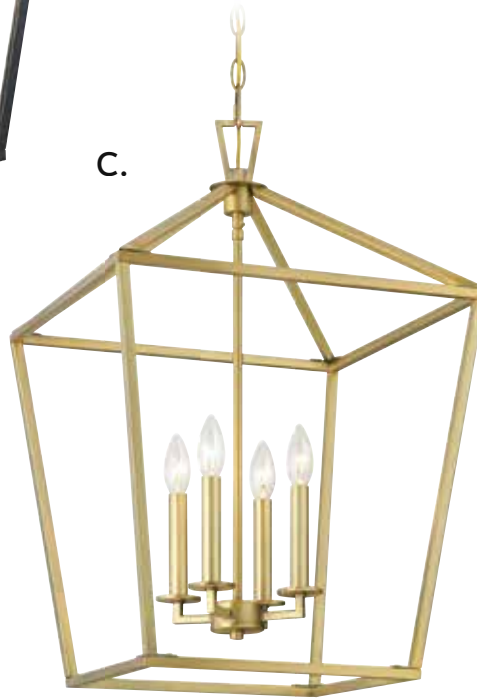

D.

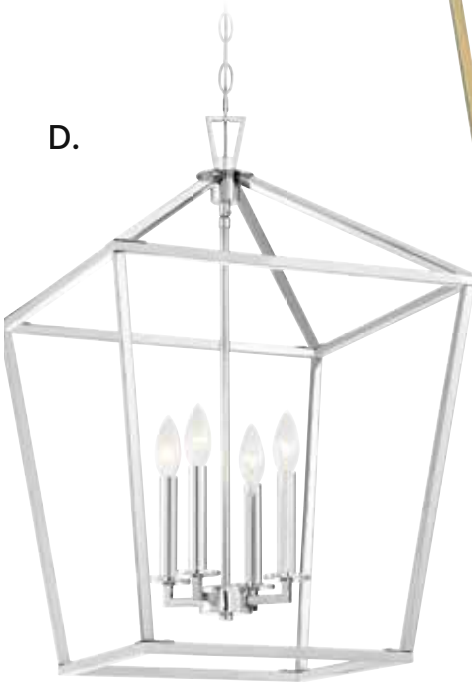

E.

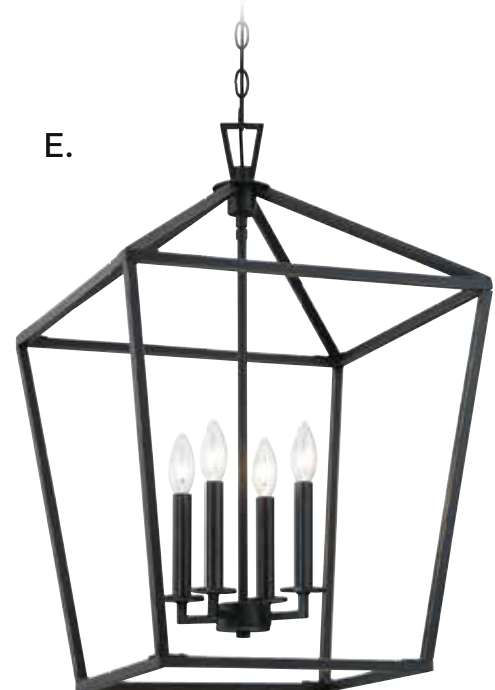

TOWNSEND

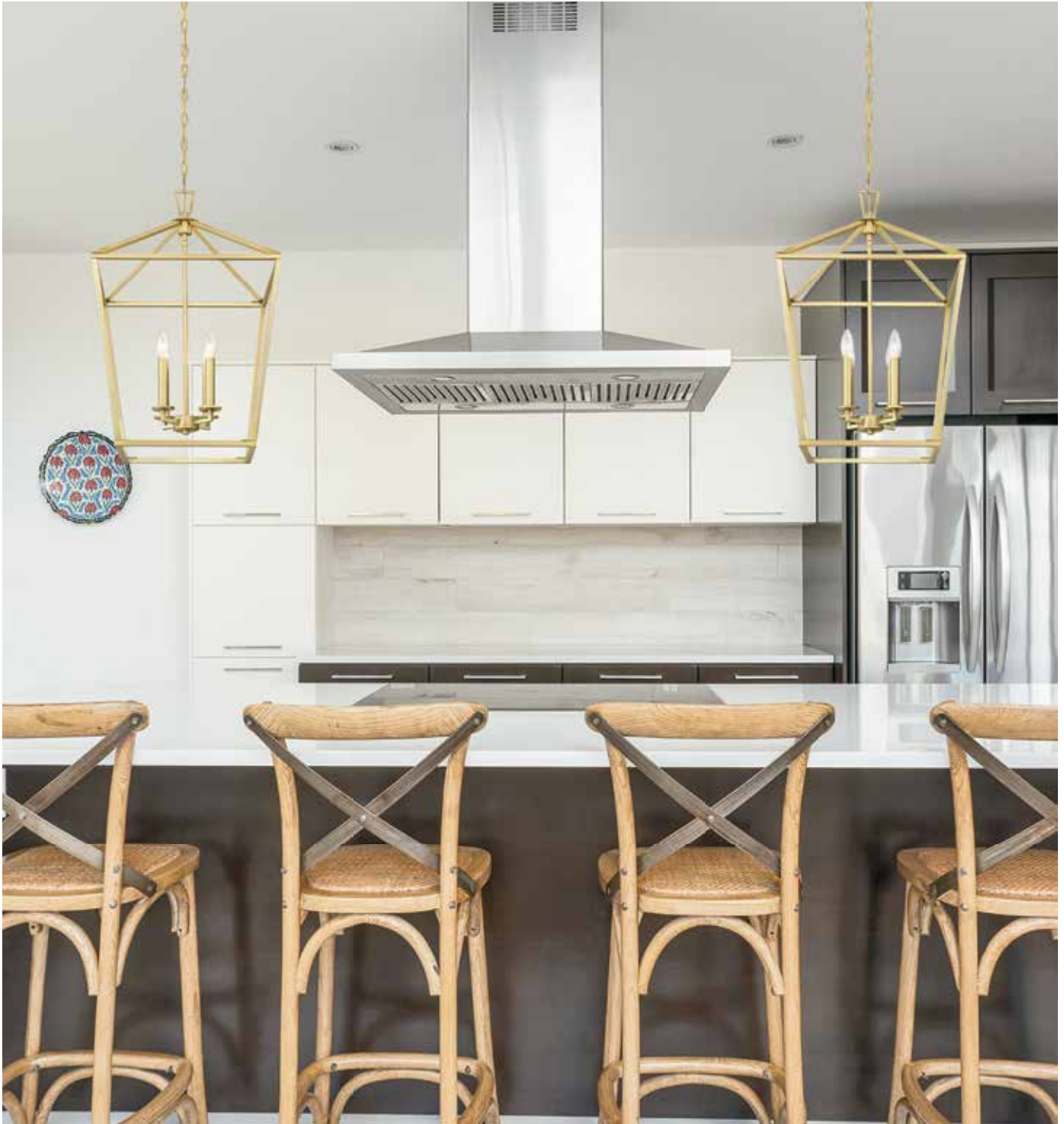

A. 3-321-4-44
4-Light Pendant
Classic Bronze Finish
17"W x 26"H
4C 60W
Metal Candle Covers

B. 3-321-4-SN
4-Light Pendant
Satin Nickel Finish
17"W x 26"H
4C 60W
Metal Candle Covers

C. 3-321-4-322
4-Light Pendant
Warm Brass Finish
17"W x 26"H
4C 60W
Metal Candle Covers

D. 3-321-4-109
4-Light Pendant
Polished Nickel Finish
17"W x 26"H
4C 60W
Metal Candle Covers

E. 3-321-4-89
4-Light Pendant
Matte Black Finish
17"W x 26-1/2"H
4C 60W
Metal Candle Covers

TOWNSEND

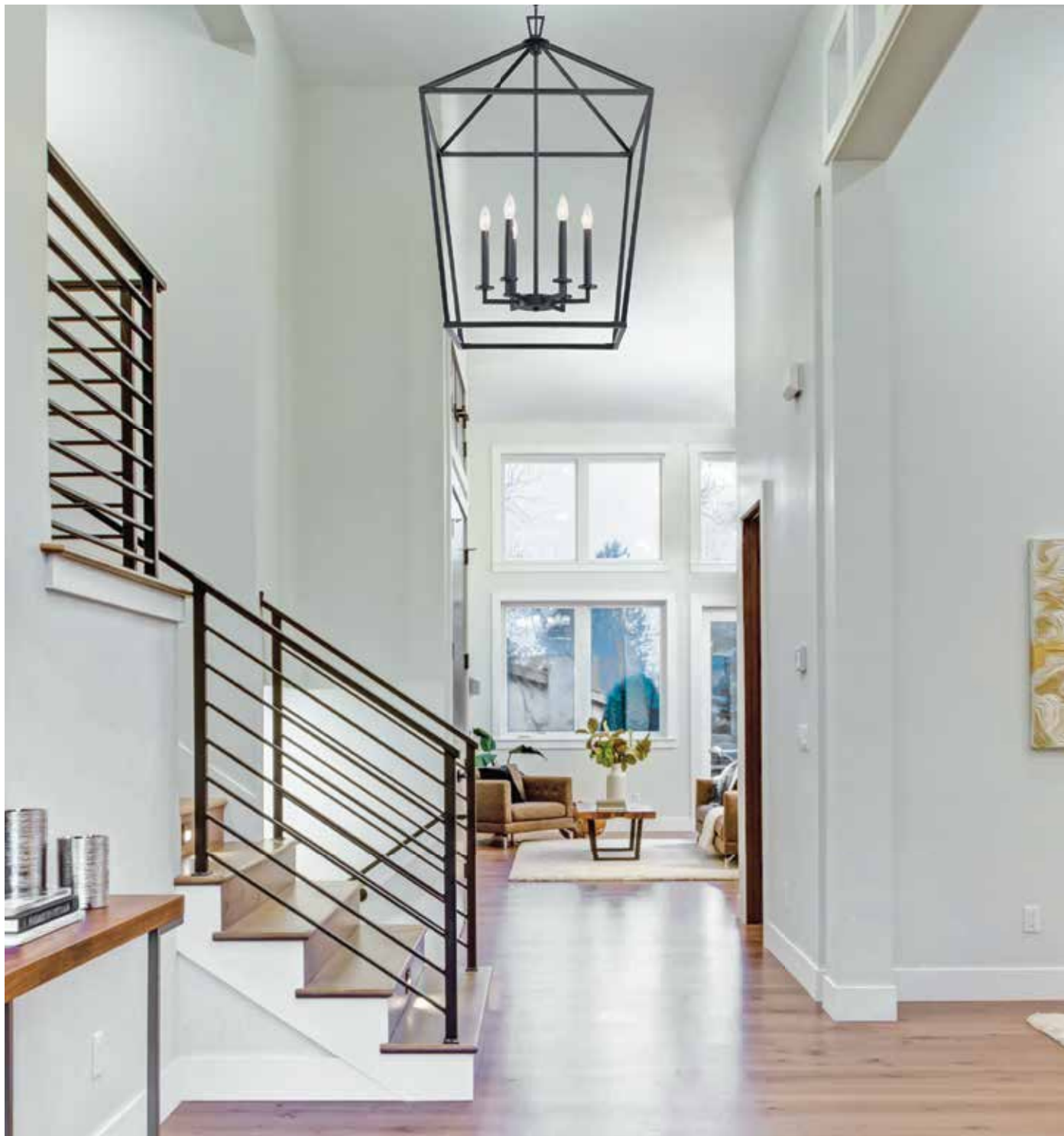

A. 3-322-6-44

6-Light Pendant
Classic Bronze Finish
24"W x 36-1/2"H
6C 60W
Metal Candle Covers

B. 3-322-6-SN

6-Light Pendant
Satin Nickel Finish
24"W x 36-1/2"H
6C 60W
Metal Candle Covers

C. 3-322-6-322

6-Light Pendant
Warm Brass Finish
24"W x 36-1/2"H
6C 60W
Metal Candle Covers

D. 3-322-6-109

6-Light Pendant
Polished Nickel Finish
24"W x 36-1/2"H
6C 60W
Metal Candle Covers

E. 3-322-6-89

6-Light Pendant
Matte Black Finish
24"W x 36-1/2"H
6C 60W
Metal Candle Covers

TOWNSEND

A.

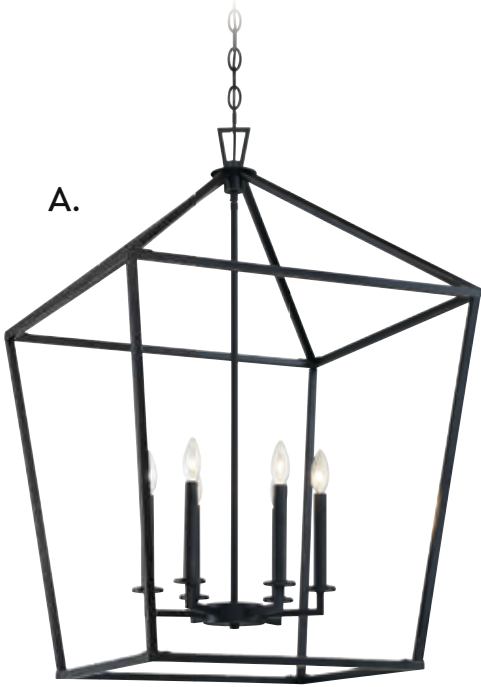

B.

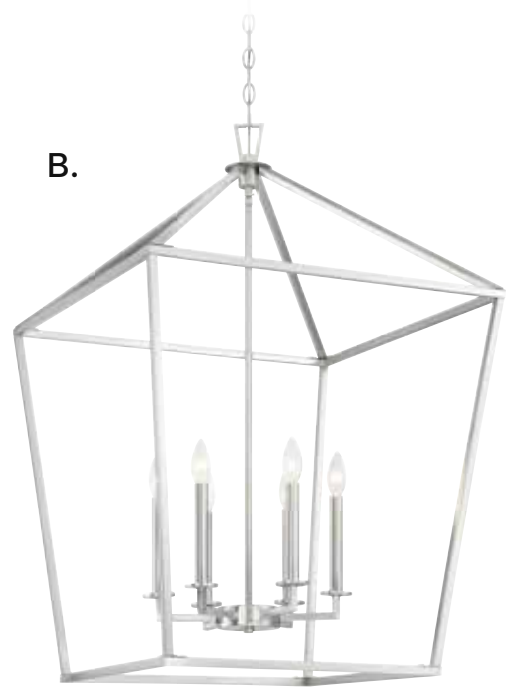

C.

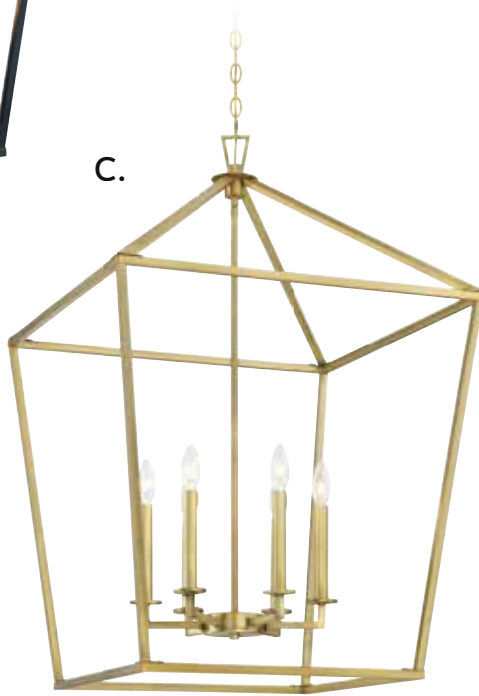

D.

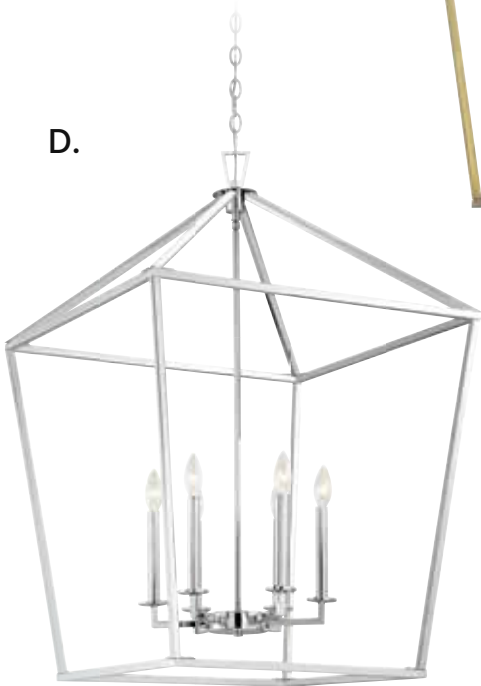

E.



TOWNSEND



A. 1-323-3-44

3-Light Linear Chandelier
Classic Bronze Finish
32"L x 16"W x 21"H
3C 60W
Metal Candle Covers

B. 1-323-3-SN

3-Light Linear Chandelier
Satin Nickel Finish
32"L x 16"W x 21"H
3C 60W
Metal Candle Covers

C. 1-323-3-322

3-Light Linear Chandelier
Warm Brass Finish
32"L x 16"W x 21"H
3C 60W
Metal Candle Covers

D. 1-323-3-109

3-Light Linear Chandelier
Polished Nickel Finish
32"L x 16"W x 21"H
3C 60W
Metal Candle Covers

E. 1-323-3-89

3-Light Linear Chandelier
Matte Black Finish
32"L x 16"W x 21"H
3C 60W
Metal Candle Covers

TOWNSEND

A.

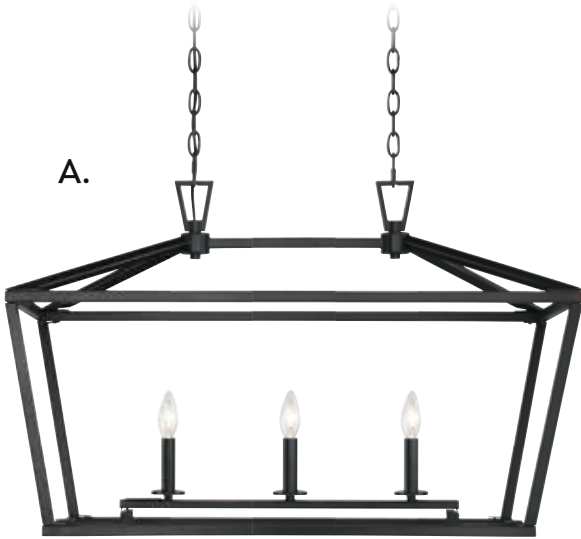

B.

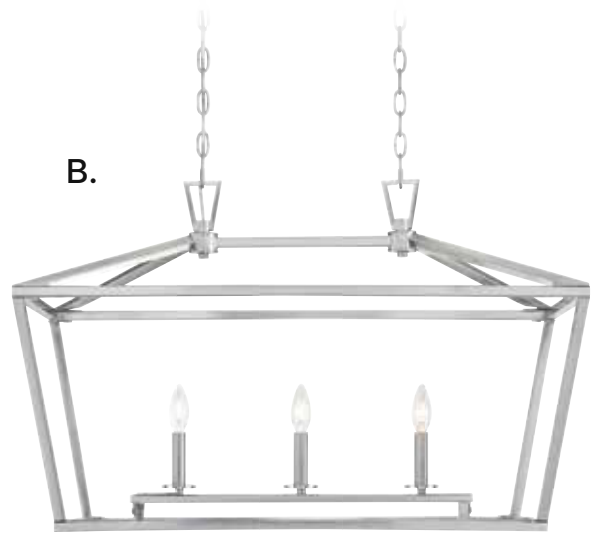

C.



D.

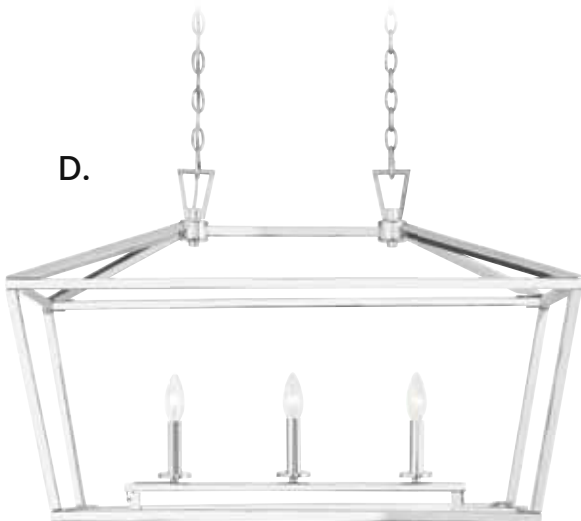

E.

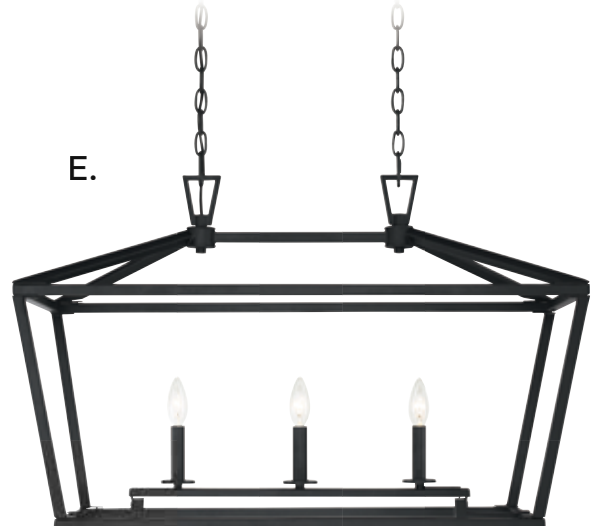

TOWNSEND

A.

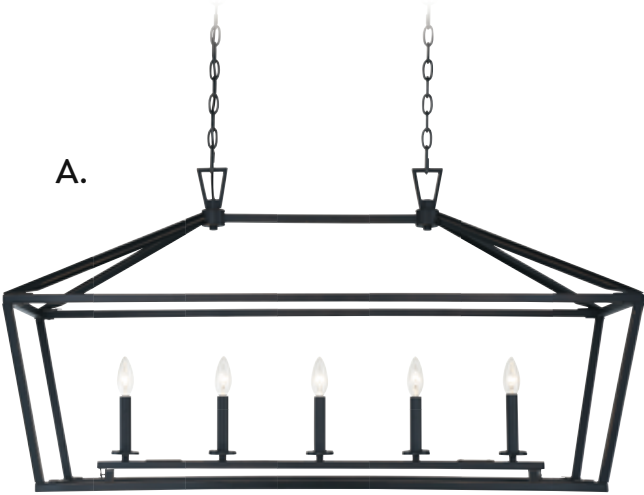

B.

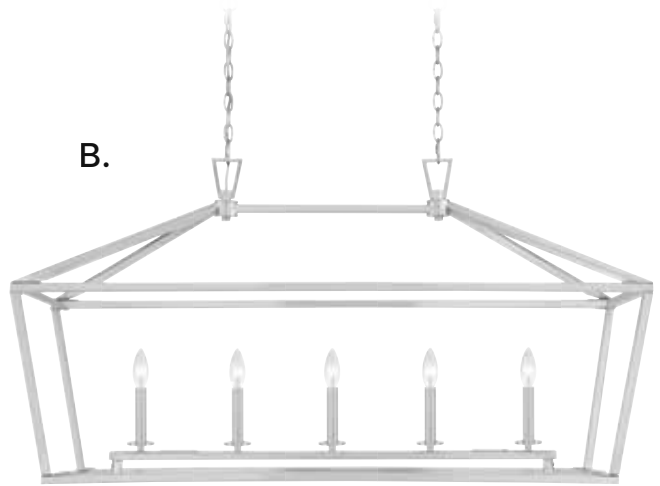

C.

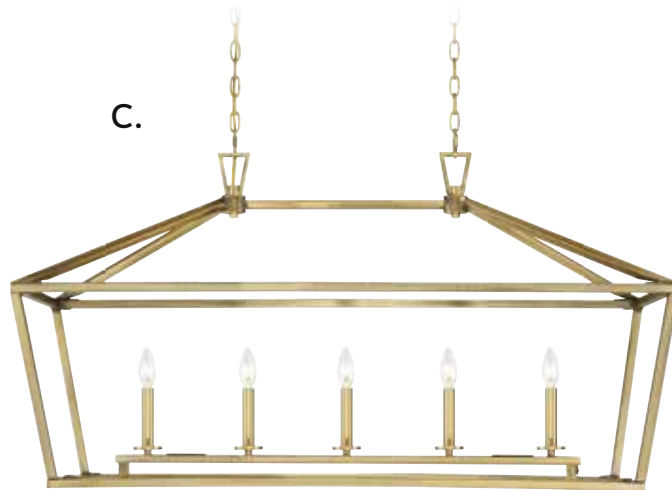

D.

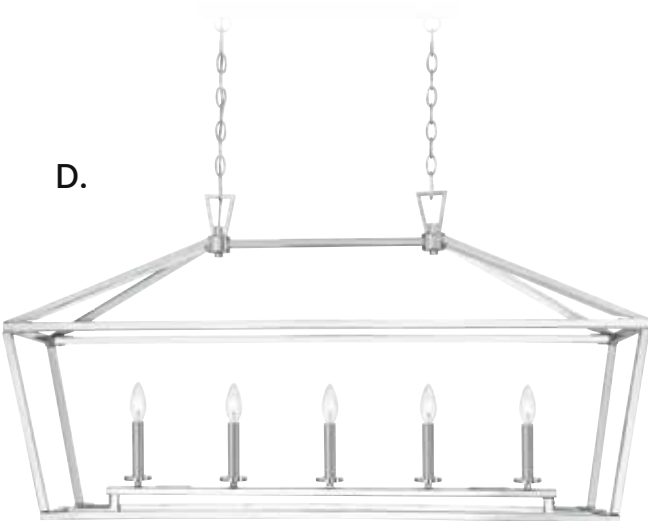

E.

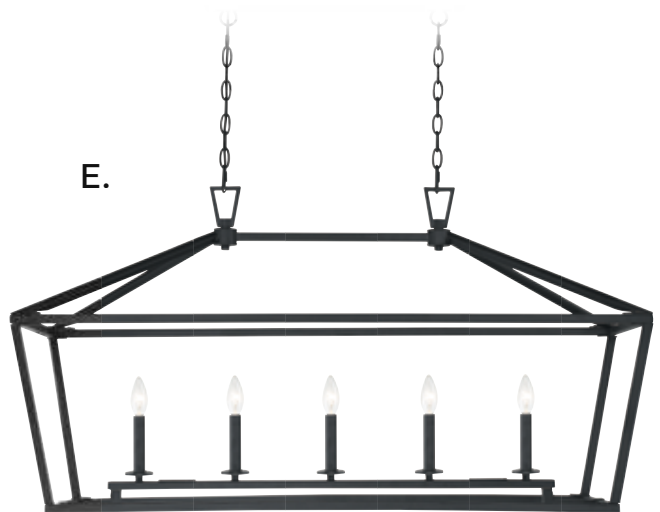

TOWNSEND



A. 1-324-5-44
5-Light Linear Chandelier
Classic Bronze Finish
44"L x 16"W x 23-1/2"H
5C 60W
Metal Candle Covers

B. 1-324-5-SN
5-Light Linear Chandelier
Satin Nickel Finish
44"L x 16"W x 23-1/2"H
5C 60W
Metal Candle Covers

C. 1-324-5-322
5-Light Linear Chandelier
Warm Brass Finish
44"L x 16"W x 23-1/2"H
5C 60W
Metal Candle Covers

D. 1-324-5-109
5-Light Linear Chandelier
Polished Nickel Finish
44"L x 16"W x 23-1/2"H
5C 60W
Metal Candle Covers

E. 1-324-5-89
5-Light Linear Chandelier
Matte Black Finish
44"L x 16"W x 23-1/2"H
5C 60W
Metal Candle Covers

PENROSE



A. 7-1041-6-109
6-Light Foyer
Polished Nickel Finish
16"W x 34"H
6C 60W
Clear Glass
Metal Candle Covers

PENROSE



B.

B. 7-1041-6-BK
6-Light Foyer
Matte Black Finish
16"W x 34"H
6C 60W
Clear Glass
Metal Candle Covers



C.

C. 7-1041-6-SN
6-Light Foyer
Satin Nickel Finish
16"W x 34"H
6C 60W
Clear Glass
Metal Candle Covers



D.

D. 7-1041-6-13
6-Light Foyer
English Bronze Finish
16"W x 34"H
6C 60W
Clear Glass
Metal Candle Covers

PENROSE



A.



B.



C.



D.



E.



F.

A. 6-1043-3-13

3-Light Semi-Flush
English Bronze Finish
12-1/2"W x 14"H
3C 60W
Clear Glass
Metal Candle Covers

B. 6-1043-3-109

3-Light Semi-Flush
Polished Nickel Finish
12-1/2"W x 14"H
3C 60W
Clear Glass
Metal Candle Covers

C. 6-1043-3-BK

3-Light Semi-Flush
Matte Black Finish
12-1/2"W x 14"H
3C 60W
Clear Glass
Metal Candle Covers

D. 7-1040-3-13

3-Light Foyer
English Bronze Finish
12"W x 26"H
3C 60W
Clear Glass
Metal Candle Covers

E. 7-1040-3-109

3-Light Foyer
Polished Nickel Finish
12"W x 26"H
3C 60W
Clear Glass
Metal Candle Covers

F. 7-1040-3-BK

3-Light Foyer
Matte Black Finish
12"W x 26"H
3C 60W
Clear Glass
Metal Candle Covers

PENROSE



G.



H.



G. 6-1043-3-SN
3-Light Semi-Flush
Satin Nickel Finish
12-1/2"W x 14"H
3C 60W
Clear Glass
Metal Candle Covers

H. 7-1040-3-SN
3-Light Foyer
Satin Nickel Finish
12"W x 26"H
3C 60W
Clear Glass
Metal Candle Covers

GARRETT

A.



B.



C.

D.



GARRETT



A. 3-3057-8-13

8-Light Foyer
English Bronze Finish
18"W x 36-1/2"H
8C 60W
Clear Glass
Metal Candle Covers

B. 3-3055-4-13

4-Light Foyer
English Bronze Finish
12"W x 23"H
4C 60W
Clear Glass
Metal Candle Covers

C. 6-3058-4-13

12" Flush Mount
English Bronze Finish
12-3/8"W x 11"H
4C 60W
Clear Glass
Metal Candle Covers

D. 3-3056-4-13

4-Light Foyer
English Bronze Finish
15"W x 28-1/4"H
4C 60W
Clear Glass
Metal Candle Covers

GARRETT



A. 3-3055-4-109

4-Light Foyer
Polished Nickel Finish
12"W x 23"H
4C 60W
Clear Glass
Metal Candle Covers

B. 3-3057-8-109

8-Light Foyer
Polished Nickel Finish
18"W x 36-1/2"H
8C 60W
Clear Glass
Metal Candle Covers

C. 3-3056-4-109

4-Light Foyer
Polished Nickel Finish
15"W x 28-1/4"H
4C 60W
Clear Glass
Metal Candle Covers

D. 6-3058-4-109

12" Flush Mount
Polished Nickel Finish
12-3/8"W x 11"H
4C 60W
Clear Glass
Metal Candle Covers

GARRETT

A.



B.



C.



D.



DUNBAR



A. 3-9074-4-67
4-Light Foyer
Matte Black w/ Polished
Chrome Accents Finish
14"W x 28"H
4C 60W
Clear Glass
Metal Candle Covers

B. 3-9074-8-67
8-Light Foyer
Matte Black w/ Polished
Chrome Accents Finish
20"W x 38"H
8C 60W
Clear Glass
Metal Candle Covers

C. 3-9074-8-79
8-Light Foyer
English Bronze & Warm
Brass Finish
20"W x 38"H
8C 60W
Clear Glass
Metal Candle Covers

D. 3-9074-4-79
4-Light Foyer
English Bronze & Warm
Brass Finish
14"W x 28"H
4C 60W
Clear Glass
Metal Candle Covers

DUNBAR

A.



B.



C.



D.



DUNBAR

A.

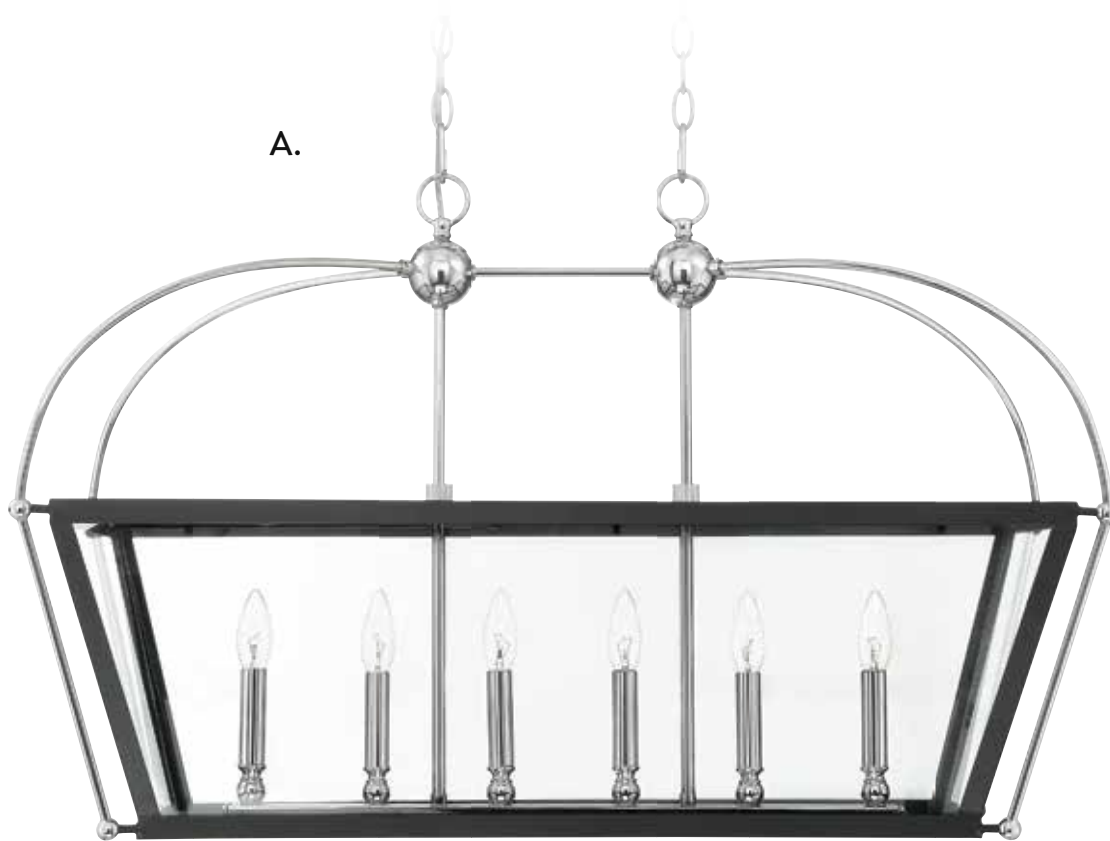

B.



DUNBAR



A. 1-9075-6-67
6-Light Linear Chandelier
Matte Black w/ Polished Chrome Accents Finish
36"L x 16"W x 22"H
6C 60W
Clear Glass
Metal Candle Covers

B. 1-9075-6-79
6-Light Linear Chandelier
English Bronze & Warm Brass Finish
36"L x 16"W x 22"H
6C 60W
Clear Glass
Metal Candle Covers

ALDEN



- A. 7-131-1-109**
1-Light Pendant
Polished Nickel Finish
18-1/4"W x 12-1/2"H
Adj H 12-1/2"- 33-3/4"
1E 60W
- B. 7-132-1-109**
1-Light Pendant
Polished Nickel Finish
12"W x 8-1/2"H
Adj H 8-1/2"-30"
1E 60W
- C. 7-131-1-323**
1-Light Pendant
Old Bronze Finish
18-1/4"W x 12-1/2"H
Adj H 12-1/2"- 33-3/4"
1E 60W
- D. 7-132-1-323**
1-Light Pendant
Old Bronze Finish
12"W x 8-1/2"H
Adj H 8-1/2"-30"
1E 60W
- E. 7-131-1-322**
1-Light Pendant
Warm Brass Finish
18-1/4"W x 12-1/2"H
Adj H 12-1/2"- 33-3/4"
1E 60W
- F. 7-132-1-322**
1-Light Pendant
Warm Brass Finish
12"W x 8-1/2"H
Adj H 8-1/2"-30"
1E 60W
- G. 7-131-1-89**
1-Light Pendant
Matte Black Finish
18-1/4"W x 12-1/2"H
Adj H 12-1/2"- 33-3/4"
1E 60W
- H. 7-132-1-89**
1-Light Pendant
Matte Black Finish
12"W x 8-1/2"H
Adj H 8-1/2"-30"
1E 60W

ALDEN



Pendants come with (2) sections of decorative linked stems, plus chain.

AUSTIN

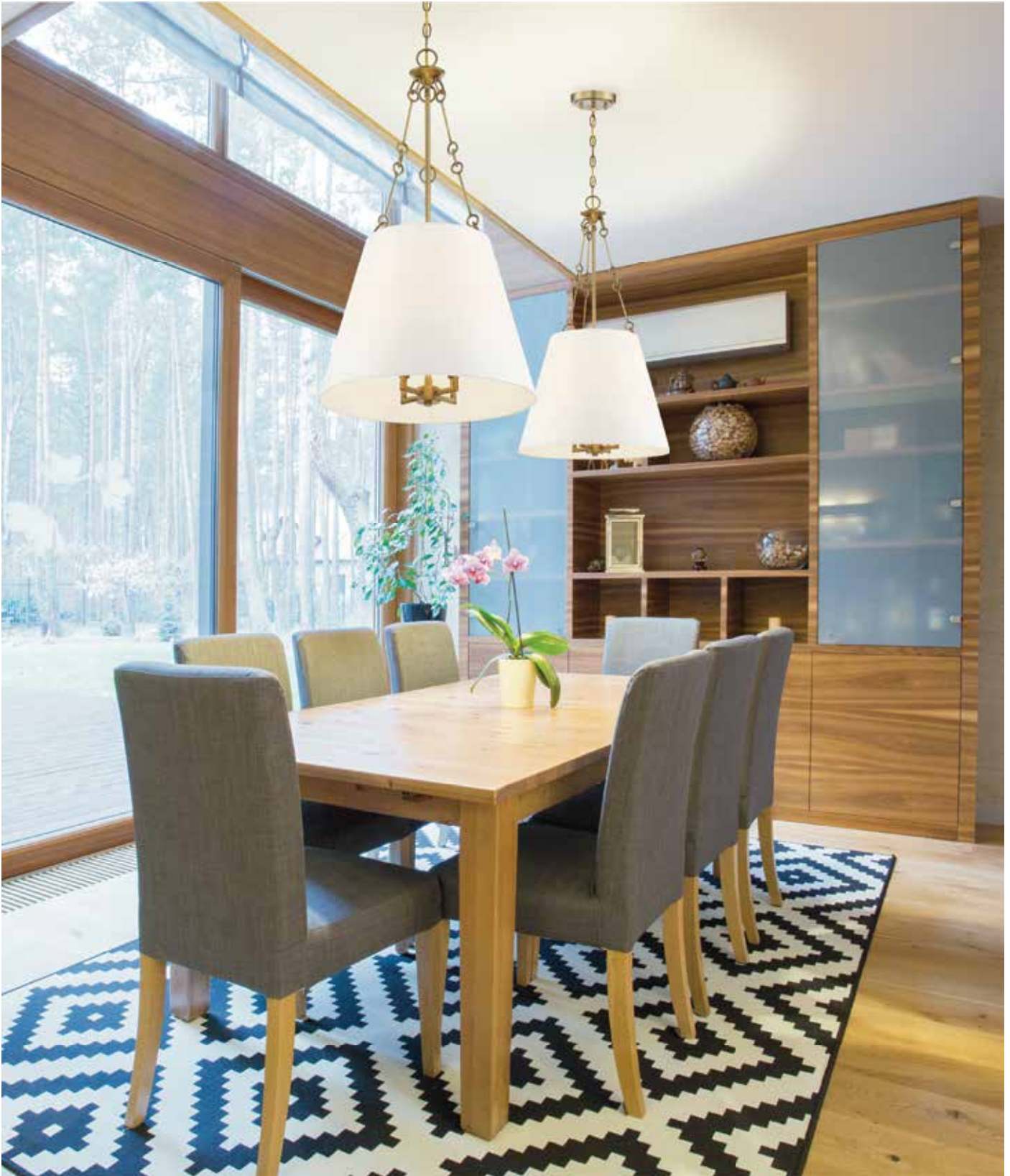

AUSTIN



A.

A. 7-2201-4-13
4-Light Pendant
English Bronze Finish
18"W x 32-1/2"H
4C 60W
White Fabric Shade



B.

B. 7-2201-4-SN
4-Light Pendant
Satin Nickel Finish
18"W x 32-1/2"H
4C 60W
White Fabric Shade



C.

C. 7-2201-4-322
4-Light Pendant
Warm Brass Finish
18"W x 32-1/2"H
4C 60W
White Fabric Shade

ASHMONT

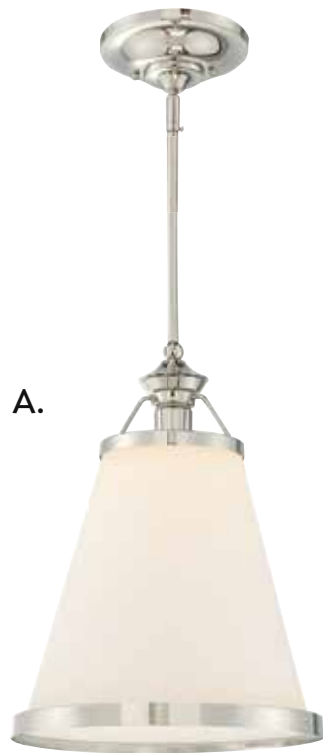

Options: 7-EXT- Extension Rod - 9-1/2"

ASHMONT



A. 7-130-1-109
1-Light Pendant
Polished Nickel Finish
13"W x 21-1/4"H
Adj H 21-1/4" - 49-3/4"
1E 60W
90° Swivel
White Opal Glass

B. 7-130-1-44
1-Light Pendant
Classic Bronze Finish
13"W x 21-1/4"H
Adj H 21-1/4" - 49-3/4"
1E 60W
90° Swivel
White Opal Glass

C. 7-130-1-63
1-Light Pendant
Warm Brass Lustre Finish
13"W x 21-1/4"H
Adj H 21-1/4" - 49-3/4"
1E 60W
90° Swivel
White Opal Glass

D. 7-130-1-SN
1-Light Pendant
Satin Nickel Finish
13"W x 21-1/4"H
Adj H 21-1/4" - 49-3/4"
1E 60W
90° Swivel
White Opal Glass

SHANE

A.



B.



C.



D.



SHANE



A. 1-2070-1-109
1-Light Pendant
Polished Nickel Finish
16"W x 12"H
1E 60W
Clear Glass

B. 1-2070-1-13
1-Light Pendant
English Bronze Finish
16"W x 12"H
1E 60W
Clear Glass

C. 1-2070-1-322
1-Light Pendant
Warm Brass Finish
16"W x 12"H
1E 60W
Clear Glass

D. 1-2070-1-SN
1-Light Pendant
Satin Nickel Finish
16"W x 12"H
1E 60W
Clear Glass

GARVEY

*A.



*B.



*C.



A. 7-5012-1-322
1-Light Pendant
Warm Brass Finish
14"W x 16-1/2"H
Adj H 16-1/2" - 48"
1E 60W
90° Swivel
Clear Glass

B. 7-5012-1-13
1-Light Pendant
English Bronze Finish
14"W x 16-1/2"H
Adj H 16-1/2" - 48"
1E 60W
90° Swivel
Clear Glass

C. 7-5012-1-109
1-Light Pendant
Polished Nickel Finish
14"W x 16-1/2"H
Adj H 16-1/2" - 48"
1E 60W
90° Swivel
Clear Glass

*Options: 7-EXT- Extension Rod - 9-1/2"

MAYFIELD

D. 7-17000-1-109
1-Light Pendant
Polished Nickel Finish
15-1/2"W x 13"H
1E 60W
Clear Glass

E. 7-17000-1-13
1-Light Pendant
English Bronze Finish
15-1/2"W x 13"H
1E 60W
Clear Glass

F. 7-17000-1-322
1-Light Pendant
Warm Brass Finish
15-1/2"W x 13"H
1E 60W
Clear Glass

D.



E.



F.

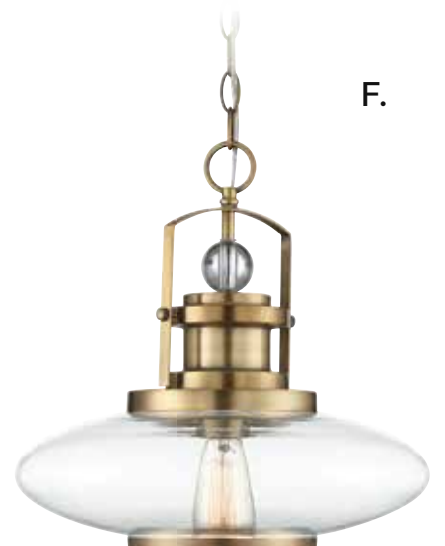

DRAKE

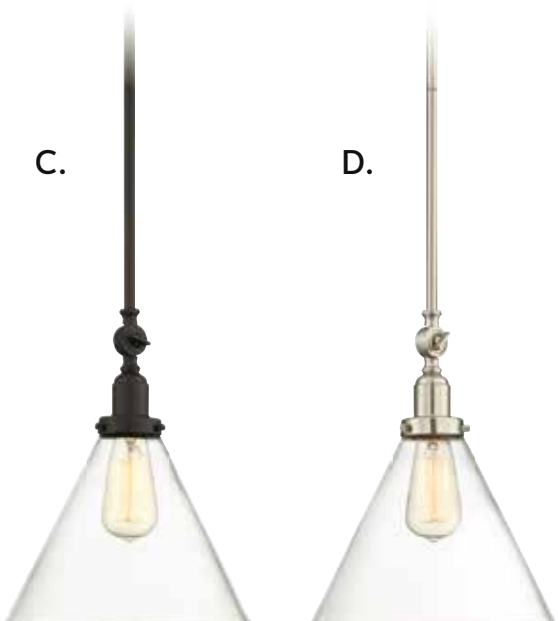
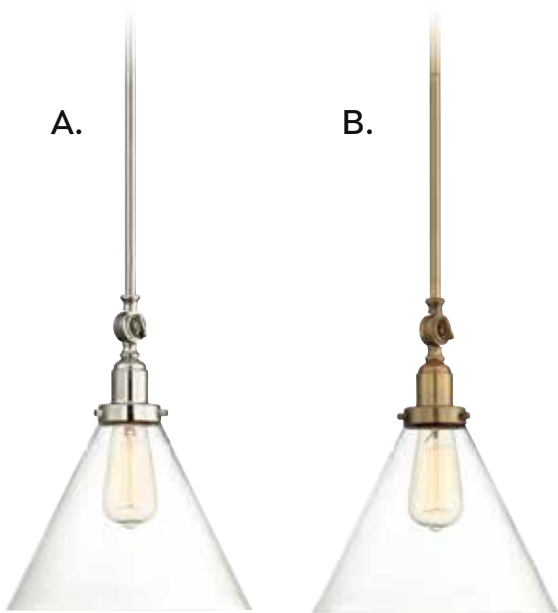

A. 7-9132-1-109
 1-Light Pendant
 Polished Nickel Finish
 10"W x 11-1-2"H
 Adj H 11-1/2" - 43"
 1E 60W
 90° Swivel
 Clear Glass

B. 7-9132-1-322
 1-Light Pendant
 Warm Brass Finish
 10"W x 11-1-2"H
 Adj H 11-1/2" - 43"
 1E 60W
 90° Swivel
 Clear Glass

C. 7-9132-1-13
 1-Light Pendant
 English Bronze Finish
 10"W x 11-1-2"H
 Adj H 11-1/2" - 43"
 1E 60W
 90° Swivel
 Clear Glass

D. 7-9132-1-SN
 1-Light Pendant
 Satin Nickel Finish
 10"W x 11-1-2"H
 Adj H 11-1/2" - 43"
 1E 60W
 90° Swivel
 Clear Glass

Options: 7-EXT- Extension Rod - 9-1/2"

OCTAVE



D.



D. 7-4036-1-13
1-Light Mini-Pendant
English Bronze Finish
8-1/2"W x 10-1/2"H
Adj H 10-1/2" - 42"
1E 60W
90° Swivel
Clear Glass

E.



E. 7-4036-1-11
1-Light Mini-Pendant
Polished Chrome Finish
8-1/2"W x 10-1/2"H
Adj H 10-1/2" - 42"
1E 60W
90° Swivel
Clear Glass

F.



F. 7-4036-1-322
1-Light Mini-Pendant
Warm Brass Finish
8-1/2"W x 10-1/2"H
Adj H 10-1/2" - 42"
1E 60W
90° Swivel
Clear Glass

FRANKLIN



A. 7-702-1-13
1-Light Pendant
English Bronze Finish
10"W x 20"H
1E 60W
Clear Glass

B. 7-703-1-SN
1-Light Pendant
Satin Nickel Finish
10"W x 20"H
1E 60W
Silver Mercury Glass

C. 7-702-1-109
1-Light Pendant
Polished Nickel Finish
10"W x 20"H
1E 60W
Clear Glass

- D. **7-700-1-109**
1-Light Mini-Pendant
Polished Nickel Finish
6-1/2"W x 12"H
1E 60W
Clear Glass
- E. **7-701-1-SN**
1-Light Mini-Pendant
Satin Nickel Finish
6-1/2"W x 12"H
1E 60W
Silver Mercury Glass
- F. **7-700-1-13**
1-Light Mini-Pendant
English Bronze Finish
6-1/2"W x 12"H
1E 60W
Clear Glass



D.



E.



F.



OCTAVE



OCTAVE



E.



F.



G.



- | | | | | | | |
|-----------------------|-----------------------|------------------------|-----------------------|-----------------------|------------------------|-----------------------|
| A. 6-4037-1-11 | B. 6-4037-1-13 | C. 6-4037-1-322 | D. 6-4037-1-BK | E. 6-4035-3-13 | F. 6-4035-3-322 | G. 6-4035-3-11 |
| 1-Light Semi-Flush | 1-Light Semi-Flush | 1-Light Semi-Flush | 1-Light Semi-Flush | 3-Light Semi-Flush | 3-Light Semi-Flush | 3-Light Semi-Flush |
| Polished Chrome | English Bronze Finish | Warm Brass Finish | Matte Black Finish | English Bronze Finish | Warm Brass Finish | Polished Chrome |
| Finish | | | | | | Finish |
| 8"W x 14"H | 8"W x 14"H | 8"W x 14"H | 8"W x 14"H | 13"W x 11"H | 13"W x 11"H | 13"W x 11"H |
| 1E 60W | 1E 60W | 1E 60W | 1E 60W | 3E 60W | 3E 60W | 3E 60W |
| Clear Glass | Clear Glass | Clear Glass | Clear Glass | Clear Glass | Clear Glass | Clear Glass |

BENTON



BRIAN THOMAS
COLLECTION



BENTON



A.



B.



C.



D.

A. **6-9069-13-SN**
13" Flush Mount
Satin Nickel Finish
13"W x 5-1/8"H
2E 60W
Clear Halophane Glass

B. **6-9069-13-13**
13" Flush Mount
English Bronze Finish
13"W x 5-1/8"H
2E 60W
Clear Halophane Glass

C. **6-9069-13-322**
13" Flush Mount
Warm Brass Finish
13"W x 5-1/8"H
2E 60W
Clear Halophane Glass

D. **6-9069-13-109**
13" Flush Mount
Polished Nickel Finish
13"W x 5-1/8"H
2E 60W
Clear Halophane Glass

LUCERNE

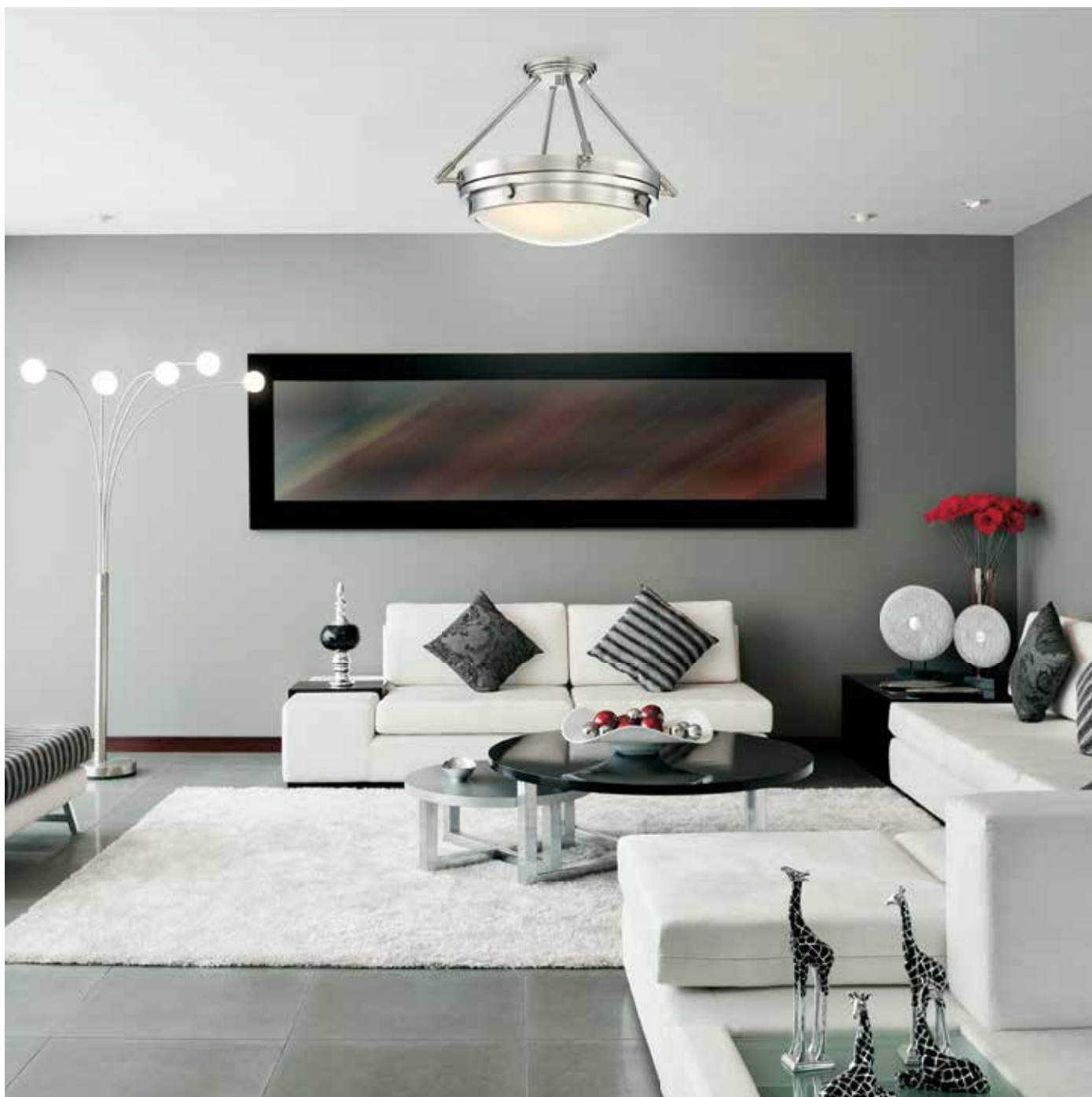

- | | | | | | |
|---|---|--|--|---|---|
| <p>A. 6-3351-3-13
 3-Light Semi-Flush
 English Bronze Finish
 18-1/2"W x 13-1/2"H
 3E 60W
 White Glass</p> | <p>B. 6-3352-2-13
 2-Light Semi-Flush
 English Bronze Finish
 16-1/2"W x 10-3/4"H
 2E 60W
 White Glass</p> | <p>C. 6-3351-3-322
 3-Light Semi-Flush
 Warm Brass Finish
 18-1/2"W x 13-1/2"H
 3E 60W
 White Glass</p> | <p>D. 6-3352-2-322
 2-Light Semi-Flush
 Warm Brass Finish
 16-1/2"W x 10-3/4"H
 2E 60W
 White Glass</p> | <p>E. 6-3351-3-SN
 3-Light Semi-Flush
 Satin Nickel Finish
 18-1/2"W x 13-1/2"H
 3E 60W
 White Glass</p> | <p>F. 6-3352-2-SN
 2-Light Semi-Flush
 Satin Nickel Finish
 16-1/2"W x 10-3/4"H
 2E 60W
 White Glass</p> |
|---|---|--|--|---|---|

LUCERNE



A.



B.



C.



D.



E.



F.

LUCERNE



A.



B.



C.



D.



E.



F.



G.



H.

LUCERNE



A. 6-3350-16-109
15" Flush Mount
Polished Nickel Finish
15"W x 4-3/4"H
3E 60W
White Glass

B. 6-3350-14-109
13" Flush Mount
Polished Nickel Finish
13-1/4"W x 4-3/4"H
2E 60W
White Glass

C. 6-3350-16-13
15" Flush Mount
English Bronze Finish
15"W x 4-3/4"H
3E 60W
White Glass

D. 6-3350-14-13
13" Flush Mount
English Bronze Finish
13-1/4"W x 4-3/4"H
2E 60W
White Glass

E. 6-3350-16-322
15" Flush Mount
Warm Brass Finish
15"W x 4-3/4"H
3E 60W
White Glass

F. 6-3350-14-322
13" Flush Mount
Warm Brass Finish
13-1/4"W x 4-3/4"H
2E 60W
White Glass

G. 6-3350-16-SN
15" Flush Mount
Satin Nickel Finish
15"W x 4-3/4"H
3E 60W
White Glass

H. 6-3350-14-SN
13" Flush Mount
Satin Nickel Finish
13-1/4"W x 4-3/4"H
2E 60W
White Glass

CEILING



A. 6-780-13-BK
13" Flush Mount
Matte Black Finish
13"W x 5"H
2E 60W
White Etched Glass



A.

B. 6-780-11-BK
11" Flush Mount
Matte Black Finish
11"W x 4-1/2"H
2E 40W
White Etched Glass



B.

CEILING



C.



D.

C. **6-780-11-SN**
11" Flush Mount
Satin Nickel Finish
11"W x 4-1/2"H
2E 40W
White Etched Glass

D. **6-780-13-SN**
13" Flush Mount
Satin Nickel Finish
13"W x 5"H
2E 60W
White Etched Glass



E.



F.

E. **6-780-13-322**
13" Flush Mount
Warm Brass Finish
13"W x 5"H
2E 60W
White Etched Glass

F. **6-780-11-322**
11" Flush Mount
Warm Brass Finish
11"W x 4-1/2"H
2E 40W
White Etched Glass



G.



H.

G. **6-780-11-13**
11" Flush Mount
English Bronze Finish
11"W x 4-1/2"H
2E 40W
White Etched Glass

H. **6-780-13-13**
13" Flush Mount
English Bronze Finish
13"W x 5"H
2E 60W
White Etched Glass



I.



J.

I. **6-780-13-109**
13" Flush Mount
Polished Nickel Finish
13"W x 5"H
2E 60W
White Etched Glass

J. **6-780-11-109**
11" Flush Mount
Polished Nickel Finish
11"W x 4-1/2"H
2E 40W
White Etched Glass

MONROE



MONROE

A. 9-302-1-SN

1-Light Sconce
Satin Nickel Finish
5"W x 20"H x 6"E
1C 60W
White Fabric Shade
Metal Candle Cover

B. 9-303-1-SN

1-Light Sconce
Satin Nickel Finish
5"W x 24"H x 6-1/2"E
1C 60W
White Fabric Shade
Metal Candle Cover

C. 9-7144-1-SN

1-Light Sconce
Satin Nickel Finish
6-3/4"W x 33-1/2"H x 8"E
1C 60W
White Fabric Shade

D. 9-7144-1-89

1-Light Sconce
Matte Black Finish
6-3/4"W x 33-1/2"H x 8"E
1C 60W
White Fabric Shade
Metal Candle Cover

E. 9-303-1-89

1-Light Sconce
Matte Black Finish
5"W x 24"H x 6-1/2"E
1C 60W
White Fabric Shade
Metal Candle Cover

F. 9-302-1-89

1-Light Sconce
Matte Black Finish
5"W x 20"H x 6"E
1C 60W
White Fabric Shade
Metal Candle Cover



MONROE



A.



B.



C.

A. 9-7144-1-322
1-Light Sconce
Warm Brass Finish
6-3/4"W x 33-1/2"H x 8"E
1C 60W
White Fabric Shade
Metal Candle Cover

B. 9-303-1-322
1-Light Sconce
Warm Brass Finish
5"W x 24"H x 6-1/2"E
1C 60W
White Fabric Shade
Metal Candle Cover

C. 9-302-1-322
1-Light Sconce
Warm Brass Finish
5"W x 20"H x 6"E
1C 60W
White Fabric Shade
Metal Candle Cover

D. 9-302-1-44
1-Light Sconce
Classic Bronze Finish
5"W x 20"H x 6"E
1C 60W
White Fabric Shade
Metal Candle Cover

E. 9-303-1-44
1-Light Sconce
Classic Bronze Finish
5"W x 24"H x 6-1/2"E
1C 60W
White Fabric Shade
Metal Candle Cover

F. 9-7144-1-44
1-Light Sconce
Classic Bronze Finish
6-3/4"W x 33-1/2"H x 8"E
1C 60W
White Fabric Shade
Metal Candle Cover

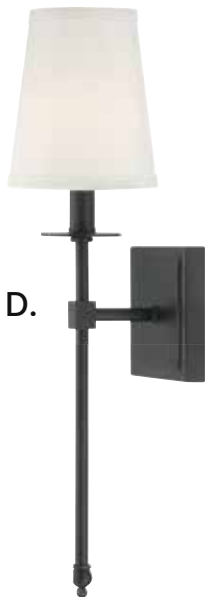

D.



E.



F.

MONROE



G. 9-7144-1-109
1-Light Sconce
Polished Nickel Finish
6-3/4"W x 33-1/2"H x 8"E
1C 60W
White Fabric Shade
Metal Candle Cover

H. 9-303-1-109
1-Light Sconce
Polished Nickel Finish
5"W x 24"H x 6-1/2"E
1C 60W
White Fabric Shade
Metal Candle Cover

I. 9-302-1-109
1-Light Sconce
Polished Nickel Finish
5"W x 20"H x 6"E
1C 60W
White Fabric Shade
Metal Candle Cover



CHAPLIN



A. 9-1000-1-109
1-Light Sconce
Polished Nickel Finish
7"W x 26"H x 8-1/2"E
1C 60W
White Fabric Shade
Metal Candle Cover

B. 9-1000-1-13
1-Light Sconce
English Bronze Finish
7"W x 26"H x 8-1/2"E
1C 60W
White Fabric Shade
Metal Candle Cover

C. 9-1000-1-322
1-Light Sconce
Warm Brass Finish
7"W x 26"H x 8-1/2"E
1C 60W
White Fabric Shade
Metal Candle Cover

D. 9-1000-1-SN
1-Light Sconce
Satin Nickel Finish
7"W x 26"H x 8-1/2"E
1C 60W
White Fabric Shade
Metal Candle Cover

CHAPLIN



A.



B.



C.



D.

PAYTON

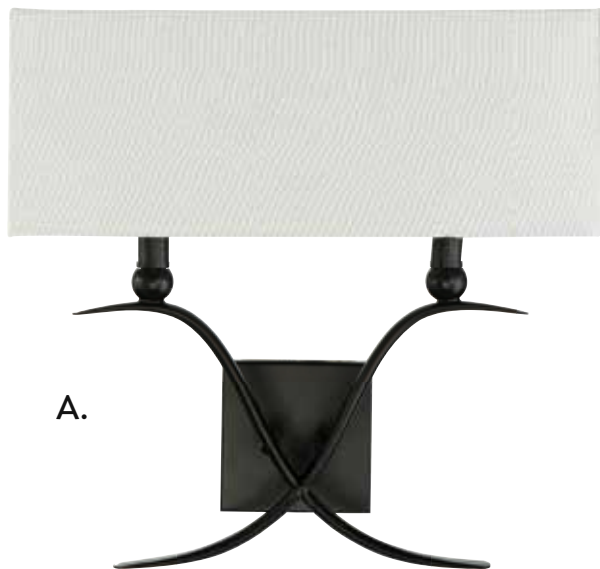

A.

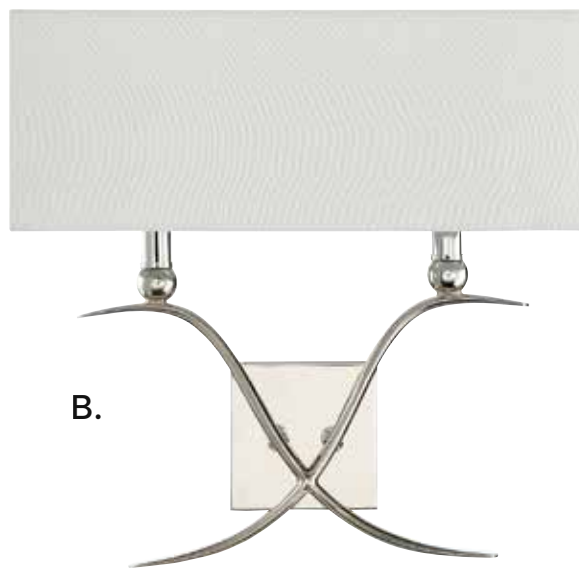

B.

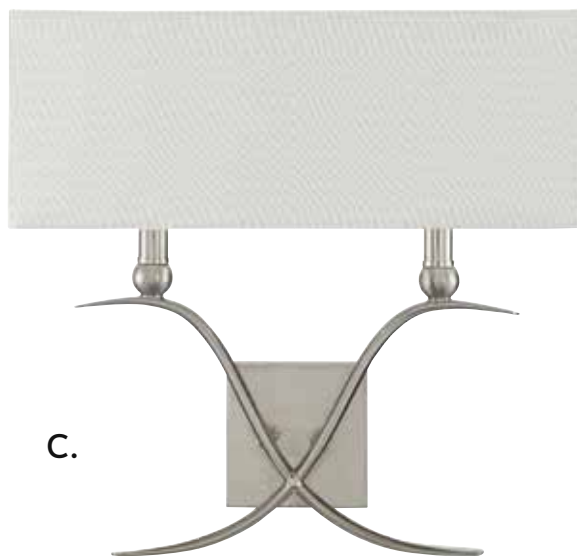

C.

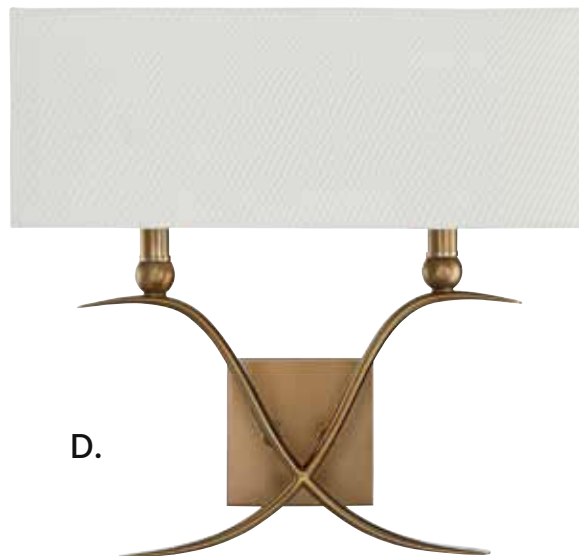

D.

A. 9-800-2-44
2-Light Sconce
Classic Bronze Finish
16"W x 15-1/2"H x 6"E
2C 60W
White Linen Shade
Metal Candle Covers

B. 9-800-2-109
2-Light Sconce
Polished Nickel Finish
16"W x 15-1/2"H x 6"E
2C 60W
White Linen Shade
Metal Candle Covers

C. 9-800-2-SN
2-Light Sconce
Satin Nickel Finish
16"W x 15-1/2"H x 6"E
2C 60W
White Linen Shade
Metal Candle Covers

D. 9-800-2-322
2-Light Sconce
Warm Brass Finish
16"W x 15-1/2"H x 6"E
2C 60W
White Linen Shade
Metal Candle Covers

PAYTON



MERRILL



- A. 5-801-322**
1-Light Indoor/Outdoor Sconce
Warm Brass Finish
8"W x 21-1/2"H x 8-1/4"E
1E 60W
Clear Glass
UL Damp Rated
- B. 5-801-13**
1-Light Indoor/Outdoor Sconce
English Bronze Finish
8"W x 21-1/2"H x 8-1/4"E
1E 60W
Clear Glass
UL Damp Rated
- C. 5-801-SN**
1-Light Indoor/Outdoor Sconce
Satin Nickel Finish
8"W x 21-1/2"H x 8-1/4"E
1E 60W
Clear Glass
UL Damp Rated
- D. 5-800-322**
1-Light Indoor/Outdoor Sconce
Warm Brass Finish
5-3/4"W x 18"H x 8"E
1E 60W
Clear Glass
UL Damp Rated
- E. 5-800-13**
1-Light Indoor/Outdoor Sconce
English Bronze Finish
5-3/4"W x 18"H x 8"E
1E 60W
Clear Glass
UL Damp Rated
- F. 5-800-SN**
1-Light Indoor/Outdoor Sconce
Satin Nickel Finish
5-3/4"W x 18"H x 8"E
1E 60W
Clear Glass
UL Damp Rated



**DAMP
Location**

MERRILL



A.



B.



C.



D.



E.



F.

WASHBURN



A. 9-0700-1-322
1-Light Sconce
Warm Brass Finish
7"W x 15"H x 9"E
1C 60W
White Linen Shade
Metal Candle Cover

B. 9-0700-1-109
1-Light Sconce
Polished Nickel Finish
7"W x 15"H x 9"E
1C 60W
White Linen Shade
Metal Candle Cover

C. 9-0700-1-SN
1-Light Sconce
Satin Nickel Finish
7"W x 15"H x 9"E
1C 60W
White Linen Shade
Metal Candle Cover

D. 9-0700-1-44
1-Light Sconce
Classic Bronze Finish
7"W x 15"H x 9"E
1C 60W
White Linen Shade
Metal Candle Cover

WASHBURN

A.



B.



C.



D.



PIKE



A.



B.



C.



- A. **9-16000-1-322**
1-Light Sconce
Warm Brass Finish
4-1/2"W x 15-1/4"H x 4-1/2"E
1E 60W
Clear Ribbed Glass
Bulb Included 300MM T9
- B. **9-16000-1-109**
1-Light Sconce
Polished Nickel Finish
4-1/2"W x 15-1/4"H x 4-1/2"E
1E 60W
Clear Ribbed Glass
Bulb Included 300MM T9
- C. **9-16000-1-44**
1-Light Sconce
Classic Bronze Finish
4-1/2"W x 15-1/4"H x 4-1/2"E
1E 60W
Clear Ribbed Glass
Bulb Included 300MM T9

CLIFTON



E.



D.



F.

- D. **9-900-1-322**
1-Light Sconce
Warm Brass Finish
4-1/4"W x 15-1/2"H x 4-1/2"E
1E 60W
Bulb Included 300MM T9
- E. **9-900-1-109**
1-Light Sconce
Polished Nickel Finish
4-1/4"W x 15-1/2"H x 4-1/2"E
1E 60W
Bulb Included 300MM T9
- F. **9-900-1-44**
1-Light Sconce
Classic Bronze Finish
4-1/4"W x 15-1/2"H x 4-1/2"E
1E 60W
Bulb Included 300MM T9

OWEN



A. 9-0900CP-1-13
 1-Light Adjustable Sconce
 English Bronze Finish
 6"W x 18"H x 6"E
 Adj E 6"-12"
 1E 60W
 150° Swivel
 White Fabric Shade
 Decorative Pull-Chain ON/OFF

B. 9-0900CP-1-109
 1-Light Adjustable Sconce
 Polished Nickel Finish
 6"W x 18"H x 6"E
 Adj E 6"-12"
 1E 60W
 150° Swivel
 White Fabric Shade
 Decorative Pull-Chain ON/OFF

C. 9-0900CP-1-SN
 1-Light Adjustable Sconce
 Satin Nickel Finish
 6"W x 18"H x 6"E
 Adj E 6"-12"
 1E 60W
 150° Swivel
 White Fabric Shade
 Decorative Pull-Chain ON/OFF

D. 9-0900CP-1-322
 1-Light Adjustable Sconce
 Warm Brass Finish
 6"W x 18"H x 6"E
 Adj E 6"-12"
 1E 60W
 150° Swivel
 White Fabric Shade
 Decorative Pull-Chain ON/OFF



Pull-chain, comes with **Cord & Plug** and **Hardwire**.

MORLAND



A. 9-961CP-1-13
1-Light Adjustable Sconce
English Bronze Finish
6"W x 16"H x 13"E
Adj E 13" - 33-3/4"
1E 60W
150° Swivel

B. 9-961CP-1-322
1-Light Adjustable Sconce
Warm Brass Finish
6"W x 16"H x 13"E
Adj E 13" - 33-3/4"
1E 60W
150° Swivel

C. 9-961CP-1-SN
1-Light Adjustable Sconce
Satin Nickel Finish
6"W x 16"H x 13"E
Adj E 13" - 33-3/4"
1E 60W
150° Swivel

D. 9-961CP-1-109
1-Light Adjustable Sconce
Polished Nickel Finish
6"W x 16"H x 13"E
Adj E 13" - 33-3/4"
1E 60W
150° Swivel

MORLAND

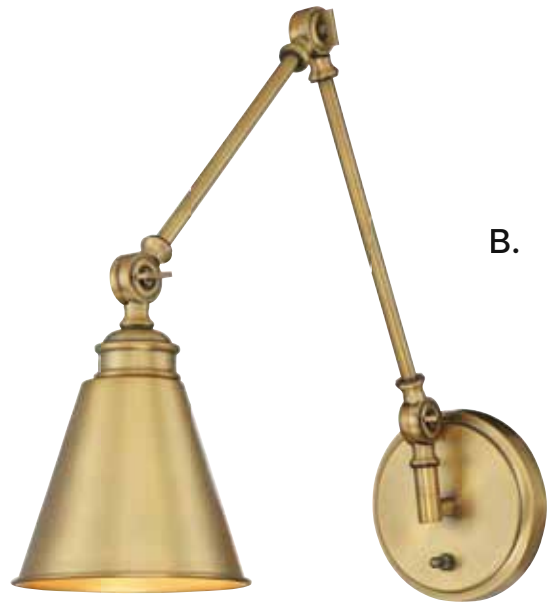

Switch, comes with **Cord & Plug** and **Hardwire**.

DAKOTA

A.



B.

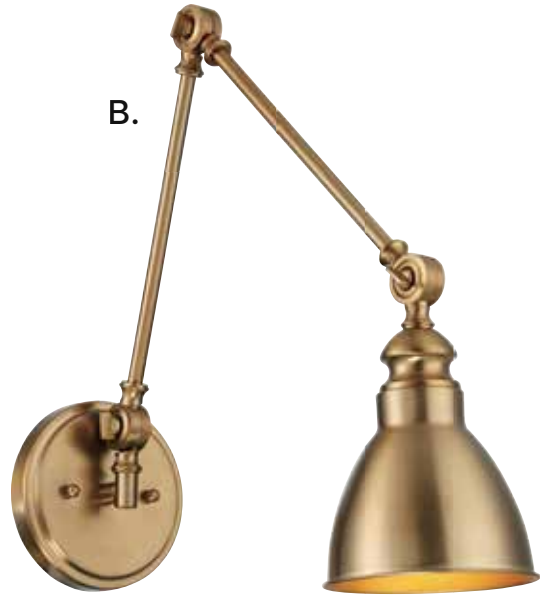

C.



D.

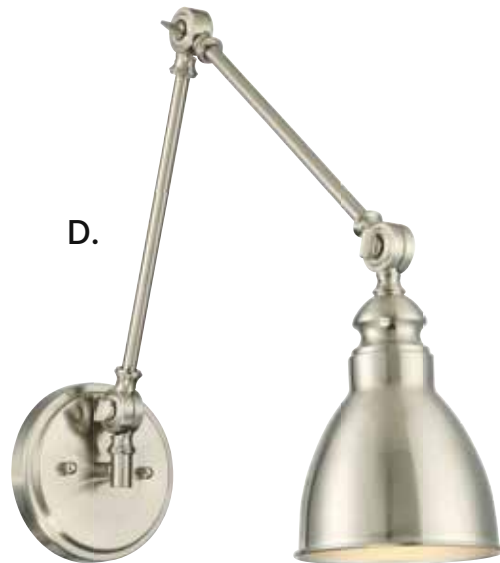

Hardwire *only*.

DAKOTA

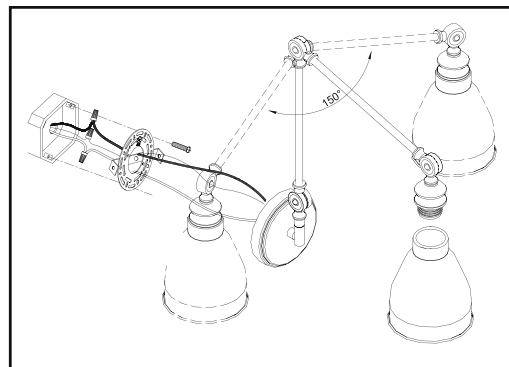

A. 9-960-1-13

1-Light Adjustable Sconce
English Bronze Finish
5-1/2"W x 17"H x 13"E
Adj E 13" - 33-3/4"
1E 60W
150° Swivel

D. 9-960-1-322

1-Light Adjustable Sconce
Warm Brass Finish
5-1/2"W x 17"H x 13"E
Adj E 13" - 33-3/4"
1E 60W
150° Swivel

C. 9-960-1-109

1-Light Adjustable Sconce
Polished Nickel Finish
5-1/2"W x 17"H x 13"E
Adj E 13" - 33-3/4"
1E 60W
150° Swivel

D. 9-960-1-SN

1-Light Adjustable Sconce
Satin Nickel Finish
5-1/2"W x 17"H x 13"E
Adj E 13" - 33-3/4"
1E 60W
150° Swivel

DRAKE

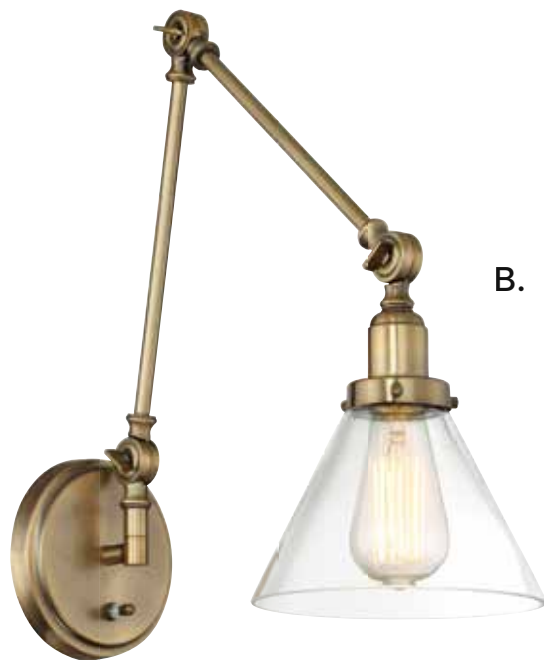

Switch, comes with **Cord & Plug** and **Hardwire**.

DRAKE

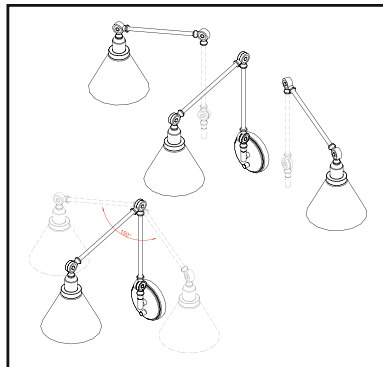

A. 9-9131CP-1-13
1-Light Sconce
English Bronze Finish
7-1/2"W x 17"H x 14"E
Adj E 14" - 34-1/2"E
1E 60W
150° Swivel
Clear Glass

B. 9-9131CP-1-322
1-Light Sconce
Warm Brass Finish
7-1/2"W x 17"H x 14"E
Adj E 14" - 34-1/2"E
1E 60W
150° Swivel
Clear Glass

C. 9-9131CP-1-SN
1-Light Sconce
Satin Nickel Finish
7-1/2"W x 17"H x 14"E
Adj E 14" - 34-1/2"E
1E 60W
150° Swivel
Clear Glass

D. 9-9131CP-1-109
1-Light Sconce
Polished Nickel Finish
7-1/2"W x 17"H x 14"E
Adj E 14" - 34-1/2"E
1E 60W
150° Swivel
Clear Glass

OCTAVE



OCTAVE



A.



C.



D.



B.

A. 8-4030-2-BK
2-Light Bath Bar
Matte Black Finish
13-3/4"W x 9"H x 5-1/2"E
2E 60W
Clear Glass

B. 9-4030-1-BK
1-Light Sconce
Matte Black Finish
5"W x 9-1/2"H x 6"E
1E 60W
Clear Glass

C. 8-4030-3-BK
3-Light Bath Bar
Matte Black Finish
21"W x 9"H x 5-1/2"E
3E 60W
Clear Glass

D. 8-4030-4-BK
4-Light Bath Bar
Matte Black Finish
28-3/4"W x 9"H x 5-1/2"E
4E 60W
Clear Glass

E. 8-4030-2-11
2-Light Bath Bar
Polished Chrome Finish
13-3/4"W x 9"H x 5-1/2"E
2E 60W
Clear Glass



E.



G.



H.



F.

F. 9-4030-1-11
1-Light Sconce
Polished Chrome Finish
5"W x 9-1/2"H x 6"E
1E 60W
Clear Glass

G. 8-4030-3-11
3-Light Bath Bar
Polished Chrome Finish
21"W x 9"H x 5-1/2"E
3E 60W
Clear Glass

H. 8-4030-4-11
4-Light Bath Bar
Polished Chrome Finish
28-3/4"W x 9"H x 5-1/2"E
4E 60W
Clear Glass

Fixtures may be mounted as either **Uplight** or **Downlight**.

OCTAVE

A. 9-4030-1-13

1-Light Sconce
 English Bronze Finish
 5"W x 9-1/2"H x 6"E
 1E 60W
 Clear Glass



B. 8-4030-2-13

2-Light Bath Bar
 English Bronze Finish
 13-3/4"W x 9"H x 5-1/2"E
 2E 60W
 Clear Glass

B.



C. 8-4030-3-13

3-Light Bath Bar
 English Bronze Finish
 21"W x 9"H x 5-1/2"E
 3E 60W
 Clear Glass

C.



D. 8-4030-4-13

4-Light Bath Bar
 English Bronze Finish
 28-3/4"W x 9"H x 5-1/2"E
 4E 60W
 Clear Glass

D.



E. 9-4030-1-322

1-Light Sconce
 Warm Brass Finish
 5"W x 9-1/2"H x 6"E
 1E 60W
 Clear Glass



F. 8-4030-2-322

2-Light Bath Bar
 Warm Brass Finish
 13-3/4"W x 9"H x 5-1/2"E
 2E 60W
 Clear Glass

F.



G. 8-4030-3-322

3-Light Bath Bar
 Warm Brass Finish
 21"W x 9"H x 5-1/2"E
 3E 60W
 Clear Glass

E.



H. 8-4030-4-322

4-Light Bath Bar
 Warm Brass Finish
 28-3/4"W x 9"H x 5-1/2"E
 4E 60W
 Clear Glass

H.



Fixtures may be mounted as either **Uplight** or **Downlight**.



DRAKE



Fixtures may be mounted as either **Uplight** or **Downlight**.

DRAKE



- | | | | | | |
|---|--|--|--|--|---|
| A. 8-9130-4-322
4-Light Bath Bar
Warm Brass Finish
38"W x 10"H x 7-1/2"E
4E 60W
Clear Glass | B. 8-9130-3-322
3-Light Bath Bar
Warm Brass Finish
28-1/2"W x 10"H x
7-1/2"E
3E 60W
Clear Glass | C. 8-9130-2-322
2-Light Bath Bar
Warm Brass Finish
17-3/4"W x 10"H x
7-1/2"E
2E 60W
Clear Glass | D. 8-9130-2-BK
2-Light Bath Bar
Matte Black Finish
17-3/4"W x 10"H x
7-1/2"E
2E 60W
Clear Glass | E. 8-9130-3-BK
3-Light Bath Bar
Matte Black Finish
28-1/2"W x 10"H x
7-1/2"E
3E 60W
Clear Glass | F. 8-9130-4-BK
4-Light Bath Bar
Matte Black Finish
38"W x 10"H x 7-1/2"E
4E 60W
Clear Glass |
|---|--|--|--|--|---|

DRAKE



- | | | | | | |
|--|--|--|--|--|--|
| <p>A. 8-9130-4-109
4-Light Bath Bar
Polished Nickel Finish
38"W x 10"H x 7-1/2"E
4E 60W
Clear Glass</p> | <p>B. 8-9130-3-109
3-Light Bath Bar
Polished Nickel Finish
28-1/2"W x 10"H x
7-1/2"E
3E 60W
Clear Glass</p> | <p>C. 8-9130-2-109
2-Light Bath Bar
Polished Nickel Finish
17-3/4"W x 10"H x
7-1/2"E
2E 60W
Clear Glass</p> | <p>D. 8-9130-2-13
2-Light Bath Bar
English Bronze Finish
17-3/4"W x 10"H x
7-1/2"E
2E 60W
Clear Glass</p> | <p>E. 8-9130-3-13
3-Light Bath Bar
English Bronze Finish
28-1/2"W x 10"H x
7-1/2"E
3E 60W
Clear Glass</p> | <p>F. 8-9130-4-13
4-Light Bath Bar
English Bronze Finish
38"W x 10"H x 7-1/2"E
4E 60W
Clear Glass</p> |
|--|--|--|--|--|--|

DRAKE



Fixtures may be mounted as either **Uplight** or **Downlight**.

CALHOUN



CALHOUN



A.



B



C.

- A. **8-1020-4-BK**
4-Light Bath Bar
Matte Black Finish
32"W x 8-3/4"H x 6-3/8"E
4E 60W
Clear Glass
- B. **8-1020-3-BK**
3-Light Bath Bar
Matte Black Finish
24"W x 8-3/4"H x 6-3/8"E
3E 60W
Clear Glass
- C. **8-1020-2-BK**
2-Light Bath Bar
Matte Black Finish
14-5/8"W x 8-3/4"H x 6-3/8"E
2E 60W
Clear Glass

Fixtures may be mounted as either **Uplight** or **Downlight**.

MELROSE



A. 8-6836-2-322
2-Light Bath Bar
Warm Brass Finish
14-1/2"W x 7-3/4"H x 6-3/4"E
2E 60W
White Opal Etched Glass

B. 8-6836-3-322
3-Light Bath Bar
Warm Brass Finish
24"W x 7-3/4"H x 6-3/4"E
3E 60W
White Opal Etched Glass

C. 8-6836-4-322
4-Light Bath Bar
Warm Brass Finish
33-1/2"W x 7-3/4"H x 6-3/4"E
4E 60W
White Opal Etched Glass

D. 9-6836-1-322
1-Light Sconce
Warm Brass Finish
5"W x 7-3/4"H x 6-3/4"E
1E 60W
White Opal Etched Glass

MELROSE

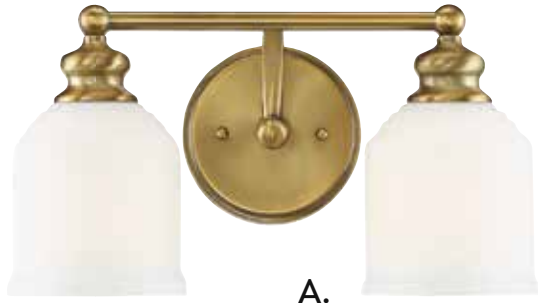

A.



B.



C.



D.

Fixtures may be mounted as either **Uplight** or **Downlight**.

BRIAN THOMAS
 COLLECTION



E.



F.



G.



H.

Fixtures may be mounted as either **Uplight** or **Downlight**.

BRIAN THOMAS
 COLLECTION

E. 8-6836-2-SN
 2-Light Bath Bar
 Satin Nickel Finish
 14-1/2"W x 7-3/4"H x 6-3/4"E
 2E 60W
 White Opal Etched Glass

F. 8-6836-3-SN
 3-Light Bath Bar
 Satin Nickel Finish
 24"W x 7-3/4"H x 6-3/4"E
 3E 60W
 White Opal Etched Glass

G. 8-6836-4-SN
 4-Light Bath Bar
 Satin Nickel Finish
 33-1/2"W x 7-3/4"H x 6-3/4"E
 4E 60W
 White Opal Etched Glass

H. 9-6836-1-SN
 1-Light Sconce
 Satin Nickel Finish
 5"W x 7-3/4"H x 6-3/4"E
 1E 60W
 White Opal Etched Glass

MELROSE



A.



B.



C.



D.

Fixtures may be mounted as either Uplight or Downlight.

BRIAN THOMAS
COLLECTION



E.



F.



G.



H.

Fixtures may be mounted as either Uplight or Downlight.

BRIAN THOMAS
COLLECTION

A. 8-6836-2-13
2-Light Bath Bar
English Bronze Finish
14-1/2"W x 7-3/4"H x 6-3/4"E
2E 60W
White Opal Etched Glass

B. 8-6836-3-13
3-Light Bath Bar
English Bronze Finish
24"W x 7-3/4"H x 6-3/4"E
3E 60W
White Opal Etched Glass

C. 8-6836-4-13
4-Light Bath Bar
English Bronze Finish
33-1/2"W x 7-3/4"H x 6-3/4"E
4E 60W
White Opal Etched Glass

D. 9-6836-1-13
1-Light Sconce
English Bronze Finish
5"W x 7-3/4"H x 6-3/4"E
1E 60W
White Opal Etched Glass

MELROSE



E. 8-6836-2-11
2-Light Bath Bar
Polished Chrome Finish
14-1/2"W x 7-3/4"H x 6-3/4"E
2E 60W
White Opal Etched Glass

F. 8-6836-3-11
3-Light Bath Bar
Polished Chrome Finish
24"W x 7-3/4"H x 6-3/4"E
3E 60W
White Opal Etched Glass

G. 8-6836-4-11
4-Light Bath Bar
Polished Chrome Finish
33-1/2"W x 7-3/4"H x 6-3/4"E
4E 60W
White Opal Etched Glass

H. 9-6836-1-11
1-Light Sconce
Polished Chrome Finish
5"W x 7-3/4"H x 6-3/4"E
1E 60W
White Opal Etched Glass

INDEX

1-1663-6-109.....	29	3-322-6-89.....	46	7-132-1-323.....	64	8-6836-4-11.....	123
1-1663-6-322.....	29	3-322-6-SN.....	46	7-132-1-89.....	64	8-6836-4-13.....	122
1-2070-1-109.....	71	3-9074-4-67.....	60	7-1660-6-109.....	26	8-6836-4-322.....	120
1-2070-1-13.....	71	3-9074-4-79.....	60	7-1660-6-322.....	24	8-6836-4-SN.....	121
1-2070-1-322.....	71	3-9074-8-67.....	60	7-1661-6-109.....	26	8-9130-2-109.....	116
1-2070-1-SN.....	71	3-9074-8-79.....	60	7-1661-6-322.....	24	8-9130-2-13.....	116
1-305-6-109.....	4	3-9099-4-109.....	40	7-17000-1-109.....	73	8-9130-2-322.....	115
1-305-6-322.....	4	3-9099-4-322.....	40	7-17000-1-13.....	73	8-9130-2-BK.....	115
1-305-6-44.....	4	3-9099-4-44.....	40	7-17000-1-322.....	73	8-9130-3-109.....	116
1-305-6-89.....	4	5-800-13.....	96	7-200-3-322.....	36	8-9130-3-13.....	116
1-305-6-SN.....	4	5-800-322.....	96	7-200-3-57.....	36	8-9130-3-322.....	115
1-306-8-109.....	7	5-800-SN.....	96	7-201-4-322.....	37	8-9130-3-BK.....	115
1-306-8-322.....	7	5-801-13.....	96	7-201-4-57.....	37	8-9130-4-109.....	116
1-306-8-44.....	7	5-801-322.....	96	7-2201-4-13.....	67	8-9130-4-13.....	116
1-306-8-89.....	7	5-801-SN.....	96	7-2201-4-322.....	67	8-9130-4-322.....	115
1-306-8-SN.....	7	6-1043-3-109.....	54	7-2201-4-SN.....	67	8-9130-4-BK.....	115
1-307-6-109.....	14	6-1043-3-13.....	54	7-3100-1-322.....	38	9-0700-1-109.....	98
1-307-6-322.....	14	6-1043-3-BK.....	54	7-3100-1-SN.....	38	9-0700-1-322.....	98
1-307-6-44.....	14	6-1043-3-SN.....	55	7-3102-1-322.....	39	9-0700-1-44.....	98
1-307-6-89.....	14	6-1662-4-109.....	26	7-3102-1-SN.....	39	9-0700-1-SN.....	98
1-307-6-SN.....	14	6-1662-4-322.....	24	7-4034-3-11.....	10	9-0900CP-1-109.....	102
1-308-8-109.....	17	6-3058-4-109.....	58	7-4034-3-13.....	12	9-0900CP-1-13.....	102
1-308-8-322.....	17	6-3058-4-13.....	57	7-4034-3-322.....	8	9-0900CP-1-322.....	102
1-308-8-44.....	17	6-3350-14-109.....	85	7-4036-1-11.....	75	9-0900CP-1-SN.....	102
1-308-8-89.....	17	6-3350-14-13.....	85	7-4036-1-13.....	75	9-1000-1-109.....	92
1-308-8-SN.....	17	6-3350-14-322.....	85	7-4036-1-322.....	75	9-1000-1-13.....	92
1-310-10-109.....	19	6-3350-14-SN.....	85	7-5012-1-109.....	72	9-1000-1-322.....	92
1-310-10-322.....	19	6-3350-16-109.....	85	7-5012-1-13.....	72	9-1000-1-SN.....	92
1-310-10-44.....	19	6-3350-16-13.....	85	7-5012-1-322.....	72	9-16000-1-109.....	100
1-310-10-89.....	19	6-3350-16-322.....	85	7-6098-12-109.....	33	9-16000-1-322.....	100
1-310-10-SN.....	19	6-3350-16-SN.....	85	7-6098-12-322.....	33	9-16000-1-44.....	100
1-312-15-109.....	22	6-3351-3-13.....	82	7-6098-12-44.....	33	9-302-1-109.....	91
1-312-15-322.....	22	6-3351-3-322.....	82	7-6099-24-109.....	30	9-302-1-322.....	90
1-312-15-44.....	22	6-3351-3-SN.....	82	7-6099-24-322.....	30	9-302-1-44.....	90
1-312-15-89.....	21	6-3352-2-13.....	82	7-6099-24-44.....	30	9-302-1-89.....	89
1-312-15-SN.....	22	6-3352-2-322.....	82	7-700-1-109.....	77	9-302-1-SN.....	89
1-323-3-109.....	48	6-3352-2-SN.....	82	7-700-1-13.....	77	9-303-1-109.....	91
1-323-3-322.....	48	6-4035-3-11.....	79	7-701-1-SN.....	77	9-303-1-322.....	90
1-323-3-44.....	48	6-4035-3-13.....	79	7-702-1-109.....	76	9-303-1-44.....	90
1-323-3-89.....	48	6-4035-3-322.....	79	7-702-1-13.....	76	9-303-1-89.....	89
1-323-3-SN.....	48	6-4037-1-11.....	79	7-703-1-SN.....	76	9-303-1-SN.....	89
1-324-5-109.....	51	6-4037-1-13.....	79	7-9006-3-109.....	41	9-4030-1-11.....	111
1-324-5-322.....	51	6-4037-1-322.....	79	7-9006-3-13.....	41	9-4030-1-13.....	112
1-324-5-44.....	51	6-4037-1-BK.....	79	7-9006-3-322.....	41	9-4030-1-322.....	112
1-324-5-89.....	51	6-780-11-109.....	87	7-9006-3-SN.....	41	9-4030-1-BK.....	111
1-324-5-SN.....	51	6-780-11-13.....	87	7-9132-1-109.....	74	9-6836-1-11.....	123
1-4031-3-11.....	10	6-780-11-322.....	87	7-9132-1-13.....	74	9-6836-1-13.....	122
1-4031-3-13.....	12	6-780-11-BK.....	86	7-9132-1-322.....	74	9-6836-1-322.....	120
1-4031-3-322.....	8	6-780-11-SN.....	87	7-9132-1-SN.....	74	9-6836-1-SN.....	121
1-4032-5-11.....	10	6-780-13-109.....	87	7-9160-1-109.....	34	9-7144-1-109.....	91
1-4032-5-13.....	12	6-780-13-13.....	87	7-9160-1-322.....	34	9-7144-1-322.....	90
1-4032-5-322.....	8	6-780-13-322.....	87	7-9161-4-109.....	34	9-7144-1-44.....	90
1-4033-9-11.....	10	6-780-13-BK.....	86	7-9161-4-322.....	34	9-7144-1-89.....	89
1-4033-9-13.....	12	6-780-13-SN.....	87	8-1020-2-BK.....	119	9-7144-1-SN.....	89
1-4033-9-322.....	8	6-9069-13-109.....	81	8-1020-3-BK.....	119	9-800-2-109.....	94
1-9075-6-67.....	63	6-9069-13-13.....	81	8-1020-4-BK.....	119	9-800-2-322.....	94
1-9075-6-79.....	63	6-9069-13-322.....	81	8-4030-2-11.....	111	9-800-2-44.....	94
3-3055-4-109.....	58	6-9069-13-SN.....	81	8-4030-2-13.....	112	9-800-2-SN.....	94
3-3055-4-13.....	57	7-1040-3-109.....	54	8-4030-2-322.....	112	9-900-1-109.....	101
3-3056-4-109.....	58	7-1040-3-13.....	54	8-4030-2-BK.....	111	9-900-1-322.....	101
3-3056-4-13.....	57	7-1040-3-BK.....	54	8-4030-3-11.....	111	9-900-1-44.....	101
3-3057-8-109.....	58	7-1040-3-SN.....	55	8-4030-3-13.....	112	9-9131CP-1-109.....	109
3-3057-8-13.....	57	7-1041-6-109.....	52	8-4030-3-322.....	112	9-9131CP-1-13.....	109
3-320-3-109.....	42	7-1041-6-13.....	53	8-4030-3-BK.....	111	9-9131CP-1-322.....	109
3-320-3-322.....	42	7-1041-6-BK.....	53	8-4030-4-11.....	111	9-9131CP-1-SN.....	109
3-320-3-44.....	42	7-1041-6-SN.....	53	8-4030-4-13.....	112	9-960-1-109.....	107
3-320-3-89.....	42	7-130-1-109.....	69	8-4030-4-322.....	112	9-960-1-13.....	107
3-320-3-SN.....	42	7-130-1-44.....	69	8-4030-4-BK.....	111	9-960-1-322.....	107
3-321-4-109.....	45	7-130-1-63.....	69	8-6836-2-11.....	123	9-960-1-SN.....	107
3-321-4-322.....	45	7-130-1-SN.....	69	8-6836-2-13.....	122	9-961CP-1-109.....	104
3-321-4-44.....	45	7-131-1-109.....	64	8-6836-2-322.....	120	9-961CP-1-13.....	104
3-321-4-89.....	45	7-131-1-322.....	64	8-6836-2-SN.....	121	9-961CP-1-322.....	104
3-321-4-SN.....	45	7-131-1-323.....	64	8-6836-3-11.....	123	9-961CP-1-SN.....	104
3-322-6-109.....	46	7-131-1-89.....	64	8-6836-3-13.....	122		
3-322-6-322.....	46	7-132-1-109.....	64	8-6836-3-322.....	120		
3-322-6-44.....	46	7-132-1-322.....	64	8-6836-3-SN.....	121		

FINISH GUIDE

02	OILED BRONZE	58	ROSE GOLD	113	BRUSHED BRONZE
04	DARK BAMBOO	59	DISTRESSED BRONZE	114	BRITANNIA GOLD
05	OILED COPPER	60	AVALITE	115	RUSTIC BLACK W/ ROPE
07	EBONY	61	BRONZE ORE	117	HERITAGE BRONZE
8	NEW TORTOISE SHELL W/ SILVER	62	COMO BLACK W/ GOLD	121	MOHICAN BRONZE
09	CENTURY BRONZE	63	WARM BRASS LUSTRE	122	GOLD DUST
11	POLISHED CHROME	64	FIELDSTONE	124	FIESTA BRONZE
12	CHATEAU LINEN	65	MIDLAND BRONZE	125	RELIC RUST
13	ENGLISH BRONZE	66	COTTAGE WOOD	128	OXIDIZED SILVER
14	RAW STEEL	67	MATTE BLACK W/ POLISHED CHROME ACCENTS	129	ESPRESSO
15	BRONZE PATINA	68	WHISKEY WOOD	131	GUILDED BRONZE
16	ANTIQUÉ COPPER	69	PEWTER	132	MOONLIT BARK
17	FORGED BLACK	70	WEATHERVANE	133	SAPELE FINISH
18	ANDALUSITE	71	ARCHITECTURAL BRONZE	139	PEWTER & GREYWOOD
19	EBONY W/ TITIAN ACCENTS	72	RUSTIC BRONZE	140	MISTY SKY
20	POLISHED NICKEL W/ BRONZE ACCENTS	73	POLISHED NICKEL W/ GRAPHITE & WOOD ACCENTS	167	TIERRA DE SIENNA
21	BARN WOOD	74	WEATHERED WOOD	176	SILVER LACE
21F	BURNISHED RUSSET	75	GUNMETAL	186	COMO BLACK
22	BURNISHED GOLD	76	FLORENCIAN BRONZE	187	BRUSHED PEWTER
23	WHITE WASHED DRIFTWOOD	77	BRONZE W/ BRASS ACCENTS	192	DISTRESSED WHITE WOOD & IRON
24	HORSESHOE BLACK	78	GRAPHITE	196	RECLAIMED WOOD
25	SLATE	79	ENGLISH BRONZE W/ WARM BRASS	211	ARGENTUM
26	POLISHED CHROME W/ SATIN CHROME ACCENTS	80	MATTE WHITE	212	ARGENTUM & GOLD
27	INDUSTRIAL STEEL	81	POLISHED PEWTER W/ BLACK LEATHERETTE	213	ENGLISH BRONZE W/ GOLD
28	OILED BURNISHED BRONZE	82	PORCELLANA	234	PARISIAN BRONZE
29	DISTRESSED SILVER LEAF	83	REMINGTON BRONZE	241	MOROCCAN BRONZE
30	CARBON W/ WARM BRASS ACCENTS	84	RUBBED BRONZE W/ GOLD LEAF	242	AGED STEEL
31	FLAT BLACK	85	RUBBED ZINC W/ SILVER LEAF	250	MERCURY BLACK
32	ARTISAN RUST	86	CUPRUM	256	NEW MOCHA
33	GOLD BULLION	87	WOODLAND BRONZE	272	SILVER DUST
34	SILVER LEAF	88	OXIDIZED BLACK	285	ANTIQUÉ NICKEL
35	BYZANTINE BRONZE	89	MATTE BLACK	286	PENATE GOLD
39	FOSSIL STONE	90	GALVANIZED METAL	290	BURNISHED SIENNA
40	WALNUT PATINA	91	SUNSET BRONZE	300	ANTIQUITY
41	DURANGO	92	AGED IRON & WOOD	306	OLD TUSCAN
42	GALAXY BRONZE	95	WARM BRASS W/ BRONZE ACCENTS	307	SILVER SPARKLE
43	VINTAGE NICKEL	96	BARRELWOOD W/ BRASS ACCENTS	322	WARM BRASS
44	CLASSIC BRONZE	97	NATURAL WOOD & ROPE	323	OLD BRONZE
45	AGED WOOD	100	AURORA	326	AGED IRON W/ SOFT COPPER ACCENTS
46	MATTE BLACK W/ GOLD ACCENTS	101	NOBLEWOOD W/ IRON	327	DARK WOOD W/ GUILDED BRONZE
47	DISTRESSED SILVER	102	CANYON	330	TEXTURED BRONZE
48	STATUARY BRONZE	105	EMPYREAN	332	HEIRLOOM SILVER
49	WINTERWOOD	107	BRONZE & CHROME W/ ANTIQUÉ MIRROR ACCENTS	AG	AUTUMN GOLD
50	HARNES LEATHER W/ RUBBED BRASS	108	BRONZE W/ STAINLESS STEEL	BK/BLK	MATTE BLACK
51	VINTAGE BLACK W/ WARM BRASS	109	POLISHED NICKEL	BN	BROWNSTONE
52	BARK & GOLD	110	SHADOW SMOKE	BZ	BRONZE
53	SILVER PATINA	111	SATIN NICKEL W/ POLISHED NICKEL ACCENTS	CH	CHROME
54	GOLD PATINA	112	WEATHERED BIRCH	CM	CREAM
55	AGED IRON			DMB	DARK METALLIC BRONZE
56	NEW TORTOISE SHELL			FB	FLAT BLACK
57	POLISHED PEWTER			SN	SATIN NICKEL
				OWB	OLD WEATHERED BRONZE
				WHWHT	WHITE

S
A
V
O
Y

H
O
U
S
E



3130 North Berkeley Lake Road NW ♦ Duluth, GA 30096
800 801 1621 TEL 404 890 7540 ♦ FAX 877 547 2869
SavoyHouse.com