

WAC LIGHTING

2018

NEW PRODUCT SUPPLEMENT

WAC LIGHTING 2018

HIGHLIGHTS

VOLTA 2" (p. 2-7)

Our 4.5" recessed lighting is a hit, but specifiers have asked for even smaller options. That's why we created the new 2" version in five styles loaded with the features they love.

AETHER TRIMLESS (p. 8-9)

Introducing the newest addition to our family of recessed LED downlights designed specifically for shallow plenums. Featuring new adjustable trimless styles and remodel options.

OCULUX DIM-TO-WARM (p. 12-13)

Ever miss the warm glow of incandescent lighting when you dim? That's why we now offer Oculux with Dim-to Warm technology.

LUCIO (p. 14-15)

Lucio is the new standard of architectural excellence a premier trackhead with multiple beam optics, including a six degree spotlight and asymmetric distribution.

PIXELS (p. 18-21)

The future of fixture-free lighting has arrived. Pixels allows you to tailor solutions for any environment with flexible, mountable, customizable 12" x 24" sheets.

FLEXLINE (p. 22-23)

Perfect for coves, Flexline adapts to the job at hand, even up to one-hundred fifty feet, thanks to various length modules, and an ultra-thin profile.

WAC LANDSCAPE (p. 32-40)

We've updated many of our designs and are introducing some new ones with special features like adjustable color temperatures and on-board dimming.

Wait...there's more.

Flip through to see all the latest from WAC Lighting, and check out wacighting.com for our complete product offering.



CUSTOM IS HERE

This year, we've seen a real desire for customization. Designers want color temperature options, adjustable optics and accessories, lighting that can seamlessly integrate into unique environments, and custom sizes and finishes.

We are committed to delivering the highest performing products with the fastest turnaround. Our teams of over 100 designers and engineers regularly invent and create new technical and decorative luminaires in a few short months, not years. We now also offer full custom capabilities.

Since we thoroughly test our luminaires and manufacture them with a zero-landfill promise, you can rest assured the best LED technology and designs are incorporated in the sustainable solutions we provide.

**small aperture
HUGE PERFORMANCE**



Round and Square form factors
 Selectable outputs up to 1600 lumens
 Die-cast self flanged aluminum construction
 Beam spreads from 12° spot to 60° wide flood
 Choices of trims include Downlights, 45° Adjustable, Pinhole, and Wall Wash

Available in six architectural grade finishes



White



Haze



Haze / White



Black / White



Black



Copper Bronze



Installation and service ease
 Quickly removable trim assembly and
 below ceiling serviceable cutout

NEW CONSTRUCTION HOUSING

- 22W and 15W power options
- Chicago Plenum and Emergency backup available
- Universal mounting bracket (Hanger bars included)
- Universal input voltage 120V - 277V
- Reverse phase (ELV) and 0-10V dimming standard

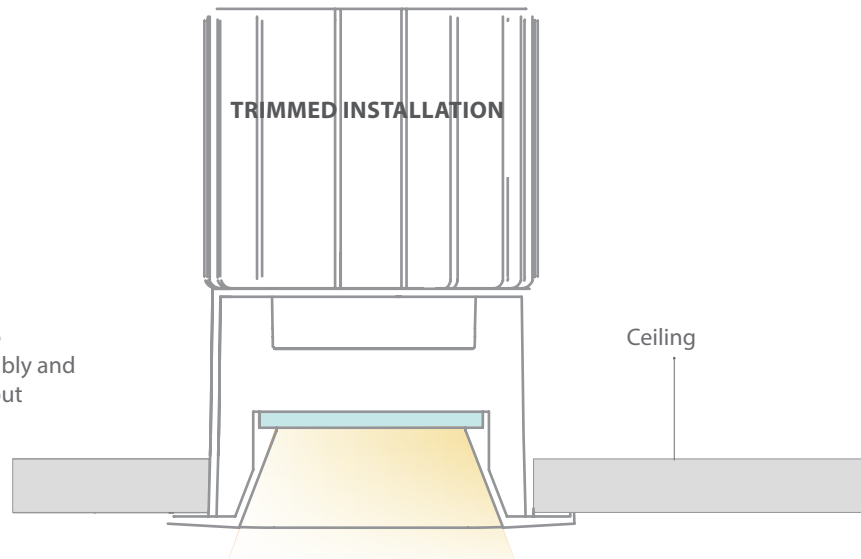

VOLTA 2" ARCHITECTURAL 2" LED RECESSED

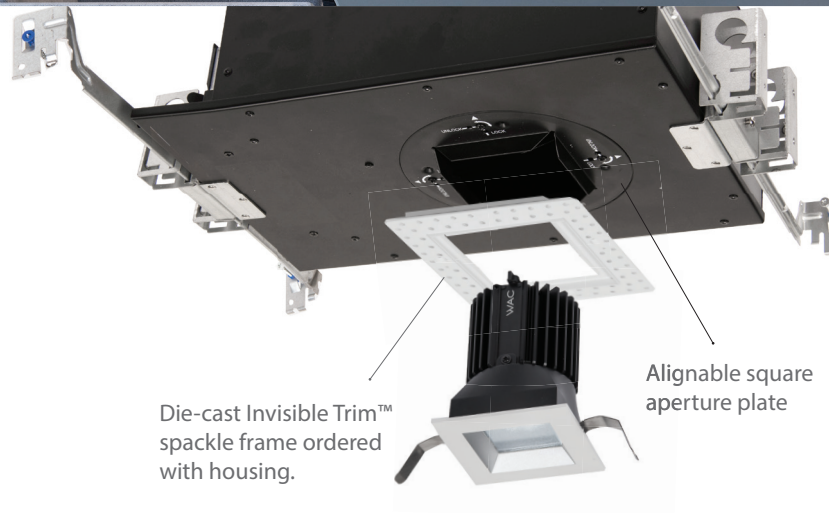

Die-cast Invisible Trim™ spackle frame ordered with housing.

Alignable square aperture plate

INVISIBLE TRIM™ INSTALLATION

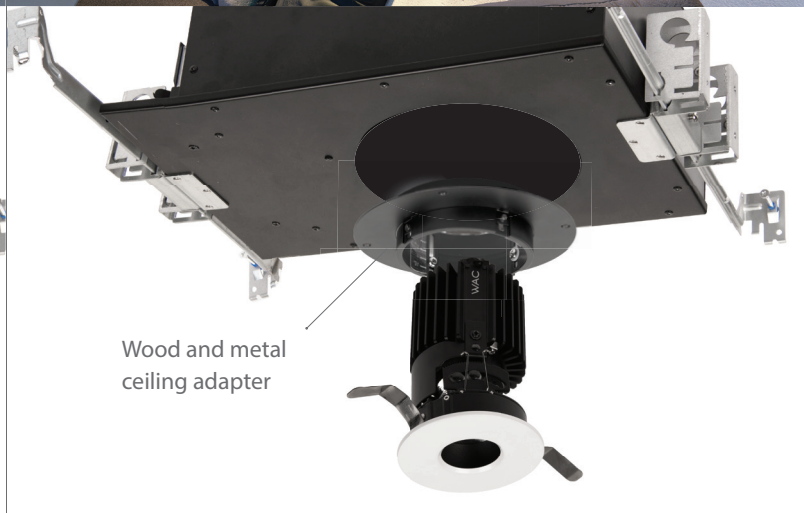

Wood and metal ceiling adapter

WOOD AND METAL CEILING INSTALLATION

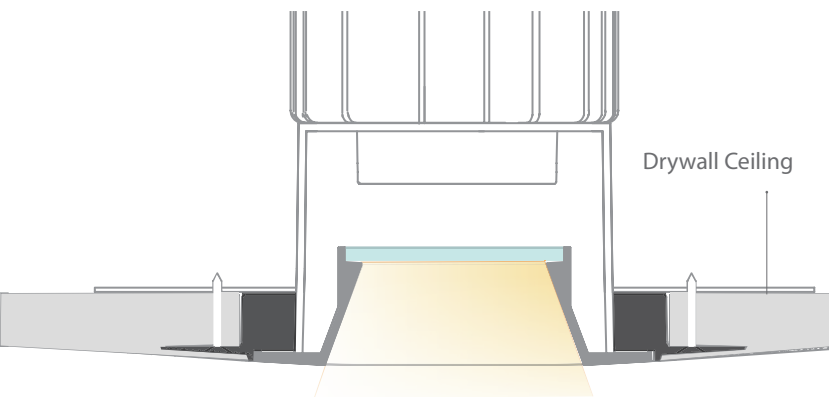

Drywall Ceiling

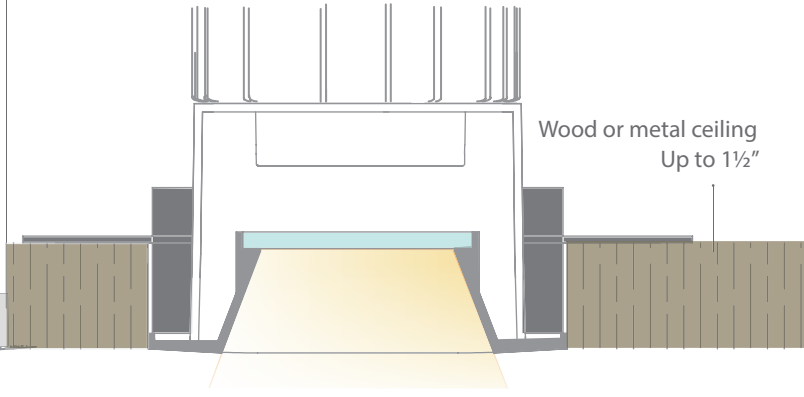

Wood or metal ceiling
Up to 1½"

VOLTA 2" ARCHITECTURAL 2" LED RECESSED

DOWNLIGHT



- General illumination
- Superior glare control

SHALLOW REGRESSED DOWNLIGHT



- Increased field angle for reduced scalloping
- Low ceiling and close to wall applications



VOLTA 2" ARCHITECTURAL 2" LED RECESSED

ADJUSTABLE

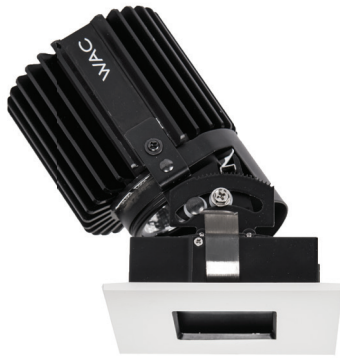

ADJUSTABLE

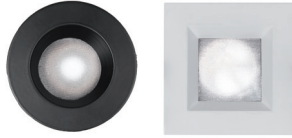

PINHOLE

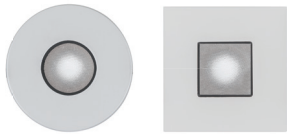

- Center beam alignment maintained throughout adjustment range
- 0–45° vertical and 365° horizontal lockable hot aiming

PRECISION AIMING

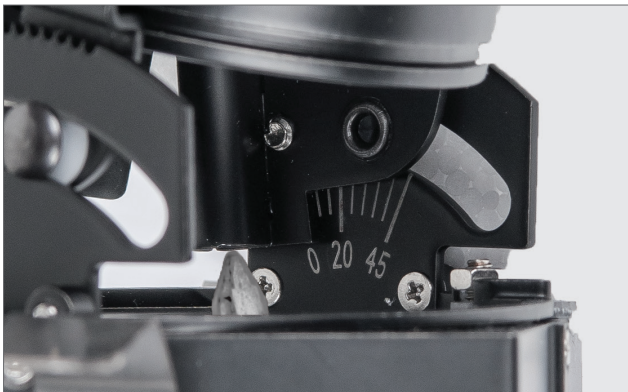

0–45° vertical lockable hot aiming



365° horizontal lockable hot aiming

WALL WASH

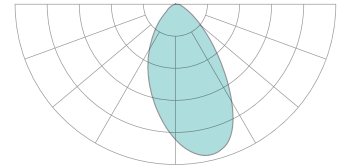

- Innovative bi-directional spread lens
- Engineered for even wall illumination horizontally and vertically

BI-DIRECTIONAL SPREAD LENS

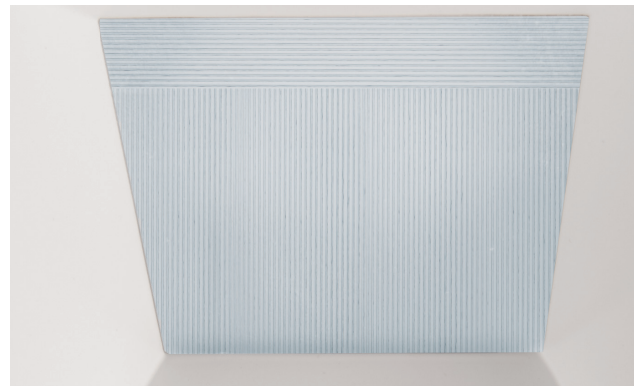

Horizontal spread

Even coverage for greater fixture spacing

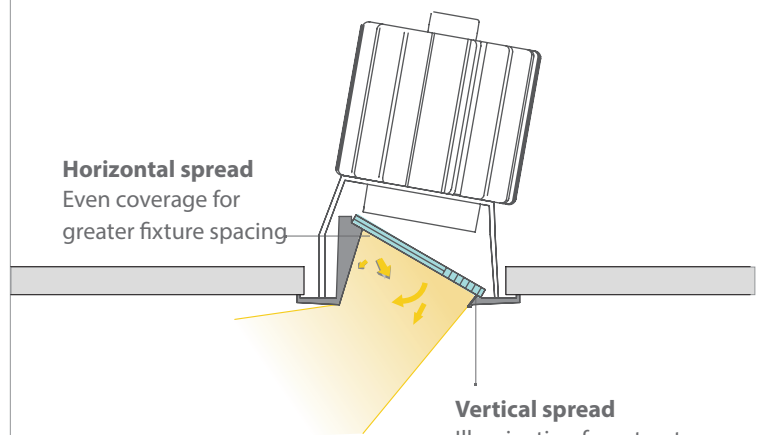

Vertical spread

Illumination from top to bottom of wall

VOLTA 2" ARCHITECTURAL 2" LED RECESSED



Lumens: Up to 1600
Input: 120 - 277V
Power: 15W, 22W
Comparable to: 35W HID

CRI: Up to 90
Dimming: ELV (100%-5%), 0-10V (100%-0%)
Rated Life: 50,000 hours
 All trims may be installed with Trim or Invisible Trim type housings.

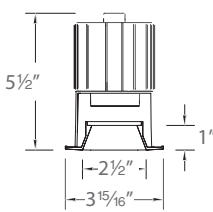
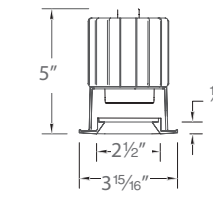
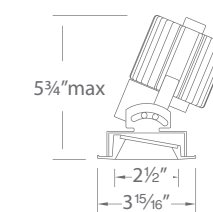
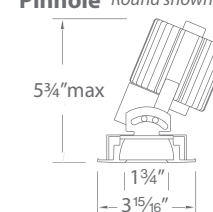
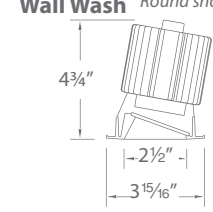
TRIM	Model	Beam		Max Lumens @ 22W and 830	CBCP	Color Temp	CRI	Finishes	Reflector/Trim						
Downlight 	R2RD2T Round Trim R2SD2T Square Trim	S 12°	Round	390	5515										
			Square	405	5405										
		N 25°	Round	1260	6030										
			Square	1375	5505										
		F 40°	Round	1305	3355										
			Square	1390	3110										
		W 60°	Round	830	1175										
			Square	985	1115										
		Shallow Regressed Downlight 	R2RD1T Round Trim R2SD1T Square Trim	S 12°	Round					395	5910				
					Square					420	6085				
N 25°	Round			1255	5380										
	Square			1460	6145										
F 40°	Round			1270	3085										
	Square			1480	3315										
W 60°	Round			905	1020										
	Square			1075	1035										
Adjustable Round shown 	R2RAT Round Trim R2SAT Square Trim			S 12°	Round	335	4300	827 2700K 85 830 3000K 85 835 3500K 85 840 4000K 85							
					Square	360	5805								
		N 25°	Round	915	5340										
			Square	1040	5960										
		F 35°	Round	940	2910										
			Square	1015	3215										
		Pinhole Round shown 	R2RPT Round Trim R2SPT Square Trim	S 12°	Round	235	3380								
					Square	285	4780								
				N 20°	Round	555	4805								
					Square	720	5340								
Wall Wash Round shown 	R2RWT Round Trim R2SWT Square Trim			A Asym	Round	1020	670								
					Square	940	655								

Example: **R2RPT-S930-BK**

PHOTOMETRIC MULTIPLIER TABLE Use to determine outputs other than 22W housing @ 830

Housing Model	CRI and Color Temp					
	827	927	830	930	835	840
22	0.95	0.81	1.00	0.86	1.05	1.07
15	0.66	0.56	0.69	0.59	0.72	0.74

WATTAGE TABLE

Housing Model	Beam Spread	
	S	N, F, W, A
22	15W	22W
15	10W	15W

VOLTA 2" ARCHITECTURAL 2" LED RECESSED



HOUSING (Required)	Model	Trim Type	Power	Emergency Backup
<p>New Construction Airtight IC</p> <p>Trim Type or Invisible Trim</p>	<p>R2RN Round</p> <p>R2RC Round Chicago Plenum</p> <p>R2SN Square</p> <p>R2SC Square Chicago Plenum</p>	<p>T Trim</p> <p>L Invisible Trim</p>	<p>15 15W IC</p> <p>22 22W IC</p>	<p>EM Optional</p>
<p>Remodel Non-IC</p>	<p>R2BR</p>	<p>T Trim</p>	<p>15 15W Non-IC</p> <p>22 22W Non-IC</p>	<p>N/A</p>

Example: **R2RNT-15** or **R2RNT-15EM** (with Emergency backup)

WOOD AND METAL CEILING ADAPTERS

Round

R2R-ADP1 1/2" to 1" ceiling thickness
(Wall wash trims 1" max ceiling thickness)

R2R-ADP2 1" to 1 1/2" ceiling thickness



Square

R2S-ADP1 1/2" to 1" ceiling thickness
(Wall wash trims 1" max ceiling thickness)

R2S-ADP2 1" to 1 1/2" ceiling thickness



FIELD CHANGEABLE GLARE CONTROL AND OPTIC SYSTEM

Accessory holder
Holds up to two lenses or one lens and one glare control
(Not compatible with wall wash)

Optical cartridge
Allows tool-free exchange of reflectors

Light engine



ACCESSORY HOLDER sold separately

LENS-16-HLD Required for use with any lens or accessory

GLARE CONTROL ACCESSORIES

LENS-16 **HCM** Honeycomb Louver
CRL Cross Louver

LENS ACCESSORIES

LENS-16

AMB Amber
RED Red
FR Frosted
SPR Spread
BEL Beam Elongating









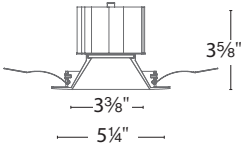

INTERCHANGEABLE REFLECTORS

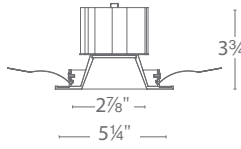
REF-R2-N Narrow Flood beam
REF-R2-F Flood beam
REF-R2-W Wide beam

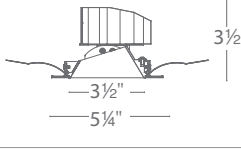

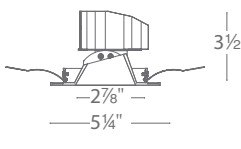

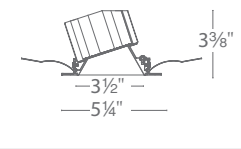

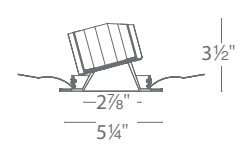
AETHER 3.5" SHALLOW LED DOWNLIGHT

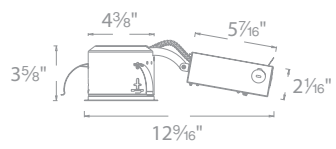

Now available for remodel installations

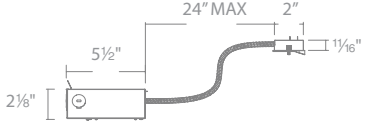
Trim (Order Housing Separately)	Model	Beam	Max Lumens	Max CBCP	Color Temp	CRI	Finish
DOWNLIGHT TRIM							
 	R3ARDT Round	N 25° F 45°	1240	3810	827 2700K 830 3000K 835 3500K 840 4000K	85	HZWT Haze/White WT White BKWT Black/White
 	R3ASDT Square				927 2700K 930 3000K	90	
Trims can be used with: Universal New Construction Housing or Downlight Remodel Housing							
ADJUSTABLE							
 	R3ARAT Round	S 15° N 25° F 45°	1205	6078	827 2700K 830 3000K 835 3500K 840 4000K	85	HZWT Haze/White WT White BKWT Black/White
 	R3ASAT Square				927 2700K 930 3000K	90	
Trims can be used with: Universal New Construction, Adjustable & Wall Wash Remodel Housing							
WALL WASH							
 	R3ARWT Round	A Asym	935		827 2700K 830 3000K 835 3500K 840 4000K	85	HZWT Haze/White WT White BKWT Black/White
 	R3ASWT Square				927 2700K 930 3000K	90	
Trims can be used with: Universal New Construction, Adjustable & Wall Wash Remodel Housing							

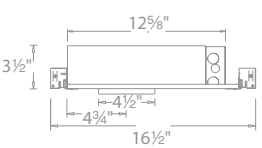
Example: **R3ARWT-A930-HZWT**

Housing (Order Trim Separately)	Model	Wattage	Compatible Trims
DOWNLIGHT REMODEL HOUSING			
 	HR-3LED-R15A Remodel Construction IC-rated, Airtight	15.5W	R3ARDT R3ASDT
ADJUSTABLE & WALL WASH REMODEL HOUSING			
 	HR-3LED-R20 Remodel Construction Non IC-rated, Airtight	15.5W	R3ARAT R3ASAT R3ARWT R3ASWT
UNIVERSAL NEW CONSTRUCTION HOUSING			
 	HR-3LED-H17A New Construction IC-rated, Airtight	15.5W	R3ARDT R3ASDT R3ARAT
	HR-3LED-H17AC New Construction IC-rated, Airtight Chicago Plenum		R3ASAT R3ARWT R3ASWT

Example: **HR-3LED-R15A**

AETHER TRIMLESS 3.5" SHALLOW LED DOWNLIGHT



Now available in adjustable and wall wash trimless options

Input: 120V-277V **Dimming:** ELV (100%-5%), 0-10V (100%-0%)
Comparable to: 75W MR16 **Rated Life:** 50,000 hours

Trim (Order Housing Separately)	Model	Beam	Max Lumens	Max CBCP	Color Temp	CRI	Finish
DOWNLIGHT 	R3ARDL Round 	N 25° F 45°	1240	3810	827 2700K 85 830 3000K 85 835 3500K 85 840 4000K 85	85	HZ Haze WT White BK Black
					927 2700K 90 930 3000K 90		
ADJUSTABLE 	R3ARAL Round 	S 15° N 25° F 50°	1205	6078	827 2700K 85 830 3000K 85 835 3500K 85 840 4000K 85	85	HZ Haze WT White BK Black
					927 2700K 90 930 3000K 90		
WALL WASH 	R3ARWL Round 	A Asym	935		827 2700K 85 830 3000K 85 835 3500K 85 840 4000K 85	85	HZ Haze WT White BK Black
					927 2700K 90 930 3000K 90		

Example: **R3ARWL-A930-WT**

Housing (Order Trim Separately)	Model	Wattage
	HR-3LED-H17A New Construction IC-rated, Airtight	15.5W
	HR-3LED-H17AC New Construction IC-rated, Airtight Chicago Plenum	15.5W

Example: **HR-3LED-H17AC**

3.5" OCULUX LED RECESSED









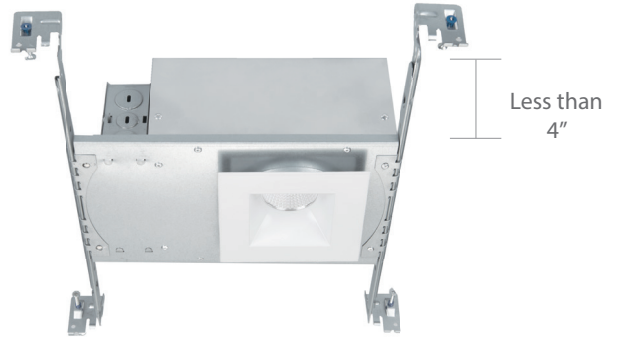

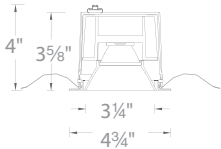
Now available in Haze White trims

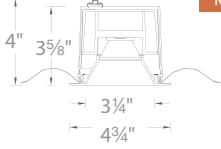

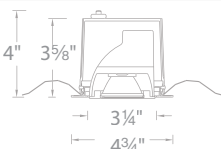
Power: 11W
Comparable to: 75W MR16
Input: 120V or 277V
Rated Life: 50,000 hours

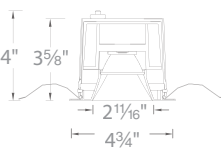
- IC-rated remodel and new construction
- Airtight in new construction
- Shallow housing under 4" depth
- Cutout: 4 1/4"
- Single LED module for high-performance illumination without hot spots
- Ceiling thickness: 1/2" - 1"
- **ELV or TRIAC or 0-10V dimming compatible**

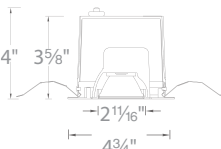

Trims (Order Housing Separately)	Model	Beam	Max Lumens	Max CBCP	Color Temp	Finish
 	R3BRD Round Open Reflector Wet Location Listed 40° visual cutoff	S 15° N 25° F 50°	970	5132	927 2700K 930 3000K	HZWT Haze/White BN Brushed Nickel WT White
 	R3BRDP Polycarbonate Trim Face* Open Reflector Wet Location Listed 40° visual cutoff	S 15° N 25° F 50°	1025	2985	927 2700K 930 3000K	WT White
 	R3BRA Round 0 - 35° Adjustable 48° visual cutoff	S 15° N 25° F 50°	985	4712	927 2700K 930 3000K	BN Brushed Nickel WT White
 	R3BSD Square Open Reflector Wet Location Listed 35° visual cutoff	S 15° N 25° F 50°	930	4710	927 2700K 930 3000K	HZWT Haze/White BN Brushed Nickel WT White
 	R3BSA Square 0 - 35° Adjustable 48° visual cutoff	S 15° N 25° F 50°	985	4712	927 2700K 930 3000K	BN Brushed Nickel WT White

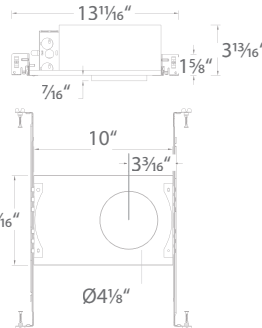
Example: **R3BRD-S927-WT**

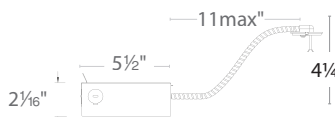
Housings (Required) - Order separately from trims	Model	Input	Dimming	Notes
<p><i>New Construction</i></p>  	R3BNICA-10 IC-Rated, Airtight	120V	100% - 5% TRIAC, ELV, 0-10V	Less than 4" plenum depth
	R3BNICA-10U IC-Rated, Airtight	120V - 277V	120V 100% - 5% TRIAC, ELV, 0-10V	Allows adjustment in any direction when used with adjustable trims Ceiling thickness: 1/2" - 1"
<p><i>Remodel</i></p>  	R3BBRT-10 IC-Rated	120V	100% - 5% TRIAC, ELV, 0-10V	4 1/4" plenum depth Allows adjustment in any direction when used with adjustable trims Ceiling thickness: 1/2" - 1"

2" OCULUX LED RECESSED







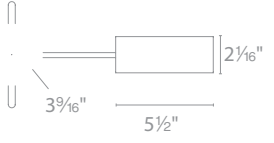

Now available in Haze White trims

Power: 9W
Comparable to: 50W MR16
Input: 120V
Rated Life: 50,000 hours

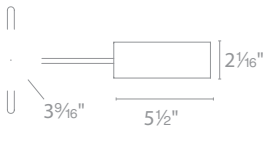
- Sold as new construction, may be reconfigured in the field for remodel use
- Cutout: 3 15/16"
- Single LED module for high-performance illumination without hot spots
- Ceiling thickness: 1/2"-1"
- ELV or TRIAC or 0-10V dimming compatible

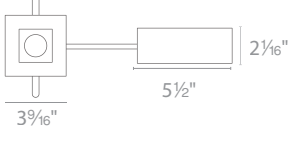

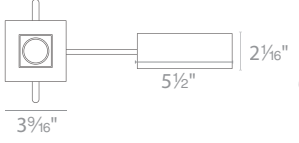
All-in-one unit, ready to install right out of box

	Model	Beam	Max Lumens	Max CBCP	Color Temp	Finish	
  <p>R2BRD Round Open Reflector Wet location listed 35° visual cutoff</p>		N 25° F 45°	680	2490	927 2700K 930 3000K	HZWT Haze/White BN Brushed Nickel WT White	 New!
  <p>R2BRA Round 0 - 35° Adjustable 45° visual cutoff</p>		S 15° N 25° F 45°	685	3245	927 2700K 930 3000K	BN Brushed Nickel WT White	
  <p>R2BSD Square Open Reflector Wet location listed 35° visual cutoff</p>		N 25° F 45°	700	2462	927 2700K 930 3000K	HZWT Haze/White BN Brushed Nickel WT White	 New!
  <p>R2BSA Square 0 - 35° Adjustable 45° visual cutoff</p>		S 15° N 25° F 45°	685	3245	927 2700K 930 3000K	BN Brushed Nickel WT White	

Example: **R2BRD-N930-WT**

INTEGRAL HOUSING AND TRIM: BOTH NEW CONSTRUCTION & REMODEL

NEW CONSTRUCTION CONFIGURATION

IC-Rated, Airtight

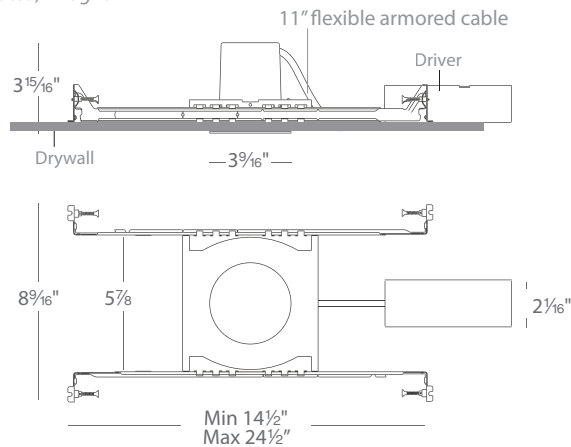

REMODEL CONFIGURATION

IC-Rated, Airtight

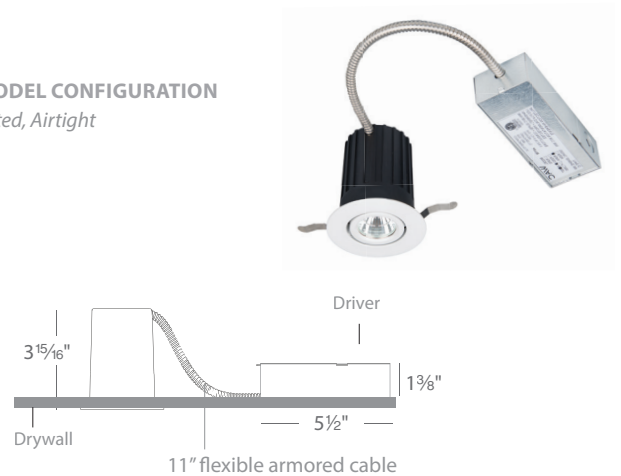



SET THE MOOD PERFECTLY cozier restaurants, more inviting living rooms and adaptable hotels. Bring the warmth whenever you need it.

3000K

1800K

YOU'RE GETTING WARMER

If we're being honest, we love the warm glow of incandescent lights, but LEDs are much more superior in every regard. What if we said you can have the best of both worlds—the high performance of LED and the intimate warmth of incandescence?

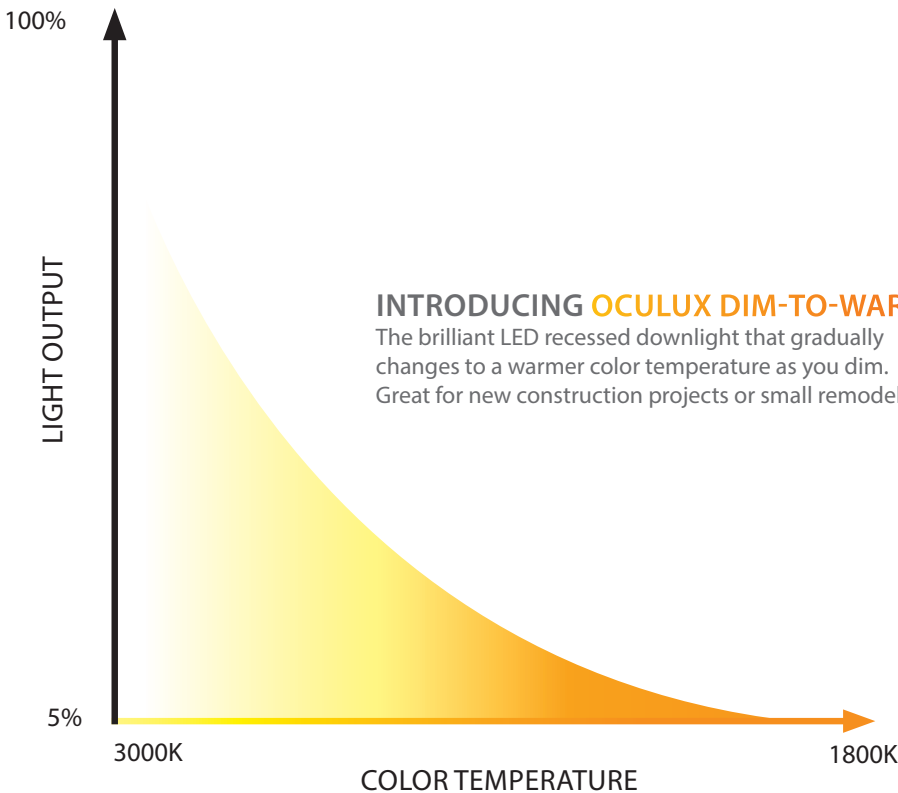







INTRODUCING OCULUX DIM-TO-WARM
 The brilliant LED recessed downlight that gradually changes to a warmer color temperature as you dim. Great for new construction projects or small remodels.

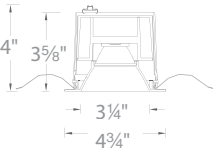

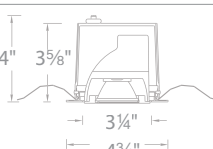
3.5" OCULUX DIM-TO-WARM LED RECESSED

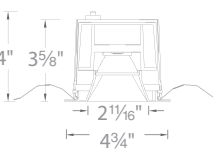

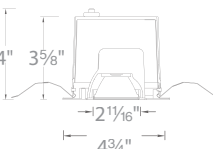
- Power:** 11W
- Comparable to:** 50W PAR20
- Input:** 120V or 277V
- Rated Life:** 50,000 hours
- CRI:** 95
- Dim-to-warm color temperature range: 3000K-1800K
 - Single LED module for high-performance illumination without hot spots
 - Ceiling thickness: ½"-1"
 - ELV, TRIAC or 0-10V dimming compatible

Trims (Order Housing Separately)		Model	Beam	Max Lumens	Max CBCP	Color Temp	Finish
		R3BRD Round Open Reflector Wet Location Listed	S 19° N 27° F 50°	765	3070	WD 3000K - 1800K	WT White
		R3BRA Round 0 - 35° Adjustable	S 19° N 27° F 50°	745	2820	WD 3000K - 1800K	WT White
		R3BSD Square Open Reflector Wet Location Listed	S 19° N 27° F 50°	735	2850	WD 3000K - 1800K	WT White
		R3BSA Square 0 - 35° Adjustable	S 15° N 25° F 50°	745	2820	WD 3000K - 1800K	WT White

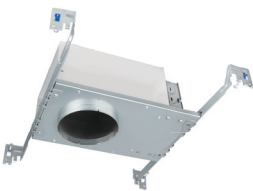
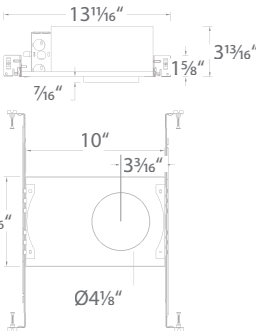
Example: **R3BRD-SWD-WT**

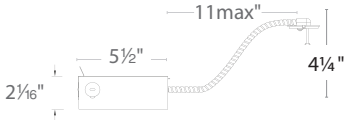
Housings (Required) - Order separately from trims		Model	Input	Dimming	Notes
<p>New Construction</p> 		R3BNICA-10 IC-Rated, Airtight	120V	100% - 5% TRIAC, ELV, 0-10V	Less than 4" plenum depth
		R3BNICA-10U IC-Rated, Airtight	120V - 277V	100% - 5% TRIAC, ELV, 0-10V	100% - 1% 0-10V
<p>Remodel</p> 		R3BBRT-10 IC-Rated	120V	100% - 5% TRIAC, ELV, 0-10V	4 ¼" plenum depth Allows adjustment in any direction when used with adjustable trims Ceiling thickness: ½"-1"



Driver hidden in W Track Channel



Monopoint



Sculpture accented with one WTK-6010U fixture illuminated with a 6° spot from 6ft away

LUCIO 6010 LED

Power: 10W
Delivered Lumens: Up to 985
Comparable to: 75W MR16
Dimming: 100% - 5% ELV
Input: 120V, 277V
Rated Life: 50,000 hours

- Accommodates 1 lens and 1 glare control accessory
- 365° horizontal aiming and 90° indexed vertical aiming
- Integral selector to choose between independently controllable track circuits
- CBCP intensive ultra spot, (6010U model)
- Asymmetrical beam distribution, (6010A model)

Track	Model	Beam	Color Temp	CRI	Lumens Up to	CBCP Up to	Finish				
<p>WTK/WHK-6010-U,A</p>	WTK	120V	6010	U	6°	827	2700K	85	985	39,695	BK Black PT Platinum WT White
N	25°	835	3500K	85							
					F	35°	840	4000K	85		
A	ASY	927	2700K	90							
					930	3000K	90				
<p>WTK/WHK-6010-S,N,F</p>	WHK	277V	6010	S				18°	835	3500K	85
					N	25°	840				
F	35°	927	2700K	90							
					A	ASY	930	3000K	90		
<p>MO Monopoint</p>	6010	U	6°	827						2700K	85
					S	18°	830	3000K	85		
N	25°	835	3500K	85							
					F	35°	840	4000K	85		
A	ASY	927	2700K	90							
					930	3000K	90				

Example: **WTK-6010A-930-WT**

LENS ACCESSORIES

Amber **LENS-16-AMB**
 Blue **LENS-16-BLU**
 Green **LENS-16-GRN**
 Red **LENS-16-RED**
 Yellow **LENS-16-YEL**

Frosted **LENS-16-FR**
 Spread **LENS-16-SPR**
 Beam **LENS-16-BEL**
 Elongating

GLARE CONTROL ACCESSORIES

Cross Louver **LENS-16P-CRL**
 Snoot **LENS-16-SNOOT**

BK
PT
WT

MONOPOINT EXTENSIONS Order as a complete unit

X6 6"
X12 12"
X18 18"
X24 24"
X36 36"
X48 48"

MO6010

U
S
N
F
A

827
830
835
840
927
930

BK
WT

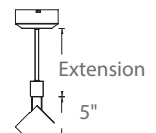

Accommodates one lens accessory and one glare control accessory

Example: **X12-MO6010S830WT**



Driver hidden in W Track Channel



Monopoint

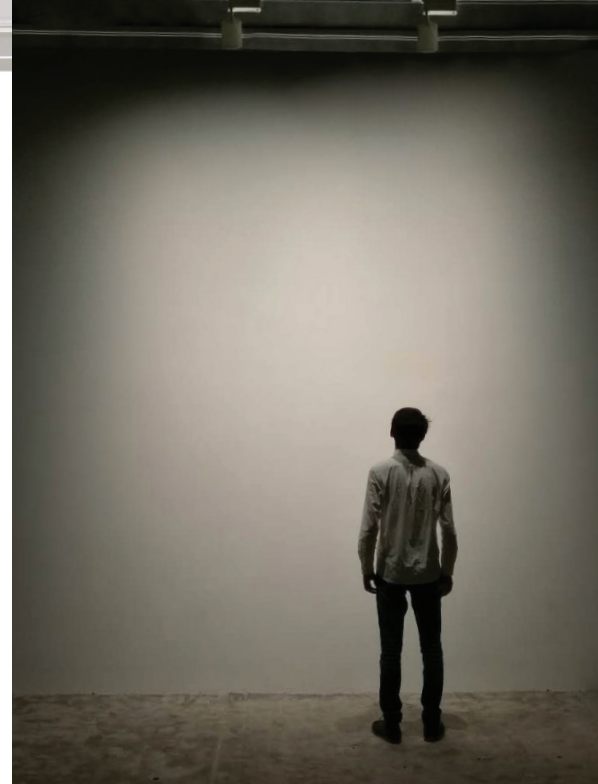

12ft Wall illuminated with two **WTK-6022A** fixtures spaced 3ft apart and 3ft away from wall

LUCIO 6022 LED

Power: 22W
Delivered Lumens: Up to 1890
Comparable to: 39W HID
Dimming: 100% - 5% ELV
Input: 120V, 277V
Rated Life: 50,000 hours

- Accommodates 1 lens and 1 glare control accessory
- 365° horizontal aiming and 90° indexed vertical aiming
- Integral selector to choose between independently controllable track circuits
- CBCP intensive ultra spot, (6022U model)
- Asymmetrical beam distribution, (6022A model)

Track		Model	Beam	Color Temp	CRI	Lumens Up to	CBCP Up to	Finish
	WTK	6022	U 8°	827 2700K	85	1890	35,930	BK Black PT Platinum WT White
	WHK 120V 277V		S 12°	830 3000K	85			
			N 20°	835 3500K	85			
			F 35°	840 4000K	85			
			A ASY	927 2700K	90			
				930 3000K	90			
	MO	6022	U 8°	827 2700K	85	1890	35,930	BK Black WT White
	Monopoint		S 12°	830 3000K	85			
			N 20°	835 3500K	85			
			F 35°	840 4000K	85			
			A ASY	927 2700K	90			
				930 3000K	90			

Example: **WTK-6022U-827-PT**

LENS ACCESSORIES				GLARE CONTROL ACCESSORIES			MONOPOINT EXTENSIONS Order as a complete unit			
Amber	LENS-25-AMB	Frosted	LENS-25-FR	Cross Louver	LENS-25P-CRL	MO6022	X6 6"	U 827	BK WT	
Blue	LENS-25-BLU	Spread	LENS-25-SPR	BK PT WT	X12 12"		S 830			
Green	LENS-25-GRN	Beam	LENS-25-BEL		X18 18"		N 835			
Red	LENS-25-RED	Elongating			X24 24"		F 840			
Yellow	LENS-25-YEL				X36 36"		A 927			
				Snoot	LENS-25-SNOOT	X48 48"	930			

Accommodates one lens accessory and one glare control accessory

Example: **X12-MO6022F930WT**

SILO X10 LED



Power: 10W
 Delivered Lumens: Up to 790
 CBCP: Up to 2575
 Comparable to: 65W MR16
 Dimming: 100% - 5% ELV
 Input: 120V
 Rated Life: 50,000 hours

- Field replaceable TIR lens for beam control (35° installed and 25° included in the box)
- Die-cast aluminum construction in a small, and clean design
- Performance luminaire with integral LED and driver



System	Model	Color Temp	CRI	Beam	Lumens	CBCP	Finish
	H H Track	2010-930	3000K	90	25°	790	2575
	L L Track				35°	790	1545
	J J/J2 Track						
							BR Brushed Brass BK Black BN Brushed Nickel DB Dark Bronze WT White

Example: **H-2010-930-BR**

Accommodates one lens accessory or one glare control accessory

LENS ACCESSORIES				GLARE CONTROL ACCESSORIES			
Amber	LENS-11-AMB	Yellow	LENS-11-YEL	Cross Louver	LENS-11P-CRL-BK	Snoot	LENS-11-SNOOT-BK
Blue	LENS-11-BLU	Frosted	LENS-11-FR		LENS-11P-CRL-BN		LENS-11-SNOOT-BN
Green	LENS-11-GRN	Spread	LENS-11-SPR		LENS-11P-CRL-WT		LENS-11-SNOOT-WT
Red	LENS-11-RED	Beam Elongating	LENS-11-BEL				

SILO X20 LED

Power: 20W
 Delivered Lumens: Up to 1080
 CBCP: Up to 6840
 Comparable to: 75W MR16
 Dimming: 100% - 5% ELV
 Input: 120V
 Rated Life: 50,000 hours

- Continuously adjustable beam angles from 15° to 50°
- Die-cast aluminum construction with rotatable front face
- Performance luminaire with integral LED and driver



System	Model	Color Temp	CRI	Beam	Lumens	CBCP	Finish
	H H Track	2020-930	3000K	90	15°	785	6840
	L L Track				50°	1080	1295
	J J/J2 Track						
							BR Brushed Brass BK Black BN Brushed Nickel DB Dark Bronze WT White

Example: **L-2020-930-DB**

Accommodates one lens accessory and one glare control accessory

LENS ACCESSORIES		GLARE CONTROL ACCESSORIES		FRAMING PROJECTOR ACCESSORIES	
Amber	LENS-16-AMB	Cross Louver	LENS-16P-CRL-BK	Framing Projector	FP-K-BK
Blue	LENS-16-BLU		LENS-16P-CRL-BN		FP-K-WT
Green	LENS-16-GRN		LENS-16P-CRL-WT		
Red	LENS-16-RED	Snoot	LENS-16-SNOOT-BK		
Yellow	LENS-16-YEL		LENS-16-SNOOT-BN		
Frosted	LENS-16-FR		LENS-16-SNOOT-WT		
Spread	LENS-16-SPR	Honeycomb Louver	LENS-16-HCL		
Beam Elongating	LENS-16-BEL				



TITLE 24
CALIFORNIA



OCULUX LED

Power: 11W
Delivered Lumens: Up to 890
CBCP: Up to 4972
Comparable to: 65W MR16
Dimming: 100% - 10% ELV, TRIAC
Input: 120V
Rated Life: 50,000 hours

- **Three beam angle options included (see diagram below):**
- 50° optic pre-installed, easily removable
- 30° optic interchangeable component
- 17° without additional optic.
- Integral driver and high output COB LED
- Outperforms halogen 65W MR16
- 350° horizontal and 90° vertical aiming

	System	Model	Beam	Lumens	CBCP	Color Temp	CRI	Finish	
	H H Track	7011	17°	890	4972	930	3000K	90	BK Black
	L L Track		30°	855	1961				BN Brushed Nickel
	J J/J2 Track		50°	830	789				DB Dark Bronze
									WT White

Example: **H-7011-930-DB**

REPLACEMENT OPTICS

30°	Narrow Flood	FILM-16-N
50°	Flood	FILM-16-F

Interchangeable beam options:

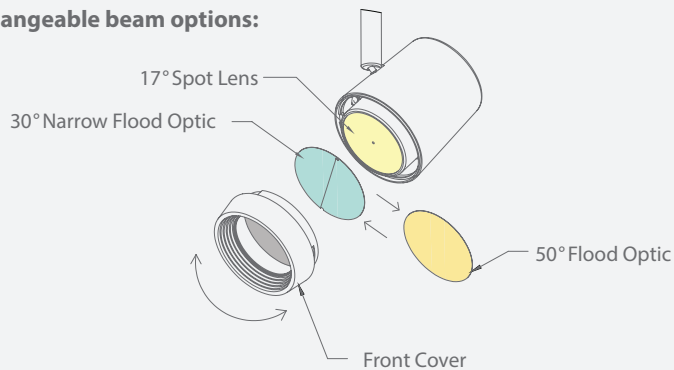

PIXELS
CONFIGURABLE LED LIGHT SHEET

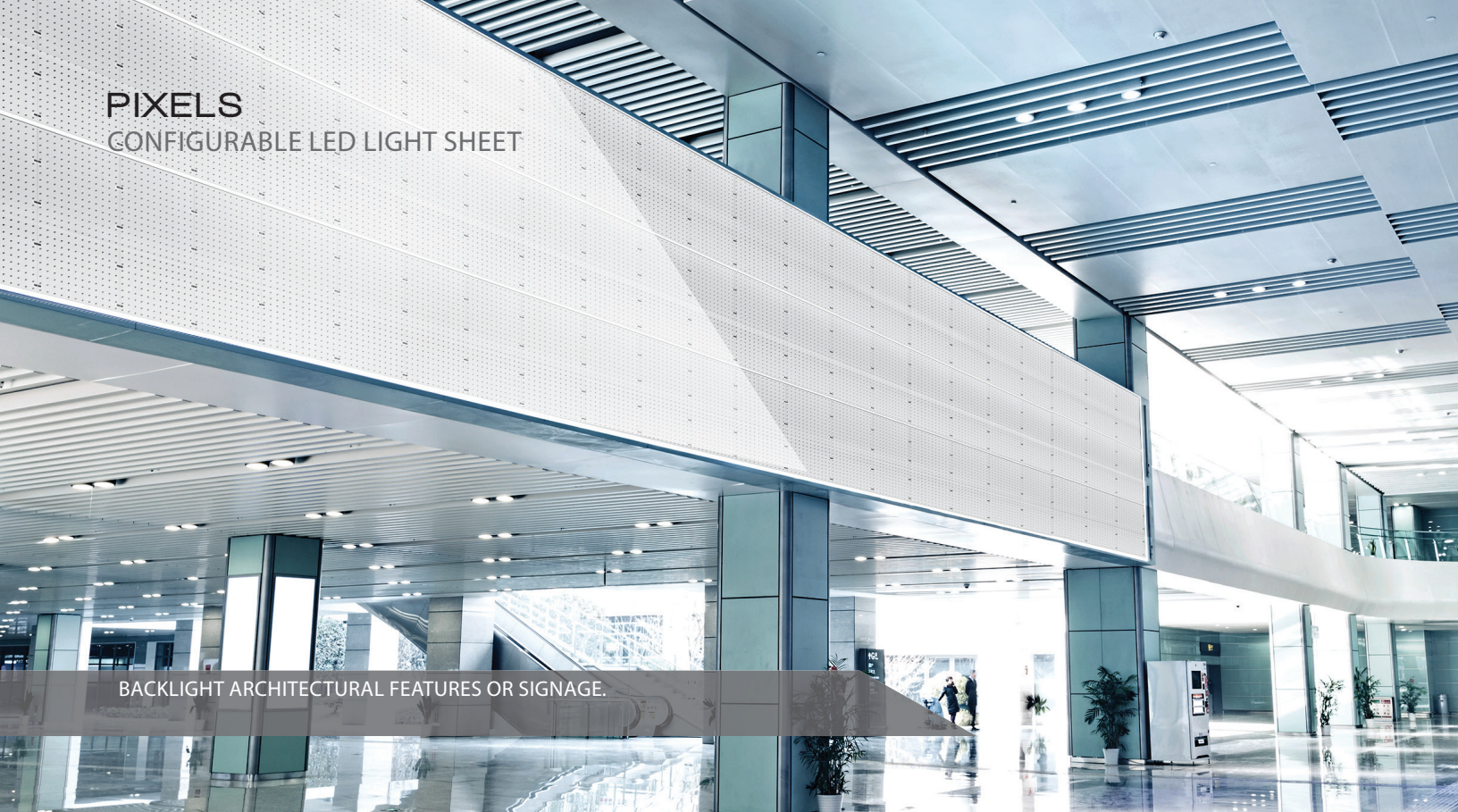

BACKLIGHT ARCHITECTURAL FEATURES OR SIGNAGE.

ILLUMINATE VIRTUALLY ANY SURFACE WITH A FLEXIBLE, PAPER THIN, MODULAR AND SCALABLE PRODUCT.

PIXELS IS UNIQUELY VERSATILE AND CAN BE APPLIED TO WALLS, CEILINGS AND DISPLAYS—IMAGINATIVELY EXTENDING THE BOUNDARIES OF WHAT CAN BE ILLUMINATED.



DRAMATICALLY ILLUMINATE A DRYWALL CEILING.



SIMULATE A SKYLIGHT FOR GENERAL ILLUMINATION.



INCORPORATE LIGHTING INTO ARCHITECTURAL FEATURES WITH AS LITTLE AS 1½ INCH RECESSED DEPTH.

PIXELS CONFIGURABLE LED LIGHT SHEET

DISCREET

Hides inside walls and ceilings at 1/8" thin with LED's spaced on 1" center

POWER

Push-in connectors located every 6 inches so you can provide power from either side

CUSTOMIZE

Create exact shapes you want by cutting along dotted lines

ADD

Modular and scalable

FLEXIBLE

Mounts to flat or curved surfaces

EASY TO APPLY

Staple through solid lines or mount with 3M adhesive on back



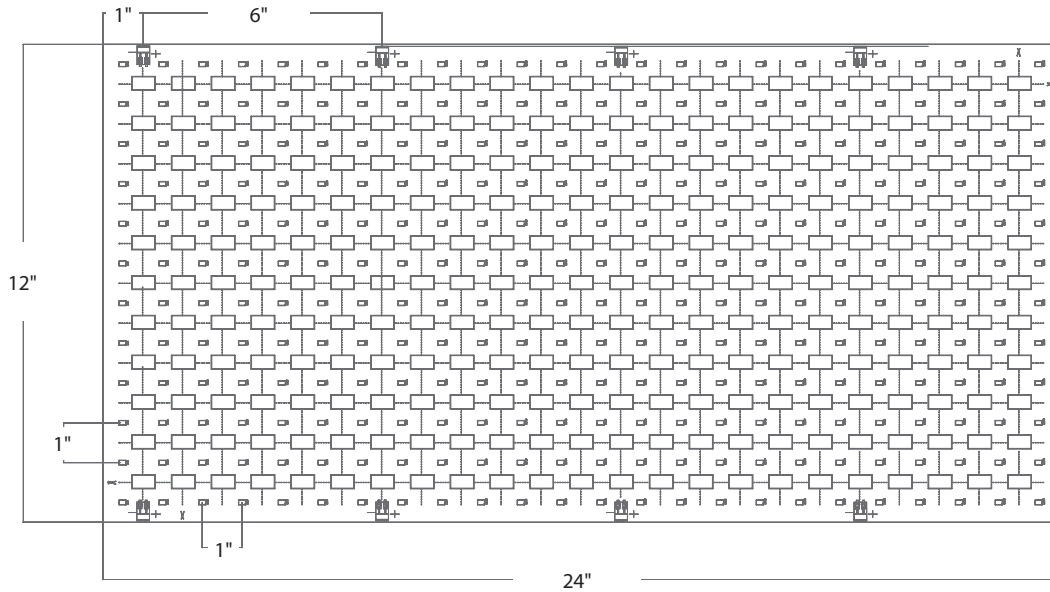

Input: 24V DC
CRI: 90
Dimming: 0-10V
Rated Life: 50,000 hours

- With a lightweight, ultra-thin 1/8" profile, Pixels requires very little space
- Even illumination of translucent surfaces from as little as 1 1/2" behind
- May be field-cut vertically or horizontally, in unique shapes or around obstructions
- Powers easily by daisy chaining with integral push-in connectors or power from any square at soldering points provided



Versatile mounting options:

- 3M-construction adhesive adheres to most surfaces (flat or curved), or open rectangles indicate where it can be stapled through
- Can be installed in either exposed or fully enclosed spaces
- Specially rated for installation in the storage area of a clothes closet

Model	Dimension	LED Lumens	Watt	Color Temp	Color			
LED	P05 P10	1224	12" x 24"	500 lm/sq ft 1000 lm/sq ft	5W/sq ft 10W/sq ft	White		
							27	2700K
							30	3000K
							35	3500K
							40	4000K
50	5000K							

Example: **LED-P10-1224-30**

Required

Type	Model	Input	Output	Max Coverage	Dim
Remote	 EN-24100-277-RB2	120-277VAC	24VDC / 96W Class 2	20 sqft (P05) 10 sqft (P10)	0-10V Includes a 6 foot lead wire
Wall Dimmer & Driver	 EN-D24100-120-R	120VAC	24VDC / 96W Class 2	20 sqft (P05) 10 sqft (P10)	Integral



FLEXLINE 120V FLEXIBLE & MODULAR LINEAR STRIP



Power: 5W/ft
Lumen: 500/ft
CRI: 95
Dimming: 100%-10% ELV
Input: 120V
Rated Life: 50,000 hours

- **Modular design available in various lengths to adapt to field conditions**
- **Ultra thin profile at 5/8" W x 3/8" H**
- Optimized connectors to maximize consistency across light connections
- Five mounting options offered for different surfaces and applications
- 150 ft max run
- UV resistant
- Per UL safety standards, line voltage strips are not field cuttable
- Suitable for indoor use in open or enclosed spaces

Model	Length	Color Temp	Lumens/ft	Watts/ft	Color
LED-HVT	7", 1' 1", 5' 1", 10' 1", 20' 1", 50' 1"	27 2700K 30 3000K 35 3500K	480	5W/ft	WT White
	6 inches				
	01 1 foot				
	05 5 feet				
	10 10 feet				
20 20 feet					
50 50 feet					

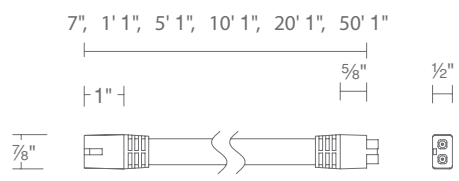

Example: **LED-HVT-10-30WT**



FLEXLINE
INSTALLED IN COVE APPLICATION











Actual size shown (5/8" W), up to 50 feet.

Required

Type	Model			
Lead Wire		LED-HVT-P6-WT	6 feet	Lead wires with plug to power LED strip. Includes fuse and surge protection.
	LED-HVT-P10-WT	10 feet		

Accessories

Type	Model			
Joiner Cable		LED-HVT-IC1-WT	1 foot	Connects LED strip sections.
	LED-HVT-IC6-WT	6 feet		
	LED-HVT-IC10-WT	10 feet		
L Connector		LED-HVT-L-WT		"L" connector has male and female connectors and is used to create 90° right angles.
T Connector		LED-HVT-T-WT		Connects three strip sections.
Mounting Clip		LED-HVT-CL1	10 pcs	Secures on both edges. Two clips per foot are recommended for straight runs. Mounting screws included.
Mounting Clip		LED-HVT-CL2	10 pcs	Secures on one edge. Two clips per foot are recommended for straight runs. Mounting screws included.
Mounting Clip		LED-HVT-CL3	10 pcs	Secures from the underside. Two clips per foot are recommended for straight runs. Mounting screws included.
Mounting Clip		LED-HVT-CL4	10 pcs	Secures two rows of LED strips from the underside. Two clips per foot are recommended for straight runs. Mounting screws included.
Channel		LED-HVT-CH	5 foot 3 inches	Mounting channel with frosted polycarbonate diffuser includes two variable angle mounting clips.

DUO AC-LED COLOR OPTION



ITL E24
CALIFORNIA



Now available in 36" and 42" lengths



Color Temp: 2700K and 3000K
CRI: 90+
Dimming: 100% – 10% smooth and continuous ELV and TRIAC dimming
Rated Life: 54,000 hours

- Extruded aluminum construction for optimal thermal management
- Diffused light source reduces glare and creates uniform illumination
- Captive screws for easy installation
- Multiple knock outs for ease of wiring
- Thin 1" profile
- 120VAC—no driver needed
- Non-metallic sheathed cable connectors included
- One "I" connector included with each luminaire

	Length	Watt	Lumens	Color Temp	Finish	
	7/30	8"	6.0W	330	BZ Bronze AL Brushed Aluminum WT White	
	27/30	12"	8.0W	475		
	27/30	18"	10.0W	545		2700K
	27/30	24"	15.0W	930		and
	27/30	30"	17.5W	1095		3000K
	27/30	36"	19.5W	1305		
	27/30	42"	22.5W	1445		

Example: **BA-ACLED12-27/30AL**

- May be hard-wired with 120V power or used with a plug-in power cord
- Subsequent fixtures may be powered with an "I" Connector or Interconnect Cable carrying 120V
- May be individually switched and/or wired to a wall box switch/dimmer

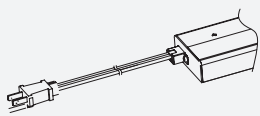

Power Cord

Model	Length
BA-PC6 WT White	6'
BK Black	

Supplies power in any application.

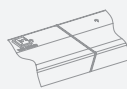

"I" Connector

Model	Max Fixture Run
BA-I-WT	6

Interconnection for seamless end to end transitions. **Each light bar includes one.**

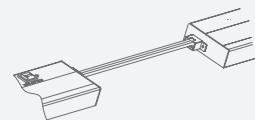

Interconnect Cable

Model	Length	Max Fixture Run
BA-IC12	12"	4
BA-IC24	24"	4
BA-IC36	36"	3

Example: **BA-IC12-WT**

Links two light bars using a single power connection.

ROUND & SQUARE

LED FUNCTIONAL CEILING OR WALL LUMINAIRE



TITLE 24
CALIFORNIA



Input: 120V
CRI: 90
Dimming: 100% - 10% ELV, 100%-5% TRIAC
Rated Life: 50,000 hours

- ADA compliant
- Opaque acrylic diffuser spreads light from multiple LED array for uniform illumination
- **Installs over a 3", 4" or 3/0 - 4/0 hybrid junction box**

		Model	Wattage	Max Lumen	Color Temp	CRI	Finish
		FM-07RN Round	15W	1050			
		FM-11RN Round	20W	1525	930 935	3000K 3500K	90 90 BN BZ WT Brushed Nickel Bronze White
		FM-15RN Round	28W	2550			
		FM-07SQ Square	15W	1100			
		FM-11SQ Square	20W	1650	930 935	3000K 3500K	90 90 BN BZ WT Brushed Nickel Bronze White

Example: **FM-15RN-930-WT**

Endurance™ LED FLOOD & FLOOD PRO



Now available in a Higher Power Option and Architectural Black



Input: 120V
CRI: 90
Dimming: 100% - 10% ELV
Rated Life: 54,000 hours

- Breathable waterproof technology and factory-sealed LED light engine ensures fixture can maintain stable atmospheric pressure and prevent condensation
- Die-cast aluminum construction
- 120V direct wire—no driver Needed
- 1/2" threaded heavy-duty mounting arm
- Photo or motion sensor sold separately

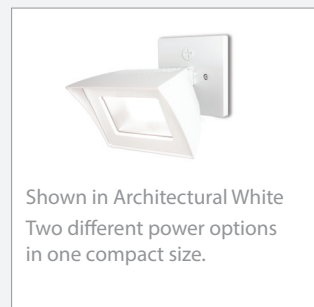
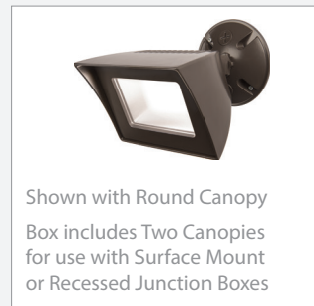

	Power	Comparable	Color Temp	Delivered Lumens	Finish
	WP-LED335	35.5W	100W HID	30 3000K 2450	aBK Architectural Black aBZ Architectural Bronze aGH Architectural Graphite aWT Architectural White
				50 5000K 2730	
	WP-LED354	53W	150W HID	35 3500K 3445	

Example: **WP-LED354-35-aWT**

MOTION SENSOR (120V) available in 3 complementary colors

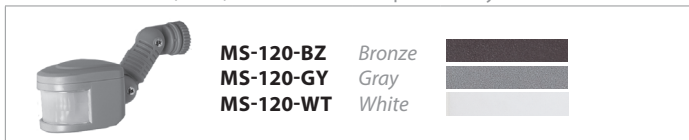

PHOTOSENSOR (120V) available in 3 complementary colors



Endurance™ LED SINGLE & DOUBLE SPOT

Now available in Architectural Black



Input: 120V
CRI: 85
Dimming: 100% - 10% ELV
Rated Life: 39,000 hours

- Factory-sealed LED light engine
- Die-cast aluminum construction
- 120V direct wire - no driver needed
- Photo/motion sensor sold separately

	Power	Comparable	Color Temp	Delivered Lumens	Finish
<p>WP-LED415</p>	15W	75W Halogen	30 50	3000K 5000K	965 1030
					aBK Architectural Black aBZ Architectural Bronze aGH Architectural Graphite aWT Architectural White

Example: **WP-LED415-30-aWT**

	Power	Comparable	Color Temp	Delivered Lumens	Finish
<p>WP-LED430</p>	30W	2 x 75W Halogen	30 50	3000K 5000K	965 x2 1030 x2
					aBK Architectural Black aBZ Architectural Bronze aGH Architectural Graphite aWT Architectural White

Example: **WP-LED430-30-aBZ**

MOTION SENSOR (120V) available in 3 complementary colors

	MS-120-BZ	Bronze	
	MS-120-GY	Gray	
	MS-120-WT	White	

PHOTOSENSOR (120V) available in 3 complementary colors

	PC-120-BZ	Bronze	
	PC-120-GY	Gray	
	PC-120-WT	White	

120V/277V RECTANGULAR STEP & WALL LIGHTS



120V/277V RECTANGULAR STEP & WALL LIGHTS



Input: 120V, 277V
Brightness: Up to 4 lm
CRI: 90
Dimming: 100% - 10% ELV (120V only)
Rated Life: 50,000 hours

- Fluid decorative profile with full cut-off illumination
- Die-cast aluminum construction with abrasion-resistant powder-coated finish, or plated brushed nickel finish
- Title 24 compliant (120V only)

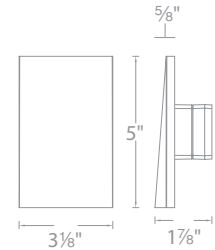
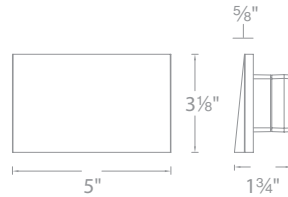

Voltage	Power	Model	Color Temp	Finishes
120V	3.5W	WL-LED110-C	3000K	BK Black on AL BN* Brushed Nickel
		WL-LED110-AM	Amber	
277V	3W	WL-LED110F-C	3000K	BZ Bronze on AL WT White on AL
		WL-LED110F-AM	Amber	

Voltage	Power	Model	Color Temp	Finishes
120V	3.5W	WL-LED210-C	3000K	BK Black on AL BN* Brushed Nickel
		WL-LED210-AM	Amber	
277V	3W	WL-LED210F-C	3000K	BZ Bronze on AL WT White on AL
		WL-LED210F-AM	Amber	

Example: **WL-LED110-C-WT**

Example: **WL-LED210-C-BK**

*BN Finish is not warranted for contact with harsh chemicals or exterior installations.

Input: 120V, 277V
Brightness: Up to 3 lm
CRI: 90
Dimming: 100% - 10% ELV (120V only)
Rated Life: 50,000 hours

- Geometric design with downward illumination
- Die-cast aluminum construction with abrasion-resistant powder-coated finish
- Title 24 compliant (120V only)

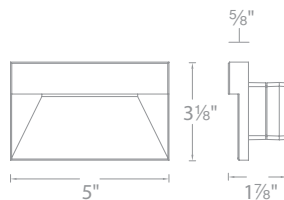

Voltage	Power	Model	Color Temp	Finishes
120V	3.5W	WL-LED140-C	3000K	BK Black on AL BZ Bronze on AL
		WL-LED140-AM	Amber	
277V	3W	WL-LED140F-C	3000K	WT White on AL
		WL-LED140F-AM	Amber	

Example: **WL-LED140-C-BK**

AL - Aluminum



IP66 rated self contained fixture with various face plates.
 Fits into a switch box or a 2" x 4" Junction Box with minimum inside dimensions of 3"L x 2"W x 2.5"D

120V/277V RECTANGULAR STEP & WALL LIGHTS



Input: 120V, 277V
Brightness: Up to 40 lm
CRI: 90
Dimming: 100% - 10% ELV (120V only)
Rated Life: 50,000 hours

- Tempered glass diffuses out light for even illumination
- Die-cast aluminum construction with abrasion-resistant powder-coated finish, or marine-grade stainless steel option available
- Title 24 compliant (120V only)

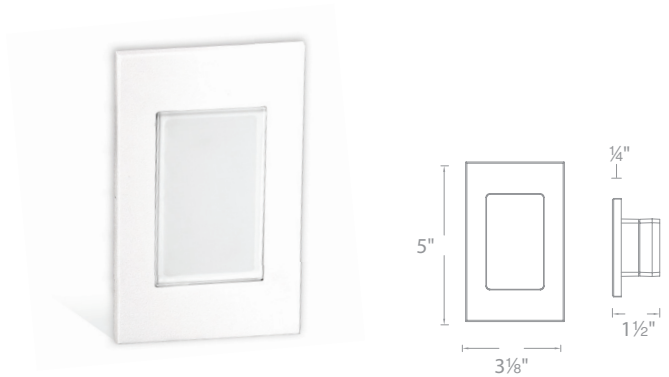
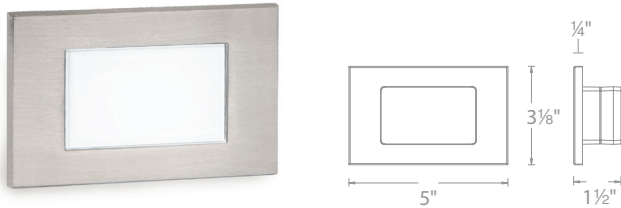

Mounts Vertically or Horizontally

Voltage	Power	Model	Color Temp	Finishes
120V	3.5W	WL-LED130-C	3000K	BK Black on AL BZ Bronze on AL SS Stainless Steel WT White on AL
		WL-LED130-AM	Amber	
277V	3W	WL-LED130F-C	3000K	
		WL-LED130F-AM	Amber	

Example: **WL-LED130-C-SS**

Input: 120V, 277V
Brightness: Up to 36 lm
CRI: 90
Dimming: 100% - 10% ELV (120V only)
Rated Life: 50,000 hours

- Louvered design shields glare for visual comfort
- Die-cast aluminum construction with abrasion-resistant powder-coated finish
- Title 24 Compliant (120V only)

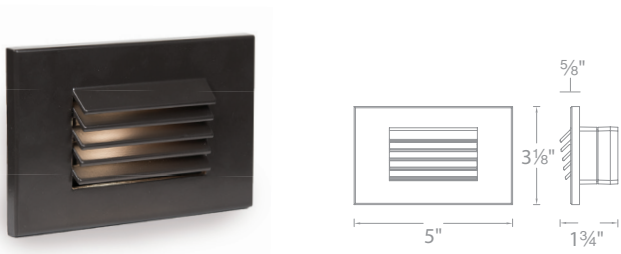

Voltage	Power	Model	Color Temp	Finishes
120V	3.5W	WL-LED120-C	3000K	BK Black on AL BZ Bronze on AL WT White on AL
		WL-LED120-AM	Amber	
277V	3W	WL-LED120F-C	3000K	
		WL-LED120F-AM	Amber	

Example: **WL-LED120-C-BZ**

AL - Aluminum

Voltage	Power	Model	Color Temp	Finishes
120V	3.5W	WL-LED220-C	3000K	BK Black on AL BZ Bronze on AL WT White on AL
		WL-LED220-AM	Amber	
277V	3W	WL-LED220F-C	3000K	
		WL-LED220F-AM	Amber	

Example: **WL-LED220-C-BZ**

120V/277V RECTANGULAR STEP & WALL LIGHTS

Now available in discreet Graphite Finish

TITLE 24
CALIFORNIA IP66

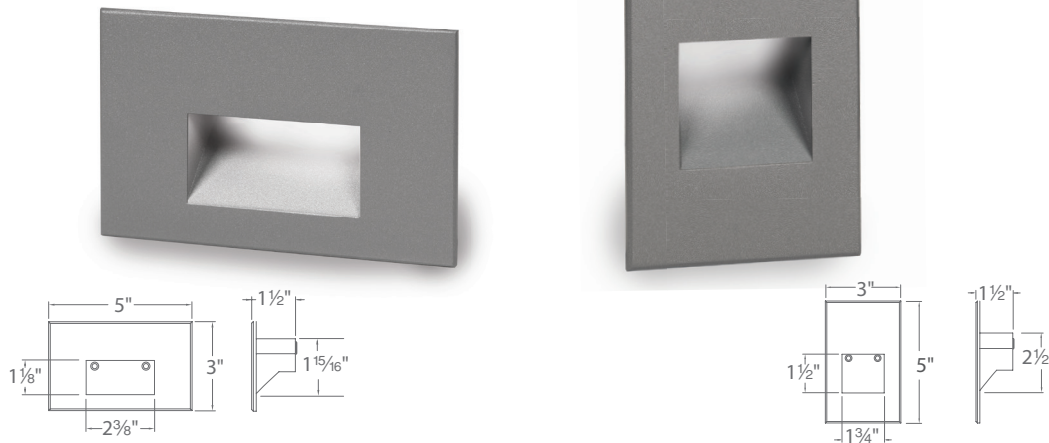

- Input:** 120V, 277V
- Power:** 3.5W
- Lumens:** Up to 65
- CRI:** 90
- Rated Life:** 54,000 hours
- Options in die-cast brass or 316 marine-grade stainless steel
 - Fits into 2"×4" J-Box with minimum inside dimensions of 3"×2"×2"
 - IP66, wet location rated for indoor and outdoor installations*
 - 5 year WAC warranty (lifetime warranty for brass and stainless steel)
 - Title 24 Compliant (120V only)
 - No driver needed
 - No heat radiation
 - ELV dimming

System	Color	Finish
WL-LED100 120V Horizontal Scoop	C White 3000K (CCT)	BBR** Bronze on Brass
	AM Amber 610nm (Peak)	
WL-LED100 120V Horizontal Scoop WL-LED100F 277V Horizontal Scoop	C White 3000K (CCT)	GH Graphite on Aluminum New!
	AM Amber 610nm (Peak)	BK Black on Aluminum
	RD Red 640nm (Peak)	BN* Brushed Nickel on Aluminum
	BL Blue 450nm (Peak)	BZ Bronze on Aluminum
		SS Stainless Steel
	WT White on Aluminum	
WL-LED200 120V Vertical Scoop WL-LED200F 277V Vertical Scoop	C White 3000K (CCT)	GH Graphite on Aluminum New!
	AM Amber 610nm (Peak)	BK Black on Aluminum
	RD Red 640nm (Peak)	BN* Brushed Nickel on Aluminum
	BL Blue 450nm (Peak)	BZ Bronze on Aluminum
		SS Stainless Steel
	WT White on Aluminum	

Example: **WL-LED100-C-GH**

*BN Finish is not warrantied for contact with chemicals or exterior installations.

Use Brass or Stainless Steel Step and Wall Lights for harsh outdoor environments.

****BBR** finish is not available in 277V option and is not Title 24 Compliant.

Spacing Recommendations for Optimal Light Distribution

Corridors / Hallways

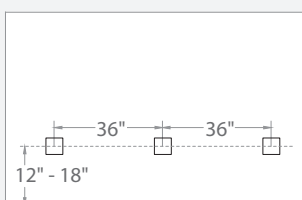

Stairs - Wall Mount

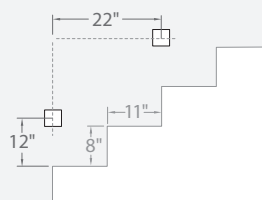

Stairs - Step Mount



Mount in center of stair as close to the upper tread as possible. For best results use one light per step for steps narrower than 5 feet

2" RECESSED INGROUNDS + INDICATORS

Now available in a single directional light

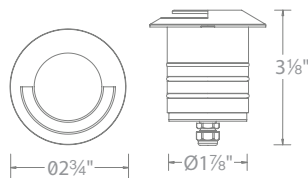
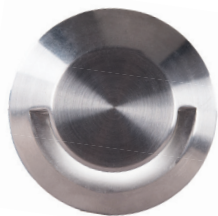

Model Finishes

2" SINGLE DIRECTION

Optional spring clip accessory included

Input 9-15VAC
Power 4.1W / 6.6VA
Brightness 5 lm
Color Temp 3000K
CRI 85
Rated Life 70,000 hours

New!

2091-30SS
2091-30BS

Stainless Steel
 Bronzed Stainless Steel

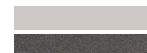

6' lead wire included

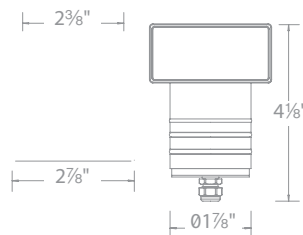

Model Finishes

2" GROUND HOOD

Optional spring clip accessory included

Input 9-15VAC
Power 4.1W / 6.6VA
Brightness 25 lm
Color Temp 3000K
CRI 85
Beam Angle Asymmetrical
Rated Life 70,000 hours

2081-30SS
2081-30BS

Stainless Steel
 Bronzed Stainless Steel

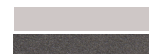

6' lead wire included

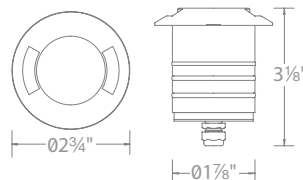
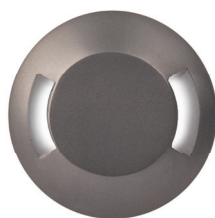

Model Finishes

2" BI-DIRECTIONAL

Optional spring clip accessory included

Input 9-15VAC
Power 4.1W / 6.6VA
Brightness 5 lm
Color Temp 3000K
CRI 85
Rated Life 70,000 hours

2071-30SS
2071-30BS

Stainless Steel
 Bronzed Stainless Steel



6' lead wire included

Accessories



2000-CON-PVC

2" Concrete Pour Kit For installation in concrete. Mounts over a 4" outdoor rated junction box.
 (18" PVC pipe included)

LOW VOLTAGE STEP LIGHTS



Input: 9 - 15VAC
Power: 2W 3.1VA
Brightness: Up to 38 lm
CRI: 90+
Rated Life: 60,000 hours

- Corrosion-resistant aluminum alloy, or cast stainless steel construction
- Fits into 2" x 4" junction box with minimum inside dimensions of 3"L x 2"W x 2.5"D
- IP66 rated, Protected against high-pressure water jets
- 100 - 10% MLV dimming
- Landscape transformer required (sold separately)

	Model	Color Temp	Finishes
	4071-27 4071-30 4071-AM	2700K 3000K Amber	BK Black on Aluminum BZ Bronze on Aluminum WT White on Aluminum SS Stainless Steel
	4051-27 4051-30 4051-AM	2700K 3000K Amber	BK Black on Aluminum BZ Bronze on Aluminum WT White on Aluminum
	4061-27 4061-30 4061-AM	2700K 3000K Amber	BK Black on Aluminum BZ Bronze on Aluminum WT White on Aluminum
	4031-27 4031-30 4031-AM	2700K 3000K Amber	BK Black on Aluminum BZ Bronze on Aluminum WT White on Aluminum
	4041-27 4041-30 4041-AM	2700K 3000K Amber	BK Black on Aluminum BZ Bronze on Aluminum WT White on Aluminum
	4091-27 4091-30 4091-AM	2700K 3000K Amber	BK Black on Aluminum BZ Bronze on Aluminum WT White on Aluminum

Example: **4071-27SS**

Transformer Required (sold separately)

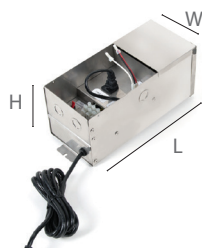

Model	
9075-TRN-SS	75W Max Dimensions: 13.97" L x 5.35"W x 5.63"H
9150-TRN-SS	150W Max Dimensions: 18.90" L x 6.69"W x 6.30"H
9300-TRN-SS	300W Max Dimensions: 18.90" L x 6.69"W x 6.30"H
9600-TRN-SS	600W Max (2 x 300W outputs) Dimensions: 14.49" L x 10.08"W x 5.94"H

HARDSCAPE
WITH DUAL CCT AND INTEGRAL BRIGHTNESS CONTROL



Transformer

For 12V Grand Accent, Accent, Mini Accent, Mini Wall Wash and Dual CCT Hardscape

- IP65 Rated
- 12V to 15V taps
- Knock outs for power and photosensor connections
- 3-prong outlet for timer
- Outdoor rated stainless steel

Model

9075-TRN-SS	75W Max Dimensions: 13.97" L x 5.35"W x 5.63"H
9150-TRN-SS	150W Max Dimensions: 18.90" L x 6.69"W x 6.30"H
9300-TRN-SS	300W Max Dimensions: 18.90" L x 6.69"W x 6.30"H
9600-TRN-SS	600W Max (2 x 300W outputs) Dimensions: 14.49" L x 10.08"W x 5.94"H



7181-27/30 18 inches



7121-27/30 12 inches



7061-27/30 6 inches



7031* 3 inches

* Due to its compact size, the 7031 is dedicated in either 2700K or 3000K. Lead Wire remains on the side of the fixture.

12V

Input: 9-15VAC
Lumens: Up to 330 lm
CRI: 90+
Rated Life: 50,000 hours

- Integral brightness control
 Select color temperature option*
- Hardscape easily detaches from capstone bracket after installation
- Corrosion-resistant aluminum alloy
- Factory-sealed water tight fixture
- Transformer required (sold separately)
- Tightly spaced and diffused LEDs for even illumination
- Direct burial gel-filled wire nuts included

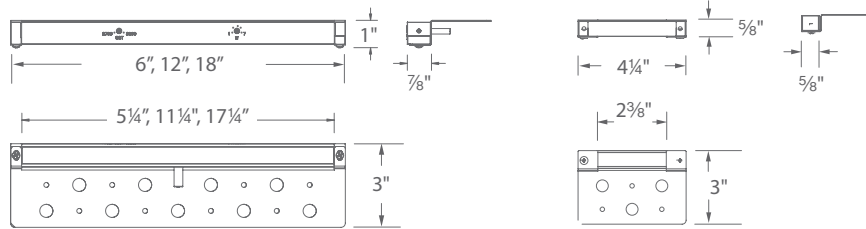

7061, 7121, 7181

7031*



Length	Model	Color Temp	Wattage	Max Lumens	Finishes
3" *	7031-27 7031-30	2700K Warm White* 3000K Pure White*	1.4W, 2.5VA	40	BZ Bronze on Aluminum GH Graphite SD Sand
6"	New 7061-27/30	2700K Warm White 3000K Pure White	4.5W, 5.6VA	120	
12"	New 7121-27/30	2700K Warm White 3000K Pure White	7.0W, 7.3VA	225	
18"	New 7181-27/30	2700K Warm White 3000K Pure White	8.5W, 8.5VA	330	

Example: **7181-27/30SD**

GRAND ACCENT



MOONLIGHTING EFFECT

Introducing the latest addition to our family of landscape accent lights, now with even more light output. When mounted high in trees and pointing downward, Grand Accent creates a beautiful moonlighting effect with a cool white light and superior lumen output.

- New 4000K Color Temperature resembles moonlight
- Adjustable beam 15° to 60°
- Continuously adjustable lumen output 740–2000 lm

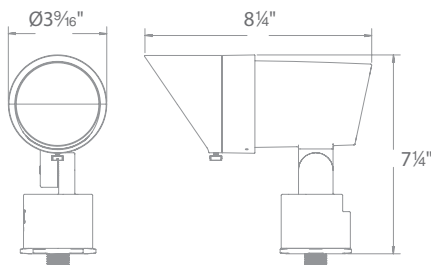

Mounting stake and direct burial gel filled wire nuts Included

12V

- Integral brightness control
- Adjustable beam angle 15°–60°
- One fixture replaces 50W to 100W halogen accent light
- Transformer required (sold separately)

Input: 9 - 15VAC
Power: 15W to 35W / 21VA - 44VA
Lumens: 740 lm to 2000 lm
Beam Angle: 15° to 60°
CRI: 85
Rated Life: 45,000 hours

Color Temperature

2700K	Warm White
5211-27BZ	Bronze on Aluminum
5211-27BK	Black on Aluminum
3000K	Pure White
5211-30BZ	Bronze on Aluminum
5211-30BK	Black on Aluminum
4000K	Cool White
5211-40BZ	Bronze on Aluminum
5211-40BK	Black on Aluminum

Accessories For Grand Accent

Grand Accent Snoot	5211-SNOOT-BZ 5211-SNOOT-BK	Bronze on Aluminum Black on Aluminum
6" Long Shroud	5211-LSHR-BZ 5211-LSHR-BK	Bronze on Aluminum Black on Aluminum
Optics	LENS-25-AMB Amber LENS-25-GRN Green LENS-25-RED Red	LENS-25-BLU Blue LENS-25-FR Frosted

MINI ACCENT

Now available in Black



1838 listed (12V)
1598 listed (120V)



Mounting stake and direct burial gel filled wire nuts Included

12V

- Integral brightness control
- Adjustable beam angle 10° to 50°
- One fixture replaces 20W to 35W halogen accent light
- Transformer required (sold separately)

Input: 9-15VAC
Power: 1W to 7W / 2VA -10.5VA
Lumens: 45 lm to 365 lm
Beam Angle: 10° to 50°
CRI: 85
Rated Life: 70,000 hours

2700K

Warm White

5111-27BZ
5111-27BBR
New! **5111-27BK**

Bronze on Aluminum
 Bronze on Brass
 Black on Aluminum

3000K

Pure White

5111-30BZ
5111-30BBR
New! **5111-30BK**

Bronze on Aluminum
 Bronze on Brass
 Black on Aluminum

Accessories For Mini Accent

 Mini Accent Snoot	5111-SNOOT-BZ 5111-SNOOT-BBR 5111-SNOOT-BK	Bronze on Aluminum Bronze on Brass Black on Aluminum
 5" Long Shroud	5111-LSHR-BZ 5111-LSHR-BBR 5111-LSHR-BK	Bronze on Aluminum Bronze on Brass Black on Aluminum

 Optics	LENS-16-AMB Amber LENS-16-GRN Green LENS-16-RED Red LENS-16-BLU Blue	LENS-16-FR Frosted LENS-16-SPR Spread LENS-16-BEL Elongating
---	---	---

ACCENT

Now available in Black



Mounting stake and direct burial gel filled wire nuts Included

12V

- Integral brightness control
- Adjustable beam angle 10° to 60°
- One fixture replaces 35W to 75W halogen accent light
- Transformer required (sold separately)

Input: 9-15VAC
Power: 2W to 16W / 2VA -23VA
Lumens: 190 lm to 1045 lm
Beam Angle: 10° to 60°
CRI: 85
Rated Life: 70,000 hours

2700K

Warm White

5011-27BZ
5011-27BBR
New! **5011-27BK**

Bronze on Aluminum
 Bronze on Brass
 Black on Aluminum

3000K

Pure White

5011-30BZ
5011-30BBR
New! **5011-30BK**

Bronze on Aluminum
 Bronze on Brass
 Black on Aluminum

120V Transformer Not Required

Input: 110V - 120VAC
Power: 3.5W to 14.5W
Lumens: 100 lm to 900 lm
Beam Angle: 15° to 60°
CRI: 85
Rated Life: 45,000 hours

3000K

Pure White

5012-30BZ
5012-30BBR
New! **5012-30BK**

Bronze on Aluminum
 Bronze on Brass
 Black on Aluminum

Accessories For Accent

 Accent Snoot	5010-SNOOT-BZ 5010-SNOOT-BBR 5010-SNOOT-BK	Bronze on Aluminum Bronze on Brass Black on Aluminum
 6" Long Shroud	5010-LSHR-BZ 5010-LSHR-BBR 5010-LSHR-BK	Bronze on Aluminum Bronze on Brass Black on Aluminum

 Optics	LENS-20-AMB Amber LENS-20-GRN Green LENS-20-RED Red	LENS-20-BLU Blue LENS-20-FR Frosted LENS-20-SPR Spread
---	--	---

MINI WALL WASH

WITH DUAL CCT AND INTEGRAL BRIGHTNESS CONTROL



1838 listed (12V)

12V

- Integral brightness control
Select color temperature option
- A uniform wide distribution wall wash from a small form factor
- Mounting stake and direct burial gel-filled wire nuts all included
- Transformer required (sold separately)

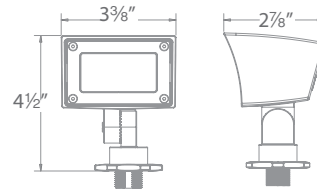

Input: 9-15VAC
Power: 1W to 8W / 2-12VA
Lumens: 80 lm to 420 lm
Beam Angle: Symmetrical (70° by 95°)
CRI: 85+
Rated Life: 60,000 hours
CCT: **2700K & 3000K**
 Warm White & Pure White

5121-27/30BZ Bronze on Aluminum
5121-27/30BBR Bronze on Brass
5121-27/30BK Black on Aluminum

A uniform wide distribution wall wash from a small form factor

Accessories For Mini Wall Wash

Mini Wall Wash Optics



LENS-2X3-AMB Amber
LENS-2X3-GRN Green
LENS-2X3-RED Red
LENS-2X3-BLU Blue
LENS-2X3-FR Frosted
LENS-2X3-SPR Spread



3000K
Pure White light

8 Watts



3000K
Pure White light

4 Watts



2700K
Warm White light

4 Watts



WALL WASH

Now available in Black



1838 listed (12V)
1598 listed (120V)

12V

- Integral brightness control
- Mounting stake and direct burial gel-filled wire nuts all included with 12V
- Transformer required (sold separately)

Input: 9-15VAC
Power: 2W to 16W / 2 - 23VA
Brightness: 190 lm to 980 lm
Beam Angle: 15° upward (50° by 80°)
CRI: 85
Rated Life: 70,000 hours



120V

Transformer Not Required

- Integral brightness control

Input: 110V - 120VAC
Power: 3.5W to 14.5W
Brightness: 95 lm to 855 lm
Beam Angle: 15° upward (50° by 80°)
CRI: 85
Rated Life: 45,000 hours

2700K

Warm White

5021-27BZ Bronze on Aluminum
5021-27BBR Bronze on Brass
5021-27BK Black on Aluminum New!

3000K

Pure White

5021-30BZ Bronze on Aluminum
5021-30BBR Bronze on Brass
5021-30BK Black on Aluminum New!

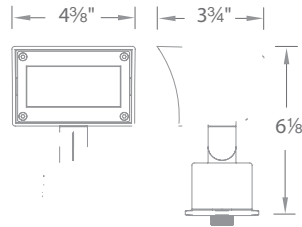

3000K

Pure White

5022-30BZ Bronze on Aluminum
5022-30BBR Bronze on Brass
5022-30BK Black on Aluminum New!

Accessories For Wall Wash

Wall Wash Optics 	LENS-2X4-AMB	Amber
	LENS-2X4-GRN	Green
	LENS-2X4-RED	Red
	LENS-2X4-BLU	Blue
	LENS-2X4-FR	Frosted
	LENS-2X4-SPR	Spread

Accessories For Mini Accent, Accent, Grand Accent, Mini Wall Wash and Wall Wash

Additional Stake		9000-ST9-BZ	Bronze	Durable PC stake
Surface Mount Flange/Stake		5000-SCP-BZ 5000-SCP-BBR	Bronze on Aluminum Bronze on Brass	Includes three 7 inch threaded stainless steel stabilizing pins for ground mounting or surface mounts with four screws or over a junction box
Guardian Mount		9000-SP9-BZ	Stainless Steel	Heavy duty stainless steel spike to position fixture Formed from a single plate of stainless steel
Gutter Mount Bracket		5000-GM-BZ	Stainless Steel	Stainless Steel universal bracket for mounting in gutter
Tree Mount Junction Box		5000-TCP-BZ	Bronze on Aluminum	Bronze on Aluminum box with Stainless steel mounting screws. Two 1/2" NPT threaded holes
Rod L-Coupler		5000-LCO-BZ	Bronze	
Extension Rods		5000-X04-BZ 5000-X08-BZ 5000-X12-BZ 5000-X18-BZ 5000-X24-BZ	4 in 8 in 12 in 18 in 24 in Bronze	Extends distance between light accent and Surface Mount Canopy, Stake, or Tree Mount box



TIKI & MINI TIKI LED AREA LIGHT

IP66  1838 listed

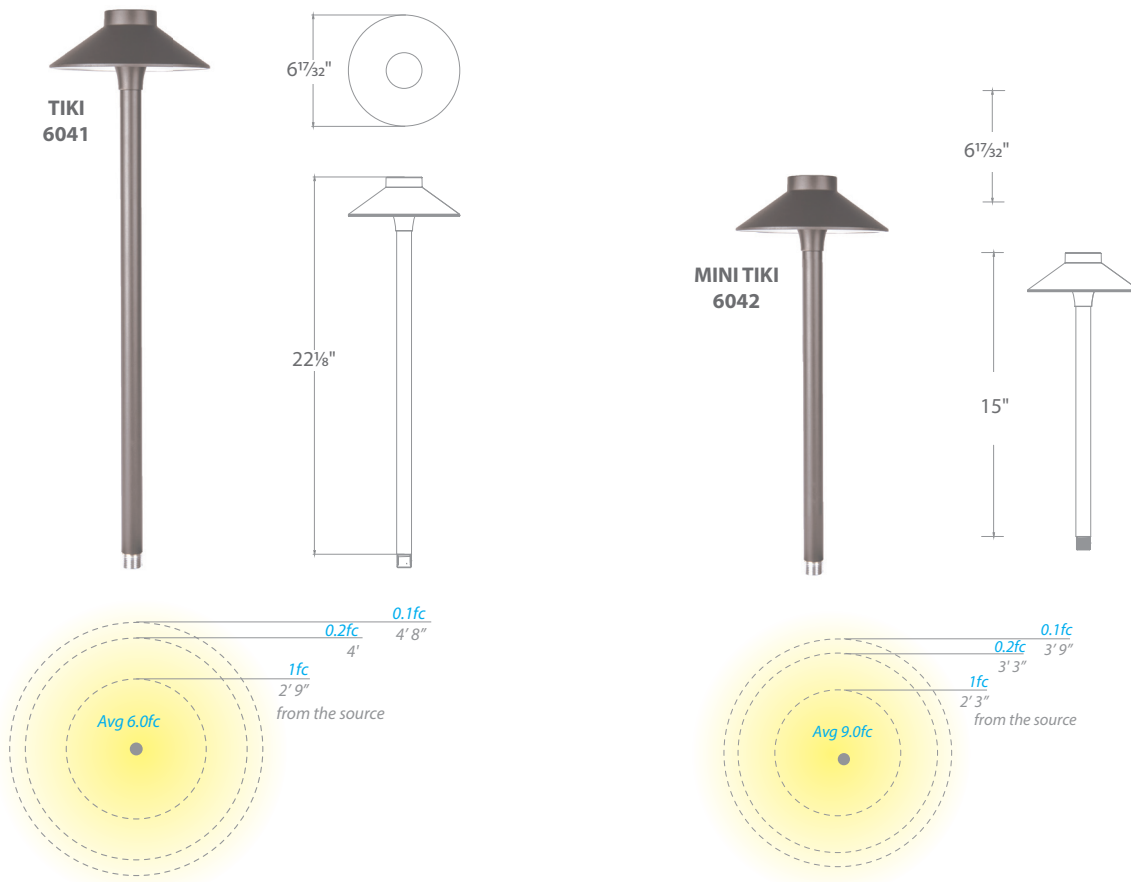
Now available in a 15inch size





- Sturdy side mount design works well in applications where directional illumination is desired
- **Recommended spacing for installation :**
Residential: 7ft to 9ft
Commercial: 5ft to 7ft

	Model	Color Temp	Finishes
Input: 9 - 15VAC	6041 22"	27 2700K Warm White 30 3000K Pure White	BZ Bronze on Aluminum  BK Black on Aluminum 
Power: 6.5W, 9.5VA			
Brightness: Up to 225 lm	New 6042 15"		
CRI: 90			
Rated Life: 60,000 hours			

Example: 6042-30BK

Mounting stake, 6 foot lead wire, and direct burial gel filled wire nuts included

Accessories

Additional Mounting Stake		9000-ST9-BZ	Bronze	Durable PC stake
Surface Mount Flange/Stake		5000-SCP-BZ 5000-SCP-BBR	Bronze on Aluminum Bronze on Brass	Includes three 7 inch threaded stainless steel stabilizing pins for ground mounting or surface mounts with four screws or over a junction box
Guardian Mount		9000-SP9-BZ	Stainless Steel	Heavy duty stainless steel spike to position fixture Formed from a single piece of metal

Headquarters
Tel: 800.526.2588
Fax: 800.526.2585

East Factory
44 Harbor Park Drive
Port Washington, NY 11050

Central Factory
1600 Distribution Ct,
Lithia Springs, GA 30122

West Factory
1750 Archibald Ave
Ontario, CA 91761

Custom Orders
customs@wacighting.com

Consult with us to take advantage of our custom capabilities.

For up to date product specifications and assistance please visit **www.wacighting.com**

Many LED luminaire designs within contain patent pending features.

WAC Lighting will not hesitate to enforce its intellectual property rights through injunctive relief and seek further relief through damages if it has reason to believe the patents are being infringed upon.

WAC Lighting retains the right to modify the design of our products at any time as part of the company's continuous improvement program.

Copyright 2018

WAC LIGHTING

☎ Tel: (664) 623 7143

✉ info@luztra.mx

Paseo De los Héroes 2503

Zona Río, Tijuana, B.C. CP 22010

www.luztra.mx