



Nothing but **HEAVY DUTY.**

# MILWAUKEE® HAND TOOLS AND STORAGE



**ULTIMATE PRODUCTIVITY.  
SUPERIOR PERFORMANCE.**

## STUD™ TAPE MEASURES

### INDUSTRY'S MOST DURABLE TAPE MEASURE



\*Functional After 80' Drop on Packed Soil

Model #	Description
48-22-9916	16ft STUD™ Tape Measure
48-22-9925	25ft STUD™ Tape Measure

## MAGNETIC TAPE MEASURES

### LONGEST LIFE

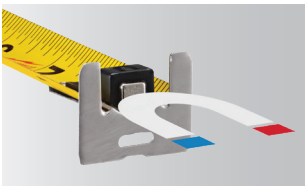

Magnet Holds EMT and Steel Studs

Model #	Description
48-22-7116	16ft Magnetic Tape Measure
48-22-7125	25ft Magnetic Tape Measure
48-22-7130	30ft Magnetic Tape Measure

Model #	Description
48-22-7135	35ft Magnetic Tape Measure
48-22-7216	5m / 16ft Magnetic Tape Measure
48-22-7225	8m / 26ft Magnetic Tape Measure

## AUTO-LOCK TAPE MEASURES

### LONGEST LIFE

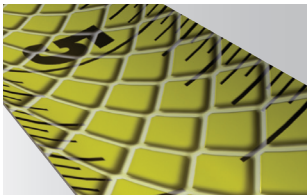

Nylon Bond Blade Protection

Model #	Description
48-22-6815	5m Tape Measure with Auto-Lock
48-22-6816	16ft Tape Measure with Auto-Lock
48-22-6817	5m/16ft Tape Measure with Auto-Lock
48-22-6818	8m Tape Measure with Auto-Lock
48-22-6825	25ft Tape Measure with Auto-Lock
48-22-6826	8m/16ft Tape Measure with Auto-Lock

## COMPACT TAPE MEASURES

### LONGEST LIFE



Also Available:



**Keychain Tape Measure**  
48-22-5506C

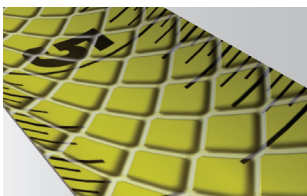

Nylon Bond Blade Protection

Model #	Description
48-22-5506	2m/6ft Keychain Tape Measure
48-22-6616	16ft Tape Measure
48-22-6625	25ft Tape Measure
48-22-6630	30ft Tape Measure
48-22-6612	12ft Tape Measure
48-22-6613	3m/12ft Tape Measure
48-22-6617	5m/16ft Tape Measure
48-22-6626	8m/26ft Tape Measure

## OPEN REEL LONG TAPES

### 50% LESS STRETCH

**3:1 Metal Planetary Gears**  
Prevents gear stripping & stress



**Nylon Bond**

**Kink-Resistant Blade**

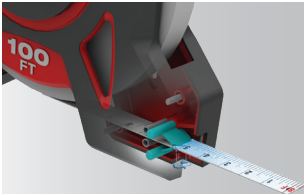

**GRIME GUARD™**  
Industry's First Blade Wiper

Model #	Description
48-22-5201	100ft Open Reel Steel Long Tape with GRIME GUARD™ – 1/2" Blade
48-22-5230	300ft Open Reel Steel Long Tape with GRIME GUARD™ – 3/4" Blade

## CLOSED REEL LONG TAPE

### LONGEST LIFE

**3:1 Torque Dispersing Planetary Gears**  
Prevents gear stripping & stress

**Reinforced Metal Frame**



**Nylon Coated Blade**

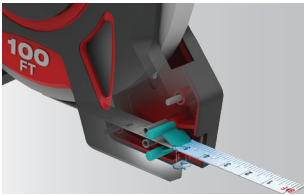

**GRIME GUARD™**  
Industry's First Blade Wiper

Model #	Description
48-22-5101	100ft Closed Reel Long Tape with GRIME GUARD™ – 1/2" Blade

## MEASURING WHEELS

### MOST DURABLE. MOST ACCURATE.

**Top Reset Button**  
12" Model

**Ergonomic Pistol Grip Design**

**Trigger Brake**

**Reinforced Folding Point & Aluminum Frame**

**Carrying Handle**

**Reinforced Folding Kickstand**

**Durable Wheel**

**Zero Point Indicator**

Also Available:



**6" Measuring Wheel**  
48-22-5006

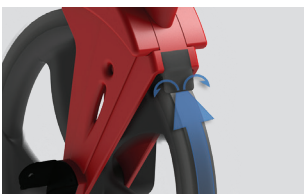

**Debris Cleaning Wheel Flap**

Model #	Description
48-22-5006	6" Measuring Wheel

Model #	Description
48-22-5012	12" Measuring Wheel

## REDSTICK™ BOX LEVELS

**MOST DURABLE.  
GUARANTEED ACCURACY.**

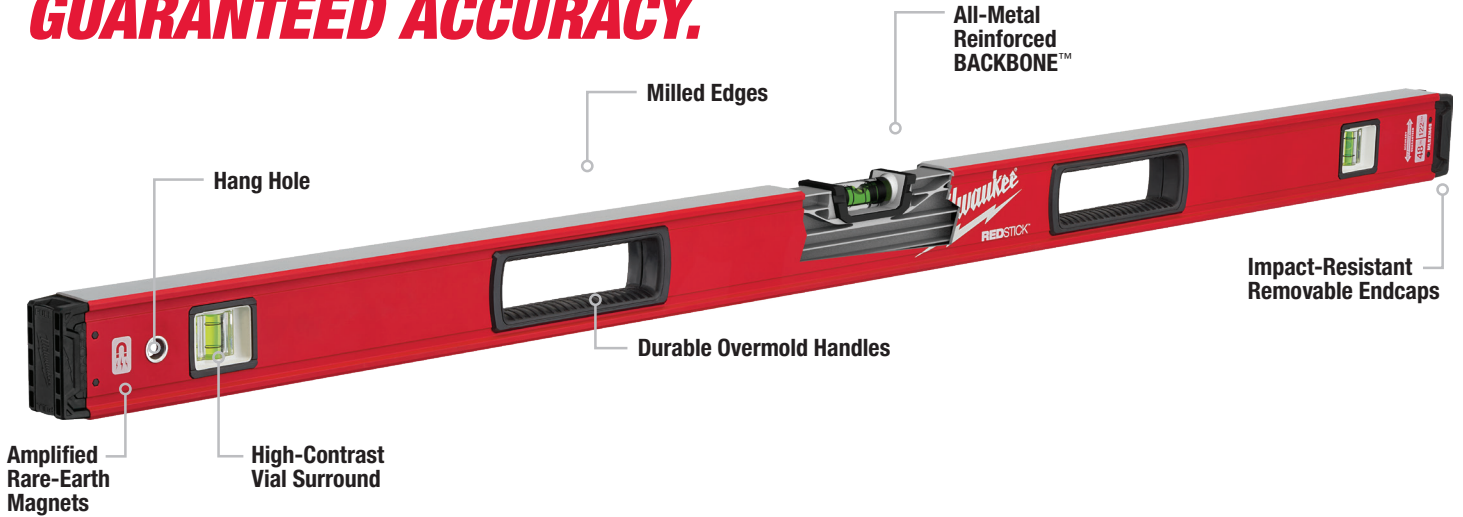

Model #	Description
MLBX16	16" REDSTICK™ Box Level
MLBXM16	16" REDSTICK™ <b>Magnetic</b> Box Level
MLBX24	24" REDSTICK™ Box Level
MLBXM24	24" REDSTICK™ <b>Magnetic</b> Box Level
MLBX32	32" REDSTICK™ Box Level
MLBXM32	32" REDSTICK™ <b>Magnetic</b> Box Level
MLBX36	36" REDSTICK™ Box Level
MLBXM36	36" REDSTICK™ <b>Magnetic</b> Box Level
MLBX48	48" REDSTICK™ Box Level
MLBXM48	48" REDSTICK™ <b>Magnetic</b> Box Level
MLBX59	59" REDSTICK™ Box Level
MLBXM59	59" REDSTICK™ <b>Magnetic</b> Box Level
MLBX72	72" REDSTICK™ Box Level
MLBXM72	72" REDSTICK™ <b>Magnetic</b> Box Level

Model #	Description
MLBX78	78" REDSTICK™ Box Level
MLBXM78	78" REDSTICK™ <b>Magnetic</b> Box Level
MLBX96	96" REDSTICK™ Box Level
MLBXM96	96" REDSTICK™ <b>Magnetic</b> Box Level
MLBXS1648	16" / 48" REDSTICK™ Box Level Set
MLBXS48	24" / 48" REDSTICK™ Box Level Set
MLBXS48M	24" / 48" REDSTICK™ <b>Magnetic</b> Box Level Set
MLBXJB	78" / 32" REDSTICK™ Box Level Jamb Set
MLBXJBM	78" / 32" REDSTICK™ <b>Magnetic</b> Box Level Jamb Set
MLSB48	48" Level Bag
MLSB78	78" Level Bag
MLBXC48	4 Pc REDSTICK™ Starter Set
MLBXC78	5 Pc REDSTICK™ Master Set

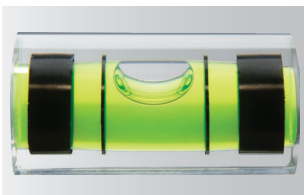

SHARPSITE™ Vial Technology

## REDSTICK™ COMPACT BOX LEVELS

**COMPACT DURABILITY**

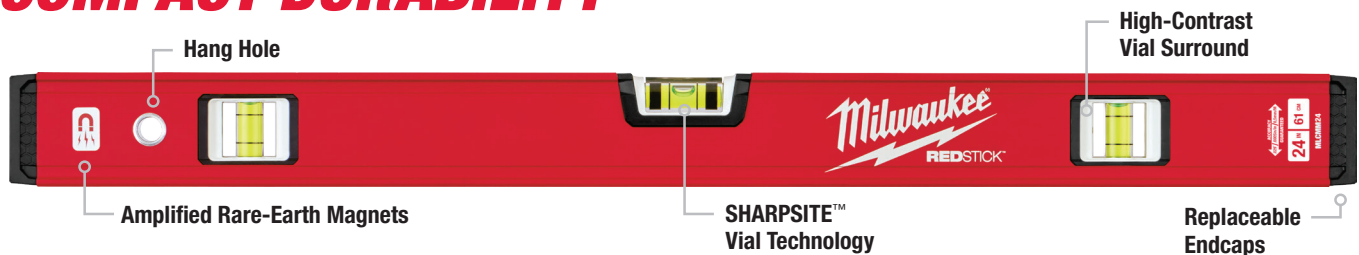

Model #	Description
MLCM24	24" REDSTICK™ Compact Box Level
MLCMM24	24" REDSTICK™ <b>Magnetic</b> Compact Box Level
MLCM48	48" REDSTICK™ Compact Box Level
MLCMM48	48" REDSTICK™ <b>Magnetic</b> Compact Box Level

Model #	Description
MLCM72	72" REDSTICK™ Compact Box Level
MLCMM72	72" REDSTICK™ <b>Magnetic</b> Compact Box Level
MLCMS48	24" / 48" REDSTICK™ Compact Box Level Set
MLCMS48M	24" / 48" REDSTICK™ <b>Magnetic</b> Compact Box Level Set

## REDSTICK™ CONCRETE LEVELS

### BUILT FOR CONCRETE



Screed



Smooth



Clean

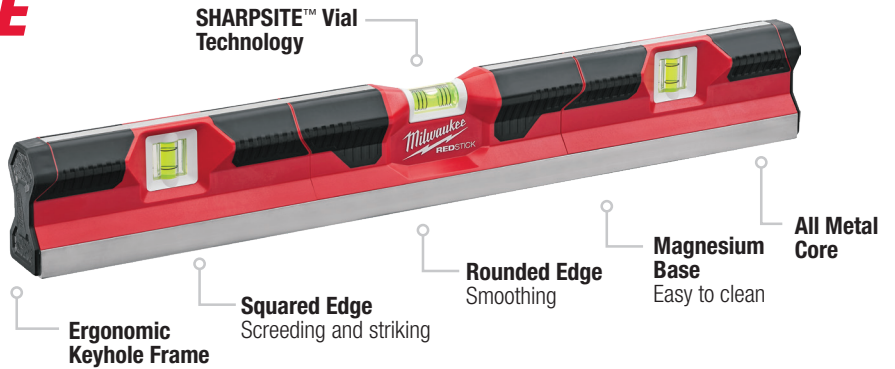

Model #	Description
MLCON24	24" REDSTICK™ Concrete Level
MLCON48	48" REDSTICK™ Concrete Level
MLCON72	72" REDSTICK™ Concrete Level

## BILLET TORPEDO LEVELS

### STRONGEST MAGNETS. EASIEST PITCH SET.

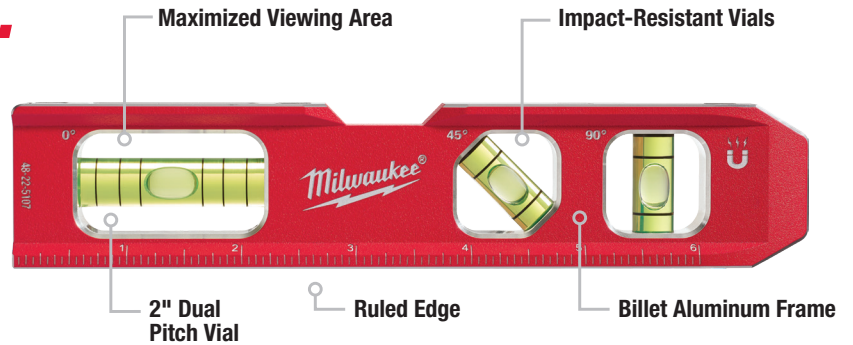

4 Amplified Rare-Earth Magnets

Model #	Description
48-22-5107	Billet Torpedo Level
48-22-5207	Metric Billet Torpedo Level

## BLOCK TORPEDO LEVEL

### STRONGEST MAGNETS. 360° ACCURACY.

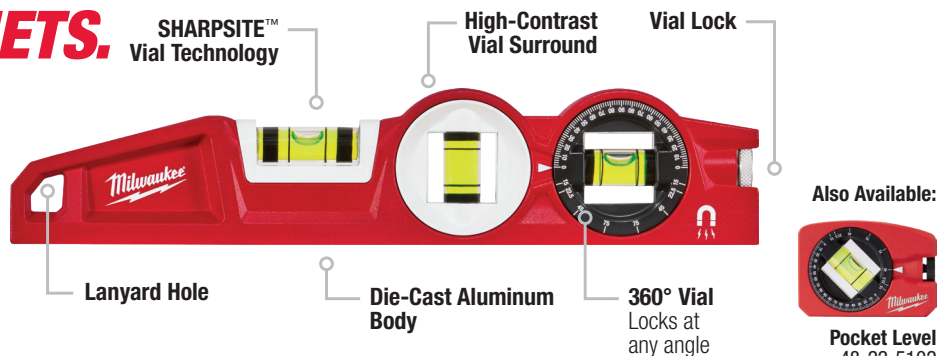

Amplified Rare-Earth Magnets

Model #	Description
48-22-5210	Block Torpedo Level
48-22-5102	Pocket Level

# LASER DISTANCE METERS, CHALK REELS & FOLDING RULES

## LASER DISTANCE METERS

**EASIEST MEASUREMENTS**



Simplified User Interface

2" Backlit Color Screen

Continuous Real-Time Measurements

2-Position Auto-Detecting Lever



Impact-Resistant Overmolding

Side-Shot Button  
Allows for one-handed measurement in all situations

Also Available:



65ft Laser Distance Meter  
48-22-9801

Model #	Description
48-22-9801	65ft Laser Distance Meter
48-22-9802	150ft Laser Distance Meter

Model #	Description
48-22-9803	330ft Laser Distance Meter

## CHALK REELS

**LONGEST GEAR LIFE. BEST PERFORMANCE.**



StripGuard™ Clutch & Planetary Gears

1.5mm High-Strength Braided Line

0.9mm High-Strength Braided Line

Aluminum Body  
Fine line model only

6X Faster Retraction



Bold Line



Fine Line

Model #	Description
48-22-3980	Bold Line Chalk Reel
48-22-3982	Bold Line Chalk Reel & Blue Chalk Refill
48-22-3986	Bold Line Chalk Reel & Red Chalk Refill
48-22-3989	Bold Replacement Line

Model #	Description
48-22-3990	Fine Line Chalk Reel
48-22-3992	Fine Line Chalk Reel & Blue Chalk Refill
48-22-3993	Chalk Reel Kit with Blue Chalk Refill
48-22-3999	Fine Replacement Line

## FOLDING RULES

**MOST DURABLE MARKINGS & BLADES**

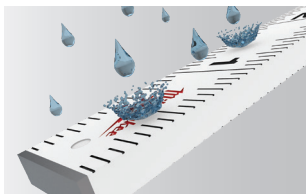

Water & Scratch Resistant Laminate

Quick Reference Bend Angles  
22.5°, 30°, 45° & 60°

Heat-Stamped Markings  
Won't wear

Corrosion-Free Embedded Joints  
Locks at 0°, 90° & 180°



Model #	Description
48-22-3801	6-1/2ft Composite Folding Rule
48-22-3802	6-1/2ft Engineer's Composite Folding Rule

## INKZALL™ JOBSITE MARKERS

**WRITES ON  
DUST  
WET  
OILY  
SURFACES**



Clog Resistant



ULTRA FINE POINT

FINE POINT

MEDIUM POINT

CHISEL TIP

Model #	Description
48-22-3150	12 Pc INKZALL™ Ultra Fine Point Black Markers
48-22-3154	4 Pc INKZALL™ Ultra Fine Point Black Markers
48-22-3104	4 Pc INKZALL™ Fine Point Black Marker
48-22-3105	2 Pc INKZALL™ Fine Point Black Markers
48-22-3107	8 Pc INKZALL™ Fine Point Color Marker
48-22-3106	4 Pc INKZALL™ Fine Point Color Marker
48-22-3101	INKZALL™ Stylus and Fine Point Black Marker
48-22-3102	2 Pc INKZALL™ Medium Point Black Marker

Model #	Description
48-22-3103	INKZALL™ Chisel Tip Black Marker
48-22-3109	4 Pc INKZALL™ Chisel Tip Color Marker
48-22-3100	INKZALL™ Fine Point Black Markers (Bulk 36 Pc)
48-22-3130	INKZALL™ Chisel Tip Black Marker (Bulk 36 Pc)
48-22-3170	INKZALL™ Fine Point Red Markers (Bulk 36 Pc)
48-22-3180	INKZALL™ Fine Point Blue Markers (Bulk 36 Pc)
48-22-3190	INKZALL™ Fine Point Green Markers (Bulk 36 Pc)

## INKZALL™ METALLIC MARKERS



Visible On Dark Surfaces



Model #	Description
48-22-3121	2 Pc INKZALL™ Fine Point Silver Metallic Marker
48-22-3122	2 Pc INKZALL™ Fine Point Gold Metallic Marker
48-22-3123	2 Pc INKZALL™ Fine Point Silver/Gold Metallic Marker



# INKZALL™ PAINT MARKERS, PENS & HIGHLIGHTERS

## INKZALL™ LIQUID PAINT MARKERS

**BLEED &  
SMEAR  
RESISTANT**



Marks on Surfaces up to 300°F

10-Second  
Dry Time

Valve Activated

Acrylic Nib

Water &  
UV Resistant  
Markings

Medium Point

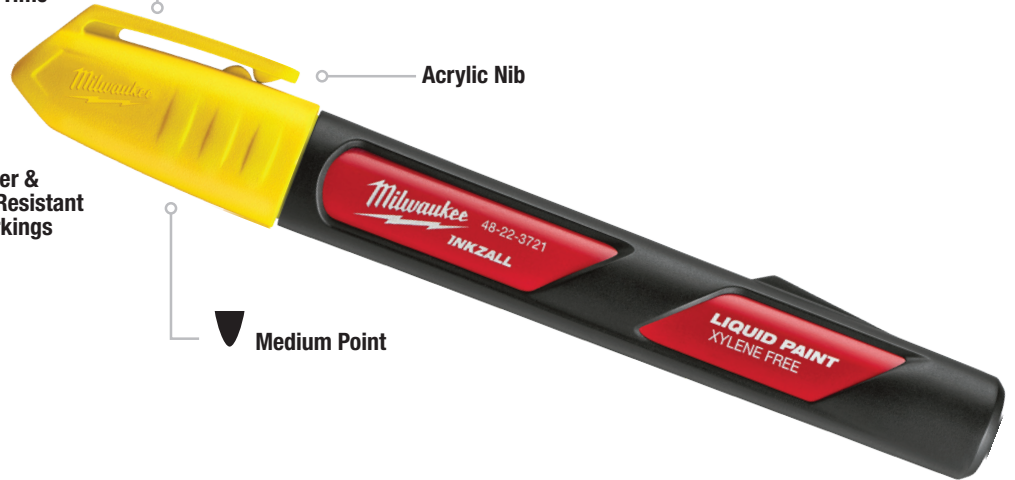

Model #	Description
48-22-3712	INKZALL™ Medium Point White Liquid Paint Marker
48-22-3722	INKZALL™ Medium Point Yellow Liquid Paint Marker
48-22-3711	INKZALL™ Medium Point White Liquid Paint Marker (Bulk 12 Pc)
48-22-3721	INKZALL™ Medium Point Yellow Liquid Paint Marker (Bulk 12 Pc)
48-22-3731	INKZALL™ Medium Point Black Liquid Paint Marker (Bulk 12 Pc)

Model #	Description
48-22-3741	INKZALL™ Medium Point Red Liquid Paint Marker (Bulk 12 Pc)
48-22-3751	INKZALL™ Medium Point Green Liquid Paint Marker (Bulk 12 Pc)
48-22-3761	INKZALL™ Medium Point Blue Liquid Paint Marker (Bulk 12 Pc)
48-22-3771	INKZALL™ Medium Point Orange Liquid Paint Marker (Bulk 12 Pc)

## INKZALL™ JOBSITE PENS

**SHARP,  
PRECISE  
LINES**

Clog Resistant Tip



Ultra Fine Point



Model #	Description
48-22-3160	12 Pc INKZALL™ Ultra Fine Point Black Pen
48-22-3161	12 Pc INKZALL™ Ultra Fine Point Red Pen
48-22-3162	12 Pc INKZALL™ Ultra Fine Point Blue Pen
48-22-3164	4 Pc INKZALL™ Ultra Fine Point Black Pen
48-22-3165	4 Pc INKZALL™ Ultra Fine Point Color Pen

## INKZALL™ JOBSITE HIGHLIGHTERS

**UP TO  
4X LONGER LIFE**

Lanyard Hole

Hard Hat Clip



Chisel Tip

Anti-Roll Body



Model #	Description
48-22-3201	5 Pc INKZALL™ Chisel Tip Yellow Highlighter
48-22-3206	5 Pc INKZALL™ Chisel Tip Colored Highlighter

## COMFORT GRIP STRAIGHT JAW PLIERS

### REAM AND PUNCH™



Ream

Punch



Model #	Description	Jaw Capacity	Reaming Capacity
48-22-6306	6" Comfort Grip Straight Jaw Pliers	1"	3/4"
48-22-6310	10" Comfort Grip Straight Jaw Pliers	2"	2"
48-22-6312	12" Comfort Grip Straight Jaw Pliers	2-1/4"	2-3/4"
48-22-6316	16" Comfort Grip Straight Jaw Pliers	4-1/4"	3"
48-22-6320	20" Comfort Grip Straight Jaw Pliers	5-1/2"	3-1/2"
48-22-6330	2 Pc 6" & 10" Comfort Grip Straight Jaw Pliers Set	1" & 2"	3/4" & 2"
48-22-6331	3 Pc Comfort Grip Pliers Set	2"	2"

## STRAIGHT JAW PLIERS

### MAXIMUM GRIP. FORGED STRENGTH.



Reaming Head

Model #	Description	Jaw Capacity	Reaming Capacity
48-22-6510	10" Straight Jaw Pliers	2"	2"
48-22-6512	12" Straight Jaw Pliers	2-1/4"	2-3/4"

## SMOOTH JAW PLIERS

### SMOOTH JAW PROTECTS SURFACES



Non-Marring Smooth Jaw  
for Finish Applications

Model #	Description	Jaw Capacity	Reaming Capacity
48-22-6550	10" Smooth Jaw Pliers	2"	2"
48-22-6552	12" Smooth Jaw Pliers	2-1/4"	2-3/4"

# FASTENING & CUTTING PLIERS

## V-JAW PLIERS



**HEX JAW**  
**BEST FIT. STRONG HOLD.**



Ream

Punch

Model #	Description	Jaw Capacity	Reaming Capacity
48-22-6208	8" Comfort Grip V-Jaw Pliers	1-1/2"	1-1/2"
48-22-6210	10" Comfort Grip V-Jaw Pliers	2"	2"
48-22-6212	12" Comfort Grip V-Jaw Pliers	2-3/4"	2-3/4"

## LINEMAN'S PLIERS

**MAXIMUM LEVERAGE.**  
**EASIER CUTS.\***



Also Available:

Comfort Grip High-Leverage  
Lineman's Pliers  
48-22-6100



Easily Cuts #2 ACSR  
\* When compared to other  
ACSR cutting lineman's pliers

Model #	Description
48-22-6100	Comfort Grip High-Leverage Lineman's Pliers with Crimper
48-22-6500	High-Leverage Lineman's Pliers with Crimper
48-22-6502	High-Leverage Lineman's Pliers
48-22-6503	High-Leverage Lineman's Pliers with Thread Cleaner

## ANGLED HEAD PLIERS

**BETTER ACCESS**



Also Available:

8" Angled Head Diagonal  
Cutting Pliers  
48-22-6528



Angled Head

Model #	Description
48-22-6128	8" Comfort Grip Angled Head Diagonal Cutting Pliers
48-22-6528	8" Angled Head Diagonal Cutting Pliers

## LONG NOSE PLIERS

### LONG REACH



2" Gripping Nose

Also Available:



8" Long Nose Pliers  
48-22-6501

Model #	Description
48-22-6101	8" Comfort Grip Long Nose Pliers
48-22-6501	8" Long Nose Pliers

## DIAGONAL PLIERS

### UP TO 2X MORE CUTS

### IRON-CARBIDE EDGE



Tapered Nose

Also Available:



8" Diagonal Cutting Pliers  
48-22-6508

Model #	Description
48-22-6106	6" Comfort Grip Diagonal Cutting Pliers
48-22-6107	7" Comfort Grip Diagonal Cutting Pliers
48-22-6108	8" Comfort Grip Diagonal Cutting Pliers
48-22-6508	8" Diagonal Cutting Pliers

# COMBINATION & MULTI-FUNCTION PLIERS

## 6 IN 1 COMBINATION PLIERS

**6IN1**

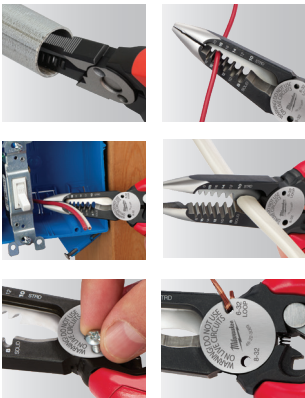
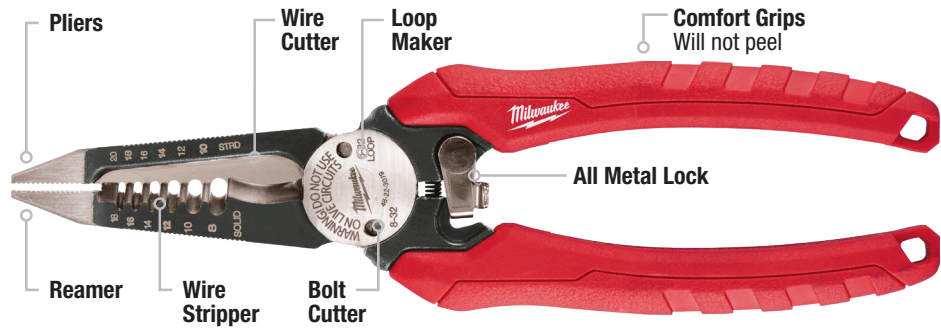

Model #	Description	Wire Stripper
48-22-3079	6IN1 Comfort Grip Combination Pliers	8-18 AWG Solid, 10-20 AWG Stranded

## MULTI-FUNCTION

**FAST, ONE-HANDED OPERATION**

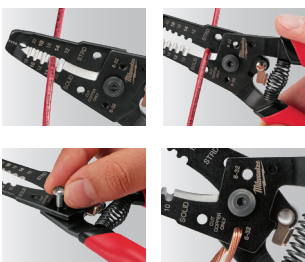
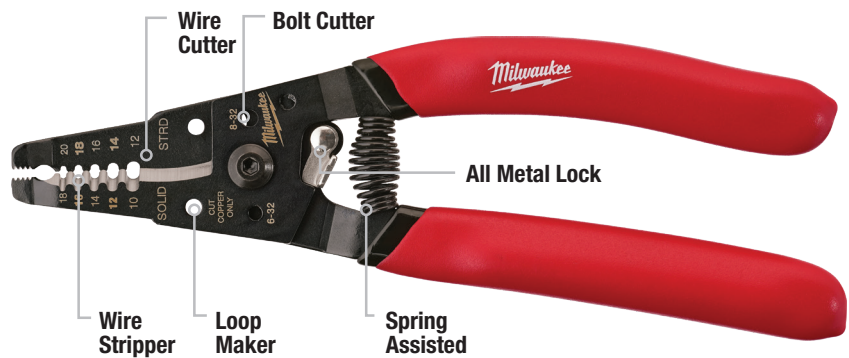

Model #	Description	Wire Stripper
48-22-6109	Wire Stripper	10-18 AWG Solid, 12-20 AWG Stranded
48-22-6579	Multi-Purpose Wire Stripper with Crimper	10-20 AWG Solid, 12-22 AWG Stranded

## IRONWORKER'S

UP TO **2X MORE CUTS**

**IRON-CARBIDE EDGE**

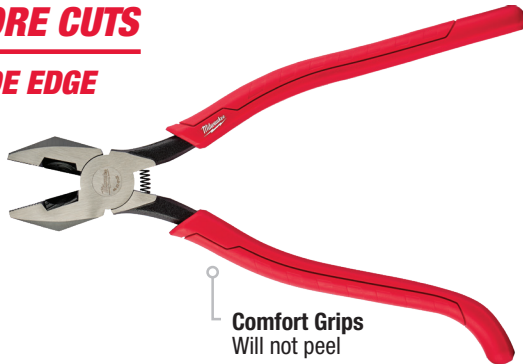

For Twisting & Cutting Rebar Ties

Model #	Description
48-22-6102	Ironworker's Pliers

## CRIMPING

UP TO **2X CRIMPING FORCE**



Crimper for Insulated & Non-Insulated Terminals

Model #	Description
48-22-6103	Crimping Pliers

## CABLE CUTTING

**CLEAN CUTS**

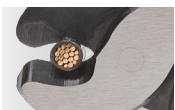

Cuts up to 2/0 Cu, 4/0 Al

Model #	Description
48-22-6104	Cable Cutting Pliers

## PVC / OIL FILTER

**3-1/2" JAW CAPACITY**



Model #	Description
48-22-6321	PVC / Oil Filter Pliers

## NIPPING

**CURVED HEAD  
PROTECTS SURFACES**



Blades Will Not Mar Surfaces

Model #	Description
48-22-6407	7" Nipping Pliers

## FENCING

**FORGED STRENGTH**

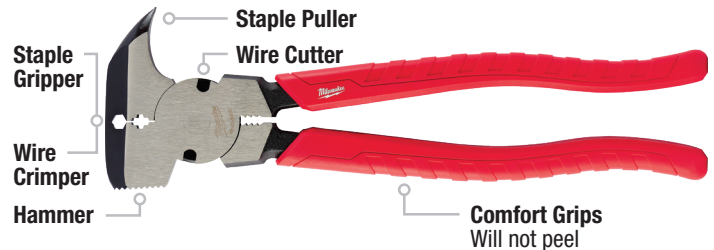

Wire Puller

Model #	Description
48-22-6410	Fencing Pliers

# TORQUE LOCK™ PLIERS, C-CLAMPS & SPECIALTY

## TORQUE LOCK™ FASTER SET-UP



### LOCKING PLIERS WITH MAX BITE™

#### MAX BITE™ 3X GRIPPING FORCE



**CHROME**  
Chrome plated rust protection



**GRIPPED**  
Rubber overmold

Model #	Description
48-22-3607	7" Locking Pliers with MAX BITE™
48-22-3610	10" Locking Pliers with MAX BITE™
48-22-3702	2 Pc 7" & 10" Locking Pliers with MAX BITE™

Model #	Description
48-22-3710	10" Locking Pliers with Grip with MAX BITE™
48-22-3707	7" Locking Pliers with Grip with MAX BITE™

### LOCKING PLIERS



**CURVED JAW**

Maximizes pressure points for any bolt, nut or locking tool application



**STRAIGHT JAW**

Maximizes contact points on jobsite work surfaces



**LONG NOSE**

Best for long reach applications

Model #	Description
48-22-3405	5" Curved Jaw Locking Pliers with Grip
48-22-3407	7" Curved Jaw Locking Pliers with Grip
48-22-3410	10" Curved Jaw Locking Pliers with Grip
48-22-3406	6" Long Nose Locking Pliers with Grip
48-22-3409	9" Long Nose Locking Pliers with Grip
48-22-3807	7" Straight Jaw Locking Pliers with Grip
48-22-3810	10" Straight Jaw Locking Pliers with Grip
48-22-3402	2 Pc 7" & 10" Curved Jaw Locking Pliers with Grip Set
48-22-3602	2 Pc 6" Long Nose & 10" Curved Jaw Locking Pliers Set
48-22-3423	4" Curved Jaw Locking Pliers
48-22-3422	5" Curved Jaw Locking Pliers
48-22-3421	7" Curved Jaw Locking Pliers

Model #	Description
48-22-3420	10" Curved Jaw Locking Pliers
48-22-3504	4" Long Nose Locking Pliers
48-22-3506	6" Long Nose Locking Pliers
48-22-3507	7" Straight Jaw Locking Pliers
48-22-3509	9" Long Nose Locking Pliers
48-22-3510	10" Straight Jaw Locking Pliers
48-22-3541	12" Large Jaw Locking Pliers
48-22-3523	9" Deep Reach Swivel Jaw Locking C-Clamp
48-22-3533	9" Deep Reach Locking C-Clamp
48-22-3631	11" Locking C-Clamp
48-22-3632	6" Locking C-Clamp

### C-CLAMPS & SPECIALTY

**STANDARD JAW C-CLAMP**

Greater clamping versatility on a variety of shapes and surfaces



**SWIVEL JAW C-CLAMP**

Pads provide surface stabilization and protect work surfaces from damage



Model #	Description
48-22-3521	11" Swivel Jaw Locking C-Clamp
48-22-3522	6" Swivel Jaw Locking C-Clamp
48-22-3531	11" Locking C-Clamp
48-22-3532	6" Locking C-Clamp
48-22-3520	18" Swivel Jaw Locking C-Clamp

Model #	Description
48-22-3529	18" Deep Reach Locking C-Clamp
48-22-3530	18" Locking C-Clamp
48-22-3540	8" Locking Seamer
48-22-3542	9" Locking Chain Wrench
48-22-3543	9" Locking Welding Clamp

## CHEATER ADAPTABLE PIPE WRENCH

**3 LENGTH DESIGN**

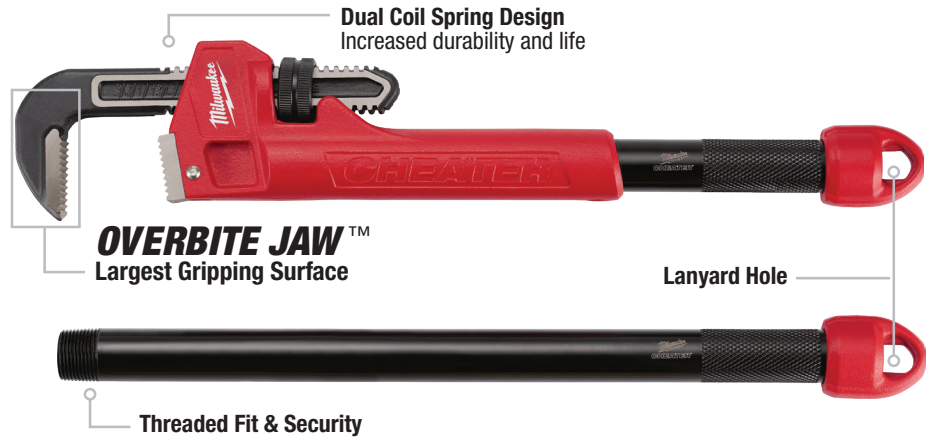

Model #	Description	Material	Max Jaw Capacity
48-22-7314	CHEATER Adaptable Pipe Wrench	Steel	2-1/2"

## 10L ALUMINUM PIPE WRENCH WITH POWERLENGTH™ HANDLE

**BETTER ACCESS.  
MAXIMUM LEVERAGE.**



Model #	Description	Material	Max Jaw Capacity
48-22-7313	10L Aluminum Pipe Wrench w/POWERLENGTH™ Handle	Aluminum	1-1/2"

## STEEL & ALUMINUM PIPE WRENCHES

**LARGEST GRIP SURFACE**



Steel



Aluminum

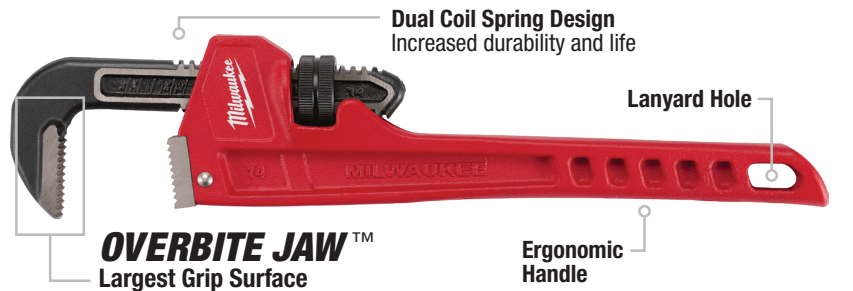

Model #	Description	Length	Material	Max Jaw Capacity	Model #	Description	Length	Material	Max Jaw Capacity
48-22-7106	6" Steel Pipe Wrench	6"	Steel	3/4"	48-22-7148	48" Steel Pipe Wrench	48"	Steel	6"
48-22-7108	8" Steel Pipe Wrench	8"	Steel	1"	48-22-7160	60" Steel Pipe Wrench	60"	Steel	8"
48-22-7110	10" Steel Pipe Wrench	10"	Steel	1-1/2"	48-22-7210	10" Aluminum Pipe Wrench	10"	Aluminum	1-1/2"
48-22-7112	12" Steel Pipe Wrench	12"	Steel	2"	48-22-7212	12" Aluminum Pipe Wrench	12"	Aluminum	2"
48-22-7114	14" Steel Pipe Wrench	14"	Steel	2"	48-22-7214	14" Aluminum Pipe Wrench	14"	Aluminum	2"
48-22-7118	18" Steel Pipe Wrench	18"	Steel	2-1/2"	48-22-7218	18" Aluminum Pipe Wrench	18"	Aluminum	2-1/2"
48-22-7124	24" Steel Pipe Wrench	24"	Steel	3"	48-22-7224	24" Aluminum Pipe Wrench	24"	Aluminum	3"
48-22-7136	36" Steel Pipe Wrench	36"	Steel	5"	48-22-7236	36" Aluminum Pipe Wrench	36"	Aluminum	5"
					48-22-7248	48" Aluminum Pipe Wrench	48"	Aluminum	6"



## STEEL OFFSET HEX PIPE WRENCH

**SMOOTH JAW WON'T MAR SURFACES**



Protects Chrome Surfaces



Model #	Description	Material	Max Jaw Capacity
48-22-7171	Steel Offset Hex Pipe Wrench	Steel	2-5/8"

## STEEL SMOOTH JAW PIPE WRENCH

**SMOOTH JAW PROTECTS SURFACES**



Protects Chrome Surfaces



Model #	Description	Material	Max Jaw Capacity
48-22-7186	12" Steel Smooth Jaw Pipe Wrench	Steel	2-5/8"

## ALUMINUM OFFSET HEX PIPE WRENCHES

**BETTER ACCESS**



Offset Head



Model #	Description	Material	Max Jaw Capacity
48-22-7184	14" Aluminum Offset Pipe Wrench	Aluminum	2"
48-22-7185	18" Aluminum Offset Pipe Wrench	Aluminum	2"
48-22-7182	24" Aluminum Offset Pipe Wrench	Aluminum	3"

## ADJUSTABLE WRENCHES

**JAWS WON'T  
BACK OFF**  
Proprietary Screw

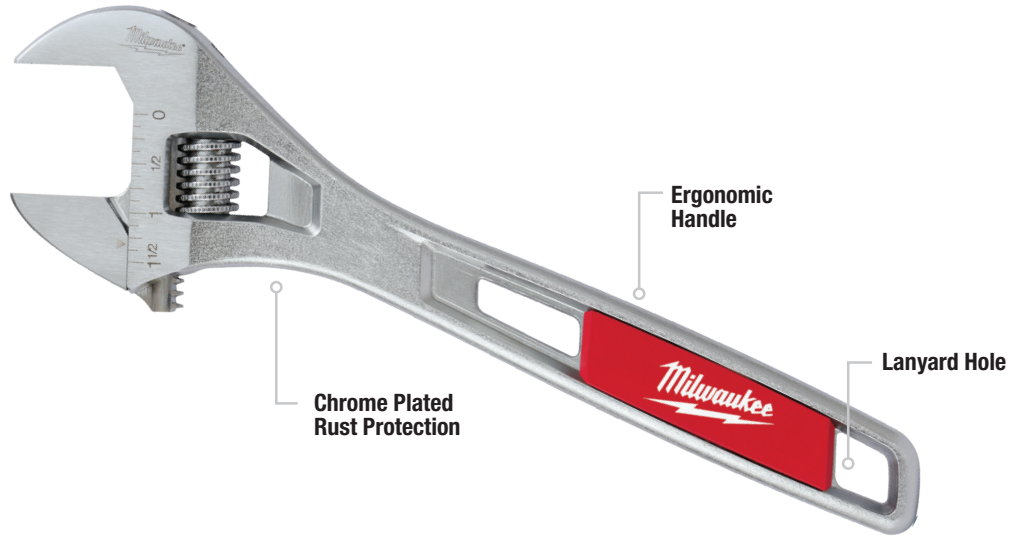
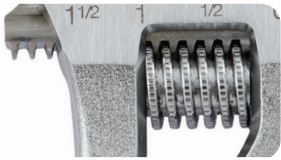

Perfectly Parallel Jaws

Model #	Description
48-22-7400	2 Pc 6" & 10" Adjustable Wrench Set
48-22-7406	6" Adjustable Wrench
48-22-7408	8" Adjustable Wrench
48-22-7410	10" Adjustable Wrench
48-22-7412	12" Adjustable Wrench
48-22-7415	15" Adjustable Wrench
48-22-7508	8" Wide Jaw Adjustable Wrench

## BASIN WRENCHES

**EASIEST  
SWAP-OUTS**



Ratchet-Ready  
Less jaw readjusting



Screwdriver-Ready  
Up to 2x breakaway torque

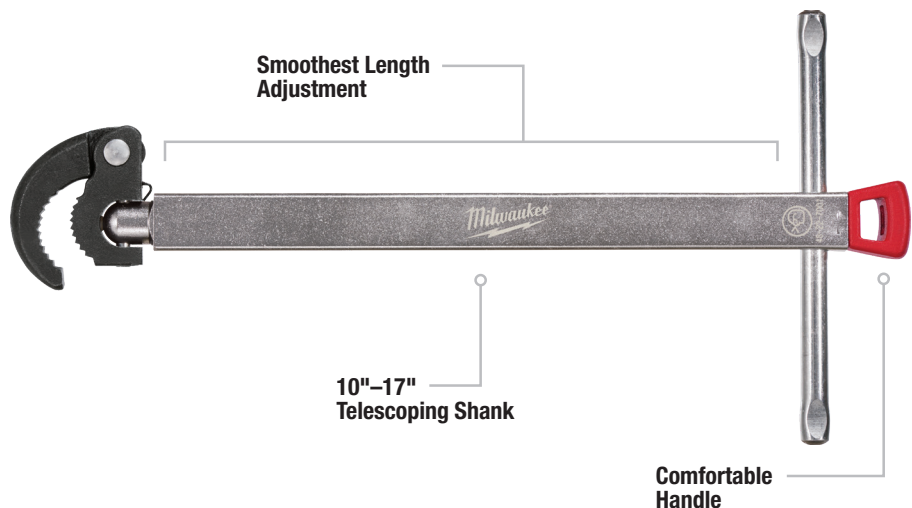

Model #	Description
48-22-7001	1-1/4" Basin Wrench
48-22-7002	2-1/2" Basin Wrench

# RATCHET & SOCKET SETS

## CONTRACTOR RATCHET & SOCKET SETS

**VERSATILE DESIGN.  
BETTER ACCESS.**



**FOUR FLAT™ SIDES**  
Anti-Roll, Wrench-Ready.

Slim Design



Pivoting Head

Model #	Description
48-22-9000	12 Pc 3/8" SAE Contractor Ratchet & Socket Set with FOUR FLAT™ Sides
48-22-9001	12 Pc 3/8" Metric Contractor Ratchet & Socket Set with FOUR FLAT™ Sides

## AUTOMOTIVE RATCHET & SOCKET SETS

**MOST VERSATILE SOCKETS.  
ANTI-ROLL, WRENCH-READY.**



Stamped Sizes  
Better visibility

**FOUR FLAT™ SIDES**  
Anti-Roll, Wrench-Ready.

90 Tooth Design

Slim Design

4° Arc Swing



Removable Storage Trays

MET Part #	Description
48-22-9404	26 Pc 1/4" SAE Drive Ratchet & Sockets with FOUR FLAT™ Sides
48-22-9408	28 Pc 3/8" SAE Drive Ratchet & Sockets with FOUR FLAT™ Sides
48-22-9504	28 Pc 1/4" Metric Drive Ratchet & Sockets with FOUR FLAT™ Sides
48-22-9014	1/4" Drive Ratchet
48-22-9508	32 Pc 3/8" Metric Drive Ratchet & Sockets with FOUR FLAT™ Sides
48-22-9004	50 Pc Metric & SAE 1/4" Drive Ratchet & Sockets with FOUR FLAT™ Sides
48-22-9008	56 Pc Metric & SAE 3/8" Drive Ratchet & Sockets with FOUR FLAT™ Sides
48-22-9038	3/8" Drive Ratchet

## RATCHETING COMBINATION WRENCHES

**BETTER ACCESS.  
LONGEST LIFE.**

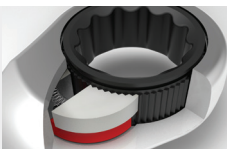

**Durable Double Stacked Pawls**

Model #	Description	Included Sizes
48-22-9406	7 Pc SAE Ratcheting Combination Wrench Set	3/8", 7/16", 1/2", 9/16", 5/8", 11/16", 3/4"
48-22-9506	7 Pc Metric Ratcheting Combination Wrench Set	8mm, 10mm, 12mm, 13mm, 14mm, 15mm, 17mm
48-22-9416	15 Pc SAE Ratcheting Combination Wrench Set	1/4", 9/32", 5/16", 11/32", 3/8", 7/16", 1/2", 9/16", 5/8", 11/16", 3/4", 13/16", 7/8", 15/16", 1"
48-22-9516	15 Pc Metric Ratcheting Combination Wrench Set	8mm, 9mm, 10mm, 11mm, 12mm, 13mm, 14mm, 15mm, 16mm, 17mm, 18mm, 19mm, 20mm, 21mm, 22mm

## COMBINATION WRENCHES

**UP TO  
25% MORE TORQUE**



**Innovative Storage Solution**

Model #	Description	Included Sizes
48-22-9407	7 Pc SAE Combination Wrench Set	3/8", 7/16", 1/2", 9/16", 5/8", 11/16", 3/4"
48-22-9507	7 Pc Metric Combination Wrench Set	8mm, 10mm, 12mm, 13mm, 14mm, 15mm, 17mm
48-22-9415	15 Pc SAE Combination Wrench Set	1/4", 9/32", 5/16", 11/32", 3/8", 7/16", 1/2", 9/16", 5/8", 11/16", 3/4", 13/16", 7/8", 15/16", 1"
48-22-9515	15 Pc Metric Combination Wrench Set	8mm, 9mm, 10mm, 11mm, 12mm, 13mm, 14mm, 15mm, 16mm, 17mm, 18mm, 19mm, 20mm, 21mm, 22mm

## PRY BARS

**UP TO  
40% MORE PRYING STRENGTH**

**I-BEAM DESIGN**

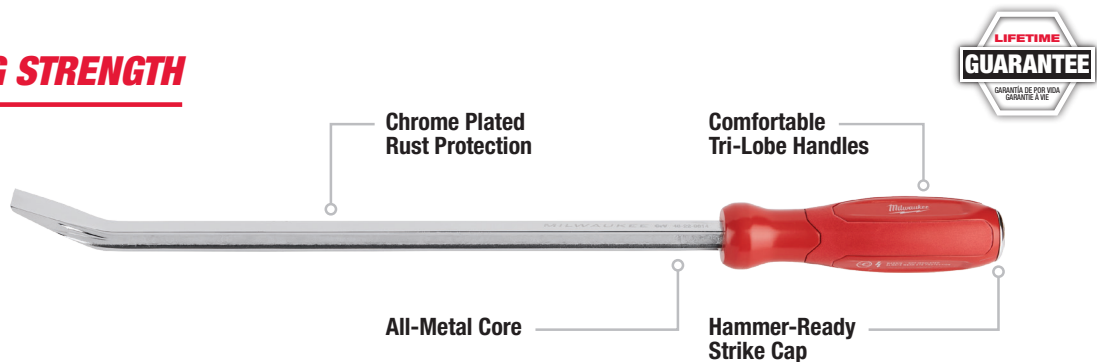

**Easy Access Storage Tray**

Model #	Description	Included Lengths
48-22-9214	4 Pc Pry Bar Set	8", 12", 18", 24"

# HOOK AND PICK SET & MULTI-BIT DRIVERS

## HOOK AND PICK SET

UP TO  
**50% MORE DURABLE**

**ALL-METAL CORE**

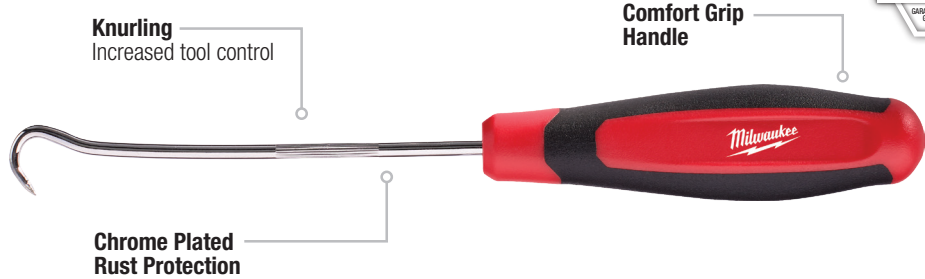

Easy Access Storage Tray

Model #	Description	Includes
48-22-9215	4 Pc Hook and Pick Set	Straight Pick, Offset Hook, Hook, 90° Hook

## 10 IN 1 MULTI-BIT / KEY DRIVERS

**10IN1**

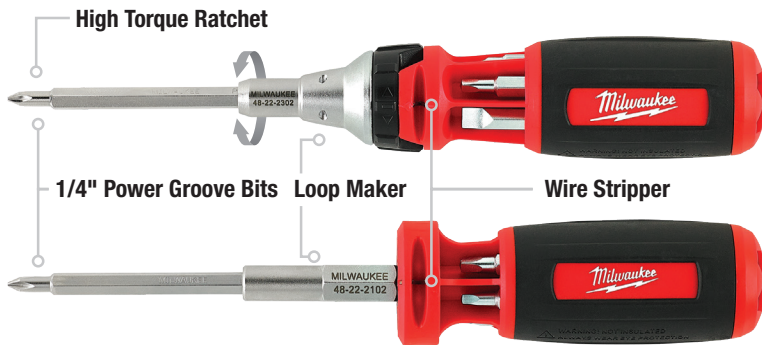

Power Tool Compatibility



In-Handle Storage

Model #	Description	Nut Drivers	Bit Types
48-22-2101	10IN1 Multi-Bit Driver w/ ECX™	1/4"	P#1, P#2, SL 3/16", SL 1/4", SQ#2, ECX™#1, ECX™#2
48-22-2102	10IN1 Square Multi-Bit Driver	1/4"	P#1, P#2, SL 3/16", SL 1/4", SQ#1, SQ#2, SQ#3
48-22-2301	10IN1 Ratchet Multi-Bit Driver w/ ECX™	1/4"	P#1, P#2, SL 3/16", SL 1/4", SQ#2, ECX™#1, ECX™#2
48-22-2302	10IN1 Ratchet Multi-Bit Driver w/ Square	1/4"	P#1, P#2, SL 3/16", SL 1/4", SQ#1, SQ#2, SQ#3
48-22-2103	10IN1 TORX® Key Driver	1/4"	T8, T10, T15, T20, T25, T27, T30
48-22-2104	10IN1 SAE Hex Key Driver	1/4"	7/64", 1/8", 9/64", 5/32", 3/16", 7/32", 1/4"
48-22-2106	10IN1 Metric Hex Key Driver	1/4"	1.5mm, 2mm, 2.5mm, 3mm, 4mm, 5mm, 6mm
48-22-2110	4 Pc Replacement Bit Set		P#1, P#2, SL 3/16", SL 1/4", SQ #1, SQ#1, ECX™#1

## 8 IN 1 COMPACT MULTI-BIT DRIVERS

**8IN1**



Power Tool Compatibility



In-Handle Storage



Model #	Description	Nut Drivers	Bit Types
48-22-2120	Compact 8IN1 Multi-Bit Driver	1/4"	P#1, P#2, SL 3/16", SL 1/4", SQ#1, SQ#2, T15
48-22-2320	Compact 8IN1 Ratchet Multi-Bit Driver	1/4"	P#1, P#2, SL 3/16", SL 1/4", SQ#1, SQ#2, T15

## 11 IN 1 MULTI-BIT DRIVERS

### 11in1



Model #	Description	Nut Drivers	Bit Types
48-22-2760	11in1 Multi-Bit Driver w/ ECX™	1/4", 5/16", 3/8"	P#1, P#2, SL 3/16", SL 1/4", SQ#1, SQ#2, ECX™#1, ECX™#2
48-22-2761	11in1 Multi-Bit Driver w/ TORX®	1/4", 5/16", 3/8"	P#1, P#2, SL 3/16", SL 1/4", SQ#1, SQ#2, T10, T15

## 13 IN 1 CUSHION-GRIP SCREWDRIVERS

### 13in1

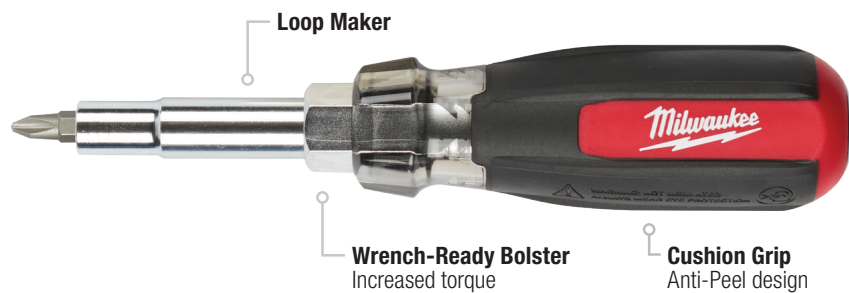

ECX™ Bit



Schrader® Valve Core Remover

Model #	Description	Nut Drivers	Bit Types
48-22-2880	13in1 Cushion-Grip Screwdriver with ECX™ Bit	1/4", 5/16", 3/8", 1/2"	P#1, P#2, SL 3/16", SL1/4", SQ#1, SQ#2, ECX™#1, ECX™#2
48-22-2881	13in1 Cushion-Grip Screwdriver with Schrader® Bit	1/4", 5/16", 3/8", 1/2"	P#1, P#2, SL 3/16", SL1/4", SQ#1, SQ#2, Std Schrader®, Large Schrader®

## SCREWDRIVERS

**HIGH-LEVERAGE HANDLE.  
MAGNETIC TIP.**



Comfortable Tri-Lobe Handle

Model #	Description	Bit Types
48-22-2702	2 Pc Demolition Screwdriver Set	P#2, SL 5/16"
48-22-2706	6 Pc Screwdriver Set	P#1, P#2, SL 3/16", SL 1/4", SL 5/16"
48-22-2708	8 Pc Screwdriver Set w/ ECX™	P#1, P#2, SL 3/16", SL 1/4", SL 5/16", ECX™#1, ECX™#2
48-22-2710	10 Pc Screwdriver Set	P#1, P#2, SL 3/16", SL 1/4", SL 5/16", SQ#1, SQ#2
48-22-2718	8 Pc Screwdriver Set w/ Square	P#1, P#2, SL 3/16", SL 1/4", SL 5/16", SQ#1, SQ#2
48-22-2700	Bottle Opener	

## CUSHION-GRIP SCREWDRIVERS

**MOST DURABLE HANDLE.  
PRECISION TIP.**

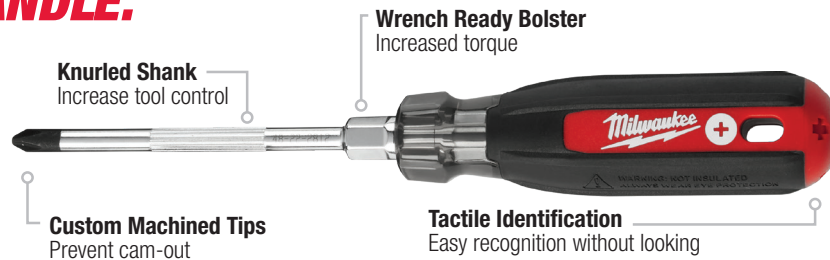

Anti-Peel Design Cushion Grips

Model #	Description
48-22-2811	#1 Phillips (3")
48-22-2812	#2 Phillips (4")
48-22-2813	#3 Phillips (6")
48-22-2814	#2 Phillips (10")
48-22-2815	#2 Phillips (6") Cushion-Grip Demolition Screwdriver

Model #	Description
48-22-2821	1/4" Slotted (4")
48-22-2822	5/16" Slotted (6")
48-22-2824	3/8" Slotted (8")
48-22-2831	3/16" Cabinet (3")
48-22-2832	3/16" Cabinet (6")
48-22-2833	3/16" Cabinet (8")
48-22-2834	1/4" Cabinet (10")

Model #	Description
48-22-2841	#1 ECX™ (4")
48-22-2842	#2 ECX™ (4")
48-22-2851	#1 Square (3")
48-22-2852	#2 Square (4")
48-22-2853	#3 Square (6")
48-22-2884	4 Pc Set
48-22-2886	6 Pc Set

## DEMO DRIVER

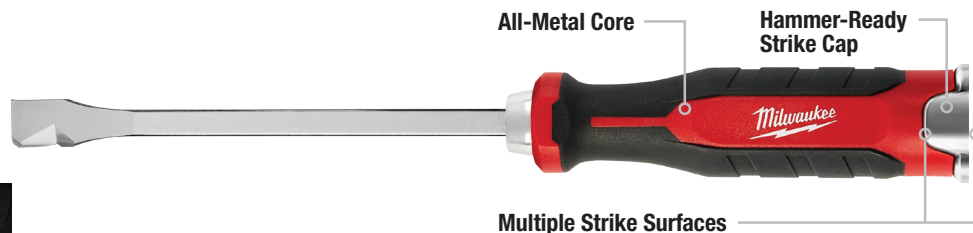

Aggressive Duct Piercing Tip

Model #	Description
48-22-2860	Demo Driver
48-22-2823	Slotted 5/16" 6" Cushion-Grip Demolition Screwdriver
48-22-2825	Slotted 3/8" 8" Cushion-Grip Demolition Screwdriver

## 1000V INSULATED SCREWDRIVERS

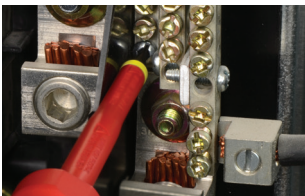

**Slim Drive Shaft**

Allows access in recessed applications

**Flame & Impact Resistant**

**1000V**

IEC 60900:2012 | ASTM F1505-10 | NFPA 70E

Model #	Description
48-22-2211	#1 Phillips (3")
48-22-2212	#2 Phillips (4")
48-22-2213	#3 Phillips (6")
48-22-2221	1/4" Slotted (6")
48-22-2222	5/16" Slotted (7")
48-22-2223	3/8" Slotted (8")
48-22-2224	3/8" Slotted (10")
48-22-2231	3/16" Cabinet (4")

Model #	Description
48-22-2232	3/16" Cabinet (6")
48-22-2233	3/16" Cabinet (8")
48-22-2241	#1 ECX™ (4")
48-22-2242	#2 ECX™ (4")
48-22-2251	#1 Square (3")
48-22-2252	#2 Square (4")
48-22-2253	#3 Square (6")

Model #	Description	Bit Types, Carrying Case
48-22-2202	3 Pc 1000V Insulated Screwdriver Set	P#2, SL 1/4", ECX™#1
48-22-2204	4 Pc 1000V Insulated Screwdriver Set w/ Case	P#1, P#2, SL 1/4", SL 3/8", Extra Capacity Roll Up Pouch
48-22-2205	4 Pc 1000V Insulated Screwdriver Set w/ Case	SL 1/4", SL 3/8", SQ#1, SQ#2, Extra Capacity Roll Up Pouch
48-22-2210	10 Pc 1000V Insulated Screwdriver Set w/ Case	P#1, P#2, P#3, SL 1/4", SL 5/16", SL 3/8", SQ#1, SQ#2, SQ#3, ECX™#1, EVA Foam Fitted Case
48-22-2203	3 Pc 1000V Insulated Screwdriver Set	#1 ECX™ (4"), #2 Phillips (4"), 1/4" Slotted (6")

## PRECISION SCREWDRIVERS

UP TO **4x STRONGER**



**360° Rotating & Impact Resistant Back Cap**

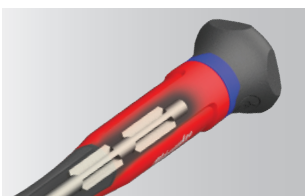

**All-Metal Core**

Model #	Description	Bit Types
48-22-2604	4 Pc Precision Screwdriver Set	P#1, SL 1/16", SL 3/32", SL 1/8"
48-22-2606	6 Pc Precision Screwdriver Set w/ Case	P#1, P#2, SL 1/16", SL 3/32", SL 1/8", SL 5/32"
48-22-2610	6 Pc TORX® Precision Screwdriver Set w/ Case	T6, T7, T8, T9, T10, T15



## HOLLOWCORE™ MAGNETIC NUT DRIVERS

UNLIMITED DEPTH

FITS 4X MORE FASTENERS

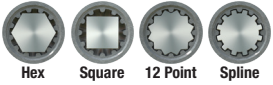

SAE

METRIC

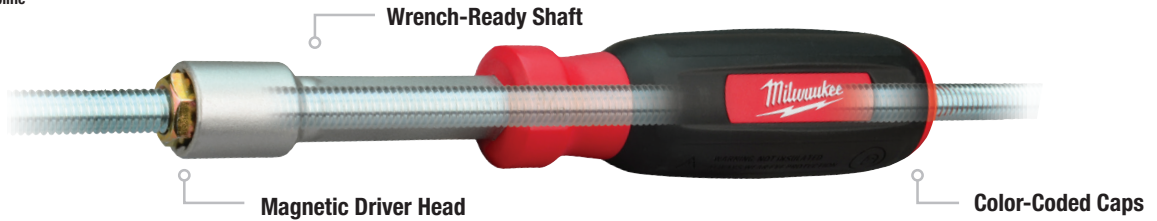

Model #	Description	Sizes
48-22-2502	2 Pc HOLLOWCORE™ Magnetic Nut Driver Set	1/4", 5/16"
48-22-2507	7 Pc HOLLOWCORE™ SAE Magnetic Nut Driver Set	1/4", 5/16", 11/32", 3/8", 7/16", 1/2", 9/16"
48-22-2517	7 Pc HOLLOWCORE™ Metric Magnetic Nut Driver Set	5mm, 5.5mm, 6mm, 7mm, 8mm, 10mm, 13mm

Model #	Description
48-22-2520	3/16" Magnetic Nut Driver
48-22-2521	1/4" HOLLOWCORE™ Magnetic Nut Driver
48-22-2522	5/16" HOLLOWCORE™ Magnetic Nut Driver
48-22-2523	11/32" HOLLOWCORE™ Magnetic Nut Driver
48-22-2524	3/8" HOLLOWCORE™ Magnetic Nut Driver

Model #	Description
48-22-2525	7/16" HOLLOWCORE™ Magnetic Nut Driver
48-22-2526	1/2" HOLLOWCORE™ Magnetic Nut Driver
48-22-2527	9/16" HOLLOWCORE™ Magnetic Nut Driver
48-22-2531	5mm HOLLOWCORE™ Magnetic Nut Driver
48-22-2532	5.5mm HOLLOWCORE™ Magnetic Nut Driver

Model #	Description
48-22-2533	6mm HOLLOWCORE™ Magnetic Nut Driver
48-22-2534	7mm HOLLOWCORE™ Magnetic Nut Driver
48-22-2535	8mm HOLLOWCORE™ Magnetic Nut Driver
48-22-2536	10mm HOLLOWCORE™ Magnetic Nut Driver
48-22-2537	13mm HOLLOWCORE™ Magnetic Nut Driver

## HOLLOW SHAFT NUT DRIVERS

FITS 4X MORE FASTENERS

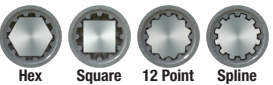

SAE

METRIC

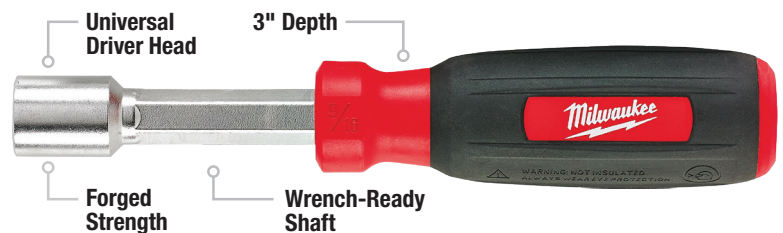

Model #	Description	Sizes
48-22-2402	2 Pc SAE Hollow Shaft Nut Driver Set	1/4", 5/16"
48-22-2404	4 Pc SAE Hollow Shaft Nut Driver Set	1/4", 5/16", 7/16", 9/16"
48-22-2407	7 Pc SAE Hollow Shaft Nut Driver Set	1/4", 5/16", 11/32", 3/8", 7/16", 1/2", 9/16"
48-22-2417	7 Pc Metric Hollow Shaft Nut Driver Set	5mm, 5.5mm, 6mm, 7mm, 8mm, 10mm, 13mm

Model #	Description
48-22-2420	3/16" Hollow Shaft Nut Driver
48-22-2421	1/4" Hollow Shaft Nut Driver
48-22-2422	5/16" Hollow Shaft Nut Driver
48-22-2423	11/32" Hollow Shaft Nut Driver
48-22-2424	3/8" Hollow Shaft Nut Driver

Model #	Description
48-22-2425	7/16" Hollow Shaft Nut Driver
48-22-2426	1/2" Hollow Shaft Nut Driver
48-22-2427	9/16" Hollow Shaft Nut Driver
48-22-2431	5mm Hollow Shaft Nut Driver
48-22-2432	5.5mm Hollow Shaft Nut Driver

Model #	Description
48-22-2433	6mm Hollow Shaft Nut Driver
48-22-2434	7mm Hollow Shaft Nut Driver
48-22-2435	8mm Hollow Shaft Nut Driver
48-22-2436	10mm Hollow Shaft Nut Driver
48-22-2437	13mm Hollow Shaft Nut Driver

## FRAMING HAMMERS

UP TO  
**10x VIBRATION REDUCTION**  
SHOCKSHIELD™ GRIP

Available in



Smooth Face

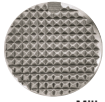

Milled Face



Magnetic Nail Set

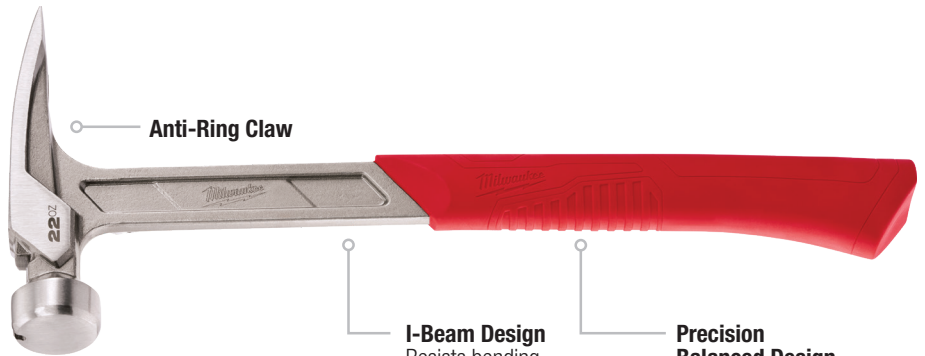

Model #	Description
48-22-9016	17oz Milled Face Hammer
48-22-9017	17oz Smooth Face Hammer
48-22-9022	22oz Milled Face Hammer

Model #	Description
48-22-9023	22oz Smooth Face Hammer
48-22-9080	20oz Curved Claw Hammer

## POLY FIBERGLASS HAMMER

**MOST DURABLE  
FIBERGLASS HANDLE**



Reinforced  
Fiberglass Handle

Model #	Description
48-22-9316	19oz Smooth Face Poly Fiberglass Hammer

## HICKORY HAMMER

**BEST DRIVING  
PERFORMANCE**



Magnetic Nail Set

Model #	Description
48-22-9419	19oz Hickory Hammer - Milled Face
48-22-9419	19oz Hickory Hammer - Smooth Face

## HAND CLAMPS

UP TO  
**2x CLAMP FORCE**

**+STOP  
LOCK™**



Model #	Description
48-22-3002	2" Hand Clamp
48-22-3004	4" Hand Clamp

# FIXED BLADE & POCKET KNIVES

## HAWKBILL KNIVES

**STAYS SHARPER LONGER**



Durable Sheath



Model #	Description
48-22-1925	Hawkbill Fixed Blade Knife

## FIXED BLADE KNIVES

**STAYS SHARPER LONGER**



Durable Sheath



Model #	Description
48-22-1926	4" Fixed Blade Knife

## HARDLINE™ FIXED BLADE KNIVES

**ULTIMATE DURABILITY™**

**AUS-8 STEEL™**



Multi-Position Sheath



Model #	Description
48-22-1928	5" HARDLINE™ Fixed Blade Knife
48-22-1928B	5" HARDLINE™ Fixed Blade Knife

## HARDLINE™ POCKET KNIVES

**EXTREME WEAR RESISTANCE™**

**D2 STEEL™**



Model #	Description
48-22-1994	HARDLINE™ 3" Smooth Blade Pocket Knife
48-22-1997	HARDLINE™ 2-1/2" Smooth Blade Pocket Knife

Model #	Description
48-22-1998	HARDLINE™ 3" Serrated Blade Pocket Knife
48-22-1999	HARDLINE™ 3-1/2" Smooth Blade Pocket Knife

## FASTBACK™ SPRING ASSISTED KNIVES

**Spring Assisted**



Ideal for Piercing & Tearing



Also Available:

**FASTBACK™ Camo Spring Assisted Knife**  
48-22-1996

Model #	Description
48-22-1995	FASTBACK™ Spring Assisted Knife
48-22-1996	FASTBACK™ Camo Spring Assisted Knife

## FASTBACK™ HAWKBILL FLIP KNIVES

**PRESS AND FLIP™**



Ideal for Piercing & Tearing



Model #	Description
48-22-1985	FASTBACK™ Hawkbill Flip Knife

## FASTBACK™ FLIP KNIVES

**PRESS AND FLIP™**



Ideal for Controlled Slicing



Model #	Description
48-22-1985	FASTBACK™ Hawkbill Flip Knife
48-22-1990	FASTBACK™ Flip Knife

## LOCKBACK POCKET KNIFE

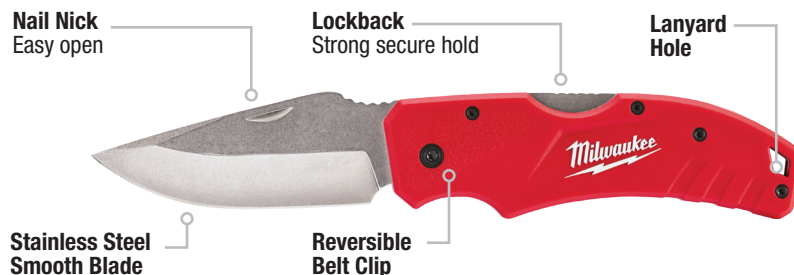

Model #	Description
48-22-1940	Lockback Pocket Knife

## FASTBACK™ FLIP UTILITY KNIFE WITH BLADE STORAGE

**PRESS  
AND FLIP™**



Quick Change

Model #	Description
48-22-1903	FASTBACK™ Flip Utility Knife with Blade Storage

## FASTBACK™ FLIP UTILITY KNIFE

**PRESS  
AND FLIP™**



Quick Change

Model #	Description
48-22-1901	FASTBACK™ Flip Utility Knife

## FASTBACK™ COMPACT FLIP UTILITY KNIFE

**PRESS  
AND FLIP™**



Quick Change

Model #	Description
48-22-1906	FASTBACK™ Compact Flip Utility Knife

## SIDE SLIDING UTILITY KNIFE

**MAXIMUM  
DEPTH CONTROL**



Blade Storage

Model #	Description
48-22-1910	Side Sliding Utility Knife

## SAFETY UTILITY KNIFE



2 Blade Positions

Model #	Description
48-22-1915	Safety Utility Knife

## SAFETY CUTTER

UP TO **5x** LONGER LIFE

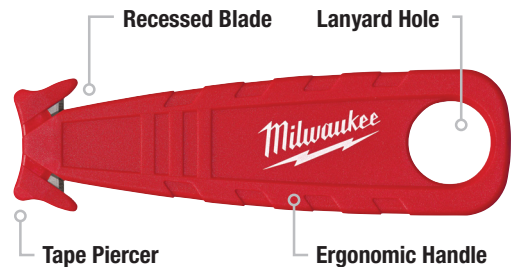

Model #	Description
48-22-1916	Safety Cutter

## PRECISION SNAP-OFF KNIFE

**METAL LOCK**

UP TO **10x** LONGER LIFE

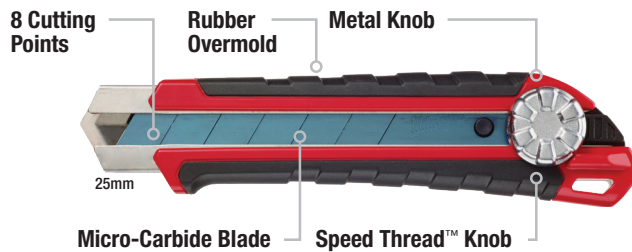

Model #	Description
48-22-1960	9mm (A) Precision Snap-Off Knife
48-22-1961	18mm (L) Precision Snap-Off Knife w/ Metal Lock

Model #	Description
48-22-1962	25mm (H) Precision Snap-Off Knife w/ Metal Lock



Blade Snap Off

Description	3 Pc	10 Pc
9mm (A) Precision Snap-Off Replacement Blades	48-22-9309	48-22-9109
18mm (L) Precision Snap-Off Replacement Blades	48-22-9318	48-22-9118
25mm (H) Precision Snap-Off Replacement Blades	48-22-9325	48-22-9125

## GENERAL PURPOSE SNAP-OFF KNIFE

**FASTER BLADE ADJUSTMENT**

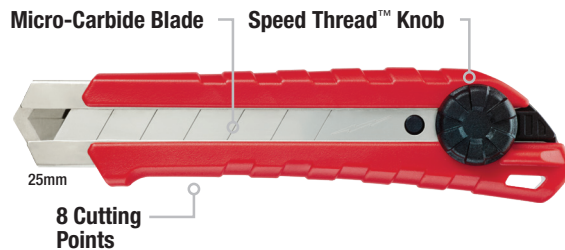

Model #	Description
48-22-1963	9mm (A) General Purpose Snap-Off Knife
48-22-1964	18mm (L) General Purpose Snap-Off Knife

Model #	Description
48-22-1965	25mm (H) General Purpose Snap-Off Knife



Blade Snap Off

Description	3 Pc	10 Pc
9mm (A) General Purpose Snap-Off Replacement Blades	48-22-1309	48-22-1109
18mm (L) General Purpose Snap-Off Replacement Blades	48-22-1318	48-22-1118
25mm (H) General Purpose Snap-Off Replacement Blades	48-22-1325	48-22-1125

## GENERAL PURPOSE

LASTS **5X LONGER**

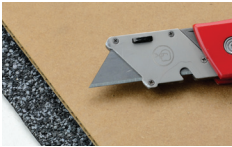

General Purpose



## HOOK

UP TO **2X STRONGER**



Ideal for Roofing

High Quality Steel



## DRYWALL

UP TO **2X SHARPER**



Ideal for Drywall

Custom Grind Angle



## CARTON

LASTS **5X LONGER**



Ideal for Cartons

Rounded Edges



Description	5 Pc	50 Pc (Dispenser Included)	75 Pc (Dispenser Included)	100 Pc (Dispenser Included)
General Purpose Utility Blades	48-22-1905	48-22-1950	48-22-1975	48-22-1900
Hook Utility Blades	48-22-1932	48-22-1952	-	-
Drywall Utility Blades	48-22-1933	48-22-1953	-	-
Carton Utility Blades	48-22-1934	48-22-1954	-	-

## INSULATION KNIVES

### STAYS SHARPER LONGER

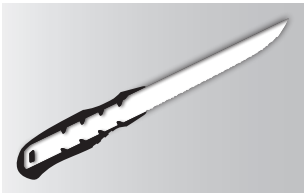
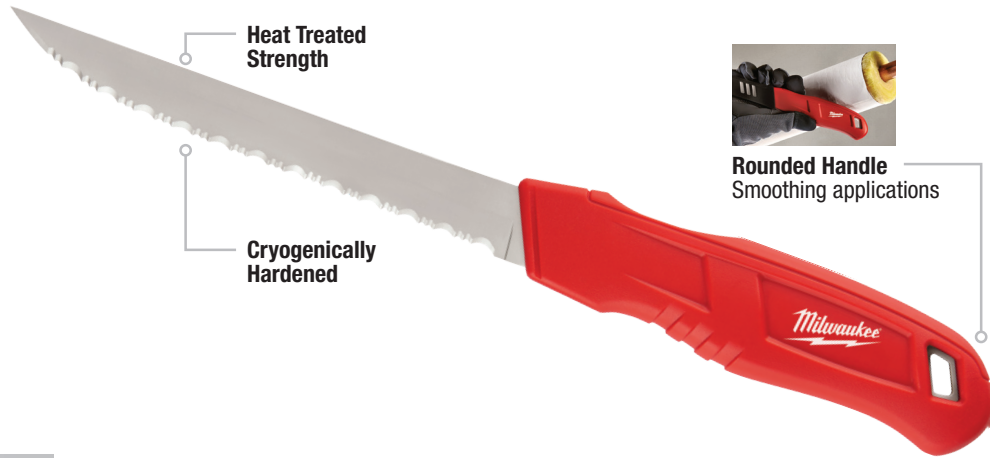

Full Tang

Model #	Description
48-22-1921	Insulation Knife (Smooth)
48-22-1922	Insulation Knife (Serrated)

## DUCT KNIFE

### STAYS SHARPER LONGER

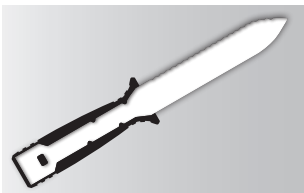
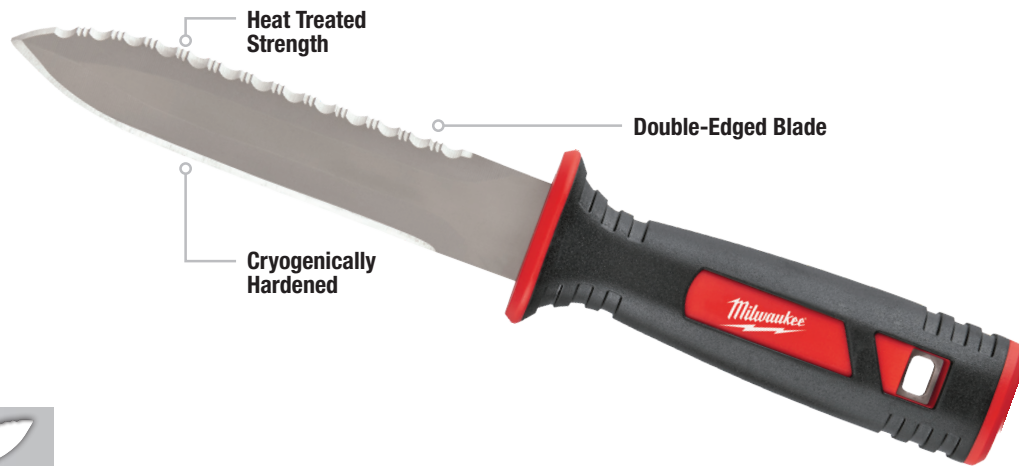

Full Tang

Model #	Description
48-22-1920	Duct Knife



## AVIATION SNIPS

UP TO  
**10X MORE CUTS**  
**FORGED BLADES**



**Flush Bolt Design**  
Won't hang up on material



Model #	Description	Cold Rolled Steel	Stainless Steel
48-22-4530	Straight Cutting Standard Snips	18ga	22ga
48-22-4510	Left Cutting Standard Snips	18ga	22ga
48-22-4520	Right Cutting Standard Snips	18ga	22ga
48-22-4533	3 Pc Standard Snips Set	18ga	22ga
48-22-4532	Straight Cutting Offset Snips	18ga	22ga
48-22-4512	Left Cutting Offset Snips	18ga	22ga
48-22-4522	Right Cutting Offset Snips	18ga	22ga

Model #	Description	Cold Rolled Steel	Stainless Steel
48-22-4523	2 Pc Offset Snips Set	18ga	22ga
48-22-4537	Long Cut Straight Cutting Snips	20ga	22ga
48-22-4538	Long Cut Offset Snips	20ga	22ga
48-22-4500	Bulldog Snips	16ga	18ga
48-22-4511	Left Cutting Right Angle Snips	24ga	28ga
48-22-4521	Right Cutting Right Angle Snips	24ga	28ga

## OFFSET COMPOUND TINNERS

**TOUGH CUTS**  
2X FORCE, LESS EFFORT



45° Offset  
Cut clearance

Model #	Description
48-22-4005	Offset Compound Tinner

## CLASSIC TINNERS

**BLADES WILL NOT LOOSEN**  
BOLT LOCK



40% Larger Handle Loops

Model #	Description
48-22-4003	10" Classic Tinner
48-22-4002	12" Classic Tinner
48-22-4001	16" Bulldog Tinner

## DUCKBILL TINNER

**BLADES WILL NOT LOOSEN**  
BOLT LOCK



40% Larger Handle Loops

Model #	Description
48-22-4004	10" Duckbill Tinner

## LIGHTWEIGHT TINNER

**STRAIGHTER, CLEANER CUTS**

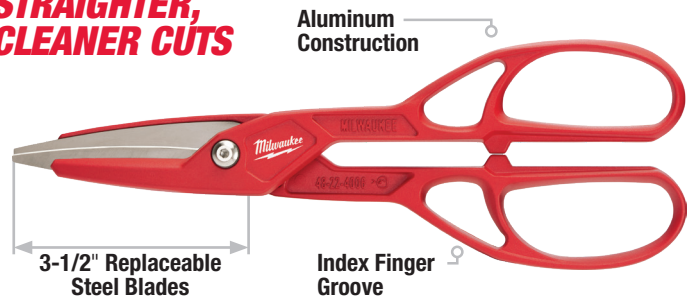

40% Larger Handle Loops

Model #	Description
48-22-4006	13" Lightweight Tinner
48-22-4007	Lightweight Tinner Replacement Blades

# SCISSORS, SEAMER & CRIMPER

## JOBSITE SCISSORS

**ALL-METAL  
HANDLES**  
UP TO 10X LONGER LIFE



Index Finger Groove

Model #	Description
48-22-4040	Offset Jobsite Scissors (Serrated)

Model #	Description
48-22-4041	Straight Jobsite Scissors (Smooth)

## SPEED SEAMER™

**FASTER, MORE ACCURATE  
HVAC FOLDS**



3/8" & 1" Markings  
More accurate folds

Model #	Description
48-22-6000	3" SPEED SEAMER™

## CRIMPER

UP TO **2X LONGER LIFE**



Symmetrical Handles  
Over-hand grip

Model #	Description
48-22-6001	5-Blade Crimper

## ADAPTABLE BOLT CUTTERS W/ POWERMOVE™ EXTENDABLE ARMS

**MORE CUTS.  
MAXIMUM VERSATILITY.**



**POWERMOVE™  
Extendable Arms**

Model #	Description	Max Capacity	
		Soft/Medium Materials (up to 31 HRC)	Hard Materials (up to 48 HRC)
48-22-4114	14" Adaptable Bolt Cutter	5/16"	3/16"
48-22-4124	24" Adaptable Bolt Cutter	7/16"	5/16"

## BOLT CUTTERS

**MORE CUTS.  
LONGER LIFE.**

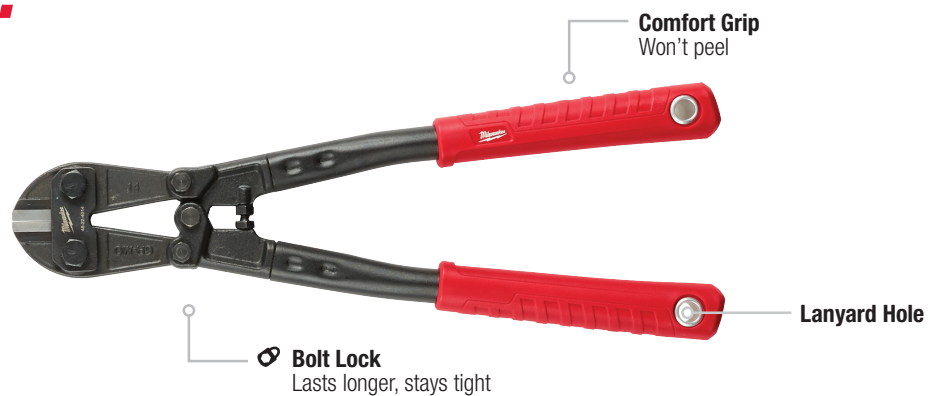

**Forged Steel Blades &  
Custom Heat Treated**  
Maximum durability

Model #	Description	Max Capacity	
		Soft/Medium Materials (up to 31 HRC)	Hard Materials (up to 48 HRC)
48-22-4014	14" Bolt Cutter	5/16"	3/16"
48-22-4024	24" Bolt Cutter	7/16"	5/16"

## HIGH-TENSION HACKSAW

**MOST DURABLE.  
HIGHEST TENSION.**

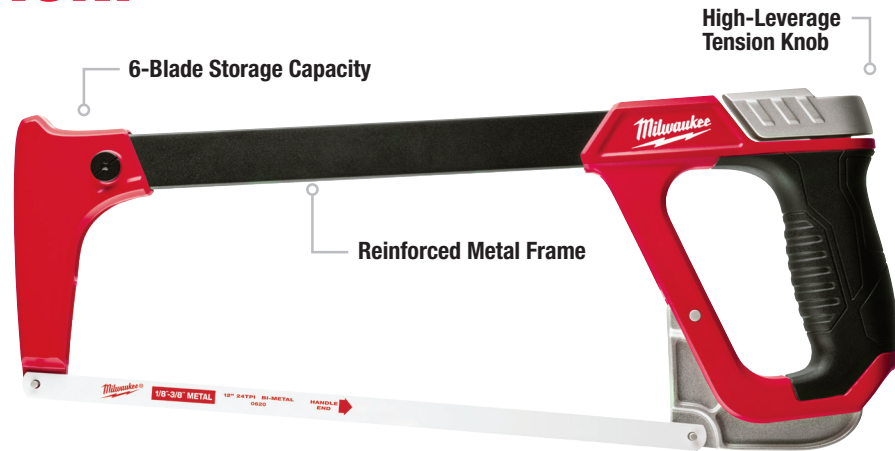

45° Angle Blade Position

Model #	Description
48-22-0050	10 Pc 12" High-Tension Hacksaw
48-43-0600	10 Pc 12" 14TPI Hacksaw Blade
48-43-0610	10 Pc 12" 18TPI Hacksaw Blade

Model #	Description
48-43-0620	10 Pc 12" 24TPI Hacksaw Blade
48-43-0630	10 Pc 12" 32TPI Hacksaw Blade

## COMPACT HACKSAW

**UP TO 10X FASTER BLADE CHANGE**



Compact Design

Model #	Description
48-22-0012	Compact Hacksaw

**RASPING JAB SAW**

UP TO **2X FASTER PLUNGE CUTS**



Piercing Tip

Model #	Description
48-22-0304	Rasping Jab Saw

**FOLDING JAB SAW**

UP TO **10X FASTER BLADE CHANGE**



Folding Blade

Model #	Description
48-22-0305	Folding Jab Saw

**PVC/ABS SAW**

**FAST CUTS THROUGH PVC**



Metal Core

Model #	Description
48-22-0212	12" PVC/ABS Saw
48-22-0222	12" PVC/ABS Saw Replacement Blade
48-22-0223	18" PVC/ABS Saw
48-22-0220	18" PVC/ABS Saw Replacement Blade

# TUBING/PIPE CUTTERS & REAMING PEN

## TUBING CUTTER

### INDESTRUCTIBLE FRAME



Replaceable Blades

Model #	Description
48-22-4202	Tubing Cutter
48-22-4203	Tubing Cutter Replacement Blade

## RATCHETING PIPE CUTTERS

### STRAIGHT, EASY CUTS



Comfortable Handle Design

Model #	Description
48-22-4210	1-5/8" Ratcheting Pipe Cutter
48-22-4211	1-5/8" Ratcheting Pipe Cutter Replacement Blade

Model #	Description
48-22-4215	2-3/8" Ratcheting Pipe Cutter
48-22-4216	2-3/8" Ratcheting Pipe Cutter Replacement Blade

## REAMING PEN

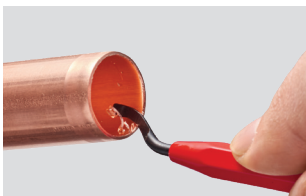

Copper

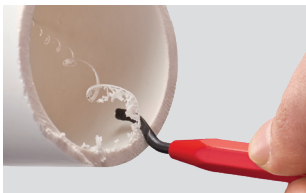

PVC



Model #	Description
48-22-4255	Reaming Pen

## MINI COPPER TUBING CUTTERS

**5X LONGER LIFE**

**REINFORCED ADJUSTMENT MECHANISM**



Chrome Rollers Rust Protection

Model #	Description	Cut Capacity	Extra Blade
48-22-4250	1/2" Mini Copper Tubing Cutter	1/8"–5/8"	
48-22-4258	3/4" Mini Copper Tubing Cutter	1/8"–7/8"	
48-22-4251	1" Mini Copper Tubing Cutter	1/8"–1-1/8"	Yes
48-22-4256	2 Pc Replacement Cutter Wheels		

## CLOSE QUARTERS COPPER TUBING CUTTERS

**MOST COMPACT.  
LONGEST LIFE.**



Additional Storage Blades and reaming pen



Chrome Rollers Rust Protection

Model #	Description
48-22-4260	1/2" Close Quarters Copper Tubing Cutter
48-22-4261	3/4" Close Quarters Copper Tubing Cutter
48-22-4262	1" Close Quarters Copper Tubing Cutter
48-22-4263	3 Pc Close Quarters Copper Tubing Cutter Set
48-22-4266	Replacement Copper Tubing Cutter Wheels



# COPPER TUBING CUTTERS

## QUICK-ADJUST TUBING CUTTERS

**STRAIGHTER,  
CLEANER CUTS**

**4 CHROME ROLLERS**

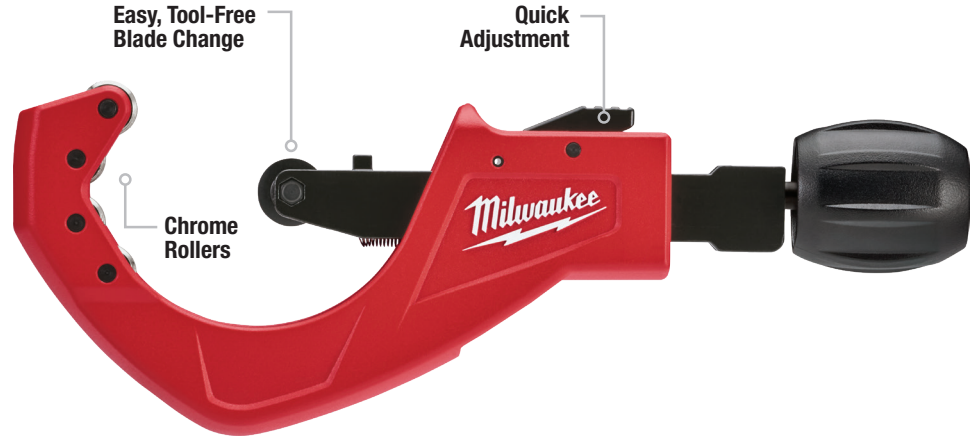

Adapt to Cut 3" PEX



Chrome Rollers Rust Protection

Model #	Description	Cut Capacity
48-22-4253	2-1/2" Quick-Adjust Copper Tubing Cutter	1/2"-2-5/8"
48-22-4254	3-1/2" Quick-Adjust Copper Tubing Cutter	1/2"-3-1/2"
48-22-4256	2 Pc Replacement Cutter Wheels	
48-22-4206	Replacement PEX Cutter Wheel	

## CONSTANT SWING COPPER TUBING CUTTERS

**STRAIGHTER,  
CLEANER CUTS**

**4 CHROME ROLLERS**



Built-In Reamer on 48-22-4252



Chrome Rollers Rust Protection

Model #	Description	Cut Capacity
48-22-4259	1" Constant Swing Copper Tubing Cutter	1/8"-1-1/8"
48-22-4252	1-1/2" Constant Swing Copper Tubing Cutter	1/8"-1-5/8"
48-22-4256	2 Pc Replacement Cutter Wheels	
48-22-4257	3 Pc Replacement Reaming Blade	

## PUNCHDOWN TOOL

**BEST ACCESS  
& VISIBILITY**



Integrated LED Light

High / Low Impacting Function

Also Available:



Extended Reach Punchdown Blade  
48-22-2166



Extended Reach Punchdown Blade

Model #	Description	Blades Included
48-22-2165	Punchdown Tool with Extended Blade	66/110 Combination and Extended Reach 110
48-22-2166	Extended Punchdown Blade	Extended Reach 110
48-22-2167	Punchdown Blade	66/110 Combination

## MINI FLUSH CUTTER

**CONSISTENT,  
PRECISE CUTS**



Light Weight



Spring Assisted

Model #	Description
48-22-6105	Mini Flush Cutter

## RATCHETING MODULAR CRIMPER

**CONSISTENT,  
ACCURATE CRIMPS**

Easy Access Jack Removal

In-Line Head Design

Ratcheting Mechanism



Parallel Crimping Design

Model #	Description
48-22-3075	Ratcheting Modular Crimper

MULTI-PICK TOOL

4in1



Model #	Description
48-22-2145	Multi-Pick Tool

ELECTRICIAN SNIPS

BLADES WON'T LOOSEN. BOLT LOCK



Wire Gullet Prevents Walking

Model #	Description
48-22-4045	Electrician Snips

UTP STRIPPER

COMFORTABLE, ONE HAND OPERATION



Optimized Finger Loop

Model #	Description
48-22-3065	UTP Stripper



PACKOUT™ MODULAR STORAGE

# PACKOUT™

**MOST** VERSATILE  
DURABLE  
MODULAR STORAGE SYSTEM

™



**FULLY  
CUSTOMIZE  
YOUR STORAGE™**



**IMPACT  
RESISTANT™**



**IP65  
RATED  
PROTECTION™**



**BUILD  
YOUR SYSTEM**

# PACKOUT™ MODULAR STORAGE

## PACKOUT™ ROLLING TOOL BOX



**250 LBS CAPACITY™**



**IMPACT RESISTANT BODY™**



**9" ALL-TERRAIN WHEELS™**

Modular Connectivity with All PACKOUT™ Components

Metal Reinforced Locking Point

IP65 Rated Protection



Industrial-Grade Extension Handle

Interior Organization Tray

Metal Reinforced Corners



9" All-Terrain Wheels

Model #	Description	Carrying Capacity
48-22-8426	PACKOUT™ Rolling Tool Box	250 lbs

## PACKOUT™ TOOL BOXES



**100 LBS CAPACITY™**



**IMPACT RESISTANT BODY™**



**METAL-REINFORCED TOP HANDLE™**

Metal Reinforced Locking Point

IP65 Rated Protection



Modular Connectivity with All PACKOUT™ Components

Metal Reinforced Corners

Also Available:



PACKOUT™ Tool Box  
48-22-8424



Interior Organizer Trays

Model #	Description	Carrying Capacity
48-22-8424	PACKOUT™ Tool Box	75 lbs
48-22-8425	PACKOUT™ Large Tool Box	100 lbs

## PACKOUT™ ORGANIZERS



**IMPACT  
RESISTANT  
BODY™**



**IP65  
RATED  
PROTECTION™**



**NO-  
TRAVEL BIN  
SEALS™**

Modular Connectivity  
with All PACKOUT™  
Components



No-Travel  
Bin Seals

Also Available:



**PACKOUT™ Compact Organizer**  
48-22-8435



Removable & Mountable Bins

Model #	Description
48-22-8435	PACKOUT™ Compact Organizer
48-22-8430	PACKOUT™ Organizer

## PACKOUT™ LOW-PROFILE ORGANIZERS



**IMPACT  
RESISTANT  
BODY™**



**IP65  
RATED  
PROTECTION™**



**NO-  
TRAVEL BIN  
SEALS™**

No-Travel Bin Seals

Modular Connectivity  
with All PACKOUT™ Components

6 Removable Bin Dividers

IP65 Rated  
Protection



Impact Resistant  
Polymer Base

Low-Profile  
Design

Also Available:



**PACKOUT™ Low-Profile  
Compact Organizer**  
48-22-8436



Removable Bins

Model #	Description
48-22-8431	PACKOUT™ Low-Profile Organizer
48-22-8436	PACKOUT™ Low-Profile Compact Organizer

# PACKOUT™ MODULAR STORAGE

## PACKOUT™ TOTES



**TEAR-RESISTANT MATERIAL™**



**IMPACT RESISTANT BASE™**



**ALL-METAL HARDWARE™**

Padded Removable Shoulder Strap

Modular Connectivity with All PACKOUT™ Components



Durable Overmold Handle

Also Available:



PACKOUT™ 10" Tote  
48-22-8310



PACKOUT™ 15" Tote  
48-22-8315



**TEAR RESISTANT**

1680D Ballistic Nylon

Model #	Description	Tool Pockets
48-22-8310	PACKOUT™ 10" Tote	28
48-22-8315	PACKOUT™ 15" Tote	31
48-22-8320	PACKOUT™ 20" Tote	32

## PACKOUT™ TOOL BAGS



**TEAR RESISTANT MATERIAL™**



**IMPACT RESISTANT BASE™**



**OPTIMIZED STORAGE CAPACITY™**

Versatile Carry  
Cushioned Shoulder Strap, Top Handles, Side Handles

Modular Connectivity with All PACKOUT™ Components



All-Metal Hardware

Impact Resistant Polymer Base

Also Available:



PACKOUT™ 20" Tool Bag  
48-22-8322



**TEAR RESISTANT**

1680D Ballistic Nylon

Model #	Description
48-22-8321	PACKOUT™ 15" Tool Bag
48-22-8322	PACKOUT™ 20" Tool Bag

**HARDTOP™ ROLLING BAGS**

**MOST DURABLE.  
ULTIMATE VERSATILITY.**

Industrial Grade  
Extension Handle



**HARDTOP™  
Construction**  
For stacking

Padded Tech  
Pocket

**Metal-Reinforced  
Skid Plates**

**6" All-Terrain  
Wheels**

**All-Metal Rims  
& Through Axle**



1680D Ballistic Nylon

Model #	Description
48-22-8221	18" Rolling Bag
48-22-8220	24" HARDTOP™ Rolling Bag

**JOBSITE TECH BAG**

**UP TO 5X MORE DURABLE**

All-Metal  
Hardware



**Integrated  
Rain Fly**

**Puncture  
Resistant  
Pocket**

Impact-Resistant Base



1680D Ballistic Nylon

Model #	Description
48-22-8210	Jobsite Tech Bag



# COOLERS & BACKPACKS

## JBSITE COOLER

HOLDS ICE UP TO **24HRS**



2x the Insulation

Model #	Description
48-22-8250	Jobsite Cooler

## LOW-PROFILE BACKPACK

**DURABLE,  
LOW-PROFILE DESIGN**



1680D Ballistic Nylon

Model #	Description	Pockets
48-22-8202	Low-Profile Backpack	22

## JOBSITE BACKPACK

UP TO **5X MORE DURABLE**



Impact-Resistant Base

Model #	Description	Pockets
48-22-8200	Jobsite Backpack	35

## ULTIMATE JOBSITE BACKPACK

**ULTIMATE DURABILITY,  
PROTECTION, & STORAGE**



Impact-Resistant Base

Model #	Description	Pockets
48-22-8201	Ultimate Jobsite Backpack	48

## PARACHUTE ORGANIZER BAG

**FASTEST ACCESS,  
BEST CONSTRUCTION**



Stand-Up & Stay-Open Design

Model #	Description
48-22-8170	Parachute Organizer Bag

## BUCKET ORGANIZER WRAP

**MOST VERSATILE  
BUCKET ORGANIZER**



Exterior Zipper Pockets

Model #	Description
48-22-8175	Bucket Organizer Wrap

## ZIPPER POUCHES

UP TO **2X MORE DURABLE**



**Colored Webbing**  
Easy size identification

Also Available:



**Heavy Duty #10 Canvas**

**3 Pc Multi-Size Zipper Pouches**  
48-22-8183



Water Resistant Stand-Up Base

Model #	Description
48-22-8180	Zipper Pouch
48-22-8193	3 Pc Zipper Pouches
48-22-8183	3 Pc Multi-Size Zipper Pouches

## JOBSITE ORGANIZER

**MOST VERSATILE  
JOBSITE ORGANIZER**

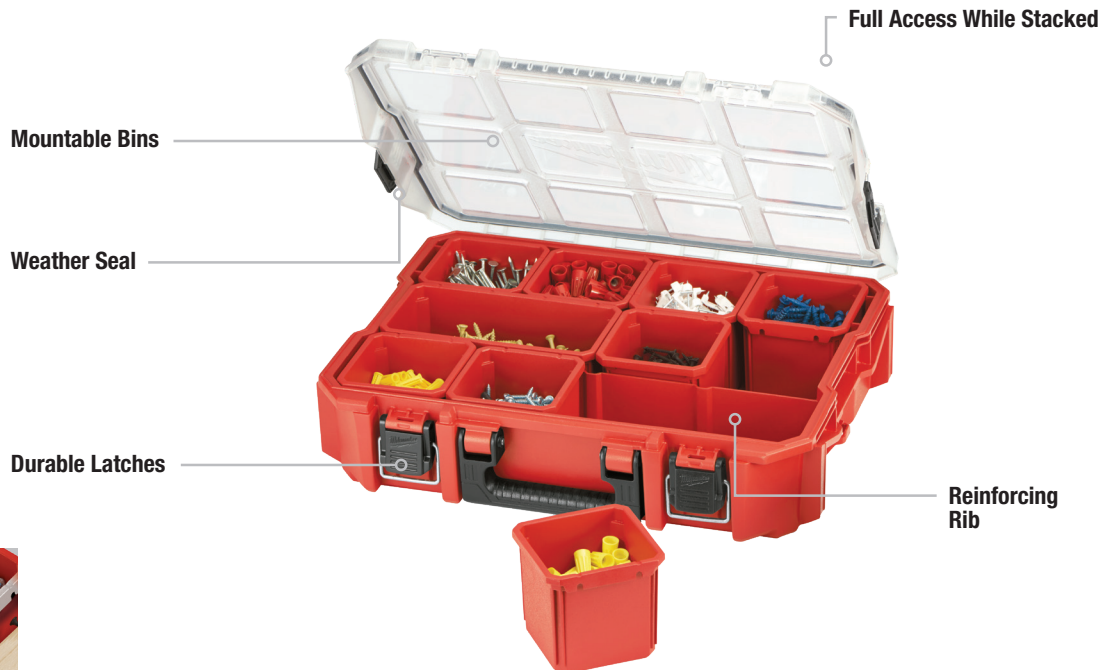

No-Travel Bin Seals

Model #	Description
48-22-8030	20" Jobsite Organizer

# WORK BELTS & UTILITY POUCHES

## WORK BELTS & POUCHES

UP TO **5X** LONGER LIFE

**Contractor's Work Belt with Suspension Rig**  
48-22-8120



**Electrician's Work Belt**  
48-22-8110

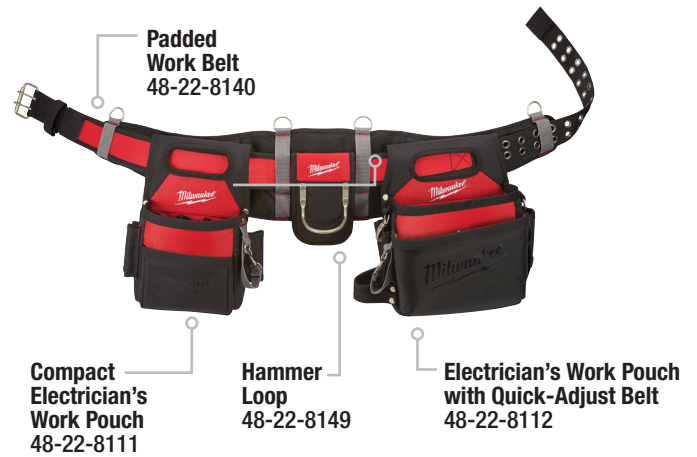

Model #	Description
48-22-8100	Electrician's Work Belt with Quick-Adjust Belt
48-22-8110	Electrician's Work Belt
48-22-8111	Compact Electrician's Work Pouch
48-22-8120	Contractor's Work Belt with Suspension Rig
48-22-8121	Carpenter's Work Pouch
48-22-8122	3-Tier Material Work Pouch

Model #	Description
48-22-8140	Padded Work Belt
48-22-8145	Padded Rig
48-22-8146	XL Padded Rig
48-22-8149	Hammer Loop
48-22-8112	Electrician's Work Pouch with Quick-Adjust Belt

## COMPACT UTILITY POUCH

UP TO **5X** LONGER LIFE



**Quick-Attach Belt Loop**

Model #	Description
48-22-8118	Compact Utility Pouch

## UTILITY POUCH



**Quick-Attach Belt Loop**

Model #	Description
48-22-8119	Utility Pouch

## DEMOLITION GLOVES WITH SMARTSWIPE™

UP TO **5X LONGER LIFE**

TPR Knuckle Protection

Breathable Lining & Mesh Backing



Terry Cloth Sweat Wipe

ARMORTEX® Reinforced Thumb, Fingers and Padded Palm



SMARTSWIPE™



Touch Screen Compatible Knuckle

Model #	Description
48-22-8735	Demolition Gloves S
48-22-8731	Demolition Gloves M
48-22-8732	Demolition Gloves L

Model #	Description
48-22-8733	Demolition Gloves XL
48-22-8734	Demolition Gloves XXL

## PERFORMANCE GLOVES WITH SMARTSWIPE™

**ULTIMATE DURABILITY.  
ALL-DAY COMFORT.**

High Dexterity Finger Tips

Breathable Lining



Terry Cloth Sweat Wipe

Reinforced Thumb Seam



Also Available:



Performance Fingerless Gloves

SMARTSWIPE™



Touch Screen Compatible Fingertips, Palm & Knuckle

Model #	Description
48-22-8725	Performance Gloves S
48-22-8721	Performance Gloves M
48-22-8722	Performance Gloves L
48-22-8723	Performance Gloves XL
48-22-8724	Performance Gloves XXL

Model #	Description
48-22-8745	Performance Fingerless Gloves S
48-22-8741	Performance Fingerless Gloves M
48-22-8742	Performance Fingerless Gloves L
48-22-8743	Performance Fingerless Gloves XL
48-22-8744	Performance Fingerless Gloves XXL

## FREE-FLEX GLOVES WITH SMARTSWIPE™

**ULTIMATE DURABILITY.  
ALL-DAY COMFORT.**

Breathable Lining

Terry Cloth Sweat Wipe



High Dexterity Finger Tips

Free-Flex Elastic Cuff



Reinforced Thumb Seam

SMARTSWIPE™



Touch Screen Compatible Fingertips, Palm & Knuckle

Model #	Description
48-22-8715	Free-Flex Gloves S
48-22-8711	Free-Flex Gloves M
48-22-8712	Free-Flex Gloves L

Model #	Description
48-22-8713	Free-Flex Gloves XL
48-22-8714	Free-Flex Gloves XXL

## CUT LEVEL 1 DIPPED GLOVES WITH SMARTSWIPE™

**ULTIMATE DURABILITY.  
ALL-DAY COMFORT.**

SMARTSWIPE™  
Touch Screen  
Compatible  
Index Finger

High Dexterity  
Fingertips

Nitrile Coated  
Better grip

Nylon/Lycra Liner  
All day comfort

Breathable  
Backing

Color-Coded Bands  
Easy cut rating  
identification



Size	1 Pair	12 Pair ( Contractor Pack)
S	48-22-8900	48-22-8900B
M	48-22-8901	48-22-8901B
L	48-22-8902	48-22-8902B

Size	1 Pair	12 Pair ( Contractor Pack)
XL	48-22-8903	48-22-8903B
XXL	48-22-8904	48-22-8904B

## CUT LEVEL 3 DIPPED GLOVES WITH SMARTSWIPE™

**ULTIMATE DURABILITY.  
ALL-DAY COMFORT.**

SMARTSWIPE™  
Touch Screen  
Compatible  
Fingertips & Palms

Nitrile Web Grip  
Comfort

Best-In-Class  
Puncture  
Resistance

Breathable  
Backing

Color-Coded Bands  
Easy cut rating  
identification



Size	1 Pair	12 Pair (Contractor Pack)
S	48-22-8930	48-22-8930B
M	48-22-8931	48-22-8931B
L	48-22-8932	48-22-8932B

Size	1 Pair	12 Pair (Contractor Pack)
XL	48-22-8933	48-22-8933B
XXL	48-22-8934	48-22-8934B

## CUT LEVEL 5 DIPPED GLOVES WITH SMARTSWIPE™

**ULTIMATE DURABILITY.  
ALL-DAY COMFORT.**

SMARTSWIPE™  
Touch Screen  
Compatible  
Fingertips & Palms

Double Dipped  
Nitrile Coating  
Best-in-class  
durability

Best-In-Class  
Puncture  
Resistance

Breathable  
Backing

Color-Coded Bands  
Easy cut rating  
identification



Size	1 Pair	12 Pair (Contractor Pack)
S	48-22-8950	48-22-8950B
M	48-22-8951	48-22-8951B
L	48-22-8952	48-22-8952B

Size	1 Pair	12 Pair (Contractor Pack)
XL	48-22-8953	48-22-8953B
XXL	48-22-8954	48-22-8954

## CUT LEVEL 1 INSULATED WINTER GLOVES

**ULTIMATE WARMTH.  
ALL-DAY COMFORT.**



Size	1 Pair	12 Pair ( Contractor Pack)
S	48-22-8910	48-22-8910B
M	48-22-8911	48-22-8911B
L	48-22-8912	48-22-8912B

Size	1 Pair	12 Pair ( Contractor Pack)
XL	48-22-8913	48-22-8913B
XXL	48-22-8914	48-22-8914B

## CUT LEVEL 3 INSULATED WINTER GLOVES

**ULTIMATE WARMTH.  
ALL-DAY COMFORT.**



Size	1 Pair	12 Pair (Contractor Pack)
S	48-22-8920	48-22-820B
M	48-22-8921	48-22-8921B
L	48-22-8922	48-22-8922B

Size	1 Pair	12 Pair (Contractor Pack)
XL	48-22-8923	48-22-8923B
XXL	48-22-8924	48-22-8924B



## LOCKING LANYARDS

**BEST SHOCK  
ABSORPTION™**



Double Locking Carabiner

Model #	Description
48-22-8810	10 lbs Locking Tool Lanyard
48-22-8811	10 lbs Extended Reach Locking Tool Lanyard
48-22-8815	15 lb Locking Tool Lanyard
48-22-8850	35 lbs Locking Tool Lanyard

## QUICK-CONNECT LOCKING TOOL LANYARD SYSTEM

**BEST SHOCK  
ABSORPTION™**

**QUICK-CONNECT  
LANYARD SYSTEM**



Quick Tool Change Out

Model #	Description
48-22-8820	10 lbs Quick-Connect Locking Tool Lanyard
48-22-8823	3 Pc 10 lbs Quick-Connect Lanyard Accessory
48-22-8822	3 Pc 5 lbs Quick-Connect Lanyard Accessory

## TAPE & D-RING WEB ATTACHMENTS

### EASILY CONNECT



48-22-8860



48-22-8870



48-22-8871



48-22-8872



Model #	Description
48-22-8860	12' Self-Adhering Tape
48-22-8870	5 Pc 2 lbs D-Ring Web Attachment
48-22-8871	5 Pc 5 lbs D-Ring Web Attachment
48-22-8872	35 lbs D-Ring Web Attachment

## SPLIT RINGS

### EASILY CONNECT

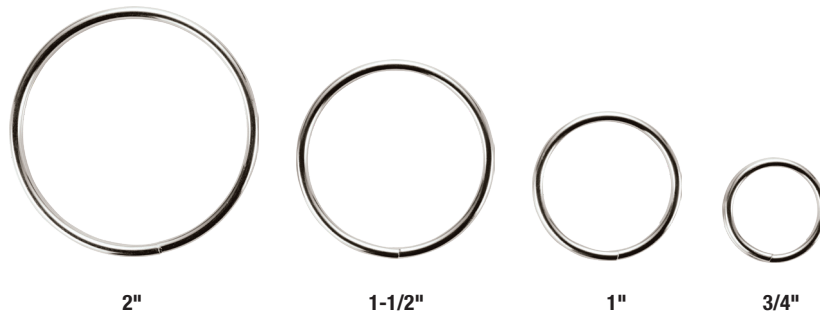

Model #	Description
48-22-8880	5 Pc 2 lbs 3/4\" Split Ring
48-22-8881	5 Pc 2 lbs 1\" Split Ring
48-22-8882	5 Pc 2 lbs 1-1/2\" Split Ring
48-22-8883	5 Pc 2 lbs 2\" Split Ring

2	<b>TAPE MEASURES</b>
4	<b>LONG TAPES &amp; MEASURING WHEELS</b>
5	<b>REDSTICK™ LEVELS</b>
6	<b>CONCRETE LEVELS &amp; TORPEDO LEVELS</b>
7	<b>LASER DISTANCE METERS, CHALK REELS &amp; FOLDING RULES</b>
8	<b>INKZALL™ JOBSITE MARKERS</b>
9	<b>INKZALL™ PAINT MARKERS, PENS &amp; HIGHLIGHTERS</b>
10	<b>FASTENING PLIERS</b>
11	<b>FASTENING &amp; CUTTING PLIERS</b>
12	<b>CUTTING PLIERS</b>
13	<b>COMBINATION &amp; MULTI-FUNCTION PLIERS</b>
14	<b>APPLICATION SPECIFIC PLIERS</b>
15	<b>TORQUE LOCK™ PLIERS, C-CLAMPS &amp; SPECIALTY</b>
16	<b>PIPE WRENCHES</b>
18	<b>ADJUSTABLE &amp; BASIN WRENCHES</b>
19	<b>RATCHET &amp; SOCKET SETS</b>
20	<b>COMBINATION WRENCHES &amp; PRY BARS</b>
21	<b>HOOK AND PICK SET &amp; MULTI-BIT DRIVERS</b>
22	<b>MULTI-BIT DRIVERS &amp; SCREWDRIVERS</b>
23	<b>SCREWDRIVERS</b>
25	<b>NUT DRIVERS</b>
26	<b>HAMMERS &amp; HAND CLAMPS</b>
27	<b>FIXED BLADE &amp; POCKET KNIVES</b>
28	<b>POCKET KNIVES</b>
29	<b>UTILITY KNIVES</b>
32	<b>INSULATION &amp; DUCT KNIVES</b>
33	<b>AVIATION SNIPS</b>
34	<b>TINNER SNIPS</b>
35	<b>SCISSORS, SEAMER &amp; CRIMPER</b>
36	<b>BOLT CUTTERS</b>
37	<b>HACKSAWS</b>
38	<b>SAWS</b>
39	<b>TUBING/PIPE CUTTERS &amp; REAMING PEN</b>
40	<b>COPPER TUBING CUTTERS</b>
42	<b>LOW VOLTAGE VDV</b>
44	<b>PACKOUT™ MODULAR STORAGE</b>
48	<b>BAGS</b>
49	<b>COOLERS &amp; BACKPACKS</b>
50	<b>BACKPACKS</b>
52	<b>ORGANIZERS</b>
53	<b>WORK BELTS &amp; POUCHES</b>
54	<b>WORK GLOVES</b>
55	<b>DIPPED GLOVES</b>
56	<b>INSULATED WINTER GLOVES</b>
57	<b>LANYARD ACCESSORIES</b>



**MILWAUKEE TOOL**  
**13135 West Lisbon Road**  
**Brookfield, WI 53005**

**[milwaukeetool.com](http://milwaukeetool.com)**

