

Pushbuttons & Indicating Lights

Contents

<i>Description</i>	<i>Page</i>
Toggle Switches — E10 Series	47-2
Toggle Switches — E10E Series	47-7
Pushbutton Control Stations — Assembled — All Series	47-13
22.5 mm Heavy-Duty Watertight/Oiltight — E22 and EM22 Series	47-28
30.5 mm Square Multifunction Watertight/Oiltight — E30 Series	47-99
30.5 mm Heavy-Duty Watertight/Oiltight — 10250T Series	47-115
30.5 mm Corrosion Resistant Watertight/Oiltight — E34 Series	47-166
30.5 mm Watertight/Oiltight — HT800 Series	47-195
30.5 mm Class I Division 2 Hazardous Locations — 10250T/E34 Series ..	47-215
Ratings	47-243

*HT800 Series*

E10 Series

Contents

<i>Description</i>	<i>Page</i>
Product Description	47-2
Standards and Certifications	47-2
Technical Data and Specifications	
Toggle Switches	47-2
Hesitation Switches	47-2
Pushbutton Actuators	47-2
Product Selection	
Toggle Switches	47-3
Hesitation Switches	47-4
Pushbutton Actuators	47-4
Circuit Arrangements	47-4
Accessories	47-5
Dimensions	47-6
Catalog Number Structure	47-6

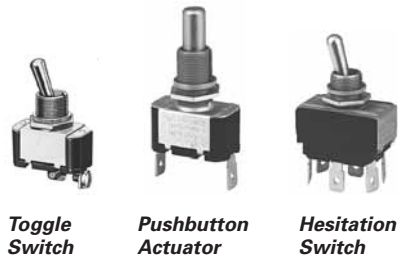

Product Description

Cutler-Hammer® E10 switches from Eaton's electrical business are intended for general purpose light industrial use. Designed for retrofit and OEM applications, the one-hole mounted units feature a bright nickel plated lever and a 0.468"-32 diameter threaded bushing with a 0.068 x 0.035 inch (1.7 x 0.9 mm) deep keyway for anti-rotation. Mounting hardware, consisting of one hexagonal locknut, one knurled or hexagonal face nut, and #6-32 x 3/16" (where applicable) binding head terminal screw. All are furnished unassembled in individually sealed poly bags, packed 10 per carton.

Standards and Certifications

- UL Recognized — File No. 2702
- CSA — File No. LR40068

Technical Data and Specifications

Toggle Switches

- AC Ratings:
 - 6 – 20A, 125V AC
 - 3 – 10A, 250V AC
 - Max. 3/4 hp @ 250V AC
- DC Ratings:
 - 6 – 20A, 28V DC
- Electrical Life: 6,000 cycles make/break at switch ampere rating
- Operation:
 - Slow make/slow break mechanism with butt action for AC and low voltage DC applications
 - Maintained and momentary contacts
- Poles/Throws: 1 through 4, single and double throw

Mounting:

- One hole with threaded 0.468"-32 bushing and 0.068 x 0.035 inch (1.7 x 0.9 mm) deep keyway that serves as anti-rotational feature
- Lever Lengths: 0.563 inch (14.3 mm) or 0.688 inch (17.5 mm), bright nickel plated
- Terminals: Screw, 0.250 inch (6.4 mm) spade and solder lug

Hesitation Switches

Operation:

- Slow make/slow break mechanism with butt action for AC and low voltage DC applications; maintained contacts; ideal for reversing motor applications; patented interlock mechanism prevents operation of lever through center position until manual pressure is momentarily relieved.

AC Ratings:

- 15A, 125V AC
- 10A, 250V AC
- Max. 3/4 hp at 250V AC

DC Ratings:

- 15A, 28V DC

- Poles/Throws: 2, 3 and 4, double throw only

Mounting:

- One pole with threaded 0.468"-32 bushing and 0.068 x 0.049 inch (1.7 x 1.2 mm) deep keyway

- Lever Length: 0.687 inch (17.4 mm), stainless steel

- Terminals: Screw

Pushbutton Actuators

AC Ratings:

- 6 – 15A, 125V AC (NO)
- 3 – 10A, 250V AC (NO)
- Max. 1/3 hp @ 125/250V AC

Operation:

- Slow make/slow break mechanism
- Normally open contacts

- Poles/Throws: Single, single and double throw

Mounting:

- One hole with 0.468"-32 threaded bushing and 0.068 x 0.035 inch (1.7 x 0.9 mm) deep keyway
- Two bushing heights: 11/16 inch (17.5 mm) and 11/32 inch (8.7 mm)





- Button Extensions: 17/32 inch (13.5 mm) and 1/4 inch (6.4 mm), bright nickel plated

- Terminals: Screw

Product Selection

Toggle Switches

Table 47-1. Toggle Switches — AC Rated — Minimum Order Quantity 10 Pieces

	Nominal AC Ratings			Poles and Throw ①	Function — Circuit with Lever In ②			Screw Terminal		0.250 Inch (6.4 mm) Spade Terminal		Solder Lug		
	Amperes		hp		UP Position	CENTER Position	DOWN Position — Keyway	Catalog Number	Price U.S. \$	Catalog Number	Price U.S. \$	Catalog Number	Price U.S. \$	
	125V	250V	250V											
 1-Pole	1-Pole													
	6 15 20	3 10 10	— 3/4 3/4	1 P.S.T.	ON	None	OFF	E10T106AS E10T115AS E10E120AS		E10T106AP E10T115AP E10E120AP		E10T106AL E10T115AL E10E120AL		
	6 15 20	3 10 10	— 3/4 3/4	1 P.D.T.	ON	OFF	ON	E10T106DS E10T115DS E10E120DS		E10T106DP E10T115DP —		— E10T115DL —		
	6 15 20	3 10 10	— 3/4 3/4	1 P.D.T.	ON	None	ON	E10T106ES E10T115ES E10E120ES		— E10T115EP —		— E10T115EL —		
	—	10	1/2	1 P.S.T. 1 P.D.T. 1 P.D.T. 1 P.D.T.	OFF ON ON (ON)	None OFF None OFF	(ON) (ON) (ON) (ON)	E10T115BS E10T115FS E10T115HS E10T115GS		E10T115BP E10T115FP E10T115HP E10T115GP		— — — —		
	 2-Pole	2-Pole												
		6 15 20	3 10 10	— 3/4 3/4	2 P.S.T.	ON	None	OFF	E10T206AS E10T215AS E10E220AS		E10T206AP E10T215AP E10E220AP		— E10T215AL E10E220AL	
		6 15 20	3 10 10	— 3/4 3/4	2 P.D.T.	ON	OFF	ON	E10T206DS E10T215DS E10E220DS		E10T206DP E10T215DP E10E220DP		— E10T215DL —	
		6 15 20	3 10 10	— 3/4 3/4	2 P.D.T.	ON	None	ON	E10T206ES E10T215ES E10E220ES		— E10T215EP —		— E10T215EL —	
15		10	1/2	2 P.S.T. 2 P.D.T. 2 P.D.T.	OFF ON (ON)	None None OFF	(ON) (ON) (ON)	E10T215BS E10T215HS E10T215GS		— E10T215HP E10T215GP		— — —		
 3-Pole		3-Pole												
	15	10	3/4	3 P.S.T. 3 P.D.T. 3 P.D.T.	ON ON ON	None OFF None	OFF ON ON	E10E315AS E10E315DS E10E315ES		E10E315AP E10E315DP E10E315EP		— E10E315DL E10E315EL		
 4-Pole	4-Pole													
15	10	3/4	4 P.S.T. 4 P.D.T. 4 P.D.T.	ON ON ON	None OFF None	OFF ON ON	E10E415AS E10E415DS E10E415ES		— — —		E10E415AL E10E415DL E10E415EL			

① See Figure 47-1 Circuit Arrangements on Page 47-4.
 ② () = Momentary contacts, spring return action.

E10 Series, Hesitation Switches and Actuators

Hesitation Switches

Table 47-2. Hesitation Switches — Special Purpose — Minimum Order Quantity 10 Pieces

Approximate Dimensions in Inches (mm)	Nominal Ratings				Operation	Function — Circuit with Lever In...			Poles and Throw ①	Screw Terminal	
	Amperes		hp			UP Position	CENTER Position	DOWN Position — Keyway		Catalog Number	Price U.S. \$
	28V DC	125V AC	250V AC	250V AC							
	15	15	10	3/4	Maintained	ON	OFF	ON	2 P.D.T. 3 P.D.T. 4 P.D.T.	E10E215SS E10E315SS E10E415SS	

① See Figure 47-1 Circuit Arrangements below.

Note: Interlock mechanism prevents operation of lever through the center position until pressure is momentarily relieved. Designed for control and protection of reversing motors.

Pushbutton Actuators

Table 47-3. Pushbutton Actuators — Minimum Order Quantity 10 Pieces

Approximate Dimensions in Inches (mm)	Nominal Ratings				Poles and Throw ②	Contacts	Bushing Length Inches (mm) Dim. "A"	Button Extension Inches (mm) Dim. "B"	Typical Maximum Operating Force	Screw Terminal		Spade Terminal 0.250 Inch (6.4 mm)	
	Amperes AC		hp							Catalog Number	Price U.S. \$	Catalog Number	Price U.S. \$
	125V	250V	125 - 250V										
	NO	NC	NO	NC									
	6	—	3	—	1 P.S.T.	NO	0.69 (17.5) 0.34 (8.6)	0.53 (13.5) 0.25 (6.4)	0.9 lbs.	E10P106RS E10P106JS		E10P106RP —	
	15	—	10	—	1/3	1 P.S.T.	NO	0.69 (17.5) 0.34 (8.6)	0.9 lbs.	E10P115RS E10P115JS		E10P115RP —	
	15	10	10	5	1/4 ③	1 P.D.T.	NO, NC	0.69 (17.5)	0.53 (13.5)	1.0 lbs.	E10P115LS		—

② See Figure 47-1 Circuit Arrangements below.

③ Rated 1/4 hp at 125V, 1/2 hp at 250V.

Circuit Arrangements

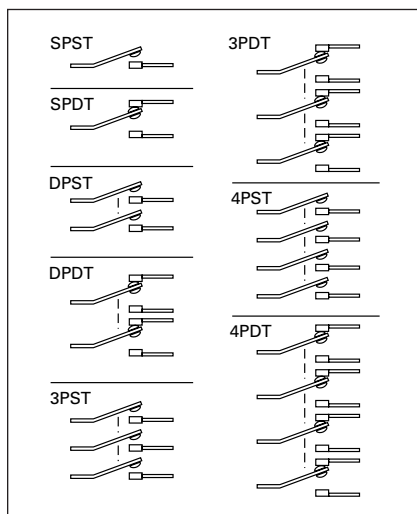
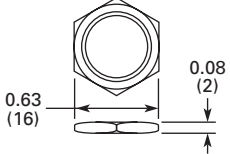
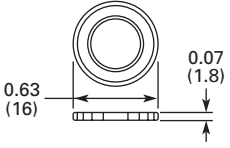
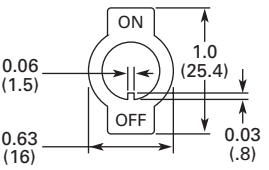





Figure 47-1. Circuit Arrangements

Discount Symbol 1CD1

Accessories

Table 47-4. Accessories — Minimum Order Quantity 100 Pieces

Description	Material/Notes	Catalog Number	Price U.S. \$	Approximate Dimensions in Inches (mm)
Hexagon Locknut	Zinc-Chromate Treated Steel	E10TA101		
Knurled Face Nut	Zinc-Chromate Treated Steel	E10TA102		
Internal Tooth Lockwasher	Cadmium Plated Steel	E10TA103		
Terminal Screws	#6-32 x 3/16" Binding Head	E10TA201		
Spade Terminal Adapter — 0.250 inch (6.4 mm)	Assembles to Screw Terminals	E10TA202		
ON-OFF Indicating Plate — Vertical Orientation	Burnished Nickel Finish Steel	E10TA301		
OFF-ON Indicating Plate — Horizontal Orientation	Burnished Nickel Finish Steel	E10TA302		
Flip-Up Guard for Toggle Switches 		E10TA104		
Fixed Shroud for Toggle Switches 		E10TA105		

Dimensions

Table 47-5. Toggle Switch — Approximate Dimensions

	No. of Poles	Operation	Approximate Dimensions in Inches (mm)										
			Bushing Length A	Lever Length B	Screw Terminals			Spade Terminals			Solder Lug		
					C	D	E	C	D	E	C	D	E
	1	Momentary & Maintained	0.47 (11.9)	0.56 (14.2)	1.00 (25.4)	1.17 (29.7)	0.63 (16.0)	1.13 (28.7)	1.13 (28.7)	0.63 (16.0)	1.00 (25.4)	1.13 (28.7)	0.63 (16.0)
	2	Maintained	0.47 (11.9)	0.56 (14.2)	1.06 (26.9)	1.31 (33.3)	0.75 (19.1)	1.19 (30.2)	1.31 (33.3)	0.75 (19.1)	1.06 (26.9)	1.31 (33.3)	0.75 (19.1)
		Momentary	0.47 (11.9)	0.56 (14.2)	1.25 (31.8)			1.31 (33.3)			1.25 (31.8)		
	3	Maintained	0.47 (11.9)	0.69 (17.5)	1.27 (32.3)	1.34 (34.0)	1.44 (36.6)	1.37 (34.8)	1.34 (34.0)	1.44 (36.6)	1.23 (31.2)	1.34 (34.0)	1.44 (36.6)
4	Maintained	0.47 (11.9)	0.69 (17.5)	1.20 (30.5)	1.30 (33.0)	1.40 (35.6)	1.30 (33.0)	1.34 (34.0)	1.40 (35.6)	1.23 (31.2)	1.34 (34.0)	1.44 (36.6)	

Note: Spade terminal adapters are used on 6 ampere, 20 ampere and momentary screw terminal switches, adding 0.42 (10.7) to dimension C.

Catalog Number Structure

Table 47-6. E10 Catalog Numbering System — Not to be used for ordering purposes

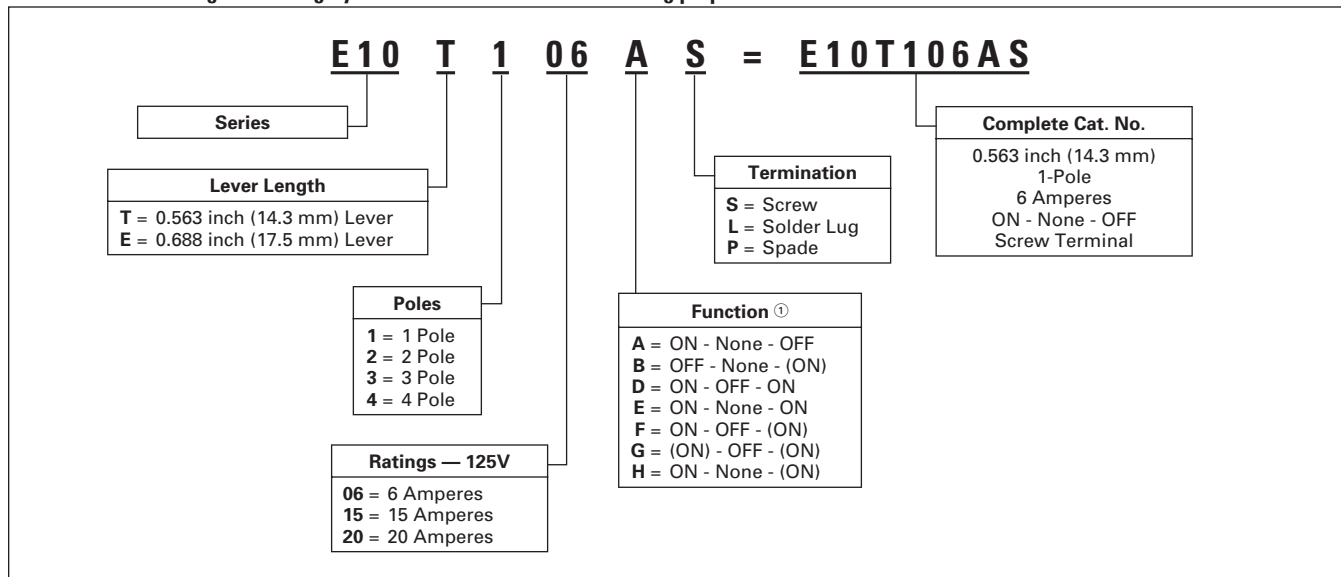

① () = Momentary contacts, spring return action.

Molded-In Screw Terminal E10E Series

Contents

<i>Description</i>	<i>Page</i>
Environmentally Sealed Toggle Switches	
Molded-In Screw Terminal E10E Series	47-7
Econoswitch E10E Series	47-9
Switch Guard	47-12



One-Pole and Two-Pole Molded-In Screw Terminal

Features

- Completely sealed against dust, moisture and other contaminants
- One-hole mounted bushing for easy installation
- Multi-circuits offered
- 2- and 3-position with maintained and momentary action
- Molded-in terminal inserts and terminals numbers
- 1- and 2-pole circuitry

Options

- Note:** Contact your local Eaton Sales Representative for more information.
- Non-UL Recognized devices
 - Alternate toggle levers
 - Locking toggle levers
 - Rocker buttons
 - Special mounting hardware
 - Mounting hardware furnished assembled
 - Terminal screws furnished assembled

- Special circuits
- Panel seal, part number 32-341
- Spade terminal adapters available

Standards and Certifications

- UL — File number E15346; Guide card number is WOYR2
- CSA — LR40068, class number 6241

Technical Data and Specifications

- Watertight seal per MIL-STD-108E and designed to meet IP68
- Thermoset molding materials meet flame retardant requirements
- Temperature Range: -50° to 150°F (-46° to 66°C)
- Life: 20,000 operations at rated load; 40,000 operations mechanical life; 6,000 operations at hp ratings per UL and CSA requirements
- Bushings: 15/32" – 32 thread

Product Selection

Table 47-7. Molded-In Screw Terminal E10E Series Toggle Switch Product Selection

Nominal AC Ratings					Circuit with Lever Position			Catalog Number	Price U.S. \$
Amperes		1-Phase hp		3-Phase hp	Up	Center	Down (Keyway)		
125V	250V	125V	250V	125/250V					
One-Pole									
18	9	1/4	1/2	—	ON ON ON	OFF NONE NONE	ON OFF ON	E10E118DM E10E118AM E10E118EM	
Two-Pole									
18	9	1/2	1	—	ON ON ON	OFF NONE NONE	ON OFF ON	E10E218DM E10E218AM E10E218EM	

Discount Symbol **1CD1**

Molded-In Screw Terminal E10E Series

Dimensions

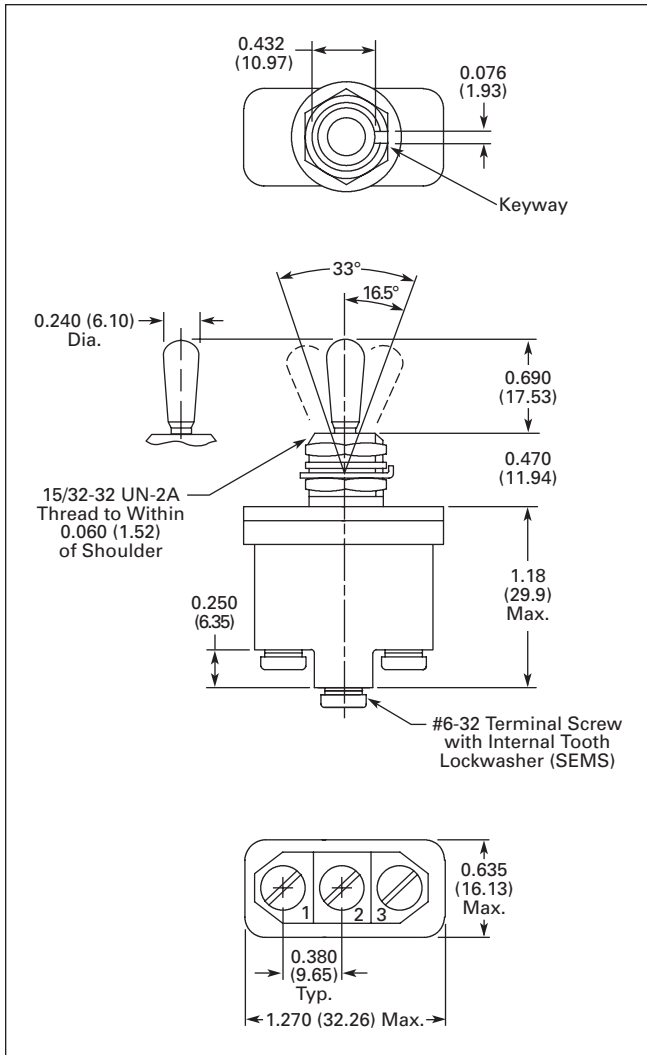

Figure 47-2. One-Pole Molded-In Screw Terminal E10E Series Toggle Switches — Approximate Dimensions in Inches (mm)

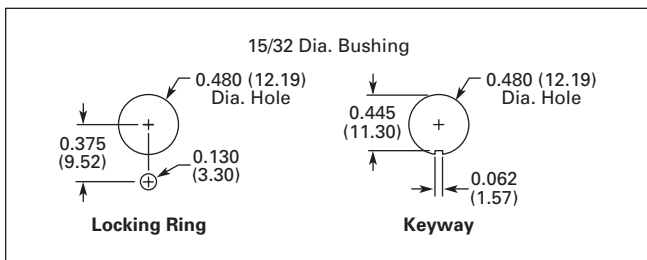

Figure 47-3. Toggle Switch Panel Cutout Dimensions in Inches (mm)

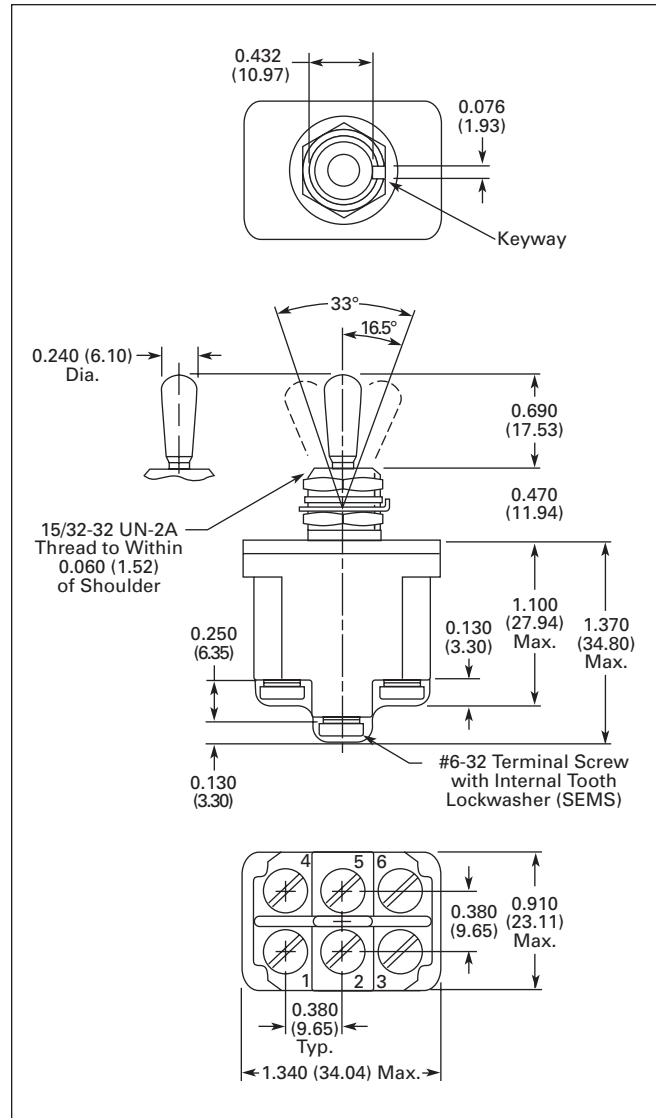

Figure 47-4. Two-Pole Molded-In Screw Terminal E10E Series — Approximate Dimensions in Inches (mm)

47

Econoswitch E10E Series



One-Pole and Two-Pole Econoswitch E10E Series Toggle Switches

Standards and Certifications

- UL — File number E15346; Guide card number is WOYR2
- CSA — LR40068, class number 6241

Table 47-9. UL and CSA Nominal Ratings

Catalog Number	Amperes		1-Phase hp		3-Phase hp
	125V AC	250V AC	125V AC	250V AC	125/250V AC
E10E118xx	18	9	1/4	1/2	—
E10E218xx	18	9	1/2	1	—

Features

- Environmentally sealed
- 1- and 2-pole circuitry
- One-hole mounting for easy installation
- Multi-circuits
- 2- and 3-position with maintained and momentary action
- Three types of termination offered as standard

Technical Data and Specifications

- Watertight seal per MIL-STD-108E and designed to meet IP68
- Three standard types of terminals:
Screws — 6-32 UNC-22A
Solder lug — 0.125 (3.17) dia. hole
Spade — 0.250 (6.35) x 0.032 (0.81) thick
- Life: 50,000 operations at rated load; 100,000 operations mechanical life
- Temperature Range: -50° to 150°F (-46° to 66°C)

Product Selection

Table 47-8. Econoswitch E10E Series Toggle Switch Product Selection

Type of Operation	Current Ratings — Amperes						Circuit with Lever Position			Screw Terminals		Solder Lug Terminals		Spade Terminals	
	28V DC			115V AC, 60 or 400 Hz			Up	Center	Down (Keyway)	Catalog Number	Price U.S. \$	Catalog Number	Price U.S. \$	Catalog Number	Price U.S. \$
	Lamp Load	Resistive Load	Inductive Load	Lamp Load	Resistive Load	Inductive Load									
One-Pole															
Maintained	5	20	15	3	15	10	ON	OFF	ON	E10E118DS		E10E118DL		E10E118DP	
Maintained	5	20	15	3	15	10	ON	NONE	OFF	E10E118AS		E10E118AL		E10E118AP	
Maintained	5	20	15	3	15	10	ON	NONE	ON	E10E118ES		E10E118EL		E10E118EP	
Momentary	4	15	10	2	15	7	ON [Ⓢ]	OFF	ON [Ⓢ]	E10E118GS		E10E118GL		E10E118GP	
Momentary	4	15	10	2	15	7	OFF	NONE	ON [Ⓢ]	E10E118BS		E10E118BL		E10E118BP	
Two-Pole															
Maintained	7	20	15	4	15	15	ON	OFF	ON	E10E218DS		E10E218DL		E10E218DP	
Maintained	7	20	15	4	15	15	ON	NONE	OFF	E10E218AS		E10E218AL		E10E218AP	
Maintained	7	20	15	4	15	15	ON	NONE	ON	E10E218ES		E10E218EL		E10E218EP	
Momentary	5	18	10	2	11	8	ON [Ⓢ]	OFF	ON [Ⓢ]	E10E218GS		E10E218GL		E10E218GP	
Momentary	5	18	10	2	11	8	OFF	NONE	ON [Ⓢ]	E10E218BS		E10E218BL		E10E218BP	

[Ⓢ] Momentary contact.

Econoswitch E10E Series

Dimensions

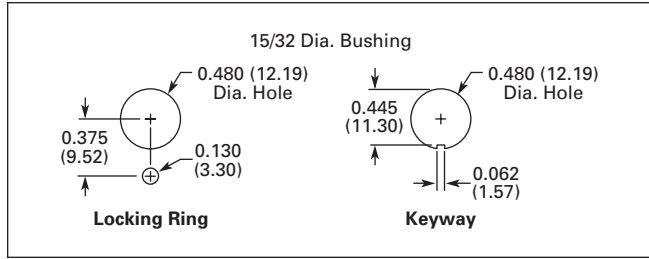

Figure 47-5. Toggle Switch Panel Cutout Dimensions in Inches (mm)

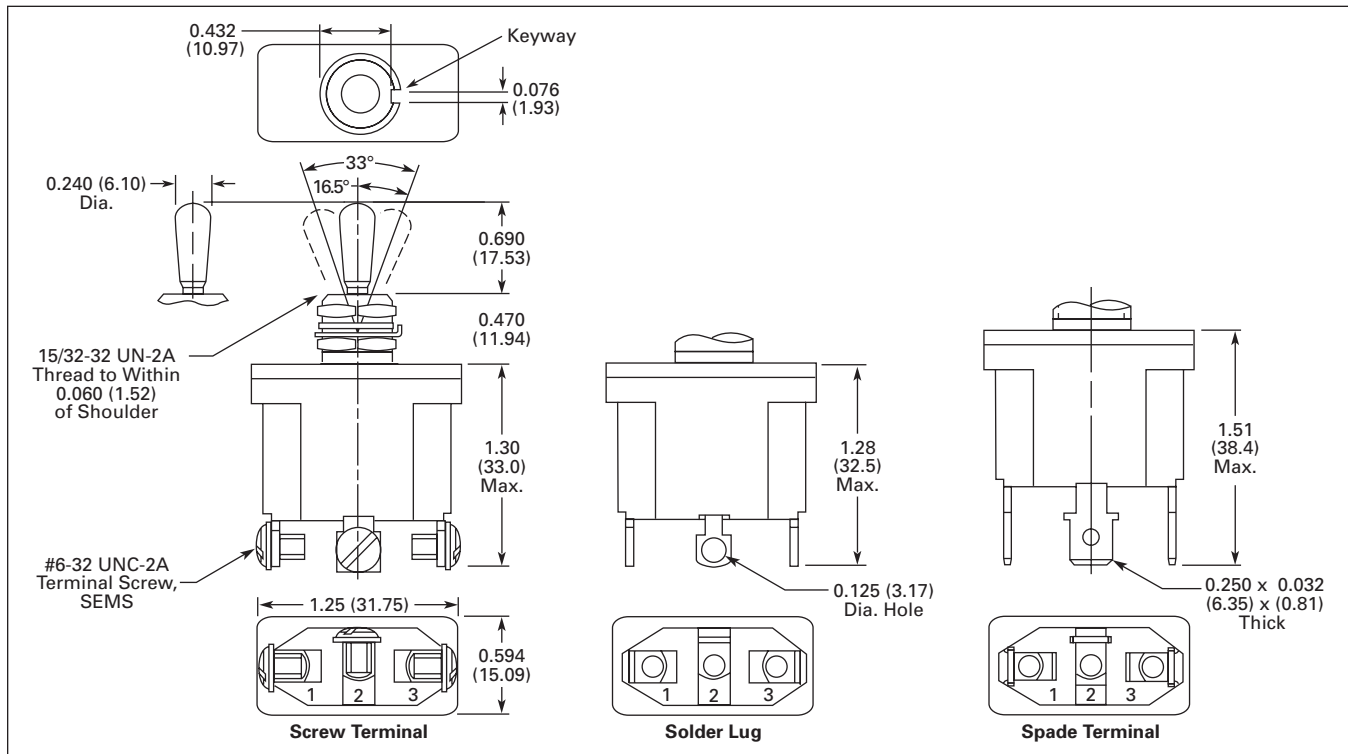

Figure 47-6. One-Pole Econoswitch E10E Series Toggle Switches — Approximate Dimensions in Inches (mm)

Econoswitch E10E Series

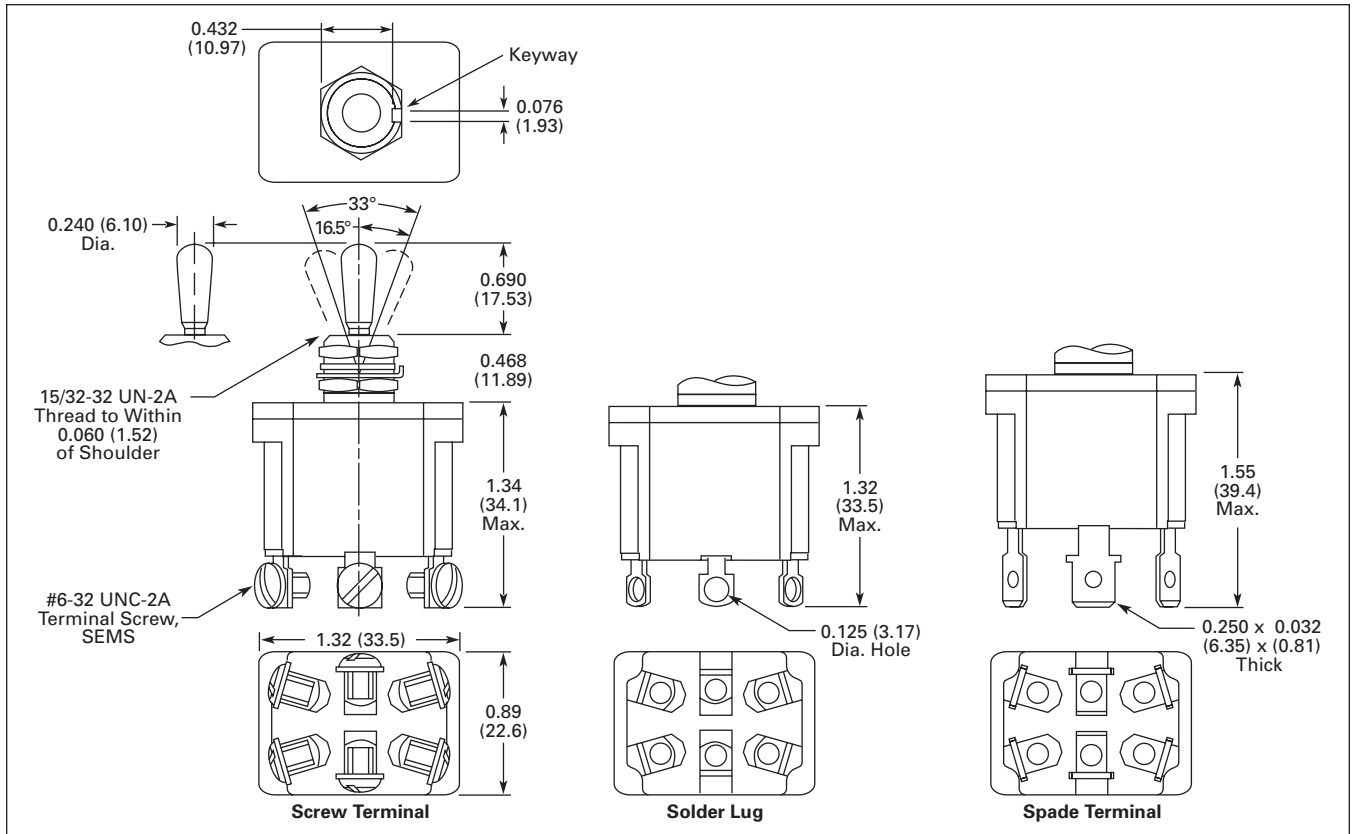

Figure 47-7. Two-Pole Econoswitch E10E Series Toggle Switches — Approximate Dimensions in Inches (mm)

Switch Guard



Switch Guard

Features

- For use with 2-position switch
- Cover closure transfers switch toggle lever to OFF position
- One-hole mounted mounting style
- Cover is molded out of red thermoset molding material
- Guard cover is spring-loaded to either close or lock in open position
- Prevents accidental operation at switches

Product Selection

Table 47-10. Switch Guard Product Selection

	Catalog Number	Price U.S. \$
Switch Guard	E10TA104	

Dimensions

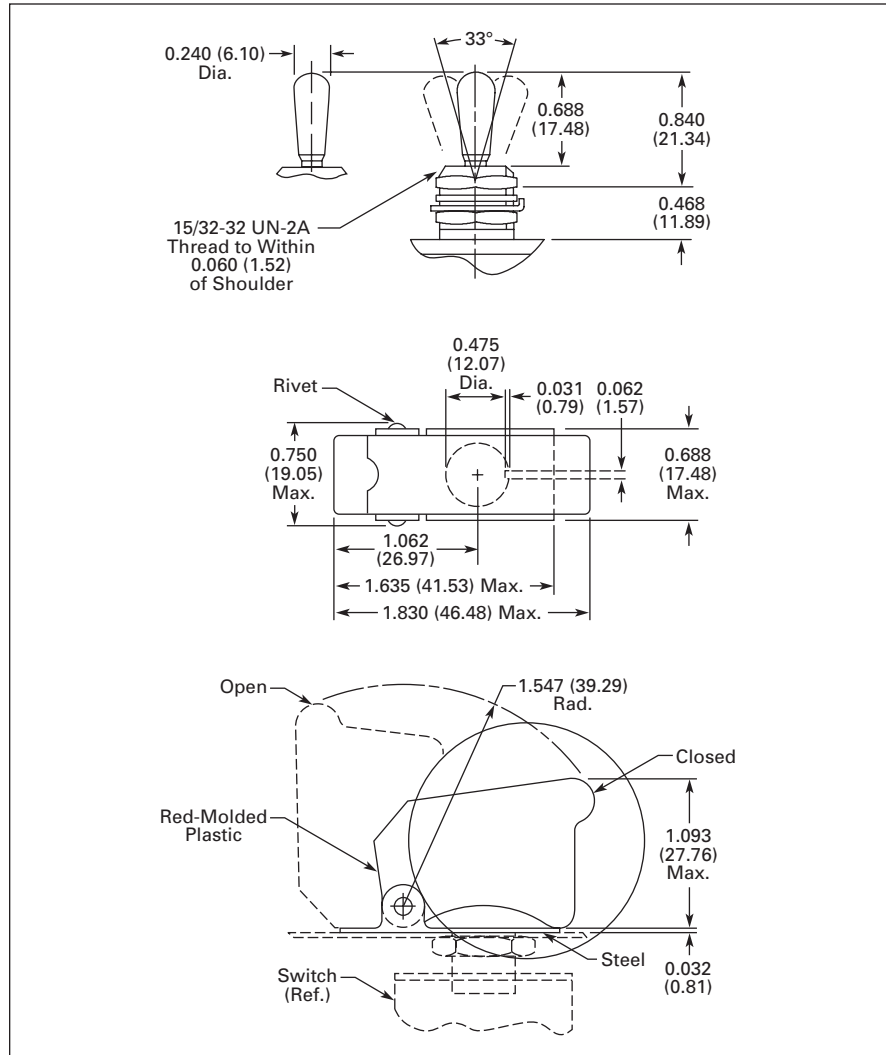

Figure 47-8. Switch Guard— Approximate Dimensions in Inches (mm)

Contents

<i>Description</i>	<i>Page</i>
Assembled Control Stations	
Features	47-13
E22 Control Stations	47-14
General Purpose Control Stations.....	47-16
Special Purpose Control Stations.....	47-18
Heavy-Duty Control Stations.....	47-19
10250T Control Stations ..	47-20
10250T Class I Division 2 Control Stations.....	47-21
E34 Class I Division 2 Corrosion Resistant Control Stations.....	47-22
Dimensions.....	47-23
Custom Assembled Stations	47-24
Renewal Parts.....	47-26

Features

E22 Control Stations



Cat. No. E22AS204

- 22.5 mm operators
- Industrial grade
- Impact resistant polycarbonate enclosures
- Compact wall mount
- Optional yellow covers
- Popular with OEMs
- UL (NEMA) Type 4, 4X, 12, 13

General Purpose Control Stations



Cat. No. 10250H5200

- Construction grade
- General purpose wall mount
- Popular with contractors
- UL (NEMA) Type 1

Special Purpose Control Stations



Cat. No. 10250H364

- Standard grade
- Polyester enclosure
- UL (NEMA) Type 3, 3R, 4, 4X, 13

Heavy-Duty Control Stations



Cat. No. 10250H1913

- Industrial grade
- Extra heavy-duty
- Polyester enclosure
- Booted buttons
- Outdoor installation
- UL (NEMA) Type 3, 3R, 3S, 4, 4X, 12, 13

10250T Control Stations



Cat. No. 10250T3525

- 30.5 mm operators
- Industrial grade
- Zinc die cast enclosure
- Popular with industrial end users
- UL (NEMA) Type 4, 4X, 12, 13

Class I Division 2 Control Stations



Cat. No. E34EX7023P

- Available with 10250T or E34 30.5 mm operators
- Zinc die cast, polyester or stainless steel enclosures
- Factory-sealed contact blocks
- Popular with industrial end users
- UL (NEMA) Type 4, 4X, 12, 13
- NEC Class I Division 2 Groups B, C and D

E22 Series, 22.5 mm Pushbutton Stations













Emergency Stop Station

Assembled E-Stop Stations

Product Description

- Safety-yellow cover and light gray base enclosures
- Polycarbonate enclosures
- Single 21 mm diameter hole for cable entry

Table 47-11. Product Selection — Emergency Stop Stations — UL (NEMA) Type 4, 4X, 12, 13

Operator	Contact Symbol	Button Type/Color	Legend Marking	Catalog Number	Price U.S. \$
 Cat. No. E22AT111	 1NC	40 mm Latching Trigger Action/Red	EMERGENCY STOP Round Yellow Nameplate	E22AT111 ①	
		40 mm Latching Trigger Action/Red	EMERGENCY STOP Safety Yellow Guard	E22AT112 ①	
		40 mm Latching Trigger Action/Red	EMO Safety Yellow Cover	E22AT113 ①	
		40 mm Latching Trigger Action/Red	EMO Safety Yellow Guard	E22AT114 ①	
 Cat. No. E22AT111C	 1NO  1NC	40 mm Latching Trigger Action/Red	EMERGENCY STOP Round Yellow Nameplate	E22AT111C ①	
		40 mm Latching Trigger Action/Red	EMERGENCY STOP Safety Yellow Guard	E22AT112C ①	
		40 mm Latching Trigger Action/Red	EMO Safety Yellow Cover	E22AT113C ①	
		40 mm Latching Trigger Action/Red	EMO Safety Yellow Guard	E22AT114C ①	
 Cat. No. E22AT111E	 1NO  1NO	40 mm Latching Trigger Action/Red	EMERGENCY STOP Round Yellow Nameplate	E22AT111E ①	
		40 mm Latching Trigger Action/Red	EMERGENCY STOP Safety Yellow Guard	E22AT112E ①	
		40 mm Latching Trigger Action/Red	EMO Safety Yellow Cover	E22AT113E ①	
		40 mm Latching Trigger Action/Red	EMO Safety Yellow Guard	E22AT114E ①	
 Cat. No. E22ASB106	 1NC	40 mm Mushroom, Momentary Action/Red	EMERGENCY STOP Yellow Cover	E22ASB105 ②	
		40 mm Latch in Twist-to-Release/Red	EMERGENCY STOP Yellow Cover	E22ASB106 ②	

① Compliant with EN418 Safety of Machinery Standard.

② Non-compliant with EN418 requirements.

Dimensions **Page 47-23**
 Custom Stations **Pages 47-24 – 47-25**
 Discount Symbol **1GD1C**



E-Stop Control Station





Assembled E22 Pushbutton Stations

Product Description

- E22 Series black bezel pushbuttons
- Light gray polycarbonate enclosures
- Single 21 mm diameter hole for cable entry

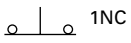
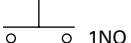
Note: For Custom Stations, see **Pages 47-24 – 47-25.**

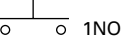
Table 47-12. Product Selection — Assembled Control Stations — UL (NEMA) Type 4, 4X, 12, 13

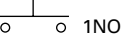
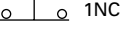
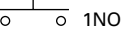
Operator	Contact Symbol	Button Type/Color	Legend Marking	Catalog Number Chrome Bezels	Catalog Number Black Bezels	Price U.S. \$	
 Cat. No. E22ASB109	 1NC	Extended/Red	STOP	E22AS109	E22ASB109		
	 1NO	Flush/Green	START	E22AS108	E22ASB108		
 Cat. No. E22AS204	 1NO	Flush/Green Extended/Red	START STOP	E22AS204	E22ASB204		
		Flush/Green Mushroom/Red	START STOP	E22AS205	E22ASB205		
		Flush/Green Latch-In Twist-to-Release/Red	START STOP	E22AS206	E22ASB206		
 Cat. No. E22AS304	 1NO	Flush/Black Extended/Red Flush/Black	FOR STOP REV	E22AS304	E22ASB304		
		 1NC	Flush/Black Extended/Red Flush/Black	CLOSE STOP OPEN	E22AS305	E22ASB305	
		 1NO	Flush/Black Extended/Red Flush/Black	UP STOP DOWN	E22AS306	E22ASB306	

Dimensions **Page 47-23**
 Custom Stations **Pages 47-24 – 47-25**
 Discount Symbol **1GD1C**

10250H Series, General Purpose Stations

General Purpose Type N Control Stations







Table 47-13. Product Selection — Type N Control Stations – UL (NEMA) Type 1

Enclosure Type	Contact Symbol	Button Type/Color	Legends	Catalog Number	Price U.S. \$	Approximate Dimensions in Inches (mm)
One Element						
Single Button with Padlock Attachment Accessory 		Flush/Green	START	10250H5100		
		Flush/Red	STOP	10250H5101		
		Extended/Red	STOP	10250H5104		
		Palm Operated/Black	None	10250H89 ①		
Selector Switch 		3-Position Selector Switch/Black Knob	RUN/OFF/AUTO	10250H289 ①		
Two Element						
Two Button Station 		Flush/Red	START/STOP	10250H5200		
		Flush/Green Extended/Red	START/STOP	10250H5207		
		Flush/Black (All)	RAISE/LOWER FOR/REV OPEN/CLOSE UP/DOWN HIGH/LOW FAST/SLOW	10250H5201 10250H5202 10250H5203 10250H5204 10250H5205 10250H5208		
Three Element						
Three Button Stations 		Flush/Black (All)	FOR/REV/STOP UP/DOWN/STOP RAISE/LOWER/STOP OPEN/CLOSE/STOP FAST/SLOW/STOP	10250H5300 10250H5301 10250H5302 10250H5303 10250H5304		
Three Button with Indicating Light 		110/220V Neon Indicating Light Clear — Flush/Green; Flush/Red Red — Flush/Green; Flush/Red Amber — Flush/Green; Flush/Red	START/STOP	10250H5310 10250ED853 10250ED853-2		

① Round button.
② 2.38 (60.5) for neon indicating light.

General Purpose Type N Open Type Assemblies

Table 47-14. Product Selection — Type N — Open Type Construction (No Cover)

Enclosure Type	Contact Symbol	Button Type/Color	Legends	Catalog Number	Price U.S. \$
One Element					
Selector Switch 		3-Position Selector Switch/Black Knob	RUN/OFF/AUTO	10250H2538	
Two Element					
Two Button Station 		Flush/Green	START/STOP	10250H2747	
Mechanically Interlocked Pushbuttons 		Flush/Black (All) Mech. Interlocked	None ①	10250H2544	

① No legend on buttons. Specify any standard legend.

Table 47-15. Accessories for Type N Control Stations









	Description	Catalog Number	Price U.S. \$
	Padlock Attachment — For field assembly on square button type (except extended button types)	10250H5110	

Table 47-16. Maximum Ampere Ratings for Type N Control Stations

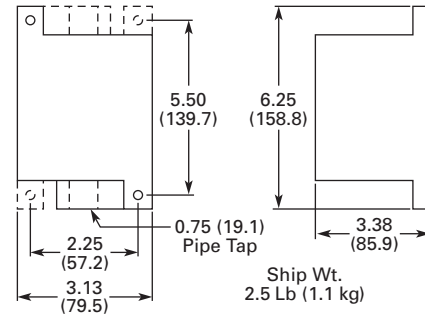
Voltage	AC				DC		
	110V	220V	440V	550V	120V	240V	600V
Make and Emergency Interrupt Capacity	30	15	7.5	6	1.0	0.5	0.1
Normal Load Break	3	1.5	0.75	0.6	1.0	0.5	0.1
Continuous Current	10	10	10	10	10	10	10

Special Purpose Control Stations

Table 47-17. Product Selection — Special Purpose Control Stations — UL (NEMA) Type 3, 3R, 4, 4X, 13

	Type	Feature	Symbol	Legends	Catalog Number	Price U.S. \$	Approximate Dimensions in Inches (mm)
	One Element Push-button	Flush		START	10250H2738		
				STOP	10250H658		
		With Lock Hasp		STOP	10250H665		
	Two Element Push-button	Flush		START/STOP	10250H364		
		With Lock Hasp		START/STOP	10250H671		
		Buttons Interlocked		FAST/SLOW FOR/REV UP/DOWN OPN/CLOSE	10250ED664 10250H2740 10250H2741 10250H2742		
Cat. No. 10250H364							

Heavy-Duty Type H Control Stations

Product Description

- 10250T Series operators
- Dark brown polyester enclosure
- Protective rubber gaskets provide NEMA 3S rating on pushbuttons
- Top and bottom 3/4-inch NPT conduit entrances
- Includes alternate legend plates and spare mounting screws

Table 47-18. Product Selection — Type H Control Stations — UL (NEMA) Type 3, 3S, 4, 4X, 12, 13



	Type of Element	Feature	Circuit	Assembled Legend Plate	Unassembled Alternate Legend Plates	Catalog Number	Price U.S. \$
One Element							
	Pushbuttons	Without Padlock Hasp	1NO-1NC	JOG	START STOP RUN	10250H1881	
		With Padlock Hasp	1NC	STOP	—	10250H4239	
	Knob Selector Switch	2-Position 3-Position	1NO-1NC 1NO-1NC	OFF/ON MAN/OFF/AUTO	— —	10250H4526 10250H4527	
Two Element							
	Pushbuttons	Standard	1NO-2NC	START/STOP	—	10250H1884	
			2NO-2NC	RAISE/LOWER	FORWARD REVERSE OPEN CLOSE	10250H1885	
	Standard and Standard w/ Padlock Hasp	1NO-2NC	START/STOP	—	10250H4240		
Three Element							
 <i>Cat. No. 10250H1913</i>	Pushbuttons	Standard	2NO-3NC	FOR/REV/STOP	START JOG RAISE LOWER	OPEN CLOSE FAST SLOW	10250H1890
		2 Standard and Standard w/ Padlock Hasp	2NO-3NC	FOR/REV/STOP	—	10250H4241	
	Indicating Light and Push-buttons	120V	Light-Red Lens and 2 Plain	1NO-2NC	MOTOR RUNNING START/STOP	—	10250H1913

Table 47-19. Approximate Dimensions in Inches (mm)

NEMA Type	No. of Elements	Dimensions		
		Wide	High	Deep
3, 3R, 3S, 4, 4X, 13	1 and 2	4.50 (114.3)	8.25 (209.6)	4.50 (114.3)
	3	4.50 (114.3)	10.75 (273.1)	4.25 (108.0)

Table 47-20. Maximum Ampere Ratings

Description	Volts AC 50/60 Hz				Volts DC	
	120	240	480	600	125	250
Make and Emerg. Inter. Capacity	60	30	15	12	1.1	0.55
Normal Load Break	6	3	1.5	1.2	1.1	0.55
Continuous Amperes	10	10	10	10	10	10
Voltamperes —						
Make and Emerg. Inter. Cap.	7200	7200	7200	7200	138	138
Normal Load Break	720	720	720	720	138	138





10250T Series, 30.5 mm Pushbutton Stations

10250T Heavy-Duty 30.5 mm Control Stations

Product Description

- 10250T Series operators
- Surface or flush mounting
- Single 1-inch NPT conduit entrance on three element stations
- ASA 61 gray die-cast zinc enclosures
- Single 3/4-inch NPT conduit entrance on one and two element stations

Table 47-21. Product Selection — Complete Assembled Stations — UL (NEMA) Type 4, 4X, 12, 13

Number of Elements	Type of Elements ②	Features	Contact Block(s)	Legend	Surface Mounting		Flush Mounting ④	
					Catalog Number	Price U.S. \$	Catalog Number	Price U.S. \$
Break Glass Station 	Break Glass Station ①	Gray Enclosure Red Enclosure	NC (Logic Level)	EMERG. OFF EMERG. OFF	10250TGS 10250TGR		— —	
One Element 	Pushbutton	Standard	NO-NC NC NO-NC	START STOP None	10250T3516 10250T3518 10250T3540		10250T3573 10250T3575 10250T3597	
		Mushroom Head	NO-NC NC	START STOP	10250T3517 10250T3519		10250T3574 10250T3576	
		With Lock Hasp ⑤	NC	STOP	10250T3520		10250T3577	
	Selector Switch	2-Position Black Knob	NO-NC	OFF/ON	10250T3523		10250T3580	
		3-Position Black Knob	2NO	MAN/OFF/AUTO	10250T3524		10250T3581	
Push-Pull 3-Position	Momentary Red Button	2NC	START/STOP	10250T3545		10250T3602		
Two Element 	Pushbuttons	Standard	1NO-2NC 2NO-2NC 2NO-2NC	START/STOP RAISE/LOWER None	10250T3525 10250T3672 10250T3541		10250T3582 10250T3673 10250T3598	
		With Lock Hasp ⑤	1NO-2NC	START/STOP	10250T3542		10250T3599	
		Standard and Mushroom Head	1NO-2NC	START/STOP	10250T3526		10250T3583	
		Standard with Maintained Contact ③	NO-NC Plus NC	START/STOP	10250T3528		10250T3585	
Three Element 	Pushbuttons	Standard	2NO-3NC 2NO-3NC 2NO-3NC 2NO-3NC	FOR, REV, STOP UP, DOWN, STOP OPEN, CLOSE, STOP None, None, STOP	10250T3532 10250T3615 10250T3614 10250T3543		10250T3589 — — 10250T3600	
		2 Standard and with Lock Hasp	2NO-3NC	None, None, STOP	10250T3544		10250T3601	
	Indicating Light (Transformer Type) and Pushbuttons	Red Lens — 120V Red Lens — 240V Red Lens — 480V Red Lens — 600V	1NO-2NC	MOTOR RUN, START/STOP	10250T3536 10250T3537 10250T3538 10250T3539		10250T3593 10250T3594 10250T3595 10250T3596	

47

- ① Breaking glass closes contact.
- ② Stop buttons are red — all others are black.
- ③ Uses deep cover instead of shallow cover. Switch component is 10250TA67.
- ④ NEMA 4 – 13, if properly mounted on a flat surface. Consists of front plate, legend, operator and contact blocks.
- ⑤ Lock is 10250TA2.



Break Glass Operator Shown Assembled to Contact Block (Contact Block Supplied Separately)

Table 47-22. Break Glass Kit

Description	Catalog Number	Price U.S. \$
Operator with Hammer and 5 Glass Discs	10250TBG	
Glass Discs Only (5)	10250TGL	

Custom Stations **Pages 47-24 – 47-25**
 Dimensions **Pages 47-160 – 47-162**
 Renewal Parts **Pages 47-157 – 47-158**
 Discount Symbol **1CD1C**

Class I Division 2 10250T Heavy-Duty 30.5 mm Control Stations

Product Description

- 10250T Series operators
- Factory sealed contact blocks
- Die-cast, polyester or stainless steel enclosures
- Approved for NEC Class I Division 2, Groups B, C and D or Class I Zone 2 Group IIB plus Hydrogen type hazardous locations



Die Cast Enclosure with One Pushbutton — Aluminum Jumbo Mushroom Red-Engraved EMER. STOP
Catalog Number 10250T7007



Polyester Enclosure with Two Pushbuttons — Flush Green and Extended Red
Catalog Number 10250T7023P



Stainless Steel Enclosure with One Red Pilot and Two Pushbuttons — Flush Green and Extended Red
Catalog Number 10250T7033S

Table 47-23. Product Selection — Complete 10250T Assembled Stations — UL (NEMA) Type 4, 4X, 12, 13; NEC Class I Division 2, Groups B, C and D

Operator	Contact Symbol	Button Type/Color	Legend Marking	Die Cast Enclosure		Polyester Molded Enclosure		Stainless Steel Enclosure	
				Catalog Number	Price U.S. \$	Catalog Number	Price U.S. \$	Catalog Number	Price U.S. \$
One Pushbutton		Flush/Green	START	10250T7003		10250T7003P		10250T7003S	
		Extended/Red	STOP	10250T7005		10250T7005P		10250T7005S	
		Alum. Jumbo Mushroom/Red	EMER. STOP (Engraved Button)	10250T7007		10250T7007P		10250T7007S	
		Flush/Black	No Legend	10250T7009		10250T7009P		10250T7009S	
Two Pushbuttons		Flush/Green Extended/Red	START STOP	10250T7023		10250T7023P		10250T7023S	
		Flush/Black Flush/Black	No Legend No Legend	10250T7025		10250T7025P		10250T7025S	
One Pilot Light Two Pushbuttons		120V AC Red Flush/Green Extended/Red	No Legend START STOP	10250T7033		10250T7033P		10250T7033S	
		120V AC Red Flush/Black Flush/Black	No Legend	10250T7035		10250T7035P		10250T7035S	
3-Position Selector Switch		Maintained Knob/Black	HAND/OFF/AUTO	10250T7011		10250T7011P		10250T7011S	
		Maintained Knob/Black	No Legend	10250T7013		10250T7013P		10250T7013S	
One Pushbutton Maintained		Push-Pull w/Jumbo Mushroom/Red	EMER. STOP (Engraved Button)	10250T7019		10250T7019P		10250T7019S	

Custom Stations **Pages 47-24 – 47-25**
 Enclosure Dimensions **Page 47-23**
 Operator Dimensions **Pages 47-160 – 47-162**
 Discount Symbol **1CD1C**

E34 Series, Class I Division 2 Corrosion Resistant Stations

Class I Division 2 E34 Corrosion Resistant 30.5 mm Control Stations

Product Description

- E34 Series operators
- Factory sealed contact blocks
- Die-cast, polyester or stainless steel enclosures
- Approved for NEC Class I Division 2 Groups B, C and D or Class I Zone 2 Group IIB plus Hydrogen type hazardous locations



Polyester Enclosure with Two Pushbuttons — Flush Green and Extended Red, Catalog Number E34EX7023P

Table 47-24. Product Selection — Complete E34 Assembled Stations — UL (NEMA) Type 4, 4X, 12, 13; NEC Class I Division 2, Groups B, C and D

Operator	Contact Symbol	Button Type/Color	Legend Marking	Die Cast Enclosure		Polyester Molded Enclosure		Stainless Steel Enclosure	
				Catalog Number	Price U.S. \$	Catalog Number	Price U.S. \$	Catalog Number	Price U.S. \$
One Pushbutton		Flush/Green	START	E34EX7003		E34EX7003P		E34EX7003S	
		Extended/Red	STOP	E34EX7005		E34EX7005P		E34EX7005S	
		Alum. Jumbo Mushroom/Red	EMER. STOP (Engraved Button)	E34EX7007		E34EX7007P		E34EX7007S	
		Flush/Black	No Legend	E34EX7009		E34EX7009P		E34EX7009S	
Two Pushbuttons		Flush/Green Extended/Red	START STOP	E34EX7023		E34EX7023P		E34EX7023S	
		Flush/Black Flush/Black	No Legend No Legend	E34EX7025		E34EX7025P		E34EX7025S	
3-Position Selector Switch		Maintained Knob/Black	HAND/OFF/AUTO	E34EX7011		E34EX7011P		E34EX7011S	
		Maintained Knob/Black	No Legend	E34EX7013		E34EX7013P		E34EX7013S	
One Pushbutton Maintained		Push-Pull w/Jumbo Mushroom/Red	EMER. STOP (Engraved Button)	E34EX7019		E34EX7019P		E34EX7019S	

Note: Use NEMA 4X 10250T operators where exposed to ultraviolet light, see Page 47-21.

Custom Pushbutton Stations **Pages 47-24 – 47-25**
 Enclosure Dimensions **Page 47-23**
 Operator Dimensions **Page 47-191**
 Discount Symbol **1GD1C**

Dimensions

E22

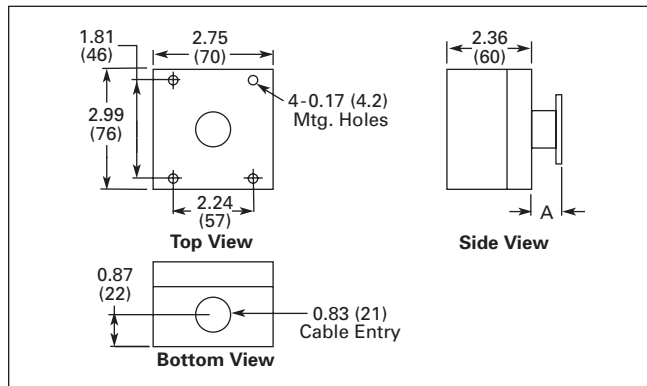

Figure 47-9. One-Element — Approximate Dimensions in Inches (mm)

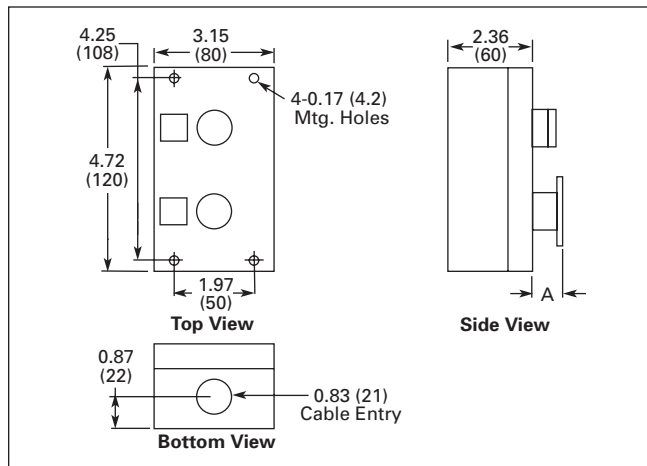

Figure 47-10. Two-Element — Approximate Dimensions in Inches (mm)

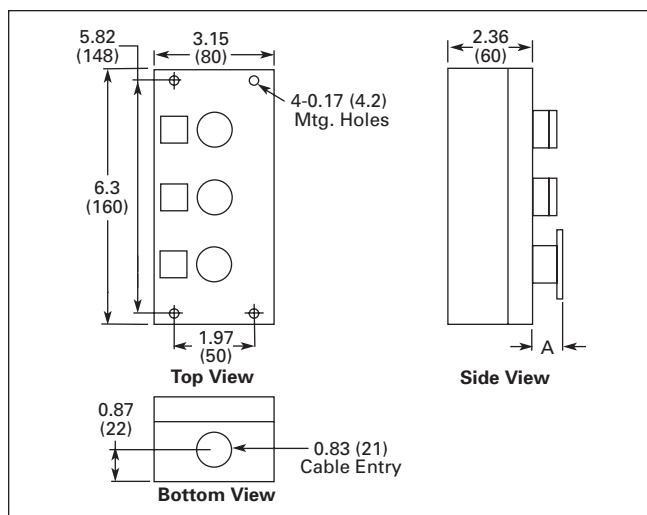

Figure 47-11. Three-Element — Approximate Dimensions in Inches (mm)

Table 47-25. E22 One-Element, Two-Element and Three-Element Approximate Dimensions

Catalog Number	Dimension A in Inches (mm)	Catalog Number	Dimension A in Inches (mm)
E22ASB105	0.87 (22.0)	E22ASB304	0.65 (16.4)
E22ASB106	0.87 (22.0)	E22ASB305	0.65 (16.4)
E22ASB108	0.57 (14.4)	E22ASB306	0.65 (16.4)
E22ASB109	0.65 (16.4)	E22AT111	1.32 (33.5)
E22ASB204	0.65 (16.4)	E22AT112	1.32 (33.5)
E22ASB205	0.87 (22.0)	E22AT113	1.32 (33.5)
E22ASB206	0.87 (22.0)		

10250T and E34

Table 47-26. Approximate Enclosure Dimensions

Number of Elements	Surface Mounting Dimensions in Inches (mm)					Conduit Entrance
	Wide A	High B	Deep C	Mounting		
				D	E	

Cast

1	3.88 (98.6)	4.0 (101.6)	3.0 (76.3)	2.69 (68.3)	3.25 (82.6)	3/4
2	3.88 (98.6)	5.88 (149.4)	3.0 (76.3)	2.69 (68.3)	5.13 (130.3)	3/4
3	3.88 (98.6)	7.75 (196.9)	3.0 (76.3)	2.69 (68.3)	7.0 (177.8)	1
4	3.88 (98.6)	9.63 (244.6)	3.0 (76.3)	2.69 (68.3)	8.88 (225.6)	1

Polyester

1	3.81 (96.8)	6.63 (168.4)	3.38 (85.9)	2.94 (74.7)	4.88 (124.0)	①
2	3.81 (96.8)	6.63 (168.4)	3.38 (85.9)	2.94 (74.7)	4.88 (124.0)	
3	3.81 (96.8)	8.88 (225.6)	3.38 (85.9)	2.94 (74.7)	7.13 (181.1)	
4	3.81 (96.8)	11.13 (282.7)	3.38 (85.9)	2.94 (74.7)	9.38 (238.3)	

Stainless Steel

1	3.00 (76.2)	3.50 (88.9)	3.00 (76.2)	1.50 (38.1)	4.25 (108.0)	①
2	3.50 (88.9)	6.75 (171.5)	3.00 (76.2)	1.50 (38.1)	7.50 (190.5)	
3	3.50 (88.9)	9.00 (228.6)	3.00 (76.2)	1.50 (38.1)	9.00 (228.6)	
4	3.50 (88.9)	11.25 (285.8)	3.00 (76.2)	1.50 (38.1)	12.00 (304.8)	

① No conduit entrance holes provided. Drill as required.

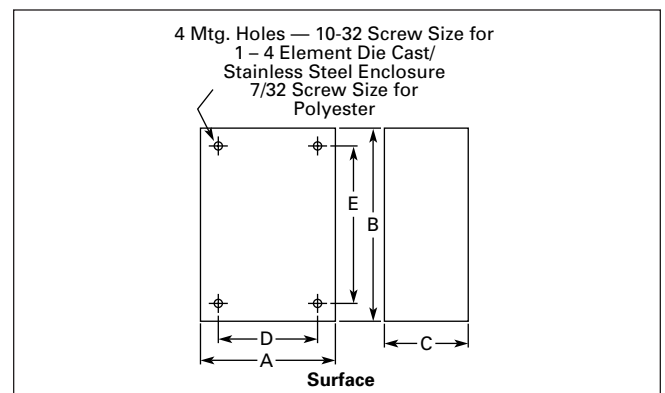

Figure 47-12. Approximate Enclosure Dimensions

Custom Assembled Stations Specification Form

Ordering Instructions

- Step 1)** Copy this ordering guide from catalog.
- Step 2)** Specify 10250T, E22 or E34 pushbutton lines in the corresponding box on the following page.

10250T	Pages 47-115 – 47-165
E22	Pages 47-28 – 47-98
E34	Pages 47-166 – 47-189
10250T & E34 Class I Div. 2	Pages 47-215 – 47-242

- Step 3)** Check back of panel dimensions — specify single or double depth enclosure on the corresponding box on the following page.
- Step 4)** Specify enclosure Catalog Number and price in the corresponding box on the following page. Enclosures can be found on **Pages 47-87 – 47-88** and **Pages 47-153 – 47-154**. For pricing, reference the most recent PAD or VISTA-line.
- Step 5)** Specify Catalog Numbers for desired operator, legend plate, light unit, accessory and contact block(s) for each location in the enclosure in the corresponding box on the following page. (See position locations below.)

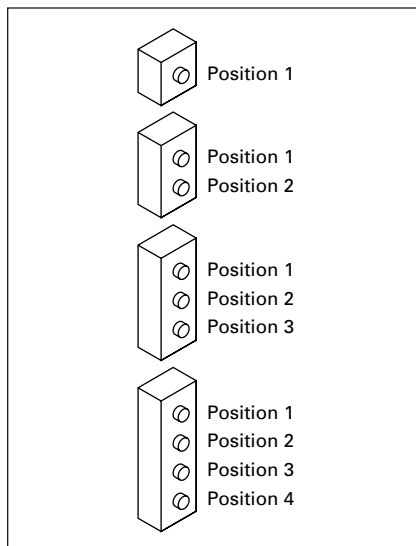
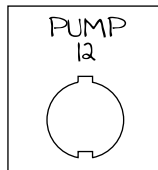

Figure 47-13. Position Locations

- Step 6)** For non-standard legends, specify legend desired, letter size and location on the layout sketches on the following page. For limitations see **Page 47-84** and **Page 47-152**. For pricing, use the blank legend Catalog Number and “STAMP” Suffix (Ex.: **10250TS36STAMP**) and reference the most recent PAD or VISTA-line.

Example: 10250TS36

Special Legend for Position # 1



LETTER SIZE	
3/32"	
1/8"	✓
3/16"	

- Step 7)** Fax Sheet 2 of this form to Eaton’s TRC, Technical Resource Center, at 828-651-0549 to the attention of — **Custom Stations Order** or email to TRC@eaton.com.

Within a few days you will receive a confirmation fax with the custom station part number and price.

- Step 8)** Place your order over the VISTA System.

For Selector and Roto-Push Operators

10250T or E34

For single contact blocks or 1NO-1NC contact blocks, the mounting position of contacts must be specified. For example: If a 1NO-1NC contact block is required, specify if NO is to be mounted in Top A position or Bottom B position.

E22

For each contact block, specify if it is to be mounted in the left or right position. For example: If an E22B1 contact block is selected, specify if it is to be mounted on the left or right side of the mounting adapter as viewed from back of operator.



To — **Eaton's TRC, Custom Station Order**
(828) 651-0549 FAX, or email to TRC@eaton.com

From — Customer Name _____
Customer Contact _____
Phone Number _____
Fax Number _____
Email Address _____

FACTORY USE ONLY	
Part Number	
Product Code	
Suffix	
Date	
Engineer	

Step 2)

- 10250T** **STD** **Class I Division 2**
E22 **STD**
E34 **STD** **Class I Division 2**

Step 3) ✓

Single Depth Enclosure	
Double Depth Enclosure	

Step 4)

Enclosure Catalog Number	Price

Step 5)

Position	Operator	Price U.S. \$	Light Unit	Price U.S. \$	Contact Block	Price U.S. \$	A/L	B/R	Contact Block	Price U.S. \$	A/L	B/R	Total Price
1													
2													
3													
4													

Position	Legend Plate	Price U.S. \$	Lens or Caps	Price U.S. \$	Accessory	Price U.S. \$	Total Price
1							
2							
3							
4							

Total:

10% Adder
for Assembled Stations

Step 6) Non-standard Legends

Special Legend for Position # _____

Special Legend for Position # _____

Special Legend for Position # _____

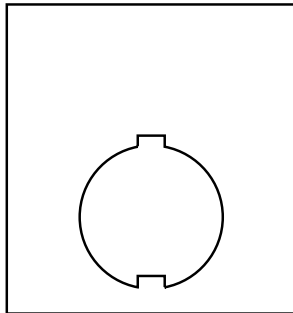

LETTER SIZE ✓

3/32 inch (2.4 mm)	
1/8 inch (3.2 mm)	
3/16 inch (4.8 mm)	

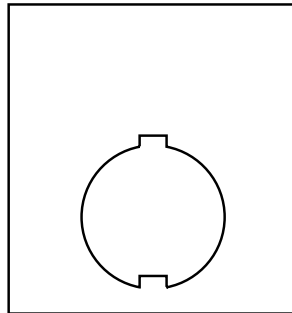

LETTER SIZE ✓

3/32 inch (2.4 mm)	
1/8 inch (3.2 mm)	
3/16 inch (4.8 mm)	

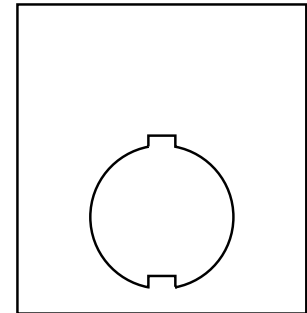

LETTER SIZE ✓

3/32 inch (2.4 mm)	
1/8 inch (3.2 mm)	
3/16 inch (4.8 mm)	

10250H Series, Renewal Parts

Renewal Parts

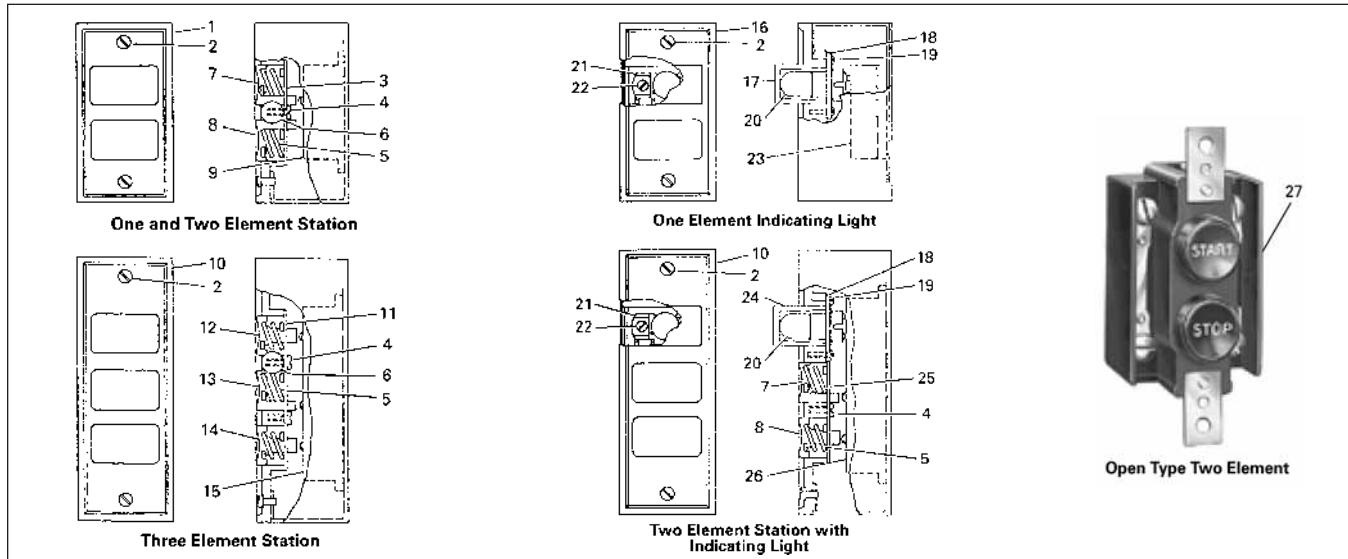

Figure 47-14. Type N Renewal Parts

Table 47-27. Assembled Stations — Type N Renewal Parts

Item No.	Description	No. Req.	Part Number	Price U.S. \$
Type N — Square Buttons				
1	Cover 2 Element Single Element — Top Button Single Element — Bottom Button	1	49-3524 49-3524-2 49-3524-3	
2	Cover Screw	2	11-2168	
3	Pushbutton Support Bracket	1	79-6649	
4	Pushbutton Support Bracket Screw	1	11-2090	
5	Pushbutton Spring	2	69-2571	
6	Disc (when used — 2 element assembly)	2	16-1960	
7	Pushbutton — Top Position START/Green RAISE/Black FORWARD/Black OPEN/Black UP/Black Blank/Green	1	53-1169-3 53-1169-66 53-1169-7 53-1169-9 53-1169-11 53-1169	
8	Pushbutton — Bottom Position STOP/Red Extended STOP/Red REVERSE/Black CLOSE/Black DOWN/Black LOWER/Black Blank/Red	1	53-1202-2 53-1202-5 53-1169-8 53-1169-10 53-1169-12 53-1169-6 53-1202	
9	Pushbutton Element 1NO-1NC 2NO 1NO 1NC	1	86-2588 86-2588-2 86-2588-3 86-2588-4	
10	Cover	1	49-3464	
11	Pushbutton Support Bracket	1	79-6650	
12	Pushbutton — Top Position FORWARD/Black UP/Black RAISE/Black OPEN/Black FAST/Black	1	53-1170-7 53-1170-4 53-1170-5 53-1170-9 53-1170-6	

Item No.	Description	No. Req.	Part Number	Price U.S. \$
Type N — Square Buttons (Continued)				
13	Pushbutton Middle Position REVERSE/Black DOWN/Black LOWER/Black CLOSE/Black SLOW/Black	1	53-1169-15 53-1169-18 53-1169-16 53-1169-17 53-1169-13	
14	Pushbutton — Bottom Position STOP/Red	1	53-1201-2	
15	Pushbutton Element 2NO-3NC	1	86-2593	
16	Cover	1	49-3524-4	
17	Lens Clear Red Amber	1	28-494 28-887-2 28-887-3	
18	Shield	1	73-1337	
19	Shield Screws	4	11-2012	
20	Lamp (Neon NE48)	1	28-494	
21	Lamp Receptacle	1	28-902	
22	Lamp Receptacle Screw	1	911-330F1	
23	Pilot Light Terminal Base	1	86-2586	
24	Lens Clear Red Amber	1	28-887 28-887-2 28-887-3	
25	Pushbutton Support Bracket	1	79-6650-2	
26	Pushbutton Element 1NO-1NC	1	86-2594	
Type N — Round Buttons				
Similar to 27	Pushbutton Assembly and Element for: 10250H289 10250H364 10250H685 10250H665 10250H671 10250H2738 10250H2740 10250H2741 10250H2742	1 1 1 1 1 1 1 1 1	10250H2538 86-353 86-353-8 86-353-8 86-353 86-353-3 86-356 86-356 86-356	

Discount Symbol 1CD1C

10250H Series, Renewal Parts

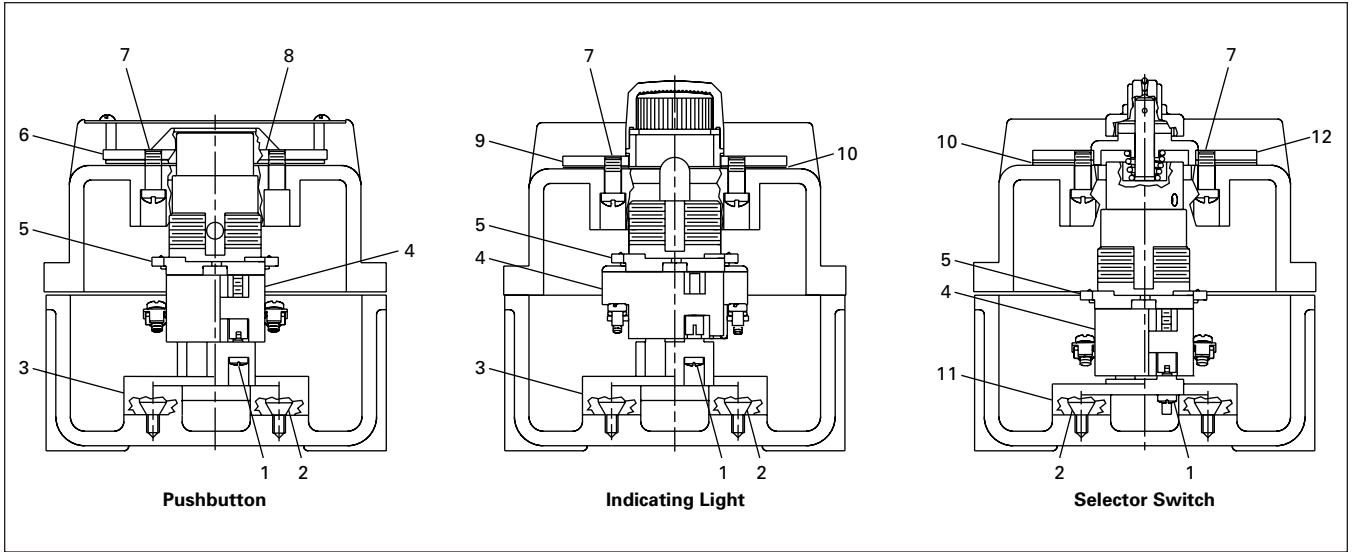

Figure 47-15. Type H Renewal Parts

Table 47-28. Assembled Stations — Type H Renewal Parts

Item No.	Description	No. Req.	Part Number	Price U.S. \$
Type H — Assembled Stations				
1	Screw	2	11-4654	
2	Screw	2	11-5719	
3	Base	1	17-16560	
4	Contact Blocks	See Page 47-116		
5	10250T Operator	See Pages 47-119 – 47-147		
6	Mounting Plate	1	17-19524	

Item No.	Description	No. Req.	Part Number	Price U.S. \$
Type H — Assembled Stations (Continued)				
7	Screw	4	11-953	
8	Diaphragm	1	32-253-2	
9	Mounting Plate	1	17-19522	
10	Gasket	1	32-254	
11	Base	1	17-16561	
12	Mounting Plate	1	17-19523	

E22 and EM22 Series

Contents

<i>Description</i>	<i>Page</i>	<i>Description</i>	<i>Page</i>	<i>Description</i>	<i>Page</i>
Product Description	47-29	Product Selection (Continued)		Accessories	47-74
Features	47-29	Push-Pull Units	47-48	5-Way Mounting Adapter	47-77
Benefits	47-29	Push-Pulls	47-49	Replacement Parts	47-78
Contact Block Operation	47-29	Selector Switch Units	47-51	Options	
Standards and Certifications	47-29	Selector Switches	47-55	Legend Plates	47-79
Technical Data and Specifications	47-29	Illuminated Selector Switches	47-58	Printed Legends	47-85
Product Selection		Selector Switch Selection	47-60	Selector Switch Legends ..	47-86
Pushbutton Units	47-31	Rotary Cam Selector Switch Units	47-62	Enclosures	47-87
Pushbuttons	47-33	Specialty Operators	47-64	Dimensions	47-89
Illuminated Momentary Pushbutton Units	47-34	Double Headed Pushbuttons	47-65	Mounting	47-94
Illuminated Pushbuttons	47-36	Joystick Units	47-67	Ordering Complete Devices	
Push-Push Units	47-37	Joysticks	47-68	Ordering Complete Devices Using Single Composite Cat. Number	47-95
Push-Push	47-39	Contact Blocks	47-69	Ordering Rotary Cam Selector Switches	47-95
Maintained Emergency Stop Pushbutton Units	47-41	Light Units and Lamps ...	47-70	Catalog Number Structure	47-97
Emergency Stop	47-42	Replacement LEDs and Bulbs	47-72	Suffix Codes	47-98
Twist-to-Release	47-43				
Indicating Light Units	47-44				
Indicating Lights	47-47				



Product Description

Eaton's Cutler-Hammer® 22.5 mm Industrial Heavy-Duty Pushbutton line offers a wide array of functional, smartly styled illuminated and non-illuminated pushbuttons, selector switches, push-pulls, alternate action and twist-to-release operators. The complete line also includes transformer, full voltage, resistor, LED or neon light units.

E22 operators are available with either a traditional chrome or matte black front-of-panel appearance. The space-saving design and modular construction of the E22 line makes on-the-job assembly fast and simplifies the stocking of both components and complete devices.

Eaton's Cutler-Hammer EM22 Metal Series is a rugged line of metal construction 22.5 mm pushbutton devices. They are an extension of the industrially proven E22 Heavy-Duty Double Insulated 22.5 mm pushbutton family.

EM22 operators are heavy-duty zinc die-cast construction plated with a corrosion resistant chromate finish. Operators are complete with a very durable chrome plated metal bezel. Indicating light units in the EM22 Series feature smartly styled round lenses that enhance their appearance and brightness.

All EM22 operators are compatible with existing E22 contact blocks, light units, accessories and enclosures.

EM22 metal operators and indicating lights are grounded when mounted to metal panels through the toothed mounting nut. They are not grounded when mounted to plastic panels.

Features

E22 Operators:

- Heavy-duty oiltight construction
- Chrome metal or black nylon bezels
- Snap-lock contact block mounting

EM22 Operators:

- Heavy-duty zinc die-cast construction
- Metal mounting nut doubles as grounding and anti-rotation device
- Chrome-plated metal bezel (matte black not available)

Common E22 & EM22 Features:

- Reliability nibs on contact blocks
- Plain or notched hole mounting
- Direct opening action \ominus normally closed contacts
- Fingerprint terminals

Benefits

Plastic Devices

- Modular construction makes assembly fast and simplifies stocking of components and complete devices
- Reliability nibs provide positive contact through light, medium or heavy loads
- Chrome finish and plastic construction are corrosion resistant

Metal Devices

- EM22 is backwards compatible with E22 operators
- Metal mounting nut cuts through painted surfaces to provide proper grounding
- Hands-free front of panel mounting reduces installation cost
- Mounting flexibility reduces installation cost, time and inventory
- Stands up well in corrosive environments
- E22 and EM22 compatibility lowers parts count and inventory requirements

Contact Block Operation

Linear make and break. All normally closed (NC) contacts are Direct Opening Action, i.e., NC contacts are physically forced open by direct linkage with the pushbutton operator in the unlikely event of contact weld.

The contact block contacts are provided with "Reliability Nibs." The precisely shaped point of the nib, coined on the silver contact alloy, penetrates dust, film oxide layers and other contaminants. This improves contact reliability even under dry circuit and fine dust conditions.

Logic level contact blocks are available for low power switching — minimum 1 mA @ 5V DC.

Standards and Certifications

- CE EN 60947-5-1
- UL 508 — File No. E131568
- CSA — File No. LR68551

Additional Certifications for Trigger Action E-Stop Devices

- UL Listed E-Stop Device — File No. E217948
- Machinery Safety Directive — EN418
- Semiconductor Manufacturing Equipment — SEMI S2-0200
- DEMKO Third Party Certification — Certificate Nos. 129648-01 and 129648-02

Technical Data and Specifications

Ingress Protection

- UL (NEMA) Type 1, 2, 3, 3R, 4, 4X, 12 and 13
- IEC IP65

Note: Ratings apply when mounted in enclosures with the same ratings.

Mechanical Endurance Ratings

- Frequency of operation
 - Pushbuttons – 6,000 operations/hr
 - Push-Pulls – 3,000 operations/hr.
 - Push-Push – 1,800 cycles/hr.
 - Selector Switches – 3,000 operations/hr.
 - Trigger-Action E-Stop – 360 cycles/hr.
 - Twist-to-Release – 1,200 cycles/hr
- Mechanical Life
 - Contact Blocks – 3 million operations
 - Pushbuttons – 5 million operations
 - Push-Pulls – 300,000 operations
 - Push-Push – 300,000 operations
 - Selector Switches – 500,000 operations
 - Trigger-Action E-Stop – 100,000 operations
 - Twist-to-Release – 300,000 operations
 - Joysticks — 500,000 operations
- Vibration (IEC 68-2 [BS 2011])
 - Vibration – 5g/0.7 mm peak to peak, 10 sweeps, 10 – 500 Hz
 - Shock – 30g, 18 ms
 - Bump – 25g, 6 ms for 1,000 cycle

Environmental Conditions

- Operating temperature: -4° to +140°F (-20° to +60°C)
- Storage temperature: -40° to +176°F (-40° to +80°C)
- Altitude: Up to 6562 feet (2000m)
- Pollution degree (IEC 947-1): 3
- Humidity: Maximum 95% RH @ 60°C

Terminal Markings

All rear of panel devices are marked with the circuit configuration per CENELEC 50013 standards.

Table 47-29. Contact Blocks

Circuit Configuration	Description	Plunger Color
	1NC	Red
	1NO	Green
	1NO-1NC	White
	2NO	Green
	1NO Early Make	Black
	1NC Late Break	Gray

Table 47-30. Lights Units

Circuit Configuration	Description
	Full Voltage
	Resistor
	Transformer

- E22CB1, E22CB11, E22CB1E, E22B1 and E22B11 contact blocks are marked with Direct Opening Action (DOA) Symbol "⊕" per IEC 60947-5-1, Annex K and NEMA ICS 5, Part 6. For Mechanical Operating Parameters, see **Page 47-69**.

- E22CB1, E22CB11 and E22CB1E contact blocks will be marked as Suitable for Isolation per IEC 60947-5-1.

Contact Block Terminal Clamps

- Clamp type: Self-lifting
- Screw type: Plus/minus, captive
- Wire range: 18 to 12 AWG (0.75 to 4.0 mm²)
- Fingerproof protection: IP2X
- Tightening torque: 7 lb-in (0.8 Nm)

Electrical Ratings

Table 47-31. Contact Block ^①

Description	Meet or Exceed NEMA Contact Rating Designations A600 and Q600							
	A600 (AC) Volts				Q600 (DC) Volts			
	120	240	480	600	125	250	440	600
Make and emergency interrupting capacity (Amp)	60	30	15	12	0.55	0.27	0.1	0.1
Normal load break (Amp)	6	3	1.5	1.2	0.55	0.27	0.1	0.1
Thermal current (Amp)	10	10	10	10	2.5	2.5	2.5	2.5

^① Ratings do not apply to rotary cam switches, see Ratings **Page 47-95**.

- A600, Q600 per UL 508
- AC15, DC13 per IEC 60947-5-1

Logic level contact blocks are UL A600, Q600 and IEC AC15, DC13 rated and also have a minimum rating of 1 mA @ 5V DC.

- Impulse withstand voltage (Uimp): 4 kV

Short Circuit Coordination to IEC/EN 60947-5-1

- Rated conditional short circuit current: 1 kA
- Fuse type: GE Power Controls TIA 10, Red Spot Type gG, 10A, 660V AC, 460V DC, BS88-2, IEC 60269-2-1

Electrical Life

- AC15 durability
 - 120V, 6A – 1 x 10⁶ operations
- DC13 durability
 - 24V, 4A – 0.15 x 10⁶ operations
 - 660V, 0.1A – 0.5 x 10⁶ operations

Material

- Housing, bezel, mounting rings: Glass filled nylon
- Metal bezels: Chrome plated brass
- Internal seal: Nitrile rubber
- Panel gasket: Nitrile rubber
- Illuminated lenses: Polycarbonate
- Buttons: Polyester or polycarbonate
- Contacts: Silver
- Terminals: Brass

Product Selection

Pushbutton Units

- Non-illuminated
- Plastic or Metal Operators













- Black or Chrome Bezel
- Flush, Extended or Mushroom Head Operators

Description

Listed below are commonly ordered complete pushbutton devices including

operator and contact block(s). These devices are shipped as unassembled components overpacked in a single bag. For instructions on how to order devices not listed below using a single composite Catalog Number, refer to **Page 47-95**.

Table 47-32. Pushbutton Units — UL (NEMA) Type 3, 3R, 4, 4X, 12, 13

	Button Color	Contact Block Circuit						
		NO	NC	Price U.S. \$	NO-NC	2NO	2NC	Price U.S. \$
		Catalog Number	Catalog Number		Catalog Number	Catalog Number	Catalog Number	
Plastic Operators — Black Bezel								
	Flush — Momentary							
	Black	E22PB1A	E22PB1B		E22PB1C	E22PB1D	E22PB1E	
	Red	E22PB2A	E22PB2B		E22PB2C	E22PB2D	E22PB2E	
	Extended — Momentary							
	Black	E22EB1A	E22EB1B		E22EB1C	E22EB1D	E22EB1E	
	Red	E22EB2A	E22EB2B		E22EB2C	E22EB2D	E22EB2E	
	40 mm Mushroom — Momentary							
	Black	E22LB1A	E22LB1B		E22LB1C	E22LB1D	E22LB1E	
	Red	E22LB2A	E22LB2B		E22LB2C	E22LB2D	E22LB2E	
	40 mm Twist-to-Release Mushroom — Latching							
	Black	E22LLB1A	E22LLB1B		E22LLB1C	E22LLB1D	E22LLB1E	
	Red	E22LLB2A	E22LLB2B		E22LLB2C	E22LLB2D	E22LLB2E	
	50 mm Jumbo Mushroom — Momentary							
	Black	E22JPB1A	E22JPB1B		E22JPB1C	E22JPB1D	E22JPB1E	
	Red	E22JPB2A	E22JPB2B		E22JPB2C	E22JPB2D	E22JPB2E	
	50 mm Jumbo Mushroom — Maintained							
	Red	E22JLB2N8A	E22JLB2N8B		E22JLB2N8C	E22JLB2N8D	E22JLB2N8E	
	EMERGENCY STOP (Metal)							
Plastic Operators — Chrome Bezel								
	Flush — Momentary							
	Black	E22P1A	E22P1B		E22P1C	E22P1D	E22P1E	
	Red	E22P2A	E22P2B		E22P2C	E22P2D	E22P2E	
	Extended — Momentary							
	Black	E22E1A	E22E1B		E22E1C	E22E1D	E22E1E	
	Red	E22E2A	E22E2B		E22E2C	E22E2D	E22E2E	
	40 mm Mushroom — Momentary							
	Black	E22L1A	E22L1B		E22L1C	E22L1D	E22L1E	
	Red	E22L2A	E22L2B		E22L2C	E22L2D	E22L2E	
	40 mm Twist-to-Release Mushroom — Latching							
	Black	E22LL1A	E22LL1B		E22LL1C	E22LL1D	E22LL1E	
	Red	E22LL2A	E22LL2B		E22LL2C	E22LL2D	E22LL2E	
	50 mm Jumbo Mushroom — Momentary							
	Black	E22JP1A	E22JP1B		E22JP1C	E22JP1D	E22JP1E	
	Red	E22JP2A	E22JP2B		E22JP2C	E22JP2D	E22JP2E	
	50 mm Jumbo Mushroom — Maintained							
	Red	E22JL2N8A	E22JL2N8B		E22JL2N8C	E22JL2N8D	E22JL2N8E	
	EMERGENCY STOP (Metal)							

Dimensions Page 47-89
 Accessories Pages 47-74 – 47-78
 Enclosures Pages 47-87 – 47-88
 Legend Plates Pages 47-79 – 47-85
 Discount Symbol 1CD1

E22 and EM22 Series, Complete Devices — Pushbutton Units

















Table 47-32. Pushbutton Units — UL (NEMA) Type 3, 3R, 4, 4X, 12, 13 (Continued)

	Button Color	Contact Block Circuit						
		NO	NC	Price U.S. \$	NO-NC	2NO	2NC	Price U.S. \$
		Catalog Number	Catalog Number		Catalog Number	Catalog Number	Catalog Number	
Metal Operators — Chrome Bezel								
	Flush — Momentary							
	Black	EM22P1A	① EM22P2B		EM22P1C	EM22P1D	① EM22P2E	
	Red	EM22P2A	①		EM22P2C	① EM22P3D	①	
Green	EM22P3A	①		EM22P3C				
	Extended — Momentary							
	Red	EM22E2A	EM22E2B		EM22E2C	①	EM22E2E	
	40 mm Mushroom — Momentary							
	Red	EM22L2A	EM22L2B		EM22L2C	①	EM22L2E	
	40 mm Twist-to-Release Mushroom — Latching							
	Red	EM22LL2A	EM22LL2B		EM22LL2C	①	EM22LL2E	
	50 mm Jumbo Mushroom — Momentary							
	Red	EM22JP2A	EM22JP2B		EM22JP2C	EM22JP2D	EM22JP2E	
	50 mm Jumbo Mushroom — Maintained							
Red	EM22JL2N8A	EM22JL2N8B		EM22JL2N8C	EM22JL2N8D	EM22JL2N8E		
EMERGENCY STOP (Metal)								

① See Page 47-95 for ordering other complete devices not shown.

Pushbutton Components

Table 47-33. Momentary Contact Pushbuttons, Non-Illuminated — UL (NEMA) Type 3, 3R, 4, 4X, 12, 13

Will Accept Maximum of 3 Contact Blocks (6 Circuits) When Used with Supplied 3-Way Adapter and Optional Operator Plug.			Color	E22 Series — Plastic Operators				EM22 Series — Metal Operators	
				Black Bezel		Chrome Bezel		Chrome Bezel	
				Catalog Number	Price U.S. \$	Catalog Number	Price U.S. \$	Catalog Number	Price U.S. \$
E22 Black	E22 Chrome	EM22 Chrome	25 mm Diameter Flush Button						
			Black	E22PB1		E22P1		EM22P1	
			Red	E22PB2		E22P2		EM22P2	
			Green	E22PB3		E22P3		EM22P3	
			Yellow	E22PB4		E22P4		EM22P4	
			White	E22PB5		E22P5		EM22P5	
			Blue	E22PB6		E22P6		EM22P6	
			Gray	E22PB7		E22P7		EM22P7	
			Orange	E22PB8		E22P8		EM22P8	
			25 mm Diameter Extended Button						
			Black	E22EB1		E22E1		EM22E1	
			Red	E22EB2		E22E2		EM22E2	
			Green	E22EB3		E22E3		EM22E3	
			Yellow	E22EB4		E22E4		EM22E4	
			White	E22EB5		E22E5		EM22E5	
			Blue	E22EB6		E22E6		EM22E6	
			Gray	E22EB7		E22E7		EM22E7	
			Orange	E22EB8		E22E8		EM22E8	
			25 mm Diameter with Full Shroud						
			Black	—		E22PF1		EM22PF1	
			Red	—		E22PF2		EM22PF2	
			Green	—		E22PF3		EM22PF3	
			Yellow	—		E22PF4		EM22PF4	
			White	—		E22PF5		EM22PF5	
			Blue	—		E22PF6		EM22PF6	
			Gray	—		E22PF7		EM22PF7	
			Orange	—		E22PF8		EM22PF8	
			28 mm Dia. Mushroom Head Button						
			Black	E22MB1		E22M1		EM22M1	
			Red	E22MB2		E22M2		EM22M2	
			Green	E22MB3		E22M3		EM22M3	
			Yellow	E22MB4		E22M4		EM22M4	
			Blue	E22MB6		E22M6		EM22M6	
			40 mm Dia. Mushroom Head Button						
			Black	E22LB1		E22L1		EM22L1	
			Red	E22LB2		E22L2		EM22L2	
			Green	E22LB3		E22L3		EM22L3	
			Yellow	E22LB4		E22L4		EM22L4	
			Blue	E22LB6		E22L6		EM22L6	
			50 mm Dia. Mushroom Head Button — Plastic						
			Black	E22JPB1		E22JP1		EM22JP1	
			Red	E22JPB2		E22JP2		EM22JP2	
			Green	E22JPB3		E22JP3		EM22JP3	
			Yellow	E22JPB4		E22JP4		EM22JP4	
			Blue	E22JPB6		E22JP6		EM22JP6	
			Red (Metal)	E22JB2		E22J2		EM22J2	
			Red (Metal) Engraved EMERGENCY STOP						
				E22JB2N8		E22J2N8		EM22J2N8	

Note: For Rear of Panel Extensions, see Table 47-128 on Page 47-94.

Ordering Example — A complete Pushbutton Unit consists of the following:

 Operator See Above	 Operator Plug E22BA2 Required if 3rd Contact Block Is Used. See Page 47-75	 Legend Plate or Print Option See Pages 47-79 – 47-85	 Mounting Adapter E22BA1 (Supplied with Operator). For 5-Way Adapter, See Page 47-77	 Contact Blocks See Page 47-69
--	---	--	---	---

Dimensions Page 47-89
 Suffix Codes Page 47-98
 Discount Symbol 1CD1

E22 and EM22 Series, Complete Devices — Illuminated Pushbutton Units

Illuminated Momentary Pushbutton Units



- Plastic or Metal Operators
- Black or Chrome Bezel
- Extended Pushbuttons
- Full Voltage, Resistor or Transformer Light Units
- Plastic Lenses
- Metal Operators available with LED

Table 47-34. Plastic Illuminated Extended Pushbutton Units — UL (NEMA) Type 3, 3R, 4, 4X, 12, 13

Description	Button Color	NO	NC	Price U.S. \$	NO-NC	2NO	2NC	Price U.S. \$
		Catalog Number	Catalog Number		Catalog Number	Catalog Number		
Plastic Operators — Black Bezel								
	24V AC/DC Full Voltage							
	Red	E22TB2X4A	E22TB2X4B		E22TB2X4C	E22TB2X4D	E22TB2X4E	
	Green	E22TB3X4A	E22TB3X4B		E22TB3X4C	E22TB3X4D	E22TB3X4E	
	White	E22TB5X4A	E22TB5X4B		E22TB5X4C	E22TB5X4D	E22TB5X4E	
	Blue	E22TB6X4A	E22TB6X4B		E22TB6X4C	E22TB6X4D	E22TB6X4E	
	Amber	E22TB9X4A	E22TB9X4B		E22TB9X4C	E22TB9X4D	E22TB9X4E	
Clear	E22TB0X4A	E22TB0X4B		E22TB0X4C	E22TB0X4D	E22TB0X4E		
	120V AC/DC Resistor Unit							
	Red	E22TB2X10A	E22TB2X10B		E22TB2X10C	E22TB2X10D	E22TB2X10E	
	Green	E22TB3X10A	E22TB3X10B		E22TB3X10C	E22TB3X10D	E22TB3X10E	
	White	E22TB5X10A	E22TB5X10B		E22TB5X10C	E22TB5X10D	E22TB5X10E	
	Blue	E22TB6X10A	E22TB6X10B		E22TB6X10C	E22TB6X10D	E22TB6X10E	
	Amber	E22TB9X10A	E22TB9X10B		E22TB9X10C	E22TB9X10D	E22TB9X10E	
Clear	E22TB0X10A	E22TB0X10B		E22TB0X10C	E22TB0X10D	E22TB0X10E		
	120V Transformer AC — 50/60 Hz							
	Red	E22TB2X11A	E22TB2X11B		E22TB2X11C	E22TB2X11D	E22TB2X11E	
	Green	E22TB3X11A	E22TB3X11B		E22TB3X11C	E22TB3X11D	E22TB3X11E	
	White	E22TB5X11A	E22TB5X11B		E22TB5X11C	E22TB5X11D	E22TB5X11E	
	Blue	E22TB6X11A	E22TB6X11B		E22TB6X11C	E22TB6X11D	E22TB6X11E	
	Amber	E22TB9X11A	E22TB9X11B		E22TB9X11C	E22TB9X11D	E22TB9X11E	
Clear	E22TB0X11A	E22TB0X11B		E22TB0X11C	E22TB0X11D	E22TB0X11E		
Plastic Operators — Chrome Bezel								
	24V AC/DC Full Voltage							
	Red	E22T2X4A	E22T2X4B		E22T2X4C	E22T2X4D	E22T2X4E	
	Green	E22T3X4A	E22T3X4B		E22T3X4C	E22T3X4D	E22T3X4E	
	White	E22T5X4A	E22T5X4B		E22T5X4C	E22T5X4D	E22T5X4E	
	Blue	E22T6X4A	E22T6X4B		E22T6X4C	E22T6X4D	E22T6X4E	
	Amber	E22T9X4A	E22T9X4B		E22T9X4C	E22T9X4D	E22T9X4E	
Clear	E22T0X4A	E22T0X4B		E22T0X4C	E22T0X4D	E22T0X4E		
	120V AC/DC Resistor Unit							
	Red	E22T2X10A	E22T2X10B		E22T2X10C	E22T2X10D	E22T2X10E	
	Green	E22T3X10A	E22T3X10B		E22T3X10C	E22T3X10D	E22T3X10E	
	White	E22T5X10A	E22T5X10B		E22T5X10C	E22T5X10D	E22T5X10E	
	Blue	E22T6X10A	E22T6X10B		E22T6X10C	E22T6X10D	E22T6X10E	
	Amber	E22T9X10A	E22T9X10B		E22T9X10C	E22T9X10D	E22T9X10E	
Clear	E22T0X10A	E22T0X10B		E22T0X10C	E22T0X10D	E22T0X10E		
	120V Transformer AC — 50/60 Hz							
	Red	E22T2X11A	E22T2X11B		E22T2X11C	E22T2X11D	E22T2X11E	
	Green	E22T3X11A	E22T3X11B		E22T3X11C	E22T3X11D	E22T3X11E	
	White	E22T5X11A	E22T5X11B		E22T5X11C	E22T5X11D	E22T5X11E	
	Blue	E22T6X11A	E22T6X11B		E22T6X11C	E22T6X11D	E22T6X11E	
	Amber	E22T9X11A	E22T9X11B		E22T9X11C	E22T9X11D	E22T9X11E	
Clear	E22T0X11A	E22T0X11B		E22T0X11C	E22T0X11D	E22T0X11E		

Dimensions Page 47-89
 Accessories Pages 47-74 – 47-78
 Enclosures Pages 47-87 – 47-88
 Legend Plates Pages 47-79 – 47-85
 Discount Symbol 1CD1

Table 47-35. Metal Illuminated Pushbutton Units — UL (NEMA) Type 3, 3R, 4, 4X, 12, 13









	Button Color	NO Contact Block				NC Contact Block			
		Incandescent		LED		Incandescent		LED	
		Catalog Number	Price U.S. \$	Catalog Number	Price U.S. \$	Catalog Number	Price U.S. \$	Catalog Number	Price U.S. \$
Metal Operators — Chrome Bezel									
	24V AC/DC Full Voltage								
	Red	EM22T2X4A		EM22T2X40A		EM22T2X4B		EM22T2X40B	
	Green	EM22T3X4A		EM22T3X41A		EM22T3X4B		EM22T3X41B	
	White	EM22T5X4A		EM22T5X90A		EM22T5X4B		EM22T5X90B	
	Blue	EM22T6X4A		EM22T6X52A		EM22T6X4B		EM22T6X52B	
	Amber	EM22T9X4A		EM22T9X95A		EM22T9X4B		EM22T9X95B	
	Clear	EM22T0X4A		EM22T0X90A		EM22T0X4B		EM22T0X90B	
	120V AC Full Voltage								
	Red	—		EM22T2X43A		—		EM22T2X43B	
	Green	—		EM22T3X44A		—		EM22T3X44B	
	White	—		EM22T5X92A		—		EM22T5X92B	
	Blue	—		EM22T6X61A		—		EM22T6X61B	
	Amber	—		EM22T9X96A		—		EM22T9X96B	
	Clear	—		EM22T0X92A		—		EM22T0X92B	
	120V AC/DC Resistor Unit								
Red	EM22T2X10A		—		EM22T2X10B		—		
Green	EM22T3X10A		—		EM22T3X10B		—		
White	EM22T5X10A		—		EM22T5X10B		—		
Blue	EM22T6X10A		—		EM22T6X10B		—		
Amber	EM22T9X10A		—		EM22T9X10B		—		
Clear	EM22T0X10A		—		EM22T0X10B		—		
	120V AC Transformer — 50/60 Hz								
	Red	EM22T2X11A		EM22T2X433A		EM22T2X11B		EM22T2X433B	
	Green	EM22T3X11A		EM22T3X444A		EM22T3X11B		EM22T3X444B	
	White	EM22T5X11A		EM22T5X922A		EM22T5X11B		EM22T5X922B	
	Blue	EM22T6X11A		EM22T6X611A		EM22T6X11B		EM22T6X611B	
	Amber	EM22T9X11A		EM22T9X966A		EM22T9X11B		EM22T9X966B	
	Clear	EM22T0X11A		EM22T0X922A		EM22T0X11B		EM22T0X922B	

Dimensions **Page 47-89**
 Accessories **Pages 47-74 – 47-78**
 Enclosures **Pages 47-87 – 47-88**
 Legend Plates **Pages 47-79 – 47-86**
 Discount Symbol **1CD1**

E22 and EM22 Series, Illuminated Pushbutton Components

Illuminated Pushbutton Components

Table 47-36. Illuminated Pushbutton and PresTest Indicating Light Operators — UL (NEMA) Type 3, 3R, 4, 4X, 12, 13

Will Accept Maximum of 2 Contact Blocks (4 Circuits) When Used with Supplied 3-Way Adapter			Color	E22 Series — Plastic Operators				EM22 Series — Metal Operators	
				Black Bezel		Chrome Bezel		Chrome Bezel	
				Catalog Number	Price U.S. \$	Catalog Number	Price U.S. \$	Catalog Number	Price U.S. \$
			25 mm Diameter Flush Lens						
			Red	E22NB2		E22N2		EM22N2	
			Green	E22NB3		E22N3		EM22N3	
			Yellow	E22NB4		E22N4		EM22N4	
			White	E22NB5		E22N5		EM22N5	
			Blue	E22NB6		E22N6		EM22N6	
			Amber	E22NB9		E22N9		EM22N9	
			Clear	E22NB0		E22N0		EM22N0	
			25 mm Diameter Extended Lens						
			Red	E22TB2		E22T2		EM22T2	
			Green	E22TB3		E22T3		EM22T3	
			Yellow	E22TB4		E22T4		EM22T4	
			White	E22TB5		E22T5		EM22T5	
			Blue	E22TB6		E22T6		EM22T6	
			Amber	E22TB9		E22T9		EM22T9	
			Clear	E22TB0		E22T0		EM22T0	
			25 mm Dia. Extended ^① Lens with Shroud						
			Red	—		E22TX2		EM22TX2	
			Green	—		E22TX3		EM22TX3	
			Yellow	—		E22TX4		EM22TX4	
			White	—		E22TX5		EM22TX5	
			Blue	—		E22TX6		EM22TX6	
			Amber	—		E22TX9		EM22TX9	
			Clear	—		E22TX0		EM22TX0	

^① If a Flush Lens type is required instead of Extended, substitute **N** for **T** in listed Catalog Number.
 Example: E22NX2 — Red flush illuminated pushbutton with full shroud. Chrome version only.

Note: For Rear of Panel Extensions, see **Table 47-128** on **Page 47-94**.

Dimensions **Page 47-89**
 Accessories **Pages 47-74 – 47-78**
 Contact Blocks **Page 47-69**
 Enclosures **Pages 47-87 – 47-88**
 Legend Plates **Pages 47-79 – 47-85**
 Light Units **Pages 47-70 – 47-71**
 Suffix Codes **Page 47-98**
 Discount Symbol **1CD1**







Alternate-Action (Push-Push) Pushbutton Units

- Non-illuminated or Illuminated
- Plastic or Metal Operators
- Black or Chrome Bezel
- Flush or Extended Operators

Description
Listed below are commonly ordered complete pushbutton devices including operator and contact block(s). These devices are shipped as unassembled

components overpacked in a single bag. For instructions on how to order devices not listed below using a single composite Catalog Number, refer to **Page 47-95**.

Table 47-37. E22 and EM22 Series Non-illuminated Flush and Extended Alternate-Action Units — UL (NEMA) Type 3, 3R, 4, 4X, 12, 13

	Button Color	Contact Block Circuit						
		NO	NC	Price U.S. \$	NO-NC	2NO	2NC	Price U.S. \$
		Catalog Number	Catalog Number		Catalog Number	Catalog Number	Catalog Number	
E22 Series — Plastic Operators — Black Bezel								
	Flush							
	Black	E22PPB1A	E22PPB1B		E22PPB1C	E22PPB1D	E22PPB1E	
	White	E22PPB5A	E22PPB5B		E22PPB5C	E22PPB5D	E22PPB5E	
Gray	E22PPB7A	E22PPB7B		E22PPB7C	E22PPB7D	E22PPB7E		
	Extended							
	Black	E22EPB1A	E22EPB1B		E22EPB1C	E22EPB1D	E22EPB1E	
	White	E22EPB5A	E22EPB5B		E22EPB5C	E22EPB5D	E22EPB5E	
Gray	E22EPB7A	E22EPB7B		E22EPB7C	E22EPB7D	E22EPB7E		
E22 Series — Plastic Operators — Chrome Bezel								
	Flush							
	Black	E22PP1A	E22PP1B		E22PP1C	E22PP1D	E22PP1E	
	White	E22PP5A	E22PP5B		E22PP5C	E22PP5D	E22PP5E	
Gray	E22PP7A	E22PP7B		E22PP7C	E22PP7D	E22PP7E		
	Extended							
	Black	E22EP1A	E22EP1B		E22EP1C	E22EP1D	E22EP1E	
	White	E22EP5A	E22EP5B		E22EP5C	E22EP5D	E22EP5E	
Gray	E22EP7A	E22EP7B		E22EP7C	E22EP7D	E22EP7E		
EM22 Series — Metal Operators — Chrome Bezel								
	Flush							
	Black	EM22PP1A	EM22PP1B		EM22PP1C	EM22PP1D	EM22PP1E	
	White	EM22PP5A	EM22PP5B		EM22PP5C	EM22PP5D	EM22PP5E	
Gray	EM22PP7A	EM22PP7B		EM22PP7C	EM22PP7D	EM22PP7E		
	Extended							
	Black	EM22EP1A	EM22EP1B		EM22EP1C	EM22EP1D	EM22EP1E	
	White	EM22EP5A	EM22EP5B		EM22EP5C	EM22EP5D	EM22EP5E	
Gray	EM22EP7A	EM22EP7B		EM22EP7C	EM22EP7D	EM22EP7E		

Note: In order to comply with NFPA 79 and IEC 60204-1 requirements:

The colors black, white or gray shall be used for Push-Push operators which act alternately as START/ON and STOP/OFF pushbuttons.

Push-Push operators shall only be used for functions which can not result in a hazardous condition.

IEC 60204-1 recommends that Push-Push operators acting alternately as START/ON and STOP/OFF pushbuttons be marked with the printed legend N124.

Dimensions **Page 47-89**
 Accessories **Pages 47-74 – 47-78**
 Enclosures **Pages 47-87 – 47-88**
 Legend Plates **Pages 47-79 – 47-85**
 Discount Symbol **1CD1**

E22 and EM22 Series, Complete Devices — Push-Push Units

Table 47-38. Illuminated Bezel Flush Assembled Push-Push Units — UL (NEMA) Type 3, 3R, 4, 4X, 12, 13

	Button Color	Contact Block Circuit						Price U.S. \$
		NO	NC	NO-NC	2NO	2NC		
		Catalog Number	Catalog Number	Catalog Number	Catalog Number	Catalog Number		
Plastic Operators — Chrome Bezel								
	24V AC/DC Full Voltage, Flush, Illuminated Bezel							
	Red	E22TP2X4A	E22TP2X4B	E22TP2X4C	E22TP2X4D	E22TP2X4E		
	Green	E22TP3X4A	E22TP3X4B	E22TP3X4C	E22TP3X4D	E22TP3X4E		
	White	E22TP5X4A	E22TP5X4B	E22TP5X4C	E22TP5X4D	E22TP5X4E		
	Blue	E22TP6X4A	E22TP6X4B	E22TP6X4C	E22TP6X4D	E22TP6X4E		
	Amber Clear	E22TP9X4A E22TP0X4A	E22TP9X4B E22TP0X4B	E22TP9X4C E22TP0X4C	E22TP9X4D E22TP0X4D	E22TP9X4E E22TP0X4E		
	120V AC/DC Resistor, Flush, Illuminated Bezel							
	Red	E22TP2X10A	E22TP2X10B	E22TP2X10C	E22TP2X10D	E22TP2X10E		
	Green	E22TP3X10A	E22TP3X10B	E22TP3X10C	E22TP3X10D	E22TP3X10E		
	White	E22TP5X10A	E22TP5X10B	E22TP5X10C	E22TP5X10D	E22TP5X10E		
	Blue	E22TP6X10A	E22TP6X10B	E22TP6X10C	E22TP6X10D	E22TP6X10E		
	Amber Clear	E22TP9X10A E22TP0X10A	E22TP9X10B E22TP0X10B	E22TP9X10C E22TP0X10C	E22TP9X10D E22TP0X10D	E22TP9X10E E22TP0X10E		
	120V AC Transformer — 50/60 Hz, Flush, Illuminated Bezel							
	Red	E22TP2X11A	E22TP2X11B	E22TP2X11C	E22TP2X11D	E22TP2X11E		
	Green	E22TP3X11A	E22TP3X11B	E22TP3X11C	E22TP3X11D	E22TP3X11E		
	White	E22TP5X11A	E22TP5X11B	E22TP5X11C	E22TP5X11D	E22TP5X11E		
	Blue	E22TP6X11A	E22TP6X11B	E22TP6X11C	E22TP6X11D	E22TP6X11E		
	Amber Clear	E22TP9X11A E22TP0X11A	E22TP9X11B E22TP0X11B	E22TP9X11C E22TP0X11C	E22TP9X11D E22TP0X11D	E22TP9X11E E22TP0X11E		
Metal Operators — Chrome Bezel								
	24V AC/DC Full Voltage Unit, Flush, Illuminated Bezel							
	Red	EM22TP2X4A	EM22TP2X4B	EM22TP2X4C	EM22TP2X4D	EM22TP2X4E		
	Green	EM22TP3X4A	EM22TP3X4B	EM22TP3X4C	EM22TP3X4D	EM22TP3X4E		
	White	EM22TP5X4A	EM22TP5X4B	EM22TP5X4C	EM22TP5X4D	EM22TP5X4E		
	Blue	EM22TP6X4A	EM22TP6X4B	EM22TP6X4C	EM22TP6X4D	EM22TP6X4E		
	Amber Clear	EM22TP9X4A EM22TP0X4A	EM22TP9X4B EM22TP0X4B	EM22TP9X4C EM22TP0X4C	EM22TP9X4D EM22TP0X4D	EM22TP9X4E EM22TP0X4E		
	120V AC/DC Resistor Unit, Flush, Illuminated Bezel							
	Red	EM22TP2X10A	EM22TP2X10B	EM22TP2X10C	EM22TP2X10D	EM22TP2X10E		
	Green	EM22TP3X10A	EM22TP3X10B	EM22TP3X10C	EM22TP3X10D	EM22TP3X10E		
	White	EM22TP5X10A	EM22TP5X10B	EM22TP5X10C	EM22TP5X10D	EM22TP5X10E		
	Blue	EM22TP6X10A	EM22TP6X10B	EM22TP6X10C	EM22TP6X10D	EM22TP6X10E		
	Amber Clear	EM22TP9X10A EM22TP0X10A	EM22TP9X10B EM22TP0X10B	EM22TP9X10C EM22TP0X10C	EM22TP9X10D EM22TP0X10D	EM22TP9X10E EM22TP0X10E		
	120V AC Transformer Unit, Flush, Illuminated Bezel							
	Red	EM22TP2X11A	EM22TP2X11B	EM22TP2X11C	EM22TP2X11D	EM22TP2X11E		
	Green	EM22TP3X11A	EM22TP3X11B	EM22TP3X11C	EM22TP3X11D	EM22TP3X11E		
	White	EM22TP5X11A	EM22TP5X11B	EM22TP5X11C	EM22TP5X11D	EM22TP5X11E		
	Blue	EM22TP6X11A	EM22TP6X11B	EM22TP6X11C	EM22TP6X11D	EM22TP6X11E		
	Amber Clear	EM22TP9X11A EM22TP0X11A	EM22TP9X11B EM22TP0X11B	EM22TP9X11C EM22TP0X11C	EM22TP9X11D EM22TP0X11D	EM22TP9X11E EM22TP0X11E		

Note: In order to comply with NFPA 79 and IEC 60204-1 requirements:

The colors black, white or gray shall be used for Push-Push operators which act alternately as START/ON and STOP/OFF pushbuttons. White shall be used for illuminated Push-Push operators.

Push-Push operators shall only be used for functions which can not result in a hazardous condition.

IEC 60204-1 recommends that Push-Push operators acting alternately as START/ON and STOP/OFF pushbuttons be marked with the printed legend N124.











Dimensions	Page 47-89
Accessories	Pages 47-74 – 47-78
Enclosures	Pages 47-87 – 47-88
Legend Plates.....	Pages 47-79 – 47-85
Discount Symbol	1CD1

Alternate Action (Push-Push) Components

Non-illuminated and Illuminated Push-Push Operators

Note: Will accept a maximum of 2 contact blocks when used with supplied 3-way adapter, 5-way mounting adapters are not to be used.

Table 47-39. Push-Push Operators — UL (NEMA) Type 3, 3R, 4, 4X, 12, 13

	E22 Series — Plastic Operators				EM22 Series — Metal Operators	
	Black Bezel		Chrome Bezel		Chrome Bezel	
Flush, Non-illuminated						
						
Color	Catalog Number	Price U.S. \$	Catalog Number	Price U.S. \$	Catalog Number	Price U.S. \$
Black White Gray	E22PPB1 E22PPB5 E22PPB7		E22PP1 E22PP5 E22PP7		EM22PP1 EM22PP5 EM22PP7	
Extended, Non-illuminated						
						
Color	Catalog Number	Price U.S. \$	Catalog Number	Price U.S. \$	Catalog Number	Price U.S. \$
Black White Gray	E22EPB1 E22EPB5 E22EPB7		E22EP1 E22EP5 E22EP7		EM22EP1 EM22EP5 EM22EP7	
Flush, Illuminated						
						
Color	Catalog Number	Price U.S. \$	Catalog Number	Price U.S. \$	Catalog Number	Price U.S. \$
White Clear Red Green Blue Amber	E22NPB5 E22NPB0 E22NPB2 E22NPB3 E22NPB6 E22NPB9		E22NP5 E22NP0 E22NP2 E22NP3 E22NP6 E22NP9		EM22NP5 EM22NP0 EM22NP2 EM22NP3 EM22NP6 EM22NP9	
Flush, Illuminated with Lens Guard						
						
Color	Catalog Number	Price U.S. \$	Catalog Number	Price U.S. \$	Catalog Number	Price U.S. \$
White Clear Red Green Blue Amber	— — — — — —		E22TP5 E22TP0 E22TP2 E22TP3 E22TP6 E22TP9		EM22TP5 EM22TP0 EM22TP2 EM22TP3 EM22TP6 EM22TP9	

Note: In order to comply with NFPA 79 and IEC 60204-1 requirements:

The colors black, white or gray shall be used for Push-Push operators which act alternately as START/ON and STOP/OFF pushbuttons. White shall be used for illuminated Push-Push operators.

Push-Push operators shall only be used for functions which cannot result in a hazardous condition.

IEC 60204-1 recommends that Push-Push operators acting alternately as START/ON and STOP/OFF pushbuttons be marked with the IEC symbol for Push-Push pushbuttons. To order with legend, add Suffix **N124** to operator Catalog Number. Example: E22PPB1**N124**

Note: For Rear of Panel Extensions, see **Table 47-128** on **Page 47-94**.

Dimensions **Page 47-89**
 Accessories **Pages 47-74 – 47-78**
 Enclosures **Pages 47-87 – 47-88**
 Legend Plates **Pages 47-79 – 47-85**
 Light Units **Pages 47-70 – 47-71**
 Suffix Codes **Page 47-98**
 Discount Symbol **1CD1**

Alternate Action (Push-Push) Components (Continued)

Contact Block Selection/Application

Non-illuminated Push-Push operators will accept a maximum of 2 contact blocks (singles or duals). 5-way mounting adapters are not suitable with Push-Push operators. Illuminated Push-Push operators will accept a maximum of 2 contact blocks (singles or duals) and one light unit.

Table 47-40. Push-Push Operators

Contact Block Required			Circuit	Circuit Operation ①	
Suffix Code	Catalog Number	Price U.S. \$		Push-ON	Push-OFF
B	E22B1		1NC	O	X
A	E22B2		1NO	X	O
W	E22B11		1NO-1NC	X	O
				O	X
V	E22B20		2NO	X	O
				X	O

① X = Closed Circuit
O = Open Circuit

Note: Add Contact Block Suffix Code from tables above to operator Catalog Number to order as a complete device. Example: E22EP1B = chrome bezel, Black button Push-Push with 1NC contact block.

Accessories	Pages 47-74 – 47-78
Enclosures	Pages 47-87 – 47-88
Legend Plates	Pages 47-79 – 47-85
Light Units	Pages 47-70 – 47-71
Suffix Codes	Page 47-98
Discount Symbol	1CD1

Trigger Action Emergency Stop Pushbutton Units — EN 418 Compliant

The European Machinery Safety Directive EN 418 requires all emergency OFF devices to be self-latching types and to have positive (direct) opening operation. Devices have to be manually reset. Actuators shall be mushroom head type and colored RED. The background immediately around the device actuator should be colored YELLOW. See Page 47-42 for yellow guard.

The new E22 trigger action operators in conjunction with yellow nameplates and DOA (Direct Opening Action) con-

tact blocks are fully compliant with this safety directive.





Features

- Safety interlock against inadvertent operation
- Stop command and latching occur simultaneously
- Contacts cannot be “teased” open
- Direct Opening Action (DOA) contact blocks
- Resettable by rotation of actuator

Periodic Inspection

Industrial control equipment should be periodically inspected. Eaton recommends inspection of Emergency Stop devices for proper mechanical operation after every 500 hours of elapsed time. See National Electrical Manufacturers Association (NEMA) Standard No. ICS 1.3, *Preventive Maintenance of Industrial Control and Systems Equipment*, for guidelines in setting up a maintenance program.

Table 47-41. Trigger Action Emergency OFF Switch Units — UL (NEMA) Type 3, 3R, 4, 4X, 12, 13



Action	Color	Legend/ Engraving	Contact Block Circuit						
			1NC		2NC	1NC-1NO		2NC-1NO	
			Catalog Number	Price U.S. \$	Catalog Number	Catalog Number	Price U.S. \$	Catalog Number	Price U.S. \$
40 mm Trigger Action Twist-to-Release ①									
	Red	 (Red)	E22LTA2QB		E22LTA2QE	E22LTA2QW		E22LTA2QWB	
40 mm Trigger Action Twist-to-Release EMO (Emergency Machine OFF) ②									
	Red	 (White) ③	E22LTA2N123QB		E22LTA2N123QE	E22LTA2N123QW		E22LTA2N123QWB	

① Third party certified by DEMKO. For specification drawing, request A70-8530 from the Cutler-Hammer TRC — call 1-800-809-2772.

② Third party certified by DEMKO and GS3 to SEMI S2-0200 specifications. For specification drawing, request A70-8508 from the Cutler-Hammer TRC — call 1-800-809-2772.

③ EMO (Emergency Machine OFF) marking per SEMI S2 requirement.

Table 47-42. Two-Position Push-Pull Emergency Stop Pushbutton Units — UL (NEMA) Type 3, 3R, 4, 4X, 12, 13

Action	Color	Legend/ Engraving	Contact Block Circuit				
			1NC		2NC	1NC-1NO	
			Catalog Number	Price U.S. \$	Catalog Number	Catalog Number	Price U.S. \$
40 mm Mushroom							
	Red	None	E22LPB2B		E22LPB2E	E22LPB2C	
	Red	 ④	E22LPB2N125B		E22LPB2N125E	E22LPB2N125C	

④ IEC Symbol for Emergency Stop.

⊖ Direct Opening Action (DOA) for IEC 60947-5-1 (Annex K) and NEMA ICS 5 (Part 6) Compliance

Table 47-43. Mechanical Operating Parameters of Operators with E22CB1 and E22CB11 (NC Contacts Only)

DOA Operating Parameters	Latching Trigger Action E-Stop		2-Position Push-Pull	
	E-Stop + E22CB1	E-Stop + E22CB11	2-Pos. Push-Pull + E22CB1	2-Pos. Push-Pull + E22CB11
Min. Travel to Open Contact — Inches (mm)	0.24 (6.1)	0.24 (6.1)	0.08 (2.1)	0.08 (2.1)
Min. Force to Open Contact — lb (N)	5.00 (22.24)	5.00 (22.24)	0	0
Total Travel — Inches (mm)	0.29 (7.4)	0.29 (7.4)	0.23 (5.8)	0.23 (5.8)

Discount Symbol **1CD1**

E22 and EM22 Series, Emergency Stop Components

Emergency Stop Components

Table 47-44. Standard Emergency Stop and Emergency OFF Operators — UL (NEMA) Type 3, 3R, 4, 4X, 12, 13

All Shown with Chrome Bezel	Action	Color	Button Diameter/ Material	Legend/ Engraving	Plastic — Black Bezel		Plastic — Chrome Bezel	
					Catalog Number	Price U.S. \$	Catalog Number	Price U.S. \$
Maximum of 2 Contact Blocks (4 Circuits) When Used with Supplied 3-Way Adapter (Unless Otherwise Noted)								
	Maintained Trigger Action Twist-to-Release	Red	40 mm/Plastic		E22LTA2 ①		—	
	Maintained Trigger Action Twist-to-Release	Red	40 mm/Plastic	EMO	E22LTA2N123 ①		—	
	Momentary ③	Red	40 mm/Plastic		E22LB2		E22L2	
			50 mm/Plastic		E22JPB2		E22JP2	
			50 mm/Alum.	EMERG. STOP	E22JB2		E22J2	
				EMERG. STOP	E22JB2N8		E22J2N8	
	Maintained — 2-Position Push-Pull ③	Red	40 mm/Plastic		E22LPB2 ①		E22LP2 ①	
	Maintained — 2-Position Push-Pull ③	Red	50 mm/Plastic		E22JPLB2 ①		E22JPL2 ①	
			50 mm/Alum.		E22JLB2 ①		E22JL2 ①	
				EMERG. STOP	E22JLB2N8 ①		E22JL2N8 ①	
	Maintained — 2-Position Push-Pull ③	Red	40 mm/Plastic		E22EDB2 ①		E22ED2 ①	
				EMERG. STOP	E22EDB2N8 ①		E22ED2N8 ①	
				EMERG. STOP	E22EDB2N796 ①②		E22ED2N796 ①②	
	Maintained — 2-Position Push-Pull ③	Red	40 mm/Plastic Illuminated		E22GDB2 ①		E22GD2 ①	
				EMERG. STOP	E22GDB2N8 ①		E22GD2N8 ①	
				EMERG. STOP	E22GDB2N796 ①②		E22GD2N796 ①②	
	Maintained — Twist-to-Release	Red	40 mm/Plastic		E22LLB2		E22LL2	
					E22LLB2N886		E22LL2N886	
	Maintained — Key Release	Red	40 mm/Plastic		E22GB2		E22G2	

① Compliant with EN418 Machinery Safety Directive.
 ② Yellow field — red letters.
 ③ Maximum of 3 contact blocks allowable (6 circuits) when optional operator plug is used.

Table 47-45. EN418 Compliant Safety Yellow Guard

	Description	Color	Catalog Number	Price U.S. \$
	Mushroom Guard for 40 mm Trigger Action Switch — To be used with E22LTA2 and E22LTA2N123 operators.	Safety Yellow	E22MGTA	

Periodic Inspection















Industrial control equipment should be periodically inspected. Eaton recommends inspection of Emergency Stop devices for proper mechanical operation after every 500 hours of elapsed time. See National Electrical

Manufacturers Association (NEMA) Standard No. ICS 1.3, *Preventive Maintenance of Industrial Control and Systems Equipment*, for guidelines in setting up a maintenance program.

Contact Blocks **Page 47-69**
 Enclosures **Pages 47-87 – 47-88**
 5-Way Adapter **Page 47-77**
 Legend Plates **Pages 47-79 – 47-85**
 Suffix Codes **Page 47-98**
 Discount Symbol **1CD1**

Twist-to-Release, Push-Pull and Key Release Components

Table 47-46. Maintained Contact Mushroom Head Operators, Non-illuminated — UL (NEMA) Type 3, 3R, 4, 4X, 12, 13

Will Accept Maximum of 2 Contact Blocks (4 Circuits) When Used with Supplied 3-Way Adapter.			E22 Series — Plastic Operators				EM22 Series — Metal Operators			
			Color	Black Bezel		Chrome Bezel		Color	Chrome Bezel	
				Catalog Number	Price U.S. \$	Catalog Number	Price U.S. \$		Catalog Number	Price U.S. \$
			Twist-to-Release — 28 mm Diameter Button (Push to Latch — Twist to Release)							
Black	E22MLB1		E22ML1		Black	EM22ML1				
Red	E22MLB2		E22ML2		Red	EM22ML2				
Green	E22MLB3		E22ML3		Green	EM22ML3				
Yellow	E22MLB4		E22ML4		Yellow	EM22ML4				
Blue	E22MLB6		E22ML6		Blue	EM22ML6				
			Twist-to-Release — 40 mm Diameter Button (Push to Latch — Twist to Release)							
Black	E22LLB1		E22LL1		Black	EM22LL1				
Red	E22LLB2		E22LL2		Red	EM22LL2				
Green	E22LLB3		E22LL3		Green	EM22LL3				
Yellow	E22LLB4		E22LL4		Yellow	EM22LL4				
Blue	E22LLB6		E22LL6		Blue	EM22LL6				
			Push-Pull — 40 mm Diameter Button (Push to Latch — Pull to Release)							
Black	E22LPB1		E22LP1		Black	EM22LP1				
Red	E22LPB2		E22LP2		Red	EM22LP2				
Green	E22LPB3		E22LP3		Green	EM22LP3				
Yellow	E22LPB4		E22LP4		Yellow	EM22LP4				
Blue	E22LPB6		E22LP6		Blue	EM22LP6				
			Push-Pull — 50 mm Diameter Button (Push to Latch — Pull to Release)							
Black	E22JPLB1		E22JPL1		Black	EM22JPL1				
Red	E22JPLB2		E22JPL2		Red	EM22JPL2				
Green	E22JPLB3		E22JPL3		Green	EM22JPL3				
Yellow	E22JPLB4		E22JPL4		Yellow	EM22JPL4				
Blue	E22JPLB6		E22JPL6		Blue	EM22JPL6				
Red (Metal)	E22JLB2		E22JL2		Red (Metal)	EM22JL2				
Red (Metal)	EMERGENCY STOP									
	E22JLB2N8		E22JL2N8			EM22JL2N8				
			Key Release — 40 mm Diameter Button (Push to Latch — Turn Key to Release) ①②							
Black	E22GB1		E22G1		Black	EM22G1				
Red	E22GB2		E22G2		Red	EM22G2				
Green	E22GB3		E22G3		Green	EM22G3				

① For legend plates, use oversize plates, Catalog Numbers E22VA1, VA2 or VA8 listed on Page 47-74.

② To order a different key and lock assembly, add suffix B1, C1, D1, E1 or F1 to the end of the Catalog Number.

Note: For Rear of Panel Extensions, see Table 47-128 on Page 47-94.

E22 and EM22 Series, Complete Devices — Indicating Light Units, Modular

Indicating Light Units — Modular

- Standard and PresTest Types
- Plastic or Metal Operators
- Full Voltage LED Light Units or
- Full Voltage, Resistor or Transformer Incandescent Light Units
- Plastic Lenses

PresTest — This device incorporates a press-to-test feature whereby depressing the lens disconnects the light from the source being monitored and connects the lamp to a continuously energized circuit for immediate test for a faulty lamp.

Table 47-47. Indicating and PresTest Light Units — UL (NEMA) Type 3, 3R, 4, 4X, 12, 13

	Color	Indicating Light				PresTest	
		LED		Incandescent		Incandescent	
		Catalog Number	Price U.S. \$	Catalog Number	Price U.S. \$	Catalog Number	Price U.S. \$
Plastic Operators							
	24V AC/DC Full Voltage						
	Red	E22H2X40		E22H2X4		E22T2X20	
	Green	E22H3X41		E22H3X4		E22T3X20	
	White	E22H5X90		E22H5X4		E22T5X20	
	Blue	E22H6X52		E22H6X4		E22T6X20	
	Amber	E22H9X95		E22H9X4		E22T9X20	
	Clear	E22H0X90		E22H0X4		E22T0X20	
	120V AC Full Voltage			120V AC/DC Resistor			
	Red	E22H2X43		E22H2X10		E22T2X26	
	Green	E22H3X44		E22H3X10		E22T3X26	
	White	E22H5X92		E22H5X10		E22T5X26	
	Blue	E22H6X61		E22H6X10		E22T6X26	
	Amber	E22H9X96		E22H9X10		E22T9X26	
	Clear	E22H0X92		E22H0X10		E22T0X26	
	120V AC Transformer						
	Red	—		E22H2X11		E22T2X27	
	Green	—		E22H3X11		E22T3X27	
	White	—		E22H5X11		E22T5X27	
	Blue	—		E22H6X11		E22T6X27	
	Amber	—		E22H9X11		E22T9X27	
	Clear	—		E22H0X11		E22T0X27	
Metal Operators							
	24V AC/DC Full Voltage						
	Red	EM22H2X40		EM22H2X4		EM22T2X20	
	Green	EM22H3X41		EM22H3X4		EM22T3X20	
	White	EM22H5X90		EM22H5X4		EM22T5X20	
	Blue	EM22H6X52		EM22H6X4		EM22T6X20	
	Amber	EM22H9X95		EM22H9X4		EM22T9X20	
	Clear	EM22H0X90		EM22H0X4		EM22T0X20	
	120V AC Full Voltage			120V AC/DC Resistor Unit			
	Red	EM22H2X43		EM22H2X8		EM22T2X26	
	Green	EM22H3X44		EM22H3X8		EM22T3X26	
	White	EM22H5X92		EM22H5X8		EM22T5X26	
	Blue	EM22H6X61		EM22H6X8		EM22T6X26	
	Amber	EM22H9X96		EM22H9X8		EM22T9X26	
	Clear	EM22H0X92		EM22H0X8		EM22T0X26	
	120V AC Transformer — 50/60 Hz						
	Red	EM22H2X433		EM22H2X11		EM22T2X27	
	Green	EM22H3X444		EM22H3X11		EM22T3X27	
	White	EM22H5X922		EM22H5X11		EM22T5X27	
	Blue	EM22H6X611		EM22H6X11		EM22T6X27	
	Amber	EM22H9X966		EM22H9X11		EM22T9X27	
	Clear	EM22H0X922		EM22H0X11		EM22T0X27	

Dimensions Page 47-89
 Accessories Pages 47-74 – 47-78
 Enclosures Pages 47-87 – 47-88
 Legend Plates Pages 47-79 – 47-85
 Discount Symbol 1CD1

Indicating Light Units — One-Piece LED

- One-Piece Body Style
- Plastic Operators
- Full Voltage LEDs
- Cluster-Style Integrated LED (non-removable) or
- Standard Bayonet Base LED
- Plastic Lenses

Table 47-48. Cluster LED Type Indicating Lights — Non-removable LEDs — UL (NEMA) Type 3, 3R, 4, 4X, 12, 13

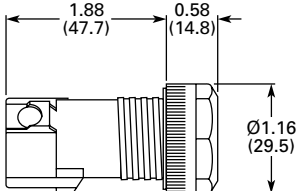
Product Description	Supply Voltage	LED Color	Lamp Life ①	Catalog Number	Price U.S. \$	Dimensions in Inches (mm)
 <p>Includes permanently attached lens and board mounted, cluster style LEDs</p> <p>Non-removable LED</p>	24V AC/DC	Red Green Amber	100,000	E22HL2X4 E22HL3X4 E22HL9X4		
	48V AC/DC	Red Green Amber	100,000	E22HL2X6 E22HL3X6 E22HL9X6		
	110/120V AC/DC	Red Green Amber	100,000	E22HL2X8 E22HL3X8 E22HL9X8		

① Published theoretical lamp lives are based on ideal laboratory conditions and should be used for comparison only. Actual life may be shorter due to application conditions.

Table 47-49. Standard LED Type Indicating Lights — Replaceable bayonet base LEDs — UL (NEMA) Type 3, 3R, 4, 4X, 12, 13

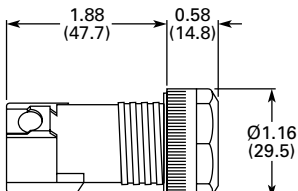
Product Description	Supply Voltage	Color	Lamp Life ②	Catalog Number	Price U.S. \$	Dimensions in Inches (mm)
 <p>Includes lens and T 3-1/4 bayonet base LED</p>	12V AC/DC	Clear Red Green Yellow White Blue Amber	100,000	E22HV0X89 E22HV2X37 E22HV3X38 E22HV4X39 E22HV5X89 E22HV6X51 E22HV9X94		
	24V AC/DC	Clear Red Green Yellow White Blue Amber		E22HV0X90 E22HV2X40 E22HV3X41 E22HV4X42 E22HV5X90 E22HV6X52 E22HV9X95		
	48V AC/DC	Clear Red Green Yellow White Blue Amber		E22HV0X91 E22HV2X53 E22HV3X54 E22HV4X55 E22HV5X91 E22HV6X56 E22HV9X87		
	60V AC/DC	Clear Red Green Yellow White Blue Amber		E22HV0X97 E22HV2X57 E22HV3X58 E22HV4X59 E22HV5X97 E22HV6X60 E22HV9X98		
	120V AC	Clear Red Green Yellow White Blue Amber		E22HV0X92 E22HV2X43 E22HV3X44 E22HV4X45 E22HV5X92 E22HV6X61 E22HV9X96		

② Published theoretical lamp lives are based on ideal laboratory conditions and should be used for comparison only. Actual life may be shorter due to application conditions.

E22 Series, Complete Devices — Indicating Light Units, One-Piece Incandescent

Indicating Light Units — One-Piece Incandescent

- One-Piece Body Style
- Plastic Operators
- Full Voltage and Resistor Type
- Bayonet Base Incandescent Lamp
- Standard or Insert (with Printed Legends) Plastic Lenses

Table 47-50. Incandescent Standard Lens Type Indicating Lights — UL (NEMA) Type 3, 3R, 4, 4X, 12, 13

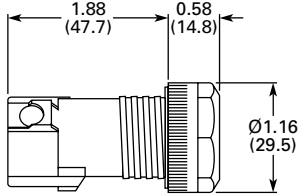
Product Description	Supply Voltage	Color	Lamp Life ①	Catalog Number	Price U.S. \$	Dimensions in Inches (mm)
	12V AC/DC #756 Lamp	Clear Red Green Yellow White Blue Amber	15,000	E22HV0X3 E22HV2X3 E22HV3X3 E22HV4X3 E22HV5X3 E22HV6X3 E22HV9X3		
	24V AC/DC #1819 Lamp	Clear Red Green Yellow White Blue Amber	2,500	E22HV0X4 E22HV2X4 E22HV3X4 E22HV4X4 E22HV5X4 E22HV6X4 E22HV9X4		
	110/120V AC/DC W1121 Lamp	Clear Red Green Yellow White Blue Amber	1,000	E22HV0X8 E22HV2X8 E22HV3X8 E22HV4X8 E22HV5X8 E22HV6X8 E22HV9X8		
	220/240V AC Resistor W1121 Lamp	Clear Red Green Yellow White Blue Amber	1,000	E22HR0X8 E22HR2X8 E22HR3X8 E22HR4X8 E22HR5X8 E22HR6X8 E22HR9X8		

① Published theoretical lamp lives are based on ideal laboratory conditions and should be used for comparison only. Actual life may be shorter due to application conditions.

47

Incandescent — Insert Lens with Printed Legends

Insert version indicating lights allow printed legends to be placed directly on the inside of the lens. To specify lens insert with printed legends, add Suffix Code from table on **Page 47-85** to the end of the catalog number.

Table 47-51. Incandescent Insert Lens Type Indicating Lights — UL (NEMA) Type 3, 3R, 4, 4X, 12, 13

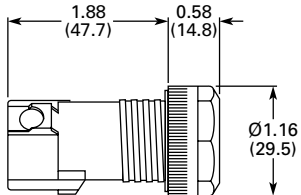
Product Description	Supply Voltage	Color	Lamp Life ②	Catalog Number	Price U.S. \$	Dimensions in Inches (mm)
 <p>Lens Insert with Printed Legend See Page 47-85.</p>	12V AC/DC #756 Lamp	Clear Red Green Yellow White Blue Amber	15,000	E22HVA0X3 E22HVA2X3 E22HVA3X3 E22HVA4X3 E22HVA5X3 E22HVA6X3 E22HVA9X3		
	24V AC/DC #1819 Lamp	Clear Red Green Yellow White Blue Amber	2,500	E22HVA0X4 E22HVA2X4 E22HVA3X4 E22HVA4X4 E22HVA5X4 E22HVA6X4 E22HVA9X4		
	110/120V AC/DC W1121 Lamp	Clear Red Green Yellow White Blue Amber	1,000	E22HVA0X8 E22HVA2X8 E22HVA3X8 E22HVA4X8 E22HVA5X8 E22HVA6X8 E22HVA9X8		

② Published theoretical lamp lives are based on ideal laboratory conditions and should be used for comparison only. Actual life may be shorter due to application conditions.

Discount Symbol **1CD1**

E22 and EM22 Series, Indicating Light Components

Indicating Light Components

Table 47-52. Indicating Lights — Without Light Unit — UL (NEMA) Type 3, 3R, 4, 4X, 12, 13





	Color	E22 Series — Plastic Operators		EM22 Series — Metal Operators	
		Catalog Number	Price U.S. \$	Catalog Number	Price U.S. \$
	25 mm Dia. Standard Lens				
	Red Green Yellow White Blue Amber Clear	E22H2 E22H3 E22H4 E22H5 E22H6 E22H9 E22H0		EM22H2 EM22H3 EM22H4 EM22H5 EM22H6 EM22H9 EM22H0	
	25 mm Dia. Lens — Insert Version (To Order with Printed Legend Insert, see Page 47-85.)				
	Red Green Yellow White Blue Amber Clear	E22A2 E22A3 E22A4 E22A5 E22A6 E22A9 E22A0		EM22A2 EM22A3 EM22A4 EM22A5 EM22A6 EM22A9 EM22A0	
	25 mm Dia. Glass Lens — Rated 4 – 13 Only				
	Red Green Yellow White Blue Amber Clear	E22F2 E22F3 E22F4 E22F5 E22F6 E22F9 E22F0		— — — — — — —	

Table 47-53. E22 Monoblock — Full Voltage Indicating Lights without Lamps ① — UL (NEMA) Type 3, 3R, 4, 4X, 12, 13

Description	Color	Catalog Number	Price U.S. \$	Description	Color	Catalog Number	Price U.S. \$
	Clear Red Green Yellow White Blue Amber	E22HV0 E22HV2 E22HV3 E22HV4 E22HV5 E22HV6 E22HV9		 <p>Lens Insert with Printed Legend</p>	Clear Red Green Yellow White Blue Amber	E22HVA0 E22HVA2 E22HVA3 E22HVA4 E22HVA5 E22HVA6 E22HVA9	
	Diffuser Style ② (Catalog Numbers are without legends)						

① For LED/incandescent lamps, see Page 47-70 – 47-71.

② For standard legends for diffuser, see Page 47-85.

Note: For Rear of Panel Extensions, see Table 47-128 on Page 47-94.

Dimensions Page 47-89
 Accessories Pages 47-74 – 47-78
 Contact Blocks Page 47-69
 Enclosures Pages 47-87 – 47-88
 Legend Plates Pages 47-79 – 47-85
 Suffix Codes Page 47-98
 Discount Symbol 1CD1

E22 and EM22 Series, Complete Devices — Push-Pull Units

Push-Pull Units

- Plastic or Metal Operators
- Black or Chrome Bezel
- Two- and Three-Position
- Illuminated and Non-illuminated
- Incandescent Bayonet Base Lamps
- Transformer or Resistor Light Units

Table 47-54. Two-Position Push-Pull Units — UL (NEMA) Type 3, 3R, 4, 4X, 12, 13

	Operator Position ①		Non-illuminated			Illuminated – Tall Incandescent Bulb				
	Pull	Push	Button Color	Catalog Number	Price U.S. \$	Lens Color	120V AC Transformer		120V AC/DC Resistor	
							Catalog Number	Price U.S. \$	Catalog Number	Price U.S. \$
Plastic Operators — Black Bezel										
	X	O	Black Red Green Red (Alum) — EMERG. STOP	E22EDB1B E22EDB2B E22EDB3B E22EDB2N8B		Red Green Amber Red (Alum) — EMERG. STOP	E22GDB2X11B E22GDB3X11B E22GDB9X11B E22GDB2N8X11B		E22GDB2X10B E22GDB3X10B E22GDB9X10B E22GDB2N8X10B	
Plastic Operators — Chrome Bezel										
	X	O	Black Red Green Red (Alum) — EMERG. STOP	E22ED1B E22ED2B E22ED3B E22ED2N8B		Red Green Amber Red (Alum) — EMERG. STOP	E22GD2X11B E22GD3X11B E22GD9X11B E22GD2N8X11B		E22GD2X10B E22GD3X10B E22GD9X10B E22GD2N8X10B	
Metal Operators — Chrome Bezel										
	X	O	Red Red – EMERG. STOP	EM22ED2B EM22ED2N8B		Red Red – EMERG. STOP	EM22GD2X11B EM22GD2N8X11B		EM22GD2X10B EM22GD2N8X10B	

① X = closed circuit, O = open circuit.

Table 47-55. Three-Position Push-Pull Units — UL (NEMA) Type 3, 3R, 4, 4X, 12, 13









	Operator Position ②			Non-illuminated			Illuminated – Tall Incandescent Bulb				
	Pull	Intermediate	Push	Button Color	Catalog Number	Price U.S. \$	Lens Color	120V AC Transformer		120V AC/DC Resistor	
								Catalog Number	Price U.S. \$	Catalog Number	Price U.S. \$
Plastic Operators — Black Bezel											
Momentary Push, Momentary Pull with 1NC and 1LONC Contact Blocks											
	X X	X O	O O	Black Red Green	E22FDB1S E22FDB2S E22FDB3S		Red Green Amber	E22HDB2X11S E22HDB3X11S E22HDB9X11S		E22HDB2X10S E22HDB3X10S E22HDB9X10S	
Momentary Push, Momentary Pull with 1NC and 1ECNO Contact Blocks											
	X O	O O	O X	Black Red Green	E22FDB1T E22FDB2T E22FDB3T		Red Green Amber	E22HDB2X11T E22HDB3X11T E22HDB9X11T		E22HDB2X10T E22HDB3X10T E22HDB9X10T	
Plastic Operators — Chrome Bezel											
Momentary Push, Momentary Pull with 1NC and 1LONC Contact Blocks											
	X X	X O	O O	Black Red Green	E22FD1S E22FD2S E22FD3S		Red Green Amber	E22HD2X11S E22HD3X11S E22HD9X11S		E22HD2X10S E22HD3X10S E22HD9X10S	
Momentary Push, Momentary Pull with 1NC and 1ECNO Contact Blocks											
	X O	O O	O X	Black Red Green	E22FD1T E22FD2T E22FD3T		Red Green Amber	E22HD2X11T E22HD3X11T E22HD9X11T		E22HD2X10T E22HD3X10T E22HD9X10T	
Metal Operators — Chrome Bezel											
3-Position Momentary Push and Pull — 1NC and 1LONO Contact Block											
	X O	O O	O X	Red	EM22FD2T		Red	EM22HD2X11T		EM22HD2X10T	
3-Position Momentary Push and Pull — 1NC and 1ECNC Contact Block											
	X X	X O	O O	Red	EM22FD2S		Red	EM22HD2X11S		EM22HD2X10S	

② X = closed circuit, O = open circuit.

Dimensions Page 47-89
 Legend Plates Pages 47-79 – 47-85
 Accessories Pages 47-74 – 47-78
 Discount Symbol 1CD1

Push-Pull Components — Non-illuminated Operators

Table 47-56. Non-illuminated Push-Pull Operators — UL (NEMA) Type 3, 3R, 4, 4X, 12, 13

			E22 Series — Plastic Operators				EM22 Series — Metal Operators			
			Color	Black Bezel		Chrome Bezel		Color	Chrome Bezel	
				Catalog Number	Price U.S. \$	Catalog Number	Price U.S. \$		Catalog Number	Price U.S. \$
E22 Black	E22 Chrome	EM22 Chrome	2-Position — 40 mm Dia. Button ^① (Maintained)							
			Black	E22EDB1		E22ED1		Red	EM22ED2	
			Red	E22EDB2		E22ED2		Green	EM22ED3	
			Green	E22EDB3		E22ED3				
			Yellow	E22EDB4		E22ED4				
			White	E22EDB5		E22ED5				
			Blue	E22EDB6		E22ED6				
			Gray	E22EDB7		E22ED7				
			Orange	E22EDB8		E22ED8				
			3-Position — 40 mm Dia. Button ^① (Spring Return to Center)							
			Black	E22FDB1		E22FD1		Red	EM22FD2	
			Red	E22FDB2		E22FD2		Green	EM22FD3	
			Green	E22FDB3		E22FD3				
			Yellow	E22FDB4		E22FD4				
			White	E22FDB5		E22FD5				
			Blue	E22FDB6		E22FD6				
			Gray	E22FDB7		E22FD7				
			Orange	E22FDB8		E22FD8				
			3-Position — 40 mm Dia. Push-Pull Pushbutton ^① (Spring Return to Center from Pulled Position)							
			Black	E22FDMB1		E22FDM1		Red	EM22FDM2	
			Red	E22FDMB2		E22FDM2		Green	EM22FDM3	
			Green	E22FDMB3		E22FDM3				
			Yellow	E22FDMB4		E22FDM4				
			White	E22FDMB5		E22FDM5				
			Blue	E22FDMB6		E22FDM6				
			Gray	E22FDMB7		E22FDM7				
			Orange	E22FDMB8		E22FDM8				

^① These operators can be supplied with EMERGENCY STOP marking (decal) on face ring. To order, add Suffix **N8** to operator Catalog Number. Example: E22ED2**N8**. With Yellow field, Red letters, add **N796**.

Note: For Rear of Panel Extensions, see **Table 47-128** on **Page 47-94**.

Contact Block Selection/Application

Push-Pull operators will accept a maximum of 2 contact blocks (4 circuits, 2-position/2 circuits, 3-position). 5-way mounting adapters can only be used on 2-position Push-Pulls and are not suitable with 3-position Push-Pulls. See **Page 47-77**.

Table 47-57. 2-Position Push-Pull

Contact Block Required			Circuit	Maintained Circuit Operation ^②	
Suffix Code	Catalog Number	Price U.S. \$		Pulled	Pushed
B	E22B1		1NC	X	O
A	E22B2		1NO	O	X
W	E22B11		1NO-1NC	X	O
				O	X
V	E22B20		2NO	O	X
				O	X

^② X = Closed Circuit O = Open Circuit

Table 47-58. 3-Position Push-Pull — E22B2, E22B11 and E22B20 Cannot Be Used

Contact Block Required			Circuit	Maintained Circuit Operation ^③		
Suffix Code	Catalog Number	Price U.S. \$		Pulled	Center	Pushed
S	E22B1 and E22B4		1NC	X	O	O
			1NC	X	X	O
T	E22B1 and E22B5		1NC	X	O	O
			1NO	O	O	X

^③ X = Closed Circuit O = Open Circuit

Note: Add Contact Block Suffix Code from tables above to operator Catalog Number to order as a complete device. Example: E22ED1**B** = 2-position chrome bezel, Black button Push-Pull with 1NC contact block.

Dimensions **Page 47-89**
 Accessories **Pages 47-74 – 47-78**
 Enclosures **Pages 47-87 – 47-88**
 Legend Plates..... **Pages 47-79 – 47-85**
 Light Units..... **Pages 47-70 – 47-73**
 Suffix Codes..... **Page 47-98**
 Discount Symbol **1CD1**

E22 and EM22 Series, Illuminated Push-Pull Components

Push-Pull Components — Illuminated Operators

Note: Will accept a maximum of 2 contact blocks when used with supplied 3-way adapter. 5-way mounting adapters are not to be used with 3-position operators, see **Page 47-77**.

Table 47-59. Illuminated Push-Pull Operators — UL (NEMA) Type 3, 3R, 4, 4X, 12, 13

			E22 Series — Plastic Operators				EM22 Series — Metal Operators			
			Color	Black Bezel		Chrome Bezel		Color	Chrome Bezel	
				Catalog Number	Price U.S. \$	Catalog Number	Price U.S. \$		Catalog Number	Price U.S. \$
E22 Black	E22 Chrome	EM22 Chrome	2-Position — 40 mm Diameter Lens ^{①②} (Maintained)							
			Red	E22GDB2		E22GD2		Red	EM22GD2	
			Green	E22GDB3		E22GD3		Green	EM22GD3	
			Yellow	E22GDB4		E22GD4		Amber	EM22GD9	
			White	E22GDB5		E22GD5				
			Blue	E22GDB6		E22GD6				
			Amber	E22GDB9		E22GD9				
			Clear	E22GBD0		E22GD0				
			3-Position — 40 mm Diameter Lens ^{①②} (Spring Return to Center)							
			Red	E22HDB2		E22HD2		Red	EM22HD2	
			Green	E22HDB3		E22HD3		Green	EM22HD3	
			Yellow	E22HDB4		E22HD4		Amber	EM22HD9	
			White	E22HDB5		E22HD5				
			Blue	E22HDB6		E22HD6				
			Amber	E22HDB9		E22HD9				
			Clear	E22HDB0		E22HD0				
			3-Position — 40 mm Dia. Push-Pull Pushbutton ^{①②} (Spring Return to Center from Pulled Position)							
			Red	E22HDMB2		E22HDM2		Red	EM22HDM2	
			Green	E22HDMB3		E22HDM3		Green	EM22HDM3	
			Yellow	E22HDMB4		E22HDM4		Amber	EM22HDM9	
			White	E22HDMB5		E22HDM5				
			Blue	E22HDMB6		E22HDM6				
			Amber	E22HDMB9		E22HDM9				
			Clear	E22HDMB0		E22HDM0				

^① These operators can be supplied with EMERGENCY STOP marking (decal) on face ring. To order, add Suffix **N8** to operator Catalog Number. Example: E22ED2**N8**. With Yellow field, Red letters, add **N796**.

^② All illuminated Push-Pull operators require tall incandescent bulbs or tall LEDs from **Table 47-103** or **Table 47-104 (Page 47-73)**.

47

29.5 mm Diameter Button — For Both Non-illuminated and Illuminated Push-Pull Operators



29.5 mm Diameter Button Operator

For Push-Pull operator with 29.5 mm diameter button, replace 5th digit (**D**) of the listed Catalog Number with letter **H**. Example: E22EH1, black, non-illuminated 2-position push-pull operator with 29.5 mm diameter button.

Note: Add Suffix Codes from the tables on **Page 47-69** (Contact Blocks) and **Pages 47-70 – 47-71** (Light Units) to operator Catalog Number to order as a complete device. Example: E22GD2**X4B** = 2-position chrome bezel, Red button lens, 24V light unit Push-Pull with 1NC contact block.

Note: For Rear of Panel Extensions, see **Table 47-128** on **Page 47-94**.

Dimensions **Page 47-89**
 Accessories **Pages 47-74 – 47-78**
 Enclosures **Pages 47-87 – 47-88**
 Legend Plates **Pages 47-79 – 47-85**
 Light Units **Pages 47-70 – 47-73**
 Suffix Codes **Page 47-98**
 Discount Symbol **1CD1**

Selector Switch Units

- Plastic Operators
- Black or Chrome Bezel
- Two-Position
- 45° Throw
- Knob or Lever
- Non-illuminated

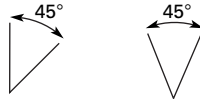













Table 47-60. Two-Position Selector Switch Units — 45° Throw — Cam 2 — UL (NEMA) Type 3, 3R, 4, 4X, 12, 13

	Operator Action ②	Operator Type	Operator Position ① 					
			Cam — 2					
			O X		X O O X		O X X O O X X O	
Catalog Number ③	Price U.S. \$	Catalog Number ③	Price U.S. \$	Catalog Number ③	Price U.S. \$	Catalog Number ③	Price U.S. \$	

Plastic Operator — Black Bezel

		Knob Lever	E22XB <u>F</u> 1A E22VB <u>F</u> 1A		E22XB <u>F</u> 1C E22VB <u>F</u> 1C		E22XB <u>F</u> 1WW E22VB <u>F</u> 1WW	
		Knob Lever	E22XB <u>5</u> 1A E22VB <u>5</u> 1A		E22XB <u>5</u> 1C E22VB <u>5</u> 1C		E22XB <u>5</u> 1WW E22VB <u>5</u> 1WW	
		Knob Lever	E22XB <u>E</u> 1A E22VB <u>E</u> 1A		E22XB <u>E</u> 1C E22VB <u>E</u> 1C		E22XB <u>E</u> 1WW E22VB <u>E</u> 1WW	
		Knob Lever	E22XB <u>6</u> 1A E22VB <u>6</u> 1A		E22XB <u>6</u> 1C E22VB <u>6</u> 1C		E22XB <u>6</u> 1WW E22VB <u>6</u> 1WW	

Plastic Operator — Chrome Bezel

		Knob Lever	E22XF <u>1</u> A E22VF <u>1</u> A		E22XF <u>1</u> C E22VF <u>1</u> C		E22XF <u>1</u> WW E22VF <u>1</u> WW	
		Knob Lever	E22X <u>5</u> 1A E22V <u>5</u> 1A		E22X <u>5</u> 1C E22V <u>5</u> 1C		E22X <u>5</u> 1WW E22V <u>5</u> 1WW	
		Knob Lever	E22XE <u>1</u> A E22VE <u>1</u> A		E22XE <u>1</u> C E22VE <u>1</u> C		E22XE <u>1</u> WW E22VE <u>1</u> WW	
		Knob Lever	E22X <u>6</u> 1A E22V <u>6</u> 1A		E22X <u>6</u> 1C E22V <u>6</u> 1C		E22X <u>6</u> 1WW E22V <u>6</u> 1WW	

① X = closed circuit, O = open circuit.

② M = Maintained. S = Spring return in direction of arrow (→).

③ To order with an alternate color, replace underlined digit (1) of listed Catalog Number with Code Number from table below.
Example: 2-position operator with Red knob, E22XBF2A

Color	Code	Color	Code	Color	Code	Color	Code	Color	Code	Color	Code	Color	Code	Color	Code
Black	1	Red	2	Green	3	Yellow	4	White	5	Blue	6	Gray	7	Orange	8

Dimensions Page 47-89
 Legend Plates Page 47-86
 Accessories Pages 47-74 – 47-78
 Discount Symbol 1CD1

E22 and EM22 Series, Complete Devices — Selector Switches

Selector Switch Units (Continued)

- Plastic or Metal Operators
- Black or Chrome Bezel
- Two-Position
- 60° Throw
- Knob or Lever
- Non-illuminated

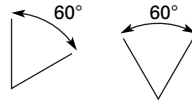

Table 47-61. Two-Position Selector Switch Units — 60° Throw — Cam 2 — UL (NEMA) Type 3, 3R, 4, 4X, 12, 13

	Operator Action ②	Operator Type	Operator Position ①							
			Cam — 2							
			O X	X O O X	O X O X	O X X O O X X O	Catalog Number ③	Price U.S. \$	Catalog Number ③	Price U.S. \$

Plastic Operator — Black Bezel

	M \swarrow M	Knob Lever	E22XBF61A E22VBF61A		E22XBF61C E22VBF61C		—		E22XBF61WW E22VBF61WW	
	M \swarrow M	Knob Lever	E22XB561A E22VB561A		E22XB561C E22VB561C		—		E22XB561WW E22VB561WW	
	M \swarrow S	Knob Lever	E22XBE61A E22VBE61A		E22XBE61C E22VBE61C		—		E22XBE61WW E22VBE61WW	
	M \swarrow S	Knob Lever	E22XB661A E22VB661A		E22XB661C E22VB661C		—		E22XB661WW E22VB661WW	

Plastic Operator — Chrome Bezel

	M \swarrow M	Knob Lever	E22XF61A E22VF61A		E22XF61C E22VF61C		—		E22XF61WW E22VF61WW	
	M \swarrow M	Knob Lever	E22X561A E22V561A		E22X561C E22V561C		—		E22X561WW E22V561WW	
	M \swarrow S	Knob Lever	E22XE61A E22VE61A		E22XE61C E22VE61C		—		E22XE61WW E22VE61WW	
	M \swarrow S	Knob Lever	E22X661A E22V661A		E22X661C E22V661C		—		E22X661WW E22V661WW	

Metal Operator — Chrome Bezel

	M \swarrow M	Knob Lever	EM22X561A EM22V561A		EM22X561C EM22V561C		EM22X561D EM22V561D		EM22X561WW EM22V561WW	
	M \swarrow S	Knob Lever	EM22X661A EM22V661A		EM22X661C EM22V661C		EM22X661D EM22V661D		EM22X661WW EM22V661WW	
	M \swarrow M	Knob Lever	EM22XF61A EM22VF61A		EM22XF61C EM22VF61C		EM22XF61D EM22VF61D		EM22XF61WW EM22VF61WW	
	M \swarrow S	Knob Lever	EM22XE61A EM22VE61A		EM22XE61C EM22VE61C		EM22XE61D EM22VE61D		EM22XE61WW EM22VE61WW	

① X = closed circuit, O = open circuit.

② M = Maintained. S = Spring return in direction of arrow (→).

③ To order with an alternate color, replace underlined digit (1) of listed Catalog Number with Code Number from table below.
Example: 2-position operator with Red knob, E22XBF62A

Color	Code	Color	Code	Color	Code	Color	Code	Color	Code	Color	Code	Color	Code	Color	Code
Black	1	Red	2	Green	3	Yellow	4	White	5	Blue	6	Gray	7	Orange	8

Dimensions Page 47-89
 Legend Plates Page 47-86
 Accessories Pages 47-74 – 47-78
 Discount Symbol 1CD1

Selector Switch Units (Continued)

- Plastic Operators
- Black or Chrome Bezel
- Three-Position
- 45° Throw
- Knob or Lever
- Non-illuminated



Table 47-62. Three-Position Selector Switch Units — 45° Throw — UL (NEMA) Type 3, 3R, 4, 4X, 12, 13

	Operator Action ^②	Operator Type	Operator Position — Circuit ^①					
			Cam 1		Cam 2		Cam 3	
			X O O O O X		X O X O O X		X O O O X O O O X	
Catalog Number ^③	Price U.S. \$	Catalog Number ^③	Price U.S. \$	Catalog Number ^③	Price U.S. \$	Catalog Number ^③	Price U.S. \$	

Plastic Operator — Black Bezel

		Knob Lever	E22XBG1D E22VBG1D		E22XBH1D E22VBH1D		E22XBG1RR E22VBG1RR	
		Knob Lever	E22XBN1D E22VBN1D		E22XBP1D E22VBP1D		E22XBN1RR E22VBN1RR	
		Knob Lever	E22XBL1D E22VBL1D		E22XBM1D E22VBM1D		E22XBL1RR E22VBL1RR	
		Knob Lever	E22XBJ1D E22VBJ1D		E22XBK1D E22VBK1D		E22XBJ1RR E22VBJ1RR	

Plastic Operator — Chrome Bezel

		Knob Lever	E22XG1D E22VG1D		E22XH1D E22VH1D		E22XG1RR E22VG1RR	
		Knob Lever	E22XN1D E22VN1D		E22XP1D E22VP1D		E22XN1RR E22VN1RR	
		Knob Lever	E22XL1D E22VL1D		E22XM1D E22VM1D		E22XL1RR E22VL1RR	
		Knob Lever	E22XJ1D E22VJ1D		E22XK1D E22VK1D		E22XJ1RR E22VJ1RR	

① X = closed circuit, O = open circuit.

② M = Maintained. S = Spring return in direction of arrow (→).

③ To order with an alternate color, replace underlined digit (1) of listed Catalog Number with Code Number from table below.

Example: 3-position operator with Red knob, E22XBG2D

Color	Code	Color	Code	Color	Code	Color	Code	Color	Code	Color	Code	Color	Code	Color	Code
Black	1	Red	2	Green	3	Yellow	4	White	5	Blue	6	Gray	7	Orange	8

Dimensions Page 47-89
 Legend Plates Page 47-86
 Accessories Pages 47-74 – 47-78
 Discount Symbol 1CD1

E22 and EM22 Series, Complete Devices — Selector Switches

Selector Switch Units (Continued)

- Plastic or Metal Operators
- Black or Chrome Bezel
- Three-Position
- 60° Throw
- Knob or Lever
- Non-illuminated

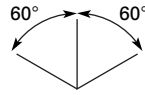

Table 47-63. Three-Position Selector Switch Units — 60° Throw — UL (NEMA) Type 3, 3R, 4, 4X, 12, 13

	Operator Action ^②	Operator Type	Operator Position ^①					
			Cam 1		Cam 2		Cam 3	
			X O O O O X		X O X O O X		X O O O X O O O X	
Catalog Number ^③	Price U.S. \$	Catalog Number ^③	Price U.S. \$	Catalog Number ^③	Price U.S. \$			

Plastic Operator — Black Bezel

		Knob Lever	E22XBG61D E22VBG61D		E22XBH61D E22VBH61D		E22XBG61RR E22VBG61RR	
		Knob Lever	E22XBN61D E22VBN61D		E22XBP61D E22VBP61D		E22XBN61RR E22VBN61RR	
		Knob Lever	E22XBL61D E22VBL61D		E22XBM61D E22VBM61D		E22XBL61RR E22VBL61RR	
		Knob Lever	E22XBJ61D E22VBJ61D		E22XBK61D E22VBK61D		E22XBJ61RR E22VBJ61RR	

Plastic Operator — Chrome Bezel

		Knob Lever	E22XG61D E22VG61D		E22XH61D E22VH61D		E22XG61RR E22VG61RR	
		Knob Lever	E22XN61D E22VN61D		E22XP61D E22VP61D		E22XN61RR E22VN61RR	
		Knob Lever	E22XL61D E22VL61D		E22XM61D E22VM61D		E22XL61RR E22VL61RR	
		Knob Lever	E22XJ61D E22VJ61D		E22XK61D E22VK61D		E22XJ61RR E22VJ61RR	

Metal Operator — Chrome Bezel

		Knob Lever	EM22XG61D EM22VG61D		EM22XH61D EM22VH61D		EM22XG61RR EM22VG61RR	
		Knob Lever	EM22XN61D EM22VN61D		EM22XP61D EM22VP61D		EM22XN61RR EM22VN61RR	
		Knob Lever	EM22XL61D EM22VL61D		EM22XM61D EM22VM61D		EM22XL61RR EM22VL61RR	
		Knob Lever	EM22XJ61D EM22VJ61D		EM22XK61D EM22VK61D		EM22XJ61RR EM22VJ61RR	

① X = closed circuit, O = open circuit.

② M = Maintained. S = Spring return in direction of arrow (→).

③ To order with an alternate color, replace underlined digit (1) of listed Catalog Number with Code Number from table below.
Example: 3-position operator with Red knob, E22XBG2D

Color	Code	Color	Code	Color	Code	Color	Code	Color	Code	Color	Code	Color	Code	Color	Code
Black	1	Red	2	Green	3	Yellow	4	White	5	Blue	6	Gray	7	Orange	8











Dimensions Page 47-89
 Legend Plates Page 47-86
 Accessories Pages 47-74 – 47-78
 Discount Symbol 1CD1

Selector Switches

45° Throw Non-illuminated Lever and Knob Operated Selector Switches — Plastic

Note: Will accept a maximum of 2 contact blocks (4 circuits) with supplied 3-way mounting adapter. Optional 5-way adapter will accept a maximum of 5 contact blocks (10 circuits). See **Page 47-77**.

Table 47-64. 45° Throw Non-illuminated Lever and Knob Operated Selector Switches — UL (NEMA) Type 3, 3R, 4, 4X, 12, 13

		Operating Mode M = Maintained S = Momentary			Cam Code	Plastic — Black Bezel		Plastic — Chrome Bezel	
		Left 	Center 	Right 		Catalog Number ①	Price U.S. \$	Catalog Number ①	Price U.S. \$
		2-Position — 45° Throw — Black Lever							
		— M	M —	M M	2 2	E22VBF1 E22VB51		E22VF1 E22V51	
		— M	M —	S S	2 2	E22VBE1 E22VB61		E22VE1 E22V61	
		3-Position — 45° Throw — Black Lever							
		M M	M M	M M	1 2	E22VBG1 E22VBH1		E22VG1 E22VH1	
		S S	M M	M M	1 2	E22VBJ1 E22VBK1		E22VJ1 E22VK1	
		S S	M M	S S	1 2	E22VBL1 E22VBM1		E22VL1 E22VM1	
		M M	M M	S S	1 2	E22VBN1 E22VBP1		E22VN1 E22VP1	
		2-Position — 45° Throw — Black Knob							
		— M	M —	M M	2 2	E22XBF1 E22XB51		E22XF1 E22X51	
		— M	M —	S S	2 2	E22XBE1 E22XB61		E22XE1 E22X61	
		3-Position — 45° Throw — Black Knob							
		M M	M M	M M	1 2	E22XBG1 E22XBH1		E22XG1 E22XH1	
		S S	M M	M M	1 2	E22XBJ1 E22XBK1		E22XJ1 E22XK1	
		S S	M M	S S	1 2	E22XBL1 E22XBM1		E22XL1 E22XM1	
		M M	M M	S S	1 2	E22XBN1 E22XBP1		E22XN1 E22XP1	

① Listed selector switches are supplied as standard with Black levers or knobs. To select an alternate color, change the last digit (underlined) in the listed Catalog Number using Code Number from following table. Example: E22VE2 — Two-Position Selector Switch with Red Lever.

Color	Code	Color	Code	Color	Code	Color	Code	Color	Code	Color	Code	Color	Code	Color	Code
Black	1	Red	2	Green	3	Yellow	4	White	5	Blue	6	Gray	7	Orange	8

Note: For Rear of Panel Extensions, see **Table 47-128** on **Page 47-94**.

Ordering Example — A complete Non-illuminated Selector Switch consists of the following:



Dimensions **Page 47-89**
 Accessories **Pages 47-74 – 47-78**
 Suffix Codes **Page 47-98**
 Discount Symbol **1CD1**

E22 and EM22 Series, Selector Switch Components

Selector Switches (Continued)

60° Throw Non-illuminated Lever and Knob Operated Selector Switches

Note: Will accept a maximum of 2 contact blocks (4 circuits) with supplied 3-way mounting adapter. Optional 5-way adapter will accept a maximum of 5 contact blocks (10 circuits). See Page 47-77.

Table 47-65. 60° Throw Non-illuminated Lever and Knob Operated Selector Switches — UL (NEMA) Type 3, 3R, 4, 4X, 12, 13

			Operating Mode			Cam Code	E22 Series — Plastic Operators				EM22 Series — Metal Operators	
			M = Maintained S = Momentary				Black Bezel		Chrome Bezel		Chrome Bezel	
			Left	Center	Right		Catalog Number ①	Price U.S. \$	Catalog Number ①	Price U.S. \$	Catalog Number ①	Price U.S. \$
			2-Position — 60° Throw — Black Lever									
			—	M	M	2	<u>E22VBF61</u>		<u>E22VF61</u>		<u>EM22VF61</u>	
			2-Position — 60° Throw — Black Knob									
			—	M	M	2	<u>E22XBF61</u>		<u>E22XF61</u>		<u>EM22XF61</u>	
			3-Position — 60° Throw — Black Lever									
			M	M	M	1	<u>E22VBG61</u>		<u>E22VG61</u>		<u>EM22VG61</u>	
			3-Position — 60° Throw — Black Knob									
			M	M	M	2	<u>E22XBH61</u>		<u>E22XH61</u>		<u>EM22XH61</u>	
			3-Position — 60° Throw — Black Lever									
			S	M	M	1	<u>E22VBJ61</u>		<u>E22VJ61</u>		<u>EM22VJ61</u>	
			3-Position — 60° Throw — Black Knob									
			S	M	M	2	<u>E22VBK61</u>		<u>E22VK61</u>		<u>EM22VK61</u>	
			3-Position — 60° Throw — Black Lever									
			S	M	S	1	<u>E22VBL61</u>		<u>E22VL61</u>		<u>EM22VL61</u>	
			3-Position — 60° Throw — Black Knob									
			S	M	S	2	<u>E22VBM61</u>		<u>E22VM61</u>		<u>EM22VM61</u>	
			3-Position — 60° Throw — Black Lever									
			M	M	S	1	<u>E22VBN61</u>		<u>E22VN61</u>		<u>EM22VN61</u>	
			3-Position — 60° Throw — Black Knob									
			M	M	S	2	<u>E22VBP61</u>		<u>E22VP61</u>		<u>EM22VP61</u>	

① Listed selector switches are supplied as standard with Black levers or knobs. To select an alternate color, change the last digit (underlined) in the listed Catalog Number using Code Number from following table. Example: E22VE62 — Two-Position Selector Switch with Red Lever.

Color	Code	Color	Code	Color	Code	Color	Code	Color	Code	Color	Code	Color	Code	Color	Code
Black	1	Red	2	Green	3	Yellow	4	White	5	Blue	6	Gray	7	Orange	8

Note: For Rear of Panel Extensions, see Table 47-128 on Page 47-94.

Ordering Example — A complete Non-illuminated Selector Switch consists of the following:









Dimensions Page 47-89
 Accessories Pages 47-74 – 47-78
 Suffix Codes Page 47-98
 Discount Symbol 1CD1

Selector Switches (Continued)

Key Operated Selector Switches

Note: Key removal from maintained positions only — will accept a maximum of 2 contact blocks (4 circuits) with supplied 3-way mounting adapter. Optional 5-way adapter will accept a maximum of 5 contact blocks (10 circuits).

Table 47-66. Key Operated Selector Switches — UL (NEMA) Type 3, 3R, 4, 4X, 12, 13

	Operating Mode M = Maintained S = Momentary			Cam Code	E22 Series — Plastic Operators				EM22 Series — Metal Operators		Allowable Key Removal Positions ①②
	Left 	Center 	Right 		Black Bezel		Chrome Bezel		Chrome Bezel		
					45°	Price U.S. \$	45°	Price U.S. \$	60°	Price U.S. \$	
					Catalog Number		Catalog Number		Catalog Number		
	2-Position										
	M	—	M	2	<u>E22KB53</u>		<u>E22K53</u>		—		1, 2
	M	—	S	2	<u>E22KB62</u>		<u>E22K62</u>		—		—
	—	M	M	2	<u>E22KBF5</u>		<u>E22KF5</u>		<u>EM22KF65</u>		1, 4
	—	M	S	2	<u>E22KBE4</u>		<u>E22KE4</u>		<u>EM22KE64</u>		—
		3-Position									
M		M	M	1	<u>E22KBG7</u>		<u>E22KG7</u>		<u>EM22KG67</u>		1 – 6
M		M	M	2	<u>E22KBH7</u>		<u>E22KH7</u>		<u>EM22KH67</u>		1 – 6
S		M	M	1	<u>E22KBJ5</u>		<u>E22KJ5</u>		<u>EM22KJ65</u>		1, 4
S		M	M	2	<u>E22KBK5</u>		<u>E22KK5</u>		<u>EM22KK65</u>		1, 4
		S	M	S	1	<u>E22KBL4</u>		<u>E22KL4</u>		<u>EM22KL64</u>	
	S	M	S	2	<u>E22KBM4</u>		<u>E22KM4</u>		<u>EM22KM64</u>		—
	M	M	S	1	<u>E22KBN6</u>		<u>E22KN6</u>		<u>EM22KN66</u>		2, 4
	M	M	S	2	<u>E22KBP6</u>		<u>E22KP6</u>		<u>EM22KP66</u>		2, 4

① To order operator with other than standard key removal position(s), select allowable option from table below and change last (underlined) digit of listed Catalog Number using Suffix Code shown. Example: E22KG66 — Three-Position Selector Switch with key removable from Left and Center positions.

② To order a different key and lock assembly, add suffix **B1, C1, D1, E1** or **F1** to the end of the Catalog Number.

Note: For Rear of Panel Extensions, see **Table 47-128** on **Page 47-94**.

Table 47-67. Key Removal Options

Key Removal Position	Code Suffix	Key Removal Position	Code Suffix	Key Removal Position	Code Suffix
Right Only	1	Center Only	4	Right, Left and Center	7
Left Only	2	Right and Center	5		
Right and Left	3	Left and Center	6		

Table 47-68. Spare Keys

Description	Reference Number Stamped on Key	Catalog Number	Price U.S. \$
Standard Lock	92239	E22KS2	
Master Key	For 95000 Series Locks	E22KM95	

Illuminated Selector Switches

45° Throw Illuminated Lever and Knob Operated Selector Switches — Plastic

Note: Will accept a maximum of 2 contact blocks (4 circuits) with supplied 3-way mounting adapter. Optional 5-way adapter will accept a maximum of 4 contact blocks (8 circuits).

Table 47-69. 45° Throw Illuminated Lever and Knob Operated Selector Switches — UL (NEMA) Type 3, 3R, 4, 4X, 12, 13

		Operating Mode M = Maintained S = Momentary			Cam Code	E22 Series — Plastic Operators			
		Left 	Center 	Right 		Black Bezel		Chrome Bezel	
						Catalog Number ①	Price U.S. \$	Catalog Number ①	Price U.S. \$
Black Bezel 	Chrome Bezel 	2-Position — 45° Throw — Red Lever							
		—	M	M	2	<u>E22WBF2</u> <u>E22WB52</u>		<u>E22WF2</u> <u>E22W52</u>	
Black Bezel 	Chrome Bezel 	—	M	S	2	<u>E22WBE2</u> <u>E22WB62</u>		<u>E22WE2</u> <u>E22W62</u>	
		M	—	S	2				
Black Bezel 	Chrome Bezel 	3-Position — 45° Throw — Red Lever							
		M	M	M	1	<u>E22WBG2</u>		<u>E22WG2</u>	
Black Bezel 	Chrome Bezel 	M	M	M	2	<u>E22WBH2</u>		<u>E22WH2</u>	
		S	M	M	1	<u>E22WBJ2</u>		<u>E22WJ2</u>	
Black Bezel 	Chrome Bezel 	S	M	M	2	<u>E22WBK2</u>		<u>E22WK2</u>	
		S	M	S	1	<u>E22WBL2</u>		<u>E22WL2</u>	
Black Bezel 	Chrome Bezel 	S	M	S	2	<u>E22WBM2</u>		<u>E22WM2</u>	
		M	M	S	1	<u>E22WBN2</u>		<u>E22WN2</u>	
Black Bezel 	Chrome Bezel 	M	M	S	2	<u>E22WBP2</u>		<u>E22WP2</u>	
		M	M	S	2				
Black Bezel 	Chrome Bezel 	2-Position — 45° Throw — Red Knob							
		—	M	M	2	<u>E22SBF2</u>		<u>E22SF2</u>	
Black Bezel 	Chrome Bezel 	M	—	M	2	<u>E22SB52</u>		<u>E22S52</u>	
		—	M	S	2	<u>E22SBE2</u>		<u>E22SE2</u>	
Black Bezel 	Chrome Bezel 	M	—	S	2	<u>E22SB62</u>		<u>E22S62</u>	
		M	—	S	2				
Black Bezel 	Chrome Bezel 	3-Position — 45° Throw — Red Knob							
		M	M	M	1	<u>E22SBG2</u>		<u>E22SG2</u>	
Black Bezel 	Chrome Bezel 	M	M	M	2	<u>E22SBH2</u>		<u>E22SH2</u>	
		S	M	M	1	<u>E22SBJ2</u>		<u>E22SJ2</u>	
Black Bezel 	Chrome Bezel 	S	M	M	2	<u>E22SBK2</u>		<u>E22SK2</u>	
		S	M	S	1	<u>E22SBL2</u>		<u>E22SL2</u>	
Black Bezel 	Chrome Bezel 	S	M	S	2	<u>E22SBM2</u>		<u>E22SM2</u>	
		M	M	S	1	<u>E22SBN2</u>		<u>E22SN2</u>	
Black Bezel 	Chrome Bezel 	M	M	S	2	<u>E22SBP2</u>		<u>E22SP2</u>	
		M	M	S	2				

① Listed selector switches are supplied as standard with Red levers or knobs. To select an alternate color, change the last digit (underlined) in the listed Catalog Number using Code Number from following table. Example: E22WF3 — Two-Position Selector Switch with Green Lever.

Color	Code	Color	Code	Color	Code	Color	Code	Color	Code	Color	Code	Color	Code
Red	2	Green	3	Yellow	4	White	5	Blue	6	Amber	9	Clear	0

Note: For Rear of Panel Extensions, see Table 47-128 on Page 47-94.

Ordering Example — A complete Illuminated Selector Switch consists of the following:

	Operator See Above		Legend Plate See Page 47-86		Mounting Adapter (Supplied with Operator). For 5-Way Adapter, See Page 47-77		Light Unit with Tall Incandescent Bulb/LED See Pages 47-70 – 47-71		Contact Blocks See Page 47-69
--	------------------------------	--	---------------------------------------	--	--	--	--	--	---

















Dimensions Page 47-89
 Accessories Pages 47-74 – 47-78
 Suffix Codes Page 47-98
 Discount Symbol 1CD1

Illuminated Selector Switches (Continued)

60° Throw Illuminated Lever and Knob Operated Selector Switches

Note: Will accept a maximum of 2 contact blocks (4 circuits) with standard mounting adapter supplied. Optional 5-way adapter will accept a maximum of 4 contact blocks (8 circuits).

Table 47-70. 60° Throw Illuminated Lever and Knob Operated Selector Switches — UL (NEMA) Type 3, 3R, 4, 4X, 12, 13

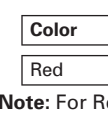
	Operating Mode M = Maintained S = Momentary			Cam Code	E22 Series — Plastic Operators				E2M2 Series — Metal Operators	
	Left 	Center 	Right 		Black Bezel		Chrome Bezel		Chrome Bezel	
					Catalog Number ①	Price U.S. \$	Catalog Number ①	Price U.S. \$	Catalog Number ①	Price U.S. \$
2-Position — 60° Throw — Red Lever										
	— M	M	M	2	E22WBF62		E22WF62		EM22WF62	
		—	—	—	2	E22WB562		E22W562		EM22W562
	— M	M	S	2	E22WBE62		E22WE62		EM22WE62	
		—	—	—	2	E22WB662		E22W662		EM22W662
	— M	M	M	2	E22WBF62		E22WF62		EM22WF62	
		—	—	—	2	E22WB562		E22W562		EM22W562
3-Position — 60° Throw — Red Lever										
	M M	M	M	1	E22WBG62		E22WG62		EM22WG62	
		M	M	2	E22WBH62		E22WH62		EM22WH62	
	S S	M	M	1	E22WBJ62		E22WJ62		EM22WJ62	
		M	M	2	E22WBK62		E22WK62		EM22WK62	
	S S	M	S	1	E22WBL62		E22WL62		EM22WL62	
		M	S	2	E22WBM62		E22WM62		EM22WM62	
	M M	M	S	1	E22WBN62		E22WN62		EM22WN62	
		M	S	2	E22WBP62		E22WP62		EM22WP62	
2-Position — 60° Throw — Red Knob										
	— M	M	M	2	E22SBF62		E22SF62		EM22SF62	
		—	—	—	2	E22SB562		E22S562		EM22S562
	— M	M	S	2	E22SBE62		E22SE62		EM22SE62	
		—	—	—	2	E22SB662		E22S662		EM22S662
	— M	M	M	2	E22SBF62		E22SF62		EM22SF62	
		—	—	—	2	E22SB562		E22S562		EM22S562
3-Position — 60° Throw — Red Knob										
	M M	M	M	1	E22SBG62		E22SG62		EM22SG62	
		M	M	2	E22SBH62		E22SH62		EM22SH62	
	S S	M	M	1	E22SBJ62		E22SJ62		EM22SJ62	
		M	M	2	E22SBK62		E22SK62		EM22SK62	
	S S	M	S	1	E22SBL62		E22SL62		EM22SL62	
		M	S	2	E22SBM62		E22SM62		EM22SM62	
	M M	M	S	1	E22SBN62		E22SN62		EM22SN62	
		M	S	2	E22SBP62		E22SP62		EM22SP62	

① Listed selector switches are supplied as standard with Red levers or knobs. To select an alternate color, change the last digit (underlined) in the listed Catalog Number using Code Number from following table. Example: E22WF63 — Two-Position Selector Switch with Green Lever.

Color	Code	Color	Code	Color	Code	Color	Code	Color	Code	Color	Code	Color	Code
Red	2	Green	3	Yellow	4	White	5	Blue	6	Amber	9	Clear	0

Note: For Rear of Panel Extensions, see **Table 47-128** on **Page 47-94**.

Ordering Example — A complete Illuminated Selector Switch consists of the following:



Operator
See Above



Legend Plate
See Page 47-86



Mounting Adapter
(Supplied with Operator). For 5-Way Adapter, See Page 47-77



Light Unit with Tall Incandescent Bulb/LED
See Pages 47-70 – 47-71



Contact Blocks
See Page 47-69

Dimensions	Page 47-89
Accessories	Pages 47-74 – 47-78
Suffix Codes	Page 47-98
Discount Symbol	1CD1

Selector Switch Selection

Cam and Contact Block Selection — For 2- and 3-Position Selector Switches

1. Develop a line circuit diagram required for each application. Then, by using the symbols "X" for contact closed and "O" for contact open, determine the contact state required in each selector switch position.
2. Visually locate the closure sequence in one of the 2- or 3-Position Selector Switch Combination tables on **Pages 47-60 – 47-61**.
3. Find the contact block(s), their Suffix Code letter(s) and their mounting location(s) required for that circuit configuration, by referring to the table next to the "X O" closure sequence that was selected.

Note: Contact Blocks must be mounted in position indicated. Selector switches will not accept a contact block in position 3 of the mounting adapter. If more circuits and/or different circuit arrangements are required, see Rotary Cam Selector Switches listed on **Pages 47-62 – 47-63 and 47-95 – 47-96**.

Example: HAND-OFF-AUTO function, two circuits are required —

Circuit #1 — X O O

This can be achieved using Cam 1 with an E22B2 contact block mounted in the left (1-) position.

Circuit #2 — O O X

This can be achieved using Cam 1 with an E22B2 block mounted in the right (2-) position.

Order a 3-Position Selector Switch with Cam #1 —

Example: E22VG1, along with 2 E22B2 Contact Blocks.

Cam and Contact Block Selection

Table 47-71. 2-Position Switches

Circuit ↖ ↗	Cam	Catalog Number of Contact Block(s)/ Mounting Position		Code Suffix
		1 & 5	2 & 4	
O X	2	E22B2 or E22B2		A
X O	2	E22B1 or E22B1		B
O X X O	2	E22B11	—	W
O X X O	2	E22B2	E22B1	C
O X O X	2	E22B20	—	V
O X O X	2	E22B2	E22B2	D
X O X O	2	E22B1	E22B1	E
O X O X O X	2	E22B20	E22B2	VA
X O O X X O	2	E22B1	E22B11	WB
X O O X O X	2	E22B1	E22B20	VB
O X X O O X	2	E22B11	E22B2	WA
O X O X O X O X	2	E22B20	E22B20	VV
O X O X O X X O	2	E22B20	E22B11	VW
O X X O O X X O	2	E22B11	E22B11	WW

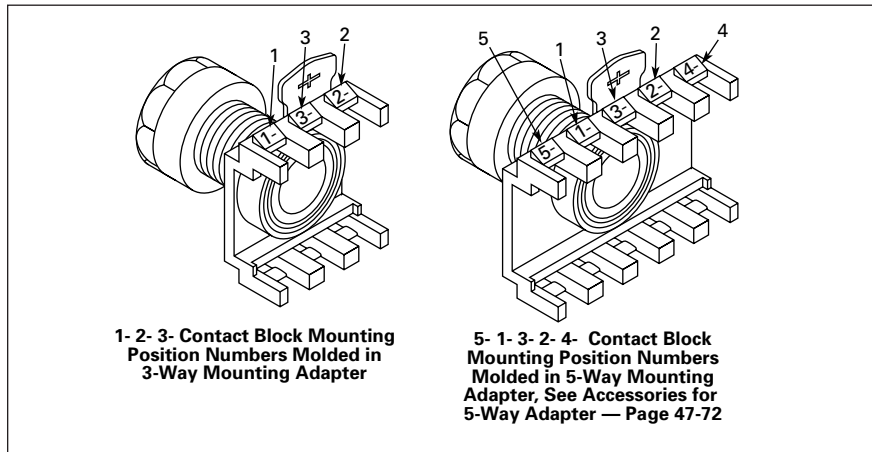

Figure 47-16. Contact Block Mounting

Cam and Contact Block Selection (Continued)

Table 47-72. 3-Position Switches

Circuit ↖ ↑ ↗	Cam	Catalog Number of Contact Block(s) Mounting Position		Code Suffix
		1 & 5	2 & 4	
		X O O	1	
O O X	1	—	E22B2	A
O X X	1	E22B1	—	B
X X O	1	—	E22B1	B
X O X	2	E22B2	—	A
O X O	2	E22B1	—	B
O O X	2	—	E22B2	A
X X O	2	—	E22B1	B
X O O	1	E22B2	E22B2	D
O O X	1	E22B2	E22B1	C
X X O	1	E22B1	E22B2	C
O X X	1	E22B1	E22B1	E
X O O	1	E22B11	—	W
O X X	1	E22B20	—	V
X O O	1	E22B20	—	V
O O X	1	—	E22B11	W
X X O	1	—	E22B20	V
O O X	1	—	E22B20	V
O O X	1	E22B11	E22B1	PP
O X O	2	E22B2	E22B2	D
X O X	2	E22B2	E22B1	C
X X O	2	E22B1	E22B2	C
O X O	2	E22B1	E22B1	E
X X O	2	E22B11	—	W
O X O	2	E22B20	—	V
X O X	2	E22B20	—	V
O O X	2	E22B11	—	W
X X O	2	—	E22B20	V
O O X	2	—	E22B20	V

Table 47-72. 3-Position Switches (Continued)

Circuit ↖ ↑ ↗	Cam	Catalog Number of Contact Block(s) Mounting Position		Code Suffix
		1 & 5	2 & 4	
		X O O	1	
O O X	1	E22B2	E22B20	VA
X O O	1	E22B1	E22B11	WB
O X X	1	E22B1	E22B20	VB
O O X	1	E22B11	E22B2	WA
X O O	1	E22B20	E22B2	VA
X O O	1	E22B11	E22B1	WB
O X X	1	E22B20	E22B1	VB
X O O	1	E22B11	E22B11	RR
O X O	1	E22B11	E22B11	RR
O O X	1	E22B11	E22B11	RR
X O X	2	E22B2	E22B11	WA
O O X	2	E22B2	E22B20	VA
X X O	2	E22B2	E22B20	VA
O X O	2	E22B1	E22B11	WB
O O X	2	E22B1	E22B20	VB
O X O	2	E22B1	E22B20	VB
O O X	2	E22B11	E22B2	WA
X O X	2	E22B11	E22B2	WA
O X O	2	E22B20	—	V
X O X	2	E22B20	—	V
O O X	2	E22B11	—	W
X X O	2	—	E22B20	V
O O X	2	—	E22B20	V

Table 47-72. 3-Position Switches (Continued)

Circuit ↖ ↑ ↗	Cam	Catalog Number of Contact Block(s) Mounting Position		Code Suffix
		1 & 5	2 & 4	
		X O X	2	
O X O	2	E22B11	E22B1	WB
X X O	2	E22B11	E22B1	WB
X O X	2	E22B20	E22B1	VB
X O X	2	E22B20	E22B1	VB
X X O	2	E22B20	E22B1	VB
X O O	1	E22B11	E22B11	WW
O X X	1	E22B11	E22B11	WW
O O X	1	E22B11	E22B11	WW
X X O	1	E22B11	E22B11	WW
X O O	1	E22B11	E22B20	VW
O X X	1	E22B11	E22B20	VW
O O X	1	E22B11	E22B20	VW
X O O	1	E22B20	E22B11	VW
X O O	1	E22B20	E22B11	VW
O O X	1	E22B20	E22B11	VW
X X O	1	E22B20	E22B11	VW
X O O	1	E22B20	E22B20	VV
X O O	1	E22B20	E22B20	VV
O O X	1	E22B20	E22B20	VV
O O X	1	E22B20	E22B20	VV
X O X	2	E22B11	E22B11	WW
O X O	2	E22B11	E22B11	WW
O O X	2	E22B11	E22B11	WW
X X O	2	E22B11	E22B11	WW
X O X	2	E22B20	E22B11	VW
X O X	2	E22B20	E22B11	VW
O O X	2	E22B20	E22B11	VW
X X O	2	E22B20	E22B11	VW
X O X	2	E22B20	E22B20	VV
X O X	2	E22B20	E22B20	VV
O O X	2	E22B20	E22B20	VV
O O X	2	E22B20	E22B20	VV

E22 and EM22 Series, Complete Devices — Rotary Cam Selector Switch Units

Rotary Cam Selector Switch Units

- Plastic Operator
- Black or Chrome Bezel
- Four- to Six-Position
- Knob, Lever or Key Version
- Non-illuminated

Table 47-73. Four- to Six-Position Selector Switch Units — UL (NEMA) Type 3, 3R, 4, 4X, 12, 13

Contact block rating, see Page 47-95. Includes contact blocks. Components overpacked in a single carton.	Terminal Numbers	Contact Sequence O = Circuit Open; X = Circuit Closed	Switch Position (45° Throw Between Each Position — Except as Noted)	Operator Type	Black Bezel		Chrome Bezel					
					Catalog Number ①	Price U.S. \$	Catalog Number ①	Price U.S. \$				
Four-Position Maintained												
 Terminal Locations Top View Bottom View 	1-2		0	1	2	3	4	(60° Throw)	Lever Knob	E22JDBN1 E22LDBN1	E22JDN1 E22LDN1	
	5-6			X	O	O	O					
	7-8				O	X	O	O				
	3-4			O	O	O	X					
	1-2			X	O	O	O			Lever Knob Key ②	E22JDB4W1 E22LDB4W1 E22KDB4W8	E22JD4W1 E22LD4W1 E22KD4W8
	5-6			O	X	O	O					
	7-8			O	O	X	O					
	3-4			O	O	O	X					
	1-2			O	X	O	O			Lever Knob Key ②	E22JDB4Y1 E22LDB4Y1 E22KDB4Y8	E22JD4Y1 E22LD4Y1 E22KD4Y8
	5-6			O	O	X	O					
	7-8			O	O	O	X					
	3-4			O	O	O	X					
Five-Position Maintained												
	1-2			X	O	O	O	O		Lever Knob Key ②	E22JDB5W1 E22LDB5W1 E22KDB5W8	E22JD5W1 E22LD5W1 E22KD5W8
	5-6			O	X	O	O	O				
	9-10			O	O	X	O	O				
	7-8			O	O	O	X	O				
	3-4			O	O	O	O	X				
	1-2			O	X	O	O	O		Lever Knob Key ②	E22JDB5Y1 E22LDB5Y1 E22KDB5Y8	E22JD5Y1 E22LD5Y1 E22KD5Y8
	5-6			O	O	X	O	O				
	3-4			O	O	O	X	O				
	7-8			O	O	O	O	X				
Six-Position Maintained												
	1-2			X	O	O	O	O		Lever Knob Key ②	E22JDB6W1 E22LDB6W1 E22KDB6W8	E22JD6W1 E22LD6W1 E22KD6W8
	5-6			O	X	O	O	O				
	9-10			O	O	X	O	O				
	11-12			O	O	O	X	O				
	3-4			O	O	O	O	X				
	7-8			O	O	O	O	X				
	1-2			O	X	O	O	O		Lever Knob Key ②	E22JDB6Y1 E22LDB6Y1 E22KDB6Y8	E22JD6Y1 E22LD6Y1 E22KD6Y8
	5-6			O	O	X	O	O				
	7-8			O	O	O	X	O				
	9-10			O	O	O	O	X				
	3-4			O	O	O	O	X				

① Listed selector switches are supplied as standard with Black levers or knobs. To select an alternate color, change the last digit in the listed Catalog Number using Code Number from following table. Example: E22LDN2 — four-position selector switch with Red knob.
 ② Key removable in all maintained positions (no alternates).

Color	Code	Color	Code	Color	Code	Color	Code	Color	Code	Color	Code	Color	Code	Color	Code
Black	1	Red	2	Green	3	Yellow	4	White	5	Blue	6	Gray	7	Orange	8

Dimensions Page 47-89
 Contact Block Ratings Page 47-95
 Custom Ordering Page 47-96
 Legend Plates and Dimensions Page 47-86
 Discount Symbol 1CD1

Rotary Cam Selector Switch Units (Continued)

- Plastic Operators
- Black or Chrome Bezel
- Seven- and Eight-Position
- Knob, Lever or Key Version
- Non-illuminated

Table 47-74. Seven- and Eight-Position Selector Switch Units — UL (NEMA) Type 3, 3R, 4, 4X, 12, 13

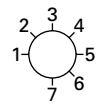
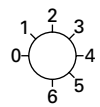
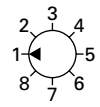
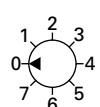
Contact block ratings, see Page 47-95. Includes contact blocks. Components overpacked in a single carton.	Terminal Numbers	Contact Sequence O = Circuit Open; X = Circuit Closed	Switch Position (45° Lever Throw Between Each Position)	Operator Type	Black Bezel		Chrome Bezel	
					Catalog Number ①	Price U.S. \$	Catalog Number ①	Price U.S. \$
Seven-Position Maintained								
		0 1 2 3 4 5 6 7		Lever Knob Key ②	E22JDB7W1 E22LDB7W1 E22KDB7W8		E22JD7W1 E22LD7W1 E22KD7W8	
1-2		X O O O O O O O						
5-6		O X O O O O O O						
9-10		O O X O O O O O						
13-14		O O O X O O O O						
3-4		O O O O X O O O						
7-8		O O O O O X O O						
11-12		O O O O O O X						
		0 1 2 3 4 5 6 7		Lever Knob Key ②	E22JDB7Y1 E22LDB7Y1 E22KDB7Y8		E22JD7Y1 E22LD7Y1 E22KD7Y8	
1-2		O X O O O O O O						
5-6		O O X O O O O O						
9-10		O O O X O O O O						
11-12		O O O O X O O O						
3-4		O O O O O X O O						
7-8		O O O O O O X						
Eight-Position Maintained								
		0 1 2 3 4 5 6 7 8		Lever Knob Key ②	E22JDB8W1 E22LDB8W1 E22KDB8W8		E22JD8W1 E22LD8W1 E22KD8W8	
1-2		X O O O O O O O						
5-6		O X O O O O O O						
9-10		O O X O O O O O						
13-14		O O O X O O O O						
3-4		O O O O X O O O						
7-8		O O O O O X O O						
11-12		O O O O O O X						
15-16		O O O O O O X						
		0 1 2 3 4 5 6 7 8		Lever Knob Key ②	E22JDB8Y1 E22LDB8Y1 E22KDB8Y8		E22JD8Y1 E22LD8Y1 E22KD8Y8	
1-2		O X O O O O O O						
5-6		O O X O O O O O						
9-10		O O O X O O O O						
13-14		O O O O X O O O						
3-4		O O O O O X O O						
7-8		O O O O O O X						
11-12		O O O O O O X						



① Listed selector switches are supplied as standard with Black levers or knobs. To select an alternate color, change the last digit in the listed Catalog Number using Code Number from following table. Example: E22LDN2 — four-position selector switch with Red knob.
 ② Key removable in all maintained positions (no alternates).

Color	Code	Color	Code	Color	Code	Color	Code	Color	Code	Color	Code	Color	Code	Color	Code
Black	1	Red	2	Green	3	Yellow	4	White	5	Blue	6	Gray	7	Orange	8

Contact Block Ratings **Page 47-95**
 Custom Ordering **Page 47-96**
 Discount Symbol **1CD1**

E22 and EM22 Series, Specialty Operators

Specialty Operators

Table 47-75. Potentiometers with Knob Operator ① — **UL (NEMA) Type 3, 3R, 4, 4X, 12, 13**

	Ohms	0.5 Watt Max./120V Max.						2 Watt Max./120V Max.					
		E22 Plastic — Black Bezel		E22 Plastic — Chrome Bezel		EM22 Metal — Chrome Bezel		E22 Plastic — Black Bezel		E22 Plastic — Chrome Bezel		EM22 Metal — Chrome Bezel	
		Catalog Number	Price U.S. \$	Catalog Number	Price U.S. \$	Catalog Number	Price U.S. \$	Catalog Number	Price U.S. \$	Catalog Number	Price U.S. \$	Catalog Number	Price U.S. \$
 Order Legend Plate from Below	1,000	E22PXB1C1		E22PX1C1		EM22PX1C1		E22PXB1F1		E22PX1F1		EM22PX1F1	
	2,500	E22PXB1C2		E22PX1C2		EM22PX1C2		E22PXB1F2		E22PX1F2		EM22PX1F2	
	5,000	E22PXB1C5		E22PX1C5		EM22PX1C5		E22PXB1F5		E22PX1F5		EM22PX1F5	
	10,000	E22PXB1C10		E22PX1C10		EM22PX1C10		E22PXB1F10		E22PX1F10		EM22PX1F10	
	25,000	E22PXB1C25		E22PX1C25		EM22PX1C25		E22PXB1F25		E22PX1F25		EM22PX1F25	
	50,000	E22PXB1C50		E22PX1C50		EM22PX1C50		E22PXB1F50		E22PX1F50		EM22PX1F50	
	Operator Only	E22PXB1C0		E22PX1C0		EM22PX1C0		E22PXB1F0		E22PX1F0		EM22PX1F0	

① Potentiometers are not IP1X or IP2X rated.

Table 47-76. Potentiometer Legend Plate





	Description	Catalog Number	Price U.S. \$
	Potentiometer Legend Plate	E22NJP99	

Table 47-77. Flush Pushbutton Operators with Mechanical Push Rod — **UL (NEMA) Type 3, 3R, 4, 4X, 12, 13**

	Description	Color	Plastic — Black Bezel		Plastic — Chrome Bezel	
			Catalog Number	Price U.S. \$	Catalog Number	Price U.S. \$
	25 mm Diameter Flush Pushbutton Operators supplied with Mechanical Push Rod — Suitable for external mechanical reset of overload relays. Push rod must be cut to desired length.	Gray Blue Red Blue (RESET)	E22PB7L E22PB6L E22PB2L E22PB6N29L		E22P7L E22P6L E22P2L E22P6N29L	

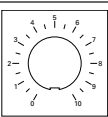
47

Table 47-78. Wobble Stick Operator — **UL (NEMA) 3, 3R, 4, 4X, 12, 13**

	Description	Catalog Number	Price U.S. \$
E22 Series 	E22 Series — Plastic Wobble Stick — Allows activation of controls by pushing stick in any direction.	E22WS	
EM22 Series 	EM22 Series — Metal Wobble Stick — Allows activation of controls by pushing stick in any direction.	EM22WS	

Note: For Rear of Panel Extensions, see **Table 47-128** on **Page 47-94**.

Dimensions **Page 47-89**
 Contact Blocks..... **Page 47-69**
 Enclosures **Pages 47-87 – 47-88**
 Legend Plates..... **Pages 47-79 – 47-85**
 Suffix Codes **Page 47-98**
 Discount Symbol **1CD1**

Double Headed Pushbuttons

Table 47-79. Illuminated and Non-illuminated Double Headed Pushbuttons — UL (NEMA) Type 1; IP40

	Description	Operator Colors	Marking	Plastic — Black Bezel		Dimensions
				Catalog Number	Price U.S. \$	
	Non-illuminated Double Headed Pushbutton	Green — Red	Unmarked	E22DB1A11		
		Green — Red	I	E22DB1A21		
	Non-illuminated Double Headed Pushbutton with 1NO and 1NC Contact Block	Green — Red	Unmarked	E22DB1A11C		
		Green — Red	I	E22DB1A21C		
	Illuminated Double Headed Pushbutton with Clear Lens ①	Green — Red	Unmarked	E22DB1A10		
		Green — Red	I	E22DB1A20		
	Illuminated Double Headed Pushbutton with Clear Lens ① and 120V Transformer Light Unit ②	Green — Red	Unmarked	E22DB1A10X11		
		Green — Red	I	E22DB1A20X11		
	Illuminated Double Headed Pushbutton with Clear Lens ①, 120V Transformer Light Unit ② and 1NO and 1NC Contact Block	Green — Red	Unmarked	E22DB1A10X11C		
		Green — Red	I	E22DB1A20X11C		

① For lens colors other than clear, replace the 0 above with the appropriate Color Code from Table 47-83 on Page 47-66.

② For light units other than 120V transformer, replace the X11 code above with the appropriate Suffix from Table 47-81 on Page 47-66.

Table 47-80. Illuminated and Non-illuminated Double Headed Pushbuttons — UL (NEMA) Type 3, 3R, 4, 4X, 12, 13; IP65 ⑤

	Description	Operator Colors	Marking	Plastic — Black Bezel		Dimensions
				Catalog Number	Price U.S. \$	
	Non-illuminated Double Headed Pushbutton	Green — Red	Unmarked	E22DB1B11		
		Green — Red	O	E22DB1B21		
	Non-illuminated Double Headed Pushbutton with 1NO and 1NC Contact Block	Green — Red	Unmarked	E22DB1B11C		
		Green — Red	O	E22DB1B21C		
	Illuminated Double Headed Pushbutton with Clear Lens ③	Green — Red	Unmarked	E22DB1B10		
		Green — Red	O	E22DB1B20		
	Illuminated Double Headed Pushbutton with Clear Lens ③ and 120V Transformer Light Unit ④	Green — Red	Unmarked	E22DB1B10X11		
		Green — Red	O	E22DB1B20X11		
	Illuminated Double Headed Pushbutton with Clear Lens ③, 120V Transformer Light Unit ④ and 1NO and 1NC Contact Block	Green — Red	Unmarked	E22DB1B10X11C		
		Green — Red	O	E22DB1B20X11C		

③ For lens colors other than clear, replace the 0 above with the appropriate Color Code from Table 47-83 on Page 47-66.

④ For light units other than 120V transformer, replace the X11 code above with the appropriate Suffix from Table 47-81 on Page 47-66.

⑤ IP65 or UL (NEMA) Type 3, 3R, 4, 4X, 12, 13 versions include protective silicon boot E22DBB.

Note: Add Contact Block Suffix from table on Page 47-98 to operator Catalog Number to order as a complete device. Example: E22DB1A11B = non-illuminated double headed pushbutton, unmarked, IP40 with 1NC contact block.

Contact Blocks Page 47-69
 Enclosures Pages 47-87 – 47-88
 Suffix Codes Page 47-98
 Discount Symbol 1CD1

E22 and EM22 Series, Double Headed Pushbutton Components

Double Headed Pushbuttons (Continued)

Table 47-81. Light Unit ①

Description	Suffix Code	Catalog Number	Price U.S. \$
Direct Voltage Unit AC/DC			
Without Lamp	X1	E22D	
Without Lamp	X1	E22DE	
With 6V Lamp	X2	E22D6	
With 12V Lamp	X3	E22D12	
With 24V Lamp	X4	E22D24	
With 48V Lamp	X6	E22D50	
With 60V Lamp	X7	E22D60	
Resistor Type Unit AC/DC			
120V/60 Hz	X10	E22R2	
Transformer Unit AC Only			
120V/60 Hz	X11	E22TL1	
240V/60 Hz	X12	E22TL2	
480V/60 Hz	X14	E22TL4	
Silicon Boot for IP65 Ingress Protection	—	E22DBB	

① Additional light units — See Pages 47-70 – 47-71.

Table 47-82. Light Unit Specifications

Catalog Number	Function	Bulb Type	Max. Voltage
E22D	Indicating Light	Incandescent, LED or Neon	250V
	Illuminated Operator	Incandescent	60V
E22DE	Illuminated Operator	LED or Neon	120V

Table 47-83. Lens Color

Lens Color	Color Code
Clear	0
Red	2
Green	3
Yellow	4
White	5
Blue	6
Amber	9



Table 47-84. Overall Dimensions in Inches (mm)

	With Boot	Without Boot
Dimension A	1.19 (30.2)	1.11 (28.2)
Dimension B	2.28 (57.9)	2.20 (55.9)
Dimension C	0.68 (17.3)	0.48 (12.2)

Contact Blocks Page 47-69
 Enclosures Pages 47-87 – 47-88
 Suffix Codes Page 47-98
 Discount Symbol 1CD1

Joystick Complete Devices Momentary and Maintained Joystick Switches

Table 47-85. Joystick Switches — UL (NEMA) Type 1, 2, 3, 4, 4X, 12, 13

	Position	Description	Catalog Number	Price U.S. \$
	2-Position	Momentary Joystick Switch Momentary Joystick Switch with Center Lock	EM22JS2Y2X EM22JS2Y4X	
		Maintained Joystick Switch Maintained Joystick Switch with Center Lock	EM22JS2Y3X EM22JS2Y5X	
	4-Position	Momentary Joystick Switch Momentary Joystick Switch with Center Lock	EM22JS4Y2X EM22JS4Y4X	
		Maintained Joystick Switch Maintained Joystick Switch with Center Lock	EM22JS4Y3X EM22JS4Y5X	

Note: Dimensions are listed on Page 47-89.

Table 47-86. Visual Aid Plates

Description	Catalog Number	Price U.S. \$
70 mm Diameter Oval — Black (Blank)	E22VA20	
70 mm Diameter Oval — Black with 2 Arrows	E22VA21	
70 mm Diameter Round — Black (Blank)	E22VA30	
70 mm Diameter Round — Black with 2 Arrows	E22VA31	
70 mm Diameter Round — Black with 4 Arrows	E22VA32	

Table 47-87. Contact Sequence for Two-Position Joystick

	Contact Blocks			Joystick Operator Position (X = Closed, O = Open)		
	Circuit	Location	Term No.	Up	Center	Down
$\frac{14}{24} / \frac{13}{23}$	NO	Top	14 – 13	O	O	X
	NO	Bottom	24 – 23	X	O	O



Table 47-88. Contact Sequence for Four-Position Joystick

	Contact Blocks				Joystick Operator Position (X = Closed, O = Open)				
	Circuit	Position	Location	Term No.	Up	Left	Center	Down	Right
$\frac{14}{24} / \frac{13}{23}$	NO	Front	Top	14 – 13	O	O	O	X	O
	NO	Front	Bottom	24 – 23	O	O	O	O	X
$\frac{34}{44} / \frac{33}{43}$	NO	Back	Top	34 – 33	X	O	O	O	O
	NO	Back	Bottom	44 – 43	O	X	O	O	O

EM22 Series — Joystick Components

EM22 Series, Joystick Components
Momentary and Maintained Joystick Operators

Table 47-89. Joystick Operators — UL (NEMA) Type 1, 2, 3, 4, 4X, 12, 13

	Position	Description	Catalog Number	Price U.S. \$
 <p>Standard</p>  <p>with Center Lock</p>	2-Position	Momentary Joystick Operator	EM22JS2Y2	
		Momentary Joystick Operator with Center Lock	EM22JS2Y4	
	4-Position	Maintained Joystick Operator	EM22JS2Y3	
		Maintained Joystick Operator with Center Lock	EM22JS2Y5	
	4-Position	Momentary Joystick Operator	EM22JS4Y2	
		Momentary Joystick Operator with Center Lock	EM22JS4Y4	
	4-Position	Maintained Joystick Operator	EM22JS4Y3	
		Maintained Joystick Operator with Center Lock	EM22JS4Y5	

Note: Dimensions are listed on **Page 47-89**. For Rear of Panel Extensions, see **Table 47-128** on **Page 47-94**.

Contact Block Selection/Application

Table 47-90. Joystick Operators



	Position	Description	Circuit	Catalog Number	Price U.S. \$
	2-Position	Joystick Contact Block Assembly	2NO	EM22JS2Y1	
	4-Position	Joystick Contact Block Assembly	4NO	EM22JS4Y1	

Table 47-91. Contact Sequence for Two-Position Joystick



	Contact Blocks			Joystick Operator Position (X = Closed, O = Open)		
	Circuit	Location	Term No.	Up	Center	Down
$\frac{14}{24} / \frac{13}{23}$	NO	Top	14 – 13	O	O	X
	NO	Bottom	24 – 23	X	O	O

Table 47-92. Contact Sequence for Four-Position Joystick

	Contact Blocks				Joystick Operator Position (X = Closed, O = Open)				
	Circuit	Position	Location	Term No.	Up	Left	Center	Down	Right
$\frac{14}{24} / \frac{13}{23}$	NO	Front	Top	14 – 13	O	O	O	X	O
	NO	Front	Bottom	24 – 23	O	O	O	O	X
$\frac{34}{44} / \frac{33}{43}$	NO	Back	Top	34 – 33	X	O	O	O	O
	NO	Back	Bottom	44 – 43	O	X	O	O	O

Contact Blocks

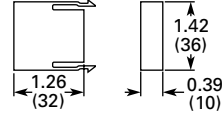
Table 47-93. Contact Blocks

	Description	Suffix Code ①	Catalog Number	Price U.S. \$	Approximate Dimensions in Inches (mm)
	1NC 1NO 1NO Early Make 1NC Late Break 1NC (Logic) 1NO (Logic) 1NC Added Spring Pressure	B A — — — — —	E22B1 ④ E22B2 E22B3 E22B4 ② E22B1E ③ E22B2E ③ E22BR1		Single Circuit
	1NO-1NC 2NO	W V	E22B11 ④ E22B20		Dual Circuit
	1 Self Monitoring 1NC	—	E22CB1M ④⑤		

- ① Add Suffix to operator Catalog Number to order as a complete device. Example E22PB1B = Flush Black pushbutton with 1NC contact block.
- ② E22B4 contact block not available for use with 5-way mounting adapter.
- ③ For low voltage applications.
- ④ Marked with Direct Opening Action (DOA) Symbol \ominus per IEC 60947-5-1 (Annex K) and NEMA ICS 5 (Part 6).
- ⑤ For use with Trigger Action Emergency Stop (E22LTA2) Operators.

⊕ Direct Opening Action (DOA) for IEC 60947-5-1 (Annex K) and NEMA ICS 5 (Part 6) Compliance

Table 47-94. Mechanical Operating Parameters of Operators with E22B1 and E22B11 (NC Contacts Only)

DOA Operating Parameters	Latching Trigger Action E-Stop		Pushbuttons				2-Position Push-Pull		3-Position Push-Pull				Key, Lever and Knob Selector Switches			
	E-Stop + E22B1	E-Stop + E22B11	25 mm + E22B1	25 mm + E22B11	Mush-room + E22B1	Mush-room + E22B11	2-Pos. Push-Pull + E22B1	2-Pos. Push-Pull + E22B11	Push + E22B1	Push + E22B11	Pull + E22B1	Pull + E22B11	Spring Return + E22B1	Spring Return + E22B11	Maintained + E22B1	Maintained + E22B11
Min. Travel to Open Contact — Inches (mm)	0.24 (6.1)	0.24 (6.1)	0.08 (2.1)	0.08 (2.1)	0.08 (2.1)	0.08 (2.1)	0.08 (2.1)	0.08 (2.1)	0.08 (2.1)	0.08 (2.1)	0.08 (2.1)	0.08 (2.1)	0.08 (2.1)	0.08 (2.1)	0.08 (2.1)	0.08 (2.1)
Min. Force to Open Contact — lb (N)	5.00 (22.24)	5.00 (22.24)	0.74 (3.27)	0.90 (4.00)	0.84 (3.74)	1.00 (4.45)	0	0	2.09 (9.31)	2.25 (10.02)	3.01 (13.37)	3.17 (14.08)	0.29 (1.29)	0.45 (2.00)	0.30 (1.34)	0.46 (2.05)
Total Travel — Inches (mm)	0.29 (7.4)	0.29 (7.4)	0.23 (5.8)	0.23 (5.8)	0.23 (5.8)	0.23 (5.8)	0.23 (5.8)	0.23 (5.8)	0.23 (5.8)	0.23 (5.8)	0.23 (5.8)	0.23 (5.8)	0.23 (5.8)	0.23 (5.8)	0.23 (5.8)	0.23 (5.8)

E22 and EM22 Series, Illuminated Components

Light Units and Lamps



E22 light units consist of two versions — standard size LED lamps and tall LED lamps. Select the standard LED light

units for all indicating lights, illuminated pushbuttons, push-push (alternate action) or double-headed pushbutton

operators. Select the tall LED light units for all illuminated selector switches and push-pull operators.

LED Light Units

Table 47-95. LED Light Units — Includes a T3-1/4 (BA9) Bayonet Base LED

	Type	Supply Voltage	LED Color	Suffix Code	Standard LED ①	Tall LED ①	Price US \$	
					Catalog Number	Catalog Number		
 Tall LED Light Unit  Standard LED Light Unit	Full Voltage	Unit without Lamp	—	X1	E22DE	E22DE		
		6V – 12V AC/DC	Red Green Yellow Blue White Orange	X37 X38 X39 X51 X89 X94	E22DL612R E22DL612G E22DL612Y E22DL612B E22DL612W E22DL612O	E22DLT612R E22DLT612G E22DLT612Y E22DLT612B E22DLT612W E22DLT612O		
		24V AC/DC	Red Green Yellow Blue White Orange	X40 X41 X42 X52 X90 X95	E22DL24R E22DL24G E22DL24Y E22DL24B E22DL24W E22DL24O	E22DLT24R E22DLT24G E22DLT24Y E22DLT24B E22DLT24W E22DLT24O		
		48V AC/DC	Red Green Yellow Blue White Orange	X53 X54 X55 X56 X91 X87	E22DL48R E22DL48G E22DL48Y E22DL48B E22DL48W E22DL48O	E22DLT48R E22DLT48G E22DLT48Y E22DLT48B E22DLT48W E22DLT48O		
		60V AC/DC	Red Green Yellow Blue White Orange	X57 X58 X59 X60 X97 X98	E22DL60R E22DL60G E22DL60Y E22DL60B E22DL60W E22DL60O	E22DLT60R E22DLT60G E22DLT60Y E22DLT60B E22DLT60W E22DLT60O		
		120V AC/DC	Red Green Yellow Blue White Orange	X43 X44 X45 X61 X92 X96	E22DL120R E22DL120G E22DL120Y E22DL120B E22DL120W E22DL120O	E22DLT120R E22DLT120G E22DLT120Y E22DLT120B E22DLT120W E22DLT120O		
	 Transformer Light Unit with Tall LED	Transformer AC Only	120V	Red	—	E22TL1LR	E22TL1TLR	
				Green	—	E22TL1LG	E22TL1TLG	
				Yellow	—	E22TL1LY	E22TL1TLY	
		Blue	—	E22TL1LB	E22TL1TLB			
		White	—	E22TL1LW	E22TL1TLW			
		Orange	—	E22TL1LO	E22TL1TLO			
240V		Red	—	E22TL2LR	E22TL2TLR			
		Green	—	E22TL2LG	E22TL2TLG			
		Yellow	—	E22TL2LY	E22TL2TLY			
Blue	—	E22TL2LB	E22TL2TLB					
White	—	E22TL2LW	E22TL2TLW					
Orange	—	E22TL2LO	E22TL2TLO					
480V	Red	—	E22TL4LR	E22TL4TLR				
	Green	—	E22TL4LG	E22TL4TLG				
	Yellow	—	E22TL4LY	E22TL4TLY				
Blue	—	E22TL4LB	E22TL4TLB					
White	—	E22TL4LW	E22TL4TLW					
Orange	—	E22TL4LO	E22TL4TLO					

① Select standard or tall LED based on Table 47-96.

Table 47-96. LED and Bulb Type Selection Chart

Illuminated Operator Type	Standard LED or Bulb	Tall LED or Bulb
Double-Headed Pushbuttons	✓	—
Indicating Lights	✓	—
Pushbuttons	✓	—
Push-Pull Operators	—	✓
Push-Push Pushbuttons	✓	—
Selector Switches	—	✓

Contact Blocks **Page 47-69**
 Suffix Codes **Page 47-98**
 Discount Symbol **1CD1**

Light Units and Lamps (Continued)

E22 light units consist of two versions — with standard bulb or with tall bulbs. Select the standard bulb light units for all indicating lights, illuminated push-buttons, push-push (alternate action) or

double-headed pushbutton operators. Select the tall bulb light units for all illuminated selector switches and push-pull operators.

Caution: Please note that 120V full voltage light units (E22D120) are only suitable for indicating light operators and will overheat in other operators.

Incandescent Light Units

Table 47-97. Incandescent Light Units — Includes a T3-1/4 (BA9) Bayonet Base Lamp (except when noted)

	Type	Supply Voltage 50/60 Hz	Lamp Voltage	Suffix Code	Standard Bulb ^①		Tall Bulb ^①		Price U.S. \$
					Catalog Number	Catalog Number	Catalog Number	Catalog Number	
	Full Voltage AC/DC	Unit without Lamp	—	X1	E22D	E22D	E22D	E22D	
		6	6	X2	E22D6	E22DT6	E22DT6	E22DT6	
		12	12	X3	E22D12	E22DT12	E22DT12	E22DT12	
		24	24	X4	E22D24	E22DT24	E22DT24	E22DT24	
		48	48	X6	E22D50	E22DT50	E22DT50	E22DT50	
		60	60	X7	E22D60	E22DT60	E22DT60	E22DT60	
		120	120	X8	E22D120 ^②	—	—	—	
		Resistor AC/DC	120	60	X10	E22R2	E22RT2	E22RT2	E22RT2
	Transformer AC Only	120	6	X11	E22TL1	E22TL1T	E22TL1T	E22TL1T	
		240	6	X12	E22TL2	E22TL2T	E22TL2T	E22TL2T	
380/415		6	X13	E22TL3	E22TL3T	E22TL3T	E22TL3T		
480		6	X14	E22TL4	E22TL4T	E22TL4T	E22TL4T		

^① Select standard or tall bulb based on **Table 47-98**.
^② E22D120 light units are suitable for indicating light operators only.

Table 47-98. LED and Bulb Type Selection Chart

Illuminated Operator Type	Standard LED or Bulb	Tall LED or Bulb
Double-Headed Pushbuttons	✓	—
Indicating Lights	✓	—
Pushbuttons	✓	—
Push-Pull Operators	—	✓
Push-Push Pushbuttons	✓	—
Selector Switches	—	✓

Table 47-99. PresTest Units — Includes Pre-wired 1NO-1NC Contact Blocks

	Type	Supply Voltage 50/60 Hz	Lamp Voltage	Light Suffix Code	Standard Bulb ^③		Tall Bulb ^③		Price U.S. \$
					Catalog Number	Catalog Number	Catalog Number	Catalog Number	
	Full Voltage AC/DC	Unit without Lamp	—	X17	E22D0C	E22D0C	E22D0C	E22D0C	
		24	24	X20	E22D24C	E22DT24C	E22DT24C	E22DT24C	
	Resistor AC/DC	120	60	X26	E22R2C	E22RT2C	E22RT2C	E22RT2C	
	Transformer AC Only	120	6	X27	E22TL1C	E22TL1C	E22TL1C	E22TL1C	
		240	6	X28	E22TL2C	E22TL2C	E22TL2C	E22TL2C	
		380/415	6	X29	E22TL3C	E22TL3C	E22TL3C	E22TL3C	
480		6	X30	E22TL4C	E22TL4C	E22TL4C	E22TL4C		

^③ Select standard or tall bulb based on **Table 47-98**.

Table 47-100. Master Packed Contact Blocks and Light Units

	Description	Catalog Number	Price U.S. \$
	Contact Blocks or Light Units Master Packed in Quantities of 100 Only — Contact Block 1NC (Available singly in Catalog as E22B1) Contact Block 1NO (Available singly in Catalog as E22B2) Light Unit without Lamp Full Voltage (Available singly in Catalog as E22D) Light Unit Resistor Type 120V 60 Hz (Available singly in Catalog as E22R2) Light Unit Transformer Type 120V 60 Hz (Available singly in Catalog as E22TL1)	E22AA6 E22AA7 E22AA12 E22AA24 E22AA11	

Contact Blocks **Page 47-69**
 Suffix Codes **Page 47-98**
 Discount Symbol **1CD1**

E22 and EM22 Series, Illuminated Components

Replacement LEDs and Bulbs — Standard Size

Table 47-101. Replacement LEDs for Indicating Lights, Illuminated Pushbuttons, Illuminated Push-Push Operators and Double-Headed Pushbuttons



	Voltage	Color	Continuous		Flashing		
			AC/DC	Price U.S. \$	AC	DC	Price U.S. \$
			Catalog Number		Catalog Number	Catalog Number	
 Standard LED Lamp	6V – 12V	Red Orange Yellow Green Blue White	E22LED612RN E22LED612ON E22LED612YN E22LED612GN E22LED612BN E22LED612WN		E22LED006RAF E22LED006OAF E22LED006YAF E22LED006GAF E22LED006BAF E22LED006WAF	E22LED006RDF E22LED006ODF E22LED006YDF E22LED006GDF E22LED006BDF E22LED006WDF	
	24V	Red Orange Yellow Green Blue White	E22LED024RN E22LED024ON E22LED024YN E22LED024GN E22LED024BN E22LED024WN		E22LED024RAF E22LED024OAF E22LED024YAF E22LED024GAF E22LED024BAF E22LED024WAF	E22LED024RDF E22LED024ODF E22LED024YDF E22LED024GDF E22LED024BDF E22LED024WDF	
	48V	Red Orange Yellow Green Blue White	E22LED048RN E22LED048ON E22LED048YN E22LED048GN E22LED048BN E22LED048WN		E22LED048RAF E22LED048OAF E22LED048YAF E22LED048GAF E22LED048BAF E22LED048WAF	E22LED048RDF E22LED048ODF E22LED048YDF E22LED048GDF E22LED048BDF E22LED048WDF	
	60V	Red Orange Yellow Green Blue White	E22LED060RN E22LED060ON E22LED060YN E22LED060GN E22LED060BN E22LED060WN		E22LED060RAF E22LED060OAF E22LED060YAF E22LED060GAF E22LED060BAF E22LED060WAF	E22LED060RDF E22LED060ODF E22LED060YDF E22LED060GDF E22LED060BDF E22LED060WDF	
	120V	Red Orange Yellow Green Blue White	E22LED120RN E22LED120ON E22LED120YN E22LED120GN E22LED120BN E22LED120WN		E22LED120RAF E22LED120OAF E22LED120YAF E22LED120GAF E22LED120BAF E22LED120WAF	E22LED120RDF E22LED120ODF E22LED120YDF E22LED120GDF E22LED120BDF E22LED120WDF	

Table 47-102. Replacement Bulbs — T3-1/4 (BA9) Bayonet Base Type for Indicating Lights, Illuminated Pushbuttons, Illuminated Push-Push Operators and Double-Headed Pushbuttons

Description	Mfg. Part Number	Operating Voltage (V)/ Wattage (W)	Catalog Number	Price U.S. \$
 Standard Incandescent Bulb	#755 #756 #1819 W1225 W1226 W1121	6V (0.9W) 12V (1.2W) 24V (1.2W) 48/50V (1.0W) 60V (1.2W) 120V (2.4W)	28-2202 28-5184 28-2468-24 28-2468-19 28-2468-20 28-2468-7	
	Neon ①	NE51H-R22 NE51H-R68	120 (0.3W) 240 (0.6W)	28-3754 28-3755

① Neon bulbs are suitable for use in indicating lights only. Not to be used with any operator.

Note: See Page 47-73 for Replacement LEDs and bulbs for Push-Pulls and selector switches.

Replacement LEDs and Bulbs — Tall Size

Table 47-103. Replacement Tall LEDs for Illuminated Selector Switches and Push-Pull Operators ONLY



	Voltage	Color	Continuous		Flashing		
			AC/DC	Price U.S. \$	AC	DC	Price U.S. \$
			Catalog Number		Catalog Number	Catalog Number	
 <p><i>Tall LED Lamp</i></p>	6V – 12V	Red Orange Yellow Green Blue White	E22LEDT612RN E22LEDT612ON E22LEDT612YN E22LEDT612GN E22LEDT612BN E22LEDT612WN		E22LEDT006RAF E22LEDT006OAF E22LEDT006YAF E22LEDT006GAF E22LEDT006BAF E22LEDT006WAF	E22LEDT006RDF E22LEDT006ODF E22LEDT006YDF E22LEDT006GDF E22LEDT006BDF E22LEDT006WDF	
	24V	Red Orange Yellow Green Blue White	E22LEDT024RN E22LEDT024ON E22LEDT024YN E22LEDT024GN E22LEDT024BN E22LEDT024WN		E22LEDT024RAF E22LEDT024OAF E22LEDT024YAF E22LEDT024GAF E22LEDT024BAF E22LEDT024WAF	E22LEDT024RDF E22LEDT024ODF E22LEDT024YDF E22LEDT024GDF E22LEDT024BDF E22LEDT024WDF	
	48V	Red Orange Yellow Green Blue White	E22LEDT048RN E22LEDT048ON E22LEDT048YN E22LEDT048GN E22LEDT048BN E22LEDT048WN		E22LEDT048RAF E22LEDT048OAF E22LEDT048YAF E22LEDT048GAF E22LEDT048BAF E22LEDT048WAF	E22LEDT048RDF E22LEDT048ODF E22LEDT048YDF E22LEDT048GDF E22LEDT048BDF E22LEDT048WDF	
	60V	Red Orange Yellow Green Blue White	E22LEDT060RN E22LEDT060ON E22LEDT060YN E22LEDT060GN E22LEDT060BN E22LEDT060WN		E22LEDT060RAF E22LEDT060OAF E22LEDT060YAF E22LEDT060GAF E22LEDT060BAF E22LEDT060WAF	E22LEDT060RDF E22LEDT060ODF E22LEDT060YDF E22LEDT060GDF E22LEDT060BDF E22LEDT060WDF	
	120V	Red Orange Yellow Green Blue White	E22LEDT120RN E22LEDT120ON E22LEDT120YN E22LEDT120GN E22LEDT120BN E22LEDT120WN		E22LEDT120RAF E22LEDT120OAF E22LEDT120YAF E22LEDT120GAF E22LEDT120BAF E22LEDT120WAF	E22LEDT120RDF E22LEDT120ODF E22LEDT120YDF E22LEDT120GDF E22LEDT120BDF E22LEDT120WDF	

Table 47-104. Replacement Tall Bulbs — T3-1/4 (BA9) Bayonet Base Type for Illuminated Selector Switches and Push-Pull Operators ONLY

Description	Operating Voltage (V)/ Wattage (W)	Catalog Number	Price U.S. \$
 <p><i>Tall Incandescent Bulb</i></p>	6V (1.0W)	28-6731	
	12V (1.2W)	28-6731-2	
	24V (1.2W)	28-6731-3	
	32V (1.2W)	28-6731-7	
	48V (1.0W)	28-6731-4	
	60V (1.2W)	28-6731-5	
	120V (2.2W)	28-6731-6	

Note: See Page 47-72 for Replacement LEDs and bulbs for indicating lights and pushbutton switches.









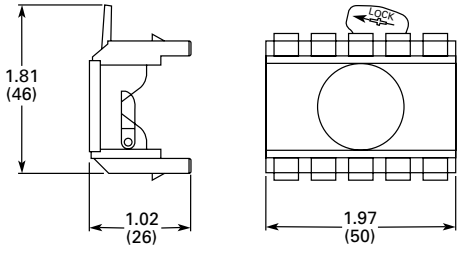

Accessories

Table 47-105. EM22 and E22 Series Accessories

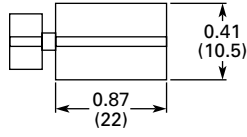
	Description	Catalog Number	Price U.S. \$	Overall Dimensions Inches (mm)
	Octagonal Wrench — For easy tightening of back-of-panel mounting nut on E22 (plastic) operators	E22CW		
	Octagonal Wrench — For easy tightening of back-of-panel mounting nut on EM22 (metal) operators	E22CWM		
	Bulb Removal Tool — To facilitate bulb removal from front of panel on all illuminated operators	E22BA3		
	Hole Cutting Tool — For 22.5 mm Diameter mounting hole. Maximum Thickness: Steel — 16 SWG (1.63 mm) Aluminum — 14 SWG (2.03 mm)	E22BA5		
	Hole Plug — Forms oil- and watertight seal for unused panel holes — UL Listed Type 4-4X-13 Black Nylon Stainless Steel	E22BHP E22BA8		
	Protective Boot — Silicon Rubber. For use with 25 mm Diameter Flush and Extended pushbutton operators only — Clear Red Green Black	E22BCM E22BRM E22BGM E22BBM		
	Enlarge Yellow Legend Plates ① — 1.77" (45 mm) Blank 1.77" (45 mm) Printed EMERGENCY STOP 2.56" (65 mm) Printed EMERGENCY STOP 2.56" (65 mm) Printed EMERGENCY OFF 2.56" (65 mm) Printed EMO 2.76" (70 mm) Blank 2.76" (70 mm) Printed EMERGENCY STOP 2.76" (70 mm) Printed EMERGENCY OFF 2.76" (70 mm) Printed EMO	E22VA2 E22VA9 E22VA7 E22VA6 E22VA3 E22VA1 E22VA8 E22VA4 E22VA5		
	Mounting Adapter — Supplied as standard with E22 operators. Provides contact block and light unit mounting.	E22BA1		
	Mounting Adapter with Barrier — Supplied as standard with E22 Trigger Action Emergency Stop Operators. Provides contact block unit mounting only.	E22BA7		
	Auto Latch Mounting Adapter — Supplied as standard with EM22 operators. Provides contact block and light unit mounting.	E22BA1A		

① Yellow plates comply with EN418 Machine Safety Standard background requirements for E-Stops.

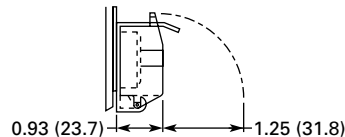
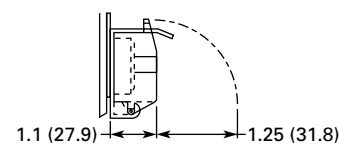
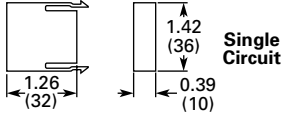

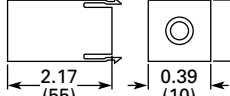

Table 47-105. EM22 and E22 Series Accessories (Continued)

	Description	Catalog Number	Price U.S. \$	Overall Dimensions Inch (mm)
	Mounting Adapter with Barrier — Supplied as standard with EM22 Trigger Action Emergency Stop Operators. Provides contact block unit mounting only.	E22BA7A		
	5-Way Mounting Adapter ① — Provides contact block and light unit mounting for up to 10 circuits. The standard 3-way mounting adapter E22BA1 allows up to 6 circuits. For non-illuminated PBs and 2-position selector switches For illuminated PBs and 2-position selector switches For non-illuminated 3-position selector switches with Cam #1 For illuminated 3-position selector switches with Cam #1 Additional information – See Page 47-77	E22BA11 E22BA11L E22BA12 E22BA12L		
	Operator Plug — Must be inserted into rear of momentary action pushbutton and mushroom head operators when 3rd Contact Block is installed in center position. Not to be used with maintained action or illuminated operators — minimum order quantity 10 pieces. To assemble, push plug into the rear of the operator. On mushroom operators, cut down the plug to 15.2 mm [0.62"] prior to assembly. Plug is notched to indicate cut down length.	E22BA2		
	Adapter Kit — Enables a 22.5 mm operator to be mounted in a 30.5 mm mounting hole — panel thickness from 1/16 to 7/32 inch (1.6 to 5.6 mm).	E22ARK		
	Locating Ring — Provides additional anti-rotation features when using optional panel mounting hole notch — minimum order quantity 10 pieces (metal)	E22LRM		
	Padlockable Transparent Cover — Suitable for use with 25 mm Flush and Extended Pushbutton operators only	E22PCM		
	Padlockable Transparent Cover — Suitable for use with 25 mm Extended Pushbutton operators only. Enables NC circuit to be held open.	E22PCPM		
	Padlockable Transparent Cover — Suitable for use with 28 mm Mushroom operators, Knob and Key Selector switches	E22BA9		
	Quick Connect Terminals — For easy installation of wired connections. 300V clearance. Minimum order quantity 10 pieces.	E22AT		

① 5-Way mounting adapters cannot be used with 3-position Push-Pull operators, Cam #2 3-position selector switches, trigger action E-Stops or E22B4/E22BF4 contact blocks.

EM22 and E22 Series, Accessories

Table 47-105. EM22 and E22 Series Accessories (Continued)

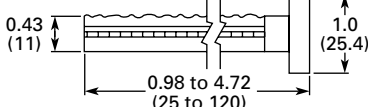
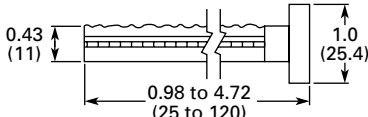
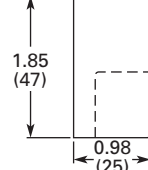
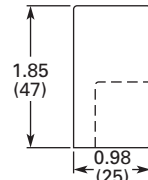
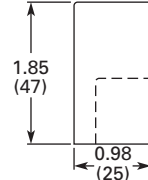
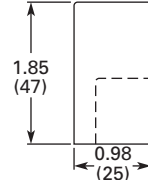
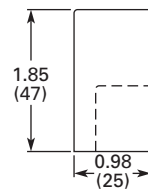
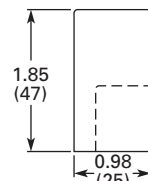
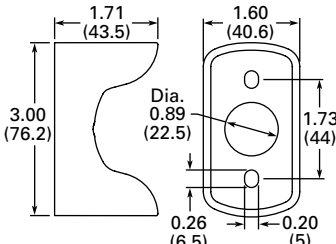
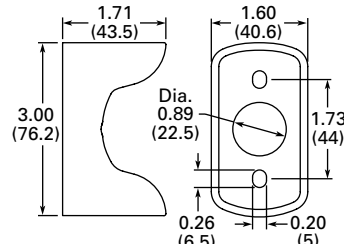
	Description	Catalog Number	Price U.S. \$	Overall Dimensions in Inches (mm)
	Contact Blocks with Quick Connect Terminal Assembled — 300V clearance — 1NC 1NO 1NO Early Make 1NC Late Break 1NO-1NC 2NO	E22BF1 E22BF2 E22BF3 E22BF4 ① E22BF11 E22BF20		 Single Circuit
	Light Units with Quick Connect Terminals Assembled ② — 300V clearance — Transformer Type AC Only — 120/110V, 60/50 Hz Resistor/Diode AC 120/110V Full Voltage AC/DC 24V Without Bulb	E22TLF1 E22RF2 E22DF24 E22DF		  Transformer Type Full Voltage & Resistor Types
	Mechanical Push Rod — For use with all non-illuminated pushbutton and momentary mushroom head operators. Suitable for external mechanical reset of overload relays. Must be cut to proper length. Uncut — 4.72 inches (119.9 mm) long	E22MRL		
	Mushroom Shroud ③ — Protects against inadvertent operation. Chrome shroud (cut-away type for use with push/pull pushbuttons) Black shroud (cut-away type for use with push/pull pushbuttons)	E22MSP E22MBSP		
	Mushroom Shroud ③ — Protects against inadvertent operation. Chrome shroud (cut-away type) Black shroud (cut-away type)	E22MS E22MBFS		
	Mushroom Shroud ③ — Protects against inadvertent operation. Chrome shroud (full type) Black shroud (full type)	E22MSF E22MBFSF		
	Mushroom Guard — For 40 mm Trigger Action Switch — To be used with E22LTA2 and E22LTA2N123 operators.	E22MGTA		

① E22BF4 contact block not available for use with 5-way mounting adapters.
② For devices not listed, contact your Eaton Distributor or call our Customer Service Center 1-800-833-3927.
③ For use with 28 mm and 40 mm diameter mushroom pushbutton operators.

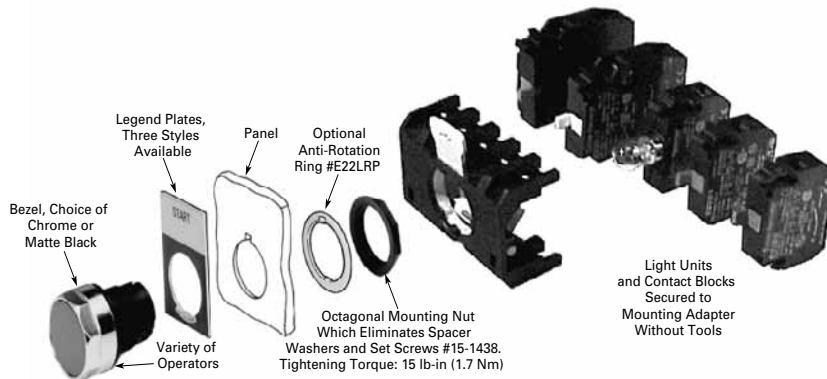

5-Way Mounting Adapter

5-Way Mounting Adapter

The E22 5-way mounting adapter listed below allows up to 5 single circuit or up to 5 double circuit contact blocks (10 total circuits) to be mounted behind a single operator.

Slightly more spacing (approximately 0.79 in. [20 mm]) is required for this mounting adapter as indicated in the Minimum Spacing table below.

For selector switch applications, the cam and contact blocks selection must be determined using the procedure and selection tables listed on **Pages 47-60 – 47-61**.

Table 47-106. Minimum Spacing — Inches (mm)

Size/Type of Operator	Dimension A			Dimension B
	Mounting Adapter Type(s)			
	Two 3-Way	One 3-Way & One 5-Way	Two 5-Way	
All Types up to 1.18 in. (30 mm) Dia. Including Knob and Key Operated Selector Switches — except those listed below	1.18 (30)	1.58 (40)	1.97 (50)	1.97 (50)
Lever Operated Selector Switch Operators and 1.18 – 1.57 in. (30 – 40 mm) Diameter Operators	1.77 (45)	1.77 (45)	1.97 (50)	1.97 (50)
1.97 in. (50 mm) Diameter Operators	2.16 (55)	2.16 (55)	2.16 (55)	2.16 (55)
Large Yellow Round Legend Plate — 2.76 in. (70 mm) Diameter	2.95 (75)	2.95 (75)	2.95 (75)	2.95 (75)
Pushbutton Operators fitted with Rubber Boots or Padlockable Cover	1.38 (35)	1.58 (40)	1.97 (50)	1.97 (50)

Table 47-107. 5-Way Mounting Adapter

Description	Catalog Number	Price U.S. \$
 <p>5-Way Mounting Adapter ① — Provides contact block and light unit mounting for up to 10 circuits. The standard 3-way mounting adapter E22BA1 allows up to 6 circuits. For non-illuminated PBs, 2-position selector switches and 2-position Push-Pulls For illuminated PBs, 2-position selector switches and 2-position Push-Pulls For non-illuminated 3-position selector switches with Cam #1 For illuminated 3-position selector switches with Cam #1</p>	<p>E22BA11 E22BA11L E22BA12 E22BA12L</p>	

① Cannot be used with 3-position Push-Pull operators, Cam #2 3-position selector switches, push-push operators, trigger action pushbutton or E22B4/E22BF4 contact blocks. See **Table 47-108**.

Table 47-108. 5-Way Mounting Adapter Selection Chart

Front of Panel Devices	Back of Panel Options			
	Non-illuminated		Illuminated	
	E22BA11	E22BA12	E22BA11L	E22BA12L
Flush and Extended Pushbuttons	✓	—	✓ ^②	—
28, 40, 50 mm Mushroom (Momentary)	✓	—	✓ ^②	—
50 mm Mushroom Latch (Pull-to-Release)	✓	—	✓ ^②	—
40 mm Mushroom Latch (Key Release)	✓ ^②	—	—	—
28 and 40 mm Mushroom Latch (Twist-to-Release)	✓ ^②	—	—	—
29.5 and 40 mm 2-Position Push-Pull	✓	—	✓ ^②	—
29.5 and 40 mm 3-Position Push-Pull	—	—	—	—
Double Headed Pushbutton	—	—	—	—
2-Position Selector Switch — Cam 2	✓	—	✓ ^②	—
3-Position Selector Switch — Cam 1	—	✓	—	✓ ^②
3-Position Selector Switch — Cam 2	—	—	—	—
Trigger Action Pushbutton	—	—	—	—
Push-Push Operator	—	—	—	—

② Four single circuit contact blocks maximum.

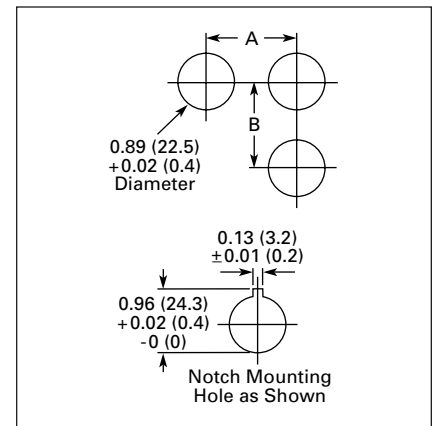

Figure 47-17. Minimum Spacing in Inches (mm)

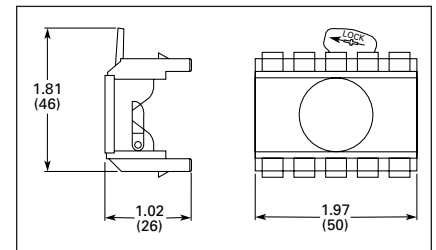

Figure 47-18. Overall Dimensions in Inches (mm)

E22 and EM22 Series, Accessories and Replacement Parts

Accessories (Continued)

Table 47-109. E22 Series Accessories (Continued)

Description		Catalog Number	Price U.S. \$
Octagonal Mounting Nut		15-1438	
	Molded Black Bezel — For converting chrome bezel to black bezel — Suitable for Knob, Lever and Key Selector Switches	E22AZB	
	Chrome Bezel — Suitable for Knob, Lever and Key Selector Switches	28-6028	
	Lenses with Octagonal Bezel for 25 mm Diameter Flush Illuminated Pushbutton — 10 per package, minimum order 10.	Red Green Blue Clear Amber White Yellow	E22ADR E22ADG E22ADV E22ADC E22ADA E22ADW E22ADY
	Lenses with Octagonal Bezel for 25 mm Diameter Extended Illuminated Pushbuttons — 10 per package, minimum order 10.	Red Green Blue Clear Amber White Yellow	E22AER E22AEG E22AEV E22AEC E22AEA E22AEW E22AEY
	Color Caps with Octagonal Bezel for Standard Non-illuminated 25 mm Diameter Flush Push-buttons — 10 per package, minimum order 10.	Red Green Blue White Yellow Black Gray Orange	E22ABR E22ABG E22ABV E22ABW E22ABY E22ABB E22ABE E22ABN
	Color Caps with Octagonal Bezel for Standard Non-illuminated 25 mm Diameter Extended Push-buttons — 10 per package, minimum order 10.	Red Green Blue White Yellow Black Gray Orange	E22ACR E22ACG E22ACV E22ACW E22ACY E22ACB E22ACE E22ACN

47

Replacement Parts

Table 47-110. Replacement Lenses — Indicating Lights

Color	Standard Indicating Light	For Use with Insert ①	Glass Lens	
	Catalog Number	Price U.S. \$	Catalog Number	Price U.S. \$
Clear	E22AE0		E22AG0	
Red	E22AE2		E22AG2	
Green	E22AE3		E22AG3	
Yellow	E22AE4		E22AG4	
White	E22AE5		E22AG5	
Blue	E22AE6		E22AG6	
Amber	E22AE9		E22AG9	
			E22AC0	
			E22AC2	
			E22AC3	
			E22AC4	
			E22AC5	
			E22AC6	
			E22AC9	

① Plastic indicating light lens with insert suitable for printed legends. For replacement Indicating Light Legend Inserts, order E22AL5. Minimum order quantity 10 pieces.

Table 47-111. Replacement Caps — Push-Pull





Description	1.16 Inches (29.5 mm)		1.57 Inches (40 mm)	
	Catalog Number	Price U.S. \$	Catalog Number	Price U.S. \$
Non-illuminated				
	Black Red Green Yellow White	E22AHS1 E22AHS2 E22AHS3 E22AHS4 E22AHS5		E22AH1 E22AH2 E22AH3 E22AH4 E22AH5
	Blue Gray Amber Red EMERGENCY STOP	E22AHS6 E22AHS7 E22AHS8 —		E22AH6 E22AH7 E22AH8 E22AH2N8
Illuminated				
	Clear Red Green Yellow White	E22AFS0 E22AFS2 E22AFS3 E22AFS4 E22AFS5		E22AF0 E22AF2 E22AF3 E22AF4 E22AF5
	Blue Amber Red EMERGENCY STOP	E22AFS6 E22AFS9 —		E22AF6 E22AF9 E22AF2N8

Table 47-112. Replacement Selector Switch Levers and Knobs

Color	Levers	Knobs	Price U.S. \$
			
	↖ ↗ ↘ ↙	↖ ↗ ↘ ↙	
	Catalog Number	Catalog Number	Catalog Number

Non-illuminated — 45° Throw

Black	E22AV1	E22AV21	E22AX1	E22AX21
Red	E22AV2	E22AV22	E22AX2	E22AX22
Green	E22AV3	E22AV23	E22AX3	E22AX23
Yellow	E22AV4	E22AV24	E22AX4	E22AX24
White	E22AV5	E22AV25	E22AX5	E22AX25
Blue	E22AV6	E22AV26	E22AX6	E22AX26
Gray	E22AV7	E22AV27	E22AX7	E22AX27
Orange	E22AV8	E22AV28	E22AX8	E22AX28

Illuminated — 45° Throw

Clear	E22AW0	E22AW20	E22AR0	E22AR20
Red	E22AW2	E22AW22	E22AR2	E22AR22
Green	E22AW3	E22AW23	E22AR3	E22AR23
Yellow	E22AW4	E22AW24	E22AR4	E22AR24
White	E22AW5	E22AW25	E22AR5	E22AR25
Blue	E22AW6	E22AW26	E22AR6	E22AR26
Amber	E22AW9	E22AW29	E22AR9	E22AR29

Non-illuminated — 60° Throw

Black	53-4122-36	53-4183-36	53-4185-36	53-4184-36
Red	53-4122-31	53-4183-31	53-4185-31	53-4184-31
Green	53-4122-32	53-4183-32	53-4185-32	53-4184-32
Yellow	53-4122-34	53-4183-34	53-4185-34	53-4184-34
White	53-4122-35	53-4183-35	53-4185-35	53-4184-35
Blue	53-4122-33	53-4183-33	53-4185-33	53-4184-33
Gray	53-4122-37	53-4183-37	53-4185-37	53-4184-37
Orange	53-4122-38	53-4183-38	53-4185-38	53-4184-38

Illuminated — 60° Throw

Clear	53-4122-26	53-4183-26	53-4185-26	53-4184-26
Red	53-4122-21	53-4183-21	53-4185-21	53-4184-21
Green	53-4122-22	53-4183-22	53-4185-22	53-4184-22
Yellow	53-4122-24	53-4183-24	53-4185-24	53-4184-24
White	53-4122-25	53-4183-25	53-4185-25	53-4184-25
Blue	53-4122-23	53-4183-23	53-4185-23	53-4184-23
Amber	53-4122-27	53-4183-27	53-4185-27	53-4184-27

Four- to Eight-Position Selector Switches — Non-illuminated

Black	53-2617-16	53-2620-16
-------	------------	------------

Discount Symbol 1CD1

Options

Legend Plates

Engraved Legend Plates with Standard Markings — 1/8" High Character Size

Aluminum — Aluminum legend plates have a plastisol backing to help prevent rotation of the operator when installed in an unnotched hole. Operators

installed with aluminum legend plates and legend plates with clip-in inserts maintain their UL Listed Type 4-4X-13 rating.

Plastic — Both the laminated plastic legend plates and legend plates with clip-in inserts offer the choice of four background colors. Either side of the legend plate or insert can be field engraved.

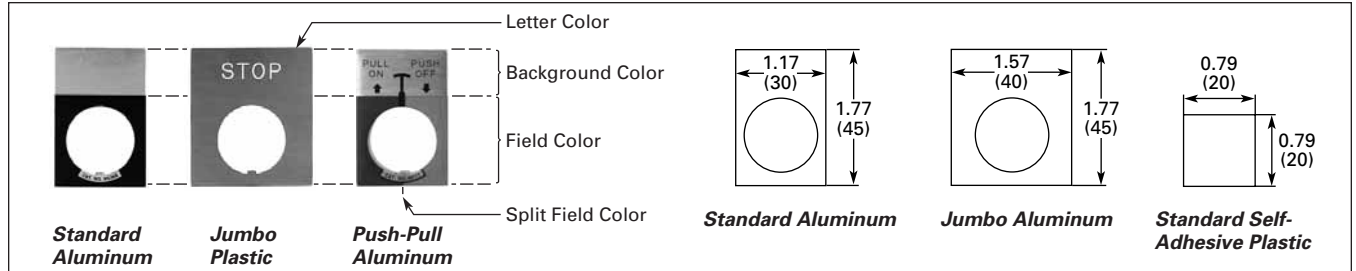

Figure 47-19. Color Diagram and Approximate Dimensions in Inches (mm)

Table 47-113. Engraved Legend Plates

Nameplate Type	Standard Aluminum with Plastisol Backing NEMA 3, 3R, 4, 4X, 12, 13 and Self-Adhesives used on Enclosures ①②		Standard Plastic, NEMA 1 Only ①			
Letter Color	Black	Black	White	White	Black	Black
Background Color	Silver	Silver	Black	Red	White	Silver
Field Color	Black	Red	Black	Red	White	Silver
Pushbutton						
	Price U.S. \$		Price U.S. \$			
(No Engraving)	E22NS36	E22NS37	E22NSP77	E22NSP77	E22NSP76	E22NSP76
CLAMP	E22NS90	—	E22NSP90	E22NSP90R	E22NSP90W	E22NSP90S
CLOSE	E22NS11	—	E22NSP11	E22NSP11R	E22NSP11W	E22NSP11S
DOWN	E22NS12	—	E22NSP12	E22NSP12R	E22NSP12W	E22NSP12S
EMERG. STOP	—	E22NS13	—	E22NSP13R	—	—
FAST	E22NS14	—	E22NSP14	E22NSP14R	E22NSP14W	E22NSP14S
FASTER	E22NS87	—	E22NSP87	E22NSP87R	E22NSP87W	E22NSP87S
FEEDER OFF	E22NS95	—	E22NSP95	E22NSP95R	E22NSP95W	E22NSP95S
FEEDER ON	E22NS94	—	E22NSP94	E22NSP94R	E22NSP94W	E22NSP94S
FOR	E22NS4	—	E22NSP4	E22NSP4R	E22NSP4W	E22NSP4S
FORWARD	E22NS15	—	E22NSP15	E22NSP15R	E22NSP15W	E22NSP15S
HIGH	E22NS16	—	E22NSP16	E22NSP16R	E22NSP16W	E22NSP16S
IN	E22NS17	—	E22NSP17	E22NSP17R	E22NSP17W	E22NSP17S
INCH	E22NS18	—	E22NSP18	E22NSP18R	E22NSP18W	E22NSP18S
JOG	E22NS19	—	E22NSP19	E22NSP19R	E22NSP19W	E22NSP19S

① To order Jumbo Legend Plates replace the 5th character with an L. For example E22NL87 is an aluminum, Jumbo Legend Plate marked "FASTER".
② To order self-adhesive legend plates replace the 5th character with a C. For example E22NC87 is a Self-Adhesive Legend Plate marked "FASTER".



Standard Size Aluminum



Jumbo Size Reversible Plastic



Standard Size Reversible Plastic



Self-Adhesive Plastic

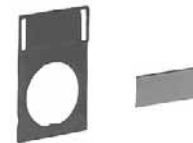





Standard Size Plastic with Clip-In Insert



Push-Pull Operators

E22 and EM22 Series, Legend Plates with Standard Markings

Table 47-113. Engraved Legend Plates (Continued)

Nameplate Type	Standard Aluminum with Plastisol Backing NEMA 3, 3R, 4, 4X, 12, 13 and Self-Adhesives used on Enclosures ①②  		Standard Plastic, NEMA 1 Only ①  			
Letter Color	Black	Black	White	White	Black	Black
Background Color	Silver	Silver	Black	Red	White	Silver
Field Color	Black	Red	Black	Red	White	Silver

Pushbutton (Cont.)

	Price U.S. \$		Price U.S. \$			
JOG FOR	E22NS96	—	E22NSP96	E22NSP96R	E22NSP96W	E22NSP96S
JOG REV	E22NS21	—	E22NSP21	E22NSP21R	E22NSP21W	E22NSP21S
LEFT	E22NS10	—	E22NSP10	E22NSP10R	E22NSP10W	E22NSP10S
LOW	E22NS22	—	E22NSP22	E22NSP22R	E22NSP22W	E22NSP22S
LOWER	E22NS23	—	E22NSP23	E22NSP23R	E22NSP23W	E22NSP23S
LUBE FAIL	E22NS92	—	E22NSP92	E22NSP92R	E22NSP92W	E22NSP92S
MOTOR RUN	E22NS81	—	E22NSP81	E22NSP81R	E22NSP81W	E22NSP81S
MOTOR RUNNING	E22NS56	—	E22NSP56	E22NSP56R	E22NSP56W	E22NSP56S
MOTOR STOP	E22NS82	—	E22NSP82	E22NSP82R	E22NSP82W	E22NSP82S
MOTOR STOPPED	E22NS57	—	E22NSP57	E22NSP57R	E22NSP57W	E22NSP57S
O	—	E22NS64	—	E22NSP64R	—	—
OFF	—	E22NS24	—	E22NSP24R	—	—
ON	E22NS25	—	E22NSP25	E22NSP25R	E22NSP25W	E22NSP25S
I	E22NS65	—	E22NSP65	E22NSP65R	E22NSP65W	E22NSP65S
OPEN	E22NS26	—	E22NSP26	E22NSP26R	E22NSP26W	E22NSP26S
OUT	E22NS27	—	E22NSP27	E22NSP27R	E22NSP27W	E22NSP27S
OVERLOAD TRIPPED	E22NS98	—	E22NSP98	E22NSP98R	E22NSP98W	E22NSP98S
OVERLOAD RESET	E22NS100	—	E22NSP100	E22NSP100R	E22NSP100W	E22NSP100S
POWER ON	E22NS80	—	E22NSP80	E22NSP80R	E22NSP80W	E22NSP80S
RAISE	E22NS28	—	E22NSP28	E22NSP28R	E22NSP28W	E22NSP28S
READY	E22NS86	—	E22NSP86	E22NSP86R	E22NSP86W	E22NSP86S
RESET	E22NS29	—	E22NSP29	E22NSP29R	E22NSP29W	E22NSP29S
REV	E22NS5	—	E22NSP5	E22NSP5R	E22NSP5W	E22NSP5S
REVERSE	E22NS30	—	E22NSP30	E22NSP30R	E22NSP30W	E22NSP30S
RIGHT	E22NS79	—	E22NSP79	E22NSP79R	E22NSP79W	E22NSP79S
RUN	E22NS31	—	E22NSP31	E22NSP31R	E22NSP31W	E22NSP31S
SAFE	E22NS85	—	E22NSP85	E22NSP85R	E22NSP85W	E22NSP85S
SLOW	E22NS32	—	E22NSP32	E22NSP32R	E22NSP32W	E22NSP32S
SLOWER	E22NS88	—	E22NSP88	E22NSP88R	E22NSP88W	E22NSP88S
START	E22NS33	—	E22NSP33	E22NSP33R	E22NSP33W	E22NSP33S
STOP	—	E22NS34	—	E22NSP34R	—	—
SUPPLY ON	E22NS61	—	E22NSP61	E22NSP61R	E22NSP61W	E22NSP61S
TEST	E22NS83	—	E22NSP83	E22NSP83R	E22NSP83W	E22NSP83S
TRANSFER	E22NS93	—	E22NSP93	E22NSP93R	E22NSP93W	E22NSP93S
TRIP	E22NS84	—	E22NSP84	E22NSP84R	E22NSP84W	E22NSP84S
UNCLAMP	E22NS91	—	E22NSP91	E22NSP91R	E22NSP91W	E22NSP91S
UP	E22NS35	—	E22NSP35	E22NSP35R	E22NSP35W	E22NSP35S

2-Position Selector Switch

INCH/REVERSE	E22NS59	—	E22NSP59	E22NSP59R	E22NSP59W	E22NSP59S
FOR/REV ↗	E22NS101	—	E22NSP101	E22NSP101R	E22NSP101W	E22NSP101S
FOR/REV ↘	E22NS38	—	E22NSP38	E22NSP38R	E22NSP38W	E22NSP38S
HAND/AUTO ↗	E22NS102	—	E22NSP102	E22NSP102R	E22NSP102W	E22NSP102S
HAND/AUTO ↘	E22NS39	—	E22NSP39	E22NSP39R	E22NSP39W	E22NSP39S
HIGH/LOW ↗	E22NS103	—	E22NSP103	E22NSP103R	E22NSP103W	E22NSP103S
HIGH/LOW ↘	E22NS40	—	E22NSP40	E22NSP40R	E22NSP40W	E22NSP40S
INCH/RUN ↗	E22NS114	—	E22NSP114	E22NSP114R	E22NSP114W	E22NSP114S
INCH/RUN ↘	E22NS60	—	E22NSP60	E22NSP60R	E22NSP60W	E22NSP60S
JOG/RUN ↗	E22NS104	—	E22NSP104	E22NSP104R	E22NSP104W	E22NSP104S
JOG/RUN ↘	E22NS41	—	E22NSP41	E22NSP41R	E22NSP41W	E22NSP41S
LEFT/RIGHT ↗	E22NS117	—	E22NSP117	E22NSP117R	E22NSP117W	E22NSP117S
LEFT/RIGHT ↘	E22NS66	—	E22NSP66	E22NSP66R	E22NSP66W	E22NSP66S
LOC/REM ↗	E22NS116	—	E22NSP116	E22NSP116R	E22NSP116W	E22NSP116S
LOC/REMOTE ↘	E22NS63	—	E22NSP63	E22NSP63R	E22NSP63W	E22NSP63S

① To order Jumbo Legend Plates replace the 5th character with an L. For example E22NL87 is an aluminum, Jumbo Legend Plate marked "FASTER".

② To order self-adhesive legend plates replace the 5th character with a C. For example E22NC87 is a Self-Adhesive Legend Plate marked "FASTER".

↗ Center to Right Throw — 45° or 60° travel.

↘ Left to Right Throw — 45° or 60° travel.

Discount Symbol 1CD1

E22 and EM22 Series, Legend Plates with Standard Markings

Table 47-113. Engraved Legend Plates (Continued)

Nameplate Type	Standard Aluminum with Plastisol Backing NEMA 3, 3R, 4, 4X, 12, 13 and Self-Adhesives used on Enclosures ①②		Standard Plastic, NEMA 1 Only ①			
Letter Color	Black	Black	White	White	Black	Black
Background Color	Silver	Silver	Black	Red	White	Silver
Field Color	Black	Red	Black	Red	White	Silver

2-Position Selector Switch (Cont.)

	Price U.S. \$		Price U.S. \$			
MAN/AUTO ↗	E22NS118	—	E22NSP118	E22NSP118R	E22NSP118W	E22NSP118S
MAN/AUTO ↘	E22NS67	—	E22NSP67	E22NSP67R	E22NSP67W	E22NSP67S
O/I ↗	E22NS120	—	E22NSP120	E22NSP120R	E22NSP120W	E22NSP120S
O/I ↘	E22NS122	—	E22NSP122	E22NSP122R	E22NSP122W	E22NSP122S
OFF/ON ↗	E22NS105	—	E22NSP105	E22NSP105R	E22NSP105W	E22NSP105S
OFF/ON ↘	E22NS42	—	E22NSP42	E22NSP42R	E22NSP42W	E22NSP42S
OPEN/CLOSE ↗	E22NS106	—	E22NSP106	E22NSP106R	E22NSP106W	E22NSP106S
OPEN/CLOSE ↘	E22NS43	—	E22NSP43	E22NSP43R	E22NSP43W	E22NSP43S
RUN/JOG ↗	E22NS107	—	E22NSP107	E22NSP107R	E22NSP107W	E22NSP107S
RUN/JOG ↘	E22NS44	—	E22NSP44	E22NSP44R	E22NSP44W	E22NSP44S
SAFE/RUN ↗	E22NS108	—	E22NSP108	E22NSP108R	E22NSP108W	E22NSP108S
SAFE/RUN ↘	E22NS45	—	E22NSP45	E22NSP45R	E22NSP45W	E22NSP45S
SEQ/TEST ↗	E22NS115	—	E22NSP115	E22NSP115R	E22NSP115W	E22NSP115S
SEQ/TEST ↘	E22NS62	—	E22NSP62	E22NSP62R	E22NSP62W	E22NSP62S
START/JOG ↗	E22NS109	—	E22NSP109	E22NSP109R	E22NSP109W	E22NSP109S
START/JOG ↘	E22NS46	—	E22NSP46	E22NSP46R	E22NSP46W	E22NSP46S
START/STOP ↗	E22NS110	—	E22NSP110	E22NSP110R	E22NSP110W	E22NSP110S
START/STOP ↘	E22NS47	—	E22NSP47	E22NSP47R	E22NSP47W	E22NSP47S
STOP/RESET ↗	—	E22NS112	—	E22NSP112R	—	—
STOP/RESET ↘	—	E22NS58	—	E22NSP58R	—	—
UP/DOWN ↗	E22NS111	—	E22NSP111	E22NSP111R	E22NSP111W	E22NSP111S
UP/DOWN ↘	E22NS48	—	E22NSP48	E22NSP48R	E22NSP48W	E22NSP48S

3-Position Selector Switch

AUTO/OFF/HAND	E22NS49	—	E22NSP49	E22NSP49R	E22NSP49W	E22NSP49S
FOR/OFF/REV	E22NS50	—	E22NSP50	E22NSP50R	E22NSP50W	E22NSP50S
FOR/SAFE/REV	E22NS69	—	E22NSP69	E22NSP69R	E22NSP69W	E22NSP69S
HAND/OFF/AUTO	E22NS51	—	E22NSP51	E22NSP51R	E22NSP51W	E22NSP51S
I/O/II	E22NS121	—	E22NSP121	E22NSP121R	E22NSP121W	E22NSP121S
MAN/OFF/AUTO	E22NS68	—	E22NSP68	E22NSP68R	E22NSP68W	E22NSP68S
ON/STOP/SAFE	—	E22NS71	—	E22NSP71R	—	—
OPEN/OFF/CLOSE	E22NS53	—	E22NSP53	E22NSP53R	E22NSP53W	E22NSP53S
RUN/SAFE/JOG	E22NS70	—	E22NSP70	E22NSP70R	E22NSP70W	E22NSP70S
UP/OFF/DOWN	E22NS54	—	E22NSP54	E22NSP54R	E22NSP54W	E22NSP54S

Push-Pulls Only ③

Pull-ON Push-OFF	—	E22NS73	E22NSP73	E22NSP73R	E22NSP73W	E22NSP73S
Pull-START Push-STOP	—	E22NS75	E22NSP75	E22NSP75R	E22NSP75W	E22NSP75S

① To order Jumbo Legend Plates replace the 5th character with an L. For example E22NL87 is an aluminum, Jumbo Legend Plate marked "FASTER".

② To order self-adhesive legend plates replace the 5th character with a C. For example E22NC87 is a Self-Adhesive Legend Plate marked "FASTER".

③ Field Color is Split, green on the left side, red on the right side.

↗ Center to Right Throw — 45° or 60° travel.

↘ Left to Right Throw — 45° or 60° travel.

E22 and EM22 Series, Legend Plates and Legend Plate Carriers

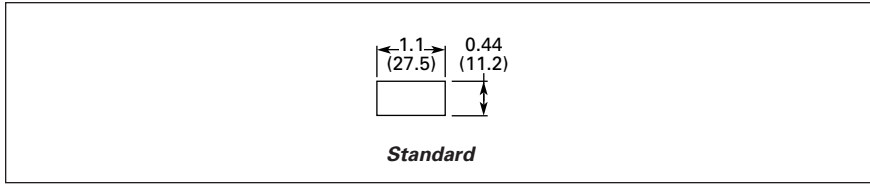



Figure 47-20. Approximate Dimensions in Inches (mm)

Table 47-114. Legend Plates and Legend Plate Carriers

Nameplate Type	Plastic with Clip-In Insert without Carrier NEMA 3, 3R, 4, 4X, 12, 13			
				
	Legend Plate Price U.S. \$...		Legend Plate Carrier Price U.S. \$...	
Letter Color	White	White	Black	Black
Background Color	Black	Red	White	Silver
Field Color	Black	Red	White	Silver

Pushbutton

Legend Plate Carrier ①	E22ND			
(No Engraving)	E22ND77	E22ND77	E22ND76	E22ND76
CLAMP	E22ND90	E22ND90R	E22ND90W	E22ND90S
CLOSE	E22ND11	E22ND11R	E22ND11W	E22ND11S
DOWN	E22ND12	E22ND12R	E22ND12W	E22ND12S
EMERG. STOP	—	E22ND13R	—	—
FAST	E22ND14	E22ND14R	E22ND14W	E22ND14S
FASTER	E22ND87	E22ND87R	E22ND87W	E22ND87S
FEED OFF	E22ND95	E22ND95R	E22ND95W	E22ND95S
FEEDER ON	E22ND94	E22ND94R	E22ND94W	E22ND94S
FOR	E22ND4	E22ND4R	E22ND4W	E22ND4S
FORWARD	E22ND15	E22ND15R	E22ND15W	E22ND15S
HIGH	E22ND16	E22ND16R	E22ND16W	E22ND16S
IN	E22ND17	E22ND17R	E22ND17W	E22ND17S
INCH	E22ND18	E22ND18R	E22ND18W	E22ND18S
JOG	E22ND19	E22ND19R	E22ND19W	E22ND19S
JOG FOR	E22ND96	E22ND96R	E22ND96W	E22ND96S
JOG REV	E22ND21	E22ND21R	E22ND21W	E22ND21S
LEFT	E22ND10	E22ND10R	E22ND10W	E22ND10S
LOW	E22ND22	E22ND22R	E22ND22W	E22ND22S
LOWER	E22ND23	E22ND23R	E22ND23W	E22ND23S
LUBE FAIL	E22ND92	E22ND92R	E22ND92W	E22ND92S
MOTOR RUN	E22ND81	E22ND81R	E22ND81W	E22ND81S
MOTOR RUNNING	E22ND56	E22ND56R	E22ND56W	E22ND56S
MOTOR STOP	E22ND82	E22ND82R	E22ND82W	E22ND82S
MOTOR STOPPED	E22ND57	E22ND57R	E22ND57W	E22ND57S
O	—	E22ND64R	—	—
OFF	—	E22ND24R	—	—
ON	E22ND25	E22ND25R	E22ND25W	E22ND25S
I	E22ND65	E22ND65R	E22ND65W	E22ND65S
OPEN	E22ND26	E22ND26R	E22ND26W	E22ND26S
OUT	E22ND27	E22ND27R	E22ND27W	E22ND27S
OVERLOAD TRIPPED	E22ND98	E22ND98R	E22ND98W	E22ND98S
OVERLOAD RESET	E22ND100	E22ND100R	E22ND100W	E22ND100S
POWER ON	E22ND80	E22ND80R	E22ND80W	E22ND80S
RAISE	E22ND28	E22ND28R	E22ND28W	E22ND28S
READY	E22ND86	E22ND86R	E22ND86W	E22ND86S
RESET	E22ND29	E22ND29R	E22ND29W	E22ND29S
REV	E22ND5	E22ND5R	E22ND5W	E22ND5S
REVERSE	E22ND30	E22ND30R	E22ND30W	E22ND30S
RIGHT	E22ND79	E22ND79R	E22ND79W	E22ND79S
RUN	E22ND31	E22ND31R	E22ND31W	E22ND31S
SAFE	E22ND85	E22ND85R	E22ND85W	E22ND85S
SLOW	E22ND32	E22ND32R	E22ND32W	E22ND32S
SLOWER	E22ND88	E22ND88R	E22ND88W	E22ND88S
START	E22ND33	E22ND33R	E22ND33W	E22ND33S

① One carrier required for each clip-in insert.

Table 47-114. Legend Plates and Legend Plate Carriers (Continued)

Nameplate Type	Plastic with Clip-In Insert without Carrier NEMA 3, 3R, 4, 4X, 12, 13			
				
	Legend Plate Price U.S. \$... Legend Plate Carrier Price U.S. \$...			
Letter Color	White	White	Black	Black
Background Color	Black	Red	White	Silver
Field Color	Black	Red	White	Silver

Pushbutton (Cont.)

STOP	—	E22ND34R	—	—
SUPPLY ON	E22ND61	E22ND61R	E22ND61W	E22ND61S
TEST	E22ND83	E22ND83R	E22ND83W	E22ND83S
TRANSFER	E22ND93	E22ND93R	E22ND93W	E22ND93S
TRIP	E22ND84	E22ND84R	E22ND84W	E22ND84S
UNCLAMP	E22ND91	E22ND91R	E22ND91W	E22ND91S
UP	E22ND35	E22ND35R	E22ND35W	E22ND35S

2-Position Selector Switch

INCH/REVERSE	E22ND59	E22ND59R	E22ND59W	E22ND59S
FOR/REV ↗	E22ND101	E22ND101R	E22ND101W	E22ND101S
FOR/REV ↘	E22ND38	E22ND38R	E22ND38W	E22ND38S
HAND/AUTO ↗	E22ND102	E22ND102R	E22ND102W	E22ND102S
HAND/AUTO ↘	E22ND39	E22ND39R	E22ND39W	E22ND39S
HIGH/LOW ↗	E22ND103	E22ND103R	E22ND103W	E22ND103S
HIGH/LOW ↘	E22ND40	E22ND40R	E22ND40W	E22ND40S
INCH/RUN ↗	E22ND114	E22ND114R	E22ND114W	E22ND114S
INCH/RUN ↘	E22ND60	E22ND60R	E22ND60W	E22ND60S
JOG/RUN ↗	E22ND104	E22ND104R	E22ND104W	E22ND104S
JOG/RUN ↘	E22ND41	E22ND41R	E22ND41W	E22ND41S
LEFT/RIGHT ↗	E22ND117	E22ND117R	E22ND117W	E22ND117S
LEFT/RIGHT ↘	E22ND66	E22ND66R	E22ND66W	E22ND66S
LOC/REM ↗	E22ND116	E22ND116R	E22ND116W	E22ND116S
LOC/REMOTE ↘	E22ND63	E22ND63R	E22ND63W	E22ND63S
MAN/AUTO ↗	E22ND118	E22ND118R	E22ND118W	E22ND118S
MAN/AUTO ↘	E22ND67	E22ND67R	E22ND67W	E22ND67S
O/I ↗	E22ND120	E22ND120R	E22ND120W	E22ND120S
O/I ↘	E22ND122	E22ND122R	E22ND122W	E22ND122S
OFF/ON ↗	E22ND105	E22ND105R	E22ND105W	E22ND105S
OFF/ON ↘	E22ND42	E22ND42R	E22ND42W	E22ND42S
OPEN/CLOSE ↗	E22ND106	E22ND106R	E22ND106W	E22ND106S
OPEN/CLOSE ↘	E22ND43	E22ND43R	E22ND43W	E22ND43S
RUN/JOG ↗	E22ND107	E22ND107R	E22ND107W	E22ND107S
RUN/JOG ↘	E22ND44	E22ND44R	E22ND44W	E22ND44S
SAFE/RUN ↗	E22ND108	E22ND108R	E22ND108W	E22ND108S
SAFE/RUN ↘	E22ND45	E22ND45R	E22ND45W	E22ND45S
SEQ/TEST ↗	E22ND115	E22ND115R	E22ND115W	E22ND115S
SEQ/TEST ↘	E22ND62	E22ND62R	E22ND62W	E22ND62S
START/JOG ↗	E22ND109	E22ND109R	E22ND109W	E22ND109S
START/JOG ↘	E22ND46	E22ND46R	E22ND46W	E22ND46S
START/STOP ↗	E22ND110	E22ND110R	E22ND110W	E22ND110S
START/STOP ↘	E22ND47	E22ND47R	E22ND47W	E22ND47S
STOP/RESET ↗	—	E22ND112R	—	—
STOP/RESET ↘	—	E22ND58R	—	—
UP/DOWN ↗	E22ND111	E22ND111R	E22ND111W	E22ND111S
UP/DOWN ↘	E22ND48	E22ND48R	E22ND48W	E22ND48S

3-Position Selector Switch

AUTO/OFF/HAND	E22ND49	E22ND49R	E22ND49W	E22ND49S
FOR/OFF/REV	E22ND50	E22ND50R	E22ND50W	E22ND50S
FOR/SAFE/REV	E22ND69	E22ND69R	E22ND69W	E22ND69S
HAND/OFF/AUTO	E22ND51	E22ND51R	E22ND51W	E22ND51S
I/O/II	E22ND121	E22ND121R	E22ND121W	E22ND121S
MAN/OFF/AUTO	E22ND68	E22ND68R	E22ND68W	E22ND68S
ON/STOP/SAFE	—	E22ND71R	—	—
OPEN/OFF/CLOSE	E22ND53	E22ND53R	E22ND53W	E22ND53S
RUN/SAFE/JOG	E22ND70	E22ND70R	E22ND70W	E22ND70S
UP/OFF/DOWN	E22ND54	E22ND54R	E22ND54W	E22ND54S

↗ Center to Right Throw — 45° or 60° travel.

↘ Left to Right Throw — 45° or 60° travel.

E22 and EM22 Series, Legend Plates with Non-standard Markings

Legend Plates with Non-standard Markings When Ordering Specify

- Catalog Number of Blank Legend Plate from previous page plus suffix "STAMP", and describe special engraving in Block Letters.
- Insert the following in Order Notes:
 - Character Size — 3/32, 1/8 or 3/16 inch (2.4, 3.2 or 4.8 mm)
 - Field Color of Plastic Legend Plates or Insert types.
 - Line location by Number(s) (1 – 17) and legend desired

Note: If legends are required in line locations not specified, drawing must be supplied with order.

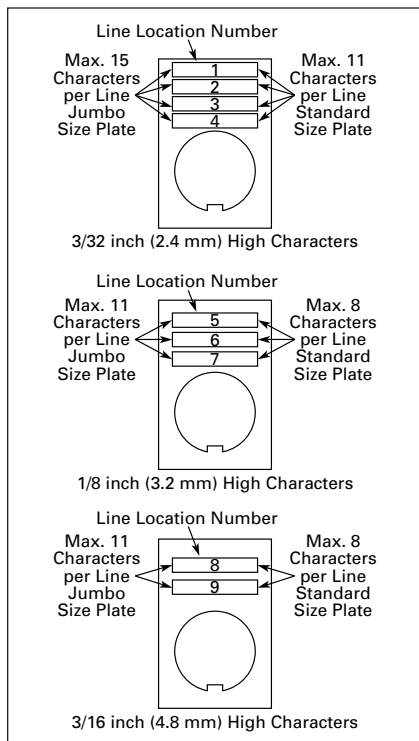

Figure 47-21. Aluminum and Plastic Legend Plates

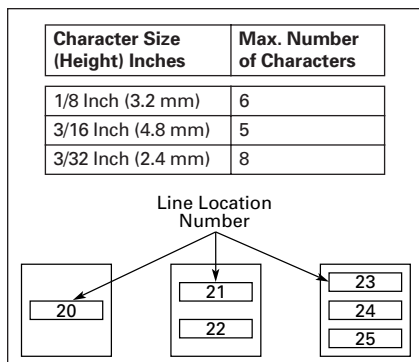

Figure 47-22. Enclosure Legend Plates — Self-Adhesive

Table 47-115. Ordering Examples

Description	Catalog Number	Price U.S. \$
Aluminum		
Letter Size: 1/8 in. (3.2 mm) Location: 5 — POWER 6 — HOUSE 7 — PUMP	E22NS36STAMP	
Plastic		
Letter Size: 3/16 in. (4.8 mm) Field Color: White Location: 8 — FEEDER 9 — OPEN	E22NLP76STAMP	

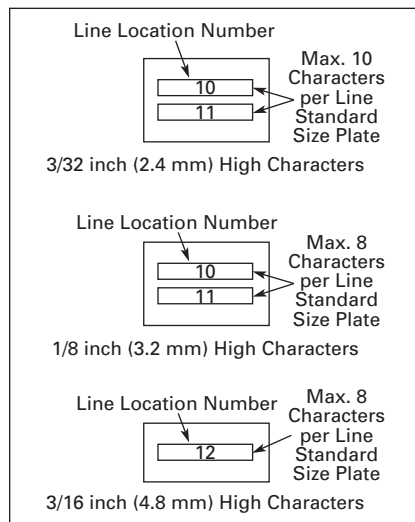

Figure 47-23. Insert Type Plates

Table 47-116. Type of Legend Plate (Used on Selector Switch)

Description	Character Size (Height)		
	3/32 Inch (2.4 mm)	1/8 Inch (3.2 mm)	3/16 Inch (4.8 mm)
Aluminum or Plastic Standard Size	5	3	3
Jumbo Size	7	5	5
Insert Type: Standard Size	5	3	—

Table 47-117. Legend Characters Available

ABCDEFGHIJKLMNOPQRSTUVWXYZ /-,1234567890

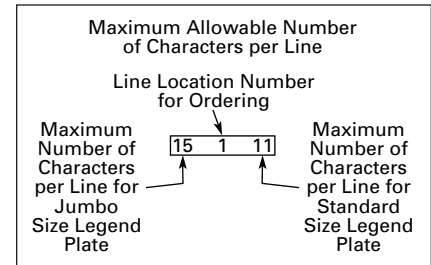

Figure 47-24. How to Use Illustrations

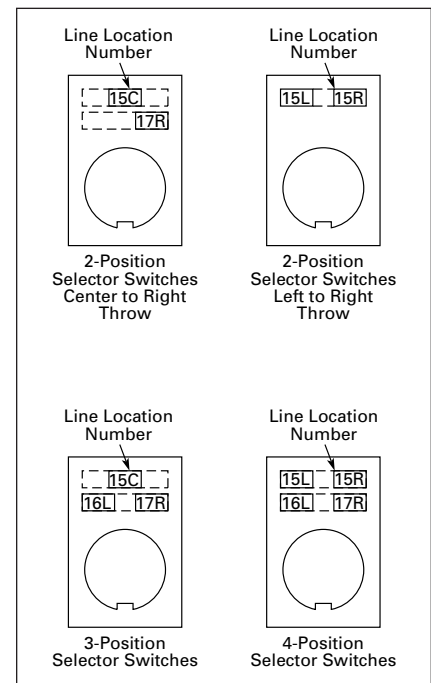

Figure 47-25. Selector Switch Legend Plates

Printed Legends

For Indicating Lights, Illuminated and Non-illuminated Pushbuttons, and 1.10, 1.57 and 1.97" (28, 40 and 50 mm) (Plastic) Diameter Mushroom Head Operators.

How To Order:

Select legend required from listing below and add Suffix Code Number to Catalog Number of operator. Example: E22A2N25 — Red indicating light with insert printed "ON."

Price Adder:

U.S. \$ —



Cat. No. E22A6N5



Cat. No. E22EB2N35

Table 47-118. Printed Legends

Legend ①	Suffix Code Number	Legend ①	Suffix Code Number	Legend ①	Suffix Code Number
FOR	N4	RESET	N29	(Emergency Stop)	N125
REV	N5	RUN	N31	(Start)	N887
	N6	START	N33	(Stop)	N888
	N7	STOP	N34	(Jog)	N889
CLOSE	N11	UP	N35	(Reset)	N890
INCH	N18	0 (Off)	N64		N892
JOG	N19	(On)	N65		N893
OFF	N24	POWER ON	N80		N894
ON	N25	READY	N86		N895
OPEN	N26	(Push-Push)	N124		N896

① Additional legends and symbols are listed in **Table 47-113** on **Pages 47-79 – 47-81** — to order as printed legend, add prefix **N** to listed Code Number and follow instructions on how to order above. A one-time set-up charge will apply to all orders for non-listed, special legends.

E22 and EM22 Series, Legend Plates for Four- to Eight-Position Selector Switch

Legend Plates for Selector Switches

Blank Plastic Legend Plates — Reversible

Legend plates without text. Black one side, red reverse side. White text.

Table 47-119. Blank and Custom Legend Plates

Size Inches (mm)	Catalog Number	Price U.S. \$
------------------	----------------	---------------

Blank

1.77 x 1.77 (45 x 45) 2.36 x 2.36 (60 x 60)	E22NJP36 E22NGP36	
--	----------------------	--

Custom Engraved [Ⓢ]

1.77 x 1.77 (45 x 45) 2.36 x 2.36 (60 x 60)	E22NJP36STAMP E22NGP36STAMP	
--	--------------------------------	--

[Ⓢ] Custom Engraved Legend Plates have the Suffix **STAMP** added to the Catalog Number.

Non-standard Legends

To order custom engraved legend plates, specify field color, add suffix “**STAMP**” to Blank Plate Catalog Number and specify desired engraving for each position.

Example: E22NGP36**STAMP**,
OFF - PUMP 1 - PUMP 2 -
PUMP 3 - PUMP 4, Black field.

Legend Plates with Standard Text

Legend plates have a black background with white lettering.

Table 47-121. Legend Plates with Standard Text

Size Inches (mm)	Switch Positions	Catalog Number	Price U.S. \$
1.77 x 1.77 (45 x 45) 2.36 x 2.36 (60 x 60)		E22NJP215 E22NGP215	
1.77 x 1.77 (45 x 45) 2.36 x 2.36 (60 x 60)		E22NJP216 E22NGP216	
1.77 x 1.77 (45 x 45) 2.36 x 2.36 (60 x 60)		E22NJP217 E22NGP217	
1.77 x 1.77 (45 x 45) 2.36 x 2.36 (60 x 60)		E22NJP218 E22NGP218	
1.77 x 1.77 (45 x 45) 2.36 x 2.36 (60 x 60)		E22NJP219 E22NGP219	
1.77 x 1.77 (45 x 45) 2.36 x 2.36 (60 x 60)		E22NJP210 E22NGP210	
1.77 x 1.77 (45 x 45) 2.36 x 2.36 (60 x 60)		E22NJP211 E22NGP211	
1.77 x 1.77 (45 x 45) 2.36 x 2.36 (60 x 60)		E22NJP212 E22NGP212	
1.77 x 1.77 (45 x 45) 2.36 x 2.36 (60 x 60)		E22NJP213 E22NGP213	
1.77 x 1.77 (45 x 45) 2.36 x 2.36 (60 x 60)		E22NJP214 E22NGP214	

47

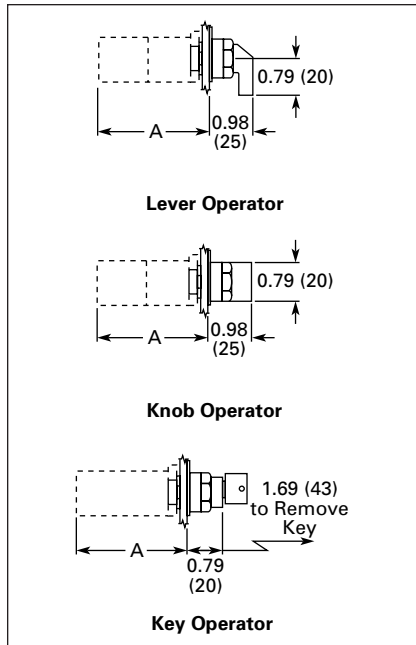

Figure 47-26. Approximate Dimensions in Inches (mm)

Table 47-120. Selector Switch Dimensions

Number of Circuits	Dimension A Inches (mm)
1 - 2	2.83 (72)
3 - 4	3.31 (84)
5 - 6	3.78 (96)
7 - 8	4.25 (108)

Discount Symbol 1CD1







E22 and EM22 Series, Enclosures

Enclosures

These totally insulated, NEMA 4, 4X, 12, 13 rated polycarbonate enclosures are available in 1, 2, 3, 4, 6 and 9 hole configurations in single or double depth.

Note: For mounting dimensions and limitations see **Pages 47-88 and 47-94.**

Table 47-122. Enclosures — UL (NEMA) 4, 4X, 12, 13

Cover Holes, Centerlines and Legend Plate Selection	Usable Depth Inches (mm)	Catalog Number	Price U.S. \$
 <p>Will Accommodate 2.65 Inch (65 mm) Legend Plates Listed on Page 47-74 With Conduit Opening in Rear of Enclosure</p>	2.5 (64) 3.4 (87)	E22CSP1 E22CDP1 E22CDP1R	
 <p>With Safety Yellow Cover With Conduit Opening in Rear of Enclosure</p>	2.2 (57) 3.15 (80)	E22CSP1Y ① E22CDP1Y ① E22CDP1RY	
 <p>1.42 inch (36 mm) Will Accommodate Self-Adhesive Legend Plates Listed on Pages 47-79 – 47-81</p>	2.2 (57) 3.15 (80)	E22CSP2 E22CDP2	
 <p>1.42 inch (36 mm) Will Accommodate Self-Adhesive Legend Plates Listed on Pages 47-79 – 47-81</p>	2.2 (57) 3.15 (80)	E22CSP3 E22CDP3	
 <p>1.18 inch (30 mm) Will Accommodate Self-Adhesive Legend Plates Listed on Pages 47-79 – 47-81</p>	2.2 (57) 3.15 (80)	E22CSP4 E22CDP4	
 <p>Vertical 1.38 inch (35 mm) Horizontal 1.89 inch (48 mm) Will Accommodate Aluminum & Plastic Legend Plates Listed on Pages 47-79 – 47-81</p>	3.15 (80)	E22CDP6	
 <p>Vertical 1.97 inch (50 mm) Horizontal 1.38 inch (35 mm) Will Accommodate Aluminum & Plastic Legend Plates Listed on Pages 47-79 – 47-81</p>	3.15 (80)	E22CDP9	

① Yellow covers comply with background requirements for EN418 Safety of Machinery Standard.

E22 and EM22 Series, Enclosures

Table 47-123. Enclosure Approximate Dimensions in Inches (mm)

No. of Elements	Outside Dimension				Mounting	
	A	B	C	D	E	F
1	2.68 (68)	2.96 (75)	2.36 (60)	3.54 (90)	2.24 (57)	1.81 (46)
2	3.15 (80)	4.72 (120)	2.36 (60)	3.54 (90)	1.97 (50)	4.09 (108)
3 or 4	3.15 (80)	6.30 (160)	2.36 (60)	3.54 (90)	1.97 (50)	5.82 (148)
6	4.72 (120)	4.80 (122)	—	3.35 (85)	3.54 (90)	4.33 (110)
9	4.72 (120)	7.87 (200)	—	3.54 (90)	3.54 (90)	7.40 (188)

Operator Mounting Dimensions

- Front of Panel — See *Product Selection — Components*
- Rear of Panel — See **Page 47-94**

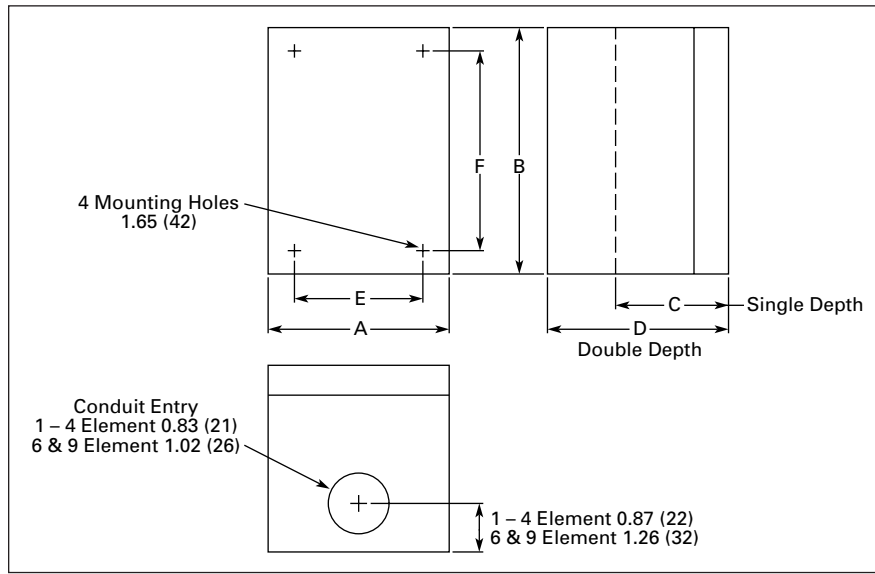

Figure 47-27. Enclosure Dimensions in Inches (mm)

Enclosure Component Application Table

Use the table below to determine which operators will or will not fit in a specific enclosure. For example, a 50 mm mushroom head pushbutton operator will only fit in a 1-hole Cutler-Hammer enclosure.

Table 47-124. Enclosure Component Application

	Number of Holes in Enclosure					
	1	2 ^④	3 ^④	4 ^④	6 ^④	9 ^⑤
Mushroom Head Pushbuttons						
1.14 inch (29 mm)	Yes	Yes	Yes	Yes	Yes	Yes
1.57 inch (40 mm)	Yes	Yes ^①	Yes ^①	Yes ^①	Yes ^①	Yes ^①
1.97 inch (50 mm)	Yes	No	No	No	No	No
Push-Pull Operators						
1.14 inch (29 mm)	Yes	Yes	Yes	Yes	Yes	Yes
1.57 inch (40 mm)	Yes	Yes ^①	Yes ^①	Yes ^①	Yes ^①	Yes ^①
Selector Switch Operators						
Knob	Yes	Yes	Yes	Yes	Yes	Yes
Lever — Vertical ^③	Yes	Yes ^②	Yes ^②	Yes ^②	Yes ^①	Yes ^①
Lever — Horizontal ^③	Yes	Yes ^①	Yes ^①	Yes ^①	Yes ^②	Yes ^②
Key	Yes	Yes	Yes	Yes	Yes	Yes
Illuminated Operators						
With Transformer	No	No	No	No	No	No
5-Way Adapter	Yes	Yes	Yes	Yes	No	No
Over-Sized Yellow Legend Plate						
45 mm	Yes	No	No	No	No	No
70 mm	Yes	No	No	No	No	No

- ① When installed next to standard-sized operator only.
- ② When installed in the bottom position only.
- ③ With conduit entrance at bottom.
- ④ With components mounted horizontally.
- ⑤ With components mounted vertically.

Approximate Dimensions

Note: Approximate dimensions in Inches (mm). For Rear of Panel Extensions. See **Table 47-128** on **Page 47-94**.

Non-illuminated Pushbutton Components

Illuminated Pushbutton Components

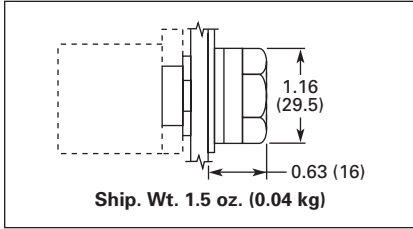

Figure 47-28. E22/EM22 Series 25 mm Dia. Flush Button

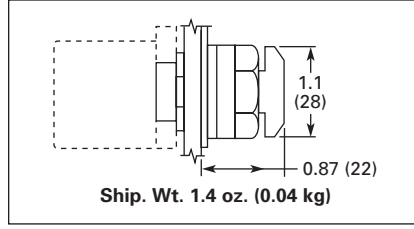

Figure 47-31. E22/EM22 Series 28 mm Dia. Mushroom Head Button

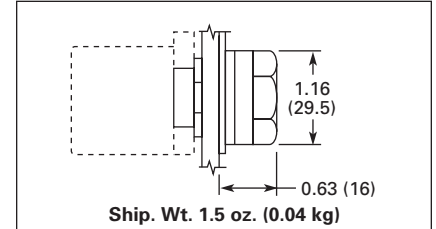

Figure 47-34. E22/EM22 Series 25 mm Dia. Flush Lens

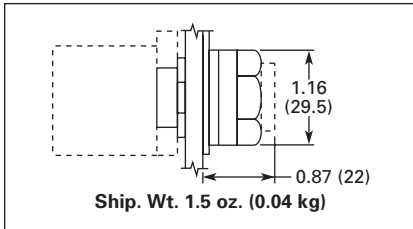

Figure 47-29. E22/EM22 Series 25 mm Dia. Extended Button

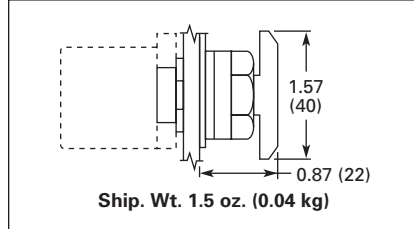

Figure 47-32. E22/EM22 Series 40 mm Dia. Mushroom Head Button

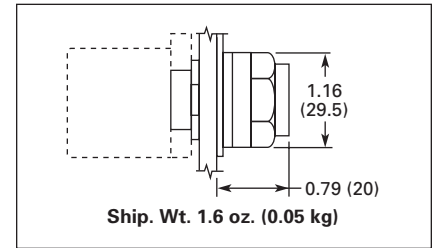

Figure 47-35. E22/EM22 Series 25 mm Dia. Extended Lens

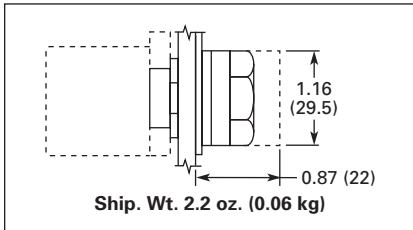

Figure 47-30. E22/EM22 Series 25 mm Dia. with Full Shroud

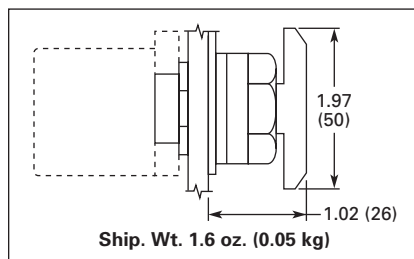

Figure 47-33. E22/EM22 Series 50 mm Dia. Mushroom Head Button

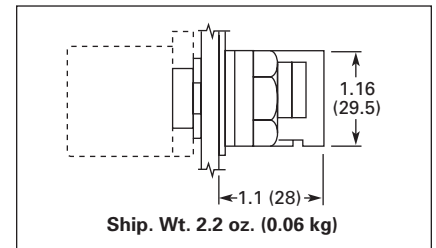

Figure 47-36. E22/EM22 Series 25 mm Dia. Extended Lens with Shroud

Alternate Action (Push-Push) Components

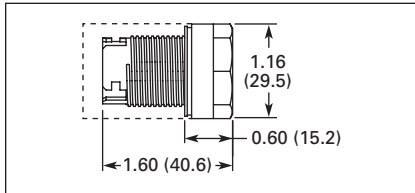

Figure 47-37. E22 Series Non-illuminated Flush Operator

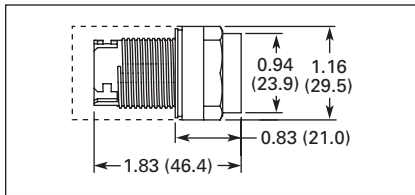

Figure 47-38. E22 Series Non-illuminated Extended Operator

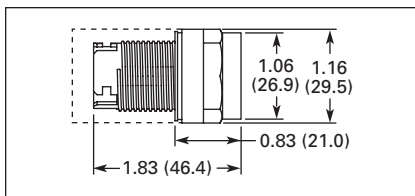

Figure 47-39. E22 Series Illuminated Flush Operator

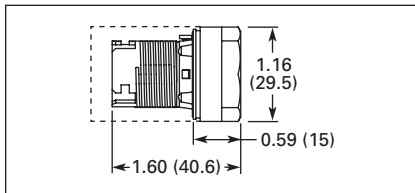

Figure 47-40. EM22 Series Non-illuminated Flush Operator

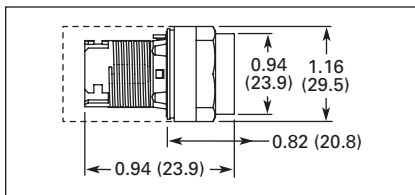

Figure 47-41. EM22 Series Non-illuminated Extended Operator

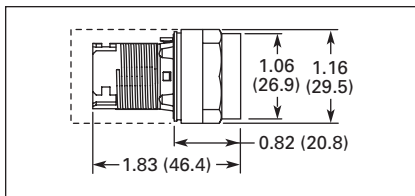

Figure 47-42. EM22 Series Illuminated Flush Operator

Table 47-125. Minimum Spacing in Inches (mm)

Size/Type of Operator	Dimensions	
	A ①	B
Push-Push Operators up to 1.18 (30) Dia. Including Knob and Key Operated Selector Switches — except those listed below 3-way adapter	1.18 (30)	1.97 (50)
Pushbutton Operators fitted with Rubber Boots or Padlockable Cover 3-way adapter	1.38 (35)	1.97 (50)

① Horizontal spacing for one 3-way mounting adapter.

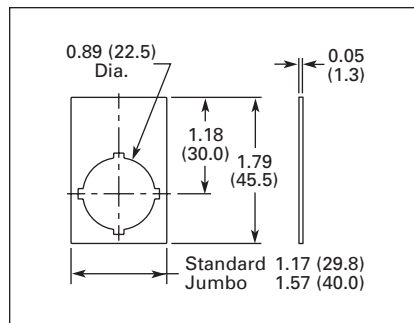
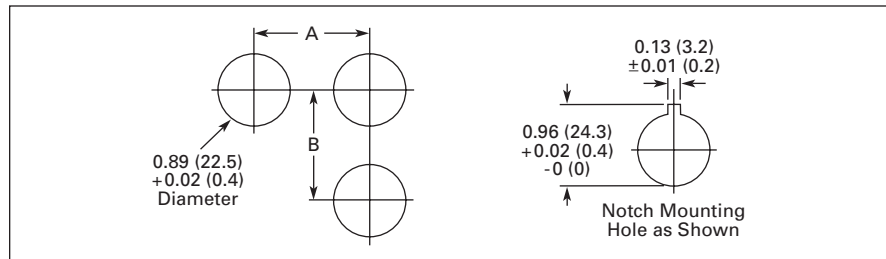

Figure 47-43. Push-Push Nameplate Dimensions

Twist-to-Release, Push-Pull and Key Release Components

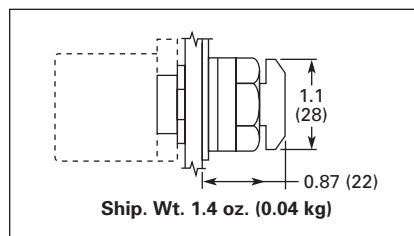

Figure 47-44. E22/EM22 Series 28 mm Diameter Twist-to-Release Button

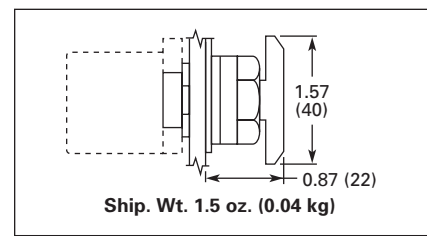

Figure 47-46. E22/EM22 Series 40 mm Dia. Push-Pull Button

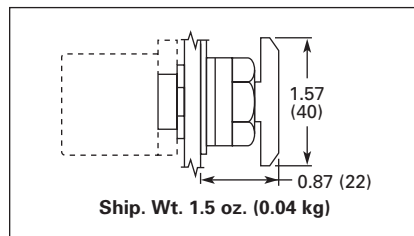

Figure 47-45. E22/EM22 Series 40 mm Dia. Twist-to-Release Button

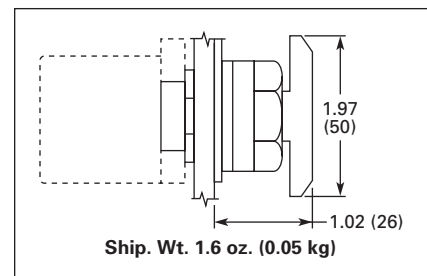

Figure 47-47. E22/EM22 Series 50 mm Dia. Push-Pull Button

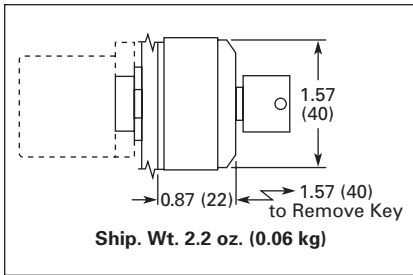

Figure 47-48. E22/EM22 Series 40 mm Dia. Key Release Button

Indicating Light Components

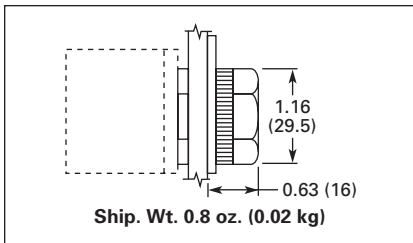

Figure 47-49. E22/EM22 Series 25 mm Dia. Standard Lens

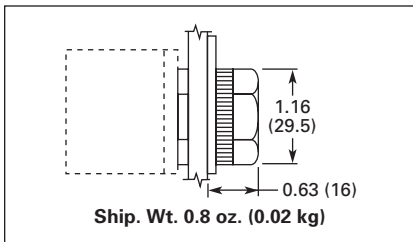

Figure 47-50. E22/EM22 Series 25 mm Dia. Lens Insert Version

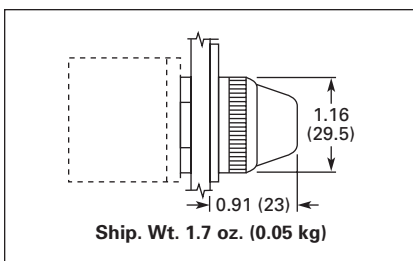

Figure 47-51. E22 Series 25 mm Dia. Glass Lens

Push-Pull Components — Non-illuminated Operators

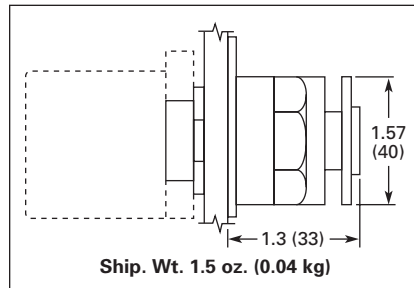

Figure 47-52. E22/EM22 Series 2-Position 40 mm Dia. Button (Maintained)

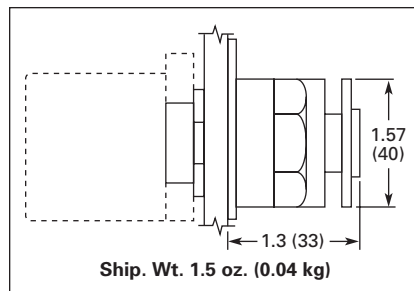

Figure 47-53. E22/EM22 Series 3-Position 40 mm Dia. Button (Spring Return to Center)

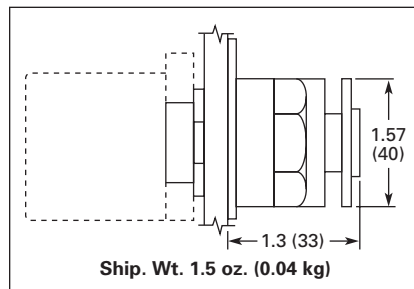

Figure 47-54. E22/EM22 Series 3-Position 40 mm Dia. Push-Pull Pushbutton (Spring Return to Center from Pulled Position)

Push-Pull Components — Illuminated Operators

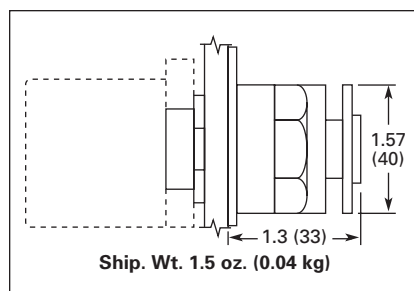

Figure 47-55. E22/EM22 Series 2-Position 40 mm Dia. Lens (Maintained)

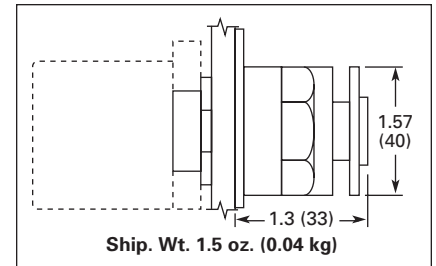

Figure 47-56. E22/EM22 Series 3-Position 40 mm Dia. Lens (Spring Return to Center)

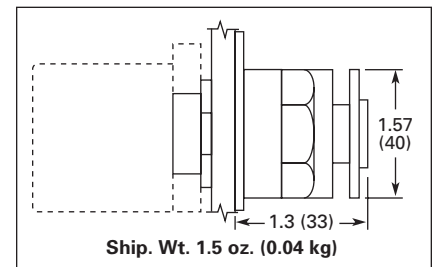

Figure 47-57. E22/EM22 Series 3-Position 40 mm Dia. Push-Pull Pushbutton (Spring Return to Center from Pulled Position)

Non-illuminated Selector Switches

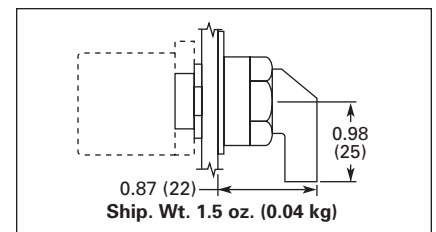

Figure 47-58. E22 Series 2-Position — 45° Throw — Lever

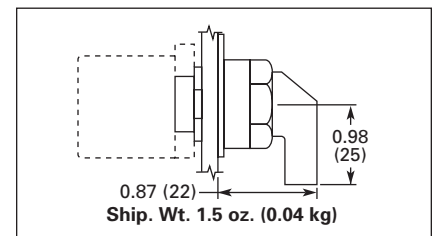

Figure 47-59. E22 Series 3-Position — 45° Throw — Lever

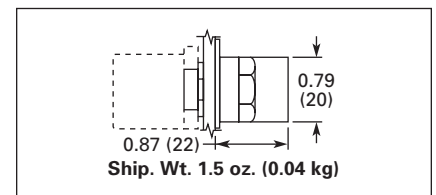

Figure 47-60. E22 Series 2-Position — 45° Throw — Knob

E22 and EM22 Series — Dimensions

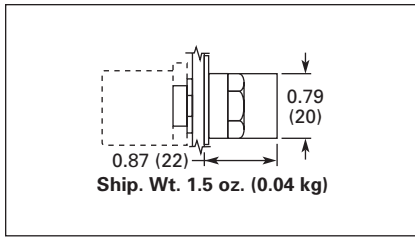

Figure 47-61. E22 Series 3-Position — 45° Throw — Knob

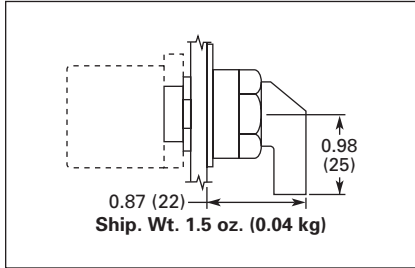

Figure 47-62. E22/EM22 Series 2-Position — 60° Throw — Lever

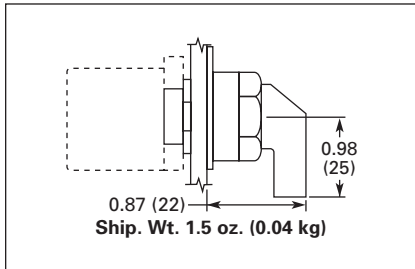

Figure 47-63. E22/EM22 Series 3-Position — 60° Throw — Lever

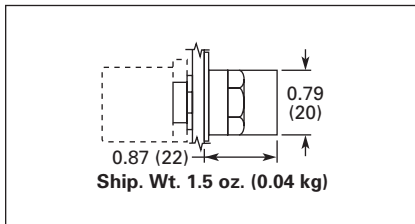

Figure 47-64. E22/EM22 Series 2-Position — 60° Throw — Knob

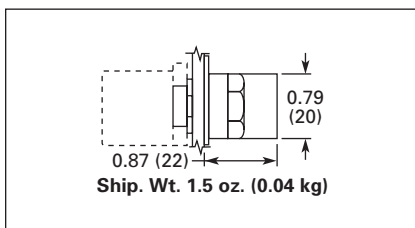

Figure 47-65. E22/EM22 Series 3-Position — 60° Throw — Knob

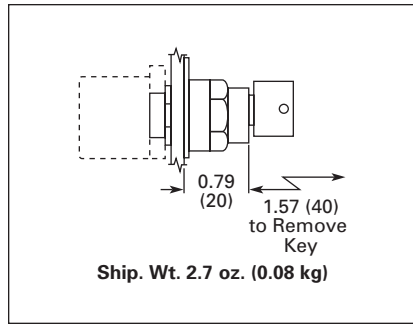

Figure 47-66. E22/EM22 Series Key Operated Illuminated Selector Switches

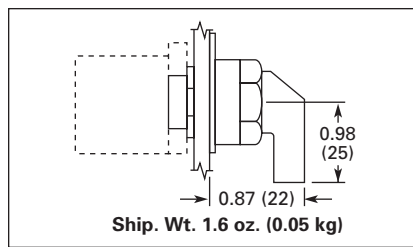

Figure 47-67. E22 Series 2-Position — 45° Throw — Lever

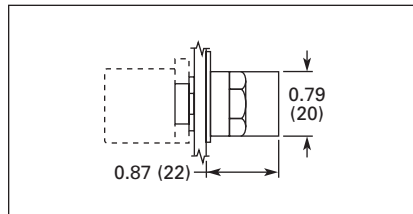

Figure 47-68. E22 Series 3-Position — 45° Throw — Knob

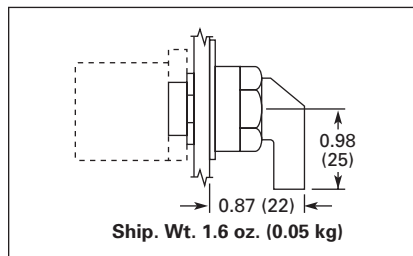

Figure 47-69. E22 Series 2-Position — 60° Throw — Lever

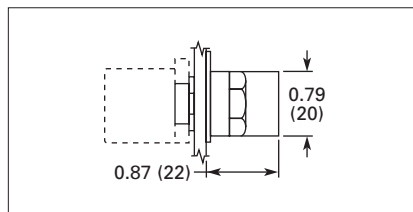

Figure 47-70. E22 Series 3-Position — 60° Throw — Knob

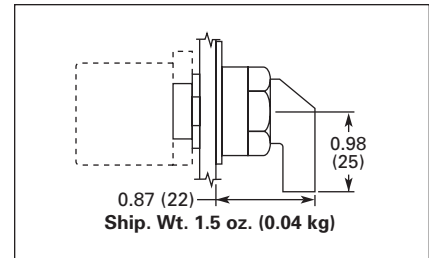

Figure 47-71. EM22 Series — 60° Throw — Lever

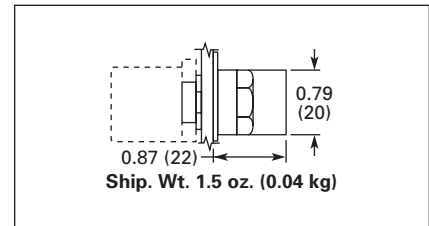

Figure 47-72. EM22 Series — 60° Throw — Knob

Rotary Cam Selector Switch

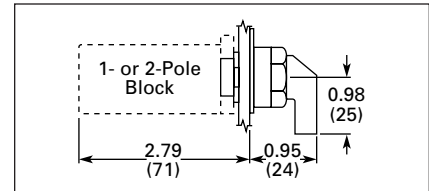

Figure 47-73. Rotary Cam Selector Switch
 For each additional (1- or 2-pole) block add 0.47" (12 mm).

Specialty Operators

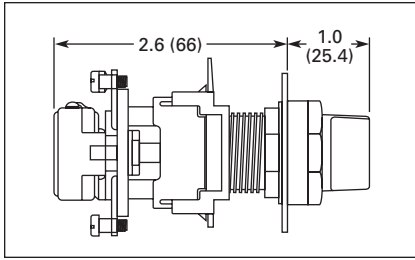

Figure 47-74. Potentiometer with Knob Operator

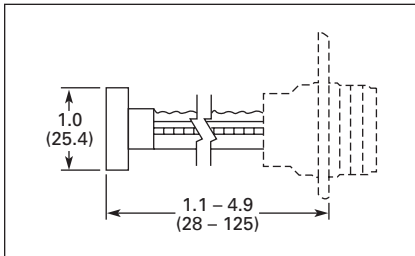

Figure 47-75. Flush Pushbutton Operator with Mechanical Push Rod

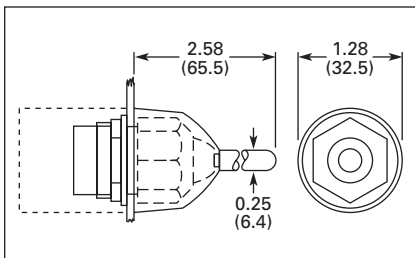

Figure 47-76. Wobble Stick Operator

Joystick

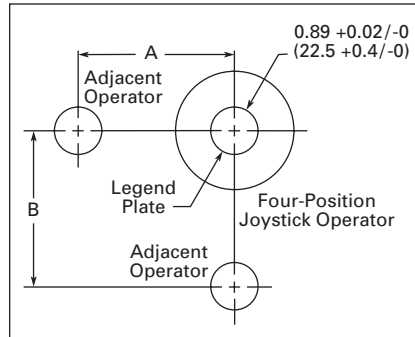

Figure 47-77. Joystick Mounting — Approximate Dimensions in Inches (mm)

Table 47-126. Minimum Panel Spacing Between 4-Position Joystick and Adjacent Operators in Inches (mm)

Size and Type of Adjacent Operator	A	B
All types except those listed below	2.56 (65)	2.56 (65)
Lever selector switches and 40 mm dia. operators	2.76 (70)	3.15 (80)
50 mm dia. operators	2.95 (75)	2.95 (75)
40 mm dia. emergency stop pushbutton	3.15 (80)	3.15 (80)
Operators with rubber boots or padlockable covers	2.76 (70)	3.35 (85)
40 mm dia. emergency stop pushbutton with 70 mm rectangular guard	3.15 (80)	3.54 (90)
Double head pushbutton	2.76 (70)	3.35 (85)
Four-position joystick operator	3.94 (100)	3.94 (100)

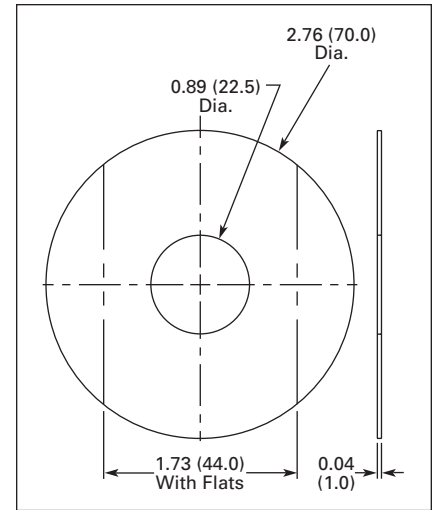

Figure 47-78. Joystick Nameplate Dimensions — Approximate Dimensions in Inches (mm)

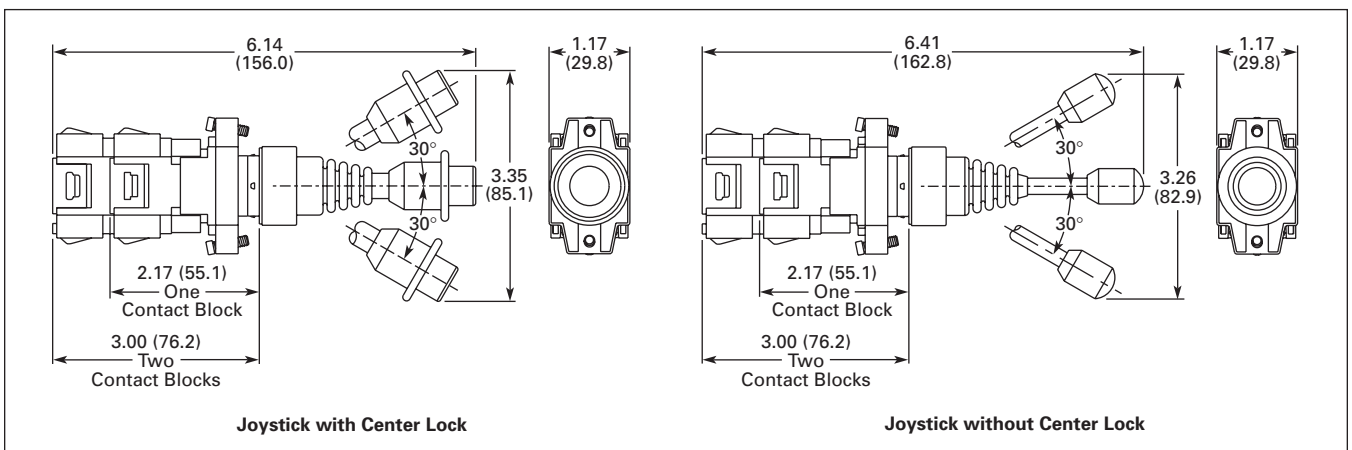

Figure 47-79. Joystick Operator Dimensions — Approximate Dimensions in Inches (mm)

Mounting

- **Panel thickness** — Inches (mm)
 - Nominal: 0.27 (6.8)
 - Legend plates, aluminum or plastic: 0.05 (1.3)
 - Locating ring: 0.06 (1.5)
 - Large yellow round legend plate: 0.04 (1.0)
 - Padlockable cover: 0.06 (1.6)
 - Rubber boot: 0.05 (1.3)
 - Minimum: 0.04 (1.0)

Note: Installation of certain accessories will increase the total (overall) panel thickness by the amount shown. The total panel thickness with all accessories installed cannot exceed the maximum allowable nominal dimension of 0.27 inch (6.8 mm).

Table 47-127. Minimum Spacing in Inches (mm)

Size/Type of Operator	Dimensions		
	A ①	A ②	B
All Types up to 1.18 (30) Dia. Including Knob and Key Operated Selector Switches — except those listed below 3-way adapter 5-way adapter	1.18 (30) 1.58 (40)	— 1.97 (50)	1.97 (50) 1.97 (50)
Lever Operated Selector Switch Operators and 1.18 – 1.57 (30 – 40) Dia. Operators	1.77 (45)	1.97 (50)	1.97 (50)
1.97 (50) Dia. Operators	2.16 (55)	2.16 (55)	2.16 (55)
Large Yellow Round Legend Plate — 2.76 (70) Dia.	2.95 (75)	2.95 (75)	2.95 (75)
Pushbutton Operators fitted with Rubber Boots or Padlockable Cover 3-way adapter 5-way adapter	1.38 (35) 1.58 (40)	— 1.97 (50)	1.97 (50) 1.97 (50)

- ① Horizontal spacing for one 3-way and one 5-way mounting adapter.
- ② Horizontal spacing for two 5-way mounting adapters.

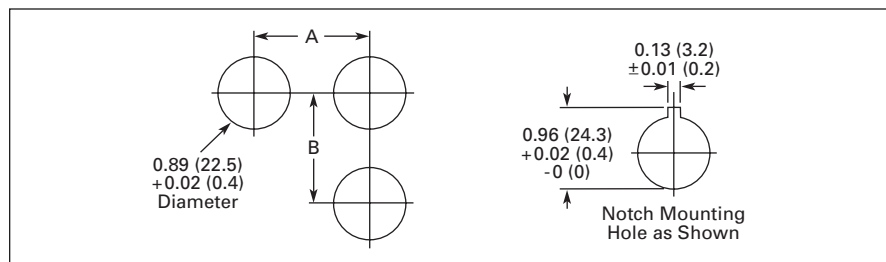

Figure 47-80. Minimum Spacing in Inches (mm)

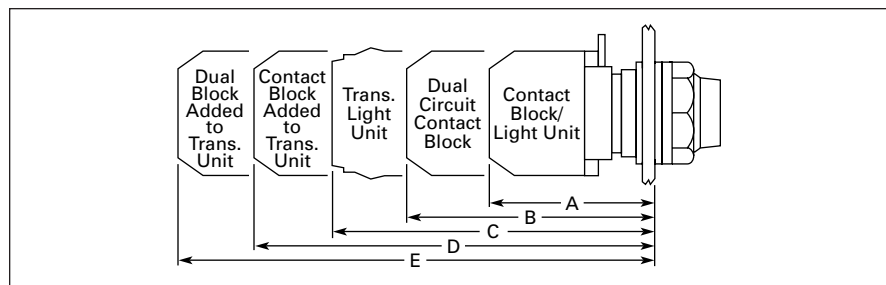

Figure 47-81. Rear of Panel Extensions

Table 47-128. Approximate Dimensions in Inches (mm)

A	B	C	D	E
Single Circuit Block — Full Voltage and Resistor Units	Dual Circuit, Contact Block	Trans-former Light Unit	Trans. Light Unit and Single Circuit Contact Block	Trans. Light Unit and Dual Circuit Contact Block
Pushbuttons All Types and Push-Pull				
2.0 (51)	2.6 (66)	2.91 (74)	3.7 (94)	4.3 (110)
Key, Lever and Knob Selector Switches				
2.22 (57)	2.83 (72)	3.15 (80)	3.9 (99)	4.5 (115)

Ordering Complete Devices

Ordering Complete Devices Using Single Composite Catalog Number

All Type E22 and EM22 Pushbuttons and Indicating Lights can be ordered as complete devices, with Light Units and/or Contact Blocks, using a single composite Catalog Number. The components including operator, Light Unit and/or Contact Blocks are shipped unassembled in an overpack bag. To order, select the required operator from the component listing on previous pages in this catalog and add Suffix Codes to the Catalog Number as listed on **Page 47-98**.

For illuminated operators, add Light Unit Suffix Code first, then the Contact Block Suffix (if required). For non-illuminated operators, simply add Contact Block Suffix Code to operator Catalog Number.

Ordering Example

Illuminated extended red pushbutton operator with 120V Transformer Type Light Unit and two contact blocks (1NO-1NC) is shown in **Table 47-129**.

Table 47-129. Catalog Numbering System

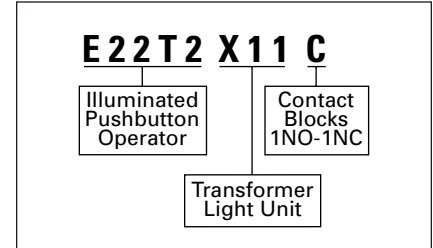

Example: Individually packaged components shipped in an overpack bag with single composite Catalog Number.



Operator
Cat. No. E22T2
from Page 47-36



Light Unit
Suffix Code X11
from Table on Page 47-98



Contact Blocks
Suffix Code C
from Table on Page 47-98

= Composite
Cat. No. E22T2X11C

Ordering Rotary Cam Selector Switches

Custom Switch Ordering Instructions

To order a custom assembled Rotary Cam Selector Switch, construct a Catalog Number from **Table 47-133** using the adjacent example and the numbering guide at the bottom for reference. Switches will accept up to 12 Poles in any sequence. List the Code Letter or Numbers for the Circuit Combinations in the assembly sequence required — the first circuit designated will be assembled directly behind the operator and the remaining Circuit Combinations will be assembled in the order listed.

Specifications

- Rated 10A @ 300V AC
- Contacts: silver with gold plating
- DOL – motor rating: 120V 1/3 hp
- Mechanical Life: 5,000,000 operations
- IP65
- Wiring terminals rated IP2X

- Wiring terminals accept one or two 20 – 14 AWG (0.5 – 2.5 mm²) solid or stranded conductors. Torque wiring terminals to 5 lb-in (0.6 Nm).
- Rated insulation voltage (U_i) is 440V.
- Rated impulse withstand voltage (U_{imp}) is 4kV.

Approvals

- UL 508
- CSA C22.2 No. 14
- IEC 408

Table 47-130. Key Removal Code ①

Key Removal Position	Code
Right	1
Left	2
Right & Left	3
Center	4
Right & Center	5
Left & Center	6
All Positions	7

① From maintained position only.

Table 47-131. Maintained

Circuit Combinations	Lever/Knob	Key
	Price U.S. \$	Price U.S. \$
Up to 3		
4		
5		
6		
7		
8		
9		
10		
11		
12		

Table 47-132. Spring Return

Circuit Combinations	Lever/Knob	Key
	Price U.S. \$	Price U.S. \$
Up to 3		
4		
5		
6		
7		
8		
9		
10		
11		
12		

Dimensions **Page 47-92**
Discount Symbol **1CD1**

E22 and EM22 Series, Ordering Examples

Ordering Example — Custom Order — Approx. 2 – 3 Weeks Delivery

Example: Three-Position Key Operated Selector Switch with Chrome Bezel, having 5 poles assembled in order as follows:

Key to be removable from center position only.

- | | | | |
|----|---|---|---|
| 1. | X | X | O |
| 2. | X | O | O |
| 3. | X | X | O |
| 4. | O | X | X |
| 5. | X | O | O |

Base Catalog Number	Operator Type	Operator Mode	Circuit Combinations	Key Removal Code	Complete Catalog Number
E22Y	D	30	D C D G C	-4	= E22YD30DCDGC-4

Black levers and knobs are standard. For alternate color, insert Code Letter as sixth digit from left — Red "R", Green "G", Yellow "Y", White "W", Blue "V" —

Example: E22YCR20AABBB

Table 47-133. Selection Table

Operator Type		Operator Mode		Circuit Combinations (Select Maximum of 12)				
Code Letter	Description	Code Number	Description	Code Letter	Circuit			
Black Bezel		Two-Position Selector Switch						
E F G	Lever Operated Knob Operated Key Operated	20	2-Position Maintained		Left	Center	Right	
			Center to Right	A	—	X	O	
		25	Left to Right	B	—	O	X	
					A	X	—	O
				B	O	—	X	
Chrome Bezel		Three-Position Selector Switch						
B C D	Lever Operated Knob Operated Key Operated	30	3-Position Maintained		Left	Center	Right	
		31	Spring Return from Right and Left	C	X	O	O	
				D	X	X	O	
				E	X	O	X	
		32	Spring Return Left to Center	F	O	O	X	
				G	O	X	X	
				H	O	X	O	
				Four-Position Selector Switch				
		40	4-Position Maintained		1	2	3	4
				J	X	O	O	O
				K	O	X	O	O
				L	O	O	X	O
				M	O	O	O	X
				N	X	O	O	X
				P	O	X	X	O
				R	O	O	X	X
				S	X	X	O	O
				T	O	X	O	X
				V	X	O	X	O
				W	X	X	X	O
				4	O	X	X	X
				5	X	O	X	X
6	X	X	O	X				

47

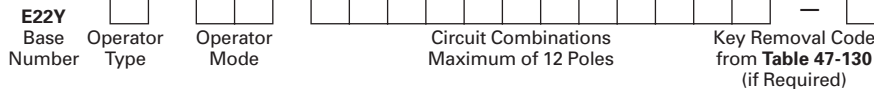

Catalog Number Structure

Table 47-134. E22 Catalog Numbering System

Code		Series	E 2 2 P				2	N 2 9	X 4	C	
E22	EM22	Plastic Operator Metal Operator									
Operator Code (1 to 3 Alphas)			Bezel Code (1 Alpha)								
Code	Description		Code	Description							
Non-illuminated, Momentary Pushbutton			(Blank)	Chrome							
P	25 mm Flush Button		B	Black (E22 Only)							
E	25 mm Extended Button		F	Full Shroud for Pushbutton							
M	28 mm Mushroom Button		X	Full Shroud for Illuminated Pushbutton							
L	40 mm Mushroom Button										
JP	P50 mm Mushroom (Plastic) Button		Color Code – Non-illuminated Operators (1 Digit)								
J	50 mm Mushroom (Aluminum) Button		Code	Description							
Non-illuminated, Maintained (Latching) Pushbutton			1	Black							
ML	28 mm Twist-to-Release		2	Red							
LL	40 mm Twist-to-Release		3	Green							
LTA	40 mm Trigger Action		4	Yellow							
JPL	50 mm Latch-In/Pull-to-Release (Plastic)		5	White							
JL	50 mm Latch-In/Pull-to-Release (Aluminum)		6	Blue							
G	40 mm Key Release Button		7	Gray							
LTG	40 mm Keyed Trigger Action		8	Orange							
Non-illuminated, Push-Pull Pushbutton			Color Code – Illuminated Operators (1 to 2 Digits)								
EH	29.5 mm, 2-Position Maintained		Code	Description							
FH	29.5 mm, 3-Position Spring Return Center		0	Clear							
ED	40 mm, 2-Position Maintained		2	Red							
FD	40 mm, 3-Position Spring Return Center		22	Red (LED)							
Non-illuminated, Push-Push Pushbutton			3	Green							
PP	25 mm Flush Button		33	Green (LED)							
EP	25 mm Extended Button		4	Yellow							
Non-illuminated, Selector Switches (Alpha + Digits)			5	White							
X ___	Knob, 2- and 3-Position		6	Blue							
V ___	Lever, 2- and 3-Position		66	Blue (LED)							
K ___	Key, 2- and 3-Position		9	Amber							
For Illuminated Devices Use These Operator Codes PLUS Use Code From Adjacent Chart			Legend Code (N + Digits)								
Illuminated, Momentary Pushbuttons			Code	Description							
N	25 mm Flush Button		(Blank)	No Legend							
T	25 mm Extended Button		N ___								
Illuminated, Push-Pull Pushbuttons			Light Source Code ② (X + Digits)								
GH	29.5 mm, 2-Position Maintained		Code	Description		Code	Description		Code	Description	
HH	29.5 mm, 3-Position Spring Return Center		X2	Direct Voltage w/6V Lamp		X29	PresTest 380V Transformer, Prewired 1NO/1NC		X55	48V Yellow LED	
GD	40 mm, 2-Position Maintained		X3	Direct Voltage w/12V Lamp		X30	PresTest 440V Transformer, Prewired 1NO/1NC		X56	48V Blue LED	
HD	40 mm, 3-Position Spring Return Center		X4	Direct Voltage w/24V Lamp		X37	6-12V Red LED		X57	60V Red LED	
Illuminated, Push-Push Pushbuttons			X6	Direct Voltage w/48V Lamp		X38	6-12V Green LED		X58	60V Green LED	
NP	25 mm Flush Button		X7	Direct Voltage w/60V Lamp		X39	6-12V Yellow LED		X59	60V Yellow LED	
TP	25 mm Extended Button		X8	Direct Voltage w/120V Lamp ①		X40	24V Red LED		X60	60V Blue LED	
Illuminated, Selector Switches (Alpha + Digits)			X10	120V Resistor w/60V Lamp		X41	24V Green LED		X61	120V Blue LED	
S ___	Knob, 2- and 3-Position		X11	120V Transformer w/6V Lamp		X42	24V Yellow LED		X62	120V Orange LED	
W ___	Lever, 2- and 3-Position		X12	240V Transformer w/6V Lamp		X43	120V Red LED		X63	120V Green LED	
Indicating Lights			X13	415V Transformer w/6V Lamp		X44	120V Green LED		X64	120V Orange LED	
H	25 mm Standard Lens		X14	480V Transformer w/6V Lamp		X45	120V Yellow LED		X65	120V Orange LED	
A	25 mm Printable Lens		X20	PresTest 24V Direct, Prewired 1NO/1NC		X51	6-12V Blue LED		X66	60V White LED	
F	25 mm Glass Lens		X26	PresTest 120V Resistor, Prewired 1NO/1NC		X52	24V Blue LED		X67	60V Orange LED	
			X27	PresTest 120V Transformer, Prewired 1NO/1NC		X53	48V Red LED		X68	60V Orange LED	
			X28	PresTest 220V Transformer, Prewired 1NO/1NC		X54	48V Green LED		Additional Units Available		

① For use with indicating lights only.

② Will have tall lamp/LED for selector switch and push-pull operators. Standard size lamp and LED for all other operators.

E22 and EM22 Series, Suffix Codes

Suffix Codes

Table 47-135. Contact Blocks

Description	Suffix Code		Component Reference Cat. No.
	Single or Combination of Single Circuit Blocks	Dual or Combination of Dual with Single Circuit Blocks	

Standard Contact Blocks for All Operators
Except 3-Position Push-Pull and Special Function

1NO	A	—	E22B2
1NC	B	—	E22B1
1NO-1NC	C	—	E22B2 + B1
1NO-1NC	—	W	E22B11
2NO	D	—	E22B2 + B2
2NO	—	V	E22B20
2NC	E	—	E22B1 + B1
1NO-1NC overlapping	K	—	E22B3 + B4 ②
2NO-1NC ①③	F	—	E22B2 + B2 + B1
2NO-1NC ③	—	WA	E22B11 + B2
2NO-1NC ③	—	VB	E22B20 + B1
2NC-1NO ①③	G	—	E22B1 + B1 + B2
2NC-1NO ③	—	WB	E22B11 + B1
3NO ①③	H	—	E22B2 + B2 + B2
3NO ③	—	VA	E22B20 + B2
3NC ①③	J	—	E22B1 + B1 + B1
1NO-3NC ①④	—	WE	E22B11 + B1 + B1
2NO-2NC ④	—	WW	E22B11 + B11
3NO-1NC ④	—	VW	E22B20 + B11
4NO ④	—	VV	E22B20 + B20

Special Function Block Combination: For Use with 3-Position Push-Pulls

1NO-1NC Late Break	S	—	E22B1 + B4 ②
1NO-1NO	T	—	E22B1 + B5

Special Function Block Combination: For Use on Selector Switches (supplied with external jumper)

1NO-2NC	—	PP	E22B12
2NO-2NC	—	RR	E22B11 + B11

Special Function Block Combination: For Use on Trigger-Action
Emergency Stop Pushbuttons

1NC	QB	—	E22CB1
2NC	QE	—	E22CB1 + CB1
1NC-1NO	QC	—	E22CB11
2NC-1NO	QG	—	E22CB1 + CB1 + B2

① Can not be used with illuminated devices, push-pulls, twist-to-release operators or selector switches. Operator plug E22BA2 must be installed.

② E22B4 contact block not available for use with 5-way mounting adapter.

③ Can not be used with illuminated push-push devices. Operator plug E22BA2P must be installed with non-illuminated devices.

④ Can not be used on push-push devices.

Table 47-136. Light Units — Standard Size for all Operators Excluding Selector Switches and Push-Pull Units

Description	Suffix Code	Component Reference Cat. No.
Direct Voltage Light Unit AC/DC —		
Without Lamp	X1	E22D ⑥
With 6V Lamp	X2	E22D6
With 12V Lamp	X3	E22D12
With 24V Lamp	X4	E22D24
With 48V Lamp	X6	E22D50
With 60V Lamp	X7	E22D60
Direct Voltage Light Unit AC/DC —		
For Indicating Lights Only	X8	E22D120
Resistor Type Light Unit AC/DC ⑤ —		
120V/60 Hz	X10	E22R2
Transformer Type Light Unit AC only ⑥ —		
120V/60 Hz	X11	E22TL1
240V/60 Hz	X12	E22TL2
480V/60 Hz	X14	E22TL4
Neon Light Unit AC only —		
120V with Lamp	X15	E22DN120
240V with Lamp	X16	E22DN240
PresTest Light Unit —		
Prewired with 1NO-1NC		
Contact Blocks — Transformer		
Type 120V/60 Hz	X27	E22TL1C ⑥
Direct Voltage without Lamp	X17	E22D0C ⑥
Direct Voltage with 24V Lamp	X20	E22D24C
Resistor Type — 120V	X26	E22R2C
LED Light Units — Direct Voltage	See Page 47-70	

⑤ Resistor unit is not available for use with LEDs, choose either transformer or full voltage LED style.

⑥ LED compatible.

Table 47-137. Light Units — For Selector Switch and Push-Pull Operators Only

Description	Suffix Code	Component Reference Cat. No.
Direct Voltage Light Unit AC/DC —		
Without Tall Lamp	X1	E22DE ⑥
With 6V Tall Lamp	X2	E22DT6
With 12V Tall Lamp	X3	E22DT12
With 24V Tall Lamp	X4	E22DT24
With 48V Tall Lamp	X6	E22DT50
With 60V Tall Lamp	X7	E22DT60
Direct Voltage Light Unit AC/DC —		
For Indicating Lights Only	X8	E22D120
Resistor Type Light Unit AC/DC ⑦ —		
120V Tall Bulb/60 Hz	X10	E22RT2
Transformer Type Light Unit AC only ⑥ —		
120V Tall Bulb/60 Hz	X11	E22TL1T
240V Tall Bulb/60 Hz	X12	E22TL2T
480V Tall Bulb/60 Hz	X14	E22TL4T
PresTest Light Unit —		
Prewired with 1NO-1NC		
Contact Blocks — Transformer		
Type 120V Tall Bulb/60 Hz	X27	E22TL1C ⑥
Direct Voltage without Tall Lamp	X17	E22DT0C ⑥
Direct Voltage with 24V Tall Lamp	X20	E22DT24C
Resistor Type — 120V Tall Lamp	X26	E22RT2C
LED Light Units — Direct Voltage	See Page 47-70	

⑦ Resistor unit is not available for use with LEDs, choose either transformer or full voltage LED style.

⑥ LED compatible.

E30 Series

Contents

<i>Description</i>	<i>Page</i>
Product Description	47-99
Features	47-99
Standards and Certifications	47-99
Technical Data and Specifications	47-100
Product Selection — Operators	
Square Multifunction Operators	47-101
Square Multifunction Operators and Indicating Lights	47-102
Product Selection — Operator Components	
Operating Buttons Only	47-105
Operating Buttons and Lens Only	47-106
Operator Lens Only	47-107
Contact Blocks	47-108
Options	
Markings and Legend Plates	47-109
Accessories	47-112
Replacement Parts	47-113
Dimensions	47-114

Product Description

The E30 industrial pushbutton and indicating light line from Eaton's electrical business features a wide selection of square, multifunction operators which conveniently mount in a standard 30.5 mm [1-13/64 inches] diameter panel hole. Up to six input and indicating functions can be grouped into a single operating head, saving valuable panel space. Attractive square operator styling, coupled with custom legending of colored buttons and lenses and many special function accessories, makes E30 components ideally suited for use on control consoles and for a variety of industrial OEM applications.

Features

Type E30 control units consist of a basic operator with one or more buttons and lenses and contact block selection dependent on the specific operator configuration.

- **Pushbutton operators** will accommodate up to four single depth stackable contact blocks behind each operating button, up to eight circuits maximum.

- **Indicating lights** are supplied complete with either a transformer light unit up to 600V AC supply line voltage or full voltage light unit up to 120V AC/DC supply line voltage.
- **Combination pushbutton with indicating light** operators are supplied complete with a transformer or full voltage unit. Contact blocks must be ordered separately, up to four circuits maximum.

Die Cast Construction

Each operator has high pressure type seals to prevent the passage of oil and other contaminants through the operator into the contact structure or panel interior. Each operator uses a Buna N cork gasket between the mounting flange on the operator and the panel to maintain oiltightness.

Standards and Certifications

- UL Listed — File No. E131568
- CSA Certified — File No. LR68551

Ingress Protection

- Single and Dual Indicating Lights
 - UL (NEMA) Type 1, 2, 3, 3R, 3S, 4, 4X, 12, 13
- All Other Operators
 - UL (NEMA) Type 3, 3R, 4, 4X, 12, 13

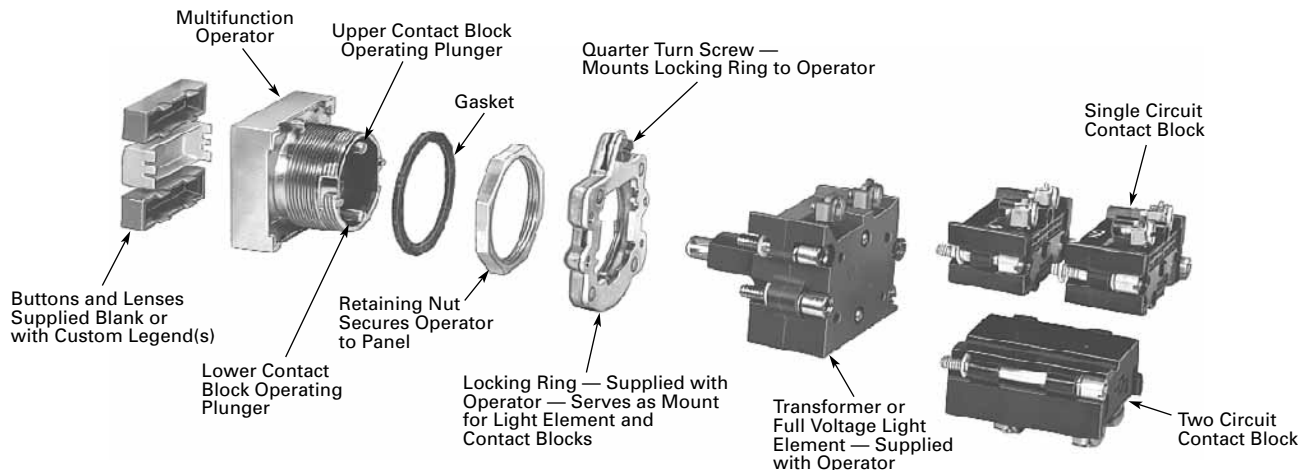

E30 Series

Technical Data and Specifications

Climate Conditions

- Operating: -20° to 150°F (-29° to 65°C)

Terminals

Light Units

- Terminals are saddle clamp type for 2 stranded or solid wires up to 12 AWG (4.0 mm²)
- Torque — 7 lb-in (0.8 Nm)

Contact Block

- Terminals are saddle clamp type for 2 stranded or solid wires up to 12 AWG (4.0 mm²)
- Torque — 7 lb-in (0.8 Nm)

Material

- Operator is a zinc base die casting with a copper-nickel-chrome plated finish. Withstands the 200 hr. salt spray test in accordance with MIL Spec. QQ-M-151A and NEMA 4X testing. All internal parts, including shafts, washers and springs, are made of stainless steel. The buttons and lenses are made of colorfast, wear resistant, molded acetal resin. The contact blocks are made of molded, heat resistant, mineral filled phenolic. The contact block plungers are molded of nylon filled phenolic. The contacts are silver.

Electrical Ratings

Table 47-138. Contact Block

Meet or Exceed NEMA Contact Rating Designation A600 and P300							
Description	A600 (AC)				P300 (DC)		
	120V	240V	480V	600V	24/28V	125V	250V
Make and Emergency Interrupting Capacity (Amps)	60	30	15	12	5.73	1.1	0.55
Normal Load Break (Amps)	6	3	1.5	1.2	5.73	1.1	0.55
Continuous Amperes	10				5		

- UL A600/P300 nominal connect 10A
- 1NO, 1NC, 2NO, 2NC, 1NO-1NC, early make, late break and overlapping configurations
- Mechanical positive drive operation on NC contacts
- Palladium alloy contact for logic level or highly corrosive environments

Reliability Nibs

These nibs combine a scrubbing action with high pressure density when the contacts are closed. They push through particles and films found on contact surfaces in industrial environments. The reliability nibs self-adjust to the application — dry circuit, normal or heavy-duty.

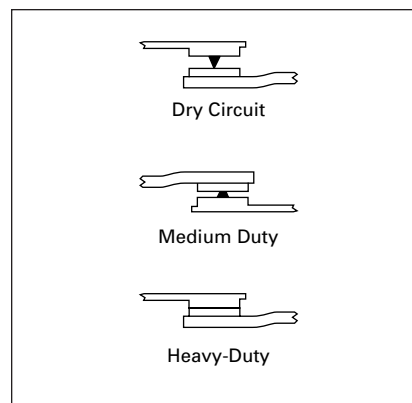

Figure 47-82. Reliability Nibs

Maximum Ratings for Logic Level and Hostile Atmosphere Applications

- Maximum amperes: 0.5A
- Maximum volts: 120V AC/DC

Light Unit

- Bulbs — average life:
 - Transformer type: 20,000 hrs.
 - Resistor/direct voltage type: 2,500 hrs. min. @ rated voltage
 - LED: 60,000 to 100,000 hrs.

Product Selection — Operators

When Ordering a Complete E30 Control Unit Specify

- Catalog Number of Operator
- Catalog Number of Button(s)
- Catalog Number of Contact Block(s)
- Catalog Number of Accessories (if required)

Ordering Example:

E30AB
 E30KB130 "START"
 E30KB231 "STOP"
 E30KLA1 1NO
 E30KLA2 1NC

Square Multifunction Operators

Table 47-139. Single Button Operator/without Button — Order Buttons Separately — UL (NEMA) Type 3, 3R, 4, 4X, 12, 13





	Operation	Special Features	Catalog Number	Price U.S. \$	Button Type
 <p>Single Button Operator shown with Extended Button</p>	Momentary	—	E30AA		<p>Button Type Required</p>  <p>Order from Table on Page 47-105</p>

Table 47-140. Two Button Operator/without Buttons — Order Buttons Separately — UL (NEMA) Type 3, 3R, 4, 4X, 12, 13

	Operation		Special Features	Catalog Number	Price U.S. \$	Button Type
	Top Button	Bottom Button				
 <p>Two Button Operator shown with Extended Buttons</p>	Momentary	Momentary	—	E30AB	<p>Button Types Required</p>  <p>Order from Table on Page 47-105</p>	
	Momentary	Momentary	With Mechanical Interlock	E30AC		
	Maintained (All Contacts)	Release (All Contacts)		E30AD ①		
	Maintained (All Contacts)	Release (All Contacts)	With Mechanical Interlock	E30AP ①②		

① Limited to two single circuit, one double circuit 600V or two 120V (E30KLA9) contact blocks behind each button.

② Buttons are interlocked so that one of the two is maintained at all times. Depressing the other button releases the maintained button and maintains the depressed button.

Table 47-141. Two Button Operator with Long (OFF) Release Bar — Includes OFF Bar/Button — Order Other Buttons Separately — UL (NEMA) Type 3, 3R, 4, 4X, 12, 13

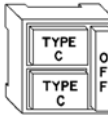
	Operation		Special Features	Catalog Number	Price U.S. \$	Button Type
	Top Button	Bottom Button				
 <p>Two Button Operator shown with Long Release Bar</p>	Maintained	Maintained	—	E30AF	<p>Button Types Required ③</p>  <p>Order from Table on Page 47-105</p>	
	Maintained	Maintained	With Mechanical Interlock	E30AG		
	Maintained	Momentary	With Mechanical Interlock	E30AH		
	Maintained (All Contacts)	Maintained (Bottom Contacts Only)	Top Button Operates Both Top and Bottom Contacts	E30AK ④		

③ Operators are supplied as standard with red extended bar(s) marked "OFF" as shown in sketch. For other colors or markings, contact your nearest Eaton Distributor or call our Customer Service Center 1-800-356-1243. For replacement of standard red release bar, order **E30KR100**.





④ Limited to two single circuit, one double circuit 600V or two 120V (E30KLA9) contact blocks behind each button.

Accessories Page 47-112
 Buttons Page 47-105
 Contact Blocks Page 47-108
 Dimensions Page 47-114
 Discount Symbol 1CD1C

E30 Series, Operators & Indicating Lights

Square Multifunction Operators and Indicating Lights

Table 47-142. Two Button Operator with (OFF) Release — Includes OFF Bar/Button(s) — Order Other Buttons Separately — UL (NEMA) Type 3, 3R, 4, 4X, 12, 13

	Operation		Special Features	Catalog Number	Price U.S. \$	Button Type
	Top Button	Bottom Button				
 <p>Two Button Operator shown with Release Bar for Top Button</p>	Maintained	Momentary	Release Bar for Top Button	E30AL		Button Types Required ^①  Order from Table on Page 47-105
 <p>Two Button Operator shown with Individual Release Bars for Each Button</p>	Maintained	Maintained	Individual Release Bars for Each Button	E30AN		Button Types Required ^①  Order from Table on Page 47-105
	Maintained with Interlock	Maintained with Interlock	Individual Release Bars for Each Button	E30AM		

^① Operators are supplied as standard with red extended release bar(s) marked "OFF" as shown in sketch. For other colors or markings, contact your nearest Eaton Distributor or call our Customer Service Center 1-800-356-1243. For replacement of standard red release bar, order **E30KR101**.

Table 47-143. Single Indicating Light Unit/without Lens — Order Lenses Separately — UL (NEMA) Type 3, 3R, 3S, 4, 4X, 12, 13

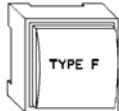
	Type of Light Element								Lens Type
	Transformer (60/50 Hertz AC)				Full Voltage (60/50 Hertz AC or DC)				
	Voltage	Lamp Number ^②	Catalog Number	Price U.S. \$	Voltage	Lamp Number ^②	Catalog Number	Price U.S. \$	
 <p>Single Indicating Light Unit shown with Lens</p>	120	6PSB	E30BA		24 120	24PSB 120PSB	E30BJ E30BM		Lens Type Required  Order from Table on Page 47-106

^② Light units will also accept LED lamps. For LED Part Numbers, see **Table 47-149** on **Page 47-104**.

Table 47-144. Dual Indicating Light Unit/without Lenses — Order Lenses Separately — UL (NEMA) Type 3, 3R, 3S, 4, 4X, 12, 13

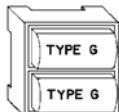
	Type of Light Element								Lens Type
	Transformer (60/50 Hertz AC)				Full Voltage (60/50 Hertz AC or DC)				
	Voltage	Lamp Number ^③	Catalog Number	Price U.S. \$	Voltage	Lamp Number ^③	Catalog Number	Price U.S. \$	
 <p>Dual Indicating Light Unit shown with Lens</p>	120	6PSB	E30CA		24 120	24PSB 120PSB	E30CJ E30CM		Lens Type Required  Order from Table on Page 47-107

^③ Light units will also accept LED lamps. For LED Part Numbers, see **Table 47-149** on **Page 47-104**.

Accessories **Page 47-112**
 Buttons and Lens **Pages 47-105 – 47-107**
 Contact Blocks **Page 47-108**
 Dimensions **Page 47-114**
 Replacement Lamps and
 Lamp Receptacles **Page 47-113**
 Discount Symbol **1CD1C**

Square Multifunction Operators and Indicating Lights (Continued)

Table 47-145. Single Button Operator with Indicating Light/without Button or Lens — Order Button and Lenses Separately — UL (NEMA) Type 3, 3R, 4, 4X, 12, 13

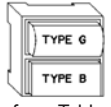
	Operation (Bottom Button)	Type of Light Element								Button/Lens Type
		Transformer (60/50 Hertz AC)				Full Voltage (60/50 Hertz AC or DC)				
		Voltage	Lamp Number ①	Catalog Number	Price U.S. \$	Voltage	Lamp Number ①	Catalog Number	Price U.S. \$	
 <p><i>Single Button Operator and Indicating Light shown with Button & Lens</i></p>	Momentary	120	6PSB	E30DA		24	24PSB	E30DX3 E30DF		 <p>Order from Tables on Pages 47-105 and 47-107</p>
						120	120PSB			

① Light units will also accept LED lamps. For LED Part Numbers, see Table 47-149 on Page 47-104.

Table 47-146. Single Button Operator with (OFF) Release Bar and Indicating Light — Includes OFF Bar/Button — Order Other Button and Lens Separately — UL (NEMA) Type 3, 3R, 4, 4X, 12, 13

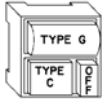
	Operation (Bottom Button)	Type of Light Element								Button/Lens Type
		Transformer (60/50 Hertz AC)				Full Voltage (60/50 Hertz AC or DC)				
		Voltage	Lamp Number ②	Catalog Number	Price U.S. \$	Voltage	Lamp Number ②	Catalog Number	Price U.S. \$	
 <p><i>Single Button Operator with Release Bar and Indicating Light shown with Button & Lens</i></p>	Maintained	120	6PSB	E30DG		24	24PSB	E30DX13 E30DM		 <p>Order from Tables on Pages 47-105 and 47-107</p>
						120	120PSB			

② These operators are supplied as standard with red extended release bar(s) marked "OFF" as shown in sketch. For other colors or markings, contact your nearest Eaton Distributor or call our Customer Service Center 1-800-356-1243. For replacement of standard red release bar, order E30KR101.

③ Light units will also accept LED lamps. For LED Part Numbers, see Table 47-149 on Page 47-104.

Table 47-147. Two Button Operator with Indicating Light/without Buttons or Lens — Order Buttons and Lenses Separately — UL (NEMA) Type 3, 3R, 4, 4X, 12, 13

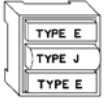

	Button Operation	Type of Light Element								Button/Lens Type
		Transformer (60/50 Hertz AC)				Full Voltage (60/50 Hertz AC or DC)				
		Voltage	Lamp Number ④	Catalog Number	Price U.S. \$	Voltage	Lamp Number ④	Catalog Number	Price U.S. \$	
 <p><i>Two Button Operator with Indicating Light shown with Button & Lens</i></p>	Momentary	120	6PSB	E30EA		24	24PSB	E30EX3 E30EF		 <p>Order from Tables on Pages 47-106 – 47-107</p>
	Momentary with Interlock	120	6PSB	E30EG		24	24PSB			

④ Light units will also accept LED lamps. For LED Part Numbers, see Table 47-149 on Page 47-104.

Accessories Page 47-112
Buttons and Lens Pages 47-105 – 47-107
Contact Blocks Page 47-108
Dimensions Page 47-114
Replacement lamps and Lamp Receptacles Page 47-113
Discount Symbol 1CD1C

Square Multifunction Operators and Indicating Lights (Continued)

Table 47-148. Two Button Operator with Dual Indicating Lights/without Buttons and Lenses — UL (NEMA) Type 3, 3R, 4, 4X, 12, 13

	Button Operation	Type of Light Element								Button/Lens Type
		Transformer (60/50 Hertz AC)				Full Voltage (60/50 Hertz AC or DC)				
		Voltage	Lamp No. ①	Catalog Number	Price U.S. \$	Voltage	Lamp No. ①	Catalog Number	Price U.S. \$	
 <p><i>Two Button Operator with Dual Indicating Lights shown with Button & Lens</i></p>	Momentary	120	6PSB	E30JA		24	24PSB	E30JX3		<p>Button and Lens Types Required</p>  <p>Order from Tables on Pages 47-106 – 47-107</p>
						120	120PSB	E30JF		

① Light units will also accept LED lamps. For LED Part Numbers, see Table 47-149.

Table 47-149. Replacement Lamps — Incandescent and LED

Lamp Voltage	Incandescent Lamps				LED Lamps				Price U.S. \$
	Manufacturers Part Number	Base Style	Eaton's Cutler-Hammer Part Number	Price U.S. \$	Eaton's Cutler-Hammer Part Number				
					Red	Green	Yellow	Blue ②	
6	6PSB	T2 Slide	28-1022		35-1523	35-1523-2	35-1523-3	35-1523-17	
12	12PSB	T2 Slide	28-1025		35-1523-11	35-1523-12	35-1523-13	35-1523-18	
24	24PSB	T2 Slide	28-1026		35-1523-4	35-1523-5	35-1523-6	35-1523-19	
28	28PSB	T2 Slide	28-1027		35-1523-4	35-1523-5	35-1523-6	35-1523-19	
48	48PSB	T2 Slide	28-1028		35-1523-14	35-1523-15	35-1523-16	35-1523-20	
120	120PSB	T2 Slide	28-1029		35-1523-7	35-1523-8	35-1523-9	35-1523-21	

② E30 blue LED bulbs may not provide sufficient intensity for some applications.

Accessories Page 47-112
Buttons and Lens Pages 47-105 – 47-107
Contact Blocks Page 47-108
Dimensions Page 47-114
Replacement Lamps and
Lamp Receptacles Page 47-113
Discount Symbol 1CD1C

Product Selection — Operator Components

Operating Buttons Only

Table 47-150. Type A Buttons with Standard Markings



	Color	Marking	Extended Button		Short Button		Color	Marking	Extended Button		Short Button		Button Application
			Catalog Number	Price U.S. \$	Catalog Number	Price U.S. \$			Catalog Number	Price U.S. \$	Catalog Number	Price U.S. \$	
 Type A Extended Button for Use with Operator E30AA, Legend Characters 3/16 Inch (4.8 mm) High	Black	Blank	E30KA100		E30KA150		Green	START	E30KA330		E30KA380		
	Black	START	E30KA200		E30KA180		Yellow	Blank	E30KA400		E30KA450		
Red	Blank	E30KA204		E30KA250		White	Blank	E30KA500		E30KA550			
Red	EMERG. STOP	E30KA218		—		Gray	Blank	E30KA600		E30KA650			
Red	OFF	—		E30KA268		Brown	Blank	E30KA700		E30KA750			
Red	STOP	E30KA231		E30KA281		Blank	Blank	—		—			
Green	Blank	E30KA300		E30KA350		Orange	Blank	E30KA800		E30KA850			
Blank	Blank	—		—		Blue	Blank	E30KA900		E30KA950			

Table 47-151. Type B Buttons with Standard Markings





	Color	Marking	Extended Button		Short Button		Color	Marking	Extended Button		Short Button		Button Application
			Catalog Number	Price U.S. \$	Catalog Number	Price U.S. \$			Catalog Number	Price U.S. \$	Catalog Number	Price U.S. \$	
 Type B Extended Button for Use with Operators E30AB thru AE, AL and DA thru DF, Legend Characters 3/16 Inch (4.8 mm) High	Black	Blank	E30KB100		E30KB150		Black	REVERSE	E30KB125		E30KB175		
	Black	AUTO	E30KB101		E30KB151		Black	RUN	E30KB126		E30KB176		
	Black	CLOSE	E30KB102		E30KB152		Black	SLOW	E30KB128		E30KB178		
	Black	DOWN	E30KB103		E30KB153		Black	START	E30KB130		E30KB180		
	Black	FAST	E30KB105		E30KB155		Black	TEST	E30KB132		E30KB182		
	Black	FORWARD	E30KB107		E30KB157		Black	UP	E30KB134		E30KB184		
	Black	HIGH	E30KB109		E30KB159		Red	Blank	E30KB200		E30KB250		
	Black	IN	E30KB110		E30KB160		Red	EMERG. STOP	E30KB204		—		
	Black	INCH	E30KB111		E30KB161		Red	OFF	E30KB218		E30KB268		
	Black	JOG	E30KB112		E30KB162		Red	STOP	E30KB231		E30KB281		
	Black	JOG FOR.	E30KB113		E30KB163		Green	Blank	E30KB300		E30KB350		
	Black	JOG REV.	E30KB114		E30KB164		Green	START	E30KB330		E30KB380		
	Black	LOW	E30KB115		E30KB165		Yellow	Blank	E30KB400		E30KB450		
	Black	LOWER	E30KB116		E30KB166		White	Blank	E30KB500		E30KB550		
	Black	MAN	E30KB117		E30KB167		White	AUTO	E30KB501		—		
	Black	ON	E30KB119		E30KB169		White	HAND	E30KB508		—		
Black	OPEN	E30KB120		E30KB170		Gray	Blank	E30KB600		E30KB650			
Black	OUT	E30KB121		E30KB171		Brown	Blank	E30KB700		E30KB750			
Black	RAISE	E30KB122		E30KB172		Orange	Blank	E30KB800		E30KB850			
Black	RESET	E30KB124		E30KB174		Blue	Blank	E30KB900		E30KB950			

Table 47-152. Type C Buttons with Standard Markings

	Color	Marking	Extended Button		Short Button		Color	Marking	Extended Button		Short Button		Button Application
			Catalog Number	Price U.S. \$	Catalog Number	Price U.S. \$			Catalog Number	Price U.S. \$	Catalog Number	Price U.S. \$	
 Type C Extended Button for Use with Operators E30AF thru AK, AL thru AM and DG thru DM, Legend Characters 1/8 Inch (3.2 mm) High	Black	Blank	E30KC100		E30KC150		Black	RESET	E30KC124		E30KC174		
	Black	AUTO	E30KC101		E30KC151		Black	REVERSE	E30KC125		E30KC175		
	Black	CLOSE	E30KC102		E30KC152		Black	RUN	E30KC126		E30KC176		
	Black	DOWN	E30KC103		E30KC153		Black	SLOW	E30KC128		E30KC178		
	Black	FAST	E30KC105		E30KC155		Black	START	E30KC130		E30KC180		
	Black	FORWARD	E30KC107		E30KC157		Black	TEST	E30KC132		E30KC182		
	Black	HAND	E30KC108		E30KC158		Black	UP	E30KC134		E30KC184		
	Black	HIGH	E30KC109		E30KC159		Red	Blank	E30KC200		E30KC250		
	Black	IN	E30KC110		E30KC160		Red	OFF	E30KC218		—		
	Black	INCH	E30KC111		E30KC161		Red	STOP	E30KC231		E30KC281		
	Black	JOG	E30KC112		E30KC162		Green	Blank	E30KC300		E30KC350		
	Black	JOG FOR.	E30KC113		E30KC163		Green	START	E30KC330		E30KC380		
	Black	JOG REV.	E30KC114		E30KC164		Yellow	Blank	E30KC400		E30KC450		
	Black	LOW	E30KC115		E30KC165		White	Blank	E30KC500		E30KC550		
	Black	LOWER	E30KC116		E30KC166		Gray	Blank	E30KC600		E30KC650		
	Black	MAN	E30KC117		E30KC167		Brown	Blank	E30KC700		E30KC750		
Black	ON	E30KC119		E30KC169		Orange	Blank	E30KC800		E30KC850			
Black	OPEN	E30KC120		E30KC170		Blue	Blank	E30KC900		E30KC950			
Black	OUT	E30KC121		E30KC171									
Black	RAISE	E30KC122		E30KC172									

Accessories Page 47-112
 Contact Blocks Page 47-108
 Blank Lens/Buttons
 with Non-standard
 Markings Pages 47-109 – 47-111
 Dimensions Page 47-114
 Discount Symbol 1CD1C

Operating Buttons and Lens Only

Standard Color Buttons and Lens Marking

BLACK LETTERING on — White, Amber, Yellow and Clear.

WHITE LETTERING on — Green, Red, Blue, Brown, Black, Orange and Gray.

For lenses with special markings or with standard markings but in a different color, refer to instructions on **Pages 47-109 – 47-111**.

Table 47-153. Type E Buttons with Standard Markings

	Color	Marking	Extended Button		Color	Marking	Extended Button		Button Application
			Catalog Number	Price U.S. \$			Catalog Number	Price U.S. \$	
 <p><i>Type E Button for Use with Operators E30EA thru EM, FA thru FM and JA thru JM, Legend Characters 1/8 inch (3.2 mm) High</i></p>	Black	Blank	E30KE100		Black	RESET	E30KE124		
	Black	CLOSE	E30KE102		Black	REVERSE	E30KE125		
	Black	DOWN	E30KE103		Black	RUN	E30KE126		
	Black	FAST	E30KE105		Black	SLOW	E30KE128		
	Black	FORWARD	E30KE107		Black	START	E30KE130		
	Black	HIGH	E30KE109		Black	TEST UP	E30KE132		
	Black	IN	E30KE110		Black	Blank	E30KE134		
	Black	INCH	E30KE111		Red	Blank	E30KE200		
	Black	JOG	E30KE112		Red	OFF	E30KE218		
	Black	JOG FOR.	E30KE113		Red	STOP	E30KE231		
	Black	JOG REV.	E30KE114		Green	Blank	E30KE300		
	Black	LOW	E30KE115		Green	START	E30KE330		
	Black	LOWER	E30KE116		Yellow	Blank	E30KE400		
	Black	ON	E30KE119		White	Blank	E30KE500		
	Black	OPEN	E30KE120		Gray	Blank	E30KE600		
	Black	OUT	E30KE121		Brown	Blank	E30KE700		
Black	PHASE	E30KE122		Orange	Blank	E30KE800			
				Blue	Blank	E30KE900			

Table 47-154. Type F Lenses with Standard Markings

	Color	Marking	Catalog Number	Price U.S. \$	Color	Marking	Catalog Number	Price U.S. \$	Lens Application
 <p><i>Type F Lens for Use with Operators E30BA thru BY, Legend Characters 3/16 inch (4.8 mm) High</i></p>	Red	Blank	E30KF10		Green	OFF	E30KF22		
	Red	MOTOR RUN	E30KF11		Amber	Blank	E30KF30		
	Red	ON	E30KF12		Blue	Blank	E30KF40		
	Red	POWER ON	E30KF13		Clear	Blank	E30KF50		
	Green	Blank	E30KF20		White	Blank	E30KF60		
	Green	MOTOR STOP	E30KF21						
	Green	MOTOR RUN	E30KF23						

Accessories Page 47-112
 Contact Blocks Page 47-108
 Dimensions Page 47-114
 Discount Symbol 1CD1C

Operator Lens Only

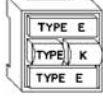
Standard Color Buttons and Lens Marking

BLACK LETTERING on — White, Amber, Yellow and Clear.

WHITE LETTERING on — Green, Red, Blue, Brown, Black, Orange and Gray.

For lenses with special markings or with standard markings but in a different color, refer to instructions on **Pages 47-109 – 47-111.**

Table 47-155. Type G Lenses with Standard Markings

	Color	Marking	Catalog Number	Price U.S. \$	Color	Marking	Catalog Number	Price U.S. \$	Lens Application
 <p><i>Type G Lens for Use with Operators E30CA thru CM and DA thru DM, Legend Characters 3/16 inch (4.8 mm) High Except MOTOR RUN, POWER ON & MOTOR STOP are 1/8 inch (3.2 mm) High</i></p>	Red	Blank	E30KG10		Green	OFF	E30KG22		
	Red	MOTOR RUN	E30KG11		Green	READY	E30KG23		
	Red	ON	E30KG12		Amber	Blank	E30KG30		
	Red	POWER ON	E30KG13		Blue	Blank	E30KG40		
	Red	Blank	E30KG20		Clear	Blank	E30KG50		
	Green	MOTOR RUN	E30KG24		White	Blank	E30KG60		
	Green	MOTOR STOP	E30KG21						

Table 47-156. Type J Lenses with Standard Markings



	Color	Marking	Catalog Number	Price U.S. \$	Color	Marking	Catalog Number	Price U.S. \$	Lens Application
 <p><i>Type J Lens for Use with Operators E30EA thru EM, FA thru FM and GA thru GM, Legend Characters 1/8 (3.2 mm) High</i></p>	Red	Blank	E30KJ10		Green	OFF	E30KJ22		
	Red	MOTOR RUN	E30KJ11		Green	ON	E30KJ24		
	Red	ON	E30KJ12		Amber	Blank	E30KJ30		
	Red	POWER ON	E30KJ13		Blue	Blank	E30KJ40		
	Red	MOTOR STOP	E30KJ14		Clear	Blank	E30KJ50		
	Green	Blank	E30KJ20		White	Blank	E30KJ60		
	Green	MOTOR STOP	E30KJ21						
	Green	MOTOR RUN	E30KJ23						

Table 47-157. Type K Lenses with Standard Markings — Sold in pairs only



	Color		Marking		Catalog Number	Price U.S. \$	Lens Application
	Left Hand Lens	Right Hand Lens	Left Hand Lens	Right Hand Lens			
 <p><i>Type K Lenses for Use with Operators E30JA thru JW, Legend Characters 1/8 inch (3.2 mm) High</i></p>	Red	Red	ON	ON	E30KK12		
	Red	Green	ON	OFF			
	Green	Green	OFF	OFF			
	Green	Red	OFF	ON			

Table 47-158. Type K Lenses — Blank — Sold in pairs only

	Color		Catalog Number	Price U.S. \$	Color		Catalog Number	Price U.S. \$
	Left Hand Lens	Right Hand Lens			Left Hand Lens	Right Hand Lens		
	Red	Red	E30KK10		Blue	Red	E30KK41	
	Red	Green	E30KK11		Blue	Green	E30KK42	
	Red	Amber	E30KK17		Blue	Amber	E30KK43	
	Red	Blue	E30KK14		Blue	Blue	E30KK40	
	Red	Clear	E30KK15		Blue	Clear	KE30K45	
	Red	White	E30KK16		Blue	White	E30KK46	
	Green	Red	E30KK21		Clear	Red	E30KK51	
	Green	Green	E30KK20		Clear	Green	E30KK52	
	Green	Amber	E30KK27		Clear	Amber	E30KK53	
	Green	Blue	E30KK24		Clear	Blue	E30KK54	
	Green	Clear	E30KK25		Clear	Clear	E30KK50	
	Green	White	E30KK26		Clear	White	E30KK56	
	Amber	Red	E30KK31		White	Red	E30KK61	
	Amber	Green	E30KK32		White	Green	E30KK62	
	Amber	Amber	E30KK30		White	Amber	E30KK63	
	Amber	Blue	E30KK34		White	Blue	E30KK64	
	Amber	Clear	E30KK35		White	Clear	E30KK65	
	Amber	White	E30KK36		White	White	E30KK60	

E30 Series, Components — Contact Blocks

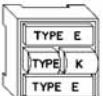
Contact Blocks

Standard Contact Blocks — Molded, phenolic construction. Enclosed silver contacts with reliability “nibs” that improve the reliability of switching performance under dry circuit, corrosive atmosphere and fine dust conditions. For more extreme conditions, the Logic Level contact blocks described below are recommended.

Table 47-159. Standard Contact Block Ratings — Maximum Amperes

Current	AC Volts A600				DC Volts P300		
	120	240	480	600	24/28	125	250
Make & Emergency Inter. Capacity	60	30	15	12	5.73	1.1	0.55
Normal Load Break	6	3	1.5	1.2	5.73	1.1	0.55
Continuous Current	10						

Logic Level Contact Blocks — Feature palladium contacts. Palladium, which is more inert than gold, is well suited for voltages and currents approaching zero. When mounted in an enclosure rated for highly corrosive environments, logic level contact blocks can be used where exposure to chemicals may cause failure to other types of materials.

Table 47-160. Maximum Ratings for Logic Level and Hostile Atmosphere Application ①

Maximum Amperes	0.5A ①
Maximum Volts	120V AC/DC

① Logic level contact blocks are UL A600/P500 rated per table above.

Mounting Limitations

Figure 47-83 and **Table 47-161** give the contact block mounting limitations for Type E30 pushbutton and combination pushbutton and light operators. Mounting positions 1 thru 8 indicate single depth contact blocks. Each of these positions can represent either a single circuit 600 volt block or a 2-circuit 120 volt block. The 2-circuit 600 volt block requires two of the numbered positions shown.

Table 47-161. Mounting Positions

Catalog Number of Operator	Contact Blocks Can Be Mounted in Positions Listed Below	
	Upper Stack	Lower Stack
E30AA thru E30AM ②	1-2-3-4	5-6-7-8
E30BA thru E30CM	None	None
E30DA thru E30DM	None	5-6-7-8
E30EA thru E30GM	2-3-4	6-7-8
E30JA thru E30JM	3-4	7-8

② Except Operator E30AD, AJ or AK which will accommodate contact blocks 1, 2, 5 and 6 only. (See figure below.)

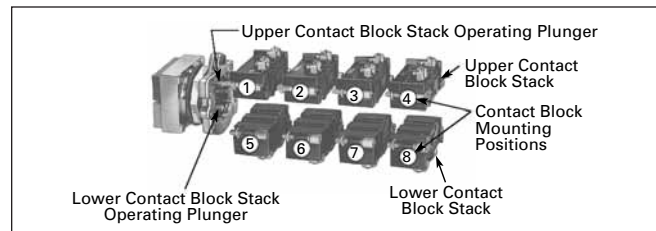

Figure 47-83. Mounting Positions

Table 47-162. Contact Block Selection Table

Contact Block Type ⑥	Circuit	Pressure Terminals				Quick Connect Terminals ⑤	
		STANDARD		LOGIC LEVEL		STANDARD	
		Catalog Number	Price U.S. \$	Catalog Number	Price U.S. \$	Catalog Number	Price U.S. \$
	1NO	600 Volt AC, 250 Volt DC — Single Circuit					
	1NC	E30KLA1		E30KLAE1		E30KLB1	
	1NO-1NC	600 Volt AC, 250 Volt DC — Two Circuit					
	2NO	E30KLA3		E30KLAE3		E30KLB3	
	2NC	E30KLA4		E30KLAE4		E30KLB4	
	Special Contact Operation	E30KLA6 ③		—		E30KLB6 ③	
	1NO-1NC Overlapping						
	2NO (One Early Closing)	E30KLA7 ③		—		E30KLB7 ③	
2NC (One Late Opening)	E30KLA8		—		E30KLB8		
	1NO-1NC	120 Volt AC Only — Two Circuit					
	1NO-1NC	E30KLA9 ④		—		E30KLB9 ④	

③ Do not use with maintained operators.

④ Contacts must be same polarity.

⑤ Supplied with non-stacking screws. Limited to 2 contact blocks mounted in positions 1 and 5.

⑥ Individually boxed contact blocks master packed 10 per carton.

Discount Symbol **1CD1C**

E30 Series, Options — Legend Plates

Options

Markings and Legend Plates

Buttons or Lenses with Non-standard Horizontal Markings

Markings not listed as STANDARD MARKINGS below are considered non-standard. If more than one marking is required on a button or lens, order non-standard markings.

Ordering Instructions

- Specify Catalog Number of blank button or lens of desired color, plus Suffix "STAMP" for Non-standard or "STD" for Standard markings in Order

Notes. See Pages 47-105 – 47-107.

- Specify size, legend desired and location in Order Notes by alphas as shown in example.
- Do not exceed maximum number of legend characters per line.

Ordering Example:

Green Type B button to be marked with non-standard legend "ALL ELEVATORS DOWN."

Catalog No.: E30KB300STAMP
 Letter Size: 1/8"
 Pos. A — ALL
 Pos. C — ELEVATORS
 Pos. F — DOWN

Table 47-163. Button Markings

Description	Price Each U.S. \$	Price Per Pair U.S. \$
All Types except K Type K		

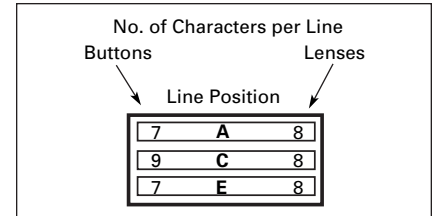

Figure 47-84. How to Use the Legend Location Figure

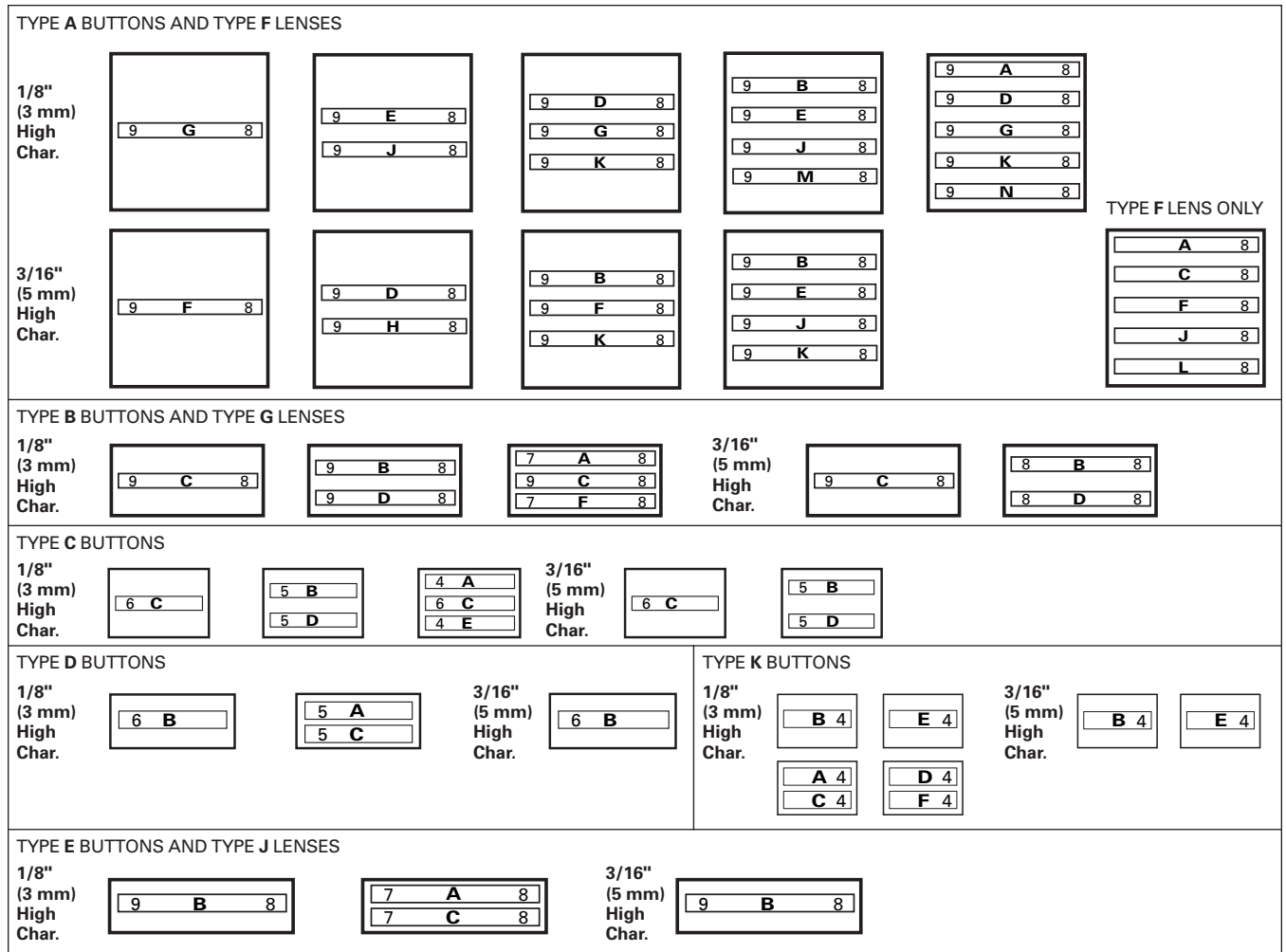

Figure 47-85. Legend Locations

Table 47-164. Standard Markings

AUTO	EMERG. STOP	HAND	INCH	JOG REV.	MAN.	OPEN	RESET	SLOW	TEST	MOTOR STOP
CLOSE	FAST	HIGH	JOG	LOW	OFF	OUT	REVERSE	START	UP	POWER ON
DOWN	FORWARD	IN	JOG FOR.	LOWER	ON	RAISE	RUN	STOP	MOTOR RUN	READY

Discount Symbol 1CD1C

E30 Series, Options — Legend Plates

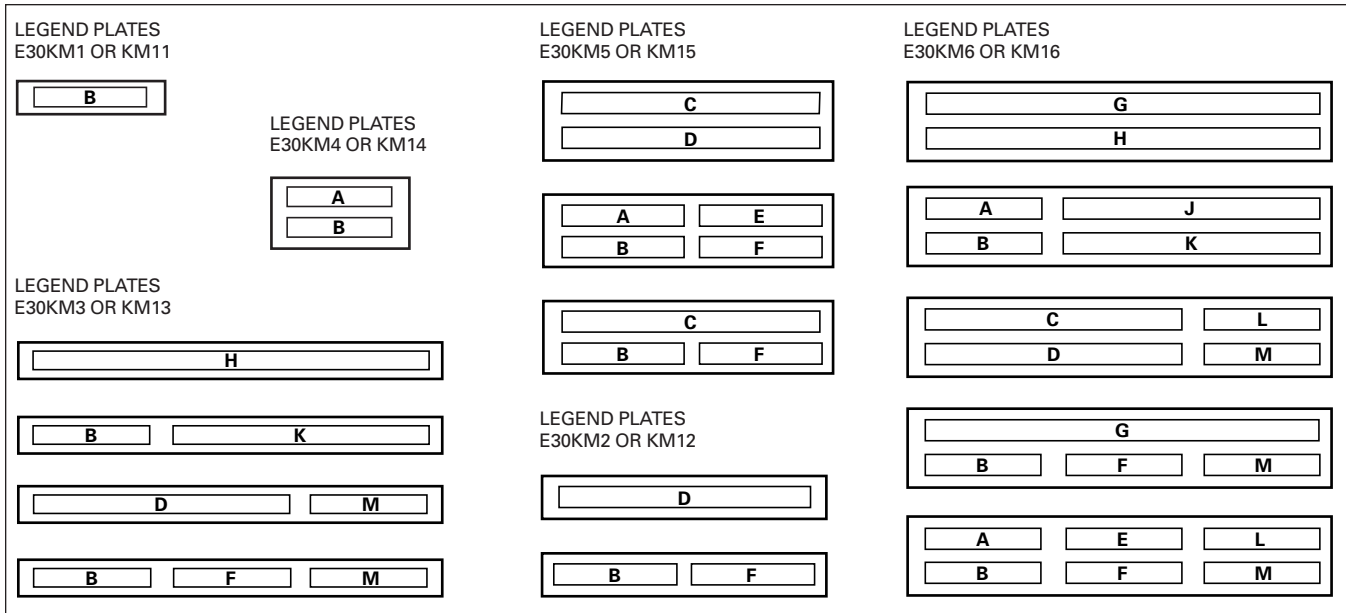

Figure 47-86. Legend Arrangements and Legend Locations

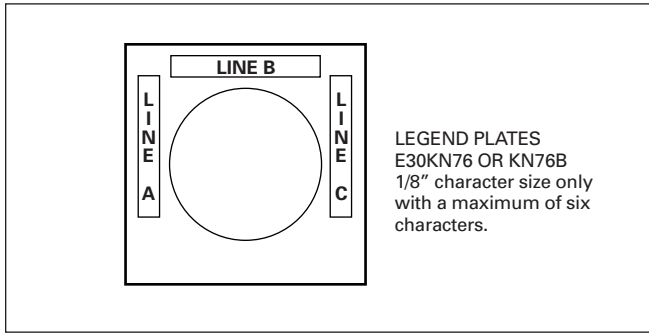

Figure 47-87. Legend Plates E30KN76 or KN76B

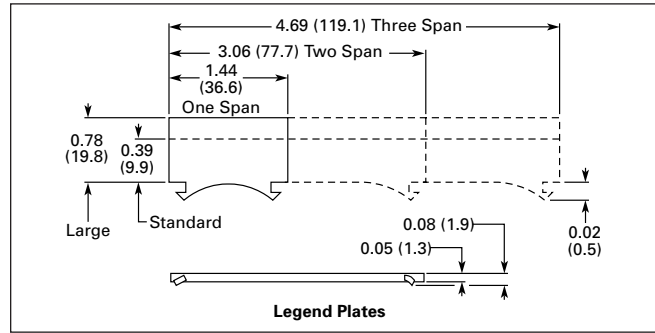

Figure 47-88. Approximate Dimensions in Inches (mm)

Table 47-165. Maximum Number and Size of Permissible Legend Characters of Custom Stamped Legend Plates

Type	No. of Lines	Size and Maximum Number of Characters Per Line								
		One Span			Two Span			Three Span		
		3/32" (2.5 mm)	1/8" (3 mm)	3/16" (5 mm)	3/32" (2.5 mm)	1/8" (3 mm)	3/16" (5 mm)	3/32" (2.5 mm)	1/8" (3 mm)	3/16" (5 mm)
Standard	1	13	10	10	30	22	22	47	34	34
Large	1	13	10	10	30	23	23	47	36	36
	2	13	10	10	30	23	23	47	36	36
CHARACTERS AVAILABLE FOR NON-STANDARD MARKINGS 3/32 Inch (2.5 mm) — 1/8 Inch (3 mm) — 3/16 Inch (5 mm)										
A B C D E F G H I J K L M N O P Q R S T U V W X Y Z . / - , 1 2 3 4 5 6 7 8 9 0										

Buttons or Lenses with Non-standard Vertical Markings

Ordering Instructions

- Specify Catalog Number of blank button or lens of desired color, selected from listings on **Pages 47-105 – 47-107**.
- Specify size, legend desired, location and state “vertically marked” in Order Notes.

Note: Specify either 1/8 or 3/16 inch (3.2 or 4.8 mm) character height. Do not exceed maximum number of characters as outlined in table below.

Ordering Example:

Green Type K button to be marked with “RUN” “ON.”

Description	Price Ea.
Catalog No.: E30KK20STAMP Letter Size: 3/16 inch (4.8 mm) Vertically Marked Pos. B — RUN Pos. E — ON	

Table 47-166. Maximum Number of Characters

Description	Type	Maximum Number of Characters	
		1/8 Inch (3.2 mm)	3/16 Inch (4.8 mm)
Buttons	A	7	5
	B	7	5
	C	4	3
	D	5	3
	E	7	5
Lenses	F	7	5
	G	7	5
	J	7	5
	K	3	2

Legend Plates

Legend plates for Type E30 Compact Pushbutton and Indicating Light operators hook directly onto the operator and are clamped in place when the operator locking nut behind the panel is secured.

Two and three span plates are designed for use where two or more operators are mounted adjacent to each other **on minimum horizontal mounting centers**. These legend plates mount in the same manner as single span units.

Blank Legend Plates and Legend Plates with Markings



When Ordering Legend Plates with Markings

- Catalog Number of Blank Legend Plate
- Insert the following in Order Notes:
 - Legends Required
 - Size of Characters — 3/32, 1/8, 3/16 inch (2.4, 3.2, 4.8 mm)
 - Positions of legends on one line Standard and two line Large legend plates by alphas as shown in sketches on following page.

Ordering Example:

Three span legend plate to be marked “MASTER CONTROL”, “STATION A” and “STATION B.”







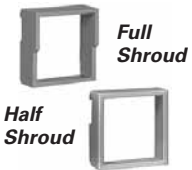

Description	Price Ea.
Catalog No: E30KM3STAMP Letter Size: 1/8 inch (3.2 mm) Pos. C — MASTER CONTROL Pos. B — STATION A Pos. F — STATION B	

Table 47-167. Blank Legend Plate

Type	One Span	
	Catalog Number	Price U.S. \$
Black		
Standard	E30KM1	
Large	E30KM4	

Accessories

Table 47-168. Accessories

Description	Color/Type	Catalog Number	Price U.S. \$
	Black Red Green Yellow White Gray Orange Blue Brown	E30KR1 E30KR2 E30KR3 E30KR4 E30KR5 E30KR6 E30KR8 E30KR9 E30KR10	
	Full Shroud (Gray) Half Shroud (Gray)	E30KT6 E30KT7	
	Red with White Slide Red with Clear Slide	E30KR31 E30KR32	
		E30KR30	
	Short Button Extended Button	E30KT1 E30KT2	
		E30KT3 ①	
	Gray Enameled Stainless Steel	E30KT4 E30KT5	
		E30KV1	
		E22CW	
		E30KV2	

① Color coordinating collars, padlock attachments or legend plates cannot be used with operators equipped with a transparent boot.

Replacement Parts

Table 47-169. Replacement Light Units for E30 Components

Voltage AC and DC	Part Numbers — Receptacles without Lamps									
	Single Indicating Light	Price U.S. \$	Dual Indicating Light	Price U.S. \$	Single Light Single Pushbutton	Price U.S. \$	Single Light Dual Pushbutton	Price U.S. \$	Dual Light Dual Pushbutton	Price U.S. \$

Full Voltage Type

6V	57-2579-3A		57-2568A		57-2568A		57-2579-3A		57-2567A	
12V	57-2579-3A		57-2568A		57-2568A		57-2579-3A		57-2567A	
18/24V	57-2579-3A		57-2568A		57-2568A		57-2579-3A		57-2567A	
28V	57-2579-3A		57-2568A		57-2568A		57-2579-3A		57-2567A	
32V	57-2579-3A		57-2568-2A		57-2568-2A		—		57-2567A	
48V	57-2579-3A		57-2568A		57-2568A		57-2579-3A		57-2567A	
120V	57-2579-3A		57-2568A		57-2568A		57-2579-3A		57-2567A	

Transformer Type

120V	42-2672A		42-2663A		42-2663A		42-2671A		42-2664A	
208V	42-2672-2A		42-2663-2A		42-2663-2A		42-2671-2A		42-2664-2A	
240V	42-2672-3A		42-2663-3A		42-2663-3A		42-2671-3A		42-2664-3A	
380V	42-2672-4A		42-2663-4A		42-2663-4A		42-2671-4A		42-2664-4A	
480V	42-2672-5A		42-2663-5A		42-2663-5A		42-2671-5A		42-2664-5A	
600V	42-2672-6A		42-2663-6A		42-2663-6A		42-2671-6A		42-2664-6A	

Description and Part Numbers — Related Parts

Inner Lens	28-1008		28-1010		28-1010		28-1010		28-1010	
Retaining Nut	15-1885		15-1885		15-1885		15-1885		15-1885	
Gasket	16-2092		16-2092		16-2092		16-2092		16-2092	
Locking Ring	52-1116		52-1116		52-1116		52-1116		52-1116	

Table 47-170. Replacement Lamps for E30 Illuminated Operators

Mfg. Lamp Type	Voltage	Base Style	Application	Part Number	Price U.S. \$
6PSB	6V	T2 Slide	E30 Transformer and Full Voltage	28-1022	
12PSB	12V	T2 Slide	E30 Full Voltage	28-1025	
24PSB	24V	T2 Slide	E30 Full Voltage	28-1026	
28PSB	28V	T2 Slide	E30 Full Voltage	28-1027	
48PSB	48V	T2 Slide	E30 Full Voltage	28-1028	
60PSB	60V	T2 Slide	E30 Full Voltage	28-1598	
120PSB	120V	T2 Slide	E30 Full Voltage	28-1029	
#259	6.3V	T3-1/4 Wedge	E30 Single Transformer	28-949	

E30 Series, Dimensions

Dimensions

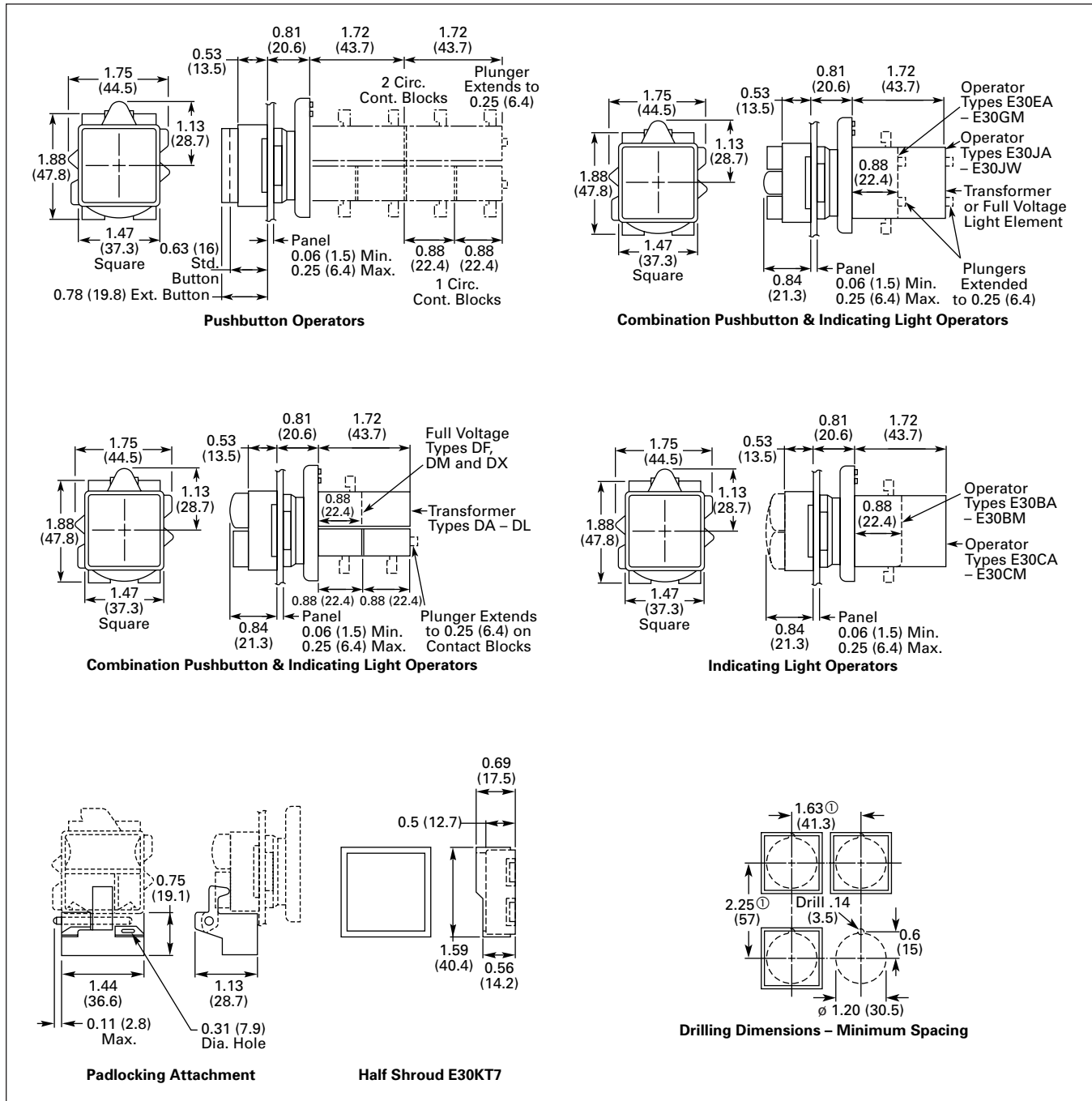

Figure 47-89. Approximate Dimensions in Inches (mm)

Drilling Dimensions — Minimum Spacing

Dimensions shown allow adequate space for the addition of one or two high legend plates and color coordinating collars.

Note: Locating nib hole or notch is 0.136" (3.5 mm) drill. Alternate to drilling mounting holes use Greenlee Tool Co. punch (No. 730-S) to punch the hole and (No. 730-K) to punch the notch.

Contents

<i>Description</i>	<i>Page</i>
Product Description	47-115
Features	47-116
Benefits	47-116
Contact Operation	47-116
Standards and Certifications	47-116
Technical Data and Specifications	47-116
Point-of-Purchase Packaging	47-117
Product Selection	
Non-illuminated Momentary Pushbutton Units	47-118
Pushbuttons	47-119
Illuminated Momentary Pushbutton Units	47-122
Indicating Light Units	47-123
Illuminated Pushbuttons and Indicating Lights	47-124
Push-Pull Units	47-125
Illuminated Push-Pull Units	47-126
Potentiometers	47-128
Push-Pulls	47-129
Selector Switch Units	47-132
Selector Switch Selection	47-133
Selector Switch Operators	47-135
Illuminated Selector Switch Operators	47-138
Joysticks Units	47-139
Joystick	47-139
Roto-Push® Units	47-142
Roto-Push Operators	47-143
Contact Blocks	47-148
Options	
Legend Plates	47-151
Enclosures	47-153
Accessories	47-155
Renewal Parts	47-157
Mounting	47-159
Dimensions	47-160
Ordering Complete Devices	47-163
Catalog Number Structure	47-164

Product Description

The 30.5 mm pushbutton line features a zinc die cast construction with chrome-plated housing and mounting nut. The same durable construction is also available with the corrosive resistant E34 line of pushbuttons. See E34 section on **Pages 47-166 – 47-189**.

Reliability Nibs

Eaton's Cutler-Hammer® contact blocks feature enclosed silver contacts with pointed "reliability nibs" for reliable performance from logic level up to 600V. To ensure reliable switching, nibs bite through oxide which can form on silver contacts, eliminating the need for expensive logic level blocks for most applications.

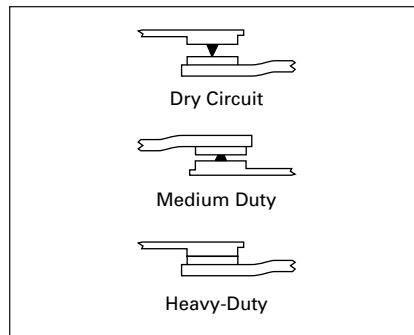
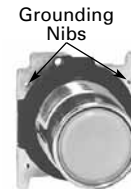

Figure 47-90. Reliability Nibs

Reliability nibs improve performance in dry circuit, corrosive, fine dust and other contaminated atmospheres. Under normal environmental conditions, the minimum operational voltage is 5V and the minimum operational current is 1 mA, AC/DC. For operation under a wider range of environmental conditions, logic level contact blocks with inert palladium tipped contacts are recommended.

Grounding Nibs

10250T line operators have "grounding nibs" — four metal points on the operator casting designed to bite through most paints and other coatings on metal panels to enhance the ground connection when the operator is securely tightened.



Grounding Nibs

Diaphragm Seal with Drainage Holes

Liquid Drainage

Eaton's Cutler-Hammer pushbutton operators offer front of panel drainage via holes in the operator bushing. Hidden from view by the mounting nut, these holes prevent buildup of liquid inside the operator, which can prevent operation in freezing environments. The holes also provide a route for escaping liquid in high pressure wash-downs, effectively relieving pressure from the internal diaphragm seal, ensuring reliable sealing in applications even beyond NEMA 4.

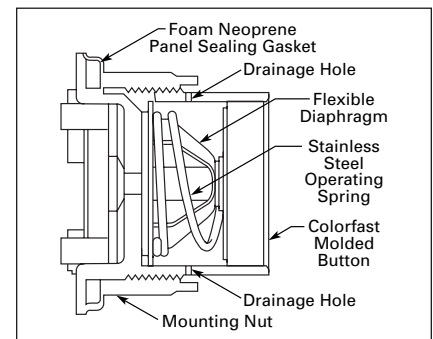
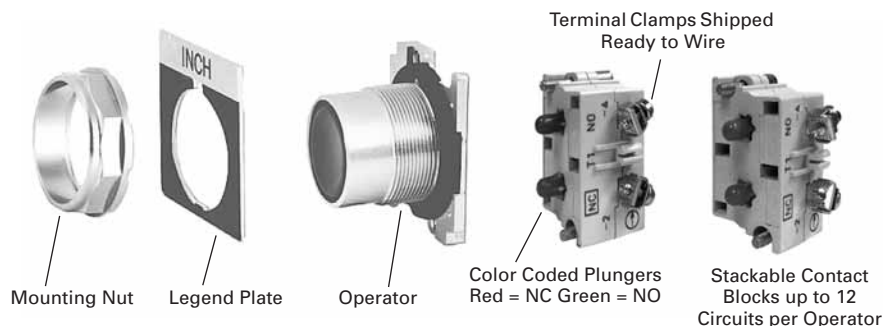

Figure 47-91. Diaphragm Seal



10250T Series

Features

- Heavy-duty zinc die cast construction
- Enclosed silver contacts with reliability nibs
- Diaphragm seals with drainage holes
- Grounding nibs on the operator casing

Benefits

- Reliability nibs improve contact reliability even under dry circuit and fine dust conditions
- Drainage holes prevent buildup of liquid inside the operator which can prevent operation in freezing environments
- Grounding nibs bit through paint and other coatings to provide secure ground

Contact Operation

Slow make and break. All normally closed contacts have positive opening operation, i.e., normally closed contacts are forced open in the event of contact weld or spring breakage.

Standards and Certifications

- CE EN60947-5-1
- UL 508 — File No. 131568
- CSA C22.2 No. 14 — File No. LR68551

Ingress Protection

When mounted in similarly rated enclosure —

- Standard Indicating Lights
 - UL (NEMA) Type 1, 2, 3, 3R, 3S, 4, 4X, 12, 13
 - IEC IP65
- All Other Operators
 - UL (NEMA) Type 1, 2, 3, 3R, 4, 4X, 12, 13
 - IEC IP65

Technical Data and Specifications

Mechanical Ratings

- Frequency of operation
 - All pushbuttons: 6000 operations/hr.
 - Key and lever selector switches: 3000 operations/hr.
 - Auto-latch devices: 1200 operations/hr.

- Life
 - Pushbuttons: 10×10^6 operations
 - Contact blocks: 10×10^6 operations
 - PresTest units: 10×10^6 operations
 - Lever and key selector switches: 0.25×10^6 operations
 - Twist to release pushbuttons: 0.3×10^6 operations
- Shock resistance
 - Duration: 20 mS \geq 5g

Climate Conditions

- Operating Temperature: 1° to 150°F (-17° to 66°C)
- Storage Temperature: -40° to 176°F (-40° to 80°C)
- Altitude: 6,562 ft. (2,000m)
- Humidity: Max. 95% RH @ 60°C

Terminals

- Marking
 - NC-NO on the contact block to meet the NEMA requirements. Dual marking system 1 – 2 for normally closed, 3 – 4 for normally open to meet BS5472 (Cenelec EN50 005)
- Clamps
 - Terminals are saddle clamp type for 1 x 22 AWG (0.34 mm²) to 2 x 14 AWG (2.5 mm²) conductors
- Torque = 7 lb-in (0.8 Nm)
- Degree of protection against direct electrical contact: IP2X with fingerproof shroud

Light Units

- Transformers: will withstand short circuit for 1 hour per IEC 60997-5-1
- Bulbs — average life
 - Transformer type: 20,000 hrs.
 - Resistor/direct voltage type: 2500 hrs. minimum @ rated V
 - LED: 60,000 to 100,000 hrs.

Electrical Ratings

- Insulation: $U_i = 660V$ AC or DC
- Thermal: $I_{th} = 10A$

Short Circuit Coordination to IEC/EN 60947-5-1

- Rated conditional short circuit current: 1 kA
- Fuse type: GE Power Controls TIA 10, Red Spot Type gG, 10A, 660V AC, 460V DC, BS88-2, IEC 60269-2-1



Fuse

- UL rating: A600, P600
 - AC load life duty cycle 1200 operations/hour
 - 10A: 110V pf 0.4 – 1×10^6 operations
 - 5A: 250V pf 0.4 – 1×10^6 operations
 - 2A: 660V pf 0.4 – 1×10^6 operations
- Switching capacity
 - AC15 rated make/break (11 x I_e at 1.1 x U_e)
 - 6A: 120V pf 0.3
 - 4A: 240V pf 0.3
 - 2A: 660V pf 0.3
 - DC13 rated make/break (1.1 x I_e at 1.1 x U_e)
 - 1.0A: 125V L/R \geq 0.95 at 300 mS
 - .55A: 250V L/R \geq 0.95 at 300 mS
 - .1A: 660V L/R \geq 0.95 at 300 mS
 - 10A: 110V pure resistive
- Maximum ratings for logic level and hostile atmosphere application
 - Maximum amperes: 0.5A
 - Maximum volts: 120V AC/DC

Table 47-171. Contact Block

Description	Meet or Exceed NEMA Rating Designations A600, A300 and B300 for AC and P600 for DC						
	Volts AC 50 or 60 Hz				Volts DC		
	120	240	480	600	24/28	125	250
Make and Emerg. Interrupting Capacity (Amp)	60	30	15	12	5.7	1.1	0.55
Normal Load Break (Amp)	6	3	1.5	1.2	5.7	1.1	0.55
Thermal Current (Amp)	10	10	10	10	5.0	5.0	5.0
Voltamperes:							
Make and Emerg. Interrupting Capacity	7200	7200	7200	7200	138	138	138
Normal Load Break	720	720	720	720	138	138	138

**Point-of-Purchase Packaged
Pilot Devices**



Table 47-172. 10250T Point-of-Purchase Packaged Pilot Devices





Product	Description	Catalog Number	Price U.S. \$
Emergency Stop Operators			
Red Non-illuminated Push-Pull	1NO-1NC contact block. Also includes two square engraved legend plates: EMERG. STOP and STOP.	10250T5B62-1-POP	
Red Mushroom Pushbutton	1NO-1NC contact block. Also includes two square engraved legend plates: EMERG. STOP and STOP.	10250T32R-POP	
Red Jumbo Mushroom Pushbutton	Engraved EMERG. STOP with 1NO-1NC contact block.	10250T33-POP	
Momentary Pushbuttons			
Black Flush Pushbutton	1NO-1NC contact block. Also includes two square engraved legend plates: START and JOG.	10250T30B-POP	
Red Extended Pushbutton	1NO-1NC contact block. Also includes one square engraved legend plate: STOP.	10250T31R-POP	
Indicating Lights			
Red Indicating Light	Full voltage 24V AC/DC with two extra lenses: Green and Amber. Also includes two square engraved legend plates: RUN and JOG.	10250T206NC1N-POP	
Red Indicating Light	Resistor 120V AC/DC with two extra lenses: Green and Amber. Also includes one square engraved legend plate: RUN and JOG.	10250T34R-POP	
Illuminated Pushbuttons			
Red Illuminating Pushbutton	Full voltage 24V AC/DC with 1NO-1NC contact block and two extra lenses: Green and Amber. Also includes one square engraved legend plate: POWER ON.	10250T476C21-1-POP	
Red Illuminating Pushbutton	Resistor 120V AC/DC with 1NO-1NC contact block and two extra lenses: Green and Amber. Also includes one square engraved legend plate: POWER ON.	10250T411C21-1-POP	
Selector Switches			
Black Knob Two-Position Selector Switch	1NO-1NC contact block. Also includes three square engraved legend plates: OFF/ON, HAND/AUTO and RUN/JOG.	10250T20KB-POP	
Black Knob Three-Position Selector Switch	1NO-1NC contact block. Also includes 1 square engraved legend plate: HAND/OFF/AUTO.	10250T22KB-POP	

Product Selection

Non-illuminated Momentary Pushbutton Units

- Flush, Extended, Mushroom Head or Jumbo Mushroom Head Operators

Table 47-173. Pushbutton Units — UL (NEMA) Type 3, 3R, 4, 4X, 12, 13

Contact Type	Button Color	Flush Button		Extended Button		Mushroom Button		Jumbo Mushroom ^①			
		 Flush Button — Black Cat. No. 10250T23B	 Extended Button — Red Cat. No. 10250T31R	 Mushroom Button — Red Cat. No. 10250T32R	 Jumbo Mushroom — Red Cat. No. 10250T17213-3	Catalog Number	Price U.S. \$	Catalog Number	Price U.S. \$	Catalog Number	Price U.S. \$
1NO	Black Red Green Yellow Red — Engraved EMERG. STOP	10250T23B 10250T23R 10250T23G 10250T23Y —	—	10250T25B 10250T112-53 10250T25G 10250T25Y —	—	10250T26B 10250T122-53 10250T26G 10250T26Y —	—	10250T27B 10250T172-53 10250T27G 10250T27Y 10250T17213-3	—	—	—
1NC	Black Red Green Yellow Red — Engraved EMERG. STOP	10250T101-51 10250T102-51 10250T103-51 10250T104-51 —	—	10250T111-51 10250T25R 10250T113-51 10250T120-51 —	—	10250T121-51 10250T26R 10250T123-51 10250T124-51 —	—	10250T171-51 10250T27R 10250T173-51 10250T174-51 10250T29	—	—	—
1NO-1NC	Black Red Green Yellow Red — Engraved EMERG. STOP	10250T30B 10250T30R 10250T30G 10250T30Y —	—	10250T31B 10250T31R 10250T31G 10250T31Y —	—	10250T32B 10250T32R 10250T32G 10250T32Y —	—	10250T33B 10250T33R 10250T33G 10250T33Y 10250T33	—	—	—
2NO	Black Red Green Yellow Red — Engraved EMERG. STOP	10250T101-2 10250T102-2 10250T103-2 10250T104-2 —	—	10250T111-2 10250T112-2 10250T113-2 10250T120-2 —	—	10250T121-2 10250T122-2 10250T123-2 10250T124-2 —	—	10250T171-2 10250T172-2 10250T173-2 10250T174-2 10250T17213-2	—	—	—
2NC	Black Red Green Yellow Red — Engraved EMERG. STOP	10250T101-3 10250T102-3 10250T103-3 10250T104-3 —	—	10250T111-3 10250T112-3 10250T113-3 10250T120-3 —	—	10250T121-3 10250T122-3 10250T123-3 10250T124-3 —	—	10250T171-3 10250T172-3 10250T173-3 10250T174-3 10250T17213-3	—	—	—







① Anodized aluminum head is not suitable for use in ultraviolet light applications.

Accessories Pages 47-155 – 47-156
 Dimensions Pages 47-160 – 47-162
 Enclosures Pages 47-153 – 47-154
 Legend Plates Pages 47-151 – 47-152
 Discount Symbol 1CD1C

10250T Series, Momentary Pushbutton Components

Pushbuttons

Table 47-174. Momentary Pushbutton Operators, Non-illuminated — UL (NEMA) Type 3, 3R, 4, 4X, 12, 13

	Color	Catalog Number	Price U.S. \$	
Flush Button ①				
	Black	10250T101		
	Red	10250T102		
	Green	10250T103		
	Yellow	10250T104		
	Gray	10250T105		
	White	10250T106		
	Blue	10250T108		
	Orange	10250T109		
	Extended Button			
	Black	10250T111		
	Red	10250T112		
	Green	10250T113		
	Yellow	10250T120		
	White	10250T116		
	Blue	10250T118		
	Orange	10250T119		
	Half Shrouded Button			
	Black	Vertical	Horizontal	
		10250T501	10250T511	
	Red	10250T502	10250T512	
		10250T503	10250T513	
	Green	10250T504	10250T514	
		10250T505	10250T515	
	Yellow	10250T506	10250T516	
		10250T508	10250T518	
	Gray	10250T509	10250T519	
		White		
	Blue			
		Orange		
Mushroom Button				
	Black	10250T121		
	Red	10250T122		
	Green	10250T123		
	Yellow	10250T124		
	Blue	10250T129		
Jumbo Mushroom Button ②				
	Black	10250T171		
	Red	10250T172		
	Red (EMERG. STOP)	10250T17213		
	Green	10250T173		
	Yellow	10250T174		
Low Operating Force — Jumbo Mushroom ②③				
	Black	10250ED1164-2		
	Red	10250ED1164-3		
	Green	10250ED1164-4		
	Yellow	10250ED1164-5		
	Clear	10250ED1164		

Note: To order complete assembled unit using one composite Catalog Number, add Contact Block and Legend Plate Suffix to the end of Operator Catalog Number.
Example: 10250T101-1TS33



Operator
10250T101

+



Contact Block
10250T1

+



Legend Plate
10250TS33

① To order operator with factory assembled Extended Retaining Nut, **10250TA12**, for thick panel applications, add Suffix Letter **E** to listed Catalog Number. Example: 10250T101E

② Anodized aluminum head is not suitable for use in ultraviolet light applications.

③ Operating Force — Standard = 2.4 lb; Low Force = 1.6 lb.

Accessories **Pages 47-155 – 47-156**
 Contact Blocks **Page 47-148**
 Dimensions **Pages 47-160 – 47-162**
 Enclosures **Pages 47-153 – 47-154**
 Legend Plates **Pages 47-151 – 47-152**
 Discount Symbol **1CD1C**

10250T Series, Interlocked and Padlockable Components

Pushbuttons (Continued)

Table 47-175. Mechanically Interlocked Pushbutton Operators — UL (NEMA) Type 3, 3R, 4, 4X, 12, 13

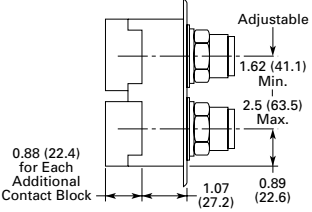
	Description	Catalog Number	Price U.S. \$	Overall Dimensions in Inches (mm)
	Minimum hole centers 1.62", maximum 250". Mounts in extra deep enclosures only. Black flush and green flush Black flush and long red Black flush and red mushroom head Black flush and lock-down red mushroom head	10250TA66 10250TA67 10250TA68 10250TA69 ①		
	Black flush and red jumbo mushroom head Green flush and long red Black long and long red Green flush and red mushroom head Green flush and black flush	10250TA76 10250TA72 10250TA73 10250TA77 10250TA75		

① NC contacts must be mounted behind lock-down mushroom head operator to ensure lockout.

Lockout Pushbutton Operators with Padlock Attachments

The following pushbutton and mushroom operators include an integral padlock attachment for applications requiring lockout/tagout of specific machine functions. They are available in styles which allow locking of a button in the down position

(stopped position) or locking a button in the up position (to prevent starting). Select the **"Hand"** latch type which functions as a momentary pushbutton until the operator presses the button and moves the padlock attachment into position for locking, or choose the

"Spring Loaded" latch type where the padlock attachment springs into place when the button is pressed. Units accept a customer supplied 1/4" padlock.

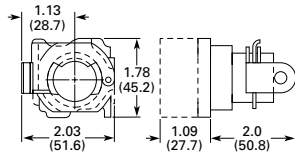
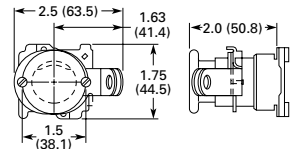

Table 47-176. Padlockable in the Down Position ② — UL (NEMA) Type 3, 3R, 4, 4X, 12, 13

	Operator Type	Color	Latch Type	Catalog Number	Price U.S. \$	Overall Dimensions in Inches (mm)
	Flush Head	Red	Hand	10250TA16		
	Mushroom Head	Red Red	Hand Spring Loaded	10250TA42 10250TA45		
	Jumbo Head ③	Red Red Red (EMERG. STOP)	Hand Spring Loaded Spring Loaded	10250TA52 10250TA55 10250ED952		

② Operators can be latched down without a padlock. Padlock not included.

③ Jumbo mushroom heads are not recommended for use in applications where exposure to ultraviolet light exists.

Table 47-177. Padlockable in the Up Position ④ — UL (NEMA) Type 3, 3R, 4, 4X, 12, 13

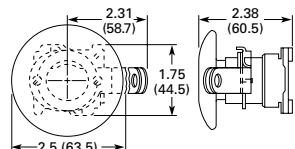
	Operator Type	Color	Latch Type	Catalog Number	Price U.S. \$	Overall Dimensions in Inches (mm)
	Mushroom Head	Black Green	Hand Hand	10250TA41 10250TA43		
	Jumbo Mushroom Head ⑤	Black Green Yellow	Hand Hand Hand	10250TA51 10250TA53 10250TA54		

④ Operators can be latched down without a padlock. Padlock not included.

⑤ Jumbo mushroom heads are not recommended for use in applications where exposure to ultraviolet light exists.

Note: Hand Attachment must be manually moved into place for locking. Spring Loaded: when operator is pressed — attachment springs into place. Must be moved manually to release button.

Contact Blocks **Page 47-148**
 Enclosures **Pages 47-153 – 47-154**
 Discount Symbol **1CD1C**

Pushbuttons (Continued)

Key Pushbutton Operator

These devices incorporate an integral locking mechanism which enables locking units in various positions (**Locked Down**), locking units to prevent operation (**Locked Up**) or setting unit to lock when the button is pressed (**Push to Lock**), requiring the key to be inserted to return to normal operation. With the key in the center position, these operators function as a normal momentary pushbutton (**Free**).

Replacement Keys or Dissimilar Locks for Key Operators Below

Listed operators have identical locks and keys (Key Code H661) Catalog Number 10250ED824. For dissimilar lock and key combinations, see listing on **Page 47-136**.

Table 47-178. Replacement Keys

Description	Catalog Number	Price U.S. \$
Replacement Keys (Code H661)	10250ED824	

Table 47-179. Key Pushbutton Operator — UL (NEMA) Type 3, 3R, 4, 4X, 12, 13

	Key Position and Pushbutton Operations			Key Removal Positions	Vertical Mounting ①		Overall Dimensions in Inches (mm)
					Catalog Number	Price U.S. \$	
	3-Position			All L and R C and R	10250T430		 Key Operated Pushbutton
	Lock Up	Free	Lock Down		10250T431		
	Lock Up	Free	Lock Down		10250T432		
	2-Position			L and C L C and R R C and R R	10250T433		
	Lock Up	Free	—		10250T434		
	Lock Up	Free	—		10250T435		
	—	Free	Lock Down		10250T436		
	—	Free	Lock Down		10250T437		
	—	Free	Push to Lock	10250T438			
	—	Free	Push to Lock	10250T438			

① Horizontal mounting available on request.

Latch-In, Twist-to-Release Operator

Table 47-180. Operator Only with Button — UL (NEMA) Type 3, 3R, 4, 4X, 12, 13

	Description	Catalog Number	Price U.S. \$	Dimensions in Inches (mm)
	Latch-In, Twist-to-Release Operator with Red Mushroom Head Button	10250ED1043-4		 0.24 (6) → 1.55 (39.3) Spring Return 0.86 (21.8) → 2.37 (60.3) Auto-Latch 1.5 (38.1)

Accessories **Pages 47-155 – 47-156**
 Contact Blocks **Page 47-148**
 Dimensions **Pages 47-160 – 47-162**
 Enclosures **Pages 47-153 – 47-154**
 Legend Plates **Pages 47-151 – 47-152**
 Discount Symbol **1CD1C**

10250T Series, Assembled Devices — Illuminated Pushbutton Units

Illuminated Momentary Pushbutton Units

- LED or Incandescent
- Full Voltage, Resistor or Transformer Type
- Plastic Lenses



*24V Full Voltage
 Illuminated Pushbutton — Red
 Catalog Number 10250T476C21-53*

Table 47-181. Illuminated Pushbutton Units — UL (NEMA) Type 3, 3R, 4, 4X, 12, 13

Lamp	Type	Voltage	Color	Illuminated Pushbutton						LED/Lamp Number			
				1NO		1NO-1NC		1NC					
				Catalog Number	Price U.S. \$	Catalog Number	Price U.S. \$	Catalog Number	Price U.S. \$				
LED	Full Voltage	24V AC/DC	Red	10250T397LRD24-53		10250T397LRD24-1		10250T397LRD24-51		Bayonet Base			
			Green	10250T397LGD24-53		10250T397LGD24-1		10250T397LGD24-51					
			Amber	10250T397LAD24-53		10250T397LAD24-1		10250T397LAD24-51					
			Yellow	10250T397LYD24-53		10250T397LYD24-1		10250T397LYD24-51					
			Blue	10250T397LLD24-53		10250T397LLD24-1		10250T397LLD24-51					
			White	10250T397LWD24-53		10250T397LWD24-1		10250T397LWD24-51					
	120V AC	Red	10250T397LRD2A-53		10250T397LRD2A-1		10250T397LRD2A-51						
		Green	10250T397LGD2A-53		10250T397LGD2A-1		10250T397LGD2A-51						
		Amber	10250T397LAD2A-53		10250T397LAD2A-1		10250T397LAD2A-51						
		Yellow	10250T397LYD2A-53		10250T397LYD2A-2		10250T397LYD2A-51						
		Blue	10250T397LLD2A-53		10250T397LLD2A-1		10250T397LLD2A-51						
		White	10250T397LWD2A-53		10250T397LWD2A-1		10250T397LWD2A-51						
Transformer	120V AC	Red	10250T411LRD06-53		10250T411LRD06-1		10250T411LRD06-51						
		Green	10250T411LGD06-53		10250T411LGD06-1		10250T411LGD06-51						
		Amber	10250T411LAD06-53		10250T411LAD06-1		10250T411LAD06-51						
		Yellow	10250T411LYD06-53		10250T411LYD06-1		10250T411LYD06-51						
		Blue	10250T411LLD06-53		10250T411LLD06-1		10250T411LLD06-51						
		White	10250T411LWD06-53		10250T411LWD06-1		10250T411LWD06-51						
Incandescent	Full Voltage	24V AC/DC	Red	10250T476C21-53		10250T476C21-1		10250T476C21-51		#757			
			Green	10250T476C22-53		10250T476C22-1		10250T476C22-51					
			Amber	10250T476C43-53		10250T476C43-1		10250T476C43-51					
			Yellow	10250T476C23-53		10250T476C23-1		10250T476C23-51					
			Blue	10250T476C24-53		10250T476C24-1		10250T476C24-51					
			Clear	10250T476C25-53		10250T476C25-1		10250T476C25-51					
			White	10250T476C26-53		10250T476C26-1		10250T476C26-51					
			Resistor	120V AC/DC	Red	10250T471C21-53		10250T471C21-1			10250T471C21-51		120MB
					Green	10250T471C22-53		10250T471C22-1			10250T471C22-51		
					Amber	10250T471C43-53		10250T471C43-1			10250T471C43-51		
					Yellow	10250T471C23-53		10250T471C23-1			10250T471C23-51		
					Blue	10250T471C24-53		10250T471C24-1			10250T471C24-51		
	Clear	10250T471C25-53				10250T471C25-1		10250T471C25-51					
	Transformer	120 AC	Red	10250T75R ①		10250T76R ①		10250T77R ①		#755			
			Green	10250T75G ①		10250T76G ①		10250T77G ①					
			Amber	10250T75A ①		10250T76A ①		10250T77A ①					
			Yellow	10250T75Y ①		10250T76Y ①		10250T77Y ①					
			Blue	10250T75B ①		10250T76B ①		10250T77B ①					
			Clear	10250T75C ①		10250T76C ①		10250T77C ①					
	White	10250T75W ①		10250T76W ①		10250T77W ①							

① For flashing module Catalog Number 10250TFL1, add Suffix Code FM to listed Catalog Number. Example: 10250T75RFM.



Accessories Pages 47-155 – 47-156
 Dimensions Pages 47-160 – 47-162
 Enclosures Pages 47-153 – 47-154
 Legend Plates Pages 47-151 – 47-152
 Replacement
 Lamps/LEDs Page 47-157
 Discount Symbol 1CD1C

Indicating Light Units

- LED or Incandescent
- Full Voltage, Resistor or Transformer Type
- Standard and PresTest Types
- Plastic Lenses

PresTest — This device incorporates a press-to-test feature whereby depressing the lens disconnects the light from the source being monitored and connects the lamp to a continuously energized circuit for immediate detection of faulty lamps.

Table 47-182. Indicating Light Units — UL (NEMA) Type 3, 3R, 4, 4X, 12, 13 ①

Lamp	Type	Voltage	Color	Indicating Light  24V Full Voltage Indicating Light — Red Catalog Number 10250T206NC1N	PresTest  120V AC Transformer PresTest — Green Catalog Number 10250T74NG	LED/Lamp Number
LED	Full Voltage	24V AC/DC	Red Green Amber Yellow Blue White	10250T197LRP24 10250T197LGP24 10250T197LAP24 10250T197LYP24 10250T197LLP24 10250T197LWP24	10250T297LRP24 10250T297LGP24 10250T297LAP24 10250T297LYP24 10250T297LLP24 10250T297LWP24	Bayonet Base
		120V AC	Red Green Amber Yellow Blue White	10250T197LRP2A 10250T197LGP2A 10250T197LAP2A 10250T197LYP2A 10250T197LLP2A 10250T197LWP2A	10250T297LRP2A 10250T297LGP2A 10250T297LAP2A 10250T297LYP2A 10250T297LLP2A 10250T297LWP2A	
	Transformer	120V AC	Red Green Amber Yellow Blue White	10250T181LRP06 10250T181LGP06 10250T181LAP06 10250T181LYP06 10250T181LLP06 10250T181LWP06	10250T221LRP06 10250T221LGP06 10250T221LAP06 10250T221LYP06 10250T221LLP06 10250T221LWP06	
Incandescent	Full Voltage	24V AC/DC	Red Green Amber Yellow Blue Clear White	10250T206NC1N 10250T206NC2N 10250T206NC19N 10250T206NC3N 10250T206NC4N 10250T206NC5N 10250T206NC6N	10250T235NC21 10250T235NC22 10250T235NC43 10250T235NC23 10250T235NC24 10250T235NC25 10250T235NC26	#757
		Resistor	120V AC/DC	Red Green Amber Yellow Blue Clear White	10250T201NC1N 10250T201NC2N 10250T201NC19N 10250T201NC3N 10250T201NC4N 10250T201NC5N 10250T201NC6N	10250T231NC21 10250T231NC22 10250T231NC43 10250T231NC23 10250T231NC24 10250T231NC25 10250T231NC26
	Transformer ②	120V AC	Red Green Amber Yellow Blue Clear White	10250T34R 10250T34G 10250T34A 10250T34Y 10250T34B 10250T34C 10250T34W	10250T74NR 10250T74NG 10250T74NA 10250T74NY 10250T74NB 10250T74NC 10250T74NW	#755

① Standard indicating lights are rated UL (NEMA) 3S as well.
 ② For flashing lamp add letter F to listed Catalog Number. Example: 10250T34RF.









Accessories **Pages 47-155 – 47-156**
 Dimensions **Pages 47-160 – 47-162**
 Enclosures **Pages 47-153 – 47-154**
 Legend Plates **Pages 47-151 – 47-152**
 Replacement
 Lamps/LEDs **Page 47-157**
 Discount Symbol **1CD1C**

10250T Series, Illuminated Components

Illuminated Pushbuttons and Indicating Lights

- LED or Incandescent
- Full Voltage, Resistor or Transformer Type

Table 47-183. Operators without Lens

Light Unit Type	Type	Voltage	Illuminated Pushbutton		Indicating Light		PresTest		Master Test		LED/Lamp Number	
												
			Catalog Number	Price U.S. \$	Catalog Number	Price U.S. \$	Catalog Number	Price U.S. \$	Catalog Number	Price U.S. \$		
Incandescent	Full Voltage AC/DC	6	10250T473		10250T203N		10250T232N		—		#755	
		12	10250T474		10250T204N		10250T233N		—		#756	
		24	10250T476		10250T206N		10250T235N		—		#757	
		32	10250T477		10250T207N		10250T238N		—		#1828	
		48	10250T478		10250T208N		10250T239N		—		#1835	
	Resistor ^② AC/DC	120	10250T471		10250T201N		10250T231N		—		120MB	
		240	10250T472		10250T202N		10250T240N		—		120MB	
	Transformer AC Only ^③	24	10250T416		—		—		—		#755	
		120	10250T411		10250T181N		10250T221N		—			
		240	10250T422		10250T182N		10250T222N		—			
		277	10250T419		10250T198N		—		—			
		380	10250T413		10250T183N		10250T223N		—			
		480	10250T414		10250T184N		10250T224N		—			
	Neon ^④ AC/DC	120	—		10250T226N		—		—		NE51H-R22	
		240	—		10250T227N		—		—		NE51H-R68	
	Solid-State 50/60 Hz Only	120	—		—		—		10250T189N		120MB	
	LED (LEDs not included) ^①	Full Voltage	—	10250T397L		10250T197L		10250T297L		—		Bayonet Base
			24	10250T416L		—		—		—		
Transformer AC Only		120	10250T411L		10250T181L		10250T221L		—			
		240	10250T412L		10250T182L		10250T222L		—			
		277	10250T419L		10250T198L		—		—			
		380	10250T413L		10250T183L		10250T223L		—			
		480	10250T414L		10250T184L		10250T224L		—			
		600	10250T415L		10250T185L		10250T225L		—			

47

- ① These units do not include lamps. Order LED separately to match lens color. See Page 47-157 for LED Selection and Page 47-165 for Catalog Numbering System.
- ② Resistor units are not available for use with LEDs, choose either transformer or full voltage LED style.
- ③ For flashing lamp, add letter F to listed Catalog Number. Example: 10250T181NF.
- ④ Resistant to shock and vibration. For best illumination use amber, yellow or clear lens.

Table 47-184. Indicating and Master Test Lenses

	Color	Plastic		Glass	
		Catalog Number	Price U.S. \$	Catalog Number	Price U.S. \$
	Red	10250TC1N		10250TC7N	
	Green	10250TC2N		10250TC8N	
	Amber	10250TC19N		10250TC9N	
	Yellow	10250TC3N		—	
	Blue	10250TC4N		10250TC10N	
	Clear	10250TC5N		10250TC11N	
	White	10250TC6N		10250TC12N	

Table 47-186. PresTest Lenses



	Color	Plastic		Glass	
		Catalog Number	Price U.S. \$	Catalog Number	Price U.S. \$
	Red	10250TC21		10250TC13N	
	Green	10250TC22		10250TC14N	
	Amber	10250TC43		10250TC15N	
	Yellow	10250TC23		—	
	Blue	10250TC24		10250TC16N	
	Clear	10250TC25		10250TC17N	
	White	10250TC26		10250TC18N	

Table 47-185. Illuminated Pushbutton Lenses

	Color	Catalog Number	Price U.S. \$
	Red	10250TC21	
	Green	10250TC22	
	Yellow	10250TC23	
	Amber	10250TC43	
	Blue	10250TC24	
	Clear	10250TC25	
	White	10250TC26	

Dimensions Pages 47-160 – 47-162
 Legend Plates Pages 47-151 – 47-152
 Replacement
 Lamps/LEDs Page 47-157
 Discount Symbol 1CD1C

Push-Pull Units

- Two- and Three-Position
- Non-illuminated

Table 47-187. 2-Position Push-Pull Units — UL (NEMA) Type 3, 3R, 4, 4X, 12, 13

	Operator Position ①		Button Type/Color ②	Push-Pull		Contact Type	Mounting Location	
	Pull	Push		Catalog Number	Price U.S. \$		A	B
	O X	X O	40 mm/Red	<u>10250T5B62</u> -1X		1NO 1NC		
	O X	X O	40 mm Engraved EMERG. STOP/Red	<u>10250T5B63</u> -1X		1NO 1NC		
	O X	X O	65 mm Alum. Engraved EMERG. STOP/Red	<u>10250T5J63</u> -1X		1NO 1NC		
	O X	X O	65 mm Alum. Engraved EMERG. STOP/Red Special Security Jumbo Mushroom Head	<u>10250ED1080</u> -2		1NO 1NC		

Table 47-188. 3-Position Pull-Pull Units — UL (NEMA) Type 3, 3R, 4, 4X, 12, 13

Operator Position ①			Button Type/Color ②	Push-Pull		Contact Type	Mounting Location	
Pull	Intermediate	Push		Catalog Number	Price U.S. \$		A	B
X X	O X	O O	40 mm/ Black 40 mm/Red 40 mm Engraved EMERG. STOP/Red	<u>10250T9B60</u> -3X <u>10250T9B62</u> -3X <u>10250T9B63</u> -3X		1NC 1NC		
X X	O X	O O	40 mm/Black 40 mm/Red	<u>10250T4B60</u> -3X <u>10250T4B62</u> -3X		1NC 1NC		
O X	O O	X O	40 mm/Black 40 mm/Red	<u>10250T10B60</u> -1X <u>10250T10B62</u> -1X		1NO 1NC		

① X = closed circuit, O = open circuit.

② To order different type or color buttons, substitute the underlined characters with appropriate Suffix Code from the table below.
Example: 10250T5B64-1X.

Table 47-189. Button and Color Selection Table

Standard — 40 mm	Color	Suffix Code	Catalog Number	Price U.S. \$	Jumbo Mushroom Head ③ (Anodized) Aluminum — 65 mm	Color	Suffix Code	Catalog Number	Price U.S. \$
	Red Red (EMERG. STOP) Green Black Blue	B62 B63 B61 B60 B64	10250TB62 10250TB63 10250TB61 10250TB60 10250TB64			Red Red (EMERG. STOP) Green Black Yellow	J62 J63 J61 J60 J64	10250TJ62 10250TJ63 10250TJ61 10250TJ60 10250TJ64	

③ Anodized aluminum head is not suitable for use in ultraviolet light applications.

Accessories **Pages 47-155 – 47-156**
 Dimensions **Pages 47-160 – 47-162**
 Enclosures **Pages 47-153 – 47-154**
 Legend Plates **Pages 47-151 – 47-152**
 Discount Symbol **1CD1C**

10250T Series, Assembled Devices — Illuminated Push-Pull Units

Illuminated Push-Pull Units

- LED or Incandescent
- Full Voltage, Resistor or Transformer Type
- Two-Position Maintained



2-Position Push-Pull Operator with Red Button (Standard) and Full Voltage Light Unit

Table 47-190. 2-Position Illuminated Maintained Push, Maintained Pull — UL (NEMA) Type 3, 3R, 4, 4X, 12, 13

Operator Position ①		Lamp	Type	Voltage	Red Standard Push-Pull ②		Contact Type	Mounting Location		LED/Lamp Number
Maintained — Pull	Maintained — Push				Catalog Number	Price U.S. \$		A	B	
O	X	LED	Full Voltage	24V AC/DC	<u>10250T597LRD24-1X</u>		1NO 1NC			Bayonet Base
X	O			120V AC/DC	<u>10250T597LRD2A-1X</u>					
			Transformer	24V AC	<u>10250T589LRD06-1X</u>					
				120V AC	<u>10250T563LRD06-1X</u>					
O	X	Incandescent	Full Voltage	24V AC/DC	<u>10250T579C47-1X</u>		1NO 1NC			#757 120MB #755
X	O			120V AC/DC	<u>10250T580C47-1X</u>					
			Transformer	24V AC	<u>10250T589C47-1X</u>					
				120V AC	<u>10250T563C47-1X</u>					

① X = closed circuit, O = open circuit.

② To order different type or color lens, substitute the underlined characters with appropriate Suffix Code from table below. Example: 10250T579C63-1X. For LEDs with different voltages see ordering example on Page 47-131.

Table 47-191. Lens and Color Selection Table

Type	Lens Color	Incand. Suffix Code	LED Suffix Code	Catalog Number	Price U.S. \$	
Standard – 40 mm 	Red	C47	RD	10250TC47		
	Red (EMERGENCY STOP)	C53	ED	10250TC53		
	Green	C48	GD	10250TC48		
	Blue	C49	LD	10250TC49		
	Amber	C50	AD	10250TC50		
	White	C51	WD	10250TC51		
	Clear	C52	CD	10250TC52		
	Side-Lighted Aluminum – 40 mm ③ 	Red	C57	RS	10250TC57	
Red (EMERGENCY STOP)		C63	ES	10250TC63		
Green		C58	GS	10250TC58		
Blue		C59	LS	10250TC59		
Amber		C64	AS	10250TC64		
Yellow		C60	YS	10250TC60		
White		C61	WS	10250TC61		
Clear		C62	CS	10250TC62		
Aluminum Transparent Center – 40 mm ③ 		Red	C65	RH	10250TC65	
		Green	C66	GH	10250TC66	
	Amber	C67	AH	10250TC67		

③ Clear anodized aluminum and colored lens.

Accessories **Pages 47-155 – 47-156**
 Additional Light Units **Page 47-131**
 Dimensions **Pages 47-160 – 47-162**
 Enclosures **Pages 47-153 – 47-154**
 Legend Plates **Pages 47-151 – 47-152**
 Replacement
 Lamps/LEDs **Page 47-157**
 Discount Symbol **1CD1C**

Illuminated Push-Pull Units
(Continued)

- LED or Incandescent
- Full Voltage, Resistor or Transformer Type
- Three-Position Momentary



3-Position Push-Pull Operator with Red Button (Standard) and Transformer Light Unit

Table 47-192. 3-Position Illuminated Momentary Push, Momentary Pull — UL (NEMA) Type 3, 3R, 4, 4X, 12, 13

Operator Position ^①			Lamp	Type	Voltage	Red Standard Push-Pull ^②		Contact Type	Mounting Location		LED/Lamp Number				
Momentary — Pull	Maintained — Intermediate	Momentary — Push				Catalog Number	Price U.S. \$		A	B					
			LED	Full Voltage	24V AC/DC	10250T1097LRD24-1X	1NO 1NC			Bayonet Base					
O X	O O	X O			120V AC	10250T1097LRD2A-1X									
X X	O X	O O			Transformer	24V AC					10250T1089LRD06-1X				
						120V AC					10250T1063LRD06-1X				
X X	O X	O O		Full Voltage	24V AC/DC	10250T497LRD24-3X		1NC 1NC				Bayonet Base			
					120V AC	10250T497LRD2A-3X									
				Transformer	24V AC	10250T489LRD06-3X									
					120V AC	10250T463LRD06-3X									
O X	O O	X O	Incandescent	Full Voltage	24V AC/DC	10250T1079C47-1X	1NO 1NC			#757 120MB #755					
					Resistor	120V AC					10250T1080C47-1X				
					Transformer	24V AC					10250T1089C47-1X				
						120V AC					10250T1063C47-1X				
				X X	O X	O O		Full Voltage	24V AC/DC		10250T479C47-3X	1NC 1NC			#757 120MB #755
									Resistor		120V AC				
								Transformer	24V AC		10250T489C47-3X				
									120V AC		10250T463C47-3X				

① X = closed circuit, O = open circuit.

② To order different type or color lens, substitute the underlined characters with appropriate Suffix Code from table on the bottom of Page 47-126. Example: 10250T1079C53-1X. For LEDs with different voltages see ordering example on Page 47-131.

Accessories **Pages 47-155 – 47-156**
 Additional Light Units **Page 47-131**
 Dimensions **Pages 47-160 – 47-162**
 Enclosures **Pages 47-153 – 47-154**
 Legend Plates **Pages 47-151 – 47-152**
 Replacement
 Lamps/LEDs **Page 47-157**
 Discount Symbol **1CD1C**

Illuminated Push-Pull Units
(Continued)

- LED or Incandescent
- Full Voltage, Resistor or Transformer Type
- Three-Position — Maintained Push, Momentary Pull



3-Position Push-Pull Operator with Red Button (Standard) and Full Voltage Light Unit

Table 47-193. 3-Position Illuminated Maintained Push, Momentary Pull — UL (NEMA) Type 3, 3R, 4, 4X, 12, 13

Operator Position ^①			Lamp	Type	Voltage	Red Standard Push-Pull ^②		Contact Type	Mounting Location		LED/Lamp Number	
Momentary — Pull	Maintained — Intermediate	Maintained — Push				Catalog Number	Price U.S. \$		A	B		
X X	O X	O O	LED	Full Voltage	24V AC/DC	<u>10250T997LRD24-3X</u>		1NC 1NC			Bayonet Base	
					120V AC	<u>10250T997LRD2A-3X</u>						
					Transformer	24V AC	<u>10250T989LRD06-3X</u>					
					120V AC	<u>10250T963LRD06-3X</u>						
X X	O X	O O	Incan- descent	Full Voltage	24V AC/DC	<u>10250T979C47-3X</u>		1NC 1NC			#757	
					Resistor	120V AC	<u>10250T980C47-3X</u>					120MB
					Transformer	24V AC	<u>10250T989C47-3X</u>					#755
						120V AC	<u>10250T963C47-3X</u>					

① X = closed circuit, O = open circuit.

② To order different type or color lens, substitute the underlined characters with appropriate Suffix Code from table on the bottom of **Page 47-126**. Example: 10250T979C53-3X. For LEDs with different voltages see ordering example on **Page 47-131**.

Potentiometers

Table 47-194. Potentiometer with Knob and Standard Dial Plate — Linear Type ±10% — UL (NEMA) Type 3, 3R, 4, 12, 13

Vertical or Horizontal One-Hole Mounting	Potentiometer Ohms	2 Watt (60V Max.) Single Potentiometer with Standard Aluminum Dial Plate ^{③④}		Dimensions in Inches (mm)
		Catalog Number	Price U.S. \$	
	1000	<u>10250T331</u>		<p>Potentiometer</p>
	2500	<u>10250T332</u>		
	5000	<u>10250T338</u>		
10000	<u>10250T333</u>			
25000	<u>10250T334</u>			
50000	<u>10250T335</u>			
	Operator Only ^⑤	<u>10250T330</u>		
	Alternative — Black Plastic Large Legend with Standard Markings	<u>E34LP99</u>		

③ Large dial plate with space for legend is available at no charge. To order, add suffix **36** to Catalog Number. Example: 10250T331**36**. To order separately, see footnote ^④ below.

④ Large dial plate has space at top for 15 letters. 3/32 inch high. For custom stamped legend plates, order legend plate as separate item **10250TR30** and specify stamping.

⑤ For use with commercially purchased potentiometers having shaft dimensions per dimension drawing on **Page 47-161**.

Accessories **Pages 47-155 – 47-156**
 Additional Light Units . . . **Page 47-131**
 Dimensions **Pages 47-160 – 47-162**
 Enclosures **Pages 47-153 – 47-154**
 Legend Plates **Pages 47-151 – 47-152**
 Replacement
 Lamps/LEDs **Page 47-157**
 Discount Symbol **1CD1C**

Push-Pull Operators

An illuminated Push-Pull pushbutton unit, arranged for one-hole mounting, can replace two pushbuttons and a pilot light or the non-illuminated form can replace two pushbuttons. These units are available in three basic types:

- **Maintained** — (Two-Position). Maintains in the pulled or pushed position until manually actuated to the opposite mode.
- **Momentary** — (Three-Position). Spring returns to an intermediate position when pulled or pushed and released.

- **Momentary Pull, Maintained Push** — (Three-Position). Spring returns to intermediate position when pulled. Maintains in pushed position until manually returned to intermediate (ready to reset) position. Maintained stop holds circuit open and will prevent other series connected operators from starting the system.

The Operators, Buttons, Contact Blocks, etc., are offered as building block components that can be intermixed to satisfy many requirements. This minimizes the need for a varied and costly inventory.



2-Position Maintained Push-Pull without Button on Lens
Catalog Number 10250T5

Table 47-195. Typical Applications

Control	Line – Diagram	Operator	Circuits	Operator Mode		
3-Wire 3-Position Momentary		Momentary Push & Pull 10250T4	2NC Contact Block 10250T3	START (Mom.) 	Normal Pos. (Maint.) 	STOP (Mom.)
		Momentary Push & Pull 10250T10	1NO-1NC Contact Block 10250T1			
2-Wire 2-Position Maintained		Maintained Push & Pull 10250T5	1NC Contact Block 10250T51	START (Maint.) 	No Intermediate Position	STOP (Maint.)
3-Wire Momentary Pull Maintained Push		Maintained Push & Momentary Pull 10250T9	2NC Contact Block 10250T3	START (Mom.) 	Normal Pos. (Maint.) 	STOP (Maint.)

Note: A and B circuits shown in the application illustrations are defined in the "Application Guide" on the following page.

10250T Series, Push-Pull Components

Push-Pull Operators (Continued)

Application Guide

To assist in the selection of contact blocks, the sketch to the right shows pictorially by symbols **A** and **B** locations of contact circuits after assembly of contact blocks and adapter to the operator. The chart below shows the effect of the push and pull operations on either NO or NC contacts. (X = contact closed, O = contact open)

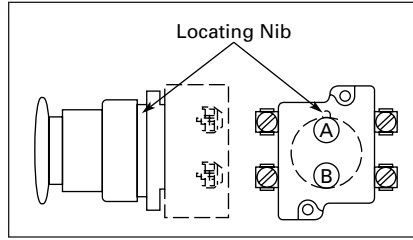

Figure 47-92. Contact Circuit Locations

Table 47-196. Push-Pull Operator Components

Type of Operator	Catalog Number	Price U.S. \$	Contact Block — Max. of 2 Blocks, 4 Circuits ①	Operator Position and Circuit Arrangement					
				Out — Pull		Intermediate		In — Push	
				Contact Block Mounting Location					
				A	B	A	B	A	B
2-Position Operator without Lens									
Maintained Push-Pull	10250T5		1NO 1NC	O or X	O X	No Intermediate Position		X or O	X O
Maintained Push-Pull with Anti-Theft Jumbo Mushroom	10250ED1080		1NO 1NC 2NO 2NC	O or X	O X	No Intermediate Position		X or O	X O
3-Position Operator without Lens									
Momentary Push-Pull	10250T4 ①		1NO 1NC	O or X	O X	O or O	O X	X or O	O O
Maintained Push-Momentary Pull	10250T9 ①		2NO 2NC	O X	O X	O O	O X	X O	O O
Momentary Push-Pull	10250T10 ①		1NO 1NC 2NO 2NC	O or X	O X	O or O	O O	X or O	X O

① Special function contact blocks shown on Page 47-148 CANNOT be used with 3-position push-pull operators 10250T4, 10250T9 or 10250T10.

Button or Lens Page 47-131
 Contact Blocks Page 47-148
 Dimensions Pages 47-160 – 47-162
 Enclosures Pages 47-153 – 47-154
 Legend Plates Pages 47-151 – 47-152
 Discount Symbol 1CD1C

Push-Pull Operators (Continued)

Push-Pull Light Units, Lenses and Buttons

Table 47-197. Light Units for Illuminated Push-Pull Devices

Light Unit Type	Type	Voltage	Catalog Number	Price U.S. \$	LED/Lamp Number	
LED (LEDs not included) ①	Full Voltage	—	10250T97L		Bayonet Base	
	Transformer AC Only 50/60 Hz	24	10250T89L			
		120	10250T63L			
		208	10250T64L			
		240	10250T65L			
		277	10250T82L			
		380	10250T66L			
		480	10250T67L			
		600	10250T68L			
	Incandescent	Full Voltage AC or DC	6	10250T69		
12			10250T70			
24/28			10250T79			
32			10250T83			
Resistor AC or DC		120	10250T80		120MB	
		240	10250T81			
Transformer AC Only 50/60 Hz		24	120	10250T89		#755
			120	10250T63		
			208	10250T64		
			240	10250T65		
	277		10250T82			
	380		10250T66			
480	10250T67					
600	10250T68					

① These units do not include lamps. Order LED separately to match lens color, see Page 47-157.

Ordering example with one composite number:

Non-illuminated **10250T5** + **10250TB62** + **10250T1** = **10250T5B62-1X**

Incandescent **10250T5** + **10250T79** + **10250TC47** + **10250T1** = **10250T579C47-1X**

LED **10250T5** + **10250T97L** + **10250TC47** + **Voltage Code** + **10250T1** = **10250T597LRD24-1X**



06 — 6V AC/DC
 12 — 12V AC/DC
 24 — 24V AC/DC
 48 — 48V AC/DC
 60 — 60V AC/DC
 2A — 120V AC
 2D — 120V DC

Table 47-198. Alternate Lenses for Illuminated Push-Pull Devices

	Color	Incand. Suffix Code	LED ② Suffix Code	Catalog Number	Price U.S. \$	
	Standard					
	Red	C47	RD	10250TC47		
	Red (EMER. STOP)	C53	ED	10250TC53		
	Green	C48	GD	10250TC48		
	Blue	C49	LD	10250TC49		
	Amber	C50	AD	10250TC50		
	White	C51	WD	10250TC51		
	Clear	C52	—	10250TC52		
	Side-Lighted Anodized Aluminum Ring					
	Red	C57	RS	10250TC57		
	Red (EMER. STOP)	C63	ES	10250TC63		
	Green	C58	GS	10250TC58		
	Blue	C59	LS	10250TC59		
	Amber	C64	AS	10250TC64		
	Yellow	C60	YS	10250TC60		
	White	C61	WS	10250TC61		
		Clear	C62	—	10250TC62	
		Heavy-Duty Aluminum with Transparent Center				
Red		C65	RH	10250TC65		
Green		C66	GH	10250TC66		
Amber		C67	AH	10250TC67		
Blue		C69	—	10250TC69		
White		C68	—	10250TC68		

② Suffix Codes should only be used for assembling composite Catalog Numbers. To order lens above, order by Catalog Number.

Table 47-199. Buttons for Non-illuminated Push-Pull Devices

	Color	Suffix Code	Catalog Number	Price U.S. \$
	Standard			
	Red	B62	10250TB62	
	Red (EMER. STOP)	B63	10250TB63	
	Green	B61	10250TB61	
	Black	B60	10250TB60	
	Blue	B64	10250TB64	
	Jumbo Mushroom Head (Anodized) Aluminum ③			
	Red	J62	10250TJ62	
	Red (EMER. STOP)	J63	10250TJ63	
	Green	J61	10250TJ61	
	Black	J60	10250TJ60	
	Yellow	J64	10250TJ64	

③ Anodized aluminum head is not suitable for use in ultraviolet light applications.

Legend Plates

For a complete listing of available Legend Plates see Pages 47-151 – 47-152.

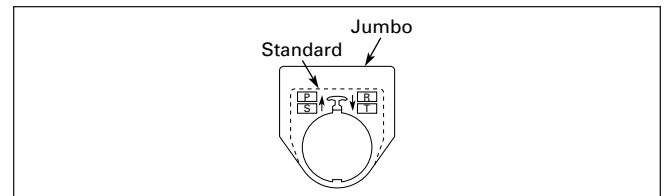

Figure 47-93. Legend Plates

Contact Blocks Page 47-148
 Dimensions Pages 47-160 – 47-162
 Enclosures Pages 47-153 – 47-154
 Legend Plates Pages 47-151 – 47-152
 Discount Symbol 1CD1C

10250T Series, Assembled Devices — Selector Switch Units

Selector Switch Units

- Two-, Three- and Four-Position Maintained
- Non-illuminated and Illuminated



3-Position Maintained Switch
Catalog Number
10250T21KB



3-Position Maintained Switch
Catalog Number
10250T22KB

Table 47-200. 2-Position Selector Switch — UL (NEMA) Type 3, 3R, 4, 4X, 12, 13

Operator Position ①		Operator Action ②	Non-illuminated			Illuminated — 120V Transformer			Contact Type	Mounting Location	
			Black Knob ③	Black Lever ③	Price U.S. \$	Red Knob ③	Red Lever ③	Price U.S. \$		A	B
Catalog Number	Catalog Number		Catalog Number	Catalog Number		Catalog Number	Catalog Number				
X O	O X		<u>10250T20KB</u>	<u>10250T20LB</u>		<u>10250ED1117-KR</u>	<u>10250ED1117-LR</u>		1NC 1NO	 	

- ① X = closed circuit, O = open circuit.
- ② M = Maintained. S = Spring return in direction of arrow (→).
- ③ To order different type or color selector switch, substitute the underlined character with appropriate Suffix Code from the Color Selection table.
Example: 10250T20KG.

Table 47-201. 3-Position Selector Switch — UL (NEMA) Type 3, 3R, 4, 4X, 12, 13

Operator Position ④			Operator Action ⑤	Non-illuminated			Illuminated — 120V Transformer			Contact Type	Mounting Location	
				Black Knob ⑥	Black Lever ⑥	Price U.S. \$	Red Knob ⑥	Red Lever ⑥	Price U.S. \$		A	B
Catalog Number	Catalog Number	Catalog Number		Catalog Number	Catalog Number		Catalog Number	Catalog Number				
X O	O O	O X		<u>10250T21KB</u>	<u>10250T21LB</u>		<u>10250ED1117-2KR</u>	<u>10250ED1117-2LR</u>		1NO 1NO	 	
X O	O X	O O		<u>10250T22KB</u>	<u>10250T22LB</u>		<u>10250ED1117-3KR</u>	<u>10250ED1117-3LR</u>		1NO 2NC (Series) 1NO	 	

- ④ X = closed circuit, O = open circuit.
- ⑤ M = Maintained. S = Spring return in direction of arrow (→).
- ⑥ To order different type or color selector switch, substitute the underlined character with appropriate Suffix Code from the Color Selection table.
Example: 10250T20KG.

Table 47-202. 4-Position Selector Switch — UL (NEMA) Type 3, 3R, 4, 4X, 12, 13

Operator Position ⑦				Operator Action ⑧	Non-illuminated			Illuminated — 120V Transformer			Contact Type	Mounting Location	
					Black Knob ⑨	Black Lever ⑨	Price U.S. \$	Red Knob ⑨	Red Lever ⑨	Price U.S. \$		A	B
Catalog Number	Catalog Number	Catalog Number	Catalog Number		Catalog Number	Catalog Number		Catalog Number	Catalog Number				
X O O O	O X O O	O O X O	O O O X		<u>10250T46KB</u>	<u>10250T46LB</u>		<u>10250ED1117-4KR</u>	<u>10250ED1117-4LR</u>		1NC 1NO 1NO 1NC	 	

- ⑦ X = closed circuit, O = open circuit.
- ⑧ M = Maintained. S = Spring return in direction of arrow (→).
- ⑨ To order different type or color selector switch, substitute the underlined character with appropriate Suffix Code from the Color Selection table.
Example: 10250T20KG.

Table 47-203. Color Selection

Illuminated						Non-illuminated					
Color	Code Letter	Color	Code Letter	Color	Code Letter	Color	Code Letter	Color	Code Letter	Color	Code Letter
Red	R	White	W	Amber	A	Black	B	Green	G	Blue	L
Green	G	Blue	B	Clear	C	Red	R	White	W	Orange	O

Accessories Pages 47-155 – 47-156
 Additional Circuit
 Arrangements Pages 47-133 – 47-134
 Dimensions Pages 47-160 – 47-162
 Enclosures Pages 47-153 – 47-154
 Legend Plates Pages 47-151 – 47-152
 Discount Symbol 1CD1C



10250T Series

Selector Switch Selection

Cam and Contact Block Selection

Selector switches in their varied forms (2-position, 3-position and 4-position) are a big factor contributing to the great flexibility of control that a well rounded line of “pushbuttons” can achieve. Because of their flexibility, they tend to cause difficulty with product selection and application. The following systematic approach should simplify that task.

Cam and contact block selection is better understood if you:

- Work with each incoming and outgoing wire/circuit separately.
- Recognize the terms NO and NC only identify the type of contact by its mode before mounting to the operator. The “X-O” table (Page 47-134) shows how that contact will act after assembly to the operator with the selected cam shape. X = closed circuit, O = open circuit.
- Up to six NO or NC contacts may be mounted behind each plunger location for a total of twelve contacts. Single circuit contact blocks have only one plunger with the other side of the block “open.” Therefore, single circuit contact blocks transmit motion to blocks behind them only for the position containing the circuit.
- Each cam has two separate lobes, each of which operates one of the two contact block plungers independently of each other. Those are identified as position A (locating nib side) and position B (opposite of locating nib). The position designations give direction in selecting and mounting of the contact blocks (see Figure 47-94).

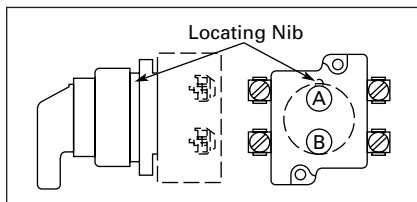

Figure 47-94. Contact Circuit Locations

Systematic Approach

Application: **HAND-OFF-AUTO** Selector Switch. In this circuit, one incoming line is distributed to two other outgoing circuits by the switch. The two circuits can be looked at individually.

Step 1: Elementary Diagram.

Construct on paper, or in your mind, a simple elementary diagram of the switching scheme as follows:

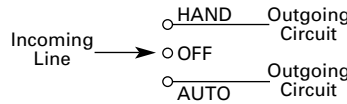

Step 2: “X-O” Pattern.

From the elementary diagram, you can construct an “X-O” diagram which describes when the contacts are to be closed (X) or open (O) in the various positions of the switch. The “X-O” for the **HAND** circuit looks like this:

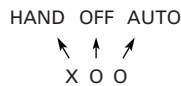

In this circuit, you want a contact closed on the left (HAND) but open in the center and right.

For the **AUTO** circuit, the “X-O” diagram would look like this:

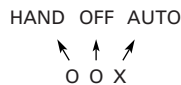

Putting them together, the complete “X-O” diagram is:



Once the “X-O” diagram has been generated, the next step is to select the cam and contact block, or blocks, needed to perform the desired “X-O” functions. The selection table on the following page lists the various types (shapes) of cams by number to choose from and the type of contact and position to achieve the function outlined in your “X-O” diagram.

Step 3: Cam Selection.

The cam you select determines the operation of all contact blocks mounted to the operator. It is selected on the basis that it provides the simplest circuitry for the desired “X-O” diagram. The selection tables of the following page show all the “X-O” combinations. For the purpose of this example, the applicable portion of those tables is shown in **Table 47-204**.

Table 47-204. Example Selection Table

No.	“X-O” Pattern	Cam Code #2		Cam Code #3	
		Top A	Bottom B	Top A	Bottom B
1	X O O	NO	NC	NO	
4	O O X		NO		NO

① Wired in series.

Now to make the cam selection, make a simple worksheet such as:

		Cam 2	Cam 3
X O O	(A)NO – (B)NC	(A)NO	(B)NO
O O X	(B)NO		

It becomes immediately obvious that cam 3 is the better choice for two reasons, (1) the series combination can be avoided making it simpler to wire, (2) only two contacts are required, which is less expensive than the three contacts required by cam 2.

Step 4: Contact Block Selection.

Having selected the cam, contact block selection is simply a matter of gathering the A position and B position circuits into pairs which make up the most convenient contact block arrangement. If there is an imbalance in the number of circuits under A or B, then single circuit blocks must be selected for these leftover circuits.

Back to the worksheet, having selected cam 3 do this:



Step 5: Selector Switch Operator.

Lastly, you have to choose from the many types of operators — knob and lever in various colors or keyed. Also what combinations of maintained and spring return functions are required. Selection of these operators can be found on **Page 47-135**. For the above example you may want a 3-position maintained black knob, cam 3 — Catalog Number 10250T1323.

The Complete Switch: 10250T1323 with one 10250T2 or, for one composite catalog number, 10250T21KB found on **Page 47-132**.

**Selector Switch Selection
(Continued)**

**Table 47-205. 2-Position Selector Switch
Contact Block Selection**

No.	Desired Circuit and Operator Position	Contact Blocks Required to Accomplish Circuit Function	
		Top Plunger A	Bottom Plunger B
1	X O	NC	NC
2	O X	NO	NO

Diagrams

Circuits shown illustrate connections to obtain a selector switch circuit combination and are shown with their appropriate line diagrams. Field wiring of jumper connections required as shown.

X = Closed Circuit
O = Open Circuit

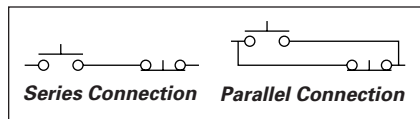

Figure 47-95. Wiring of Jumper Connections

Note: 4-Position Selector Switches limited to 4 contact blocks.

Contact Blocks

For selection and number of available contact blocks per operator, see **Page 47-148**.

Table 47-206. 3-Position Switch — Cam and Contact Block Selection

No.	Desired Circuit and Operator Position	Contact Blocks Required to Accomplish Circuit Function (Jumpers must be installed where indicated)			
		Operator with Cam Code #2		Operator with Cam Code #3	
		Mounting Location		Mounting Location	
		Top Plunger A	Bottom Plunger B	Top Plunger A	Bottom Plunger B
1	X O O	NO	NC	NO	
2	X X O		NC		NC
3	X O X	NO		NO	NO
4	O O X		NO		NO
5	O X X	NC	NO	NC	
6	O X O	NC		NC	NC

Table 47-207. 4-Position Switch — Contact Block Selection

No.	Desired Circuit and Operator Position	Contact Blocks Required to Accomplish Circuit Function		Combination No.	Desired Circuit and Operator Position	Contact Blocks Required to Accomplish Circuit Function	
		Mounting Location				Mounting Location	
		Top Plunger A	Bottom Plunger B			Top Plunger A	Bottom Plunger B
1	X O O O	NC		10	X O X O	NC	NO
2	O X O O		NO			NO	NO
3	O O X O	NO		11	X X X O	NC	NO
4	O O O X		NC			NO	NO
5	X O O X	NC	NC	12	O X X X	NO	NC
6	O X X O	NO	NO			NO	NO
7	O O X X	NO	NC	13	X O X X	NO	NC
8	X X O O	NC	NO			NO	NC
9	O X O X		NO	14	X X O X	NC	NO

Selector Switch Operators



2-Position Maintained Black Knob Selector Switch — Cam 1
 Cat. No. 10250T1311



3-Position Maintained Black Lever Selector Switch — Cam 3
 Cat. No. 10250T3023



2-Position Maintained Horizontal Mount, Key Removal #1 Keyed Selector Switch — Cam 1
 Cat. No. 10250T16111

Selector Switch Operators with Caps

Table 47-208. Selector Switch Operators with Caps — UL (NEMA) Type 3, 3R, 4, 4X, 12, 13

Positions	Operator Action ^①	Black Knob Selector Switch — Vertical Mounting ^③			Black Lever Selector Switch — Vertical Mounting ^③		
		Cam Code ^②	Catalog Number	Price U.S. \$	Cam Code ^②	Catalog Number	Price U.S. \$
2-Position — 60° Throw		1	10250T1311		1	10250T3011	
		1	10250T1371		1	10250T3071	
3-Position — 60° Throw		2 3	10250T1322 10250T1323		2 3	10250T3022 10250T3023	
		2 3	10250T1332 10250T1333		2 3	10250T3032 10250T3033	
		2 3	10250T1342 10250T1343		2 3	10250T3042 10250T3043	
		2 3	10250T1352 10250T1353		2 3	10250T3052 10250T3053	
4-Position — 40° Throw		7	10250T1367		7	10250T3067	

① M = Maintained. S = Spring return in direction of arrow (→).

② For selection of the proper cam and contact block to obtain the proper circuit sequence, see selection instructions and table on **Pages 47-133 – 47-134**.

③ Field convertible to Horizontal Mounting or order operator only and separate operator cap.

Table 47-209. Key Operators with Cam — UL (NEMA) Type 3, 3R, 4, 4X, 12, 13

Positions	Operator Action ^④	Cam Code ^⑤	Optional Key Removal Positions ^⑥	Vertical Mounting	Horizontal Mounting	Price U.S. \$
				Catalog Number	Catalog Number	
2-Position — 60° Throw		1	1, 2, 3	10250T1511_	10250T1611_	
		1	2	10250T1571_	10250T1581_	
3-Position — 60° Throw		2 3	1 – 7	10250T1522_ 10250T1523_	10250T1622_ 10250T1623_	
		2 3	1, 4, 5	10250T1532_ 10250T1533_	10250T1632_ 10250T1633_	
		2 3	4	10250T1542_ 10250T1543_	10250T1642_ 10250T1643_	
		2 3	2, 4, 6	10250T1652_ 10250T1653_	10250T1662_ 10250T1663_	
4-Position — 40° Throw		7	7	10250T1677_	10250T1687_	

④ M = Maintained. S = Spring return in direction of arrow (→).

⑤ For selection of the proper cam and contact block to obtain the proper circuit sequence, see selection instructions and table on **Pages 47-133 – 47-134**.

⑥ Choose key removal position required for application from **Table 47-210** on **Page 47-136**. Add key removal Code No. to listed Catalog Number.
 Example: 10250T15112.

Accessories **Pages 47-155 – 47-156**
 Contact Blocks **Page 47-148**
 Dimensions **Pages 47-160 – 47-162**
 Enclosures **Pages 47-153 – 47-154**
 Legend Plates **Pages 47-151 – 47-152**
 Discount Symbol **1CD1C**

10250T Series, Selector Switch Components

Selector Switch Operators (Continued)

Table 47-210. Key Removal Positions

Code Suffix	Key Removal Positions	Code Suffix	Key Removal Positions
1	Right Only	5	Right & Center
2	Left Only	6	Left & Center
3	Right & Left	7	All Positions
4	Center Only		

Note: Key removal in "spring return from" positions not recommended.

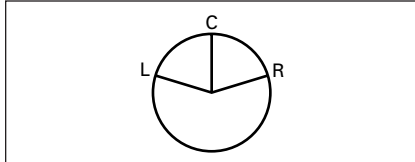

Figure 47-96. Key Removal Positions

Replacement Keys or Dissimilar Locks for Key Operators

Operators listed on **Page 47-135** have identical locks and keys (Key Code H661) Catalog Number 10250ED824. For dissimilar lock and key combinations, see listing at right.

Table 47-211. Replacement Key

Description	Catalog Number	Price U.S. \$
Replacement Keys (Code H661)	10250ED824	

Selector Switch Operators with Dissimilar Locks and Keys — UL (NEMA) 4, 4X and 13

The locks in all key operators listed on **Pages 47-121, 47-135 and 47-180** are identical and use key code number H661. Two keys are supplied with every lock. For additional code number H661 keys, order **Catalog Number 10250ED824**. For others, order 10250ED1130 and designate lock number. When dissimilar locks for each operator or each group of operators are required, select from the lock and key combination listed below. **When Ordering Operator Only** or a Complete Control Unit with a substitute lock, order from table below and add "except Lock and Key Code No. ..."

Table 47-212. "H" Series Locks without Master Key — with Key Slot Cover

Lock and Key Code Numbers			Adder U.S. \$
H501	H635	H663	
H620	H639	H675	
H621	H643	H683	
H634	H654	H688	

Table 47-213. "M" Series Locks with Master Key — with Key Slot Cover

Lock and Key Code Numbers				Adder U.S. \$
MD1	MD14	ME8	MJ6	
MD2	MD15	ME11	MJ10	
MD3	MD16	ME16	MJ11	
MD4	MD19	ME17	MJ13	
MD5	MD20	ME18	MJ15	
MD7	ME2	ME19	MJ16	
MD9	ME3	MJ1	MD17	
MD10	ME5	MJ3		
MD11	ME6	MJ4		
MD13	ME7	MJ5		

Table 47-214. Master Keys for Above Locks

Application	Catalog Number	Price U.S. \$
For Code: MD1 – MD20	10250ED825-3	
ME2 – ME18	10250ED825-4	
MJ1 – MJ16	10250ED825-5	

Selector Switch Operators (Continued)

Selector Switch Operators without Caps

Note: Operators below can be ordered with caps assembled to them by adding the Code Number from **Table 47-216** to the end of Catalog Number below.
Example: 10250T4011KB



**2-Position
Selector Switch
Maintained,
Cam Code 1
Catalog Number
10250T4011**

Table 47-215. Selector Switch Operators without Caps

Positions	Operator Action ①	Cam Code ②	Catalog Number	Price U.S. \$
2-Position — 60° Throw		1	10250T4011	
		1	10250T4081	
3-Position — 60° Throw		2 3	10250T4022 10250T4023	
		2 3	10250T4032 10250T4033	
		2 3	10250T4042 10250T4043	
		2 3	10250T4052 10250T4053	
		2 3	10250T4052 10250T4053	
4-Position — 40° Throw		7	10250T4067	

① M = Maintained. S = Spring return in direction of arrow (→).

② For selection of the proper cam and contact block to obtain the proper circuit sequence, see selection instructions and table on **Pages 47-133 – 47-134**.

Table 47-216. Operating Caps

Color	Knob		Lever	
	Catalog and Code Number	Price U.S. \$	Catalog and Code Number	Price U.S. \$
Black	10250TKB		10250TLB	
Red	10250TKR		10250TLR	
Green	10250TKG		10250TLG	
Yellow	10250TKY		10250TLY	
White	10250TKW		10250TLW	
Gray	10250TKA		10250TLA	
Blue	10250TKL		10250TLL	
Orange	10250TKO		10250TLO	

Color	Lever ③		Coin Slot	
	Catalog and Code Number	Price U.S. \$	Catalog and Code Number	Price U.S. \$
Black	10250TSB		10250TCB	
Red	10250TSR		10250TCR	
Green	10250TSG		10250TCG	
Yellow	10250TSY		10250TCY	
White	10250TSW		10250TCW	
Gray	10250TSA		10250TCA	
Blue	10250TSL		10250TCL	
Orange	10250TSO		10250TCO	

③ Designed for added ingress protection. For use in maintained operators only.

Accessories **Pages 47-155 – 47-156**
 Contact Blocks **Page 47-148**
 Dimensions **Pages 47-160 – 47-162**
 Enclosures **Pages 47-153 – 47-154**
 Legend Plates **Pages 47-151 – 47-152**
 Discount Symbol **1CD1C**

10250T Series, Selector Switch Components

Illuminated Selector Switch Operators

Illuminated Selector Switches without Caps



*2-Position Maintained 120V AC
 Transformer Selector Switch,
 Cam Code 1
 Catalog Number 10250T5971*

Table 47-217. Operator without Knob or Lever

Positions	Operator Action ^①	Transformer Type — 50/60 Hz				Full Voltage Type — AC or DC ^④			
		6 Volt #755 Lamp				Lamps: 6V — #755, 12V — #756, 24V — #757, 48V — #1835, 120/240V — 120MB			
		Voltage	Catalog and Code Number ^②	Cam Code ^③	Price U.S. \$	Voltage	Catalog and Code Number ^②	Cam Code ^③	Price U.S. \$
2-Position – 60° Throw		24	10250T5961	1		6	10250T6201	1	
		120	10250T5971			12	10250T6211		
		208	10250T6511			24	10250T6221		
		240	10250T5981			48	10250T6231		
		380	10250T5991			120	10250T6361		
		480	10250T6001			240 ^⑤	10250T6371		
		600	10250T6011						
3-Position – 60° Throw		24	10250T602_	+ 2 or 3		6	10250T624_	+ 2 or 3	
		120	10250T603_			12	10250T625_		
		208	10250T652_			24	10250T626_		
		240	10250T604_			48	10250T627_		
		380	10250T605_			120	10250T638_		
	480	10250T606_			240 ^⑤	10250T639_			
	600	10250T607_							
		24	10250T654_	+ 2 or 3		6	10250T612_	+ 2 or 3	
		120	10250T620_			12	10250T632_		
		208	10250T655_			24	10250T642_		
		240	10250T656_			48	10250T672_		
		380	10250T657_			120	10250T622_		
	480	10250T658_			240	10250T682_			
	600	10250T659_							
		24	10250T660_	+ 2 or 3		6	10250T613_	+ 2 or 3	
		120	10250T621_			12	10250T633_		
		208	10250T661_			24	10250T643_		
		240	10250T662_			48	10250T673_		
		380	10250T663_			120	10250T623_		
	480	10250T664_			240	10250T683_			
600	10250T665_								
	24	10250T614_	+ 2 or 3		6	10250T628_	+ 2 or 3		
	120	10250T615_			12	10250T629_			
	208	10250T653_			24	10250T630_			
	240	10250T616_			48	10250T631_			
	380	10250T617_			120	10250T640_			
480	10250T618_			240 ^⑤	10250T641_				
600	10250T619_								
4-Position – 40° Throw		24	10250T6087	7		6	10250T6327	7	
		120	10250T6097			12	10250T6337		
		208	10250T6547			24	10250T6347		
		240	10250T6107			48	10250T6357		
		380	10250T6117			120	10250T6427		
		480	10250T6127			240 ^⑤	10250T6437		
		600	10250T6137						

47

- ① M = Maintained. S = Spring return in direction of arrow (→).
- ② Operator includes lens gasket and lens attachment screws.
- ③ For selection of the proper cam and contact block, to obtain the proper circuit sequence, see selection table on **Pages 47-133 – 47-134**.
- ④ Full voltage light units can be used at other than listed voltages by changing lamp. Replacement lamps are listed on **Page 47-157**.
- ⑤ Resistor type. May generate excess heat if used in high density.

Table 47-218. Illuminated Knobs and Levers

Color ^⑥	Knob		Lever	
	Cat. and Code No.	Price U.S. \$	Cat. and Code No.	Price U.S. \$
Red	10250TER		10250TFR	
Green	10250TEG		10250TFG	
Yellow	10250TEA		10250TFA	
Blue	10250TEL		10250TFL	
Clear	10250TEC		10250TFC	
White	10250TEW		10250TFW	
Amber	10250TEM		10250TFM	

⑥ Amber, Clear and White lenses have a black arrow (pointer), Red, Green and Blue lenses have a white arrow (pointer).

Accessories **Pages 47-155 – 47-156**
 Contact Blocks **Page 47-148**
 Dimensions **Pages 47-160 – 47-162**
 Enclosures **Pages 47-153 – 47-154**
 Legend Plates **Pages 47-151 – 47-152**
 Discount Symbol **1CD1C**

Joystick Units

Table 47-219. Joystick Units — UL (NEMA) Type 3, 3R, 4, 4X, 12, 13

Two-Position	Operator Position ①			Operator Action ②	2-Position Assembled Unit		Contact Type	Mounting Location	
	Up	Center	Down		Catalog Number ③	Price U.S. \$		A	B
	X O	O O	O X		10250T452-3X		1NC 1NC		

- ① X = closed circuit, O = open circuit.
- ② M = Maintained. S = Spring return in direction of arrow (→).
- ③ Field convertible momentary to maintained or vice versa.

Joysticks

Two-Position Joystick Operators

The device mounts in the standard 30.5 mm mounting hole. Allow sufficient panel space for lever movement.

The maximum travel of the knob operator (full up to full down) is 2.2" (24°) momentary, 2.5" (30°) maintained, but ample space for lever operation must

be allowed. These operators are field convertible from momentary to maintained operation or vice versa.

The use of NC contacts is preferred because they provide positive drive contact opening and a direct relationship between lever movement and affected terminal, i.e., up movement affects the top terminals.



2-Position Joystick Operator

Table 47-220. 2-Position Joystick Operators — UL (NEMA) Type 3, 3R, 4, 4X, 12, 13

Contact Block Limitations	Description ④	Catalog Number	Price U.S. \$	Overall Dimensions in Inches (mm)
Momentary Mode 4NC Contact Blocks Max. 3NO Contact Blocks Max. Maintained Mode 2 Contact Blocks Max.	2-Position Operator Only — AC Applications Only Momentary Up and Down Maintained Up — Momentary Down Maintained Down — Momentary Up Maintained Up and Down	10250T452 10250T4521 10250T4522 10250T4525		

- ④ Field convertible momentary to maintained or vice versa. To expedite shipment of maintained types, order momentary operator 10250T452 which is a stocked device.

Table 47-221. Contact Block Operation and Selection

Handle Position ⑤			Contact Block			Mounting Location ⑥⑦	
Up	Center	Down	Catalog Number	Price U.S. \$	Type ⑦	Top A	Bottom B
X	O	O	10250T51		1NC		
O	O	X	10250T51		1NC		
O	X	O	10250T45		2LONC (Series)		
X	O	O	10250T3		1NC		
O	O	X	10250T3		1NC		
X	X	O	10250T45		1LONC		
O	X	X	10250T45		1LONC		
X	O	O	10250T44 ⑧		1NC		
O	O	X	10250T44 ⑧		1NO		
O	O	X	10250T44 ⑧		1NC		
X	O	O	10250T44 ⑧		1NO		

- ⑤ Bolded circuit corresponds to "X-O" circuit selection. X = closed circuit, O = open circuit.
- ⑥ See Figure 47-97 for "A" and "B" mounting location.
- ⑦ NO = Normally Open, NC = Normally Closed, LONC = Late Opening Normally Closed.
- ⑧ Four circuits in single block depth — rated 300V max.

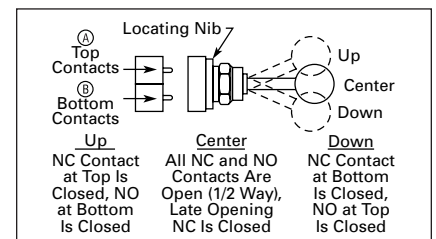

Figure 47-97. A and B Mounting Location

Application Caution

Joystick operators are not recommended on certain DC applications above 24V DC which may involve lightly engaging the contacts (teasing) to achieve speed control, positioning, jogging, etc. Excessive arcing and deterioration of the contacts will occur.

- Contact Blocks Page 47-148
- Enclosures Pages 47-153 – 47-154
- Legend Plates Pages 47-151 – 47-152
- Discount Symbol 1CD1C

10250T Series, Joystick Components

Joysticks (Continued)

Four-Position Joystick Operators

The joystick operated control unit is intended for AC application only. For other use, see **Application Caution** on preceding page.

The panel area required for the 4-position operator is equivalent to two standard pushbutton operators.

Note: The latch holds the lever in the center position. The trigger latch must be released before lever can be moved into any position.

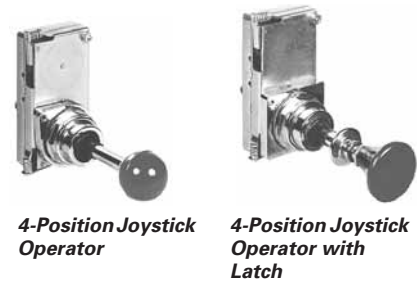

Table 47-222. 4-Position Joystick Operators — UL (NEMA) Type 3, 3R, 4, 4X, 12, 13

Contact Block Limitations	Description ①	Catalog Number	Price U.S. \$	Overall Dimensions in Inches (mm)
4 Contact Blocks Max. — 2 in Each Position	Operator Only — AC Application Only			
	4-Position — without Latch	10250T451_		
	4-Position — with Latch	10250T461_		
Hole Plug				
	To plug unused hole	10250TA7		

① Momentary operators — spring return to center. For maintained operators add Suffix Code from Table 47-223. Example: 10250T45110. Operator without latch, maintained in left and right positions.

Field Conversion — Gate

The factory assembled 4-position operator is assembled with a gate arranged for four handle positions.

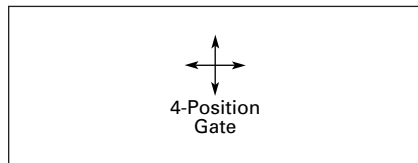

Figure 47-98. Handle Positions

Three additional gates, supplied with every operator, allow on the job conversion to 3- or 8-position operation as illustrated below.

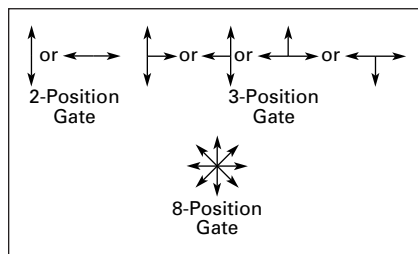

Figure 47-99. 2-, 3- or 8-Position Operation

The 8-position gate controls the four functions shown as “Up,” “Down,” “Left” and “Right.” The remaining four diagonal positions each actuate two adjacent functions (see Figure 47-100); for example, “Left Down” actuates both “Left” and “Down.” The operator may be arranged for spring return of handle to center position, or maintained in up to eight positions (see description of maintained position operator).

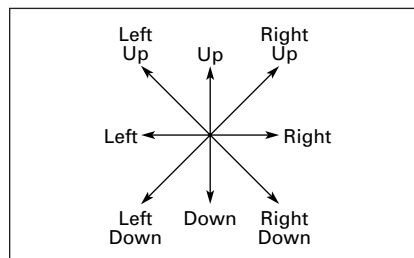

Figure 47-100. Adjacent Functions

Maintained Position

For maintained position (non-spring return), locate required maintained position or positions of operating lever in Table 47-223 and add appropriate Suffix Number to the Catalog Number selected from Table 47-222.

Table 47-223. Maintained Positions

Maintained Positions				Suffix Number
Up	Down	Left	Right	
X	—	—	—	1
—	X	—	—	2
—	—	X	—	3
—	—	—	X	4
X	X	—	—	5
X	—	X	—	6
X	—	—	X	7
—	X	X	—	8
—	X	—	X	9
—	—	X	X	10
X	X	X	—	11
X	X	—	X	12
X	—	X	X	13
—	X	X	X	14
X	X	X	X	15

Note: On an 8-position gate, when an adjacent vertical and horizontal position are both maintained, the included diagonal position is also maintained.

Contact Blocks Page 47-148
 Enclosures Pages 47-153 – 47-154
 Legend Plates Pages 47-151 – 47-152
 Discount Symbol 1CD1C

Joysticks (Continued)

Four-Position Joystick Operators (Continued)

Contact Block Operation

Contact blocks mount directly to the back of the operator. For reliable operation, the maximum number of contact blocks that should be installed behind each operator lever is 2 (4 total).

Figure 47-101 identifies the circuits activated by each of the eight possible lever positions. Contact block plungers 1, 2, 3, 4 are depressed (change state) when handle is in the position indicated by arrows below.

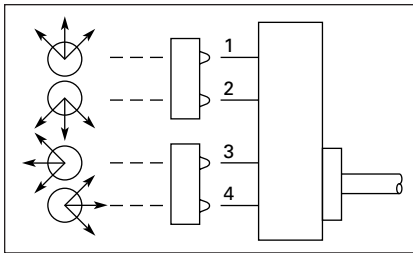

Figure 47-101. Circuit Activation

Note: Joystick in its resting state, center position, does not activate contact block plungers.

Ordering Example:

Suppose you are looking for a 4-position momentary joystick without a latch and the following circuit arrangements. X = Closed Circuit, O = Open Circuit.

Table 47-224. Example Circuit Arrangements

	Up	Down	Left	Right
1st Circuit	X	X	X	X
2nd Circuit	X	O	O	X

The contact blocks and their mounting locations would be as follows:

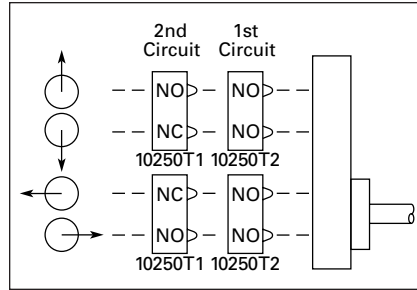

Figure 47-102. Example Contact Blocks and Locations

A complete bill of material for this example would include:

Table 47-225. Example Order

Qty.	Catalog Number
1	10250T451
2	10250T2
2	10250T1

Blank Legend Plates for Joystick Operators

When ordering engraved legend plates, order by Catalog Number and insert the following into Order Notes:

- Legend required
- Size of characters: 3/16, 1/8, 3/32 inch (4.8, 3.2, 2.4 mm)
- Location by letter (A – N)

Locations K and M can accommodate up to 2 lines horizontally; L and N up to 2 lines vertically.

Maximum number of characters:

- Horizontal
3/16" — 13, 1/8" — 14, 3/32" — 19
- Vertical
3/16" — 10, 1/8" — 13, 3/32" — 14

Ordering Example:

2-position legend plate to be marked "UP" "DOWN."

Catalog No.: 10250TJ2S4STAMP
Letter Size: 3/16 inch (4.8 mm)
Pos. K — UP
Pos. M — DOWN

Table 47-226. 2-Position

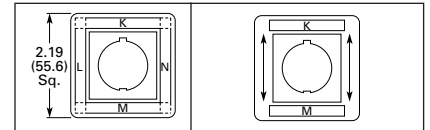

Catalog Number	Catalog Number	Price U.S. \$
10250TJS3	10250TJS4	

Blank Plate

10250TJS3	10250TJS4	
-----------	-----------	--

Engraved Plate

10250TJS3STAMP	10250TJS4STAMP	
----------------	----------------	--

Table 47-227. 4-Position

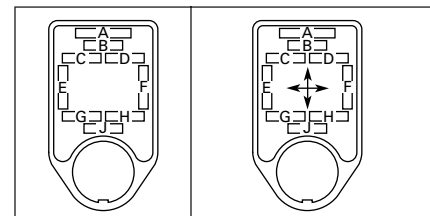

Catalog Number	Catalog Number	Price U.S. \$
10250TJS1	10250TJS2	

Blank Plate

10250TJS1	10250TJS2	
-----------	-----------	--

Engraved Plate

10250TJS1STAMP	10250TJS2STAMP	
----------------	----------------	--

10250T Series, Assembled Devices — Roto-Push Units

Roto-Push® Units

Two-Position Momentary

Complete assembled Two-Position Roto-Push Units are listed below. These operators have black flush buttons and are arranged for vertical mounting. Order legend plates separately.

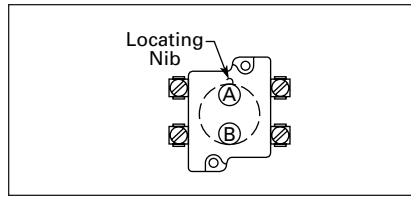



Figure 47-103. Mounting Location

Table 47-228. Roto-Push Units — UL (NEMA) Type 3, 3R, 4, 4X, 12, 13

	Typical Applications (Most Common Examples)	Operator Position ①				Roto-Push Assembled with Contact Blocks		Contact Type	Mounting Location	
		Collar Left		Collar Right		Catalog Number	Price U.S. \$		A	B
		Normal	Depressed	Normal	Depressed					
2-Position										
 Roto-Push — Black Flush Button for Vertical Mounting Cat. No. 10250T24111-1	FORWARD/REVERSE; HIGH/LOW; OPEN/CLOSE; UP/DOWN; etc.	O	O	O	X	10250T2411-2		1NO		
	JOG/RUN; MAN./AUTO; etc.	O	X	O	X	10250T24111-2		1NO 1NO		
	RUN/JOG; START/JOG; etc.	O	X	O	X	10250T24111-1		1NO 1NC		
	SAFE/RUN; etc.	O	O	O	X	10250T2415-2		1NO 1NO		

① X = Closed Circuit, O = Open Circuit.

Two-Position Latched

The Two-Position Roto-Push Latch Unit is fully assembled and only requires a legend plate for a great variety of applications. When the selector collar is in the extreme left position, the button is in the free or normal position and can be operated as a standard pushbutton. Rotating the collar to the extreme right position automatically depresses and latches the button in the depressed position. The white filled groove in the button indicates the selector collar position. The selector collar has spring return to the left position except when in the extreme right latched position.

Table 47-229. Rotates to a Latch-Out Mode

Color and Type of Button	Contact Block	Vertical Mounting	
		Catalog Number	Price U.S. \$
 Red Long	1NC 2NC	10250T72 10250T73	

Accessories Pages 47-155 – 47-156
 Additional Circuit Arrangements Pages 47-133 – 47-134
 Dimensions Pages 47-160 – 47-162
 Enclosures Pages 47-153 – 47-154
 Legend Plates Pages 47-151 – 47-152
 Discount Symbol 1CD1C

Roto-Push Operators

Roto-Push Components

A Roto-Push control unit combines the function of a pushbutton and a selector switch. The contacts are operated by the combined action of rotating the outer collar and pushing a button contained in the collar.

In selecting the cam and contact blocks for the listed function, the analysis involves considering the function with the collar rotated to the given position with the button free (designated as "N") and then in that same position with the button depressed (designated "D"). This is done for each rotational position of the collar.

When Ordering Specify

- Catalog Number of Operator with Cam Code Suffix from tables below and on following pages, Example: 10250T2411.
- Catalog Number(s) for Contact Blocks and Legend Plates if required.
- To select the cam and contact blocks needed for 2-position and 3-position switches, use the tables on following pages.



**Operator and Cam
10250T2411**

Table 47-230. Operator and Cam

Color and Type of Button	Vertical Mounting	Horizontal Mounting	Cam Code No. Select from Tables	Price U.S. \$	Overall Dimensions in Inches (mm)
	Catalog and Code Number	Catalog and Code Number			
Black Flush Red Flush ① Green Flush Black Long Red Long ① Green Long	10250T241_ 10250T242_ 10250T243_ 10250T261_ 10250T262_ 10250T263_	10250T251_ 10250T252_ 10250T253_ 10250T271_ 10250T272_ 10250T273_	+ 1 to 18		

① Not to be used for Emergency Stop application.

Two-Position Roto-Push Operator — Rotates to a Latch-Out Mode



**Special Roto Latch —
Red Long Button
Catalog Number
10250T3213**

Special Rotor Latch

This differs from the other Roto-Push operators in that as the collar is rotated to the right it depresses the button and releases the button when rotated left. But the button in the released position can be momentarily

pushed independent of the collar or its position. As the button is depressed by rotating the collar, the button also rotates and indicates its mode by a white line on the button face. This button can be used as an emergency stop or latched stop.

Table 47-231. Special Rotor Latch — UL (NEMA) Type 3, 3R, 4, 4X, 12, 13

Color and Type of Button	Vertical Mounting		Overall Dimensions in Inches (mm)
	Catalog Number	Price U.S. \$	
Red Long Black Long	10250T3213 10250T3214		

Contact Blocks **Page 47-148**
 Enclosures **Pages 47-153 – 47-154**
 Legend Plates **Pages 47-151 – 47-152**
 Discount Symbol **1CD1C**

10250T Series, Roto-Push Components

Roto-Push Operators (Continued)

Table 47-232. Cam and Contact Block Selection for Two-Position Roto-Push

Combination Number	Collar Position		Cam Code 1	Cam Code 2	Cam Code 3	Cam Code 4	Cam Code 5	Cam Code 6
	Circuit Sequence ①							
	N	D						
1	O O	O X	A	A	—	—	A	—
2	O O	X O	—	—	—	A B	A B	—
3	O O	X X	—	—	—	—	B	A
4	O X	O O	B	A B	—	—	—	A B
5	O X	O X	A B	B	—	A	—	—
6	O X	X O	—	—	—	—	—	—
7	O X	X X	—	—	A or B NO	B	—	B
8	X O	O O	—	—	A or B NC	B	—	B
9	X O	O X	—	—	—	—	—	—
10	X O	X O	A B	B	—	A	—	—
11	X O	X X	B	A B	—	—	—	A B
12	X X	O O	—	—	—	—	B	A
13	X X	O X	—	—	—	A B	A B	—
14	X X	X O	A	A	—	—	A	—

① N = Button in free or normal position. D = Button depressed.

47

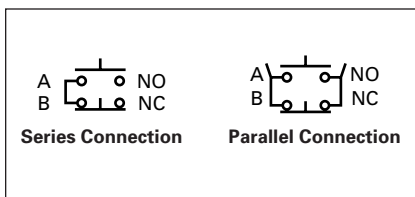

Figure 47-104. Series and Parallel Connections

The connections are not made at the factory. They are illustrated in the selection table as requirements, but must be made on the job.

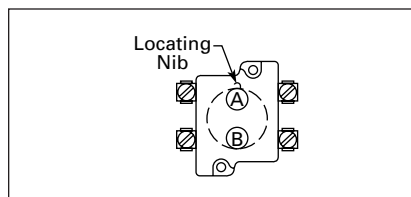

Figure 47-105. Circuit Location

Letters "A" and "B" represent the locations which the two circuits of a contact block will occupy in relation to the locating nib of the operator.

Figure 47-104 illustrates this pictorially.

Roto-Push Operators (Continued)

Table 47-232. Cam and Contact Block Selection for Two-Position Roto-Push (Continued)

Combination Number	Collar Position		Cam Code 10	Cam Code 11	Cam Code 12	Cam Code 13	Cam Code 14
	Circuit Sequence ①						
	N D	N D					
15	O O	O X	—		—	—	—
16	O O	X O	—		A	A or B NC	A
17	O O	X X	B	B	—	—	—
18	O X	O O	A		—	—	B
19	O X	O X	—	A	B	—	—
20	O X	X O	—	—	—	—	A
21	O X	X X	A	A	A	—	—
22	X O	O O	A	A	A	—	—
23	X O	O X	—	—	—	—	A
24	X O	X O	—	A	B	—	—
25	X O	X X	A	A	—	—	B
26	X X	O O	B	B	—	—	—
27	X X	O X	—		A	A or B NO	A
28	X X	X O	—	A	—	—	—

① N = Button in free or normal position. D = Button depressed.

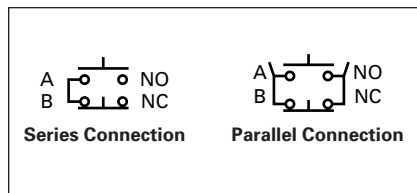

Figure 47-106. Series and Parallel Connections

The connections are not made at the factory. They are illustrated in the selection table as requirements, but must be made on the job.

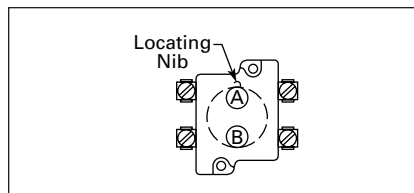

Figure 47-107. Circuit Location

Letters "A" and "B" represent the locations which the two circuits of a contact block will occupy in relation to the locating nib of the operator. **Figure 47-106** illustrates this pictorially.

10250T Series, Roto-Push Components

Roto-Push Operators (Continued)

Table 47-233. Cam and Contact Block Selection for Three-Position Roto-Push

Combination Number	Collar Position			Cam Code 7	Cam Code 8	Cam Code 9 ①	Cam Code 15 ①	Cam Code 16	Cam Code 17	Cam Code 18
	N	D	N							
1	O O	O O	O X			—			—	
2	O O	O O	X X	—	—		—	—		—
3	O O	O X	O O	—	—		—	—	—	
4	O O	O X	O X	—	—	—	—	—	—	
5	O O	O X	X X	—	—		—	—	—	—
6	O O	X X	O O	—		—	—	—	—	—
7	O O	X X	O X	—		—	—	—	—	—
8	O O	X X	X O		—	—	—	—	—	—
9	O O	X X	X X		—	—	—	—	—	—
10	O X	O O	O O			—				
11	O X	O O	O X		—	—			—	—
12	O X	O O	X X	—	—	—	—	—		—
13	O X	O X	O O	—	—	—	—	—	—	
14	O X	O X	O X	—	—	—	—	—	—	
15	O X	X X	O O	—		—	—	—	—	—
16	O X	X X	O X	—		—	—	—	—	—
17	O X	X X	X X		—	—	—	—	—	—

47

① Limited to 4 contact blocks. See Note on Page 47-148.
 ② N = Button in free or normal position. D = Button depressed.

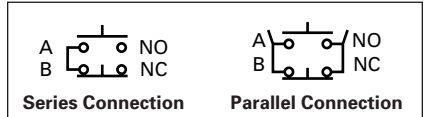

Figure 47-108. Series and Parallel Connections

The connections are not made at the factory. They are illustrated in the selection table as requirements, but must be made on the job.

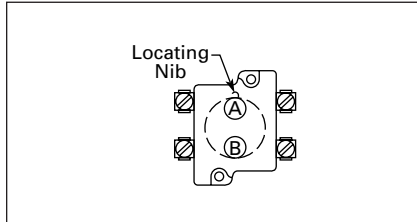

Figure 47-109. Circuit Location

Letters “A” and “B” represent the locations which the two circuits of a contact block will occupy in relation to the locating nib of the operator. **Figure 47-108** illustrates this pictorially.

Contact Blocks..... **Page 47-148**

Roto-Push Operators (Continued)

Table 47-233. Cam and Contact Block Selection for Three-Position Roto-Push (Continued)

Combination Number	Collar Position			Cam Code 7	Cam Code 8 ①	Cam Code 9	Cam Code 15	Cam Code 16	Cam Code 17	Cam Code 18	
	Circuit Sequence ②										
N	D	N	D	N	D	N	D	N	D	N	D
18	X	O	O	O	O						
19	X	O	O	O	X						
20	X	O	O	O	X	O					
21	X	O	X	X	O	O					
22	X	O	X	X	X	X					
23	X	O	X	X	X	O					
24	X	O	X	O	X	O					
25	X	O	X	O	X	X					
26	X	X	O	O	O	O					
27	X	X	O	O	O	X					
28	X	X	O	O	X	O					
29	X	X	O	O	X	X					
30	X	X	X	X	O	O					
31	X	X	X	X	X	O					
32	X	X	X	O	X	O					
33	X	X	X	O	X	X					

① Limited to 4 contact blocks.

② N = Button in free or normal position. D = Button depressed.

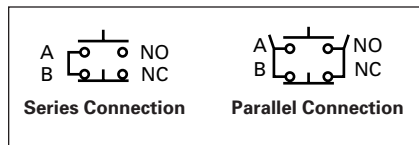

Figure 47-110. Series and Parallel Connection

The connections are not made at the factory. They are illustrated in the selection table as requirements, but must be made on the job.

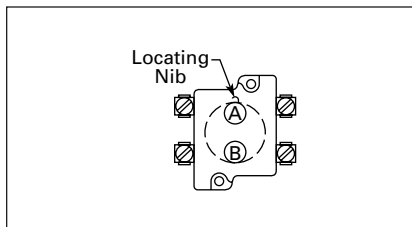

Figure 47-111. Circuit Location

Letters "A" and "B" represent the locations which the two circuits of a contact block will occupy in relation to the locating nib of the operator. **Figure 47-110** illustrates this pictorially.

Contact Blocks **Page 47-148**

10250T Series, Components — Contact Blocks

Contact Blocks

Standard Contact Blocks

- UL A600/P600 rated
- Color-coded plungers – red/green for NC/NO circuits
- Silver contact tips with “reliability nibs”
- Gray (opaque) or amber (translucent) housings
- Pressure plate or spade terminals
- Fingerproof shrouds (for pressure terminals only)

Logic Level Contact Blocks

- UL A600/P600 rated
- Color-coded plungers
- Inert palladium knife-blade contacts
- Gray (opaque) housings
- Pressure plate or spade terminals

Special Function Contact Blocks

- UL A600/P600 rated
- Color-coded plungers
- Silver contact tips with “reliability nibs”
- Gray (opaque) housings
- Pressure plate terminals only

Special Purpose Contact Block

- Maximum 300V rated
- Black plungers
- Silver contact tips with “reliability nibs”
- Black (opaque) housings
- Pressure plate terminals only
- Fingerproof shrouds not available

Reliability Nibs

Reliability nibs are the hallmark of Eaton’s Cutler-Hammer contact blocks. A pointed silver nib on the contact tip ensures reliable switching from logic level (5V) up to 600V applications.

Therefore standard contact blocks can be used for most logic level applications where the contacts are not exposed to any harsh environmental conditions.

Palladium Contacts

Palladium, which is more inert than gold, is well suited for voltages and currents approaching zero and is recommended for applications where environmental conditions are a factor.

Maximum Contact Block Mounting per Operator Type

Operator	Max. Stack	Operator	Max. Stack
Pushbuttons	6	2- or 3-Position Selector Switches	6
Push-Pull Operators	2	4-Position Selector Switches	4
Roto-Push Operators	4	Joysticks	4

Table 47-234. Contact Blocks

Symbol	Circuit	Description n/Notes ①	Standard				Logic Level			
			Pressure Terminals		Spade Terminals ②		Pressure Terminals		Spade Terminals ②	
			Catalog Number	Price U.S. \$	Catalog Number	Price U.S. \$	Catalog Number	Price U.S. \$	Catalog Number	Price U.S. \$
	1NC	Stack up to 6 blocks (6 circuits) unless otherwise noted.	10250T51		10250T59		10250T51E		10250T59E	
	1NO	Stack up to 6 blocks (6 circuits) unless otherwise noted.	10250T53		10250T60		10250T53E		10250T60E	
	NO-NC	Stack up to 6 blocks (12 circuits) unless otherwise noted.	10250T1		10250T40		10250T1E		10250T40E	
	2NC	Stack up to 6 blocks (12 circuits) unless otherwise noted.	10250T3		10250T42		10250T3E		10250T42E	
	2NO	Stack up to 6 blocks (12 circuits) unless otherwise noted.	10250T2		10250T41		10250T2E		10250T41E	
Special Function Blocks ③										
	LONC	Late opening NC. Stack up to 6 blocks (6 circuits) unless otherwise noted.	10250T71 ③		—		10250T71E ③		—	
	ECNO-NC	Early closing NO and standard NC. Stack up to 6 blocks unless otherwise noted.	10250T47 ③ ④		—		10250T47E ③		—	
	ECNO-NO	Early closing NO and standard NO. Stack up to 4 blocks unless otherwise noted.	10250T57 ③ ④		—		10250T57E ③		—	
	2LONC	Two late opening NC contacts. Stack up to 6 blocks unless otherwise noted.	10250T45 ③		—		10250T45E ③		—	
	LONC-ECNO	Overlapping contacts. Stack up to 4 blocks unless otherwise noted.	10250T55 ③ ④		—		10250T55E ③		—	
Special Purpose Blocks ⑤										
	2NO-2NC	Four circuits in single block depth. Rated 300V max. Stack up to 4 blocks unless otherwise noted.	10250T44 ⑤		—					

① All 10250T contact blocks shown are suitable for use on standard 10250T and E34 operators. These contact blocks are not suitable for Class I Division 2 type 10250T or E34 devices.
 ② Contact blocks with spade terminals are limited to a maximum of one contact block per operator and minimum spacing between devices is 2.5” (63.5 mm). Not suitable for use in 10250T or E34 enclosures. Also available in amber housing. Not available with fingerproof shrouds.

③ Special function contact blocks are not suitable for use with roto-push operators, 3-position push-pull operators, or 4-position selector switches.
 ④ ECNO contact blocks are not suitable for use with 2-position joysticks or when operators are used with padlock attachments.

⑤ Special purpose 10250T44 contact blocks are not suitable on selector switches or roto-push operators. Okay to use with 3-position push-pull operators only on low voltage (30V or less) circuits. Fingerproof shrouds not available.

Ratings Page 47-116
 Dimensions Pages 47-160 – 47-162
 Discount Symbol 1CD1C

Contact Blocks (Continued)

Table 47-235. Contact Blocks with Fingerproof Shrouds

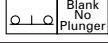
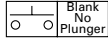
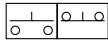
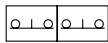
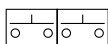
Symbol	Circuit	Description/ Notes ①	Standard		Logic Level	
			Pressure Terminals ②		Pressure Terminals ②	
			Catalog Number	Price U.S. \$	Catalog Number	Price U.S. \$
	1NC	Stack up to 6 blocks (6 circuits) unless otherwise noted.	10250T51P		10250T51EP	
	1NO	Stack up to 6 blocks (6 circuits) unless otherwise noted.	10250T53P		10250T53EP	
	NO-NC	Stack up to 6 blocks (12 circuits) unless otherwise noted.	10250T1P		10250T1EP	
	2NC	Stack up to 6 blocks (12 circuits) unless otherwise noted.	10250T3P		10250T3EP	
	2NO	Stack up to 6 blocks (12 circuits) unless otherwise noted.	10250T2P		10250T2EP	

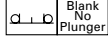
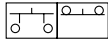
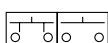
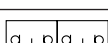
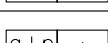

Special Function Blocks ④

	LONC	Late opening NC. Stack up to 6 blocks (6 circuits) unless otherwise noted.	10250T71P ③		10250T71EP ③	
	ECNO-NC	Early closing NO and standard NC. Stack up to 6 blocks unless otherwise noted.	10250T47P ③ ④		10250T47EP ③	
	ECNO-NO	Early closing NO and standard NO. Stack up to 4 blocks unless otherwise noted.	10250T57P ③ ④		10250T57EP ③	
	2LONC	Two late opening NC contacts. Stack up to 6 blocks unless otherwise noted.	10250T45P ③		10250T45EP ③	
	LONC-ECNO	Overlapping contacts. Stack up to 4 blocks unless otherwise noted.	10250T55P ③ ④		10250T55EP ③	

① All 10250T contact blocks shown are suitable for use on standard 10250T and E34 operators. These contact blocks are not suitable for Class I Division 2 type 10250T or E34 devices.

② To order contact blocks with translucent amber housing, change Suffix P to **CP** in Catalog Number e.g. 10250T51**CP**.

③ Special function contact blocks are not suitable for use with roto-push operators, 3-position push-pull operators, or 4-position selector switches.

④ ECNO contact blocks are not suitable for use with 2-position joysticks or when operators are used with padlock attachments.

10250T Series, Components — Contact Blocks

Contact Blocks (Continued)

Table 47-236. Amber Contact Blocks

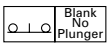
Symbol	Circuit	Description/ Notes ^①	 10250T1C	Standard				Logic Level			
				Pressure Terminals ^②		Spade Terminals ^③		Pressure Terminals ^②		Spade Terminals ^③	
				Catalog Number	Price U.S. \$	Catalog Number	Price U.S. \$	Catalog Number	Price U.S. \$	Catalog Number	Price U.S. \$
	1NC	Stack up to 6 blocks (6 circuits) unless otherwise noted.	10250T51C		10250T59C		10250T51EC		10250T59EC		
	1NO	Stack up to 6 blocks (6 circuits) unless otherwise noted.	10250T53C		10250T60C		10250T53EC		10250T60EC		
	NO-NC	Stack up to 6 blocks (12 circuits) unless otherwise noted.	10250T1C		10250T40C		10250T1EC		10250T40EC		
	2NC	Stack up to 6 blocks (12 circuits) unless otherwise noted.	10250T3C		10250T42C		10250T3EC		10250T42EC		
	2NO	Stack up to 6 blocks (12 circuits) unless otherwise noted.	10250T2C		10250T41C		10250T2EC		10250T41EC		

Special Function Blocks ^③

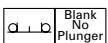
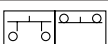
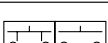
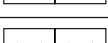
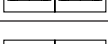
	LONC	Late opening NC. Stack up to 6 blocks (6 circuits) unless otherwise noted.	10250T71C ^④		—		10250T71EC ^④		—	
	ECNO-NC	Early closing NO and standard NC. Stack up to 6 blocks unless otherwise noted.	10250T47C ^{④ ⑤}		—		10250T47EC ^④		—	
	ECNO-NO	Early closing NO and standard NO. Stack up to 4 blocks unless otherwise noted.	10250T57C ^{④ ⑤}		—		10250T57EC ^④		—	
	2LONC	Two late opening NC contacts. Stack up to 6 blocks unless otherwise noted.	10250T45C ^④		—		10250T45EC ^④		—	
	LONC-ECNO	Overlapping contacts. Stack up to 4 blocks unless otherwise noted.	10250T55C ^{④ ⑤}		—		10250T55EC ^④		—	

^① All 10250T contact blocks shown are suitable for use on standard 10250T and E34 operators. These contact blocks are not suitable for Class I Division 2 type 10250T or E34 devices.

^② To order amber contact blocks with fingerproof shrouds, change Suffix to **CP** in the Catalog Number e.g. 10250T51**CP**. Not available with spade terminals.

^③ Contact blocks with spade terminals are limited to a maximum of one contact block per operator and minimum spacing between devices is 2.5" (63.5 mm). Not suitable for use in 10250T or E34 enclosures. Also available in amber housing. Not available with fingerproof shrouds.

^④ Special function contact blocks are not suitable for use with roto-push operators, 3-position push-pull operators, or 4-position selector switches.

^⑤ ECNO contact blocks are not suitable for use with 2-position joysticks or when operators are used with padlock attachments.

Options

Legend Plates

Legend Plates with Standard Markings

The legend plates listed below are sized for all standard commercial enclosures and Eaton's Cutler-Hammer cast enclosures. For vertical spacing less than 1.75", replace the **S** in the Catalog Number with **MS**, or the **M** with **P** (except Push-Pull). No change in price. The smaller size legend plates, "MS" or "P" size, have limited space for legend.

Table 47-237. For Pushbutton Operators and Indicating Lights — Standard

Price Each — U.S. \$			
Legend	Color of Field	Catalog Number	
		Square ①	1/2 Round
Blank		See Table 47-243 on Page 47-152	

Letters on Legend Plates Below are 3/16" High

CLAMP	Black	10250TS90	10250TM90
CLOSE	Black	10250TS73	10250TM11
DOWN	Black	10250TS74	10250TM12
EMERG. STOP	Red	10250TS13	10250TM13
FAST	Black	10250TS75	10250TM14
FASTER	Black	10250TS87	10250TM87
FEEDER ON	Black	10250TS94	10250TM94
FEEDER OFF	Black	10250TS95	10250TM95
FORWARD	Black	10250TS15	10250TM15
HIGH	Black	10250TS16	10250TM16
IN	Black	10250TS17	10250TM17
INCH	Black	10250TS18	10250TM18
JOG	Black	10250TS19	10250TM19
JOG FOR.	Black	10250TS20	10250TM20
JOG REV.	Black	10250TS21	10250TM21
LOW	Black	10250TS22	10250TM22
LOWER	Black	10250TS23	10250TM23
LUBE-FAIL	Black	10250TS92	10250TM92
MOTOR RUN	Black	10250TS81	10250TM81
MOTOR STOP	Black	10250TS82	10250TM82
OFF	Red	10250TS24	10250TM24
ON	Black	10250TS25	10250TM25
OPEN	Black	10250TS26	10250TM26
OUT	Black	10250TS27	10250TM27
POWER ON	Black	10250TS80	10250TM80
RAISE	Black	10250TS28	10250TM28
READY	Black	10250TS86	10250TM86
RESET	Black	10250TS29	10250TM29
REVERSE	Black	10250TS30	10250TM30
RUN	Black	10250TS31	10250TM31
SAFE	Black	10250TS85	10250TM85
SLOW	Black	10250TS32	10250TM32
SLOWER	Black	10250TS88	10250TM88
START	Black	10250TS33	10250TM33
STOP	Red	10250TS34	10250TM34
TEST	Black	10250TS83	10250TM83
TRANSFER	Black	10250TS93	10250TM93
TRIP	Black	10250TS84	10250TM84
UNCLAMP	Black	10250TS91	10250TM91
UP	Black	10250TS35	10250TM35

① Square legend plates have a satin aluminum field. Color is on lower portion.

Table 47-238. Blank Plastic Legend Plates — Square

Price Each — U.S. \$				
Color		Catalog Number		
Lettering	Field	Standard	Jumbo ③	Extra Large
Black	White or Silver ②	10250TSP76	10250TLP76	10250TEP76
White	Red or Black ②	10250TSP77	10250TLP77	10250TEP77

② If legend plate is to be engraved, specify field color required.

③ Cannot be used on cast enclosures except for top row. Suitable for most sheet metal enclosures.



Square Legend Plate
Catalog Number
10250TS41



1/2 Round Legend Plate
Catalog Number
10250TM38



70 mm Round — Plastic
Catalog Number
10250TRP79

Table 47-239. For Selector Switch and Roto-Push Operators — Standard Size

Price Each — U.S. \$			
Legend	Color of Field	Catalog Number	
		Square ④	1/2 Round
Blank		See Table 47-243 on Page 47-152	

2-Position — 5/32" High Lettering

FOR. REV.	Black	10250TS38	10250TM38
HAND AUTO	Black	10250TS39	10250TM39
HIGH LOW	Black	10250TS40	10250TM40
JOG RUN	Black	10250TS41	10250TM41
MAN. AUTO	Black	10250TS67	10250TM67
OFF ON	Black	10250TS42	10250TM42
OPEN CLOSE	Black	10250TS43	10250TM43
RUN JOG	Black	10250TS44	10250TM44
SAFE RUN	Black	10250TS45	10250TM45
START JOG	Black	10250TS46	10250TM46
START STOP	Black	10250TS47	10250TM47
UP DOWN	Black	10250TS48	10250TM48

3-Position — 1/8" High Lettering

AUTO OFF HAND	Black	10250TS49	10250TM49
FOR. OFF REV.	Black	10250TS50	10250TM50
FOR. SAFE REV.	Black	10250TS69	10250TM69
HAND OFF AUTO	Black	10250TS51	10250TM51
MAN. OFF AUTO	Black	10250TS68	10250TM68
OPEN OFF CLOSE	Black	10250TS53	10250TM53
RUN SAFE JOG	Black	10250TS70	10250TM70
UP OFF DOWN	Black	10250TS54	10250TM54
ON STOP SAFE	Red	10250TS71	10250TM71

④ Square legend plates have a satin aluminum field. Color is on lower portion.

Table 47-240. 45 mm and 70 mm Plastic — Round

Color		Catalog Number	Price U.S. \$
Lettering	Field		
45 mm			
Blank	Yellow or Red ⑤	10250TRP78	
70 mm			
Blank	Yellow or Red ⑤	10250TRP76	
Red EMERG. STOP	Yellow	10250TRP79	

⑤ If legend plate is to be engraved, specify field color required.

Table 47-241. For Push-Pull Units ⑥

Price Each — U.S. \$			
Legend	Color of Field	Catalog Number	
		Square ⑦	1/2 Round

Standard Size — Letters on Legend Plates Below are 3/32" High

PULL START/PUSH STOP	Green/Red	10250TPP2	10250TR2
PUSH ON/PULL OFF	Black	10250TPP5	10250TR5
PULL OPEN/PUSH CLOSE	Black	10250TPP8	10250TR8
PULL UP/PUSH DOWN	Black	10250TPP11	10250TR11

Jumbo Size — Letters on Legend Plates Below are 1/8" High

PULL START/PUSH STOP	Green/Red	10250TPP3	10250TR3
PULL ON/PUSH OFF	Black	10250TPP6	10250TR6
PULL OPEN/PUSH CLOSE	Black	10250TPP9	10250TR9
PULL UP/PUSH DOWN	Black	10250TPP12	10250TR12

⑥ All Push-Pull Legend Plates include the symbols ↑↓ in the center of the plate.

⑦ Square legend plates have a satin aluminum field. Color is on lower portion.

10250T Series, Legend Plates

Legend Plates with Non-standard Markings

When Ordering Specify

- Catalog Number of Blank Plate Phase plus Suffix "STAMP."
- Insert the following into Order Notes: Legend, Letter Size and Locations (Letters A - W) — combine letters for definitive locations as shown.

Ordering Example:

Catalog No.: 10250TS36STAMP
 Letter Size: 3/32 inch (2.4 mm)
 Pos. A — POWER HOUSE
 Pos. B — START PUMP 1

Legend Characters Available

ABCDEFGHIJKLMN OPQRSTUVWXYZ
 -./,1234567890

Legend characters on black and red plates are white — on satin aluminum plates, characters are black.

Blackening Kit

Solution blackens aluminum exposed by engraving process. Must be applied immediately after engraving. 0.3 oz. bottle — sufficient for approximately 1100 legend plates.

Table 47-242. Blackening Kit

Catalog Number	Price U.S. \$
10250TBK	

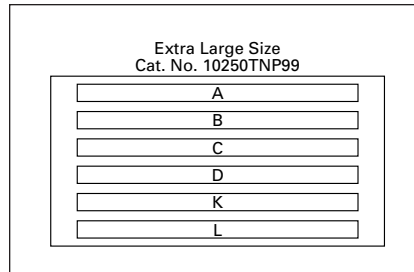

Figure 47-112. Legend Positions

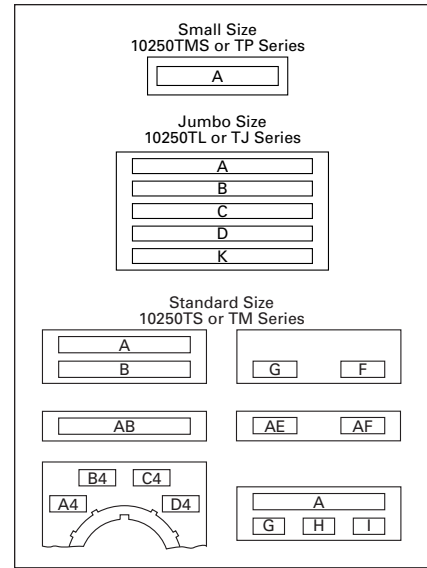

Figure 47-113. Legend Positions

Table 47-243. Blank and Custom Engraved Legend Plates

Style	Color	Small	Standard	Jumbo ③	Extra Large ②	4-Position Selector Switch		Push-Pull with Symbols ①		Price U.S. \$	
		Catalog Number	Catalog Number	Catalog Number	Catalog Number	Custom ⑤	Standard	Standard	Jumbo ③	Blank	Custom Engraved
Square ④	Black	10250TMS36	10250TS36	10250TL36	—	10250TS76	10250TS72	10250TPP17	10250TPP18		
	Red	10250TMS37	10250TS37	10250TL37	—	—	—	—	—		
	Green/Red Satin Alum.	—	—	—	10250TNP99	—	—	10250TPP20	10250TPP21		
1/2 Round	Black	10250TP36	10250TM36	10250TJ36	—	—	10250TM72	10250TR17	10250TR18		
	Red	10250TP37	10250TM37	10250TJ37	—	—	—	10250TR20	10250TR21		
	Green/Red Satin Alum.	—	10250TM89	10250TJ89	—	—	—	—	—		

- ① All Push-Pull Legend Plates include the symbols ↑ ↓ in the center of the plate.
- ② When used to meet Ford Motor Co. specifications, specify engraved legend. Cannot be used on standard cast or sheet metal enclosures.
- ③ Cannot be used on cast enclosures except for top row. Suitable for most sheet metal enclosures.
- ④ Square legend plates have a satin aluminum field. Color is on lower portion.
- ⑤ Slightly larger than standard size for legends requiring more space — fits cast enclosures.

Table 47-244. Maximum Characters per Legend Plate and Approximate Dimensions

Top (Aluminum and Plastic)	Approximate Dimensions in Inches (mm)		Style	Character Size					
	Width	Height		3/32" High		1/8" High		3/16" High	
				Number of Lines	Number of Characters	Number of Lines	Number of Characters	Number of Lines	Number of Characters
Small ⑥	1.59 (40.4)	1.59 (40.4)	Square	1	17	—	—	—	—
			1/2 Round	1	15	1	12	1	9
Standard and Custom	1.75 (44.5)	1.75 (44.5)	Square	2	18	2	13	1	9
			1/2 Round	2	15	2	12	1	9
Jumbo ⑦	2.19 (55.6)	2.19 (55.6)	Square	5	23	3	18	2	12
			1/2 Round	5	19	4	15	2	11
Extra Large ⑧	2.44 (62)	2.44 (62)	Square	6	25	3	18	3	12



- ⑥ Recommended only when mounting on minimum centers [less than 1-3/4 inch (44.5 mm) vertical centers].
- ⑦ Can be used on top row only of any enclosure.
- ⑧ When used to meet Ford Motor Co. specifications, specify engraved legend. Cannot be used on standard cast or sheet metal enclosures.

Legend Plates for
 Joystick Operator Page 47-141
 Discount Symbol 1CD1C

Enclosures

Die Cast, Polyester and Stainless Steel Enclosures

Table 47-245. Enclosures (Case and Cover) — Surface Mounting ①

	Number of Elements	1 Contact Block Depth		2 Contact Block Depth	
		Catalog Number	Price U.S. \$	Catalog Number	Price U.S. \$
 Die Cast Enclosure — Cat. No. 10250TN11	Cast Enclosure — In-Line ②③⑤ NEMA 4, 4X, 12, 13				
	1	10250TN1		10250TN11	
	2	10250TN2		10250TN12	
	3	10250TN3		10250TN13	
	4	10250TN4		10250TN14	
 Polyester Enclosure — Cat. No. E34N52	Polyester ⑤ — In-Line NEMA 3, 4X, 12				
	1	—		E34N51	
	2	—		E34N52	
	3	—		E34N53	
	4	—		E34N54	
 Stainless Steel Enclosure — Cat. No. 10250TN35	Stainless Steel ④⑤ — In-Line NEMA 4, 4X, 12				
	1	—		10250TN33	
	2	—		10250TN34	
	3	—		10250TN35	
	4	—		10250TN36	

① For spacing increments, see Page 47-154.

② All cast enclosures can be converted to base mounting of contact blocks, with spacers 10250TA22 or 10250TA23. See listing on Page 47-156.

③ When used with E30 pushbuttons, only the one element enclosure can be used.

④ 14 gauge, type 304.

⑤ When used with resistor light units, only the 2 contact block depth enclosure can be used.

Table 47-246. Approximate Dimensions

Number of Elements	Element Arrangement	Surface Mounting					Conduit Entrance	Approximate Dimensions
		Dimensions in Inches (mm)						
		Wide A	High B	Deep C	Mounting			
					D	E		
Cast								
1	In-Line	3.88 (98.6)	4.0 (101.6)	3.0 (76.3) ⑦	2.69 (68.3)	3.25 (82.6)	3/4	
2	In-Line	3.88 (98.6)	5.88 (149.4)	3.0 (76.3) ⑦	2.69 (68.3)	5.13 (130.3)	3/4	
3	In-Line	3.88 (98.6)	7.75 (196.9)	3.0 (76.3) ⑦	2.69 (68.3)	7.0 (177.8)	1	
4	In-Line	3.88 (98.6)	9.63 (244.6)	3.0 (76.3) ⑦	2.69 (68.3)	8.88 (225.6)	1	
Polyester								
1	In-Line	3.81 (96.8)	6.63 (168.4)	3.38 (85.9)	2.94 (74.7)	4.88 (124.0)	⑥	
2	In-Line	3.81 (96.8)	6.63 (168.4)	3.38 (85.9)	2.94 (74.7)	4.88 (124.0)		
3	In-Line	3.81 (96.8)	8.88 (225.6)	3.38 (85.9)	2.94 (74.7)	7.13 (181.1)		
4	In-Line	3.81 (96.8)	11.13 (282.7)	3.38 (85.9)	2.94 (74.7)	9.38 (238.3)		
Stainless Steel								
1	In-Line	3.00 (76.2)	3.50 (88.9)	3.00 (76.2)	1.50 (38.1)	4.25 (108.0)	⑥	
2	In-Line	3.50 (88.9)	6.75 (171.5)	3.00 (76.2)	1.50 (38.1)	7.50 (190.5)		
3	In-Line	3.50 (88.9)	9.00 (228.6)	3.00 (76.2)	1.50 (38.1)	9.00 (228.6)		
4	In-Line	3.50 (88.9)	11.25 (285.8)	3.00 (76.2)	1.50 (38.1)	12.00 (304.8)		

⑥ No conduit entrance holes provided. Drill as required.

⑦ Depth given is for two contact block deep stations. One contact block deep stations subtract 3/4 inch (19.1 mm).

Note: 2-position joystick must be used with two contact block deep enclosures (maximum number of contact blocks = 1). 4-position joysticks can not be used within these enclosures.



One Contact Block Depth Enclosure



Two Contact Block Depth Enclosure

4 Mtg. Holes — 10-32 Screw Size for
1 – 4 Element Die Cast/
Stainless Steel Enclosure
7/32 Screw Size for
Polyester

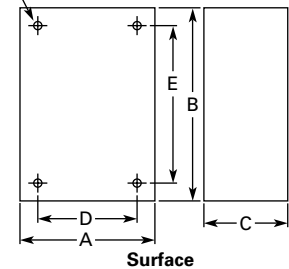

Surface

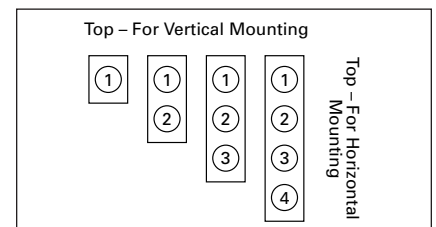

Figure 47-114. Enclosure Layouts

Discount Symbol 1CD1C

10250T Series, Enclosures

Die Cast and Stainless Steel — Flush Mount, Covers Only

Table 47-247. Covers Only — Flush Mounting

	Number of Elements	Catalog Number	Price U.S. \$	Catalog Number	Price U.S. \$
	Flush Cast Covers				
			In-Line Deep Cover		In-Line Flat Cover
	1	10250TF11		10250TF1	
	2	10250TF12		10250TF2	
	3	10250TF13		10250TF3	
	4	10250TF14		10250TF4	
	In-Line Stainless Steel Flush Plates ①				
			With Pullbox		Without Pullbox
	1	10250TS10		10250TS1	
	2	10250TS11		10250TS2	
	3	10250TS12		10250TS3	
	4	10250TS14		10250TS4	

① Not oiltight. NEMA 1 applications only.

Table 47-248. Approximate Dimensions

Number of Elements	Flush Mounting					Approximate Dimensions
	Dimensions in Inches (mm)					
	Wide A	High B	Deep C	Mounting		
				D	E	
Cast						
1	3.88 (98.6)	4.0 (101.6)	0.25 (6.4) ②	3.50 (88.9)	3.63 (92.2)	
2	3.88 (98.6)	5.88 (149.4)	0.25 (6.4) ②	3.50 (88.9)	5.50 (139.7)	
3	3.88 (98.6)	7.75 (196.9)	0.25 (6.4) ②	3.50 (88.9)	6.0 (152.4)	
4	3.88 (98.6)	9.63 (244.6)	0.25 (6.4) ②	3.50 (88.9)	9.25 (235)	
Stainless Steel						
1	5.0 (127)	5.0 (127)	2.50 (63.5) ③	3.25 (82.6)	1.88 (47.8)	
2	5.0 (127)	6.88 (174.8)	2.50 (63.5) ③	3.25 (82.6)	3.63 (92.2)	
3	5.0 (127)	8.63 (219.2)	2.50 (63.5) ③	3.25 (82.6)	5.50 (139.7)	
4	5.0 (127)	10.50 (266.7)	2.50 (63.5) ③	3.25 (82.6)	7.25 (184.2)	

② Depth given is for flat cover. Deep cover 3/4 inch (19.1 mm) deeper.

③ Depth given includes pull box.

Table 47-249. Spacing Increments

Type	Approximate Dimensions in Inches (mm)		
	F	G	H
Cast	2.44 (62)	2.5 (63.5)	1.88 (47.8)
Polyester	1.88 (47.8)	Min. 2.13 (54.1)	2.25 (57.2)
Stainless Steel	1.69 (42.9)	Min. 1.73 (43.9)	2.25 (57.2)

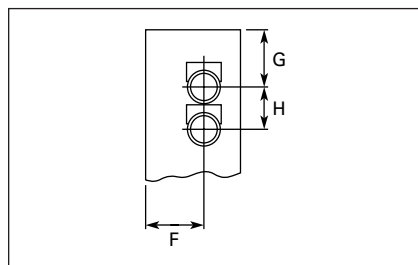

Figure 47-115. Spacing Increments for Enclosures

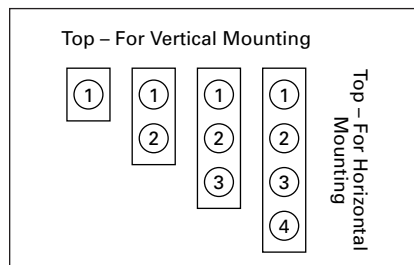









Figure 47-116. Enclosure Arrangement Diagram

Accessories



Padlocks not included with padlocking attachments. For operators with built-in padlock attachment, see **Page 47-120**.

Table 47-250. Accessories







	Description	Catalog Number	Price U.S. \$
Padlock Attachments			
	Padlocking Attachment for Flush Pushbutton Operators Permits locking NC contacts in open position with 1/4" padlock. Will not lock NO contact.	10250TA2	
	Padlocking Attachment for Use with Extended Pushbutton Permits locking NC contacts in open position with 1/4" padlock.	10250TA26	
	Padlocking Cover Guard Cover locked over flush button makes it unaccessible or on extended button locks NC contacts open. Takes 1/4" shank size padlock.	10250TA36	
	Padlock Hasp or Flip-Up Guard When used with a 1/4" padlock, makes flush and long button and knob selector switch unaccessible, but not locked down. Without the padlock, it is a flip-up guard. Padlock hasp can be removed before assembly.	10250TA38	
	Padlocking Attachment for Use with Flexible Weather Resistant Boot Used on long button operators. Stainless steel. Use only for locking NC contacts open.	10250TA63	
	Padlock Attachment For use with Illuminated Push-buttons and maintained Push-Pull operators having standard button or lens only. Use 1/4" padlock. Locks in down position only.	10250TA64	
	Padlocking Attachment for Non-illuminated Knob Selector Switches Provision for up to 5, 1/4" padlocks.	10250TA11	

Shrouds and Guards

	Shroud for Mushroom Head Operator Prevents accidental operation. (Not for push-pull operators.)	10250TA6	
	Extended Retaining Nut Replaces standard nut and provides guard for flush head push-button operators.	10250TA12	
	Guard for Illuminated Pushbutton	10250TA15	
	Shroud For jumbo mushroom head operator. Gray Yellow	10250TA56 10250TA56Y	
	Half Shroud - Yellow For jumbo mushroom head operator.	10250ED1241	
	Fingerproof Shroud — 10 per Package Fits new style contact blocks and light units.	10250TA101	

	Description	Catalog Number	Price U.S. \$
Boots			
	Flexible Weather Resistant Boot For use with button operators (extended buttons preferred). Temperature to -25°F (-32°C) Black Red Green (See Page 47-156 for 10250TA96 Tightening Tool.)	10250TA3 10250TA4 ① 10250TA10	
	Transparent Boot For regular illuminated pushbutton operators and PresTest — Temperature to -38°F (-39°C) ②	10250TA25	
	Boot for Flush Pushbutton Clear Black Red Green	10250TA46 10250TA47 10250TA48 10250TA49	

Hardware and Kits









	Thrust Washers — To meet Ford Motor Co. mounting specifications.	10250TK3	
	Contact Block Tape Seal — Seals plunger openings on last contact block. Order in multiples of 10 pieces.	10250TK5	
	Selector Switch Operator Gasket — Seals out dust from getting in-between the cam and contact block plungers. Supplied as standard with all selector switches.	56-9337	
	Special Retaining Nut — to accommodate thick panel: Indicating lights PresTest, pushbuttons and selector switches	10250TA30 10250TA31	
	Terminal Block — Two terminals, each will accommodate two wire terminations.	10250TA62	
	Spacer Ring — Used when legend plate is not required.	10250TA8	
	Stacking Screw — Replaces transformer mounting screws on indicating light so terminal block 10250TA62 can be mounted to light to support and connect a series resistor. This screw also fits all contact blocks. Order in multiples of 10.	10250TA79	

① Should not be used on flush button for STOP function.

② Not suitable for single contact block depth cast enclosure. Cover is too thick.

10250T Series, Accessories

Table 47-250. Accessories (Continued)

Description	Catalog Number	Price U.S. \$
Hardware and Kits (Continued)		
 Base Mounting Spacers ① — Equivalent to contact block in depth — Complete with screws, washers, etc.	1 Block Deep 2 Block Deep	10250TA22 10250TA23
 Grounding Kits — Kits consist of a ring connector and a #6 screw for mounting connector to rear of contact block mounting screw.		10250TKG1
All components except Standard Indicating Lights and PresTest Indicating Lights		10250TKG2 ② 10250TKG3 ②
 Contact Block Terminal Jumpers — Available in multiples of 100 only. Term. to Term. — within Block (short) 100 per pkg. 1000 per pkg. Term. to Term. — Block to Block (long) 100 per pkg. 1000 per pkg.		10250TA70 10250TA70-2 10250TA71 10250TA71-2
Special Operators and Attachments		
 Wobble Stick Complete with retaining nut — fits standard button.		10250TA5
 Lever Operator For use with two vertically mounted flush pushbuttons.		10250TA14
 Maintained Contact Attachment Release Button Assembly ② Mechanically interlocks with another pushbutton and contact block (not included). Provides mode indication. Minimum hole centers 1.62 inch (41.1 mm), maximum 2.313 inch (58.8 mm). Black Red Green Yellow Same with Long Button — Black		10250TA17 10250TA18 10250TA19 10250TA20 10250TA39
 Maintained Contact Attachment ② Mechanically interlocks two buttons and provides position indication for one. Use with two pushbutton operators and one or more contact blocks.		10250TA1
 Roto-Push Lever Operator — Used to provide lever operation for Roto-Push operators.		10250TA13

47

Description	Catalog Number	Price U.S. \$
Special Light Modules		
 Master Test (Dual Input) Module — Internal Form C relay suitable for either AC or DC applications. Total electrical isolation between monitored and test circuit. Fits all illuminated 10250T, E22, E30 and E34 devices. 48V DC		10250TMT8
 Flasher Module — Changes any AC illuminated device to a controlled flashing light. Fits 10250T, E30 and E34 devices. 24V 120V		10250TFL2 10250TFL1
 Flashing Incandescent Lamp — For use with 120V transformer type or 6V full voltage type Indicating Lights including PresTest and most E29 devices.		10250ED986-4
Hole Plugs		
 Plug — For unused holes — Steel, painted gray (Stainless steel, use E30KT5, see Page 47-112)		10250TA7
Tools		
 Octagonal 10250T (notched to fit over selector switch lever), E29 and E30		10250TA95
 E22, E30, E34 and Octagonal 10250T (will not fit over selector switch levers)		E22CW
 Tool for Tightening Boots — Used to install boot Catalog Numbers, 10250TA3, A4, A10 and A25.		10250TA96
 10250T, E34 Allen Wrench — Used for removal of jumbo mushroom head.		10250TA102
 Lamp Removal Tools — For transformer type illuminated pushbuttons, push-pull and selector switches. Fits #12 lamp.		10250TA74
 For full voltage and resistor type illuminated pushbuttons, push-pull and selector switches and E30.		E30KV1
 Standard indicating lights. Fits #44, #755, #6S6 and #10S6.		E29KLT

- ① Component only. Not to be used for custom built (factory assembled) stations.
- ② Not suitable for single contact block depth cast enclosure. Cover is too thick.

Dimensions **Pages 47-160 – 47-162**
 Discount Symbol **1CD1C**

Renewal Parts

Table 47-251. Replacement Lamps — For 10250T Illuminated Operators

Mfg. Lamp Type	Voltage	Base Style	Application	Part Number	Price U.S. \$
120MB	120V	T 3-1/4 Bayonet	10250T Resistor Indicating Light	28-3044	
#267	6.3V	T 3-1/4 Bayonet	10250T Flasher	10250ED986-4	
#755	6.3V	T 3-1/4 Bayonet	10250T Transformer, PresTest and Full Voltage		
#756	12V	T 3-1/4 Bayonet	10250T Full Voltage		
#757	24V	T 3-1/4 Bayonet	10250T Full Voltage		
#1828	32V	T 3-1/4 Bayonet	10250T Full Voltage	28-5186	
#1835	55V	T 3-1/4 Bayonet	10250T Resistor	28-5187	
NE48	120V	T 4-1/2 Bayonet	10250T Neon	28-494	
NE51H-R22	120V	T 3-1/4 Bayonet	10250T Neon	28-3754	
NE51H-R68	240V	T 3-1/4 Bayonet	10250T Neon	28-3755	

Table 47-252. Replacement LED Lamps — For 10250T, E34 and E22 Units

	Voltage	Color	Continuous		Flashing		
			AC/DC	Price U.S. \$	AC	DC	Price U.S. \$
			Catalog Number		Catalog Number	Catalog Number	
 <p>Standard LED Lamp</p>	6V – 12V	Red Orange Yellow Green Blue White	E22LED612RN E22LED612ON E22LED612YN E22LED612GN E22LED612BN E22LED612WN		E22LED006RAF E22LED006OAF E22LED006YAF E22LED006GAF E22LED006BAF E22LED006WAF	E22LED006RDF E22LED006ODF E22LED006YDF E22LED006GDF E22LED006BDF E22LED006WDF	
	24V	Red Orange Yellow Green Blue White	E22LED024RN E22LED024ON E22LED024YN E22LED024GN E22LED024BN E22LED024WN		E22LED024RAF E22LED024OAF E22LED024YAF E22LED024GAF E22LED024BAF E22LED024WAF	E22LED024RDF E22LED024ODF E22LED024YDF E22LED024GDF E22LED024BDF E22LED024WDF	
	48V	Red Orange Yellow Green Blue White	E22LED048RN E22LED048ON E22LED048YN E22LED048GN E22LED048BN E22LED048WN		E22LED048RAF E22LED048OAF E22LED048YAF E22LED048GAF E22LED048BAF E22LED048WAF	E22LED048RDF E22LED048ODF E22LED048YDF E22LED048GDF E22LED048BDF E22LED048WDF	
	60V	Red Orange Yellow Green Blue White	E22LED060RN E22LED060ON E22LED060YN E22LED060GN E22LED060BN E22LED060WN		E22LED060RAF E22LED060OAF E22LED060YAF E22LED060GAF E22LED060BAF E22LED060WAF	E22LED060RDF E22LED060ODF E22LED060YDF E22LED060GDF E22LED060BDF E22LED060WDF	
	120V	Red Orange Yellow Green Blue White	E22LED120RN E22LED120ON E22LED120YN E22LED120GN E22LED120BN E22LED120WN		E22LED120RAF E22LED120OAF E22LED120YAF E22LED120GAF E22LED120BAF E22LED120WAF	E22LED120RDF E22LED120ODF E22LED120YDF E22LED120GDF E22LED120BDF E22LED120WDF	

10250T Series, Renewal Parts

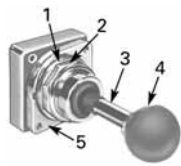

2-Position Joystick Operator



Flush Head Pushbutton Operator

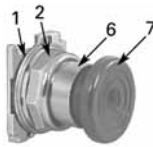

Mushroom Head Pushbutton Operator



Mushroom Head Operator with Padlock Attachment

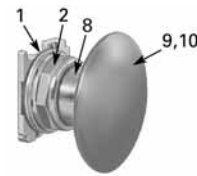

Jumbo Mushroom Head Operator

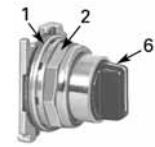

Knob-Operated Selector Switch Operator

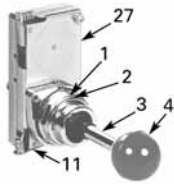

4-Position Joystick Operator (w/o Latch)



Illuminated Pushbutton Operator

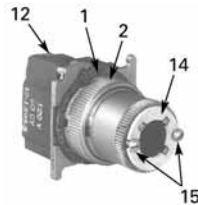

Full Voltage, Resistor and Transformer Type Illuminated Selector Switch



Transformer Type Indicating Light

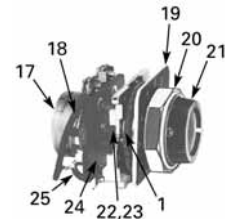

Potentiometers

Table 47-253. 10250T Style Operator Renewal Parts

Item No.	Description	No. Req.	Part Number	Price U.S. \$
1	Gasket	1	16-1548	
2	Mounting Nut	1	15-1530	
3	Handle	1	24-5045	
4	Knob Knob (Not Shown) for Joystick Operator with Latch	1 1	53-3157 53-3159	
5	Common Gate (Supplied with Operator)	2	16-3400	
6	Set Screw (#6-32 x 0.250" Long Hollow Hex)	2	11-2014	
7	Mushroom Head Button (Includes (2) Item 6) Black Red Yellow Green Blue	1 — — — —	As Req. Below 53-1317 53-1317-2 53-1317-3 53-1317-4 53-1317-22	
8	Set Screw (#10-32 x 0.250" Long Hollow Hex)	2	11-544	
9	Jumbo Mushroom Head Button (Aluminum — Includes (2) Item 8) Red Black Yellow Green	1 — — — —	As Req. Below 53-1317-9 53-1317-10 53-1317-11 53-1317-12	
10	Jumbo Mushroom Head Button (Aluminum — Red EMERG. STOP) Does Not Include Item (8)	1	53-1349-18	
11	Position Gate: 2 Position 3 Position 4 Position 8 Position	1 1 1 1	54-7278 54-7173 54-12278 54-12279	
12	Mounting Screw (#6-32 x 0.710" Long) Washer	2 2	10250TA79 16-2038	
13	Terminal Screw and Lug (Captive)	Req.	80-5502	
14	Gasket (Supplied with Basic Unit)	1	32-803	

Item No.	Description	No. Req.	Part Number	Price U.S. \$
15	Round Head Screw (#4-40 x 0.344" Long) (Supplied with Basic Unit)	2	11-4553	
16	Mounting Screw	2	11-1632	
17	Simple Potentiometer (Does Not Include Items 18, 28 or 29) 1,000 Ohms 2,500 Ohms 5,000 Ohms 10,000 Ohms 25,000 Ohms 50,000 Ohms	1 — — — — —	As Req. Below 41-782-2 41-782-3 41-782-10 41-782-4 41-782-5 41-782-6	
18	Connector (Includes Screw and Lug)	2	25-1851	
19	Indicating Plate Standard Size (Without Legend) Large Size (Specify Legend)	1 — —	As Req. Above 30-4460 10250TR30	
20	Retaining Nut	1	15-1547	
21	Knob Socket Set Screw (#6-32 x 0.250" Long)	1 1	53-1314 11-2014	
22	Coupling	1	29-3749-2	
23	Set Screw (#6-32 x 0.188" Long)	1	11-1199	
24	Spacer	2	56-1066-18	
25	Connector (Includes Screw and Lug)	1	25-1851-2	
26	Mounting Nut	1	15-1938	
27	4-Position Joystick Operating Mechanism (Complete)	1	24-6565	
28	(Not Shown) 4-Position Joystick Operating Mechanism (With Latch) Complete	1	24-6565-2	
29	Spring Loaded Latch	1	52-1214-2	
30	Hand Operated Latch	1	52-913-3	

Mounting

Panel Thickness

- Minimum: 0.06 inch (1.6 mm)
- Maximum: 0.25 inch (8 mm) including legend plate
- Maximum can be increased to 0.375 inch (15.9 mm) using optional retaining nut
 - Indicating light: 10250TA30
 - Pushbutton/selector switch: 10250TA31

Table 47-254. Mounting Matrix

Legend Plate	Dimensions in Inches (mm)			
	A	B	C	D
Small	1.63 (41.3)	2.25 (57.2)	2.25 (57.2)	1.63 (41.3)
Medium	1.75 (44.5)	2.25 (57.2)	2.25 (57.2)	1.75 (44.5)
Large	2.25 (57.2)	2.25 (57.2)	2.25 (57.2)	2.25 (57.2)

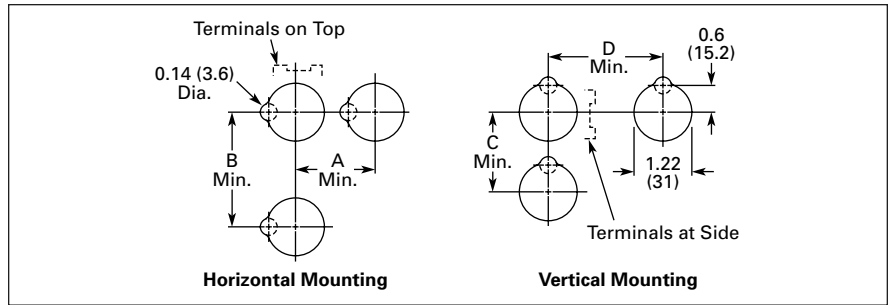

Figure 47-117. Mounting Options in Inches (mm)

Horizontal mounting means terminals are located top and bottom of contact block. Vertical mounting means terminals are left and right of contact block. This allows close spacing of adjacent operators with easy access to terminals.

Note: Locating nib hole or notch is 0.14 inch (3.6 mm) #29 drill.

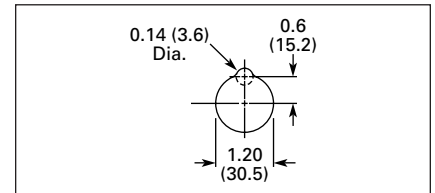
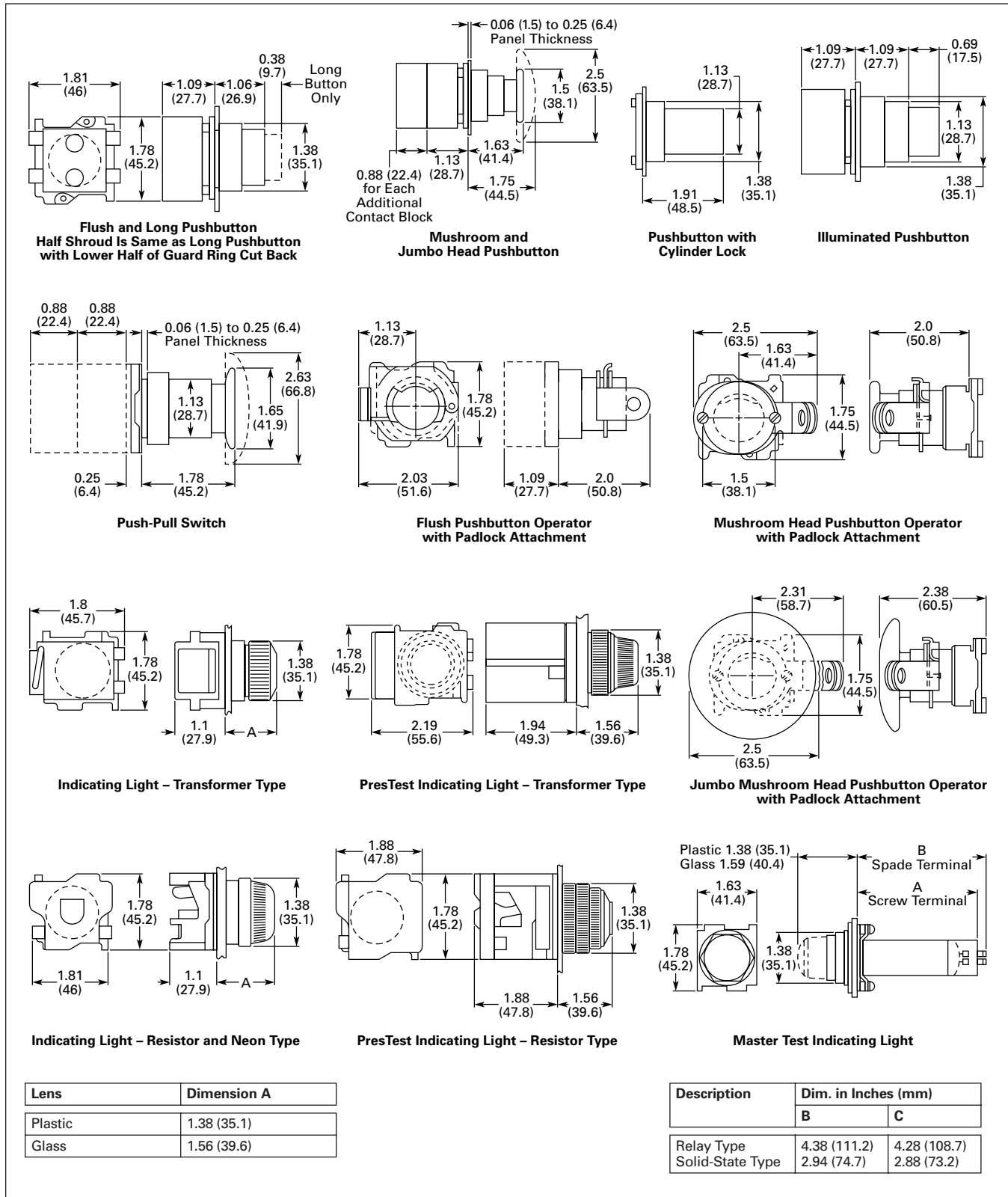

Figure 47-118. Drilling Dimensions in Inches (mm)

10250T Series, Dimensions

Dimensions



47

Lens	Dimension A
Plastic	1.38 (35.1)
Glass	1.56 (39.6)

Description	Dim. in Inches (mm)	
	B	C
Relay Type	4.38 (111.2)	4.28 (108.7)
Solid-State Type	2.94 (74.7)	2.88 (73.2)

Figure 47-119. Approximate Dimensions in Inches (mm)

10250T Series, Dimensions

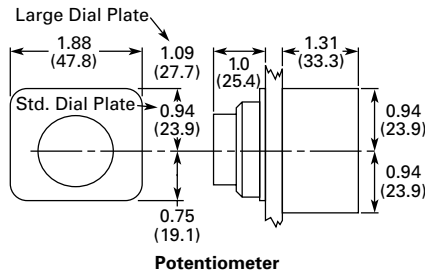

Potentiometer

Potentiometer	Dimensions in Inches (mm)		
	A	B	C
2 Watt Single	1.31 (33.3)	0.94 (23.9)	0.94 (23.9)
25 Watt — Up to 25M Ohms	2.38 (60.5)	1.19 (30.2)	0.81 (20.6)
50M Ohms	2.56 (65)	1.69 (42.9)	1.25 (31.8)

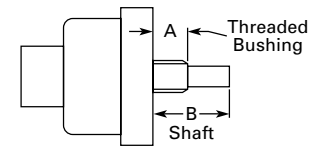

Shaft Dimensions of Potentiometer That C-H Operator Will Accept

Cat. No. Operator	Dimensions in Inches (mm)	
	A	B
10250T330	0.38 (9.7) Dia. x 0.38 (9.7) Long	0.25 (6.4) Dia. x 0.63 (16) Long
10250TH3872	0.38 (9.7) Dia. x 0.38 (9.7) Long	0.25 (6.4) Dia. x 0.88 (22.4) Long

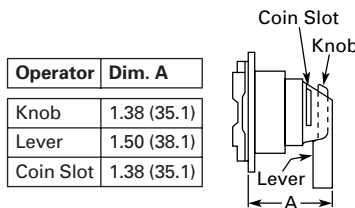

Operator	Dim. A
Knob	1.38 (35.1)
Lever	1.50 (38.1)
Coin Slot	1.38 (35.1)

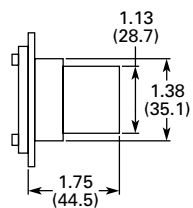

Key Operated Selector Switch

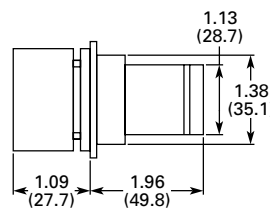

Illuminated Selector Switch

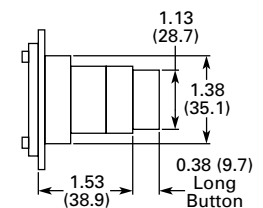

Roto-Push

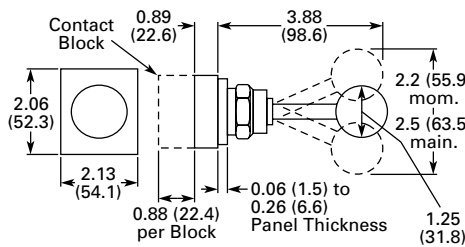

2-Position Joystick Operator

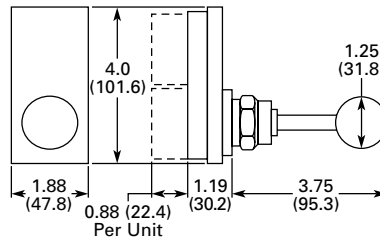

4-Position Joystick Operator

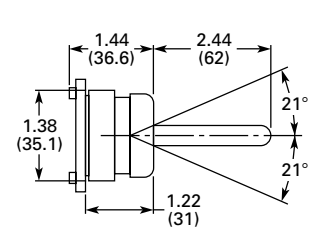

**Wobble Stick
Catalog No. 10250TA5**

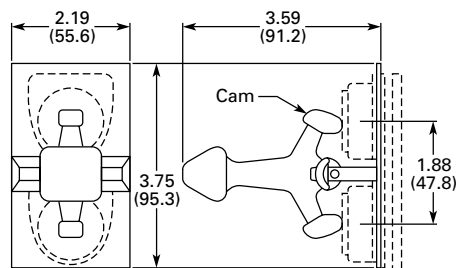

**Lever Operator
(For Use with Two Vertically Mounted Flush Pushbuttons)
Catalog No. 10250TA14**

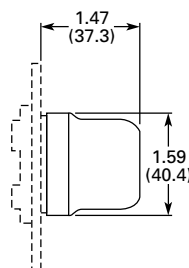

**Flexible Boot for Protecting Flush or Long Pushbutton
Catalog No. 10250TA3
Typical**

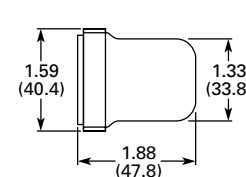

**Transparent Flexible Boot for Illuminated Pushbutton
Catalog No. 10250TA25**

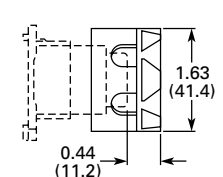

**Padlock Attachment for Knob Selector Switch
Catalog No. 10250TA11**

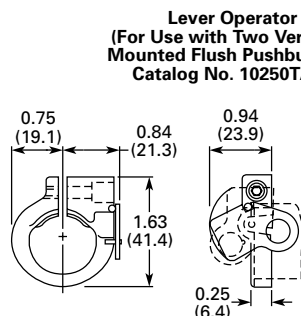

**Padlock Attachment for Flush Pushbutton
Catalog No. 10250TA2**

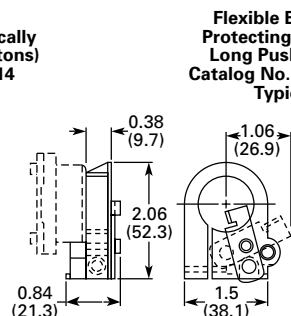

**Padlock Attachment for Extended Pushbutton
Catalog No. 10250TA26**

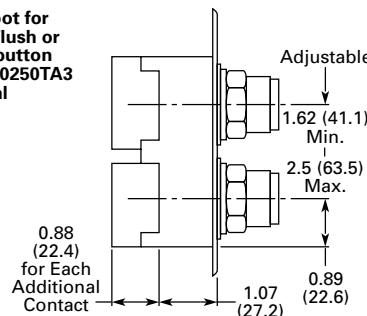

**Maintained Pushbutton
Catalog No. 10250TA66 Typical**

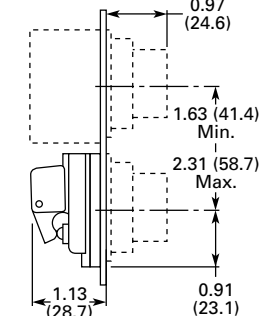

**Maintained Contact Attachment
Catalog No. 10250TA17 Typical**

Figure 47-120. Approximate Dimensions in Inches (mm)

10250T Series, Dimensions

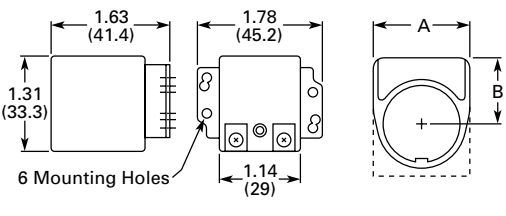
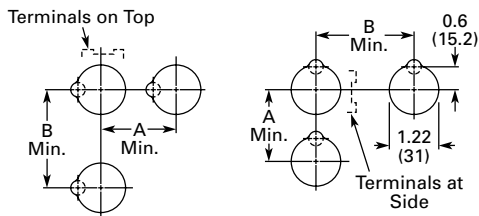
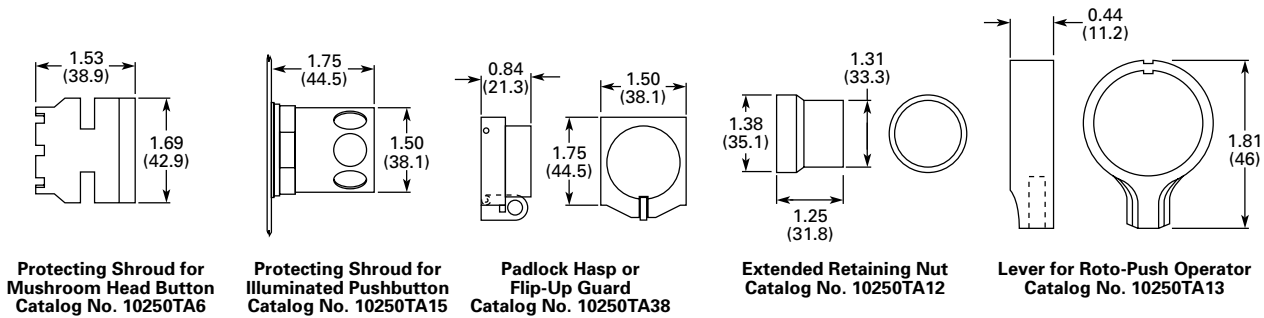
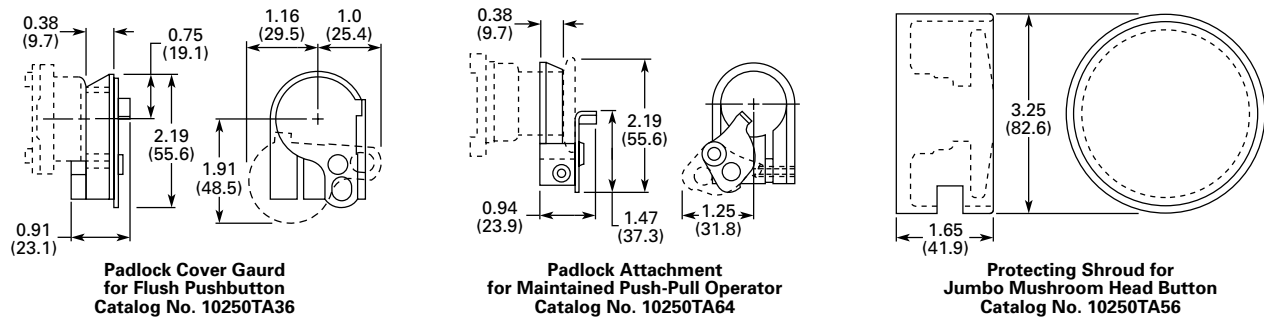

Panel Drilling and Minimum Spacing

Legend Plate	Dim. in Inches (mm)	
	A Min.	B Min.

1 or 2 Circuit Contact Blocks

Small or None	1.63 (41.4)	2.25 (57.2)
Standard	1.75 (44.5)	2.25 (57.2)
Jumbo ①	2.25 (57.2)	2.25 (57.2)
Extra Large	2.50 (63.5)	2.60 (66)

4 Circuit Contact Block 10250T44

Small or None	1.88 (47.8)	2.25 (57.2)
Standard	1.88 (47.8)	2.25 (57.2)
Jumbo ①	2.25 (57.2)	2.25 (57.2)
Extra Large	2.50 (63.5)	2.60 (66)

① If Jumbo plates are to be placed one above the other vertically, add 0.13 (3.3) to minimum dimensions listed.

Note: Locating nib hole or notch is 1.36" - 1.4" (34.5 - 35.6 mm) #29 drill.

Enclosure Size (No. of Elements)	Dimensions in Inches (mm)				
	Wide A	High B	Deep C	Mounting	
				D	E
2, 3, & 4	3.75 (95.3)	1.94 (49.3)	0.13 (3.3)	2.69 (68.3)	1.38 (35.1)
6 & 7	4.0 (101.6)	2.19 (55.6)	0.13 (3.3)	2.88 (73.2)	1.63 (41.4)

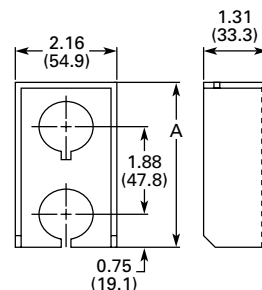

Number of Elements	Dimension A
2	4.0 (101.6)
3	5.88 (149.4)
4	7.88 (200.2)
7	13.38 (339.9)

Legend Plate	Dim. in Inches (mm)	
	A	B

1/2 Round Legend Plates

Small	1.56 (39.6)	0.91 (23.1)
Standard	1.59 (40.4)	1.07 (27.2)
Jumbo	2.06 (52.3)	1.53 (38.9)

Square Legend Plates

Small	1.59 (40.4) Sq.	0.90 (22.9)
Standard	1.75 (44.5) Sq.	1.06 (26.9) ②
Jumbo	2.19 (55.6) Sq.	1.50 (38.1)
Extra Large	2.44 (62.0) Sq.	1.63 (41.4)

② For plastic legend plate, Dimension B is 1.12 (28.4).

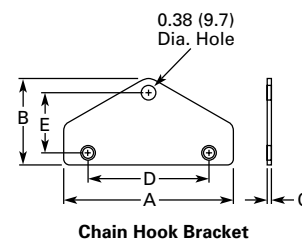

Figure 47-121. Approximate Dimensions in Inches (mm)

Ordering Complete Devices

Complete 10250T Pushbuttons, Indicating Lights and/or Selector Switch operators including contact block(s) and legend plate can be ordered using a single composite catalog number. The individually packaged components will be shipped unassembled in a single overpack carton marked with the composite Catalog Number. Construct Catalog Number as follows.

Ordering Example

Example: Illuminated Pushbutton Device — Catalog Number 10250T411C21-153S33

Table 47-255. Catalog Numbering System

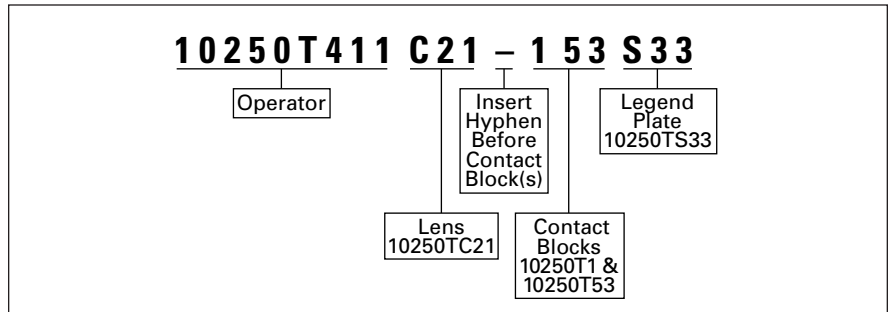

For a complete Catalog Number breakdown, see **Pages 47-164 – 47-165**.

Catalog Number Structure

Table 47-256. Non-illuminated Pushbuttons Catalog Numbering System

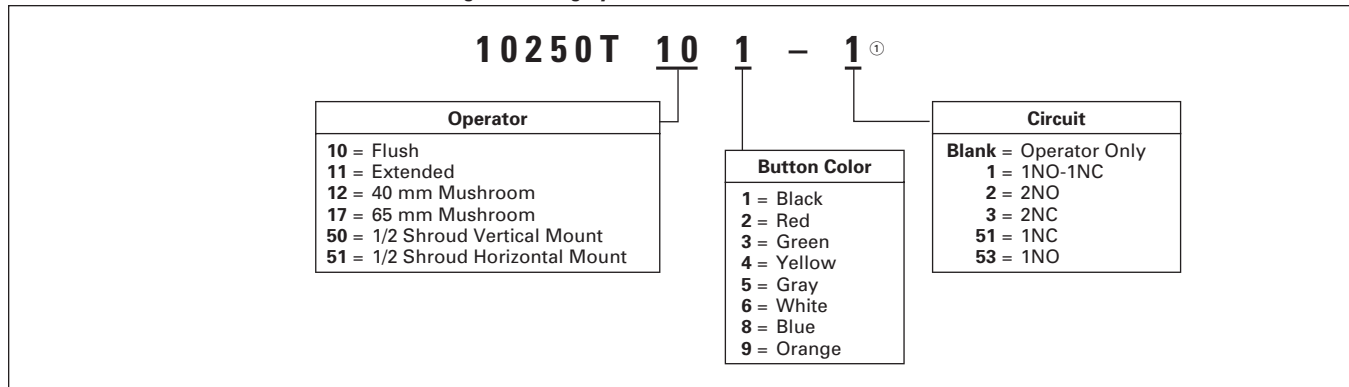

① Add X at end of Catalog Number to receive parts assembled from factory.

Table 47-257. Illuminated and Non-illuminated Push-Pulls Catalog Numbering System

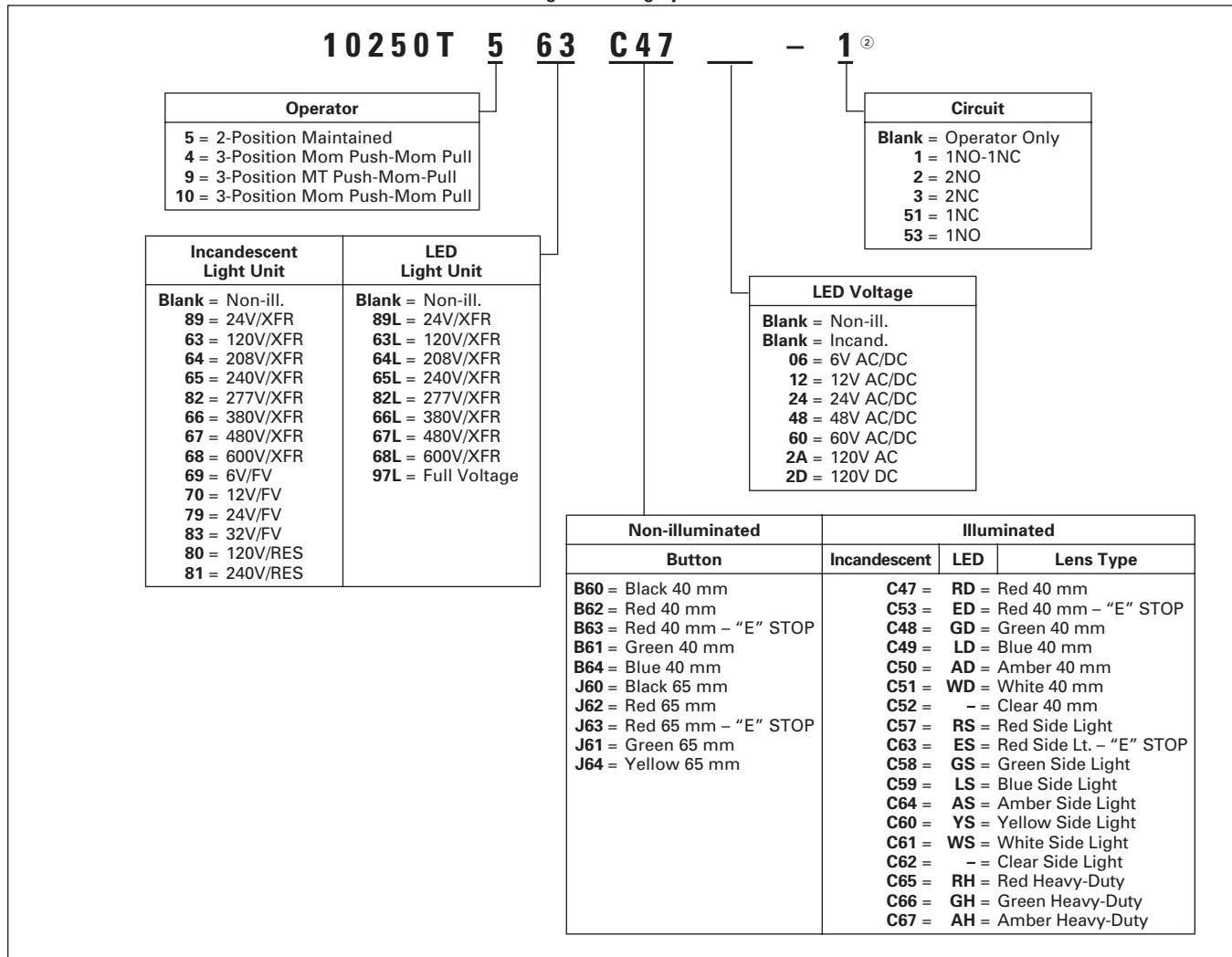

② Add X at end of Catalog Number to receive parts assembled from factory.

Table 47-258. Illuminated Pushbuttons Catalog Numbering System

1 0 2 5 0 T 4 1 6 C 2 1 - 1 ^①

<table border="1" style="width: 100%; border-collapse: collapse;"> <tr> <th style="text-align: left;">Incandescent Light Unit</th> <th style="text-align: left;">LED Light Unit</th> </tr> <tr> <td>416 = 24V/XFR</td> <td>416L = 24V/XFR</td> </tr> <tr> <td>412 = 120V/XFR</td> <td>411L = 120V/XFR</td> </tr> <tr> <td>412 = 240V/XFR</td> <td>412L = 240V/XFR</td> </tr> <tr> <td>419 = 277V/XFR</td> <td>419L = 277V/XFR</td> </tr> <tr> <td>413 = 380V/XFR</td> <td>413L = 380V/XFR</td> </tr> <tr> <td>414 = 480V/XFR</td> <td>414L = 480V/XFR</td> </tr> <tr> <td>415 = 600V/XFR</td> <td>415L = 600V/XFR</td> </tr> <tr> <td>473 = 6V/FV</td> <td>497L = Full Voltage</td> </tr> <tr> <td>474 = 12V/FV</td> <td></td> </tr> <tr> <td>476 = 24V/FV</td> <td></td> </tr> <tr> <td>477 = 32V/FV</td> <td></td> </tr> <tr> <td>478 = 48V/FV</td> <td></td> </tr> <tr> <td>471 = 120V/RES</td> <td></td> </tr> <tr> <td>472 = 240V/RES</td> <td></td> </tr> </table>	Incandescent Light Unit	LED Light Unit	416 = 24V/XFR	416L = 24V/XFR	412 = 120V/XFR	411L = 120V/XFR	412 = 240V/XFR	412L = 240V/XFR	419 = 277V/XFR	419L = 277V/XFR	413 = 380V/XFR	413L = 380V/XFR	414 = 480V/XFR	414L = 480V/XFR	415 = 600V/XFR	415L = 600V/XFR	473 = 6V/FV	497L = Full Voltage	474 = 12V/FV		476 = 24V/FV		477 = 32V/FV		478 = 48V/FV		471 = 120V/RES		472 = 240V/RES		<table border="1" style="width: 100%; border-collapse: collapse;"> <tr> <th style="text-align: left;">Incandescent Lens Color</th> <th style="text-align: left;">LED Lens Color</th> </tr> <tr> <td>C21 = Red</td> <td>RD = Red</td> </tr> <tr> <td>C22 = Green</td> <td>GD = Green</td> </tr> <tr> <td>C23 = Yellow</td> <td>YD = Yellow</td> </tr> <tr> <td>C26 = White</td> <td>WD = White</td> </tr> <tr> <td>C24 = Blue</td> <td>LD = Blue</td> </tr> <tr> <td>C43 = Amber</td> <td>AD = Amber</td> </tr> <tr> <td>C25 = Clear</td> <td></td> </tr> </table>	Incandescent Lens Color	LED Lens Color	C21 = Red	RD = Red	C22 = Green	GD = Green	C23 = Yellow	YD = Yellow	C26 = White	WD = White	C24 = Blue	LD = Blue	C43 = Amber	AD = Amber	C25 = Clear		<table border="1" style="width: 100%; border-collapse: collapse;"> <tr> <th style="text-align: left;">Circuit</th> </tr> <tr> <td>Blank = Operator Only</td> </tr> <tr> <td>1 = 1NO-1NC</td> </tr> <tr> <td>2 = 2NO</td> </tr> <tr> <td>3 = 2NC</td> </tr> <tr> <td>51 = 1NC</td> </tr> <tr> <td>53 = 1NO</td> </tr> </table> <table border="1" style="width: 100%; border-collapse: collapse;"> <tr> <th style="text-align: left;">LED Voltage</th> </tr> <tr> <td>Blank = Incand.</td> </tr> <tr> <td>06 = 6V AC/DC</td> </tr> <tr> <td>12 = 12V AC/DC</td> </tr> <tr> <td>24 = 24V AC/DC</td> </tr> <tr> <td>48 = 48V AC/DC</td> </tr> <tr> <td>60 = 60V AC/DC</td> </tr> <tr> <td>2A = 120V AC</td> </tr> <tr> <td>2D = 120V DC</td> </tr> </table>	Circuit	Blank = Operator Only	1 = 1NO-1NC	2 = 2NO	3 = 2NC	51 = 1NC	53 = 1NO	LED Voltage	Blank = Incand.	06 = 6V AC/DC	12 = 12V AC/DC	24 = 24V AC/DC	48 = 48V AC/DC	60 = 60V AC/DC	2A = 120V AC	2D = 120V DC
Incandescent Light Unit	LED Light Unit																																																															
416 = 24V/XFR	416L = 24V/XFR																																																															
412 = 120V/XFR	411L = 120V/XFR																																																															
412 = 240V/XFR	412L = 240V/XFR																																																															
419 = 277V/XFR	419L = 277V/XFR																																																															
413 = 380V/XFR	413L = 380V/XFR																																																															
414 = 480V/XFR	414L = 480V/XFR																																																															
415 = 600V/XFR	415L = 600V/XFR																																																															
473 = 6V/FV	497L = Full Voltage																																																															
474 = 12V/FV																																																																
476 = 24V/FV																																																																
477 = 32V/FV																																																																
478 = 48V/FV																																																																
471 = 120V/RES																																																																
472 = 240V/RES																																																																
Incandescent Lens Color	LED Lens Color																																																															
C21 = Red	RD = Red																																																															
C22 = Green	GD = Green																																																															
C23 = Yellow	YD = Yellow																																																															
C26 = White	WD = White																																																															
C24 = Blue	LD = Blue																																																															
C43 = Amber	AD = Amber																																																															
C25 = Clear																																																																
Circuit																																																																
Blank = Operator Only																																																																
1 = 1NO-1NC																																																																
2 = 2NO																																																																
3 = 2NC																																																																
51 = 1NC																																																																
53 = 1NO																																																																
LED Voltage																																																																
Blank = Incand.																																																																
06 = 6V AC/DC																																																																
12 = 12V AC/DC																																																																
24 = 24V AC/DC																																																																
48 = 48V AC/DC																																																																
60 = 60V AC/DC																																																																
2A = 120V AC																																																																
2D = 120V DC																																																																

① Add X at end of Catalog Number to receive parts assembled from factory.

Table 47-259. Standard Indicating Lights, PresTest and Master Test Catalog Numbering System

1 0 2 5 0 T 2 0 3 N C 1 N ^②

<table border="1" style="width: 100%; border-collapse: collapse;"> <tr> <th colspan="2" style="text-align: center;">Light Unit Type</th> </tr> <tr> <th style="text-align: left;">Standard – Incandescent</th> <th style="text-align: left;">Standard – LED</th> </tr> <tr> <td>181N = 120V/XFR</td> <td>181L = 120V/XFR</td> </tr> <tr> <td>182N = 240V/XFR</td> <td>182L = 240V/XFR</td> </tr> <tr> <td>198N = 277V/XFR</td> <td>198L = 277V/XFR</td> </tr> <tr> <td>183N = 380V/XFR</td> <td>183L = 380V/XFR</td> </tr> <tr> <td>184N = 480V/XFR</td> <td>184L = 480V/XFR</td> </tr> <tr> <td>185N = 600V/XFR</td> <td>185L = 600V/XFR</td> </tr> <tr> <td>203N = 6V/FV</td> <td>197L = Full Voltage</td> </tr> <tr> <td>204N = 12V/FV</td> <td></td> </tr> <tr> <td>206N = 24V/FV</td> <td></td> </tr> <tr> <td>207N = 32V/FV</td> <td></td> </tr> <tr> <td>208N = 48V/FV</td> <td></td> </tr> <tr> <td>201N = 120V/RES</td> <td></td> </tr> <tr> <td>202N = 240V/RES</td> <td></td> </tr> <tr> <td>226N = 120V/Neon</td> <td></td> </tr> <tr> <td>227N = 240V/Neon</td> <td></td> </tr> <tr> <th colspan="2" style="text-align: left;">PresTest – LED</th> </tr> <tr> <td>221L = 120V/XFR</td> <td>221L = 120V/XFR</td> </tr> <tr> <td>222L = 240V/XFR</td> <td>222L = 240V/XFR</td> </tr> <tr> <td>223L = 380V/XFR</td> <td>223L = 380V/XFR</td> </tr> <tr> <td>224L = 480V/XFR</td> <td>224L = 480V/XFR</td> </tr> <tr> <td>225L = 600V/XFR</td> <td>225L = 600V/XFR</td> </tr> <tr> <td>297L = Full Voltage</td> <td></td> </tr> <tr> <th colspan="2" style="text-align: left;">PresTest – Incandescent</th> </tr> <tr> <td>221N = 120V/XFR</td> <td></td> </tr> <tr> <td>222N = 240V/XFR</td> <td></td> </tr> <tr> <td>223N = 380V/XFR</td> <td></td> </tr> <tr> <td>224N = 480V/XFR</td> <td></td> </tr> <tr> <td>225N = 600V/XFR</td> <td></td> </tr> <tr> <td>232N = 6V/FV</td> <td></td> </tr> <tr> <td>233N = 12V/FV</td> <td></td> </tr> <tr> <td>235N = 24V/FV</td> <td></td> </tr> <tr> <td>238N = 32V/FV</td> <td></td> </tr> <tr> <td>239N = 48V/FV</td> <td></td> </tr> <tr> <td>231N = 120V/RES</td> <td></td> </tr> <tr> <td>240N = 240V/RES</td> <td></td> </tr> <tr> <th colspan="2" style="text-align: left;">Master Test – Incandescent</th> </tr> <tr> <td>187N = 120V/XFR</td> <td></td> </tr> <tr> <td>189N = 240V AC – SS</td> <td></td> </tr> </table>	Light Unit Type		Standard – Incandescent	Standard – LED	181N = 120V/XFR	181L = 120V/XFR	182N = 240V/XFR	182L = 240V/XFR	198N = 277V/XFR	198L = 277V/XFR	183N = 380V/XFR	183L = 380V/XFR	184N = 480V/XFR	184L = 480V/XFR	185N = 600V/XFR	185L = 600V/XFR	203N = 6V/FV	197L = Full Voltage	204N = 12V/FV		206N = 24V/FV		207N = 32V/FV		208N = 48V/FV		201N = 120V/RES		202N = 240V/RES		226N = 120V/Neon		227N = 240V/Neon		PresTest – LED		221L = 120V/XFR	221L = 120V/XFR	222L = 240V/XFR	222L = 240V/XFR	223L = 380V/XFR	223L = 380V/XFR	224L = 480V/XFR	224L = 480V/XFR	225L = 600V/XFR	225L = 600V/XFR	297L = Full Voltage		PresTest – Incandescent		221N = 120V/XFR		222N = 240V/XFR		223N = 380V/XFR		224N = 480V/XFR		225N = 600V/XFR		232N = 6V/FV		233N = 12V/FV		235N = 24V/FV		238N = 32V/FV		239N = 48V/FV		231N = 120V/RES		240N = 240V/RES		Master Test – Incandescent		187N = 120V/XFR		189N = 240V AC – SS		<table border="1" style="width: 100%; border-collapse: collapse;"> <tr> <th colspan="6" style="text-align: center;">LED Voltage</th> </tr> <tr> <td colspan="6">Blank = Incand.</td> </tr> <tr> <td colspan="6">06 = 6V AC/DC</td> </tr> <tr> <td colspan="6">12 = 12V AC/DC</td> </tr> <tr> <td colspan="6">24 = 24V AC/DC</td> </tr> <tr> <td colspan="6">48 = 48V AC/DC</td> </tr> <tr> <td colspan="6">60 = 60V AC/DC</td> </tr> <tr> <td colspan="6">2A = 120V AC</td> </tr> <tr> <td colspan="6">2D = 120V DC</td> </tr> </table> <table border="1" style="width: 100%; border-collapse: collapse;"> <tr> <th>Plastic</th> <th>Glass</th> <th>Lens Color</th> <th>Plastic</th> <th>Glass</th> <th>Lens Color</th> </tr> <tr> <th colspan="3">Standard/Master – Incandescent</th> <th colspan="3">Standard/Master/PresTest – LED</th> </tr> <tr> <td>C1N =</td> <td>C7N =</td> <td>Red</td> <td>RP =</td> <td>RG =</td> <td>Red</td> </tr> <tr> <td>C2N =</td> <td>C8N =</td> <td>Green</td> <td>GP =</td> <td>GG =</td> <td>Green</td> </tr> <tr> <td>C3N =</td> <td>- =</td> <td>Yellow</td> <td>YP =</td> <td>- =</td> <td>Yellow</td> </tr> <tr> <td>C6N =</td> <td>C12N =</td> <td>White</td> <td>WP =</td> <td>WG =</td> <td>White</td> </tr> <tr> <td>C4N =</td> <td>C10N =</td> <td>Blue</td> <td>LP =</td> <td>LG =</td> <td>Blue</td> </tr> <tr> <td>C19N =</td> <td>C9N =</td> <td>Amber</td> <td>AP =</td> <td>AG =</td> <td>Amber</td> </tr> <tr> <td>C5N =</td> <td>C11N =</td> <td>Clear</td> <td></td> <td></td> <td></td> </tr> <tr> <th colspan="6" style="text-align: left;">PresTest – Incandescent</th> </tr> <tr> <td>C21 =</td> <td>C13N =</td> <td>Red</td> <td></td> <td></td> <td></td> </tr> <tr> <td>C22 =</td> <td>C14N =</td> <td>Green</td> <td></td> <td></td> <td></td> </tr> <tr> <td>C23 =</td> <td>- =</td> <td>Yellow</td> <td></td> <td></td> <td></td> </tr> <tr> <td>C26 =</td> <td>C18N =</td> <td>White</td> <td></td> <td></td> <td></td> </tr> <tr> <td>C24 =</td> <td>C16N =</td> <td>Blue</td> <td></td> <td></td> <td></td> </tr> <tr> <td>C43 =</td> <td>C15N =</td> <td>Amber</td> <td></td> <td></td> <td></td> </tr> <tr> <td>C25 =</td> <td>C17N =</td> <td>Clear</td> <td></td> <td></td> <td></td> </tr> </table>	LED Voltage						Blank = Incand.						06 = 6V AC/DC						12 = 12V AC/DC						24 = 24V AC/DC						48 = 48V AC/DC						60 = 60V AC/DC						2A = 120V AC						2D = 120V DC						Plastic	Glass	Lens Color	Plastic	Glass	Lens Color	Standard/Master – Incandescent			Standard/Master/PresTest – LED			C1N =	C7N =	Red	RP =	RG =	Red	C2N =	C8N =	Green	GP =	GG =	Green	C3N =	- =	Yellow	YP =	- =	Yellow	C6N =	C12N =	White	WP =	WG =	White	C4N =	C10N =	Blue	LP =	LG =	Blue	C19N =	C9N =	Amber	AP =	AG =	Amber	C5N =	C11N =	Clear				PresTest – Incandescent						C21 =	C13N =	Red				C22 =	C14N =	Green				C23 =	- =	Yellow				C26 =	C18N =	White				C24 =	C16N =	Blue				C43 =	C15N =	Amber				C25 =	C17N =	Clear			
Light Unit Type																																																																																																																																																																																																																																													
Standard – Incandescent	Standard – LED																																																																																																																																																																																																																																												
181N = 120V/XFR	181L = 120V/XFR																																																																																																																																																																																																																																												
182N = 240V/XFR	182L = 240V/XFR																																																																																																																																																																																																																																												
198N = 277V/XFR	198L = 277V/XFR																																																																																																																																																																																																																																												
183N = 380V/XFR	183L = 380V/XFR																																																																																																																																																																																																																																												
184N = 480V/XFR	184L = 480V/XFR																																																																																																																																																																																																																																												
185N = 600V/XFR	185L = 600V/XFR																																																																																																																																																																																																																																												
203N = 6V/FV	197L = Full Voltage																																																																																																																																																																																																																																												
204N = 12V/FV																																																																																																																																																																																																																																													
206N = 24V/FV																																																																																																																																																																																																																																													
207N = 32V/FV																																																																																																																																																																																																																																													
208N = 48V/FV																																																																																																																																																																																																																																													
201N = 120V/RES																																																																																																																																																																																																																																													
202N = 240V/RES																																																																																																																																																																																																																																													
226N = 120V/Neon																																																																																																																																																																																																																																													
227N = 240V/Neon																																																																																																																																																																																																																																													
PresTest – LED																																																																																																																																																																																																																																													
221L = 120V/XFR	221L = 120V/XFR																																																																																																																																																																																																																																												
222L = 240V/XFR	222L = 240V/XFR																																																																																																																																																																																																																																												
223L = 380V/XFR	223L = 380V/XFR																																																																																																																																																																																																																																												
224L = 480V/XFR	224L = 480V/XFR																																																																																																																																																																																																																																												
225L = 600V/XFR	225L = 600V/XFR																																																																																																																																																																																																																																												
297L = Full Voltage																																																																																																																																																																																																																																													
PresTest – Incandescent																																																																																																																																																																																																																																													
221N = 120V/XFR																																																																																																																																																																																																																																													
222N = 240V/XFR																																																																																																																																																																																																																																													
223N = 380V/XFR																																																																																																																																																																																																																																													
224N = 480V/XFR																																																																																																																																																																																																																																													
225N = 600V/XFR																																																																																																																																																																																																																																													
232N = 6V/FV																																																																																																																																																																																																																																													
233N = 12V/FV																																																																																																																																																																																																																																													
235N = 24V/FV																																																																																																																																																																																																																																													
238N = 32V/FV																																																																																																																																																																																																																																													
239N = 48V/FV																																																																																																																																																																																																																																													
231N = 120V/RES																																																																																																																																																																																																																																													
240N = 240V/RES																																																																																																																																																																																																																																													
Master Test – Incandescent																																																																																																																																																																																																																																													
187N = 120V/XFR																																																																																																																																																																																																																																													
189N = 240V AC – SS																																																																																																																																																																																																																																													
LED Voltage																																																																																																																																																																																																																																													
Blank = Incand.																																																																																																																																																																																																																																													
06 = 6V AC/DC																																																																																																																																																																																																																																													
12 = 12V AC/DC																																																																																																																																																																																																																																													
24 = 24V AC/DC																																																																																																																																																																																																																																													
48 = 48V AC/DC																																																																																																																																																																																																																																													
60 = 60V AC/DC																																																																																																																																																																																																																																													
2A = 120V AC																																																																																																																																																																																																																																													
2D = 120V DC																																																																																																																																																																																																																																													
Plastic	Glass	Lens Color	Plastic	Glass	Lens Color																																																																																																																																																																																																																																								
Standard/Master – Incandescent			Standard/Master/PresTest – LED																																																																																																																																																																																																																																										
C1N =	C7N =	Red	RP =	RG =	Red																																																																																																																																																																																																																																								
C2N =	C8N =	Green	GP =	GG =	Green																																																																																																																																																																																																																																								
C3N =	- =	Yellow	YP =	- =	Yellow																																																																																																																																																																																																																																								
C6N =	C12N =	White	WP =	WG =	White																																																																																																																																																																																																																																								
C4N =	C10N =	Blue	LP =	LG =	Blue																																																																																																																																																																																																																																								
C19N =	C9N =	Amber	AP =	AG =	Amber																																																																																																																																																																																																																																								
C5N =	C11N =	Clear																																																																																																																																																																																																																																											
PresTest – Incandescent																																																																																																																																																																																																																																													
C21 =	C13N =	Red																																																																																																																																																																																																																																											
C22 =	C14N =	Green																																																																																																																																																																																																																																											
C23 =	- =	Yellow																																																																																																																																																																																																																																											
C26 =	C18N =	White																																																																																																																																																																																																																																											
C24 =	C16N =	Blue																																																																																																																																																																																																																																											
C43 =	C15N =	Amber																																																																																																																																																																																																																																											
C25 =	C17N =	Clear																																																																																																																																																																																																																																											

② Add X at end of Catalog Number to receive parts assembled from factory.

E34 Series

Contents

<i>Description</i>	<i>Page</i>
Product Description	47-166
Features	47-166
Standards and Certifications	47-167
Technical Data and Specifications	47-167
Product Selection	
Momentary Pushbutton Units	47-168
Indicating Light Units	47-168
Pushbuttons	47-169
Illuminated Pushbuttons and Indicating Lights	47-170
Push-Pull Units	47-171
Illuminated Push-Pull Units	47-172
Potentiometers	47-174
Push-Pulls	47-175
Selector Switch Units	47-177
Selector Switch Selection	47-178
Selector Switch Operators	47-180
Illuminated Selector Switch Operators	47-181
Contact Blocks	47-182
Options	
Legend Plates	47-184
Enclosures	47-185
Accessories	47-187
Renewal Parts	47-189
Mounting	47-190
Dimensions	47-191
Ordering Complete Devices	47-192
Catalog Number Structure	47-193

Product Description

Operator

Eaton's Cutler-Hammer® E34 Series 30.5 mm pushbutton line features the same rugged die cast construction of our 10250T line with an additional two-layer 100% solid thermosetting cathodic epoxy coating. This coating provides a flat black smooth, consistent, corrosion resistant surface that has passed a demanding 600 hour salt spray test. (The industry standard for this 4X test requires only 200 hours.)

Ultraviolet Light

E34 cathodic coating is not recommended for use in applications where exposure to ultraviolet light exists — use NEMA 4X 10250T operators.

Reliability Nibs

Eaton's Cutler-Hammer contact blocks feature enclosed silver contacts with pointed "reliability nibs" for reliable performance from logic level up to 600V. To ensure reliable switching, nibs bite through oxide which can form on silver contacts, eliminating the need for expensive logic level blocks for most applications.

Liquid Drainage

Eaton's Cutler-Hammer pushbutton operators offer front of panel drainage via holes in the operator bushing. Hidden from view by the mounting nut, these holes prevent buildup of liquid inside the operator, which can prevent operation in freezing environments. The holes also provide a route for escaping liquid in high pressure wash-downs, effectively relieving pressure from the internal diaphragm seal, ensuring reliable sealing in applications even beyond NEMA 4.

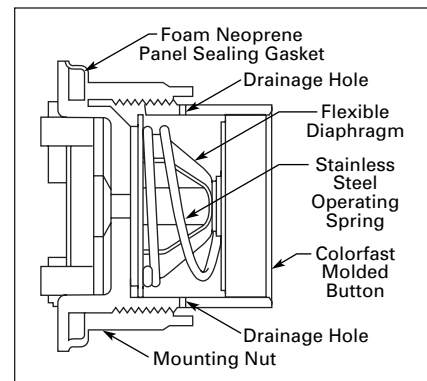

Figure 47-123. Diaphragm Seal

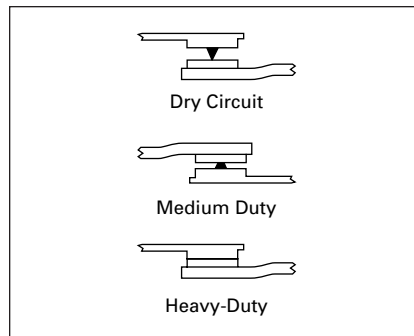

Figure 47-122. Reliability Nibs

Features

- Epoxy-coated metal operators
- Corrosion resistant
- Integral ground screw terminal on operators
- FDA approved for sanitary chemical resistance requirements

Octagonal Mounting Nut Self-Adjusts to Panel Thickness — Eliminates Spacer Washers and Set Screws



Die Cast Construction with Thick, Tough Corrosion Resistant Coating



3 Styles of Legend Plates in 4 Sizes

Internal Sealing Diaphragm for Excellent Sealing



Wide Variety of Operator Types and Colors

Terminal Clamps Shipped Open Ready to Wire

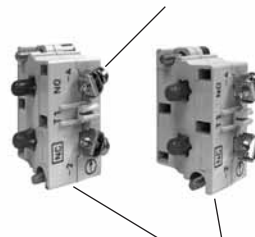

Stackable Contact Blocks up to 12 Circuits per Operator

E34 Series

Standards and Certifications

- CE EN60947-5-1
- UL 508 — File No. E131568
- CSA C22.2 No. 14 — File No. LR68551
- FDA 3-A Sanitary Standards

Ingress Protection

When mounted in similarly rated enclosure —

- Standard Indicating Lights
 - UL (NEMA) Type 1, 2, 3, 3R, 3S, 4, 4X, 12, 13
 - IEC IP65
- All Other Operators
 - UL (NEMA) Type 1, 2, 3, 3R, 4, 4X, 12, 13
 - IEC IP65

Technical Data and Specifications

Mechanical Ratings

- Frequency of operation
 - All pushbuttons: 6000 operations/hr.
 - Key and lever selector switches: 3000 operations/hr.
 - Auto-latch devices: 1200 operations/hr.
- Life
 - Pushbuttons: 10×10^6 operations
 - Contact blocks: 10×10^6 operations
 - PresTest units: 10×10^6 operations
 - Lever and key selector switches: 0.25×10^6 operations
 - Twist to release pushbuttons: 0.3×10^6 operations
- Shock resistance
 - Duration: 210 mS $\geq 5g$

Climate Conditions

- Operating Temperature: 1° to 150°F (-17° to 66°C)
- Storage Temperature: -40° to 176°F (-40° to 80°C)
- Altitude: 6,562 ft. (2,000m)
- Humidity: Max. 95% RH @ 60°C

Electrical Ratings

Table 47-260. Contact Block

Meet or Exceed NEMA Rating Designations A600, A300 and B300 for AC and P600 for DC							
Description	Volts AC 50 or 60 Hz				Volts DC		
	120	240	480	600	24/28	125	250
Make and Emergency Interrupting Capacity (Amp)	60	30	15	12	5.7	1.1	0.55
Normal Load Break (Amp)	6	3	1.5	1.2	5.7	1.1	0.55
Thermal Current (Amp)	10	10	10	10	5.0	5.0	5.0
Voltamperes:							
Make and Emergency Interrupting Capacity	7200	7200	7200	7200	138	138	138
Normal Load Break	720	720	720	720	138	138	138

- Insulation: $U_i = 660V$ AC or DC
- Thermal: $I_{th} = 10A$

Short Circuit Coordination to IEC/EN 60947-5-1

- Rated conditional short circuit current: 1 kA
- Fuse type: GE Power Controls TIA 10, Red Spot Type gG, 10A, 660V AC, 460V DC, BS88-2, IEC 60269-2-1



Fuse

- UL rating: A600, P600
 - AC load life duty cycle 1200 operations/hour
 - 10A: 110V pf 0.4 – 1×10^6 operations
 - 5A: 250V pf 0.4 – 1×10^6 operations
 - 2A: 660V pf 0.4 – 1×10^6 operations
- Switching capacity
 - AC15 rated make/break ($11 \times I_e$ at $1.1 \times U_e$)
 - 6A: 120V pf 0.3
 - 4A: 240V pf 0.3
 - 2A: 660V pf 0.3
 - DC13 rated make/break ($1.1 \times I_e$ at $1.1 \times U_e$)
 - 1.0A: 125V L/R ≥ 0.95 at 300 mS
 - 0.55A: 250V L/R ≥ 0.95 at 300 mS
 - 0.1A: 660V L/R ≥ 0.95 at 300 mS
 - 10A: 110V pure resistive
- Maximum ratings for logic level and hostile atmosphere application
 - Maximum amperes: 0.5A
 - Maximum volts: 120V AC/DC

- Low voltage switching: Conical shaped points or “reliability nibs” improve performance in dry circuit, corrosive, fine dust and other contaminated atmospheres. Under normal environmental conditions, the minimum operational voltage is 5V and the minimum operational current is 1 mA, AC/DC.
- Contact operation: Slow make and break. All normally closed contacts have positive opening operation, i.e., normally closed contacts are forced open in the event of contact weld or spring breakage.

Light Units

- Transformers: will withstand short circuit for 1 hour per IEC 60947-5-1
- Bulbs — average life:
 - Transformer type: 20,000 hrs.
 - Resistor/direct voltage type: 2500 hrs. minimum @ rated V
 - LED: 60,000 to 100,000 hrs.

Terminals

- Marking: NC-NO on the contact block to meet the NEMA requirements. Dual marking system 1 – 2 for normally closed, 3 – 4 for normally open to meet BS5472 (Cenelec EN50 005).
- Clamps: Terminals are saddle clamp type for 1 x 22 AWG (0.34 mm²) to 2 x 14 AWG (2.5 mm²) conductors.
- Torque = 7 lb-in (0.8 Nm)
- Degree of protection against direct electrical contact: IP2X with finger-proof shroud

Product Selection

Momentary Pushbutton Units

- Non-illuminated

Table 47-261. Pushbutton Units — UL (NEMA) Type 3, 3R, 4, 4X, 12, 13

Contact Type	Button Color	Flush Button		Extended Button		Mushroom Button		Jumbo Mushroom ①	
		Catalog Number	Price U.S. \$	Catalog Number	Price U.S. \$	Catalog Number	Price U.S. \$	Catalog Number	Price U.S. \$
1NO	Black Red Green Red — Engraved EMERG. STOP	E34PB1-53X E34PB2-53X E34PB3-53X —		E34EB1-53X E34EB2-53X E34EB3-53X —		E34LB1-53X E34LB2-53X E34LB3-53X —		E34JB1-53X E34JB2-53X E34JB3-53X E34JB2N8-53X	
1NC	Black Red Green Red — Engraved EMERG. STOP	E34PB1-51X E34PB2-51X E34PB3-51X —		E34EB1-51X E34EB2-51X E34EB3-51X —		E34LB1-51X E34LB2-51X E34LB3-51X —		E34JB1-51X E34JB2-51X E34JB3-51X E34JB2N8-51X	
1NO-1NC	Black Red Green Red — Engraved EMERG. STOP	E34PB1-1X E34PB2-1X E34PB3-1X —		E34EB1-1X E34EB2-1X E34EB3-1X —		E34LB1-1X E34LB2-1X E34LB3-1X —		E34JB1-1X E34JB2-1X E34JB3-1X E34JB2N8-1X	

① Anodized aluminum head — may not be suitable for some corrosive environments.

Indicating Light Units

- Plastic Lenses



*24V Full Voltage
 Indicating Light — Red
 Catalog Number
 E34FB24H2X*

Table 47-262. Indicating Light Units — UL (NEMA) Type 3, 3R, 3S, 4, 4X, 12, 13

Lamp	Type	Voltage	Color	Indicating Light ②		LED/Lamp Number
				Catalog Number	Price U.S. \$	
LED	Full Voltage	24V AC/DC	Red Green Amber	E34FB197LRP24 E34FB197LGP24 E34FB197LAP24		Bayonet Base
		120V AC	Red Green Amber	E34FB197LRP2A E34FB197LGP2A E34FB197LAP2A		
Incandescent	Full Voltage	24V AC/DC	Red Green Amber	E34FB24H2X E34FB24H3X E34FB24H9X		#757
	Resistor	120V AC/DC	Red Green Amber	E34RB120H2X E34RB120H3X E34RB120H9X		120MB
	Transformer	120V AC 50/60 Hz	Red Green Amber	E34TB120H2X E34TB120H3X E34TB120H9X		#755

② Anodized aluminum head — may not be suitable for some corrosive environments.

Note: Use NEMA 4X 10250T operators where exposed to ultraviolet light, see Pages 47-115 – 47-165.

Additional Light Units Page 47-170
 Dimensions Page 47-191
 Enclosures Pages 47-185 – 47-186
 Legend Plates Page 47-184
 Replacement
 Lamps/LEDs Page 47-157
 Discount Symbol 1CD1C

E34 Series, Momentary Pushbutton Components

Pushbuttons

Table 47-263. Momentary Pushbutton Operators, Non-illuminated — UL (NEMA) Type 3, 3R, 4, 4X, 12, 13

	Color	Catalog Number	Price U.S. \$
	Black	E34PB1	
	Red	E34PB2	
	Green	E34PB3	
	Yellow	E34PB4	
	White	E34PB5	
	Blue	E34PB6	
	Gray	E34PB7	
	Orange	E34PB8	

Extended Button

	Black	E34EB1	
	Red	E34EB2	
	Green	E34EB3	
	Yellow	E34EB4	
	White	E34EB5	
	Blue	E34EB6	
	Gray	E34EB7	
	Orange	E34EB8	

Half Shrouded Button

	Color	Vertical	Horizontal	Price U.S. \$
		Black	E34EVB1	
	Red	E34EVB2	E34EHB2	
	Green	E34EVB3	E34EHB3	
	Yellow	E34EVB4	E34EHB4	
	White	E34EVB5	E34EHB5	
	Blue	E34EVB6	E34EHB6	
	Gray	E34EVB7	E34EHB7	
	Orange	E34EVB8	E34EHB8	

Mushroom Button

	Black	E34LB1	
	Red	E34LB2	
	Green	E34LB3	
	Yellow	E34LB4	
	Blue	E34LB6	

Anodized Aluminum Jumbo Mushroom Button ①

	Black	E34JB1	
	Red	E34JB2	
	Red (Engraved EMER. STOP)	E34JB2N8	
	Green	E34JB3	
	Yellow	E34JB4	

① Anodized aluminum head — may not be suitable for some corrosive environments.

Note: Use NEMA 4X 10250T operators where exposed to ultraviolet light, see **Pages 47-115 – 47-165.**





Contact Blocks

See **Page 47-182** for additional contact blocks, fingerproof shrouds and Transparent Amber colored blocks.



Contact Block

Table 47-264. Contact Blocks







Symbol	Circuit	Catalog Number	Price U.S. \$
	NC	10250T51	
	NO	10250T53	
	NO-NC	10250T1	
	2NC	10250T3	
	2NO	10250T2	

Accessories	Pages 47-187 – 47-188
Dimensions	Page 47-191
Enclosures	Pages 47-185 – 47-186
Legend Plates	Page 47-184
Discount Symbol	1CD1C

E34 Series, Illuminated Components

Illuminated Pushbuttons and Indicating Lights

Table 47-265. Operators without Lens

Light Unit Type	Type	Voltage	Illuminated Pushbutton		Indicating Light		PresTest		Lamp Number
									
			Catalog Number	Price U.S. \$	Catalog Number	Price U.S. \$	Catalog Number	Price U.S. \$	
LED (LEDs not included) ①	Full Voltage	—	E34CB497L		E34FB197L		E34FPB297L		Bayonet Base
	Transformer AC Only	24	E34XB024L		—		—		
		120	E34XB120L		E34TB120L		E34TPB120L		
		240	E34XB240L		E34TB240L		E34TPB240L		
		277	E34XB277L		E34TB277L		—		
		380	E34XB380L		E34TB380L		E34TPB380L		
		480	E34XB480L		E34TB480L		E34TPB480L		
600	E34XB600L		E34TB600L		E34TPB600L				
Incandescent	Full Voltage AC/DC	6	E34CB06		E34FB06		E34FPB06		#755
		12	E34CB12		E34FB12		E34FPB12		#756
		24	E34CB24		E34FB24		E34FPB24		#757
		32	E34CB32		E34FB32		E34FPB32		#1828
		48	E34CB48		E34FB48		E34FPB48		#1835
	Resistor ② AC/DC	120	E34SB120		E34RB120		E34RPB120		120MB
		240	E34SB240		E34RB240		E34RPB240		120MB
	Transformer AC Only	24	E34XB024		—		—		#755
		120	E34XB120		E34TB120		E34TPB120		
		240	E34XB240		E34TB240		E34TPB240		
		277	E34XB277		E34TB277		—		
		380	E34XB380		E34TB380		E34TPB380		
		480	E34XB480		E34TB480		E34TPB480		
	600	E34XB600		E34TB600		E34TPB600			
	Neon AC/DC	120	—		E34NB120		—		NE51H-R-22
		240	—		E34NB240		—		NE51H-4-68

① These units do not include lamps. Order LED separately to match lens color, see Page 47-157 for LED Selection and Pages 47-193 – 47-194 for Catalog Numbering Structure.

② Resistor units are not available for use with LEDs, choose either transformer or full voltage LED style.

Note: Use NEMA 4X 10250T operators where exposed to ultraviolet light, see Pages 47-115 – 47-165.

Table 47-266. Indicating Light Lens

	Color	Plastic		Glass ③	
		Catalog Number	Price U.S. \$	Catalog Number	Price U.S. \$
 Plastic	Red	E34H2		E34G2	
	Green	E34H3		E34G3	
 Glass	Yellow	E34H4		E34G4	
	White	E34H5		E34G5	
	Blue	E34H6		E34G6	
	Amber	E34H9		E34G9	
	Clear	E34H0		E34G0	

③ Glass lens has black anodized aluminum bezel.

Table 47-268. PresTest Lens

	Color	Plastic		Glass ④	
		Catalog Number	Price U.S. \$	Catalog Number	Price U.S. \$
 Plastic	Red	E34V2		E34P2	
	Green	E34V3		E34P3	
 Glass	Yellow	E34V4		E34P4	
	White	E34V5		E34P5	
	Blue	E34V6		E34P6	
	Amber	E34V9		E34P9	
	Clear	E34V0		E34P0	

④ Glass lens has black anodized aluminum bezel.

Table 47-267. Illuminated Pushbutton Lens

	Color	Catalog Number	Price U.S. \$
	Red	E34V2	
	Green	E34V3	
	Yellow	E34V4	
	White	E34V5	
	Blue	E34V6	
	Amber	E34V9	
	Clear	E34V0	

Dimensions Page 47-191
 Enclosures Pages 47-185 – 47-186
 Legend Plates Page 47-184
 Replacement
 Lamps/LEDs Page 47-157
 Discount Symbol 1CD1C

Push-Pull Units

- Two- and Three-Position
- Non-illuminated

Table 47-269. 2-Position Push-Pull Units Non-illuminated — UL (NEMA) Type 3, 3R, 4, 4X, 12, 13

	Operator Position ①		Button Type/Color ②	Push-Pull		Contact Type	Mounting Location	
	Pull	Push		Catalog Number	Price U.S. \$		A	B
Maintained Push, Maintained Pull								
	O	X	40 mm/Red	<u>E34GDBC2</u> -1X				
	X	O	40 mm Engraved EMERGENCY STOP/Red	<u>E34GDBC2N8</u> -1X		1NO		
			65 mm Alum. Engraved EMERGENCY STOP/Red	<u>E34GDBJ2N8</u> -1X		1NC		

① X = closed circuit, O = open circuit.

② To order different type or color buttons, substitute the underlined characters with appropriate Suffix Code from the table below. Example: E34GDBCC6-1X.

Table 47-270. 3-Position Push-Pull Units Non-illuminated — UL (NEMA) Type 3, 3R, 4, 4X, 12, 13

	Operator Position ③			Button Type/Color ④	Push-Pull		Contact Type	Mounting Location	
	Pull	Intermediate	Push		Catalog Number	Price U.S. \$		A	B
Maintained Push, Momentary Pull									
	X	O	O	40 mm/ Black	<u>E34GFBC1</u> -3X				
	X	X	O	40 mm/Red	<u>E34GFBC2</u> -3X		1NC		
				40 mm Engraved EMERGENCY STOP/Red	<u>E34GFBC2N8</u> -3X		1NC		
Momentary Push, Momentary Pull									
	X	O	O	40 mm/Black	<u>E34GEB1</u> -3X		1NC		
	X	X	O	40 mm/Red	<u>E34GEB2</u> -3X		1NC		
	O	O	X	40 mm/Black	<u>E34GHBC1</u> -1X		1NO		
	X	O	O	40 mm/Red	<u>E34GHBC2</u> -1X		1NC		

③ X = closed circuit, O = open circuit.

④ To order different type or color buttons, substitute the underlined characters with appropriate Suffix Code from the Button and Color Selection Table below. Example: E34GDBCC6-1X.

Table 47-271. Button and Color Selection Table

Standard — 40 mm	Color	Suffix Code	Catalog Number	Price U.S. \$	Jumbo Mushroom Head ⑤ (Anodized) Aluminum — 65 mm	Color	Suffix Code	Catalog Number	Price U.S. \$
	Black Red Red (EMERG. STOP) Green Blue	C1 C2 C2N8 C3 C6	E34C1 E34C2 E34C2N8 E34C3 E34C6			Red Red (EMERG. STOP)	J2 J2N8	E34J2 E34J2N8	

⑤ Anodized aluminum may not be suitable for use on some corrosive applications.

Note: Use NEMA 4X 10250T operators where exposed to ultraviolet light, see **Pages 47-115 – 47-165**.

Accessories **Pages 47-187 – 47-188**
 Dimensions **Page 47-191**
 Enclosures **Pages 47-185 – 47-186**
 Legend Plates **Page 47-184**
 Discount Symbol **1CD1C**

E34 Series, Assembled Devices — Illuminated Push-Pull Units

Illuminated Push-Pull Units

- Two-Position Maintained
- Illuminated



Illuminated Push-Pull Unit

Table 47-272. 2-Position Illuminated Maintained Push, Maintained Pull — UL (NEMA) Type 3, 3R, 4, 4X, 12, 13

Operator Position ①		Lamp	Type	Voltage	Red Standard Push-Pull ②		Contact Type	Mounting Location		LED/Lamp Number
Maintained — Pull	Maintained — Push				Catalog Number	Price U.S. \$		A	B	
 O X	 X O	LED	Full Voltage	24V AC/DC	<u>E34GDB97LRD24-1X</u>	1NO	 	 	Bayonet Base	
				120V AC/DC	<u>E34GDB97LRD2A-1X</u>					
				Transformer	24V AC	<u>E34GDB89LRD06-1X</u>				1NC
					120V AC	<u>E34GDB63LRD06-1X</u>				
O X	X O	Incan- descent	Full Voltage	24V AC/DC	<u>E34GDB79M2-1X</u>	1NO	 	 	#757	
				Resistor	120V AC/DC				<u>E34GDB80M2-1X</u>	1NC
				Transformer	24V AC	<u>E34GDB89M2-1X</u>			1NC	
					120V AC	<u>E34GDB63M2-1X</u>				#755

① X = closed circuit, O = open circuit.

② To order different type or color lens, substitute the underlined characters with appropriate Suffix Code from Lens and Color Selection Table below. Example: E34GDB79 M3-1X. For LEDs with different voltages see ordering example on Page 47-176.

Table 47-273. Lens and Color Selection Table

Type	Color	Incand. Suffix Code	LED Suffix Code	Catalog Number	Price U.S. \$
Standard 	Red	M2	RD	E34M2	
	Red (EMER. STOP)	M2N8	ED	E34M2N8	
	Green	M3	GD	E34M3	
	Blue	M6	LD	E34M6	
	Amber	M9	AD	E34M9	
	White	M5	WD	E34M5	
	Clear	M0	CD	E34M0	

Note: Use NEMA 4X 10250T operators where exposed to ultraviolet light, see Pages 47-115 – 47-165.

Accessories **Pages 47-187 – 47-188**
 Additional Light Units **Page 47-176**
 Dimensions **Page 47-191**
 Enclosures **Pages 47-185 – 47-186**
 Legend Plates **Page 47-184**
 Replacement
 Lamps/LEDs **Page 47-157**
 Discount Symbol **1CD1C**

Illuminated Push-Pull Units
(Continued)

- Three-Position Momentary
- Illuminated



*Illuminated
 Push-Pull Unit*

Table 47-274. 3-Position Illuminated Momentary Push, Momentary Pull — UL (NEMA) Type 3, 3R, 4, 4X, 12, 13

Operator Position ①			Lamp	Type	Voltage	Red Standard Push-Pull ②		Contact Type	Mounting Location		LED/Lamp Number
Momentary — Pull	Maintained — Intermediate	Momentary — Push				Catalog Number	Price U.S. \$		A	B	
O X	O O	X O	LED	Full Voltage	24V AC/DC	<u>E34GHB97LRD24-1X</u>	1NO			Bayonet Base	
					120V AC	<u>E34GHB97LRD2A-1X</u>					
				Transformer	24V AC	<u>E34GHB89LRD06-1X</u>	1NC				
					120V AC	<u>E34GHB63LRD06-1X</u>					
X X	O X	O O	LED	Full Voltage	24V AC/DC	<u>E34GEB97LRD24-3X</u>	1NC			Bayonet Base	
					120V AC	<u>E34GEB97LRD2A-3X</u>					
				Transformer	24V AC	<u>E34GEB89LRD06-3X</u>	1NC				
					120V AC	<u>E34GEB63LRD06-3X</u>					
O X	O O	X O	Incandescent	Full Voltage	24V AC/DC	<u>E34GHB79M2-1X</u>	1NO			#757	
					Resistor	120V AC				<u>E34GHB80M2-1X</u>	120MB
				Transformer	24V AC	<u>E34GHB89M2-1X</u>	1NC				
					120V AC	<u>E34GHB63M2-1X</u>					
X X	O X	O O	Incandescent	Full Voltage	24V AC/DC	<u>E34GEB79M2-3X</u>	1NC			#757	
					Resistor	120V AC				<u>E34GEB80M2-3X</u>	120MB
				Transformer	24V AC	<u>E34GEB89M2-3X</u>	1NC				
					120V AC	<u>E34GEB63M2-3X</u>					

① X = closed circuit, O = open circuit.

② To order different type or color lens, substitute the underlined characters with appropriate Suffix Code from Lens and Color Selection Table on the bottom of Page 47-172. Example: E34GEB79M3-3X. For LEDs with different voltages see ordering example on Page 47-176.

Note: Use NEMA 4X 10250T operators where exposed to ultraviolet light, see Pages 47-115 – 47-165.

Accessories **Pages 47-187 – 47-188**
 Additional Light Units **Page 47-176**
 Dimensions **Page 47-191**
 Enclosures **Pages 47-185 – 47-186**
 Legend Plates **Page 47-184**
 Replacement
 Lamps/LEDs **Page 47-157**
 Discount Symbol **1CD1C**

E34 Series, Assembled Devices — Illuminated Push-Pull Units and Potentiometers

**Illuminated Push-Pull Units
(Continued)**

- Three-Position — Maintained Push, Momentary Pull
- Illuminated



Illuminated Push-Pull Unit

Table 47-275. 3-Position Illuminated Maintained Push, Momentary Pull — UL (NEMA) Type 3, 3R, 4, 4X, 12, 13

Operator Position ^①			Lamp	Type	Voltage	Red Standard Push-Pull ^②		Contact Type	Mounting Location		LED/Lamp Number
Momentary — Pull	Maintained — Intermediate	Maintained — Push				Catalog Number	Price U.S. \$		A	B	
			LED	Full Voltage	24V AC/DC	E34GFB97LRD24-3X	1NC			Bayonet Base	
X	O	O			120V AC	E34GFB97LRD2A-3X					
X	X	O			Trans-former	24V AC	E34GFB89LRD06-3X				1NC
						120V AC	E34GFB63LRD06-3X				
X	O	O	Incan-descent	Full Voltage	24V AC/DC	E34GFB79M2-3X	1NC			#757	
					120V AC	E34GFB80M2-3X				120MB	
					Trans-former	24V AC	E34GFB89M2-3X			1NC	#755
						120V AC	E34GFB63M2-3X				

① X = closed circuit, O = open circuit.

② To order different type or color lens, substitute the underlined characters with appropriate Suffix Code from table on the bottom of **Page 47-172**. Example: E34GFB79M3-3X. For LEDs with different voltages see ordering example on **Page 47-176**.

Potentiometers

Table 47-276. Potentiometer with Knob and Standard Dial Plate — Linear Type ±10% — UL (NEMA) Type 3, 3R, 4, 4X, 12, 13

Vertical or Horizontal One-Hole Mounting	Potentiometer Ohms	2 Watt (60V Max.) Single Potentiometer with Standard Aluminum Dial Plate ^{③④}		Dimensions in Inches (mm)
		Catalog Number	Price U.S. \$	
	1000	E34PDB1F1		<p>Potentiometer</p>
	2500	E34PDB1F2		
	5000	E34PDB1F5		
	10000	E34PDB1F10		
	25000	E34PDB1F25		
50000	E34PDB1F50			
	Operator Only ^⑤	E34PDB1A0		
	Alternative – Black Plastic Large Legend with Standard Markings	E34LP99		

With Standard Aluminum Dial Plate

- ③ Large dial plate with space for legend is available at no charge. To order, add Suffix **36** to Catalog Number. Example: E34PDB1F1**36**. To order separately, see footnote ^④ below.
- ④ Large dial plate has space at top for 15 letters. 3/32 inch high. For custom stamped legend plates, order legend plate as separate item **10250TR30** and specify stamping.
- ⑤ For use with commercially purchased potentiometers having shaft dimensions per dimension drawing on **Page 47-161**.

Note: Use NEMA 4X 10250T operators where exposed to ultraviolet light, see **Pages 47-115 – 47-165**.

Accessories **Pages 47-187 – 47-188**
 Additional Light Units **Page 47-176**
 Dimensions **Page 47-191**
 Enclosures **Pages 47-185 – 47-186**
 Legend Plates **Page 47-184**
 Replacement
 Lamps/LEDs **Page 47-157**
 Discount Symbol **1CD1C**

E34 Series, Push-Pull Components



2-Position Maintained Push-Pull without Button on Lens
Catalog Number E34GDB

Push-Pull Operators

An illuminated Push-Pull pushbutton unit, arranged for one-hole mounting, can replace two pushbuttons and a pilot light or the non-illuminated form can replace two pushbuttons. These units are available in three basic types:

- **Maintained** — (Two-Position). Maintains in the pulled or pushed position until manually actuated to the opposite mode.

- **Momentary** — (Three-Position). Spring returns to an intermediate position when pulled or pushed and released.
- **Momentary Pull, Maintained Push** — (Three-Position). Spring returns to intermediate position when pulled. Maintains in pushed position until manually returned to intermediate (ready to reset) position. Maintained stop holds circuit open and will prevent other series connected operators from starting the system.

The Operators, Buttons, Contact Blocks, etc., are offered as building block components that can be intermixed to satisfy many requirements. This minimizes the need for a varied and costly inventory.

Application Guide

To assist in the selection of contact blocks, the sketch to the right shows pictorially by symbols **A** and **B** locations of contact circuits after assembly of contact blocks and adapter to the operator. The chart below shows the effect of the push and pull operations on either NO or NC contacts. (X = contact closed, O = contact open)

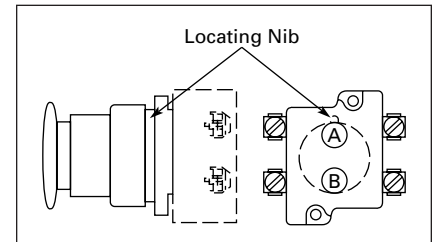

Figure 47-124. Contact Circuit Locations

Table 47-277. Push-Pull Operator Components

Type of Operator	Catalog Number	Price U.S. \$	Contact Block — Max. of 2 Blocks, 4 Circuits ①	Operator Position and Circuit Arrangement								
				Out — Pull		Intermediate		In — Push				
				Contact Block Mounting Location								
		A		B		A		B				
2-Position Operator without Lens												
Maintained Push-Pull	E34GDB		1NO 1NC	O X	or	O X	No Intermediate Position		X O	or	X O	
			2NO 2NC	O X	or	O X			X O	or	X O	
3-Position Operator without Lens												
Momentary Push-Pull	E34GEB ①		1NO 1NC	O X	or	O X	O O	or	O X	X O	or	O O
Maintained Push-Momentary Pull	E34GFB ①		2NO 2NC	O X	or	O X	O O	or	X X	X O	or	O O
Momentary Push-Pull	E34GHB ①		1NO 1NC	O X	or	O X	O O	or	O O	X O	or	X O
			2NO 2NC	O X	or	O X	O O	or	O O	X O	or	X O

① Special function contact blocks shown on Page 47-182 CANNOT be used with 3-position push-pull operators E34GEB, E34GFB or E34GHB.

Note: Use NEMA 4X 10250T operators where exposed to ultraviolet light, see Pages 47-115 – 47-165.

Note: See Typical Applications on Page 47-129.

Button or Lens **Page 47-176**
 Contact Blocks **Page 47-182**
 Dimensions **Page 47-191**
 Enclosures **Pages 47-185 – 47-186**
 Legend Plates **Page 47-184**
 Discount Symbol **1CD1C**

E34 Series, Push-Pull Components

Push-Pull Operators (Continued)



Push-Pull Light Units, Lenses and Buttons

Table 47-278. Light Units for Illuminated Push-Pull Devices

Light Unit Type	Type	Voltage	Catalog Number	Price U.S. \$	LED/Lamp Number
LED (LEDs not included) ①	Full Voltage	—	10250T97L		Bayonet Base
	Transformer AC Only 50/60 Hz	120	10250T89L		
		208	10250T63L		
		240	10250T64L		
		277	10250T65L		
		380	10250T82L		
		480	10250T66L		
		600	10250T67L		
		600	10250T68L		
	Incandescent	Full Voltage AC or DC	6	10250T69	
12			10250T70	#756	
24/28			10250T79	#757	
32			10250T83	#1828	
Resistor AC or DC		120	10250T80		120MB
		240	10250T81		
Transformer AC Only 50/60 Hz		24	10250T89		#755
		120	10250T63		
		208	10250T64		
		240	10250T65		
	277	10250T82			
	380	10250T66			
480	10250T67				
600	10250T68				

① These units do not include lamps. Order LED separately to match lens color from chart at right.

Table 47-279. Buttons for Non-illuminated Push-Pull Devices

	Color	Incand. Suffix Code	Catalog Number	Price U.S. \$
	Black	C1	E34C1	
	Red	C2	E34C2	
	Red (EMERG. STOP)	C2N8	E34C2N8	
	Green	C3	E34C3	
	Blue	C6	E34C6	
	Jumbo — Red ②	J2	E34J2	
	Jumbo — Red (EMERGENCY STOP)	J2N8	E34J2N8	

② Anodized aluminum may not be suitable for use on some corrosive applications.

Note: Use NEMA 4X 10250T operators where exposed to ultraviolet light, see **Pages 47-115 – 47-165**.

Table 47-280. Alternate Lenses for Illuminated Push-Pull Devices

	Color	Incand. Suffix Code	LED Suffix Code ③	Catalog Number	Price U.S. \$
	Red	M2	RD	E34M2	
	Red (EMERG. STOP)	M2N8	ED	E34M2N8	
	Green	M3	GD	E34M3	
	Blue	M6	LD	E34M6	
	Amber	M9	AD	E34M9	
	White	M5	WD	E34M5	
	Clear	M0	—	E34M0	

③ Suffix Codes should only be used for assembling composite Catalog Numbers. To order lens, order by Catalog Number.

Table 47-281. LED Selection Table

Voltage	Color	Catalog Number	Price U.S. \$
6V AC/DC Suitable for Use with Transformers	Red	E22LED006RN	
	Orange	E22LED006ON	
	Yellow	E22LED006YN	
	Green	E22LED006GN	
	Blue	E22LED006BN	
12V AC/DC	White	E22LED006WN	
	Red	E22LED012RN	
	Orange	E22LED012ON	
	Yellow	E22LED012YN	
	Green	E22LED012GN	
24V AC/DC	Blue	E22LED012BN	
	White	E22LED012WN	
	Red	E22LED024RN	
	Orange	E22LED024ON	
	Yellow	E22LED024YN	
48V AC/DC	Green	E22LED024GN	
	Blue	E22LED024BN	
	White	E22LED024WN	
	Red	E22LED048RN	
	Orange	E22LED048ON	
60V AC/DC	Yellow	E22LED048YN	
	Green	E22LED048GN	
	Blue	E22LED048BN	
	White	E22LED048WN	
	120V AC	Red	E22LED060RN
Orange		E22LED060ON	
Yellow		E22LED060YN	
Green		E22LED060GN	
Blue		E22LED060BN	
120V DC	White	E22LED060WN	
	Red	E22LED120RA	
	Orange	E22LED120OA	
	Yellow	E22LED120YA	
	Green	E22LED120GA	
	Blue	E22LED120BA	
	White	E22LED120WA	
	Red	E22LED120RD	
	Orange	E22LED120OD	
	Yellow	E22LED120YD	
	Green	E22LED120GD	
	Blue	E22LED120BD	
	White	E22LED120WD	

Note: For a complete listing of all LEDs available, see **Page 47-165**.

Ordering example with one composite number:

Non-illuminated [E34GDB](#) + [E34C2](#) + 10250T1 = [E34GDBC2-1X](#)

Incandescent [E34GDB](#) + 10250T79 + [E34M2](#) + 10250T1 = [E34GDB79M2-1X](#)

LED [E34GDB](#) + 10250T97L + [E34M2](#) + Voltage Code + 10250T1 = [E34GDB97LRD24-1X](#)

- 06 — 6V AC/DC
- 12 — 12V AC/DC
- 24 — 24V AC/DC
- 48 — 48V AC/DC
- 60 — 60V AC/DC
- 2A — 120V AC
- 2D — 120V DC

Contact Blocks **Page 47-182**
 Dimensions **Page 47-191**
 Enclosures **Pages 47-185 – 47-186**
 Legend Plates **Page 47-184**
 Replacement
 Lamps/LEDs **Page 47-157**
 Discount Symbol **1CD1C**

E34 Series, Assembled Devices — Selector Switch Units

Selector Switch Units

- Two-, Three- and Four-Position — Maintained
- Non-illuminated and Illuminated



*2-Position
Maintained
Switch Knob*



*4-Position
Maintained
Switch Lever*

Table 47-282. 2-Position Selector Switch — UL (NEMA) Type 3, 3R, 4, 4X, 12, 13

Operator Position ①		Operator Action ②	Non-illuminated		Price U.S. \$	Illuminated — 120V Transformer		Price U.S. \$	Contact Type	Mounting Location		Cam Code
			Black Knob ③	Black Lever ③		Red Knob ③	Red Lever ③			A	B	
Catalog Number	Catalog Number	Catalog Number	Catalog Number	Catalog Number	Catalog Number							
X O	O X		E34VFBK1-1X	E34VFB1-1X		E34VFB120ER-1X	E34VFB120FR-1X		1NC 1NO			1

① X = closed circuit, O = open circuit.

② M = Maintained.

③ To order different type or color selector switch, substitute the underlined character with appropriate Suffix Code from the Color Selection table.
 Example: E34VFBK2-X1.

Table 47-283. 3-Position Selector Switch — UL (NEMA) Type 3, 3R, 4, 4X, 12, 13

Operator Position ④			Operator Action ⑤	Non-illuminated		Price U.S. \$	Illuminated — 120V Transformer		Price U.S. \$	Contact Type	Mounting Location		Cam Code
				Black Knob ⑥	Black Lever ⑥		Red Knob ⑥	Red Lever ⑥			A	B	
Catalog Number	Catalog Number	Catalog Number	Catalog Number	Catalog Number	Catalog Number	Catalog Number	Catalog Number						
X O O	O O X		E34VHBK1-2X	E34VHBL1-2X		E34VHB120TER-2X	E34VHB120TFR-2X		1NO 1NO			3	
X O O O	O X O X		E34VHBK1-23X	E34VHBL1-23X		E34VHB120TER-23X	E34VHB120TFR-23X		1NO 2NC (Series) 1NO			3	

④ X = closed circuit, O = open circuit.

⑤ M = Maintained.

⑥ To order different type or color selector switch, substitute the underlined character with appropriate Suffix Code from the Color Selection table.
 Example: E34VFBK2-X1.

Table 47-284. 4-Position Selector Switch — UL (NEMA) Type 3, 3R, 4, 4X, 12, 13

Operator Position ⑦				Operator Action ⑧	Non-illuminated		Price U.S. \$	Illuminated — 120V Transformer		Price U.S. \$	Contact Type	Mounting Location		Cam Code
					Black Knob ⑨	Black Lever ⑨		Red Knob ⑨	Red Lever ⑨			A	B	
Catalog Number	Catalog Number	Catalog Number	Catalog Number	Catalog Number	Catalog Number	Catalog Number	Catalog Number							
X O O O	O X O O	O O X O	O O O X		E34VTBK1-23X	E34VTBL1-23X		E34VRB120TER-23X	E34VRB120TFR-23X		1NC 1NO 1NO 1NC			7

⑦ X = closed circuit, O = open circuit.

⑧ M = Maintained.

⑨ To order different type or color selector switch, substitute the underlined character with appropriate Suffix Code from the Color Selection table.
 Example: E34VFBK2-X1.

Table 47-285. Color Selection, Non-illuminated

Color	Code Letter
Black	1
Red	2
Green	3
Yellow	4
White	5
Blue	6
Gray	7
Orange	8

Note: For Light Unit Voltage Suffix and Knobs, Levers tables, see Page 47-181.

Note: Use NEMA 4X 10250T operators where exposed to ultraviolet light, see Pages 47-115 – 47-165.

Accessories Pages 47-187 – 47-188
 Additional Circuit Arrangements Pages 47-178 – 47-179
 Dimensions Page 47-191
 Enclosures Pages 47-185 – 47-186
 Legend Plates Page 47-184
 Discount Symbol 1CD1C

E34 Series, Selector Switch Selection



E34 Series

Selector Switch Selection

Cam and Contact Block Selection

Selector switches in their varied forms (2-position, 3-position and 4-position) are a big factor contributing to the great flexibility of control that a well rounded line of "pushbuttons" can achieve. Because of their flexibility, they tend to cause difficulty with product selection and application. The following systematic approach should simplify that task.

Cam and contact block selection is better understood if you:

- Work with each incoming and outgoing wire/circuit separately.
- Recognize the terms NO and NC only identify the type of contact by its mode before mounting to the operator. The "X-O" chart (Page 47-179) shows how that contact will act after assembly to the operator with the selected cam shape. X = closed circuit, O = open circuit.
- Up to six NO or NC contacts may be mounted behind each plunger location for a total of twelve contacts. Single circuit contact blocks have only one plunger with the other side of the block "open." Therefore, single circuit contact blocks transmit motion to blocks behind them only for the position containing the circuit.
- Each cam has two separate lobes, each of which operates one of the two contact block plungers independently of each other. Those are identified as position A (locating nib side) and position B (opposite of locating nib). The position designations give direction in selecting and mounting of the contact blocks (see Illustration below).

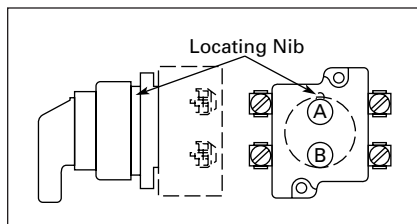

Figure 47-125. Contact Circuit Locations

Systematic Approach

Application: **HAND-OFF-AUTO** Selector Switch. In this circuit, one incoming line is distributed to two other outgoing circuits by the switch. The two circuits can be looked at individually.

Step 1: Elementary Diagram.

Construct on paper, or in your mind, a simple elementary diagram of the switching scheme as follows:

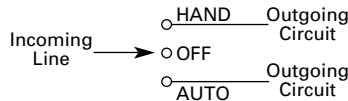

Step 2: "X-O" Pattern.

From the elementary diagram, you can construct an "X-O" diagram which describes when the contacts are to be closed (X) or open (O) in the various positions of the switch. The "X-O" for the **HAND** circuit looks like this:

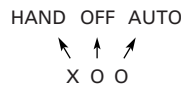

In this circuit, you want a contact closed on the left (HAND) but open in the center and right.

For the **AUTO** circuit, the "X-O" diagram would look like this:

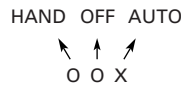

Putting them together, the complete "X-O" diagram is:



Once the "X-O" diagram has been generated, the next step is to select the cam and contact block, or blocks, needed to perform the desired "X-O" functions. The selection table on the following page lists the various types (shapes) of cams by number to choose from and the type of contact and position to achieve the function outlined in your "X-O" diagram.

Step 3: Cam Selection.

The cam you select determines the operation of all contact blocks mounted to the operator. It is selected on the basis that it provides the simplest circuitry for the desired "X-O" diagram. The selection tables of the following page show all the "X-O" combinations. For the purpose of this example, the applicable portion of those charts is shown in **Table 47-286**.

Table 47-286. Example Selection Table

No.	"X-O" Pattern	Cam Code #2		Cam Code #3	
		Top A	Bottom B	Top A	Bottom B
1	X O O	NO	NC	NO	
4	O O X		NO		NO

① Wired in series.

Now to make the cam selection, make a simple worksheet such as:

	Cam 2	Cam 3
X O O	(A)NO - (B)NC	(A)NO
O O X	(B)NO	(B)NO

It becomes immediately obvious that cam 3 is the better choice for two reasons, (1) the series combination can be avoided making it simpler to wire, (2) only two contacts are required, which is less expensive than the three contacts required by cam 2.

Step 4: Contact Block Selection.

Having selected the cam, contact block selection is simply a matter of gathering the A position and B position circuits into pairs which make up the most convenient contact block arrangement. If there is an imbalance in the number of circuits under A or B, then single circuit blocks must be selected for these leftover circuits.

Back to the worksheet, having selected cam 3 do this:









Step 5: Selector Switch Operator.

Lastly, you have to choose from the many types of operators — knob and lever in various colors or keyed. Also what combinations of maintained and spring return functions are required. Selection of these operators can be found on **Page 47-180**. For the above example you may want a 3-position maintained black knob, cam 3 — Catalog Number E34VHBK1.

The Complete Switch: E34VHBK1 with one 10250T2 or, for one composite catalog number, E34VHBK1-Y1 found on **Page 47-177**.

Selector Switch Selection
(Continued)

Table 47-287. 2-Position Selector Switch Contact Block Selection

No.	Desired Circuit and Operator Position		Contact Blocks Required to Accomplish Circuit Function	
			Top Plunger A	Bottom Plunger B
1	X	O		
2	O	X		

Diagrams

Circuits shown illustrate connections to obtain a selector switch circuit combination and are shown with their appropriate line diagrams. Field wiring of jumper connections required as shown.

X = Closed Circuit
 O = Open Circuit

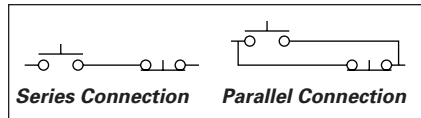

Figure 47-126. Wiring of Jumper Connections

Note: 4-Position Selector Switches limited to 4 contact blocks.

Contact Blocks

For selection and number of available contact blocks per operator, see **Page 47-182**.

Table 47-288. 3-Position Switch — Cam and Contact Block Selection











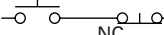

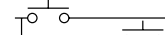



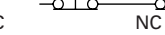

No.	Desired Circuit and Operator Position	Contact Blocks Required to Accomplish Circuit Function (Jumpers must be installed where indicated)			
		Operator with Cam Code #2		Operator with Cam Code #3	
		Mounting Location		Mounting Location	
		Top Plunger A	Bottom Plunger B	Top Plunger A	Bottom Plunger B
1	X O O	NO		NO	
2	X X O		NC		NC
3	X O X	NO		NO	
4	O O X		NO		NO
5	O X X	NC		NC	
6	O X O	NC		NC	

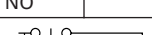
Table 47-289. 4-Position Switch — Contact Block Selection

No.	Desired Circuit and Operator Position	Contact Blocks Required to Accomplish Circuit Function		Combination No.	Desired Circuit and Operator Position	Contact Blocks Required to Accomplish Circuit Function	
		Mounting Location				Mounting Location	
		Top Plunger A	Bottom Plunger B			Top Plunger A	Bottom Plunger B
1	X O O O			10	X O X O		
2	O X O O					NC NO	
3	O O X O			11	X X X O		
4	O O O X					NC NO NO	
5	X O O X			12	O X X X		
6	O X X O					NO NC NO	
7	O O X X			13	X O X X		
8	X X O O					NO NC NC	
9	O X O X			14	X X O X		

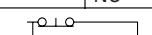
E34 Series, Selector Switch Components

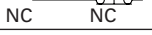
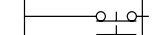
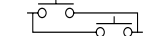

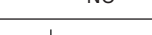
2-Position Maintained Black Knob Selector Switch — Cam 1
Catalog Number E34VFBK1



3-Position Maintained Keyed Selector Switch
Catalog Number E34KGHB1

Selector Switch Operators

Table 47-290. Operators with Knob Assembled — UL (NEMA)
Type 3, 3R, 4, 4X, 12, 13

Positions	Operator Action ①	Black Knob Selector Switch — Vertical Mounting ③		
		Cam Code ②	Catalog Number ④	Price U.S. \$
2-Position — 60° Throw		1	<u>E34VFBK1</u>	
		1	<u>E34VEBK1</u>	
3-Position — 60° Throw		2 3	<u>E34VGBK1</u> <u>E34VHBK1</u>	
		2 3	<u>E34VJBK1</u> <u>E34VKBK1</u>	
		2 3	<u>E34VLBK1</u> <u>E34VMBK1</u>	
		2 3	<u>E34VNBK1</u> <u>E34VPBK1</u>	
4-Position — 40° Throw		7	<u>E34VTBK1</u>	

- ① M = Maintained. S = Spring return in direction of arrow (→).
- ② For selection of the proper cam and contact block to obtain the proper circuit sequence, see selection instructions and table on Pages 47-178 – 47-179.
- ③ Field convertible to Horizontal Mounting.
- ④ For other colors of either the knob or lever, replace the underlined characters of the Catalog Number with the appropriate Suffix Code from Alternate Knob and Lever Table below. Example: E34VFBL.

Note: Use NEMA 4X 10250T operators where exposed to ultraviolet light, see Pages 47-115 – 47-165.

Table 47-293. Alternate Knobs and Levers for Operators Above

Color	Knob			Lever			Lever Designed for Added Ingress Protection ⑤		
	Suffix Code	Catalog Number	Price U.S. \$	Suffix Code	Catalog Number	Price U.S. \$	Suffix Code	Catalog Number	Price U.S. \$
Black	K1	E34K1		L1	E34L1		A1	E34A1	
Red	K2	E34K2		L2	E34L2		A2	E34A2	
Green	K3	E34K3		L3	E34L3		A3	E34A3	
Yellow	K4	E34K4		L4	E34L4		A4	E34A4	
White	K5	E34K5		L5	E34L5		A5	E34A5	
Blue	K6	E34K6		L6	E34L6		A6	E34A6	
Gray	K7	E34K7		L7	E34L7		A7	E34A7	
Orange	K8	E34K8		L8	E34L8		A8	E34A8	

⑤ For use on maintained operators only.

Table 47-291. Key Operators with Cam and Cap — UL (NEMA)
Type 3, 3R, 4, 4X, 12, 13

Positions	Operator Action ⑤	Cam Code ⑥	Key Removal Positions ⑦	Vertical Mounting	Horiz. Mounting	Price U.S. \$
				Catalog Number	Catalog Number	
2-Position — 60° Throw		1	1, 2, 3	E34KFB_	E34KFHB_	
		1	2	E34KEB_	E34KEHB_	
3-Position — 60° Throw		2 3	1 – 7	E34KGB_	E34KGHB_	
		2 3	1, 4, 5	E34KJB_	E34KJHB_	
		2 3	4	E34KLB_	E34KLHB_	
		2 3	2, 4, 6	E34KNB_	E34KNHB_	
4-Position — 40° Throw		7	7	E34KTB_	E34KTHB_	

- ⑤ M = Maintained. S = Spring return in direction of arrow (→).
- ⑥ For selection of the proper cam and contact block to obtain the proper circuit sequence, see selection instructions and table on Pages 47-178 – 47-179.
- ⑦ Choose key removal position required for application from Table 47-292. Add key removal Code No. to listed Catalog Number. Example: E34KFB2.

Table 47-292. Key Removal Positions

Code Suffix	Key Removal Positions	Code Suffix	Key Removal Positions
1	Right Only	5	Right & Center
2	Left Only	6	Left & Center
3	Right & Left	7	All Positions
4	Center Only		

Note: Key removal in “spring return from” positions not recommended.

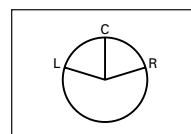

Figure 47-127. Key Removal Positions

Dissimilar Locks and Keys

Listed operators have identical locks and keys (Key Code H661), Catalog Number 10250ED824. For dissimilar lock and key combinations, see Page 47-136.

Accessories Page 47-187 – 47-188
 Dimensions Page 47-191
 Legend Plates Page 47-184
 Discount Symbol 1CD1C



**2-Position Maintained
120V AC Transformer
Selector Switch, Cam 1
Catalog Number E34VFB120**

Illuminated Selector Switch Operators

Table 47-294. Operator without Knob or Lever

Positions	Operator Action	Transformer Type — 50/60 Hz		Full Voltage Type — AC or DC ^③	
		6 Volt #755 Lamp		Lamps — #755, #757, #1835, 120MB ^④	
		Catalog Number ^{①⑤}	Price U.S. \$	Catalog Number ^⑤	Price U.S. \$
2-Position — 60° Throw		Cam Code 1 ^②		Cam Code 1 ^②	
		E34VFB_		E34SFB_	
3-Position — 60° Throw		Cam Code 2 ^②		Cam Code 2 ^②	
		E34VGB_		E34SHB_	
		Cam Code 3 ^②		Cam Code 3 ^②	
		E34VHB_		E34SHB_	
	E34VNB_ ^⑥	E34VPB_ ^⑥	E34SNB_ ^⑦	E34SPB_ ^⑦	
	E34VJB_ ^⑥	E34VKB_ ^⑥	E34SJB_ ^⑦	E34SKB_ ^⑦	
	E34VLB_	E34VMB_	E34SLB_	E34SMB_	
4-Position — 40° Throw		E34VRB_	—	E34SRB_	—

- ① Operator includes lens gasket and lens attachment screws.
- ② For selection of the proper cam and contact block required to obtain a specific circuit sequence, see selection table on **Pages 47-178 – 47-179**.
- ③ Full voltage light units can be used at other than listed voltages by changing lamp. Replacement lamps are listed in **Page 47-157**.
- ④ 120MB lamps are used on both 120V and 240V operators.
- ⑤ Add Code Suffix for Light Unit Voltage to listed Catalog Number from Light Unit Voltage Suffix Table at bottom of page.
Example: For 24V transformer type light unit, order E34VFB024.
- ⑥ 120 and 240V transformer only.
- ⑦ 120 full voltage only.

Table 47-295. Light Unit Voltage Suffix — Add to operator Catalog Number listed in table above.

Type of Light Unit			Full Voltage Type AC or DC ^⑥		
Transformer Type 50/60 Hz			Full Voltage Type AC or DC ^⑥		
Voltage	Suffix Code	Adder U.S. \$	Voltage	Suffix Code	Adder U.S. \$
24	024		6	06	
120	120		12	12	
208	208		24	24	
240	240		48	48	
380	380		120	120	
480	480		240 ^⑦	240	
600	600				

- ⑥ Full voltage light units can be used at other than listed voltages by changing lamp. Replacement lamps are listed in **Page 47-157**.
- ⑦ Resistor type. May generate excess heat if used in high density.

Table 47-296. Knobs, Levers

	Color ^⑩	Knob	Lever	Price U.S. \$
		Catalog Number and Code Number		
	Red	10250TER	10250TFR	
	Green	10250TEG	10250TFG	
	Yellow	10250TEA	10250TFA	
	Blue	10250TEL	10250TFL	
	Clear	10250TEW	10250TFW	
	White	10250TEV	10250TFV	
	Amber	10250TEM	10250TFM	

- ⑩ Amber, clear and white lenses have a black arrow (pointer). Red, green and blue lenses have a white arrow (pointer).

Note: Use NEMA 4X 10250T operators where exposed to ultraviolet light, see **Pages 47-115 – 47-165**.

Contact Blocks **Page 47-182**
 Dimensions **Page 47-191**
 Enclosures **Pages 47-185 – 47-186**
 Legend Plates **Page 47-184**
 Discount Symbol **1CD1C**

E34 Series, Components — Contact Blocks

Contact Blocks

Standard Contact Blocks

- UL A600/P600 rated
- Color-coded plungers – red/green for NC/NO circuits
- Silver contact tips with “reliability nibs”
- Black (opaque) or amber (translucent) housings
- Pressure plate or spade terminals
- Fingerproof shrouds (for pressure terminals only)

Logic Level Contact Blocks

- UL A600/P600 rated
- Black plungers
- Inert palladium knife-blade contacts
- Black (opaque) housings
- Pressure plate or spade terminals
- Fingerproof shrouds not available

Special Function Contact Blocks

- UL A600/P600 rated
- Black plungers
- Silver contact tips with “reliability nibs”
- Black (opaque) housings
- Pressure plate terminals only
- Fingerproof shrouds not available

Special Purpose Contact Block

- Maximum 300V rated
- Black plungers
- Silver contact tips with “reliability nibs”
- Black (opaque) housings
- Pressure plate terminals only
- Fingerproof shrouds not available

Reliability Nibs

Reliability nibs are the hallmark of Eaton’s Cutler-Hammer contact blocks. A pointed silver nib on the contact tip

ensures reliable switching from logic level (5V) up to 600V applications. Therefore standard contact blocks can be used for most logic level applications where the contacts are not exposed to any harsh environmental conditions.

Palladium Contacts

Palladium, which is more inert than gold, is well suited for voltages and currents approaching zero and is recommended for applications where environmental conditions are a factor.

Maximum Contact Block Mounting per Operator Type

Operator	Max. Stack	Operator	Max. Stack
Pushbuttons	6	2- or 3-Position Selector Switches	6
Push-Pull Operators	2	4-Position Selector Switches	4
Roto-Push Operators	4	Joysticks	4

Table 47-297. Contact Blocks

Symbol	Circuit	Description/ Notes ①	Standard				Logic Level			
			Pressure Terminals		Spade Terminals ②		Pressure Terminals		Spade Terminals ②	
			Catalog Number	Price U.S. \$	Catalog Number	Price U.S. \$	Catalog Number	Price U.S. \$	Catalog Number	Price U.S. \$
	1NC	Stack up to 6 blocks (6 circuits) unless otherwise noted.	10250T51		10250T59		10250T51E		10250T59E	
	1NO	Stack up to 6 blocks (6 circuits) unless otherwise noted.	10250T53		10250T60		10250T53E		10250T60E	
	NO-NC	Stack up to 6 blocks (12 circuits) unless otherwise noted.	10250T1		10250T40		10250T1E		10250T40E	
	2NC	Stack up to 6 blocks (12 circuits) unless otherwise noted.	10250T3		10250T42		10250T3E		10250T42E	
	2NO	Stack up to 6 blocks (12 circuits) unless otherwise noted.	10250T2		10250T41		10250T2E		10250T41E	

Special Function Blocks ③

	LONC	Late opening NC. Stack up to 6 blocks (6 circuits) unless otherwise noted.	10250T71		—		10250T71E		—	
	ECNO-NC	Early closing NO and standard NC. Stack up to 6 blocks unless otherwise noted.	10250T47		—		10250T47E		—	
	ECNO-NO	Early closing NO and standard NO. Stack up to 4 blocks unless otherwise noted.	10250T57		—		10250T57E		—	
	2LONC	Two late opening NC contacts. Stack up to 6 blocks unless otherwise noted.	10250T45		—		10250T45E		—	
	LONC-ECNO	Overlapping contacts. Stack up to 4 blocks unless otherwise noted.	10250T55		—		10250T55E		—	

Special Purpose Blocks ⑤

	2NO-2NC	Four circuits in single block depth. Rated 300V max. Stack up to 4 blocks unless otherwise noted.	10250T44		—					
--	---------	---	----------	--	---	--	--	--	--	--

① All 10250T contact blocks shown are suitable for use on standard 10250T and E34 operators. These contact blocks are not suitable for Class I Division 2 type 10250T or E34 devices.

② Contact blocks with spade terminals are limited to a maximum of one contact block per operator and minimum spacing between devices is 2.5” (63.5 mm). Not suitable for use in 10250T or E34 enclosures. Also available in amber housing. Not available with fingerproof shrouds.

③ Special function contact blocks are not suitable for use with roto-push operators, 3-position push-pull operators, or 4-position selector switches.

④ ECNO contact blocks are not suitable for use with 2-position joysticks or when operators are used with padlock attachments.

⑤ Special purpose 10250T44 contact blocks are not suitable on selector switches or roto-push operators. Okay to use with 3-position push-pull operators only on low voltage (30V or less) circuits.

Ratings Page 47-116
Dimensions Pages 47-160 – 47-162
Discount Symbol 1CD1C

Contact Blocks (Continued)

Table 47-298. Contact Blocks with Fingerproof Shrouds

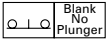
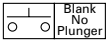
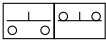
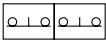
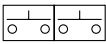
Symbol	Circuit	Description/ Notes ①	 10250T1CP	Standard		Logic Level	
				Pressure Terminals ②		Pressure Terminals ②	
				Catalog Number	Price U.S. \$	Catalog Number	Price U.S. \$
 Blank No Plunger	1NC	Stack up to 6 blocks (6 circuits) unless otherwise noted.	10250T51P		10250T51EP		
 Blank No Plunger	1NO	Stack up to 6 blocks (6 circuits) unless otherwise noted.	10250T53P		10250T53EP		
	NO-NC	Stack up to 6 blocks (12 circuits) unless otherwise noted.	10250T1P		10250T1EP		
	2NC	Stack up to 6 blocks (12 circuits) unless otherwise noted.	10250T3P		10250T3EP		
	2NO	Stack up to 6 blocks (12 circuits) unless otherwise noted.	10250T2P		10250T2EP		

Special Function Blocks ③

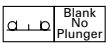
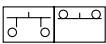
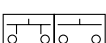
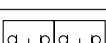
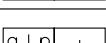
 Blank No Plunger	LONC	Late opening NC. Stack up to 6 blocks (6 circuits) unless otherwise noted.	10250T71P ③		10250T71EP ③	
	ECNO-NC	Early closing NO and standard NC. Stack up to 6 blocks unless otherwise noted.	10250T47P ③ ④		10250T47EP ③	
	ECNO-NO	Early closing NO and standard NO. Stack up to 4 blocks unless otherwise noted.	10250T57P ③ ④		10250T57EP ③	
	2LONC	Two late opening NC contacts. Stack up to 6 blocks unless otherwise noted.	10250T45P ③		10250T45EP ③	
	LONC-ECNO	Overlapping contacts. Stack up to 4 blocks unless otherwise noted.	10250T55P ③ ④		10250T55EP ③	

① All 10250T contact blocks shown are suitable for use on standard 10250T and E34 operators. These contact blocks are not suitable for Class I Division 2 type 10250T or E34 devices.

② To order contact blocks with translucent amber housing, change Suffix P to **CP** in Catalog Number e.g. **10250T51CP**.

③ Special function contact blocks are not suitable for use with roto-push operators, 3-position push-pull operators, or 4-position selector switches.

④ ECNO contact blocks are not suitable for use with 2-position joysticks or when operators are used with padlock attachments.

E34 Series, Legend Plates

Options

Legend Plates

Field Color

Legend plates can be supplied printed on black, red, silver or white field. To order legend printed on a color other than indicated — add Suffix Code to the end of the Catalog Number as follows:

“R” for Red field;
 “W” for White field; or
 “S” for Silver field.

Example: E34SP26R — Standard plate with red field marked OPEN.

Table 47-299. For Pushbutton Operators and Indicating Lights

Price Each — U.S. \$			
Legend	Color of Field	Catalog Number	
		Standard ①	Jumbo

Letters on Legend Plates Below are 3/16" High

CLAMP	Black	E34SP90	E34LP90
CLOSE	Black	E34SP73	E34LP73
DOWN	Black	E34SP74	E34LP74
EMERG. STOP	Red	E34SP13	E34LP13
FAST	Black	E34SP75	E34LP75
FASTER	Black	E34SP87	E34LP87
FEEDER ON	Black	E34SP94	E34LP94
FEEDER OFF	Black	E34SP95	E34LP95
FORWARD	Black	E34SP15	E34LP15
HIGH	Black	E34SP16	E34LP16
IN	Black	E34SP17	E34LP17
INCH	Black	E34SP18	E34LP18
JOG	Black	E34SP19	E34LP19
JOG FOR.	Black	E34SP20	E34LP20
JOG REV.	Black	E34SP21	E34LP21
LOW	Black	E34SP22	E34LP22
LOWER	Black	E34SP23	E34LP23
LUBE-FAIL	Black	E34SP92	E34LP92
MOTOR RUN	Black	E34SP81	E34LP81
MOTOR STOP	Black	E34SP82	E34LP82
OFF	Red	E34SP24	E34LP24
ON	Black	E34SP25	E34LP25
OPEN	Black	E34SP26	E34LP26
OUT	Black	E34SP27	E34LP27
POWER ON	Black	E34SP80	E34LP80
RAISE	Black	E34SP28	E34LP28
READY	Black	E34SP86	E34LP86
RESET	Black	E34SP29	E34LP29
REVERSE	Black	E34SP30	E34LP30
RUN	Black	E34SP31	E34LP31
SAFE	Black	E34SP85	E34LP85
SLOW	Black	E34SP32	E34LP32
SLOWER	Black	E34SP88	E34LP88
START	Black	E34SP33	E34LP33
STOP	Red	E34SP34	E34LP34
TEST	Black	E34SP83	E34LP83
TRANSFER	Black	E34SP93	E34LP93
TRIP	Black	E34SP84	E34LP84
UNCLAMP	Black	E34SP91	E34LP91
UP	Black	E34SP35	E34LP35

① 3/32" high lettering.

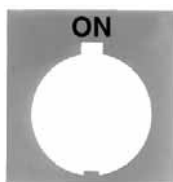

Standard

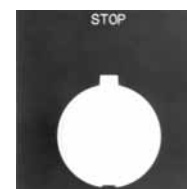

Jumbo

Table 47-300. For Selector Switch Operators

Price Each — U.S. \$			
Legend	Color of Field	Catalog Number	
		Standard	Jumbo

2 Position — 3/16" High Lettering

FOR. REV.	Black	E34SP38	E34LP38
HAND AUTO	Black	E34SP39	E34LP39
HIGH LOW	Black	E34SP40	E34LP40
JOG RUN	Black	E34SP41	E34LP41
MAN. AUTO	Black	E34SP67	E34LP67
OFF ON	Black	E34SP42	E34LP42
OPEN CLOSE	Black	E34SP43	E34LP43
RUN JOG	Black	E34SP44	E34LP44
SAFE RUN	Black	E34SP45	E34LP45
START JOG	Black	E34SP46	E34LP46
START STOP	Black	E34SP47	E34LP47
UP DOWN	Black	E34SP48	E34LP48

3 Position — 3/16" High Lettering

AUTO OFF HAND	Black	E34SP49	E34LP49
FOR. OFF REV.	Black	E34SP50	E34LP50
FOR. SAFE REV.	Black	E34SP69	E34LP69
HAND OFF AUTO	Black	E34SP51	E34LP51
MAN. OFF AUTO	Black	E34SP68	E34LP68
OPEN OFF CLOSE	Black	E34SP53	E34LP53
RUN SAFE JOG	Black	E34SP70	E34LP70
UP OFF DOWN	Black	E34SP54	E34LP54
ON STOP SAFE	Black	E34SP71	E34LP71

Table 47-301. For Push-Pull Units

Price Each — U.S. \$			
Legend	Color of Field	Catalog Number	
		Standard ②	Jumbo ③

PULL ON/ PUSH OFF	Black	E34PP5	E34R5
PULL OPEN/ PUSH CLOSE	Black	E34PP8	E34R8
PULL UP/ PUSH DOWN	Black	E34PP11	E34R11

② 3/32 inch (2.4 mm) high lettering.

③ 1/8 inch (3.2 mm) high lettering.

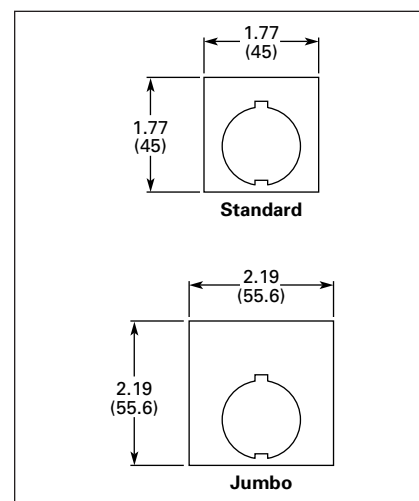

Figure 47-128. Approximate Dimensions in Inches (mm)

Table 47-302. Blank Plastic Legend Plates — Square

Price Each — U.S. \$					
Colors			Catalog Number		
Lettering	Field		Standard	Jumbo	Extra Large
	Side 1	Side 2			
Black	White	Silver	10250TSP76	10250TLP76	10250TEP76
White	Red	Black	10250TSP77	10250TLP77	10250TEP77



Legend Plates with Non-standard Markings or Aluminum Legend Plates

See 10250T listing on Page 47-152.

Enclosures

Die Cast, Polyester and Stainless Steel Enclosures

Table 47-303. Enclosures (Case and Cover) — Surface Mounting ①

	Number of Elements	1 Contact Block Depth		2 Contact Block Depth	
		Catalog Number	Price U.S. \$	Catalog Number	Price U.S. \$
 Die Cast Enclosure — Cat. No. E34N11	Cast Enclosure — In-Line ②③ NEMA 4, 4X, 12, 13				
	1	E34N1		E34N11	
	2	E34N2		E34N12	
	3	E34N3		E34N13	
	4	E34N4		E34N14	
 Polyester Enclosure — Cat. No. E34N52	Polyester — In-Line NEMA 3, 4X, 12				
	1	—		E34N51	
	2	—		E34N52	
	3	—		E34N53	
	4	—		E34N54	
 Stainless Steel Enclosure — Cat. No. 10250TN35	Stainless Steel ④ — In-Line NEMA 4, 4X, 12				
	1	—		10250TN33	
	2	—		10250TN34	
	3	—		10250TN35	
	4	—		10250TN36	

① For spacing increments, see **Page 47-186**.

② All cast enclosures can be converted to base mounting of contact blocks, with spacers 10250TA22 or 10250TA23. See listing on **Page 47-156**.

③ When used with E30 pushbuttons, only the one element enclosure can be used.

④ 14 gauge, type 304.

Table 47-304. Approximate Dimensions

Number of Elements	Element Arrangement	Surface Mounting					Conduit Entrance	Approximate Dimensions
		Dimensions in Inches (mm)						
		Wide A	High B	Deep C	Mounting			
				D	E			
Cast								
1	In-Line	3.88 (98.6)	4.0 (101.6)	3.0 (76.3) ⑥	2.69 (68.3)	3.25 (82.6)	3/4	
2	In-Line	3.88 (98.6)	5.88 (149.4)	3.0 (76.3) ⑥	2.69 (68.3)	5.13 (130.3)	3/4	
3	In-Line	3.88 (98.6)	7.75 (196.9)	3.0 (76.3) ⑥	2.69 (68.3)	7.0 (177.8)	1	
4	In-Line	3.88 (98.6)	9.63 (244.6)	3.0 (76.3) ⑥	2.69 (68.3)	8.88 (225.6)	1	
Polyester								
1	In-Line	3.81 (96.8)	6.63 (168.4)	3.38 (85.9)	2.94 (74.7)	4.88 (124.0)	⑤	
2	In-Line	3.81 (96.8)	6.63 (168.4)	3.38 (85.9)	2.94 (74.7)	4.88 (124.0)		
3	In-Line	3.81 (96.8)	8.88 (225.6)	3.38 (85.9)	2.94 (74.7)	7.13 (181.1)		
4	In-Line	3.81 (96.8)	11.13 (282.7)	3.38 (85.9)	2.94 (74.7)	9.38 (238.3)		
Stainless Steel								
1	In-Line	3.00 (76.2)	3.50 (88.9)	3.00 (76.2)	1.50 (38.1)	4.25 (108.0)	⑤	
2	In-Line	3.50 (88.9)	6.75 (171.5)	3.00 (76.2)	1.50 (38.1)	7.50 (190.5)		
3	In-Line	3.50 (88.9)	9.00 (228.6)	3.00 (76.2)	1.50 (38.1)	9.00 (228.6)		
4	In-Line	3.50 (88.9)	11.25 (285.8)	3.00 (76.2)	1.50 (38.1)	12.00 (304.8)		

⑤ No conduit entrance holes provided. Drill as required.

⑥ Depth given is for two contact block deep stations. One contact block deep stations subtract 3/4 inch (19.1 mm).

Note: These E34 Die Cast Enclosures feature a corrosion resistant coating identical to finish on the E34 operators except gray in color. Not for use in ultraviolet light applications.



One Contact Block Depth Enclosure



Two Contact Block Depth Enclosure

4 Mtg. Holes — 10-32 Screw Size for 1 – 4 Element Die Cast/ Stainless Steel Enclosure
7/32 Screw Size for Polyester

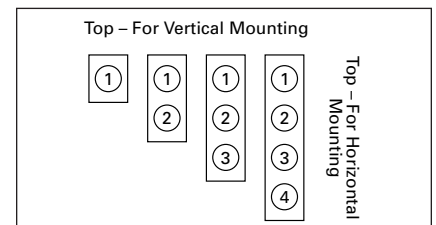
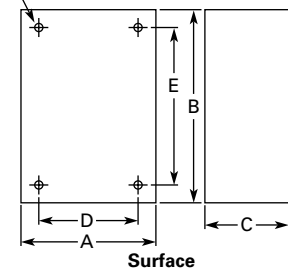

Figure 47-129. Enclosure Layouts

E34 Series, Enclosures

Enclosures (Continued)

Die Cast and Stainless Steel — Flush Mount, Covers Only

These E34 Die Cast Covers feature a corrosion resistant coating identical to the finish on the E34 operators except gray in color.

Table 47-305. Covers Only — Flush Mounting

	Number of Elements	Catalog Number	Price U.S. \$	Catalog Number	Price U.S. \$
	Flush Cast Covers				
			In-Line Deep Cover		In-Line Flat Cover
	1	E34F11		E34F1	
	2	E34F12		E34F2	
	3	E34F13		E34F3	
	4	E34F14		E34F4	
	In-Line Stainless Steel Flush Plates ①				
			With Pullbox		Without Pullbox
	1	10250TS10		10250TS1	
	2	10250TS11		10250TS2	
3	10250TS12		10250TS3		
4	10250TS14		10250TS4		

① Not oiltight. NEMA 1 applications only.

Table 47-306. Approximate Dimensions

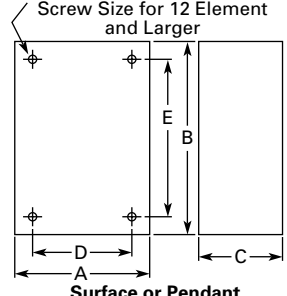
Number of Elements	Flush Mounting					Approximate Dimensions
	Dimensions in Inches (mm)					
	Wide A	High B	Deep C	Mounting		
				D	E	
Cast						
1	3.88 (98.6)	4.0 (101.6)	0.25 (6.4) ②	3.50 (88.9)	3.63 (92.2)	
2	3.88 (98.6)	5.88 (149.4)	0.25 (6.4) ②	3.50 (88.9)	5.50 (139.7)	
3	3.88 (98.6)	7.75 (196.9)	0.25 (6.4) ②	3.50 (88.9)	6.0 (152.4)	
4	3.88 (98.6)	9.63 (244.6)	0.25 (6.4) ②	3.50 (88.9)	9.25 (235)	
Stainless Steel						
1	5.0 (127)	5.0 (127)	2.50 (63.5) ③	3.25 (82.6)	1.88 (47.8)	
2	5.0 (127)	6.88 (174.8)	2.50 (63.5) ③	3.25 (82.6)	3.63 (92.2)	
3	5.0 (127)	8.63 (219.2)	2.50 (63.5) ③	3.25 (82.6)	5.50 (139.7)	
4	5.0 (127)	10.50 (266.7)	2.50 (63.5) ③	3.25 (82.6)	7.25 (184.2)	

② Depth given is for flat cover. Deep cover 3/4 inch (19.1 mm) deeper.

③ Depth given includes pull box.

Table 47-307. Spacing Increments

Type	Approximate Dimensions in Inches (mm)		
	F	G	H
Cast	2.44 (62)	2.5 (63.5)	1.88 (47.8)
Polyester	1.88 (47.8)	Min. 2.13 (54.1)	2.25 (57.2)
Stainless Steel	1.69 (42.9)	Min. 1.73 (43.9)	2.25 (57.2)

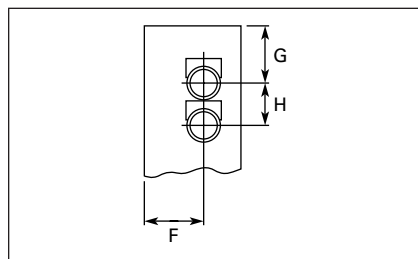

Figure 47-130. Spacing Increments for Enclosures

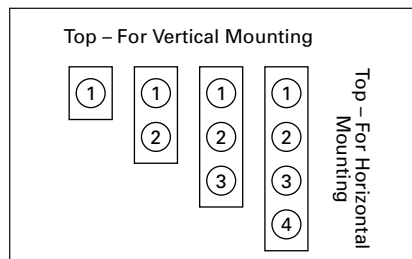

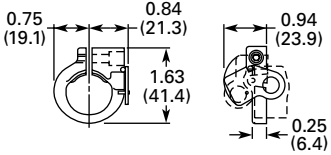

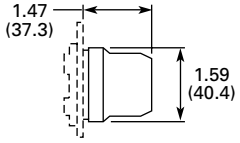
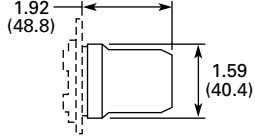

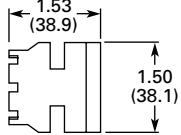

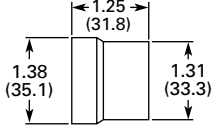

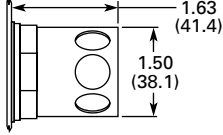



Figure 47-131. Enclosure Layouts

Accessories



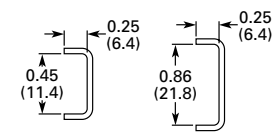

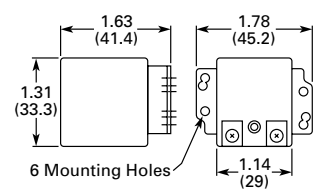

Table 47-308. Accessories

Description	Catalog Number	Price U.S. \$	Overall Dimensions in Inches (mm)	
 <p>Padlocking Attachment for Flush Pushbutton Operators. Permits locking NC contacts in open position with 1/4" padlock. Will not lock NO contact.</p>	E34TA2			
	<p>Flexible Weather Resistant Boot for use with flush pushbutton operators.</p>	<p>Clear Black Red Green</p>	<p>10250TA46 10250TA47 10250TA48 10250TA49</p>	
	<p>Flexible Weather Resistant Boot for use with button operators (extended buttons preferred).</p>	<p>Black Red Green Clear</p>	<p>10250TA3 10250TA4 ① 10250TA10 10250TA85</p>	
	<p>Transparent Boot for regular, illuminated pushbutton operators and PresTest.</p>		<p>10250TA25 ②</p>	
 <p>Special Retaining Nut — to accommodate thick panel. Indicating light PresTest, pushbuttons and selector switches</p>	<p>E34TA30 E34TA31</p>			
 <p>Shroud for Mushroom Head Operator — prevents accidental operation. (Not for Push-Pull operators.)</p>	E34TA6			
 <p>Extended Retaining Nut — Replaces standard nut and provides guard for flush type pushbutton operators.</p>	E34TA12			
 <p>Guard for Illuminated Pushbutton</p>	E34TA15			
 <p>Padlocking Attachment for non-illuminated knob selector switches — accommodates up to 5, 1/4" padlocks.</p>	E34TA11			

① Should not be used on flush button for STOP function.
② Not suitable for single contact block depth cast enclosure. Cover is too thick.

E34 Series, Accessories

Table 47-308. Accessories (Continued)

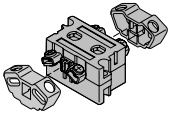
Description	Catalog Number	Price U.S. \$	Overall Dimensions in Inches (mm)
 Thrust Washer — To meet Ford Motor Company mounting specifications.	E34TK3		
 Contact Block Terminal Jumps — Available in multiples of 100 only. Term. to Term. — Within Block (short): 100 per package 1000 per package Terminal to Terminal — Block to Block (long): 100 per package 1000 per package	10250TA70 10250TA70-2 10250TA71 10250TA71-2		 0.25 (6.4) 0.45 (11.4) 0.86 (21.8)
 Master Test (Dual Input) Module — Internal Form C relay suitable for either AC or DC applications. Total electrical isolation between monitored and test circuit. Fits all illuminated 10250T, E22, E30 and E34 devices. 48V DC	10250TMT8		 1.63 (41.4) 1.78 (45.2) 1.31 (33.3) 1.14 (29) 6 Mounting Holes
 Flasher Module — Internal Form C relay suitable for AC applications. One unit required for each operator in master test circuit. 24V AC 120V AC	10250TFL2 10250TFL1		
 Panel Mounting Nut Wrench — E22, E30, E34 and Octagonal 10250T.	E22CW		
 Fingerproof Shroud — 10 per Package Fits new style contact blocks and light units.	10250TA101		

47

Table 47-309. Replacement Lamps — For E34 Illuminated Operators

Mfg. Lamp Type	Voltage	Base Style	Application	Part Number	Price U.S. \$
120MB	120V	T 3-1/4 Bayonet	10250T Resistor Indicating Light	28-3044	
#267	6.3V	T 3-1/4 Bayonet	10250T Flasher	10250ED986-4	
#755	6.3V	T 3-1/4 Bayonet	10250T Transformer, PresTest and Full Voltage	28-2202	
#756	12V	T 3-1/4 Bayonet	10250T Full Voltage	28-5184	
#757	24V	T 3-1/4 Bayonet	10250T Full Voltage	28-5185	
#1828	32V	T 3-1/4 Bayonet	10250T Full Voltage	28-5186	
#1835	55V	T 3-1/4 Bayonet	10250T Resistor	28-5187	
NE48	120V	T 4-1/2 Bayonet	10250T Neon	28-494	
NE51H-R22	120V	T 3-1/4 Bayonet	10250T Neon	28-3754	
NE51H-R68	240V	T 3-1/4 Bayonet	10250T Neon	28-3755	

Discount Symbol **1CD1C**

Renewal Parts



Flush Head Pushbutton Operator



Mushroom Head Pushbutton Operator

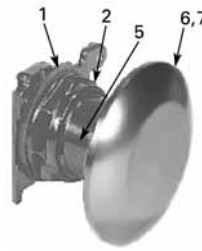

Jumbo Mushroom Head Operator

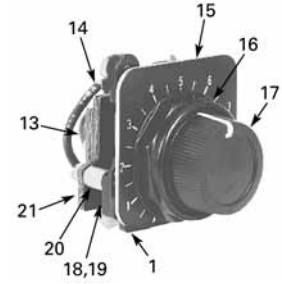

Potentiometers



Illuminated Pushbutton Operator



Transformer Type Indicating Light



Knob-Operated Selector Switch Operator

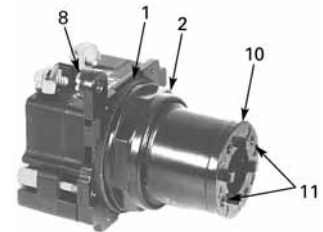

Full Voltage, Resistor and Transformer Type Illuminated Selector Switch

Table 47-310. Numbers Listed Are for E34 Style Operators

Item No.	Description	No. Req.	Part Number	Price U.S. \$
1	Gasket	1	16-1548	
2	Mounting Nut	1	15-1530-4	
3	Set Screw (#6-32 x 0.250" Long Hollow Hex)	2	11-2014	
4	Mushroom Head Button (Includes (2) Item 5) Black Red Yellow Green Blue	1 — — — — —	As Req. Below 53-1317 53-1317-2 53-1317-3 53-1317-4 53-1317-22	
5	Set Screw (#10-32 x 0.250" Long Hollow Hex)	2	11-544	
6	Jumbo Mushroom Head Button (Aluminum — Includes (2) Item 5) Red Black Yellow Green	1 — — — —	As Req. Below 53-1317-9 53-1317-10 53-1317-11 53-1317-12	
7	Jumbo Mushroom Head Button (Aluminum — Red EMERG. STOP) Does Not Include Item 5	1	53-1349-18	
8	Mounting Screw (#6-32 x 0.710" Long) Washer	2 2	10250TA79 16-2038	
9	Terminal Screw and Lug (Captive)	Req.	80-5502	
10	Gasket (Supplied with Basic Unit)	1	32-803	
11	Round Head Screw (#4-40 x 0.344" Long) (Supplied with Basic Unit)	2	11-4553	

Item No.	Description	No. Req.	Part Number	Price U.S. \$
12	Mounting Screw	2	11-1632	
13	Simple Potentiometer (Does Not Include Items 18, 28 or 29) 1,000 Ohms 2,500 Ohms 5,000 Ohms 10,000 Ohms 25,000 Ohms 50,000 Ohms	1 — — — — —	As Req. Below 41-782-2 41-782-3 41-782-10 41-782-4 41-782-5 41-782-6	
14	Connector (Includes Screw and Lug)	2	25-1851	
15	Indicating Plate Standard Size (Without Legend) Large Size (Specify Legend)	1 — —	As Req. Above 30-4460 10250TR30	
16	Retaining Nut	1	15-1547-3	
17	Knob Socket Set Screw (#6-32 x 0.250" Long)	1 1	53-1314 11-2014	
18	Coupling	1 1	11-2014 29-3749-2	
19	Set Screw (#6-32 x 0.188" Long)	1	11-1199	
20	Spacer	2	56-1066-18	
21	Connector (Includes Screw and Lug)	1	25-1851-2	
22	Mounting Nut	1	15-1938-2	

E34 Series, Mounting Options

Mounting

Panel Thickness

- Minimum: 0.06 inch (1.6 mm)
- Maximum: 0.25 inch (8 mm) including legend plate
- Maximum can be increased to 0.375 inch (15.9 mm) using optional retaining nut
 - Indicating light: E34TA30
 - Pushbutton/selector switch: E34TA31

Table 47-311. Mounting Matrix

Legend Plate	Dimensions in Inches (mm)			
	A	B	C	D
Small	1.63 (41.3)	2.25 (57.2)	2.25 (57.2)	1.63 (41.3)
Medium	1.75 (44.5)	2.25 (57.2)	2.25 (57.2)	1.75 (44.5)
Large	2.25 (57.2)	2.25 (57.2)	2.25 (57.2)	2.25 (57.2)

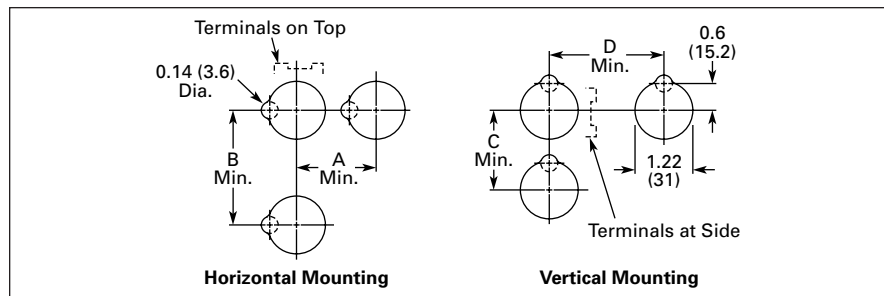

Figure 47-132. Mounting Options in Inches (mm)

Horizontal mounting means terminals are located top and bottom of contact block. Vertical mounting means terminals are left and right of contact block. This allows close spacing of adjacent operators with easy access to terminals.

Note: Locating nib hole or notch is 0.14 inch (3.6 mm)

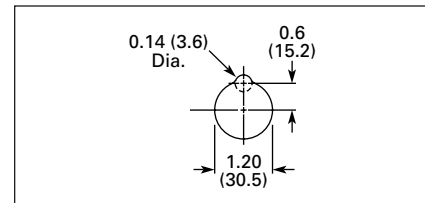

Figure 47-133. Drilling Dimensions in Inches (mm)

Dimensions

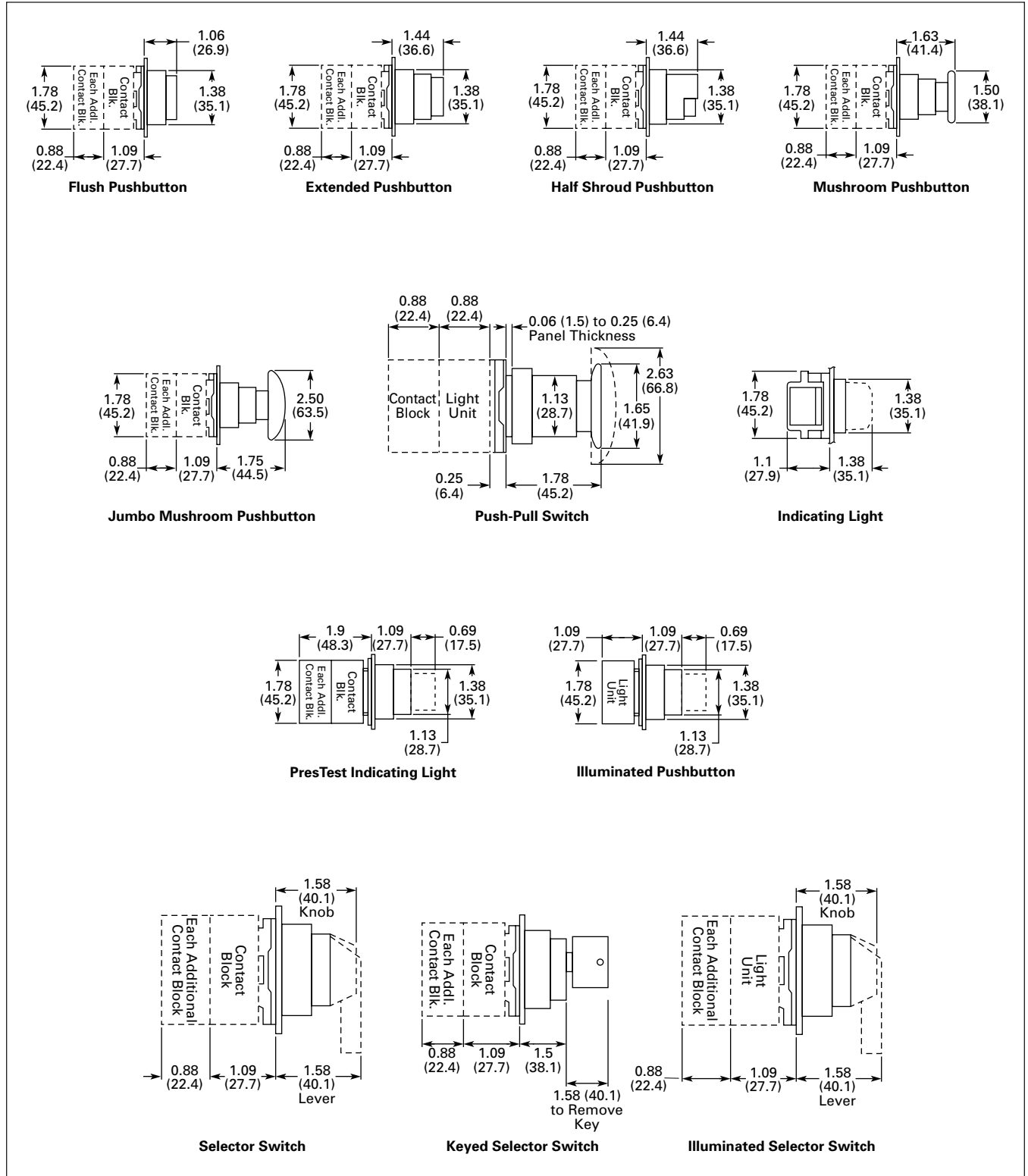

Figure 47-134. Approximate Dimensions in Inches (mm)

E34 Series, Ordering Example

Ordering Complete Devices

Complete E34 Pushbuttons, Indicating Lights and/or Selector Switch operators including contact block(s) and legend plate can be ordered using a single composite catalog number. The individually packaged components will be shipped unassembled in a single overpack carton marked with the composite Catalog Number.

Ordering Example

Illuminated Pushbutton Device —
Catalog Number E34XB120V2-153SP90

Table 47-312. Catalog Numbering System

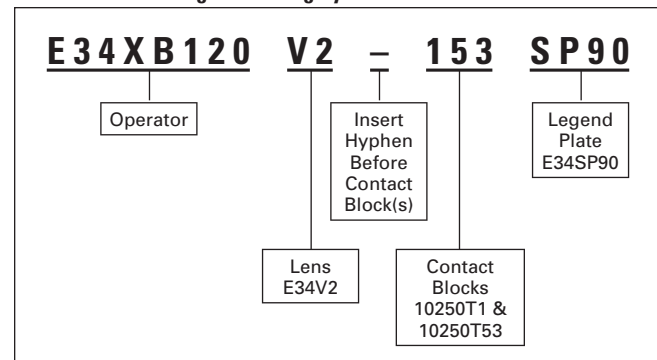

For a complete Catalog Number breakdown, see
Pages 47-193 – 47-194.

Catalog Number Structure

Table 47-313. Non-illuminated Pushbuttons Catalog Numbering System

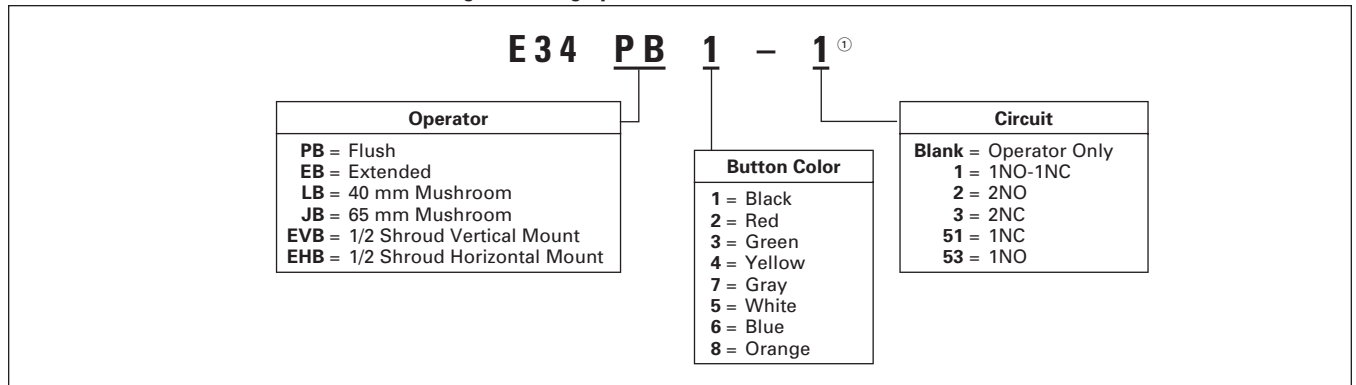

① Add X at end of Catalog Number to receive parts assembled from factory.

Table 47-314. Illuminated and Non-illuminated Push-Pulls Catalog Numbering System

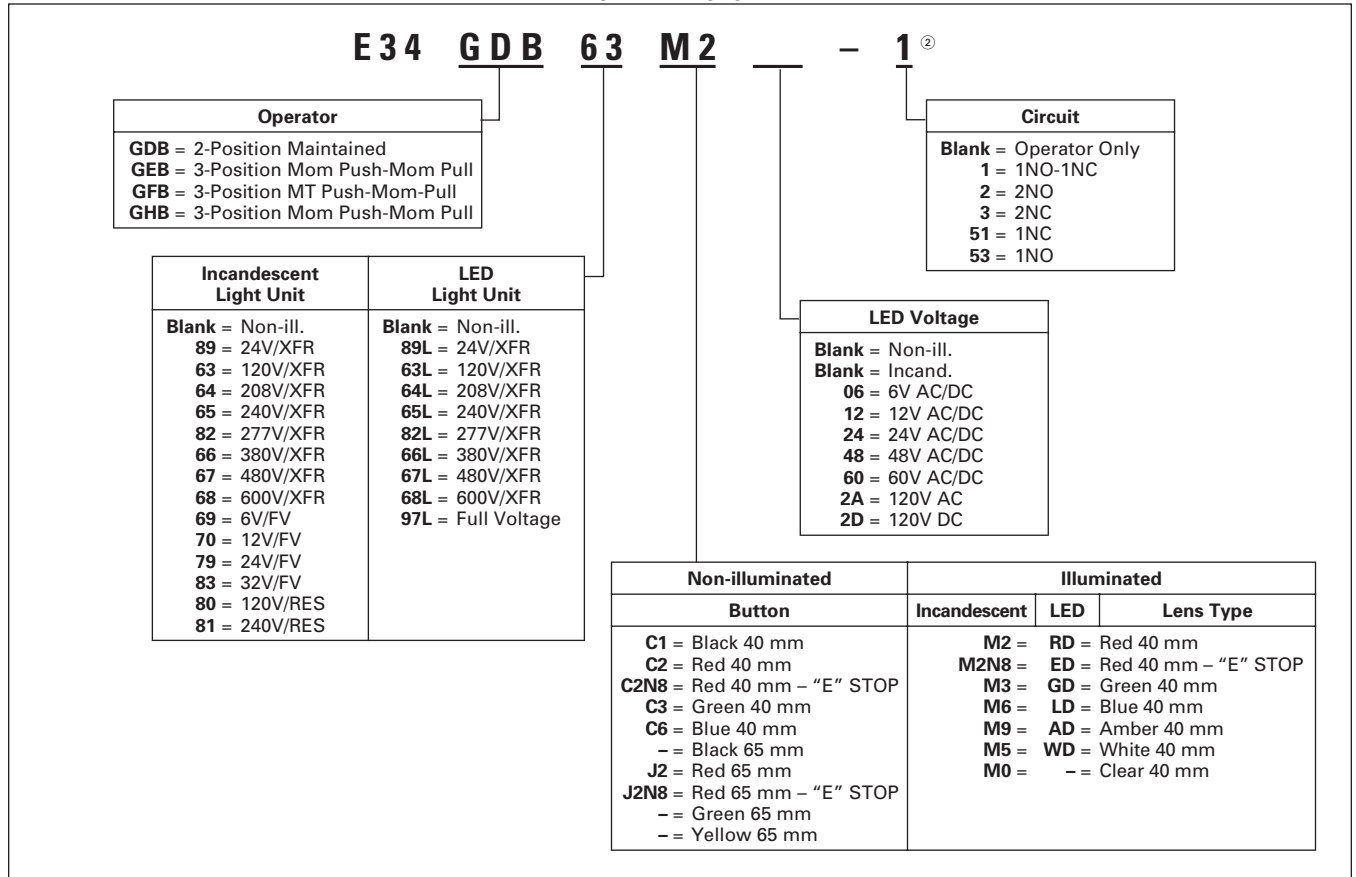

② Add X at end of Catalog Number to receive parts assembled from factory.

E34 Series, Catalog Number Structure

Table 47-315. Illuminated Pushbuttons Catalog Numbering System

E 34 X B 24 V 2 - 1 ^①																																									
<table border="1" style="width: 100%; border-collapse: collapse;"> <tr> <th colspan="2" style="text-align: center;">Light Unit Type</th> </tr> <tr> <td colspan="2">XB = Transformer</td> </tr> <tr> <td colspan="2">CB = Full Voltage</td> </tr> <tr> <td colspan="2">SB = Resistor</td> </tr> </table>	Light Unit Type		XB = Transformer		CB = Full Voltage		SB = Resistor		<table border="1" style="width: 100%; border-collapse: collapse;"> <tr> <th colspan="2" style="text-align: center;">Circuit</th> </tr> <tr> <td colspan="2">Blank = Operator Only</td> </tr> <tr> <td colspan="2">1 = 1NO-1NC</td> </tr> <tr> <td colspan="2">2 = 2NO</td> </tr> <tr> <td colspan="2">3 = 2NC</td> </tr> <tr> <td colspan="2">51 = 1NC</td> </tr> <tr> <td colspan="2">53 = 1NO</td> </tr> </table>	Circuit		Blank = Operator Only		1 = 1NO-1NC		2 = 2NO		3 = 2NC		51 = 1NC		53 = 1NO																			
Light Unit Type																																									
XB = Transformer																																									
CB = Full Voltage																																									
SB = Resistor																																									
Circuit																																									
Blank = Operator Only																																									
1 = 1NO-1NC																																									
2 = 2NO																																									
3 = 2NC																																									
51 = 1NC																																									
53 = 1NO																																									
<table border="1" style="width: 100%; border-collapse: collapse;"> <tr> <th style="width: 50%;">Incandescent Light Unit</th> <th style="width: 50%;">LED Light Unit</th> </tr> <tr> <td>024 = 24V/XFR</td> <td>024L = 24V/XFR</td> </tr> <tr> <td>120 = 120V/XFR</td> <td>120L = 120V/XFR</td> </tr> <tr> <td>240 = 240V/XFR</td> <td>240L = 240V/XFR</td> </tr> <tr> <td>277 = 277V/XFR</td> <td>277L = 277V/XFR</td> </tr> <tr> <td>380 = 380V/XFR</td> <td>380L = 380V/XFR</td> </tr> <tr> <td>480 = 480V/XFR</td> <td>480L = 480V/XFR</td> </tr> <tr> <td>600 = 600V/XFR</td> <td>600L = 600V/XFR</td> </tr> <tr> <td>06 = 6V/FV</td> <td>497L = Full Voltage</td> </tr> <tr> <td>12 = 12V/FV</td> <td></td> </tr> <tr> <td>24 = 24V/FV</td> <td></td> </tr> <tr> <td>32 = 32V/FV</td> <td></td> </tr> <tr> <td>48 = 48V/FV</td> <td></td> </tr> <tr> <td>120 = 120V/RES</td> <td></td> </tr> <tr> <td>240 = 240V/RES</td> <td></td> </tr> </table>	Incandescent Light Unit	LED Light Unit	024 = 24V/XFR	024L = 24V/XFR	120 = 120V/XFR	120L = 120V/XFR	240 = 240V/XFR	240L = 240V/XFR	277 = 277V/XFR	277L = 277V/XFR	380 = 380V/XFR	380L = 380V/XFR	480 = 480V/XFR	480L = 480V/XFR	600 = 600V/XFR	600L = 600V/XFR	06 = 6V/FV	497L = Full Voltage	12 = 12V/FV		24 = 24V/FV		32 = 32V/FV		48 = 48V/FV		120 = 120V/RES		240 = 240V/RES		<table border="1" style="width: 100%; border-collapse: collapse;"> <tr> <th colspan="2" style="text-align: center;">LED Voltage</th> </tr> <tr> <td>Blank = Incand.</td> <td>48 = 48V AC/DC</td> </tr> <tr> <td>06 = 6V AC/DC</td> <td>60 = 60V AC/DC</td> </tr> <tr> <td>12 = 12V AC/DC</td> <td>2A = 120V AC</td> </tr> <tr> <td>24 = 24V AC/DC</td> <td>2D = 120V DC</td> </tr> </table>	LED Voltage		Blank = Incand.	48 = 48V AC/DC	06 = 6V AC/DC	60 = 60V AC/DC	12 = 12V AC/DC	2A = 120V AC	24 = 24V AC/DC	2D = 120V DC
Incandescent Light Unit	LED Light Unit																																								
024 = 24V/XFR	024L = 24V/XFR																																								
120 = 120V/XFR	120L = 120V/XFR																																								
240 = 240V/XFR	240L = 240V/XFR																																								
277 = 277V/XFR	277L = 277V/XFR																																								
380 = 380V/XFR	380L = 380V/XFR																																								
480 = 480V/XFR	480L = 480V/XFR																																								
600 = 600V/XFR	600L = 600V/XFR																																								
06 = 6V/FV	497L = Full Voltage																																								
12 = 12V/FV																																									
24 = 24V/FV																																									
32 = 32V/FV																																									
48 = 48V/FV																																									
120 = 120V/RES																																									
240 = 240V/RES																																									
LED Voltage																																									
Blank = Incand.	48 = 48V AC/DC																																								
06 = 6V AC/DC	60 = 60V AC/DC																																								
12 = 12V AC/DC	2A = 120V AC																																								
24 = 24V AC/DC	2D = 120V DC																																								
<table border="1" style="width: 100%; border-collapse: collapse;"> <tr> <th style="width: 50%;">Incandescent Lens Color</th> <th style="width: 50%;">LED Lens Color</th> </tr> <tr> <td>V2 = Red</td> <td>RD = Red</td> </tr> <tr> <td>V3 = Green</td> <td>GD = Green</td> </tr> <tr> <td>V4 = Yellow</td> <td>YD = Yellow</td> </tr> <tr> <td>V5 = White</td> <td>WD = White</td> </tr> <tr> <td>V6 = Blue</td> <td>LD = Blue</td> </tr> <tr> <td>V9 = Amber</td> <td>AD = Amber</td> </tr> <tr> <td>V0 = Clear</td> <td></td> </tr> </table>	Incandescent Lens Color	LED Lens Color	V2 = Red	RD = Red	V3 = Green	GD = Green	V4 = Yellow	YD = Yellow	V5 = White	WD = White	V6 = Blue	LD = Blue	V9 = Amber	AD = Amber	V0 = Clear		<table border="1" style="width: 100%; border-collapse: collapse;"> <tr> <th colspan="2" style="text-align: center;">LED Lens Color</th> </tr> <tr> <td>RD = Red</td> <td></td> </tr> <tr> <td>GD = Green</td> <td></td> </tr> <tr> <td>YD = Yellow</td> <td></td> </tr> <tr> <td>WD = White</td> <td></td> </tr> <tr> <td>LD = Blue</td> <td></td> </tr> <tr> <td>AD = Amber</td> <td></td> </tr> </table>	LED Lens Color		RD = Red		GD = Green		YD = Yellow		WD = White		LD = Blue		AD = Amber											
Incandescent Lens Color	LED Lens Color																																								
V2 = Red	RD = Red																																								
V3 = Green	GD = Green																																								
V4 = Yellow	YD = Yellow																																								
V5 = White	WD = White																																								
V6 = Blue	LD = Blue																																								
V9 = Amber	AD = Amber																																								
V0 = Clear																																									
LED Lens Color																																									
RD = Red																																									
GD = Green																																									
YD = Yellow																																									
WD = White																																									
LD = Blue																																									
AD = Amber																																									

① Add X at end of Catalog Number to receive parts assembled from factory.

Table 47-316. Standard Indicating Lights, PresTest and Master Test Catalog Numbering System

E 34 F B 06 H 2 - ②																																																																																													
<table border="1" style="width: 100%; border-collapse: collapse;"> <tr> <th colspan="2" style="text-align: center;">Light Unit Type</th> </tr> <tr> <th style="width: 50%;">Standard - Incandescent</th> <th style="width: 50%;">Standard - LED</th> </tr> <tr> <td>TB120 = 120V/XFR</td> <td>TB120L = 120V/XFR</td> </tr> <tr> <td>TB240 = 240V/XFR</td> <td>TB240L = 240V/XFR</td> </tr> <tr> <td>TB277 = 277V/XFR</td> <td>TB277L = 277V/XFR</td> </tr> <tr> <td>TB380 = 380V/XFR</td> <td>TB380L = 380V/XFR</td> </tr> <tr> <td>TB480 = 480V/XFR</td> <td>TB480L = 480V/XFR</td> </tr> <tr> <td>TB600 = 600V/XFR</td> <td>TB600L = 600V/XFR</td> </tr> <tr> <td>FB06 = 6V/FV</td> <td>FB197L = Full Voltage</td> </tr> <tr> <td>FB12 = 12V/FV</td> <td></td> </tr> <tr> <td>FB24 = 24V/FV</td> <td></td> </tr> <tr> <td>FB32 = 32V/FV</td> <td></td> </tr> <tr> <td>FB48 = 48V/FV</td> <td></td> </tr> <tr> <td>RB120 = 120V/RES</td> <td></td> </tr> <tr> <td>RB240 = 240V/RES</td> <td></td> </tr> <tr> <td>NB120 = 120V/Neon</td> <td></td> </tr> <tr> <td>NB240 = 240V/Neon</td> <td></td> </tr> <tr> <th colspan="2" style="text-align: center;">PresTest - LED</th> </tr> <tr> <td>TPB120L = 120V/XFR</td> <td></td> </tr> <tr> <td>TPB240L = 240V/XFR</td> <td></td> </tr> <tr> <td>TPB380L = 380V/XFR</td> <td></td> </tr> <tr> <td>TPB480L = 480V/XFR</td> <td></td> </tr> <tr> <td>TPB600L = 600V/XFR</td> <td></td> </tr> <tr> <td>FPB297L = Full Voltage</td> <td></td> </tr> <tr> <th colspan="2" style="text-align: center;">PresTest - Incandescent</th> </tr> <tr> <td>TPB120 = 120V/XFR</td> <td></td> </tr> <tr> <td>TPB240 = 240V/XFR</td> <td></td> </tr> <tr> <td>TPB380 = 380V/XFR</td> <td></td> </tr> <tr> <td>TPB480 = 480V/XFR</td> <td></td> </tr> <tr> <td>TPB600 = 600V/XFR</td> <td></td> </tr> <tr> <td>FPB06 = 6V/FV</td> <td></td> </tr> <tr> <td>FPB12 = 12V/FV</td> <td></td> </tr> <tr> <td>FPB24 = 24V/FV</td> <td></td> </tr> <tr> <td>FPB32 = 32V/FV</td> <td></td> </tr> <tr> <td>FPB48 = 48V/FV</td> <td></td> </tr> <tr> <td>RPB120 = 120V/RES</td> <td></td> </tr> <tr> <td>RPB240 = 240V/RES</td> <td></td> </tr> </table>	Light Unit Type		Standard - Incandescent	Standard - LED	TB120 = 120V/XFR	TB120L = 120V/XFR	TB240 = 240V/XFR	TB240L = 240V/XFR	TB277 = 277V/XFR	TB277L = 277V/XFR	TB380 = 380V/XFR	TB380L = 380V/XFR	TB480 = 480V/XFR	TB480L = 480V/XFR	TB600 = 600V/XFR	TB600L = 600V/XFR	FB06 = 6V/FV	FB197L = Full Voltage	FB12 = 12V/FV		FB24 = 24V/FV		FB32 = 32V/FV		FB48 = 48V/FV		RB120 = 120V/RES		RB240 = 240V/RES		NB120 = 120V/Neon		NB240 = 240V/Neon		PresTest - LED		TPB120L = 120V/XFR		TPB240L = 240V/XFR		TPB380L = 380V/XFR		TPB480L = 480V/XFR		TPB600L = 600V/XFR		FPB297L = Full Voltage		PresTest - Incandescent		TPB120 = 120V/XFR		TPB240 = 240V/XFR		TPB380 = 380V/XFR		TPB480 = 480V/XFR		TPB600 = 600V/XFR		FPB06 = 6V/FV		FPB12 = 12V/FV		FPB24 = 24V/FV		FPB32 = 32V/FV		FPB48 = 48V/FV		RPB120 = 120V/RES		RPB240 = 240V/RES		<table border="1" style="width: 100%; border-collapse: collapse;"> <tr> <th colspan="2" style="text-align: center;">LED Voltage</th> </tr> <tr> <td colspan="2">Blank = Incand.</td> </tr> <tr> <td colspan="2">06 = 6V AC/DC</td> </tr> <tr> <td colspan="2">12 = 12V AC/DC</td> </tr> <tr> <td colspan="2">24 = 24V AC/DC</td> </tr> <tr> <td colspan="2">48 = 48V AC/DC</td> </tr> <tr> <td colspan="2">60 = 60V AC/DC</td> </tr> <tr> <td colspan="2">2A = 120V AC</td> </tr> <tr> <td colspan="2">2D = 120V DC</td> </tr> </table>	LED Voltage		Blank = Incand.		06 = 6V AC/DC		12 = 12V AC/DC		24 = 24V AC/DC		48 = 48V AC/DC		60 = 60V AC/DC		2A = 120V AC		2D = 120V DC	
Light Unit Type																																																																																													
Standard - Incandescent	Standard - LED																																																																																												
TB120 = 120V/XFR	TB120L = 120V/XFR																																																																																												
TB240 = 240V/XFR	TB240L = 240V/XFR																																																																																												
TB277 = 277V/XFR	TB277L = 277V/XFR																																																																																												
TB380 = 380V/XFR	TB380L = 380V/XFR																																																																																												
TB480 = 480V/XFR	TB480L = 480V/XFR																																																																																												
TB600 = 600V/XFR	TB600L = 600V/XFR																																																																																												
FB06 = 6V/FV	FB197L = Full Voltage																																																																																												
FB12 = 12V/FV																																																																																													
FB24 = 24V/FV																																																																																													
FB32 = 32V/FV																																																																																													
FB48 = 48V/FV																																																																																													
RB120 = 120V/RES																																																																																													
RB240 = 240V/RES																																																																																													
NB120 = 120V/Neon																																																																																													
NB240 = 240V/Neon																																																																																													
PresTest - LED																																																																																													
TPB120L = 120V/XFR																																																																																													
TPB240L = 240V/XFR																																																																																													
TPB380L = 380V/XFR																																																																																													
TPB480L = 480V/XFR																																																																																													
TPB600L = 600V/XFR																																																																																													
FPB297L = Full Voltage																																																																																													
PresTest - Incandescent																																																																																													
TPB120 = 120V/XFR																																																																																													
TPB240 = 240V/XFR																																																																																													
TPB380 = 380V/XFR																																																																																													
TPB480 = 480V/XFR																																																																																													
TPB600 = 600V/XFR																																																																																													
FPB06 = 6V/FV																																																																																													
FPB12 = 12V/FV																																																																																													
FPB24 = 24V/FV																																																																																													
FPB32 = 32V/FV																																																																																													
FPB48 = 48V/FV																																																																																													
RPB120 = 120V/RES																																																																																													
RPB240 = 240V/RES																																																																																													
LED Voltage																																																																																													
Blank = Incand.																																																																																													
06 = 6V AC/DC																																																																																													
12 = 12V AC/DC																																																																																													
24 = 24V AC/DC																																																																																													
48 = 48V AC/DC																																																																																													
60 = 60V AC/DC																																																																																													
2A = 120V AC																																																																																													
2D = 120V DC																																																																																													
<table border="1" style="width: 100%; border-collapse: collapse;"> <tr> <th style="width: 50%;">Standard/Master - Incandescent</th> <th style="width: 50%;">Standard/Master/PresTest - LED</th> </tr> <tr> <td>H2 = G2 = Red</td> <td>RP = RG = Red</td> </tr> <tr> <td>H3 = G3 = Green</td> <td>GP = GG = Green</td> </tr> <tr> <td>H4 = G4 = Yellow</td> <td>YP = YG = Yellow</td> </tr> <tr> <td>H5 = G5 = White</td> <td>WP = WG = White</td> </tr> <tr> <td>H6 = G6 = Blue</td> <td>LP = LG = Blue</td> </tr> <tr> <td>H9 = G9 = Amber</td> <td>AP = AG = Amber</td> </tr> <tr> <td>H0 = G0 = Clear</td> <td></td> </tr> </table>	Standard/Master - Incandescent	Standard/Master/PresTest - LED	H2 = G2 = Red	RP = RG = Red	H3 = G3 = Green	GP = GG = Green	H4 = G4 = Yellow	YP = YG = Yellow	H5 = G5 = White	WP = WG = White	H6 = G6 = Blue	LP = LG = Blue	H9 = G9 = Amber	AP = AG = Amber	H0 = G0 = Clear		<table border="1" style="width: 100%; border-collapse: collapse;"> <tr> <th colspan="2" style="text-align: center;">Plastic</th> <th colspan="2" style="text-align: center;">Glass</th> <th colspan="2" style="text-align: center;">Lens Color</th> </tr> <tr> <td></td> <td></td> <td></td> <td></td> <td></td> <td></td> </tr> </table>	Plastic		Glass		Lens Color																																																																							
Standard/Master - Incandescent	Standard/Master/PresTest - LED																																																																																												
H2 = G2 = Red	RP = RG = Red																																																																																												
H3 = G3 = Green	GP = GG = Green																																																																																												
H4 = G4 = Yellow	YP = YG = Yellow																																																																																												
H5 = G5 = White	WP = WG = White																																																																																												
H6 = G6 = Blue	LP = LG = Blue																																																																																												
H9 = G9 = Amber	AP = AG = Amber																																																																																												
H0 = G0 = Clear																																																																																													
Plastic		Glass		Lens Color																																																																																									
<table border="1" style="width: 100%; border-collapse: collapse;"> <tr> <th colspan="2" style="text-align: center;">PresTest - Incandescent</th> </tr> <tr> <td>V2 = P2 = Red</td> <td></td> </tr> <tr> <td>V3 = P3 = Green</td> <td></td> </tr> <tr> <td>V4 = P4 = Yellow</td> <td></td> </tr> <tr> <td>V5 = P5 = White</td> <td></td> </tr> <tr> <td>V6 = P6 = Blue</td> <td></td> </tr> <tr> <td>V9 = P9 = Amber</td> <td></td> </tr> <tr> <td>V0 = P0 = Clear</td> <td></td> </tr> </table>	PresTest - Incandescent		V2 = P2 = Red		V3 = P3 = Green		V4 = P4 = Yellow		V5 = P5 = White		V6 = P6 = Blue		V9 = P9 = Amber		V0 = P0 = Clear		<table border="1" style="width: 100%; border-collapse: collapse;"> <tr> <th colspan="2" style="text-align: center;">Plastic</th> <th colspan="2" style="text-align: center;">Glass</th> <th colspan="2" style="text-align: center;">Lens Color</th> </tr> <tr> <td></td> <td></td> <td></td> <td></td> <td></td> <td></td> </tr> </table>	Plastic		Glass		Lens Color																																																																							
PresTest - Incandescent																																																																																													
V2 = P2 = Red																																																																																													
V3 = P3 = Green																																																																																													
V4 = P4 = Yellow																																																																																													
V5 = P5 = White																																																																																													
V6 = P6 = Blue																																																																																													
V9 = P9 = Amber																																																																																													
V0 = P0 = Clear																																																																																													
Plastic		Glass		Lens Color																																																																																									

② Add X at end of Catalog Number to receive parts assembled from factory.

Contents

<i>Description</i>	<i>Page</i>
Product Description	47-195
Features	47-195
Benefits	47-195
Standards and Certifications	47-195
Technical Data and Specifications	47-196
Product Selection	
Momentary Pushbutton Units	47-197
Illuminated Pushbutton Units	47-198
Indicating Light Units	47-200
Push-Pull Units	47-201
Selector Switch Units	47-203
Selector Switch Contact Block Selection	47-205
Contact Blocks	47-205
Options	
Legend Plates	47-206
Accessories	47-208
Dimensions	47-210
Catalog Number Structure	47-214

Product Description

The Cutler-Hammer® HT800 Series from Eaton's electrical business is a family of 30.5 mm pushbutton devices which includes momentary, illuminated and mushroomhead pushbuttons, selector switches, indicating lights and push-pull switches. The HT800 devices have a familiar appearance found in most industrial applications and are suitable for replacement of several other manufacturers' 30.5 mm pushbutton devices.

Features

- Anodized aluminum mounting rings
- Watertight double V-gasket seals
- Extended height bulbs
- Transparent housing contact blocks
- Color-coded contact blocks
- Gold-plated contacts (on low voltage contact block)
- Reliability ridge on movable contact
- Stackable screw-mounted contact blocks
- Contact blocks can be mounted in left/right or top/bottom positions
- Standard NC contact opens before NO contact closes (break before make operation)
- Bright and long lasting LED indicating lights in six colors
- Field convertible maintained selector switches — from two- to three-position and vice versa
- Field selectable knob/lever mounting positions — at any 22.5° increment

Benefits

- Corrosion resistant NEMA 4X finish
- Watertight and oiltight NEMA 4, 13 ingress protection
- Increased side illumination of indicating lights and illuminated pushbuttons
- Easy visual inspection of contact conditions
- Easily identifiable NO (white) or NC (black) contact blocks
- Gold-plated contacts suitable for logic level circuits
- Reliability ridge penetrates contamination buildup on stationary contacts
- Left/right or top/bottom mounted contact blocks allow correct positioning in retrofit applications
- All-purpose selector switches are convertible and can rotate in 22.5° increments to suit panel layouts

Standards and Certifications

- UL508 per File No. E131568
- CSA C22.2 No. 14 per File No. LR68551

Ingress Protection

- UL (NEMA) Type 1, 2, 3, 3R, 4, 4X, 12 and 13 when mounted in similarly rated enclosures



HT800 Series

Technical Data and Specifications

Table 47-317. HT800 — Specifications

Description	Specification
Mechanical Ratings	
Frequency of Operation Pushbuttons Selector Switches Push-Pull Operators	6,000 Operations per hour 3,000 Operations per hour 3,000 Operations per hour
Mechanical Endurance/Life Pushbuttons Selector Switches Push-Pull Operators	10 x 10 ⁶ Operations 6K Ops/Hr with 6 NO on left and 6 NC on right 250 x 10 ³ Operations 3K Ops/Hr with 2 NO on left and 2 NC on right 250 x 10 ³ Operations 3K Ops/Hr with 6 NO on left and 6 NC on right
Climatic Conditions	
Operating Temperature	10° to 140°F (-12° to 60°C)
Storage Temperature	-40° to 176°F (-40° to 80°C)
Altitude	6,562 ft. (2,000m)
Humidity	95% RH @ 60°C
Terminals	
Contact Blocks	#6-32 posi-drive saddle clamp type, 1 x 16 AWG to 2 x 14 AWG, 12 in-lbs max.
Light Units	#6-32 posi-drive saddle clamp type, 1 x 22 AWG to 2 x 14 AWG, 7 in-lbs max.
Electrical Ratings	
Standard Contact Blocks UL (NEMA) Rating	See Table 47-318 .
Logic Level Contact Block Power Rating	5V 1 mA (minimum) 28V 500 mA (maximum)

Table 47-318. Electrical Ratings — HT800 Standard Contact Blocks, UL Rating

Description/Function	Contact Type	Catalog Number	AC	DC
Standard Normally Open contact	NO	HT8A	A600 ①	P600 ②
Standard Normally Closed contact	NC	HT8B	A600 ①	P600 ②
Normally Open Early Make Contact will make circuit before standard NO contact. DC ratings do not apply.	NOEM	HT8C	A600 ①	—
Normally Closed Late Break contact will open after standard NC contact. DC ratings do not apply.	NCLB	HT8D	A600 ①	—
Logic level, low voltage NO contact. Gold plated contacts.	NO	HT8E	5V 1 mA (minimum) 28V 500 mA (maximum)	

① Heavy duty.

② Standard duty.

Table 47-319. UL A600 and P600 Ratings

Description	Volts AC 50 or 60 Hz				Volts DC ③		
	120	240	480	600	125	250	600
Make and Emerg. Interrupting Capacity (Amp)	60	30	15	12	1.1	0.55	0.2
Normal Load Break (Amp)	6	3	1.5	1.2	1.1	0.55	0.2
Thermal Current (Amp)	10	10	10	10	5	5	5
Voltamperes:							
Make and Emerg. Interrupting Capacity	7200	7200	7200	7200	138 ④	138 ④	138 ④
Normal Load Break	720	720	720	720	138	138	138

③ DC ratings do not apply to NOEM (Normally Open Early Make) and NCLB (Normal Closed Late Break) contact blocks HT8C and HT8D.

④ Maximum make or break volt-amperes at 300V or less.

Product Selection

Momentary Pushbutton Units, Non-illuminated

- Flush, Extended or 40 mm Mushroom Head Operators



*Flush Head Operator
Cat. No. HT8AAH*



*Extended Head Operator
Cat. No. HT8ABH*



*40 mm Mushroom Head Operator
Cat. No. HT8AEH*

Table 47-320. Momentary Contact Pushbutton Units, Non-illuminated — UL (NEMA) Type 3, 3R, 4, 4X, 12 and 13

Contact Type	Button Color	Flush Head		Extended Head		Mushroom Head (40 mm)	
		Catalog Number	Price U.S. \$	Catalog Number	Price U.S. \$	Catalog Number	Price U.S. \$
No Contact	Black Red Green	HT8AAH HT8AAR HT8AAG		HT8ABH HT8ABR HT8ABG		HT8AEH HT8AER HT8AEG	
1NO	Black Red Green	HT8AAHA HT8AARA HT8AAGA		HT8ABHA HT8ABRA HT8ABGA		HT8AEHA HT8AERA HT8AEGA	
1NC	Black Red Green	HT8AAHB HT8AARB HT8AAGB		HT8ABHB HT8ABRB HT8ABGB		HT8AEHB HT8AERB HT8AEGB	
1NO-1NC	Black Red Green	HT8AAHAB HT8AARAB HT8AAGAB		HT8ABHAB HT8ABRAB HT8ABGAB		HT8AEHAB HT8AERAB HT8AEGAB	
2NO-2NC	Black Red Green	HT8AAHF1Q1 HT8AARF1Q1 HT8AAGF1Q1		HT8ABHF1Q1 HT8ABRF1Q1 HT8ABGF1Q1		HT8AEHF1Q1 HT8AERF1Q1 HT8AEGF1Q1	



NO Contact Block



NC Contact Block

Table 47-321. Contact Blocks ①

Description/Function	Contact Type	Catalog Number	Price U.S. \$
Standard Normally Open contact	NO	HT8A	
Standard Normally Closed contact	NC	HT8B	
Normally Open Early Make contact will make circuit before standard NO contact. DC ratings do not apply.	NOEM	HT8C	
Normally Closed Late Break contact will open after standard NC contact. DC ratings do not apply.	NCLB	HT8D	
Logic level, low voltage NO contact. Gold plated contacts.	NO	HT8E	

① Maximum of (4) contact blocks per side or a total of (8) contact blocks recommended.

Accessories Page 47-208
 Dimensions Page 47-210
 Legend Plates Page 47-206
 Discount Symbol 1CD1C

HT800 Series, Illuminated Pushbutton Units

Illuminated Pushbutton Units

- Incandescent or LED
- Full Voltage or Transformer Type
- 24V and 120V



*Illuminated Pushbutton Operator
 Cat. No. HT8GBRV7*

Table 47-322. Illuminated Pushbuttons — UL (NEMA) Type 3, 3R, 4, 4X, 12 and 13

Type	Volts	Lens Color	Operator Only		1NO		1NC		1NO-1NC		2NO-2NC	
			Catalog Number	Price U.S. \$	Catalog Number	Price U.S. \$	Catalog Number	Price U.S. \$	Catalog Number	Price U.S. \$	Catalog Number	Price U.S. \$
Incandescent Lamp												
Full Voltage	120V AC/DC	No Lens ① Red Green Amber Clear White Yellow Blue	HT8GBFV HT8GBRV7 HT8GBGV7 HT8GBAV7 HT8GBCV7 HT8GBWV7 HT8GBYV7 HT8GBBV7	—	HT8GBRAV7 HT8GBGAV7 HT8GBAAV7 HT8GBCAV7 HT8GBWAV7 HT8GBYAV7 HT8GBBAV7	—	HT8GBRBV7 HT8GBGBV7 HT8GBABV7 HT8GBCBV7 HT8GBWBV7 HT8GBYBV7 HT8GBBBV7	—	HT8GBRABV7 HT8GBGABV7 HT8GBAABV7 HT8GBCABV7 HT8GBWABV7 HT8GBYABV7 HT8GBBABV7	—	HT8GBRF1Q1V7 HT8GBGF1Q1V7 HT8GBAF1Q1V7 HT8GBCF1Q1V7 HT8GBWF1Q1V7 HT8GBYF1Q1V7 HT8GBBF1Q1V7	—
	24V AC/DC	No Lens ① Red Green Amber Clear White Yellow Blue	HT8GBFV HT8GBRV3 HT8GBGV3 HT8GBAV3 HT8GBCV3 HT8GBWV3 HT8GBYV3 HT8GBBV3	—	HT8GBRAV3 HT8GBGAV3 HT8GBAAV3 HT8GBCAV3 HT8GBWAV3 HT8GBYAV3 HT8GBBAV3	—	HT8GBRBV3 HT8GBGBV3 HT8GBABV3 HT8GBCBV3 HT8GBWBV3 HT8GBYBV3 HT8GBBBV3	—	HT8GBRABV3 HT8GBGABV3 HT8GBAABV3 HT8GBCABV3 HT8GBWABV3 HT8GBYABV3 HT8GBBABV3	—	HT8GBRF1Q1V3 HT8GBGF1Q1V3 HT8GBAF1Q1V3 HT8GBCF1Q1V3 HT8GBWF1Q1V3 HT8GBYF1Q1V3 HT8GBBF1Q1V3	—
Transformer	120V AC	No Lens ① Red Green Amber Clear White Yellow Blue	HT8GBT1 HT8GBRT1 HT8GBGT1 HT8GBAT1 HT8GBCT1 HT8GBWT1 HT8GBYT1 HT8GBBT1	—	HT8GBRAT1 HT8GBGAT1 HT8GBAAT1 HT8GBCAT1 HT8GBWAT1 HT8GBYAT1 HT8GBBAT1	—	HT8GBRBT1 HT8GBGBT1 HT8GBABT1 HT8GBCBT1 HT8GBWBT1 HT8GBYBT1 HT8GBBBT1	—	HT8GBRABT1 HT8GBGABT1 HT8GBAABT1 HT8GBCABT1 HT8GBWABT1 HT8GBYABT1 HT8GBBABT1	—	HT8GBRF1Q1T1 HT8GBGF1Q1T1 HT8GBAF1Q1T1 HT8GBCF1Q1T1 HT8GBWF1Q1T1 HT8GBYF1Q1T1 HT8GBBF1Q1T1	—
LED												
Full Voltage	120V AC/DC	No Lens ① Red Green Amber Clear White Yellow Blue	HT8GBFV HT8GBRF7 HT8GBGF7 HT8GBAF7 HT8GBCF7 HT8GBWF7 HT8GBYF7 HT8GBBF7	—	HT8GBRAF7 HT8GBGAF7 HT8GBAAF7 HT8GBCAF7 HT8GBWAF7 HT8GBYAF7 HT8GBBAF7	—	HT8GBRBF7 HT8GBGBF7 HT8GBABF7 HT8GBCBF7 HT8GBWBF7 HT8GBYBF7 HT8GBBBF7	—	HT8GBRABF7 HT8GBGABF7 HT8GBAABF7 HT8GBCABF7 HT8GBWABF7 HT8GBYABF7 HT8GBBABF7	—	HT8GBRF1Q1F7 HT8GBGF1Q1F7 HT8GBAF1Q1F7 HT8GBCF1Q1F7 HT8GBWF1Q1F7 HT8GBYF1Q1F7 HT8GBBF1Q1F7	—
	24V AC/DC	No Lens ① Red Green Amber Clear White Yellow Blue	HT8GBFV HT8GBRF3 HT8GBGF3 HT8GBAF3 HT8GBCF3 HT8GBWF3 HT8GBYF3 HT8GBBF3	—	HT8GBRAF3 HT8GBGAF3 HT8GBAAF3 HT8GBCAF3 HT8GBWAF3 HT8GBYAF3 HT8GBBAF3	—	HT8GBRBF3 HT8GBGBF3 HT8GBABF3 HT8GBCBF3 HT8GBWBF3 HT8GBYBF3 HT8GBBBF3	—	HT8GBRABF3 HT8GBGABF3 HT8GBAABF3 HT8GBCABF3 HT8GBWABF3 HT8GBYABF3 HT8GBBABF3	—	HT8GBRF1Q1F3 HT8GBGF1Q1F3 HT8GBAF1Q1F3 HT8GBCF1Q1F3 HT8GBWF1Q1F3 HT8GBYF1Q1F3 HT8GBBF1Q1F3	—
Transformer	120V AC	No Lens ① Red Green Amber Clear White Yellow Blue	HT8GBT1 HT8GBRL1 HT8GBGL1 HT8GBAL1 HT8GBCL1 HT8GBWL1 HT8GBYL1 HT8GBBL1	—	HT8GBRAL1 HT8GBGAL1 HT8GBAAL1 HT8GBCAL1 HT8GBWAL1 HT8GBYAL1 HT8GBBAL1	—	HT8GBRBL1 HT8GBGBL1 HT8GBABL1 HT8GBCBL1 HT8GBWBL1 HT8GBYBL1 HT8GBBBL1	—	HT8GBRABL1 HT8GBGABL1 HT8GBAABL1 HT8GBCABL1 HT8GBWABL1 HT8GBYABL1 HT8GBBABL1	—	HT8GBRF1Q1L1 HT8GBGF1Q1L1 HT8GBAF1Q1L1 HT8GBCF1Q1L1 HT8GBWF1Q1L1 HT8GBYF1Q1L1 HT8GBBF1Q1L1	—

① Light unit base operator without lens or bulb.

Accessories Page 47-208
 Dimensions Page 47-210
 Legend Plates Page 47-206
 Discount Symbol 1CD1C

Guarded Illuminated Pushbutton Units

- Incandescent or LED
- Full Voltage or Transformer Type
- 24V and 120V



*Guarded Illuminated Pushbutton Operator
Cat. No. HT8GDRV7*

Table 47-323. Guarded Illuminated Pushbuttons — UL (NEMA) Type 3, 3R, 4, 4X, 12 and 13

Type	Volts	Lens Color	Operator Only		1NO		1NC		1NO-1NC		2NO-2NC	
			Catalog Number	Price U.S. \$	Catalog Number	Price U.S. \$	Catalog Number	Price U.S. \$	Catalog Number	Price U.S. \$	Catalog Number	Price U.S. \$
Incandescent Lamp												
Full Voltage	120V AC/DC	No Lens ①	HT8GDFV	—	—	—	—	—	—	—	—	—
		Red	HT8GDRV7	HT8GDRAV7	HT8GDRBV7	HT8GDRABV7	HT8GDRF1Q1V7					
		Green	HT8GDGV7	HT8GDGAV7	HT8GDGBV7	HT8GDGABV7	HT8GDGF1Q1V7					
		Amber	HT8GDAV7	HT8GDAAV7	HT8GDABV7	HT8GDAABV7	HT8GDAF1Q1V7					
		Clear	HT8GDCV7	HT8GDCAV7	HT8GDCBV7	HT8GDCABV7	HT8GDCF1Q1V7					
		White	HT8GDWV7	HT8GDWAV7	HT8GDWVBV7	HT8GDWABV7	HT8GDWF1Q1V7					
Yellow	HT8GDYV7	HT8GDYAV7	HT8GDYBV7	HT8GDYABV7	HT8GDYF1Q1V7							
Blue	HT8GDBV7	HT8GDBAV7	HT8GDBBV7	HT8GDBABV7	HT8GDBF1Q1V7							
24V AC/DC	24V AC/DC	No Lens ①	HT8GDFV	—	—	—	—	—	—	—	—	—
		Red	HT8GDRV3	HT8GDRAV3	HT8GDRBV3	HT8GDRABV3	HT8GDRF1Q1V3					
		Green	HT8GDGV3	HT8GDGAV3	HT8GDGBV3	HT8GDGABV3	HT8GDGF1Q1V3					
		Amber	HT8GDAV3	HT8GDAAV3	HT8GDABV3	HT8GDAABV3	HT8GDAF1Q1V3					
		Clear	HT8GDCV3	HT8GDCAV3	HT8GDCBV3	HT8GDCABV3	HT8GDCF1Q1V3					
		White	HT8GDWV3	HT8GDWAV3	HT8GDWVBV3	HT8GDWABV3	HT8GDWF1Q1V3					
Yellow	HT8GDYV3	HT8GDYAV3	HT8GDYBV3	HT8GDYABV3	HT8GDYF1Q1V3							
Blue	HT8GDBV3	HT8GDBAV3	HT8GDBBV3	HT8GDBABV3	HT8GDBF1Q1V3							
Transformer	120V AC	No Lens ①	HT8GDT1	—	—	—	—	—	—	—	—	—
		Red	HT8GDR1	HT8GDRAT1	HT8GDRBT1	HT8GDRABT1	HT8GDRF1Q1T1					
		Green	HT8GDGT1	HT8GDGAT1	HT8GDGBT1	HT8GDGABT1	HT8GDGF1Q1T1					
		Amber	HT8GDAT1	HT8GDAAT1	HT8GDABT1	HT8GDAABT1	HT8GDAF1Q1T1					
		Clear	HT8GDCT1	HT8GDCAT1	HT8GDCBT1	HT8GDCABT1	HT8GDCF1Q1T1					
		White	HT8GDWT1	HT8GDWAT1	HT8GDWBT1	HT8GDWABT1	HT8GDWF1Q1T1					
Yellow	HT8GDYT1	HT8GDYAT1	HT8GDYBT1	HT8GDYABT1	HT8GDYF1Q1T1							
Blue	HT8GDBT1	HT8GDBAT1	HT8GDBBT1	HT8GDBABT1	HT8GDBF1Q1T1							
LED												
Full Voltage	120V AC/DC	No Lens ①	HT8GDFV	—	—	—	—	—	—	—	—	—
		Red	HT8GDRF7	HT8GDRAF7	HT8GDRBF7	HT8GDRABF7	HT8GDRF1Q1F7					
		Green	HT8GDGF7	HT8GDGAF7	HT8GDGBF7	HT8GDGABF7	HT8GDGF1Q1F7					
		Amber	HT8GDAF7	HT8GDAAF7	HT8GDABF7	HT8GDAABF7	HT8GDAF1Q1F7					
		Clear	HT8GDCF7	HT8GDCAF7	HT8GDCBF7	HT8GDCABF7	HT8GDCF1Q1F7					
		White	HT8GDWF7	HT8GDWAF7	HT8GDWBF7	HT8GDWABF7	HT8GDWF1Q1F7					
Yellow	HT8GDYF7	HT8GDYAF7	HT8GDYBF7	HT8GDYABF7	HT8GDYF1Q1F7							
Blue	HT8GDBF7	HT8GDBAF7	HT8GDBBF7	HT8GDBABF7	HT8GDBF1Q1F7							
24V AC/DC	24V AC/DC	No Lens ①	HT8GDFV	—	—	—	—	—	—	—	—	—
		Red	HT8GDRF3	HT8GDRAF3	HT8GDRBF3	HT8GDRABF3	HT8GDRF1Q1F3					
		Green	HT8GDGF3	HT8GDGAF3	HT8GDGBF3	HT8GDGABF3	HT8GDGF1Q1F3					
		Amber	HT8GDAF3	HT8GDAAF3	HT8GDABF3	HT8GDAABF3	HT8GDAF1Q1F3					
		Clear	HT8GDCF3	HT8GDCAF3	HT8GDCBF3	HT8GDCABF3	HT8GDCF1Q1F3					
		White	HT8GDWF3	HT8GDWAF3	HT8GDWBF3	HT8GDWABF3	HT8GDWF1Q1F3					
Yellow	HT8GDYF3	HT8GDYAF3	HT8GDYBF3	HT8GDYABF3	HT8GDYF1Q1F3							
Blue	HT8GDBF3	HT8GDBAF3	HT8GDBBF3	HT8GDBABF3	HT8GDBF1Q1F3							
Transformer	120V AC	No Lens ①	HT8GDT1	—	—	—	—	—	—	—	—	—
		Red	HT8GDR1	HT8GDRAL1	HT8GDRBL1	HT8GDRABL1	HT8GDRF1Q1L1					
		Green	HT8GDGL1	HT8GDGAL1	HT8GDGBL1	HT8GDGABL1	HT8GDGF1Q1L1					
		Amber	HT8GDAL1	HT8GDAAL1	HT8GDABL1	HT8GDAABL1	HT8GDAF1Q1L1					
		Clear	HT8GDCL1	HT8GDCL1	HT8GDCBL1	HT8GDCABL1	HT8GDCF1Q1L1					
		White	HT8GDWL1	HT8GDWAL1	HT8GDWBL1	HT8GDWABL1	HT8GDWF1Q1L1					
Yellow	HT8GDYL1	HT8GDYAL1	HT8GDYBL1	HT8GDYABL1	HT8GDYF1Q1L1							
Blue	HT8GDBL1	HT8GDBAL1	HT8GDBBL1	HT8GDBABL1	HT8GDBF1Q1L1							

① Light unit base operator without lens or bulb.

Accessories Page 47-208
 Dimensions Page 47-210
 Legend Plates Page 47-206
 Discount Symbol 1CD1C

HT800 Series, Indicating Light Units

Indicating Light Units

- Incandescent or LED
- Full Voltage or Transformer Type
- Standard and PresTest Types
- 24V and 120V

PresTest — This device incorporates a press-to-test feature whereby depressing the lens disconnects the light from the source being monitored and connects the lamp to a continuously energized circuit for immediate detection of faulty lamps.



*Indicating Light Unit
Cat. No. HT8HFRV7*



*PresTest Light Unit
Cat. No. HT8GTRV7*

Table 47-324. Indicating Light Units — UL (NEMA) Type 3, 3R, 4, 4X, 12 and 13

Type	Volts	Lens Color	Indicating Light		PresTest	
			Catalog Number	Price U.S. \$	Catalog Number	Price U.S. \$
Incandescent						
Full Voltage	120V AC/DC	No Lens ① Red Green Amber Clear White Yellow Blue	HT8HFFV HT8HFRV7 HT8HFGV7 HT8HFAV7 HT8HFCV7 HT8HFWV7 HT8HFYV7 HT8HFBV7		HT8GTFV HT8GTRV7 HT8GTGV7 HT8GTAV7 HT8GTCV7 HT8GTWV7 HT8GTYV7 HT8GTBV7	
	24V AC/DC	No Lens ① Red Green Amber Clear White Yellow Blue	HT8HFFV HT8HFRV3 HT8HFGV3 HT8HFAV3 HT8HFCV3 HT8HFWV3 HT8HFYV3 HT8HFBV3		HT8GTFV HT8GTRV3 HT8GTGV3 HT8GTAV3 HT8GTCV3 HT8GTWV3 HT8GTYV3 HT8GTBV3	
Transformer	120V AC 50/60 Hz	No Lens ① Red Green Amber Clear White Yellow Blue	HT8HBT1 HT8HBRT1 HT8HBGT1 HT8HBAT1 HT8HBCT1 HT8HBWT1 HT8HBYT1 HT8HBBT1		HT8GTT1 HT8GTRT1 HT8GTGT1 HT8GTAT1 HT8GTCT1 HT8GTWT1 HT8GTYT1 HT8GTBT1	
LED						
Full Voltage	120V AC/DC	No Lens ① Red Green Amber Clear White Yellow Blue	HT8HFFV HT8HFRF7 HT8HFGF7 HT8HFAF7 HT8HFCF7 HT8HFWF7 HT8HFYF7 HT8HFBF7		HT8GTFV HT8GTRF7 HT8GTGF7 HT8GTAF7 HT8GTCF7 HT8GTWF7 HT8GTYF7 HT8GTBF7	
	24V AC/DC	No Lens ① Red Green Amber Clear White Yellow Blue	HT8HFFV HT8HFRF3 HT8HFGF3 HT8HFAF3 HT8HFCF3 HT8HFWF3 HT8HFYF3 HT8HFBF3		HT8GTFV HT8GTRF3 HT8GTGF3 HT8GTAF3 HT8GTCF3 HT8GTWF3 HT8GTYF3 HT8GTBF3	
Transformer	120V AC 50/60 Hz	No Lens ① Red Green Amber Clear White Yellow Blue	HT8HBT1 HT8HBRL1 HT8HBGL1 HT8HBAL1 HT8HBCL1 HT8HBWL1 HT8HBYL1 HT8HBBL1		HT8GTT1 HT8GTRL1 HT8GTGL1 HT8GTAL1 HT8GTCL1 HT8GTWL1 HT8GTYL1 HT8GTBL1	



① Light unit base operator without lens or bulb.

Accessories Page 47-208
 Dimensions Page 47-210
 Legend Plates Page 47-206
 Discount Symbol 1CD1C

Push-Pull Units

- 40 mm Mushroom Head
- Two-Position Maintained
- Non-illuminated

**Table 47-325. 2-Position Push-Pull, Maintained, Non-illuminated —
UL (NEMA) Type 3, 3R, 4, 4X, 12 and 13**

Contact Type	Operator Position		Button Color	2-Position Maintained Push-Pull			
	 Maintained Out	 Maintained In		Round Head Mushroomhead Button		Flat Head Mushroomhead Button	
				Catalog Number	Price U.S. \$	Catalog Number	Price U.S. \$
No Contact	—	—	Black Red Green	HT8CBH HT8CBR HT8CBG		HT8DBH HT8DBR HT8DBG	
NO	O	X	Black Red Green	HT8CBHA HT8CBRA HT8CBGA		HT8DBHA HT8DBRA HT8DBGA	
NC	X	O	Black Red Green	HT8CBHB HT8CBRB HT8CBGB		HT8DBHB HT8DBRB HT8DBGB	
NO-NC	O X	X O	Black Red Green	HT8CBHAB HT8CBRAB HT8CBGAB		HT8DBHAB HT8DBRAB HT8DBGAB	
NCLB ^① NC	X X	O O	Black Red Green	HT8CBHD1B HT8CBRD1B HT8CBGD1B		HT8DBHD1B HT8DBRD1B HT8DBGD1B	
NCLB ^① NCLB ^①	X X	O O	Black Red Green	HT8CBHD1D HT8CBRD1D HT8CBGD1D		HT8DBHD1D HT8DBRD1D HT8DBGD1D	

① NCLB = Normally Closed Late Break.



NO Contact Block



NC Contact Block

Table 47-326. Contact Blocks^②

Description/Function	Contact Type	Catalog Number	Price U.S. \$
Standard Normally Open contact	NO	HT8A	
Standard Normally Closed contact	NC	HT8B	
Normally Open Early Make contact will make circuit before standard NO contact. DC ratings do not apply.	NOEM	HT8C	
Normally Closed Late Break contact will open after standard NC contact. DC ratings do not apply.	NCLB	HT8D	
Logic level, low voltage NO contact. Gold plated contacts.	NO	HT8E	

② Maximum of (4) contact blocks per side or a total of (8) contact blocks recommended.



**Round Head
2-Position Push-Pull Unit
Cat. No. HT8CBR**



**Flat Head
2-Position Push-Pull Unit
Cat. No. HT8DBH**

Accessories Page 47-208
 Dimensions Page 47-210
 Legend Plates Page 47-206
 Discount Symbol 1CD1C

HT800 Series, Illuminated Push-Pull Units

Illuminated Push-Pull Units

- Incandescent or LED
- Full Voltage or Transformer Type
- 24V and 120V



*Illuminated Push-Pull Unit
 Cat. No. HT8FBRABV7*

Table 47-327. Illuminated Push-Pull Units — UL (NEMA) Type 3, 3R, 4, 4X, 12 and 13

Type	Volts	Lens Color	Operator Only		1NO ①		1NC ①		1NO-1NC ①		2NCLB ①	
			Catalog Number	Price U.S. \$	Catalog Number	Price U.S. \$	Catalog Number	Price U.S. \$	Catalog Number	Price U.S. \$	Catalog Number	Price U.S. \$
Incandescent Lamp												
Full Voltage	120V AC/DC	Red Green	HT8FBRV7 HT8FBGV7		HT8FBRAV7 HT8FBGAV7		HT8FBRBV7 HT8FBGBV7		HT8FBRABV7 HT8FBGABV7		HT8FBRD1DV7 HT8FBGD1DV7	
	24V AC/DC	Red Green	HT8FBRV3 HT8FBGV3		HT8FBRAV3 HT8FBGAV3		HT8FBRBV3 HT8FBGBV3		HT8FBRABV3 HT8FBGABV3		HT8FBRD1DV3 HT8FBGD1DV3	
Transformer	120V AC	Red Green	HT8FBRT1 HT8FBGT1		HT8FBRA1 HT8FBGAT1		HT8FBRBT1 HT8FBGBT1		HT8FBRABT1 HT8FBGABT1		HT8FBRD1DT1 HT8FBGD1DT1	
LED												
Full Voltage	120V AC/DC	Red Green	HT8FBRF7 HT8FBGF7		HT8FBRAF7 HT8FBGAF7		HT8FBRBF7 HT8FBGBF7		HT8FBRABF7 HT8FBGABF7		HT8FBRD1DF7 HT8FBGD1DF7	
	24V AC/DC	Red Green	HT8FBRF3 HT8FBGF3		HT8FBRAF3 HT8FBGAF3		HT8FBRBF3 HT8FBGBF3		HT8FBRABF3 HT8FBGABF3		HT8FBRD1DF3 HT8FBGD1DF3	
Transformer	120V AC	Red Green	HT8FBRL1 HT8FBGL1		HT8FBRAL1 HT8FBGAL1		HT8FBRBL1 HT8FBGBL1		HT8FBRABL1 HT8FBGABL1		HT8FBRD1DL1 HT8FBGD1DL1	

① Complete illuminated push-pull switches will not fit in a standard 3" deep enclosure.

Accessories Page 47-208
 Contact Blocks Page 47-197
 Dimensions Page 47-210
 Legend Plates Page 47-206
 Discount Symbol 1CD1C

Selector Switch Units

- Two-, Three- and Four-Position
- Non-illuminated









*Standard Knob Operator
Cat. No.
HT8JAH3A*



*Standard Lever Operator
Cat. No.
HT8JDH3A*

Table 47-328. 2-Position Selector Switch Units, Non-illuminated — UL (NEMA) Type 3, 3R, 4, 4X, 12 and 13

Contact Type	Operator Position ①		Operating Mode M = Maintained S = Momentary		Standard Black Knob 		Standard Black Lever 	
					Catalog Number	Price U.S. \$	Catalog Number	Price U.S. \$
No Contacts	—	—	M S M	M M S	HT8JAH3A HT8JKH3A HT8JNH3A		HT8JDH3A HT8JLH3A HT8JPH3A	
1NO	O	X	M S M	M M S	HT8JAH3AA5 HT8JKH3AA5 HT8JNH3AA5		HT8JDH3AA5 HT8JLH3AA5 HT8JPH3AA5	
2NO	X O	O X	M S M	M M S	HT8JAH3AAA5 HT8JKH3AAA5 HT8JNH3AAA5		HT8JDH3AAA5 HT8JLH3AAA5 HT8JPH3AAA5	
2NO-2NC	X O X O	O X O X	M S M	M M S	HT8JAH3AF1Q1 HT8JKH3AF1Q1 HT8JNH3AF1Q1		HT8JDH3AF1Q1 HT8JLH3AF1Q1 HT8JPH3AF1Q1	

① X = closed circuit, O = open circuit.

Accessories Page 47-208
 Contact Blocks Page 47-205
 Dimensions Page 47-210
 Legend Plates Page 47-206
 Discount Symbol 1CD1C

HT800 Series, Selector Switch Units



Standard Knob Operator
Cat. No. HT8JBH1D



Standard Lever Operator
Cat. No. HT8JEH1D

Table 47-329. 3-Position Selector Switch Units, Non-illuminated — UL (NEMA) Type 3, 3R, 4, 4X, 12 and 13

Contact Type	Operator Position ^①			Operating Mode M = Maintained S = Momentary			Standard Black Knob		Standard Black Lever	
							Catalog Number	Price U.S. \$	Catalog Number	Price U.S. \$
No Contacts	—	—	—	M S M S	M M M M	M M S S	HT8JBH1D HT8JRH1D HT8JUH1D HT8JXH1D		HT8JEH1D HT8JSH1D HT8JVH1D HT8JYH1D	
2NO	X O	O O	O X	M S M S	M M M M	M M S S	HT8JBH1DAA5 HT8JRH1DAA5 HT8JUH1DAA5 HT8JXH1DAA5		HT8JEH1DAA5 HT8JSH1DAA5 HT8JVH1DAA5 HT8JYH1DAA5	
2NO-2NC ^②	X O O	O X O	O O X	M S M S	M M M M	M M S S	HT8JBH1DF1Q1 HT8JRH1DF1Q1 HT8JUH1DF1Q1 HT8JXH1DF1Q1		HT8JEH1DF1Q1 HT8JSH1DF1Q1 HT8JVH1DF1Q1 HT8JYH1DF1Q1	
2NO-2NC	X O O X	O X O X	O X X O	M S M S	M M M M	M M S S	HT8JBH1DF1Q1 HT8JRH1DF1Q1 HT8JUH1DF1Q1 HT8JXH1DF1Q1		HT8JEH1DF1Q1 HT8JSH1DF1Q1 HT8JVH1DF1Q1 HT8JYH1DF1Q1	

^① X = closed circuit, O = open circuit.

^② For OXO, NC contacts must be wired in series — see Table 47-332 on Page 47-205.



Standard Knob Operator
Cat. No. HT8JCH8E



Standard Lever Operator
Cat. No. HT8JFH8E

Table 47-330. 4-Position Selector Switch Units, Non-illuminated — UL (NEMA) Type 3, 3R, 4, 4X, 12 and 13

Contact Type	Operator Position ^③				Operating Mode M = Maintained S = Momentary				Standard Black Knob		Standard Black Lever	
									Catalog Number	Price U.S. \$	Catalog Number	Price U.S. \$
No Contacts	—	—	—	—	M S M	M M M	M M M	M M S	HT8JCH8E HT8LNH8E HT8LRH8E		HT8JFH8E HT8LPH8E HT8LSH8E	
2NO-2NC	X O O O	O X O O	O O X O	O O O X	M S M	M M M	M M M	M M S	HT8JCH8EF1Q1 HT8LNH8EF1Q1 HT8LRH8EF1Q1		HT8JFH8EF1Q1 HT8LPH8EF1Q1 HT8LSH8EF1Q1	

^③ X = closed circuit, O = open circuit.

Accessories Page 47-208
 Contact Blocks Page 47-205
 Dimensions Page 47-210
 Legend Plates Page 47-206
 Discount Symbol 1CD1C

Selector Switch Contact Block Selection

For 2-, 3- and 4-Position Selector Switches

Table 47-331. 2-Position Selector Switch (Cam Code 3A)

Operator Position	Left	Right
X O		or
O X		or

Table 47-332. 3-Position Selector Switch (Cam Code 1D)

Operator Position	Left	Right
X O O		
O X O		
O O X		
O X X		
X X O		

Table 47-333. 4-Position Selector Switch (Cam Code 8E)

Operator Position	Left	Right
X O O O		
O X O O		
O O X O		
O O O X		

Contact Blocks



NO Contact Block



NC Contact Block

Table 47-334. Contact Blocks ①

Description/Function	Contact Type	Catalog Number	Price U.S. \$
Standard Normally Open contact	NO	HT8A	
Standard Normally Closed contact	NC	HT8B	
Normally Open Early Make contact will make circuit before standard NO contact. DC ratings do not apply.	NOEM	HT8C	
Normally Closed Late Break contact will open after standard NC contact. DC ratings do not apply.	NCLB	HT8D	
Logic level, low voltage NO contact. Gold plated contacts.	NO	HT8E	

① See Page 47-196 for contact block electrical ratings.

Table 47-335. Contact Block Location (Viewed from Rear) Suffix Codes ②

Left Side	Right Side
A = NO	A5 = NO
A2 = 2NO	A6 = 2NO
B1 = NC	B = NC
B2 = 2NC	B6 = 2NC
C = NOEM	C5 = NOEM
C2 = 2 NOEM	C6 = 2 NOEM
D1 = NCLB	D = NCLB
D2 = 2 NCLB	D6 = 2 NCLB
E1 = NOEM-NCLB	E5 = NOEM-NCLB
F1 = NO & NC	Q1 = NO & NC
F4 = 1NO-1NC	

② Maximum of (2) contact blocks per side or a total of (4) contact blocks recommended.

HT800 Series, Legend Plates

Options

Legend Plates



Standard

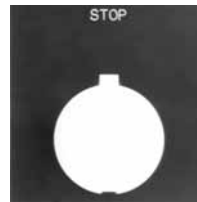

Jumbo

Table 47-336. For Pushbutton Operators and Indicating Lights

Legend	Color of Field	Catalog Number (Standard)	Price U.S. \$	Catalog Number (Jumbo)	Price U.S. \$
Letters on Legend Plates Below are 3/16" High					
CLAMP	Black	HT8SP90		HT8LP90	
CLOSE	Black	HT8SP73		HT8LP73	
DOWN	Black	HT8SP74		HT8LP74	
EMERG. STOP	Red	HT8SP13		HT8LP13	
FAST	Black	HT8SP75		HT8LP75	
FASTER	Black	HT8SP87		HT8LP87	
FEEDER ON	Black	HT8SP94		HT8LP94	
FEEDER OFF	Black	HT8SP95		HT8LP95	
FORWARD	Black	HT8SP15		HT8LP15	
HIGH	Black	HT8SP16		HT8LP16	
IN	Black	HT8SP17		HT8LP17	
INCH	Black	HT8SP18		HT8LP18	
JOG	Black	HT8SP19		HT8LP19	
JOG FOR.	Black	HT8SP20		HT8LP20	
JOG REV.	Black	HT8SP21		HT8LP21	
LOW	Black	HT8SP22		HT8LP22	
LOWER	Black	HT8SP23		HT8LP23	
LUBE-FAIL	Black	HT8SP92		HT8LP92	
MOTOR RUN	Black	HT8SP81		HT8LP81	
MOTOR STOP	Black	HT8SP82		HT8LP82	
OFF	Red	HT8SP24		HT8LP24	
ON	Black	HT8SP25		HT8LP25	
OPEN	Black	HT8SP26		HT8LP26	
OUT	Black	HT8SP27		HT8LP27	
POWER ON	Black	HT8SP80		HT8LP80	
RAISE	Black	HT8SP28		HT8LP28	
READY	Black	HT8SP86		HT8LP86	
RESET	Black	HT8SP29		HT8LP29	
REVERSE	Black	HT8SP30		HT8LP30	
RUN	Black	HT8SP31		HT8LP31	
SAFE	Black	HT8SP85		HT8LP85	
SLOW	Black	HT8SP32		HT8LP32	
SLOWER	Black	HT8SP88		HT8LP88	
START	Black	HT8SP33		HT8LP33	
STOP	Red	HT8SP34		HT8LP34	
TEST	Black	HT8SP83		HT8LP83	
TRANSFER	Black	HT8SP93		HT8LP93	
TRIP	Black	HT8SP84		HT8LP84	
UNCLAMP	Black	HT8SP91		HT8LP91	
UP	Black	HT8SP35		HT8LP35	

Table 47-337. For Selector Switch Operators

Legend	Color of Field	Catalog Number (Standard)	Price U.S. \$	Catalog Number (Jumbo)	Price U.S. \$
2-Position — 3/16" High Lettering					
FOR. REV.	Black	HT8SP38		HT8LP38	
HAND AUTO	Black	HT8SP39		HT8LP39	
HIGH LOW	Black	HT8SP40		HT8LP40	
JOG RUN	Black	HT8SP41		HT8LP41	
MAN. AUTO	Black	HT8SP67		HT8LP67	
OFF ON	Black	HT8SP42		HT8LP42	
OPEN CLOSE	Black	HT8SP43		HT8LP43	
RUN JOG	Black	HT8SP44		HT8LP44	
SAFE RUN	Black	HT8SP45		HT8LP45	
START JOG	Black	HT8SP46		HT8LP46	
START STOP	Black	HT8SP47		HT8LP47	
UP DOWN	Black	HT8SP48		HT8LP48	
3-Position — 3/16" High Lettering					
AUTO OFF HAND	Black	HT8SP49		HT8LP49	
FOR. OFF REV.	Black	HT8SP50		HT8LP50	
FOR. SAFE REV.	Black	HT8SP69		HT8LP69	
HAND OFF AUTO	Black	HT8SP51		HT8LP51	
MAN. OFF AUTO	Black	HT8SP68		HT8LP68	
OPEN OFF CLOSE	Black	HT8SP53		HT8LP53	
RUN SAFE JOG	Black	HT8SP70		HT8LP70	
UP OFF DOWN	Black	HT8SP54		HT8LP54	
ON STOP SAFE	Black	HT8SP71		HT8LP71	

Table 47-338. For Push-Pull Units

Legend	Color of Field	Catalog Number (Standard) ①	Price U.S. \$	Catalog Number (Jumbo) ②	Price U.S. \$
ON / OFF	Black	HT8PP5		HT8R5	
OPEN / CLOSE	Black	HT8PP8		HT8R8	
UP / DOWN	Black	HT8PP11		HT8R11	

① 3/32" high lettering.
② 1/8" high lettering.

Table 47-339. Blank Plastic Legend Plates — Square

Legend	Color of Field	Catalog Number (Standard)	Price U.S. \$	Catalog Number (Jumbo)	Price U.S. \$
Black	White/Silver	HT8SP76		HT8LP76	
White	Red/ Black	HT8SP77		HT8LP77	

HT800 Series, Legend Plates

Legend Plates with Non-standard Markings

When Ordering Specify

- Catalog Number of Blank Plate per **Table 47-340**.
- Insert the following into Order Notes: Legend, Letter Size per **Table 47-341** and Locations per **Figure 47-135**.

Ordering Example:

Catalog No.: **HT85P76STAMP**
 Letter Size: 3/32 inch (2.4 mm)
 Pos. A — POWER HOUSE
 Pos. B — START PUMP 1

Legend Characters Available

ABCDEFGHIJKLMN OPQRSTUVWXYZ / - , 1 2 3 4 5 6 7 8 9 0

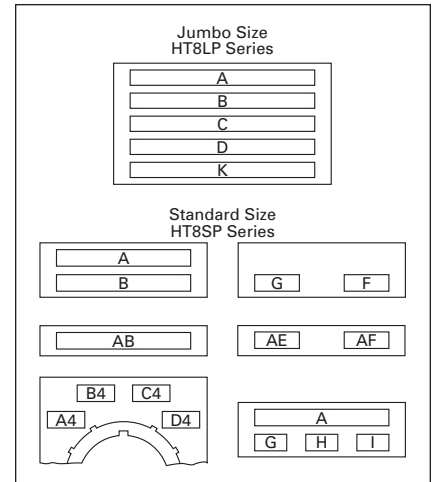

Figure 47-135. Legend Positions

Table 47-340. Blank Plastic Legend Plates for Non-standard Markings — Plastic

Legend	Color of Field	Standard		Jumbo	
		Catalog Number	Price U.S. \$	Catalog Number	Price U.S. \$
Black White	White/Silver Red/Black	HT8SP76STAMP HT8SP77STAMP		HT8LP76STAMP HT8LP77STAMP	







Table 47-341. Maximum Characters per Legend Plate and Approximate Dimensions

Top (Aluminum and Plastic)	Approximate Dimensions in Inches (mm)		Style	Character Size					
	Width	Height		3/32" High		1/8" High		3/16" High	
				Number of Lines	Number of Characters	Number of Lines	Number of Characters	Number of Lines	Number of Characters
Standard	1.75 (44.5)	1.75 (44.5)	Square	2	18	2	13	1	9
Jumbo ①	2.19 (55.6)	2.19 (55.6)	Square	5	23	3	18	2	12

① Can be used on top row only of any enclosure.

Accessories

Table 47-342. HT800 Accessories

	Description	Catalog Number	Price U.S. \$
	Illuminated Pushbutton Guard	HT8A15	
	Wrench Tool	HT8WRENCH	
	Lamp/Bulb Removal Tool	HT8LAMP TOOL	
	Thrust Washer (Anti-rotation) (Included with every operator)	HT8X1	
	Trim Ring (Included with every operator)	HT8X2	
	Sealing/Spacer Washer (Five included with every operator)	HT8X3	
	Grounding Kit for Pushbuttons and Selector Switches (Included with every operator)	HT8GR1	
	Grounding Kit for Indicating Lights (Included with indicating lights)	HT8GR2	

HT800 Series, Accessories



Light Unit



Incandescent Bulb



LED Bulb

Table 47-343. Light Units

Type	Voltage	Catalog Number	Price U.S. \$
Full Voltage	24V AC/DC 120V AC/DC	HT8F3V3 HT8F7V8	
Transformer	120V AC	HT8L1T1	

Table 47-344. Replacement Bulbs and LEDs

Voltage	Color	Catalog Number	Price U.S. \$
---------	-------	----------------	---------------

Incandescent

6V	—	HT8BULBV1	
24V	—	HT8BULBV3	
120V	—	HT8BULBV7	

LED

6 – 12V (For use with transformers with 6V secondary winding)	Red Green Amber/Orange	HT8LEDRF1 HT8LEDGF1 HT8LEDAF1	
	White/Clear Yellow Blue	HT8LEDWF1 HT8LEDYF1 HT8LEDBF1	
	24V	Red Green Amber/Orange	HT8LEDRF3 HT8LEDGF3 HT8LEDAF3
	White/Clear Yellow Blue	HT8LEDWF3 HT8LEDYF3 HT8LEDBF3	
120V	Red Green Amber/Orange	HT8LEDRF7 HT8LEDGF7 HT8LEDAF7	
	White/Clear Yellow Blue	HT8LEDWF7 HT8LEDYF7 HT8LEDBF7	

Table 47-345. Replacement Lenses

Color	Indicating Lights	Price U.S. \$	PresTest Lights Illuminated Pushbuttons	Price U.S. \$
Amber Blue Clear Green	HT8LA HT8LB HT8LC HT8LG		HT8BA HT8BB HT8BC HT8BG	
Red White Yellow	HT8LR HT8LW HT8LY		HT8BR HT8BW HT8BY	

HT800 Series, Dimensions

Dimensions

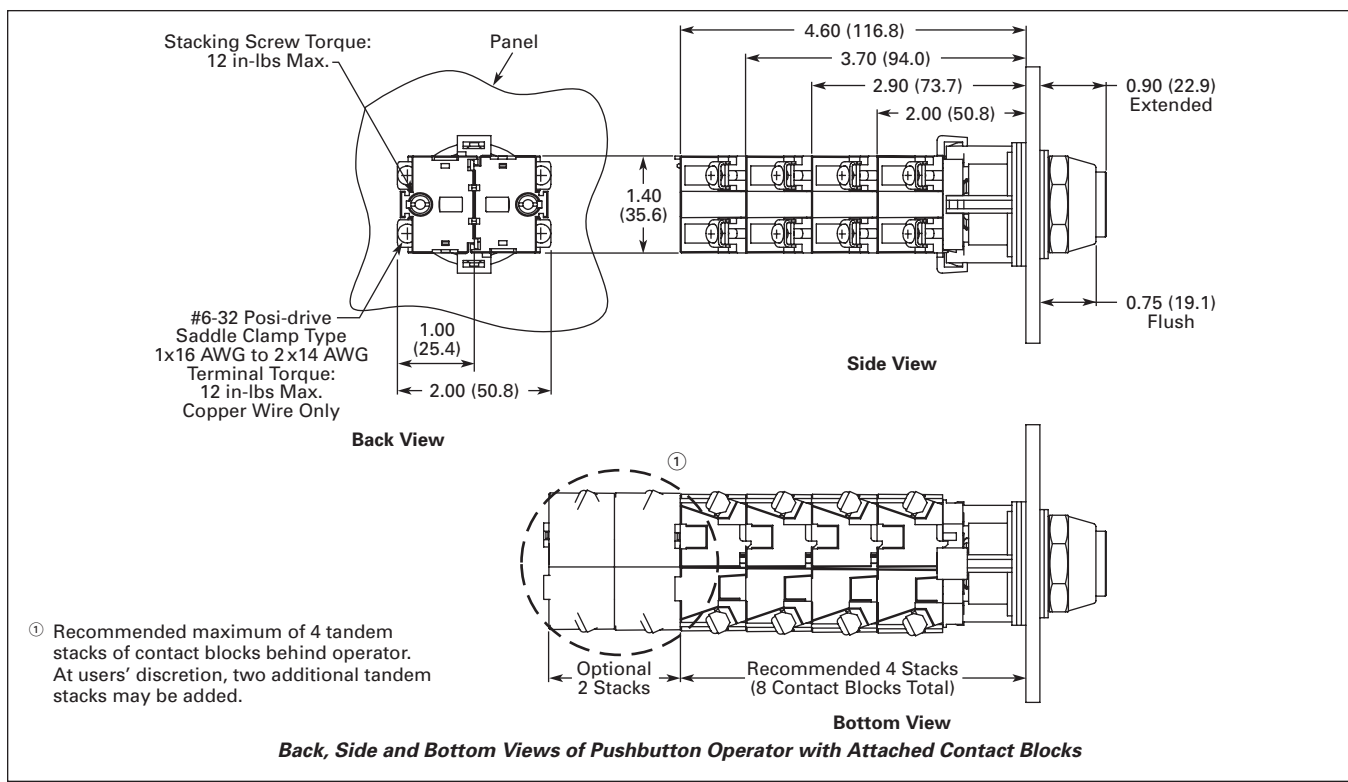

Figure 47-136. Momentary Pushbuttons — Non-illuminated — Approximate Dimensions in Inches (mm)

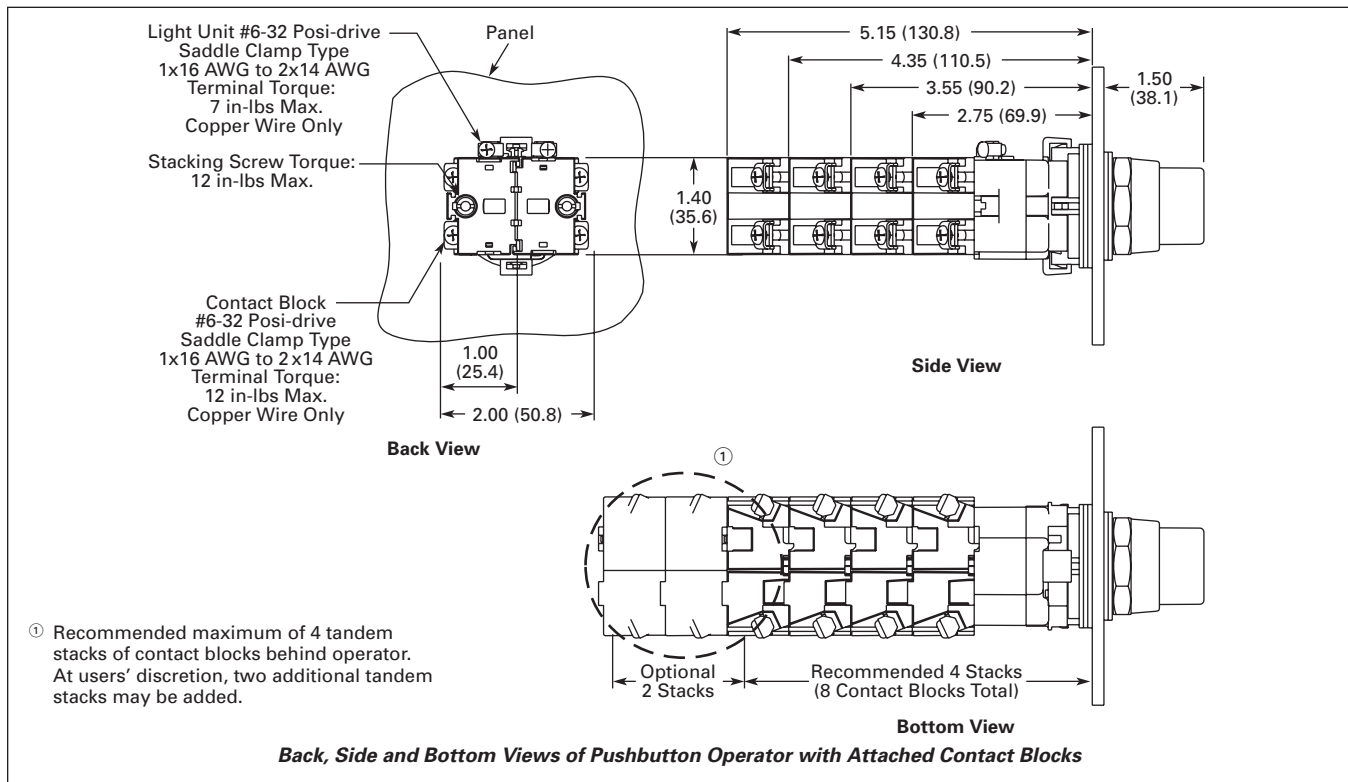

Figure 47-137. Illuminated Pushbuttons — Approximate Dimensions in Inches (mm)

HT800 Series, Dimensions

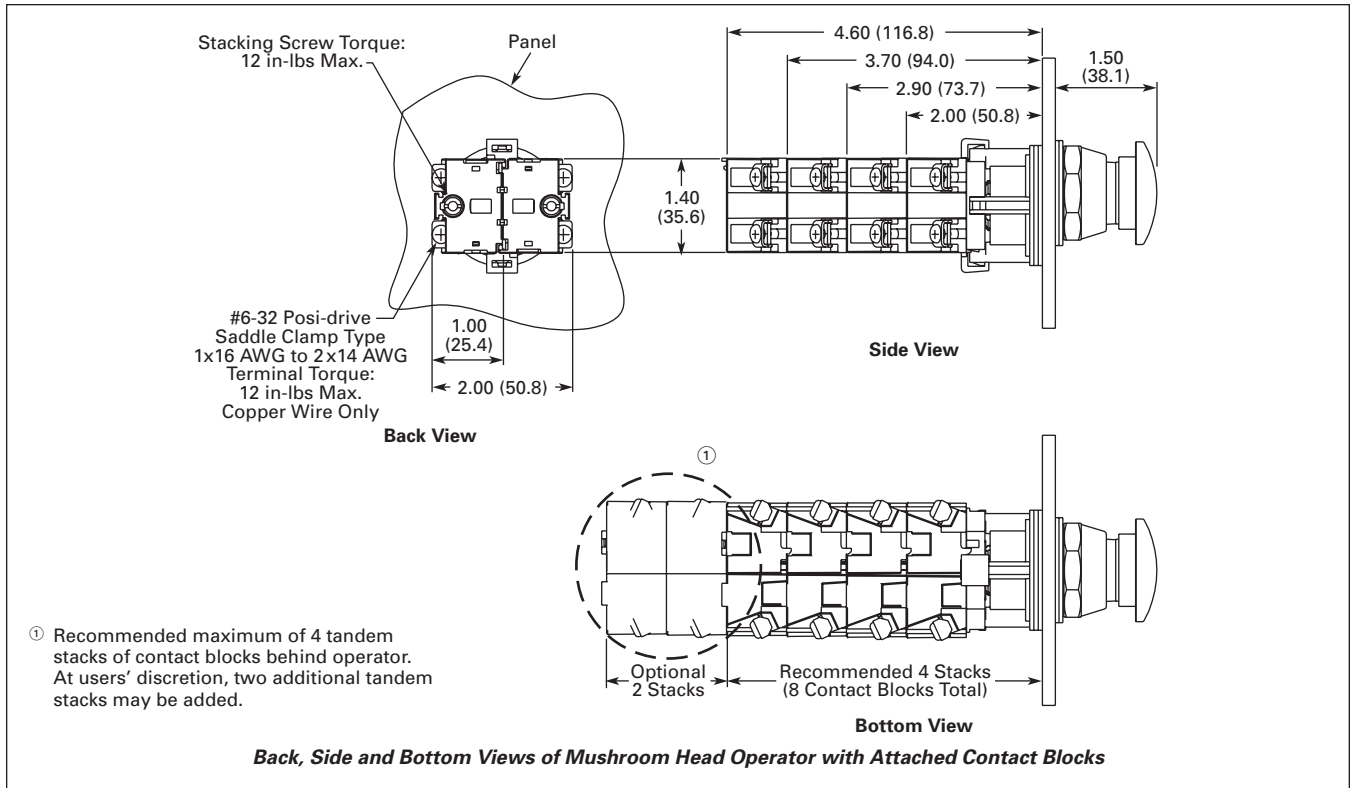

Figure 47-138. Mushroom Head Pushbuttons and Round Head MRH Push-Pull Operators — Approximate Dimensions in Inches (mm)

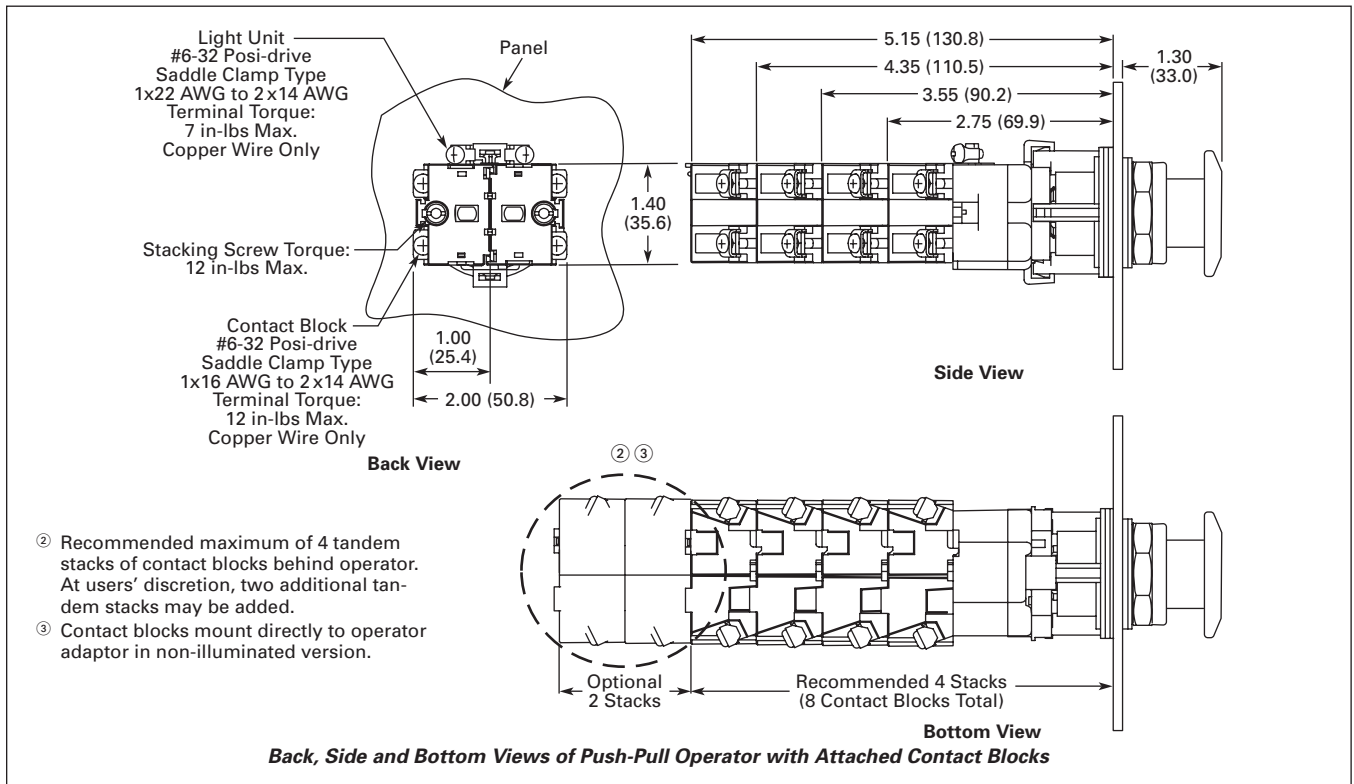

Figure 47-139. Illuminated and Non-illuminated Flat Head MRH Push-Pull Operators — Approximate Dimensions in Inches (mm)

HT800 Series, Dimensions

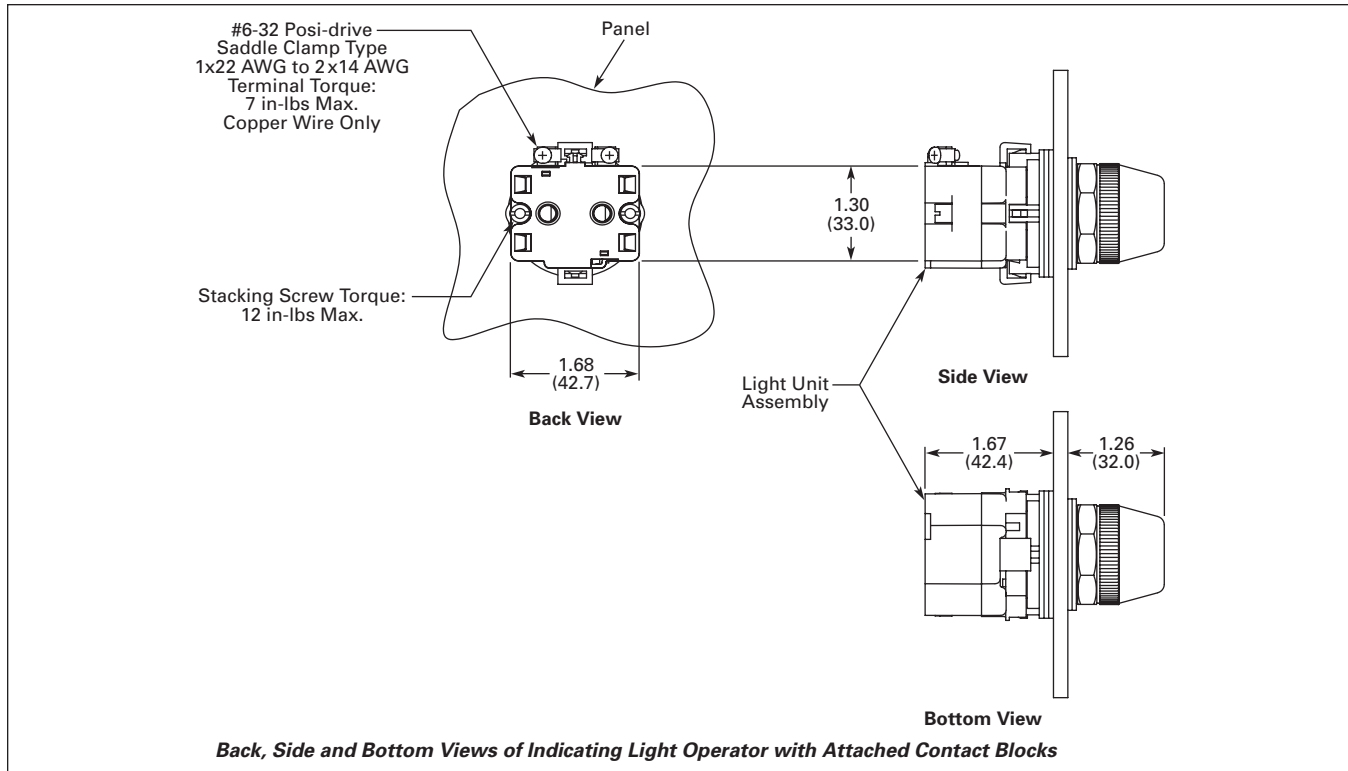

Figure 47-140. Indicating Lights — Approximate Dimensions in Inches (mm)

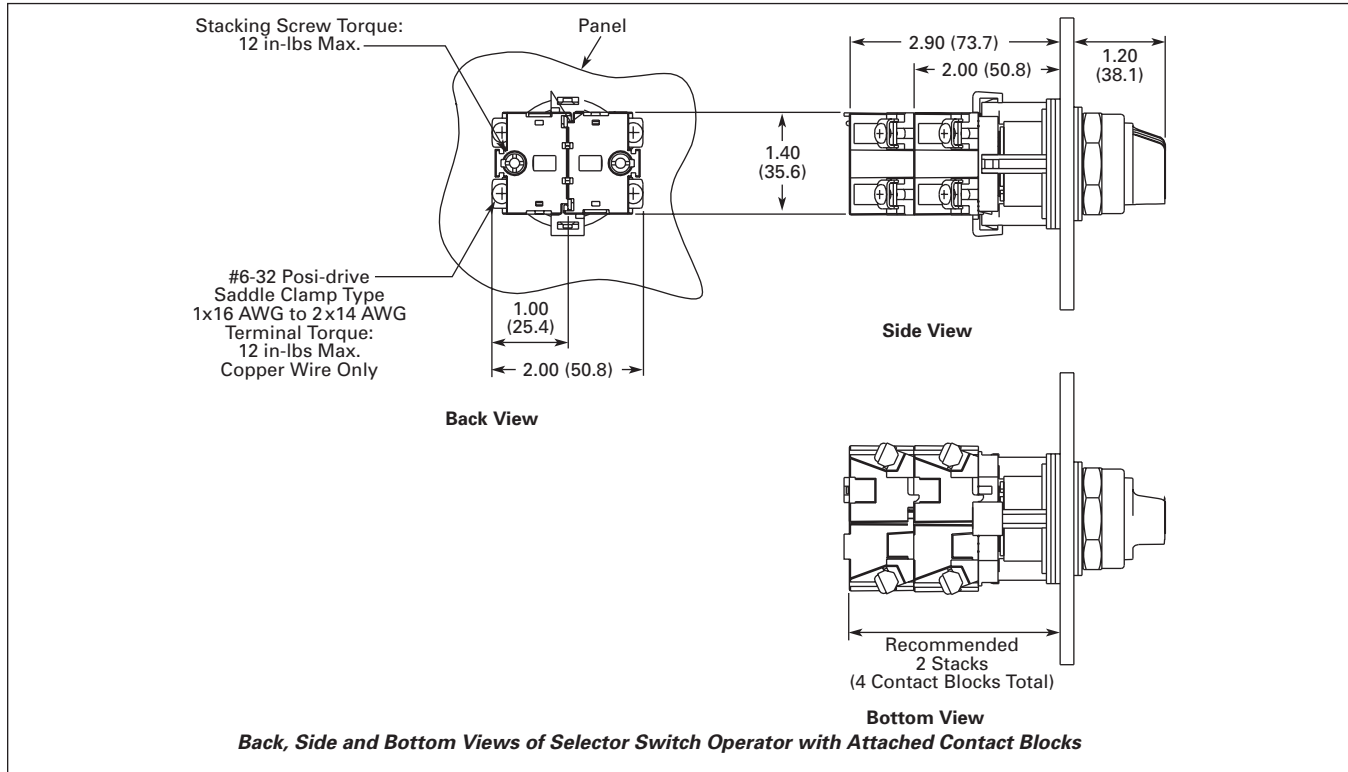

Figure 47-141. Selector Switches— Approximate Dimensions in Inches (mm)

HT800 Series, Dimensions

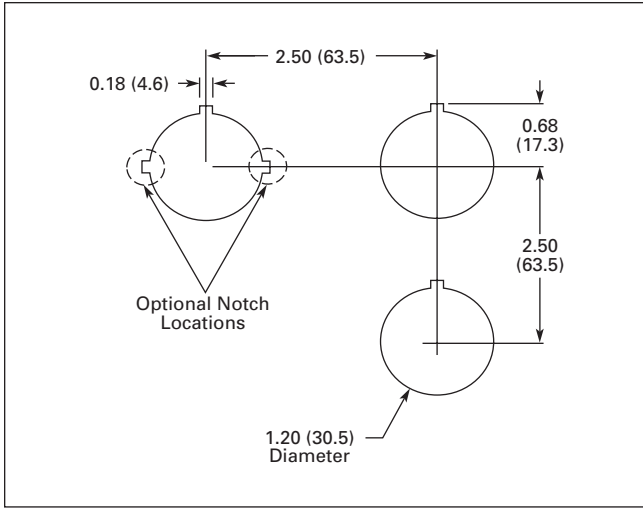

Figure 47-142. Mounting Matrix and Minimum Panel Spacing Requirements in Inches (mm)

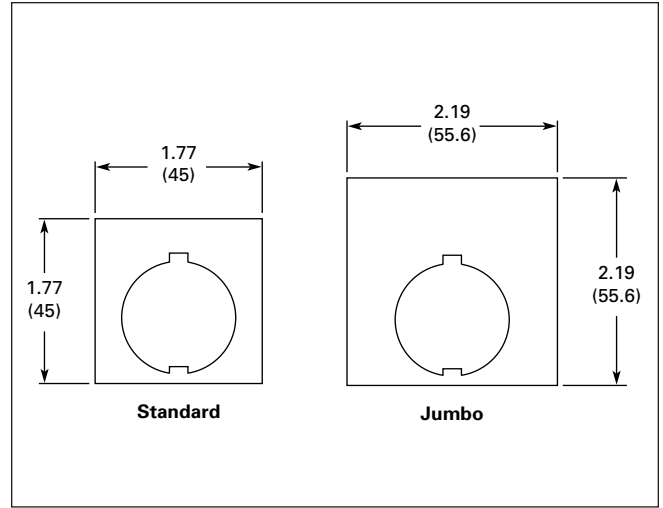
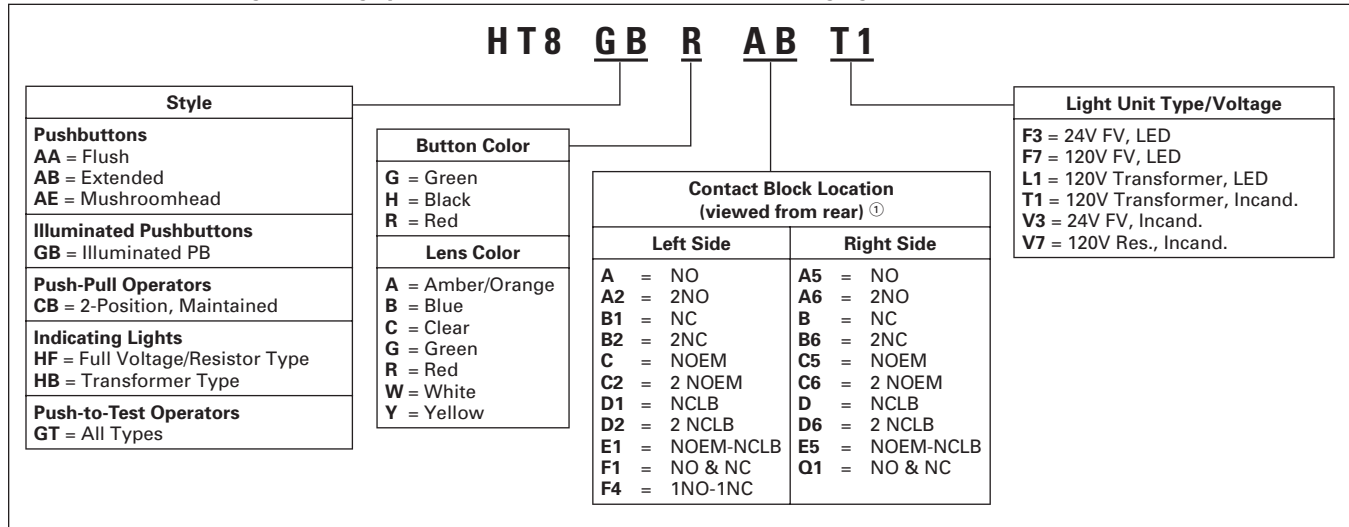

Figure 47-143. Legend Plates — Approximate Dimensions in Inches (mm)

Catalog Number Structure

For deciphering Catalog Numbers. Not all combinations are suitable for ordering.

Table 47-346. HT800 Catalog Numbering System for Pushbuttons, Push-Pulls and Indicating Lights



① Maximum of (4) contact blocks per side or a total of (8) contact blocks recommended.

Table 47-347. HT800 Selector Switch Catalog Numbering System

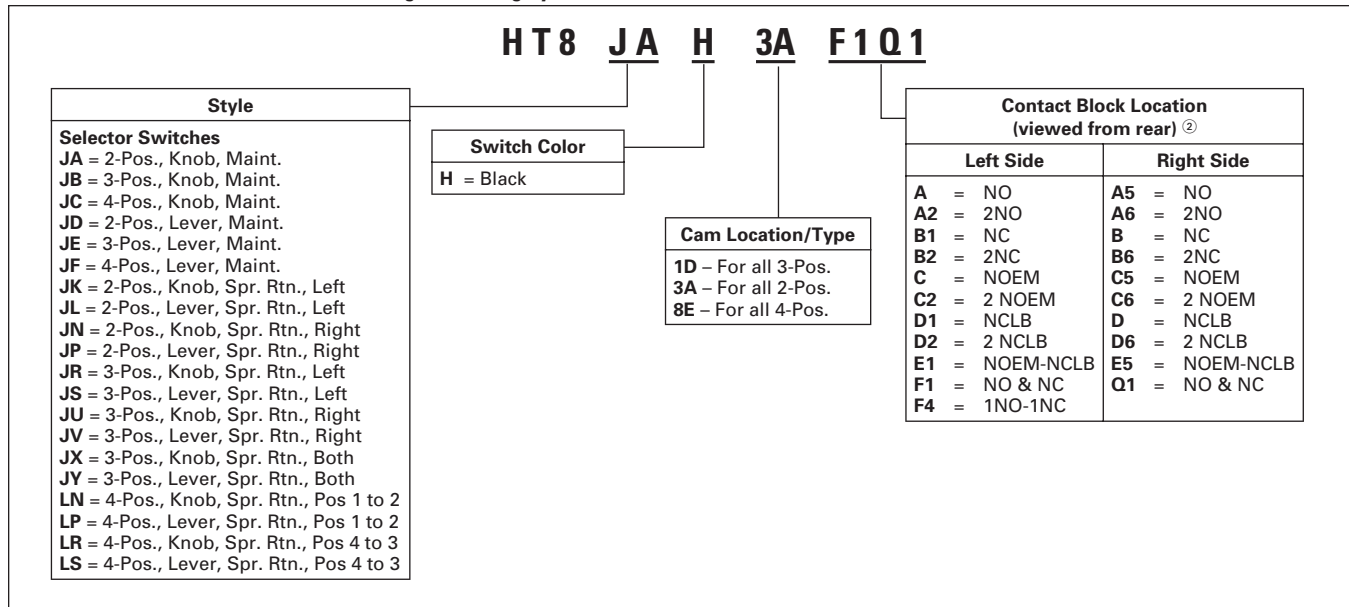

② Maximum of (2) contact blocks per side or a total of (4) contacts blocks recommended.

Contents

Description	Page
Product Description	47-215
Features	47-216
Benefits	47-216
Standards and Certifications	47-216
Technical Data and Specifications	47-217
Product Selection	
Momentary Pushbutton Units	47-218
Non-illuminated Pushbuttons	47-220
Illuminated Pushbutton Units	47-221
Indicating Light Units	47-223
Illuminated Pushbuttons and Indicating Lights	47-224
Push-Pull Units	47-225
Illuminated Push-Pull Units	47-226
Push-Pulls	47-229
Selector Switch Units	47-231
Selector Switch Selection	47-233
Selector Switch Operators	47-235
Illuminated Selector Switch Operators	47-237

Description	Page
Options	
Contact Block and Mounting Adapters	47-239
Enclosures	47-240
Mounting and Assembly	47-241
Catalog Number Structure	47-242

Product Description

All the Industry-Proven Quality of Eaton's Cutler-Hammer® 10250T and E34 Series of Logic Devices, plus Class I Division 2 Certification

The **10250T1H** consists of a normally open-normally closed factory sealed contact block that is UL Listed for use in Class I, Division 2, Groups B, C and D (NEC 500 – 503) — Class I, Zone 2, IIB + H₂ (NEC 505) hazardous locations and is rated for both NEMA A600 and NEMA Q300. 10250T and E34 illuminated components have also been UL Listed for use in Class I, Division 2, Groups B, C and D (NEC 500 – 503) — Class I, Zone 2, IIB + H₂ (NEC 505).

This, combined with the industry-proven Cutler-Hammer 10250T 30.5 mm pushbutton line, offers a complete solution to Division 2 hazardous location requirements.

Single composite catalog numbers for complete assembled stations and operators for use in Division 2 hazardous locations are featured throughout this section.

Operator

The 30.5 mm 10250T pushbutton line features a zinc die cast construction with chrome-plated housing and mounting nut.

Eaton's Cutler-Hammer E34 Series 30.5 mm pushbutton line features the same rugged die cast construction of our 10250T line with an additional two-layer 100% solid thermosetting cathodic epoxy coating. This coating provides a flat black smooth, consistent, corrosion resistant surface that has passed a demanding 600 hour salt spray test. (The industry standard for this 4X test requires only 200 hours.)

Ultraviolet Light

E34 epoxy coating is not recommended for use in applications where exposure to ultraviolet light exists — use NEMA 4X 10250T operators.

Ratings

Our Class I Division 2 line of pushbuttons are UL Listed (NEMA type) 1, 2, 3, 3R, 4, 4X, 12 and 13. Our Class I Division 2 E34 line meets IEC 947-1 IP66 standards and the cathodic coating meets FDA 3A sanitary chemical resistance requirements. For a complete listing of all applicable ratings see **Page 47-217**.

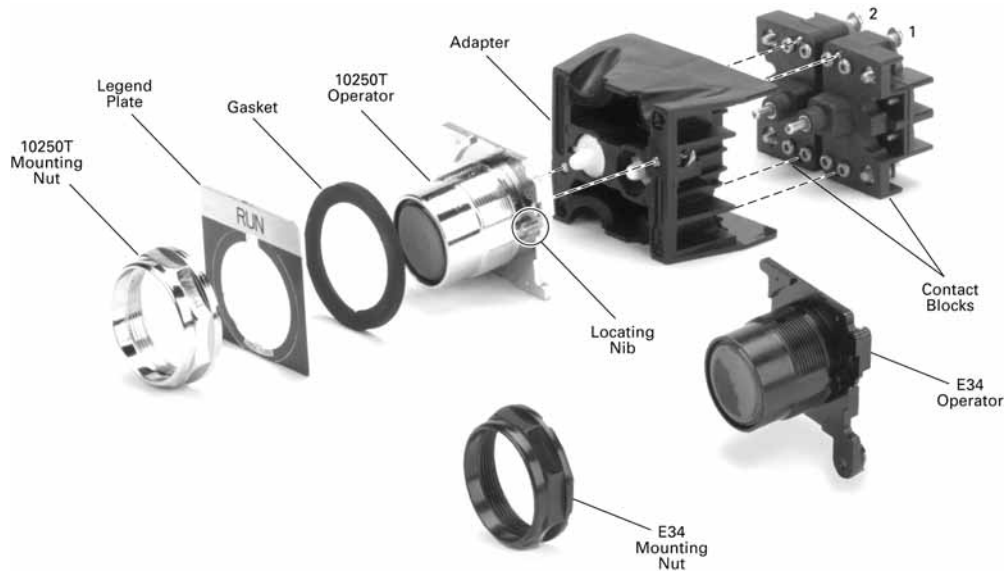

Class I Division 2

10250T Heavy-Duty Oiltight and E34 Corrosion Resistant

Liquid Drainage

Eaton's Cutler-Hammer pushbutton operators offer front of panel drainage via holes in the operator bushing. Hidden from view by the mounting nut, these holes prevent buildup of liquid inside the operator, which can prevent operation in freezing environments. The holes also provide a route for escaping liquid in high pressure wash-downs, effectively relieving pressure from the internal diaphragm seal, ensuring reliable sealing in applications even beyond NEMA 4.

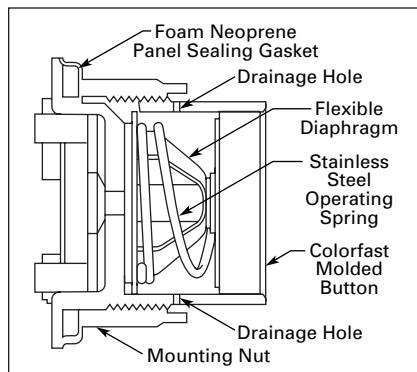

Figure 47-144. Diaphragm Seal

10250T Grounding

10250T line operators have "grounding nibs" — four metal points on the operator casting designed to bite through most paints and other coatings on metal panels to enhance the grounding connection when the operator is securely tightened.



10250T Grounding Nibs

E34 Grounding

E34 line of operators is equipped with a ground screw terminal as part of its die cast construction. This earthing terminal provides an easily accessible point for grounding operators when used in a painted or nonmetallic enclosure and eliminates the need for extra kits when daisy chain grounding is required.

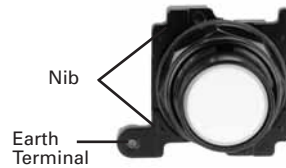

E34 Grounding Nibs

Features

- Factory sealed contact blocks
- Heavy-duty zinc die cast construction
- NEMA rated 1, 2, 3, 3R, 4, 4X, 12, 13
- Front-of-panel drainage holes
- Grounding nibs on the operator casing
- Solid thermosetting cathodic epoxy coating on E34
- Corrosion resistance in E34

Benefits

- Pushbutton for hazardous locations
- Drainage holes prevent buildup of liquid inside the operator which can prevent operation in freezing environments
- Grounding nibs bite through paint and other coatings to provide secure ground
- Suitable for corrosive environments (E34 only)
- Earth terminal provides additional grounding point and allows for daisy chain grounding (E34 line)

Standards and Certifications

- UL 508 — File No. E131568
- UL 1604 — File No. E10323
- CSA Certified C22.2 No.14 — File No. LR 68551
- CSA Certified C22.2 No. 213-M1987 — File No. LR 20713

Ingress Protection

- Standard Indicating Lights
 - UL (NEMA) Type 3, 3R, 3S, 4, 4X, 12, 13
 - IEC IP65
- All Other Operators
 - UL (NEMA) Type 3, 3R, 4, 4X, 12, 13
 - IEC IP65

Technical Data and Specifications

Mechanical Ratings

- Frequency of Operation
 - All pushbuttons: 6000 operations/hr.
 - Key and lever selector switches: 3000 operations/hr.
- Life
 - Pushbuttons: 10 x 10⁶ operations
 - Contact block: 10 x 10⁶ operations
 - Key and lever selector switches: 0.25 x 10⁶ operations
- Shock Resistance
 - Duration/force: 20 mS ≥5g

Climatic Conditions

- Operating: 32° to 140°F (0° to 60°C)
- Storage: -40° to 176°F (-40° to 80°C)
- Altitude: 6,562 ft. (2,000m)
- Humidity: Max. 95% RH @ 60°C

Terminals

Light Units

- Terminals are saddle clamp type for 1 x 22 AWG (0.34 sq. mm) to 2 x 14 AWG (4.0 sq. mm) conductors
- Torque = 7 lb-in (0.8 Nm)
- Degree of protection against direct electrical contact: IP2X with finger-proof shroud

Contact Blocks

- Terminals are Stainless Steel saddle clamp type for 1 x 18 – 14 AWG (0.75 – 2.5 sq. mm) solid or stranded copper conductor
- Torque = 9 lb-in (1.0 Nm) with size 2 Phillips screwdriver
- Degree of protection against direct electrical contact: IP2X with finger-proof shroud

Electrical Ratings

Table 47-348. Contact Block

Meet or Exceed NEMA Contact Rating Designations A600 and Q300						
Description	A600 (AC)				Q300 (DC)	
	120V	240V	480V	600V	125V	250V
Make and Emergency Interrupting Capacity (Amps)	60	30	15	12	0.55	0.27
Normal Load Break (Amps)	6	3	1.5	1.2	0.55	0.27
Thermal Current (Amps)	10	10	10	10	2.5	2.5
Voltamperes						
Max. Make	7200	7200	7200	7200	69	69
Max. Break	720	720	720	720	69	69

Light Units

- Bulbs — Average Life
 - Transformer type: 20,000 hrs.
 - Resistor/direct voltage type: 2,500 hrs. min. @ rated voltage
 - LED: 60,000 to 100,000 hrs.

Note: For additional technical information, see Pub. **TD.7.4.T.E.04**.

All illuminated devices have operating temperatures below 100°C except for the following Catalog Numbers with temperature codes per NEC table 500-5(d) and UL 1604:

Table 47-349. Temperature Codes

10250T	E34	Temp. Code
10250T201H	E34RB120H	T3C
10250T202H	E34RB240H	T3A
10250T471H	E34SB120H	TC3
10250T472H	E34SB240H	T3B
10250T80H	—	T3C
10250T81H	—	T3B
All Selector Switches w/120MB Lamp		T3C
All Illuminated Devices with Lamp 1835		T4A

Product Selection

Momentary Pushbutton Units

Table 47-350. Non-illuminated Flush and Extended Pushbuttons — UL (NEMA) Type 3, 3R, 4, 4X, 12, 13, NEC Class I Division 2, Groups B, C and D

Contact Type	Button Color ①	Flush Button				Extended Button			
		10250T		E34		10250T		E34	
		Catalog Number	Price U.S. \$	Catalog Number	Price U.S. \$	Catalog Number	Price U.S. \$	Catalog Number	Price U.S. \$
1NO-1NC	Black Red Green	<u>10250T706B</u> <u>10250T706R</u> <u>10250T706G</u>		<u>E34EX706B</u> <u>E34EX706R</u> <u>E34EX706G</u>		<u>10250T708B</u> <u>10250T708R</u> <u>10250T708G</u>		<u>E34EX708B</u> <u>E34EX708R</u> <u>E34EX708G</u>	
2NO-2NC	Black Red Green	<u>10250T707B</u> <u>10250T707R</u> <u>10250T707G</u>		<u>E34EX707B</u> <u>E34EX707R</u> <u>E34EX707G</u>		<u>10250T709B</u> <u>10250T709R</u> <u>10250T709G</u>		<u>E34EX709B</u> <u>E34EX709R</u> <u>E34EX709G</u>	

① To order different color guarded button, simply substitute the underlined character in Catalog Number with appropriate Suffix Code from Color Selection Table below. Example: 10250T706Y

Table 47-351. Non-illuminated Mushroom and Jumbo Mushroom Pushbuttons — UL (NEMA) Type 3, 3R, 4, 4X, 12, 13, NEC Class I Division 2, Groups B, C and D

Contact Type	Button Color ②	Mushroom Button				Jumbo Mushroom Button			
		10250T		E34		10250T ③		E34 ③	
		Catalog Number	Price U.S. \$	Catalog Number	Price U.S. \$	Catalog Number	Price U.S. \$	Catalog Number	Price U.S. \$
1NO-1NC	Black Red Green	<u>10250T710B</u> <u>10250T710R</u> <u>10250T710G</u>		<u>E34EX710B</u> <u>E34EX710R</u> <u>E34EX710G</u>		<u>10250T712B</u> <u>10250T712R</u> <u>10250T712G</u>		<u>E34EX712B</u> <u>E34EX712R</u> <u>E34EX712G</u>	
2NO-2NC	Black Red Green	<u>10250T711B</u> <u>10250T711R</u> <u>10250T711G</u>		<u>E34EX711B</u> <u>E34EX711R</u> <u>E34EX711G</u>		<u>10250T713B</u> <u>10250T713R</u> <u>10250T713G</u>		<u>E34EX713B</u> <u>E34EX713R</u> <u>E34EX713G</u>	

② To order different color guarded button, simply substitute the underlined character in Catalog Number with appropriate Suffix Code from Color Selection Table below. Example: 10250T710Y

③ Anodized aluminum head is not suitable for use in ultraviolet applications.

Table 47-352. Color Selection Table

Color	Suffix Code
Black	B
Red	R
Green	G
Yellow	Y
White	W
Blue	L ④
Orange ⑤	N
Red (EMERG. STOP) ⑥	E

④ Blue not available on Jumbo Mushroom Pushbutton.

⑤ Orange is only available on Flush or Extended Pushbuttons.

⑥ Red with EMERG. STOP engraved on button head for Jumbo Mushroom Pushbutton only.

Note: Use NEMA 4X 10250T operators where exposed to ultraviolet light.

Accessories **Pages 47-155 & 47-187**
 Dimensions **Pages 47-239, 47-160 & 47-191**
 Enclosures **Page 47-240**
 Legend Plates **Pages 47-151 & 47-184**
 Discount Symbol **1CD1C**

Momentary Pushbutton Units (Continued)

- Momentary Contact
- Non-illuminated
- Booted or Guarded

Table 47-353. 10250T Pushbuttons Booted and Guarded — UL (NEMA) Type 3, 3R, 4, 4X, 12, 13, NEC Class I Division 2, Groups B, C and D

Contact Type	Button Color	Booted Flush Button		Booted Extended Button		Guarded Extended Button ^②	
		Catalog Number	Price U.S. \$	Catalog Number	Price U.S. \$	Catalog Number	Price U.S. \$
1NO-1NC	Black	10250T706BB		10250T708BB		10250T706BG	
	Red	10250T706RB ^①		10250T708RB		10250T706RG	
	Green	10250T706GB		10250T708GB		10250T706GG	
2NO-2NC	Black	10250T707BB		10250T709BB		10250T707BG	
	Red	10250T707RB ^①		10250T709RB		10250T707RG	
	Green	10250T707GB		10250T709GB		10250T707GG	

① Red Booted Flush Pushbutton is not recommended for STOP function.

② To order different color guarded button, simply substitute the underlined character in Catalog Number with appropriate Suffix Code from Color Selection Table below. Example: 10250T706YG

Table 47-354. E34 Pushbuttons Booted and Guarded — UL (NEMA) Type 3, 3R, 4, 4X, 12, 13, NEC Class I Division 2, Groups B, C and D

Contact Type	Button Color	Booted Flush Button		Booted Extended Button		Guarded Extended Button ^④	
		Catalog Number	Price U.S. \$	Catalog Number	Price U.S. \$	Catalog Number	Price U.S. \$
1NO-1NC	Black	E34EX706BB		E34EX708BB		E34EX706BG	
	Red	E34EX706RB ^③		E34EX708RB		E34EX706RG	
	Green	E34EX706GB		E34EX708GB		E34EX706GG	
2NO-2NC	Black	E34EX707BB		E34EX709BB		E34EX707BG	
	Red	E34EX707RB ^③		E34EX709RB		E34EX707RG	
	Green	E34EX707GB		E34EX709GB		E34EX707GG	

③ Red Booted Flush Pushbutton is not recommended for STOP function.

④ To order different color guarded button, simply substitute the underlined character in Catalog Number with appropriate Suffix Code from Color Selection Table below. Example: 10250T706YG

Table 47-355. Color Selection Table

Color	Suffix Code
Black	B
Red	R
Green	G
Yellow	Y
White	W
Blue	L
Orange	N

Note: Use NEMA 4X 10250T operators where exposed to ultraviolet light.

Accessories **Pages 47-155 & 47-187**
 Dimensions **Pages 47-239, 47-160 & 47-191**
 Enclosures **Page 47-240**
 Legend Plates **Pages 47-151 & 47-184**
 Discount Symbol . **1CD1C**

10250T/E34 Series, Momentary Pushbutton Components

Pushbuttons

Table 47-356. Non-illuminated Pushbuttons, Momentary Contact — UL (NEMA) Type 3, 3R, 4, 4X, 12, 13

Color	Flush Button				Extended Button				Half Shrouded Button					
	10250T ①		E34		10250T		E34		10250T			E34		
	Catalog Number	Price U.S. \$	Catalog Number	Price U.S. \$	Catalog Number	Price U.S. \$	Catalog Number	Price U.S. \$	Vertical Catalog Number	Horizontal Catalog Number	Price U.S. \$	Vertical Catalog Number	Horizontal Catalog Number	Price U.S. \$
Black	10250T101		E34PB1		10250T111		E34EB1		10250T501	10250T511		E34EVB1	E34EHB1	
Red	10250T102		E34PB2		10250T112		E34EB2		10250T502	10250T512		E34EVB2	E34EHB2	
Green	10250T103		E34PB3		10250T113		E34EB3		10250T503	10250T513		E34EVB3	E34EHB3	
Yellow	10250T104		E34PB4		10250T120		E34EB4		10250T504	10250T514		E34EVB4	E34EHB4	
Gray	10250T105		E34PB5		—		E34EB5		10250T505	10250T515		E34EVB5	E34EHB5	
White	10250T106		E34PB6		10250T116		E34EB6		10250T506	10250T516		E34EVB6	E34EHB6	
Blue	10250T108		E34PB7		10250T118		E34EB7		10250T508	10250T518		E34EVB7	E34EHB7	
Orange	10250T109		E34PB8		10250T119		E34EB8		10250T509	10250T519		E34EVB8	E34EHB8	

① To order operator with factory assembled Extended Retaining Nut, 10250TA12, for thick panel applications, add Suffix letter E to listed Catalog Number.

Table 47-357. Mushroom Head Non-illuminated Pushbuttons, Momentary Contact — UL (NEMA) Type 3, 3R, 4, 4X, 12, 13

Color	Mushroom Button				Anodized Aluminum Jumbo Mushroom Button			
	10250T		E34		10250T ②		E34 ③	
	Catalog Number	Price U.S. \$	Catalog Number	Price U.S. \$	Catalog Number	Price U.S. \$	Catalog Number	Price U.S. \$
Black	10250T121		E34LB1		10250T171		E34JB1	
Red	10250T122		E34LB2		10250T172		E34JB2	
Red (EMERG. STOP)	—		—		10250T17213		E34JB2N8	
Green	10250T123		E34LB3		10250T173		E34JB3	
Yellow	10250T124		E34LB4		10250T174		E34JB4	
Blue	10250T129		E34LB6		—		—	

② Anodized aluminum head is not suitable for use in ultraviolet light applications.

③ Anodized aluminum head may not be suitable for some corrosive environments.



Note: Use NEMA 4X 10250T operators where exposed to ultraviolet light.

Accessories **Pages 47-155 & 47-187**
 Contact Blocks **Page 47-239**
 Dimensions **Pages 47-239, 47-160 & 47-191**
 Enclosures **Page 47-240**
 Legend Plates **Pages 47-151 & 47-184**
 Discount Symbol **1CD1C**

Illuminated Pushbutton Units

- Momentary Contact
- Illuminated
- Plastic Lenses

Table 47-358. Illuminated Pushbuttons — UL (NEMA) Type 3, 3R, 4, 4X, 12, 13, NEC Class I Division 2, Groups B, C and D

Lamp	Type	Voltage	Color	Contact	10250T			E34		
					Catalog Number ①	Price U.S. \$	LED/Lamp Number	Catalog Number ①	Price U.S. \$	LED/Lamp Number
										
LED	Full Voltage	24V AC/DC	Red	1NO-1NC	10250T828RD24		Bayonet Base	E34EX828RD24		Bayonet Base
			<u>Green</u>		10250T828GD24			E34EX828GD24		
		Amber	10250T828AD24	E34EX828AD24						
	Transformer	120V AC	Red	1NO-1NC	10250T828RD2A			E34EX828RD2A		
			<u>Green</u>		10250T828GD2A			E34EX828GD2A		
		Amber	10250T828AD2A	E34EX828AD2A						
Incandescent	Full Voltage	24V AC/DC	Red	1NO-1NC	10250T818RD		#757	E34EX818RD		#757
			<u>Green</u>		10250T818GD			E34EX818GD		
	Amber	10250T818AD	E34EX818AD							
Resistor	120V AC/DC	Red	1NO-1NC	10250T824RD		120MB	E34EX824RD		120MB	
		<u>Green</u>		10250T824GD			E34EX824GD			
	Amber	10250T824AD	E34EX824AD							
Transformer	120V AC	Red	1NO-1NC	10250T802RD		#755	E34EX802RD		#755	
		<u>Green</u>		10250T802GD			E34EX802GD			
	Amber	10250T802AD	E34EX802AD							

① To order different color lens, simply substitute the underlined character in the Catalog Number with appropriate Suffix Code from Lenses Selection Table below. Example: 10250T828YD24

Table 47-359. Lenses Selection Table

10250T	Color	Suffix Code	Catalog Number	Price U.S. \$	E34	Color	Suffix Code	Catalog Number	Price U.S. \$
	Red	<u>R</u>	10250TC21			Red	<u>R</u>	E34V2	
	Green	<u>G</u>	10250TC22			Green	<u>G</u>	E34V3	
	Yellow	<u>Y</u>	10250TC23			Yellow	<u>Y</u>	E34V4	
	Amber	<u>A</u>	10250TC43			Amber	<u>A</u>	E34V9	
	Blue	<u>L</u>	10250TC24			Blue	<u>L</u>	E34V6	
	Clear	<u>C</u>	10250TC25			Clear	<u>C</u>	E34V0	
	White	<u>W</u>	10250TC26			White	<u>W</u>	E34V5	

Additional Light
 Units Page 47-224
 Dimensions..... Pages 47-239, 47-160 & 47-191
 Enclosures Page 47-240
 Legend Plates Pages 47-151 & 47-184
 Replacement
 Lamps/LEDs.... Page 47-157
 Discount Symbol .. 1CD1C

10250T/E34 Series, Assembled Devices — Illuminated Pushbutton Units

Guarded Illuminated Pushbutton Units

- Momentary Contact
- Guarded Illuminated
- Plastic Lenses

Table 47-360. Guarded Illuminated Pushbuttons — UL (NEMA) Type 3, 3R, 4, 4X, 12, 13, NEC Class I Division 2, Groups B, C and D

Lamp	Type	Voltage	Color	Contact	10250T			E34			
					Catalog Number ①	Price U.S. \$	LED/Lamp Number	Catalog Number ①	Price U.S. \$	LED/Lamp Number	
LED	Full Voltage	24V AC/DC	Red Green Amber	1NO-1NC	10250T828RG24 10250T828GG24 10250T828AG24		Bayonet Base	E34EX828RG24 E34EX828GG24 E34EX828AG24		Bayonet Base	
		120V AC	Red Green Amber	1NO-1NC	10250T828RG2A 10250T828GG2A 10250T828AG2A			E34EX828RG2A E34EX828GG2A E34EX828AG2A			
	Transformer	120V AC	Red Green Amber	1NO-1NC	10250T802RG06 10250T802GG06 10250T802AG06			E34EX802RG06 E34EX802GG06 E34EX802AG06			
	Incandescent	Full Voltage	24V AC/DC	Red Green Amber	1NO-1NC	10250T818RG 10250T818GG 10250T818AG		#757	E34EX818RG E34EX818GG E34EX818AG		#757
		Resistor	120V AC/DC	Red Green Amber	1NO-1NC	10250T824RG 10250T824GG 10250T824AG		120MB	E34EX824RG E34EX824GG E34EX824AG		120MB
		Transformer	120V AC	Red Green Amber	1NO-1NC	10250T802RG 10250T802GG 10250T802AG		#755	E34EX802RG E34EX802GG E34EX802AG		#755 6V AC

47

① To order different color lens, simply substitute the underlined character in the Catalog Number with appropriate Suffix Code from Lenses Selection Table below. Example: 10250T828YG24

Table 47-361. Lenses Selection Table

10250T	Color	Suffix Code	Catalog Number	Price U.S. \$	E34	Color	Suffix Code	Catalog Number	Price U.S. \$
	Red Green Yellow Amber Blue Clear White	<u>R</u> G Y A L C W	10250TC21 10250TC22 10250TC23 10250TC43 10250TC24 10250TC25 10250TC26			Red Green Yellow Amber Blue Clear White	<u>R</u> G Y A L C W	E34V2 E34V3 E34V4 E34V9 E34V6 E34V0 E34V5	

Additional Light
 Units Page 47-224
 Dimensions Pages 47-239, 47-160 & 47-191
 Enclosures Page 47-240
 Legend Plates Pages 47-151 & 47-184
 Replacement
 Lamps/LEDs Page 47-157
 Discount Symbol 1CD1C

Indicating Light Units



- Standard
- Plastic Lens

Table 47-362. Indicating Lights — UL (NEMA) Type 3, 3R, 3S, 4, 4X, 12, 13, NEC Class I Division 2, Groups B, C and D

Lamp	Type	Voltage	Color	10250T		E34		LED/Lamp Number
				Catalog Number ①	Price U.S. \$	Catalog Number ①	Price U.S. \$	
LED	Full Voltage	24V AC/DC	Red Green Amber	10250T197HLRP24 10250T197HLGP24 10250T197HLAP24		E34FB197HLRP24 E34FB197HLGP24 E34FB197HLAP24		Bayonet Base
		120V AC	Red Green Amber	10250T197HLRP2A 10250T197HLGP2A 10250T197HLAP2A		E34FB197HLRP2A E34FB197HLGP2A E34FB197HLAP2A		
	Transformer	120V AC	Red Green Amber	10250T181HLRP06 10250T181HLGP06 10250T181HLAP06		E34TB120HLRP06 E34TB120HLGP06 E34TB120HLAP06		
Incandescent	Full Voltage	24V AC/DC	Red Green Amber	10250T206HRP 10250T206HGP 10250T206HAP		E34FB24HRP E34FB24HGP E34FB24HAP		#757
	Resistor	120V AC/DC	Red Green Amber	10250T201HRP 10250T201HGP 10250T201HAP		E34RB120HRP E34RB120HGP E34RB120HAP		120MB
	Transformer	120V AC	Red Green Amber	10250T181HRP 10250T181HGP 10250T181HAP		E34HB120HRP E34HB120HGP E34HB120HAP		#755

① To order different color lens, simply substitute the underlined characters in the Catalog Number with appropriate Suffix Code from the Lenses Selection Table below. Example: 10250T201HYP

Table 47-363. Lenses Selection Table

	Color	10250T						E34					
		Plastic			Glass			Plastic			Glass		
		Suffix Code	Catalog Number	Price U.S. \$	Suffix Code	Catalog Number	Price U.S. \$	Suffix Code	Catalog Number	Price U.S. \$	Suffix Code	Catalog Number	Price U.S. \$
 <i>Plastic</i>	Red Green Amber Yellow	RP GP AP	10250TC1N 10250TC2N 10250TC19N		RG GG AG	10250TC7N 10250TC8N 10250TC9N		RP GP AP	E34H2 E34H3 E34H9		RG GG AG	E34G2 E34G3 E34G9	
 <i>Glass</i>	Blue Clear White	YP LP CP WP	10250TC3N 10250TC4N 10250TC5N 10250TC6N		— LG CG WG	— 10250TC10N 10250TC11N 10250TC12N		YP LP CP WP	E34H4 E34H6 E34H0 E34H5		YG LG CG WG	E34G4 E34G6 E34G0 E34G5	

Note: Use NEMA 4X 10250T operators where exposed to ultraviolet light.

Additional Light
 Units **Page 47-224**
 Dimensions **Pages 47-239, 47-160 & 47-191**
 Enclosures **Page 47-240**
 Legend Plates **Pages 47-151 & 47-184**
 Replacement
 Lamps/LEDs **Page 47-157**
 Discount Symbol **1CD1C**

10250T/E34 Series, Illuminated Pushbutton and Indicating Light Components

Illuminated Pushbuttons and Indicating Lights

Table 47-364. Operators without Lens — NEC Class I Division 2, Groups B, C and D

Light Unit Type	Type	Voltage	Illuminated Pushbutton				Indicating Light				LED/Lamp Number
			10250T		E34		10250T		E34		
			Catalog Number	Price U.S. \$	Catalog Number	Price U.S. \$	Catalog Number	Price U.S. \$	Catalog Number	Price U.S. \$	
LED (LEDs not included) ①	Full Voltage	—	10250T397HL		E34CB497HL		10250T197HL		E34FB197HL		Bayonet Base
	Transformer AC Only	24	10250T416HL		E34XB024HL		—		—		
		120	10250T411HL		E34XB120HL		10250T181HL		E34TB120HL		
		240	10250T412HL		E34XB240HL		10250T182HL		E34TB240HL		
		277	10250T419HL		E34XB277HL		10250T198HL		E34TB277HL		
		380	10250T413HL		E34XB380HL		10250T183HL		E34TB380HL		
		480	10250T414HL		E34XB480HL		10250T184HL		E34TB480HL		
		600	10250T415HL		E34XB600HL		10250T185HL		E34TB600HL		
Incandescent	Full Voltage AC/DC	6	10250T473H		E34CB06H		10250T203H		E34FB06H		#755
		12	10250T474H		E34CB12H		10250T204H		E34FB12H		#756
		24	10250T476H		E34CB24H		10250T206H		E34FB24H		#757
		32	10250T477H		E34CB32H		10250T207H		E34FB32H		#1828
		48	10250T478H		E34CB48H		10250T208H		E34FB48H		#1835
	Resistor ② AC/DC	120	10250T471H		E34SB120H		10250T201H		E34RB120H		120MB
		240	10250T472H		E34SB240H		10250T202H		E34RB240H		120MB
	Transformer AC Only	24	10250T416H		E34XB024H		—		—		#755
		120	10250T411H		E34XB120H		10250T181H		E34TB120H		
		240	10250T412H		E34XB240H		10250T182H		E34TB240H		
		277	10250T419H		E34XB277H		10250T198H		E34TB277H		
		380	10250T413H		E34XB380H		10250T183H		E34TB380H		
		480	10250T414H		E34XB480H		10250T184H		E34TB480H		
		600	10250T415H		E34XB600H		10250T185H		E34TB600H		
	Neon AC/DC	120	—		—		10250T226H		E34NB120H		NE51H-R-22
		240	—		—		10250T227H		E34NB240H		NE51H-4-68

① These units do not include lamps. Order LED separately to match lens color from the LED Selection Table on Page 47-230.

② Resistor units are not available for use with LEDs, choose either transformer or full voltage LED style.

Note: Use NEMA 4X 10250T operators where exposed to ultraviolet light.

Table 47-365. Indicating Light Lens

Plastic	Color	10250T		E34		Glass	Color	10250T		E34	
		Catalog Number	Price U.S. \$	Catalog Number	Price U.S. \$			Catalog Number	Price U.S. \$	Catalog Number	Price U.S. \$
	Red	10250TC1N		E34H2			Red	10250TC7N		E34G2	
	Green	10250TC2N		E34H3			Green	10250TC8N		E34G3	
	Amber	10250TC19N		E34H9			Amber	10250TC9N		E34G9	
	Yellow	10250TC3N		E34H4			Yellow	—		E34G4	
	Blue	10250TC4N		E34H6			Blue	10250TC10N		E34G6	
	Clear	10250TC5N		E34H0			Clear	10250TC11N		E34G0	
White	10250TC6N		E34H5		White	10250TC12N		E34G5			

Table 47-366. Illuminated Pushbutton Lenses

	Color	10250T		E34	
		Catalog Number	Price U.S. \$	Catalog Number	Price U.S. \$
	Red	10250TC21		E34V2	
	Green	10250TC22		E34V3	
	Yellow	10250TC23		E34V4	
	Amber	10250TC43		E34V9	
	Blue	10250TC24		E34V6	
	Clear	10250TC25		E34V0	
	White	10250TC26		E34V5	

Accessories **Pages 47-155 & 47-187**
 Contact Blocks . . . **Page 47-239**
 Dimensions **Pages 47-239, 47-160 & 47-191**
 Enclosures **Page 47-240**
 Legend Plates **Pages 47-151 & 47-184**
 Replacement
 Lamps/LEDs . . . **Page 47-157**
 Discount Symbol . . **1CD1C**

Push-Pull Units

- Two- and Three-Position
- Non-illuminated

Table 47-367. 2-Position Maintained Push, Maintained Pull — UL (NEMA) Type 3, 3R, 4, 4X, 12, 13, NEC Class I Division 2, Groups B, C and D

Operator Function (Position) ①		Red Standard Push-Pull ②				Contact Type	Mounting Location ①	
Maintained (Pull)	Maintained (Push)	10250T	E34	10250T	E34		1	2
		Catalog Number	Price U.S. \$	Catalog Number	Price U.S. \$			
O X	X O	<u>10250T714R</u>		<u>E34EX714R</u>		1NO 1NC		
O X O X	X O X O	<u>10250T715R</u>		<u>E34EX715R</u>		2NO 2NC		

① Bolded circuit corresponds to "X-O" circuit selection. X = closed circuit, O = open circuit.
 ② To order different type or color buttons, simply substitute underlined character with appropriate Suffix Code from the Button and Color Selection Table below. Example: 10250T714G

Table 47-368. 3-Position Maintained Push, Momentary Pull — UL (NEMA) Type 3, 3R, 4, 4X, 12, 13, NEC Class I Division 2, Groups B, C and D

Operator Function (Position) ③			Red Standard Push-Pull ④				Contact Type	Mounting Location ③	
Momentary (Pull)	Maintained (Intermediate)	Maintained (Push)	10250T	E34	10250T	E34		1	2
			Catalog Number	Price U.S. \$	Catalog Number	Price U.S. \$			
O X	O O	X O	<u>10250T716R</u>		<u>E34EX716R</u>		1NO 1NC		
X X	O X	O O	<u>10250T717R</u>		<u>E34EX717R</u>		1NC 1NC		

③ Bolded circuit corresponds to "X-O" circuit selection. X = closed circuit, O = open circuit.
 ④ To order different type or color buttons, simply substitute underlined character with appropriate Suffix Code from the Button and Color Selection Table below. Example: 10250T716G

Table 47-369. 3-Position Momentary Push, Momentary Pull — UL (NEMA) Type 3, 3R, 4, 4X, 12, 13, NEC Class I Division 2, Groups B, C and D

Operator Function (Position) ⑤			Red Standard Push-Pull ⑥				Contact Type	Mounting Location ⑤	
Momentary (Pull)	Maintained (Intermediate)	Momentary (Push)	10250T	E34	10250T	E34		1	2
			Catalog Number	Price U.S. \$	Catalog Number	Price U.S. \$			
O X	O O	X O	<u>10250T718R</u>		<u>E34EX718R</u>		1NO 1NC		
X X	O X	O O	<u>10250T721R</u>		<u>E34EX721R</u>		1NC 1NC		

⑤ Bolded circuit corresponds to "X-O" circuit selection. X = closed circuit, O = open circuit.
 ⑥ To order different type or color buttons, simply substitute underlined character with appropriate Suffix Code from the Button and Color Selection Table below. Example: 10250T718G

Table 47-370. Button and Color Selection Table

Standard	Color	Suffix Code	Catalog Number		Price U.S. \$	Jumbo Mushroom Head (Anodized) Aluminum	Color	Suffix Code	Catalog Number		Price U.S. \$
	Red (EMER. STOP) Green Black Blue	R E G B L	10250TB62 10250TB63 10250TB61 10250TB60 10250TB64	E34C2 E34C2N8 E34C3 E34C1 E34C6			Red (EMER. STOP) Green Black Yellow	RJ EJ GJ BJ VJ	10250TJ62 10250TJ63 10250TJ61 10250TJ60 10250TJ64	E34J2 E34J2N8 — — —	

Accessories Pages 47-155 & 47-187
 Dimensions Pages 47-239, 47-160 & 47-191
 Enclosures Page 47-240
 Legend Plates Pages 47-151 & 47-184
 Discount Symbol . . . 1CD1C

10250T/E34 Series, Assembled Devices — Illuminated Push-Pull Units

Illuminated Push-Pull Units

- Two-Position Maintained
- Illuminated

Table 47-371. 2-Position Illuminated Maintained Push, Maintained Pull — UL (NEMA) Type 3, 3R, 4, 4X, 12, 13, NEC Class I Division 2, Groups B, C and D

Operator Position ①		Lamp	Type	Voltage	Red Standard Push-Pull ②				Contact Type	Mounting Location ①						
Maintained — Pull	Maintained — Push				10250T	E34	Catalog Number	Price U.S. \$		Catalog Number	Price U.S. \$	1	2			
		LED	Full Voltage	24V AC/DC	10250T853RD24		E34EX853RD24		1NO 1NC							
				120V AC	10250T853RD2A		E34EX853RD2A									
				Transformer	24V AC	10250T843RD06		E34EX843RD06								
					120V AC	10250T844RD06		E34EX844RD06								
			Incandescent	Full Voltage	24V AC/DC	10250T849RD		E34EX849RD					1NO 1NC			
					120V AC/DC	10250T851RD		E34EX851RD								
					Transformer	24V AC	10250T843RD					E34EX843RD				
						120V AC	10250T844RD					E34EX844RD				

① Bolded circuit corresponds to "X-O" circuit selection. X = closed circuit, O = open circuit.

② To order different type or color lens, simply substitute the underlined characters with appropriate Suffix Code from the Lens and Color Selection Table below. Example: 10250T851GS

47

Table 47-372. Lens and Color Selection Table

Color	10250T			E34		
	Suffix Code	Catalog Number	Price U.S. \$	Suffix Code	Catalog Number	Price U.S. \$
Standard						
Red	RD	10250TC47		RD	E34M2	
Red (EMER. STOP)	ED	10250TC53		ED	E34M2N8	
Green	GD	10250TC48		GD	E34M3	
Blue	LD	10250TC49		LD	E34M6	
Amber	AD	10250TC50		AD	E34M9	
White	WD	10250TC51		WD	E34M5	
Clear	CD	10250TC52		CD	E34M0	

Color	10250T		
	Suffix Code	Catalog Number	Price U.S. \$
Side-Lighted (Anodized) Aluminum			
Red	RS	10250TC57	
Red (EMER. STOP)	ES	10250TC63	
Green	GS	10250TC58	
Blue	LS	10250TC59	
Amber	AS	10250TC64	
Yellow	YS	10250TC60	
White	WS	10250TC61	
Clear	CS	10250TC62	

HD Alum. with Transparent Center			
Red	RH	10250TC65	
Green	GH	10250TC66	
Amber	AH	10250TC67	



Standard



Side-Lighted (Anodized) Aluminum



HD Alum. with Transparent Center

- Accessories **Pages 47-155 & 47-187**
- Additional Light Units **Page 47-224**
- Dimensions **Pages 47-239, 47-160 & 47-191**
- Enclosures **Page 47-240**
- Legend Plates **Pages 47-151 & 47-184**
- Replacement Lamps/LEDs **Page 47-157**
- Discount Symbol **1CD1C**

Illuminated Push-Pull Units (Continued)

- Three-Position — Maintained Push, Momentary Pull
- Illuminated

Table 47-373. 3-Position Illuminated Maintained Push, Momentary Pull — UL (NEMA) Type 3, 3R, 4, 4X, 12, 13, NEC Class I Division 2, Groups B, C and D

Operator Position ①			Lamp	Type	Voltage	Red Standard Push-Pull ②				Contact Type	Mounting Location ①		
Momentary — Pull	Maintained — Intermediate	Maintained — Push				10250T	E34	Catalog Number	Price U.S. \$		Catalog Number	Price U.S. \$	1
			LED	Full Voltage	24V AC/DC	10250T864RD24		E34EX864RD24		1NO 1NC			
					120V AC	10250T864RD2A		E34EX864RD2A					
					Transformer	24V AC	10250T854RD06		E34EX854RD06				
						120V AC	10250T855RD06		E34EX855RD06				
				Full Voltage	24V AC/DC	10250T875RD24		E34EX875RD24		1NC 1NC			
					120V AC	10250T875RD2A		E34EX875RD2A					
					Transformer	24V AC	10250T865RD06		E34EX865RD06				
						120V AC	10250T866RD06		E34EX866RD06				
			Incandescent	Full Voltage	24V AC/DC	10250T860RD		E34EX860RD		1NO 1NC			
					Resistor	120V AC	10250T862RD		E34EX862RD				
					Transformer	24V AC	10250T854RD		E34EX854RD				
						120V AC	10250T855RD		E34EX855RD				
				Full Voltage	24V AC/DC	10250T871RD		E34EX871RD		1NC 1NC			
					Resistor	120V AC	10250T873RD		E34EX873RD				
					Transformer	24V AC	10250T865RD		E34EX865RD				
						120V AC	10250T866RD		E34EX866RD				

① Bolded circuit corresponds to "X-O" circuit selection. X = closed circuit, O = open circuit.
 ② To order different type or color lens, simply substitute the underlined characters with appropriate Suffix Code from the Lens and Color Selection Table on the bottom of **Page 47-226**. Example: 10250T862AS

Accessories **Pages 47-155 & 47-187**
 Additional Light
 Units **Page 47-224**
 Dimensions **Pages 47-239, 47-160 & 47-191**
 Enclosures **Page 47-240**
 Legend Plates **Pages 47-151 & 47-184**
 Replacement
 Lamps/LEDs **Page 47-157**
 Discount Symbol **1CD1C**

Illuminated Push-Pull Units (Continued)

- Three-Position Momentary
- Illuminated

Table 47-374. 3-Position Illuminated Momentary Push, Momentary Pull — UL (NEMA) Type 3, 3R, 4, 4X, 12, 13, NEC Class I Division 2, Groups B, C and D

Operator Position ①			Lamp	Type	Voltage	Red Standard Push-Pull ②				Contact Type	Mounting Location ①		
Momentary — Pull	Maintained — Intermediate	Maintained — Push				10250T	E34	Catalog Number	Price U.S. \$		Catalog Number	Price U.S. \$	1
			LED	Full Voltage	24V AC/DC	10250T886RD24		E34EX886RD24		1NO 1NC			
O	O	X			120V AC	10250T886RD2A		E34EX886RD2A					
X	O	O			Transformer	24V AC	10250T876RD06		E34EX876RD06				
X	X	O			120V AC	10250T877RD06		E34EX877RD06					
X	O	O		Full Voltage	24V AC/DC	10250T897RD24		E34EX897RD24		1NC 1NC			
X	X	O			120V AC	10250T897RD2A		E34EX897RD2A					
X	O	O			Transformer	24V AC	10250T887RD06		E34EX887RD06				
X	X	O			120V AC	10250T888RD06		E34EX888RD06					
O	O	X	Incandescent	Full Voltage	24V AC/DC	10250T882RD		E34EX882RD		1NO 1NC			
O	O	X			Resistor	120V AC	10250T884RD		E34EX884RD				
X	O	O			Transformer	24V AC	10250T876RD		E34EX876RD				
X	X	O			120V AC	10250T877RD		E34EX877RD					
X	O	O		Full Voltage	24V AC/DC	10250T893RD		E34EX893RD		1NC 1NC			
X	X	O			Resistor	120V AC	10250T895RD		E34EX895RD				
X	O	O			Transformer	24V AC	10250T887RD		E34EX887RD				
X	X	O			120V AC	10250T888RD		E34EX888RD					

47

① Bolded circuit corresponds to “X-O” circuit selection. X = closed circuit, O = open circuit.

② To order different type or color lens, simply substitute the underlined characters with appropriate Suffix Code from the Lens and Color Selection Table on the bottom of **Page 47-226**. Example: 10250T884GD

Accessories **Pages 47-155 & 47-187**
 Additional Light
 Units **Page 47-224**
 Dimensions **Pages 47-239, 47-160 & 47-191**
 Enclosures **Page 47-240**
 Legend Plates **Pages 47-151 & 47-184**
 Replacement
 Lamps/LEDs **Page 47-157**
 Discount Symbol **1CD1C**

Push-Pull Operators

An illuminated Push-Pull pushbutton unit, arranged for one-hole mounting, can replace two pushbuttons and a pilot light or the non-illuminated form can replace two pushbuttons. These units are available in three basic types:

- **Maintained** — (Two-Position). Maintains in the pulled or pushed position until manually actuated to the opposite mode.
- **Momentary** — (Three-Position). Spring returns to an intermediate position when pulled or pushed and released.
- **Momentary Pull, Maintained Push** — (Three-Position). Spring returns to intermediate position when pulled. Maintains in pushed position until manually returned to intermediate (ready to reset) position. Maintained stop holds circuit open and will prevent other series connected operators from starting the system.

The Operators, Buttons, Contact Blocks, etc., are offered as building block components that can be intermixed to satisfy many requirements. This minimizes the need for a varied and costly inventory.

Application Guide

To assist in the selection of contact blocks, the sketch to the right shows pictorially by symbols 1 and 2 locations of contact circuits after assembly of contact blocks and adapter to the operator. The chart below shows the effect of the push and pull operations on either NO or NC contacts. (X = contact closed, O = contact open)



2-Position Maintained Push-Pull without Button on Lens
Catalog Number E34GDB



2-Position Maintained Push-Pull without Button on Lens
Catalog Number 10250T5

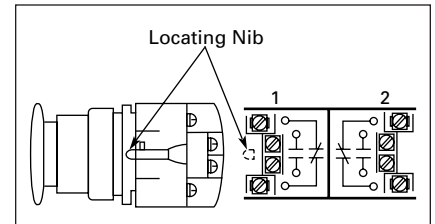

Figure 47-145. Locating Nibs

Table 47-375. Push-Pull Operator Components

Type of Operator	10250T		E34		Contact Block	Operator Position and Circuit Arrangement					
	Catalog Number	Price U.S. \$	Catalog Number	Price U.S. \$		Out — Pull		Intermediate		In — Push	
						Contact Block Mounting Location					
		1	2	1	2	1	2	1	2		
2-Position Operator without Lens											
Maintained Push-Pull	10250T5		E34GDB		1NO 1NC	O or X	O or X	No Intermediate Position	X or O	X or O	
					2NO 2NC	O or X	O or X		X or O	X or O	
3-Position Operator without Lens											
Momentary Push-Pull	10250T4		E34GEB		1NO 1NC	O or X	O or X	O or X	X or O	X or O	
Maintained Push-Momentary Pull	10250T9		E34GFB		2NO 2NC	O or X	O or X	O or X	X or O	O or O	
Momentary Push-Pull	10250T10		E34GHB		1NO 1NC	O or X	O or X	O or X	X or O	X or O	
					2NO 2NC	O or X	O or X	O or X	X or O	X or O	

Note: Use NEMA 4X 10250T operators where exposed to ultraviolet light.

Button or Lens **Page 47-230**
 Contact Blocks **Page 47-239**
 Dimensions **Pages 47-160 & 47-191**
 Enclosures **Page 47-240**
 Legend Plates **Pages 47-151 & 47-184**
 Discount Symbol **1CD1C**

10250T/E34 Series, Push-Pull Components

Push-Pull Operators (Continued)

Push-Pull Light Units, Lens and Buttons

Table 47-376. Light Units for Illuminated Push-Pull Devices — NEC Class I Division 2 Groups B, C and D

Light Unit Type	Type	Voltage	Catalog Number	Price U.S. \$	LED/Lamp Number
LED (LEDs not included) ①	Full Voltage	—	10250T97HL		Bayonet Base
	Transformer AC Only 50/60 Hz	24	10250T89HL		
		120	10250T63HL		
		208	10250T64HL		
		240	10250T65HL		
		277	10250T82HL		
		380	10250T66HL		
		480	10250T67HL		
		600	10250T68HL		
		Incandescent	Full Voltage AC or DC	6	
12	10250T70H				#756
24/28	10250T79H				#757
32	10250T83H				#1828
Resistor AC or DC	120		10250T80H		120MB
	240		10250T81H		
Transformer AC Only 50/60 Hz	24		10250T89H		#755
	120		10250T63H		
	208		10250T64H		
	240		10250T65H		
	277		10250T82H		
	380		10250T66H		
480	10250T67H				
600	10250T68H				

① These units do not include lamps. Order LED separately to match lens color from **Table 47-379**.

Table 47-377. Alternate Lenses for Illuminated Push-Pull Devices

Color	10250T		E34	
	Catalog Number	Price U.S. \$	Catalog Number	Price U.S. \$
Standard				
Red	10250TC47		E34M2	
Red (EMER. STOP)	10250TC53		E34M2N8	
Green	10250TC48		E34M3	
Blue	10250TC49		E34M6	
Amber	10250TC50		E34M9	
White	10250TC51		E34M5	
Clear	10250TC52		E34M0	
Side-Lighted Anodized Aluminum Ring				
Red	10250TC57		—	
Red (EMER. STOP)	10250TC63		—	
Green	10250TC58		—	
Blue	10250TC59		—	
Amber	10250TC64		—	
Yellow	10250TC60		—	
White	10250TC61		—	
Clear	10250TC62		—	
Heavy-Duty Aluminum with Transparent Center				
Red	10250TC65		—	
Green	10250TC66		—	
Amber	10250TC67		—	

Table 47-378. Buttons for Non-Illuminated Push-Pull Devices

Color	10250T		E34	
	Catalog Number	Price U.S. \$	Catalog Number	Price U.S. \$
Standard				
Red	10250TB62		E34C2	
Red (EMER. STOP)	10250TB63		E34C2N8	
Green	10250TB61		E34C3	
Black	10250TB60		E34C1	
Blue	10250TB64		E34C6	

Table 47-378. Buttons for Non-Illuminated Push-Pull Devices (Continued)

Color	10250T		E34	
	Catalog Number	Price U.S. \$	Catalog Number	Price U.S. \$
	Jumbo Mushroom Head (Anodized) Aluminum ②			
	Red	10250TJ62		E34J2
	Red (EMER. STOP)	10250TJ63		E34J2N8
	Green	10250TJ61		—
	Black	10250TJ60		—
Yellow	10250TJ64		—	

② Anodized aluminum head is not suitable for use with ultraviolet light applications.

Note: Use NEMA 4X 10250T operators where exposed to ultraviolet light.

Table 47-379. LED Selection Table

Voltage	Color	Catalog Number	Price U.S. \$
6V AC/DC Suitable for Use with Transformers	Red	E22LED006RN	
	Orange	E22LED006ON	
	Yellow	E22LED006YN	
	Green	E22LED006GN	
	Blue	E22LED006BN	
12V AC/DC	White	E22LED006WN	
	Red	E22LED012RN	
	Orange	E22LED012ON	
	Yellow	E22LED012YN	
	Green	E22LED012GN	
24V AC/DC	Blue	E22LED012BN	
	White	E22LED012WN	
	Red	E22LED024RN	
	Orange	E22LED024ON	
	Yellow	E22LED024YN	
48V AC/DC	Green	E22LED024GN	
	Blue	E22LED024BN	
	White	E22LED024WN	
	Red	E22LED048RN	
	Orange	E22LED048ON	
60V AC/DC	Yellow	E22LED048YN	
	Green	E22LED048GN	
	Blue	E22LED048BN	
	White	E22LED048WN	
	120V AC	Red	E22LED060RN
Orange		E22LED060ON	
Yellow		E22LED060YN	
Green		E22LED060GN	
Blue		E22LED060BN	
120V DC	White	E22LED060WN	
	Red	E22LED120RA	
	Orange	E22LED120OA	
	Yellow	E22LED120YA	
	Green	E22LED120GA	
	Blue	E22LED120BA	
	White	E22LED120WA	
	Red	E22LED120RD	
	Orange	E22LED120OD	
	Yellow	E22LED120YD	
	Green	E22LED120GD	
	Blue	E22LED120BD	
	White	E22LED120WD	

For a complete listing of all LEDs available, see Page 47-157.

Accessories Pages 47-155 & 47-187
 Contact Blocks Page 47-239
 Dimensions Pages 47-160 & 47-191
 Enclosures Page 47-240
 Legend Plates Pages 47-151 & 47-184
 Replacement Lamps/LEDs Page 47-157
 Discount Symbol 1CD1C

Selector Switch Units

- Two- and Three-Position
- Non-illuminated

Table 47-380. 2-Position Selector Switch — Non-illuminated — UL (NEMA) Type 3, 3R, 4, 4X, 12, 13, NEC Class I Division 2, Groups B, C and D

Operator Position ①		Operator Action ②	Black Knob — Selector Switch ③				Contact Type	Mounting Location ④		Cam Code
			10250T		E34			1	2	
			Catalog Number	Price U.S. \$	Catalog Number	Price U.S. \$				
X	O	M ↘ M	<u>10250T722BK</u>		<u>E34EX722BK</u>		1NC		1	
O	X	M ↘ S	<u>10250T724BK</u>		<u>E34EX724BK</u>		1NO			
X	O	M ↘ M	<u>10250T723BK</u>		<u>E34EX723BK</u>		1NC		1	
O	X	M ↘ S	<u>10250T725BK</u>		<u>E34EX725BK</u>		1NO			

① Bolded circuit corresponds to “X-O” circuit selection. X = closed circuit, O = open circuit.

② M = Maintained. S = Spring return in direction of arrow (→).

③ To order different type or color selector switch, simply substitute the underlined characters with appropriate Suffix Code from the table on **Page 47-232**. Example: 10250T722LL. For keyed selector switch, substitute the underlined characters with T_ (cam)+_ (key removal position). Example: 10250T722T13

Table 47-381. 3-Position Selector Switch — Non-illuminated — UL (NEMA) Type 3, 3R, 4, 4X, 12, 13, NEC Class I Division 2, Groups B, C and D

Operator Position ④			Operator Action ⑤	Black Knob — Selector Switch ⑥				Contact Type	Mounting Location ④		Cam Code
				10250T		E34			1	2	
				Catalog Number	Price U.S. \$	Catalog Number	Price U.S. \$				
X	O	O	M ↘ M	<u>10250T726BK</u>		<u>E34EX726BK</u>		1NO		3	
O	O	X	S ↘ M	<u>10250T728BK</u>		<u>E34EX728BK</u>		1NO			
			S ↘ S	<u>10250T730BK</u>		<u>E34EX730BK</u>					
			M ↘ S	<u>10250T732BK</u>		<u>E34EX732BK</u>					
X	O	O	M ↘ M	<u>10250T727BK</u>		<u>E34EX727BK</u>		1NO		3	
O	X	X	S ↘ M	<u>10250T729BK</u>		<u>E34EX729BK</u>		1NC-1NC			
O	O	X	S ↘ S	<u>10250T731BK</u>		<u>E34EX731BK</u>		(Series)			
			M ↘ S	<u>10250T733BK</u>		<u>E34EX733BK</u>		1NO			

④ Bolded circuit corresponds to “X-O” circuit selection. X = closed circuit, O = open circuit.

⑤ M = Maintained. S = Spring return in direction of arrow (→).

⑥ To order different type or color selector switch, simply substitute the underlined characters with appropriate Suffix Code from the Switch and Color Selection Table on **Page 47-232**. Example: 10250T726LL. For keyed selector switch, substitute the underlined characters with T_ (cam)+_ (key removal position). Example: 10250T726T13

- Accessories **Pages 47-155 & 47-187**
- Additional Circuit Arrangements **Pages 47-233 – 47-234**
- Dimensions **Pages 47-239, 47-160 & 47-191**
- Enclosures **Page 47-240**
- Legend Plates **Pages 47-151 & 47-184**
- Discount Symbol **1CD1C**

10250T/E34 Series, Assembled Devices — Selector Switch Units

Selector Switch Units (Continued)

- Four-Position Maintained
- Non-illuminated

Table 47-382. 4-Position Selector Switch — Non-illuminated — UL (NEMA) Type 3, 3R, 4, 4X, 12, 13, NEC Class I Division 2, Groups B, C and D

Operator Position ①				Operator Action ②		Black Knob — Selector Switch ③				Contact Type	Mounting Location ①		Cam Code
						10250T		E34			1	2	
X	O	O	O	M	M	<u>10250T743BK</u>		<u>E34EX743BK</u>		1NC			7
O	X	O	O							1NO			
O	O	X	O							1NO			
O	O	O	X							1NC			

① Bolded circuit corresponds to “X-O” circuit selection. X = closed circuit, O = open circuit.

② M = Maintained.

③ To order different type or color selector switch, simply substitute the underlined characters with appropriate Suffix Code from the Switch and Color Selection Table below.

Example: 10250T743LL. For keyed selector switch, substitute the underlined characters with T_ (cam) + _ (key removal position). Example: 10250T743T77

Table 47-383. Switch and Color Selection Table

Color	Knob		Lever		Lever ④		Coin Slot ⑤	
	Suffix Code	Adder U.S. \$	Suffix Code	Adder U.S. \$	Suffix Code	Adder U.S. \$	Suffix Code	Adder U.S. \$
Black	BK		BL		BA		BC	
Red	RK		RL		RA		RC	
Green	GK		GL		GA		GC	
Yellow	YK		YL		YA		YC	
White	WK		WL		WA		WC	
Gray	AK		AL		AA		AC	
Blue	LK		LL		LA		LC	
Orange	NK		NL		NA		NC	

④ Designed for added ingress protection. For use in maintained operators only.

⑤ 10250T only.

Table 47-384. Key Operated Selection Table

Number of Position	Operator Action ⑥	Suffix and Removal Positions
2	M M M ← S	T1 + 1, 2, 3 T1 + 2
3	M M M S → M M S → M ← S M M ← S	T3 + 1 – 7 T3 + 1, 4, 5 T3 + 4 T3 + 2, 4, 6
4	MMMM	T7 + 7

⑥ M = Maintained. S = Spring return in direction of arrow (→).

Table 47-385. Key Removal Positions

Code Suffix	Key Removal Positions	Code Suffix	Key Removal Positions
1	Right Only	5	Right & Center
2	Left Only	6	Left & Center
3	Right & Left	7	All Positions
4	Center Only		

Note: Key removal in “spring return from” positions not recommended.

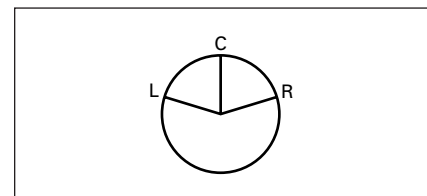

Figure 47-146. Key Removal Positions

- Accessories **Pages 47-155 & 47-187**
- Additional Circuit Arrangements . **Pages 47-233 – 47-234**
- Dimensions **Pages 47-239, 47-160 & 47-191**
- Enclosures **Page 47-240**
- Legend Plates **Pages 47-151 & 47-184**
- Discount Symbol . . **1CD1C**



Selector Switch Selection

Cam and Contact Block Selection

Selector switches in their varied forms (2-position, 3-position, and 4-position) are a big factor contributing to the great flexibility of control that a well rounded line of “pushbuttons” can achieve. Because of their flexibility, they tend to cause difficulty with product selection and application. The following systematic approach should simplify that task.

Cam and contact block selection is better understood if you:

- Work with each incoming and outgoing wire/circuit separately.
- Recognize the terms NO and NC only identify the type of contact by its mode before mounting to the operator. The “X-O” table (Page 47-234) shows how that contact will act after assembly to the operator with the selected cam shape. X = closed circuit, O = open circuit.
- One NO-NC contact block may be mounted behind each plunger of the mounting adapter for a total of four circuits.
- Each cam has two separate lobes, each of which operates one of the two contact block plungers independently of each other. Those are identified as position 1 (locating nib side) and position 2 (opposite of locating nib). The position designations give direction in selecting and mounting of the contact blocks (see Figure 47-147).

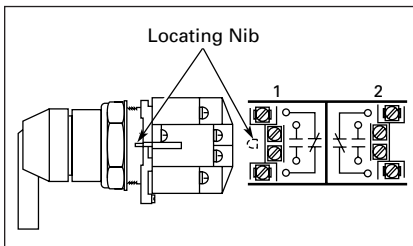

Figure 47-147. Contact Circuit Locations

Systematic Approach

Application: **HAND-OFF-AUTO** Selector Switch. In this circuit, one incoming line is distributed to two other outgoing circuits by the switch. The two circuits can be looked at individually.

Step 1: Elementary Diagram.

Construct on paper, or in your mind, a simple elementary diagram of the switching scheme as follows:

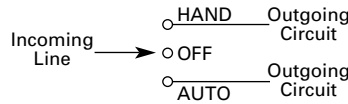

Step 2: “X-O” Pattern.

From the elementary diagram, you can construct an “X-O” diagram which describes when the contacts are to be closed (X) or open (O) in the various positions of the switch. The “X-O” for the **HAND** circuit looks like this:

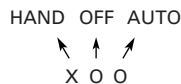

In this circuit, you want a contact closed on the left (HAND) but open in the center and right.

For the **AUTO** circuit, the “X-O” diagram would look like this:

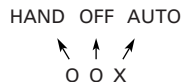

Putting them together, the complete “X-O” diagram is:



Once the “X-O” diagram has been generated, the next step is to select the cam and contact block, or blocks, needed to perform the desired “X-O” functions. The selection table on the following page lists the various types (shapes) of cams by number to choose from and the type of contact and position to achieve the function outlined in your “X-O” diagram.

Step 3: Cam Selection.

The cam you select determines the operation of all contact blocks mounted to the operator. It is selected on the basis that it provides the simplest circuitry for the desired “X-O” diagram. The selection tables of the following page show all the “X-O” combinations. For the purpose of this example, the applicable portion of those tables is shown in **Table 47-386**.

Table 47-386. Example Selection Table

No.	Desired Circuit & Operator Position	Cam Code #2		Cam Code #3	
		Contact Blocks & Mounting Location	Contact Blocks & Mounting Location	Contact Blocks & Mounting Location	Contact Blocks & Mounting Location
		1	2	1	2
1	X O O				
4	O O X				

① Wired in series.

Now to make the cam selection, make a simple worksheet such as below. (1) or (2) = mounting location from chart above:

		Cam 2	Cam 3
X O O	(1)NO – (2)NC ①	(1)NO	(2)NO
O O X	(2)NC		

It becomes obvious that cam 3 is the better choice because the series connection can be avoided, making it simpler to wire.

Step 4: Contact Block Selection.

Having selected the cam, contact block selection is simply a matter of determining if you require one NO-NC contact block (Cat. No 10250T1H) or two. Given the limitations of the factory sealed contact block and the desired “X-O” application, you may have circuits that will not be needed — as seen here with the two additional NC circuits. (1) or (2) = mounting location from chart above.

Qty	Catalog No.	Cam 3
2	10250T1H	(1)NO (2)NC (1)NC (2)NO

Step 5: Selector Switch Operator.

Lastly, you have to choose from the many types of operators — knob and lever in various colors or keyed. Also what combinations of maintained and spring return functions are required. Selection of these operators can be found on **Page 47-235**. For the above example you may want a 3-position maintained black knob, cam 3 — Catalog Number 10250T1323 (or 34VHBK1).

The Complete Switch: 10250T1323 (or 34VHBK1) with two 10250T1H or for one composite catalog number — 10250T726BK (or E34EX726BK) found on **Page 47-231**.

10250T/E34 Series, Selector Switch Selection

Selector Switch Selection (Continued)

Circuits shown illustrate connections to obtain a selector circuit combination and are shown with their appropriate line diagrams in **BOLD**. Field wiring of jumper connections required as shown.

X = Closed Circuit, O = Open Circuit

Table 47-387. 2-Position Selector Switch

Number	Desired Circuit and Operator Position 	Cam Code #1	
		Contact Blocks and Mounting Location	
		1	2
1	X O		
2	O X		

Table 47-388. 3-Position Selector Switch

No.	Desired Circuit and Operator Position 	Cam Code #2		Cam Code #3	
		Contact Blocks and Mounting Location		Contact Blocks and Mounting Location	
		1	2	1	2
1	X O O				
2	X X O				
3	X O X				
4	O O X				
5	O X X				
6	O X O				

Table 47-389. 4-Position Selector Switch

Number	Desired Circuit and Operator Position 	Cam Code #7	
		Contact Blocks and Mounting Location	
		1	2
1	X O O O		
2	O X O O		
3	O O X O		
4	O O O X		
5	X O O X		
6	O X X O		
7	O O X X		
8	X X O O		
9	O X O X		
10	X O X O		

Selector Switch Operators

10250T Selector Switch Operators with Caps

Table 47-390. 10250T Selector Switch Operators with Caps — UL (NEMA) Type 3, 3R, 4, 4X, 12, 13

Positions	Operator Action ①	Black Knob Selector Switch — Vertical Mounting ③			Black Lever Selector Switch — Vertical Mounting ③		
		Cam Code ②	Catalog Number	Price U.S. \$	Cam Code ②	Catalog Number	Price U.S. \$
2-Position — 60° Throw		1	10250T1311		1	10250T3011	
		1	10250T1371		1	10250T3071	
3-Position — 60° Throw		2	10250T1322		2	10250T3022	
		3	10250T1323		3	10250T3023	
		2	10250T1332		2	10250T3032	
		3	10250T1333		3	10250T3033	
		2	10250T1342		2	10250T3042	
		3	10250T1343		3	10250T3043	
4-Position — 40° Throw		2	10250T1352		2	10250T3052	
		3	10250T1353		3	10250T3053	
4-Position — 40° Throw		7	10250T1367		7	10250T3067	

- ① M = Maintained. S = Spring return in direction of arrow (→).
- ② For selection of the proper cam and contact block to obtain the proper circuit sequence, see selection instructions and table on **Pages 47-233 – 47-234**.
- ③ Field convertible to Horizontal Mounting or order operator only and separate operator cap.

Table 47-391. 10250T Key Operators with Cam — UL (NEMA) Type 3, 3R, 4, 4X, 12, 13

Positions	Operator Action ④	Cam Code ⑤	Optional Key Removal Positions ⑥	Vertical Mounting	Horizontal Mounting	Price U.S. \$
				Catalog Number ⑥	Catalog Number ⑥	
2-Position — 60° Throw		1	1, 2, 3	10250T1511_	10250T1611_	
		1	2	10250T1571_	10250T1581_	
3-Position — 60° Throw		2	1 – 7	10250T1522_	10250T1622_	
		3		10250T1523_	10250T1623_	
		2	1, 4, 5	10250T1532_	10250T1632_	
		3		10250T1533_	10250T1633_	
		2	4	10250T1542_	10250T1642_	
		3		10250T1543_	10250T1643_	
	2	2, 4, 6	10250T1652_	10250T1662_		
	3		10250T1653_	10250T1663_		
4-Position — 40° Throw		7	7	10250T1677_	10250T1687_	

- ④ M = Maintained. S = Spring return in direction of arrow (→).
- ⑤ For selection of the proper cam and contact block to obtain the proper circuit sequence, see selection instructions and table on **Pages 47-233 – 47-234**.
- ⑥ Choose key removal position required for application from **Table 47-392**. Add key removal Code No. to listed Catalog Number. Example: 10250T15112.

Table 47-392. Key Removal Positions

Code Suffix	Key Removal Positions	Code Suffix	Key Removal Positions
1	Right Only	5	Right & Center
2	Left Only	6	Left & Center
3	Right & Left	7	All Positions
4	Center Only		

Note: Key removal in “spring return from” positions not recommended.

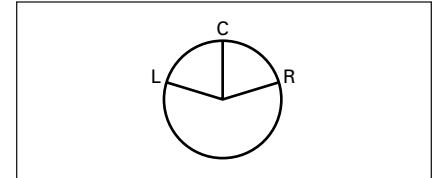

Figure 47-148. Key Removal Positions

Replacement Keys or Dissimilar Locks for Above Key Operators

Listed operators have identical locks and keys (Key Code H661) Catalog Number 10250ED824.

Table 47-393. Replacement Keys

Description	Catalog Number	Price U.S. \$
Replacement Keys (Code H661)	10250ED824	

Contact Blocks **Page 47-239**
Dimensions..... **Pages 47-160 – 47-162**
Enclosures **Page 47-240**
Legend Plates **Pages 47-151 – 47-152**
Discount Symbol **1CD1C**

E34 Series, Selector Switch Components

Selector Switch Operators (Continued)

Table 47-394. E34 Selector Switch Operators with Knob Assembled — UL (NEMA) Type 3, 3R, 4, 4X, 12, 13

Positions	Operator Action ①	Black Knob Selector Switch — Vertical Mounting ③		
		Cam Code ②	Catalog Number ④	Price U.S. \$
2-Position — 60° Throw		1	<u>E34VFBK1</u>	
		1	<u>E34VEBK1</u>	
3-Position — 60° Throw		2	<u>E34VGBK1</u>	
		3	<u>E34VHBK1</u>	
		2	<u>E34VJBK1</u>	
		3	<u>E34VKBK1</u>	
		2	<u>E34VLBK1</u>	
		3	<u>E34VMBK1</u>	
4-Position — 40° Throw		2	<u>E34VNBK1</u>	
		3	<u>E34VPBK1</u>	
4-Position — 40° Throw		7	<u>E34VTBK1</u>	

- ① M = Maintained. S = Spring return in direction of arrow (→).
- ② For selection of the proper cam and contact block to obtain the proper circuit sequence, see selection instructions and table on Pages 47-233 – 47-234.
- ③ Field convertible to Horizontal Mounting.
- ④ For other colors of either knob or lever, replace the underlined characters of the Catalog Number with the appropriate Suffix Code from Alternate Knob and Lever Table below. Example: E34VFBL2

Table 47-395. E34 Key Operators with Cam and Cap — UL (NEMA) Type 3, 3R, 4, 4X, 12, 13

Positions	Operator Action ⑤	Cam Code ⑥	Key Removal Positions ⑦	Vertical Mounting	Horizontal Mounting	Price U.S. \$
				Catalog Number	Catalog Number	
2-Position — 60° Throw		1	1, 2, 3	E34KFB_	E34KFHB_	
		1	2	E34KEB_	E34KEHB_	
3-Position — 60° Throw		2	1 – 7	E34KGB_	E34KGHB_	
		3		E34KHB_	E34KHGB_	
		2	1, 4, 5	E34KJB_	E34KJHB_	
		3		E34KKB_	E34KKHB_	
		2	4	E34KLB_	E34KLHB_	
		3		E34KMB_	E34KMHB_	
4-Position — 40° Throw		2	2, 4, 6	E34KNB_	E34KNHB_	
		3		E34KPB_	E34KPHB_	
4-Position — 40° Throw		7	7	E34KTB_	E34KTHB_	

- ⑤ M = Maintained. S = Spring return in direction of arrow (→).
- ⑥ For selection of the proper cam and contact block to obtain the proper circuit sequence, see selection instructions and table on Pages 47-233 – 47-234.
- ⑦ Choose key removal position required for application from Table 47-396. Add key removal Code No. to listed Catalog Number. Example: E34KFB2

Note: Use NEMA 4X 10250T operators where exposed to ultraviolet light, see Page 47-235.

Table 47-396. Key Removal Positions

Code Suffix	Key Removal Positions	Code Suffix	Key Removal Positions
1	Right Only	5	Right & Center
2	Left Only	6	Left & Center
3	Right & Left	7	All Positions
4	Center Only		

Note: Key removal in “spring return from” positions not recommended.

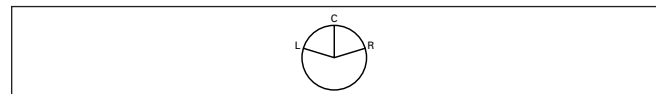

Figure 47-149. Key Removal Positions

Table 47-397. Alternate Knobs and Levers for Operators Above

Color	Knob			Lever			Lever Designed for Added Ingress Protection ⑧		
	Suffix Code	Catalog Number	Price U.S. \$	Suffix Code	Catalog Number	Price U.S. \$	Suffix Code	Catalog Number	Price U.S. \$
Black	K1	E34K1		L1	E34L1		A1	E34A1	
Red	K2	E34K2		L2	E34L2		A2	E34A2	
Green	K3	E34K3		L3	E34L3		A3	E34A3	
Yellow	K4	E34K4		L4	E34L4		A4	E34A4	
White	K5	E34K5		L5	E34L5		A5	E34A5	
Blue	K6	E34K6		L6	E34L6		A6	E34A6	
Gray	K7	E34K7		L7	E34L7		A7	E34A7	
Orange	K8	E34K8		L8	E34L8		A8	E34A8	

⑧ For use on maintained operators only.

Contact Blocks Page 47-239
 Dimensions Page 47-191
 Enclosures Page 47-240
 Legend Plates Page 47-184
 Discount Symbol 1CD1C

10250T Series, Selector Switch Components

Illuminated Selector Switch Operators



*2-Position Maintained
 120V AC Transformer
 Selector Switch,
 Cam Code 1
 Catalog Number
 10250T5971*

Table 47-398. 10250T Illuminated Selector Switch Operator Only without Knob or Lever

Positions	Operator Action ①	Transformer Type — 50/60 Hz				Full Voltage Type — AC or DC ④						
		6 Volt #755 Lamp				Lamps: 6V — #755, 12V — #756, 24V — #757, 48V — #1835, 120/240V — 120MB						
		Voltage	Cam Code ③	Catalog and Code Number ②	Price U.S. \$	Voltage	Cam Code ③	Catalog and Code Number ②	Price U.S. \$			
2-Position – 60° Throw		24	1	10250T5961H		6	1	10250T6201H				
		120		10250T5971H		12		10250T6211H				
208	10250T6511H	24		10250T6221H								
240	10250T5981H	48		10250T6231H								
380	10250T5991H	120		10250T6361H								
480	10250T6001H	240 ⑤		10250T6371H								
600	10250T6011H											
3-Position – 60° Throw		24	+ 2 or 3	10250T602_H		6	+ 2 or 3	10250T624_H				
		120		10250T603_H		12		10250T625_H				
		208		10250T652_H		24		10250T626_H				
		240		10250T604_H		48		10250T627_H				
		380		10250T605_H		120		10250T638_H				
	480	10250T606_H	240 ⑤	10250T639_H								
	600	10250T607_H										
		120	+ 2 or 3	10250T620_H		120	+ 2 or 3	10250T622_H				
		240		10250T656_H								
		120	+ 2 or 3	10250T621_H		120	+ 2 or 3	10250T623_H				
		240		10250T662_H								
		24		+ 2 or 3		10250T614_H				6	+ 2 or 3	10250T628_H
120		10250T615_H				12				10250T629_H		
208	10250T653_H	24	10250T630_H									
240	10250T616_H	48	10250T631_H									
380	10250T617_H	120	10250T640_H									
480	10250T618_H	240 ⑤	10250T641_H									
600	10250T619_H											
4-Position – 40° Throw		24	7	10250T6087H		6	7	10250T6327H				
		120		10250T6097H		12		10250T6337H				
		208		10250T6547H		24		10250T6347H				
		240		10250T6107H		48		10250T6357H				
		380		10250T6117H		120		10250T6427H				
		480		10250T6127H		240 ⑤		10250T6437H				
		600		10250T6137H								

- ① M = Maintained. S = Spring return in direction of arrow (→).
- ② Operator includes lens gasket and lens attachment screws.
- ③ For selection of the proper cam and contact block, to obtain the proper circuit sequence, see selection table on **Page 47-234**.
- ④ Full voltage light units can be used at other than listed voltages by changing lamp. Replacement lamps are listed on **Page 47-157**.
- ⑤ Resistor type. May generate excess heat if used in high density.

Table 47-399. Knobs, Levers

Color ⑥	Catalog and Code Number		Price U.S. \$
	Knob	Lever	
Red	10250TER	10250TFR	
Green	10250TEG	10250TFG	
Yellow	10250TEA	10250TFA	
Blue	10250TEL	10250TFL	
Clear	10250TEC	10250TFC	
White	10250TEW	10250TFW	
Amber	10250TEM	10250TFM	

⑥ Amber, Clear and White lenses have a black arrow (pointer), Red, Green and Blue lenses have a white arrow (pointer).

Contact Blocks **Page 47-239**
 Dimensions..... **Pages 47-160 – 47-162**
 Enclosures **Page 47-240**
 Legend Plates **Pages 47-151 – 47-152**
 Discount Symbol **1CD1C**

E34 Series, Selector Switch Components

Illuminated Selector Switch Operators (Continued)



2-Position Maintained 120V AC
Transformer Selector Switch, Cam 1
Catalog Number E34VFB120

Table 47-400. E34 Illuminated Selector Switch Operator Only without Knob or Lever

Positions	Operator Action	Transformer Type — 50/60 Hz		Full Voltage Type — AC or DC ^③	
		6 Volt #755 Lamp		Lamps — #755, #757, #1835, 120MB ^④	
		Catalog Number ^{① ⑤}	Price U.S. \$	Catalog Number ^⑤	Price U.S. \$
2-Position — 60° Throw		Cam Code 1 ^②		Cam Code 1 ^②	
		E34VFB_H		E34SFB_H	
3-Position — 60° Throw		Cam Code 2 ^②	Cam Code 3 ^②	Cam Code 2 ^②	Cam Code 3 ^②
		E34VGB_H	E34VHB_H	E34SGB_H	E34SHB_H
	E34VNB_H ^⑥	E34VPB_H ^⑥	E34SNB_H ^⑦	E34SPB_H ^⑦	
	E34VJB_H ^⑥	E34VKB_H ^⑥	E34SJB_H ^⑦	E34SKB_H ^⑦	
	E34VLB_H	E34VMB_H	E34SLB_H	E34SMB_H	
4-Position — 40° Throw		E34VRB_H	—	E34SRB_H	—

- ① Operator includes lens gasket and lens attachment screws.
- ② For selection of the proper cam and contact block required to obtain a specific circuit sequence, see selection table on Page 47-234.
- ③ Full voltage light units can be used at other than listed voltages by changing lamp. Replacement lamps are listed on Page 47-157.
- ④ 120MB lamps are used on both 120V and 240V operators.
- ⑤ Replace underscore with proper voltage Suffix Code from Light Unit Voltage Suffix Table below. Example: 3-position maintained with 120V transformer type light unit: E34VGB120H
- ⑥ 120 and 240V transformer only.
- ⑦ 120 full voltage only.

Table 47-401. Light Unit Voltage Suffix — Add to operator Catalog Number listed in table above.

Type of Light Unit			
Transformer Type 50/60 Hz		Full Voltage Type AC or DC ^②	
Voltage	Suffix Code	Voltage	Suffix Code
24	024	6	06
120	120	12	12
208	208	24	24
240	240	48	48
380	380	120	120
480	480	240 ^③	240
600	600		

- ② Full voltage light units can be used at other than listed voltages by changing lamp. Replacement lamps are listed on Page 47-157.
- ③ Resistor type. May generate excess heat if used in high density.

Table 47-402. Knobs, Levers

	Color ^①	Catalog Number and Code Number		Price U.S. \$
		Knob	Lever	
	Red	10250TER	10250TFR	
	Green	10250TEG	10250TFG	
	Yellow	10250TEA	10250TFA	
	Blue	10250TEL	10250TFL	
	Clear	10250TEC	10250TFC	
	White	10250TEW	10250TFW	
	Amber	10250TEM	10250TFM	

- ① Amber, clear and white lenses have a black arrow (pointer). Red, green and blue lenses have a white arrow (pointer).

Note: Use NEMA 4X 10250T operators where exposed to ultraviolet light, see Page 47-237.

Contact Blocks Page 47-239
 Dimensions Page 47-191
 Enclosures Page 47-240
 Legend Plates Page 47-184
 Discount Symbol 1CD1C



Contact Block
Catalog Number 10250T1H



Mounting Adapter
Catalog Number 10250TD2

Options

Contact Blocks and Mounting Adapters

Table 47-403. Contact Block — NEC Class I Division 2, Groups B, C and D

Units	Description	Catalog Number	Price U.S. \$
1NO-1NC	Class I Div. 2 Factory Sealed Contact Block	10250T1H	

Table 47-404. Mounting Adapter

Units	Description	Catalog Number	Price U.S. \$
	Mounting Adapter for Pushbuttons	10250TD2	
	Mounting Adapter for Selector Switches	10250TD3	

Table 47-405. Mounting Adapters with Contact Block(s) — Overpacked — NEC Class I Division 2 Groups B, C and D

Units	Description	Catalog Number	Price U.S. \$
	Pushbutton Adapter with 1NO-1NC	10250TD21H	
	Pushbutton Adapter with 2 (1NO-1NC)	10250TD21H1H	
	Selector Switch Adapter with 1NO-1NC	10250TD31H	
	Selector Switch Adapter with 2 (1NO-1NC)	10250TD31H1H	

Approximate Dimensions

Dimensions in Inches (mm). Dimensions are not intended to be used for manufacturing purposes.

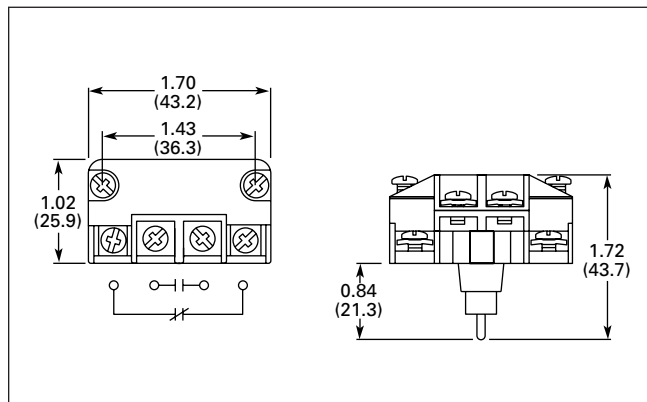

Figure 47-150. Contact Block

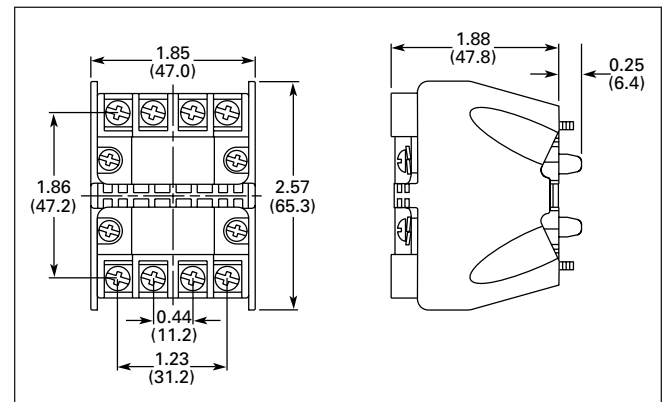





Figure 47-151. Mounting Adapter

10250T/E34 Series, Enclosures

Enclosures

Die Cast, Polyester and Stainless Steel Enclosures

Table 47-406. Enclosures (Case and Cover) — Surface Mounting ①

	Number of Elements	10250T		E34	
		Catalog Number	Price U.S. \$	Catalog Number	Price U.S. \$
 Die Cast Enclosure Catalog Number 10250TN11	Cast Enclosure — Deep Cover — In-Line NEMA 4, 4X, 12, 13				
	1	10250TN11		E34N11	
	2	10250TN12		E34N12	
	3	10250TN13		E34N13	
	4	10250TN14		E34N14	
 Polyester Enclosure Catalog Number E34N52	Polyester — In-Line NEMA 3, 4X, 12				
	1	—		E34N51	
	2	—		E34N52	
	3	—		E34N53	
	4	—		E34N54	
 Stainless Steel Enclosure Catalog Number 10250TN35	Stainless Steel ② — In-Line NEMA 4, 4X, 12				
	1	—		10250TN33	
	2	—		10250TN34	
	3	—		10250TN35	
	4	—		10250TN36	

① For spacing increments, see Page 47-154.

② 14 gauge, type 304.

Table 47-407. Approximate Dimensions

Number of Elements	Element Arrangement	Surface Mounting					Conduit Entrance	Approximate Dimensions
		Dimensions in Inches (mm)						
		Wide A	High B	Deep C	Mounting			
					D	E		
Cast								
1	In-Line	3.88 (98.6)	4.0 (101.6)	3.0 (76.3)	2.69 (68.3)	3.25 (82.6)	3/4	
2	In-Line	3.88 (98.6)	5.88 (149.4)	3.0 (76.3)	2.69 (68.3)	5.13 (130.3)	3/4	
3	In-Line	3.88 (98.6)	7.75 (196.9)	3.0 (76.3)	2.69 (68.3)	7.0 (177.8)	1	
4	In-Line	3.88 (98.6)	9.63 (244.6)	3.0 (76.3)	2.69 (68.3)	8.88 (225.6)	1	
Polyester								
1	In-Line	3.81 (96.8)	6.63 (168.4)	3.38 (85.9)	2.94 (74.7)	4.88 (124.0)	③	
2	In-Line	3.81 (96.8)	6.63 (168.4)	3.38 (85.9)	2.94 (74.7)	4.88 (124.0)		
3	In-Line	3.81 (96.8)	8.88 (225.6)	3.38 (85.9)	2.94 (74.7)	7.13 (181.1)		
4	In-Line	3.81 (96.8)	11.13 (282.7)	3.38 (85.9)	2.94 (74.7)	9.38 (238.3)		
Stainless Steel								
1	In-Line	3.00 (76.2)	3.50 (88.9)	3.00 (76.2)	1.50 (38.1)	4.25 (108.0)	③	
2	In-Line	3.50 (88.9)	6.75 (171.5)	3.00 (76.2)	1.50 (38.1)	7.50 (190.5)		
3	In-Line	3.50 (88.9)	9.00 (228.6)	3.00 (76.2)	1.50 (38.1)	9.00 (228.6)		
4	In-Line	3.50 (88.9)	11.25 (285.8)	3.00 (76.2)	1.50 (38.1)	12.00 (304.8)		

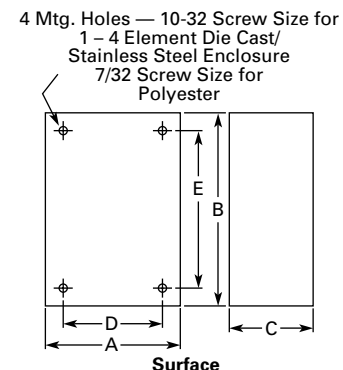

③ No conduit entrance holes provided. Drill as required.

Application Notes:

- Operators need to be mounted in their horizontal orientation for all enclosures. For die cast enclosures remove locating nib on operators and use thrust washer (Catalog Number 10250TK3).
- Polyester enclosures must be used when mounting illuminated operators.

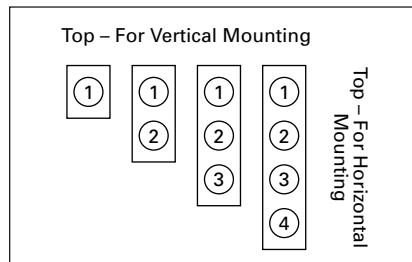

Figure 47-152. Enclosure Layouts

Discount Symbol 1CD1C

Mounting and Assembly

Panel Thickness

- Minimum: 0.06 inch (1.6 mm)
- Maximum: 0.25 inch (8 mm) including legend plate
- Maximum can be increased to 0.375" (15.9 mm) using optional retaining nut
 - Indicating Light: 10250TA30/E34TA30
 - Pushbutton/Selector Switch: 10250TA31/E34TA31

Table 47-408. Mounting Matrix

Legend Plate	Dimensions in Inches (mm)			
	A	B	C	D
Small	2.87 (72.6)	2.25 (57.2)	2.25 (57.2)	2.87 (72.6)
Jumbo	2.87 (72.6)	2.32 (58.6)	2.32 (58.6)	2.87 (72.6)
Extra Large	2.87 (72.6)	2.56 (65.2)	2.52 (64.1)	2.87 (72.6)

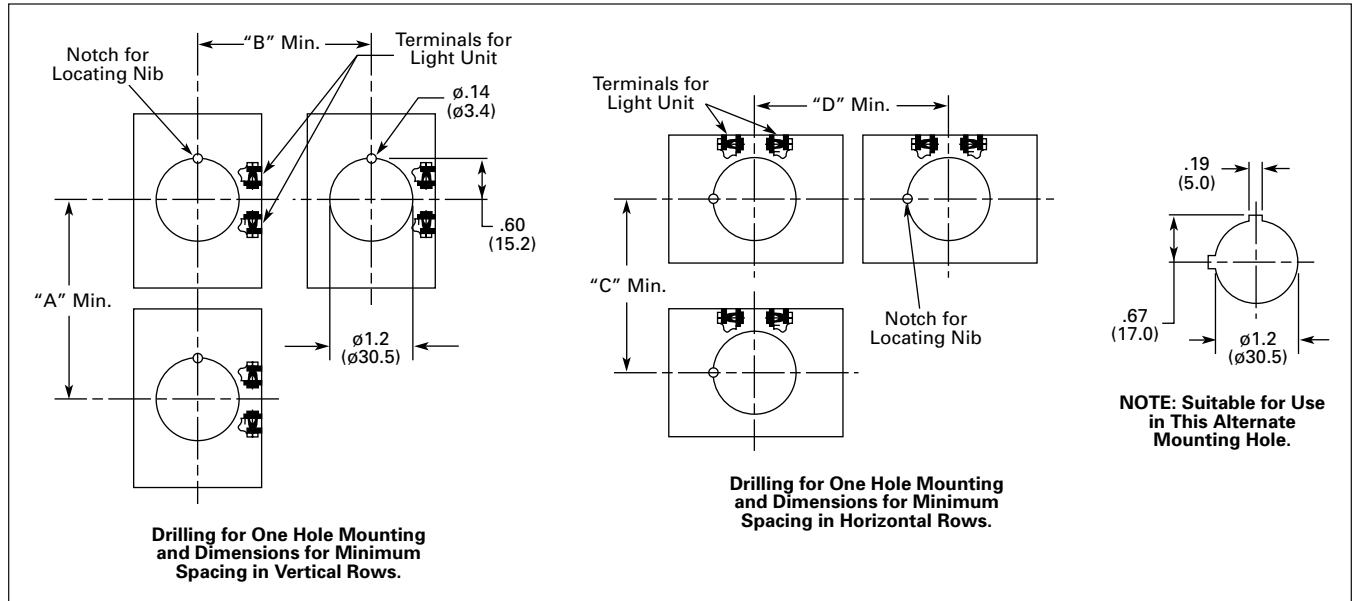

Figure 47-153. Panel Spacing and Drilling Drawings

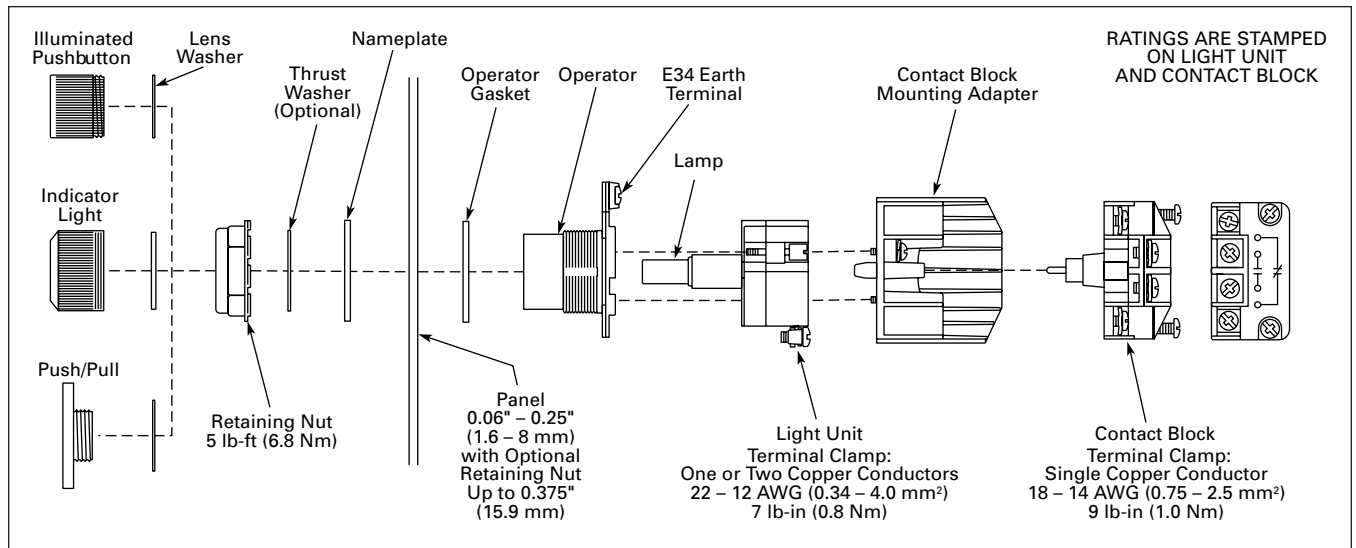
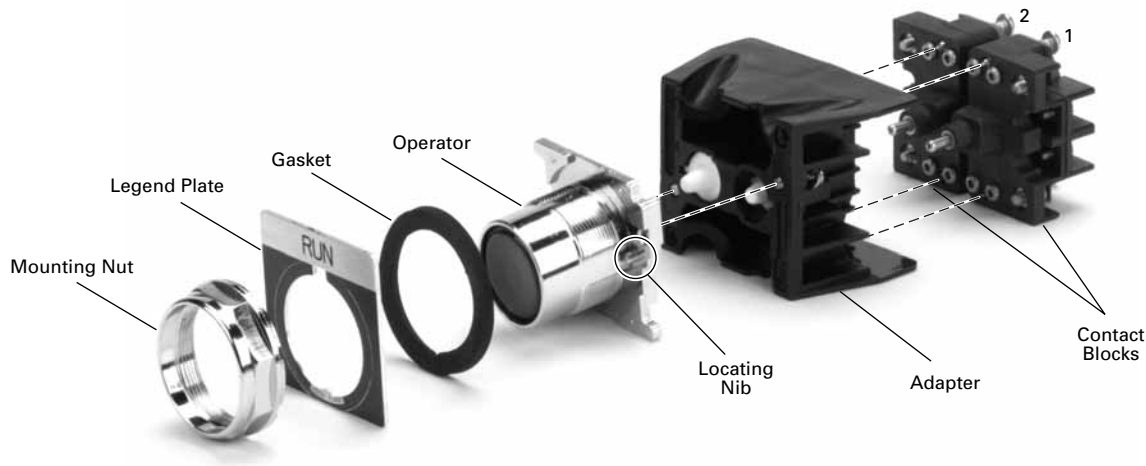

Figure 47-154. Operator Assembly

Catalog Number Structure



10250T/E34 Series

Table 47-409. Non-illuminated Assembled Operators — Class I Division 2 Catalog Numbering System

47

10250T 718 E J

Operator Type
10250T = Heavy-Duty Oiltight
E34EX = Corrosion Resistant Oiltight

Operator and Contact Block
706 = Flush 1NO-1NC
707 = Flush 2NO-2NC
708 = Extended 1NO-1NC
709 = Extended 2NO-2NC
710 = Mushroom 1NO-1NC
711 = Mushroom 2NO-2NC
712 = JMB Mushroom 1NO-1NC
713 = JMB Mushroom 2NO-2NC
714 = 2P MT Push-Pull 1NO-1NC
715 = 2P MT Push-Pull 2NO-2NC
716 = 3P MT Push-Mom Pull 1NO-1NC
717 = 3P MT Push-Mom Pull 2NO-2NC
718 = 3P Mom Push-Pull 1NO-1NC
721 = 3P Mom Push-Pull 2NO-2NC
722 = 2P SS MT XO,OX-CAM1
723 = 2P SS MT XO,OX,XO,OX-CAM1
724 = 2P SS SPR-R XO,OX-CAM1
725 = 2P SS SPR-R XO,OX,XO,OX-CAM1
726 = 3P SS MT XOO,OOX-CAM3
727 = 3P SS MT XOO,OXO,OOX-CAM3
728 = 3P SS SPR-L XOO,OOX-CAM3
729 = 3P SS SPR-L XOO,OXO,OOX-CAM3
730 = 3P SS SPR-L&R XOO,OOX-CAM3
731 = 3P SS SPR-L&R XOO,OXO,OOX-CAM3
732 = 3P SS SPR-R XOO,OOX-CAM3
733 = 3P SS SPR-R XOO,OXO,OOX-CAM3
743 = 4P SS MT XOOO,OXOO,OOXO,OOOX-CAM7

ACC/SS Type
Blank = None
J = JMB Push-Pull
B = Booted-FL/EXT
G = Guarded-FL
K = Knob-SS
L = Lever-SS
A = Lever W/IP-SS
C = Coin-SS
Keyed-SS

Cam
1
2
3
7

Key Removal
1 = RT Only
2 = LT Only
3 = RT & LT
4 = CT Only
5 = RT & CT
6 = LT & CT
7 = All

Button Color
B = Black
R = Red
G = Green
Y = Yellow
W = White
L = Blue
N = Orange
E = Red EMERG STOP
T = Keyed-SS

Summary of NEC Article 500

The NEC Article 500 explains in great detail the requirements for the installation of wiring and electrical equipment in hazardous locations. The purpose of this summary is for general reference only, the National Electric Code along with other applicable authorities having jurisdiction over the site should be the installer’s guidelines when wiring or installing electrical equipment in any hazardous or potentially hazardous location.

Class I, Division 2 Definition

Class I, Division 2 covers hazardous locations where flammable gases, vapors or volatile liquids are handled either in a closed system, or confined within suitable enclosures, or where hazardous concentrations are normally prevented by positive mechanical ventilation. Areas adjacent to Division 1 locations, into which gases might occasionally flow, would also belong to Division 2 (NEC (500-5[b])).

Hazardous Location

Any area where there is the possibility of explosion and fire resulting from the presence of flammable vapors, liquids or gas, or combustible dust or fibers.

Summary of NEC Article 505

The NEC also classifies hazardous locations for flammable gases and vapors into zones under NEC 505. This system is more in line with the European Standards, CENELEC and IEC, with the major difference being that NEC 505 only classifies gases and vapors while CENELEC and IEC also include dusts.

Summary of Classifications — NEC 500 – 503

Class	Division	Group
I. Gas	1. Hazard may exist — May exist in atmosphere under normal operating conditions	A. Acetylene
		B. Hydrogen and manufactured gases containing 30% hydrogen by volume (e.g. butadiene, ethylene oxide, propylene oxide)
	2. Potential hazard — May be present in atmosphere only under abnormal circumstances OR location adjacent to Class I, Division 1 location	C. Petrochemicals (e.g. carbon monoxide, ether, ethylene, hydrogen sulfide, morpholine, cyclopropane)
		D. Petrochemicals (e.g. gasoline, benzene, butane, propane, acetone, ammonia, vinyl chloride)
II. Dust	1. Hazard may exist — May exist in atmosphere under normal operating conditions	A. Acetylene
		B. Hydrogen and manufactured gases containing 30% hydrogen by volume (e.g. butadiene, ethylene oxide, propylene oxide)
		C. Petrochemicals (e.g. carbon monoxide, ether, ethylene, hydrogen sulfide, morpholine, cyclopropane)
	2. Potential hazard — May be present in atmosphere only under abnormal circumstances	D. Petrochemicals (e.g. gasoline, benzene, butane, propane, acetone, ammonia, vinyl chloride)
		E. Conductive and combustible dust (resistivity <10 ⁵ ohm/cm) (metal dusts)
		F. Carbonaceous dusts (resistivity >10 ² ohms/cm but ≤10 ⁸ ohms/cm) (e.g. carbon black, coke dust, coal)
III. Fibers	1. Production areas	Easily ignitable fibers or flyings
	2. Handling and storage areas	Easily ignitable fibers or flyings

Note: For additional information on grouping of compounds, see NFPA 497M-1991 and NFPA 325-1994.

Summary of Classifications — NEC 505

Class	Zone	Group
I. Gas	0. Continuously present or present for long periods of time	II.C. Acetylene, hydrogen or equivalent hazard
		II.B. Acetaldehyde, ethylene or equivalent hazard
	1. Likely to exist under normal operating or maintenance conditions or adjacent to Zone 0	II.A. Acetone, ammonia, ethyl alcohol, gasoline, methane, propane or equivalent hazard
		II.C. Acetylene, hydrogen or equivalent hazard
	2. Not likely to occur in normal operation and if they do occur will only exist for short period or adjacent to Zone 1	II.B. Acetaldehyde, ethylene or equivalent hazard
		II.A. Acetone, ammonia, ethyl alcohol, gasoline, methane, propane or equivalent hazard

Summary of Basic Methods Available for Class I, Division 2 Locations

Method	Features		
	Configuration	Advantages	Disadvantages
Factory Sealed Contact Block	Closed-ended labyrinth contact block with an incandive circuit incapable of external ignition	<ul style="list-style-type: none"> Higher continuous carrying amperages — up to 10A Direct drive contacts — contacts can be forced open Suitable for use in all enclosures Best suited for motor control applications 	<ul style="list-style-type: none"> May not be suitable for logic level circuits
Hermetically Sealed Block	Reed switch sealed against an external atmosphere	<ul style="list-style-type: none"> Suitable for low energy level circuits Suitable for use in all enclosures 	<ul style="list-style-type: none"> Lower continuous carrying amperages are not suitable for motor control applications (typically 3A to 5A rated) Contacts cannot be forced open Permanent magnet attracts metallic dust and filings that can reduce the electrical creepage distance between live terminals
Explosion Proof Enclosures (Class I, Division 1 and 2)	Enclosures capable of withstanding an internal explosion while preventing external ignition. Enclosures designed for Class I, Div. 1 can safely be used in Class I, Div. 2	<ul style="list-style-type: none"> Higher level of protection than required for Class I Division 2 	<ul style="list-style-type: none"> Higher material and installation costs Conduit sealing is still required Time consuming maintenance

47

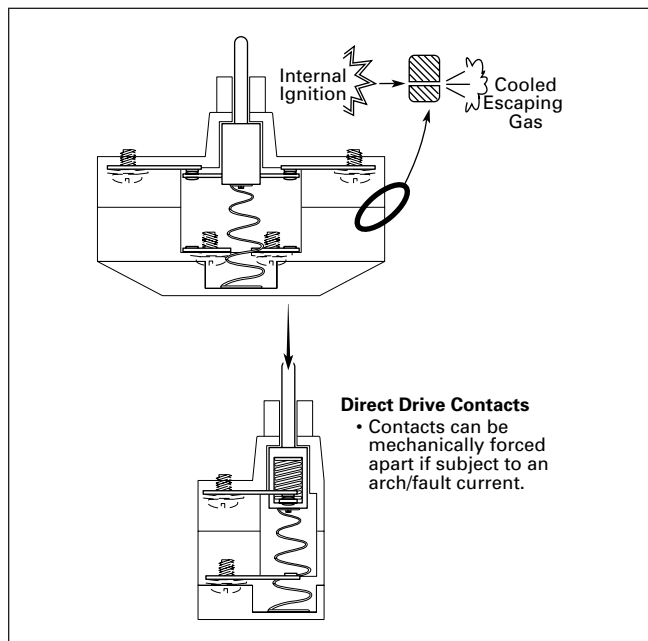

Figure 47-155. Factory Sealed Contact Blocks

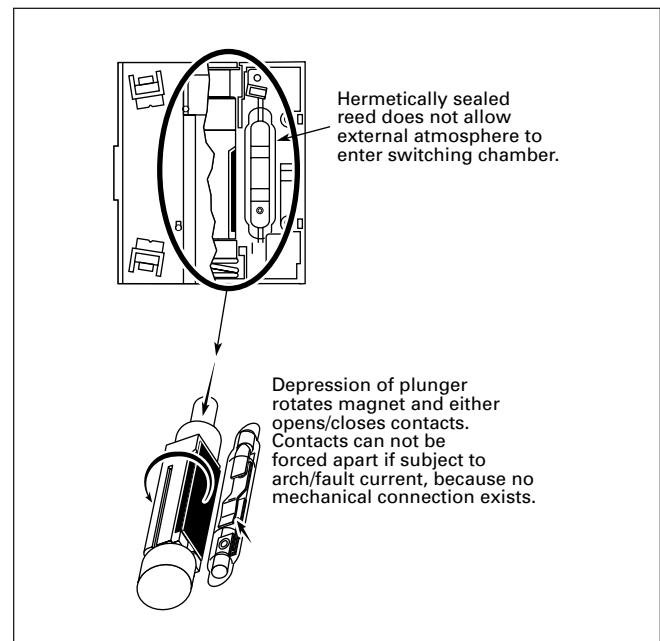

Figure 47-156. Hermetically Sealed Reed Contact Block

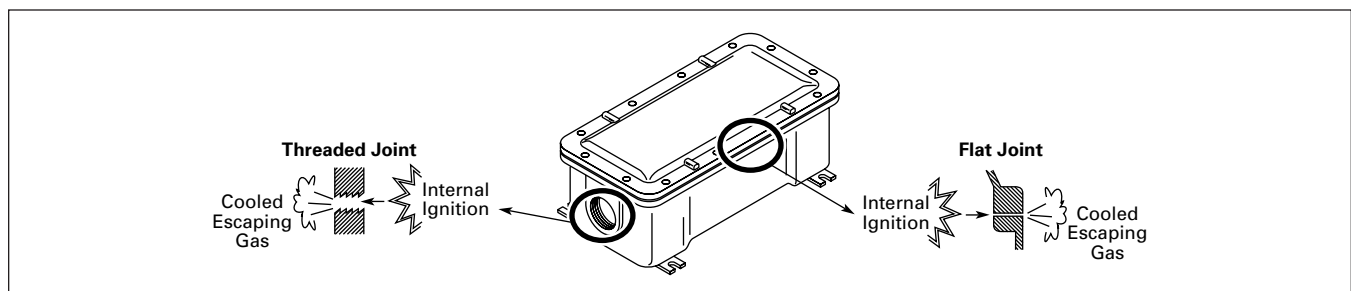

Figure 47-157. Explosion Proof Enclosure