



FANIMATION®
SHOWROOM COLLECTION





Ceiling fans have evolved
from more than just
a functional source of air movement.
In today's authentic living spaces,
fans add a finishing touch.
Our vast collection of artful styles
and customizable features
provides the perfect blend of
air flow, ambiance and aesthetics,
so you can create a space
that is uniquely your own.













Choosing Your Fan

There are many factors to consider when choosing a fan. This catalog will help you purchase the ideal fan for you and your space.

Location Where you will install your fan is the first step in selecting the right fan for your space.

- Dry, indoor location: Choose from any of our fans—dry, damp or wet rated.
- Outdoor covered or high-humidity indoor location: Choose from our damp or wet rated fans.
- Outdoor location with likely direct contact with water: Choose from our wet rated fans.

Features We offer a diverse line of fans with equally diverse features. As you choose your fan, identify the features that matter to you—use Features Legend below to understand the Features icons.

	fan control type	light kit included + lamping info	number of fan speeds + location of reversing switch	Bluetooth® control—if included or compatible	features energy-efficient DC motor	fan has earned the Energy Star		
								
CONTROL wall	CONTROL remote	CONTROL pull chain	CONTROL rotary	WATTAGE bulb style	SPEED reverse location	FANSYNCTM		

Airflow We provide airflow information—at high speed and average—for each fan. Airflow is represented by Total Air Delivery, measured in cubic feet per minute (CFM). Energy used—at high speed and average—is also included, measured in watts, along with energy efficiency of the fan, measured in CFM per watt. Estimated yearly energy costs helps you understand how much you might expect to pay to run your fan for the year.

ENERGY GUIDE:

TOTAL AIR VOLUME (CFM)	ENERGY USE (Watts)	ESTIMATED YEARLY ENERGY COST	AIRFLOW EFFICIENCY (CFM/W)
4,256 _{ave}	20 _{ave}	\$6 _{ave}	211 _{ave}
5,859 _{high}	32 _{high}	\$9 _{high}	183 _{high}

Rotation Your ceiling fan rotation should be set in the direction that provides the most comfort for the room's occupants.

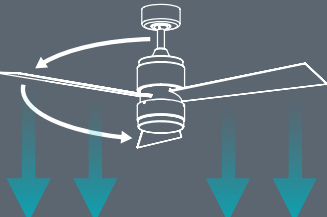
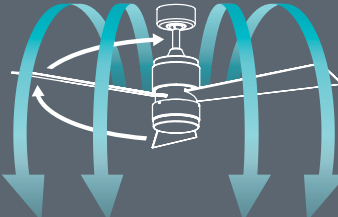
<p>forward rotation</p> <p>A counter-clockwise rotation, as you look up, provides a downward draft</p> 	<p>reverse rotation</p> <p>A clockwise rotation, as you look up, forces air upward, then downward off your ceiling</p> 
---	---

Support Need more assistance? We're here to help! 888-567-2055



FANS :: INDOOR

AIRE DÉCOR
126



AIRE DELUXE 44
32



AIRE DELUXE 52
34



BECKWITH
12



BOURBON STREET
43



CAMHAVEN
24



CANCUN 42
30



CELANO v2
20



DUPLEX
18



EDGEWOOD DECORATIVE
36



EDGEWOOD DELUXE
38



EDGEWOOD SUPREME
40



EMBRACE 44
14



EMBRACE 52
16



KELLAN
42



LEVANO AC
28



PALMETTO
44



STAFFORD
22



VENTANA
26



FANS :: INDOOR/OUTDOOR

AIRE DÉCOR DAMP
126



ASCENSION
60



AVASTON
112



BELLERIA
148



BENITO v2
124



BIG ISLAND
154



BREWMASTER
162



CANCUN WET
140



FANS :: INDOOR/OUTDOOR

CARUSO
158



CRESTFORD
136



DRONE
56



EDGEWOOD
DELUXE WET
130



EDGEWOOD
WET
128



ENIGMA
122



EXTRAORDINAIRE
50



HUGH 44
52



HUGH 52
54

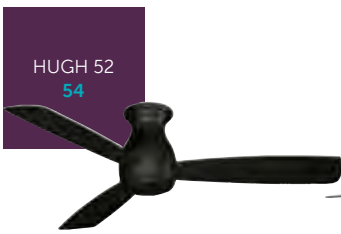

ISLANDER AC
150



ISLANDER DC
152



KAYA
138



LEVON
CUSTOM
78



My FANIMATION
DISTINCTION AC
114



My FANIMATION
DISTINCTION DC
120

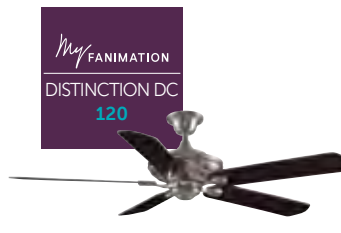

ODYN CUSTOM
86



ODYN 84
94

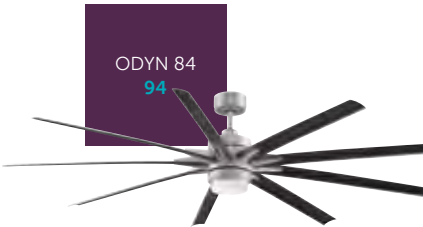

PALISADE
156



PALMA
142



PICKETT
134



PICKETT DRUM
132



PUNKAH
160



ROTATION
48

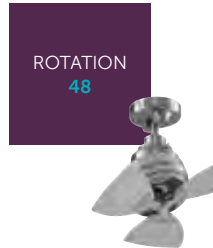

SPITFIRE
74



STELLAR
CUSTOM
96



SUBTLE
76



TORCH
58



TORTO
108



FANS :: INDOOR/OUTDOOR

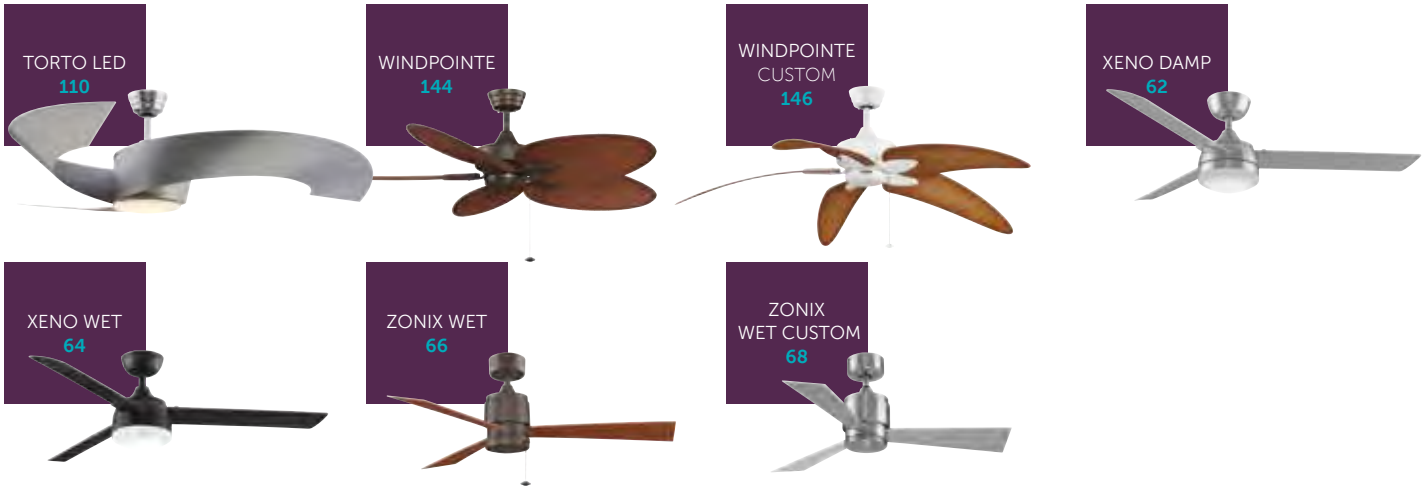

FANS :: PORTABLE



ACCESSORIES



TABLE OF CONTENTS

Aire Décor®	126	Odyn™ Custom 64.....	90
Aire Deluxe™ 44.....	32	Odyn™ Custom 72	92
Aire Deluxe™ 52.....	34	Odyn™ 84.....	94
Arden™	176	Old Havana®	178
Ascension™	60	Palisade®	156
Avaston™	112	Palma™	142
Baby Breezy™	165	Palmetto®	44
Beckwith™	12	Pickett™	134
Belleria®	148	Pickett™ Drum.....	132
Benito™ v2.....	124	Punkah®	160
Big Island™	154	Retro Breeze	170
Bourbon Street®	43	Rotation™	48
Brewmaster®	162	Spitfire™	74
Camhaven™	24	Stafford™	22
Cancun™ 42.....	30	Stellar™ Custom 56.....	98
Cancun™ Wet.....	140	Stellar™ Custom 64	100
Caruso™	158	Stellar™ Custom 72.....	102
Celano v2™	20	Stellar™ Custom 84	104
Crestford™	136	Stellar™ Custom 96.....	106
Drone™	56	Subtle™	76
Duplex™	18	Torch™	58
Edgewood® Decorative	36	Torto™	108
Edgewood® Deluxe.....	38	Torto™ LED	110
Edgewood® Deluxe Wet.....	130	Urbanjet™	174
Edgewood® Supreme.....	40	Urbanjet™ Jr.....	172
Edgewood® Wet	128	Ventana™	26
Embrace™ 44	14	Windpointe®	144
Embrace™ 52.....	16	Windpointe® Custom	146
Enigma®	122	Xeno™ Damp.....	62
Extraordinaire®	50	Xeno™ Wet.....	64
Hugh™ 44.....	52	Zonix™ Wet	66
Hugh™ 52.....	54	Zonix™ Wet Custom 44.....	70
Islander® AC.....	150	Zonix™ Wet Custom 52	72
Islander® DC	152	Choosing a Fan	3
Junior Breeze™	168	Blades.....	179
Kaya™	138	Light Kits	181
Kellan™	42	Fitters, Shades & Decorative Glass.....	182
Levon™ AC	28	Downrods & Accessories	183
Levon™ Custom 52.....	80	Hand-Held Controls.....	185
Levon™ Custom 64.....	82	Wall Controls.....	189
Levon™ Custom 72	84	fanSync	193
Mini Breeze™	166	Bulb Reference	194
myFanimation™ Distinction™ AC.....	114	Finish Swatches.....	195
myFanimation™ Distinction™ DC.....	120	Antique Fan Museum	197
Odyn™ Custom 56	88	Index.....	199





FANS :: INDOOR

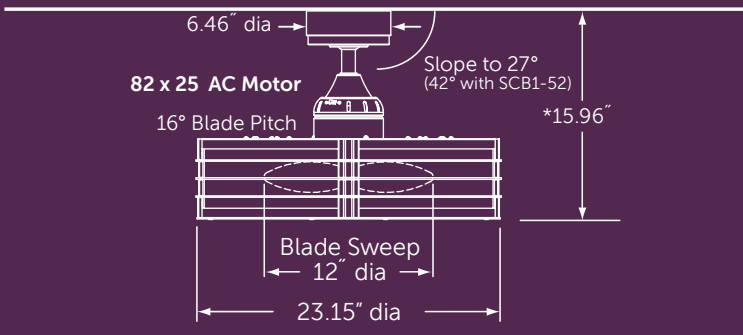



 1,368 Lumens
 2,478K CCT
 99 CRI

NOTES: THE LIGHT ON THE BECKWITH™ IS CONSIDERED AN ACCENT LIGHT AND IS NOT INTENDED TO BE USED AS A PRIMARY LIGHT SOURCE. NOT RECOMMENDED FOR SOUND SENSITIVE AREAS

*With included 4.5" downrod—longer lengths available
 Close-to-ceiling kit compatible
 Net Hanging Weight: 27.16 lbs.

 **FAN: FP7964BN** (1)
 brushed nickel assembly
 with frosted white shade



 **FAN: FP7964OB** (1)
 oil-rubbed bronze assembly
 with frosted white shade



For compatible controls & accessories see pages 183 - 193

Recommended optional control



C25

BECKWITH™



 **FAN: FP7964OB (1)**
oil-rubbed bronze assembly
with frosted white shade

FP7964—AVAILABLE FINISHES:**

BN brushed nickel	OB oil-rubbed bronze
aluminum	black

INCLUDED:



TR24WH remote

- 
FANSYNC™
sold separately
- 
(4) 43W
halogen
candelabra
- 
3-SPEED AC
reverse switch
on fan
- 
CONTROL
remote
- 
DRY
indoor only

ENERGY GUIDE:

TOTAL AIR VOLUME (CFM)	ENERGY USE (Watts)	ESTIMATED YEARLY ENERGY COST	AIRFLOW EFFICIENCY (CFM/W)
943 _{ave}	39 _{ave}	\$11 _{ave}	24 _{ave}
1,363 _{high}	56 _{high}	\$16 _{high}	24 _{high}

LIMITED LIFETIME MOTOR WARRANTY



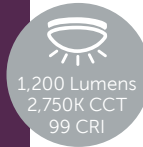
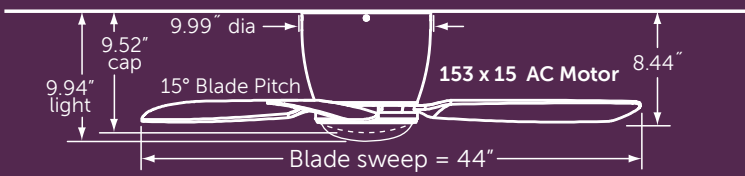

Net Hanging Weight: 18.9 lbs.

- FAN: FPS7981BN (1)**
brushed nickel assembly with brushed nickel blades and matching light cover (included)



- FAN: FPS7981DZ (1)**
dark bronze assembly with dark bronze blades and opal frosted glass



- FAN: FPS7981GR (1)**
matte greige assembly with matte greige blades and matching light cover (included)



- FAN: FPS7981MW (1)**
matte white assembly with matte white blades and opal frosted glass



For compatible controls & accessories see pages 183 - 192

Recommended optional control



C21

EMBRACE™ 44

FAN: FPS7981GR (1)
matte greige assembly
with matte greige blades
and opal frosted glass

FPS7981—AVAILABLE FINISHES:**

BN brushed nickel	DZ dark bronze	GR matte greige	MW matte white
brushed nickel	dark bronze	matte greige	matte white

INCLUDED:



blade set



light kit
light cover



TR20WH remote



(1) 100W
halogen
mini-can



3-SPEED AC
reverse switch
on remote



CONTROL
remote



DRY
indoor only

ENERGY GUIDE:

TOTAL AIR VOLUME (CFM)	ENERGY USE (Watts)	ESTIMATED YEARLY ENERGY COST	AIRFLOW EFFICIENCY (CFM/W)
2,754 _{ave}	33 _{ave}	\$9 _{ave}	84 _{ave}
3,769 _{high}	45 _{high}	\$13 _{high}	84 _{high}

LIMITED LIFETIME MOTOR WARRANTY



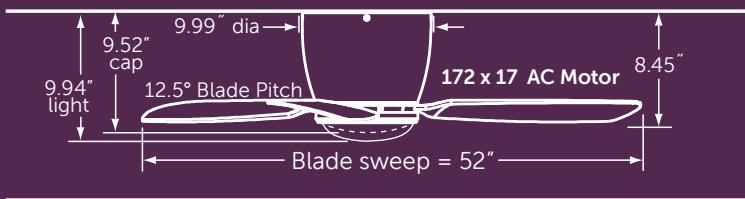

Net Hanging Weight: 21.5 lbs.

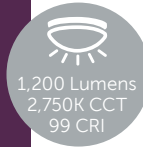

FAN: FPS7955BN (1)
brushed nickel assembly with
brushed nickel blades and
matching light cover (included)



FAN: FPS7955DZ (1)
dark bronze assembly with
dark bronze blades and
opal frosted glass



FAN: FPS7955GR (1)
matte greige assembly with
matte greige blades and
matching light cover (included)



FAN: FPS7955MW (1)
matte white assembly with
matte white blades and
opal frosted glass



For compatible controls &
accessories see pages 183 - 192

Recommended
optional control



C21

EMBRACE™ 52

FAN: FPS7955DZ (1)
dark bronze assembly with
dark bronze blades and
opal frosted glass

FPS7955**—AVAILABLE FINISHES:

BN brushed nickel	DZ dark bronze	GR matte greige	MW matte white
brushed nickel	dark bronze	matte greige	matte white

INCLUDED:



blade set



light kit



light cover



TR20WH remote



(1) 100W
halogen
minican



3-SPEED AC
reverse switch
on remote



CONTROL
remote



DRY
indoor only

ENERGY GUIDE:

TOTAL AIR VOLUME (CFM)	ENERGY USE (Watts)	ESTIMATED YEARLY ENERGY COST	AIRFLOW EFFICIENCY (CFM/W)
3,348 _{ave}	33 _{ave}	\$9 _{ave}	102 _{ave}
4,741 _{high}	47 _{high}	\$13 _{high}	101 _{high}

LIMITED LIFETIME MOTOR WARRANTY



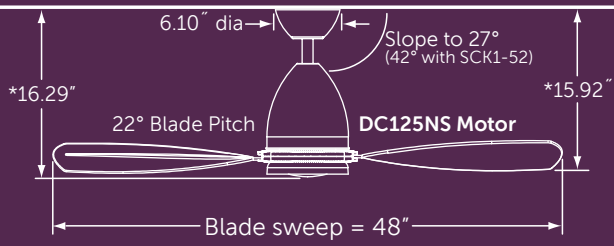



 1,440 Lumens
 3,000K CCT
 80 CRI

*With included 6" downrod—longer lengths available

Net Hanging Weight: 16.06 lbs.



FAN: FPD6254GR (1)
 matte greige fan with gray tinted fan & light housing, matte greige blades and frosted glass

For compatible controls & accessories see pages 183 - 192

Recommended optional control



TW40

DUPLEX™

FAN: FPD6254GR (1)
matte greige fan with gray tinted fan & light housing, matte greige blades and frosted glass

FPD6254**—AVAILABLE FINISHES:

GR
matte gray
greige tinted
matte greige

INCLUDED:



blade



light kit



TR39 remote

ENERGY SAVINGS

18W
LED

6-SPEED DC
reverse switch
on remote

CONTROL
remote

DRY
indoor only

ENERGY GUIDE:

TOTAL AIR VOLUME (CFM)	ENERGY USE (Watts)	ESTIMATED YEARLY ENERGY COST	AIRFLOW EFFICIENCY (CFM/W)
4,256 _{ave}	20 _{ave}	\$6 _{ave}	211 _{ave}
5,859 _{high}	32 _{high}	\$9 _{high}	183 _{high}

LIMITED LIFETIME MOTOR WARRANTY



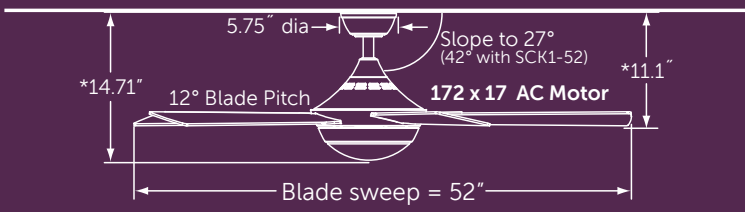



 1,350 Lumens
 3,000K CCT
 80 CRI

*With included 4.5" downrod—longer lengths available Net Hanging Weight: 18.74 lbs.



 **FAN: FP8062BN** (1)
 brushed nickel assembly with
 frosted white glass and reversible
 cherry/dark walnut blades

- cherry side showing



 **FAN: FP8062DZ** (1)
 dark bronze assembly with
 frosted glass and reversible
 cherry/dark walnut blades

- dark walnut side showing



 **FAN: FP8062MW** (1)
 matte white assembly
 with frosted glass and
 matte white blades



For compatible controls & accessories see pages 183 - 192

Recommended optional control



C25

CELANO v2™



FAN: FP8062BN (1)
brushed nickel assembly
with cherry/dark walnut
reversible blades.
● dark walnut side showing

FP8062**—AVAILABLE FINISHES:

BN brushed nickel	DZ dark bronze	MW matte white
cherry dark walnut	cherry dark walnut	matte white

INCLUDED:

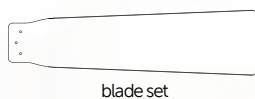

- FANSYNC™** included
- 18W LED**
- 3-SPEED AC** reverse switch on fan
- CONTROL** remote
- DRY** indoor only

ENERGY GUIDE:

TOTAL AIR VOLUME (CFM)	ENERGY USE (Watts)	ESTIMATED YEARLY ENERGY COST	AIRFLOW EFFICIENCY (CFM/W)
3,402 _{ave}	38 _{ave}	\$11 _{ave}	90 _{ave}
4,915 _{high}	58 _{high}	\$16 _{high}	85 _{high}



LIMITED LIFETIME MOTOR WARRANTY



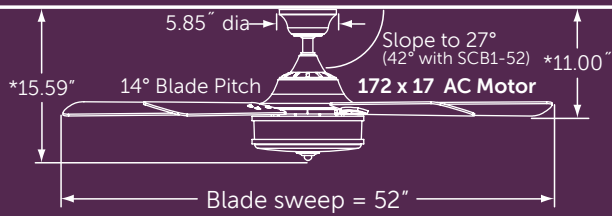



 1,020 Lumens
 2,700K CCT
 99 CRI

*With included 4.5" downrod—longer lengths available
Close-to-ceiling kit compatible

Net Hanging Weight: 23.2 lbs.

- 
FAN: PL8274BN (1)
 brushed nickel assembly with
 frosted white glass and reversible
 cherry/dark walnut blades
 - dark walnut side showing



- 
FAN: PL8274DZ (1)
 dark bronze assembly with
 frosted white glass and reversible
 cherry/dark walnut blades
 - cherry side showing



- 
FAN: PL8274BN (1)
 brushed nickel assembly with
 frosted white glass and reversible
 cherry/dark walnut blades
 - cherry side showing



- 
FAN: PL8274DZ (1)
 dark bronze assembly with
 frosted white glass and reversible
 cherry/dark walnut blades
 - dark walnut side showing



For compatible controls & accessories see pages 183 - 193

Recommended optional controls



C25

or



CW60WH

STAFFORD™

FAN: PL8274DZ (1)
 dark bronze assembly with frosted white glass and reversible cherry/dark walnut blades
 • dark walnut side showing

PL8274**—AVAILABLE FINISHES:

BN brushed nickel	DZ dark bronze
dark cherry walnut	dark cherry walnut

INCLUDED:



blade set



light kit



TR24WH remote



FANSYNC™
sold separately

(3) 40W
incandescent
candelabra

3-SPEED AC
reverse switch
on fan

CONTROL
remote

DRY
indoor only

ENERGY GUIDE:

TOTAL AIR VOLUME (CFM)	ENERGY USE (Watts)	ESTIMATED YEARLY ENERGY COST	AIRFLOW EFFICIENCY (CFM/W)
3,346 _{ave}	39 _{ave}	\$11 _{ave}	85 _{ave}
5,039 _{high}	63 _{high}	\$18 _{high}	80 _{high}

LIMITED LIFETIME MOTOR WARRANTY



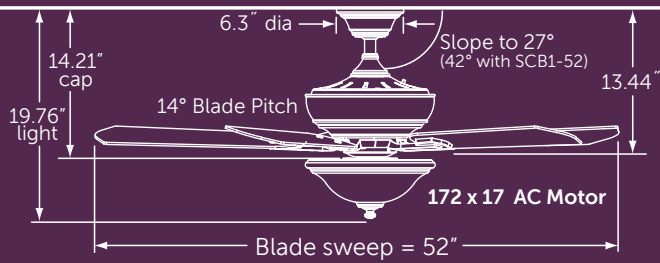



 2,062 Lumens
 2,756K CCT
 99 CRI

*With included 4.5" downrod—longer lengths available
 Close-to-ceiling kit compatible
 Net Hanging Weight: 24.47 lbs.

FAN: FP8095BA (1)
 bronze accent assembly with
 frosted white glass and reversible
 cherry/walnut wood blades
 ● walnut side showing





FAN: FP8095OB (1)
 oil-rubbed bronze assembly (shown
 without light kit) with reversible
 cherry/walnut wood blades
 ● cherry side showing



FAN: FP8095PW (1)
 pewter assembly with frosted
 white glass and reversible
 cherry/walnut wood blades
 ● walnut side showing



FAN: FP8095WH (1)
 white assembly with white frosted
 glass and white wood blades



For compatible controls &
 accessories see pages 183 - 193

Recommended optional controls



C25

or



CW60WH

CAMHAVEN™

FAN: FP8095PW (1)
 pewter assembly with frosted white glass and reversible cherry/walnut wood blades
 • walnut side showing

FP8095**—AVAILABLE FINISHES:

BA bronze accent	OB oil-rubbed bronze	PW pewter	WH white
cherry walnut	cherry walnut	cherry walnut	white

INCLUDED:



blade set



light kit



TR24WH remote



FANSYNC™
sold separately



(2) 75W
halogen
minican



3-SPEED AC
reverse switch
on fan



CONTROL
remote



DRY
indoor only

ENERGY GUIDE:

TOTAL AIR VOLUME (CFM)	ENERGY USE (Watts)	ESTIMATED YEARLY ENERGY COST	AIRFLOW EFFICIENCY (CFM/W)
3,668 _{ave}	42 _{ave}	\$12 _{ave}	87 _{ave}
5,565 _{high}	68 _{high}	\$19 _{high}	82 _{high}

LIMITED LIFETIME MOTOR WARRANTY



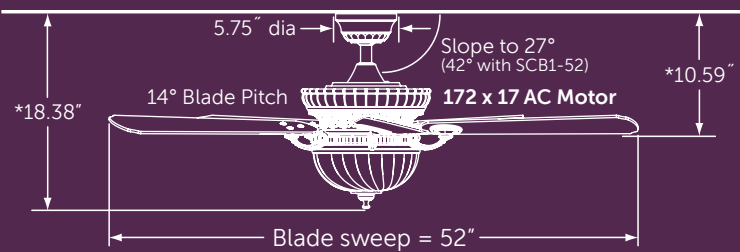

 1,092 Lumens
 2,653K CCT
 99 CRI

*With included 4.5" downrod—longer lengths available
 Close-to-ceiling kit compatible
 Net Hanging Weight: 24.5 lbs.



FAN: FP8032DZ (1)
 dark bronze assembly
 with frosted white glass
 and reversible cherry/dark
 walnut blades
 ● cherry side showing



FAN: FP8032DZ (1)
 dark bronze assembly
 with frosted white glass
 and reversible cherry/dark
 walnut blades
 ● dark walnut side showing

For compatible controls &
 accessories see pages 183 - 193

Recommended optional controls



C25

or



CW60WH

VENTANA™

FAN: FP8032DZ (1)
 dark bronze assembly with frosted white glass and reversible cherry/dark walnut blades
 • dark walnut side showing

FP8032**—AVAILABLE FINISHES:

- DZ**
dark bronze
- dark cherry**
dark walnut

INCLUDED:

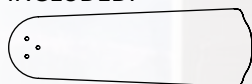

blade set



light kit



TR24WH remote



FANSYNC™
sold separately



(2) 50W halogen minican



3-SPEED AC reverse switch on fan



CONTROL remote



DRY indoor only

ENERGY GUIDE:

TOTAL AIR VOLUME (CFM)	ENERGY USE (Watts)	ESTIMATED YEARLY ENERGY COST	AIRFLOW EFFICIENCY (CFM/W)
3,638 _{ave}	45 _{ave}	\$13 _{ave}	81 _{ave}
5,261 _{high}	70 _{high}	\$20 _{high}	75 _{high}

LIMITED LIFETIME MOTOR WARRANTY



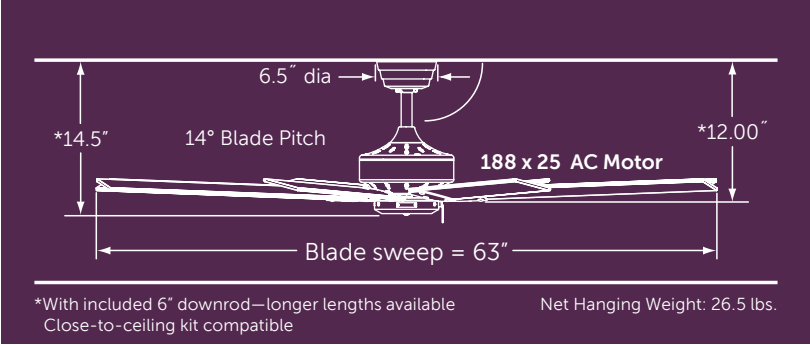

FAN: FP7910BL (1)
black assembly with black blades



FAN: FP7910BN (1)
brushed nickel assembly with reversible
cherry/walnut wood blades
● walnut side showing



FAN: FP7910MW (1)
matte white assembly with
matte white blades



FAN: FP7910OB (1)
oil-rubbed bronze assembly
with walnut blades



For compatible controls &
accessories see pages 183 - 193

Recommended
optional controls



CRL4WH

or



CW1WH
without light

or



CW60WH
with light

LEVON™ AC



FAN: FP7910BN (1)
brushed nickel assembly
with reversible cherry/
walnut wood blades
• walnut side showing

FP7910**—AVAILABLE FINISHES:

BN brushed nickel	BL black	MW matte white	OB oil-rubbed bronze
cherry walnut	black	matte white	walnut

INCLUDED:



blade set



FANSYNC™
sold separately



3-SPEED AC
reverse switch
on fan



CONTROL
pull chain



DRY
indoor only

ENERGY GUIDE:

TOTAL AIR VOLUME (CFM)	ENERGY USE (Watts)	ESTIMATED YEARLY ENERGY COST	AIRFLOW EFFICIENCY (CFM/W)
4,273 _{ave}	42 _{ave}	\$12 _{ave}	102 _{ave}
5,878 _{high}	66 _{high}	\$19 _{high}	89 _{high}



LIMITED LIFETIME MOTOR WARRANTY



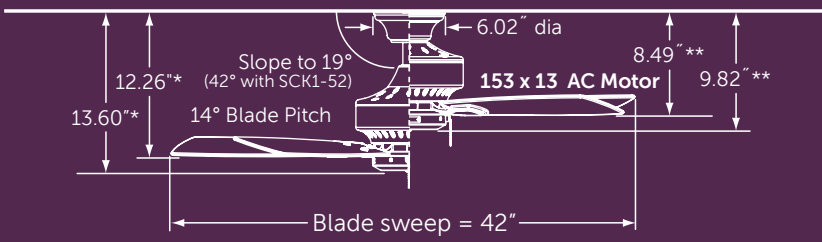

*With included 4.5" downrod—longer lengths available
 **With included flush mount kit

Net Hanging Weight: 15.37 lbs.



FAN: FP8042OB (1)
 oil-rubbed bronze assembly in flush-mount configuration with reversible cherry/walnut wood blades
 ● walnut side showing

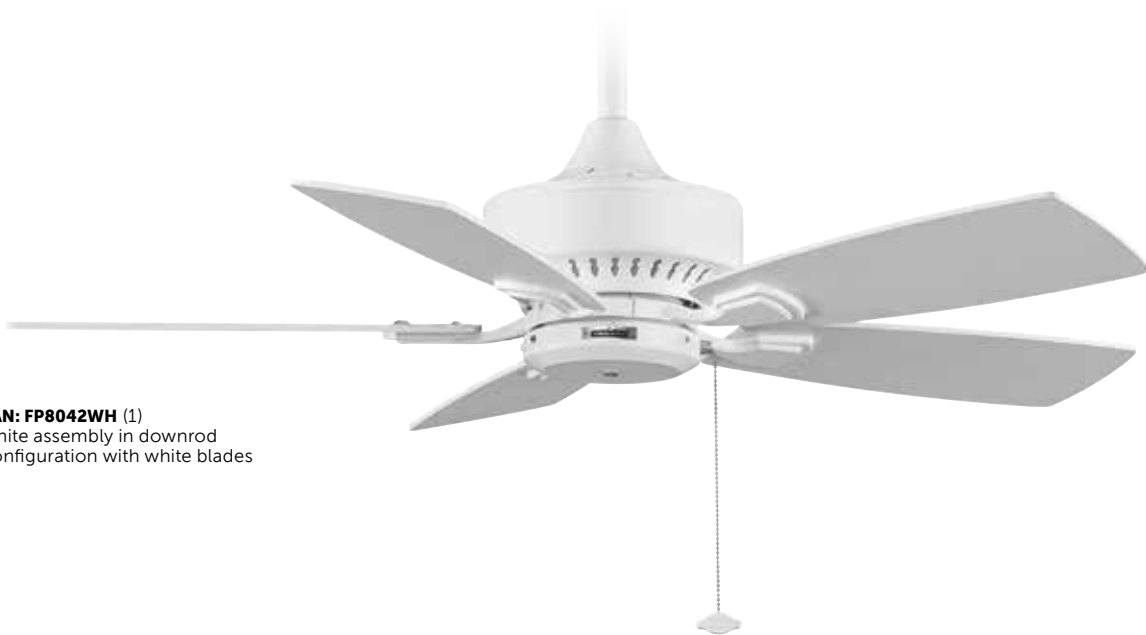

FAN: FP8042WH (1)
 white assembly in downrod configuration with white blades

For compatible controls & accessories see pages 183 - 193

Recommended optional controls



CRL4WH

or



CW1WH
 without light

or



CW60WH
 with light

CANCUN™ 42

- FAN: FP8042OB (1)**
oil-rubbed bronze assembly with reversible cherry/walnut wood blades
- cherry side showing

FP8042**—AVAILABLE FINISHES:

OB oil-rubbed bronze	WH white
cherry walnut	white

INCLUDED:



blade set



FANSYNC™
sold separately



3-SPEED AC
reverse switch
on fan



CONTROL
pull chain



DRY
indoor only

ENERGY GUIDE:

TOTAL AIR VOLUME (CFM)	ENERGY USE (Watts)	ESTIMATED YEARLY ENERGY COST	AIRFLOW EFFICIENCY (CFM/W)
2,598 _{ave}	30 _{ave}	\$8 _{ave}	88 _{ave}
3,426 _{high}	45 _{high}	\$13 _{high}	76 _{high}

LIMITED LIFETIME MOTOR WARRANTY



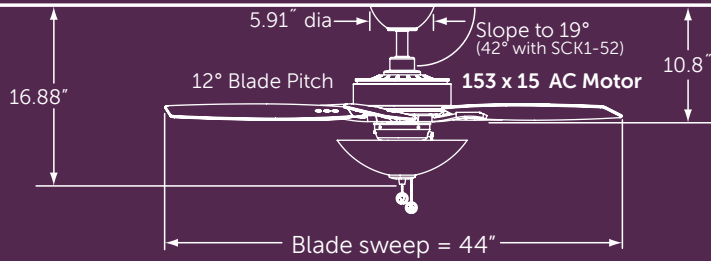



 1,600 Lumens
 2,700K CCT
 90 CRI

*With included 4.5" downrod—longer lengths available
 Close-to-ceiling kit compatible

Net Hanging Weight: 16.64 lbs.

- 
FAN: FP6245BDZ (1)
 dark bronze assembly with
 white frosted glass bowl
 and reversible cherry/dark
 walnut blades
 - cherry side showing



- 
FAN: FP6245BMW (1)
 matte white assembly with
 white frosted glass bowl and
 matte white blades



For compatible controls & accessories see pages 183 - 193

Recommended optional controls



CRL4WH

or



CW60WH

AIRE DELUXE™ 44



FAN: FP6245BBN (1)
 brushed nickel assembly
 with white frosted glass
 bowl and reversible cherry/
 dark walnut blades
 ● dark walnut side showing

FP6245B**—AVAILABLE FINISHES:

BN brushed nickel	DZ dark bronze	MW matte white
cherry dark walnut	cherry dark walnut	matte white

INCLUDED:



blade set



light kit

 FANSYNC™ sold separately	 (2) 10W E26 LED	 3-SPEED AC reverse switch on fan	 CONTROL pull chain	 DRY indoor only
---	--	--	--	---

ENERGY GUIDE:

TOTAL AIR VOLUME (CFM)	ENERGY USE (Watts)	ESTIMATED YEARLY ENERGY COST	AIRFLOW EFFICIENCY (CFM/W)
2,900 _{ave}	34 _{ave}	\$9 _{ave}	86 _{ave}
3,969 _{high}	54 _{high}	\$15 _{high}	74 _{high}

LIMITED LIFETIME MOTOR WARRANTY



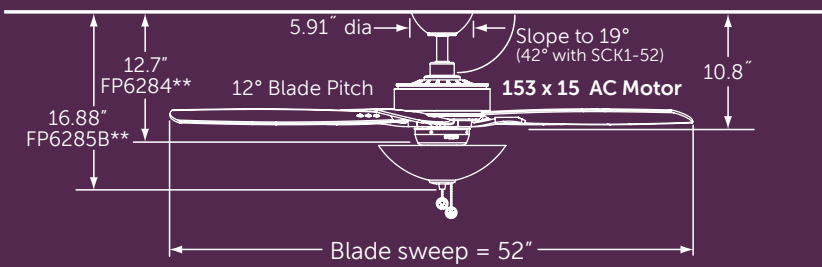



 1,600 Lumens
 2,700K CCT
 90 CRI

*With included 4.5" downrod—longer lengths available
 Close-to-ceiling kit compatible

FP6284** Net Hanging Weight: 15.36 lbs.
 FP6285B** Net Hanging Weight: 17.34 lbs.



 **FAN: FP6284BN** (1)
 brushed nickel assembly
 with reversible cherry/dark
 walnut wood blades

- dark walnut side showing



 **FAN: FP6284DZ** (1)
 dark bronze assembly with reversible
 cherry/dark walnut wood blades

- cherry side showing



 **FAN: FP6284MW** (1)
 matte white assembly with
 matte white wood blades



For compatible controls & accessories see pages 183 - 193

Recommended optional controls



CRL4WH

or



CW60WH



AIRE DELUXE™ 52



FAN: FP6285BBN (1)
 brushed nickel assembly with white frosted glass bowl and reversible cherry/dark walnut blades
 ● dark walnut side showing



FAN: FP6285BDZ (1)
 dark bronze assembly with white frosted glass bowl and reversible cherry/dark walnut blades
 ● cherry side showing



FAN: FP6285BMW (1)
 matte white assembly with white frosted glass bowl and matte white blades



FP6284** & FP6285B**—AVAILABLE FINISHES:

BN brushed nickel	DZ dark bronze	MW matte white
cherry dark walnut	cherry dark walnut	matte white

INCLUDED:



blade set

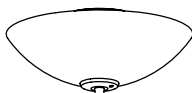

light kit—FP6285B** only

- FANSYNC™**
 sold separately
- (2) 10W E26 LED**
 FP6285B** only
- 3-SPEED AC reverse switch**
 on fan
- CONTROL pull chain**
- DRY indoor only**

ENERGY GUIDE:

TOTAL AIR VOLUME (CFM)	ENERGY USE (Watts)	ESTIMATED YEARLY ENERGY COST	AIRFLOW EFFICIENCY (CFM/W)
3,476 _{ave}	34 _{ave}	\$10 _{ave}	102 _{ave}
4,908 _{high}	55 _{high}	\$15 _{high}	89 _{high}



LIMITED LIFETIME MOTOR WARRANTY



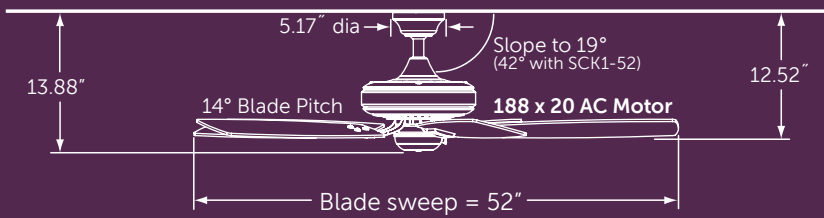

*With included 4.5" downrod—longer lengths available
Close-to-ceiling kit compatible

Net Hanging Weight: 21.19 lbs.



- FAN: TF610OB (1)**
oil-rubbed bronze assembly with reversible cherry/walnut wood blades
 - walnut side showing



- FAN: TF610SN (1)**
satin nickel assembly with reversible walnut/light walnut wood blades
 - walnut side showing



- FAN: TF610WH (1)**
white assembly with reversible white/white oak wood blades
 - white side showing



For compatible controls & accessories see pages 183 - 193

Recommended optional controls



CRL4WH

or



CW1WH
without light

or



CW60WH
with light

EDGEWOOD® DECORATIVE



FAN: TF610SN (1)
oil-rubbed bronze assembly with
reversible cherry/walnut wood blades
• walnut side showing



FANSYNC™
sold separately



3-SPEED AC
reverse switch
on fan



CONTROL
pull chain



DRY
indoor only

TF610**—AVAILABLE FINISHES:

OB oil-rubbed bronze	SN satin nickel	WH white
cherry walnut	walnut light walnut	white white oak

INCLUDED:



blade set

ENERGY GUIDE:

TOTAL AIR VOLUME (CFM)	ENERGY USE (Watts)	ESTIMATED YEARLY ENERGY COST	AIRFLOW EFFICIENCY (CFM/W)
4,168 _{ave}	49 _{ave}	\$14 _{ave}	84 _{ave}
6,083 _{high}	82 _{high}	\$23 _{high}	74 _{high}



LIMITED LIFETIME MOTOR WARRANTY



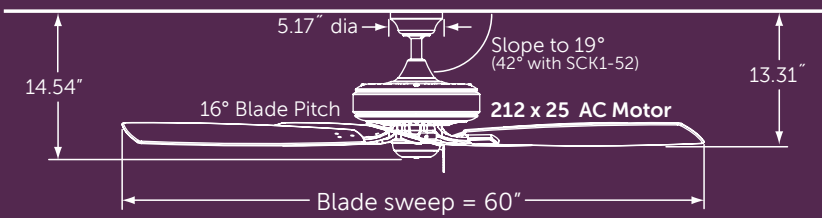

*With included 4.5" downrod—longer lengths available
Close-to-ceiling kit compatible

Net Hanging Weight: 29.78 lbs.



- FAN: TF710OB (1)** oil-rubbed bronze assembly with reversible cherry/walnut wood blades
 - walnut side showing



- FAN: TF710SN (1)** satin nickel assembly with reversible walnut/light walnut wood blades
 - light walnut side showing



- FAN: TF710WH (1)** white assembly with reversible white/white oak wood blades
 - white oak side showing



For compatible controls & accessories see pages 183 - 193

Recommended optional controls



CRL4WH

or



CW1WH
without light

or



CW60WH
with light

EDGEWOOD® DELUXE



FAN: TF710OB (1)
oil-rubbed bronze assembly
with reversible cherry/
walnut wood blades
• cherry side showing



FANSYNC™
sold separately



3-SPEED AC
reverse switch
on fan



CONTROL
pull chain



DRY
indoor only

TF710**—AVAILABLE FINISHES:

OB oil-rubbed bronze	SN satin nickel	WH white
cherry walnut	walnut light walnut	white white oak

INCLUDED:



blade set

ENERGY GUIDE:

TOTAL AIR VOLUME (CFM)	ENERGY USE (Watts)	ESTIMATED YEARLY ENERGY COST	AIRFLOW EFFICIENCY (CFM/W)
5,232 _{ave}	57 _{ave}	\$16 _{ave}	92 _{ave}
7,083 _{high}	87 _{high}	\$24 _{high}	81 _{high}



LIMITED LIFETIME MOTOR WARRANTY



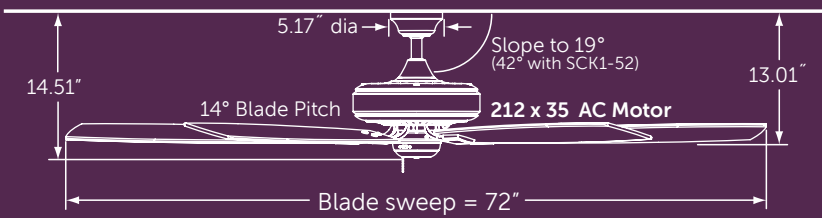

*With included 4.5" downrod—longer lengths available
Close-to-ceiling kit compatible

Net Hanging Weight: 37.92 lbs.



- ❖
FAN: TF721OB (1)
 oil-rubbed bronze assembly with reversible cherry/walnut wood blades
 - cherry side showing



- ❖
FAN: TF721WH (1)
 white assembly with reversible white/white oak wood blades
 - white side showing

For compatible controls & accessories see pages 183 - 193

Recommended optional controls



CRL4WH

or



CW1WH
without light

or



CW60WH
with light

EDGEWOOD® SUPREME



FAN: TF721OB (1)
oil-rubbed bronze
assembly with
reversible cherry/
walnut wood blades
● cherry side showing

TF721**—AVAILABLE FINISHES:

OB oil-rubbed bronze	WH white
cherry walnut	white white oak

INCLUDED:



blade set



FANSYNC™
sold separately



3-SPEED AC
reverse switch
on fan



CONTROL
pull chain



DRY
indoor only

ENERGY GUIDE:

TOTAL AIR VOLUME (CFM)	ENERGY USE (Watts)	ESTIMATED YEARLY ENERGY COST	AIRFLOW EFFICIENCY (CFM/W)
4,906 _{ave}	50 _{ave}	\$14 _{ave}	98 _{ave}
6,185 _{high}	69 _{high}	\$19 _{high}	90 _{high}



LIMITED LIFETIME MOTOR WARRANTY





For dimensions and configurations, please see our model-specific specification sheet, available at fanimation.com

Not recommended for use in sound sensitive areas.

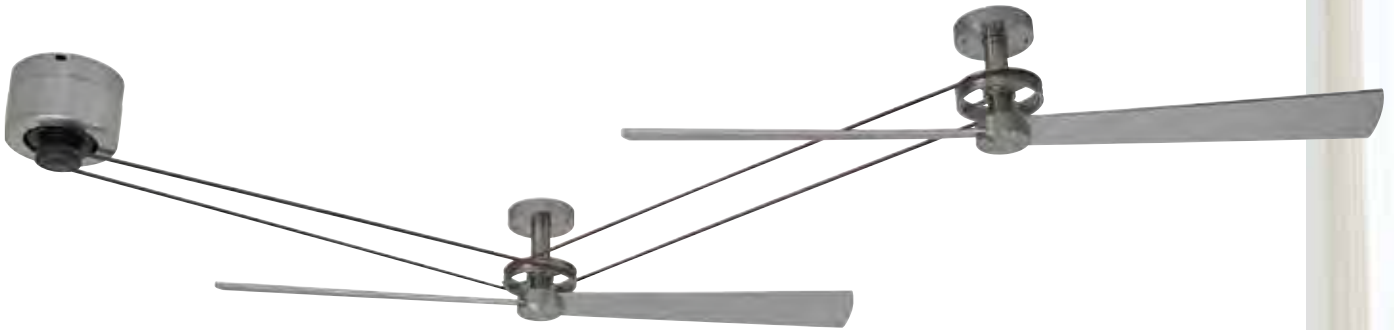

- ◆ **MOTOR: MA7966BN** (1)
brushed nickel
- HEAD: HA7966BN** (2)
brushed nickel assembly
- BLADE SET: B7966BN** (2)
56" sweep brushed nickel



- ◆ **MOTOR: MA7966DZ** (1)
dark bronze
- HEAD: HA7966DZ** (1)
dark bronze assembly
- BLADE SET: B7966CYDWA** (1)
56" sweep reversible
cherry/dark walnut
● dark walnut side showing

For compatible controls & accessories see pages 183 - 192

Recommended optional control



C25



B7966**
56" wood

BN—brushed nickel

CYDWA—cherry/dark walnut reversible



KELLAN™

- ◆ **MOTOR: MA7966BN** (1)
brushed nickel
- ◆ **HEAD: HA7966BN** (1)
brushed nickel assembly
- ◆ **BLADE SET: B7966CYDWA** (1)
56" sweep reversible cherry/dark walnut
 - dark walnut side showing

MA7966** & HA7966**—AVAILABLE FINISHES:

BN
brushed
nickel

DZ
dark
bronze

INCLUDED:



TR33 control



MIX & MATCH
components
sold separately



3-SPEED AC
reverse switch
on fan



CONTROL
remote



DRY
indoor only

LIMITED LIFETIME MOTOR WARRANTY



Due to their complex systems, multiple components and special installation requirements, we recommend contacting our Customer Service department for assistance with ordering—888.567.2055

For dimensions and configurations, please see our model-specific specification sheet, available at www.fanimation.com

BOURBON STREET®

- ◆ **MOTOR: FP580BL** (1)
black (required but not shown)
- ◆ **HEAD: FP510BL** (3)
black short assembly
- ◆ **BLADES: FP1018** (3)
52" sweep reversible oak/walnut wood
- oak side showing

PALMETTO®

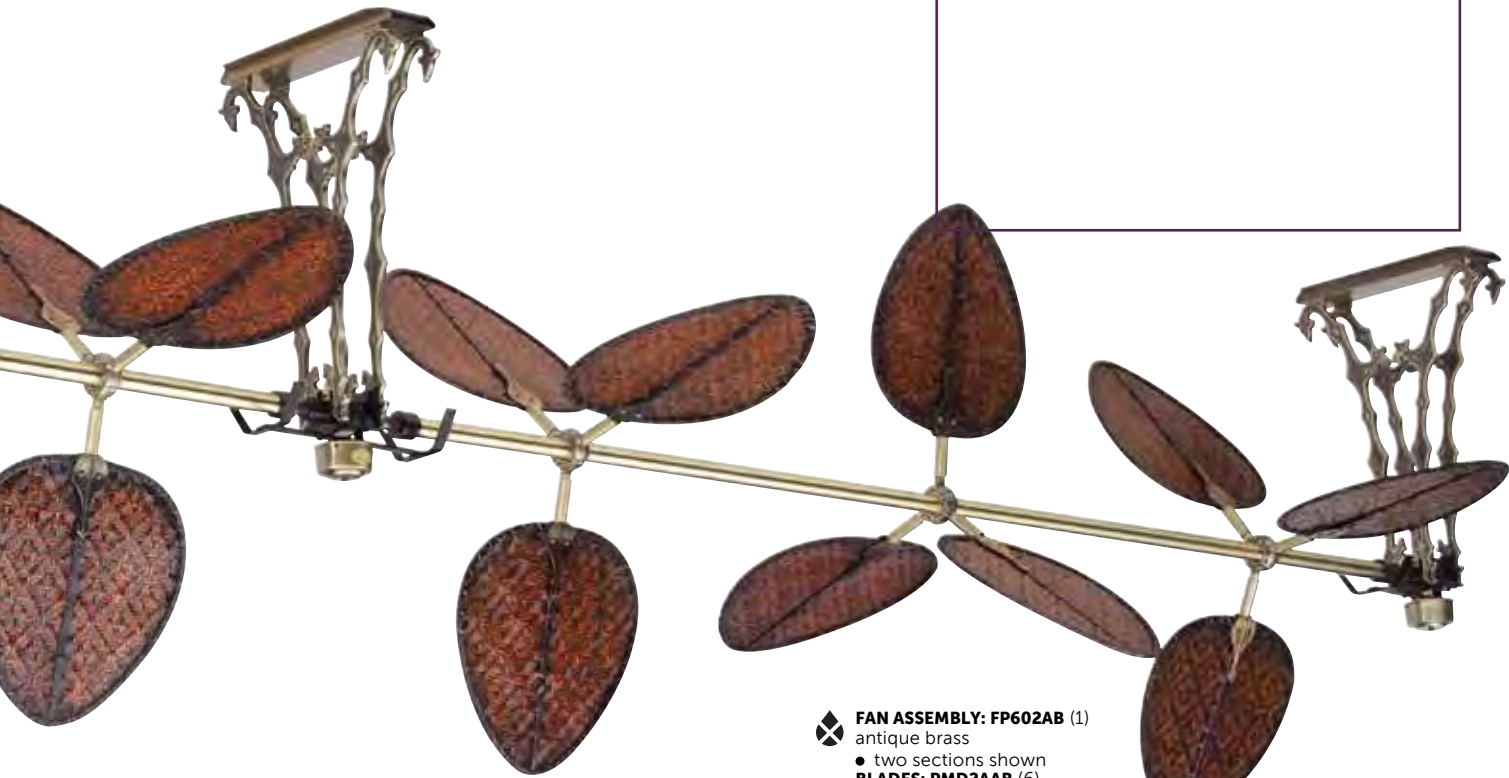

FAN ASSEMBLY: FP602AB (1)
antique brass
● two sections shown
BLADES: PMD2AAB (6)
antique brass assemblies
with antique woven
bamboo wide oval blades







FANS :: INDOOR/OUTDOOR

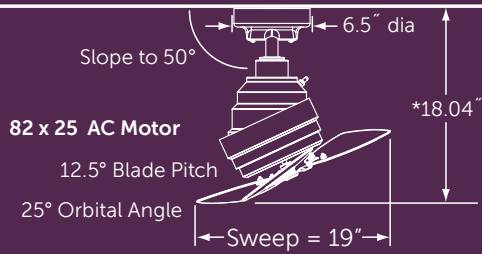

*With included 4.5" downrod—longer lengths available
 True stainless steel rust resistant downrods available

Net Hanging Weight: 10.21 lbs.

NOTE: DISTANCE FROM FLOOR TO BLADES MUST BE AT LEAST 10 FEET FOR THE ROTATION™

 **FAN: FP8018BL (1)**
 black assembly with black blades



 **FAN: FP8018BN (1)**
 brushed nickel assembly with brushed nickel blades



 **FAN: FP8018GR (1)**
 matte greige assembly with weathered wood blades



 **FAN: FP8018MW (1)**
 matte white assembly with matte white blades



For compatible controls & accessories see pages 183 - 193

Recommended optional control



CRL4WH

ROTATION™

 **FAN: FP8018BL (1)**
black assembly with
black blades

FP8018**—AVAILABLE FINISHES:

BL black black	BN brushed nickel brushed nickel	GR matte greige weathered wood	MW matte white matte white
-----------------------------	---	---	---

INCLUDED:

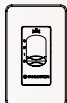

CW1-8018 wall control



3-SPEED AC
reverse switch
on fan



CONTROL
wall



DAMP
indoor/outdoor

LIMITED LIFETIME MOTOR WARRANTY



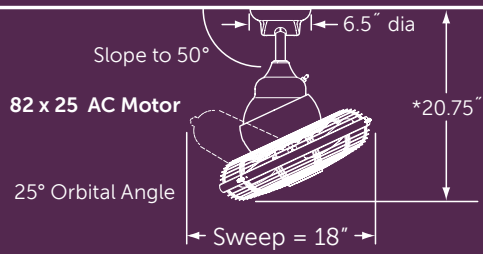

*With included 6" downrod—longer lengths available

Net Hanging Weight: 14.5 lbs.

NOTE: FAN ORBIT IS CONTINUOUS. CANNOT STOP OR REVERSE. NOT RECOMMENDED FOR SOUND SENSITIVE AREAS

FAN: OF110BL (1)
black assembly with black cage



FAN: OF110OB (1)
oil-rubbed bronze assembly with black cage



FAN: OF110SN (1)
satin nickel assembly with black cage



For compatible controls & accessories see pages 183 - 192

Recommended optional control



RC110WH

EXTRAORDINAIRE™



FAN: OF110OB (1)
oil-rubbed bronze
assembly with black cage

OF110**—AVAILABLE FINISHES:

BL black	OB oil-rubbed bronze	SN satin nickel
black	black	black

INCLUDED:



CW110WH wall control



3-SPEED AC
no reverse



CONTROL
wall



DAMP
indoor/outdoor

LIMITED LIFETIME MOTOR WARRANTY



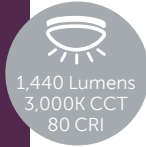
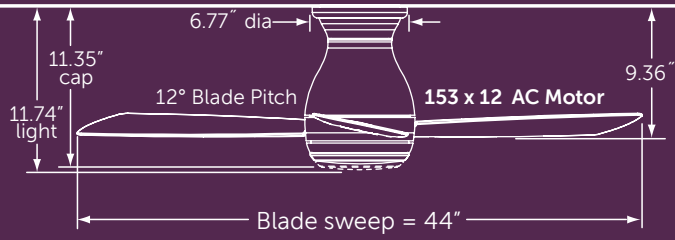

Net Hanging Weight: 13.89 lbs.

FAN: FPS8332BNW (1)
brushed nickel assembly
with brushed nickel blades
and opal frosted shade



FAN: FPS8332DZW (1)
dark bronze assembly with dark
bronze blades and matching light
cover (included)



FAN: FPS8332GRW (1)
matte greige assembly with
matte greige blades and opal
frosted shade



FAN: FPS8332MWW (1)
matte white assembly with matte
white blades and matching light
cover (included)



For compatible controls &
accessories see pages 183 - 193

Recommended
optional control



CRL4WH

HUGH™ 44

FAN: FPS8332BNW (1)
brushed nickel assembly with
brushed nickel blades and
matching light cover (included)

FPS8332**—AVAILABLE FINISHES:

BNW brushed nickel	DZW dark bronze	GRW matte greige	MWW matte white
brushed nickel	dark bronze	matte greige	matte white

INCLUDED:



blade set



light kit



light cover



CW60WH-8332-8355
wall control



FANSYNC™
sold separately



18W
LED



3-SPEED AC
reverse switch
on fan



CONTROL
wall



WET
indoor/outdoor

ENERGY GUIDE:

TOTAL AIR VOLUME (CFM)	ENERGY USE (Watts)	ESTIMATED YEARLY ENERGY COST	AIRFLOW EFFICIENCY (CFM/W)
2,854 _{ave}	34 _{ave}	\$9 _{ave}	85 _{ave}
3,806 _{high}	52 _{high}	\$15 _{high}	73 _{high}

LIMITED LIFETIME MOTOR WARRANTY



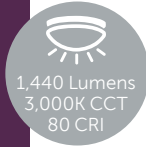
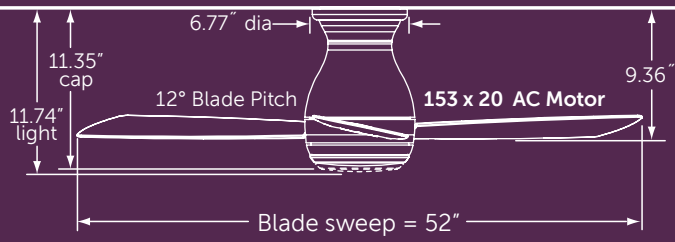

Net Hanging Weight: 16.53 lbs.

FAN: FPS8355BNW (1)
brushed nickel assembly with
brushed nickel blades and
opal frosted shade



FAN: FPS8355DZW (1)
dark bronze assembly with dark
bronze blades and matching light
cover (included)



FAN: FPS8355GRW (1)
matte greige assembly with
matte greige blades and
opal frosted shade



FAN: FPS8355MWW (1)
matte white assembly with matte
white blades and matching light
cover (included)



For compatible controls &
accessories see pages 183 - 193

Recommended
optional control



CRL4WH

HUGH™ 52

FAN: FPS8355GRW (1)
matte greige assembly with
matte greige blades and
matching light cover (included)

FPS8355**—AVAILABLE FINISHES:

BNW brushed nickel	DZW dark bronze	GRW matte greige	MWW matte white
brushed nickel	dark bronze	matte greige	matte white

INCLUDED:



light kit



light cover



CW60WH-8332-8355
wall control

- FANSYNC™**
sold separately
- 18W LED**
- 3-SPEED AC**
reverse switch
on fan
- CONTROL**
wall
- WET**
indoor/outdoor

ENERGY GUIDE:

TOTAL AIR VOLUME (CFM)	ENERGY USE (Watts)	ESTIMATED YEARLY ENERGY COST	AIRFLOW EFFICIENCY (CFM/W)
3,314 ^{ave}	33 ^{ave}	\$9 ^{ave}	99 ^{ave}
4,509 ^{high}	51 ^{high}	\$14 ^{high}	88 ^{high}

LIMITED LIFETIME MOTOR WARRANTY



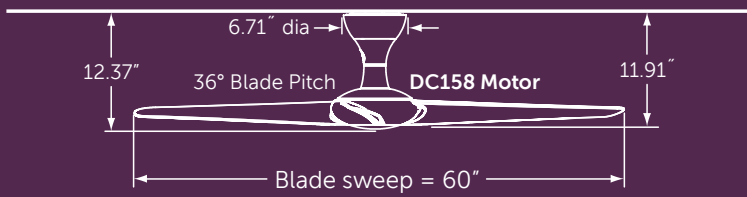

Extension rods available—6", 12", 24", 36" and 48"

Net Hanging Weight: 16.32 lbs.



FAN: FPD6235SL (1)
silver assembly with silver blades
TUBE: ET6235-24SL (1)
silver 24" extension tube



FAN: FPD6235GBL (1)
glossy black assembly with glossy black blades



FAN: FPD6235GWH (1)
glossy white assembly with glossy white blades

Special features



Sets timer for fan to turn off (max 6 hours)



FRESH AIR

Variable fan speeds simulate a natural breeze.

For compatible controls & accessories see pages 183 - 193

Recommended optional control



TW206

Order by length and finish code

Example: ET6235-12,GWH
tube finish length code



GBL—glossy black
GWH—glossy white
SL—silver

ET6235-___***
extension tube



DRONE™

FAN: FPD6235SL (1)
silver assembly
with silver blades

FPD6235**—AVAILABLE FINISHES:

GBL glossy black	SL silver	GWH glossy white
glossy black	silver	glossy white

INCLUDED:

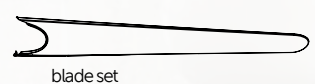

blade set



TR205 remote

- ENERGY SAVINGS
- FANSYNC™ included
- 31-SPEED DC reverse switch on remote
- CONTROL remote
- DAMP indoor/outdoor

ENERGY GUIDE:

TOTAL AIR VOLUME (CFM)	ENERGY USE (Watts)	ESTIMATED YEARLY ENERGY COST	AIRFLOW EFFICIENCY (CFM/W)
3,410 _{ave}	21 _{ave}	\$6 _{ave}	160 _{ave}
5,683 _{high}	34 _{high}	\$10 _{high}	167 _{high}

LIMITED LIFETIME MOTOR WARRANTY



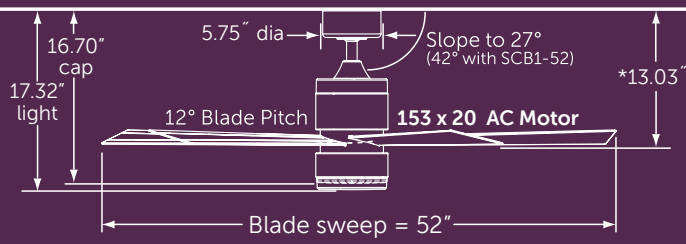

1,241 Lumens
 3,000K CCT
 90 CRI

1,400 Lumens
 3,000K CCT
 90 CRI

*With included 4.5" downrod—longer lengths available
 True stainless steel rust resistant downrods available

Net Hanging Weight: 20.95 lbs.

FAN: FP8458BL (1)
 black assembly with black blades, pc upright lens and opal frosted lower glass



FAN: FP8458BN (1)
 brushed nickel assembly with brushed nickel blades, pc upright lens and matching brushed nickel cap (included)



FAN: FP8458DZ (1)
 dark bronze assembly with dark bronze blades, pc upright lens and opal frosted lower glass



FAN: FP8458GR (1)
 matte greige assembly with weathered wood blades, pc upright lens and matching matte greige cap (included)



FAN: FP8458MW (1)
 matte white assembly with matte white blades, pc upright lens and opal frosted lower glass



For compatible controls & accessories see pages 183 - 193

Recommended optional control



BT-CR9U

TORCH™

FAN: FP8458DZ (1)
dark bronze assembly with dark bronze blades, pc upright lens and opal frosted lower glass

FP8458**—AVAILABLE FINISHES:

BL black	BN brushed nickel	DZ dark bronze	GR matte greige	MW matte white
black	brushed nickel	dark bronze	weathered wood	matte white

INCLUDED:

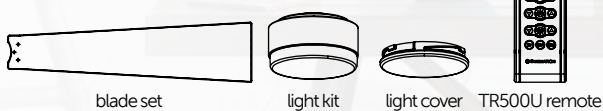

- FANSYNC™**
sold separately
- LED**
13W upright
18W downlight
- 3-SPEED AC**
reverse switch
on fan
- CONTROL**
remote
- DAMP**
indoor/outdoor

ENERGY GUIDE:

TOTAL AIR VOLUME (CFM)	ENERGY USE (Watts)	ESTIMATED YEARLY ENERGY COST	AIRFLOW EFFICIENCY (CFM/W)
4,362 _{ave}	39 _{ave}	\$11 _{ave}	112 _{ave}
5,727 _{high}	59 _{high}	\$17 _{high}	97 _{high}

LIMITED LIFETIME MOTOR WARRANTY



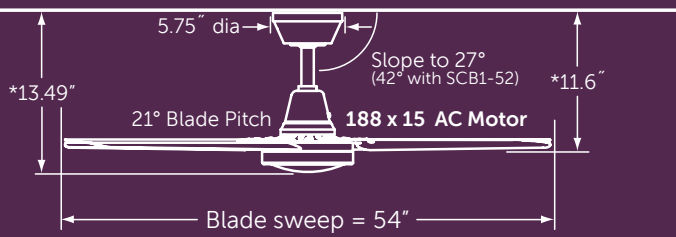

NOTE: DISTANCE FROM FLOOR TO BLADES MUST BE AT LEAST 10 FEET FOR THE ASCENSION™

*With included 6" downrod—longer lengths available
 True stainless steel rust resistant downrods available
 Net Hanging Weight: 18.44 lbs.



FAN: FP6717BN (1)
 brushed nickel assembly with
 brushed nickel blades



FAN: FP6717MW (1)
 matte white assembly with matte
 white blades



For compatible controls & accessories see pages 183 - 193

Recommended optional control



CRL4WH

ASCENSION™



FAN: FP6717BN (1)
brushed nickel assembly with
brushed nickel blades



FANSYNC™
sold separately



3-SPEED AC
reverse switch
on fan



CONTROL
wall



DAMP
indoor/outdoor

FP6717**—AVAILABLE FINISHES:

BN brushed nickel	MW matte white
brushed nickel	matte white

INCLUDED:

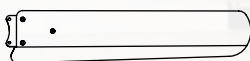

blade set

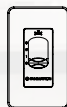

CW6717WH wall control

ENERGY GUIDE:

TOTAL AIR VOLUME (CFM)	ENERGY USE (Watts)	ESTIMATED YEARLY ENERGY COST	AIRFLOW EFFICIENCY (CFM/W)
7,071 _{high ave}	57 _{high ave}	\$30 _{high ave}	124 _{high ave}

Ascension is a high speed, small diameter (HSSD) fan and test procedures differ from our other fans. The average of two high-speed tests is reported instead of the average of a high- and a low-speed test.



LIMITED LIFETIME MOTOR WARRANTY



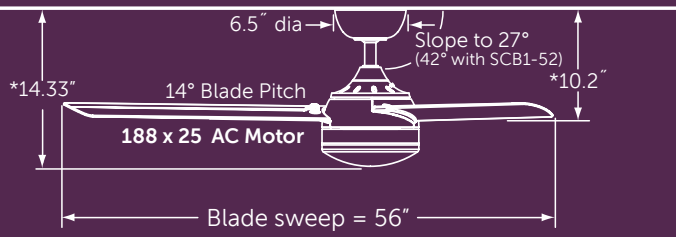



 1,350 Lumens
 3,000K CCT
 80 CRI

*With included 4.5" downrod—longer lengths available
 True stainless steel rust resistant downrods available
 Net Hanging Weight: 16.32 lbs.



FAN: FP6728BN (1)
 brushed nickel assembly with
 opal frosted glass and brushed
 nickel blades



FAN: FP6728DZ (1)
 dark bronze assembly with opal
 frosted glass and dark walnut
 blades

For compatible controls & accessories see pages 183 - 193

Recommended optional controls



C25

or



CW60WH

XENO™ DAMP



FAN: FP6728BN (1)
brushed nickel assembly
with opal frosted glass and
brushed nickel blades

FP6728**—AVAILABLE FINISHES:

BN brushed nickel	DZ dark bronze
brushed nickel	dark walnut

INCLUDED:



blade set



light kit



BTT9



FANSYNC™
included



18W
LED



3-SPEED AC
reverse switch
on fan



CONTROL
remote



DAMP
indoor/outdoor

ENERGY GUIDE:

TOTAL AIR VOLUME (CFM)	ENERGY USE (Watts)	ESTIMATED YEARLY ENERGY COST	AIRFLOW EFFICIENCY (CFM/W)
4,654 _{ave}	44 _{ave}	\$12 _{ave}	106 _{ave}
6,605 _{high}	66 _{high}	\$19 _{high}	100 _{high}



LIMITED LIFETIME MOTOR WARRANTY



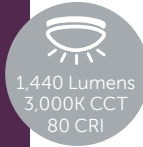
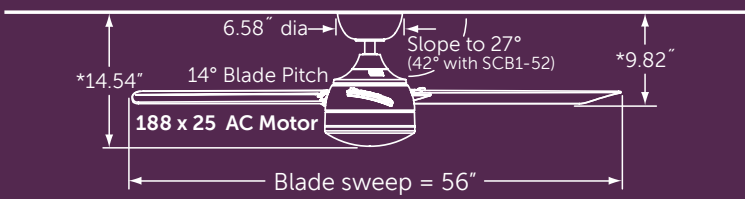

*With included 4.5" downrod—longer lengths available Net Hanging Weight: 23.81 lbs.
Close-to-ceiling kit compatible; *True stainless steel rust resistant downrods available*



FAN: FP6729BNW (1)
brushed nickel assembly with
opal frosted glass and brushed
nickel blades



FAN: FP6729DZW (1)
dark bronze assembly with dark
bronze blades and matching
light cover (included)



FAN: FP6729MWW (1)
matte white assembly with matte
white blades and matching light
cover (included)



For compatible controls &
accessories see pages 183 - 193

Recommended
optional control



CRL4WH

XENO™ WET



FAN: FP6729MWW (1)
matte white assembly with
matte white blades and
matching light cover (included)

FP6729***—AVAILABLE FINISHES:

BNW brushed nickel	DZW dark bronze	MWW matte white
brushed nickel	dark bronze	matte white

INCLUDED:

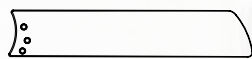

blade set



light kit



light cover



CW60WH-6729
wall control



FANSYNC™
sold separately



**18W
LED**



**3-SPEED AC
reverse switch
on fan**



**CONTROL
wall**



**WET
indoor/outdoor**

ENERGY GUIDE:

TOTAL AIR VOLUME (CFM)	ENERGY USE (Watts)	ESTIMATED YEARLY ENERGY COST	AIRFLOW EFFICIENCY (CFM/W)
4,669 _{ave}	36 _{ave}	\$10 _{ave}	130 _{ave}
6,475 _{high}	56 _{high}	\$16 _{high}	116 _{high}



LIMITED LIFETIME MOTOR WARRANTY



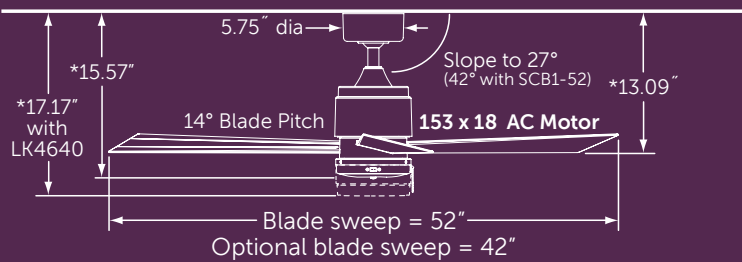

*With included 4.5" downrod—longer lengths available
Close-to-ceiling kit compatible; *True stainless steel rust resistant downrods available*

Net Hanging Weight: 14.7 lbs.



FAN: FP4640OB (1)
oil-rubbed bronze assembly with
cherry all weather composite blades



FAN: FP4640SN (1)
satin nickel assembly with satin
nickel all weather composite blades



FAN: FP4640WH (1)
white assembly with white all
weather composite blades



FAN: FP4640OB (1)
oil-rubbed bronze
assembly with cherry all
weather composite blades
LIGHT KIT: LK4640OB (1)
oil-rubbed bronze finish
18W LED light kit



For compatible controls &
accessories see pages 183 - 193



CY—cherry

WA—walnut

BPW4426**
54" composite



CY—cherry

SN—satin nickel

WA—walnut

BPW4442**
42" composite



LK4640**
18W LED

1,300 Lumens
3,000K CCT
80 CRI

use with
CW60WH



CW60WH
wall control

must be
paired
with WP60
for outdoor
application



WP60
waterproof box

ZONIX™ WET



FAN: FP4640OB(1)
oil rubbed bronze assembly with cherry all weather composite blades

FP4640**—AVAILABLE FINISHES:

OB oil-rubbed bronze	SN satin nickel	WH white
cherry	satin nickel	white

INCLUDED:



blade set

FANSYNC™
sold separately

3-SPEED AC
reverse switch on fan

CONTROL
pull chain

WET
indoor/outdoor

ENERGY GUIDE:

TOTAL AIR VOLUME (CFM)	ENERGY USE (Watts)	ESTIMATED YEARLY ENERGY COST	AIRFLOW EFFICIENCY (CFM/W)
3,125 _{ave}	32 _{ave}	\$9 _{ave}	98 _{ave}
5,261 _{high}	70 _{high}	\$20 _{high}	75 _{high}



LIMITED LIFETIME MOTOR WARRANTY







ZONIX™ WET CUSTOM

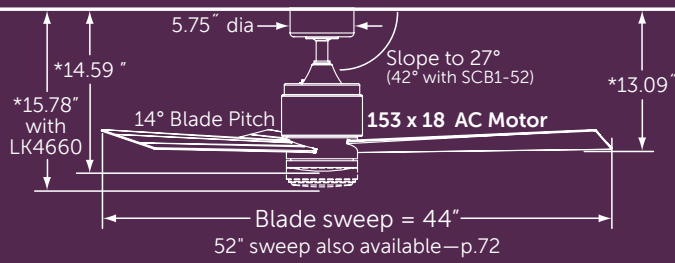

*With included 4.5" downrod—longer lengths available
 Close-to-ceiling kit compatible; *True stainless steel rust resistant downrods available*
 Net Hanging Weight: 15.08 lbs. (MA4660**) 16.07 lbs. (MA4660SSBN)

FAN: MA4660BLW (1)
 black assembly
BLADES: BPW4660-44BLW (1)
 44" sweep black finish composite



FAN: MA4660SSBNW (1)
 stainless steel brushed nickel assembly
BLADES: BPW4660-44BNW (1)
 44" sweep brushed nickel finish composite



FAN: MA4660DZW (1)
 dark bronze assembly
BLADES: BPW4660-44CYW (1)
 44" sweep cherry finish composite



FAN: MA4660GRW (1)
 matte greige assembly
BLADES: BPW4660-44GRW (1)
 44" sweep matte greige finish composite



FAN: MA4660MWW (1)
 matte white assembly
BLADES: BPW4660-44MWW (1)
 44" sweep black finish composite
LIGHT KIT: LK4660MWW (1)
 matte white finish



For compatible controls & accessories see pages 183 - 193

Recommended optional controls



CW1
without light



CW60WH
with light

must be paired with WP60 for outdoor application



WP60
waterproof box



BPW4660-44W**
44" composite

BL—black
 BN—brushed nickel
 CY—cherry
 DWA—dark walnut
 DZ—dark bronze
 GR—matte greige
 MW—matte white
 WE—weathered wood
 WW—white washed



LK4660**
18W LED



ZONIX™ WET CUSTOM 44



FAN: MA4660BLW (1)
black assembly
BLADES: BPW4660-44BLW (1)
44" sweep black finish
composite blades
LIGHT KIT: LK4660BLW (1)
black finish

MA4660 —AVAILABLE FINISHES:**

- BLW**
black
- DZW**
dark bronze
- GRW**
matte greige
- MWW**
matte white
- SSBNW**
brushed nickel

INCLUDED:



TR500 remote

- FANSYNC™**
sold separately
- MIX & MATCH**
components
sold separately
- 3-SPEED AC**
reverse switch
on fan
- CONTROL**
remote
- WET**
indoor/outdoor

ENERGY GUIDE:

TOTAL AIR VOLUME (CFM)	ENERGY USE (Watts)	ESTIMATED YEARLY ENERGY COST	AIRFLOW EFFICIENCY (CFM/W)
3,185 _{ave}	32 _{ave}	\$9 _{ave}	98 _{ave}
4,188 _{high}	47 _{high}	\$13 _{high}	89 _{high}



LIMITED LIFETIME MOTOR WARRANTY



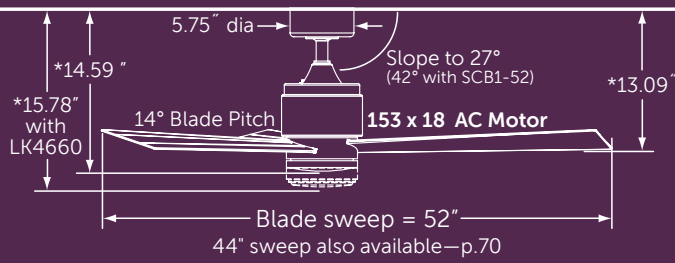

*With included 4.5" downrod—longer lengths available
 Close-to-ceiling kit compatible; *True stainless steel rust resistant downrods available*

Net Hanging Weight: 15.57 lbs. (MA4660**)
 16.56 lbs. (MA4660SSBN)

FAN: MA4660BLW (1)
 black assembly
BLADES: BPW4660-52BLW (1)
 52" sweep black finish composite
LIGHT KIT: LK4660BLW (1)
 black finish

FAN: MA4660SSBNW (1)
 brushed nickel assembly
BLADES: BPW4660-52DWA (1)
 52" sweep dark walnut finish composite

FAN: MA4660DZW (1)
 dark bronze assembly
BLADES: BPW4660-52DZW (1)
 52" sweep dark bronze finish composite

FAN: MA4660GRW (1)
 matte greige assembly
BLADES: BPW4660-52WEW (1)
 52" sweep weathered wood finish composite

FAN: MA4660MWW (1)
 matte white assembly
BLADES: BPW4660-52MWW (1)
 52" sweep matte white finish composite



For compatible controls & accessories see pages 183 - 193

Recommended optional controls



CW1
without light



CW60WH
with light

must be paired with WP60 for outdoor application



WP60
waterproof box



BPW4660-52W**
52" composite

BL—black
 BN—brushed nickel
 CY—cherry
 DWA—dark walnut
 DZ—dark bronze
 GR—matte greige
 MW—matte white
 WE—weathered wood
 WW—white washed



LK4660SSBNW
LK4660W**
 18W LED

1,400 Lumens
 3,000K CCT
 90 CRI

ZONIX™ WET CUSTOM 52

 **FAN: MA4660GRW** (1)
 matte greige assembly
BLADES: BPW4660-52WEW (1)
 52" sweep weathered wood
 finish composite blades
LIGHT KIT: LK4660GRW (1)
 matte greige finish





MA4660** —AVAILABLE FINISHES:

- BLW**
black
- DZW**
dark
bronze
- GRW**
matte
greige
- MWW**
matte
white
- SSBNW**
brushed
nickel

INCLUDED:



TR500 remote

- 
FANSYNC™
sold separately
- 
MIX & MATCH
components
sold separately
- 
3-SPEED AC
reverse switch
on fan
- 
CONTROL
remote
- 
WET
indoor/outdoor

ENERGY GUIDE:

TOTAL AIR VOLUME (CFM)	ENERGY USE (Watts)	ESTIMATED YEARLY ENERGY COST	AIRFLOW EFFICIENCY (CFM/W)
3,697 _{ave}	34 _{ave}	\$10 _{ave}	108 _{ave}
4,836 _{high}	49 _{high}	\$14 _{high}	99 _{high}

LIMITED LIFETIME MOTOR WARRANTY



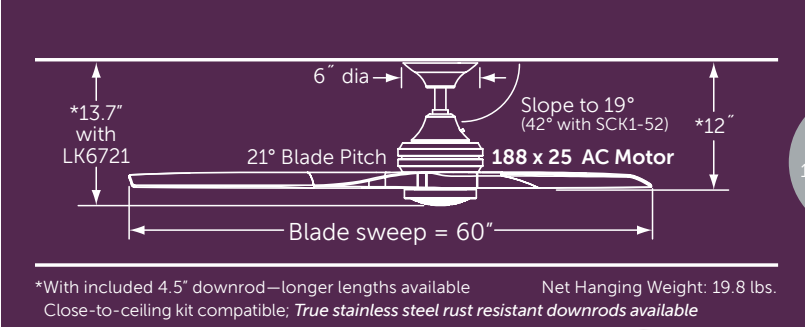

1,350 Lumens
3,000K CCT
80 CRI



FAN: MA6721BN (1)
brushed nickel assembly
BLADES: B6720BN (1)
brushed nickel finish buttonwood



FAN: MA6721BL (1)
black assembly
BLADES: B6720BL (1)
black finish buttonwood



FAN: MA6721BS (1)
brushed satin brass assembly
BLADES: B6720WK (1)
whiskey wood finish buttonwood



FAN: MA6721DF (1)
driftwood assembly
BLADES: B6720DF (1)
driftwood finish buttonwood



FAN: MA6721GR (1)
matte greige assembly
BLADES: B6720WE (1)
weathered wood finish buttonwood



FAN: MA6721GZ (1)
galvanized assembly
BLADES: B6720WK (1)
whiskey wood finish buttonwood



FAN: MA6721MW (1)
matte white assembly
BLADES: B6720WW (1)
white washed finish buttonwood
LIGHT KIT: LK6721MW (1)
matte white
(shown with frosted pc lens—included)



For compatible controls & accessories see pages 183 - 193

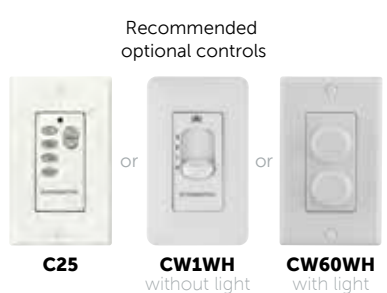

BL—black
BN—brushed nickel
DF—driftwood
DWA—dark walnut
N—natural
WE—weathered wood
WK—whiskey wood
WW—white washed



1,350 Lumens
3,000K CCT
80 CRI

LK6721**
18W LED

SPITFIRE™



FAN: MA6721DZ (1)
dark bronze assembly
BLADES: B6720N (1)
natural finish buttonwood
LIGHT KIT: LK6721DZ (1)
dark bronze with frosted fresnel glass

MA6721**—AVAILABLE FINISHES:

BL black	BN brushed nickel	BS brushed satin brass	DF driftwood	DZ dark bronze	GR matte greige	GZ galvanized	MW matte white
--------------------	-----------------------------	----------------------------------	------------------------	--------------------------	---------------------------	-------------------------	--------------------------

- FANSYNC™** included
- MIX & MATCH** components sold separately
- 3-SPEED AC** reverse switch on fan
- CONTROL** remote
- DAMP** indoor/outdoor

INCLUDED:



BTT9

ENERGY GUIDE:

TOTAL AIR VOLUME (CFM)	ENERGY USE (Watts)	ESTIMATED YEARLY ENERGY COST	AIRFLOW EFFICIENCY (CFM/W)
3,776 _{ave}	41 _{ave}	\$12 _{ave}	92 _{ave}
5,427 _{high}	62 _{high}	\$17 _{high}	88 _{high}



LIMITED LIFETIME MOTOR WARRANTY



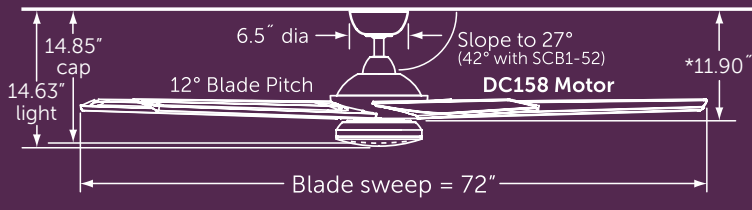

1,350 Lumens
3,000K CCT
80 CRI

*With included 6" downrod—longer lengths available
True stainless steel rust resistant downrods available

Net Hanging Weight: 26.5 lbs.



FAN: FPD6236BN (1)
brushed nickel assembly
with bourbon blades and
opal frosted glass



FAN: FPD6236DZ (1)
dark bronze assembly
with bourbon blades
and matching dark
bronze cap (included)



FAN: FPD6236GR (1)
matte greige assembly
with wheathered wood
blades and matching matte
greige cap (included)



Special features

<p>FAN TIMER</p>	<p>Sets timer for fan & light to turn off (max 6 hours)</p>	<p>HOME AWAY</p>	<p>Light turns on and off at set intervals to simulate someone being home.</p>
<p>FRESH AIR</p>	<p>Variable fan speeds simulate a natural breeze.</p>	<p>SAFE EXIT</p>	<p>Fan & light will turn off after one minute to allow for safe exit</p>

For compatible controls & accessories see pages 183 - 193

Recommended optional control



TW206

SUBTLE™



FAN: FPD6236GR (1)
matte greige assembly with weathered wood blades and opal frosted glass



ENERGY SAVINGS



FAN Sync™ included



18W LED



31-SPEED DC reverse switch on remote



CONTROL remote



DAMP indoor/outdoor

FPD6236**—AVAILABLE FINISHES:

BN brushed nickel	DZ dark bronze	GR matte greige
bourbon	bourbon	weathered wood

INCLUDED:



blade set



light kit



light cover



TR205 remote

ENERGY GUIDE:

TOTAL AIR VOLUME (CFM)	ENERGY USE (Watts)	ESTIMATED YEARLY ENERGY COST	AIRFLOW EFFICIENCY (CFM/W)
3,361 _{ave}	23 _{ave}	\$6 _{ave}	148 _{ave}
5,738 _{high}	40 _{high}	\$11 _{high}	143 _{high}



LIMITED LIFETIME MOTOR WARRANTY







LEVON™ CUSTOM

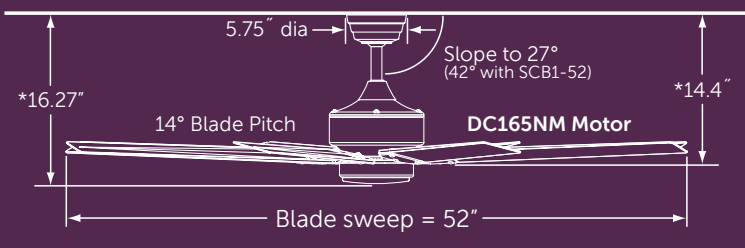

*With included 6" downrod—longer lengths available Net Hanging Weight: 25.87 lbs.
Close-to-ceiling kit compatible; True stainless steel rust resistant downrods available



FAN: MAD7912BN (1)
brushed nickel assembly
BLADES: BPW7914CY (1)
52" sweep cherry finish
LIGHT KIT: LK7912BN (1)
18W dimmable LED



FAN: MAD7912BL (1)
black assembly
BLADES: BPW7914BL (1)
52" sweep black finish



FAN: MAD7912GR (1)
matte greige assembly
BLADES: BPW7914WE (1)
52" sweep weathered wood finish



FAN: MAD7912GZ (1)
galvanized assembly
BLADES: BPW7914BL (1)
52" sweep black finish



FAN: MAD7912MW (1)
matte white assembly
BLADES: BPW7914MW (1)
52" sweep matte white finish



FAN: MAD7912DZ (1)
dark bronze assembly
BLADES: BPW7914DWA (1)
52" sweep dark walnut finish



For compatible controls & accessories see pages 183 - 192

Recommended optional control



TW40WH



BN—brushed nickel



B7914**
52" buttonwood



BL—black
BN—brushed nickel
CY—cherry
DWA—dark walnut
MW—matte white
N—natural
WE—weathered wood
WP—washed pine
WW—white washed

BPW7914**
52" composite



1,350 Lumens
3,000K CCT
80 CRI



NOT FOR USE WITH FP7910**

LK7912**
18W LED



LEVON™ CUSTOM 52



FAN: MAD7912GZ (1)
galvanized assembly
BLADES: BPW7914N (1)
52" sweep natural finish
LIGHT KIT: LK7912GZ (1)
18W dimmable LED

MAD7912**—AVAILABLE FINISHES:

BL black	BN brushed nickel	DZ dark bronze	GR matte greige	GZ galvanized	MW matte white
--------------------	--------------------------------	-----------------------------	------------------------------	-------------------------	-----------------------------

INCLUDED:



TR39 remote

ENERGY SAVINGS	MIX & MATCH components sold separately	6-SPEED DC reverse switch on remote	CONTROL remote	DAMP indoor/outdoor

ENERGY GUIDE:

TOTAL AIR VOLUME (CFM)	ENERGY USE (Watts)	ESTIMATED YEARLY ENERGY COST	AIRFLOW EFFICIENCY (CFM/W)
4,221 _{ave}	21 _{ave}	\$6 _{ave}	198 _{ave}
6,593 _{high}	32 _{high}	\$9 _{high}	205 _{high}



LIMITED LIFETIME MOTOR WARRANTY



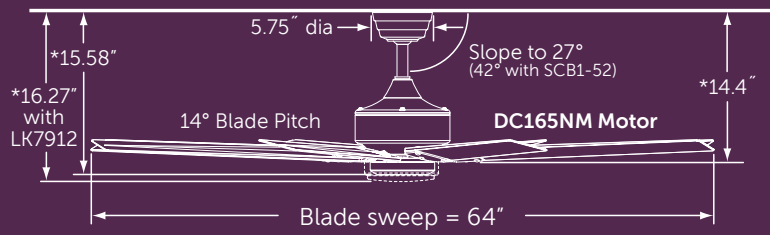



 1,350 Lumens
 3,000K CCT
 80 CRI

*With included 6" downrod—longer lengths available Net Hanging Weight: 26.68 lbs.
 Close-to-ceiling kit compatible; True stainless steel rust resistant downrods available



 **FAN: MAD7912BN** (1)
 brushed nickel assembly
BLADES: BPW7912BN (1)
 64" sweep brushed nickel finish



 **FAN: MAD7912BL** (1)
 black assembly
BLADES: BPW7912WP (1)
 64" sweep washed pine finish



 **FAN: MAD7912GR** (1)
 matte greige assembly
BLADES: BPW7912WE (1)
 64" sweep weathered wood finish



 **FAN: MAD7912GZ** (1)
 galvanized assembly
BLADES: BPW7912N (1)
 64" sweep natural finish



 **FAN: MAD7912MW** (1)
 matte white assembly
BLADES: BPW7912WP (1)
 64" sweep washed pine finish



 **FAN: MAD7912DZ** (1)
 dark bronze assembly
BLADES: BPW7912DWA (1)
 64" sweep dark walnut finish
LIGHT KIT: LK7912DZ (1)
 18W dimmable LED



For compatible controls & accessories see pages 183 - 192

Recommended optional control



TW40WH



N—natural
 WA—walnut
 WP—washed pine

B7912** 
64" buttonwood



BL—black
 BN—brushed nickel
 CY—cherry
 DWA—dark walnut
 MW—matte white
 N—natural
 WE—weathered wood
 WP—washed pine
 WW—white washed

BPW7912** 
64" composite



NOT FOR USE WITH FP7910**

LK7912** 
18W LED

 1,350 Lumens
 3,000K CCT
 80 CRI

LEVON™ CUSTOM 64



FAN: MAD7912MW (1)
matte white assembly
BLADES: BPW7912MW (1)
64" sweep matte white finish

MAD7912**—AVAILABLE FINISHES:

BL black	BN brushed nickel	DZ dark bronze	GR matte greige	GZ galvanized	MW matte white
--------------------	--------------------------------	-----------------------------	------------------------------	-------------------------	-----------------------------

INCLUDED:



TR39 remote

- ENERGY SAVINGS
- MIX & MATCH components sold separately
- 6-SPEED DC reverse switch on remote
- CONTROL remote
- DAMP indoor/outdoor

ENERGY GUIDE:

TOTAL AIR VOLUME (CFM)	ENERGY USE (Watts)	ESTIMATED YEARLY ENERGY COST	AIRFLOW EFFICIENCY (CFM/W)
5,681 _{ave}	22 _{ave}	\$6 _{ave}	255 _{ave}
7,695 _{high}	34 _{high}	\$10 _{high}	226 _{high}



LIMITED LIFETIME MOTOR WARRANTY



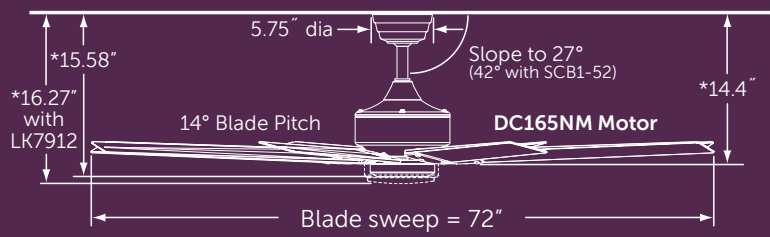



 1,350 Lumens
 3,000K CCT
 80 CRI

*With included 6" downrod—longer lengths available Net Hanging Weight: 29.10 lbs.
 Close-to-ceiling kit compatible; True stainless steel rust resistant downrods available



 **FAN: MAD7912BN** (1)
 brushed nickel assembly
BLADES: BPW7913BN (1)
 72" sweep brushed nickel finish



 **FAN: MAD7912BL** (1)
 black assembly
BLADES: BPW7913BL (1)
 72" sweep black finish



 **FAN: MAD7912GR** (1)
 matte greige assembly
BLADES: BPW7913WE (1)
 72" sweep weathered wood finish



 **FAN: MAD7912GZ** (1)
 galvanized assembly
BLADES: BPW7913N (1)
 72" sweep natural finish



 **FAN: MAD7912MW** (1)
 matte white assembly
BLADES: BPW7913DWA (1)
 72" sweep dark walnut finish



 **FAN: MAD7912DZ** (1)
 dark bronze assembly
BLADES: BPW7913CY (1)
 72" sweep cherry finish



For compatible controls & accessories see pages 183 - 192

Recommended optional control



TW40WH



B7913**
72" buttonwood

BN—brushed nickel

CYWA—cherry/walnut reversible



BL—black
 BN—brushed nickel
 CY—cherry
 DWA—dark walnut
 MW—matte white
 N—natural
 WE—weathered wood
 WP—washed pine
 WW—white washed



NOT FOR USE WITH FP7910**

 1,350 Lumens
 3,000K CCT
 80 CRI

LK7912**
18W LED

LEVON™ CUSTOM 72



FAN: MAD7912BN (1)
brushed nickel assembly
BLADES: BPW7913BN (1)
72" sweep brushed nickel finish
LIGHT KIT: LK7912BN (1)
18W dimmable LED

MAD7912**—AVAILABLE FINISHES:

BL black	BN brushed nickel	DZ dark bronze	GR matte greige	GZ galvanized	MW matte white
--------------------	--------------------------------	-----------------------------	------------------------------	-------------------------	-----------------------------

INCLUDED:



TR39 remote

- ENERGY SAVINGS
- MIX & MATCH components sold separately
- 6-SPEED DC reverse switch on remote
- CONTROL remote
- DAMP indoor/outdoor

ENERGY GUIDE:

TOTAL AIR VOLUME (CFM)	ENERGY USE (Watts)	ESTIMATED YEARLY ENERGY COST	AIRFLOW EFFICIENCY (CFM/W)
5,977 _{ave}	22 _{ave}	\$6 _{ave}	270 _{ave}
9,521 _{high}	32 _{high}	\$9 _{high}	299 _{high}



LIMITED LIFETIME MOTOR WARRANTY







ODYN™ CUSTOM

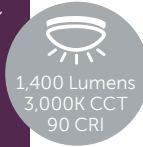
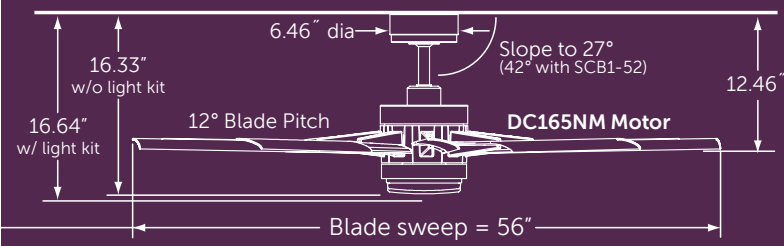

1,400 Lumens
3,000K CCT
90 CRI

*With included 6" downrod—longer lengths available
True stainless steel rust resistant downrods available

Net Hanging Weight: 30.72 lbs.



FAN: MAD8152BLW (1)
black assembly with opal
frosted glass
BLADES: BPW8152-56BNW (1)
56" sweep brushed nickel finish



FAN: MAD8152BNW (1)
brushed nickel assembly with
opal frosted glass
BLADES: BPW8152-56BNW (1)
56" sweep brushed nickel finish



FAN: MAD8152DZW (1)
dark bronze assembly with matching
dark bronze light cover (included)
BLADES: BPW8152-56DWW (1)
56" sweep dark walnut finish



FAN: MAD8152MWW (1)
matte white assembly with
opal frosted glass
BLADES: BPW8152-56MWW (1)
56" sweep matte white finish

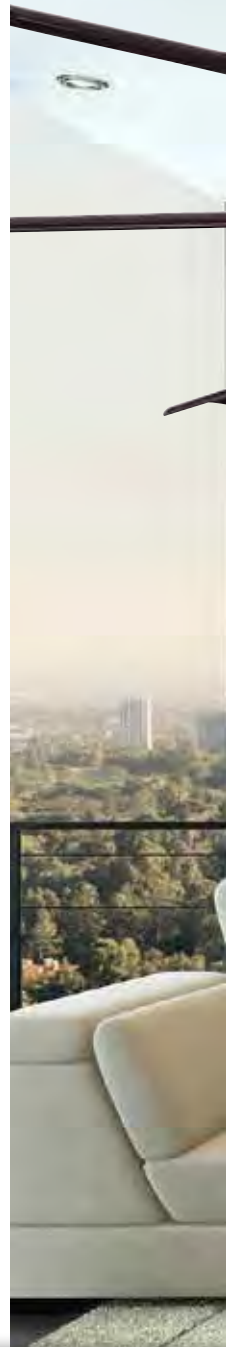

Special features

<p>FAN TIMER</p>	<p>Sets timer for fan & light to turn off (max 6 hours)</p>	<p>HOME AWAY</p>	<p>Light turns on and off at set intervals to simulate someone being home.</p>
<p>FRESH AIR</p>	<p>Variable fan speeds simulate a natural breeze.</p>	<p>SAFE EXIT</p>	<p>Fan & light will turn off after one minute to allow for safe exit</p>

For compatible controls & accessories see pages 183 - 193

Recommended optional control



TW206



BL—black
BN—brushed nickel
DWA—dark walnut
MW—matte white
WE—weathered wood

BPW8152-56W**
56" composite

ODYN™ CUSTOM 56



FAN: MAD8152MWW (1)
matte white assembly with opal frosted glass
BLADES: BPW8152-56DWAW (1)
56" sweep dark walnut finish



MAD8152***—AVAILABLE FINISHES:

BLW black	BNW brushed nickel	DZW dark bronze	GRW matte greige	MWW matte white
---------------------	------------------------------	---------------------------	----------------------------	---------------------------

- ENERGY SAVINGS
- MIX & MATCH blades sold separately
- FANSYNC™ included
- 18W LED
- 31-SPEED DC reverse switch on remote
- CONTROL remote
- WET indoor/outdoor

INCLUDED:



ENERGY GUIDE:

TOTAL AIR VOLUME (CFM)	ENERGY USE (Watts)	ESTIMATED YEARLY ENERGY COST	AIRFLOW EFFICIENCY (CFM/W)
4,663 _{ave}	21 _{ave}	\$6 _{ave}	220 _{ave}
7,402 _{high}	34 _{high}	\$10 _{high}	218 _{high}



LIMITED LIFETIME MOTOR WARRANTY



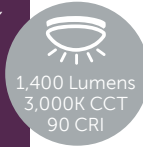
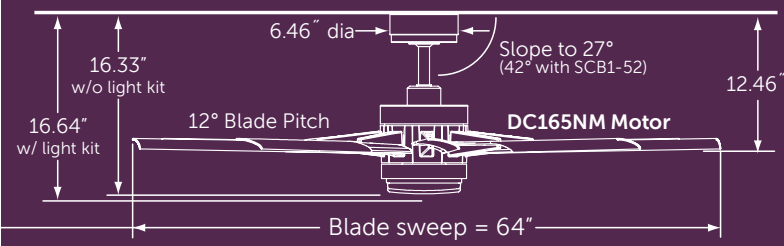

*With included 6" downrod—longer lengths available
 True stainless steel rust resistant downrods available
 Net Hanging Weight: 31.60 lbs.



FAN: MAD8152BLW (1)
 black assembly with opal
 frosted glass
BLADES: BPW8152-64BLW (1)
 64" sweep black finish



FAN: MAD8152BNW (1)
 brushed nickel assembly
 with opal frosted glass
BLADES: BPW8152-64BLW (1)
 64" sweep black finish



FAN: MAD8152DZW (1)
 dark bronze assembly with
 opal frosted glass
BLADES: BPW8152-64DWA (1)
 64" sweep dark walnut finish



FAN: MAD8152MWW (1)
 matte white assembly with
 matching matte white light cover
 (included)
BLADES: BPW8152-64WEW (1)
 64" sweep weathered wood finish



Special features

FAN TIMER	Sets timer for fan & light to turn off (max 6 hours)	HOME AWAY	Light turns on and off at set intervals to simulate someone being home.
FRESH AIR	Variable fan speeds simulate a natural breeze.	SAFE EXIT	Fan & light will turn off after one minute to allow for safe exit

For compatible controls & accessories see pages 183 - 193

Recommended optional control



TW206

must be paired with WP60 for outdoor application



WP60
waterproof box



BL—black
 BN—brushed nickel
 DWA—dark walnut
 MW—matte white
 WE—weathered wood

BPW8152-64W**
64" composite

ODYN™ CUSTOM 64



FAN: MAD8152BLW (1)
black assembly with opal
frosted glass
BLADES: BPW8152-64WEW (1)
64" sweep weathered wood
finish

MAD8152***—AVAILABLE FINISHES:

BLW black	BNW brushed nickel	DZW dark bronze	GRW matte greige	MWW matte white
---------------------	---------------------------------	------------------------------	-------------------------------	------------------------------

- ENERGY SAVINGS
- MIX & MATCH
blades sold
separately
- FAN SYNC™
included
- 18W
LED
- 31-SPEED DC
reverse switch
on remote
- CONTROL
remote
- WET
indoor/outdoor

INCLUDED:



ENERGY GUIDE:

TOTAL AIR VOLUME (CFM)	ENERGY USE (Watts)	ESTIMATED YEARLY ENERGY COST	AIRFLOW EFFICIENCY (CFM/W)
5,164 _{ave}	21 _{ave}	\$6 _{ave}	252 _{ave}
8,085 _{high}	33 _{high}	\$9 _{high}	248 _{high}



LIMITED LIFETIME MOTOR WARRANTY



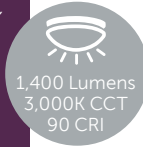
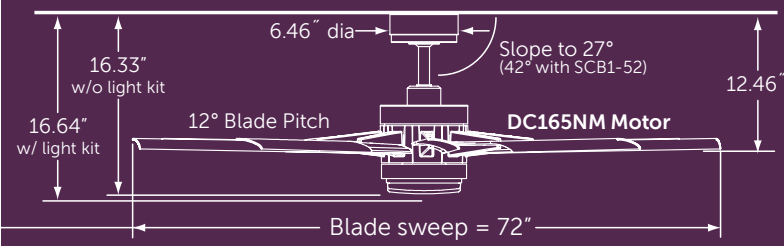

1,400 Lumens
3,000K CCT
90 CRI

*With included 6" downrod—longer lengths available
True stainless steel rust resistant downrods available
Net Hanging Weight: 32.50 lbs.



FAN: MAD8152BLW (1)
black assembly with matching black light cover (included)
BLADES: BPW8152-72WEW (1)
72" sweep weatherted wood finish



FAN: MAD8152BNW (1)
brushed nickel assembly with opal frosted glass
BLADES: BPW8152-72BNW (1)
72" sweep brushed nickel finish



FAN: MAD8152DZW (1)
dark bronze assembly with opal frosted glass
BLADES: BPW8152-72DWA (1)
72" sweep dark walnut finish



FAN: MAD8152MWW (1)
matte white assembly with opal frosted glass
BLADES: BPW8152-72MWW (1)
72" sweep matte white finish



Special features

FAN TIMER	Sets timer for fan & light to turn off (max 6 hours)	HOME AWAY	Light turns on and off at set intervals to simulate someone being home.
FRESH AIR	Variable fan speeds simulate a natural breeze.	SAFE EXIT	Fan & light will turn off after one minute to allow for safe exit

For compatible controls & accessories see pages 183 - 193

Recommended optional control



TW206

must be paired with WP60 for outdoor application



WP60
waterproof box

BPW8152-72W**
72" composite

- BL—black
- BN—brushed nickel
- DWA—dark walnut
- MW—matte white
- WE—weathered wood

ODYN™ CUSTOM 72



FAN: MAD8152DZW (1)
dark bronze assembly with
matching dark bronze light
cover (included)
BLADES: BPW8152-72DWA (1)
72" sweep dark walnut finish

MAD8152***—AVAILABLE FINISHES:

BLW black	BNW brushed nickel	DZW dark bronze	GRW matte greige	MWW matte white
---------------------	---------------------------------	------------------------------	-------------------------------	------------------------------

- ENERGY SAVINGS
- MIX & MATCH
blades sold
separately
- FAN SYNC™
included
- 18W
LED
- 31-SPEED DC
reverse switch
on remote
- CONTROL
remote
- WET
indoor/outdoor

INCLUDED:



ENERGY GUIDE:

TOTAL AIR VOLUME (CFM)	ENERGY USE (Watts)	ESTIMATED YEARLY ENERGY COST	AIRFLOW EFFICIENCY (CFM/W)
5,639 _{ave}	18 _{ave}	\$5 _{ave}	305 _{ave}
8,198 _{high}	28 _{high}	\$8 _{high}	289 _{high}



LIMITED LIFETIME MOTOR WARRANTY



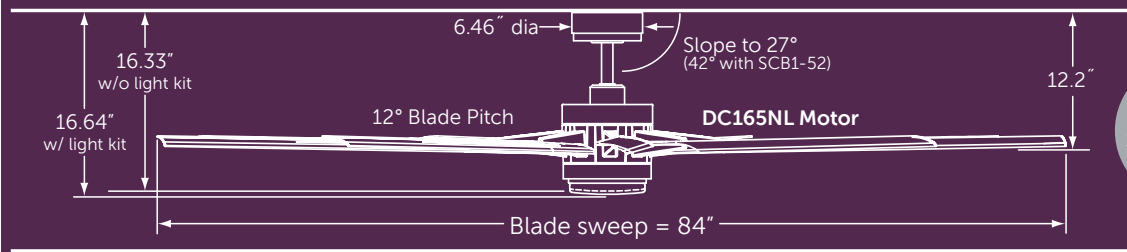

1,400 Lumens
3,000K CCT
90 CRI

*With included 6" downrod—longer lengths available
True stainless steel rust resistant downrods available
Net Hanging Weight: 34.18 lbs.



FAN: FPD8159BNWBL (1)
brushed nickel assembly
with black blades and opal
frosted glass



FAN: FPD8159BNWBN (1)
brushed nickel assembly with
brushed nickel blades and
matching brushed nickel light
cover (included)



FAN: FPD8159DZW (1)
dark bronze assembly with
dark walnut blades and opal
frosted glass



FAN: FPD8159GRW (1)
matte greige assembly with
weathered wood blades and
matching matte greige light
cover (included)



FAN: FPD8159MWW (1)
matte white assembly with
matte white blades and opal
frosted glass



Special features

 FAN TIMER	Sets timer for fan & light to turn off (max 6 hours)	 HOME AWAY	Light turns on and off at set intervals to simulate someone being home.
 FRESH AIR	Variable fan speeds simulate a natural breeze.	 SAFE EXIT	Fan & light will turn off after one minute to allow for safe exit

For compatible controls & accessories see pages 183 - 193

Recommended optional control



TW206

must be paired with WP60 for outdoor application



WP60
waterproof box

ODYN™ 84



FAN: FPD8159GRW (1)
matte greige assembly with weathered wood blades and opal frosted glass



ENERGY SAVINGS



FANSync™ included



18W LED



31-SPEED DC reverse switch on remote



CONTROL remote



WET indoor/outdoor

FPD8159***—AVAILABLE FINISHES:

BLW black	BNWBL brushed nickel	BNWBN brushed nickel	DZW dark bronze	GRW matte greige	MWW matte white
black	black	brushed nickel	dark walnut	weathered wood	matte white

INCLUDED:

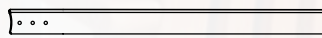

blade set



light kit

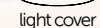

light cover



TR205 remote

ENERGY GUIDE:

TOTAL AIR VOLUME (CFM)	ENERGY USE (Watts)	ESTIMATED YEARLY ENERGY COST	AIRFLOW EFFICIENCY (CFM/W)
7,210 _{ave}	27 _{ave}	\$8 _{ave}	268 _{ave}
13,103 _{high}	41 _{high}	\$11 _{high}	322 _{high}



LIMITED LIFETIME MOTOR WARRANTY







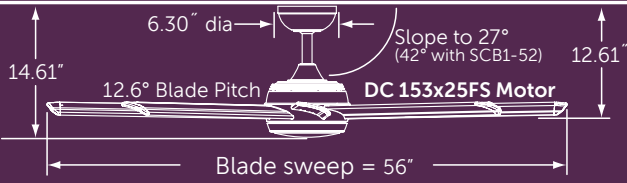

STELLAR™ CUSTOM





 1,400 Lumens
 3,000K CCT
 90 CRI

*With included 6" downrod—longer lengths available Net Hanging Weight: 27.98 lbs.
 Close-to-ceiling kit compatible; *True stainless steel rust resistant downrods available*



 **FAN: MAD7997BLW (1)**
 black assembly with silver accents
 and matching light cover (included)
BLADES: B7997-56BLW (1)
 56" sweep black with silver wing tips



 **FAN: MAD7997SLW (1)**
 silver assembly with black accents
 and opal frosted glass
BLADES: B7997-56SLW (1)
 56" sweep silver with black wing tips



 **FAN: MAD7997SLW (1)**
 silver assembly with black accents
 and opal frosted glass
BLADES: B7997-56BLW (1)
 56" sweep black with silver wing tips

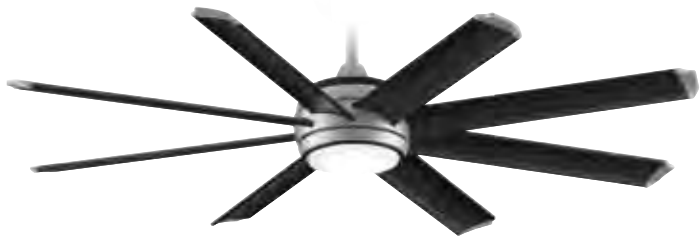

Special features

 **FAN TIMER**
 Sets timer for fan & light to turn off (max 6 hours)

 **HOME AWAY**
 Light turns on and off at set intervals to simulate someone being home.

 **FRESH AIR**
 Variable fan speeds simulate a natural breeze.

 **SAFE EXIT**
 Fan & light will turn off after one minute to allow for safe exit

For compatible controls & accessories see pages 183 - 193

Recommended optional control



TW206

must be paired with WP60 for outdoor application



WP60
waterproof box



B7997-56BLW
56" aluminum

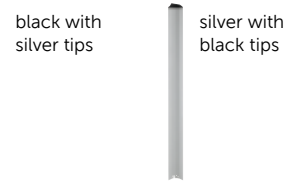

B7997-56SLW
56" aluminum

STELLAR™ CUSTOM 56



FAN: MAD7997BLW (1)
black assembly with silver accents
and matching light cover (included)
BLADES: B7997-56SLW (1)
56" sweep silver with black wing tips



ENERGY SAVINGS



MIX & MATCH
blades sold
separately



FAN SYNC™
included



18W
LED



31-SPEED DC
reverse switch
on remote



CONTROL
remote



WET
indoor/outdoor

MAD7997*** AVAILABLE FINISHES:

BLW **SLW**
black silver

INCLUDED:



light kit



light cover



TR205 remote

ENERGY
GUIDE:

TOTAL AIR VOLUME (CFM)	ENERGY USE (Watts)	ESTIMATED YEARLY ENERGY COST	AIRFLOW EFFICIENCY (CFM/W)
5,371 _{ave}	23 _{ave}	\$7 _{ave}	229 _{ave}
9,276 _{high}	34 _{high}	\$10 _{high}	274 _{high}



LIMITED LIFETIME MOTOR WARRANTY



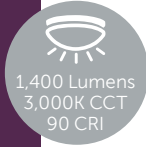
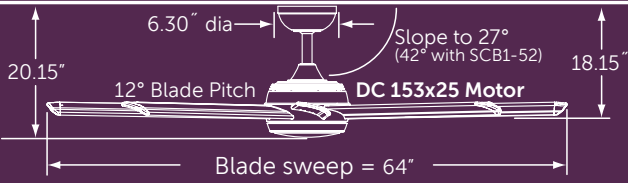

*With included 6" downrod—longer lengths available Net Hanging Weight: 29.72 lbs.
Close-to-ceiling kit compatible; True stainless steel rust resistant downrods available



FAN: MAD7997BLW (1)
black assembly with silver accents and opal frosted glass
BLADES: B7997-64BLW (1)
64" sweep black with silver wing tips

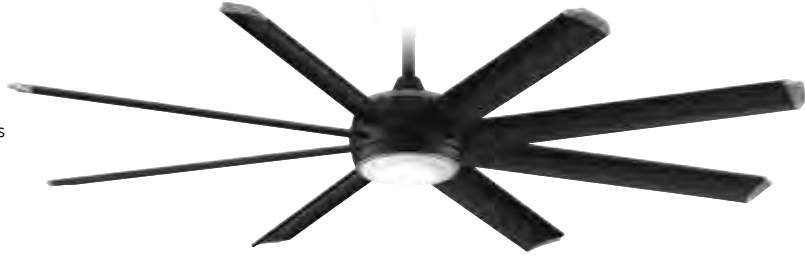

FAN: MAD7997SLW (1)
silver assembly with black accents and matching light cover (included)
BLADES: B7997-64SLW (1)
64" sweep silver with black wing tips

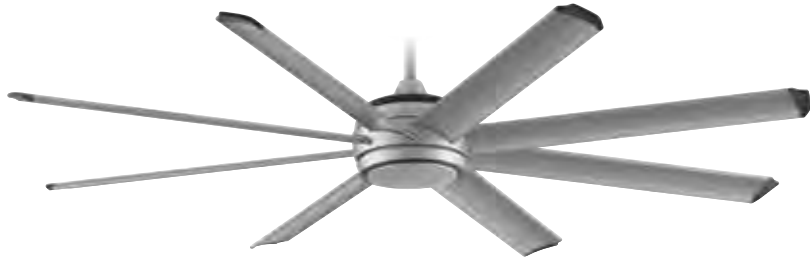

FAN: MAD7997BLW (1)
black assembly with silver accents and matching light cover (included)
BLADES: B7997-64SLW (1)
64" sweep silver with black wing tips

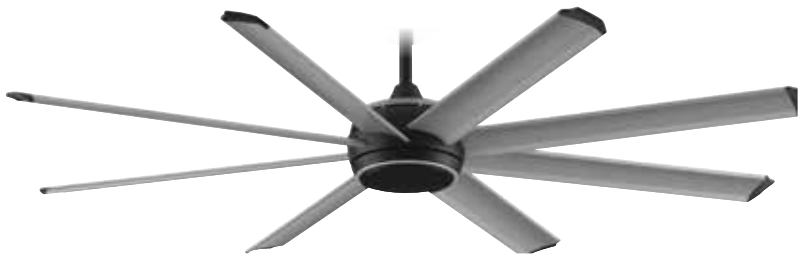

Special features

- | | |
|--|---|
|
FAN TIMER
Sets timer for fan & light to turn off (max 6 hours) |
HOME AWAY
Light turns on and off at set intervals to simulate someone being home. |
|
FRESH AIR
Variable fan speeds simulate a natural breeze. |
SAFE EXIT
Fan & light will turn off after one minute to allow for safe exit |

For compatible controls & accessories see pages 183 - 193

Recommended optional control



TW206

must be paired with WP60 for outdoor application



WP60
waterproof box



black with silver tips

B7997-64BLW
64" aluminum



silver with black tips

B7997-64SLW
64" aluminum

STELLAR™ CUSTOM 64



FAN: MAD7997SLW (1)
silver assembly with black accents
and opal frosted glass
BLADES: B7997-64BLW (1)
64" sweep black with silver wing tips

MAD7997*** AVAILABLE FINISHES:

BLW **SLW**
black silver

- ENERGY SAVINGS
- MIX & MATCH blades sold separately
- FAN SYNC™ included
- 18W LED
- 31-SPEED DC reverse switch on remote
- CONTROL remote
- WET indoor/outdoor

INCLUDED:



ENERGY GUIDE:

TOTAL AIR VOLUME (CFM)	ENERGY USE (Watts)	ESTIMATED YEARLY ENERGY COST	AIRFLOW EFFICIENCY (CFM/W)
6,074 ^{ave}	23 ^{ave}	\$6 ^{ave}	265 ^{ave}
9,482 ^{high}	35 ^{high}	\$10 ^{high}	270 ^{high}



LIMITED LIFETIME MOTOR WARRANTY



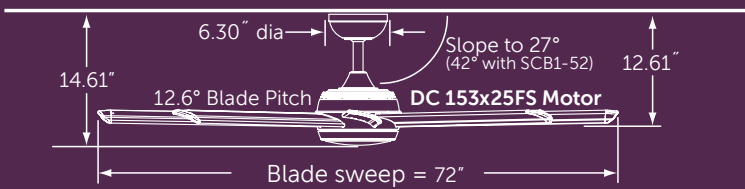

1,400 Lumens
3,000K CCT
90 CRI

*With included 6" downrod—longer lengths available Net Hanging Weight: 31.33 lbs.
Close-to-ceiling kit compatible; True stainless steel rust resistant downrods available



FAN: MAD7997BLW (1)
black assembly with silver accents
and opal frosted glass
BLADES: B7997-72SLW (1)
72" sweep silver with black wing tips



FAN: MAD7997SLW (1)
silver assembly with black accents and
matching light cover (included)
BLADES: B7997-72SLW (1)
72" sweep silver with black wing tips



FAN: MAD7997SLW (1)
silver assembly with black accents
and opal frosted glass
BLADES: B7997-72BLW (1)
72" sweep black with silver wing tips

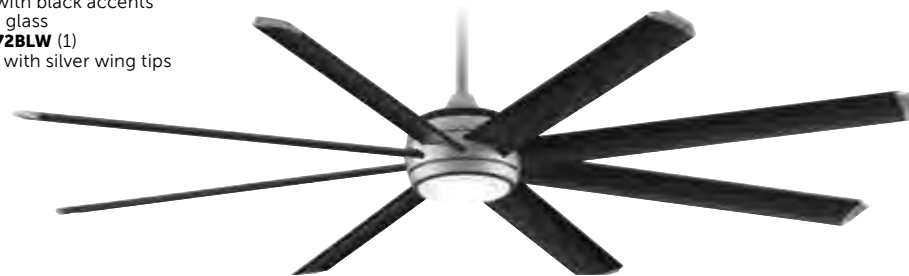

Special features

FAN TIMER
Sets timer for fan & light to turn off (max 6 hours)

HOME AWAY
Light turns on and off at set intervals to simulate someone being home.

FRESH AIR
Variable fan speeds simulate a natural breeze.

SAFE EXIT
Fan & light will turn off after one minute to allow for safe exit

For compatible controls & accessories see pages 183 - 193

Recommended optional control



TW206

must be paired with WP60 for outdoor application



WP60
waterproof box



black with silver tips

B7997-72BLW
72" aluminum



silver with black tips

B7997-72SLW
72" aluminum

STELLAR™ CUSTOM 72



FAN: MAD7997BLW (1)
black assembly with silver accents
and matching light cover (included)
BLADES: B7997-72BLW (1)
72" sweep black with silver wing tips



ENERGY SAVINGS



MIX & MATCH
blades sold
separately



FAN SYNC™
included



18W
LED



31-SPEED DC
reverse switch
on remote



CONTROL
remote



WET
indoor/outdoor

MAD7997*** AVAILABLE FINISHES:

BLW
black

SLW
silver

INCLUDED:



light kit



light cover



TR205 remote

ENERGY
GUIDE:

TOTAL AIR VOLUME (CFM)	ENERGY USE (Watts)	ESTIMATED YEARLY ENERGY COST	AIRFLOW EFFICIENCY (CFM/W)
8,034 _{ave}	23 _{ave}	\$7 _{ave}	346 _{ave}
12,074 _{high}	36 _{high}	\$10 _{high}	337 _{high}



LIMITED LIFETIME MOTOR WARRANTY



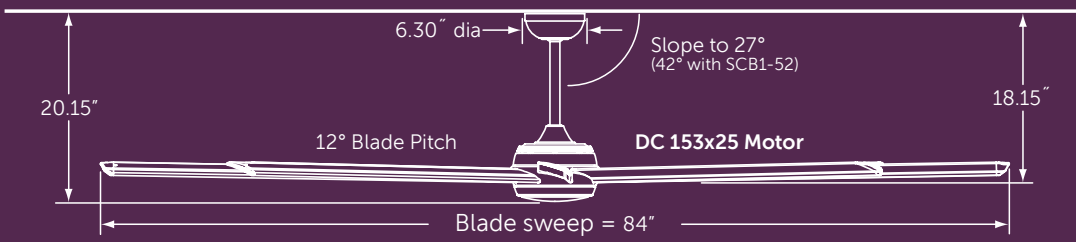

 1,400 Lumens
 3,000K CCT
 90 CRI

*With included 12" downrod—longer lengths available
 True stainless steel rust resistant downrods available

Net Hanging Weight: 32.80 lbs.



FAN: MAD7993BLW (1)
 black assembly with silver accents
 and opal frosted glass
BLADES: B7993-84BLW (1)
 84" sweep black with silver wing tips



FAN: MAD7993SLW (1)
 silver assembly with black accents and
 matching light cover (included)
BLADES: B7993-84SLW (1)
 84" sweep silver with black wing tips



FAN: MAD7993SLW (1)
 silver assembly with black accents
 and opal frosted glass
BLADES: B7993-84BLW (1)
 84" sweep black with silver wing tips

Special features



FAN TIMER

Sets timer for fan & light to turn off (max 6 hours)



HOME AWAY

Light turns on and off at set intervals to simulate someone being home.



FRESH AIR

Variable fan speeds simulate a natural breeze.



SAFE EXIT

Fan & light will turn off after one minute to allow for safe exit

For compatible controls & accessories see pages 183 - 193

Recommended optional control



TW206

must be paired with WP60 for outdoor application



WP60
waterproof box



black with silver tips

B7993-84BLW
84" aluminum



silver with black tips

B7993-84SLW
84" aluminum

STELLAR™ CUSTOM 84



FAN: MAD7993BLW (1)
black assembly with silver accents
and matching light cover (included)
BLADES: B7993-84SLW (1)
84" sweep silver with black wing tips

MAD7993*** AVAILABLE FINISHES:

BLW black
SLW silver



ENERGY SAVINGS



MIX & MATCH
blades sold
separately



FAN SYNC™
included



18W
LED



31-SPEED DC
reverse switch
on remote



CONTROL
remote



WET
indoor/outdoor

INCLUDED:



light kit



light cover



TR205 remote

ENERGY GUIDE:

TOTAL AIR VOLUME (CFM)	ENERGY USE (Watts)	ESTIMATED YEARLY ENERGY COST	AIRFLOW EFFICIENCY (CFM/W)
9,427 _{ave}	27 _{ave}	\$8 _{ave}	346 _{ave}
12,768 _{high}	43 _{high}	\$12 _{high}	297 _{high}



LIMITED LIFETIME MOTOR WARRANTY



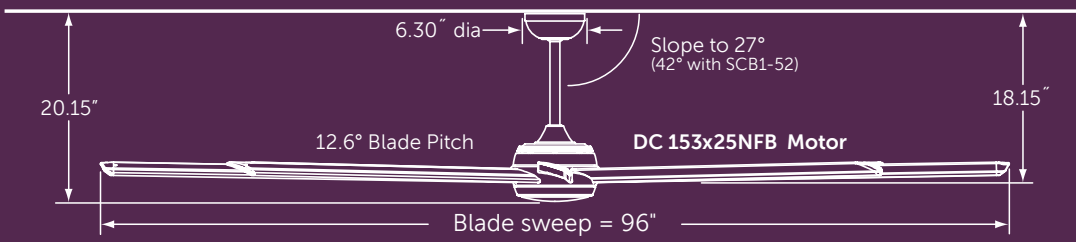

1,400 Lumens
3,000K CCT
90 CRI

*With included 12" downrod—longer lengths available
True stainless steel rust resistant downrods available

Net Hanging Weight: 35.27 lbs.

FAN: MAD7998BLW (1)
black assembly with silver accents
and opal frosted glass
BLADES: B7998-96SLW (1)
96" sweep silver with black wing tips

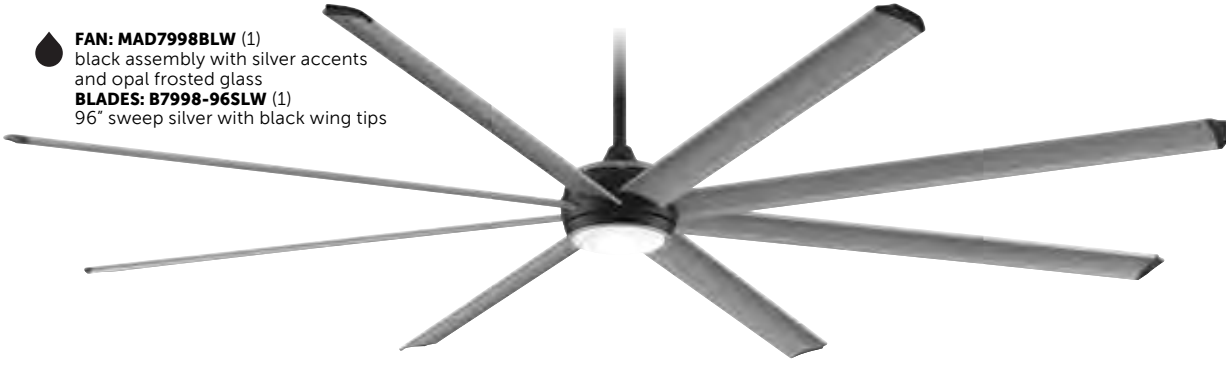

FAN: MAD7998BLW (1)
black assembly with silver accents
and matching light cover (included)
BLADES: B7998-96BLW (1)
96" sweep black with silver wing tips



FAN: MAD7998SLW (1)
silver assembly with black accents
and opal frosted glass
BLADES: B7998-96SLW (1)
96" sweep silver with black wing tips



Special features

FAN TIMER
Sets timer for fan & light to turn off (max 6 hours)

HOME AWAY
Light turns on and off at set intervals to simulate someone being home.

FRESH AIR
Variable fan speeds simulate a natural breeze.

SAFE EXIT
Fan & light will turn off after one minute to allow for safe exit

For compatible controls & accessories see pages 183 - 193

Recommended optional control



TW206

must be paired with WP60 for outdoor application



WP60
waterproof box



black with silver tips

B7998-96BLW
96" aluminum



silver with black tips

B7998-96SLW
96" aluminum

STELLAR™ CUSTOM 96

FAN: MAD7998SLW (1)
silver assembly with black accents
and opal frosted glass
BLADES: B7998-96BLW (1)
96" sweep black with silver wing tips

MAD7998*** AVAILABLE FINISHES:

BLW black
SLW silver

- ENERGY SAVINGS
- MIX & MATCH blades sold separately
- FANSYNC™ included
- 18W LED
- 31-SPEED DC reverse switch on remote
- CONTROL remote
- WET indoor/outdoor

INCLUDED:



ENERGY GUIDE:

TOTAL AIR VOLUME (CFM)	ENERGY USE (Watts)	ESTIMATED YEARLY ENERGY COST	AIRFLOW EFFICIENCY (CFM/W)
10,679 _{ave}	25 _{ave}	\$7 _{ave}	421 _{ave}
14,548 _{high}	39 _{high}	\$11 _{high}	376 _{high}

LIMITED LIFETIME MOTOR WARRANTY



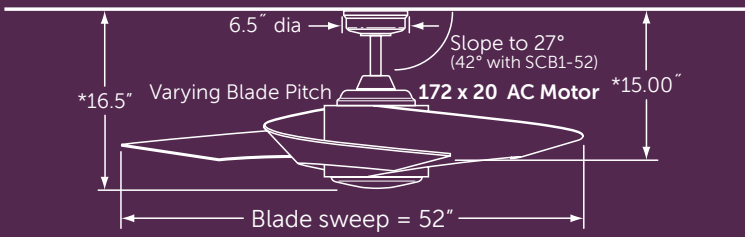

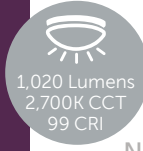

*With included 6" downrod—longer lengths available Net Hanging Weight: 27.4 lbs.
Close-to-ceiling kit compatible; True stainless steel rust resistant downrods available

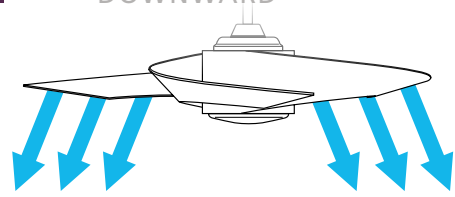

NOTE: AIRFLOW MOVES OUTWARD AT AN ANGLE INSTEAD OF DIRECTLY DOWNWARD



 **FAN: FP7900BL** (1)
black assembly with
opal frosted glass



 **FAN: FP7900MG** (1)
metro gray assembly
with opal frosted glass



 **FAN: FP7900MW** (1)
matte white assembly
with opal frosted glass



 **FAN: FP7900OB** (1)
oil-rubbed bronze assembly
with opal frosted glass



For compatible controls & accessories see pages 183 - 193





Recommended optional control



C21

TORTO™

 **FAN: FP7900BL (1)**
black assembly with
opal frosted glass

- 
FANSYNC™
sold separately
- 
(2) 60W
incandescent
candelabra
- 
3-SPEED AC
reverse switch
on remote
- 
CONTROL
remote
- 
DAMP
indoor/outdoor

FP7900**—AVAILABLE FINISHES:

BL black	MG metro gray	MW matte white	OB oil-rubbed bronze
black	metro gray	matte white	oil-rubbed bronze

INCLUDED:

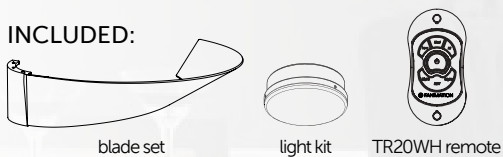



ENERGY GUIDE:

TOTAL AIR VOLUME (CFM)	ENERGY USE (Watts)	ESTIMATED YEARLY ENERGY COST	AIRFLOW EFFICIENCY (CFM/W)
2,177 _{ave}	32 _{ave}	\$9 _{ave}	68 _{ave}
3,098 _{high}	56 _{high}	\$16 _{high}	55 _{high}

LIMITED LIFETIME MOTOR WARRANTY

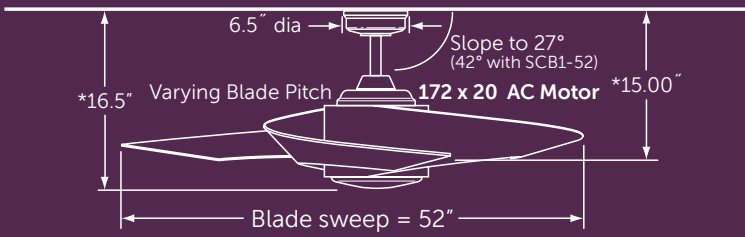



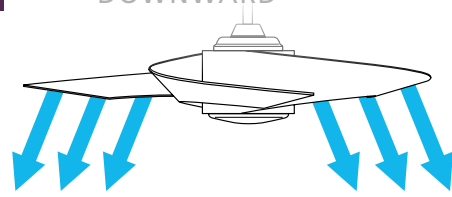

 1,350 Lumens
 3,000K CCT
 80 CRI

NOTE: AIRFLOW MOVES OUTWARD AT AN ANGLE INSTEAD OF DIRECTLY DOWNWARD



*With included 6" downrod—longer lengths available Net Hanging Weight: 27.4 lbs.
 Close-to-ceiling kit compatible; True stainless steel rust resistant downrods available



 **FAN: FP7902BN (1)**
 brushed nickel assembly with
 18W LED opal frosted glass
 and fanSync fan control

For compatible controls & accessories see pages 183 - 193

Recommended optional control



C21

TORTO™ LED

 **FAN: FP7902BN (1)**
brushed nickel assembly with
18W LED opal frosted glass
and fanSync fan control

FP7902—AVAILABLE FINISHES:**

BN
brushed
nickel
brushed
nickel

INCLUDED:

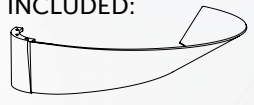



blade set



light kit



BTT9R

- 
FANSYNC™
included
- 
18W
LED
- 
3-SPEED AC
reverse switch
on remote
- 
CONTROL
remote
- 
DAMP
indoor/outdoor

ENERGY GUIDE:

TOTAL AIR VOLUME (CFM)	ENERGY USE (Watts)	ESTIMATED YEARLY ENERGY COST	AIRFLOW EFFICIENCY (CFM/W)
2,177 _{ave}	32 _{ave}	\$9 _{ave}	68 _{ave}
3,098 _{high}	56 _{high}	\$16 _{high}	55 _{high}

LIMITED LIFETIME MOTOR WARRANTY



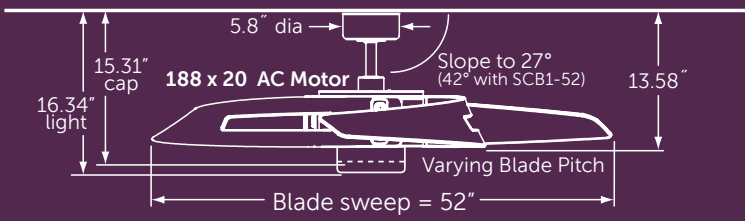



 1,176 Lumens
 2,800K CCT
 99 CRI

*With included 6" downrod—longer lengths available Net Hanging Weight: 28.4 lbs.
 Close-to-ceiling kit compatible; *True stainless steel rust resistant downrods available*

 **FAN: FP6210SN (1)**
 satin nickel assembly
 with walnut blades
 and opal frosted glass



 **FAN: FP6210OB (1)**
 oil-rubbed bronze assembly
 with cherry blades and opal
 frosted glass



 **FAN: FP6210SN (1)**
 satin nickel assembly with
 walnut blades and matching
 light cover (included)



For compatible controls & accessories see pages 183 - 193

Recommended optional control



C25

AVASTON™

 **FAN: FP6210OB** (1)
oil-rubbed bronze assembly
with cherry blades and
matching light cover (included)

FP6210**—AVAILABLE FINISHES:

OB oil-rubbed bronze	SN satin nickel
cherry	walnut

INCLUDED:

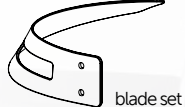

blade set



light kit



light cover



TR24WH remote

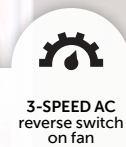

ENERGY GUIDE:

TOTAL AIR VOLUME (CFM)	ENERGY USE (Watts)	ESTIMATED YEARLY ENERGY COST	AIRFLOW EFFICIENCY (CFM/W)
2,741 _{ave}	40 _{ave}	\$11 _{ave}	69 _{ave}
3,716 _{high}	72 _{high}	\$20 _{high}	52 _{high}

LIMITED LIFETIME MOTOR WARRANTY



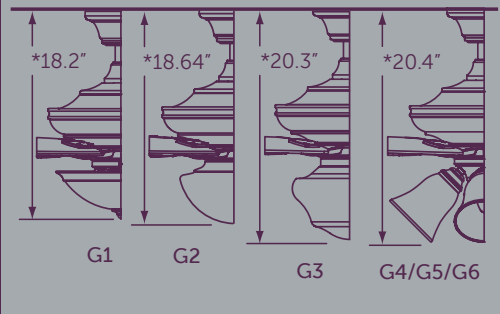
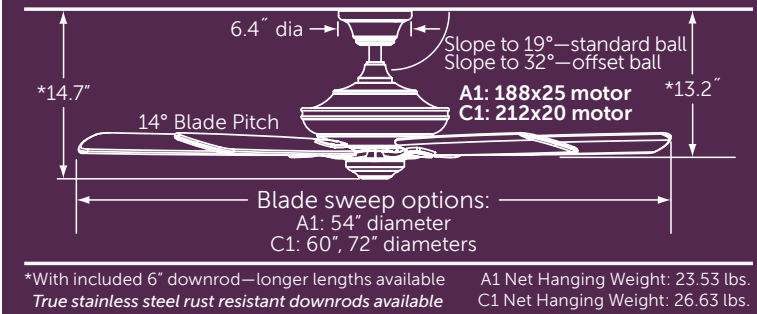

 **FAN: A1DZ** (1)
dark bronze assembly
BLADES: B754DWA (1)
54" sweep dark walnut



 **FAN: C1BN** (1)
brushed nickel assembly
BLADES: B172DWA (1)
72" sweep dark walnut
LIGHT FITTER: F2BN (1)
brushed nickel globe fitter
GLASS: G3CL (1)
clear schoolhouse glass globe
● shown with optional vintage bulb



 **FAN: A1MW** (1)
matte white assembly
BLADES: B254MW (1)
54" sweep matte white



 **FAN: C1DZ** (1)
dark bronze assembly
BLADES: B560DWA (1)
60" sweep dark walnut
LIGHT FITTER: F3DZ (1)
dark bronze LED bowl fitter
GLASS: G1MS (1)
marble swirl glass bowl



 **FAN: C1MW** (1)
matte white assembly
BLADES: B460CYN (1)
60" sweep cherry
LIGHT FITTER: F4MW (1)
matte white 4 light fitter
GLASS: G5OP (4)
2 1/4" opal frosted



For compatible controls & accessories see pages 183 - 193

Recommended optional control



C21

My FANIMATION

DISTINCTION™ DC

-  **FAN: D1BN** (1)
brushed nickel assembly
- BLADES: B172DWA** (1)
72" sweep dark walnut
- LIGHT FITTER: F2BN** (1)
brushed nickel globe fitter
- GLASS: G3CL** (1)
clear schoolhouse glass globe
- shown with optional vintage bulb





D1**—AVAILABLE FINISHES:

- BN**
brushed nickel
- DZ**
dark bronze
- MW**
matte white

INCLUDED: fanSync™



TR205 control

- 
ENERGY SAVINGS
- 
MIX & MATCH
components
sold separately
- 
FANSYNC™
included
- 
31-SPEED DC
reverse switch
on remote
- 
CONTROL
remote
- 
DAMP
indoor/outdoor

ENERGY GUIDE:

Tested with B172 blades

TOTAL AIR VOLUME (CFM)	ENERGY USE (Watts)	ESTIMATED YEARLY ENERGY COST	AIRFLOW EFFICIENCY (CFM/W)
5,378 _{ave}	23 _{ave}	\$6 _{ave}	210 _{ave}
7,126 _{high}	34 _{high}	\$10 _{high}	210 _{high}

Energy Star applies to specific blade and motor and light kit combinations



LIMITED LIFETIME MOTOR WARRANTY



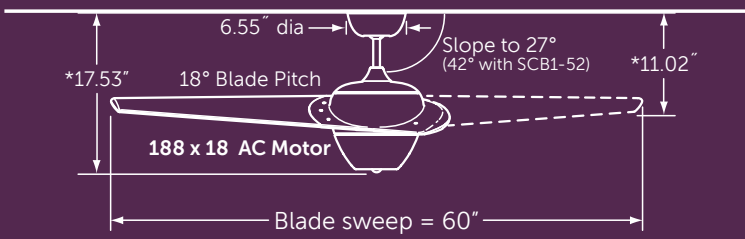

*With included 6" downrod—longer lengths available
 True stainless steel rust resistant downrods available

Net Hanging Weight: 38 lbs.

FAN: FP2120MG (1)
 metro gray assembly with light
 socket cover (included)



FAN: FP2120MG (1)
 metro gray assembly with light
 socket cover (included)



For compatible controls &
 accessories see pages 183 - 193

Recommended
 optional control



C25

My FANIMATION
 DISTINCTION™ AC

-  **FAN: A1MW** (1)
matte white assembly
- BLADES: B654MW** (1)
54" sweep matte white
- LIGHT FITTER: F2MW** (1)
matte white globe fitter
- GLASS: G2OP** (1)
opal frosted glass globe





A1** & C1**—AVAILABLE FINISHES:

BN brushed nickel	DZ dark bronze	MW matte white
--------------------------------	-----------------------------	-----------------------------

INCLUDED: 



BTT9R

- 
MIX & MATCH
components
sold separately
- 
FANsync™
included
- 
3-SPEED AC
reverse switch
on remote
- 
CONTROL
remote
- 
DAMP
indoor/outdoor

ENERGY GUIDE:

	TOTAL AIR VOLUME (CFM)	ENERGY USE (Watts)	ESTIMATED YEARLY ENERGY COST	AIRFLOW EFFICIENCY (CFM/W)
A1**	3,505 _{ave}	71 _{ave}	\$13 _{ave}	71 _{ave}
Tested with B154** blades	5,572 _{high}	76 _{high}	\$21 _{high}	73 _{high}
C1**	3,373 _{ave}	45 _{ave}	\$13 _{ave}	67 _{ave}
Tested with B172** blades	5,761 _{high}	71 _{high}	\$20 _{high}	81 _{high}

Energy Star applies to specific blade and motor and light kit combinations



LIMITED LIFETIME MOTOR WARRANTY



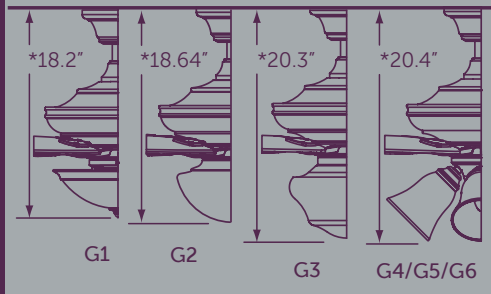
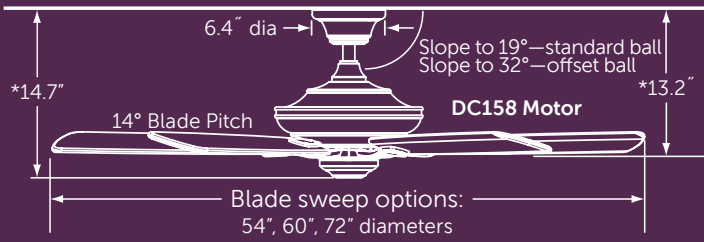

*With included 6" downrod—longer lengths available
 True stainless steel rust resistant downrods available
 Net Hanging Weight: 17.57 lbs.

FAN: D1DZ (1)
 dark bronze assembly
BLADES: B360CY (1)
 60" sweep cherry



FAN: D1BN (1)
 brushed nickel assembly
BLADES: B260DWA (1)
 60" sweep dark walnut
LIGHT FITTER: F4BN (1)
 brushed nickel 4 light fitter
GLASS: G4OPS (4)
 2 1/4" opal frosted shiny



FAN: D1MW (1)
 matte white assembly
BLADES: B654MW (1)
 54" sweep matte white
LIGHT FITTER: F2MW (1)
 matte white globe fitter
GLASS: G2OP (1)
 opal frosted glass globe



FAN: D1DZ (1)
 dark bronze assembly
BLADES: B154CY (1)
 54" sweep cherry
LIGHT FITTER: F1DZ (1)
 dark bronze bowl fitter
GLASS: G1TST (1)
 tea stain glass bowl



FAN: D1BN (1)
 brushed nickel assembly
BLADES: B860MW (1)
 60" sweep matte white



For compatible controls & accessories see pages 183 - 193

Recommended optional control



TW206

my FANIMATION
DISTINCTION™

40+ YEARS OF DESIGNING AND
ENGINEERING CEILING FANS



Tom Frampton, Founder and CEO of Fanimation knows ceiling fans. While a junior in high school, Tom went to work for a fan design and manufacturing company, gaining experience in most departments and learning every facet of the business. Fast forward over forty years and enter the myFanimation™ collection. Distinction, the first introduction under the collection, is defined by its clean design and advanced technology. The myFanimation™ collection is a culmination of his life's commitment to transforming the ceiling fan as we know it.

Two hanger balls: _____

- Standard—slope to 19°
- Offset—slope to 32°

Tri-mount system: _____

- Downrod straight
- Downrod slope
- Motor-to-canopy snugger

Outer canopy trim _____
ring hides screws



DAMP
indoor/outdoor
(including blades
and accessories)

Fan Shield™: _____

- Rubber grommets attach to the hub*
- The isolation ring system prevents noise and vibration from traveling from the motor through the blade holders and blades
- System is fail-safe and serviceable

No unsightly center screw _____

*Utility patent pending

myFanimation fans include fanSync™ smart device controls

AC: 3-SPEED INFINITE LIGHT FAN DIRECTION FAN TIMER SAFE EXIT
AC control via fanSync app only AC control via fanSync app only

DC: 31-SPEED INFINITE LIGHT FAN DIRECTION FAN TIMER FRESH AIR HOME AWAY SAFE EXIT

Unique features

FAN TIMER	Sets timer for fan & light to turn off (max 6 hours)	HOME AWAY	Light turns on and off at set intervals to simulate someone being home.
FRESH AIR	Variable fan speeds simulate a natural breeze.	SAFE EXIT	Fan & light will turn off after one minute to allow for safe exit

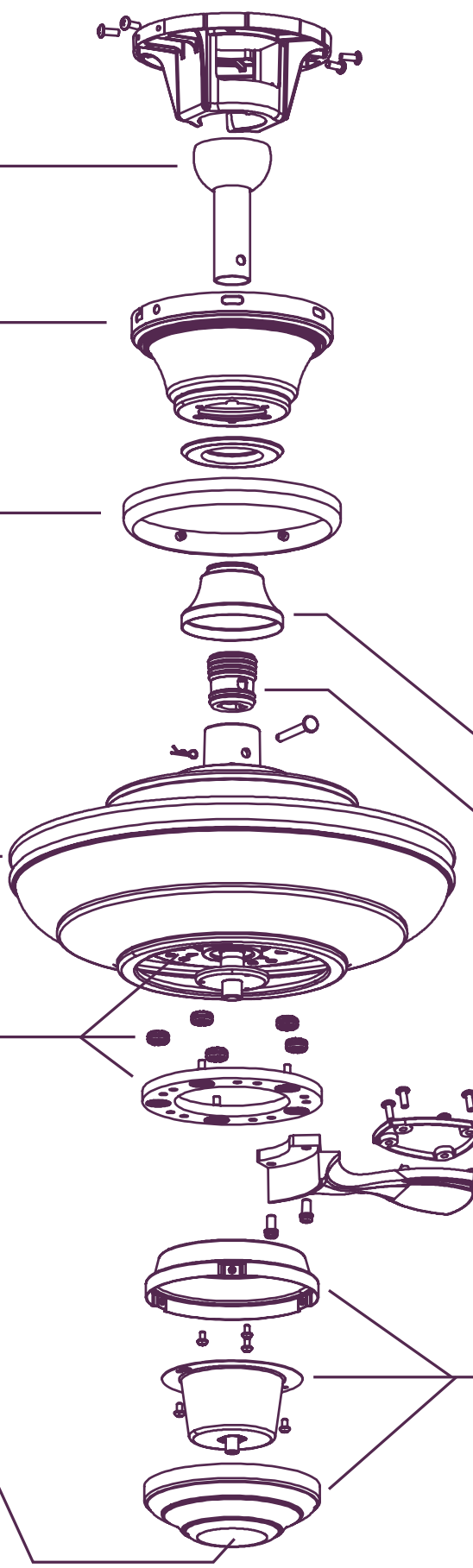

Decorative cover hides top support

Hang Right™:

- Rubber boot mounts in-between the down rod and top support*
- The downrod mounts perfectly straight and snug in the top support and does not offset or sit at angle from securing old style set screws
- No top support sets screws to loosen and vibrate
- The downrods mount faster onto the motor and without tools
- Less motor vibration travelling up the downrod and into the ceiling

Recessed screw holes in blade holder top piece hide screws from visibility

Switch cup cover hides screws

SIMPLE PART NUMBERING SYSTEM:

1. Motor: **A, C or D**

Example: **A1BN**

myFanimation motor finish code

2. Blades: **B**

Example: **B160WA**

myFanimation blade finish blade style sweep code

3. Fitter: **F**

Example: **F1DZ**

myFanimation finish fitter style code

4. Glass: **G**

Example: **G2CL**

myFanimation finish glass style code

1. Motors



A1 (188 x 25)

TOTAL AIR VOLUME (CFM)	ENERGY USE (Watts)	ESTIMATED YEARLY ENERGY COST	AIRFLOW EFFICIENCY (CFM/W)
3,505 _{ave}	71 _{ave}	\$13 _{ave}	71 _{ave}
5,572 _{high}	76 _{high}	\$21 _{high}	73 _{high}

*tested using B154 blade set

BN | DZ | MW

Order with 54" sweep blade sets only



C1 (212 x 20)

TOTAL AIR VOLUME (CFM)	ENERGY USE (Watts)	ESTIMATED YEARLY ENERGY COST	AIRFLOW EFFICIENCY (CFM/W)
3,373 _{ave}	45 _{ave}	\$13 _{ave}	67 _{ave}
5,761 _{high}	71 _{high}	\$20 _{high}	81 _{high}

*tested using B172 blade set

BN | DZ | MW

Order with 60" or 72" sweep blade sets only



D1 (DC158)

TOTAL AIR VOLUME (CFM)	ENERGY USE (Watts)	ESTIMATED YEARLY ENERGY COST	AIRFLOW EFFICIENCY (CFM/W)
5,378 _{ave}	23 _{ave}	\$6 _{ave}	210 _{ave}
7,126 _{high}	34 _{high}	\$10 _{high}	210 _{high}

*tested using B172 blade set

BN | DZ | MW

Order with 54", 60" or 72" sweep blade sets

Finish Codes

Motors:

BN brushed nickel
DZ dark bronze
MW matte white

Blades:

CY cherry
CYN cherry with natural inlay
DC dark cherry
DWA dark walnut
MW matte white
WA walnut
WADWA walnut with dark walnut inlay
WE weathered wood

Light Kits:

BN brushed nickel
DZ dark bronze
MW matte white

Glass:

CL clear
FW frosted white
MS marble swirl
OP opal frosted
OPS opal frosted shiny
TST tea stained

2. Blades



	B1			B2			B3			B4			B5		B6		B7		B8	
	54"	60"	72"	54"	60"	72"	54"	60"	72"	54"	60"	72"	54"	60"	54"	60"	54"	60"	54"	60"
CY	Ⓢ	Ⓢ	Ⓢ	Ⓢ	Ⓢ	Ⓢ	Ⓢ	Ⓢ	Ⓢ											
CYN										Ⓢ	Ⓢ	Ⓢ								
DC																			Ⓢ	Ⓢ
DWA	Ⓢ	Ⓢ	Ⓢ	Ⓢ	Ⓢ	Ⓢ	Ⓢ	Ⓢ	Ⓢ				Ⓢ	Ⓢ	Ⓢ	Ⓢ	Ⓢ	Ⓢ		
MW	Ⓢ	Ⓢ	Ⓢ	Ⓢ	Ⓢ	Ⓢ	Ⓢ	Ⓢ	Ⓢ				Ⓢ	Ⓢ	Ⓢ	Ⓢ			Ⓢ	Ⓢ
WA	Ⓢ	Ⓢ	Ⓢ	Ⓢ	Ⓢ	Ⓢ	Ⓢ	Ⓢ	Ⓢ											
WADWA										Ⓢ	Ⓢ	Ⓢ								
WE	Ⓢ	Ⓢ	Ⓢ																	

my FANIMATION DISTINCTION™

3. Fitters

- Lumens: 1,650
- Color Temp: 2,700
- CRI: 99



F1		
BN	DZ	MW

- Lumens: 1,600
- Color Temp: 2,700
- CRI: 80



F2		
BN	DZ	MW

- Lumens: 1,350
- Color Temp: 3,000
- CRI: 80



F3		
BN	DZ	MW

- Lumens: 1,400
- Color Temp: 2,700
- CRI: 99



F4*		
BN	DZ	MW

4. Glass

	F1			F2			F3			F4*		
	G1	G2	G3	G1	G4	G5	G6					
CL			☒		☒		☒					
MS	☒			☒								
OP		☒	☒			☒	☒					
OPS			☒		☒							
TST	☒	☒		☒	☒	☒	☒					

*Additional glass available on page 154

5. Controls





For use with A1 and C1 motors		For use with D1 motor	
BTT9R —included	C21 —sold separately	TR205 —included	TW206 —sold separately
White hand-held remote control with wall mount	White wall control with wall plate	White hand-held remote control with wall mount	White wall control with wall plate

ENIGMA™

FAN: FP2120MG (1)
metro gray assembly with light
socket cover (included)

FP2120—AVAILABLE FINISHES:**

MG
metro
gray
metro
gray

- 
FANSYNC™
sold separately
- 
11W
E26 LED
- 
3-SPEED AC
no reverse
- 
CONTROL
remote
- 
DAMP
indoor/outdoor

INCLUDED:

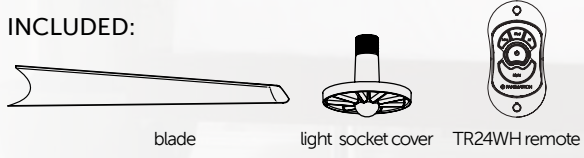



ENERGY GUIDE:

TOTAL AIR VOLUME (CFM)	ENERGY USE (Watts)	ESTIMATED YEARLY ENERGY COST	AIRFLOW EFFICIENCY (CFM/W)
2,805 _{ave}	32 _{ave}	\$9 _{ave}	86 _{ave}
4,055 _{high}	47 _{high}	\$13 _{high}	86 _{high}

LIMITED LIFETIME MOTOR WARRANTY

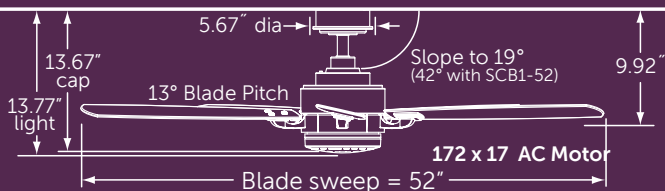





 1,400 Lumens
 3,000K CCT
 90 CRI

*With included 4.5" downrod—longer lengths available
 Close-to-ceiling kit compatible; *True stainless steel rust resistant downrods available*

Net Hanging Weight: 20.94 lbs.

FAN: FP8003BBN (1)
 brushed nickel assembly with dark walnut blades and opal frosted glass





FAN: FP8003BDZ (1)
 dark bronze assembly with dark walnut blades and matching light cover (included)





FAN: FP8003BGR (1)
 matte greige assembly with weathered wood finish blades and opal frosted glass



FAN: FP8003BMW (1)
 matte white assembly with matte white blades and matching light cover (included)



FAN: FP8003BPN (1)
 polished nickel assembly with black blades and opal frosted glass



For compatible controls & accessories see pages 183 - 193

Recommended optional control



CW60WH

BENITO™ v2

FAN: FP8003BBN (1)
brushed nickel assembly
with dark walnut blades and
matching cap (included)

FP8003B**—AVAILABLE FINISHES:

BN brushed nickel	DZ dark bronze	GR matte greige	MW matte white	PN polished nickel
dark walnut	dark walnut	weathered wood	matte white	black

INCLUDED:



blade set



light kit



light cover



TR500 remote



FANSYNC™
sold separately



18W
LED



3-SPEED AC
reverse switch
on fan



CONTROL
remote



DAMP
indoor/outdoor

ENERGY GUIDE:

TOTAL AIR VOLUME (CFM)	ENERGY USE (Watts)	ESTIMATED YEARLY ENERGY COST	AIRFLOW EFFICIENCY (CFM/W)
3,590 _{ave}	43 _{ave}	\$12 _{ave}	83 _{ave}
5,200 _{high}	67 _{high}	\$19 _{high}	78 _{high}

LIMITED LIFETIME MOTOR WARRANTY



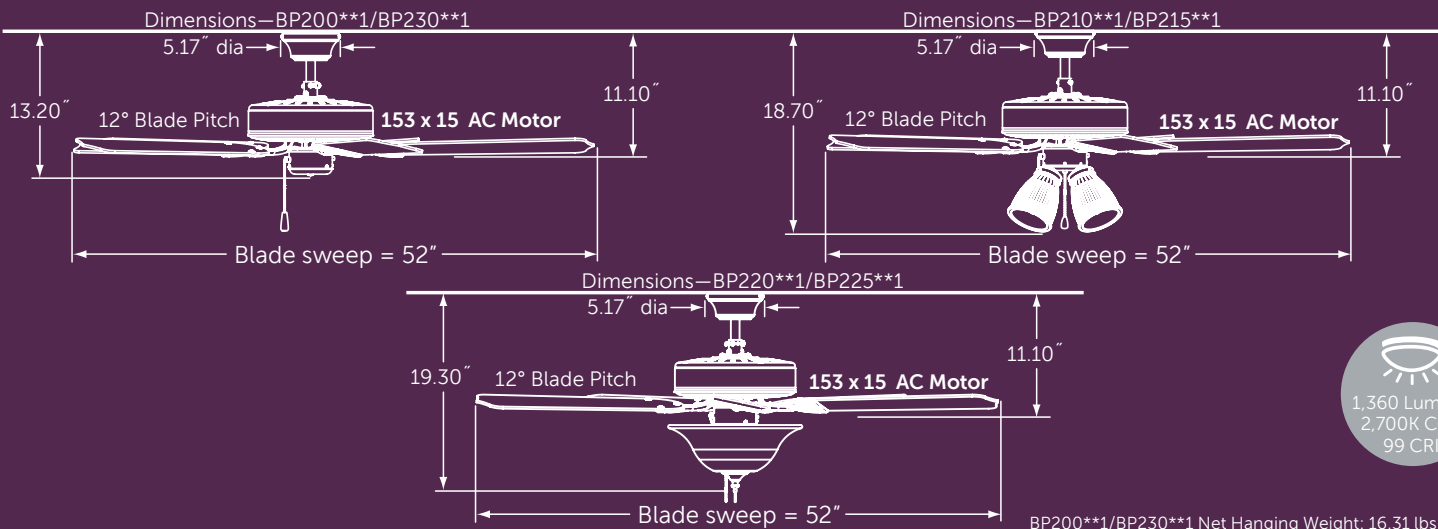



 1,360 Lumens
 2,700K CCT
 99 CRI

*With included 4.5" downrod—longer lengths available. Can be flush mounted to canopy.
 True stainless steel rust resistant downrods available

BP200**1/BP230**1 Net Hanging Weight: 16.31 lbs.
 BP210**1/BP215**1 Net Hanging Weight: 20.94 lbs.
 BP220**1/BP225**1 Net Hanging Weight: 18.5 lbs.

 **FAN: BP200SN1 (1)**
 satin nickel assembly in flush-mount configuration with reversible cherry/walnut wood blades

- walnut side showing



 **FAN: BP210MW1 (1)**
 matte white assembly in downrod configuration with white frosted glass shades and matte white wood blades



 **FAN: BP215OB1 (1)**
 oil-rubbed bronze assembly in downrod configuration with white frosted glass shades (amber shades version available: BP210OB1) and reversible cherry/walnut wood blades

- cherry side showing



 **FAN: BP230BL1 (1)**
 black assembly in downrod configuration with black blades



For compatible controls & accessories see pages 183 - 193

Recommended optional controls





AIRE DECOR®

FAN: BP220SN1 (1)
satin nickel assembly in downrod configuration with white frosted glass bowl and reversible cherry/walnut blades
● walnut side showing



FAN: BP220MW1 (1)
matte white assembly in downrod configuration with white frosted glass bowl and matte white wood blades



FAN: BP225OB1 (1)
oil-rubbed bronze assembly in downrod configuration with white frosted glass bowl (amber glass version available: BP220OB1) and cherry/walnut reversible wood blades
● walnut side showing

AVAILABLE FINISHES:

BL black	MW matte white	OB oil-rubbed bronze	OB oil-rubbed bronze	SN satin nickel	SN satin nickel
black	matte white	cherry walnut	walnut	cherry walnut	cherry
BP230**1	BP200**1 BP210**1 BP220**1 BP230**1	BP200**1 BP210**1 BP215**1 BP220**1 BP225**1	BP230**1	BP200**1 BP210**1 BP220**1	BP230**1

INCLUDED:





FANSYNC™
sold separately

SEE INCLUDED
incandescent
candelabra

3-SPEED AC
reverse switch
on fan

CONTROL
pull chain



DRY OR DAMP
model specific

ENERGY GUIDE:

TOTAL AIR VOLUME (CFM)	ENERGY USE (Watts)	ESTIMATED YEARLY ENERGY COST	AIRFLOW EFFICIENCY (CFM/W)
3,059 _{ave}	29 _{ave}	\$8 _{ave}	104 _{ave}
4,402 _{high}	48 _{high}	\$14 _{high}	92 _{high}

LIMITED LIFETIME MOTOR WARRANTY

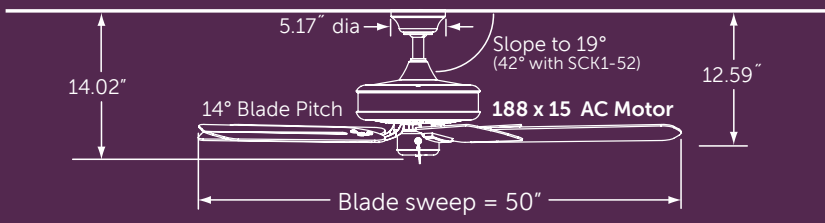



*With included 4.5" downrod—longer lengths available
True stainless steel rust resistant downrods available

Net Hanging Weight: 19.73 lbs.



FAN: TF910AZ (1)
aged bronze assembly with
dark cherry all-weather
composite blades



FAN: TF910BL (1)
black assembly with
black all-weather
composite blades



FAN: TF910OB (1)
oil-rubbed bronze assembly
with dark cherry all-weather
composite blades



FAN: TF910WH (1)
white assembly with
white all-weather
composite blades



For compatible controls & accessories see pages 183 - 193

Recommended optional controls



CRL4WH



CW1WH
without light



CW60WH
with light

EDGEWOOD® WET



FAN: TF910WH(1)
white assembly with all-weather composite white blades



FANSYNC™
sold separately



3-SPEED AC
reverse switch
on fan



CONTROL
pull chain



WET
indoor/outdoor

TF910**—AVAILABLE FINISHES:

AZ aged bronze	BL black	OB oil-rubbed bronze	WH white
dark cherry	black	dark cherry	white

INCLUDED:



blade set

ENERGY GUIDE:

TOTAL AIR VOLUME (CFM)	ENERGY USE (Watts)	ESTIMATED YEARLY ENERGY COST	AIRFLOW EFFICIENCY (CFM/W)
3,336 _{ave}	32 _{ave}	\$9 _{ave}	104 _{ave}
4,919 _{high}	53 _{high}	\$15 _{high}	93 _{high}



LIMITED LIFETIME MOTOR WARRANTY



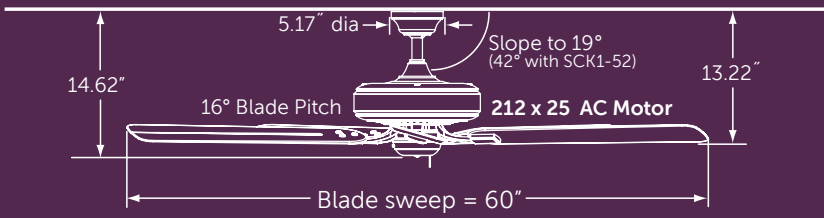

*With included 4.5" downrod—longer lengths available Net Hanging Weight: 32.1 lbs.
Close-to-ceiling kit compatible; True stainless steel rust resistant downrods available



FAN: TF971AZ (1)
aged bronze assembly with dark cherry all-weather composite blades



FAN: TF971OB (1)
oil-rubbed bronze assembly with dark cherry all-weather composite blades



FAN: TF971WH (1)
white assembly with white all-weather composite blades



For compatible controls & accessories see pages 183 - 193

Recommended optional controls



CRL4WH



CW1WH
without light



CW60WH
with light

EDGEWOOD® DELUXE WET



FAN: TF971AZ (1)
aged bronze assembly with
all-weather composite
dark cherry blades

TF971**—AVAILABLE FINISHES:

AZ aged bronze	OB oil-rubbed bronze	WH white
dark cherry	dark cherry	white

INCLUDED:



blade set



FANSYNC™
sold separately



3-SPEED AC
reverse switch
on fan



CONTROL
pull chain



WET
indoor/outdoor

ENERGY GUIDE:

TOTAL AIR VOLUME (CFM)	ENERGY USE (Watts)	ESTIMATED YEARLY ENERGY COST	AIRFLOW EFFICIENCY (CFM/W)
4,594 _{ave}	48 _{ave}	\$13 _{ave}	96 _{ave}
6,659 _{high}	77 _{high}	\$22 _{high}	86 _{high}



LIMITED LIFETIME MOTOR WARRANTY



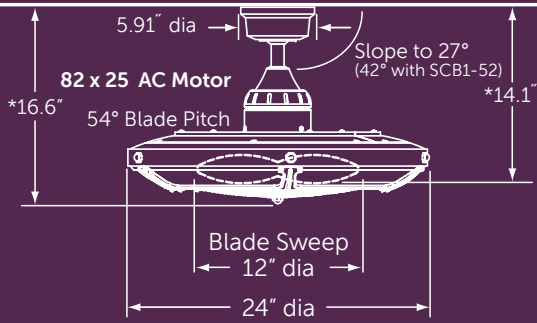



 2,200 Lumens
 3,000K CCT
 80 CRI

NOTE: NOT RECOMMENDED FOR SOUND SENSITIVE AREAS

*With included 4.5" downrod—longer lengths available Net Hanging Weight: 25.85 lbs.
 Close-to-ceiling kit compatible; True stainless steel rust resistant downrods available



FAN: FP6260BLBN (1)
 black assembly with brushed nickel accents, black blades and opal frosted glass



FAN: FP6260BLBS (1)
 black assembly with brushed satin accents, black blades and opal frosted glass

For compatible controls & accessories see pages 183 - 193

Recommended optional control



CW60WH

PICKETT™ DRUM

FAN: FP6260BLBS (1)
black assembly with brushed satin accents, black blades and opal frosted glass

FP6260****—AVAILABLE FINISHES:

BLBN black with brushed nickel	BLBS black with brushed satin
black	black

INCLUDED:



TR400 remote

- FANSYNC™**
sold separately
- 23W LED strip**
- 3-SPEED AC reverse switch on fan**
- CONTROL remote**
- DAMP indoor/outdoor**

ENERGY GUIDE:

TOTAL AIR VOLUME (CFM)	ENERGY USE (Watts)	ESTIMATED YEARLY ENERGY COST	AIRFLOW EFFICIENCY (CFM/W)
705 _{ave}	33 _{ave}	\$9 _{ave}	21 _{ave}
881 _{high}	40 _{high}	\$11 _{high}	22 _{high}

LIMITED LIFETIME MOTOR WARRANTY



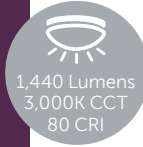
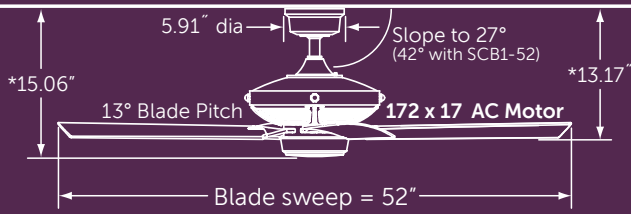

*With included 4.5" downrod—longer lengths available Net Hanging Weight: 23.15 lbs.
Close-to-ceiling kit compatible; True stainless steel rust resistant downrods available



FAN: FP7996BLBNW (1)
black assembly with
brushed nickel accents,
opal frosted glass and
black blades



FAN: FP7996BLBSW (1)
black assembly with
brushed brass accents,
opal frosted glass and
black blades

For compatible controls & accessories see pages 183 - 193

Recommended optional control



CRL4WH

PICKETT™



FAN: FP7996BLBNW (1)
black assembly with brushed nickel accents, opal frosted glass and black blades

FP7996****—AVAILABLE FINISHES:

BLBNW black with brushed nickel	BLBSW black with brushed brass
black	black

INCLUDED:



blade set



light kit



CW60WH-7996 wall control



FANSYNC™
sold separately



18W LED



3-SPEED AC
reverse switch on fan



CONTROL
wall



WET
indoor/outdoor

ENERGY GUIDE:

TOTAL AIR VOLUME (CFM)	ENERGY USE (Watts)	ESTIMATED YEARLY ENERGY COST	AIRFLOW EFFICIENCY (CFM/W)
4,228 _{ave}	41 _{ave}	\$11 _{ave}	109 _{ave}
5,897 _{high}	66 _{high}	\$19 _{high}	89 _{high}



LIMITED LIFETIME MOTOR WARRANTY



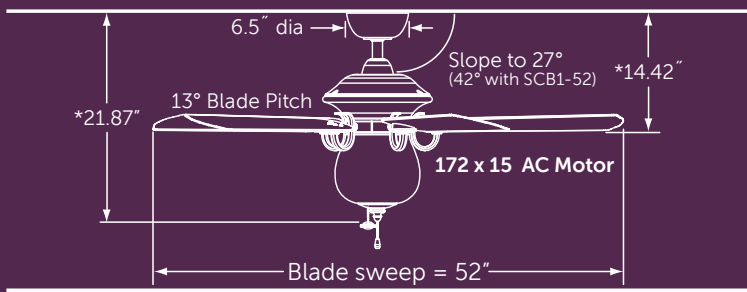

 1,020 Lumens
 2,700K CCT
 99 CRI

*With included 4.5" downrod—longer lengths available Net Hanging Weight: 22.9 lbs.
 Close-to-ceiling kit compatible; *True stainless steel rust resistant downrods available*



FAN: FP7954OB (1)
 oil-rubbed bronze assembly with seeded glass light kit and reversible cherry/walnut composite blades

- cherry side showing



FAN: FP7954OB (1)
 oil-rubbed bronze assembly with seeded glass light kit and reversible cherry/walnut composite blades

- walnut side showing



For compatible controls & accessories see pages 183 - 193

Recommended optional controls



CRL4WH

or



CW60WH

CRESTFORD™

FAN: FP7954OB (1)
 oil-rubbed bronze assembly
 with seeded glass light kit
 and reversible cherry/walnut
 composite blades

- cherry side showing



FANSYNC™
 sold separately



(3) 40W
 incandescent
 candelabra



3-SPEED AC
 reverse switch
 on fan



CONTROL
 pull chain



WET
 indoor/outdoor

FP7954**—AVAILABLE FINISHES:

- OB**
oil-rubbed
bronze
- cherry walnut**

INCLUDED:



blade set



light kit

ENERGY GUIDE:

TOTAL AIR VOLUME (CFM)	ENERGY USE (Watts)	ESTIMATED YEARLY ENERGY COST	AIRFLOW EFFICIENCY (CFM/W)
3,906 _{ave}	40 _{ave}	\$11 _{ave}	97 _{ave}
5,396 _{high}	63 _{high}	\$18 _{high}	86 _{high}

LIMITED LIFETIME MOTOR WARRANTY



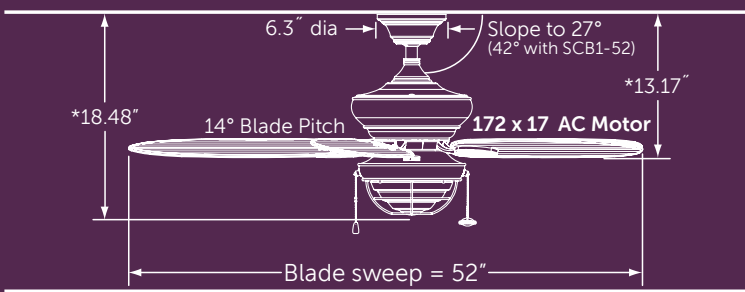



 1,600 Lumens
 2,700K CCT
 80 CRI

*With included 4.5" downrod—longer lengths available Net Hanging Weight: 23.13 lbs.
 Close-to-ceiling kit compatible; *True stainless steel rust resistant downrods available*



 **FAN: FP7963RS** (1)
 rust assembly with
 cherry bronze blades
 and opal frosted glass



For compatible controls & accessories see pages 183 - 193

Recommended optional controls



CRL4WH

or



CW60WH

KAYA™

FAN: FP7963RS (1)
rust assembly with
cherry bronze blades
and opal frosted glass



FANSYNC™
sold separately



**(1) 26W
GU24 CFL**



**3-SPEED AC
reverse switch
on fan**



**CONTROL
pull chain**



**WET
indoor/outdoor**

FP7963**—AVAILABLE FINISHES:

RS
rust
cherry
bronze

INCLUDED:



blade set



light kit

ENERGY
GUIDE:

TOTAL AIR VOLUME (CFM)	ENERGY USE (Watts)	ESTIMATED YEARLY ENERGY COST	AIRFLOW EFFICIENCY (CFM/W)
3,617 _{ave}	40 _{ave}	\$11 _{ave}	90 _{ave}
5,203 _{high}	66 _{high}	\$19 _{high}	79 _{high}

LIMITED LIFETIME MOTOR WARRANTY



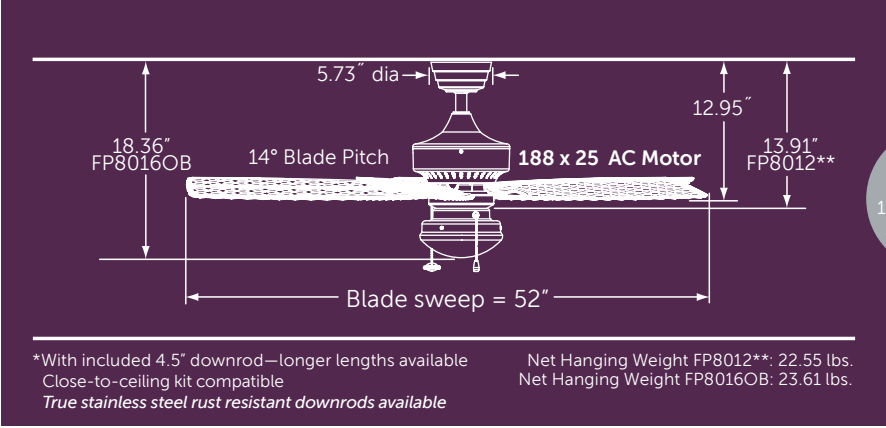

1,600 Lumens
2,800K CCT
99 CRI



FAN: FP8012OB (1)
oil-rubbed bronze assembly with all-weather composite antique woven bamboo blades



FAN: FP8012WH (1)
white assembly with all-weather composite white woven bamboo blades

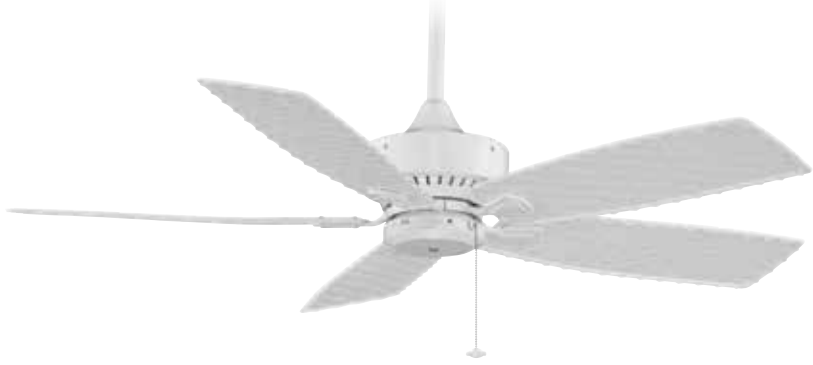

FAN: FP8016OB (1)
oil-rubbed bronze assembly with frosted white low profile light kit and all-weather composite antique woven bamboo blades



For compatible controls & accessories see pages 183 - 193

Recommended optional controls



CRL4WH



CW1WH
without light



CW60WH
with light

CANCUN™ WET

FAN: FP8016OB (1)
oil-rubbed bronze assembly with frosted white low profile light kit and all-weather composite antique woven bamboo blades

FP8012** & FP8016**(OB only)—AVAILABLE FINISHES:

OB oil-rubbed bronze	WH white
antique bamboo	white bamboo

INCLUDED:



blade set



light kit—FP8016OB only



FANSYNC™
sold separately



(1) 100W
halogen
minican
FP8016OB



3-SPEED AC
reverse switch
on fan



CONTROL
pull chain



WET
indoor/outdoor

ENERGY GUIDE:

TOTAL AIR VOLUME (CFM)	ENERGY USE (Watts)	ESTIMATED YEARLY ENERGY COST	AIRFLOW EFFICIENCY (CFM/W)
3,421 _{ave}	43 _{ave}	\$12 _{ave}	79 _{ave}
5,087 _{high}	73 _{high}	\$20 _{high}	70 _{high}

FP8012** only



LIMITED LIFETIME MOTOR WARRANTY



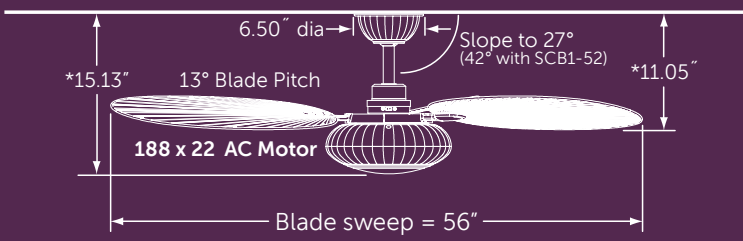

1,440 Lumens
3,000K CCT
90 CRI

*With included 6" downrod—longer lengths available Net Hanging Weight: 24.69 lbs.
Close-to-ceiling kit compatible; *True stainless steel rust resistant downrods available*



FAN: FP6258BNMW (1)
brushed nickel and matte white fan with matte white blades and matte white light cover (included)



FAN: FP6258BNMW (1)
brushed nickel and matte white fan with matte white blades and opal frosted shade



For compatible controls & accessories see pages 183 - 193

Recommended optional control



CRL4WH

PALMA™



FAN: FP6258BNMW (1)
brushed nickel and matte white fan with matte white blades and opal frosted shade

FP6258****—AVAILABLE FINISHES:

BN brushed nickel
MW matte white

matte white

INCLUDED:



blade



light kit



light cover



CW60WH-6258 wall control



FANSYNC™
sold separately



18W LED



3-SPEED AC
reverse switch
on fan



CONTROL
wall



DAMP
indoor/outdoor

ENERGY GUIDE:

TOTAL AIR VOLUME (CFM)	ENERGY USE (Watts)	ESTIMATED YEARLY ENERGY COST	AIRFLOW EFFICIENCY (CFM/W)
3,346 _{ave}	45 _{ave}	\$13 _{ave}	75 _{ave}
4,758 _{high}	73 _{high}	\$20 _{high}	65 _{high}



LIMITED LIFETIME MOTOR WARRANTY



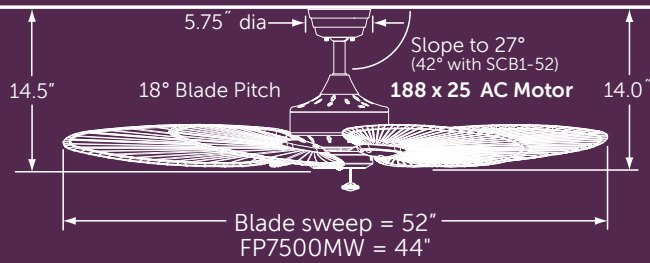

*With included 6" downrod—longer lengths available
Close-to-ceiling kit compatible
True stainless steel rust resistant downrods available

FP7500AB Net Hanging Weight: 23.84 lbs.
FP7500MW Net Hanging Weight: 23.66 lbs.
FP7500OBP4 Net Hanging Weight: 29.87 lbs.
FP7500RS Net Hanging Weight: 25.41 lbs.

FAN: FP7500AB (1)
52" sweep antique brass assembly
with natural palm narrow oval blades



FAN: FP7500MW (1)
44" sweep matte white assembly
with natural palm narrow oval blades



FAN: FP7500OBP4 (1)
52" sweep oil-rubbed bronze
assembly with all weather composite
red/brown narrow oval palm blades



FAN: FP7500RS (1)
52" sweep rust assembly with antique
woven bamboo narrow oval blades

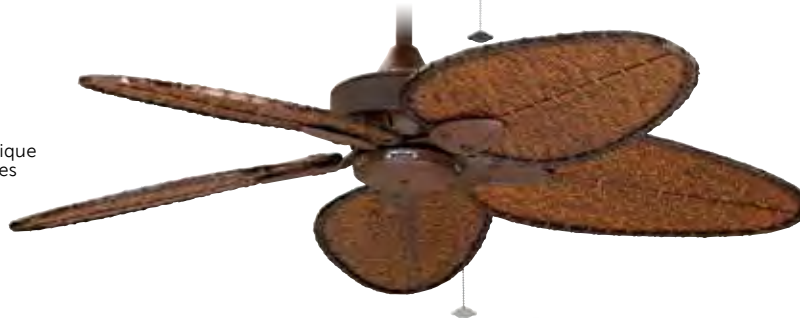

For compatible controls &
accessories see pages 183 - 193

Recommended
optional controls



CRL4WH



CW1WH
without light



CW60WH
with light

WINDPOINTE®

FAN: FP7500AB (1)
52" sweep antique brass assembly with natural narrow oval palm blades



FANSYNC™
sold separately



3-SPEED AC
reverse switch
on fan



CONTROL
pull chain



DRY OR DAMP
model specific

FP7500**—AVAILABLE FINISHES:

AB antique brass	MW matte white	OB oil-rubbed bronze	RS rust
natural palm	natural palm	red/brown palm	antique bamboo

INCLUDED:



blade set

ENERGY GUIDE:

	TOTAL AIR VOLUME (CFM)	ENERGY USE (Watts)	ESTIMATED YEARLY ENERGY COST	AIRFLOW EFFICIENCY (CFM/W)
FP7500AB	2,964 ^{ave}	33 ^{ave}	\$9 ^{ave}	91 ^{ave}
	3,765 ^{high}	76 ^{high}	\$14 ^{high}	77 ^{high}
FP7500MW	1,372 ^{ave}	45 ^{ave}	\$9 ^{ave}	42 ^{ave}
	788 ^{high}	48 ^{high}	\$13 ^{high}	16 ^{high}
FP7500OBP4	3,354 ^{ave}	33 ^{ave}	\$9 ^{ave}	101 ^{ave}
	4,357 ^{high}	49 ^{high}	\$14 ^{high}	89 ^{high}
FP7500RS	2,374 ^{ave}	33 ^{ave}	\$9 ^{ave}	74 ^{ave}
	3,177 ^{high}	48 ^{high}	\$13 ^{high}	66 ^{high}

LIMITED LIFETIME MOTOR WARRANTY



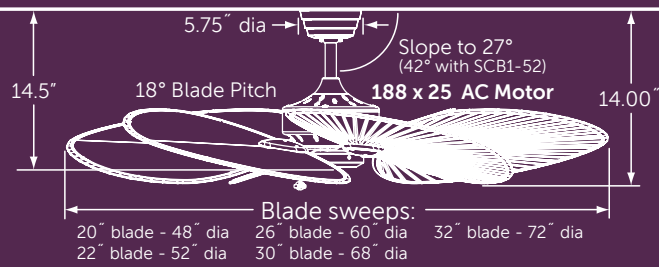

*With included 6" downrod—longer lengths available
Close-to-ceiling kit compatible; *True stainless steel rust resistant downrods available*

Net Hanging Weight: 24.87 lbs.

FAN: MA7500AB (1)
antique brass assembly
BLADES: B5340WA (1)
52" sweep walnut carved wood

FAN: MA7500MW (1)
matte white assembly
BLADES: BPW6090DNA (1)
60" sweep all-weather composite dark
natural accent narrow palm

FAN: MA7500OB (1)
oil-rubbed bronze assembly
BLADES: BPW20CY (1)
48" sweep all-weather composite cherry
LIGHT KIT: LKLP102OB (1)
opal frosted glass low profile
CLOSE TO CEILING KIT: CCK8002OB (1)
oil-rubbed bronze

FAN: MA7500PW (1)
pewter assembly
BLADES: ISD1A (1)
52" sweep antique wide oval woven
bamboo

FAN: MA7500RS (1)
rust assembly
BLADES: B5280WA (1)
52" sweep walnut wide oval leaf carved
wood



For compatible controls & accessories see pages 179 - 193

Recommended optional controls



CRL4WH

or



CW1WH
without light

or



CW60WH
with light

WINDPOINTE® CUSTOM

FAN: MA7500MW (1)
matte white assembly
BLADES: BPW6090DNA (1)
60" sweep all-weather
composite dark natural
accent narrow palm

MA7500**—AVAILABLE FINISHES:

AB antique brass	MW matte white	OB oil-rubbed bronze	PW pewter	RS rust
-------------------------------	-----------------------------	-----------------------------------	---------------------	-------------------



FANSYNC™
sold separately



MIX & MATCH
components
sold separately



3-SPEED AC
reverse switch
on fan



CONTROL
pull chain



DRY OR DAMP
model specific

ENERGY GUIDE:

Tested with
BPW6090
blades

TOTAL AIR VOLUME (CFM)	ENERGY USE (Watts)	ESTIMATED YEARLY ENERGY COST	AIRFLOW EFFICIENCY (CFM/W)
3,845 _{ave}	33 _{ave}	\$9 _{ave}	116 _{ave}
5,027 _{high}	49 _{high}	\$14 _{high}	103 _{high}

LIMITED LIFETIME MOTOR WARRANTY



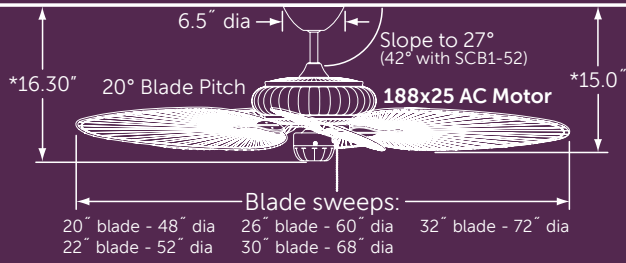

*With included 6" downrod—longer lengths available Net Hanging Weight: 25.0 lbs.
 Close-to-ceiling kit compatible; *True stainless steel rust resistant downrods available*

FAN: FP4320AZ1 (1)
 aged bronze assembly
BLADES: BPD4A (1)
 52" sweep all-weather
 composite antique woven
 bamboo narrow oval



FAN: FP4320MW1 (1)
 matte white assembly
BLADES: BPP4TN (1)
 52" sweep natural palm
 finish narrow oval all-
 weather composite



FAN: FP4320TB1 (1)
 textured black assembly
BLADES: BPP4BR (1)
 52" sweep brown/red palm
 narrow oval all-weather
 composite



FAN: FP4320TS1 (1)
 tortoise shell assembly
BLADES: B5340WA (1)
 52" sweep walnut
 carved wood



For compatible controls &
 accessories see pages 179 - 193

Recommended
 optional controls



CRL4WH



CW1WH
 without light



CW60WH
 with light

BELLERIA®

FAN: FP4320AZ1 (1)
aged bronze assembly
BLADES: BPW6090DNA (1)
60" sweep all-weather composite
dark natural accent narrow palm

FP4320**1—AVAILABLE FINISHES:

AZ aged bronze	MW matte white	TB textured black	TS tortoise shell
-----------------------------	-----------------------------	--------------------------------	--------------------------------



FANSYNC™
sold separately



MIX & MATCH
components
sold separately



3-SPEED AC
reverse switch
on fan



CONTROL
pull chain



DRY or WET
blade finish
specific

ENERGY GUIDE:

Tested with
BPW6090
blades

TOTAL AIR VOLUME (CFM)	ENERGY USE (Watts)	ESTIMATED YEARLY ENERGY COST	AIRFLOW EFFICIENCY (CFM/W)
3,498 _{ave}	44 _{ave}	\$12 _{ave}	80 _{ave}
4,835 _{high}	69 _{high}	\$19 _{high}	71 _{high}

LIMITED LIFETIME MOTOR WARRANTY



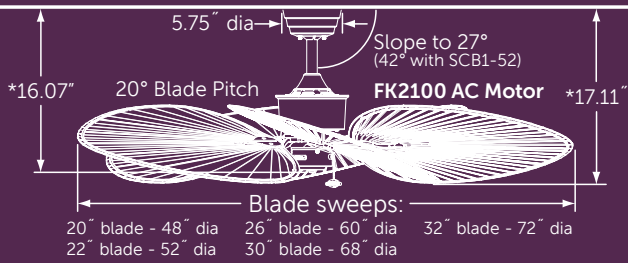

*With included 6" downrod—longer lengths available
True stainless steel rust resistant downrods available

Net Hanging Weight: 19.0 lbs.

- ◆ **FAN: FP320AB1** (1)
antique brass assembly
BLADES: ISP1 (1)
52" sweep natural palm leaf wide oval



- **FAN: FP320OB1** (1)
oil-rubbed bronze assembly
BLADES: BPW20CY (1)
48" sweep all-weather composite cherry



- ◆ **FAN: FP320PW1** (1)
pewter assembly
BLADES: B5133TKMH (1)
52" sweep reversible teak/
mahogany wood blades
● teak side showing



- **FAN: FP320RS1** (1)
rust assembly
BLADES: ISD1A (1)
52" sweep antique wide oval
woven bamboo

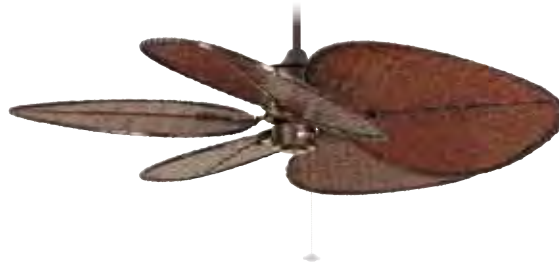

For compatible controls &
accessories see pages 179 - 193

Recommended
optional controls



CRL4WH





CW1WH
without light



CW60WH
with light

ISLANDER® AC

 **FAN: FP320RS1** (1)
 rust assembly
 **BLADE SET: ISP1** (1)
 52" sweep natural palm
 leaf wide oval

FP320**1—AVAILABLE FINISHES:

AB antique brass	OB oil-rubbed bronze	PW pewter	RS rust
-------------------------------	-----------------------------------	---------------------	-------------------



FANSYNC™
sold separately



MIX & MATCH
components
sold separately



3-SPEED AC
reverse switch
on fan



CONTROL
pull chain



DRY OR DAMP
model specific

ENERGY GUIDE:

Tested with
BPD4 blades

TOTAL AIR VOLUME (CFM)	ENERGY USE (Watts)	ESTIMATED YEARLY ENERGY COST	AIRFLOW EFFICIENCY (CFM/W)
1,927 _{ave}	50 _{ave}	\$14 _{ave}	38 _{ave}
3,497 _{high}	86 _{high}	\$24 _{high}	41 _{high}

LIMITED LIFETIME MOTOR WARRANTY



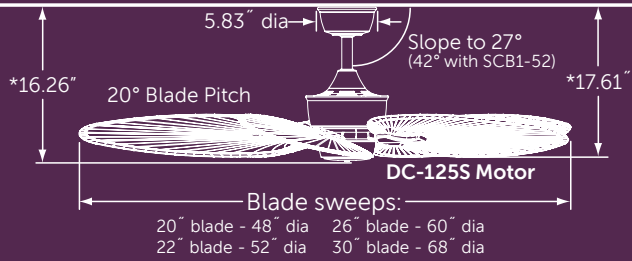

*With included 6" downrod—longer lengths available
Close-to-ceiling kit compatible; *True stainless steel rust resistant downrods available*

Net Hanging Weight: 14.04 lbs.

- ◆ **FAN: MAD3250AB** (1)
antique brass assembly
- BLADES: ISP1** (1)
52" sweep natural palm leaf wide oval
- FITTER: F423AB** (1)
antique brass bowl fitter
- GLASS: G439** (1)
hand-painted parrot bowl



- ◆ **FAN: MAD3250BA** (1)
bronze accent assembly
- BLADES: ISP4** (1)
52" sweep natural palm leaf narrow oval



- ◆ **FAN: MAD3250OB** (1)
oil-rubbed bronze assembly
- BLADES: BPW6090DNA** (1)
60" sweep dark natural accent narrow palm all-weather composite



- ◆ **FAN: MAD3250PW** (1)
pewter assembly
- BLADES: ISD1A** (1)
52" sweep antique woven bamboo wide oval
- FITTER: F423PW** (1)
pewter bowl fitter
- GLASS: G450** (1)
amber glass bowl



For compatible controls & accessories see pages 179 - 192

Recommended optional control



TW40WH

ISLANDER® DC



FAN: MAD3250OB (1)
oil-rubbed bronze assembly
BLADE SET: ISD4A (1)
antique narrow oval woven bamboo

MAD3250**—AVAILABLE FINISHES:

AB antique brass	BA bronze accent	OB oil-rubbed bronze	PW pewter
-------------------------------	-------------------------------	-----------------------------------	---------------------

INCLUDED:



TR39 remote

- ENERGY SAVINGS**
- MIX & MATCH**
components
sold separately
- 6-SPEED DC**
reverse switch
on remote
- CONTROL**
remote
- DRY OR DAMP**
model specific

ENERGY GUIDE:

Tested with BPD4 blades

TOTAL AIR VOLUME (CFM)	ENERGY USE (Watts)	ESTIMATED YEARLY ENERGY COST	AIRFLOW EFFICIENCY (CFM/W)
3,858 _{ave}	22 _{ave}	\$6 _{ave}	176 _{ave}
5,217 _{high}	32 _{high}	\$9 _{high}	163 _{high}



Energy Star applies to specific blade and motor combinations

LIMITED LIFETIME MOTOR WARRANTY



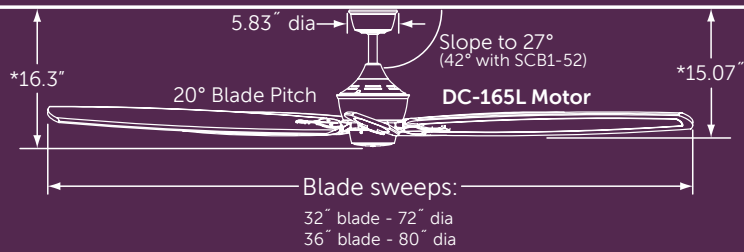

*With included 6" downrod—longer lengths available
Close-to-ceiling kit compatible; *True stainless steel rust resistant downrods available*

Net Hanging Weight: 18.13 lbs.



FAN: MAD3252OB (1)
oil-rubbed bronze assembly
BLADES: B5300WA (1)
72" sweep walnut carved wood



FAN: MAD3252BN (1)
brushed nickel assembly
BLADES: B6801DWA (1)
80" sweep dark walnut carved wood



FAN: MAD3252OB (1)
oil-rubbed bronze assembly
BLADES: B6831WA (1)
80" sweep walnut carved wood

For compatible controls & accessories see pages 183 - 192

Recommended optional control



TW40WH



MH—mahogany

TK—teak

BPW6000**
80" composite



walnut

B5300WA
72" wood



CY—cherry

DWA—dark walnut

B6801**
80" wood



walnut

B6831WA
80" wood



dark walnut

B6841DWA
80" wood

BIG ISLAND™



FAN: MAD3252BN (1)
brushed nickel assembly
BLADES: BPW6000TK (1)
80" sweep teak composite

MAD3252**—AVAILABLE FINISHES:

BN
brushed
nickel

OB
oil-rubbed
bronze

INCLUDED:

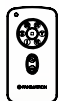

TR39 remote

- ENERGY SAVINGS
- MIX & MATCH components sold separately
- 6-SPEED DC reverse switch on remote
- CONTROL remote
- DRY OR DAMP model specific

ENERGY GUIDE:

Tested with BPW6000 blades

TOTAL AIR VOLUME (CFM)	ENERGY USE (Watts)	ESTIMATED YEARLY ENERGY COST	AIRFLOW EFFICIENCY (CFM/W)
6,668 _{ave}	21 _{ave}	\$6 _{ave}	315 _{ave}
10,037 _{high}	32 _{high}	\$9 _{high}	320 _{high}





Energy Star applies to specific blade and motor combinations

LIMITED LIFETIME MOTOR WARRANTY

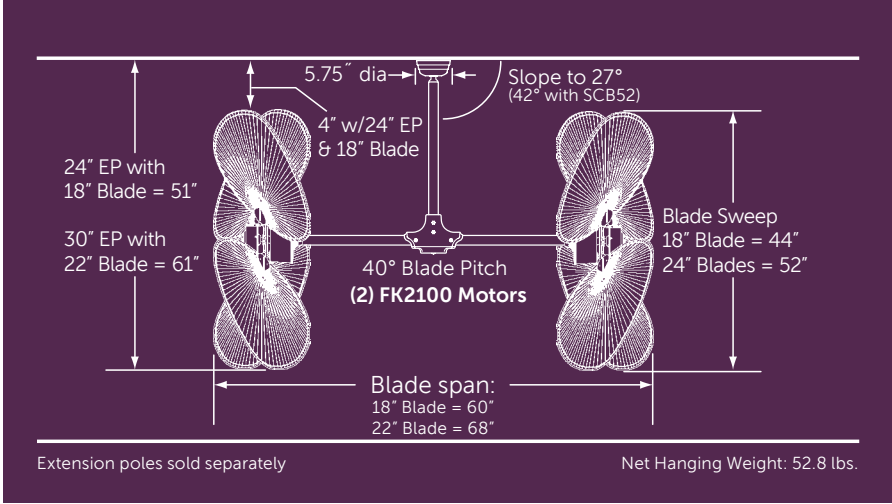



 **FAN: FP240OB** (1)
 oil-rubbed bronze assembly
EXTENSION POLE: EP300B (1)
 30" oil-rubbed bronze
BLADES: PAD1A (1)
 52" sweep antique wide oval woven bamboo

 **FAN: FP240PW** (1)
 pewter assembly
EXTENSION POLE: EP30PW (1)
 30" pewter
BLADES: PAD1C (1)
 52" sweep clear wide oval woven bamboo
ACCESSORY: P48 (1)
 monkey

 **FAN: FP240RS** (1)
 rust assembly
EXTENSION POLE: EP30RS (1)
 30" rust
BLADES: PAD1A (1)
 52" sweep antique wide oval woven bamboo
FILIGREE: FLRS (1)
 rust

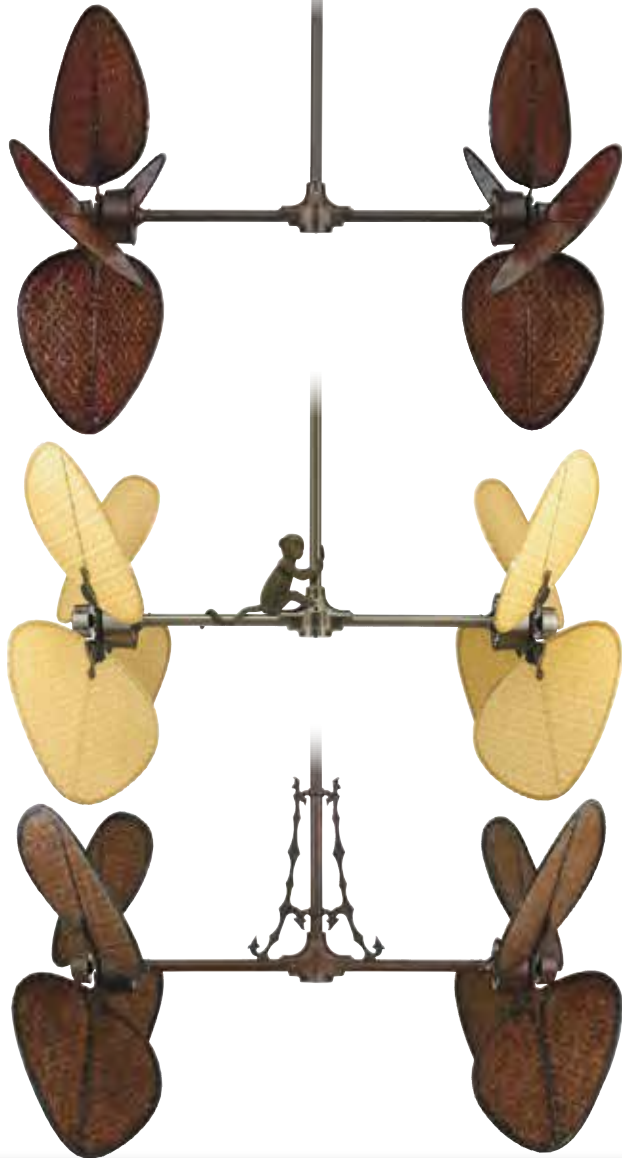

For compatible controls & accessories see pages 179 - 192

Recommended optional controls



TR24WH



SW24**

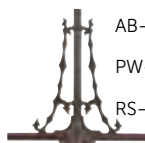

FL**
filigree

AB—antique brass 

PW—pewter 

RS—rust 



P48
monkey 



B5080CP
cairo purple 



B5080SS
samble sand 



B5213WA
walnut 

PALISADE®

 **FAN: FP240OB** (1)
oil-rubbed bronze assembly
EXTENSION POLE: EP48OB (1)
48" oil-rubbed bronze
BLADES: B5080CP (1)
52" sweep cairo purple wood

FP240**—AVAILABLE FINISHES:

OB oil-rubbed bronze	PW pewter	RS rust
-----------------------------------	---------------------	-------------------

INCLUDED:



CW3WH wall control

MIX & MATCH
components
sold separately



2-SPEED AC
reverse switch
on fans

CONTROL
wall

DRY OR DAMP
model specific

LIMITED LIFETIME MOTOR WARRANTY

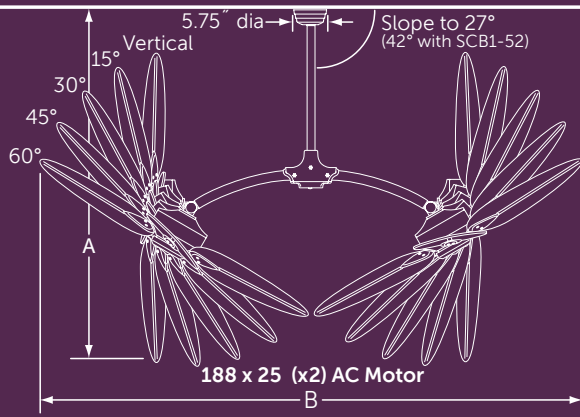



24" downrod included—longer lengths available
 True stainless steel rust resistant downrods available

Net Hanging Weight: 60 lbs.

Motor Tilt Angle	44" Sweep Blades		49" Sweep Blades		52" Sweep Blades	
	Dim. A w/24" DR	Dim. B w/24" DR	Dim. A w/24" DR	Dim. B w/24" DR	Dim. A w/24" DR	Dim. B w/24" DR
Vertical	54.5"	56.5"	56.5"	56.5"	58.5"	56.5"
15°	55.0"	63.5"	58.0"	64.5"	59.0"	65.5"
30°	54.5"	73.0"	56.0"	75.0"	58.0"	77.0"
45°	52.5"	80.5"	54.0"	83.0"	55.0"	86.0"
60°	49.0"	85.0"	50.0"	88.5"	*51.0"	*92.0"

FAN: FP7000OB (1)
 oil-rubbed bronze assembly
 (motor heads at 30°)
BLADES: CABPP4BR (1)
 52" sweep bronze/red all-weather
 composite oval palm

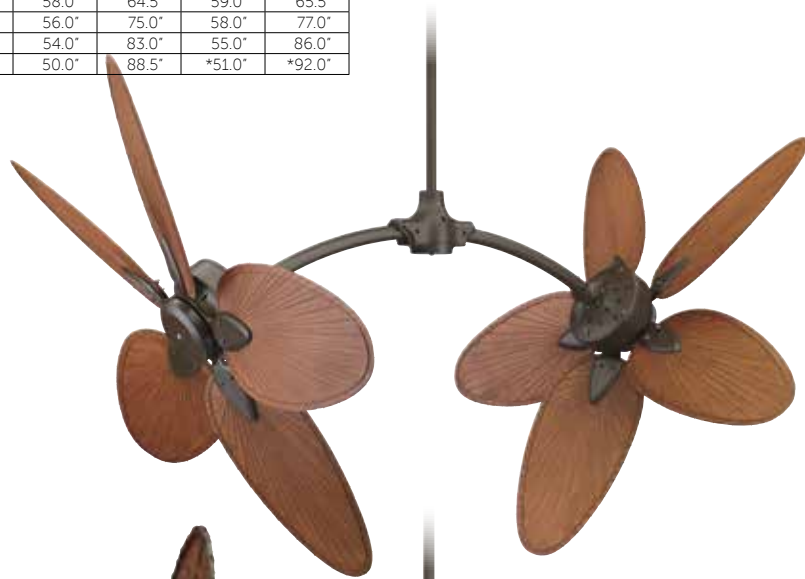

FAN: FP7000OB (1)
 oil-rubbed bronze assembly
 (motor heads vertical)
BLADES: CAISD2A (1)
 44" sweep antique wide
 oval woven bamboo



For compatible controls & accessories see pages 179 - 192

Recommended optional controls



TR24WH



SW70**



B5213WA
 walnut



CARUSO™

FAN: FP7000OB (1)
oil-rubbed bronze
assembly
BLADES: B5213WA (1)
52" sweep walnut
carved wood

FP7000**—AVAILABLE FINISHES:

OB
oil-rubbed
bronze

INCLUDED:



CW3WH-CA wall control



MIX & MATCH
components
sold separately



2-SPEED AC
reverse switch
on fans



CONTROL
wall



DRY OR DAMP
model specific

LIMITED LIFETIME MOTOR WARRANTY



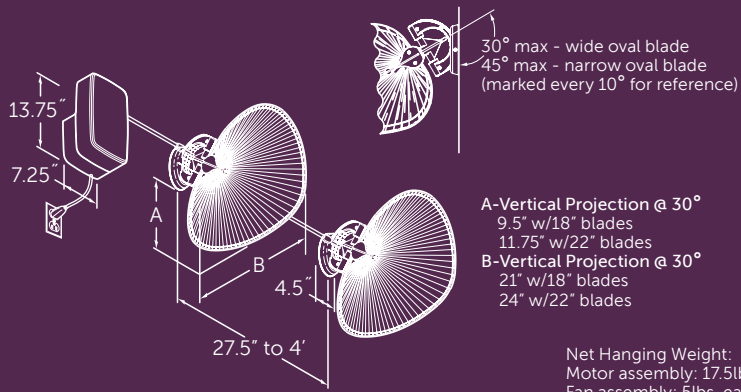

Not recommended for use in sound sensitive areas.



- ❖ **MOTOR: FP780AB** (1)
antique brass assembly
- FAN ASSEMBLIES: FP720AB** (4)
antique brass
- BLADES: PUP1** (4)
22" natural palm leaf wide oval



- ❖ **MOTOR: FP780PW** (1)
pewter assembly
- FAN ASSEMBLIES: FP720PW** (6)
pewter
- BLADES: PUD1A** (6)
22" antique woven bamboo
wide oval

PUNKAH®

◆ **MOTOR: FP780PW** (1)
pewter assembly
FAN ASSEMBLIES: FP720PW (5)
pewter
BLADES: PUP1 (5)
22" natural palm leaf wide oval

FP780** & FP720**—AVAILABLE FINISHES:

AB antique brass	PW pewter
-------------------------------	---------------------



POWER CORD
2' cord



MIX & MATCH
components
sold separately



1-SPEED AC
no reverse



DRY OR DAMP
model specific

LIMITED LIFETIME MOTOR WARRANTY



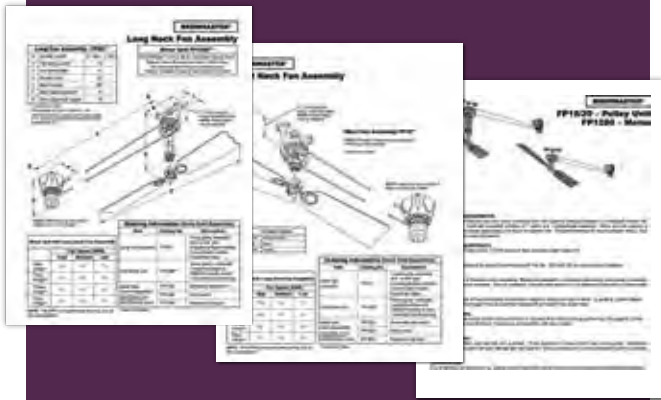

For dimensions and configurations, please see our model-specific specification sheet, available at fanimation.com

Not recommended for use in sound sensitive areas.



The Brewmaster® carries on Fanimation's reputation for reproducing unusual, yet functional, belt-drive fans. These fans were originally produced in the late 1800s by Snediker & Carr®, the premier belt-drive fan manufacturer of their day. Fanimation has adapted this timeless masterpiece to install and operate with more ease and durability.

- Neoprene belting replaces the high-maintenance leather belts.
- Lead and copper babbitt sleeves have given way to sealed ball bearings.
- Hardwood laminate blades that resist warping and splitting replace the temperamental solid wood blades.

The Brewmaster® combines the latest technology with several blade options including the original oversized wood blade design. The Brewmaster® is powered by a gearless direct drive motor, and allows you to operate one or two fans.

- ◆ **MOTOR: FP1280AB** (1)
antique brass assembly
- HEAD: FP10AB** (2)
antique brass short neck assembly
- BLADE SET: BMP1** (2)
50° sweep natural finish wide oval palm

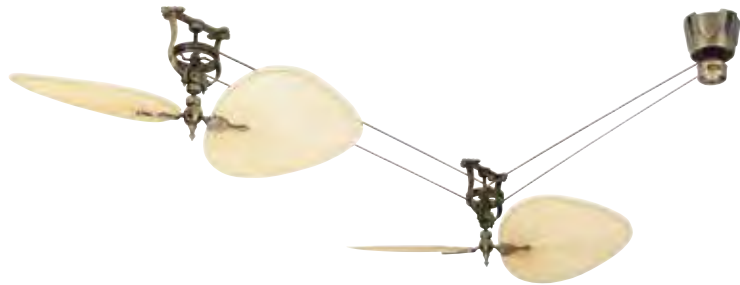

- ◊ **MOTOR: FP1280BL** (1)
black assembly (required but not shown)
- HEAD: FP20BL** (1)
black long neck assembly
- BLADE SET: BMD4A** (1)
50° sweep narrow oval woven bamboo



For compatible controls & accessories see pages 179 - 192

Recommended optional control



C21



reversible oak/walnut

FP1022
wood



cherry

FP1026
wood



rosewood

FP1030
wood



BREWMASTER™

-  **MOTOR: FP1280BL** (1)
black assembly (required but not shown)
- HEAD: FP20BL** (1)
black long neck assembly
- BLADE SET: FP1026** (1)
25" cherry

FP1280**, FP10** & FP20**—AVAILABLE FINISHES:

- AB**
antique
brass
- BL**
black

INCLUDED:



TR20WH control



MIX & MATCH
components
sold separately



3-SPEED AC
reverse switch
on remote



CONTROL
remote



DRY OR DAMP
model specific

FAN SPEED (RPM):	Fan Assemblies	High	Medium	Low
One		127	100	82
Two		106	60	46
Three		89	46	35
Four		76	38	28

LIMITED LIFETIME MOTOR WARRANTY





FANIMATION



FANS :: PORTABLE

5V DC Motor

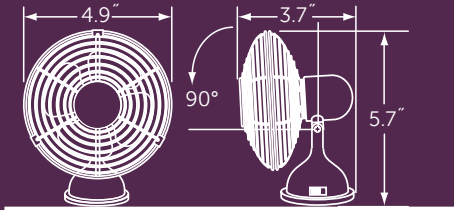

Net Weight: 1.1 lbs.

FAN: FP6252BN (1)
brushed nickel assembly with
brushed nickel fan blades and
brushed nickel cage



FAN: FP6252BN (1)
brushed nickel assembly with
brushed nickel fan blades and
brushed nickel cage



FAN: FP6252BN (1)
brushed nickel assembly with
brushed nickel fan blades and
brushed nickel cage



BABY BREEZY™

- Single speed
- ON/OFF slide switch
- AAA-battery powered (included)



FAN: MF90BL (1)
black metal assembly with
black composite fan blades

MINI BREEZE™



 **FAN: FP6252BN (1)**
brushed nickel assembly with
brushed nickel blades and
brushed nickel cage

FPD6252**—AVAILABLE FINISHES:

- BN**
brushed
nickel
- brushed
nickel

INCLUDED:

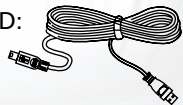

USB power cord



USB PLUG



1-SPEED
no reverse



DRY
indoor only

LIMITED LIFETIME MOTOR WARRANTY

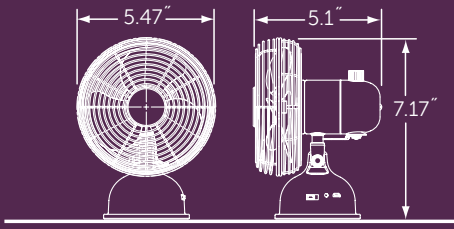

Net Weight: 1.32 lbs.

- ❖ **FAN: FP6272BN (1)**
brushed nickel assembly with
aluminum fan blades and
brushed nickel cage

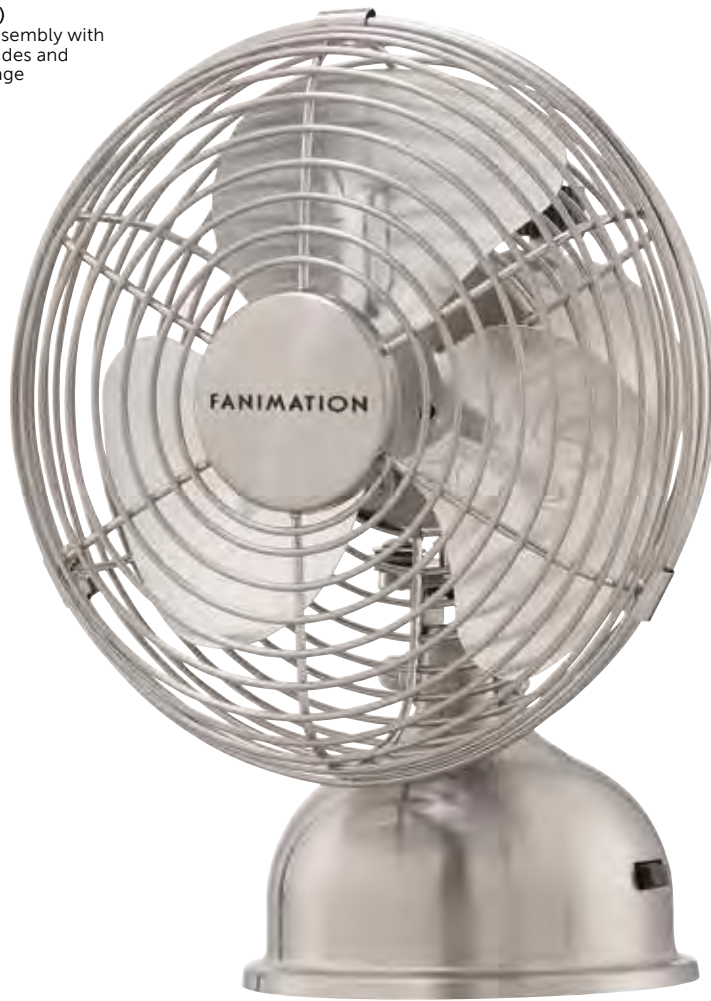

JUNIOR BREEZE™



 **FAN: FP6272BN (1)**
brushed nickel assembly
with aluminum blades and
brushed nickel cage

FP6272**—AVAILABLE FINISHES:

BN
brushed
nickel

aluminum

INCLUDED:

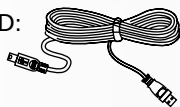

USB power cord



OSCILLATING



RECHARGEABLE
BATTERY
4-hour charge



USB PLUG



1-SPEED
no reverse



DRY
indoor only

LIMITED LIFETIME MOTOR WARRANTY

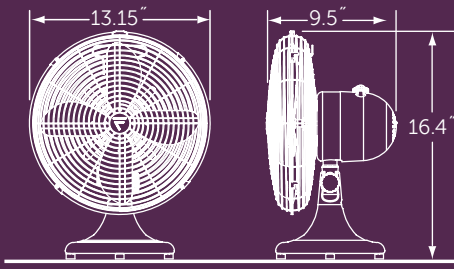

Net Weight: 6.84 lbs.

 **FAN: FP6274BL (1)**
black assembly with black
fan blades and black cage



 **FAN: FP6274BN (1)**
brushed nickel assembly
with aluminum blades
and cage



RETRO BREEZE™

 **FAN: FP6274BL (1)**
black assembly with black
fan blades and black cage

FP6274**—AVAILABLE FINISHES:

BN brushed nickel	BL black
aluminum	black

OSCILLATING



3-SPEED
no reverse

POWER CORD
8' cord

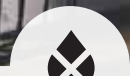
CONTROL
rotary

DRY
indoor only

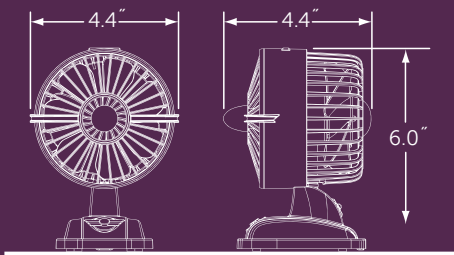
LIMITED LIFETIME MOTOR WARRANTY



Net Weight: 0.47 lbs.



FAN: FP7988MB (1)
mysterious black assembly
with chrome accents and black
blades



URBANJET JR™



FAN: FP7988MB (1)
mysterious black assembly
with chrome accents and
black blades



USB PLUG



2-SPEED
no reverse



DRY
indoor only

FP7988**—AVAILABLE FINISHES:

MB
mysterious
black
black

INCLUDED:

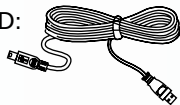

USB power cord

LIMITED LIFETIME MOTOR WARRANTY

76 x 66 AC Motor

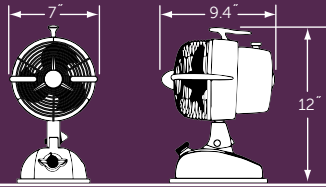

Net Weight: 5.1 lbs.

FAN: FP7958BB (1)
baby blue assembly with chrome accents and black blades



FAN: FP7958MB (1)
mysterious black assembly with chrome accents and black blades



FAN: FP7958MI (1)
milky ivory assembly with chrome accents and black blades



FAN: FP7958RG (1)
rose gold assembly with rose gold accents and black blades



FAN: FP7958SR (1)
spicy red assembly with chrome accents and black blades



FAN: FP7958SS (1)
sonic silver assembly with chrome accents and black blades



URBANJET™

 **FAN: FP7958RG (1)**
rose gold assembly with rose gold accents and black blades

FP7958**—AVAILABLE FINISHES:

BB baby blue	MB mysterious black	MI milky ivory	RG rose gold	SR spicy red	SS sonic silver
black	black	black	black	black	black

-  **OSCILLATING**
-  **3-SPEED**
no reverse
-  **POWER CORD**
5.5' cord
-  **CONTROL**
rotary
-  **DRY**
indoor only

LIMITED LIFETIME MOTOR WARRANTY

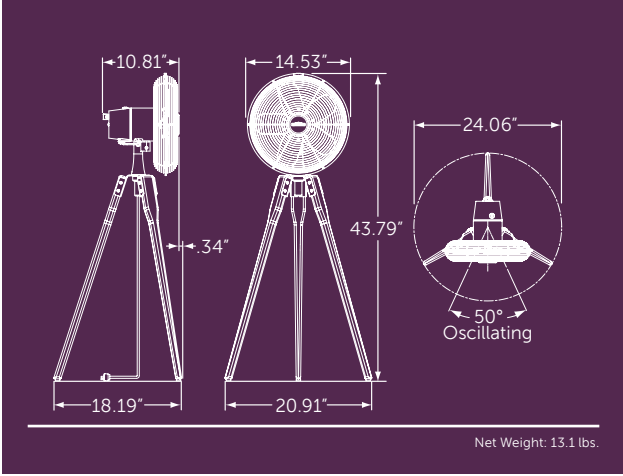

FAN: FP8014OB (1)
oil-rubbed bronze assembly with black blades and walnut finish legs



FAN: FP8014SN (1)
satin nickel assembly with black blades and walnut finish legs





ARDEN™

 **FAN: FP8014SN (1)**
satin nickel assembly with black
blades and walnut finish legs

FP8014**—AVAILABLE FINISHES:

OB oil-rubbed bronze	SN satin nickel
walnut	walnut

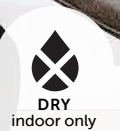
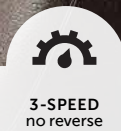

LIMITED LIFETIME MOTOR WARRANTY

For dimensions and configurations, please see our model-specific specification sheet, available at fanimation.com

FAN: FPH210AC (1)
antique copper with black motor assembly
CEILING MOUNT: FPH81BL1 (1)
black ceiling mount—1" dia. x 6" long downrod included



FAN: FPH210BL (1)
black assembly
BASE: FPH21BL (1)
black floor base
COLUMN: FPH70CP (1)
carved post column



FAN: FPH210RS (1)
rust assembly
WALL MOUNT: FPH61RS (1)
rust wall mount



For compatible controls & accessories see pages 159 - 170

Recommended optional control



CW1WH
wall control

COLUMNS



FPH70**

BL—black

CP—carved post

PEDESTAL MOUNT



FPH21BL
black

WALL MOUNT



FPH61**
black or rust

CEILING MOUNT



FPH811**
black or rust

use with CW1WH

OLD HAVANA™



 **MOTOR: FPH210RS** (1)
 rust assembly
BASE: FPH21BL (1)
 black pedestal base
COLUMN: FPH70CP (1)
 carved post

FPH210**—AVAILABLE FINISHES:

AC	BL	RS
antique copper	black	rust
black	black	rust



MIX & MATCH
components
sold separately



3-SPEED
no reverse



POWER CORD
8' cord



CONTROL
rotary



DRY OR DAMP
model specific

LIMITED LIFETIME MOTOR WARRANTY



BLADES

- Blades listed come in sets of five (5) except those for Punkah®—one (1), Brewmaster®—two (2), Palisade®—eight (8), Palmetto—three (3) and Caruso™—ten (10).
- Blades should be ordered based on the fan model selected
- Blade sets vary based on catalog number and are specific to fan models
- Some blade catalog numbers require fan finish codes
- Due to the nature of the materials and the hand-crafted processes; stain, color, texture and shading will vary



Belleria®	ISP1		ISP4		B5280WA	B6080WA	
Bourbon Street®	ISP1		ISP4	FP1018	B5280WA	B6080WA	
Brewmaster®	BMP1						
Caruso™			CAISP4				
Islander® AC	ISP1		ISP4		B5280WA	B6080WA	
Islander® DC	ISP1		ISP4		B5280WA	B6080WA	
Palisade®	PAP1						
Palmetto®		PMP2**					
Punkah®	PUP1						
Windpointe® Custom	ISP1		ISP4		B5280WA	B6080WA	



Belleria®	ISD1A			ISD4A	BPD1A	BPD4A	BPD4MW
Bourbon Street®	ISD1A			ISD4A	BPD1A	BPD4A	BPD4MW
Brewmaster®				BMD4A			
Caruso™				CAISD4A		CABPD4A	
Islander® AC	ISD1A			ISD4A	BPD1A	BPD4A	BPD4MW
Islander® DC	ISD1A			ISD4A	BPD1A	BPD4A	BPD4MW
Palisade®	PAD1A	PAD1C	PAD2A				
Palmetto®			PMD2A**				
Punkah®	PUD1A	PUD1C					
Windpointe® Custom	ISD1A			ISD4A	BPD1A	BPD4A	BPD4MW

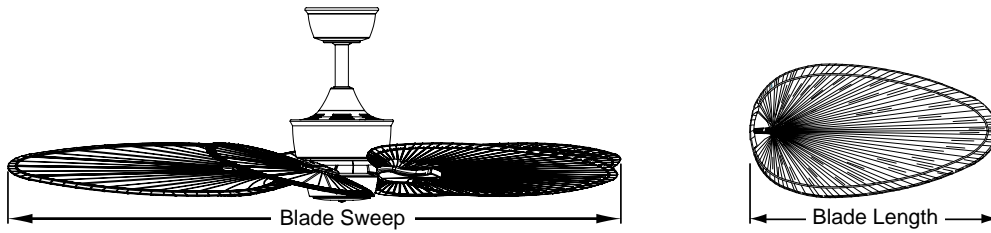

	B5340WA	B5350WA	B5330WA	B6130WA		B5133TKMH	B6133TKMH
	B5340WA	B5350WA	B5330WA	B6130WA		B5133TKMH	B6133TKMH
					B5213WA		
	B5340WA	B5350WA	B5330WA	B6130WA		B5133TKMH	B6133TKMH
	B5340WA	B5350WA	B5330WA	B6130WA		B5133TKMH	B6133TKMH
					B5213WA		
	B5340WA	B5350WA	B5330WA	B6130WA		B5133TKMH	B6133TKMH

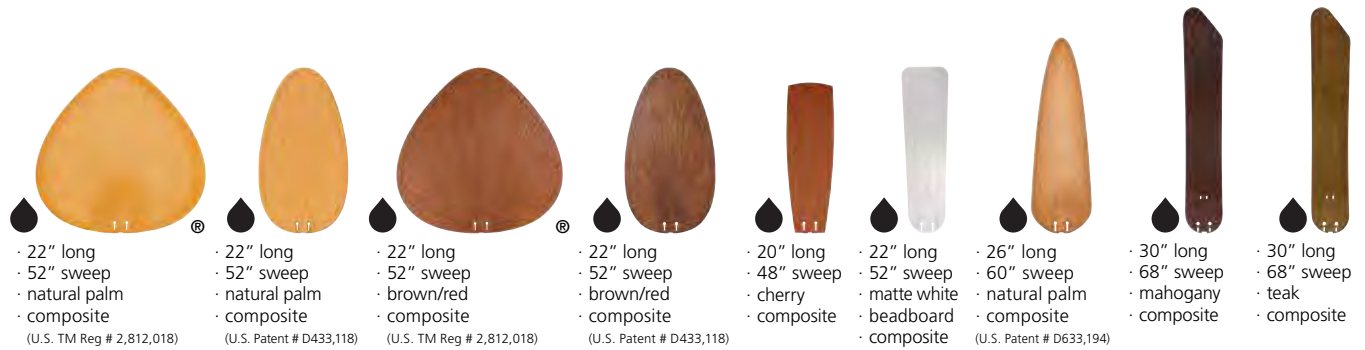

	BPP1TN	BPP4TN	BPP1BR	BPP4BR	BPW20CY	BPW24MW	BPW6090DNA	BPW6030TK
	BPP1TN	BPP4TN	BPP1BR	BPP4BR	BPW20CY	BPW24MW	BPW6090DNA	BPW6030TK
		CABPP4TN		CABPP4BR				
	BPP1TN	BPP4TN	BPP1BR	BPP4BR	BPW20CY	BPW24MW	BPW6090DNA	BPW6030TK
	BPP1TN	BPP4TN	BPP1BR	BPP4BR	BPW20CY	BPW24MW	BPW6090DNA	
	BPP1TN	BPP4TN	BPP1BR	BPP4BR	BPW20CY	BPW24MW	BPW6090DNA	BPW6030TK

LIGHT KITS

- Light kits are for use with most Fanimation fans
- Light bulb requirements vary and are listed for each light kit
- Pull-chain light kits come with chain and fob
- Light bulbs included
- **UL LISTED**



❖ **LK113WH** white fabric drum lamp shade

- 6.9" (H) x 14" (W)
- Three 50W halogen minican bulbs included
- Lumens: 1,500
- Color Temp: 2,750
- CRI: 99.7



◊ **LK114AOB** oil-rubbed bronze

- low-profile light kit
- opal frosted glass
- pull chain operation
- 4.8" (H) x 14" (W)
- Three 50W halogen minican bulb included
- Lumens: 1,500
- Color Temp: 2,750
- CRI: 99

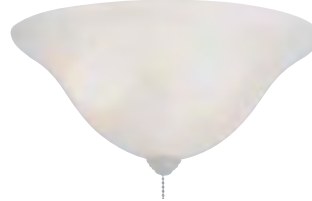

◊ **LK250** white frosted 13" bowl light kit

- 8" (H) x 13" (W)
- Three 50W halogen minican bulbs included
- Lumens: 1,500
- Color Temp: 2,750
- CRI: 99



◊ **LK260** amber frosted 13" bowl light kit

- 8" (H) x 13" (W)
- Three 50W halogen minican bulbs included
- Lumens: 1,500
- Color Temp: 2,750
- CRI: 99



◊ **LKLP101OB** oil-rubbed bronze

- low-profile light kit
- opal frosted glass
- pull chain operation
- 5.2" (H) x 8.5" (W)
- One 100W halogen minican bulb included
- Lumens: 1,600
- Color Temp: 2,800
- CRI: 99



◊ **LKLP102OB** oil-rubbed bronze

- low-profile light kit
- opal frosted glass
- pull chain operation
- 5.2" (H) x 8" (W)
- One 100W halogen minican bulb included
- Lumens: 1,600
- Color Temp: 2,800
- CRI: 99



◊ **LKLP111AOB** oil-rubbed bronze

- low-profile light kit
- amber linen glass
- pull chain operation
- 5.2" (H) x 8.5" (W)
- One 100W halogen minican bulb included
- Lumens: 1,600
- Color Temp: 2,800
- CRI: 99



◊ **LKLP111WWH** oil-rubbed bronze

- low-profile light kit
- white linen glass
- pull chain operation
- 5.2" (H) x 8.5" (W)
- One 100W halogen minican bulb included
- Lumens: 1,600
- Color Temp: 2,800
- CRI: 99



◊ **LKLP112AOB** oil-rubbed bronze

- low-profile light kit
- amber linen glass
- pull chain operation
- 5.2" (H) x 8.5" (W)
- One 100W halogen minican bulb included
- Lumens: 1,600
- Color Temp: 2,800
- CRI: 99



◊ **LKLP112WSN** satin nickel

- low-profile light kit
- white linen glass
- pull chain operation
- 5.2" (H) x 8.5" (W)
- One 100W halogen minican bulb included
- Lumens: 1,600
- Color Temp: 2,800
- CRI: 99

FITTERS, SHADES & DECORATIVE GLASS

- Bowl fitters are for use with most Fanimation fans
- Fitter glass sold separately below
- Glass bowls—12.75" diameter x 4.75" height (G210 and G400 series) require fitters F423 and FW423
- Small glass and shades (G200 series) for use with myFanimation F4 fitter only—page 63
- Finishes and light bulb requirements vary and are listed for each
- Glass and shades should be ordered based on the fitter model selected
- Light bulbs included

UL LISTED



- ◆ F423AB antique brass
- F423MW matte white
- F423OB oil-rubbed bronze
- ◆ F423PW pewter
- F423RS rust
- F423WH white

- 6" (H) x 6" (W)
- Three 50W halogen minican bulbs included
- Lumens: 1,500
- Color Temp: 2,750
- CRI: 99



- ◆ FW423AZ aged bronze
- ◆ FW423OB oil-rubbed bronze
- ◆ FW423RS shown in rust
- ◆ FW423TS tortoise shell
- ◆ FW423WH white

- Uses glass bowls only, sold separately below
- 7" (H) x 13" (W)
- Three 60W candelabra bulbs included
- Lumens: 1,530
- Color Temp: 2,700
- CRI: 99.7



G210
Tropical bowl



G439
Hand-painted parrot



G450
Amber



G451
Powdered amber



G456
White frost

ADDITIONAL *my* FANIMATION GLASS



G235
Tropical etched glass



G239
Hand-painted parrot



G244
Aged bronze/amber shade



G250
Amber



G256
White frost

DOWNRODS & ACCESSORIES

DOWNRODS

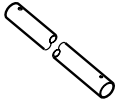

- Order according to length
- Use finish code to complete the part number—larger swatches on page 173
- See page bottom of page for suggested lengths

DOWNROD COUPLERS



- Joins two downrods together for extended lengths
- When ordering, use finish code for steel downrods shown above to complete the part number.

DR1-CP** 1" diameter downrod coupler

STEEL

- DR1-12** 12" downrod
- DR1-18** 18" downrod
- DR1-24** 24" downrod
- DR1-36** 36" downrod
- DR1-48** 48" downrod
- DR1-60** 60" downrod
- DR1-72** 72" downrod

AB antique brass	AZ aged bronze	BA bronze accent	BL black	BN brushed nickel	BS brushed satin brass	DCP dark copper penny
DF driftwood	DZ dark bronze	GR matte greige	GZ galvanized	MG metro gray	MW matte white	OB oil-rubbed bronze
PN polished nickel	PW pewter	RS rust	SN satin nickel	TB textured black	TS tortoise shell	WH white

STAINLESS STEEL

- DR1SS-12*** 12" wet downrod
- DR1SS-18*** 18" wet downrod
- DR1SS-24*** 24" wet downrod
- DR1SS-36*** 36" wet downrod
- DR1SS-48*** 48" wet downrod
- DR1SS-60*** 60" wet downrod
- DR1SS-72*** 72" wet downrod

TRUE STAINLESS STEEL DOWNROD.
Wet location rated. Resistant to rust and corrosion.

ABW antique brass	AZW aged bronze	BLW black	BNW brushed nickel	BSW brushed satin brass	DCPW dark copper penny	DFW driftwood
DZW dark bronze	GRW matte greige	GZ galvanized	MGW metro gray	MWW matte white	OBW oil-rubbed bronze	PWW pewter
RSW rust	SLW silver	SNW satin nickel	SSBNW stainless steel brushed nickel	TBW textured black	TSW tortoise shell	WHW white

Recommended downrod length is based on ceiling height. Ideal distance from floor to fan blades is 7 to 9 feet.

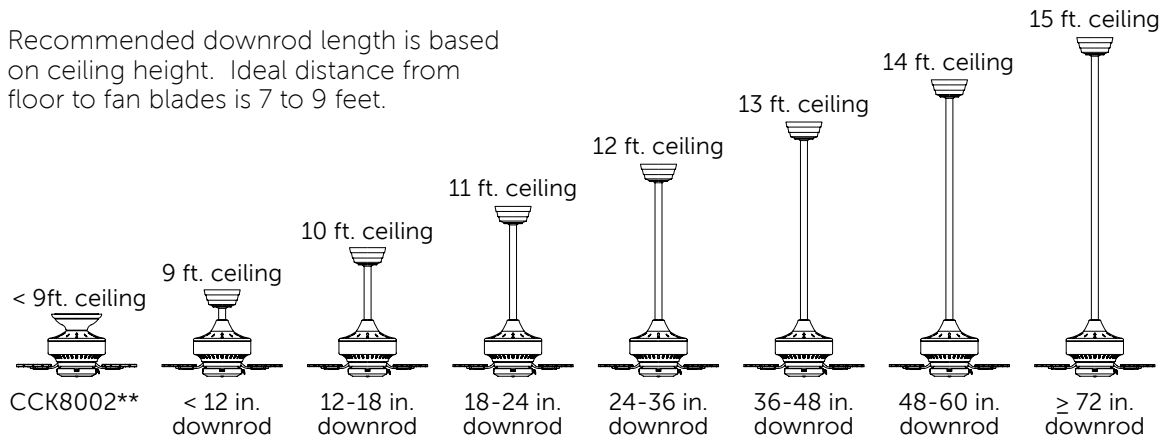

For lengths greater than 72 in., join two downrods with DR1-CP** coupler

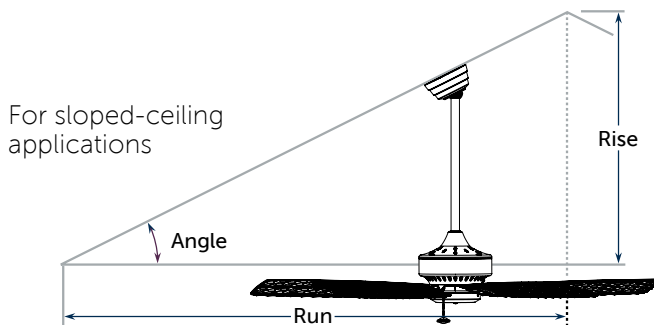

Pitch (Rise/Run)	Angle	Minimum Downrod
1/12	4.8°	Standard
2/12	9.5°	6"
3/12	14.0°	12"
4/12	18.4°	12"
5/12	22.6°	18"
6/12	26.5°	18"
7/12	30.3°	24"
8/12	33.7°	24"
> 8/12	> 33.7°	> 36"

Ideal distance from floor to fan blades is 7 to 9 feet.

CLOSE-TO-CEILING KIT



- Replaces hanger bracket/downrod assembly to move your fan closer to the ceiling, creating more head room
- Intended for use with low ceilings.
- Please see individual fan pages for compatibility
- Tall and short kits both included.
- Tall dimensions: 5.13" (H) x 8" (DIA.)
- Short dimensions: 2.67" (H) x 8" (DIA.)

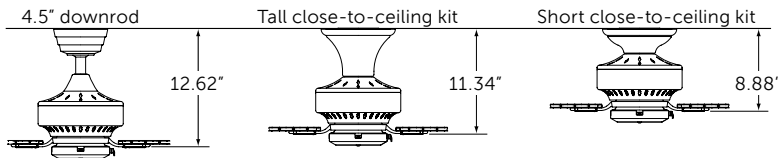

STANDARD

CCK8002AB	antique brass	CCK8002OB	oil-rubbed bronze
CCK8002AZ	aged bronze	CCK8002PN	polished nickel
CCK8002BA	bronze accent	CCK8002PW	pewter
CCK8002BL	black	CCK8002RS	rust
CCK8002BN	brushed nickel	CCK8002SN	satin nickel
CCK8002CH	chrome	CCK8002TS	tortoise shell
CCK8002DCP	dark copper penny	CCK8002WH	white
CCK8002DZ	dark bronze		
CCK8002GZ	galvanized		
CCK8002MW	matte white		

WET RATED

CCK8002ABW	antique brass	CCK8002MWW	matte white wet
CCK8002AZW	aged bronze	CCK8002OBW	oil-rubbed bronze wet
CCK8002BLW	black	CCK8002MWW	pewter wet
CCK8002BNW	brushed nickel wet	CCK8002RSW	rust wet
CCK8002BSW	brushed satin brass wet	CCK8002SLW	silver wet
CCK8002DCPW	dark copper penny wet	CCK8002SNW	satin nickel wet
CCK8002DFW	driftwood wet	CCK8002TBW	textured black wet
CCK8002DZW	dark bronze wet	CCK8002TSW	tortoise shell wet
CCK8002GRW	matte greige wet	CCK8002WHW	white wet
CCK8002MGW	metro gray wet		

EXTENSION POLES

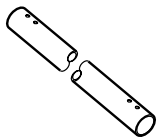

- For use with Palisade® only
- Order according to length
- Use finish code to complete the part number

EP24**	24" downrod
EP30**	30" downrod
EP36**	36" downrod
EP48**	48" downrod
EP60**	60" downrod
EP72**	72" downrod

OB	PW	RS
oil-rubbed bronze	pewter	rust

EXTENSION POLE COUPLERS



- For use with Palisade® only
- Joins two extension poles together for extended lengths
- Use finish code to complete the part number.

EPCC** Extension pole coupler

SLOPED CEILING BALL KIT



- Includes black hanger ball only
- See spec section of individual fan pages for compatibility with your fan.
- Hanger ball works with current Fanimation canopy and hanger bracket.
- Allows for ceiling slope up to 42°.
- For use with any length downrod

SCB1-52 For use with 1" dia. downrods

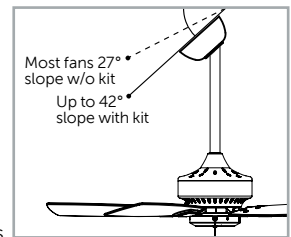

SLOPED CEILING KIT



- Includes hanger bracket, hanger ball, ceiling canopy, canopy screw cover and mounting hardware
- See spec section of individual fan pages for compatibility with your fan.
- Allows for ceiling slope up to 42°
- For use with any length downrod

SCK1-52AZ	aged bronze	SCK1-52MW	matte white
SCK1-52BL	black	SCK1-52OB	oil-rubbed bronze
SCK1-52BN	brushed nickel	SCK1-52PN	polished nickel
SCK1-52BS	brushed satin brass	SCK1-52PW	pewter
SCK1-52DF	driftwood	SCK1-52SN	satin nickel
SCK1-52DZ	dark bronze	SCK1-52TS	tortoise shell
SCK1-52GR	matte greige	SCK1-52WH	white

HAND-HELD CONTROLS

- Control options are not available for Bourbon Street®, Palmetto® and Punkah®

UL LISTED

-  Included
-  Optional

Do not store or mount remote controls outdoors

WH—White LA—Light Almond



- BTCR9**
- Bluetooth® connectivity
 - Fan and downlight
 - Receiver unit and hand-held transmitter



- BTCR9U**
- Bluetooth® connectivity
 - Fan and uplight/ downlight
 - Receiver unit and hand-held transmitter





































































- BTR9**
- Bluetooth® connectivity
 - Fan and downlight
 - Receiver unit only



- BTT9**
- fanSync™ companion remote control
 - Hand-held transmitter only
 - 3 fan speeds
 - Downlight control
 - Wall mount for remote



- BTT9R**
- fanSync™ companion remote control
 - Hand-held transmitter only
 - 3 fan speeds with reverse
 - Downlight control
 - Wall mount for remote

Aire Décor®—All					
Aire Deluxe™—All					
Ascension™					
Avaston™					
Beckwith™					
Belleria®					
Benito™ v2					
Big Island™					
Brewmaster®					
Camhaven™					
Cancun™—All					
Caruso™					
Celano v2™					
Crestford™					
Drone™					
Duplex™					
Edgewood®—All					
Embrace™—All					
Enigma®					
Extraordinaire®					
Hugh™—All					
Islander® AC					
Islander® DC					
Kaya™					
Kellan™					
Levon™ AC					
Levon™ Custom—All					
myFanimation™ Distinction™ AC					
myFanimation™ Distinction™ DC					
Odyn™—All					
Old Havana®					
Palisade®					
Palma™					
Pickett™					
Pickett™ Drum					
Rotation™					
Spitfire™					
Stafford™					
Stellar™—All					
Subtle™					
Torch™					
Torto™					
Torto™ LED					
Ventana™					
Windpointe®					
Xeno™ Damp					
Xeno™ Wet					
Zonix™ Wet					
Zonix™ Wet Custom					

HAND-HELD CONTROLS

- Control options are not available for Bourbon Street®, Palmetto® and Punkah®

UL LISTED

-  Included
-  Optional

Do not store or mount remote controls outdoors

WH—White LA—Light Almond



RC110WH

- Extraordinaire® non-reversing fan remote
- Receiver unit and hand-held transmitter
- Mounts over switch plate
- 3 fan speeds



SW24**

- Palisade® receiver unit
- Receiver unit only
- For use with TR24** control

SW70**

- Caruso™ receiver unit
- Receiver unit only
- For use with TR24** control



TR20WH

- Reversible fan and light remote
- Hand-held transmitter only
- Mounts over switch plate
- 3 fan speeds
- Downlight control





















TR24WH

- Non-reversible fan and light remote
- Hand-held transmitter only
- Mounts over switch plate
- 3 fan speeds
- Downlight control



TR33WH

- Hand-held remote with wall mount
- Hand-held transmitter only

Aire Décor®—All						
Aire Deluxe™—All						
Ascension™						
Avaston™						
Beckwith™						
Belleria®						
Benito™ v2						
Big Island™						
Brewmaster®						
Camhaven™						
Cancun™—All						
Caruso™						
Celano v2™						
Crestford™						
Drone™						
Duplex™						
Edgewood®—All						
Embrace™—All						
Enigma®						
Extraordinaire®						
Hugh™—All						
Islander® AC						
Islander® DC						
Kaya™						
Kellan™						
Levon™ AC						
Levon™ Custom—All						
myFanimation™ Distinction™ AC						
myFanimation™ Distinction™ DC						
Odyn™—All						
Old Havana®						
Palisade®						
Palma™						
Pickett™						
Pickett™ Drum						
Rotation™						
Spitfire™						
Stafford™						
Stellar™—All						
Subtle™						
Torch™						
Torto™						
Torto™ LED						
Ventana™						
Windpointe®						
Xeno™ Damp						
Xeno™ Wet						
Zonix™ Wet						
Zonix™ Wet Custom						

*Must use with SW24 **Must use with SW50** *** Must use with SW70

WALL CONTROLS

- Wall controls include matching face plate
- Control options are not available for Bourbon Street®, Palmetto® and Punkah®

• UL LISTED

-  Included
-  Optional

Do not store or mount wall controls outdoors unless using WP60 waterproof box

WH—White LA—Light Almond



C21

- Reversible fan and light control
- 2-wire installation
- 3 fan speeds
- infinite light levels
- Control only. Does not include receiver.
- Four use with 4-dipswitch and fansync receivers

C25





















































- Non-reversing fan and light control
- battery operated
- 3 fan speeds
- infinite light levels
- Control only. Does not include receiver.
- Four use with 4-dipswitch and fansync receivers

CW1WH & CW1LA

- Fan-only slide control
- 2-wire installation
- 3 fan speeds
- 1.25 amps max. fan load

CW1SWWH & CW1SWLA

- Fan slide control with
- light on/off toggle switch
- 3-wire installation
- 3 fan speeds
- 1.25 amps max. fan load

Aire Décor®—All				
Aire Deluxe™—All				
Ascension™				
Avaston™				
Beckwith™				
Belleria®				
Benito™ v2				
Big Island™				
Brewmaster®				
Camhaven™				
Cancun™—All				
Caruso™				
Celano v2™				
Crestford™				
Drone™				
Duplex™				
Edgewood®—All				
Embrace™—All				
Enigma®				
Extraordinaire®				
Hugh™—All				
Islander® AC				
Islander® DC				
Kaya™				
Kellan™				
Levon™ AC				
Levon™ Custom—All				
myFanimation™ Distinction™ AC				
myFanimation™ Distinction™ DC				
Odyn™—All				
Old Havana®				
Palisade®				
Palma™				
Pickett™				
Pickett™ Drum				
Rotation™				
Spitfire™				
Stafford™				
Stellar™—All				
Subtle™				
Torch™				
Torto™				
Torto™ LED				
Ventana™				
Windpointe®—All				
Xeno™ Damp				
Xeno™ Wet				
Zonix™ Wet				
Zonix™ Wet Custom				

WALL CONTROLS

- Wall controls include matching face plate
- Control options are not available for Bourbon Street®, Palmetto® and Punkah®

• UL LISTED

-  Included
-  Optional

Do not store or mount wall controls outdoors unless using WP60 waterproof box

WH—White LA—Light Almond



- CW40**
- Fan-only slide control
 - 2-wire installation
 - 4 fan speeds
 - 1.25 amps max. fan load











































- CW60WH**
- Fan and light control
 - 3-wire installation
 - Infinite light levels
 - 3 fan speeds
 - 1.25 amps max. fan load
 - Wet rated when used with WP60—this page



- CW110WH**
- Extraordinaire® fan-only slide control
 - 2-wire installation
 - 3 fan speeds
 - 1.25 amps max. fan load



- CWRL4WH & CWRL4LA**
- Non-reversing fan and light control
 - 2-wire installation
 - 3 fan speeds
 - 1.0 amps max. fan load
 - Learn-mode canopy receiver unit with 65,000 code settings included
 - Infinite light levels up to 190 watts
 - Dimmer on/off switch for use with CFL bulbs
 - May be used with CRL4WH

Aire Décor®—All				
Aire Deluxe™—All				
Ascension™				
Avaston™				
Beckwith™				
Belleria®				
Benito™ v2				
Big Island™				
Brewmaster®				
Camhaven™				
Cancun™—All				
Caruso™				
Celano v2™				
Crestford™				
Drone™				
Duplex™				
Edgewood®—All				
Embrace™—All				
Enigma®				
Extraordinaire®				
Hugh™—All				
Islander® AC				
Islander® DC				
Kaya™				
Kellan™				
Levon™ AC				
Levon™ Custom—All				
myFanimation™ Distinction™ AC				
myFanimation™ Distinction™ DC				
Odyn™—All				
Old Havana®				
Palisade®				
Palma™				
Pickett™				
Pickett™ Drum				
Rotation™				
Spitfire™				
Stafford™				
Stella™—All				
Subtle™				
Torch™				
Torto™				
Torto™ LED				
Ventana™				
Windpointe®—All				
Xeno™ Damp				
Xeno™ Wet				
Zonix™ Wet				
Zonix™ Wet Custom				

CONTROL ACCESSORY



CONTROL YOUR CEILING FAN WITH YOUR SMART DEVICES!



BTCR9

- fanSync™ Bluetooth® receiver & companion remote control
- 3 fan speeds
- Downlight control
- Timer, safe exit and favorites list via smart device
- Wall mount for remote



BTCR9U

- Bluetooth® connectivity
- Fan and uplight/downlight
- Receiver unit and hand-held transmitter



BTR9

- fanSync™ Bluetooth® receiver
- Controls fan and light via smart device
- 3 fan speeds
- Downlight control
- Timer, safe exit and favorites list via smart device
- Wall mount for remote



BTT9

- fanSync™ companion remote control
- 3 fan speeds
- Downlight control
- Wall mount for remote



BTT9R

- fanSync™ companion remote control
- 3 fan speeds with reverse
- Downlight control
- Wall mount for remote



BTT9U

- fanSync™ companion remote control
- 3 fan speeds
- Uplight/downlight control
- Wall mount for remote

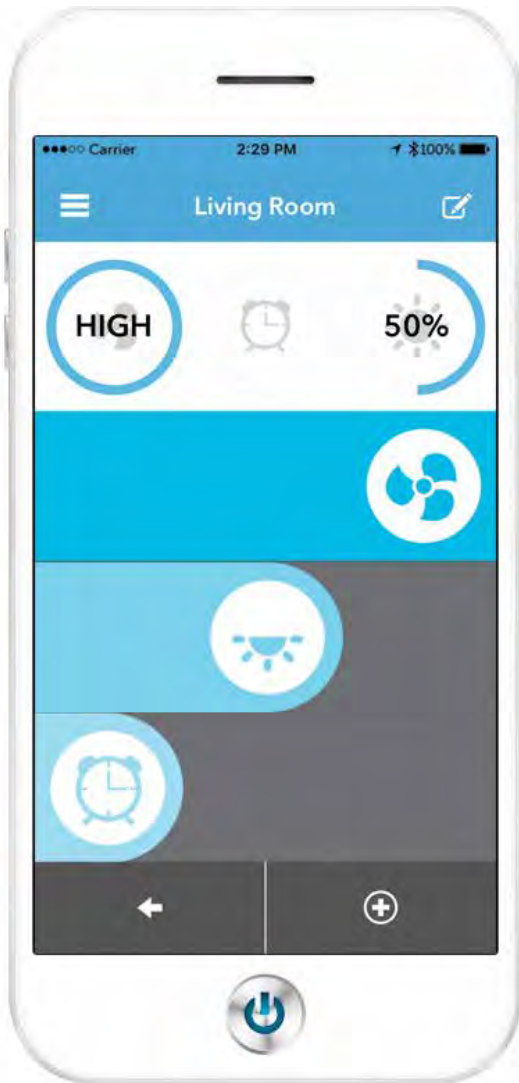

1 fanSync is universal and works with most brands of **3-speed AC ceiling fans**.

2 Easily wire and install the fanSync receiver into your ceiling fan's hanger bracket/canopy.

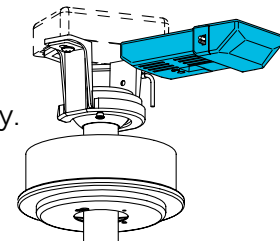

3 Download the fanSync app to your smart device from Google Play or the App Store.

4 Easily find and set up your fan(s) in the fanSync app.



5 Explore and enjoy the many features of the fanSync app!



Fan Speed



Light Dimming



Timer



Safe Exit



Favorites List

BULB REFERENCE

- Fans that include a light kit list the light source under the light kit feature icon on the fan page
- Understanding lumens, correlated color temperature and color rendering index values will help you understand what light output to expect from each fan

LUMENS VERSUS WATTS

In years past, consumers used wattage to rate the brightness of a lamp. However, wattage is a measure of energy use and is not an accurate indicator of lamp brightness. Energy efficient light sources such as LEDs and Compact Fluorescent Lamps (CFL) have much lower wattages while still producing a great amount of light. While wattage measures energy use, lumens measure light output—luminous flux. When determining light output, it is best to compare lumens.

WHAT IS CORRELATED COLOR TEMPERATURE?

Color appearance, also known as Correlated Color Temperature (CCT), is a measure of how warm or cool a light source appears to the human eye. It is measured in degrees Kelvin. The majority of light sources have a Kelvin temperature within the range of 2700K to 6500K. For reference, noon-time daylight has a Kelvin temperature of 5000K. Incandescent light sources generally range from 2700-3500K. Compact Fluorescents and LEDs can range from 2700-6500K. The lower the Kelvin temperature, the warmer the light source appears and the higher the Kelvin temperature, the cooler the light source appears.

WARM WHITE	2700K
SOFT WHITE	3000K
NEUTRAL	3500K
COOL	4100K
SOFT DAYLIGHT	5000K
DAYLIGHT	6500K

WHAT IS THE COLOR RENDERING INDEX?

CRI is the ability of a light source to light up objects of different colors and properly display the colors without influence or making the color look adjusted. CRI is represented by a number on a scale from 0 to 100 with 100 being best. The lower the number, the more distorted a color will look under the light source.

EXAMPLES OF BULB BASES AND TYPES

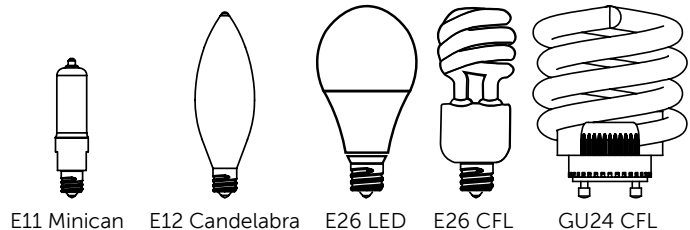

Bulb Base	Bulb Type	Watts	Lumens per Bulb	Correlated Color Temperature (CCT)	Color Rendering Index (CRI)
E11	Minican Halogen Frosted	50	500	2,800	100
E11	Minican Halogen Frosted	75	1,031	2,800	100
E11	Minican Halogen Clear	100	1,600	2,800	100
E12	Candelabra Incandescent Frosted	40	340	2,800	100
E12	Candelabra Incandescent Clear	40	358	2,800	100
E12	Candelabra Halogen (B10)	43	342	2,800	100
E12	Candelabra Incandescent Frosted	60	510	2,800	100
E12	Candelabra Incandescent Clear	60	560	2,800	100
E26	Compact Fluorescent (CFL)	13	959	2,700	80
E26	Compact Fluorescent (CFL)	23	1,600	2,700	80
E26	10W LED	10	800	2,700	90
GU24	Compact Fluorescent (CFL)	13	900	2,700	80
GU24	Compact Fluorescent (CFL)	26	1,600	2,700	80
Connector Pin	16W LED Module	16	1,350	3,000	80
Connector Pin	18W LED Module	18	1,350-1,440	3,000	80-90

FINISH SWATCHES

MOTOR, DOWNROD & LIGHT KIT FINISHES



BA :: ANTIQUE BRASS



AZ :: AGED BRONZE



BA :: BRONZE ACCENT



BL :: BLACK



BN :: BRUSHED NICKEL
SSBNW :: STAINLESS STEEL
BRUSHED NICKEL



BNW :: BRUSHED NICKEL WET



BS :: BRUSHED SATIN BRASS



DCP :: DARK COPPER PENNY



DF :: DRIFTWOOD



DZ :: DARK BRONZE



GBL :: GLOSSY BLACK



GWH :: GLOSSY WHITE



GR :: MATTE GREIGE



GZ :: GALVANIZED



MG :: METRO GRAY



MW :: MATTE WHITE

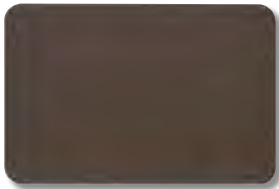

OB :: OIL-RUBBED BRONZE

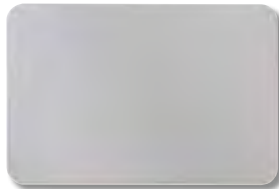

PN :: POLISHED NICKEL



PW :: PEWTER



RS :: RUST



SL :: SILVER
SLW :: SILVER WET



SN :: SATIN NICKEL



TB :: TEXTURED BLACK



TS :: TORTOISE SHELL

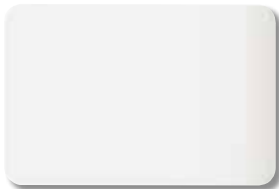

WH :: WHITE

BLADE FINISHES



**A :: ANTIQUE WOVEN
BAMBOO**



BL :: BLACK



BN :: BRUSHED NICKEL



BOB :: BOURBON



CY :: CHERRY



DC :: DARK CHERRY



DF :: DRIFTWOOD



DWA :: DARK WALNUT



DZ :: DARK BRONZE



GR :: MATTE GREIGE

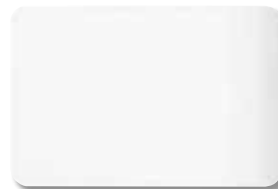

MW :: MATTE WHITE



N :: NATURAL



P :: NATURAL PALM



SL :: SILVER



WA :: WALNUT



WE :: WEATHERED WOOD



WK :: WHISKEY WOOD



WP :: WASHED PINE



WW :: WHITE WASHED

ANTIQUe FAN MUSEUM

presented by the Antique Fan Collectors Association



PASSION, HERITAGE & PRESERVATION

Led by our Founder and CEO, Tom Frampton, Fanimation is dedicated to preserving the history of fans and the fan industry. For years, Tom has been an avid antique fan collector and member of the Antique Fan Collectors Association (AFCA). The AFCA membership has operated a museum since 1997, displaying fans on loan by the membership; this museum was in Wichita, Kansas up until 2008, when the need to relocate the museum arose. Answering the call to preserve viewing of the one-of-a-kind collection, Fanimation made the offer to house the museum at its facility in Zionsville. The move and set-up took nearly a year and the museum saw its reopening July 23, 2009. Since that time, the museum has grown and continues to grow, housing over a thousand antique fans on two floors. Tom's own unique collection of fans is a part of the museum collection along with over 500 antique advertising style hand fans and other fan memorabilia.





LOCATION

10983 Bennett Parkway
Zionsville, IN 46077



HOURS

Monday thru Friday 10 am - 4 pm
Or call for an appointment, 317-733-4113



MUSEUM HIGHLIGHTS

- The AFCA museum contains more than 1,000 antique ceiling, desk and hand fans with over 140 manufacturers represented
- The oldest electric desk fan in the museum dates from the early 1890's
- The oldest non-electric fans (steam, belt & pulley or water powered) date from the early 1880's.
- It is the only antique fan museum open to the public in the world
- The AFCA has approximately 700 members worldwide
- The museum contains some of the earliest battery-powered fans, water-powered fans, wind-up fans, electric hand-held fans, ceiling fans, wall fans, desk fans, pedestal fans, rail-car fans and fans that don't even look like fans.
- The museum contains hundreds of hand-held fans that feature advertising from manufactures, retailers, politicians and movie stars.



INDEX

FANS	PAGE	FANS	PAGE	FANS	PAGE
A1**	113, 114, 118	FP7000OB	157, 158	MA4660**	69 - 72
BP200**1	125, 126	FP720**	159, 160	MA4660SSBNW	69, 71
BP210**1	125, 126	FP7500**	143, 144	MA6721**	73, 74
BP215OB1	125, 126	FP780**	159, 160	MA7500**	145, 146
BP220**1	125, 126	FP7900**	107, 108	MA7966**	41, 42
BP225OB1	125, 126	FP7902BN	109, 110	MAD3250**	151, 152
BP230**1	125, 126	FP7910**	27, 28	MAD3252**	153, 154
C1**	113, 114, 118	FP7954OB	135, 136	MAD7912**	79 - 84
D1**	115, 118, 120	FP7958**	173, 174	MAD7993**	103, 104
FP10**	161, 162	FP7963RS	137, 138	MAD7997**	97 - 102
FP1280**	161, 162	FP7964**	11, 12	MAD7998**	105, 106
FP20**	161, 162	FP7988**	171, 172	MAD8152**	87 - 92
FP2120MG	121, 122	FP7996BL**W	133, 134	MF90BL	165
FP240**	155, 156	FP8003B**	123, 124	OF110**	49, 50
FP320**1	149, 150	FP8012**	139, 140	PL8274**	21, 22
FP4320**1	147, 148	FP8014**	175, 176	TF610**	35, 36
FP4640**	65, 66	FP8016OB	139, 140	TF710**	37, 38
FP510**	43, 44	FP8018**	47, 48	TF721**	39, 40
FP520**	43, 44	FP8032DZ	25, 26	TF910**	127, 128
FP580**	43, 44	FP8042**	29, 30	TF971**	129, 130
FP601**	43, 44	FP8062**	19, 20		
FP602**	43, 44	FP8095**	23, 24	LIGHT KITS	PAGE
FP603**	43, 44	FP8458**	57, 58	LK113WH	181
FP604**	43, 44	FPD6235**	55, 56	LK114AOB	181
FP605**	43, 44	FPD6236**	75, 76	LK250	181
FP6210**	111, 112	FPD6254GR	17, 18	LK260	181
FP6245B**	31, 32	FPD8159**	93, 94	LK4640**	65
FP6252BN	165, 166	FPH21**	177, 178	LK4660**	69 - 71
FP6258BNMW	141, 142	FPH210**	177, 178	LK6721**	73, 74
FP6260BL**	131, 132	FPH61**	177	LK7912**	79 - 84
FP6272**	167, 168	FPH70**	177, 178	LKLP101OB	181
FP6274**	169, 170	FPH81**1	177	LKLP102OB	145, 181
FP6284**	33, 34	FPS7955**	13, 14	LKLP111AOB	181
FP6285B**	33, 34	FPS7981**	15, 16	LKLP111WWH	181
FP6717**	59, 60	FPS8332**W	51, 52	LKLP112AOB	181
FP6728**	61, 62	FPS8355**W	53, 54	LKLP112WSN	181
FP6729**W	63, 64	HA7966**	41, 42		

FITTERS	PAGE	BLADES	PAGE	BLADES	PAGE
F1**	115, 118, 119	B472**	118	BPD4**	147, 179
F2**	113 - 115, 119, 120	B5080CP	155, 156	BPP1**	180
F3**	113, 119	B5080SS	155	BPP4**	147, 180
F4**	113, 115, 119, 182	B5133TKMH	149, 180	BPW20CY	145, 149, 180
F423**	151, 182	B5213WA	155, 157, 158, 180	BPW24MW	180
FW423**	182	B5280WA	145, 179	BPW4426**	65
		B5300WA	153	BPW4442**	65
		B5330WA	180	BPW4660-44**W	69, 70
		B5340WA	145, 147, 180	BPW4660-52**W	71, 72
		B5350WA	180	BPW6000**	153, 154
		B554**	118	BPW6030**	180
		B560**	113, 118	BPW6090DNA	145, 146, 148, 151, 180
		B6080WA	179	BPW7912**	81, 82
		B6130WA	180	BPW7913**	83, 84
		B6133TKMH	180	BPW7914**	79, 80
		B654**	114, 115, 118	BPW8152-56**W	87, 88
		B660**	118	BPW8152-64**W	89, 90
		B6720**	73, 74	BPW8152-72**W	91, 92
		B6801**	153	CABPD4A	170
		B6831WA	153	CABPP4**	157, 180
		B6841DWA	153	CAISD4A	179
		B754DWA	113, 118	CAISP4	179
		B760DWA	118	FP1018	43, 179
		B7912**	81	FP1022	161
		B7913**	83	FP1026	161, 162
		B7914**	79	FP1030	161
		B7966**	41, 42	ISD1A	145, 149, 151, 179
		B7993-84**W	103, 104	ISD4A	152, 179
		B7997-56**W	97, 98	ISP1	149 - 151, 179
		B7997-64**W	99, 100	ISP4	151, 179
		B7997-72**W	101, 102	PAD1*	155, 179
		B7998-96**W	105, 106	PAD2A	179
		B854**	118	PAP1	179
		B860**	115, 118	PMD2A**	44, 179
		BMD4A	161, 179	PMP2**	179
		BMP1	161, 179	PUD1*	159, 179
		BPD1A	179		

CONTINUED ON NEXT PAGE

INDEX

BLADES	PAGE	CONTROLS	PAGE	ACCESSORIES	PAGE
PUP1.....	159, 160, 179	TR500.....	188	ET6235-48**.....	55
CONTROLS	PAGE	TR500U.....	188	FL**.....	155
BTCR9.....	185, 193	TW206.....	55, 75, 87, 89, 91, 93, 97, 99, 101, 103, 105, 115, 119, 192	P48.....	155
BTCR9U.....	57, 185, 193	TW40**.....	17, 79, 81, 83, 151, 153, 192	SCB1-52.....	184
BTR9.....	185, 193	WP60.....	65, 192	SCK1-52**.....	184
BTT9.....	20, 62, 74, 185, 193	ACCESSORIES	PAGE		
BTT9R.....	110, 114, 119, 185, 193	CCK8002**.....	145, 183, 184		
BTT9U.....	186, 193	CCK8002**W.....	183, 184		
C21.....	13, 15, 107, 109, 113, 119, 161, 189	DR1-12**.....	183		
C25.....	11, 19, 21, 23, 25, 41, 61, 73, 111, 121, 189	DR1-18**.....	183		
C4.....	186	DR1-24**.....	183		
CH1WH.....	186	DR1-36**.....	183		
CRL4**.....	27, 29, 31, 33, 35, 37, 39, 51, 53, 59, 63, 125, 127, 129, 133, 135, 137, 141, 143, 145, 147, 149, 186	DR1-48**.....	183		
CRL8TS.....	186	DR1-60**.....	183		
CW1**.....	27, 29, 35, 37, 39, 69, 71, 73, 113, 125, 127, 129, 139, 143, 145, 147, 149, 177, 189	DR1-72**.....	183		
CW1SW**.....	189	DR1-CP**.....	183		
CW2**.....	190	DR1SS-12**W.....	183		
CW5**.....	190	DR1SS-18**W.....	183		
CW60WH.....	21, 23, 25, 27, 29, 31, 33, 35, 37, 39, 61, 65, 69, 71, 73, 113, 123, 125, 127, 129, 135, 137, 139, 143, 145, 147, 149, 191	DR1SS-24**W.....	183		
CW6WH.....	190	DR1SS-36**W.....	183		
CW7WH.....	190	DR1SS-48**W.....	183		
CWRL4**.....	191	DR1SS-60**W.....	183		
RC110WH.....	49, 187	DR1SS-72**W.....	183		
SW24**.....	155, 187	EP24**.....	184		
SW70OB.....	157, 187	EP30**.....	184		
TR20WH.....	187	EP36**.....	184		
TR24WH.....	155, 157, 187	EP48**.....	184		
TR33WH.....	188	EP60**.....	184		
TR39.....	188	EP72**.....	184		
		EPCP**.....	184		
		ET6235-6**.....	55		
		ET6235-12**.....	55		
		ET6235-24**.....	55		
		ET6235-36**.....	55		



FANIMATION[®]
C E I L I N G F A N S

10983 Bennett Parkway
Zionsville, IN 46077

888 567 2055 (toll-free)
317 733 4113
317 733 4162 (fax)

FANIMATION.COM



LTFC0218
JANUARY 2018