

Stock Guide

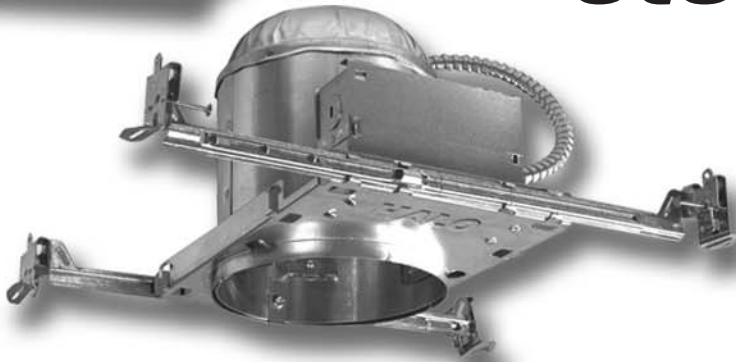

HALO
HALO TRAC & SURFACE
ALL-PRO
METALUX
LUMARK
STREET-WORKS
PORTFOLIO
PDS
FAIL-SAFE

2010

5dfj Version 1

Stocking Guide

COOPER Lighting

Canadian Terms and Conditions

Freight Terms:

Freight will be pre-paid on each order or partial release totaling \$1500 or more.

Orders not qualified for pre-paid freight will be shipped with transportation charges added to the invoice.

All shipments will be made via carrier selected by shipper.

Unless otherwise noted, sales of Cooper Lighting Products will be F.O.B. factory. Title to all products shall pass from Cooper Lighting to our customers upon execution of a bill of lading or tender of freight to carrier's agent or customer's agent, whichever shall first occur. When shipments of Cooper Lighting products are to be made via company truck, title to the products shall pass to our customers at time of delivery to the final destination or to the forwarding carrier. Consignee must make all claims for loss or damage in transit to carrier within 30 days.

Payment Terms:

Halo Recessed and Trac Products Only:

2% - 10th month following, net 25th

All Other Cooper Lighting Products:

1% - 10th month following, net 25th

Net 30 Days on Utility Sales

Dates are from date of invoice. Invoices are mailed within one (1) day of shipment.

Date of Shipment:

Shipping dates are approximate and are based on conditions existing at the time of Cooper Lighting's receipt of customer's firm order and full information. Cooper Lighting will in good faith endeavor to ship by the estimate shipping date but it shall not be responsible for any delay or any damage arising there from. It is agreed that time is not of the essence.

Merchandise and Claims Terms:

No merchandise may be returned without prior written authorization. This written authorization will be issued at the discretion of Cooper Lighting and must be requested by the customer within 90 days of the original shipment date. Non-defective materials must be in sealed original carton.

All returns will be subject to a minimum 25% handling and factory inspection charge, except on products considered by the manufacturer to be defective in workmanship and materials. Minimum value for return authorization is \$250.

Custom made equipment and "specials" may not be returned except for defects proven to be the manufacturer's responsibility.

Order Cancellation Terms:

Cancellation of orders will be accepted only if made in writing and received prior to shipment of order. Verbal order cancellations will not be accepted.

Custom made equipment and "specials" may not be cancelled after Release of Order.

Minimum Order Value:

There is a minimum order value of \$300.00.

Pricing:

Prices are subject to change without notice. Merchandise will be shipped at prices prevailing at time of shipment.

Conditions of Sale:

General:

Acceptance of any proposal submitted to Cooper lighting, Division of Cooper Industries for the sale of merchandise and acceptance by the buyer of any order it submits for such merchandise is expressly limited to the terms and conditions set forth herein. In the event of any conflict between the General Terms and Conditions of Sale of Cooper Lighting, and their terms and conditions contained in the customers order of response to quotation, the General Terms and Conditions of Sale of Cooper Lighting shall prevail unless such variance is assented to in writing and signed by an authorized representative of Cooper Lighting. The customer will be deemed to have assented to the General Terms and Conditions of Sale set forth herein upon ordering merchandise quoted by Cooper Lighting.

Warranty and Obligations:

(i) Cooper Lighting warrants to the Purchaser for resale only that its products are free from defective materials and workmanship. Cooper Industries, Cooper Lighting's obligation is expressly limited to repair or replacement, at its option without charge, at Cooper Lighting's factory within a period of one year from the date of shipment and only after prior written return authorization has been granted.

This warranty does not apply to Cooper products which have been altered or repaired outside of Cooper's factory, or have been subject to neglect, abuse misuse or accident (including shipping damages). THIS WARRANTY SHALL ALSO NOT APPLY TO PRODUCTS NOT MANUFACTURED BY COOPER WHICH HAVE BEEN INSTALLED AND USED IN CONJUNCTION WITH COOPER PRODUCTS.

This warranty is in lieu of all other warranties, expressed or implied, and excludes any implied warranty of merchantability. There are no warranties, which extend beyond the description of the product on the Company's literature setting forth the conditions of sale.

(ii) Cooper Lighting shall repair or replace the product or refund the purchase price at its option, upon notification and confirmation by its local representative of the defect. The obligation of Cooper Lighting under this warranty and buyer's remedy is expressly limited to repair or replacement of the defective product whether the claim is made in tort or in contract; including claims based on warranty, negligence, strict liability, fraud, misrepresentation or otherwise.

Cooper Lighting shall not be responsible for material, labor or freight costs incurred in connection with the installation, removal or replacement of any products. In no event shall Cooper Lighting be liable for special, indirect, incidental or consequential damages (regardless of the form of action) whether in contract, strict liability or in tort, involving negligence) nor for lost profit.

(iii) Cooper Lighting does not accept any responsibility for failure, of any of the goods delivered hereunder to meet the standards imposed under the Occupational Safety Health Act 1970 as said standards now exists or as they may be hereinafter set or amended.

Management further reserves the right under special conditions to replace or repair defective products at their own discretion.

ALL TAXES EXTRA.











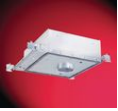

HALO®

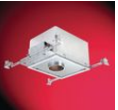













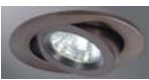

Recessed, Track & Surface Luminaires

Halo lighting products are designed and engineered with the quality difference you've come to expect from the industry leader.

For over forty years, Halo has developed and expanded product offerings for commercial, residential, institutional and industrial applications. No other manufacturer offers a more complete line of lighting products, accommodating a wide variety of lamp types.

You can be assured of quality material, sound construction and unmatched service in every recessed, track and surface luminaire you purchase.

Catalogue No.	Min. Order Qty.	Std. Pkg. Qty.	Gross Weight Ea.	Description	
H3 GU10 (ES16) Line Voltage Housings				HALO	
	H36ICAT	36	4	5.0	3" IC Air-Tite Housing, GU10 (ES16) Socket
	H36TAT	36	6	2.0	3" Non-IC Air Tite Housing, GU10 (ES 16) Socket
H3 MR 16 Low Voltage Housings					
	H36LVICAT	36	4	7.25	3" IC Air-Tite LV Housing, MR16 GU5.3 Socket
	H36LVTAT	36	6	4.0	3" Non-IC Air-Tite LV Housing, MR16 GU5.3 Socket
H3 GU10 (ES16) Line Voltage Standard Housing					
	H38ICAT	36	4	5.0	3" IC Air-Tite Housing, GU10 (ES16) Socket
H3 MR16 Low Voltage Standard Housing					
	H38LVICAT	36	4	6.0	3" IC Air-Tite LV Housing, MR16 GU5.3 Socket
H3 - GU10 / MR16 Trims				HALO	
	3003WHBB	12	6	0.6	Adjustable Baffle, White Trim Ring, Black Baffle
	3003WHWB	12	6	0.6	Adjustable Baffle, White Trim Ring, White Baffle
	3003BKBB	12	6	0.6	Adjustable Baffle, Black Trim Ring and Black Baffle
	3003SNB	12	6	0.6	Adjustable Baffle, Satin Nickel Trim Ring and Satin Nickel Baffle
	3003ACB	12	6	0.6	Adjustable Baffle, Antique Cooper Trim Ring, Antique Copper Baffle
	3003TBZB	12	6	0.6	Adjustable Baffle, Tuscan Bronze Trim Ring, Tuscan Bronze Baffle

Catalogue No.	Min. Order Qty.	Std. Pkg. Qty.	Gross Weight Ea.	Description	
 3004WHC	12	6	0.6	Adjustable Reflector, White Trim Ring, Clear Reflector	
 3007WHC	12	6	0.6	Lens Downlight, White Trim Ring, Black Baffle (Suitable for showers)	
 3008FG	12	6	0.6	Shower Light, White Trim, Frosted Glass	
 3009WHBB	12	6	0.6	Adjustable Gimbal, White Trim Ring, Black Baffle	
 3009WHWB	12	6	0.6	Adjustable Gimbal, White Trim Ring, White Baffle	
 3009BKBB	12	6	0.6	Adjustable Gimbal, Black Trim Ring, Black Baffle	
 3009SNBB	12	6	0.6	Adjustable Gimbal, Satin Nickel Trim Ring, Black Baffle	
 3009ACBB	12	6	0.6	Adjustable Gimbal, Antique Copper Trim Ring, Black Baffle	
 3009TBZBB	12	6	0.6	Adjustable Gimbal, Tuscan Bronze Trim Ring, Black Baffle	
 3010SN	12	6	0.6	SUPER ADJUSTABLE GU10/MR16 TRIM, SATIN NICKEL FINISH, SMOOTHLY ADJUSTS FROM A DOWNLIGHT TO 80 DEGREE TILT SPOTLIGHT	
 3010WH	12	6	0.6	SUPER ADJUSTABLE GU10/MR16 TRIM, WHITE FINISH, SMOOTHLY ADJUSTS FROM A DOWNLIGHT TO 80 DEGREE TILT SPOTLIGHT	
 3013WH	12	6	0.6	SQUARE ADJUSTABLE GU10/MR16 TRIM, WHITE FINISH, 35 DEGREE TILT	
 3014FBWH	12	6	0.6	DECORATIVE TAPERED GLASS CYLINDER GU10/MR16 TRIM, WHITE FINISH w FROST GLASS. (BLUE GLASS ALSO SUPPLIED)	

Catalogue No.	Min. Order Qty.	Std. Pkg. Qty.	Gross Weight Ea.	Description
---------------	-----------------	----------------	------------------	-------------

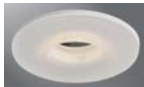

3016FG

12

6

0.6

DECORATIVE LOW-PROFILE GLASS CURVE GU10/MR16 TRIM, WHITE FINISH w FROST GLASS CURVE.



H99 LINE VOLTAGE HOUSINGS

HALO



H99T

48

6

2.62

Feed-Thru Housing with Thermal Protector. UL Damp Location Listed.



H99RT

48

6

1.83

Remodel Housing with Thermal Protector. UL Damp location listed.



H99ICT

48

6

2.60

Feed-Thru Air-Tite housing with Thermal Protector for use in Insulated Ceilings. Supplied with captive bar hangers for 24" joist spacing. UL Damp location listed. Air-Tite For restricted air-flow requirements.

H99 LINE VOLTAGE TRIMS



985GUWHT

24

12

0.92

Gloss White Steel Trim, 5 1/16" O.D. 50W GU10 120V



985GUSC

24

12

0.50

Satin Chrome Steel Trim, 5 1/16" O.D. 50W GU10 120V 30deg Tilt



983GUWHT

24

12

1.00

Gloss White Steel Trim, 5 1/16" O.D. 50W GU10 120V 30deg Tilt



995GUP

24

12

0.50

Gloss White Cast Trim, 5 1/16" O.D. 50W GU10 120V 30deg Tilt



987WHT

24

12

0.50

Gloss White Steel Trim, 5 1/16" O.D. 50W PAR20



987SC,AB

24

12

0.50

Satin Chrome or Antique Brass Steel Trim, 5 1/16" O.D. 50W PAR20, 20deg Tilt



997P

24

12

1.00

Satin White Cast Trim, 5 1/16" O.D. 50W PAR20 20deg Tilt



951PS

12

6

0.57

Shower Light, 5 1/16" O.D.
H99RT - 50W PAR20/R20/40W A19
H99ICT - 30W R20/35W PAR20







993P

24





6

0.28

Deep Black Coilex Baffle Trim, 5 1/16" O.D.





Catalogue No.	Min. Order Qty.	Std. Pkg. Qty.	Gross Weight Ea.	Description
 993W	24	6	0.48	Deep White Coilex Baffle Trim, 5 1/16" O.D.
 993SN	12	12	0.04	Deep Black Coilex Baffle, Satin Nickel Trim Ring, 5 1/16" O.D
 996SN	12	12	0.68	4IN EYEBALL TRIM 15DEG SATIN NICKEL
 996P	24	12	0.68	White Eyeball Trim, 5 1/16" O.D. 15deg Tilt
 999P	48	12	0.31	Clear Reflector Trim, 5 1/16" O.D.

VALUE PRICED ALL-PRO LINE VOLTAGE TRIMS



 ERT410	48	12	0.19	Black Metal Baffle. Fits all H99 Series Housings, 5" O.D.	
 ERT410WHT	24	12	0.19	White Metal Baffle. Fits all H99 Series Housings, 5". O.D.	







H1499 LOW VOLTAGE HOUSINGS

HALO

 H1499T	48	6	4.53	Low Voltage Housing with Thermal Protector. Includes 12V magnetic transformer (50W Max). Feed-Thru listed. UL Damp location listed. Supplied with bar hangers for 24" joist spacing.
 H1499T75	24	6	5.80	Same as above, for 75W MR16 max.
 H1499RT	48	6	3.85	Low Voltage Remodel Housing Includes 12V transformer (50W Max). UL Damp Location listed.
 H1499IC	24	4	6.14	Low Voltage Air-Tite Housing with Thermal Protector for use in Insulated Ceilings. Includes 12V magnetic transformer (50W Max).

H1499 LOW VOLTAGE TRIMS

 1421C	36	12	0.38	Clear Specular Reflector Trim, 5 1/16" O.D. 30deg. Tilt
 1421MB1	36	20	0.44	Black Specular Reflector Trim, 5 1/16" O.D. 30deg. Tilt

Catalogue No.	Min. Order Qty.	Std. Pkg. Qty.	Gross Weight Ea.	Description
 1493P	72	6	0.42	Black Coilex Trim, 5 1/16" O.D. 30deg Tilt
 1493W	36	6	0.48	White Coilex Trim, 5 1/16" O.D. 30deg Tilt
 1485WHT	24	1	0.40	Gloss White Trim, 5 1/16" O.D.
1485SC,AB	24	1	0.40	Satin Chrome or Antique Brass Trim, 5 1/16" O.D. 30deg Tilt
 1495P	12	6	0.46	Adjustable Gimbal Ring, 5 1/16" O.D. 30deg Tilt
 1496P	12	6	0.38	Retractable Super Adjustable, 5 1/16" O.D. 60deg Tilt
 1951PS	12	12	0.75	White Trim Ring, Specular Reflector Wet Location Listed Shower Light
HPF99	24	1	0.12	Plaster frame accessory for quick rough-in installations. Designed for use with both H99RT and H1499RT remodel housings.

P= Satin White W= White Baffle BA= Deep Black Metal Baffle BAW= Deep White Metal Baffle C= Clear RG= Residential Gold SC= Satin Chrome AB= Antique Brass





















VALUE PRICED ALL-PRO LOW VOLTAGE TRIMS (Fits All H1499 Series Housings)







HALO

 ERT401LV	24	12	0.59	Economy Black Baffle, High Gloss Appliance White Trim Ring. 5" O.D.
 ERT401LW	24	12	0.50	Economy White Baffle, High Gloss Appliance White Trim Ring. 5" O.D.
 ERT403LV	12	12	0.49	Economy Clear Reflector, High Gloss Appliance White Trim Ring. 5" O.D.

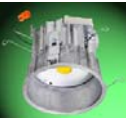
H645IC HOUSING

 H645ICJ	24	4	5.25	Allslope Ceiling Housing for 2/12 to 12/12 ceiling slopes. Insulated Ceiling and Air-Tite Construction Feed-Through junction box. Factory Installed, Nailless Bar Hangers
--	----	---	------	---

Catalogue No.	Min. Order Qty.	Std. Pkg. Qty.	Gross Weight Ea.	Description
H645IC TRIMS				
 456P	12	6	0.60	6" Allslope Black Baffle, 65 BR30, 50PAR30L. 7 1/4" O.D.
 456W	12	6	0.58	6" Allslope White Baffle, 65BR30, 50PAR30L. 7 1/4" O.D.
H745 ALLSLOPE HOUSING				
 H745ICAT	20	4	5.00	Allslope Ceiling Housing for 2/12 to 12/12 ceiling slopes. Insulated Ceiling and Air-Tite Construction Feed-Through junction box. Factory Installed, Nailless Bar Hangers 9 3/4" O.D.
Halo LED Recessed				
 H455ICAT120D				4" LED IC RATED REMODEL HOUSING W DRIVER, 120V 
 H455RICAT120D				4" LED IC RATED REMODEL HOUSING W DRIVER, 120V 
 EL405830				4" LED ENGINE, 80CRI, 3000K 
 TL400H				4" LED TRIM HAZE REFLECTOR w WHITE TRIM RING 
 TL400SC				4" LED TRIM CLEAR REFLECTOR w WHITE TRIM RING 
 TL401WB				4" LED TRIM WHITE BAFFLE w WHITE TRIM RING 
 TL402SCS				4" LED TRIM CLEAR REFLECTOR w SOLITE® LENS, WHITE TRIM RING 
 TL403WBS				4" LED TRIM WHITE BAFFLE w SOLITE® LENS, WHITE TRIM RING 
 H750ICAT	20	6	2.77	6" H7 New Construction Housing (No Edison Base)
 H750T				HALO - LED RECESSED NON-IC RATED NEW CONSTRUCTION HOUSING, FOR 6" SERIES LED MODULES

Catalogue No.	Min. Order Qty.	Std. Pkg. Qty.	Gross Weight Ea.	Description
 ML706830	4	4	4.50	6" H7 LED module, 600 lumen, 80+ CRI, 3000K
 ML709830ICAT120D				HALO - LED 900 SERIES MODULE, 3000K ONLY RECESSED
 493WBS06	48	12	0.30	6" LED Trim White Baffle w/ Solite Lens & white trim ring.
 494P06	48	12	0.30	6" Matte White Reflector , Matte White Trim Ring
 494WB06	48	12	0.30	6" Matte White Baffle , Matte White Trim Ring
 494SC06	48	12	0.30	6" Specular Clear Reflector , Matte White Trim Ring
 494H06	48	12	0.30	6" Haze Reflector , Matte White Trim Ring
 TRM490WH	48	12	0.20	White Slim Trim Ring Option (.120" at OD, .180" at ID)



P= Satin White W= White Baffle

H5 FITALL HOUSINGS

HALO



H5TM 72 6 4.04 Feed-Thru Housing with Thermal Protector. Supplied with captive bar hangers for 24" joist spacing. UL Damp location listed.



H5ICAT 48 6 3.40 Feed-Thru Air-Tite Housing with Thermal Protector for use in Insulated Ceilings. Supplied with captive bar hangers for 24" joist spacing. UL Damp location listed.



H5RT 24 6 2.53 Quick 'N Easy Remodel Housing with Thermal Protector. UL Damp location listed.











H5RICAT 24 6 1.54 Air-Tite Quick Easy Remodel Housing for use in Insulated Ceilings.

H5 FITALL TRIMS

















5001P 24 6 0.56 5" Deep Splay Trim, R20 or 30, PAR20 or 30, White. 6 1/2" O.D.



Catalogue No.	Net Price	Min. Order Qty.	Std. Pkg. Qty.	Gross Weight Ea.	Description	
 5001MB		24	6	0.58	5" Deep Splay Trim, R20 or PAR20 or 30, Black. O.D.	6 1/2"
 5010		48	6	0.74	5" Stepped Baffle Trim, R30 or PAR 30, Black. O.D.	6 1/2"
 5010W		24	6	0.74	5" Stepped Baffle Trim, R30 or PAR30 White. 6 1/2" O.D.	
 ERT513WHTTS		24	36	0.40	5" Metal Baffle, High Gloss Appliance White w Torsion Spring mounting which pull trim tight to ceiling	
 5020SC		12	6	0.86	5" Reflector Cone, BR30, PAR30. 6 1/2" O.D.	
 5051PS		12	6	1.10	5" Shower-Light, Frosted Albalite Flat Lens, 6 3/8" O.D.	
 5054PS		12	6	1.50	5" Shower Lite, PAR30/ A19. 6 1/2" O.D.	Replaces 5050PS
 5060P		12	6	0.75	5" Gimbal Trim PAR30, Short Neck, White. 6 1/2" O.D.	
 5070P		12	6	0.83	5" Miniature Eyeball Trim, PAR30 Short Neck, White. 6 1/2" O.D.	

H7 FITALL HOUSINGS

HALO

 H7T		288	6	3.68	Feed-Thru Housing with thermal protector supplied with captive bar hangers for 24" joist spacing. UL damp location listed.	
 H27T		48	6	3.52	Same as above, but 5 1/2" in height.	
 H7ICAT		144	6	3.00	Feed-Thru Air-Tite housing with thermal protector for use in insulated ceilings. Supplied with captive bar hangers for 24" joist spacing. UL damp location listed. For restricted air flow requirements.	
 H7RT		48	6	2.46	Quick 'N Easy remodel housing with thermal protector for non-insulated ceilings. UL damp location listed.	

Catalogue No.	Min. Order Qty.	Std. Pkg. Qty.	Gross Weight Ea.	Description
 H7RICAT	48	6	2.08	Quick 'N Easy remodel housing with thermal protector for insulated ceilings. UL damp location listed. For restricted air flow requirements.
 H7UICAT	24	4	4.58	Universal Air-Tite insulated ceiling housing. For restricted air flow requirements.
H7 SERIES COMPACT FLUORESCENT RECESSED HOUSINGS				
 H280E	12	1	6.26	120V round compact fluorescent housing Electronic ballast. 1-18W TTT 4 pin lamp. Not Included.
 H285E	12	6	7.30	120V round compact fluorescent housing Electronic ballast. 1-26W TTT 4 pin lamp. Not Included.
 H272ICAT	12	4	3.70	120V Compact fluorescent AIR-TITE™ IC housing w Electronic ballast for 1-26W DTT or TTT 4 pin lamp. Not included. For use in insulated ceilings
 H800E	12	4	6.28	120V compact fluorescent Non IC housing w Electronic Ballast for 2-13W, for two DTT horizontal, 4pin lamps, Not included.
 H802E	12	4	3.95	120V compact fluorescent Non IC housing w Electronic Ballast for 2 18W, for two DTT horizontal, 4 pin lamps, Not Included.
 H803E	12	4	4.90	120V compact fluorescent Non IC housing w Electronic Ballast for 2 26W, for two DTT horizontal 4 pin lamps, Not Included.
 H278ICAT	12			6" ECO-TWIST IC RATED NEW CONSTRUCTION HOUSING, 120V (OPERATES 16,21 OR 28 WATT TWIST CFL w GZ16q BASE
 H578ICAT	12			5" ECO-TWIST IC RATED NEW CONSTRUCTION HOUSING, 120V (OPERATES 16,21 OR 28 WATT TWIST CFL w GZ16q BASE
Z216				21 WATT LIVING SPACES TWIST CFL w/ GZ16q BASE (H278ICAT & H578ICAT HOUSINGS ONLY)
Z228				28 WATT LIVING SPACES TWIST CFL w/ GZ16q BASE (H278ICAT & H578ICAT HOUSINGS ONLY)
 H471ICAT				4" IC RATED NEW CONSTRUCTION HOUSING, 120V OPERATES 18 WATT TTT CFL LAMPS

Catalogue No.	Min. Order Qty.	Std. Pkg. Qty.	Gross Weight Ea.	Description
 H471RICAT				4" IC RATED REMODEL HOUSING, 120V OPERATES 18 WATT TTT CFL LAMPS
 VBB2	48	24	0.50	Vapour barrier for a complete Air-Tite seal when installing IC housings on 16" or 24" beam centers. *This maybe a requirement by some local building codes.

H37TN HEAT LAMP



H37T	12	6	3.22	250W Infra-Red heat lamp
------	----	---	------	--------------------------

NOTE: HEAT LAMP NOT FOR USE IN INSULATED CEILINGS. REQUIRES 401AL TRIM SOLD SEPARATELY.

H7 FITALL TRIMS

HALO



401AL	12	12	0.47	To be used with H37TN Infra- Red lamp only.
-------	----	----	------	---



71PS	36	6	0.89	Showerlite Drop Opal Trim, 8" O.D.
------	----	---	------	------------------------------------



78P	36	6	1.37	Eyeball Trim, 8" O.D.
-----	----	---	------	-----------------------



171PS	36	6	1.38	Showerlite Drop Opal Trim, 8" O.D.
-------	----	---	------	------------------------------------



172PS	12	6	1.74	Showerlite Drop Glass Trim 8" O.D.
-------	----	---	------	------------------------------------



301P	48	12	0.39	Open Trim, 7 1/4" O.D.
------	----	----	------	------------------------



310P	144	6	0.54	Black Coilex Trim, 7 1/4" O.D.
------	-----	---	------	--------------------------------







310W	144	6	0.60	White Coilex Trim, 7 1/4" O.D.
------	-----	---	------	--------------------------------



328P	48	12	0.54	White Splay Trim 7 3/4" O.D.
------	----	----	------	------------------------------





376W	24	12	0.62	Adjustable White Baffle, 7 1/4" O.D.
------	----	----	------	--------------------------------------

Catalogue No.	Min. Order Qty.	Std. Pkg. Qty.	Gross Weight Ea.	Description
 378P	24	6	0.83	Adjustable Baffle, 7 1/4" O.D.
 401P	48	12	0.48	Open Trim, 8" O.D.
 405SC	72	6	0.70	Reflector Clear Cone Trim, 7 1/4" O.D.
 410P	72	6	0.54	Black Coilex Baffle Trim, 7 1/4" O.D.



AL= Satin Aluminum PS= Wet Location Listed, Shower/Light Option W= White Baffle SC= Specular Clear P= Satin White

H7 FITALL TRIMS (continued)



HALO





 410W	36	6	0.58	White Coilex Baffle Trim, 7 1/4" O.D.
 426	72	6	0.33	Clear Reflector Cone Trim, 7 1/4" O.D.
 428P	48	12	0.51	Open Trim, 7 3/4" O.D.

AIR-TITE TRIMS

 30PAT, WAT	48	18	0.50	Baffle - Air-Tite. Instantly converts any IC housing to Air-Tite construction, including remodelers. 7 1/4" O.D.
 30CAT	12	18	0.50	Reflector Cone - Air-Tite. Instantly converts any IC housing to Air-Tite construction, including remodelers. 7 1/4" O.D.



VALUE PRICED ALL-PRO LINE VOLTAGE TRIMS

 ERT707	54	18	0.50	Black Metal Baffle. Fits all H7 Series Housings, 8". O.D.
 ERT707WHT	54	18	0.50	White Metal Baffle. Fits all H7 Series Housings, 8". O.D.
 ERT713WHTTS				6" METAL BAFFLE, HIGH GROSS APPLIANCE WHITE w TORSION SPRINGS MOUNTING

Catalogue No.	Min. Order Qty	Std. Pkg. Qty	Gross Weight Ea.	Description
 406SC	12	6	0.70	Specular reflector, 18W, 26W DTT/TTT. Designed for use with H280 series housing. 7 1/4" O.D.
 406WB	12	6	0.52	White Coilex Baffle, 18W, 26W DTT/TTT. Designed for use with H280 series housing. 7 1/4" O.D.
 406BA	12	6	0.52	Black Coilex Baffle, 18W, 26W DTT/TTT. Designed for use with H280 series housing. 7 1/4" O.D.
 810C	12	4	1.03	Specular Reflector, (2) - 13,18,26W DTT, Designed for the H800/H802/H803 Series Housings.

P= Satin White W= White Baffle MB= Specular Black PAT= White Air-Tite WAT= White Baffle Air-Tite CAT= Clear Reflector Air-Tite
 SC= Specular Clear WB= White Baffle BA= Black Baffle

PDS... Performance Downlight System PORTFOLIO
Frames

 PD6	12	6	2.33	6" Frame Only *
 PD7	12	6	3.57	7" Frame Only *
 PD8	12	6	3.33	8" Frame Only *

* Must order socket adapters for complete rough-in assembly

Frames





V120	6	4	1.1	Medium Base Incandescent, Vertical Module
V701E	6	6	1	70W Metal Halide Electronic Ballast, 120 volt only for ED17P Lamp
V1001E	6	6	1	100W Metal Halide Electronic Ballast, 120 volt only for ED17P Lamp
V142E	6	6	1.51	(1) 42, 32 or 26 Watt Triple Tube, 120 Volt Vertical Module
V1423E	6	6	1.42	(1) 42, 32 or 26 Watt Triple Tube, 347 Volt Vertical Module

Catalogue No.	Min. Order Qty	Std. Pkg. Qty	Gross Weight Ea.	Description
H142E	12	6	2	(1) 42, 32 or 26 Watt Triple Tube, 120 Volt Horizontal Module
H1423E	6	6	1.8	(1) 42, 32 or 26 Watt Triple Tube, 347 Volt Horizontal Module
H226E	12	6	1.7	(2) 26 Watt Quad Tube, 120 Volt Horizontal Module
H2263E	6	6	1.95	(2) 26 Watt Quad Tube, 347 Volt Horizontal Module
HW242E	6	6	2.15	(2) 42, 32 or 26 Watt Triple Tube , 120 Volt Horizontal Module
HW2423E	6	6	2.68	(2) 42, 32 or 26 Watt Triple Tube , 347 Volt Horizontal Module







Frames



6VC	6	6	1	6" Vertical Clear
6HC	6	1	0.8	6" Horizontal Clear
7VC	6	1	1.26	7" Vertical Clear
7HC	6	1	1	7" Horizontal Clear
8HC	6	1	1.56	8" Horizontal Clear
8HRC	6	1	1	8" Turbo Reflector

Notes: Reflectors are used with their corresponding frame size.
Socket adapters must be used with corresponding type of reflectors.
120-277V TTT modules will operate 26, 32 and 42-watt lamps.
347V TTT modules will operate 26, 32 and 42-watt lamps.

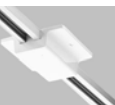



Catalogue No.	Min. Order Qty	Std. Pkg. Qty	Gross Weight Ea.	Description
SINGLE CIRCUIT POWER-TRAC				HALO
 L650P	Group A	6	0.85	2' Trac. Supplied with dead end and mounting hardware.
 L651MB,P	Group A	1	1.90	4' Trac. Supplied with dead end and mounting hardware.
 L656MB,P	Group A	1	4.68	6' Trac. Supplied with dead end and mounting hardware.
 L652MB,P	Group A	1	3.90	8' Trac. Supplied with dead end and mounting hardware.
 L653MB,P	Group A	1	6.00	12' Trac. Supplied with dead end and mounting hardware.

SINGLE CIRCUIT POWER-TRAC ACCESSORIES



 L900P	Group B	12	0.35	Outlet Cover Plate.
 L901MB,P	Group B	12	0.19	Live end Connector.
 L902MB,P	Group B	6	0.54	Flex Connector.
 L903MB,P	Group B	12	0.33	Straight Connector. Joins two Trac sections end to end for straight runs.
 L904MB,P	Group B	6	0.32	"L" Connector.
 L908MB,P	Group B	12	0.07	Mini-Connector to join two Trac Sections end to end.
 L909MB,P	Group B	12	0.60	Floating Canopy and Feed Point. Can be used anywhere along length of Trac.
 L973PN	Group B	12	0.25	Canopy Adapter. (Not for use with L2001 Transformer).

Catalogue No.	Min. Order Qty	Std. Pkg. Qty	Gross Weight Ea.	Description
 L973MBN	Group B	12	0.29	Canopy Adapter. (Not for use with L2001 Transformer).
 L1973P	Group B	12	0.34	Canopy Adapter for low voltage. Solid State Transformer.
 L992P	Group B	6	1.28	18" Pendant Kit.







SINGLE CIRCUIT POWER-TRAC HALO

 L702PX,MBX	48	6	0.75	Universal Lampholder for use with 30 to 300W R lamps, 75W PAR16, 50W PAR20, 75W PAR30, Long neck only, and 150W PAR38 Lamps.	2 15/16"	5 15/16"
 L703PX,MBX	48	24	0.74	Universal Lampholder for use with 50W PAR20, 75W PAR30. Short neck lamps only.	2 15/16"	5 15/16"
 L1730PX,MBX	48	6	1.04	50W PAR30, 75W PAR30. (Short necks only).	3 15/16"	6 1/4"
 L1738PX,MBX	24	6	1.15	Q45, Q90, Q150W PAR38, 250W PAR38	5"	9 1/2"







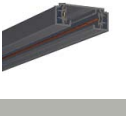

12V POWER-TRAC LAMPHOLDERS

 L2001PX,MBX	12	6	0.44	12V Solid State. Not for use with four circuit Trac. 5 1/4"L x 1 3/8"W x 1 1/8"H. Not for use with four circuit trac.	-	1 1/8"
 L2716P,MB	48	48	0.35	20/50W 12V MR16. Must be used with L2001.	2 1/8"	2 5/8"
 L2717MBX,PX	12	12	0.83	45/50/75W 12V MR16. Complete with 12V solid state transformer. Not for use with four Circuit Trac.	2 1/8"	4 5/8"

LED POWER-TRAC LAMPHOLDERS

 L805SMLSP830P				SMALL LED LAMP-HOLDER, 8 DEGREE SPOT, WHITE FINISH, CRI 80, 3000K, 8 WATTS		
 L805MEDSP830P				MEDIUM LED LAMP-HOLDER, 8 DEGREE SPOT, WHITE FINISH, CRI 80, 3000K, 18 WATTS		
 L805MEDNF830P				MEDIUM LED LAMP-HOLDER, 25DEGREE NARROW, WHITE FINISH, CRI 80, 3000K, 18 WATTS		

P=White MB=Black













Catalogue No.	Min. Order Qty.	Std. Pkg. Qty.	Gross Weight Ea.	Description
LAZER TRACK LIGHTING				
HALO				
	LZR104P	12	1.70	White 4' Track (actual length 44 1/8")
	LZR104MB	12	1.70	Black 4' Track (actual length 44 1/8")
	LZR106P	12	2.55	White 6' Track (actual length 68 1/8")
	LZR108P	12	3.40	White 8' Track (actual length 92 1/8")
	LZR108MB	12	3.40	Black 8' Track (actual length 92 1/8")
	LZR201P	9	0.16	Live End Feed - White
	LZR201MB	8	0.16	Live End Feed - Black
	LZR202P	4	0.49	Floating Canopy & Connector Feed - White
	LZR202MB	4	0.49	Floating Canopy & Connector Feed - Black
	LZR203P	48	0.32	Adjustable L and Straight Connector Feed - White
	LZR203MB	4	0.32	Adjustable L and Straight Connector Feed - Black
	LZR209P	9	0.30	Monopoint Feed - White
	LZR212P	12	0.10	Mini Connector - White
	LZR212MB	12	0.10	Mini Connector - Black

Note: Lazer Channel & Connectors are not compatible with Halo Channel & Connectors. Lazer Track accepts both Lazer & Halo Power Trac Lamp Holders.

P= White MB= Black

LAZER LAMPHOLDERS (compatible with Halo Power-Trac)

	LZR301P	12	12	1.24	Roundback-white with black baffle. 50W R20/PAR20/60W A19.
	LZR301MB	12	12	1.24	Roundback-black with black baffle. 50W R20/PAR20/60W A19.

Catalogue No.	Min. Order Qty.	Std. Pkg. Qty.	Gross Weight Ea.	Description
 LZR302P	10	10	1.35	Roundback-white with black baffle. 75W R30/PAR30/75W A19/100W.
 LZR305P	12	12	1.24	Step Cylinder-white with black baffle. 75W R30/PAR30/75W A19/100W BR25.
LAZER LAMP HOLDERS (compatible with Halo Power-Trac)				
 LZR330P	24	6	1.09	White Gimbal ring 75W PAR30 Short Neck.
 LZR330MB	12	6	1.09	Black Gimbal ring 75W PAR30 Short Neck.
 LZR338P	24	6	1.38	White Gimbal ring 150W PAR38.
 LZR338MB	19	19	1.38	Black Gimbal ring 150W PAR38.
 LZR401P	24	12	0.78	White Gimbal ring with low voltage solid state transformer. 50W MR16.
 LZR401MB	12	12	0.78	Black Gimbal ring with low voltage solid state Transformer. 50W MR16.
 LZR402P	12	12	1.12	White perforated bell with low voltage solid state transformer. 50W MR16.
 LZR402MB	12	12	1.12	Black perforated bell with low voltage solid state transformer. 50W MR16.
 LZR403P	12	12	1.13	White Glass bell with low voltage solid state transformer. 50W MR16.
 LZR404P	12	12	0.77	White Pendant with low voltage solid state transformer. 50W MR16.
 LZR404MB	12	12	0.77	Black Pendant with low voltage solid state transformer. 50W MR16.



Indoor & Outdoor HID Products

Lumark combines craftsmanship and affordability in its full-line of indoor and outdoor high intensity discharge (HID) lighting.

HID lighting applications often involve tasks, environments and surfaces of varying and demanding degrees. Lumark has the experience and product line to properly illuminate complex applications, providing superior lighting for virtually every application. Lumark's complete product line includes lighting for factories, warehouses, sports fields, parking lots, retail stores, and other industrial and commercial applications.

Catalogue No.	Lamp Wattage	Lamp Type	Voltage
---------------	--------------	-----------	---------

SMALL FLOODS

LUMARK

SMALL FALCON



KNUCKLE MOUNT

MPSF10K-TT

100

MP

120/277/347

MHSF17K-TT

175

MH

120/277/347

1) ALL PRICES INCLUDE LAMP

2) BRONZE FINISH STANDARD



TRUNNION MOUNT

MPSF10T-TT

100

MP

120/277/347

MHSF17T-TT

175

MH

120/277/347

HPSF15T-TT

150

HPS

120/277/347

1) ALL PRICES INCLUDE LAMP

2) BRONZE FINISH STANDARD

IMPACT FLOOD



Knuckle Mount

Small Housing

MHMS17TT

175W

MH

120/277/347

1) ALL PRICES INCLUDE LAMP

2) BRONZE FINISH STANDARD



Medium Housing

MHMM25TT

250W

MH

120/277/347

MHMM40TT

400W

MH

120/277/347

1) ALL PRICES INCLUDE LAMP

2) BRONZE FINISH STANDARD

ARROWHEAD



TRUNNION MOUNT

MHAH258T

250

MH

120/277/347

MHAH408T

400

MH

120/277/347

1) ALL PRICES INCLUDE LAMP

2) BRONZE FINISH STANDARD

3) HPF BALLAST

HPAH408T

400

HPS

120/277/347

****AVAILABLE Q3, 2010**

1) ALL PRICES INCLUDE LAMP

2) BRONZE FINISH STANDARD

3) HPF BALLAST

AH/WG

AH/V-BZ

WIREGUARD
SIDE & TOP VISOR

Catalogue No.	Lamp Wattage	Lamp Type	Voltage
MEDIUM-LARGE FLOODS			LUMARK
NIGHTHAWK			



YOKE MOUNT
MHNK-Y76-1000-TT-LL

1000 MH 120/277/347



SLIPFITTER MOUNT
MHNK-S76-1000-TT-LL
TYS-BZ
2 3/8" SLIPFITTER ADAPTER

1000 MH 120/277/347

- 1) ALL PRICES INCLUDE LAMP
- 2) BRONZE FINISH STANDARD
- 3) HPF BALLAST

WARRIOR



SLIPFITTER MOUNT
XM258
XM408
XS408

250 MH 120/277/347
 400 MH 120/277/347
 400 HPS 120/277/347



TRUNNION MOUNT
WM258
WM408
WS408

250 MH 120/277/347
 400 MH 120/277/347
 400 HPS 120/277/347

- 1) ALL PRICES INCLUDE LAMP
- 2) BRONZE FINISH STANDARD
- 3) HPF BALLAST

DUSK TO DAWN
DUSKLIGHT



HPEL70
HPEL15
MVEL17

70 HPS 120
 150 HPS 120
 175 MV 120

VANGUARD



VAN25MW255LV5A
VAN40MW255LV5A

VAN15SH255LV5A
VAN25SC255LV5A

VAN25VW255LV5A
VAN40VW255LV5A

250 MH 120
 400 MH 120

 150 HPS 120
 250 HPS 120

 250 MV 120
 400 MV 120

- 1) 120V ONLY
- 2) ALL PRICES INCLUDE LAMP, PHOTOCELL AND MOUNTING HARDWARE

HALOGEN FLOODLIGHTING
WEDGE



QZ5L

500 INC 120

- 1) PRICE INCLUDES LAMP

Catalogue No.	Lamp Wattage	Lamp Type	Voltage
---------------	--------------	-----------	---------

WALL MOUNTED

WAL-PAK



WPM178	175	MH	120/277/347
WPM258	250	MH	120/277/347
WPM408	400	MH	120/277/347
WPS158	150	HPS	120/277/347
WPS258	250	HPS	120/277/347
WPS408	400	HPS	120/277/347
LDWP-GL-4A-ED	40	LED	120/277
LDWP-GL-4A-347V	40	LED	347



- 1) DOOR WITH BOROSILICATE GLASS STANDARD
- 2) 175W MH MEDIUM BASE SOCKET, ALL OTHERS MOGUL BASE SOCKET
- 3) ALL PRICES INCLUDE LAMP
- 4) STANDARD BALLAST HPF
- 5) BRONZE FINISH STANDARD

GLASS WALLY



LP10G	100	MP	120
LS70G	70	HPS	120
LS10G	100	HPS	120
LS15G	150	HPS	121

- 1) 120V NPF ONLY
- 2) ALL PRICES INCLUDE LAMP
- 3) BRONZE FINISH STANDARD

WALLY CUTOFF



LP70C	70	MP	120
LP10C	100	MP	120
LS70C	70	HPS	120

- 1) 120V NPF ONLY
- 2) ALL PRICES INCLUDE LAMP
- 3) BRONZE FINISH STANDARD

IMPACT



TRAPEZOID SMALL HOUSING			
MHIT178	175	MH	120/277/347

- 1) ALL PRICES INCLUDE LAMP
- 2) BRONZE FINISH STANDARD

SMOKEY



BP708	70	MP	120/277/347
--------------	----	----	-------------

- 1) POLYCARBONATE LENS STANDARD
- 2) 120V HPS UNITS ARE NPF
- 3) ALL PRICES INCLUDE LAMP
- 4) BRONZE FINISH STANDARD

Catalogue No.	Lamp Wattage	Lamp Type	Voltage
---------------	--------------	-----------	---------

Z-PAK



MHFZ178	175	MH	120/277/347
HPFZ158	150	HPS	120/277/347
MPFZ108	100	MP	120/277/347

- 1) PRISMATIC GLASS LENS
- 2) ALL PRICES INCLUDE **MEDIUM** LAMP
- 3) BRONZE FINISH STANDARD

Z-PAK CUTOFF



MHFZ178C	175	MH	120/277/347
HPFZ158C	150	HPS	120/277/347

- 1) PRISMATIC GLASS LENS
- 2) ALL PRICES INCLUDE **MEDIUM** LAMP
- 3) BRONZE FINISH STANDARD

WAL-LITE



HPWM70	70	HPS	120
HPWM70P	70	HPS	120
HPWM70WP	70	HPS	120

- 1) PRISMATIC POLYCARBONATE LENS
- 2) 120V HPS UNITS ARE NPF
- 3) ALL PRICES INCLUDE LAMP
- 4) UNITS ENDING WITH "P" INCLUDE PHOTOCONTROL
- 5) BRONZE FINISH STANDARD - UNITS ENDING WITH- "WP" ARE FINISHED IN WHITE AND INCLUDE PHOTOCONTROL.

INDOOR INDUSTRIAL

LUMARK

STEELER

Unit Packs (complete*)



MHSS408-OR Unit Pack	400	MH	120/277/347
MPSS408-OR Unit Pack, Pulse Start	400	MP	120/277/347
HPSS408 Unit Pack	400	HPS	120/277/347

- 1) *COMPLETE WITH BALLAST, HOUSING, REFLECTOR AND LAMP
- 2) INCLUDES 3FT CABTIRE AND SAFETY HOOK INSTALLED STANDARD
- 3) TRI-TAP BALLAST (120/277/347) AVAILABLE ONLY, WIRED FOR 347V
- 4) WHITE HOUSING FINISH STANDARD
- 5) METAL HALIDE AND PULSE START METAL HALIDE STANDARD
WITH OPEN RATED SOCKET, FOR USE WITH PROTECTED LAMP ONLY

Catalogue No.	Lamp Wattage	Lamp Type	Voltage
---------------	--------------	-----------	---------



Project Ballast Housing Assemblies (400W Max)

MHSS-400-TT-OR-SHK-C3

Ballast & Housing Only, No Lamp or Optics 400 MH 120/277/347

- 1) INCLUDES 3FT CABTIRE AND SAFETY HOOK INSTALLED STANDARD
- 2) TRI-TAP BALLAST (120/277/347) AVAILABLE ONLY, WIRED FOR 347V
- 3) WHITE HOUSING FINISH STANDARD
- 4) STANDARD WITH OPEN RATED SOCKET, FOR USE WITH PROTECTED LAMP ONLY

Optic Components (400W Max)

TCSA15-400MH	Cone/Door for 15" Reflector 400W MH only
SGB15	Safety Glass Bottom, Not Compatible with WG15
WG15	15" Wire Guard (not for use with Door)
SA15	15" Aluminum Reflector 400W Max
SA15E	15" Aluminum Reflector c/w hole for Quartz Aux Lamp 400W Max
WG18	18" Wire Guard (not for use with Door)
SA18	8" Aluminum Reflector 400W Max
PD16	16" Prismatic Reflector/Refractor 400W Max
PD22	22" Prismatic Reflector/Refractor 400W Max

Project Ballast Housing Assemblies (1000W Max)

MHSS-1000-TT-OR-SHK-C3

Ballast & Housing Only, No Lamp or Optics 1000 MH 120/277/347

- 1) INCLUDES 3FT CABTIRE AND SAFETY HOOK INSTALLED STANDARD
- 2) TRI-TAP BALLAST (120/277/347) AVAILABLE ONLY, WIRED FOR 347V
- 3) WHITE HOUSING FINISH STANDARD
- 4) STANDARD WITH OPEN RATED SOCKET, FOR USE WITH PROTECTED LAMP ONLY

Optic Components (1000W Max)

SA23
23" Aluminum Reflector 1000W



ENTERPRISE

Unit Packs (complete*)



FM258-OR Unit Pack	250	MH	120/277/347
FM408-OR Unit Pack	400	MH	120/277/347
FP408-OR Unit Pack	400	MP	120/277/347

- 1) *COMPLETE WITH BALLAST, HOUSING, REFLECTOR AND LAMP
- 2) INCLUDES 3FT CABTIRE AND SAFETY HOOK INSTALLED STANDARD
- 3) TRI-TAP BALLAST (120/277/347) AVAILABLE ONLY, WIRED FOR 347V
- 4) WHITE HOUSING FINISH STANDARD
- 5) STANDARD WITH OPEN RATED SOCKET, FOR USE WITH PROTECTED LAMP ONLY

Catalogue No.	Lamp Wattage	Lamp Type	Voltage
---------------	--------------	-----------	---------

VERTIMARK II



MHBE-5A-250H-TT-OR-FH-1-C3-WLB-LL	250	MH	120/277/347
--	-----	----	-------------

Wet Location

- 1) COMPLETE WITH BALLAST, HOUSING, REFRACTOR AND LAMP
- 2) INCLUDES 3FT CABTIRE AND SAFETY HOOK INSTALLED STANDARD
- 3) TRI-TAP BALLAST (120/277/347) AVAILABLE ONLY, WIRED FOR 347V
- 4) WHITE HOUSING FINISH STANDARD
- 5) STANDARD WITH OPEN RATED SOCKET, FOR USE WITH PROTECTED LAMP ONLY



Fluorescent Products

Metalux is a leader in the design, development and production of high performance fluorescent lighting for commercial, industrial, institutional, retail and residential markets.

Our fluorescent fixtures are made with the highest quality materials and components available. The heavy gauge steel construction, durable baked white finish and electrical assemblies ensure years of performance integrity.

TROFFERS

METALUX



GR8-232A-UNV-EB81-U 1' x 4' - 2 lamp T8 Electronic 120V thru 277V UNV

GR8-232A-347V-EB81-U 1' x 4' - 2 lamp T8 Electronic 347V

2GR8-2U6T8A-UNV-EB81-U 2' x 2' - 2 U lamp T8 Electronic 120V thru 277V UNV

2GR8-2U6T8A-347V-EB81-U 2' x 2' - 2 U lamp T8 Electronic 347V

2GR8-232A-UNV-EB81-U 2' x 4' - 2 lamp T8 Electronic 120V thru 277V UNV



2GR8-232A-347V-EB81-U 2' x 4' - 2 lamp T8 Electronic 347V

2GR8-332A-UNV-EB81-U 2' x 4' - 3 lamp T8 Electronic 120V thru 277V UNV

2GR8-332A-347V-EB81-U 2' x 4' - 3 lamp T8 Electronic 347V

2GR8-432A-UNV-EB81-U 2' x 4' - 4 lamp T8 Electronic 120V thru 277V UNV

2GR8-432A-347V-EB81-U 2' x 4' - 4 lamp T8 Electronic 347V

DF-14W-U 1' x 4' Drywall Frame Kit

DF-22W-U 2' x 2' Drywall Frame Kit

DF-24W-U 2' x 4' Drywall Frame Kit

ACCORD - ENHANCED LIGHTING SOLUTION



2AC-228T5-UNV-L5841-EBT1N-U 2' X 4' -2 Lamp Recessed Enhanced Lighting 120 thru 277V T5 Electronic w/ 41K lamp. Lamps included.

2AC-254T5-UNV-L5841-EBT1-U 2' X 4' -2 Lamp Recessed Enhanced Lighting 120 thru 277V T5HO Electronic w/41K lamp. Lamps included.

RECESSED DIRECT/INDIRECT



2RDI-2BX40RP-UNV-TU-C240PUNVHPB-U 2' x 2' - 2 lamp Centre Basket TT5 Electronic 120V thru 277V UNV

2RDI-2BX40RP-347V-AD-GCN2TTP40SC-U 2' x 2' - 2 lamp Centre Basket TT5 Electronic 347V

2RDI-232RP-UNV-EB81-U 2' x 4' - 2 lamp Centre Basket T8 Electronic 120V thru 277V UNV



2RDI-232RP-347V-EB81-U 2' x 4' - 2 lamp Centre Basket T8 Electronic 347V

2RDI-332RP-UNV-EB81-U 2' x 4' - 3 lamp Centre Basket T8 Electronic 120V thru 277V UNV

2RDI-332RP-347V-EB81-U 2' x 4' - 3 lamp Centre Basket T8 Electronic 347V

PARABOLIC TROFFERS



2EP3GAVX-332S36I-UNV-EB81-U

2' x 4' 3" Deep 18 Cell Air 3 lamp T8 Electronic 120 thru 277V UNV

2EP3GAVX-2U6T8S33I-UNV-EB81-U

2' x 2' 3" Deep 9 Cell Air 2 lamp T8 Electronic 120 thru 277V UNV

2EP3GAX-332S36I-347V-EB81-U

2' x 4' 3" Deep 18 Cell Air 3 lamp T8 Electronic 347V



2EP3GAX-2BX40S33I-120V-EB51-U

2' x 2' 3" Deep 9 Cell Air 2 lamp BX Electronic 120V

2EP3GAX-3BX40S33I-120V-EB51-U

2' x 2' 3" Deep 9 Cell Air 3 lamp BX Electronic 120V

2EP3GAX-2U6T8S33I-347V-EB81-U

2' x 2' 3" Deep 9 Cell Air 2 lamp T8 Electronic 347V

INDUSTRIAL FLUORESCENT HIGH BAYS - F-BAYS



8TI5-354T5-TBW-UNV-EHT2-UPL-MP-U

8ft Narrow housing w/thin blade louver, uplight apertures and modular power receptacle, 6 lamp T5HO Electronic 120V thru 277V UNV

8TI5-354T5-TBW-UNC-EBT2-UPL-MP-U

8ft Narrow housing w/thin blade louver, uplight apertures and modular power receptacle, 6 lamp T5HO Electronic 347V UNC

8TI5-354T5-UNV-L5841-EHT2-UPL-MP-U

8ft Narrow housing w/uplight apertures and modular power receptacle, 6 lamp T5HO Electronic w/41K lamp 120V thru 277V UNV



8TI5-354T5-UNC-L5841-EBT2-UPL-MP-U

8ft Narrow housing w/uplight apertures and modular power receptacle, 6 lamp T5HO Electronic w/41K lamp 347V UNC

8TI8-332-UNV-EB82/PLUS-UPL-MP-U

8ft Narrow housing w/uplight apertures and modular power receptacle, 6 lamp T8 Electronic 120V thru 277V UNV

8TI8-332-347V-EB82/PLUS-UPL-MP-U

8ft Narrow housing w/uplight apertures and modular power receptacle, 6 lamp T8 Electronic PLUS 347V



I5-454T5-UNV-EHT1-UPL-MP-U

4ft Narrow housing w/uplight apertures and modular power receptacle, 4 lamp T5HO Electronic 120V thru 277V UNV

I5-454T5-UNC-EBT1-UPL-MP-U

4ft Narrow housing w/uplight apertures and modular power receptacle, 4 lamp T5HO Electronic 347V UNC



HBI454HT5-MP-UPL (Alt. Desc: HBI-454T5-N-UNV-EHT1-UPL-MP-U)

4ft Specification F-Bay w/uplight apertures and modular power receptacle 4 lamp T5HO Electronic 120V thru 277V UNV

HBI454HCT5-MP-UPL (Alt. Desc: HBI-454T5-N-UNC-EBT1-UPL-MP-U)

4ft Specification F-Bay w/uplight apertures and modular power receptacle 4 lamp T5HO Electronic 347V UNC

HBI654HT5-MP-UPL (Alt. Desc: HBI-654T5-N-UNV-EHT1-UPL-MP-U)

4ft Specification F-Bay w/uplight apertures and modular power receptacle 6 lamp T5HO Electronic 120V thru 277V UNV

HBI654HCT5-MP-UPL (Alt. Desc: HBI-654T5-N-UNC-EBT1-UPL-MP-U)

4ft Specification F-Bay w/uplight apertures and modular power receptacle 6 lamp T5HO Electronic 347V UNC

HBL454HT5-MP-UPL (Alt. Desc: HBL-454T5-N-UNV-EHT1-UPL-MP-U)

4ft Open F-Bay w/uplight apertures and modular power receptacle 4 lamp T5HO Electronic 120V thru 277V UNV

HBL454HCT5-MP-UPL (Alt. Desc: HBL-454T5-N-UNC-EBT1-UPL-MP-U)

4ft Open F-Bay w/uplight apertures and modular power receptacle 4 lamp T5HO Electronic 347V UNC



HBL632-MP-UPL (Alt. Desc: HBL-632-N-UNV-EB82/PLUS-UPL-MP-U)

4ft Open F-Bay w/uplight apertures and modular power receptacle 6 lamp T8 PLUS Electronic 120V thru 277V UNV

HBL-632-N-347V-EB82/PLUS-UPL-MP-U







4ft Open F-Bay w/uplight apertures and modular power receptacle 6 lamp T8 PLUS Electronic 347V

HBL654HT5-MP-UPL (Alt. Desc: HBL-654T5-N-UNV-EHT1-UPL-MP-U)



4ft Open F-Bay w/uplight apertures and modular power receptacle 6 lamp T5HO Electronic 120V thru 277V UNV



HBL654HCT5-MP-UPL (Alt. Desc: HBL-654T5-N-UNC-EBT1-UPL-MP-U)

4ft Open F-Bay w/uplight apertures and modular power receptacle 6 lamp T5HO Electronic 347V UNC



Catalogue No.	Description
	HBL-854T5-N-UNV-EHT2-UPL-MP-U 4ft Open F-Bay w/uplight apertures and modular power receptacle 8 lamp T5HO Electronic 120V thru 277V UNV
	HBL-854T5-N-UNC-EBT2-UPL-MP-U 4ft Open F-Bay w/uplight apertures and modular power receptacle 8 lamp T5HO Electronic 347V UNC
	HBE454HT5-MP-UPL-L4 (HBE-454T5-N-UNV-L5841-EHT1-UPL-MP-U) 4ft Frame F-Bay w/uplight apertures and modular power receptacle 4 lamp T5HO Electronic w/41K lamps 120V thru 277V UNV
	HBE454HCT5-MP-UPL-L4 (HBE-454T5-N-UNC-L5841-EBT1-UPL-MP-U) 4ft Frame F-Bay w/uplight apertures and modular power receptacle 4 lamp T5HO Electronic w/41K lamps 347V UNC
	HBE654HT5-MP-UPL-L4 (HBE-654T5-N-UNV-L5841-EHT2-UPL-MP-U) 4ft Frame F-Bay w/uplight apertures and modular power receptacle 6 lamp T5HO Electronic w/41K lamps 120V thru 277V UNV
	HBE654HCT5-MP-UPL-L4 (HBE-654T5-N-UNC-L5841-EBT1-UPL-MP-U) 4ft Frame F-Bay w/uplight apertures and modular power receptacle 6 lamp T5HO Electronic w/41K lamps 347V UNC
	HBE632-MP-UPL-L4 (HBE-632-N-UNV-L8841HL-EB81/PLUS-UPL-MP-U) 4ft Frame F-Bay w/uplight apertures and modular power receptacle 6 lamp T8 PLUS Electronic w/41K HL lamps 120V thru 277V UNV
	HBE-632-N-347V-L8841HL-EB82/PLUS-UPL-MP-U 4ft Frame F-Bay w/uplight apertures and modular power receptacle 6 lamp T8 PLUS Electronic w/41K HL lamps 347V UNC
	MC6 6ft Modular Cord Set for fixtures with MP feature
	MC12 12ft Modular Cord Set for fixtures with MP feature
	WG/HBL6-4FT-B Wireguard for HBL/HBE 4 to 6 lamp
	HBE-4/6LT-FRM/LENS WDF PK Frame and prismatic lens for HBL/HBE 4 to 6 lamp
	HBE-4/6LT-FRM/LENS/WG WDF PK Frame and prismatic lens w/wireguard for HBL/HBE 4 to 6 lamp
	HBI-FRM/LENS PK Frame and prismatic acrylic lens for HBI
	HBI-FRM/LENS/WG PK Frame and prismatic acrylic lens w/wireguard for HBI
	HBI-FRM/POLY125/WG PK Frame and clear polycarbonate lens .125 w/wireguard for HBI

INDUSTRIALS

	IAF-232-UNV-EB81-U 4ft Industrial w/uplight apertures 2 lamp T8 Electronic 120V thru 277V UNV
	IAF-232-347V-EB81-U 4ft Industrial w/uplight apertures 2 lamp T8 Electronic 347V
	ICF-232-UNV-EB81-U 4ft Industrial (closed) 2 lamp T8 Electronic 120V thru 277V UNV
	ICF-232-347V-EB81-U 4ft Industrial (closed) 2 lamp T8 Electronic 347V
	8TIAF-232-UNV-EB81-U 8ft Industrial w/uplight apertures 4 lamp T8 Electronic 120V thru 277V UNV
	8TIAF-232-347V-EB81-U 8ft Industrial w/uplight apertures 4 lamp T8 Electronic Osram QHE Ballast 347V
	8TICF-232-UNV-EB81-U 8ft Industrial (closed) 4 lamp T8 Electronic 120V thru 277V UNV
	8TICF-232-347V-EB81-U 8ft Industrial (closed) 4 lamp T8 Electronic 347V

Catalogue No.	Description
 8TICF-254T5-UNV-EBT1-U	8ft Industrial (closed) 4 lamp T5 Electronic 120V thru 277V UNV
8TICF-254T5-UNC-EBT1-U	8ft Industrial (closed) 4 lamp T5 Electronic 347V UNC
DIM-232-UNV-EB81-U	4ft Heavy Duty Industrial w/uplight apertures and turret sockets 2 lamp T8 Electronic 120V thru 277V UNV
 WG/ICF-4FT-B	4' Wireguard Industrial
WG/DI-4FT-B	4ft Wireguard Heavy Duty Industrial

VAPOUR-TITES **METALUX**

 VT1-154T5-PCR-UNV-EHT1-WL-U	4ft Vapourtite narrow housing WL & IP65 rated 1 lamp T5HO Electronic 120V thru 277V UNV
VT3-232DR-UNV-EB81-WL-M4-U	4ft Vapourtite w/mirrored reflector WL & IP65 rated 2 lamp T8 Electronic 120V thru 277V UNV
VT3-232DR-347V-EB81-WL-M4-U	4ft Vapourtite w/mirrored reflector WL & IP65 rated 2 lamp T8 Electronic 347V
 VT3-254T5DR-UNV-EHT1-WL-M4-U	4ft Vapourtite w/mirrored reflector WL & IP65 rated 2 lamp T5HO Electronic 120V thru 277V UNV
VT3-254T5DR-UNC-EBT1-WL-M4-U	4ft Vapourtite w/mirrored reflector WL & IP65 rated 2 lamp T5HO Electronic 347V
VT4-454T5-M-DR-UNV-EHT1-WL-U	4ft Vapourtite w/mirrored reflector medium beam WL, IP65 & IP67 rated 4 lamp T5HO Electronic 120V thru 277V UNV
 VT4-454T5-M-DR-UNC-EBT1-WL-U	4ft Vapourtite w/mirrored reflector medium beam WL, IP65 & IP67 rated 4 lamp T5HO Electronic 347V UNC
VT4-654T5-M-DR-UNV-EHT2-WL-U	4ft Vapourtite w/mirrored reflector medium beam WL, IP65 & IP67 rated 6 lamp T5HO Electronic 120V thru 277V UNV
VT4-654T5-M-DR-UNC-EBT2-WL-U	4ft Vapourtite w/mirrored reflector medium beam WL, IP65 & IP67 rated 6 lamp T5HO Electronic 347V UNC

WRAPS

 BC-232-UNV-EB81-U	4ft Wall Bracket/Wrap 2 lamp T8 Electronic 120V thru 277V UNV
BC-232-347V-EB81-U	4ft Wall Bracket/Wrap 2 lamp T8 Electronic 347V
 WE-232A-UNV-EB81-U	4ft Economy Wrap 2 lamp T8 Electronic 120V thru 277V UNV
WE-232A-347V-EB81-U	4ft Economy Wrap 2 lamp T8 Electronic 347V
 WN-232A-UNV-EB81-U	4ft Standard Wrap 2 lamp T8 Electronic 120V thru 277V UNV
WN-232A-347-EB81-U	4ft Standard Wrap 2 lamp T8 Electronic 347V
WN-432A-UNV-EB81-U	4ft Standard Wrap 4 lamp T8 Electronic 120V thru 277V UNV
 WS-232A-UNV-EB81-U	4ft Specification Wrap 2 lamp T8 Electronic 120V thru 277V UNV
WN-2A-U	2ft WN Series Replacement lens
WN-4A-U	4ft WN Series Replacement lens

*WE: NOT SUITABLE FOR CONT. ROW MOUNT

Catalogue No.

Description

STRIPS

SNF-117-UNV-EB81-U 2ft Flip Strip narrow 1 lamp T8 Electronic 120V thru 277V UNV

SNF-117-347V-EB81-U 2ft Flip Strip narrow 1 lamp T8 Electronic 347V



SNF-125-UNV-EB81-U 3ft Flip Strip narrow 1 lamp T8 Electronic 120V thru 277V UNV

SNF-125-347V-EB81-U 3ft Flip Strip narrow 1 lamp T8 Electronic 347V

SNF-132-UNV-EB81-U 4ft Flip Strip narrow 1 lamp T8 Electronic 120V thru 277V UNV

SNF-132-347V-EB81-U 4ft Flip Strip narrow 1 lamp T8 Electronic 347V

SNF-154T5-UNV-EBT1-U 4ft Flip Strip narrow 1 lamp T5Ho Electronic 120V thru 277V UNV

SNF-154T5-UNC-EBT1-U 4ft Flip Strip narrow 1 lamp T5Ho Electronic 347V UNC

SSF-217-UNV-EB81-U 2ft Flip Strip 2 lamp T8 Electronic 120V thru 277V UNV

SSF-217-347V-EB81-U 2ft Flip Strip 2 lamp T8 Electronic 347

SSF-225-UNV-EB81-U 3ft Flip Strip 2 lamp T8 Electronic 120V thru 277V UNV



SSF-225-347V-EB81-U 3ft Flip Strip 2 lamp T8 Electronic 347V

SSF-232-UNV-EB81-U 4ft Flip Strip 2 lamp T8 Electronic 120V thru 277V UNV

SSF-232-347V-EB81-U 4ft Flip Strip 2 lamp T8 Electronic 347V

SSF-254T5-UNV-EBT1-U 4ft Flip Strip 2 lamp T5HO Electronic 120V thru 277V UNV

SSF-254T5-UNC-EBT1-U 4ft Flip Strip 2 lamp T5HO Electronic 347V UNC

8TSNF-132-UNV-EB81-U 8ft Tandem Flip Strip narrow 2 lamp T8 Electronic 120V thru 277V

8TSNF-132-347V-EB81-U 8ft Tandem Flip Strip narrow 2 lamp T8 Electronic 347V

8TSSF-232-UNV-EB81-U 8ft Tandem Flip Strip 4 lamp T8 Electronic 120V thru 277V UNV

8TSSF-232-347V-EB81-U 8ft Tandem Flip Strip 4 lamp T8 Electronic 347V

WG/SNF-4FT-B 4ft Wireguard for Narrow Flip Strip (For T8 only)

WG/SSF-4FT-B 4ft Wireguard for Standard Flip Strip (For T8 only)

The logo for Fail-Safe features the words "FAIL" and "SAFE" in a bold, black, sans-serif font. A stylized black waveform, resembling a sine wave, is positioned between the two words, connecting the end of "FAIL" to the start of "SAFE". The entire logo is set against a white rectangular background with a subtle drop shadow.

FAIL SAFE

VR2000 - Vandal Resistant Products

Demanding environments, demand Fail-Safe.

Fail-Safe lighting products are designed for exceptional performance and structural integrity. Developing markets like correctional facilities, clean rooms, public access areas and hospitals have distinguished Fail-Safe as a quality manufacturer of lighting fixtures for both commercial and complex environments.

Catalogue No.	Wattage	Lens Material Configuration	Paint Configuration	Lamp Type / Description
---------------	---------	--------------------------------	------------------------	-------------------------

VANDAL RESISTANT

FAIL-SAFE



FPS-232-UNV-EB81

32

Polycarbonate Refractor

32W T8 Fluorescent



HPEC-HE-70H-120V-LL

70

Clear/Horiz. Eyelid

70W HPS lamp (incl) 120V HPF



HPGC-HE-150H-120V-LL

150

Clear/Horiz. Eyelid

150W HPS lamp (incl) 120V HPF



MHEC-100N-120V-PAL-CSA

100

Portable Light

100W MH lamp (incl) 120V NPF



IB-O-100-CSA/UL

100

Opal



IB-P-100-CSA/UL

100

Prismatic

ACCESSORIES (order separately)

FAIL-SAFE

All Accessories are ordered separately



VRSD

Vandal Resistant Screwdriver

Brand	Catalogue No.	Page	UPC Code
Halo	H36ICAT	3	623961361302
Halo	H36TAT	3	623961377662
Halo	H36LVICAT	3	623961361333
Halo	H36LVTAT	3	623961361357
Halo	H38ICAT	3	623961361272
Halo	H38LVICAT	3	623961361289
Halo	3003WHBB	3	623961384431
Halo	3003WHWB	3	623961384455
Halo	3003BKBB	3	623961384929
Halo	3003SNB	3	623961384417
Halo	3003ACB	3	623961384363
Halo	3003TBZB	3	623961591990
Halo	3004WHC	4	623961384547
Halo	3007WHC	4	623961384813
Halo	3008FG	4	623961384837
Halo	3009WHBB	4	623961384646
Halo	3009WHWB	4	623961384660
Halo	3009BKBB	4	623961384592
Halo	3009SNBB	4	623961384615
Halo	3009ACBB	4	623961384578
Halo	3009TBZBB	4	623961592249
Halo	3010SN	4	80083514380
Halo	3010WH	4	80083514366
Halo	3013WH	4	623961978432
Halo	3014FBWH	4	80083514410
Halo	3016FG	5	80083514472
Halo	H99T	5	662400133391
Halo	H99RT	5	662400133377
Halo	H99ICT	5	662400133353
Halo	985GUWHT	5	622696814497
Halo	985GUSC	5	622697250355
Halo	983GUWHT	5	622696814466
Halo	995GUP	5	622696814510
Halo	987WHT	5	622696814480
Halo	987SC,AB	5	622697250232, 622697250249
Halo	997P	5	622696501182
Halo	951PS	5	622697283117
Halo	993P	5	662400321064
Halo	993W	6	662400164289
Halo	993SN	6	623960250485
Halo	996SN	6	623960282769
Halo	996P	6	662400320630
Halo	999P	6	662400320586
Halo	ERT410	6	662400679684
Halo	ERT410WHT	6	662400660361
Halo	H1499T	6	662400134466
Halo	H1499T75	6	662400611660
Halo	H1499RT	6	662400160083
Halo	H1499IC	6	662400302490
Halo	1421C	6	662400320524
Halo	1421MB1	6	662400102045
Halo	1493P	7	662400320555
Halo	1493W	7	662400320623
Halo	1485WHT	7	622696814459
Halo	1485SC,AB	7	622697250263, 622697250300
Halo	1495P	7	662400659679
Halo	1496P	7	662400659686
Halo	1951PS	7	622697464974
Halo	HPF99	7	622697028138
Halo	ERT401LV	7	662400213574
Halo	ERT401LVW	7	662400213581
Halo	ERT403LV	7	662400213604
Halo	H645ICJ	7	662400213604
Halo	456P	8	662400676270

Brand	Catalogue No.	Page	UPC Code
Halo	456W	8	662400676287
Halo	H745ICAT	8	662400601197
Halo	H455ICAT120D	8	80083525096
Halo	H455RICAT120D	8	80083525119
Halo	EL405830	8	80083529025
Halo	TL400H	8	80083527854
Halo	TL400SC	8	80083527847
Halo	TL401WB	8	80083527878
Halo	TL402SCS	8	80083527885
Halo	TL403WBS	8	80083527915
Halo	H750ICAT	8	623961872655
Halo	H750ICAT	8	623961872655
Halo	H750T	8	623961052224
Halo	ML706830	9	623961881206
Halo	ML709830ICAT120D	9	80083523047
Halo	493WBS06	9	80083510641
Halo	494P06	9	80083507825
Halo	494WB06	9	80083508136
Halo	494SC06	9	80083508150
Halo	494H06	9	80083508143
Halo	TRM490WH	9	80083508174
Halo	H5TM	9	662400602934
Halo	H5ICAT	9	662400602675
Halo	H5RT	9	662400602668
Halo	H5RICAT	9	662400610557
Halo	5001P	9	662400602729
Halo	5001MB	10	662400602736
Halo	5010	10	662400602743
Halo	5010W	10	662400602750
Halo	ERT513WHTTS	10	623960380595
Halo	5020SC	10	662400602767
Halo	5051PS	10	80083521388
Halo	5054PS	10	623961531644
Halo	5060P	10	662400610700
Halo	5070P	10	662400602682
Halo	H7T	10	662400133025
Halo	H27T	10	662400133148
Halo	H7ICAT	10	662400164470
Halo	H7RT	10	662400600725
Halo	H7RICAT	11	662400610588
Halo	H7UICAT	11	662400164753
Halo	H280E	11	623961486661
Halo	H285E	11	662400623847
Halo	H272ICAT	11	622697900700
Halo	H800E	11	662400308485
Halo	H802E	11	662400623083
Halo	H803E	11	662400618706
Halo	H278ICAT	11	80083516582
Halo	H578ICAT	11	80083516544
Halo	Z216	11	80083512690
Halo	Z228	11	80083512676
Halo	H471ICAT	11	80083516674
Halo	H471RICAT	12	80083516643
Halo	VBB2	12	662400500575
Halo	H37T	12	662400162889
Halo	401AL	12	662400131045
Halo	71PS	12	662400646631
Halo	78P	12	662400130628
Halo	171PS	12	662400130796
Halo	172PS	12	662400663553
Halo	301P	12	662400130864
Halo	310P	12	662400130932
Halo	310W	12	662400163022
Halo	328P	12	662400163831
Halo	376W	12	622696508648
Halo	378P	13	662400164630

Brand	Catalogue No.	Page	UPC Code
Halo	401P	13	662400131069
Halo	405SC	13	662400131175
Halo	410P	13	662400131229
Halo	410W	13	662400163039
Halo	426	13	662400131311
Halo	428P	13	662400163848
Halo	30PAT, WAT	13	662400603313, 662400603320
Halo	30CAT	13	662400603337
Halo	ERT707	13	662400316749
Halo	ERT707WHT	13	662400212874
Halo	ERT713WHTTS	13	662400687474
Halo	406SC	14	662400615798
Halo	406WB	14	662400615828
Halo	406BA	14	662400615811
Halo	810C	14	662400132028
Halo	PD6	14	662400673286
Halo	PD7	14	662400673293
Halo	PD8	14	662400673309
Halo	V120	14	662400673378
Halo	V701E	14	662400673323
Halo	V1001E	14	662400673330
Halo	V142E	14	662400673347
Halo	V1423E	14	662400629641
Halo	H142E	15	662400673385
Halo	H1423E	15	662400629627
Halo	H226E	15	662400673392
Halo	H2263E	15	662400629665
Halo	HW242E	15	622696020294
Halo	HW2423E	15	623961313011
Halo	6VC	15	662400671176
Halo	6HC	15	662400671206
Halo	7VC	15	662400671237
Halo	7HC	15	662400671268
Halo	8HC	15	662400682042
Halo	8HRC	15	662400682028
Halo	L650P	16	662400137603
Halo	L651MB,P	16	662400137672, 662400137689
Halo	L656MB,P	16	662400605539, 662400605546
Halo	L652MB,P	16	662400137764, 662400137771
Halo	L653MB,P	16	662400137818, 662400137825
Halo	L900P	16	662400140788
Halo	L901MB,P	16	662400140825, 662400140832
Halo	L902MB,P	16	662400140863, 662400140870
Halo	L903MB,P	16	662400140894, 662400140900
Halo	L904MB,P	16	662400140924, 662400140931
Halo	L908MB,P	16	662400141037, 662400141044
Halo	L909MB,P	16	662400141068, 662400141075
Halo	L973PN	16	662400142133
Halo	L973MBN	17	662400142126
Halo	L1973P	17	662400145059
Halo	L992P	17	662400142362
Halo	L702PX,MBX	17	662400164326, 662400164333
Halo	L703PX,MBX	17	662400301387, 662400301394

Brand	Catalogue No.	Page	UPC Code
Halo	L1730PX,MBX	17	662400144038, 662400144014
Halo	L1738PX,MBX	17	662400144175, 662400144151
Halo	L2001PX,MBX	17	662400602989, 662400602996
Halo	L2716P,MB	17	662400145332, 662400145325
Halo	L2717MBX,PX	17	662400145394, 662400145417
Halo	L805SMLSP830P	17	80083530892
Halo	L805MEDSP830P	17	80083531165
Halo	L805MEDNF830P	17	80083530649
Halo	LZR104P	18	662400617419
Halo	LZR104MB	18	662400617426
Halo	LZR106P	18	662400617433
Halo	LZR108P	18	662400617457
Halo	LZR108MB	18	662400617402
Halo	LZR201P	18	662400617020
Halo	LZR201MB	18	662400617013
Halo	LZR202P	18	662400617044
Halo	LZR202MB	18	662400617037
Halo	LZR203P	18	662400617068
Halo	LZR203MB	18	662400617051
Halo	LZR209P	18	662400617167
Halo	LZR212P	18	662400617228
Halo	LZR212MB	18	662400617211
Halo	LZR301P	18	662400612636
Halo	LZR301MB	18	662400612643
Halo	LZR302P	19	662400612674
Halo	LZR305P	19	662400612759
Halo	LZR330P	19	662400613299
Halo	LZR330MB	19	662400613305
Halo	LZR338P	19	662400613312
Halo	LZR338MB	19	662400613329
Halo	LZR401P	19	662400613992
Halo	LZR401MB	19	662400614005
Halo	LZR402P	19	662400616542
Halo	LZR402MB	19	662400616559
Halo	LZR403P	19	662400616566
Halo	LZR404P	19	662400616580
Halo	LZR404MB	19	662400616597
Lumark	MPSF10K-TT	21	623961529610
Lumark	MHSF17K-TT	21	80083550036
Lumark	MPSF10T-TT	21	80083550135
Lumark	MHSF17T-TT	21	623961219962
Lumark	HPSF15T-TT	21	623961220036
Lumark	MHMS17TT	21	80083550098
Lumark	MHMM25TT	21	80083550074
Lumark	MHMM40TT	21	80083550081
Lumark	MHAH258T	21	80083549061
Lumark	MHAH408T	21	80083549054
Lumark	HPAH408T	21	80083549078
Lumark	AH/WG	21	80083533459
Lumark	AH/V-BZ	21	80083533466
Lumark	MHMK-Y76-1000-TT-LL	22	662400923251
Lumark	MHMK-S76-1000-TT-LL	22	662400923213
Lumark	TYS-BZ	22	623961808302
Lumark	XM258	22	662401106097
Lumark	XM408	22	662401106059
Lumark	XS408	22	662401106196
Lumark	WM258	22	662401106110
Lumark	WM408	22	662401106158
Lumark	WS408	22	662401106172
Lumark	HPEL70	22	662401746927
Lumark	HPEL15	22	662401746972

Brand	Catalogue No.	Page	UPC Code
Lumark	MVEL17	22	662401746637
Lumark	VAN25MMW255LV5A	22	662400752332
Lumark	VAN40MMW255LV5A	22	662400659358
Lumark	VAN15SH255LV5A	22	622696340712
Lumark	VAN25SC255LV5A	22	623961553097
Lumark	VAN25VW255LV5A	22	622696340767
Lumark	VAN40VW255LV5A	22	622696340798
Lumark	QZ5L	22	662400116813
Lumark	WPM178	23	80083550166
Lumark	WPM258	23	80083550173
Lumark	WPM408	23	80083550180
Lumark	WPS158	23	80083550197
Lumark	WPS258	23	80083550203
Lumark	WPS408	23	80083550210
Lumark	LDWP-GL-4A-ED	23	80083551880
Lumark	LDWP-GL-4A-347V	23	80083551583
Lumark	LP10G	23	623961978258
Lumark	LS70G	23	622696399413
Lumark	LS10G	23	622696399406
Lumark	LS15G	23	662401051496
Lumark	LP70C	23	623961978265
Lumark	LP10C	23	623961978272
Lumark	LS70C	23	622696399161
Lumark	MHIT178	23	80083551378
Lumark	BP708	23	662401102365
Lumark	MHFZ178	24	623961378775
Lumark	HPFZ158	24	623961379987
Lumark	MPFZ108	24	623961378744
Lumark	MHFZ178C	24	80083550067
Lumark	HPFZ158C	24	623961380037
Lumark	HPWM70	24	662401326693
Lumark	HPWM70P	24	662401326679
Lumark	HPWM70WP	24	662401702732
Lumark	MHSS408-OR <input type="checkbox"/> Unit Pack	24	80083550128
Lumark	MPSS408-OR <input type="checkbox"/> Unit Pack, <input type="checkbox"/> Pulse Start	24	80083550159
Lumark	HPSS408 <input type="checkbox"/> Unit Pack	24	662400646303
Lumark	MHSS-400-TT-OR-SHK-C3 <input type="checkbox"/> Ballast & Housing Only, No Lamp or Optics	25	80083550111
Lumark	TCSA15-400MH	25	80083550012
Lumark	SGB15	25	662400121473
Lumark	WG15	25	662400121381
Lumark	SA15	25	662400127505
Lumark	SA15E	25	662400121329
Lumark	WG18	25	662400121404
Lumark	SA18	25	662400127512
Lumark	PD16	25	662400118275
Lumark	PD22	25	662400125211
Lumark	MHSS-1000-TT-OR-SHK-C3 <input type="checkbox"/> Ballast & Housing Only, No Lamp or Optics	25	80083550104
Lumark	SA23 <input type="checkbox"/> 23" Aluminum Reflector 1000W Max	25	662400609636
Lumark	FM258-OR <input type="checkbox"/> Unit Pack	25	80083550029
Lumark	FM408-OR <input type="checkbox"/> Unit Pack	25	80083550043
Lumark	FP408-OR <input type="checkbox"/> Unit Pack	25	80083550050
Lumark	MHBE-5A-250H-TT-OR-FH-1-C3-WLB-LL	26	80083550142
Metalux	GR8-232A-UNV-EB81-U	28	662401551330
Metalux	GR8-232A-347V-EB81-U	28	623961289064
Metalux	2GR8-2U6T8A-UNV-EB81-U	28	623961643842
Metalux	2GR8-2U6T8A-347V-EB81-U	28	623961247736
Metalux	2GR8-232A-UNV-EB81-U	28	623961759802
Metalux	2GR8-232A-347V-EB81-U	28	623961247552
Metalux	2GR8-332A-UNV-EB81-U	28	662401286805
Metalux	2GR8-332A-347V-EB81-U	28	623961247767
Metalux	2GR8-432A-UNV-EB81-U	28	662401286812
Metalux	2GR8-432A-347V-EB81-U	28	623961247811
Metalux	DF-14W-U	28	662401232949
Metalux	DF-22W-U	28	662401232963
Metalux	DF-24W-U	28	662401232970
Metalux	2AC-228T5-UNV-L5841-EBT1N-U	28	623961511394

Brand	Catalogue No.	Page	UPC Code
Metalux	2AC-254T5-UNV-L5841-EBT1-U	28	623961003493
Metalux	2RDI-2BX40RP-UNV-TU-C240PUNVHPB-U	28	662401926923
Metalux	2RDI-2BX40RP-347V-AD-GCN2TTP40SC-U	28	623961313868
Metalux	2RDI-232RP-UNV-EB81-U	28	622696409877
Metalux	2RDI-232RP-347V-EB81-U	28	662401900770
Metalux	2RDI-332RP-UNV-EB81-U	28	662401732708
Metalux	2RDI-332RP-347V-EB81-U	28	662401566587
Metalux	2EP3GAVX-332S36I-UNV-EB81-U	29	662401000685
Metalux	2EP3GAVX-2U6T8S33I-UNV-EB81-U	29	80083520220
Metalux	2EP3GAX-332S36I-347V-EB81-U	29	623961286216
Metalux	2EP3GAX-2BX40S33I-120V-EB51-U	29	662401153183
Metalux	2EP3GAX-3BX40S33I-120V-EB51-U	29	662401958481
Metalux	2EP3GAX-2U6T8S33I-347V-EB81-U	29	80083520190
Metalux	8TI5-354T5-TBW-UNV-EHT2-UPL-MP-U	29	80083521296
Metalux	8TI5-354T5-TBW-UNC-EBT2-UPL-MP-U	29	80083554171
Metalux	8TI5-354T5-UNV-L5841-EHT2-UPL-MP-U	29	80083521289
Metalux	8TI5-354T5-UNC-L5841-EBT2-UPL-MP-U	29	80083521333
Metalux	8TI8-332-UNV-EB82/PLUS-UPL-MP-U	29	623961557378
Metalux	8TI8-332-347V-EB82/PLUS-UPL-MP-U	29	80083553839
Metalux	I5-454T5-UNV-EHT1-UPL-MP-U	29	80083521241
Metalux	I5-454T5-UNC-EBT1-UPL-MP-U	29	80083521272
Metalux	HBI454HT5-MP-UPL (Alt. Desc: HBI-454T5-N-UNV-EHT1-UPL-MP-U)	29	80083549771
Metalux	HBI454HCT5-MP-UPL (Alt. Desc: HBI-454T5-N-UNC-EBT1-UPL-MP-U)	29	80083549764
Metalux	HBI654HT5-MP-UPL (Alt. Desc: HBI-654T5-N-UNV-EHT1-UPL-MP-U)	29	80083549641
Metalux	HBI654HCT5-MP-UPL (Alt. Desc: HBI-654T5-N-UNC-EBT1-UPL-MP-U)	29	80083549634
Metalux	HBL454HT5-MP-UPL (Alt. Desc: HBL-454T5-N-UNV-EHT1-UPL-MP-U)	29	80083549788
Metalux	HBL454HCT5-MP-UPL (Alt. Desc: HBL-454T5-N-UNC-EBT1-UPL-MP-U)	29	80083552535
Metalux	HBL632-MP-UPL (Alt. Desc: HBL-632-N-UNV-EB82/PLUS-UPL-MP-U)	29	80083549795
Metalux	HBL-632-N-347V-EB82/PLUS-UPL-MP-U	29	80083553808
Metalux	HBL654HT5-MP-UPL (Alt. Desc: HBL-654T5-N-UNV-EHT1-UPL-MP-U)	29	80083549825
Metalux	HBL654HCT5-MP-UPL (Alt. Desc: HBL-654T5-N-UNC-EBT1-UPL-MP-U)	29	80083552481
Metalux	HBL-854T5-N-UNV-EHT2-UPL-MP-U	30	80083553884
Metalux	HBL-854T5-N-UNC-EBT2-UPL-MP-U	30	80083553891
Metalux	HBE454HT5-MP-UPL-L4 (HBE-454T5-N-UNV-L5841-EHT1-UPL-MP-U)	30	80083545636
Metalux	HBE454HCT5-MP-UPL-L4 (HBE-454T5-N-UNC-L5841-EBT1-UPL-MP-U)	30	80083545643
Metalux	HBE654HT5-MP-UPL-L4 (HBE-654T5-N-UNV-L5841-EHT2-UPL-MP-U)	30	80083545650
Metalux	HBE654HCT5-MP-UPL-L4 (HBE-654T5-N-UNC-L5841-EBT1-UPL-MP-U)	30	80083546763
Metalux	HBE632-MP-UPL-L4 (HBE-632-N-UNV-L8841HL-EB81/PLUS-UPL-MP-U)	30	80083552542
Metalux	HBE-632-N-347V-L8841HL-EB82/PLUS-UPL-MP-U	30	80083553907
Metalux	MC6	30	623961368455
Metalux	MC12	30	80083552498
Metalux	WG/HBL6-4FT-B	30	80083521494
Metalux	HBE-4/6LT-FRM/LENS WDF PK	30	80083552559
Metalux	HBE-4/6LT-FRM/LENS/WG WDF PK	30	80083552566
Metalux	HBI-FRM/LENS PK	30	80083545872
Metalux	HBI-FRM/LENS/WG PK	30	80083545889
Metalux	HBI-FRM/POLY125/WG PK	30	80083552573
Metalux	IAF-232-UNV-EB81-U	30	80083519392
Metalux	IAF-232-347V-EB81-U	30	80083519408
Metalux	ICF-232-UNV-EB81-U	30	80083519361
Metalux	ICF-232-347V-EB81-U	30	80083519378
Metalux	8TIAF-232-UNV-EB81-U	30	80083519453
Metalux	8TIAF-232-347V-EB81-U	30	80083519460
Metalux	8TICF-232-UNV-EB81-U	30	80083519439
Metalux	8TICF-232-347V-EB81-U	30	80083519446
Metalux	8TICF-254T5-UNV-EBT1-U	31	N/A
Metalux	8TICF-254T5-UNC-EBT1-U	31	N/A
Metalux	DIM-232-UNV-EB81-U	31	662401732760
Metalux	WG/ICF-4FT-B	31	662400106623
Metalux	WG/DI-4FT-B	31	662400106616
Metalux	VT1-154T5-PCR-UNV-EHT1-WL-U	31	80083521326
Metalux	VT3-232DR-UNV-EB81-WL-M4-U	31	623961632945
Metalux	VT3-232DR-347V-EB81-WL-M4-U	31	623961632990
Metalux	VT3-254T5DR-UNV-EHT1-WL-M4-U	31	623961875892
Metalux	VT3-254T5DR-UNC-EBT1-WL-M4-U	31	623961634581
Metalux	VT4-454T5-M-DR-UNV-EHT1-WL-U	31	80083521425

Brand	Catalogue No.	Page	UPC Code
Metalux	VT4-454T5-M-DR-UNC-EBT1-WL-U	31	80083521401
Metalux	VT4-654T5-M-DR-UNV-EHT2-WL-U	31	80083521432
Metalux	VT4-654T5-M-DR-UNC-EBT2-WL-U	31	80083521371
Metalux	BC-232-UNV-EB81-U	31	662401620364
Metalux	WE-232A-UNV-EB81-U	31	662401234493
Metalux	WE-232A-347V-EB81-U	31	623961699634
Metalux	WN-232A-UNV-EB81-U	31	80083518845
Metalux	WN-432A-UNV-EB81-U	31	80083518517
Metalux	WS-232A-UNV-EB81-U	31	662401191352
Metalux	WN-2A-U	31	80083517749
Metalux	WN-4A-U	31	80083517756
Metalux	SNF-117-UNV-EB81-U	32	80083519897
Metalux	SNF-117-347V-EB81-U	32	80083519903
Metalux	SNF-125-UNV-EB81-U	32	80083519873
Metalux	SNF-125-347V-EB81-U	32	80083519880
Metalux	SNF-132-UNV-EB81-U	32	80083519859
Metalux	SNF-132-347V-EB81-U	32	80083519866
Metalux	SNF-154T5-UNV-EBT1-U	32	80083548705
Metalux	SNF-154T5-UNC-EBT1-U	32	80083552504
Metalux	SSF-217-UNV-EB81-U	32	80083519613
Metalux	SSF-217-347V-EB81-U	32	80083519620
Metalux	SSF-225-UNV-EB81-U	32	80083519521
Metalux	SSF-225-347V-EB81-U	32	80083519538
Metalux	SSF-232-UNV-EB81-U	32	80083519590
Metalux	SSF-232-347V-EB81-U	32	80083519606
Metalux	SSF-254T5-UNV-EBT1-U	32	80083552511
Metalux	SSF-254T5-UNC-EBT1-U	32	80083552528
Metalux	8TSNF-132-UNV-EB81-U	32	80083519927
Metalux	8TSNF-132-347V-EB81-U	32	80083519934
Metalux	8TSSF-232-UNV-EB81-U	32	80083519682
Metalux	8TSSF-232-347V-EB81-U	32	80083519712
Metalux	WG/SNF-4FT-B	32	662400106630
Metalux	WG/SSF-4FT-B	32	662400106647
Failsafe	FPS-232-UNV-EB81	34	622696936069
Failsafe	HPEC-HE-70H-120V-LL	34	662401005109
Failsafe	HPGC-HE-150H-120V-LL	34	662400111542
Failsafe	MHEC-100N-120V-PAL-CSA	34	662401024940
Failsafe	IB-O-100-CSA/UL	34	662400648055
Failsafe	IB-P-100-CSA/UL	34	662400111672
Failsafe	VRSD	34	662400129509

Cooper Lighting Canada

5925 McLaughlin Road
Mississauga, Ontario L5R 1B8

P: 905-507-4000

F: 905-568-7049

International Sales, USA

Cooper Lighting
1121 Highway 74 South
Peachtree City, GA 30269

P: 770-486-4800

F: 770-486-4801

Cooper Lighting

Customer First Center
1121 Highway 74 South
Peachtree City, GA 30269

P: 770-486-4800

F: 770-486-4801

www.cooperlighting.com

The Cooper Lighting Family

Halo
Metalux
Lumark
Sure-Lites
Neo-Ray
Corelite
Portfolio
Iris
Shaper
io
Lumière
Invue
McGraw-Edison
Streetworks
Fail-Safe
MWS
DLS
RSA
Ametrix

Canadian Facilities

Calgary, Alberta T2E 7V9
Mississauga, Ontario L5R 1B8

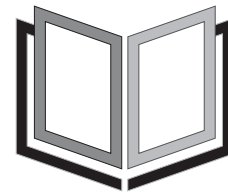

Stock Guide

Halo, All-Pro, Metalux, Lumark, Sure-Lites, Portfolio, PDS, Iris, Lumière, McGraw-Edison, Fail-Safe and MWS are valuable trademarks of Cooper Industries in the United States and other countries. You are not permitted to use the Cooper Trademarks without the prior written consent of Cooper Industries.

Cooper Lighting

5925 McLaughlin Road

Mississauga, Ontario L5R 1B8

P: 905-507-4000 F: 905-568-7049